



FERVI
PRO SMART EQUIPMENT

CATALOGO 2016
MACCHINE UTENSILI
E FERRAMENTA

#38

since 1978

fervi.com

FERVI RISPONDE

059.767172

NUMERO VERDE
800 17 25 99

✉ info@fervi.com

1 UFFICIO COMMERCIALE

2 ASSISTENZA TECNICA

5 LINGUA INGLESE

ASSISTENZA TECNICA

- Informazioni tecniche
- Richiesta di assistenza
- Ricambi

UFFICIO COMMERCIALE

- Disponibilità e prezzi prodotti
- Gestione Ordine
- Informazioni commerciali
- Rivenditori e rappresentanti
- Preventivi
- Info aziendali

MINIMO ORDINABILE PER ARTICOLO

Art. 0221
SERIE CHIAVI FISSE € 15,50



8 Pz DIN 3110 Cr-V

Serie	6 + 22 mm
Misure	6x7 8x9 10x11 12x13 14x15 16x17 18x19 20x22 mm
Pezzi	8
Imballo	5* / 20

Tutti i nostri prodotti sono **acquistabili in quantità 1 (uno) pezzo**, ad eccezione degli articoli che riportano un asterisco (*); Tali articoli sono acquistabili solo nella quantità minima indicata.

Art. 0137
CHIAVE DINAMOMETRICA € 55,00



Cr-V

Attacco quadro	1/2" - 3/8"
Capacità	28 - 210 Nm
Prolunga	120 mm
Imballo	12

Inoltre alcuni articoli riportano l'indicazione della quantità di prodotti all'interno dell'imballo. Tali informazioni sono di servizio al solo fine di agevolare la pianificazione dello stoccaggio del materiale e **non devono ritenersi vincolanti**.

MINIMO FATTURABILE*

L'importo **minimo fatturabile è di Euro 125,00** (centoventicinque) IVA esclusa - articolo 11 delle condizioni generali di vendita Fervi S.r.l.

Tale importo viene ridotto a Euro 50,00 (cinquanta) IVA esclusa se il Cliente ritira il materiale direttamente al banco vendita presso i Centri di Distribuzione di Fervi - articolo 11 delle condizioni generali di vendita Fervi S.r.l.

GUIDA ALLA LETTURA



Guarda le foto dei nostri articoli, completi di descrizione e codice: grazie ai QR codes potrai accedere subito alle schede tecniche e vedere quali sono i prodotti compatibili con ogni referenza Fervi.



NUMERO PEZZI



MATERIALE



FINITURA SUPERFICIALE



NORMATIVA



ANGOLO D'AFFILATURA



INCLINAZIONE



RINFORZATO



NUMERO LAMELLE



GRADO IP



ATTACCO QUADRO FEMMINA



ATTACCO QUADRO MASCHIO



TIPOLOGIA IMBALLO



* Tutti i prezzi in questo catalogo si intendono non comprensivi di IVA

ABRASIVI



MACCHINE E ACCESSORI



MATERIALI DI CONSUMO



STRUMENTI DI MISURA



UTENSILERIA



FERVI ARREDA IL TUO SPAZIO !



 CERCA IL TUO PRODOTTO



PRODOTTI



OFFERTE



VALORE



QUALITÀ MADE IN FERVI

LA FORZA DI UN GRUPPO CHE CRESCE

La voglia di crescere e sviluppare tutte le proprie potenzialità caratterizza da sempre il marchio Fervi e anche l'acquisizione di **Ri-Flex**, azienda leader mondiale nella **produzione Made in Italy di dischi abrasivi di alta gamma** e macchine automatiche per la produzione e confezionamento dei dischi stessi, **è un altro passo importante nella costituzione del Gruppo Fervi:**

questo percorso di crescita dimostra la **volontà** e la **capacità** aziendale di **evolversi** costantemente negli anni, rispondendo alle richieste di un mercato attento ed esigente, che non aspetta e che pretende sempre **più velocità, più qualità, più specializzazione** ed **un'offerta sempre più completa** di prodotti selezionati, capaci di soddisfare altissimi standard pur restando estremamente competitivi.

Fervi è un'azienda in costante evoluzione e con un approccio "customer-oriented" finalizzato ad offrire sempre i migliori prodotti con il miglior servizio ai lavoratori professionisti, alle industrie, alle officine e agli artigiani.

MISSION

Offrire i prodotti più adeguati, più funzionali e sicuri, ai lavoratori dell'industria e dell'artigianato per migliorare concretamente la produttività e la qualità del loro lavoro quotidiano.

VISION

Ricerca, selezionare, distribuire e riparare prodotti di ferramenta e macchine utensili con il miglior rapporto qualità-prezzo, garantendo standard qualitativi di sicurezza e di servizio altamente superiori alla media dei nostri concorrenti diretti.

VALUES

- IL CLIENTE AL CENTRO DI TUTTO
- TRASPARENZA NEI COMPORAMENTI
- SPIRITO DI SQUADRA
- MIGLIORAMENTO CONTINUO



SE TI SERVE CE L'ABBIAMO, SE NON SAI COSA TI SERVE... PARLIAMONE!

LA COERENZA DEL NOSTRO PERCORSO

+ ESPERIENZA
+ RISULTATI
+ OBIETTIVI
= OFFERTA E SERVIZIO ALLA CLIENTELA!

1978

Nasce Veprug Srl, grossista di riferimento per tutto il territorio modenese

1991

Inizia il percorso di creazione del marchio Fervi

2011

Cambia la proprietà aziendale: l'obiettivo è quello di consolidare e sviluppare il percorso di crescita

2012

Viene distribuito in 35.000 copie il primo catalogo Fervi



2014

catalogo #36
+ sito web + Fervi arredo
= formula del successo FERVI

IL NOSTRO OBIETTIVO:
inserire **nuove referenze** e **nuove aziende** eccellenti nel nostro organico impegnando sempre **più risorse** nella **selezione di prodotti**, anche realizzati in Italia e in Europa, per offrire sempre **più qualità e competitività** facendo leva sulle capacità ed esperienze del management e sull'**entusiasmo** di un team di giovani preparati ed in costante crescita.

Trasferimento nei nuovi uffici energeticamente autosufficienti

2013



2015



Fervi acquisisce Ri-Flex ed allarga la propria offerta con una ampia gamma di prodotti abrasivi di alta qualità

2016

Viene pubblicato il catalogo #38 con una nuova sezione completamente dedicata agli abrasivi a marchio Ri-flex

2018

Sviluppo della "Fervi digital attitude" per comunicare in maniera adeguata con i clienti del futuro.

OBIETTIVO IMPATTO ZERO: RAGGIUNTO!

L'**etica** sociale e commerciale di Fervi si deduce anche dall'**attenzione** riposta verso l'**ambiente** e dal valore dell'**ecosostenibilità** che contraddistingue costantemente il metodo di lavoro Fervi: infatti, come promesso, abbiamo raggiunto il nostro obiettivo di **autosufficienza energetica** grazie all'installazione di impianti fotovoltaici di ultima generazione, contribuendo così in prima persona sia a preservare le preziose risorse del nostro pianeta sia ad abbassare le emissioni di CO2 e il livello di inquinamento globale.

IL METODO CHE CREA LA QUALITÀ

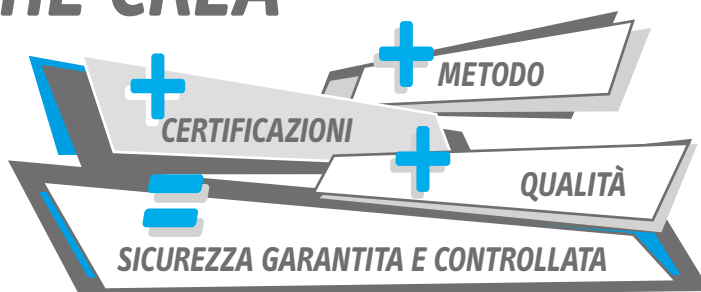

analisi sul responso dei clienti e conseguenti azioni di miglioramento

ricerca e selezione continua di nuovi prodotti

risponso dei clienti sui nuovi prodotti

verifiche di qualità sui nuovi prodotti

distribuzione dei nuovi prodotti

processo di certificazione dei nuovi prodotti

inserimento a catalogo dei nuovi prodotti certificati

QUALITÀ CERTIFICATA

La nostra affidabilità e qualità è costantemente verificata, comprovata ed attestata da uno dei più importanti organismi notificati CE: l'**ECM, Ente di Certificazione Macchine**. Grazie alla costante collaborazione con questo ente indipendente, tutte le referenze a marchio Fervi sono sempre sottoposte a **scrupolosi test di verifica della qualità** e a **controlli rigorosi** secondo gli attuali **standard di sicurezza europei**. Fervi inoltre è conforme al sistema di gestione per la qualità **UNI EN ISO 9001**. L'Azienda Fervi ha ottenuto il **D&B RATING 1: "Indice di Massima Affidabilità"**



ABBIAMO SOLO TUTTO QUELLO CHE TI SERVE



MACCHINE E ACCESSORI

Tutti i macchinari e gli accessori a marchio **Fervi** sono estremamente **pratici e funzionali** per rispondere alle esigenze lavorative delle **aziende**, ma anche e soprattutto dei **professionisti** e degli **hobbisti** di ogni **categoria**. Grazie alla nostra **gamma completa** e pluriaccessoriata, tagliare con semplicità, movimentare e sollevare in sicurezza, forare, tornire o fresare con precisione non saranno più problemi da risolvere ma certezze su cui contare... perché non esistono sul mercato soluzioni più pratiche e più competitive di quelle che vi offre Fervi! Solo Fervi presenta al mercato una gamma completa di macchine e accessori perfetti per ogni esigenza lavorativa professionale o amatoriale, dalla lavorazione ferro alla lavorazione legno, dai trattamenti alle finiture, dalle presse ai divaricatori, dal sollevamento alla movimentazione!



CONSUMABILI

Fervi è la prima azienda in Italia a catalogare l'**intera gamma dei prodotti consumabili**, solitamente distribuiti nei cataloghi generali insieme agli utensili o con le macchine su cui i consumabili vengono normalmente utilizzati... per facilitarvi la scelta dei prodotti a voi necessari, migliorare la fruizione da parte dei **clienti** e rispondere in modo più **rapido** a tutte le **esigenze** di un mercato in continua evoluzione come il nostro abbiamo deciso di inserire i nostri **materiali di consumo** in una sezione speciale, dedicata esclusivamente a loro! Tra i consumabili Fervi a vostra disposizione troverete: inserti, brasati e barrette, punte e seghe a tazza, utensili a fresare, azzeratori, maschi e filiere, pulitura e finitura, abrasivi, nastri, dischi e lame, fissaggio, assortimenti e batterie, spray e ingrassatori... e molto altro ancora!



STRUMENTI DI MISURA

Alti standard di precisione, garantiti ad ogni utilizzo, e una **gamma completa** di prodotti specifici per qualsiasi tipo di **misurazione**, dedicati alle singole esigenze di ogni appassionato professionista, è ciò che contraddistingue principalmente la categoria degli Strumenti di Misurazione a marchio Fervi. Hai bisogno di un calibro, di un comparatore, di un tester o di un amperometro? Affidati alla nostra vasta offerta di **qualità a prezzi imbattibili** e troverai facilmente tutto quello che ti serve per misurare dimensioni, distanze e lunghezze, per controllare temperature, potenze e durezza, per verificare pesi, tensioni e correnti e molto altro ancora, grazie ai nostri strumenti di ispezione. Solidi e calibrati, rapidi e precisi, sicuri e affidabili, tutti i nostri prodotti per la misurazione garantiscono la massima semplicità d'uso e tutta l'affidabilità che è giusto pretendere sul lavoro: scopri quante referenze abbiamo a disposizione per te e scegli subito il tuo sistema di misura ideale, con Fervi!



UTENSILERIA

Carrelli, banchi, chiavi, cacciaviti, estrattori, pinze, martelli, lime, scalpelli... tutto ciò che è **normalmente disponibile** tra i comuni utensili venduti normalmente in ogni ferramenta è presente anche nel nostro catalogo, ma con il valore aggiunto della **qualità e sicurezza garantita** da Fervi a tutti gli appassionati del fai-da-te e ai professionisti più esigenti di ogni settore. Non accontentatevi di un tool qualsiasi! Gli articoli da ferramenta Fervi sono **adatti ad ogni tipologia di lavoro** e si distinguono sul mercato per l'ottimo rapporto tra prezzo e prodotto. La gamma di utensili e prodotti da ferramenta offerta da Fervi include non solo chiavi, cacciaviti, estrattori, pinze, martelli, lime e scalpelli, ma anche morse da banco, strettoi, incudini, utensili da taglio carrelli, banchi, armadietti cassettiere, valigette e kits, riscaldatori, illuminazione e lenti, saldatori, sverniciatori e pistole termocollanti, pneumatica, articoli per il giardinaggio, sicurezza e infortunistica e molto altro ancora!

NUOVI PRODOTTI, NUOVI VANTAGGI

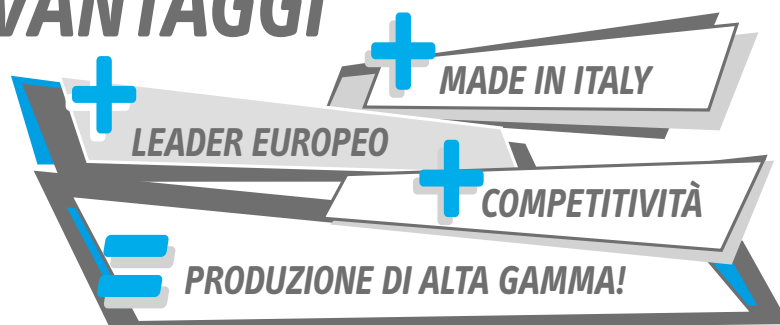

ABRASIVI



Per oltre 30 anni l'azienda Ri-Flex si è distinta sullo scenario europeo per la specifica esperienza **Made in Italy** nella produzione di abrasivi e relativi sistemi interni per produrre e confezionare dischi lamellari: dopo decenni di collaborazione continuativa e sulla base di **valori comuni e condivisi**, Fervi ha deciso nel 2015 di acquisire l'azienda modenese per **arricchire il proprio marchio e la propria gamma** con una nuova offerta di altissima qualità.

Qui nel nostro nuovo Catalogo a partire da pagina 4 potrete subito apprezzare tutte le nuove referenze Fervi prodotte in Italia da Ri-Flex, i particolare i **dischi abrasivi flessibili di alta gamma** costruiti con macchinari automatizzati progettati e sviluppati internamente, prodotti già largamente utilizzati dalle migliori aziende di tutto il mondo grazie alla loro capacità comprovata di garantire **prestazioni elevate e una qualità costante nel tempo**, ma senza rinunciare alla competitività necessaria per affrontare il mercato.



DISCHI LAMELLARI



MOLE E DISCHI DA TAGLIO



PULITURA E LUCIDATURA



DISCHI E NASTRI
IN TELA ABRASIVA



IL MONDO FERVI A PORTATA DI CLICK

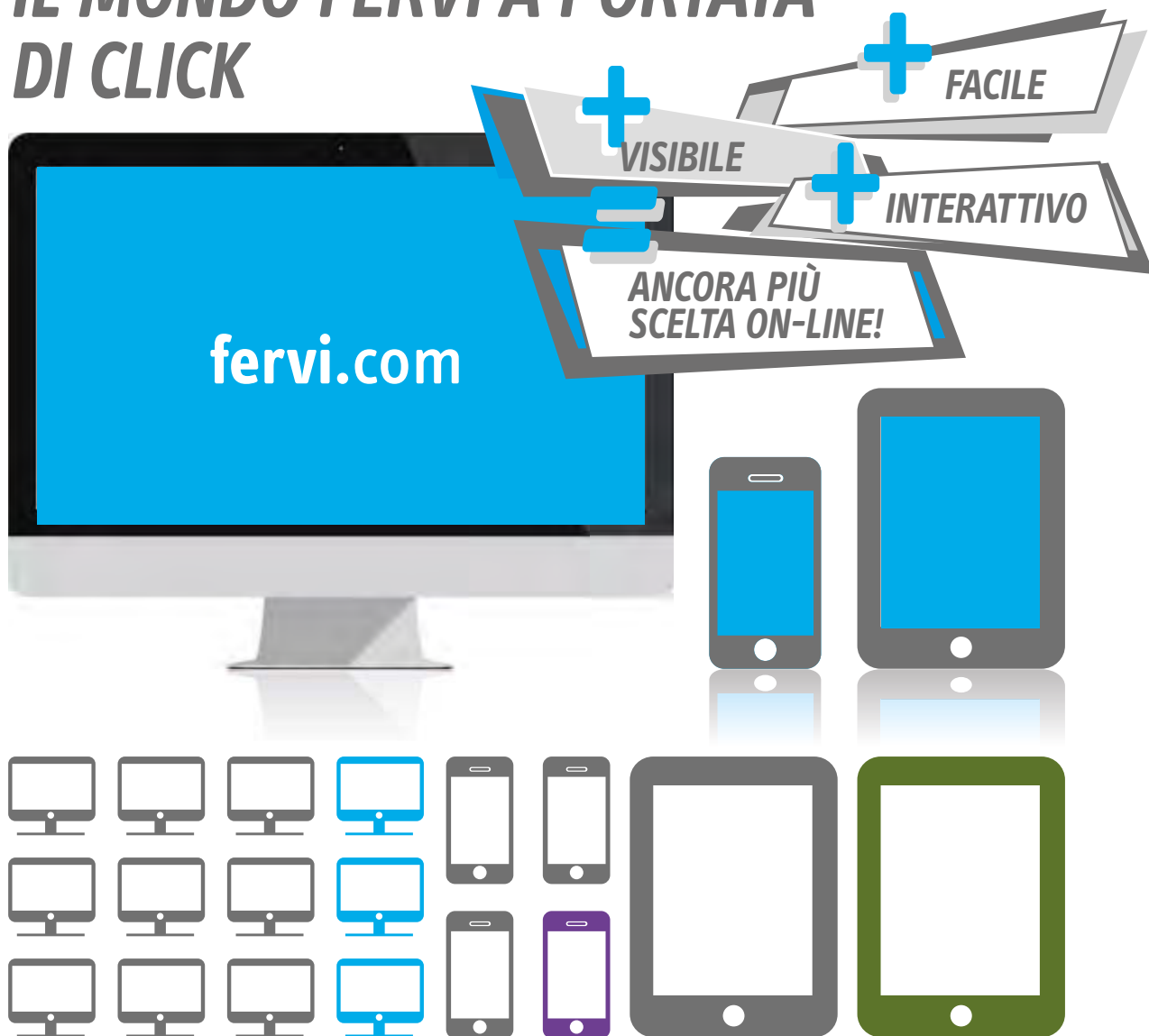

INCREMENTO ACCESSI PER DISPOSITIVO: +25%; +25%; +50%
75% ACCESSI DESKTOP 15% ACCESSI MOBILE 10% ACCESSI TABLET
+25% NUOVI UTENTI +25% SESSIONI +20% PAGINE VISITATE

Il sito Fervi – **facile da navigare e da consultare** anche da **smartphone** o **tablet** – è sempre stato un vero **strumento operativo** di **dialogo** e di **lavoro**, che riesce a valorizzare quotidianamente la **relazione diretta** dell'azienda con i suoi **clienti finali**, con i **dealer** e con i vari **partner** commerciali. Per semplificare e migliorare il business di ogni professionista, officina o showroom, è infatti possibile sfogliare online il nuovo catalogo e i suoi aggiornamenti stagionali esaminando comodamente in un click **tutti i prodotti**, divisi per **categorie** o **tipologia**

di intervento; visualizzare per ogni referenza le informazioni delle schede tecniche chiare, precise e complete dei prezzi; individuare i **rivenditori** e tutti i **punti vendita** del marchio Fervi e, soprattutto, restare sempre **aggiornati** sulle **offerte** commerciali in corso: ben visibile subito in home page, la sezione dedicata alle **Offerte Promozionali** sul nostro sito sarà ancora più evidente e sempre più ricca, con nuovi prodotti in primo piano e subito disponibili e perfettamente integrate nell'ottica di un servizio sempre più **"customer oriented"**.



PIÙ VICINI ALLE TUE ESIGENZE, PIÙ VICINI A TE.

Una distribuzione capillare e organizzata, che vanta oltre **4000 punti vendita in tutta Italia e una importante presenza all'estero**, in particolare nella Penisola Iberica, nell' Est Europa e nel Nord Africa. La lunga esperienza maturata nel settore delle attrezzature e dei macchinari da lavoro, l'attenta **cura del servizio** e la **competitività commerciale** dei prodotti

Fervi caratterizzano lo **spirito imprenditoriale** e commerciale dell'azienda, che si propone con propositività come un vero **partner** a rivenditori e ferramenta specializzati di tutto il territorio nazionale e all'estero, distinguendosi per la costante disponibilità al dialogo e per un **rapporto qualità-prezzo che non conosce rivali**.

- **Oltre 6.000 referenze.**
- **Oltre 3.000 ordini al mese.**
- **Oltre 100 mln di pezzi sul mercato.**

- **Oltre 1000 referenze di ricambistica sempre disponibili in magazzino.**

- ABRASIVI**
- MACCHINE E ACCESSORI**
- CONSUMABILI**
- STRUMENTI DI MISURA**
- UTENSILERIA**
- RICAMBI**

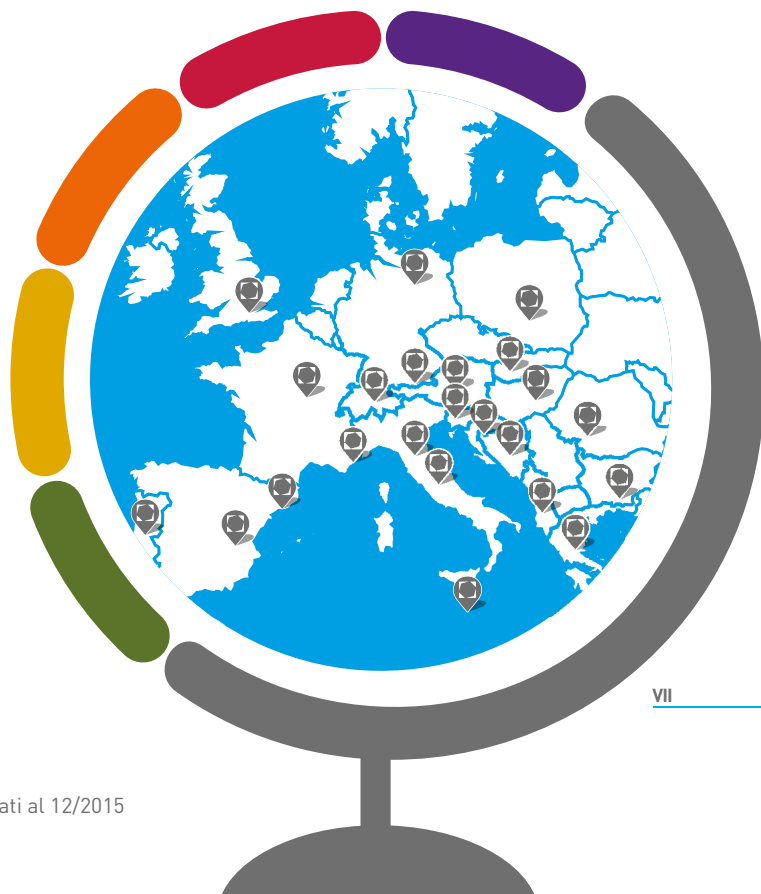

FERVI ARREDA IL TUO SPAZIO!

DIVENTA RIVENDITORE AUTORIZZATO:

- FERVI TI REGALA GLI ARREDI
- TU INCREMENTI IL FATTURATO
E IL RENDIMENTO AL METRO QUADRO,
COME HANNO GIÀ FATTO OLTRE 400 CLIENTI!



UNA PROPOSTA ESCLUSIVA PER I RIVENDITORI AUTORIZZATI

Si conferma il successo dell'iniziativa "Fervi arreda il tuo spazio" rivolta esclusivamente ai **rivenditori autorizzati** del nostro marchio per valorizzare l'immagine di ogni punto vendita e favorire il traffico dal sell-in al sell-out: infatti, **solo**

i dealer Fervi possono richiedere gratuitamente le nostre soluzioni di arredo componibili quali **gazebo, teche o espositori** personalizzati perfetti anche per allestire il **proprio spazio espositivo** in occasione di fiere o eventi.





OLTRE 1000 MQ INSTALLATI

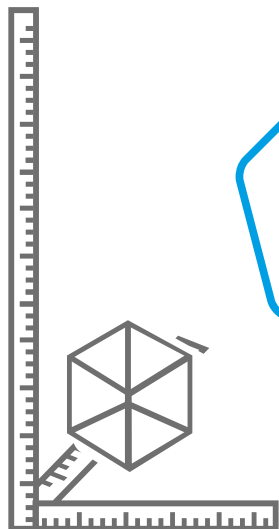

**OLTRE 160
PARETI**



**OLTRE 120
TECHE**



**OLTRE 70
GAZEBO**



Le nostre proposte **modulari**, create appositamente per **incrementare il fatturato dei nostri clienti** e il rendimento a metro quadro di ogni punto vendita, sono visualizzabili sia nel nostro sito che nella sezione finale di questo Catalogo.

*dati aggiornati al 12/2015



NEL CUORE DI FERVI: VALORI OLTRE L'AZIENDA

+

IMPEGNO

+

PASSIONE

+

PARTECIPAZIONE

+

VALORE AL MARCHIO FERVI!

La condivisione di **valori profondi**, sia dal punto di vista umano che professionale, è il prezioso presupposto con cui **Fervi** decide di sostenere progetti **artistici** o **sportivi**, partecipando in prima persona a prestigiose **operazioni di restauro** o supportando **team di corsa**, moto e rally, in qualità di sponsor.



Nel mese di Maggio 2015, fornendo gratuitamente i macchinari necessari al lavoro che è stato anche trasmesso esclusivamente in diretta streaming su web, Fervi ha collaborato alla creazione del **più grande laboratorio di restauro mobile di Europa**, finalizzato al recupero dei sarcofagi protetti in delicatissime teche di cristallo presso il **Castello Aragonese di Ischia** / al recupero del **coro ligneo** della cattedrale di **Ragusa**, sostenendo spontaneamente un progetto che non aveva ricevuto nessun tipo di finanziamento statale.



Da anni Fervi supporta con i suoi prodotti alcuni team di motorsport tra cui **Blacksheep Team**, una scuderia di campioni sempre pronti a gareggiare in sella alle loro moto nel **Campionato Italiano di Velocità**, attraverso i circuiti e gli autodromi più belli e famosi d'Italia, **Stefano Pelloni** che ha partecipato all'**Africa Race 2015** e **2016** con partenza da **Monaco** e arrivo a **Dakar** e **Edo Mossi** che ha partecipato al **Merzouga Rally 2015** un rally di oltre 1.000 km fra le dune del deserto del Marocco.



1000 NUOVE REFERENZE PER TE!

P017
pag 552

0188/100G
pag 181

L008
pag 552

M036
pag 278

ML30
pag 343

Il catalogo **Fervi #38** include circa **1000 nuove referenze** che vanno ad integrare la vasta offerta di prodotti. Questi sono solo alcuni! **Sfoglia il catalogo per scoprirle tutte**, aiutandoti con **le tabelle qui di seguito** li troverai con facilità!

0105
pag 520

0123
pag 551

C880/006
pag 431

M029
pag 278

A007A
pag 495

W021PN
pag 573



NUOVI PRODOTTI INSERITI A CATALOGO

ART	PAG	ART	PAG	ART	PAG	ART	PAG
RAPTOR...	006	T069/400V3A	039	M021/...	314	R607	531
L80FP...	006	T069/400V	040	0109	335	R608	531
L82FI...	007	R001/...	087	0112	336	0128	546
L86NP...	007	0302/305	122			0107	549
TIGER...	008	0302/245	122	ART	PAG	0597	550
BIGGER...	009	0138	124	0134S	367	0123	551
L50FP...	010	0144	124	0541S	367	L008	552
L50FP...	010	0601	131	0540/...	369	0033/TIP1	558
L52FI...	011	U003	138	0540/3	369	W021PA	572
L52FI...	011	0490/20	138	0540S	369	W021PG	572
L22NP...	012	0490/03	139	C391/...	375	W021PN	573
L22NP...	012	0601/24	139	G090/...	381	0125	573
L60NP...	013	0601/30	139	F090/...	381	TH601A	575
L60NP...	013	0490/11	139	CB01/...	423	TH602A	575
L23NP...	014	A040/30A	144	CB02/...	423	TH901A	575
L23NP...	014	A040/60A	144	CB01/04P	424	TH601A13...	579
MAGNUM...	015	A040/802	144	CBF1/...	424	TH602A08...	579
L70FP...	016	A040/803	145	CBF1/10P	424	TH901A13...	579
L70FP...	016	A040/...	146	CB01/07P	425	A601DS14...	579
L72FI...	017	A040/...	146	CB01/11P	425	TH250	580
L72FI...	017	P017	180	CB02/04P	425	TH500	580
L77FP...	018	M027/100	180	CB02/07P	425	016R/...	592
L77FP...	018	0188/100G	181	CB02/11P	426	0121/...	596
L79FI...	019	M004/...	199	C880/006	427	0148/64	600
L79FI...	019	3D40/...	205	C180/006	431	0142/25	601
L42NP...	020	3A40/...	205	C180/120	432	0135/...	601
L42NP...	020	G016...	207	PIF1	433	M122P220	602
CSCD/...	026	CHER25...	207	E005	440	M122P215V	602
CSDS/...	026	SNR12...	218	0136	448	M122P310V	602
ADF/...	026			0603	448	A360/...	603
UNCD/...	027	ART	PAG	B006/...	457	G882/...	603
RLP...	027	ADLT1503ZZR...	239	C012/...	457	G810/...	603
RLM...	027	11IRA55134...	240	S022/...	457	G820/...	603
RLT...	027	ST1A10.25R10...	245	S011	458		
RGP...	028	ST1A13.25R13...	245	C015/...	458		
RGM...	028	ST1A02.00C...	246	C015	458		
FPA...	028	P023/...	249	L002/...	466		
RGT...	029	P023/...	250	A007A	495		
RFP/...	029	P023/19	251	A007B	495		
RFT...	030	P023/25	251	A007C	496		
DFV...	031	P023/19A	251	A007D	496		
RAS...	032	P023/25A	251	C980	509		
SPI...	032	F011/...	267	C960C01	511		
N1...	033	F011/6	268	C960C02	512		
		F002/...	268	C960C03	512		
		F002/P	269	0105	520		
		F002/PL	269	0110	521		
		F002/6	270	0645/SS	528		
		M020	278	GI01/32AE	529		
		M029	278				
		M036	278				

PRODOTTI ELIMINATI E SOSTITUITI

ART	#36	ART	PAG	ART	#36	ART	PAG	ART	#36	ART	PAG
0565SI	37			M077/250GD	147	Ricambio		P025/14	155		
0652/1000	52			M077/315GD	147	Ricambio		P025/16	155		
0191	54			M075/160GR	147	Ricambio		P025/18	155		
0743	60	0498	108	M075/200GR	147	Ricambio		P025/20	155		
0743/C	60			M075/250GR	147	Ricambio		P025/25	155		
0275	66	0285/75	99	M075/315GR	147	Ricambio		S032/A4007P	156		
D028	83			M075/400GR	147	Ricambio		S032/B4007P	156		
0131	111			M076/160GR	147	Ricambio		S032/D4007P	156		
0061	112			M076/200GR	147	Ricambio		S032/CM207P	156		
0262	112			M076/250GR	147	Ricambio		S032/CM307P	156		
S1/800	113	S2/800	175	M076/315GR	147	Ricambio		S032/CM407P	156		
0014	115			M076/400GR	147	Ricambio		S032/A4018P	156		
M029/125M	117			M077/160GR	147	Ricambio		S032/B4018P	156		
M029/150M	117			M077/200GR	147	Ricambio		S032/D4018P	156		
M029/125F	119			M077/250GR	147	Ricambio		S032/CM218P	156		
M029/150F	119			M077/315GR	147	Ricambio		S032/CM318P	156		
M025/12	136			M075/160P	148	Ricambio		S032/CM418P	156		
M025/16	136			M075/200P	148	Ricambio		U001	175		
M025/20	136			M075/250P	148	Ricambio		U001/2/3	175		
M005/200G	144	Ricambio		M075/315P	148	Ricambio		U001/2/4	175		
M005/250G	144	Ricambio		M075/400P	148	Ricambio		U001/2/5	175		
M005/320G	144	Ricambio		M076/160P	148	Ricambio		U002	175		
M005/400G	144	Ricambio		M076/200P	148	Ricambio		C321	191		
M005/500G	144	Ricambio		M076/250P	148	Ricambio		ADLX1503Z..	198	ADLT1503..	239
M005/630G	144	Ricambio		M076/315P	148	Ricambio		P059	211		
M075/160GBD	147	Ricambio		M076/400P	148	Ricambio		P048	217		
M075/200GBD	147	Ricambio		M077/160P	148	Ricambio		P049/20	218		
M075/250GBD	147	Ricambio		M077/200P	148	Ricambio		0015	235		
M075/315GBD	147	Ricambio		M077/250P	148	Ricambio		0016	235		
M075/400GBD	147	Ricambio		M077/315P	148	Ricambio		D115/N40	255	L22NP115/040Z	12
M076/160GBD	147	Ricambio		M075/160C	148	Ricambio		D115/N60	255	L22NP115/060Z	12
M076/200GBD	147	Ricambio		M075/200C	148	Ricambio		D115/N80	255	L22NP115/080Z	12
M076/250GBD	147	Ricambio		M075/250C	148	Ricambio		D115/F40	255	L50FP115/040Z	10
M076/315GBD	147	Ricambio		M075/315C	148	Ricambio		D115/F60	255	L50FP115/060Z	10
M076/400GBD	147	Ricambio		M075/400C	148	Ricambio		D115/F80	255	L50FP115/080Z	10
M077/160GBD	147	Ricambio		M076/160C	148	Ricambio		D115/NY	256	CSCD/F115	26
M077/200GBD	147	Ricambio		M076/200C	148	Ricambio		0677/IM	272		
M077/250GBD	147	Ricambio		M076/250C	148	Ricambio		C008/200	283		
M077/315GBD	147	Ricambio		M076/315C	148	Ricambio		C008/300	283		
M075/160GD	147	Ricambio		M076/400C	148	Ricambio		B020/000.500	300	*	
M075/200GD	147	Ricambio		M077/160C	148	Ricambio		B020/001.000	300	*	
M075/250GD	147	Ricambio		M077/200C	148	Ricambio		B020/001.001	300	*	
M075/315GD	147	Ricambio		M077/250C	148	Ricambio		B020/001.002	300	*	
M075/400GD	147	Ricambio		M077/315C	148	Ricambio		B020/001.003	300	*	
M076/160GD	147	Ricambio		T035/A40	154			B020/001.004	300	*	
M076/200GD	147	Ricambio		T035/A50	154			B020/001.005	300	*	
M076/250GD	147	Ricambio		T035/D40	154			B020/001.006	300	*	
M076/315GD	147	Ricambio		T035/D50	154			B020/001.007	300	*	
M076/400GD	147	Ricambio		T035/A40M	154			B020/001.008	300	*	
M077/160GD	147	Ricambio		T035/A50M	154			B020/001.009	300	*	
M077/200GD	147	Ricambio		T035/D40M	154			B020/001.010	300	*	
M077/250GD	147	Ricambio		T035/D50M	154			B020/001.020	300	*	
M077/315GD	147	Ricambio		P016/04	155			B020/001.030	300	*	
M075/160GD	147	Ricambio		P016/05	155			B020/001.040	300	*	
M075/200GD	147	Ricambio		P016/06	155			B020/001.050	300	*	
M075/250GD	147	Ricambio		P016/08	155			B020/001.060	300	*	
M075/315GD	147	Ricambio		P016/10	155			B020/001.070	300	*	
M075/400GD	147	Ricambio		P016/12	155			B020/001.080	300	*	
M076/160GD	147	Ricambio		P016/14	155			B020/001.090	300	*	
M076/200GD	147	Ricambio		P016/16	155			B020/001.100	300	*	
M076/250GD	147	Ricambio		P025/04	155			B020/001.110	300	*	
M076/315GD	147	Ricambio		P025/05	155			B020/001.120	300	*	
M076/400GD	147	Ricambio		P025/06	155			B020/001.130	300	*	
M077/160GD	147	Ricambio		P025/08	155			B020/001.140	300	*	
M077/200GD	147	Ricambio		P025/10	155			B020/001.150	300	*	
				P025/12	155			B020/001.160	300	*	
								B020/001.170	300	*	
								B020/001.180	300	*	

* articolo ancora disponibile in serie

PRODOTTI ELIMINATI E SOSTITUITI

ART	#36	ART	PAG	ART	#36	ART	PAG	ART	#36	ART	PAG
B020/001.190	300	*		B020/018.000	300	*		0528/9	587	G528/09	595
B020/001.200	300	*		B020/018.500	300	*		0528/10	587	G528/10	595
B020/001.210	300	*		B020/019.000	300	*		0141/33	591	A141/33	599
B020/001.220	300	*		B020/019.500	300	*		0141/36	592	A141/36	599
B020/001.230	300	*		B020/020.000	300	*		0142/755	594		
B020/001.240	300	*		B020/020.500	300	*		0122CE	594	M122CE	602
B020/001.250	300	*		B020/021.000	300	*		0122E	594	M122E	602
B020/001.260	300	*		B020/021.500	300	*		0122P2	595	M122P2	602
B020/001.270	300	*		B020/022.000	300	*		G3054/40	595		
B020/001.280	300	*		B020/022.500	300	*		G3054/41	595		
B020/001.290	300	*		B020/023.000	300	*		G3054/42	595		
B020/001.300	300	*		B020/023.500	300	*		G3054/43	595		
B020/001.310	300	*		B020/024.000	300	*		G3054/44	595		
B020/001.320	300	*		B020/024.500	300	*		G3054/45	595		
B020/001.330	300	*		B020/025.000	300	*		G2400/40	595	A360/40	603
B020/001.340	300	*		B020/030.000	300	*		G2400/41	595	A360/41	603
B020/001.350	300	*		B020/040.000	300	*		G2400/42	595	A360/42	603
B020/001.360	300	*		B020/050.000	300	*		G2400/43	595	A360/43	603
B020/001.370	300	*		B020/060.000	300	*		G2400/44	595	A360/44	603
B020/001.380	300	*		B020/070.000	300	*		G2400/45	595	A360/45	603
B020/001.390	300	*		B020/075.000	300	*		G8100/40	596	G810/40	603
B020/001.400	300	*		B020/080.000	300	*		G8100/41	596	G810/41	603
B020/001.410	300	*		B020/090.000	300	*		G8100/42	596	G810/42	603
B020/001.420	300	*		B020/100.000	300	*		G8100/43	596	G810/43	603
B020/001.430	300	*		B020/125.000	300	*		G8100/44	596	G810/44	603
B020/001.440	300	*		B020/150.000	300	*		G8100/45	596	G810/45	603
B020/001.450	300	*		B020/175.000	300	*		G862/40	596	G820/40	603
B020/001.460	300	*		B020/200.000	300	*		G862/41	596	G820/41	603
B020/001.470	300	*		B020/250.000	300	*		G862/42	596	G820/42	603
B020/001.480	300	*		B020/300.000	300	*		G862/43	596	G820/43	603
B020/001.490	300	*		B020/400.000	300	*		G862/44	596	G820/44	603
B020/001.500	300	*		B020/500.000	300	*		G862/45	596	G820/45	603
B020/001.600	300	*		L090	321	L090A	336				
B020/001.700	300	*		M053	327						
B020/001.800	300	*		D013	344						
B020/001.900	300	*		D008	345						
B020/002.000	300	*		C390/06	373	C391/06	375				
B020/002.500	300	*		C390/07	373	C391/07	375				
B020/003.000	300	*		C390/08	373	C391/08	375				
B020/003.500	300	*		C390/09	373	C391/09	375				
B020/004.000	300	*		C390/10	373	C391/10	375				
B020/004.500	300	*		C390/11	373	C391/11	375				
B020/005.000	300	*		C390/12	373	C391/12	375				
B020/005.500	300	*		C390/13	373	C391/13	375				
B020/006.000	300	*		C390/14	373	C391/14	375				
B020/006.500	300	*		C390/15	373	C391/15	375				
B020/007.000	300	*		C390/16	373	C391/16	375				
B020/007.500	300	*		C390/17	373	C391/17	375				
B020/008.000	300	*		C390/18	373	C391/18	375				
B020/008.500	300	*		C390/19	373	C391/19	375				
B020/009.000	300	*		0542	452						
B020/009.500	300	*		T2010	473						
B020/010.000	300	*		T2016	473						
B020/010.500	300	*		0374	491	0655/S	491				
B020/011.000	300	*		0699/270	493						
B020/011.500	300	*		G100	499						
B020/012.000	300	*		0182	509						
B020/012.500	300	*		C161	512						
B020/013.000	300	*		0114	513						
B020/013.500	300	*		0335	541						
B020/014.000	300	*		0621/230V	541						
B020/014.500	300	*		0621/N	541						
B020/015.000	300	*		0033/TIP	546	Ricambio					
B020/015.500	300	*		0099	581						
B020/016.000	300	*		A039/8	584						
B020/016.500	300	*		A039/10	584						
B020/017.000	300	*		0528/7	587	G528/07	595				
B020/017.500	300	*		0528/8	587	G528/08	595				



#38

since 1978





DISCHI LAMELLARI

pag 004



MOLE E DISCHI DA TAGLIO

pag 022



PULITURA E LUCIDATURA

pag 026



DISCHI E NASTRI IN TELA ABRASIVA

pag 032



A partire dal **2016 Fervi** diventa distributore ufficiale dei dischi abrasivi prodotti dalla **Ri-Flex Abrasives Srl**.



Ri-Flex Abrasives produce una **gamma completa** di abrasivi flessibili con una forte specializzazione nella produzione

di **dischi lamellari** con supporti sia in nylon sia in fibra di vetro e la possibilità di personalizzare l'etichetta con il logo del cliente (OEM).



L'elemento distintivo dei prodotti **Ri-Flex** è dato dal fatto che le **macchine per la produzione** dei dischi lamellari sono costruite

internamente con un **know-how proprietario** sviluppato nel corso di oltre **30 anni** di attività. **Ri-Flex Abrasives** annovera tra i suoi clienti **importanti Gruppi multinazionali** sia produttori che distributori di abrasivi e realizza all'estero una quota significativa delle vendite.

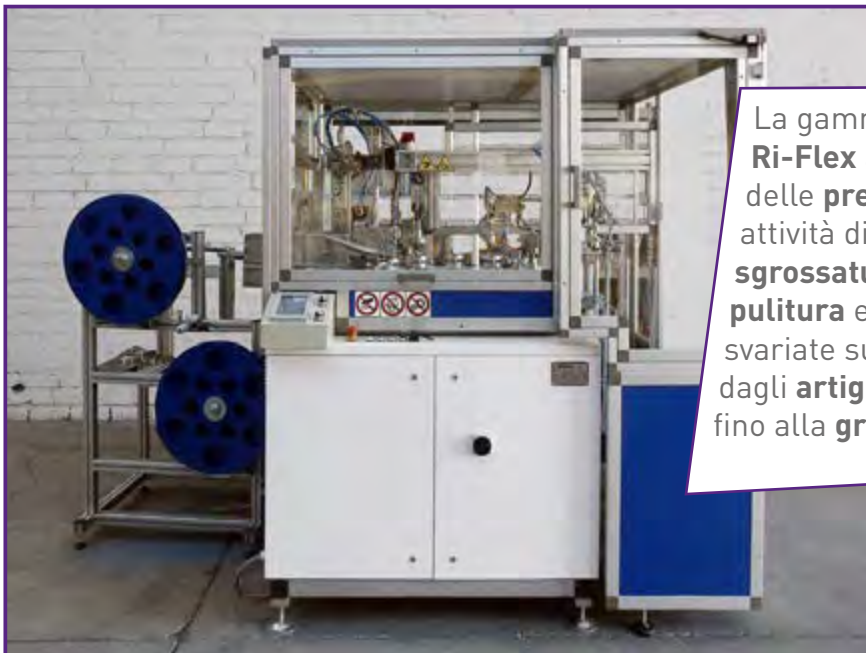

La gamma di dischi lamellari **Ri-Flex** assicura il **massimo** delle **prestazioni** per le attività di **smerigliatura, sgrossatura, sbavatura, pulitura e trattamento** di svariate superfici, utilizzabili dagli **artigiani** più esigenti fino alla **grande industria**.



Le famiglie prodotto



GRIND-FLEX

**IL PIÙ VENDUTO.
LA QUALITÀ AL GIUSTO PREZZO**

IN ZIRCONIO E OSSIDO DI
ALLUMINIO IDEALE PER L'USO
SU TUTTI I TIPI DI METALLO



RIFLEX PRO

**MULTIUSO DI ALTISSIMA
QUALITÀ**

IN ZIRCONIO E OSSIDO DI
ALLUMINIO, IDEALE PER
IMPIEGHI MULTIUSO



REAL FLAT

GLI UNICI REALMENTE PIANI

FORMA PIANA E DENSITÀ
COSTANTE, IDEALE PER
LAVORAZIONI SPECIALI



ZIRCOCER INOX

**IL MEGLIO PER CURARE
IL TUO INOX**

IDEALE PER ACCIAIO INOX
CON INNOVATIVO TOP SIZE
PER LA RIDUZIONE DEL
RISCALDAMENTO

Abrasivo



OSSIDO DI ALLUMINIO



ZIRCONIO



ZIRCONIO
CERAMICATO

Lamelle



SINGOLA



DOPPIA

Supporto

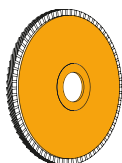

PLASTICA

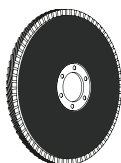

FIBRA
DI VETRO

Inclinazione



CONICO



PIANO



CONVESSO
"REAL FLAT"

Come leggere l'etichetta



1 - LINEA PRODOTTO

2 - PITTOGRAMMI DI SICUREZZA

3 - CODICE PRODOTTO

4 - DIAMETRO DISCO/FORO

5 - TIPOLOGIA ABRASIVO E GRANA

6 - MAX GIRI AL MINUTO

Art. L80FP Z
 DISCO LAMELLARE PROFESSIONALE PER ACCIAIO INOX

Codice	Dimensioni	Grana	Max rpm	Ordine min	€
L80FP115/040ZC	115 x 22 mm	40	10500	20	3,20
L80FP115/060ZC	115 x 22 mm	60	10500	20	3,20
L80FP115/080ZC	115 x 22 mm	80	10500	20	3,20
L80FP115/120ZC	115 x 22 mm	120	10500	20	3,20
L80FP125/040ZC	125 x 22 mm	40	9700	20	3,60
L80FP125/060ZC	125 x 22 mm	60	9700	20	3,60
L80FP125/080ZC	125 x 22 mm	80	9700	20	3,60
L80FP125/120ZC	125 x 22 mm	120	9700	20	3,60

Supporto

- Fibra di vetro
- Piano

Tela

- Zirconio ceramico
- Lamella singola

Velocità consigliata

Diametro	rpm
115	5000/7500
125	4800/7300

Art. RAPTOR
 DISCO LAMELLARE PROFESSIONALE PER ACCIAIO INOX

ZIRCO CER inox II RAPTOR

- MASSIMA AGGRESSIVITÀ E VELOCITÀ DI ASPORTAZIONE
- PARTICOLARE COSTRUZIONE CHE ESALTA LE CARATTERISTICHE DI VELOCITÀ DI ASPORTAZIONE



Codice	Dimensioni	Grana	Max rpm	Ordine min	€
RAPTOR115/040ZC	115 x 22 mm	40	10500	20	2,90
RAPTOR125/040ZC	125 x 22 mm	40	9700	20	3,20

Supporto

- Fibra di vetro
- Rinforzato
- Piano

Tela

- Zirconio ceramico
- Lamella singola

Velocità consigliata

Diametro	rpm
115	5000/7500
125	4800/7300



Art. L82FI Z DISCO LAMELLARE PROFESSIONALE PER ACCIAIO INOX



Codice	Dimensioni	Grana	Max rpm	Ordine min	€
L82FI115/040ZC	115 x 22 mm	40	10500	20	3,20
L82FI115/060ZC	115 x 22 mm	60	10500	20	3,20
L82FI115/080ZC	115 x 22 mm	80	10500	20	3,20
L82FI115/120ZC	115 x 22 mm	120	10500	20	3,20
L82FI125/040ZC	125 x 22 mm	40	9700	20	3,60
L82FI125/060ZC	125 x 22 mm	60	9700	20	3,60
L82FI125/080ZC	125 x 22 mm	80	9700	20	3,60
L82FI125/120ZC	125 x 22 mm	120	9700	20	3,60

Supporto

- Fibra di vetro
- Conico

Tela

- Zirconio ceramico
- Lamella singola

Velocità consigliata

Diametro	rpm
115	5000/7500
125	4800/7300



Art. L86NP Z DISCO LAMELLARE PROFESSIONALE PER ACCIAIO INOX



Codice	Dimensioni	Grana	Max rpm	Ordine min	€
L86NP115/040ZC	115 x 22 mm	40	10500	20	3,10
L86NP115/060ZC	115 x 22 mm	60	10500	20	3,10
L86NP115/080ZC	115 x 22 mm	80	10500	20	3,10
L86NP115/120ZC	115 x 22 mm	120	10500	20	3,10
L86NP125/040ZC	125 x 22 mm	40	9700	20	3,90
L86NP125/060ZC	125 x 22 mm	60	9700	20	3,90
L86NP125/080ZC	125 x 22 mm	80	9700	20	3,90
L86NP125/120ZC	125 x 22 mm	120	9700	20	3,90

Supporto

- Nylon
- Rinforzato
- Piano

Tela

- Zirconio ceramico
- Lamella singola

Velocità consigliata

Diametro	rpm
115	5000/7500
125	4800/7300

ZIRCOCER INOX è un disco lamellare costituito da una tela abrasiva "TOP SIZE" con una miscela di zirconio e abrasivo ceramico. Questi materiali di elevata qualità consentono una altissima velocità di taglio assieme ad una eccezionale durata del disco. L'ulteriore strato "TOP SIZE" riduce drasticamente il surriscaldamento del disco e del pezzo da lavorare con evidenti benefici nelle lavorazioni degli acciai inossidabili. Il tessuto particolarmente resistente permette forti pressioni di lavoro. Il colore azzurro è per sua natura privo di ossidi di ferro in modo da prevenire la contaminazione degli acciai inossidabili ($\geq 0,1\%$ Fe, S, Cl)

Art. TIGER
DISCO LAMELLARE PROFESSIONALE PER FORTI ASPORTAZIONI

RIFLEX PRO // TIGER

- MIGLIOR RAPPORTO QUALITÀ PREZZO
- IL MASSIMO DELLA CAPACITÀ DI ASPORTAZIONE CON RIDUZIONE DEI TEMPI DI LAVORO

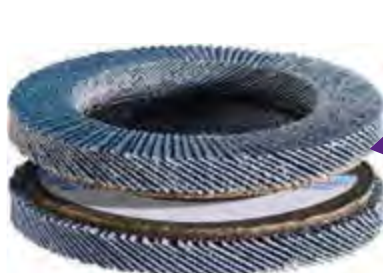

TAGLIO PIÙ FREDDO
DURATA PIÙ CHE DOPPIA
RIDUZIONE DEI TEMPI E DEI COSTI

Supporto

- Fibra di vetro
- Rinforzato
- Piano

Tela

- Zirconio Premium
- Lamella singola

Velocità consigliata

Diametro	rpm
115	5000/7500

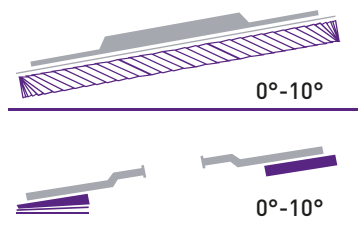

Con la forma piana si ottiene una naturale regolazione dell'angolo di taglio ottimizzandolo fra 0 e 10°

Codice	Dimensioni	Grana	Max rpm	Ordine min	€
TIGER115/040Z	115 x 22 mm	40	10500	20	2,80
TIGER115/050Z	115 x 22 mm	50	10500	20	2,80
TIGER115/060Z	115 x 22 mm	60	10500	20	2,80
TIGER115/080Z	115 x 22 mm	80	10500	20	2,80
TIGER115/100Z	115 x 22 mm	100	10500	20	2,80
TIGER115/120Z	115 x 22 mm	120	10500	20	2,80

Per acciaio inossidabile, ferro, metalli non ferrosi, alluminio, ecc...

TIGER è un disco lamellare con il **70% in più** di tela abrasiva rispetto ai dischi professionali standard.

La sua forma permette l'**utilizzo completo della parte abrasiva** oltre a renderlo particolarmente compatto.

Questa caratteristica abbinata al supporto rinforzato, permette di esercitare una **pressione specifica superiore** e di conseguenza una **asportazione più rapida**.

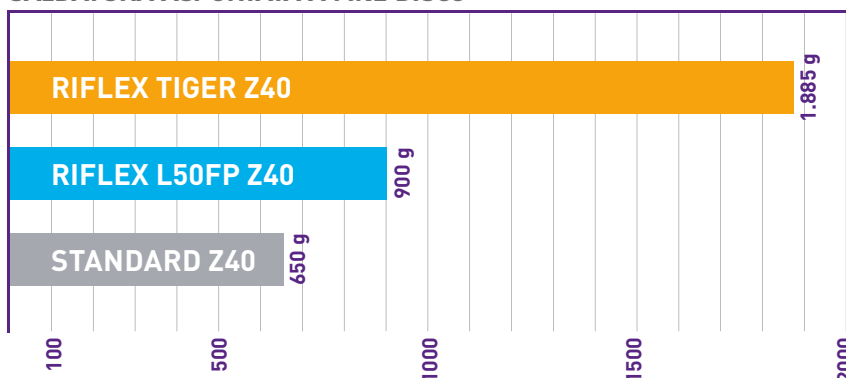
SALDATURA ASPORTATA A FINE DISCO



Art. BIGGER

DISCO LAMELLARE PROFESSIONALE PER FORTI ASPORTAZIONI



Codice	Dimensioni	Grana	Max rpm	Ordine min	€
BIGGER115/036Z	115 x 22 mm	36	10500	20	2,50
BIGGER115/040Z	115 x 22 mm	40	10500	20	2,50
BIGGER115/050Z	115 x 22 mm	50	10500	20	2,50
BIGGER115/060Z	115 x 22 mm	60	10500	20	2,50
BIGGER115/080Z	115 x 22 mm	80	10500	20	2,50
BIGGER115/100Z	115 x 22 mm	100	10500	20	2,50
BIGGER115/120Z	115 x 22 mm	120	10500	20	2,50
BIGGER125/036Z	125 x 22 mm	36	9700	20	2,80
BIGGER125/040Z	125 x 22 mm	40	9700	20	2,80
BIGGER125/050Z	125 x 22 mm	50	9700	20	2,80
BIGGER125/060Z	125 x 22 mm	60	9700	20	2,80
BIGGER125/080Z	125 x 22 mm	80	9700	20	2,80
BIGGER125/100Z	125 x 22 mm	100	9700	20	2,80
BIGGER125/120Z	125 x 22 mm	120	9700	20	2,80
BIGGER180/036Z	180 x 22 mm	36	7000	20	5,90
BIGGER180/040Z	180 x 22 mm	40	7000	20	5,90
BIGGER180/050Z	180 x 22 mm	50	7000	20	5,90
BIGGER180/060Z	180 x 22 mm	60	7000	20	5,90
BIGGER180/080Z	180 x 22 mm	80	7000	20	5,90
BIGGER180/100Z	180 x 22 mm	100	7000	20	5,90
BIGGER180/120Z	180 x 22 mm	120	7000	20	5,90

Supporto

- Fibra di vetro
- Rinforzato
- Piano

Tela

- Zirconio Premium
- Lamella singola

Velocità consigliata

Diametro	rpm
115	5000/7500
125	4800/7300
180	3250/4900

Per acciaio inox, acciaio, ghisa, metalli non ferrosi, alluminio, ecc..

Con il disco lamellare **BIGGER** si smeriglia più a lungo, **più velocemente**, ottenendo una **miglior finitura**.

La **nuova struttura** e la tela allo zirconio "**R-Premium**" assicurano **migliori risultati** se comparati ai dischi lamellari convenzionali o ad altri dischi abrasivi: **50% in più nella capacità di asportazione**, con riduzione dei tempi di lavoro; **doppia durata**; ottimo rapporto qualità prezzo; **taglio più freddo**; riduzione dei tempi e dei costi.

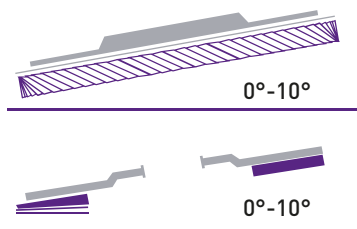

Con la forma piana si ottiene una naturale regolazione dell'angolo di taglio ottimizzandolo fra 0 e 10°

SALDATURA ASPORTATA A FINE DISCO

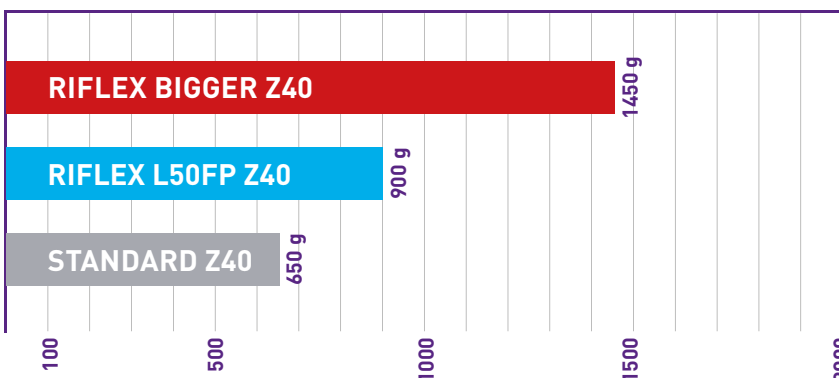

Art. L50FP Z
DISCO LAMELLARE PROFESSIONALE

Supporto
 Fibra di vetro

 Piano

Tela
 Zirconio Plus

 Lamella singola

Velocità consigliata

Diametro	rpm
115	5000/7500
125	4800/7300
180	3250/4900

Codice	Dimensioni	Grana	Max rpm	Ordine min	€
L50FP115/036Z	115 x 22 mm	36	10500	20	2,00
L50FP115/040Z	115 x 22 mm	40	10500	20	2,00
L50FP115/050Z	115 x 22 mm	50	10500	20	2,00
L50FP115/060Z	115 x 22 mm	60	10500	20	2,00
L50FP115/080Z	115 x 22 mm	80	10500	20	2,00
L50FP115/100Z	115 x 22 mm	100	10500	20	2,00
L50FP115/120Z	115 x 22 mm	120	10500	20	2,00
L50FP125/036Z	125 x 22 mm	36	9700	20	2,50
L50FP125/040Z	125 x 22 mm	40	9700	20	2,50
L50FP125/050Z	125 x 22 mm	50	9700	20	2,50
L50FP125/060Z	125 x 22 mm	60	9700	20	2,50
L50FP125/080Z	125 x 22 mm	80	9700	20	2,50
L50FP125/100Z	125 x 22 mm	100	9700	20	2,50
L50FP125/120Z	125 x 22 mm	120	9700	20	2,50
L50FP180/036Z	180 x 22 mm	36	7000	20	5,40
L50FP180/040Z	180 x 22 mm	40	7000	20	5,40
L50FP180/050Z	180 x 22 mm	50	7000	20	5,40
L50FP180/060Z	180 x 22 mm	60	7000	20	5,40
L50FP180/080Z	180 x 22 mm	80	7000	20	5,40
L50FP180/100Z	180 x 22 mm	100	7000	20	5,40
L50FP180/120Z	180 x 22 mm	120	7000	20	5,40

Per acciaio inossidabile, ferro, metalli non ferrosi, alluminio, ecc...

Art. L50FP A
DISCO LAMELLARE PROFESSIONALE

Supporto
 Fibra di vetro

 Piano

Tela
 Ossido di alluminio

 Lamella singola

Velocità consigliata

Diametro	rpm
115	5000/7500
125	4800/7300
180	3250/4900

Codice	Dimensioni	Grana	Max rpm	Ordine min	€
L50FP115/036A	115 x 22 mm	36	10500	20	1,90
L50FP115/040A	115 x 22 mm	40	10500	20	1,90
L50FP115/050A	115 x 22 mm	50	10500	20	1,90
L50FP115/060A	115 x 22 mm	60	10500	20	1,90
L50FP115/080A	115 x 22 mm	80	10500	20	1,90
L50FP115/100A	115 x 22 mm	100	10500	20	1,90
L50FP115/120A	115 x 22 mm	120	10500	20	1,90
L50FP125/036A	125 x 22 mm	36	9700	20	2,30
L50FP125/040A	125 x 22 mm	40	9700	20	2,30
L50FP125/050A	125 x 22 mm	50	9700	20	2,30
L50FP125/060A	125 x 22 mm	60	9700	20	2,30
L50FP125/080A	125 x 22 mm	80	9700	20	2,30
L50FP125/100A	125 x 22 mm	100	9700	20	2,30
L50FP125/120A	125 x 22 mm	120	9700	20	2,30
L50FP180/036A	180 x 22 mm	36	7000	20	4,90
L50FP180/040A	180 x 22 mm	40	7000	20	4,90
L50FP180/050A	180 x 22 mm	50	7000	20	4,90
L50FP180/060A	180 x 22 mm	60	7000	20	4,90
L50FP180/080A	180 x 22 mm	80	7000	20	4,90
L50FP180/100A	180 x 22 mm	100	7000	20	4,90
L50FP180/120A	180 x 22 mm	120	7000	20	4,90

Alte prestazioni. Per ferro, metalli non ferrosi, alluminio.



Art. L52FI Z DISCO LAMELLARE PROFESSIONALE



Supporto

Fibra di vetro

Conico



Tela

Zirconio Plus

Lamella singola

Velocità consigliata

Diametro	rpm
115	5000/7500
125	4800/7300
180	3250/4900

Codice	Dimensioni	Grana	Max rpm	Ordine min	€
L52FI115/036Z	115 x 22 mm	36	10500	20	2,20
L52FI115/040Z	115 x 22 mm	40	10500	20	2,20
L52FI115/050Z	115 x 22 mm	50	10500	20	2,20
L52FI115/060Z	115 x 22 mm	60	10500	20	2,20
L52FI115/080Z	115 x 22 mm	80	10500	20	2,20
L52FI115/100Z	115 x 22 mm	100	10500	20	2,20
L52FI115/120Z	115 x 22 mm	120	10500	20	2,20
L52FI125/036Z	125 x 22 mm	36	9700	20	2,70
L52FI125/040Z	125 x 22 mm	40	9700	20	2,70
L52FI125/050Z	125 x 22 mm	50	9700	20	2,70
L52FI125/060Z	125 x 22 mm	60	9700	20	2,70
L52FI125/080Z	125 x 22 mm	80	9700	20	2,70
L52FI125/100Z	125 x 22 mm	100	9700	20	2,70
L52FI125/120Z	125 x 22 mm	120	9700	20	2,70
L52FI180/036Z	180 x 22 mm	36	7000	20	5,40
L52FI180/040Z	180 x 22 mm	40	7000	20	5,40
L52FI180/050Z	180 x 22 mm	50	7000	20	5,40
L52FI180/060Z	180 x 22 mm	60	7000	20	5,40
L52FI180/080Z	180 x 22 mm	80	7000	20	5,40
L52FI180/100Z	180 x 22 mm	100	7000	20	5,40
L52FI180/120Z	180 x 22 mm	120	7000	20	5,40

Per acciaio inossidabile, ferro, metalli non ferrosi, alluminio, ecc...



Art. L52FI A DISCO LAMELLARE PROFESSIONALE



Supporto

Fibra di vetro

Conico



Tela

Ossido di alluminio

Lamella singola

Velocità consigliata

Diametro	rpm
115	5000/7500
125	4800/7300
180	3250/4900

Codice	Dimensioni	Grana	Max rpm	Ordine min	€
L52FI115/036A	115 x 22 mm	36	10500	20	1,90
L52FI115/040A	115 x 22 mm	40	10500	20	1,90
L52FI115/050A	115 x 22 mm	50	10500	20	1,90
L52FI115/060A	115 x 22 mm	60	10500	20	1,90
L52FI115/080A	115 x 22 mm	80	10500	20	1,90
L52FI115/100A	115 x 22 mm	100	10500	20	1,90
L52FI115/120A	115 x 22 mm	120	10500	20	1,90
L52FI125/036A	125 x 22 mm	36	9700	20	2,30
L52FI125/040A	125 x 22 mm	40	9700	20	2,30
L52FI125/050A	125 x 22 mm	50	9700	20	2,30
L52FI125/060A	125 x 22 mm	60	9700	20	2,30
L52FI125/080A	125 x 22 mm	80	9700	20	2,30
L52FI125/100A	125 x 22 mm	100	9700	20	2,30
L52FI125/120A	125 x 22 mm	120	9700	20	2,30
L52FI180/036A	180 x 22 mm	36	7000	20	4,90
L52FI180/040A	180 x 22 mm	40	7000	20	4,90
L52FI180/050A	180 x 22 mm	50	7000	20	4,90
L52FI180/060A	180 x 22 mm	60	7000	20	4,90
L52FI180/080A	180 x 22 mm	80	7000	20	4,90
L52FI180/100A	180 x 22 mm	100	7000	20	4,90
L52FI180/120A	180 x 22 mm	120	7000	20	4,90

Alte prestazioni. Per ferro, metalli non ferrosi, alluminio.

Artt. L20NP / L22NP Z
DISCO LAMELLARE PROFESSIONALE

Supporto

Nylon

Rinforzato

Piano

Tela

Zirconio Plus

Lamella doppia

Velocità consigliata

Diametro	rpm
115	5000/7500
125	4800/7300
180	3250/4900

Codice	Dimensioni	Grana	Max rpm	Ordine min	€
L22NP115/036Z	115 x 22 mm	36	10500	20	2,20
L22NP115/040Z	115 x 22 mm	40	10500	20	2,20
L22NP115/050Z	115 x 22 mm	50	10500	20	2,20
L22NP115/060Z	115 x 22 mm	60	10500	20	2,20
L22NP115/080Z	115 x 22 mm	80	10500	20	2,20
L22NP115/100Z	115 x 22 mm	100	10500	20	2,20
L22NP115/120Z	115 x 22 mm	120	10500	20	2,20
L20NP165/036Z	165 x 22 mm	36	7300	20	5,40
L20NP165/040Z	165 x 22 mm	40	7300	20	5,40
L20NP165/050Z	165 x 22 mm	50	7300	20	5,40
L20NP165/060Z	165 x 22 mm	60	7300	20	5,40
L20NP165/080Z	165 x 22 mm	80	7300	20	5,40
L20NP165/100Z	165 x 22 mm	100	7300	20	5,40
L20NP165/120Z	165 x 22 mm	120	7300	20	5,40
L20NP180/036Z	180 x 22 mm	36	7000	20	5,40
L20NP180/040Z	180 x 22 mm	40	7000	20	5,40
L20NP180/050Z	180 x 22 mm	50	7000	20	5,40
L20NP180/060Z	180 x 22 mm	60	7000	20	5,40
L20NP180/080Z	180 x 22 mm	80	7000	20	5,40
L20NP180/100Z	180 x 22 mm	100	7000	20	5,40
L20NP180/120Z	180 x 22 mm	120	7000	20	5,40

Per acciaio inossidabile, ferro, metalli non ferrosi, alluminio, ecc...

Artt. L20NP / L22NP A
DISCO LAMELLARE PROFESSIONALE

Supporto

Nylon

Rinforzato

Piano

Tela

Ossido di alluminio

Lamella doppia

Velocità consigliata

Diametro	rpm
115	5000/7500
125	4800/7300
180	3250/4900

Codice	Dimensioni	Grana	Max rpm	Ordine min	€
L22NP115/036A	115 x 22 mm	36	10500	20	2,00
L22NP115/040A	115 x 22 mm	40	10500	20	2,00
L22NP115/050A	115 x 22 mm	50	10500	20	2,00
L22NP115/060A	115 x 22 mm	60	10500	20	2,00
L22NP115/080A	115 x 22 mm	80	10500	20	2,00
L22NP115/100A	115 x 22 mm	100	10500	20	2,00
L22NP115/120A	115 x 22 mm	120	10500	20	2,00
L20NP165/036A	165 x 22 mm	36	7300	20	4,60
L20NP165/040A	165 x 22 mm	40	7300	20	4,60
L20NP165/050A	165 x 22 mm	50	7300	20	4,60
L20NP165/060A	165 x 22 mm	60	7300	20	4,60
L20NP165/080A	165 x 22 mm	80	7300	20	4,60
L20NP165/100A	165 x 22 mm	100	7300	20	4,60
L20NP165/120A	165 x 22 mm	120	7300	20	4,60
L20NP180/036A	180 x 22 mm	36	7000	20	4,80
L20NP180/040A	180 x 22 mm	40	7000	20	4,80
L20NP180/050A	180 x 22 mm	50	7000	20	4,80
L20NP180/060A	180 x 22 mm	60	7000	20	4,80
L20NP180/080A	180 x 22 mm	80	7000	20	4,80
L20NP180/100A	180 x 22 mm	100	7000	20	4,80
L20NP180/120A	180 x 22 mm	120	7000	20	4,80

Alte prestazioni. Per ferro, metalli non ferrosi, alluminio.



Art. L60NP Z DISCO LAMELLARE PROFESSIONALE



Supporto

- Nylon
- Rinforzato
- Piano

Tela

- Zirconio Plus
- Lamella singola

Velocità consigliata

Diametro	rpm
115	5000/7500
125	4800/7300
180	3250/4900

Codice	Dimensioni	Grana	Max rpm	Ordine min	€
L60NP115/036Z	115 x 22 mm	36	10500	20	2,20
L60NP115/040Z	115 x 22 mm	40	10500	20	2,20
L60NP115/050Z	115 x 22 mm	50	10500	20	2,20
L60NP115/060Z	115 x 22 mm	60	10500	20	2,20
L60NP115/080Z	115 x 22 mm	80	10500	20	2,20
L60NP115/100Z	115 x 22 mm	100	10500	20	2,20
L60NP115/120Z	115 x 22 mm	120	10500	20	2,20
L60NP125/036Z	125 x 22 mm	36	9700	20	3,10
L60NP125/040Z	125 x 22 mm	40	9700	20	3,10
L60NP125/050Z	125 x 22 mm	50	9700	20	3,10
L60NP125/060Z	125 x 22 mm	60	9700	20	3,10
L60NP125/080Z	125 x 22 mm	80	9700	20	3,10
L60NP125/100Z	125 x 22 mm	100	9700	20	3,10
L60NP125/120Z	125 x 22 mm	120	9700	20	3,10
L60NP180/036Z	180 x 22 mm	36	7000	20	5,10
L60NP180/040Z	180 x 22 mm	40	7000	20	5,10
L60NP180/050Z	180 x 22 mm	50	7000	20	5,10
L60NP180/060Z	180 x 22 mm	60	7000	20	5,10
L60NP180/080Z	180 x 22 mm	80	7000	20	5,10
L60NP180/100Z	180 x 22 mm	100	7000	20	5,10
L60NP180/120Z	180 x 22 mm	120	7000	20	5,10

Per acciaio inossidabile, ferro, metalli non ferrosi, alluminio, ecc...



Art. L60NP A DISCO LAMELLARE PROFESSIONALE



Supporto

- Nylon
- Rinforzato
- Piano

Tela

- Ossido di alluminio
- Lamella singola

Velocità consigliata

Diametro	rpm
115	5000/7500
125	4800/7300
180	3250/4900

Codice	Dimensioni	Grana	Max rpm	Ordine min	€
L60NP115/036A	115 x 22 mm	36	10500	20	2,00
L60NP115/040A	115 x 22 mm	40	10500	20	2,00
L60NP115/050A	115 x 22 mm	50	10500	20	2,00
L60NP115/060A	115 x 22 mm	60	10500	20	2,00
L60NP115/080A	115 x 22 mm	80	10500	20	2,00
L60NP115/100A	115 x 22 mm	100	10500	20	2,00
L60NP115/120A	115 x 22 mm	120	10500	20	2,00
L60NP125/036A	125 x 22 mm	36	9700	20	2,70
L60NP125/040A	125 x 22 mm	40	9700	20	2,70
L60NP125/050A	125 x 22 mm	50	9700	20	2,70
L60NP125/060A	125 x 22 mm	60	9700	20	2,70
L60NP125/080A	125 x 22 mm	80	9700	20	2,70
L60NP125/100A	125 x 22 mm	100	9700	20	2,70
L60NP125/120A	125 x 22 mm	120	9700	20	2,70
L60NP180/036A	180 x 22 mm	36	7000	20	4,60
L60NP180/040A	180 x 22 mm	40	7000	20	4,60
L60NP180/050A	180 x 22 mm	50	7000	20	4,60
L60NP180/060A	180 x 22 mm	60	7000	20	4,60
L60NP180/080A	180 x 22 mm	80	7000	20	4,60
L60NP180/100A	180 x 22 mm	100	7000	20	4,60
L60NP180/120A	180 x 22 mm	120	7000	20	4,60

Alte prestazioni. Per ferro, metalli non ferrosi, alluminio.

Artt. L23NP Z & L23NP A
DISCO LAMELLARE PROFESSIONALE REALMENTE PIANO

Codice	Dimensioni	Grana	Max rpm	Ordine min	€
L23NP115/036Z	115 x 22 mm	36	10500	20	2,90
L23NP115/040Z	115 x 22 mm	40	10500	20	2,90
L23NP115/050Z	115 x 22 mm	50	10500	20	2,90
L23NP115/060Z	115 x 22 mm	60	10500	20	2,90
L23NP115/080Z	115 x 22 mm	80	10500	20	2,90
L23NP115/100Z	115 x 22 mm	100	10500	20	2,90
L23NP115/120Z	115 x 22 mm	120	10500	20	2,90

Alte prestazioni. Per ferro, metalli non ferrosi, alluminio.

Supporto

- Nylon
- Rinforzato
- Concavo

Tela

- Zirconio Plus
- Lamella larga, doppia

Velocità consigliata

Diametro	rpm
115	5000/7500



Codice	Dimensioni	Grana	Max rpm	Ordine min	€
L23NP115/036A	115 x 22 mm	36	10500	20	2,70
L23NP115/040A	115 x 22 mm	40	10500	20	2,70
L23NP115/050A	115 x 22 mm	50	10500	20	2,70
L23NP115/060A	115 x 22 mm	60	10500	20	2,70
L23NP115/080A	115 x 22 mm	80	10500	20	2,70
L23NP115/100A	115 x 22 mm	100	10500	20	2,70
L23NP115/120A	115 x 22 mm	120	10500	20	2,70

Alte prestazioni. Per ferro, metalli non ferrosi, alluminio.

Supporto

- Nylon
- Rinforzato
- Concavo

Tela

- Ossido di alluminio
- Lamella larga, doppia

Velocità consigliata

Diametro	rpm
115	5000/7500

RIFLEX PRO // REAL FLAT
 L'unico disco realmente piano

I dischi lamellari **L23NP** sono fabbricati con uno **speciale supporto di forma convessa** grazie al quale si ottiene un **disco perfettamente piano** con lamelle larghe e con **densità e durezza costante** sia al centro che sul diametro esterno.

Questa caratteristica unita alla quantità e alla qualità dell'abrasivo permette di ottenere: **maggiore aggressività** con angoli di taglio accentuati, **migliore finitura** anche con grane grosse. Inoltre lavorando con il disco parallelo al pezzo si ottiene il **50% in più nella capacità di asportazione** con riduzione dei tempi di lavoro, durata più lunga, miglior rapporto qualità prezzo, taglio più freddo, riduzione dei tempi e dei costi.



Art. MAGNUM Z

DISCO LAMELLARE PER FORTI ASPORTAZIONI



Codice	Dimensioni	Grana	Max rpm	Ordine min	€
MAGNUM115/040Z	115 x 22 mm	40	10500	20	2,40
MAGNUM115/060Z	115 x 22 mm	60	10500	20	2,40
MAGNUM115/080Z	115 x 22 mm	80	10500	20	2,40
MAGNUM115/120Z	115 x 22 mm	120	10500	20	2,40
MAGNUM125/040Z	125 x 22 mm	40	9700	20	2,70
MAGNUM125/060Z	125 x 22 mm	60	9700	20	2,70
MAGNUM125/080Z	125 x 22 mm	80	9700	20	2,70
MAGNUM125/120Z	125 x 22 mm	120	9700	20	2,70
MAGNUM180/040Z	180 x 22 mm	40	7000	20	4,90
MAGNUM180/060Z	180 x 22 mm	60	7000	20	4,90
MAGNUM180/080Z	180 x 22 mm	80	7000	20	4,90
MAGNUM180/120Z	180 x 22 mm	120	7000	20	4,90

Alte prestazioni. Per ferro, metalli non ferrosi, alluminio.

Supporto

- Fibra di vetro
- Rinforzato
- Piano

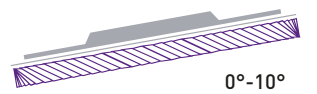

0°-10°



0°-10°

Con la forma piana si ottiene una naturale regolazione dell'angolo di taglio ottimizzandolo fra 0 e 10°

Tela

- Zirconio
- Lamella singola

Velocità consigliata

Diametro	rpm
115	5000/7500
125	4800/7300
180	3250/4900

MAGNUM è il disco Grind-Flex con le migliori prestazioni: altissima capacità di asportazione con riduzione dei tempi di lavoro, doppia durata, miglior rapporto qualità prezzo, taglio più freddo, riduzione dei tempi e dei costi.

Art. L70FP Z
DISCO LAMELLARE

Supporto

Fibra di vetro

Piano

Tela

Zirconio

Lamella singola

Velocità consigliata

Diametro	rpm
115	5000/7500
125	4800/7300
180	3250/4900

Codice	Dimensioni	Grana	Max rpm	Ordine min	€
L70FP115/040Z	115 x 22 mm	40	10500	20	1,90
L70FP115/060Z	115 x 22 mm	60	10500	20	1,90
L70FP115/080Z	115 x 22 mm	80	10500	20	1,90
L70FP115/120Z	115 x 22 mm	120	10500	20	1,90
L70FP125/040Z	125 x 22 mm	40	9700	20	2,30
L70FP125/060Z	125 x 22 mm	60	9700	20	2,30
L70FP125/080Z	125 x 22 mm	80	9700	20	2,30
L70FP125/120Z	125 x 22 mm	120	9700	20	2,30
L70FP180/040Z	180 x 22 mm	40	7000	20	4,50
L70FP180/060Z	180 x 22 mm	60	7000	20	4,50
L70FP180/080Z	180 x 22 mm	80	7000	20	4,50
L70FP180/120Z	180 x 22 mm	120	7000	20	4,50

Per acciaio inossidabile, ferro, metalli non ferrosi, alluminio, ecc...

Art. L70FP A
DISCO LAMELLARE

Supporto

Fibra di vetro

Piano

Tela

Ossido di alluminio

Lamella singola

Velocità consigliata

Diametro	rpm
115	5000/7500
125	4800/7300
180	3250/4900

Codice	Dimensioni	Grana	Max rpm	Ordine min	€
L70FP115/040A	115 x 22 mm	40	10500	20	1,80
L70FP115/060A	115 x 22 mm	60	10500	20	1,80
L70FP115/080A	115 x 22 mm	80	10500	20	1,80
L70FP115/120A	115 x 22 mm	120	10500	20	1,80
L70FP125/040A	125 x 22 mm	40	9700	20	2,20
L70FP125/060A	125 x 22 mm	60	9700	20	2,20
L70FP125/080A	125 x 22 mm	80	9700	20	2,20
L70FP125/120A	125 x 22 mm	120	9700	20	2,20

Per ferro, metalli non ferrosi, alluminio



Art. L72FI Z

DISCO LAMELLARE



Supporto

Fibra di vetro

Conico

Tela

Zirconio

Lamella singola

Velocità consigliata

Diametro	rpm
115	5000/7500
125	4800/7300
180	3250/4900

Codice	Dimensioni	Grana	Max rpm	Ordine min	€
L72FI115/040Z	115 x 22 mm	40	10500	20	1,90
L72FI115/060Z	115 x 22 mm	60	10500	20	1,90
L72FI115/080Z	115 x 22 mm	80	10500	20	1,90
L72FI115/120Z	115 x 22 mm	120	10500	20	1,90
L72FI125/040Z	125 x 22 mm	40	9700	20	2,30
L72FI125/060Z	125 x 22 mm	60	9700	20	2,30
L72FI125/080Z	125 x 22 mm	80	9700	20	2,30
L72FI125/120Z	125 x 22 mm	120	9700	20	2,30
L72FI180/040Z	180 x 22 mm	40	7000	20	4,50
L72FI180/060Z	180 x 22 mm	60	7000	20	4,50
L72FI180/080Z	180 x 22 mm	80	7000	20	4,50
L72FI180/120Z	180 x 22 mm	120	7000	20	4,50

Per acciaio inossidabile, ferro, metalli non ferrosi, alluminio, ecc...



Art. L72FI A

DISCO LAMELLARE



Supporto

Fibra di vetro

Conico

Tela

Ossido di alluminio

Lamella singola

Velocità consigliata

Diametro	rpm
115	5000/7500
125	4800/7300
180	3250/4900

Codice	Dimensioni	Grana	Max rpm	Ordine min	€
L72FI115/040A	115 x 22 mm	40	10500	20	1,80
L72FI115/060A	115 x 22 mm	60	10500	20	1,80
L72FI115/080A	115 x 22 mm	80	10500	20	1,80
L72FI115/120A	115 x 22 mm	120	10500	20	1,80
L72FI125/040A	125 x 22 mm	40	9700	20	2,20
L72FI125/060A	125 x 22 mm	60	9700	20	2,20
L72FI125/080A	125 x 22 mm	80	9700	20	2,20
L72FI125/120A	125 x 22 mm	120	9700	20	2,20

Per ferro, metalli non ferrosi, alluminio

Art. L77FP Z
DISCO LAMELLARE

Supporto

Fibra di vetro



Piano

Tela

Zirconio



Lamella singola

Velocità consigliata

Diametro	rpm
115	5000/7500
125	4800/7300
180	3250/4900

Codice	Dimensioni	Grana	Max rpm	Ordine min	€
L77FP115/040Z	115 x 22 mm	40	10500	20	1,80
L77FP115/060Z	115 x 22 mm	60	10500	20	1,80
L77FP115/080Z	115 x 22 mm	80	10500	20	1,80
L77FP115/100Z	115 x 22 mm	100	10500	20	1,80
L77FP115/120Z	115 x 22 mm	120	10500	20	1,80
L77FP125/040Z	125 x 22 mm	40	9700	20	2,10
L77FP125/060Z	125 x 22 mm	60	9700	20	2,10
L77FP125/080Z	125 x 22 mm	80	9700	20	2,10
L77FP125/100Z	125 x 22 mm	100	9700	20	2,10
L77FP125/120Z	125 x 22 mm	120	9700	20	2,10
L77FP180/040Z	180 x 22 mm	40	7000	20	3,80
L77FP180/060Z	180 x 22 mm	60	7000	20	3,80
L77FP180/080Z	180 x 22 mm	80	7000	20	3,80
L77FP180/100Z	180 x 22 mm	100	7000	20	3,80
L77FP180/120Z	180 x 22 mm	120	7000	20	3,80

Per acciaio inossidabile, ferro, metalli non ferrosi, alluminio, ecc...

Art. L77FP A
DISCO LAMELLARE

Supporto

Fibra di vetro



Piano

Tela

Ossido di alluminio



Lamella singola

Velocità consigliata

Diametro	rpm
115	5000/7500
125	4800/7300
180	3250/4900

Codice	Dimensioni	Grana	Max rpm	Ordine min	€
L77FP115/040A	115 x 22 mm	40	10500	20	1,70
L77FP115/060A	115 x 22 mm	60	10500	20	1,70
L77FP115/080A	115 x 22 mm	80	10500	20	1,70
L77FP115/100A	115 x 22 mm	100	10500	20	1,70
L77FP115/120A	115 x 22 mm	120	10500	20	1,70
L77FP125/040A	125 x 22 mm	40	9700	20	2,00
L77FP125/060A	125 x 22 mm	60	9700	20	2,00
L77FP125/080A	125 x 22 mm	80	9700	20	2,00
L77FP125/100A	125 x 22 mm	100	9700	20	2,00
L77FP125/120A	125 x 22 mm	120	9700	20	2,00

Per ferro, metalli non ferrosi, alluminio

Art. L79FI Z
DISCO LAMELLARE
**Supporto**

Fibra di vetro



Conico

**Tela**

Zirconio



Lamella singola

Velocità consigliata

Diametro	rpm
115	5000/7500
125	4800/7300
180	3250/4900

Codice	Dimensioni	Grana	Max rpm	Ordine min	€
L79FI115/040Z	115 x 22 mm	40	10500	20	1,80
L79FI115/060Z	115 x 22 mm	60	10500	20	1,80
L79FI115/080Z	115 x 22 mm	80	10500	20	1,80
L79FI115/100Z	115 x 22 mm	100	10500	20	1,80
L79FI115/120Z	115 x 22 mm	120	10500	20	1,80
L79FI125/040Z	125 x 22 mm	40	9700	20	2,10
L79FI125/060Z	125 x 22 mm	60	9700	20	2,10
L79FI125/080Z	125 x 22 mm	80	9700	20	2,10
L79FI125/100Z	125 x 22 mm	100	9700	20	2,10
L79FI125/120Z	125 x 22 mm	120	9700	20	2,10
L79FI180/040Z	180 x 22 mm	40	7000	20	3,80
L79FI180/060Z	180 x 22 mm	60	7000	20	3,80
L79FI180/080Z	180 x 22 mm	80	7000	20	3,80
L79FI180/100Z	180 x 22 mm	100	7000	20	3,80
L79FI180/120Z	180 x 22 mm	120	7000	20	3,80

Per acciaio inossidabile, ferro, metalli non ferrosi, alluminio, ecc...

Art. L79FI A
DISCO LAMELLARE
**Supporto**

Fibra di vetro



Conico

**Tela**

Ossido di alluminio



Lamella singola

Velocità consigliata

Diametro	rpm
115	5000/7500
125	4800/7300
180	3250/4900

Codice	Dimensioni	Grana	Max rpm	Ordine min	€
L79FI115/040A	115 x 22 mm	40	10500	20	1,70
L79FI115/060A	115 x 22 mm	60	10500	20	1,70
L79FI115/080A	115 x 22 mm	80	10500	20	1,70
L79FI115/100A	115 x 22 mm	100	10500	20	1,70
L79FI115/120A	115 x 22 mm	120	10500	20	1,70
L79FI125/040A	125 x 22 mm	40	9700	20	2,00
L79FI125/060A	125 x 22 mm	60	9700	20	2,00
L79FI125/080A	125 x 22 mm	80	9700	20	2,00
L79FI125/100A	125 x 22 mm	100	9700	20	2,00
L79FI125/120A	125 x 22 mm	120	9700	20	2,00

Per ferro, metalli non ferrosi, alluminio



Art. L42NP Z

DISCO LAMELLARE



Supporto

Fibra di vetro

Piano

Tela

Zirconio

Lamella singola

Velocità consigliata

Diametro	rpm
115	5000/7500

Codice	Dimensioni	Grana	Max rpm	Ordine min	€
L42NP115/040Z	115 x 22 mm	40	10500	20	2,00
L42NP115/060Z	115 x 22 mm	60	10500	20	2,00
L42NP115/080Z	115 x 22 mm	80	10500	20	2,00
L42NP115/120Z	115 x 22 mm	120	10500	20	2,00

Per acciaio inossidabile, ferro, metalli non ferrosi, alluminio, ecc...



Art. L42NP A

DISCO LAMELLARE



Supporto

Fibra di vetro

Piano

Tela

Ossido di alluminio

Lamella singola

Velocità consigliata

Diametro	rpm
115	5000/7500

Codice	Dimensioni	Grana	Max rpm	Ordine min	€
L42NP115/040A	115 x 22 mm	40	10500	20	1,90
L42NP115/060A	115 x 22 mm	60	10500	20	1,90
L42NP115/080A	115 x 22 mm	80	10500	20	1,90
L42NP115/120A	115 x 22 mm	120	10500	20	1,90

Per ferro, metalli non ferrosi, alluminio



MOLE ABRASIVE

Codice	Dimensioni	Specifiche	€
M159	Ø 100 x 4,5 x 10 mm	GR80	8,70
M160	Ø 100 x 3,2 x 10 mm	GR80	8,70
M162	Ø 145 x 4,7 x 22,3 mm	GR80	26,80

MOLE ABRASIVE, CORINDONE ROSA

MOLE ABRASIVE

Codice	Dimensioni	Specifiche	€
M150	Ø 150 x 20 x 12,7 mm	GR36/40	8,30
M151	Ø 150 x 20 x 12,7 mm	GR80	8,90
M153	Ø 150 x 20 x 16 mm	GR36/40	8,80
M154	Ø 150 x 20 x 16 mm	GR80	8,30
M156	Ø 200 x 25 x 20 mm	GR36/40	11,70
M157	Ø 200 x 25 x 20 mm	GR80	11,70
M161	Ø 200 x 40 x 20 mm	GR80	22,00

MOLE ABRASIVE, CORINDONE GRIGIO

MOLE ABRASIVE

Codice	Dimensioni	Specifiche	€
M152	Ø 150 x 20 x 12,7 mm	GR80	13,90
M155	Ø 150 x 20 x 16 mm	GR80	13,90
M158	Ø 200 x 25 x 20 mm	GR80	20,20

MOLE ABRASIVE, CARBURO SILICIO VERDE

Art. 0163
SET MOLE ABRASIVE 10 PZ
€ 9,50

Gambo	Ø 3 - 6 mm
Imballo	12* / 240
Blister	

SET MOLE ABRASIVE 10 PZ

**Art. 0816****PIETRA PER AFFILARE IN CARBURO DI SILICIO GRANA MEDIA E GRANA FINE****€ 6,90**

Dimensioni	200 x 50 x 25h mm
Imballo	10* / 20
Blister	

**Art. 0817****PIETRA PER AFFILARE IN OSSIDO DI ALLUMINIO GRANA MEDIA E GRANA FINE****€ 6,90**

Dimensioni	200 x 50 x 25h mm
Imballo	10* / 20
Blister	

**Art. D100****DIAMANTE PER RAVVIVARE MOLE****€ 50,00**

Gambo	Ø 10 mm
Lunghezza	48 mm

DIAMANTE PER RAVVIVARE MOLE, TIPO NATURALE

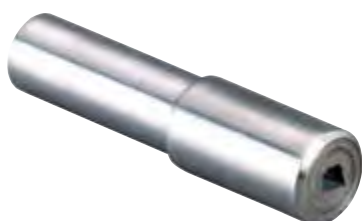
**Art. D100/S****DIAMANTE PER RAVVIVARE MOLE****€ 34,50**

Gambo	Ø 10 mm
Lunghezza	48 mm

DIAMANTE PER RAVVIVARE MOLE, TIPO SINTETICO

DISCHI ABRASIVI

Codice	Misure	Specifica	Imballo	€
D075/1.5	75 x 1,6 x 10 mm	A46-S-BF 80	25* / 100	2,66
D115/1.2	115 x 1,2 x 22 mm	A 46-R-BF 80	10* / 600	1,40
D115/1.6	115 x 1,6 x 22 mm	A 46-R-BF 80	10* / 500	1,40
D125/1.2	125 x 1,2 x 22 mm	A 46-S5-BF	10* / 600	1,50
D125/1.6	125 x 1,6 x 22 mm	A 46-S5-BF	10* / 600	1,50
D230/2	230 x 2 x 22 mm	A 30-R-BF 80	5* / 100	3,70

DISCHI ABRASIVI PER IL TAGLIO DI MATERIALI FERROSI

DISCHI ABRASIVI

Codice	Misure	Specifica	Imballo	€
D115/3	115 x 3 x 22 mm	A30-R-BF 80	5* / 200	1,60
D125/3.2	125 x 3,2 x 22 mm	A30-S-BF	5* / 200	1,90
D230/3	230 x 3x 22 mm	A30-R-BF 80	5* / 50	3,20
D350/3	350 x 3 x 25,4 mm	A46-S-BF 80	5* / 35	11,10

DISCHI ABRASIVI PER IL TAGLIO DI MATERIALI FERROSI

DISCHI ABRASIVI

Codice	Misure	Specifica	Imballo	€
D115/6	115 x 6 x 22 mm	A24-R-BF 80	5* / 100	2,20
D125/6.5	125 x 6,5 x 22 mm	A30-S-BF	5* / 100	2,60
D230/6	230 x 6 x 22 mm	A24-R-BF 80	5* / 50	6,10

DISCHI ABRASIVI PER LA SBAVATURA DI METALLI FERROSI

Art. 0350
DISCO DIAMANTATO TURBO VENTILATO
€ 53,30

Dimensione	Ø 230 mm
Foro	Ø 22,2 mm
Imballo	25
Secco - Acqua	



Art. 0709
DISCO DIAMANTATO TURBO VENTILATO

€ 14,50



Dimensione	Ø 115 mm
Foro	Ø 22,2 mm
Imballo	100
Secco - Acqua	



Art. 0527
DISCO DIAMANTATO TURBO

€ 38,90



Dimensione	Ø 230 mm
Foro	Ø 22,2 mm
Imballo	25
Secco - Acqua	



Art. 0349
DISCO DIAMANTATO TURBO

€ 10,90



Dimensione	Ø 115 mm
Foro	Ø 22,2 mm
Imballo	25
Secco - Acqua	



Art. 0279
DISCO DIAMANTATO

€ 9,50



Dimensione	Ø 115 mm
Foro	Ø 22,2 mm
Imballo	25
Secco - Acqua	

DISCO DIAMANTATO PER PIASTRELLE IN CERAMICA



Art. 0833
PLATORELLO DIAMANTATO TURBO A TAZZA PER GRANITO E PIETRE

€ 71,50



Dimensione	Ø 100 mm
Foro	Ø 22,2 mm
Imballo	50
Secco - Acqua	

Art. CSCD F / CSCD F HD
 DISCHI IN NYLON ABRASIVO

RIFLEX PRO II

DISCHI IN FIBRE DI NYLON MOLTO RESISTENTI CON INCORPORATO ABRASIVO AL CARBURO DI SILICIO IN GRANA GROSSA. VELOCITÀ DI UTILIZZO: TRA 20 E 25 m/sec. IN RELAZIONE AL LAVORO DA EFFETTUARE. PER ACCIAIO INOSSIDABILE, FERRO, METALLI NON FERROSI, ALLUMINIO, ECC...

Supporto

- Fibra di vetro
- Piano

Abrasivo

- Nylon & carburo di silicio

Codice	Dimensioni	Max rpm	Imballo	€
CSCD/F115	115 x 22 mm	11000	5*	6,40
CSCD/F180	180 x 22 mm	7000	5*	9,30

Abrasivo

- Nylon & Carburo di silicio ad alta densità

Codice	Dimensioni	Max rpm	Imballo	€
CSCD/F115HD	115 x 22 mm	11000	5*	7,10
CSCD/F180HD	180 x 22 mm	7000	5*	9,90

Per la pulitura delle saldature nell'acciaio inox, disossidazione e pulitura di saldature in genere, rimozione di ruggine e calamina, pulizia delle superfici da stucco, gomma, materie plastiche e altri materiali.

Art. CSDS
 DISCHI PIANI CON FORO PER TRAPANO

Codice	Diametro	Max rpm	Imballo	€
CSDS/100	100 mm	8000	10	4,40
CSDS/150	150 mm	5350	10	7,20
CSDS/200	200 mm	4000	10	11,00

Art. ADF
 ALBERINI DI FISSAGGIO

Codice	Dimensioni	Tipo	Imballo	€
ADF/01	10 x 6 mm	25	10	2,10
ADF/02	12,8 x 8 mm	24	10	2,20



Artt. UNCD F

DISCHI NON-WOVEN PER FINITURA



RIFLEX PRO II

DISCHI IN TESSUTO NON
TESSUTO ABRASIVO COMPRESSO
ED IMBEVUTO DI RESINA.

Supporto

- Fibra di vetro
- Piano

Abrasivo

- Carburo di silicio

Abrasivo

- Ossido di alluminio

UNCD/F115F
UNCD/F115M



UNCD/F115C

Grane disponibili

S/C-F (fine) - finiture accurate - pressione di lavoro leggera
S/C-M (media) - finiture medie - pressione di lavoro leggera
A/O-C (grossa) - taglio più aggressivo - pressione di lavoro media

Codice	Dimensioni	Grana	Max rpm	Imballo	€
UNCD/F115F	115 x 22 mm	S/C-F	11000	5*	15,00
UNCD/F115M	115 x 22 mm	S/C-M	11000	5*	15,00

Codice	Dimensioni	Grana	Max rpm	Imballo	€
UNCD/F115C	115 x 22 mm	A/O-C	11000	5*	15,00

Per sbavatura leggera, pulitura, finitura, rimozione di segni ed imperfezioni, su tutti i tipi di metalli quali acciaio inox, ferro, alluminio, leghe, titanio. I dischi UNCD-F si adattano perfettamente anche alla lavorazione di materie plastiche e materiali compositi. Ideali per la finitura dopo le lavorazioni con dischi lamellari e dischi in fibra. Velocità di utilizzo: tra 20 e 25 m/sec. in relazione al lavoro da effettuare



Art. RLP

RUOTE LAMELLARI IN PANNO ABRASIVO



Grane disponibili

S/C-VF (molto fine) - finiture accurate - pressione di lavoro leggera
S/C-F (fine) - finiture accurate - pressione di lavoro leggera
A/O-M (media) - finiture medie - pressione di lavoro leggera
COARSE (grossa) - taglio più aggressivo - pressione di lavoro media

Codice	Dimensioni	Colore	Grana	€
RLP100/C	110 x 100 mm	Rosso	COARSE	20,20
RLP100/M	110 x 100 mm	Rosso	A/O-M	20,20
RLP100/F	110 x 100 mm	Nero	S/C-F	20,20
RLP100/VF	110 x 100 mm	Nero	S/C-VF	20,20



Art. RLM

RUOTE LAMELLARI MISTE



Grane disponibili

S/C-F (fine) - finiture accurate - pressione di lavoro leggera
S/C-M (media) - finiture medie - pressione di lavoro leggera

Codice	Dimensioni	Panno	Tela	€
RLM100/080M	110 x 100 mm	S/C-M	80	30,70
RLM100/100F	110 x 100 mm	S/C-F	150	30,70



Art. RLT

RUOTE LAMELLARI IN TELA



Codice	Dimensioni	Grana	€
RLT050/040	100 x 50 mm	40	14,80
RLT050/060	100 x 50 mm	60	15,60
RLT050/100	100 x 50 mm	100	16,30
RLT100/040	100 x 100 mm	40	28,00
RLT100/060	100 x 100 mm	60	29,60
RLT100/080	100 x 100 mm	80	30,60
RLT100/100	100 x 100 mm	100	31,10



Art. RGP

RUOTE CON GAMBO IN PANNO ABRASIVO

Ruote con gambo costituite da lamelle di panno abrasivo disposte in senso radiale. Applicazioni: decapaggio - rimozione di ruggine - sbavatura leggera - preparazione alla verniciatura - finitura delle superfici



Codice	Dimensioni	Gambo	Grana	Imballo	€
RGP040/20C	40 x 20 mm	6 mm	COARSE	10*	6,50
RGP040/20M	40 x 20 mm	6 mm	MEDIUM	10*	6,50
RGP040/20F	40 x 20 mm	6 mm	FINE	10*	6,50
RGP040/20VF	40 x 20 mm	6 mm	VERY FINE	10*	6,50
RGP060/30C	60 x 30 mm	6 mm	COARSE	10*	8,40
RGP060/30M	60 x 30 mm	6 mm	MEDIUM	10*	8,40
RGP060/30F	60 x 30 mm	6 mm	FINE	10*	8,40
RGP060/30VF	60 x 30 mm	6 mm	VERY FINE	10*	8,40
RGP080/50C	80 x 50 mm	6 mm	COARSE	10*	12,70
RGP080/50M	80 x 50 mm	6 mm	MEDIUM	10*	12,70
RGP080/50F	80 x 50 mm	6 mm	FINE	10*	12,70
RGP080/50VF	80 x 50 mm	6 mm	VERY FINE	10*	12,70

Panno



Ossido di alluminio

Particolarmente indicate per la satinatura degli acciai inossidabili.



Art. RGM

RUOTE CON GAMBO MISTE IN TELA E PANNO ABRASIVO



Ruote con gambo costituite da lamelle di panno abrasivo intercalate a lamelle di tela disposte in senso radiale.

Codice	Dimensioni	Gambo	Panno	Tela	Imballo	€
RGM040/20M	40 x 20 mm	6 mm	A/O-M	60	10*	7,90
RGM040/20F	40 x 20 mm	6 mm	A/O-F	100	10*	7,90
RGM040/20VF	40 x 20 mm	6 mm	A/O-VF	150	10*	7,90
RGM060/30M	60 x 30 mm	6 mm	A/O-M	60	10*	10,30
RGM060/30F	60 x 30 mm	6 mm	A/O-F	100	10*	10,30
RGM060/30VF	60 x 30 mm	6 mm	A/O-VF	150	10*	10,30
RGM080/50M	80 x 50 mm	6 mm	A/O-M	60	10*	15,90
RGM080/50F	80 x 50 mm	6 mm	A/O-F	100	10*	15,90
RGM080/50VF	80 x 50 mm	6 mm	A/O-VF	150	10*	15,90

Panno



Ossido di alluminio

Per decapaggio, rimozione di ruggine, sbavatura leggera, preparazione alla verniciatura, finitura delle superfici.



Art. FPA

FOGLI IN PANNO ABRASIVO



Codice	Dimensioni	Grana	Imballo	€
FPA120/M	120 x 280 mm	A/O-M	20	2,50
FPA120/VF	120 x 280 mm	A/O-VF	20	2,20
FPA120/UF	120 x 280 mm	S/C-UF	20	2,20



Art. RGT

RUOTE LAMELLARI CON GAMBO IN TELA ALL' OSSIDO DI ALLUMINIO



Il perno consente il montaggio su mandrini di macchine portatili elettriche, pneumatiche e ad albero flessibile.

Codice	Dimensioni	Gambo	Grana	Max rpm	Imballo	€
RGT3010/60	30 x 10 mm	6 mm	60	22900	25	2,90
RGT3010/80	30 x 10 mm	6 mm	80	22900	25	3,00
RGT3010/120	30 x 10 mm	6 mm	120	22900	25	3,00
RGT3015/60	30 x 15 mm	6 mm	60	22900	25	3,00
RGT3015/80	30 x 15 mm	6 mm	80	22900	25	3,00
RGT3015/120	30 x 15 mm	6 mm	120	22900	25	3,10
RGT3020/60	30 x 20 mm	6 mm	60	22900	25	3,20
RGT3020/80	30 x 20 mm	6 mm	80	22900	25	3,30
RGT3020/120	30 x 20 mm	6 mm	120	22900	25	3,30
RGT4015/60	40 x 15 mm	6 mm	60	17100	25	3,10
RGT4015/80	40 x 15 mm	6 mm	80	17100	25	3,10
RGT4015/120	40 x 15 mm	6 mm	120	17100	25	3,20
RGT4020/40	40 x 20 mm	6 mm	40	17100	25	3,20
RGT4020/60	40 x 20 mm	6 mm	60	17100	25	3,30
RGT4020/80	40 x 20 mm	6 mm	80	17100	25	3,40
RGT4020/120	40 x 20 mm	6 mm	120	17100	25	3,40
RGT4020/220	40 x 20 mm	6 mm	220	17100	25	3,70
RGT5030/40	50 x 30 mm	6 mm	40	13700	25	4,30
RGT5030/60	50 x 30 mm	6 mm	60	13700	25	4,30
RGT5030/80	50 x 30 mm	6 mm	80	13700	25	4,40
RGT5030/120	50 x 30 mm	6 mm	120	13700	25	4,80
RGT5030/220	50 x 30 mm	6 mm	220	11400	25	5,30
RGT6030/40	60 x 30 mm	6 mm	40	11400	25	5,00
RGT6030/60	60 x 30 mm	6 mm	60	11400	25	5,00
RGT6030/80	60 x 30 mm	6 mm	80	11400	25	5,20
RGT6030/120	60 x 30 mm	6 mm	120	11400	25	5,50
RGT6030/220	60 x 30 mm	6 mm	220	11400	25	6,10
RGT8030/40	80 x 30 mm	6 mm	40	8500	25	6,60
RGT8030/60	80 x 30 mm	6 mm	60	8500	25	6,80
RGT8030/80	80 x 30 mm	6 mm	80	8500	25	6,90
RGT8030/120	80 x 30 mm	6 mm	120	8500	25	7,30
RGT8050/40	80 x 50 mm	6 mm	40	8500	25	8,90
RGT8050/60	80 x 50 mm	6 mm	60	8500	25	9,00
RGT8050/80	80 x 50 mm	6 mm	80	8500	25	9,20
RGT8050/120	80 x 50 mm	6 mm	120	8500	25	9,50

Per: sgrossatura, smerigliatura, pulitura, satinatura e finitura: particolarmente indicate per operare su piccole superfici o all'interno di fori.

Il perno consente il montaggio su mandrini di macchine portatili elettriche, pneumatiche e ad albero flessibile.

Tela

 Ossido di alluminio



Art. RFP

RUOTE CON FORO IN PANNO ABRASIVO



Ruote con foro costituite da lamelle di panno abrasivo disposte in senso radiale.

Codice	Dimensioni	Grana	€
RFP200/50M	200 x 50 x 76 mm	Medium	31,20
RFP200/50F	200 x 50 x 76 mm	Fine	31,20
RFP200/50VF	200 x 50 x 76 mm	Very Fine	31,20

Panno

 Ossido di alluminio

Per decapaggio, rimozione di ruggine, sbavatura leggera, preparazione alla verniciatura, finitura delle superfici. Particolarmente indicate per la satinatura degli acciai inossidabili.

Art. RFT
RUOTE LAMELLARI CON FORO IN TELA ALL' OSSIDO DI ALLUMINIO

Le ruote si possono controsagomare sul profilo del pezzo da lavorare. Lubrificando la ruota con olio o con grasso, si migliora il grado di finitura, la durata della ruota stessa e si svolge una azione antipolvere.

Codice	Dimensioni	Grana	Max rpm	Imballo	€
RFT165/30050	165 x 30 x 54 mm	50	5200	5	38,00
RFT165/30060	165 x 30 x 54 mm	60	5200	5	38,40
RFT165/30150	165 x 30 x 54 mm	150	5200	5	47,60
RFT165/30220	165 x 30 x 54 mm	220	5200	5	50,50
RFT165/50040	165 x 50 x 54 mm	40	5200	5	52,20
RFT165/50060	165 x 50 x 54 mm	60	5200	5	55,50
RFT165/50080	165 x 50 x 54 mm	80	5200	5	55,00
RFT165/50150	165 x 50 x 54 mm	150	5200	5	65,50
RFT250/50080	250 x 50 x 100 mm	80	3400	3	128,50
RFT250/50120	250 x 50 x 100 mm	120	3400	3	133,20
RFT250/50150	250 x 50 x 100 mm	150	3400	3	148,00
RFT250/50180	250 x 50 x 100 mm	180	3400	3	148,00

Tela



Ossido di alluminio

Per sgrossatura, smerigliatura, pulitura, satinatura ed operazioni di finitura e lucidatura. Preparazione delle superfici da sottoporre a trattamenti galvanici.

Art. S163
SPAZZOLA PER LUCIDATURA METALLI
€ 12,70

Dimensioni Ø 150 x 17 x 16 mm
Imballo 100

SPAZZOLA PER LUCIDATURA METALLI IN SISAL E COTONE PER SGRUSSATURA

Art. S166
SPAZZOLA PER LUCIDATURA METALLI
€ 20,20

Dimensioni Ø 200 x 17 x 20 mm
Imballo 50

SPAZZOLA PER LUCIDATURA METALLI IN SISAL E COTONE PER SGRUSSATURA

Art. S164
SPAZZOLA PER LUCIDATURA METALLI
€ 12,30

Dimensioni Ø 150 x 17 x 16 mm
Imballo 100

SPAZZOLA PER LUCIDATURA METALLI IN COTONE PER LUCIDATURA

Art. S167
SPAZZOLA PER LUCIDATURA METALLI
€ 18,90

Dimensioni Ø 200 x 17 x 20 mm
Imballo 50

SPAZZOLA PER LUCIDATURA METALLI IN COTONE PER LUCIDATURA

Art. S169
SET PASTE PER LUCIDATURA METALLI
€ 10,90

Peso 250 g
Imballo 5* / 50
Blister



SET 5 DISCHI ABRASIVI

5 Pz Ossido di alluminio



Codice	Diametro	Grana	Imballo	€
0438/040	150 mm	40	100	4,00
0438/060	150 mm	60	100	4,00
0438/080	150 mm	80	100	4,00
0438/100	150 mm	100	100	4,00
0438/120	150 mm	120	100	4,00
0438/150	150 mm	150	100	4,00
0438/180	150 mm	180	100	4,00
0438/240	150 mm	240	100	4,00

5 DISCHI ABRASIVI, DI Ø 150 mm, PER LEVIGATRICI ROTO - ORBITALI, CON 15 FORI E FISSAGGIO A STRAPPO, PER USO GENERALE



DISCHI ABRASIVI

Ossido di alluminio



Codice	Misure	Grana	Imballo	€
D174	150 mm	60	10* / 1000	1,50
D175	150 mm	100	10* / 1000	1,50
D178/060	200 mm	60	10* / 1000	1,50
D178/100	200 mm	100	10* / 1000	1,50
D176	226 mm	60	10* / 500	2,52
D177	226 mm	100	10* / 1000	2,52

Art. DFV
 DISCHI IN FIBRA VULCANIZZATA

I dischi in fibra sono costituiti da un supporto di spessore 0,8 mm in fibra di cellulosa vulcanizzata sulla quale vengono depositi vari tipi di abrasivo. Questi sono legati con un doppio strato di resina termoindurente additivata con cariche attive che conferiscono ai prodotti proprietà raffreddanti e anti intasamento. Applicati ad un plattello di supporto, vengono usati su levigatrici portatili.

Tela

Zirconio

Disco molto veloce ed aggressivo dal taglio freddo per sgrossatura e finitura di metalli in genere. Eccezionale resa nelle lavorazioni gravose e specifico per ACCIAIO INOX.

Codice	Dimensioni	Grana	Max rpm	Imballo	€
DFV115/050Z	115 x 22 mm	50	13300	25/100	1,00
DFV115/060Z	115 x 22 mm	60	13300	25/100	1,00
DFV115/080Z	115 x 22 mm	80	13300	25/100	1,90
DFV180/050Z	180 x 22 mm	50	8600	25/100	1,90
DFV180/060Z	180 x 22 mm	60	8600	25/100	1,90
DFV180/080Z	180 x 22 mm	80	8600	25/100	0,80

Tela

Ossido di alluminio

Disco veloce ed aggressivo dal taglio freddo per sgrossatura e finitura di metalli in genere.

Codice	Dimensioni	Grana	Max rpm	Imballo	€
DFV115/036A	115 x 22 mm	36	13300	25/100	0,80
DFV115/050A	115 x 22 mm	50	13300	25/100	0,80
DFV115/060A	115 x 22 mm	60	13300	25/100	0,80
DFV115/080A	115 x 22 mm	80	13300	25/100	0,80
DFV115/120A	115 x 22 mm	120	13300	25/100	1,30
DFV180/050A	180 x 22 mm	50	8600	25/100	1,30
DFV180/060A	180 x 22 mm	60	8600	25/100	1,30
DFV180/080A	180 x 22 mm	80	8600	25/100	1,30
DFV180/120A	180 x 22 mm	120	8600	25/100	1,30

Art. RAS
ROTOLI ANTISPRECO

Tela extra flessibile all'ossido di alluminio doppia resina per lavorazioni manuali o con levigatrici orbitali su metalli e acciaio. Specifica per torneria, stampi, armi e per tutte le lavorazioni che necessitano di una tela ad elevata flessibilità e durata superiore

Tela extra flessibile AJM

Ossido di alluminio

Codice	Dimensioni	Grana	€
RAS60	50 mm x 25 m	60	40,70
RAS80	50 mm x 25 m	80	36,60
RAS100	50 mm x 25 m	100	35,30
RAS120	50 mm x 25 m	120	35,30
RAS150	50 mm x 25 m	150	35,30
RAS180	50 mm x 25 m	180	35,30
RAS240	50 mm x 25 m	240	35,30
RAS320	50 mm x 25 m	320	35,30
RAS400	50 mm x 25 m	400	35,30

Art. SPI
ANELLI ABRASIVI RINFORZATI SPIRABANDS ALLO ZIRCONIO

Tela

Zirconio

Codice	Dimensioni	Grana	€
SPI10/80	10 x 15 mm	80	0,40
SPI10/120	10 x 15 mm	120	0,40
SPI15/60	15 x 30 mm	60	0,60
SPI15/80	15 x 30 mm	80	0,60
SPI15/120	15 x 30 mm	120	0,60
SPI22/40	22 x 20 mm	40	0,50
SPI22/60	22 x 20 mm	60	0,50
SPI22/80	22 x 20 mm	80	0,50
SPI22/120	22 x 20 mm	120	0,50
SPI30/40	30 x 30 mm	40	0,80
SPI30/60	30 x 30 mm	60	0,80
SPI30/80	30 x 30 mm	80	0,80
SPI45/40	45 x 30 mm	40	1,00
SPI45/60	45 x 30 mm	60	1,00
SPI45/80	45 x 30 mm	80	1,00



NASTRI ABRASIVI IN OSSIDO DI ALLUMINIO



Tela



Ossido di alluminio

Codice	Dimensioni	Grana	Imballo	€
N160/060	1075 x 25 mm	60	10*	5,40
N160/100	1075 x 25 mm	100	10*	5,40
N162	686 x 50 mm	60	10*	6,40
N163	686 x 50 mm	100	10*	6,40
N130	686 x 50 mm	120	10*	6,40
N164	914 x 100 mm	60	10*	7,50
N165	914 x 100 mm	100	10*	7,50
N131	914 x 100 mm	120	10*	7,50
N166	1219 x 152 mm	60	10*	8,90
N167	1219 x 152 mm	100	10*	8,90
N132	1219 x 152 mm	120	10*	8,90



SERIE DI NASTRI ABRASIVI IN ZIRCONIO



Tela



Zirconio

10 Pz

Codice	Dimensioni	Grana	€
N177	330 x 10 mm	60	12,00
N178	330 x 10 mm	80	12,00
N179	330 x 10 mm	120	12,00



NASTRI ABRASIVI IN ZIRCONIO

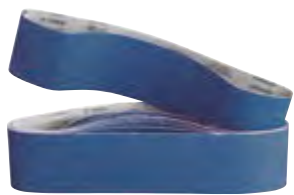

Tela



Zirconio

Codice	Dimensioni	Grana	€
N133	914 x 100 mm	40	8,80
N134	914 x 100 mm	60	8,80
N135	914 x 100 mm	80	8,80
N136	914 x 100 mm	120	8,80
N137	1000 x 100 mm	40	12,80
N174	1000 x 100 mm	60	12,80
N175	1000 x 100 mm	80	12,80
N176	1000 x 100 mm	120	12,80
N138	1219 x 152 mm	40	14,80
N139	1219 x 152 mm	60	14,80
N140	1219 x 152 mm	120	14,80
N141	1500 x 120 mm	40	20,00
N170	1500 x 120 mm	60	20,00
N171	1500 x 120 mm	80	20,00
N142	1500 x 120 mm	120	20,00
N143	1750 x 150 mm	40	24,80
N172	1750 x 150 mm	60	24,80
N173	1750 x 150 mm	80	24,80
N144	2000 x 150 mm	40	24,80
N168	2000 x 150 mm	60	24,80
N169	2000 x 150 mm	80	24,80





MACCHINE PER LAVORAZIONI MECCANICHE

pag 036



MACCHINE PER LAVORAZIONI LEGNO

pag 104



MACCHINE PER TRATTAMENTI E FINITURE

pag 333



PRESSE E DIVARICATORI

pag 151



SOLLEVAMENTO E MOVIMENTAZIONE

pag 156



ACCESSORI PER MACCHINE

pag 176

TORNI PARALLELI



T070/400V3A



T069/400V..



T998/..



T999/..



T940/230VI..



T940/..

ALTEZZA PUNTE

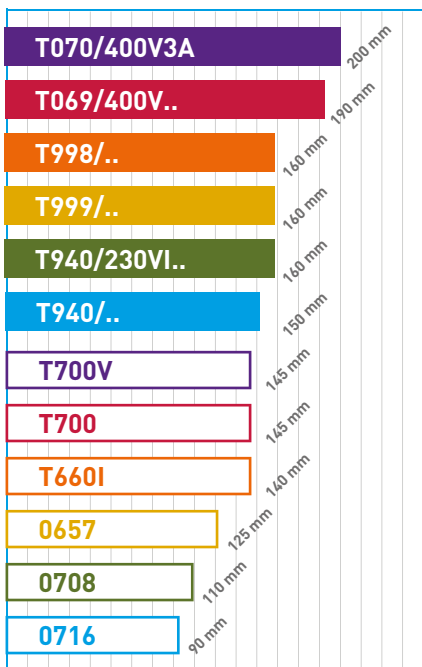

DISTANZA PUNTE

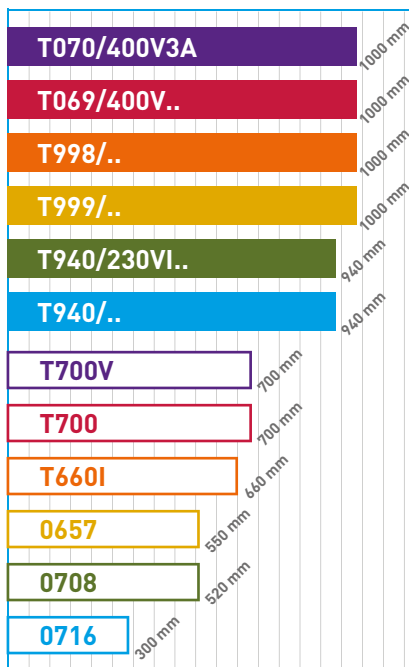

PASSAGGIO BARRA

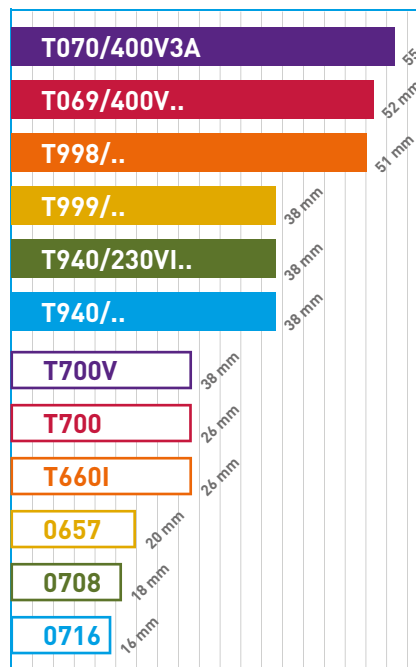

TORNI PARALLELI



T700V



T700



T660..



0657



0708



0716

DIAMETRO MANDRINO

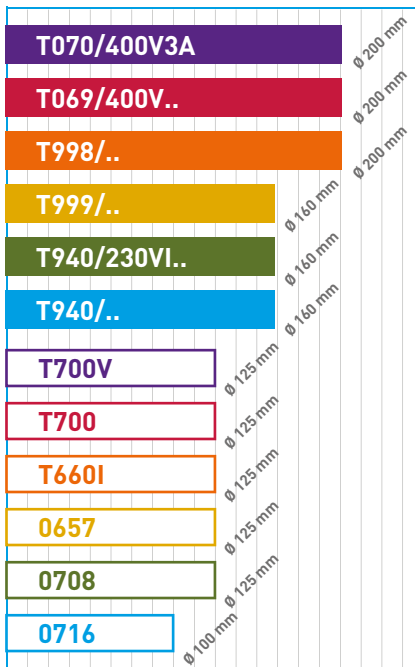

POTENZA

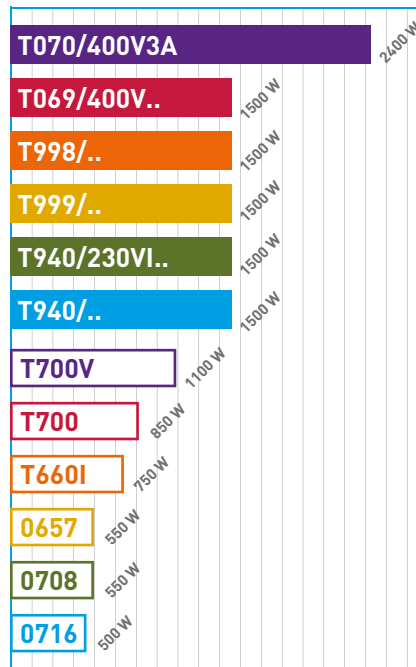

DIAMETRO MAX SUL CARRO

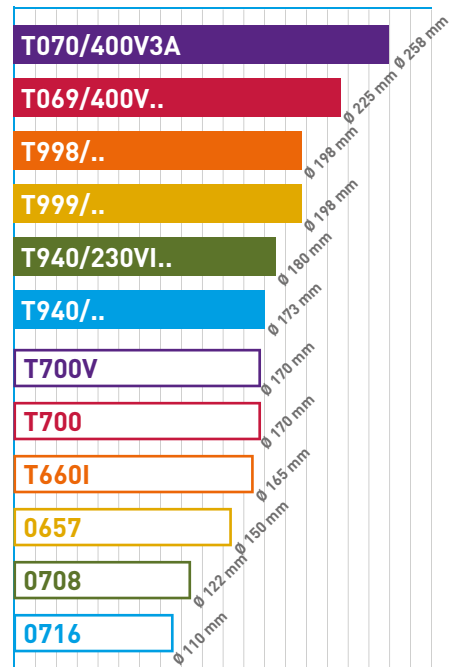

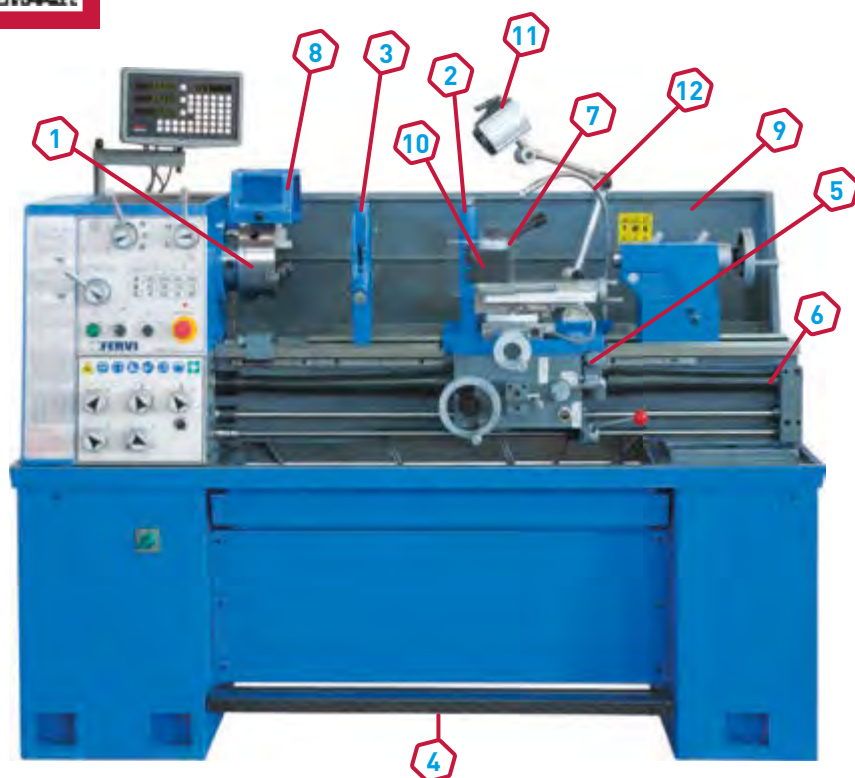
Art. T070/400V3A
TORNIO PARALLELO AD INGRANAGGI CON VISUALIZZATORE
€ 13850,00

- 1** Mandrino autocentrante 3+3 Ø 200 mm
- 2** Lunetta mobile
- 3** Lunetta fissa
- 4** Freno a pedale
- 5** Comparatore di filettatura
- 6** Protezione vite madre
- 7** Protezione torretta
- 8** Protezione mandrino
- 9** Paraspruzzi posteriore
- 10** Torretta a cambio rapido TOAE
- 11** Lampada
- 12** Sistema di raffreddamento
- 13** Carter con micro interruttore
- 14** Cambio velocità mandrino
- 15** Longitudinale torretta
- 16** SEMI NORTON

Altezza punta	200 mm
Diametro max sul banco	400 mm
Diametro max sul carro	258 mm
Diametro max sull'incavo	550 mm
Distanza tra le punte	1000 mm
Passaggio barra	55 mm
Attacco mandrino	Camlock D1-5
Conicità attacco mandrino CM	6
Velocità mandrino	(12) 45 ÷ 2000 rpm
Avanzamenti longitudinali mm/giro	0,06 ÷ 2,78
Avanzamenti trasversali mm/giro	0,01 ÷ 0,72
Filettature metriche	0,8 ÷ 14 mm
Filettature in pollici	2 ÷ 28 TPI
Conicità contropunta CM	4
Motore trifase	400V 50 Hz 1,5 / 2,4 kW
Peso	845 kg
Dimensioni imballo	1930 x 760 x 1600h mm

ACCESSORI INCLUSI

Mandrino a 4 griffe indipendenti reversibili Ø 200 mm
 Bussola di riduzione CM 6/4
 Flangia Ø 320 mm
 Contropunta fissa CM 4
 Contropunta rotante CM 4

**TORNIO PARALLELO CON ELETTROFRENO E MOTORE A 2 VELOCITÀ,
 VISUALIZZATORE A 3 ASSI E SCATOLA INGRANAGGI SEMI NORTON**





Art. T069/400V3A

TORNIO PARALLELO AD INGRANAGGI CON VISUALIZZATORE

€ 11300,00

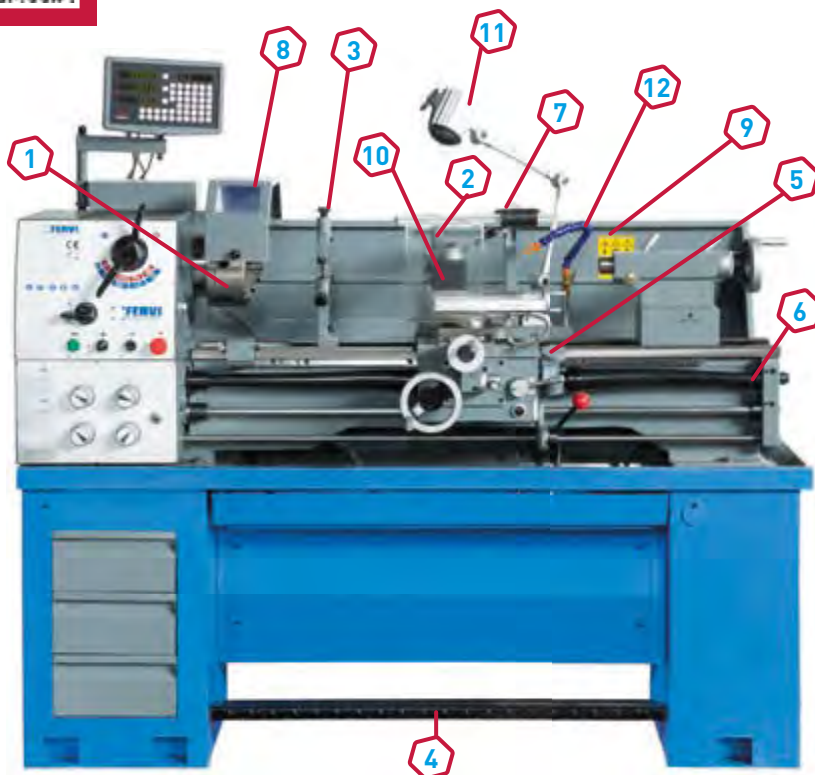

- 1** Mandrino autocentrante 3+3 Ø 200 mm
- 2** Lunetta mobile
- 3** Lunetta fissa
- 4** Freno a pedale
- 5** Comparatore di filettatura
- 6** Protezione vite madre
- 7** Protezione torretta
- 8** Protezione mandrino
- 9** Paraspruzzi posteriore
- 10** Torretta a cambio rapido TOAE
- 11** Lampada
- 12** Sistema di raffreddamento
- 13** Carter con micro interruttore
- 14** Visualizzatore
- 15** Longitudinale torretta
- 16** Illuminazione e refrigerazione

Altezza punte	190 mm
Diametro max sul banco	380 mm
Diametro max sul carro	225 mm
Diametro max sull'incavo	503 mm
Distanza tra le punte	1000 mm
Passaggio barra	52 mm
Attacco mandrino	Camlock D1-5
Conicità attacco mandrino CM	6
Velocità mandrino	70 ÷ 2000 rpm
Avanzamenti longitudinali mm/giro	0,052 ÷ 1,392
Avanzamenti trasversali mm/giro	0,014 ÷ 0,380
Filettature metriche	0,4 ÷ 7 mm
Filettature in pollici	4 ÷ 56 TPI
Conicità contropunta CM	4
Motore trifase	400V 50 Hz 1,5 kW
Peso	650 kg
Dimensioni imballo	1930 x 760 x 1600h mm

ACCESSORI INCLUSI

- Mandrino a 4 griffe indipendenti reversibili Ø 200 mm
- Bussola di riduzione CM 6/4
- Flangia Ø 320 mm
- Contropunta fissa CM 4
- Contropunta rotante CM 4

TORNIO PARALLELO VISUALIZZATORE A 3 ASSI E SCATOLA INGRANAGGI SEMI NORTON



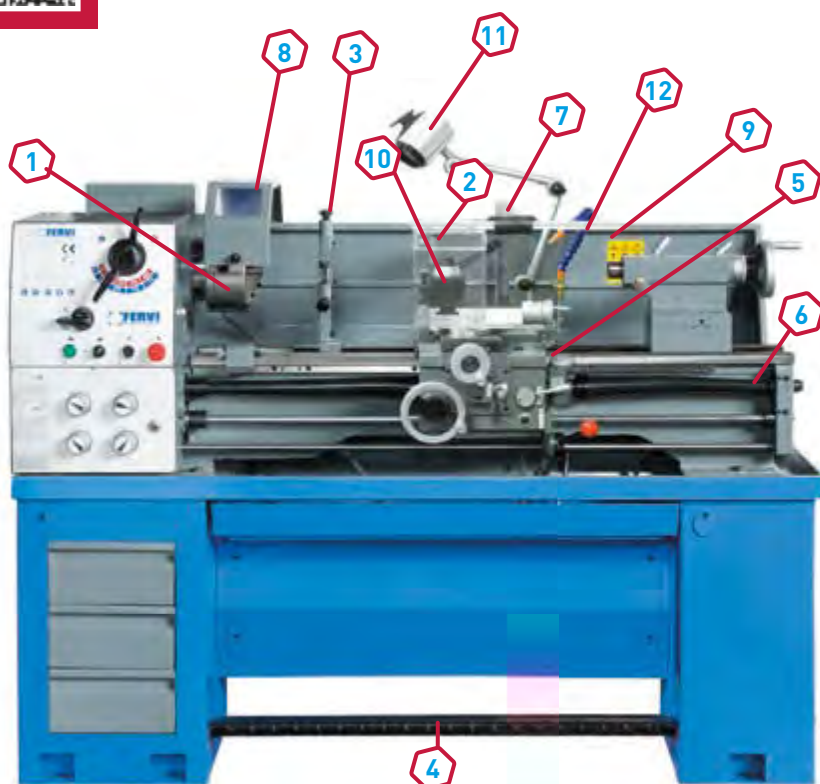

Art. T069/400V
TORNIO PARALLELO AD INGRANAGGI
€ 10300,00

- 1** Mandrino autocentrante 3+3 Ø 200 mm
- 2** Lunetta mobile
- 3** Lunetta fissa
- 4** Freno a pedale
- 5** Comparatore di filettatura
- 6** Protezione vite madre
- 7** Protezione torretta
- 8** Protezione mandrino
- 9** Paraspruzzi posteriore
- 10** Torretta a cambio rapido T0AE
- 11** Lampada
- 12** Sistema di raffreddamento
- 13** Cassettiera
- 14** Quadro elettrico
- 15** Frizione tornitura
- 16** Illuminazione e refrigerazione

Altezza punta	190 mm
Diametro max sul banco	380 mm
Diametro max sul carro	225 mm
Diametro max sull'incavo	503 mm
Distanza tra le punte	1000 mm
Passaggio barra	52 mm
Attacco mandrino	Camlock D1-5
Conicità attacco mandrino CM	6
Velocità mandrino	70 ÷ 2000 rpm
Avanzamenti longitudinali mm/giro	0,052 ÷ 1,392
Avanzamenti trasversali mm/giro	0,014 ÷ 0,380
Filettature metriche	0,4 ÷ 7 mm
Filettature in pollici	4 ÷ 56 TPI
Conicità contropunta CM	4
Motore trifase	400V 50 Hz 1,5 kW
Peso	650 kg
Dimensioni imballo	1930 x 760 x 1600h mm

ACCESSORI INCLUSI

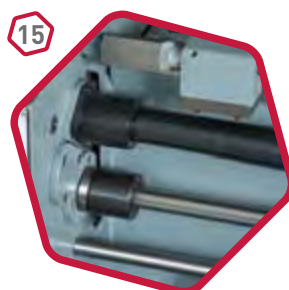
Mandrino a 4 griffe indipendenti reversibili Ø 200 mm
 Bussola di riduzione CM 6/4
 Flangia Ø 320 mm
 Contropunta fissa CM 4
 Contropunta rotante CM 4

TORNIO PARALLELO CON SCATOLA INGRANAGGI SEMI NORTON



Art. T998/230V3A & T998/400V3A
TORNIO PARALLELO CON VISUALIZZATORE

€ 10200,00

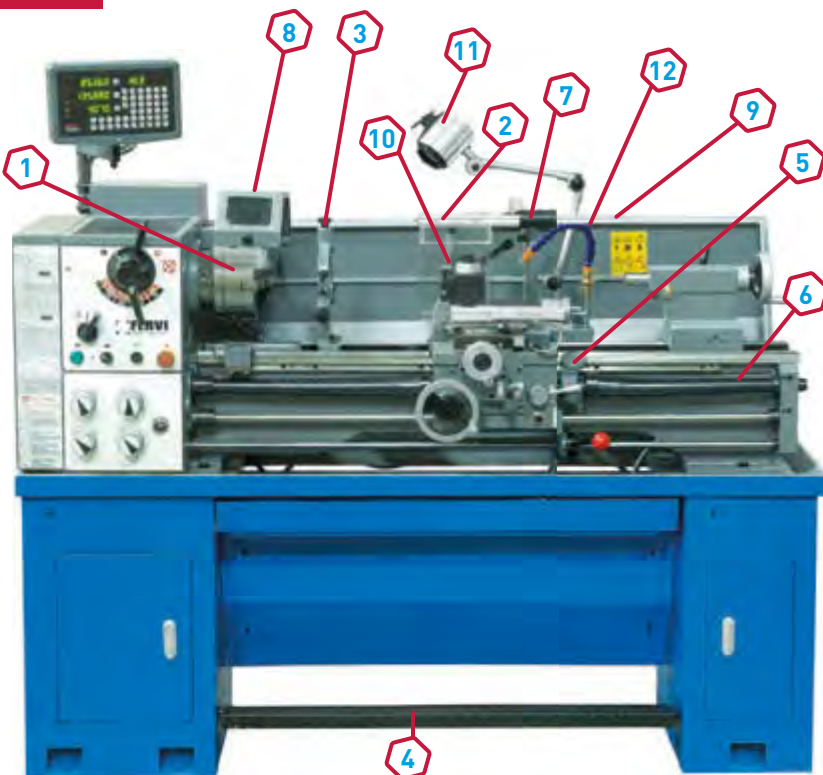

- 1** Mandrino autocentrante 3+3 Ø 200 mm
- 2** Lunetta mobile
- 3** Lunetta fissa
- 4** Freno a pedale
- 5** Comparatore di filettatura
- 6** Protezione vite madre
- 7** Protezione torretta
- 8** Protezione mandrino
- 9** Paraspruzzi posteriore
- 10** Torretta a cambio rapido T0AE
- 11** Lampada
- 12** Sistema di raffreddamento
- 13** Carter con micro interruttore
- 14** Visualizzatore
- 15** Longitudinale torretta
- 16** Blocco contropunta

	T998/230V3A	T998/400V3A
Altezza punta	160 mm	160 mm
Diametro max sul banco	320 mm	320 mm
Diametro max sul carro	198 mm	198 mm
Diametro max sull'incavo	470 mm	470 mm
Distanza tra le punte	1000 mm	1000 mm
Passaggio barra	51 mm	51 mm
Attacco mandrino	Camlock D1-5	Camlock D1-5
Conicità attacco mandrino CM	5	5
Velocità mandrino	(8) 70 ÷ 2000 rpm	(8) 70 ÷ 2000 rpm
Avanzamenti longitudinali mm/giro	0.052 ÷ 1.392	0.052 ÷ 1.392
Avanzamenti trasversali mm/giro	0.009 ÷ 0.253	0.009 ÷ 0.253
Filettature metriche	0,4 ÷ 7 mm	0,4 ÷ 7 mm
Filettature in pollici	4 ÷ 56 TPI	4 ÷ 56 TPI
Conicità contropunta CM	3	3
Motore	1.8kW 50Hz 230V	1.5kW 50Hz 400V
Peso	630 kg	630 kg

ACCESSORI INCLUSI

- Mandrino a 4 griffe indipendenti reversibili Ø 200 mm
- Bussola di riduzione CM 5/3
- Flangia Ø 250 mm
- Contropunta rotante CM 3
- Freno a pedale

TORNIO PARALLELO CON VISUALIZZATORE A 3 ASSI, SCATOLA INGRANAGGI SEMI NORTON

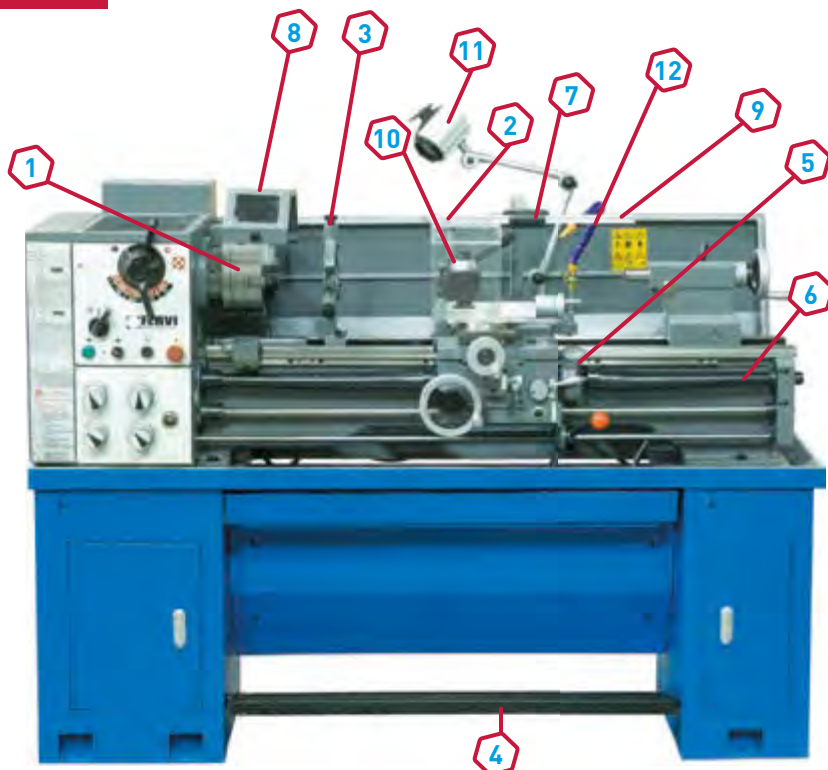

Art. T998/230V & T998/400V
TORNIO PARALLELO
€ 9250,00

- 1** Mandrino autocentrante 3+3 Ø 200 mm
- 2** Lunetta mobile
- 3** Lunetta fissa
- 4** Freno a pedale
- 5** Comparatore di filettatura
- 6** Protezione vite madre
- 7** Protezione torretta
- 8** Protezione mandrino
- 9** Paraspruzzi posteriore
- 10** Torretta a cambio rapido TOAE
- 11** Lampada
- 12** Sistema di raffreddamento
- 13** Carter con micro interruttore
- 14** Quadro elettrico
- 15** Longitudinale torretta
- 16** Frizione tornitura

	T998/230V	T998/400V
Altezza punta	160 mm	160 mm
Diametro max sul banco	320 mm	320 mm
Diametro max sul carro	198 mm	198 mm
Diametro max sull'incavo	470 mm	470 mm
Distanza tra le punte	1000 mm	1000 mm
Passaggio barra	51 mm	51 mm
Attacco mandrino	Camlock D1-5	Camlock D1-5
Conicità attacco mandrino CM	5	5
Velocità mandrino	(8) 70 ÷ 2000 rpm	(8) 70 ÷ 2000 rpm
Avanzamenti longitudinali mm/giro	0.052 ÷ 1.392	0.052 ÷ 1.392
Avanzamenti trasversali mm/giro	0.009 ÷ 0.253	0.009 ÷ 0.253
Filettature metriche	0,4 ÷ 7 mm	0,4 ÷ 7 mm
Filettature in pollici	4 ÷ 56 TPI	4 ÷ 56 TPI
Conicità contropunta CM	3	3
Motore	1.8kW 50Hz 230V	1.5kW 50Hz 400V
Peso	630 kg	630 kg

ACCESSORI INCLUSI

Mandrino a 4 griffe indipendenti reversibili Ø 200 mm
 Bussola di riduzione CM 5/3
 Flangia Ø 250 mm
 Contropunta rotante CM 3

TORNIO PARALLELO CON SCATOLA INGRANAGGI SEMI NORTON



Art. T999/230V3A & T999/400V3A
TORNIO PARALLELO CON VISUALIZZATORE

€ 9750,00

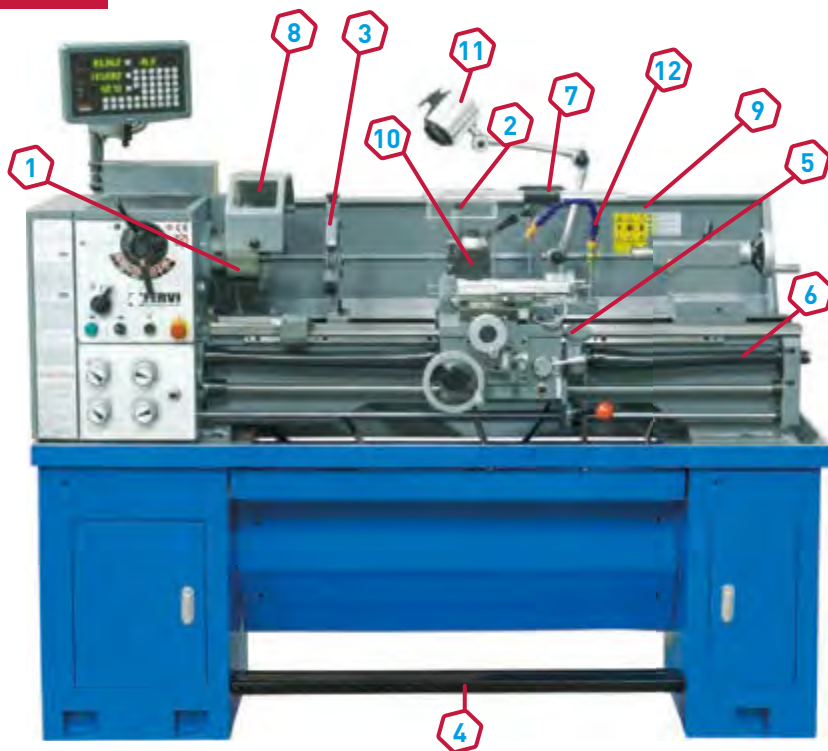

- 1** Mandrino autocentrante 3+3 Ø 160 mm
- 2** Lunetta mobile
- 3** Lunetta fissa
- 4** Freno a pedale
- 5** Comparatore di filettatura
- 6** Protezione vite madre
- 7** Protezione torretta
- 8** Protezione mandrino
- 9** Paraspruzzi posteriore
- 10** Torretta a cambio rapido T0AE
- 11** Lampada
- 12** Sistema di raffreddamento
- 13** Visualizzatore
- 14** Quadro elettrico
- 15** Longitudinale torretta
- 16** Pompa refrigerazione

	T999/230V3A	T999/400V3A
Altezza punta	160 mm	160 mm
Diametro max sul banco	320 mm	320 mm
Diametro max sul carro	198 mm	198 mm
Diametro max sull'incavo	470 mm	470 mm
Distanza tra le punte	1000 mm	1000 mm
Passaggio barra	38 mm	38 mm
Attacco mandrino	Camlock D1-4	Camlock D1-4
Conicità attacco mandrino CM	5	5
Velocità mandrino	(8) 70 ÷ 2000 rpm	(8) 70 ÷ 2000 rpm
Avanzamenti longitudinali mm/giro	0,052 ÷ 1,392	0,052 ÷ 1,392
Avanzamenti trasversali mm/giro	0,009 ÷ 0,253	0,009 ÷ 0,253
Filettature metriche	0,4 ÷ 7 mm	0,4 ÷ 7 mm
Filettature in pollici	4 ÷ 56 TPI	4 ÷ 56 TPI
Conicità contropunta CM	3	3
Motore	230 V 50 Hz 1,8 kW	400 V 50 Hz 1,5 kW
Peso	615 kg	615 kg
Dimensioni imballo	1980 x 750 x 1450h mm	1980 x 750 x 1450h mm

ACCESSORI INCLUSI

- Mandrino a 4 griffe indipendenti reversibili Ø 200 mm
- Bussola di riduzione CM 5/3
- Flangia Ø 250 mm
- Contropunta rotante CM 3

TORNIO PARALLELO CON VISUALIZZATORE A 3 ASS, SCATOLA INGRANAGGI SEMI NORTON



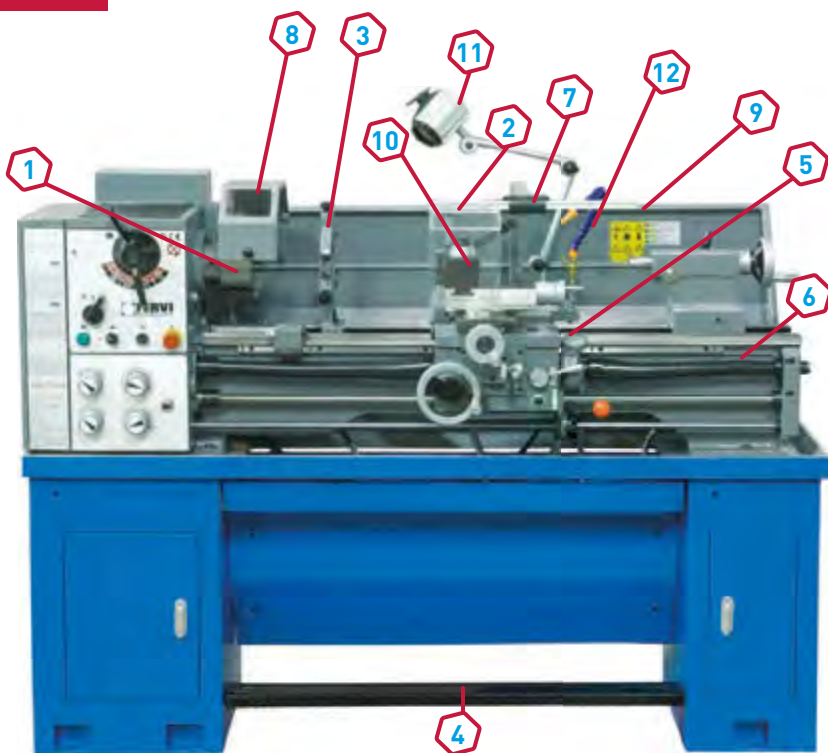

Art. T999/230V & T999/400V
TORNIO PARALLELO
€ 8550,00

- 1** Mandrino autocentrante 3+3 Ø 160 mm
- 2** Lunetta mobile
- 3** Lunetta fissa
- 4** Freno a pedale
- 5** Comparatore di filettatura
- 6** Protezione vite madre
- 7** Protezione torretta
- 8** Protezione mandrino
- 9** Paraspruzzi posteriore
- 10** Torretta a cambio rapido TOAE
- 11** Lampada
- 12** Sistema di raffreddamento
- 13** Carter con micro interruttore
- 14** Quadro elettrico
- 15** Longitudinale torretta
- 16** Blocco contropunta

	T999/230V	T999/400V
Altezza punta	160 mm	160 mm
Diametro max sul banco	320 mm	320 mm
Diametro max sul carro	198 mm	198 mm
Diametro max sull'incavo	470 mm	470 mm
Distanza tra le punte	1000 mm	1000 mm
Passaggio barra	38 mm	38 mm
Attacco mandrino	Camlock D1-4	Camlock D1-4
Conicità attacco mandrino CM	5	5
Velocità mandrino	(8) 70 ÷ 2000 rpm	(8) 70 ÷ 2000 rpm
Avanzamenti longitudinali mm/giro	0,052 ÷ 1,392	0,052 ÷ 1,392
Avanzamenti trasversali mm/giro	0,009 ÷ 0,253	0,009 ÷ 0,253
Filettature metriche	0,4 ÷ 7 mm	0,4 ÷ 7 mm
Filettature in pollici	4 ÷ 56 TPI	4 ÷ 56 TPI
Conicità contropunta CM	3	3
Motore	230 V 50 Hz 1,8 kW	400 V 50 Hz 1,5 kW
Peso	615 kg	615 kg
Dimensioni imballo	1980 x 750 x 1450h mm	1980 x 750 x 1450h mm

ACCESSORI INCLUSI

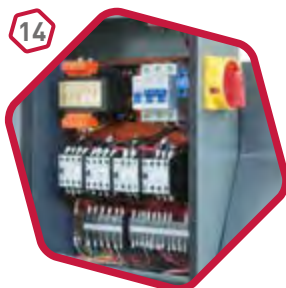
Mandrino a 4 griffe indipendenti reversibili Ø 200 mm
 Bussola di riduzione CM 5/3
 Flangia Ø 250 mm
 Contropunta rotante CM 3

TORNIO PARALLELO, SCATOLA INGRANAGGI SEMI NORTON



Art. T940/230VI3A

TORNIO PARALLELO CON VISUALIZZATORE ED INVERTER

€ 9800,00

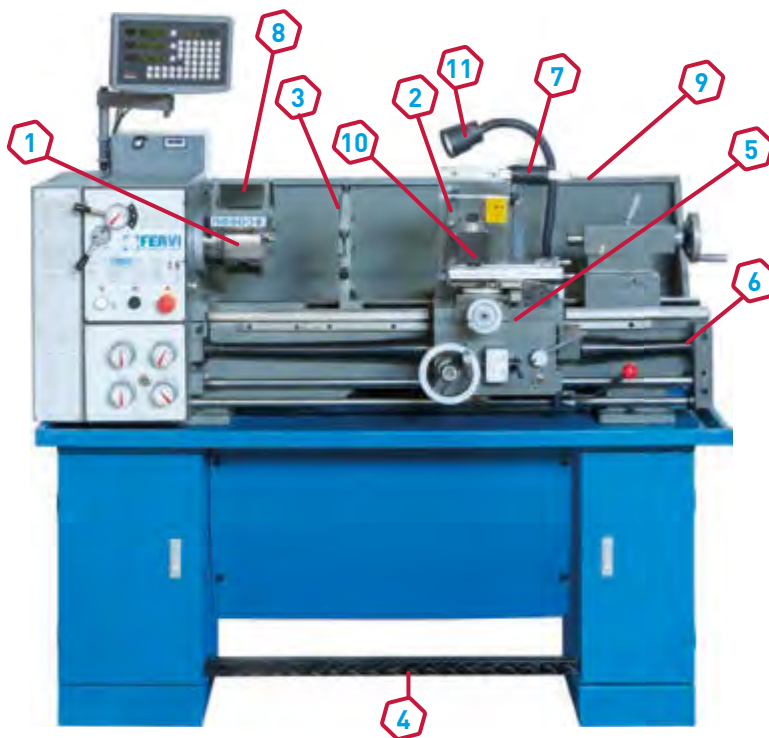

- 1** Mandrinoautocentrante 3+3 Ø 160 mm
- 2** Lunetta mobile
- 3** Lunetta fissa
- 4** Freno a pedale
- 5** Comparatore di filettatura
- 6** Protezione vite madre
- 7** Protezione torretta
- 8** Protezione mandrino
- 9** Paraspruzzi posteriore
- 10** Torretta a cambio rapido T0AE
- 11** Lampada
- 12** Longitudinale torretta
- 13** Mandrino
- 14** Visualizzatore a tre assi
- 15** Carter con micro interruttore

Inverter giapponese con regolazione velocità mandrino	70 ÷ 1700 rpm
Altezza punte	160 mm
Diametro max sul banco	320 mm
Diametro max sull'incavo	460 mm
Diametro max sul carro	180 mm
Distanza tra le punte	940 mm
Cono albero CM	5
Passaggio barra	38 mm
Attacco mandrino	Camlock D1-4
Avanzamenti longitudinali mm/giro	0,053 ÷ 1,291
Avanzamenti trasversali mm/giro	0,011 ÷ 0,276
Filettature metriche	0,4 ÷ 7 mm
Filettature in pollici	4 ÷ 60 TPI
Conicità contropunta CM	3
Motore trifase	230V 1,5 kW
Alimentazione monofase	200-240 V 50 / 60 Hz
Peso	465 kg
Dimensioni imballo	750 x 1640 x 1500 mm
Dimensioni tornio	650 x 1570 x 1300 mm

ACCESSORI INCLUSI

- Mandrino a 4 griffe indipendenti reversibili Ø 200 mm
- Contropunta fissa CM 5
- Contropunta fissa CM 3
- Contropunta rotante CM 3
- Bussola di riduzione CM 5/3
- Flangia Ø 240 mm
- Flangia Ø 200 mm

TORNIO PARALLELO CON INVERTER, VISUALIZZATORE A 3 ASSI, SCATOLA INGRANAGGI SEMI NORTON

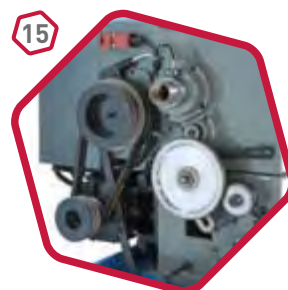

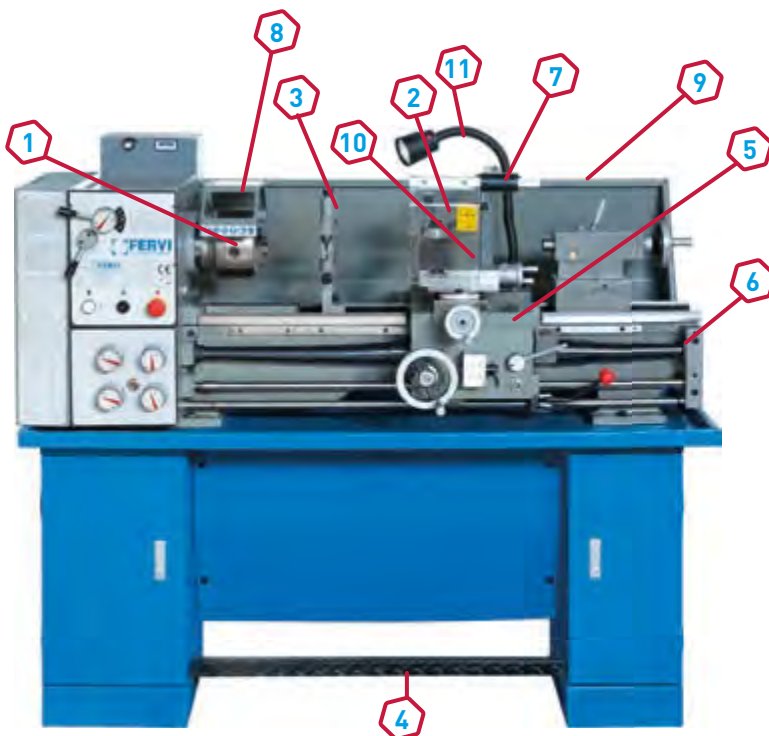

Art. T940/230VI
TORNIO PARALLELO CON INVERTER
€ 8500,00

- 1** Mandrinoautocentrante 3+3 Ø 160 mm
- 2** Lunetta mobile
- 3** Lunetta fissa
- 4** Freno a pedale
- 5** Comparatore di filettatura
- 6** Protezione vite madre
- 7** Protezione torretta
- 8** Protezione mandrino
- 9** Paraspruzzi posteriore
- 10** Torretta a cambio rapido TOAE
- 11** Lampada
- 12** Carter con micro interruttore
- 13** Quadro elettrico
- 14** Longitudinale torretta
- 15** Blocco contropunta

Inverter giapponese con regolazione velocità mandrino	70 ÷ 1700 rpm
Altezza punte	160 mm
Diametro max sul banco	320 mm
Diametro max sull'incavo	460 mm
Diametro max sul carro	180 mm
Distanza tra le punte	940 mm
Cono albero CM	5
Passaggio barra	38 mm
Attacco mandrino	Camlock D1-4
Avanzamenti longitudinali mm/giro	0,053 ÷ 1,291
Avanzamenti trasversali mm/giro	0,011 ÷ 0,276
Filettature metriche	0,4 ÷ 7 mm
Filettature in pollici	4 ÷ 60 TPI
Conicità contropunta CM	3
Motore trifase	230V 1,5 kW
Alimentazione monofase	200-240 V 50 / 60 Hz
Peso	465 kg
Dimensioni imballo	750 x 1640 x 1500 mm
Dimensioni tornio	650 x 1570 x 1300 mm

ACCESSORI INCLUSI

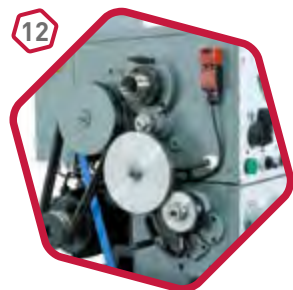
- Mandrino a 4 griffe indipendenti reversibili Ø 200 mm
- Contropunta fissa CM 5
- Contropunta fissa CM 3
- Contropunta rotante CM 3
- Bussola di riduzione CM 5/3
- Flangia Ø 240 mm
- Flangia Ø 200 mm

TORNIO PARALLELO CON INVERTER, SCATOLA INGRANAGGI SEMI NORTON



Art. T940/230V & T940/400V
TORNIO PARALLELO

€ 7200,00

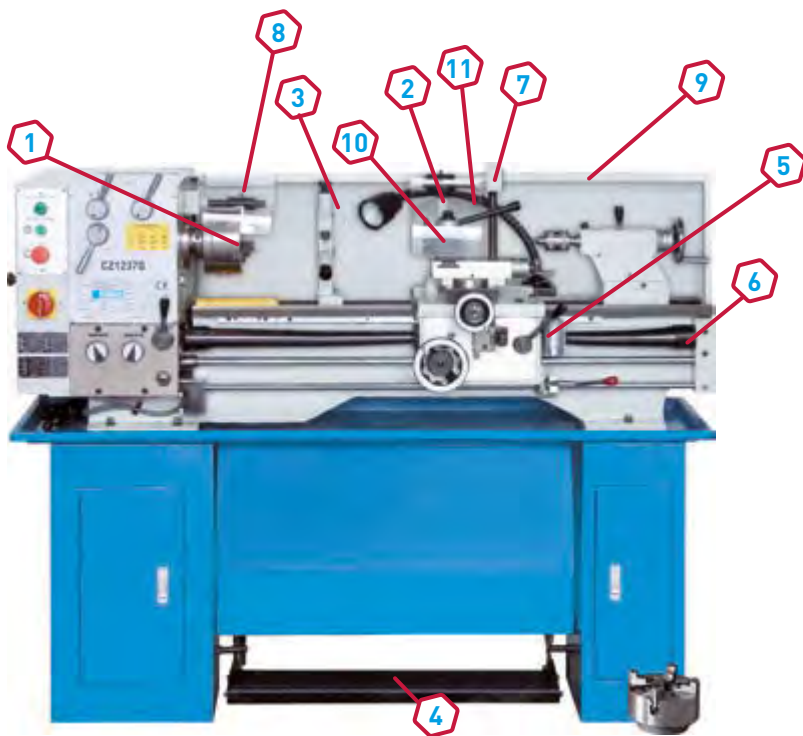

- 1** Mandrinoautocentrante 3+3 Ø 160 mm
- 2** Lunetta mobile
- 3** Lunetta fissa
- 4** Freno a pedale
- 5** Comparatore di filettatura
- 6** Protezione vite madre
- 7** Protezione torretta
- 8** Protezione mandrino
- 9** Paraspruzzi posteriore
- 10** Torretta a cambio rapido T0AE
- 11** Lampada
- 12** Cambio ad ingranaggi
- 13** Contropunta rotante CM/MT 3
- 14** Mandrino
- 15** Carro

	T940/230V	T940/400V
Altezza punte	150 mm	150 mm
Diametro max sul banco	300 mm	300 mm
Diametro max sull'incavo	480 mm	480 mm
Diametro max sul carro	173 mm	173 mm
Distanza tra le punte	940 mm	940 mm
Cono albero CM	5	5
Passaggio barra	38 mm	38 mm
Velocità mandrino	(9) 64 ÷ 1500 rpm	(9) 64 ÷ 1500 rpm
Avanzamenti longitudinali mm/giro	0,051 ÷ 0,303	0,051 ÷ 0,303
Avanzamenti trasversali mm/giro	0,051 ÷ 0,303	0,051 ÷ 0,303
Filettature metriche	0,5 ÷ 3,5 mm	0,5 ÷ 3,5 mm
Filettature in pollici	7,5 ÷ 48 TPI	7,5 ÷ 48 TPI
Conicità contropunta CM	3	3
Motore	230 V 50 Hz 1,5 kW	400 V 50 Hz 1,1 kW
Peso	465 kg	465 kg
Dimensioni imballo	740 x 1780 x 1460 mm	740 x 1780 x 1460 mm
Dimensioni tornio	600 x 1600 x 1270 mm	600 x 1600 x 1270 mm

ACCESSORI INCLUSI

- Mandrino a 4 griffe indipendenti reversibili Ø 200 mm
- Contropunta fissa CM 5
- Contropunta fissa CM 3
- Bussola di riduzione CM 5/3
- Flangia Ø 240 mm
- Flangia Ø 200 mm

TORNIO PARALLELO, SCATOLA INGRANAGGI SEMI NORTON



Art. T700V
TORNIO PARALLELO
€ 5200,00



- 1** Mandrino autocentrante 3+3 Ø 125mm
- 2** Lunetta mobile
- 3** Lunetta fissa
- 4** Comparatore di filettatura
- 5** Protezione vite madre
- 6** Protezione torretta
- 7** Protezione mandrino
- 8** Paraspruzzi posteriore
- 9** Torretta fissa per utensili da 12 mm
- 10** Flangia Ø 240 mm
- 11** Mandrino a 4 griffe indipendenti reversibili Ø 125 mm
- 12** Display
- 13** Longitudinale carro
- 14** Carter con micro interruttore
- 15** Carrello contropunta a bloccaggio rapido e corsa di 85 mm

Altezza punta	140 mm
Diametro max sul banco	280 mm
Diametro max sul carro	170 mm
Distanza tra le punte	700 mm
Cono morse CM	4
Passaggio barra	26 mm
Velocità mandrino	50 ÷ 850 rpm 110 ÷ 1800 rpm
Avanzamenti longitudinali mm/giro	0,07 ÷ 0,65
Avanzamenti trasversali mm/giro	0,03 ÷ 0,12
Filettature metriche	0,2 ÷ 3,5 mm
Filettature in pollici	8 ÷ 56 TPI
Conicità contropunta CM	2
Motore monofase	230 V 50 Hz 1,1 kW
Peso	300 kg
Dimensioni tornio	1129 x 690 x 1127 mm

TORNIO PARALLELO SCATOLA INGRANAGGI SEMI NORTON E CAMBIO A VELOCITÀ VARIABILE, AVANZAMENTI LONGITUDINALI E TRASVERSALI, BARRA DI TORNITURA, BANCO PARZIALMENTE ASSEMBLATO CON 3 CASSETTI E ARMADIETTO

ACCESSORI INCLUSI

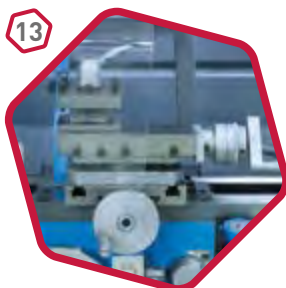
- Attacco mandrino a cambio rapido tipo C
- Contropunta fissa CM 4
- Contropunta fissa CM 2
- Ingranaggi del carro a bagno d'olio
- Torretta fissa per utensili da 12 mm





Art. T700
TORNIO PARALLELO

€ 4500,00



- 1** Mandrino autocentrante 3+3 Ø 125mm
- 2** Lunetta mobile
- 3** Lunetta fissa
- 4** Comparatore di filettatura
- 5** Protezione vite madre
- 6** Protezione torretta
- 7** Protezione mandrino
- 8** Paraspruzzi posteriore
- 9** Torretta fissa per utensili da 12 mm
- 10** Flangia Ø 240 mm
- 11** Mandrino a 4 griffe indipendenti reversibili Ø 125 mm
- 12** Scatola ingranaggi SEMI NORTON
- 13** Mandrino
- 14** Carter con micro interruttore
- 15** Longitudinale torretta

Altezza punta	140 mm
Diametro max sul banco	280 mm
Diametro max sul carro	170 mm
Distanza tra le punte	700 mm
Cono morse CM	4
Passaggio barra	26 mm
Velocità mandrino	(6) 150 ÷ 2000 rpm
Avanzamenti longitudinali mm/giro	0,07 ÷ 0,65
Avanzamenti trasversali mm/giro	0,03 ÷ 0,12
Filettature metriche	0,2 ÷ 3,5 mm
Filettature in pollici	8 ÷ 56 TPI
Conicità contropunta CM	2
Motore monofase	230 V 50 Hz 0,85 kW
Peso	300 kg
Dimensioni tornio	1129 x 690 x 1127 mm

ACCESSORI INCLUSI

- Attacco mandrino a cambio rapido tipo C
- Contropunta fissa CM 4
- Contropunta fissa CM 2
- Ingranaggi del carro a bagno d'olio
- Torretta fissa per utensili da 12 mm

TORNIO PARALLELO CON SCATOLA INGRANAGGI SEMI NORTON E CAMBIO VELOCITÀ A CINGHIA, AVANZAMENTI LONGITUDINALI E TRASVERSALI, BARRA DI TORNITURA, BANCO PARZIALMENTE ASSEMBLATO CON 3 CASSETTI E ARMADIETTO

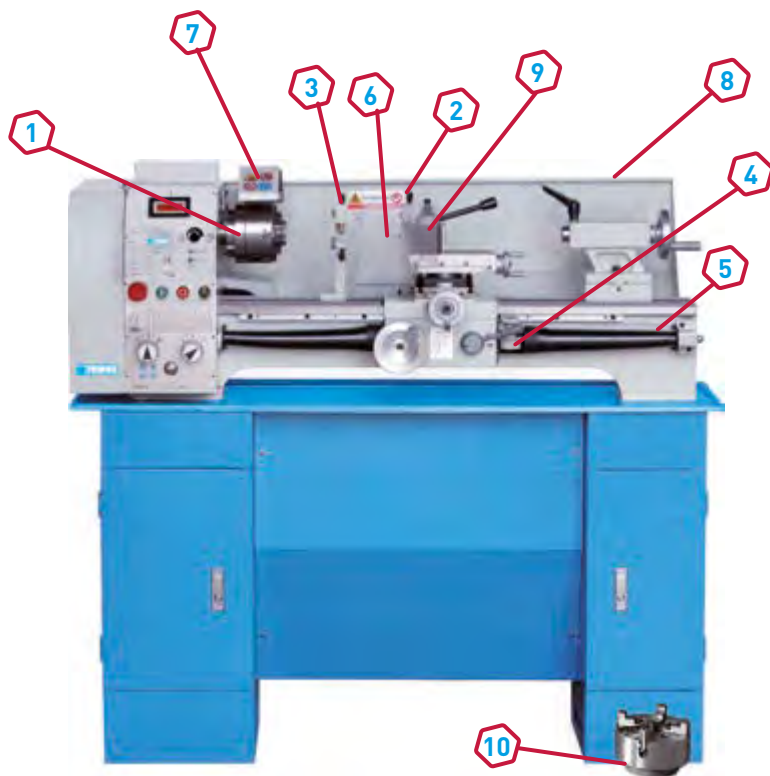

Art. T660I
TORNIO PARALLELO CON INVERTER
€ 5350,00

- 1** Mandrino autocentrante 3+3 Ø 125 mm
- 2** Lunetta mobile
- 3** Lunetta fissa
- 4** Comparatore di filettatura
- 5** Protezione vite madre
- 6** Protezione torretta
- 7** Protezione mandrino
- 8** Paraspruzzi posteriore
- 9** Torretta a cambio rapido T0AA
- 10** Mandrino a 4 griffe indipendenti reversibili Ø 160 mm
- 13** Carter con micro interruttore
- 14** Longitudinale torretta
- 15** Torretta
- 16** Display

Inverter giapponese con regolazione velocità mandrino	100 ÷ 2000 rpm
Altezza punte	140 mm
Diametro max sul banco	280 mm
Diametro max sul carro	165 mm
Distanza tra le punte	660 mm
Cono albero CM	4
Passaggio barra	26 mm
Avanzamenti longitudinali mm/giro	0,063 ÷ 0,35
Filettature metriche	0,25 ÷ 3,5 mm
Filettature in pollici	8 ÷ 72 TPI
Conicità contropunta CM	2
Motore trifase	230V 0,75 kW
Alimentazione monofase	200-240 V 50/60 Hz
Peso	260 kg
Dimensioni tornio	1325 x 550 x 1230 mm

ACCESSORI INCLUSI

- Contropunta fissa CM 2
- Contropunta rotante CM 2
- Flangia Ø 200 mm

**TORNIO PARALLELO CON INVERTER, SCATOLA INGRANAGGI SEMI NORTON,
 BANCO PARZIALMENTE ASSEMBLATO**



Art. T660
TORNIO PARALLELO

€ 4000,00

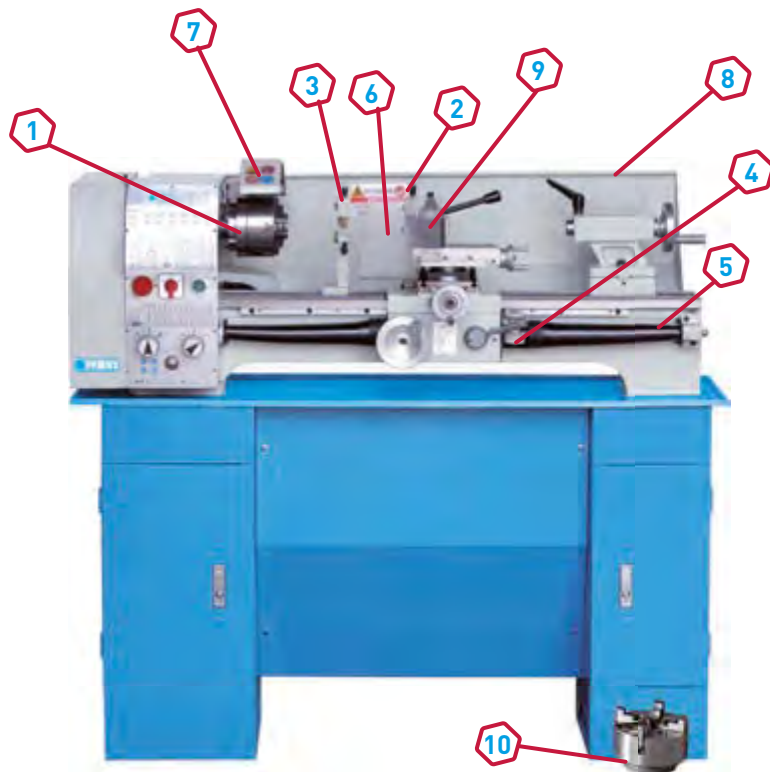

- 1** Mandrino autocentrante 3+3 Ø 125 mm
- 2** Lunetta mobile
- 3** Lunetta fissa
- 4** Comparatore di filettatura
- 5** Protezione vite madre
- 6** Protezione torretta
- 7** Protezione mandrino
- 8** Paraspruzzi posteriore
- 9** Torretta a cambio rapido T0AA
- 10** Mandrino a 4 griffe indipendenti reversibili Ø 160 mm
- 13** Carter con micro interruttore
- 14** Scatola ingranaggi SEMI NORTON
- 15** Longitudinale torretta
- 16** Blocco contropunta

Altezza punte	140 mm
Diametro max sul banco	280 mm
Diametro max sul carro	165 mm
Distanza tra le punte	660 mm
Cono albero CM	4
Passaggio barra	26 mm
Velocità mandrino	(6) 125 ÷ 2000 rpm
Avanzamenti longitudinali mm/giro	0,063 ÷ 0,35
Filettature metriche	0,25 ÷ 3,5 mm
Filettature in pollici	8 ÷ 72 TPI
Conicità contropunta CM	2
Motore monofase	230 V 50 Hz 0,75 kW
Peso	260 kg
Dimensioni tornio	1325 x 550 x 1230 mm

ACCESSORI INCLUSI

TORNIO PARALLELO SCATOLA INGRANAGGI SEMI NORTON E CAMBIO VELOCITÀ A CINGHIA, BANCO PARZIALMENTE ASSEMBLATO

- Contropunta fissa CM 2
- Contropunta rotante CM 2
- Flangia Ø 200 mm



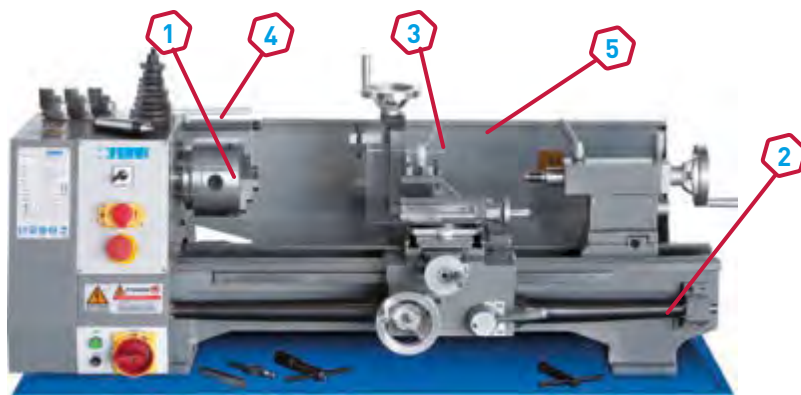

Art. 0657
TORNIO PARALLELO
€ 2750,00

Altezza punta	125 mm
Distanza tra le punte	550 mm
Diametro max sul banco	250 mm
Diametro max sul carro	150 mm
Mandrino autocentrante 3+3	Ø 125 mm
Cono albero CM	3
Passaggio barra	20 mm
Contropunta fissa	CM / MT 2
Filettatura metrica e a pollici	0,4 ÷ 3,5 mm / 18 ÷ 44 TPI
Avanzamenti longitudinali mm/giro	0,1 / 0,2 mm / giro
Velocità mandrino	(6) 125 ÷ 2000 rpm
Motore monofase	220 ÷ 240 V 50 Hz 0,55 kW
Dimensioni	1120 x 480 x 460h mm
Dimensioni imballo	1230 x 730 x 610h mm
Peso	160 kg

- 1** Mandrino autocentrante 3+3 Ø 125 mm
- 2** Protezione vite madre
- 3** Protezione torretta
- 4** Protezione mandrino
- 5** Paraspruzzi posteriore
- 6** Carter con micro interruttore
- 7** Blocco contropunta
- 8** Carro
- 9** Attrezzo a fresare

ACCESSORI INCLUSI

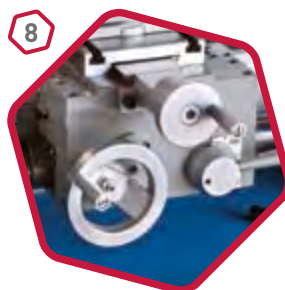
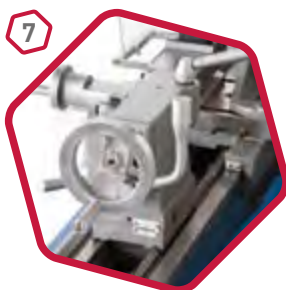
- Contropunta fissa CM 2
- Contropunta fissa CM 3
- Torretta fissa per utensili da 18 mm

TORNIO PARALLELO CON DISPOSITIVO DI FRESATURA, CAMBIO VELOCITÀ A CINGHIA

Art. 0657/B
BANCO PER TORNIO
€ 430,00

Dimensioni	1050 x 433 x 720h mm
Peso	36,5 kg

BANCO PER TORNIO DA ASSEMBLARE



Art. 0708
TORNIO PARALLELO

€ 2250,00

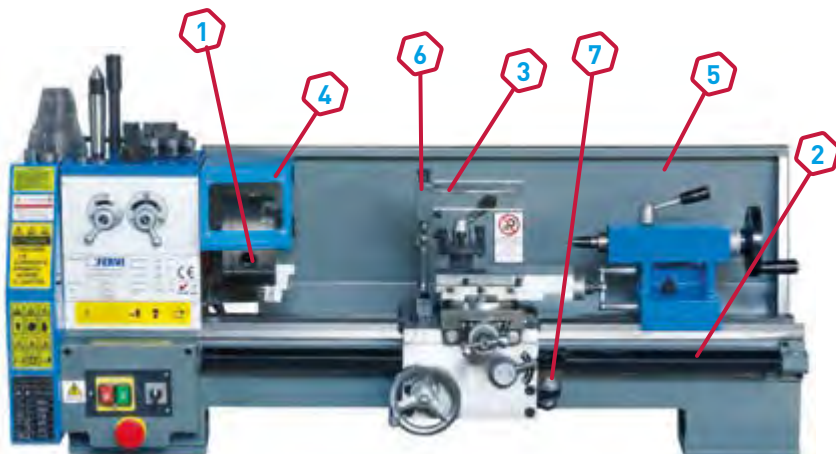

- 1** Mandrino autocentrante 3+3 Ø 125 mm
- 2** Protezione vite madre
- 3** Protezione torretta
- 4** Protezione mandrino
- 5** Paraspruzzi posteriore
- 6** Lunetta mobile
- 7** Comparatore di filettatura
- 8** Quadro comandi
- 9** Carter con micro interruttore
- 10** Cambio di velocità ad ingranaggi
- 11** Blocco contropunta

Dimensioni senza base	1080 x 440 x 400h mm
Altezza punte	110 mm
Distanza tra le punte	520 mm
Diametro max sul banco	200 mm
Diametro max sul carro	122 mm
Mandrino autocentrante 3+3	Ø125 mm
Cono albero CM	3
Passaggio barra	18 mm
Contropunta fissa	CM / MT 2
Avanzamento automatico longitudinale	0,04 - 0,08 - 0,12 - 0,16 - 0,20 mm
Filettatura metrica e a pollici	0,25 ÷ 3 mm / 8 ÷ 48 TPI
Velocità mandrino	(6) 170 ÷ 1950 rpm
Motore monofase	230 V 50 Hz 0,55 kW
Peso	142 kg

ACCESSORI INCLUSI

- Contropunta fissa CM 2
- Contropunta fissa CM 3
- Torretta fissa per utensili da 16 mm
- Cuscinetti conici albero mandrino

TORNIO PARALLELO CON CAMBIO DI VELOCITÀ AD INGRANAGGI

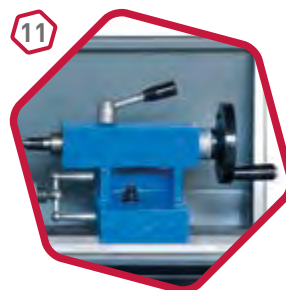

Art. 0710
BASE PER TORNIO

€ 314,00

Dimensioni	1050 x 320 x 725h mm
Peso	21,5 kg

BASE PER TORNIO PARZIALMENTE ASSEMBLATO

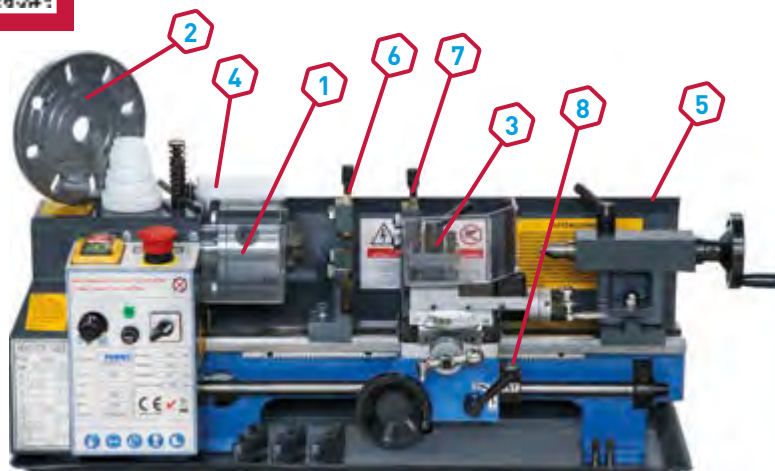
Art. 0716
TORNIO PARALLELO
€ 1620,00

- 1** Mandrino autocentrante 3+3 Ø 100 mm
- 2** Flangia Ø 125 mm
- 3** Protezione torretta
- 4** Protezione mandrino
- 5** Paraspruzzi posteriore
- 6** Lunetta fissa
- 7** Lunetta mobile
- 8** Comparatore di filettatura
- 9** Quadro comandi
- 10** Carter trasmissione
- 11** Cambio di velocità ad ingranaggi
- 12** Blocco contropunta

Altezza punte	90 mm
Mandrino autocentrante 3+3	Ø 100 mm
Cono albero CM	3
Distanza tra le punte	300 mm
Diametro max sul banco	180 mm
Diametro max sul carro	110 mm
Passaggio barra	16 mm
Filettature metriche	0,5 ÷ 2,5 mm
Velocità meccaniche	2
Velocità mandrino	1° 100 ÷ 1100 rpm - 2° 200 ÷ 2500 rpm
Conicità contropunta CM	2
Motore monofase	230 V 50 Hz 0,5 kW
Dimensioni	700 x 230 x 270h mm
Peso	41 kg

ACCESSORI INCLUSI

- Contropunta fissa CM 2
- Contropunta fissa CM 3

TORNIO PARALLELO CON AVANZAMENTI AUTOMATICI LONGITUDINALI E VELOCITÀ VARIABILE VISUALIZZATA SU DISPLAY DIGITALE

Art. 0716/B
BASE PER TORNIO
€ 297,00

BASE PER TORNIO, CHIUSURA SENZA CHIAVE, CON MENSOLA INTERNA

Dimensioni	760 x 240 x 760 mm
Interasse fori	475 x 70 mm
Altezza mensola interna	405 mm
Peso	29 kg

TABELLA DI COMPATIBILITÀ

Codice Compatibile	Descrizione	€	T070/400V3A	T069/400V3A	T069/400V	T998/400V3A	T998/230V3A	T998/400V	T998/230V	T999/230V3A	T999/400V3A	T999/230V	T999/400V	T940/230V3A	T940/230V1	T940/230V	T940/400V	T700V	T700	T6601	T660	0657	0708	0716	Pag
0657/B	BANCO PER TORNIO	430,00																							52
0710	BASE PER TORNIO	314,00																							53
0716/B	BASE PER TORNIO	297,00																							54
C046/2	CONTROPUNTA ROTANTE	77,00																							193
C046/3	CONTROPUNTA ROTANTE	93,50																							193
C046/4	CONTROPUNTA ROTANTE	99,00																							193
C050/2	SET CONTROPUNTA GIREVOLE	186,00																							193
C050/3	SET CONTROPUNTA GIREVOLE	208,00																							193
C050/4	SET CONTROPUNTA GIREVOLE	303,00																							193
C055/3	CONTROPUNTA ROTANTE PER TUBI	205,00																							193
C055/4	CONTROPUNTA ROTANTE PER TUBI	290,00																							193
ST45/4/1	BUSSOLA DI RIDUZIONE	20,20																							194
ST45/4/2	BUSSOLA DI RIDUZIONE	20,20																							194
ST45/4/3	BUSSOLA DI RIDUZIONE	20,20																							194
ST45/3/1	BUSSOLA DI RIDUZIONE	14,60																							194
ST45/3/2	BUSSOLA DI RIDUZIONE	15,70																							194
ST45/2/1	BUSSOLA DI RIDUZIONE	12,00																							194
M051/08	MANDRINO AUTOSERRANTE DI PRECISIONE	54,40																							195
M051/10	MANDRINO AUTOSERRANTE DI PRECISIONE	54,40																							195
M051/13	MANDRINO AUTOSERRANTE DI PRECISIONE	63,80																							195
M051/16	MANDRINO AUTOSERRANTE DI PRECISIONE	77,00																							195
M051/20	MANDRINO AUTOSERRANTE DI PRECISIONE	99,00																							195
3/CM2	PORTA PINZA	93,50																							204
3/CM3	PORTA PINZA	93,50																							204
3/CM4	PORTA PINZA	105,00																							204
P032/18P	SERIE PINZE ER32	260,00																							206
M060/2	MASCHIATORE CON BUSSOLE	473,00																							199
M060/3	MASCHIATORE CON BUSSOLE	473,00																							199
M060/4	MASCHIATORE CON BUSSOLE	505,00																							199
M049/100	MANDRINO AUTOCENTRANTE DI PRECISIONE	186,00																							195
M049/125	MANDRINO AUTOCENTRANTE DI PRECISIONE	197,00																							195
M049/160	MANDRINO AUTOCENTRANTE DI PRECISIONE	260,00																							195
M049/200	MANDRINO AUTOCENTRANTE DI PRECISIONE	359,00																							195
M049/250	MANDRINO AUTOCENTRANTE DI PRECISIONE	418,00																							195
M049/200	MANDRINO AUTOCENTRANTE DI PRECISIONE	359,00																							195
M049/250	MANDRINO AUTOCENTRANTE DI PRECISIONE	418,00																							195
M449/100	MANDRINO AUTOCENTRANTE	197,00																							196
M449/125	MANDRINO AUTOCENTRANTE	227,00																							196
M449/160	MANDRINO AUTOCENTRANTE	287,00																							196
M449/200	MANDRINO AUTOCENTRANTE	405,00																							196
M449/250	MANDRINO AUTOCENTRANTE	524,00																							196
M449/200	MANDRINO AUTOCENTRANTE	405,00																							196
M449/250	MANDRINO AUTOCENTRANTE	524,00																							196
FD04/200	FLANGIA CON PERNI	208,00																							195
FD05/200	FLANGIA CON PERNI	208,00																							195
FD05/250	FLANGIA CON PERNI	287,00																							195
0688	APPARECCHIO UNIVERSALE A FRESARE PER TORNIO	195,00																							182
T00A0	TORRETTA A CAMBIO RAPIDO	118,00																							182
T00A1	TORRETTA A CAMBIO RAPIDO	254,00																							182
T00A1R	TORRETTA A CAMBIO RAPIDO	156,00																							182
T0AA	TORRETTA A CAMBIO RAPIDO	287,00																							183
T0AE	TORRETTA A CAMBIO RAPIDO	364,00																							183
B007/10	SET 5 UTENSILI AD INSERTO	109,00																							209
B007/12	SET 5 UTENSILI AD INSERTO	115,00																							209
B007/16	SET 5 UTENSILI AD INSERTO	142,00																							209
KISCLCR	SET UTENSILI PER INTERNO 95°	249,00																							213
KISTCMT	SET UTENSILI PER INTERNO 90°	270,00																							213
KISTFCR	SET UTENSILI PER INTERNO BLOCCAGGIO A VITE 90°	213,00																							214
B005	SERIE UTENSILI BRASATI	27,80																							241
B005/16	SERIE UTENSILI BRASATI	41,70																							241
B005/20	SERIE UTENSILI BRASATI	52,20																							241
T089	SET DA TAGLIO	70,00																							218
T091	SET DA TAGLIO	120,00																							218
KISER	KIT FILETTATURA PER ESTERNO	181,00																							217
KISNR	KIT FILETTATURA PER INTERNO	208,00																							217
KICAN	SET PER CANALINI ESTERNI ED INTERNI	232,00																							217
T201	TUBO COMPONIBILE SNODABILE PER LIQUIDI REFRIGERANTI	19,10																							228

TRAPANI FRESA



T047/..

T044/..

T046

T045

T061

T058

CAPACITÀ DI FORATURA SU GHISA CON PREFORO

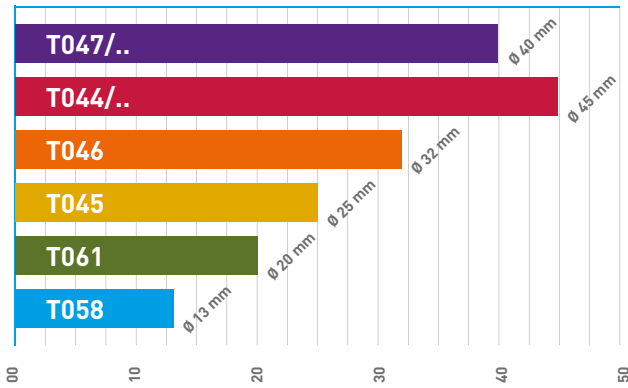

CAPACITÀ DI FRESATURA

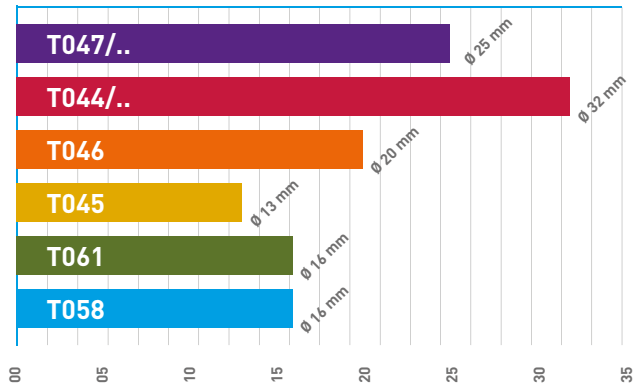

CORSA MANDRINO

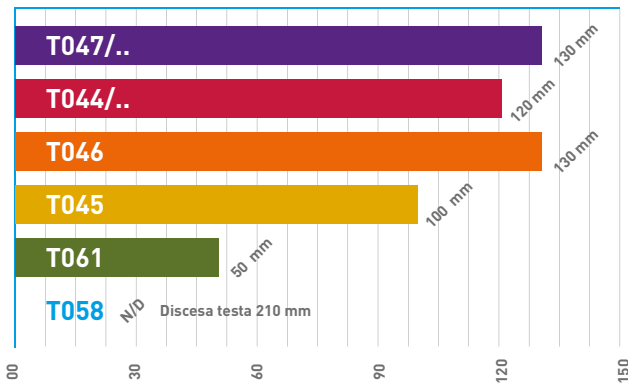

CONO MORSE

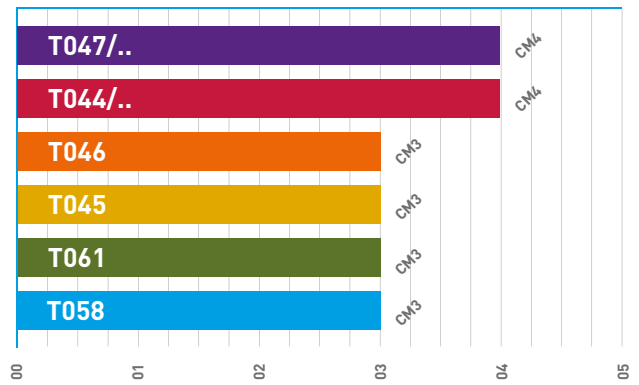

DIMENSIONI TAVOLA

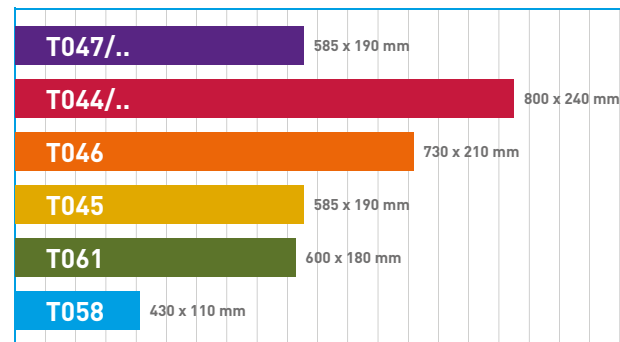

POTENZA

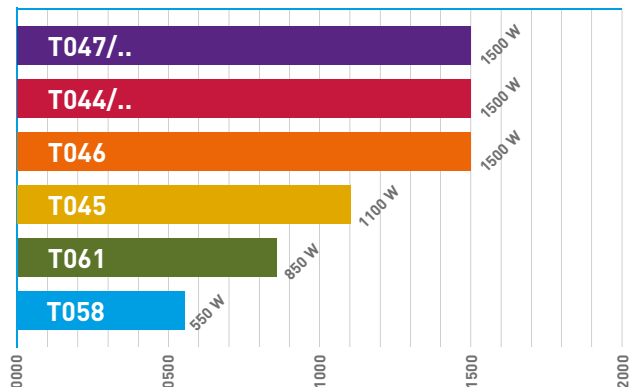



Art. T047/230V & T047/400V
TRAPANO FRESA AD INGRANAGGI

€ 4450,00

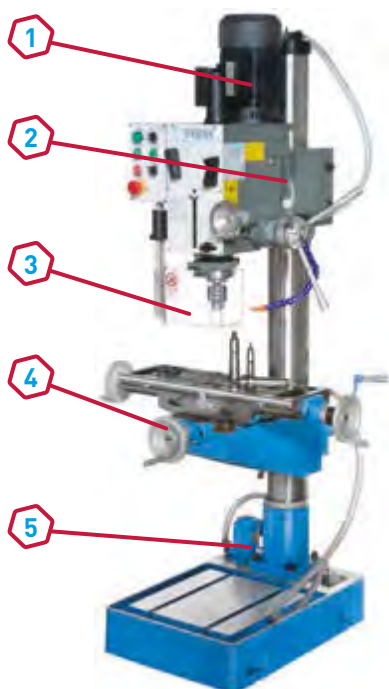

- 1 Motore ad induzione
- 2 Testa mobile
- 3 Protezione mandrino
- 4 Tavola girevole
- 5 Pompa di refrigerazione
- 6 Discesa micrometrica
- 7 Accessori
- 8 Cambio ad ingranaggi
- 9 Quadro comandi

ACCESSORI INCLUSI

- Mandrino a cremagliera 1 ÷ 13 B16
- Attacco mandrino forato CM 4
- Bussola di riduzione CM 4/3 + CM 3/2
- Attacco fresa CM 4 Ø 27 mm

	T047/230V	T047/400V
Capacità di foratura su ghisa con preforo	Ø 40 mm	40 mm
Capacità di foratura su acciaio con preforo	32 mm	32 mm
Capacità di fresatura con fresa a inserti	Ø 63 mm	Ø 63 mm
Capacità di fresatura	Ø 25 mm	Ø 25 mm
Capacità di maschiatura	22 mm	22 mm
Attacco conico CM	4	4
Corsa mandrino	130 mm	130 mm
Canotto	Ø 76 mm	Ø 76 mm
Distanza mandrino colonna	260 mm	260 mm
Colonna	Ø 115 mm	Ø 115 mm
Inclinazione testa	± 60°	± 60°
Velocità mandrino	(6) 75 ÷ 1600 rpm	(12) 75 ÷ 3200 rpm
Motore monofase	230 V 50 Hz 1,5 kW	400 V 50 Hz 1,1 - 1,5 kW
Peso	390 kg	390 kg
Dimensioni tavola	585 x 190 mm	585 x 190 mm
Cava	12 mm	12 mm
Dimensioni base	648 x 412 mm	648 x 412 mm
Dimensioni	740 x 790 x 1960h mm	740 x 790 x 1960h mm

TRAPANO FRESA AD INGRANAGGI - INVERSIONE DI MARCIA, MASCHIATURA TEMPORIZZATA, IMPIANTO DI REFRIGERAZIONE

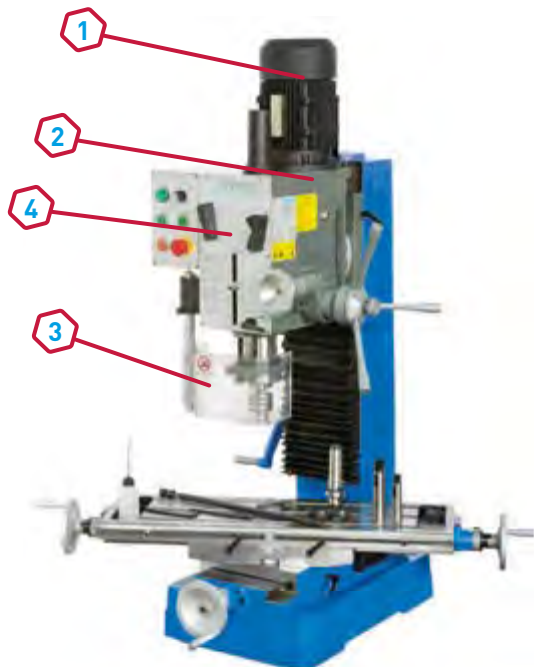

Art. T044/230V & T044/400V
TRAPANO FRESA DA BANCO AD INGRANAGGI
€ 4250,00

- 1 Motore ad induzione
- 2 Testa mobile
- 3 Protezione mandrino
- 4 Cambio velocità ad ingranaggi
- 5 Quadro comandi
- 6 Testa inclinabile
- 7 Discesa micrometrica
- 8 Tavola girevole

ACCESSORI INCLUSI

- Mandrino a cremagliera 1 ÷ 13 B16
- Attacco mandrino forato CM 4
- Bussola di riduzione CM 4/3
- Attacco fresa CM 4 Ø 27 mm

	T044/230V	T044/400V
Capacità max di foratura su ghisa	Ø 45 mm	Ø 45 mm
Capacità di fresatura con fresa a inserti	Ø 80 mm	Ø 80 mm
Capacità di fresatura	Ø 32 mm	Ø 32 mm
Inclinazione testa	± 60°	±60°
Cono morse CM	4	4
Distanza mandrino colonna	240 mm	240 mm
Distanza max asse mandrino - tavola	460 mm	460 mm
Corsa del mandrino	120 mm	120 mm
Divisione avanzamento verticale manuale	0,02 mm	0,02 mm
Canotto	Ø 75 mm	Ø 75 mm
Dimensione tavola	800 x 240 mm	800 x 240 mm
Cava	14 mm	14 mm
Corsa longitudinale	560 mm	560 mm
Corsa trasversale	190 mm	190 mm
Velocità mandrino	95 - 170 - 280 - 540 - 960 - 1600 rpm	95 - 170 - 280 - 540 - 960 - 1600 rpm
Motore monofase	230 V 50 Hz 1,5 kW	400 V 50 Hz 1,5 kW
Peso	350 kg	350 kg
Dimensioni imballo	1090 x 785 x 1120 mm	1090 x 785 x 1120 mm
Dimensioni base	405 x 630 mm	405 x 630 mm

TRAPANO FRESA DA BANCO AD INGRANAGGI, COLONNA QUADRA E GUIDE A CODA DI RONDINE, INVERSIONE DI MARCIA TEMPORIZZATA, ROTAZIONE MANDRINO DESTRA E SINISTRA

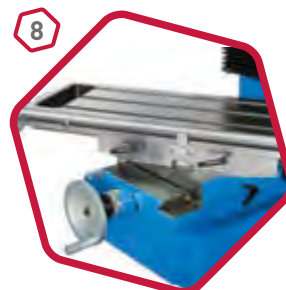



Art. T046

TRAPANO FRESA DA BANCO

€ 3200,00



- 1 Motore ad induzione
- 2 Testa regolabile
- 3 Protezione mandrino
- 4 Tavola girevole
- 5 Discesa micrometrica
- 6 Quadro comandi
- 7 Accessori
- 8 Carter pulegge con micro interruttore

ACCESSORI INCLUSI

- Mandrino a cremagliera 1 ÷ 13 B16
- Attacco mandrino forato CM 3
- Attacco fresa CM 3 Ø 27 mm

Capacità di foratura con preforo	Ø 32 mm
Capacità di fresatura con fresa a inserti	Ø 76 mm
Capacità di fresatura	Ø 20 mm
Corsa testa	405 mm
Cono morse CM	3
Distanza mandrino colonna	200 mm
Distanza max asse mandrino - tavola	457 mm
Corsa del mandrino	130 mm
Divisione avanzamento verticale manuale	0,05 mm
Canotto	Ø 75 mm
Colonna	Ø 115 mm
Dimensione tavola	730 x 210 mm
Cava	16 mm
Corsa longitudinale	175 mm
Corsa trasversale	500 mm
Velocità mandrino	100 ÷ 2080 rpm
Motore monofase	230 V 50 Hz 1,5 kW
Peso	290 kg
Dimensioni imballo	870 x 760 x 1150 mm

TRAPANO FRESA DA BANCO CON SCELTA SENSO DI ROTAZIONE E TRASMISSIONE A CINGHIA





Art. T045
TRAPANO FRESA DA BANCO
€ 2600,00

- 1** Motore ad induzione
- 2** Testa regolabile
- 3** Protezione mandrino
- 4** Tavola girevole
- 5** Quadro comandi
- 6** Accessori
- 7** Discesa micrometrica
- 8** Volantino tavola

ACCESSORI INCLUSI

- Mandrino a cremagliera 1 ÷ 13 B16
- Attacco mandrino forato CM 3
- Attacco fresa CM 3 Ø 22 mm

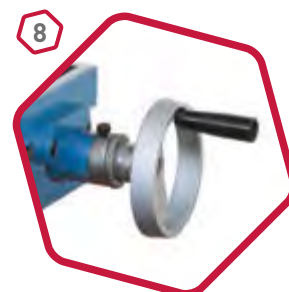
Capacità di foratura con preforo	Ø 25 mm
Capacità di fresatura con fresa a inserti	Ø 63 mm
Capacità di fresatura	Ø 13 mm
Corsa testa	400 mm
Cono morse CM	3
Canotto	Ø 62 mm
Colonna	Ø 92 mm
Dimensione tavola	585 x 190 mm
Cava	14 mm
Corsa longitudinale	160 mm
Corsa trasversale	370 mm
Velocità mandrino	90 ÷ 2150 rpm
Dimensioni imballo	730 x 670 x 1020 mm
Peso	200 kg
Motore monofase	230 V 50 Hz 1,1 kW
Distanza mandrino colonna	200 mm
Distanza max asse mandrino - tavola	380 mm
Corsa del mandrino	100 mm
Divisione avanzamento verticale manuale	0,03 mm

TRAPANO FRESA DA BANCO CON SCELTA DEL SENSO DI ROTAZIONE E TRASMISSIONE A CINGHIA



Art. T061
TRAPANO FRESA DA BANCO AD INGRANAGGI

€ 2950,00

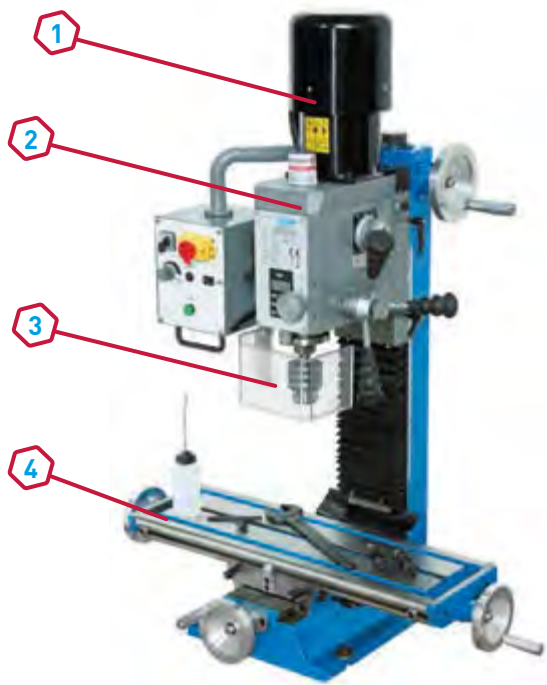

- 1** Motore a spazzole
- 2** Testa regolabile
- 3** Protezione mandrino
- 4** Tavola girevole
- 5** Cambio velocità ad ingranaggi
- 6** Quadro comandi
- 7** Indicatore di profondità
- 8** Volantino discesa testa

ACCESSORI INCLUSI

- Mandrino a cremagliera 3 ÷ 16 B16
- Attacco mandrino forato CM 3

Capacità di foratura con preforo	Ø 20 mm
Capacità di fresatura con fresa cilindrica	Ø 16 mm
Capacità di fresatura a manicotto	Ø 63 mm
Corsa del canotto	50 mm
Corsa testa	300 mm
Inclinazione testa	±90°
Cono morse CM	3
Cava	12 mm
Spostamento tavola longitudinale	190 mm
Spostamento tavola trasversale	340 mm
Velocità mandrino	1° 100 ÷ 1000 rpm ±10% -- 2° 300 ÷ 3000 rpm ±10%
Rotazione mandrino	Dx - Sx / L - R
Dimensione tavola	600 x 180 mm
Motore monofase	230 V 50 Hz 850 W
Peso	145 kg
Dimensioni imballo	710 x 570 x 990 mm

**TRAPANO FRESA DA BANCO AD INGRANAGGI
 CON SISTEMA DI ILLUMINAZIONE**





Art. T058

TRAPANO FRESA DA BANCO AD INGRANAGGI

€ 1600,00



- 1 Motore a spazzole
- 2 Testa inclinabile
- 3 Protezione mandrino
- 4 Tavola girevole
- 5 Quadro comandi
- 6 Cambio di velocità ad ingranaggi
- 7 Discesa micrometrica
- 8 Mandrino

ACCESSORI INCLUSI

- Mandrino a cremagliera 3 ÷ 16 B16
- Attacco mandrino forato CM 3

Capacità di foratura con preforo	Ø 13 mm
Capacità di fresatura con fresa cilindrica	Ø 16 mm
Capacità di fresatura a manicotto	Ø 30 mm
Corsa testa	210 mm
Inclinazione macchina	±45°
Cono morse CM	3
Cava	12 mm
Distanza tavola naso macchina	290 mm
Spostamento tavola longitudinale	130 mm
Spostamento tavola trasversale	250 mm
Velocità mandrino	1° 50 ÷ 1100 rpm ±10% - 2° 120 ÷ 2500 rpm ±10%
Dimensione tavola	430 x 110 mm
Motore monofase	230 V 50 Hz 0,55 kW
Peso	74 kg
Dimensioni imballo	660 x 550 x 720 mm



Art. 0599

BANCO UNIVERSALE PER TRAPANI FRESA

€ 360,00

Dimensioni base	415 x 625 x 750h mm
Dimensioni vasca	615 x 820 x 30h mm
Dimensioni fondo vasca	530 x 735 mm
Peso	59 kg

BANCO UNIVERSALE PER TRAPANI FRESA CON VANO PORTA
ATTREZZI E SERRATURA



TRAPANI



T066



T062



T032DA



T032



T071



T026



T024



0512

CONO MORSE

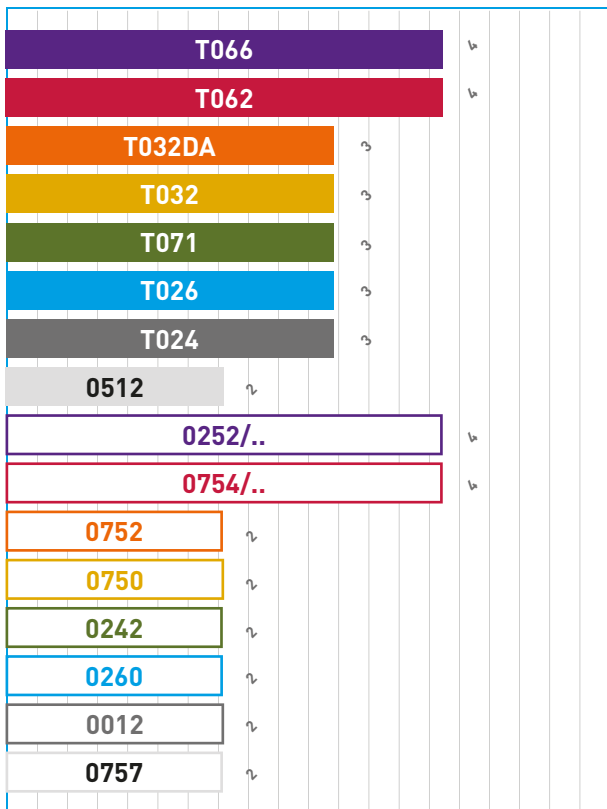

CORSA MANDRINO

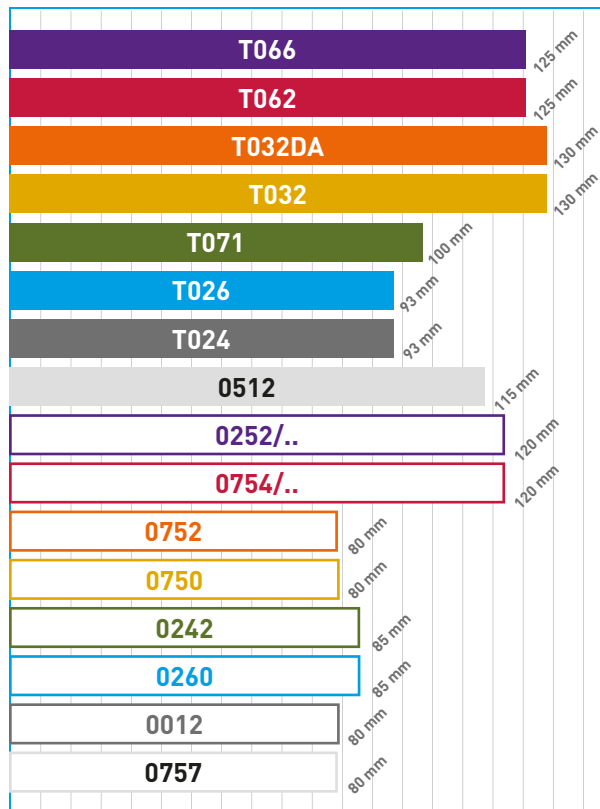

TRAPANI



0252/..



0754/..



0752



0750



0242



0260



0012



0757

DIAMETRO COLONNA

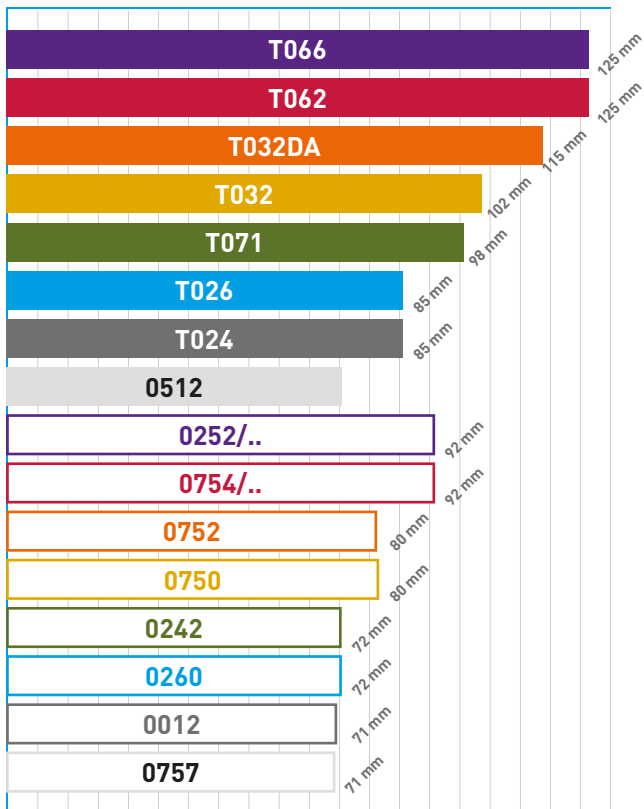

AREA TAVOLA

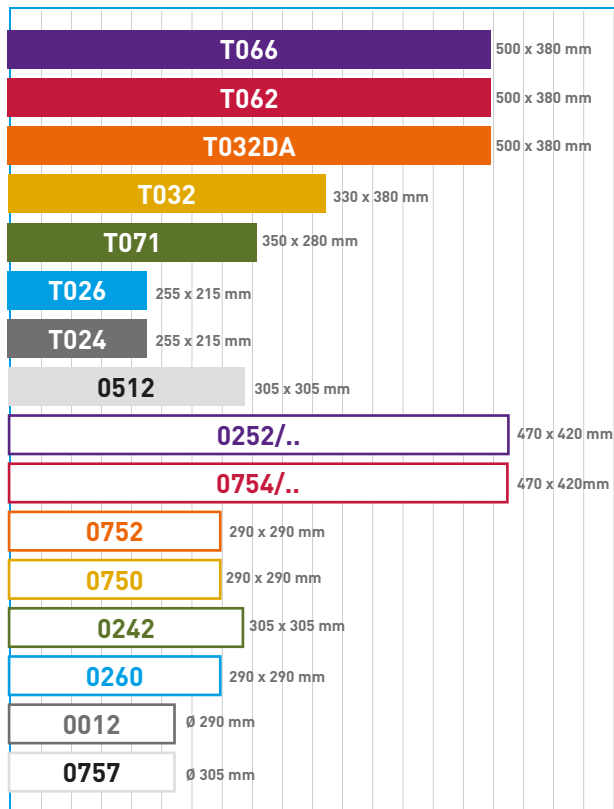

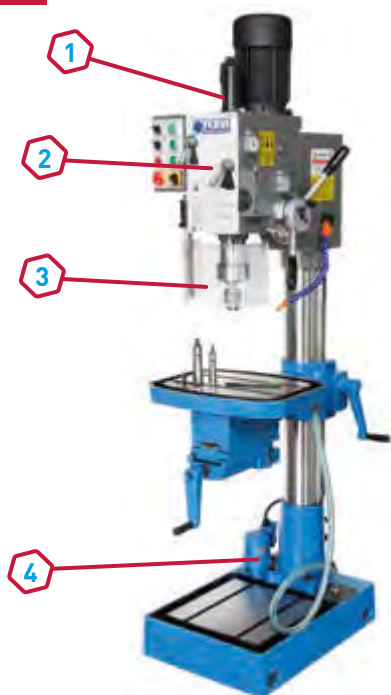
Art. T066
TRAPANO AD INGRANAGGI
€ 5350,00

- 1** Motore ad induzione
- 2** Leve cambio
- 3** Protezione mandrino
- 4** Pompa di refrigerazione
- 5** Quadro comandi
- 6** Discesa automatica
- 7** Illuminazione
- 8** Tavola ribaltabile con morsa incorporata

ACCESSORI INCLUSI

- Mandrino a cremagliera 1 ÷ 13 B16
- Attacco mandrino forato CM 4
- Bussola di riduzione CM 4/3
- Bussola di riduzione CM 3/2

Capacità di foratura con preforo	Ø 40 mm
Cono morse CM	4
Corsa del mandrino	125 mm
Velocità mandrino	(12) 75 ÷ 3200 rpm
Velocità di discesa	(3) 0,1 - 0,18 - 0,26 mm/g
Canotto	Ø 75 mm
Distanza asse mandrino e colonna	320 mm
Distanza tra naso macchina e tavola	80-680 mm
Distanza tra naso macchina e base	1140 mm
Colonna	Ø 125 mm
Cava	14 mm
Dimensione tavola	500 x 380 mm
Inclinazione tavola	±90°
Apertura morse	125 mm
Dimensione della base	470 x 670 mm
Motore trifase due velocità	400 V 50 Hz 1,1/1,5 kW
Pompa di refrigerazione	400 V 50 Hz 40 W
Peso	440 kg
Dimensioni ingombro	500 x 750 x 2000 mm
Dimensioni imballo	670 x 820 x 2090 mm

TRAPANO AD INGRANAGGI, DISCESA AUTOMATICA, INVERSIONE DI MARCIA, SISTEMA DI REFRIGERAZIONE, TAVOLA CON MORSA DI 145 mm, DOTATO DI ILLUMINAZIONE

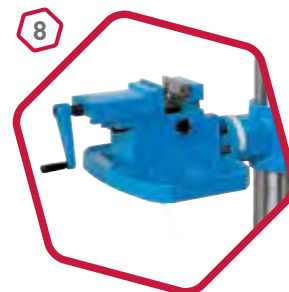



Art. T062
TRAPANO AD INGRANAGGI

€ 4500,00

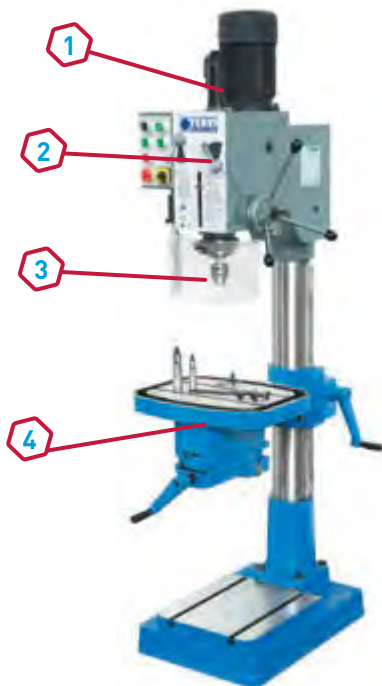

- 1** Motore ad induzione
- 2** Leve cambio
- 3** Protezione mandrino
- 4** Tavola ribaltabile con morsa incorporata
- 5** Quadro comandi
- 6** Interruttore generale
- 7** Illuminazione
- 8** Scala graduata di profondità

ACCESSORI INCLUSI

- Mandrino a cremagliera 1 ÷ 13 B16
- Attacco mandrino forato CM 4
- Bussola di riduzione CM 4/3
- Bussola di riduzione CM 3/2

Capacità di foratura con preforo	Ø 40 mm
Cono morse CM	4
Corsa del mandrino	125 mm
Velocità mandrino	(12) 75 ÷ 3200 rpm
Canotto	Ø 75 mm
Distanza asse mandrino e colonna	320 mm
Distanza tra naso macchina e tavola	80 ÷ 680 mm
Distanza tra naso macchina e base	1140 mm
Colonna	Ø 125 mm
Cava	14 mm
Dimensione tavola	500 x 380 mm
Inclinazione tavola	±90°
Apertura morsa	125 mm
Dimensione della base	460 x 650 mm
Motore trifase due velocità	400 V 50 Hz 1,1/1,5 kW
Peso	385 kg
Dimensioni ingombro	500 x 750 x 2000 mm
Dimensioni imballo	670 x 820 x 2090 mm

TRAPANO AD INGRANAGGI, INVERSIONE DI MARCIA, MORSA DI 145 mm. DOTATO DI ILLUMINAZIONE

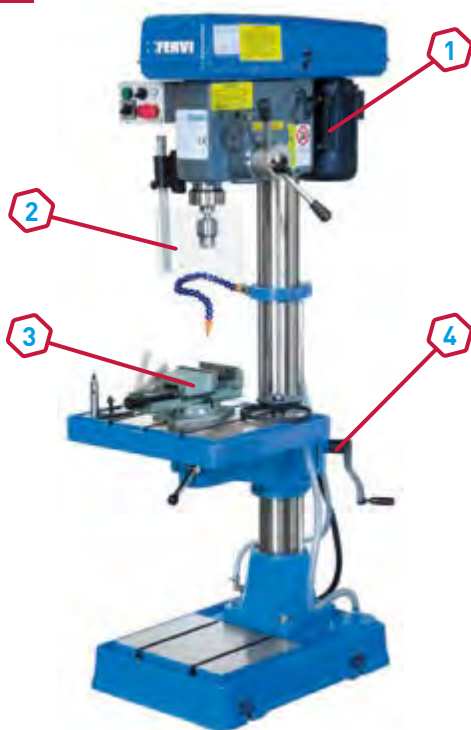

Art. T032DA
TRAPANO A COLONNA CON TRASMISSIONE A CINGHIA
€ 3250,00

- 1** Motore ad induzione
- 2** Protezione mandrino
- 3** Morsa in dotazione
- 4** Leva sollevamento tavola
- 5** Quadro comandi
- 6** Discesa automatica
- 7** Impianto di refrigerazione
- 8** Carter trasmissione con micro interruttore

ACCESSORI INCLUSI

- Mandrino a cremagliera 1 ÷ 16 B18
- Attacco mandrino CM 3
- Bussola di riduzione CM 3/2

Capacità max di foratura su ghisa	31,75 mm
Colonna	Ø 115 mm
Corsa mandrino	130 mm
Distanza asse mandrino e colonna	223 mm
Distanza max asse mandrino - tavola	696 mm
Distanza max asse mandrino - base	1135 mm
Cono morse CM	3
Velocità mandrino	(8) 160 ÷ 2200 rpm
Velocità di discesa	0,1- 0,16- 0,26 mm/giro
Area di lavoro della tavola	400 x 470 mm
Area di lavoro della base	400 x 310 mm
Corsa tavola	510 mm
Motore trifase due velocità	400 V 50 Hz 0,85 kW / 1,1 kW
Pompa di refrigerazione	400 V 50 Hz 40 W
Peso	360 kg
Dimensioni	900 x 545 x 1765 mm
Dimensioni imballo	970 x 570 x 1910 mm

**TRAPANO A COLONNA CON DISCESA AUTOMATICA, TRASMISSIONE A CINGHIA, SISTEMA DI REFRIGERAZIONE
 MORSA DA 125 mm**



Art. T032

TRAPANO A COLONNA CON TRASMISSIONE A CINGHIA

€ 2750,00



- 1 Motore ad induzione
- 2 Protezione mandrino
- 3 Tavola regolabile
- 4 Leva sollevamento tavola
- 5 Quadro comandi
- 6 Morsa in dotazione
- 7 Volantino discesa
- 8 Carter trasmissione con micro interruttore

ACCESSORI INCLUSI

- Mandrino a cremagliera 1 ÷ 16 B18
- Attacco mandrino CM 3
- Bussola di riduzione CM 3/2

Capacità max di foratura su ghisa	31,75 mm
Colonna	Ø 102 mm
Corsa mandrino	130 mm
Distanza asse mandrino e colonna	230 mm
Distanza max asse mandrino - tavola	700 mm
Distanza max asse mandrino - base	1175 mm
Cono morse CM	3
Velocità mandrino	(9) 160 ÷ 1880 rpm
Area di lavoro della tavola	330 x 380 mm
Area di lavoro della base	300 x 325 mm
Corsa tavola	670 mm
Motore trifase	400V 50Hz 1,5 kW
Peso	260 kg
Dimensioni	900 x 430 x 1760 mm
Dimensioni imballo	950 x 460 x 1910 mm

TRAPANO A COLONNA, TRASMISSIONE A CINGHIA, MORSA DA 125 mm

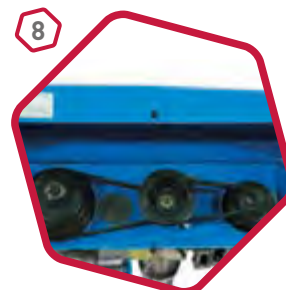



Art. T071
TRAPANO A COLONNA CON TRASMISSIONE A CINGHIA
€ 2950,00

- 1** Motore ad induzione
- 2** Protezione mandrino
- 3** Leva sollevamento tavola
- 4** Tavola ribaltabile con morsa
- 5** Quadro comandi
- 6** Fermo di profondità mandrino
- 7** Morsa incorporata
- 8** Carter trasmissione con micro interruttore

ACCESSORI INCLUSI

- Mandrino a cremagliera 1 ÷ 13 B16
- Attacco mandrino CM 3
- Bussola di riduzione CM 3/2 e CM 2/1

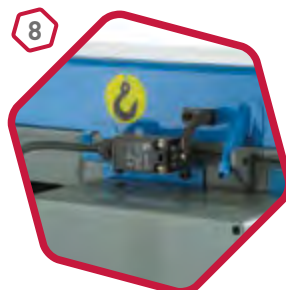
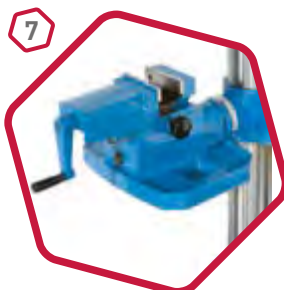
Capacità di foratura con preforo	Ø 28 mm
Cono morse CM	3
Corsa del mandrino	100 mm
Velocità mandrino	(16) 127 ÷ 2380 rpm
Canotto	Ø 62 mm
Distanza asse mandrino e colonna	203 mm
Distanza tra naso macchina e tavola	145-895 mm
Distanza tra naso macchina e base	1200 mm
Colonna	Ø 98 mm
Cava	12 mm
Dimensione tavola	350 x 280 mm
Inclinazione tavola	±90°
Apertura morsa	90 mm
Dimensione della base	410 x 560 mm
Motore trifase due velocità	400 V 50 Hz 0,5 / 1 kW
Peso	240 kg
Dimensioni ingombro	530 x 820 x 1700 mm
Dimensioni imballo	570 x 815 x 1810 mm

TRAPANO A COLONNA, TRASMISSIONE A CHINGHIA, INVERSIONE DI MARCIA, MORSA DA 120 mm



Art. T026
TRAPANO A COLONNA

€ 2400,00



- 1** Motore ad induzione
- 2** Protezione mandrino
- 3** Leva sollevamento tavola
- 4** Tavola regolabile
- 5** Quadro comandi
- 6** Carter trasmissione con micro interruttore
- 7** Volantino discesa
- 8** Carter trasmissione con micro interruttore

ACCESSORI INCLUSI

- Mandrino a cremagliera 1 ÷ 16 mm B 18
- Attacco mandrino CM 3 B 18
- Bussola di riduzione CM 3/2

Capacità max di foratura su ghisa	25 mm
Colonna	Ø 85 mm
Corsa mandrino	93 mm
Distanza asse mandrino e colonna	180 mm
Distanza max asse mandrino - tavola	620 mm
Distanza max asse mandrino - base	1230 mm
Cono morse CM	3
Velocità mandrino	(9) 240 ÷ 2710 rpm
Area di lavoro della tavola	255 x 215 mm
Dimensione tavola	310 x 280 mm
Cava	14 mm
Area di lavoro della base	300 x 295 mm
Corsa tavola	520 mm
Motore trifase	400V 50Hz 1,1 kW
Peso	167,5 kg
Dimensioni	780 x 440 x 1690 mm
Dimensioni imballo	800 x 550 x 1820 mm

TRAPANO A COLONNA CON TRASMISSIONE A CINGHIA





Art. T024
TRAPANO DA BANCO
€ 2200,00

- 1 Motore ad induzione
- 2 Protezione mandrino
- 3 Leva sollevamento tavola
- 4 Tavola regolabile
- 5 Quadro comandi
- 6 Carter trasmissione con micro interruttore
- 7 Volantino discesa
- 8 Carter trasmissione

ACCESSORI INCLUSI

- Mandrino a cremagliera 1 ÷ 16 mm B 18
- Attacco mandrino CM 3 B 18
- Bussola di riduzione CM 3/2

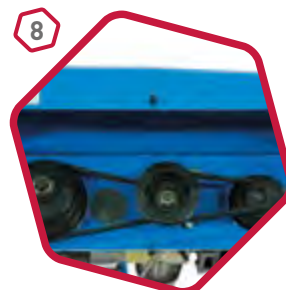
Capacità max di foratura su ghisa	25 mm
Colonna	Ø 85 mm
Corsa mandrino	93 mm
Distanza asse mandrino e colonna	180 mm
Distanza max asse mandrino - tavola	360 mm
Distanza max asse mandrino - base	595 mm
Cono morse CM	3
Velocità mandrino	[9] 240 ÷ 2710 rpm
Area di lavoro della tavola	255 x 215 mm
Dimensione tavola	310 X 280 mm
Cava	14 mm
Area di lavoro della base	245 x 250 mm
Corsa tavola	265 mm
Motore trifase	400V 50Hz 1,1 kW
Peso	118 kg
Dimensioni	730 x 440 x 1060 mm
Dimensioni imballo	750 x 550 x 1200 mm

TRAPANO DA BANCO CON TRASMISSIONE A CINGHIA



Art. 0512

TRAPANO A COLONNA CON DOPPIA TAVOLA

€ 1650,00



- 1 Motore ad induzione
- 2 Protezione mandrino
- 3 Tavola da legno girevole
- 4 Tavola da ferro inclinabile
- 5 Illuminazione
- 6 Display
- 7 Cambio velocità
- 8 Carter trasmissione con micro interruttore

ACCESSORI INCLUSI

- Mandrino autoserrante 3 ÷ 16 B16
- Attacco mandrino CM 2

Mandrino autoserrante CM	2 - Ø 16mm
Motore monofase	230 V 50 Hz 0.9 kW
Peso	90 kg
Corsa del mandrino	115 mm
Colonna	Ø 72 mm
Distanza asse mandrino - colonna	190 mm
Velocità variabile	420 ÷ 1950 rpm
Area di lavoro della tavola per metalli	305 x 305 mm
Area di lavoro della tavola per legno	600 x 300 mm
Corsa tavola	490 mm
Dimensioni	610 x 830 x 1550 mm
Dimensioni imballo	1150 x 500 x 300 mm

TRAPANO A COLONNA CON TRASMISSIONE A CINGHIA E PULEGGE A VELOCITÀ VARIABILE. DOPPIA TAVOLA PER LAVORI DI OFFICINA E FALEGNAMERIA. TAVOLA PER METALLI GIREVOLE E INCLINABILE LATERALMENTE $0 \div \pm 45^\circ$. TAVOLA PER LEGNO INCLINABILE LATERALMENTE $0 \div \pm 45^\circ$ E FRONTALMENTE $0 \div 45^\circ$. LAMPADA A LED E INDICATORE DI VELOCITÀ DIGITALE.



Art. 0252/230V & 0252/400V
TRAPANO A COLONNA CON TRASMISSIONE A CINGHIA
€ 1750,00

- 1** Motore ad induzione
- 2** Quadro comandi
- 3** Protezione mandrino telescopica
- 4** Tavola ribaltabile con morsa
- 5** Morsa incorporata
- 6** Illuminazione
- 7** Quadro elettrico
- 8** Tendicinghia

ACCESSORI INCLUSI

- Mandrino autoserrante 3 ÷ 16 B16
- Attacco mandrino CM 4

	0252/230V	0252/400V
Morsa	120 x 155 mm	120 x 155 mm
Cava	14 mm	14 mm
Mandrino autoserrante CM	Ø 16 mm, CM 4	Ø 16 mm, CM 4
Dimensioni tavola	470 x 420 mm	470 x 420 mm
Corsa mandrino	120 mm	120 mm
Altezza	1720 mm	1720 mm
Distanza mandrino-colonna	255 mm	255 mm
Distanza naso macchina-tavola	700 mm	700 mm
Canotto	Ø 62 mm	Ø 62 mm
Colonna	Ø 92 mm	Ø 92 mm
Distanza naso macchina-base	1220 mm	1220 mm
Velocità mandrino	(12) 150 ÷ 2450 rpm	(12) 150 ÷ 2450 rpm
Motore	230 V 50 Hz 1,5 kW	400 V 50 Hz 1,5 kW
Peso	160 kg	160 kg

TRAPANO A COLONNA CON TRASMISSIONE A CINGHIA, MISURATORE DIGITALE DI PROFONDITÀ, MORSA INTEGRATA SCORREVOLE, NUOVO TENDICINGHIA, LUCE A LED INTEGRATA





Art. 0754/230V & 0754/400V
TRAPANO A COLONNA CON TRASMISSIONE A CINGHIA

€ 1500,00



- 1** Motore ad induzione
- 2** Leva sollevamento tavola
- 3** Testa in fusione
- 4** Tavola inclinabile
- 5** Protezione mandrino telescopica
- 6** Quadro comandi
- 7** Quadro elettrico
- 8** Carter trasmissione con micro interruttore

ACCESSORI INCLUSI

- Mandrino autoserrante 3 ÷ 20 B22
- Attacco mandrino CM 4

	0754/230V	0754/400V
Dimensioni tavola	475 x 425 mm	475 x 425 mm
Cava	14 mm	14 mm
Mandrino	Ø 20 mm B 22 CM 4	Ø 20 mm B 22 CM 4
Corsa mandrino	120 mm	120 mm
Altezza	1710 mm	1710 mm
Distanza colonna-mandrino	260 mm	260 mm
Canotto	Ø 62 mm	Ø 62 mm
Colonna	Ø 92 mm	Ø 92 mm
Velocità mandrino	(12) 150 ÷ 2450 rpm	(12) 150 ÷ 2450 rpm
Motore	230 V 50 Hz 1,5 kW	400 V 50 Hz 1,5 kW
Peso	130 kg	130 kg

TRAPANO A COLONNA CON TRASMISSIONE A CINGHIA, TAVOLA INCLINABILE

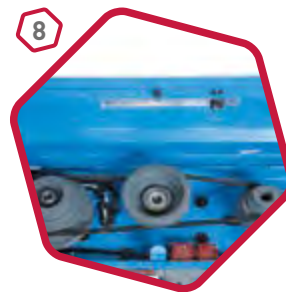



Art. 0752
TRAPANO A COLONNA CON TRASMISSIONE A CINGHIA
€ 880,00

- 1** Motore ad induzione
- 2** Leva sollevamento tavola
- 3** Testa in fusione
- 4** Tavola inclinabile
- 5** Protezione mandrino telescopica
- 6** Quadro comandi
- 7** Quadro elettrico
- 8** Carter trasmissione con micro interruttore

ACCESSORI INCLUSI

- Mandrino autoserrante Ø16 B16
- Attacco mandrino CM 2

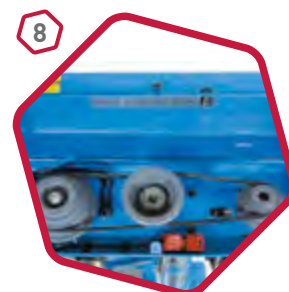
Mandrino autoserrante CM	Ø 16 mm B16 CM 2
Corsa mandrino	80 mm
Altezza	1630 mm
Dimensioni tavola	290 x 290 mm
Distanza asse mandrino - colonna	178 mm
Distanza tra naso macchina e base	1170 mm
Canotto	Ø 47 mm
Colonna	Ø 80 mm
Velocità mandrino	(12) 180 ÷ 2740 rpm
Motore monofase	230 V 50 Hz 0,75 kW
Peso	63 kg

TRAPANO A COLONNA CON TRASMISSIONE A CINGHIA, TAVOLA INCLINABILE



Art. 0750

TRAPANO DA BANCO CON TRASMISSIONE A CINGHIA

€ 735,00



- 1 Motore ad induzione
- 2 Leva sollevamento tavola
- 3 Testa in fusione
- 4 Tavola inclinabile
- 5 Protezione mandrino telescopica
- 6 Quadro comandi
- 7 Quadro elettrico
- 8 Carter trasmissione con micro interruttore

ACCESSORI INCLUSI

- Mandrino autoserrante Ø16 B16
- Attacco mandrino CM 2

Mandrino autoserrante CM	Ø 16 mm CM 2
Corsa mandrino	80 mm
Altezza	980 mm
Dimensioni tavola	290 x 290 mm
Distanza asse mandrino - colonna	178 mm
Canotto	Ø 47 mm
Colonna	Ø 80 mm
Distanza tra naso macchina e base	650 mm
Velocità mandrino	(12) 180 ÷ 2740 rpm
Motore monofase	230 V 50 Hz 0,75 kW
Peso	58 kg

TRAPANO DA BANCO CON TRASMISSIONE A CINGHIA, TAVOLA INCLINABILE

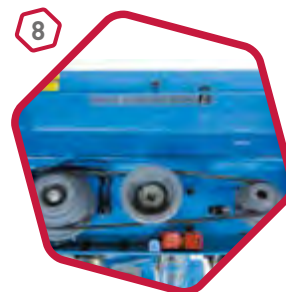

Art. 0242
TRAPANO DA BANCO CON TRASMISSIONE A CINGHIA
€ 840,00

- 1 Motore ad induzione
- 2 Leva sollevamento tavola
- 3 Illuminazione
- 4 Tavola inclinabile
- 5 Quadro comandi
- 6 Quadro elettrico
- 7 Protezione mandrino telescopica
- 8 Tendicinghia

ACCESSORI INCLUSI

- Mandrino autoserrante Ø16 B16
- Attacco mandrino CM 2

Mandrino autoserrante CM	Ø 16 mm, CM 2
Dimensioni tavola	305 x 305 mm
Cava	16 mm
Corsa mandrino	85 mm
Altezza	990 mm
Distanza mandrino-colonna	180 mm
Distanza naso macchina-tavola	420 mm
Canotto	Ø 47 mm
Colonna	Ø 72 mm
Distanza naso macchina-base	600 mm
Velocità mandrino	(16) 180 ÷ 2770 rpm
Motore monofase	230 V 50 Hz 0,75 kW
Peso	60 kg

TRAPANO DA BANCO CON TRASMISSIONE A CINGHIA, MISURATORE DIGITALE DI PROFONDITÀ, NUOVO TENDICINGHIA, LUCE A LED INTEGRATA, TAVOLA INCLINABILE





Art. 0260

TRAPANO DA BANCO CON TRASMISSIONE A CINGHIA

€ 700,00



- 1** Motore ad induzione
- 2** Leva sollevamento tavola
- 3** Illuminazione
- 4** Tavola inclinabile
- 5** Quadro comandi
- 6** Quadro elettrico
- 7** Protezione mandrino telescopica
- 8** Tendicinghia

ACCESSORI INCLUSI

- Mandrino autoserrante Ø13 B16
- Attacco mandrino CM 2

Mandrino autoserrante CM	Ø 13 mm, CM 2
Dimensioni tavola	290 x 290 mm
Cava	16 mm
Corsa mandrino	85 mm
Altezza	980 mm
Distanza mandrino-colonna	162 mm
Distanza naso macchina-tavola	435 mm
Canotto	Ø 40 mm
Colonna	Ø 72 mm
Distanza naso macchina-base	625 mm
Velocità mandrino	(16) 180 ÷ 2770 rpm
Motore monofase	230 V 50 Hz 550 W
Peso	50 kg

TRAPANO DA BANCO CON TRASMISSIONE A CINGHIA, MISURATORE DIGITALE DI PROFONDITÀ, NUOVO TENDICINGHIA, LUCE A LED INTEGRATA, TAVOLA INCLINABILE





Art. 0012
TRAPANO DA BANCO CON TRASMISSIONE A CINGHIA
€ 550,00

- 1** Motore ad induzione
- 2** Leva sollevamento tavola
- 3** Testa in fusione
- 4** Tavola inclinabile e girevole
- 5** Quadro comandi
- 6** Quadro elettrico
- 7** Protezione mandrino telescopica
- 8** Carter trasmissione con micro interruttore

ACCESSORI INCLUSI

- Mandrino autoserrante Ø16 B16
- Attacco mandrino CM 2

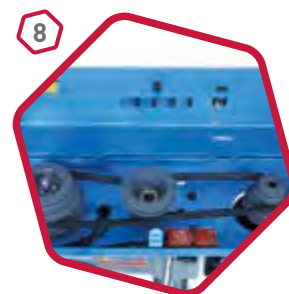
Mandrino autoserrante CM	2 - Ø 16 mm
Corsa mandrino	80 mm
Altezza	990 mm
Dimensioni tavola	Ø 290 mm
Distanza asse mandrino - colonna	160 mm
Canotto	Ø 40 mm
Colonna	Ø 71 mm
Distanza tra naso macchina e base	650 mm
Velocità mandrino	(12) 280 ÷ 2380 rpm
Motore monofase	230 V 50 Hz 0,65 kW
Peso	51 kg

TRAPANO DA BANCO CON TRASMISSIONE A CINGHIA, TAVOLA GIREVOLE E INCLINABILE



Art. 0757

TRAPANO DA BANCO CON TRASMISSIONE A CINGHIA

€ 650,00



- 1 Motore ad induzione
- 2 Leva sollevamento tavola
- 3 Quadro comandi
- 4 Tavola inclinabile e girevole
- 5 Testa inclinabile
- 6 Movimento radiale
- 7 Braccio tavola snodato
- 8 Carter trasmissione con micro interruttore

ACCESSORI INCLUSI

- Mandrino autoserrante 16 B16
- Attacco mandrino CM 2

Mandrino autoserrante CM	2 - Ø 16 mm
Corsa mandrino	80 mm
Altezza	1000 mm
Distanza mandrino-colonna	430 mm
Tavola rotonda	Ø 305 mm
Inclinazione testa	90° Sx / L. 45° Dx / R.
Canotto	Ø 40 mm
Colonna	Ø 71 mm
Distanza tra naso macchina e base	670 mm
Velocità mandrino	(5) 500 ÷ 2450 rpm
Motore monofase	230 V 50 Hz 0,55 kW
Peso	57 kg

TRAPANO DA BANCO CON TRASMISSIONE A CINGHIA, TAVOLA GIREVOLE E INCLINABILE



Art. 0518/20
TRAPANO MAGNETICO
€ 756,00

Mandrino a cremagliera	Ø 13 mm
Albero	Weldon Ø 19,05 mm
Corsa del mandrino	165 mm
Forza magnetica	8500 N
Velocità mandrino	750 rpm
Motore monofase	230 V 50 Hz 0.9 kW
Dimensioni	300 x 260 x 450 mm
Valigetta	442 x 395 x 175 mm
Peso	18,5 kg

TRAPANO MAGNETICO, CON RAFFREDDAMENTO A LIQUIDO PER FRESE A CAROTARE FINO A Ø 20 mm CON ATTACCO WELDON Ø 19.05 mm E PUNTE CILINDRICHE FINO A Ø 20 mm CON CODOLO RIDOTTO A Ø 13mm

Art. 0518/30
TRAPANO MAGNETICO
€ 1029,00

Mandrino a cremagliera	Ø 16 mm
Albero	Weldon Ø 19,05 mm
Corsa del mandrino	175 mm
Forza magnetica	11000 N
Velocità mandrino	550 rpm
Motore monofase	230 V 50 Hz 1.1 kW
Dimensioni	360 x 280 x 490 mm
Valigetta	527 x 472 x 242 mm
Peso	27 kg

TRAPANO MAGNETICO, CON RAFFREDDAMENTO A LIQUIDO PER FRESE A CAROTARE FINO A Ø 30 mm CON ATTACCO WELDON Ø 19.05 mm E PUNTE CILINDRICHE FINO A Ø 20 mm CON CODOLO RIDOTTO A Ø 13 - 16 mm

Art. 0518/50
TRAPANO MAGNETICO
€ 1407,00

Mandrino a cremagliera	Ø 16 mm
Mandrino CM	3 - Weldon Ø 19,05 mm
Cono albero CM	3
Corsa del mandrino	220 mm
Forza magnetica	15000 N
Velocità mandrino	450, 650 rpm
Motore monofase	230 V 50 Hz 1.5 kW
Dimensioni	400 x 310 x 475 mm
Valigetta	587 x 489 x 265 mm
Peso	37.5 kg

TRAPANO MAGNETICO, CON RAFFREDDAMENTO A LIQUIDO PER FRESE A CAROTARE FINO A Ø 50 mm CON ATTACCO WELDON Ø 19.05 mm, PUNTE CON ATTACCO CONICO CM 3 E PUNTE CILINDRICHE FINO A Ø 20 mm CON CODOLO RIDOTTO A Ø 13 - 16 mm

Art. 0692/230V & 0692/400V
SEGATRICE A NASTRO CON DISCESA MANUALE E IDRAULICA
€ 2850,00

	0692/230V	0692/400V
Dimensioni lama	2100 x 20 x 0,9 mm	
Motore	Monofase 230V 50 Hz 0,75 kW	Trifase 400V 50 Hz 0,55 / 0,9 kW
Velocità	40 rpm	40 rpm - 80 rpm
Angolo di taglio	0° ÷ 60°	
Peso	170 kg	
Capacità di taglio	90° ● 170 mm - ■ 170 mm - ■ 210 mm	
	45° ● 120 mm - ■ 110 mm - ■ 140 mm	

SEGATRICE A NASTRO CON DISCESA MANUALE E IDRAULICA, CON STRUMENTO DI REGOLAZIONE TENSIONE LAMA, SISTEMA DI REFRIGERAZIONE, MORSA RAPIDA

- 1 Discesa idraulica
- 2 Morsa a serraggio rapido
- 3 Tensionatore lama

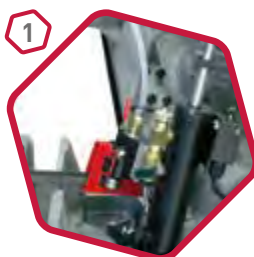
Art. 0255
SEGATRICE A NASTRO PER METALLI
€ 1500,00

Dimensioni lama	1735 x 13 x 0,65 mm
Angolo di taglio	0 ÷ 60°
Velocità di taglio	34 m / min
Motore monofase	230 V 50 Hz 0,5 kW
Capacità di taglio	90° ● 150 x 140 mm ■ 140 mm
Capacità di taglio	45° ● 140 x 105 mm ■ 105 mm
Peso	89 kg

SEGATRICE A NASTRO PER METALLI, CON SISTEMA DI REFRIGERAZIONE, MORSA RAPIDA, BASAMENTO CON VANO PORTAUTENSILI

- 1 Morsa a serraggio rapido
- 2 Taglio a 45°
- 3 Pompa di refrigerazione





Art. 0362
SEGATRICE A NASTRO

€ 725,00



Dimensioni lama	1435 x 12,7 x 0,65 mm
Angolo di taglio	0° ÷ 60°
Motore monofase	230 V 50 Hz 0,4 kW
Peso	22 kg
Capacità di taglio	90° ● 125 mm ■ 125 mm
Capacità di taglio	45° ● 76 mm ■ 76 mm

SEGATRICE A NASTRO ELETTRONICA DA BANCO
CON MOTORE INVERTER

- 1 Potenziometro
- 2 Taglio a 45°
- 3 Blocco per trasporto



Art. 0500
SEGATRICE A NASTRO ELETTRONICA DA BANCO

€ 595,00



Dimensioni lama	1140 x 13 x 0,65 mm
Velocità	20-70 m / min
Angolo di taglio	0° ÷ 45°
Motore monofase	230 V 50 Hz 1,8 kW
Peso	20 kg
Capacità di taglio	90° ● 105 mm ■ 110 x 105 mm
Capacità di taglio	45° ● 55 mm ■ 55 x 60 mm
Morsa	100 x 54 mm
Apertura morsa	125 mm

SEGATRICE A NASTRO ELETTRONICA DA BANCO CON MOTORE A SPAZZOLE

- 1 Potenziometro
- 2 Taglio a 45°
- 3 Guida lama regolabile



TABELLA DI COMPATIBILITÀ

Codice Compatibile	Descrizione	€	0692/230V	0692/400V	0255	0362	0500	Pag
0133	CAVALLETTO A RULLO	135,00	•	•	•			88
R001/04	RULLIERA REGOLABILE IN ALTEZZA	320,00	•	•	•			87
R001/07	RULLIERA REGOLABILE IN ALTEZZA	450,00	•	•	•			87
0522	SUPPORTO PIEGHEVOLE PER MACCHINE PORTATILI	240,00				•	•	86
N180	LAMA BIMETALLICA PER METALLO	20,70					•	86
N181	LAMA BIMETALLIA PER METALLO	20,70					•	86
N182	LAMA BIMETALLICA PER METALLO	23,60				•		86
N183	LAMA BIMETALLICA PER METALLO	23,60				•		86
N184	LAMA BIMETALLICA PER METALLO	40,30	•	•				86
N185	LAMA BIMETALLICA PER METALLO	30,00			•			86
0536	LAMPADA ALOGENA PER MACCHINE UTENSILI	71,50	•	•	•			231

LAMA BIMETALLICA PER METALLO

Codice	Misure	Specifiche	€
N180	1140 x 13 x 0,65 mm	T8 / 12 Bi-Metal	20,70
N181	1140 x 13 x 0,65 mm	T6 Bi-Metal	20,70
N182	1435 x 12,7 x 0,65 mm	T8 / 12 Bi-Metal	23,60
N183	1435 x 12,7 x 0,65 mm	T6 Bi-Metal	23,60
N184	2100 x 20 x 0,9 mm	T8 / 12 Bi-Metal	40,30
N185	1735 x 12,7 x 0,65 mm	T8 / 12 Bi-Metal	30,00

Art. 0522
SUPPORTO PIEGHEVOLE PER MACCHINE PORTATILI
€ 240,00

Portata	150 kg	Distanza rulli	870 - 1070 - 1350 mm
Dimensioni piano	820 x 460 mm	Altezza rulli	37 ÷ 470 mm
Altezza tavola	600 - 715 - 745 - 770 - 795 - 820 mm	Peso	17 kg



Art. 0642
TRONCATRICE VELOCE

€ 314,00



Motore monofase	230 V 50 Hz 2 kW
Dimensioni disco	355 x 3.0 x 25.4 mm
Velocità disco	3800 rpm
Angolo di taglio	± 45°
Capacità di taglio	<ul style="list-style-type: none"> ■ 100 x 100 mm ■ 200 x 40 mm ● 100 mm
Apertura morsa	155 mm - 190 mm - 230 mm
Peso	20 kg



RULLIERA REGOLABILE IN ALTEZZA

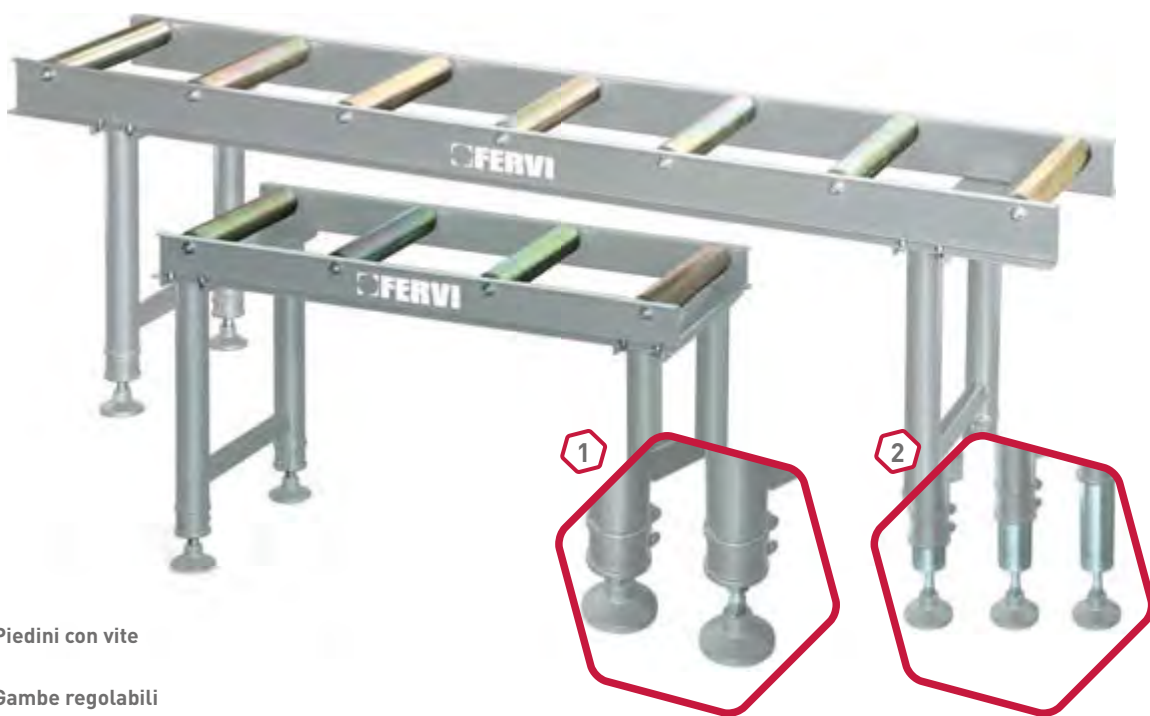

- 1** Piedini con vite
- 2** Gambe regolabili

	R001/04	R001/07
Dimensioni	1000 x 420 mm	2000 x 420 mm
Distanza rulli	230 mm	230 mm
Dimensioni rulli	Ø 60 x 360 mm M12	Ø 60 x 360 mm M12
Altezza	580 / 1030 mm	580 / 1030 mm
Portata max	400 kg	400 kg
Peso	27 kg	45 kg
€	320,00	450,00

RULLIERA CON PIEDINI A REGOLAZIONE INDIPENDENTE DELL'ALTEZZA

Art. 0133 € 135,00
CAVALLETTO A RULLO

Dimensioni rullo	Ø 52 x 350 mm
Altezza	690 / 1200 mm
Portata max	50 ÷ 60 kg
Peso	17 kg

Art. 0565 € 159,00
SMERIGLIATRICE AD ALBERO FLESSIBILE

Mandrino di precisione con chiave	0 - 4 mm
Velocità variabile	500 ÷ 22000 rpm
Lunghezza albero flessibile	900 mm
Motore monofase	230 V 50 Hz 185 W
Imballo	10

SMERIGLIATRICE AD ALBERO FLESSIBILE
 CON VARIATORE DI VELOCITÀ A PEDALE

Art. 0568 € 53,30
MINI SMERIGLIATRICE CON UTENSILI

Mandrino di precisione con chiave	Ø 3 mm
Velocità variabile	8000 ÷ 32500 rpm
Lunghezza albero flessibile	1000 mm
Altezza supporto	650 mm
Capacità morsetto	65 mm
Motore monofase	230 V 50 Hz 135 W
Imballo	10

MINI SMERIGLIATRICE CON UTENSILI, SUPPORTO DA
 BANCO ED ALBERO FLESSIBILE

MOLE DA BANCO



0383



0510



0503



0023



0551



0552/..



0553



0554/..



0556



0377

POTENZA

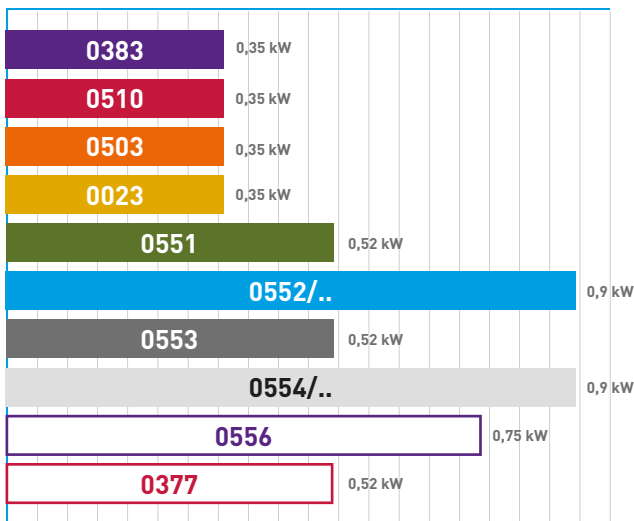

PESO

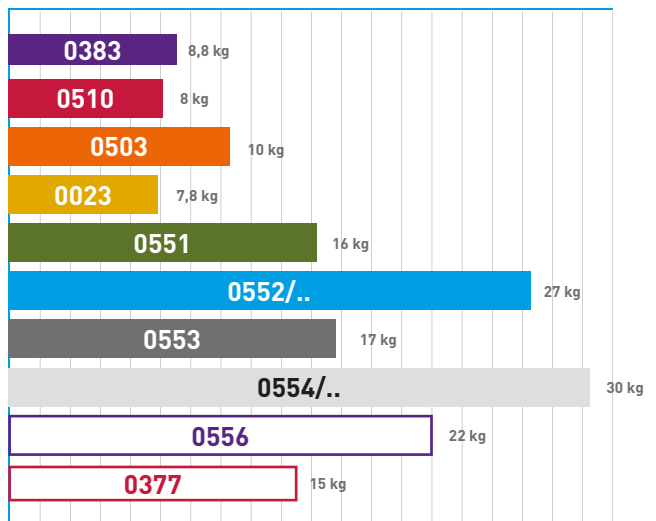

Art. 0383
SMERIGLIATRICE DA
BANCO CON LEVIGATRICE
€ 160,00

Nastro	50 x 686 mm GR100
Mola	2950 rpm Ø 150 x 20 x 16 mm GR36
Motore monofase	230 V 50 Hz 0,35 kW
Peso	8,8 kg

Art. 0510
SMERIGLIATRICE COMBINATA DA BANCO
€ 102,00

Spazzola	2950 rpm - Ø 150 x 20 x 12,7 mm
Mola	2950 rpm - Ø 150 x 20 x 12,7 mm GR36
Motore monofase	230 V 50 Hz 0,35 kW
Peso	8 kg

Art. 0503
SMERIGLIATRICE COMBINATA DA BANCO
€ 105,00

Mola ad acqua	130 rpm - Ø 200 x 40 x 20 mm GR80
Mola a secco	2950 rpm - Ø 150 x 20 x 12,7 mm GR80
Motore monofase	230 V 50 Hz 0,35 kW
Peso	10 kg



Art. 0023
SMERIGLIATRICE DA BANCO

€ 92,50



Mola	2950 rpm - Ø 150 x 20 x 12,7 mm GR36 - GR80
Motore monofase	2950 rpm - 230 V 50 Hz 0,35 kW
Peso	7,8 kg



Art. 0551
SMERIGLIATRICE DA BANCO PROFESSIONALE

€ 186,00



Mola	2950 rpm - Ø 150 x 20 x 16 mm GR36 - GR80
Motore monofase	230 V 50 Hz 0,52 kW
Peso	16 kg



Art. 0552 & 0552/400V
SMERIGLIATRICE DA BANCO PROFESSIONALE

€ 295,00



	0552	0552/400V
Mola	2950 rpm - Ø 200 x 25 x 20 mm GR36 - GR80	2950 rpm - Ø 200 x 25 x 20 mm GR36 - GR80
Motore	230V 50Hz 0,9 kW	400V 50 Hz 0,9 kW
Peso	27 kg	27 kg

**Art. 0553****SMERIGLIATRICE COMBINATA PROFESSIONALE****€ 200,00**

Spazzola	2950 rpm - Ø 150 x 20 x 16 mm
Mola	2950 rpm - Ø 150 x 20 x 16 mm GR36
Motore monofase	230 V 50 Hz 0,52 kW
Peso	17 kg

**Art. 0554 & 0554/400V****SMERIGLIATRICE COMBINATA PROFESSIONALE****€ 320,00****0554****0554/400V**

Spazzola	2950 rpm - Ø 200 x 25 x 20 mm	2950 rpm - Ø 200 x 25 x 20 mm
Mola	2950 rpm - Ø 200 x 25 x 20 mm GR36	2950 rpm - Ø 200 x 25 x 20 mm GR36
Motore monofase	230V 50 Hz 0,9 kW	400V 50 Hz 0,9 kW
Peso	30 kg	30 kg

**Art. 0556****SMERIGLIATRICE COMBINATA PROFESSIONALE CON ALBERI LUNGHI****€ 232,00**

Spazzola	2950 rpm - Ø 200 x 25 x 20 mm
Mola	2950 rpm - Ø 200 x 25 x 20 mm GR36
Motore monofase	230 V 50 Hz 0,75 kW
Peso	22 kg

Art. 0316
AFFILACATENE PER MOTOSEGA
€ 165,00

Mola rosa	Ø 145 x 4,7 x 22,3 mm
Affilatura	+30° / -35°
Per catene	1/4" - 325" - 3/8" - 404" - 3/4"
Motore monofase	230 V 50 Hz 0,23 kW
Peso	5 kg
Imballo	3

Art. 0502
AFFILACATENE PER MOTOSEGA
€ 80,00

Mola rosa	Ø 100 x 4,5 x 10 mm	Motore monofase	230 V 50 Hz 0,25 kW
Affilatura	+35° / -35°	Peso	1,8 kg
Per catene	1/4" - 325" / 3/8" - 404"	Imballo	6

TABELLA DI COMPATIBILITÀ

Codice compatibile	Descrizione	€	0316	0502	A003/13	A013/26	A0132A	A003/13M	0804	A059	Pag.
M159	MOLE ABRASIVE	8,70	•								022
M160	MOLE ABRASIVE	8,70	•								022
M162	MOLE ABRASIVE	26,80	•								022
A0132A/MR	MOLA ROSA	20,20					•				096
A0132A/MB	MOLA BIANCA	20,20					•				096
A003/13M	MOLA DIAMANTATA	105,00			•						096
A013/26M	MOLA DIAMANTATA	162,00				•					096
0804/MD	MOLA DIAMANTATA	105,00						•			096
A059/M	MOLA DIAMANTATA	11,20								•	096



Art. A003/13
AFFILATRICE PER PUNTE ELICOIDALI

€ 750,00



Capacità di affilatura	3 ÷ 13 mm
Inclinazione punta	118° ÷ 135°
Velocità	7000 rpm
Motore monofase	230 V 50 Hz 120 W
Dimensioni	300 x 140 x 170 mm
Peso	9,5 kg



Art. A013/26
AFFILATRICE PER PUNTE ELICOIDALI

€ 1163,00



Capacità di affilatura	13 ÷ 26 mm
Inclinazione punta	118° ÷ 135°
Velocità	4200 rpm
Motore monofase	230 V 50 Hz 0,2 kW
Dimensioni	370 x 165 x 200 mm
Peso	24,5 kg



Art. A0132A
AFFILATRICE PER PUNTE ELICOIDALI

€ 1061,00



Capacità di affilatura	3 ÷ 20 mm
Inclinazione punta	90° ÷ 140°
Velocità	7000 rpm
Motore monofase	230 V 50 Hz 0,6 kW
Dimensioni	500 x 230 x 250 mm
Peso	21 kg



Art. 0804
AFFILATRICE MANUALE PER DISCHI

€ 552,00



Capacità di affilatura	Ø 80 ÷ 700 mm
Velocità	2850 rpm
Motore monofase	230 V 50 Hz 0,25 kW
Peso	39 kg

Art. A059
AFFILATRICE MULTIFUNZIONE
€ 108,00

Capacità di affilatura	3 - 13 mm
Velocità	3000 rpm
Motore monofase	230 V 50 Hz 0,15 kW
Dimensioni	232 x 160 x 110 mm
Peso	2 kg

Art. A0132A/MR € 20,20
MOLA ROSA

MOLA ROSA
 FILETTO M8 , Ø 40 X 38 mm INTERNO Ø 26 mm

Art. A0132A/MB € 20,20
MOLA BIANCA

MOLA BIANCA
 FILETTO M8 , Ø 40 X 38 mm INTERNO Ø 26 mm

Art. A003/13M € 105,00
MOLA DIAMANTATA

MOLA CBN DI RICAMBIO

Art. A013/26M € 162,00
MOLA DIAMANTATA

MOLA CBN DI RICAMBIO

Art. 0804/MD € 105,00
MOLA DIAMANTATA 125 mm

MOLA DIAMANTATA 125 mm
 125 x 10 x F32 x 8 mm

Art. A059/M € 11,20
SET 5 MOLE

SET MOLE DI RICAMBIO



Art. 0691/400V
LEVIGATRICE A NASTRO INCLINABILE

€ 2370,00



- 1 Levigatura piana
- 2 Levigatura frontale
- 3 Leva tensionamento
- 4 3 livelli di inclinazione

Dimensioni nastro	2000 x 150 mm
Velocità	(2) 18 ÷ 37 m/sec
Motore trifase	400 V 50 Hz 4 kW
Peso	122 kg



Art. 0662
LEVIGATRICE A NASTRO INCLINABILE CON BANCO

€ 650,00



Dimensioni nastro	1219 x 152 mm	Velocità disco	1400 m/min
Diametro disco	Ø 230 mm	Dimensioni	710 x 510 x 1000 mm
Dimensioni piano di lavoro	330 x 152 mm	Dimensioni imballo	705 x 455 x 385 mm
Velocità nastro	330 m/min	Motore monofase	230 V 50 Hz 0,75 kW
		Peso	54 kg

LEVIGATRICE A NASTRO INCLINABILE CON BANCO, BANCO DA ASSEMBLARE

Art. 0560
SMUSSATRICE DA BANCO
€ 665,00

Smusso	45° 0 - 5 mm	Dimensioni fresa	Ø 80 mm - Z 8
Velocità	2800 rpm	Inserto	SPUN13P
Motore monofase	230 V 50 Hz 0,25 kW	Peso	25 kg
Dimensione piani	2 - 400 x 50 mm		

Art. 0022
SMUSSATRICE PORTATILE
€ 683,00

Smusso	15° - 45° 0 - 5 mm	Dimensioni fresa	Ø 80 mm - Z 8
Velocità	2950 rpm	Inserto	SPUN13P
Motore monofase	230 V 50 Hz 0,25 kW	Peso	12,5 kg
Dimensioni piani	2 - 200 x 50 mm		

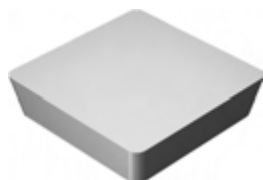
Art. SPUN13P
INSERTO DI RICAMBIO
€ 9,20

Imballo	10
----------------	----



Art. 0285/75
CALANDRA MOTORIZZATA

€ 4838,00



- 1 Rullo estraibile
- 2 Microinterruttore 3 posizioni

Lunghezza utile	1300 mm
Spessore max	1.5 mm
Diametro dei rulli	75 mm
Motore trifase	400 V 50 Hz 0.75 kW
Peso	310 kg

CALANDRA MOTORIZZATA A 3 RULLI IN ACCIAIO CON DUREZZA 52HRC, BARRIERA DI ARRESTO DI EMERGENZA A FILO CON MICRO DI SICUREZZA A 3 FUNZIONI, COMANDI MOBILI CON DOPPIO PEDALE AVANTI/INDIETRO E PULSANTE A FUNGO DI ARRESTO DI EMERGENZA



Art. 0235
MINI CALANDRA

€ 228,00



Lunghezza max	300 mm
Spessore max	2,5 mm
Diametro dei rulli	30 mm
Peso	11 kg

MINI CALANDRA PER MORSA DOTATA DI 3 RULLI, MORSA NON INCLUSA



Art. 0892
MINI CESCOIA - PIEGATRICE

€ 465,00



Lavoro utile	200 mm
Max. spessore taglio su lamiera ferrosa	1 mm
Max. spessore piegatura su lamiera ferrosa	1 mm
Peso	18 kg

MINI CESCOIA - PIEGATRICE PER MORSA, LAMA INTERCAMBIABILE, MORSA NON INCLUSA

Art. 0775
PIEGATRICE PER LAMIERA
€ 1520,00

Utile max	1000 mm
Max. spessore piegatura su lamiera ferrosa	1,2 mm
Max angolo di piegatura	140°
Peso	150 kg

Art. 0776 **€ 1132,00**
CALANDRA

Lunghezza max	1000 mm
Spessore max	0,8 mm
Diametro dei rulli	50 mm
Peso	130 kg

CALANDRA A 3 RULLI

CALANDRA CESOIA PIEGATRICE

	0772/1000	0772/600
Lunghezza utile	1016 mm	610 mm
Max spessore lavorabile	0,8 mm	0,8 mm
Angolo di piegatura	90°	90°
Ø min. di calandratura	47 mm	43 mm
Dimensioni mm	1420 x 640 x 740	960 x 410 x 610
Peso	205 kg	130 kg
€	1652,00	945,00

Art. 0773/05 & 0773/10
CESOIA A LEVA

	0773/05	0773/10
Dimensioni	290 x 120 x 240 mm	420 x 120 x 390 mm
Dimensioni base	290 x 90 mm	420 x 90 mm
Lungh. leva	620 mm	800 mm
Lungh. lama	130 mm	250 mm
Taglio piatto	38 x 3 mm	70 x 3 mm
Taglio lamiera	0,5 ÷ 3 mm	0,5 ÷ 3 mm
Tondo	Ø 6 mm	Ø 6 mm
Peso	10 kg	23 kg
€	161,00	234,00

Art. 0773/05L **€ 82,50**
SERIE LAME

Art. 0773/10L **€ 108,00**
SERIE LAME



Art. 0668
FORNO PER FUCINAZIONE

€ 1300,00



Temperatura di esercizio	1300° C ÷ 1400° C
Capacità max. di lavoro	Ø 70 mm / quadro 50 mm
Alimentazione	G.P.L.
Consumo	0,05 - 1,5 kg / h
Dimensioni interne	280 x 210 x 100h mm
Dimensioni esterne	400 x 260 x 250h mm
Peso	20 kg

FORNO PER FUCINAZIONE, FACILE DA USARE, ACCENSIONE RAPIDA, NESSUNA EMISSIONE NOCIVA.
RETRO SMONTABILE PER SCALDARE LE BARRE DI FERRO AL CENTRO
ISOLAMENTO CAMERA IN FIBRO CERAMICA. COMPLETO DI REGOLATORE, VALVOLA DI NON RITORNO E TERMOCOPPIA



Art. 0197
PIEGATRICE UNIVERSALE

€ 567,00



Tondino	15 mm	Quadro	13 mm
Piatto	30 x 8 mm	Peso	22 kg
		Piegatura a riccio	8 x 30 mm A caldo



Art. 0102
PIEGAFERRI

€ 321,00



Ferro dolce	A freddo	Quadro	20 mm
Tondino	22 mm	Peso	30 kg
Piatto	100 x 8 mm		

Art. 0113
CURVAFERRI
€ 322,00

Ferro dolce	A freddo
Tondino	10 mm
Piatto	10 x 30 mm
Quadro	10 mm
Peso	27 kg

Art. 0893
CURVATUBI IDRAULICO 1\2 - 2"
€ 519,00

- 1 Doppio pompante 2 Inclinazione regolabile

Matrici	1/2" 3/4" 1" 1-1/4" 1-1/2" 2" gas
Forza	10 tons N
Corsa pistone	250 mm
Peso	48 kg

CURVATUBI IDRAULICO 1\2 - 2" CON POMPA A 2 VELOCITÀ

Art. 0292 & 0292/14 & 0292/16
CURVATUBO PER TUBI IN RAME

	1 0292	2 0292/14	2 0292/16
Misure	Ø 8 - 10 - 12 mm	Ø 14 mm	Ø 16 mm
Imballo	20	5* / 20	5* / 20
€	15,70	13,50	13,50





Art. 0796
TORNIO DA LEGNO CON COPIA

€ 3117,00



1 Micro protezione mandrino



2 Trasmissione a cinghia



Distanza tra le punte	1300 mm
Altezza punte	210 mm
Attacco mandrino	M 33x3,5 DIN800
Flangia per mandrino	Ø 125 mm
Contropunta	CM / MT 2
Motore monofase	230 V 50 Hz 1,5 kW
Velocità mandrino	500 - 1000 - 1950 - 2800 rpm
Dimensioni	2100 x 400 x 1200h mm
Peso	253 kg

TORNIO DA LEGNO CON COPIA TRASMISSIONE A CINGHIA





Art. 0758
TORNIO DA LEGNO

€ 1190,00



1 Cambio velocità



2 Blocco contropunta

Distanza tra le punte	1100 mm
Altezza punte	185 mm
Motore monofase	230 V 50 Hz 0,75 kW
Velocità mandrino	500 ÷ 2000 rpm
Filetto	1" - 8 TPI
Contropunta	CM 2
Peso	130 kg

TORNIO DA LEGNO CON TESTA GIREVOLE, TRASMISSIONE A CINGHIA CON PULEGGE A VELOCITÀ VARIABILE E BANCO IN GHISA



Art. 0751
TORNIO DA LEGNO

€ 790,00

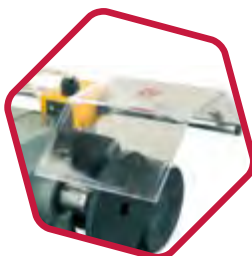

1 Protezione mandrino



2 Flangia

Distanza tra le punte	900 mm
Altezza punte	155 mm
Motore monofase	230 V 50 Hz 0,37 kW
Velocità	500 ÷ 2000 rpm
Filetto	1" - 8 TPI
Contropunta	CM 2
Peso	80 kg

TORNIO DA LEGNO CON TESTA GIREVOLE, TRASMISSIONE A CINGHIA CON PULEGGE A VELOCITÀ VARIABILE E BANCO IN LAMIERA

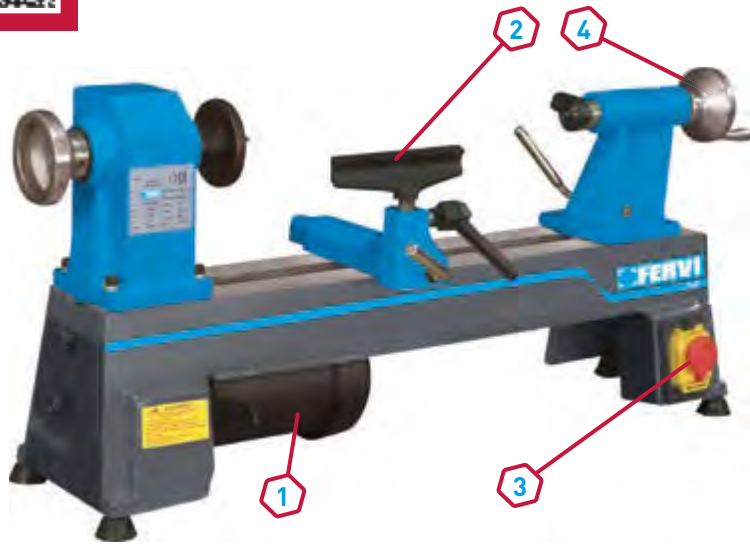
TORNIO PER LEGNO

- 1** Motore a spazzole
- 2** Poggia sgorbia
- 3** Interruttore
- 4** Volantino
- 5** Vano cinghia
- 6** Tensionatore cinghia
- 7** Flangia
- 8** Blocco contropunta

Codice	Distanza tra le punte	Altezza punte	Motore monofase	Velocità mandrino	Peso	€
0497/250	457 mm	254 mm	230 V 50 Hz 0.37 kW	(5) 700 - 3000 rpm	33 kg	575,00
0497/300	457 mm	305 mm	230 V 50 Hz 0.55 kW	(5) 700 - 3000 rpm	38 kg	640,00

TORNIO PER LEGNO CON CAMBIO VELOCITÀ A CINGHIA

TABELLA DI COMPATIBILITÀ

Codice Compatibile	Descrizione	€	0796	0758	0751	0497/250	0497/300	Pag
0758/C	COPIA PER TORNIO LEGNO	345,00	•	•	•	•	•	107
0425/100	MANDRINO AUTOCENTRANTE A 4 GRIFFE	188,00	•	•	•	•	•	107
0425/125	MANDRINO AUTOCENTRANTE A 4 GRIFFE	213,00	•	•	•	•	•	107
0751/A4	MANDRINO PER TORNIO	120,00	•	•	•	•	•	107
0751/P	MANDRINO PER TORNIO	66,00	•	•	•	•	•	107
0162	SERIE SGORBIE DA LEGNO PER TORNIO	17,70	•	•	•	•	•	462
0306	SERIE SGORBIE PER INTAGLIATORE	60,50	•	•	•	•	•	461
0168	SERIE SCALPELLI DA LEGNO	10,50	•	•	•	•	•	461
0300	SERIE SCALPELLI DA LEGNO	18,00	•	•	•	•	•	461
0301/06-10-16-20-24	SCALPELLO PER FALEGNAME	4,20-6,00	•	•	•	•	•	461
C028/150-200-250-300	COMPASSO PER SPESSORI ESTERNI	9,50-16,50	•	•	•	•	•	331
C029/150-200-250-300	COMPASSO PER INTERNI	9,50-16,50	•	•	•	•	•	331
0087	SERIE PUNTE PER CERNIERE CON RIPIRTO IN METALLO DURO	45,00	•	•	•	•	•	262
0087/35	PUNTA PER CERNIERE CON RIPIRTO IN METALLO DURO	11,40	•	•	•	•	•	262
A001/2/12	ATTACCO PER MANDRINO	9,60	•	•	•	•	•	194
A001/2/16	ATTACCO PER MANDRINO	10,90	•	•	•	•	•	194
A001/2/18	ATTACCO PER MANDRINO	11,20	•	•	•	•	•	194
M051/10	MANDRINO AUTOSERRANTE DI PRECISIONE	54,40	•	•	•	•	•	195
M051/13	MANDRINO AUTOSERRANTE DI PRECISIONE	63,80	•	•	•	•	•	195
M051/16	MANDRINO AUTOSERRANTE DI PRECISIONE	77,00	•	•	•	•	•	195
M049/125	MANDRINO AUTOCENTRANTE DI PRECISIONE	197,00	•	•	•	•	•	195
M449/125	MANDRINO AUTOCENTRANTE	227,00	•	•	•	•	•	196



Art. 0758/C
COPIA PER TORNIO LEGNO

€ 345,00



Distanza tra le punte	1000 mm
Peso	18 kg



MANDRINO AUTOCENTRANTE A 4 GRIFFE



Codice	Ø	Capacità di serraggio	Capacità di serraggio	Filetto	Peso	€
0425/100	100 mm	Int. 32 - 45 mm	Ext. 68 - 85 mm	1" - 8 TPI	2,24 kg	188,00
0425/125	125 mm	Int. 50 - 70 mm	Ext. 85 - 110 mm	1" - 8 TPI e M33 x 3,5	4,54 kg	213,00

MANDRINO AUTOCENTRANTE A 4 GRIFFE PER TORNIO DA LEGNO



Art. 0751/A4
MANDRINO PER TORNIO

€ 120,00



Autocentrante 4 griffe reversibili	Ø 125 mm
Filetto	1" - 8 TPI
Foro	Ø 22 mm
Peso	2 kg



Art. 0751/P
MANDRINO PER TORNIO

€ 66,00



4 griffe reversibili indipendenti	Ø 150 mm
Filetto	1" - 8 TPI
Foro	Ø 22 mm
Peso	2,5 kg

Art. 0498
COMBINATA DA LEGNO 8 LAVORAZIONI
€ 8700,00

- 1 Sega circolare, squadratrice con incisore
- 2 Toupie, carteggiatrice
- 3 Pialla a spessore
- 4 Pialla a filo, cavatrice

Dimensioni ingombro 1880 x 1500 x 1050 mm

Altezza piani 840 mm

SEGA CIRCOLARE
Dimensioni tavola principale 1045 x 800 mm

Dimensioni lama 254 x 3,2 x 30 mm 24 Z

Velocità lama 4050 rpm

Altezza di taglio 65 mm 90° - 45 mm 45°

SQUADRATRICE
Capacità di taglio con squadratrice 1370 mm

Tavola scorrevole 1500 x 840 mm

INCISORE
Dimensioni lama Ø 80 x 3,2 x 20 mm 8 Z

Velocità lama 6300 rpm

PIALLA FILO SPESSORE
Dimensioni piani 1285 x 310 mm

Sezione albero Ø 75 mm

Diametro aspirazione Ø 100 mm

Lame 3

Capacità pialla filo 310 x 5 mm

Capacità spessore 310 x 180 mm

Giri albero 4000 rpm

CAVATRICE
Dimensioni piani 150 x 365 mm

Corsa verticale 0 ÷ 80 mm

Corsa longitudinale 0 ÷ 85 mm

Corsa trasversale 0 ÷ 140 mm

Giri albero 4000 rpm

TOUPIE
Sezione albero Ø 30 mm

Corsa albero 130 mm

Giri albero 1500 / 4000 / 6000 rpm

CARTEGGIATRICE A RULLO
Dimensioni Ø 100 x 100h mm

Giri albero 1500 rpm

Motore monofase 3 x 230 V 50 Hz 2.2 kW

Peso 445 kg

Dimensioni imballo 1600 x 1300 x 1010 mm

COMBINATA DA LEGNO 8 LAVORAZIONI: SEGA CIRCOLARE, SQUADRATRICE, INCISORE, TOUPIE, PIALLA A FILO, PIALLA SPESSORE, CAVATRICE E CARTEGGIATRICE A RULLO A 1500 rpm. LA MACCHINA PUÒ ESSERE DIVISA VELOCEMENTE (SEI BULLONI) IN DUE PARTI PER ENTRARE ATTRAVERSO PICCOLE APERTURE.





Art. 0499
PIALLA FILO SPESSORE 310 mm

€ 2600,00



1 Pialla spessore



2 Quadro comando

Dimensioni ingombro	1290 x 550 x 1000 mm
Altezza piani	810 mm
Dimensioni piani	310 x 1285 mm
Sezione albero	Ø 75 mm
Lame	3
Capacità spessore	310 x 2,5 x 180h mm

Giri albero	4000 rpm
Motore monofase	230 V 50 Hz 2.2 kW
Peso	179 kg
Dimensioni imballo	1350 x 590 x 950 mm

PIALLA FILO SPESSORE DA 310 mm CON PREDISPOSIZIONE AL MONTAGGIO DELLA CAVATRICE



Art. 0749
PIALLA FILO SPESSORE

€ 1930,00



Dimensioni	1050 x 485 x 800h mm
Altezza piani	810 mm
Dimensioni piani	1050 x 250 mm
Albero	Ø 75 mm
Lame	N° 3
Capacità pialla filo	250 x 2 mm
Capacità spessore	250 x 1,2 180h mm
Giri albero	4000 rpm
Motore monofase	230 V - 50H z - 1,5 kW
Peso	164 kg

PIALLA FILO SPESSORE CON PIANI IN GHISA

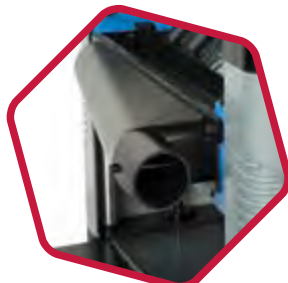
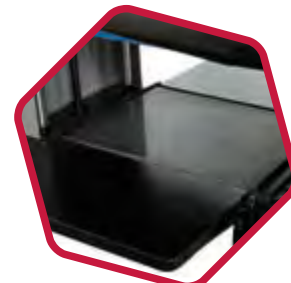
Art. 0517
PIALLA SPESSORE
€ 802,00

1 Bocchettone aspirazione

2 Piano in granito

Dimensioni	610 x 600 x 470 mm
Dimensione piani	316 x 238 mm
Albero	Ø 51.5 mm
Lame	n. 2 - 312 x 12 x 1.5 mm
Capacità spessore	316 x 2 x 152h mm
Giri albero	9500 rpm
Motore monofase	230 V 50 Hz 1.5 kW
Peso	35 kg

PIALLA SPESSORE DA 316 mm, CON PIANO DI LAVORO IN GRANITO

Art. 0686/200
PIALLA FILO SPESSORE
€ 550,00

Dimensioni	770 x 430 x 450h mm
Altezza piani	360 mm
Dimensioni piani	737 x 210 mm
Albero	Ø 50 mm
Lame	N° 2
Capacità pialla filo	204 x 2 mm
Capacità spessore	204 x 2 x 120h mm
Giri albero	8000 rpm
Motore monofase	230 V 50 Hz 1,25 kW
Peso	27 kg

PIALLA FILO SPESSORE CON PIANI IN ALLUMINIO

TABELLA DI COMPATIBILITÀ

Codice Compatibile	Descrizione	€	0498	0499	0749	0517	0686/200C	Pag
0686/200C	COLTELLO PER PIALLA	18,50					•	111
0499/C	SET 3 COLTELLI	78,00	•	•				111
0749/C	COLTELLO PER PIALLA	20,20			•			111
0517/59	SET DUE COLTELLI PER PIALLA SPESSORE 316 mm	57,00				•		111
0749/M	CAVATRICE	437,00	•		•			111
0749/MC	MANDRINO WESTCOTT	119,00	•	•	•			111
0697	SET 2 CALIBRI MAGNETICI UNIVERSALI	55,00	•	•	•			112
0799/SX	SERIE PUNTE PER MORTASA	69,70	•	•	•			262
0559/T	RULLO PER CARTEGGIARE	148,00	•					112
0684	INCISORE CON DENTI RIPORTATI IN METALLO DURO	25,00	•					117
0702	DISCHI PER LEGNO CON RIPOSTO IN METALLO DURO	50,10	•					116
0703	DISCHI PER LEGNO CON RIPOSTO IN METALLO DURO	57,80	•					116
0685	DISCO PER LEGNO CON RIPOSTO IN METALLO DURO	30,00	•					116
0756	ASPIRATORE PER TRUCIOLI	372,00			•	•		128
0759	ASPIRATORE PER TRUCIOLI PARZIALMENTE ASSEMBLATO	640,00	•	•	•			127
0496	ASPIRATORE PER TRUCIOLI	720,00	•	•	•			127
0756/T	TUBO SNODATO ESTENSIBILE	37,80	•	•	•			129
A030/30A	ASPIRAPOLVERE ASPIRALIQUIDI 30L	197,00				•	•	143
A030/60A	ASPIRAPOLVERE ASPIRALIQUIDI 60L	314,00				•	•	143
A040/30A	ASPIRAPOLVERE ASPIRALIQUIDI 30L	178,00				•	•	144
A040/60A	ASPIRAPOLVERE ASPIRALIQUIDI 60L	280,00				•	•	144
R001/04	RULLIERA REGOLABILE IN ALTEZZA	320,00	•					87
R001/07	RULLIERA REGOLABILE IN ALTEZZA	450,00	•					87



Art. 0686/200C € 18,50
COLTELLO PER PIALLA



Misure 210 X 22 X 2 mm



Art. 0499/C € 78,00
SERIE COLTELLI



Misure 310 x 30 x 3 mm **3 Pz**



Art. 0749/C € 20,20
COLTELLO PER PIALLA



Misure 250 x 30 x 3 mm



Art. 0517/59 € 57,00
SERIE COLTELLI PER PIALLA SPESSORE 316 mm



Lame 2 - 320 x 12 x 1.5 mm **2 Pz**



Art. 0749/M € 437,00
CAVATRICE



Mandrino	Ø 16 mm
Dimensioni tavola	370 x 150 mm
Corsa verticale	0 - 80 mm
Corsa laterale	0 - 140 mm
Peso	26 kg



Art. 0749/MC € 119,00
MANDRINO WESTCOTT



Capacità	16 mm
Attacco femmina	M20 x 1,5 Sx
Misure	Ø 60 x 65 mm

Art. M057/16 € 121,00
MANDRINO "WESTCOTT"

Capacità	16 mm
Attacco femmina	B18
Misure	Ø 60 x 65 mm

Art. 0697 € 55,00
SERIE CALIBRI
MAGNETICI UNIVERSALI

2 Pz

Per coltelli pialla con alberi	Ø 75 ÷ 125 mm
Peso	0,4 kg

Art. 0559 € 1440,00
2 IN 1 TOUPIE E CARTEGGIATRICE A RULLO

- 1 Tavola scorrevole
- 2 Adattatori per coltello toupie
- 3 Quadro comandi
- 4 Vano cambio velocità con micro interruttore

Motore monofase	230V 50Hz 1,5kW
Giri albero	1500 / 4000 / 6000 rpm
Diametro albero	30 mm
Corsa albero	105 mm
Diametro massimo fresa	160 mm
Piani in ghisa	600 x 400 mm
Piano scorrevole in ghisa	400 x 250 mm
Corsa del carrello	700 mm
Altezza piani	850 mm
Dimensioni	74 x 66 x 98 cm
Peso	116 kg

Art. 0559/T € 148,00
RULLO PER CARTEGGIARE

Dimensioni	Ø 100 x 100h mm
Foro	30 mm

Art. 0504
SEGA CIRCOLARE SQUADRATRICE INCISORE TOUPIE CARTEGGIATRICE
€ 5500,00

- 1 Incisore
- 2 Protezione lama circolare
- 3 Quadro comandi
- 4 Protezione toupie carteggiatrice

Altezza piani	840 mm
Dimensioni ingombro	1670 x 1200 x 1050 mm
SEGA CIRCOLARE	
Dimensioni tavola principale	1045 x 800 mm
Dimensioni lama	Ø 254 x 3.2 x 30 mm 24 Z
Velocità lama	4050 rpm
Altezza di taglio	65 mm 90° - 45 mm 45°
SQUADRATRICE	
Capacità di taglio con squadratrice	1070 mm
Tavola scorrevole	1200 x 840 mm
INCISORE	
Dimensioni lama	Ø 80 x 3.2 x 20 mm 8 Z
Velocità lama	6300 rpm
TOUPIE	
Sezione albero	Ø 30 mm
Corsa albero	130 mm
Giri albero	1500 / 4000 / 6000 rpm
CARTEGGIATRICE A RULLO	
Dimensioni	Ø 100 x 100h mm
Giri albero	1500 rpm
Motore monofase	2 x 230 V 50 Hz 2.2 kW
Peso	230 kg
Dimensioni imballo	1300 x 930 x 1010 mm

SEGA CIRCOLARE, CARRELLO A SQUADRARE, INCISORE, TOUPIE E CARTEGGIATRICE A 1500 rpm



Art. 0665
SEGA CIRCOLARE SQUADRATRICE PARZIALMENTE MONTATA
€ 3000,00

Lama	250 x 3 x 30 mm Z 40
Velocità lama	2800 rpm
Dimensioni tavola principale	800 x 560 mm
Dimensioni allungamento tavola	800 x 305 mm
Altezza tavola	860 mm
Taglio a 45°	60 mm
Taglio a 90°	75 mm
Tavola scorrevole	500 x 600 mm
Dimensioni ingombro	1860 x 2030 x 1070h mm
Motore monofase	230 V 50 Hz 2,2 kW
Peso	243 kg
Capacità di taglio con squadratrice	1460 mm

Art. 0280
BANCO SEGA DOTATO DI LAMA CON RIPORTO IN METALLO DURO
€ 924,00

Dimensioni tavola	800 x 550 mm
Prolunga tavola	800 x 550 mm
Altezza tavola	810 mm
Capacità di taglio a 90°	90 mm ca.
Capacità di taglio a 45°	50 mm ca.
Dimensioni lama	315 x 3 x 30 mm Z 36
Inclinazione lama	45°
Corsa piano scorrevole	1160 mm
Dim. piano scorrevole	230 x 230 mm
Velocità motore	2800 rpm
Motore monofase	230 V 50 Hz 2,2 kW
Peso	63 kg



Art. 0871
TRONCATRICE RADIALE PER LEGNO

€ 573,00



Disco	Ø 305 x 30 x 3,2 mm Z 40	Motore monofase	230 V 50 Hz 2 kW
Taglio massimo 0° - 90°	340 x 100 mm	Velocità motore	4500 rpm
Taglio massimo 45° - 90°	240 x 100 mm	Peso	25 kg
Spostamento radiale	215 mm		

TRONCATRICE RADIALE PER LEGNO DOTATA DI INDICATORE LASER DELLA LINEA DI TAGLIO



Art. 0870/250
TRONCATRICE PER LEGNO

€ 404,00



Disco	Ø 250 x 30 x 2,5 mm Z 36	Taglio massimo 0° - 45°	50 x 130 mm
Taglio massimo 0° - 90°	75 x 130 mm	Taglio massimo tavola superiore	40 mm
Taglio massimo 45° - 45°	75 x 50 mm	Motore monofase	230 V 50 Hz 1,8 kW
Taglio massimo 45° - 90°	75 x 90 mm	Velocità motore	4500 rpm
		Peso	18 kg

TRONCATRICE PER LEGNO CON TAVOLA SUPPLEMENTARE SUPERIORE PER FUNZIONAMENTO COME SEGA DA BANCO.

Art. 0365
SUPPORTO UNIVERSALE PER TRONCATRICE PORTATILE
€ 232,00

Altezza tavola	860 mm
Altezza prolunghe	950 ÷ 1100 mm
Lunghezza supporto	1200 mm
Lunghezza bracci estensibili	1350 ÷ 3000 mm
Misure morsetti	500 x 35 mm
Dimensioni	1300 x 230 x 950h mm
Peso	18 kg

DISCHI PER LEGNO CON RIPORTO IN METALLO DURO

Codice	Ø	Denti Z	Foro	Spessore taglio	Spessore disco	Max rpm	Imballo	€
0685	254 mm	24	Ø 30 mm	3,2 mm	2,2 mm	6300	10	30,00
0702	250 mm	60	Ø 30 mm	3,2 mm	2,2 mm	7000	10	50,10
0703	250 mm	80	Ø 30 mm	3,2 mm	2,2 mm	7000	10	57,80
0704	300 mm	72	Ø 30 mm	3,2 mm	2,2 mm	6000	10	74,30
0705	300 mm	96	Ø 30 mm	3,2 mm	2,2 mm	6000	10	80,20
0899	315 mm	25	Ø 30 mm	2,8 mm	1,8 mm	6000	10	55,40
0745	350 mm	54	Ø 30 mm	3,5 mm	2,5 mm	5000	10	90,90
0707	400 mm	48	Ø 30 mm	3,5 mm	2,5 mm	4500	10	92,40
0746	450 mm	60	Ø 30 mm	4 mm	3,0 mm	4000	5	159,00

DISCHI PER LEGNO CON RIPORTO IN METALLO DURO
 DENTATURA ALTERNATA UNIVERSALE PER TAGLIO DI LEGNO IN GENERE PER MULTISTRATI, COMPENSATI, FAESITE



Art. 0684
INCISORE CON DENTI RIPORTATI IN METALLO DURO

€ 25,00



Ø	80 mm
Denti Z	8
Foro	Ø 20 mm
Spessore taglio	3.2 mm
Spessore disco	2.2 mm
Max rpm	4050 rpm

INCISORE PER LEGNO CON DENTI RIPORTATI IN METALLO DURO,
DENTATURA ALTERNATA UNIVERSALE PER INCIDERE IL LEGNO SENZA SCHEGGIARLO



DISCO PER ALLUMINIO E MATERIALI PLASTICI CON RIPORTO IN METALLO DURO



Codice	Ø	Denti Z	Foro	Spessore taglio	Spessore disco	Max rpm	Imballo	€
0762/250	250 mm	60	Ø 32 mm	3,2 mm	2,8 mm	7000	10	57,50
0762/300	300 mm	72	Ø 32 mm	3,2 mm	2,8 mm	6000	10	72,60

TABELLA DI COMPATIBILITÀ

Codice Compatibile	Descrizione	€	0559	0504	0665	0280	0871	0870/250	Pag
0559/T	RULLO PER CARTEGGIARE	148,00	•	•					112
A030/30A	ASPIRAPOLVERE ASPIRALIQUIDI 30L	197,00	•	•	•	•	•	•	143
A030/60A	ASPIRAPOLVERE ASPIRALIQUIDI 60L	314,00	•	•	•	•	•	•	143
A040/30A	ASPIRAPOLVERE ASPIRALIQUIDI 30L	178,00	•	•	•	•	•	•	144
A040/60A	ASPIRAPOLVERE ASPIRALIQUIDI 60L	280,00	•	•	•	•	•	•	144
0365	SUPPORTO UNIVERSALE PER TRONCATRICE PORTATILE	232,00					•	•	116
0522	SUPPORTO PIEGHEVOLE PER MACCHINE PORTATILI	240,00						•	86
R001/04	RULLIERA REGOLABILE IN ALTEZZA	320,00	•	•	•				87
R001/07	RULLIERA REGOLABILE IN ALTEZZA	450,00	•	•	•				87
0495	ASPIRATORE PORTATILE	382,00	•	•	•	•			128
0756	ASPIRATORE PER TRUCIOLI	372,00	•	•	•	•			128
0759	ASPIRATORE PER TRUCIOLI PARZIALMENTE ASSEMBLATO	640,00	•	•	•	•			127
0496	ASPIRATORE PER TRUCIOLI	720,00	•	•	•	•			127
0756/T	TUBO SNODATO ESTENSIBILE	37,80	•	•	•	•			129
0684	INCISORE CON DENTI RIPORTATI IN METALLO DURO	25,00		•					117
0702	DISCHI PER LEGNO CON RIPORTO IN METALLO DURO	50,10		•	•			•	116
0703	DISCHI PER LEGNO CON RIPORTO IN METALLO DURO	57,80		•	•			•	116
0685	DISCO PER LEGNO CON RIPOSRTO IN METALLO DURO	30,00		•				•	116
0704	DISCHI PER LEGNO CON RIPORTO IN METALLO DURO	74,30			•	•			116
0705	DISCHI PER LEGNO CON RIPORTO IN METALLO DURO	80,20			•	•			116
0899	DISCHI PER LEGNO CON RIPORTO IN METALLO DURO	55,40			•	•			116



0764/455



0764



0509/340



0509/305



0509/245



FC94/350



0855



FC94/245



0302/305



0302/245



0717

CAPACITÀ DI TAGLIO

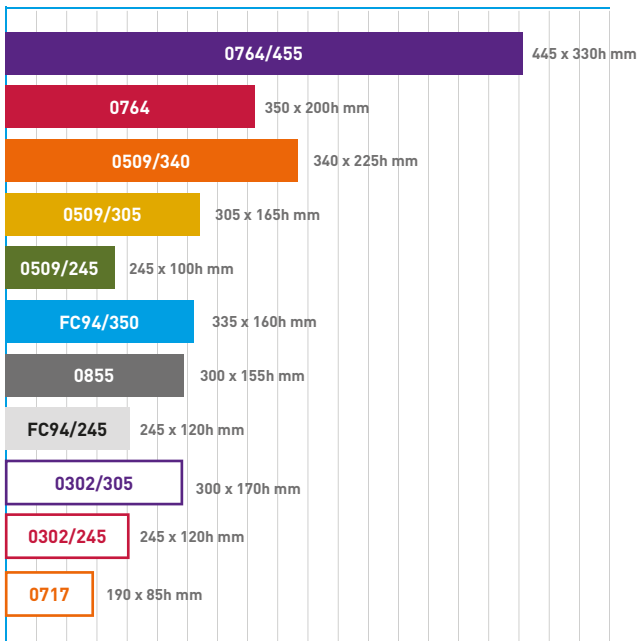

POTENZA

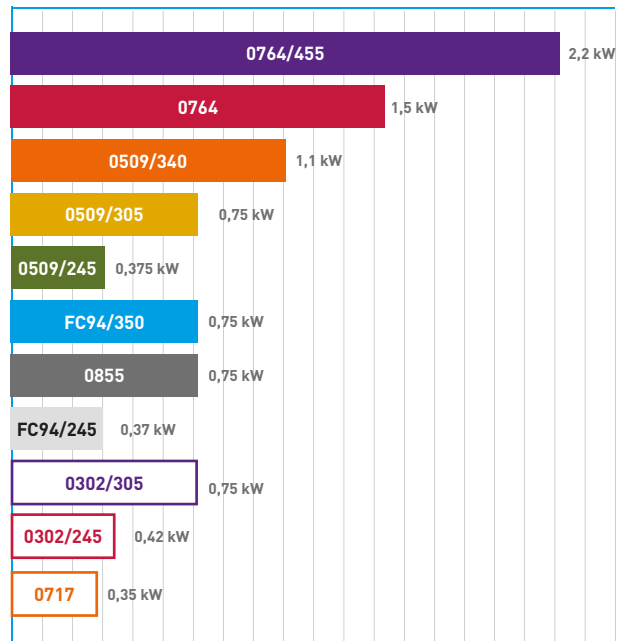



Art. 0764/455
SEGA A NASTRO PER LEGNO

€ 2336,00

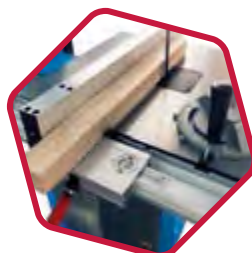

1 Squadra graduata



2 Guida lama regolabile



3 Indicatore tensione lama

Volano	Ø 455 mm
Capacità di taglio	445 x 330h mm
Lame	3430 x 20 x 0,65 mm T4
Dimensioni tavola	500 x 600 x 40h mm
Velocità di taglio	10 m/s
Inclinazione tavola	0 ÷ 20°
Altezza tavola	950 mm
Dimensioni	1000 x 900 x 1860h mm
Motore monofase	230 V 50 Hz 2,2 kW
Peso	216 kg



Art. 0764
SEGA A NASTRO PER LEGNO

€ 1570,00



1 Squadra graduata



2 Guida lama regolabile



3 Indicatore tensione lama

Volano	Ø 405 mm
Capacità di taglio	350 x 200h mm
Lame	2950 x 16 x 0,65 mm T4
Dimensioni tavola	500 x 395 x 32h mm
Velocità di taglio	10 m/s
Inclinazione tavola	0 ÷ 20°
Altezza tavola	995 mm
Dimensioni	750 x 650 x 1710h mm
Motore monofase	230 V 50 Hz 1,5 kW
Peso	136 kg

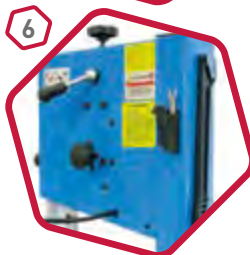
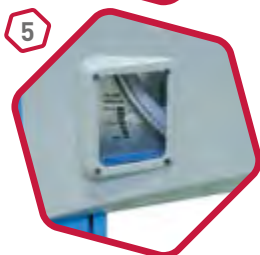
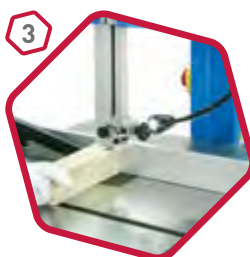
SEGA A NASTRO PER LEGNO

- 1 Taglio circolare
- 2 Taglio lineare
- 3 Illuminazione
- 4 Cassetto raccogli segatura
- 5 Indicatore di tensione lama
- 6 Tensionatore

	0509/340	0509/305	0509/245
Volano	Ø 347 mm	Ø 314 mm	Ø 254 mm
Capacità di taglio	340 x 225 mm	305 x 165 mm	245 x 100 mm
Lame	2560 x 12.7 x 0.5 mm T4	2240 x 12.7 x 0.5 mm T4	1826 x 10 x 0.35 mm T6
Dimensioni tavola	545 x 400 mm	480 x 390 mm	360 x 320 mm
Velocità di taglio	6-12 m/s	6-12 m/s	6.7 - 13.3 m/s
Inclinazione tavola	0-45°	0-45°	0-45°
Altezza tavola	1010 mm	990 mm	925 mm
Dimensioni	900 x 670 x 1720 mm	700 x 600 x 1585 mm	750 x 480 x 1420 mm
Motore monofase	230V 50Hz 1.1kW	230V 50Hz 0.750kW	230V 50Hz 0.375kW
Peso	70 kg	62 kg	37 kg
€	1325,00	1150,00	750,00

SEGA A NASTRO PER LEGNO DA 245 mm, CON ACCESSORIO PER TAGLI CIRCOLARI, LAMPADA A LED E CASSETTO RACCOGLI SEGATURA



Art. 0855
SEGA A NASTRO PER LEGNO

€ 954,00



- 1 Guida lama regolabile
- 2 Cambio di velocità
- 3 Spingipezzo
- 4 Tavola inclinabile



Volano	Ø 315 mm
Lama	2240 x 16 x 0,65 mm T4
Capacità di taglio	300 x 155h mm
Dimensioni tavola	390 x 500 mm
Velocità di taglio	6 - 12 m/s 370 - 800 rpm

Inclinazione tavola	0 ÷ 20°
Altezza tavola	1010 mm
Dimensioni	650 x 650 x 1610h mm
Motore monofase	230 V 50 Hz 0,75 kW
Peso	77 kg



Art. FC94/350 **€ 1166,00**
SEGA A NASTRO PER LEGNO



Volano	Ø 350 mm
Capacità di taglio	335 x 160 mm
Lame	2400 x 13 x 0.52 mm 4T
Dimensione tavola	500 x 400 mm
Velocità di taglio	10 - 12 m/s
Inclinazione tavola	0° - 45°
Altezza tavola	1015 mm
Dimensioni	730 x 620 x 1540 mm
Motore monofase	230 V 50 Hz 0.75 kW
Peso	82 kg



Art. FC94/245 **€ 585,00**
SEGA A NASTRO PER LEGNO



Volano	Ø 255 mm
Capacità di taglio	245 x 120 mm
Lame	1790 x 8,4 x 0.35 mm 6T
Dimensione tavola	340 x 340 mm
Velocità di taglio	11 - 16 m/s
Inclinazione tavola	0° - 45°
Altezza tavola	1000 mm
Dimensioni	420 x 250 x 800 mm
Motore monofase	230 V 50 Hz 0.37 kW
Peso	29 kg

Art. 0302/305
 SEGA A NASTRO PER LEGNO

€ 725,00

Volano	Ø 315 mm
Capacità di taglio	300 x 170 mm
Lame	2240 x 11 x 0.8 mm T6
Dimensioni tavola	500 x 400 mm
Velocità di taglio	6 ÷ 12 m/s
Inclinazione tavola	0° ÷ 45°
Altezza tavola	960 mm
Dimensioni	80 x 500 x 1580 mm
Motore monofase	230 V 50 Hz 0.75 kW
Peso	58 kg

SEGA A NASTRO PER LEGNO CON TAVOLA IN ALLUMINIO

Art. 0302/245
 SEGA A NASTRO PER LEGNO

€ 475,00

Volano	Ø 255 mm
Capacità di taglio	245 x 120 mm
Lame	1790 x 9 x 0.5 mm T6
Dimensioni tavola	290 x 290 mm
Velocità di taglio	11 ÷ 16 m/s
Inclinazione tavola	0° ÷ 45°
Altezza tavola	1000 mm
Dimensioni tavola	600 x 400 x 1480 mm
Motore monofase	230 V 50 Hz 0.42 kW
Peso	30 kg

SEGA A NASTRO PER LEGNO CON TAVOLA IN ALLUMINIO

Art. 0717
 SEGA A NASTRO PER LEGNO

€ 292,00

Volano	Ø 200 mm
Lama	1430 x 6 x 0,36 mm T6
Capacità di taglio	190 x 85h mm
Dimensioni tavola	290 x 290 mm
Velocità di taglio	13,3 m/s
Inclinazione tavola	0 ÷ 45°
Dimensioni	430 x 355 x 665h mm
Motore monofase	230 V 50 Hz 0,35 kW
Peso	18 kg

TABELLA DI COMPATIBILITÀ

Codice Compatibile	Descrizione	€	0764/455	0764	0509/340	0509/305	0509/245	FC94/350	0855	FC94/245	0302/305	0302/245	0717	Pag
N717/N	LAME PER LEGNO	23,60											•	123
N717/N1	LAME PER LEGNO	23,60											•	123
N186	LAMA PER LEGNO	24,00						•						123
N187	LAMA PER LEGNO	24,00						•						123
N188	LAMA PER LEGNO	28,00								•			•	123
N189	LAMA PER LEGNO	28,00								•			•	123
N190	LAMA PER LEGNO	28,00					•							123
N191	LAMA PER LEGNO	28,00					•							123
N192	LAMA PER LEGNO	24,00			•									123
N193	LAMA PER LEGNO	24,00			•									123
N855/N	LAME PER LEGNO	26,90				•			•			•		123
N855/N2	LAME PER LEGNO	26,90				•			•			•		123
N764/N	LAME PER LEGNO	26,90		•										123
N764/N2	LAME PER LEGNO	26,90		•										123
N764/455/N	LAME PER LEGNO	37,30	•											123
N764/455/N2	LAME PER LEGNO	37,30	•											123
0495	ASPIRATORE PORTATILE	382,00	•	•	•	•	•	•	•	•	•	•	•	128
0496	ASPIRATORE PER TRUCIOLI	720,00	•	•	•	•	•	•	•	•	•	•	•	127
0759	ASPIRATORE PER TRUCIOLI PARZIALMENTE ASSEMBLATO	640,00	•	•	•	•	•	•	•	•	•	•	•	127
0756	ASPIRATORE PER TRUCIOLI	372,00	•	•	•	•	•	•	•	•	•	•	•	128
0756/T	TUBO SNODATO ESTENSIBILE	37,80	•	•	•	•	•	•	•	•	•	•	•	129
A030/30A	ASPIRAPOLVERE ASPIRALIQUIDI 30L	197,00											•	143
A040/30A	ASPIRAPOLVERE ASPIRALIQUIDI 30L	178,00											•	144

LAMA PER LEGNO

Codice	Misure	Specifiche	€
N717/N	1430 x 6 x 0,36 mm	T6	23,60
N188	1790 x 6 x 0,36 mm	T10	28,00
N190	1826 x 6 x 0,36 mm	T10	28,00
N855/N2	2240 x 13 x 0,65 mm	T8	26,90
N186	2400 x 13 x 0,65 mm	T8	24,00
N192	2560 x 13 x 0,65 mm	T8	24,00
N764/N2	2950 x 13 x 0,65 mm	T6	26,90
N764/455/N2	3430 x 16 x 0,65 mm	T6	37,30

LAMA PER IL TAGLIO SAGOMATO DI LEGNO SOTTILE

LAMA PER LEGNO

Codice	Misure	Specifiche	€
N717/N1	1430 x 10 x 0,36 mm	T6	23,60
N189	1790 x 10 x 0,36 mm	T6	28,00
N191	1826 x 10 x 0,36 mm	T6	28,00
N855/N	2240 x 16 x 0,65 mm	T4	26,90
N187	2400 x 16 x 0,65 mm	T4	24,00
N193	2560 x 16 x 0,65 mm	T4	24,00
N764/N	2950 x 16 x 0,65 mm	T4	26,90
N764/455/N	3430 x 20 x 0,65 mm	T4	37,30

LAMA PER IL TAGLIO DRITTO DI LEGNO SPESSE

Art. 0523

LEVIGATRICE NASTRO DISCO

€ 396,00

1 Bocchettone di aspirazione

2 Disco laterale

3 Rullo trainato con cuscinetto

Dimensioni	530 x 430 x 330 mm
Nastro	914 x 100 mm
Diametro disco	Ø 150 mm
Motore monofase	230V 50Hz 0.375kW 1850rpm
Peso	20 kg

LEVIGATRICE NASTRO DISCO ORIZZONTALE E VERTICALE

Art. 0505
LEVIGATRICE A NASTRO DA BANCO INCLINABILE
€ 265,00

1 Lavorazione orizzontale

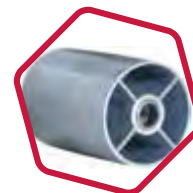
2 Disco laterale

3 Rullo trainato con cuscinetto

Dimensioni	460 x 380 x 270h mm
Nastro	914 x 100 mm
Diametro disco	Ø 150 mm
Motore monofase	230V 50 Hz 0,5 kW 2850 rpm
Peso	18 kg

Art. 0138
LEVIGATRICE A NASTRO VERTICALE E DISCO
€ 550,00

1 Disco laterale

2 Tavola frontale

Dimensioni	A x B x C mm
Nastro	25 x 1075 mm
Diametro disco	200 mm
Motore monofase	230 V 50 Hz 0,45 kW 1450 rpm
Peso	26 kg

LEVIGATRICE A NASTRO VERTICALE E DISCO, CON PIANI DI LAVORO INCLINABILI

Art. 0144
SEGHETTO A LAMA VIBRANTE A VELOCITÀ VARIABILE
€ 450,00

Capacità di taglio	457 x 50h mm
Lunghezza lama	127 mm
Oscillazioni	550 ÷ 1650 rpm
Dimensioni piano	480 x 250 mm
Inclinazione tavola	0 ÷ 45° sx
Dimensioni base	220 x 420 mm
Motore monofase	230 V 50 Hz 0,12 kW
Peso	20 kg

SEGHETTO A LAMA VIBRANTE A VELOCITÀ VARIABILE CON LAMPADA LED. PIANO INCLINABILE, STRUTTURA ROBUSTA, ADATTO AL TAGLIO DI BALSAMICA, COMPENSATI, LEGNI LEGGERMENTE PIÙ DURI, PLASTICA E METALLI NON FERROSI



Art. 0765
SEGHETTO A LAMA VIBRANTE A VELOCITÀ VARIABILE

€ 242,00



Capacità di taglio	400 x 50h mm
Lunghezza lama	127 mm
Oscillazioni	800 ÷ 1400 rpm
Dimensioni piano	410 x 250 mm
Inclinazione tavola	0 ÷ 45° sx
Dimensioni base	230 x 390 mm
Motore monofase	230 V 50 Hz 0,12 kW
Peso	14,5 kg

SEGHETTO A LAMA VIBRANTE A VELOCITÀ VARIABILE CON LAMPADA LED. PIANO INCLINABILE, STRUTTURA ROBUSTA, ADATTO AL TAGLIO DI Balsa E COMPENSATI



Art. 0753/A
ADATTATORE LAMA

€ 13,50



Art. 0753/L
SERIE LAME

€ 4,56



10 Pz



Art. 0720
TAGLIA CORNICE

€ 54,60



Altezza di taglio	110 mm
Larghezza di taglio	120 mm
Inclinazione di taglio	0° ±45°
Base	400 x 80 mm
Dimensioni lama	550 x 45 mm
Peso	4,1 kg



Art. 0720/L
LAMA

€ 8,70



Art. S009
SPACCALEGNA VERTICALE
€ 1360,00

1 Tavola regolabile

2 Carrellata

Capacità di lavoro in altezza	1040 / 780 / 520 mm
Capacità di lavoro	Ø 50 ÷ 320 mm
Forza di spinta	7 ton
Motore monofase	230 V 50 Hz 3 kW
Giri motore a vuoto	2950 rpm
Peso	123 kg
Dimensioni imballo	575 x 635 x 1110h mm

SPACCALEGNA VERTICALE DA 7 TONNELLATE CON CUNEO A CROCE

Art. S021
SPACCALEGNA ORIZZONTALE
AD ENERGIA CINETICA
€ 788,00

1 Leve di azionamento

2 Carrellata

Capacità di lavoro	Ø 300 x 400 mm
Forza di spinta	5 ton
Motore monofase	230 V 50 Hz 1,5 kW
Giri motore a vuoto	2950 rpm
Peso	60 kg
Dimensioni	1090 x 320 x 570 mm

SPACCALEGNA ORIZZONTALE CON MOTORE ELETTRICO CHE AZIONA UN DISPOSITIVO AD ENERGIA CINETICA PER SPACCARE PIÙ VELOCEMENTE GRANDI QUANTITÀ DI LEGNA, NON HA OLIO ED È PIÙ SILENZIOSO DI UNO SPACCALEGNA IDRAULICO

Art. S015
SPACCALEGNA MANUALE
€ 110,00

Capacità di lavoro	Ø 254 x 460 mm
Forza di spinta	1,2 ton
Dimensioni lama	100 x 80h mm
Peso	8,6 kg

SPACCALEGNA MANUALE A PEDALE PER SPACCARE LA LEGNA DA CAMINO IN PICCOLI PEZZI PER ACCENDERE IL FUOCO



Art. 0496
ASPIRATORE PER TRUCIOLI

€ 720,00



Dimensioni	1450 x 800 x 2000 mm
Diametro aspirazione	3 x Ø 100 mm
Portata aria	3900 m ³ / h
Motore monofase	230 V 50 Hz 2.2 kW
Filtro in tessuto	Ø 510 mm x 855h mm
Peso	50 kg



Art. 0759
ASPIRATORE PER TRUCIOLI PARZIALMENTE ASSEMBLATO

€ 640,00



Dimensioni	840 x 560 x 1800h mm
Diametro aspirazione	2 x diam. 100 mm
Capacità filtrante	5 micron
Portata d'aria	2500 m ³ / h
Motore monofase	230 V 50 Hz 1,5 kW
Velocità motore	2950 rpm
Peso	44 kg
Filtro in tessuto	Ø 510 mm
Depressione	1,95 kPa

Art. 0756
ASPIRATORE PER TRUCIOLI
€ 372,00

Dimensioni	500 x 600 x 1700h mm
Diametro aspirazione	100 mm
Filtro in tessuto	Ø 370 mm
Capacità filtrante	5 micron
Portata d'aria	850 m ³ / h
Motore monofase	230 V 50 Hz 0,75 kW
Velocità motore	2950 rpm
Depressione	1,08 kPa
Peso	25 kg

ASPIRATORE PER TRUCIOLI PARZIALMENTE ASSEMBLATO

Art. 0495
ASPIRATORE PORTATILE
€ 382,00

Dimensioni	395 x 325 x 350 mm
Diametro aspirazione	1 x Ø 100 mm
Portata aria	830 m ³ / h
Motore monofase	230 V 50 Hz 0.75 kW
Filtro in tessuto	Ø 380 mm x 530h mm
Peso	22 kg

**ASPIRATORE PORTATILE CON RUOTE PER SEGHE A NASTRO
 E TRONCATRICI PER LEGNO**

TABELLA DI COMPATIBILITÀ

Codice Compatibile	Descrizione	€	0496	0759	0756	0495	Pag
0759/F	SACCO FILTRAGGIO	27,80	•	•			129
0759/S	SET 10 SACCHI IN PLASTICA	51,20	•	•			129
0756/F	SACCO FILTRAGGIO	22,40			•		129
0756/S	10 SACCHI IN PLASTICA	42,20			•		129
0756/T	TUBO SNODATO ESTENSIBILE	37,80	•	•	•	•	129
0756/Y	RACCORDO A Y	19,10			•		129
0495/24	SACCO FILTRAGGIO	18,00				•	129



Art. 0759/F
SACCO FILTRAGGIO

€ 27,80



Dimensioni Ø 510 mm x 855h mm



Art. 0756/F
SACCO FILTRAGGIO

€ 22,40



Dimensioni Ø 370 mm x 590h mm



Art. 0759/S
SERIE SACCHI IN PLASTICA

€ 51,20



10 Pz

Dimensioni Ø 510 mm x 855h mm



Art. 0756/T
TUBO SNODATO ESTENSIBILE

€ 37,80



Lunghezza massima	2 m
Diametro	100 mm
Imballo	10



Art. 0756/S
SERIE SACCHI IN PLASTICA

€ 42,20



10 Pz

Dimensioni Ø 370 mm x 590h mm



Art. 0495/24
SACCO FILTRAGGIO

€ 18,00



Art. 0756/Y
RACCORDO A Y

€ 19,10



Diametro	100 mm
Imballo	50



SABBIATRICI

0601



0687



0878



0575S



0575



0487



0580S



0580



0490



0462

DIMENSIONI INTERNE

0601	1180 x 850 x 890h mm
0687	1200 x 600 x 600h mm
0878	960 x 480 x 250h mm
0575S	860 x 560 x 560h mm
0575	850 x 480 x 340h mm
0487	685 x 455 x 420h mm
0580S	560 x 460 x 280h mm
0580	590 x 480 x 290h mm
0490	410 x 310 x 200h mm
0462	ND

CONSUMO D'ARIA TEORICO

0601	880 l/min
0687	630 l/min
0878	540 l/min
0575S	300 l/min
0575	300 l/min
0487	300 l/min
0580S	300 l/min
0580	300 l/min
0490	50 l/min
0462	420 l/min



Art. 0601
SABBIATRICE CON ASPIRATORE

€ 2950,00

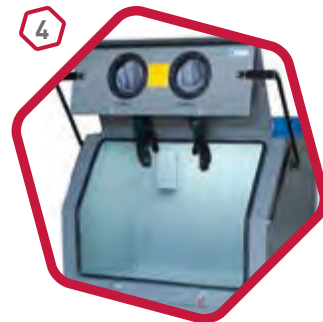
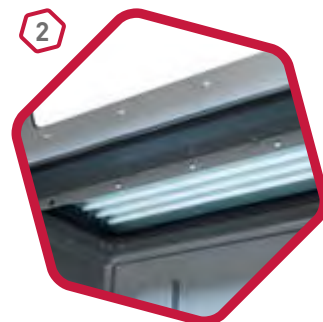
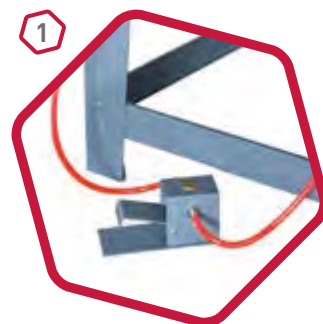

- 1 Comando a pedale
- 2 Illuminazione interna
- 3 Filtro aspiratore
- 4 Sportello frontale ammortizzato

Dimensioni ingombro	1330 x 1240 x 1770h mm
Dimensioni utili interne	1180 x 850 x 890h mm
Pressione di esercizio	6 ÷ 8 bar
Consumo aria	31 SCFM 880 l / min
Ugelli pistola	Ø 6 - 7 mm
Aspiratore elettrico	230 V 50 Hz 1,2 kW
Capacità filtrante	5 micron
Dimensioni imballo	1330 x 960 x 1070h mm
Peso	160 kg

SABBIATRICE CON ASPIRATORE A CICLONE, FILTRO IN CARTA, APERTURA FRONTALE E PLAFONIERA CON 3 LAMPADE FLUORESCENTI.

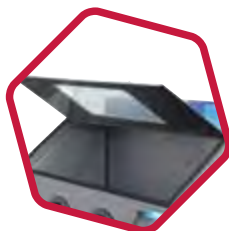
Art. 0687
SABBIATRICE CON ASPIRATORE
€ 2100,00

1 Apertura frontale

2 Apertura laterale

3 Aspiratore

Dimensioni ingombro	1220 x 910 x 1740h mm
Dimensioni utili interne	1200 x 600 x 600h mm
Pressione di esercizio	6,5 ÷ 7,5 bar
Consumo aria	21 SCFM 630 l / min
Ugelli pistola	Ø 6 - 7 mm
Aspiratore elettrico	230 V 50 Hz 1,2 kW
Capacità filtrante	5 micron
Dimensioni imballo	1320 x 1300 x 770h mm
Peso	149 kg

SABBIATRICE CON ASPIRATORE E FILTRO IN CARTA

Art. 0878
SABBIATRICE CON ASPIRATORE
€ 1730,00

1 Apertura laterale

2 Pistola fissa e mobile

3 Aspiratore

Dimensioni ingombro	1030 x 850 x 1640h mm
Dimensioni utili interne	960 x 480 x 250 ÷ 470h mm
Pressione di esercizio	6,5 ÷ 7,5 bar
Consumo aria	18 SCFM 540 l / min
Ugelli pistola	Ø 4 - 5 - 6 - 7 mm
Aspiratore elettrico	230 V 50 Hz 1,2 kW
Capacità filtrante	5 micron
Dimensioni imballo	1300 x 1010 x 755h mm
Peso	110 kg

SABBIATRICE CON ASPIRATORE E FILTRO IN CARTA



Art. 0575S
SABBIATRICE

€ 652,00



Dimensioni ingombro	905 x 620 x 1390h mm
Dimensioni utili interne	860 x 560 x 560h mm
Pressione di esercizio	6,5 ÷ 7,5 bar
Consumo aria	8 ÷ 10 SCFM (240 ÷ 300 l / min)
Ugelli pistola	Ø 4 - 5 - 6 - 7 mm
Peso	49 kg

SABBIATRICE FORNITA SMONTATA, CON PREDISPOSIZIONE PER IL COLLEGAMENTO DI UN ASPIRAPOLVERE ALLA MACCHINA PER EVITARE CONTINUI E FASTIDIOSI FERMI MACCHINA DOVUTI, ALL'IMPOSSIBILITÀ DI VEDERE IL PEZZO CHE SI STA SABBIANDO, PER LA TROPPIA POLVERE IN SOSPENSIONE ALL'INTERNO DELLA SABBIATRICE, AMPIA PORTA SUPERIORE, ILLUMINAZIONE CON LAMPADA A BASSO CONSUMO, PISTOLA PER SABBIARE E GUANTI



Art. 0575
SABBIATRICE

€ 725,00



1 Apertura laterale



2 Pistola mobile

Dimensioni ingombro	890 x 560 x 1385h mm
Dimensioni utili interne	850 x 480 x 340 ÷ 540h mm
Pressione di esercizio	6,5 ÷ 7,5 bar
Consumo aria	8 ÷ 10 SCFM (240 ÷ 300 l / min)
Ugelli pistola	Ø 4 - 5 - 6 - 7 mm
Peso	46 kg



Art. 0487
SABBIATRICE DA BANCO
€ 288,00

1 Apertura laterale

2 Pistola mobile

Dimensioni ingombro	755 x 495 x 720 mm
Dimensioni utili interne	685 x 455 x 420 mm
Pressione di esercizio	6,5 - 7,5 bar

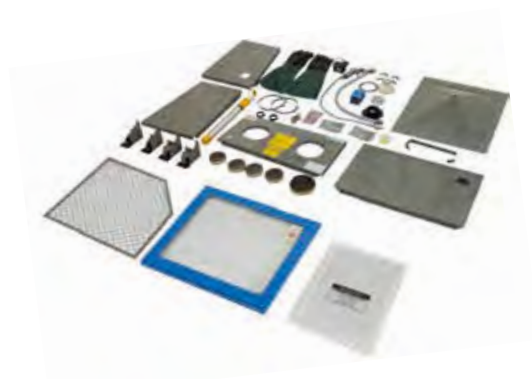
Ugelli pistola	Ø 4 - 5 - 6 - 7 mm
Dotata di illuminazione	230 V 50 Hz; 6 W 12 V
Peso	26,5 kg

Art. 0580S
SABBIATRICE DA BANCO
€ 242,00

Dimensioni ingombro	585 x 485 x 495h mm
Dimensioni utili interne	560 x 460 x 280h mm
Pressione di esercizio	6,5 - 7,5 bar

Consumo aria	8 ÷ 10 SCFM (240 ÷ 300 l / min)
Ugelli pistola	Ø 4 - 5 - 6 - 7 mm
Peso	17 kg

SABBIATRICE DA BANCO FORNITA SMONTATA, CON ADATTATORE PER COLLEGARE UN ASPIRAPOLVERE ALLA MACCHINA PER EVITARE CONTINUI E FASTIDIOSI FERMI MACCHINA DOVUTI, ALL'IMPOSSIBILITÀ DI VEDERE IL PEZZO CHE SI STA SABBIANDO, PER LA TROPPIA POLVERE IN SOSPENSIONE ALL'INTERNO DELLA SABBIATRICE, AMPIA PORTA SUPERIORE, ILLUMINAZIONE CON LAMPADA A BASSO CONSUMO, PISTOLA PER SABBIARE E GUANTI



Art. 0580
SABBIATRICE DA BANCO

€ 281,00



1 Filtro



2 Illuminazione

Dimensioni ingombro	630 x 510 x 490h mm
Dimensioni utili interne	590 x 480 x 290h mm
Pressione di esercizio	6,5 - 7,5 bar
Consumo aria	8 ÷ 10 SCFM (240 ÷ 300 l / min)
Ugelli pistola	Ø 4 - 5 - 6 - 7 mm
Peso	19 kg

SABBIATRICE DA BANCO CON ADATTATORE PER COLLEGARE UN ASPIRAPOLVERE ALLA MACCHINA PER EVITARE CONTINUI E FASTIDIOSI FERMI MACCHINA DOVUTI, ALL'IMPOSSIBILITÀ DI VEDERE IL PEZZO CHE SI STA SABBIANDO, PER LA TROPPIA POLVERE IN SOSPENSIONE ALL'INTERNO DELLA SABBIATRICE



Art. 0490
MINI SABBIATRICE DA BANCO

€ 410,00



Dimensioni ingombro	475 x 370 x 370 mm
Dimensioni utili interne	410 x 310 x 200 mm
Pressione di esercizio	4 - 7,5 bar
Ugelli pistola	Ø 3.5 mm
Dotata di illuminazione	230 V 50 Hz, 6 W 12 V
Peso	12.5 kg

MINI SABBIATRICE DA BANCO, CON COMANDO A PEDALE E PISTOLA FISSA, PER SABBIARE PARTI PICCOLE NEL SETTORE ORAFO, DENTALE E FAI DA TE

Art. 0462
SABBIATRICE PER ESTERNO CON ASPIRATORE
€ 771,00

Lunghezza tubi	2,5 m
Motore monofase	230 V 50 Hz 1,2 kW
Capacità di aspirazione	13÷15 kPa
Pressione di esercizio	8 bar
Dimensioni	404 x 612 x 1046 mm
Peso	40 kg

SABBIATRICE PER ESTERNO CON ASPIRATORE, PER OGGETTI METALLICI ARRUGGINITI O DA SVERNICIARE CHE NON POSSONO ESSERE INSERITI IN UNA SABBIATRICE TRADIZIONALE. SE L'OGGETTO DA TRATTARE È PIANO. L'ASPIRATORE CONSENTE DI NON PERDERE LA MAGGIOR PARTE DI ABRASIVO CHE SI STA USANDO. LE QUATTRO RUOTE PERMETTONO ALL'OPERATORE DI PORTARE LA MACCHINA VICINO ALL'OGGETTO DA SABBIARE

TABELLA DI COMPATIBILITÀ

Codice Compatibile	Descrizione	€	0601	0687	0878	0575S	0575	0487	0580S	0580	0490	0462	Pag
SA01/A	ASPIRATORE PER SABBIATRICI	345,00	•	•	•	•	•	•					137
0687/029	FILTRO CICLONE	72,60	•	•	•								137
0581	MICROSFERE DI VETRO	82,50	•	•	•	•	•	•	•	•	•	•	137
0582/36	CORINDONE	93,50	•	•	•	•	•	•	•	•	•	•	137
0582/80	CORINDONE	93,50	•	•	•	•	•	•	•	•	•	•	137
0290	PISTOLA SABBIATRICE	36,70			•	•	•	•	•	•			138
0687/041	PISTOLA	99,00	•	•									137
0577/17	PISTOLA FISSA	42,80			•								138
0490/03	SET 5 PELLICOLE	24,00									•		139
U003	UGELLO IN CARBURO DI BORO LUNGA DURATA	99,00	•	•									138
0490/20	SET 4 UGELLI PER SABBIATRICE DA 3,5 mm	9,00									•		138
0462/55	SET 5 UGELLI	35,00										•	138
0575/0580/12	SET 4 UGELLI IN CERAMICA	16,80			•	•	•	•	•	•			138
0687/102	SET 4 UGELLI IN CERAMICA	18,20	•	•									138
0601/24	SET 5 PROTEZIONI PER FINESTRA	22,00	•										139
0601/30	SET 5 PROTEZIONI PER PLAFONIERA	16,00	•										139
0687/005	SET 10 PROTEZIONI PLAFONIERA	26,90		•									139
0575/04	SET 10 PROTEZIONI FINESTRA	42,20				•	•						139
0580/01-6	SET 5 PROTEZIONI FINESTRA	26,90								•			139
0490/11	GUANTI PER SABBIATRICE	22,00									•		139
0575/29	COPIA GUANTI	38,90	•	•	•	•	•	•					139
0580/21	COPIA GUANTI	38,90							•	•			139
A030/30A	ASPIRAPOLVERE ASPIRALIQUIDI 30L	197,00				•	•	•	•	•			143
A030/60A	ASPIRAPOLVERE ASPIRALIQUIDI 60L	314,00				•	•	•	•	•			143
A040/30A	ASPIRAPOLVERE ASPIRALIQUIDI 30L	178,00				•	•	•	•	•			144
A040/60A	ASPIRAPOLVERE ASPIRALIQUIDI 60L	280,00				•	•	•	•	•			144



Art. SA01/A
ASPIRATORE PER SABBIASTRICI

€ 345,00



Aspiratore elettrico	230 V 50 Hz 1,2 kW
Capacità filtrante	5 micron
Permeabilità all'aria	185 l/(m ² s)
Diametro aspirazione	Ø 55 mm
Interasse fori	305 X 240 mm
Dimensioni	Ø 290 X 730 mm

ASPIRATORE PER SABBIASTRICI CILINDRICO A BASE CHIUSA CON FILTRO IN CARTA



Art. 0581
MICROSFERE DI VETRO

€ 82,50



Grana	50 ÷ 70 (0,3 ÷ 0,2 mm)
Durezza	5-7 Mohs
Peso	25 kg
Imballo	40

MICROSFERE DI VETRO PER SABBIASTRICE (FINITURA)



CORINDONE

€ 75,00



Codice	Grana	Durezza	Peso	Imballo	€
0582/36	36	9 Mohs	25 kg	40	93,50
0582/80	80	9 Mohs	25 kg	40	93,50



Art. 0687/029
FILTRO CICLONE

€ 72,60



Diametro	170 mm
Altezza	305 mm



Art. 0687/041
PISTOLA

€ 99,00



Art. 0290
 PISTOLA SABBIAATRICE

€ 36,70

Ugelli in ceramica	Ø 4 - 5 - 6 - 7 mm
Lunghezza tubo in gomma	1,5 m
Imballo	10

Art. 0577/17 € 42,80
 PISTOLA FISSA

Art. U003 € 99,00
 UGELLO IN CARBURO DI BORO LUNGA DURATA

Diametro ugello Ø 7,5 mm

Art. 0490/20 € 9,00
 SERIE UGELLI IN CERAMICA

4 Pz

Diametro ugello Ø 3,5 mm

Art. 0462/55 € 35,00
 SERIE UGELLI IN CERAMICA

5 Pz

Diametro ugello Ø 7,5 mm

Art. 0575/0580/12 € 16,80
 SERIE UGELLI IN CERAMICA

4 Pz

Diametro ugello Ø 4 - 5 - 6 - 7 mm

Art. 0687/102 € 18,20
 SERIE UGELLI IN CERAMICA

4 Pz

Diametro ugello Ø 6 - 7 mm



Art. 0490/03 € 24,00
SERIE PROTEZIONI FINESTRA



5 Pz



Art. 0601/24 € 22,00
SERIE PROTEZIONI FINESTRA



5 Pz



Art. 0601/30 € 16,00
SERIE PROTEZIONI PLAFONIERA



5 Pz



Art. 0687/005 € 26,90
SERIE PROTEZIONI PLAFONIERA



10 Pz



Art. 0575/04 € 42,20
SERIE PROTEZIONI FINESTRA



10 Pz



Art. 0580/01-6 € 26,90
SERIE PROTEZIONI FINESTRA



5 Pz



Art. 0490/11 € 22,00
GUANTI PER SABBIAATRICE



COPPIA GUANTI



Codice	Lunghezza	Diametro guanti	€
0575/29	600 mm	180 mm	38,90
0580/21	450 mm	230 mm	38,90

Art. 0486
VASCA DI LAVAGGIO DOPPIO USO
€ 515,00

1 Pennello

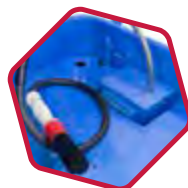
2 Pompa

3 Tubo flessibile

Dimensioni interne vasca sinistra	470 x 520 x 270 mm
Dimensioni interne vasca destra	590 x 520 x 270 mm
Capacità	150 l
Pompa	230V 50Hz 26 + 26 W
Portata pompa	3,3 l/min
Ingombro	1140 x 550 x 330 mm
Peso	45 kg

Art. 0038
VASCA DI LAVAGGIO
€ 268,00

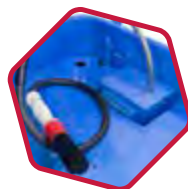
1 Pennello

2 Pompa

3 Tubo flessibile

Dimensioni interne vasca	710 x 480 x 260h mm
Altezza	880 mm
Capacità	75 l
Pompa	230V 50Hz 26W
Portata pompa	10-12 l / min
Ingombro	775 x 540 x 880h mm
Peso	25 kg



Art. 0232
VASCA DI LAVAGGIO
SU CARRELLO

€ 338,00



1 Pennello

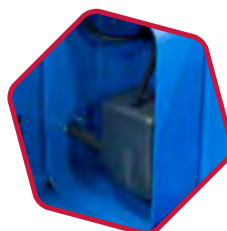

2 Pompa

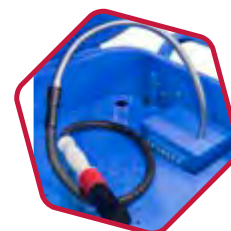

3 Tubo flessibile

Dimensioni interne vasca	710 x 480 x 200h mm
Altezza	890 mm
Capacità	60 l
Pompa	230 V 50 Hz 26 W
Portata pompa	10-12 l / min
Ingombro	970 x 540 x 930 h mm
Peso	36 kg



Art. 0632
VASCA DI LAVAGGIO PNEUMATICA

€ 761,00



Dimensioni interne vasca	775 x 540 x 200h mm
Altezza	1015 mm
Capacità	65 l
Pressione di alimentazione	0,5 bar
Peso	42 kg



Art. 0392
VASCA DI LAVAGGIO DA BANCO

€ 364,00



Capacità	14 l
Luce al neon	24 V 8 W
Pompa	230 V 50 Hz 26 W
Portata pompa	10-12 l / min
Dimensioni	560 x 545 x 635h mm
Peso	27 kg

VASCA DI LAVAGGIO DA BANCO PER MONTAGGIO A PARETE

Art. 0233
VASCA DI LAVAGGIO PORTATILE
€ 247,00

Dimensioni interne vasca	460 x 660 x 260 mm
Capacità	9 l
Pompa	230 V 50 Hz 16 W
Peso	5 kg

VASCA DI LAVAGGIO PORTATILE, COSTRUITA IN ABS
 CON GUARNIZIONI IN GOMMA NBR

LIQUIDO LAVAPEZZI

Codice	Contenuto	Portata del liquido	€
0632/D	25 l	A base solvente	135,00
0632/DA	25 l	Diluibile con acqua max. 50%	180,00

Art. 0435
POSTAZIONE SOFFIAGGIO
€ 270,00

Dimensioni schermo	250 x 515 mm
Dimensioni cabina	560 x 545 x 630 mm
Alimentazione	230 V 50 Hz 10 W
Peso	22 kg

POSTAZIONE SOFFIAGGIO, DA BANCO O PER MONTAGGIO
 A PARETE, REALIZZATA IN ACCIAIO, CON SCHERMO DI
 PROTEZIONE IN PLASTICA TRASPARENTE, LAMPADA AL
 NEON E ATTACCO ASPIRAZIONE ARIA



Art. A030/30A
ASPIRAPOLVERE ASPIRALIQUIDI 30L

€ 197,00



Potenza	1,4 kW
Capienza	30 l
Motori	1 (230 V 50 Hz)
Portata aria	35 l / s
Presa elettroutensile	1600 W
Peso	7 kg
Dimensioni	36 x 36 x 61 cm

ASPIRAPOLVERE-LIQUIDO PER USO INDUSTRIALE COMPLETO DI ACCESSORI - DOTATO DI PRESA PER ELETTROUTENSILI CON ACCENSIONE E SPEGNIMENTO AUTOMATICO



Art. A030/60A
ASPIRAPOLVERE ASPIRALIQUIDI 60L

€ 314,00



Potenza	1,4 kW
Capienza	60 l
Motori	1 (230 V 50 Hz)
Portata aria	46 l / s
Presa elettroutensile	1600 W
Peso	13 kg
Dimensioni	51 x 46 x 84 cm

ASPIRAPOLVERE-LIQUIDO PER USO INDUSTRIALE COMPLETO DI ACCESSORI - DOTATO DI PRESA PER ELETTROUTENSILI CON ACCENSIONE E SPEGNIMENTO AUTOMATICO



Art. A030/80
ASPIRAPOLVERE ASPIRALIQUIDI 80L 3 MOTORI

€ 590,00



1 Scarico acqua



2 Fusto ribaltabile

Potenza	3 kW
Capienza	80 l
Motori	3 (230 V 50 Hz)
Portata aria	108 l / s
Peso	27 kg
Dimensioni	59 x 58 x 88 cm

ASPIRAPOLVERE-LIQUIDO PER USO INDUSTRIALE COMPLETO DI ACCESSORI

Art. A040/30A
 ASPIRAPOLVERE ASPIRALIQUIDI 30L

€ 178,00

Potenza	1,4 kW
Capienza	30 l
Motori	1 (230 V 50 Hz)
Portata aria	35 l / s
Presseletroutensile	1600 W
Peso	7,5 kg
Dimensioni imballo	36,5 x 36,5 x 59 cm mm

ASPIRAPOLVERE-LIQUIDO PER USO INDUSTRIALE COMPLETO DI ACCESSORI - DOTATO DI PRESA PER ELETTROUTENSILI CON ACCENSIONE E SPEGNIMENTO AUTOMATICO

Art. A040/60A
 ASPIRAPOLVERE ASPIRALIQUIDI 60L

€ 280,00

Potenza	1,4 kW
Capienza	60 l
Motori	1 (230 V 50 Hz)
Portata aria	46 l / s
Presseletroutensile	1600 W
Peso	13,8 kg
Dimensioni imballo	49 x 47 x 69 cm mm

ASPIRAPOLVERE-LIQUIDO PER USO INDUSTRIALE COMPLETO DI ACCESSORI - DOTATO DI PRESA PER ELETTROUTENSILI CON ACCENSIONE E SPEGNIMENTO AUTOMATICO

Art. A040/802
 ASPIRAPOLVERE ASPIRALIQUIDI 80L 2 MOTORI

€ 490,00

Potenza	2 kW
Capienza	80 l
Motori	2 (230 V 50 Hz)
Portata aria	75 l / s
Peso	28 kg
Dimensioni	60 x 58 x 95 cm

ASPIRAPOLVERE-LIQUIDO PER USO INDUSTRIALE COMPLETO DI ACCESSORI



Art. A040/803
ASPIRAPOLVERE ASPIRALIQUIDI 80L 3 MOTORI

€ 625,00



Potenza	3 kW
Capienza	80 l
Motori	3 (230 V 50 Hz)
Portata aria	96 l / s
Peso	30 kg
Dimensioni	60 x 58 x 95 cm

ASPIRAPOLVERE-LIQUIDO PER USO INDUSTRIALE COMPLETO DI ACCESSORI



TABELLA DI COMPATIBILITÀ

Codice Compatibile	Descrizione	€	A030/30A	A030/60A	A030/80	Pag
A030/A02	SPAZZOLA GRANDE	13,68	•	•		145
A030/A04	PROLUNGA	13,68	•	•		145
A030/A05	SPAZZOLA ROTONDA	10,83	•	•		145
A030/A06	LANCIA CORTA	10,83	•	•		145
A030/A07	TUBO DA 1.7 m	13,68	•	•		145
A030/30A18	5 SACCHETTI POLVERE	43,66	•	•		145
A030/60A25	FILTRO	15,40	•	•		145
A030/8016	SPAZZOLA GRANDE PER SECCO	17,40			•	146
A030/8017	SPAZZOLA GRANDE PER UMIDO	17,40			•	146
A030/8018	SPAZZOLA ROTONDA	10,90			•	146
A030/8019	LANCIA CORTA	10,90			•	146
A030/8020	TUBO DA 1,7m	20,20			•	146
A030/8021	TUBI IN ACCIAIO (2 PZ)	28,90			•	146
A030/8022	FILTRO • ASPIRATORE 80L	20,20			•	146

Codice Compatibile	Descrizione	€	A040/30A	A040/60A	A040/802	A040/803	Pag
A040/A30	SPAZZOLA GRANDE	13,00	•	•			146
A040/A26	COPPIA PROLUNGHE	12,00	•	•			146
A040/A45	SPAZZOLA ROTONDA	9,50	•	•			146
A040/A28	LANCIA CORTA	9,50	•	•			146
A040/A50	TUBO DA 1,5 m	12,00	•	•			146
A040/A27	SET 5 SACCHETTI PER POLVERE	45,00	•	•			146
A040/A49	FILTRO IN HEPA	14,00	•	•			146
A040/8037	TUBO DA 2,5 m	18,00			•	•	146
A040/8040	COPPIA TUBI IN METALLO	26,00			•	•	146
A040/8047U	SPAZZOLA PER UMIDO	14,00			•	•	146
A040/8047S	SPAZZOLA PER SECCO	13,00			•	•	146
A040/8029	FILTRO IN PANNO	15,00			•	•	146
A040/8046	LANCIA CORTA	5,00			•	•	146
A040/8048	SPAZZOLA ROTONDA	8,00			•	•	146



ACCESSORI DI RICAMBIO PER ASPIRAPOLVERE



Codice	Lettera	Ricambi	€
A030/A02	A	Spazzola grande	13,68
A030/A04	B	Prolunga	13,68
A030/A05	C	Spazzola rotonda	10,84
A030/A06	D	Lancia corta	10,84
A030/A07	E	Tubo da 1,7 m	13,68
A030/30A18	F	Set 5 sacchetti per polvere	43,66
A030/60A25	G	Filtro	15,40

ACCESSORI DI RICAMBIO PER ASPIRAPOLVERE

Codice	Lettera	Ricambi	€
A030/8016	A	Spazzola grande per secco	17,40
A030/8017	B	Spazzola grande per umido	17,40
A030/8018	C	Spazzola rotonda	10,90
A030/8019	D	Lancia corta	10,90
A030/8020	E	Tubo da 1,7 m	20,20
A030/8021	F	Tubi in acciaio	28,90
A030/8022	G	Filtro	20,20

ACCESSORI DI RICAMBIO PER ASPIRAPOLVERE

Codice	Lettera	Ricambi	€
A040/A30	A	Spazzola grande	13,00
A040/A26	B	Prolunga	12,00
A040/A45	C	Spazzola rotonda	9,50
A040/A28	D	Lancia corta	9,50
A040/A50	E	Tubo da 1,5 m	12,00
A040/A27	F	Set 5 sacchetti per polvere	45,00
A040/A49	G	Filtro per A040/30A - A040/60A	14,00

ACCESSORI DI RICAMBIO PER ASPIRAPOLVERE

Codice	Lettera	Ricambi	€
A040/8037	E	Tubo da 2,5 m	18,00
A040/8040	F	Coppia tubi in metallo	26,00
A040/8047U	B	Spazzola grande per umido	14,00
A040/8047S	A	Spazzola grande per secco	13,00
A040/8029	G	Filtro	15,00
A040/8046	D	Lancia corta	5,00
A040/8048	C	Spazzola rotonda	8,00



Art. M040

MACCHINA MARCATRICE A MICROPUNTI, PNEUMATICA

€ 5720,00



Area di marcatura	110 x 80 mm	Dimensioni tavola	320 x 300 mm
Velocità di scrittura	30 - 40 mm / sec	Massima durezza del pezzo	<= HRC62
		Peso	68 kg

MACCHINA MARCATRICE A MICROPUNTI, PNEUMATICA
 CONNESSIONE USB, SOFTWARE PER WINDOWS XP E WINDOWS 7 32 BIT



Art. M040/P12 € 168,00

PORTA PUNZONE +
 PUNZONE 3 x 12 mm



Art. M040/P14 € 153,00

PORTA PUNZONE +
 PUNZONE 3 x 14 mm



Art. M040/P20 € 186,00

PORTA PUNZONE +
 PUNZONE 4 x 20 mm



Art. M040/R € 108,00

RIDUZIONE PER PORTA
 PUNZONE 4 x 20 mm



ACCESSORI PER MARCATRICE M040

M040/CF

M040/CP

M040/D

M040/SA

M040/SP

M040/ST

Codice	Ricambi	€
M040/CF	Comando a distanza	130,00
M040/CP	Comando a pedale	280,00
M040/D	Divisore	1880,00
M040/SA	Supporto per alberi	150,00
M040/SP	Supporto per targhette	343,00
M040/ST	Supporto per tubi	130,00

LETTERE HRC 58-60

Codice	Dimensioni carattere	Dimensioni gambo	€
P012/L03	3 mm	6 x 6 x 60h mm	16,30
P012/L04	4 mm	7 x 7 x 61h mm	17,00
P012/L05	5 mm	7,5 x 7,5 x 61h mm	19,10
P012/L06	6 mm	8,8 x 8,8 x 63h mm	21,30
P012/L08	8 mm	10 x 10 x 66h mm	27,80

LETTERE HRC 58-60, CHROME-VANADIUM, 27 PEZZI

LETTERE HRC 58-60

Codice	Dimensioni carattere	Dimensioni gambo	€
P012/L03P	3 mm	7 x 7 x 61h mm	36,70
P012/L04P	4 mm	7,5 x 7,5 x 61h mm	40,00
P012/L05P	5 mm	8,8 x 8,8 x 63h mm	44,40
P012/L06P	6 mm	10 x 10 x 66h mm	52,00
P012/L08P	8 mm	12 x 12 x 70h mm	88,00

LETTERE HRC 58-60, MICRO STRESS, CHROME-VANADIUM, 27 PEZZI



NUMERI HRC 58-60



Codice	Dimensioni carattere	Dimensioni gambo	€
P012/N03	3 mm	6 x 6 x 60h mm	9,20
P012/N04	4 mm	7 x 7 x 61h mm	10,30
P012/N05	5 mm	7,5 x 7,5 x 61h mm	11,20
P012/N06	6 mm	8,8 x 8,8 x 63h mm	12,40
P012/N08	8 mm	10 x 10 x 66h mm	13,50

NUMERI HRC 58-60, CHROME-VANADIUM, 9 PEZZI



NUMERI HRC 58-60



Codice	Dimensioni carattere	Dimensioni gambo	€
P012/N03P	3 mm	7 x 7 x 61h mm	16,80
P012/N04P	4 mm	7,5 x 7,5 x 61h mm	20,20
P012/N05P	5 mm	8,8 x 8,8 x 63h mm	25,20
P012/N06P	6 mm	10 x 10 x 66h mm	28,90
P012/N08P	8 mm	12 x 12 x 70h mm	34,50

NUMERI HRC 58-60, MICRO STRESS, CHROME-VANADIUM, 9 PEZZI



Art. P021
PENNA ELETTRICA A BATTERIA

€ 24,00



Velocità	20000 rpm
Lunghezza	160 mm
Batterie non incluse	2 x 1,5 V AAA
Peso	55 g
Blister	
Imballo	12 / 72

PENNA ELETTRICA ROTATIVA A BATTERIA CON 2 PUNTE DIAMANTATE Ø 2,35 mm, MANEGGEVOLE E LEGGERA, ADATTA ALL'INCISIONE DI VETRO, CERAMICA, PLASTICA, LEGNO, INOX, OTTONE, ALLUMINIO, ACCIAI TENERI



Art. P002
PUNTE PER TRACCIARE CON CUSPIDE IN METALLO DURO

€ 4,00



Lunghezza	145 mm
Imballo	10* / 500



Art. P005
PUNTA PER TRACCIARE IN ACCIAIO

€ 4,56



Lunghezza	200 mm
Imballo	10* / 250



Art. P006 € 8,30
**PUNTE PER TRACCIARE CON
 CUSPIDE IN METALLO DURO**



Punta a scomparsa

Lunghezza 140 mm
Imballo 10* / 50



Art. P006/PR € 5,50
**SET 2 PUNTE DI RICAMBIO
 IN METALLO DURO**



Imballo 5*



Art. P020 € 26,90
PENNA ELETTRICA A VIBRAZIONE



Vibrazioni 7200 / min
Alimentazione 230 V 50 Hz 13 W
Imballo 20

PENNA ELETTRICA A VIBRAZIONE CON REGOLAZIONE DELLA VIBRAZIONE, ADATTA ALL'INCISIONE DI VETRO, CERAMICA, PLASTICA, LEGNO, INOX, OTTONE, ALLUMINIO, ACCIAI TENERI



Art. P020/P € 7,50
SERIE PUNTE DI RICAMBIO



 2 Pz





Art. P001/75
PRESSA IDRAULICA MANUALE E PNEUMATICA

€ 5050,00



1 Pistone mobile carrellato

2 Comando pneumatico di discesa

Portata	75000 kg
Area di lavoro	800 x 279 x 1450h mm
Diametro del cilindro	125 mm
Diametro del pistone	125 mm
Corsa del pistone	250 mm
Pressione di esercizio	0,75 ÷ 0,85 MPa
Dimensioni	1140 x 800 x 1896 mm
Peso	498 kg

PRESSA IDRAULICA MANUALE E PNEUMATICA DA 75 Ton, COSTRUITA IN ACCIAIO, DOTATA DI PISTONE MOBILE CARRELLATO, CON DOPPIO COMANDO MANUALE A DUE VELOCITÀ E COMANDO PNEUMATICO DI DISCESA

Art. P001/45
PRESSA IDRAULICA MANUALE E PNEUMATICA
€ 2632,00

1 Argano sollevamento piano

2 Pistone mobile carrellato

Portata	45000 kg
Area di lavoro	830 x 360 x 1000h mm
Ø del cilindro	90 mm
Ø del pistone	58 mm
Corsa del pistone	190 mm
Pressione di esercizio	7÷ 8 bar
Pressione massima	63,5 MPa
Peso	305 kg
Dimensioni	1400 x 800 x 1700h mm

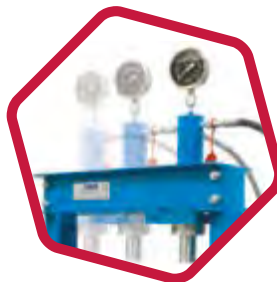
Art. P001/20
PRESSA MANUALE IDRAULICA
€ 935,00

1 Pistone mobile

2 Piano regolabile in altezza

Portata	20000 kg
Area di lavoro	540 x 210 x 1000h mm
Ø del cilindro	70 mm
Ø del pistone	48 mm
Corsa del pistone	155 mm
Pressione massima	69.3 MPa
Peso	100 kg
Dimensioni	770 x 700 x 1800h mm

PRESSA MANUALE IDRAULICA CON PISTONE MOBILE



Art. P001/04
PRESSA MANUALE IDRAULICA

€ 281,00



1 Pompa manuale



2 Prolunghe pistone

Portata	4000 kg	Corsa del pistone	125 mm
Area di lavoro	350 x 115 x 325h mm	Pressione massima	51 MPa
Ø del cilindro	Ø 40 mm	Peso	29 kg
Ø del pistone	Ø 25 mm	Dimensioni	450 x 400 x 655h mm



PRESSA MANUALE A CREMAGLIERA



Codice	Forza	Dimensioni	Altezza max pezzo	Max Ø pezzo	Sezione albero	Peso	€
P029/3	25000 N	450 x 200 x 570h mm	310 mm	300 mm	37,8 x 37,8mm	57 kg	404,00
P029/2	15000 N	400 x 175 x 450h mm	210 mm	300 mm	31,5 x 31,5mm	42 kg	319,00

PRESSA MANUALE A CREMAGLIERA CON TAVOLA GIREVOLE ESTRAIBILE



PRESSA MANUALE



Codice	Forza	Dimensioni	Altezza max pezzo	Max Ø pezzo	Corsa albero	Peso	€
P028/14	2000 N	280 x 170 x 760h mm	275 mm	180 mm	70 mm	19 kg	213,00
P028/07	1500 N	240 x 155 x 335h mm	170 mm	160 mm	60 mm	9 kg	126,00

PRESSA MANUALE CON MOLLA DI RITORNO

Art. 0664
POMPA IDRAULICA CON COMANDO PNEUMATICO A PEDALE
€ 322,00

Pressione nominale	70 MPa
Pressione di esercizio	7 ÷ 8 bar
Capacità olio	690 c.c.
Consumo aria	10 SCFM
Dimensioni imballo	380 x 180 x 200 mm
Peso	9 kg

**POMPA IDRAULICA CON COMANDO PNEUMATICO A PEDALE
ADATTA PER PRESSE, CRIC E PISTONI**

Art. 0271
POMPA IDRAULICA
€ 130,00

Pressione nominale	63,7 MPa
Capacità olio	790 ml
Dimensioni imballo	73 x 37,5 x 19 mm
Peso	7,7 kg

Art. 0663
TIRANTE IDRAULICO
€ 120,00

Portata	5 ton
Lunghezza Chiuso	560 mm
Lunghezza Aperto	690 mm
Stelo	Ø 33 mm
Corsa	130 mm
Peso	5,5 kg
Imballo	6



UNITÀ IDRAULICA IN KIT

0054/10

0054/4



Codice	Capacità	Lunghezza pistone	Corsa pistone	Peso	€
0054/10	10 ton	330 mm	150 mm	33 kg	354,00
0054/4	4 ton	270 mm	120 mm	17 kg	285,00



TABELLA DI COMPATIBILITÀ

Codice compatibile	Descrizione	€	P001/75	P001/45	P001/20	P001/04	0664	0271	0663	0054/10	0054/4	Pag
0256/05	CRIC IDRAULICO A PROFILO RIBASSATO	55,00					•	•	•	•	•	156
0256/10	CRIC IDRAULICO A PROFILO RIBASSATO	93,50					•	•	•	•	•	156
0256/20	CRIC IDRAULICO A PROFILO RIBASSATO	115,00					•	•	•	•	•	156
0256/30	CRIC IDRAULICO A PROFILO RIBASSATO	126,00					•	•	•	•	•	156
0256/50	CRIC IDRAULICO A PROFILO RIBASSATO	180,00					•	•	•	•	•	156
0664	POMPA IDRAULICA CON COMANDO PNEUMATICO A PEDALE	322,00			•	•			•	•	•	154
0271	POMPA IDRAULICA	130,00			•	•			•	•	•	154
0785/1F	RUBINETTO FEMMINA UNIVERSALE	10,50	•	•			•					582
0777/2	RIDUTTORE CON MANOMETRO E SEPARATORE	40,30	•	•			•					582
0777/3	RIDUTTORE CON MANOMETRO, SEPARATORE E OLIAIORE	71,50	•	•			•					582
S100/10X6.5	SPIRALE IN POLIURETANO CON RACCORDO GIREVOLE MASCHIO	24,00	•	•			•					582
S100/12X8	SPIRALE IN POLIURETANO CON RACCORDO GIREVOLE MASCHIO	26,50	•	•			•					582
S100/08X5	SPIRALE IN POLIURETANO CON RACCORDO GIREVOLE MASCHIO	16,30	•	•			•					582
S075/08X5	SPIRALE IN POLIURETANO CON RACCORDO GIREVOLE MASCHIO	13,50	•	•			•					582
S075/10X6.5	SPIRALE IN POLIURETANO CON RACCORDO GIREVOLE MASCHIO	18,90	•	•			•					582

CRIC IDRAULICO A PROFILO RIBASSATO

Codice	Portata max	Pressione di esercizio	Altezza min-max sollevabile	Stelo	Corsa pistone	Dimensioni	Peso	Imballo	€
0256/05	5 ton	63 Mpa	33 ÷ 39 mm	Ø 24 mm	6 mm	45 x 95 mm	0,65 kg	25	55,00
0256/10	10 ton	63.7 Mpa	44 ÷ 55 mm	Ø 38 mm	11 mm	56 x 118 mm	1,80 kg	10	93,50
0256/20	20 ton	63.7 Mpa	52 ÷ 63 mm	Ø 50 mm	11 mm	76 x 138 mm	2,80 kg	10	115,00
0256/30	30 ton	63.7 Mpa	60 ÷ 72 mm	Ø 63 mm	12 mm	95 x 158 mm	4,75 kg	4	126,00
0256/50	50 ton	63.7 Mpa	66 ÷ 78 mm	Ø 70 mm	12 mm	118 x 186 mm	6,80 kg	4	180,00

CRIC A BOTTIGLIA

Codice	Portata	Altezza min.	Alzata	Regolazione	Dimensioni base	Diametro del pistone	Imballo	Peso	€
0062/2	2 ton	181 mm	116 mm	48 mm	90 x 85 mm	Ø 22 mm	10	2,7 kg	25,00
0062/5	5 ton	220 mm	127 mm	70 mm	115 x 100 mm	Ø 32 mm	4	4,3 kg	38,90
0062/10	10 ton	230 mm	150 mm	80 mm	125 x 110 mm	Ø 40 mm	4	6,5 kg	52,20
0062/15	15 ton	230 mm	150 mm	80 mm	140 x 135 mm	Ø 48 mm	2	8,4 kg	77,00
0062/20	20 ton	242 mm	150 mm	60 mm	155 x 145 mm	Ø 53 mm	6	11 kg	88,00
0062/32	32 ton	285 mm	180 mm	- mm	170 x 160 mm	Ø 56 mm	1	17,6 kg	169,00
0062/50	50 ton	295 mm	180 mm	- mm	215 x 175 mm	Ø 85 mm	1	33 kg	290,00

CRIC IDRAULICO A BOTTIGLIA, GARANTISCE UN' OTTIMA STABILITÀ GRAZIE ALLE SUE RIDOTTE DIMENSIONI, FACILE DA TRASPORTARE E DA UTILIZZARE



Art. 0457
CRIC A PROFILO RIBASSATO

€ 530,00



CRIC A PROFILO RIBASSATO DA 2 ton, COSTRUITO IN ACCIAIO, CON IMPUGNATURA CIRCOLARE

Capacità	2 ton
Alzata	70 ÷ 500 mm
Dimensioni	785 x 350 x 152 mm
Peso	43 kg



Art. 0788
CRIC A CARRELLO

€ 476,00



CRIC A CARRELLO IN ALLUMINIO A DOPPIO POMPANTE, AVVICINAMENTO RAPIDO

Capacità	1,5 ton
Dimensioni	600 x 300 x 170 mm
Alzata	85 ÷ 445 mm
Peso	21 kg



Art. 0369
CRIC A PROFILO RIBASSATO

€ 330,00

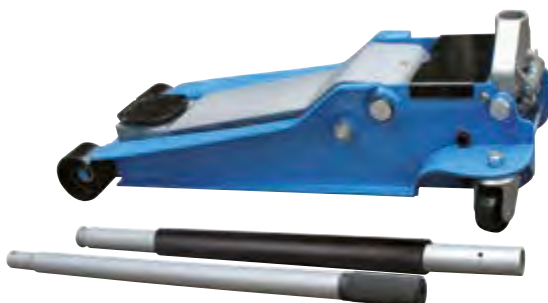

CRIC A PROFILO RIBASSATO A DOPPIO POMPANTE CON SELLA SMONTABILE E TAMPONE IN GOMMA

Capacità	3,5 ton
Dimensioni	745 x 335 x 180 mm
Alzata	110 ÷ 560 mm
Peso	46 kg

Art. 0375
 CRIC A PROFILO RIBASSATO

€ 277,00

Capacità	2 ton
Dimensioni	790 x 285 x 180 mm
Alzata	90 ÷ 533 mm
Peso	35 kg

Art. 0065
 CRIC A CARRELLO

€ 217,00

CRIC A CARRELLO CON SELLA SMONTABILE

Capacità	2,25 ton
Dimensioni	625 x 350 x 170 mm
Alzata	145 ÷ 530 mm
Peso	38 kg

Art. 0060
 CRIC A CARRELLO

€ 70,00

Capacità	2 ton
Dimensioni	535 x 225 x 145 mm
Alzata	135 ÷ 385 mm
Peso	11 kg



Art. 0658 € 814,00
SOLLEVATORE IDRAULICO



Capacità	10 ton
Sollevamento sul piede	30 ÷ 260 mm
Sollevamento sulla testa	420 ÷ 665 mm
Peso	37 kg



COPPIA DI CAVALLETTI



	0069/6	0069/3
Portata	6 ton	3 ton
Altezza min - max	400 ÷ 610 mm	298 ÷ 428 mm
Dimensioni base	260 x 285 mm	190 x 210 mm
Peso	13 kg	6,4 kg
€	82,50	44,40



Art. 0067
COPPIA DI CAVALLETTI

€ 26,90



Portata	2 ton
Altezze	240 - 270 - 320 - 365 mm
Peso	3 kg
Imballo	6

Art. R015
 SET 2 RAMPE PER AUTO

€ 155,00

Dimensioni	905 x 330 x 218mm
Capacità	2,5 ton
Larghezza max pneumatico	240 mm
Inclinazione	15°
Peso	8 kg

 SET 2 RAMPE PER AUTO, IN POLIPROPILENE, CON
 CAPACITÀ MAX DI 2.5 ton

Art. 0598
 FERMA RUOTE DA GARAGE

€ 19,00

Dimensioni	685 x 305 x 38 mm
Peso	1,16 kg
Imballo	6

FERMA RUOTE DA GARAGE IN POLIPROPILENE

Art. 0592
 PARACOLPI DA GARAGE

€ 7,00

Dimensioni	640 x 165 x 15 mm
Peso	0,45 kg
Imballo	24

PARACOLPI DA GARAGE, IN POLIPROPILENE

RAMPE IN ALLUMINIO

Codice	Dimensioni	Portata	Peso	Pendenza max	Dislivello max	€
0649/1500	1520 x 735 mm	170 kg	14 kg	12,5 % [7°]	180 mm	350,00
0649/1800	1800 x 735 mm	150 kg	17 kg	12,5 % [7°]	220 mm	435,00



Art. S008/M
SOLLEVATORE IDRAULICO

€ 893,00



1 Fermo meccanico



2 Fermo di stazionamento



Capacità di sollevamento	400 kg
Dimensioni piattaforma	1825 x 660 mm
Lunghezza totale	2500 mm
Altezza di sollevamento	195 ÷ 750 mm
Peso	160 kg

SOLLEVATORE IDRAULICO PER MOTO CON POMPA A PEDALE



Art. S013
SOLLEVATORE IDRAULICO

€ 1750,00

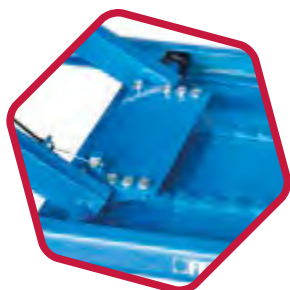

1 Fermo meccanico



2 Pompa idraulica



Capacità di sollevamento	600 kg
Dimensioni piattaforma	2000 x 1220 mm
Lunghezza totale	2575 mm
Altezza di sollevamento	185 ÷ 825 mm
Peso	230 kg

SOLLEVATORE IDRAULICO PER MOTO E QUAD CON POMPA A PEDALE E PNEUMATICA



Art. 0452
SOLLEVATORE A PANTOGRAFO PER MOTO

€ 147,00



Capacità di sollevamento	400 kg
Dimensioni piattaforma	470 x 150 mm
Altezza di sollevamento	95 ÷ 400
Peso	14 kg

SOLLEVATORE A PANTOGRAFO PER MOTO, DA USARE SU PONTE O A TERRA PER RIPARARE O FARE MANUTENZIONE ALLA MOTO



Art. 0430
CARRELLO SPOSTA MOTO

€ 252,00



Portata max	300 kg
Lunghezza	1929 mm
Peso	32,5 / 30 kg
Dimensioni imballo	1100 x 405 x 135 mm

CARRELLO SPOSTA MOTO IN ACCIAIO, VERNICIATO A POLVERE, IDONEO PER LE MOTO E GLI SCOOTER CHE HANNO IL CAVALLETTO LATERALE PERMETTE DI PARCHEGGIARE E SPOSTARE LA TUA MOTO IN SPAZI RISTRETTI





Art. 0010 CARRELLO REGOLABILE IN ALTEZZA

€ 785,00

1 Manico
ripiegabile2 Fermo
meccanico3 Scarico
a leva

Portata	500 kg
Dimensioni tavola	850 x 500 x 50 mm
Alzata	290 ÷ 880 mm
Peso	91 kg
Imballo	4

CARRELLO REGOLABILE IN ALTEZZA A PANTOGRAFO CON MANIGLIA RIPIEGABILE, DOTATO DI SISTEMA DI BLOCCAGGIO MECCANICO DELLA PIATTAFORMA E RUOTE PIVOTANTI FRENATE



Art. 0075 CARRELLO REGOLABILE IN ALTEZZA

€ 718,00

1 Manico
ripiegabile2 Fermo
meccanico3 Scarico
a leva

Portata	300 kg
Dimensioni tavola	850 x 500 x 50 mm
Alzata	290 ÷ 880 mm
Peso	81 kg
Imballo	4

CARRELLO REGOLABILE IN ALTEZZA A PANTOGRAFO CON MANIGLIA RIPIEGABILE DOTATO DI SISTEMA DI BLOCCAGGIO MECCANICO, RUOTE PIVOTANTI FRENATE



Art. 0467 CARRELLO REGOLABILE IN ALTEZZA

€ 930,00

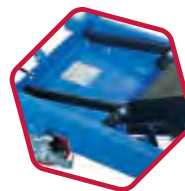
1 sollevamento
a pedale2 Fermo
meccanico3 Scarico
a leva

Portata	350 kg
Dimensioni tavola	910 x 500 x 53 mm
Alzata	335 ÷ 1300 mm
Peso	105 kg

CARRELLO REGOLABILE IN ALTEZZA A DOPPIO PANTOGRAFO CON MANIGLIA FISSA. DOTATO DI SISTEMA DI BLOCCAGGIO MECCANICO DELLA PIATTAFORMA E RUOTE PIVOTANTI FRENATE

Art. 0072
GRU IDRAULICA PIEGHEVOLE
€ 646,00

Portata	1000 kg
Dimensioni	1640 x 970 x 1670 mm
Dimensioni chiusa	620 x 460 x 1460 mm
Altezza gancio con braccio abbassato	100 - 220 - 340 mm (500, 750, 1000 kg)
Altezza gancio con braccio alzato	2070 - 2140 - 2210 mm (1000, 750, 500 kg)
Sbraccio min/max	750 ÷ 1000 mm
Apertura anteriore	680 mm
Peso	76 kg

GRU IDRAULICA PIEGHEVOLE PER RIDURRE AL MINIMO GLI INGOMBRI QUANDO NON SI USA, ANCHE DA PIEGATA PUÒ ESSERE SPOSTATA FACILMENTE SENZA PREGIUDICARNE LA STABILITÀ

Art. 0063
GRUETTA IDRAULICA PIEGHEVOLE
€ 640,00

Portata	1000 kg
Dimensioni	1800 x 1000 x 1500h mm
Dimensioni chiusa	800 x 860 x 1600h mm
Altezza gancio	480 ÷ 2100 mm (1000 kg)
Altezza gancio	0 ÷ 2550 mm (250 kg)
Sbraccio min/max	680 ÷ 1220 mm
Apertura anteriore	800 mm
Peso	95 kg

Art. 0094
SOLLEVATORE IDRAULICO PER FOSSA E SOTTOPONTE
€ 320,00

Portata	500 kg
Dimensioni	1190 x 700 x 660 mm
Altezza di sollevamento	1190 ÷ 2000 mm
Peso	37 kg

SOLLEVATORE IDRAULICO PER FOSSA E SOTTOPONTE CON SUPPORTO A CROCE E SUPPORTO INCLINABILE PER ALLINEARE E POSIZIONARE MEGLIO CAMBI E DIFFERENZIALI



Art. S019
SUPPORTO MOTORE

€ 137,00



Capacità	450 kg
Dimensioni	865 x 810 x 870 mm
Peso	22 kg

SUPPORTO MOTORE, 2 RUOTE GIREVOLI CON FRENO
E 2 RUOTE FISSE, POSSIBILITÀ DI INCLINARE IL MOTORE



PARANCO A CATENA



Codice	Portata	Alzata	Peso	€
0056/1	1000 kg	3000 mm	12 kg	145,00
0056/2	2000 kg	3000 mm	22 kg	214,00



PARANCO A LEVA



Codice	Portata	Alzata	Peso	€
0237/05	500 kg	1500 mm	5 kg	175,00
0237/15	1500 kg	1500 mm	12 kg	260,00

Art. 0602
PARANCO ELETTRICO
€ 265,00

1 Sollevamento doppio tiro

2 Pulsantiera

Portata	200 / 400 kg
Lunghezza cavo	18 m
Velocità	8 m/min
Motore monofase	230 V 50 Hz 1 kW
Peso	16,7 kg
Imballo	2

Art. 0600
PARANCO ELETTRICO
€ 295,00

1 Sollevamento doppio tiro

2 Pulsantiera

Portata	200 / 400 kg
Lunghezza cavo	18 m
Velocità	8 m / min
Motore monofase	230 V 50 Hz 0,75 kW
Peso	18 kg
Imballo	2

Art. 0236
SUPPORTO A BANDIERA
€ 85,00

Esempio installazione

Portata	300 kg
Lunghezza braccio	750 mm
Interasse fori	380 mm
Sezione	45 X 45 mm ²
Imballo	4



SOLLEVATORE MAGNETICO



NEODIMIO

Codice	Portata max	Portata barre tonde	Diametro min-max sollevabile	Peso	€
S0300	300 kg	100 kg	50 ÷ 300 mm	9,5 kg	610,00
S0600	600 kg	200 kg	70 ÷ 400 mm	19 kg	964,00
S1000	1000 kg	330 kg	75 ÷ 450 mm	36 kg	1450,00



PENDENTI DI CATENA



EN 818-4

Codice	Lunghezza	Portata verticale	Catena	Gancio	€
PDC4/7/2	2000 mm	4500 kg	Ø 7 mm	SLF	391,00
PDC4/7/3	3000 mm	4500 kg	Ø 7 mm	SLF	451,00
PDC4/7/4	4000 mm	4500 kg	Ø 7 mm	SLF	509,00
PDC4/10/2	2000 mm	9000 kg	Ø 10 mm	SLF	777,00
PDC4/10/3	3000 mm	9000 kg	Ø 10 mm	SLF	856,00
PDC4/10/4	4000 mm	9000 kg	Ø 10 mm	SLF	977,00

PENDENTI DI CATENA "NERA" IN ACCIAIO LEGATO A 4 BRACCI GR 80 CON GANCIO ACCORCIATORE, COEFFICIENTE DI SICUREZZA 4:1, EN 818-4, LA PORTATA VERTICALE È CALCOLATA SOLO SU 3 BRACCI IN QUANTO IL QUARTO BRACCIO È SOLO PER EQUILIBRARE IL CARICO



PENDENTI DI CATENA



EN 818-4

Codice	Lunghezza	Portata verticale	Catena	Gancio	€
PDC2/7/2	2000 mm	3000 kg	Ø 7 mm	SLF	190,00
PDC2/7/3	3000 mm	3000 kg	Ø 7 mm	SLF	202,00
PDC2/7/4	4000 mm	3000 kg	Ø 7 mm	SLF	227,00
PDC2/10/2	2000 mm	6000 kg	Ø 10 mm	SLF	270,00
PDC2/10/3	3000 mm	6000 kg	Ø 10 mm	SLF	310,00
PDC2/10/4	4000 mm	6000 kg	Ø 10 mm	SLF	355,00

PENDENTI DI CATENA "NERA" IN ACCIAIO LEGATO A 2 BRACCI GR 80, CON GANCI ACCORCIATORI, COEFFICIENTE DI SICUREZZA 4:1, EN 818-4

PENDINGI DI CATENA

EN 818-4

Codice	Lunghezza	Portata verticale	Catena	Gancio	€
PDC1/7/1	1000 mm	1200 kg	Ø 7 mm	SLF	77,00
PDC1/7/2	2000 mm	1200 kg	Ø 7 mm	SLF	88,00
PDC1/10/1	1000 mm	3000 kg	Ø 10 mm	SLF	115,00
PDC1/10/2	2000 mm	3000 kg	Ø 10 mm	SLF	135,00

PENDINGI DI CATENA "NERA" IN ACCIAIO LEGATO A 1 BRACCIO GR 80, CON GANCIO ACCORCIATORE, COEFFICIENTE DI SICUREZZA 4:1, EN 818-4

Art. AN2G/12/1
PENDENTE A 2 BRACCI IN ACCIAIO
€ 81,80

Fune	Ø 12 mm
Lunghezza	1000 mm
Portata	30° 2600 kg
Portata	90° 2100 kg

SISTEMA DI ANCORAGGIO CON NASTRO IN POLIESTERE

EN 12195-2

Codice	Nastro con tenditore	Larghezza nastro	Portata	Ganci	Imballo	€
0635	5,50 + 0,50 m	35 mm	1000 kg	2	30	27,80
0650	8,00 + 0,50 m	50 mm	2000 kg	2	10	38,90
0675	10,00 + 1,00 m	75 mm	3000 kg	2	4	143,00

Art. 0635/25 **€ 13,50**
SISTEMA DI ANCORAGGIO
CON NASTRO IN POLIESTERE

EN 12195-2

Nastro da mm 25 con tenditore e 2 ganci	4,00 + 0,30 m
Portata	250 kg
Imballo	24

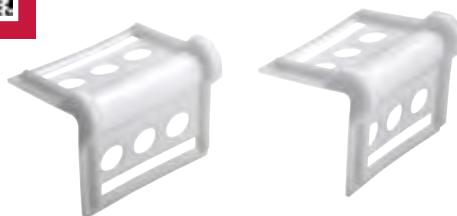
Art. 0117 **€ 13,70**
COPPIA PROTEZIONI IN PLASTICA

Dimensioni	135 x 125 mm
Imballo	6* / 24



BRACHE PIATTE IN POLIESTERE COLORATO



EN 1492-1

Codice	m	Largh.	Colore	Lungh. asole	Portata verticale	Portata canestro	Portata canestro β 45° kg	Portata canestro β 60° kg	Portata cappio	€
1/1000	1	50 mm	Viola	250 mm	1000 kg	2000 kg	1400	1000	800 kg	13,40
2/1000	2	50 mm	Viola	250 mm	1000 kg	2000 kg	1400	1000	800 kg	18,00
3/1000	3	50 mm	Viola	250 mm	1000 kg	2000 kg	1400	1000	800 kg	21,30
4/1000	4	50 mm	Viola	250 mm	1000 kg	2000 kg	1400	1000	800 kg	25,80
1/2000	1	60 mm	Verde	250 mm	2000 kg	4000 kg	2800	2000	1600 kg	17,30
2/2000	2	60 mm	Verde	250 mm	2000 kg	4000 kg	2800	2000	1600 kg	24,70
3/2000	3	60 mm	Verde	250 mm	2000 kg	4000 kg	2800	2000	1600 kg	32,20
4/2000	4	60 mm	Verde	250 mm	2000 kg	4000 kg	2800	2000	1600 kg	38,90
5/2000	5	60 mm	Verde	250 mm	2000 kg	4000 kg	2800	2000	1600 kg	48,90
6/2000	6	60 mm	Verde	250 mm	2000 kg	4000 kg	2800	2000	1600 kg	57,20
1/3000	1	90 mm	Giallo	300 mm	3000 kg	6000 kg	4200	3000	2400 kg	23,60
2/3000	2	90 mm	Giallo	300 mm	3000 kg	6000 kg	4200	3000	2400 kg	33,30
3/3000	3	90 mm	Giallo	300 mm	3000 kg	6000 kg	4200	3000	2400 kg	46,70
4/3000	4	90 mm	Giallo	300 mm	3000 kg	6000 kg	4200	3000	2400 kg	57,20
5/3000	5	90 mm	Giallo	300 mm	3000 kg	6000 kg	4200	3000	2400 kg	66,00
6/3000	6	90 mm	Giallo	300 mm	3000 kg	6000 kg	4200	3000	2400 kg	77,00

BRACHE PIATTE IN POLIESTERE COLORATO A DOPPIO STRATO, ASOLE RIVESTITE, ETICHETTE DI IDENTIFICAZIONE SECONDO LA NORMATIVA CEN EN 1492-1, COEFFICIENTE DI SICUREZZA 7:1



FUNI TONDE IN POLIESTERE



EN 1492-2

Codice	Anello	Colore	Verticale	Portata canestro	Portata canestro β 45° kg	Portata canestro β 60° kg	Portata cappio	€
FT1/1000	1 m	Viola	1000 kg	2000 kg	1400	1000	800 kg	6,80
FT2/1000	2 m	Viola	1000 kg	2000 kg	1400	1000	800 kg	9,60
FT3/1000	3 m	Viola	1000 kg	2000 kg	1400	1000	800 kg	13,50
FT4/1000	4 m	Viola	1000 kg	2000 kg	1400	1000	800 kg	17,40
FT5/1000	5 m	Viola	1000 kg	2000 kg	1400	1000	800 kg	21,30
FT6/1000	6 m	Viola	1000 kg	2000 kg	1400	1000	800 kg	25,40
FT1/2000	1 m	Verde	2000 kg	4000 kg	2800	2000	1600 kg	9,60
FT2/2000	2 m	Verde	2000 kg	4000 kg	2800	2000	1600 kg	11,90
FT3/2000	3 m	Verde	2000 kg	4000 kg	2800	2000	1600 kg	19,90
FT4/2000	4 m	Verde	2000 kg	4000 kg	2800	2000	1600 kg	25,20
FT5/2000	5 m	Verde	2000 kg	4000 kg	2800	2000	1600 kg	27,90
FT6/2000	6 m	Verde	2000 kg	4000 kg	2800	2000	1600 kg	33,30
FT1/3000	1 m	Giallo	3000 kg	6000 kg	4200	3000	2400 kg	11,90
FT2/3000	2 m	Giallo	3000 kg	6000 kg	4200	3000	2400 kg	17,50
FT3/3000	3 m	Giallo	3000 kg	6000 kg	4200	3000	2400 kg	25,20
FT4/3000	4 m	Giallo	3000 kg	6000 kg	4200	3000	2400 kg	32,80
FT5/3000	5 m	Giallo	3000 kg	6000 kg	4200	3000	2400 kg	38,30
FT6/3000	6 m	Giallo	3000 kg	6000 kg	4200	3000	2400 kg	48,00

FUNI TONDE IN POLIESTERE, ANELLO CHIUSO CON CALZA ESTERNA, SECONDO LA NORMATIVA CEN EN 1492-2 COEFFICIENTE DI SICUREZZA 7:1

Art. 0630/0900
 ARGANO ELETTRICO A 12 V IN CORRENTE CONTINUA

€ 297,00

IP 55

Tiro nominale orizzontale	450 / 900 kg	Dimensioni tamburo	Ø 31,5 x 73 mm
Velocità	1,3 - 3,2 m / min	Dimensioni ingombro	285 x 105 x 105h mm
Motore: magnete permanente	12 V 0,7 kW 0,9 hp	Peso	6,7 kg
Riduzione	153:1	Imballo	4
Dimensioni cavo	Ø 4 mm x 15 m		

Art. 0630/2200
 ARGANO ELETTRICO A 12 V IN CORRENTE CONTINUA

€ 735,00

IP 55

Tiro nominale orizzontale	2000 kg	Dimensioni tamburo	Ø 45 x 97 mm
Velocità	1,5 - 3,6 m / min	Dimensioni ingombro	364 x 126 x 141h mm
Motore: magnete permanente	12 V 2,4 kW 3,2 hp	Peso	13 kg
Riduzione	172:1	Imballo	2
Dimensioni cavo	Ø 6,4 mm x 14,5 m		



Art. 0630/2720

ARGANO ELETTRICO A 12 V IN CORRENTE CONTINUA

€ 1000,00



IP 55

Tiro nominale orizzontale	2720 kg	Dimensioni cavo	Ø 7,2 mm x 32 m
Velocità	1,3 - 4,5 m / min	Dimensioni tamburo	Ø 63 x 228 mm
Motore: magnete permanente	12 V 1,3 kW 1,8 hp	Dimensioni ingombro	520 x 180 x 175h mm
Riduzione	294:1	Peso	29 kg



ARGANO MANUALE A FUNE



Codice	Tiro massimo	Cavo	Peso	€
0791/08	800 kg	Ø 8,3mm x 20m	11 kg	354,00
0791/16	1600 kg	Ø 11mm x 20m	27 kg	477,00
0791/32	3200 kg	Ø 16mm x 20m	50 kg	935,00

ARGANO MANUALE A FUNE PER IL TIRO ED IL SOLLEVAMENTO



Art. 0066

TENDI CAVO CON DOPPIO CRICCHETTO

€ 32,20



Tiro massimo	800 kg
Diametro cavo	Ø 5 mm
Lunghezza massima	2 m
Peso	2,7 kg
Imballo	6



ARGANO MANUALE

Codice	Tiro massimo	Larghezza gola	Diametro esterno roccetto	Diametro minimo roccetto	Dimensioni cavo	Dimensioni base	Imballo	€
0070/C	500 kg	50 mm	133 mm	40 mm	Ø 4,5 mm x 10 m	140 x 90 mm	6	42,20
0070	500 kg	50 mm	133 mm	40 mm	-	140 x 90 mm	6	32,50

ARGANO MANUALE ZINCATO CON CAVO E GANCIO

Art. 0590
ARGANO MANUALE CON FRENO
€ 68,20

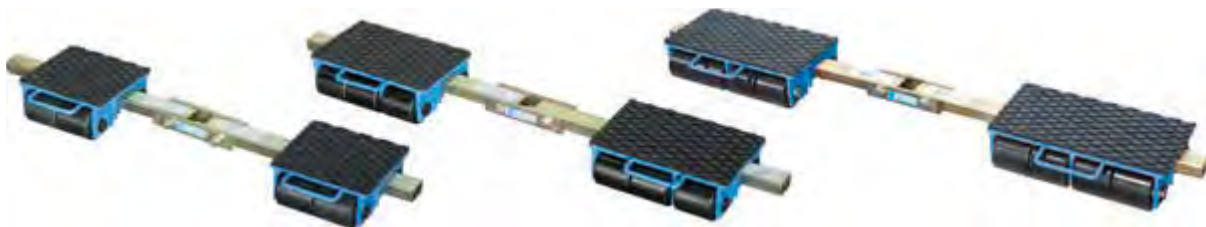
Tiro massimo	450 kg
Larghezza gola	49 mm
Diametro esterno roccetto	110 mm
Diametro minimo roccetto	45 mm
Dimensioni ingombro senza leva	170 x 150 x 125h mm
Peso	2,7 kg
Imballo	10

CARRELLI DA TRASPORTO

Codice	Capacità	Altezza utile	Dimensioni rulli	Ruote ogni carrello	Dimensioni appoggio	Lunghezza barra	Peso	€
0654/06F	6 Ton	110 mm	85 x 85 mm	4	200 x 220 mm	640 ÷ 1030 mm	30 kg	358,00
0654/09F	9 Ton	110 mm	85 x 85 mm	6	200 x 320 mm	840 ÷ 1230 mm	43 kg	479,00
0654/12F	12 Ton	110 mm	85 x 85 mm	8	200 x 407 mm	1104 ÷ 1430 mm	52 kg	545,00

CARRELLI DA TRASPORTO CON RUOTE IN NYLON



CARRELLI DA TRASPORTO



Codice	Capacità	Altezza utile	Dimensioni rulli	Ruote	Dimensioni appoggio	Lunghezza timone	Angolo di sterzata	Dimensioni	Peso	€
0654/06L	6 Ton	110 mm	85 x 85 mm	8	Ø 170 mm	1080 mm	±90°	610 x 520 mm	41 kg	525,00
0654/09L	9 Ton	110 mm	85 x 85 mm	12	Ø 170 mm	1080 mm	±90°	840 x 583 mm	59 kg	590,00
0654/12L	12 Ton	110 mm	85 x 85 mm	16	Ø 170 mm	1080 mm	±90°	1030 x 620 mm	80 kg	795,00

CARRELLI DA TRASPORTO CARRELLI DA TRASPORTO CON RUOTE IN NYLON DOTATO DI OCCHIELLO PER TRAINO



Art. 0068
TRANSPALLET
CON BILANCIA



€ 2810,00



Portata	2000 kg	Dimensioni forche	1150 x 568 mm	Stampante	No
Capacità pesatura	2000 kg	Lettura	1 kg	Ruota anteriore	2x
Altezza forche	88 ÷ 200 mm	Precisione	±2 kg	Peso	155 kg

TRANSPALLET CON BILANCIA NON IDONEI NEI RAPPORTI CON TERZI - FUNZIONE TARA ALIMENTAZIONE CON BATTERIE RICARICABILI - BATTISTRADA IN POLIURETANO



Art. 0068/S
TRANSPALLET CON
BILANCIA E STAMPANTE



€ 3230,00



Portata	2000 kg	Dimensioni forche	1150 x 568 mm	Stampante	Si
Capacità pesatura	2000 kg	Lettura	1 kg	Ruota anteriore	Doppia
Altezza forche	88 ÷ 200 mm	Precisione	±2 kg	Peso	155 kg

TRANSPALLET CON BILANCIA E STAMPANTE NON IDONEI NEI RAPPORTI CON TERZI - FUNZIONE TARA ALIMENTAZIONE CON BATTERIE RICARICABILI - BATTISTRADA IN POLIURETANO

TRANSPALLET MANUALE

Codice	Portata	Altezza forche	Dimensioni forche	Spessore telaio	Ruota anteriore	Peso	Imballo	€
0028	2500 kg	85 ÷ 200 mm	1150 x 540 mm	3 mm	Doppia	72 kg	1 / 6	550,00
0064	2500 kg	85 ÷ 200 mm	910 x 540 mm	3 mm	Singola	64 kg	6	635,00

TRANSPALLET MANUALE CON BATTISTRADA IN POLIURETANO

Art. S2/800
SOLLEVATORE PER PALLETS

€ 1092,00



Portata	1000 kg
Altezza forche	85 ÷ 800 mm
Dimensioni forche	1170 x 540 mm
Battistrada	Poliuretano/Polyurethane
Ruota anteriore	Singola/Single
Peso	117 kg
Imballo	4

SOLLEVATORE PER PALLETS A PANTOGRAFO



Art. 0782
SOLLEVATORE CON PIATTAFORMA E FORCHE

€ 1040,00



1 Ruota con freno



2 Sollevamento a pedale



3 Manopola di scarico

Portata	400 kg
Altezza forche	85 ÷ 1500 mm
Dimensioni forche	545 x 650 mm
Piattaforma	576 x 650 mm
Ruote sterzanti	Ø 127 x 40 mm
Ruote fisse	Ø 75 x 40 mm
Battistrada	Poliuretano / Polyurethane
Dimensioni	1100 x 600 x 1725h mm
Peso	90 kg



Art. 0143
SOLLEVATORE PER PALLET CON FRENO E PEDALE DI SOLLEVAMENTO

€ 1813,00



1 Ruota con freno



2 Sollevamento a pedale



3 Sollevamento a timone

Portata	1000 kg
Altezza forche	90 ÷ 1600 mm
Dimensioni forche	1150 x 560 mm
Altezza montante	2100 mm
Battistrada	Poliuretano / Polyurethane
Ruota anteriore	Doppia / Double
Dimensioni	750 x 1650 x 2100h mm
Peso	200 kg

Art. M061
MORSA DI PRECISIONE CON BARRA SENO
€ 419,00

Lunghezza morsa	235 mm
Larghezza ganaschia	88 mm
Interasse dei perni	100 mm
Altezza ganaschia	40 mm
Apertura	120 mm
Precisione	0,005 mm
Inclinazione	0° ÷ 45°
Peso	12,5 kg

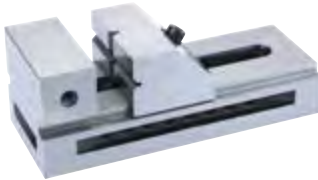
MORSA DI PRECISIONE IN ACCIAIO TEMPERATO E RETTIFICATO

Codice	Dimensioni	Apertura	Altezza ganaschia	Peso	Precisione	€
M012/038	38 x 105 x 45h mm	44 mm	25 mm	1,3 kg	0,005 mm	84,20
M012/050	50 x 140 x 50h mm	65 mm	25 mm	2 kg	0,005 mm	88,00
M012/080	73 x 190 x 67h mm	110 mm	35 mm	4 kg	0,005 mm	213,00
M012/100	100 x 245 x 90h mm	125 mm	45 mm	9,3 kg	0,005 mm	297,00

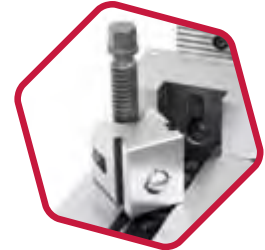
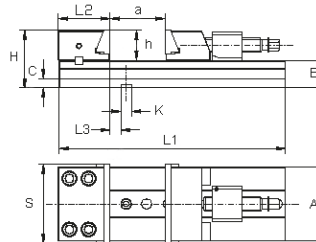
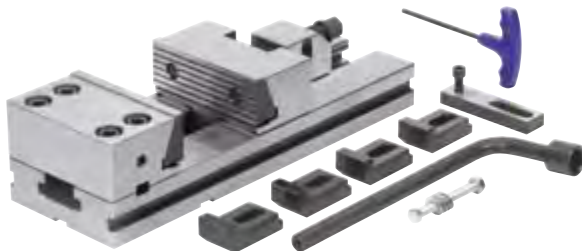
MORSA DI PRECISIONE IN ACCIAIO

Codice	Dimensioni ganaschia	Precisione	S	A	B	C	H	L1	L2	L3	h	K h7	a	Peso	€
M011/125/150	125 x 50h mm	0,02 mm	125 mm	125 mm	40 mm	15 mm	90 mm	350 mm	80 mm	25,6 mm	50 mm	16 mm	150 mm	20 kg	1040,00
M011/150/210	150 x 60h mm	0,02 mm	150 mm	150 mm	50 mm	20 mm	110 mm	435 mm	93 mm	25,6 mm	60 mm	16 mm	210 mm	36 kg	1200,00
M011/150/300	150 x 60h mm	0,02 mm	150 mm	150 mm	50 mm	20 mm	110 mm	525 mm	93 mm	25,6 mm	60 mm	16 mm	300 mm	40 kg	1360,00

GANASCE DI RICAMBIO

Codice	Descrizione	Dimensioni ganaschia	€
M011/125GP	Ganaschia prismatica	125 x 40h mm	222,00
M011/125GR	Coppia ganasce rigate	125 x 40h mm	374,00
M011/150GP	Ganaschia prismatica	150 x 45h mm	268,00
M011/150GR	Coppia ganasce rigate	150 x 45h mm	400,00



MORSA DI PRECISIONE IN ACCIAIO

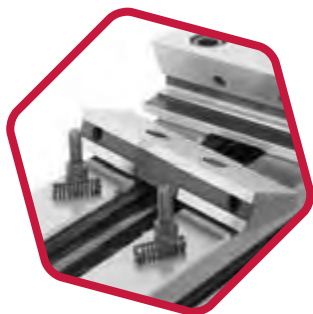
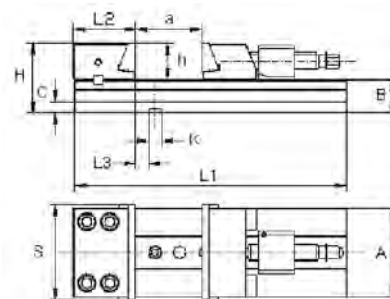
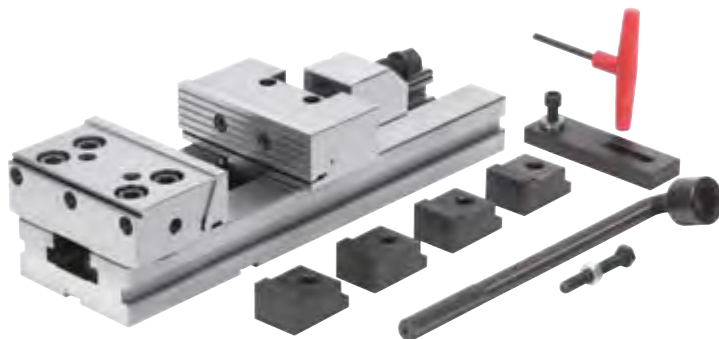

Codice	Dimensioni ganascia	Precisione	S	A	B	C	H	L1	L2	L3	h	K h7	a	Peso	€
M028/100/100	100 x 30h mm	0,02 mm	100 mm	75 mm	35 mm	15 mm	65 mm	270 mm	77,9 mm	25,6 mm	30 mm	16 mm	100 mm	7 kg	747,00
M028/125/150	125 x 40h mm	0,02 mm	125 mm	95 mm	40 mm	15 mm	80 mm	345 mm	77,9 mm	25,6 mm	40 mm	16 mm	150 mm	13 kg	812,00
M028/150/200	150 x 50h mm	0,02 mm	150 mm	125 mm	50 mm	20 mm	100 mm	420 mm	89,4 mm	25,6 mm	50 mm	16 mm	200 mm	26 kg	968,00
M028/150/300	150 x 50h mm	0,02 mm	150 mm	125 mm	50 mm	20 mm	100 mm	520 mm	89,4 mm	25,6 mm	50 mm	16 mm	300 mm	30 kg	1040,00
M028/150/400	150 x 50h mm	0,02 mm	150 mm	125 mm	50 mm	20 mm	100 mm	620 mm	89,4 mm	25,6 mm	50 mm	16 mm	400 mm	34 kg	1200,00
M028/175/200	175 x 60h mm	0,02 mm	175 mm	145 mm	58 mm	20 mm	118 mm	455 mm	96,9 mm	25,6 mm	60 mm	16 mm	200 mm	51 kg	1200,00
M028/175/300	175 x 60h mm	0,02 mm	175 mm	145 mm	58 mm	20 mm	118 mm	555 mm	96,9 mm	25,6 mm	60 mm	16 mm	300 mm	43 kg	1230,00
M028/175/400	175 x 60h mm	0,02 mm	175 mm	145 mm	58 mm	20 mm	118 mm	655 mm	96,9 mm	25,6 mm	60 mm	16 mm	400 mm	51 kg	1250,00
M028/175/500	175 x 60h mm	0,02 mm	175 mm	145 mm	58 mm	20 mm	118 mm	755 mm	96,9 mm	25,6 mm	60 mm	16 mm	500 mm	59 kg	1550,00
M028/200/300	200 x 65h mm	0,02 mm	200 mm	170 mm	70 mm	26 mm	135 mm	595 mm	113,4 mm	25,6 mm	65 mm	16 mm	300 mm	80 kg	1864,00
M028/200/400	200 x 65h mm	0,02 mm	200 mm	170 mm	70 mm	26 mm	135 mm	695 mm	113,4 mm	25,6 mm	65 mm	16 mm	400 mm	71 kg	1916,00
M028/200/500	200 x 65h mm	0,02 mm	200 mm	170 mm	70 mm	26 mm	135 mm	795 mm	113,4 mm	25,6 mm	65 mm	16 mm	500 mm	79 kg	2240,00
M028/200/600	200 x 65h mm	0,02 mm	200 mm	170 mm	70 mm	26 mm	135 mm	895 mm	113,4 mm	25,6 mm	65 mm	16 mm	600 mm	84 kg	2540,00



GANASCE DI RICAMBIO



Codice	Descrizione	Dimensioni ganascia	€
M028/100GP	Ganascia prismatica	100 x 24,5h mm	232,00
M028/175GP	Ganascia prismatica	175 x 43h mm	290,00
M028/200GP	Ganascia prismatica	200 x 53h mm	322,00
M028M029/125GP	Ganascia prismatica	125 x 32h mm	243,00
M028M029/150GP	Ganascia prismatica	150 x 40h mm	261,00

MORSA A MACCHINA CON BASE GIREVOLE 360°

Codice	Ganasce	Apertura	Dimensioni	Dimensioni base	Interasse fori	Cava	Peso	€
M023/100	100 x 35 mm	80 mm	270 x 130 x 105h mm	215 X 165 mm	195 mm	14 mm	11 kg	208,00
M023/125	125 x 40 mm	100 mm	355 x 190 x 127h mm	215 X 165 mm	195 mm	14 mm	17 kg	249,00
M023/160	160 x 50 mm	125 mm	422 x 235 x 162h mm	300 X 235 mm	275 mm	18 mm	32 kg	338,00
M023/200	200 x 61 mm	160 mm	490 x 270 x 175h mm	300 X 235 mm	275 mm	18 mm	50 kg	425,00

MORSA A MACCHINA CON BASE GIREVOLE 360°

M024/250

Codice	Ganasce	Apertura	Dimensioni	Dimensioni base	Interasse fori	Cava	Peso	€
M024/136	136 x 32 mm	170 mm	375 x 162 x 123h mm	223 x 165 mm	200 mm	14 mm	14 kg	180,00
M024/160	160 x 50 mm	180 mm	402 x 182 x 142h mm	252 x 182 mm	225 mm	14 mm	23 kg	260,00
M024/200	200 x 63 mm	220 mm	470 x 234 x 172h mm	- mm	- mm	- mm	33 kg	343,00
M024/250	250 x 63 mm	320 mm	612 x 280 x 186h mm	- mm	- mm	- mm	66 kg	498,00

MORSA A MACCHINA INCLINABILE CON BASE GIREVOLE 360°

Codice	Ganasce	Apertura	Dimensioni	Dimensioni base	Interasse fori	Cava	Peso	€
M530/100	100 x 32 mm	90 mm	325 x 180 x 150h mm	250 x 180 mm	230 mm	14 mm	19 kg	338,00
M530/125	125 x 40 mm	100 mm	360 x 206 x 165h mm	290 x 226 mm	260 mm	18 mm	26 kg	402,00
M530/160	160 x 50 mm	125 mm	443 x 270 x 194h mm	- mm	- mm	- mm	35 kg	493,00



Art. P014
SERIE PARALLELE IN ACCIAIO

€ 321,00



28 Pz

Dimensioni	150 x 10 x (14-16-18-20-22-24-26-28-30-32-35-40-45-50) mm
Durezza	HRC 60
Precisione	± 0,005 mm
Pezzi	28
Scatola di legno	
Imballo	2

SERIE PARALLELE IN ACCIAIO, TEMPERATE E RETTIFICATE IN COPPIA DI PRECISIONE



Art. P015
SERIE PARALLELE IN ACCIAIO

€ 175,00



18 Pz

Dimensioni	160 x 4 x (10-14-18-22-26-30-34-38-42) mm
Durezza	HRC 60
Precisione	± 0,005 mm
Pezzi	18
Scatola di legno	8,5 kg
Imballo	4

SERIE PARALLELE IN ACCIAIO, TEMPERATE E RETTIFICATE IN COPPIA DI PRECISIONE



Art. P017
SERIE PARALLELE IN ACCIAIO

€ 120,00



18 Pz

Dimensioni	150 x 8 x (14-16-20-24-30-32-36-40-44) mm
Durezza	HRC 45
Pezzi	18
Scatola di plastica	
Peso	4.9 kg

SERIE PARALLELE IN ACCIAIO, TEMPERATE E RETTIFICATE IN COPPIA DI PRECISIONE

Art. M027/100
MORSA TRAPANO
€ 155,00

Ganasce	100 X 44 mm
Apertura	110 mm
Dimensioni base	290 x 170 mm
Dimensioni imballo	400 x 220 x 120 mm
Peso	8,5 kg

MORSA TRAPANO CON GUIDE RASCHIETTATE

MORSA TRAPANO

Codice	Ganasce	Apertura	Peso	Imballo	€
M001/100	100 mm	80 mm	4,2 kg	5	58,30
M001/120	120 x 33,5 mm	110 mm	6,2 kg	4	71,50
M001/150	150 mm	135 mm	7,5 kg	5	89,70

MORSA TRAPANO

Codice	Ganasce	Interasse fori	Apertura morsa	Larg. asola	Peso	Imballo	€
0142/75	75 X 24 mm	95 mm	55 mm	9 mm	1,8 kg	10	20,20
0142/100	100 x 25,5 mm	125 mm	85 mm	12 mm	2,8 kg	10	28,50
0142/125	125 x 30 mm	140 mm	100 mm	13 mm	4,4 kg	5	35,50

Art. 0698/100
MORSA INCLINABILE
€ 90,20

Ganasce	105 x 47 mm
Apertura	105 mm
Fori	0°-15°-30°-45°-60°-75°-90°
Base	192 x 185 mm
Interasse fori	160 mm
Dimensioni	192 x 185 x 115h mm
Peso	8,5 kg

**Art. M034/120****MORSA TRAPANO A SERRAGGIO RAPIDO****€ 261,00**

Ganasce	120 x 40 mm
Apertura	120 mm
Peso	7 kg
Imballo	4

MORSA TRAPANO A SERRAGGIO RAPIDO CON GANASCIA PRISMATICA E BASE GIREVOLE

**MORSA A CROCE**

Codice	Ganasce	Apertura	Dimensioni base	Altezza	Corsa longitudinale	Corsa trasversale	Peso	€
0188/100	100 x 25 mm	90 mm	240 x 140 mm	140 mm	130 mm	110 mm	7,5 kg	84,70
0188/125	125 x 40 mm	110 mm	255 x 160 mm	150 mm	170 mm	130 mm	13 kg	120,00
0188/150	150 x 40 mm	145 mm	280 x 170 mm	160 mm	160 mm	180 mm	15 kg	151,00

**Art. 0188/100G****MORSA A CROCE CON GIREVOLE****€ 155,00**

Ganasce	100 X 25 mm
Apertura	90 mm
Dimensioni base	210 x 150 mm
Altezza	175 mm
Corsa longitudinale	130 mm
Corsa trasversale	110 mm
Peso	12 kg

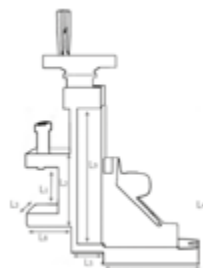
**Art. 0688****APPARECCHIO UNIVERSALE A FRESARE PER TORNIO****€ 195,00**

L1	52 mm
L2	80 mm
L3	65 mm
L4	220 mm
L5	37 mm
L6	110 mm
L8	46 mm
L9	150 mm



TORRETTA A CAMBIO RAPIDO



Codice	Lunghezza	Larghezza	Altezza	Foro	h utensile	€
T00A0	60 mm	50 mm	30 mm	10	12 mm	118,00
T00A1R	68 mm	68 mm	47 mm	10 mm	19 mm	156,00

TORRETTA A CAMBIO RAPIDO COMPOSIZIONE DEL SET:
- 1 TORRETTA PORTAUTENSILI
- 3 PORTAUTENSILI A SEDE PIANA



Art. T00A1 TORRETTA A CAMBIO RAPIDO

€ 254,00



Lunghezza	57 mm
Larghezza	57 mm
Altezza	37 mm
Foro	16
h utensile	12 mm

TORRETTA A CAMBIO RAPIDO, COMPOSIZIONE DEL SET:
- 1 TORRETTA PORTAUTENSILI
- 3 PORTAUTENSILI A SEDE PIANA



TORRETTA A CAMBIO RAPIDO



Codice	Lunghezza	Larghezza	Altezza utile	Foro	h utensile	€
T0AA	57 mm	64 mm	56 mm	14,4 mm	14 mm	287,00
T0AB	85 mm	85 mm	76 mm	19,9 mm	20 mm	482,00
T0AC	100 mm	100 mm	92 mm	22,22 mm	25 mm	622,00
T0AE	76,5 mm	76,5 mm	70 mm	16,5 mm	16 mm	364,00

TORRETTA A CAMBIO RAPIDO, COMPOSIZIONE DEL SET:
- 1 TORRETTA PORTAUTENSILI
- 4 PORTAUTENSILI A SEDE PIANA



**PORTAUTENSILI
A SEDE PIANA**



Codice	Lunghezza	Larghezza	Altezza	h utensile	€
T00A0/PP	50 mm	22 mm	24 mm	12 mm	40,00
T00A1R/PP	66 mm	27 mm	46 mm	19 mm	41,10



**Art. T00A1/PP
PORTAUTENSILI
A SEDE PIANA**

€ 55,50



Lunghezza	57 mm
Larghezza	25 mm
Altezza	25 mm
h utensile	12 mm



PORTAUTENSILI A SEDE PIANA



Codice	Lunghezza	Larghezza	Altezza	h utensile	€
T0AA/D	76 mm	25,5 mm	38 mm	14 mm	66,00
T0AB/D	108 mm	35 mm	54 mm	20 mm	92,40
T0AC/D	125 mm	40 mm	63 mm	25 mm	108,00
T0AE/D	89 mm	29 mm	45 mm	16 mm	79,20



TABELLA DI COMPATIBILITÀ

Descrizione	€	T00A0	T00A1R	T00A1	T0AA	T0AE	T0AB	T0AC	T00A	T00E	T00B	T00C	Pag
T00A0/PP	40,00	•											183
T00A1R/PP	41,10		•										183
T00A1/PP	55,50			•									183
T0AA/D	66,00				•								183
T0AE/D	79,20					•							183
T0AB/D	92,40						•						183
T0AC/D	108,00							•					183
T00A/D	112,00								•				184
T00E/D	150,00									•			184
T00B/D	168,00										•		184
T00C/D	259,00											•	184
T00A/B	117,00								•				184
T00E/B	168,00									•			184
T00B/B	172,00										•		184
T00C/B	255,00											•	184
T00A/S	128,00								•				184
T00E/S	173,00									•			184
T00B/S	212,00										•		184
T00C/S	299,00											•	184
T00AE/LCM1	37,30								•	•			185
T00AE/LCM2	37,30								•	•			185
T00BC/LCM2	40,30										•	•	185
T00BC/LCM3	40,30										•	•	185
T00BC/LCM4	55,00										•	•	185



TORRETTA PORTA UTENSILI A CAMBIO RAPIDO

Codice	R max	S max	P	T	H	X min	€
T00A	100 mm	54 mm	48 mm	20 mm	16 mm	30 mm	791,00
T00B	150 mm	75 mm	71 mm	32 mm	25 mm	37 mm	1008,00
T00C	202 mm	105 mm	102 mm	40 mm	32 mm	47 mm	1620,00
T00E	125 mm	68 mm	60 mm	20 mm	20 mm	35 mm	837,00

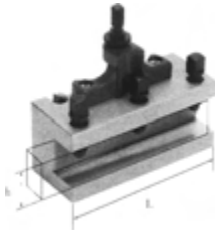
**TORRETTA PORTA UTENSILI A CAMBIO RAPIDO - REGOLAZIONE DEL PORTAUTENSILE IN 40 DIVERSE ANGOLAZIONI -
COMPOSTO DA:
1 TORRETTA PORTAUTENSILI
3 PORTAUTENSILI A SEDE PIANA
1 PORTAUTENSILE A SEDE PRISMATICA**

**PORTA UTENSILI
A SEDE PIANA**

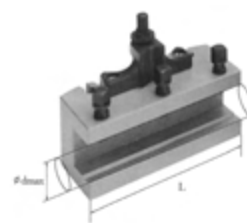
Codice	L	h	€
T00A/D	80 mm	16 mm	112,00
T00B/D	120 mm	25 mm	168,00
T00C/D	150 mm	32 mm	259,00
T00E/D	100 mm	20 mm	150,00

**PORTA UTENSILI A
SEDE PRISMATICA**

Codice	L	d max	€
T00A/B	80 mm	20 mm	117,00
T00B/B	130 mm	32 mm	172,00
T00C/B	160 mm	32 mm	255,00
T00E/B	100 mm	30 mm	168,00

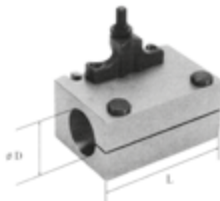
PORTA UTENSILI PER BUSSOLA

Codice	L	D	€
T00A/S	80 mm	30 mm	128,00
T00B/S	120 mm	40 mm	212,00
T00C/S	150 mm	40 mm	299,00
T00E/S	100 mm	30 mm	173,00

BUSSOLA A CONO MORSE

Codice	L	d	CM	€
T00AE/LCM1	80 mm	30 mm	1	37,30
T00AE/LCM2	95 mm	30 mm	2	37,30
T00BC/LCM2	105 mm	36 mm	2	40,30
T00BC/LCM3	120 mm	40 mm	3	40,30
T00BC/LCM4	150 mm	40 mm	4	55,00



Art. D023 € 1750,00
**DIVISORE RAPIDO A
 SCATTI ORIZZONTALE
 E VERTICALE**

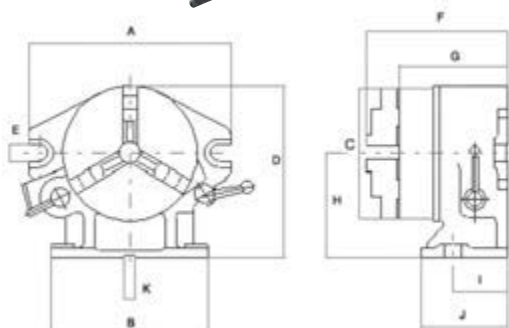

Divisioni	2 - 3 - 4 - 6 - 8 - 12 - 24
A	230 mm
B	230 mm
C	160 mm
D	236 mm
E	18 mm
F	320 mm
G	285 mm
H	125 mm
I	- mm
J	210 mm
K	18 mm
Foro	30 mm
Peso	66,5 kg
Portata max orizzontale	50 kg
Portata max verticale	10 kg



Art. D003 € 1380,00
**DIVISORE ORIZZONTALE
 VERTICALE A SCATTI RAPIDO**

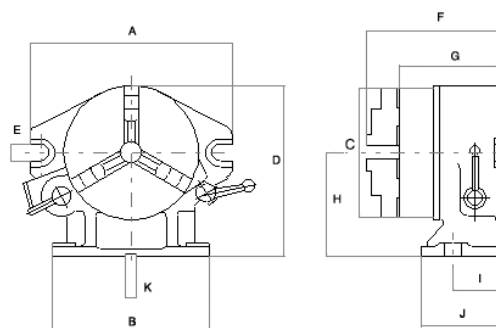
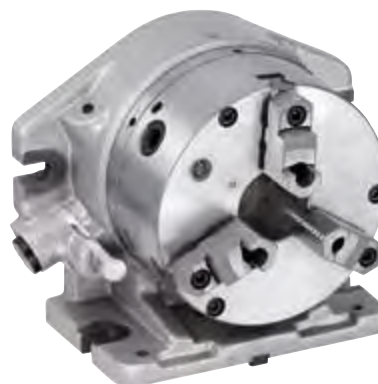

A	310 mm
B	255 mm
C	210 mm
D	259,25 mm
E	18 mm
F	214 mm
G	171,5 mm
H	149,25 mm
I	80 mm
J	130 mm
K	16 mm
Foro	62 mm
Peso	52 kg
Portata max orizzontale	50 kg
Portata max verticale	10 kg
Divisioni	2 - 3 - 4 - 6 - 8 - 12 - 24



Art. T017/110 € 600,00
TAVOLA GIREVOLE BASCULANTE 0° ÷ 90°

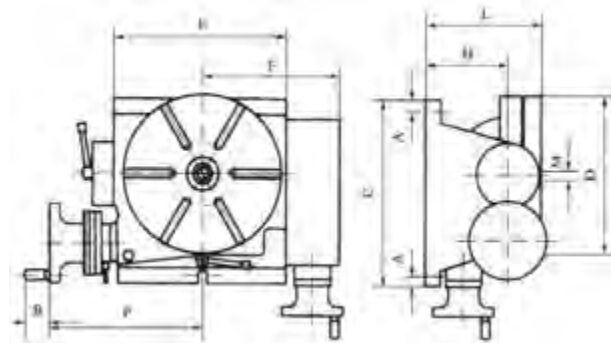

Mandrino	Ø 110 mm
Altezza punta	70 mm
Lettura	1°
Ingombro	190 x 130 x 140h mm
Altezza in verticale	140 mm
Altezza in orizzontale	100 mm
Passaggio barra	25 mm
Peso	8,5 kg

TAVOLA A DIVIDERE BASCULANTE 0° ÷ 90°

Codice	Rapporto	Peso	Lettura nonio	Cave	Portata max orizzontale	Portata max verticale	€
T001/250	1:90	78 kg	10"	6 da 12 mm	200 kg	100 kg	2340,00
T001/320	1:90	133 kg	10"	6 da 14 mm	250 kg	125 kg	2580,00

Codice	A	B	C	D	E	F	G	H	L	CM
T001/250	14 mm	40 mm	310 mm	250 mm	252 mm	199 mm	14 mm	140 mm	205 mm	3
T001/320	16 mm	40 mm	380 mm	320 mm	322 mm	241 mm	18 mm	185 mm	257 mm	4

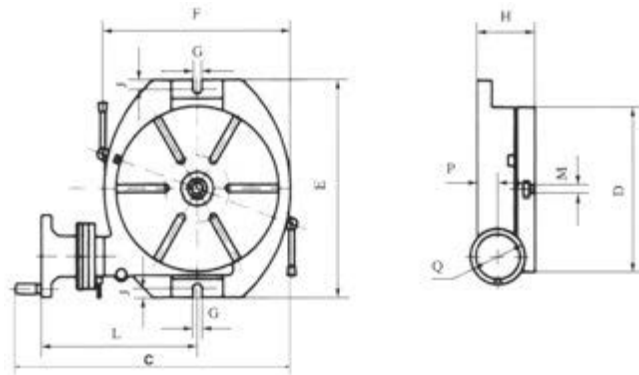
TAVOLA A DIVIDERE ORIZZONTALE

Codice	Lettura nonio	Rapporto	Cave	Portata	Peso	€
T012/500	10"	1:120	8 da 18 mm	550 kg	238 kg	3980,00
T012/630	10"	1:120	8 da 18 mm	700 kg	345 kg	8360,00

Codice	C	D	E	F	G	H	J	L	CM	P	Q
T012/500	753 mm	500 mm	640 mm	560 mm	22 mm	158,5 mm	20 mm	393 mm	5	65 mm	180 mm
T012/630	898 mm	630 mm	820 mm	700 mm	22 mm	160 mm	20 mm	468 mm	5	68 mm	220 mm

DISCHI DIVISORI PER TAVOLA A DIVIDERE

Codice	Per tavole	Rapporto	Fori nei dischi	Foro	Esterno	€
D005	T001/250 - 320, T002/160 - 320	1:90	A: 34-37-38-39-41-43-44-50-52-56-6, B: 46-47-49-51-53-54-57-58-59-62-64	38 mm	130 mm	228,00
D005/100	T002/100	1:72	A:10	29 mm	90 mm	69,90
D005/400	T002/400	1:90	A: 34-37-38-39-41-43-44-50-52-56-61, B: 46-47-49-51-53-54-57-58-59-62-64	53 mm	170 mm	256,00
D005/500	T012/500 T012/630	1:120	A: 33-34-37-38-39-41-43-44-50-52-56-61, B: 46-47-49-51-53-54-57-58-59-62-63-64	53 mm	170 mm	340,00



TAVOLA A DIVIDERE ORIZZONTALE VERTICALE

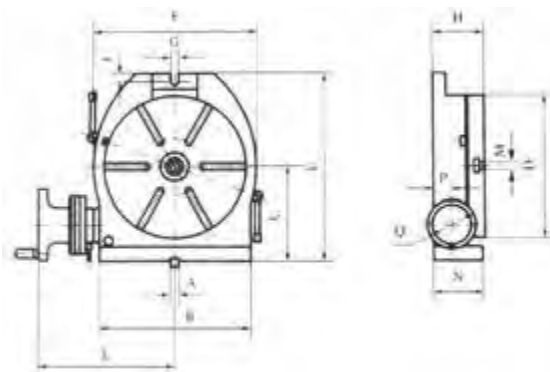

Codice	Lettura nonio	Rapporto	Cave	Portata max orizzontale	Portata max verticale	Peso	€
T002/100	10"	1:72	4 da 6 mm	20 kg	10 kg	7 kg	626,00
T002/160	10"	1:90	4 da 10 mm	100 kg	50 kg	23 kg	788,00
T002/200	10"	1:90	4 da 12 mm	150 kg	75 kg	30,5 kg	919,00
T002/250	10"	1:90	6 da 12 mm	200 kg	100 kg	44 kg	972,00
T002/320	10"	1:90	6 da 14 mm	250 kg	125 kg	75 kg	1560,00
T002/400	10"	1:90	6 da 14 mm	300 kg	150 kg	174 kg	2190,00

Codice	A	B	C	D	E	F	G	H	J	L	CM	N	P	Q
T002/100	10 mm	125 mm	70 mm	100 mm	125 mm	125 mm	0 mm	70 mm	0 mm	104 mm	2	48 mm	30 mm	50 mm
T002/160	12 mm	186 mm	125 mm	160 mm	242 mm	196 mm	12 mm	85 mm	12 mm	194 mm	2	82 mm	37 mm	125 mm
T002/200	14 mm	208 mm	150 mm	200 mm	285 mm	236 mm	14 mm	100 mm	15 mm	211 mm	3	99 mm	48 mm	125 mm
T002/250	14 mm	253 mm	170 mm	250 mm	328 mm	286 mm	14 mm	110 mm	16 mm	241 mm	4	106 mm	48 mm	125 mm
T002/320	18 mm	321 mm	210 mm	320 mm	410 mm	360 mm	18 mm	120 mm	16 mm	273 mm	4	118 mm	48 mm	125 mm
T002/400	18 mm	400 mm	260 mm	400 mm	525 mm	450 mm	18 mm	150 mm	16 mm	337 mm	4	145 mm	70 mm	160 mm



Art. C054
CONTROPUNTA
REGOLABILE IN ALTEZZA

€ 232,00



Per tavole	T002/160
CM	-
Altezza punta	85 - 135 mm
Peso	9 kg



Art. C051
CONTROPUNTA
REGOLABILE IN ALTEZZA

€ 307,00



Per tavole	T001/250 - T002/200 - T002/250
CM	2
Altezza punta	140 - 180 mm
Peso	18 kg



Art. C052
CONTROPUNTA
REGOLABILE IN ALTEZZA

€ 396,00



Per tavole	T002/320 - T001/320
CM	2
Altezza punta	180 - 224 mm
Peso	21 kg



TABELLA DI COMPATIBILITÀ

Codice compatibile	Descrizione	€	D003	D023	T001/250	T001/320	T012/500	T012/630	T002/100	T002/160	T002/200	T002/250	T002/320	T002/400	D004/100L	D004/125L	D004/160L	D006/100	D006/128	Pag
D005	DISCHI DIVISORI PER TAVOLA A DIVIDERE	228,00			•	•														187
D005/100	DISCHI DIVISORI PER TAVOLA A DIVIDERE	69,90																		187
D005/400	DISCHI DIVISORI PER TAVOLA A DIVIDERE	256,00												•						187
D005/500	DISCHI DIVISORI PER TAVOLA A DIVIDERE	340,00					•	•												187
C054	CONTROPUNTA REGOLABILE IN ALTEZZA	232,00		•						•										187
C051	CONTROPUNTA REGOLABILE IN ALTEZZA	307,00	•		•						•	•								187
C052	CONTROPUNTA REGOLABILE IN ALTEZZA	396,00				•							•							188
M049/125	MANDRINO AUTOCENTRANTE DI PRECISIONE	197,00													•			•		195
M049/160	MANDRINO AUTOCENTRANTE DI PRECISIONE	260,00		•												•			•	195
M449/125	MANDRINO AUTOCENTRANTE	227,00													•				•	196
M449/160	MANDRINO AUTOCENTRANTE	287,00		•												•			•	196
M075/160	MANDRINO AUTOCENTRANTE DI PRECISIONE	458,00		•												•			•	196
M076/160	MANDRINO AUTOCENTRANTE DI PRECISIONE	524,00		•												•			•	197
M077/160	MANDRINO AUTOCENTRANTE DI PRECISIONE	650,00		•												•			•	198
M049/200	MANDRINO AUTOCENTRANTE DI PRECISIONE	359,00															•			195
M449/200	MANDRINO AUTOCENTRANTE	405,00															•			196
M075/200	MANDRINO AUTOCENTRANTE DI PRECISIONE	585,00															•			196
M076/200	MANDRINO AUTOCENTRANTE DI PRECISIONE	683,00															•			197
M077/200	MANDRINO AUTOCENTRANTE DI PRECISIONE	720,00															•			198
C053/2	CONTROPUNTA FISSA	20,20																•		193
C053/3	CONTROPUNTA FISSA	22,40			•										•				•	193
C053/4	CONTROPUNTA FISSA	33,00				•										•			•	193

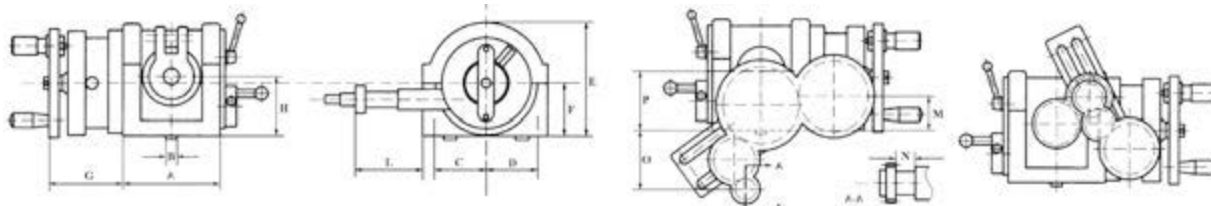

DIVISORE UNIVERSALE COMPLETO DI MANDRINO, CONTROPUNTA E DISCHI DIVISORI

Codice	Mandrino	Rapporto	Portata	Peso	Fori nei dischi	€
D004/100L	Ø 125 mm	1:40	100 kg	67 / 79 kg	24-25-28-30-34-37-38-39-41-42-43-46-47-49-51-53-54-57-58-59-62-66	2280,00
D004/125L	Ø 160 mm	1:40	130 kg	119 / 132 kg	24-25-28-30-34-37-38-39-41-42-43-46-47-49-51-53-54-57-58-59-62-66	2550,00
D004/160L	Ø 200 mm	1:40	130 kg	125 / 140 kg	24-25-28-30-34-37-38-39-41-42-43-46-47-49-51-53-54-57-58-59-62-66	2860,00

Codice	A	B	C	D	E	F	G	H	L	CM	N	P	Q
D004/100L	162 mm	14 mm	102 mm	87 mm	186 mm	95 mm	116 mm	100 mm	93 mm	3	30 mm	100 mm	100 mm
D004/125L	209 mm	18 mm	116 mm	98 mm	224 mm	117 mm	120 mm	125 mm	103 mm	4	34,5 mm	100 mm	125 mm
D004/160L	209 mm	18 mm	116 mm	98 mm	259 mm	152 mm	120 mm	160 mm	103 mm	4	34,5 mm	100 mm	160 mm

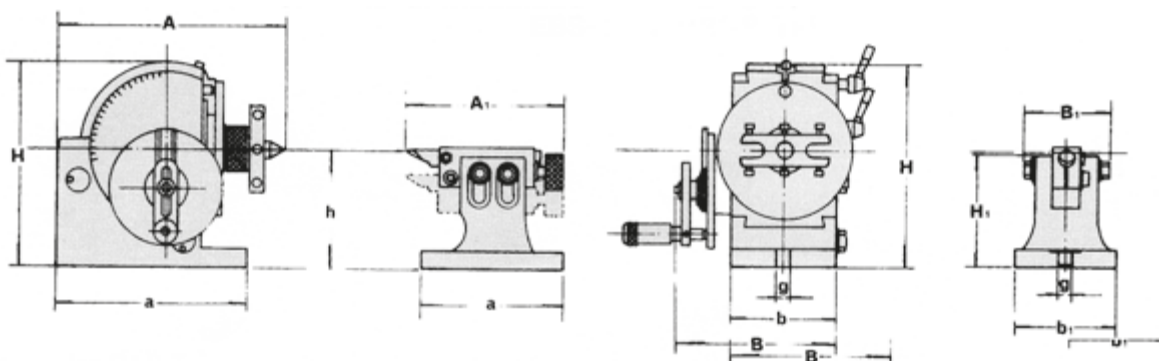

DIVISORE SEMI UNIVERSALE COMPLETO DI CONTROPUNTA E DISCHI DIVISORI



Codice	Mandrino adattabile	Foro	CM	Rapporto	Peso	Fori nei dischi	€
D006/100	Ø 125 mm	Ø 18 mm	2	1:40	21 kg	15-16-17-18-19-20-21-23-27-29-31-33-37-39-41-43-47-49	788,00
D006/128	Ø 160 mm	Ø 20 mm	3	1:40	30 kg	15-16-17-18-19-20-21-23-27-29-31-33-37-39-41-43-47-49	1280,00

Codice	A	B	H	h	a	b	G	A ₁	B ₁	H ₁	h ₁	a ₁	b ₁	g ₁
D006/100	193 mm	131 mm	173 mm	100 mm	166 mm	90 mm	16 mm	175 mm	87 mm	102 mm	100 mm	130 mm	82 mm	16 mm
D006/128	242 mm	168 mm	220 mm	128 mm	206 mm	113 mm	16 mm	183 mm	87 mm	137 mm	128 mm	158 mm	110 mm	16 mm

DIVISORE SEMI UNIVERSALE COMPLETO DI CONTROPUNTA E DISCHI DIVISORI, MANDRINO NON INCLUSO



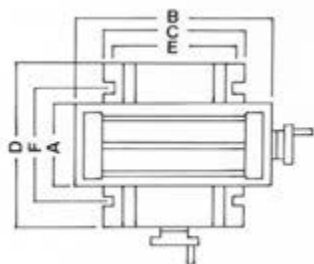

Art. T013
TAVOLA A CROCE
€ 1060,00

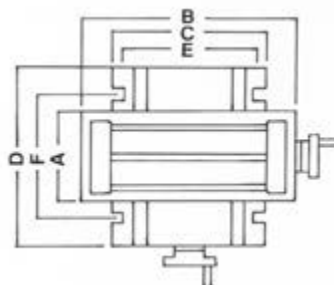
A	210 mm
B	730 mm
C	315 mm
D	395 mm
E	240 mm
F	300 mm
Cava	14 mm
Altezza	155 mm
Spostamenti	160 x 360 mm
Divisione	0,05 mm
Dimensioni imballo	960 x 510 x 280 mm
Peso	75 kg

Art. T014G
TAVOLA A CROCE
€ 961,00

A	240 mm
B	600 mm
C	280 mm
D	340 mm
E	260 mm
F	250 mm
Cava	12 mm
Altezza	160 mm
Spostamenti	155 x 370 mm
Divisione	0,02 mm
Dimensioni imballo	770 x 440 x 230 mm
Peso	60 kg

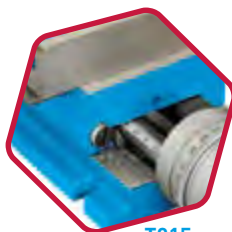
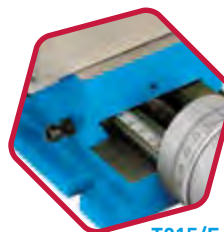
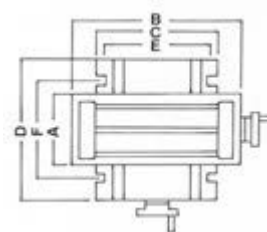
TAVOLA A CROCE GIREVOLE

TAVOLA A CROCE

T015

T015/E

Codice	A	B	C	D	E	F	Cava	Altezza	Spostamenti	Divisione	Dimensioni imballo	Peso	€
T015	100 mm	185 mm	130 mm	170 mm	104 mm	103 mm	10 mm	100 mm	50 x 80 mm	0,01 mm	290 x 240 x 140 mm	10 kg	509,00
T015/E	100 mm	185 mm	130 mm	173 mm	102 mm	100 mm	10 mm	104 mm	50 x 80 mm	0,01 mm	290 x 280 x 180 mm	10 kg	270,00



Art. T008

TAVOLA A CROCE

€ 314,00



Dimensioni tavola	475 x 153 x 130h mm
Spostamenti	120 x 325 mm
Dimensioni base	200 x 270 mm
Interasse fori base	162 mm
Interasse cava	75 mm
Cava	16 mm
Peso	23 kg



TAVOLA BASCULANTE

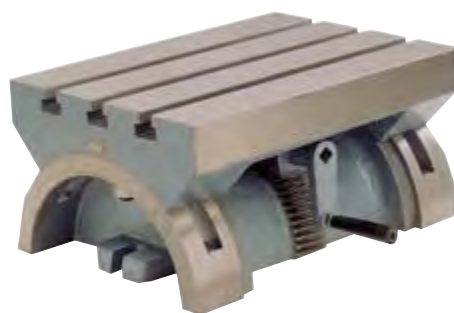

Codice	Dimensioni	Cava	Inclinazione	Peso	€
T004/250	255 x 180 x 135h mm	12 mm	± 40°	20 kg	402,00
T004/380	380 x 250 x 180h mm	16 mm	± 45°	51 kg	610,00
T004/600	610 x 305 x 253h mm	18 mm	± 45°	122 kg	1040,00



PIANO MAGNETICO



Codice	Dimensioni	Forza magnetica	Passo polarità	Peso	€
P770/1	150 x 300 x 48h mm	120 N/cm ²	0,5 + 1,5 mm	18 kg	665,00
P770/2	150 x 350 x 48h mm	120 N/cm ²	0,5 + 1,5 mm	21 kg	766,00
P770/3	200 x 500 x 53h mm	120 N/cm ²	0,5 + 1,5 mm	44 kg	1530,00

PIANO MAGNETICO PERMANENTE CON POLARITÀ FITTA. PERMETTE LA LAVORAZIONE DI PEZZI PICCOLISSIMI E DI BASSO SPESSORE GRAZIE AL PASSO FINE

PIANI MAGNETICI PERMANENTI

Codice	Dimensioni	Forza magnetica	Passo polarità	Peso	€
P070	260 x 125 x 75h mm	120 N/cm ²	16 / 12+4 mm	16 kg	582,00
P071	300 x 150 x 75h mm	120 N/cm ²	16 / 12+4 mm	21 kg	788,00
P072	350 x 150 x 75h mm	120 N/cm ²	16 / 12+4 mm	26 kg	935,00
P073	500 x 200 x 80h mm	120 N/cm ²	16 / 12+4 mm	48 kg	1450,00

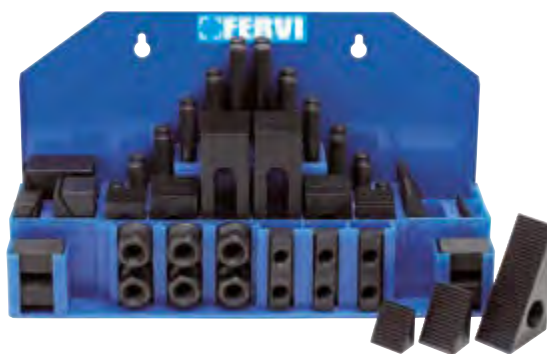
KIT STAFFAGGIO

58 Pz

Codice	Cava	MA	Set pz	€
K001/12	12 mm	10	58	108,00
K001/14	14 mm	12	58	120,00
K001/16	16 mm	14	58	140,00
K001/18	18 mm	16	58	175,00

SET STAFFAGGIO

6 Pz

Codice	2 Cunei di blocco	2 Staffe	2 Tiranti a T con dado	Cava	Scatola in metallo	Peso	€
K002/08	25 x 25 x 42 mm	100 x 25 x 15 mm	M6 x 100 mm	8 mm	125 x 154 x 32mm	1 kg	29,00
K002/10	25 x 25 x 42 mm	100 x 25 x 15 mm	M8 x 100 mm	10 mm	125 x 154 x 32 mm	1 kg	31,00
K002/12	25 x 25 x 42 mm	100 x 25 x 15 mm	M10 x 100 mm	12 mm	125 x 154 x 32 mm	1 kg	34,00
K002/14	25 x 25 x 42 mm	100 x 31 x 19 mm	M12 x 100 mm	14 mm	125 x 154 x 32 mm	1.15 kg	40,00

SET STAFFAGGIO 6 PZ, CUNEO DI BLOCCO IN ACCIAIO SINTERIZZATO ZINCATO E STAFFE IN ACCIAIO #45 ZINCATO

CONTROPUNTA ROTANTE

Codice	CM	Cuspide	Corpo	Lunghezza	€
C046/2	2	60°	Ø 45 mm	155 mm	77,00
C046/3	3	60°	Ø 53 mm	175 mm	93,50
C046/4	4	60°	Ø 63 mm	208 mm	99,00
C046/5	5	60°	Ø 87 mm	256 mm	137,00

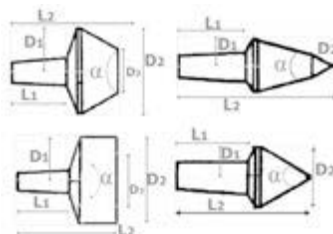
SET CONTROPUNTA GIREVOLE

Codice		A mm	B mm	C mm	D mm	E mm	F mm	G mm	CM	€
C050/2	L2	39	35,5	33	46	40	36	39	2	186,00
	D2 - D3	16	16	16	16	25 - 10	16 - 10	20 - 16		
	α	60°	75°	90°	60°	60°	60°	60°		
C050/3	L2	48	43,5	40,5	56	50	42	48	3	208,00
	D2 - D3	20	20	20	18	35 - 15	22 - 18	35 - 30		
	α	60°	75°	90°	60°	60°	60°	60°		
C050/4	L2	61,5	55,5	51,5	73	61,5	55	60	4	303,00
	D2 - D3	28	28	28	26	55 - 30	40 - 35	55 - 48		
	α	60°	75°	90°	60°	60°	60°	60°		

CONTROPUNTA ROTANTE PER TUBI

Codice	CM	Ø	Lunghezza	Velocità	€
C055/3	3	30 ÷ 100 mm	170 mm	max 2500 rpm	205,00
C055/4	4	40 ÷ 160 mm	230 mm	max 1600 rpm	290,00
C055/5	5	66 ÷ 200 mm	260 mm	max 1500 rpm	407,00

CONTROPUNTA FISSA CON CUSPIDE IN METALLO DURO

Codice	CM	Cuspide in metallo duro max	Lunghezza	€
C053/2	2 - 60°	Ø 8 mm	100 mm	20,20
C053/3	3 - 60°	Ø 11 mm	125 mm	22,40
C053/4	4 - 60°	Ø 13 mm	160 mm	33,00
C053/5	5 - 60°	Ø 17 mm	200 mm	51,10

BUSSOLA DI RIDUZIONE

Codice	CM	€
ST45/2/1	2 / 1	12,00
ST45/3/1	3 / 1	14,60
ST45/3/2	3 / 2	15,70
ST45/4/1	4 / 1	20,20
ST45/4/2	4 / 2	20,20
ST45/4/3	4 / 3	20,20
ST45/5/3	5 / 3	32,20
ST45/5/4	5 / 4	32,20

ESTRATTORI PER CONO MORSE

Codice	CM	€
E002/12	1-2	8,30
E002/3	3	8,30
E002/4	4	12,00

ATTACCO PER MANDRINO

Codice	CM	B	€
A001/2/12	2	12 mm	9,60
A001/2/16	2	16 mm	10,90
A001/2/18	2	18 mm	11,20
A001/3/16	3	16 mm	16,80
A001/3/18	3	18 mm	16,80
A001/3/22	3	22 mm	16,80
A001/4/16	4	16 mm	20,20
A001/4/18	4	18 mm	20,20
A001/4/22	4	22 mm	20,20

MANDRINO AUTOSERRANTE

Codice	Capacità	Attacco	Imballo	€
M050/10	1 ÷ 10 mm	3/8 24 UNF	10 / 50	13,50
M050/13	2 ÷ 13 mm	1/2 20 UNF	50	16,50

Art. M080/10 € 17,30
MANDRINO AUTOSERRANTE
CON GHIERA DI BLOCCAGGIO

Capacità	0,8 ÷ 10 mm
Attacco	3/8 24 UNF
Imballo	100

Art. M080/13 € 20,20
MANDRINO
AUTOSERRANTE CON
GHIERA DI BLOCCAGGIO

Capacità	2 ÷ 13 mm
Attacco	1/2 20 UNF
Imballo	50



MANDRINO AUTOSERRANTE DI PRECISIONE

Codice	Capacità	Attacco DIN	Dimensione	Dimensione	Imballo	€
M051/08	0,5 ÷ 8 mm	B 12	Ø 39 mm	80h mm	20	54,40
M051/10	1 ÷ 10 mm	B 12	Ø 44,5 mm	82h mm	20	54,40
M051/13	1 ÷ 13 mm	B 16	Ø 49,5 mm	91h mm	10	63,80
M051/16	1 ÷ 16 mm	B 18	Ø 54 mm	102,5h mm	20	77,00
M051/20	1 ÷ 20 mm	B 22	Ø 59 mm	119h mm	10	99,00

FLANGIA CON PERNI

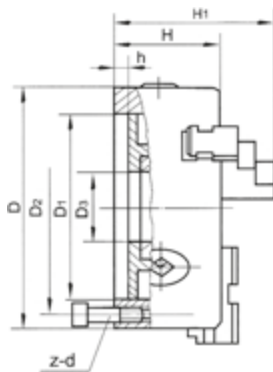

Codice	Cam lock Tipo	Misura	Spessore	Perni	€
FD04/200	4"	Ø 200 mm	28 mm	Ø 15,9 mm	208,00
FD05/200	5"	Ø 200 mm	30 mm	Ø 19 mm	208,00
FD05/250	5"	Ø 250 mm	30 mm	Ø 19 mm	287,00
FD06/250	6"	Ø 250 mm	30 mm	Ø 22 mm	293,00
FD06/380	6"	Ø 400 mm	30 mm	Ø 22 mm	389,00
FD08/380	8"	Ø 400 mm	30 mm	Ø 25,4 mm	517,00
FD08/500	8"	Ø 500 mm	36 mm	Ø 25,4 mm	595,00
FD11/500	11"	Ø 500 mm	36 mm	Ø 30 mm	633,00

FLANGIA CON PERNI, LATO MANDRINO GREZZO

MANDRINO AUTOCENTRANTE DI PRECISIONE

Codice	D	D1	D2	D3	H1	H	h	z-d	Quadro chiave	Peso	€
M049/080	80 mm	55 mm	66 mm	16 mm	66 mm	50 mm	3,5 mm	3-M6 mm	8 mm	2 kg	167,00
M049/100	100 mm	72 mm	84 mm	22 mm	74,5 mm	55 mm	3,5 mm	3-M8 mm	8 mm	3,3 kg	186,00
M049/125	125 mm	95 mm	108 mm	30 mm	78 mm	55 mm	3,5 mm	3-M8 mm	10 mm	4,8 kg	197,00
M049/160	160 mm	130 mm	142 mm	40 mm	95 mm	65 mm	5 mm	3-M8 mm	12 mm	9,1 kg	260,00
M049/200	200 mm	165 mm	180 mm	60 mm	109 mm	75 mm	5 mm	3-M10 mm	12 mm	15,7 kg	359,00
M049/250	250 mm	206 mm	250 mm	80 mm	120 mm	80 mm	5 mm	3-M12 mm	12 mm	30 kg	418,00

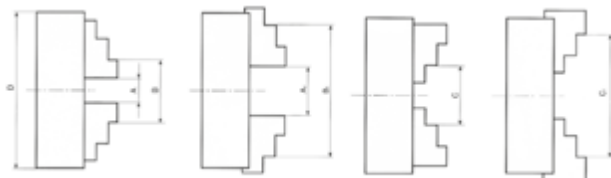
Codice	D	A - A1	B - B1	C - C1
M049/080	80 mm	2 - 22 mm	25 - 70 mm	22 - 63 mm
M049/100	100 mm	2 - 30 mm	30 - 90 mm	30 - 80 mm
M049/125	125 mm	2,5 - 40 mm	38 - 125 mm	38 - 110 mm
M049/160	160 mm	3 - 55 mm	50 - 160 mm	55 - 145 mm
M049/200	200 mm	4 - 85 mm	65 - 200 mm	65 - 200 mm
M049/250	250 mm	6 - 110 mm	80 - 250 mm	90 - 250 mm

CAPACITÀ DI SERRAGGIO

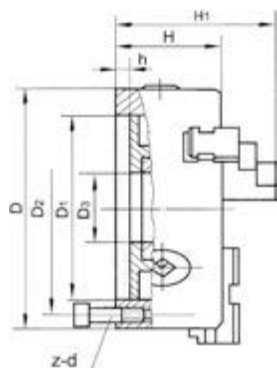
MANDRINO AUTOCENTRANTE

Codice	D	D1	D2	D3	H1	H	h	z-d	Quadro chiave	Peso	€
M449/080	80 mm	55 mm	66 mm	16 mm	66 mm	50 mm	3,5 mm	3 - M6 mm	8 mm	2 kg	175,00
M449/100	100 mm	72 mm	84 mm	22 mm	74,5 mm	55 mm	3,5 mm	3 - M8 mm	8 mm	3,5 kg	197,00
M449/125	125 mm	95 mm	108 mm	30 mm	84 mm	58 mm	4 mm	3 - M8 mm	10 mm	5,5 kg	227,00
M449/160	160 mm	130 mm	142 mm	40 mm	95 mm	65 mm	5 mm	3 - M8 mm	10 mm	9,4 kg	287,00
M449/200	200 mm	165 mm	187 mm	65 mm	109 mm	75 mm	5 mm	3 - M10 mm	12 mm	17,5 kg	405,00
M449/250	250 mm	206 mm	226 mm	80 mm	120 mm	80 mm	5 mm	3 - M12 mm	12 mm	28,9 kg	524,00

MANDRINO AUTOCENTRANTE 4+4 GRIFFE Ø 100 mm, CON ATTACCO POSTERIORE DIN E CHIAVE MANDRINO CON MOLLA DI SICUREZZA

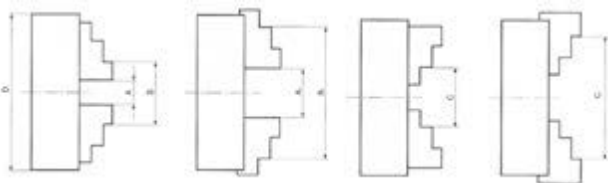

Codice	D	A - A ₁	B - B ₁	C - C ₁
M049/080	80 mm	2 - 22 mm	25 - 70 mm	22 - 63 mm
M049/100	100 mm	2 - 30 mm	30 - 90 mm	30 - 80 mm
M049/125	125 mm	2,5 - 40 mm	38 - 125 mm	38 - 110 mm
M049/160	160 mm	3 - 55 mm	50 - 160 mm	55 - 145 mm
M049/200	200 mm	4 - 85 mm	65 - 200 mm	65 - 200 mm
M049/250	250 mm	6 - 110 mm	80 - 250 mm	90 - 250 mm

CAPACITÀ DI SERRAGGIO

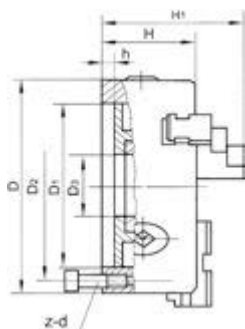

MANDRINO AUTOCENTRANTE DI PRECISIONE

Codice	D	D1	D2	D3	H1	H	h	z-d	Quadro chiave	Peso	€
M075/160	160 mm	130 mm	142 mm	40 mm	95 mm	65 mm	5 mm	3-M8 mm	10 mm	12 kg	458,00
M075/200	200 mm	165 mm	180 mm	65 mm	109 mm	75 mm	5 mm	3-M10 mm	12 mm	20 kg	585,00
M075/250	250 mm	206 mm	226 mm	80 mm	120 mm	80 mm	5 mm	3-M12 mm	12 mm	34,5 kg	782,00
M075/315	315 mm	260 mm	285 mm	100 mm	147 mm	90 mm	6 mm	3-M16 mm	14 mm	67,5 kg	1085,00
M075/400	400 mm	340 mm	368 mm	130 mm	172,5 mm	100 mm	6 mm	3-M16 mm	15 mm	86 kg	1440,00

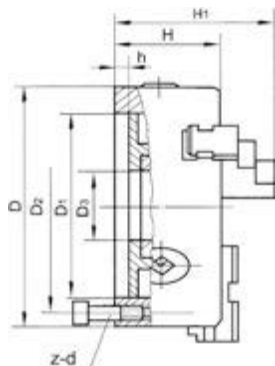
MANDRINO AUTOCENTRANTE DI PRECISIONE 3+3+3 GRIFFE A GUIDA SEMPLICE

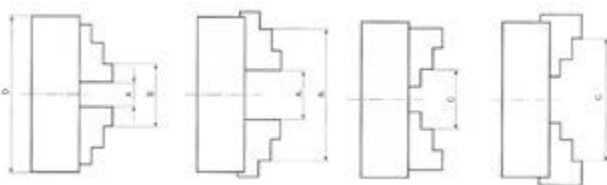

MANDRINO AUTOCENTRANTE DI PRECISIONE

Codice	D	D1	D2	D3	H1	H	h	z-d	Quadro chiave	Peso	€
M005/200	200 mm	165 mm	180 mm	65 mm	122 mm	75 mm	5 mm	3-M10 mm	12 mm	18 kg	359,00
M005/250	250 mm	206 mm	226 mm	80 mm	135 mm	80 mm	5 mm	3-M12 mm	12 mm	29 kg	418,00
M005/320	320 mm	270 mm	290 mm	100 mm	135 mm	90 mm	6 mm	3-M16 mm	14 mm	55 kg	659,00
M005/400	400 mm	340 mm	368 mm	130 mm	172 mm	100 mm	6 mm	3-M16 mm	17 mm	80 kg	1061,00
M005/500	500 mm	440 mm	465 mm	200 mm	202 mm	115 mm	6 mm	6-M16 mm	17 mm	132 kg	1803,00
M005/630	630 mm	560 mm	595 mm	260 mm	218 mm	130 mm	7 mm	6-M16 mm	19 mm	200 kg	5100,00

MANDRINO AUTOCENTRANTE DI PRECISIONE A 3 GRIFFE REVERSIBILI

Codice	D mm	A - A, mm	B - B, mm	C - C, mm
M005/200	200	4 - 85	65 - 200	65 - 200
M005/250	250	6 - 110	80 - 250	90 - 250
M005/320	320	10 - 140	95 - 315	100 - 315
M005/400	400	15 - 210	120 - 400	120 - 400
M005/500	500	25 - 280	150 - 500	150 - 500
M005/630	630	50 - 350	170 - 630	170 - 630

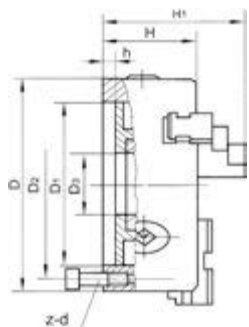
CAPACITÀ DI SERRAGGIO

MANDRINO AUTOCENTRANTE DI PRECISIONE

Codice	D	D1	D2	D3	H1	H	h	z-d	Quadro chiave	Peso	€
M076/160	160 mm	130 mm	142 mm	40 mm	95 mm	65 mm	5 mm	3-M8 mm	10 mm	13 kg	524,00
M076/200	200 mm	165 mm	180 mm	65 mm	109 mm	75 mm	5 mm	3-M10 mm	12 mm	22,5 kg	683,00
M076/250	250 mm	206 mm	226 mm	80 mm	120 mm	80 mm	5 mm	3-M12 mm	12 mm	38 kg	956,00
M076/315	315 mm	260 mm	285 mm	100 mm	147 mm	90 mm	6 mm	3-M16 mm	14 mm	74 kg	1430,00
M076/400	400 mm	340 mm	368 mm	130 mm	172,5 mm	100 mm	6 mm	3-M16 mm	15 mm	100 kg	1550,00

MANDRINO AUTOCENTRANTE DI PRECISIONE 4+4+4 GRIFFE A GUIDA SEMPLICE

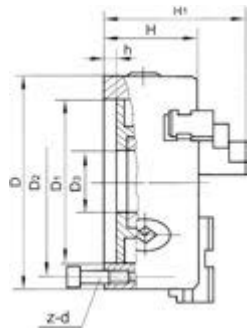
MANDRINO AUTOCENTRANTE DI PRECISIONE

Codice	D	D1	D2	D3	H1	H	h	z-d	Quadro chiave	Peso	€
M077/160	160 mm	125 mm	140 mm	42 mm	106 mm	76 mm	5 mm	6-M8 mm	10 mm	13,5 kg	650,00
M077/200	200 mm	165 mm	180 mm	65 mm	120 mm	86 mm	6 mm	6-M10 mm	12 mm	24,5 kg	720,00
M077/250	250 mm	206 mm	226 mm	80 mm	134 mm	94 mm	5 mm	6-M12 mm	12 mm	39,5 kg	1150,00
M077/315	315 mm	260 mm	285 mm	100 mm	163 mm	116 mm	6 mm	6-M16 mm	14 mm	78,5 kg	1360,00

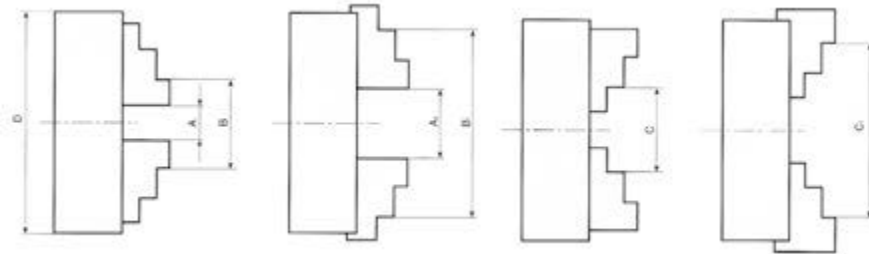
MANDRINO AUTOCENTRANTE DI PRECISIONE A DOPPIA GUIDA 3+3+3 GRIFFE

Codice	D mm	A - A, mm	B - B, mm	C - C, mm
M075/M076/M077/160	160	5 - 55	52 - 160	55 - 145
M075/M076/M077/200	200	6 - 85	65 - 200	65 - 200
M075/M076/M077/250	250	9 - 110	80 - 250	90 - 250
M075/M076/M077/315	315	13 - 140	93 - 315	101 - 315
M075/M076/400	400	15 - 210	120 - 400	120 - 400

CAPACITÀ DI SERRAGGIO

MORSETTO TENERO PER MANDRINI

Codice	Ø	Interasse fori	€
M075/160T	160 mm	38,1 mm	25,20
M075/200T	200 mm	44,50 mm	27,80
M075/250T	250 mm	54 mm	30,00
M075/315T	315 mm	63,5 mm	37,60
262206R	400 mm	76,2 mm	74,20
262207R	500 - 630 mm	76,2 mm	103,00

MORSETTO TENERO PER MANDRINI M005 - M075 - M076 - M077



MASCHIATORE A FRIZIONE REGISTRABILE CON INVERSIONE



Codice	Campo maschiatura	Dimensioni senza CM	CM	Attacco	Peso	€
M059/07	M 2 - 7	Ø 55 x 130h mm	2	B16	2 kg	472,00
M059/12	M 5 - 12	Ø 75 x 162h mm	3	B16	2,75 kg	541,00
M059/20	M 8 - 20	Ø 91 x 204h mm	4	B22	5 kg	662,00



MASCHIATORE CON BUSSOLE



Codice	Campo maschiatura	Lunghezza mandrino con e senza bussola	CM	Peso	€
M060/2	M 3 - 12	213 - 175 - Ø 46 mm	2	3 kg	473,00
M060/3	M 3 - 12	228 - 190 - Ø 46 mm	3	3,2 kg	473,00
M060/4	M 3 - 12	253 - 215 - Ø 46 mm	4	3,6 kg	505,00

MASCHIATORE CON BUSSOLE A FRIZIONE REGISTRABILE E COMPENSAZIONE ASSIALE, 6 BUSSOLE CON ATTACCO Ø 19 mm, BUSSOLE: FORO PER QUADRO 3,5 x 2,7 mm, 4,5 x 3,4 mm, 6 x 4,9 mm, 8 x 6,2 mm, 10 x 8 mm, 9 x 7 mm



MANDRINO CON LUBRIFICAZIONE INTERNA PER FRESE A CAROTARE



Codice	Attacco conico CM	Lunghezza totale	Attacco femmina	Peso	€
M004/2	2	170,5 mm	Weldon 19,05 mm	0,76 kg	188,00
M004/3	3	190,5 mm	Weldon 19,05 mm	0,95 kg	188,00

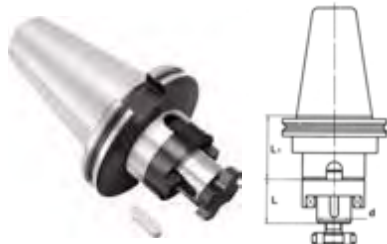

MANDRINO PORTA FRESE COMBINATO

DIN 69871/A

Codice	ISO	d-h6	L	L1	Equilibratura rpm	€
16A40	40	16 mm	27 mm	35 mm	12000	106,00
22A40	40	22 mm	31 mm	41 mm	12000	106,00
27A40	40	27 mm	33 mm	41 mm	12000	106,00
32A40	40	32 mm	38 mm	45 mm	12000	118,00
16A50	50	16 mm	27 mm	35 mm	12000	147,00
22A50	50	22 mm	31 mm	35 mm	12000	147,00
27A50	50	27 mm	33 mm	35 mm	12000	147,00
32A50	50	32 mm	38 mm	40 mm	12000	157,00
40A50	50	40 mm	41 mm	40 mm	12000	171,00

CORPO MANDRINO BILANCIATO

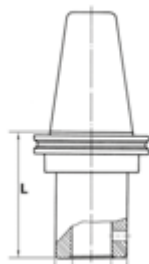
MANDRINO PORTA FRESE TIPO WELDON

DIN 69871/A

Codice	ISO	d1 - h6	D	L	Equilibratura rpm	€
4/06A40	40	6 mm	25 mm	60 mm	12000	93,50
4/08A40	40	8 mm	28 mm	60 mm	12000	93,50
4/10A40	40	10 mm	35 mm	50 mm	12000	93,50
4/12A40	40	12 mm	42 mm	60 mm	12000	93,50
4/14A40	40	14 mm	42 mm	70 mm	12000	93,50
4/16A40	40	16 mm	48 mm	70 mm	12000	93,50
4/18A40	40	18 mm	48 mm	70 mm	12000	93,50
4/20A40	40	20 mm	52 mm	75 mm	12000	93,50
4/25A40	40	25 mm	40 mm	100 mm	12000	93,50
4/32A40	40	32 mm	72 mm	100 mm	12000	93,50
4/06A50	50	6 mm	25 mm	65 mm	12000	129,00
4/08A50	50	8 mm	28 mm	65 mm	12000	129,00
4/10A50	50	10 mm	35 mm	70 mm	12000	129,00
4/12A50	50	12 mm	42 mm	75 mm	12000	129,00
4/14A50	50	14 mm	42 mm	75 mm	12000	129,00
4/16A50	50	16 mm	48 mm	80 mm	12000	129,00
4/18A50	50	18 mm	48 mm	80 mm	12000	129,00
4/20A50	50	20 mm	52 mm	80 mm	12000	129,00
4/25A50	50	25 mm	65 mm	100 mm	12000	137,00
4/32A50	50	32 mm	72 mm	105 mm	12000	137,00
4/40A50	50	40 mm	80 mm	120 mm	12000	148,00

CORPO MANDRINO BILANCIATO

MANDRINO PORTA PUNTE

DIN 69871/A

Codice	ISO	CM	D	L	Equilibratura rpm	€
1/1A40	40	1	25 mm	45 mm	12000	93,50
1/2A40	40	2	32 mm	60 mm	12000	93,50
1/3A40	40	3	40 mm	75 mm	12000	93,50
1/4A40	40	4	50 mm	98 mm	12000	93,50
1/2A50	50	2	32 mm	40 mm	12000	137,00
1/3A50	50	3	40 mm	50 mm	12000	137,00
1/4A50	50	4	48 mm	95 mm	12000	148,00
1/5A50	50	5	63 mm	110 mm	12000	180,00

CORPO MANDRINO BILANCIATO



MANDRINO PORTA FRESE A GAMBO CONICO

 DIN 69871/A

Codice	ISO	CM	D	L	Equilibratura rpm	€
2/1A40	40	1	25 mm	45 mm	12000	129,00
2/2A40	40	2	32 mm	60 mm	12000	129,00
2/3A40	40	3	40 mm	75 mm	12000	129,00
2/4A40	40	4	50 mm	98 mm	12000	129,00
2/2A50	50	2	32 mm	40 mm	12000	159,00
2/3A50	50	3	40 mm	50 mm	12000	159,00
2/4A50	50	4	50 mm	80 mm	12000	180,00
2/5A50	50	5	63 mm	110 mm	12000	213,00

CORPO MANDRINO BILANCIATO

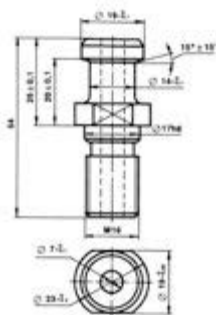

CODOLINO

 DIN 69871/A

Codice	ISO	€
TIPA40	40	19,10
TIPA50	50	20,20

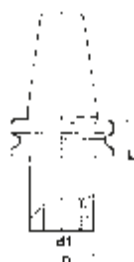

MANDRINO PORTA FRESE TIPO WELDON

 MAS - 403 BT

Codice	BT	d1 - h6	D	L	Equilibratura rpm	€
4/06D40	40	6 mm	25 mm	60 mm	12000	93,50
4/08D40	40	8 mm	28 mm	60 mm	12000	93,50
4/10D40	40	10 mm	35 mm	60 mm	12000	93,50
4/12D40	40	12 mm	42 mm	70 mm	12000	93,50
4/14D40	40	14 mm	42 mm	70 mm	12000	93,50
4/16D40	40	16 mm	48 mm	70 mm	12000	93,50
4/18D40	40	18 mm	48 mm	70 mm	12000	93,50
4/20D40	40	20 mm	52 mm	75 mm	12000	93,50
4/25D40	40	25 mm	63 mm	100 mm	12000	93,50
4/32D40	40	32 mm	72 mm	100 mm	12000	93,50
4/06D50	50	6 mm	25 mm	65 mm	12000	123,00
4/08D50	50	8 mm	28 mm	65 mm	12000	123,00
4/10D50	50	10 mm	35 mm	70 mm	12000	123,00
4/12D50	50	12 mm	42 mm	75 mm	12000	123,00
4/14D50	50	14 mm	42 mm	75 mm	12000	123,00
4/16D50	50	16 mm	48 mm	80 mm	12000	123,00
4/18D50	50	18 mm	48 mm	80 mm	12000	123,00
4/20D50	50	20 mm	52 mm	80 mm	12000	123,00
4/25D50	50	25 mm	65 mm	100 mm	12000	137,00
4/32D50	50	32 mm	72 mm	105 mm	12000	137,00
4/40D50	50	40 mm	80 mm	120 mm	12000	303,00

CORPO MANDRINO BILANCIATO

MANDRINO PORTA PUNTE

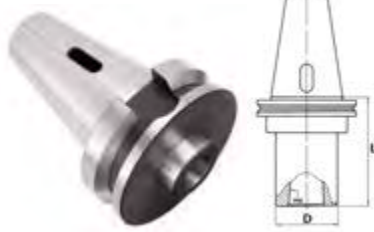
MAS - 403 BT

Codice	BT	CM	D	L	Equilibratura rpm	€
1/1D40	40	1	25 mm	45 mm	12000	93,50
1/2D40	40	2	32 mm	60 mm	12000	93,50
1/3D40	40	3	40 mm	75 mm	12000	93,50
1/4D40	40	4	50 mm	98 mm	12000	93,50
1/2D50	50	2	32 mm	40 mm	12000	137,00
1/3D50	50	3	40 mm	75 mm	12000	137,00
1/4D50	50	4	50 mm	80 mm	12000	153,00
1/5D50	50	5	63 mm	110 mm	12000	180,00

CORPO MANDRINO BILANCIATO

MANDRINO PORTA FRESA A GAMBO CONICO

MAS - 403 BT

Codice	BT	CM	D	L	Equilibratura rpm	€
2/1D40	40	1	25 mm	45 mm	12000	123,00
2/2D40	40	2	32 mm	60 mm	12000	123,00
2/3D40	40	3	40 mm	75 mm	12000	123,00
2/4D40	40	4	50 mm	98 mm	12000	129,00
2/2D50	50	2	32 mm	40 mm	12000	164,00
2/3D50	50	3	40 mm	75 mm	12000	164,00
2/4D50	50	4	50 mm	80 mm	12000	191,00
2/5D50	50	5	63 mm	110 mm	12000	216,00

CORPO MANDRINO BILANCIATO

MANDRINO PORTA FRESE COMBINATO

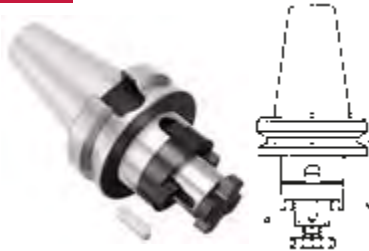
MAS - 403 BT

Codice	BT	d - h6	L	L1	Equilibratura rpm	€
16/D40	40	16 mm	27 mm	35 mm	12000	106,00
22/D40	40	22 mm	31 mm	35 mm	12000	106,00
27/D40	40	27 mm	33 mm	35 mm	12000	106,00
32/D40	40	32 mm	38 mm	40 mm	12000	118,00
16/D50	50	16 mm	27 mm	35 mm	12000	148,00
22/D50	50	22 mm	31 mm	35 mm	12000	148,00
27/D50	50	27 mm	33 mm	35 mm	12000	159,00
32/D50	50	32 mm	38 mm	40 mm	12000	159,00
40/D50	50	40 mm	41 mm	40 mm	12000	169,00

CORPO MANDRINO BILANCIATO

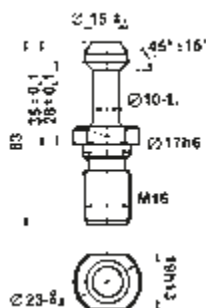
CODOLINO

MAS - 403 BT

Codice	ISO	€
TIPD40	40	19,10
TIPD50	50	20,20



MANDRINO PORTA FRESE A GAMBO CONICO

 DIN 2080

Codice	ISO	CM	D	L	Equilibratura rpm	€
2/1B40	40	1	25 mm	15 mm	2000	123,00
2/2B40	40	2	32 mm	30 mm	2000	123,00
2/3B40	40	3	40 mm	64 mm	2000	123,00
2/4B40	40	4	50 mm	94 mm	2000	138,00
2/2B50	50	2	32 mm	20 mm	2000	166,00
2/3B50	50	3	40 mm	30 mm	2000	166,00
2/4B50	50	4	50 mm	65 mm	2000	180,00
2/5B50	50	5	63 mm	105 mm	2000	197,00

CORPO MANDRINO BILANCIATO



MANDRINO PORTA FRESE COMBINATO

 DIN 2080

Codice	ISO	d - h6	L	L1	Equilibratura rpm	€
16/B40	40	16 mm	27 mm	35 mm	2000	117,00
22/B40	40	22 mm	31 mm	35 mm	2000	117,00
27/B40	40	27 mm	33 mm	40 mm	2000	117,00
32/B40	40	32 mm	38 mm	40 mm	2000	117,00
16/B50	50	16 mm	27 mm	35 mm	2000	141,00
22/B50	50	22 mm	31 mm	35 mm	2000	141,00
27/B50	50	27 mm	33 mm	35 mm	2000	141,00
32/B50	50	32 mm	38 mm	40 mm	2000	152,00
40/B50	50	40 mm	41 mm	40 mm	2000	163,00

CORPO MANDRINO BILANCIATO

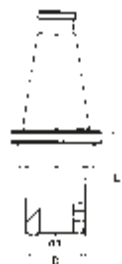

MANDRINO PORTAFRESE TIPO WELDON

 DIN 2080

Codice	ISO	d1 - h6	D	L	Equilibratura rpm	€
4/06B40	40	6 mm	25 mm	50 mm	2000	93,50
4/08B40	40	8 mm	28 mm	50 mm	2000	93,50
4/10B40	40	10 mm	35 mm	50 mm	2000	93,50
4/12B40	40	12 mm	42 mm	50 mm	2000	93,50
4/16B40	40	16 mm	48 mm	63 mm	2000	93,50
4/18B40	40	18 mm	48 mm	50 mm	2000	93,50
4/20B40	40	20 mm	52 mm	63 mm	2000	93,50
4/25B40	40	25 mm	65 mm	100 mm	2000	93,50
4/32B40	40	32 mm	72 mm	80 mm	2000	93,50
4/06B50	50	6 mm	25 mm	50 mm	2000	126,00
4/08B50	50	8 mm	28 mm	50 mm	2000	126,00
4/10B50	50	10 mm	35 mm	50 mm	2000	126,00
4/12B50	50	12 mm	42 mm	50 mm	2000	126,00
4/16B50	50	16 mm	48 mm	50 mm	2000	126,00
4/20B50	50	20 mm	52 mm	63 mm	2000	137,00
4/25B50	50	25 mm	65 mm	80 mm	2000	137,00
4/32B50	50	32 mm	72 mm	80 mm	2000	137,00
4/40B50	50	40 mm	90 mm	90 mm	2000	148,00

CORPO MANDRINO BILANCIATO

ATTREZZO INCLINABILE DA 0° ÷ 90°

DIN 2080 & DIN 69871 & MAS BT -TC

Codice	Conicità	HSK	€
S007/30	30 ISO	-	219,00
S007/40	40 ISO	63	223,00
S007/50	50 ISO	100	249,00

ATTREZZO INCLINABILE DA 0° ÷ 90°, PER IL MONTAGGIO E LO SMONTAGGIO DI MANDRINI PORTA UTENSILI, DIN 2080 - DIN 69871, MAS BT -TC

SMONTA MANDRINO

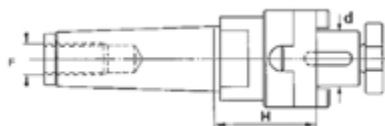

Codice	Mandrino	Peso	€
S014/40BT	BT 40 ISO 40	3,8 kg	77,00
S014/40DIN	DIN 69871.40 ISO 40	3,8 kg	77,00
S014/50BT	BT 50 ISO 50	11,4 kg	175,00
S014/50DIN	DIN 69871.50 ISO 50	11,4 kg	175,00

SMONTA MANDRINO VERTICALE E ORIZZONTALE PER BT 40 E ISO 40. PRATICO ATTREZZO PER BLOCCARE I MANDRINI DA ATTREZZARE PER LE MACCHINE CNC

MANDRINO CONO MORSE COMBINATO

DIN 228/A

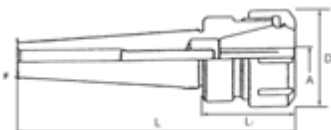
Codice	d - h6	CM	F	H	€
16/CM3	16 mm	3	M 12	50 mm	99,00
16/CM4	16 mm	4	M 16	55 mm	99,00
22/CM3	22 mm	3	M 12	50 mm	99,00
22/CM4	22 mm	4	M 16	55 mm	99,00
27/CM3	27 mm	3	M 12	50 mm	99,00
27/CM4	27 mm	4	M 16	55 mm	99,00



PORTA PINZA

DIN 228/A

Codice	Pinze	D	L	L1	F	A	€
3/CM2	ER 32	50 mm	135 mm	60 mm	M 10	3 / 20 mm	93,50
3/CM3	ER 32	50 mm	146 mm	60 mm	M 12	3 / 20 mm	93,50
3/CM4	ER 32	50 mm	166 mm	58 mm	M 16	3 / 20 mm	105,00

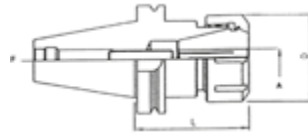

PORTA PINZA



MAS - 403 BT

Equilibratura rpm

Codice	Pinze	A	D	L	F	Equilibratura rpm	€
3D40/16	ER 16	1 / 10 mm	28 mm	100 mm	M 16	12000	69,00
3D40/20	ER 20	2 / 13 mm	34 mm	100 mm	M 16	12000	69,00
3D40/25	ER 25	2 / 16 mm	42 mm	100 mm	M 16	12000	69,00
3/D/40	ER 32	3/20 mm	50 mm	63 mm	M 16	12000	109,00

CORPO MANDRINO BILANCIATO



PORTA PINZA

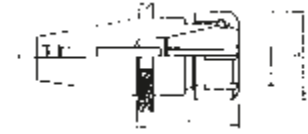

DIN 69871/A

Equilibratura rpm

Codice	Pinze	A	D	L	F	Equilibratura rpm	€
3A40/16	ER 16	1 / 10 mm	28 mm	100 mm	M 16	12000	69,00
3A40/20	ER 20	2 / 13 mm	34 mm	100 mm	M 16	12000	69,00
3A40/25	ER 25	2 / 16 mm	42 mm	100 mm	M 16	12000	69,00
3/A/40	ER 32	3/20 mm	50 mm	72 mm	M 16	12000	109,00

CORPO MANDRINO BILANCIATO



**Art. 3/B/40
PORTA PINZA**

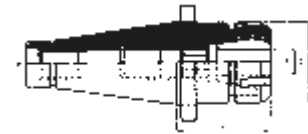

€ 109,00

DIN 2080

Pinze	ER 32
A	3/20 mm
D	50 mm
L	65 mm
F	M 16
Equilibratura rpm	2000

CORPO MANDRINO BILANCIATO



**Art. PR16/10P
SERIE PINZE ER16**



€ 85,00

10 Pz

Misure	Ø 1-2-3-4-5-6-7-8-9-10 mm
Peso	0.5 kg

SERIE DI 15 PINZE DI PRECISIONE ER16

Art. PR20/12P
 SERIE PINZE ER20

€ 95,00

12 Pz

Misure	Ø 2-3-4-5-6-7-8-9-10-11-12-13 mm
Peso	0.9 kg

SERIE DI 12 PINZE DI PRECISIONE ER20

Art. PR25/15P
 SERIE PINZE ER25

€ 125,00

15 Pz

Misure	Ø 2-3-4-5-6-7-8-9-10-11-12-13-14-15-16mm
Peso	1.68 kg

SERIE DI 15 PINZE DI PRECISIONE ER25

Art. P032/7P
 SERIE PINZE ER32

€ 115,00

7 Pz

Misure	4-6-8-10-12-16-20 mm
Peso	1,1 kg
Imballo	6

SERIE PINZE 7 PZ ER32



Art. P032/18P
 SERIE PINZE ER32

€ 260,00



18 Pz

Misure	3-4-5-6-7-8-9-10-11-12-13-14-15-16-17-18-19-20 mm
Peso	3 kg
Imballo	2

SERIE PINZE 18 PZ ER32



PINZA

 **ER 32**



Codice	Capacità A	D	L	€
P032/03	2-3 mm	33 mm	40 mm	15,20
P032/04	3-4 mm	33 mm	40 mm	15,20
P032/05	4-5 mm	33 mm	40 mm	15,20
P032/06	5-6 mm	33 mm	40 mm	15,20
P032/07	6-7 mm	33 mm	40 mm	15,20
P032/08	7-8 mm	33 mm	40 mm	15,20
P032/09	8-9 mm	33 mm	40 mm	15,20
P032/10	9-10 mm	33 mm	40 mm	15,20
P032/11	10-11 mm	33 mm	40 mm	15,20
P032/12	11-12 mm	33 mm	40 mm	15,20
P032/13	12-13 mm	33 mm	40 mm	15,20
P032/14	13-14 mm	33 mm	40 mm	15,20
P032/15	14-15 mm	33 mm	40 mm	15,20
P032/16	15-16 mm	33 mm	40 mm	15,20
P032/17	16-17 mm	33 mm	40 mm	15,20
P032/18	17-18 mm	33 mm	40 mm	15,20
P032/19	18-19 mm	33 mm	40 mm	15,20
P032/20	19-20 mm	33 mm	40 mm	15,20

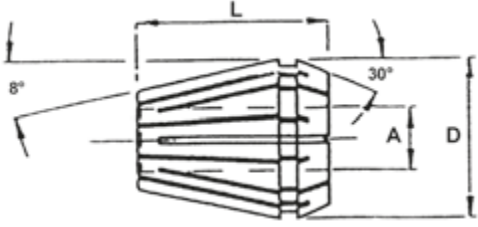





GHIERA DI RICAMBIO



Codice	€
G016	10,00
G020	11,00
G025	15,00
G032	37,60



CHIAVE PER GHIERE



Codice	€
CHER25	16,00
CHER32	20,40

Codice compatibile	Descrizione	€	3/CM2	3/CM3	3/CM4	3/D/40	3/B/40	3/A/40	3A40/16	3A40/20	3A40/25	3D40/16	3D40/20	3D40/25	Pag
P032/03	PINZA	15,20	•	•	•	•	•	•							207
P032/04	PINZA	15,20	•	•	•	•	•	•							207
P032/05	PINZA	15,20	•	•	•	•	•	•							207
P032/06	PINZA	15,20	•	•	•	•	•	•							207
P032/07	PINZA	15,20	•	•	•	•	•	•							207
P032/08	PINZA	15,20	•	•	•	•	•	•							207
P032/09	PINZA	15,20	•	•	•	•	•	•							207
P032/10	PINZA	15,20	•	•	•	•	•	•							207
P032/11	PINZA	15,20	•	•	•	•	•	•							207
P032/12	PINZA	15,20	•	•	•	•	•	•							207
P032/13	PINZA	15,20	•	•	•	•	•	•							207
P032/14	PINZA	15,20	•	•	•	•	•	•							207
P032/15	PINZA	15,20	•	•	•	•	•	•							207
P032/16	PINZA	15,20	•	•	•	•	•	•							207
P032/17	PINZA	15,20	•	•	•	•	•	•							207
P032/18	PINZA	15,20	•	•	•	•	•	•							207
P032/19	PINZA	15,20	•	•	•	•	•	•							207
P032/20	PINZA	15,20	•	•	•	•	•	•							207
P032/18P	SERIE PINZE ER32	260,00	•	•	•	•	•	•							206
G032	GHIERA DI RICAMBIO	37,60	•	•	•	•	•	•							207
CHER32	CHIAVE PER GHIERE	20,40	•	•		•	•	•							207
PR16/10P	SERIE PINZE ER16	85,00							•			•			205
PR20/12P	SERIE PINZE ER20	95,00								•			•		206
PR25/15P	SERIE PINZE ER25	125,00									•			•	206
G016	GHIERA DI RICAMBIO	10,00							•			•			207
G020	GHIERA DI RICAMBIO	11,00								•			•		207
G025	GHIERA DI RICAMBIO	15,00									•			•	207
CHER25	CHIAVE PER GHIERE	16,00									•			•	207

TESTINA PER ALESARE CENTESIMALE

Codice	Corpo testina	Attacco	Bareni	Spostamento	A	Peso	€
T010/5003	Ø 50 mm	CM/MT3-DIN228A	Ø 12 mm	15 mm	75 mm	1,2 kg	281,00
T010/5004	Ø 50 mm	CM/MT4-DIN228A	Ø 12 mm	15 mm	75 mm	1,8 kg	281,00
T010/5040	Ø 50 mm	ISO 40-DIN2080	Ø 12 mm	15 mm	81 mm	1,9 kg	281,00
T010/7540	Ø 75 mm	ISO 40-DIN2080	Ø 18 mm	25 mm	99 mm	3,2 kg	321,00

TESTINA PER ALESARE CENTESIMALE, KIT UTENSILI NON COMPRESO

TESTINA PER ALESARE CENTESIMALE CON AVANZAMENTO AUTOMATICO

Codice	Attacco	€
T021/030	ISO40	1850,00
T021/030CM3	CM3	1850,00
T021/050	ISO40	2160,00
T021/100	ISO40	2490,00
T021/100/50	ISO50	2490,00

Codice	T021/030 T021/030CM3	T021/050	T021/100 T021/100/50
Diametro max di spianatura e foratura	150 mm	350 mm	450 mm
Max spostamento della slitta	± 15 mm	± 25 mm	± 50 mm
Avanzamento fine	0,005 mm	0,005 mm	0,005 mm
Avanzamento manuale per giro	2 mm	3 mm	3 mm
Avanzamento automatico per giro	0,02-0,04-0,06 0,08-0,10-0,12 mm	0,03-0,06-0,09 0,12-0,15-0,18 mm	0,03-0,06-0,09 0,12-0,15-0,18 mm
Diametro dei fori della testina	18 mm	22 mm	22 mm
Diametro della testina	90 mm	120 mm	168 mm
Altezza della testina senza attacco	87,5 mm	118 mm	118 mm
Peso della testina senza attacco	2,9 kg	6,1 kg	7,8 kg
Lunghezza della testa	75 mm	105 mm	160 mm
Larghezza della testa	70 mm	90 mm	90 mm
Foro pinze	4 - 8 - 12 mm	8 - 10 - 12 - 14 mm	8 - 10 - 12 - 14 mm
Accessori in dotazione	1 - 2 - 6	1 - 2 - 3 - 4 - 5	1 - 2 - 3 - 4 - 5
Foro prolunga per utensile	<input type="checkbox"/> 6 mm	Ø 10 mm	Ø 10 mm



SET UTENSILI PER TESTE ALESARE



Codice	Adattabile	Stelo	Lunghezza	Inserto (non incluso)	€
B001/12	T010/50	12 Ø mm	60 mm	TCMT110204N	120,00
B001/18	T010/75	18 Ø mm	99 mm	TCMT110204N	120,00



SET 5 UTENSILI AD INSERTO



Codice	Stelo ut. est. / Inserto	Stelo ut. int. / Inserto	€
B007/10	10 mm / TCMT110204N	8 mm / TCMT090204N	109,00
B007/12	12 mm / TCMT110204N	10 mm / TCMT110204N	115,00
B007/16	16 mm / TCMT16T304N	12 mm / TCMT110204N	142,00



Art. KITCKJ

UTENSILE PER ESTERNO CON INSERTI



Codice	Contenuto del set	€
KITCKJ20	CKJNR20 + 10 KNUX160405RN	186,00
KITCKJ25	CKJNR25 + 10 KNUX160405RN	188,00

UTENSILE PER ESTERNO 90°

Codice	Lato	Stelo	Vite	Bussola	Base	Inserto (non incluso)	€
STGCR16/11	Dx/R	16 x 16 mm	T8 / M2,5 mm	-----	-----	TCMT110204N	48,00
STGCL16/11	Sx/L	16 x 16 mm	T8 / M2,5 mm	-----	-----	TCMT110204N	48,00
STGCR20	Dx/R	20 x 20 mm	T15 / M3,5 mm	BU3550	BSTG16	TCMT16T304N - TCMT16T308N	54,20
STGCL20	Sx/L	20 x 20 mm	T15 / M3,5 mm	BU3550	BSTG16	TCMT16T304N - TCMT16T308N	54,20
STGCR25	Dx/R	25 x 25 mm	T15 / M3,5 mm	BU3550	BSTG16	TCMT16T304N - TCMT16T308N	66,60
STGCL25	Sx/L	25 x 25 mm	T15 / M3,5 mm	BU3550	BSTG16	TCMT16T304N - TCMT16T308N	66,60

UTENSILE PER ESTERNO 95°

Codice	Lato	Stelo	Vite	Bussola	Base	Inserto (non incluso)	€
SCLCR12E	Dx/R	12 x 12 mm	T15 / M4,0 mm	-----	-----	CCMT09T304N - CCMT09T308N	41,10
SCLCL12E	Sx/L	12 x 12 mm	T15 / M4,0 mm	-----	-----	CCMT09T304N - CCMT09T308N	41,10
SCLCR16E	Dx/R	16 x 16 mm	T15 / M4,0 mm	BU4560	BSCL09	CCMT09T304N - CCMT09T308N	49,60
SCLCL16E	Sx/L	16 x 16 mm	T15 / M4,0 mm	BU4560	BSCL09	CCMT09T304N - CCMT09T308N	49,60
SCLCR20E	Dx/R	20 x 20 mm	T15 / M4,5 mm	BU4560	BSCL12	CCMT120408N	55,40
SCLCL20E	Sx/L	20 x 20 mm	T15 / M4,5 mm	BU4560	BSCL12	CCMT120408N	55,40
SCLCR25E	Dx/R	25 x 25 mm	T15 / M4,5 mm	BU4560	BSCL12	CCMT120408N	66,60
SCLCL25E	Sx/L	25 x 25 mm	T15 / M4,5 mm	BU4560	BSCL12	CCMT120408N	66,60

UTENSILE PER ESTERNO 45°

Codice	Lato	Stelo	Vite	Bussola	Base	Inserto (non incluso)	€
SSSCR20E	Dx/R	20 x 20 mm	T15 / M4,5 mm	BU4560	BSSS12	SCMT120408N	54,20
SSSCL20E	Sx/L	20 x 20 mm	T15 / M4,5 mm	BU4560	BSSS12	SCMT120408N	54,20
SSSCR25E	Dx/R	25 x 25 mm	T15 / M4,5 mm	BU4560	BSSS12	SCMT120408N	69,90
SSSCL25E	Sx/L	25 x 25 mm	T15 / M4,5 mm	BU4560	BSSS12	SCMT120408N	69,90

UTENSILE PER ESTERNO 93°

Codice	Lato	Stelo	Vite	Bussola	Base	Inserto (non incluso)	€
SVJBR20	Dx/R	20 x 20 mm	T15 / M3,5 mm	BU3550	BSVJ16	VBMT160404N - VBMT160408N	54,20
SVJBL20	Sx/L	20 x 20 mm	T15 / M3,5 mm	BU3550	BSVJ16	VBMT160404N - VBMT160408N	54,20
SVJBR25	Dx/R	25 x 25 mm	T15 / M3,5 mm	BU3550	BSVJ16	VBMT160404N - VBMT160408N	69,90
SVJBL25	Sx/L	25 x 25 mm	T15 / M3,5 mm	BU3550	BSVJ16	VBMT160404N - VBMT160408N	69,90

UTENSILE PER ESTERNO 93°

Codice	Lato	Stelo	Vite	Bussola	Base	Inserto (non incluso)	€
SDJCR10	Dx/R	10 x 10 mm	T8 / M2,5 mm	-----	-----	DCMT070204N	31,20
SDJCR12	Dx/R	12 x 12 mm	T8 / M2,5 mm	-----	-----	DCMT070204N	44,80
SDJCR16	Dx/R	16 x 16 mm	T8 / M2,5 mm	-----	-----	DCMT070204N	51,60
SDJCR20	Dx/R	20 x 20 mm	T15 / M3,5 mm	BU4050	BSDJ11	DCMT11T304N	58,50
SDJCL20	Sx/L	20 x 20 mm	T15 / M3,5 mm	BU4050	BSDJ11	DCMT11T304N	58,50
SDJCR25	Dx/R	25 x 25 mm	T15 / M3,5 mm	BU4050	BSDJ11	DCMT11T304N	74,20
SDJCL25	Sx/L	25 x 25 mm	T15 / M3,5 mm	BU4050	BSDJ11	DCMT11T304N	74,20

UTENSILE PER ESTERNO

Codice	Lato	Stelo	Angolo	Inserto (non incluso)	€
PCLNR20	Dx/R	20 x 20 mm	95°	CNMG120408N	58,80
PCLNL20	Sx/L	20 x 20 mm	95°	CNMG120408N	58,80
PCLNR25	Dx/R	25 x 25 mm	95°	CNMG120408N	69,90
PCLNL25	Sx/L	25 x 25 mm	95°	CNMG120408N	69,90

UTENSILE PER ESTERNO

Codice	Lato	Stelo	Angolo	Inserto (non incluso)	€
PTGNR20	Dx/R	20 x 20 mm	90°	TNMG160408N	55,00
PTGNL20	Sx/L	20 x 20 mm	90°	TNMG160408N	55,00
PTGNR25	Dx/R	25 x 25 mm	90°	TNMG160408N	69,90
PTGNL25	Sx/L	25 x 25 mm	90°	TNMG160408N	69,90

UTENSILE PER ESTERNO

Codice	Lato	Stelo	Angolo	Inserto (non incluso)	€
PSSNR20	Dx/R	20 x 20 mm	45°	SNMG120408N	55,40
PSSNL20	Sx/L	20 x 20 mm	45°	SNMG120408N	55,40
PSSNR25	Dx/R	25 x 25 mm	45°	SNMG120408N	69,90
PSSNL25	Sx/L	25 x 25 mm	45°	SNMG120408N	69,90

UTENSILE PER ESTERNO

Codice	Lato	Stelo	Angolo	Inserto (non incluso)	€
CKJNL20	Sx/L	20 x 20 mm	93°	KNUX160405LN	66,60
CKJNL25	Sx/L	25 x 25 mm	93°	KNUX160405LN	77,30
CKJNR20	Dx/R	20 x 20 mm	93°	KNUX160405RN	66,60
CKJNR25	Dx/R	25 x 25 mm	93°	KNUX160405RN	77,30

UTENSILE PER ESTERNO

Codice	Lato	Stelo	Angolo	Inserto (non incluso)	€
PDJNR20	Dx/R	20 x 20 mm	93°	DNMG150608N	57,00
PDJNR25	Dx/R	25 x 25 mm	93°	DNMG150608N	69,90
PDJNL25	Sx/L	25 x 25 mm	93°	DNMG150608N	69,90

UTENSILE PER ESTERNO

Codice	Lato	Stelo	Angolo	Inserto (non incluso)	€
PWLN20	Dx/R	20 x 20 mm	95°	WNMG080408N	57,00
PWLN25	Dx/R	25 x 25 mm	95°	WNMG080408N	69,90
PWLN25	Sx/L	25 x 25 mm	95°	WNMG080408N	69,90

PORTA GODRONI COMPLETO DI N° 3 COPPIE DI GODRONI, TAGLIO A DIAMANTE

Codice	Stelo	Passo	€
G007/16	16 mm	0,8 - 1,2 - 1,8 mm	65,00
G007/20	20 mm	0,8 - 1,2 - 1,8 mm	66,50

Art. KISCLCR
SET UTENSILI PER INTERNO 95°
€ 249,00

SET UTENSILI PER INTERNO 95°

COMPOSTO DA:
 1PZ UTENSILI PER INTERNO: SCLCR08; SCLCR10; SCLCR12;
 SCLCR16
 1PZ VITE: T8 Ø 2,5 MM
 2 PZ CHIAVE TORX: T8
 10 PZ INSERTO: CCMT060204N

Art. KISTCMT
SET UTENSILI PER INTERNO 90°
€ 270,00

Utensili per interno	STFCR08; STFCR10; STFCR12; STFCR16; STFCR20
Vite	T8 Ø 2,5 mm
Chiave torx	T8 x 2 Pz / Pcs
Inserto	TCMT110204N x 10 Pz / Pcs

Art. KISTFCR
SET UTENSILI PER INTERNO BLOCCAGGIO A VITE 90°

Dimensioni STFCR08	Ø 8 x 100 mm
Dimensioni STFCR10	Ø10 x 125 mm
Dimensioni STFCR12	Ø12 x 150 mm
Dimensioni STFCR16	Ø16 x 200 mm
Dimensioni STFCR20	Ø20 x 250 mm
Dimensioni viti T8	Ø2,5 x 6 mm

SET UTENSILI PER INTERNO BLOCCAGGIO A VITE 90°, COMPOSTO DAGLI UTENSILI STFCR08, STFCR10, STFCR12, STFCR16, STFCR20 (1pz CIASCUNO), VITI DI RICAMBIO 2,5MM (5pz) E CHIAVI TORX T8 (2pz)

UTENSILI PER INTERNO

Codice	Dimensioni	Inserto (non incluso)	€
SSSCR16	Ø 16 mm, L 200 mm	SCMT09T304N - SCMT09T308N	53,30
SSSCR20	Ø 20 mm, L 250 mm	SCMT09T304N - SCMT09T308N	59,40
SSSCR25	Ø 25 mm, L 300 mm	SCMT09T304N - SCMT09T308N	69,90

UTENSILE PER INTERNO

Codice	Lato	D	h	L	Inserto (non incluso)	€
SCLCR08	Dx/R	8 mm	7 mm	125 mm	CCMT060204N	58,30
SCLCL08	Sx/L	8 mm	7 mm	125 mm	CCMT060204N	58,30
SCLCR10	Dx/R	10 mm	9 mm	140 mm	CCMT060204N	58,30
SCLCL10	Sx/L	10 mm	9 mm	140 mm	CCMT060204N	58,30
SCLCR12	Dx/R	12 mm	11 mm	160 mm	CCMT060204N	58,30
SCLCL12	Sx/L	12 mm	11 mm	160 mm	CCMT060204N	58,30
SCLCR16	Dx/R	16 mm	14,5 mm	180 mm	CCMT09T304N	66,00
SCLCL16	Sx/L	16 mm	14,5 mm	180 mm	CCMT09T304N	66,00
SCLCR20	Dx/R	20 mm	18 mm	200 mm	CCMT09T304N	66,00
SCLCL20	Sx/L	20 mm	18 mm	200 mm	CCMT09T304N	66,00
SCLCR25	Dx/R	25 mm	22,5 mm	250 mm	CCMT09T304	73,70
SCLCL25	Sx/L	25 mm	22,5 mm	250 mm	CCMT09T304N	73,70
SCLCR32	Dx/R	32 mm	29 mm	300 mm	CCMT09T304N	104,00
SCLCL32	Sx/L	32 mm	29 mm	300 mm	CCMT09T304N	104,00

UTENSILE PER INTERNO BLOCCAGGIO A VITE 95°



UTENSILE PER INTERNO



Codice	Lato	D	h	L	Inserto (non incluso)	€
STFCR08	Dx/R	8 mm	7 mm	125 mm	TCMT110204N	58,30
STFCL08	Sx/L	8 mm	7 mm	125 mm	TCMT110204N	58,30
STFCR10	Dx/R	10 mm	9 mm	150 mm	TCMT110204N	58,30
STFCL10	Sx/L	10 mm	9 mm	150 mm	TCMT110204N	58,30
STFCR12	Dx/R	12 mm	11 mm	150 mm	TCMT110204N	58,30
STFCL12	Sx/L	12 mm	11 mm	150 mm	TCMT110204N	58,30
STFCR16	Dx/R	16 mm	14,5 mm	200 mm	TCMT110204N	66,00
STFCL16	Sx/L	16 mm	14,5 mm	200 mm	TCMT110204N	66,00
STFCR20	Dx/R	20 mm	18,5 mm	250 mm	TCMT110204N	66,00
STFCL20	Sx/L	20 mm	18,5 mm	200 mm	TCMT110204N	66,00
STFCR25	Dx/R	25 mm	22,5 mm	250 mm	TCMT16T304N	73,70
STFCL25	Sx/L	25 mm	22,5 mm	250 mm	TCMT16T304N	73,70
STFCR32	Dx/R	32 mm	29 mm	300 mm	TCMT16T304N	104,00
STFCL32	Sx/L	32 mm	29 mm	300 mm	TCMT16T304N	104,00

UTENSILE PER INTERNO BLOCCAGGIO A VITE 90°



UTENSILE PER INTERNO



Codice	Lato	D	h	L	Inserto (non incluso)	€
SDUCR10	Dx/R	10 mm	9 mm	140 mm	DCMT070204N	58,30
SDUCL10	Sx/L	10 mm	9 mm	140 mm	DCMT070204N	58,30
SDUCR12	Dx/R	12 mm	11 mm	160 mm	DCMT070204N	58,30
SDUCL12	Sx/L	12 mm	11 mm	160 mm	DCMT070204N	58,30
SDUCR16	Dx/R	16 mm	15 mm	180 mm	DCMT070204N	66,00
SDUCL16	Sx/L	16 mm	15 mm	180 mm	DCMT070204N	66,00
SDUCR20	Dx/R	20 mm	18 mm	200 mm	DCMT11T304N	66,00
SDUCL20	Sx/L	20 mm	18 mm	200 mm	DCMT11T304N	66,00
SDUCR25	Dx/R	25 mm	23 mm	250 mm	DCMT11T304N	73,70
SDUCL25	Sx/L	25 mm	23 mm	250 mm	DCMT11T304N	73,70
SDUCR32	Dx/R	32 mm	30 mm	300 mm	DCMT11T304N	104,00
SDUCL32	Sx/L	32 mm	30 mm	300 mm	DCMT11T304N	104,00

UTENSILE PER INTERNO BLOCCAGGIO A VITE 93°

UTENSILE PER INTERNO

Codice	Lato	D	h	L	Inserto (non incluso)	€
MCLNR16	Dx/R	16 mm	15 mm	210 mm	CNMG120404N	75,90
MCLNL16	Sx/L	16 mm	15 mm	210 mm	CNMG120404N	75,90
MCLNR20	Dx/R	20 mm	18 mm	255 mm	CNMG120404N	83,60
MCLNL20	Sx/L	20 mm	18 mm	255 mm	CNMG120404N	83,60
MCLNR25	Dx/R	25 mm	23 mm	300 mm	CNMG120404N	106,00
MCLNL25	Sx/L	25 mm	23 mm	300 mm	CNMG120404N	106,00
MCLNR32	Dx/R	32 mm	30 mm	355 mm	CNMG120404N	129,00
MCLNL32	Sx/L	32 mm	30 mm	355 mm	CNMG120404N	129,00

UTENSILE PER INTERNO CON PERNO E STAFFA 95°

UTENSILE PER INTERNO

Codice	Lato	D	h	L	Inserto (non incluso)	€
MTFNR16	Dx/R	16 mm	15 mm	210 mm	TNMG160404N	74,80
MTFNL16	Sx/L	16 mm	15 mm	210 mm	TNMG160404N	74,80
MTFNR20	Dx/R	20 mm	18 mm	255 mm	TNMG160404N	83,60
MTFNL20	Sx/L	20 mm	18 mm	255 mm	TNMG160404N	83,60
MTFNR25	Dx/R	25 mm	23 mm	300 mm	TNMG160404N	106,00
MTFNL25	Sx/L	25 mm	23 mm	300 mm	TNMG160404N	106,00
MTFNR32	Dx/R	32 mm	30 mm	355 mm	TNMG160404N	129,00
MTFNL32	Sx/L	32 mm	30 mm	355 mm	TNMG160404N	129,00

UTENSILE PER INTERNO CON PERNO E STAFFA 90°

UTENSILE PER INTERNO

Codice	Lato	D	h	L	Inserto (non incluso)	€
CTFPR10	Dx/R	10 mm	9 mm	150 mm	TPMR090204N	63,80
CTFPL10	Sx/L	10 mm	9 mm	150 mm	TPMR090204N	63,80
CTFPR12	Dx/R	12 mm	11 mm	150 mm	TPMR110304N	63,80
CTFPL12	Sx/L	12 mm	11 mm	150 mm	TPMR110304N	63,80
CTFPR16	Dx/R	16 mm	15 mm	210 mm	TPMR110304N	73,70
CTFPL16	Sx/L	16 mm	15 mm	210 mm	TPMR110304N	73,70
CTFPR20	Dx/R	20 mm	18 mm	255 mm	TPMR160304N	83,60
CTFPL20	Sx/L	20 mm	18 mm	255 mm	TPMR160304N	83,60
CTFPR25	Dx/R	25 mm	23 mm	300 mm	TPMR160304N	103,00
CTFPL25	Sx/L	25 mm	23 mm	300 mm	TPMR160304N	103,00
CTFPR32	Dx/R	32 mm	30 mm	355 mm	TPMR160304N	129,00
CTFPL32	Sx/L	32 mm	30 mm	355 mm	TPMR160304N	129,00

UTENSILE PER INTERNO BLOCCAGGIO A STAFFA 90°

UTENSILE PER INTERNO

Codice	Lato	D	h	L	Inserto (non incluso)	€
CKUNR25	Dx/R	25 mm	23 mm	300 mm	KNUX160405LN	183,00
CKUNR32	Dx/R	32 mm	30 mm	350 mm	KNUX160405LN	209,00
CKUNR40	Dx/R	40 mm	37 mm	400 mm	KNUX160405LN	219,00

UTENSILE PER INTERNO BLOCCAGGIO A STAFFA 93°

KIT FILETTATURA PER ESTERNO

Codice	Stelo	L	Inserto	€
KISER	20 x 20 mm	125 mm	16ER...	181,00
KISER25	25 x 25 mm	150 mm	16ER...	238,00

KIT FILETTATURA PER INTERNO

Codice	Ø	h	L	Inserto	€
KISNR	20 mm	18 mm	170 mm	16IR...	208,00
KISNR25	25 mm	23 mm	200 mm	16IR...	248,00

Art. KICAN
SET PER CANALINI ESTERNI ED INTERNI

€ 232,00



SET PER CANALINI ESTERNI ED INTERNI
 1 PZ UTENSILE PER CANALINI ESTERNI: 20 x 20 mm
 1 PZ UTENSILE PER CANALINI INTERNI: Ø 20 mm
 2 PZ VITE: M4 x 12 mm - 1 PZ CHIAVE TORX: T 15
 INSERTI PER SCANALATURA 16 mm TIN:
 2 PZ 165110134 - 2 PZ 165130134
 2 PZ 165160134 - 1 PZ 165185134
 1 PZ 165215134 - 1 PZ 165265134
 1 PZ 165315134

UTENSILE FILETTARE ESTERNO FISSAGGIO A VITE

Codice	Stelo	L	Inserto (non incluso)	€
SER16	16 x 16 mm	100 mm	16ER..	60,00
SER20	20 x 20 mm	125 mm	16ER...	77,00
SER25	25 x 25 mm	150 mm	16ER...	89,10

UTENSILE A FILETTARE PER ESTERNO CON FISSAGGIO A VITE PER INSERTI IN METALLO DURO DA 16

UTENSILE FILETTARE INTERNO FISSAGGIO A VITE

Codice	Ø	h	L	Inserto (non incluso)	€
SNR12	12 mm	11 mm	150 mm	11IR...	60,00
SNR16	16 mm	15 mm	170 mm	16IR...	70,00
SNR20	20 mm	18 mm	170 mm	16IR...	84,70
SNR25	25 mm	23 mm	300 mm	16IR...	105,00

Art. T089
SET DA TAGLIO

Contenuto del set 1 Pz / Pc SGIH19/2 - 1 Pz / Pc SGTBK10

SET DA TAGLIO PER ESTERNO

SET DA TAGLIO

Codice	Contenuto del set	€
T090	1 Pz / Pc - SGIH32/3 1 Pz / Pc - SGIH32/4 1 Pz / Pc - SGIH32/5 1 Pz / Pc - SGTBK25	164,00
T091	1 Pz / Pc - SGIH26/2 - 1 Pz / Pc - SGIH26/3 - 1 Pz / Pc - SGTBK20	120,00

SET DA TAGLIO PER ESTERNO

UTENSILE PER TAGLIO ESTERNO - LAMA

Codice	Dimensioni	Inserito (non incluso)	€
SGIH19/2	19,5 x 85 mm	GCMX2N134	29,00
SGIH26/2	25,75h x 109 mm	GCMX2N134	36,10
SGIH26/3	25,75h x 109 mm	GCMX3N134	36,10
SGIH32/3	31,75h x 150 mm	GCMX3N134	36,10
SGIH32/4	31,75h x 160 mm	GCMX4N134	36,10
SGIH32/5	31,75h x 160 mm	GCMX5N134	36,10

UTENSILE PER TAGLIO ESTERNO - LAMA DA TAGLIO PER INSERTI IN METALLO DURO

UTENSILE PER TAGLIO ESTERNO - BLOCCO PORTA LAMA

Codice	Stelo	Dimensioni	Lama	€
SGTBK10	10 x 10 mm	56 x 25 x 30 mm	19 mm	48,00
SGTBK16	16 x 16 mm	87 x 38 x 33 mm	26 mm	52,00
SGTBK20	20 x 20 mm	100 x 38 x 45h mm	26 mm	57,20
SGTBK25	25 x 25 mm	110 x 49 x 48h mm	32 mm	71,50



Art. BSTG16
SET 5 BASI 16 mm

€ 26,90



Art. BU3550
SET 5 BUSSOLE

€ 26,90



Art. BSCL09
SET 5 BASI 9 mm

€ 26,90



Art. BSCL12
SET 5 BASI 12 mm

€ 26,90



Art. BU4560
SET 5 BUSSOLE

€ 26,90



Art. BSSS12
5 BASI QUADRATE 12 mm

€ 26,90



Art. BSVJ16
SET 5 BASI 16 mm

€ 26,90



Art. BSDJ11
5 BASI ROMBOIDALI 11 mm

€ 30,00



Art. BU4050
SET 5 BUSSOLE

€ 29,50



Art. RICAPCLN
STAFFA BASE VITE

€ 16,80

Art. RICAPTGN
 SET BASE STAFFA VITE

€ 16,80

Art. RICAPSSN
 STAFFA BASE STAFFA VITE

€ 16,80

Art. STAFCKJNR
 STAFFA UTENSILE DX

€ 21,30

Art. STAFCKJNL
 STAFFA UTENSILE SX

€ 21,30

Art. BASECKJNR
 BASE UTENSILE DX

€ 12,40

Art. BASECKJNL
 BASE UTENSILE SX

€ 12,40

Art. VITECKJN
 VITE UTENSILE

€ 4,62

Art. PDJNRKIT
 KIT RICAMBI

€ 19,20

Art. PWLNRKIT
 SET BASE STAFFA VITE

€ 17,40

Art. MCLNBASE25/32
 BASE

€ 19,50

Art. CTMTMC16/20
 STAFFA DI RICAMBIO
 PER 16 - 20

€ 24,00

Art. CTMTMC25/32
 STAFFA DI RICAMBIO
 PER 25 - 32

€ 24,00

Art. MTFNBASE25/32
 BASE

€ 15,20

Art. CTFP10/12
 STAFFA

€ 24,00

Art. CTFPBASE25/32
 BASE

€ 15,20

Art. BSER16
 SET 5 BASI
 TRIANGOLARI 16mm

€ 35,60

Art. BSNR16
 SET 5 BASI

€ 35,60

SET 10 VITI

Codice	Vite	€
KV200	T8 / M2	22,40
KV250	T8 / M2,5	22,40
KV300	T15 / M 3	22,40
KV350	T15 / M 3,5	22,40
KV400	T15 / M 4	22,40
KV450	T15 / M 4,5	22,40
KV500	T20 / M 5	22,40



TABELLA DI COMPATIBILITÀ

Set di viti Compatibili € 22,40 pag 220	KV200	KV250	KV350	KV400	KV450	Set di viti Compatibili € 22,40 pag 220	KV200	KV250	KV350	KV400	KV450	Set di viti Compatibili € 22,40 pag 220	KV200	KV250	KV350	KV400	KV450	
STGCR16/11		•				B001/12		•				STFCLR25					•	
STGCL16/11		•				B001/18		•				STFCL25					•	
STGCR20			•			SSSCR16				•		STFCR32					•	
STGCL20			•			SSSCR20				•		STFCL32					•	
STGCR25			•			SSSCR25				•		SDUCR10						
STGCL25			•			SCLCR08		•				SDUCL10		•				
SCLCR12E				•		SCLCL08		•				SDUCR12		•				
SCLCL12E				•		SCLCR10		•				SDUCL12		•				
SCLCR16E				•		SCLCL10		•				SDUCR16		•				
SCLCL16E				•		SCLCR12		•				SDUCL16		•				
SCLCR20E					•	SCLCL12		•				SDUCR20			•			
SCLCL20E					•	SCLCR16				•		SDUCL20			•			
SCLCR25E					•	SCLCL16				•		SDUCR25			•			
SCLCL25E					•	SCLCR20				•		SDUCL25			•			
SSSCR20E					•	SCLCL20				•		SDUCR32			•			
SSSCL20E					•	SCLCR25				•		SDUCL32			•			
SSSCR25E					•	SCLCL25				•		SER16			•			
SSSCL25E					•	SCLCR32				•		SER20			•			
SVJBR20			•			SCLCL32				•		SER25			•			
SVJBL20			•			STFCR08		•				SNR12		•				
SVJBR25			•			STFCL08		•				SNR16			•			
SVJBL25			•			STFCR10		•				SNR20			•			
SDJCR10		•				STFCL10		•				SNR25			•			
SDJCR12		•				STFCR12		•				KITCKJ20						
SDJCR16		•				STFCL12		•				KITCKJ25						
SDJCR20			•			STFCR16		•				B007/10	•		•			
SDJCL20			•			STFCL16		•				B007/12			•			
SDJCR25			•			STFCR20		•				B007/16				•		
SDJCL25			•			STFCL20		•										

Set di basi e bussole compatibili € 26,90 pag 219	B5TG16	BU3550	B5CL09	B5CL12	BU4560	B55512	B5VJ16	BU3550	B5CL09	B5CL12	BU4560	B55512	B5VJ16	Set di basi e bussole compatibili € 26,90 pag 219	B5TG16	BU3550	B5CL09	B5CL12	BU4560	B55512	B5VJ16	BU3550	B5CL09	B5CL12	BU4560	B55512	B5VJ16
STGCR16/11														SSSCR25E													
STGCL16/11														SSSCL25E													
STGCR20	•	•						•						SVJBR20		•											•
STGCL20	•	•						•						SVJBL20		•											•
STGCR25	•	•						•						SVJBR25		•											•
STGCL25	•							•						SVJBL25		•											•
SCLCR16E			•	•	•				•	•	•			SDJCR20													•
SCLCL16E			•	•	•				•	•	•			SDJCL20													•
SCLCR20E			•	•	•				•	•	•			SDJCR25													•
SCLCL20E			•	•	•				•	•	•			SDJCL25													•
SCLCR25E			•	•	•				•	•	•			SER20									•				•
SCLCL25E			•	•	•				•	•	•			SER25									•				•
SSSCR20E					•	•				•	•			SNR20									•				•
SSSCL20E					•	•				•	•			SNR25									•				•

Utensili compatibili	Descrizione	€	SGTBK10	SGTBK16	SGTBK20	SGTBK25	T089	T090	T091	Pag
SGIH19/2	UTENSILE PER TAGLIO ESTERNO - LAMA	29,00	•				•			219
SGIH26/2	UTENSILE PER TAGLIO ESTERNO - LAMA	36,10		•	•				•	219
SGIH26/3	UTENSILE PER TAGLIO ESTERNO - LAMA	36,10		•	•				•	219
SGIH32/3	UTENSILE PER TAGLIO ESTERNO - LAMA	36,10				•		•		219
SGIH32/4	UTENSILE PER TAGLIO ESTERNO - LAMA	36,10				•		•		219
SGIH32/5	UTENSILE PER TAGLIO ESTERNO - LAMA	36,10				•		•		219

FRESA A INSERTO



Codice	D	d	Z	L1	L2	Viti	Inserto (non incluso)	€
F300/12	12 mm	12 mm	1	27 mm	120 mm	T8/25 KV250	APKT1003PDER20A	41,10
F300/14	14 mm	12 mm	1	27 mm	120 mm	T8/25 KV250	APKT1003PDER20A	41,10
F300/16	16 mm	16 mm	2	27 mm	120 mm	T8/25 KV250	APKT1003PDER20A	48,90
F300/18	18 mm	16 mm	2	27 mm	120 mm	T8/25 KV250	APKT1003PDER20A	54,40
F300/20	20 mm	20 mm	3	32 mm	120 mm	T8/25 KV250	APKT1003PDER20A	58,30
F300/22	22 mm	20 mm	3	27 mm	120 mm	T8/25 KV250	APKT1003PDER20A	58,30
F300/25	25 mm	20 mm	4	27 mm	120 mm	T8/25 KV250	APKT1003PDER20A	69,90
F300/25/16	25 mm	20 mm	2	44 mm	120 mm	T15/40 KV400	APKT1604PDER20A	69,90
F300/25/16L	25 mm	20 mm	2	44 mm	200 mm	T15/40 KV400	APKT1604PDER20A	81,20
F300/32/16	32 mm	25 mm	3	50 mm	120 mm	T15/40 KV400	APKT1604PDER20A	81,20
F300/32/16L	32 mm	32 mm	3	55 mm	200 mm	T15/40 KV400	APKT1604PDER20A	113,00

FRESA A INSERTO 90°

FRESA A INSERTO

Codice	D	CM	Z	L1	L2	Viti	Inserto (non incluso)	€
F301/25	25 mm	3	2	40 mm	125 mm	T15/40 KV400	APKT1604PDER20A	72,40
F301/32	32 mm	3	3	40 mm	125 mm	T15/40 KV400	APKT1604PDER20A	77,30
F301/40	40 mm	3	4	35 mm	125 mm	T15/40 KV400	APKT1604PDER20A	98,70
F301/32CM4	32 mm	4	3	45 mm	150 mm	T15/40 KV400	APKT1604PDER20A	98,70
F301/40CM4	40 mm	4	4	40 mm	150 mm	T15/40 KV400	APKT1604PDER20A	105,00

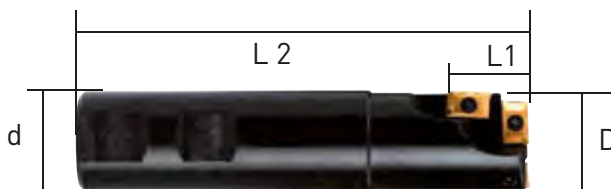
FRESA A INSERTO 90°

FRESA A INSERTO

Codice	D	d	Z	L1	L2	Viti	Inserto (non incluso)	€
F306/20	20 mm	20 mm	2	18 mm	90 mm	T8/25 KV250	APKT1003PDER20A	175,00
F306/25	25 mm	25 mm	2	18 mm	100 mm	T8/25 KV250	APKT1003PDER20A	216,00

FRESA A INSERTO 90° TAGLIO AL CENTRO



FRESA A INSERTO

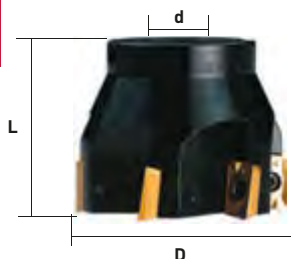

Codice	D	L	d	Z	Viti	Inserto (non incluso)	€
F302/040	40 mm	40 mm	16 mm	4	KV400	APKT1604PDER20A	159,00
F302/050	50 mm	50 mm	22 mm	4	KV400	APKT1604PDER20A	164,00
F302/063	63 mm	50 mm	22 mm	6	KV400	APKT1604PDER20A	173,00
F302/080	80 mm	50 mm	27 mm	7	KV400	APKT1604PDER20A	204,00
F302/100	100 mm	50 mm	32 mm	8	KV400	APKT1604PDER20A	254,00

FRESA A INSERTO 90°



FRESA PER RECUPERO INSERTO

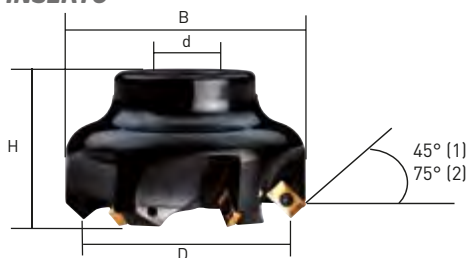

Codice	D	h	B	d	Z	Viti	Inserto (non incluso)	€
F304/063	63 mm	42 mm	71,2 mm	22 mm	6	T8/25 KV250	APKT1003PDER20A	270,00
F304/080	80 mm	47 mm	84 mm	27 mm	5	T15/40 KV400	APKT1003PDER20A	219,00



FRESA PER SPALLAMENTI



Codice	D	d	Z	L1	L2	Viti	Inserto (non incluso)	€
F402/25	25 mm	20 mm	2	35 mm	110 mm	T15/40 KV400	ADLX1503ZZR234	58,80
F402/32	32 mm	25 mm	3	35 mm	120 mm	T15/40 KV400	ADLX1503ZZR234	74,20
F402/25L	25 mm	25 mm	2	35 mm	200 mm	T15/40 KV400	ADLX1503ZZR234	80,20
F402/32L	32 mm	25 mm	3	35 mm	200 mm	T15/40 KV400	ADLX1503ZZR234	103,00

FRESA PER SPALLAMENTI 90°



FRESA PER SPALLAMENTI

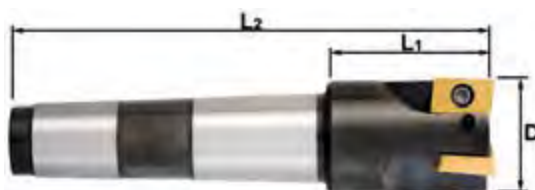

Codice	D	CM	Z	L1	L2	Viti	Inserto (non incluso)	€
F401/25	25 mm	3	2	44 mm	130 mm	T15/40 KV400	ADLX1503ZZR234	65,60
F401/32	32 mm	3	3	44 mm	130 mm	T15/40 KV400	ADLX1503ZZR234	80,20
F401/40	40 mm	3	4	44 mm	130 mm	T15/40 KV400	ADLX1503ZZR234	87,80
F401/40CM4	40 mm	4	4	44 mm	153 mm	T15/40 KV400	ADLX1503ZZR234	103,00

FRESA PER SPALLAMENTI 90°

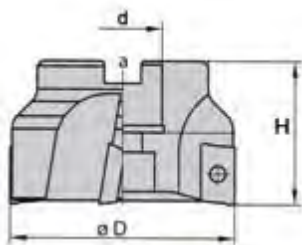
FRESA PER SPALLAMENTI

Codice	D	H	a	d	Z	Viti	Inserto (non incluso)	€
F400/040	40 mm	40 mm	8,4 mm	16 mm	4	T15/40 KV400	ADLX1503ZZR234	102,00
F400/050	50 mm	40 mm	10,4 mm	22 mm	5	T15/40 KV400	ADLX1503ZZR234	137,00
F400/063	63 mm	40 mm	10,4 mm	22 mm	6	T15/40 KV400	ADLX1503ZZR234	156,00
F400/080	80 mm	50 mm	12,4 mm	27 mm	7	T15/40 KV400	ADLX1503ZZR234	201,00
F400/100	100 mm	50 mm	14,4 mm	32 mm	8	T15/40 KV400	ADLX1503ZZR234	246,00

FRESA PER SPALLAMENTI 90°

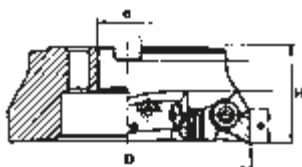
FRESA PER SPALLAMENTI

Codice	D	H	a	d	Z	Inserto (non incluso)	€
F256/040	40 mm	44 mm	16 mm	16 mm	3	TPKN1603R25	160,00
F256/050	50 mm	44 mm	16 mm	22 mm	3	TPKN1603R25	166,00
F256/063	63 mm	44 mm	16 mm	22 mm	3	TPKN1603R25	179,00
F256/080	80 mm	52 mm	22 mm	27 mm	4	TPKN2204R25	184,00
F256/100	100 mm	52 mm	22 mm	32 mm	5	TPKN2204R25	238,00

FRESA PER SPALLAMENTI 90°

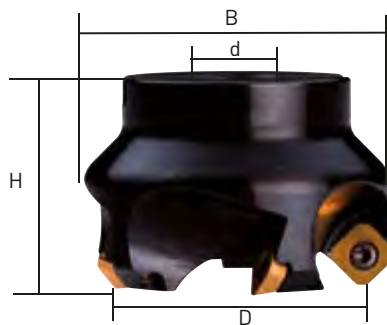
FRESA A INSERTO

Codice	D	H	B	d	Z	Viti	Inserto (non incluso)	€
F303/040	40 mm	45 mm	53 mm	16 mm	3	T20/50 KV500	SEHX1204234 / SEHT1204AFN234	117,00
F303/050	50 mm	48 mm	60 mm	22 mm	4	T20/50 KV500	SEHX1204234 / SEHT1204AFN234	131,00
F303/063	63 mm	50 mm	76 mm	22 mm	5	T20/50 KV500	SEHX1204234 / SEHT1204AFN234	153,00
F303/080	80 mm	50 mm	93 mm	27 mm	5	T20/50 KV500	SEHX1204234 / SEHT1204AFN234	183,00
F303/100	100 mm	50 mm	113 mm	32 mm	6	T20/50 KV500	SEHX1204234 / SEHT1204AFN234	216,00
F303/125	125 mm	60 mm	138 mm	40 mm	7	T20/50 KV500	SEHX1204234 / SEHT1204AFN234	316,00

FRESA A INSERTO A 45°

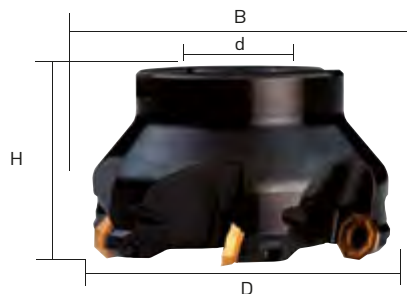
FRESA A INSERTO PER SPIANATURA

Codice	D	H	L2	d	Z	Viti	Inserto (non incluso)	€
F308/063	63 mm	40 mm	68 mm	22 mm	5	T15/40 KV400	OFEX05T305234	217,00
F308/080	80 mm	50 mm	86 mm	27 mm	6	T15/40 KV400	OFEX05T305234	280,00
F308/100	100 mm	50 mm	106 mm	32 mm	7	T15/40 KV400	OFEX05T305234	356,00

FRESA A INSERTO PER SPIANATURA ANGOLO DI SPOGLIA 43°

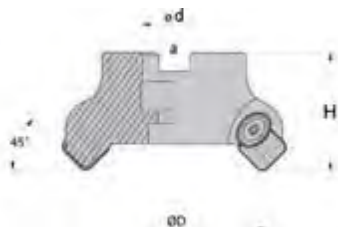
FRESA PER SPIANATURA

Codice	D	H	a	d	Z	Viti	Inserto (non incluso)	€
F406/40	40 mm	45 mm	8,4 mm	16 mm	3	T15/40 KV400	SEKN1203AFN25	161,00
F406/50	50 mm	45 mm	10,4 mm	22 mm	4	T15/40 KV400	SEKN1203AFN25	168,00
F406/63	63 mm	45 mm	12,4 mm	22 mm	5	T15/40 KV400	SEKN1203AFN25	179,00
F406/80	80 mm	50 mm	14,4 mm	27 mm	5	T15/40 KV400	SEKN1203AFN25	207,00
F406/100	100 mm	50 mm	16,4 mm	32 mm	6	T15/40 KV400	SEKN1203AFN25	266,00

FRESA PER SPIANATURA A 45°

Art. F307/16/22
SERIE SVASATORI A INSERTO

€ 173,00



D	16 / 22 mm
d	12 / 20 mm
L1	7 mm
L2	90 / 100 mm
Z	1 / 2
Viti	T8/25 KV250
Inserto (non incluso)	TCMT110204N

SERIE SVASATORI A INSERTO A 45°

FRESA CILINDRICA PER CONTORNATURA

Codice	D	d	H	L	Z	Viti	Inserto (non incluso)	€
F405/25	25 mm	25 mm	55 mm	200 mm	2	T15/40 KV400	RDHT10T3MO-N	74,20
F405/32	32 mm	32 mm	55 mm	200 mm	3	T15/40 KV400	RDHT10T3MO-N	103,00

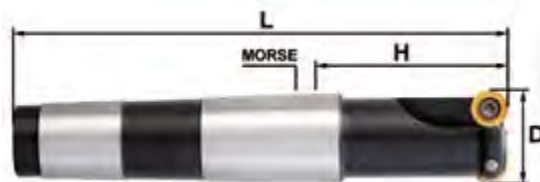
FRESA PER CONTORNATURA
€ 158,00

Codice	D	CM	H	L	Z	Viti	Inserto (non incluso)	€
F404/25	25 mm	3	44 mm	130 mm	2	T15/40 KV400	RDHT10T3MO-N	60,70
F404/32	32 mm	3	44 mm	130 mm	3	T15/40 KV400	RDHT10T3MO-N	76,70
F404/40	40 mm	3	44 mm	130 mm	3	T15/40 KV400	RDHT10T3MO-N	89,70

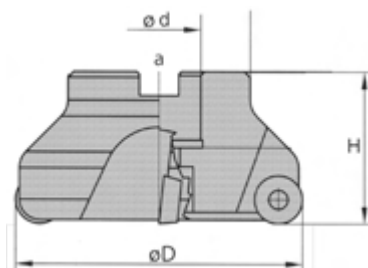
FRESA PER SPIANATURA

Codice	D	H	a	d	Z	Viti	Inserto (non incluso)	€
F403/40	40 mm	40 mm	8,4 mm	16 mm	3	T15/40 KV400	RPMT1204N	109,00
F403/50	50 mm	42 mm	10,4 mm	22 mm	4	T15/40 KV400	RPMT1204N	142,00
F403/63	63 mm	45 mm	10,4 mm	22 mm	5	T15/40 KV400	RPMT1204N	169,00
F403/80	80 mm	50 mm	12,4 mm	27 mm	6	T15/40 KV400	RPMT1204N	201,00
F403/100	100 mm	50 mm	14,4 mm	32 mm	6	T15/40 KV400	RPMT1204N	238,00

Art. F256/648
 VITI FRESA 080/125

€ 13,70

Art. F256/644
 VITI FRESA 040/063

€ 7,70

Art. WSSP
 SOTTOPLACCHETTA

€ 9,30

Art. VT00440
 5 VITI PER FRESA

€ 22,70

KIT DI REFRIGERAZIONE PER MACCHINE UTENSILI

Codice	Alimentazione	Capacità serbatoio	Portata pompa	Peso	€
P018/230V	230V - 50Hz - 40W	10 l	22 l/min	7 kg	328,00
P018/400V	400V - 50Hz - 40W	10 l	22 l/min	7 kg	328,00

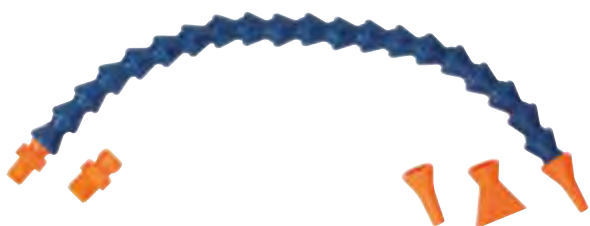
Art. T200 € 17,40
TUBO COMPONENTE SNODABILE PER LIQUIDI REFRIGERANTI

Lunghezza totale 350 mm
 Diametro tubo 6 mm - 1/4"

TUBO COMPONENTE SNODABILE PER LIQUIDI REFRIGERANTI COMPOSTO DA:
 N. 21 SEGMENTI
 N. 1 UGELLO: FORO Ø 1,5 mm
 N. 1 UGELLO: FORO Ø 3 mm
 N. 1 RACCORDO: 1/8"
 N. 1 RACCORDO: 1/4"
 N. 1 UGELLO A SPATOLA

Art. T201 € 19,10
TUBO COMPONENTE SNODABILE PER LIQUIDI REFRIGERANTI

Lunghezza totale 400 mm
 Diametro tubo 12 mm - 1/2"

TUBO COMPONENTE SNODABILE PER LIQUIDI REFRIGERANTI COMPOSTO DA:
 N. 16 SEGMENTI
 N. 1 UGELLO - FORO: Ø 5 mm
 N. 1 RACCORDO: 1/2"
 N. 1 UGELLO A SPATOLA

Art. S100 € 54,40
PROTEZIONE REGOLABILE PER MOLA CON SCHERMO IN LEXAN

Dimensioni 110 x 120 mm



**PROTEZIONE PER TORNO
CON SCHERMO IN LEXAN
E STRUTTURA IN ACCIAIO**



Codice	Dimensioni	€
T400	Ø 400 x 200 mm	175,00
T500	Ø 500 x 220 mm	185,00
T600	Ø 600 x 280 mm	202,00



**ATTACCO UNIVERSALE PER TORNO
CON MICROINTERRUPTORE DI
SICUREZZA**



Codice	Stelo	Lunghezza	€
M400	Ø 30 mm	350 mm	219,00
M500	Ø 30 mm	400 mm	227,00
M600	Ø 30 mm	450 mm	237,00



Art. P100/250 € 120,00
**PROTEZIONE
ANTINFORTUNISTICA
PER MACCHINE UTENSILI**



Stelo	400 mm
Schermo	150x250 H x L mm



**PROTEZIONE
ANTINFORTUNISTICA
PER MACCHINE UTENSILI**



Codice	Stelo	Schermo	€
P101/300	400L mm	150 x 350 H x L mm	375,00
P101/350	600L mm	200 x 440 H x L mm	395,00
P101/400	500L mm	150 x 370 H x L mm	407,00

Art. 0371
 LAMPADA A LED PER MACCHINE UTENSILI

€ 164,00
IP 65

Alimentazione	24V 10W
Altezza snodo	110 mm
Diametro	110 mm
Snodi	1
Resistenza alla polvere e all'acqua	IP 65
Peso	1,7 kg
Imballo	6

LAMPADA A LED PER MACCHINE UTENSILI SENZA TRASFORMATORE

Art. 0372
 LAMPADA A LED PER MACCHINE UTENSILI

€ 249,00
IP 65

Alimentazione	24V 10W
Altezza	890 mm
Diametro	110 mm
Snodi	3
Resistenza alla polvere e all'acqua	IP 65
Peso	2,1 kg
Imballo	6

LAMPADA A LED PER MACCHINE UTENSILI SENZA TRASFORMATORE

Art. 0531
 LAMPADA ALOGENA PER MACCHINE UTENSILI

€ 148,00
IP 65

Alimentazione	24V 50W
Altezza snodo	110 mm
Diametro	125 mm
Snodi	1
Resistenza alla polvere e all'acqua	IP 65
Peso	1,7 kg
Imballo	6

LAMPADA ALOGENA PER MACCHINE UTENSILI SENZA TRASFORMATORE

Art. 0532
 LAMPADA ALOGENA PER MACCHINE UTENSILI

€ 208,00
IP 65

Alimentazione	24V 50W
Altezza	890 mm
Diametro	125 mm
Snodi	3
Resistenza alla polvere e all'acqua	IP 65
Peso	2,1 kg
Imballo	6

LAMPADA ALOGENA PER MACCHINE UTENSILI SENZA TRASFORMATORE

**Art. 0532/230V****LAMPADA ALOGENA PER MACCHINE UTENSILI****€ 208,00**

IP 65



Alimentazione	230V 50Hz
Lampadina alogena	24V 50W
Altezza	890 mm
Diametro	125 mm
Snodi	3
Resistenza alla polvere e all'acqua	IP 65
Peso	2,1 kg
Imballo	4

LAMPADA ALOGENA PER MACCHINE UTENSILI CON TRASFORMATORE

**Art. 0537****LAMPADA ALOGENA PER MACCHINE UTENSILI****€ 117,00**

IP 44



Alimentazione	24V 50W
Altezza snodo	100 mm
Diametro	90 mm
Snodi	1
Resistenza alla polvere e all'acqua	IP 44
Peso	1,5 kg
Imballo	20

LAMPADA ALOGENA PER MACCHINE UTENSILI SENZA TRASFORMATORE

**Art. 0538****LAMPADA ALOGENA PER MACCHINE UTENSILI****€ 164,00**

IP 44



Alimentazione	24V 50W
Altezza	650 mm
Diametro	90 mm
Snodi	3
Resistenza alla polvere e all'acqua	IP 44
Peso	2,0 kg
Imballo	6

LAMPADA ALOGENA PER MACCHINE UTENSILI SENZA TRASFORMATORE

**Art. 0536****LAMPADA ALOGENA PER MACCHINE UTENSILI****€ 71,50**

IP 44



Altezza massima	620 mm
Resistenza alla polvere e all'acqua	IP 40
Completa di trasformatore	230 V / 24 V 25 W
Imballo	20

LAMPADA ALOGENA FLESSIBILE CON BASE MAGNETICA PER MACCHINE UTENSILI

LAMPADINA ALOGENA

Codice	Alimentazione	€
0534	H3 - 24 V 70 W	16,40
0535	H3 - 12 V 50 W	16,40

Art. 0539 € 16,40
LAMPADINA ALOGENA

Alimentazione GY 6,35 - 24 V 50 W

Art. 0874/M € 20,20
MORSETTO PER LAMPADE

Capacità morsetto	65 mm
Interasse fori	60 mm
Imballo	5

Art. 0536/L € 16,20
LAMPADINA ALOGENA 25W

Alimentazione 24 V 25 W

TABELLA DI COMPATIBILITÀ

Codice compatibile	Descrizione	€	0371	0372	0531	0532	0532/230V	0537	0538	0536	Pag
0534	LAMPADINA ALOGENA	16,40			•	•	•				232
0535	LAMPADINA ALOGENA	16,40			•	•					232
0539	LAMPADINA ALOGENA	16,40						•	•		232
0536/L	LAMPADINA ALOGENA 25W	16,20								•	232
0874/M	MORSETTO PER LAMPADE	20,20	•	•	•	•	•	•	•		232

Art. P340 € 170,00
SUPPORTI PORTACONI DA BANCO



Dimensioni 600 x 500 x 350h mm
 Peso 13 kg

SUPPORTI PORTACONI DA BANCO, IN KIT DI MONTAGGIO,
 TELAIO CON 21 PORTACONI ISO40

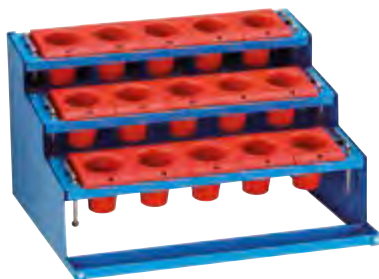

Art. P350
SUPPORTI PORTACONI DA BANCO

€ 169,00



Dimensioni 600 x 500 x 350h mm

Peso 13 kg

SUPPORTI PORTACONI DA BANCO, IN KIT DI MONTAGGIO,
TELAIO CON 15 PORTACONI ISO50



Art. P440
CARRELLO PORTACONI

€ 425,00



Dimensioni 950 x 650 x 830h mm

Peso 35 kg

CARRELLO PORTACONI, IN KIT DI MONTAGGIO CON 28
PORTACONI ISO40



Art. P450
CARRELLO PORTACONI

€ 518,00



Dimensioni 950 x 650 x 830h mm

Peso 35 kg

CARRELLO PORTACONI, IN KIT DI MONTAGGIO CON 20
PORTACONI ISO50



Art. PC40
MENSOLE PORTACONI

€ 49,60



Dimensioni 600 x 145 mm

Imballo 4

MENSOLA CON 7 PORTACONI ISO40



Art. PC50
MENSOLE PORTACONI

€ 49,60



Dimensioni 600 x 145 mm

Imballo 4

MENSOLA CON 5 PORTACONI ISO50



Art. PC40/R
 BOCCOLE PORTACONO

€ 53,10

10 Pz

Dimensioni 136 x 72 mm
Imballo 4

SERIE 10 BOCCOLE PORTACONO, ISO40

Art. PC50/R
 BOCCOLE PORTACONO

€ 57,00

10 Pz

Dimensioni 136 x 102 mm
Imballo 4

SERIE 10 BOCCOLE PORTACONO, ISO50

Art. P4CS
 COPPIA SUPPORTI MENSOLA

€ 21,20

Art. PC4P
 SERIE 4 PIEDINI

€ 22,70

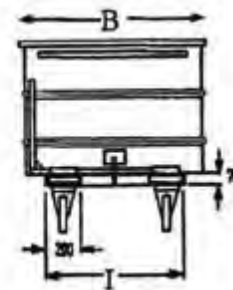
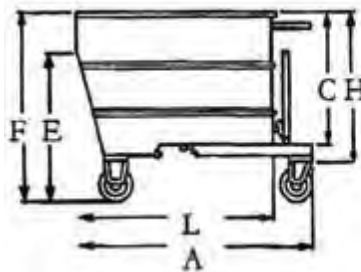
CONTENITORE RIBALTABILE PER TRUCIOLI CON RUOTE

Codice	Litri	A	B	C	E	F	H	I	L	Portata	Ruote	Ruote	Peso	Colore	€
C030/0300	300	1280 mm	820 mm	395 mm	530 mm	650 mm	490 mm	700 mm	1010 mm	600 kg	Ø 125 mm	165h mm	95 kg	RAL6011	1400,00
C030/0500	500	1280 mm	920 mm	600 mm	750 mm	915 mm	710 mm	800 mm	1010 mm	1000 kg	Ø 180 mm	210h mm	130 kg	RAL6011	1590,00
C030/0750	750	1280 mm	1070 mm	730 mm	800 mm	1035 mm	830 mm	800 mm	1055 mm	1350 kg	Ø 180 mm	210h mm	150 kg	RAL6011	1750,00
C030/1000	1000	1510 mm	1070 mm	870 mm	925 mm	1220 mm	975 mm	800 mm	1255 mm	1700 kg	Ø 200 mm	245h mm	182 kg	RAL6011	1880,00
C030/1350	1350	1510 mm	1320 mm	870 mm	925 mm	1220 mm	975 mm	800 mm	1255 mm	2000 kg	Ø 200 mm	245h mm	205 kg	RAL6011	2170,00



Art. C030/R € 222,00
RUBINETTO CON VASCA



RUBINETTO CON VASCA, RUBINETTO, SCARICO E RETE
SEPARA TRUCIOLI PER CONTENITORI



Art. C030/C € 851,00
CILINDRO IDRAULICO PER
RIBALTAMENTO VASCA



Art. P40VD € 9,50
PEDANE

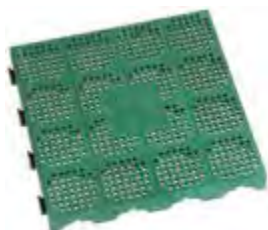

Dimensioni 400 x 400 x 48 mm
Pz. - Pallet 120 = 20 m2

PEDANE IN POLIPROPILENE COMPONIBILI, PIASTRELLA
AUTOBLOCCANTE DRENANTE VERDE



Art. PSV-F € 6,80
SCIVOLO IN POLIPROPILENE



Dimensioni 205 x 400 x 48 mm

SCIVOLO IN POLIPROPILENE PER PEDANE, VERDE,
FEMMINA (SENZA GANCI)



Art. PSV-M € 6,80
SCIVOLO IN POLIPROPILENE



Dimensioni 205 x 400 x 48 mm

SCIVOLO IN POLIPROPILENE PER PEDANE, VERDE,
MASCHIO (CON GANCI)



Art. PAV € 9,60
SCIVOLI AD ANGOLO



Dimensioni 200 x 200 x 270 x 48 mm

SCIVOLI AD ANGOLO PER PEDANE IN POLIPROPILENE
COMPONIBILI, KIT COMPOSTO DA 4 ANGOLARI VERDI



FERVI
Art. E010
KIT RIPARAZIONE FILETTI INOX
STAINLESS STEEL THREAD REPAIR INSERT SET
JUEGO REPARACION ROSCAS INOX
M5 - M12





INSERTI, BRASATI E BARRETTE

pag 238



PUNTE E SEGHE A TAZZA

pag 244



UTENSILI A FRESARE

pag 264



MASCHI E FILIERE

pag 276



PULITURA E FINITURA

pag 284



FISSAGGIO

pag 287



ASSORTIMENTI E BATTERIE

pag 288



SPRAY E INGRASSATORI

pag 292



INSERTI PER TORNITURA

Codice	€
CCMT060204N	7,80
CCMT09T304N	9,10
CCMT09T308N	9,10
CCMT120408N	12,00



Codice	€
CNMG120404N	10,10
CNMG120408N	10,10



Codice	€
DCMT070204N	7,80
DCMT11T304N	10,30



Codice	€
DNMG150608N	15,20



Codice	€
SCMT09T304N	9,20



Codice	€
KNUX160405RN	12,90
KNUX160410RN	12,90
KNUX160405LN	12,90
KNUX160410LN	12,90



Codice	€
SNMG120404N	11,30
SNMG120408N	11,30



Codice	€
SCMT09T308N	9,20
SCMT120408N	12,70



Codice	€
TCMT090204N	7,70
TCMT110204N	8,00
TCMT16T304N	10,20
TCMT16T308N	10,20



Codice	€
SPMR120304N	10,50
SPMR120308N	10,50



Codice	€
TNMG160404N	10,90
TNMG220408N	12,00



Codice	€
WNMG080408N	12,70



Codice	€
TNMG160408N	10,90



Codice	€
TPMR090204N	6,20
TPMR110304N	6,90
TPMR110308N	6,90
TPMR160304N	9,20
TPMR160308N	9,20



Codice	€
VBMT160404N	14,70



Codice	€
WCMT040208234	0,00
WCMT050308234	12,30
WCMT06T308234	12,30
WCMT080412234	13,90

INSERTI PER FRESATURA

Codice	€
ADLT150308R20A	11,20



Codice	€
ADLT1503ZZR234	9,90



Codice	€
APKT1003PDER20A	12,90
APKT1604PDER20A	14,60



Codice	€
OFEX05T305234	13,50



Codice	€
RDHT10T3MO-N	12,00



Codice	€
RPMT1204N	11,40



Codice	€
SEHT1204AFN234	17,70



Codice	€
SEKN1203AFN25	9,30



Codice	€
SEHX1204234	13,30



Codice	€
SPKN1203R25	11,80



Codice	€
TPKN1603R25	9,20
TPKN2204R25	13,30



INSERTI PER FILETTATURA INTERNA

Codice	€	Codice	€
11IRA55134 ⁽²⁾	12,00	16IR150ISO134	13,50
11IRA60134 ⁽¹⁾	12,00	16IR175ISO134	13,50
16IR100ISO134	13,50	16IR200ISO134	13,50
16IR125ISO134	13,50	16IR250ISO134	13,50
		16IR300ISO134	13,50
		16IRAG60134 ⁽³⁾	13,50
		16IR14W134	13,50
		16IR11W134	13,50
		16IRAG55134 ⁽⁴⁾	13,50

- ⁽¹⁾ PASSO 0.5 ÷ 1.5 mm 60°
⁽²⁾ FILETTI PER POLLICE 48 ÷ 16 TPI 55°
⁽³⁾ PASSO 1 ÷ 3 mm 60°
⁽⁴⁾ FILETTI PER POLLICE 28 ÷ 11 TPI 55°

INSERTI PER FILETTATURA ESTERNA

Codice	€	Codice	€
16ER100ISO134	13,50	16ER200ISO134	13,50
16ER125ISO134	13,50	16ER250ISO134	13,50
16ER150ISO134	13,50	16ER300ISO134	13,50
16ER175ISO134	13,50	16ERAG60134 ⁽¹⁾	13,50
		16ER14W134	13,50
		16ER11W134	13,50
		16ERAG55134 ⁽²⁾	13,50

- ⁽¹⁾ PASSO 1 ÷ 3 mm 60°
⁽²⁾ FILETTI PER POLLICE 28 ÷ 11 TPI 55°

INSERTI PER TRONCATURA

Codice	€
GCMX2N134	9,60
GCMX3N134	9,60
GCMX4N134	10,90
GCMX5N134	11,40

INSERTI PER SCANALATURA

Codice	€
165110134	13,50
165130134	13,50
165160134	13,50
165185134	13,50
165215134	13,50
165265134	13,50
165315134	13,50

CARATTERISTICHE DEI GRADI DEGLI INSERTI

GRADO	CLASSE ISO DEI MATERIALI		DESCRIZIONE
N	P15	M15	Grado ricoperto MT-CVD adatto per lavorazioni di sgrossatura e finitura di acciai sia a secco che con refrigerazione. Il particolare substrato tenacizzato abbinato alla nuova ricopertura ad alto spessore rende questo grado utilizzabile in varie applicazioni.
	P25	M25	
	P30	M30	
134	P20		Grado ricoperto MT-CVD ideale per lavorazioni di sgrossatura di acciai a taglio interrotto. Il particolare substrato tenacizzato abbinato alla nuova ricopertura ad alto spessore garantisce notevole resistenza all'usura e consente notevoli volumi di asportazione truciolo.
	P30		
	P45		
234	P30		Grado ricoperto MT-CVD adatto per lavorazioni di sgrossatura di acciai. La tenacità del substrato e la ricopertura ad alto spessore garantiscono grande resistenza in condizione di taglio interrotto e buona resistenza ai colpi. Da utilizzare a velocità di taglio medio-basse.
	P45		
25	P10		Grado versatile ricoperto MT-CVD che abbina una buona capacità produttiva e tenacità. Qualità adatta ad ogni tipo di lavorazione (sia a secco che con lubrificazione) con particolare efficacia nel campo della spianatura.
	P40		
20A		M15	Grado ricoperto con tecnologia PVD adatto a lavorazioni di acciaio inossidabile di tipo austenitico. Il particolare abbinamento di un substrato omogeneo e ricopertura al silicio rende questa qualità ideale per velocità di taglio medio-alte.
		M25	
		M30	



SERIE UTENSILI BRASATI



5 Pz **HM - P25**

Codice	Kit	Imballo	€
B005	1BRAS411108RP - 1BRAS411110RP - 1BRAS410312RP - 1BRAS410412RP - 1BRAS410912RP	24	27,80
B005/16	1BRAS411110RP - 1BRAS411112RP - 1BRAS410316RP - 1BRAS410416RP - 1BRAS410916RP	24	41,70
B005/20	1BRAS411112RP - 1BRAS411116RP - 1BRAS410320RP - 1BRAS410420RP - 1BRAS410920RP	12	52,20



BRASATO PER FILETTATURA ESTERNA

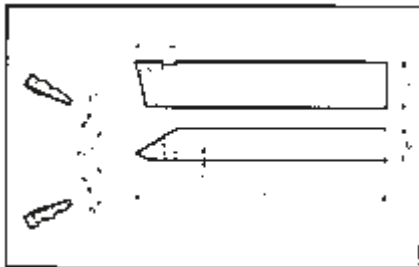

DIN 282 **HM - P25**

Codice	L	b	h	Imballo	€
BRFE12RP	100 mm	12 mm	12 mm	10	11,90
BRFE16RP	100 mm	16 mm	16 mm	10	13,50
BRFE20RP	125 mm	20 mm	20 mm	8	16,80
BRFE25RP	140 mm	25 mm	25 mm	5	20,20



BRASATO PER FILETTATURA INTERNA

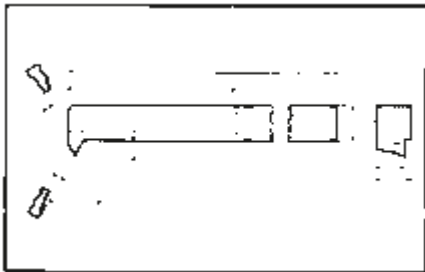

DIN 283 **HM - P25**

Codice	L	b	h	Imballo	€
BRFI10RP	150 mm	10 mm	10 mm	10	12,40
BRFI12RP	180 mm	12 mm	12 mm	10	13,50
BRFI16RP	210 mm	16 mm	16 mm	10	16,80
BRFI20RP	250 mm	20 mm	20 mm	10	17,40
BRFI25RP	300 mm	25 mm	25 mm	3	21,70



BRASATO PER FORI CIECHI



ISO 9 - DIN 4974 **HM - P25**

Codice	L	b	h	Imballo	€
BRAS411108RP	125 mm	8 mm	8 mm	10	7,60
BRAS411110RP	150 mm	10 mm	10 mm	10	9,20
BRAS411112RP	180 mm	12 mm	12 mm	10	9,70
BRAS411116RP	210 mm	16 mm	16 mm	10	11,70
BRAS411120RP	250 mm	20 mm	20 mm	10	12,60
BRAS411125RP	300 mm	25 mm	25 mm	4	18,90
BRAS411132RP	355 mm	32 mm	32 mm	3	20,40

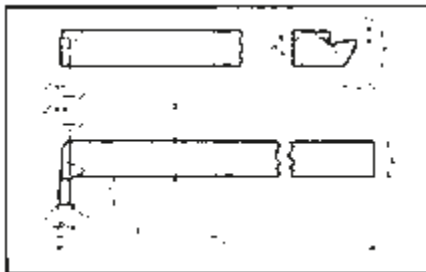

BRASATO PER CANALINI INTERNI

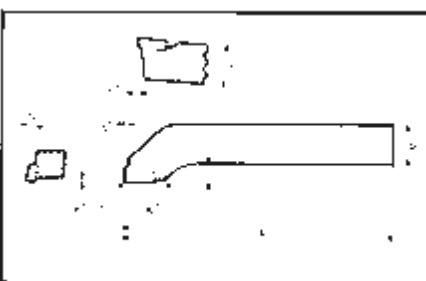
DIN 263 **HM - P25**

Codice	L	b	h	b1	Imballo	€
BRCI10RP	150 mm	10 mm	10 mm	3 mm	10	10,90
BRCI12RP	180 mm	12 mm	12 mm	4 mm	10	10,90
BRCI16RP	210 mm	16 mm	16 mm	5 mm	10	12,40
BRCI20RP	250 mm	20 mm	20 mm	6 mm	4	13,50
BRCI25RP	300 mm	25 mm	25 mm	8 mm	2	17,40

BRASATO PER SFACCIARE

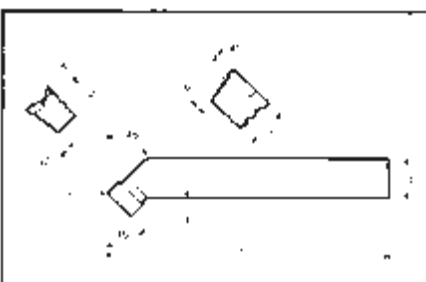
ISO 6 - DIN 4980 **HM - P25**

Codice	L	b	h	Imballo	€
BRAS410410LP	90 mm	10 mm	10 mm	10	6,90
BRAS410410RP	90 mm	10 mm	10 mm	10	6,90
BRAS410412LP	100 mm	12 mm	12 mm	10	7,60
BRAS410412RP	100 mm	12 mm	12 mm	10	7,60
BRAS410416LP	110 mm	16 mm	16 mm	10	9,10
BRAS410416RP	110 mm	16 mm	16 mm	10	9,10
BRAS410420LP	125 mm	20 mm	20 mm	10	11,10
BRAS410420RP	125 mm	20 mm	20 mm	10	11,10
BRAS410425RP	140 mm	25 mm	25 mm	5	16,10

"R" destri - "L" sinistri (come in figura "R") - "P" per acciaio

BRASATO PER SGROSSARE

ISO 2 - DIN 4972 **HM - P25**

Codice	L	b	h	Imballo	€
BRAS410310LP	90 mm	10 mm	10 mm	10	0,00
BRAS410310RP	90 mm	10 mm	10 mm	10	6,90
BRAS410312LP	100 mm	12 mm	12 mm	10	7,60
BRAS410312RP	100 mm	12 mm	12 mm	10	7,60
BRAS410316LP	110 mm	16 mm	16 mm	10	9,10
BRAS410316RP	110 mm	16 mm	16 mm	10	9,10
BRAS410320LP	125 mm	20 mm	20 mm	10	11,10
BRAS410320RP	125 mm	20 mm	20 mm	10	11,10
BRAS410325RP	140 mm	25 mm	25 mm	5	16,10

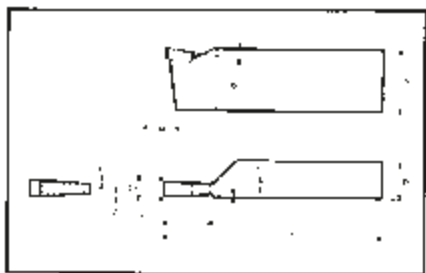
"R" destri - "L" sinistri (come in figura "R") - "P" per acciaio

BRASATO PER TRONCARE

ISO 7 - DIN 4981 **HM - P25**

Codice	L	b	h	b1	Imballo	€
BRAS410912RP	100 mm	8 mm	12 mm	3 mm	20	7,00
BRAS410916RP	110 mm	10 mm	16 mm	3,5 mm	10	7,60
BRAS410920RP	125 mm	12 mm	20 mm	5 mm	10	8,40
BRAS410925RP	140 mm	16 mm	25 mm	6 mm	5	11,90



BARRETTE TRATTATE E RETTIFICATE



HSS - Co 8%

Codice	∅	Lunghezza	€
B012/04	4 mm	200 mm	9,70
B012/05	5 mm	200 mm	10,90
B012/06	6 mm	200 mm	12,40
B012/08	8 mm	200 mm	16,10
B012/10	10 mm	200 mm	20,00
B012/12	12 mm	200 mm	25,20
B012/13	13 mm	135 mm	31,10
B012/16	16 mm	200 mm	47,60
B012/20	20 mm	200 mm	61,50



BARRETTE TRATTATE E RETTIFICATE



HSS - Co 8%

Codice	Dimensioni lati	Lunghezza	€
B013/04X04	4 x 4 mm	200 mm	11,20
B013/05X05	5 x 5 mm	200 mm	14,30
B013/06X06	6 x 6 mm	200 mm	15,70
B013/08X08	8 x 8 mm	200 mm	18,90
B013/10X10	10 x 10 mm	200 mm	26,50
B013/12X12	12 x 12 mm	200 mm	31,20
B013/14X14	14 x 14 mm	200 mm	43,70
B013/16X16	16 x 16 mm	200 mm	50,10
B013/20X20	20 x 20 mm	200 mm	74,20



BARRETTE TRATTATE E RETTIFICATE



HSS - Co 8%

Codice	Dimensioni lati	Lunghezza	€
B014/20X04	20 x 04 mm	200 mm	26,90
B014/20X05	20 x 05 mm	200 mm	28,90
B014/20X06	20 x 06 mm	200 mm	43,30
B014/20X08	20 x 08 mm	200 mm	55,00
B014/20X10	20 x 10 mm	200 mm	58,30
B014/20X12	20 x 12 mm	200 mm	58,30
B014/25X06	25 x 06 mm	200 mm	42,20

PUNTA CILINDRICA ELICOIDALE

DIN 338/N

118°

HSS

PUNTE CILINDRICHE
ELICOIDALI, DESTRE,
SERIE CORTA, RULLATE,
NERE, PER LAVORAZIONE
DI MATERIALI CON
RESISTENZA R= 650 N/
mm², DUREZZA PUNTA
HV= 700 ÷ 740

Codice	∅	Lunghezza totale	Lunghezza elica	€
ST1A01	1,00 mm	34 mm	12 mm	0,56
ST1A01.25	1,25 mm	38 mm	16 mm	0,56
ST1A01.50	1,50 mm	40 mm	18 mm	0,56
ST1A01.75	1,75 mm	46 mm	22 mm	0,56
ST1A02	2,00 mm	49 mm	24 mm	0,56
ST1A02.25	2,25 mm	53 mm	27 mm	0,56
ST1A02.50	2,50 mm	57 mm	30 mm	0,56
ST1A02.75	2,75 mm	61 mm	33 mm	0,56
ST1A03	3,00 mm	61 mm	33 mm	0,56
ST1A03.25	3,25 mm	65 mm	36 mm	0,60
ST1A03.50	3,50 mm	70 mm	39 mm	0,60
ST1A03.75	3,75 mm	70 mm	39 mm	0,60
ST1A04	4,00 mm	75 mm	43 mm	0,60
ST1A04.25	4,25 mm	75 mm	43 mm	0,70
ST1A04.50	4,50 mm	80 mm	47 mm	0,70
ST1A04.75	4,75 mm	80 mm	47 mm	0,70
ST1A05	5,00 mm	86 mm	52 mm	0,80
ST1A05.25	5,25 mm	86 mm	52 mm	0,80
ST1A05.50	5,50 mm	93 mm	57 mm	0,80
ST1A05.75	5,75 mm	93 mm	57 mm	0,92
ST1A06	6,00 mm	93 mm	57 mm	0,92
ST1A06.25	6,25 mm	101 mm	63 mm	1,04
ST1A06.50	6,50 mm	101 mm	63 mm	1,04
ST1A06.75	6,75 mm	109 mm	69 mm	1,38
ST1A07	7,00 mm	109 mm	69 mm	1,38
ST1A07.25	7,25 mm	109 mm	69 mm	1,38
ST1A07.50	7,50 mm	109 mm	69 mm	1,50
ST1A07.75	7,75 mm	117 mm	75 mm	1,60
ST1A08	8,00 mm	117 mm	75 mm	1,60
ST1A08.25	8,25 mm	117 mm	75 mm	1,84
ST1A08.50	8,50 mm	117 mm	75 mm	1,84
ST1A08.75	8,75 mm	125 mm	81 mm	2,06
ST1A09	9,00 mm	125 mm	81 mm	2,06
ST1A09.25	9,25 mm	125 mm	81 mm	2,28
ST1A09.50	9,50 mm	125 mm	81 mm	2,28
ST1A09.75	9,75 mm	133 mm	87 mm	2,40
ST1A10	10,00 mm	133 mm	87 mm	2,52
ST1A10.25	10,25 mm	133 mm	87 mm	2,98
ST1A10.50	10,50 mm	133 mm	87 mm	2,98
ST1A10.75	10,75 mm	142 mm	94 mm	3,42
ST1A11	11,00 mm	142 mm	94 mm	3,42
ST1A11.25	11,25 mm	142 mm	94 mm	3,88
ST1A11.50	11,50 mm	142 mm	94 mm	3,88
ST1A11.75	11,75 mm	142 mm	94 mm	4,34
ST1A12	12,00 mm	151 mm	101 mm	4,34
ST1A12.25	12,25 mm	151 mm	101 mm	4,92
ST1A12.50	12,50 mm	151 mm	101 mm	4,92
ST1A12.75	12,75 mm	151 mm	101 mm	4,92
ST1A13	13,00 mm	151 mm	101 mm	4,92

CONFEZIONI DA 10* PEZZI FINO AL Ø 8 mm - CONFEZIONI DA 5* PEZZI DAL Ø 8,25 mm



PUNTA CILINDRICA ELICOIDALE



DIN 338/N
 118°
 HSS

PUNTE CILINDRICHE ELICOIDALI, DESTRE, SERIE CORTA, RULLATE, NERE, CON GAMBO RIDOTTO A 10 mm, PER LAVORAZIONE DI MATERIALI CON RESISTENZA R= 650 N/mm², DUREZZA PUNTA HV= 700 ÷ 740

Codice	Ø	Lunghezza totale	Lunghezza elica	€
ST1A10.25R10	10,25 mm	133 mm	87 mm	3,00
ST1A10.50R10	10,5 mm	133 mm	87 mm	3,00
ST1A10.75R10	10,75 mm	142 mm	94 mm	3,40
ST1A11.00R10	11,00 mm	142 mm	94 mm	3,40
ST1A11.25R10	11,25 mm	142 mm	94 mm	3,90
ST1A11.50R10	11,5 mm	142 mm	94 mm	3,90
ST1A11.75R10	11,75 mm	142 mm	94 mm	4,40
ST1A12.00R10	12 mm	151 mm	101 mm	4,40
ST1A12.25R10	12,25 mm	151 mm	101 mm	4,90
ST1A12.50R10	12,50 mm	151 mm	101 mm	4,90
ST1A12.75R10	12,75 mm	151 mm	101 mm	4,90
ST1A13.00R10	13 mm	151 mm	101 mm	4,90
ST1A13.25R10	13,25 mm	160 mm	108 mm	6,20
ST1A13.50R10	13,5 mm	160 mm	108 mm	6,20
ST1A13.75R10	13,75 mm	160 mm	108 mm	6,20
ST1A14.00R10	14,00 mm	160 mm	108 mm	6,20
ST1A14.25R10	14,25 mm	169 mm	114 mm	6,80
ST1A14.50R10	14,5 mm	169 mm	114 mm	6,80
ST1A14.75R10	14,75 mm	169 mm	114 mm	6,80
ST1A15.00R10	15 mm	169 mm	114 mm	6,80
ST1A15.25R10	15,25 mm	178 mm	120 mm	8,30
ST1A15.50R10	15,50 mm	178 mm	120 mm	8,30
ST1A15.75R10	15,75 mm	178 mm	120 mm	8,30
ST1A16.00R10	16 mm	178 mm	120 mm	8,30

CONFEZIONI DA 5* PEZZI FINO AL Ø 16.00 mm



PUNTA CILINDRICA ELICOIDALE



DIN 338/N
 118°
 HSS

PUNTE CILINDRICHE ELICOIDALI, DESTRE, SERIE CORTA, RULLATE, NERE, CON GAMBO RIDOTTO A 13 mm, PER LAVORAZIONE DI MATERIALI CON RESISTENZA R= 650 N/mm², DUREZZA PUNTA HV= 700 ÷ 740

Codice	Ø	Lunghezza totale	Lunghezza elica	€
ST1A13.25R13	13,25 mm	160 mm	108 mm	6,20
ST1A13.50R13	13,50 mm	160 mm	108 mm	6,20
ST1A13.75R13	13,75 mm	160 mm	108 mm	6,20
ST1A14.00R13	14,00 mm	160 mm	108 mm	6,20
ST1A14.25R13	14,25 mm	169 mm	114 mm	6,80
ST1A14.50R13	14,50 mm	169 mm	114 mm	6,80
ST1A14.75R13	14,75 mm	169 mm	114 mm	6,80
ST1A15.00R13	15,00 mm	169 mm	114 mm	6,80
ST1A15.25R13	15,25 mm	178 mm	120 mm	8,30
ST1A15.50R13	15,50 mm	178 mm	120 mm	8,30
ST1A15.75R13	15,75 mm	178 mm	120 mm	8,30
ST1A16.00R13	16,00 mm	178 mm	120 mm	8,30

CONFEZIONI DA 5* PEZZI FINO AL Ø 16.00 mm

PUNTA CILINDRICA ELICOIDALE

DIN 1897/N 118° HSS

PUNTE CILINDRICHE ELICOIDALI, DESTRE, SERIE EXTRA CORTA, RULLATE, NERE, PER LAVORAZIONE DI MATERIALI CON RESISTENZA R= 650 N/mm², DUREZZA PUNTA HV= 700 ÷ 740

Codice	Ø	Lunghezza totale	Lunghezza elica	€
ST1A02.00C	2,00 mm	38 mm	12 mm	0,36
ST1A02.50C	2,50 mm	43 mm	14 mm	0,36
ST1A03.00C	3,00 mm	46 mm	16 mm	0,36
ST1A03.25C	3,25 mm	49 mm	18 mm	0,42
ST1A03.50C	3,50 mm	52 mm	20 mm	0,42
ST1A03.75C	3,75 mm	52 mm	20 mm	0,48
ST1A04.00C	4,00 mm	55 mm	22 mm	0,48
ST1A04.25C	4,25 mm	55 mm	22 mm	0,52
ST1A04.50C	4,50 mm	58 mm	24 mm	0,52
ST1A05.00C	5,00 mm	62 mm	26 mm	0,62
ST1A05.50C	5,50 mm	66 mm	28 mm	0,84
ST1A06.00C	6,00 mm	66 mm	28 mm	0,84

CONFEZIONI DA 10* PEZZI FINO AL Ø 6.00 mm

Art. P045
SERIE PUNTE
€ 16,80

PUNTE CILINDRICHE ELICOIDALI, DESTRE, SERIE CORTA, RULLATE, NERE, PER LAVORAZIONE DI MATERIALI CON RESISTENZA R= 650 N/mm², DUREZZA PUNTA HV= 700 ÷ 740

19 Pz DIN 338/N 118° HSS

Misura	1 ÷ 10 mm
Pezzi	19
Imballo	20

Art. P046
SERIE PUNTE
€ 33,30

PUNTE CILINDRICHE ELICOIDALI, DESTRE, SERIE CORTA, RULLATE, NERE, PER LAVORAZIONE DI MATERIALI CON RESISTENZA R= 650 N/mm², DUREZZA PUNTA HV= 700 ÷ 740

25 Pz DIN 338/N 118° HSS

Misura	1 ÷ 13 mm
Pezzi	25
Imballo	12



PUNTA CILINDRICA RETTIFICATA



DIN 338 **135°** **TiN** **HSS**

PUNTE ELICOIDALI
CILINDRICHE,
AUTOCENTRANTI,
DESTRE, SERIE
CORTA, RETTIFICATE,
PER LAVORAZIONE
DI MATERIALI CON
RESISTENZA R= 700 N/
mm², DUREZZA PUNTA HV=
740 ÷ 780

Codice	∅	Lunghezza totale	Lunghezza elica	€
P058/01.00	1 mm	34 mm	12 mm	0,92
P058/01.25	1,25 mm	38 mm	16 mm	0,92
P058/01.50	1,50 mm	40 mm	18 mm	0,92
P058/01.75	1,75 mm	46 mm	22 mm	0,92
P058/02.00	2 mm	49 mm	24 mm	1,04
P058/02.25	2,25 mm	53 mm	27 mm	1,14
P058/02.50	2,50 mm	57 mm	30 mm	1,14
P058/02.75	2,75 mm	61 mm	33 mm	1,14
P058/03.00	3 mm	61 mm	33 mm	1,14
P058/03.25	3,25 mm	65 mm	36 mm	1,38
P058/03.50	3,50 mm	70 mm	39 mm	1,38
P058/03.75	3,75 mm	70 mm	39 mm	1,38
P058/04.00	4 mm	75 mm	43 mm	1,38
P058/04.25	4,25 mm	75 mm	43 mm	1,84
P058/04.50	4,50 mm	80 mm	47 mm	1,84
P058/04.75	4,75 mm	80 mm	47 mm	1,84
P058/05.00	5 mm	86 mm	52 mm	1,84
P058/05.25	5,25 mm	86 mm	52 mm	2,28
P058/05.50	5,50 mm	93 mm	57 mm	2,28
P058/05.75	5,75 mm	93 mm	57 mm	2,28
P058/06.00	6 mm	93 mm	57 mm	2,28
P058/06.25	6,25 mm	101 mm	63 mm	2,52
P058/06.50	6,50 mm	101 mm	63 mm	2,52
P058/06.75	6,75 mm	109 mm	69 mm	2,52
P058/07.00	7 mm	109 mm	69 mm	2,52
P058/07.25	7,25 mm	109 mm	69 mm	3,88
P058/07.50	7,50 mm	109 mm	69 mm	3,88
P058/07.75	7,75 mm	117 mm	75 mm	3,88
P058/08.00	8 mm	117 mm	75 mm	3,88
P058/08.25	8,25 mm	117 mm	75 mm	5,30
P058/08.50	8,50 mm	117 mm	75 mm	5,30
P058/08.75	8,75 mm	125 mm	81 mm	5,30
P058/09.00	9 mm	125 mm	81 mm	5,30
P058/09.25	9,25 mm	125 mm	81 mm	6,10
P058/09.50	9,50 mm	125 mm	81 mm	6,10
P058/09.75	9,75 mm	133 mm	87 mm	6,10
P058/10.00	10 mm	133 mm	87 mm	6,10
P058/10.25	10,25 mm	133 mm	87 mm	6,90
P058/10.50	10,50 mm	133 mm	87 mm	6,90
P058/10.75	10,75 mm	142 mm	94 mm	6,90
P058/11.00	11 mm	142 mm	94 mm	6,90
P058/11.25	11,25 mm	142 mm	94 mm	8,10
P058/11.50	11,50 mm	142 mm	94 mm	8,10
P058/11.75	11,75 mm	142 mm	94 mm	8,10
P058/12.00	12 mm	151 mm	101 mm	8,10
P058/12.25	12,25 mm	151 mm	101 mm	10,10
P058/12.50	12,50 mm	151 mm	101 mm	10,10
P058/12.75	12,75 mm	151 mm	101 mm	10,10
P058/13.00	13 mm	151 mm	101 mm	10,10

CONFEZIONI DA 10* PEZZI FINO AL ∅ 8 mm - CONFEZIONI DA 5* PEZZI DAL ∅ 8,25 mm

Art. P068
 SERIE PUNTE

€ 8,00

20 Pz DIN 338 135° TiN HSS

Misure x 1Pz	0.25 - 0.30 - 0.35 - 0.40 - 0.45 - 0.55 - 0.65 - 0.70 - 0.75 - 0.85 - 0.90 - 0.95 mm
--------------	---

Misure x 2 Pz	0.50 - 0.60 - 0.80 - 1.00 mm
---------------	------------------------------

Scatola di plastica	
---------------------	--

Imballo	5* / 200
---------	----------

PUNTE ELICOIDALI CILINDRICHE, AUTOCENTRANTI, DESTRE, SERIE CORTA, RETTIFICATE, PER LAVORAZIONE DI MATERIALI CON RESISTENZA R= 700 N/mm², DUREZZA PUNTA HV= 740 ÷ 780

Art. P061
 SERIE PUNTE RETTIFICATE E AUTOCENTRANTI

€ 40,00

19 Pz DIN 338 135° TiN HSS

Misura (progressione 0,5 mm)	1 ÷ 10 mm
------------------------------	-----------

Pezzi	19
-------	----

Imballo	5 / 35
---------	--------

PUNTE ELICOIDALI CILINDRICHE, AUTOCENTRANTI, DESTRE, SERIE CORTA, RETTIFICATE, PER LAVORAZIONE DI MATERIALI CON RESISTENZA R= 700 N/mm², DUREZZA PUNTA HV= 740 ÷ 780

Art. P062
 SERIE PUNTE RETTIFICATE E AUTOCENTRANTI

€ 71,50

25 Pz DIN 338 135° TiN HSS

Misura (progressione 0,5 mm)	1 ÷ 13 mm
------------------------------	-----------

Pezzi	25
-------	----

Imballo	20
---------	----

PUNTE ELICOIDALI CILINDRICHE, AUTOCENTRANTI DESTRE, SERIE CORTA, RETTIFICATE, PER LAVORAZIONE DI MATERIALI CON RESISTENZA R= 700 N/mm², DUREZZA PUNTA HV= 740 ÷ 780



SERIE PUNTE CILINDRICHE A DECIMI RETTIFICATE

€ 172,00



DIN 338 **135°** **TiN** **HSS**

Codice	Misura (progressione 0,1 mm)	Pezzi	€
P010/51	1 ÷ 6 mm	51	64,90
P010/41	6 ÷ 10 mm	41	151,00

PUNTE ELICOIDALI CILINDRICHE, AUTOCENTRANTI, DESTRE, SERIE CORTA, RETTIFICATE, PER LAVORAZIONE DI MATERIALI CON RESISTENZA R= 700 N/mm², DUREZZA PUNTA HV= 740 ÷ 780



Art. P058/170
SERIE PUNTE RETTIFICATE

€ 188,00



170 Pz **DIN 338** **135°** **TiN** **HSS**

150 (10x) Pz (progressione 0,5 mm)	Ø 1 ÷ 8 mm
20 (5x) Pz (progressione 0,5 mm)	Ø 8,5 ÷ 10 mm

PUNTE ELICOIDALI CILINDRICHE, AUTOCENTRANTI, DESTRE, SERIE CORTA, RETTIFICATE, PER LAVORAZIONE DI MATERIALI CON RESISTENZA R= 700 N/mm², DUREZZA PUNTA HV= 740 ÷ 780



PUNTA ELICOIDALE CILINDRICA



DIN 1897 **135°** **HSS**

PUNTE ELICOIDALI CILINDRICHE, AUTOCENTRANTI, DESTRE, SERIE EXTRA CORTA, RETTIFICATE, PER LAVORAZIONE DI MATERIALI CON RESISTENZA R= 800 N/mm², DUREZZA PUNTA HV= 770 ÷ 830

Codice	Ø	Lunghezza totale	Lunghezza elica	€
P023/03.00C	3,00 mm	46 mm	16 mm	1,00
P023/03.25C	3.25 mm	49 mm	18 mm	1,10
P023/03.50C	3,50 mm	52 mm	20 mm	1,10
P023/03.75C	3,75 mm	52 mm	20 mm	1,20
P023/04.00C	4,00 mm	55 mm	22 mm	1,20
P023/04.25C	4,25 mm	55 mm	22 mm	1,60
P023/04.50C	4,50 mm	58 mm	24 mm	1,40
P023/05.00C	5,00 mm	62 mm	26 mm	1,50
P023/05.50C	5,50 mm	66 mm	28 mm	2,00
P023/06.00C	6,00 mm	66 mm	28 mm	2,10

Confezioni da 10* pezzi fino al Ø 6,00 mm

PUNTA ELICOIDALE CILINDRICA

DIN 338

135°

HSS

PUNTE ELICOIDALI
CILINDRICHE,
AUTOCENTRANTI,
DESTRE, SERIE
CORTA, RETTIFICATE,
PER LAVORAZIONE
DI MATERIALI CON
RESISTENZA
R= 800 N/mm², DUREZZA
PUNTA HV= 770 ÷ 830

Codice	∅	Lunghezza totale	Lunghezza elica	€
P023/01.00	1,00 mm	34 mm	12 mm	1,00
P023/01.25	1.25 mm	38 mm	16 mm	1,00
P023/01.50	1,50 mm	40 mm	18 mm	0,90
P023/01.75	1.75 mm	46 mm	22 mm	0,80
P023/02.00	2,00 mm	49 mm	24 mm	0,80
P023/02.25	2.25 mm	53 mm	27 mm	0,90
P023/02.50	2,50 mm	57 mm	30 mm	0,80
P023/02.75	2.75 mm	61 mm	33 mm	1,00
P023/03.00	3,00 mm	61 mm	33 mm	0,90
P023/03.25	3.25 mm	65 mm	36 mm	1,10
P023/03.50	3,50 mm	70 mm	39 mm	1,00
P023/03.75	3.75 mm	70 mm	39 mm	1,20
P023/04.00	4,00 mm	75 mm	43 mm	1,10
P023/04.25	4.25 mm	75 mm	43 mm	1,50
P023/04.50	4,50 mm	80 mm	47 mm	1,30
P023/04.75	4.75 mm	80 mm	47 mm	1,50
P023/05.00	5,00 mm	86 mm	52 mm	1,40
P023/05.25	5.25 mm	86 mm	52 mm	1,90
P023/05.50	5,50 mm	93 mm	57 mm	1,80
P023/05.75	5.75 mm	93 mm	57 mm	2,10
P023/06.00	6,00 mm	93 mm	57 mm	1,90
P023/06.25	6.25 mm	101 mm	63 mm	2,70
P023/06.50	6,50 mm	101 mm	63 mm	2,40
P023/06.75	6.75 mm	109 mm	69 mm	3,10
P023/07.00	7,00 mm	109 mm	69 mm	2,90
P023/07.25	7.25 mm	109 mm	69 mm	3,40
P023/07.50	7,50 mm	109 mm	69 mm	3,00
P023/07.75	7.75 mm	117 mm	75 mm	3,80
P023/08.00	8,00 mm	117 mm	75 mm	3,60
P023/08.25	8.25 mm	117 mm	75 mm	4,60
P023/08.50	8,50 mm	117 mm	75 mm	4,50
P023/08.75	8.75 mm	125 mm	81 mm	4,90
P023/09.00	9,00 mm	125 mm	81 mm	4,70
P023/09.25	9.25 mm	125 mm	81 mm	5,50
P023/09.50	9,50 mm	125 mm	81 mm	5,00
P023/09.75	9.75 mm	133 mm	87 mm	5,90
P023/10.00	10,00 mm	133 mm	87 mm	5,40
P023/10.25	10.25 mm	133 mm	87 mm	7,50
P023/10.50	10,50 mm	133 mm	87 mm	6,60
P023/10.75	10.75 mm	142 mm	94 mm	9,00
P023/11.00	11,00 mm	142 mm	94 mm	7,90
P023/11.25	11.25 mm	142 mm	94 mm	9,60
P023/11.50	11,50 mm	142 mm	94 mm	8,30
P023/11.75	11.75 mm	142 mm	94 mm	10,40
P023/12.00	12,00 mm	151 mm	101 mm	9,00
P023/12.25	12.25 mm	151 mm	101 mm	11,30
P023/12.50	12,50 mm	151 mm	101 mm	9,90
P023/12.75	12.75 mm	151 mm	101 mm	12,80
P023/13.00	13,00 mm	151 mm	101 mm	10,60

Confezioni da 10* pezzi fino al ∅ 7,75 mm Confezioni da 5* pezzi dal ∅ 8,00 mm



Art. P023/19
SERIE PUNTE ELICOIDALI CILINDRICHE

€ 38,50



19 Pz DIN 338 135° HSS

Misura (progressione 0,5 mm)	1 ÷ 10 mm
Pezzi	19
Imballo	20

SERIE PUNTE ELICOIDALI CILINDRICHE, AUTOCENTRANTI, DESTRE, SERIE CORTA, RETTIFICATE, PER LAVORAZIONE DI MATERIALI CON RESISTENZA R= 800 N/mm², DUREZZA PUNTA HV= 770 ÷ 830



Art. P023/25
SERIE PUNTE ELICOIDALI CILINDRICHE

€ 78,00



25 Pz DIN 338 135° HSS

Misura (progressione 0,5 mm)	1 ÷ 13 mm
Pezzi	25
Imballo	10

SERIE PUNTE ELICOIDALI CILINDRICHE, AUTOCENTRANTI, DESTRE, SERIE CORTA, RETTIFICATE, PER LAVORAZIONE DI MATERIALI CON RESISTENZA R= 800 N/mm², DUREZZA PUNTA HV= 770 ÷ 830



Art. P023/19A
SERIE PUNTE ELICOIDALI CILINDRICHE

€ 43,70



19 Pz DIN 338 135° HSS

Misura (progressione 0,5 mm)	1 ÷ 10 mm
Pezzi	19
Imballo	20

Astuccio di plastica

SERIE PUNTE ELICOIDALI CILINDRICHE, AUTOCENTRANTI, DESTRE, SERIE CORTA, RETTIFICATE, PER LAVORAZIONE DI MATERIALI CON RESISTENZA R= 800 N/mm², DUREZZA PUNTA HV= 770 ÷ 830



Art. P023/25A
SERIE PUNTE ELICOIDALI CILINDRICHE

€ 91,50



25 Pz DIN 338 135° HSS

Misura (progressione 0,5 mm)	1 ÷ 13 mm
Pezzi	25
Imballo	10

Astuccio di plastica

SERIE PUNTE ELICOIDALI CILINDRICHE, AUTOCENTRANTI, DESTRE, SERIE CORTA, RETTIFICATE, PER LAVORAZIONE DI MATERIALI CON RESISTENZA R= 800 N/mm², DUREZZA PUNTA HV= 770 ÷ 830

PUNTA CILINDRICA RETTIFICATA

DIN 338

135°

HSS - Co 5%

PUNTE ELICOIDALI
CILINDRICHE,
AUTOCENTRANTI,
DESTRE, SERIE
CORTA, RETTIFICATE,
PER LAVORAZIONE
DI MATERIALI CON
RESISTENZA
R= 1250 N/mm²,
DUREZZA PUNTA
HV= 800 ÷ 900

Codice	∅	Lunghezza totale	Lunghezza elica	€
P065/01.00	1 mm	34 mm	12 mm	1,14
P065/01.25	1,25 mm	38 mm	16 mm	1,38
P065/01.50	1,50 mm	40 mm	18 mm	1,38
P065/01.75	1,75 mm	46 mm	22 mm	1,38
P065/02.00	2 mm	49 mm	24 mm	1,38
P065/02.25	2,25 mm	53 mm	27 mm	1,60
P065/02.50	2,50 mm	57 mm	30 mm	1,60
P065/02.75	2,75 mm	61 mm	33 mm	1,60
P065/03.00	3 mm	61 mm	33 mm	1,60
P065/03.25	3,25 mm	69 mm	39 mm	2,18
P065/03.50	3,50 mm	70 mm	39 mm	2,18
P065/03.75	3,75 mm	70 mm	39 mm	2,18
P065/04.00	4 mm	75 mm	43 mm	2,18
P065/04.25	4,25 mm	75 mm	43 mm	3,08
P065/04.50	4,50 mm	80 mm	47 mm	3,08
P065/04.75	4,75 mm	80 mm	47 mm	3,08
P065/05.00	5 mm	86 mm	52 mm	3,08
P065/05.25	5,25 mm	86 mm	52 mm	3,88
P065/05.50	5,50 mm	93 mm	57 mm	3,88
P065/05.75	5,75 mm	93 mm	57 mm	3,88
P065/06.00	6 mm	93 mm	57 mm	3,88
P065/06.25	6,25 mm	101 mm	63 mm	4,80
P065/06.50	6,50 mm	101 mm	63 mm	4,80
P065/06.75	6,75 mm	109 mm	69 mm	4,80
P065/07.00	7 mm	109 mm	69 mm	4,80
P065/07.25	7,25 mm	109 mm	69 mm	8,30
P065/07.50	7,50 mm	109 mm	69 mm	8,30
P065/07.75	7,75 mm	117 mm	75 mm	8,30
P065/08.00	8 mm	117 mm	75 mm	8,30
P065/08.25	8,25 mm	117 mm	75 mm	10,30
P065/08.50	8,50 mm	117 mm	75 mm	10,30
P065/08.75	8,75 mm	125 mm	81 mm	10,30
P065/09.00	9 mm	125 mm	81 mm	10,30
P065/09.25	9,25 mm	125 mm	81 mm	12,90
P065/09.50	9,50 mm	125 mm	81 mm	12,90
P065/09.75	9,75 mm	133 mm	87 mm	12,90
P065/10.00	10 mm	133 mm	87 mm	12,90
P065/10.25	10,25 mm	133 mm	87 mm	15,50
P065/10.50	10,50 mm	133 mm	87 mm	15,50
P065/10.75	10,75 mm	142 mm	94 mm	15,50
P065/11.00	11 mm	142 mm	94 mm	15,50
P065/11.25	11,25 mm	142 mm	94 mm	18,50
P065/11.50	11,50 mm	142 mm	94 mm	18,50
P065/11.75	11,75 mm	142 mm	94 mm	18,50
P065/12.00	12 mm	151 mm	101 mm	18,50
P065/12.25	12,25 mm	151 mm	101 mm	22,40
P065/12.50	12,50 mm	151 mm	101 mm	22,40
P065/12.75	12,75 mm	151 mm	101 mm	22,40
P065/13.00	13 mm	151 mm	101 mm	22,40

Confezioni da 10* pezzi fino al ∅ 7,75 mm - Confezioni da 5* pezzi dal ∅ 8,00 mm



Art. P067
SERIE PUNTE AL COBALTO

€ 71,50



19 Pz DIN 338 135° HSS - Co 5%

Misura (progressione 0,5 mm)	1 ÷ 10 mm
Pezzi	19
Imballo	20

PUNTE ELICOIDALI CILINDRICHE, AUTOCENTRANTI, DESTRE, SERIE CORTA, RETTIFICATE, PER LAVORAZIONE DI MATERIALI CON RESISTENZA R= 1250 N/mm², DUREZZA PUNTA HV= 800 ÷ 900



Art. P069
SERIE PUNTE AL COBALTO

€ 140,00



25 Pz DIN 338 135° HSS - Co 5%

Misura (progressione 0,5 mm)	1 ÷ 13 mm
Pezzi	25
Imballo	10

PUNTE ELICOIDALI CILINDRICHE, AUTOCENTRANTI, DESTRE, SERIE CORTA, RETTIFICATE, PER LAVORAZIONE DI MATERIALI CON RESISTENZA R= 1250 N/mm², DUREZZA PUNTA HV= 800 ÷ 900



Art. P065/170
SERIE PUNTE CILINDRICHE RETTIFICATE

€ 389,00



170 Pz DIN 338 135° HSS - Co 5%

150 (10x) Pz (progressione 0,5 mm)	Ø 1 ÷ 8 mm
20 (5x) Pz (progressione 0,5 mm)	Ø 8,5 ÷ 10 mm

PUNTE ELICOIDALI CILINDRICHE, AUTOCENTRANTI, DESTRE, SERIE CORTA, RETTIFICATE, PER LAVORAZIONE DI MATERIALI CON RESISTENZA R= 1250 N/mm², DUREZZA PUNTA HV= 800 ÷ 900

PUNTA ELICOIDALE DESTRA CON CODOLO CONICO

DIN 345/N

118°

HSS

PUNTE ELICOIDALI CON
CODOLO CONICO, DESTRE,
PER LAVORAZIONE
DI MATERIALI CON
RESISTENZA R= 650 N/
mm², DUREZZA PUNTA HV=
700 ÷ 740

Codice	Ø	CM	Lunghezza totale	Lunghezza elica	€
ST2A05.75	5,75 mm	1	138 mm	57 mm	9,50
ST2A06	6,00 mm	1	138 mm	57 mm	9,50
ST2A06.25	6,25 mm	1	144 mm	63 mm	9,50
ST2A06.50	6,50 mm	1	144 mm	63 mm	9,50
ST2A06.75	6,75 mm	1	150 mm	69 mm	9,50
ST2A07	7,00 mm	1	150 mm	69 mm	9,50
ST2A07.25	7,25 mm	1	150 mm	69 mm	9,50
ST2A07.50	7,50 mm	1	150 mm	69 mm	9,50
ST2A07.75	7,75 mm	1	156 mm	75 mm	9,50
ST2A08	8,00 mm	1	156 mm	75 mm	9,50
ST2A08.25	8,25 mm	1	156 mm	75 mm	9,50
ST2A08.50	8,50 mm	1	156 mm	75 mm	9,50
ST2A08.75	8,75 mm	1	156 mm	75 mm	9,50
ST2A09	9,00 mm	1	162 mm	81 mm	9,50
ST2A09.25	9,25 mm	1	162 mm	81 mm	9,50
ST2A09.50	9,50 mm	1	162 mm	81 mm	9,50
ST2A09.75	9,75 mm	1	162 mm	81 mm	9,50
ST2A10	10,00 mm	1	168 mm	81 mm	9,50
ST2A10.25	10,25 mm	1	168 mm	87 mm	10,90
ST2A10.50	10,50 mm	1	168 mm	87 mm	10,90
ST2A10.75	10,75 mm	1	175 mm	87 mm	10,90
ST2A11	11,00 mm	1	175 mm	94 mm	10,90
ST2A11.25	11,25 mm	1	175 mm	94 mm	10,90
ST2A11.50	11,50 mm	1	175 mm	94 mm	10,90
ST2A11.75	11,75 mm	1	175 mm	94 mm	10,90
ST2A12	12,00 mm	1	182 mm	94 mm	10,90
ST2A12.25	12,25 mm	1	182 mm	101 mm	12,40
ST2A12.50	12,50 mm	1	182 mm	101 mm	12,40
ST2A12.75	12,75 mm	1	182 mm	101 mm	12,40
ST2A13	13,00 mm	1	182 mm	101 mm	12,40
ST2A13.25	13,25 mm	1	182 mm	101 mm	12,40
ST2A13.50	13,50 mm	1	189 mm	108 mm	12,40
ST2A13.75	13,75 mm	1	189 mm	108 mm	12,40
ST2A14	14,00 mm	1	189 mm	108 mm	12,40
ST2A14.25	14,25 mm	2	212 mm	114 mm	12,40
ST2A14.50	14,50 mm	2	212 mm	114 mm	12,40
ST2A14.75	14,75 mm	2	212 mm	114 mm	12,40
ST2A15	15,00 mm	2	212 mm	114 mm	12,40
ST2A15.25	15,25 mm	2	218 mm	120 mm	18,50
ST2A15.50	15,50 mm	2	218 mm	120 mm	18,50
ST2A15.75	15,75 mm	2	218 mm	120 mm	18,50
ST2A16	16,00 mm	2	218 mm	120 mm	18,50
ST2A16.25	16,25 mm	2	223 mm	125 mm	18,50
ST2A16.50	16,50 mm	2	223 mm	125 mm	18,50
ST2A16.75	16,75 mm	2	223 mm	125 mm	18,50
ST2A17	17,00 mm	2	223 mm	125 mm	18,50
ST2A17.25	17,25 mm	2	228 mm	130 mm	18,50
ST2A17.50	17,50 mm	2	228 mm	130 mm	18,50
ST2A17.75	17,75 mm	2	228 mm	130 mm	18,50
ST2A18	18,00 mm	2	228 mm	130 mm	22,70
ST2A18.25	18,25 mm	2	233 mm	135 mm	22,70
ST2A18.50	18,50 mm	2	233 mm	135 mm	22,70
ST2A18.75	18,75 mm	2	233 mm	135 mm	22,70
ST2A19	19,00 mm	2	233 mm	135 mm	22,70

Codice	Ø	CM	Lunghezza totale	Lunghezza elica	€
ST2A19.25	19,25 mm	2	238 mm	140 mm	24,00
ST2A19.50	19,50 mm	2	238 mm	130 mm	24,00
ST2A19.75	19,75 mm	2	238 mm	140 mm	24,00
ST2A20	20,00 mm	2	238 mm	140 mm	24,00
ST2A20.25	20,25 mm	2	243 mm	145 mm	24,00
ST2A20.50	20,50 mm	2	243 mm	145 mm	27,80
ST2A20.75	20,75 mm	2	243 mm	145 mm	27,80
ST2A21	21,00 mm	2	243 mm	145 mm	27,80
ST2A21.25	21,25 mm	2	248 mm	150 mm	30,60
ST2A21.50	21,50 mm	2	248 mm	150 mm	30,60
ST2A21.75	21,75 mm	2	248 mm	150 mm	30,60
ST2A22	22,00 mm	2	248 mm	150 mm	30,60
ST2A22.25	22,25 mm	2	248 mm	150 mm	32,20
ST2A22.50	22,50 mm	2	253 mm	155 mm	32,20
ST2A22.75	22,75 mm	2	253 mm	155 mm	32,20
ST2A23	23,00 mm	2	253 mm	155 mm	32,20
ST2A23.25	23,25 mm	3	276 mm	155 mm	32,20
ST2A23.50	23,50 mm	3	276 mm	155 mm	35,60
ST2A23.75	23,75 mm	3	281 mm	160 mm	35,60
ST2A24	24,00 mm	3	281 mm	160 mm	35,60
ST2A24.25	24,25 mm	3	281 mm	160 mm	39,50
ST2A24.50	24,50 mm	3	281 mm	160 mm	39,50
ST2A24.75	24,75 mm	3	281 mm	160 mm	39,50
ST2A25	25,00 mm	3	281 mm	160 mm	39,50
ST2A25.25	25,25 mm	3	281 mm	160 mm	42,20
ST2A25.50	25,50 mm	3	281 mm	160 mm	42,20
ST2A25.75	25,75 mm	3	281 mm	160 mm	42,20
ST2A26	26,00 mm	3	286 mm	165 mm	42,20
ST2A26.25	26,25 mm	3	286 mm	165 mm	50,00
ST2A26.50	26,50 mm	3	286 mm	165 mm	50,00
ST2A26.75	26,75 mm	3	291 mm	170 mm	50,00
ST2A27	27,00 mm	3	291 mm	170 mm	50,00
ST2A27.25	27,25 mm	3	291 mm	170 mm	50,00
ST2A27.50	27,50 mm	3	291 mm	170 mm	50,00
ST2A27.75	27,75 mm	3	291 mm	170 mm	50,00
ST2A28	28,00 mm	3	291 mm	170 mm	50,00
ST2A28.25	28,25 mm	3	296 mm	175 mm	56,10
ST2A28.50	28,50 mm	3	296 mm	175 mm	56,10
ST2A28.75	28,75 mm	3	296 mm	175 mm	56,10
ST2A29	29,00 mm	3	296 mm	175 mm	56,10
ST2A29.25	29,25 mm	3	296 mm	175 mm	56,10
ST2A29.50	29,50 mm	3	296 mm	175 mm	56,10
ST2A29.75	29,75 mm	3	296 mm	175 mm	56,10
ST2A30	30,00 mm	3	296 mm	175 mm	56,10
ST2A30.25	30,25 mm	3	301 mm	180 mm	57,20
ST2A30.50	30,50 mm	3	301 mm	180 mm	57,20
ST2A30.75	30,75 mm	3	301 mm	180 mm	57,20
ST2A31	31,00 mm	3	301 mm	180 mm	57,20
ST2A31.25	31,25 mm	3	301 mm	180 mm	59,40
ST2A31.50	31,50 mm	3	301 mm	180 mm	59,40
ST2A31.75	31,75 mm	3	306 mm	185 mm	59,40
ST2A32	32,00 mm	4	334 mm	185 mm	59,40
ST2A32.50	32,50 mm	4	334 mm	185 mm	78,10
ST2A33	33,00 mm	4	334 mm	185 mm	78,10
ST2A33.50	33,50 mm	4	334 mm	185 mm	78,10
ST2A34	34,00 mm	4	339 mm	190 mm	78,10
ST2A34.50	34,50 mm	4	339 mm	190 mm	78,10
ST2A35	35,00 mm	4	339 mm	190 mm	78,10
ST2A35.50	35,50 mm	4	339 mm	190 mm	91,30
ST2A36	36,00 mm	4	344 mm	195 mm	91,30
ST2A36.50	36,50 mm	4	344 mm	195 mm	91,30





 DIN 345/N
 
 118°
 
 HSS

PUNTE ELICOIDALI CON
CODOLO CONICO, DESTRE,
PER LAVORAZIONE
DI MATERIALI CON
RESISTENZA R= 650 N/
mm², DUREZZA PUNTA HV=
700 ÷ 740

Codice	Ø	CM	Lunghezza totale	Lunghezza elica	€
ST2A37	37,00 mm	4	344 mm	195 mm	91,30
ST2A37.50	37,50 mm	4	344 mm	195 mm	91,30
ST2A38	38,00 mm	4	349 mm	200 mm	91,30
ST2A38.50	38,50 mm	4	349 mm	200 mm	105,00
ST2A39	39,00 mm	4	349 mm	200 mm	105,00
ST2A39.50	39,50 mm	4	349 mm	200 mm	105,00
ST2A40	40,00 mm	4	349 mm	200 mm	105,00
ST2A40.50	40,50 mm	4	354 mm	205 mm	118,00
ST2A41	41,00 mm	4	354 mm	205 mm	118,00
ST2A41.50	41,50 mm	4	354 mm	205 mm	118,00
ST2A42	42,00 mm	4	354 mm	205 mm	118,00
ST2A42.50	42,50 mm	4	354 mm	205 mm	130,00
ST2A43	43,00 mm	4	359 mm	210 mm	130,00
ST2A43.50	43,50 mm	4	359 mm	210 mm	130,00
ST2A44	44,00 mm	4	359 mm	210 mm	130,00
ST2A44.50	44,50 mm	4	359 mm	210 mm	130,00
ST2A45	45,00 mm	4	359 mm	210 mm	145,00
ST2A45.50	45,50 mm	4	364 mm	215 mm	145,00
ST2A46	46,00 mm	4	364 mm	215 mm	145,00
ST2A46.50	46,50 mm	4	364 mm	215 mm	168,00
ST2A47	47,00 mm	4	364 mm	215 mm	168,00
ST2A47.50	47,50 mm	4	364 mm	215 mm	168,00
ST2A48	48,00 mm	4	369 mm	220 mm	168,00
ST2A48.50	48,50 mm	4	369 mm	220 mm	187,00
ST2A49	49,00 mm	4	369 mm	220 mm	187,00
ST2A49.50	49,50 mm	4	369 mm	220 mm	187,00
ST2A50	50,00 mm	4	369 mm	220 mm	189,00
ST2A50.50	50,50 mm	4	374 mm	225 mm	195,00
ST2A51	51,00 mm	5	412 mm	225 mm	201,00
ST2A51.50	51,50 mm	5	412 mm	225 mm	208,00
ST2A52	52,00 mm	5	412 mm	225 mm	232,00
ST2A53	53,00 mm	5	412 mm	225 mm	232,00
ST2A54	54,00 mm	5	417 mm	230 mm	232,00
ST2A55	55,00 mm	5	417 mm	230 mm	232,00
ST2A56	56,00 mm	5	417 mm	230 mm	270,00
ST2A57	57,00 mm	5	422 mm	235 mm	270,00
ST2A58	58,00 mm	5	422 mm	235 mm	270,00
ST2A59	59,00 mm	5	422 mm	235 mm	270,00
ST2A60	60,00 mm	5	422 mm	235 mm	270,00
ST2A61	61,00 mm	5	427 mm	240 mm	322,00
ST2A62	62,00 mm	5	427 mm	240 mm	370,00
ST2A63	63,00 mm	5	427 mm	240 mm	424,00
ST2A65	65,00 mm	5	432 mm	245 mm	424,00
ST2A66	66,00 mm	5	432 mm	245 mm	424,00
ST2A67	67,00 mm	5	432 mm	245 mm	429,00
ST2A68	68,00 mm	5	437 mm	250 mm	441,00
ST2A69	69,00 mm	5	437 mm	250 mm	446,00
ST2A70	70,00 mm	5	437 mm	250 mm	446,00
ST2A71	71,00 mm	5	437 mm	250 mm	446,00
ST2A72	72,00 mm	5	442 mm	255 mm	446,00
ST2A73	73,00 mm	5	442 mm	255 mm	505,00
ST2A74	74,00 mm	5	442 mm	255 mm	505,00
ST2A75	75,00 mm	5	442 mm	255 mm	530,00
ST2A77	77,00 mm	6	514 mm	260 mm	618,00
ST2A78	78,00 mm	6	514 mm	260 mm	812,00
ST2A79	79,00 mm	6	514 mm	260 mm	1060,00



Art. P057
SERIE PUNTE ELICOIDALI DESTRE CON CODOLO CONICO

€ 109,00



10 Pz DIN 345/N 118° HSS

CM 1	14 mm
CM 2	15 - 16 - 17 - 18 - 19 - 20 - 21 - 22 - 23 mm
Pezzi	10

PUNTE ELICOIDALI CON CODOLO CONICO, DESTRE, PER LAVORAZIONE DI MATERIALI CON RESISTENZA R= 650 N/mm², DUREZZA PUNTA HV= 700 ÷ 740



PUNTA DA CENTRO



DIN 333 60° HSS

Codice	Ø	Gambo	Lunghezza	Imballo	€
P056/1	1 mm	Ø 3 mm	30,5 mm	10* / 100	2,74
P056/1.6	1,6 mm	Ø 4 mm	35,5 mm	10* / 400	2,74
P056/2	2 mm	Ø 5 mm	40 mm	10* / 350	4,12
P056/2.5	2,5 mm	Ø 6,3 mm	45 mm	10* / 300	4,34
P056/3.15	3,15 mm	Ø 8 mm	50 mm	10* / 300	4,80
P056/4	4 mm	Ø 10 mm	56 mm	10* / 100	8,50
P056/5	5 mm	Ø 12,5 mm	63 mm	10* / 100	11,50



Art. 0712/002
ASSORTIMENTO IN VALIGETTA

€ 92,40



9 Pz HSS M3

Tazze	22 - 29 mm
Alberi, punte, adattatore corrispondenti	0712/600
Tazze	35 - 44 mm
Alberi, punte, adattatore corrispondenti	0712/800
Tazze	51 - 64 mm
Alberi, punte, adattatore corrispondenti	0712/900

KIT ELETTRICISTA



Art. 0712/005
ASSORTIMENTO IN VALIGETTA

€ 60,50



7 Pz HSS M3

Tazze	22 - 25 - 29 mm
Alberi, punte, adattatore corrispondenti	0712/600
Tazze	32 - 38 mm
Alberi, punte, adattatore corrispondenti	0712/900

KIT RIPARATORE

Art. 0712/008
 ASSORTIMENTO IN VALIGETTA

€ 92,40

9 Pz HSS M3

Tazze	19 - 22 - 29 mm
Alberi, punte, adattatore corrispondenti	0712/600
Tazze	38 - 44 - 57 mm
Alberi, punte, adattatore corrispondenti	0712/800 - 0712/900

KIT IDRAULICO

Art. 0712/009
 ASSORTIMENTO IN VALIGETTA

€ 105,00

13 Pz HSS M3

Tazze	19 - 22 - 29 mm
Alberi, punte, adattatore corrispondenti	0712/600 - 0712/900 - 0712/300
Tazze	35 - 38 - 44 - 51 - 57 - 64 mm
Alberi, punte, adattatore corrispondenti	0712/800

KIT INSTALLATORE

SEGA A TAZZA BIMETALLICA HSS M3 PASSO VARIABILE

HSS M3



SEGA A TAZZA BIMETALLICA HSS M3 PASSO VARIABILE
 ADATTA PER IL TAGLIO DI ACCIAI DURI, ACCIAIO INOX, GHISA, ALLUMINIO, BRONZO, OTTONE, RAME, FIBRA DI VETRO, LAMINATI PLASTICI, LEGNO

Codice	Ø	Ø inch	€	Codice	Ø	Ø inch	€
0712/014	14 mm	9/16	5,50	0712/057	57 mm	2-1/4	12,00
0712/016	16 mm	5/8	5,50	0712/059	59 mm	2-5/16	12,00
0712/017	17 mm	11/16	5,50	0712/060	60 mm	2-3/8	12,00
0712/019	19 mm	3/4	5,50	0712/064	64 mm	2-1/2	13,50
0712/020	20 mm	25/32	5,50	0712/065	65 mm	2-9/16	13,50
0712/021	21 mm	13/16	5,50	0712/067	67 mm	2-5/8	13,50
0712/022	22 mm	7/8	7,90	0712/068	68 mm	2-11/16	13,50
0712/024	24 mm	15/16	7,90	0712/070	70 mm	2-3/4	13,50
0712/025	25 mm	1	7,90	0712/073	73 mm	2-7/8	15,70
0712/027	27 mm	1-1/16	7,90	0712/076	76 mm	3	15,70
0712/029	29 mm	1-1/8	7,90	0712/079	79 mm	3-1/8	15,70
0712/030	30 mm	1-3/16	8,00	0712/083	83 mm	3-1/4	17,40
0712/032	32 mm	1-1/4	8,00	0712/085	85 mm	3-3/8	17,40
0712/033	33 mm	1-5/16	8,00	0712/089	89 mm	3-1/2	17,40
0712/035	35 mm	1-3/8	10,20	0712/092	92 mm	3-5/8	17,40
0712/037	37 mm	1-7/16	10,20	0712/095	95 mm	3-3/4	19,40
0712/038	38 mm	1-1/2	10,20	0712/098	98 mm	3-7/8	19,40
0712/040	40 mm	1-9/16	10,20	0712/102	102 mm	4	20,80
0712/041	41 mm	1-5/8	10,20	0712/105	105 mm	4-1/8	22,70
0712/043	43 mm	1-11/16	10,20	0712/108	108 mm	4-1/4	27,80
0712/044	44 mm	1-3/4	10,20	0712/111	111 mm	4-3/8	34,50
0712/046	46 mm	1-13/16	10,20	0712/114	114 mm	4-1/2	34,50
0712/048	48 mm	1-7/8	10,20	0712/121	121 mm	4-3/4	34,50
0712/051	51 mm	2	10,20	0712/127	127 mm	5	34,50
0712/052	52 mm	2-1/16	12,00	0712/140	140 mm	5-1/2	40,00
0712/054	54 mm	2-1/8	12,00	0712/152	152 mm	6	40,00

CONFEZIONI DA 5* PEZZI FINO AL Ø 60 mm



Art. 0712/900
ADATTATORE PER SEGHE A TAZZA



Riduzione	1/2" - 5/8"
Per alberi	0712/600 - 0712/700
Imballo	10* / 100

INTERCAMBIABILE CON TUTTE LE MARCHE



PUNTA PER ALBERI € 4,22



Codice	Gambo	Per alberi	Imballo	€
0712/300	Ø 6,35 mm	0712/600	10* / 1000	4,22
0712/200	Ø 6,35 mm	0712/700 - 800	10* / 1000	4,22

INTERCAMBIABILE CON TUTTE LE MARCHE



ALBERO COMPLETO DI PUNTA



Codice	Gambo	Tazze	Filetto	Imballo	€
0712/600	Ø 6,35 mm	Ø 14÷30 mm	1/2"	5* / 100	7,60
0712/700	Ø 9,5 mm	Ø 14÷30 mm	1/2"	5* / 100	8,50
0712/800	Ø 11 mm	Ø 32÷152 mm	5/8"	100	13,50

ALBERO COMPLETO DI PUNTA
INTERCAMBIABILE CON TUTTE LE MARCHE



PUNTA PER MURO



PUNTA PER MURO CON
INSERTO IN METALLO
DURO, USO GENERICO

Codice	Ø	Lunghezza totale	Lunghezza elica	Gambo	€
P049/03	3 mm	70 mm	40 mm	Ø 2,5 mm	0,42
P049/04	4 mm	75 mm	40 mm	Ø 3,5 mm	0,44
P049/05	5 mm	85 mm	40 mm	Ø 4,5 mm	0,48
P049/06	6 mm	100 mm	55 mm	Ø 4,5 mm	0,54
P049/07	7 mm	100 mm	55 mm	Ø 6,5 mm	0,78
P049/08	8 mm	120 mm	70 mm	Ø 6,5 mm	0,84
P049/09	9 mm	120 mm	70 mm	Ø 6,5 mm	1,00
P049/10	10 mm	120 mm	70 mm	Ø 7 mm	1,12
P049/11	11 mm	150 mm	90 mm	Ø 7 mm	1,90
P049/12	12 mm	150 mm	90 mm	Ø 9 mm	1,92
P049/13	13 mm	150 mm	90 mm	Ø 9 mm	2,16
P049/14	14 mm	150 mm	90 mm	Ø 11 mm	2,44
P049/15	15 mm	150 mm	90 mm	Ø 12 mm	3,16
P049/16	16 mm	150 mm	90 mm	Ø 12 mm	3,20
P049/18	18 mm	160 mm	100 mm	Ø 13 mm	6,10
P049/22	22 mm	160 mm	100 mm	Ø 13 mm	9,20
P049/24	24 mm	160 mm	100 mm	Ø 13 mm	10,90

CONFEZIONE 10* PZ DAL Ø 3 AL Ø 12 mm - CONFEZIONE 5* PZ DAL Ø 13 AL Ø 24 mm



PUNTA PER MURO



DIN 8039 HM & C45

PUNTA PER MURO LUNGA,
CON INSERTO IN METALLO
DURO, USO GENERICO

Codice	Ø	Lunghezza totale	Lunghezza elica	Gambo	€
P050/06	6 mm	400 mm	240 mm	Ø 4,5 mm	2,16
P050/08	8 mm	400 mm	240 mm	Ø 7 mm	2,50
P050/09	9 mm	400 mm	240 mm	Ø 7 mm	3,06
P050/10	10 mm	400 mm	240 mm	Ø 7 mm	3,66
P050/12	12 mm	400 mm	240 mm	Ø 9 mm	5,10
P050/14	14 mm	400 mm	240 mm	Ø 10 mm	6,20
P050/16	16 mm	400 mm	240 mm	Ø 12 mm	6,90
P050/18	18 mm	400 mm	240 mm	Ø 12,5 mm	8,40
P050/20	20 mm	400 mm	240 mm	Ø 12,5 mm	10,70

CONFEZIONE 5* PZ DAL Ø 6 AL Ø 20 mm



PUNTA PER MURO



DIN 8039 135° HM & C45

PUNTA PER MURO,
CEMENTO, MARMO,
GRANITO, CON INSERTO
IN METALLO DURO, PER
ROTOPERCUSSIONE

Codice	Ø	Lunghezza totale	Lunghezza elica	Gambo	€
P051/03	3 mm	70 mm	40 mm	Ø 2,5 mm	2,96
P051/04	4 mm	75 mm	40 mm	Ø 3,5 mm	3,00
P051/05	5 mm	85 mm	40 mm	Ø 4,5 mm	3,34
P051/06	6 mm	100 mm	55 mm	Ø 5,5 mm	3,66
P051/07	7 mm	100 mm	55 mm	Ø 5,5 mm	3,66
P051/08	8 mm	120 mm	70 mm	Ø 6,5 mm	4,10
P051/09	9 mm	120 mm	70 mm	Ø 8 mm	4,38
P051/10	10 mm	120 mm	70 mm	Ø 9 mm	5,10
P051/12	12 mm	150 mm	90 mm	Ø 10 mm	5,90
P051/14	14 mm	150 mm	90 mm	Ø 12 mm	7,60
P051/16	16 mm	150 mm	90 mm	Ø 12 mm	8,50

CONFEZIONE 10* PZ DAL Ø 3 AL Ø 7 mm - CONFEZIONE 5* PZ DAL Ø 8 AL Ø 16 mm



PUNTA PER MURO



SDS PLUS

Codice	Misura	Imballo	€	Codice	Misura	Imballo	€
P063/5110	5 x 110 mm	10*	3,42	P063/15160	15 x 160 mm	10*	5,50
P063/6110	6 x 110 mm	10*	3,42	P063/16160	16 x 160 mm	10*	5,50
P063/6160	6 x 160 mm	10*	3,42	P063/16300	16 x 300 mm	10*	5,50
P063/8110	8 x 110 mm	10*	3,42	P063/16450	16 x 450 mm	5*	10,30
P063/8160	8 x 160 mm	20*	3,42	P063/18160	18 x 160 mm	5*	7,60
P063/9160	9 x 160 mm	10*	3,42	P063/18300	18 x 300 mm	5*	7,60
P063/10160	10 x 160 mm	10*	4,12	P063/18450	18 x 450 mm	5*	11,20
P063/12160	12 x 160 mm	20*	4,12	P063/20160	20 x 160 mm	5*	7,60
P063/12300	12 x 300 mm	10*	4,80	P063/20450	20 x 450 mm	5*	11,20
P063/14160	14 x 160 mm	10*	4,80	P063/22450	22 x 450 mm	5*	13,30
P063/14300	14 x 300 mm	10*	4,80	P063/24450	24 x 450 mm	5*	15,00

PUNTA PER MURO CON INSERTO IN METALLO DURO CON ATTACCO SCANALATO SDS PLUS



Art. 0332

€ 33,00

SERIE PUNTE CON INSERTO IN METALLO DURO E SCALPELLI PER MURO



12 Pz SDS PLUS

Blister 22 - 29 - 32 - 38 - 44 - 52 - 57 - 67 mm
Imballo 10

- | | |
|------------|---------------------|
| 9 PUNTE | 9 X 160 mm |
| 4 X 110 mm | 10 X 160 mm |
| 5 X 110 mm | 12 X 160 mm |
| 6 X 110 mm | 1 PORTAINSERTI |
| 5 X 160 mm | 1 SCALPELLO PIATTO |
| 6 X 160 mm | 1 SCALPELLO A PUNTA |
| 8 X 160 mm | |



Art. 0238

€ 12,40

SERIE FRESE A TAZZA PER LEGNO



10 Pz

Misure ø 22 - 29 - 32 - 38 - 44 - 52 - 57 - 67 mm
Imballo 5* / 30

Art. 0463
 SERIE PUNTE CON SVASATORE PER LEGNO

€ 22,40

4 Pz HSS & C45

Misure	2 - 2,5 - 3 - 3,5 mm
Attacco	1/4"

PER SVASARE IL LEGNO



SERIE PUNTE PER MORTASA



6 Pz HLS - Cr 13%

Codice	Misure	Rotazione	Gambo	€
0799/SX	ø 6 - 8 - 10 - 12 - 14 - 16 mm	Sx / Lx	ø 16 x 50 mm	69,70
0799/DX	ø 6 - 8 - 10 - 12 - 14 - 16 mm	Dx / Rx	ø 16 x 50 mm	69,70

Art. 0087
 SERIE PUNTE PER CERNIERE CON RIPORTO IN METALLO DURO

€ 45,00

5 Pz

Punta	ø 15 - 20 - 26 - 30 - 35 mm
Gambo	ø 10 mm
Imballo	10

Art. 0087/35
 PUNTA PER CERNIERE CON RIPORTO IN METALLO DURO

€ 11,40

Punta	ø 35 mm
Gambo	ø 10 mm
Imballo	5* / 100



Art. 0526
SERIE PUNTE CON SVASATORE PER LEGNO

€ 32,00



3 Pz HSS

Punte	2,75 - 3,25 - 3,5 mm
Attacco	1/4"
Doppio Blister	
Imballo	10

PER FORARE E SVASARE IL LEGNO SENZA ROVINARLO



Art. 0524
SERIE PORTA PUNTE CON ATTACCO 1/4"

€ 52,00



10 Pz

Misure	3-3.5-4-4.5-5-5.5-6-6.5-8-10 mm
Attacco	1/4"
Scatola di plastica	
Imballo	20

PER VELOCIZZARE IL LAVORO SOSTITUENDO VELOCEMENTE LE PUNTE



Art. 0529
SERIE PUNTE DIAMANTATE CON ATTACCO DA 1/4"

€ 40,00



6 Pz

Punte	5 - 6 - 8 - 10 - 12 mm
Attacco	1/4"
Lunghezza totale	60 mm
Taglio utile	30 mm
Peso	230 g
Doppio Blister	
Imballo	10 / 20

PER FORARE NON A SECCO MARMO, GRANITO, CERAMICA E GRES

ALESATORE A MACCHINA

H 7
TAGLIO DESTRO
TAGLIANTI ELICOIDALI
SINISTRI
CODOLO CONICO

Codice	øH7	L	I	CM	€
A208B/05	5 mm	133 mm	23 mm	1	24,00
A208B/06	6 mm	138 mm	26 mm	1	26,00
A208B/07	7 mm	150 mm	31 mm	1	26,00
A208B/08	8 mm	156 mm	33 mm	1	27,30
A208B/09	9 mm	162 mm	36 mm	1	27,30
A208B/10	10 mm	168 mm	38 mm	1	29,70
A208B/11	11 mm	175 mm	41 mm	1	29,70
A208B/12	12 mm	180 mm	43 mm	1	31,20
A208B/13	13 mm	182 mm	44 mm	1	31,20
A208B/14	14 mm	189 mm	47 mm	1	32,60
A208B/15	15 mm	204 mm	50 mm	2	37,30
A208B/16	16 mm	210 mm	52 mm	2	37,30
A208B/17	17 mm	214 mm	54 mm	2	38,30
A208B/18	18 mm	219 mm	56 mm	2	38,90
A208B/19	19 mm	223 mm	58 mm	2	40,00
A208B/20	20 mm	228 mm	60 mm	2	44,40
A208B/21	21 mm	232 mm	62 mm	2	46,70
A208B/22	22 mm	237 mm	64 mm	2	51,10
A208B/23	23 mm	241 mm	66 mm	2	56,10
A208B/24	24 mm	268 mm	68 mm	3	58,30
A208B/25	25 mm	268 mm	68 mm	3	63,80
A208B/26	26 mm	273 mm	70 mm	3	67,10
A208B/27	27 mm	277 mm	71 mm	3	74,80
A208B/28	28 mm	277 mm	71 mm	3	81,40
A208B/29	29 mm	281 mm	73 mm	3	83,60
A208B/30	30 mm	281 mm	73 mm	3	89,10
A208B/31	31 mm	285 mm	75 mm	3	93,50
A208B/32	32 mm	317 mm	77 mm	4	97,90
A208B/34	34 mm	321 mm	78 mm	4	130,00
A208B/35	35 mm	321 mm	78 mm	4	136,00
A208B/36	36 mm	325 mm	79 mm	4	141,00
A208B/38	38 mm	329 mm	81 mm	4	157,00
A208B/40	40 mm	329 mm	81 mm	4	171,00

LAMATORE CON ATTACCO CILINDRICO TIPO MEDIO

Codice	Viti	D	d1	d2	L1	L2	L	€
L020/03	M 3	6 mm	3,4 mm	5 mm	4 mm	14 mm	71 mm	15,20
L020/04	M 4	8 mm	4,5 mm	5 mm	5 mm	14 mm	71 mm	16,40
L020/05	M 5	10 mm	5,5 mm	8 mm	6 mm	18 mm	80 mm	17,70
L020/06	M 6	11 mm	6,6 mm	8 mm	7 mm	18 mm	80 mm	18,60
L020/08	M 8	15 mm	9 mm	12,5 mm	9 mm	22 mm	100 mm	28,40
L020/10	M 10	18 mm	11 mm	12,5 mm	14 mm	22 mm	100 mm	32,20
L020/12	M 12	20 mm	13,5 mm	12,5 mm	14 mm	22 mm	100 mm	36,20



ALESATORE A MACCHINA

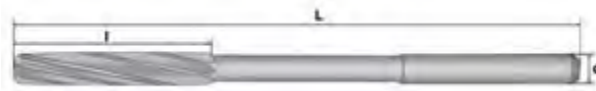

DIN 212/B **HSS**

H 7
TAGLIO DESTRO
TAGLIENTI ELICOIDALI
SINISTRI
ATTACCO CILINDRICO

Codice	øH7	L	l	d h9	Z	€
A212/02.00	2 mm	49 mm	11 mm	2 mm	4	22,70
A212/02.50	2,5 mm	57 mm	14 mm	2,5 mm	4	22,70
A212/03.00	3 mm	61 mm	15 mm	3 mm	4	22,70
A212/03.50	3,5 mm	70 mm	18 mm	3,5 mm	6	22,70
A212/04.00	4 mm	75 mm	19 mm	4 mm	6	15,20
A212/04.50	4,5 mm	80 mm	21 mm	4,5 mm	6	15,20
A212/05.00	5 mm	86 mm	23 mm	5 mm	6	15,20
A212/05.50	5,5 mm	93 mm	26 mm	5,5 mm	6	15,20
A212/06.00	6 mm	93 mm	26 mm	6 mm	6	15,20
A212/06.50	6,5 mm	101 mm	28 mm	6,5 mm	6	19,20
A212/07.00	7 mm	109 mm	31 mm	7 mm	6	19,20
A212/07.50	7,5 mm	109 mm	31 mm	7 mm	6	19,20
A212/08.00	8 mm	117 mm	33 mm	8 mm	6	19,20
A212/08.50	8,5 mm	117 mm	33 mm	8 mm	6	23,80
A212/09.00	9 mm	125 mm	36 mm	9 mm	6	23,80
A212/09.50	9,5 mm	125 mm	36 mm	9 mm	6	23,80
A212/10.00	10 mm	133 mm	38 mm	10 mm	6	23,80
A212/11.00	11 mm	142 mm	41 mm	10 mm	6	27,30
A212/12.00	12 mm	151 mm	44 mm	10 mm	6	37,30
A212/13.00	13 mm	151 mm	44 mm	10 mm	6	37,30
A212/14.00	14 mm	160 mm	47 mm	12 mm	6	45,00
A212/15.00	15 mm	162 mm	50 mm	12 mm	8	45,00
A212/16.00	16 mm	170 mm	52 mm	12 mm	8	45,00



Art. L020

SERIE LAMATORI TIPO MEDIO CON ATTACCO CILINDRICO

€ 105,00



7 Pz **DIN 373** **TiN** **HSS**

Per viti M 3 - 4 - 5 - 6 - 8 - 10 - 12

COLTELLO STOZZATORE NORMALE A DISCO

DIN 1825

TiN

HSS

Ø 100 mm NOMINALE
FORMA BASE
FORO 44,45 mm
ANGOLO DI PRESSIONE 20°
CLASSE A

Codice	Modulo	Ø max	Ø d0	Altezza b1	Denti	€
C003/1	1,00	102 mm	100 mm	16 mm	100	331,00
C003/1.25	1,25	105 mm	100 mm	16 mm	80	331,00
C003/1.50	1,50	107 mm	102 mm	18 mm	68	360,00
C003/1.75	1,75	107,4 mm	101,5 mm	20 mm	58	389,00
C003/2	2,00	107,31 mm	100 mm	20 mm	50	389,00
C003/2.25	2,25	109,29 mm	101,25 mm	20 mm	45	389,00
C003/2.50	2,50	108,46 mm	100 mm	20 mm	40	445,00
C003/2.75	2,75	108,36 mm	99 mm	24 mm	36	445,00
C003/3	3,00	111,82 mm	99 mm	24 mm	33	445,00
C003/3.25	3,25	110,99 mm	99 mm	24 mm	31	488,00
C003/3.50	3,50	108,72 mm	101,5 mm	24 mm	29	488,00
C003/3.75	3,75	112,35 mm	101,5 mm	24 mm	27	488,00
C003/4	4,00	111,75 mm	100 mm	24 mm	25	488,00
C003/4.25	4,25	114,12 mm	102 mm	24 mm	24	520,00
C003/4.50	4,50	111,65 mm	99 mm	24 mm	22	520,00
C003/5	5,00	114,05 mm	100 mm	24 mm	20	529,00
C003/5.50	5,50	119,96 mm	99 mm	24 mm	18	562,00
C003/6	6,00	118,86 mm	102 mm	24 mm	17	562,00
C003/6.50	6,50	122,5 mm	112 mm	24 mm	16	704,00
C003/7	7,00	127 mm	105 mm	24 mm	15	820,00
C003/8	8,00	135 mm	112 mm	24 mm	14	920,00
C003/10	10,00	168 mm	140 mm	24 mm	14	1260,00

CREATORE PER INGRANAGGI CILINDRICI CON ANGOLO DI PRESSIONE 20°

DIN 8002/B

TiN

HSS

CON ANGOLO DI
PRESSIONE 20°
PROFILO RETTIFICATO
FINITORE
CLASSE A

Codice	Modulo	Diametro Ø	Lunghezza	Foro	€
C001/1	1,00	50 mm	31 mm	22 mm	385,00
C001/1.25	1,25	50 mm	31 mm	22 mm	385,00
C001/1.50	1,50	63 mm	50 mm	27 mm	385,00
C001/1.75	1,75	56 mm	38 mm	22 mm	385,00
C001/2	2,00	63 mm	46 mm	27 mm	396,00
C001/2.25	2,25	70 mm	56 mm	27 mm	458,00
C001/2.50	2,50	71 mm	63 mm	27 mm	458,00
C001/2.75	2,75	70 mm	56 mm	27 mm	458,00
C001/3	3,00	80 mm	71 mm	32 mm	557,00
C001/3.25	3,25	80 mm	69 mm	32 mm	651,00
C001/3.50	3,50	80 mm	71 mm	32 mm	677,00
C001/3.75	3,75	90 mm	78 mm	32 mm	775,00
C001/4	4,00	90 mm	78 mm	32 mm	775,00
C001/4.25	4,25	90 mm	78 mm	32 mm	845,00
C001/4.50	4,50	90 mm	78 mm	32 mm	845,00
C001/5	5,00	100 mm	88 mm	32 mm	845,00
C001/5.50	5,50	100 mm	88 mm	32 mm	845,00
C001/6	6,00	110 mm	108 mm	40 mm	1120,00
C001/6.50	6,50	110 mm	109 mm	40 mm	1180,00
C001/7	7,00	110 mm	110 mm	40 mm	1180,00
C001/8	8,00	125 mm	130 mm	40 mm	1851,00
C001/9	9,00	125 mm	140 mm	40 mm	2120,00
C001/10	10,00	140 mm	160 mm	40 mm	2866,00
C001/12	12,00	170 mm	195 mm	50 mm	4100,00
C001/13	13,00	180 mm	210 mm	50 mm	4320,00



FRESE A CAROTARE CON ATTACCO WELDON



CON ATTACCO WELDON
DA 19,05 mm PER
TRAPANI MAGNETICI E
TRAPANI A COLONNA,
PER LAVORAZIONE
DI MATERIALI CON
RESISTENZA R= 850N/
mm²

Codice	Capacità di taglio	Ø	Lunghezza totale	€
F011/12	30 mm	12 mm	62 mm	25,00
F011/13	30 mm	13 mm	62 mm	26,00
F011/14	30 mm	14 mm	62 mm	30,20
F011/15	30 mm	15 mm	62 mm	31,20
F011/16	30 mm	16 mm	62 mm	33,30
F011/17	30 mm	17 mm	62 mm	34,30
F011/18	30 mm	18 mm	62 mm	36,40
F011/19	30 mm	19 mm	62 mm	37,40
F011/20	30 mm	20 mm	62 mm	38,50
F011/21	30 mm	21 mm	62 mm	39,00
F011/22	30 mm	22 mm	62 mm	40,60
F011/23	30 mm	23 mm	62 mm	41,60
F011/24	30 mm	24 mm	62 mm	44,20
F011/25	30 mm	25 mm	62 mm	45,80
F011/26	30 mm	26 mm	62 mm	52,00
F011/27	30 mm	27 mm	62 mm	53,60
F011/28	30 mm	28 mm	62 mm	55,10
F011/29	30 mm	29 mm	62 mm	56,70
F011/30	30 mm	30 mm	62 mm	58,20
F011/31	30 mm	31 mm	62 mm	60,80
F011/32	30 mm	32 mm	62 mm	62,40
F011/33	30 mm	33 mm	62 mm	64,30
F011/34	30 mm	34 mm	62 mm	66,00
F011/35	30 mm	35 mm	62 mm	67,60
F011/36	30 mm	36 mm	62 mm	69,50
F011/37	30 mm	37 mm	62 mm	71,20
F011/38	30 mm	38 mm	62 mm	73,60
F011/39	30 mm	39 mm	62 mm	75,80
F011/40	30 mm	40 mm	62 mm	77,00
F011/41	30 mm	41 mm	62 mm	88,90
F011/42	30 mm	42 mm	62 mm	91,00
F011/43	30 mm	43 mm	62 mm	92,60
F011/44	30 mm	44 mm	62 mm	94,60
F011/45	30 mm	45 mm	62 mm	111,30
F011/46	30 mm	46 mm	62 mm	113,40
F011/47	30 mm	47 mm	62 mm	115,90
F011/48	30 mm	48 mm	62 mm	118,00
F011/49	30 mm	49 mm	62 mm	120,10
F011/50	30 mm	50 mm	62 mm	122,20
F011/51	30 mm	51 mm	62 mm	133,10
F011/52	30 mm	52 mm	62 mm	135,70
F011/53	30 mm	53 mm	62 mm	138,30
F011/54	30 mm	54 mm	62 mm	140,90
F011/55	30 mm	55 mm	62 mm	145,10
F011/60	30 mm	60 mm	62 mm	171,10

Art. F011/6
SERIE DI FRESE A CAROTARE CON ATTACCO WELDON
€ 197,60

7 Pz **HSS**
Misure 12 x 62 - 14 x 62 - 16 x 62 - 18 x 62 - 20 x 62 - 22 x 62 mm

Attacco Weldon 19,05 mm

PER TRAPANI MAGNETICI E TRAPANI A COLONNA, PER LAVORAZIONE DI MATERIALI CON RESISTENZA R= 850 N/mm²

FRESE A CAROTARE CON ATTACCO WELDON
HSS - Co 5%

**CON ATTACCO WELDON
DA 19,05 mm PER
TRAPANI MAGNETICI E
TRAPANI A COLONNA,
PER LAVORAZIONE
DI MATERIALI CON
RESISTENZA R= 1200N/
mm²**

Codice	Ø	Capacità di taglio	Lunghezza totale	€
F002/12	12 mm	30 mm	62 mm	41,40
F002/13	13 mm	30 mm	62 mm	43,70
F002/14	14 mm	30 mm	62 mm	47,80
F002/15	15 mm	30 mm	62 mm	52,00
F002/16	16 mm	30 mm	62 mm	54,10
F002/17	17 mm	30 mm	62 mm	54,10
F002/18	18 mm	30 mm	62 mm	54,10
F002/19	19 mm	30 mm	62 mm	55,10
F002/20	20 mm	30 mm	62 mm	57,20
F002/21	21 mm	30 mm	62 mm	59,30
F002/22	22 mm	30 mm	62 mm	61,40
F002/23	23 mm	30 mm	62 mm	62,90
F002/24	24 mm	30 mm	62 mm	66,60
F002/25	25 mm	30 mm	62 mm	68,60
F002/26	26 mm	30 mm	62 mm	79,00
F002/27	27 mm	30 mm	62 mm	82,20
F002/28	28 mm	30 mm	62 mm	84,20
F002/29	29 mm	30 mm	62 mm	85,30
F002/30	30 mm	30 mm	62 mm	88,40
F002/31	31 mm	30 mm	62 mm	92,60
F002/32	32 mm	30 mm	62 mm	95,70
F002/33	33 mm	30 mm	62 mm	103,00
F002/34	34 mm	30 mm	62 mm	108,20
F002/35	35 mm	30 mm	62 mm	112,30
F002/36	36 mm	30 mm	62 mm	116,50
F002/37	37 mm	30 mm	62 mm	121,70
F002/38	38 mm	30 mm	62 mm	125,80
F002/39	39 mm	30 mm	62 mm	131,00
F002/40	40 mm	30 mm	62 mm	135,20
F002/41	41 mm	30 mm	62 mm	140,40
F002/42	42 mm	30 mm	62 mm	146,60
F002/43	43 mm	30 mm	62 mm	150,80
F002/44	44 mm	30 mm	62 mm	158,10
F002/45	45 mm	30 mm	62 mm	168,50
F002/46	46 mm	30 mm	62 mm	171,60
F002/47	47 mm	30 mm	62 mm	174,70
F002/48	48 mm	30 mm	62 mm	178,90
F002/49	49 mm	30 mm	62 mm	183,00
F002/50	50 mm	30 mm	62 mm	187,20
F002/55	55 mm	30 mm	62 mm	219,40
F002/60	60 mm	30 mm	62 mm	337,00



FRESA A CAROTARE LUNGA CON ATTACCO WELDON

HSS - Co 5%



CON ATTACCO WELDON
DA 19,05 mm PER
TRAPANI MAGNETICI E
TRAPANI A COLONNA,
PER LAVORAZIONE
DI MATERIALI CON
RESISTENZA R= 1200N/
mm²

Codice	Ø	Capacità di taglio	Lunghezza totale	€
F002/12L	12 mm	50 mm	85 mm	58,20
F002/13L	13 mm	50 mm	85 mm	59,30
F002/14L	14 mm	50 mm	85 mm	69,70
F002/15L	15 mm	50 mm	85 mm	70,70
F002/16L	16 mm	50 mm	85 mm	75,90
F002/17L	17 mm	50 mm	85 mm	79,00
F002/18L	18 mm	50 mm	85 mm	82,20
F002/19L	19 mm	50 mm	85 mm	84,20
F002/20L	20 mm	50 mm	85 mm	86,30
F002/21L	21 mm	50 mm	85 mm	88,40
F002/22L	22 mm	50 mm	85 mm	90,50
F002/23L	23 mm	50 mm	85 mm	92,60
F002/24L	24 mm	50 mm	85 mm	97,80
F002/25L	25 mm	50 mm	85 mm	99,80
F002/26L	26 mm	50 mm	85 mm	116,50
F002/27L	27 mm	50 mm	85 mm	118,60
F002/28L	28 mm	50 mm	85 mm	121,70
F002/29L	29 mm	50 mm	85 mm	123,80
F002/30L	30 mm	50 mm	85 mm	126,90
F002/31L	31 mm	50 mm	85 mm	133,10
F002/32L	32 mm	50 mm	85 mm	136,20
F002/33L	33 mm	50 mm	85 mm	138,30
F002/34L	34 mm	50 mm	85 mm	141,40
F002/35L	35 mm	50 mm	85 mm	144,60
F002/36L	36 mm	50 mm	85 mm	149,80
F002/37L	37 mm	50 mm	85 mm	150,80
F002/38L	38 mm	50 mm	85 mm	155,00
F002/39L	39 mm	50 mm	85 mm	159,10
F002/40L	40 mm	50 mm	85 mm	161,20
F002/41L	41 mm	50 mm	85 mm	187,20
F002/42L	42 mm	50 mm	85 mm	191,40
F002/43L	43 mm	50 mm	85 mm	194,50
F002/44L	44 mm	50 mm	85 mm	198,60
F002/45L	45 mm	50 mm	85 mm	237,10
F002/46L	46 mm	50 mm	85 mm	240,20
F002/47L	47 mm	50 mm	85 mm	244,40
F002/48L	48 mm	50 mm	85 mm	248,60
F002/49L	49 mm	50 mm	85 mm	252,70
F002/50L	50 mm	50 mm	85 mm	256,90
F002/55L	55 mm	50 mm	85 mm	302,60
F002/60L	60 mm	50 mm	85 mm	349,40



**Art. F002/P
ESPULSORE**

€ 8,30



Dimensioni 6,35 x 77 mm

ESPULSORE PER FRESE A CAROTARE



**Art. F002/PL
ESPULSORE**

€ 10,40



Dimensioni 6,35 x 102 mm

ESPULSORE PER FRESE A CAROTARE LUNGHE

Art. F002/6
SERIE FRESE A CAROTARE LUNGHE CON ATTACCO WELDON
€ 301,60

7 Pz **HSS - Co 5%**
Misure 12 x 62 - 14 x 62 - 16 x 62 - 18 x 62 - 20 x 62 - 22 x 62 mm
Attacco Weldon 19,05 mm

PER TRAPANI MAGNETICI E TRAPANI A COLONNA, PER LAVORAZIONE DI MATERIALI CON RESISTENZA R= 1200 N/mm²

Art. F001/10
SERIE FRESE FRONTALI A PIÙ TAGLIENTI
€ 243,00

10 Pz **DIN 844/B** **TiN** **HSS**
Fresa Ø 6 | 8 | 10 | 12 | 14 | 16 | 18 | 20 | 22 | 25 mm
Gambo Ø 6 | 10 | 10 | 12 | 12 | 16 | 16 | 20 | 20 | 25 mm

TAGLIO AL CENTRO, PER SGROSSATURA, PASSO FINE, GAMBO CILINDRICO, SERIE NORMALE, ATTACCO WELDON

Art. F001/20
SERIE FRESE FRONTALI A 2 E 4 TAGLI
€ 243,00

20 Pz
DIN 327/D & DIN 844/B **TiN** **HSS**
Fresa 2 T Ø 3 - 4 - 5 - 6 - 8 - 10 - 12 - 14 - 18 - 20 mm
Gambo Ø 6 - 6 - 6 - 6 - 10 - 10 - 12 - 12 - 16 - 20 mm
Fresa 4 T Ø 3 - 4 - 5 - 6 - 8 - 10 - 12 - 14 - 18 - 20 mm
Gambo Ø 6 - 6 - 6 - 6 - 10 - 10 - 12 - 12 - 16 - 20 mm

TAGLIO AL CENTRO, PER FINITURA, GAMBO CILINDRICO, SERIE NORMALE, ATTACCO WELDON



FRESA FRONTALE A 2 TAGLIENTI



TAGLIO AL CENTRO
GAMBO CILINDRICO
SERIE NORMALE,
ATTACCO WELDON

DIN 327/D **TiN** **HSS**

Codice	D	d	l	Z	L	Imballo	€
F005/03	3 mm	6 mm	5 mm	2	49 mm	5*	8,00
F005/04	4 mm	6 mm	7 mm	2	51 mm	5*	8,30
F005/05	5 mm	6 mm	8 mm	2	52 mm	5*	9,40
F005/06	6 mm	6 mm	8 mm	2	52 mm	5*	9,60
F005/08	8 mm	10 mm	11 mm	2	61 mm	5*	11,50
F005/10	10 mm	10 mm	13 mm	2	63 mm	5*	11,60
F005/12	12 mm	12 mm	16 mm	2	73 mm	10	13,50
F005/14	14 mm	12 mm	16 mm	2	73 mm	10	18,00
F005/16	16 mm	16 mm	19 mm	2	79 mm	10	26,80
F005/18	18 mm	16 mm	19 mm	2	79 mm	10	27,90
F005/20	20 mm	20 mm	22 mm	2	88 mm	10	37,80
F005/22	22 mm	20 mm	22 mm	2	88 mm	10	46,80
F005/24	24 mm	25 mm	26 mm	2	92 mm	10	53,10
F005/25	25 mm	25 mm	26 mm	2	92 mm	10	57,50



FRESA FRONTALE A 4 TAGLIENTI



TAGLIO AL CENTRO
GAMBO CILINDRICO
SERIE NORMALE,
ATTACCO WELDON

DIN 844 **TiN** **HSS**

Codice	D	d	l	Z	L	Imballo	€
F006/03	3 mm	6 mm	8 mm	4	52 mm	5*	8,30
F006/04	4 mm	6 mm	11 mm	4	55 mm	5*	8,30
F006/05	5 mm	6 mm	13 mm	4	57 mm	5*	9,50
F006/06	6 mm	6 mm	13 mm	4	57 mm	5*	9,60
F006/08	8 mm	10 mm	19 mm	4	69 mm	5*	12,00
F006/10	10 mm	10 mm	22 mm	4	72 mm	5*	12,60
F006/12	12 mm	12 mm	26 mm	4	83 mm	10	16,40
F006/14	14 mm	12 mm	26 mm	4	83 mm	10	16,40
F006/16	16 mm	16 mm	32 mm	4	92 mm	10	24,00
F006/18	18 mm	16 mm	32 mm	4	92 mm	10	24,20
F006/20	20 mm	20 mm	38 mm	4	104 mm	10	34,00



FRESA FRONTALE A 4 TAGLIENTI



TAGLIO AL CENTRO
PER SGROSSATURA
PASSO FINE, GAMBO
CILINDRICO, SERIE
NORMALE, ATTACCO
WELDON

DIN 844/B **TiN** **HSS**

Codice	D	d	l	Z	L	Imballo	€
F007/06	6 mm	6 mm	13 mm	4	57 mm	5*	13,50
F007/07	7 mm	10 mm	16 mm	4	66 mm	5*	13,50
F007/08	8 mm	10 mm	19 mm	4	69 mm	5*	14,90
F007/09	9 mm	10 mm	19 mm	4	69 mm	5*	17,30
F007/10	10 mm	10 mm	22 mm	4	72 mm	5*	17,30
F007/11	11 mm	12 mm	22 mm	4	76 mm	10	17,30
F007/12	12 mm	12 mm	26 mm	4	83 mm	10	17,30
F007/13	13 mm	12 mm	26 mm	4	83 mm	10	18,60
F007/14	14 mm	12 mm	26 mm	4	83 mm	10	18,60
F007/15	15 mm	12 mm	26 mm	4	83 mm	10	23,50
F007/16	16 mm	16 mm	32 mm	4	92 mm	10	23,50
F007/18	18 mm	16 mm	32 mm	4	92 mm	10	32,20
F007/20	20 mm	20 mm	38 mm	4	104 mm	10	43,70
F007/22	22 mm	20 mm	38 mm	4	104 mm	10	50,10
F007/25	25 mm	25 mm	45 mm	4	121 mm	10	55,50

Art. F639
FRESA A SCALINI
€ 83,60

TiN HSS

Gambo	10 mm
∅	6 ÷ 39 (6-9-12-15-18-21-24-27-30-33-36-39) mm

Art. F232
FRESA A SCALINI
€ 77,00

TiN HSS

Gambo	10 mm
∅	2,5 ÷ 32 (2,5-6,3-11,2-14,5-18,2-22,3-27,9-32) mm

CON PUNTA INTERCAMBIABILE

Art. F238
FRESA A SCALINI
€ 82,50

TiN HSS

Gambo	10 mm
∅	2,5 ÷ 38 (2,5-6,3-13-16-19-21-23-26-29-32-35-38) mm

CON PUNTA INTERCAMBIABILE

Art. F025
PUNTA DI RICAMBIO
€ 6,90

Gambo	4 mm
Punta di ricambio	∅ 2,5 mm

COMPATIBILE CON F232 - F238

Art. F430
SERIE FRESE A SCALINI
€ 79,20

3 Pz TiN HSS

Gambo	6 - 8 - 10 mm
∅	4 ÷ 12 - 6 ÷ 20 - 6 ÷ 30 mm





FRESA A SVASARE ANTIVIBRANTE



3 TAGLIENTI A 90°

DIN 335/C TiN HSS

Codice	Ø max	Per Viti M	Gambo	€
S006	6,3 mm	3	Ø 5 mm	10,90
S010	10,4 mm	5	Ø 6 mm	12,70
S012	12,4 mm	6	Ø 8 mm	14,70
S016	16,5 mm	8	Ø 10 mm	19,10
S020	20,5 mm	10	Ø 10 mm	23,20
S025	25 mm	12	Ø 10 mm	27,90
S028	28 mm	14	Ø 12 mm	35,20
S031	31 mm	16	Ø 12 mm	37,80
S040	40 mm	--	Ø 15 mm	63,80



Art. S001 SERIE FRESE A SVASARE ANTIVIBRANTI

€ 99,00



DIN 335/C
 5 Pz TiN HSS
Ø max 8 - 10 - 12,4 - 16,5 - 20,5 mm

3 TAGLIENTI A 90°



FRESE ROTATIVE



8 Pz HM

Codice	Serie frese Pz	Gambo	Imballo	€
F008/3	8	Ø 3 mm	50	63,80
F008/6	8	Ø 6 mm	50	108,00

IN METALLO DURO CON TAGLIO INCROCIATO



FRESE ROTATIVE



HM

Codice	Tagliante	Lunghezza	Gambo	Imballo	€
F008/B06	Ø 6 x 16 mm	58 mm	Ø 6 mm	200	16,10
F008/B08	Ø 8 x 20 mm	60 mm	Ø 6 mm	100	16,10
F008/B10	Ø 10 x 20 mm	70 mm	Ø 6 mm	10 / 150	18,90
F008/B12	Ø 12 x 25 mm	65 mm	Ø 6 mm	10 / 250	22,60
F008/C06	Ø 6 x 18 mm	58 mm	Ø 6 mm	200	14,70
F008/C10	Ø 10 x 20 mm	65 mm	Ø 6 mm	100	19,10
F008/D06	Ø 6 mm	45 mm	Ø 6 mm	100	15,70
F008/D10	Ø 10 mm	55 mm	Ø 6 mm	100	17,40
F008/H10	Ø 10 x 20 mm	65 mm	Ø 6 mm	300	18,30
F008/H12	Ø 12 x 25 mm	65 mm	Ø 6 mm	100	21,70
F008/K10	Ø 10 x 20 mm	65 mm	Ø 6 mm	500	19,10
F008/K12	Ø 12 x 25 mm	68 mm	Ø 6 mm	500	19,00

IN METALLO DURO CON TAGLIO INCROCIATO



Art. D020 € 26,90
**SERIE FRESE ROTATIVE
 DIAMANTATE**



20 Pz

Gambo	Ø 3 mm
Lunghezza	45 mm
Imballo	10

PER: METALLI INDURITI, METALLO DURO, CERAMICA,
 PIASTRELLE, MARMO, GRANITO



Art. D050 € 52,90
**SERIE FRESE ROTATIVE
 DIAMANTATE**



50 Pz

Gambo	Ø 3 mm
Lunghezza	45 mm
Imballo	50

PER: METALLI INDURITI, METALLO DURO, CERAMICA,
 PIASTRELLE, MARMO, GRANITO



Art. 0835/15 € 55,00
SERIE FRESE PER LEGNO



15 Pz **HM**

Gambo	Ø 6 mm
Imballo	10

CON RIPORTO IN METALLO DURO



Art. 0830 € 238,00
SERIE FRESE PER LEGNO



35 Pz **HM**

Gambo	Ø 6 mm
Imballo	5

CON RIPORTO IN METALLO DURO



Art. 0718 € 275,00
SET A FRESARE PER TOUPIE



27 Pz **HSS**

Corpo fresa	Ø 100 x 40h mm
Foro	Ø 30 mm
Coltelli in HSS	26
Valigetta in plastica	

Art. M312/P
SERIE MASCHI PER FORI PASSANTI GAMBO RINFORZATO
€ 63,30

8 Pz **DIN 371/B** **HSS G**

Misura	M3 x 0,50 - M4 x 0,70 - M5 x 0,80 - M6 x 1 - M8 x 1,25 - M10 x 1,50 - M12 x 1,75
Giramaschio	1
Imballo	20

Art. M312/C
SERIE MASCHI PER FORI CIECHI 35° GAMBO RINFORZATO
€ 68,80

8 Pz **DIN 371/B** **HSS G**

Misura	M3 x 0,50 - M4 x 0,70 - M5 x 0,80 - M6 x 1 - M8 x 1,25 - M10 x 1,50 - M12 x 1,75
Giramaschio	1
Imballo	14

Art. M218
SERIE MASCHI E FILIERE IN ACCIAIO AL TUNGSTENO
€ 245,00

110 Pz

Girafiliera	2
Giramaschio	2
Maschi a mano serie 2pz e filiera	M2 x 0,40 - M3 x 0,50 - M4 x 0,70 - M5 x 0,80 - M6 x 0,75 - M6 x 1 - M7 x 0,75 - M7 x 1 - M8 x 0,75 - M8 x 1 - M8 x 1,25 - M9 x 0,75 - M9 x 1 - M9 x 1,25 - M10 x 0,75 - M10 x 1 - M10 x 1,25 - M10 x 1,5 - M11 x 0,75 - M11 x 1 - M11 x 1,25 - M11 x 1,5 - M12 x 0,75 - M12 x 1 - M12 x 1,25 - M12 x 1,5 - M12 x 1,75 - M14 x 1 - M14 x 1,25 - M14 x 1,5 - M14 x 2 - M16 x 1 - M16 x 1,5 - M16 x 2 - M18 x 1,5
Imballo	3



Art. M100
SERIE MASCHI E FILIERE

€ 153,00



45 Pz

Girafiliera	1
Giramaschio	1
Maschio a mano e filiera	M6x0,75 - M6x1 - M8x1 - M8x1,25 - M10x1,25 - M10x1,5 - M12x1,5 - M12x1,75 - M14x1,5 - M14x2 - M16x1,5 - M16x2 - M18x1,5 - M18x2,5 - M20x1,5 - M20x2,5 - M22x1,5 - M22x2,5 - M24x1,5 - M24x3
Imballo	2

IN ACCIAIO AL TUNGSTENO



Art. M032
SERIE MASCHI E FILIERE

€ 115,00



32 Pz HSS

Giramaschio	1
Contafiletto	1
Girafiliera	25 x 9 mm
Giravite	3,5 x 50 mm
Maschi 3 Pz	M3x0,5 M4x0,7 M5x0,8 M6x1 M8x1,25 M10x1,5 M12x1,75
Filiera	M3x0,5 M4x0,7 M5x0,8 M6x1 M8x1,25 M10x1,5 M12x1,75
Imballo	10



Art. M101
SERIE MASCHI E FILIERE IN ACCIAIO LEGATO

€ 114,00



60 Pz

Metric	Maschio a mano e filiera			
	UNC	NPT	UNF	
M3 x 0,5	1/4 20	1/8 27	4	40
M4 x 0,7	1/4 28		6	32
M5 x 0,8	5/16 18		8	32
M6 x 1	5/16 24		10	32
M7 x 1	3/8 16		10	24
M8 x 1,25	3/8 24		12	24
M9 x 1,25	7/16 14			
M10 x 1,5	7/16 20			
M10 x 1	1/2 13			
M12 x 1,75	1/2 20			
Imballo	8			

Art. M020 € 32,00
 SERIE MASCHI E FILIERE

 20Pz

Giramaschio	M3 - 12
Girafiliera	25 x 9 mm
Giravite	3,5 x 50 mm
Maschi	M3x0,5 - M4x0,7 - M5x0,8 - M6x1 - M7x1 - M8x1,25 - M10x1,5 - M12x1,75 - 1/8" NPT27
Filiera	M3x0,5 - M4x0,7 - M5x0,8 - M6x1 - M7x1 - M8x1,25 - M10x1,5 - M12x1,75 - 1/8" NPT27
Imballo	10

Art. M029 € 123,60
 SERIE MASCHI E FILIERE

 27 Pz

Manico a cricchetto	200 mm
Adattatore per filiere	25 x 9 mm
Adattatore per maschi	5 - 7,5 mm
Maschi	M3x0,5 - M4x0,7 - M5x0,8 - M6x1 - M8x1,25 - M10x1,5 - M12x1,75
Filiera	M3x0,5 - M4x0,7 - M5x0,8 - M6x1 - M8x1,25 - M10x1,5 - M12x1,75
Punte	2,5 - 3,3 - 4,2 - 5 - 6,8 - 8,5 - 10,3 mm
Giravite	6,5 x 50 mm
Giramaschio	
Manico	
Giravite	3 x 50 mm
Imballo	5

Art. M036 € 62,00
 SERIE MASCHI E FILIERE

 34 Pz

Giramaschio	M3 - 12
Girafiliera	25 x 9 mm
Giravite	6,5 x 50 mm
Maschi	M3x0,5 - M4x0,7 - M5x0,8 - M6x1 - M7x1 - M8x1,25 - M10x1,5 - M12x1,75 - 1/8" BSP28 - 1/4" BSP19
Filiera	M3x0,5 - M4x0,7 - M5x0,8 - M6x1 - M7x1 - M8x1,25 - M10x1,5 - M12x1,75 - 1/8" BSP28 - 1/4" BSP19
Punte	2,5 - 3,3 - 4,2 - 5 - 6 - 6,8 - 8,5 - 10,3 mm
Contafiletti	
Giramaschio	
Manico	
Imballo	5

Art. M030 € 72,10
 SERIE MASCHI E FILIERE

 30 Pz  HSS

Misura	M1 - M1.1 - M1.2 - M1.4 - M1.6 - M1.8 - M2.0 - M2.2 - M2.5
Imballo	48



MASCHI A MACCHINA PER FORI PASSANTI, IMBOCCO CORRETTO



FILETTATURA METRICA A PASSO GROSSO (MA) - GAMBO RINFORZATO - VAPORIZZATI

DIN 371/B **HSS**

Codice	Misure	€
M001/03V	M3 x 0,50	7,60
M001/04V	M4 x 0,70	7,60
M001/05V	M5 x 0,80	8,50
M001/06V	M6 x 1	9,20
M001/08V	M8 x 1,25	11,60
M001/10V	M10 x 1,5	14,50



MASCHI A MACCHINA PER FORI PASSANTI, IMBOCCO CORRETTO



FILETTATURA METRICA A PASSO GROSSO (MA) - GAMBO RINFORZATO

DIN 371/B **HSS**

Codice	Misure	€
M001/3	M3 x 0,50	6,10
M001/4	M4 x 0,70	6,10
M001/5	M5 x 0,80	7,50
M001/6	M6 x 1	8,00
M001/8	M8 x 1,25	9,70
M001/10	M10 x 1,5	12,40



MASCHI A MACCHINA PER FORI PASSANTI IMBOCCO CORRETTO



FILETTATURA METRICA A PASSO GROSSO (MA) - VAPORIZZATI

DIN 376/B **HSS**

Codice	Misure	€
M002/12V	M12 x 1,75	15,20
M002/14V	M14 x 2	19,90
M002/16V	M16 x 2	22,70
M002/18V	M18 x 2,5	32,20
M002/20V	M20 x 2,5	40,60



MASCHI A MACCHINA PER FORI PASSANTI IMBOCCO CORRETTO



FILETTATURA METRICA A PASSO GROSSO (MA)

DIN 376/B **HSS**

Codice	Misure	€
M002/12	M12 x 1,75	13,50
M002/14	M14 x 2	17,40
M002/16	M16 x 2	19,40
M002/18	M18 x 2,5	30,00
M002/20	M20 x 2,5	35,80
M002/22	M22 x 2,5	50,00
M002/24	M24 x 3	55,00
M002/27	M27 x 3	76,80
M002/30	M30 x 3,5	89,10

MASCHI A MACCHINA PER FORI CIECHI A FORTE TORSIONE 35°

FILETTATURA METRICA A PASSO GROSSO (MA) -
VAPORIZZATI - GAMBO RINFORZATO

DIN 371/C  **HSS**

Codice	Misure	€
M003/03V	M3 x 0,50	7,60
M003/04V	M4 x 0,70	7,60
M003/05V	M5 x 0,80	9,10
M003/06V	M6 x 1	10,30
M003/08V	M8 x 1,25	11,90
M003/10V	M10 x 1,5	14,90

MASCHI A MACCHINA PER FORI CIECHI A FORTE TORSIONE 35°

FILETTATURA METRICA A PASSO GROSSO (MA) - GAMBO
RINFORZATO

DIN 371/C  **HSS**

Codice	Misure	€
M003/3	M3 x 0,50	6,10
M003/4	M4 x 0,70	6,10
M003/5	M5 x 0,80	6,80
M003/6	M6 x 1	8,40
M003/8	M8 x 1,25	10,30
M003/10	M10 x 1,5	12,70

MASCHI A MACCHINA PER FORI CIECHI A FORTE TORSIONE 35°

FILETTATURA METRICA A PASSO GROSSO (MA) -
VAPORIZZATI

DIN 376/C  **HSS**

Codice	Misure	€
M003/12V	M12 x 1,75	17,70
M003/14V	M14 x 2	19,90
M003/16V	M16 x 2	23,80
M003/18V	M18 x 2,5	32,20
M003/20V	M20 x 2,5	40,60

MASCHI A MACCHINA PER FORI CIECHI A FORTE TORSIONE 35°

FILETTATURA METRICA A PASSO GROSSO (MA)

DIN 376/C  **HSS**

Codice	Misure	€
M003/12	M12 x 1,75	13,90
M003/14	M14 x 2	17,70
M003/16	M16x2	20,20
M003/18	M18 x 2,5	33,00
M003/20	M20 x 2,5	36,20
M003/22	M22 x 2,5	50,00
M003/24	M24 x 3	54,80
M003/27	M27 x 3	76,80
M003/30	M30 x 3,5	89,10



GIRAMASCHI REGOLABILI



DIN 1814

Codice	Maschio	Quadro	€
G002/1	M1 ÷ M10	1,75 ÷ 5,5	6,80
G002/2	M4 ÷ M12	2,4 ÷ 8 mm	10,00
G002/3	M5 ÷ M20	2,7 ÷ 12	13,90



GIRAMASCHI A CRICCHETTO



Codice	Maschio	Quadro	Imballo	€
G003/1	M3 ÷ M 8	1,75 ÷ 5,5	100	12,40
G003/2	M5 ÷ M 12	4 ÷ 8	100	15,20



Art. 0890

UTENSILI 3 IN 1, PUNTA-MASCHIO-SVASATORE E SERIE INSERTI

€ 55,50



HSS

Maschi 6 Pz	M3 x 0,5 - M4 x 0,7 - M5 x 0,8 - M6 x 1 - M8 x 1,25 - M10 x 1,5
Attacco	1/4"
Phillips	1 - 2
Pozi-driv	1 - 2
Taglio	4 - 5 mm
Imballo	50

CON PORTAINSERI A CAMBIO RAPIDO



UTENSILE 3 IN 1, PUNTA - MASCHIO - SVASATORE



HSS

Codice	Maschio	Attacco	Dimensione	€
0890/M3	M3 x 0,5	1/4"	52 mm	6,90
0890/M4	M4 x 0,7	1/4"	52 mm	6,90
0890/M5	M5 x 0,8	1/4"	54 mm	8,00
0890/M6	M6 x 1	1/4"	56 mm	8,00
0890/M8	M8 x 1,25	1/4"	58 mm	9,20
0890/M10	M10 x 1,5	1/4"	60 mm	11,20

CON ATTACCO ESAGONALE DA 1/4"



GIRAFILIERA

DIN 225

Codice	Dimensioni filiera	Per filiere	€
G001/20	20 x 7 mm	M4.5 ÷ M6	6,80
G001/25	25 x 9 mm	M7 ÷ M9	6,80
G001/30	30 x 11 mm	M10 ÷ M11	8,30
G001/38	38 x 14 mm	M12 ÷ M14	12,70
G001/45	45 x 18 mm	M16 ÷ M20	14,50
G001/55	55 x 22 mm	M22 ÷ M24	15,70



FILIERA METRICA PER PASSO MA

DIN 223

HSS

Codice	Passo	Dimensioni	€
F121/03	3 x 0,5 mm	20 x 5 mm	8,30
F121/04	4 x 0,7 mm	20 x 5 mm	8,30
F121/05	5 x 0,8 mm	20 x 7 mm	9,50
F121/06	6 x 1 mm	20 x 7 mm	11,00
F121/08	8 x 1,25 mm	25 x 9 mm	11,00
F121/10	10 x 1,5 mm	30 x 11 mm	12,50
F121/12	12 x 1,75 mm	38 x 14 mm	14,50
F121/14	14 x 2 mm	38 x 14 mm	20,40
F121/16	16 x 2 mm	45 x 18 mm	24,00
F121/18	18 x 2,5 mm	45 x 18 mm	27,90
F121/20	20 x 2,5 mm	45 x 18 mm	29,50



FILIERA PER FILETTATURA GAS CILINDRICA

DIN 5158/B

HSS

Codice	Passo	Dimensioni	€
F122/1/1/4	G1.1/4-11	75 x 20 mm	0,00
F122/1/1/8	G1.1/8-11	75 x 20 mm	0,00
F122/1/8	G1/8-28	30 x 11 mm	10,90
F122/1/4	G1/4-19	38 x 10 mm	18,90
F122/3/8	G3/8-19	45 x 14 mm	23,50
F122/1/2	G1/2-14	45 x 14 mm	25,20
F122/5/8	G5/8-14	55 x 16 mm	45,20
F122/3/4	G3/4-14	55 x 16 mm	49,60
F122/7/8	G7/8-14	65 x 18 mm	55,00
F122/1	G1-11	65 x 18 mm	55,50

Art. E010
KIT RIPARAZIONE FILETTI M5 - M12 INOX
€ 142,00

COMPOSIZIONE

130 Pz HSS & INOX

Peso	2,5 kg
Imballo	5
Manici a "T"	5 Pz
Cacciaspine	5 Pz

Filetto	Quantità Pz	Maschi	Quantità Pz	Punte mm	Quantità Pz
M5	25	x M5	1	5,2	1
M6	25	x M6	1	6,3	1
M8	25	x M8	1	8,3	1
M10	25	x M10	1	10,4	1
M12	10	x M12	1	12,4	1

KIT RIPARAZIONE FILETTI INOX

HSS & INOX

Codice	Filetto inserto	Punta	Maschio	Manico	Imballo	€
E010/M05	M5	5,2 mm	x M5	2	25	31,20
E010/M06	M6	6,3 mm	x M6	2	25	33,80
E010/M08	M8	8,3 mm	x M8	2	25	37,30
E010/M10	M10	10,4 mm	x M10	2	25	45,00
E010/M12	M12	12,4 mm	x M12	2	20	47,60
E010/M14	M14 x 1,25	14,4 mm	x M14 x 1,25	2	25	57,00

SET FILETTI INOX DI RICAMBIO

INOX

Codice	Filetto inserto	Altezza	Quantità a set Pz	Imballo	€
E010/M05E	M5	4 mm	25	5* / 200	8,90
E010/M06E	M6	5 mm	25	5* / 250	8,90
E010/M08E	M8	7 mm	25	5* / 150	10,10
E010/M10E	M10	9 mm	25	5* / 100	11,40
E010/M12E	M12	11 mm	10	5* / 50	8,50
E010/M14E	M14 x 1,25	16,4 mm	10	5* / 100	8,50

Art. S002
 SBAVATORE ESTENSIBILE CON 3 LAME

€ 14,60

HSS

Lama	ø 3,2 mm
Imballo	5* / 200

CON UNA LAMA PER TIPO E100, E200, E300 DI ø 3,2 mm, MANICO IN PLASTICA

Art. 0420
 SBAVATORE CON 1 LAMA

€ 6,90

HSS

Lunghezza	120 mm
Diametro massimo manico	9,2 mm
Lama	ø 3,2 mm
Materiale lama	HSS
Imballo	200

CON UNA LAMA DI TIPO E100, DI DIAMETRO ø 3,2 mm, MANICO IN PLASTICA

Art. 0411
 SBAVATORE CON 1 LAMA

€ 13,50

HSS

Lunghezza	124 mm
Diametro massimo manico	29 mm
Lama	ø 3,2 mm
Materiale lama	HSS
Imballo	100

CON UNA LAMA DI TIPO E100, DI ø 3,2 mm, MANICO IN PLASTICA E TPR

Art. 0415
 SBAVATORE CON 2 LAME

€ 9,20

HSS

Lunghezza	125 mm
Diametro massimo manico	22 mm
Lama	ø 3,2 mm
Materiale lama	HSS
Imballo	100

CON DUE LAME DI TIPO E100 E E200, DI ø 3,2 mm, MANICO IN PLASTICA



Art. S002/E100 € 14,50
 SERIE LAME IN HSS
 CON GAMBO LUNGO



10 Pz HSS

Imballo 100

PER SBAVATURA INTERNA ED ESTERNA DI MATERIALI A TRUCIOLO LUNGO COME ACCIAIO, ALLUMINIO, MATERIE PLASTICHE



Art. S002/E200 € 13,50
 SERIE LAME IN
 HSS BIDIREZIONALI



10 Pz HSS

Imballo 25

CON GAMBO LUNGO PER SBAVATURA INTERNA ED ESTERNA DI MATERIALI A TRUCIOLO CORTO COME OTTONE E GHISA



Art. S002/E300 € 14,50
 SERIE LAME IN
 HSS BIDIREZIONALI



10 Pz HSS

Imballo 100

CON GAMBO LUNGO PER SBAVATURA INTERNA ED ESTERNA DI FORI FINO A 4 mm DI SPESSORE



Art. S005 € 13,70
 SBAVATORE DOPPIO
 CON DISCHI IN HSS



HSS

Imballo 50

PER SBAVARE LAMIERE D'ACCIAIO, ALLUMINIO, OTTONE, RAME E PLASTICA MAX 10 mm



Art. S005/R € 15,20
 SERIE ROTELLINE



4 Pz HSS

Scatola Imballo 10



Art. 0384 € 6,20
 SBAVATORE INTERNO
 ED ESTERNO PER TUBI



Capacità 3 ÷ 32 mm 3/16" ÷ 1-1/2"
 Imballo 10* / 100

PER TUBI IN PLASTICA, RAME E METALLI FERROSI



Art. 0251 € 2,06
 SPAZZOLA ABRASIVA IN ACCIAIO ONDULATO OTTONATO



Lunghezza 240 mm
 Scatola
 Imballo 12* / 120



Art. 0331
SET SPAZZOLE PER L'OFFICINA E L'AUTORIPARATORE

€ 32,80



Misure	Ø 9 - 11 - 13 - 15 - 17 - 19 mm
Materiale Nylon - Acciaio - Ottone	
Scatola	
Imballo	20

CON PROLUNGA E MANICO IN PLASTICA



Art. S161
SPAZZOLA IN ACCIAIO

€ 12,00



Dimensioni	Ø 150 x 20 x 16 - 12,7 mm
Imballo	50



Art. S162
SPAZZOLA IN ACCIAIO

€ 19,50



Dimensioni	Ø 200 x 25 x 20 mm
Imballo	20



PUNTI METALLICI



80

5000 Pz

Codice	Serie	Misura	€
0587/8006	80	12,9 x 6h mm	6,90
0587/8008	80	12,9 x 8h mm	8,00
0587/8010	80	12,9 x 10h mm	8,70
0587/8012	80	12,9 x 12h mm	9,60
0587/8014	80	12,9 x 14h mm	10,30
0587/8016	80	12,9 x 16h mm	11,20



PUNTI METALLICI

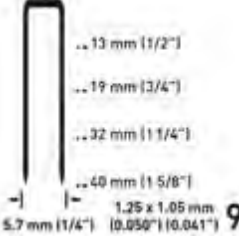

90

2500 Pz

Codice	Serie	Misura	€
0585/9013	90	5,7 x 13h mm	7,10
0585/9019	90	5,7 x 19h mm	9,90
0585/9032	90	5,7 x 32h mm	12,60
0585/9040	90	5,7 x 40h mm	13,50



CHIODI METALLICI

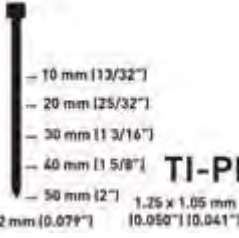

TI-PIN

5000 Pz

Codice	Serie	Misura	€
0584/F10	TI-PIN	1,25 x 10h mm	6,90
0584/F20	TI-PIN	1,25 x 20h mm	10,30
0584/F30	TI-PIN	1,25 x 30h mm	12,40
0584/F40	TI-PIN	1,25 x 40h mm	15,20
0584/F50	TI-PIN	1,25 x 50h mm	15,70



SPILLI

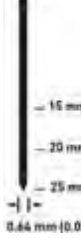

22

10000 Pz

Codice	Serie	Misura	€
0588/615	0,60	0,63 x 15h mm	7,50
0588/620	0,60	0,63 x 20h mm	9,40
0588/625	0,60	0,63 x 25h mm	11,00



Art. 0150

CHIODI



500 Pz

€ 2,88

Testa	1,7 x 1,33 mm
Sezione	1 x 1,33 mm
Blister	
Imballo	10* / 160



Art. 0151

GRAFFE



500 Pz

€ 3,02

Sezione	0,58 x 1,2 mm
Blister	
Imballo	10* / 100

Art. 0295 € 10,90
ASSORTIMENTO RIVETTI

225 Pz

 Scatola di plastica
 Imballo

10* / 40

Art. 0178 € 10,50
ASSORTIMENTO RONDELLE

720 Pz

 Scatola di plastica
 Imballo

10* / 40

Art. 0229 € 15,70
**ASSORTIMENTO RONDELLE
 IN RAME**

110 Pz

 Scatola di plastica
 Imballo

4* / 24

Art. 0294 € 11,20
**ASSORTIMENTO
 COPPIGLIE**

555 Pz

 Scatola di plastica
 Imballo

6* / 24

Art. 0298 € 10,30
**ASSORTIMENTO COPPIGLIE DI
 SICUREZZA**

150 Pz

 Scatola di plastica
 Imballo

6* / 24

Art. 0231 € 11,30
ASSORTIMENTO SPINE ELASTICHE

120 Pz

 Scatola di plastica
 Imballo

4* / 24

**Art. 0296****ASSORTIMENTO ANELLI
ELASTICI PER ESTERNI****€ 11,20** **300 Pz**Scatola di plastica
Imballo

6* / 24

**Art. 0179****ASSORTIMENTO ANELLI
ELASTICI****€ 10,30** **100 Pz**Scatola di plastica
Imballo

6* / 24

**Art. 0263****ASSORTIMENTO CHIAVETTE
A DISCO****€ 13,50** **80 Pz**Scatola di plastica
Imballo

4* / 24

**Art. 0257****ASSORTIMENTO CHIAVETTE
PARALLELE****€ 13,50** **60 Pz**Scatola di plastica
Imballo

4* / 24

**Art. 0116****ASSORTIMENTO SFERE
D'ACCIAIO CROMATE METRICHE****€ 11,20** **450 Pz**Scatola di plastica
Imballo

4* / 24

**Art. 0116P****ASSORTIMENTO SFERE
D'ACCIAIO CROMATE IN POLLICI****€ 13,90** **430 Pz**Scatola di plastica
Imballo

6* / 24



Art. 0180 € 11,20
ASSORTIMENTO MOLLE

200 Pz

Scatola di plastica
Imballo

6* / 24

ASSORTIMENTO OR

419 Pz

Codice	Tipologia	Imballo	€
0299	Metrici	20	21,30
0299/P	Pollici	20	21,30

Art. 0177 € 10,90
ASSORTIMENTO OR

225 Pz

Scatola di plastica
Imballo

5* / 40

Art. 0828 € 2,64
SERIE FASCETTE

6 Pz

Dimensione Ø 6 ÷ 45 mm

Blister
Imballo

10* / 100

Art. 0261 € 9,30
SERIE FASCETTE

20 Pz

Dimensione

 10 x 0,8 x 12-22 mm ; 12,8 x 0,9 x
 25-40 mm; 12,8 x 0,9 x 35-50 mm;
 12,8 x 0,9 x 50-70 mm

Scatola di plastica
Imballo

4* / 24

Art. 0876 € 12,40
ASSORTIMENTO FASCETTE

650 Pz

300 Pz 2,5 x 100 mm

200 Pz 3,6 x 150 mm

100 Pz 3,6 x 150 mm

Peso 450 g

Imballo 5* / 40



Art. 0293 € 14,60
ASSORTIMENTO CAPICORDA



200 Pz

Scatola di plastica
Imballo 10* / 40



Art. 0877 € 11,40
ASSORTIMENTO TERMINALI



400 Pz

Terminale Bianco	50 x 0,5 mm ²
Terminale Grigio	100 x 0,75 mm ²
Terminale Rosso	100 x 1 mm ²
Terminale Nero	100 x 1,5 mm ²
Terminale Blu	50 x 2,5 mm ²
Peso	80 g
Imballo	5* / 125



Art. 0380 € 10,30
ASSORTIMENTO GUAINE
TERMORESTRINGENTI



127 Pz

Scatola di plastica
Imballo 6* / 12 / 48



Art. 0176 € 32,20
ASSORTIMENTO INGRASSATORI



110 Pz

Scatola di plastica
Imballo 2* / 20



Art. SR44W € 5,60
BATTERIE PER STRUMENTI
DIGITALI



Voltaggio 1,5 V
Imballo 10* / 20



BATTERIE PER STRUMENTI
DIGITALI



Codice	Voltaggio	Imballo	€
CR2025	3 V	10* / 20	7,70
CR2032	3 V	10* / 20	7,70



Art. 0677/500
INGRASSATORE MANUALE A LEVA 500 cc
€ 17,00

Capacità	500 cc
Dimensioni tubo flessibile	ø 8 x 300 mm
Pressione di esercizio	6000-8000 psi
Peso	1,3 kg
Scatola	

INGRASSATORE MANUALE A LEVA 500 cc, COMPOSTO DA SERBATOIO E POMPA IN METALLO, TESTINA REGOLABILE E TUBO FLESSIBILE IN PVC DI 300 mm, PER UTILIZZO CON GRASSO SFUSO O CARTUCCE DI GRASSO DI DIAMETRO ø 53mm

Art. 0677
INGRASSATORE MANUALE
€ 38,90

Capacità	1000 cc
Dimensioni tubo flessibile	ø 9 x 450 mm
Peso	2 kg
Scatola	

INGRASSATORE MANUALE COMPOSTO DA SERBATOIO E POMPA IN METALLO, TESTINA REGOLABILE E TUBO FLESSIBILE IN PVC DI 450 mm, PER UTILIZZO CARTUCCE DI GRASSO DI Ø 55 mm O GRASSO SFUSO POSSIBILITÀ SOSTITUZIONE OR DEL POMPANTE

Art. 0677/IA
INGRASSATORE PNEUMATICO
€ 241,00

Capacità	800 cc
Dimensioni	ø 60 x 500 mm
Pressione di esercizio	4 - 6 bar
Scatola	

INGRASSATORE PNEUMATICO - UTILIZZO CON CARTUCCIA Ø 55 mm O GRASSO SFUSO - CON 2 CARTUCCE DI GRASSO, TUBO RINFORZATO DI 400 mm E TESTINA REGOLABILE A 4 GRIFFE

Art. 0677/CG **€ 10,10**
CARTUCCIA DI GRASSO

Capacità	650 cc
Dimensioni	ø 55 mm
Imballo	12*
Scatola	

Art. 0677/SO **€ 25,20**
SIRINGA IN ALLUMINIO E MOPLEN PER OLIO

Capacità	500 g
Dimensioni	ø 50 x 500 mm
Imballo	12
Scatola	



Art. S401/01
ZINCO CHIARO

€ 8,30



Capacità	400 ml
Imballo	12*
Scatola	

ZINCANTE A FREDDO AD ALTO PESO MOLECOLARE VERNICIABILE



Art. S401/02
GRASSO MULTIUSO

€ 7,50



Capacità	400 ml
Imballo	12*
Scatola	

COMPOSTO A BASE DI GRASSI SAPONIFICATI DI ALTA QUALITÀ



Art. S401/03
SBLOCCANTE E SOLVENTE

€ 6,50



Capacità	400 ml
Imballo	12*
Scatola	

FLUIDO SINTETICO PENETRANTE AD ALTO POTERE SOLVENTE E SBLOCCANTE



Art. S401/04
SILICONE LUBRIFICANTE

€ 7,30



Capacità	400 ml
Imballo	12*
Scatola	

SOLUZIONE A BASE DI PURO OLIO DI SILICONE CON PROPRIETÀ ANTIADESIVE DISTACCANTI E LUBRIFICANTI SUI PIÙ SVARIATI MATERIALI



Art. S401/05
ANTIADESIVO PER SALDATURE

€ 7,20



Capacità	400 ml
Imballo	12*
Scatola	

PRODOTTO A BASE DI POLIMERI SINTETICI FILMOGENI, CHE IMPEDISCONO IL GRIPPAGGIO DELLE GOCCE DI SALDATURA SU QUALSIASI SUPPORTO



Art. S401/06
INOX SPRAY

€ 12,00



Capacità	400 ml
Imballo	12*
Scatola	

RIVESTIMENTO PROTETTIVO A BASE DI PURO ACCIAIO INOX





Art. S401/08 € 12,70
LUBRIFICANTE SECCO AL PTFE
(TEFLON)



Capacità	400 ml
Imballo	12*
Scatola	

LUBRIFICANTE ANTIADESIVO
IDROREPELENTE ASCIUTTO



Art. S401/09 € 9,10
GRASSO AL RAME



Capacità	400 ml
Imballo	12*
Scatola	

ANTIGRIPPANTE RESISTENTE AD
ALTISSEME TEMPERATURE



Art. S401/10 € 8,40
OLIO DA TAGLIO



Capacità	400 ml
Imballo	12*
Scatola	

MISCELA DI OLI MINERALI AD
ALTO POTERE LUBRIFICANTE
SPECIFICI PER ESSERE USATI
NELLA FORATURA, FILETTATURA,
FRESATURA E TAGLIO DI ACCIAI
INOSSIDABILI ED ALTRI METALLI



Art. S401/11 € 6,40
ARIA SPRAY



Capacità	400 ml
Imballo	12*
Scatola	

INDICATO PER LA PULIZIA DI
LENTI, OBIETTIVI, COMPUTER,
OROLOGERIA E MECCANICA IN
GENERE



Art. S401/12 € 7,00
DISSODIANTE PER CONTATTI
ELETTRICI ED ELETTRONICI



Capacità	400 ml
Imballo	12*
Scatola	

PRODOTTO SPECIFICO PER
PROTEGGERE I CIRCUITI ELETTRICI
DALLA FORMAZIONE DI OSSIDI



Art. S401/13 € 7,80
OLIO DI VASELINA



Capacità	400 ml
Imballo	12*
Scatola	

OLIO DI VASELLINA AD ALTO
GRADO DI PUREZZA





**CALIBRI, TRUSCHINI E GONIOMETRI****pag 298****COMPARATORI, SPESSIMETRI, ALESAMETRI,
AZZERATORI E CENTRATORI****pag 306****MICROMETRI****pag 314****BLOCCHETTI, ANELLI E TAMPONI****pag 318****ACCESSORI PER LA MISURAZIONE****pag 322****FLESSOMETRI E LIVELLE****pag 333****VIDEO RILEVAZIONI E MICROSCOPI****pag 338****MISURATORI ANALOGICI E DIGITALI****pag 340****BILANCE****pag 355**

Art. C031/150
CALIBRO ELETTRONICO DIGITALE INOX
€ 175,00

IP 67 **DIN 862**

Utile	0 ÷ 150 mm - 0 ÷ 6 inch
Lettura	0,01 mm - 0.0005 inch
Becchi	40 mm
Asta	16 x 3 mm
Imballo	50

CALIBRO ELETTRONICO DIGITALE INOX, IP67, DIN 862, A 2 FUNZIONI CON SCHERMO GRANDE

CALIBRO ELETTRONICO DIGITALE INOX

DIN 862

Codice	Utile	Lettura	Asta	Becchi	Imballo	€
C033/150	0 ÷ 150 mm - 0 ÷ 6 inch	0,01 mm - 0.0005 inch	16 x 3,2 mm	40 mm	50	60,50
C033/200	0 ÷ 200 mm - 0 ÷ 8 inch	0,01 mm - 0.0005 inch	16 x 3,2 mm	50 mm	50	88,00
C033/300	0 ÷ 300 mm - 0 ÷ 12 inch	0,01 mm - 0.0005 inch	16 x 3,2 mm	60 mm	20	131,00

CALIBRO ELETTRONICO DIGITALE, COSTRUITO IN ACCIAIO INOX, DIN 862, A 3 FUNZIONI CON SCHERMO GRANDE

CALIBRO ELETTRONICO DIGITALE MONOBLOCCO INOX

Codice	Utile	Lettura	Becchi	Asta	Imballo	€
C041/100	0 ÷ 100 mm - 0 ÷ 4 inch	0,01 mm - 0.0005 inch	30 mm	13 x 3 mm	50	36,70
C041/150	0 ÷ 150 mm - 0 ÷ 6 inch	0,01 mm - 0.0005 inch	40 mm	16 x 3 mm	50	36,70
C041/200	0 ÷ 200 mm - 0 ÷ 8 inch	0,01 mm - 0.0005 inch	50 mm	16 x 3 mm	50	0,00
C041/300	0 ÷ 300 mm - 0 ÷ 12 inch	0,01 mm - 0.0005 inch	60 mm	20 x 4 mm	5 / 25	0,00

CALIBRO ELETTRONICO DIGITALE MONOBLOCCO INOX A 3 FUNZIONI CON SCHERMO GRANDE



CALIBRO ELETTRONICO DIGITALE INOX



DIN 862

Codice	Utile	Lettura	Becchi	Asta	Imballo	€
C043/500	0 ÷ 500 mm - 0 ÷ 20 inch	0,01 mm - 0,0005 inch	100 mm	25 x 6 mm	10	321,00
C043/1000	0 ÷ 1000 mm - 0 ÷ 40 inch	0,01 mm - 0,0005 inch	150 mm	30 x 8 mm	5	644,00

CALIBRO ELETTRONICO DIGITALE INOX, A 4 FUNZIONI CON SCHERMO GRANDE, REGOLAZIONE MICROMETRICA, DIN 862



Art. C047/500
CALIBRO ELETTRONICO DIGITALE INOX

€ 424,00



DIN 862

Utile	0 ÷ 500 mm - 0 ÷ 20 inch
Lettura	0,01 mm - 0.0005 inch
Becchi	150 mm
Asta	24 x 5,5 mm
Imballo	10

CALIBRO ELETTRONICO DIGITALE INOX, A 4 FUNZIONI CON SCHERMO GRANDE, REGOLAZIONE MICROMETRICA E BECCHI LUNGI, DIN 862



Art. C005/150
CALIBRO CON COMPARATORE INOX

€ 53,30



DIN 862

Utile	0 ÷ 150 mm
Lettura	0,01 mm
Becchi	40 mm
Asta	15,5 x 3 mm
Imballo	50

CALIBRO CON COMPARATORE INOX

DIN 862

Codice	Utile	Lettura	Becchi	Asta	Imballo	€
C006/150	0 ÷ 150 mm	0,02 mm	40 mm	16 x 3 mm	50	47,60
C006/200	0 ÷ 200 mm	0,02 mm	50 mm	16 x 3 mm	50	72,60
C006/300	0 ÷ 300 mm	0,02 mm	60 mm	20 x 4 mm	25	118,00

CALIBRO MONOBLOCCO INOX CROMATO OPACO

DIN 862

Codice	Utile	Lettura	Becchi	Asta	Imballo	€
C018/150	0 ÷ 150 mm - 0 ÷ 6 inch	1/20 0,05 mm - 1/128 inch	40 mm	16 x 3 mm	50	38,90
C018/200	0 ÷ 200 mm - 0 ÷ 8 inch	1/50 0,02 mm - 1/1000 inch	50 mm	16 x 3 mm	30	60,50

Art. C057/150
CALIBRO SATINATO
€ 22,40

DIN 862

Utile	0 ÷ 150 mm - 0 ÷ 6 inch
Lettura	1/20 0,05 mm - 1/128 inch
Becchi	40 mm
Asta	16 x 3 mm
Imballo	50



CALIBRO MONOBLOCCO INOX CROMATO OPACO



DIN 862

Codice	Utile	Lettura	Becchi	Asta	Imballo	€
C011/150	0 ÷ 150 mm - 0 ÷ 6 inch	1/50 0,02 mm - 1/1000 inch	40 mm	16 x 3 mm	100	39,10
C011/200	0 ÷ 200 mm - 0 ÷ 8 inch	1/50 0,02 mm - 1/1000 inch	50 mm	16 x 3 mm	40	64,80



Art. C019/150
CALIBRO SATINATO

€ 16,30



DIN 862

Utile	0 ÷ 150 mm - 0 ÷ 6 inch
Lettura	1/20 0,05 mm - 1/128 inch
Becchi	40 mm
Asta	14,5 x 3 mm
Imballo	10 / 100



Art. C056/200
CALIBRO SATINATO

€ 31,10



DIN 862

Utile	0 ÷ 200 mm - 0 ÷ 8 inch
Lettura	1/50 0,02 mm - 1/1000 inch
Becchi	50 mm
Asta	16,5 x 3,5 mm
Imballo	50



Art. C049/300
CALIBRO SATINATO
€ 60,50

DIN 862

Utile	0 ÷ 300 mm
Lettura	1/50 - 0,02 mm
Becchi	60 mm
Asta	18,5 x 4 mm
Imballo	5 / 25

CALIBRO SATINATO, REGISTRAZIONE MICROMETRICA, DIN 862

CALIBRO MONOBLOCCO SATINATO INOX

DIN 862

Codice	Utile	Lettura	Becchi	Asta	Imballo	€
C021/300	0 ÷ 300 mm - 0 ÷ 12 inch	1/50 0,02 mm - 1/128 inch	100 mm	23 x 6 mm	25	169,00
C021/500	0 ÷ 500 mm - 0 ÷ 20 inch	1/50 0,02 mm - 1/128 inch	150 mm	23 x 6 mm	10	233,00
C021/1000	0 ÷ 1000 mm - 0 ÷ 40 inch	1/50 0,02 mm - 1/128 inch	150 mm	32 x 10 mm	5	520,00

CALIBRO MONOBLOCCO SATINATO INOX, REGISTRAZIONE MICROMETRICA, DIN 862

CALIBRO SATINATO

DIN 862

Codice	Utile	Lettura	Becchi	Asta	Imballo	€
C020/500	0 ÷ 500 mm	1/50 0,02 mm	100 mm	23 x 6 mm	10	159,00
C020/1000	0 ÷ 1000 mm	1/50 0,02 mm	150 mm	30 x 10 mm	5	391,00
C020/1500	0 ÷ 1500 mm	1/50 0,02 mm	225 mm	49 x 14 mm	2	1100,00
C020/2000	0 ÷ 2000 mm	1/50 0,02 mm	250 mm	50 x 15 mm	2	1770,00

CALIBRO SATINATO, REGISTRAZIONE MICROMETRICA, DIN 862



CALIBRO ELETTRONICO DIGITALE INOX DI PROFONDITÀ



DIN 862

Codice	Utile	Letture	Base	Asta	Imballo	€
C044/200	0 ÷ 200 mm - 0 ÷ 8 inch	0,01 mm - 0.0005 inch	100 mm	13 x 3,5 mm	50	92,40
C044/300	0 ÷ 300 mm - 0 ÷ 12 inch	0,01 mm - 0.0005 inch	150 mm	15 x 4 mm	10	159,00

CALIBRO ELETTRONICO DIGITALE INOX DI PROFONDITÀ A 3 FUNZIONI CON SCHERMO GRANDE, DIN 862



CALIBRO DI PROFONDITÀ SATINATO



DIN 862

Codice	Utile	Letture	Base	Asta	Imballo	€
C007/200	0 ÷ 200 mm	1/50 0,02 mm	100 mm	11 x 4,5 mm	20	40,00
C007/300	0 ÷ 300 mm	1/50 0,02 mm	150 mm	12 x 4 mm	12	55,00



Art. C010/200

CALIBRO PER TRACCIATURA MONOBLOCCO SATINATO

€ 57,80



Utile	0 ÷ 200 mm - 0 ÷ 8 inch
Letture	1/10 0,1 mm - 1/128 inch
Becchi	10 mm
Asta	16 x 3 mm



Art. C010/200P

SET 2 PUNTE PER CALIBRO C010/200

€ 7,80



TRUSCHINO DIGITALE MULTIFUNZIONE

DIN 862

Codice	Campo di misura	Lettura	Precisione	Peso	Imballo	€
T092/300	0÷300 mm - 0÷12"	0,01 mm - 0.005"	0,03 mm - 0.015"	4 kg	1	537,00
T092/600	0÷600 mm - 0÷24"	0,01 mm - 0.005"	0,15 mm - 0.025"	14 kg	2	893,00

TRUSCHINO DIGITALE A 4 FUNZIONI CON SCHERMO GRANDE, DIN 862, CON PUNTA A TRACCIARE

Art. T092/P
PUNTA A TRACCIARE

€ 37,30

TRUSCHINO IN ACCIAIO CROMATO OPACO

DIN 862

Codice	Campo di misura	Lettura	Peso	Imballo	€
T100/300	0 ÷ 300 mm	0,02 mm	3 kg	5	109,00
T100/500	0 ÷ 500 mm	0,02 mm	6 kg	2	216,00

TRUSCHINO IN ACCIAIO CROMATO OPACO, DIN 862, CON PUNTA A TRACCIARE

PUNTA A TRACCIARE

Codice	€
T100/300P	29,70
T100/500P	34,20



RIGA CON DISPLAY DIGITALE MULTIFUNZIONE



Codice	Lunghezza totale	Utile	Letture	€
R060	720 mm - 28.3" inch	620 mm - 24.5" inch	0,01 mm - 0.001" inch	88,00
R100	1000 mm - 40" inch	900 mm - 35" inch	0,01 mm - 0.001" inch	115,00

RIGA CON DISPLAY DIGITALE MULTIFUNZIONE
 LA RIGA PUÒ ESSERE TAGLIATA PER UTILIZZARE LA LUNGHEZZA DESIDERATA
 FUNZIONI: ON / OFF - mm / inch - ZERO - ABS / INC - AUTOSPEGNIMENTO



Art. G008
GONIOMETRO DIGITALE E LIVELLA CON 2 FIALE

€ 50,00



Lunghezza	400 mm
Scala	0 ÷ 225°
Letture	0,1°
Accuratezza	± 0,5°
Batteria	9 V - 6F22

GONIOMETRO DIGITALE E LIVELLA CON 2 FIALE. CALCOLO AUTOMATICO DI ANGOLI E INCLINAZIONI



GONIOMETRO SEMPLICE



Codice	Arco	Asta	€
G006/120	120 mm	150 mm	29,50
G006/150	150 mm	200 mm	40,00
G006/200	200 mm	300 mm	50,00



Art. G005
GONIOMETRO UNIVERSALE

€ 83,60



Letture	5'
Scala	0° ÷ 360°
Asta	300 mm
Astuccio di plastica	

Art. C064
COMPARATORE DIGITALE CENTESIMALE MULTIFUNZIONE
€ 115,00

 **DIN 878**

Campo di misura	0 ÷ 12,7 mm / 0 ÷ 0.5 inch
Risoluzione	0,01 mm / 0.005 inch
Precisione	0,02 mm / 0.002 inch
Diametro quadrante	60 mm

FUNZIONI PRINCIPALI: AZZERAMENTO IN OGNI POSIZIONE, CONVERSIONE mm / inch MEMORIA E RICERCA DEL VALORE MIN/MAX, SPEGNIMENTO AUTOMATICO, BATTERIA SR44W, DIN 878

Art. C060
COMPARATORE DIGITALE MILLESIMALE MULTIFUNZIONE
€ 222,00

 **DIN 878**

Campo di misura	0 ÷ 12,7 mm / 0 ÷ 0.5 inch
Risoluzione	0,001 mm / 0.0005 inch
Precisione	0,005 mm / 0.0025 inch
Diametro quadrante	60 mm

FUNZIONI PRINCIPALI: AZZERAMENTO IN OGNI POSIZIONE, CONVERSIONE mm / inch, MEMORIA E RICERCA DEL VALORE MIN-MAX, SPEGNIMENTO AUTOMATICO, ABS, BATTERIA CR2025, DIN 878

Art. C004
COMPARATORE MILLESIMALE
€ 87,40

 **DIN 878**

Diametro quadrante	60 mm
Campo di misura	0 ÷ 1 mm
Letture	0,001 mm
Precisione	0,002 mm

Art. C017
COMPARATORE CENTESIMALE ANTIURTO
€ 60,50

 **DIN 878**

Diametro quadrante	60 mm
Campo di misura	10 mm
Letture	0,01 mm
Precisione	0,015 mm

COMPARATORE CENTESIMALE ANTIURTO CON MOVIMENTO SU RUBINI E RESISTENTE AGLI SPRUZZI D'ACQUA, CON NASELLO, DIN 878



Art. C002
COMPARATORE CENTESIMALE

€ 52,50



DIN 878

Diametro quadrante	60 mm
Campo di misura	10 mm
Letture	0,01 mm
Precisione	0,015 mm



COMPARATORE CENTESIMALE



C023/N

DIN 878

Codice	Diametro quadrante	Campo di misura	Letture	Precisione	€
C023	60 mm	10 mm	0,01 mm	0,015 mm	33,30
C023/N	60 mm	10 mm	0,01 mm	0,015 mm	37,80



Art. C002/42
COMPARATORE CENTESIMALE

€ 41,10



DIN 878

Diametro quadrante	42 mm
Campo di misura	5 mm
Letture	0,01 mm
Precisione	0,015 mm



Art. C048
COMPARATORE CENTESIMALE

€ 80,30



DIN 878

Diametro quadrante	60 mm
Campo di misura	30 mm
Letture	0,01 mm
Precisione	0,015 mm

COMPARATORE CENTESIMALE CON NASELLO, DIN 878



Art. T003
 INDICATORE A TASTO CENTESIMALE

€ 101,00



 DIN 2270

Diametro quadrante	32 mm
Campo di misura	0,8 mm
Lettura	0,01 mm
Precisione	0,015 mm
Punta tastatrice	Ø 2 mm

Art. T007
 INDICATORE A TASTO CENTESIMALE

€ 102,00



 DIN 2270

Diametro quadrante	40 mm
Campo di misura	0,8 mm
Lettura	0,01 mm
Precisione	0,011 mm
Punta tastatrice	Ø 2 mm

Art. T006
 INDICATORE A TASTO CENTESIMALE CON TASTATORE LUNGO

€ 109,00



 DIN 2270

Diametro quadrante	40 mm
Campo di misura	0,8 mm
Lettura	0,01 mm
Precisione	0,011 mm
Punta tastatrice	Ø 2 mm
Lunghezza punta tastatrice	29 mm

Art. T005
 INDICATORE A TASTO BIMILLESIMALE

€ 120,00



 DIN 2270

Diametro quadrante	32 mm
Campo di misura	0,2 mm
Lettura	0,002 mm
Precisione	0,005 mm
Punta tastatrice	Ø 2 mm



Art. T011
INDICATORE A TASTO CENTESIMALE

€ 92,40



DIN 2270

Diametro quadrante	32 mm
Campo di misura	0,8 mm
Letture	0,01 mm
Precisione	0,011 mm
Punta tastatrice	Ø 2 mm

TABELLA DI COMPATIBILITÀ

Descrizione	€	C064	C060	C004	C017	C002	C023	C023/N	C002/42	C048	T003	T007	T006	T005	T011	M062	Pag
T009 SUPPORTO TASTATORE AD ARCO	33,30	•	•	•	•	•	•	•	•	•	•	•	•	•	•	•	322
S049 SUPPORTO MAGNETICO PORTA COMPARATORE	36,70	•	•	•	•	•	•	•	•	•	•	•	•	•	•	•	323
S047 SUPPORTO MAGNETICO PORTA COMPARATORE	68,80	•	•	•	•	•	•	•	•	•	•	•	•	•	•	•	324
S054 SUPPORTO MAGNETICO PORTA COMPARATORE	33,30	•	•	•	•	•	•	•	•	•	•	•	•	•	•	•	324
S055 SUPPORTO MAGNETICO PORTA COMPARATORE	64,90	•	•	•	•	•	•	•	•	•	•	•	•	•	•	•	324
S045 SUPPORTO ARTICOLATO MECCANICO	77,00	•	•	•	•	•	•	•	•	•	•	•	•	•	•	•	325
S046 SUPPORTO ARTICOLATO IDRAULICO	118,00	•	•	•	•	•	•	•	•	•	•	•	•	•	•	•	325
S041/1 MINI SUPPORTO MAGNETICO PORTA COMPARATORE	45,00	•	•	•	•	•	•	•	•	•	•	•	•	•	•	•	326
S041/2 MINI SUPPORTO MAGNETICO PORTA COMPARATORE	67,00	•	•	•	•	•	•	•	•	•	•	•	•	•	•	•	326
S042/1 SUPPORTO ARTICOLATO MECCANICO	60,00	•	•	•	•	•	•	•	•	•	•	•	•	•	•	•	324
S042/2 SUPPORTO ARTICOLATO MECCANICO	70,00	•	•	•	•	•	•	•	•	•	•	•	•	•	•	•	325
S042/3 SUPPORTO ARTICOLATO MECCANICO	90,00	•	•	•	•	•	•	•	•	•	•	•	•	•	•	•	325
S052/2 SUPPORTO MAGNETICO PORTA COMPARATORE	30,00	•	•	•	•	•	•	•	•	•	•	•	•	•	•	•	323
S052/3 SUPPORTO MAGNETICO PORTA COMPARATORE	52,00	•	•	•	•	•	•	•	•	•	•	•	•	•	•	•	323
S052/4 SUPPORTO MAGNETICO PORTA COMPARATORE	77,00	•	•	•	•	•	•	•	•	•	•	•	•	•	•	•	323
B025 STATIVO PORTA COMPARATORE	210,00	•	•	•	•	•	•	•	•	•	•	•	•	•	•	•	326
B010 STATIVO PORTA COMPARATORE	281,00	•	•	•	•	•	•	•	•	•	•	•	•	•	•	•	326
SR44W BATTERIE PER STRUMENTI DIGITALI	5,60	•														•	291
CR2025 BATTERIE PER STRUMENTI DIGITALI	7,70		•														291



Art. M062

MISURATORE DI SPESSORI DIGITALE

€ 26,00

Campo di misura	0 ÷ 12 mm - 0 ÷ 0.5 inch
Lettura	0,01 mm - 0.0005 inch
Profondità di misurazione	20 mm
Precisione	±0,1 mm - 0.004 inch

Art. M055

MISURATORE DI SPESSORI

€ 63,60

Campo di misura	0 ÷ 10 mm
Lettura	0,01 mm
Profondità di misurazione	9 ÷ 16 mm

Art. M055/120

MISURATORE DI SPESSORI

€ 105,00

Campo di misura	0 ÷ 10 mm
Lettura	0,01 mm
Profondità di misurazione	120 mm



ALESAMETRO CON COMPARATORE



Codice	Campo di misura	Letture	Profondità foro	€
A016/6/10	6 ÷ 10 mm	0,01 mm	40 mm	155,00
A016/10/18	10 ÷ 18 mm	0,01 mm	100 mm	160,00
A016/18/35	18 ÷ 35 mm	0,01 mm	125 mm	160,00
A016/35/50	35 ÷ 50 mm	0,01 mm	150 mm	160,00
A016/50/160	50 ÷ 160 mm	0,01 mm	150 mm	160,00
A016/160/250	160 ÷ 250 mm	0,01 mm	400 mm	179,00
A016/250/450	250 ÷ 450 mm	0,01 mm	400 mm	203,00



**Art. C013/10/30
MISURATORE RAPIDO PER INTERNI**

€ 143,00



Campo di misura	10 ÷ 30 mm
Bracci	50 mm
Tastatori	Ø 2,5 x 2 mm
Letture	0,01 mm



MISURATORE RAPIDO PER INTERNI



Codice	Campo di misura	Bracci	Tastatori	Letture	€
C014/15/35	15 ÷ 35 mm	50 mm	Ø 3 x 3 mm	0,01 mm	143,00
C014/35/55	35 ÷ 55 mm	80 mm	Ø 3 x 6 mm	0,01 mm	143,00
C014/55/75	55 ÷ 75 mm	80 mm	Ø 3 x 6 mm	0,01 mm	143,00
C014/75/95	75 ÷ 95 mm	100 mm	Ø 3 x 8 mm	0,01 mm	143,00

Art. C016
 MISURATORE DI PROFONDITÀ

€ 159,00

Campo di misura	0 ÷ 110 mm
Corsa comparatore	0 ÷ 10 mm
Dimensioni base	63 x 17 mm
Lettura	0,01 mm
Prolunghe Pz	10

Art. A020
 AZZERATORE CON COMPARATORE CON BASE MAGNETICA

€ 135,00

Altezza di azzeramento	50 mm
Lettura	0,01 mm
Utile	0 ÷ 8 mm

Art. C062
 CENTRATORE MECCANICO A MOLLA

€ 41,10

Gambo	Ø 10 mm
Tastatori	Ø 4 - 10 mm



Art. C063
CENTRATORE LUMINOSO

€ 72,60



Gambo	Ø 20 mm
Tastatore	Ø 10 mm
Lunghezza totale	100 mm
Peso	100 g
Alimentazione	2 x SR44W
Imballo	100



Art. C063/L
CENTRATORE LUMINOSO E SONORO

€ 96,20



Gambo	Ø 20 mm
Tastatore	Ø 10 mm
Lunghezza totale	160 mm
Peso	120 g
Alimentazione	2 x LR1 1.5 V
Imballo	50



Art. C061
CENTRATORE A 2 ASSI

€ 249,00



Comparatore	Ø 40 mm
Corsa max	4,9 mm
Lettura	0,01 mm
Velocità max di utilizzo	800 rpm
Attacco cilindrico	Ø 10 mm
Tastatori dritti	3
Tastatori curvi	3
Lunghezza tastatori	50 - 100 - 150 mm
Punta tastatrice	Ø 3 mm
Tracciatore snodato	50 mm

CENTRATORE A 2 ASSI CON ASTA DI POSIZIONAMENTO



MICROMETRO DIGITALE ELETTRONICO

 **DIN 863**

Codice	Misura	Letture	Precisione	€
M021/00/25	0 ÷ 25 mm - 0 ÷ 1"	0,001 mm - 0.0005"	0,003 mm - 0.00015"	100,00
M021/25/50	25 ÷ 50 mm - 1" ÷ 2"	0,001 mm - 0.0005"	0,003 mm - 0.00015"	125,00
M021/50/75	50 ÷ 75 mm - 2" ÷ 3"	0,001 mm - 0.0005"	0,004 mm - 0.0002"	150,00
M021/75/100	75 ÷ 100 mm - 3" ÷ 4"	0,001 mm - 0.0005"	0,004 mm - 0.0002"	175,00

MICROMETRO DIGITALE ELETTRONICO CON FRIZIONE SUL TAMBURO, CONTATTI IN METALLO DURO, FUNZIONI: ABS/INC, SET, ON/OFF E mm/inch, DIN 863

MICROMETRO DIGITALE ELETTRONICO

 **DIN 863**

Codice	Misura	Letture	Precisione	€
M026/0/25	0 ÷ 25 mm - 0 ÷ 1"	0,001 mm - 0.0001"	0,0002 mm - 0.00008"	195,00
M026/25/50	25 ÷ 50 mm - 1" ÷ 2"	0,001 mm - 0.0001"	0,0002 mm - 0.00008"	242,00
M026/50/75	50 ÷ 75 mm - 2" ÷ 3"	0,001 mm - 0.0001"	0,0003 mm - 0.00012"	262,00
M026/75/100	75 ÷ 100 mm - 3" ÷ 4"	0,001 mm - 0.0001"	0,0003 mm - 0.00012"	289,00

MICROMETRO DIGITALE ELETTRONICO CON FRIZIONE SUL TAMBURO CON CONTATTI IN METALLO DURO, DIN 863

MICROMETRO CENTESIMALE PER ESTERNI

 **DIN 863**

Codice	Misura	Letture	Precisione	€
M022/00/25	0 ÷ 25 mm	0,01 mm	0,004 mm	67,80
M022/25/50	25 ÷ 50 mm	0,01 mm	0,004 mm	84,30
M022/50/75	50 ÷ 75 mm	0,01 mm	0,005 mm	99,30
M022/75/100	75 ÷ 100 mm	0,01 mm	0,005 mm	114,00

MICROMETRO CENTESIMALE PER ESTERNI CON TAMBURO GRANDE A 100 DIVISIONI CON CONTATTI IN METALLO DURO E FRIZIONE SUL TAMBURO, DIN 863

**Art. M033****ASSORTIMENTO MICROMETRI CENTESIMALI PER ESTERNI****€ 213,00**
DIN 863

Misura	0÷25 - 25÷50 - 50÷75 - 75÷100 - 100÷125 - 125÷150 mm
Lettura	0,01 mm
Precisione	0,004 - 0,004 - 0,005 - 0,005 - 0,006 - 0,006 mm
Stelo	∅ 6,3 mm

ASSORTIMENTO MICROMETRI CENTESIMALI PER ESTERNI CON CONTATTI IN METALLO DURO E ARCO VERNICIATO, DIN 863

**MICROMETRO CENTESIMALE PER ESTERNI**
DIN 863

Codice	Misura	Lettura	Stelo	Imballo	€
M033/00/25	0÷25 mm	0,01 mm	∅ 6,3 mm	50	26,90
M033/25/50	25÷50 mm	0,01 mm	∅ 6,3 mm	50	37,80
M033/50/75	50÷75 mm	0,01 mm	∅ 6,3 mm	25	42,20
M033/75/100	75÷100 mm	0,01 mm	∅ 6,3 mm	25	46,70

MICROMETRO CENTESIMALE PER ESTERNI CON CONTATTI IN METALLO DURO E ARCO VERNICIATO, DIN 863

**MICROMETRO CENTESIMALE PER ESTERNI**
DIN 863

Codice	Misura	Lettura	Stelo	€
M033/100/125	100÷125 mm	0,01 mm	∅ 6,3 mm	50,00
M033/125/150	125÷150 mm	0,01 mm	∅ 6,3 mm	53,30
M033/150/175	150÷175 mm	0,01 mm	∅ 6,3 mm	63,80
M033/175/200	175÷200 mm	0,01 mm	∅ 6,3 mm	72,60
M033/200/225	200÷225 mm	0,01 mm	∅ 6,3 mm	84,30
M033/225/250	225÷250 mm	0,01 mm	∅ 6,3 mm	103,00
M033/250/275	250÷275 mm	0,01 mm	∅ 6,3 mm	106,00
M033/275/300	275÷300 mm	0,01 mm	∅ 6,3 mm	119,00

MICROMETRO CENTESIMALE PER ESTERNI CON CONTATTI IN METALLO DURO E ARCO VERNICIATO, DIN 863

**MICROMETRO CENTESIMALE PER ESTERNI**
DIN 863

Codice	Misura	Lettura	Stelo	€
M009/300/400	300 ÷ 400 mm	0,01 mm	∅ 6,5 mm	338,00
M009/400/500	400 ÷ 500 mm	0,01 mm	∅ 6,5 mm	369,00
M009/500/600	500 ÷ 600 mm	0,01 mm	∅ 6,5 mm	426,00
M009/600/700	600 ÷ 700 mm	0,01 mm	∅ 6,5 mm	507,00
M009/700/800	700 ÷ 800 mm	0,01 mm	∅ 6,5 mm	608,00
M009/800/900	800 ÷ 900 mm	0,01 mm	∅ 6,5 mm	702,00
M009/900/1000	900 ÷ 1000 mm	0,01 mm	∅ 6,5 mm	834,00
M009/1000/1200	1000 ÷ 1200 mm	0,01 mm	∅ 6,5 mm	1240,00

MICROMETRO CENTESIMALE PER ESTERNI CON CONTATTI IN METALLO DURO, ARCO VERNICIATO, DIN 863

MICROMETRO A PIATTELLO

DIN 863

Codice	Misura	Lettura	Piattelli	€
M010/0/25	0 ÷ 25 mm	0,01 mm	Ø 20 mm	106,00
M010/25/50	25 ÷ 50 mm	0,01 mm	Ø 20 mm	131,00
M010/50/75	50 ÷ 75 mm	0,01 mm	Ø 20 mm	138,00
M010/75/100	75 ÷ 100 mm	0,01 mm	Ø 20 mm	144,00
M010/100/125	100 ÷ 125 mm	0,01 mm	Ø 27 mm	184,00
M010/125/150	125 ÷ 150 mm	0,01 mm	Ø 27 mm	208,00
M010/150/175	150 ÷ 175 mm	0,01 mm	Ø 27 mm	232,00
M010/175/200	175 ÷ 200 mm	0,01 mm	Ø 27 mm	245,00

MICROMETRO A PIATTELLO, ARCO VERNICIATO, DIN 863

MICROMETRO A TRE PUNTE PER INTERNI, PER FORI CIECHI

Codice	Anello	Misura	Lettura	Precisione	€
M019/06/08	1	6 ÷ 8 mm	0,001 mm	0,004 mm	377,00
M019/08/10	1	8 ÷ 10 mm	0,001 mm	0,004 mm	377,00
M019/10/12	1	10 ÷ 12 mm	0,001 mm	0,004 mm	377,00
M019/12/16	1	12 ÷ 16 mm	0,005 mm	0,004 mm	353,00
M019/16/20	1	16 ÷ 20 mm	0,005 mm	0,004 mm	353,00
M019/20/25	1	20 ÷ 25 mm	0,005 mm	0,004 mm	379,00
M019/25/30	1	25 ÷ 30 mm	0,005 mm	0,004 mm	379,00
M019/30/40	1	30 ÷ 40 mm	0,005 mm	0,004 mm	417,00
M019/40/50	1	40 ÷ 50 mm	0,005 mm	0,005 mm	497,00
M019/50/63	1	50 ÷ 63 mm	0,005 mm	0,005 mm	507,00
M019/62/75	1	62 ÷ 75 mm	0,005 mm	0,005 mm	561,00
M019/75/88	1	75 ÷ 88 mm	0,005 mm	0,005 mm	568,00
M019/87/100	1	87 ÷ 100 mm	0,005 mm	0,005 mm	568,00
M019/100/125	0	100 ÷ 125 mm	0,005 mm	0,005 mm	633,00
M019/125/150	0	125 ÷ 150 mm	0,005 mm	0,005 mm	698,00



ASSORTIMENTO MICROMETRI A TRE PUNTE PER INTERNI, PER FORI CIECHI



Codice	Micrometri	Anelli	Misura	Letture	Precisione	€
M019/06/12	3	3	6 ÷ 12 mm	0,001 mm	0,004 mm	981,00
M019/12/20	2	1	12 ÷ 20 mm	0,005 mm	0,004 mm	535,00
M019/20/40	3	2	20 ÷ 40 mm	0,005 mm	0,004 mm	1040,00
M019/40/100	5	3	40 ÷ 100 mm	0,005 mm	0,005 mm	2300,00



Art. M013/0/100
MICROMETRO CENTESIMALE DI PROFONDITÀ

€ 120,00



Campo di misura	0 ÷ 25 mm, 25 ÷ 50 mm, 50 ÷ 75 mm, 75 ÷ 100 mm
Letture	0,01 mm
Base	100 x 17 mm

SERIE BLOCCHETTI DI RISCONTRO PIANO PARALLELI IN ACCIAIO LAPPATO

DIN 861

Codice	Grado	Nr. pezzi	Misura nominale (mm)	Progressione (mm)	Pz per passo	€
B011/0	0	11	2,5 - 5,1 - 7,7 - 10,3 - 12,9 - 15 - 17,6 - 20,2 - 22,8 - 23,4 - 25		1	203,00
B032/1	1	32	1,005 1,01 ÷ 1,09 1,1 ÷ 1,9 1 ÷ 9 10 - 20 - 30 - 50	- 0,01 0,1 1	1 9 9 9 4	254,00
B047/0	0	47	1,005 1,01 ÷ 1,2 1,3 ÷ 1,9 1 ÷ 9 10 ÷ 100	- 0,01 0,1 1 10	1 20 7 9 10	583,00
B047/1	1	47	1,005 1,01 ÷ 1,2 1,3 ÷ 1,9 1 ÷ 9 10 ÷ 100	- 0,01 0,1 1 10	1 20 7 9 10	345,00
B087/0	0	87	1,001 ÷ 1,009 1,01 ÷ 1,49 0,5 ÷ 9,5 10 ÷ 100	0,001 0,01 0,5 10	9 49 19 10	969,00
B087/1	1	87	1,001 ÷ 1,009 1,01 ÷ 1,49 0,5 ÷ 9,5 10 ÷ 100	0,001 0,01 0,5 10	9 49 19 10	520,00
B112/0	0	112	1,005 1,001 ÷ 1,009 1,01 ÷ 1,49 0,5 ÷ 24,5 25 - 50 - 75 - 100	- 0,001 0,01 0,5 25	1 9 49 49 4	976,00
B112/1	1	112	1,005 1,001 ÷ 1,009 1,01 ÷ 1,49 0,5 ÷ 24,5 25 - 50 - 75 - 100	- 0,001 0,01 0,5 25	1 9 49 49 4	689,00
B008/1	1	8	25 - 50 - 75 - 100 250 - 300 - 400 - 500		1	981,00

**SERIE BLOCCHETTI DI RISCONTRO PIANO PARALLELI IN ACCIAIO LAPPATO, DIN861, CERTIFICATO DI COLLAUDO EMESSE
DALLA FABBRICA, CERTIFICATO SIT A RICHIESTA**



CALIBRO TAMPONE LISCIO H 7 PASSA E NON PASSA TEMPERATO E CEMENTATO



Codice	∅	Pezzi	€
C025/03	3 mm	1	42,20
C025/04	4 mm	1	42,20
C025/05	5 mm	1	42,20
C025/06	6 mm	1	42,20
C025/07	7 mm	1	42,20
C025/08	8 mm	1	42,20
C025/09	9 mm	1	42,20
C025/10	10 mm	1	42,20
C025/11	11 mm	1	52,20
C025/12	12 mm	1	52,20
C025/13	13 mm	1	52,20
C025/14	14 mm	1	52,20
C025/15	15 mm	1	52,20
C025/16	16 mm	1	52,20
C025/17	17 mm	1	52,20
C025/18	18 mm	1	52,20

Codice	∅	Pezzi	€	Codice	∅	Pezzi	€
C025/19	19 mm	1	52,20	C025/48	48 mm	1	111,00
C025/20	20 mm	1	52,20	C025/50	50 mm	1	111,00
C025/21	21 mm	1	78,10	C025/51	51 mm	2	117,00
C025/22	22 mm	1	78,10	C025/52	52 mm	2	117,00
C025/23	23 mm	1	78,10	C025/55	55 mm	2	117,00
C025/24	24 mm	1	78,10	C025/56	56 mm	2	117,00
C025/25	25 mm	1	78,10	C025/57	57 mm	2	117,00
C025/26	26 mm	1	78,10	C025/58	58 mm	2	117,00
C025/27	27 mm	1	78,10	C025/59	59 mm	2	117,00
C025/28	28 mm	1	78,10	C025/60	60 mm	2	117,00
C025/29	29 mm	1	78,10	C025/62	62 mm	2	142,00
C025/30	30 mm	1	97,90	C025/63	63 mm	2	142,00
C025/32	32 mm	1	97,90	C025/65	65 mm	2	142,00
C025/33	33 mm	1	97,90	C025/66	66 mm	2	142,00
C025/34	34 mm	1	97,90	C025/67	67 mm	2	142,00
C025/35	35 mm	1	97,90	C025/68	68 mm	2	142,00
C025/36	36 mm	1	97,90	C025/69	69 mm	2	142,00
C025/37	37 mm	1	97,90	C025/70	70 mm	2	188,00
C025/38	38 mm	1	97,90	C025/71	71 mm	2	188,00
C025/40	40 mm	1	97,90	C025/72	72 mm	2	188,00
C025/42	42 mm	1	97,90	C025/74	74 mm	2	188,00
C025/44	44 mm	1	97,90	C025/75	75 mm	2	188,00
C025/45	45 mm	1	97,90	C025/76	76 mm	2	188,00
C025/46	46 mm	1	111,00	C025/78	78 mm	2	188,00
C025/47	47 mm	1	111,00	C025/80	80 mm	2	188,00



SERIE CALIBRI TAMPONE LISCI PASSA NON PASSA H 7 TEMPERATI E CEMENTATI



Codice	Pezzi	Passo	∅	€
C025/3/30	28	1 mm	3 ÷ 30 mm	1030,00
C025/32/62	16	-	32-35-37-38-40-42-45-47-48-50-52-55-56-58-60-62 mm	1230,00

ANELLO DI AZZERAMENTO

DIN 2250

Codice	Misura	€	Codice	Misura	€
A015/008	8 mm	63,80	A015/040	40 mm	133,00
A015/010	10 mm	71,50	A015/062	62 mm	147,00
A015/011	11 mm	71,50	A015/087	87 mm	348,00
A015/017	17 mm	78,10	A015/100	100 mm	366,00
A015/025	25 mm	78,10	A015/125	125 mm	451,00
A015/035	35 mm	78,10	A015/150	150 mm	631,00

ANELLO DI AZZERAMENTO PRECISIONE 6g, DIN 2250

TAMPONE FILETTATO DOPPIO PNP

ISO 228/1

Codice	Dimensioni	€	Codice	Dimensioni	€
T0481/8	1/8" - 28 TPI	79,20	T0485/8	5/8" - 14 TPI	119,00
T0481/4	1/4" - 19 TPI	79,20	T0483/4	3/4" - 14 TPI	127,00
T0483/8	3/8" - 19 TPI	79,20	T0487/8	7/8" - 14 TPI	165,00
T0481/2	1/2" - 14 TPI	102,00	T0481	1" - 11 TPI	193,00

TAMPONE FILETTATO DOPPIO PNP, PASSO GAS CILINDRICO, ISO228/1

ANELLO FILETTATO TIPO PASSA

ISO 228/1

Codice	Dimensioni	€	Codice	Dimensioni	€
A0181/8	1/8" - 28 TPI	81,80	A0185/8	5/8" - 14 TPI	112,00
A0181/4	1/4" - 19 TPI	81,80	A0183/4	3/4" - 14 TPI	136,00
A0183/8	3/8" - 19 TPI	81,80	A0187/8	7/8" - 14 TPI	165,00
A0181/2	1/2" - 14 TPI	112,00	A0181	1" - 11 TPI	217,00

ANELLO FILETTATO TIPO PASSA, ISO228/1, PASSO GAS CILINDRICO

TAMPONE FILETTATO DOPPIO PNP METRICO 6H

Codice	Dimensioni	€	Codice	Dimensioni	€
T0493X0.5	3 x 0,5 mm	72,60	T04914X2	14 x 2 mm	96,80
T0494X0.7	4 x 0,7 mm	93,50	T04916X1.5	16 x 1,5 mm	101,00
T0495X0.8	5 x 0,8 mm	96,80	T04916X2	16 x 2 mm	101,00
T0496X1	6 x 1 mm	96,80	T04918X1.5	18 x 1,5 mm	113,00
T0498X1	8 x 1 mm	88,00	T04918X2.5	18 x 2,5 mm	113,00
T0498X1.25	8 x 1,25 mm	88,00	T04920X1.5	20 x 1,5 mm	120,00
T04910X1	10 x 1 mm	90,20	T04920X2.5	20 x 2,5 mm	120,00
T04910X1.25	10 x 1,25 mm	90,20	T04922X1.5	22 x 1,5 mm	127,00
T04910X1.5	10 x 1,5 mm	90,20	T04922X2.5	22 x 2,5 mm	127,00
T04912X1.25	12 x 1,25 mm	90,20	T04924X1.5	24 x 1,5 mm	147,00
T04912X1.5	12 x 1,5 mm	90,20	T04924X2	24 x 2 mm	147,00
T04912X1.75	12 x 1,75 mm	90,20	T04924X3	24 x 3 mm	147,00
T04914X1.5	14 x 1,5 mm	96,80			



ANELLO FILETTATO 6g TIPO PASSA METRICO



Codice	Dimensioni	€	Codice	Dimensioni	€
A0173X0.5	3 x 0,5 mm	70,40	A01714X2	14 x 2 mm	101,00
A0174X0.7	4 x 0,7 mm	79,20	A01716X1.5	16 x 1,5 mm	107,00
A0175X0.8	5 x 0,8 mm	79,20	A01716X2	16 x 2 mm	107,00
A0176X1	6 x 1 mm	66,00	A01718X1.5	18 x 1,5 mm	113,00
A0178X1	8 x 1 mm	66,00	A01718X2.5	18 x 2,5 mm	113,00
A0178X1.25	8 x 1,25 mm	66,00	A01720X1.5	20 x 1,5 mm	119,00
A01710X1	10 x 1 mm	93,50	A01720X2.5	20 x 2,5 mm	119,00
A01710X1.25	10 x 1,25 mm	72,60	A01722X1.5	22 x 1,5 mm	133,00
A01710X1.5	10 x 1,5 mm	72,60	A01722X2.5	22 x 2,5 mm	133,00
A01712X1.25	12 x 1,25 mm	101,00	A01724X1.5	24 x 1,5 mm	160,00
A01712X1.5	12 x 1,5 mm	101,00	A01724X2	24 x 2 mm	160,00
A01712X1.75	12 x 1,75 mm	101,00	A01724X3	24 x 3 mm	160,00
A01714X1.5	14 x 1,5 mm	101,00			



SERIE SPINE CALIBRATE



Codice	Pezzi	Misura	Progressione	Lunghezza	Durezza	Precisione	€
S091	91	1÷10 mm	0,1 mm	50 mm	HRC-60-62	±0,002 mm	647,00
S091/61	61	10÷16 mm	0,1 mm	50 mm	HRC-60-62	±0,002 mm	364,00

Art. T009 € 33,30
 SUPPORTO TASTATORE AD ARCO

Attacco maschio	Ø 8 mm
Attacco femmina	Ø 4 mm

Art. B201/1 € 16,00
 BASE MAGNETICA

Dimensioni base	36 x 30 x 35 mm
Foro	M5 x 0,8
Forza magnetica	300 N
Peso	0,2 kg
Imballo	50

BASE MAGNETICA PER PORTA COMPARATORE,
MATERIALE MAGNETICO N35, SELETTORE IN ABS E
BASE PRISMATICA

Art. B201/2 € 19,00
 BASE MAGNETICA

Dimensioni base	60 x 50 x 55 mm
Foro	M8 x 1,25
Forza magnetica	800 N
Peso	1 kg
Imballo	20

BASE MAGNETICA PER PORTA COMPARATORE,
MATERIALE MAGNETICO N35, SELETTORE IN ABS E
BASE PRISMATICA

Art. B201/3 € 25,00
 BASE MAGNETICA

Dimensioni base	73 x 50 x 55 mm
Foro	M8 x 1,25
Forza magnetica	1000 N
Peso	1,25 kg
Imballo	20

BASE MAGNETICA PER PORTA COMPARATORE,
MATERIALE MAGNETICO N35, SELETTORE IN ABS E
BASE PRISMATICA

Art. B201/4 € 35,00
 BASE MAGNETICA

Dimensioni base	117 x 50 x 55 mm
Foro	M8 x 1,25
Forza magnetica	1300 N
Peso	2 kg
Imballo	10

BASE MAGNETICA PER PORTA COMPARATORE,
MATERIALE MAGNETICO N35, SELETTORE IN ABS E
BASE PRISMATICA

Art. B100 € 24,70
 BASE MAGNETICA

Dimensioni	63 x 50 x 55h mm
Foro	M 8 x 1,25
Forza magnetica	600 N
Imballo	20

BASE MAGNETICA PER PORTA COMPARATORE,
SELETTORE IN ABS E BASE PRISMATICA



Art. S052/2 € 30,00
SUPPORTO MAGNETICO
PORTA COMPARATORE



Asta principale	∅ 12 x 176 mm
Asta secondaria	∅ 10 x 150 mm
Forza magnetica	800 N
Dimensioni base	60 x 50 x 55 mm
Peso	1,5 kg
Imballo	10

SUPPORTO MAGNETICO PORTA COMPARATORE, CON REGOLAZIONE MICROMETRICA, COLONNA ROBUSTA E BRACCIO TRASVERSALE REGOLABILE. BASE MAGNETICA CON APPOGGIO PRISMATICO E COMMUTATORE



Art. S052/3 € 52,00
SUPPORTO MAGNETICO
PORTA COMPARATORE



Asta principale	∅ 16 x 225 mm
Asta secondaria	∅ 14 x 165 mm
Forza magnetica	1000 N
Dimensioni base	73 x 50 x 55 mm
Peso	2 kg
Imballo	10

SUPPORTO MAGNETICO PORTA COMPARATORE, CON REGOLAZIONE MICROMETRICA, COLONNA ROBUSTA E BRACCIO TRASVERSALE REGOLABILE. BASE MAGNETICA CON APPOGGIO PRISMATICO E COMMUTATORE



Art. S052/4 € 77,00
SUPPORTO MAGNETICO
PORTA COMPARATORE



Asta principale	∅ 20 x 355 mm
Asta secondaria	∅ 14 x 210 mm
Forza magnetica	1300 N
Dimensioni base	117 x 50 x 55 mm
Peso	3 kg
Imballo	5

SUPPORTO MAGNETICO PORTA COMPARATORE, CON REGOLAZIONE MICROMETRICA, COLONNA ROBUSTA E BRACCIO TRASVERSALE REGOLABILE. BASE MAGNETICA CON APPOGGIO PRISMATICO E COMMUTATORE



Art. S049 € 36,70
SUPPORTO MAGNETICO
PORTA COMPARATORE



Asta principale	∅ 12 x 170 mm
Asta secondaria	∅ 10 x 150 mm
Forza magnetica	600 N
Dimensioni base	63 x 50 x 55h mm
Imballo	10

SUPPORTO MAGNETICO PORTA COMPARATORE CON REGOLAZIONE MICROMETRICA

Art. S047 € 68,80
SUPPORTO MAGNETICO
PORTA COMPARATORE

Asta principale	Ø 16 x 220 mm
Asta secondaria	Ø 12 x 180 mm
Forza magnetica	800 N
Dimensioni base	75 x 50 x 55h mm
Imballo	10

SUPPORTO MAGNETICO PORTA COMPARATORE CON
REGOLAZIONE MICROMETRICA

Art. S054 € 33,30
SUPPORTO MAGNETICO
PORTA COMPARATORE

Asta principale	Ø 12 x 170 mm
Asta secondaria	Ø 10 x 140 mm
Forza magnetica	600 N
Dimensioni base	63 x 50 x 55h mm
Imballo	10

Art. S055 € 64,90
SUPPORTO MAGNETICO
PORTA COMPARATORE

Asta principale	Ø 16 x 210 mm
Asta secondaria	Ø 12 x 175 mm
Forza magnetica	800 N
Dimensioni base	75 x 50 x 55h mm
Imballo	10

Art. S042/1 € 60,00
SUPPORTO ARTICOLATO
MECCANICO

Dimensioni base	36 x 30 x 35 mm
Forza magnetica	300 N
Lunghezza braccio	145 mm
Peso	0,5 kg
Imballo	50

SUPPORTO ARTICOLATO MECCANICO CON BLOCCAGGIO
CENTRALE 3D DELLE ASTE



Art. S042/2 € 70,00
SUPPORTO ARTICOLATO
MECCANICO



Dimensioni base	60 x 50 x 55 mm
Forza magnetica	800 N
Lunghezza braccio	290 mm
Peso	1,4 kg
Imballo	10

SUPPORTO ARTICOLATO MECCANICO CON MICROREGOLAZIONE E BLOCCAGGIO CENTRALE 3D DELLE ASTE



Art. S042/3 € 90,00
SUPPORTO ARTICOLATO
MECCANICO



Dimensioni base	75 x 50 x 55 mm
Forza magnetica	1000 N
Lunghezza braccio	365 mm
Peso	1,7 kg
Imballo	10

SUPPORTO ARTICOLATO MECCANICO CON MICROREGOLAZIONE E BLOCCAGGIO CENTRALE 3D DELLE ASTE



Art. S045 € 77,00
SUPPORTO ARTICOLATO
MECCANICO



Asta principale	Ø 12 x 160 mm
Asta secondaria	Ø 10 x 180 mm
Forza magnetica	600 N
Dimensioni base	63 x 50 x 55h mm
Imballo	10



Art. S046 € 118,00
SUPPORTO ARTICOLATO
IDRAULICO



Asta principale	Ø 12 x 180 mm
Asta secondaria	Ø 10 x 200 mm
Forza magnetica	600 N
Dimensioni base	63 x 50 x 55h mm
Imballo	10



Art. S041/1 € 45,00
 MINI SUPPORTO MAGNETICO
 PORTA COMPARATORE

Dimensioni base	73 x 37 x 12 mm
Forza magnetica	200 N
Peso	0,16 kg
Imballo	25

MINI SUPPORTO MAGNETICO PORTA COMPARATORE, SUPERFICIE D'APPOGGIO PIANA, OTTIMA ADESIONE.

Art. S041/2 € 67,00
 MINI SUPPORTO MAGNETICO
 PORTA COMPARATORE

Dimensioni base	73 x 37 x 26 mm
Forza magnetica	200 N
Peso	0,3 kg
Imballo	25

MINI SUPPORTO MAGNETICO PORTA COMPARATORE CON BASE PRISMATICA, OTTIMA ADESIONE.

Art. B025 € 210,00
 STATIVO PORTA COMPARATORE

Porta comparatore	ø 8 mm
Dimensioni piano	80 x 80 mm
Dimensioni base	150 x 100 mm
Colonna	ø 25 x 180 mm
Peso	3,8 kg

STATIVO PORTA COMPARATORE CON PIANO SCANALATO E BASE IN GRANITO

Art. B010 € 281,00
 STATIVO PORTA COMPARATORE

Porta comparatore	ø 8 mm
Dimensioni base	300 x 200 x 50h mm
Colonna	ø 35 x 300 mm
Planarità base	0,002 mm
Peso	13 kg

STATIVO PORTA COMPARATORE CON BASE IN GRANITO



APPARECCHIO A DUE PUNTE PER IL CONTROLLO DELLA CONCENTRICITÀ



Codice	Distanza tra le punte	Altezza punte Min. - Max	CM	Dimensioni	Peso	Porta comparatore	€
A019/300	300 mm	145 / 175 mm	2	730 x 310 x 370h mm	43 kg	2	1180,00
A019/500	500 mm	135 / 170 mm	2	924 x 330 x 482h mm	86 kg	2	1504,00
A019/1000	1000 mm	135 / 170 mm	2	1400 x 330 x 430h mm	104 kg	2	1770,00

APPARECCHIO A DUE PUNTE PER IL CONTROLLO DELLA CONCENTRICITÀ, COSTRUITO IN GHISA STABILIZZATA CON SUPERFICI DI SCORRIMENTO RETTIFICATE E DOTATO DI SUPPORTO PORTA COMPARATORE



Art. S051 SUPPORTO MICROMETRO

€ 32,80



Imballo 10

SUPPORTO MICROMETRO
CORPO IN GHISA CON GANASCE RICOPERTE DI PLASTICA MORBIDA



Art. A009 ACCESSORI PER BLOCCHETTI DI RISCONTRO

€ 702,00



15 Pz

Forcelle	n° 3 (50-100-200 mm)
Coppia incudini raggiati	n° 3 (2°- 5°-10°)
Punta a tracciare	n° 1
Punta a centrare	n° 1
Righe	n° 2 (100 mm)
Coppia incudini triangolari	n° 1

PIANO DI RISCONTRO IN GRANITO

DIN 876

Codice	Dimensioni	Peso	€
P040	310 x 230 x 80 mm	21 kg	84,30
P042	630 x 400 x 100 mm	87 kg	270,00
P043	1000 x 630 x 150 mm	322 kg	725,00
P047	1200 x 800 x 160 mm	497 kg	1200,00
P044	1600 x 1000 x 200 mm	1059 kg	2540,00

PIANO DI RISCONTRO IN GRANITO, DIN 876, GRADO 00

BANCO PER PIANO IN GRANITO CON DUE CASSETTI

Codice	Dimensioni base	Dimensioni piano	Peso	€
B040/1	945 x 590 mm	1000 x 630 mm	66 kg	851,00
B040/2	1200 x 750 mm	1200 x 800 - 1600 x 1000 mm	77 kg	927,00

SQUADRA DI RISCONTRO IN GRANITO

DIN 876

Codice	Dimensioni	Precisione	€
S061	250 x 40 x 400h mm	± 6 µm	402,00
S062	400 x 100 x 600h mm	± 9 µm	567,00

SQUADRA DI RISCONTRO IN GRANITO, DIN 876, GRADO 0



SQUADRA A 90°

 **DIN 875/1**

Codice	Dimensioni	Sezione	€
S050/150	150 x 100 mm	25,5 x 4,8 mm ²	35,00
S050/200	200 x 130 mm	28 x 6,5 mm ²	44,40
S050/250	250 x 160 mm	31 x 9 mm ²	59,40
S050/300	300 x 200 mm	36 x 9 mm ²	66,00
S050/400	400 x 265 mm	39 x 9 mm ²	147,00
S050/500	500 x 330 mm	50 x 9 mm ²	176,00

SQUADRA A 90° IN ACCIAIO INDEFORMABILE, CON CAPPELLO, DIN 875/1



SQUADRA A 90°



Codice	Dimensioni	Sezione	€
S051/150	150 x 100 mm	20 x 5,5 mm ²	19,20
S051/200	200 x 130 mm	20 x 5,5 mm ²	22,00
S051/250	250 x 160 mm	25 x 5,5 mm ²	26,00
S051/300	300 x 175 mm	25 x 5,5 mm ²	32,50
S051/400	400 x 200 mm	29,5 x 5,5 mm ²	36,00
S051/500	500 x 250 mm	29,5 x 5,5 mm ²	37,80

SQUADRA A 90° IN ACCIAIO INDEFORMABILE, DI TIPO ECONOMICO, CON CAPPELLO



SQUADRA BISELLATA A 90°

 **DIN 875/00**

Codice	Dimensioni	Sezione	€
S048/100	100 x 70 mm	20 x 5 mm ²	34,20
S048/150	150 x 100 mm	28 x 5 mm ²	52,00

SQUADRA BISELLATA A 90°, DIN 875/00



SQUADRA FALEGNAME MILLIMETRATA



Codice	Dimensioni	Imballo	€
0286/250	250 x 130 x 0,8 mm	12* / 120	2,96
0286/300	300 x 130 x 0,8 mm	12* / 120	3,48
0286/350	350 x 155 x 0,8 mm	12* / 120	3,88



Art. S058
SQUADRA MAGNETICA INCLINABILE
€ 91,30

Dimensioni	115 x 115 x 35 mm
Gradi	45° ÷ 90°
Forza magnetica	250 N
Peso	1,5 kg
Imballo	10

SQUADRA MAGNETICA A 90°

Codice	Dimensioni	Forza magnetica	Peso	Imballo	€
S056/150	150 x 150 x 50 mm	500 N	2,2 kg	5	79,20
S056/200	200 x 200 x 50 mm	1000 N	3,2 kg	1	99,00

Art. S057/060S
SERIE POSIZIONATORI MAGNETICI
€ 13,50

4 Pz

Dimensioni	50 x 60 x 12,5 mm
Forza magnetica	45 N
Angolo di posizionamento	45 - 90 - 135°
Peso	0,4 kg
Imballo	10 / 60

Art. S057/125
POSIZIONATORE MAGNETICO
€ 19,90

Dimensioni	135 x 135 x 25 mm
Forza magnetica	340 N
Angolo di posizionamento	45 - 90 - 135°
Peso	1,1 kg
Imballo	24



Art. 0212
SPESSIMETRO

€ 8,30



Lame num.	20
Misure	0,05 - 1,00 mm
Imballo	6* / 120



Art. C058
CONTAFILETTI A 58 LAME

€ 12,40



Lame metriche	0.25 - 6 mm 60°
Lame a pollici	4 - 62 TPI 55°
Lame a gas	8 - 28 TPI 55°
Imballo	10* / 200



COMPASSO



Codice	Lunghezza	Imballo	€
C026/150	150 mm	20	10,90
C026/200	200 mm	20	13,50
C026/250	250 mm	20	18,50
C026/300	300 mm	20	21,30

COMPASSO A PUNTA CON GAMBO QUADRATO



COMPASSO



Codice	Lunghezza	Imballo	€
C027/150	150 mm	33	15,30
C027/200	200 mm	20	18,00
C027/250	250 mm	20	22,40
C027/300	300 mm	20	24,70

COMPASSO CON GUIDA E GAMBO QUADRATO



COMPASSO



Codice	Lunghezza	Imballo	€
C028/150	150 mm	20	10,90
C028/200	200 mm	20	13,50
C028/250	250 mm	20	15,70
C028/300	300 mm	20	18,50

COMPASSO PER SPESSORI ESTERNI



COMPASSO



Codice	Lunghezza	Imballo	€
C029/150	150 mm	20	10,90
C029/200	200 mm	20	13,50
C029/250	250 mm	20	15,70
C029/300	300 mm	20	18,50

COMPASSO PER INTERNI



PRISMA MAGNETICO

Codice	Dimensioni	Larghezza	Peso	Pezzi	€
P007/1	70 x 60 x 72 mm	38 mm	1,6 kg	1	159,00
P007/2	100 x 70 x 95 mm	50 / 16 mm	3,7 kg	1	208,00
P007/1C	71 x 60 x 73 mm	38 mm	3,2 kg	2	314,00
P007/2C	100 x 70 x 95 mm	50 / 16 mm	7,4 kg	2	407,00

PRISMA MAGNETICO, SINGOLO OD IN COPPIA

PRISMA A 90°

Codice	Dimensioni	Bloccaggio massimo	Precisione	Pezzi	€
P301/2	63,5 x 63,5 x 50 mm	ø 35 mm	±0,01 mm	1	60,50
P302/2	100 x 75 x 75 mm	ø 65 mm	±0,01 mm	1	103,00
P303/2	150 x 125 x 100 mm	ø 110 mm	±0,01 mm	1	159,00
P301/2C	63,5 x 63,5 x 50,8 mm	ø 35 mm	±0,01 mm	2	117,00
P302/2C	100 x 75 x 75 mm	ø 65 mm	±0,01 mm	2	203,00
P303/2C	150 x 127 x 100 mm	ø 110 mm	±0,01 mm	2	317,00

PRISMA A 90° IN ACCIAIO TEMPERATO, CON MORSETTO SINGOLO ED IN COPPIA

COPPIA PRISMI RETTIFICATI

C45

Codice	Dimensioni	Precisione	€
P200/1	75 x 75 x 60 mm	1/100 mm	220,00
P201/1	100 x 80 x 60 mm	1/100 mm	292,00

COPPIA PRISMI RETTIFICATI IN ACCIAIO INDEFORMABILE C45

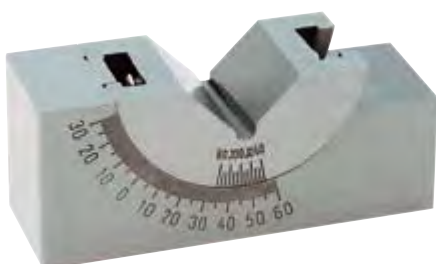
PRISMA INCLINABILE

Codice	Dimensioni	Peso	€
P011/075	75 x 32 x 25 mm	1,1 kg	102,00
P011/100	102 x 48 x 46 mm	1,3 kg	121,00



FLESSOMETRO



Codice	Dimensioni nastro	Classe di precisione	Imballo	€
F2G2	2 m x 16 mm	II	12* / 120	3,20
F2G3	3 m x 16 mm	II	12* / 120	3,66
F2G5	5 m x 19 mm	II	12* / 72	5,60

FLESSOMETRO, CON MECCANISMO DI ARRESTO IN ACCIAIO, GANCIO RIVETTATO ALL'ESTREMITÀ CON PROTEZIONE DELLA LAMA INFERIORE MEDIANTE AMMORTIZZATORE



FLESSOMETRO MAGNETICO



Codice	Dimensioni nastro	Classe di precisione	Imballo	€
F683	3 m x 19 mm	II	12* / 120	6,40
F685	5 m x 25 mm	II	12* / 72	9,10
F688	8 m x 25 mm	II	12* / 48	13,00

FLESSOMETRO MAGNETICO, CON MECCANISMO DI ARRESTO IN ACCIAIO, GANCIO RIVETTATO ALL'ESTREMITÀ CON PROTEZIONE DELLA LAMA INFERIORE MEDIANTE AMMORTIZZATORE



FLESSOMETRO



Codice	Dimensioni nastro	Classe di precisione	Imballo	€
F802	2 m x 16 mm	II	12* / 120	2,74
F803	3 m x 16 mm	II	12* / 120	4,46
F805	5 m x 19 mm	II	12* / 120	6,30
F808	8 m x 25 mm	II	6* / 48	9,10

FLESSOMETRO DI FORMA ERGONOMICA ANTISCIVOLO, CON BLOCCAGGIO SICURO E PRECISO, GANCIO PER CINTURA, NASTRO DI SPESSORE MAGGIORATO CON RIVESTIMENTO IN POLIESTERE ANTIABRASIVO

FLESSOMETRO MAGNETICO

Codice	Dimensioni nastro	Classe di precisione	Imballo	€
F322	2 m x 16 mm	II	12* / 120	4,12
F323	3 m x 19 mm	II	12* / 72	5,50
F325	5 m x 25 mm	II	12* / 72	7,50
F328	8 m x 25 mm	II	12* / 48	10,40

FLESSOMETRO CON FRENO AUTOMATICO E MAGNETE

ROTELLA METRICA

Codice	Dimensioni nastro	Imballo	€
R030	30 m x 13 mm	12	25,20
R050	50 m x 13 mm	12	38,90

ROTELLA METRICA CON NASTRO IN ACCIAIO

Art. 0646/A
LASER AUTOLIVELLANTE

€ 115,00



Precisione di livellamento	0,5 mm / m
Precisione linea orizzontale e verticale	± 0,5 mm / m
Batteria	3 x 1,5V AA
Tipo laser	Classe II / 650 nm
Distanza di lavoro consigliata	10 m
H massima	126,5 cm
H minima	52,5 cm
Peso	3 kg
Imballo	4

**Art. 0807/150**
MINI LIVELLA LASER

€ 27,20



Dimensioni	150 x 19 x 38 mm
Tipo laser	classe II / 650 nm
Distanza di lavoro	30m
Potenza	< 1mW
Batteria	2 x 1,5V AAA
Imballo	40

MINI LIVELLA LASER TASCABILE MAGNETICA, A 1 FIALA, CON CORPO IN ALLUMINIO

**Art. 0449**
MINI LIVELLA LASER

€ 24,70



Tipo laser	Classe II / 650 nm
Distanza di lavoro	20 m
Potenza	< 1 mW
Accuratezza	0,05°
Batteria	2 x 1,5V AAA
Peso	0,3 kg

MINI LIVELLA LASER, A 4 FIALE, CON CORPO IN ABS, RAGGIO LASER IN GRADO DI EMETTERE UN UNICO PUNTO O UNA CROCE PERPENDICOLARE

**Art. 0666**
LIVELLA DIGITALE CON RAGGIO LASER

€ 172,00



Lunghezza	600 mm	Precisione livella	± 0,05°
Autospegnimento	5 min	Precisione del punto	±1 mm / m
Gamma di misurazione	0 ~ 360°	Batteria	9 V
Lunghezza d'onda	650 nm	Peso	0,5 kg
Risoluzione	0,1°	Imballo	20
Potenza laser	<1 mW		

LIVELLA DIGITALE CON RAGGIO LASER VISUALIZZAZIONE DELL'ANGOLO O DELLA PERCENTUALE DI INCLINAZIONE

**Art. 0109**
LIVELLA DIGITALE

€ 51,00



Lunghezza	400 mm
Autospegnimento	5 min
Gamma di misurazione	0 ~ 90° x 4
Risoluzione	0° - 90°: 0,1°
Precisione livella	0° - 90°: ±0,2°
Batteria	2 x AAA 1,5 V
Peso	0,26 kg
Imballo	30

LIVELLA DIGITALE MAGNETICA CON CORPO IN ALLUMINIO, AUTOSPEGNIMENTO, SCHERMO RETROILLUMINATO, 2 FIALE, LETTURA ASSOLUTA E RELATIVA, FUNZIONE "HOLD"

Art. 0112
LIVELLA DIGITALE
€ 103,00

Lunghezza	600 mm
Autospegnimento	5 min
Gamma di misurazione	0 ~ 90° x 4
Risoluzione	0° & 90°: 0,05°; 0° - 89°: 0,1°
Precisione livella	0° & 90°: ±0,05°; 0,1° - 89,9°: ±0,2°
Batteria	2 x AAA 1,5 V
Peso	0,6 kg
Imballo	20

LIVELLA DIGITALE MAGNETICA CON CORPO IN ALLUMINIO E BASE FRESATA, AUTOSPEGNIMENTO, SCHERMO RETROILLUMINATO, 2 FIALE, FUNZIONE "HOLD", RICERCA DEL 0° E 90° SONORO, LETTURA: ASSOLUTA E RELATIVA, GRADI, PERCENTUALE, mm/m E in/ft, BORSA PER IL TRASPORTO

Art. L090A
**LIVELLA DIGITALE INCLINOMETRO
 E GONIOMETRO CON MAGNETE**
€ 107,00

Precisione	± 0.15°
Gamma di misurazione	0 ÷ 90° x 4
Risoluzione	0.05°
Dimensioni	151 x 31 x 60 mm
Batteria	2 x 1.5 V AAA
Peso	285 g
Custodia in plastica	
Imballo	25

LIVELLA DIGITALE INCLINOMETRO E GONIOMETRO CON MAGNETE, FUNZIONI: 0 ÷ 90° IN TUTTE LE 4 DIREZIONI, INCLINAZIONE mm/m, INCLINAZIONE in/ft, PERCENTUALE D'INCLINAZIONE %, RETROILLUMINAZIONE, AUTOSPEGNIMENTO, MISURAZIONE ASSOLUTA (ABS) E RELATIVA, INVERSIONE AUTOMATICA DEI NUMERI PER LETTURE SOTTOSOPRA, CON SEGNALE ACUSTICO

Art. L080
LIVELLA QUADRA DIGITALE
€ 52,00

Precisione	0° ± 0.1°; 90° ± 0.1°; 0.1° ÷ 89.9° ± 0.2°
Gamma di misurazione	0 ÷ 90° x 4
Risoluzione	0.1°
Dimensioni	59 x 27 x 59 mm
Batteria	1 x 1.5 V AAA
Peso	82 g
Doppio Blister	
Imballo	7 / 35

LIVELLA QUADRA DIGITALE MAGNETICA 0 ÷ 90° IN TUTTE LE 4 DIREZIONI, RETROILLUMINAZIONE, AUTOSPEGNIMENTO, MISURAZIONE ASSOLUTA (ABS) E RELATIVA, INVERSIONE AUTOMATICA DEI NUMERI PER LETTURE SOTTOSOPRA

Art. L085
LIVELLA QUADRA DIGITALE
€ 82,00

Precisione	± 0.1°
Gamma di misurazione	0° ÷ 180°
Risoluzione	0.1°
Dimensioni	51 x 51 x 33 mm
Batteria	1 x 3 V CR2032
Peso	150 g
Doppio Blister	
Imballo	10 / 50

LIVELLA QUADRA DIGITALE MAGNETICA IN 2 x 0 ÷ 180°, AUTOSPEGNIMENTO, MISURAZIONE ASSOLUTA (ABS) E RELATIVA, INVERSIONE AUTOMATICA DEI NUMERI PER LETTURE SOTTOSOPRA E FUNZIONE HOLD

**Art. 0805/400**
LIVELLA MAGNETICA**€ 9,70**

Dimensioni	400 x 49 x 23 mm
Imballo	6* / 60

LIVELLA MAGNETICA A 3 FIALE MILLIMETRATA



LIVELLA



Codice	Dimensioni	Imballo	€
0824/300	300 x 49 x 23 mm	6* / 60	5,50
0824/400	400 x 49 x 23 mm	6* / 60	6,20
0824/500	500 x 49 x 23 mm	6* / 60	7,20
0824/600	600 x 49 x 23 mm	6* / 60	8,30

LIVELLA IN ALLUMINIO A 3 FIALE, FRESATA E MILLIMETRATA

**Art. L200**
LIVELLA LINEARE**€ 184,00**

Dimensioni	200 x 45 x 45 mm
Precisione	0,02 mm / m
Imballo	10

LIVELLA LINEARE RETTIFICATA DI ALTA PRECISIONE, CON BASE PRISMATICA

**Art. L150**
LIVELLA QUADRA**€ 232,00**

Dimensioni	150 x 38 x 150 mm
Precisione	0,02 mm / m
Imballo	10

LIVELLA QUADRA RETTIFICATA DI ALTA PRECISIONE, CON 2 FACCE PIANE E 2 PRISMATICHE

Art. E023/5
ENDOSCOPIO FLESSIBILE PER MECCANICA
€ 650,00

Lunghezza senza manico	1000 mm
Sonda	Ø 5,5 mm
Zoom digitale	4 X
Profondità di campo	50 mm
Visione	60°
Batteria ricaricabile	Lithium
Imballo	4
Valigetta in plastica	

ENDOSCOPIO FLESSIBILE PER MECCANICA CON SONDA Ø 5,5 mm - WI-FI USB
 DOTATO DI: Schermo a colori lcd 3,5" con connessione wi-fi alla sonda - Memoria micro SD 2GB con adattatore SD - Porta USB - Uscita con cavo USB - Sonda flessibile - Videocamera dotata di luci LED - Specchio a 45° - Sfera di direzione - Ghiera di protezione

Art. E022/12
ENDOSCOPIO FLESSIBILE PER MECCANICA
€ 364,00

Lunghezza senza manico	900 mm
Sonda	Ø 12 mm
Visione	0° - 60°
Batteria	9 V
Imballo	4
Valigetta in plastica	

ENDOSCOPIO FLESSIBILE PER MECCANICA CON SONDA Ø 12 mm DOTATO DI: schermo a colori lcd 3,5" - sonda flessibile - videocamera dotata di luci led - possono essere aggiunte fino a 2 prolunghie - terminale magnetico - terminale a gancio - terminale con specchio

Art. E022/5 **€ 364,00**
SONDA FLESSIBILE

Dimensioni	Ø 4,7 mm
Lunghezza	1070 mm

Art. E022/P **€ 79,20**
PROLUNGA FLESSIBILE

Dimensioni	Ø 18 mm
Lunghezza	2750 mm

**Art. M069**
MICROSCOPIO STEREOSCOPICO**€ 536,00**

Luce propria diretta	12 V - 10 W
Distanza di lavoro	165 mm 10x - 119 mm 20x
Alimentazione	230 V 50 Hz
Oculari	10x - 20x
Obiettivi	1x - 2x
Ingrandimenti	10x ÷ 40x
Peso	2,8 kg
Scatola	

MICROSCOPIO STEREOSCOPICO 45°

**Art. M071**
MICROSCOPIO STEREOSCOPICO**€ 411,00**

Luce propria incidente e diretta	12 V - 10 W
Altezza massima del pezzo da controllare	75 mm
Alimentazione	230 V 50 Hz
Oculari	10x
Obiettivi	2x - 4x
Ingrandimenti	20x ÷ 40x
Peso	2,8 kg
Imballo	5
Scatola	

MICROSCOPIO STEREOSCOPICO 45°

**Art. M058**
MICROSCOPIO DIGITALE PORTATILE USB**€ 188,00**

USB	2.0
Risoluzione	640 x 480
Colore	24bit (RGB)
Ingrandimenti	Max 40 x monitor 17"
Risoluzione	800 x 600
Distanza di fuoco	20 mm
Alimentazione	USB
Peso	100 g
Scatola	

MICROSCOPIO DIGITALE PORTATILE USB, ILLUMINAZIONE A LED

**Art. M063** € 255,00
OCULARE DIGITALE PER MICROSCOPIO

Sensore	1/2" 1.3MP CMOS
Risoluzione	1280 x 1024
Zoom ottico	10x
Frequenza di scansione	16 f/s @ 1280 x 1024
Diametro degli adattatori	23,2 / 30 mm
USB	2.0, 480 MB /s

**Art. M072** € 27,60
LENTE DI PRECISIONE PER MISURAZIONI

Ingrandimenti	10x
Campo di vista	24 mm
Campo di misura	0-20 mm
Letture	0,1 mm
Scatola	

Art. P080
PINZA AMPEROMETRICA DIGITALE
€ 75,90

ACV	4 / 40 / 400 / 600 V $\pm 1,5\%$ + 4
ACA	4 / 40 / 400 / 600 A $\pm 1,5\%$ + 4
DCV	4 / 40 / 400 / 600 V $\pm 1,0\%$ + 2
RES	400 Ω / 4 k Ω / 40 k Ω / 400 k Ω / 4 M Ω / 40 M Ω $\pm 1,0\%$ + 2
FREQ	10 MHz $\pm 0,8\%$ + 2
Batteria	2 x 1,5 V x AA
Imballo	40

Art. P075
PINZA AMPEROMETRICA DIGITALE
€ 138,50

ACV	750 V $\pm 1,2\%$
ACA	200 - 1000 A $\pm 2,0\%$
DCV	1000 V $\pm 1,0\%$
DCA	200 - 1000 A $\pm 2,0\%$
RES	200 Ω $\pm 1,0\%$
FREQ	2k Hz $\pm 2,5\%$
Batteria	9 V
Imballo	18

Art. T051
MULTIMETRO DIGITALE TASCABILE
€ 19,60

DCV	2-20-200-500V $\pm 0,5\%$
ACV	200-500V $\pm 1,2\%$
DCA	200mA $\pm 1,5\%$
RES	2K-20K-200K-2M Ω $\pm 1\%$
Batteria	12V
Imballo	5* / 100

MULTIMETRO DIGITALE TASCABILE, CONTINUITÀ SONORA E CONTROLLO DIODI



Art. T050

MULTIMETRO DIGITALE

€ 38,90



DCV	200 mV ±0,5%
DCV	2 V - 20 V - 200 V ±0,8%
DCV	1000 V ±0,1%
ACV	2mV - 20 V - 200 V ±1,0%
ACV	750 V ±1,2%
DCA	2 mA - 20 mA ±1,8%
DCA	200 mA ±2,0%
DCA	20 A ±2,0%
ACA	200 mA ±2,0%
ACA	20 A ±3,0%
RES	200 Ω ±1,0%
RES	2KΩ - 20KΩ - 200KΩ - 2MΩ ±1,0%
RES	20 MΩ ± 1.0%
RES	200 MΩ ±5.0%
CAP	2000 pF - 20 nF - 200 nF - 2 μF - 20 μF ±4%
Temperatura	-40 °C ÷ 400 °C ±1,0%
Temperatura	400 °C ÷ 1000 °C ±1,5%
Batteria	9 V

MULTIMETRO DIGITALE CON SONDA PER MISURAZIONE TEMPERATURA, CONTINUITÀ SONORA E CONTROLLO DIODI



Art. T053

MULTIMETRO DIGITALE

€ 93,50



DCV	200 mV - 2 V - 20 V - 200 V - 1000 V ±0,5%
ACV	200 mV - 2 V - 20 V - 750 V ±1,2%
DCA / ACA	2 mA - 20 mA - 200 mA - 20 A ±1,5%
RES	2kΩ - 20kΩ - 200kΩ - 2 MΩ ±1%
RES	200Ω - 2kΩ - 20kΩ - 200kΩ - 2 MΩ - 20 MΩ - 2000 MΩ ±0,8%
CAP	20 nF / 200 nF / 2 μF / 20 μF / 200 μF ±2,5%
Induttanza	2 mH - 20mH - 200 mH - 2 H - 20 H
Batteria	9 V
Temperatura	-50 °C ÷ 150 °C
Frequenza	10 mHz
Continuità sonora e controllo diodi	200 Ω937; ±1,0%
Test transistor hFE	0 ~ 1000
Peso	400 g
Imballo	30

MULTIMETRO DIGITALE CON SONDA PER MISURAZIONE TEMPERATURA, CONTINUITÀ SONORA E CONTROLLO DIODI

Art. 0446
PROVA BATTERIA E CARICA DELL'ALTERNATORE
€ 14,60

Batteria	11,5 ÷ 12,6V
Stato della carica	13,2 ÷ 15,5 V
Lunghezza cavo	800 mm
Peso	0,1 kg
Blister	
Imballo	72

PROVA BATTERIA E CARICA DELL'ALTERNATORE, DI FACILE USO, CON LED DI SEGNALAZIONE STATO DELLA BATTERIA E DELLA CARICA

Art. 0013/142
CACCIAVITE CERCAFASE
€ 1,72

Campo di misura	100 ÷ 500 V
Lunghezza	142 mm

CACCIAVITE CERCAFASE, CON IMPUGNATURA IN MATERIALE ISOLANTE, LUCE AL NEON E LAMA IN ACCIAIO

Art. 0013/185
CACCIAVITE CERCAFASE
€ 1,72

Campo di misura	80 ÷ 500 V
Lunghezza	185 mm

CACCIAVITE CERCAFASE, CON IMPUGNATURA IN MATERIALE ISOLANTE, LUCE AL NEON E LAMA IN ACCIAIO

Art. 0029
TESTER RUBACORRENTE
€ 5,70

Peso	40 g
Voltaggio	6 - 12 - 24 V

TESTER RUBACORRENTE, PER RILEVARE LA CORRENTE NEI CAVI DELLE AUTOMOBILI, CON VALORI DI TENSIONE DA 6-12-24 V



Art. ML80

MISURATORE DI DISTANZA LASER

€ 197,00



Campo di misura	0,05 ÷ 80 m
Precisione	±2 mm
Batteria	3 AAA x 1,5 V
Peso	140 g
Imballo	20

MISURATORE DI DISTANZA LASER, MANEGGEVOLE E LEGGERO, IDEALE PER MISURAZIONI NELL'EDILIZIA E IN CARPENTERIA, FUNZIONI: ADDIZIONI, SOTTRAZIONI, AREA E VOLUME, AUTOSPEGNIMENTO



Art. ML30

MISURATORE DI DISTANZA LASER

€ 116,00



Campo di misura	0,05 ÷ 30 m
Precisione	± 2 mm
Batteria	2 AAA x 1.5 V
Peso	0.16 kg
Imballo	50

MISURATORE DI DISTANZA LASER, MANEGGEVOLE E LEGGERO, IDEALE PER MISURAZIONI IN EDILIZIA E IN CARPENTERIA, FUNZIONI: ADDIZIONI, SOTTRAZIONI, AREA E VOLUME, AUTOSPEGNIMENTO



Art. M035

MISURATORE DI DISTANZA AD ULTRASUONI

€ 53,30



Campo di misura	0,9 ÷ 18,30 m / 3 ÷ 60 piedi
Letture	0,01 m / 0,5 pollici
Precisione	0,5% ±1 cifra
Tasto conversione	m/piedi
Memorie	3
Batteria	9 V
Dimensioni	155 x 72 x 43 mm
Scatola	
Imballo	50

MISURATORE DI DISTANZA AD ULTRASUONI CON PUNTATORE LASER, FUNZIONI: ADDIZIONI, SOTTRAZIONI, AREA E VOLUME, AUTOSPEGNIMENTO



Art. T068
€ 186,00
MISURATORE DI TEMPERATURA AD INFRAROSSI CON PUNTATORE LASER

Campo di misura	-30°C ÷ 550 °C / -22 °F ÷ 1022 °F
Precisione	-30 °C ÷ 0 °C (-22 °F ÷ 32 °F) ±3 % o ±3 °C
Precisione	0 °C ÷ 100 °C (32 °F ÷ 212 °F) ±2 % o ±2 °C
Precisione	> 100 °C (> 212 °F) ±3 % o ±3 °C
Letture	0,1 °C / 0.1 °F
Emissività	0,1 ÷ 1,0
Batteria	9 V
Peso	130 g
Dimensioni	146 x 80 x 38 mm
Distanza / Diametro dell'area	1 : 12
Blister	
Imballo	40

MISURATORE DI TEMPERATURA AD INFRAROSSI CON PUNTATORE LASER

Art. T064
€ 105,00
MISURATORE DI TEMPERATURA AD INFRAROSSI CON PUNTATORE LASER

Campo di misura	-25°C ÷ 400 °C / -13 °F ÷ 752 °F
Precisione	-25 °C ÷ 400 °C ±(2 % + 1 °C)
Precisione	-13 °F ÷ 752 °F ±(2 % + 1 °F)
Letture	1 °C / 2 °F
Batteria	9 V
Peso	300 g
Distanza / Diametro dell'area	1 : 10
Blister	
Imballo	20

Art. T054
€ 38,90
MISURATORE DI TEMPERATURA DIGITALE TASCABILE

Letture	1° C
Campo di misura	-50°C ÷ 1100°C con uso sonda T056/TP03 non in dotazione, -50°C ÷ 750°C con uso sonda T056/TP02 in dotazione, -50°C ÷ 250°C con uso sonda T056/TP01 in dotazione
Precisione	0°C ÷ 500°C ±(0,75% + 1°C), 500°C ÷ 750°C ± (1% + 1°C), 750°C ÷ 1000°C ± (2% + 1°C), 1000°C ÷ 1200°C ± (4% + 3°C)
Sonda tipo	"K"
Batteria	9 V
Scatola	
Imballo	10

MISURATORE DI TEMPERATURA DIGITALE TASCABILE, CON SONDE PER RILEVARE LA TEMPERATURA O PER IMMERSIONE

Art. T063
MISURATORE DI TEMPERATURA DIGITALE PORTATILE
€ 64,90

Campo di misura	T056/TP01: -50°C ÷ 250°C
Campo di misura	T056/TP02: -50°C ÷ 750°C
Letture	1° C
Precisione	-50 °C ÷ 1200 °C ±(0.3 % + 2 °C)
Precisione	1200°C ÷ 1300 °C ±(0.6 % + 2 °C)
Precisione	-58 °F ~ 1200°F ±(0.3 % + 2 °F)
Precisione	1200 °F ~ 1999 °F ±(0.6 % + 2 °F)
Batteria	9 V

MISURATORE DI TEMPERATURA DIGITALE PORTATILE; SONDE TIPO "K" PER AMBIENTE E PER IMMERSIONE, DOPPIA RILEVAZIONE DELLA TEMPERATURA, CON SCATOLA

Art. T055
MISURATORE DI TEMPERATURA DIGITALE PORTATILE
€ 140,00

Campo di misura	T056/TP01: -50°C ÷ 250°C
Campo di misura	T056/TP02: -50°C ÷ 750°C
Letture	0,1 °C (<1000 °C)
Letture	0,1 °F (<1000 °F) mm
Precisione	±(0,3% n+1.8 °F)
Precisione	±(0,3% n+1 °C)
Dimensioni	178 x 68 x 39 mm
Peso	190 g
Lunghezza totale sonda	120 mm
Batteria	4 x 1,5 V AA
Imballo	20

MISURATORE DI TEMPERATURA DIGITALE PORTATILE, SONDE TIPO "K" PER AMBIENTE E PER IMMERSIONE CON CUSTODIA IN PLASTICA

Art. T056/TP01 € 9,20
 SONDA TIPO "K" PER
 TEMPERATURA AMBIENTE

Campo di misura	-50°C ÷ 250°C
Tipo sonda	"K"
Lunghezza sonda	2 mm

Art. T056/TP02 € 11,20
 SONDA TIPO "K" PER
 TEMPERATURA AMBIENTE
 O PER IMMERSIONE

Campo di misura	-50°C ÷ 750°C
Tipo sonda	"K"
Lunghezza totale	240 mm

Art. T056/TP03 € 62,00
 SONDA TIPO "K"

Campo di misura	-50 °C ÷ 1100 °C
Tipo sonda	"K"
Lunghezza sonda	650 mm

SONDA TIPO "K" PER TEMPERATURA AMBIENTE O PER IMMERSIONE

Codice compatibile	Descrizione	€	T063	T054	T055	T050	Pag
T056/TP01	SONDA TIPO "K" PER TEMPERATURA AMBIENTE	9,20	•	•	•	•	346
T056/TP02	SONDA TIPO "K" PER TEMPERATURA AMBIENTE O PER IMMERSIONE	11,20	•	•	•	•	346
T056/TP03	SONDA TIPO "K"	62,00	•	•	•	•	346

Art. T057 € 215,00
 MISURATORE DIGITALE DI TEMPERATURA E UMIDITÀ AMBIENTE

Temperatura	-10 °C ÷ +65 °C
Lettura temperatura	0,1° C
Precisione temperatura	±0,5 °C
Umidità	10 % ÷ 100 %
Precisione	2 % ±1 % RH
Peso	650 g
Imballo	1
Batteria	4 x 1,5 V AA
Custodia in plastica	



Art. I002

IGROMETRO PER LA MISURAZIONE DI UMIDITÀ

€ 314,00



Temperatura di esercizio	0 °C - 40 °C
Campo di misura	0 - 80 %
Materiali da costruzione	0 - 50 %
Letture	0,1 %
Precisione	± (0,5 % n+1)
Batteria	4 x 1,5 V AA

IGROMETRO PER LA MISURAZIONE DI UMIDITÀ DEL LEGNO E MATERIALI DA COSTRUZIONE



Art. F010

FONOMETRO INTEGRATORE DIGITALE

€ 322,00

IEC651 CLASSE II

Risposta di frequenze	31,5 Hz ÷ 8 kHz
Campo di misura	30 dB ÷ 130 dB (A) / 32 dB ÷ 130 dB (C) / 35 dB ÷ 130 dB (Lineare)
Letture	0,1 dB
Funzioni	SL, LN, Leq (livello equivalente)
Caratteristiche di rilevamento	Fast, Slow, Max
Tempo di misurazione	0,1 s
Display	10 mm
Temperatura di esercizio	-10 °C ÷ 40 °C
Peso	300 g
Batteria	4 x 1,5 V AA
Custodia in plastica	

FONOMETRO INTEGRATORE DIGITALE, IEC651 CLASSE II



Art. L014

LUXMETRO DIGITALE

€ 75,20



Campo di misura	0 LUX ÷ 2000 LUX ÷ 20000 LUX ÷ 50000 LUX
Risoluzione	1 LUX
Precisione	± 5 %
Imballo	50
Batteria	9 V

Art. A005
ANEMOMETRO DIGITALE
€ 215,00

MISURAZIONE VELOCITÀ DELL'ARIA

Unità di misura	m/s - Km/h - ft/min - Knots
Gamma velocità madrino	0,4 ÷ 30,0 / 1,4 ÷ 108 / 80 ÷ 5910 / 0,8 ÷ 58,3
Letture	0,1
Precisione	± (2 % + 1 cifra) / ± (2 % + 3 cifra) / ± (2 % + 2 cifra) / ± (2 % + 2 cifra)

MISURAZIONE TEMPERATURA

Campo di misura	0° C ÷ 60° C / 32° F ÷ 140° F
Letture	0,1° C / 0.1° F
Precisione	0,5° C / 0.9° F
Peso	325 g
Batteria	9 V
Custodia in plastica	

Art. 0387
RILEVATORE DIGITALE
€ 71,50

Massima profondità di rilevazione

Metalli ferrosi	60 mm
Metalli non ferrosi	50 mm
Legno	20 mm
Cavi in tensione	40 mm
Batteria	9 V
Peso	250 g
Imballo	24
Scatola	

Art. MD01
CERCAMETALLI
€ 123,00

Diametro bobina	170 mm
Connettore jack	1/4"
Sensibilità	> 15 cm per una moneta di ø 25 mm
Batteria	9 V
Peso	1,7 kg

CERCAMETALLI ANALOGICO COMPOSTO DA 2 LED A COLORI CHE MOSTRANO IL TIPO DI METALLO RILEVATO, SENSORE AUDIO, VOLUME REGOLABILE, SINTONIZZAZIONE AUTOMATICA, DISCO SEMPLICE, BOBINA DI RICERCA IMPERMEABILE, SUPPORTO COMODO PER BRACCIO E INDICATORE STATO BATTERIA



Art. C069

CONTAGIRI DIGITALE A CONTATTO

€ 115,00



Velocità di rotazione	2,5 - 9999,9 rpm
Velocità tangenziale	0,05 - 999,99 m/min
Lettura	0,1 (7,5 - 999,9) rpm
Lettura	1 (1000-9999,9) rpm
Precisione	± 0,05 % + 1 cifra
Dimensioni	190 x 72 x 37 mm
Peso	300 g
Imballo	20
Batteria	4 x 1,5 V AA
Custodia in plastica	



Art. C067

CONTAGIRI DIGITALE OTTICO

€ 115,00



Campo di misura	2,5 ÷ 9999,9 rpm
Lettura	0,1 (2,5 ÷ 999,9) rpm
Lettura	1 (1000 ÷ 9999,9) rpm
Distanza d'uso	da 50 ÷ 60 mm a 50 ÷ 250 mm
Precisione	± 0,05 % della lettura + 1 cifra / ± 0.05 % of reading + 1 dgt
Dimensioni	170 x 72 x 37 mm
Imballo	20
Batteria	4 x 1,5V AA
Custodia in plastica	

CONTAGIRI DIGITALE OTTICO CON STRISCE CATADIOTTRICHE



Art. C070

CONTAGIRI DIGITALE OTTICO E A CONTATTO

€ 197,00



Velocità di rotazione ottica	2,5 ÷ 9999,9 rpm
Velocità di rotazione contatto	0,05 ÷ 999,9 rpm
Velocità tangenziale	0,1 ÷ 999,99 m / min
Lettura	0,1 (2,5 ÷ 999,9) rpm
Lettura	1 (1000 ÷ 9999,9) rpm
Distanza d'uso	da 50 ÷ 60 mm a 50 ÷ 250 mm (con ottico)
Precisione	± 0,05 % + 1 cifra
Dimensioni	220 x 75 x 29 mm
Imballo	20
Batteria	4 x 1,5V AA
Custodia in plastica	

CONTAGIRI DIGITALE OTTICO E A CONTATTO CON STRISCE CATADIOTTRICHE

Art. V002
 MISURATORE DI VIBRAZIONI

€ 1040,00

Accelerazione	0,1 ÷ 400 m/s ²
Velocità	0,01 ÷ 40 cm/s
Spostamento	0,001 ÷ 4 mm
Equilibratura rpm	60 ÷ 99,990
Frequenza	1÷20 kHz
Precisione	± 5 %
Batteria	4 x 1,5 V AA

 MISURATORE DI VIBRAZIONI, COMPLETO DI SONDA
 MAGNETICA, 2 PUNTALI, SOFTWARE E CAVO USB

Art. S004
 MISURATORE DI SPESSORI AD ULTRASUONI

€ 1550,00

Risoluzione	4-digit LCD
Campo di misura	1,0 - 225,0 mm
Precisione	±0,1 mm
Dimensioni	126 x 68 x 23 mm
Peso	170 g
Batteria	2 x 1,5 V AA
Valigetta in plastica	

Art. R008
 MISURATORE DI RICOPERTURA SU BASI FERROSE E NON FERROSE

€ 976,00

Campo di misura	0 ÷ 1250 µm
Divisione	0,1 µm
Precisione	±3 % µm o/or 2,5 µm
Batteria	3 x 1,5V AAA
Valigetta in plastica	

 MISURATORE DI RICOPERTURA SU BASI FERROSE E NON
 FERROSE, SOFTWARE IN DOTAZIONE



Art. 0583
RIFRATTOMETRO BRIX

€ 93,50



Campo di misura	0 ÷ 80 % Brix
Lettura	1 % Brix
Imballo	20
Scatola di plastica	



Art. 0433
RIFRATTOMETRO

€ 85,80



Campo di misura	0 ÷ 32% Brix
Lettura	0,2% Brix
Imballo	20
Scatola di plastica	

RIFRATTOMETRO BRIX PER CONTROLLO DI OLI EMULSIONABILI



Art. 0312
RIFRATTOMETRO TRIVALENTE PER LIQUIDI AUTO

€ 93,50



Scala per liquidi antigelo E	-50 °C ÷ 0 °C
Lettura	1°C
Scala per liquidi antigelo P	-50 °C ÷ 0 °C
Lettura	1°C
Scala per liquidi batteria B	1,10 ÷ 1,40 sg
Lettura	0,01 sg
Scala per liquidi tergicristallo C	-40 ÷ 0°C
Lettura	5°C
Imballo	20
Scatola di plastica	

Art. D007/A
DUROMETRO SHORE "A"
€ 82,00

Campo di misura	0 ÷ 100 A
Letture	2 A
Peso	128 g

DUROMETRO SHORE "A", MISURATORE DI DUREZZA PER GOMME MORBIDE, PELLE, FELTRO, CERE

Art. D011/A
DUROMETRO DIGITALE SHORE "A"
€ 143,00

Campo di misura	0 ÷ 100 A
Letture	0.5 A

DUROMETRO DIGITALE SHORE "A", MISURATORE DI DUREZZA PER GOMME MORBIDE, PELLE, FELTRO, CERE

Art. D011/D
DUROMETRO DIGITALE SHORE "D"
€ 143,00

Campo di misura	0 ÷ 100 D
Letture	0.5 D

DUROMETRO DIGITALE SHORE "D", MISURATORE DI DUREZZA PER GOMME DURE E MATERIE PLASTICHE

Art. P013
PROVINI IN GOMMA SHORE "A"
€ 138,00

7 Pz

PROVINI IN GOMMA SHORE "A" CON DUREZZA VARIABILE DA 26HA A 88HA. PROVINI DI COLORE VIOLA, MARRONE, VERDE, ARANCIONE, ROSSO, GIALLO E GRIGIO. PRECISIONE ±2HA

**Art. D001****DUROMETRO DA BANCO ROCKWELL****€ 2340,00**

Lettura	0,5 HR
Penetratore a diamante e a sfera	n° 1+1
Incudini piani	n° 2
Incudine a V	n° 1
Blocchetti di taratura	n° 5 (HRC, 3xHRB, HRA)
Altezza max del pezzo da misurare	170 mm
Profondità di misurazione	125 mm
Dimensioni durometro	185 x 445 x 640 mm
Forza di misurazione	588,4 N / 980,7 / 1471 N (60 kgf / 100 kgf / 150 kgf)
Peso	90 kg
Cassa di legno	

SCALE DI MISURAZIONE:

HRC	20 ÷ 70
HRB	25 ÷ 100
HRA	20 ÷ 88

**Art. D018****DUROMETRO DA BANCO****€ 4480,00**

Forza di misurazione	294,2 N / 306,5 N / 588,4 N / 612,9 N / 980,7 N / 1471 N / 1839 N; 30 kgf / 31,25 kgf / 60 kgf / 62,5 kgf / 100 kgf / 150 kgf / 187,5 kgf
Penetratore in diamante a cono e piramide	n° 1+1
Penetratore a sfera	n° 3
Incudini piani	n° 2
Incudine a V	n° 1
Blocchetti di taratura	n° 1 Brinell; n° 5 Rockwell; n° 1 Vickers
Ingrandimenti	37,5x - 75x
Altezza max del pezzo da misurare	Rockwell: 175 mm; Brinell - Vickers: 145 mm
Profondità di misurazione	160 mm
Alimentazione	230 V - 50 / 60 Hz
Dimensioni durometro	525 x 240 x 730h mm
Peso	70 kg
Cassa di legno	

SCALE DI MISURAZIONE:

HBS	4 - 450
HRB	20 - 100
HRA	20 - 88
HRC	20 - 70
HV	200 - 1000

DUROMETRO DA BANCO MOTORIZZATO, ROCKWELL, BRINELL E VICKERS

Art. R002
 RUGOSIMETRO PORTATILE DIGITALE

€ 2710,00

Ra	0,03 ÷ 6,30 µm
R max	0,20 ÷ 25,00
Rz	0,20 ÷ 25,00
Cut off	0,8 mm
Lunghezza di valutazione	0,8 mm / 2,4 mm / 4,0 mm
Risoluzione	0,01 µm
Dimensioni	150 x 33 x 83 mm
Peso	490 g
Batteria	9 V

Valigetta in plastica

 RUGOSIMETRO PORTATILE DIGITALE CON TASTATORE
 PIEZOELETTRICO

Art. S110
 SCLEROMETRO

€ 410,00

Energia di percussione	2.207 Nm
Tensione molla	7.84 N
Corsa	75 mm
Peso	1,5 kg

 SCLEROMETRO PER LA MISURAZIONE DI DUREZZA DEI
 MANUFATTI IN CEMENTO

Art. S111 **€ 454,00**
 INCUDINE PER TARATURA
 SCLEROMETRO

Peso 1,5 kg

059.767172
1 UFFICIO
 COMMERCIALE

 SERVIZIO DI
 TARATURA **2**
5 INGLESE



Art. B031
BILANCINA DIGITALE DI PRECISIONE TASCABILE

€ 24,80



Capacità	100 g
Letture	0,01 g
Tipo di pesatura	g / dwt / tl / ct
Peso	100 g
Scatola	
Imballo	50

BILANCINA DIGITALE DI PRECISIONE TASCABILE
 NON IDONEO NEI RAPPORTI CON TERZI



Art. B021
BILANCINA DIGITALE DI PRECISIONE TASCABILE

€ 20,20



Capacità	500 g
Letture	0,1 g
Tipo di pesatura	g / dwt / gn / ct
Peso	100 g
Scatola	
Imballo	50

BILANCINA DIGITALE DI PRECISIONE TASCABILE
 NON IDONEO NEI RAPPORTI CON TERZI



Art. B003/5/1
BILANCIA ELETTRONICA DIGITALE

€ 36,10



Capacità	5 kg - 176,4 oz
Letture	1 g - 0.1 oz
Batteria	2 x 1,5V AA
Dimensioni	170 x 240 x 35 mm
Peso	0,5 kg
Scatola	
Imballo	20

BILANCIA ELETTRONICA DIGITALE, NON IDONEO
 NEI RAPPORTI CON TERZI, FUNZIONE TARA,
 AUTOSPEGNIMENTO



Art. B018
BILANCIA ELETTRONICA DIGITALE CON DOPPIO DISPLAY
€ 131,00

Capacità	30 kg
Letture	10 g
Dimensione piatto	340 x 230 mm
Dimensioni	350 x 330 x 120 mm
Alimentazione	230V 50 Hz
Batteria ricaricabile	4 V 4 Ah
Peso	3,5 kg
Scatola	

**BILANCIA ELETTRONICA DIGITALE CON DOPPIO DISPLAY
NON IDONEO NEI RAPPORTI CON TERZI, DOTATA DI BATTERIA 4V 4Ah E CARICABATTERIA**

BILANCIA ELETTRONICA DIGITALE CONTAPEZZI RICARICABILE

Codice	Capacità	Letture	Peso	Dimensioni bilancia da banco	Dimensioni piatto	Batteria ricaricabile	Imballo	€
B004/7	7,5 kg	0,2 g	5 kg	350 x 340 x 105 mm	335 x 228 mm	6 V 4 Ah	2	402,00
B004/30	30 kg	1 g	5 kg	350 x 340 x 105 mm	335 x 228 mm	6 V 4 Ah	2	402,00

**BILANCIA ELETTRONICA DIGITALE CONTAPEZZI RICARICABILE
NON IDONEO NEI RAPPORTI CON TERZI DOTATA DI BATTERIA 6V 4 Ah E CARICABATTERIE**



Art. B004/150

BILANCIA ELETTRONICA DIGITALE CONTAPEZZI RICARICABILE

€ 783,00



Capacità	150 kg
Letture	10 g
Peso	17 kg
Batteria ricaricabile	6 V 4 Ah

BILANCIA ELETTRONICA DIGITALE CONTAPEZZI RICARICABILE, NON IDONEO NEI RAPPORTI CON TERZI DOTATA DI BATTERIA 6V 4 Ah E CARICABATTERIE



Art. 0561/B

BATTERIA DI RICAMBIO

€ 37,60



Voltaggio	6 V
Quantità di carica	4 Ah

BATTERIA DI RICAMBIO PER TUTTE LE BILANCE B004



DINAMOMETRI DIGITALI



Codice	Grandezza caratteri	Portata	Letture	Pesata minima	Carico limite	Peso	Batteria ricaricabile	€
D012/0100	40 x 20 mm	1000 kg	0,200 kg	0,200 kg	150%	14 kg	6 V 10 Ah	847,00
D012/0300	40 x 20 mm	3000 kg	0,500 kg	0,500 kg	150%	14,5 kg	6 V 10 Ah	1004,00
D012/0500	40 x 20 mm	5000 kg	1 kg	1 kg	150%	21 kg	6 V 10 Ah	1163,00
D012/1000	40 x 20 mm	10000 kg	2 kg	2 kg	150%	34 kg	6 V 10 Ah	1370,00

DINAMOMETRI DIGITALI DOTATI DI BATTERIA 6V 10Ah E CARICABATTERIE
NON IDONEO NEI RAPPORTI CON TERZI





CHIAVI

pag 360



CHIAVI A BUSSOLA ED ACCESSORI

pag 381



CACCIAVITI ED ESTRATTORI

pag 422



PINZE, MARTELLI, LIME E SCALPELLI

pag 441



GENERAL TOOLS

pag 466





MORSE DA BANCO, STRETTOI E INCUDINI

pag 479



UTENSILI DA TAGLIO

pag 485



CARRELLI, BANCHI, ARMADIETTI, CASSETTIERE, VALIGETTE E KITS

pag 495



GRUPPI ELETTOGENI

pag 529



RISCALDATORI, ILLUMINAZIONE E LENTI

pag 531



**SALDATORI, SVERNICIATORI
E PISTOLE ERMOCOLLANTI**

pag 557



PNEUMATICA

pag 562



PER IL GIARDINAGGIO

pag 583



SICUREZZA E INFORTUNISTICA

pag 592



CHIAVE COMBINATA CON TESTA A CRICCHETTO SNODATA

Cromata



Cr-V

Codice	Misura	Imballo	€
0690/08	8 mm	10	13,50
0690/09	9 mm	10	13,50
0690/10	10 mm	10	16,80
0690/11	11 mm	10	16,80
0690/12	12 mm	10	16,80
0690/13	13 mm	10	16,80

Codice	Misura	Imballo	€
0690/14	14 mm	10	21,30
0690/15	15 mm	10	21,30
0690/16	16 mm	10	21,30
0690/17	17 mm	10	23,00
0690/18	18 mm	10	24,10
0690/19	19 mm	10	25,80

Art. 0690/07P
€ 109,00
SERIE CHIAVI COMBinate CON TESTA A CRICCHETTO SNODATA

7 Pz



Cromata



Cr-V

Pezzi	7
Misure	8 - 10 - 11 - 13 - 15 - 17 - 19 mm
Imballo	20

Art. 0690/12P
€ 175,00
SERIE CHIAVI COMBinate CON TESTA A CRICCHETTO SNODATA

12 Pz



Cromata



Cr-V

Pezzi	12
Misure	8 - 9 - 10 - 11 - 12 - 13 - 14 - 15 - 16 - 17 - 18 - 19 mm
Imballo	6

Art. 0700/07P
€ 68,80
SERIE CHIAVI COMBinate CON TESTA A CRICCHETTO

7 Pz



Cromata



Cr-V

Pezzi	7
Misure	8 - 10 - 11 - 13 - 15 - 17 - 19 mm
Imballo	20





CHIAVI COMBinate SATINATE



Satinata **Cr-V**

Codice	Misura	Imballo	€	Codice	Misura	Imballo	€
0544/06	6 mm	10	4,00	0544/19	19 mm	10	10,00
0544/07	7 mm	10	4,00	0544/20	20 mm	10	11,00
0544/08	8 mm	10	4,00	0544/21	21 mm	10	12,00
0544/09	9 mm	10	4,00	0544/22	22 mm	10	13,00
0544/10	10 mm	10	4,50	0544/23	23 mm	10	13,00
0544/11	11 mm	10	4,50	0544/24	24 mm	10	14,00
0544/12	12 mm	10	4,50	0544/25	25 mm	5	14,00
0544/13	13 mm	10	5,00	0544/26	26 mm	5	14,00
0544/14	14 mm	10	6,00	0544/27	27 mm	5	15,00
0544/15	15 mm	10	7,00	0544/28	28 mm	5	15,00
0544/16	16 mm	10	8,00	0544/29	29 mm	5	15,00
0544/17	17 mm	10	9,00	0544/30	30 mm	5	16,00
0544/18	18 mm	10	9,50	0544/32	32 mm	5	18,00



Art. 0546
SERIE CHIAVI COMBinate SATINATE

€ 55,00



12 Pz **Satinata** **Cr-V**

Serie	6 ÷ 22 mm
Pezzi	12
Misure	6 - 7 - 8 - 9 - 10 - 11 - 12 - 13 - 14 - 17 - 19 - 22 mm
Imballo	20



Art. 0544
SERIE CHIAVI COMBinate SATINATE

€ 144,00



25 Pz **Satinata** **Cr-V**

Serie	6 ÷ 32 mm
Pezzi	25
Misure	6-7-8-9-10-11-12-13-14-15-16-17-18-19-20-21-22-23-24-25-26-27-28-29-30-32 mm
Imballo	4



CHIAVI FISSE CROMATE, LUCIDATE A SPECCHIO

 **DIN 3110**
 **Cromata**
 **Cr-V**

Codice	Misura	Imballo	€	Codice	Misura	Imballo	€
0201/06X07	6x7 mm	10* / 100	2,18	0201/18X19	18x19 mm	5* / 50	6,20
0201/08X09	8x9 mm	10* / 100	2,86	0201/20X22	20x22 mm	5* / 50	7,10
0201/10X11	10x11 mm	10* / 100	2,86	0201/21X23	21x23 mm	5* / 50	8,30
0201/12X13	12x13 mm	10* / 100	4,12	0201/24X27	24x27 mm	5* / 50	8,90
0201/14X15	14x15 mm	10* / 100	4,12	0201/25X28	25x28 mm	5* / 50	11,20
0201/16X17	16x17 mm	10* / 100	5,10	0201/30X32	30x32 mm	5* / 50	11,80

Art. 0200
SERIE CHIAVI FISSE CROMATE, LUCIDATE A SPECCHIO
€ 33,30

 **8 Pz**
 **DIN 3110**
 **Cromata**
 **Cr-V**

Serie	6 ÷ 22 mm
Misure	6x7 8x9 10x11 12x13 14x15 16x17 18x19 20x22 mm
Pezzi	8
Imballo	24

Art. 0201
SERIE CHIAVI FISSE CROMATE, LUCIDATE A SPECCHIO
€ 77,00

 **12 Pz**
 **DIN 3110**
 **Cromata**
 **Cr-V**

Serie	6 ÷ 32 mm
Misure	6x7 8x9 10x11 12x13 14x15 16x17 18x19 20x22 21x23 24x27 25x28 30x32 mm
Pezzi	12
Imballo	12





CHIAVI COMBinate CROMATE, LUCIDATE A SPECCHIO



DIN 3113 **Cromata** **Cr-V**

Codice	Misura	Imballo	€
0208/06	6 mm	10* / 100	4,12
0208/07	7 mm	10* / 100	4,12
0208/08	8 mm	10* / 100	4,12
0208/09	9 mm	10* / 100	4,12
0208/10	10 mm	10* / 100	4,22
0208/11	11 mm	10* / 100	4,22
0208/12	12 mm	10* / 100	4,22
0208/13	13 mm	10* / 100	4,22
0208/14	14 mm	10* / 100	6,30
0208/15	15 mm	10* / 100	6,30
0208/16	16 mm	10* / 100	6,30
0208/17	17 mm	10* / 100	7,10
0208/18	18 mm	10* / 100	7,10

Codice	Misura	Imballo	€
0208/19	19 mm	5* / 50	8,30
0208/20	20 mm	5* / 50	10,20
0208/21	21 mm	5* / 50	10,20
0208/22	22 mm	5* / 50	11,80
0208/23	23 mm	5* / 50	12,40
0208/24	24 mm	5* / 50	13,50
0208/25	25 mm	5* / 50	13,50
0208/26	26 mm	5* / 50	13,50
0208/27	27 mm	5* / 50	14,60
0208/28	28 mm	5* / 50	14,60
0208/30	30 mm	5* / 50	14,60
0208/32	32 mm	5* / 50	16,80



SERIE CHIAVI COMBinate CROMATE, LUCIDATE A SPECCHIO



DIN 3113 **Cromata** **Cr-V**

Codice	Serie	Misure	Pezzi	Imballo	€
0199	6 ÷ 22 mm	6-7-8-9-10-11-12-13-14-17-19-22 mm	12	24	55,00
0199P	1/4" ÷ 1"	1/4" - 5/16" - 3/8" - 7/16" - 1/2" - 9/16" - 5/8" - 11/16" - 3/4" - 13/16" - 7/8" - 15/16" - 1"	13	12	64,90



Art. 0208

SERIE CHIAVI COMBinate CROMATE, LUCIDATE A SPECCHIO

€ 131,00



DIN 3113
25 Pz **Cromata** **Cr-V**

Serie	6 ÷ 32 mm
Misure	6-7-8-9-10-11-12-13-14-15-16-17-18-19-20-21-22-23-24-25-26-27-28-30-32 mm
Pezzi	25
Imballo	4





Art. 0221
SERIE CHIAVI FISSE

€ 17,40



8 Pz DIN 3110 Cr-V

Serie	6 ÷ 22 mm
Misure	6x7 8x9 10x11 12x13 14x15 16x17 18x19 20x22 mm
Pezzi	8
Imballo	5* / 20



Art. 0222
SERIE CHIAVI FISSE

€ 42,20



12 Pz DIN 3110 Cr-V

Serie	6 ÷ 32 mm
Misure	6x7 8x9 10x11 12x13 14x15 16x17 18x19 20x22 21x23 24x27 25x28 30x32 mm
Pezzi	12
Imballo	2* / 10





CHIABI COMBinate



DIN 3113 **Cr-V**

Codice	Misura	Imballo	€	Codice	Misura	Imballo	€
0224/06	6 mm	20* / 200	1,38	0224/20	20 mm	10* / 100	5,70
0224/07	7 mm	20* / 200	1,38	0224/21	21 mm	10* / 100	6,00
0224/08	8 mm	20* / 200	1,38	0224/22	22 mm	10* / 100	6,00
0224/09	9 mm	20* / 200	1,44	0224/23	23 mm	10* / 100	6,10
0224/10	10 mm	20* / 200	1,50	0224/24	24 mm	10* / 100	6,10
0224/11	11 mm	10* / 100	1,84	0224/25	25 mm	5* / 50	6,70
0224/12	12 mm	10* / 100	1,84	0224/26	26 mm	5* / 50	7,60
0224/13	13 mm	10* / 100	1,84	0224/27	27 mm	5* / 50	8,60
0224/14	14 mm	10* / 100	2,28	0224/28	28 mm	5* / 50	10,30
0224/15	15 mm	10* / 100	2,28	0224/30	30 mm	5* / 50	10,90
0224/16	16 mm	10* / 100	2,28	0224/32	32 mm	5* / 50	12,40
0224/17	17 mm	10* / 100	2,28	0224/34	34 mm	2* / 20	13,50
0224/18	18 mm	10* / 100	2,28	0224/36	36 mm	2* / 20	19,10
0224/19	19 mm	10* / 100	3,88				



Art. 0073
SERIE CHIAVI COMBinate

€ 18,90



12 Pz **DIN 3113** **Cr-V**

Serie	6 ÷ 22 mm
Pezzi	12
Misure	6 - 7 - 8 - 9 - 10 - 11 - 12 - 13 - 14 - 17 - 19 - 22 mm
Imballo	6* / 24



Art. 0223
SERIE CHIAVI COMBinate

€ 74,80



25 Pz **DIN 3113** **Cr-V**

Serie	6 ÷ 32 mm
Pezzi	25
Misure	6-7-8-9-10-11-12-13-14-15-16-17-18-19-20-21-22-23-24-25-26-27-28-30-32 mm
Imballo	4



CHIAVI POLIGONALI

 **DIN 838**
 **Cromata**
 **Cr-V**

Codice	Misura	€
0476/06X07	6 x 7 mm	2,52
0476/08X09	8 x 9 mm	2,74
0476/10X11	10 x 11 mm	2,86
0476/12X13	12 x 13 mm	2,98
0476/14X15	14 x 15 mm	3,66
0476/16X17	16 x 17 mm	4,12
0476/18X19	18 x 19 mm	4,56
0476/20X22	20 x 22 mm	6,40
0476/21X23	21 x 23 mm	6,90
0476/24X27	24 x 27 mm	8,90
0476/25X28	25 x 28 mm	10,30
0476/30X32	30 x 32 mm	12,40

CHIAVE POLIGONALE COSTRUITA IN ACCIAIO CR-V, DIN 838, CROMATA E LUCIDATA A SPECCHIO

Art. 0477
SERIE CHIAVI POLIGONALI
€ 27,80

 **8 Pz**
 **DIN 838**
 **Cromata**
 **Cr-V**

Serie	6 ÷ 22 mm
Pezzi	8
Misure	6x7 8x9 10x11 12x13 14x15 16x17 18x19 20x22 mm

SERIE 8 Pz CHIAVI POLIGONALI 6 ÷ 22 mm, CROMATE E LUCIDATE A SPECCHIO, CHROME - VANADIUM, DIN 838

Art. 0476
SERIE CHIAVI POLIGONALI
€ 63,80

 **12 Pz**
 **DIN 838**
 **Cromata**
 **Cr-V**

Serie	6 ÷ 32 mm
Pezzi	12
Misure	6x7 8x9 10x11 12x13 14x15 16x17 18x19 20x22 21x23 24x27 25x28 30x32 mm

SERIE 12 Pz CHIAVI POLIGONALI 6 ÷ 32 mm CROMATE E LUCIDATE, A SPECCHIO CHROME-VANADIUM, DIN 838





Art. 0134S
SERIE CHIAVI POLIGONALI

€ 33,40



8 Pz DIN 837 Cr-V

Serie	6 ÷ 22 mm
Pz	8
Misure	100 - 6x7 mm, 115 - 8x9 mm, 130 - 10x11 mm, 145 - 12x13 mm, 160 - 14x15 mm, 170 - 16x17 mm, 185 - 18x19 mm, 205 - 20x22 mm

Scatola
SERIE 8 Pz CHIAVI POLIGONALI DOPPIE DIRITTE, DIN837, CHROME-VANADIUM



CHIAVI A MEZZALUNA



DIN 838 Cr-V

Codice	Misura	€
0614/08X10	8 x 10 mm	6,00
0614/10X12	10 x 12 mm	6,50
0614/11X13	11 x 13 mm	7,00
0614/13X15	13 x 15 mm	7,50
0614/14X17	14 x 17 mm	9,00
0614/16X18	16 x 18 mm	11,00
0614/19X22	19 x 22 mm	12,00



Art. 0541S
SERIE CHIAVI PER RACCORDI

€ 29,00



6 Pz DIN 3118 Cr-V

Serie	8 ÷ 22 mm
Pz	6
Misure	140 - 8x10 mm, 150 - 9x11 mm, 175 - 11x13 mm, 175 - 12x14 mm, 210 - 17x19 mm, 220 - 19x22 mm

Scatola
SERIE 6 Pz CHIAVI PER RACCORDI, DA 8 mm A 14 mm ESAGONALI, DA 17 mm A 22 mm POLIGONALI, DIN3118, CHROME-VANADIUM



CHIAVI INGLESE CROMATE

Codice	Misura	Apertura	Imballo	€
0084/150	6"-150 mm	18 mm	5* / 100	5,40
0084/250	10"- 250 mm	30 mm	5* / 50	9,50
0084/375	15"- 375 mm	48 mm	5* / 10	26,90

CHIAVI A TUBO ESAGONALI

 Cr-V

Codice	Misura	Lunghezza	€
0442/06X07	6 x 7 mm	105 mm	7,50
0442/08X09	8 x 9 mm	110 mm	8,00
0442/10X11	10 x 11 mm	120 mm	8,60
0442/12X13	12 x 13 mm	140 mm	9,70
0442/14X15	14 x 15 mm	145 mm	10,90
0442/16X17	16 x 17 mm	155 mm	12,40
0442/18X19	18 x 19 mm	165 mm	15,20
0442/20X22	20 x 22 mm	170 mm	19,10

CHIAVI A TUBO ESAGONALI COSTRUITA IN ACCIAIO CR-V, CROMATA E LUCIDATA A SPECCHIO CON CORPO ESAGONALE

Art. 0442
SERIE CHIAVI A TUBO ESAGONALI
€ 88,00

 8 Pz  Cr-V

Misure 105 - 6x7 mm, 110 - 8x9 mm, 120 - 10x11 mm, 140 - 12x13 mm, 145 - 14x15 mm, 155 - 16x17 mm, 165 - 18x19 mm, 170 - 20x22 mm

SERIE 8 Pz CHIAVI A TUBO A DUE BOCHE ESAGONALI, COSTRUITE IN ACCIAIO CR-V, CROMATE E LUCIDATE A SPECCHIO CON CORPO ESAGONALE



CHIAVI A TUBO



Codice	Misura	Lunghezza	€
0540/06X07	6 x 7 mm	110 mm	2,80
0540/08X09	8 x 9 mm	120 mm	2,96
0540/10X11	10 x 11 mm	125 mm	3,00
0540/12X13	12 x 13 mm	135 mm	3,20
0540/14X15	14 x 15 mm	135 mm	3,40
0540/16X17	16 x 17 mm	150 mm	4,00
0540/18X19	18 x 19 mm	160 mm	4,50
0540/20X22	20 x 22 mm	170 mm	5,00

CHIAVI A TUBO ESAGONALI TIPO LEGGERO



Art. 0540S
SERIE DI CHIAVI A TUBO

€ 18,40



8 Pz

Serie	6 ÷ 22 mm
Misure	6x7 8x9 10x11 12x13 14x15 16x17 18x19 20x22 mm
Imballo	20

SERIE DI 8 Pz CHIAVI A TUBO ESAGONALI, TIPO LEGGERO, CON SPINA DI MANOVRA A 3 DIAMETRI



Art. 0540/3
SPINA DI MANOVRA

€ 3,00



Lunghezza	165 mm
Ø	9,5 - 7,5 - 6 mm
Appendibile	

SPINA DI MANOVRA A 3 DIAMETRI PER CHIAVI A TUBO



Art. 0266
CHIAVE PER BOMBOLA GAS

€ 1,56



Misura	25 mm
Imballo	10* / 200



Art. 0545/EM
SERIE CHIAVI ESAGONALI LUNGHE MAGNETICHE CON TESTA SFERICA
€ 31,00

 **9 Pz**  **Mo-V S2**
Misure 1.5 - 2 - 2.5 - 3 - 4 - 5 - 6 - 8 - 10 mm

Blister
Imballo 12 / 48

SERIE 9 Pz CHIAVI ESAGONALI LUNGHE MAGNETICHE CON TESTA SFERICA, COSTRUITE IN MATERIALE S2, IL COLORE IDENTIFICA LA MISURA, MOLYBDENUM-VANADIUM

SERIE CHIAVI ESAGONALI LUNGHE CON PUNTA SFERICA

 **9 Pz**  **Satinata**  **Cr-V**

Codice	Misure	Imballo	€
0215	1,5-2-2,5-3-4-5-6-8-10 mm	6* / 60	12,40
0215P	1/16" 5/64" 3/32" 1/8" 5/32" 3/16" 1/4" 5/16" 3/8"	6* / 60	12,40

CHIAVI ESAGONALI CON MANICO ANATOMICO IN PLASTICA

 **Cr-V**

Codice	Dimensioni	Imballo	€
0856/02	2x100 mm	200	4,12
0856/02.5	2,5x100 mm	200	4,12
0856/03	3x100 mm	200	4,12
0856/04	4x100 mm	200	4,80
0856/05	5x150 mm	50	4,80
0856/06	6x150 mm	200	5,50
0856/08	8x200 mm	50	6,40
0856/10	10x200 mm	50	7,50



CHIAVI ESAGONALI MASCHIO A "T"



Cr-V

Codice	Misura	Dimensioni	Imballo	€
0400/02	2 mm	125 x 65 mm	20 / 100	8,60
0400/025	2,5 mm	125 x 65 mm	20	8,60
0400/03	3 mm	125 x 65 mm	20	8,60
0400/035	3,5 mm	125 x 65 mm	20 / 100	8,60
0400/04	4 mm	180 x 90 mm	20 / 100	9,20
0400/045	4,5 mm	180 x 90 mm	20 / 100	9,20
0400/05	5 mm	180 x 90 mm	20	9,20
0400/06	6 mm	210 x 105 mm	20 / 100	9,70
0400/07	7 mm	210 x 105 mm	20 / 100	9,70
0400/08	8 mm	250 x 125 mm	10 / 50	11,20
0400/09	9 mm	300 x 145 mm	10 / 50	13,50
0400/10	10 mm	300 x 145 mm	10 / 50	13,50
0400/12	12 mm	320 x 165 mm	10 / 20	21,30
0400/14	14 mm	340 x 170 mm	10 / 20	28,90

CHIAVE ESAGONALE MASCHIO A "T", IN CR-V, CON ASTA SCORREVOLE CHE LA RENDE VERSATILE ALL'USO IN SITUAZIONI DIFFICILI E IN CONDIZIONI GRAVOSE



Art. 0400
SERIE CHIAVI ESAGONALI MASCHIO A "T"

€ 66,00



7 Pz **Cr-V**

Misure	2 - 3 - 4 - 5 - 6 - 8 - 10 mm
Imballo	15

SERIE 7 Pz CHIAVI ESAGONALI MASCHIO A "T", IN CR-V, CON ASTA SCORREVOLE CHE LE RENDE VERSATILI ALL'USO IN SITUAZIONI DIFFICILI E IN CONDIZIONI GRAVOSE



Art. 0269
SERIE CHIAVI ESAGONALI

€ 5,50



9 Pz **Cr-V**

Misure	1,5 - 2 - 2,5 - 3 - 4 - 5 - 6 - 8 - 10 mm
Imballo	6* / 60

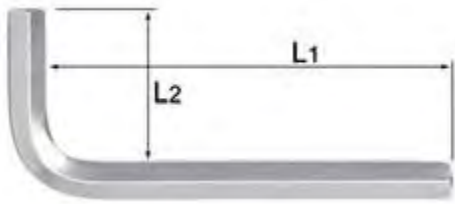

CHIAVI MASCHIO ESAGONALI

 **DIN 911**
 **Zincata**
 **Cr-V**

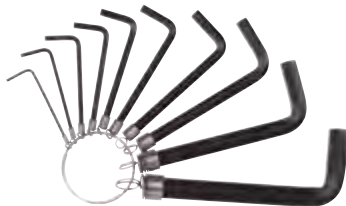
Codice	L1	L2	Imballo	€
0090/015	45 mm	14 mm	10* / 200	0,70
0090/02	50 mm	16 mm	10* / 200	0,70
0090/025	56 mm	18 mm	10* / 200	0,70
0090/03	63 mm	20 mm	10* / 200	0,76
0090/04	70 mm	25 mm	10* / 200	0,76
0090/05	80 mm	28 mm	10* / 200	1,14
0090/06	90 mm	32 mm	10*/200	1,38
0090/08	100 mm	36 mm	5* / 200	2,06
0090/10	112 mm	40 mm	5* / 200	2,52
0090/12	125 mm	45 mm	5* / 100	3,88
0090/14	140 mm	56 mm	50	5,50
0090/17	160 mm	63 mm	50	7,20
0090/19	180 mm	70 mm	50	11,60

Art. 0090
SERIE CHIAVI ESAGONALI
€ 2,80

 **10 Pz**
Misure 1,5 - 2 - 2,5 - 3 - 3,5 - 4 - 5 - 6 - 8 - 10 mm
Imballo 25* / 100

Art. 0545/TM
SERIE CHIAVI TORX LUNGHE MAGNETICHE
€ 33,00

 **9 Pz**
 **Mo-V S2**
Misure T10 - T15 - T20 - T25 - T27 - T30 - T40 - T45 - T50
Blister
Imballo 12 / 48

SERIE 9 Pz CHIAVI TORX LUNGHE MAGNETICHE, CON FORO NELLA PARTE CORTA, COSTRUITE IN MATERIALE S2, IL COLORE IDENTIFICA LA MISURA, MOLYBDENUM-VANADIUM



Art. 0220
SERIE CHIAVI TORX LUNGHE

€ 14,60



9 Pz Satinata Cr-V

Misure T10 - T15 - T20 - T25 - T27 - T30 - T40 - T45 - T50

Imballo 6* / 60

SERIE 9 Pz CHIAVI TORX LUNGHE CON FORO DI GUIDA NEL GAMBO LUNGO, CHROME - VANADIUM, SATINATE



Art. 0210
SERIE CHIAVI TORX

€ 4,48



8 Pz

Misure T9 - T10 - T15 - T20 - T25 - T27 - T30 - T40

Imballo 10* / 100



CHIAVI TORX CON MANICO ANATOMICO IN PLASTICA



Cr-V

Codice	Dimensioni	Imballo	€
0855/T10	T10x100 mm	300	4,80
0855/T15	T15x100 mm	300	4,80
0855/T20	T20x100 mm	300	4,80
0855/T25	T25x100 mm	200	5,50
0855/T30	T30x150 mm	50	6,20
0855/T40	T40x150 mm	100	6,90



CHIAVE TORX MASCHIO A "T"

Cr-V



Codice	Misure	Imballo	€
0405/T06	125 x 65 mm	20 / 100	10,90
0405/T07	125 x 65 mm	20 / 100	10,90
0405/T08	125 x 65 mm	20 / 100	10,90
0405/T09	125 x 65 mm	20 / 100	10,90
0405/T10	125 x 65 mm	20 / 100	10,90
0405/T15	125 x 65 mm	20 / 100	10,90
0405/T20	125 x 65 mm	20 / 100	10,90
0405/T25	180 x 90 mm	20 / 100	11,20
0405/T27	180 x 90 mm	20 / 100	11,20
0405/T30	180 x 90 mm	20 / 100	11,20
0405/T40	210 x 105 mm	20 / 100	13,50
0405/T45	210 x 105 mm	20 / 100	14,60
0405/T50	210 x 105 mm	10 / 50	15,70

CHIAVE TORX MASCHIO A "T", IN CR-V, CON ASTA SCORREVOLE CHE LA RENDE VERSATILE ALL'USO IN SITUAZIONI DIFFICILI E IN CONDIZIONI GRAVOSE

Art. 0405
SERIE CHIAVI TORX MASCHIO A "T"
€ 70,40

7 Pz Cr-V

Misure	T8-T9-T10-T15-T20-T25-T30
Imballo	3

SERIE 7 Pz CHIAVI TORX MASCHIO A "T", IN CR-V, CON ASTA SCORREVOLE CHE LE RENDE VERSATILI ALL'USO IN SITUAZIONI DIFFICILI E IN CONDIZIONI GRAVOSE

CHIAVE A T CON BUSSOLA ESAGONALE SNODATA MAGNETICA

Cr-V



Codice	Esagono	Lunghezza	€
C395/06	6 mm	390 mm	17,50
C395/07	7 mm	390 mm	17,50
C395/08	8 mm	390 mm	17,50
C395/09	9 mm	390 mm	17,50
C395/10	10 mm	500 mm	19,80
C395/11	11 mm	500 mm	19,80
C395/12	12 mm	500 mm	19,80
C395/13	13 mm	500 mm	20,80
C395/14	14 mm	500 mm	20,80
C395/15	15 mm	500 mm	23,50
C395/16	16 mm	500 mm	23,50
C395/17	17 mm	500 mm	23,50
C395/18	18 mm	500 mm	24,50
C395/19	19 mm	500 mm	26,00





CHIAVE A T CON BUSSOLA ESAGONALE SNODATA



CHIAVE A T CON BUSSOLA ESAGONALE SNODATA, PER SERVIZIO GRAVOSO, CHROME - VANADIUM

Codice	Misura	Lunghezza	Imballo	€
C391/06	6 mm	395 mm	50	20,00
C391/07	7 mm	395 mm	50	20,00
C391/08	8 mm	395 mm	50	20,00
C391/09	9 mm	400 mm	50	20,00
C391/10	10 mm	400 mm	50	22,00
C391/11	11 mm	400 mm	50	22,00
C391/12	12 mm	400 mm	50	22,00
C391/13	13 mm	432 mm	50	24,00
C391/14	14 mm	432 mm	50	24,00
C391/15	15 mm	450 mm	36	29,00
C391/16	16 mm	450 mm	36	29,00
C391/17	17 mm	450 mm	36	29,00
C391/18	18 mm	450 mm	36	29,00
C391/19	19 mm	500 mm	30	32,00



CHIAVE PER CANDELA



Codice	Misura	Lunghezza	Imballo	€
0078	20,8	500 mm	6* / 48	6,90
0079	16 mm	510 mm	6* / 24	6,90

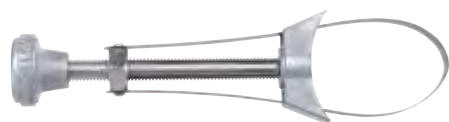

Art. 0076
 CHIAVE FILTRO A NASTRO

€ 4,50

Imballo 5* / 50

Art. 0077
 CHIAVE FILTRO A CATENA

€ 6,00

Imballo 5* / 50

Art. 0018/15
 SERIE CHIAVI PER FILTRI OLIO

€ 63,80

 15 Pz  3/8"

Misure (Ø mm - lati)

65 mm - 14, 65/67 mm - 14, 68 mm - 14, 74 mm - 15, 74/76 mm - 15, 75/77 mm - 15, 76 mm - 14, 76 mm - 30, 80 mm - 15, 80/82 mm - 15, 90 mm - 15, 93 mm - 15, 93 mm - 36, 100 mm - 15

Attacco adattatore

1/2" (F) 3/8" (M)

SERIE 15 PZ CHIAVI PER FILTRI OLIO, CON ATTACCO FEMMINA DA 3/8", COSTRUITE IN ACCIAIO AL CARBONIO, UTILI PER LO SMONTAGGIO DEI FILTRI DELL'OLIO DI MOLTE AUTOVETTURE. ADATTATORE DA 3/8" MASCHIO E 1/2" FEMMINA INCLUSO NEL SET. LE CHIAVI SONO RIPOSTE IN UNA COMODA E RESISTENTE VALIGETTA IN PLASTICA.

Art. 0018/30
 SERIE CHIAVI PER FILTRI OLIO

€ 142,00

 28 Pz  3/8"

Misure (Ø mm - lati)

65 mm - 14, 65/67 mm - 14, 66 mm - 6, 68 mm - 14, 73 mm - 14, 74 mm - 15, 74/76 mm - 15, 75/77 mm - 15, 76 mm - 8, 76 mm - 12, 76 mm - 14, 76 mm - 30, 78 mm - 15, 80 mm - 15, 80/82 mm - 15, 86 mm - 16, 86 mm - 18, 90 mm - 15, 92 mm - 10, 93 mm - 15, 93 mm - 36, 93 mm - 45, 95 mm - 15, 96 mm - 18, 100 mm - 15, 106 mm - 15, 108 mm - 15, 108 mm - 18

Attacco adattatore

1/2" (F) 3/8" (M)

Chiave a 3 griffe

65 ÷ 120 mm

SERIE 28 PZ CHIAVI PER FILTRI OLIO, CON ATTACCO FEMMINA DA 3/8", COSTRUITE IN ACCIAIO AL CARBONIO, UTILI PER LO SMONTAGGIO DEI FILTRI DELL'OLIO DI MOLTE AUTOVETTURE. ADATTATORE DA 3/8" MASCHIO E 1/2" FEMMINA E CHIAVE A 3 GRIFFE INCLUSI NEL SET. LE CHIAVI SONO RIPOSTE IN UNA COMODA E RESISTENTE VALIGETTA IN PLASTICA



Art. 0080
CHIAVE A CROCE

€ 9,20



DIN 899

Misure	17 - 19 - 21 mm
Dimensioni	381 x 16 mm
Imballo	10

CHIAVE A CROCE COSTRUITA IN ACCIAIO ZINCATO, DIN 899, ATTACCO MASCHIO DA 1/2"



Art. 0426/30
CHIAVE A CROCE

€ 33,30



Misure	24 - 27 - 30 mm
Dimensioni	550 x 20 mm

CHIAVE A CROCE PER AUTOCARRO LEGGERO, COSTRUITA IN ACCIAIO ZINCATO, CON BUSSOLE FISSE ESAGONALI DI 24 mm, 27 mm, 30 mm E ATTACCO MASCHIO DA 3/4"



Art. 0426/32
CHIAVE A CROCE

€ 42,20



Misure	24 - 27 - 32 mm
Dimensioni	700 x 22 mm

CHIAVE A CROCE PER AUTOCARRO, COSTRUITA IN ACCIAIO ZINCATO, CON BUSSOLE FISSE ESAGONALI DI 24 mm, 27 mm, 32 mm E ATTACCO MASCHIO DA 3/4"



Art. 0451
CHIAVE A CROCE SMONTABILE

€ 35,60



Cr-V

Misure bussole	17 - 19 - 21 - 23 mm
Dimensioni leva	Ø15 x 400 mm
Lunghezza manico	330 mm

CHIAVE A CROCE SMONTABILE, COSTRUITA IN CROMO-VANADIO, COMPOSTA DA 2 BUSSOLE ESAGONALI A 4 MISURE, LEVA E MANICO ROTANTE, ATTACCO QUADRO DA 1/2"



Art. 0806/200
CHIAVE DINAMOMETRICA ELETTRONICA DIGITALE, LETTURA DI COPPIA E ANGOLO
€ 552,00

 1/2"

SCALE DI MISURAZIONE:	Nm / kgm / lbft / lbin	Modalità operativa	Peak / Track
Capacità	20 ÷ 200 Nm	Memorie coppia - angolo	5
Letture	0,1 Nm	Attacco quadro	1/2"
Precisione	±2%, 10% @ 200 Nm	Lunghezza	605 mm
Angolo di misurazione	0 ÷ 360°	Batteria	4x 1,5 V AAA
Precisione angolo	±1%	Peso	1,5 kg

CHIAVE DINAMOMETRICA ELETTRONICA DIGITALE, LETTURA DI COPPIA E ANGOLO. PERMETTE SERRAGGI IN SENSO ORARIO E ANTIORARIO E UNA DIAGNOSTICA LUMINOSA E SONORA DELLO STATO COPPIA/ANGOLO. FORNITA IN VALIGETTA DI PLASTICA

Art. 0270
CHIAVE DINAMOMETRICA DIGITALE PER GOMMISTI
€ 270,00

 1/2"

SCALE DI MISURAZIONE:	Nm	Temperatura di esercizio	0°C; ÷ 50°C; (31°F; ÷ 122°F;)
Coppie di serraggio preimpostate	90, 110, 135, 160, 190 Nm	Autospegnimento	80"
Precisione	0.1 Nm	Batterie non incluse	3 x AAA
Numero dei LED	3	Autonomia	110 h
Attacco quadro	1/2"	Peso	1.75 kg
Denti	36	Valigetta in plastica	

CHIAVE DINAMOMETRICA DIGITALE PER GOMMISTI CON ATTACCO DA 1/2" E DISPLAY SUL FIANCO PER LEGGERE MEGLIO LA FORZA DI SERRAGGIO. INDICAZIONE SONORA E LUMINOSA DELLA COPPIA DI SERRAGGIO OTTENUTA.

Art. 0806/020
CACCIAVITE DINAMOMETRICO DIGITALE
€ 108,00

SCALE DI MISURAZIONE:	Nm / lbft / lbin
Capacità	0 ÷ 20 Nm
Letture	0,01 Nm
Precisione	±2%
Modalità operativa	Peak / Track
Autospegnimento	5 min.
Attacco esagonale	1/4"
Lunghezza	175 mm
Batteria	2 x 1,5 V AAA
Peso	0,25 kg

CACCIAVITE DINAMOMETRICO DIGITALE, PERMETTE SERRAGGIO IN SENSO ORARIO E ANTIORARIO, DIAGNOSTICA SONORA E A VIBRAZIONE DELLA COPPIA RAGGIUNTA PREIMPOSTATA





Art. 0268
CHIAVE DINAMOMETRICA DIGITALE

€ 92,40

1/2"



SCALE DI MISURAZIONE:	Nm / kgm / kgcm / lbft / lbin
Capacità	40 ÷ 200 Nm
Lettura	0,1 Nm
Modalità operativa	Peak / Track
Memorie	50
Precisione	±2%
Attacco quadro	1/2"
Dimensioni	75 x 44 mm
Batteria	1 x CR2032
Peso	0,25 kg
Imballo	24

CHIAVE DINAMOMETRICA DIGITALE, FORNITA IN VALIGETTA IN PLASTICA



Art. 0137
CHIAVE DINAMOMETRICA

€ 60,50



Cr-V

Attacco quadro	1/2" - 3/8"
Capacità	28 ÷ 210 Nm
Prolunga	120 mm
Imballo	12



CHIAVI DINAMOMETRICHE



Cr-V

Codice	Capacità	Lunghezza	Attacco	Precisione	Imballo	€
0803/110	20 - 110 Nm	380 mm	3/8"	±4%	12	137,00
0803/210	40 - 210 Nm	535 mm	1/2"	±4%	10	197,00
0803/700	140 - 700 Nm	805 mm	3/4"	±4%	4	639,00





Art. 0803/S210
 CHIAVE DINAMOMETRICA IN SET

€ 314,00

 11 Pz  Cr-V

Capacità	40 ÷ 210 Nm
Precisione	±4%
Chiavi	13 - 14 - 15 - 17 - 19 - 22 - 24 - 27 - 30 mm
Attacco chiavi	14 x 18 mm
Testa reversibile	1/2"

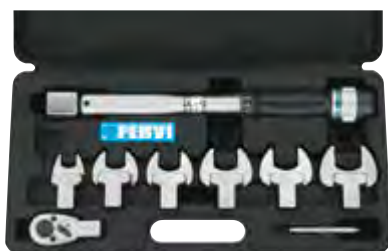
Art. 0803/S080
 CHIAVE DINAMOMETRICA IN SET

€ 214,00

 8 Pz  Cr-V

Capacità	15 ÷ 80 Nm
Precisione	±4%
Chiavi	17 - 22 - 24 - 26 - 27 - 30 mm
Attacco chiavi	14x 18 mm
Testa reversibile	3/8"

Art. 0329
 MOLTIPLICATORE DI FORZA

€ 169,00

Bussole da 1"	32 - 33 mm
Rapporto	1:60
Forza massima	3200 Nm
Forza di lavoro	1200 Nm
Peso	8,3 kg
Imballo	3

MOLTIPLICATORE DI FORZA, SMONTARUOTE PER AUTOCARRO, FORNITO IN VALIGETTA DI PLASTICA

Art. 0360
 MOLTIPLICATORE DI FORZA

€ 77,00

Bussole da 1"	32 - 33 mm
Rapporto	1 : 56
Forza massima	3000 Nm
Forza di lavoro	1000 Nm
Peso	7,1 kg
Valigetta in plastica	

MOLTIPLICATORE DI FORZA, SMONTARUOTE PER AUTOCARRO, FORNITO IN VALIGETTA DI PLASTICA





Art. CN450N0/0

CRICCHETTO REVERSIBILE A CAMBIO RAPIDO 3 IN 1

€ 50,00



Cr-V & Cr-Mo

CRICCHETTO REVERSIBILE A CAMBIO RAPIDO 3 IN 1, CON ATTACCO QUADRO DA 1/2", 3/8" E 1/4", FACILE DA SOSTITUIRE, AFFIDABILE E ROBUSTO

Attacco	1/2", 3/8", 1/4"
Lunghezza	230 mm
Denti	72
Astuccio	24
Imballo	20



CRICCHETTO ERGONOMICO



Cr-V & Cr-Mo

Codice	Attacco quadro	Lunghezza	Denti	Peso	Imballo	€
G090/1/2	1/2"	265 mm	90	470 g	4 / 32	32,00
G090/1/4	1/4"	145 mm	90	115 g	10 / 120	23,00
G090/3/8	3/8"	195 mm	90	245 g	6 / 60	28,00

CRICCHETTO ERGONOMICO, COSTRUITO IN ACCIAIO CR-V E CR-MO, CON APPENDIBILE



CRICCHETTO ERGONOMICO



Cr-V & Cr-Mo

Codice	Attacco quadro	Lunghezza	Denti	Peso	Imballo	€
F090/1/2	1/2"	265 mm	90	470 g	4 / 32	32,00
F090/1/4	1/4"	145 mm	90	115 g	10 / 120	23,00
F090/3/8	3/8"	195 mm	90	245 g	6 / 60	28,00

CRICCHETTO ERGONOMICO, COSTRUITO IN ACCIAIO CR-V E CR-MO, CON APPENDIBILE



CRICCHETTO ERGONOMICO CON TESTA ANTISPORCO

Cr-V & Cr-Mo

Codice	Attacco quadro	Lunghezza	Denti	Peso	€
0494/1/4	1/4"	165 mm	72	0,13 kg	28,00
0494/3/8	3/8"	215 mm	72	0,27 kg	32,00
0494/1/2	1/2"	276 mm	72	0,52 kg	38,50

CRICCHETTO ERGONOMICO

Cr-V & Cr-Mo

Codice	Attacco quadro	Lunghezza	Denti	Peso	Imballo	€
CN450N1/4A	1/4"	150 mm	72	125 g	20	27,80
CN450N3/8A	3/8"	205 mm	72	280 g	20	32,20
CN450N1/2A	1/2"	250 mm	72	540 g	20	33,30

CRICCHETTO ERGONOMICO

Cr-V & Cr-Mo

Codice	Attacco quadro	Lunghezza	Denti	Imballo	€
0439/1/4	1/4"	155 mm	72	10 / 80	19,00
0439/3/8	3/8"	200 mm	72	10 / 40	26,90
0439/1/2	1/2"	260 mm	72	5 / 20	32,20



CRICCHETTO ERGONOMICO



Cr-V & Cr-Mo

Codice	Attacco quadro	Lunghezza	Denti	Imballo	€
0440/1/4	1/4"	155 mm	72	10 / 80	20,20
0440/3/8	3/8"	200 mm	72	10 / 40	25,80
0440/1/2	1/2"	240 mm	72	5 / 20	31,10



LEVA A CRICCO REVERSIBILE CON ESTRATTORE



Cr-V & Cr-Mo

Codice	Lunghezza	Attacco quadro	Denti	Imballo	€
0019/1/4	154 mm	1/4"	24	50	16,80
0019/3/8	215 mm	3/8"	24	30	24,10
0019/1/2	275 mm	1/2"	24	30	30,60



Art. 0308 € 34,60
CRICCHETTO REVERSIBILE



3/4"

Quadro	3/4"
Imballo	10



Art. 0228 € 11,80
CRICCHETTO REVERSIBILE



1/2"

Quadro	1/2"
Imballo	60



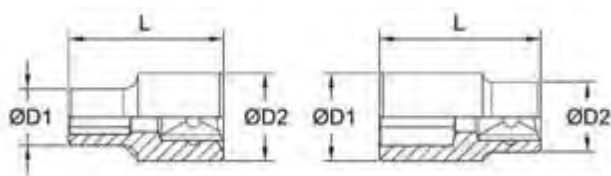

CHIAVE A BUSSOLA ESAGONALE, SERIE NORMALE

DIN 3124

1/4"

Cromata

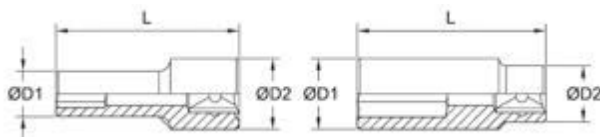
Cr-V

Codice	Misura	D1	D2	Lunghezza	Peso	€
BN4E5N004A	4 mm	6,8 mm	12 mm	25 mm	10 g	1,60
BN4E5N0045A	4,5 mm	7,2 mm	12 mm	25 mm	10 g	1,60
BN4E5N005A	5 mm	7,8 mm	12 mm	25 mm	11 g	1,60
BN4E5N0055A	5,5 mm	8,4 mm	12 mm	25 mm	11 g	1,60
BN4E5N006A	6 mm	9,3 mm	12 mm	25 mm	11 g	1,60
BN4E5N007A	7 mm	10,8 mm	12 mm	25 mm	11 g	1,60
BN4E5N008A	8 mm	12 mm	11 mm	25 mm	11 g	1,84
BN4E5N009A	9 mm	13 mm	12 mm	25 mm	15 g	1,84
BN4E5N010A	10 mm	14,6 mm	12 mm	25 mm	14 g	1,84
BN4E5N011A	11 mm	16 mm	12,5 mm	25 mm	20 g	2,06
BN4E5N012A	12 mm	17 mm	13,5 mm	25 mm	22 g	2,06
BN4E5N013A	13 mm	18 mm	13,5 mm	25 mm	24 g	2,28
BN4E5N014A	14 mm	19 mm	14,5 mm	25 mm	30 g	2,52

CHIAVE A BUSSOLA ESAGONALE LUNGA

DIN 3124

1/4"

Cromata

Cr-V

Codice	Misura	D1	D2	Lunghezza	Peso	€
BN4E5L004A	4 mm	6,8 mm	12 mm	50 mm	20 g	3,78
BN4E5L0045A	4,5 mm	7,2 mm	12 mm	50 mm	21 g	3,78
BN4E5L005A	5 mm	7,8 mm	12 mm	50 mm	21 g	3,78
BN4E5L0055A	5,5 mm	8,4 mm	12 mm	50 mm	21 g	3,78
BN4E5L006A	6 mm	9,3 mm	12 mm	50 mm	23 g	3,78
BN4E5L007A	7 mm	10,8 mm	12 mm	50 mm	23 g	3,78
BN4E5L008A	8 mm	12 mm	11 mm	50 mm	24 g	3,78
BN4E5L009A	9 mm	13 mm	12 mm	50 mm	29 g	3,78
BN4E5L010A	10 mm	14,6 mm	12 mm	50 mm	38 g	3,78
BN4E5L011A	11 mm	16 mm	13 mm	50 mm	44 g	4,12
BN4E5L012A	12 mm	17 mm	13 mm	50 mm	53 g	4,12
BN4E5L013A	13 mm	18 mm	13 mm	50 mm	51 g	4,34
BN4E5L014A	14 mm	19 mm	14,5 mm	50 mm	68 g	4,34



CHIAVE A BUSSOLA POLIGONALE, SERIE NORMALE

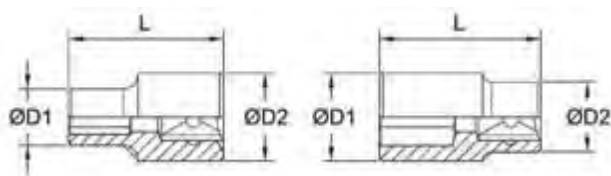

DIN 3124 **1/4"** **Cromata** **Cr-V**

Codice	Misura	D1	D2	Lunghezza	Peso	€
BN4P5N004A	4 mm	6,8 mm	12 mm	25 mm	10 g	1,50
BN4P5N005A	5 mm	7,8 mm	12 mm	25 mm	11 g	1,50
BN4P5N0055A	5,5 mm	8,4 mm	12 mm	25 mm	11 g	1,50
BN4P5N006A	6 mm	9,3 mm	12 mm	25 mm	11 g	1,50
BN4P5N007A	7 mm	10,8 mm	12 mm	25 mm	11 g	1,50
BN4P5N008A	8 mm	12 mm	11 mm	25 mm	11 g	1,72
BN4P5N009A	9 mm	13 mm	12 mm	25 mm	15 g	1,72
BN4P5N010A	10 mm	14,6 mm	12 mm	25 mm	14 g	1,72
BN4P5N011A	11 mm	16 mm	12,5 mm	25 mm	20 g	1,94
BN4P5N012A	12 mm	17 mm	13,5 mm	25 mm	22 g	1,94
BN4P5N013A	13 mm	18 mm	13,5 mm	25 mm	24 g	2,18
BN4P5N014A	14 mm	19 mm	14,5 mm	25 mm	30 g	2,28



BUSSOLA CON INSERTO ESAGONALE

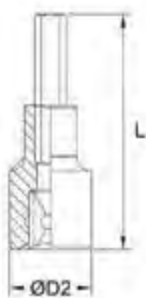

1/4" **Cromata** **Cr-V**

Codice	Misura	D2	Peso	€
BN415N003A	3 mm	12 mm	13 g	2,86
BN415N004A	4 mm	12 mm	15 g	2,86
BN415N005A	5 mm	12 mm	15 g	2,86
BN415N006A	6 mm	12 mm	15 g	2,86
BN415N008A	8 mm	12 mm	17 g	2,86

BUSSOLA CON INSERTO ESAGONALE LUNGHEZZA 37 mm, CON ATTACCO DA 1/4", COSTRUITA IN ACCIAIO CR-V, MICRO CROMATA



BUSSOLA CON INSERTO TORX

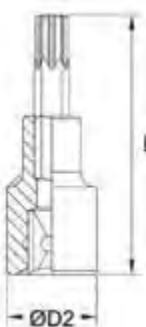

1/4" **Cromata** **Cr-V**

Codice	Misura	D2	Peso	€
BN425N008A	T8	12 mm	12 g	2,86
BN425N009A	T9	12 mm	12 g	2,86
BN425N010A	T10	12 mm	13 g	2,86
BN425N015A	T15	12 mm	14 g	2,86
BN425N020A	T20	12 mm	14 g	2,86
BN425N025A	T20	12 mm	14 g	2,86
BN425N027A	T27	12 mm	14 g	2,86
BN425N030A	T30	12 mm	15 g	2,86
BN425N040A	T40	12 mm	16 g	2,86

BUSSOLA CON INSERTO TORX LUNGHEZZA 37 mm, CON ATTACCO DA 1/4", COSTRUITA IN ACCIAIO CR-V, MICRO CROMATA

BUSSOLA CON INSERTO XZN

1/4" Cromata Cr-V

Codice	Misura	D2	Peso	€
BN445N004A	M 4	15 mm	12 g	9,60
BN445N005A	M 5	15 mm	12 g	9,60
BN445N006A	M 6	15 mm	13 g	9,60
BN445N008A	M 8	15 mm	14 g	9,60
BN445N009A	M 9	15 mm	14 g	9,60
BN445N010A	M 10	15 mm	15 g	9,60

BUSSOLA CON INSERTO XZN LUNGHEZZA 37mm, CON ATTACCO DA 1/4", COSTRUITA IN ACCIAIO CR-V, MICRO CROMATA

Art. RN4054NA € 3,42
RACCORDO

Cromata Cr-V

Attacco femmina e maschio	1/4" 3/8"
Lunghezza	26 mm
Peso	20 g
Imballo	12

Art. JN405NA € 6,20
SNODO A CARDANO

1/4" Cromata Cr-V

Attacco quadro	1/4"
Lunghezza	38 mm
Peso	29 g
Imballo	24

PROLUNGA

1/4" Cromata Cr-V

Codice	Attacco quadro	Lunghezza	Peso	Imballo	€
PN405N050A	1/4"	50 mm	24 g	50	3,42
PN405N075A	1/4"	75 mm	37 g	50	3,66
PN405N150A	1/4"	150 mm	67 g	25	5,50

PROLUNGA A TESTA SFERICA

1/4" Cromata Cr-V

Codice	Attacco quadro	Lunghezza	Peso	Imballo	€
EN405N050A	1/4"	50 mm	23 g	50	4,56
EN405N075A	1/4"	75 mm	35 g	50	5,20
EN405N150A	1/4"	150 mm	68 g	25	5,70



Art. LN400N1/4A € 5,20
LEVA A T SCORREVOLE

1/4" Cromata Cr-V

Attacco quadro	1/4"
Lunghezza	115 mm
Peso	41 g
Imballo	12

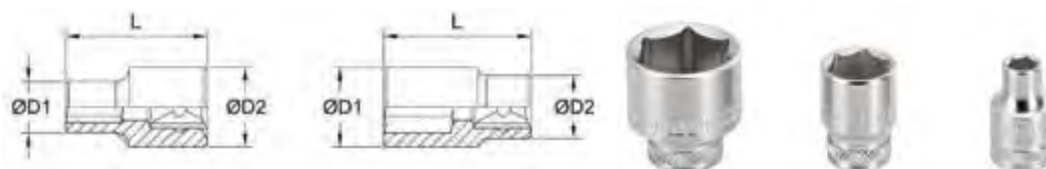

CHIAVE A BUSSOLA ESAGONALE, SERIE NORMALE



DIN 3124 **3/8"** **Cromata** **Cr-V**

Codice	Misura	D1	D2	Lunghezza	Peso	€
BN4E4N006A	6 mm	9,3 mm	17 mm	28 mm	25 g	2,74
BN4E4N007A	7 mm	10,6 mm	17 mm	28 mm	24 g	2,74
BN4E4N008A	8 mm	11,8 mm	17 mm	28 mm	25 g	2,74
BN4E4N009A	9 mm	13,2 mm	17 mm	28 mm	25 g	2,74
BN4E4N010A	10 mm	14,5 mm	17 mm	28 mm	27 g	2,74
BN4E4N011A	10 mm	15,7 mm	17 mm	28 mm	28 g	2,74
BN4E4N012A	12 mm	17 mm	16,4 mm	28 mm	28 g	2,74
BN4E4N013A	13 mm	18 mm	17 mm	28 mm	31 g	2,74
BN4E4N014A	14 mm	20 mm	17 mm	28 mm	34 g	3,42
BN4E4N015A	15 mm	20,9 mm	18 mm	28 mm	47 g	3,42
BN4E4N016A	16 mm	22 mm	18 mm	28 mm	45 g	3,42
BN4E4N017A	17 mm	24 mm	18 mm	30 mm	53 g	3,42
BN4E4N018A	18 mm	26 mm	18 mm	30 mm	58 g	4,12
BN4E4N019A	19 mm	26 mm	20 mm	30 mm	64 g	4,34
BN4E4N020A	20 mm	27,1 mm	20 mm	30 mm	73 g	5,10
BN4E4N021A	21 mm	28 mm	20 mm	30 mm	82 g	5,10
BN4E4N022A	22 mm	30 mm	20 mm	32 mm	87 g	6,00



CHIAVE A BUSSOLA ESAGONALE LUNGA

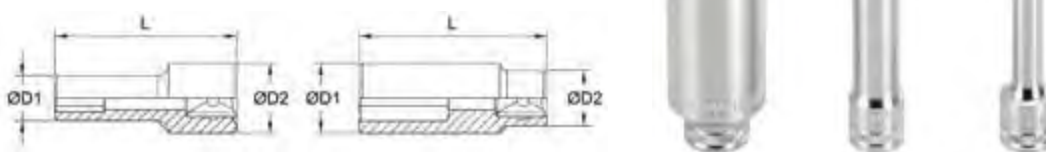

DIN 3124 **3/8"** **Cromata** **Cr-V**

Codice	Misura	D1	D2	Lunghezza	Peso	€
BN4E4L006A	6 mm	9,3 mm	17 mm	63 mm	50 g	6,00
BN4E4L007A	7 mm	10,6 mm	17 mm	62 mm	52 g	6,00
BN4E4L008A	8 mm	11,8 mm	17 mm	63 mm	52 g	6,00
BN4E4L009A	9 mm	13,2 mm	17 mm	63 mm	56 g	6,00
BN4E4L010A	10 mm	14,5 mm	17 mm	63 mm	60 g	6,00
BN4E4L011A	11 mm	15,7 mm	17 mm	63 mm	68 g	6,00
BN4E4L012A	12 mm	17 mm	16,4 mm	63 mm	68 g	6,00
BN4E4L013A	13 mm	18 mm	17 mm	63 mm	64 g	6,00
BN4E4L014A	14 mm	19,6 mm	17 mm	63 mm	72 g	6,80
BN4E4L015A	15 mm	20,9 mm	18 mm	63 mm	88 g	6,80
BN4E4L016A	16 mm	22 mm	18 mm	63 mm	88 g	6,80
BN4E4L017A	17 mm	23,4 mm	18 mm	63 mm	112 g	6,80
BN4E4L018A	18 mm	24,6 mm	20 mm	63 mm	126 g	7,80
BN4E4L019A	19 mm	26 mm	20 mm	63 mm	124 g	7,80
BN4E4L020A	20 mm	27,1 mm	20 mm	63 mm	125 g	7,80
BN4E4L021A	21 mm	28 mm	20 mm	63 mm	126 g	9,20
BN4E4L022A	22 mm	30 mm	20 mm	63 mm	128 g	9,20

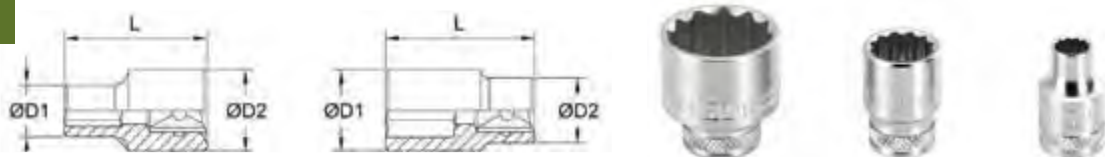
CHIAVE A BUSSOLA POLIGONALE, SERIE NORMALE

DIN 3124

3/8"

Cromata

Cr-V

Codice	Misura	D1	D2	Lunghezza	Peso	€
BN4P4N006A	6 mm	9,3 mm	17 mm	28 mm	25 g	2,52
BN4P4N007A	7 mm	10,6 mm	17 mm	28 mm	24 g	2,52
BN4P4N008A	8 mm	11,8 mm	17 mm	28 mm	25 g	2,52
BN4P4N009A	9 mm	13,2 mm	17 mm	28 mm	25 g	2,52
BN4P4N010A	10 mm	14,5 mm	17 mm	28 mm	27 g	2,52
BN4P4N011A	11 mm	15,7 mm	17 mm	28 mm	28 g	2,52
BN4P4N012A	12 mm	17 mm	16,4 mm	28 mm	28 g	2,52
BN4P4N013A	13 mm	18 mm	17 mm	28 mm	31 g	2,52
BN4P4N014A	14 mm	20 mm	17 mm	28 mm	34 g	3,20
BN4P4N015A	15 mm	20,9 mm	18 mm	28 mm	47 g	3,20
BN4P4N016A	16 mm	22 mm	18 mm	28 mm	45 g	3,20
BN4P4N017A	17 mm	24 mm	18 mm	30 mm	53 g	3,20
BN4P4N018A	18 mm	26 mm	18 mm	30 mm	58 g	3,88
BN4P4N019A	19 mm	26 mm	20 mm	30 mm	64 g	4,12
BN4P4N020A	20 mm	28 mm	20 mm	30 mm	73 g	4,68
BN4P4N021A	21 mm	28 mm	20 mm	30 mm	82 g	4,68
BN4P4N022A	22 mm	30 mm	20 mm	32 mm	87 g	5,60

BUSSOLA CON INSERTO ESAGONALE

3/8"

Cromata

Cr-V

Codice	Misura	D2	Peso	€
BN414N003A	3 mm	18 mm	28 g	6,50
BN414N004A	4 mm	18 mm	30 g	6,50
BN414N005A	5 mm	18 mm	34 g	6,50
BN414N006A	6 mm	18 mm	38 g	6,50
BN414N007A	7 mm	18 mm	38 g	6,50
BN414N008A	8 mm	18 mm	40 g	6,50
BN414N009A	9 mm	20 mm	40 g	6,50
BN414N010A	10 mm	20 mm	40 g	6,50
BN414N012A	12 mm	20 mm	42 g	6,70

BUSSOLA CON INSERTO ESAGONALE LUNGHEZZA 48 mm, CON ATTACCO DA 3/8", COSTRUITA IN ACCIAIO CR-V, MICRO CROMATA

BUSSOLA CON INSERTO ESAGONALE LUNGO

3/8"

Cromata

Cr-V

Codice	Misura	D2	Peso	€
BN414L003A	3 mm	18 mm	39 g	9,40
BN414L004A	4 mm	18 mm	41 g	9,40
BN414L005A	5 mm	18 mm	45 g	9,40
BN414L006A	6 mm	18 mm	49 g	9,40
BN414L007A	7 mm	18 mm	56 g	9,60
BN414L008A	8 mm	18 mm	56 g	9,60
BN414L009A	9 mm	20 mm	56 g	9,60
BN414L010A	10 mm	20 mm	66 g	9,60
BN414L012A	12 mm	20 mm	79 g	10,90

BUSSOLA CON INSERTO ESAGONALE LUNGO LUNGHEZZA 95 mm, CON ATTACCO DA 3/8", COSTRUITA IN ACCIAIO CR-V, MICRO CROMATA



BUSSOLA CON INSERTO TORX



3/8" **Cromata** **Cr-V**

Codice	Misura	D2	Peso	€
BN424N010A	T10	18 mm	26 g	6,90
BN424N015A	T15	18 mm	28 g	6,90
BN424N020A	T20	18 mm	30 g	6,90
BN424N025A	T25	18 mm	34 g	6,90
BN424N027A	T27	18 mm	38 g	6,90
BN424N030A	T30	18 mm	38 g	6,90
BN424N040A	T40	18 mm	40 g	6,90
BN424N045A	T45	18 mm	40 g	6,90
BN424N050A	T50	20 mm	40 g	7,80
BN424N055A	T55	20 mm	45 g	9,20

BUSSOLA CON INSERTO TORX LUNGHEZZA 48, CON ATTACCO DA 3/8", COSTRUITA IN ACCIAIO CR-V, MICRO CROMATA



BUSSOLA CON INSERTO TORX LUNGO



3/8" **Cromata** **Cr-V**

Codice	Misura	D2	Peso	€
BN424L015A	T15	18 mm	39 g	11,50
BN424L020A	T20	18 mm	41 g	11,50
BN424L025A	T25	18 mm	45 g	11,50
BN424L027A	T27	18 mm	49 g	11,50
BN424L030A	T30	18 mm	49 g	11,50
BN424L040A	T40	18 mm	51 g	11,50
BN424L045A	T45	18 mm	51 g	15,30

BUSSOLA CON INSERTO TORX LUNGO LUNGHEZZA 95 mm, CON ATTACCO DA 3/8", COSTRUITA IN ACCIAIO CR-V, MICRO CROMATA



BUSSOLA CON INSERTO RIBE



3/8" **Cromata** **Cr-V**

Codice	Misura	D2	Peso	€
BN434N004A	M 4	18 mm	59 g	14,60
BN434N005A	M 5	18 mm	60 g	14,90
BN434N006A	M 6	18 mm	62 g	15,20
BN434N007A	M 7	18 mm	63 g	15,40
BN434N008A	M 8	18 mm	79 g	15,70
BN434N009A	M 9	18 mm	80 g	16,40
BN434N010A	M 10	20 mm	82 g	17,90

BUSSOLA CON INSERTO RIBE LUNGHEZZA 50 mm, CON ATTACCO DA 3/8", COSTRUITA IN ACCIAIO CR-V, MICRO CROMATA



BUSSOLA CON INSERTO RIBE LUNGO



3/8" **Cromata** **Cr-V**

Codice	Misura	D2	Peso	€
BN434L004A	M 4	18 mm	70 g	15,70
BN434L005A	M 5	18 mm	71 g	16,00
BN434L006A	M 6	18 mm	73 g	16,20
BN434L007A	M 7	18 mm	74 g	16,20
BN434L008A	M 8	18 mm	90 g	17,20
BN434L009A	M 9	18 mm	91 g	17,20
BN434L010A	M 10	20 mm	93 g	21,00

BUSSOLA CON INSERTO RIBE LUNGO LUNGHEZZA 95 mm, CON ATTACCO DA 3/8", COSTRUITA IN ACCIAIO CR-V, MICRO CROMATA



BUSSOLA CON INSERTO XZN

3/8"



Cromata



Cr-V



Codice	Misura	D2	Peso	€
BN444N004A	M 4	18 mm	28 g	11,40
BN444N005A	M 5	18 mm	30 g	11,40
BN444N006A	M 6	18 mm	34 g	11,40
BN444N008A	M 8	18 mm	38 g	11,40
BN444N009A	M 9	20 mm	38 g	11,40
BN444N010A	M 10	20 mm	40 g	11,50
BN444N012A	M 12	20 mm	40 g	12,10
BN444N014A	M 14	20 mm	40 g	12,90

BUSSOLA CON INSERTO XZN LUNGHEZZA 48 mm, CON ATTACCO DA 3/8",
COSTRUITA IN ACCIAIO CR-V, MICRO CROMATA

BUSSOLA CON INSERTO XZN LUNGO

3/8"



Cromata



Cr-V



Codice	Misura	D2	Peso	€
BN444L004A	M 4	18 mm	28 g	12,50
BN444L005A	M 5	18 mm	30 g	12,50
BN444L006A	M 6	18 mm	34 g	12,50
BN444L008A	M 8	18 mm	38 g	12,50
BN444L009A	M 9	20 mm	38 g	12,50
BN444L010A	M 10	20 mm	40 g	12,90
BN444L012A	M 12	20 mm	40 g	13,90
BN444L014A	M 14	20 mm	40 g	14,80

BUSSOLA CON INSERTO XZN LUNGO LUNGHEZZA 95 mm, CON ATTACCO DA
3/8", COSTRUITA IN ACCIAIO CR-V, MICRO CROMATA

CHIAVE A BUSSOLA PER CANDELA

3/8"



Cromata



Cr-V

Codice	Misura	Lunghezza	Peso	€
BN4C4L016A	16 mm	63 mm	69,4 g	5,70
BN4C4L018A	18 mm	63 mm	98,2 g	8,00
BN4C4L021A	21 mm	65 mm	99 g	8,60

Art. LN400N3/8A € 10,00
LEVA A T SCORREVOLE

3/8"



Cromata



Cr-V

Attacco quadro	3/8"
Lunghezza	200 mm
Peso	182 g
Imballo	4

Art. RN4045NA € 3,42
RACCORDO

Cromata



Cr-V

Attacco femmina e maschio	3/8" 1/4"
Lunghezza	27 mm
Peso	31,5 g
Imballo	12



Art. RN4043NA € 4,00

RACCORDO



Cromata Cr-V

Attacco femmina e maschio	3/8" 1/2"
Lunghezza	35 mm
Peso	47 g
Imballo	12



Art. JN404NA € 7,80

SNODO A CARDANO



Cromata Cr-V 3/8"

Attacco quadro	3/8"
Lunghezza	54 mm
Peso	80 g
Imballo	12



PROLUNGA



3/8" Cromata Cr-V

Codice	Attacco quadro	Lunghezza	Peso	Imballo	€
PN404N050A	3/8"	50 mm	50 g	20	3,88
PN404N075A	3/8"	75 mm	75 g	20	5,30
PN404N150A	3/8"	150 mm	150 g	10	6,40



PROLUNGA A TESTA SFERICA



3/8" Cromata Cr-V

Codice	Attacco quadro	Lunghezza	Peso	Imballo	€
EN404N038A	3/8"	38 mm	39 g	20	4,56
EN404N075A	3/8"	75 mm	75 g	20	5,70
EN404N150A	3/8"	150 mm	150 g	20	6,90
EN404N250A	3/8"	250 mm	240 g	20	11,20

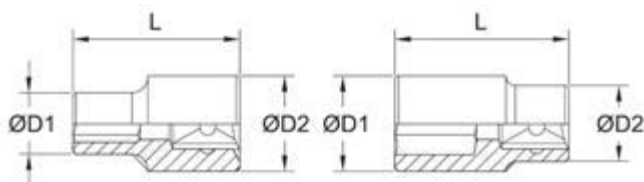

CHIAVE A BUSSOLA ESAGONALE, SERIE NORMALE

DIN 3124

1/2"

Cromata

Cr-V

Codice	Misura	D1	D2	Lunghezza	Peso	€
BN4E3N008A	8 mm	12,2 mm	22 mm	38 mm	61 g	3,42
BN4E3N009A	9 mm	13,5 mm	22 mm	38 mm	59 g	3,42
BN4E3N010A	10 mm	15 mm	22 mm	38 mm	60 g	3,42
BN4E3N011A	11 mm	16,3 mm	22 mm	38 mm	60 g	3,42
BN4E3N012A	12 mm	17,6 mm	22 mm	38 mm	61 g	3,42
BN4E3N013A	13 mm	18,8 mm	22 mm	38 mm	63 g	3,42
BN4E3N014A	14 mm	20,4 mm	22 mm	38 mm	63 g	3,42
BN4E3N015A	15 mm	21 mm	22 mm	38 mm	66 g	3,54
BN4E3N016A	16 mm	22 mm	20,5 mm	38 mm	64 g	3,84
BN4E3N017A	17 mm	24 mm	22 mm	38 mm	68 g	4,12
BN4E3N018A	18 mm	25,4 mm	22 mm	38 mm	75 g	4,46
BN4E3N019A	19 mm	26 mm	22 mm	38 mm	86 g	4,46
BN4E3N020A	20 mm	28 mm	22 mm	38 mm	95 g	4,76
BN4E3N021A	21 mm	28 mm	22 mm	38 mm	97 g	4,98
BN4E3N022A	22 mm	30 mm	26 mm	38 mm	105 g	5,60
BN4E3N023A	23 mm	31,6 mm	26 mm	38 mm	118 g	5,70
BN4E3N024A	24 mm	32 mm	26 mm	38 mm	138 g	5,70
BN4E3N025A	25 mm	34 mm	26 mm	42 mm	141 g	6,30
BN4E3N026A	26 mm	35,4 mm	28 mm	42 mm	158 g	6,40
BN4E3N027A	27 mm	36 mm	28 mm	42 mm	161 g	6,40
BN4E3N028A	28 mm	38 mm	28 mm	42 mm	162 g	6,80
BN4E3N029A	29 mm	38 mm	28 mm	43 mm	199 g	7,00
BN4E3N030A	30 mm	40 mm	28 mm	43 mm	214 g	7,00
BN4E3N032A	32 mm	42 mm	28 mm	44 mm	236 g	7,00



CHIAVE A BUSSOLA ESAGONALE LUNGA

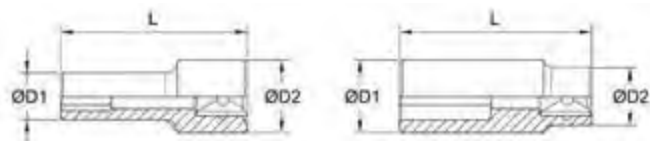

DIN 3124



1/2"



Cromata



Cr-V

Codice	Misura	D1	D2	Lunghezza	Peso	€
BN4E3L010A	10 mm	15 mm	22 mm	77 mm	116 g	7,50
BN4E3L011A	11 mm	16,3 mm	22 mm	77 mm	118 g	7,50
BN4E3L012A	12 mm	17,6 mm	22 mm	77 mm	125 g	7,50
BN4E3L013A	13 mm	18,8 mm	22 mm	77 mm	124 g	7,50
BN4E3L014A	14 mm	20,4 mm	22 mm	77 mm	127 g	7,80
BN4E3L015A	15 mm	21 mm	22 mm	77 mm	140 g	7,80
BN4E3L016A	16 mm	22 mm	20,5 mm	77 mm	139 g	7,80
BN4E3L017A	17 mm	24 mm	22 mm	77 mm	132 g	8,00
BN4E3L018A	18 mm	25,4 mm	22 mm	77 mm	136 g	8,60
BN4E3L019A	19 mm	26 mm	22 mm	77 mm	151 g	8,60
BN4E3L020A	20 mm	28 mm	22 mm	77 mm	194 g	9,10
BN4E3L021A	21 mm	28 mm	22 mm	77 mm	163 g	9,50
BN4E3L022A	22 mm	30 mm	26 mm	77 mm	166 g	9,50
BN4E3L023A	23 mm	31,6 mm	26 mm	77 mm	208 g	11,30
BN4E3L024A	24 mm	32 mm	26 mm	77 mm	212 g	11,80
BN4E3L027A	27 mm	36 mm	28 mm	77 mm	312 g	16,60
BN4E3L030A	30 mm	40 mm	28 mm	77 mm	307 g	18,00
BN4E3L032A	32 mm	42 mm	28 mm	77 mm	334 g	18,00

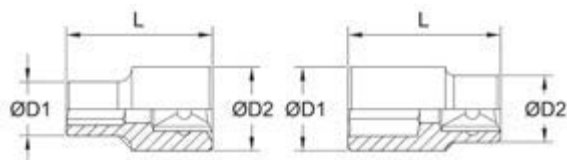

CHIAVE A BUSSOLA POLIGONALE, SERIE NORMALE

DIN 3124

1/2"

Cromata

Cr-V

Codice	Misura	D1	D2	Lunghezza	Peso	€
BN4P3N008A	8 mm	12,2 mm	22 mm	38 mm	61 g	3,20
BN4P3N009A	9 mm	13,5 mm	22 mm	38 mm	59 g	3,20
BN4P3N010A	10 mm	15 mm	22 mm	38 mm	60 g	3,20
BN4P3N011A	11 mm	16,3 mm	22 mm	38 mm	60 g	3,20
BN4P3N012A	12 mm	17,6 mm	22 mm	38 mm	61 g	3,20
BN4P3N013A	13 mm	18,8 mm	22 mm	38 mm	63 g	3,20
BN4P3N014A	14 mm	20,4 mm	22 mm	38 mm	63 g	3,20
BN4P3N015A	15 mm	21 mm	22 mm	38 mm	66 g	3,32
BN4P3N016A	16 mm	22 mm	20,5 mm	38 mm	64 g	3,54
BN4P3N017A	17 mm	24 mm	22 mm	38 mm	68 g	3,88
BN4P3N018A	18 mm	25,4 mm	22 mm	38 mm	75 g	4,22
BN4P3N019A	19 mm	26 mm	22 mm	38 mm	86 g	4,22
BN4P3N020A	20 mm	28 mm	22 mm	38 mm	95 g	4,46
BN4P3N021A	21 mm	28 mm	22 mm	38 mm	97 g	4,68
BN4P3N022A	22 mm	30 mm	26 mm	38 mm	105 g	5,30
BN4P3N023A	23 mm	31,6 mm	26 mm	38 mm	118 g	5,40
BN4P3N024A	24 mm	32 mm	26 mm	38 mm	138 g	5,40
BN4P3N025A	25 mm	34 mm	26 mm	42 mm	141 g	6,30
BN4P3N026A	26 mm	35,4 mm	28 mm	42 mm	158 g	6,40
BN4P3N027A	27 mm	36 mm	28 mm	42 mm	161 g	6,40
BN4P3N028A	28 mm	38 mm	28 mm	43 mm	162 g	6,80
BN4P3N029A	28 mm	38 mm	28 mm	43 mm	199 g	7,00
BN4P3N030A	30 mm	40 mm	28 mm	43 mm	214 g	7,00
BN4P3N032A	32 mm	42 mm	28 mm	44 mm	236 g	7,00



CHIAVE A BUSSOLA POLIGONALE LUNGA

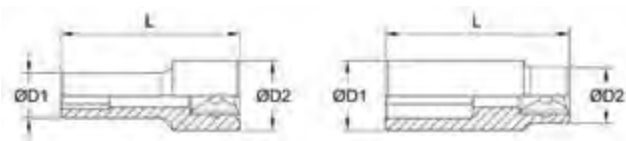

DIN 3124



1/2"



Cromata



Cr-V

Codice	Misura	D1	D2	Lunghezza	Peso	€
BN4P3L010A	10 mm	15 mm	22 mm	77 mm	116 g	7,00
BN4P3L011A	11 mm	16,3 mm	22 mm	77 mm	118 g	7,00
BN4P3L012A	12 mm	17,6 mm	22 mm	77 mm	125 g	7,00
BN4P3L013A	13 mm	18,8 mm	22 mm	77 mm	124 g	7,00
BN4P3L014A	14 mm	20,4 mm	22 mm	77 mm	127 g	7,30
BN4P3L015A	15 mm	21 mm	22 mm	77 mm	140 g	7,30
BN4P3L016A	16 mm	22 mm	20,5 mm	77 mm	139 g	7,30
BN4P3L017A	17 mm	24 mm	22 mm	77 mm	132 g	7,60
BN4P3L018A	18 mm	25,4 mm	22 mm	77 mm	136 g	8,10
BN4P3L019A	19 mm	26 mm	22 mm	77 mm	151 g	8,10
BN4P3L020A	20 mm	28 mm	22 mm	77 mm	194 g	8,50
BN4P3L021A	21 mm	28 mm	22 mm	77 mm	163 g	8,90
BN4P3L022A	22 mm	30 mm	26 mm	77 mm	166 g	9,50
BN4P3L023A	23 mm	31,6 mm	26 mm	77 mm	208 g	11,30
BN4P3L024A	24 mm	32 mm	26 mm	77 mm	212 g	11,30
BN4P3L027A	27 mm	36 mm	28 mm	77 mm	312 g	16,60
BN4P3L030A	30 mm	40 mm	28 mm	77 mm	307 g	18,00
BN4P3L032A	32 mm	42 mm	28 mm	77 mm	334 g	18,00



**BUSSOLA CON
INSERTO ESAGONALE**

1/2" **Cromata** **Cr-V**

Codice	Misura	D2	Peso	€
BN413N004A	4 mm	22 mm	68 g	6,50
BN413N005A	5 mm	22 mm	70 g	6,50
BN413N006A	6 mm	22 mm	72 g	6,50
BN413N007A	7 mm	22 mm	75 g	7,20
BN413N008A	8 mm	22 mm	75 g	7,20
BN413N010A	10 mm	22 mm	85 g	7,20
BN413N012A	12 mm	22 mm	117 g	7,20
BN413N014A	14 mm	24 mm	120 g	8,50
BN413N017A	17 mm	26 mm	153 g	9,20
BN413N019A	19 mm	28 mm	185 g	9,20

BUSSOLA CON INSERTO ESAGONALE LUNGHEZZA 55 mm, CON ATTACCO DA 1/2", COSTRUITA IN ACCIAIO CR-V, MICRO CROMATA

**BUSSOLA CON INSERTO
ESAGONALE LUNGO**

1/2" **Cromata** **Cr-V**

Codice	Misura	D2	Peso	€
BN413L004A	4 mm	22 mm	90 g	8,50
BN413L005A	5 mm	22 mm	90 g	8,50
BN413L006A	6 mm	22 mm	90 g	8,50
BN413L007A	7 mm	22 mm	90 g	8,50
BN413L008A	8 mm	22 mm	93 g	8,50
BN413L010A	10 mm	22 mm	107 g	8,50
BN413L012A	12 mm	22 mm	145 g	8,60
BN413L014A	14 mm	24 mm	145 g	8,60
BN413L017A	17 mm	26 mm	200 g	12,50
BN413L019A	19 mm	28 mm	245 g	13,50

BUSSOLA CON INSERTO ESAGONALE LUNGO LUNGHEZZA 100 mm, CON ATTACCO DA 1/2", COSTRUITA IN ACCIAIO CR-V, MICRO CROMATA

BUSSOLA CON INSERTO TORX

1/2" **Cromata** **Cr-V**

Codice	Misura	D2	Peso	€
BN423N020A	T20	22 mm	70 g	8,10
BN423N025A	T25	22 mm	70 g	8,10
BN423N027A	T27	22 mm	70 g	8,10
BN423N030A	T30	22 mm	73 g	8,10
BN423N040A	T40	22 mm	73 g	8,80
BN423N045A	T45	22 mm	78 g	8,80
BN423N050A	T50	22 mm	80 g	8,80
BN423N055A	T55	22 mm	83 g	9,90
BN423N060A	T60	22 mm	113 g	10,40
BN423N070A	T70	22 mm	115 g	12,80

BUSSOLA CON INSERTO TORX LUNGHEZZA 55 mm, CON ATTACCO DA 1/2", COSTRUITA IN ACCIAIO CR-V, MICRO CROMATA

BUSSOLA CON INSERTO TORX LUNGO

1/2" **Cromata** **Cr-V**

Codice	Misura	D2	Peso	€
BN423L020A	T20	22 mm	90 g	9,20
BN423L025A	T25	22 mm	90 g	9,20
BN423L027A	T27	22 mm	90 g	9,20
BN423L030A	T30	22 mm	90 g	9,20
BN423L040A	T40	22 mm	93 g	9,60
BN423L045A	T45	22 mm	93 g	9,60
BN423L050A	T50	22 mm	100 g	9,60
BN423L055A	T55	22 mm	103 g	11,50
BN423L060A	T60	22 mm	133 g	11,50
BN423L070A	T70	22 mm	135 g	15,40

BUSSOLA CON INSERTO TORX LUNGO LUNGHEZZA 100 mm, CON ATTACCO DA 1/2", COSTRUITA IN ACCIAIO CR-V, MICRO CROMATA



BUSSOLA CON INSERTO RIBE



1/2" Cromata Cr-V

Codice	Misura	D2	Peso	€
BN433N008A	M 8	22 mm	78 g	8,80
BN433N009A	M 9	22 mm	80 g	8,80
BN433N010A	M 10	22 mm	86 g	8,80
BN433N012A	M 12	22 mm	112 g	9,60
BN433N013A	M 13	24 mm	142 g	10,20
BN433N014A	M 14	24 mm	144 g	10,30

BUSSOLA CON INSERTO RIBE LUNGHEZZA 55 mm, CON ATTACCO DA 1/2", COSTRUITA IN ACCIAIO CR-V, MICRO CROMATA



BUSSOLA CON INSERTO RIBE LUNGO



1/2" Cromata Cr-V

Codice	Misura	D2	Peso	€
BN433L008A	M 8	24 mm	98 g	10,90
BN433L009A	M 9	24 mm	100 g	10,90
BN433L010A	M 10	24 mm	106 g	10,90
BN433L012A	M 12	24 mm	132 g	11,80
BN433L013A	M 13	24 mm	162 g	11,80
BN433L014A	M 14	24 mm	164 g	13,80

BUSSOLA CON INSERTO RIBE LUNGO LUNGHEZZA 100 mm, CON ATTACCO DA 1/2", COSTRUITA IN ACCIAIO CR-V, MICRO CROMATA



BUSSOLA CON INSERTO XZN



1/2" Cromata Cr-V

Codice	Misura	D2	Peso	€
BN443N005A	M 5	22 mm	50 g	9,20
BN443N006A	M 6	22 mm	50 g	9,20
BN443N008A	M 8	22 mm	50 g	9,20
BN443N009A	M 9	22 mm	54 g	9,20
BN443N010A	M 10	22 mm	56 g	9,20
BN443N012A	M 12	22 mm	60 g	10,40
BN443N014A	M 14	24 mm	64 g	10,40
BN443N016A	M 16	24 mm	65 g	10,50

BUSSOLA CON INSERTO XZN LUNGHEZZA 55 mm, CON ATTACCO DA 1/2", COSTRUITA IN ACCIAIO CR-V, MICRO CROMATA



BUSSOLA CON INSERTO XZN LUNGO



1/2" Cromata Cr-V

Codice	Misura	D2	Peso	€
BN443L005A	M 5	22 mm	66 g	10,50
BN443L006A	M 6	22 mm	67 g	10,50
BN443L008A	M 8	22 mm	68 g	10,50
BN443L009A	M 9	22 mm	71 g	11,10
BN443L010A	M 10	22 mm	72 g	11,10
BN443L012A	M 12	22 mm	73 g	11,60
BN443L014A	M 14	24 mm	73 g	12,30
BN443L016A	M 16	24 mm	73 g	12,60

BUSSOLA CON INSERTO XZN LUNGO LUNGHEZZA 100 mm, CON ATTACCO DA 1/2", COSTRUITA IN ACCIAIO CR-V, MICRO CROMATA

CHIAVE A BUSSOLA PER CANDELA

1/2" Cromata Cr-V

Codice	Misura	Lunghezza	Peso	€
BN4C3L016A	16 mm	65 mm	115 g	5,30
BN4C3L018A	18 mm	65 mm	140 g	6,20
BN4C3L021A	21 mm	65 mm	165 g	7,50

PROLUNGA

1/2" Cromata Cr-V

Codice	Attacco quadro	Lunghezza	Peso	Imballo	€
PN403N050A	1/2"	50 mm	98 g	40	5,50
PN403N075A	1/2"	75 mm	138 g	40	6,90
PN403N150A	1/2"	150 mm	230 g	10	9,70
PN403N250A	1/2"	250 mm	433 g	10	12,00

PROLUNGA A TESTA SFERICA

1/2" Cromata Cr-V

Codice	Attacco quadro	Lunghezza	Peso	Imballo	€
EN403N050A	1/2"	50 mm	94 g	40	6,40
EN403N075A	1/2"	75 mm	100 g	40	6,90
EN403N125A	1/2"	125 mm	198 g	10	9,70
EN403N250A	1/2"	250 mm	357 g	10	16,70
EN403N500A	1/2"	500 mm	420 g	10	27,80

Art. LN400N1/2A € 13,50
LEVA A T SCORREVOLE

1/2" Cromata Cr-V

Attacco quadro	1/2"
Lunghezza	300 mm
Peso	433 g
Imballo	3



Art. RN4034NA € 4,00
RACCORDO



Cromata Cr-V

Attacco femmina e maschio	1/2" 3/8"
Lunghezza	36 mm
Peso	61 g
Imballo	10



Art. RN4032NA € 9,20
RACCORDO



Cromata Cr-V

Attacco femmina e maschio	1/2" 3/4"
Lunghezza	46 mm
Peso	114 g
Imballo	10



Art. JN403NA € 11,30
SNODO A CARDANO



1/2" Cromata Cr-V

Attacco quadro	1/2"
Lunghezza	75 mm
Peso	163 g
Imballo	12

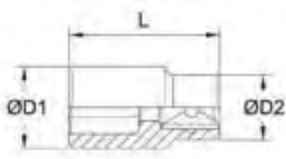
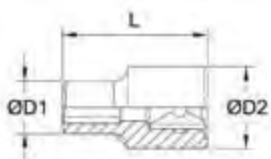

CHIAVE A BUSSOLA ESAGONALE, SERIE NORMALE

DIN 3124

Cromata

Cr-V

Codice	Misura	D1	D2	Lunghezza	Peso	€
BN4E2N019	19 mm	30 mm	36 mm	50 mm	207 g	8,60
BN4E2N020	20 mm	31 mm	36 mm	50 mm	209 g	8,60
BN4E2N021	21 mm	32 mm	36 mm	50 mm	210 g	8,60
BN4E2N022	22 mm	33 mm	36 mm	50 mm	209 g	8,60
BN4E2N023	23 mm	34 mm	36 mm	50 mm	216 g	8,60
BN4E2N024	24 mm	35 mm	36 mm	50 mm	219 g	8,60
BN4E2N025	25 mm	36 mm	35 mm	52 mm	240 g	8,60
BN4E2N026	26 mm	37 mm	36 mm	52 mm	243 g	8,60
BN4E2N027	27 mm	38 mm	36 mm	52 mm	238 g	10,30
BN4E2N028	28 mm	39 mm	38 mm	52 mm	233 g	10,30
BN4E2N029	29 mm	40 mm	38 mm	52 mm	261 g	10,30
BN4E2N030	30 mm	42 mm	38 mm	54 mm	295 g	10,30
BN4E2N032	32 mm	43 mm	38 mm	56 mm	305 g	10,30
BN4E2N033	33 mm	44 mm	38 mm	56 mm	317 g	10,90
BN4E2N034	34 mm	46 mm	38 mm	56 mm	317 g	10,90
BN4E2N035	35 mm	47 mm	42 mm	56 mm	400 g	11,20
BN4E2N036	36 mm	48 mm	42 mm	58 mm	406 g	11,20
BN4E2N038	38 mm	50 mm	42 mm	58 mm	434 g	13,50
BN4E2N041	41 mm	52 mm	45 mm	60 mm	497 g	15,20
BN4E2N046	46 mm	56 mm	45 mm	64 mm	581 g	16,80
BN4E2N050	50 mm	62 mm	48 mm	68 mm	724 g	20,20
BN4E2N055	55 mm	68 mm	48 mm	72 mm	889 g	24,70
BN4E2N060	60 mm	74 mm	48 mm	76 mm	889 g	30,60



CHIAVE A BUSSOLA POLIGONALE, SERIE NORMALE

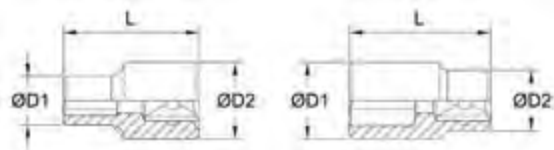

DIN 3124



3/4"



Cromata



Cr-V

Codice	Misura	D1	D2	Lunghezza	Peso	€
BN4P2N019	19 mm	30 mm	36 mm	50 mm	207 g	8,00
BN4P2N020	20 mm	31 mm	36 mm	50 mm	209 g	8,00
BN4P2N021	21 mm	32 mm	36 mm	50 mm	210 g	8,00
BN4P2N022	22 mm	33 mm	36 mm	50 mm	209 g	8,00
BN4P2N023	23 mm	34 mm	36 mm	50 mm	216 g	8,00
BN4P2N024	24 mm	35 mm	36 mm	50 mm	219 g	8,00
BN4P2N025	25 mm	36 mm	35 mm	52 mm	240 g	8,00
BN4P2N026	26 mm	37 mm	36 mm	52 mm	243 g	8,00
BN4P2N027	27 mm	38 mm	36 mm	52 mm	238 g	9,70
BN4P2N028	28 mm	39 mm	38 mm	52 mm	233 g	9,70
BN4P2N029	29 mm	40 mm	38 mm	52 mm	261 g	9,70
BN4P2N030	30 mm	42 mm	38 mm	54 mm	295 g	9,70
BN4P2N032	32 mm	43 mm	38 mm	56 mm	305 g	9,70
BN4P2N033	33 mm	44 mm	38 mm	56 mm	317 g	10,30
BN4P2N034	34 mm	46 mm	38 mm	56 mm	317 g	10,90
BN4P2N035	35 mm	47 mm	42 mm	56 mm	400 g	10,90
BN4P2N036	36 mm	48 mm	42 mm	58 mm	406 g	10,90
BN4P2N038	38 mm	50 mm	42 mm	58 mm	434 g	12,80
BN4P2N041	41 mm	52 mm	45 mm	60 mm	497 g	14,40
BN4P2N046	46 mm	56 mm	45 mm	64 mm	581 g	16,00
BN4P2N050	50 mm	62 mm	48 mm	68 mm	724 g	19,20
BN4P2N055	55 mm	68 mm	48 mm	72 mm	889 g	24,70
BN4P2N060	60 mm	74 mm	48 mm	76 mm	1095 g	30,60



PROLUNGA



3/4"



Cromata



Cr-V

Codice	Attacco quadro	Lunghezza	Peso	Imballo	€
PN402N200A	3/4"	200 mm	650 g	10	20,20
PN402N400A	3/4"	400 mm	940 g	2	31,10

Art. LN400N3/4A
 LEVA A T SCORREVOLE

€ 33,30

3/4" Cromata Cr-V

Attacco quadro	3/4"
Lunghezza	500 mm
Peso	1542 g
Imballo	1

Art. RN4023NA € 9,20
 RACCORDO

Cromata Cr-V

Attacco femmina e maschio	3/4" 1/2"
Lunghezza	50 mm
Peso	131 g
Imballo	8

Art. JN402NA € 46,10
 SNODO A CARDANO

3/4" Cromata Cr-V

Attacco quadro	3/4"
Lunghezza	108 mm
Peso	590 g
Imballo	6

Art. 0795/1 € 22,40
 SERIE CHIAVI MULTILOCK

1/2" 19 Pz Cr-V

Attacco	1/4"
Misure	4 - 4,5 - 5 - 5,5 - 6 - 7 - 8 - 9 - 10 - 11 - 12 - 13 - 14 mm
Misure in pollici	5/32" - 7/32" - 1/4" - 5/16" - 11/32" - 3/8" - 7/16" - 15/32" - 1/2"
Misure torx	E5 - E6 - E8 - E10 - E12 - E14 - E16 - E18
Misure XZN	M5 - M6 - M8 - M9 - M10 - M12 - M14 - M16 - M18
Imballo	50

SERIE 13 Pz CHIAVI MULTILOCK, ADATTE PER DADI E BULLONI METRICI, A POLLICI, TORX E XZN, CHROME - VANADIUM

Art. 0393 € 75,90
 SERIE CHIAVI A PIPA ESAGONALI

1/4" 13 Pz Cr-V

Misure	6 - 7 - 8 - 10 - 11 - 12 - 13 - 14 - 17 - 19 - 22 mm
Imballo	6

SERIE CHIAVI A PIPA ESAGONALI



Art. 0795/2
SERIE CHIAVI MULTILOCK

€ 61,80

11 Pz



Attacco	1/2"
Misure	8 - 9 - 10 - 11 - 12 - 13 - 14 - 15 - 16 - 17 - 18 - 19 - 20 - 21 - 22 - 24 - 27 - 30 - 32 mm
Misure in pollici	3/8" - 7/16" - 15/32" - 1/2" - 19/32" - 5/8" - 3/4" - 25/32" - 13/16" - 7/8" - 15/16" - 1-1/16" - 1-13/16" - 1-1/4"
Misure torx	E12 - E14 - E16 - E18 - E20 - E22 - E24 - E26 - E28 - E30 - E34 - E38 - E40
Misure XZN	M12 - M14 - M16 - M18
Imballo	10



Art. SN4E5C012
SERIE BUSSOLE A PROFILO RIBASSATO

€ 71,50

12 Pz 1/4" Cromata Cr-V



Attacco quadro	1/4"
Bussole	4, 5, 6, 7, 8, 9, 10, 11, 12, 13, 14 mm
Imballo	30

SERIE 12 Pz BUSSOLE A PROFILO RIBASSATO, BOCCA POLIGONALE CON ATTACCO QUADRO FEMMINA DA 1/4", IN ACCIAIO CR-V, COMPOSTO DA 11 BUSSOLE E 1 CRICCHETTO REVERSIBILE RIBASSATO A 60 DENTI, DI ALTEZZA RIDOTTA PER POTER OPERARE IN PICCOLI SPAZI



Art. SN4E4C013
SERIE BUSSOLE A PROFILO RIBASSATO

€ 93,50

13 Pz 3/8" Cromata Cr-V



Attacco quadro	3/8"
Bussole	8, 9, 10, 11, 12, 13, 14, 15, 16, 17, 18, 19 mm
Imballo	15

SET 13 Pz BUSSOLE A PROFILO RIBASSATO, BOCCA POLIGONALE CON ATTACCO QUADRO FEMMINA DA 3/8", IN ACCIAIO CR-V, COMPOSTO DA 12 BUSSOLE E 1 CRICCHETTO REVERSIBILE RIBASSATO A 60 DENTI, DI ALTEZZA RIDOTTA PER POTER OPERARE IN PICCOLI SPAZI, CHROME - VANADIUM



Art. SN4E3C015
SERIE BUSSOLE A PROFILO RIBASSATO

€ 119,00

15 Pz 1/2" Cromata Cr-V



Attacco quadro	1/2"
Bussole	8, 10, 11, 12, 13, 14, 15, 17, 18, 19, 21, 22, 23, 24 mm
Imballo	20

SERIE 15 Pz BUSSOLE POLIGONALI A PROFILO RIBASSATO, CON ATTACCO QUADRO FEMMINA DA 1/2", IN ACCIAIO CR-V, COMPOSTO DA 14 BUSSOLE E 1 CRICCHETTO REVERSIBILE RIBASSATO A 60 DENTI, DI ALTEZZA RIDOTTA PER POTER OPERARE IN PICCOLI SPAZI, CHROME - VANADIUM



Art. 0589
SERIE BUSSOLE MULTIPROFILO RIBASSATE
€ 69,00

24 Pz Cromata Cr-V

Bussole	4.5 - 5 - 5.5 - 6 - 7 - 8 - 9 - 10 - 11 - 12 - 13 mm
Cricchetto reversibile	
Prolunga	50 mm
Adattatore	1/4"
Adattatore inserti	
Inserti	PH: 1 - 2 - 3 (S2) Torx: T10- T15-T20-T25-T30-T40 (S2)
Valigetta	
Imballo	12

SERIE 24 Pz BUSSOLE MULTIPROFILO RIBASSATE CON FORO PASSANTE, IN ACCIAIO CR-V, COMPOSTO DA 11 BUSSOLE, 1 CRICCHETTO REVERSIBILE RIBASSATO A 72 DENTI CON FORO PASSANTE E ACCESSORI, ADATTE A ESAGONI METRICI, IN POLLICI, TORX, XZN, BARRE FILETTATE E PRIGIONIERI, DI ALTEZZA RIDOTTA PER POTER OPERARE IN PICCOLI SPAZI, CHROME - VANADIUM

Art. 0593
SERIE BUSSOLE MULTIPROFILO RIBASSATE
€ 62,50

13 Pz Cromata Cr-V

Bussole	8 - 10 - 11 - 12 - 13 - 14 - 15 - 16 - 17 - 19 mm
Cricchetto reversibile	
Prolunga	75 mm
Adattatore	3/8"
Valigetta	
Imballo	12

SERIE 13 Pz BUSSOLE MULTIPROFILO RIBASSATE CON FORO PASSANTE, IN ACCIAIO CR-V, COMPOSTO DA 10 BUSSOLE MULTIPROFILO, 1 CRICCHETTO REVERSIBILE RIBASSATO A 72 DENTI CON FORO PASSANTE E ACCESSORI, ADATTE A ESAGONI METRICI, IN POLLICI, TORX, XZN, BARRE FILETTATE E PRIGIONIERI, DI ALTEZZA RIDOTTA PER POTER OPERARE IN PICCOLI SPAZI, CHROME - VANADIUM



Art. 0624

SERIE CHIAVI A BUSSOLA DA 1/4"

€ 64,90



46 Pz **Cromata** **1/4"** **Cr-V**

Bussole da 1/4"	4 - 4.5 - 5 - 5.5 - 6 - 7 - 8 - 9 - 10 - 11 - 12 - 13 - 14 mm
Bussole con inserti	1/4" : T8 - T10 - T15 - T20 - T25 - T30 - T40 - H3 - H4 - H5 - H6 - H7 - H8 - SL4 - SL5.5 - SL7 - PH1 - PH2 - PH3 - PZ1 - PZ2 - PH3
Cricchetto reversibile	1/4"
Prolunga flessibile	1/4" - 150 mm
Prolunghe da 1/4"	50 - 100 mm
Manico per bussole	1/4"
Snodo universale	1/4"
Leva a T scorrevole	1/4"
Chiavi esagonali	1,27 - 1,5 - 2 - 2.5 mm
Imballo	10



Art. 0679

SERIE CHIAVI A BUSSOLA DA 3/8" E 1/4"

€ 74,30



42 Pz **Satinata** **1/4"** **Cr-V**

Bussole da 3/8"	9 - 10 - 11 - 12 - 13 - 14 - 15 - 17 - 19 mm
Misure bussole per candela	3/8" : 16 - 21 mm
Prolunghe da 3/8"	75 - 150 mm
Snodo universale	3/8"
Raccordo	F. 1/2" - M. 3/8"
Cricchetto reversibile	3/8"
Bussole da 1/4"	4 - 4,5 - 5 - 5,5 - 6 - 7 - 8 - 9 - 10 - 11 - 12 - 13 mm
Manico per bussole	1/4"
Raccordo	F. 3/8" - M. 1/4"
Bussola porta inserti	1/4"
Inserti	PH1 - PH2 - PH3 - H3 - H4 - H5 - H6 - H7 - SL4 - SL5,5 - SL7
Imballo	5

Art. S108
SERIE CHIAVI A BUSSOLA DA 1/4" E 1/2"
€ 173,00
 **108 Pz**
 **Cromata**
 **Cr-V**

Bussole da 1/4"	4 - 4.5 - 5 - 5.5 - 6 - 7 - 8 - 9 - 10 - 11 - 12 - 13 - 14 mm
Bussole lunghe da 1/4"	6 - 7 - 8 - 9 - 10 - 11 - 12 - 13 mm
Bussole lunghe da 1/4"	Torx: E4 - E5 - E6 - E7 - E8 mm
Bussole da 1/2"	10 - 11 - 12 - 13 - 14 - 15 - 16 - 17 - 18 - 19 - 20 - 21 - 22 - 24 - 27 - 30 - 32 mm
Bussole lunghe da 1/2"	14 - 15 - 17 - 19 - 22 mm
Bussole da 1/2"	Torx: E10 - E11 - E12 - E14 - E16 - E18 - E20 - E24
Bussole con inserti	1/4" : T8 - T10 - T15 - T20 - T25 - T27 - T30 - H3 - H4 - H5 - H6 - SL4 - SL5.5 - SL6.5 - PH1 - PH2 - PH2 - PZ1 - PZ2
Misure bussole per candela	1/2" : 16 - 21 mm
Bussola porta inserti	1/2"
Inserti	5/16" x 30mm : H7 - H8 - H10 - H12 - H14 - SL8 - SL10 - SL12 - PH3 - PH4 - PZ3 - PZ4 - T40 - T45 - T50 - T55 - T60
Prolunghe da 1/4"	50 - 85 mm
Prolunghe da 1/2"	125 - 250 mm
Manico per bussole	1/4"
Raccordo	F. 3/8" - M. 1/2"
Snodo universale	1/4"
Snodo universale	1/2"
Leva a T scorrevole	1/4"
Cricchetto reversibile	1/4"
Cricchetto reversibile	1/2"
Chiavi esagonali	1.5 - 2 - 2.5 mm
Imballo	2

Art. 0618
SERIE CHIAVI A BUSSOLA DA 1/2" E 1/4"
€ 191,00
 **94 Pz**
 **Cromata**
 **Cr-V**

Bussole da 1/4"	4 - 4.5 - 5 - 5.5 - 6 - 7 - 8 - 9 - 10 - 11 - 12 - 13 - 14 mm
Bussole lunghe da 1/4"	6 - 7 - 8 - 9 - 10 - 11 - 12 - 13 mm
Adattatore maschio con quadro da 1/4" e esagono da 1/4"	
Bussole da 1/2"	10 - 11 - 12 - 13 - 14 - 15 - 16 - 17 - 18 - 19 - 20 - 21 - 22 - 23 - 24 - 27 - 30 - 32 mm
Bussole lunghe da 1/2"	14 - 15 - 17 - 19 mm
Prolunga flessibile	1/4" - 150 mm
Bussole con inserti	1/4" : T8 - T10 - T15 - T20 - T25 - T30 - H3 - H4 - H5 - H6 - SL4 - SL5.5 - SL7 - PH1 - PH2 - PZ1 - PZ2
Misure bussole per candela	1/2" : 16 - 21 mm
Bussola per inserti da 5/16"	1/2"
Inserti	5/16" x 30mm : H8 - H10 - H12 - H14 - SL8 - SL10 - SL12 - PH3 - PH4 - PZ3 - PZ4 - T40 - T45 - T50 - T55
Prolunghe da 1/4"	50 - 100 mm
Prolunghe da 1/2"	125 - 250 mm
Manico per bussole	1/4"
Raccordo	F. 3/8" - M. 1/2"
Snodo universale	1/4"
Snodo universale	1/2"
Leva a T scorrevole	1/4"
Cricchetto reversibile	1/4"
Cricchetto reversibile	1/2"
Chiavi esagonali	1.5 - 2 - 2.5 mm
Imballo	3



Art. S179

SERIE CHIAVI A BUSSOLA DA 1/4", 3/8" E 1/2"

€ 296,00



179 Pz **Cromata** **Cr-V**

Bussole da 1/4"	4 - 4.5 - 5 - 5.5 - 6 - 7 - 8 - 9 - 10 - 11 - 12 - 13 - 14 mm
Bussole lunghe da 1/4"	6 - 7 - 8 - 9 - 10 mm
Bussole lunghe da 1/4"	Torx: E4 - E5 - E6 - E7 - E8 mm
Prolunghe da 1/4"	50 - 100 mm
Leva a T scorrevole	1/4"
Bussola porta inserti	1/4"
Bussole con inserti	1/4" - Torx: T8 - T9 - T10 - T15 - T20 - T25 - T27 - T30
Bussole con inserti con foro	1/4" - Torx: T8H - T9H - T10H - T15H - T20H - T25H - T27H - T30H
Bussole con inserti	1/4" : PH0 - PH1 - PH2
Bussole con inserti	1/4" : PZ0 - PZ1 - PZ2
Bussole con inserti esagonali	1/4" : 3 - 4 - 5 - 6 mm
Bussole con inserti a taglio	1/4" : 4 - 5.5 - 6.5 - 7 mm
Snodo universale	1/4"
Manico per bussole	1/4"
Cricchetto reversibile	1/4"
Bussole da 3/8"	10 - 11 - 12 - 13 - 14 - 15 - 16 - 17 - 18 - 19 mm
Bussole da 3/8"	Torx: E10 - E11 - E12 - E13
Bussole lunghe da 3/8"	10 - 11 - 12 - 13 - 14 - 15 mm

Misure bussole per candela	3/8" - 18 mm
Prolunghe da 3/8"	150 mm
Bussola per inserti da 5/16"	3/8"
Snodo universale	3/8"
Cricchetto reversibile	3/8"
Bussole da 1/2"	10 - 11 - 12 - 13 - 14 - 15 - 16 - 17 - 18 - 19 - 20 - 21 - 22 - 24 - 27 - 30 - 32 mm
Bussole lunghe da 1/2"	16 - 17 - 18 - 19 - 22 mm
Bussole da 1/2"	Torx: E16 - E18 - E20 - E24
Misure bussole per candela	1/2" : 16 - 21 mm
Prolunghe da 1/2"	125 - 250 mm
Bussola per inserti da 5/16"	1/2"
Snodo universale	1/2"
Raccordo	F. 3/8" - M. 1/2"
Cricchetto reversibile	1/2"
Inserti	1/4" x 25 mm XZN: M5 - M6 - M8
Inserti	1/4" x 25 mm Torx: T5 - T6 - T7 - T8 - T9 - T10 - T15 - T20 - T25 - T27 - T30
Inserti	1/4" x 25 mm Ribe: RM5 - RM6 - RM7 - RM8 - RM9
Inserti	1/4" x 25 mm Torx "5": TS7 - TS10 - TS15 - TS20 - TS25 - TS27 - TS30 - TS40 - TS45
Inserti	5/16" x 30 mm Torx: T40 - T45 - T50 - T55 - T60 - T70
Inserti con foro	5/16" x 30 mm Torx: T40H - T45H - T50H - T55H - T60H - T70H
Inserti esagonali	5/16" x 30 mm: 7 - 8 - 10 - 12 - 14 mm
Inserti	5/16" x 30 mm: PH3 - PH4
Inserti	5/16" x 30 mm: PZ3 - PZ4
Inserti a taglio	5/16" x 30 mm: 8 - 10 - 12 mm
Chiavi esagonali	1.3 - 1.5 - 2 - 2.5 - 3 - 4 - 5 mm
Imballo	2



Art. S328

SERIE CHIAVI A BUSSOLA DA 1/2"

€ 129,00



28 Pz **Cromata** **1/2"** **Cr-V**

Bussole da 1/2"	8 - 9 - 10 - 11 - 12 - 13 - 14 - 15 - 16 - 17 - 18 - 19 - 20 - 21 - 22 - 23 - 24 - 27 - 30 - 32 mm
Misure bussole per candela	1/2" : 16 - 21 mm
Prolunghe da 1/2"	75 - 150 - 250 mm
Snodo universale	1/2"
Raccordo	F. 3/8" - M. 1/2"
Cricchetto reversibile	1/2"
Imballo	5

Art. SN4P3N027
 SERIE BUSSOLE ESAGONALI A POLLICE DA 1/2"

€ 115,00

27 Pz **Cromata** **1/2"** **Cr-V**

Misure bussole normali	5/16", 3/8", 7/16", 15/32", 1/2", 9/16", 19/32", 5/8", 11/16", 3/4", 25/32", 13/16", 7/8", 15/16", 1", 1-1/16", 1-3/16", 1-1/4", 23/32", 1-1/8"
Misure bussole per candela	5/8", 13/16"
Misure prolunghe	3", 10"

SERIE 27 Pz BUSSOLE ESAGONALI A POLLICE CON
 ATTACCO QUADRO DA 1/2", IN ACCIAIO CR-V, COMPOSTA
 DA 20 BUSSOLE NORMALI, 2 BUSSOLE PER CANDELA,
 1 CRICCHETTO REVERSIBILE, 1 SNODO UNIVERSALE, 2
 PROLUNGHE E 1 LEVA A T SCORREVOLE

Art. 0620
 SERIE CHIAVI A BUSSOLA DA 1/2"

€ 115,00

24 Pz **Cromata** **1/2"** **Cr-V**

Bussole da 1/2"	10 - 11 - 12 - 13 - 14 - 15 - 16 - 17 - 18 - 19 - 20 - 21 - 22 - 23 - 24 - 27 - 30 - 32 mm
Misure bussole per candela	1/2" : 21 mm
Prolunghe da 1/2"	125 - 250 mm
Snodo universale	1/2"
Leva a T scorrevole	1/2"
Cricchetto reversibile	1/2"
Imballo	5

Art. 0181
 SERIE CHIAVI A BUSSOLA DA 3/4"

€ 153,00

20 Pz **Satinata** **3/4"**

Misure	19 - 21 - 22 - 23 - 24 - 26 - 27 - 30 - 32 - 34 - 36 - 38 - 41 - 46 - 48 - 50 mm
Cricchetto reversibile	3/4"
Leva a T scorrevole	3/4"
Prolunghe	3/4" : 100 - 200 mm
Imballo	2



Art. 0622
SERIE BUSSOLE CON INSERTI TORX

€ 49,00



10 Pz Satinata 1/2" Cr-V

Misure
Imballo

T20 - T25 - T27 - T30 - T40 T45 - T50 - T55 - T60 - T70
15



O-RING PER CHIAVI A BUSSOLA

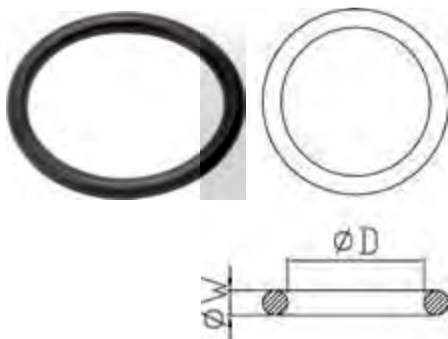

Codice	Attacco quadro	Bussole	D	W	Imballo	€
AI401NA44	3/4" 1"	17÷70 mm	44 mm	5,7 mm	100	1,78
AI401NA75	3/4" 1"	17÷70 mm	44 mm	5,7 mm	100	4,80
AI402NA36	3/4"	17÷48 mm	36 mm	5 mm	100	1,22
AI402NA46	3/4"	50÷70 mm	46 mm	5 mm	100	1,78
AI403NA19	1/2"	8÷14 mm	19 mm	4 mm	100	0,92
AI403NA24	1/2"	15÷38 mm	24 mm	4 mm	100	0,92

O-RING PER CHIAVI A BUSSOLA IMPACT, PER FERMARE LA SPINA DI BLOCCAGGIO



SPINA PER CHIAVI A BUSSOLA

€ 30,00



Cr-Mo

Codice	Attacco quadro	Bussole	Lunghezza	D	Imballo	€
AI401NS45	1"	17÷70 mm	45 mm	5 mm	100	0,80
AI401NS75	1"	71÷95 mm	75 mm	5 mm	100	1,78
AI402NS35	3/4"	17÷48 mm	35 mm	4 mm	100	0,80
AI402NS45	3/4"	50÷70 mm	45 mm	4 mm	100	0,80
AI403NS20	1/2"	8÷14 mm	20 mm	3 mm	100	0,68
AI403NS25	1/2"	15÷38 mm	25 mm	3 mm	100	0,68

SPINA PER CHIAVI A BUSSOLA, CON ATTACCO QUADRO, COSTRUITA IN ACCIAIO AL CR-MO, UTILE A FERMARE LA BUSSOLA SULL'AVVITATORE

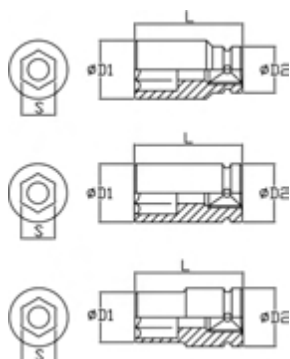
CHIAVE A BUSSOLA AD IMPATTO, SERIE NORMALE

1/2"
Fosfatata
DIN 3129
Cr-Mo

Codice	Misura	Lunghezza	D1	D2	€
BI4E3N008	8 mm	38 mm	15 mm	24 mm	7,10
BI4E3N009	9 mm	38 mm	16 mm	24 mm	7,10
BI4E3N010	10 mm	38 mm	17,5 mm	24 mm	7,10
BI4E3N011	11 mm	38 mm	18,5 mm	24 mm	7,10
BI4E3N012	12 mm	38 mm	19,5 mm	24 mm	7,10
BI4E3N013	13 mm	38 mm	20,5 mm	24 mm	7,10
BI4E3N014	14 mm	38 mm	22 mm	24 mm	7,10
BI4E3N015	15 mm	38 mm	24 mm	24 mm	8,00
BI4E3N016	16 mm	38 mm	24 mm	24 mm	8,00
BI4E3N017	17 mm	38 mm	26 mm	26 mm	8,00
BI4E3N018	18 mm	38 mm	28 mm	28 mm	8,00
BI4E3N019	19 mm	38 mm	28 mm	28 mm	8,00
BI4E3N020	20 mm	38 mm	30 mm	30 mm	9,70
BI4E3N021	21 mm	38 mm	30 mm	30 mm	9,70
BI4E3N022	22 mm	38 mm	32 mm	30 mm	9,70
BI4E3N023	23 mm	38 mm	34 mm	30 mm	10,10
BI4E3N024	24 mm	38 mm	34 mm	30 mm	10,10
BI4E3N025	25 mm	38 mm	36 mm	30 mm	10,10
BI4E3N026	26 mm	38 mm	36 mm	30 mm	11,30
BI4E3N027	27 mm	42 mm	38 mm	30 mm	11,30
BI4E3N028	28 mm	42 mm	40 mm	30 mm	13,50
BI4E3N029	29 mm	42 mm	42 mm	30 mm	13,50
BI4E3N030	30 mm	42 mm	42 mm	30 mm	14,60
BI4E3N031	31 mm	42 mm	44 mm	30 mm	14,80
BI4E3N032	32 mm	44 mm	44 mm	30 mm	16,40

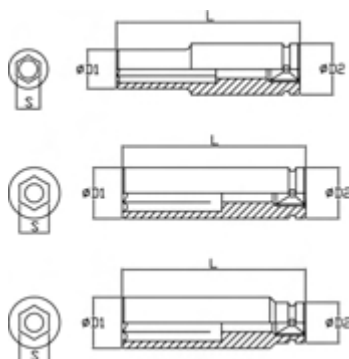

CHIAVE A BUSSOLA AD IMPATTO LUNGA



1/2"



Fosfatata



DIN 3129



Cr-Mo

Codice	Misura	Lunghezza	D1	D2	€
BI4E3L008	8 mm	78 mm	15 mm	24 mm	11,80
BI4E3L009	9 mm	78 mm	16 mm	24 mm	11,80
BI4E3L010	10 mm	78 mm	17,5 mm	24 mm	11,80
BI4E3L011	11 mm	78 mm	18,5 mm	24 mm	11,80
BI4E3L012	12 mm	78 mm	19,5 mm	24 mm	11,80
BI4E3L013	13 mm	78 mm	20,5 mm	24 mm	11,80
BI4E3L014	14 mm	78 mm	22 mm	24 mm	11,80
BI4E3L015	15 mm	78 mm	24 mm	24 mm	13,90
BI4E3L016	16 mm	78 mm	24 mm	24 mm	13,90
BI4E3L017	17 mm	78 mm	26 mm	26 mm	14,00
BI4E3L018	18 mm	78 mm	28 mm	28 mm	14,00
BI4E3L019	19 mm	78 mm	28 mm	28 mm	14,00
BI4E3L020	20 mm	78 mm	30 mm	30 mm	14,00
BI4E3L021	21 mm	78 mm	30 mm	30 mm	14,00
BI4E3L022	22 mm	78 mm	32 mm	30 mm	14,60
BI4E3L023	23 mm	78 mm	34 mm	30 mm	14,80
BI4E3L024	24 mm	78 mm	34 mm	30 mm	17,10
BI4E3L025	25 mm	78 mm	36 mm	30 mm	18,50
BI4E3L026	26 mm	78 mm	36 mm	30 mm	18,90
BI4E3L027	27 mm	78 mm	38 mm	30 mm	18,90
BI4E3L028	28 mm	78 mm	40 mm	30 mm	20,00
BI4E3L029	29 mm	78 mm	42 mm	30 mm	20,00
BI4E3L030	30 mm	78 mm	42 mm	30 mm	20,00
BI4E3L031	31 mm	78 mm	44 mm	30 mm	20,80
BI4E3L032	32 mm	78 mm	44 mm	30 mm	20,80

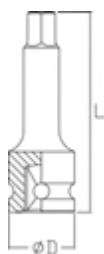

BUSSOLA ESAGONALE MASCHIO AD IMPATTO

Codice	Misura	Lunghezza	D	€
BI413L004	4 mm	78 mm	25 mm	11,20
BI413L005	5 mm	78 mm	25 mm	11,20
BI413L006	6 mm	78 mm	25 mm	11,20
BI413L008	8 mm	78 mm	25 mm	11,20
BI413L010	10 mm	78 mm	25 mm	11,20
BI413L012	12 mm	78 mm	25 mm	11,20
BI413L014	14 mm	78 mm	25 mm	11,20
BI413L017	17 mm	78 mm	25 mm	12,40
BI413L019	19 mm	78 mm	25 mm	13,50

BUSSOLA ESAGONALE MASCHIO AD IMPATTO DIN312, CON ATTACCO QUADRO FEMMINA DIN3129 DA 1/2", COSTRUITA IN ACCIAIO LEGATO 42CRM02, ESECUZIONE FOSFATATA

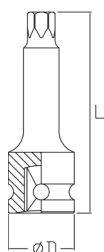
BUSSOLA TORX MASCHIO AD IMPATTO

Codice	Misura	Lunghezza	D	€
BI423L025	T25	78 mm	25 mm	12,40
BI423L027	T27	78 mm	25 mm	12,40
BI423L030	T30	78 mm	25 mm	12,40
BI423L040	T40	78 mm	25 mm	13,40
BI423L045	T45	78 mm	25 mm	13,50
BI423L050	T50	78 mm	25 mm	13,50
BI423L060	T60	78 mm	25 mm	17,40
BI423L070	T70	78 mm	25 mm	19,60
BI423L080	T80	78 mm	25 mm	20,20

BUSSOLA TORX MASCHIO AD IMPATTO DIN3121 DA 30 mm, CON ATTACCO QUADRO FEMMINA DIN3129 DA 1/2", COSTRUITA IN ACCIAIO LEGATO 42CRM02, ESECUZIONE FOSFATATA

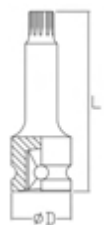
BUSSOLA RIBE MASCHIO AD IMPATTO

Codice	Misura	Lunghezza	D	€
BI433M004	4	60 mm	25 mm	10,90
BI433M005	5	60 mm	25 mm	10,90
BI433M006	6	60 mm	25 mm	10,90
BI433M007	7	60 mm	25 mm	10,90
BI433M008	8	60 mm	25 mm	10,90
BI433M009	9	60 mm	25 mm	10,90
BI433M010	10	60 mm	25 mm	10,90
BI433M012	12	60 mm	25 mm	12,40
BI433M014	14	60 mm	25 mm	13,50
BI433M016	16	60 mm	25 mm	14,00
BI433M018	18	60 mm	25 mm	14,60

BUSSOLA RIBE MASCHIO AD IMPATTO DIN3121 DA 12 mm, CON ATTACCO QUADRO FEMMINA DIN3129 DA 1/2", COSTRUITA IN ACCIAIO LEGATO 42CRM02, ESECUZIONE FOSFATATA



BUSSOLA XZN MASCHIO AD IMPATTO

DIN 3121 & 3129



1/2"

Fosfatata

Cr-Mo



Codice	Misura	Lunghezza	D	€
BI443M004	4	60 mm	25 mm	10,90
BI443M005	5	60 mm	25 mm	10,90
BI443M006	6	60 mm	25 mm	10,90
BI443M008	8	60 mm	25 mm	10,90
BI443M010	10	60 mm	25 mm	10,90
BI443M012	12	60 mm	25 mm	10,90
BI443M014	14	60 mm	25 mm	11,30
BI443M016	16	60 mm	25 mm	11,70
BI443M018	18	60 mm	25 mm	12,70
BI443M020	20	60 mm	25 mm	13,50

BUSSOLA XZN MASCHIO AD IMPATTO DIN3121 DA 12 mm, CON ATTACCO QUADRO FEMMINA DIN3129 DA 1/2", COSTRUITA IN ACCIAIO LEGATO 42CRM02, ESECUZIONE FOSFATATA



PROLUNGA AD IMPATTO

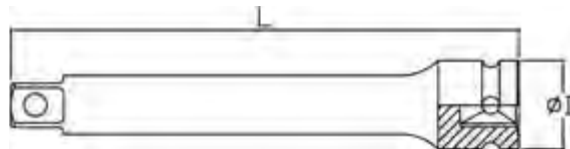

1/2"

Fosfatata

DIN 3121 & 3129

Cr-Mo

Codice	Attacco quadro	Lunghezza	D	Imballo	€
PI403075	1/2"	75 mm	25 mm	40 / 120	14,00
PI403125	1/2"	125 mm	25 mm	20 / 80	15,20
PI403150	1/2"	150 mm	25 mm	16 / 48	18,50
PI403250	1/2"	250 mm	25 mm	10 / 50	23,00



PROLUNGA A SGANCIO RAPIDO AD IMPATTO

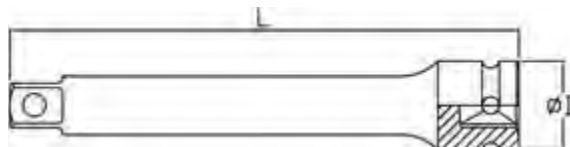

1/2"

Fosfatata

DIN 3121 & 3129

Cr-Mo

Codice	Attacco quadro	Lunghezza	D	Imballo	€
PI453075	1/2"	75 mm	25 mm	30 / 120	20,20
PI453150	1/2"	125 mm	25 mm	10 / 60	21,90
PI453250	1/2"	250 mm	25 mm	50	24,70

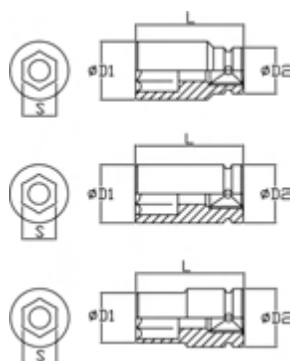

CHIAVE A BUSSOLA AD IMPATTO, SERIE NORMALE

3/4"
 Fosfatata
 DIN 3129
 Cr-Mo

Codice	Misura	Lunghezza	D1	D2	€
BI4E2N018	18 mm	51 mm	30 mm	44 mm	18,50
BI4E2N019	19 mm	51 mm	32 mm	44 mm	18,50
BI4E2N020	20 mm	51 mm	33 mm	44 mm	18,50
BI4E2N021	21 mm	51 mm	35 mm	44 mm	18,50
BI4E2N022	22 mm	51 mm	36 mm	44 mm	18,50
BI4E2N023	23 mm	51 mm	38 mm	44 mm	18,50
BI4E2N024	24 mm	51 mm	39 mm	44 mm	18,50
BI4E2N025	25 mm	54 mm	41 mm	44 mm	18,60
BI4E2N026	26 mm	54 mm	41 mm	44 mm	18,60
BI4E2N027	27 mm	54 mm	42 mm	44 mm	18,60
BI4E2N028	28 mm	54 mm	44 mm	44 mm	19,80
BI4E2N029	29 mm	54 mm	46 mm	44 mm	19,80
BI4E2N030	30 mm	54 mm	46 mm	44 mm	19,80
BI4E2N032	32 mm	57 mm	48 mm	44 mm	22,10
BI4E2N033	33 mm	57 mm	50 mm	44 mm	22,10
BI4E2N034	34 mm	57 mm	52 mm	44 mm	23,80
BI4E2N035	35 mm	57 mm	52 mm	44 mm	24,10
BI4E2N036	36 mm	57 mm	54 mm	44 mm	24,40
BI4E2N038	38 mm	57 mm	56 mm	44 mm	28,40
BI4E2N041	41 mm	58 mm	60 mm	44 mm	31,60
BI4E2N046	46 mm	68 mm	66 mm	44 mm	34,70
BI4E2N050	50 mm	68 mm	71 mm	54 mm	39,70
BI4E2N055	55 mm	73 mm	77 mm	54 mm	48,40
BI4E2N060	60 mm	75 mm	84 mm	54 mm	52,70
BI4E2N065	65 mm	78 mm	88 mm	54 mm	80,30

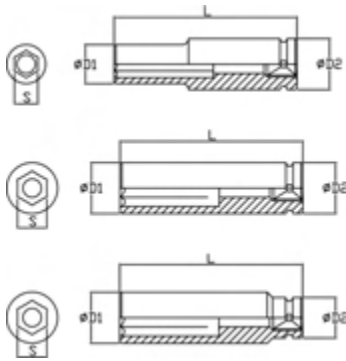

CHIAVE A BUSSOLA AD IMPATTO LUNGA



3/4"



Fosfatata



DIN 3129



Cr-Mo

Codice	Misura	Lunghezza	D1	D2	€
BI4E2L018	18 mm	90 mm	30 mm	44 mm	33,20
BI4E2L019	19 mm	90 mm	32 mm	44 mm	33,20
BI4E2L020	20 mm	90 mm	33 mm	44 mm	33,20
BI4E2L021	21 mm	90 mm	35 mm	44 mm	33,20
BI4E2L022	22 mm	90 mm	36 mm	44 mm	33,20
BI4E2L023	23 mm	90 mm	38 mm	44 mm	33,20
BI4E2L024	24 mm	90 mm	39 mm	44 mm	33,20
BI4E2L025	25 mm	90 mm	41 mm	44 mm	33,20
BI4E2L026	26 mm	90 mm	41 mm	44 mm	33,20
BI4E2L027	27 mm	90 mm	42 mm	44 mm	33,20
BI4E2L028	28 mm	90 mm	44 mm	44 mm	33,20
BI4E2L029	29 mm	90 mm	46 mm	44 mm	33,20
BI4E2L030	30 mm	90 mm	46 mm	44 mm	33,20
BI4E2L032	32 mm	90 mm	48 mm	44 mm	35,50
BI4E2L033	33 mm	90 mm	50 mm	44 mm	35,50
BI4E2L034	34 mm	90 mm	52 mm	44 mm	36,50
BI4E2L035	35 mm	90 mm	52 mm	44 mm	36,50
BI4E2L036	36 mm	90 mm	54 mm	44 mm	36,50
BI4E2L038	38 mm	90 mm	56 mm	44 mm	43,30
BI4E2L041	41 mm	90 mm	60 mm	44 mm	45,60
BI4E2L046	46 mm	90 mm	66 mm	44 mm	59,40
BI4E2L050	50 mm	90 mm	71 mm	54 mm	73,70



PROLUNGA AD IMPATTO

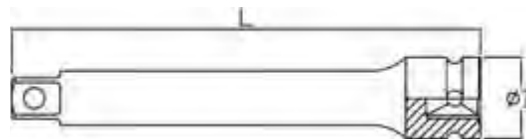

3/4"



Fosfatata



DIN 3121 & 3129



Cr-Mo

Codice	Attacco quadro	Lunghezza	D	Imballo	€
PI402175	3/4"	175 mm	44 mm	2 / 12	32,20
PI402200	3/4"	200 mm	44 mm	2 / 18	35,60
PI402300	3/4"	300 mm	44 mm	6	46,70
PI402400	3/4"	400 mm	44 mm	4	66,00

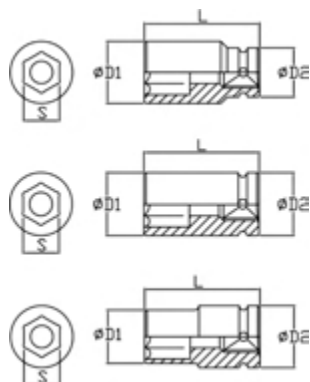
CHIAVE A BUSSOLA AD IMPATTO

1"



Fosfatata



DIN 3129



Cr-Mo

Codice	Misura	Lunghezza	D1	D2	€
BI4E1N021	21 mm	58 mm	38 mm	54 mm	28,90
BI4E1N022	22 mm	58 mm	39 mm	54 mm	28,90
BI4E1N023	23 mm	58 mm	41 mm	54 mm	28,90
BI4E1N024	24 mm	58 mm	42 mm	54 mm	28,90
BI4E1N025	25 mm	58 mm	43 mm	54 mm	28,90
BI4E1N026	26 mm	58 mm	44 mm	54 mm	28,90
BI4E1N027	27 mm	58 mm	46 mm	54 mm	28,90
BI4E1N028	28 mm	58 mm	47 mm	54 mm	28,90
BI4E1N029	29 mm	58 mm	48 mm	54 mm	28,90
BI4E1N030	30 mm	62 mm	49 mm	54 mm	28,90
BI4E1N031	31 mm	62 mm	50 mm	54 mm	28,90
BI4E1N032	32 mm	62 mm	52 mm	54 mm	28,90
BI4E1N033	33 mm	62 mm	54 mm	54 mm	28,90
BI4E1N034	34 mm	62 mm	54 mm	54 mm	32,20
BI4E1N035	35 mm	62 mm	54 mm	54 mm	32,20
BI4E1N036	36 mm	65 mm	56 mm	54 mm	33,30
BI4E1N037	37 mm	65 mm	57 mm	54 mm	33,90
BI4E1N038	38 mm	65 mm	58 mm	54 mm	38,30
BI4E1N039	39 mm	65 mm	59 mm	54 mm	38,30
BI4E1N040	40 mm	65 mm	60 mm	54 mm	38,30
BI4E1N041	41 mm	68 mm	61 mm	54 mm	38,30
BI4E1N042	42 mm	68 mm	64 mm	54 mm	42,80
BI4E1N043	43 mm	68 mm	66 mm	54 mm	42,80
BI4E1N044	44 mm	68 mm	66 mm	54 mm	42,80
BI4E1N045	45 mm	68 mm	67 mm	54 mm	42,80
BI4E1N046	46 mm	72 mm	68 mm	54 mm	42,80
BI4E1N047	47 mm	72 mm	69 mm	54 mm	47,80
BI4E1N048	48 mm	72 mm	70 mm	54 mm	47,80
BI4E1N050	50 mm	75 mm	74 mm	54 mm	47,80
BI4E1N052	52 mm	75 mm	75 mm	54 mm	59,40
BI4E1N054	54 mm	80 mm	78 mm	54 mm	59,40
BI4E1N055	55 mm	83 mm	80 mm	54 mm	61,60
BI4E1N056	56 mm	83 mm	81 mm	54 mm	61,60
BI4E1N060	60 mm	87 mm	86 mm	54 mm	61,60
BI4E1N065	65 mm	90 mm	92 mm	54 mm	67,10
BI4E1N070	70 mm	93 mm	97 mm	54 mm	75,40
BI4E1N075	75 mm	95 mm	104 mm	86 mm	89,10
BI4E1N080	80 mm	95 mm	112 mm	86 mm	110,00
BI4E1N085	85 mm	100 mm	115 mm	86 mm	119,00
BI4E1N090	90 mm	105 mm	124 mm	86 mm	133,00
BI4E1N095	95 mm	105 mm	130 mm	86 mm	202,00
BI4E1N100	100 mm	105 mm	135 mm	86 mm	251,00



CHIAVE A BUSSOLA AD IMPATTO LUNGA

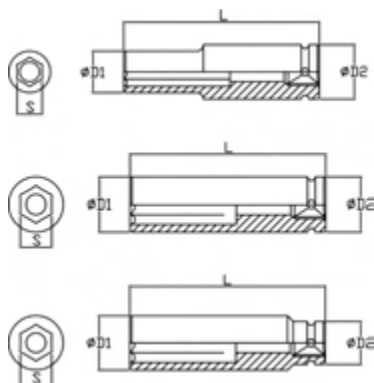

Fosfatata



DIN 3129



Cr-Mo

Codice	Misura	Lunghezza	D1	D2	€
BI4E1L021	21 mm	90 mm	38 mm	54 mm	43,60
BI4E1L022	22 mm	90 mm	39 mm	54 mm	43,60
BI4E1L023	23 mm	90 mm	41 mm	54 mm	43,60
BI4E1L024	24 mm	90 mm	42 mm	54 mm	43,60
BI4E1L027	27 mm	90 mm	46 mm	54 mm	43,60
BI4E1L028	28 mm	90 mm	47 mm	54 mm	43,60
BI4E1L030	30 mm	90 mm	49 mm	54 mm	43,60
BI4E1L032	32 mm	90 mm	52 mm	54 mm	43,60
BI4E1L033	33 mm	90 mm	54 mm	54 mm	43,60
BI4E1L034	34 mm	90 mm	54 mm	54 mm	44,00
BI4E1L035	35 mm	90 mm	54 mm	54 mm	44,40
BI4E1L036	36 mm	90 mm	56 mm	54 mm	44,40
BI4E1L038	38 mm	95 mm	58 mm	54 mm	47,20
BI4E1L039	39 mm	95 mm	59 mm	54 mm	49,40
BI4E1L040	40 mm	95 mm	60 mm	54 mm	49,40
BI4E1L041	41 mm	95 mm	61 mm	54 mm	50,70
BI4E1L042	42 mm	95 mm	64 mm	54 mm	50,70
BI4E1L043	43 mm	95 mm	66 mm	54 mm	53,80
BI4E1L044	44 mm	95 mm	66 mm	54 mm	53,80
BI4E1L045	45 mm	95 mm	67 mm	54 mm	54,90
BI4E1L046	46 mm	95 mm	68 mm	54 mm	54,90
BI4E1L048	48 mm	100 mm	70 mm	54 mm	67,10
BI4E1L049	49 mm	100 mm	72 mm	54 mm	69,30
BI4E1L050	50 mm	100 mm	74 mm	54 mm	69,30
BI4E1L051	51 mm	100 mm	74 mm	54 mm	71,50
BI4E1L052	52 mm	100 mm	74 mm	54 mm	72,60
BI4E1L054	54 mm	100 mm	78 mm	54 mm	72,60
BI4E1L055	55 mm	105 mm	80 mm	54 mm	78,10
BI4E1L057	57 mm	105 mm	82 mm	54 mm	81,40
BI4E1L060	60 mm	110 mm	86 mm	54 mm	82,50
BI4E1L065	65 mm	115 mm	92 mm	54 mm	99,00
BI4E1L070	70 mm	120 mm	97 mm	54 mm	129,00
BI4E1L075	75 mm	135 mm	104 mm	86 mm	144,00
BI4E1L080	80 mm	135 mm	112 mm	86 mm	155,00
BI4E1L085	85 mm	140 mm	115 mm	86 mm	164,00
BI4E1L090	90 mm	140 mm	124 mm	86 mm	214,00
BI4E1L095	95 mm	140 mm	130 mm	86 mm	279,00





Art. I340 € 252,00
 SERIE BUSSOLE AD IMPATTO,
 SERIE NORMALE E LUNGHE

40 Pz

Fosfatata 1/2" Cr-Mo

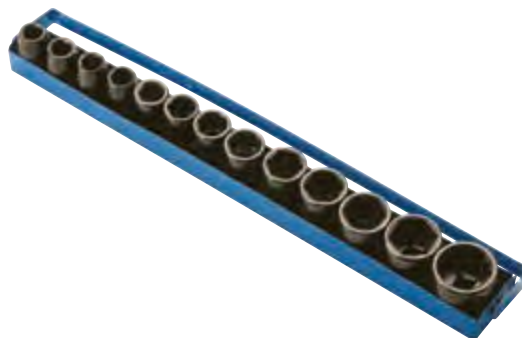
Bussole da 1/2"	9 - 10 - 11 - 12 - 13 - 14 - 15 - 16 - 17 - 18 - 19 - 20 - 21 - 22 - 23 - 24 - 26 - 27 - 30 mm
Bussole lunghe da 1/2"	9 - 10 - 11 - 12 - 13 - 14 - 15 - 16 - 17 - 18 - 19 - 20 - 21 - 22 - 23 - 24 - 26 - 27 - 30 mm
Snodo universale	1/2"
Prolunghe da 1/2"	125 mm
Imballo	2

Art. SI4E3N013 € 71,50
 SERIE BUSSOLE AD
 IMPATTO, SERIE NORMALE

1/2" DIN 3129

13 Pz Fosfatata Cr-Mo

Attacco quadro	1/2"
Bussole	10, 11, 12, 13, 14, 16, 17, 19, 21, 22, 24, 27, 30 mm

Art. SI413M006 € 50,00
 SERIE BUSSOLE ESAGONALI
 MASCHIO AD IMPATTO

1/2" DIN 3129

6 Pz Fosfatata Cr-Mo

Attacco quadro	1/2"
Lunghezza	60 mm
Bussole	8, 10, 12, 14, 17, 19 mm

Art. SI423M006 € 57,20
 SERIE BUSSOLE TORX
 MASCHIO AD IMPATTO

1/2" DIN 3129

6 Pz Fosfatata Cr-Mo

Attacco quadro	1/2"
Lunghezza	60 mm
Bussole	T40, T45, T50, T55, T60, T70



Art. 0341

SERIE CHIAVI BUSSOLA ESAGONALI IMPACT RIVESTITE IN PLASTICA

€ 35,60



3 Pz 1/2" Cr-Mo

Attacco	1/2"
Misure	17 - 19 - 21 mm
Lunghezza	87 mm
Imballo	10



Art. I306

SERIE CHIAVI A BUSSOLA LUNGHE AD IMPATTO

€ 68,00



3 Pz 1/2" Cr-Mo

Attacco quadro	1/2"
Misure	17 - 19 - 21 mm
Lunghezza	150 mm
Imballo	10



Art. I217

SERIE BUSSOLE AD IMPATTO, SERIE NORMALE

€ 299,00



17 Pz Fosfatata 3/4" Cr-Mo

Bussole da 3/4"	19 - 21 - 22 - 24 - 27 - 30 - 32 - 33 - 34 - 35 - 36 - 38 - 40 - 41 - 46 - 50 - 55 mm
Imballo	2



Art. SI4E2N008
 SERIE BUSSOLE AD IMPATTO, SERIE NORMALE

€ 106,00

3/4" DIN 3129
 8 Pz Fosfatata Cr-Mo

Attacco quadro	3/4"
Bussole	26, 27, 29, 30, 32, 35, 36, 38 mm

Art. I109
 SERIE BUSSOLE AD IMPATTO

€ 170,00

1" DIN 3129
 9 Pz Fosfatata Cr-Mo

Bussole da 1"	21 - 22 - 24 - 26 - 30 - 38 mm
Bussole lunghe da 1"	27 - 28 - 32 mm
Imballo	2

Art. SI4E1N008
 SERIE BUSSOLE AD IMPATTO

€ 156,00

1" DIN 3129 Fosfatata Cr-Mo
 8 Pz

Attacco quadro	1"
Bussole	24, 27, 30, 32, 33, 36, 38, 41 mm



PROLUNGA AD IMPATTO



1" DIN 3121 - 3129
Fosfatata Cr-Mo

Codice	Attacco quadro	Lunghezza	D	Imballo	€
PI401175	1"	175 mm	54 mm	2 / 12	53,30
PI401200	1"	200 mm	54 mm	2 / 12	57,20
PI401250	1"	250 mm	54 mm	2 / 8	69,30
PI401300	1"	300 mm	54 mm	2 / 8	73,70
PI401400	1"	400 mm	54 mm	6	93,50



SNODO A CARDANO AD IMPATTO



Fosfatata Cr-Mo

Codice	Attacco quadro	Lunghezza	D	Imballo	€
J1401L	1"	130 mm	54 mm	2 / 8	109,00
J1402L	3/4"	105 mm	44 mm	4 / 10	68,20



SNODO A CARDANO AD IMPATTO



Fosfatata Cr-Mo

Codice	Attacco quadro	Lunghezza	D	Imballo	€
J1401N	1"	115 mm	54 mm	4 / 20	109,00
J1402N	3/4"	90 mm	44 mm	4 / 10	68,20
J1403N	1/2"	63 mm	30 mm	10 / 80	33,30



RACCORDO AD IMPATTO



Fosfatata DIN 3121 Cr-Mo

Codice	Attacco femmina	Attacco maschio	Lunghezza	D	Imballo	€
RI4012N	1"	3/4"	70 mm	54 mm	4 / 36	25,20
RI4021N	3/4"	1"	63 mm	44 mm	6 / 36	20,20
RI4023N	3/4"	1/2"	58 mm	44 mm	6 / 60	15,70
RI4032N	1/2"	3/4"	48 mm	30 mm	10	11,20



Art. SI40N006
SERIE RACCORDI AD IMPATTO

€ 36,00



6 Pz Fosfatata Cr-Mo

Misure	1/4" int. - 3/8" ext.; 3/8" int. - 1/4" ext.; 3/8" int. - 1/2" ext.; 1/2" int. - 3/8" ext.; 1/2" int. - 3/4" ext.; 3/4" int. - 1/2" ext.
Valigetta in plastica	126 x 100 x 52 mm
Peso	0.78 kg
Imballo	20





CHIAVE A BUSSOLA CON IMPUGNATURA

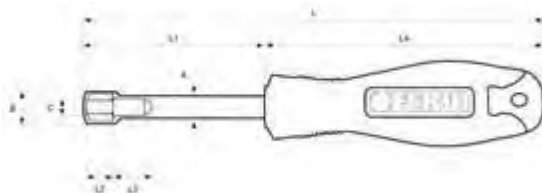

Cr-V

Codice	Misura	L	L1	L2	L3	L4	A	B	C	€
CB01/04	4 mm	185 mm	75 mm	4 ~ 5 mm	20,5 mm	110 mm	Ø 5,9 mm	Ø 7 mm	Ø 3,3 mm	6,00
CB01/05	5 mm	185 mm	75 mm	4,5 ~ 5,5 mm	20 mm	110 mm	Ø 5,9 mm	Ø 8,3 mm	Ø 3,7 mm	6,00
CB01/055	5,5 mm	185 mm	75 mm	5,5 ~ 6,5 mm	19 mm	110 mm	Ø 5,9 mm	Ø 9 mm	Ø 3,7 mm	6,00
CB01/06	6 mm	185 mm	75 mm	6,5 ~ 7,5 mm	18 mm	110 mm	Ø 5,9 mm	Ø 9,5 mm	Ø 3,7 mm	6,00
CB01/07	7 mm	185 mm	75 mm	7,5 ~ 8,5 mm	17 mm	110 mm	Ø 5,9 mm	Ø 10,5 mm	Ø 3,7 mm	6,50
CB01/08	8 mm	185 mm	75 mm	8,5 ~ 9,5 mm	16 mm	110 mm	Ø 7,2 mm	Ø 11,9 mm	Ø 5 mm	6,50
CB01/09	9 mm	185 mm	75 mm	8,5 ~ 9,5 mm	16 mm	110 mm	Ø 7,2 mm	Ø 12,8 mm	Ø 5 mm	6,50
CB01/10	10 mm	185 mm	75 mm	10,5 ~ 11,5 mm	14 mm	110 mm	Ø 9,3 mm	Ø 14,1 mm	Ø 7 mm	7,00
CB01/11	11 mm	185 mm	75 mm	10,5 ~ 11,5 mm	14 mm	110 mm	Ø 9,3 mm	Ø 15 mm	Ø 7 mm	7,00
CB01/12	12 mm	185 mm	75 mm	10,5 ~ 11,5 mm	14 mm	110 mm	Ø 9,3 mm	Ø 16 mm	Ø 7 mm	7,00
CB01/13	13 mm	185 mm	75 mm	11,5 ~ 12,5 mm	14 mm	110 mm	Ø 11 mm	Ø 17 mm	Ø 8,5 mm	7,00

CHIAVE A BUSSOLA CON IMPUGNATURA BICOMPONENTE CHROME-VANADIUM CON APPENDIBILE



CHIAVE A BUSSOLA CON IMPUGNATURA

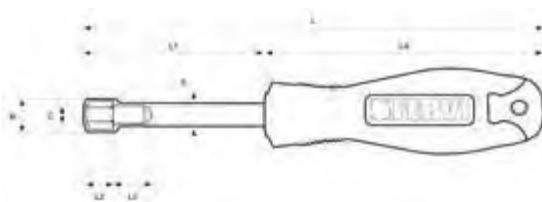

Cr-V

Codice	Misura	L	L1	L2	L3	L4	A	B	C	€
CB02/04	4 mm	185 mm	75 mm	4 ~ 5 mm	105,5 mm	110 mm	Ø 7,2 mm	Ø 7 mm	Ø 3,3 mm	7,50
CB02/05	5 mm	185 mm	75 mm	4,5 ~ 5,5 mm	105 mm	110 mm	Ø 7,2 mm	Ø 8,3 mm	Ø 3,7 mm	7,50
CB02/055	5,5 mm	185 mm	75 mm	5,5 ~ 6,5 mm	104 mm	110 mm	Ø 7,2 mm	Ø 9 mm	Ø 3,7 mm	7,50
CB02/06	6 mm	185 mm	75 mm	6,5 ~ 7,5 mm	103 mm	110 mm	Ø 7,2 mm	Ø 9,5 mm	Ø 3,7 mm	7,50
CB02/07	7 mm	185 mm	75 mm	7,5 ~ 8,5 mm	102 mm	110 mm	Ø 7,2 mm	Ø 10,5 mm	Ø 3,7 mm	8,00
CB02/08	8 mm	185 mm	75 mm	8,5 ~ 9,5 mm	101 mm	110 mm	Ø 9,3 mm	Ø 11,9 mm	Ø 5 mm	8,00
CB02/09	9 mm	185 mm	75 mm	8,5 ~ 9,5 mm	101 mm	110 mm	Ø 9,3 mm	Ø 12,8 mm	Ø 5 mm	8,00
CB02/10	10 mm	185 mm	75 mm	10,5 ~ 11,5 mm	100 mm	110 mm	Ø 9,3 mm	Ø 14,1 mm	Ø 7 mm	8,00
CB02/11	11 mm	185 mm	75 mm	10,5 ~ 11,5 mm	100 mm	110 mm	Ø 11 mm	Ø 15 mm	Ø 7 mm	9,00
CB02/12	12 mm	185 mm	75 mm	10,5 ~ 11,5 mm	100 mm	110 mm	Ø 11 mm	Ø 16 mm	Ø 7 mm	9,00
CB02/13	13 mm	185 mm	75 mm	11,5 ~ 12,5 mm	99 mm	110 mm	Ø 11 mm	Ø 17 mm	Ø 8,5 mm	10,00

CHIAVE A BUSSOLA CON FORO PROFONDO E IMPUGNATURA BICOMPONENTE CHROME-VANADIUM CON APPENDIBILE

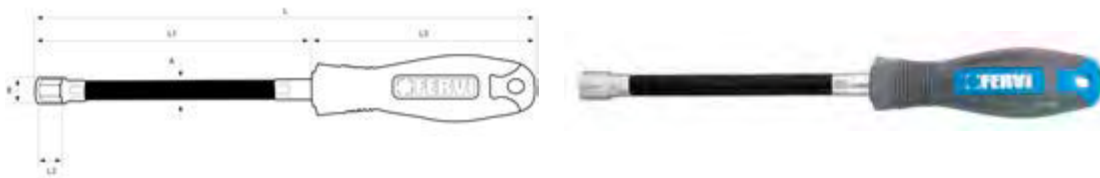

CHIAVE A BUSSOLA FLESSIBILE CON IMPUGNATURA

Codice	Misura	L	L1	L2	L3	A	B	€
CBF1/05	5 mm	265 mm	150 mm	9,5 mm	115 mm	Ø 11 mm	Ø 11,8 mm	7,50
CBF1/055	5,5 mm	265 mm	150 mm	9,5 mm	115 mm	Ø 11 mm	Ø 11,8 mm	7,50
CBF1/06	6 mm	265 mm	150 mm	9,5 mm	115 mm	Ø 11 mm	Ø 11,8 mm	7,50
CBF1/07	7 mm	265 mm	150 mm	9,5 mm	115 mm	Ø 11 mm	Ø 11,8 mm	7,50
CBF1/08	8 mm	265 mm	150 mm	9,5 mm	115 mm	Ø 11 mm	Ø 11,8 mm	7,50
CBF1/09	9 mm	265 mm	150 mm	9,5 mm	115 mm	Ø 11 mm	Ø 13 mm	7,70
CBF1/10	10 mm	265 mm	150 mm	10 mm	115 mm	Ø 11 mm	Ø 14,5 mm	8,00
CBF1/11	11 mm	265 mm	150 mm	9 mm	115 mm	Ø 11 mm	Ø 15,9 mm	8,50
CBF1/12	12 mm	265 mm	150 mm	9 mm	115 mm	Ø 11 mm	Ø 17 mm	8,50
CBF1/13	13 mm	265 mm	150 mm	8,5 mm	115 mm	Ø 11 mm	Ø 17,8 mm	8,50

CHIAVE A BUSSOLA FLESSIBILE CON IMPUGNATURA BICOMPONENTE CON APPENDIBILE

Art. CBF1/10P

SERIE CHIAVI A BUSSOLA FLESSIBILI CON IMPUGNATURA

€ 74,00



10 Pz

SERIE 10Pz CHIAVI A BUSSOLA FLESSIBILI CON IMPUGNATURA BICOMPONENTE

Misure 5 - 5.5 - 6 - 7 - 8 - 9 - 10 - 11 - 12 - 13 mm
Scatola

Art. CB01/04P

SERIE CHIAVI A BUSSOLA CON IMPUGNATURA

€ 27,50



4 Pz Cr-V

SERIE 4Pz CHIAVI A BUSSOLA CON IMPUGNATURA BICOMPONENTE, CHROME-VANADIUM

Misure 10 - 11 - 12 - 13 mm
Scatola



Art. CB01/07P
SERIE CHIAVI A BUSSOLA CON IMPUGNATURA

€ 42,00



7 Pz Cr-V

SERIE 7Pz CHIAVI A BUSSOLA CON IMPUGNATURA BICOMPONENTE, CHROME-VANADIUM

Misure Scatola 4 - 5 - 5.5 - 6 - 7 - 8 - 9 mm



Art. CB01/11P
SERIE CHIAVI A BUSSOLA CON IMPUGNATURA

€ 68,00



11 Pz Cr-V

SERIE 11Pz CHIAVI A BUSSOLA CON IMPUGNATURA BICOMPONENTE, CHROME-VANADIUM

Misure Scatola 4 - 5 - 5.5 - 6 - 7 - 8 - 9 - 10 - 11 - 12 - 13 mm



Art. CB02/04P
SERIE CHIAVI A BUSSOLA CON IMPUGNATURA

€ 35,00



4 Pz Cr-V

SERIE DI 4Pz CHIAVI A BUSSOLA CON FORO PROFONDO E IMPUGNATURA BICOMPONENTE, CHROME-VANADIUM

Misure Scatola 10 - 11 - 12 - 13 mm



Art. CB02/07P
SERIE CHIAVI A BUSSOLA CON IMPUGNATURA

€ 55,00



7 Pz Cr-V

SERIE 7Pz CHIAVI A BUSSOLA CON FORO PROFONDO E IMPUGNATURA BICOMPONENTE, CHROME-VANADIUM

Misure Scatola 4 - 5 - 5.5 - 6 - 7 - 8 - 9 - 10 mm



Art. CB02/11P
 SERIE CHIAVI A BUSSOLA CON IMPUGNATURA

€ 89,00

11 Pz Cr-V

SERIE 11Pz CHIAVI A BUSSOLA CON FORO PROFONDO E IMPUGNATURA BICOMPONENTE, CHROME-VANADIUM

Misure 4 - 5 - 5.5 - 6 - 7 - 8 - 9 - 10 - 11 - 12 - 13 mm
Scatola

GIRAVITE ELETTRICISTA, APPENDIBILE

50 Cr-V



Codice	Misura	Imballo	€
C883/3075	3 x 75 mm	12 / 240	2,40
C883/4100	4 x 100 mm	12 / 240	3,54

GIRAVITE ELETTRICISTA, A TAGLIO, COSTRUITO IN ACCIAIO 50 CR-V, CON PUNTA MAGNETICA FOSFATATA NERA DIRITTA E MANICO REALIZZATO IN RESINA TPR ALTAMENTE ELASTICA E MATERIALE POLIPROPILENE RESISTENTE ALL'OLIO

GIRAVITE A TAGLIO, APPENDIBILE

50 Cr-V



Codice	Misura	Imballo	€
C884/3075	3 x 75 mm	12 / 240	2,40
C884/4100	4 x 100 mm	12 / 240	3,08
C884/5125	5 x 125 mm	12 / 240	3,66
C884/6150	6 x 150 mm	12 / 240	4,12
C884/8150	8 x 150 mm	12 / 240	4,80

GIRAVITE A TAGLIO, COSTRUITO IN ACCIAIO 50 CR-V, CON PUNTA MAGNETICA FOSFATATA NERA E MANICO REALIZZATO IN RESINA TPR ALTAMENTE ELASTICA E MATERIALE POLIPROPILENE RESISTENTE ALL'OLIO

Art. C884/6038
 GIRAVITE A TAGLIO, APPENDIBILE

€ 3,20

50 Cr-V

Misura 6 x 38 mm
Imballo 12 / 240

GIRAVITE A TAGLIO, COSTRUITO IN ACCIAIO 50 CR-V, CON PUNTA MAGNETICA FOSFATATA NERA E MANICO REALIZZATO IN RESINA TPR ALTAMENTE ELASTICA E MATERIALE POLIPROPILENE RESISTENTE ALL'OLIO

GIRAVITE A CROCE PH, APPENDIBILE

50 Cr-V



Codice	Misura	Imballo	€
C882/1075	PH 1 x 75 mm	12 / 240	3,66
C882/2100	PH 2 x 100 mm	12 / 240	4,80
C882/3150	PH 3 x 150 mm	12 / 240	5,10

GIRAVITE A CROCE PH, COSTRUITO IN ACCIAIO 50 CR-V, CON PUNTA MAGNETICA FOSFATATA NERA E MANICO REALIZZATO IN RESINA TPR ALTAMENTE ELASTICA E MATERIALE POLIPROPILENE RESISTENTE ALL'OLIO



Art. C882/2038
GIRAVITE A CROCE PH, APPENDIBILE

€ 3,20



Misura PH 2 x 38 mm
Imballo 12 / 240

50 Cr-V

GIRAVITE A CROCE PZ, COSTRUITO IN ACCIAIO 50 CR-V, CON PUNTA MAGNETICA FOSFATATA NERA E MANICO REALIZZATO IN RESINA TPR ALTAMENTE ELASTICA E MATERIALE POLIPROPILENE RESISTENTE ALL'OLIO



GIRAVITE A CROCE PZ, APPENDIBILE

50 Cr-V

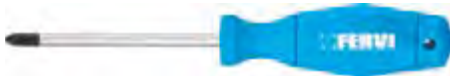

Codice	Misura	Imballo	€
C885/1075	PZ 1 x 75 mm	12 / 240	3,66
C885/2100	PZ 2 x 100 mm	12 / 240	4,80
C885/3150	PZ 3 x 150 mm	12 / 240	5,10

GIRAVITE A CROCE PH, COSTRUITO IN ACCIAIO 50 CR-V, CON PUNTA MAGNETICA FOSFATATA NERA E MANICO REALIZZATO IN RESINA TPR ALTAMENTE ELASTICA E IN POLIPROPILENE RESISTENTE ALL'OLIO



Art. C885/2038
GIRAVITE A CROCE PZ, APPENDIBILE

€ 3,20



Misura PZ 2 x 38 mm
Imballo 12 / 240

50 Cr-V

GIRAVITE A CROCE PZ, COSTRUITO IN ACCIAIO 50 CR-V, CON PUNTA MAGNETICA FOSFATATA NERA E MANICO REALIZZATO IN RESINA TPR ALTAMENTE ELASTICA E MATERIALE POLIPROPILENE RESISTENTE ALL'OLIO



Art. C880/006
SERIE GIRAVITI

€ 16,80



6 Pz 50 Cr-V

Misure Taglio (-) 4 x 100 mm, (-) 5 x 125 mm, (-) 6 x 150 mm
Croce (+) PH 1 x 75 mm, (+) PH 2 x 100 mm, (+) PH 3 x 150 mm
Imballo 6* / 24

SERIE GIRAVITI 6 PZ, COSTRUITI IN ACCIAIO 50 CR-V, CON PUNTA MAGNETICA FOSFATATA NERA E MANICO REALIZZATO IN RESINA TPR ALTAMENTE ELASTICA E MATERIALE POLIPROPILENE RESISTENTE ALL'OLIO, CHROME - VANADIUM, SCATOLA

Art. C880/160CTZ
ESPOSITORE CON GIRAVITI
€ 420,00

192 Pz 50 Cr-V

Pz per tipo	12		
Giravite a croce per meccanica	PH 1 x 75 mm	Giravite a croce per viti da legno	PZ 3 x 150 mm
Giravite a croce per meccanica	PH 2 x 38 mm	Giravite a taglio elettricista	3 X 75 mm
Giravite a croce per meccanica	PH 2 x 100 mm	Giravite a taglio elettricista	4 x 100 mm
Giravite a croce per meccanica	PH 3 x 150 mm	Giravite a taglio per meccanica	3 x 75 mm
Giravite a croce per viti da legno	PZ 1 x 75 mm	Giravite a taglio per meccanica	4 x 100 mm
Giravite a croce per viti da legno	PZ 2 x 38 mm	Giravite a taglio per meccanica	5 x 125 mm
Giravite a croce per viti da legno	PZ 2 x 100 mm	Giravite a taglio per meccanica	6 x 150 mm
		Giravite a taglio per meccanica	8 x 150 mm
		Giravite a taglio per meccanica	6 x 38 mm

ESPOSITORE CON 192 GIRAVITI COSTRUITI IN ACCIAIO 50 CR-V, CON PUNTA MAGNETICA FOSFATATA NERA E MANICO REALIZZATO IN RESINA TPR ALTAMENTE ELASTICA E IN POLIPROPILENE RESISTENTE ALL'OLIO - 4 TIPI A CROCE PH, 4 TIPI A CROCE PZ E 8 TIPI A TAGLIO, CHROME - VANADIUM

GIRAVITE CON MANICO ERGONOMICO ANTISCIVOLO

Mo-V

Codice	Misure	Imballo	€
0883/3075	(-) 3,0x0,5x75 mm	10* / 100	2,98
0883/4100	(-) 4,0x0,5x100 mm	10* / 100	3,32

GIRAVITE CON MANICO ERGONOMICO ANTISCIVOLO MOLYBDENUM - VANADIUM, TAGLIO ELETTRICISTA, CONFEZIONE APENDIBILE, HRC52

GIRAVITE CON MANICO ERGONOMICO ANTISCIVOLO

Mo-V

Codice	Misure	Imballo	€
0884/3075	(-) 3,0x0,5x75 mm	10* / 100	3,08
0884/4100	(-) 4,0x0,8x100 mm	10* / 100	3,20
0884/5125	(-) 5,5x1,0x125 mm	10* / 100	3,42
0884/6150	(-) 6,5x1,2x150 mm	10* / 100	3,88
0884/8150	(-) 8,0x1,2x150 mm	10* / 100	4,56

GIRAVITE CON MANICO ERGONOMICO ANTISCIVOLO CON PUNTA MAGNETICA, MOLYBDENUM - VANADIUM, TAGLIO, CONFEZIONE APENDIBILE, HRC52



GIRAVITE CON MANICO ERGONOMICO ANTISCIVOLO



Mo-V

GIRAVITE CON MANICO ERGONOMICO ANTISCIVOLO CON PUNTA MAGNETICA, MOLYBDENUM - VANADIUM, CROCE PH, CONFEZIONE APENDIBILE, HRC52

Codice	Misure	Imballo	€
0882/1080	(+) PH 1x80 mm	10* / 100	3,42
0882/2100	(+) PH 2x100 mm	10* / 100	4,56
0882/3150	(+) PH 3x150 mm	10* / 100	4,80



GIRAVITE CON MANICO ERGONOMICO ANTISCIVOLO



Mo-V

GIRAVITE CON MANICO ERGONOMICO ANTISCIVOLO CON PUNTA MAGNETICA, CROCE PZ, MOLYBDENUM - VANADIUM, CONFEZIONE APPENDIBILE, HRC52

Codice	Misure	Imballo	€
0885/1080	(+) Pz 1x80 mm	10* / 100	3,42
0885/2100	(+) Pz 2x100 mm	10* / 100	4,56
0885/3150	(+) Pz 3x150 mm	10* / 100	5,10



GIRAVITE CON MANICO ERGONOMICO ANTISCIVOLO



Mo-V

GIRAVITE CON MANICO ERGONOMICO ANTISCIVOLO, MOLYBDENUM - VANADIUM, TORX, CONFEZIONE APPENDIBILE, HRC52

Codice	Misure	Imballo	€
0881/06006	T6x60 mm	10* / 100	4,00
0881/06007	T7x60 mm	10* / 100	4,00
0881/06008	T8x60 mm	10* / 100	4,00
0881/06009	T9x60 mm	10* / 100	4,12
0881/08010	T10x80 mm	10* / 100	4,12
0881/08015	T15x80 mm	10* / 100	4,56
0881/10020	T20x100 mm	10* / 100	4,80
0881/10025	T25x100 mm	10* / 100	4,92
0881/11530	T30x115 mm	10* / 100	5,30



Art. 0880/307 € 20,20
SERIE GIRAVITI



7 Pz Mo-V

Taglio	(-) 3,0x0,5x75 mm, (-) 4,0x0,8x100 mm, (-) 5,5x1,0x125 mm, (-) 6,5x1,2x150 mm, (-) 8,0x1,2x150 mm
Croce	(+) PH 1x80 mm, (+) PH 2x100 mm
Imballo	12



Art. 0881/008 € 16,80
SERIE GIRAVITI TORX



8 Pz Mo-V

Torx	T 7x60 - T 8x60 - T 9x60 - T 10x80 - T 15x80 - T 20x100 - T 25x100 - T 30x115 mm
Imballo	12

Art. 0880/002
 ESPOSITORE CON GIRAVITI

€ 470,00

130 Pz Mo-V

Pz per tipo	10	Giravite a taglio per meccanica	8 x 150 mm
Giravite a taglio elettricista	3 x 75 mm	Giravite a croce per meccanica	PH 1 x 80 mm
Giravite a taglio elettricista	4 x 100 mm	Giravite a croce per meccanica	PH 2 x 100 mm
Giravite a taglio per meccanica	3 x 75 mm	Giravite a croce per meccanica	PH 3 x 150 mm
Giravite a taglio per meccanica	4 x 100 mm	Giravite a croce per viti da legno	PZ 1 x 80 mm
Giravite a taglio per meccanica	5,5 x 125 mm	Giravite a croce per viti da legno	PZ 2 x 100 mm
Giravite a taglio per meccanica	6,5 x 150 mm	Giravite a croce per viti da legno	PZ 3 x 150 mm

Art. 0288
 SERIE GIRAVITI CON ESPOSITORE

€ 27,50

25 Pz Mo-V

Giraviti	
Taglio	6x100 - 5x75 - 6x38 mm
Phillips	PH2x100 - PH1x75 - PH2x38 mm
Giraviti di precisione	
Taglio	2,4x50 - 3x50 mm
Phillips	PH0x50 - PH00x50 mm
Torx	T6 - T8
Porta inserti	1/4"
Inserti	
Taglio	4 - 5 - 6 mm
Phillips	PH1 - PH2 - PH3
Pozi-driv	PZ1 - PZ2 - PZ3
Torx	T10 - T15 - T20
Imballo	12

Art. 0887
 SERIE GIRAVITI EXTRA LUNGHI INTERCAMBIABILI

€ 37,60

Mo-V

Torx con foro	T10 - T15 - T20 - T25 - T27 - T30 - T40
Torx 5 punte con foro	TS10 - TS15 - TS20 - TS25 - TS27 - TS30 - TS40
Taglio	4 - 5 mm
Lunghezza	300 mm
Imballo	20

9 DOPPIE LAME - LUNGHEZZA 300 mm



Art. 0633
SERIE GIRAVITI A
LAME PASSANTI

€ 15,70



6 Pz Cr-Mo

Misure Taglio	(-) 5,0x1,0x75 mm, (-) 6,0x1,2x100 mm, (-) 6,0x1,2x125 mm, (-) 8,0x1,2x150 mm
Croce	(+) PH 1x5x75 mm, (+) PH 2x6x100 mm
Imballo	6* / 24



Art. 0634
SERIE GIRAVITI

€ 12,40



6 Pz Cr-Mo

Misure Taglio	(-) 4x0,8x75 mm, (-) 5,5x1,0x100 mm, (-) 6,5x1,2x150 mm
Croce	(+) PH 0x3x75 mm, (+) PH 1x5x100 mm, (+) PH 2x6x125 mm
Imballo	6* / 24



GIRAVITE A CROCE ISOLATO

1000 V IEC 60900



Codice	Misura	Lunghezza totale	Imballo	€
CI82/0060	PH0 x 3 x 60 mm	160 mm	12 / 120	3,00
CI82/1080	PH1 x 4.5 x 80 mm	185 mm	12 / 120	3,90
CI82/2100	PH2 x 6 x 100 mm	210 mm	12 / 120	4,60
CI82/3150	PH3 x 8 x 150 mm	265 mm	12 / 120	7,50

PUNTA MAGNETICA, APPENDIBILE



GIRAVITE A TAGLIO ISOLATO

1000 V IEC 60900



Codice	Misura	Lunghezza totale	Imballo	€
CI83/25075	0.4 x 2.5 x 75 mm	175 mm	12 / 120	3,00
CI83/30100	0.6 x 3 x 100 mm	200 mm	12 / 120	3,90
CI83/40100	0.8 x 4 x 100 mm	200 mm	12 / 120	3,90
CI83/55125	1 x 5.5 x 125 mm	230 mm	12 / 120	4,20
CI83/65150	1.2 x 6.5 x 150 mm	260 mm	12 / 120	5,50
CI83/80175	1.6 x 8 x 175 mm	290 mm	12 / 120	7,30

PUNTA MAGNETICA, APPENDIBILE



Art. CI80/006
SERIE GIRAVITI ISOLATI

€ 22,50



6 Pz 1000 V IEC 60900 Mo-V

Misure Taglio	(-) 0,6 x 3 x 100 mm, (-) 0,8 x 4 x 100 mm, (-) 1 x 5,5 x 125 mm
Croce	(+) PH 0 x 3 x 60 mm, (+) PH 1 x 4,5 x 80 mm, (+) PH 2 x 6 x 100 mm
Imballo	6 / 24

CON PUNTA MAGNETICA FOSFATATA NERA E MANICO BI-COLORE IN POLIPROPILENE RESISTENTE ALL'OLIO



Art. CI80/120
ESPOSITORE CON GIRAVITI ISOLATI 1000V IEC 60900
€ 550,00

120 Pz 1000 V IEC 60900 Mo-V

Pz per tipo	12	Giravite a taglio isolato	0.6 x 3 x 100 mm
Giravite a croce isolato	PH 0 x 3 x 60 mm	Giravite a taglio isolato	0.8 x 4 x 100 mm
Giravite a croce isolato	PH 1 x 4,5 x 80 mm	Giravite a taglio isolato	1 x 5.5 x 125 mm
Giravite a croce isolato	PH 2 x 6 x 100 mm	Giravite a taglio isolato	1.2 x 6.5 x 150 mm
Giravite a croce isolato	PH 3 x 8 x 150 mm	Giravite a taglio isolato	1.6 x 8 x 175 mm
Giravite a taglio isolato	0.4 x 2.5 x 75 mm		

CON PUNTA MAGNETICA FOSFATATA NERA E MANICO REALIZZATO IN RESINA TPR ALTAMENTE ELASTICA E IN POLIPROPILENE RESISTENTE ALL'OLIO - 4 TIPI A CROCE PH E 6 TIPI A TAGLIO ELETTRICISTA

Art. 0355
SERIE GIRAVITI ELETTRICISTA
€ 19,60

7 Pz Cr-Mo

Misure Taglio	(-) 0,4x2,5x85 mm, (-) 0,8x4,0x100 mm, (-) 1,0x5,5x125 mm, (-) 1,2x6,5x150 mm
Croce	(+) PH 0x75 mm, (+) PH 1x100 mm, (+) PH 2x100 mm
Imballo	6* / 36

Art. 0083
GIRAVITE A PERCUSSIONE
€ 11,70

Dimensioni	165x42 mm
Inserti	6
Attacco	5/16"
Imballo	20

Art. 0244
SERIE GIRAVITI TORX
€ 13,50

7 Pz Cr-Mo-V

Misure	T4 - T5 - T6 - T7 - T8 - T9 - T10
Lunghezza totale	137 mm
Imballo	10* / 60

SERIE GIRAVITI TORX 7 PZ, CHROME VANADIUM MOLYBDENUM, FORNITA IN BLISTER



Art. 0245 € 12,40
SERIE GIRAVITI DI PRECISIONE



6 Pz **Cr-Mo-V**

Croce	00x50 - 0x50 mm
Taglio	1,5x50 - 2x50 - 2,5x50 - 3x50 mm
Imballo	10* / 50

SERIE GIRAVITI DI PRECISIONE 6 PZ, CHROME VANADIUM MOLYBDENUM, FORNITA IN BLISTER



Art. 0829 € 6,20
SERIE GIRAVITI E
CHIAVI DI PRECISIONE



16 Pz

Imballo 10* / 40



Art. 0082 € 1,54
SERIE GIRAVITI PRECISIONE



6 Pz

4 a taglio	4 Pcs 1,4x20 mm - 2x23 mm - 2,4x24 mm - 3x27 mm
2 a croce	2 Pcs PH 1x30 mm - PH 0x25 mm
Imballo	10* / 100

SERIE GIRAVITI PRECISIONE 6 PZ, FORNITA IN BLISTER



Art. 0086 € 6,90
PORTA INSERTI
MAGNETICO CON 6 INSERTI



7 Pz

Imballo 10* / 100

PORTA INSERTI MAGNETICO CON 6 INSERTI, FORNITO IN BLISTER



Art. PIF1 € 8,50
PORTA INSERTI FLESSIBILE MAGNETICO

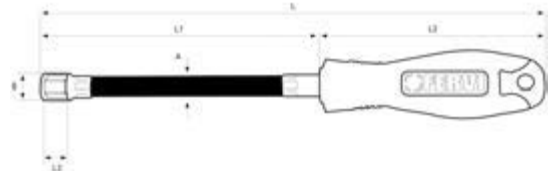

L	265 mm
L1	150 mm
L2	9,5 mm
L3	115 mm
A	10 mm
B	11,8 mm

Appendibile

PORTA INSERTI FLESSIBILE MAGNETICO CON ATTACCO DA 1/4"



Art. 0466/DM
 MAGNETIZZATORE/DEMAGNETIZZATORE PER GIRAVITI

€ 2,00

ABS

Dimensioni	52 x 50 x 28.5 mm
Doppio Blister	
Imballo	24 / 96

Art. 0626L
 SERIE INSERTI LUNGI

€ 21,50

33 Pz
Mo-V

Attacco	1/4"
Lunghezza	50 mm
Inserti	
Torx con foro	T7 - T8 - T10 - T15 - T20 - T25 - T30 - T35 - T40
Esagonali con foro	6 - 5 - 4 - 3 - 2.5 - 2 mm
Esagonali con foro	5/32 - 9/64 - 1/8 - 7/64 - 3/32 - 5/64
Spanner	4 - 6 - 8 - 10
Torq-set	6 - 8 - 10
Tri-wing	1 - 2 - 3 - 4
Imballo	12 / 48
Blister	

Art. 0626
 SERIE INSERTI

€ 9,70

33 Pz
Mo-V

Attacco	1/4"
Inserti	
Torx	T7 - T8 - T10 - T15 - T20 - T25 - T30 - T35 - T40
Esagonali	
Metrici	6 - 5 - 4 - 3 - 2.5 - 2 mm
Pollici	5/32 - 9/64 - 1/8 - 7/64 - 3/32 - 5/64
Spanner	4 - 6 - 8 - 10
Torq-set	6 - 8 - 10
Tri-wing	1 - 2 - 3 - 4
Imballo	12* / 120
Blister	



Art. 0403

SERIE BUSSOLE E INSERTI ESAGONALI

€ 17,40

26 Pz Mo-V & Cr-V



Attacco	1/4"
Porta inserti a cricchetto	1
Porta inserti magnetico	1
Adattatore	25 mm
Bussole	5 - 6 - 7 - 8 - 9 - 10 mm
Taglio	3 - 4 - 5 - 6 - 7 mm
Phillips	0 - 1 - 2 - 3
Pozi-driv	0 - 1 - 2 - 3
Punta quadrata	S0 - S1 - S2 - S3
Peso	355 g
Doppio Blister	
Imballo	24

RIVESTITI DI NICHEL, COMPOSTO DA 6 BUSSOLE, 18 INSERTI, 1 ADATTATORE PER BUSSOLE E 1 GIRAVITE A CRICCHETTO



Art. 0404

SERIE BUSSOLE E INSERTI ESAGONALI

€ 15,20

35 Pz Mo-V & Cr-V



Attacco	1/4"
Adattatore	25 mm
Portainserito magnetico	1
Prolunga per bussole	1
Bussole	5 - 6 - 7 - 8 - 9 - 10 - 11 - 12 mm
Taglio	3 - 4 - 5 - 5,5 - 6 - 7 mm
Phillips	0 - 1 - 2 - 3
Pozi-driv	0 - 1 - 2 - 3
Punta quadrata	S0 - S1 - S2 - S3
Torx	T10 - T15 - T20 - T25 - T30 - T40
Peso	395 g
Doppio Blister	
Imballo	24

SERIE 35 PEZZI BUSSOLE IN CR-V E INSERTI ESAGONALI IN ACCIAIO S2, RIVESTITI DI NICHEL, CON ATTACCO DA 1/4", CON PORTA INSERTO A CAMBIO RAPIDO, CHROME - VANADIUM, MOLYBDENUM - VANADIUM



Art. 0402

SERIE INSERTI ESAGONALI

€ 18,00

41 Pz Mo-V & Cr-V



Attacco	1/4"
Taglio	3 - 4 - 5 - 5,5 - 6 - 7 mm
Phillips	2 x 0 - 2 x 1 - 2 x 2 - 2 x 3
Pozi-driv	2 x 0 - 2 x 1 - 2 x 2 - 2 x 3
Punta quadrata	S0 - S1 - S2 - S3
Torx	T10 - T15 - T20 - T25 - T27 - T30 - T40
Esagonali	2 - 2,5 - 3 - 4 - 5 - 5,5 - 6 mm
Peso	355 g
Doppio Blister	
Imballo	24

SERIE 41 PZ INSERTI ESAGONALI DA 1/4", IN ACCIAIO S2 E RIVESTITI DI NICHEL, COMPOSTO DA 40 INSERTI E 1 CRICCHETTO REVERSIBILE A 72 DENTI IN CR-V, MOLYBDENUM - VANADIUM



Art. 0548 € 13,00
PORTA INSERTO A CRICCHETTO

Attacco	1/4"
Dimensioni	Ø 29 x 60 mm
Peso	8 g
Blister	
Imballo	12 / 144

PORTA INSERTI CORTO A CRICCHETTO REVERSIBILE DA 72 DENTI, CON UN INSERTO, DI DIMENSIONI MOLTO RIDOTTE PER AVVITARE E SVITARE IN POCO SPAZIO

Art. 0549 € 17,00
PORTA INSERTI A CRICCHETTO

Attacco	1/4"
Dimensioni	Ø 24 x 80 mm
Lunghezza manico	80 mm
Inserti	PH: 1 - 2
Inserti a taglio	6 mm
Peso	25 g
Blister	
Imballo	12 / 72

PORTA INSERTI A CRICCHETTO REVERSIBILE DA 72 DENTI, CON 3 INSERTI, MODULARE E DI DIMENSIONI MOLTO RIDOTTE PER AVVITARE E SVITARE IN POCO SPAZIO, MANICO CON ATTACCO DA 1/4"

Art. 0547 € 14,00
PORTA INSERTI A CRICCHETTO

Attacco	1/4"
Dimensioni	Ø 45 x 30 mm
Peso	10 g
Inserti	PH: 1 - 2 - 3
Inserti a taglio	5,5 mm 7 mm
Blister	
Imballo	6 / 48

PORTA INSERTI PIATTO A CRICCHETTO REVERSIBILE DA 72 DENTI, CON 5 INSERTI, DI DIMENSIONI MOLTO RIDOTTE PER AVVITARE E SVITARE IN POCO SPAZIO

Art. 0406 € 43,30
SERIE PORTA INSERTI ESAGONALI A CAMBIO RAPIDO

12 Pz Cr-V

Attacco	1/4"
Lunghezza	60 mm
Peso	25 g
Espositore	
Imballo	10

SERIE 12 PZ PORTA INSERTI ESAGONALI MAGNETICI A CAMBIO RAPIDO, CON ATTACCO DA 1/4", COSTRUITI IN ACCIAIO CR-V

**Art. 0407**
PORTA INSERTI

€ 4,00



Attacco	1/4"	Taglio	2 - 3 - 4 mm
Lunghezza	105 mm	Peso	100 g
Phillips	1 - 2	Blister	
Pozi-driv	1 - 2	Imballo	12/96

PORTA INSERTI CON IMPUGNATURA DRITTA E A 90°, CON 7 INSERTI ESAGONALI DA 1/4", UTILE AD AGEVOLARE IL LAVORO IN PICCOLI SPAZI

**Art. 0089**
SERIE INSERTI

€ 1,86



7 Pz

Portainserito magnetico	1/4"
Phillips	1 - 2
Pozi-driv	1 - 2
Taglio	4 - 6 mm
Imballo	20* / 200

SERIE INSERTI 7 PEZZI, FORNITO IN BLISTER

**Art. 0888**
PORTA INSERTI AD ANGOLO 90° CON ATTACCO DA 1/4"

€ 22,40



Imballo	4* / 32
---------	---------

PORTA INSERTI AD ANGOLO 90° CON ATTACCO DA 1/4", MANICO PORTA BIT

**Art. 0484**
SERIE INSERTI RIBE

€ 43,00



22 Pz Cr-Mo

Adattatore inserti	DR. 3/8" x 29 mm - DR. 1/2" x 38 mm
Inserti	Ribe 3/8" x 30 mm: M5 - M6 - M7 - M8 - M9 - M10 - M11 - M12 - M13
Inserti	Ribe 3/8" x 100 mm: M5 - M6 - M7 - M8 - M9 - M10 - M10.3 - M11 - M12 - M13 - M14
Valigetta in plastica	230 x 145 x 50 mm
Peso	0,93 kg
Imballo	20

Art. 0104
 SERIE INSERTI ATTACCO 3/8"

€ 36,70

40 Pz Cr-V

1 Bussola porta inserti 1/2"	10 mm	5 Inserti "XZN" 5-6-8-10-12 mm	30 mm
1 Bussola porta inserti 3/8"	10 mm	5 Inserti "XZN" 5-6-8-10-12 mm	75 mm
7 Inserti esagonali 4-5-6-7-8-10-12 mm	30 mm	7 Inserti TORX T20-T25-T30-T40-T45-T50-T55	30 mm
7 Inserti esagonali 4-5-6-7-8-10-12 mm	75 mm	7 Inserti TORX T20-T25-T30-T40-T45-T50-T55	75 mm
		Imballo	20

Art. 0640
 SERIE INSERTI

€ 22,40

100 Pz Mo-V

Attacco	1/4"
Inserti	0 - 1 - 2 (x5 Pz/Pcs) - 3
Phillips	0 - 1 - 2 (x5 Pz/Pcs) - 3
Pozi-driv	0 - 1 - 2 (x5 Pz/Pcs) - 3
Taglio	3 - 4 - 4,5 - 5 - 5,5 - 6 - 7 - 8 mm
Spanner	4 - 6 - 8 - 10
Torx	8 - 10 - 15 - 20 - 25 - 27 - 30 - 40 - 45
Tripley	1 - 2 - 3 - 4
Torx con foro	8 - 10 - 15 - 20 - 25 - 27 - 30 - 35 - 40
Torq-set	6 - 8 - 10
Esagonali metrici	1,5 - 2 - 2,5 - 3 - 4 - 5 - 5,5 - 6 - 8 mm
Robertson	0 - 1 - 2 - 3
Esagonali pollici	1/16 - 5/64 - 3/32 - 7/64 - 1/8 - 9/64 - 3/16 - 7/32 - 1/4
XZN	M5 - M6 - M8
Esagonali con foro	2 - 2,5 - 3 - 4 - 5 - 6 - 5/64 - 3/32 - 7/64 - 1/8 - 9/64 - 5/32
Clutch	1 - 2 - 3
Imballo	2* / 20

Art. 0277
 SERIE BUSSOLE E INSERTI

€ 33,00

58 Pz



Attacco	1/4"	Tri-wing	1 - 2 - 3 - 4
Inserti	25 mm	Torq-set	6 - 8 - 10
Phillips (25 mm)	1 - 2 - 3	Esagonali	2 - 3 - 4 - 5 - 6 - 8 mm
Pozi-driv	1 - 2 - 3	Robertson	1 - 2 - 3
Taglio	3,5 - 4,5 - 5,5 - 6,5 mm	XZN	5 - 6 - 8
Spanner	4 - 6 - 8	Clutch	1 - 2 - 3
Torx	10 - 15 - 20 - 25 - 27 - 30 - 40	Bussole esagonali	5 - 6 - 7 - 8 - 10 mm
		Bussole esagonali	3/16 - 1/4 - 9/32 - 5/16 - 3/8
		Adattatore 1\4"	1
		Inserto a "Y"	1
		Adattatore	1
		Portainseri magnetico	1
		Portainseri	1
		Cricchetto reversibile	1/4"
		Valigetta in plastica	10
		Imballo	10



Art. 0088
ESTRATTORE MAGNETICO FLESSIBILE LUMINOSO

€ 12,00



Misure	Ø 9 / 17 x 430 mm
Batterie non incluse	2 x 1.5 V AA
Peso	85 g
Imballo	5* / 100

ESTRATTORE MAGNETICO FLESSIBILE LUMINOSO, CORPO IN ALLUMINIO, FORNITO IN BLISTER



Art. 0853
ESTRATTORE MAGNETICO FLESSIBILE CON LUCE A LED E BASE CALAMITATA

€ 29,50



Misure	Ø9 / 19 x 440 mm
Peso	80 g
Imballo	72

ESTRATTORE MAGNETICO FLESSIBILE CON LUCE A LED E BASE CALAMITATA, FORNITO IN BLISTER



Art. 0471 € 5,70
SERIE GANCI PER RIMOZIONE OR



Lunghezza 135 mm

SERIE 4 GANCI PER RIMOZIONE OR, CON PUNTE IN ACCIAIO AL CARBONIO E MANICO IN POLIPROPILENE, ADATTE ANCHE PER RIMOZIONI GUARNIZIONI SU MOTORI



Art. 0456 € 5,70
SERIE GANCI PER OR



Dimensioni manico 8 x 90 mm

SERIE GANCI PER OR IN ACCIAIO CROMATO, DOTATO DI MANICO ESAGONALE CON MAGNETE



Art. E003 € 20,70
SERIE ESTRATTORI IN HSS CON ATTACCO DA 1/4"



5 Pz HSS

num. 0	2-3 mm
num. 1	4-5 mm
num. 2	6-8 mm
num. 3	8-10 mm
num. 4	10-12 mm
Imballo	50



Art. E001 € 13,50
SERIE ESTRATTORI PER VITI



5 Pz

num. 1	M3 - M6
num. 2	M6 - M8
num. 3	M8 - M11
num. 4	M11 - M14
num. 5	M14 - M18
Imballo	100

Art. E005
 SERIE DI ESTRATTORI

€ 34,00

11 Pz Cr-Mo

Misure	9 - 10 - 11 - 12 - 13 - 14 - 15 - 16 - 17 - 19 mm
Altezza	27 mm
Imballo	20
Astuccio di plastica	

SERIE DI 10 ESTRATTORI PER DADI E BULLONI CON
 ATTACCO DA 3/8" ED ESAGONO ESTERNO
 CHROME-MOLYBDENUM

ESTRATTORE A 3 GRIFFE

Codice	Dimensioni	Imballo	€
E191/120	Max Ø 120 mm - h 108 mm	16	55,50
E191/200	Max Ø 200 mm - h 150 mm	5	104,00

ESTRATTORE A 2 GRIFFE

Codice	Dimensioni	€
E190/080	Max Ø 80 mm - h 100 mm	28,90
E190/130	Max Ø 130 mm - h 100 mm	37,80
E190/160	Max Ø 160 mm - h 150 mm	46,60
E190/200	Max Ø 200 mm - h 150 mm	50,10



GRIFFA PROLUNGATA

Codice	Lunghezza	€
E190/B1	200 mm	24,20
E190/B2	300 mm	27,80

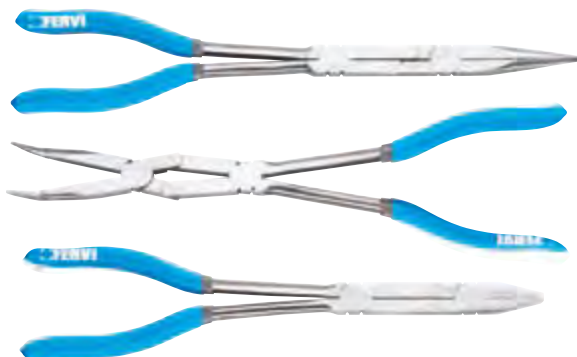

Art. 0872/P
SERIE PINZE LUNGHE
A DOPPIO SNODO

€ 66,00



3Pz Cr-V

Lunghezza	335 mm
Lunghezza	300 mm
Peso	1,35 kg
Imballo	20
Appendibile	



Art. 0872/PDD
PINZA LUNGA A
DOPPIO FULCRO DRITTA

€ 24,70



Cr-V

Lunghezza	335 mm
Spessore	10 mm
Peso	390 g
Imballo	6 / 24
Appendibile	

PINZA LUNGA A DOPPIO FULCRO DRITTA, CON MANICO IN PVC, CHROME - VANADIUM



Art. 0872/PCD
PINZA LUNGA A
DOPPIO FULCRO A 45°

€ 24,70



Cr-V

Lunghezza	335 mm
Spessore	10 mm
Peso	390 g
Imballo	6 / 24
Appendibile	

PINZA LUNGA A DOPPIO FULCRO A 45°, CON MANICO IN PVC, CHROME - VANADIUM



Art. 0872/OPD
PINZA LUNGA A
DOPPIO FULCRO

€ 25,80



Cr-V

Lunghezza	335 mm
Spessore	10 mm
Peso	450 g
Imballo	6 / 24
Appendibile	

PINZA LUNGA A DOPPIO FULCRO AD OCCHIO, CON MANICO IN PVC, CON GANASCE TONDE CHE PERMETTONO UNA PRESA NON INFERIORE A 8 mm, CHROME - VANADIUM



PINZE UNIVERSALI

Codice	Lunghezza	Spessore	Peso	Imballo	€
0810	160 mm	11 mm	250 g	5* / 50	5,60
0811	180 mm	11 mm	290 g	5* / 50	6,80
0850	200 mm	13 mm	410 g	5* / 50	7,50

PINZE UNIVERSALI - FINITURE AL MOLIBDENO, CON APPENDIBILE

PINZE A BECCHI MEZZITONDI

Codice	Lunghezza	Spessore	Peso	Imballo	€
0812	160 mm	10 mm	160 g	5* / 50	5,70
0851	200 mm	11 mm	260 g	5* / 50	7,20

PINZE A BECCHI MEZZITONDI - FINITURE AL MOLIBDENO, CON APPENDIBILE

Art. 0813
PINZE A BECCHI
MEZZITONDI PIEGATI 45°
€ 6,10

Lunghezza	160 mm
Spessore	10 mm
Peso	160 g
Imballo	5* / 50
Appendibile	

PINZE A BECCHI MEZZITONDI PIEGATI 45°, FINITURE AL MOLIBDENO

Art. 0814
TRONCHESE A
TAGLIENTE LATERALE
€ 5,20

Lunghezza	160 mm
Spessore	10 mm
Peso	180 g
Imballo	5* / 50
Appendibile	

TRONCHESE A TAGLIENTE LATERALE, FINITURE AL MOLIBDENO





PINZE UNIVERSALI



Cr-V

Codice	Lunghezza	Spessore	Peso	Imballo	€
0873/U6	160 mm	11 mm	200 g	5* / 50	8,00
0873/U7	180 mm	10,5 mm	260 g	6* / 48	8,60
0873/U8	200 mm	12 mm	330 g	6* / 48	9,70

PINZE UNIVERSALI SATINATE, CHROME - VANADIUM, CON APPENDIBILE



PINZA A BECCHI MEZZITONDI



Cr-V

Codice	Lunghezza	Spessore	Peso	Imballo	€
0873/BD6	160 mm	9 mm	150 g	5* / 50	6,90
0873/BD8	200 mm	10 mm	250 g	5* / 50	8,30

PINZA A BECCHI MEZZITONDI SATINATE, CHROME - VANADIUM, CON APPENDIBILE



PINZA A BECCHI MEZZITONDI PIEGATI 45°



Cr-V

Codice	Lunghezza	Spessore	Peso	Imballo	€
0873/BC6	160 mm	9 mm	150 g	5* / 50	6,90
0873/BC8	200 mm	10 mm	250 g	5* / 50	8,30

PINZA A BECCHI MEZZITONDI PIEGATI 45°, CHROME - VANADIUM, CON APPENDIBILE



**Art. 0873/TL
TRONCHESE A
TAGLIENTE LATERALE**

€ 7,60



Cr-V

Lunghezza	160 mm
Spessore	9 mm
Peso	210 g
Imballo	5* / 50
Appendibile	



Art. 0873/TF
 TRONCHESE A
 TAGLIENTE FRONTALE

€ 9,60

Cr-V

Lunghezza	160 mm
Spessore	11 mm
Peso	220 g
Imballo	5* / 50
Appendibile	

Art. 0020
 SERIE PINZE PER
 ELETTRONICA

€ 16,00

5 Pz

Lunghezza	110 ÷ 125 mm
Imballo	5* / 40
Blister	

Art. 0020/1
 PINZA PER ELETTRONICA
 A BECCHI EXTRA LUNGI

€ 5,20

Lunghezza	150 mm
Imballo	10* / 100
Blister	

Art. 0020/2
 PINZA PER ELETTRONICA
 A BECCHI CURVI

€ 3,88

Lunghezza	125 mm
Imballo	10* / 100
Blister	





Art. 0020/3
 PINZA PER ELETTRONICA
 A BECCHI PIATTI

€ 4,22



Lunghezza	125 mm
Imballo	10* / 100
Blister	



Art. 0020/4
 PINZA PER ELETTRONICA
 A BECCHI LUNGHI

€ 4,14



Lunghezza	125 mm
Imballo	10* / 100
Blister	



Art. 0020/5
 TRONCHESINA PER ELETTRONICA
 A TAGLIO FRONTALE

€ 4,66



Lunghezza	110 mm
Imballo	10* / 100
Blister	



Art. 0020/6
 TRONCHESINA PER ELETTRONICA
 A TAGLIO LATERALE

€ 4,50



Lunghezza	110 mm
Imballo	10* / 100
Blister	



Art. 0841
 PINZE A CRICCHETTO

€ 21,90

Per capicorda preisolati	Ø 0,8 ÷ 3,5 mm / 0,25 ÷ 6 mm ² AWG 22-10
Lunghezza	230 mm
Spessore	12 mm
Imballo	60
Blister	

PINZE A CRICCHETTO CON LEVA DI SBLOCCAGGIO

Art. 0843
 PINZE A CRICCHETTO

€ 22,80

Per capicorda non isolati	Ø 1 ÷ 3,5 mm / 0,5 ÷ 6 mm ² AWG 20-10
Lunghezza	230 mm
Spessore	12 mm
Imballo	60
Blister	

PINZE A CRICCHETTO CON LEVA DI SBLOCCAGGIO

Art. 0847
 PINZA PER TERMINALI
 DRITTI PREISOLATI

€ 71,50

Terminali	0,25 ÷ 6 mm ² AWG 23-10
Lunghezza	175 mm
Spessore	12 mm
Imballo	40
Blister	

 PINZA PER TERMINALI DRITTI PREISOLATI CON LEVA
 DI SBLOCCAGGIO

Art. 0628
 PINZA PER CONNETTORI

€ 17,30

Connettori	RJ-11 (6P4C); RJ-12 (6P6C); RJ-45 (8P8C)
Imballo	5* / 50
Blister	

 PINZA PER CONNETTORI CON MANOPOLA DI
 SBLOCCAGGIO



Art. 0826
PINZA FASTONATRICE
E SPELLAFILO

€ 28,00



Lunghezza	215 mm
Terminali	AWG 30-26 - AWG 24-20 - AWG 18-14
Capacità di taglio	Ø 0,25 - 0,3 - 0,4 - 0,5 - 0,65 - 0,8 - 1,0 mm AWG30 - AWG28 - AWG26 - AWG24 - AWG22 - AWG20 - AWG18
Imballo	5 / 50
Blister	

PINZA FASTONATRICE PER FASTON PICCOLI NON ISOLATI E SPELLAFILO PER FILI SOTTILI, SETTORE AUTO E COMPUTER



Art. 0122
PINZA FASTONATRICE
UNIVERSALE IN KIT

€ 9,30



Lunghezza	220 mm
Imballo	6* / 24
Blister	

PINZA FASTONATRICE UNIVERSALE IN KIT CON TERMINALI ISOLATI



PINZE PER ANELLI ELASTICI DI SICUREZZA



Cr-V

Codice	Tipo pinza	Anelli elastici	Lunghezza	Imballo	€
0246	Dritta per esterni A2	Ø 19 ÷ 60 mm	175 mm	50	10,90
0248	Dritta per interni J2	Ø 19 ÷ 60 mm	175 mm	50	10,90
0636	Dritta per esterni A1	Ø 10 ÷ 25 mm	150 mm	50	9,20
0638	Dritta per interni J1	Ø 8 ÷ 25 mm	150 mm	50	9,20

PINZE PER ANELLI ELASTICI DI SICUREZZA PER ESTERNO, CHROME - VANADIUM, CON APPENDIBILE



PINZE PER ANELLI ELASTICI DI SICUREZZA



Cr-V

Codice	Tipo pinza	Anelli elastici	Lunghezza	Imballo	€
0247	Curva per esterni A21	Ø 19 ÷ 60 mm	175 mm	50	10,90
0249	Curva per interni J21	Ø 19 ÷ 60 mm	175 mm	50	10,90
0637	Curva per esterni A11	Ø 10 ÷ 25 mm	150 mm	50	9,20
0639	Curva per interni J11	Ø 8 ÷ 25 mm	150 mm	50	9,20

PINZE CURVE PER ANELLI ELASTICI DI SICUREZZA PER ESTERNO, CHROME - VANADIUM, CON APPENDIBILE



Art. 0136
 SERIE PINZE IN NYLON

€ 23,00

3 Pz

Lunghezza 158 - 185 - 254 mm

Ø max tubo 10 - 15 - 24 mm

Imballo 12 / 48

Blister

 SERIE 3 PINZE IN NYLON PER STRINGERE TUBI PER
 LIQUIDI AUTO

Art. 0603
 SERIE PINZE PER FASCETTE

€ 98,00

9 Pz

Imballo 5

Valigetta in plastica

SERIE 9Pz PINZE PER FASCETTE AUTO

Art. 0118
 PINZA IDRAULICO

€ 4,80

Lunghezza 240 mm

Imballo 10* / 60

Appendibile

PINZA IDRAULICO 6 POSIZIONI



PINZA IDRAULICO

DIN ISO 8976/C **Cr-V**

Codice	Lunghezza	Imballo	€
0831/175	175 mm	10* / 80	7,80
0831/250	250 mm	10* / 60	9,20
0831/300	300 mm	5* / 40	11,30

 PINZA IDRAULICO - 7 POSIZIONI, CHROME - VANADIUM,
 DIN ISO 8976-C, CON APPENDIBILE



Art. 0834
TENAGLIA CEMENTISTA

€ 5,60



DIN ISO 9242

Lunghezza	220 mm
Imballo	10* / 60
Appendibile	

TENAGLIA CEMENTISTA, DIN ISO 9242



Art. 0121
PINZA GRIP A MORSETTO

€ 24,00



Lunghezza	230 mm
Regolabile	0 ÷ 165 mm
Imballo	6* / 24
Scatola	



Art. 0120
PINZA REGOLABILE A GINOCCHIERA 4 POSIZIONI

€ 9,30



Lunghezza	230 mm
Apertura	18 - 39 - 43 mm
Imballo	6* / 48
Scatola	



Art. 0119
PINZA GRIP

€ 6,80



Lunghezza	220 mm
Imballo	12* / 60
Scatola	





Art. 0379
PINZA GRIP CON
GANASCE A FORCELLA

€ 11,80



Lunghezza	225 mm
Imballo	6* / 18
Scatola	



PINZA A MORSETTO
AUTOMATICA



 Cr-V

Codice	Lunghezza	Peso	Imballo	€
0368/7	160 mm	160 g	60	26,50
0368/10	230 mm	260 g	30	33,80



PINZA A MORSETTO AUTOMATICA
CON BECCHI LUNGH



 Cr-V

Codice	Lunghezza	Peso	Imballo	€
0370/8	200 mm	160 g	100	28,80
0370/11	275 mm	260 g	30	41,20



PINZA A MORSETTO
AUTOMATICA CON BECCHI A 'C'



 Cr-V

Codice	Lunghezza	Apertura	Peso	Imballo	€
0373/9	210 mm	65 mm	160 g	30	33,00
0373/11	300 mm	95 mm	260 g	25	40,00





GIRATUBO



Codice	Dimensioni	Apertura max	Imballo	€
0130/350	350 mm - 14"	50 mm	6* / 24	15,20
0130/600	600 mm - 24"	90 mm	2* / 8	23,50



GIRATUBO A 45°



Codice	Dimensioni	Apertura max	Imballo	€
0225/340	340 mm - 1"	46 mm	24	21,40
0225/440	440 mm - 1,5"	62 mm	24	32,20
0225/580	580 mm - 2"	78 mm	12	40,00
0225/700	700 mm - 3"	100 mm	6	54,40



GIRATUBO A 90°



Codice	Dimensioni	Apertura max	Imballo	€
0227/340	340 mm - 1"	41 mm	24	21,40
0227/440	440 mm - 1,5"	62 mm	24	30,60
0227/580	580 mm - 2"	75 mm	12	44,40
0227/700	700 mm - 3"	100 mm	6	54,40



Art. 0511
MAZZA
€ 36,50

Lunghezza	820 mm
Peso della testa	3,50 kg
Peso totale	4,46 kg
Imballo	6

MAZZA CON MANICO DI SICUREZZA IN FIBRA DI VETRO E PLASTICA, RIVESTITO IN GOMMA ANTISCIVOLO

Art. 0781
MAZZETTA PER MURATORE
€ 12,40

DIN 6475

Lunghezza	260 mm
Peso	1000 kg
Imballo	6* / 24

MAZZETTA PER MURATORE CON MANICO DI SICUREZZA IN FIBRA DI VETRO E PLASTICA, RIVESTITO IN GOMMA ANTISCIVOLO, DIN 6475

Art. 0780
MARTELLINO CARPENTIERE
€ 9,70

Peso	500 g
Imballo	6* / 36

MARTELLINO CARPENTIERE CON MANICO DI SICUREZZA IN FIBRA DI VETRO E PLASTICA, RIVESTITO IN GOMMA ANTISCIVOLO





MARTELLINO TIPO TEDESCO



DIN 1041

Codice	Peso	Imballo	€
0514/200	200 g	6* / 48	5,20
0514/300	300 g	6* / 48	6,30
0514/400	400 g	6* / 36	7,60
0514/500	500 g	6* / 36	9,10
0514/1000	1000 g	6* / 24	13,50

MARTELLINO TIPO TEDESCO, CON MANICO DI SICUREZZA IN FIBRA DI VETRO E PLASTICA, RIVESTITO IN GOMA ANTISCIVOLO, DIN 1041



MARTELLINO TIPO TEDESCO



DIN 1041

Codice	Peso	Imballo	€	Codice	Peso	Imballo	€
0154/100DIN	100 g	6* / 120	2,74	0154/600DIN	600 g	6* / 36	6,20
0154/200DIN	200 g	6* / 60	3,86	0154/800DIN	800 g	6* / 24	7,00
0154/300DIN	300 g	10* / 60	4,06	0154/1000DIN	1000 g	6* / 24	10,30
0154/400DIN	400 g	6* / 60	5,30	0154/1500DIN	1500 g	6* / 12	11,40
0154/500DIN	500 g	6* / 24	5,70	0154/2000DIN	2000 g	6* / 12	14,50

MARTELLINO TIPO TEDESCO CON MANICO IN LEGNO, DIN 1041



MAZZETTA PER MURATORE



DIN 6475

Codice	Peso	Imballo	€
0153/800DIN	800 g	6* / 24	7,00
0153/1000DIN	1000 g	6* / 24	7,70
0153/1250DIN	1250 g	6* / 24	9,30
0153/1500DIN	1500 g	6* / 12	10,90



MARTELLLO CARPENTIERE

Codice	Peso	Imballo	€
0169/300	300 g	6* / 36	7,00
0169/400	400 g	6* / 36	8,40

MARTELLLO CARPENTIERE CON PORTA CHiodO
MAGNETICO

Art. 0148/500
MAZZUOLO GOMMA
€ 4,16

Peso	500 g
Testa	Ø 65 mm
Imballo	6* / 24

MAZZUOLO GOMMA E FIBRA

Codice	Peso	Testa	Imballo	€
0243/30	350 g	Ø 30 mm	12* / 48	5,50
0243/40	500 g	Ø 40 mm	6* / 36	7,70

MAZZUOLO GOMMA

Codice	Peso	Testa	Imballo	€
0794/350	350 g	Ø 55 mm	6* / 24	5,60
0794/450	500 g	Ø 58 mm	6* / 24	7,80

MAZZUOLO GOMMA CON MANICO IN FIBRA DI VETRO E
PLASTICA





MAZZUOLO ANTIRIMBALZO



Codice	Peso	Testa	Imballo	€
0336	500 g	Ø 45 mm	6* / 24	12,00
0337	850 g	Ø 50 mm	6* / 24	13,50



MAZZUOLO ANTIRIMBALZO



Codice	Peso	Testa	Imballo	€
0839/40	0,75 kg	Ø 40 mm	24	50,60
0839/50	1,1 kg	Ø 50 mm	4	58,90
0839/60	1,5 kg	Ø 60 mm	4	66,00

MAZZUOLO ANTIRIMBALZO IN NYLON, TESTE DI RICAMBIO



MAZZUOLO ANTIRIMBALZO



Codice	Peso	Testa	Imballo	€
0726	0,55 kg	Ø 40 mm	10	71,10
0727	0,9 kg	Ø 50 mm	10	83,30
0728	1,1 kg	Ø 60 mm	10	90,70

MAZZUOLO ANTIRIMBALZO CON TESTE IN NYLON, CORPO MONOBLOCCO IN LEGA ANTIURTO. MANICO ANATOMICO IN RUBINIA ANTISCIVOLO. MASSA INTERNA COMPOSTA DA SFERE DI PIOMBO. PERCUSSORI SOSTITUIBILI IN NYLON INDEFORMABILE.



TESTA DI RICAMBIO



Codice	Testa	Imballo	€
0839/40T	Ø 40 mm	2* / 10	11,90
0839/50T	Ø 50 mm	2* / 10	11,90
0839/60T	Ø 60 mm	2* / 10	17,40

TESTA DI RICAMBIO PER MAZZUOLO ANTIRIMBALZO 0839/..



TESTA DI RICAMBIO



Codice	Testa	Imballo	€
0729	Ø 40 mm	2* / 10	21,10
0730	Ø 50 mm	2* / 10	25,20
0731	Ø 60 mm	2* / 10	32,60

TESTA DI RICAMBIO PER MAZZUOLO ANTIRIMBALZO 072..



MAZZUOLO

Codice	Peso	Testa	Durezza	€
0488/35	0,26 kg	Ø 35 mm	SHORE A 80 (+/-5)	14,50
0488/60	0,52 kg	Ø 60 mm	SHORE A 80 (+/-5)	25,00

MAZZUOLO IN ALLUMINIO CON MANICO ANATOMICO IN HICKORY E TESTE IN POLIURETANO

MAZZUOLO

Codice	Testa	Imballo	€
0808/35	Ø 35 mm	6* / 36	18,30
0808/60	Ø 60 mm	4* / 16	43,70

MAZZUOLO IN ALLUMINIO CON MANICO ANATOMICO E TESTE IN POLIETILENE

COPPIA TESTE DI RICAMBIO

Codice	Peso	Testa	Durezza	€
0488/35R	0,15 kg	Ø 35 mm	SHORE A 80 (+/-5)	3,00
0488/60R	0,21 kg	Ø 60 mm	SHORE A 80 (+/-5)	9,20

COPPIA TESTE DI RICAMBIO PER MAZZUOLO 0488/..

COPPIA TESTE DI RICAMBIO



Codice	Testa	Imballo	€
0808/35R	Ø 35 mm	5* / 20	11,40
0808/60R	Ø 60 mm	5* / 20	21,40

COPPIA TESTE DI RICAMBIO PER MAZZUOLO 0808/..



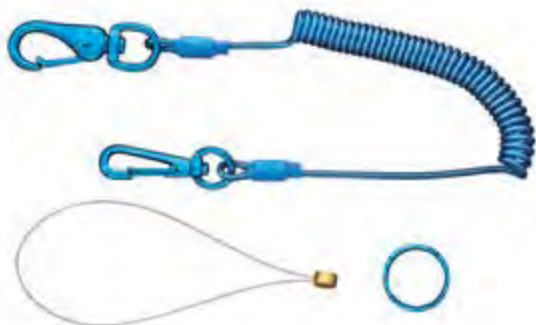

Art. G009 € 16,00
CAVO A SPIRALE DI SICUREZZA PER UTENSILI



Capacità	5 kg
Lunghezza	430 ÷ 1600 mm
Peso	75 g
Blister	
Imballo	12 / 144

CAVO A SPIRALE DI SICUREZZA CON GANCI, PER METTERE IN SICUREZZA UTENSILI QUANDO SI LAVORA SU SCALE O PONTEGGI



BULINO



Cr-Mo

Codice	Misure	Imballo	€
B006/4	4 x 120 mm	10	4,00
B006/5	5 x 150 mm	10	5,50

BULINO CON STELO OTTAGONALE, CHROME-MOLYBDENUM, CON APPENDIBILE



CACCIASPINE



Cr-Mo

Codice	Dimensioni	Imballo	€
C012/02	Ø 2 x 150 mm	10	4,60
C012/03	Ø 3 x 150 mm	10	4,60
C012/04	Ø 4 x 150 mm	10	4,60
C012/05	Ø 5 x 150 mm	10	5,20
C012/06	Ø 6 x 150 mm	10	5,76
C012/08	Ø 8 x 150 mm	10	6,26

CACCIASPINE CON STELO OTTAGONALE, CHROME-MOLYBDENUM



SCALPELLO PER METALLO



Cr-Mo

Codice	Dimensioni	Imballo	€
S022/18	18 x 150 mm	10	8,00
S022/21	21 x 200 mm	5*	11,00
S022/25	25 x 250 mm	5*	15,00
S022/26	26 x 240 mm	5*	14,50

SCALPELLO EXTRA PIATTO PER METALLO, CHROME-MOLYBDENUM



Art. S011
SERIE SCALPELLI, CACCIASPINE E BULINI
€ 430,00

60 Pz Cr-Mo

Scalpellini	18 x 150 mm, 21 x 200 mm, 25 x 250 mm, 26 x 240 mm
Bulini	4 x 120 mm, 5 x 150 mm
Cacciaspine cilindrico	2 x 150 mm, 3 x 150 mm, 4 x 150 mm, 5 x 150 mm, 6 x 150 mm, 8 x 150 mm

SERIE 60Pz SCALPELLI, CACCIASPINE E BULINI CON STELO OTTAGONALE, CHROME - MOLYBDENUM

CACCIASPINE

Cr-Mo

Codice	Dimensioni	Imballo	€
C015/2	Ø 2 x 8 x 140 mm	5	8,00
C015/3	Ø 3 x 8 x 150 mm	5	8,40
C015/4	Ø 4 x 10 x 180 mm	5	9,00
C015/5	Ø 5 x 10 x 220 mm	5	9,46
C015/6	Ø 6 x 12 x 210 mm	5	11,00
C015/7	Ø 7 x 12 x 210 mm	5	11,00
C015/8	Ø 8 x 12 x 220 mm	5	11,40

CACCIASPINE CON STELO OTTAGONALE E PARAMANO, CHROME - MOLYBDENUM, CON APPENDIBILE

Art. C015
SERIE DI CACCIASPINE
€ 64,00

7 Pz Cr-Mo

Misure	Ø 2 - 3 - 4 - 5 - 6 - 7 - 8 mm
Imballo	5
Scatola	

SERIE 7Pz CACCIASPINE CON STELO OTTAGONALE E PARAMANO, CHROME - MOLYBDENUM



Art. 0126 € 14,00
 SERIE CACCIASPINE CON
 SUPPORTO IN PLASTICA



6 Pz Cr-V

Dimensioni	Ø 3-4-5-6-8-10 mm
Lunghezza	150 mm
Imballo	2* / 40
Blister	



Art. 0127 € 14,60
 SERIE SCALPELLI,
 PUNZONI E BULINO CON
 SUPPORTO IN PLASTICA



6 Pz Cr-V

Lunghezza	120 - 150 mm
Imballo	2* / 40
Blister	



Art. 0391 € 31,20
 SERIE SCALPELLI, PUNZONI
 E BULINO CON PARAMANO



6 Pz Cr-V

Scalpellini	10 x 135 mm, 13 x 150 mm, 16 x 160 mm
Bulini	04 x 130 mm
Cacciaspine conico	03 x 120 mm
Cacciaspine cilindrico	03 x 120 mm
Imballo	10
Appendibile	



Art. 0381 € 8,40
 SEGNACENTRO AUTOMATICO



Lunghezza	125 mm
Imballo	6* / 60
Blister	

SEGNACENTRO AUTOMATICO A MOLLA



Art. 0152
 SERIE SCALPELLI
 CON PARAMANO

€ 5,60

2 Pz

Dimensioni	16 x 250 mm
Imballo	5* / 25
Scatola	

Art. 0258
 SCALPELLO A TAGLIO
 CON PARAMANO

€ 4,16

Dimensioni	16 x 300 mm
Imballo	10* / 40

Art. 0259
 SCALPELLO A PUNTA
 CON PARAMANO

€ 4,00

Dimensioni	16 x 300 mm
Imballo	10* / 40

Art. 0396
 SERIE SCALPELLI DA FERRO

€ 12,70

3 Pz Cr-V

Dimensioni	10 x 8 x 140 mm, 13 x 9,5 x 150 mm, 16 x 12 x 170 mm
Imballo	10* / 40
Appendibile	





Art. 0300 € 18,00
SERIE SCALPELLI DA LEGNO



4 Pz

Durezza	HRC 58-60
Dimensioni	10-16-20-25 mm
Imballo	6* / 24
Blister	



SCALPELLO PER FALEGNAME



Codice	Dimensioni	Imballo	€
0301/06	6 mm	6* / 24	4,80
0301/10	10 mm	6* / 24	4,80
0301/16	16 mm	6* / 24	5,70
0301/20	18.5 mm	10* / 50	5,70
0301/24	25 mm	6* / 24	6,90

SCALPELLO PER FALEGNAME, DUREZZA HRC 58-60, BLISTER



Art. 0168 € 10,50
SERIE SCALPELLI DA LEGNO



5 Pz

Durezza	HRC 58-60
Misure	240 x 6-10-16-20-24 mm
Imballo	4* / 24
Blister	



Art. 0306 € 60,50
SERIE SGORBIE
PER INTAGLIATORE



12 Pz

Lunghezza	215 mm
Durezza	HRC 58-60
Materiale	C50
Imballo	6
Scatola di legno	



Art. 0162
 SERIE SGORBIE DA
 LEGNO PER TORNIO

€ 17,70

3 Pz

Durezza	HRC 58-60
Lunghezza totale	370 mm
Imballo	2* / 24
Blister	

Art. 0875
 MINI PIALLETTO

€ 20,20

Dimensioni	155 x 50 mm
Con due lame	50 mm
Imballo	6* / 36
Scatola	

Art. 0875/L
 SERIE LAME PER 0875

€ 7,70

4 Pz

Blister

Art. 0166
 PIALLA FALEGNAME
 CON DOPPIA LAMA

€ 19,00

Lunghezza pialla	225 mm
Larghezza lama	50 mm
Imballo	2* / 16
Scatola	



Art. 0519
 SERIE RASPE PER LEGNO
 CON MANICO IN PLASTICA

€ 5,00



3 Pz

Dimensioni	200 mm - 8"
Imballo	10* / 30
Appendibile	



Art. 0160
 SERIE LIME DA FERRO
 CON MANICO ANATOMICO

€ 16,80



5 Pz

Dimensioni	200 mm - 8"
Imballo	10* / 40
Blister	



Art. 0219
 SERIE LIME

€ 5,40



6 Pz

Lunghezza totale	180 mm
Imballo	12* / 120
Blister	



Art. 0214
 SERIE LIME AGO

€ 5,50



12 Pz

Dimensioni	Ø 3 x 140 mm
Imballo	10* / 100
Appendibile	



LIME PER MECCANICA

Codice	Lima	Dimensioni	Forma	Blister	€
0737/150T2	Lime con taglio mezzo dolce	150 mm 6 Inch	rettangolare	10* / 100	4,68
0737/150T3	Lime con taglio dolce	150 mm 6 Inch	rettangolare	10* / 100	4,68
0737/200T2	Lime con taglio mezzo dolce	200 mm 8 Inch	rettangolare	10* / 100	5,60
0737/200T3	Lime con taglio dolce	200 mm 8 Inch	rettangolare	10* / 100	5,60
0737/250T2	Lime con taglio mezzo dolce	250 mm 10 Inch	rettangolare	10* / 100	6,80
0737/250T3	Lime con taglio dolce	250 mm 10 Inch	rettangolare	10* / 100	6,80
0738/150T2	Lime con taglio mezzo dolce	150 mm 6 Inch	triangolare	10* / 100	4,68
0738/150T3	Lime con taglio dolce	150 mm 6 Inch	triangolare	10* / 100	4,68
0738/200T2	Lime con taglio mezzo dolce	200 mm 8 Inch	triangolare	10* / 100	5,60
0738/200T3	Lime con taglio dolce	200 mm 8 Inch	triangolare	10* / 100	5,60
0738/250T2	Lime con taglio mezzo dolce	250 mm 10 Inch	triangolare	10* / 100	6,80
0738/250T3	Lime con taglio dolce	250 mm 10 Inch	triangolare	10* / 100	6,80
0739/150T2	Lime con taglio mezzo dolce	150 mm 6 Inch	mezzatonda	10* / 100	4,68
0739/150T3	Lime con taglio dolce	150 mm 6 Inch	mezzatonda	10* / 100	4,68
0739/200T2	Lime con taglio mezzo dolce	200 mm 8 Inch	mezzatonda	10* / 100	5,60
0739/200T3	Lime con taglio dolce	200 mm 8 Inch	mezzatonda	10* / 100	5,60
0739/250T2	Lime con taglio mezzo dolce	250 mm 10 Inch	mezzatonda	10* / 100	6,80
0739/250T3	Lime con taglio dolce	250 mm 10 Inch	mezzatonda	10* / 100	6,80
0740/150T2	Lime con taglio mezzo dolce	150 mm 6 Inch	tonda	10* / 100	4,68
0740/150T3	Lime con taglio dolce	150 mm 6 Inch	tonda	10* / 100	4,68
0740/200T2	Lime con taglio mezzo dolce	200 mm 8 Inch	tonda	10* / 100	5,60
0740/200T3	Lime con taglio dolce	200 mm 8 Inch	tonda	10* / 100	5,60
0740/250T2	Lime con taglio mezzo dolce	250 mm 10 Inch	tonda	10* / 100	6,80
0740/250T3	Lime con taglio dolce	250 mm 10 Inch	tonda	10* / 100	6,80
0741/150T2	Lime con taglio mezzo dolce	150 mm 6 Inch	quadrata	10* / 100	4,68
0741/150T3	Lime con taglio dolce	150 mm 6 Inch	quadrata	10* / 100	4,68
0741/200T2	Lime con taglio mezzo dolce	200 mm 8 Inch	quadrata	10* / 100	5,60
0741/200T3	Lime con taglio dolce	200 mm 8 Inch	quadrata	10* / 100	5,60
0741/250T2	Lime con taglio mezzo dolce	250 mm 10 Inch	quadrata	10* / 100	6,80
0741/250T3	Lime con taglio dolce	250 mm 10 Inch	quadrata	10* / 100	6,80

LIME PER MECCANICA, COMPLETE DI IMPUGNATURA, ANATOMICA ANTISDRUCCIOLO

IMPUGNATURA ANATOMICA ANTISDRUCCIOLO

Codice	Per lima	Imballo	€
0742/4	4" - 6"	12* / 120	1,34
0742/6	6" - 10"	12* / 120	1,34
0742/10	10" - 16"	12* / 120	1,54



Art. L011
SERIE LIME
DIAMANTATE CURVE

€ 25,80



5 Pz

Imballo 100

SET 5 LIME DIAMANTATE CURVE DI LUNGHEZZA
TOTALE 140 mm



Art. L012
SERIE LIME DIAMANTATE

€ 39,50



5 Pz

Imballo 100

SET 5 LIME DIAMANTATE DI LUNGHEZZA TOTALE 180 mm



Art. L013
SERIE LIME DIAMANTATE

€ 25,80



5 Pz

Imballo 500

SET 5 LIME DIAMANTATE DI LUNGHEZZA TOTALE 140 mm



Art. L012/PIA
LIMA PIATTA DIAMANTATA

€ 10,90



Imballo 100

LIMA PIATTA DIAMANTATA 180 mm



LEVA

Cr-V

Codice	Lunghezza	Imballo	€
L002/200	200 mm	10 / 50	27,00
L002/250	250 mm	10 / 50	28,00

LEVA CON TESTA REGOLABILE INCLINABILE, CHROME - VANADIUM, CON APPENDIBILE

Art. 0202
 SERIE LEVE A BATTERE

4 Pz

€ 35,20

Imballo 6 / 12

Blister

SERIE 4 LEVE A BATTERE 1 Pz 230 mm / 9", 1 Pz 300 mm / 12", 1 Pz 450 mm / 18", 1 Pz 590 mm / 24"

Art. 0320
 LEVICINO CARPENTIERE IN ACCIAIO FORGIATO

€ 6,30

Lunghezza totale	600 mm
Esagono	15,6 mm
Peso	1 kg
Imballo	6* / 12

Art. 0192
 SERIE LEVE A BATTERE

4 Pz Cr-V

€ 141,00

Imballo 3

Valigetta in plastica

SERIE 4 LEVE A BATTERE 1 Pz DRITTA 910 mm / 36", 1 Pz CURVA 45° 910 mm / 36", 1 Pz CURVA 60° 610 mm / 24", 1 Pz CURVA 90° 610 mm / 24", CHROME - VANADIUM

LEVE A BATTERE

Cr-V

Codice	Articoli singoli	Lunghezza	€
0192/24C	Leva 45°	610 mm / 24"	42,20
0192/24C90	Leva 90°	610 mm / 24"	42,20
0192/36C	Leva 45°	910 mm / 36"	42,20
0192/36D	Leva dritta	910 mm / 36"	42,20

Art. L007 **€ 8,00**
 LEVA GOMMISTA PER MOTO

Dimensioni	215 x 16 X 5 mm
Peso	120 g
Imballo	10* / 100
Scatola di cartone	

Art. 0267 **€ 9,20**
 LEVA GOMMISTA

Dimensioni	510 x 26 x 9 mm
Zincato	
Imballo	5* / 20
Scatola	



Art. S018

SET RIVETTATRICI CON RIVETTI

€ 90,00



Rivetti	Ø 2,4 ÷ 4,8 mm
Rivetti filettati	M3 - M4 - M5 - M6 - M8
Imballo	6
Valigetta in plastica	

RIVETTATRICI CON RIVETTI NORMALI: 50Pz Ø 2,4 mm - 50Pz Ø 3,2 mm - 50Pz Ø 4 mm - 50Pz Ø 4,8 mm, RIVETTATRICE CON RIVETTI FILETTATI: 50Pz M3 - 50Pz M4 - 25Pz M5 - 25Pz M6 - 20Pz M8, IN VALIGETTA



Art. 0455

RIVETTATRICE A DOPPIA LEVA PER INSERTI FILETTATI

€ 99,00



Tiranti filettati	M3 - M4 - M5 - M6 - M8 - M10 - M12
Lunghezza	400 mm
Imballo	6
Valigetta	

RIVETTATRICE A DOPPIA LEVA PER INSERTI FILETTATI DA M3 A M12, COMPLETA DI 7 TIRANTI FILETTATI E 7 TESTINE. FORNITA IN PRATICA VALIGETTA



Art. 0469

RIVETTATRICE PER INSERTI FILETTATI

€ 55,00



Tiranti filettati	M3 - M4 - M5 - M6
Lunghezza	200 mm
Imballo	20
Scatola	

RIVETTATRICE PER INSERTI FILETTATI DA M3 A M6, COMPLETA DI 4 TIRANTI FILETTATI E 4 TESTINE



Art. 0453
RIVETTATRICE A DOPPIA LEVA
€ 44,40

Rivetti	Ø 3,2 – 4,0 – 4,8 – 6,4 mm
Lunghezza	400 mm
Imballo	12
Scatola	

RIVETTATRICE A DOPPIA LEVA PER RIVETTI DA 3,2 A 6,4 mm. LE LEVE LUNGHE CONSENTONO ALL'UTILIZZATORE DI LAVORARE SENZA SFORZO, ANCHE CON RIVETTI DA 6,4 mm. IL CONTENITORE IN PLASTICA, SOTTO ALLA RIVETTATRICE, PERMETTE DI RACCOGLIERE I PERNI DEI RIVETTI USATI DA RICICLARE

Art. 0454
RIVETTATRICE A DOPPIA LEVA A CAMBIO RAPIDO
€ 50,00

Rivetti	Ø 3,2 – 4,0 – 4,8 – 6,4 mm
Lunghezza	400 mm
Imballo	12
Scatola	

RIVETTATRICE A DOPPIA LEVA A CAMBIO RAPIDO PER RIVETTI DA 3,2 A 6,4 mm, CON TESTINA ROTANTE PER SCEGLIERE IL FORO ADATTO AL RIVETTO IN USO, SENZA USARE CHIAVI. IL CONTENITORE IN PLASTICA, SOTTO ALLA RIVETTATRICE, PERMETTE DI RACCOGLIERE I PERNI DEI RIVETTI USATI DA RICICLARE

Art. 0470
RIVETTATRICE A CAMBIO RAPIDO
€ 18,00

Rivetti	2,4 mm – 3 / 32", 3,2 mm – 1 / 8", 4,0 mm – 5 / 32", 4,8 mm – 3 / 16"
Blister	

RIVETTATRICE A CAMBIO RAPIDO, COSTRUITA IN ACCIAIO, CON TESTINA ROTANTE A 4 POSIZIONI

Art. 0124
RIVETTATRICE MANUALE
€ 11,90

Rivetti	Ø 2,4 ÷ 4,0 mm
Imballo	6* / 24
Blister	5* / 40



Art. 0058 € 14,90
SET RIVETTATRICE CON RIVETTI



Rivetti	Ø 2,4 ÷ 4,0 mm
Imballo	6* / 24
Blister	



Art. 0789 € 18,00
RIVETTATRICE MANUALE



Rivetti	Ø 2,4 ÷ 4,8 mm
Lunghezza	255 mm
Imballo	5* / 40
Blister	



Art. 0424 € 12,40
FUSTELLATRICE RINFORZATA



Lunghezza	250 mm
Peso	426 g
Imballo	50
Blister	

PINZA FUSTELLATRICE RINFORZATA DA 250 mm, COSTRUITA IN ACCIAIO, PERMETTE DI ESEGUIRE PICCOLI FORI SU MATERIALI DI PICCOLO SPESSORE COME: CARTA, CARTONE, GOMMA E CUOIO



Art. 0081 € 31,70
SERIE FUSTELLE



9 Pz

Misure	Ø 5 - 6 - 8 - 10 - 12,5 - 16 - 20 - 25 - 32 mm
Imballo	20
Valigetta in plastica	



Art. 0111 € 55,00
FUSTELLATRICE PER LAMIERA 1T



Gola	44 x 6,35 mm
Fori	Ø 3/32" - 1/8" - 5/32" - 3/16" - 7/32" - 1/4" - 9/32"
Imballo	12



Art. 0472 € 18,00
BORDATUBO PER RAME E ALLUMINIO



Diametro tubi	Ø5 - 6 - 8 - 10 - 12 - 14 - 16 mm
Peso	750 g

BORDATUBO PER TUBI IN RAME E ALLUMINIO, COSTRUITO IN ACCIAIO, CON CAPACITÀ DI BORDATURA PER TUBI Ø 5-6-8-10-12-14-16 mm





Art. 0678
 PISTOLA PER SCHIUMA POLIURETANICA

€ 20,20

Lunghezza	290 mm
Imballo	20
Scatola	

 PISTOLA PER SCHIUMA POLIURETANICA
 REGOLAZIONE DEL FLUSSO RESINA E DELLA GHIERA
 FILETTATA DI MONTAGGIO BOMBOLA

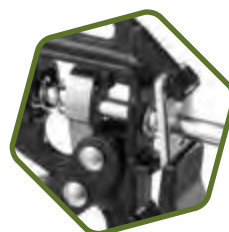
Art. 0085
 PISTOLA SILICONE SUPER RINFORZATA

€ 12,40

Peso	700 g
Imballo	12*

Art. 0521
 PISTOLA SILICONE SUPER RINFORZATA

€ 9,20

Peso	600 g
Imballo	12*

Art. 0234
 PISTOLA SILICONE A DOPPIO STELO RINFORZATA, ASTA ESAGONALE

€ 4,00

Peso	380 g
Imballo	24*



Art. 0091
PISTOLA SILICONE A CREMAGLIERA

€ 3,78

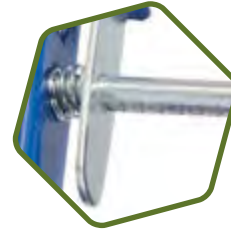

Peso	380 g
Imballo	24*



Art. 0604
PISTOLA PER TASSELLI CHIMICI DA 345 ml E 235 ml

€ 20,20



Peso	1000 g
Imballo	6* / 12



Art. 0861
PISTOLA PER TASSELLI CHIMICI DA 380 ml

€ 20,20



Peso	950 g
Imballo	24*



CAZZUOLA PUNTA TONDA



Codice	Lunghezza	Imballo	€
0819/18	180 mm	6* / 72	4,50
0819/20	200 mm	6* / 72	4,66



CAZZUOLA PUNTA QUADRA



Codice	Lunghezza	Imballo	€
0820/18	180 mm	6* / 72	4,50
0820/20	200 mm	6* / 72	4,66



Art. 0821/14 € 3,48
CAZZUOLINO PUNTA TONDA

Lunghezza 140 mm
 Imballo 12* / 120

Art. 0822 € 5,40
**FRATTONE PER STUCCATORI
 CON MANICO IN ABS**

Lunghezza 280 x 120 mm
 Imballo 6* / 60

Art. 0823 € 5,40
**FRATTONE PER COLLA
 CON MANICO IN ABS**

Lunghezza 280 x 120 mm
 Imballo 6* / 60

**SPATOLA CON MANICO IN PLASTICA
 LUCIDATA A SPECCHIO**

Codice	Dimensioni lama	Imballo	€
0184/01	30 x 90h mm	12* / 240	1,50
0184/02	50 x 95h mm	12* / 240	1,50
0184/03	75 x 100h mm	12* / 240	1,94
0184/04	100 x 100h mm	6* / 240	2,98

Art. 0647/25 € 16,80
**RASCHIETTO CON LAMA
 IN METALLO DURO DA
 25 mm A TRE TAGLIENTI**

Imballo 72
 Blister

Art. 0647/50 € 17,50
**RASCHIETTO CON LAMA
 IN METALLO DURO DA
 50 mm A DUE TAGLIENTI**

Imballo 60
 Blister

Art. 0647/65 € 19,10
**RASCHIETTO CON LAMA
 IN METALLO DURO DA
 65 mm A DUE TAGLIENTI**

Imballo 60
 Blister

Art. 0647/25L € 13,70
SERIE 2 PZ LAME RICAMBIO
 Imballo 5*

Art. 0647/50L € 13,90
SERIE 2 PZ LAME RICAMBIO
 Imballo 5*

Art. 0647/65L € 13,90
SERIE 2 PZ LAME RICAMBIO
 Imballo 5*



Art. 0606
SECCHIO IN POLIETILENE

€ 4,06



Dimensioni	Ø 360 x 240h mm
Capacità	14 l
Peso	720 g
Imballo	10



**OLIATORE IN METALLO
CON CANNA FLESSIBILE**



Codice	Capacità	Imballo	€
0156/200	200 cc	10* / 100	6,00
0156/500	500 cc	10* / 100	7,50



Art. 0158/500
**OLIATORE IN PLASTICA CON
CANNA FLESSIBILE**

€ 8,40



Capacità	500 cc
Imballo	10* / 80



Art. 0164/250
**OLIATORE IN PLASTICA CON
CANNA VERTICALE FLESSIBILE**

€ 7,20



Capacità	250 cc
Imballo	10* / 160



BACINELLA PER CAMBIO OLIO



Codice	Capacità	Dimensioni	Peso	Imballo	€
0473/10	10 l	Ø400 x 120h mm	0,83 kg	5	19,60
0473/15	15 l	Ø500 x 130h mm	1 kg	4	21,30



Art. 0171/2
**BROCCA GRADUATA IN
PLASTICA CON CANNA
FLESSIBILE E COPERCHIO**

€ 11,20



Capacità	2 l
Imballo	2* / 24



BROCCA GRADUATA

Codice	Capacità	€
0171/3	3 l	10,30
0171/5	5 l	14,00



BROCCA GRADUATA
REALIZZATA IN PLASTICA,
CON BECCUCCIO FLESSIBILE,
COPERCHIO AVVITABILE E
TAPPO DI CHIUSURA ANTI-
SGOCCIOLAMENTO



Art. 0183/750
RABBOCCATORE

€ 3,32



Capacità	750 cc
Imballo	10* / 90



Art. 0172/150
IMBUTO IN PLASTICA
€ 8,60

Diametro	Ø150 mm
Altezza	435 mm

IMBUTO IN PLASTICA CON DIAMETRO DI Ø 150 mm, CHIUSURA A VITE, BECCUCCIO FLESSIBILE, COPERCHI PER LE ESTREMITÀ ANTISGOCCIOLAMENTO E MANIGLIA SUPERIORE PER L'APPENSIONE

Art. 0172/180
IMBUTO IN PLASTICA
€ 11,40

Diametro	180 mm
Altezza	435 mm
Imballo	2* / 36

IMBUTO IN PLASTICA CON DIAMETRO DI Ø 180 mm, SMONTATO IN DUE PARTI CON CHIUSURA A VITE, COPERCHIO SUPERIORE, BECCUCCIO FLESSIBILE, FILTRO INTERNO, COPERCHIO A VITE PER L'ESTREMITÀ INFERIORE ANTISGOCCIOLAMENTO

TANICA IN MATERIALE PLASTICO

Codice	Capacità Litri	Dimensioni	Peso	Imballo	€
0660/05	5	260 x 120 x 250h mm	540 g	12*	11,20
0660/10	10	330 x 160 x 300h mm	680 g	5*	16,30
0660/20	20	400 x 200 x 360h mm	1080 g	4*	21,30

TANICA IN MATERIALE PLASTICO CON TUBO FLESSIBILE, PER IL TRASPORTO DI LIQUIDI INFIAMMABILI, CON OMOLOGAZIONE "UN" IN ACCORDO CON LA DIRETTIVA EUROPEA

TANICA IN METALLO

Codice	Capacità Litri	Peso	Imballo	€
0189/05C	5	1,50 kg	5	38,90
0189/10C	10	2,50 kg	5	39,50
0189/20C	20	3,80 kg	5	45,00

TANICA IN METALLO PER IL TRASPORTO DI LIQUIDI INFIAMMABILI, CON OMOLOGAZIONE "UN" IN ACCORDO CON LA DIRETTIVA EUROPEA

BECCUCCIO IN METALLO E GUARNIZIONI

Codice	Descrizione	Imballo	€
0189/G	Guarnizione per taniche	10*	1,82
0194	Beccuccio in metallo	5* / 25	13,50
0194/G	Guarnizione per beccuccio	10*	2,02



Art. 0594 € 135,00
**CARRELLINO RACCOGLI
 OLIO SENZA SERBATOIO**



Dimensioni base	390 x 390 mm
Altezza massima	1700 mm
Peso	15 kg

CARRELLINO RACCOGLI OLIO SENZA SERBATOIO PER
 USO SOTTO PONTE



Art. 0595 € 271,00
UNITÀ RACCOGLI OLIO



Capacità serbatoio	70 l
Altezza min - max	1170 ÷ 1860 mm
Peso	26 kg

UNITÀ RACCOGLI OLIO ESAUSTO, CARRELLATA CON
 SERBATOIO PER USO SOTTO PONTE



Art. 0596 € 436,00
UNITÀ ASPIRA OLIO PNEUMATICA



Capacità serbatoio	70 l
Capacità serbatoio graduato	10 l
Altezza massima	1410 mm
Sonda in metallo	1x Ø 8 x 7 mm - 1x Ø 6 x 5 mm
Sonda in nylon	2x Ø 8 x 7 mm - 2x Ø 6 x 5 mm
Aspirazione	6 x 4,5 mm - 0,4 ÷ 0,8 L/min 8 x 6,5 mm - 1 ÷ 1,6 L/min
Pressione di esercizio	8 ÷ 10 bar
Peso	22,5 kg

UNITÀ ASPIRA OLIO PNEUMATICA, CARRELLATA, PER OLIO ESAUSTO, CON
 SONDE DI ASPIRAZIONE DI VARIO DIAMETRO, ANCHE PER USO SOTTO PONTE





Art. P024/06
 POMPA TRAVASO IN ALLUMINIO

€ 48,50

Portata	6 l/min
Portata ogni pompata	0.1 l
Filetto pompa	2" / 1-1/2"
Peso	1.5 kg
Imballo	12
Scatola	12

POMPA IN ALLUMINIO A LEVA PER TRAVASO FUSTI OLIO LUBRIFICANTE, GASOLIO E KEROSENE, CON TUBO RIGIDO IN ACCIAIO Ø 16 x 700 mm CON FILETTO M16 x 1 E TUBO DI MANDATA IN PLASTICA

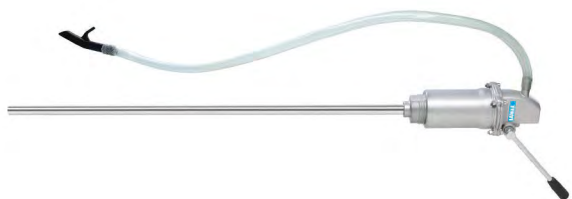
Art. P024/15
 POMPA TRAVASO IN ALLUMINIO

€ 57,50

Portata	15 l/min
Portata ogni pompata	0.350 l
Filetto pompa	2" / 1-1/2"
Peso	2.2 kg
Imballo	12
Scatola	12

POMPA IN ALLUMINIO A LEVA PER TRAVASO FUSTI OLIO LUBRIFICANTE, GASOLIO E KEROSENE, CON TUBO RIGIDO IN ACCIAIO Ø 20 x 820 mm CON FILETTO GAS DA 1/2" E TUBO DI MANDATA IN PLASTICA

Art. 0385
 POMPA ROTATIVA IN ALLUMINIO PER FUSTI OLIO LUBRIFICANTE

€ 54,40

Portata	20 l/min
Filetto pompa	2"
Peso	1,4 kg
Imballo	10
Scatola	

POMPA ROTATIVA IN ALLUMINIO PER FUSTI OLIO LUBRIFICANTE CON TUBO DI PESCA TELESCOPICO

Art. 0386
 POMPA A LEVA PER FUSTI OLIO LUBRIFICANTE

€ 38,90

Portata	18 l/min
Filetto pompa	2" / 1-1/2"
Peso	2 kg
Imballo	10
Scatola	

POMPA A LEVA PER FUSTI OLIO LUBRIFICANTE CON TUBO DI PESCA TELESCOPICO



Art. 0474/PP € 15,70

PISTOLA PER TRAVASO GASOLIO IN PVC



Portata	60÷80 l/min
Boccaglio	Ø25 mm
Peso	0,8 kg
Attacco di entrata	1" BSP
Imballo	10

PISTOLA PER TRAVASO GASOLIO, COSTRUITA IN PVC, CON BOCCAGLIO Ø 25 mm



Art. 0474/PE € 27,80

PISTOLA PER TRAVASO GASOLIO IN ALLUMINIO



Portata	60÷120 l/min
Boccaglio	Ø25 mm
Peso	0,80 kg
Attacco di entrata	1" BSP
Imballo	10

PISTOLA PER TRAVASO GASOLIO, COSTRUITA IN ALLUMINIO, CON BOCCAGLIO Ø 25 mm E RACCORDO GIREVOLE



Art. 0474/PA € 74,80

PISTOLA PER TRAVASO GASOLIO AUTOMATICA



Portata	90 l/min
Boccaglio	Ø25 mm
Peso	1,4 kg
Attacco di entrata	1" BSP
Imballo	10

PISTOLA PER TRAVASO GASOLIO AUTOMATICA, CON BOCCAGLIO Ø 25 mm E RACCORDO GIREVOLE



Art. 0755 € 98,00

POMPA 12V PER GASOLIO



Dimensioni base	200 x 120 x 110 mm
Motore	DC 12 V, 175 W
Velocità motore	4500 rpm
Portata pompa	40 l/min
Prevalenza	2 m
Aspirazione	4 m
Attacco di entrata	25 mm
Peso	3.8 kg

POMPA IN CORRENTE CONTINUA A 12V PER TRAVASO GASOLIO E OLI MINERALI, MASSIMO UTILIZZO CONTINUATO 30 min



Art. 0272 € 13,50

POMPA TRAVASO PER TRAPANO



Peso	450 g
Imballo	6*
Blister	

POMPA TRAVASO PER TRAPANO PER LIQUIDI NON: INFIAMMABILI, ESPLOSIVI, CORROSIVI E OLEOSI



Art. 0103
 DISPENSER PER NASTRI
 DA IMBALLAGGIO

€ 8,00

Imballo 6* / 36

Art. 0747
 NASTRO PER IMBALLAGGIO
 IN PPL COLOR AVANA

€ 2,34

 Dimensioni nastro 50 mm x 66 m
 Imballo 6* / 36

Art. 0760
 MANIGLIA PER FILM ESTENSIBILE

€ 8,00



Imballo 12* / 48

Art. PVC300/125
 FILM ESTENSIBILE
 PER IMBALLAGGIO

€ 5,20

 Dimensioni 0,125h x 100 m
 Spessore 20 µm
 Imballo 48*

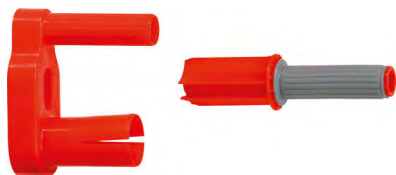
Art. 0748
 MANIGLIA PER FILM ESTENSIBILE

€ 9,60

Imballo 6* / 32

Art. PVC300
 FILM ESTENSIBILE
 PER IMBALLAGGIO

€ 18,20

 Dimensioni 0,5h x 300 m
 Spessore 23 µm
 Imballo 6*

TELO IN POLIETILENE PESANTE ANELLATO BORDATO, BICOLORE VERDE - BLU

Codice	Dimensioni	Peso	Imballo	€
0281	2 x 3 m	0,8 kg	8	10,90
0282	4 x 5 m	2,8 kg	4	31,70
0283	5 x 8 m	5,6 kg	4	63,30
0284	6 x 10 m	8,4 kg	2	82,50

 TELO IN POLIETILENE PESANTE ANELLATO BORDATO, BICOLORE VERDE - BLU, STABILIZZATO AI RAGGI UV, TELONE
 TESSUTO IN POLIETILENE, 140/150 g/m², OCCHIELLI METALLICI OGNI 50 cm



MORSA DA BANCO IN GHISA



Codice	Ganasce	Apertura	Altezza utile	Interasse fori	Peso	Imballo	€
0174/100	100 x 20 mm	100 mm	50 mm	85 mm	4,8 kg	4	60,00
0174/125	125 x 22 mm	130 mm	60 mm	95 mm	7,7 kg	2	74,80
0174/150	150 x 22 mm	150 mm	75 mm	105 mm	10 kg	2	93,50

MORSA DA BANCO IN GHISA CON GANASCE INTERCambiabili



MORSA PARALLELA DA BANCO



Codice	Ganasce	Apertura	Peso	Imballo	€
0427/080	80 mm	80 mm	6,5 kg	2	75,90
0427/100	100 mm	100 mm	10,1 kg	2	97,90
0427/125	125 mm	125 mm	12,2 kg	2	130,00

MORSA PARALLELA DA BANCO, IN GHISA DI ALTA QUALITÀ, CON GUIDE PRISMATICHE



Art. 0146/60
MORSA GIREVOLE CON MORSETTO

€ 24,70



Ganascia	60 mm
Apertura	50 mm
Capacità morsetto	45 mm
Peso	2,3 kg
Imballo	2*/10



MORSA IN ACCIAIO



0145/80



Codice	Ganasce	Apertura	Altezza utile	Interasse fori	Peso	Imballo	€
0145/80	80 x 20 mm	80 mm	58 mm	90 mm	3,8 kg	6	38,00
0145/100	100 x 20 mm	100 mm	70 mm	85 mm	5,5 kg	4	42,20
0145/125	125 x 20 mm	125 mm	75 mm	90 mm	7,4 kg	2	56,10
0145/150	150 x 27 mm	150 mm	95 mm	105 mm	12 kg	2	91,30

MORSA IN ACCIAIO

Codice	Ganascia	Apertura	Altezza utile	Interasse fori	Peso	€
0036/100	100 mm	90 mm	60 mm	85 mm	4,9 kg	112,00
0036/125	125 mm	138 mm	75 mm	110 mm	10 kg	165,00
0036/150	150 mm	190 mm	90 mm	150 mm	19 kg	280,00

MORSA GIREVOLE IN ACCIAIO

Codice	Ganascia	Apertura	Peso	€
0036/100G	100 mm	90 mm	5 kg	132,00
0036/125G	125 mm	138 mm	11 kg	180,00
0036/150G	150 mm	190 mm	23 kg	310,00

MORSA IN ACCIAIO

MORSA IN ACCIAIO CON CUSCINETTO SULLA VITE,
GANASCE INTERCAMBIABILI E STRINGITUBO

Codice	Ganascia	Apertura	Peso	€
0591/100	100 mm	105 mm	6,1 kg	148,00
0591/125	125 mm	138 mm	12,3 kg	208,00
0591/150	150 mm	230 mm	26,6 kg	315,00

COPPIA GANASCE MAGNETICHE IN ALLUMINIO

Codice	Ganascia	Imballo	€
0042/100	100 mm	100	13,50
0042/125	125 mm	100	20,80
0042/150	150 mm	100	21,30



Art. 0205

€ 33,30

**MORSA PER SALDARE
PROFILATI A 90°**



Capacità	70 mm + 70 mm
Altezza utile	35 mm
Peso	0,9 kg
Imballo	20



Art. 0205/120

€ 115,00

**MORSA PER SALDARE
PROFILATI A 90°**



Capacità	110 mm + 110 mm
Altezza utile	60 mm
Peso	10 kg

MORSA PER SALDARE PROFILATI A 90°



Art. 0265/05

INCUDINE IN GHISA

€ 37,30

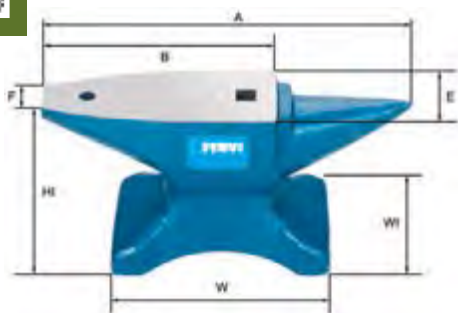

A	230 mm	WI	85 mm
B	160 mm	HI	95 mm
E	57 mm	Tolleranza	±5%
F	10,5 mm	Peso	5 kg
W	112 mm	Imballo	4

INCUDINE IN GHISA DA 5 kg



INCUDINI IN ACCIAIO INDURITO C50

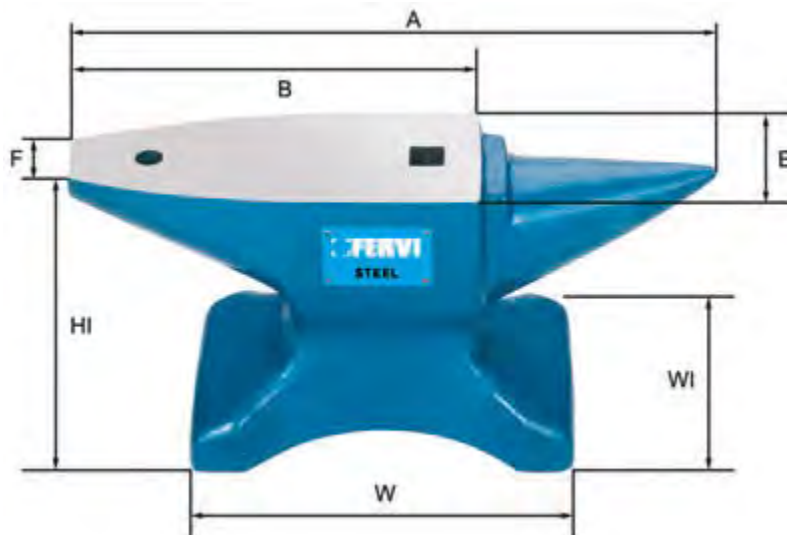

Codice	A	B	E	F	W	WI	HI	Tolleranza	Peso	€
0157/10	270 mm	185 mm	80 mm	30 mm	195 mm	85 mm	150 mm	±5%	10 kg	110,00
0157/30	415 mm	265 mm	110 mm	50 mm	245 mm	160 mm	185 mm	±5%	30 kg	265,00
0157/50	500 mm	310 mm	140 mm	60 mm	300 mm	190 mm	220 mm	±5%	50 kg	384,00
0157/100	635 mm	420 mm	200 mm	85 mm	350 mm	250 mm	260 mm	±5%	100 kg	804,00

MORSETTO IN ACCIAIO TEMPERATO PER MECCANICA



Codice	Apertura x Profondità	Stelo	Peso	Imballo	€
M006/200	200 x 120 mm	22 x 10,5 mm	1,20 kg	4 / 16	28,90
M006/300	300 x 140 mm	25 x 12 mm	1,80 kg	12	40,60
M006/400	420 x 120 mm	25 x 12 mm	1,90 kg	12	41,10
M006/500	500 x 120 mm	25 x 12 mm	2,10 kg	8	45,60
M006/600	600 x 120 mm	25 x 12 mm	2,30 kg	8	65,50
M006/800	800 x 120 mm	25 x 12 mm	3,00 kg	8	78,70
M006/1000	1000 x 120 mm	25 x 12 mm	3,50 kg	4	93,50

MORSETTO IN ACCIAIO TEMPERATO PER MECCANICA

MORSETTO IN ACCIAIO TEMPERATO PER MECCANICA

Codice	Apertura x Profondità	Stelo	Peso	Imballo	€
M007/250	250 x 120 mm	22 x 10,5 mm	1,46 kg	12	56,70
M007/300	300 x 140 mm	25 x 12 mm	2,42 kg	10	65,50
M007/400	400 x 120 mm	25 x 12 mm	2,55 kg	10	71,50
M007/500	500 x 120 mm	25 x 12 mm	2,76 kg	10	77,00
M007/600	600 x 120 mm	25 x 12 mm	2,97 kg	8	85,80

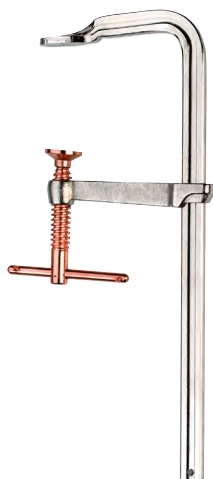
MORSETTO IN ACCIAIO TEMPERATO PER MECCANICA

MORSETTO IN ACCIAIO TEMPERATO PER MECCANICA E FALEGNAMERIA

Codice	Apertura x Profondità	Stelo	Peso	Imballo	€
M018/0200	200 x 100 mm	19 x 9,5 mm	0,90 kg	20	20,00
M018/0300	300 x 100 mm	19 x 9,5 mm	1,00 kg	20	24,00
M018/0400	400 x 120 mm	21,5 x 10,5 mm	1,40 kg	10	27,40
M018/0500	500 x 120 mm	21,5 x 10,5 mm	1,60 kg	10	30,00
M018/0600	600 x 120 mm	21,5 x 10,5 mm	1,70 kg	10	30,00
M018/0800	800 x 120 mm	21,5 x 10,5 mm	2,00 kg	8	35,00
M018/1000	1000 x 120 mm	21,5 x 10,5 mm	2,20 kg	8	40,00
M018/1200	1200 x 120 mm	21,5 x 10,5 mm	2,50 kg	8	45,00

MORSETTO IN ACCIAIO TEMPERATO PER MECCANICA E FALEGNAMERIA



MORSETTO PER FALEGNAME



Codice	Apertura x Profondità	Imballo	€
0167/150	150 x 50 mm	5* / 20	3,36
0167/200	200 x 80 mm	5* / 20	6,30
0167/250	250 x 100 mm	5* / 20	7,00
0167/400	400 x 100 mm	5* / 20	9,60
0167/500	500 x 120 mm	5* / 10	12,00



MORSETTO RAPIDO AUTOMATICO



Codice	Apertura x Profondità	Stelo	Peso	Imballo	€
0394/150	150 x 63 mm	18 x 5,5 mm	0,50 kg	6* / 48	8,10
0394/300	300 x 63 mm	18 x 5,5 mm	0,60 kg	6* / 24	10,90
0394/450	450 x 63 mm	18 x 5,5 mm	0,70 kg	6* / 24	12,50
0394/600	600 x 63 mm	18 x 5,5 mm	0,80 kg	6* / 24	15,20

Art. 0353/085
 SERIE MORSETTI A MOLLA IN POLIPROPILENE

€ 6,90

12 Pz

Lunghezza	85 mm
Apertura	35 mm
Appendibile	

SERIE 12 MORSETTI A MOLLA, REALIZZATI IN POLIPROPILENE, CON LUNGHEZZA DI 85 mm, UTILI IN LABORATORIO PER FACILITARE GLI INCOLLAGGI E LAVORI SIMILI

Art. 0353/110
 SERIE MORSETTI A MOLLA IN POLIPROPILENE

€ 8,00

8 Pz

Lunghezza	110 mm
Apertura	40 mm
Appendibile	

SERIE 8 MORSETTI A MOLLA, REALIZZATI IN POLIPROPILENE, CON LUNGHEZZA DI 110 mm, UTILI IN LABORATORIO PER FACILITARE GLI INCOLLAGGI E LAVORI SIMILI

MORSETTO A MOLLA

Codice	Lunghezza	Apertura	Imballo	€
0353/150	150 mm	55 mm	10* / 100	3,50
0354/225	225 mm	100 mm	10* / 80	4,80

MORSETTO A MOLLA, IN CONFEZIONE APPENDIBILE



Art. 0627

CUTTER AUTOMATICO CON GUIDALAMA IN ACCIAIO, LAME DI RICAMBIO INCLUSE

€ 4,34



Lame in dotazione	5
Larghezza lama	9 mm
Scatola	
Imballo	24* / 192



Art. 0623

CUTTER AUTOMATICO CON GUIDALAMA IN ACCIAIO, LAME DI RICAMBIO INCLUSE

€ 5,20



Lame in dotazione	3
Larghezza lama	18 mm
Scatola	
Imballo	24* / 144



Art. 0617

CUTTER CON GUIDALAMA IN ACCIAIO, LAME DI RICAMBIO INCLUSE

€ 2,52



Lame in dotazione	3
Larghezza lama	18 mm
Scatola	
Imballo	20* / 120



Art. 0096

CUTTER CON GUIDALAMA IN ACCIAIO, LAME DI RICAMBIO INCLUSE

€ 2,52



Lame in dotazione	3
Larghezza lama	18 mm
Scatola	
Imballo	20* / 120



Art. 0035

CUTTER DI SICUREZZA, LAME DI RICAMBIO INCLUSE

€ 6,20



Lame in dotazione	4
Lama trapezoidale	19 x 61 x 0,6 mm
Scatola	
Imballo	24* / 144



Art. 0475
 CUTTER CON FODERO

€ 9,70

Lunghezza cutter	170 mm
Lunghezza fodero	150 mm
Lama trapezoidale	19 x 61 x 0,6 mm

Art. 0792
 CUTTER AUTOMATICO CON GUIDALAMA IN ACCIAIO, LAME DI RICAMBIO INCLUSE

€ 10,30

Lame in dotazione	5
Larghezza lama	25 x 0,7 mm
Scatola	
Imballo	6* / 36

Art. 0696
 CUTTER A SERRAMANICO, LAME DI RICAMBIO INCLUSE

€ 7,70

Lame in dotazione	5
Larghezza lama	150 mm
Blister	
Imballo	12* / 48

Art. 0095
 SERIE CUTTER

€ 1,66

3 Pz

 Appendibile
 Imballo

24* / 240

Art. 0696/L
 SERIE LAME PER CUTTER

€ 1,90

10 Pz



Lama trapezoidale	19 x 61 x 0,6 mm
Imballo	48* / 288
Astuccio di plastica	

Art. 0627/L
 SET 10 LAME PER CUTTER

€ 2,06

10 Pz



Lunghezza lama	9 mm
Imballo	48* / 288
Astuccio di plastica	



Art. 0096/L
SERIE LAME PER CUTTER

€ 2,06

 **10 Pz**



Lunghezza lama	18 mm
Imballo	48* / 288
Astuccio di plastica	



Art. 0792/L
SERIE LAME PER CUTTER

€ 7,90

 **10 Pz**



Larghezza lama	25 mm
Imballo	24* / 96
Astuccio di plastica	

Codice compatibile	Descrizione	€	0627	0623	0617	0096	0035	0475	0792	0696	0095	Pag
0696/L	SERIE LAME PER CUTTER	1,90										486
0627/L	SET 10 LAME PER CUTTER	2,06	•								•	486
0096/L	SERIE LAME PER CUTTER	2,06		•	•	•					•	487
0792/L	SERIE LAME PER CUTTER	7,90							•			487



Art. 0367
SERIE COLTELLI TAGLIABALSA

€ 25,80

 **34 Pz**





Pietra per affilare	1 - grana / grain 240
Giravite di precisione	1
Pinzetta	1
Manici a 2 colori	4
Coltelli di ricambio	26
Cofanetto	1, ABS+TPR
Blister	
Imballo	20



Art. 0388
SERIE COLTELLI A SERRAMANICO E PINZE MULTIUSO

€ 173,00

 **11 Pz**



Lame e utensili in acciaio inox	AISI 420
Dimensioni valigetta	410 x 350 x 90 mm
Peso	2,8 kg

SERIE DI 11 COLTELLI A SERRAMANICO: 0388/01, 0388/02, 0388/03, 0388/04, 0388/05, 0388/06, 0388/07, 0388/08, 0388/09, 0388/10, 0388/11
E 2 PINZE MULTIUSO: 0389/01, 0389/02
IN COMODA VALIGETTA DI PLASTICA; COLTELLI CON LAMA IN ACCIAIO INOX, PINZE MULTIUSO CON 12 UTENSILI IN ACCIAIO INOX



PINZA MULTIFUNZIONE

 **AISI 420**



Codice	Lunghezza chiusa	12 utensili in acciaio	Imballo	€
0389/01	69 mm	AISI 420	6* / 120	13,90
0389/02	102 mm	AISI 420	6* / 60	18,30

PINZA MULTIFUNZIONE, CON MANICO IN ALLUMINIO ANODIZZATO, FONDINA IN NYLON



Art. 0388/01 € 15,20
 COLTELLO A SERRAMANICO

AISI 420

Lunghezza aperto-chiuso	177 / 103 mm
Lama in acciaio	AISI 420
Manico	PAKKAWOOD
Scatolina regalo	
Imballo	5* / 100

Art. 0388/02 € 15,20
 COLTELLO A SERRAMANICO

AISI 420

Lunghezza aperto-chiuso	195 / 115 mm
Lama in acciaio	AISI 420
Manico in alluminio anodizzato	
Scatolina regalo	
Imballo	5* / 100

Art. 0388/03 € 15,80
 COLTELLO A SERRAMANICO

AISI 420

Lunghezza aperto-chiuso	180 / 100 mm
Lama in acciaio	AISI 420
Manico	PAKKAWOOD
Scatolina regalo	
Imballo	5* / 100

Art. 0388/04 € 16,40
 COLTELLO A SERRAMANICO

AISI 420

Lunghezza aperto-chiuso	198 / 115 mm
Lama in acciaio	AISI 420
Manico	Micarta
Scatolina regalo	
Imballo	5* / 100

Art. 0388/05 € 20,20
 COLTELLO A SERRAMANICO

AISI 420

Lunghezza aperto-chiuso	200 / 115 mm
Lama in acciaio	AISI 420
Manico	Camo G10
Scatolina regalo	
Imballo	5* / 100

Art. 0388/06 € 17,70
 COLTELLO A SERRAMANICO

AISI 420

Lunghezza aperto-chiuso	200 / 115 mm
Lama in acciaio	AISI 420
Manico in legno-alluminio anodizzato	
Scatolina regalo	
Imballo	5* / 100



Art. 0388/07 € 11,40
COLTELLO A SERRAMANICO



AISI 420

Lunghezza aperto-chiuso	190 / 115 mm
Lama in acciaio	AISI 420
Manico	ROSEWOOD
Scatolina regalo	
Imballo	5* / 100



Art. 0388/08 € 16,40
COLTELLO A SERRAMANICO



AISI 420

Lunghezza aperto-chiuso	178 / 102 mm
Lama in acciaio	AISI 420
Manico	PAKKAWOOD
Scatolina regalo	
Imballo	5* / 100



Art. 0388/09 € 17,70
COLTELLO A SERRAMANICO



AISI 420

Lunghezza aperto-chiuso	190 / 115 mm
Lama in acciaio	AISI 420
Manico	Micarta
Scatolina regalo	
Imballo	5* / 100



Art. 0388/10 € 11,40
COLTELLO A SERRAMANICO



AISI 420

Lunghezza aperto-chiuso	170 / 113 mm
Lama in acciaio	AISI 420
Manico	ROSEWOOD
Scatolina regalo	
Imballo	5* / 100



Art. 0388/11 € 15,80
COLTELLO A SERRAMANICO



AISI 420

Lunghezza aperto-chiuso	200 / 120 mm
Lama in acciaio	AISI 420
Manico	PAKKAWOOD
Scatolina regalo	
Imballo	5* / 100



Art. 0276 € 16,40
COLTELLO A SERRAMANICO CON
MANICO IN ALLUMINIO



Lunghezza	185 mm
Blister	
Imballo	16 / 48



Art. 0869
 SEGACCIO DA FALEGNAME CON TRIPLA AFFILATURA A DIAMANTE

€ 14,50

Lunghezza lama	400 mm
Imballo	6* / 48

Art. 0226
 ARCHETTO CON LAMA, IMPUGNATURA IN ALLUMINIO

€ 9,10

Lunghezza lama	310 mm
Imballo	10* / 40

ARCHETTO CON LAMA, IMPUGNATURA IN ALLUMINIO E IMPUGNATURA SUPPLEMENTARE PER PICCOLI TAGLI

Art. 0629
 ARCHETTO CON LAMA

€ 20,00

Lunghezza lama	300 mm
Imballo	6* / 36

Art. 0161
 MINI ARCHETTO CON LAMA

€ 3,84

Lunghezza lama	150 mm
Imballo	15* / 30

Art. 0327
 SEGACCIO AD ARCO PER LEGNO

€ 7,60

Lunghezza lama	530 mm / 21"
Peso	0,5 kg
Imballo	6* / 24



Art. 0724/B
LAMA BIMETALLICA

€ 1,92



Misure 300 x 12,7 x 0,62 mm x 24T - 12" x 1/2" x 0.025" x 24T
Imballo 10* / 100



Art. 0159
LAMA IN ACCIAIO AL CARBONIO

€ 0,28



Misure 300 x 12,7 x 0,62 mm x 24T - 12" x 1/2" x 0.025" x 24T
Imballo 100* / 1000

Codice compatibile	Descrizione	€	0226	0629	Pag
0724/B	LAMA BIMETALLICA	1,92	•	•	491
0159	LAMA IN ACCIAIO AL CARBONIO	0,28	•	•	491



Art. 0670
RODITRICE PER TRAPANO

€ 51,70



RODITRICE PER TRAPANO A DOPPIA TESTA CON ACCESSORIO PER TAGLI DRITTI E CIRCOLARI

Capacità di taglio	Ø 4,15 x 128 mm
lamiere ferrose	1,8 mm
lamiere acciaio inox	1,2 mm
lamiere di rame e alluminio	2,0 mm
materiali plastici	2,0 mm
Velocità di rotazione	1500 ÷ 3000 rpm
Collare	Ø 43,2 mm
Peso	400 g
Cassetina di metallo	
Imballo	20



Art. 0670/U
SERIE UTENSILI DI RICAMBIO

€ 13,70

2 Pz



Dimensioni Ø 4,15 x 128 mm



Art. 0655/L
CESOIA SINISTRA
PER LAMIERA

€ 9,50



Lunghezza 245 mm
Durezza 50 - 52 HRC
Blister
Imballo 6 / 48



Art. 0655/S
CESOIA DRITTA
PER LAMIERA

€ 9,50



Lunghezza 245 mm
Durezza 50 - 52 HRC
Blister
Imballo 6 / 48



Art. 0655/R
CESOIA DESTRA
PER LAMIERA

€ 9,50



Lunghezza 245 mm
Durezza 50 - 52 HRC
Blister
Imballo 6 / 48



Art. 0818/250
FORBICE LAMIERA TIPO AMERICANO
€ 10,50

Lunghezza	250 mm
Blister	
Imballo	8* / 20 / 60

Art. 0699/240
FORBICE INOX
€ 6,20

Lunghezza	240 mm
Blister	
Imballo	12* / 120

Art. 0672 **€ 7,50**
FORBICE PER ELETTRICISTA

Lunghezza	5" 1/2 - 140 mm
Blister	
Imballo	12* / 120

FORBICE PER ELETTRICISTA, CON LAMA A RASOIO MICRODENTATA IN ACCIAIO INOX, MANICO ERGONOMICO IN ABS

Art. 0672/B **€ 10,30**
FORBICE PER ELETTRICISTA

Lunghezza	5" 1/2 - 140 mm
Blister	
Imballo	12* / 120

FORBICE PER ELETTRICISTA, CON LAMA A RASOIO MICRODENTATA IN ACCIAIO INOX, MANICO ERGONOMICO BICOLORE ANTISCIVOLO

Art. 0141 **€ 11,20**
FORBICE PER ELETTRICISTA

Lunghezza	5" 1/2 - 140 mm
Blister	
Imballo	12* / 120

FORBICE PROFESSIONALE PER ELETTRICISTA, IN ACCIAIO INOX

Art. F018 **€ 26,00**
FORBICE PER ELETTRICISTA CON MANICI ISOLATI

Lunghezza	6" - 160 mm
Blister	
Imballo	6 / 48

FORBICE PER ELETTRICISTA CON ISOLAMENTO 1000 V, CON LAMA A RASOIO, MICRODENTATA IN ACCIAIO INOX, MANICO ERGONOMICO IN ABS, IEC 60900

Art. 0673 **€ 10,30**
FORBICE MULTIUSO

Lunghezza	175 mm / 7"
Blister	
Imballo	10* / 100

FORBICE MULTIUSO CON LAMA A RASOIO MICRODENTATA IN ACCIAIO INOX, MANICO ERGONOMICO ANTISCIVOLO BICOLORE IN PLASTICA E GOMMA

Art. 0325 **€ 13,30**
FORBICE MULTIUSO

Lunghezza	210 mm / 8"
Blister	
Imballo	12* / 120

FORBICE MULTIUSO, CON LAMA A RASOIO MICRODENTATA IN ACCIAIO INOX, MANICO ERGONOMICO ANTISCIVOLO BICOLORE



Art. 0093/22
TAGLIATUBO PER RAME/PLASTICA

€ 5,70



Capacità di taglio	3÷22 mm , 1 / 8" ÷ 55 / 64"
Peso	100 g

TAGLIATUBO PER RAME/PLASTICA, CON CORPO IN LEGA DI ZINCO E LAMA DI TAGLIO IN ACCIAIO, CAPACITÀ DI TAGLIO 3÷22 mm



Art. 0093/42
TAGLIATUBO PER RAME/FERRO

€ 22,40



Capacità di taglio	6÷42 mm , 15 / 64" ÷ 1-21 / 32"
Peso	320 g

TAGLIATUBO PER RAME/FERRO, CON CORPO IN LEGA DI ALLUMINIO, LAMA DI TAGLIO IN ACCIAIO 9CRS1 E DUREZZA DI HRC 58-60, CAPACITÀ DI TAGLIO 6÷42 mm



Art. 0093/22R **€ 3,20**
ROTELLA DI RICAMBIO PER
TAGLIATUBO



Diametro	Ø18 mm - 45 / 64"
Foro	Ø 5 mm
Spessore	5,9 mm - 15 / 64"

ROTELLA DI RICAMBIO IN ACCIAIO PER TAGLIATUBO 0093/22 PER RAME/PLASTICA



Art. 0093/42R **€ 3,42**
ROTELLA DI RICAMBIO PER
TAGLIATUBO



Diametro	Ø18,5 mm - 47 / 64"
Foro	Ø 4,7 mm
Spessore	5,9 mm - 15 / 64"

ROTELLA DI RICAMBIO IN ACCIAIO 9CRS1 E DUREZZA HRC 58-60 PER TAGLIATUBO 0093/42 PER RAME/FERRO



Art. 0092
TAGLIATUBO PER TUBI RAME

€ 6,20



Capacità	3 ÷ 28 mm - 1/8" ÷ 1 1/8"
Blister	
Imballo	10* / 50



Art. 0297
TAGLIATUBO A CRICCHETTO PER PLASTICA

€ 91,30



Taglio massimo	Ø 42 mm
Scatola	
Imballo	5 / 20



Art. 0844
TAGLIATUBO PER POLIURETANO E GOMMA
€ 10,30

Taglio massimo	Ø 25 mm
Blister	
Imballo	50

TAGLIA BULLONI
Cr-V

Codice	Dimensioni	Imballo	€
0287/300	300 mm - 12"	24	16,30
0287/350	350 mm - 14"	6	18,60
0287/450	450 mm - 18"	20	23,80
0287/600	600 mm - 24"	10	30,00
0287/750	750 mm - 30"	5	38,90

TAGLIA BULLONI, COSTRUITO IN ACCIAIO CR-V, IDEALE PER TRANCIARE TONDINI DI FERRO, CATENE E UNA VASTA TIPOLOGIA DI MATERIALI FERROSI E NON FERROSI

Art. 0846/150
TAGLIACAVI MANUALE A CRICCHETTO
€ 117,00

Capacità di taglio	150 mm ² (Al - Cu)
Lunghezza	250 mm
Peso	0,66 kg
Blister	
Imballo	10

TAGLIACAVI MANUALE A CRICCHETTO PER CAVI ELETTRICI

Art. 0862
SPELLAFILO AUTOMATICO
REGOLABILE
€ 7,00

Taglio massimo	Ø 0,8 ÷ 3,5mm 0,25 ÷ 6 mm ²
Blister	
Imballo	10* / 60

Art. 0801
SPELLACAVO
€ 6,90

Taglio massimo	Ø 0,8 ÷ 28,0 mm
Blister	
Imballo	6* / 48



Art. A007A

ARREDAMENTO MODULARE PER OFFICINA

€ 4250,00



- 1 4 ARMADI PENSILI CON AMMORTIZZATORI [A007/01]
- 2 2 ARMADI ALTI CON 3 PIANI INTERNI [A007/02]
- 3 4 PANNELLI FORATI [A007/10]
- 4 5 PROFILI DI GIUNZIONE PER PANNELLI FORATI [A007/07]
- 5 2 PIANI IN LEGNO [A007/08]
- 6 2 CASSETTIERE A 5 CASSETTI SU CUSCINETTI [A007/05]
- 7 1 ARMADIO BASSO A DUE ANTE CON UN PIANO INTERNO [A007/03]
- 8 1 CASSETTIERA A 4 CASSETTI SU CUSCINETTI [A007/04]

LA SOLUZIONE OTTIMALE PER ARREDARE LA TUA OFFICINA, IL TUO GARAGE O IL TUO ANGOLO RACING

Dimensioni

3920 x 498 x 2000h mm



Art. A007B

ARREDAMENTO MODULARE PER OFFICINA

€ 4160,00



- 1 4 ARMADI PENSILI CON AMMORTIZZATORI [A007/01]
- 2 2 ARMADI ALTI CON 3 PIANI INTERNI [A007/02]
- 3 4 PANNELLI FORATI [A007/10]
- 4 5 PROFILI DI GIUNZIONE PER PANNELLI FORATI [A007/07]
- 5 2 PIANI IN LEGNO [A007/08]
- 6 2 CASSETTIERE A 5 CASSETTI SU CUSCINETTI [A007/05]
- 7 1 ARMADIO BASSO A DUE ANTE CON UN PIANO INTERNO [A007/03]
- 8 1 ARMADIO BASSO MULTIFUNZIONE [A007/06]

LA SOLUZIONE OTTIMALE PER ARREDARE LA TUA OFFICINA, IL TUO GARAGE O IL TUO ANGOLO RACING

Dimensioni

3920 x 498 x 2000h mm





Art. A007C

ARREDAMENTO MODULARE PER OFFICINA

€ 2050,00



- 1 2 ARMADI PENSILI CON AMMORTIZZATORI [A007/01]
- 2 1 ARMADIO ALTO CON 3 PIANI INTERNI [A007/02]
- 3 2 PANNELLI FORATI [A007/10]
- 4 2 PROFILI DI GIUNZIONE PER PANNELLI FORATI [A007/07]
- 5 1 PIANO IN LEGNO [A007/08]
- 6 1 CASSETTIERE A 5 CASSETTI SU CUSCINETTI [A007/05]
- 7 1 ARMADIO BASSO A DUE ANTE CON UN PIANO INTERNO [A007/03]
- 8 1 PROFILO PER PANNELLO FORATO [A007/11]

LA SOLUZIONE OTTIMALE PER ARREDARE LA TUA OFFICINA, IL TUO GARAGE O IL TUO ANGOLO RACING

Dimensioni

1960 x 498 x 2000h mm



Art. A007D

ARREDAMENTO MODULARE PER OFFICINA

€ 2850,00



- 1 3 ARMADI PENSILI CON AMMORTIZZATORI [A007/01]
- 2 1 ARMADIO ALTO CON 3 PIANI INTERNI [A007/02]
- 3 3 PANNELLI FORATI [A007/10]
- 4 3 PROFILI DI GIUNZIONE PER PANNELLI FORATI [A007/07]
- 5 1 PIANO IN LEGNO [A007/09]
- 6 1 CASSETTIERE A 5 CASSETTI SU CUSCINETTI [A007/05]
- 7 1 ARMADIO BASSO A DUE ANTE CON UN PIANO INTERNO [A007/03]
- 8 1 CASSETTIERA A 4 CASSETTI SU CUSCINETTI [A007/04]
- 9 1 PROFILO PER PANNELLO FORATO [A007/11]

LA SOLUZIONE OTTIMALE PER ARREDARE LA TUA OFFICINA, IL TUO GARAGE O IL TUO ANGOLO RACING

Dimensioni

2640 x 498 x 2000h mm





Art. B019

BANCO CHIUDIBILE IN ACCIAIO

€ 520,00



Dimensioni piano	1195 x 648 x 41 mm
Portata	225 kg
Peso	47 kg
Dimensioni imballo	1420 x 705 x 170 mm

BANCO CHIUDIBILE IN ACCIAIO, CON PIANO RICHIUDIBILE AIUTATO DA 2 AMMORTIZZATORI AD ARIA, PANNELLO PORTA ATTREZZI 1195 x 458 x 20 mm, ALTEZZA MASSIMA 1380 mm, LARGHEZZA MASSIMA 1280 mm, PROFONDITÀ BANCO APERTO 648 mm, PROFONDITÀ BANCO CHIUSO 130 mm AD UN'ALTEZZA DI 330 mm, BLOCCAGGI PER PIANO APERTO E CHIUSO, PANNELLO CON FORI Ø 4 mm, INTERASSE FORI 25 mm PER GANCI CON FILO DI Ø 3 mm



Art. B019/G030

SERIE GANCI

€ 10,90



10 Pz

Lunghezza	30 mm
Interasse dei perni	25 mm



Art. B015

BANCO DA LAVORO IN FERRO IN KIT DI MONTAGGIO

€ 519,00



Dimensioni banco	1500 x 645 x 865h mm
Spessore gambe	1,0 mm
Spessore piano	2 mm
Cassetti con chiave	2
Peso	69,5 kg





Art. B017
BANCO DA LAVORO IN KIT DI MONTAGGIO

€ 345,00



Dimensioni banco	1524 x 650 x 845h mm
Spessore gambe	1,0 mm
Spessore piano	40 mm
Peso	42,5 kg



Art. B017/C
CASSETTO IN ACCIAIO CON SERRATURA

€ 70,00



Dimensioni	680 x 270 x 130 mm
Portata	18,5 kg
Peso	4,3 kg



Art. B016
BANCO DA LAVORO IN KIT DI MONTAGGIO

€ 922,00



Dimensioni banco	1524 x 650 x 845h mm
Spessore gambe	1,0 mm
Spessore piano	40 mm
Cassetti con chiave	3
Peso	120 kg



Art. B009/A
BANCO DA LAVORO IN KIT DI MONTAGGIO

€ 477,00



Dimensioni banco	1400 x 700 x 850h mm
Spessore gambe	1,0 mm
Spessore piano	40 mm
Cassetti con chiave	3
Peso	64 kg





Art. B009/B
BANCO DA LAVORO IN KIT DI MONTAGGIO

€ 675,00



Dimensioni banco	1400 x 700 x 850h mm
Spessore gambe	1,0 mm
Spessore piano	40 mm
Cassetti con chiave	3
Armadietto con chiave	1
Peso	83 kg



Art. P009
ARMADIETTO DA PARETE IN KIT DI MONTAGGIO

€ 181,00

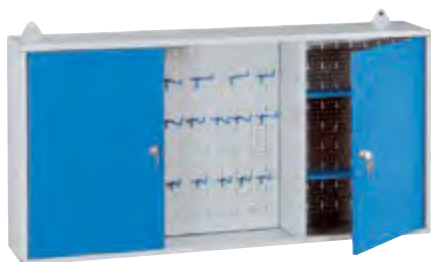

Dimensioni armadietto	1200 x 200 x 600h mm
Spessore lamiera	0,8 mm
Ripiani interni	4
Ganci	18 (6 + 6 + 6)
Peso	18 kg



SERIE GANCI



10 Pz

Codice	Interasse dei perni	Lunghezza	€
G050	30 mm	80 mm	10,90
G130	30 mm	155 mm	15,20



Art. C032
CASSETTIERA PORTA UTENSILI

€ 585,00



Portata cassetto	50 kg
Dimensioni esterne	580 x 600 x 775h mm
Dim. interne cassetto 1	470 x 470 x 140h mm
Dim. interne cassetto 2	470 x 470 x 190h mm
Dim. interne cassetto 3	470 x 470 x 285h mm
Peso	79,5 kg

CASSETTIERA PORTA UTENSILI, 3 CASSETTI SU CUSCINETTI CON SERRATURA, SENZA DIVISORIE



Art. A100
 ARMADIETTO

€ 260,00

Dimensioni armadietto	500 x 460 x 1000h mm
Spessore lamiera	1 mm
Ripiani interni	2
Peso	35 kg

ARMADIETTO CON 1 CASSETTO SU SFERE CON SERRATURA

Art. A300
 ARMADIETTO

€ 418,00

Dimensioni armadietto	1000 x 460 x 1000h mm
Spessore lamiera	1 mm
Ripiani interni	2
Peso	66 kg

ARMADIETTO CON 2 CASSETTI SU SFERE CON SERRATURA

Art. C800
 CASSETTIERA PORTA UTENSILI

€ 898,00

Portata cassetto	50 kg
Dimensioni esterne	630 x 550 x 930h mm
8 cassetti tipo A dimensioni interne	517 x 440 x 73h mm
Peso	61 kg

CASSETTIERA PORTA UTENSILI CON 8 CASSETTI SU CUSCINETTI CON SERRATURA, SENZA DIVISORIE

Art. C600
 CASSETTIERA PORTA UTENSILI

€ 725,00

Portata cassetto	50 kg
Dimensioni esterne	630 x 550 x 930h mm
6 cassetti tipo B dimensioni interne	517 x 440 x 115h mm
Peso	56 kg

CASSETTIERA PORTA UTENSILI CON 6 CASSETTI SU CUSCINETTI CON SERRATURA, SENZA DIVISORIE





Art. C603
CASSETTIERA PORTA UTENSILI

€ 872,00



Portata cassetto	50 kg
Dimensioni esterne	630 x 550 x 930h mm
3 cassetti tipo A dimensioni interne	517 x 440 x 73h mm
2 cassetti tipo B dimensioni interne	517 x 440 x 115h mm
1 cassetto tipo C dimensioni interne	517 x 440 x 175h mm
Peso	53,5 kg

CASSETTIERA PORTA UTENSILI CON 6 CASSETTI SU CUSCINETTI CON SERRATURA, SENZA DIVISORIE



SEPARATORI PER CASSETTO "A"



10 Pz

Codice	Separatore longitudinale	Separatore trasversale	Set pz	€
C800/CC	440 x 70h mm	-	10	53,80
C800/LL	-	517 x 70h mm	10	59,20



SEPARATORI PER CASSETTO "B"



10 Pz

Codice	Separatore longitudinale	Separatore trasversale	Set pz	€
C600/C	440 x 110h mm	-	10	117,00
C600/L	-	120 x 110h mm	10	26,90



SEPARATORI PER CASSETTO "C"



10 Pz

Codice	Separatore longitudinale	Separatore trasversale	Set pz	€
C603/C	440 x 165h mm	-	10	154,00
C603/L	-	120 x 165h mm	10	32,20



Art. C700
CASSETTIERA IN ACCIAIO CON VALIGETTE IN PLASTICA

€ 585,00



Dimensioni	490 x 343 x 987h mm
Peso totale	27 kg

CASSETTIERA IN ACCIAIO CON VALIGETTE IN PLASTICA, VANO INFERIORE CON SERRATURA, VANO SUPERIORE CON 7 VALIGETTE CON SERRATURA CENTRALE 4xC360 + 3xC371





Art. C900/A
CASSETTA ATTREZZI

€ 270,00



Dimensioni	660 x 322 x 380h mm
Peso	23 kg

CASSETTA ATTREZZI CON 6 CASSETTI CON SERRATURA CENTRALE E VASSOIO PORTATILE



Art. 0423/1
VALIGETTA PORTAMINUTERIA

€ 31,10



Dimensioni	334 x 240 x 45 mm
Peso	1,7 kg
Imballo	10

VALIGETTA IN METALLO PORTA MINUTERIA CON 16 CONTENITORI PLASTICI PICCOLI E 4 MEDI, CON DIMENSIONI RISPETTIVAMENTE DI 54 x 52 x 43h mm E 54 x 105 x 43h mm. LA VALIGETTA, IDEALE PER RIPORRE MINUTERIA, HA UNA CHIUSURA DI SICUREZZA CENTRALE PER EVITARE IL ROVESCIAMENTO INVOLONTARIO DELLA MINUTERIA



Art. 0423/2
VALIGETTA PORTAMINUTERIA

€ 36,70



Dimensioni	388 x 295 x 45 mm
Peso	1,9 kg
Imballo	6

VALIGETTA IN METALLO PORTA MINUTERIA CON 29 CONTENITORI PLASTICI PICCOLI E 3 MEDI, CON DIMENSIONI RISPETTIVAMENTE DI 54 x 52 x 43h mm E 54 x 105 x 43h mm. LA VALIGETTA, IDEALE PER RIPORRE MINUTERIA, HA UNA CHIUSURA DI SICUREZZA CENTRALE PER EVITARE IL ROVESCIAMENTO INVOLONTARIO DELLA MINUTERIA





CASSETTIERE CON CASSETTI ESTRAIBILI TRASPARENTI



Codice	Dimensioni esterne	Dimensioni cassetto	Numero cassetti	Imballo	€
C080/3	382 x 290 x 230h mm	372 x 285 x 73h mm	3	4*	57,80
C080/6	382 x 290 x 230h mm	184 x 285 x 73h mm	6	4*	57,50
C080/9	382 x 290 x 230h mm	122 x 285 x 73h mm	9	4*	58,50



CASSETTIERE CON CASSETTI ESTRAIBILI TRASPARENTI



Codice	Dimensioni esterne	Dimensioni cassetto	Numero cassetti	Imballo	€
C085/12	382 x 148 x 230h mm	122 x 145 x 55h mm	12	8*	35,00
C085/16	382 x 148 x 230h mm	90 x 145 x 55h mm	16	8*	35,00
C085/24	382 x 148 x 230h mm	59 x 145 x 55h mm	24	8*	39,50



CONTENITORE UNIVERSALE



Codice	Dimensioni	Imballo	€
C090/2	108 x 167 x 75h mm	60*	2,52
C090/3	151 x 237 x 126h mm	24*	5,00
C090/4	213 x 350 x 164h mm	21*	11,20
C090/5	310 x 490 x 190h mm	12*	18,50
C090/6	380 x 610 x 250h mm	1	37,20



SERIE CONTENITORI BIVALVE

 **20 Pz**

Codice	Dimensione	€
0422/B1	65 x 47 x 30 mm	8,80
0422/B3	75 x 60 x 40mm	15,20

SERIE 20 CONTENITORI BIVALVE, PRATICHE PER IMMAGAZZINARE PICCOLI OGGETTI COME VITI, BULLONI, DADI, GANCETTI, CHIODI

Art. C312
VALIGETTA PORTA MINUTERIA
€ 8,00

Dimensioni	320 x 260 x 50 mm
Peso	0,5 kg
Imballo	48

VALIGETTA PORTA MINUTERIA IN PLASTICA CON 21 SCOMPARTI E DIVISORIE RIMOVIBILI, PER POTER IMMAGAZZINARE OGGETTI PIÙ GRANDI DELLO SCOMPARTO ORIGINALE

Art. C315
VALIGETTA PORTA MINUTERIA
€ 12,50

Dimensioni	380 x 310 x 60 mm
Peso	0,75 kg
Imballo	16

VALIGETTA PORTA MINUTERIA IN PLASTICA CON 21 SCOMPARTI E DIVISORIE RIMOVIBILI, PER POTER IMMAGAZZINARE OGGETTI PIÙ GRANDI DELLO SCOMPARTO ORIGINALE

Art. C313
CASSETTIERA CON 4 VALIGETTE PORTA MINUTERIA
€ 69,90

Dimensioni	377 x 265 x 310 mm
Peso	4,7 kg
Imballo	2

CASSETTIERA MODULARE CON 4 VALIGETTE PORTA MINUTERIA IN PLASTICA, CON 13 VASCHETTE ESTRAIBILI DI VARIE DIMENSIONI DOTATA DI INCASTRI LATERALI PER LA SOVRAPPOSIZIONE E FORI POSTERIORI PER IL FISSAGGIO A MURO





Art. C360
VALIGETTA PORTA MINUTERIA

€ 23,60



Dimensioni 443 x 317 x 80h mm
Imballo 8

VALIGETTA IN PLASTICA PORTA MINUTERIA CON 23 SCOMPARTI E 16 SEPARATORI RIMOVIBILI



Art. C371
VALIGETTA PORTA MINUTERIA

€ 38,50



Dimensioni 443 x 317 x 107h mm
Imballo 6

VALIGETTA IN PLASTICA PORTA MINUTERIA CON 2 VASCHEE GRANDI, 3 VASCHEE MEDIE, 6 VASCHEE PICCOLE



Art. C163
VALIGETTA PER UTENSILI

€ 14,50



Dimensioni 394 x 160 x 195h mm
Imballo 8*

VALIGETTA PER UTENSILI LUCCHETTABILE IN POLIPROPILENE 16" CON VASCETTA MOBILE E 2 SCOMPARTI PORTA MINUTERIA NEL COPERCHIO



Art. C165
VALIGETTA PER UTENSILI

€ 27,50



Dimensioni 514 x 225 x 260h mm
Imballo 6*

VALIGETTA PER UTENSILI IN POLIPROPILENE 20" CON VASCETTA MOBILE E 2 SCOMPARTI PORTA MINUTERIA NEL COPERCHIO



Art. C648
VALIGETTA PER UTENSILI

€ 53,30



Dimensioni 510 x 280 x 220h mm
Imballo 2

VALIGETTA PER UTENSILI IN INOX - POLIPROPILENE CON VASCETTA MOBILE



VALIGIA RESISTENTE ALL'ACQUA

Codice	Dimensioni esterne	Dimensioni interne	Peso	Imballo	€
M138	465 x 360 x 175h mm	425 x 287 x 115h mm	2,9 kg	2	63,30
M139	570 x 410 x 215h mm	505 x 353 x 140h mm	5,1 kg	2	86,90

VALIGIA PORTA STRUMENTI A TENUTA STAGNA IN POLIPROPILENE, CON VALVOLA DI DEPRESSURIZZAZIONE, INTERNO PERSONALIZZABILE CON SPUGNA PRETAGLIATA A CUBETTI PER ALLOGGIARE QUALSIASI TIPO DI STRUMENTO

VALIGIA PORTA UTENSILI IN ALLUMINIO

Codice	A	B	C	D	E	Peso	Imballo	€
0680	510 mm	375 mm	185 mm	110 mm	75 mm	5,8 kg	3	130,00
0681	440 mm	390 mm	185 mm	110 mm	75 mm	5,2 kg	3	112,00

UTENSILI NON INCLUSI

Art. 0682 € 93,50
VALIGIA PORTA UTENSILI IN ABS

A	460 mm
B	330 mm
C	150 mm
D	98 mm
E	52 mm
Peso	2,9 kg
Imballo	5

UTENSILI NON INCLUSI

Art. 0683 € 159,00
VALIGIA PORTA UTENSILI IN ABS CON CARRELLO

A	460 mm
B	330 mm
C	190 mm
D	98 mm
E	92 mm
Peso	4,5 kg
Imballo	4

UTENSILI NON INCLUSI





Art. 0390
BORSA PORTA UTENSILI

€ 43,30



Tasche	14
Dimensioni	400 x 225 x 250h mm 16" x 9" x 10" h
Peso	1,6 kg
Imballo	3

BORSA PORTA UTENSILI CON TRACCOLLA IN POLIESTERE 1680 DENARI



Art. 0395
BORSA PORTA UTENSILI

€ 53,30



Tasche	19
Dimensioni	480 x 250 x 225h mm / 19" x 10" x 9" h
Peso	2 kg
Imballo	2

BORSA PORTA UTENSILI CON TRACCOLLA IN POLIESTERE 1680 DENARI



Art. 0408
BORSA PORTA UTENSILI

€ 9,20



Dimensioni	240 x 140 x 100 mm
Imballo	100

BORSA PORTA UTENSILI A 4 TASCHE, COSTRUITA IN POLIESTERE. SI ADATTA AD OGNI CINTURA E PUÒ ESSERE USATA PER CONTENERE PICCOLI TESTER, PINZE, FORBICI, CACCIAVITI E UTENSILI VARI



Art. 0409
BORSA PORTA UTENSILI

€ 11,20



Dimensioni	250 x 210 x 70 mm
Imballo	100

BORSA PORTA UTENSILI A 10 TASCHE CON CINTURA, COSTRUITA IN POLIESTERE. SI PUÒ USARE PER CONTENERE PICCOLI TESTER, PINZE, FORBICI, CACCIAVITI E UTENSILI VARI



Art. 0254
BORSA INSTALLATORE

€ 8,30



Tasche	5
Imballo	10* / 40

BORSA INSTALLATORE IN PELLE CON CINTURA



Art. 0264
BORSA INSTALLATORE
€ 16,80

Tasche	11
Imballo	6* / 24

BORSA INSTALLATORE IN PELLE CON CINTURA

Art. C670
BANCO MOBILE
€ 1110,00

Dimensioni	1170 x 475 x 1015h mm
Dimensioni piano	1060 x 460 x 15h mm
Dimensioni armadietto	320 x 445 x 560h mm
Cassetti armadietto	n°2 290 x 400 x 65h mm
Dimensioni cassetto	1) 935 x 405 x 105h mm
Dimensioni cassetto	2) 565 x 405 x 65h mm
Dimensioni cassetto	3) 565 x 405 x 65h mm
Dimensioni cassetto	4) 565 x 405 x 65h mm
Dimensioni cassetto	5) 565 x 405 x 145h mm
Dimensioni cassetto	6) 565 x 405 x 145h mm
Portata cassetto	25 kg
Peso	97 kg

BANCO MOBILE COMPOSTO DA 6 CASSETTI CON GUIDE SU SFERE, ARMADIETTO CON 2 CASSETTI, 2 RUOTE FISSE E 2 GIREVOLI, PORTAROTOLO CARTA

Art. C660
BANCO MOBILE
€ 872,00

Dimensioni	1170 x 475 x 850h mm
Dimensioni piano	1060 x 460 x 15h mm
Dimensioni armadietto	320 x 445 x 560h mm
Mensola interna	410 x 410 mm
Dimensioni cassetto	1) 570 x 405 x 65h mm
Dimensioni cassetto	2) 570 x 405 x 65h mm
Dimensioni cassetto	3) 570 x 405 x 65h mm
Dimensioni cassetto	4) 570 x 405 x 145h mm
Dimensioni cassetto	5) 570 x 405 x 145h mm
Portata cassetto	25 kg
Peso	80 kg

BANCO MOBILE COMPOSTO DA 5 CASSETTI CON GUIDE SU SFERE, ARMADIETTO, 2 RUOTE FISSE E 2 GIREVOLI, PORTAROTOLO CARTA



Art. C980
CARRELLO PORTA UTENSILI

€ 980,00



3 cassetti	565 x 405 x 50h mm
3 cassetti	565 x 405 x 105h mm
1 cassetto	565 x 405 x 165h mm
Portata cassetto	25 kg
Dimensioni cassettiera	890 x 530 x 1030h mm
Peso	101 kg

CARRELLO PORTA UTENSILI A 7 CASSETTI, CON DUE ARMADI LATERALI PROVISTI DI 12 GANCI E 10 CONTENITORI PORTAMINUTERIA ESTRAIBILI, BLOCCAGGIO DI SICUREZZA SU OGNI CASSETTO, GUIDE SU CUSCINETTI, SERRATURA CENTRALE, 2 RUOTE FISSE E 2 GIREVOLI



Art. C960
CARRELLO PORTA UTENSILI

€ 606,00



CARRELLO PORTA UTENSILI, CON CASSETTI DI SICUREZZA ANTI-RIBALTAMENTO CON GUIDE SU SFERE, SERRATURA CENTRALE, PORTAROTOLO E VASSOIO, 2 RUOTE FISSE E 2 GIREVOLI

5 Cassetti	565 x 405 x 65h mm
2 Cassetti	565 x 405 x 145h mm
Portata cassetto	25 kg
Dimensioni cassettiera	890 x 475 x 1015h mm
Peso	65 kg



Art. C900/B
CARRELLO PORTA UTENSILI

€ 486,00



Dimensioni	685 x 455 x 850h mm
2 Cassetti	585 x 410 x 45 mm
2 Cassetti	585 x 410 x 100 mm
2 Cassetti	585 x 410 x 150 mm
Portata cassetto	25 kg
Peso	48 kg

CARRELLO PORTA UTENSILI COMPOSTO DA 6 CASSETTI CON SERRATURA CENTRALE 2 RUOTE FISSE E 2 GIREVOLI





Art. C902/B
CARRELLO PORTA UTENSILI

€ 331,00



Dimensioni del vano	575 x 430 x 315h mm
Dimensioni	680 x 435 x 780h mm
Portata cassetto	25 kg
Peso	27 kg

CARRELLO PORTA UTENSILI COMPOSTO DA 3 CASSETTI E VANO INFERIORE PORTA ATTREZZI, CON SERRATURA CENTRALE, 2 RUOTE FISSE E 2 GIREVOLI



Art. C655
CARRELLO PORTA UTENSILI

€ 640,00



Dimensioni	748 x 520 x 850h mm
Portata cassetto	25 kg
Peso	54 kg

CARRELLO PORTA UTENSILI COMPOSTO DA 3 CASSETTI, VANO SUPERIORE PORTA ATTREZZI CON SERRATURA CENTRALE, 2 RUOTE FISSE E 2 GIREVOLI



Art. C190C
CARRELLO A 7 CASSETTI COMPLETO DI UTENSILI

€ 1277,00



152 Pz

Dimensioni	724 x 470 x 1032 mm
Peso	92,7 kg

CARRELLO A 7 CASSETTI COMPLETO DI 152 UTENSILI, CON SISTEMA ANTIRIBALTAMENTO. SI PUÒ APRIRE UN SOLO CASSETTO ALLA VOLTA; PIANO DI LAVORO IN MATERIALE PLASTICO E LEGNO CON PRATICI SCOMPARTI, MENSOLA A SCOMPARSA E VANO PORTA ATTREZZI O BOMBOLETTE SU DI UN LATO, PORTA CACCIAVITI E VANO PORTA ATTREZZI O BOMBOLETTE SULL'ALTRO LATO





Art. C960C

CARRELLO COMPLETO DI UTENSILI

€ 1060,00



291 Pz

Pezzi	291
Imballo	1

CARRELLO COMPLETO DI UTENSILI
CON I SEGUENTI TERMOFORMATI:

C960/1 - C960/2
C960/3 - C960/4

C960/5 - C960/6
C960/7 - C960/8



Art. C960C01

CARRELLO COMPLETO DI UTENSILI

€ 1392,00



221 Pz

Pezzi	221
Imballo	1

CARRELLO COMPLETO
DI UTENSILI COMPOSTO
DAI TERMOFORMATI:

C900/B01 - C900/B02
C900/B03 - C900/B05
C900/B06 - C900/B07

C900/B09 - C900/B10
C900/B11 - C900/B12



Art. C960C02

CARRELLO COMPLETO DI UTENSILI

€ 1510,00

192 Pz

Pezzi	192
Imballo	1

 CARRELLO COMPLETO
DI UTENSILI COMPOSTO
DAI TERMOFORMATI:

 C900/B01 - C900/B02
C900/B03 - C900/B04
C900/B05 - C900/B06

 C900/B07 - C900/B08
C900/B11 - C900/B12

Art. C960C03

CARRELLO COMPLETO DI UTENSILI

€ 1360,00

163 Pz

Pezzi	163
Imballo	1

 CARRELLO COMPLETO
DI UTENSILI COMPOSTO
DAI TERMOFORMATI:

 C900/B03 - C900/B04
C900/B05 - C900/B06
C900/B07 - C900/B08

 C900/B09 - C900/B10
C900/B11 - C900/B12



Art. C900/B01

SERIE DI CHIAVI A BUSSOLA 1/4" - 3/8" - 1/2" IN VASSOIO TERMOFORMATO

€ 105,00



62 Pz Cr-V

Misure	400 x 280 x 40 mm
Pezzi	62
Peso	3.89 kg
Imballo	5

1 SNODO A CARDANO DA 1/2" , 3/8" E 1/4"; 8 BUSSOLE LUNGHE 1/4": 6, 7, 8, 9, 10, 11, 12, 13 mm; 17 BUSSOLE DA 1/2": 12, 13, 14, 16, 17, 18, 19, 20, 21, 22, 24, 25, 27, 28, 29, 30, 32 mm; 2 BUSSOLE PER CANDELA DA: 16, 21 mm; 10 BUSSOLE 3/8": 15, 16, 17, 18, 19, 20, 21, 22, 23, 24 mm; 13 BUSSOLE DA 1/4": 4, 4.5, 5, 5.5, 6, 7, 8, 9, 10, 11, 12, 13, 14 mm; 11 BUSSOLE SAE DA: 1/4", 1/2", 7/16", 15/32", 13/32", 3/8", 11/32", 9/32", 7/3", 1/4", 3/16", 5/32", CHROME- VANADIUM



Art. C900/B02

SERIE DI CRICCHETTI, BRUGOLE, PROLUNGHE E MANICI IN VASSOIO TERMOFORMATO

€ 99,00



20 Pz Cr-V

Misure	400 x 280 x 40 mm
Pezzi	20
Peso	3.3 kg
Imballo	5

3 CRICCHETTI REVERSIBILI DA 1/2", 3/8" E 1/4"; 9 CHIAVI A BRUGOLA A "L" CON PUNTA ARROTONDATA: 1.5, 2, 2.5, 3, 4, 5, 6, 8, 10 mm; 3 LEVE A T SCORREVOLI DA 1/2", 3/8" E DA 1/4"; 1 PROLUNGA DA 1/2": 254 mm; 1 PROLUNGA DA 1/4": 50 mm; 2 PROLUNGHE DA 3/8": 76 e 127 mm; 1 MANICO PER BUSSOLE DA 1/4", CHROME- VANADIUM



Art. C900/B03

SERIE DI PINZE E CHIAVI A RULLINO IN VASSOIO TERMOFORMATO

€ 45,00



6 Pz

Misure	400 x 280 x 34 mm
Pezzi	6
Peso	1,9 kg
Imballo	5

3 CHIAVI A RULLINO: 150 - 200 - 250 mm; 1 PINZA UNIVERSALE: 200 mm; 1 PINZA BECCHI LUNGI: 200 mm; 1 TRONCHESE A TAGLIENTE LATERALE: 150 mm



Art. C900/B04

SERIE DI PINZE PER ANELLI ELASTICI IN VASSOIO TERMOFORMATO

€ 50,00



8 Pz

Misure	400 x 280 x 42 mm
Pezzi	8
Peso	1,8 kg
Imballo	5

2 PINZE CURVE PER SEEGER ESTERNI: 150 - 170 mm;
2 PINZE CURVE PER SEEGER INTERNI: 150 - 180 mm;
2 PINZE DRITTE PER SEEGER ESTERNI: 160 - 180 mm;
2 PINZE DRITTE PER SEEGER INTERNI: 160 - 180 mm



Art. C900/B05

SERIE DI GIRAVITI IN VASSOIO TERMOFORMATO

€ 59,00

16 Pz Cr-Mo

Misure	400 x 280 x 40 mm
Pezzi	16
Peso	1.29 kg
Imballo	5

5 GIRAVITI A TAGLIO: 6x38, 3x75, 5x100, 6x125, 8x150 mm; 4 GIRAVITI A CROCE PH: 2x38, 0x75, 1x100, 2x125 mm; 2 GIRAVITI A CROCE PZ: 0x75, 1x100 mm; 5 GIRAVITI TORX: T10x75, T15x75, T20x100, T25x100, T30x100, CHROME - MOLYBDENUM

Art. C900/B06

SERIE DI CHIAVI TORX E ESAGONALI IN VASSOIO TERMOFORMATO

€ 32,00

10 Pz

Misure	400 x 280 x 34 mm
Pezzi	10
Peso	0.84 kg
Imballo	5

5 CHIAVI ESAGONALI: 2, 3, 4, 5, 8 mm; 5 CHIAVI TORX: T15, T20, T25, T27, T30

Art. C900/B07

SERIE DI CHIAVI COMBinate IN VASSOIO TERMOFORMATO

€ 143,00

22 Pz Cr-V

Misure	400 x 280 x 42 mm
Pezzi	22
Peso	3.74 kg
Imballo	5

22 CHIAVI COMBIANTE: 6, 7, 8, 9, 10, 11, 12, 13, 14, 15, 16, 17, 18, 19, 20, 21, 22, 23, 24, 26, 28, 30 mm, CHROME- VANADIUM

Art. C900/B08

SERIE DI CHIAVI FISSE E CHIAVI SNODATE IN VASSOIO TERMOFORMATO

€ 122,00

16 Pz Cr-V

Misure	400 x 280 x 42 mm
Pezzi	16
Peso	2.95 kg
Imballo	5

10 CHIAVI FISSE: 6x7, 8x9, 10x11, 12x13, 14x15, 16x17, 18x19, 20x22, 21x23, 24x26 mm; 6 CHIAVI CON BUSSOLA SNODATA: 8x9, 10x11, 12x13, 14x15, 16x17, 18x19 mm; CHROME- VANADIUM





Art. C900/B09

SERIE DI SCALPELLI E PINZE IN VASSOIO TERMOFORMATO

€ 51,00



15 Pz

Misure	400 x 280 x 32 mm
Pezzi	15
Peso	2.65 kg
Imballo	5

1 PINZA GRIP; 1 PINZA DA IDRAULICO; 6x150 mm; 3 CACCIASPINE: 3 - 4 - 6 x 150 mm; 3 CACCIASPINE CONICI: 3 - 4 - 5 x 125 mm; 1 BULINO 6x150 mm



Art. C900/B10

SERIE DI MARTELLI BRUGOLE E BUSSOLE IN VASSOIO TERMOFORMATO

€ 47,00



38 Pz

Misure	400 x 280 x 42 mm
Pezzi	38
Peso	1,89 kg
Imballo	5

13 BUSSOLE DA 1/4": 4, 4.5, 5, 5.5, 6, 7, 8, 9, 10, 11, 12, 13, 14 mm; 9 CHIAVI A "L" TORX: T10, T15, T20, T25, T27, T30, T40, T45, T50; 2 INSERTI DA 3/8": M12, T60; 5 INSERTI TORX DA 1/4": T20, T25, T27, T30, T40; 7 INSERTI ESAGONALI DA 3/8": 4, 5, 6, 7, 8, 10, 12 mm; 1 MAZZUOLO ANTIRIMBALZO; 1 MARTELLINO TIPO TEDESCO



Art. C900/B11

SERIE DI CHIAVI POLIGONALI IN VASSOIO TERMOFORMATO

€ 93,00



16 Pz Cr-V

Misure	400 x 280 x 43 mm
Pezzi	16
Peso	2.47 kg
Imballo	5

8 CHIAVI POLIGONALI: 6x7, 8x9, 10x11, 12x13, 14x15, 16x17, 18x19, 20x22 mm; 8 CHIAVI POLIGONALI A PROFILO RIBASSATO: 6x7, 8x9, 10x11, 12x13, 14x15, 16x17, 18x19, 20x22 mm; CHROME- VANADIUM



Art. C900/B12

SERIE DI CHIAVI A PIPA E CHIAVI PER RACCORDI IN VASSOIO TERMOFORMATO

€ 158,00



16 Pz Cr-V

Misure	400 x 280 x 46 mm
Pezzi	16
Peso	4 kg
Imballo	5

8 CHIAVI PER RACCORDI: 8x10, 11x13, 12x14, 21x23, 17x19, 19x22, 24x27, 30x32 mm; 8 CHIAVI A TUBO A "L": 8, 10, 11, 13, 16, 17, 18, 19 mm; CHROME- VANADIUM



**Art. C960/1**

UTENSILI IN VASSOIO TERMOFORMATO PER CASSETTIERE

€ 188,00
 **121 Pz**

Serie chiavi a bussola esagonali	Dr. 1/4" - 3/8" 1/2" (4 - 32mm)
Misure	560 x 395 x 52h mm
Pezzi	121

**Art. C960/2**

UTENSILI IN VASSOIO TERMOFORMATO PER CASSETTIERE

€ 89,60
 **23 Pz**

Misure	560 x 395 x 52h mm
Pezzi	23

UTENSILI IN VASSOIO TERMOFORMATO PER CASSETTIERE, SERIE UTENSILI

**Art. C960/3**

UTENSILI IN VASSOIO TERMOFORMATO PER CASSETTIERE

€ 114,00
 **34 Pz**

Misure	330 x 395 x 52h mm
Pezzi	34

UTENSILI IN VASSOIO TERMOFORMATO PER CASSETTIERE, SERIE CHIAVI COMBinate, A RULLINO ED ESAGONALI

**Art. C960/4**

UTENSILI IN VASSOIO TERMOFORMATO PER CASSETTIERE

€ 57,00
 **60 Pz**

Misure	330 x 395 x 52h mm
Pezzi	60

UTENSILI IN VASSOIO TERMOFORMATO PER CASSETTIERE, SERIE CACCIATIVI



Art. C960/5

UTENSILI IN VASSOIO TERMOFORMATO PER CASSETTIERE

€ 71,10



8 Pz

Misure 330 x 395 x 52h mm

Pezzi 8

UTENSILI IN VASSOIO TERMOFORMATO PER CASSETTIERE, SERIE PINZE



Art. C960/6

UTENSILI IN VASSOIO TERMOFORMATO PER CASSETTIERE

€ 133,00



20 Pz

Misure 230 x 395 x 52h mm

Pezzi 20

UTENSILI IN VASSOIO TERMOFORMATO PER CASSETTIERE, SERIE CHIAVI FISSE E POLIGONALI DOPPIE



Art. C960/7

UTENSILI IN VASSOIO TERMOFORMATO PER CASSETTIERE

€ 42,50



17 Pz

Misure 230 x 395 x 52h mm

Pezzi 17

UTENSILI IN VASSOIO TERMOFORMATO PER CASSETTIERE, SERIE CHIAVI ESAGONALI E TORX



Art. C960/8

UTENSILI IN VASSOIO TERMOFORMATO PER CASSETTIERE

€ 51,70



7 Pz

Misure Size 230 x 395 x 52h mm

Pezzi 7

UTENSILI IN VASSOIO TERMOFORMATO PER CASSETTIERE, SERIE PINZE PER ANELLI ELASTICI E TRONCHESINA



Art. 0466/4V
 SERIE VASSOI MAGNETICI

€ 33,60

 4 Pz

Dimensioni ingombro	310 x 130 x 120h mm; 270 x 130 x 120h mm; 210 x 130 x 120h mm; 150 x 130 x 120h mm
Capacità	1,17 kg; 1 kg; 0,77 kg; 0,6 kg
Spessore lamiera	0,7 mm
Peso	3 kg

SERIE 4 VASSOI MAGNETICI, IN ACCIAIO VERNICIATO, PER ORGANIZZARE AL MEGLIO LO SPAZIO DI LAVORO

Art. 0466/C
 PORTA GIRAVITI MAGNETICO

€ 8,00

Dimensioni ingombro	280 x 60 x 60h mm
Giraviti	9
Fori	5 x Ø 9 mm; 4 x Ø 8 mm
Spessore lamiera	1,5 mm

PORTA GIRAVITI MAGNETICO, IN ACCIAIO VERNICIATO, PER ORGANIZZARE AL MEGLIO LO SPAZIO DI LAVORO

Art. 0466/CV
 VASSOIO MAGNETICO CON PORTA GIRAVITI

€ 14,00

Dimensioni	360 x 130 x 110h mm
Dimensioni cassetto	305 x 115 x 30h mm
Fori	6 x Ø 10 mm
Capacità	3.18 kg
Spessore lamiera	1 mm
Peso	1 kg

VASSOIO MAGNETICO CON PORTA GIRAVITI, IN ACCIAIO VERNICIATO, PER ORGANIZZARE AL MEGLIO LO SPAZIO DI LAVORO

Art. 0466/PB
 PORTA BUSSOLE MAGNETICO

€ 8,00

Dimensioni ingombro	280 x 45 x 90h mm
Misure bussole	1/4" - 3/8" - 1/2"
Spessore lamiera	0,9 mm

PORTA BUSSOLE MAGNETICO, IN ACCIAIO VERNICIATO, PER ORGANIZZARE AL MEGLIO LO SPAZIO DI LAVORO





Art. 0466/SA
SUPPORTO MAGNETICO PER AVVITATORE E BUSSOLE

€ 22,00



Dimensioni ingombro	130 x 120 x 400h mm
Diametro foro	80 mm
Capacità	9 kg
Peso	1,3 kg

SUPPORTO MAGNETICO PER AVVITATORE E BUSSOLE, IN ACCIAIO VERNICIATO, PER ORGANIZZARE AL MEGLIO LO SPAZIO DI LAVORO



Art. 0466/SC
SUPPORTO MAGNETICO PER 3 BOMBOLETTE SPRAY E 7 GIRAVITI

€ 16,00



Dimensioni ingombro	130 x 300 x 130h mm
Fori	3 x Ø 75 mm; 2 x Ø 12 mm; 1 x Ø 11 mm; 1 x Ø 10 mm; 1 x Ø 9 mm; 2 x Ø 7,5 mm
Capacità	1,19 kg
Spessore lamiera	0,8 mm
Peso	1,25 kg

SUPPORTO MAGNETICO PER 3 BOMBOLETTE SPRAY E 7 GIRAVITI, IN ACCIAIO VERNICIATO, PER ORGANIZZARE AL MEGLIO LO SPAZIO DI LAVORO

TABELLA DI COMPATIBILITÀ

Codice compatibile	Descrizione	€	C670	C660	C655	C900/c	C902/B	C960	C980	Pag
C900/B01	SERIE DI CHIAVI A BUSSOLA 1/4" - 3/8" - 1/2" IN VASSOIO TERMOFORMATO	105,00				•		•	•	513
C900/B02	SERIE DI CRICCHETTI, BRUGOLE, PROLUNGHE E MANICI IN VASSOIO TERMOFORMATO	99,00				•		•	•	513
C900/B03	SERIE DI PINZE E CHIAVI A RULLINO IN VASSOIO TERMOFORMATO	45,00				•		•	•	513
C900/B04	SERIE DI PINZE PER ANELLI ELASTICI IN VASSOIO TERMOFORMATO	50,00				•		•	•	513
C900/B05	SERIE DI GIRAVITI IN VASSOIO TERMOFORMATO	59,00				•		•	•	514
C900/B06	SERIE DI CHIAVI TOR• E ESAGONALI IN VASSOIO TERMOFORMATO	32,00				•		•	•	514
C900/B07	SERIE DI CHIAVI COMBinate IN VASSOIO TERMOFORMATO	143,00				•		•	•	514
C900/B08	SERIE DI CHIAVI FISSE E CHIAVI SNODATE IN VASSOIO TERMOFORMATO	122,00				•		•	•	514
C900/B09	SERIE DI SCALPELLI E PINZE IN VASSOIO TERMOFORMATO	51,00				•		•	•	515
C900/B10	SERIE DI MARTELLI BRUGOLE E BUSSOLE IN VASSOIO TERMOFORMATO	47,00				•		•	•	515
C900/B11	SERIE DI CHIAVI POLIGONALI IN VASSOIO TERMOFORMATO	93,00				•		•	•	515
C900/B12	SERIE DI CHIAVI A PIPA E CHIAVI PER RACCORDI IN VASSOIO TERMOFORMATO	158,00				•		•	•	515
C960/1	UTENSILI IN VASSOIO TERMOFORMATO PER CASSETTIERE	188,00	•	•				•	•	516
C960/2	UTENSILI IN VASSOIO TERMOFORMATO PER CASSETTIERE	89,60	•	•				•	•	516
C960/3	UTENSILI IN VASSOIO TERMOFORMATO PER CASSETTIERE	114,00	•	•				•	•	516
C960/4	UTENSILI IN VASSOIO TERMOFORMATO PER CASSETTIERE	57,00	•	•				•	•	516
C960/5	UTENSILI IN VASSOIO TERMOFORMATO PER CASSETTIERE	71,10	•	•				•	•	517
C960/6	UTENSILI IN VASSOIO TERMOFORMATO PER CASSETTIERE	133,00	•	•				•	•	517
C960/7	UTENSILI IN VASSOIO TERMOFORMATO PER CASSETTIERE	42,50	•	•				•	•	517
C960/8	UTENSILI IN VASSOIO TERMOFORMATO PER CASSETTIERE	51,70	•	•				•	•	517



Art. 0105
VALIGIA CON UTENSILI E ACCESSORI
€ 264,00

162 Pz Cr-V

Peso	11,8 kg
Chiavi esagonali	1,5-2-2,5-3-4-5-6-8-10 mm
Giraviti	(-) 5 x 75 - 6 x 100 mm - (+) 1 x 75 - 2 x 100 mm
Cercafasi	100 ÷ 250 V
Giraviti di precisione	(-) 2 x 140 - 2,4 x 140 - 3 x 140 - (+) 00 x 140 mm - 0 x 140 mm
Pinze	160 mm
Chiave a rullino	200 mm
Tronchese taglio laterale	160 mm
Pinze a becchi mezzitondi	160 mm
Tenaglia cementista	220 mm
Forbici multiuso	175 mm
Cacciapine e scalpelli	5
Pinze per anelli elastici con 3 teste	1
Pinza idraulico	240 mm
Chiavi combinate	8-10-11-12-13-15-17-19-21 mm
Bussole da 1/4"	4-4,5-5-5,5-6-7-8-9-10-11-12-13-14 mm
Bussole da 1/2"	12-13-14-15-16-17-18-19-21-24-27-30-32 mm
Leva a T scorrevole	1/4"
Snodo universale	1/4" - 1/2"
Prolunghe da 1/4"	50 mm - 100 mm
Prolunghe da 1/2"	125 mm - 250 mm
Attacco da 1/2" per leva a T	1
Misure bussole per candela	16 mm - 21 mm
Leve a cricchetto	1/4" - 1/2"
Lima	200 mm
Martello tedesco	300 g
Flessometro	5 m
Mini archetto con lama	1
Lame	3
Torcia in alluminio	1
Pinza fastonatrice	200 mm
Capicorda	35
Cutter	1
Livella	300 mm
Calibro a corsoio	150 mm
Porta inserti magnetico	1
Inserti	30 - 1/4"
Porta inserti a cricchetto	1
Adattatore maschio con quadro da 1/4" e esagono da 1/4"	1
Dimensioni valigia	470 x 350 x 135 mm
Valigia	Spessore lamiera





Art. 0110
VALIGIA CON UTENSILI E ACCESSORI

€ 215,00



130 Pz Cr-V

Peso	9,8 kg
Chiavi esagonali	1,5-2-2,5-3-4-5-6-8 mm
Giraviti	(-) 3 x 75 - 5 x 75 - 6 x 100 - 8 x 150 mm - (+) 0 x 75 - 1 x 75 - 2 x 100 3 x 100 mm
Giraviti di precisione	(-) 2,4 x 140 - (+) 00 x 140 mm - 0 x 140 mm
Pinze	180 mm
Pinza a 2 posizioni	150 mm
Tronchese taglio laterale	115 mm
Pinze a becchi mezzitondi	150 mm
Pinza spelafili	160 mm
Forbici	200 mm
Pinza idraulico	240 mm
Chiavi combinate	13-14-15-17-19 mm
Bussole da 1/4"	4-5-6-7-8-9-10-11-12-13-14 mm
Bussole da 1/2"	8-9-10-11-12-13-14-15-16-17-18-19-20-21-22 mm
Leva a T scorrevole	1/4"
Snodo universale	1/4" - 1/2"
Prolunghe da 1/4"	100 mm
Prolunghe da 1/2"	250 mm
Attacco da 1/2" per leva a T	1
Misure bussole per candela	16 mm - 21 mm
Leve a cricchetto	1/4" - 1/2"
Prolunga flessibile	1/4" - 145 mm
Bussola porta inserti	1/4"
Martello tedesco	300 g
Flessometro	5 m
Mini archetto con lama	1
Capicorda	20
Cutter	1
Lame	5
Livella	300 mm
Manico per bussole	1/4"
Porta inserti magnetico	1/4"
Inserti	30 - 1/4"
Adattatore maschio con quadro da 1/4" e esagono da 1/4"	1
Dimensioni valigia	470 x 350 x 135 mm
Valigia	Peso



**Art. 0165****VALIGETTA CON UTENSILI ED ACCESSORI****€ 260,00**

175 Pz Cr-V

Leve a cricchetto	1/4" - 1/2"
Chiavi a bussola per candele 1\2"	16 mm - 21 mm
Riduzione	1/2" (M) - 3/8" (F)
Porta inserti a cricchetto	1/4"
Bussole da 1/4"	4-4,5-5-5,5-6-7-8-9-10-11-12-13 mm
Porta bussole	1/4"
Bussole da 1/2"	10-11-12-13-14-15-16-17-18-19-20-21-22 23-24-27-30 mm
Leve a "T"	1/4" - 1/2"
Prolunghe da 1/4"	50 - 100 mm
Snodi a cardano	1/4" - 1/2"
Prolunga flessibile	1/4" - 150 mm
Chiavi esagonali a punta sferica	1,5-2-2,5-3-4-5-6-8-10 mm
Cercafasi	100 ÷ 250 V
Giraviti di precisione	(-) 1 - 1,4 - 1,8 - 2,4 - (+) 0 - 1
Pinze	200 - 180 - 160 mm
Chiave a rullino	200 mm
Pinza idraulico	250 mm
Chiavi combinate	6-8-10-11-12-13-14-15-17-19 mm
Martello tedesco	300 g
Flessometro	5 m
Mini archetto con lama	1
Livella magnetica	250 mm
Torcia in alluminio	1
Pinza fastonatrice	200 mm
Capicorda	50
Cutter	1
Pinza grip	175 mm
Nastro isolante	1
Calamita telescopica	1
Calibro a corsoio	150 mm
Giraviti per elettricista	(-) 5 x 125 - 4 x 100 - (+) 3 x 75 mm
Giraviti	(-) 3 x 75 - 3 x 100 - 5 x 75 - 6 x 38 - 6 x 100 mm (+) 3 x 75 - 3 x 100 - 5 x 75 - 6 x 38 - 6 x 100 - 8 x 150 mm
Porta inserti magnetico	1
Inserti	25 1/4"
Dimensioni valigetta	500 x 440 x 200/270 mm trolley
Carrello	1
Valigetta in plastica	1
Peso	15,5 kg

VALIGETTA CON UTENSILI ED ACCESSORI CON CARRELLO, CHROME-VANADIUM, 175 PEZZI





Art. 0315
VALIGETTA CON UTENSILI E ACCESSORI

€ 179,00



132 Pz Cr-V

Peso	9,5 kg
Chiavi esagonali	1,5 - 2 - 2,5 - 3 - 4 - 5 - 6 - 8 - 10 mm
Cercafasi	100 ÷ 250 V
Giraviti di precisione	(-) 1 - 1,4 - 1,8 - 2,4 - (+) 0 - 1
Pinze	200 - 180 - 160 mm
Chiave a rullino	250 mm
Pinza idraulico	250 mm
Chiavi combinate	6 - 8 - 10 - 11 - 12 - 13 - 14 - 15 - 17 - 19 mm
Martello tedesco	300 g
Flessometro	5 m
Mini archetto con lama	1
Livella magnetica	250 mm
Torcia in alluminio	1
Pinza fastonatrice	200 mm
Capicorda	50
Cutter	1
Pinza grip	175 mm
Nastro isolante	1
Calamita telescopica	1
Calibro a corsoio	150 mm
Giraviti per elettricista	(-) 5 x 125 - 4 x 100 - (+) 3 x 75 mm
Giraviti	(-) 3 x 75 - 3 x 100 - 5 x 75 - 6 x 38 - 6 x 100 mm (+) 3 x 75 - 3 x 100 - 5 x 75 - 6 x 38 - 6 x 100 - 8 x 150 mm
Porta inserti magnetico	1
Inserti	25 - 1/4"
Dimensioni valigetta	500 x 440 x 150 mm
Valigetta in plastica	1



Art. C081
SERIE BAULI CARRELLATI PORTA UTENSILI

€ 199,00



2 Pz

Dimensioni Baule piccolo con 2 vassoi mobili	610 x 375 x 415h mm
Dimensioni Baule grande	750 x 487 x 493h mm
Dimensioni imballo	750 x 495 x 500h mm
Peso	18 kg



Art. C087 € 216,00
CARRELLO PORTA UTENSILI

Dimensioni	560 x 350 x 770h mm
Dimensioni imballo	585 x 365 x 775h mm
Peso	14 kg

Art. 0849 € 227,00
SERIE BAULI IN ALLUMINIO

3 Pz

Dimensioni bauli	730 x 380 x 360h mm - 680 x 310 x 320h mm - 475 x 260 x 210h mm
Peso	15 kg

BAULE IN ALLUMINIO

Codice	Dimensioni esterne	Dimensioni interne	Peso	€
0382/02	760 x 335 x 250h mm	710 x 285 x 225h mm	5,5 kg	422,00
0382/03	1240 x 385 x 385h mm	1185 x 335 x 365h mm	14 kg	597,00
0382/04	1445 x 520 x 460h mm	1395 x 435 x 440h mm	21,5 kg	828,00
0382	760 x 335 x 250h mm, 1240 x 385 x 385h mm, 1445 x 520 x 460h mm	710 x 285 x 225h mm, 1185 x 335 x 365h mm, 1395 x 435 x 440h mm	41 kg	1410,00

BAULE IN ACCIAIO

Codice	Dimensioni esterne	Dimensioni interne	Peso	€
0363/30	770x420x305h mm	750 x 400 x 300h mm	14,5 kg	304,00
0363/36	915 x 440 x 565h mm	825 x 350 x 430h mm	35 kg	537,00
0363/48	1220 x 620 x 700h mm	1130 x 520 x 600h mm	57,5 kg	768,00
0363	770 x 420 x 305h mm, 915 x 440 x 565h mm, 1220 x 620 x 700h mm	750 x 400 x 300h mm, 825 x 350 x 430h mm, 1130 x 520 x 600h mm	107 kg	1060,00





Art. C650
CARRELLO A 3 VASCHE

€ 166,00



Dimensioni	800 x 450 x 800h mm
Spessore lamiera	2 mm
Ruote	Ø 80 mm
Portata	100 kg
Peso	23 kg

CARRELLO A 3 VASCHE, ROBUSTO E PRATICO DA ASSEMBLARE, 2 RUOTE FISSE E 2 RUOTE GIREVOLI



Art. C750
CARRELLO A 3 VASCHE

€ 273,00



Dimensioni	940 x 600 x 870h mm
Spessore lamiera	2,3 mm
Ruote	Ø 150 mm
Portata	200 kg
Peso	52 kg

CARRELLO A 3 VASCHE, ROBUSTO E PRATICO DA ASSEMBLARE, 2 RUOTE FISSE E 2 RUOTE GIREVOLI



Art. C009
CARRELLO CON PIANO IN LEGNO

€ 368,00



Dimensioni ingombro	1000 x 800 x 750h mm
Spessore lamiera	2 mm
Spessore piano	36 mm
Ruote	Ø 150 mm
Portata	150 kg
Peso	60 kg

CARRELLO IN ACCIAIO CON PIANO IN LEGNO, CON 2 RUOTE FISSE E 2 RUOTE GIREVOLI CON FRENO



Art. C1102
CARRELLO GOMMATO
€ 88,00

Ruote pneumatiche	Ø 260 x 85 mm
Portata	200 kg
Dimensioni pala	450 x 215 mm
Peso	8,5 kg
Imballo	40

CARRELLO GOMMATO PER VASI E SCATOLE, CON MANOPOLE ANTINFORTUNISTICHE, VERNICIATURA EPOSSIDICA

Art. C182
CARRELLO GOMMATO
€ 175,00

Ruote pneumatiche	Ø 260 x 85 mm
Portata	200 kg
Dimensioni pala	300 x 205 mm
Peso	6,5 kg

CARRELLO GOMMATO IN ALLUMINIO

Art. C189
CARRELLO MULTIUSO
€ 86,90

Ruote pneumatiche	Ø 260 x 85 mm
Portata	150 kg
Dimensioni pala	400 x 250 mm
Dimensioni pala mobile	340 x 390 mm
Peso	11,5 kg

CARRELLO MULTIUSO GOMMATO PER IL TRASPORTO DI LEGNA, VASI, SCATOLE E OGGETTI VARI. ROBUSTO, MANEGGEVOLE E VERSATILE

Art. 0461
RUOTA IN POLIURETANO
€ 19,10

Dimensioni ruota	250 x 75 mm
Dimensioni foro	Ø 20 - 18 x 74 mm
Peso	1,1 kg
Imballo	10

RUOTA IN POLIURETANO NON PERFORABILE DI DIMENSIONI 260 x 85 mm, CON CUSCINETTI A RULLI, FORO Ø 20 mm E RIDUZIONE DA 20 mm A 18 mm, PER CARRELLI CON ALBERO RUOTA 18-20 mm





Art. C150
CARRELLO CON PIATTAFORMA IN PVC

€ 64,90



Ruote gommate	Ø 100 mm
Portata	150 kg
Dimensioni piattaforma	700 x 450 mm
Altezza	820 mm
Peso	7,8 kg

CARRELLO CON PIATTAFORMA IN PVC, MANICO PIEGHEVOLE, 2 RUOTE FISSE E 2 RUOTE GIREVOLI



Art. C300
CARRELLO CON PIATTAFORMA IN PVC

€ 173,00



Ruote gommate	Ø 125 mm
Portata	400 kg
Dimensioni piattaforma	900 x 600 mm
Altezza	890 mm
Peso	15,6 kg

CARRELLO CON PIATTAFORMA IN PVC, MANICO PIEGHEVOLE, 2 RUOTE FISSE E 2 RUOTE GIREVOLI



Art. S017
SUPPORTO UNIVERSALE TELESCOPICO

€ 200,00



Altezza min - max	840 ÷ 1320 mm
Lunghezza	225 ÷ 1380 mm
Larghezza	860 mm
Portata	100 kg
Peso	24.5 kg

SUPPORTO UNIVERSALE REGOLABILE IN ALTEZZA E IN LUNGHEZZA COSTRUITO IN TUBI QUADRATI DI ACCIAIO, DOPO L'USO LO SI PUÒ RIPORRE IN POCO SPAZIO, PIANI DI APPOGGIO RIVESTITI IN GOMMA PER NON GRAFFIARE E RENDERE STABILE L'OGGETTO APPOGGIATO, 4 RUOTE GIREVOLI DI CUI 2 CON FRENO, ADATTO A LAVORI DI CARROZZERIA PER RIPARAZIONI, PREPARAZIONE E VERNICIATURA



Art. P019
PIATTAFORMA ANTISCIVOLO PIEGHEVOLE

€ 155,00



Portata	150 kg
Dimensioni	1260x380x500 mm
Dimensioni piattaforma	950x300 mm
Peso	7,5 kg

PIATTAFORMA ANTISCIVOLO PIEGHEVOLE IN ALLUMINIO, PROFESSIONALE E DI FACILE USO, IDEALE PER UNA VASTA GAMMA DI LAVORI IN DIVERSI SETTORI, DA QUELLO DOMESTICO A QUELLO AUTO





Art. 0645/S
SGABELLO PER OFFICINA

€ 52,20



Dimensioni	368 x 360 x 365 mm
Peso	3,8 kg
Scatola	



Art. 0645/CP
CARRELLO SOTTOAUTO IN PLASTICA

€ 64,90



Dimensioni	1000 x 470 x 120h mm
Peso	5,5 kg
Scatola	



Art. 0645/CS
CARRELLO SGABELLO SOTTOAUTO 2 IN 1

€ 96,80



Dimensioni carrello	1030 x 420 x 125h mm
Dimensioni sgabello	630 x 420 x 410h mm
Peso	11 kg
Scatola	



Art. 0645/SS
CARRELLO SGABELLO SOTTOAUTO 2 IN 1

€ 58,00



Dimensioni carrello	1020 x 410 x 150h mm
Dimensioni sgabello	550 x 410 x 500h mm
Peso	9 kg
Scatola	



Art. 0645/C
CARRELLO SOTTOAUTO A 6 RUOTE

€ 58,30



Dimensioni	1030 x 420 x 110h mm
Peso	6,5 kg
Scatola	220 kg





Art. GI01/32AE

GENERATORE AD INVERTER CARRELLATO CON AVVIAMENTO ELETTRICO

€ 2300,00



Potenza	230 V 50 Hz 3,5 kVA
Potenza nominale in corrente alternata	3,1 kVA
Potenza nominale in corrente continua	12 V / 8,3 A
Frequenza	50 Hz
Tensione	230 V
Capacità serbatoio	6 l
Carburante	Benzina verde
Presa di corrente	Schuko
Dimensioni	571 x 436 x 462 mm
Peso	43 kg
Cilindrata-tipo motore	161 cc - 4 tempi, OHV
Potenza massima motore	4,5 kW / 4000 rpm
Rumorosità	61 dB(A) a 7m

GENERATORE AD INVERTER SILENZIATO 3,5 kVA, COSTITUITO DA ROBUSTI ELEMENTI IN FERRO E PLASTICA, AVVIAMENTO ELETTRICO CON RADIOCOMANDO, SISTEMA DI ACCENSIONE A TRANSISTOR, INTERRUTTORE MAGNETOTERMICO, SENSORE OLIO E SISTEMA DI RAFFREDDAMENTO AD ARIA



Art. GI01/32

GENERATORE AD INVERTER CARRELLATO

€ 1890,00



Potenza	230 V 50 Hz 3,5 kVA
Potenza nominale in corrente alternata	3,1 kVA
Potenza nominale in corrente continua	12 V / 8,3 A
Frequenza	50 Hz
Tensione	230 V
Capacità serbatoio	6 l
Carburante	Benzina verde
Presa di corrente	Schuko
Dimensioni	571 x 436 x 462 mm
Peso	43 kg
Cilindrata-tipo motore	161 cc - 4 tempi, OHV
Potenza massima motore	4,5 kW / 4000 rpm
Rumorosità	61 dB(A) a 7m

GENERATORE AD INVERTER SILENZIATO 3,5 kVA, COSTITUITO DA ROBUSTI ELEMENTI IN FERRO E PLASTICA, AVVIAMENTO A MANO DOTATO DI SISTEMA DI ACCENSIONE A TRANSISTOR, INTERRUTTORE MAGNETOTERMICO, SENSORE OLIO E SISTEMA DI RAFFREDDAMENTO AD ARIA

Art. GI01/20
GENERATORE AD INVERTER
€ 1410,00

Potenza massima	2 kVA
Potenza nominale in corrente alternata	1,6 kVA
Potenza nominale in corrente continua	12 V / 8,3 A
Frequenza	50 Hz
Tensione	230 V
Capacità serbatoio	3,8 l
Carburante	Benzina verde
Presa di corrente	Schuko
Dimensioni	490 x 335 x 415 mm
Peso	24,5 kg
Cilindrata-tipo motore	80 cc - 4 tempi, OHV
Potenza massima motore	2,5 kW / 5500 rpm
Rumorosità	60 dB(A) a 7m

GENERATORE AD INVERTER SILENZIATO 2 kVA, COSTITUITO DA ROBUSTI ELEMENTI IN FERRO E PLASTICA, AVVIAMENTO A MANO DOTATO DI SISTEMA DI ACCENSIONE A TRANSISTOR, INTERRUTTORE MAGNETOTERMICO, SENSORE OLIO E SISTEMA DI RAFFREDDAMENTO AD ARIA

Art. GI01/11
GENERATORE AD INVERTER
€ 1112,00

Potenza massima	1,1 kVA
Potenza nominale in corrente alternata	0,9 kVA
Frequenza	50 Hz
Tensione	230 V
Capacità serbatoio	2,8 l
Carburante	Benzina verde
Presa di corrente	Schuko
Dimensioni	450 x 280 x 395 mm
Peso	18,4 kg
Cilindrata-tipo motore	49,7 cc - 4 tempi, OHV
Potenza massima motore	1,4 kW / 5500 rpm
Rumorosità	59,5 dB(A) a 7 m

GENERATORE AD INVERTER SILENZIATO 1,1 kVA, COSTITUITO DA ROBUSTI ELEMENTI IN FERRO E PLASTICA, AVVIAMENTO A MANO DOTATO DI SISTEMA DI ACCENSIONE A TRANSISTOR, INTERRUTTORE MAGNETOTERMICO, SENSORE OLIO E SISTEMA DI RAFFREDDAMENTO AD ARIA



Art. R607
RISCALDATORE ELETTRICO A RAGGI INFRAROSSI

€ 102,00



Alimentazione	230 V, 1800 W
Peso	1,8 kg

RISCALDATORE A RAGGI INFRAROSSI DA 1800 W CON SUPPORTO PER MONTAGGIO A PARETE, IP55, CORPO IN METALLO CON GRIGLIA DI PROTEZIONE IN METALLO



Art. R608
RISCALDATORE ELETTRICO A RAGGI INFRAROSSI

€ 230,00



Alimentazione	230 V, 2000 W
Peso	3,0 kg

RISCALDATORE A RAGGI INFRAROSSI DA 2000 W CON SUPPORTO PER MONTAGGIO A PARETE, IP55, CORPO IN METALLO CON GRIGLIA DI PROTEZIONE IN METALLO E CONTROLLO REMOTO



Art. R609
RISCALDATORE ELETTRICO A RAGGI INFRAROSSI CON SUPPORTO PER FISSAGGIO A PARETE DA 1300 W

€ 109,00



Alimentazione	230 V, 1300 W
Peso	2,75 kg
Imballo	4

RISCALDATORE A RAGGI INFRAROSSI DA 1300 W CON SUPPORTO PER MONTAGGIO A PARETE, IP20, CORPO IN METALLO CON GRIGLIA DI PROTEZIONE IN METALLO, CON LAMPADA A RAGGI INFRAROSSI R7S DA 1300 W, 0,3 m DI CAVO 3X1,5mm² H07RN-F



Art. R610
RISCALDATORE ELETTRICO A RAGGI INFRAROSSI CON SUPPORTO PER FISSAGGIO A PARETE DA 2000 W

€ 150,00



Alimentazione	230 V, 2000 W
Peso	3,2 kg
Imballo	4

RISCALDATORE A RAGGI INFRAROSSI DA 2000 W CON SUPPORTO PER MONTAGGIO A PARETE, IP20, CORPO IN METALLO CON GRIGLIA DI PROTEZIONE IN METALLO, CON LAMPADA A RAGGI INFRAROSSI R7S DA 2000 W, 0,3 m DI CAVO 3X1,5mm² H07RN-F



RISCALDATORE ELETTRICO A RAGGI INFRAROSSI CON TREMPIEDE

Codice	Alimentazione	Altezza treppiede senza riscaldatore	Grado di protezione	€
R609A	230 V 1,3 kW	600 ÷ 1500 mm	IP20	145,00
R610A	230 V 2 kW	600 ÷ 1500 mm	IP20	208,00

RISCALDATORE ELETTRICO A RAGGI INFRAROSSI CON TREMPIEDE

RISCALDATORE ELETTRICO A RAGGI INFRAROSSI CON SUPPORTO

Codice	Alimentazione	Grado di protezione	€
R609B	230 V 1,3 kW	IP20	138,00
R610B	230 V 2 kW	IP20	181,00

RISCALDATORE ELETTRICO A RAGGI INFRAROSSI CON SUPPORTO

**Art. T609
TRIPODE REGOLABILE
IN ALTEZZA**
€ 44,40

Altezza	600 ÷ 1500 mm
Fissaggio superiore	M 8
Peso	2,3 kg
Imballo	4

Tripode regolabile in altezza, utilizzabile per faretto, riscaldatori

**Art. B609
BULBO A RAGGI INFRAROSSI**
€ 31,10

BULBO A RAGGI INFRAROSSI 230V, 1300 W

**Art. B610
BULBO A RAGGI INFRAROSSI**
€ 41,10

BULBO A RAGGI INFRAROSSI 230V, 200 W

TABELLA DI COMPATIBILITÀ

Codice compatibile	Descrizione	€	R609	R610	R609A	R610A	R609B	R610B	Pag
B609	BULBO A RAGGI INFRAROSSI	31,10	•		•		•		532
B610	BULBO A RAGGI INFRAROSSI	41,10		•		•		•	532
T609	TRIPODE REGOLABILE IN ALTEZZA	44,40	•	•					532

**Art. 0886/1**
LAMPADA A BASSO CONSUMO ENERGETICO**€ 133,00**

Alimentazione	230 V 50 Hz PL 3 x 24W
Dimensioni lampada	285 x 110 x 420 mm
Resistente alla polvere e agli spruzzi	IP44
Cavo	5 m 3x1,5 mm ² H07RN-F
Prese posteriori	2 Schuko
Peso	5,5 kg
Scatola	
Imballo	3

**Art. 0886/2**
LAMPADA A BASSO CONSUMO ENERGETICO**€ 303,00**

Alimentazione	230 V 50 Hz PL 4 x 36 W
Dimensioni lampada	350 x 130 x 490 mm
Resistente alla polvere e agli spruzzi	IP44
Cavo	5 m 3x1,5 mm ² H07RN-F
Prese posteriori	3 Schuko
Treppiede regolabile in altezza	1,9 ÷ 3,5 m
Peso	17 kg
Scatola	
Imballo	2

**Art. 0886/1L** **€ 7,80**
LAMPADA FLUORESCENTE DI
RICAMBIO PL 24W**Art. 0886/2L** **€ 7,70**
LAMPA DA FLUORESCENTE
DI RICAMBIO PL 36W**Art. 0361**
FARETTO A BASSO CONSUMO ENERGETICO CON SUPPORTO**€ 84,70**

Alimentazione	230 V 50 Hz 60 W
2 Lampade	E27 18 W
1 Lampada	E27 24 W
2 Interruttori con accensione combinata	36 W, 24 W o 60 W
Resistente alla polvere e agli spruzzi	IP44
Prese posteriori	2 Schuko
Cavo	1,5 m 3 x 1,5 mm ² H07RN-F
Scatola	
Imballo	4



Art. 0345
FARETTO ALOGENO CON LAMPADINA
€ 16,80

Alimentazione	230 V 400 W
Resistente alla polvere e agli spruzzi	IP54
Scatola	
Imballo	16

Art. 0346
FARETTO ALOGENO CON SUPPORTO E LAMPADINA
€ 32,20

Alimentazione	230 V 400 W
Resistente alla polvere e agli spruzzi	IP54
Cavo	1,5 m 3 x 1 mm ² H07RN-F
Scatola	
Imballo	8

Art. 0348
FARETTO ALOGENO CON TREMPIEDE E LAMPADINA
€ 71,50

Alimentazione	230 V 400 W
Resistente alla polvere e agli spruzzi	IP54
Cavo	3 m 3 x 1 mm ² H07RN-F
Altezza min - max	630 ÷ 1520 mm
Scatola	
Imballo	4

LAMPADINA ALOGENA

Codice	Alimentazione	Lunghezza	Durata ore	Imballo	€
0347/300	230 V 300 W	118 mm	1800	25* / 100	5,10
0347/500	230 V 400 W	118 mm	1800	20* / 200	5,10

Codice compatibile	Descrizione	€	0345	0346	0348	0886/1	0886/2	Pag
0347/300	LAMPADINA ALOGENA	5,10	•	•	•			534
0347/500	LAMPADINA ALOGENA	5,10	•	•	•			534
0886/1L	LAMPADA FLUORESCENTE	7,80				•		533
0886/2L	LAMPADA FLUORESCENTE	7,70					•	533

**Art. S448/10****FARETTO CON LED SAMSUNG* 10 W 850 lm****€ 46,00**

Alimentazione	110 - 265 V, 50 - 60 Hz, 10 W
Numero dei LED	9 SMD, 850 lm
Grado di protezione	IP 65
Cavo	30 cm, 3x1 mm ² H05VV-F
Durata ore	30000
Temperatura colore	4000° K
Peso	0,7 kg

FARETTO CON LED SAMSUNG* 10 W 850 lm

*Samsung è un marchio registrato di proprietà della Samsung Group

**Art. S448/20****FARETTO CON LED SAMSUNG* 20 W 1700 lm****€ 88,00**

Alimentazione	110 - 265 V, 50 - 60 Hz, 20 W
Numero dei LED	16 SMD, 1700 lm
Grado di protezione	IP 65
Cavo	30 cm, 3x1 mm ² H05VV-F
Durata ore	30000
Temperatura colore	4000° K
Peso	0,7 kg

FARETTO CON LED SAMSUNG* 20 W 1700 lm

*Samsung è un marchio registrato di proprietà della Samsung Group

**Art. S450/10****FARETTO CON LED SAMSUNG* 10 W 850 lm E SUPPORTO****€ 61,00**

Alimentazione	110 - 265 V, 50 - 60 Hz, 10 W
Numero dei LED	9 SMD, 850 lm
Resistente alla polvere e agli spruzzi	IP 65
Cavo	2 m, 3x1 mm ² H05VV-F
Durata ore	30000
Temperatura colore	4000° K
Peso	1 kg

FARETTO CON LED SAMSUNG* 10 W 850 lm E SUPPORTO

*Samsung è un marchio registrato di proprietà della Samsung Group

**Art. S450/20****FARETTO CON LED SAMSUNG* 20 W 1700 lm E SUPPORTO****€ 105,00**

Alimentazione	110 - 265 V, 50 - 60 Hz, 20 W
Numero dei LED	16 SMD, 1700 lm
Resistente alla polvere e agli spruzzi	IP 65
Cavo	2 m, 3x1 mm ² H05VV-F
Durata ore	30000
Temperatura colore	4000° K
Peso	2 kg

FARETTO CON LED SAMSUNG* 20 W 1700 lm E SUPPORTO

*Samsung è un marchio registrato di proprietà della Samsung Group



Art. S464/10
FARETTO CON LED SAMSUNG* 10 W 850 lm E SENSORE
€ 58,00

Alimentazione	110 - 265 V, 50 - 60 Hz, 10 W
Numero dei LED	9 SMD, 850 lm
Resistente alla polvere e agli spruzzi	IP 65
Cavo	30 cm, 3x1 mm ² H05VV-F
Durata ore	30000
Temperatura colore	4000° K
Peso	0,6 kg

FARETTO CON LED SAMSUNG* 10 W 850 lm E SENSORE DI MOVIMENTO E LUMINOSITÀ
 *Samsung è un marchio registrato di proprietà della Samsung Group

Art. S464/20
FARETTO CON LED SAMSUNG* 20 W 1700 lm E SENSORE
€ 102,00

Alimentazione	110 - 265 V, 50 - 60 Hz, 20 W
Numero dei LED	16 SMD, 1700 lm
Resistente alla polvere e agli spruzzi	IP 65
Cavo	30 cm, 3x1 mm ² H05VV-F
Durata ore	30000
Temperatura colore	4000° K
Peso	1,1 kg

FARETTO CON LED SAMSUNG* 20 W 1700 lm E SENSORE DI MOVIMENTO E LUMINOSITÀ
 *Samsung è un marchio registrato di proprietà della Samsung Group

Art. 0448/10
FARETTO CON LED 10 W 600 lm
€ 30,00

Alimentazione	110 - 265 V, 50 - 60 Hz, 10 W
Luminosità	600 lm
Grado di protezione	IP 65
Cavo	30 cm, 3x1 mm ² H05VV-F
Temperatura colore	4000° K
Peso	0,7 kg

Art. 0448/20
FARETTO CON LED 20 W 1450 lm
€ 69,00

Alimentazione	110 - 265 V, 50 - 60 Hz, 20 W
Luminosità	1450 lm
Resistente alla polvere e agli spruzzi	IP 65
Cavo	30 cm, 3x1 mm ² H05VV-F
Temperatura colore	4000° K
Peso	1,35 kg

**Art. 0450/10****FARETTO CON LED 10 W 600 lm E SUPPORTO****€ 60,00**

Alimentazione	110 - 265 V, 50 - 60 Hz, 10 W
Luminosità	600 lm
Resistente alla polvere e agli spruzzi	IP 65
Cavo	2 m, 3x1 mm ² H05VV-F
Temperatura colore	4000° K
Peso	1 kg

**Art. 0450/20****FARETTO CON LED 20 W 1450 lm E SUPPORTO****€ 85,00**

Alimentazione	110 - 265 V, 50 - 60 Hz, 20 W
Luminosità	1450 lm
Resistente alla polvere e agli spruzzi	IP 65
Cavo	2 m, 3x1 mm ² H05VV-F
Temperatura colore	4000° K
Peso	2 kg

**Art. 0464/10****FARETTO CON LED 10 W 600 lm E SENSORE****€ 48,00**

Alimentazione	110 - 265 V, 50 - 60 Hz, 10 W
Luminosità	600 lm
Resistente alla polvere e agli spruzzi	IP 65
Cavo	30 cm, 3x1 mm ² H05VV-F
Temperatura colore	4000°K
Peso	0,6 kg

FARETTO CON LED 10 W 600 lm E SENSORE DI MOVIMENTO E LUMINOSITÀ

**Art. 0464/20****FARETTO CON LED 20 W 1450 lm E SENSORE****€ 80,00**

Alimentazione	110 - 265 V, 50 - 60 Hz, 20 W
Luminosità	1450 lm
Resistente alla polvere e agli spruzzi	IP 65
Cavo	30 cm, 3x1 mm ² H05VV-F
Temperatura colore	4000° K
Peso	1,5 kg

FARETTO CON LED 20 W 1450 lm E SENSORE DI MOVIMENTO E LUMINOSITÀ



Art. 0713/15
FARO A LED CON BASE MAGNETICA
€ 62,00



Alimentazione	DC 9 ÷ 32 V (12 V, 24 V) 15 W
Numero dei LED	5 x 3 W 1050 lm
Distanza di illuminazione	5 m - 23 lux; 8,5 m - 10 lux
Temperatura colore	6000° K
Grado di protezione	IP 65
Lunghezza cavo	2 m
Dimensione faro	108 x 108 mm
Dimensioni base	Ø 86,50 mm
Interasse dei fori posteriori	87 x 28 mm M6
Dimensioni ingombro	108 x 86,50 x 160 mm
Peso	0,55 kg
Imballo	20

Art. 0713/18
FARO A LED CON BASE MAGNETICA
€ 70,00

Alimentazione	DC 9 ÷ 32 V (12 V, 24 V) 18 W
Numero dei LED	6 x 3 W 1260 lm
Distanza di illuminazione	5 m - 45 lux; 12 m - 10 lux
Temperatura colore	6000° K
Grado di protezione	IP 65
Lunghezza cavo	2 m
Dimensione faro	Ø 116 mm
Dimensioni base	Ø 86,50 mm
Interasse dei fori posteriori	87 x 28 mm M6
Dimensioni ingombro	116 x 86,50 x 165 mm
Peso	0,6 kg
Imballo	20

Art. 0713/27
FARO A LED CON BASE MAGNETICA
€ 108,00

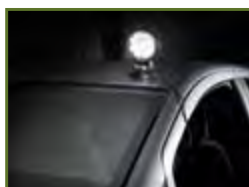
Alimentazione	DC 9 ÷ 32 V (12 V, 24 V) 27 W
Numero dei LED	9 x 3 W 1890 lm
Distanza di illuminazione	5 m - 85 lux; 15,5 m - 10 lux
Temperatura colore	6000° K
Grado di protezione	IP 65
Lunghezza cavo	2 m
Dimensione faro	Ø 116 mm
Dimensioni base	Ø 86,50 mm
Interasse dei fori posteriori	87 x 28 mm M6
Dimensioni ingombro	116 x 86,50 x 165 mm
Peso	0,8 kg
Imballo	20



FARO A LED CON BASE MAGNETICA DA APPLICARE SUL TETTO O SUL COFANO DELLE AUTO, DEI CAMPER, DEI FUORISTRADA, DELLE BARCHE, DELLE MACCHINE AGRICOLE E DELLE MACCHINE MOVIMENTO TERRA, CON FUSIBILE DA 3 A E SPINA PER ACCENDISIGARI, FASCIO DI LUCE AMPIO

**Art. 0343**
LAMPADA SNODATA**€ 26,40**

Alimentazione	110 / 230 V 50 / 60 Hz max 60 W, E27
Raggio d'azione	800 mm
Capacità morsetto	35 mm
Scatola	
Imballo	12

**Art. 0366**
LAMPADA A 48 LED CON LENTE**€ 108,00**

Alimentazione	230 V 50 Hz 4,8 W
Ingrandimenti	2x
Lente	Ø 127 mm
Raggio d'azione	810 mm
Capacità morsetto	70 mm
Scatola	
Imballo	4

**Art. 0530**
LAMPADA A BASSO CONSUMO ENERGETICO**€ 120,00**

Alimentazione	230 V 50 Hz 22 W
Ingrandimenti	2x
Lente	Ø 120 mm
Raggio d'azione	810 mm
Capacità morsetto	70 mm
Scatola	
Imballo	6

**Art. 0891**
LAMPADA A BASSO CONSUMO ENERGETICO**€ 181,00**

Alimentazione	230 V 50 Hz 2 x 9 W
Ingrandimenti	2x + 6x
Lente	190 x 157 mm
Raggio d'azione	810 mm
Capacità morsetto	70 mm
Scatola	
Imballo	4



Art. 0516
LAMPADA A BASSO CONSUMO ENERGETICO
€ 153,00

Alimentazione	230V 50Hz 2 x 9W
Ingrandimenti	2x
Lente	190 x 157 mm
Raggio d'azione	810 mm
Capacità morsetto	70 mm
Scatola	
Imballo	6

Art. 0344
LAMPADA SNODATA CONLENTE
€ 34,00

Alimentazione	230 V 50/60 Hz
Lampadina non inclusa	Max 60 W, E27
Ingrandimenti	2x
Lente	Ø 100 mm
Raggio d'azione	800 mm
Capacità morsetto	35 mm
Scatola	
Imballo	6

Art. 0661
LAMPADA DA TAVOLO
€ 51,10

Alimentazione	230 V 50 Hz 11 W
Ingrandimenti	2x
Lente	Ø 89 mm
Scatola	
Imballo	6

Art. 0530/N
TUBO
FLUORESCENTE 22W

€ 12,00

Art. 0516/N
TUBO FLUORESCENTE
PL 9W G23

€ 7,70

Art. 0661/N1
TUBO
FLUORESCENTE 11W

€ 9,30

Codice compatibile	Descrizione	€	0530	0516	0661	Pag
0530/N	LAMPADINA ALOGENA	12,00	•			540
0516/N	LAMPADINA ALOGENA	7,70		•		540
0661/N1	LAMPADA FLUORESCENTE	9,30			•	540

**Art. 0625**
SET LENTI A VISIERA**€ 33,30**

Moltiplicatore	Distanza del fuoco mm
1,2x	520 ÷ 620
1,8x	230 ÷ 320
2,5x	150 ÷ 250
3,5x	80 ÷ 120
Lampadina	2,2 V - 0,25 A
Batteria	2 AAA
Imballo	24
Scatola	

**Art. 0659**
SERIE DI LENTI IN CRISTALLO**€ 38,90**

12 Pz



Contenuto	Ingrandimenti
3 Pz Ø 50	3x - 10x mm
3 Pz Ø 60	3x - 8x mm
3 Pz Ø 75	3x - 8x mm
3 Pz Ø 90	3x - 8x mm
Imballo	8



LENTE IN CRISTALLO



Codice	Ø	Ingrandimenti	Imballo	€
0659/50	50 mm	3x - 10x	10* / 200	4,22
0659/60	60 mm	3x - 8x	10* / 200	5,50
0659/75	75 mm	3x - 8x	10* / 200	6,90
0659/90	90 mm	3x - 8x	10* / 120	11,60

**Art. L005**
LENTE IN CRISTALLO CON LED**€ 29,50**

Lente	Ø 125 mm
Ingrandimenti	2x
LED	6 - 9000 mcd
Batteria	4 AA
Scatola	
Imballo	6

**Art. L006**
LENTE IN CRISTALLO CON LED**€ 10,30**

Lente	50 x 50 mm
Ingrandimenti	3x
LED	5 - 9000 mcd
LED	1
Batteria	4 Ag10
Scatola	
Imballo	10* / 120



Art. 0447
CARICA BATTERIE DIGITALE INTELLIGENTE DA 12 V - 2 A
€ 66,00

Alimentazione	220 ÷ 240 V, 50 ÷ 60 Hz
Potenza	14,4 V 4 A max
Peso	430 g
Appendibile	
Imballo	30

Carica batterie digitale intelligente da 12 V - 2 A, con microprocessore, carica automatica a 3 stadi, per caricare batterie: al piombo, AMG, al GEL, WET, VRLA, MF ricarica in modalità: 14,4 V - 2 A, per allungare la vita della batteria, al termine della carica, lo strumento automaticamente si commuta in modalità mantenimento della carica

Art. 0432
CARICA BATTERIE DIGITALE INTELLIGENTE DA 6 - 12 V - 4 A
€ 89,10

Alimentazione	230 V 50 ÷ 60 Hz
Potenza	14,7 V 4 A max
Peso	500 g
Appendibile	
Imballo	30

Con microprocessore, modalità recupero batteria, carica automatica a 9 stadi, per caricare batterie al piombo, AMG, al GEL, WET, VRLA, MF. Ricarica in modalità moto: 14,4 V - 1 A, in modalità auto: 14,4 V - 4 A, in modalità inverno: 14,7 V - 4 A, in modalità batterie a 6 - 7,2 V - 4 A. Per allungare la vita della batteria, al termine della carica, lo strumento automaticamente si commuta in modalità mantenimento della carica

Art. 0478
CARICA BATTERIE DIGITALE INTELLIGENTE DA 12 V - 8 A
€ 125,00

Alimentazione	230 V, 50 ÷ 60 Hz
Potenza	14.4 V, 8 A
Peso	1,07 kg

ADATTO PER CARICARE TUTTI I TIPI DI BATTERIE 12V AL PIOMBO, INCLUSE WET, GEL E AGM. CARICA LE BATTERIE ANCHE A TEMPERATURE FREDDHE. GESTIONE AUTOMATICA DEL CICLO DI CARICA A 9 STADI. QUESTO CARICA BATTERIA RICARICA LE BATTERIE FINO AL 100% DELLA LORO CAPACITA INIZIALE. PUÒ IN CERTI CASI AUTOMATICAMENTE RECUPERARE BATTERIE LEGGERMENTE SOLFATATE.

**Art. 0479****CARICA BATTERIE DIGITALE INTELLIGENTE DA 12 V 2 - 6 - 12A****€ 137,00**

Alimentazione	230V 50Hz
Potenza	12 V 2 - 6 - 12 A
Peso	1,4 kg

CARICA BATTERIE DIGITALE INTELLIGENTE A 3 STADI DA 12 V 2 - 6 - 12A, CON PRESA PER APPARECCHI A 12 V 12A IN CORRENTE CONTINUA

**TORCIA IMPERMEABILE A BATTERIA**

Codice	Lampadina	Batterie non incluse	Confezione	Imballo	€
0643/1	Krypton	2 AA	Blister	12* / 96	5,50
0643/2	Krypton	2 D	Blister	12* / 24	8,30
0643/3	Krypton	3 D	Blister	6* / 24	12,40

**Art. 0436****TORCIA IMPERMEABILE A LED****€ 18,00**

Batterie non incluse	4 AA
Potenza LED	3 W
Peso	200 g
Blister	
Imballo	72

TORCIA IMPERMEABILE A LED, BATTERIA A LUNGA DURATA, DISTANZA DI ILLUMINAZIONE PIU' DI 150 m

**Art. 0437****FARETTO A LED AD ALTA POTENZA****€ 24,70**

Batterie non incluse	4 C
Potenza LED	3 W
Autonomia	25 h / 100 %
Peso	350 g
Scatola	
Imballo	32

FARETTO A LED AD ALTA POTENZA A LUNGA AUTONOMIA, DISTANZA DI ILLUMINAZIONE PIU' DI 150 m



Art. 0480
 COPPIA LUCI A LED PER BICICLETTA

€ 4,80

Numero dei LED	2, 400 - 500 mcd
Batterie incluse	2 x CR-2032
Peso	23 g
Blister	
Imballo	400

COPPIA LUCI A LED PER BICICLETTA, IN SILICONE, 3 FUNZIONI: LUCE CONTINUA, INTERMITTENTE VELOCE, INTERMITTENTE LENTA

Art. 0482/09
 LUCE A LED PER BICICLETTA E CASCO

€ 59,60

Batteria	4,2 V Lithium
Autonomia	4 - 5 h
Peso	0,42 kg
Scatola	
Imballo	30

LUCE A LED PER BICICLETTA E CASCO, RICARICABILE, CON CARICA BATTERIA. 3 FUNZIONI: 200 lm, 900 lm E LAMPEGGIANTE

Art. 0482/30
 LUCE A LED PER BICICLETTA E CASCO

€ 93,80

Batteria	8,4 V Lithium
Autonomia	2 h x 100% - 3000 lumen
Peso	0,52 kg
Scatola	
Imballo	30

LUCE A LED PER BICICLETTA E CASCO, RICARICABILE, CON CARICA BATTERIA. 4 FUNZIONI: 1 LED - 2 LED - 3 LED - 3 LED LAMPEGGIANTI

Art. 0491
 SERIE TORCE A LED BICI/TASCABILE

€ 67,00

12 Pz



Batterie non incluse	3 x AA
Numero dei LED	9
Luminosità	20 lm
Misure	Ø 36 x 36 x 105 mm
Autonomia	8 h
Peso	0,6 kg
Espositore	

SERIE 12 TORCE A LED BICI/TASCABILE, IN ABS E RIVESTIMENTO IN GOMMA, CON SUPPORTO PER BICI

**Art. 0493/1**
LUCE A LED DA CASCO**€ 8,50**

Batterie non incluse	3 x AAA
Luminosità	80 lm
Misure	Ø 50 x 42 x 58 mm
Autonomia	10 h
Peso	0,096 kg
Scatola	

LUCE A LED DA CASCO 80 lm, IN ABS E RIVESTIMENTO IN GOMMA, CON FASCIA ELASTICA REGOLABILE, 2 FUNZIONALITÀ: LUCE FISSA E LAMPEGGIANTE, DA UTILIZZARE CON 3 BATTERIE DI TIPO AAA

**Art. 0493/2**
LUCE A LED DA CASCO**€ 22,00**

Batterie non incluse	3 x AAA
Luminosità	120 lm
Misure	Ø 75 x 45 x 45 mm
Autonomia	5 h
Peso	0,136 kg
Scatola	

LUCE A LED DA CASCO 120 lm, IN ALLUMINIO, CON FASCIA ELASTICA REGOLABILE, 2 FUNZIONALITÀ: LUCE FISSA E LAMPEGGIANTE, DA UTILIZZARE CON 3 BATTERIE DI TIPO AAA

**Art. 0309/12**
LAMPADA A LED FLESSIBILE**€ 17,00**

Numero dei LED	12 - 13,000 mcd per LED
Dimensioni	210 x 71 mm
Batterie non incluse	3 x AAA
Peso	0,162 kg
Doppio Blister	
Imballo	24

LAMPADA A LED FLESSIBILE MAGNETICA, IN ABS E SILICONE, 3 FUNZIONI: 4 LED, 12 LED, FLASH

**Art. 0309/15**
LAMPADA A LED FLESSIBILE**€ 31,00**

Numero dei LED	15 - 13,000 mcd per LED
Dimensioni	350 x 21 mm
Batterie non incluse	3 x AAA
Peso	0,33 kg
Blister	
Imballo	24

LAMPADA A LED FLESSIBILE MAGNETICA, IN ABS E SILICONE, 3 FUNZIONI: 6 LED, 15 LED, FLASH



Art. 0309/16
LAMPADA A LED FLESSIBILE
€ 29,20

Numero dei LED	16 - 13,000 mcd per LED
Dimensioni	340 x 18 mm
Batterie non incluse	3 x AAA
Peso	0,33 kg
Blister	
Imballo	24

LAMPADA A LED FLESSIBILE MAGNETICA, IN ABS E SILICONE, 3 FUNZIONI: 6 LED, 16 LED, FLASH

Art. 0309/21
LAMPADA A LED FLESSIBILE
€ 20,00

Numero dei LED	21 - 13,000 mcd per LED
Dimensioni	250 x 71 mm
Batterie non incluse	3 x AAA
Peso	0,2 kg
Doppio Blister	
Imballo	24

LAMPADA A LED FLESSIBILE MAGNETICA, IN ABS E SILICONE, 3 FUNZIONI: 7 LED, 21 LED, FLASH

Art. 0397
TORCIA TASCABILE A 7 LED
€ 6,90

Batterie non incluse	3 AAA
Misure	33 x 16 x 160 mm
Imballo	12* / 96

TORCIA TASCABILE A 7 LED CON CLIP MAGNETICO E GIREVOLE, CON ELEVATA AUTONOMIA, DI PICCOLE DIMENSIONI E GRANDE LUMINOSITÀ LA RENDONO INDISPENSABILE SIA NEL PROFESSIONALE CHE NEL FAI DA TE

Art. 0128
TORCIA TASCABILE MAGNETICA A 12 + 1 LED
€ 11,00

Batterie incluse	3 AAA
Misure	174 x 3.4 x 2.2 mm
Luminosità	30 lm
Peso	49 g
Imballo	12* / 96

TORCIA TASCABILE A 12 + 1 LED CON CLIP MAGNETICO E GIREVOLE, CON ELEVATA AUTONOMIA, DI PICCOLE DIMENSIONI E GRANDE LUMINOSITÀ LA RENDONO INDISPENSABILE SIA NEL PROFESSIONALE CHE NEL FAI DA TE

**Art. 0671/8**

TORCIA IN ALLUMINIO CON LED A LUCE BIANCA AD ALTA LUMINOSITÀ

€ 14,00

Batterie non incluse	2 AA
Numero dei LED	8 - 9000 mcd
Misure	Ø 25 x 20 x 140 mm
Imballo	10* / 200
Blister	

**Art. 0671/1P**

TORCIA IN ALLUMINIO CON LED A LUCE BIANCA AD ALTA LUMINOSITÀ

€ 7,10

Batterie non incluse	2 AAA
Numero dei LED	1 - 9000 mcd
Misure	Ø 12,5 x 141 mm
Imballo	10* / 200
Blister	

**Art. 0489/2B**
SERIE TORCE A LED
MINI COLORE NERO**€ 111,00****3 + 3 Pz**

Batterie non incluse	3 x AA - 2 x AA
Misure	3 x Ø 30 x 22 x 220 mm; 3 x Ø 30 x 22 x 170 mm
Potenza LED	120 lm
Autonomia	4 - 5 h
Peso	0,608 kg
Espositore	

SERIE 3 + 3 TORCE A LED MINI IN ALLUMINIO, CON LED A LUCE BIANCA DI ALTA DURATA, CON 3 FUNZIONI: LUCE FISSA, LUCE LAMPEGGIANTE E REGOLAZIONE DISTANZA FOCALE

**Art. 0489/2S**
SERIE TORCE A LED
MINI COLOR ARGENTO**€ 111,00****3 + 3 Pz**

Batterie non incluse	3 x AA - 2 x AA
Misure	3 x Ø 30 x 22 x 220 mm; 3 x Ø 30 x 22 x 170 mm
Potenza LED	120 lm
Autonomia	4 - 5 h
Peso	0,608 kg
Espositore	

SERIE 3 + 3 TORCE A LED MINI IN ALLUMINIO, CON LED A LUCE BIANCA DI ALTA DURATA, CON 3 FUNZIONI: LUCE FISSA, LUCE LAMPEGGIANTE E REGOLAZIONE DISTANZA FOCALE



Art. 0489/3B
TORCIA A LED MAXI COLOR NERO
€ 38,00

Batterie non incluse	2 x D
Misure	Ø 50 x 35 x 275 mm
Potenza LED	Lumen 120 lm
Autonomia	9 ore
Peso	0,375 kg

TORCIA A LED MAXI COLOR NERO, IN ALLUMINIO, CON 3 FUNZIONI: LUCE FISSA, LUCE LAMPEGGIANTE E REGOLAZIONE DISTANZA FOCALIA

Art. 0489/3S
TORCIA A LED MAXI COLOR ARGENTO
€ 38,00

Batterie non incluse	2 x D
Misure	Ø 50 x 35 x 275 mm
Potenza LED	Lumen 120 lm
Durata ore	9
Peso	0,375 kg

TORCIA A LED MAXI COLOR ARGENTO, IN ALLUMINIO, CON 3 FUNZIONI: LUCE FISSA, LUCE LAMPEGGIANTE E REGOLAZIONE DISTANZA FOCALIA

Art. 0489/4B
TORCIA A LED MAGNUM COLORE NERO
€ 40,00

Batterie non incluse	3 x D
Misure	Ø 50 x 35 x 315 mm
Potenza LED	Lumen 120 lm
Durata ore	12
Peso	0,415 kg

TORCIA A LED MAGNUM COLORE NERO, IN ALLUMINIO, CON 3 FUNZIONI: LUCE FISSA, LUCE LAMPEGGIANTE E REGOLAZIONE DISTANZA FOCALIA

Art. 0489/4S
TORCIA A LED MAGNUM COLOR ARGENTO
€ 40,00

Batterie non incluse	3 x D
Misure	Ø 50 x 35 x 315 mm
Potenza LED	Lumen 120 lm
Autonomia	12
Peso	0,415 kg

TORCIA A LED MAGNUM COLOR ARGENTO, IN ALLUMINIO, CON 2 FUNZIONI: LUCE FISSA, LUCE LAMPEGGIANTE E REGOLAZIONE DISTANZA FOCALIA

**Art. 0787**
TORCIA IN ALLUMINIO

€ 19,60



Batterie non incluse	2 C
Numero dei LED	8 LED 11000 mcd
Misure	Ø 48,5 x 31 x 215 mm
Imballo	6* / 60
Blister	

**Art. 0492**
SERIE TORCE A LED CON MAGNETE TELESCOPICO

€ 71,00



6 Pz

Batteria a bottone	4-LR44
Numero dei LED	6
Luminosità	6 x 10 lm
Misure	Ø 30 x 21 x 180 mm
Lunghezza massima	710 mm
Autonomia	3 h
Peso	0,12 kg
Espositore	

**Art. 0107**
LAMPADA MAGNETICA CON 30 + 7 LED

€ 8,00



Vita per singolo LED	100000 ore / hours
Corpo	ABS
Luminosità	50 lm
Batterie non incluse	3 AA
Dimensioni	40 x 35 x 203 mm
Peso	130 g
Imballo	12* / 24 / 48

LAMPADA MAGNETICA CON 30 + 7 LED CON MAGNETE E GANCIO NELLA PARTE POSTERIORE.

**Art. 0311**
LAMPADA MAGNETICA CON 24 LED

€ 11,20



Vita per singolo LED	100000 ore / hours
Corpo	ABS
Batterie non incluse	3 AA
Imballo	12* / 48

LAMPADA MAGNETICA CON 24 LED CON MAGNETE E GANCIO NELLA PARTE POSTERIORE.



Art. 0291
LAMPADA MAGNETICA
CON 24 + 3 LED
€ 9,20

Vita per singolo LED	100000 ore / hours
Corpo	ABS
Batterie non incluse	3 AAA
Imballo	12* / 48

LAMPADA MAGNETICA CON 24 + 3 LED CON MAGNETE E GANCIO NELLA PARTE POSTERIORE.

Art. 0338
TORCIA IN ALLUMINIO CON 1 LED
E FUNZIONE ZOOM MANUALE
€ 38,90

Batteria	1 lithium (ricaricabile / rechargeable), 3 AAA
LED	Q3 3 W
Misure	Ø 34,5 x 28 x 135 mm
Carica batteria	110 / 230 V 50 / 60 Hz
Autonomia	4 h
Peso	350 g
Imballo	40

TORCIA IN ALLUMINIO CON 1 LED E FUNZIONE ZOOM MANUALE, 3 TIPI DI LUCE: FORTE, MEDIA E LAMPEGGIANTE; ADATTATORE PER FUNZIONAMENTO CON 3 BATTERIE DI TIPO AAA E SCATOLA

Art. 0597
LAMPADA A LED RICARICABILE
€ 27,00

Batteria	3.7 V 1800 mAh
LED	8 SMD + 5 LED
Tempo di ricarica	8 ÷ 10 h
Autonomia	7 ÷ 8 h
Peso	0,55 kg

LAMPADA A LED RICARICABILE CON CARICABATTERIA DC12V E AC 230V, PIEGHEVOLE, APPENDIBILE E MAGNETICA

Art. 0889
LAMPADA A LED
RICARICABILE MAGNETICA
€ 60,50

Batteria	3,7 V - 1100 mAh - Lithium
LED	21 + 5 - 9000 mcd
Tempo di ricarica	4 ÷ 5 h
Autonomia	4 ÷ 6 h
Scatola	
Imballo	20

LAMPADA A LED RICARICABILE CON CARICABATTERIA DC12V E AC 230V, PIEGHEVOLE, APPENDIBILE E MAGNETICA



Art. 0693 € 120,00
LAMPADA A LED RICARICABILE



Batteria	7,4 V - 1900 mAh - Lithium
LED	30 - 9000 mcd
Tempo di ricarica	5 ÷ 6 h
Autonomia	8 h
Scatola	
Imballo	8



Art. 0401 € 88,00
LAMPADA RICARICABILE
CON TECNOLOGIA LED COB



Alimentazione	100 ÷ 240 V , 50 ÷ 60 Hz
Batteria	3,7 V 2 x 2000 mAh Lithium
Tempo di ricarica	6 h
Autonomia	3,5 h
Peso	550 g
Scatola	
Imballo	20

LAMPADA RICARICABILE CON TECNOLOGIA LED COB, BATTERIE AL LITIO AD ALTA CAPACITÀ PER LUNGA AUTONOMIA, DORSO MAGNETICO PER UN USO SENZA L'AIUTO DELLE MANI, APPOGGIO FLESSIBILE E MAGNETICO, LUCE POTENTE DA 180 LUMEN



Art. 0123 € 62,00
FARO MULTIFUNZIONE A
LED RICARICABILE CON USB



Batteria	1 lithium (rechargeable) 3.7V, 1800 mAh
LED	24 Cree XPG R5
Luminosità	30 - 300 lm
Dimensioni	191 x 99 x 148 mm
Carica batteria	USB 110 - 230 V 50 - 60 Hz
Autonomia	2.5 h
Peso	386 g
Imballo	5 / 10

FARO MULTIFUNZIONE DOTATO DI TORCIA LED ANTERIORE CON VARI LIVELLI DI LUMINOSITÀ, LED BIANCHI E ROSSI LATERALI CON FUNZIONE LAMPEGGIO. CAVO DI RICARICA USB E TRAFORMATORE. LED DI STATO DI CARICA E RICARICA. POSSIBILE RICARICA DIRETTAMENTE DAL COMPUTER.



Art. L008
LAMPADA LED RICARICABILE ULTRA SOTTILE
€ 128,00

Alimentazione	100 ÷ 240 V , 50 ÷ 60 Hz
Batteria	3,7 V 2400 mAh Lithium
Tempo di ricarica	3,5 h
Autonomia	3 - 10 h
Peso	115 g
Scatola	
Imballo	12

LAMPADA LED ULTRA SOTTILE RICARICABILE, BATTERIE AL LITIO AD ALTA CAPACITÀ PER LUNGA AUTONOMIA, LUCE POTENTE DA 400 LUMEN, IL DESIGN SOTTILE E LA STRUTTURA ROBUSTA LA RENDONO INDISTRUTTIBILE ANCHE SE CADE DA UN METRO DI ALTEZZA O, SE DIMENTICATA SU DI UN PAVIMENTO PIANO, L'AUTO CI PASSA SOPRA

Art. 0445/20
FARETTO A LED RICARICABILE 20W 600/1450 lm
€ 156,00

Alimentazione	DC 12 - 24 V , 20 W; AC 230 V 20W
Luminosità	600 - 1450 lm
Batteria	7.4V Li-Ion, 54000mAh
Grado di protezione	IP 65
Peso	1,5 kg

FARETTO A LED RICARICABILE 20W 1450 lm CON INTERRUOTORE PER FUNZIONAMENTO A 600 lm, RICARICA AUTO CON SPINA PER ACCENDISIGARI E ALIMENTATORE 230 V DA CASA, ROBUSTO SUPPORTO ORIENTABILE

Art. 0429
PORTALAMPADA CON CAVO DI ALIMENTAZIONE DI 5 m
€ 25,80

Lunghezza cavo	5 m
Attacco lampadina	E27
Voltaggio	12 ÷ 230 V
Peso	1000 g
Appendibile	
Imballo	20

PORTALAMPADA CON CAVO DI ALIMENTAZIONE LUNGO 5 m, CLASSE DI PROTEZIONE IP54, MASSIMO 60 W PER LAMPADINE AD INCANDESCENZA, ATTACCO LAMPADINA E27 POSSIBILITÀ DI FUNZIONE DA 12 A 230 V CON LAMPADINA DELLO STESSO VOLTAGGIO; LAMPADINA NON INCLUSA



Art. 0342
LAMPADA AL NEON APPENDIBILE

€ 15,50



Alimentazione	230 V 50 Hz 8 W
Dimensioni	Ø 31 x 435 mm
Cavo	5 m
Blister	
Imballo	5* / 20



Art. 0840
LAMPADA A LED RICARICABILE MAGNETICA CON GANCI ESTENSIBILI

€ 120,00



Alimentazione	DC 12 V 7,2 W; AC 230V
Dimensioni lampada	Ø 38 x 1080 mm
Regolazione ganci a molla	1210 ÷ 1950 mm
Batteria	7.4 V, 1800 mAh Lithium
Luminosità	900 lm, 36 SMD
Tempo di ricarica	4 - 5 h
Autonomia	3h



LAMPADA A LED RICARICABILE MAGNETICA CON GANCI ESTENSIBILI, IN ABS E POLICARBONATO, 2 FUNZIONI: 18 LED SMD - 36 LED SMD, CON BATTERIA AL LITIO, RICARICA AUTO CON SPINA PER ACCENDISIGARI E ALIMENTATORE 230 V DA CASA, INDICATORE STATO DELLA CARICA



LAMPADA FLUORESCENTE CON GANCI ESTENSIBILI



Codice	Alimentazione	Dimensioni lampada	Regolazione ganci a molla	Imballo	€
0802	230 v 50 Hz 30 W	Ø 75 x 1100 mm	1,15 - 1,90 m	4	126,00
0802/24V	24 V 50 Hz 30 W	Ø 75 x 1100 mm	1,15 - 1,90 m	4	133,00

LAMPADA FLUORESCENTE CON GANCI ESTENSIBILI E 5 m DI CAVO 2 x 0,75 mm² H05VV-F



Art. 0621/A3
AVVOLGICAVO AUTO RIENTRANTE
€ 108,00

Senza Lampada	
Lunghezza cavo	10 m
Tipo cavo	3 x 1,50 mm ² H05VV-F
Alimentazione	12 V ÷ 240 V
Massima potenza collegabile al cavo avvolto	1200 W
Massima potenza collegabile al cavo svolto	1800 W
Scatola	
Imballo	4

Art. 0428
AVVOLGICAVO AUTO RIENTRANTE CON PORTALAMPADA
€ 105,00

Dimensioni cavo	13 + 1 m - H05RR-F - 2 x 1mm ²
Attacco lampadina	E27
Voltaggio	12 ÷ 230 V
Peso	3,2 kg
Scatola	
Imballo	4

AVVOLGICAVO AUTO RIENTRANTE CON PORTALAMPADA E PROTEZIONE CONTRO I SOVRACCARICHI, CLASSE DI PROTEZIONE IP20, MASSIMO 60 W PER LAMPADINE AD INCANDESCENZA, ATTACCO LAMPADINA E27, LED SULL'AVVOLGICAVO CHE SEGNALE SE COLLEGATO ALLA RETE ELETTRICA E POSSIBILITÀ DI FUNZIONE DA 12 A 230 V; LAMPADINA NON INCLUSA

AVVOLGICAVO

Codice	Lunghezza cavo	Sezione	Tamburo	Imballo	€
A010/10	10 m	3 x 1,5 mm ²	Ø 200 mm	10	36,60
A010/20	20 m	3 x 1,5 mm ²	Ø 250 mm	10	59,40

AVVOLGICAVO COSTRUITI IN RIFERIMENTO ALLE NORME EN 61242, CAVO DOPPIO ISOLAMENTO < HAR > H05VV-F OMOLOGATO SPINA PRESSOFUSA IN PVC OMOLOGATA CON SPINOTTI PROTETTI, DISGIUNTORE TERMICO A RIPRISTINO MANUALE, MAX POTENZA PRELEVABILE CON CAVO AVVOLTO 1,2 kW, MAX POTENZA PRELEVABILE CON CAVO SVOLTO 3,4 kW

**AVVOLGICAVO**

Codice	Lunghezza cavo	Sezione	Tamburo	Imballo	€
A010/15	15 m	3 x 1,5 mm ²	Ø 190 mm	4	53,30
A010/25	25 m	3 x 1,5 mm ²	Ø 240 mm	2	77,00
A010/50	50 m	3 x 1,5 mm ²	Ø 310 mm	2	137,00

AVVOLGICAVO COSTRUITI IN RIFERIMENTO ALLE NORME EN 61242, CAVO DOPPIO ISOLAMENTO < HAR > H05VV-F OMOLOGATO SPINA PRESSOFUSA IN PVC OMOLOGATA CON SPINOTTI PROTETTI, DISGIUNTORE TERMICO A RIPRISTINO MANUALE, MAX POTENZA PRELEVABILE CON CAVO AVVOLTO 1,2 kW, MAX POTENZA PRELEVABILE CON CAVO SVOLTO 3,4 kW

**Art. A010/20G**
AVVOLGICAVO DA GIARDINO**€ 55,00**

Lunghezza cavo	20 m
Sezione	3 x 1 mm ²
Tamburo	Ø 250 mm
Imballo	10

AVVOLGICAVO DA GIARDINO DA 20 m, COSTRUITI IN RIFERIMENTO ALLE NORME EN 61242, CAVO DOPPIO ISOLAMENTO < HAR > H05VV-F OMOLOGATO, SPINA E PRESA SCHUKO OMOLOGATA, DISGIUNTORE TERMICO A RIPRISTINO MANUALE, MAX POTENZA PRELEVABILE CON CAVO AVVOLTO 1,2 kW, MAX POTENZA PRELEVABILE CON CAVO SVOLTO 3,4 kW

**Art. A010/30**
AVVOLGICAVO INDUSTRIALE**€ 250,00**

Alimentazione	230 V
Lunghezza cavo	30 m
Sezione	3 x 2,5 mm ²
Tamburo	Ø 340 mm

AVVOLGICAVO INDUSTRIALE COSTRUITO IN RIFERIMENTO ALLE NORME EN 61316, CAVO FLESSIBILE < HAR > H07RN-F OMOLOGATO IN NEOPRENE, PRESE IP 44 / DISGIUNTORE TERMICO A RIPRISTINO MANUALE MAX. POTENZA PRELEVABILE CON CAVO AVVOLTO 5 kW, MAX. POTENZA PRELEVABILE CON CAVO SVOLTO 11 kW

**Art. A010/30T**
AVVOLGICAVO INDUSTRIALE**€ 345,00**

Alimentazione	380 V
Lunghezza cavo	30 m
Sezione	4 x 2,5 mm ²
Tamburo	Ø 340 mm

AVVOLGICAVO INDUSTRIALE, COSTRUITI IN RIFERIMENTO ALLE NORME EN 61316, CAVO FLESSIBILE < HAR > H07RN-F OMOLOGATO IN NEOPRENE, PRESE IP 44 / DISGIUNTORE TERMICO A RIPRISTINO MANUALE, MAX. POTENZA PRELEVABILE CON CAVO AVVOLTO 5 kW, MAX. POTENZA PRELEVABILE CON CAVO SVOLTO 11 kW



Art. 0651/5
€ 11,20
MULTIPRESA CON 5 PRESE BIPASSO + SCHUKO E SPINA ITALIANA DA 16A

Sezione cavo	3 x 1 mm ²
Lunghezza cavo	1,5 m
Imballo	6* / 48

Art. 0651/6
€ 12,00
MULTIPRESA CON 6 PRESE BIPASSO + SCHUKO, E SPINA ITALIANA DA 16A

Sezione cavo	3 x 1 mm ²
Lunghezza cavo	1,5 m
Imballo	6* / 48

Art. 0651/5S
€ 11,10
MULTIPRESA CON 5 PRESE BIPASSO + SCHUKO E SPINA TEDESCA

Sezione cavo	3 x 1 mm ²
Lunghezza cavo	1,5 m
Imballo	6* / 48

Art. 0651/6S
€ 11,40
MULTIPRESA CON 6 PRESE BIPASSO + SCHUKO, E SPINA TEDESCA

Sezione cavo	3 x 1 mm ²
Lunghezza cavo	1,5 m
Imballo	6* / 48



Art. 0793
PIROGRAFO COMPLETO DI N° 6 PUNTALINI

€ 19,10



Potenza	230 V 50 Hz 30 W
Imballo	5* / 50



Art. 0033
STAZIONE DI SALDATURA A TEMPERATURA CONTROLLATA

€ 109,00



Fusione dello stagno comune	215°C
Temperatura di esercizio	215 ÷ 300°C
Temperatura massima	420°C
Alimentazione stazione	230 V 50 Hz
Alimentazione saldatore	24 V 48 W
Imballo	8



Art. 0027
SALDATORE STILO

€ 12,40



Potenza	230 V 50 Hz 30 W
Temperatura di esercizio	450°C ± 10%
Imballo	10* / 100



Art. 0037
SET PER SALDATURA A STAGNO

€ 18,50



Potenza	230V 50Hz 30W
Imballo	5* / 20





Art. 0033/TIP1 € 17,40
SERIE PUNTE PER SALDATORE
A STAGNO



7 Pz

Imballo 5* / 300

SERIE 7 PUNTE CON FORO Ø 6 mm



Art. 0037/TIP € 16,40
SERIE PUNTE PER
SALDATORE A STAGNO



5 Pz

Imballo 5* / 20

SERIE 5 PUNTE CON FORO Ø 6 mm



Art. 0864 € 42,50
MINI SALDATORE A GAS



Dimensioni 165 x 23 mm
Imballo 100

MINI SALDATORE A GAS, TESTA A SILDARE E A BRASARE CON PROTEZIONE E ACCENSIONE

Codice compatibile	Descrizione	€	0033	0027	0037	Pag
0033/TIP1	SERIE PUNTE PER SALDATORE A STAGNO	17,40	•			558
0037/TIP	SERIE PUNTE PER SALDATORE A STAGNO	16,40		•	•	557



Art. 0026 € 18,90
SALDATORE Istantaneo



Potenza 230 V 50 Hz 100 W
Imballo 5* / 20

SALDATORE Istantaneo con punta di ricambio e stagno

**Art. 0443**
SALDATORE A PISTOLA MULTIFUNZIONE**€ 53,30**

Alimentazione	230V 50Hz 200W
Temperatura	70 °C ÷ 500 °C
Peso	1350 g
Valigetta in plastica	
Imballo	10

SALDATORE A PISTOLA MULTIFUNZIONE CON REGOLAZIONE DELLA TEMPERATURA, FUNZIONE: COLTELLO A CALDO, SALDATORE E PIROGRAFO

**Art. 0024**
SVERNICIATORE**€ 28,40**

2 velocità	375 °C - 495 °C
Flusso d'aria	280 l/min - 480 l/min
Potenza	230 V 50Hz 1,5 kW
Imballo	10

**Art. 0694**
SET SVERNICIATORE**€ 42,20**

10 Pz

2 velocità	300 °C - 600 °C
Flusso d'aria	500 l/min - 650 l/min
Potenza	230 V 50 Hz 1 - 2 kW
Imballo	10
Valigetta	

**Art. 0444**
SET SVERNICIATORE DIGITALE**€ 79,50**

6 Pz



Alimentazione	230 V, 50 Hz, 2000 W
Temperatura	I 50°C - II 70°C ÷ 600°C - III 70°C ÷ 600°C
Flusso d'aria	I 300L/min - II 300L/min - III 500L/min
Peso	735 g
Imballo	10

SVERNICIATORE DIGITALE CON REGOLAZIONE ELETTRONICA DELLA TEMPERATURA, INDICAZIONE DELLA TEMPERATURA MEDIANTE SCHERMO LCD, 2 LIVELLI DI FLUSSO ARIA, IDEALE PER SCALDARE, PIEGARE, CURVARE, SVERNICIARE



Art. 0865
ACCENDI BARBECUE ELETTRICO
€ 60,00

Alimentazione	230 V, 50 Hz, 2000 W
Temperatura	600° C
Peso	1 kg
Imballo	10
Scatola	

ACCENDI BARBECUE ELETTRICO, ACCENDE LA CARBONELLA NELLA GRIGLIA O NEL CAMINO SENZA BISOGNO DI PRODOTTI CHIMICI O FIAMMIFERI. QUESTO POTENTE STRUMENTO GENERA UN CALORE DI 600 °C ED ACCENDE LA CARBONELLA APPROSSIMATIVAMENTE IN 30 - 60 SECONDI

Art. 0441
COLTELLO A CALDO TAGLIA POLISTIROLO CON TEMPERATURA REGOLABILE
€ 66,00

Alimentazione	230 V, 50 Hz, 220 W
Temperatura	120 - 220 - 330 - 400 - 450 °C
Capacità di taglio con regolazione	20 ÷ 90 mm
Taglio max	150 mm
Peso	770 g
Imballo	10

COLTELLO A CALDO TAGLIA POLISTIROLO, PLASTICA, GOMMA PIUMA, SPUGNA CON TEMPERATURA REGOLABILE, PROFONDITÀ DI TAGLIO REGOLABILE, SUPPORTO IN METALLO

Art. 0706
PISTOLA TERMOCOLLANTE AUTOMATICA
€ 34,50

Alimentazione	230 V 40W 300 °C
Colla in stick	Ø 12 mm
Imballo	24

Art. 0431
PISTOLA TERMOCOLLANTE AUTOMATICA
€ 17,00

Alimentazione	230 V, 35 W, 200 °C
Colla in stick	Ø 12 mm
Flusso colla	16 ÷ 20 g/min
Peso	413 g
Imballo	12 / 24

PISTOLA TERMOCOLLANTE CON AVANZAMENTO AUTOMATICO, CON LED CHE SEGNALE SE LA PISTOLA È COLLEGATA ALLA RETE ELETTRICA



Art. 0032
PISTOLA TERMOCOLLANTE AUTOMATICA

€ 26,40



Alimentazione	230 V 30 W 170 °C
Colla in stick	Ø 12 mm
Imballo	6* / 24



Art. 0508
PISTOLA TERMOCOLLANTE AUTOMATICA

€ 12,90



Alimentazione	230 V 28 W 160 °C
Colla in stick	Ø 12 mm
Imballo	6* / 24



Art. 0034 € 5,20
CANDELETTE DI COLLA PER PISTOLA
TERMOCOLLANTE



10 Pz

Dimensioni	Ø 12 x 200 mm 200 gr
Imballo	10* / 30



Art. 0071 € 5,50
CANDELETTE DI COLLA PER PISTOLA
TERMOCOLLANTE



10 Pz

Dimensioni	Ø 12 x 200 mm 200 gr
Imballo	10* / 30



Art. 0149
 GRAFFATRICE
 CHIODATRICE MANUALE

€ 29,50

Imballo	24
Blister	

GRAFFATRICE CHIODATRICE MANUALE CON 500 PUNTI
E 500 CHIODI

Art. 0585
 FISSATRICE\CHIODATRICE
 PNEUMATICA

€ 191,00

Capacità caricatore	80
Pressione di esercizio	5 - 7 bar
Peso	1,38 kg
Dimensioni	245 x 230 x 55 mm
Chiodi	F - 10 / 50 mm
Punti	90 - 10 / 40 mm
Imballo	10
Valigetta	

Art. 0586
 CHIODATRICE PNEUMATICA

€ 126,00

Capacità caricatore	110
Pressione di esercizio	5 - 7 bar
Peso	1,48 kg
Dimensioni	245 x 225 x 55 mm
Chiodi	F - 10 / 50 mm
Imballo	10
Valigetta	

Art. 0587
 FISSATRICE PNEUMATICA

€ 99,00

Capacità caricatore	100
Pressione di esercizio	5 - 7 bar
Peso	0,86 kg
Dimensioni	225 x 165 x 45 mm
Punti	80 - 6 / 16 mm
Imballo	6
Valigetta	



Art. 0588/6 € 93,50
FISSATRICE PNEUMATICA PER SPILLI



Capacità caricatore	130
Pressione di esercizio	5 - 7 bar
Peso	1,05 kg
Dimensioni	225 x 170 x 45 mm
Punti	0,60 - 12 / 25 mm
Imballo	10
Valigetta	

Codice compatibile	€	0587/8006	0587/8008	0587/8010	0587/8012	0587/8014	0587/8016	0585/9013	0585/9019	0585/9032	0585/9040	Pag
0149	29,50											562
0585	191,00							•	•	•		562
0586	126,00											562
0587	99,00	•	•	•	•	•	•					562
0588/6	93,50											563

TABELLA DI COMPATIBILITÀ

Codice compatibile	€	0584/F10	0584/F20	0584/F30	0584/F40	0584/F50	0588/615	0588/620	0588/625	0150	0151	Pag
0149	29,50									•	•	562
0585	191,00	•	•	•	•	•						562
0586	126,00	•	•	•	•	•						562
0587	99,00											562
0588/6	93,50						•	•	•			563

Codice compatibile	€	0049	0240/15	0075/08x5	0075/10x6.5	0075/08x5	0100/08x5	0100/10x6.5	0100/12x8	0783/1M	0777/2	0777/3	Pag
0149	29,50	•	•	•	•	•	•	•	•	•	•	•	562
0585	191,00	•	•	•	•	•	•	•	•	•	•	•	562
0586	126,00	•	•	•	•	•	•	•	•	•	•	•	562
0587	99,00	•	•	•	•	•	•	•	•	•	•	•	562
0588/6	93,50	•	•	•	•	•	•	•	•	•	•	•	563



Art. 0573 € 124,00
AVVITATORE AD IMPULSI



3/8"

Quadro	3 / 8"
Velocità	10000 rpm
Coppia max	244 Nm
Consumo aria stimato	4 SCFM (120 l/min)
Pressione di esercizio	6 bar / 90 psi
Peso	1,5 kg
Imballo	10
Scatola	



Art. 0571 € 169,00
AVVITATORE AD IMPULSI



1/2"

Quadro	1/2"
Velocità	7000 rpm
Coppia max	610 Nm
Consumo aria stimato	5 SCFM (150 l/min)
Pressione di esercizio	6 bar / 90 psi
Peso	2,6 kg
Imballo	8
Scatola	



Art. 0576 € 164,00
AVVITATORE AD IMPULSI

1/2"

Quadro	1/2"
Velocità	7000 rpm
Coppia max	435 Nm
Consumo aria stimato	5 SCFM (150 l/min)
Pressione di esercizio	6 bar / 90 psi
Peso	2,48 kg
Imballo	10
Scatola	

Art. 0786 € 276,00
AVVITATORE AD IMPULSI

3/4"

Quadro	3/4"
Ø max bullone	25 mm
Velocità	4200 rpm
Coppia max	950 Nm
Consumo aria stimato	8 SCFM (240 l/min)
Pressione di esercizio	6 bar / 90 psi
Peso	4,8 kg
Imballo	4
Scatola	

Art. 0044 € 99,00
SET AVVITATORE AD IMPULSI

13 Pz 1/2"

Quadro	1 / 2"
Velocità	7000 rpm
Coppia max	320 Nm
Bussole	9-10-11-13-14-17-19-22-24-27 mm
Prolunga	125 mm
Consumo aria stimato	5 SCFM (150 l/min)
Pressione di esercizio	6 bar/90 psi
Peso	4,2 kg
Imballo	4
Scatola	

Art. 0045 € 59,40
AVVITATORE AD IMPULSI

1/2"

Quadro	1 / 2"
Velocità	7000 rpm
Coppia max	320 Nm
Consumo aria stimato	5 SCFM (150 l/min)
Pressione di esercizio	6 bar / 90 psi
Peso	2,3 kg
Imballo	6
Scatola	



Art. 0052 € 129,00

AVVITATORE AD IMPULSI



3/4"

Quadro	3 / 4"
Ø max bullone	25 mm
Velocità	4800 rpm
Coppia max	680 Nm
Consumo aria stimato	6 SCFM (180 l/min.)
Pressione di esercizio	6 bar / 90 psi
Peso	4,7 kg
Imballo	4
Scatola	



Art. 0046 € 93,50

AVVITATORE A
CRICCHETTO CON BUSSOLE



16 Pz 1/2"

Quadro	1/2"
Velocità	160 rpm
Coppia max	65 Nm
Bussole	9-10-11-13-14-17-19 mm
Prolunga	75 mm
Snodo universale	1/2"
Adattatore inserti	1/4"
Consumo aria stimato	4 SCFM (120 l/min.)
Pressione di esercizio	6 bar / 90 psi
Peso	2,86 kg
Imballo	10
Scatola	



Art. 0047 € 75,50

CACCIA VITE PNEUMATICO
REVERSIBILE DA 1/4"



Velocità	9000 rpm
Vite	4-5 mm
Coppia max	2,3 - 6,8 Nm
Lunghezza	180 mm
Consumo aria stimato	5 SCFM (150 l/min.)
Pressione di esercizio	6 bar / 90 psi
Imballo	20
Scatola	



Art. 0339 € 77,00

TRAPANO AD ARIA REVERSIBILE



Mandrino	Ø 10 mm
Velocità	1800 rpm
Consumo aria stimato	5 SCFM (150 l/min.)
Pressione di esercizio	6 bar / 90 psi
Peso	1,1 kg
Imballo	10
Scatola	



Art. 0574
TRAPANO AD
ARIA REVERSIBILE

€ 94,60



Mandrino	Ø 10 mm
Velocità	1800 rpm
Consumo aria stimato	5 SCFM (150 l/min)
Pressione di esercizio	6 bar / 90 psi
Peso	1 kg
Imballo	10
Scatola	



TABELLA DI COMPATIBILITÀ

Codice compatibile	Descrizione	€	0049	0240/15	S075/08x5	S075/10x6.5	S075/08x5	Pag
0573	AVVITATORE	124,00	•	•	•	•	•	563
0571	AVVITATORE	169,00	•	•	•	•	•	563
0576	AVVITATORE	164,00	•	•	•	•	•	564
0786	AVVITATORE	276,00	•	•	•	•	•	564
0044	SET AVVITATORE	99,00	•	•	•	•	•	564
0045	AVVITATORE	59,40	•	•	•	•	•	564
0052	AVVITATORE	129,00	•	•	•	•	•	565
0046	AVVITATORE A CRICCHETTO	93,50	•	•	•	•	•	565
0047	GIRAVITE PNEUMATICO	75,50	•	•	•	•	•	565
0339	TRAPANO AD ARIA	77,00	•	•	•	•	•	565
0574	TRAPANO AD ARIA	94,60	•	•	•	•	•	566

Codice compatibile	Descrizione	€	S100/08x5	S100/10x6.5	S100/12x8	0783/1M	0777/2	0777/3	Pag
0573	AVVITATORE	124,00	•	•	•	•	•	•	563
0571	AVVITATORE	169,00	•	•	•	•	•	•	563
0576	AVVITATORE	164,00	•	•	•	•	•	•	564
0786	AVVITATORE	276,00	•	•	•	•	•	•	564
0044	SET AVVITATORE	99,00	•	•	•	•	•	•	564
0045	AVVITATORE	59,40	•	•	•	•	•	•	564
0052	AVVITATORE	129,00	•	•	•	•	•	•	565
0046	AVVITATORE A CRICCHETTO	93,50	•	•	•	•	•	•	565
0047	GIRAVITE PNEUMATICO	75,50	•	•	•	•	•	•	565
0339	TRAPANO AD ARIA	77,00	•	•	•	•	•	•	565
0574	TRAPANO AD ARIA	94,60	•	•	•	•	•	•	566



Art. 0313
SMERIGLIATRICE
PNEUMATICA ANGOLARE

€ 105,00



Disco	Ø 125 mm
Velocità	10000 rpm
Consumo aria stimato	5 SCFM (150 l/min)
Pressione di esercizio	6 bar / 90 psi
Peso	2,2 kg
Imballo	10
Scatola	



Art. 0050
SET SMERIGLIATRICE
PNEUMATICA ASSIALE
CON MOLLETTINE

€ 41,70



Pinze	Ø 3 mm - Ø 6 mm
Mollettine	10 Pz / Pcs
Velocità	22000 rpm
Consumo aria stimato	4 SCFM (120 l/min.)
Pressione di esercizio	6 bar / 90 psi
Peso	1,4 kg
Imballo	10
Valigetta	



Art. 0051
SMERIGLIATRICE PNEUMATICA ASSIALE

€ 28,40



Pinze	Ø 3 mm - Ø 6 mm
Velocità	22000 rpm
Consumo aria stimato	4 SCFM (120 l/min.)
Pressione di esercizio	6 bar / 90 psi
Peso	0,8 kg
Imballo	20
Scatola	



Art. 0570
SET SMERIGLIATRICE PNEUMATICA ASSIALE CON MOLLETTINE

€ 95,70



Pinze	Ø 3 mm - Ø 6 mm
Mollettine	10 Pz / Pcs
Velocità	21000 rpm
Potenza	0,45 hp
Consumo aria stimato	5 SCFM (150 l/min.)
Pressione di esercizio	6 bar / 90 psi
Scarico aria posteriore	
Peso	1,3 kg
Imballo	10
Valigetta in plastica	



Art. 0115
SMERIGLIATRICE PNEUMATICA ASSIALE

€ 53,30



Pinze	Ø 3 mm - Ø 6 mm
Velocità	20000 rpm
Lunghezza	295 mm
Consumo aria stimato	4 SCFM (120 l/min.)
Pressione di esercizio	6 bar / 90 psi
Peso	0,7 kg
Imballo	25
Scatola	



Art. 0641
MICROSMERIGLIATRICE FLESSIBILE PNEUMATICA

€ 66,00



Capacità pinza	3 mm
Velocità	56000 rpm
Consumo aria stimato	2 SCFM (60 l/min.)
Pressione di esercizio	6 bar / 90 psi
Peso	0,82 kg
Imballo	10
Valigetta	

Art. 0784
 LEVIGATRICE PNEUMATICA

€ 71,50

Velocità	16000 rpm
Consumo aria stimato	6 SCFM (180 l / min.)
Pressione di esercizio	6 bar / 90 psi
Nastro	10 x 330 mm
Imballo	10
Scatola	

Art. 0644
 TRONCATRICE PNEUMATICA

€ 42,70

Disco	Ø 75 x 1,5 x Ø 10 mm
Velocità	15000 rpm
Consumo aria stimato	5 SCFM (150 l/min.)
Pressione di esercizio	6 bar / 90 psi
Peso	0,72 kg
Imballo	20
Valigetta in plastica	

Art. 0059
 MARTELLO PESANTE CON 4 SCALPELLI ESAGONALI

€ 33,30

Velocità	BPM 3500
Alesaggio-corsa	19 x 66 mm / 3/4" x 2 5/8"
Consumo aria stimato	4,5 SCFM (135 l/min)
Pressione di esercizio	6 bar / 90 psi
Peso	1,5 kg
Imballo	10
Scatola	

Art. 0413
 MINI SMERIGLIATRICE PNEUMATICA ASSIALE

€ 32,20

Pinze	Ø 3 mm - Ø 6 mm
Velocità	25000 rpm
Consumo aria stimato	4 SCFM (113 l/min)
Pressione di esercizio	6 bar / 90 psi
Attacco aria	1/4"
Peso	350 g
Imballo	40
Scatola	

MINI SMERIGLIATRICE PNEUMATICA ASSIALE CON PINZE DA 3 E 6 mm, SCARICO ARIA POSTERIORE GIREVOLE, CORPO IN MATERIALE COMPOSITO





Art. 0414
SMERIGLIATRICE
PNEUMATICA ASSIALE

€ 36,70



Pinze	Ø 3 mm - Ø 6 mm
Velocità	22000 rpm
Consumo aria stimato	7 SCFM (198 l/min)
Pressione di esercizio	6 bar / 90 psi
Attacco aria	1/4"
Peso	580 g
Imballo	30
Scatola	

SMERIGLIATRICE PNEUMATICA ASSIALE, CON PINZE DA 3 E 6 MM, SCARICO ARIA POSTERIORE GIREVOLE, CORPO IN MATERIALE COMPOSITO



Art. 0416
SMERIGLIATRICE
PNEUMATICA A 90°

€ 57,20



Pinze	Ø 3 mm - Ø 6 mm
Velocità	20000 rpm
Consumo aria stimato	4 SCFM (113 l/min)
Pressione di esercizio	6 bar / 90 psi
Peso	550 g
Imballo	30
Attacco aria	1/4"
Scatola	

SMERIGLIATRICE PNEUMATICA A 90° CON PINZE DA 3 E 6 MM, SCARICO ARIA POSTERIORE GIREVOLE, CORPO IN MATERIALE COMPOSITO



Art. 0417
SMERIGLIATRICE
PNEUMATICA ASSIALE LUNGA

€ 58,30



Pinze	Ø 3 mm - Ø 6 mm
Lunghezza	295 mm
Velocità	20000 rpm
Consumo aria stimato	4 SCFM (113 l/min)
Pressione di esercizio	6 bar / 90 psi
Peso	600 g
Scatola	
Imballo	25
Attacco aria	1/4"

SMERIGLIATRICE PNEUMATICA ASSIALE, CON PINZE DA 3 E 6 MM, SCARICO ARIA POSTERIORE GIREVOLE, CORPO IN MATERIALE COMPOSITO



Art. 0418
TRAPANO AD
ARIA REVERSIBILE

€ 51,70



Mandrino	10 Ø mm
Velocità	1800 rpm
Consumo aria stimato	4 SCFM (113 l/min)
Pressione di esercizio	6 bar / 90 psi
Peso	850 g
Imballo	20
Attacco aria	1/4"
Scatola	

TRAPANO AD ARIA REVERSIBILE CON MANDRINO DA 10 MM A CREMAGLIERA, SCARICO ARIA POSTERIORE GIREVOLE, CORPO IN MATERIALE COMPOSITO

Art. 0419
LEVIGATRICE PNEUMATICA ROTORBITALE DA 150 mm CON ASPIRAZIONE
€ 94,60

Diametro disco	150 mm - 6"
Orbita	5 mm, 3/16"
Velocità	10500 rpm MAX.
Consumo aria stimato	3 SCFM (85 l/min)
Pressione di esercizio	6 bar / 90 psi
Attacco aria	1/4"
Lunghezza	200 mm
Peso	950 g
Imballo	10
Scatola	

LEVIGATRICE PNEUMATICA ROTORBITALE DA 150 MM CON ASPIRAZIONE E REGOLAZIONE DELLA VELOCITÀ, SUPPORTO DISCO A STRAPPO, SCARICO ARIA POSTERIORE GIREVOLE, CORPO LEGGERO IN ALLUMINIO CON IMPUGNATURA SOFFICE ED ERGONOMICA

Art. 0421
LEVIGATRICE PNEUMATICA ROTORBITALE DA 150 mm CON ASPIRAZIONE INTEGRATA
€ 103,00

Diametro disco	150 mm - 6"
Orbita	5 mm, 3/16"
Velocità	10500 rpm
Consumo aria stimato	3 SCFM (85 l/min)
Pressione di esercizio	6 bar / 90 psi
Attacco aria	1/4"
Lunghezza	200 mm
Peso	980 g
Imballo	10
Scatola	

LEVIGATRICE PNEUMATICA ROTORBITALE DA 150 MM CON ASPIRAZIONE INTEGRATA E REGOLAZIONE DELLA VELOCITÀ, SUPPORTO DISCO A STRAPPO, SCARICO ARIA POSTERIORE GIREVOLE, CORPO LEGGERO IN ALLUMINIO CON IMPUGNATURA SOFFICE ED ERGONOMICA, TUBO ASPIRAZIONE E SACCHETTO RACCOGLI POLVERE

Art. 0458
LEVIGATRICE PNEUMATICA ROTORBITALE DA 150 mm CON ASPIRAZIONE
€ 94,60

Diametro disco	150 mm - 6"
Orbita	2,5 mm - 3 / 32"
Velocità max di utilizzo	10500 rpm
Consumo aria stimato	3 SCFM (85 l/min)
Pressione di esercizio	6 bar / 90 psi
Attacco aria	1/4"
Lunghezza	200 mm
Peso	950 g
Imballo	10
Scatola	

LEVIGATRICE ROTORBITALE DA 150 mm CON ASPIRAZIONE E REGOLAZIONE DELLA VELOCITÀ, ORBITA 2,5 mm, SUPPORTO DISCO A STRAPPO, SCARICO ARIA POSTERIORE GIREVOLE, CORPO LEGGERO IN ALLUMINIO IMPUGNATURA SOFFICE ED ERGONOMICA



**Art. 0460****LEVIGATRICE PNEUMATICA ROTORBITALE DA 150 mm CON ASPIRAZIONE INTEGRATA****€ 103,00**

Diametro disco	150 mm - 6"
Orbita	2,5 mm - 3 / 32"
Velocità max di utilizzo	10500 rpm
Consumo aria stimato	3 SCFM (85 l/min)
Pressione di esercizio	6 bar / 90 psi
Attacco aria	1/4"
Lunghezza	200 mm
Peso	980 g
Imballo	10
Scatola	

LEVIGATRICE ROTORBITALE DA 150 mm CON ASPIRAZIONE INTEGRATA E REGOLAZIONE DELLA VELOCITÀ, ORBITA 2,5 mm, SUPPORTO DISCO A STRAPPO, SCARICO ARIA POSTERIORE GIREVOLE, CORPO LEGGERO IN ALLUMINIO IMPUGNATURA SOFFICE ED ERGONOMICA, TUBO ASPIRAZIONE E SACCHETTO RACCOGLI POLVERE

TABELLA DI COMPATIBILITÀ

Codice compatibile	Descrizione	€	0459	0049	0240/15	S075/08x5	S075/10x4.5	S075/08x5	S100/08x5	S100/10x4.5	S100/12x8	0783/1M	0777/2	0777/3	Pag
0313	SMERIGLIATRICE PNEUMATICA ANGOLARE	105,00	•	•	•	•	•	•	•	•	•	•	•	•	566
0050	SET SMERIGLIATRICE PNEUMATICA ASSIALE CON MOLLETTINE	41,70	•	•	•	•	•	•	•	•	•	•	•	•	566
0051	SMERIGLIATRICE PNEUMATICA ASSIALE	28,40	•	•	•	•	•	•	•	•	•	•	•	•	567
0570	SET SMERIGLIATRICE PNEUMATICA ASSIALE CON MOLLETTINE	95,70	•	•	•	•	•	•	•	•	•	•	•	•	567
0115	SMERIGLIATRICE PNEUMATICA ASSIALE	53,30	•	•	•	•	•	•	•	•	•	•	•	•	567
0641	MICROSMERIGLIATRICE FLESSIBILE PNEUMATICA	66,00	•	•	•	•	•	•	•	•	•	•	•	•	567
0784	LEVIGATRICE PNEUMATICA	71,50	•	•	•	•	•	•	•	•	•	•	•	•	568
0644	TRONCATRICE PNEUMATICA	42,70	•	•	•	•	•	•	•	•	•	•	•	•	568
0059	MARTELLO PESANTE CON 4 SCALPELLI ESAGONALI	33,30	•	•	•	•	•	•	•	•	•	•	•	•	568
0413	MINI SMERIGLIATRICE PNEUMATICA ASSIALE	32,20	•	•	•	•	•	•	•	•	•	•	•	•	568
0414	SMERIGLIATRICE PNEUMATICA ASSIALE	36,70	•	•	•	•	•	•	•	•	•	•	•	•	569
0416	SMERIGLIATRICE PNEUMATICA A 90°	57,20	•	•	•	•	•	•	•	•	•	•	•	•	569
0417	SMERIGLIATRICE PNEUMATICA ASSIALE LUNGA	58,30	•	•	•	•	•	•	•	•	•	•	•	•	569
0418	TRAPANO AD ARIA REVERSIBILE	51,70	•	•	•	•	•	•	•	•	•	•	•	•	569
0419	LEVIGATRICE PNEUMATICA ROTORBITALE DA 150 mm CON ASPIRAZIONE	94,60	•	•	•	•	•	•	•	•	•	•	•	•	570
0421	LEVIGATRICE PNEUMATICA ROTORBITALE DA 150 mm CON ASPIRAZIONE INTEGRATA	103,00	•	•	•	•	•	•	•	•	•	•	•	•	570
0458	LEVIGATRICE PNEUMATICA ROTORBITALE DA 150 mm CON ASPIRAZIONE	94,60	•	•	•	•	•	•	•	•	•	•	•	•	570
0460	LEVIGATRICE PNEUMATICA ROTORBITALE DA 150 mm CON ASPIRAZIONE INTEGRATA	103,00	•	•	•	•	•	•	•	•	•	•	•	•	571

**Art. 0459****PLATORELLO CON FISSAGGIO A STRAPPO****€ 8,00**

Diametro disco	150 mm - 6"
Velocità max di utilizzo	12000 rpm
Peso	130 g

**Art. 0049**
OLIATORE 1/4"**€ 9,20**

Imballo	10* / 50
Blister	

Art. 0543 € 20,00
**MISURATORE DI PRESSIONE
 PNEUMATICI E EMERGENZA AUTO**

Campo di misura	3÷150 psi, 0.21÷10.34 bar, 21÷1034 kPa
Temperatura di esercizio	-20°C ~ + 50° C
Batterie incluse	2 AA
Peso	0,152 kg
Doppio Blister	
Imballo	72

IDEALE IN CONDIZIONI DI EMERGENZA PUÒ ESSERE UTILIZZATO IN 4 MODI DIFFERENTI: MISURATORE DI PRESSIONE PNEUMATICI, TORCIA ELETTRICA A LED, MARTELLO ROMPI VETRO DI EMERGENZA, TAGLIA CINTURA DI SICUREZZA

Art. 0836 € 18,00
**MISURATORE DI
 PRESSIONE DIGITALE**

Campo di misura	0,5 ÷ 99.5 psi, 0.034 ÷ 6.86 bar, 3,45 ÷ 686 kPa
Precisione	±1%
Batterie incluse	3 x SR44
Imballo	60
Blister	

MISURATORE DI PRESSIONE DIGITALE, DOTATO DI MISURATORE DI SPESSORE DEL BATTISTRADA E DI LUCE AL LED

Art. W021PA € 7,50
PISTOLA PER SOFFIAGGIO

Ugello	2.0 mm
Pressione di esercizio	2 - 6 bar
Imballo	20* / 40
Blister	

Art. W021PG € 19,00
PISTOLA GONFIAGGIO

Pressione massima	12 bar (170 psi)
Pressione di esercizio	2 - 4 bar (30 - 60 psi)
Precisione	±1%
Lunghezza tubo in gomma	440 mm
Imballo	10 / 40
Blister	



Art. W021PN € 15,50
PISTOLA PER LAVAGGIO



Capacità	900 ml
Ugello	4.5 mm
Pressione di esercizio	3 - 4 bar
Peso	520 g
Imballo	20
Scatola	

PISTOLA PER LAVAGGIO CON CORPO IN ALLUMINIO E
 SERBATOIO IN ACCIAIO



Art. 0607 € 6,80
PISTOLA PER SOFFIAGGIO



Imballo 10* / 40
 Blister



Art. 0125 € 39,00
PISTOLA GONFIAGGIO DIGITALE



Pressione massima	8 bar (110 psi)
Pressione di esercizio	2 - 4 bar (30 - 60 psi)
Risoluzione	0.05 bar (0.7 psi)
Batterie non incluse	2 x 1.5V AAA
Lunghezza tubo in gomma	80 mm
Imballo	4 / 24
Blister	

PISTOLA GONFIAGGIO DIGITALE CON
 RETROILLUMINAZIONE E CAMBIO UNITÀ DI MISURA



Art. 0608 € 19,10
PISTOLA GONFIAGGIO



Manometro	Ø 63 mm
Lettura	0 ÷ 12 bar (0 ÷ 174 psi)
Lunghezza tubo in gomma	420 mm
Imballo	40
Blister	

Art. 0610 € 15,70
 PISTOLA PER LAVAGGIO

Capacità	1000 cc
Imballo	10
Scatola	

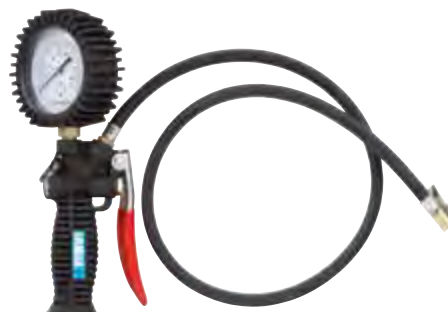
Art. 0609 € 46,70
 PISTOLA GONFIAGGIO

Manometro	Ø 80 mm
Lettura	0 ÷ 12 bar (0 ÷ 174 psi)
Lunghezza tubo in gomma	1.000 mm
Imballo	6
Blister	

Art. 0725 € 7,00
 PISTOLA PER SOFFIAGGIO

Lunghezza tubo	100 mm
Imballo	25 / 50
Blister	

Art. 0725L € 9,50
 PISTOLA LUNGA PER SOFFIAGGIO

Lunghezza tubo	275 mm
Imballo	50
Blister	

Art. 0412 € 11,20
 PISTOLA PER SOFFIAGGIO

Lunghezza tubo	100 mm
Attacco aria	1/4"
Blister	
Imballo	25 / 50

Pistola per soffiaggio di alta qualità con beccuccio in acciaio cromato da 100 mm
 Corpo in plastica POM (Poliossimetilene)
 Valvola in ottone



Art. TH601A

AEROGRAFO CON SERBATOIO A GRAVITÀ

€ 158,00

HVLP



Capacità	600 ml
Diametro ugello	1,3 mm
Portata del liquido	130 ml/min
Pressione di esercizio	2 bar (29 PSI)
Distanza di lavoro	200 mm
Ventaglio	280 - 300 mm
Peso	500 g
Imballo	10
Scatola	

AEROGRAFO HVLP CON SERBATOIO A GRAVITÀ DA 600 ml, SERBATOIO IN NYLON, COSTRUITA CON MACCHINE A CONTROLLO NUMERICO, SENZA O-RING, UGELLO E SPILLO IN ACCIAIO INOX, NEBULIZZATORE IN OTTONE, GHIERA REGISTRI IN ALLUMINIO, RACCORDO MASCHIO DA 1/4"
HVLP = ALTO VOLUME, BASSA PRESSIONE



Art. TH602A

AEROGRAFO CON SERBATOIO A GRAVITÀ

€ 119,00

HVLP



Capacità	100 ml
Diametro ugello	1,0 mm
Portata del liquido	50 ml/min
Pressione di esercizio	1,5 bar (20 PSI)
Distanza di lavoro	150 mm
Ventaglio	160 mm
Peso	300 g
Imballo	20
Scatola	

AEROGRAFO HVLP CON SERBATOIO A GRAVITÀ DA 100 ml, SERBATOIO IN NYLON, COSTRUITA CON MACCHINE A CONTROLLO NUMERICO, SENZA O-RING, UGELLO E SPILLO IN ACCIAIO INOX, NEBULIZZATORE IN OTTONE, GHIERA E REGISTRI IN ALLUMINIO, RACCORDO MASCHIO DA 1/4"
HVLP = ALTO VOLUME, BASSA PRESSIONE



Art. TH901A

AEROGRAFO CON SERBATOIO A GRAVITÀ

€ 158,00

LVMP



Capacità	600 ml
Diametro ugello	1,3 mm
Portata del liquido	140 ml/min
Pressione di esercizio	2 ÷ 2,2 bar (29 ÷ 32 PSI)
Distanza di lavoro	200 mm
Ventaglio	270 - 300 mm
Peso	500 g
Imballo	10
Scatola	

AEROGRAFO LVMP CON SERBATOIO A GRAVITÀ DA 600 ml, SERBATOIO IN NYLON, COSTRUITA CON MACCHINE A CONTROLLO NUMERICO, SENZA O-RING, UGELLO E SPILLO IN ACCIAIO INOX, NEBULIZZATORE IN OTTONE, GHIERA REGISTRI IN ALLUMINIO, RACCORDO MASCHIO DA 1/4"
LVMP = BASSO VOLUME, MEDIA PRESSIONE



Art. A601DS
AEROGRAFO CON SERBATOIO A CHIUSURA AUTOCLAVE
€ 96,80

HVLP

Ugello	Ø 1,4mm
Capacità	1000 cc
Pressione di esercizio	2,5 - 3 bar
Imballo	20
Scatola	

AEROGRAFO HVLP CON SERBATOIO A CHIUSURA AUTOCLAVE DA 1000 ml, SERBATOIO IN ALLUMINIO, COSTRUITA CON MACCHINE A CONTROLLO NUMERICO, SENZA O-RING, UGELLO E SPILLO IN ACCIAIO INOX, NEBULIZZATORE IN OTTONE, GHIERE E REGISTRI IN ALLUMINIO, CORPO CROMATO, RACCORDO MASCHIO DA 1/4"
 HVLP = ALTO VOLUME, BASSA PRESSIONE

Art. A601A
AEROGRAFO CON SERBATOIO A GRAVITÀ
€ 93,50

HVLP

Ugello	Ø 1,4mm
Capacità	600 cc
Pressione di esercizio	2,5 - 3,5 bar
Imballo	20
Scatola	

AEROGRAFO HVLP CON SERBATOIO A GRAVITÀ DA 600 ml, SERBATOIO IN NYLON, COSTRUITA CON MACCHINE A CONTROLLO NUMERICO, SENZA O-RING, UGELLO E SPILLO IN ACCIAIO INOX, NEBULIZZATORE IN OTTONE, GHIERE E REGISTRI IN ALLUMINIO, CORPO CROMATO, RACCORDO MASCHIO DA 1/4"
 HVLP = ALTO VOLUME, BASSA PRESSIONE

Art. A602A
AEROGRAFO CON SERBATOIO A GRAVITÀ
€ 65,50

HVLP

Ugello	Ø 1,0mm
Capacità	100 cc
Pressione di esercizio	2 - 2,5 bar
Imballo	20
Scatola	

AEROGRAFO HVLP CON SERBATOIO A GRAVITÀ DA 100 ml, SERBATOIO IN NYLON, COSTRUITA CON MACCHINE A CONTROLLO NUMERICO, SENZA O-RING, UGELLO E SPILLO IN ACCIAIO INOX, NEBULIZZATORE IN OTTONE, GHIERE E REGISTRI IN ALLUMINIO, CORPO CROMATO, RACCORDO MASCHIO DA 1/4"
 HVLP = ALTO VOLUME, BASSA PRESSIONE





Art. A901A

AEROGRAFO CON SERBATOIO A GRAVITÀ

€ 99,60



LVMP

Capacità	600 ml
Diametro ugello	1,4 mm
Portata del liquido	200-380 ml/min
Pressione massima	2-3 bar (30-43 PSI)
Peso	606 g
Imballo	20
Scatola	

AEROGRAFO LVMP CON SERBATOIO A GRAVITÀ DA 600 ml, SERBATOIO IN NYLON, COSTRUITA CON MACCHINE A CONTROLLO NUMERICO, SENZA O-RING, UGELLO E SPILLO IN ACCIAIO INOX, NEBULIZZATORE IN OTTONE, GHIERE IN ALLUMINIO, CORPO CROMATO, RACCORDO MASCHIO DA 1/4"
LVMP = BASSO VOLUME, MEDIA PRESSIONE



Art. A902A

AEROGRAFO CON SERBATOIO A GRAVITÀ

€ 61,60



LVMP

Capacità	100 ml
Diametro ugello	1 mm
Portata del liquido	45 - 65 ml/min
Pressione massima	1.5 - 2.5 bar (22 - 36 PSI)
Peso	306 g
Imballo	20
Scatola	

AEROGRAFO LVMP CON SERBATOIO A GRAVITÀ DA 100 ml, SERBATOIO IN NYLON, COSTRUITA CON MACCHINE A CONTROLLO NUMERICO, SENZA O-RING, UGELLO E SPILLO IN ACCIAIO INOX, NEBULIZZATORE IN OTTONE, GHIERE IN ALLUMINIO, CORPO CROMATO, RACCORDO MASCHIO DA 1/4"
LVMP = BASSO VOLUME, MEDIA PRESSIONE



Art. A162DS

AEROGRAFO CON SERBATOIO A CHIUSURA AUTOCLAVE

€ 40,00



Ugello	Ø 1,8 mm
Capacità	1000 cc
Pressione di esercizio	4-8 bar
Consumo aria	100-200 l/min
Imballo	10
Scatola	

Art. A162C
AEROGRAFO CON SERBATOIO A CHIUSURA RAPIDA
€ 28,40

Ugello	Ø 1,8 mm
Capacità	1000 cc
Pressione di esercizio	4-8 bar
Consumo aria	100-200 l/min
Imballo	10
Scatola	

Art. A162A
AEROGRAFO CON SERBATOIO A GRAVITÀ
€ 24,00

Ugello	Ø 1,8 mm
Capacità	500 cc
Pressione di esercizio	4-8 bar
Consumo aria	100-200 l/min
Imballo	20
Scatola	

Art. 0048
MINI AEROGRAFO
€ 16,80

Imballo	20
Scatola di plastica	

MINI AEROGRAFO DOTATO DI RACCORDO PER BOMBOLETTA ARIA COMPRESSA E RACCORDO DA 1/4" PER COMPRESSORE



SET RICAMBI PER AEROGRAFO



Codice	Misura	Adattabile	Imballo	€
TH601A13	1,3 mm	TH601A	50	29,00
TH601A14	1,4 mm	TH601A	50	29,00
TH601A17	1,7 mm	TH601A	50	29,00
TH601A20	2,0 mm	TH601A	50	29,00

SET RICAMBI PER AEROGRAFO TH601A, COMPOSTO DA UGELLO E AGO IN ACCIAIO INOX, NEBULIZZATORE IN OTTONE E GHIERA IN ALLUMINIO



SET RICAMBI PER AEROGRAFO



Codice	Misura	Adattabile	Imballo	€
TH602A08	0,8 mm	TH602A	50	27,00
TH602A10	1,0 mm	TH602A	50	27,00

SET RICAMBI PER AEROGRAFO TH602A, COMPOSTO DA UGELLO E AGO IN ACCIAIO INOX, NEBULIZZATORE IN OTTONE E GHIERA IN ALLUMINIO



SET RICAMBI PER AEROGRAFO



Codice	Misura	Adattabile	Imballo	€
TH901A13	1,3 mm	TH901A	50	29,00
TH901A14	1,4 mm	TH901A	50	29,00
TH901A17	1,7 mm	TH901A	50	29,00
TH901A20	2,0 mm	TH901A	50	29,00

SET RICAMBI PER AEROGRAFO TH901A, COMPOSTO DA UGELLO E AGO IN ACCIAIO INOX, NEBULIZZATORE IN OTTONE E GHIERA IN ALLUMINIO



SET UGELLI DI RICAMBIO



Codice	Misura	Adattabile	Imballo	€
A601DS14	Ø 1,4 mm	A601DS	20	19,70
A601DS17	Ø 1,7 mm	A601DS	50	19,70
A601DS20	Ø 2,0 mm	A601DS	20	19,70

SET UGELLI DI RICAMBIO, ACCIAIO INOX

SET UGELLI DI RICAMBIO



Codice	Misura	Adattabile	Imballo	€
A601A14	Ø 1,4 mm	A601A	20	22,10
A601A17	Ø 1,7 mm	A601A	50	22,10
A601A20	Ø 2,0 mm	A601A	20	22,10
A602A08	Ø 0,8 mm	A602A	20	22,10
A602A10	Ø 1,0 mm	A602A	1	22,10

SET UGELLI DI RICAMBIO, ACCIAIO INOX

SET RICAMBI PER AEROGRAFO A901A

Codice	Misura	Adattabile	Imballo	€
A901A14	1,4 mm	A901A	20	20,20
A901A17	1,7 mm	A901A	20	20,20
A901A20	2 mm	A901A	20	20,20
A902A08	Ø 0,8 mm	A902A	20	20,20
A902A10	Ø 1 mm	A902A	20	20,20

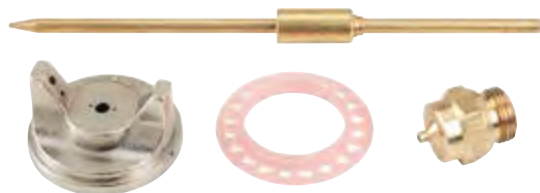
Set ricambi per aerografo A901A composto da ugello, ago, diffusore e ghiera da 1,4 mm costruiti in acciaio inossidabile, ottone e alluminio

SET UGELLI DI RICAMBIO

Codice	Misura	Imballo	€
A162DS/1.2C	Ø 1,2 mm	20	13,70
A162DS/1.5C	Ø 1,5 mm	20	13,70
A162DS/1.8C	Ø 1,8 mm	20	13,70
A162DS/2.0C	Ø 2,0 mm	20	13,70
A162DS/2.5C	Ø 2,5 mm	20	13,70
U1500R/1.2C	Ø 1,2 mm	20	13,70
U1500R/1.5C	Ø 1,5 mm	20	13,70
U1500R/1.8C	Ø 1,8 mm	20	13,70
U1500R/2.0C	Ø 2,0 mm	20	13,70
U1500R/2.5C	Ø 2,5 mm	20	13,70

Art. TH250 € 16,00
REGOLATORE DI PRESSIONE

Manometro	Ø 40 mm
Lettura	0 ÷ 11 bar (0 ÷ 160 psi)
Imballo	50
Blister	

Art. TH500 € 28,00
REGOLATORE DI PRESSIONE

Manometro	Ø 30 mm
Lettura	0 ÷ 10 bar (0 ÷ 145 psi)
Imballo	50
Blister	

Codice compatibile	Descrizione	€	TH601A	TH602A	TH901A	A601DS	A601A	A602A	A901A	A902A	A162DS	A162C	A162A	Pag
TH601A13	SET RICAMBI	29,00	*											579
TH601A14	SET RICAMBI	29,00	*											579
TH601A17	SET RICAMBI	29,00	*											579
TH601A20	SET RICAMBI	29,00	*											579
TH602A08	SET RICAMBI	27,00		*										579
TH602A10	SET RICAMBI	27,00		*										579
TH901A13	SET RICAMBI	29,00		*	*									579
TH901A14	SET RICAMBI	29,00		*	*									579
TH901A17	SET RICAMBI	29,00		*	*									579
TH901A20	SET RICAMBI	29,00		*	*									579
A601DS14	SET RICAMBI	19,70				*								579
A601DS17	SET RICAMBI	19,70				*								579
A601DS20	SET RICAMBI	19,70				*								579
A601A14	SET RICAMBI	22,10					*							580
A601A17	SET RICAMBI	22,10					*							580
A601A20	SET RICAMBI	22,10					*							580

Codice compatibile	Descrizione	€	TH601A	TH602A	TH901A	A601DS	A601A	A602A	A901A	A902A	A162DS	A162C	A162A	Pag
A602A08	SET RICAMBI	22,10						*						580
A602A10	SET RICAMBI	22,10						*						580
A901A14	SET RICAMBI	20,20						*	*					580
A901A17	SET RICAMBI	20,20						*	*					580
A901A20	SET RICAMBI	20,20						*	*					580
A902A08	SET RICAMBI	20,20						*	*	*				580
A902A10	SET RICAMBI	20,20						*	*	*				580
A162DS/1.2C	SET RICAMBI	13,70								*	*			580
A162DS/1.5C	SET RICAMBI	13,70								*	*			580
A162DS/1.8C	SET RICAMBI	13,70								*	*			580
A162DS/2.0C	SET RICAMBI	13,70								*	*			580
A162DS/2.5C	SET RICAMBI	13,70								*	*			580
U1500R/1.2C	SET RICAMBI	13,70									*	*		580
U1500R/1.5C	SET RICAMBI	13,70									*	*		580
U1500R/1.8C	SET RICAMBI	13,70									*	*		580
U1500R/2.0C	SET RICAMBI	13,70									*	*		580
U1500R/2.5C	SET RICAMBI	13,70									*	*		580

TABELLA DI COMPATIBILITÀ

Codice compatibile	Descrizione	€	TH601A	TH602A	TH901A	A601DS	A601A	A602A	A901A	A902A	A162DS	A162C	A162A	Pag
TH250	REGOLATORE DI PRESSIONE	16,00	*	*	*	*	*	*	*	*	*	*	*	580
TH500	REGOLATORE DI PRESSIONE	28,00	*	*	*	*	*	*	*	*	*	*	*	580
S075/08x5	SPIRALE IN POLIURETANO	13,50	*	*	*	*	*	*	*	*	*	*	*	582
S075/10x6.5	SPIRALE IN POLIURETANO CON RACCORDO GIREVOLE MASCHIO	18,90	*	*	*	*	*	*	*	*	*	*	*	582
S100/08x5	SPIRALE IN POLIURETANO CON RACCORDO GIREVOLE MASCHIO	16,30	*	*	*	*	*	*	*	*	*	*	*	582
S100/10x6.5	SPIRALE IN POLIURETANO CON RACCORDO GIREVOLE MASCHIO	24,00	*	*	*	*	*	*	*	*	*	*	*	582
S100/12x8	SPIRALE IN POLIURETANO CON RACCORDO GIREVOLE MASCHIO	26,50	*	*	*	*	*	*	*	*	*	*	*	582
0783/1F	INNESTO RAPIDO FEMMINA TIPO TEDESCO	2,74	*	*	*	*	*	*	*	*	*	*	*	582



Art. 0481/15
AVVOLGITUBO AUTO RIENTRANTE PER ARIA

€ 122,00



Portata aria	16 bar / 250 psi
Lunghezza tubo	15 + 1 m
Raccordi maschio	1/4" BSPT
Diametro tubo	Ø 12 x 8 mm
Temperatura di esercizio	0 ÷ 45° C
Peso	5 kg
Scatola	

AVVOLGITUBO PER ARIA AUTO RIENTRANTE, IN ABS, CON TUBO IN POLIURETANO RINFORZATO, RUBINETTO FEMMINA UNIVERSALE, INNESTO RAPIDO FEMMINA TIPO TEDESCO E CARRELLO PER DISTRIBUIRE UNIFORMEMENTE IL TUBO ALL'INTERNO DELL'AVVOLGITUBO



Art. 0240/15
AVVOLGITUBO AUTO RIENTRANTE PER ARIA

€ 145,00



Portata	16 bar / 250 psi
Lunghezza tubo	15 m + 1m
Raccordi maschio	1/4" BSPT
Diametro tubo	12 x 8 mm



SPIRALE IN POLIURETANO CON RACCORDO GIREVOLE MASCHIO

Codice	Lunghezza	Diametro	Filetto	Imballo	€
S075/08x5	7,5 m	Ø 8 x 5 mm	1/4"	60	13,50
S075/10x6.5	7,5 m	Ø 10 x 6,5 mm	1/4"	48	18,90
S100/08x5	10 m	Ø 8 x 5 mm	1/4"	60	16,30
S100/10x6.5	10 m	Ø 10 x 6,5 mm	1/4"	48	24,00
S100/12x8	10 m	Ø 12 x 8 mm	3/8"	10	26,50

RUBINETTO MASCHIO UNIVERSALE

Codice	Attacco	Imballo	€
0785/1M	1/4"	10* / 100	10,50
0785/2M	3/8"	10* / 100	10,50

RUBINETTO FEMMINA UNIVERSALE

Codice	Attacco	Imballo	€
0785/1F	1/4"	10* / 100	10,50
0785/2F	3/8"	10* / 100	10,50

INNESTO RAPIDO MASCHIO TIPO TEDESCO

Codice	Attacco	Imballo	€
0783/1M	1/4"	10* / 100	2,74
0783/2M	3/8"	10* / 100	2,74

INNESTO RAPIDO FEMMINA TIPO TEDESCO

Codice	Attacco	Imballo	€
0783/1F	1/4"	10* / 100	2,74
0783/2F	3/8"	10* / 100	2,74

Art. 0777/2 € 40,30
RIDUTTORE CON MANOMETRO E SEPARATORE

Attacco	1/4" - 3/8" - 1/2"
Imballo	50

Art. 0777/3 € 71,50
RIDUTTORE CON MANOMETRO, SEPARATORE E OLIIATORE

Attacco	1/4" - 3/8" - 1/2"
Lettura	0 ÷ 10 bar (0 ÷ 140 psi)
Imballo	25





Art. 0410/01
PISTOLA MULTIGETTO
A 10 FUNZIONI

€ 12,90



Appendibile
 Imballo

48

Pistola multigetto in metallo e gomma con la possibilità di selezionare 10 differenti getti, grilletto posteriore con fermo per regolare il getto dell'acqua, compatibile con le altre marche



Art. 0410/02
PISTOLA MULTIGETTO
A 3 FUNZIONI

€ 14,70



Appendibile
 Imballo

48

Pistola multigetto in metallo e gomma con la possibilità di selezionare 3 differenti getti, grilletto posteriore con fermo per regolare il getto dell'acqua, compatibile con le altre marche





Art. 0410/03
LANCIA CON SPRUZZO
REGOLABILE

€ 3,88



 ABS

Appendibile

Imballo

144

Lancia in ABS con spruzzo regolabile, regolazione del getto dell'acqua per lavare o per innaffiare, regolazione continua del getto da potente e concentrato a lieve e nebulizzato, compatibile con le altre marche



Art. 0410/04
DOCCETTA A VENTAGLIO
CON PUNTALE IN METALLO

€ 5,10



Appendibile

Imballo

48

Doccetta a ventaglio con puntale in metallo, adatto per irrigare piccole aree con poca pressione, compatibile con le altre marche



Art. 0410/05
IRRIGATORE ROTANTE IN ABS

€ 6,70



Scatola	
Imballo	48

Irrigatore circolare in ABS per aree medio piccole, con ugelli orientabili per distribuire l'acqua in modo uniforme, compatibile con le altre marche



Art. 0410/06
IRRIGATORE PULSANTE A SETTORE CON PUNTALE IN METALLO

€ 19,10



Appendibile	
Imballo	24

Irrigatore pulsante a settore in ABS e metallo, con puntale in metallo anti-rotazione, per irrigare aree estese, compatibile con le altre marche



Art. 0410/07
IRRIGATORE PULSANTE A SETTORE CON PUNTALE IN METALLO

€ 9,60



Appendibile	
Imballo	48

Irrigatore pulsante a settore in ABS con puntale in metallo, per irrigare aree estese, compatibile con le altre marche



Art. 0410/18
PRESA RUBINETTO DA 1" E 3/4" IN ABS A 4 VIE

€ 12,40



Appendibile	
Imballo	36

Preso rubinetto con attacco filettato femmina da 1" e 3/4" a 4 vie, corpo in ABS, per collegare 4 utenze al rubinetto, compatibile con le altre marche



Art. 0410/19
PRESA RUBINETTO DA 3/4" E 1/2" A 2 VIE, IN OTTONE

€ 21,80



Appendibile	
Imballo	120

Preso rubinetto con attacco filettato femmina da 3/4" e 1/2" a 2 vie, corpo in ottone, per collegare 2 utenze al rubinetto, compatibile con le altre marche



Art. 0410/08
RACCORDO RAPIDO DA 3/4" A 5/8"
€ 2,74

Appendibile
Imballo

200

Raccordo rapido in ABS per tubo da 3/4" a 5/8", per collegare o scollegare rapidamente il tubo a un innaffiatore o al rubinetto, compatibile con le altre marche

Art. 0410/09
RACCORDO RAPIDO DA 3/4" A 5/8" CON ACQUA STOP
€ 2,98

Appendibile
Imballo

200

Raccordo rapido in ABS per tubo da 3/4" a 5/8" con acqua stop, per collegare o scollegare rapidamente il tubo a un innaffiatore senza dover chiudere l'acqua, compatibile con le altre marche

Art. 0410/10
RACCORDO RAPIDO DA 1/2"
€ 2,28

Appendibile
Imballo

200

Raccordo rapido in ABS per tubo da 1/2", per collegare o scollegare rapidamente il tubo a un innaffiatore o al rubinetto, compatibile con le altre marche

Art. 0410/11
RACCORDO RAPIDO DA 1/2" CON ACQUA STOP
€ 2,52

Appendibile
Imballo

200

Raccordo rapido in ABS per tubo da 1/2" con acqua stop, per collegare o scollegare rapidamente il tubo a un innaffiatore senza dover chiudere l'acqua, compatibile con le altre marche

Art. 0410/12
RACCORDO RIPARATORE DA 1/2"
€ 2,18

Appendibile
Imballo

200

Raccordo riparatore in ABS per tubo in gomma da 1/2", per riparare facilmente tubi senza bisogno di attrezzi



Art. 0410/13
RACCORDO RIPARATORE DA 3/4" A 5/8"

€ 2,40



Appendibile	
Imballo	200

Raccordo riparatore in ABS per tubi in gomma da 3/4" a 5/8", per riparare facilmente tubi senza bisogno di attrezzi



Art. 0410/14
PRESA RUBINETTO DA 1" E 3/4"

€ 2,06



Appendibile	
Imballo	200

Presa rubinetto a innesto rapido in ABS con attacco filettato femmina da 1" - 3/4", compatibile con le altre marche



Art. 0410/15
PRESA RUBINETTO DA 3/4" E 1/2"

€ 1,14



Appendibile	
Imballo	200

Presa rubinetto a innesto rapido in ABS con attacco filettato femmina da 3/4" e 1/2", compatibile con le altre marche



Art. 0410/16
DEVIATORE A 3 VIE IN ABS

€ 1,38



Appendibile	
Imballo	200

Deviatore a 3 vie ad innesto rapido in ABS, per collegare contemporaneamente 2 innaffiatori o tubi di diverso diametro, compatibile con le altre marche



Art. 0410/17
GIUNTO A 2 VIE AD INNESTO RAPIDO IN ABS

€ 1,26



Appendibile	
Imballo	200

Giunto a 2 vie ad innesto rapido in ABS, per allungare o accorciare facilmente la lunghezza del tubo, per aumentare o ridurre il diametro tubo, compatibile con le altre marche



Art. 0319
 FORBICE PER POTATURA, LAMA TEMPERATA

€ 19,60

Lunghezza	210 mm
Imballo	60
Blister	

Art. 0863
 FORBICE PER POTATURA A CRICCHETTO

€ 14,00

Lunghezza	205 mm
Taglio max	Ø 24 mm
Imballo	10* / 60
Blister	

Art. 0314
 FORBICE POTATURA, LAMA TEMPERATA E RIVESTITA IN TEFLON

€ 11,90

Lunghezza	182 mm
Imballo	10* / 60
Blister	

Art. 0328
 FORBICE PER POTATURA, LAMA TEMPERATA

€ 11,90

Lunghezza	182 mm
Imballo	10* / 60
Blister	

Art. 0858
 FORBICE POTATURA, LAMA TEMPERATA E RIVESTITA IN TEFLON

€ 8,90

Lunghezza	200 mm
Imballo	10* / 60
Blister	

Art. 0330
 FORBICE PER FIORI, LAMA TEMPERATA

€ 3,84

Lunghezza	200 mm
Imballo	10* / 100
Blister	



Art. 0322 € 43,70
**TAGLIARAMI TELESCOPICO
 A CRICCHETTO CON LAMA
 TEMPERATA E RIVESTITA IN TEFLON**



Lunghezza	690 - 1030 mm
Imballo	12
Appendibile	



Art. 0860 € 25,00
TAGLIARAMI TELESCOPICO



Lunghezza	660 - 990 mm
Imballo	12
Appendibile	



Art. 0866 € 23,50
**FORBICE TELESCOPICA PER
 SIEPE CON LAME TEMPERATE
 E RIVESTITE IN TEFLON**



Lunghezza lama	250 mm
Imballo	12
Appendibile	



Art. 0326 € 40,80
**SVETTATOIO CON ASTA
 TELESCOPICA IN ALLUMINIO**



Lunghezza asta	1600 ÷ 3100 mm
Lunghezza lama	600 mm
Imballo	20

SVETTATOIO CON ASTA TELESCOPICA IN ALLUMINIO
 SEGACCIO CON LAMA TEMPERATA
 TAGLIARAMI CON LAMA RIVESTITA IN TEFLON



Art. 0868 € 12,70
**SEGACCIO A SERRAMANICO
 TRIPLA AFFILATURA DIAMANTATA**



Lunghezza lama	210 mm
Imballo	6* / 72
Blister	



Art. 0761 € 9,60
**SCOPA DA GIARDINO
 REGOLABILE CON
 MANICO IN LEGNO**



Numero dei denti	22
Imballo	24





Art. 0356 € 58,30
NEBULIZZATORE CARRELLATO
CON LANCIA IN OTTONE



Capacità	16 l
Imballo	2
Scatola	

NEBULIZZATORE CARRELLATO CON LANCIA IN OTTONE
CON GUARNIZIONI IN FPM



Art. 0303 € 43,10
NEBULIZZATORE CON
LANCIA IN OTTONE



Capacità	8 l
Imballo	2
Scatola	

NEBULIZZATORE CON LANCIA IN OTTONE CON
MANOMETRO E GUARNIZIONI IN FPM



Art. 0274 € 7,70
NEBULIZZATORE CON
UGELLO IN OTTONE



Capacità	2 l
Imballo	20

NEBULIZZATORE CON UGELLO IN OTTONE CON
GUARNIZIONI IN FPM



Art. 0289 € 5,60
NEBULIZZATORE CON
UGELLO IN OTTONE



Capacità	2 l
Peso	0,35 kg
Imballo	15

NEBULIZZATORE CON UGELLO IN OTTONE E
GUARNIZIONI IN GOMMA



Art. 0101/500
SCURETTO

€ 8,70



Peso totale	600 g
Imballo	6* / 24



Art. 0513
SCURETTO CON MANICO IN FIBRA DI VETRO

€ 12,00



Peso totale	1 kg
Imballo	6* / 24



Art. 0515
SCURE CON MANICO IN FIBRA DI VETRO

€ 27,40



Peso totale	2,6 kg
Imballo	6
Lunghezza	900 mm



Art. 0842
INNESTATRICE UNIVERSALE

€ 35,80



Imballo	60
---------	----

4 Pz





Art. 0043
NASTRO SEGNALETICO ROSSO E BIANCO
€ 5,30

Lunghezza	200 m
Altezza	70 mm
Imballo	12* / 24

GUANTI IN FIORE DI VITELLO BIANCO ORLATO

Codice	Taglia	Spessore pelle	Imballo	€
0005/B7	7	0,9 ÷ 1,1 mm	12* / 72	8,60
0005/B8	8	0,9 ÷ 1,1 mm	12* / 72	8,60
0005/B9	9	0,9 ÷ 1,1 mm	12* / 72	8,60
0005/B10	10	0,9 ÷ 1,1 mm	12* / 120	8,60

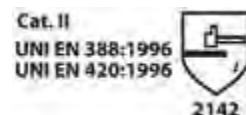
GUANTI IN FIORE DI VITELLO BIANCO ORLATO,
 SCONSIGLIATO IL CONTATTO CON OLI, ACQUA E LIQUIDI IN
 GENERE

GUANTI IN FIORE E CROSTA DI VITELLO

Codice	Taglia	Spessore pelle	Imballo	€
016R/07	7	1,0 ÷ 1,1 mm	12* / 120	5,60
016R/08	8	1,0 ÷ 1,1 mm	12* / 120	5,60
016R/09	9	1,0 ÷ 1,1 mm	12* / 120	5,60
016R/10	10	1,0 ÷ 1,1 mm	12* / 120	5,60

GUANTI IN FIORE DI VITELLO BIANCO ORLATO, DORSO IN
 CROSTA, SCONSIGLIATO IL CONTATTO CON OLI, ACQUA E
 LIQUIDI IN GENERE



GUANTI IN TESSUTO INTERLOCK COTONE 100%



EN 388
EN 420 4111

Codice	Taglia	Imballo	€
A055/7	7	12* / 72	2,96
A055/8	8	12* / 72	2,96
A055/9	9	12* / 120	2,96
A055/10	10	12* / 120	2,96

GUANTI IN TESSUTO INTERLOCK COTONE 100%,
IMPREGNATI IN NBR LEGGERO, POLSINO IN MAGLIA, DORSO
AERATO, OTTIMI A CONTATTO CON OLI, VERNICI E GASOLIO



GUANTI IN FIORE DI MAIALINO



EN 388
EN 420 1121

Codice	Taglia	Imballo	€
A358/7	7 - Verde	12* / 72	7,70
A358/8	8 - Blue	12* / 72	7,70
A358/9	9 - Giallo	12* / 120	7,70
A358/10	10 - Rosso	12* / 120	7,70
A358/11	11 - Nero	12* / 120	7,70

GUANTI IN FIORE DI MAIALINO, POLSINO CON ELASTICO
CHIUSO CON VELCRO, DORSO IN COTONE 100%,
SCONSIGLIATO IL CONTATTO CON OLI, ACQUA E LIQUIDI IN
GENERE



Art. A540
GUANTI IN NBR

€ 3,20



EN 388
EN 420 4111

Taglia	10
Imballo	12* / 144

GUANTI IN NBR, MANICOTTO IN TELA, DORSO AERATO,
BUONA SENSIBILITÀ, BUONA RESISTENZA ALL'ABRASIONE
E AL TAGLIO. OTTIMI NEL SETTORE MECCANICO,
INDUSTRIALE, EDILE, AGRICOLO, LAVORAZIONE LAMIERATI

Art. A541
GUANTI IN NBR
€ 3,42

 EN 388
 EN 420 4111

Taglia	10
Imballo	12* / 120

GUANTI IN NBR, MANICOTTO IN TELA, DORSO RICOPERTO, BUONA SENSIBILITÀ, BUONA RESISTENZA ALL'ABRASIONE E AL TAGLIO. OTTIMI NEL SETTORE MECCANICO, INDUSTRIALE, EDILE, AGRICOLO, LAVORAZIONE LAMIERATI

GUANTI IN NITRILE

 EN 388
 EN 420 4132

Codice	Taglia	Resistenza all'abrasione	Imballo	€
0057/7	7	2 (1.500 cicli / cycles)	12* / 240	1,54
0057/8	8	2 (1.500 cicli / cycles)	12* / 240	1,54
0057/9	9	2 (1.500 cicli / cycles)	12* / 240	1,54
0057/10	10	2 (1.500 cicli / cycles)	12* / 240	1,54

GUANTI IN NITRILE, SUPPORTO A FILO CONTINUO, SENZA CUCITURE

GUANTI IN FILATO ELASTICO

 EN 388
 EN 420 4131
 3131

Codice	Taglia	Imballo	€
0525/M	M	12* / 240	1,54
0525/L	L	12* / 240	1,54
0525/XL	XL	12* / 240	1,54
0525/XXL	XXL	12* / 72	1,54

GUANTI IN FILATO ELASTICO CON PALMO RICOPERTO IN POLIURETANO, I POLSINI IN LATTICE PERMETTONO UNA PERFETTA ADERENZA AL POLSO



GUANTI IN FILATO DI NYLON ELASTICO



EN 388:2003
EN 420:2003

4131

Codice	Taglia	Imballo	€
G052/M	M	12* / 240	2,80
G052/L	L	12* / 240	2,80
G052/XL	XL	12* / 240	2,80
G052/XXL	XXL	12* / 72	2,80

GUANTI IN FILATO DI NYLON ELASTICO CON PALMO RICOPERTO IN POLIURETANO, I POLSINI IN NYLON



GUANTI ANTITAGLIO



EN 388:03
EN 420:03+A1:09

4541

Codice	Taglia	Imballo	€
G528/07	7	12* / 72	8,60
G528/08	8	12* / 240	8,60
G528/09	9	12* / 240	8,60
G528/10	10	12* / 72	8,60

GUANTI ANTITAGLIO IN FILO CONTINUO ELASTICIZZATO, PALMO RICOPERTO, POLSINI ELASTICIZZATI



GUANTI IN FILATO DI NYLON ELASTICIZZATO



EN 388:2003
EN 420:2003

4141

Codice	Taglia	Imballo	€
A526/7	7	12* / 72	3,84
A526/8	8	12* / 72	3,84
A526/9	9	12* / 240	3,84
A526/10	10	12* / 240	3,84

GUANTI IN FILATO DI NYLON ELASTICIZZATO, TESSUTO A NIDO D'APE, DORSO AERATO, PALMO RICOPERTO DI POLIURETANO RUVIDO PER UN OTTIMO GRIP

GUANTI MONOUSO, NON STERILI, AMBIDESTRI IN LATTICE

100 Pz

CAT.1

Codice	Taglia	Categoria	Imballo	€
0121/10S	S	1	10	12,00
0121/10M	M	1	10	12,00
0121/10L	L	1	10	12,00
0121/10XL	XL	1	10	12,00

GUANTI IN LATTICE CON POLVERE. MONOUSO, AMBIDESTRI, FINEMENTE TALCATI CON AMIDO DI MAIS. BORDINO ARROTOLATO. PRODOTTO LEGGERO. OTTIMO RAPPORTO QUALITÀ/PREZZO. CATEGORIA I DI RISCHIO PER UTILIZZO IN AMBITO PROFESSIONALE (DIR. 89/686/CEE). IDONEI AL CONTATTO CON DIVERSE TIPOLOGIE DI ALIMENTI. SUPERFICIE: LISCIA. COLORI: BIANCO, 100 Pz

GUANTI MONOUSO, NON STERILI, AMBIDESTRI IN VINILE

100 Pz

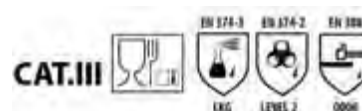

Codice	Taglia	Categoria	Imballo	€
A121/11P	P	3	10	11,20
A121/11M	M	3	10	11,20
A121/11L	L	3	10	11,20
A121/11XL	XL	3	10	11,20

FINEMENTE TALCATI CON AMIDO DI MAIS, BORDINO ARROTOLATO, GRANDE ELASTICITÀ, 100% LATEX FREE. PRODOTTO CON SPECIALI FTALATI (DINP) A BASSA TOSSICITÀ. CATEGORIA III DI RISCHIO, ADATTI PER LA PROTEZIONE DA AGENTI CHIMICI E MICRORGANISMI. DISPOSITIVO MEDICO IN AMBITO OSPEDALIERO E ODONTOIATRICO (AQL 1,5) - DIR. 93/42/CEE NORME EN 455 1, 2 & 3. SUPERFICIE LISCIA. VINILE CON POLVERE. 100 Pz

GUANTI MONOUSO, NON STERILI, AMBIDESTRI IN NITRILE

100 Pz



Codice	Taglia	Categoria	Imballo	€
G121/13S	S	3	10	18,00
G121/13M	M	3	10	18,00
G121/13L	L	3	10	18,00
G121/13XL	XL	3	10	18,00

PIÙ ELASTICI, PIÙ PESANTI, PIÙ RESISTENTI ALLA ROTTURA. NON TALCATI. OTTIMI NELLE APPLICAZIONI CHE RICHIEDONO UNA SOSTITUZIONE FREQUENTE DEI GUANTI. APPLICAZIONI: PULIZIE INDUSTRIALI, MONTAGGI DI PRECISIONE, LAVORI DI LABORATORIO, MANEGGIO DI COLLE E RESINE, PULIZIA DI MOBILI, PITTURA, INTONACATURA E PULIZIA. NITRILE, 100 Pz



Art. 0142/405
OCCHIALI PROTETTIVI

€ 3,36

EN 166



Classe ottica	1
Imballo	12* / 144

OCCHIALI MONOLENTE IN POLICARBONATO ANTIGRAFFIO LEGGERISSIMI. SI POSSONO SOVRAPPORRE AD OCCHIALI DA VISTA, EN 166



Art. 0175
OCCHIALI PROTETTIVI

€ 3,20

EN 166



Classe ottica	1
Imballo	12* / 120

OCCHIALI PROTETTIVI CON MONTATURA MORBIDA, LENTI INCOLORE IN POLICARBONATO ANTIGRAFFIO. CLASSE OTTICA 1. EN 166



Art. 0142/29
OCCHIALI PROTETTIVI

€ 6,50

EN 166



Classe ottica	1
Imballo	12* / 300

OCCHIALI AVVOLGENTI, LENTI IN POLICARBONATO ANTIGRAFFIO, ASTINE IN NYLON REGOLABILI, EN 166



Art. 0142/29G
OCCHIALI PROTETTIVI

€ 6,20

EN 166



Classe ottica	1
Imballo	12* / 120

OCCHIALE CON LENTI INCOLORE IN POLICARBONATO ANTIGRAFFIO, MONTATURA COMPLETA CON RIPARO SULLE ASTINE. CLASSE OTTICA 1, EN 166



Art. 0142/400
OCCHIALI PROTETTIVI

€ 3,20

EN 166



Classe ottica	1
Imballo	12* / 120

OCCHIALI PROTETTIVI CON VALVOLINE DI AEREAZIONE, MONTATURA MORBIDA, LENTI INCOLORE IN POLICARBONATO ANTIGRAFFIO. CLASSE OTTICA 1. EN 166

Art. 0616
ELMETTO
€ 7,70

UNI EN 358 & CE 95/0098
Imballo 6* / 24

ELMETTO DA CANTIERE CON REGOLAZIONE NUCALE MANUALE, IN PE HD "UV", RESISTENZA TERMICA: +50 -20° C. 6 PUNTI DI ANCORAGGIO, FASCIA ANTERIORE CON PARASUDORE IN SPUGNA E TESSUTO. PREDISPOSIZIONE PER L'INSERIMENTO DI CUFFIE E VISIERA CHE UTILIZZANO ATTACCHI DA 30 mm. ISOLAMENTO ELETTRICO 440 V C.A., UNI-EN 397, CE 95/0098

Art. 0141/310
CINTURA DI POSIZIONAMENTO REGOLABILE IN VITA
€ 37,00

EN 358

CINTURA DI POSIZIONAMENTO REGOLABILE IN VITA, IN POLIESTERE HT, EN 358

Art. 0141/340
CORDINO DI POSIZIONAMENTO REGOLABILE E MOSCHETTONE
€ 41,80

EN 358
Lunghezza

Max 1,8 m - Min 0,5 m

Resistenza statica del moschettone

25 kN

Art. 0141/31
KIT DI POSIZIONAMENTO
€ 92,70

EN 358

KIT DI POSIZIONAMENTO CON CINTURA DI POSIZIONAMENTO E CORDINO REGOLABILE E MOSCHETTONE



Art. A141/33 € 46,00
IMBRACATURA ANTICADUTA



EN 361

IMBRACATURA ANTICADUTA CON ATTACCHI DORSALE E STERNALE, FASCIA SOTTOGLUTEI E REGOLAZIONE SUI COSCIALI, EN 361



Art. 0141/39 € 11,40
MOSCHETTONE OVALE
CON DOPPIA CHIUSURA A
VITE, AD ALTA RESISTENZA



EN 362

Lunghezza totale	110 mm
Imballo	5* / 100

MOSCHETTONE OVALE CON DOPPIA CHIUSURA A VITE, AD ALTA RESISTENZA, EN 362



Art. A141/36
ASSORBITORE DI ENERGIA

€ 32,00



EN 355

ASSORBITORE DI ENERGIA A NASTRO, UTILIZZABILE PER ALTEZZE NON INFERIORI A 6 m, EN 355



Art. 0141/330
KIT ANTICADUTA

€ 95,30



EN 362 & EN 361 & EN 355

KIT ANTICADUTA, IMBRACATURA CON ATTACCO DORSALE E STERNALE, MOSCHETTONE E ASSORBITORE DI ENERGIA

Art. 0148/72
 PRODOTTI DI PRIMO SOCCORSO

€ 37,80

Dimensioni valigia	309 x 209 x 97 mm
Imballo	5

PRODOTTI DI PRIMO SOCCORSO, CONFORMI ALL'ALLEGATO 2 PER AZIENDE FINO A 2 PERSONE, IN VALIGIA DI POLIPROPILENE CON VITI DI FISSAGGIO A MURO

Art. 0148/73
 PRODOTTI DI PRIMO SOCCORSO

€ 140,00

Dimensioni valigia	405 x 300 x 114 mm
Imballo	4

PRODOTTI DI PRIMO SOCCORSO, CONFORMI ALL'ALLEGATO 1 PER AZIENDE CON PIU' DI 2 PERSONE, IN VALIGIA DI POLIPROPILENE CON VITI DI FISSAGGIO A MURO

Art. 0148/64
 PRODOTTI DI PRIMO SOCCORSO

€ 23,00

Dimensioni valigia	250 x 180 x 90 mm
Imballo	10

BORSA IN NYLON PER AUTOMEZZI E AZIENDE FINO A 2 PERSONE, CON MANIGLIA E TRACOLLA, CHIUSURA CON CERNIERA, CONTENUTO ALLEGATO 2 A NORMA DM 388 DEL 15.7.2003 ALLEGATO 2 E D.L.81



Art. 0142/250
CUFFIA ANTIRUMORE

€ 15,20



EN 352-1

Imballo

10* / 60

CUFFIA ANTIRUMORE. OTTIMA ATTENUAZIONE, MOLTO LEGGERA, DOPPIO ATTACCO, EN 352-1



Art. 0142/25
CUFFIA ANTIRUMORE

€ 12,80



EN 352-1

Imballo

6* / 60

CUFFIA ANTIRUMORE, OTTIMA DOVE SI PRESENTI LA NECESSITÀ DI SOSTITUZIONE CONTINUA



TUTA MONOUSO



CAT. 1

Codice	Categoria	Peso	Imballo	€
0135/5L	1	40 g/m ²	25* / 100	4,00
0135/5XL	1	40 g/m ²	25* / 100	4,00

TUTA IN PLP, TESSUTO PUNTINATO, PESO 40 g/m², MOLTO RESISTENTE, ELASTICO AI POLSI, ALLE CAVIGLIE, IN VITA E NEL CAPPUCCIO, CAT. 1



TUTA MONOUSO



CAT. 3

Codice	Categoria	Peso	Imballo	€
0135/6TL	3	50 g/m ²	25* / 100	8,00
0135/6TXL	3	50 g/m ²	25* / 100	8,00

TUTA DOPPIO STRATO SPALMATA IN PU IN 3° CATEGORIA, PESO 50 g/m². ELASTICO AI POLSI, ALLE CAVIGLIE, IN VITA E NEL CAPPUCCIO. CHIUSURA CON CERNIERA.

Art. M122E
 MASCHERINE IGIENICHE

€ 6,60

50 Pz

Imballo 10* / 20

Art. M122CE
 FACCIALE FILTRANTE

€ 1,40

EN 149:2001 + A1:2009

Caratteristiche	FFP1 - MAX 4 X TLV
Peso	9 g
Imballo	20* / 240

Art. M122P220
 FACCIALE FILTRANTE

€ 2,00

EN 149:2001 + A1:2009

Caratteristiche	FFP2 - MAX 12 x TLV
Peso	9 g
Imballo	20* / 240

Art. M122P215V
 FACCIALE FILTRANTE

€ 3,10

EN 149:2001 + A1:2009

Caratteristiche	FFP2 - MAX 12 x TLV
Peso	13 g
Imballo	15* / 180

Art. M122P2
 FACCIALE FILTRANTE

€ 4,90

EN 149:2001 + A1:2009

Caratteristiche	FFP2 - MAX 12 x TLV
Peso	15 g
Imballo	12* / 144

Art. M122P310V
 FACCIALE FILTRANTE

€ 6,40

EN 149:2001 + A1:2009

Caratteristiche	FFP3 - MAX 50 x TLV
Peso	16 g
Imballo	10* / 120



CALZATURE ANTINFORTUNISTICHE



EN ISO 20345:2011



Codice	Taglia	Imballo	€
G810/40	40	6	54,00
G810/41	41	6	54,00
G810/42	42	6	54,00
G810/43	43	6	54,00
G810/44	44	6	54,00
G810/45	45	6	54,00



CALZATURE ANTINFORTUNISTICHE



EN ISO 20345:2011 SRC: SRA+SRB



Codice	Taglia	Imballo	€
A360/40	40	6	42,50
A360/41	41	6	42,50
A360/42	42	6	42,50
A360/43	43	6	42,50
A360/44	44	6	42,50
A360/45	45	6	42,50



CALZATURE ANTINFORTUNISTICHE



EN ISO 20345:2011



Codice	Taglia	Imballo	€
G820/40	40	6	56,00
G820/41	41	6	56,00
G820/42	42	6	56,00
G820/43	43	6	56,00
G820/44	44	6	56,00
G820/45	45	6	56,00



CALZATURE ANTINFORTUNISTICHE



EN ISO 20345:2011



Codice	Taglia	Imballo	€
G882/40	40	6	54,00
G882/41	41	6	54,00
G882/42	42	6	54,00
G882/43	43	6	54,00
G882/44	44	6	54,00
G882/45	45	6	54,00



CALZATURE ANTINFORTUNISTICHE

EN ISO 20345:2011 S1P

Codice	Taglia	Imballo	€
G8401/40	40	6	48,90
G8401/41	41	6	48,90
G8401/42	42	6	48,90
G8401/43	43	6	48,90
G8401/44	44	6	48,90
G8401/45	45	6	48,90

STIVALE PROFESSIONALE IN GOMMA NITRILICA

EN ISO 20347:2012 SRA

Codice	Taglia	€
SP01/39	39	29,50
SP01/40	40	29,50
SP01/41	41	29,50
SP01/42	42	29,50
SP01/43	43	29,50
SP01/44	44	29,50
SP01/45	45	29,50
SP01/46	46	29,50
SP01/47	47	29,50

STIVALE DI SICUREZZA IN GOMMA NITRILICA

EN ISO 20345:2011 SRC

Codice	Taglia	€
SP02/39	39	42,50
SP02/40	40	42,50
SP02/41	41	42,50
SP02/42	42	42,50
SP02/43	43	42,50
SP02/44	44	42,50
SP02/45	45	42,50
SP02/46	46	42,50
SP02/47	47	42,50

STIVALE DI SICUREZZA IN PVC

EN ISO 20345:2011 SRC

Codice	Taglia	€
SP03/39	39	32,50
SP03/40	40	32,50
SP03/41	41	32,50
SP03/42	42	32,50
SP03/43	43	32,50
SP03/44	44	32,50
SP03/45	45	32,50
SP03/46	46	32,50
SP03/47	47	32,50



STIVALE DA LAVORO IN PVC



Codice	Taglia	€
SP04/39	39	24,90
SP04/40	40	24,90
SP04/41	41	24,90
SP04/42	42	24,90
SP04/43	43	24,90
SP04/44	44	24,90
SP04/45	45	24,90
SP04/46	46	24,90
SP04/47	47	24,90



STIVALE INVERNALE



Codice	Taglia	€	Codice	Taglia	€
SP05/36	36	41,50	SP05/43	43	41,50
SP05/37	37	41,50	SP05/44	44	41,50
SP05/38	38	41,50	SP05/45	45	41,50
SP05/39	39	41,50	SP05/46	46	41,50
SP05/40	40	41,50	SP05/47	47	41,50
SP05/41	41	41,50	SP05/48	48	41,50
SP05/42	42	41,50			



CANADESE BASSO IN TEFAPRENE



Codice	Taglia	€
SP06/39	39	55,00
SP06/40	40	55,00
SP06/41	41	55,00
SP06/42	42	55,00
SP06/43	43	55,00
SP06/44	44	55,00
SP06/45	45	55,00
SP06/46	46	55,00
SP06/47	47	55,00



CANADESE IN TEFAPRENE



Codice	Taglia	€
SP07/39	39	57,50
SP07/40	40	57,50
SP07/41	41	57,50
SP07/42	42	57,50
SP07/43	43	57,50
SP07/44	44	57,50
SP07/45	45	57,50
SP07/46	46	57,50
SP07/47	47	57,50



le immagini sono indicative delle configurazioni degli allestimenti e potrebbero variare in base alla disponibilità



ESPOSITORI A PARETE

pag 608



TECHE CON CUBO

pag 619



GAZEBO

pag 621



PROPOSTA ESPOSITORE 01
**ESPOSITORE
IN OMAGGIO**

ART	PAG	#	ART	PAG	#
P062	248	5	E010/M14E	283	20
P046	246	5	G003/1	281	10
P061	248	5	G003/2	281	10
P067	253	2	P068	248	20
M312/C	276	3	M032	277	2
M312/P	276	3	M218	276	1
P045	246	5	E010	283	1
F430	272	3	G002/1	281	10
S001	274	3	G002/2	281	10
E010/M05	283	5	G002/3	281	10
E010/M06	283	5	G001/20	282	10
E010/M08	283	3	G001/25	282	10
E010/M10	283	3	G001/30	282	10
E010/M12	283	3	G001/45	282	10
E010/M14	283	3	G001/55	282	10
E010/M05E	283	20	0121	449	12
E010/M06E	283	20	0373/11	450	3
E010/M08E	283	15	0373/9	450	5
E010/M10E	283	15	0379	450	6
E010/M12E	283	20	0368/10	450	2
			0120	449	12

PROPOSTA ESPOSITORE 02
**ESPOSITORE
IN OMAGGIO**

ART	PAG	#	ART	PAG	#
0154/1000DIN	453	6	0249	447	10
0154/400DIN	453	12	0020	444	10
0154/800DIN	453	6	0456	439	6
0154/600DIN	453	12	0404	435	5
0154/100DIN	453	12	0850	442	10
0154/500DIN	453	12	0811	442	10
0514/400	453	12	0810	442	10
0514/1000	453	12	0814	442	10
0514/300	453	12	0636	447	10
0514/500	453	6	0637	447	10
0514/200	453	6	0672/B	492	12
0873/U7	443	10	0672	492	12
0873/U6	443	10	0407	437	12
0873/U8	443	10	0402	435	3
0873/BD6	443	10	0403	435	3
0873/BC6	443	10	0089	437	20
0873/BD8	443	10	0638	447	10
0873/BC8	443	10	0639	447	10
0873/TL	443	10	C880/16OCTZ	428	1
0248	447	10			

IL TUO RAPPRESENTANTE TI POTRÀ OFFRIRE UNA PROPOSTA PERSONALIZZATA PER PREZZI E CONDIZIONI DI PAGAMENTO



PROPOSTA ESPOSITORE 03

ESPOSITORE
IN OMAGGIO



ART	PAG	#	ART	PAG	#
0208/06	363	20	0476/06X07	366	12
0208/07	363	20	0476/08X09	366	12
0208/08	363	20	0476/10X11	366	12
0208/09	363	20	0476/12X13	366	12
0208/10	363	20	0476/14X15	366	12
0208/11	363	20	0476/16X17	366	12
0208/12	363	20	0476/18X19	366	12
0208/13	363	20	0476/20X22	366	6
0208/14	363	20	0476/21X23	366	6
0208/15	363	20	0476/24X27	366	6
0208/16	363	20	0476/25X28	366	6
0208/17	363	20	0476/30X32	366	6
0208/18	363	20	0201/06X07	362	20
0208/19	363	20	0201/08X09	362	20
0208/20	363	20	0201/10X11	362	20
0208/21	363	20	0201/12X13	362	10
0208/22	363	10	0201/14X15	362	10
0208/23	363	10	0201/16X17	362	10
0208/24	363	10	0201/18X19	362	10
0208/25	363	10	0201/20X22	362	10
0208/26	363	10	0201/21X23	362	10
0208/27	363	10	0201/24X27	362	10
0208/28	363	10	0201/25X28	362	10
0208/30	363	10	0201/30X32	362	10
0208/32	363	10	0201	362	3
0073	365	12	0477	366	6
0442/20X22	368	5	0690/12P	360	1
0442/18X19	368	5	0690/07P	360	1
0442/16X17	368	5	0270	378	1
0442/10X11	368	5	0803/210	379	2
0442/08X09	368	5	0803/110	379	2
0442/06X07	368	5			



PROPOSTA ESPOSITORE 04

ESPOSITORE
IN OMAGGIO



ART	PAG	#	ART	PAG	#
EN403N500A	398	5	0826	447	5
EN403N250A	398	5	0872/OPD	441	6
PN403N150A	398	5	0872/PDD	441	6
EN403N125A	398	5	0080	377	20
JN403NA	399	5	0370/8	450	2
LN400N1/2A	398	5	0370/11	450	2
0439/1/2	382	5	0013/142	342	12
0439/3/8	382	5	0020/6	445	10
0439/1/4	382	5	0862	494	10
0440/1/4	383	5	0077	376	10
0440/3/8	383	5	0446	342	5
0440/1/2	383	5	0088	439	5
0841	446	4	0801	494	12
0122	447	12	0608	573	5
BN4C3L016A	398	5	0447	542	2
BN4C3L018A	398	5	0432	542	2
BN4C3L021A	398	5	0479	543	2
RN4034NA	399	5	0478	542	2
PN403N050A	398	5	0451	377	2
0212	331	12	0029	342	12
0607	573	10	0078	375	12
0076	376	5	0079	375	12

IL TUO RAPPRESENTANTE TI POTRÀ OFFRIRE UNA PROPOSTA PERSONALIZZATA PER PREZZI E CONDIZIONI DI PAGAMENTO



PROPOSTA ESPOSITORE 05
**ESPOSITORE
IN OMAGGIO**

ART	PAG	#	ART	PAG	#
C391/06	375	2	0400/14	371	5
C391/07	375	2	0400/025	371	5
C391/08	375	2	0400/035	371	5
C391/09	375	2	0400/045	371	5
C391/10	375	2	0405/T06	374	5
C391/11	375	2	0405/T07	374	5
C391/12	375	2	0405/T08	374	5
C391/13	375	2	0405/T09	374	5
C391/14	375	2	0405/T10	374	5
C391/15	375	2	0405/T15	374	5
C391/16	375	2	0405/T20	374	5
C391/17	375	2	0405/T25	374	5
C391/18	375	2	0405/T27	374	5
C391/19	375	2	0405/T30	374	5
0210	373	20	0405/T40	374	5
0215	370	12	0405/T45	374	5
0220	373	12	0405/T50	374	5
0090	372	50	0855/T30	373	20
0269	371	1	0855/T20	373	20
0471	439	6	0855/T25	373	20
0400/02	371	5	0855/T40	373	20
0400/03	371	5	0856/03	370	20
0400/04	371	5	0856/04	370	20
0400/05	371	5	0856/05	370	20
0400/06	371	1	0856/06	370	20
0400/07	371	1	0856/08	370	20
0400/08	371	1	0856/10	370	20
0400/09	371	1	0806/200	378	1
0400/10	371	1	0803/S080	380	1
0400/12	371	5	0803/S210	380	1

PROPOSTA ESPOSITORE 06
**ESPOSITORE
IN OMAGGIO**

ART	PAG	#	ART	PAG	#
0780	452	12	F683	333	12
0153/1500DIN	453	12	0234	470	24
0153/1000DIN	453	12	0678	470	6
0794/450	454	6	0091	471	24
0781	452	12	0834	449	10
0794/350	454	12	0807/150	335	10
R050	334	12	0449	335	3
R030	334	12	0470	468	6
0824/500	337	1	0332	261	5
0824/400	337	12	0821/14	472	12
0824/600	337	12	0819/18	471	6
0824/300	337	1	0819/20	471	12
0320	466	12	0820/20	471	12
F2G5	333	12	0032	561	6
F2G3	333	12	S018	467	1
F2G2	333	12	0058	469	12
F688	333	12	0606	473	1
F685	333	12			

IL TUO RAPPRESENTANTE TI POTRÀ OFFRIRE UNA PROPOSTA PERSONALIZZATA PER PREZZI E CONDIZIONI DI PAGAMENTO



PROPOSTA ESPOSITORE 07

ESPOSITORE
IN OMAGGIO



ART	PAG	#	ART	PAG	#
0084/375	368	5	0672/B	492	12
0084/250	368	12	0629	490	6
0084/150	368	12	0472	469	5
0420	284	10	0130/350	451	6
0415	284	10	0287/300	494	6
0844	494	10	0287/450	494	5
0093/42	493	6	0287/600	494	5
0673	492	12	0453	468	2
0818/250	492	8	0160	463	5
0635/25	168	12	0292	102	8
0124	469	12	0292/14	102	8
0655/R	491	12	0292/16	102	8
0655/S	491	12	0130/600	451	6
0655/L	491	12	0199P	363	4
0093/22	493	10	0222	364	4
0672	492	12	0455	467	2



PROPOSTA ESPOSITORE 08

ESPOSITORE
IN OMAGGIO



ART	PAG	#	ART	PAG	#
M006/200	482	4	0167/150	483	5
M006/300	482	4	0394/150	483	12
M006/400	482	3	0394/300	483	12
M006/500	482	4	0394/450	483	12
M006/600	482	3	0394/600	483	12
M006/1000	482	2	0051	567	4
M007/600	482	2	0413	568	3
M007/500	482	3	0416	569	2
M007/400	482	3	0417	569	2
M007/300	482	3	0418	569	2
M007/250	482	3	0414	569	3
0167/250	483	20			

IL TUO RAPPRESENTANTE TI POTRÀ OFFRIRE UNA PROPOSTA PERSONALIZZATA PER PREZZI E CONDIZIONI DI PAGAMENTO



PROPOSTA ESPOSITORE 09
**ESPOSITORE
IN OMAGGIO**

ART	PAG	#
0410/01	583	6
0410/02	583	6
0410/03	584	12
0410/04	584	12
0410/05	585	12
0410/06	585	4
0410/07	585	6
0410/08	586	20
0410/09	586	20
0410/10	586	20
0410/11	586	20
0410/12	586	25
0410/13	587	25
0410/14	587	25
0410/15	587	25
0410/16	587	25
0410/17	587	25
0410/18	585	6

ART	PAG	#
0410/19	585	4
0860	589	6
0866	589	6
0858	588	10
0325	492	12
0314	588	10
0328	588	10
0319	588	10
0863	588	10
0101/500	591	12
0868	589	6
0515	591	12
0513	591	12
0274	590	10
0289	590	5
0303	590	2

PROPOSTA ESPOSITORE 10
**ESPOSITORE
IN OMAGGIO**

ART	PAG	#
0225/700	451	6
0225/580	451	6
0225/440	451	6
0831/175	448	20
0831/250	448	10
0831/300	448	10
0161	490	30
0226	490	6
0227/700	451	6
0227/580	451	6
0227/440	451	6
0297	493	3

ART	PAG	#
0225/340	451	6
0227/340	451	6
0741/250T2	464	10
0741/200T2	464	10
0741/200T3	464	10
0738/200T2	464	10
0740/200T2	464	10
0739/200T3	464	10
0739/200T2	464	10
0737/200T2	464	10
0737/200T3	464	10
0395	507	2
0390	507	2

IL TUO RAPPRESENTANTE TI POTRÀ OFFRIRE UNA PROPOSTA PERSONALIZZATA PER PREZZI E CONDIZIONI DI PAGAMENTO

PROPOSTA ESPOSITORE 11

ESPOSITORE
IN OMAGGIO



ART	PAG	#	ART	PAG	#
0208/06	363	20	BN4E4L022A	387	5
0208/07	363	20	BN4C4L021A	390	5
0208/08	363	20	BN4C4L018A	390	5
0208/09	363	20	BN4C4L016A	390	5
0208/10	363	20	0808/35	456	12
0208/11	363	20	0808/60	456	1
0208/12	363	20	0488/60	456	6
0208/13	363	20	0488/35	456	6
0208/14	363	20	0727	455	3
0208/15	363	20	0728	455	3
0208/16	363	20	C395/06	374	3
0208/17	363	20	C395/07	374	3
0208/18	363	20	C395/08	374	3
0208/19	363	20	C395/09	374	3
0208/20	363	20	C395/10	374	3
0208/21	363	20	C395/11	374	3
0208/22	363	10	C395/12	374	3
0208/23	363	10	C395/13	374	3
0208/24	363	10	C395/14	374	3
0208/25	363	10	C395/15	374	3
0208/26	363	10	C395/16	374	3
0208/27	363	10	C395/17	374	3
0208/28	363	10	C395/18	374	3
0208/30	363	10	C395/19	374	3
0208/32	363	10	BN4E3N008A	392	10
0439/1/2	382	5	BN4E3N009A	392	10
0439/3/8	382	5	BN4E3N010A	392	10
0439/1/4	382	5	BN4E3N011A	392	10
0440/1/2	383	5	BN4E3N012A	392	10
0440/3/8	383	5	BN4E3N013A	392	10
0440/1/4	383	5	BN4E3N014A	392	10
BN4E4N006A	387	5	BN4E3N015A	392	10
BN4E4N007A	387	5	BN4E3N016A	392	10
BN4E4N008A	387	5	BN4E3N017A	392	10
BN4E4N009A	387	5	BN4E3N018A	392	10
BN4E4N010A	387	5	BN4E3N019A	392	10
BN4E4N011A	387	5	BN4E3N020A	392	10
BN4E4N012A	387	5	BN4E3N021A	392	10
BN4E4N013A	387	5	BN4E3N022A	392	10
BN4E4N014A	387	5	BN4E3N023A	392	10
BN4E4N015A	387	5	BN4E3N024A	392	10
BN4E4N016A	387	5	BN4E3N025A	392	10
BN4E4N017A	387	5	BN4E3N026A	392	10
BN4E4N018A	387	5	BN4E3N027A	392	10
BN4E4N019A	387	5	BN4E3N028A	392	10
BN4E4N020A	387	5	BN4E3N029A	392	10
BN4E4N021A	387	5	BN4E3N030A	392	10
BN4E4N022A	387	5	BN4E3N032A	392	10
BN4E4L006A	387	5	JN403NA	399	10
BN4E4L007A	387	5	RN4032NA	399	10
BN4E4L008A	387	5	RN4034NA	399	10
BN4E4L009A	387	5	LN400N1/2A	398	5
BN4E4L010A	387	5	EN403N050A	398	5
BN4E4L011A	387	5	EN403N075A	398	5
BN4E4L012A	387	5	EN403N125A	398	3
BN4E4L013A	387	5	EN403N250A	398	3
BN4E4L014A	387	5	EN403N500A	398	3
BN4E4L015A	387	5	PN403N050A	398	5
BN4E4L016A	387	5	PN403N075A	398	5
BN4E4L017A	387	5	PN403N150A	398	3
BN4E4L018A	387	5	PN403N250A	398	3
BN4E4L019A	387	5	BN4C3L016A	398	3
BN4E4L020A	387	5	BN4C3L018A	398	3
BN4E4L021A	387	5	BN4C3L021A	398	3



IL TUO RAPPRESENTANTE TI POTRÀ OFFRIRE UNA PROPOSTA PERSONALIZZATA PER PREZZI E CONDIZIONI DI PAGAMENTO

PROPOSTA ESPOSITORE 12
**ESPOSITORE
IN OMAGGIO**

ART	PAG	#
0544/06	361	5
0544/07	361	5
0544/08	361	5
0544/09	361	5
0544/10	361	5
0544/11	361	5
0544/12	361	5
0544/13	361	5
0544/14	361	5
0544/15	361	5
0544/16	361	5
0544/17	361	5
0544/18	361	5
0544/19	361	5
0544/20	361	5
0544/21	361	5
0544/22	361	5
0544/23	361	5
0544/24	361	5
0544/25	361	5
0544/26	361	5
0544/27	361	5
0544/28	361	5
0544/29	361	5
0544/30	361	5
0544/32	361	5
0405/T06	374	5

ART	PAG	#
0405/T07	374	5
0405/T09	374	5
0405/T10	374	5
0405/T15	374	5
0405/T20	374	5
0405/T25	374	5
0405/T27	374	5
0405/T30	374	5
0405/T40	374	5
0405/T45	374	5
0405/T50	374	5
0400/02	371	5
0400/025	371	5
0400/03	371	5
0400/035	371	5
0400/04	371	5
0400/045	371	5
0400/06	371	1
0400/07	371	1
0400/08	371	1
0856/02.5	370	10
0856/03	370	10
0856/04	370	10
0856/05	370	10
0856/06	370	10
0856/08	370	10
0855/T15	373	10
0855/T20	373	10
0855/T25	373	10
0855/T30	373	10
0855/T40	373	10
0494/1/4	382	3
0494/3/8	382	3
0494/1/2	382	3
EN404N038A	391	3
EN404N075A	391	3
EN404N150A	391	3
EN404N250A	391	3
JN404NA	391	3
RN4045NA	390	3
RN4054NA	386	3
RN4043NA	391	2
BN424L045A	389	5
BN424L040A	389	5
BN424L030A	389	5
BN424L027A	389	5
BN424L025A	389	5
BN424L020A	389	5
BN424L015A	389	5
BN424N010A	389	5
BN424N015A	389	5
BN424N020A	389	5
BN424N025A	389	5
BN424N027A	389	5
BN424N030A	389	5
BN424N040A	389	5
BN424N045A	389	5
BN424N050A	389	5
BN424N055A	389	5
BN414L003A	388	5
BN414L004A	388	5
BN414L005A	388	5
BN414L006A	388	5

ART	PAG	#
BN414L007A	388	5
BN414L008A	388	5
BN414L009A	388	5
BN414L010A	388	5
BN414L012A	388	5
BN414N003A	388	5
BN414N004A	388	5
BN414N006A	388	5
BN414N007A	388	5
BN414N008A	388	5
BN414N009A	388	5
BN414N010A	388	5
BN414N012A	388	5
0337	455	6
0336	455	6
0794/450	454	6
0794/350	454	6
0243/30	454	6
0243/40	454	1
0839/40	455	6
0839/50	455	6
0839/60	455	6
0614/08X10	367	5
0614/10X12	367	5
0614/13X15	367	5
0614/14X17	367	5
0614/16X18	367	5
0614/19X22	367	5
CI80/120	432	1
BI4E3N008	410	10
BI4E3N009	410	10
BI4E3N010	410	10
BI4E3N011	410	10
BI4E3N012	410	10
BI4E3N013	410	10
BI4E3N014	410	10
BI4E3N015	410	10
BI4E3N016	410	10
BI4E3N017	410	10
BI4E3N018	410	10
BI4E3N019	410	10
BI4E3N020	410	10
BI4E3N021	410	10
BI4E3N022	410	10
BI4E3N023	410	10
BI4E3N024	410	10
BI4E3N025	410	10
BI4E3N026	410	10
BI4E3N027	410	10
BI4E3N028	410	10
BI4E3N029	410	10
BI4E3N030	410	10
BI4E3N031	410	10
BI4E3N032	410	10
RI4032N	421	10
JI403N	421	10
PI453075	413	5
PI453150	413	5
PI453250	413	3
PI403075	413	5
PI403125	413	5
PI403150	413	3
PI403250	413	3

PROPOSTA ESPOSITORE 13
**ESPOSITORE
IN OMAGGIO**

ART	PAG	#	ART	PAG	#
0224/06	365	20	BN444N006A	390	5
0224/07	365	20	BN444N014A	390	5
0224/08	365	20	BN444N008A	390	5
0224/09	365	20	BN444N009A	390	5
0224/10	365	20	BN444N010A	390	5
0224/11	365	20	0514/1000	453	12
0224/12	365	20	0514/200	453	6
0224/13	365	20	0514/300	453	12
0224/14	365	20	0514/400	453	12
0224/15	365	20	0514/500	453	6
0224/16	365	20	0154/400DIN	453	12
0224/17	365	20	0154/500DIN	453	12
0224/18	365	20	0154/600DIN	453	12
0224/19	365	20	0154/800DIN	453	6
0224/20	365	20	0154/300DIN	453	10
0224/21	365	20	0154/100DIN	453	12
0224/22	365	20	BN4P3N008A	394	10
0224/23	365	20	BN4P3N009A	394	10
0224/24	365	20	BN4P3N010A	394	10
0224/25	365	20	BN4P3N011A	394	10
0224/26	365	20	BN4P3N012A	394	10
0224/27	365	20	BN4P3N013A	394	10
0224/28	365	20	BN4P3N014A	394	10
0224/30	365	20	BN4P3N015A	394	10
0224/32	365	10	BN4P3N016A	394	10
0442	368	2	BN4P3N017A	394	10
CN450N1/2A	382	5	BN4P3N018A	394	10
CN450N3/8A	382	5	BN4P3N019A	394	10
CN450N1/4A	382	5	BN4P3N020A	394	10
LN400N3/8A	390	5	BN4P3N021A	394	10
PN404N050A	391	5	BN4P3N022A	394	10
PN404N075A	391	5	BN4P3N023A	394	10
PN404N150A	391	5	BN4P3N024A	394	10
BN444L004A	390	5	BN4P3N025A	394	10
BN444L005A	390	5	BN4P3N026A	394	10
BN444L006A	390	5	BN4P3N027A	394	10
BN444L008A	390	5	BN4P3N028A	394	10
BN444L009A	390	5	BN4P3N029A	394	10
BN444L010A	390	5	BN4P3N030A	394	10
BN444L012A	390	5	BN4P3N032A	394	10
BN444L014A	390	5	JN403NA	399	10
BN434N004A	389	5	RN4032NA	399	10
BN434N005A	389	5	RN4034NA	399	10
BN434N006A	389	5	LN400N1/2A	398	5
BN434N007A	389	5	EN403N050A	398	5
BN434N008A	389	5	EN403N075A	398	5
BN434N009A	389	5	EN403N125A	398	3
BN434N010A	389	5	EN403N250A	398	3
BN434L004A	389	5	EN403N500A	398	3
BN434L005A	389	5	PN403N050A	398	5
BN434L006A	389	5	PN403N075A	398	5
BN434L007A	389	5	PN403N150A	398	3
BN434L008A	389	5	PN403N250A	398	3
BN434L009A	389	5	BN4C3L016A	398	3
BN434L010A	389	5	BN4C3L018A	398	3
BN444N004A	390	5	BN4C3L021A	398	3
BN444N005A	390	5			

PROPOSTA ESPOSITORE 14
**ESPOSITORE
IN OMAGGIO**

ART	PAG	#
0873/U8	443	10
0873/U7	443	10
0873/U6	443	10
0873/TL	443	10
0873/BD8	443	10
0873/BC6	443	10
0873/BC8	443	10
0872/OPD	441	6
0020	444	10
0215P	370	12
0220	373	12
0215	370	12
0545/TM	372	6
0545/EM	370	6
0020/1	444	20
0020/2	444	1
0402	435	3
0403	435	3

ART	PAG	#
0404	435	5
0127	459	10
0872/PDD	441	6
0020/3	445	15
0020/6	445	10
0548	436	10
0547	436	10
0407	437	12
0549	436	10
0090	372	50
0626L	434	6
0626	434	12
0210	373	20
0126	459	10
0872/PCD	441	6
S179	407	1
0618	406	2

PROPOSTA ESPOSITORE 15
**ESPOSITORE
IN OMAGGIO**

ART	PAG	#
0690/08	360	10
0690/09	360	10
0690/10	360	10
0690/11	360	10
0690/12	360	10
0690/13	360	10
0690/14	360	5
0690/15	360	5
0690/16	360	5
0690/17	360	5
0690/18	360	5
0690/19	360	5
0690/07P	360	1
0700/07P	360	6

ART	PAG	#
0200	362	6
0221	364	10
0476	366	3
0690/12P	360	1
0477	366	6
0199	363	6
0199P	363	4
0201	362	3
0222	364	4
0073	365	12
0546	361	4
SN4P3N027	408	2
S108	406	1

IL TUO RAPPRESENTANTE TI POTRÀ OFFRIRE UNA PROPOSTA PERSONALIZZATA PER PREZZI E CONDIZIONI DI PAGAMENTO



PROPOSTA ESPOSITORE 16

ESPOSITORE
IN OMAGGIO

ART	PAG	#
0309/15	545	10
0309/16	546	10
0309/21	546	10
0309/12	545	10
0647/65	472	6
0342	553	5
0466/DM	434	20
F018	492	6
0672/B	492	12
0672	492	12
0841	446	4
0826	447	5
0847	446	5
0381	459	6
0029	342	12
0446	342	5
6009	457	10
0037	557	5
0076	376	5
0077	376	10
0470	468	6
0027	557	10
0431	560	6
0635/25	168	12
0160	463	5
0543	572	10
0471	439	6
S328	407	2
0620	408	2
0679	405	2



PROPOSTA ESPOSITORE 17

ESPOSITORE
IN OMAGGIO

**COMPONI IL TUO ESPOSITORE
CON GLI ARTICOLI CHE TROVI
NELLA SEZIONE ABRASIVI
DA PAGINA 4 A PAGINA 33**

**PROPOSTA BUSSOLE
ESAGONALI**

ART	PAG	#
BN4E3N008A	389	10
BN4E3N009A	389	10
BN4E3N010A	389	10
BN4E3N011A	389	10
BN4E3N012A	389	10
BN4E3N013A	389	10
BN4E3N014A	389	10
BN4E3N015A	389	10
BN4E3N016A	389	10
BN4E3N017A	389	10
BN4E3N018A	389	10
BN4E3N019A	389	10
BN4E3N020A	389	10
BN4E3N021A	389	10
BN4E3N022A	389	10
BN4E3N023A	389	10
BN4E3N024A	389	10
BN4E3N025A	389	10
BN4E3N026A	389	10
BN4E3N027A	389	10
BN4E3N028A	389	10
BN4E3N029A	389	10
BN4E3N030A	389	10
BN4E3N032A	389	10
JN403NA	398	10
RN4032NA	398	10
RN4034NA	398	10
LN400N1/2A	397	5
EN403N050A	397	5
EN403N075A	397	5
EN403N125A	397	3
EN403N250A	397	3
EN403N500A	397	3
PN403N050A	397	5
PN403N075A	397	5
PN403N150A	397	3
PN403N250A	397	3
BN4C3L016A	399	3
BN4C3L018A	399	3
BN4C3L021A	399	3

**PROPOSTA BUSSOLE
POLIGONALI**

ART	PAG	#
BN4P3N008A	394	10
BN4P3N009A	394	10
BN4P3N010A	394	10
BN4P3N011A	394	10
BN4P3N012A	394	10
BN4P3N013A	394	10
BN4P3N014A	394	10
BN4P3N015A	394	10
BN4P3N016A	394	10
BN4P3N017A	394	10
BN4P3N018A	394	10
BN4P3N019A	394	10
BN4P3N020A	394	10
BN4P3N021A	394	10
BN4P3N022A	394	10
BN4P3N023A	394	10
BN4P3N024A	394	10
BN4P3N025A	394	10
BN4P3N026A	394	10
BN4P3N027A	394	10
BN4P3N028A	394	10
BN4P3N029A	394	10
BN4P3N030A	394	10
BN4P3N032A	394	10
JN403NA	399	10
RN4032NA	399	10
RN4034NA	399	10
LN400N1/2A	398	5
EN403N050A	398	5
EN403N075A	398	5
EN403N125A	398	3
EN403N250A	398	3
EN403N500A	398	3
PN403N050A	398	5
PN403N075A	398	5
PN403N150A	398	3
PN403N250A	398	3
BN4C3L016A	398	3
BN4C3L018A	398	3
BN4C3L021A	398	3

**PROPOSTA BUSSOLE
IMPACT**

ART	PAG	#
BI4E3N008	407	10
BI4E3N009	407	10
BI4E3N010	407	10
BI4E3N011	407	10
BI4E3N012	407	10
BI4E3N013	407	10
BI4E3N014	407	10
BI4E3N015	407	10
BI4E3N016	407	10
BI4E3N017	407	10
BI4E3N018	407	10
BI4E3N019	407	10
BI4E3N020	407	10
BI4E3N021	407	10
BI4E3N022	407	10
BI4E3N023	407	10
BI4E3N024	407	10
BI4E3N025	407	10
BI4E3N026	407	10
BI4E3N027	407	10
BI4E3N028	407	10
BI4E3N029	407	10
BI4E3N030	407	10
BI4E3N031	407	10
BI4E3N032	407	10
RI4032N	416	10
JI403N	416	10
PI453075	411	5
PI453150	411	5
PI453250	411	3
PI403075	411	5
PI403125	411	5
PI403150	411	3
PI403250	411	3

PROPOSTA TECA 01:

TECA
IN OMAGGIO



ART	PAG	#
CKJNR25	212	4
KNUX160405RN	238	50
PCLNR20	211	4
CNMG120408N	238	50
KISCLCR	213	5
T091	218	2

IL TUO RAPPRESENTANTE TI POTRÀ OFFRIRE
UNA PROPOSTA PERSONALIZZATA PER PREZZI E
CONDIZIONI DI PAGAMENTO

PROPOSTA TECA 02:

TECA
IN OMAGGIO



ART	PAG	#
KISER	217	2
KISNR	217	2
KICAN	217	3
T090	218	2
B005	241	12

IL TUO RAPPRESENTANTE TI POTRÀ OFFRIRE
UNA PROPOSTA PERSONALIZZATA PER PREZZI E
CONDIZIONI DI PAGAMENTO



PROPOSTA TECA 03:

TECA
IN OMAGGIO



ART	PAG	#
B007/10	209	2
B007/12	209	3
B007/16	209	3
T089	218	2
B005	241	12

IL TUO RAPPRESENTANTE TI POTRÀ OFFRIRE
UNA PROPOSTA PERSONALIZZATA PER PREZZI E
CONDIZIONI DI PAGAMENTO

PROPOSTA TECA 04:

TECA
IN OMAGGIO



ART	PAG	#
S042/2	325	4
C033/150	298	4
C002/42	307	6
C002	307	5
T007	308	4
M033/00/25	315	6

IL TUO RAPPRESENTANTE TI POTRÀ OFFRIRE
UNA PROPOSTA PERSONALIZZATA PER PREZZI E
CONDIZIONI DI PAGAMENTO





PROPOSTA TECA 05:

TECA
IN OMAGGIO

ART	PAG	#
ML80	343	3
ML30	343	2
T068	344	4
T053	341	6
P075	340	4
0387	348	5

IL TUO RAPPRESENTANTE TI POTRÀ OFFRIRE
UNA PROPOSTA PERSONALIZZATA PER PREZZI E
CONDIZIONI DI PAGAMENTO



PROPOSTA GAZEBO 01:

GAZEBO
IN OMAGGIODISPONIBILE
CON E SENZA
PARETE

ART	PAG	#
T998/400V3A	41	1
T700V	48	1
T024	72	1
T026	71	1



PROPOSTA GAZEBO 02:

**GAZEBO
IN OMAGGIO**

**DISPONIBILE
CON E SENZA
PARETE**

ART	PAG	#
0498	108	1
0509/340	120	1
0496	127	1
0512	73	1

IL TUO RAPPRESENTANTE TI POTRÀ OFFRIRE UNA PROPOSTA PERSONALIZZATA PER PREZZI E CONDIZIONI DI PAGAMENTO



PROPOSTA GAZEBO 03:



GAZEBO
IN OMAGGIO

DISPONIBILE
CON E SENZA
PARETE

ART	PAG	#
T026	71	1
0072	164	1
0094	165	1
S019	165	1
0596	475	1
0595	475	1
S008/M	161	1

IL TUO RAPPRESENTANTE TI POTRÀ OFFRIRE UNA PROPOSTA PERSONALIZZATA PER PREZZI E CONDIZIONI DI PAGAMENTO



PROPOSTA GAZEBO 04:

**GAZEBO
IN OMAGGIO**

**DISPONIBILE
CON E SENZA
PARETE**

ART	PAG	#
0575S	133	1
0487	134	1
0486	140	1
0233	142	1
C009	525	1
0687	132	1

IL TUO RAPPRESENTANTE TI POTRÀ OFFRIRE UNA PROPOSTA PERSONALIZZATA PER PREZZI E CONDIZIONI DI PAGAMENTO



PROPOSTA GAZEBO 05:



GAZEBO
IN OMAGGIO

DISPONIBILE
CON E SENZA
PARETE

ART	PAG	#
0499	109	1
0504	113	1
FC94/350	121	1
0497/300	106	1
C009	525	1

IL TUO RAPPRESENTANTE TI POTRÀ OFFRIRE UNA PROPOSTA PERSONALIZZATA PER PREZZI E CONDIZIONI DI PAGAMENTO



PROPOSTA GAZEBO 06:

**GAZEBO
IN OMAGGIO**

**DISPONIBILE
CON E SENZA
PARETE**

ART	PAG	#
0285/75	99	1
0518/50	82	1
T026	71	1
T700	49	1
C009	525	1

IL TUO RAPPRESENTANTE TI POTRÀ OFFRIRE UNA PROPOSTA PERSONALIZZATA PER PREZZI E CONDIZIONI DI PAGAMENTO



PROPOSTA GAZEBO 07:



**GAZEBO
IN OMAGGIO**

**DISPONIBILE
CON E SENZA
PARETE**

ART	PAG	#
T069/400V3A	39	1
0601	131	1
C980	509	1
T024	72	1
T032DA	68	1

IL TUO RAPPRESENTANTE TI POTRÀ OFFRIRE UNA PROPOSTA PERSONALIZZATA PER PREZZI E CONDIZIONI DI PAGAMENTO



CODICE	PAG	CODICE	PAG	CODICE	PAG
0005/...	592	0067	159	0121	449
0010	163	0068	173	0121/...	596
0012	80	0068/S	174	0122	447
0013/142	342	0069/...	159	0123	551
0013/185	342	0070/...	172	0124	469
0018/15	376	0071	561	0125	573
0018/30	376	0072	164	0126	459
0019/...	383	0073	365	0127	459
0020	444	0075	163	0128	546
0020/1	444	0076	376	0130/...	451
0020/2	444	0077	376	0133	88
0020/3	445	0078...	375	0134S	367
0020/4	445	0080	377	0135/...	601
0020/5	445	0081	469	0135/...	601
0020/6	445	0082	433	0136	448
0022	98	0083	432	0137	379
0023	91	0084/...	368	0138	124
0024	559	0085	470	0141	492
0026	558	0086	433	0141/31	598
0027	557	0087	262	0141/310	598
0028...	174	0087/35	262	0141/330	599
0029	342	0088	439	0141/340	598
0032	561	0089	437	0141/39	599
0033	557	0090	372	0142/...	180
0033/TIP1	558	0090/...	372	0142/25	601
0034	561	0091	471	0142/250	601
0035	485	0092	493	0142/29	597
0036/...	480	0093/22	493	0142/29G	597
0036/...	480	0093/22R	493	0142/400	597
0037	557	0093/42	493	0142/405	597
0037/TIP	558	0093/42R	493	0143	176
0038	140	0094	165	0144	124
0042/...	480	0095	486	0145/...	479
0043	592	0096	485	0146/60	479
0044	564	0096/L	487	0148/500	454
0045	564	0101/500	591	0148/64	600
0046	565	0102	101	0148/72	600
0047	565	0103	478	0148/73	600
0048	578	0104	438	0149	562
0049	571	0105	520	0150	287
0050	566	0107	549	0151	287
0051	567	0109	335	0152	460
0052	565	0110	521	0153/...	453
0054/...	155	0111	469	0154/...	453
0056/...	165	0112	336	0156/...	473
0057/...	594	0113	102	0157/...	481
0058	469	0115	567	0158/500	473
0059	568	0116	289	0159	491
0060	158	0116P	289	0160	463
0062/...	156	0117	169	0161	490
0063	164	0118	448	0162	462
0065	158	0119	449	0163	22
0066	172	0120	449	0164/250	473



CODICE	PAG	CODICE	PAG	CODICE	PAG
0165	522	0233	142	0299...	290
0166	462	0234	470	0300	461
0167/...	483	0235	99	0301/...	461
0168	461	0236	167	0302/245	122
0169/...	454	0237/...	166	0302/305	122
016R/...	592	0238	261	0303	590
0171/...	473	0240/15	581	0306	461
0171/2	473	0242	78	0308	383
0172/150	474	0243/...	454	0309/12	545
0172/180	474	0244	432	0309/15	545
0174/...	479	0245	433	0309/16	546
0175	597	0246...	447	0309/21	546
0176	291	0247...	447	0311	549
0177	290	0251	285	0312	351
0178	288	0252/...	74	0313	566
0179	289	0254	507	0314	588
0180	290	0255	84	0315	523
0181	408	0256/...	156	0316	94
0183/750	473	0257	289	0319	588
0184/...	472	0258	460	0320	466
0188/...	181	0259	460	0322	589
0188/100G	181	0260	79	0325	492
0189/...	474	0261	290	0326	589
0189/...	474	0263	289	0327	490
0192	466	0264	508	0328	588
0192/...	466	0265/05	481	0329	380
0197	101	0266	369	0330	588
0199...	363	0267	466	0331	286
0200	362	0268	379	0332	261
0201	362	0269	371	0336...	455
0201/...	362	0270	378	0338	550
0202	466	0271	154	0339	565
0205	481	0272	477	0341	419
0205/120	481	0274	590	0342	553
0208	364	0276	489	0343	539
0208/...	363	0277	438	0344	540
0210	373	0279	25	0345	534
0212	331	0280	114	0346	534
0214	463	0281...	478	0347/...	534
0215...	370	0285/75	99	0348	534
0219	463	0286/...	329	0349	25
0220	373	0287/...	494	0350	24
0221	364	0288	430	0353/...	484
0222	364	0289	590	0353/085	484
0223	365	0290	138	0353/110	484
0224/...	365	0291	550	0355	432
0225/...	451	0292...	102	0356	590
0226	490	0293	291	0360	380
0227/...	451	0294	288	0361	533
0228	383	0295	288	0362	85
0229	288	0296	289	0363/...	524
0231	288	0297	493	0365	116
0232	141	0298	288	0366	539
				0367	487



CODICE	PAG	CODICE	PAG	CODICE	PAG
0368/...	450	0410/04	584	0447	542
0369	157	0410/05	585	0448/10	536
0370/...	450	0410/06	585	0448/20	536
0371	230	0410/07	585	0449	335
0372	230	0410/08	586	0450/10	537
0373/...	450	0410/09	586	0450/20	537
0375	158	0410/10	586	0451	377
0377	93	0410/11	586	0452	162
0379	450	0410/12	586	0453	468
0380	291	0410/13	587	0454	468
0381	459	0410/14	587	0455	467
0382/...	524	0410/15	587	0456	439
0383	90	0410/16	587	0457	157
0384	285	0410/17	587	0458	570
0385	476	0410/18	585	0459	571
0386	476	0410/19	585	0460	571
0387	348	0411	284	0461	526
0388	487	0412	574	0462	136
0388/01	488	0413	568	0462/55	138
0388/02	488	0414	569	0463	262
0388/03	488	0415	284	0464/10	537
0388/04	488	0416	569	0464/20	537
0388/05	488	0417	569	0466/4V	518
0388/06	488	0418	569	0466/C	518
0388/07	489	0419	570	0466/CV	518
0388/08	489	0420	284	0466/DM	434
0388/09	489	0421	570	0466/PB	518
0388/10	489	0422/...	504	0466/SA	519
0388/11	489	0423/1	502	0466/SC	519
0389/...	487	0423/2	502	0467	163
0390	507	0424	469	0469	467
0391	459	0425/...	107	0470	468
0392	141	0426/30	377	0471	439
0393	403	0426/32	377	0472	469
0394/...	483	0427/...	479	0473/...	473
0395	507	0428	554	0474/PA	477
0396	460	0429	552	0474/PE	477
0397	546	0430	162	0474/PP	477
0400	371	0431	560	0475	486
0400/...	371	0432	542	0476	366
0401	551	0433	351	0476/...	366
0402	435	0435	142	0477	366
0403	435	0436	543	0478	542
0404	435	0437	543	0479	543
0405	374	0438/...	31	0480	544
0405/...	374	0439/...	382	0481/15	581
0406	436	0440/...	383	0482/09	544
0407	437	0441	560	0482/30	544
0408	507	0442	368	0484	437
0409	507	0442/...	368	0486	140
0410/01	583	0443	559	0487	134
0410/02	583	0444	559	0488/...	456
0410/03	584	0445/20	552	0488/...	456
		0446	342		

CODICE	PAG	CODICE	PAG	CODICE	PAG
0489/2B	547	0532	230	0586	562
0489/2S	547	0532/230V	231	0587	562
0489/3B	548	0534...	232	0587/...	287
0489/3S	548	0536	231	0588/...	287
0489/4B	548	0536/L	232	0588/6	563
0489/4S	548	0537	231	0589	404
0490	135	0538	231	0590	172
0490/03	139	0539	232	0591/...	480
0490/11	139	0540/...	369	0592	160
0490/20	138	0540/3	369	0593	404
0491	544	0540S	369	0594	475
0492	549	0541S	367	0595	475
0493/1	545	0543	572	0596	475
0493/2	545	0544	361	0597	550
0494/...	382	0544/...	361	0598	160
0495	128	0545/EM	370	0599	62
0495/24	129	0545/TM	372	0600	166
0496	127	0546	361	0601	131
0497/...	106	0547	436	0601/24	139
0498	108	0548	436	0601/30	139
0499	109	0549	436	0602	166
0499/C	111	0551	91	0603	448
0500	85	0552...	91	0604	471
0502	94	0553	92	0606	473
0503	90	0554...	92	0607	573
0504	113	0555	93	0608	573
0505	124	0556	92	0609	574
0508	561	0559	112	0610	574
0509/...	120	0559/T	112	0614/...	367
0510	90	0560	98	0616	598
0511	452	0561/B	357	0617	485
0512	73	0565	88	0618	406
0513	591	0568	88	0620	408
0514/...	453	0570	567	0621/A3	554
0515	591	0571	563	0622	409
0516	540	0573	563	0623	485
0516/N	540	0574	566	0624	405
0517	110	0575	133	0625	541
0517/59	111	0575/...	139	0626	434
0518/20	82	0575/04	139	0626L	434
0518/30	82	0575/0580/12	138	0627	485
0518/50	82	0575S	133	0627/L	486
0519	463	0576	564	0628	446
0521	470	0577/17	138	0629	490
0522	86	0580	135	0630/0900	170
0523	123	0580/01-6	139	0630/2200	171
0524	263	0580S	134	0630/2720	171
0525/...	594	0581	137	0632	141
0526	263	0582/...	137	0632/...	142
0527	25	0583	351	0633	431
0529	263	0584/...	287	0634	431
0530	539	0585	562	0635...	168
0530/N	540	0585/...	287	0635/25	168
0531	230				



CODICE	PAG	CODICE	PAG	CODICE	PAG
0640	438	0678	470	0729...	455
0641	567	0679	405	0737/...	464
0642	87	0680...	506	0742/...	464
0643/...	543	0682	506	0747	478
0644	568	0683	506	0748	478
0645/C	528	0684	117	0749	109
0645/CP	528	0685...	116	0749/C	111
0645/CS	528	0686/200	110	0749/M	111
0645/S	528	0686/200C	111	0749/MC	111
0645/SS	528	0687	132	0750	77
0646/A	334	0687/005	139	0751	105
0647/25	472	0687/029	137	0751/A4	107
0647/25L	472	0687/041	137	0751/P	107
0647/50	472	0687/102	138	0752	76
0647/50L	472	0688	182	0753/A	125
0647/65	472	0690/...	360	0753/L	125
0647/65L	472	0690/07P	360	0754/...	75
0649/...	160	0690/12P	360	0755	477
0651/5	556	0691/400V	97	0756	128
0651/5S	556	0692/...	84	0756/F	129
0651/6	556	0693	551	0756/S	129
0651/6S	556	0694	559	0756/T	129
0654/...	173	0696	486	0756/Y	129
0654/...	173	0696/L	486	0757	81
0655/L	491	0697	112	0758	105
0655/R	491	0698/100	181	0758/C	107
0655/S	491	0699/240	492	0759	127
0657	52	0700/07P	360	0759/F	129
0657/B	52	0706	560	0759/S	129
0658	159	0708	53	0760	478
0659	541	0709	25	0761	589
0659/...	541	0710	53	0762/...	117
0660/...	474	0712/...	258	0764	119
0661	540	0712/...	259	0764/455	119
0661/N1	540	0712/...	259	0765	125
0662	97	0712/002	257	0772/...	100
0663	154	0712/005	257	0773/...	100
0664	154	0712/008	258	0773/05L	100
0665	114	0712/009	258	0773/10L	100
0666	335	0712/900	259	0775	100
0668	101	0713/15	538	0776	100
0670	491	0713/18	538	0777/2	582
0670/U	491	0713/27	538	0777/3	582
0671/1P	547	0716	54	0780	452
0671/8	547	0716/B	54	0781	452
0672	492	0717	122	0782	175
0672/B	492	0718	275	0783/...	582
0673	492	0720	125	0783/...	582
0677	292	0720/L	125	0784	568
0677/500	292	0724/B	491	0785/...	582
0677/CG	292	0725	574	0785/...	582
0677/IA	292	0725L	574	0786	564
0677/SO	292	0726...	455	0787	549
				0788	157



CODICE	PAG	CODICE	PAG	CODICE	PAG
0789	468	0849	524	1/...	200
0791/...	171	0853	439	1/...	202
0792	486	0855	121	11IRA55134...	240
0792/L	487	0855/...	373	16/...	202
0793	557	0856/...	370	16/...	203
0794/...	454	0858	588	16/...	204
0795/1	402	0860	589	165110134...	240
0795/2	402	0861	471	16A40...	200
0796	105	0862	494	16ER100ISO134...	240
0799/...	262	0863	588	2/...	201
0801	494	0864	558	2/...	202
0802...	553	0865	560	2/...	203
0803/...	379	0866	589	3/...	204
0803/S080	380	0868	589	3/B/40	205
0803/S210	380	0869	490	3A40/...	205
0804	95	0870/250	115	3D40/...	205
0804/MD	96	0871	115	4/...	200
0805/400	337	0872/OPD	441	4/...	201
0806/020	378	0872/P	441	4/...	203
0806/200	378	0872/PCD	441	A001/...	194
0807/150	335	0872/PDD	441	A003/13	95
0808/...	456	0873/...	443	A003/13M	96
0808/...	456	0873/...	443	A005	348
0810...	442	0873/...	443	A007A	495
0812...	442	0873/TF	444	A007B	495
0813	442	0873/TL	443	A007C	496
0814	442	0874/M	232	A007D	496
0816	23	0875	462	A009	327
0817	23	0875/L	462	A010/...	554
0818/250	492	0876	290	A010/...	555
0819/...	471	0877	291	A010/20G	555
0820/...	471	0878	132	A010/30	555
0821/14	472	0880/002	430	A010/30T	555
0822	472	0880/307	429	A013/26	95
0823	472	0881/...	429	A013/26M	96
0824/...	337	0881/008	429	A0132A	95
0826	447	0882/...	429	A0132A/MB	96
0828	290	0883/...	428	A0132A/MR	96
0829	433	0884/...	428	A015/...	320
0830	275	0885/...	429	A016/...	311
0831/...	448	0886/1	533	A0173X0.5...	321
0833	25	0886/1L	533	A0181/...	320
0834	449	0886/2	533	A019/...	327
0835/15	275	0886/2L	533	A020	312
0836	572	0887	430	A030/...	145
0839/...	455	0888	437	A030/...	146
0839/...	455	0889	550	A030/30A	143
0840	553	0890	281	A030/60A	143
0841	446	0890/...	281	A030/80	143
0842	591	0891	539	A040/...	146
0843	446	0892	99	A040/...	146
0844	494	0893	102	A040/30A	144
0846/150	494	1/...	169	A040/60A	144
0847	446			A040/802	144



CODICE	PAG	CODICE	PAG	CODICE	PAG
A040/803	145	B018	356	BN4E5L004A...	384
A055/...	593	B019	497	BN4E5N004A...	384
A059	96	B019/G030	497	BN4P2N019...	401
A059/M	96	B021	355	BN4P3L010A...	395
A100	500	B025	326	BN4P3N008A...	394
A121/...	596	B031	355	BN4P4N006A...	388
A141/33	599	B040/...	328	BN4P5N004A...	385
A141/36	599	B100	322	BRAS410310RP...	242
A162A	578	B201/1	322	BRAS410410LP...	242
A162C	578	B201/2	322	BRAS410912RP...	242
A162DS	577	B201/3	322	BRAS411108RP...	241
A162DS/...	580	B201/4	322	BRC110RP...	242
A208B/...	264	B609	532	BRFE12RP...	241
A212/...	265	B610	532	BRF110RP...	241
A300	500	BASECKJNL	220	BSCL09	219
A358/...	593	BASECKJNR	220	BSCL12	219
A360/...	603	BI413L004...	412	BSDJ11	219
A526/...	595	BI423L025...	412	BSER16	220
A540	593	BI433M004...	412	BSNR16	220
A541	594	BI443M004...	413	BSSS12	219
A601A	576	BI4E1L021...	417	BSTG16	219
A601A14...	580	BI4E1N021...	416	BSVJ16	219
A601DS	576	BI4E2L018...	415	BU3550	219
A601DS14...	579	BI4E2N018...	414	BU4050	219
A602A	576	BI4E3L008...	411	BU4560	219
A901A	577	BI4E3N008...	410	C001/...	266
A901A14...	580	BIGGER115/...	9	C002	307
A902A	577	BN413L004A...	396	C002/42	307
ADF/...	26	BN413N004A...	396	C003/...	266
ADLT150308R20A...	239	BN414L003A...	388	C004	306
ADLT1503ZZR234...	239	BN414N003A...	388	C005/150	299
AI401NA44...	409	BN415N003A...	385	C006/...	300
AI401NS45...	409	BN423L020A...	396	C007/...	303
AN2G/12/1	168	BN423N020A...	396	C009	525
APKT1003PDER20A...	239	BN424L015A...	389	C010/200	303
B001/...	209	BN424N010A...	389	C010/200P	303
B003/5/1	355	BN425N008A...	385	C011/...	301
B004/...	356	BN433L008A...	397	C012/...	457
B004/150	357	BN433N008A...	397	C013/10/30	311
B005...	241	BN434L004A...	389	C014/...	311
B006/...	457	BN434N004A...	389	C015	458
B007/...	209	BN443L005A...	397	C015/...	458
B009/A	498	BN443N005A...	397	C016	312
B009/B	499	BN444L004A...	390	C017	306
B010	326	BN444N004A...	390	C018/...	300
B011/...	318	BN445N004A...	386	C019/150	301
B012/...	243	BN4C3L016A...	398	C020/...	302
B013/...	243	BN4C4L016A...	390	C021/...	302
B014/...	243	BN4E2N019...	400	C023...	307
B015	497	BN4E3L010A...	393	C025/...	319
B016	498	BN4E3N008A...	392	C025/...	319
B017	498	BN4E4L006A...	387	C026/...	331
B017/C	498	BN4E4N006A...	387	C027/...	331

CODICE	PAG	CODICE	PAG	CODICE	PAG
C028/...	331	C600	500	CB01/07P	425
C029/...	331	C600/...	501	CB01/11P	425
C030/...	234	C603	501	CB02/...	423
C030/C	235	C603/...	501	CB02/04P	425
C030/R	235	C648	505	CB02/07P	425
C031/150	298	C650	525	CB02/11P	426
C032	499	C655	510	CBF1/...	424
C033/...	298	C660	508	CBF1/10P	424
C041/...	298	C670	508	CCMT060204N...	238
C043/...	299	C700	501	CHER25...	207
C044/...	303	C750	525	CI80/006	431
C046/...	193	C800	500	CI80/120	432
C047/500	299	C800/...	501	CI82/...	431
C048	307	C880/006	427	CI83/...	431
C049/300	302	C880/160CTZ	428	CKJNL20...	212
C050/...	193	C882/...	426	CKUNR25...	217
C051	187	C882/2038	427	CN450N0/0	381
C052	188	C883/...	426	CN450N1/...	382
C053/...	193	C884/...	426	CNMG120404N...	238
C054	187	C884/6038	426	CR2025...	291
C055/...	193	C885/...	427	CSCD/...	26
C056/200	301	C885/2038	427	CSDS/...	26
C057/150	300	C900/A	502	CTFP10/12	220
C058	331	C900/B	509	CTFPBASE25/32	220
C060	306	C900/B01	513	CTFPR10...	216
C061	313	C900/B02	513	CTMTMC16/20	220
C062	312	C900/B03	513	CTMTMC25/32	220
C063	313	C900/B04	513	D001	353
C063/L	313	C900/B05	514	D003	185
C064	306	C900/B06	514	D004/...	189
C067	349	C900/B07	514	D005...	187
C069	349	C900/B08	514	D006/...	190
C070	349	C900/B09	515	D007/A	352
C080/...	503	C900/B10	515	D011/A	352
C081	523	C900/B11	515	D011/D	352
C085/...	503	C900/B12	515	D012/...	357
C087	524	C902/B	510	D018	353
C090/...	503	C960	509	D020	275
C1102	526	C960/1	516	D023	185
C150	527	C960/2	516	D050	275
C163	505	C960/3	516	D075/...	24
C165	505	C960/4	516	D100	23
C182	526	C960/5	517	D100/S	23
C189	526	C960/6	517	D115/...	24
C190C	510	C960/7	517	D115/...	24
C300	527	C960/8	517	D174...	31
C312	504	C960C	511	DCMT070204N...	238
C313	504	C960C01	511	DFV115/...	31
C315	504	C960C02	512	DNMG150608N...	238
C360	505	C960C03	512	E001	439
C371	505	C980	509	E002/...	194
C391/...	375	CB01/...	423	E003	439
C395/...	374	CB01/04P	424	E005	440



CODICE	PAG	CODICE	PAG	CODICE	PAG
E010	283	F405/...	226	KITCKJ20...	209
E010/...	283	F406/...	225	KNUX160405RN...	238
E010/...	283	F430	272	KV200...	220
E022/12	338	F639	272	L002/...	466
E022/5	338	F683...	333	L005	541
E022/P	338	F802...	333	L006	541
E023/5	338	FC94/245	121	L007	466
E190/...	440	FC94/350	121	L008	552
E190/...	440	FD04/...	195	L011	465
E191/...	440	FPA120/...	28	L012	465
EN403N050A...	398	FT1/...	170	L012/PIA	465
EN404N038A...	391	G001/...	282	L013	465
EN405N050A...	386	G002/...	281	L014	347
F001/10	270	G003/...	281	L020	265
F001/20	270	G005	305	L020/...	264
F002/...	268	G006/...	305	L080	336
F002/...	269	G007/...	213	L085	336
F002/6	270	G008	305	L090A	336
F002/P	269	G009	457	L150	337
F002/PL	269	G016...	207	L200	337
F005/...	271	G050...	499	L22NP115/...	12
F006/...	271	G052/...	595	L22NP115/...	12
F007/...	271	G090/...	381	L23NP115/...	14
F008/...	274	G121/...	596	L23NP115/...	14
F008/...	274	G528/...	595	L42NP115/...	20
F010	347	G810/...	603	L42NP115/...	20
F011/...	267	G820/...	603	L50FP115/...	10
F011/6	268	G8401/...	604	L50FP115/...	10
F018	492	G882/...	603	L52FI115/...	11
F025	272	GCMX2N134...	240	L52FI115/...	11
F090/...	381	GI01/11	530	L60NP115/...	13
F121/...	282	GI01/20	530	L60NP115/...	13
F122/...	282	GI01/32	529	L70FP115/...	16
F232	272	GI01/32AE	529	L70FP115/...	16
F238	272	I002	347	L72FI115/...	17
F256/...	224	I109	420	L72FI115/...	17
F256/644	226	I217	419	L77FP115/...	18
F256/648	226	I306	419	L77FP115/...	18
F2G2...	333	I340	418	L79FI115/...	19
F300/...	222	JI401L...	421	L79FI115/...	19
F301/...	222	JI401N...	421	L80FP115/...	6
F302/...	223	JN402NA	402	L82FI115/...	7
F303/...	224	JN403NA	399	L86NP115/...	7
F304/...	223	JN404NA	391	LN400N1/2A	398
F306/...	222	JN405NA	386	LN400N1/4A	386
F307/16/22	225	K001/...	192	LN400N3/4A	402
F308/...	225	K002/...	192	LN400N3/8A	390
F322...	334	KICAN	217	M001/...	180
F400/...	224	KISCLCR	213	M001/...	279
F401/...	223	KISER...	217	M001/...	279
F402/...	223	KISNR...	217	M002/...	279
F403/...	226	KISTCMT	213	M002/...	279
F404/...	226	KISTFCR	214	M003/...	280

CODICE	PAG	CODICE	PAG	CODICE	PAG
M003/...	280	M071	339	P012/...	148
M003/...	280	M072	339	P012/...	149
M003/...	280	M075/...	196	P012/...	149
M004/...	199	M075/...	198	P013	352
M005/...	197	M076/...	197	P014	179
M006/...	482	M077/...	198	P015	179
M007/...	482	M080/10	194	P017	180
M009/...	315	M080/13	194	P018/...	228
M010/...	316	M100	277	P019	527
M011/...	176	M101	277	P020	150
M011/...	177	M122CE	602	P020/P	150
M012/...	176	M122E	602	P021	149
M013/0/100	317	M122P2	602	P023/...	249
M018/...	482	M122P215V	602	P023/...	250
M019/...	316	M122P220	602	P023/19	251
M019/...	317	M122P310V	602	P023/19A	251
M020	278	M138...	506	P023/25	251
M021/...	314	M150...	22	P023/25A	251
M022/...	314	M152...	22	P024/06	476
M023/...	178	M159...	22	P024/15	476
M024/...	178	M218	276	P028/...	153
M026/...	314	M312/C	276	P029/...	153
M027/100	180	M312/P	276	P032/...	207
M028/...	177	M400...	229	P032/18P	206
M028/...	177	M449/...	196	P032/7P	206
M029	278	M530/...	179	P040...	328
M030	278	MAGNUM115/...	15	P045	246
M032	277	MCLNBASE25/32	220	P046	246
M033	315	MCLNR16...	216	P049/...	259
M033/...	315	MD01	348	P050/...	260
M033/...	315	ML30	343	P051/...	260
M034/120	181	ML80	343	P056/...	257
M035	343	MTFNBASE25/32	220	P057	257
M036	278	MTFN16...	216	P058/...	247
M040	147	N160/...	33	P058/170	249
M040/...	148	N177...	33	P061	248
M040/P12	147	N180...	86	P062	248
M040/P14	147	N717/...	123	P063/...	261
M040/P20	147	N717/...	123	P065/...	252
M040/R	147	OFEX05T305234...	239	P065/170	253
M049/...	195	P001/04	153	P067	253
M050/...	194	P001/20	152	P068	248
M051/...	195	P001/45	152	P069	253
M055	310	P001/75	151	P070...	192
M055/120	310	P002	149	P075	340
M057/16	112	P005	149	P080	340
M058	339	P006	150	P100/250	229
M059/...	199	P006/PR	150	P101/...	229
M060/...	199	P007/...	332	P200/...	332
M061	176	P009	499	P301/...	332
M062	310	P010/...	249	P340	232
M063	339	P011/...	332	P350	233
M069	339	P012/...	148	P40VD	235



CODICE	PAG	CODICE	PAG	CODICE	PAG
P440	233	RGM040/...	28	S052/3	323
P450	233	RGP040/...	28	S052/4	323
P4CS	234	RGT3010/...	29	S054	324
P770/...	191	RI4012N...	421	S055	324
PAV	235	RICAPCLN	219	S056/...	330
PC40	233	RICAPSSN	220	S057/060S	330
PC40/R	234	RICAPTGN	220	S057/125	330
PC4P	234	RLM100/...	27	S058	330
PC50	233	RLP100/...	27	S061...	328
PC50/R	234	RLT050/...	27	S075/...	582
PCLNR20...	211	RN4023NA	402	S091...	321
PDC1/...	168	RN4032NA	399	S100	228
PDC2/...	168	RN4034NA	399	S108	406
PDC4/...	167	RN4043NA	391	S110	354
PDJNR20...	212	RN4045NA	390	S111	354
PDJNRKIT	220	RN4054NA	386	S161	286
PI401175...	421	RPMT1204N...	239	S162	286
PI402175...	415	S001	274	S163	30
PI403075...	413	S002	284	S164	30
PI453075...	413	S002/E100	285	S166	30
PIF1	433	S002/E200	285	S167	30
PN402N200A...	401	S002/E300	285	S169	30
PN403N050A...	398	S004	350	S179	407
PN404N050A...	391	S005	285	S2/800	175
PN405N050A...	386	S005/R	285	S328	407
PR16/10P	205	S006...	274	S401/01	293
PR20/12P	206	S007/...	204	S401/02	293
PR25/15P	206	S008/M	161	S401/03	293
PSSNR20...	212	S009	126	S401/04	293
PSV-F	235	S011	458	S401/05	293
PSV-M	235	S013	161	S401/06	293
PTGNR20...	212	S014/...	204	S401/08	294
PVC300	478	S015	126	S401/09	294
PVC300/125	478	S017	527	S401/10	294
PWLNR20...	213	S018	467	S401/11	294
PWLNRKIT	220	S019	165	S401/12	294
R001/...	87	S021	126	S401/13	294
R002	354	S022/...	457	S448/10	535
R008	350	S0300...	167	S448/20	535
R015	160	S041/1	326	S450/10	535
R030...	334	S041/2	326	S450/20	535
R060...	305	S042/1	324	S464/10	536
R607	531	S042/2	325	S464/20	536
R608	531	S042/3	325	SA01/A	137
R609	531	S045	325	SCLCR08...	214
R609A...	532	S046	325	SCLCR12E...	210
R609B...	532	S047	324	SCMT09T304N...	238
R610	531	S048/...	329	SCMT09T308N...	238
RAPTOR115/...	6	S049	323	SDJCR10...	211
RAS60...	32	S050/...	329	SDUCR10...	215
RDHT10T3MO-N...	239	S051	327	SEHT1204AFN234...	239
RFP/...	29	S051/...	329	SEHX1204234...	239
RFT165/...	30	S052/2	323	SEKN1203AFN25...	239

CODICE	PAG	CODICE	PAG	CODICE	PAG
SER16...	218	T00A0...	182	T0AC...	183
SGIH19/...	219	T00A0/...	183	T0AC/...	183
SGTBK10...	219	T00A1	182	T0AE...	183
SI40N006	421	T00A1/PP	183	T0AE/...	183
SI413M006	418	T00A1R...	182	T100/...	304
SI423M006	418	T00A1R/...	183	T100/...	304
SI4E1N008	420	T00AE/...	185	T200	228
SI4E2N008	420	T010/...	208	T201	228
SI4E3N013	418	T011	309	T400...	229
SN4E3C015	403	T012/...	186	T609	532
SN4E4C013	403	T013	190	T660	51
SN4E5C012	403	T014G	190	T660I	50
SN4P3N027	408	T015...	190	T700	49
SNMG120404N...	238	T017/110	186	T700V	48
SNR12...	218	T021/...	208	T940/...	47
SP01/...	604	T024	72	T940/230VI	46
SP02/...	604	T026	71	T940/230VI3A	45
SP03/...	604	T032	69	T998/...	41
SP04/...	605	T032DA	68	T998/...	42
SP05/...	605	T044/...	58	T999/...	43
SP06/...	605	T045	60	T999/...	44
SP07/...	605	T046	59	TCMT090204N...	238
SPI10/...	32	T047/...	57	TH250	580
SPKN1203R25...	239	T0481/...	320	TH500	580
SPMR120304N...	238	T0493X0.5...	320	TH601A	575
SPUN13P	98	T050	341	TH601A13...	579
SR44W	291	T051	340	TH602A	575
SSSCR16...	214	T053	341	TH602A08...	579
SSSCR20E...	210	T054	344	TH901A	575
ST1A01...	244	T055	345	TH901A13...	579
ST1A02.00C...	246	T056/TP01	346	TIGER115/...	8
ST1A10.25R10...	245	T056/TP02	346	TIPA40...	201
ST1A13.25R13...	245	T056/TP03	346	TIPD40...	202
ST2A05.75...	256	T057	346	TNMG160404N...	238
ST45/...	194	T058	62	TNMG160408N...	238
STAFCKJNL	220	T061	61	TNMG220408N...	238
STAFCKJNR	220	T062	67	TPKN1603R25...	239
STFCR08...	215	T063	345	TPMR090204N...	238
STGCR16/...	210	T064	344	U003	138
SVJBR20...	211	T066	66	UNCD/...	27
T001/...	186	T068	344	V002	350
T002/...	187	T069/400V	40	VBMT160404N...	238
T003	308	T069/400V3A	39	VITECKJN	220
T004/...	191	T070/400V3A	38	VT00440	226
T005	308	T071	70	W021PA	572
T006	308	T089	218	W021PG	572
T007	308	T090...	218	W021PN	573
T008	191	T092/...	304	WCMT050308234...	238
T009	322	T092/P	304	WNMG080408N...	238
T00A...	184	T0AA...	183	WSSP	226
T00A/...	184	T0AA/...	183		
T00A/...	184	T0AB...	183		
T00A/...	184	T0AB/...	183		



TITOLO	pag
2 in 1 toupie e carteggiatrice a rullo	112
5 basi quadrate 12 mm	219
5 basi romboidali 11 mm	219
5 viti per fresa	226
accendi barbecue elettrico	560
accessori di ricambio per aspirapolvere	145
accessori per blocchetti di riscontro	327
accessori per marcatrice m040	148
adattatore lama	125
adattatore per seghe a tazza	259
aerografo con serbatoio a chiusura autoclave	576
aerografo con serbatoio a chiusura rapida	578
aerografo con serbatoio a gravita'	575
affilcatene per motosega	94
affilatrice manuale per dischi	95
affilatrice multifunzione	96
affilatrice per punte elicoidali	95
alberini di fissaggio	42
albero completo di punta	259
alesometro con comparatore	311
alesatore a macchina	264
anelli abrasivi rinforzati spirabands allo zirconio	48
anello di azzeramento	320
anello filettato 6g tipo passa metrico	321
anello filettato tipo passa	320
anemometro digitale	348
antiadesivo per saldature	293
apparecchio a due punte per il controllo della concentricità	327
apparecchio universale a fresare per tornio	181
archetto con lama	490
archetto con lama, impugnatura in alluminio	490
argano elettrico a 12 v in corrente continua	170
argano manuale	172
argano manuale a fune	171
argano manuale con freno	172
aria spray	294
armadietto	500
armadietto da parete in kit di montaggio	499
arredamento modulare per officina	495

TITOLO	pag
aspirapolvere aspiraliquidi 30l	143
aspirapolvere aspiraliquidi 60l	143
aspirapolvere aspiraliquidi 80l 2 motori	144
aspirapolvere aspiraliquidi 80l 3 motori	143
aspiratore per sabbiatrici	137
aspiratore per trucioli	127
aspiratore per trucioli parzialmente assemblato	127
aspiratore portatile	128
assorbitore di energia	599
assortimento anelli elastici	289
assortimento anelli elastici per esterni	289
assortimento capicorda	291
assortimento chiavette a disco	289
assortimento chiavette parallele	289
assortimento coppiglie	288
assortimento coppiglie di sicurezza	288
assortimento fascette	290
assortimento guaine termorestringenti	291
assortimento in valigetta	257
assortimento ingrassatori	291
assortimento micrometri a tre punte per interni, per fori ciechi	317
assortimento micrometri centesimali per esterni	315
assortimento molle	290
assortimento or	290
assortimento rivetti	288
assortimento rondelle	288
assortimento rondelle in rame	288
assortimento sfere d'acciaio cromate in pollici	289
assortimento sfere d'acciaio cromate metriche	289
assortimento spine elastiche	288
assortimento terminali	291
attacco per mandrino	194
attacco universale per tornio con microinterruttore di sicurezza	229
attrezzo inclinabile da 0° ÷ 90°	204
avvitatore a cricchetto con bussole	565
avvitatore ad impulsi	563
avvolgicavo	554
avvolgicavo auto rientrante	554



TITOLO	pag
avvolgicavo auto rientrante con portalampada	554
avvolgicavo da giardino	555
avvolgicavo industriale	555
avvolgitubo auto rientrante per aria	581
azzeratore con comparatore con base magnetica	312
bacinella per cambio olio	473
banco chiudibile in acciaio	497
banco da lavoro in ferro in kit di montaggio	497
banco da lavoro in kit di montaggio	498
banco mobile	508
banco per piano in granito con due cassette	328
banco per tornio	52
banco sega dotato di lama con riporto in metallo duro	114
banco universale per trapani fresa	62
barrette trattate e rettificata	243
base	220
base magnetica	322
base per tornio	53
base utensile dx	220
base utensile sx	220
batteria di ricambio	357
batterie per strumenti digitali	291
baule in acciaio	524
baule in alluminio	524
beccuccio in metallo e guarnizioni	474
bilancia elettronica digitale	355
bilancia elettronica digitale con doppio display	356
bilancia elettronica digitale contapezzi ricaricabile	356
bilancina digitale di precisione tascabile	355
boccole portacono	234
bordatubo per rame e alluminio	469
borsa installatore	507
borsa porta utensili	507
brache piatte in poliestere colorato	169
brasato per canalini interni	242
brasato per filettatura esterna	241
brasato per filettatura interna	241
brasato per fori ciechi	241
brasato per sfacciare	242
brasato per sgrossare	242

TITOLO	
brasato per troncare	242
brocca graduata	473
brocca graduata in plastica con canna flessibile e coperchio	473
bulbo a raggi infrarossi	532
bulino	457
bussola a cono morse	184
bussola con inserto esagonale	385
bussola con inserto esagonale lungo	388
bussola con inserto ribe	389
bussola con inserto ribe lungo	389
bussola con inserto torx	385
bussola con inserto torx lungo	389
bussola con inserto xzn	386
bussola con inserto xzn lungo	390
bussola esagonale maschio ad impatto	412
bussola ribe maschio ad impatto	412
bussola torx maschio ad impatto	412
bussola xzn maschio ad impatto	413
caccia vite pneumatico reversibile da 1\4"	565
cacciaspine	457
cacciavite cercafase	342
cacciavite dinamometrico digitale	378
calandra	100
calandra cesoia piegatrice	100
calandra motorizzata	99
calibro con comparatore inox	299
calibro di profondità satinato	303
calibro elettronico digitale inox	298
calibro elettronico digitale inox di profondità	303
calibro elettronico digitale monoblocco inox	298
calibro monoblocco inox cromato opaco	300
calibro monoblocco satinato inox	302
calibro per tracciatura monoblocco satinato	303
calibro satinato	300
calibro tampone liscio h 7 passa e non passa temperato e cementato	319
calzature antinfortunistiche	603
canadese basso in tefaprene	605
candelette di colla per pistola termocollante	561



TITOLO	pag
carica batterie digitale intelligente da 12 v - 2 a	542
carica batterie digitale intelligente da 12 v - 8 a	542
carica batterie digitale intelligente da 12 v 2 - 6 - 12a	543
carica batterie digitale intelligente da 6 - 12 v - 4 a	542
carrelli da trasporto	172
carrellino raccogli olio senza serbatoio	475
carrello a 3 vasche	525
carrello a 7 cassette completo di utensili	510
carrello completo di utensili	511
carrello con piano in legno	525
carrello con piattaforma in pvc	527
carrello gommato	526
carrello multiuso	526
carrello porta utensili	509
carrello portaconi	233
carrello regolabile in altezza	163
carrello sgabello sottauto 2 in 1	528
carrello sottauto a 6 ruote	528
carrello sottauto in plastica	528
carrello sposta moto	162
cartuccia di grasso	292
cassetta attrezzi	502
cassetiera con 4 valigette porta minuteria	504
cassetiera in acciaio con valigette in plastica	501
cassetiera porta utensili	499
cassettiere con cassette estraibili trasparenti	503
cassetto in acciaio con serratura	498
cavalletto a rullo	88
cavatrice	111
cavo a spirale di sicurezza per utensili	457
cazzuola punta quadra	471
cazzuola punta tonda	471
cazzuolino punta tonda	472
centratore a 2 assi	313
centratore luminoso	313
centratore luminoso e sonoro	313
centratore meccanico a molla	312
cercametalli	348
cesoia a leva	100

TITOLO	pag
cesoia destra per lamiera	491
cesoia dritta per lamiera	491
cesoia sinistra per lamiera	491
chiave a bussola ad impatto	416
chiave a bussola ad impatto lunga	411
chiave a bussola ad impatto, serie normale	410
chiave a bussola con impugnatura	423
chiave a bussola esagonale lunga	384
chiave a bussola esagonale, serie normale	384
chiave a bussola flessibile con impugnatura	424
chiave a bussola per candela	390
chiave a bussola poligonale lunga	395
chiave a bussola poligonale, serie normale	385
chiave a croce	377
chiave a croce smontabile	377
chiave a t con bussola esagonale snodata	375
chiave a t con bussola esagonale snodata magnetica	374
chiave combinata con testa a cricchetto snodata	360
chiave dinamometrica	379
chiave dinamometrica digitale	379
chiave dinamometrica digitale per gommisti	378
chiave dinamometrica elettronica digitale, lettura di coppia e angolo	378
chiave dinamometrica in set	380
chiave filtro a catena	376
chiave filtro a nastro	376
chiave per bombola gas	369
chiave per candela	375
chiave per ghiere	207
chiave torx maschio a "t"	374
chiavi a mezzaluna	367
chiavi a tubo	369
chiavi a tubo esagonali	368
chiavi combinate	365
chiavi combinate cromate, lucidate a specchio	363
chiavi combinate satinare	361
chiavi dinamometriche	379
chiavi esagonali con manico anatomico in plastica	370
chiavi esagonali maschio a "t"	371



TITOLO	pag
chiavi fisse cromate, lucidate a specchio	362
chiavi inglese cromate	368
chiavi maschio esagonali	372
chiavi poligonali	366
chiavi torx con manico anatomico in plastica	373
chiodatrice pneumatica	562
chiodi	287
chiodi metallici	287
cilindro idraulico per ribaltamento vasca	235
cintura di posizionamento regolabile in vita	598
codolino	201
colonna per smerigliatrici	93
coltello a caldo taglia polistirolo con temperatura regolabile	560
coltello a serramanico	488
coltello a serramanico con manico in alluminio	489
coltello per pialla	111
coltello stozzatore normale a disco	266
combinata da legno 8 lavorazioni	108
comparatore centesimale	307
comparatore centesimale antiurto	306
comparatore digitale centesimale multifunzione	306
comparatore digitale millesimale multifunzione	306
comparatore millesimale	306
compasso	331
contafilette a 58 lame	331
contagiri digitale a contatto	349
contagiri digitale ottico	349
contagiri digitale ottico e a contatto	349
contenitore ribaltabile per trucioli con ruote	234
contenitore universale	503
contropunta fissa con cuspidi in metallo duro	193
contropunta regolabile in altezza	187
contropunta rotante	193
contropunta rotante per tubi	193
copia per tornio legno	107
coppia di cavalletti	159
coppia ganasce magnetiche in alluminio	480
coppia guanti	139

TITOLO	pag
coppia luci a led per bicicletta	544
coppia prismi rettificati	332
coppia protezioni in plastica	168
coppia supporti mensola	234
coppia teste di ricambio	456
cordino di posizionamento regolabile e moschettone	598
corindone	137
creatore per ingranaggi cilindrici con angolo di pressione 20°	266
cric a bottiglia	156
cric a carrello	157
cric a profilo ribassato	157
cric idraulico a profilo ribassato	156
cricchetto ergonomico	381
cricchetto ergonomico con testa antisporcio	382
cricchetto reversibile	383
cricchetto reversibile a cambio rapido 3 in 1	381
cuffia antirumore	601
curvaferri	102
curvatubi idraulico 1\2 - 2"	102
curvatubo per tubi in rame	102
cutter a serramanico, lame di ricambio incluse	486
cutter automatico con guidalama in acciaio, lame di ricambio incluse	485
cutter con fodero	486
cutter con guidalama in acciaio, lame di ricambio incluse	485
cutter di sicurezza, lame di ricambio incluse	485
deviatore a 3 vie in abs	587
diamante per ravvivare mole	39
dinamometri digitali	357
dischi abrasivi	40
dischi divisori per tavola a dividere	186
dischi in fibra vulcanizzata	47
dischi in nylon abrasivo	42
dischi non-woven per finitura	43
dischi per legno con riporto in metallo duro	116
dischi piani con foro per trapano	42
disco diamantato	41
disco diamantato turbo	41
disco diamantato turbo ventilato	40
disco lamellare	34



TITOLO	pag	TITOLO	pag
disco lamellare	32	faretto a led ricaricabile 20w 600/1450 lm	552
disco lamellare per forti asportazioni	31	faretto alogeno con lampadina	534
disco lamellare professionale	26	faretto alogeno con supporto e lampadina	534
disco lamellare professionale per acciaio inox	22	faretto alogeno con treppiede e lampadina	534
disco lamellare professionale per acciaio inox	22	faretto con led 10 w 600 lm	536
disco lamellare professionale per forti asportazioni	24	faretto con led 10 w 600 lm e sensore	537
disco lamellare professionale realmente piano	30	faretto con led 10 w 600 lm e supporto	537
disco per alluminio e materiali plastici con riporto in metallo duro	117	faretto con led 20 w 1450 lm	536
disossidante per contatti elettrici ed elettronici	294	faretto con led 20 w 1450 lm e sensore	537
dispenser per nastri da imballaggio	478	faretto con led 20 w 1450 lm e supporto	537
divisore orizzontale verticale a scatti rapido	185	faretto con led samsung* 10 w 850 lm	535
divisore rapido a scatti orizzontale e verticale	185	faretto con led samsung* 10 w 850 lm e sensore	536
divisore semi universale completo di contropunta e dischi divisori	189	faretto con led samsung* 10 w 850 lm e supporto	535
divisore universale completo di mandrino, contropunta e dischi divisori	188	faretto con led samsung* 20 w 1700 lm	535
doccetta a ventaglio con puntale in metallo	584	faretto con led samsung* 20 w 1700 lm e sensore	536
durometro da banco	353	faretto con led samsung* 20 w 1700 lm e supporto	535
durometro da banco rockwell	353	faro a led con base magnetica	538
durometro digitale shore "a"	352	faro multifunzione a led ricaricabile con usb	551
durometro digitale shore "d"	352	ferma ruote da garage	160
durometro shore "a"	352	filiera metrica per passo ma	282
elmetto	598	filiera per filettatura gas cilindrica	282
endoscopio flessibile per meccanica	338	film estensibile per imballaggio	478
espositore con giraviti	428	filtro ciclone	137
espositore con giraviti isolati 1000v iec 60900	432	fissatrice pneumatica	562
espulsore	269	fissatrice pneumatica per spilli	563
estrattore a 2 griffe	440	fissatrice\chiodatrice pneumatica	562
estrattore a 3 griffe	440	flangia con perni	195
estrattore magnetico flessibile con luce a led e base calamitata	439	flessometro	333
estrattore magnetico flessibile luminoso	439	flessometro magnetico	333
estrattori per cono morse	194	fogli in panno abrasivo	44
faccia filtrante	602	fonometro integratore digitale	347
faretto a basso consumo energetico con supporto	533	forbice inox	492
faretto a led ad alta potenza	543	forbice lamiera tipo americano	492
		forbice multiuso	492
		forbice per elettricista	492
		forbice per elettricista con manici isolati	492
		forbice per fiori, lama temperata	588
		forbice per potatura a cricchetto	588



TITOLO	pag
forbice per potatura, lama temperata	588
forbice potatura, lama temperata e rivestita in teflon	588
forbice telescopica per siepe con lame temperate e rivestite in teflon	589
forno per fucinazione	101
frattone per colla con manico in abs	472
frattone per stuccatori con manico in abs	472
fresa a carotare lunga con attacco weldon	269
fresa a inserto	222
fresa a inserto per spianatura	225
fresa a scalini	272
fresa a svasare antivibrante	274
fresa cilindrica per contornatura	226
fresa frontale a 2 taglienti	271
fresa frontale a 4 taglienti	271
fresa per contornatura	226
fresa per recupero inserto	223
fresa per spallamenti	223
fresa per spianatura	225
frese a carotare con attacco weldon	267
frese rotative	274
funi tonde in poliestere	169
fustellatrice per lamiera 1t	469
fustellatrice rinforzata	469
ganasce di ricambio	176
generatore ad inverter	530
generatore ad inverter carrellato	529
generatore ad inverter carrellato con avviamento elettrico	529
ghiera di ricambio	207
girafiliera	282
giraschi a cricchetto	281
giraschi regolabili	281
giratubo	451
giratubo a 45°	451
giratubo a 90°	451
giravite a croce isolato	431
giravite a croce ph, appendibile	426
giravite a croce pz, appendibile	427
giravite a percussione	432
giravite a taglio isolato	431
giravite a taglio, appendibile	426
giravite con manico ergonomico antiscivolo	428

TITOLO	pag
giravite elettricista, appendibile	426
giunto a 2 vie ad innesto rapido in abs	587
goniometro digitale e livella con 2 fiale	305
goniometro semplice	305
goniometro universale	305
graffatrice chiodatrice manuale	562
graffe	287
grasso al rame	294
grasso multiuso	293
griffa prolungata	440
gru idraulica pieghevole	164
gruetta idraulica pieghevole	164
guanti antitaglio	595
guanti in filato di nylon elasticizzato	595
guanti in filato di nylon elastico	595
guanti in filato elastico	594
guanti in fiore di maialino	593
guanti in fiore di vitello bianco orlato	592
guanti in fiore e crosta di vitello	592
guanti in nbr	593
guanti in nitrile	594
guanti in tessuto interlock cotone 100%	593
guanti monouso, non sterili, ambidestri in lattice	596
guanti monouso, non sterili, ambidestri in nitrile	596
guanti monouso, non sterili, ambidestri in vinile	596
guanti per sabbiatrice	139
igrometro per la misurazione di umidità	347
imbracatura anticaduta	599
imbuto in plastica	474
impugnatura anatomica antisdrucchiolo	464
incisore con denti riportati in metallo duro	117
incudine in ghisa	481
incudine per taratura sclerometro	354
incudini in acciaio indurito c50	481
indicatore a tasto bimillesimale	308
indicatore a tasto centesimale	308
indicatore a tasto centesimale con tastatore lungo	308
ingrassatore manuale	292
ingrassatore manuale a leva 500 cc	292
ingrassatore pneumatico	292



TITOLO	pag	TITOLO	pag
innestatrice universale	591	lampada fluorescente di ricambio pl 24w	533
innesto rapido femmina tipo tedesco	582	lampada led ricaricabile ultra sottile	552
innesto rapido maschio tipo tedesco	582	lampada magnetica con 24 + 3 led	550
inox spray	293	lampada magnetica con 24 led	549
inserti per filettatura esterna	240	lampada magnetica con 30 + 7 led	549
inserti per filettatura interna	240	lampada ricaricabile con tecnologia led cob	551
inserti per scanalatura	240	lampada snodata	539
inserti per troncatura	240	lampada snodata con lente	540
inserto di ricambio	98	lampadina alogena	232
irrigatore pulsante a settore con puntale in metallo	585	lampadina alogena 25w	232
irrigatore rotante in abs	585	lancia con spruzzo regolabile	584
kit anticaduta	599	laser autolivellante	334
kit di posizionamento	598	lente di precisione per misurazioni	339
kit di refrigerazione per macchine utensili	228	lente in cristallo	541
kit filettatura per esterno	217	lente in cristallo con led	541
kit filettatura per interno	217	lettere hrc 58-60	148
kit ricambi	220	leva	466
kit riparazione filetti inox	283	leva a cricco reversibile con estrattore	383
kit riparazione filetti m5 - m12 inox	283	leva a t scorrevole	386
kit staffaggio	192	leva gommista	466
lama	125	leva gommista per moto	466
lama bimetallica	491	leve a batterie	466
lama bimetallica per metallo	86	levicino carpentiere in acciaio forgiato	466
lama in acciaio al carbonio	491	levigatrice a nastro da banco inclinabile	124
lama per legno	123	levigatrice a nastro inclinabile	97
lamatore con attacco cilindrico tipo medio	264	levigatrice a nastro inclinabile con banco	97
lampa da fluorescente di ricambio pl 36w	533	levigatrice a nastro verticale e disco	124
lampada a basso consumo energetico	539	levigatrice nastro disco	123
lampada a 48 led con lente	539	levigatrice pneumatica	568
lampada a basso consumo energetico	533	levigatrice pneumatica rotorbitale da 150 mm con aspirazione	570
lampada a led flessibile	545	levigatrice pneumatica rotorbitale da 150 mm con aspirazione integrata	570
lampada a led per macchine utensili	230	lima piatta diamantata	465
lampada a led ricaricabile	550	lime per meccanica	464
lampada a led ricaricabile magnetica	550	liquido lavapezzi	142
lampada a led ricaricabile magnetica con ganci estensibili	553	livella	337
lampada al neon appendibile	553	livella digitale	335
lampada alogena per macchine utensili	231	livella digitale con raggio laser	335
lampada alogena per macchine utensili	230	livella digitale inclinometro e goniometro con magnete	336
lampada da tavolo	540	livella lineare	337
lampada fluorescente con ganci estensibili	553	livella magnetica	337



TITOLO	pag
livella quadra	337
livella quadra digitale	336
lubrificante secco al ptfe (teflon)	294
luce a led da casco	545
luce a led per bicicletta e casco	544
luxmetro digitale	347
macchina marcatrice a micropunti, pneumatica	147
magnetizzatore/demagnetizzatore per giraviti	434
mandrino autocentrante	196
mandrino autocentrante a 4 griffe	107
mandrino autocentrante di precisione	195
mandrino autoserrante	194
mandrino autoserrante con ghiera di bloccaggio	194
mandrino autoserrante di precisione	195
mandrino con lubrificazione interna per frese a carotare	199
mandrino cono morse combinato	204
mandrino per tornio	107
mandrino porta fresa a gambo conico	202
mandrino porta frese a gambo conico	201
mandrino porta frese combinato	200
mandrino porta frese tipo weldon	200
mandrino porta punte	200
mandrino portafrese tipo weldon	203
mandrino westcott	111
mandrino "westcott"	112
maniglia per film estensibile	478
martello carpentiere	452
martello pesante con 4 scalpelli esagonali	568
martello tipo tedesco	453
mascherine igieniche	602
maschi a macchina per fori ciechi a forte torsione 35°	280
maschi a macchina per fori passanti imbocco corretto	279
maschi a macchina per fori passanti, imbocco corretto	279
maschiatore a frizione registrabile con inversione	199
maschiatore con bussole	199
mazza	452
mazzetta per muratore	452
mazzuolo	456
mazzuolo antirimbalo	455

TITOLO	pag
mazzuolo gomma	454
mazzuolo gomma e fibra	454
mensole portaconi	233
micrometro a piattello	316
micrometro a tre punte per interni, per fori ciechi	316
micrometro centesimale di profondità	317
micrometro centesimale per esterni	314
micrometro digitale elettronico	314
microscopio digitale portatile usb	339
microscopio stereoscopico	339
microsfere di vetro	137
microsmerigliatrice flessibile pneumatica	567
mini aerografo	578
mini archetto con lama	490
mini calandra	99
mini cesoia - piegatrice	99
mini livella laser	335
mini pialletto	462
mini sabbiatrice da banco	135
mini saldatore a gas	558
mini smerigliatrice con utensili	88
mini smerigliatrice pneumatica assiale	568
mini supporto magnetico porta comparatore	326
misuratore di distanza ad ultrasuoni	343
misuratore di distanza laser	343
misuratore di pressione digitale	572
misuratore di pressione pneumatici e emergenza auto	572
misuratore di profondità	312
misuratore di ricopertura su basi ferrose e non ferrose	350
misuratore di spessori	310
misuratore di spessori ad ultrasuoni	350
misuratore di spessori digitale	310
misuratore di temperatura ad infrarossi con puntatore laser	344
misuratore di temperatura digitale portatile	345
misuratore di temperatura digitale tascabile	344
misuratore di vibrazioni	350
misuratore digitale di temperatura e umidità ambiente	346
misuratore rapido per interni	311



TITOLO	pag
mola bianca	96
mola diamantata	96
mola diamantata 125 mm	96
mola rosa	96
mole abrasive	38
moltiplicatore di forza	380
morsa a croce	181
morsa a croce con girevole	181
morsa a macchina con base girevole 360°	178
morsa a macchina inclinabile con base girevole 360°	178
morsa da banco in ghisa	479
morsa di precisione con barra seno	176
morsa di precisione in acciaio	176
morsa di precisione in acciaio temperato e rettificato	176
morsa girevole con morsetto	479
morsa girevole in acciaio	480
morsa in acciaio	479
morsa inclinabile	180
morsa parallela da banco	479
morsa per saldare profilati a 90°	481
morsa trapano	180
morsa trapano a serraggio rapido	181
morsetto a molla	484
morsetto in acciaio temperato per meccanica	482
morsetto in acciaio temperato per meccanica e falegnameria	482
morsetto per falegname	483
morsetto per lampade	232
morsetto rapido automatico	483
morsetto tenero per mandrini	198
moschettone ovale con doppia chiusura a vite, ad alta resistenza	599
multimetro digitale	341
multimetro digitale tascabile	340
multipresa con 5 prese bipasso + schuko e spina italiana da 16a	556
multipresa con 5 prese bipasso + schuko e spina tedesca	556
multipresa con 6 prese bipasso + schuko, e spina italiana da 16a	556
multipresa con 6 prese bipasso + schuko, e spina tedesca	556
nastri abrasivi in ossido di alluminio	49
nastri abrasivi in zirconio	49

TITOLO	pag
nastro per imballaggio in ppl color avana	478
nastro segnaletico rosso e bianco	592
nebulizzatore carrellato con lancia in ottone	590
nebulizzatore con lancia in ottone	590
nebulizzatore con ugello in ottone	590
numeri hrc 58-60	149
occhiali protettivi	597
oculare digitale per microscopio	339
oliatore 1\4"	571
oliatore in metallo con canna flessibile	473
oliatore in plastica con canna flessibile	473
oliatore in plastica con canna verticale flessibile	473
olio da taglio	294
olio di vaselina	294
o-ring per chiavi a bussola	409
paracolpi da garage	160
paranco a catena	165
paranco a leva	165
paranco elettrico	166
pedane	235
pendente a 2 bracci in acciaio	168
pendenti di catena	167
penna elettrica a batteria	149
penna elettrica a vibrazione	150
pialla falegname con doppia lama	462
pialla filo spessore	109
pialla filo spessore 310 mm	109
pialla spessore	110
piani magnetici permanenti	192
piano di riscontro in granito	328
piano magnetico	191
piattaforma antiscivolo pieghevole	527
piegaferrì	101
piegatrice per lamiera	100
piegatrice universale	101
pietra per affilare in carburo di silicio grana media e grana fine	39
pietra per affilare in ossido di alluminio grana media e grana fine	39
pinza	207
pinza a becchi mezzitondi	443
pinza a becchi mezzitondi piegati 45°	443
pinza a morsetto automatica	450



TITOLO	pag
pinza a morsetto automatica con becchi a 'c'	450
pinza a morsetto automatica con becchi lunghi	450
pinza amperometrica digitale	340
pinza fastonatrice e spellafilo	447
pinza fastonatrice universale in kit	447
pinza grip	449
pinza grip a morsetto	449
pinza grip con ganasce a forcilla	450
pinza idraulico	448
pinza lunga a doppio fulcro	441
pinza lunga a doppio fulcro a 45°	441
pinza lunga a doppio fulcro dritta	441
pinza multifunzione	487
pinza per connettori	446
pinza per elettronica a becchi curvi	444
pinza per elettronica a becchi extra lunghi	444
pinza per elettronica a becchi lunghi	445
pinza per elettronica a becchi piatti	445
pinza per terminali dritti preisolati	446
pinza regolabile a ginocchiera 4 posizioni	449
pinze a becchi mezzitondi	442
pinze a becchi mezzitondi piegati 45°	442
pinze a cricchetto	446
pinze per anelli elastici di sicurezza	447
pinze universali	442
pirografo completo di n° 6 puntalini	557
pistola	137
pistola fissa	138
pistola gonfiaggio	572
pistola gonfiaggio digitale	573
pistola lunga per soffiaggio	574
pistola multigetto a 10 funzioni	583
pistola multigetto a 3 funzioni	583
pistola per lavaggio	573
pistola per schiuma poliuretanic	470
pistola per soffiaggio	572
pistola per tasselli chimici da 345 ml e 235 ml	471
pistola per tasselli chimici da 380 ml	471
pistola per travaso gasolio in pvc	477
pistola per travaso gasolio automatica	477
pistola per travaso gasolio in alluminio	477

TITOLO	pag
pistola sabbiatrice	138
pistola silicone a cremagliera	471
pistola silicone a doppio stelo rinforzata, asta esagonale	470
pistola silicone super rinforzata	470
pistola termocollante automatica	560
platorello con fissaggio a strappo	571
platorello diamantato turbo a tazza per granito e pietre	41
pompa 12v per gasolio	477
pompa a leva per fusti olio lubrificante	476
pompa idraulica	154
pompa idraulica con comando pneumatico a pedale	154
pompa rotativa in alluminio per fusti olio lubrificante	476
pompa travaso in alluminio	476
pompa travaso per trapano	477
porta bussole magnetico	518
porta giraviti magnetico	518
porta godroni completo di n° 3 coppie di godroni, taglio a diamante	213
porta inserti	437
porta inserti a cricchetto	436
porta inserti ad angolo 90° con attacco da 1/4"	437
porta inserti flessibile magnetico	433
porta inserti magnetico con 6 inserti	433
porta inserto a cricchetto	436
porta pinza	204
porta punzone + punzone 3 x 12 mm	147
porta punzone + punzone 3 x 14 mm	147
porta punzone + punzone 4 x 20 mm	147
porta utensili a sede piana	184
porta utensili a sede prismatica	184
porta utensili per bussola	184
portalampada con cavo di alimentazione di 5 m	552
portautensili a sede piana	183
posizionatore magnetico	330
postazione soffiaggio	142
presa rubinetto da 1" e 3/4"	587
presa rubinetto da 1" e 3/4" in abs a 4 vie	585
presa rubinetto da 3/4" e 1/2"	587
presa rubinetto da 3/4" e 1/2" a 2 vie, in ottone	585



TITOLO	pag	TITOLO	pag
pressa idraulica manuale e pneumatica	151	raccordo riparatore da 1/2"	586
pressa manuale	153	raccordo riparatore da 3/4" a 5/8"	587
pressa manuale a cremagliera	153	rampe in alluminio	160
pressa manuale idraulica	152	raschietto con lama in metallo duro da 25 mm a tre taglienti	472
prisma a 90°	332	raschietto con lama in metallo duro da 50 mm a due taglienti	472
prisma inclinabile	332	raschietto con lama in metallo duro da 65 mm a due taglienti	472
prisma magnetico	332	regolatore di pressione	580
prodotti di primo soccorso	600	riduttore con manometro e separatore	582
prolunga	386	riduttore con manometro, separatore e oliatore	582
prolunga a sgancio rapido ad impatto	413	riduzione per porta punzone 4 x 20 mm	147
prolunga a testa sferica	386	rifrattometro	351
prolunga ad impatto	413	rifrattometro brix	351
prolunga flessibile	338	rifrattometro trivalente per liquidi auto	351
protezione antinfortunistica per macchine utensili	229	riga con display digitale multifunzione	305
protezione per tornio con schermo in lexan e struttura in acciaio	229	rilevatore digitale	348
protezione regolabile per mola con schermo in lexan	228	riscaldatore elettrico a raggi infrarossi	531
prova batteria e carica dell'alternatore	342	riscaldatore elettrico a raggi infrarossi con supporto	532
provini in gomma shore "a"	352	riscaldatore elettrico a raggi infrarossi con supporto per fissaggio a parete da 1300 w	531
punta a tracciare	304	riscaldatore elettrico a raggi infrarossi con supporto per fissaggio a parete da 2000 w	531
punta cilindrica elicoidale	244	riscaldatore elettrico a raggi infrarossi con treppiede	532
punta cilindrica rettificata	247	rivettatrice a cambio rapido	468
punta da centro	257	rivettatrice a doppia leva	468
punta di ricambio	272	rivettatrice a doppia leva a cambio rapido	468
punta elicoidale cilindrica	249	rivettatrice a doppia leva per inserti filettati	467
punta elicoidale destra con codolo conico	254	rivettatrice manuale	468
punta per alberi	259	rivettatrice per inserti filettati	467
punta per cerniere con riporto in metallo duro	262	roditrice per trapano	491
punta per muro	259	rotella di ricambio per tagliatubo	493
punta per tracciare in acciaio	149	rotella metrica	334
punte per tracciare con cuspidi in metallo duro	149	rotoli antispreco	48
punti metallici	287	rubinetto con vasca	235
rabboccatore	473	rubinetto femmina universale	582
raccordo	386	rubinetto maschio universale	582
raccordo a y	129	rugosimetro portatile digitale	354
raccordo ad impatto	421		
raccordo rapido da 1/2"	586		
raccordo rapido da 1/2" con acqua stop	586		
raccordo rapido da 3/4" a 5/8"	586		
raccordo rapido da 3/4" a 5/8" con acqua stop	586		



TITOLO	pag
rulliera regolabile in altezza	87
rullo per carteggiare	112
ruota in poliuretano	526
ruote con foro in panno abrasivo	45
ruote con gambo in panno abrasivo	44
ruote con gambo miste in tela e panno abrasivo	44
ruote lamellari con foro in tela all'ossido di alluminio	46
ruote lamellari con gambo in tela all'ossido di alluminio	45
ruote lamellari in panno abrasivo	43
ruote lamellari in tela	43
ruote lamellari miste	43
sabbiatrice	133
sabbiatrice con aspiratore	131
sabbiatrice da banco	134
sabbiatrice per esterno con aspiratore	136
sacco filtraggio	129
saldatore a pistola multifunzione	559
saldatore istantaneo	558
saldatore stilo	557
saldatura asportata a fine disco	24
sbavatore con 1 lama	284
sbavatore con 2 lame	284
sbavatore doppio con dischi in hss	285
sbavatore estensibile con 3 lame	284
sbavatore interno ed esterno per tubi	285
sbloccante e solvente	293
scalpello a punta con paramano	460
scalpello a taglio con paramano	460
scalpello per falegname	461
scalpello per metallo	457
scivoli ad angolo	235
scivolo in polipropilene	235
sclerometro	354
scopa da giardino regolabile con manico in legno	589
scure con manico in fibra di vetro	591
scuretto	591
scuretto con manico in fibra di vetro	591
secchio in polietilene	473
sega a nastro per legno	119
sega a tazza bimetallica hss m3 passo variabile	258
sega circolare squadratrice incisore toupie carteggiatrice	113

TITOLO	pag
sega circolare squadratrice parzialmente montata	114
segaccio a serramanico tripla affilatura diamantata	589
segaccio ad arco per legno	490
segaccio da falegname con tripla affilatura a diamante	490
segatrice a nastro	85
segatrice a nastro con discesa manuale e idraulica	84
segatrice a nastro elettronica da banco	85
segatrice a nastro per metalli	84
seghetto a lama vibrante a velocita' variabile	124
segnacento automatico	459
separatori per cassetto "a"	501
separatori per cassetto "b"	501
separatori per cassetto "c"	501
serie di giraviti in vassoio termoformato	514
serie punte di ricambio	150
serie torce a led mini colore nero	547
serie 4 piedini	234
serie bauli carrellati porta utensili	523
serie bauli in alluminio	524
serie blocchetti di riscontro piano paralleli in acciaio lappato	318
serie bussole a profilo ribassato	403
serie bussole ad impatto	420
serie bussole ad impatto, serie normale	418
serie bussole ad impatto, serie normale e lunghe	418
serie bussole con inserti torx	409
serie bussole e inserti	438
serie bussole e inserti esagonali	435
serie bussole esagonali a pollice da 1/2"	408
serie bussole esagonali maschio ad impatto	418
serie bussole multiprofilo ribassate	404
serie bussole torx maschio ad impatto	418
serie cacciaspine con supporto in plastica	459
serie calibri magnetici universali	112
serie calibri tampone lisci passa non passa h 7 temperati e cementati	319
serie chiavi a bussola con impugnatura	424



TITOLO	pag
serie chiavi a bussola da 1/2"	407
serie chiavi a bussola da 1/2" e 1/4"	406
serie chiavi a bussola da 1/4"	405
serie chiavi a bussola da 1/4" e 1/2"	406
serie chiavi a bussola da 1/4", 3/8" e 1/2"	407
serie chiavi a bussola da 3/4"	408
serie chiavi a bussola da 3/8" e 1/4"	405
serie chiavi a bussola flessibili con impugnatura	424
serie chiavi a bussola lunghe ad impatto	419
serie chiavi a pipa esagonali	402
serie chiavi a tubo esagonali	368
serie chiavi bussola esagonali impact rivestite in plastica	419
serie chiavi combinate	365
serie chiavi combinate con testa a cricchetto	360
serie chiavi combinate con testa a cricchetto snodata	360
serie chiavi combinate cromate, lucidate a specchio	363
serie chiavi combinate satinare	361
serie chiavi esagonali	371
serie chiavi esagonali lunghe con punta sferica	370
serie chiavi esagonali lunghe magnetiche con testa sferica	370
serie chiavi esagonali maschio a "t"	371
serie chiavi fisse	364
serie chiavi fisse cromate, lucidate a specchio	362
serie chiavi multilock	402
serie chiavi per filtri olio	376
serie chiavi per raccordi	367
serie chiavi poligonali	366
serie chiavi torx	373
serie chiavi torx lunghe	373
serie chiavi torx lunghe magnetiche	372
serie chiavi torx maschio a "t"	374
serie coltelli	111
serie coltelli a serramanico e pinze multiuso	487
serie coltelli per pialla spessore 316 mm	111
serie coltelli tagliabalsa	487
serie contenitori bivalve	504
serie cutter	486

TITOLO	pag
serie di cacciapine	458
serie di chiavi a bussola 1/4" - 3/8" - 1/2" in vassoio termoformato	513
serie di chiavi a pipa e chiavi per raccordi in vassoio termoformato	515
serie di chiavi a tubo	369
serie di chiavi combinate in vassoio termoformato	514
serie di chiavi fisse e chiavi snodate in vassoio termoformato	514
serie di chiavi poligonali in vassoio termoformato	515
serie di chiavi torx e esagonali in vassoio termoformato	514
serie di cricchetti, brugole, prolunghe e manici in vassoio termoformato	513
serie di estrattori	440
serie di frese a carotare con attacco weldon	268
serie di lenti in cristallo	541
serie di martelli brugole e bussole in vassoio termoformato	515
serie di nastri abrasivi in zirconio	49
serie di pinze e chiavi a rullino in vassoio termoformato	513
serie di pinze per anelli elastici in vassoio termoformato	513
serie di scalpelli e pinze in vassoio termoformato	515
serie estrattori in hss con attacco da 1/4"	439
serie estrattori per viti	439
serie fascette	290
serie frese a carotare lunghe con attacco weldon	270
serie frese a scalini	272
serie frese a svasare antivibranti	274
serie frese a tazza per legno	261
serie frese frontali a 2 e 4 tagli	270
serie frese frontali a più taglienti	270
serie frese per legno	275
serie frese rotative diamantate	275
serie fustelle	469
serie ganci	497
serie ganci per or	439
serie ganci per rimozione or	439
serie giraviti	427
serie giraviti a lame passanti	431
serie giraviti con espositore	430



TITOLO	pag
serie giraviti di precisione	433
serie giraviti e chiavi di precisione	433
serie giraviti elettricista	432
serie giraviti extra lunghi intercambiabili	430
serie giraviti isolati	431
serie giraviti precisione	433
serie giraviti torx	429
serie inserti	434
serie inserti attacco 3/8"	438
serie inserti esagonali	435
serie inserti lunghi	434
serie inserti ribe	437
serie lamatori tipo medio con attacco cilindrico	265
serie lame	100
serie lame in hss bidirezionali	285
serie lame in hss con gambo lungo	285
serie lame per 0875	462
serie lame per cutter	486
serie leve a battere	466
serie lime	463
serie lime ago	463
serie lime da ferro con manico anatomico	463
serie lime diamantate	465
serie lime diamantate curve	465
serie maschi e filiere	277
serie maschi e filiere in acciaio al tungsteno	276
serie maschi e filiere in acciaio legato	277
serie maschi per fori ciechi 35° gambo rinforzato	276
serie maschi per fori passanti gambo rinforzato	276
serie morsetti a molla in polipropilene	484
serie parallele in acciaio	179
serie pinze er16	205
serie pinze er20	206
serie pinze er25	206
serie pinze er32	206
serie pinze in nylon	448
serie pinze lunghe a doppio snodo	441
serie pinze per elettronica	444
serie pinze per fascette	448
serie porta inserti esagonali a cambio rapido	436
serie porta punte con attacco 1/4"	263

TITOLO	pag
serie posizionatori magnetici	330
serie protezioni finestra	139
serie protezioni plafoniera	139
serie punte	246
serie punte al cobalto	253
serie punte cilindriche a decimi rettificate	249
serie punte cilindriche rettificate	253
serie punte con inserto in metallo duro e scalpelli per muro	261
serie punte con svasatore per legno	262
serie punte diamantate con attacco da 1/4"	263
serie punte elicoidali cilindriche	251
serie punte elicoidali destre con codolo conico	257
serie punte per cerniere con riporto in metallo duro	262
serie punte per mortasa	262
serie punte per saldatore a stagno	558
serie punte rettificate	249
serie punte rettificate e autocentranti	248
serie raccordi ad impatto	421
serie raspe per legno con manico in plastica	463
serie rotelline	285
serie sacchi in plastica	129
serie scalpelli con paramano	460
serie scalpelli da ferro	460
serie scalpelli da legno	461
serie scalpelli, cacciaspine e bulini	458
serie scalpelli, punzoni e bulino con paramano	459
serie scalpelli, punzoni e bulino con supporto in plastica	459
serie sgorbie da legno per tornio	462
serie sgorbie per intagliatore	461
serie spine calibrate	321
serie svasatori a inserto	225
serie torce a led bici/tascabile	544
serie torce a led con magnete telescopico	549
serie torce a led mini color argento	547
serie ugelli in ceramica	138
serie utensili brasati	241
serie utensili di ricambio	491
serie vassoi magnetici	518
set 10 lame per cutter	486



TITOLO	pag	TITOLO	pag
set 10 viti	220	smerigliatrice ad albero flessibile	88
set 2 punte di ricambio in metallo duro	150	smerigliatrice combinata	93
set 2 punte per calibro c010/200	303	smerigliatrice combinata da banco	90
set 2 pz lame ricambio	472	smerigliatrice combinata professionale	92
set 2 rampe per auto	160	smerigliatrice combinata professionale con alberi lunghi	92
set 5 basi	220	smerigliatrice da banco	91
set 5 basi 12mm	219	smerigliatrice da banco con levigatrice	90
set 5 basi 16mm	219	smerigliatrice da banco professionale	91
set 5 basi 9mm	219	smerigliatrice pneumatica a 90°	569
set 5 basi triangolari 16mm	220	smerigliatrice pneumatica angolare	566
set 5 bussole	219	smerigliatrice pneumatica assiale	567
set 5 dischi abrasivi	47	smerigliatrice pneumatica assiale lunga	569
set 5 mole	96	smonta mandrino	204
set 5 utensili ad inserto	209	smussatrice da banco	98
set a fresare per toupie	275	smussatrice portatile	98
set avvitatore ad impulsi	564	snodo a cardano	386
set base staffa vite	220	snodo a cardano ad impatto	421
set contropunta girevole	193	sollevatore a pantografo per moto	162
set da taglio	218	sollevatore con piattaforma e forche	175
set filetti inox di ricambio	283	sollevatore idraulico	159
set lenti a visiera	541	sollevatore idraulico per fossa e sottoponte	164
set mole abrasive 10 pz	38	sollevatore magnetico	167
set paste per lucidatura metalli	46	sollevatore per pallet con freno e pedale di sollevamento	175
set per canalini esterni ed interni	217	sollevatore per pallets	174
set per saldatura a stagno	557	sonda flessibile	338
set ricambi per aerografo	579	sonda tipo "k"	346
set ricambi per aerografo a901a	580	sonda tipo "k" per temperatura ambiente	346
set rivettatrice con rivetti	469	sonda tipo "k" per temperatura ambiente o per immersione	346
set rivettatrici con rivetti	467	sottoplacchetta	226
set smerigliatrice pneumatica assiale con mollettine	566	spaccalegna manuale	126
set spazzole per l'officina e l'autoriparatore	286	spaccalegna orizzontale ad energia cinetica	126
set staffaggio	192	spaccalegna verticale	126
set sverniciatore	559	spatola con manico in plastica lucidata a specchio	472
set sverniciatore digitale	559	spazzola abrasiva in acciaio ondulato ottonato	285
set ugelli di ricambio	579	spazzola in acciaio	286
set utensili per interno 90°	213	spazzola per lucidatura metalli	46
set utensili per interno 95°	213	spellacavo	494
set utensili per interno bloccaggio a vite 90°	214	spellafilo automatico regolabile	494
set utensili per teste alesare	209	spessimetro	331
sgabello per officina	528		
silicone lubrificante	293		
siringa in alluminio e moplen per olio	292		
sistema di ancoraggio con nastro in poliestere	168		

TITOLO	pag
spilli	287
spina di manovra	369
spina per chiavi a bussola	409
spirale in poliuretano con raccordo girevole maschio	582
squadra a 90°	329
squadra bisellata a 90°	329
squadra di riscontro in granito	328
squadra falegname millimetrata	329
squadra magnetica a 90°	330
squadra magnetica inclinabile	330
staffa	220
staffa base vite	219
staffa base staffa vite	220
staffa di ricambio per 16 - 20	220
staffa di ricambio per 25 - 32	220
staffa utensile dx	220
staffa utensile sx	220
stativo porta comparatore	326
stazione di saldatura a temperatura controllata	557
stivale da lavoro in pvc	605
stivale di sicurezza in gomma nitrilica	604
stivale di sicurezza in pvc	604
stivale invernale	605
stivale professionale in gomma nitrilica	604
supporti portaconi da banco	232
supporto a bandiera	166
supporto articolato idraulico	325
supporto articolato meccanico	324
supporto magnetico per 3 bombolette spray e 7 giraviti	519
supporto magnetico per avvitatore e bussole	519
supporto magnetico porta comparatore	323
supporto micrometro	327
supporto motore	165
supporto pieghevole per macchine portatili	86
supporto tastatore ad arco	322
supporto universale per troncatrice portatile	116
supporto universale telescopico	527
sverniciatore	559
svettatoio con asta telescopica in alluminio	589

TITOLO	pag
taglia bulloni	494
taglia cornice	125
tagliacavi manuale a cricchetto	494
tagliarami telescopico	589
tagliarami telescopico a cricchetto con lama temperata e rivestita in teflon	589
tagliatubo a cricchetto per plastica	493
tagliatubo per poliuretano e gomma	494
tagliatubo per rame/ferro	493
tagliatubo per rame/plastica	493
tagliatubo per tubi rame	493
tampone filettato doppio pnp	320
tampone filettato doppio pnp metrico 6h	320
tanica in materiale plastico	474
tanica in metallo	474
tavola a croce	190
tavola a dividere basculante 0° ÷ 90°	186
tavola a dividere orizzontale	186
tavola a dividere orizzontale verticale	187
tavola basculante	191
tavola girevole basculante 0° ÷ 90°	185
telo in polietilene pesante anellato bordato, bicolore verde - blu	478
tenaglia cementista	449
tendi cavo con doppio cricchetto	171
testa di ricambio	455
tester rubacorrente	342
testina per alesare centesimale	208
testina per alesare centesimale con avanzamento automatico	208
tirante idraulico	154
torcia a led magnum color argento	548
torcia a led magnum colore nero	548
torcia a led maxi color argento	548
torcia a led maxi color nero	548
torcia impermeabile a batteria	543
torcia impermeabile a led	543
torcia in alluminio	549
torcia in alluminio con 1 led e funzione zoom manuale	550
torcia in alluminio con led a luce bianca ad alta luminosità	547
torcia tascabile a 7 led	546
torcia tascabile magnetica a 12 + 1 led	546
tornio ad ingranaggi	40
tornio ad ingranaggi con visualizzatore	39



TITOLO	pag	TITOLO	pag
tornio da legno	105	unità aspira olio pneumatica	475
tornio da legno con copia	104	unità idraulica in kit	155
tornio parallelo	38	unità raccogli olio	475
tornio parallelo con inverter	46	utensile 3 in 1, punta - maschio - svasatore	281
tornio parallelo con visualizzatore	41	utensile filettare esterno fissaggio a vite	218
tornio parallelo con visualizzatore ed inverter	45	utensile filettare interno fissaggio a vite	218
tornio per legno	106	utensile per esterno	211
torretta a cambio rapido	182	utensile per esterno 45°	210
torretta porta utensili a cambio rapido	184	utensile per esterno 90°	210
transpallet con bilancia	173	utensile per esterno 93°	211
transpallet con bilancia e stampante	173	utensile per esterno 95°	210
transpallet manuale	174	utensile per esterno con inserti	209
trapano a colonna	71	utensile per interno	214
trapano a colonna con doppia tavola	73	utensile per taglio esterno - blocco porta lama	219
trapano a colonna con trasmissione a cinghia	68	utensile per taglio esterno - lama	219
trapano ad aria reversibile	565	utensili 3 in 1, punta-maschio-svasatore e serie inserti	281
trapano ad ingranaggi	66	utensili in vassoio termoformato per cassettiere	516
trapano da banco	72	utensili per interno	214
trapano da banco con trasmissione a cinghia	77	valigetta portaminuteria	502
trapano fresa ad ingranaggi	57	valigetta con utensili e accessori	523
trapano fresa da banco	59	valigetta con utensili ed accessori	522
trapano fresa da banco ad ingranaggi	58	valigetta per utensili	505
trapano magnetico	82	valigetta porta minuteria	504
tripode regolabile in altezza	532	valigetta portaminuteria	502
troncatrice per legno	115	valigia porta utensili in alluminio	506
troncatrice pneumatica	568	valigia con utensili e accessori	520
troncatrice radiale per legno	115	valigia porta utensili in abs	506
troncatrice veloce	87	valigia porta utensili in abs con carrello	506
tronchese a tagliente frontale	444	valigia resistente all'acqua	506
tronchese a tagliente laterale	442	vasca di lavaggio	140
tronchesina per elettronica a taglio frontale	445	vasca di lavaggio da banco	141
tronchesina per elettronica a taglio laterale	445	vasca di lavaggio doppio uso	140
truschino digitale multifunzione	304	vasca di lavaggio pneumatica	141
truschino in acciaio cromato opaco	304	vasca di lavaggio portatile	142
tubo componibile snodabile per liquidi refrigeranti	228	vasca di lavaggio su carrello	141
tubo fluorescente pl 9w g23	540	vassoio magnetico con porta giraviti	518
tubo fluorescente 11w	540	vite utensile	220
tubo fluorescente 22w	540	viti fresa 040/063	226
tubo snodato estensibile	129	viti fresa 080/125	226
tuta monouso	601	zinco chiaro	293
ugello in carburo di boro lunga durata	138		

