DORNIER

INSIDER

Customer Magazine of Lindauer DORNIER GmbH / No. 13 / October 2003



“Grey eminence” of the fashion world	
Marzotto S.p.A., Valdagno, Italy	3/4
DORNIER at ITMA 2003 with an innovation push	
New technologies stabilize market position	5/7
Decisive handling simplification through semi-automatic filling threading	5
“Far and wide”	
The DORNIER air-jet weaving machine, new also with 540 cm nominal width	8
Better quality in knitted goods finishing	
New DORNIER magnet support and new circular squeezing machine EcoSqueeze®	9
DORNIER Machinery (Shanghai) Co. Ltd. opening in Shanghai in September 2003	9
“Blue jeans wonder”	
GAP Tekstil AS, Turkey	10/11
Leno weaving – easy and fast	
Doubled performance thanks to DORNIER EasyLeno®	12/13
Flexibility + Performance are not a contradiction	
New DORNIER air-jet terry weaving machine, type ServoTerry®	14
Worldwide competence for superior home furnishings	
Vincenzo Zucchi Group, Italy	15/16

Insider IMPRINT

Publisher and copyright:

Lindauer DORNIER GmbH
D-88129 Lindau/Germany
Telephone ++49 83 82 70 30
Telefax ++49 83 82 70 33 86
E-mail: webmaster@lindauer-dornier.com

Editor:

Egon Wirth

Graphics and realization:

Sutter Design Identity, Zürich, Switzerland

Print:

REPRO-TEAM GmbH, Weingarten, Germany

Issued:

Once a year
Date of this edition: October 2003

Reprinting:

Only with our previous consent, even for extracts.
Printed in Germany

**You can find the Insider on the Internet
using the following address:
<http://www.lindauer-dornier.com>**

“GREY EMINENCE” OF THE FASHION WORLD

History and tradition of the Marzotto Group are long and based on intelligent work and entrepreneurial spirit over 160 years. Five generations of the same family have guided the company, with high ethical standards, through the ups and downs of political, economical and industrial history.

Company history

Marzotto was founded in 1836. The group now has a leading worldwide role in the clothing industry and textile sector. Turnover in 2002 was 1,788 million Euro, approximately 80% attained outside Italy. With 12,027 employees, customers in over 100 countries, production locations in Italy, Tunisia, the Czech Republic, Lithuania, Germany, Switzerland, Turkey and the USA, the Group is the worldwide leader in men's ready-to-wear clothes. The Group has also extended its already important presence into the sportswear and ladieswear sectors.

Marzotto plays an important role in both woolen yarn production (15 million running meters annually from Marzotto, Guabello and Marlane and 6 million running meters cotton and linen fabric for sportswear from Tessuti di Sondrio) and linen yarn production (Linificio and Canapificio Nazionale).

In the clothing sector, the Group designs ladies' and men's collections, sportswear and leisure wear. Labels include the three Hugo Boss labels purchased in 1991 (Boss, Hugo Boss, Baldessarini), those purchased in 2002 from the Valentino Group (Valentino, Valentino Roma, Valentino Garavani, Valentino R.E.D.), own labels (UomoLebole, UL Trendy, Principe, Borgofiori, Marzotto Lab.). Licenses for Marlboro Classics (extended to 2019), Gianfranco Ferré Studio, GFF Gianfranco Ferré, Gianfranco Ferré Forma, M. Missoni,



Marzotto S.p.A. woolen fabric collection

round off the wide range of worldwide renowned brands.

The year 2002 had high strategic importance for Group growth with the purchase of Valentino, concentration on the core business and reorganization in the textile and fashion sector.

Strategy

Company strategy is based on rationalizing and developing the three main labels (Hugo Boss, Valentino, Marlboro Classics), extending labels in the ladieswear sector (future integration of Valentino in the current Group labels strengthens presence in top range textiles in ladies' wear as well), retail trade development and

further penetration of growing markets (especially China and Russia).

The Valentino extension reflects extending the range especially in young fashion and sportswear as well as license development. In the textile sector, the primary objective is production rationalization to increase product value with regard to quality and cost efficiency. The target is to attain a positive balance in 2003 already to finance development of the fashion sector in the Valentino Group.

Marzotto plans using 90% of all investments over the next three years 2003 - 2005 in the fashion sector with the aim to bring Valentino to the break-even point in 2004 and Boss Woman in the current year.



From left to right: Eng. Gianluca Tanzi, Technical Director, Eng. Fabrizio Giardino, Marketing Director and Mr. Mario Disconzi, Chief Designer of Marzotto S.p.A.

In accordance with the consolidations plan, the Group has withdrawn from the real-estate business, sold its own hydroelectric power plants and included a capital gain of 43.7 million Euro in the consolidated calculations for 2002.

Textile sector

With regard to yarns and fabrics, Marzotto produces and markets either directly or via franchising knitting yarns made of wool with the Lanerossi label and linen yarns with the Linificio and Canapificio Nazionale labels. Apart from that, Marzotto produces fabrics from wool and blended fabrics from wool and cotton with Guabello, Marzotto, Tessuti di Sondrio, Lanerossi and Marlane labels as well as blankets marketed with Marzotto Wool Home Collection, Lanerossi Arredo and Liteksas labels.

Innovations

Marzotto has always laid particular emphasis on comfortable fabrics. This involves a large innovative effort in developing yarns, fabrics and special finishing methods, and led to a fabric called "NATURAL STRETCH",

now standard in Marzotto fabric production with over 40% of the overall production.

"PLASMATO", the latest Marzotto fabric innovation, is created from a special selection of raw materials, on through yarn structure and on up to special dyeing and finishing methods. Varying properties such as shiny/matte, washed, coated are always combined with a silky character. Used for poplin weave as well as other weaves such as Ottoman, gabardine, serge and cady, this method provides excellent properties such as perfect final quality, easy care, 3-D surface, soft feel, wear resistance and natural stretch effect.

Weaving mills

Between 1990 and 1998, Marzotto installed 124 DORNIER rapier weaving machines in the Valdarno (VI) and Biella factories to manufacture fine, fashionable wool and Elastan fabrics. 24 machines of the same type were installed in Sondrio to manufacture cotton fabrics.

Marzotto started to manufacture wool fabrics and wool-Elastan blended fabrics in 2002 using 20 DORNIER

air-jet weaving machines, type AS. The experiment was successful: The air-jet weaving machines deliver highest productivity with excellent fabric quality at speeds between 700 and 750 ppm. Using the DORNIER system family of air-jet and rapier weaving machines supports optimum economic manufacturing of the wide range of different styles.

This secures the Marzotto company an important lead in the extremely competitive world market for high-class ladies' and men's fashion.

New technologies stabilize market position

DORNIER AT ITMA 2003 WITH AN INNOVATION PUSH

The Lindauer DORNIER GmbH uses this year's ITMA to again emphasize its drive in technological progress. New developments cover the complete textile machines product line. The new performance generation of air-jet and rapier weaving machines, a new 540 cm wide air-jet weaving machine for technical fabrics and new machine models for leno and terry weaving complement decisive innovative advances in finishing machines for circular fabrics.

Ongoing development of the DORNIER weaving machine system family

The new performance generation of DORNIER type AS air-jet weaving machines has been successful in production since 2002. This performance level has now also been integrated in our PS rapier weaving machines within the scope of our system family. Shorter, strengthened power train, mechanical modifications in design and optimized material selection adapt both machine types to meet future market demands on reed beat-up force and speed together with a further significant improvement in the reduction of vibrations. Recent

development on rapier and air-jet weaving machines concentrates primarily on quick, reliable style and warp changes. For example, two rapier weaving machines and one air-jet dobby weaving machine are fitted with the patented PSL pneumatic shaft lock. This allows engaging and disengaging shafts via the machine display. The company's main effort is directed in developing both weaving machine types into generally self-adjusting systems. Three rapier and three air-jet weaving machines demonstrate their performance scope in the home furnishings, clothing and technical fabrics sectors.

Rapier weaving machines

All three rapier weaving machines shown are fitted with a new patented air guide system for the filling insertion elements, type AirGuide®. The linear movement of the rigid DORNIER rapier rod is ideal for this air cushion guide – the perfect technical solution for contact-free, aerostatic support. Further new constructional developments reduce the time needed for width changes and improve cloth guidance and temple efficiency, e.g. for Jacquard weaving with extreme up and down move-

Decisive handling simplification through semi-automatic filling threading

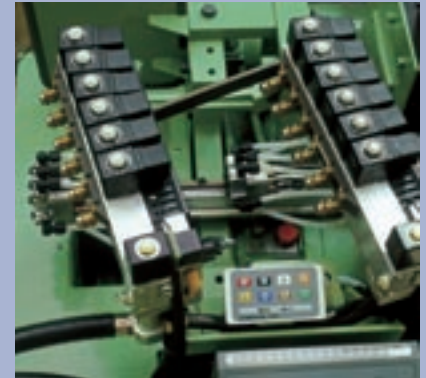

The high universality of DORNIER air-jet weaving machines is based on, among other factors, up to 8 mobile tandem nozzles (TDM), which support a straight filling thread path during the acceleration phase. They optimize energy consumption and support gentle yarn processing during force application by the main nozzles. The combination with main and tandem nozzles activated by a servo-valve makes semi-automatic filling threading possible for the first time. Each of the eight different filling threads can be threaded automatically through both nozzles easily and quickly per push-button. Operation is simplified because push-button position and color correspond to the individual main nozzles and are located in the weavers immediate work area. This saves correction time and supports a higher machine allocation per weaver.



Rapier weaving machine, type PS, in 180 cm nominal width, 12 colors and Jacquard machine with 10,780 lifting hooks

ments. DORNIER's open shed filling insertion proven in more than 45,000 units remains and ensures excellent final fabric quality especially for trendy piece-dyed Elastan fabrics.

Rapier weaving machine for universal use

This DORNIER machine demonstrates the almost unlimited use of filling yarns with speeds up to 600 ppm with 190 cm nominal width and shows that DORNIER's positive controlled central transfer is designed for highest speeds. Fillings inserted include sensitive, non-reinforced Lurex, 22 den fine monofilament, 5 mm PP narrow tapes and various fancy yarns.

Rapier weaving machine for technical fabrics

A 220 cm wide dobby weaving machine with 20 shafts is used to weave filter fabric from 0.15 mm diameter monofilament. This demonstrates the special advantage of a positive insertion system in meeting extreme demands made by cloth thickness and high number of shafts. This machine of technical weavers meets the specific requirements in shed setting options,

sturdiness and high reed beat-up force. The machine also has an optical warp stop motion and integrated optical fabric inspection.

Rapier weaving machine for home furnishings

For over 30 years, DORNIER rapier weaving machines have been in use worldwide by the most important fashionable upholstery fabric weavers as reliable production equipment for their superior collections. A 180 cm wide rapier weaving machine with 12 colors combined with a Jacquard machine with 10,752 lifting hooks is also shown at the exhibition. It demonstrates the sturdiness of its drive concept at 600 ppm, particularly on Jacquard machines with a high number of hooks and strong lifting movements. An on-the-fly pattern change with high quality upholstery and decorative fabrics impressively underlines the reliability of the positive controlled central transfer.

Air-jet weaving machines

All three air-jet weaving machines on the DORNIER stand are equipped with the new, patented pressure regu-

lation system, ServoControl®.

This minimizes thread load and allows automatic, reproducible pressure adjustment, for yarn lot changes as well, plus higher performance with better final fabric quality. Filling threading in main and tandem nozzles of the mobile tandem system is now semi-automatic with easy push-button control (see also page 5).

Air-jet weaving machine for clothing

For the clothing sector, DORNIER shows an air-jet weaving machine with dobby machine in 200 cm nominal width that weaves finest wool fabric with wool/Elastan filling at 900 ppm. This machine also demonstrates our economical, automatic rear shed setting system AutoWarpII®, which can adjust the warp stop motion across three axes via the machine display even when the machine is running.

This machine is fitted with DORNIER's patented Fast Dobby Change (FDC®) system to demonstrate the economical advantages of later switches from dobby to cam machine and vice-versa.

Air-jet weaving machine for technical and leno fabrics

DORNIER shows as worldwide innovation for the first time at this Exhibition a 540 cm wide air-jet weaving machine designed to underline the success of DORNIER air-jet weaving machines in the technical textile sector (see also page 8).

The new positive weft clamp PWC (patent applied), retains the filling thread in the main nozzle tube so that it cannot be blown out and does not lose twist. Holding air pressure is then more or less obsolete. This device is advantageous when processing soft-twisted yarns, Lycra core yarns and cloth patterns with long repeats, for example in clothing and home furnishings.

The style produced is PP carpet backing in leno technology. A true

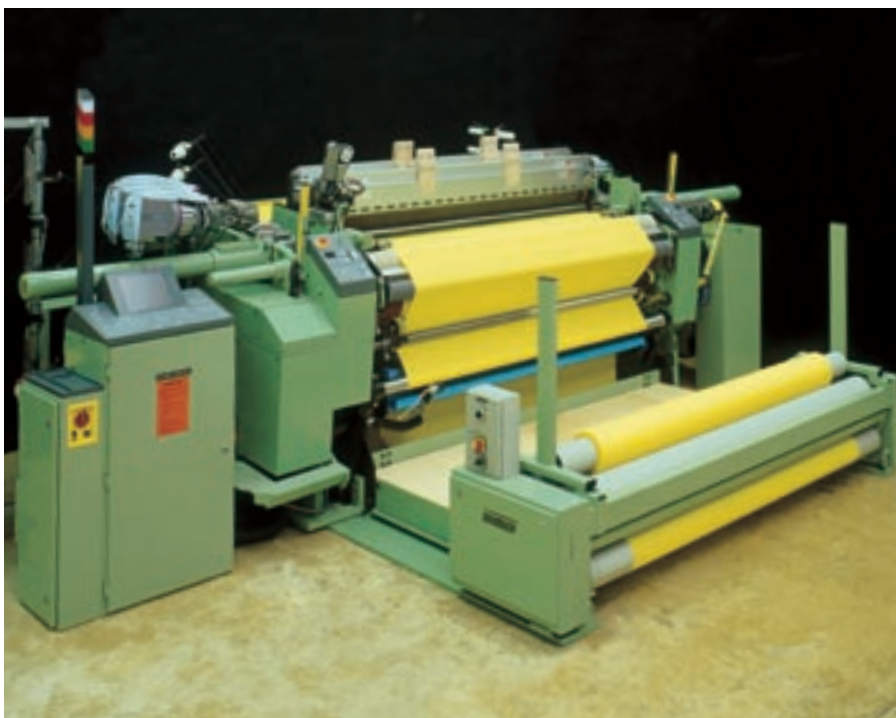

Rapier weaving machine, type PS, in 220 cm nominal width, producing extremely dense filter fabrics



Air-jet weaving machine , type AS, in 360 cm nominal width with 8 colors, pneumatic outer and center tuckers, type PneumaTucker® and Jacquard machine with 10,400 lifting hooks

innovation in leno technology, the patented DORNIER EasyLeno®-system is fitted on this machine. See pages 12/13 for more details. DORNIER's also patented PneumaTucker®, pneumatic tuck in motion, is used for selvage formation.

Air-jet weaving machine for terry fabrics

DORNIER's new development for air-jet terry weaving machines, ServoTerry®, embraces the home furnishing sector (see page 14). The decisive advantage over existing systems is the direct drive for the terry movement using a servomotor whilst retaining precise but gentle reed beat-up. This allows efficient production of high pile terry fabrics in all weave variations under reliable conditions on air-jet weaving machines. The 260 cm wide machine is combined with a Jacquard machine with 6,000 lifting hooks and weaves bath towels in two widths at 700 ppm.

Further DORNIER weaving machines at the ITMA

The Stäubli stand includes a 360 cm

wide DORNIER air-jet weaving machine combined with a Stäubli Jacquard machine with 10,400 lifting hooks producing 6-width serviettes with five center and two outer PneumaTucker® tuckers. This selvage device does not restrict the machine speed and provides uniform tuck-in selvages with hardly any thickening. The DORNIER full-width temple integrated in the machine can be used independently of the width and is patented in combination with the cloth table. It can be quickly changed to commercial cylinder temples.

Further DORNIER weaving machines are shown on the Bonas stand with decorative fabrics, Grosse with automotive fabrics, MEI International and Vaupel with labels.

Worldwide, comprehensive service concept for the DORNIER system family

The CAN-Bus introduced by DORNIER already in 1989 together with the VGA color display used on both air-jet as well as rapier machines supports reliable internal and external control, regulation and monitoring

processes. DORNIER is also recognized as innovative leader in Teleservice because the necessary Ethernet connections have been standard for the complete system family since 1997. Teleservice rounds off the DORNIER service concept providing comprehensive, on-site service with competent advice from local experts. This reduces downtimes, increases production reliability and provides significant extra usage benefits for DORNIER weaving machines. The service concept combined with Teleservice will be demonstrated at the ITMA together with several well-known European weavers.

New development for finishing of tubular knitted goods

DORNIER presents at ITMA for the first time a patented, contact-free magnetic support for the DORNIER circular expander to ensure fabric transport almost free from pressure and distortion on finishing processes for tubular knitted goods (see also page 9).

The DORNIER air-jet weaving machine, new also with 540 cm nominal width

“FAR AND WIDE“

More and more fabrics for industrial applications are being woven on air-jet weaving machines, and in larger widths as well.

Following this trend, DORNIER presents for the first time at the Exhibition an air-jet weaving machine in 540 cm width to continue the previous success of DORNIER's air-jet weaving machines in the technical textile sector with airbags, awnings, coating fabrics etc.

Technical fabrics for geotextiles, coatings, advertising banners as well as project fabrics for textile curtains and carpet backings are gaining “width“. With DORNIER being a leader in the technical textiles sector it was only natural for the company to offer a wider machine for this sector.

The key factor in developing this machine was the use of the proven basic concept of DORNIER's sturdy rapier weaving machine. The latter has been in use in all areas of technical textiles since the Seventies and is indispensable when processing especially thick and heavy fabrics as well as filling threads that no other filling insertion system can cope with.

Thus the DORNIER air-jet weaving machine combines all the experience and machine design criteria to meet the technological challenge of 540 cm nominal widths.

The pneumatic filling insertion has been modified to cope with the higher demands. The main nozzle on the DORNIER air-jet weaving machine is the primary component that determines thread acceleration and speed during filling insertion. Optimum force application without affecting filling yarn properties demands a precise air stream attained through special developments in internal main nozzle geometry. Mobile tandem main nozzles were developed to double the main nozzle effect. This demands a stable slay construction, a stable double-sided drive with complementary cam assemblies and mass compensating machine dynamics.

Decisively for larger widths the powerful mobile main and tandem nozzles are now combined with our patented ServoControl® system providing faster air regulation. Here just one servo-valve supports pressure control and regulation for up to 8 main and tandem nozzles. Pressure changes up

to 2 bar can be controlled, pick by pick, in the highest resolution. The servo-valve is compact and located close to the consumers to ensure short reaction times. Pressure is displayed as absolute values, numeric and graphic, on the machine Dialog Panel. Special jet design for the relay nozzles supports processing filament yarns in yarn count range 167 dtex to 2500 dtex and fiber yarns from Ne 3 to Ne 12.

The machine equipment was specially designed to meet the specific demands of technical fabrics. Filling threads are monitored by the patented Triple Weft Sensor (TWS) controlling fiber and filament yarns as well. Leno, hot melt or pneumatic tucker devices are available for selvedge formation. Apart from cam, dobby and Jacquard machines, as shedding motions, the new EasyLeno® technology can also be used for leno as well as plain weaves.



Air-jet weaving machine, type AS in 540 cm nominal width with new EasyLeno®-system

BETTER QUALITY IN KNITTED GOODS FINISHING

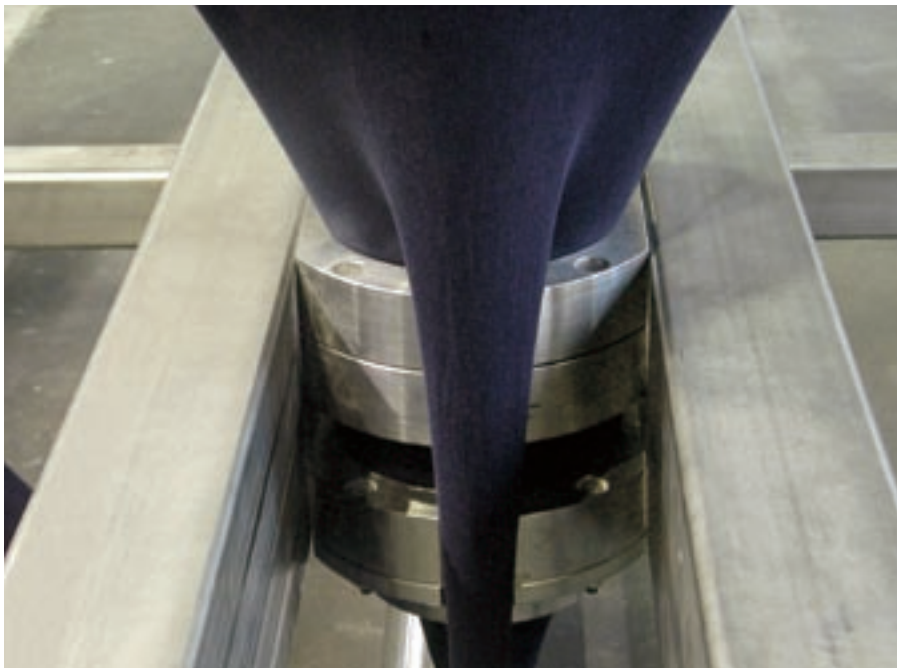

New contact-free magnetic support for the DORNIER circular expander

Most gentle processing of sensitive tubular knitted fabrics using patented, contact-free magnetic mounting of the DORNIER circular expander.

DORNIER has established itself as one of the market leaders in textile finishing machines for tubular knitwear fabrics in the processes bleaching, mercerising, singeing and heat setting. Innovative designs already anticipate future finishing development demands. Materials such as Micromodal, Elastan etc. are becoming more and more popular but are highly sensitive and therefore not always easy to process and also place high demands on production machines. DORNIER meets these demands with a new patented, contact-free magnetic mounting that ensures fabric transport almost free from pressure and distortion over the proven, patented DORNIER circular expander. The magnetic mounting support shown at the ITMA for the first time decisively reduces the overall load on the fabric during continuous processing. This is a significant contribution to quality improvement giving DORNIER customers a competitive advantage in the hard-fought market.

DORNIER circular squeezing machine EcoSqueeze®

The patented circular squeezing machine EcoSqueeze® is a further new development in DORNIER's finishing machine system family. DORNIER's circular expander also serves as basis here. A drive gear ring drives three squeezing units comprising two outer press rollers and an inner fixing roller. This allows simultaneous and multiple squeezing from the outside and inside for tubular knitted fabrics in round condition. This brings significant quality improvement compared to conventional methods because the previous spin process is very prone to squeezing creases for knitted goods using Micromodal or Elastan mixes. Squeezing effects up to 50% residual moisture are attained, of course without selvedge marks as well as free from distortion and creases.

DORNIER Machinery (Shanghai) Co. Ltd. opening in Shanghai in September 2003

The East Asian market is rapidly gaining significance for Lindauer DORNIER GmbH. Around 18% of the total DORNIER worldwide turnover is achieved in this region. Since the representation office in Beijing was no longer capable of handling the various sales and service activities arising from increasing market demands, DORNIER decided to establish its own subsidiary in Shanghai (CHINDO). All customer activities are now bundled in sales offices, spare parts warehouse, training center and test weaving shop over 760 m². The Pudong location in the free trade zone of Shanghai allows short routes to China's textile centers and close international airport and harbor facilities provide excellent connections to the various parts of Asia such as Japan, Taiwan, Korea, Indonesia, Thailand, Vietnam etc. By employing native experts and being close to the markets at the same time DORNIER provides new quality standards in sales, spare parts, training and consulting support.

Contact address:
DORNIER Machinery (Shanghai)
Co. Ltd.
Area B G/F Block 45
No. 299 FuTeZhong Road
WaiGaoQiao Tax Free Zone
Shanghai 200131, P.R. China
Tel. + 86 21 5046 2838
Fax. + 86 21 5046 2138
info@lindauer-dornier.cn
<http://www.lindauer-dornier.cn>

“BLUE JEANS WONDER”



DORNIER rapier weaving machine installation in the Malatya factory

The company supplies the leading jeans manufacturers, worldwide, plans on tripling production and has therefore made massive investments in production plants over the last years – mainly in 144 DORNIER rapier weaving machines. GAP Tekstil, the leading Turkish denim weaver, is specialized in both classic and trendy jeans fabrics.

Jeans are always in. The fabric that started out as American working trousers adapts to every fashion trend. At the moment, trendy denims combined with various materials such as stretch are in demand to meet designers ideas. Fashionable denim is used for both men's and women's clothing.

Jeans fabric manufacturing has moved from the USA and Europe to Turkey, India and Brazil. This is the opinion of Erdinc Taskoparan, the young GAP Tekstil director, who leaves no doubt that a team of professional managers run the modern company. The classic manufacturing countries have lost ground and new companies

have increased their market shares. GAP is the youngest denim weaving mill in Turkey and determined to exploit their market chance. This necessitated a range of investments to provide the capacities demanded by the world market.

The number of weaving machines rose from 28 to 284 within two years, including 144 DORNIER rapier weaving machines. GAP is one of the few weavers in the world using rapier technology for denim production. This is exceptional and not without risk. But, here as well, the GAP professionals did not go “shopping” without previous exact detailed analysis. They found DORNIER with the same quality awareness. The success is impressive: The new technology catapulted GAP into a new quality dimension.

Enormous capacity increase

The immense production capacity is surprising at first but immediately put into perspective by Director

Taskoparan. The annual worldwide denim production is an amazing 4 billion meters. There are other denim manufacturers apart from GAP in Turkey. No other weaver has however specialized in “fancy denims”



Examples of fashion denim

as GAP has or attained such a high market share. And this for a good reason: Weavers not just providing classic jeans fabric are independent of fashion trends. GAP aims at establishing itself on the worldwide market primarily as manufacturer of high quality, innovative fashionable denim fabrics. These fabrics include denim and Lycra mixes which are very much in demand. These fabrics, as well as denim combined with nylon and polyester, can be manufactured in perfect quality on DORNIER rapier weaving machines.

60% Fancy Denims

Trendy mixed denims are around 60% of GAP's production. An impressive figure when one considers that it is usually only around 6 - 7% for traditional manufacturers. This is not surprising because manufacturing denim mix fabrics is especially complicated. For example, no seconds can be tolerated for denim-lycra mixes. Special attention must be paid to weaving machine performance to be successful here. It must be higher than for classic denim fabrics.

This was the reason for GAP's clear decision for DORNIER after evaluating the new weaving machines. Erdinc Taskoparan "We want to, and must, deliver the world market with best quality and highest consistency. This is only attainable when we can rely on weaving machines with equivalent high quality and consistency." Another statistic emphasizes the high production standard: GAP has an even lower share of rejects for denim-lycra mixes than for classic denim fabrics.

DORNIER's filling insertion system technology plays a role here. Positive control of all phases of the central transfer ensures reliable thread transfer that is important for Lycra core yarn to avoid thread loss and buttons. Open shed filling insertion is another decisive technical detail. The

rapier inserts each filling thread at open shed and they become released, just 8 mm from the right reed edge, only when the catch selvedge has clamped the filling thread safely. Therefore the Elastane threads can relax equally from left to right fabric side before the shed closes. This guarantees even coloring and elasticity.

What brand jeans are made of

GAP was founded in 1989. Normal cotton fabrics were manufactured in the early years. In 1992, yarn production using an own OE spinning mill started, followed by denim fabrics in 1995. GAP imported Lycra yarn from Switzerland to meet the first demands for stretch denim. Then in 1998, an own core yarn spinning mill was established to allow independent production, even more precise quality control and adaption as required.

The company also has a flat management structure supporting very fast, efficient decisions.

GAP's marketing concept is clear and simple: Three main turnover markets exist, Belgium as location for well-

known ready-to-wear manufacturers, Italy as fashion trendsetter and the USA as mass consumer. Marketing outlets are sales organizations that can only sell GAP products in the denim sector.

Worldwide trade name designers Levi's, Lee, Wrangler, Gap, Diesel, Guess, Benetton, Tommy Hilfiger, Marks & Spencer and Mavi Jeans use GAP denim fabrics, especially stretch denim from GAP.



Director Erdinc Taskoparan in the DORNIER weaving machine plant

Doubled performance thanks to DORNIER-EasyLeno®

LENO WEAVING – EASY AND FAST

Technical textiles and home furnishings include fabrics that must be manufactured in open fabric constructions but being slip resistant. These are referred to as leno fabrics. Known manufacturing processes only permit low speeds. DORNIER's system EasyLeno® (patent applied), is a new development in leno technology bringing up to 100% higher performance potential on DORNIER weaving machines. The system is available for both DORNIER air-jet and rapier weaving machines.

Leno technology

Weaving a normal fabric warp ends lay parallel and cross over or under the filling thread whereas the warp ends are themselves crossed as well during leno weaving. That means, leno fabrics comprise a warp end and filling thread system just the same as normal fabrics. However, the warp end system is split into straight and looping warp ends. Straight warp ends are always under the filling threads and represent the lower shed during weaving. On the other hand,

looping warp ends are always above the filling threads and represent the upper shed during weaving. Leno fabric cohesion is attained by positioning looping warp ends once on the left and once on the right of straight warp ends of a leno group. This leno interlace supports leno fabrics with non-slip, latticed cloth designs with open fabric construction in warp and filling direction.

Today, interlacing is attained using the inverted leno method that restricts weaving machine speed and causes excessive wear on leno heddle pairs.

The new DORNIER EasyLeno®-system

Contrary to the classic system, two needle bars moved by the existing weaving machine drive are used. Straight warp ends are drawn into a stationary needle bar (blue in the graphic). This bar is shifted once per weaving machine cycle the length of one leno pair to the right and once to the left. To create a leno interlace, the looping warp ends, drawn in the movable needle bar (grey in the

graphic), just have to be moved up and down between upper and lower shed. Leno movement for warp ends and weaving machine reed beat-up are made with the movable needle bar in the lower shed. The reed (green in graphic) moves from the beat-up to the rearmost position at the same time when the movable needle bar moves from lower to upper shed. This means, slay movement also serves simultaneously as drive for reed and movable needle bar movement. This automatically ensures that reed movement is synchronous to shedding motion movement.

Flat bars separate the needles in the needle bar for the following tasks:

- Warp end can only spring past one needle for leno interlacing.
- The needles in the stationary needle bar can be held and driven in a substructure in the machine. No foreign elements penetrate the warp ends across the whole width.

Decisive advantages of this leno method:

- Weaving machine without superstructure.



DORNIER rapier weaving machine plant with new EasyLeno®-system for glass leno fabric in Slovakia

- From left to right:
- Curtain material
 - Glass leno fabric for building protection
 - PP leno fabric for carpet backing

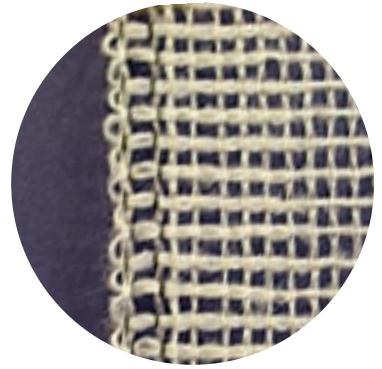
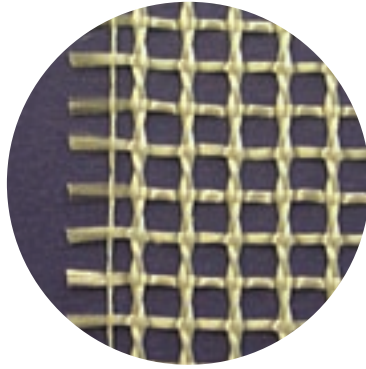

- Normal front and read shed, with option to read in a lease during style changes.
- Minimum warp end needle wrap that means gentle warp end processing, low needle wear and easy maintenance.
- Both thread systems, looping and straight warp ends have the same lift even with symmetrical shed. This means an even load for both thread systems that protects sensitive warp yarns such as glass.
- The high cleaning effort required on traditional glass weaving machines to maintain the demanded quality is no longer necessary - an additional time advantage.
- Filling break repair and warp-changes are simple and easy for the operator.
- High thread densities up to 20 threads/cm possible.
- Speed limits only from filling insertion system, machine width, warp and filling materials used, but no limit by the leno device. This supports insertion performance on wide air-jet weaving machines up to 2,300 m/min.
- Leno interlace via machine drive. Shedding machine, undermotions, shafts and heddles not necessary.
- System can be used on both DORNIER air-jet and rapier weaving machines.

EasyLeno® applications

This new method is suitable for all leno fabrics – from very light curtains to heaviest glass rovings. Leno fabrics are mainly produced from materials such as glass, polypropylene, polyester yarns but also from aramide, linen yarns for home furnishings and technical fabrics.

In the home furnishings sector, curtains from polyester leno fabrics mainly on air-jet and rapier weaving machines in nominal widths 300 cm to 360 cm.

There are many applications for technical fabrics. For example, glass leno fabrics to reinforce plaster layers on house walls and as carrier material for separating and grinding discs, mainly produced on rapier weaving machines in nominal widths 200 cm to 240 cm. Polypropylene leno fabrics are used as non-slip textile fabrics in geotextile and agriculture sectors. This type of leno fabric replaces the foamed material coating as second backing for latex-free carpets or flooring. Here, air-jet weaving machines in nominal widths 400 cm to 540 cm are used.

Even though new on the market, several plants already use EasyLeno® technology on DORNIER air-jet and rapier weaving machines in industrial applications.

Further development for 1/1 fabrics

A further development of this technology supports weaving in plain and leno technology and creates a new dimension in flexibility. This allows curtain weavers to use the same weaving machine for leno fabrics and plain styles. This also opens up options for completely new creations for fabric design. For example, decorative and clothing fabrics with vertical stripes from plain and leno warp ends.

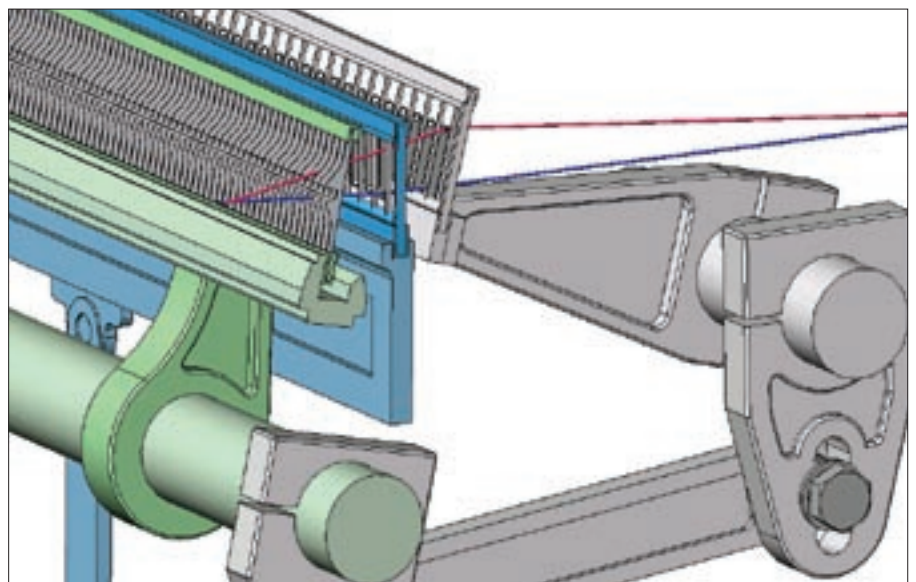

Drive with stationary needle bar (blue), movable needle bar (grey) and reed (green)

New DORNIER air-jet terry weaving machine, type ServoTerry®

FLEXIBILITY + PERFORMANCE ARE NOT A CONTRADICTION

The new DORNIER air-jet terry weaving machine, type ServoTerry®, is based on the stable basic concept for the proven DORNIER air-jet weaving machine. Electronic drives and optimized mechanical engineering support a wide range of applications to achieve optimum running condition and easiest handling. At the same time, highest demands on fabric quality are met and all pile formation options supported at a significantly higher performance level.

Pile formation

A servo-motor replaces the terry cam for pile formation on this new machine. This supports weaving various pile heights and number of fillings per terry group in a hand towel with a decisive increase in machine flexibility. A positive drive system consisting of a back-rest roll and terry bar in combination with the temples move the fabric to the reed for group beat-up. Contrary to a solution with variable reed beat-up point, the low-backlash reed drive remains and therefore provides the precision required for group beat-up at highest performance.

Electronics have also improved pile warp feed precision. Pile heights are calculated automatically from terry spacing, work-in and filling group. A measuring device ensures the value needed for pile formation with a positively controlled increment precision of 0.1 mm independent of the warp beam diameter. The resulting

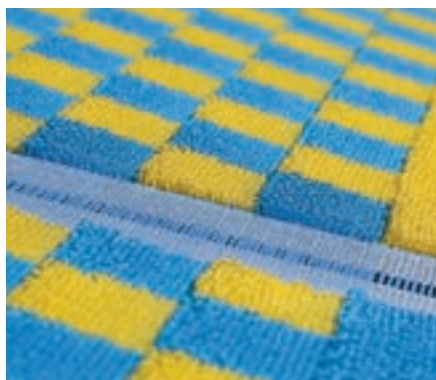

Terry fabric with variable pile height



Air-jet terry weaving machine, type "ServoTerry®" with 8 colors in Jacquard version

pile height consistency means constant fabric weight and best quality. The weaving process is so exact that precise mirrored patterns are possible with only minimum shearing waste for velour weavers. This pile warp end feed method supports precise transition between varying pile heights, from border to first pile loop as well as from 3 to 4, 5, 6 or 7-pick terry fabric. DORNIER's newly developed pile control supports programming all terry parameters on the machine display as required and in a reproducible way.

Patented soft reed beat-up

A further special DORNIER ServoTerry® feature is the patented soft reed beat-up that reduces the speed by 43% in the terry spacing area. Despite higher speeds, friction in the high-load pile formation area is lower than that on, for example, flexible rapier weaving machines. Warp end breaks are more than halved using the same warp preparation. This inevitably means a drastic reduction in seconds and therefore better quality. Soft reed beat-up avoids the risk of loops slipping so that extremely high terry spacing, up to maximum 22 mm, and cloths up to pile relation 120:10 can be manufactured with

extremely consistent pile height at elevated speeds.

Automatic filling break repair clears filling insertion faults automatically except the last terry group filling thread. The compact machine design, even with 940 mm ground warps, eases operating decisively for weavers.

Selvedge formation

DORNIER offers innovative, patented selvedge devices with decisive advantages. The fully electronic selvedge leno, MotoLeno®, hinders drop wires dropping in the selvedge area. The patented pneumatic tuckers, Pneuma-Tucker®, on the outside and in the center, work with a single cloth table so that it does not have to be adjusted for width changes.

With its new "ServoTerry®" air-jet weaving machine DORNIER provides quality terry weavers a high value, flexible and extremely economical tool.

Vincenzo Zucchi Group, Italy

WORLDWIDE COMPETENCE FOR SUPERIOR HOME FURNISHINGS

A company with employees from differing cultures and with different ideas, with their artistic expressions, professional experience and traditions are the foundation for manufacturing high quality, aesthetically pleasing products. This is the world of the Zucchi company group, a world filled with people committed daily to excellence in home furnishings.

The Zucchi Group

The modular Group comprises a large number of subsidiary companies developing, manufacturing and marketing finished as well as semi-finished products and high quality fabrics for third-parties in the home textile sector.

The companies responsible for yarn and fabric production, Standardtela-filati and Standardtela-tessuti, manufacture mainly for the style program of the labels of Zucchi, Bassetti and Descamps. The same applies for the finishing and making up process by subsidiary Mascioni (bleaching, dyeing, printing, quilting and ready to wear).

Zucchi, Bassetti and Descamps also hold a range of companies operating in special market niches and marketing leading labels abroad, especially in Italy and France.

History

Vincenzo Zucchi founded the company in 1920 as weaving mill for home furnishings. After diverse extensions, bed and table linen and various mixes were added in 1953 under the present company name Vincenzo Zucchi S.p.A. In the Sixties, the company started its development concept by taking over or combining other companies to secure raw materials (yarns) and semi-finished products (fabrics), create new production areas and gain access to new markets with appropriate sales structures. At the same time, the company followed a label concept using pattern collections to introduce dyed and printed styles. To acceler-



DORNIER-air-jet weaving machine installation at the Standardtela plant in Notaresco



DORNIER-rapier weaving machine installation at the Zucchi plant in Casorezzo

ate this process the textile refining plants were modernized with the latest bleaching, dyeing, printing and finishing machines.

Today, Vincenzo Zucchi S.p.A is an industrial holding with comprehensive know-how in all production levels involved in manufacturing home furnishings and using state-of-the-art technical plants. It relies on an efficient sales network with its own, highly qualified sales points worldwide. The Group has a total of 3,500 employees, 1,200 of which are operative in France.

The market

Average annual expenditure on home furnishings in Europe is 22 Euro per person. This also applies to the most

important markets for the company, Italy and France. Zucchi's excellent price/performance ratio attained a 25% market share in Italy and 15% in France.

The Group has more than 300 shops and factory outlets across the European market with trade names Zucchi Stores, Bassetti, Descamps, Martins Bleus, Texaffaires and Bianca.

Standardtela S.p.A

Standardtela S.p.A has three factories in Italy manufacturing yarns and raw fabrics from 100% cotton for both the Zucchi Group and for direct sales in Europe and the USA.

Standardtela set the following targets in the last years in order to remain competitive in the market that was

becoming more and more difficult: Maximum service for customers (just in time and technical support), highest quality for its own products, versatility and reliability.

Considerable investments and organizational changes were necessary to reach these targets:

1. Creation of a team working closely together, kept at a high know-how level by on-going training and oriented to common targets.
2. Installation of a fast, comprehensive information system for all operational levels to support quick, individual decisions.
3. New automated production plants and integration of modern machines in production cycles to optimize performance and Zucchi product quality.

Weaving mills

Quality was also decisive for the Zucchi Group when selecting weaving machines. Today, the company uses 98 double-width DORNIER air-jet weaving machines with 8 employees

per shift in Notaresco to produce high quality bed linen, 340 working days per year. Up to 95% integral efficiency is attained. Double-width DORNIER rapier weaving machines are used in Casorezzo to develop new Jacquard creations.

The decision in Notaresco was based on a comprehensive, systematic comparison of air-jet weaving machines and multiphase technology from competitors. The result in favour of DORNIER resulted from higher flexibility at high speeds, lower filling thread break level, better fabric quality and the advantages of pneumatic tucker selvages as against conventional selvages with mechanical tuckers. Together with favourable energy consumption, the final result was significantly lower production costs as compared to competitors.

DORNIER's Fast Dobby Change (FDC®) system was also an important factor to protect the investment concerning Standardtela's future development of complex fabric designs. This patented system allows custom-



Eng. Matteo Zucchi with Eng. Peter D. Dornier during a visit to the Notaresco factory

ers to easily switch from plain weave cam motion to doobby version with a high number of shafts to meet possible future market demands.

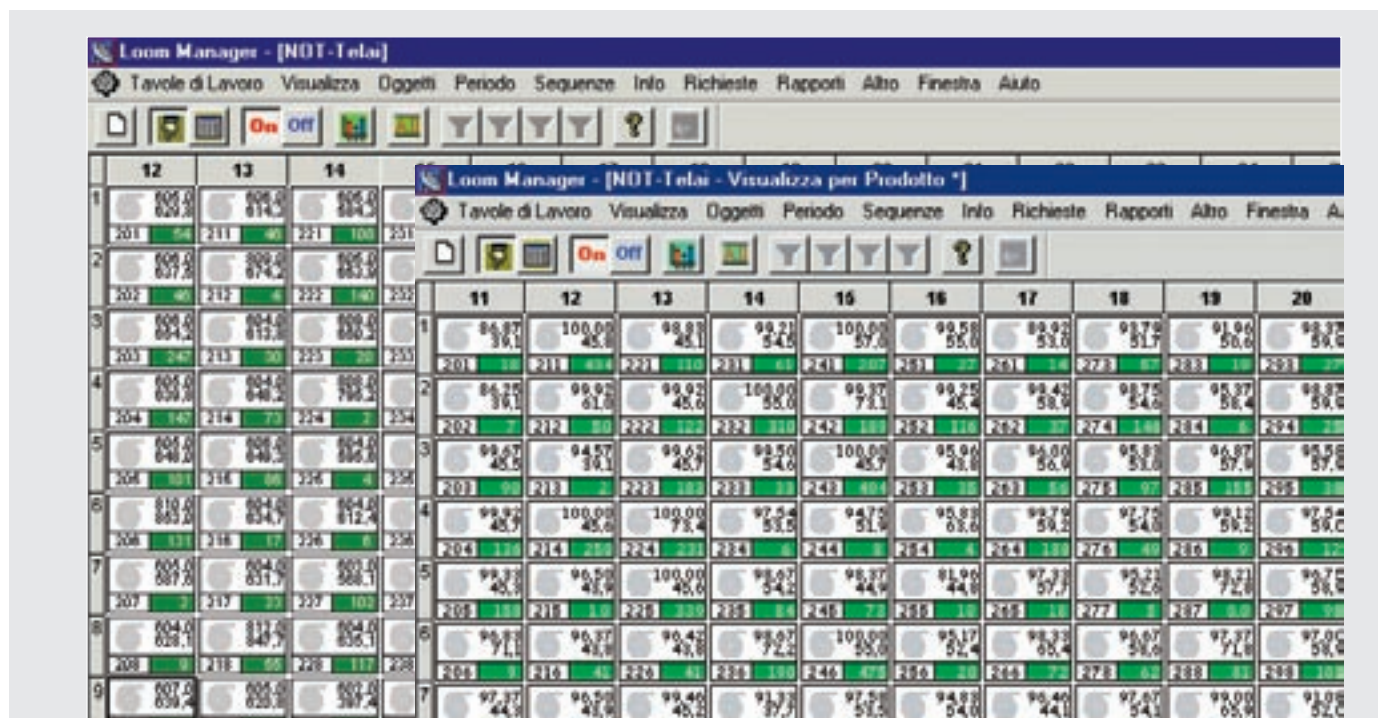

Zucchi's "Loom Manager" protocol on speeds and efficiency of the DORNIER plant in Notaresco