



3367

CITY



**WARNING:** CHOKING HAZARD.  
Toy contains small parts and a small ball.  
Not for children under 3 years.

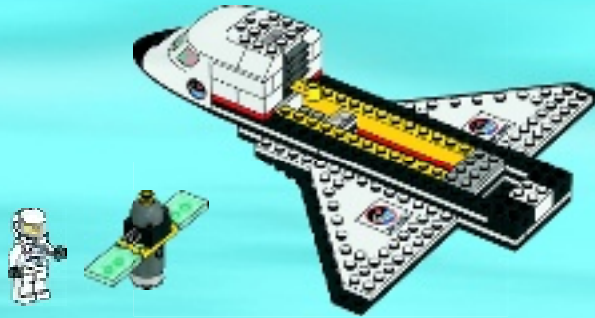

**AVERTISSEMENT** : RISQUE D'ÉTOUFFEMENT.  
Le jouet contient des petites pièces ainsi qu'une petite boule.  
Il ne convient pas aux enfants de moins de 3 ans.



**ADVERTENCIA**: PELIGRO DE ASFIXIA.  
Juguete que contiene partes pequeñas y una pelota pequeña.  
No recomendado para niños menores de 3 años.

1

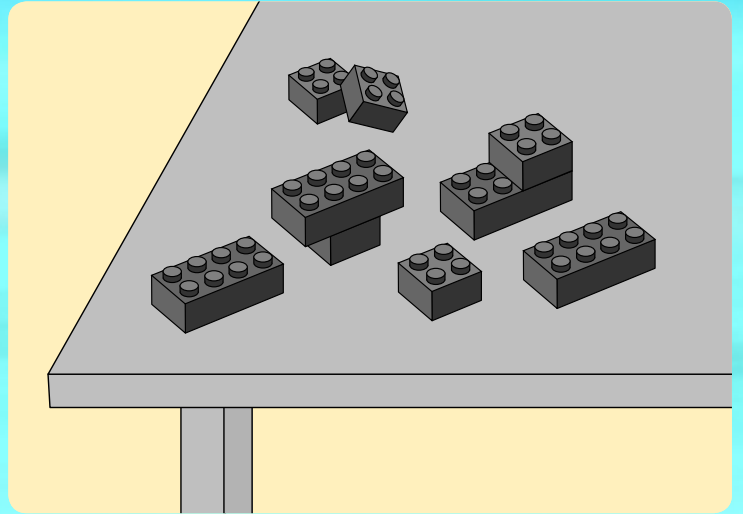
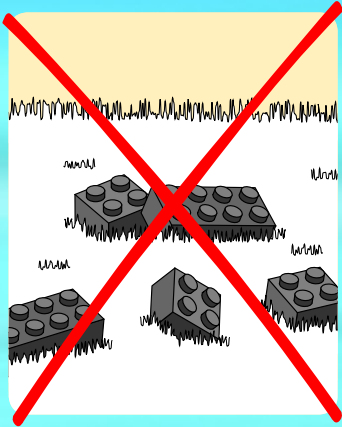

2

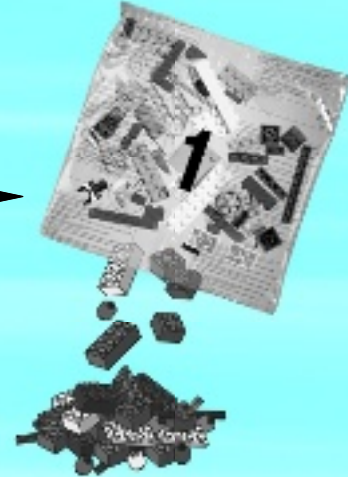
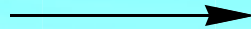



+

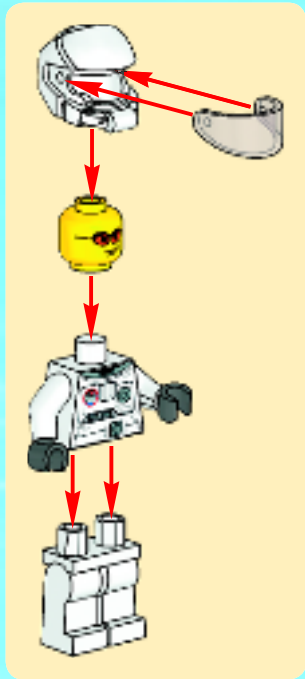
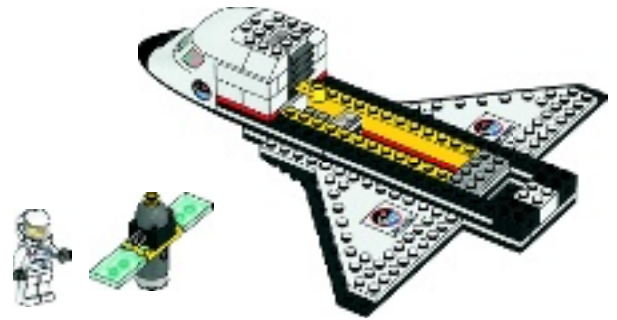

1



2



3

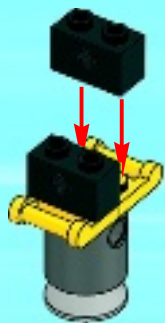

4



5



6



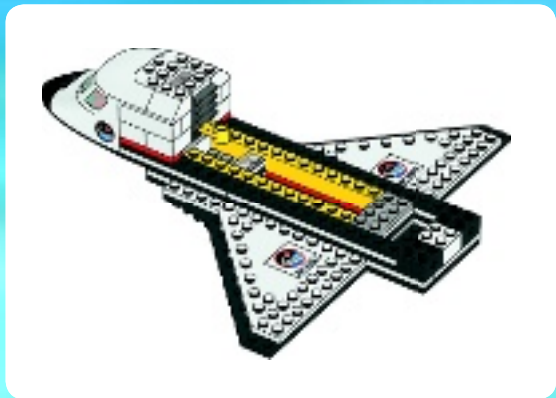

1



2



3

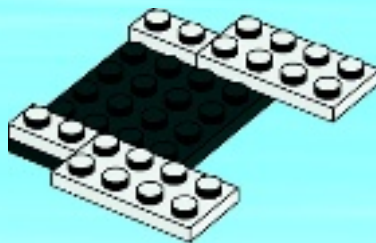

4

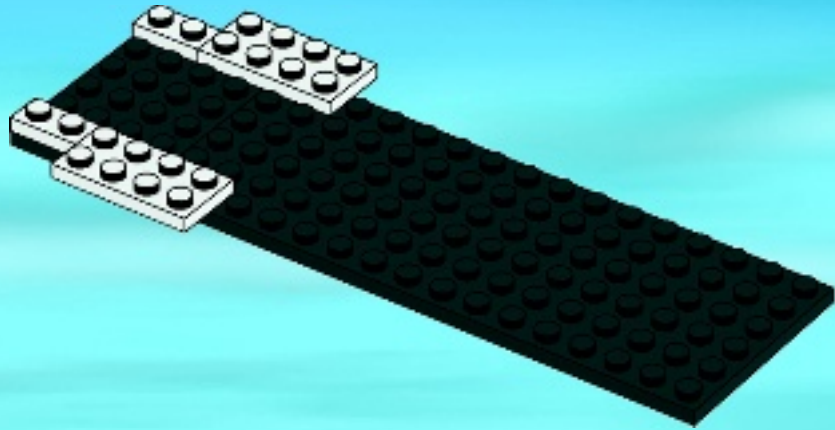

5

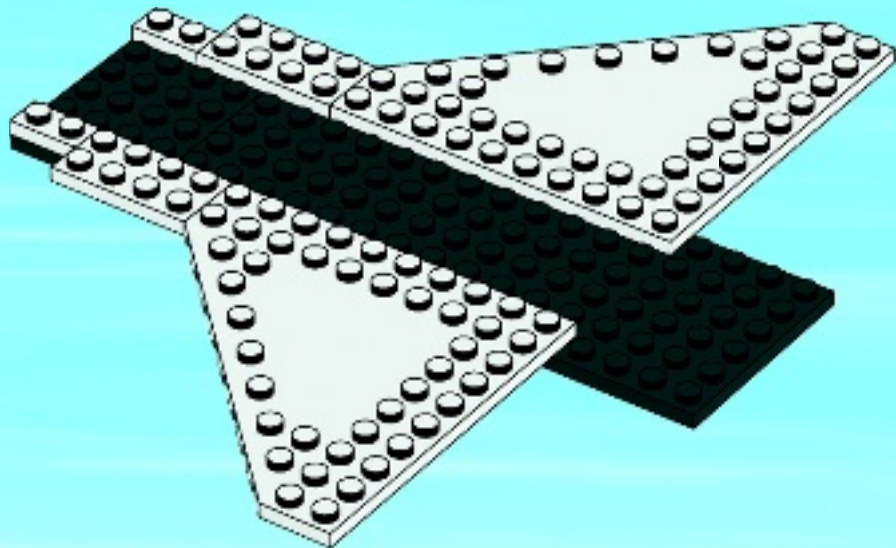

6

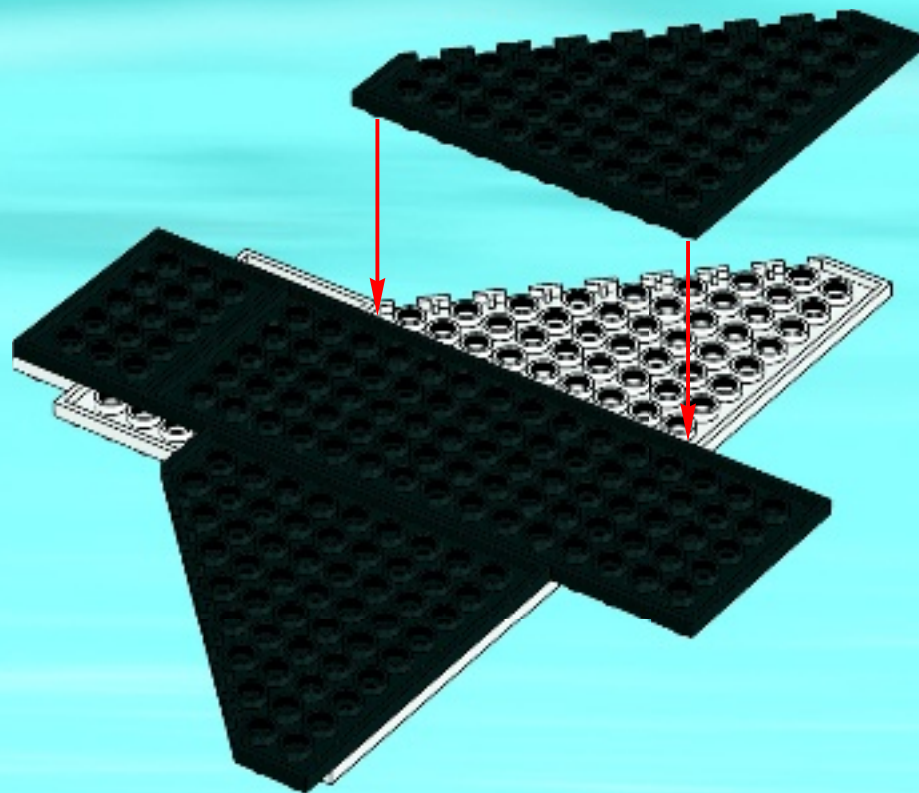



7

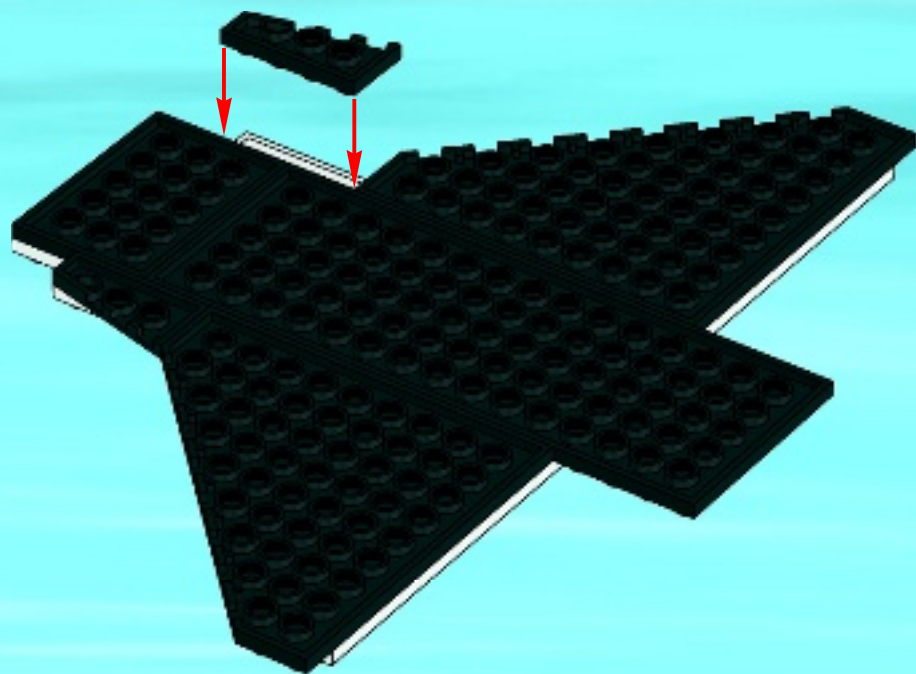



**1**



**2**

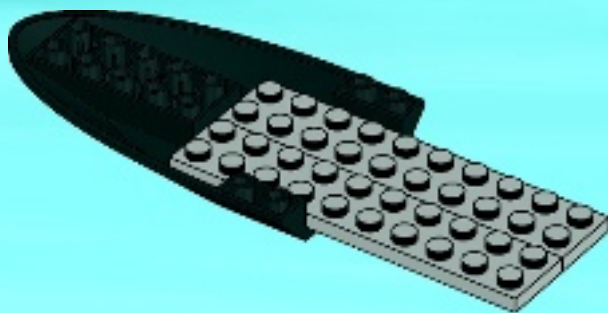

**3**

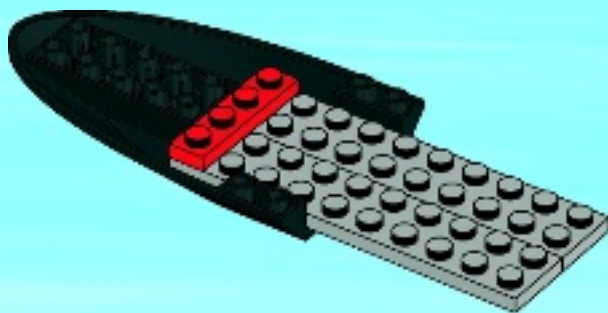



8

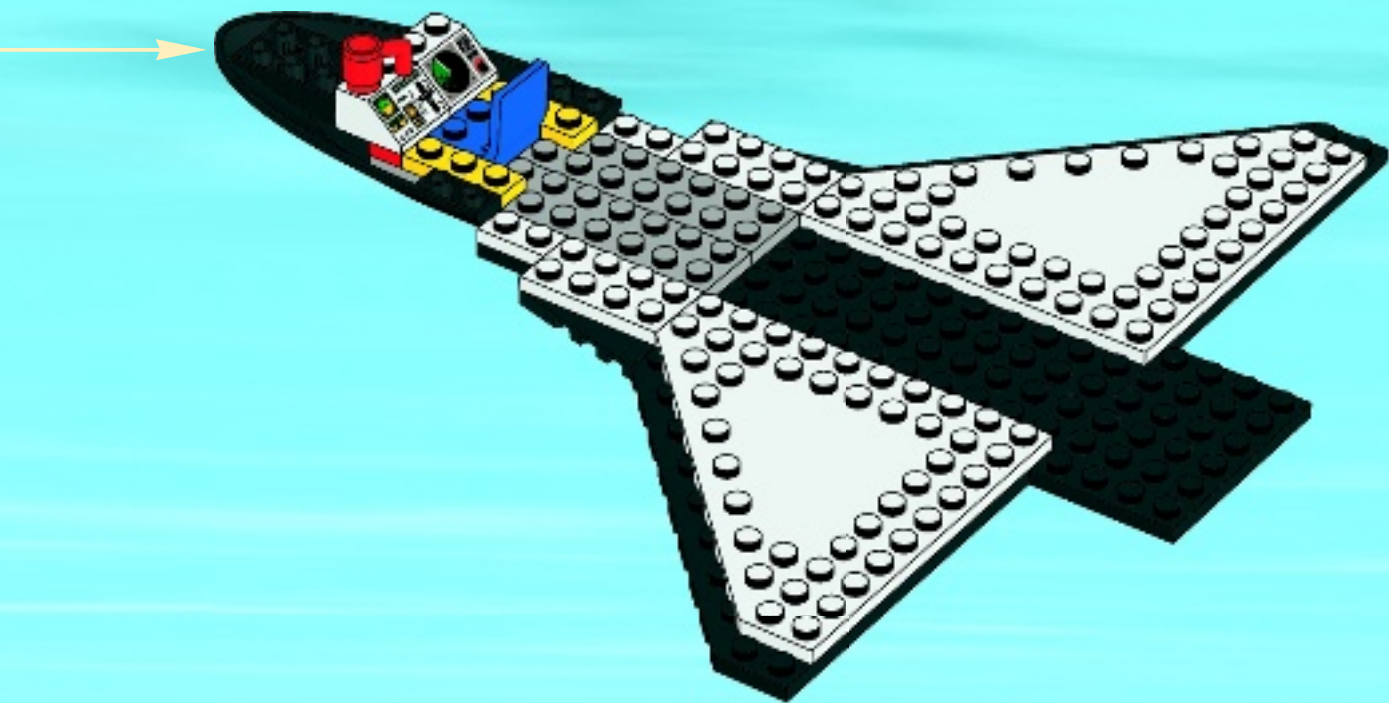

9

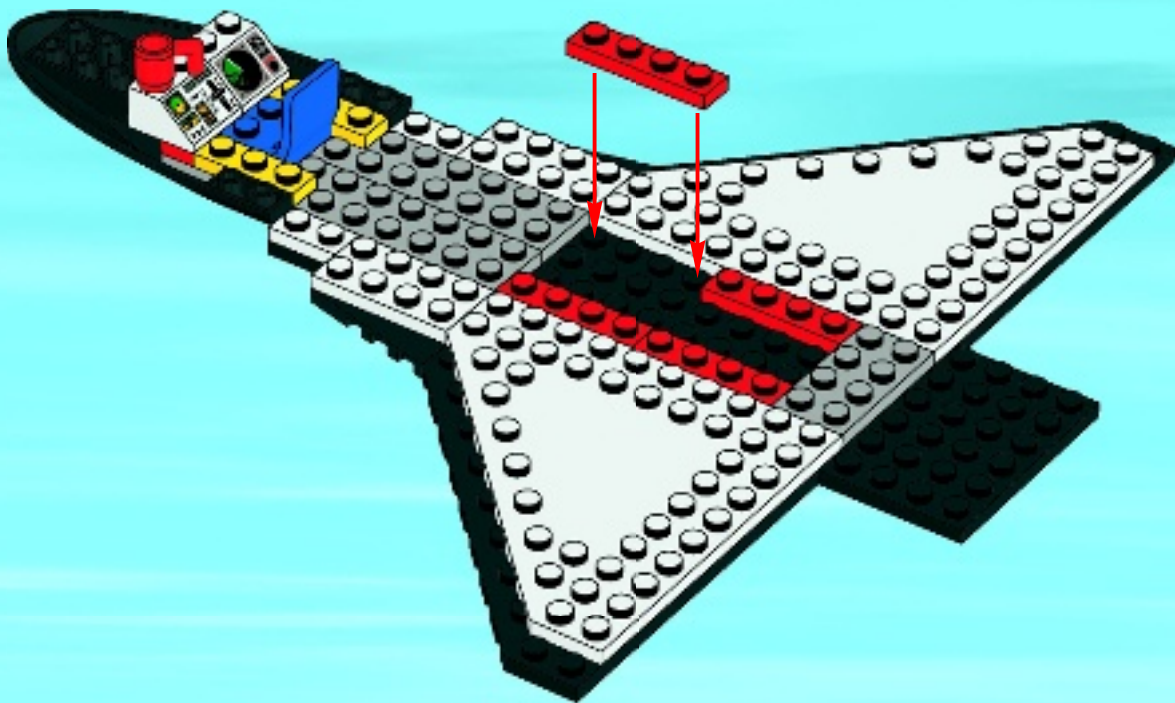



11

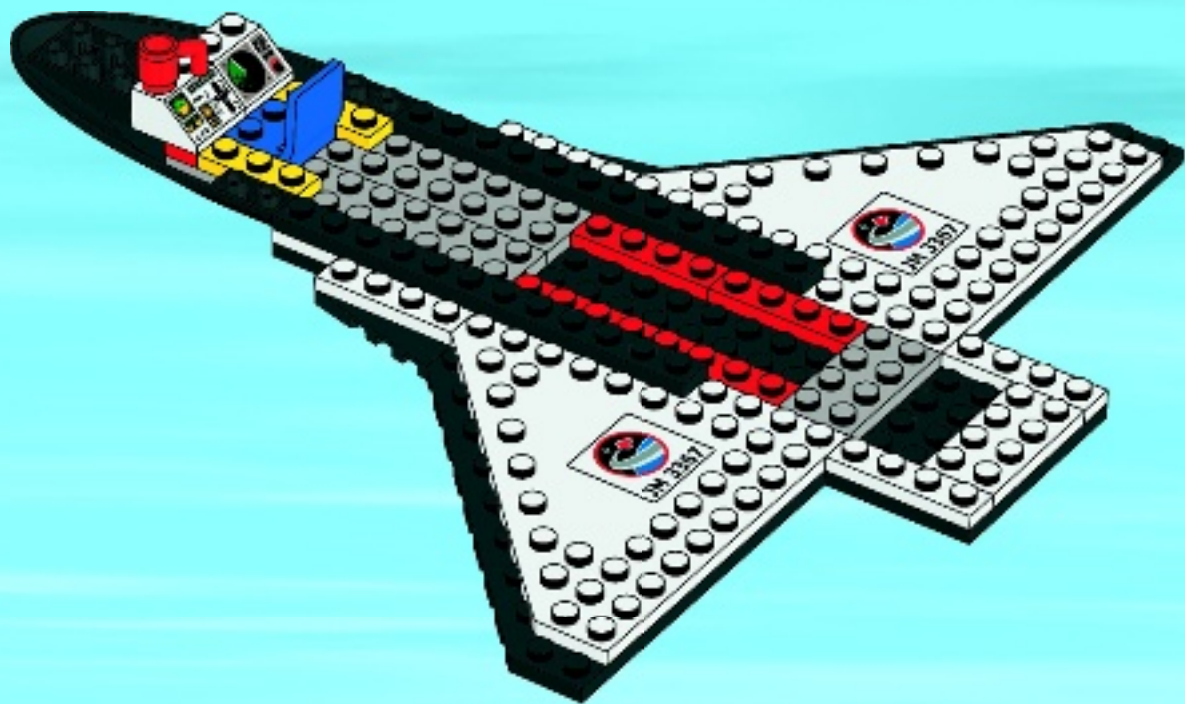

12

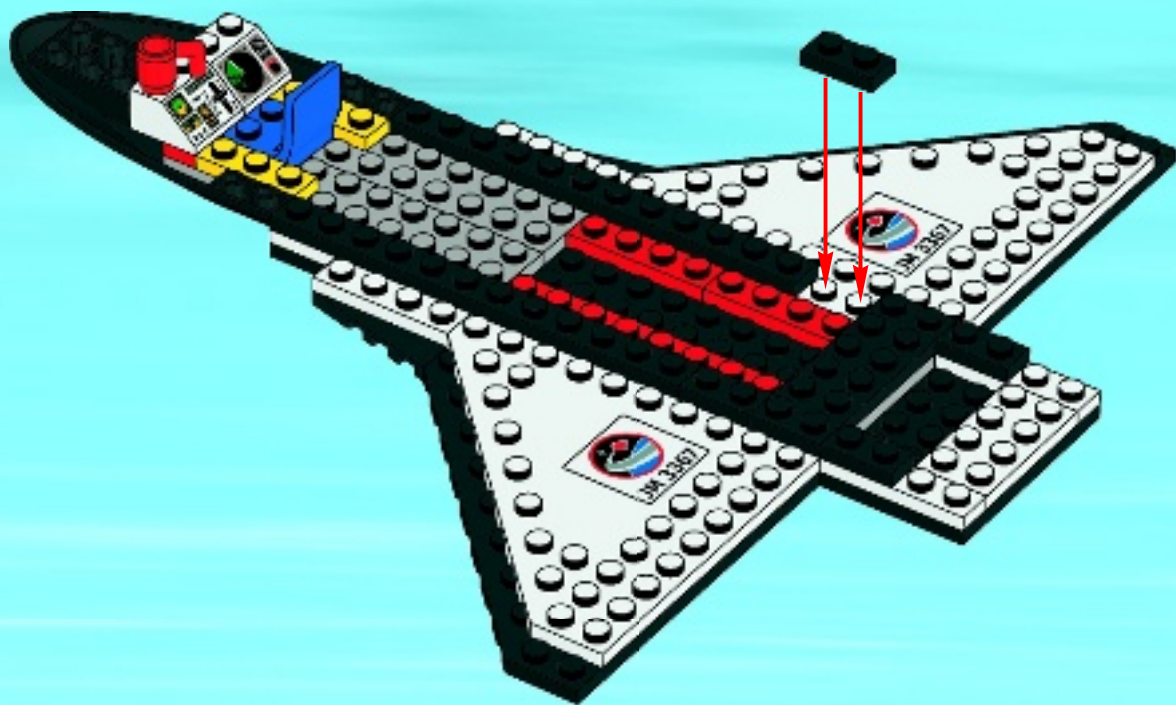



13

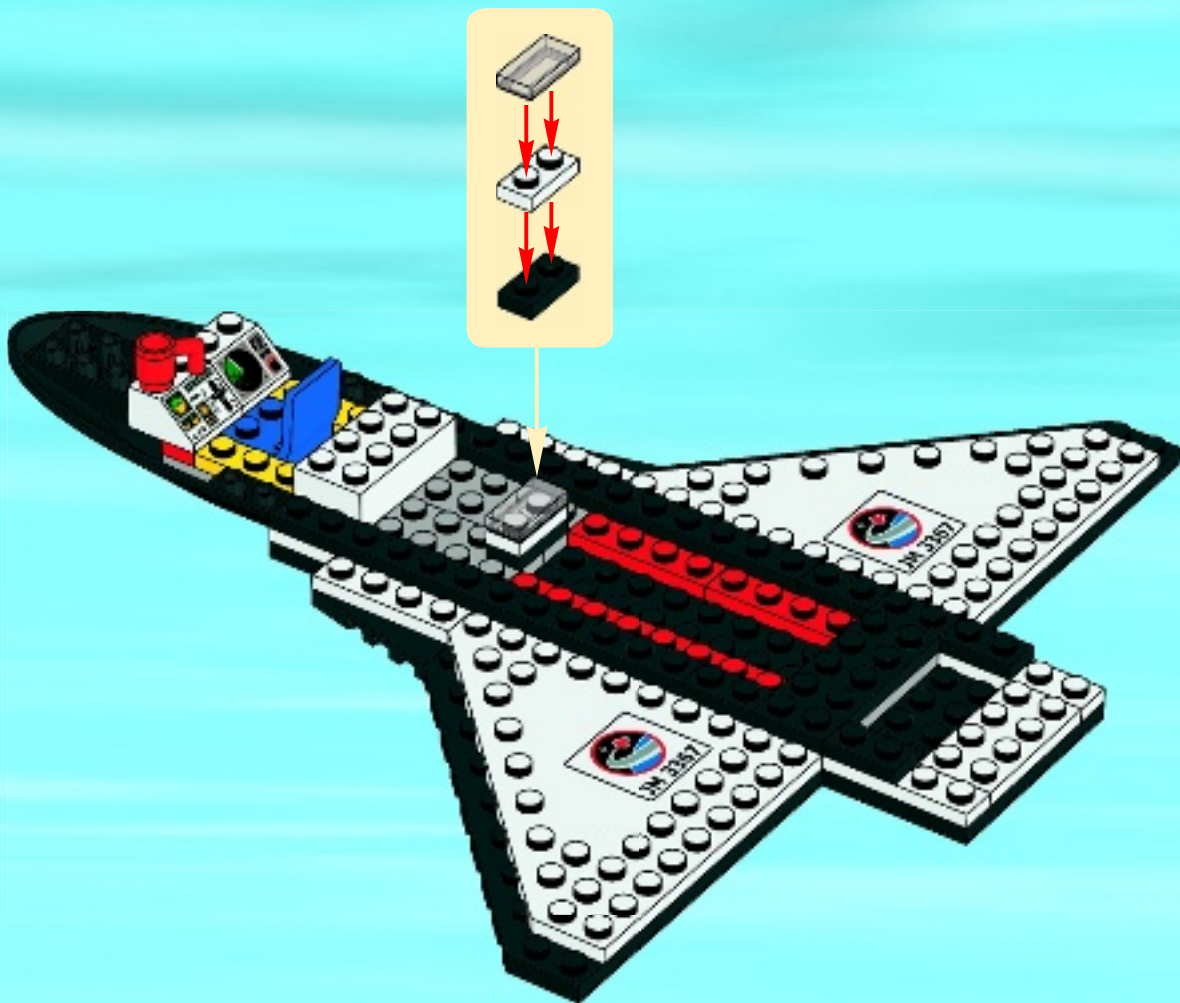

14

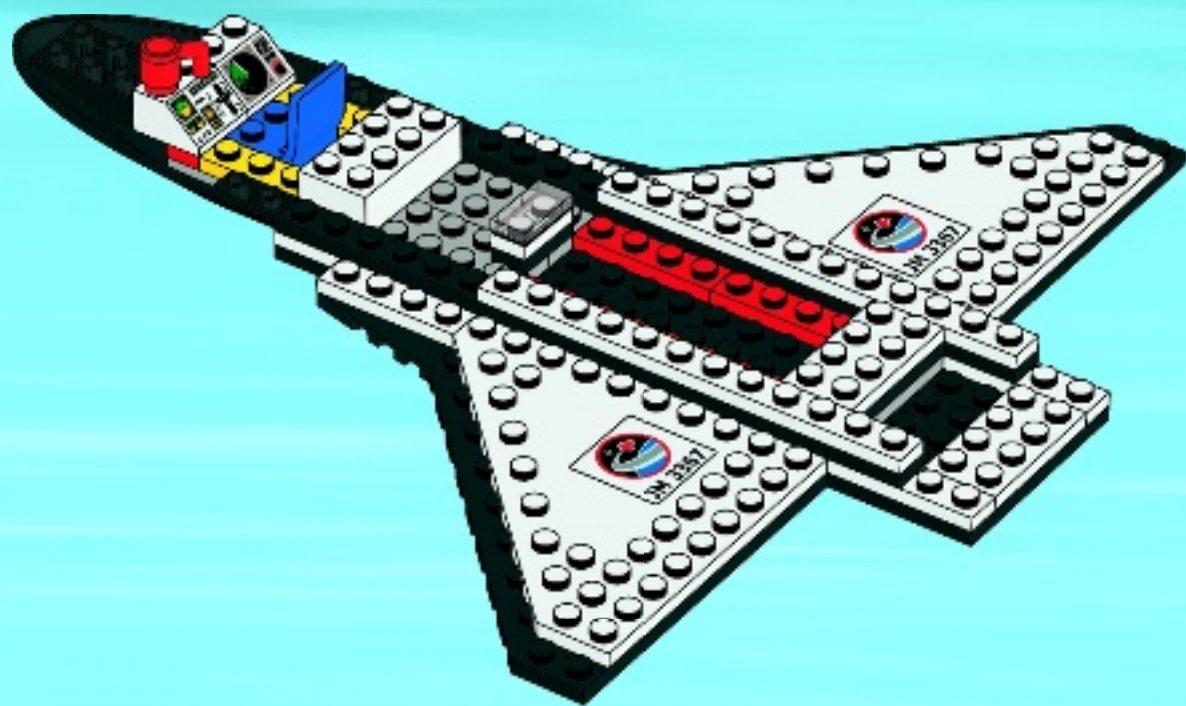

15

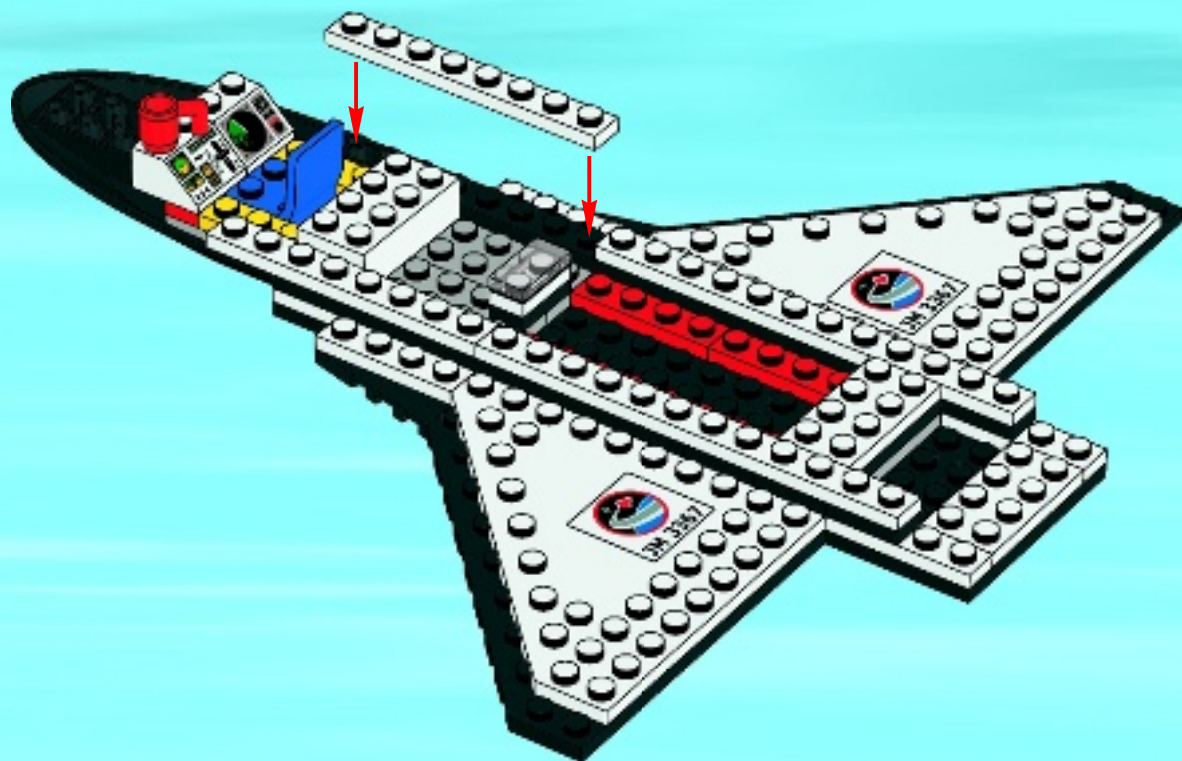

16

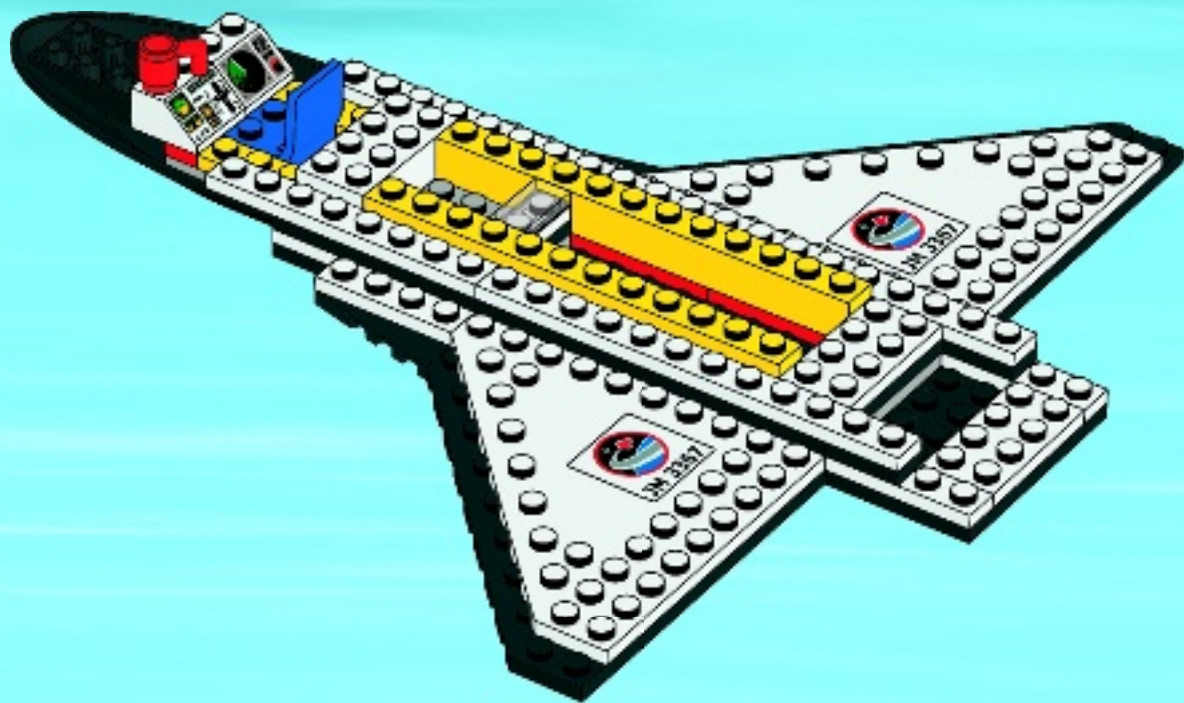

17

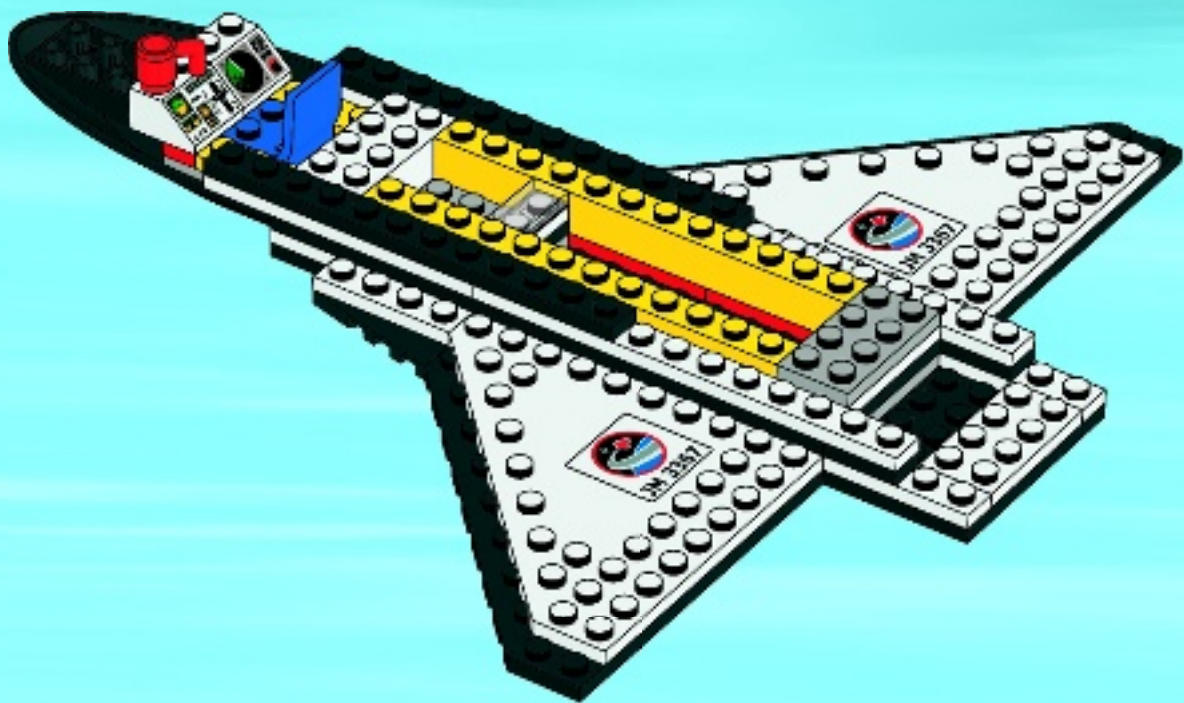

18

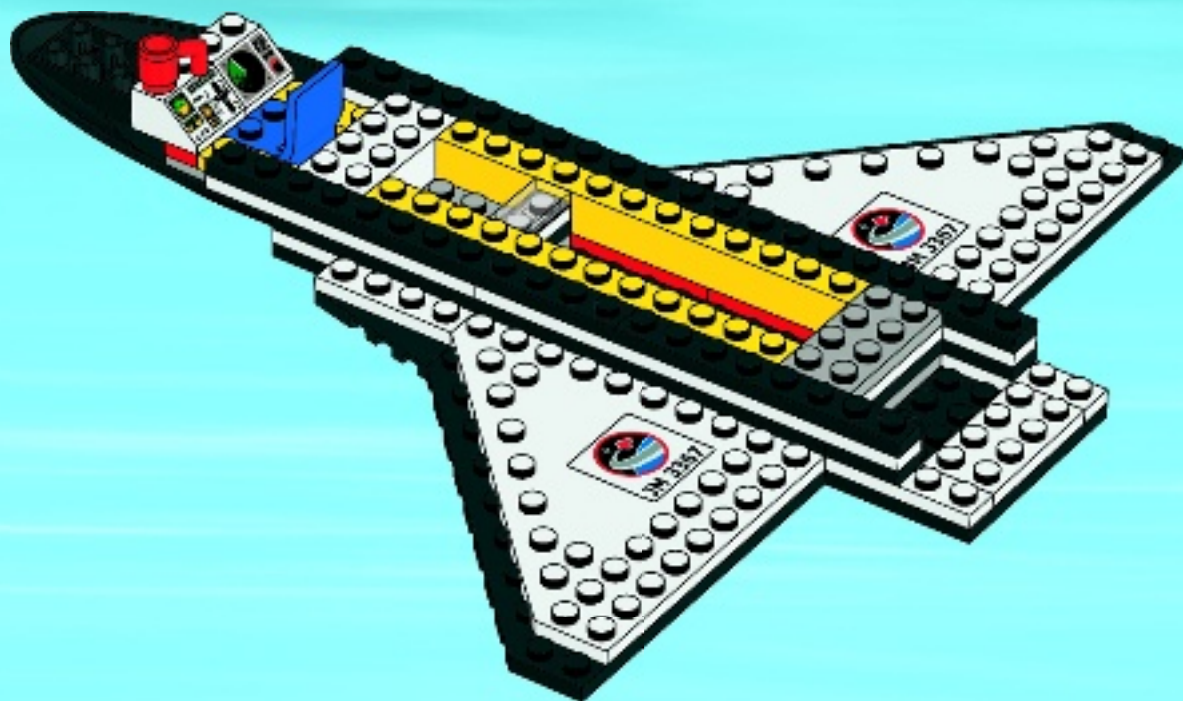

19

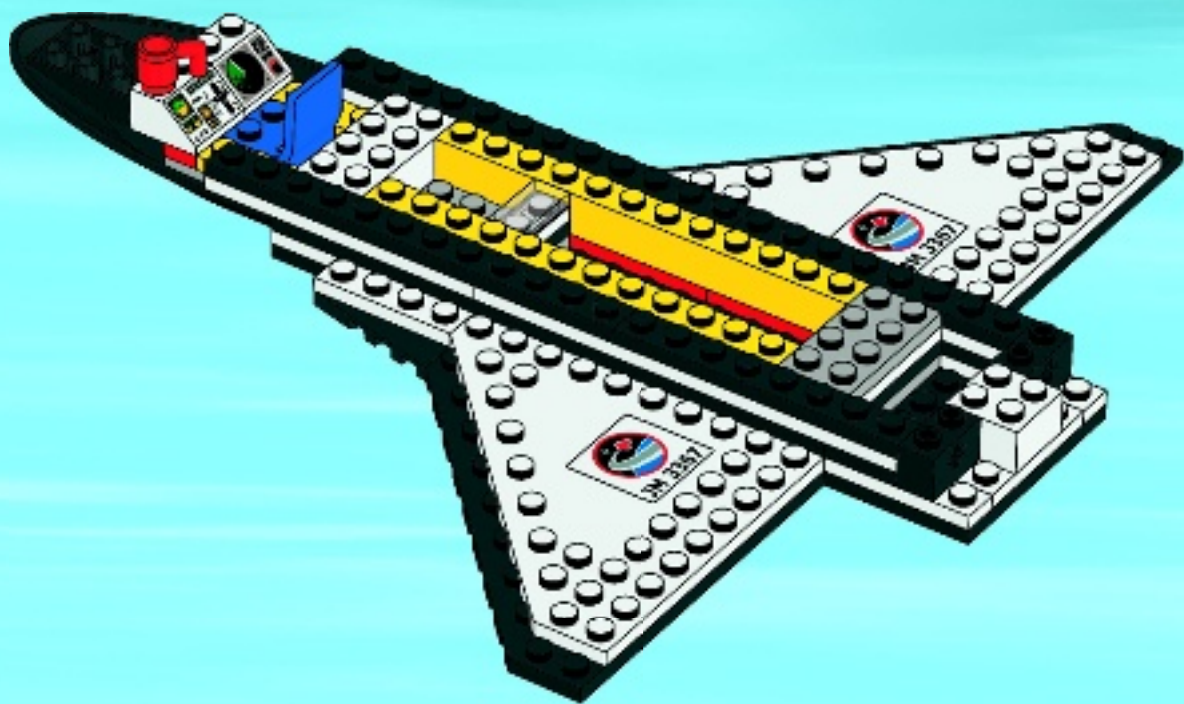

20

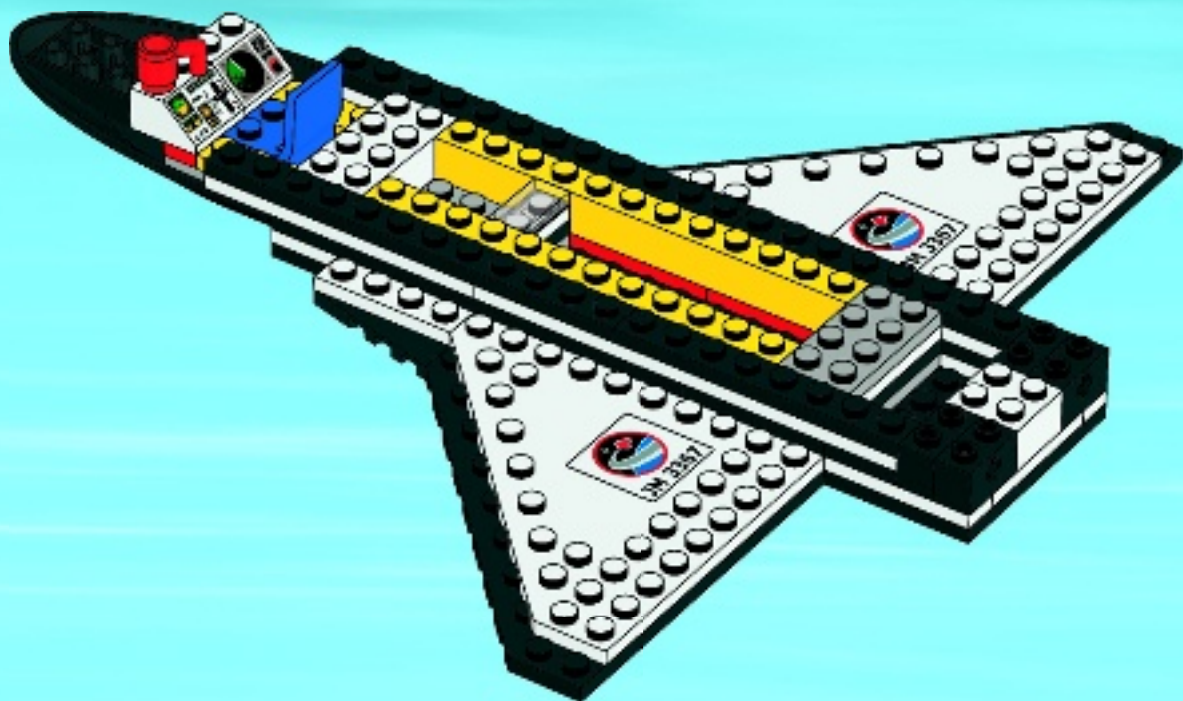



21

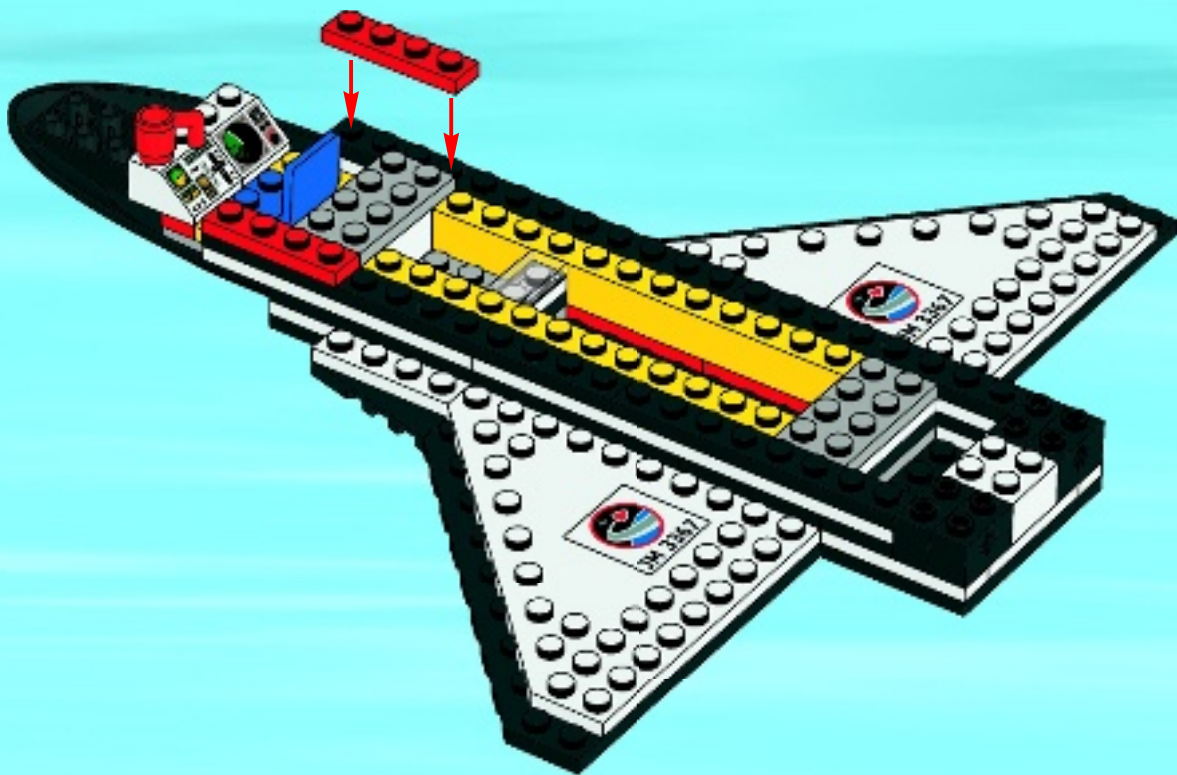

22

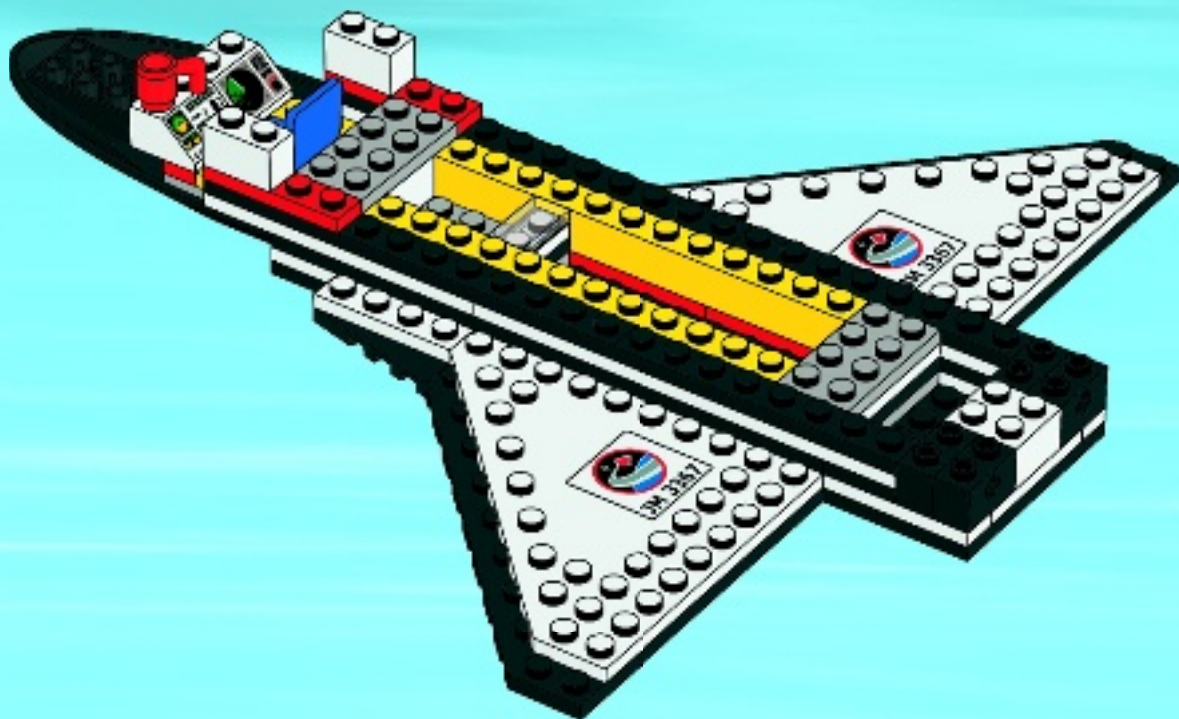

23

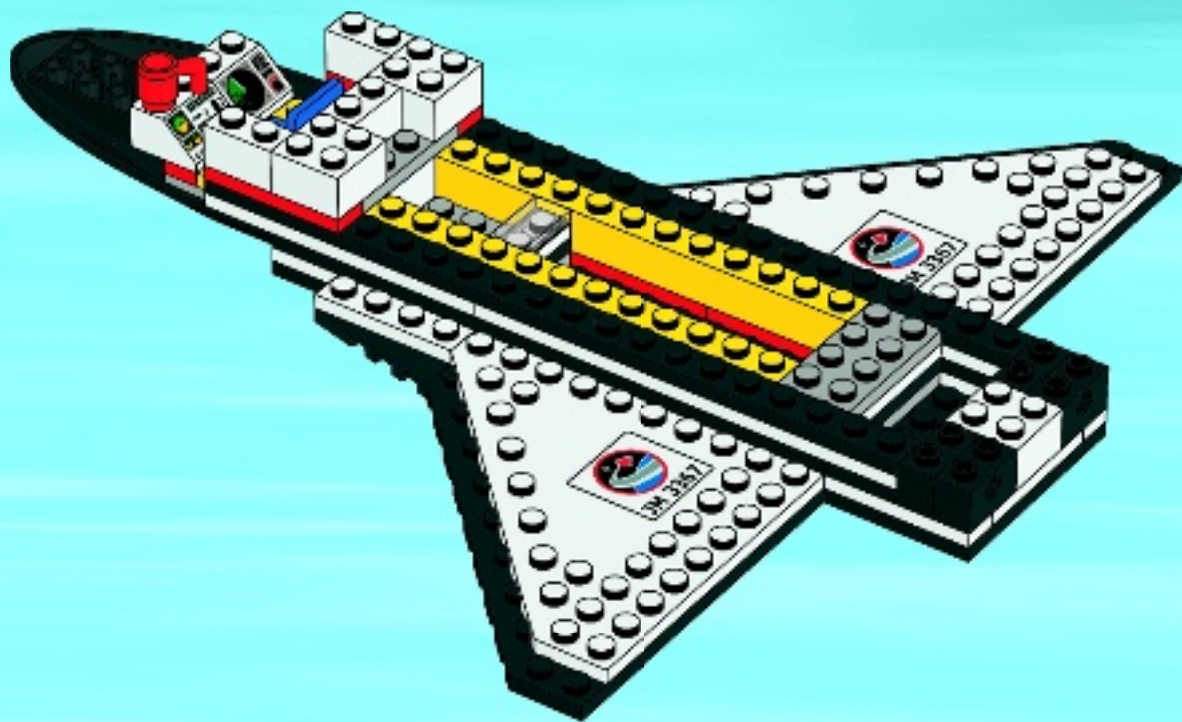

1

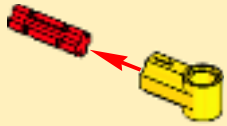

2

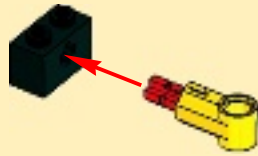

3



24

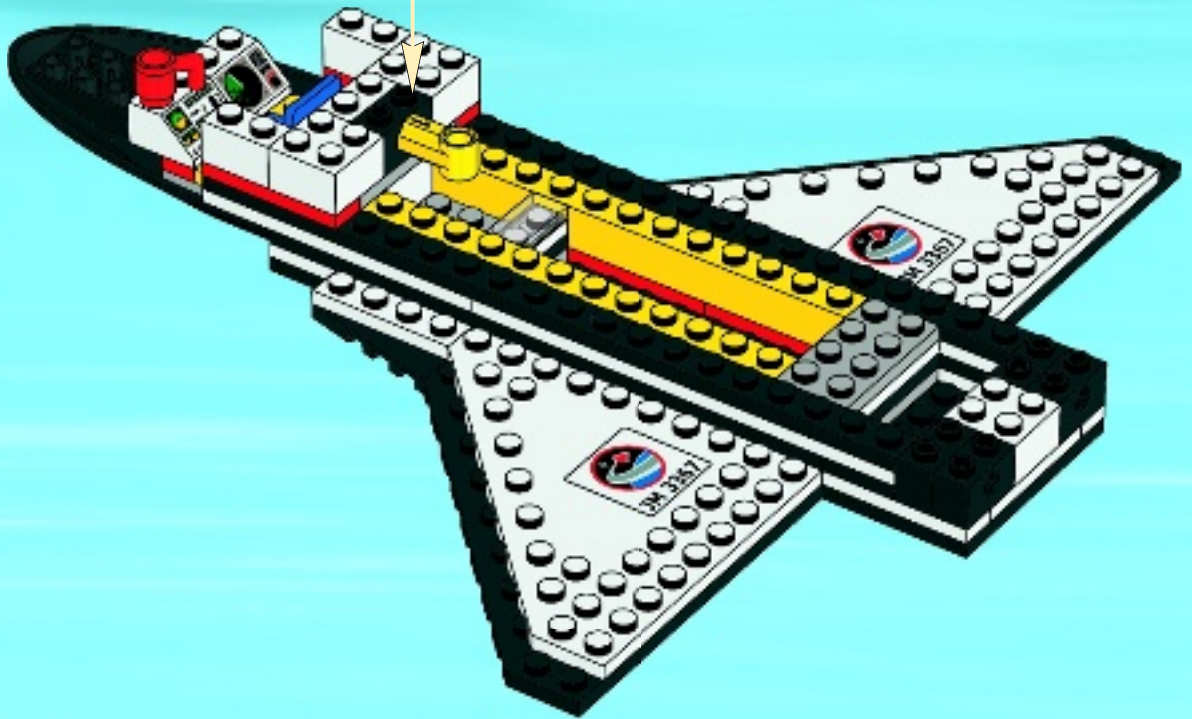

25

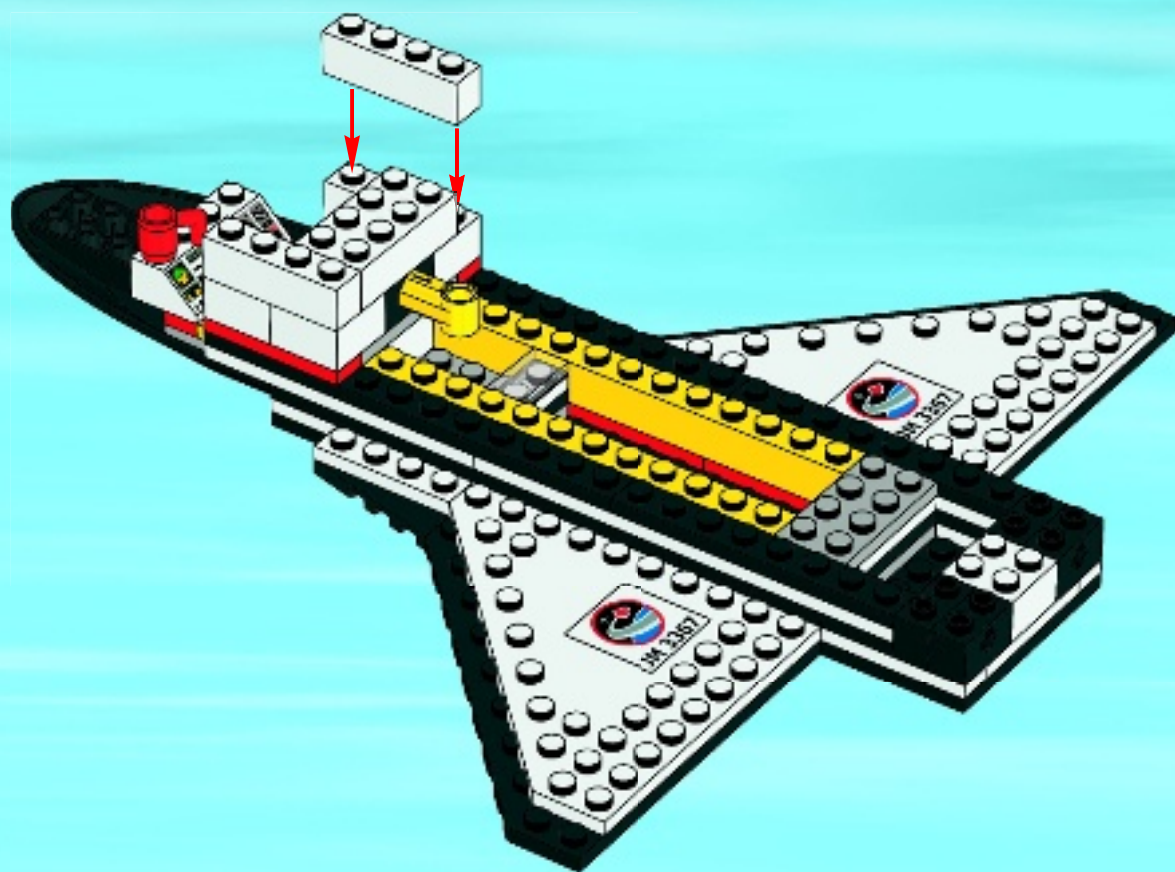

26

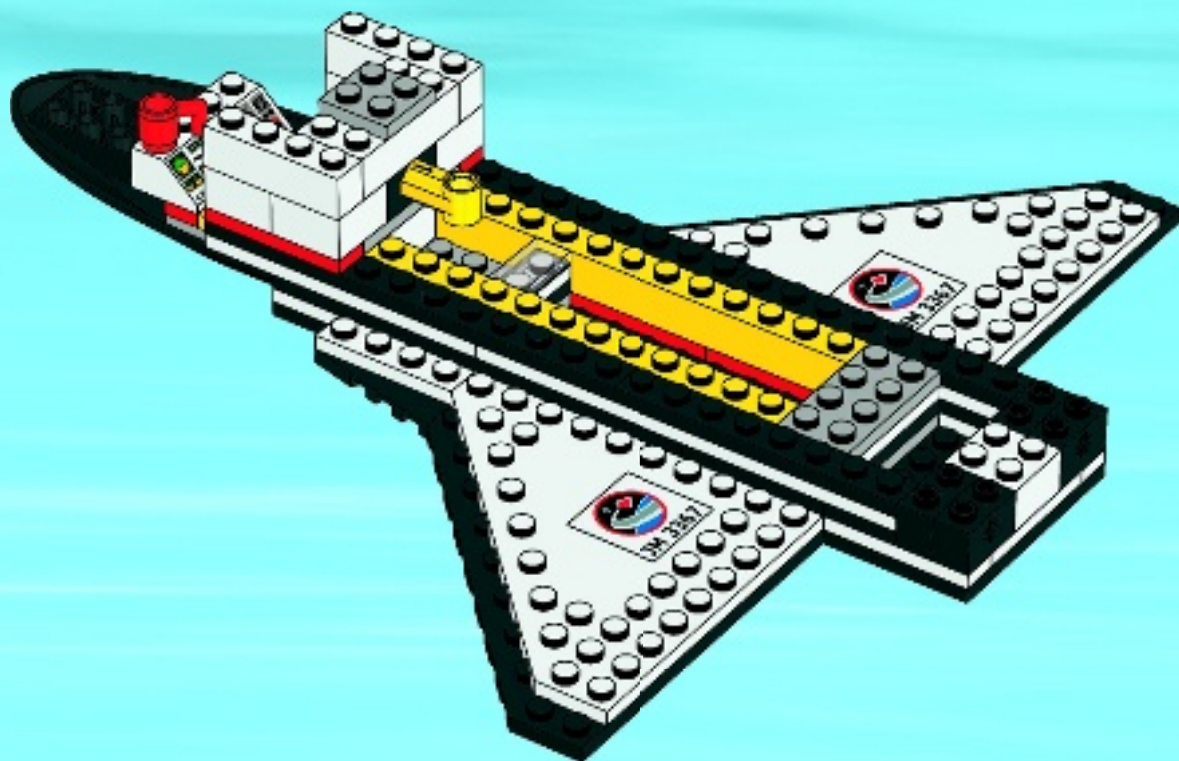

27

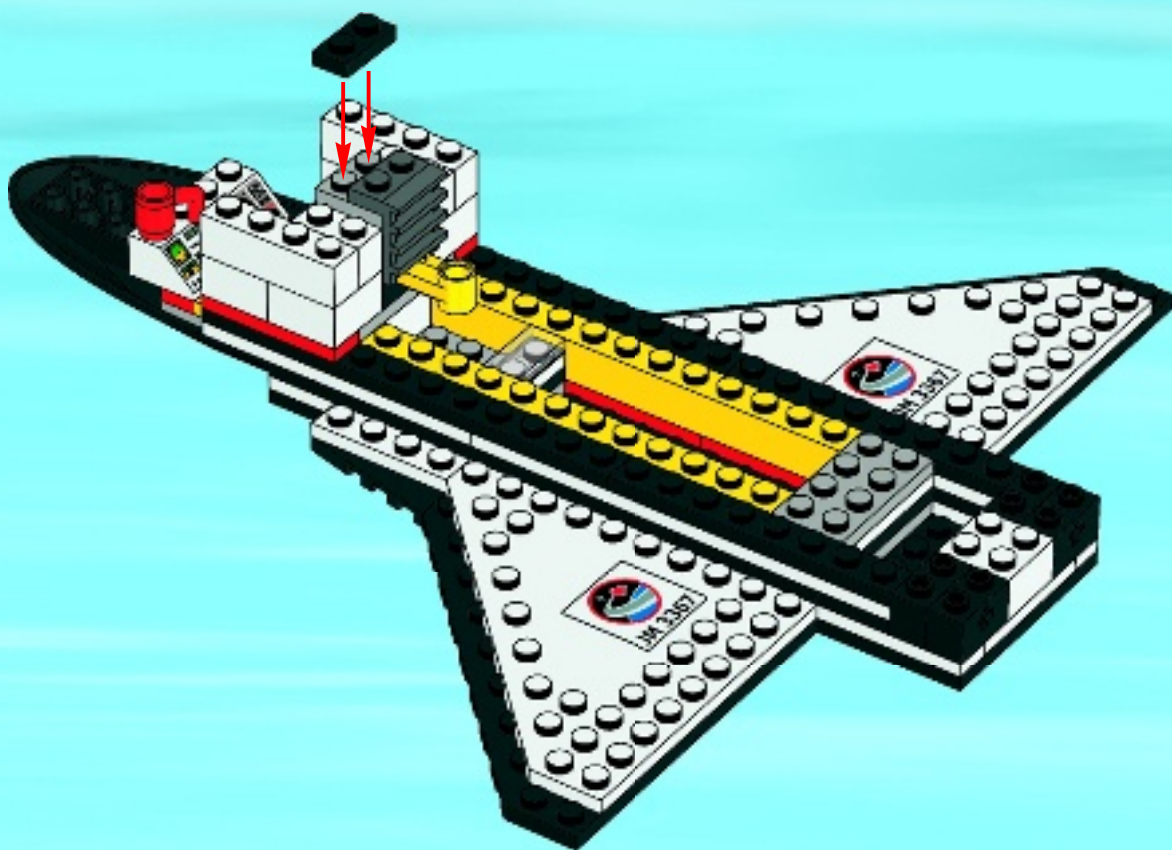

28

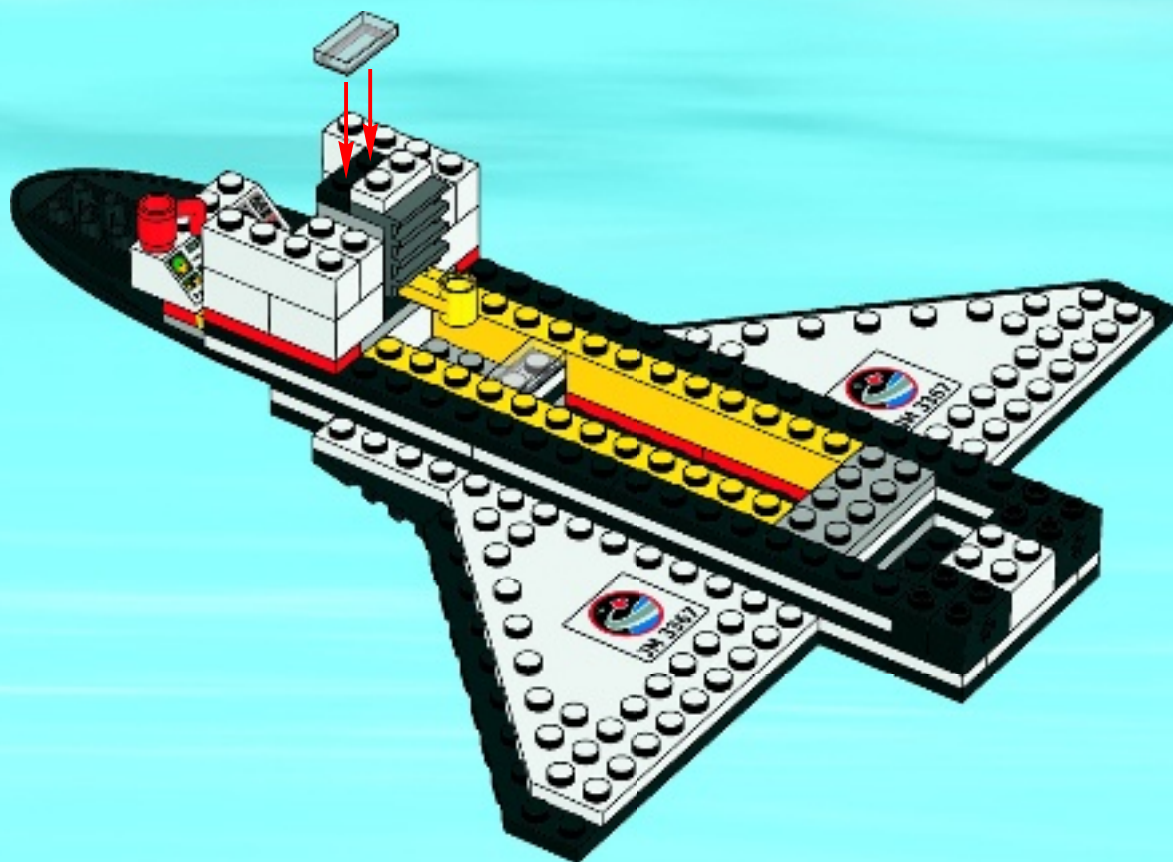



29

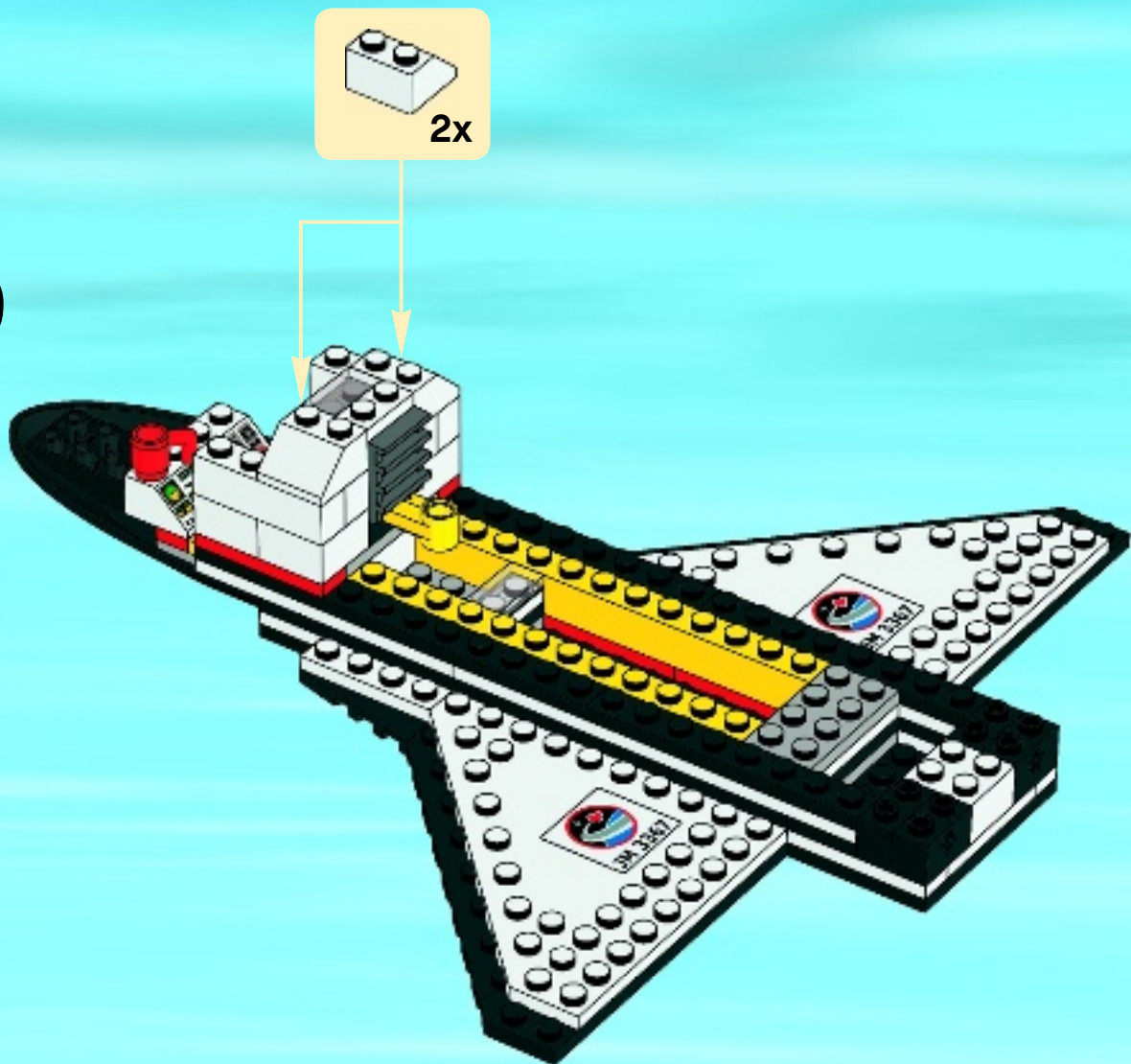

1

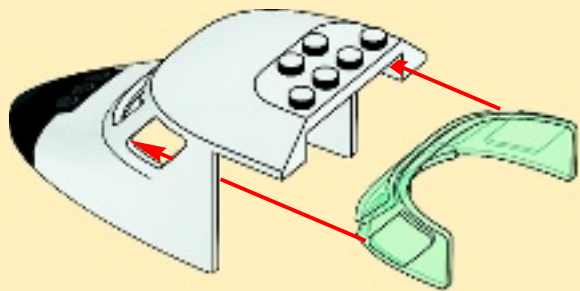

2



30

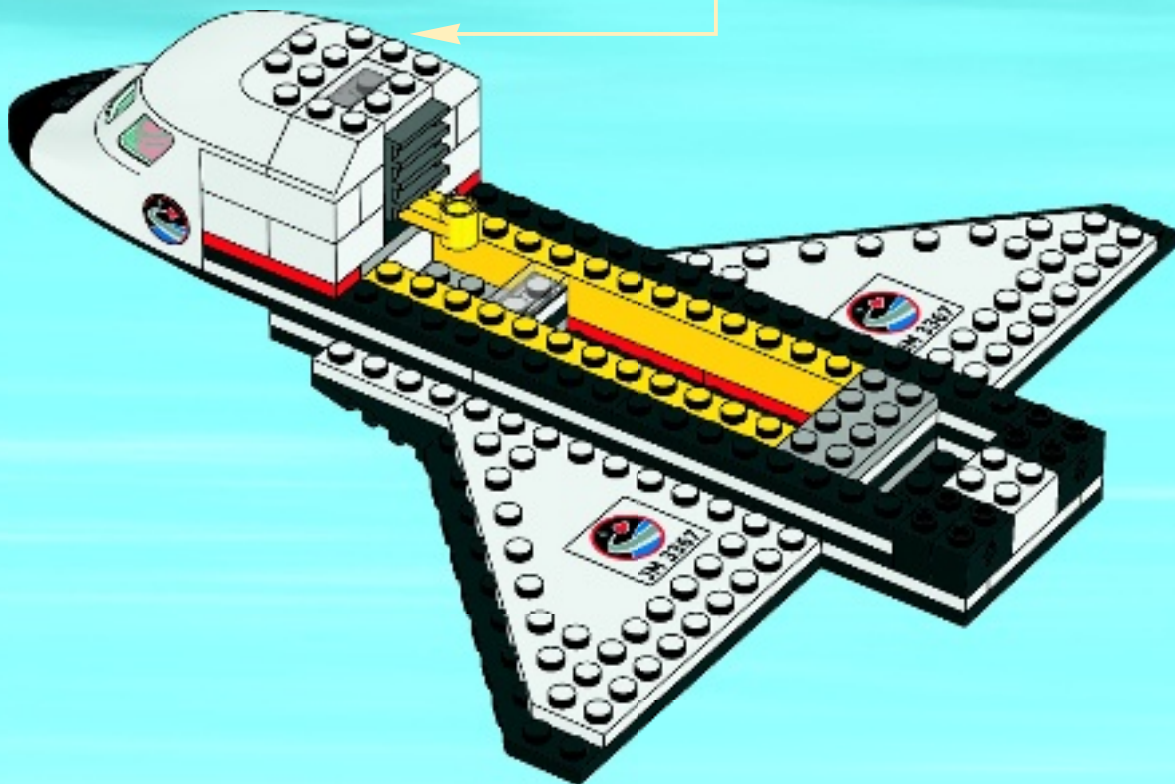



2



31

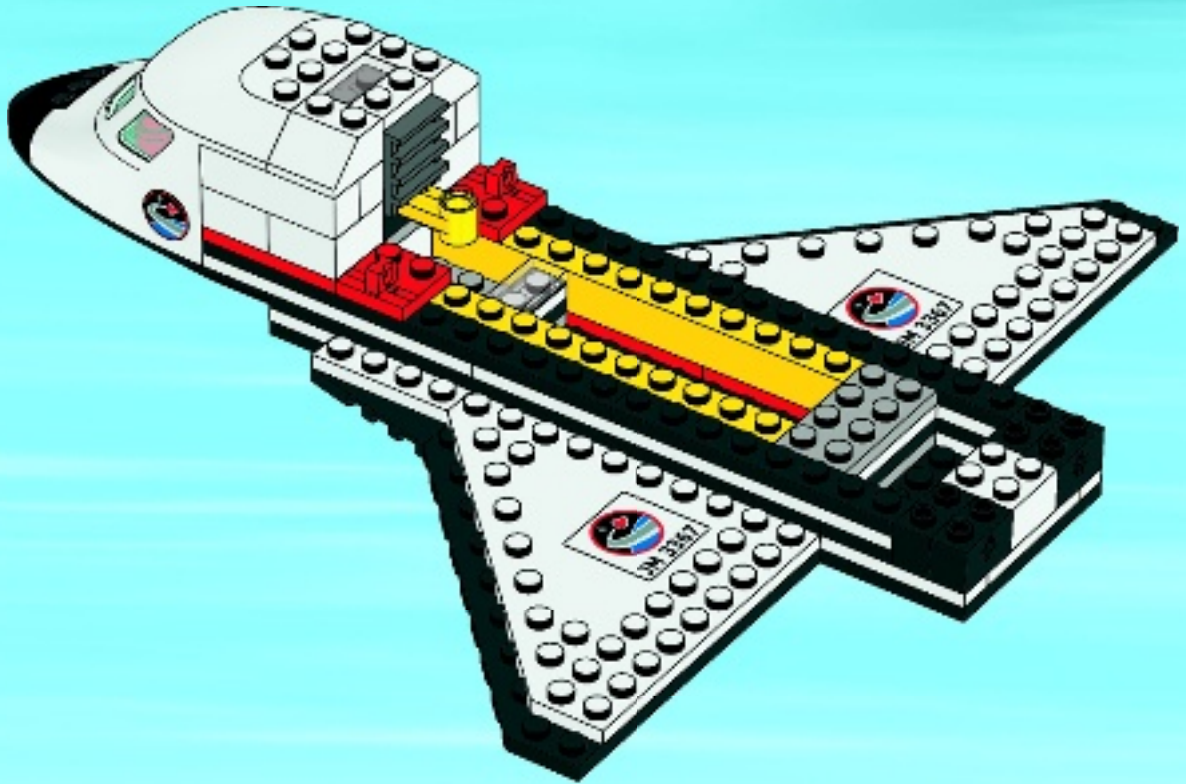

32

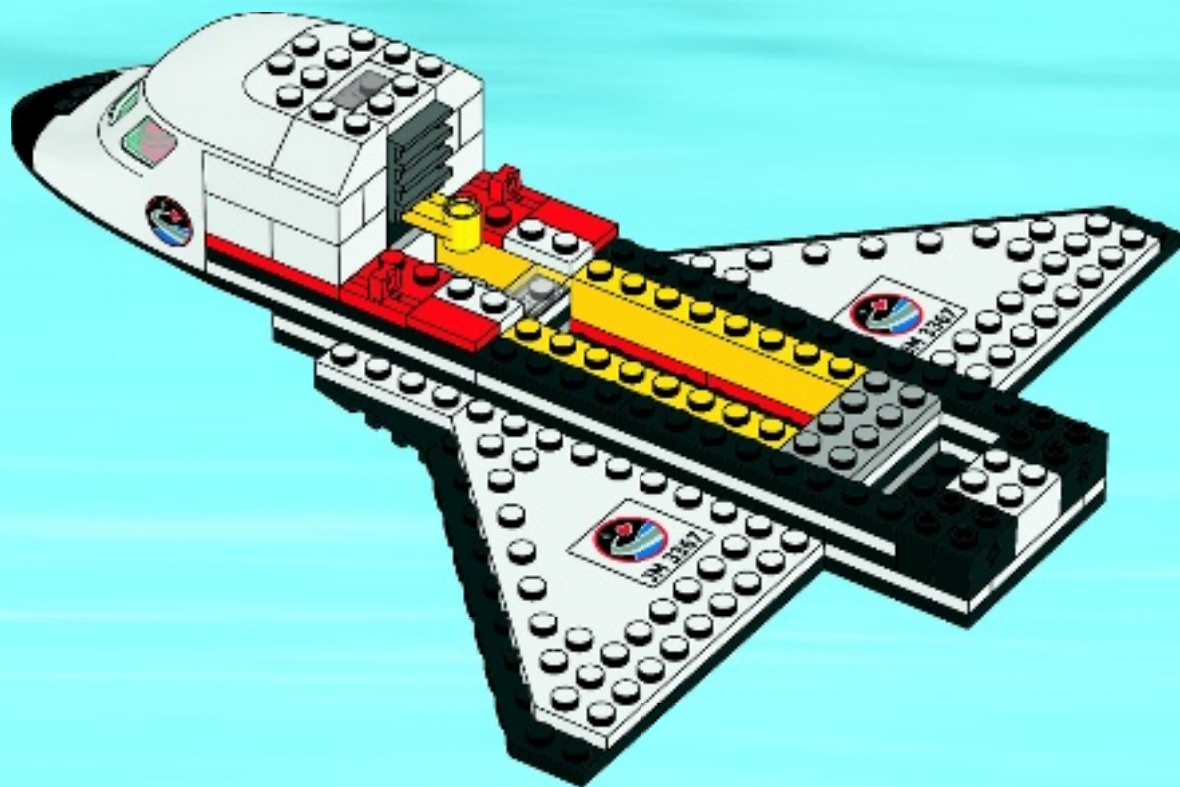

33

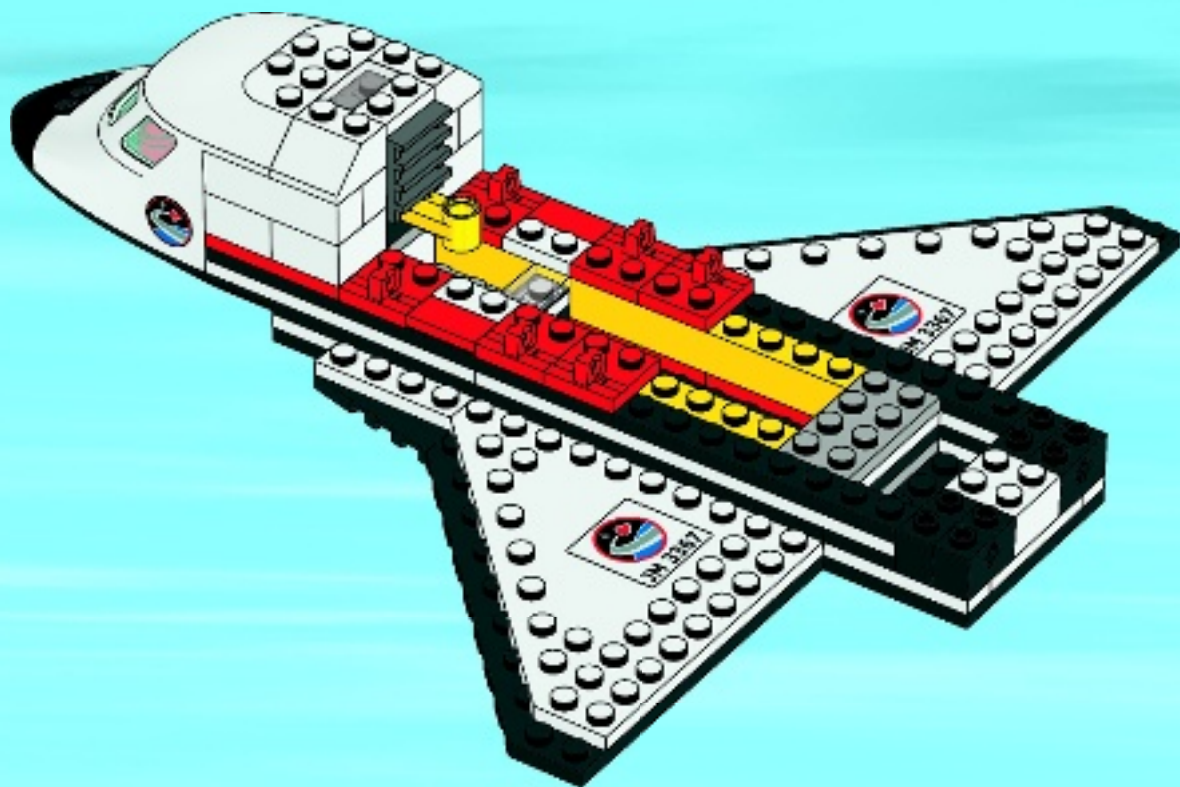

34

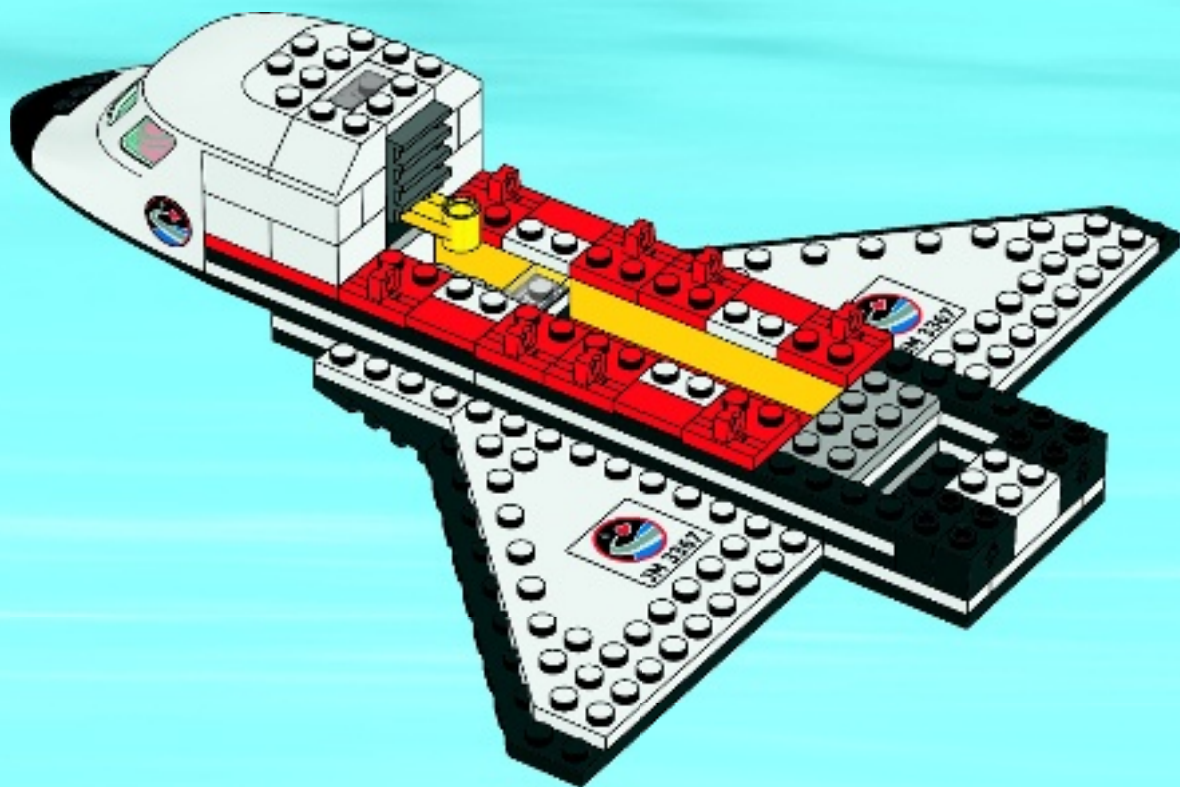

35

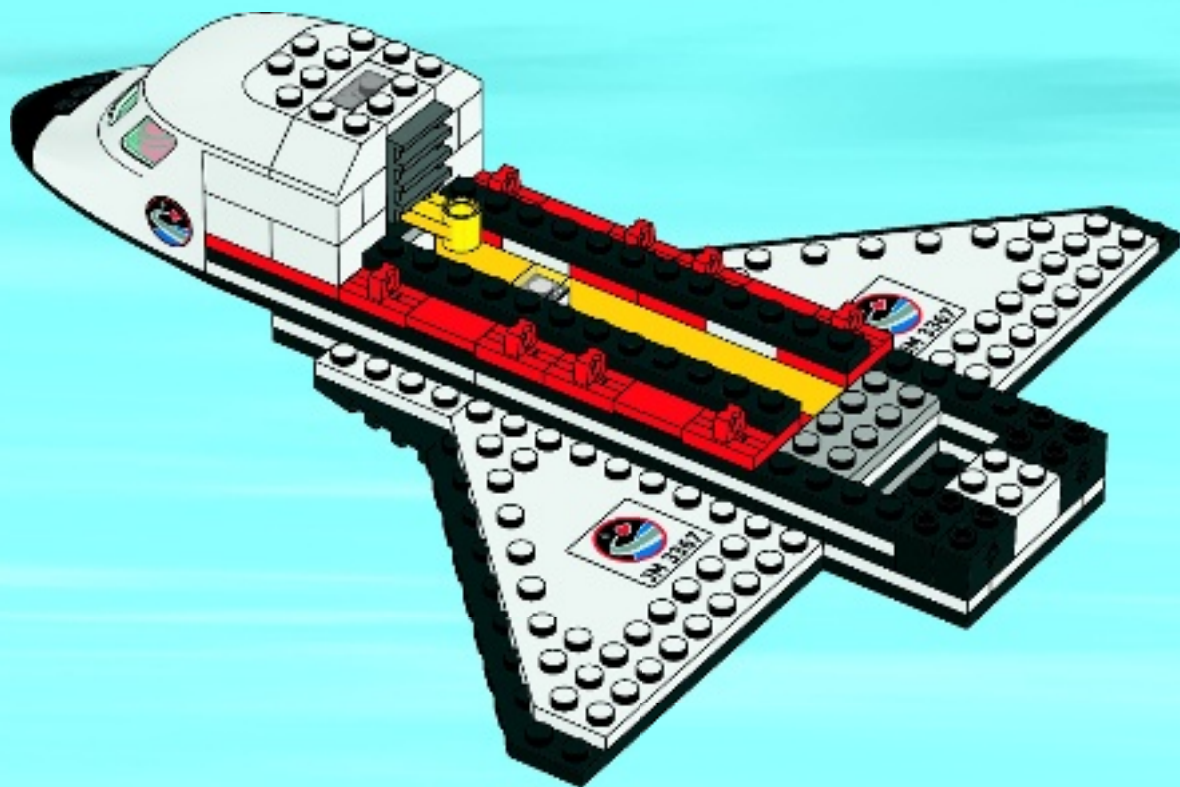

36

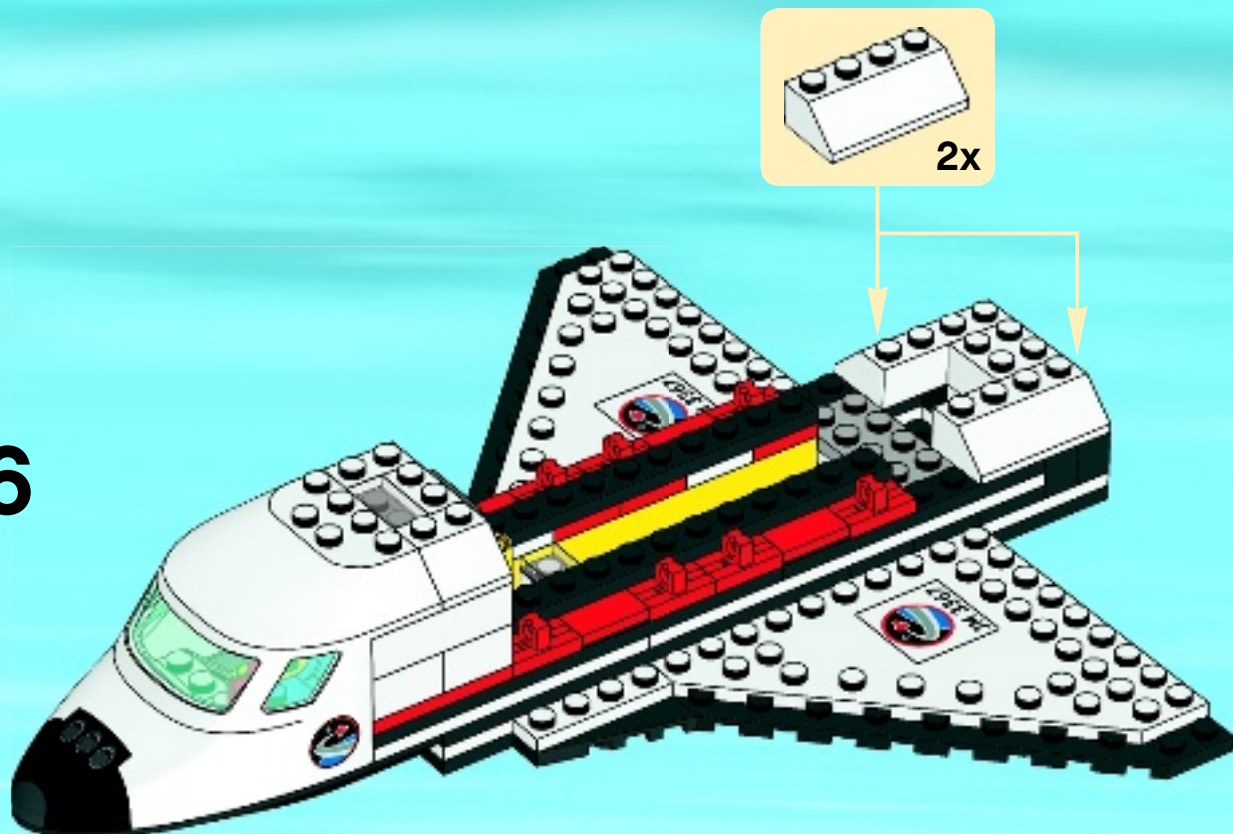



1

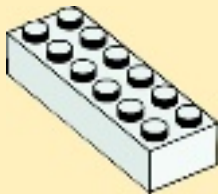

2

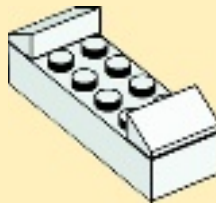

37

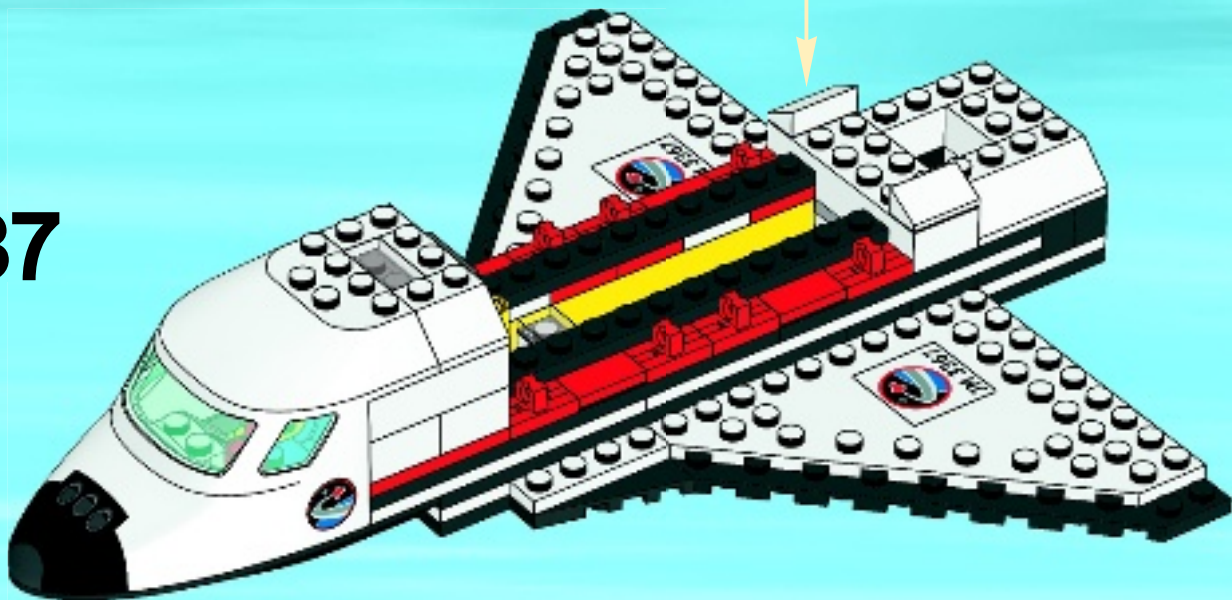

38

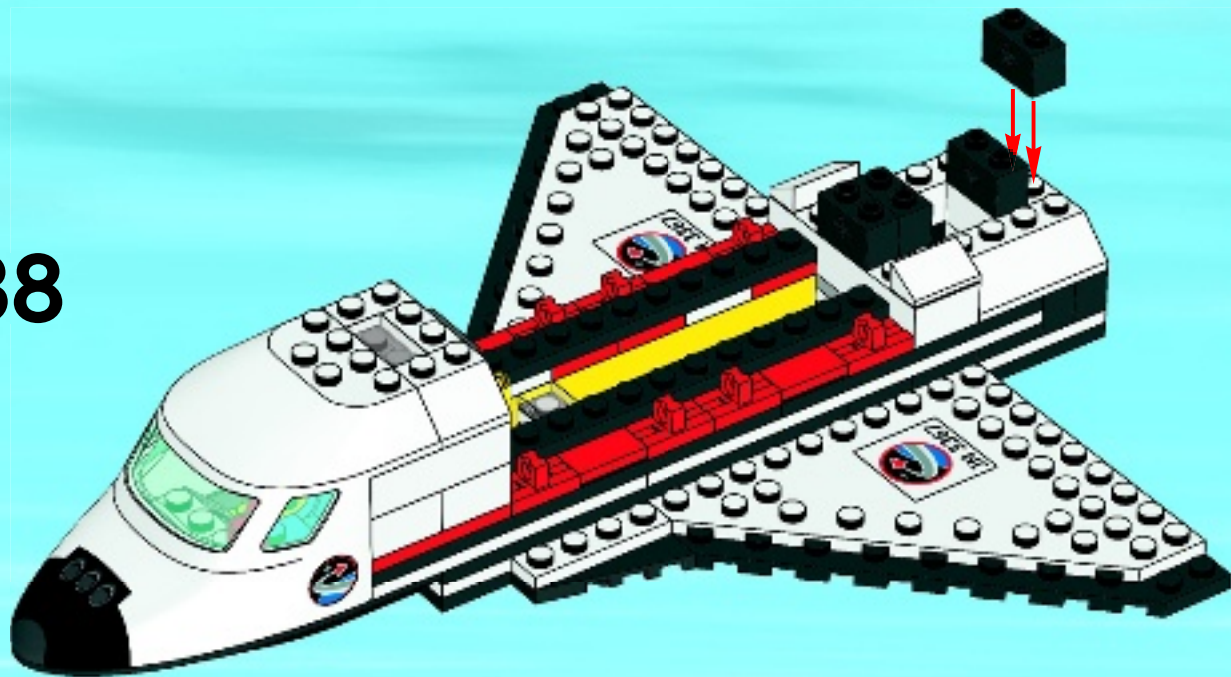

39

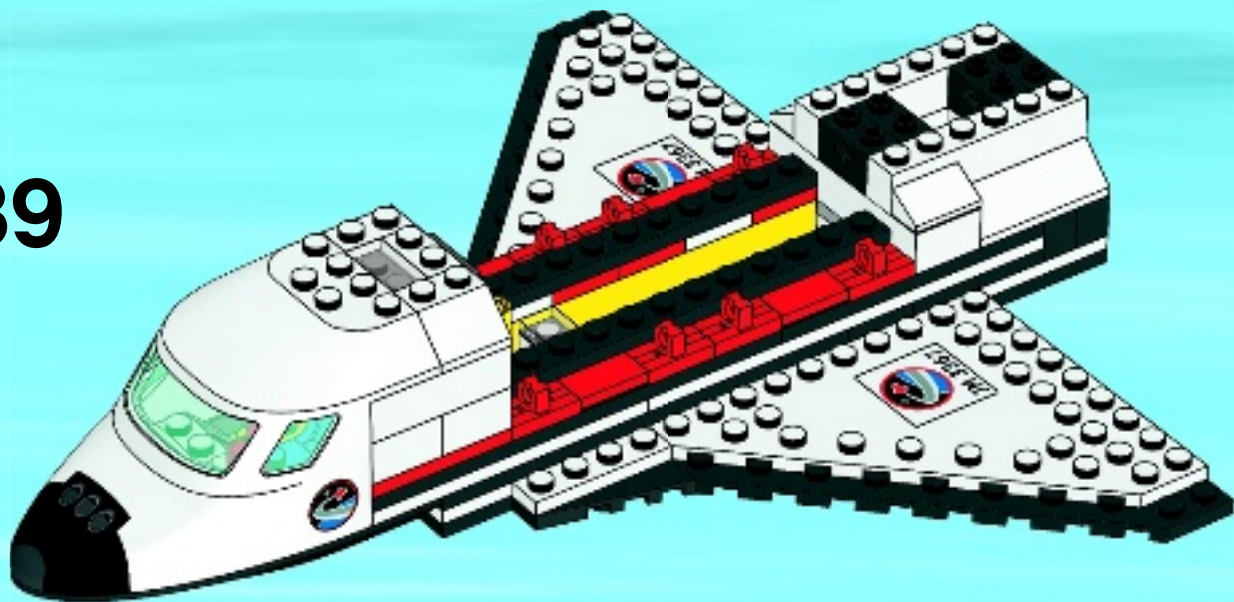

1



2

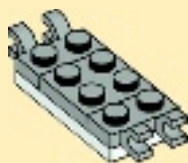

3

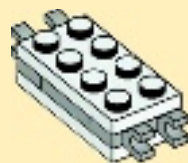

40

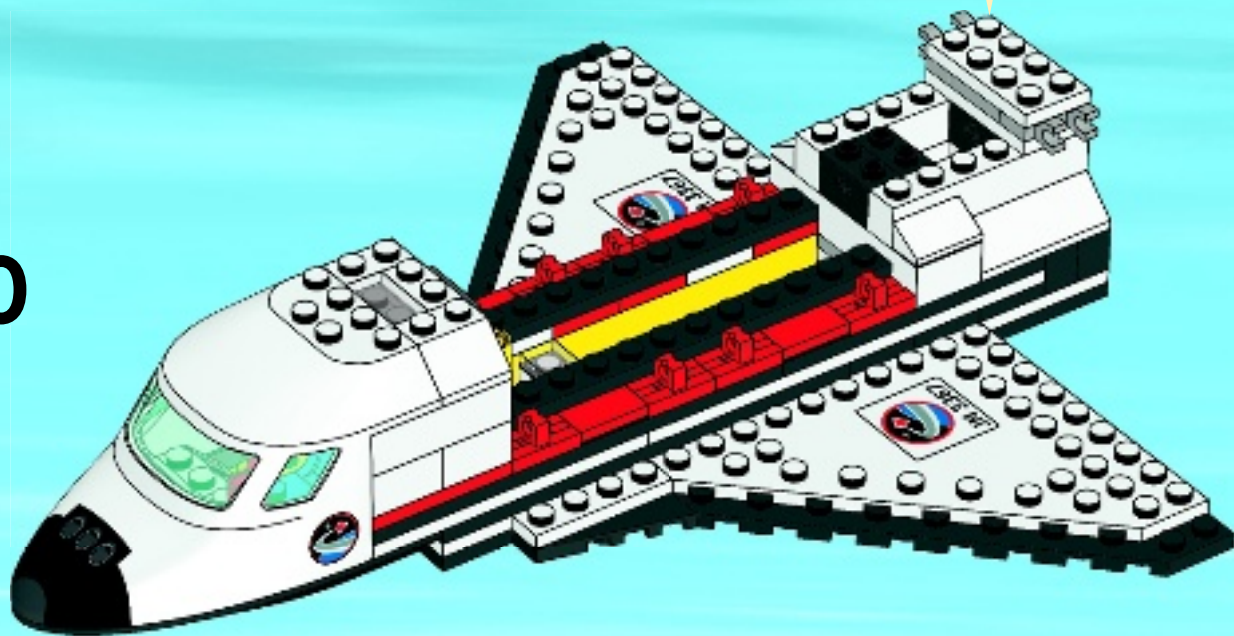

41

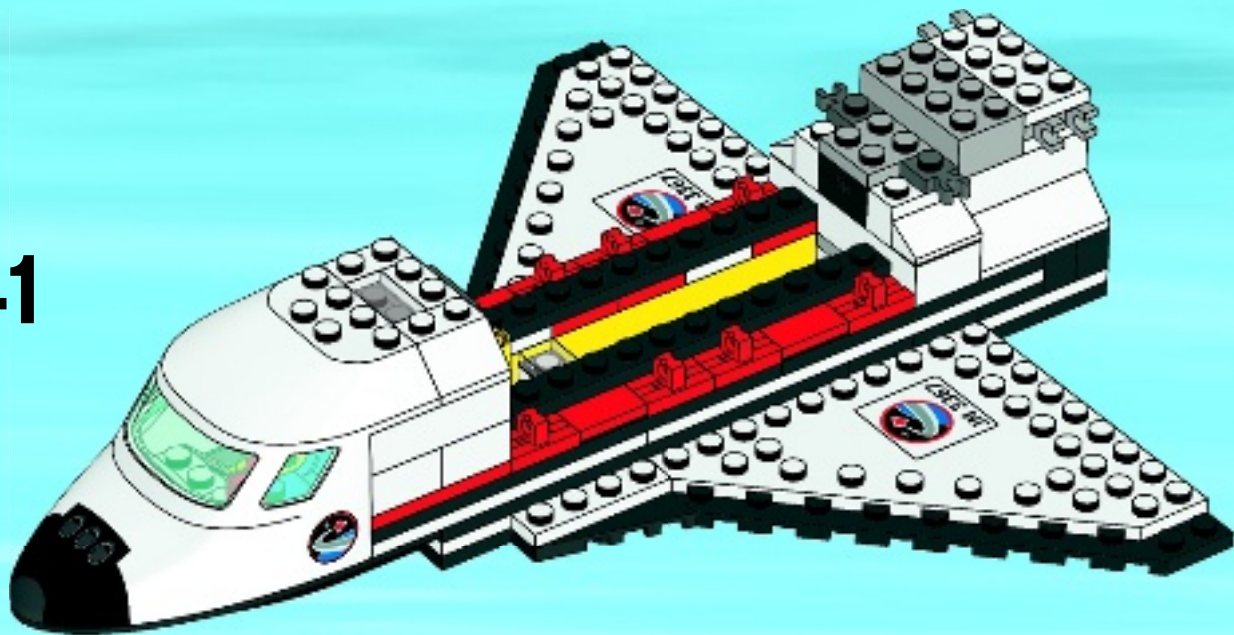

42

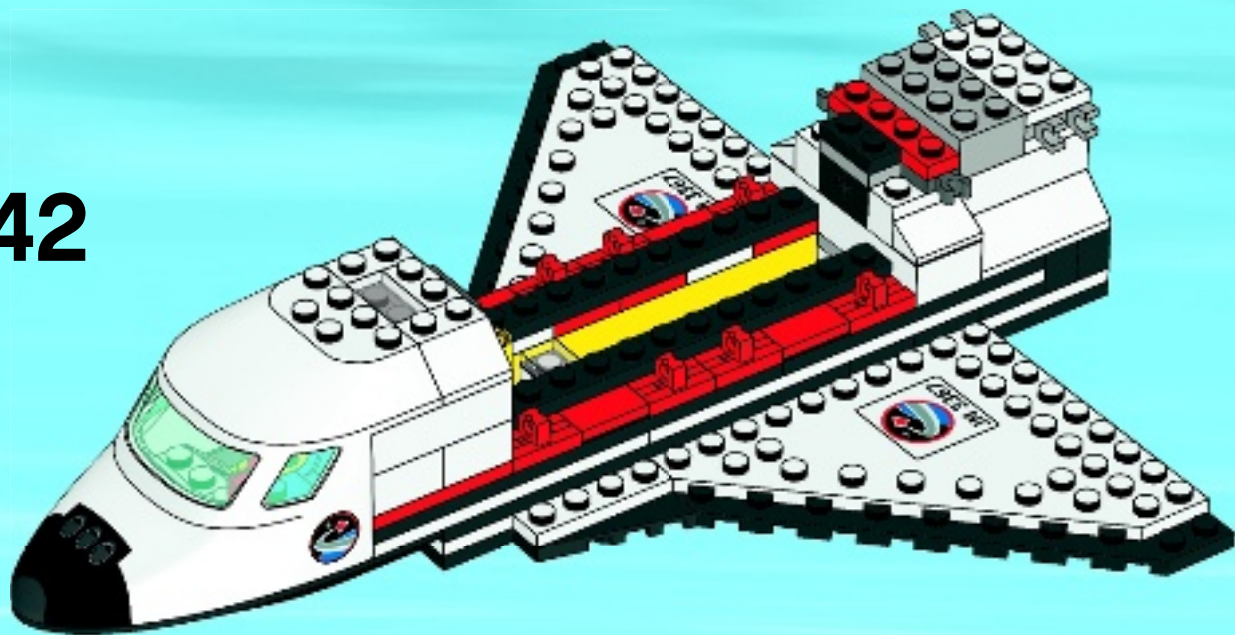

43

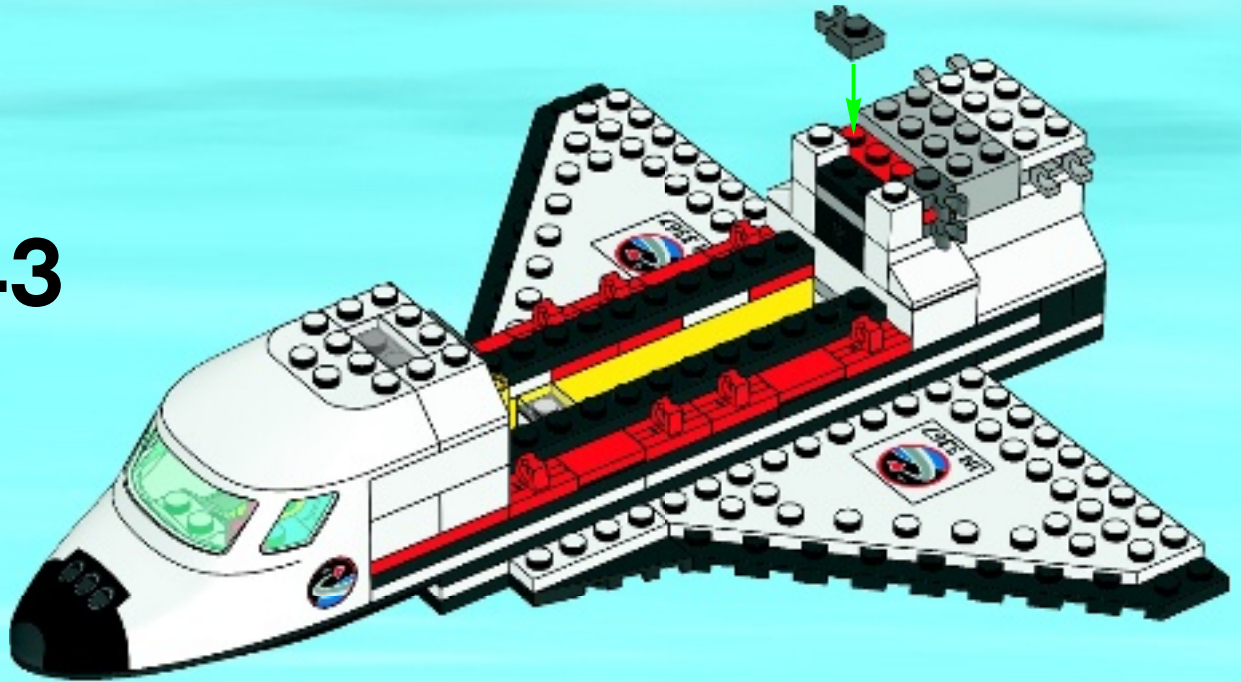

44

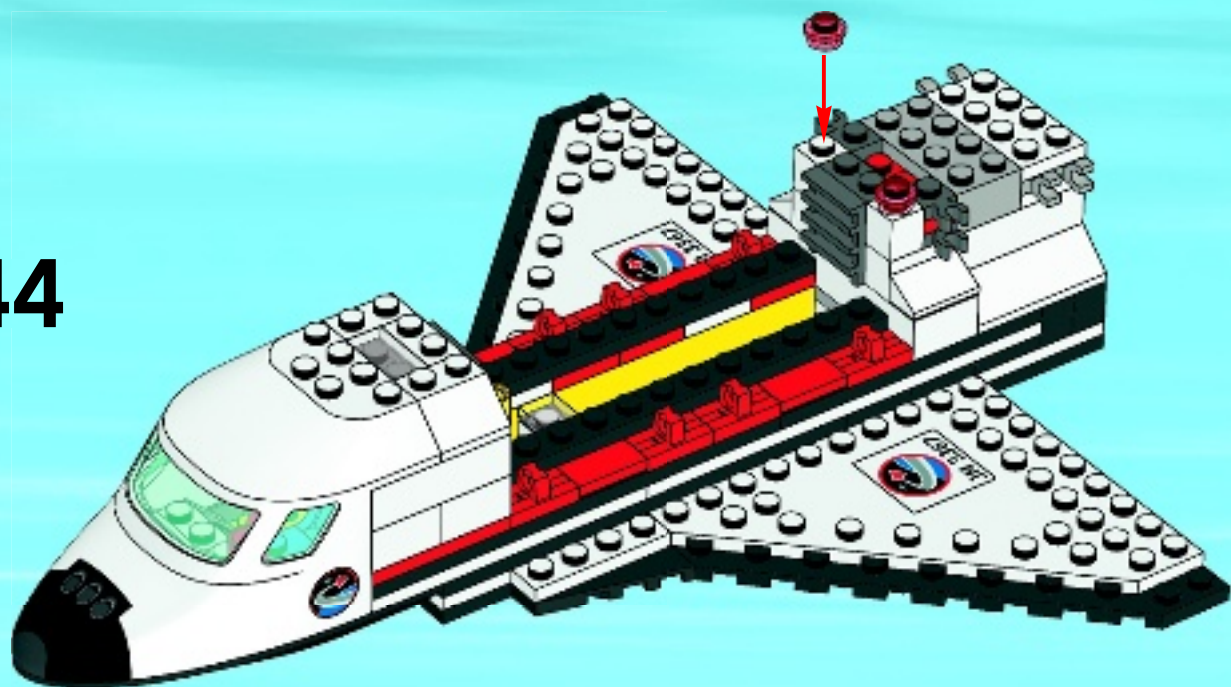



45



46



47

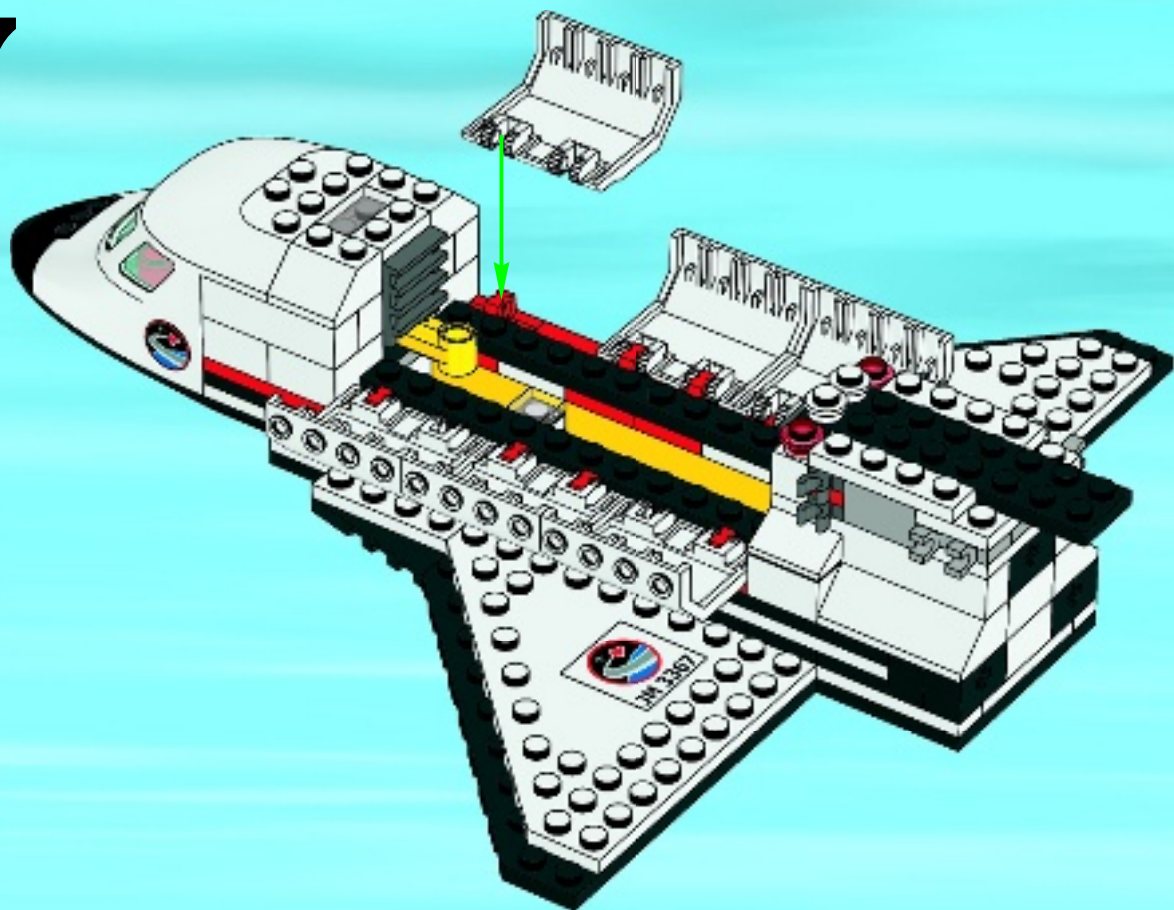

48

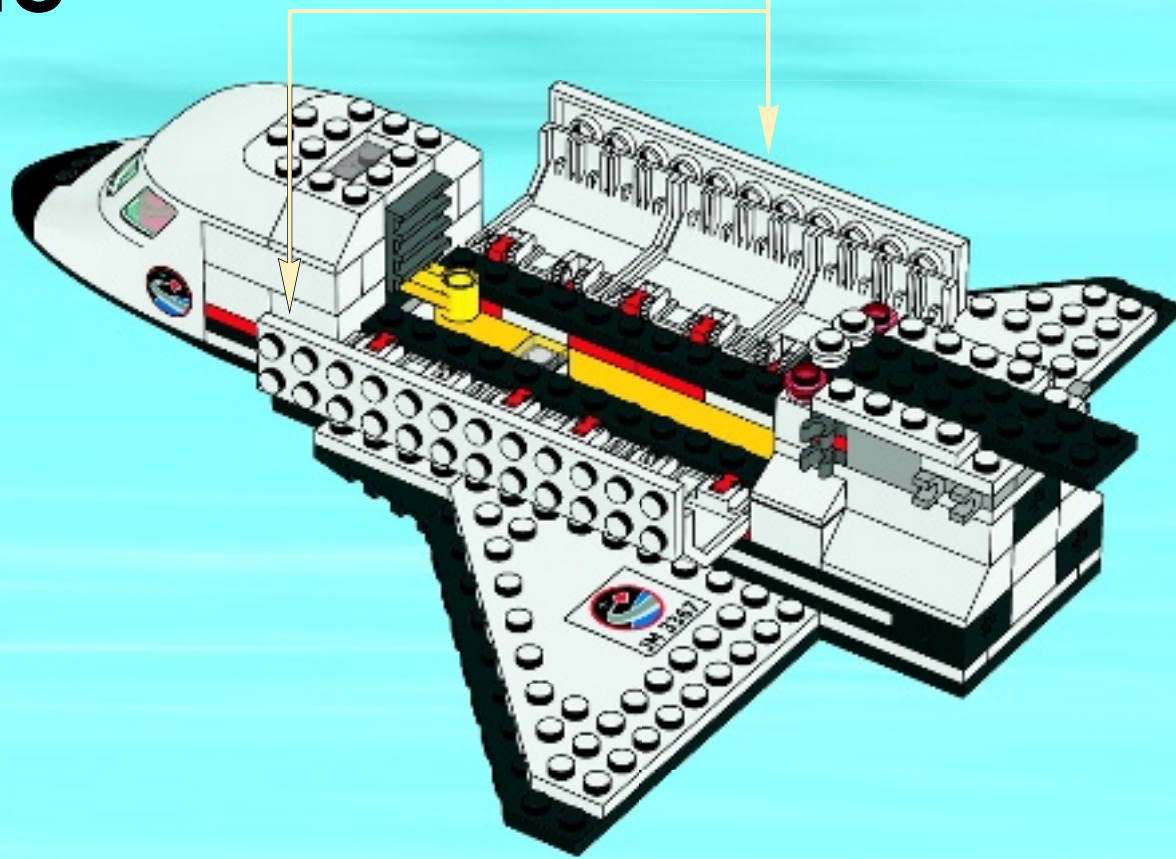
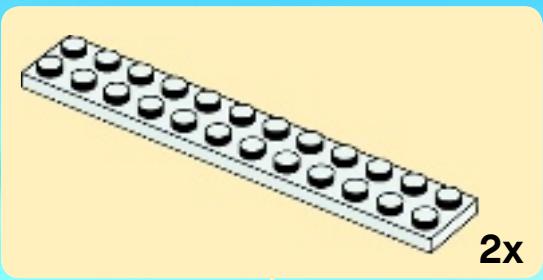

# 49

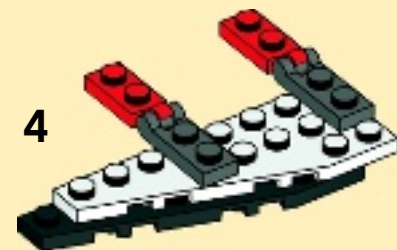
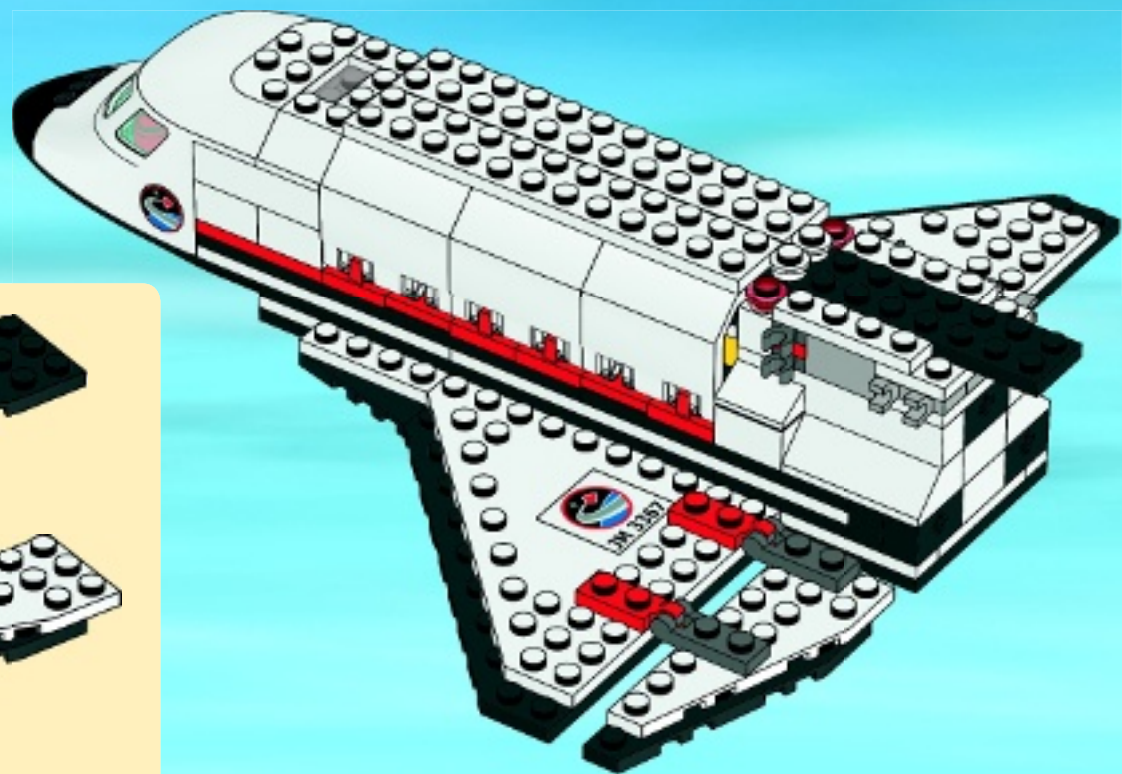

50

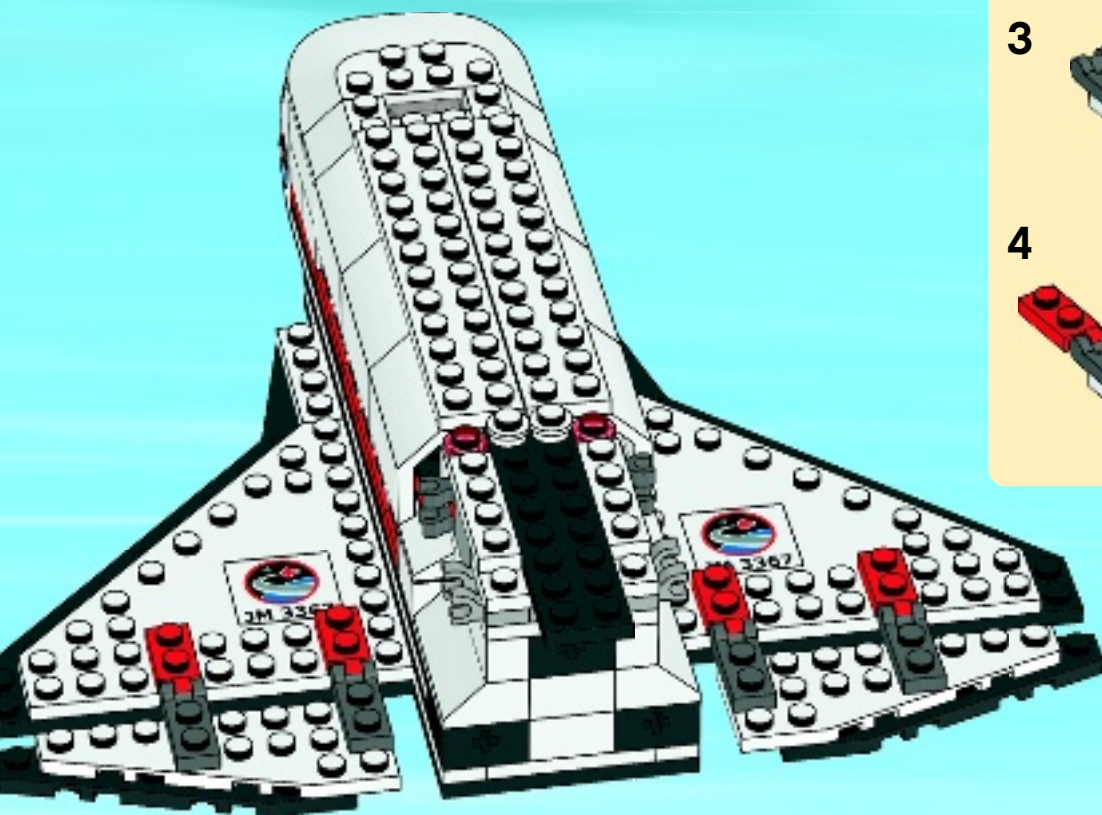

1



2



3



4



# 51

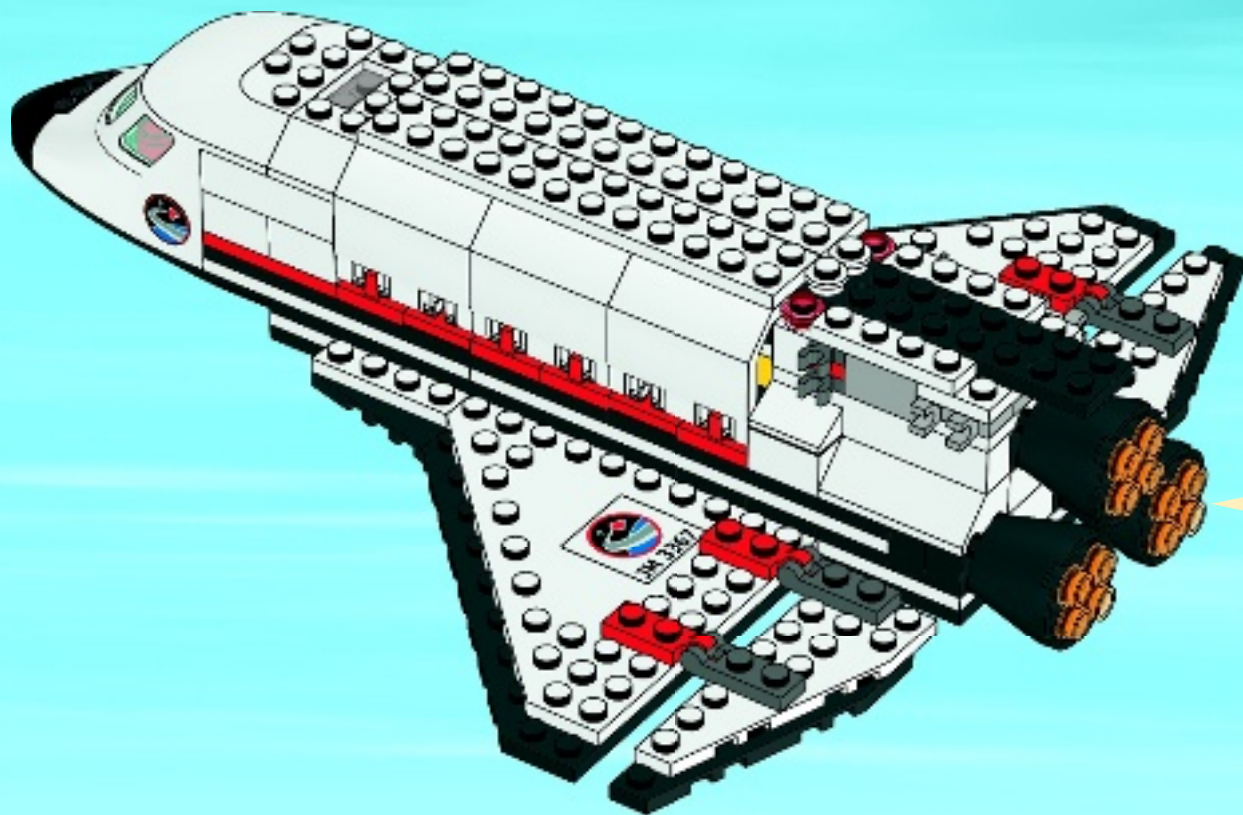

52

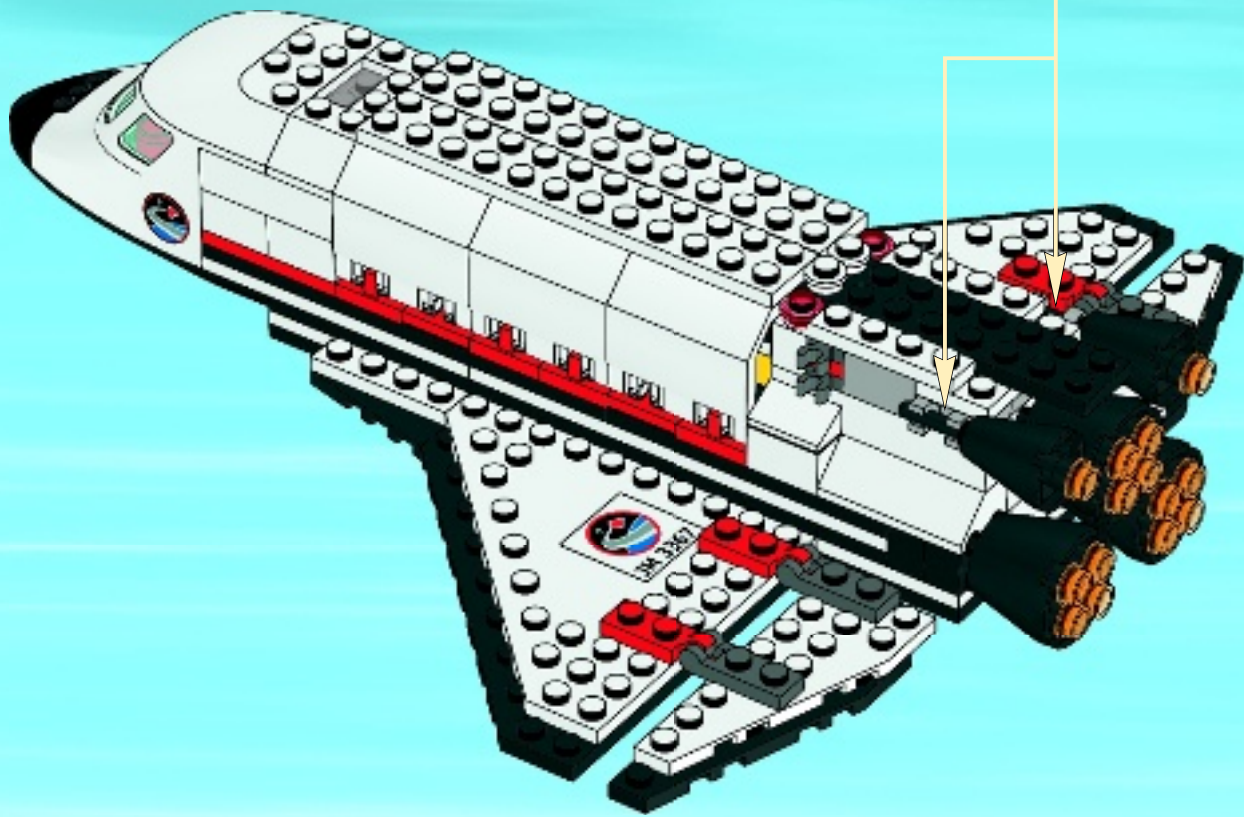



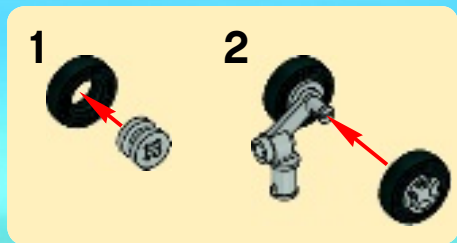

53

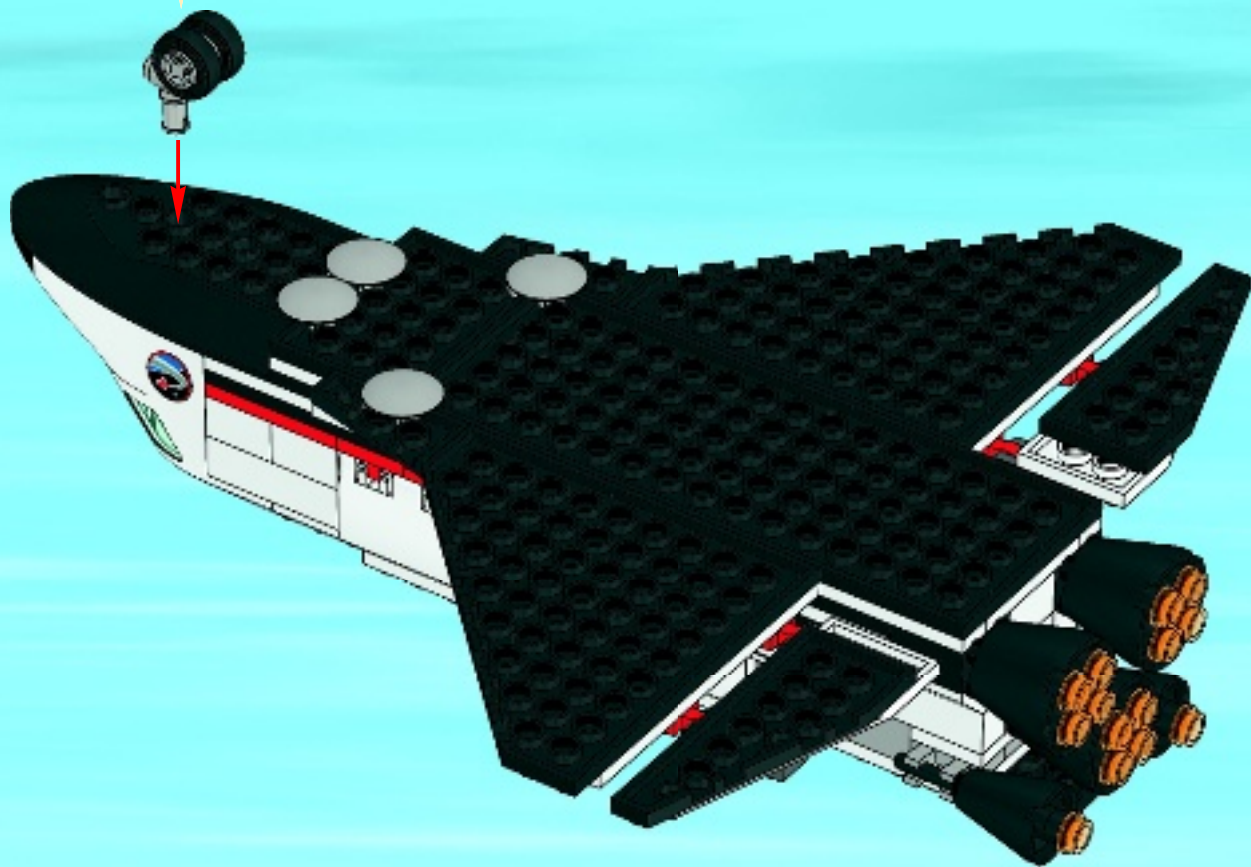

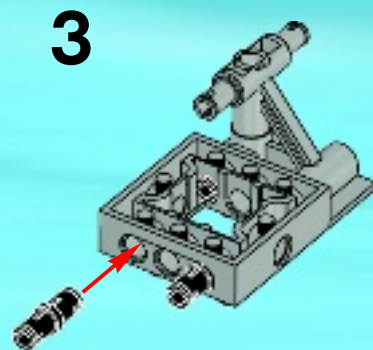
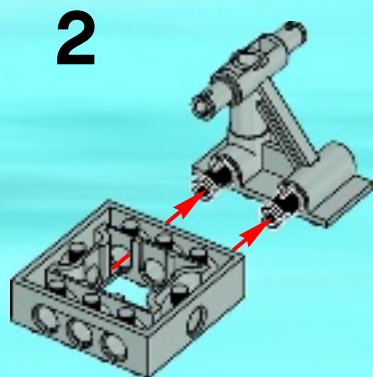
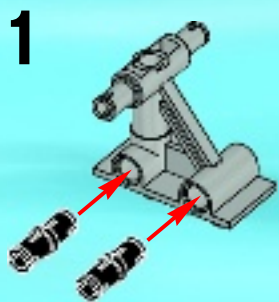

4

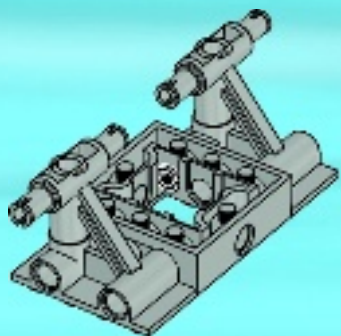

5

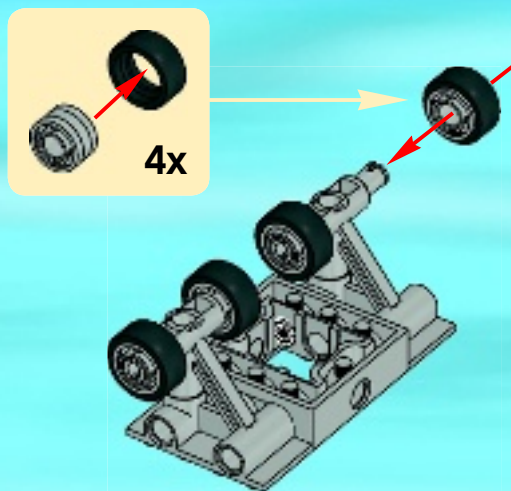

54

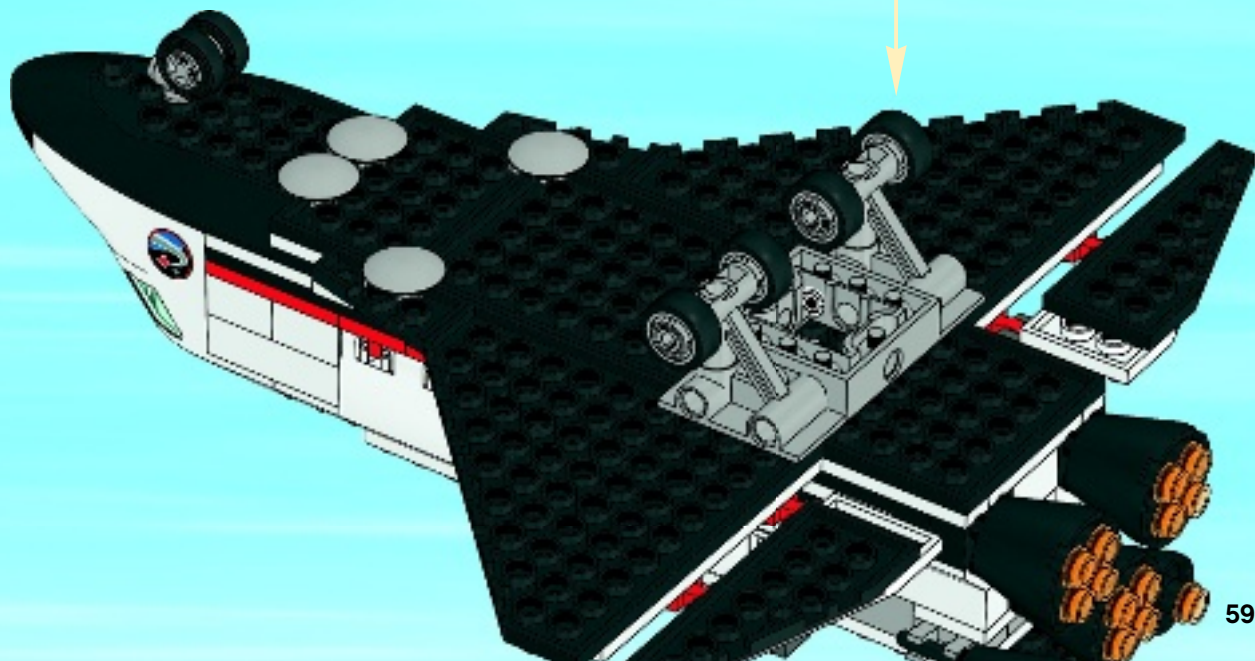

55

1

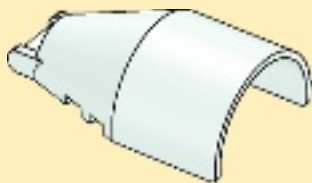

2

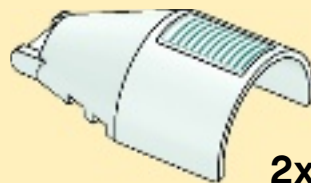

2x

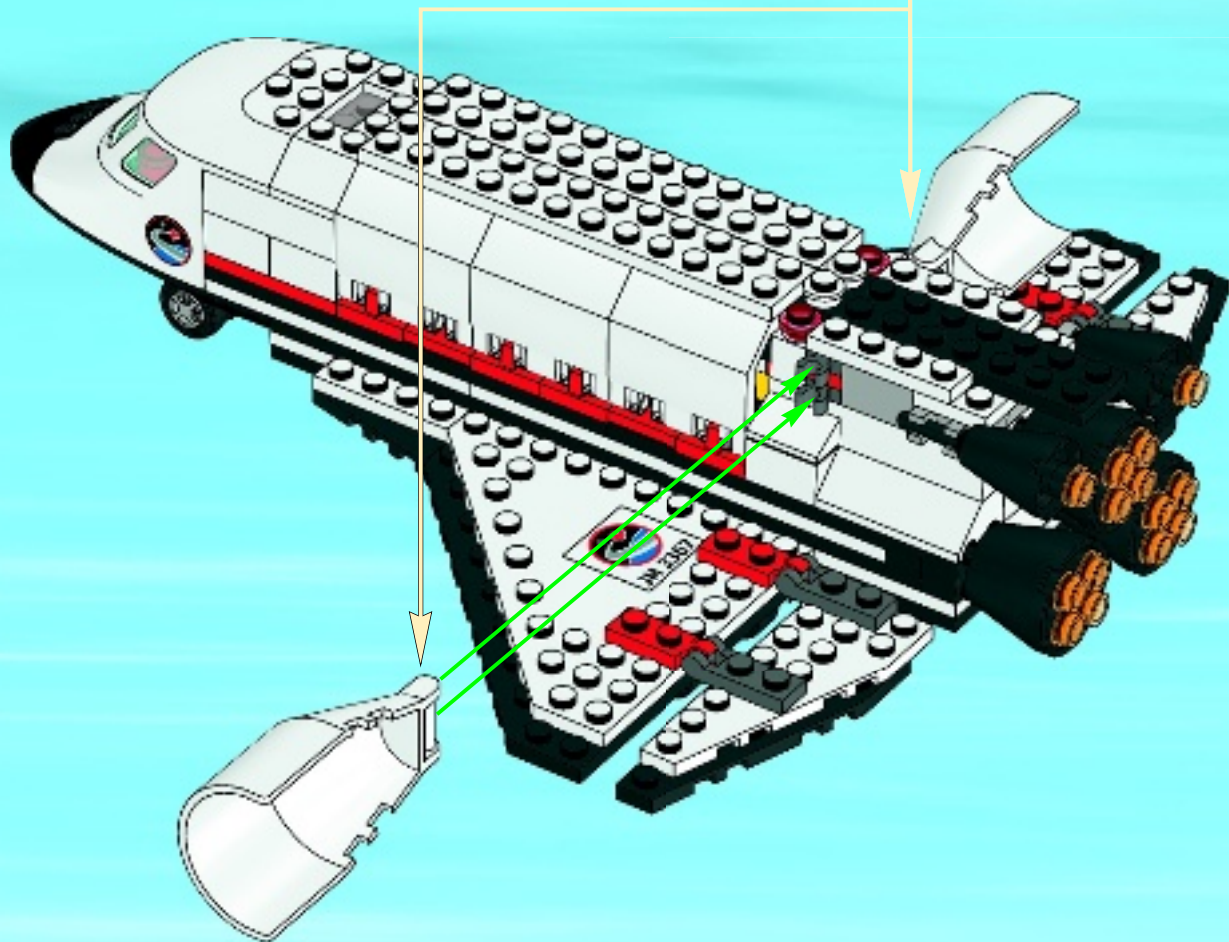

1

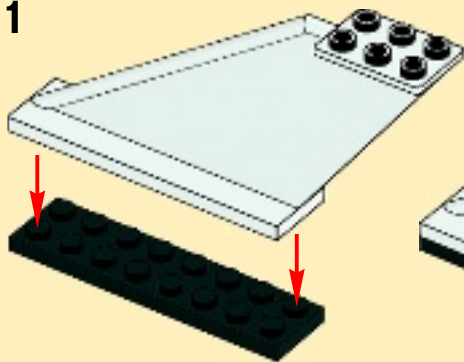

2

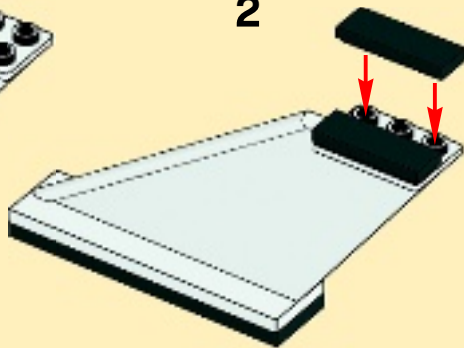

3



56

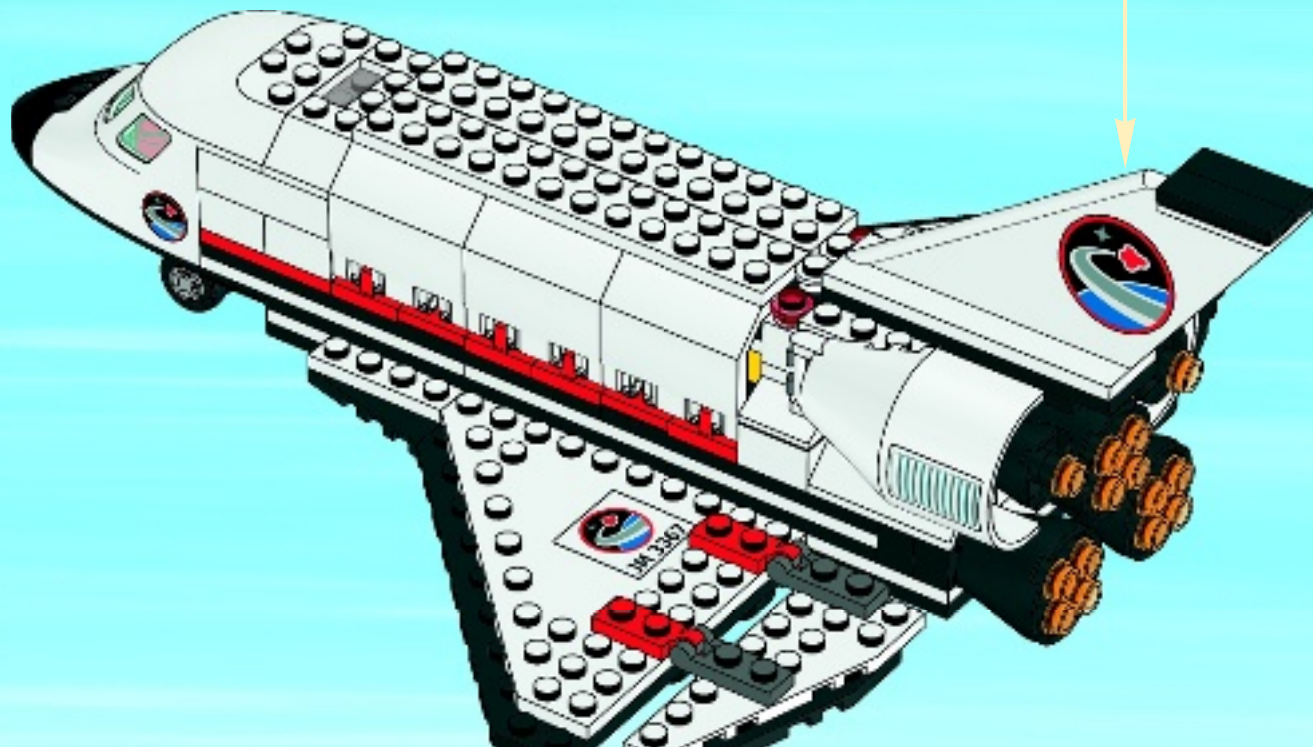

1

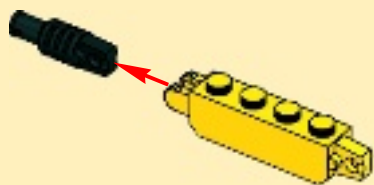

2

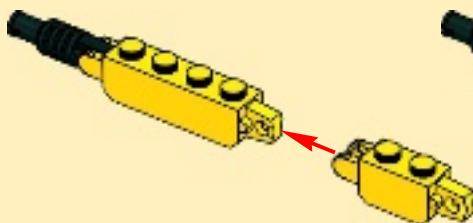

3

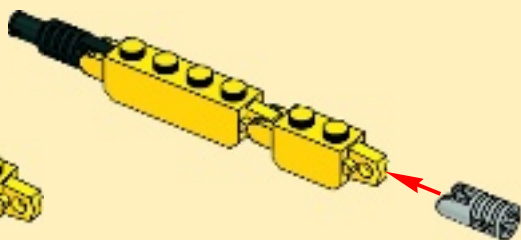

57

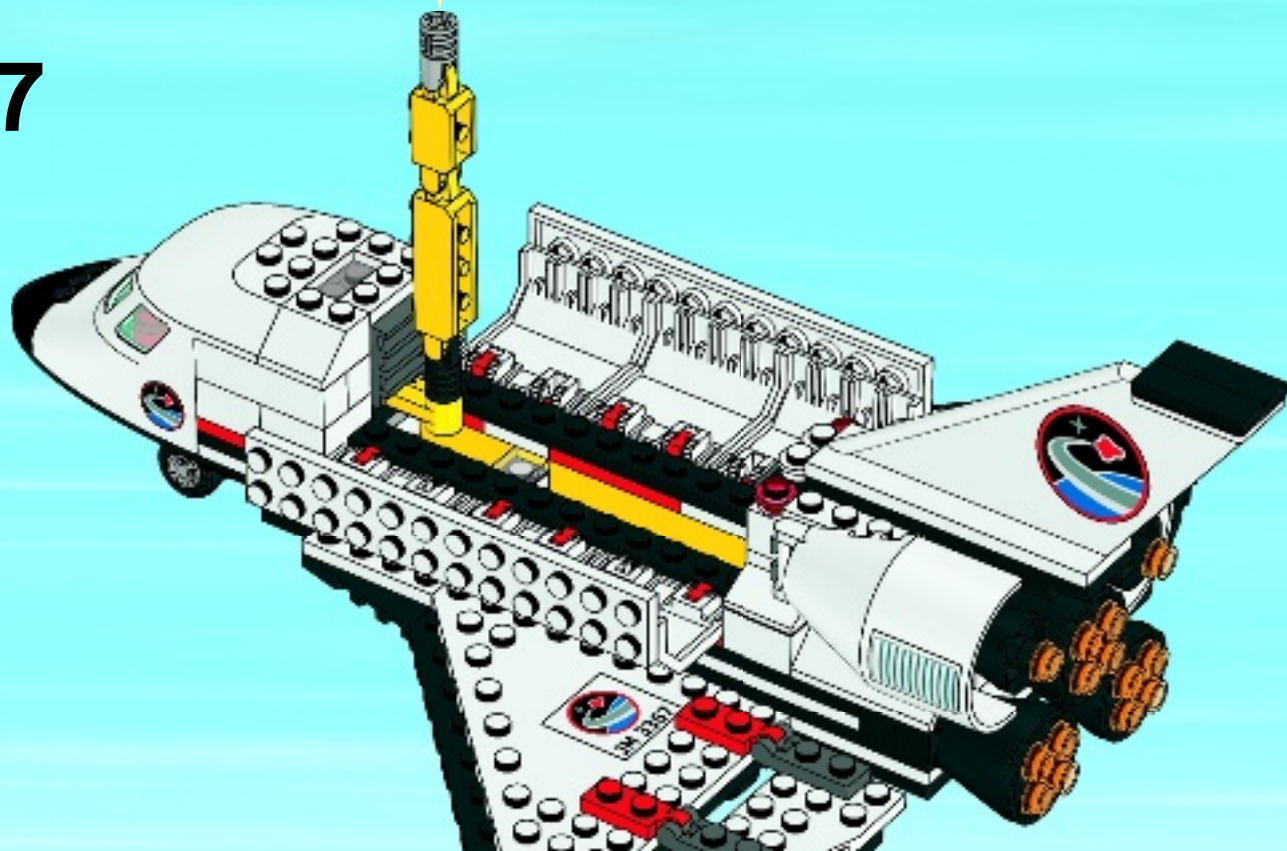

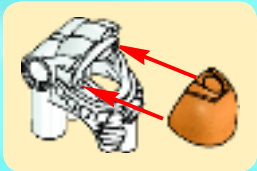
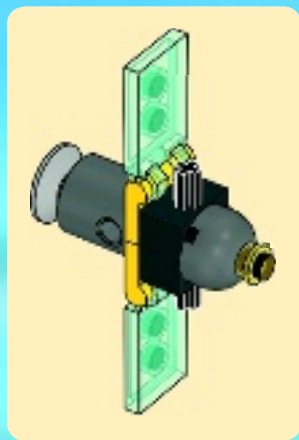

58

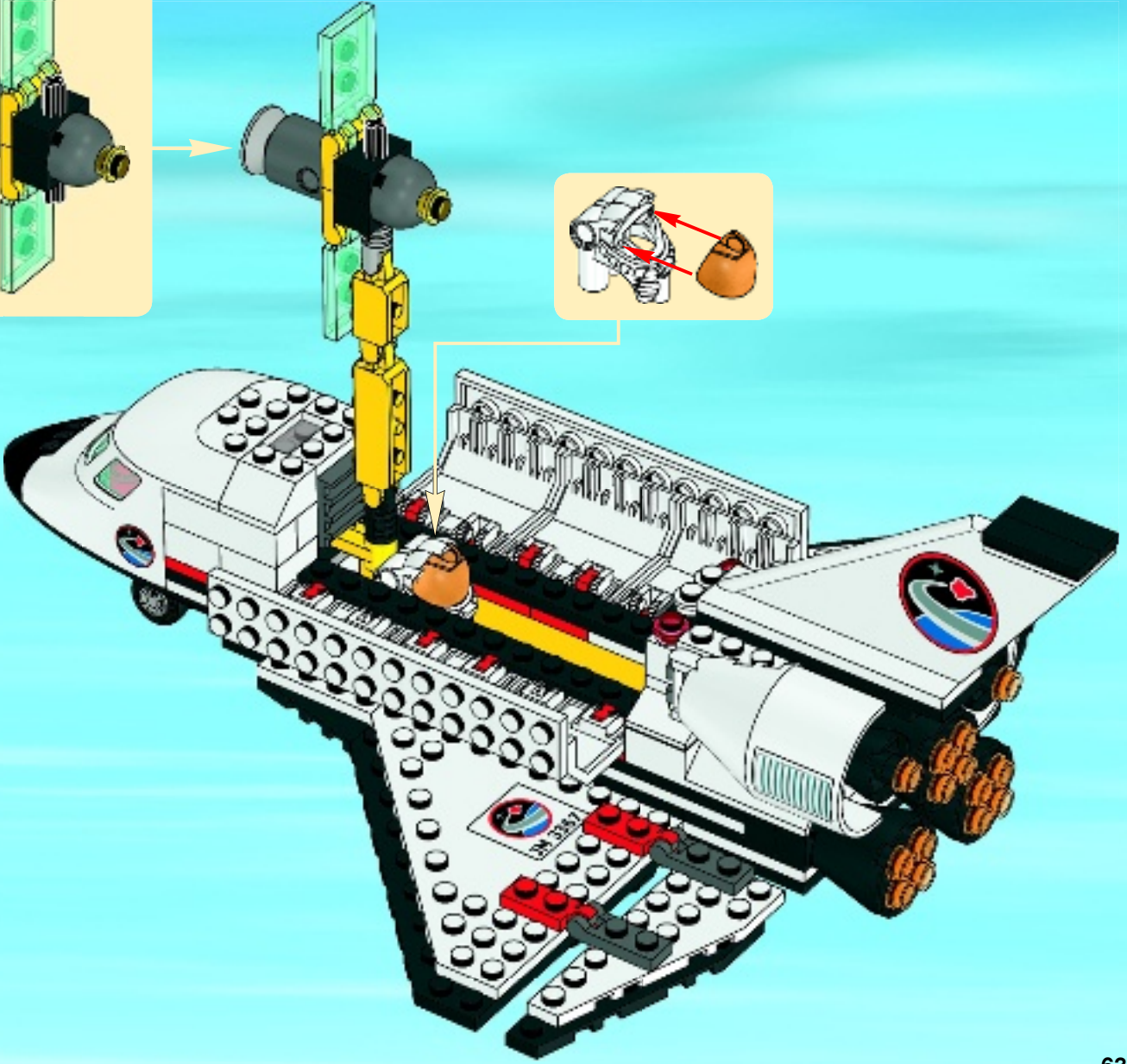

59

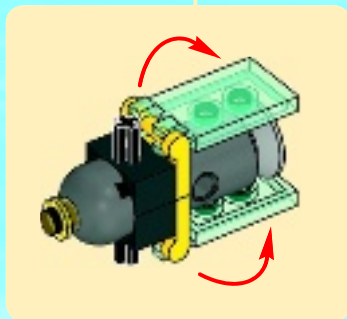
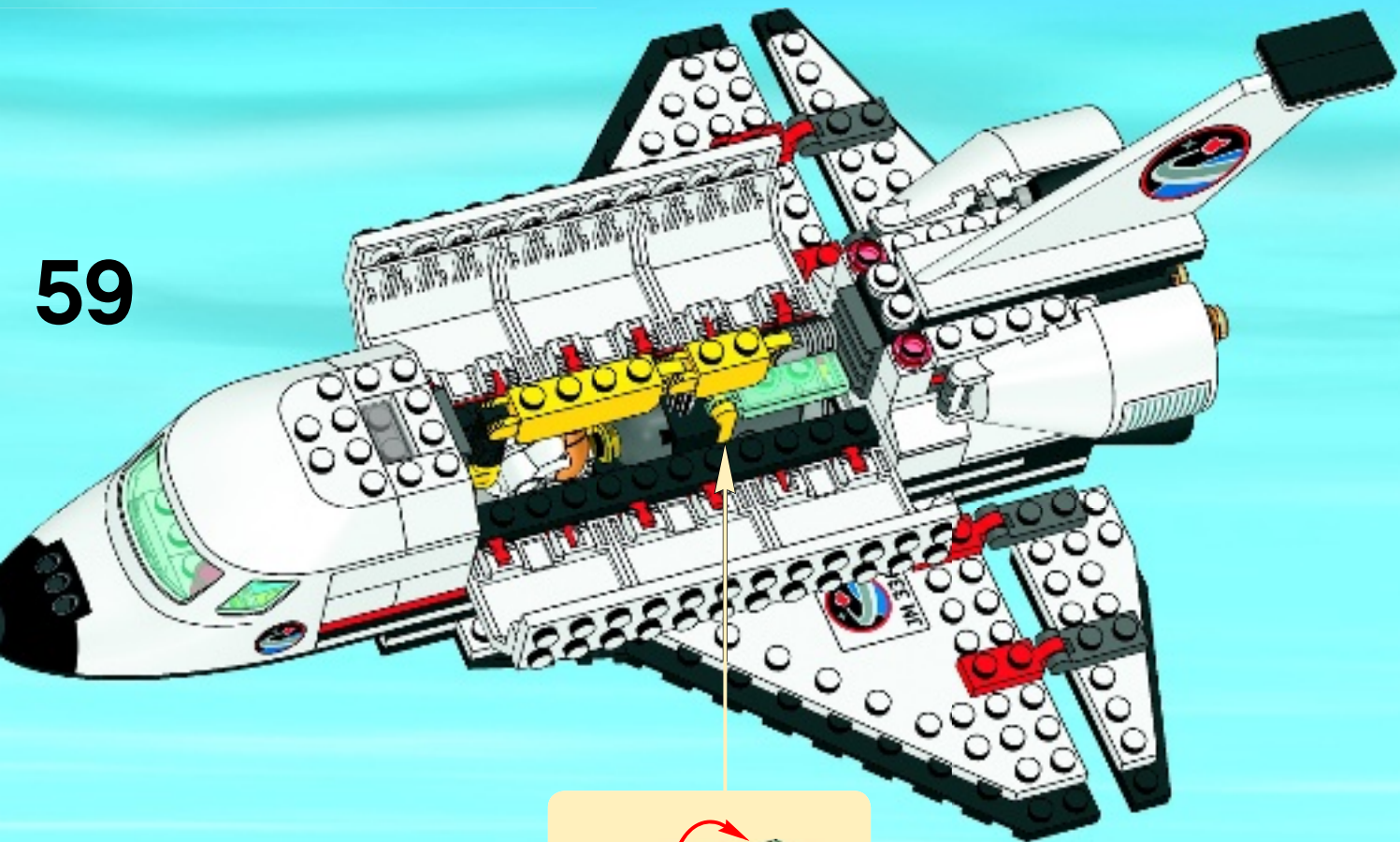



60

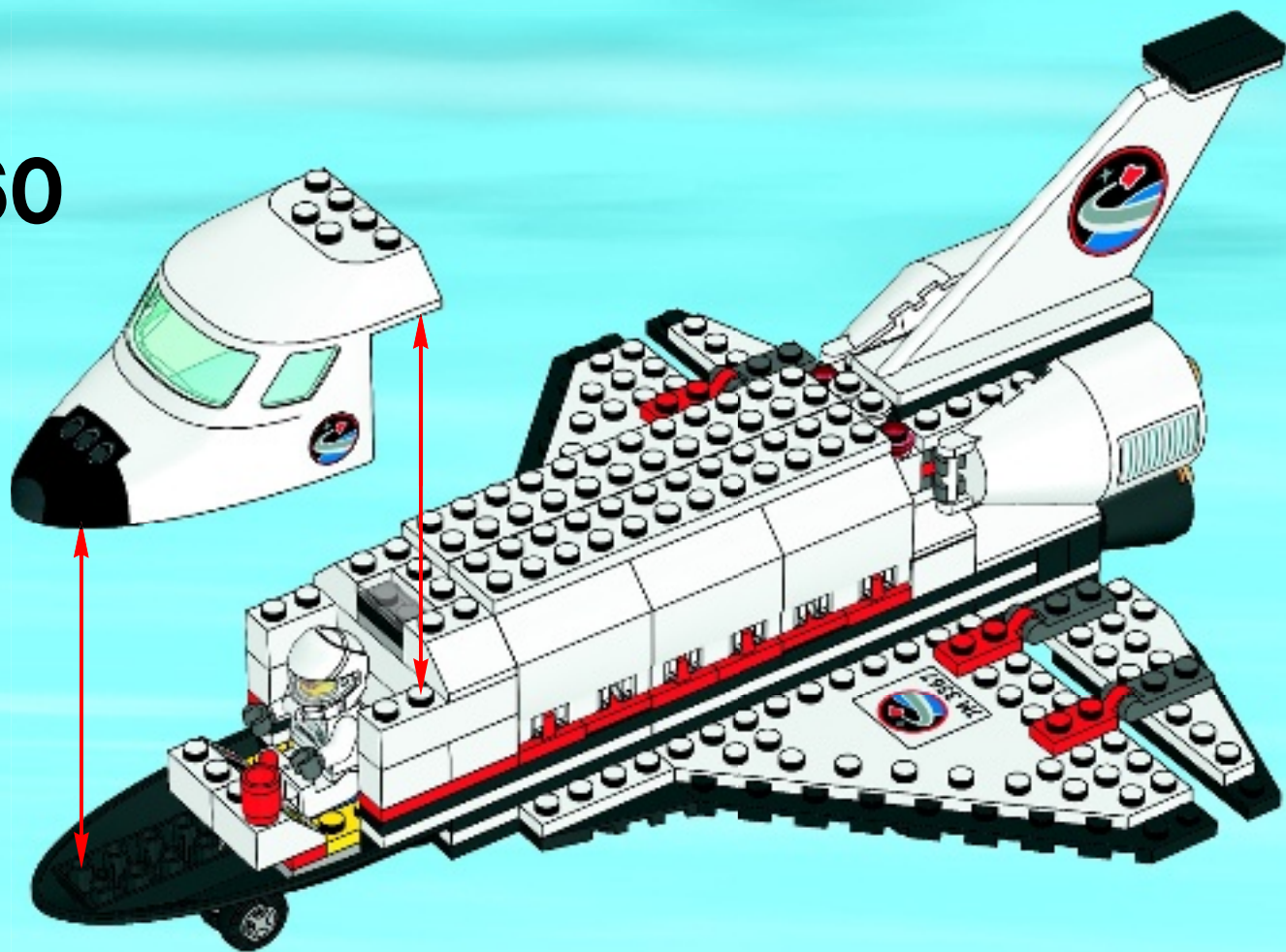



**An astronaut's feet can be attached to the end of the Canadian arm to position him or her at a specific location for work in space.**

Les pieds d'un astronaute peuvent être attachés à l'extrémité du Bras Canadien afin de le positionner à l'endroit précis où il doit travailler dans l'espace.

Los astronautas pueden sujetar sus pies al extremo de un brazo mecánico denominado Canadarm para alcanzar una posición específica y llevar a cabo su labor en el espacio.

#### NASA Astronaut



**LEGO**

**CITY**



**438 days was the longest duration for single human space mission.**

La misión espacial humana la plus longue en un seul vol a été de 438 jours.

La misión espacial más larga en la que han intervenido seres humanos duró 438 días.

**“Happy Birthday” was the first song to be performed in space.**

« Happy Birthday » a été la première chanson chantée dans l'espace.

La primera canción que se cantó en el espacio fue “Cumpleaños Feliz”.

**NASA Space Shuttle**





**The Space Shuttle's total thrust at liftoff is 7.8 million pound-force.**

La poussée totale de la navette spatiale lors du décollage est de 7,8 millions de livre-force.

Al despegar, una lanzadera espacial desarrolla un empuje total de 34,7 millones de newtons.

**NASA Space Shuttle**



The LEGO CITY logo is located in the top left corner. It consists of the word "LEGO" in its signature yellow font on a red background, followed by the word "CITY" in a white, bold, sans-serif font.The word "CITY" is part of the LEGO CITY logo, positioned to the right of the "LEGO" text.

**If someone next to you  
shouted in the vacuum of space you wouldn't be able  
to hear them.**

*Si une personne située à côté de vous dans le vide spatial criait,  
vous ne pourriez pas l'entendre.*

*Si alguien gritara junto a ti en el vacío del espacio, no podrías oírle.*



**A Space Shuttle is used to launch satellites, space telescopes and to fix other spacecraft.**

Une navette spatiale sert à lancer des satellites, des télescopes spatiaux et à réparer les autres vaisseaux spatiaux.

Un transbordador espacial sirve para lanzar satélites y telescopios espaciales, así como para solucionar los problemas de otras naves.



**A School bus can fit in the payload bay of the Space Shuttle.**

Un autobus scolaire peut entrer dans la soute de la navette spatiale.

La bodega de carga de un transbordador espacial podría albergar un autobús escolar.

**NASA Space Shuttle**





# CITY

In collaboration with NASA, En collaboration avec la NASA,  
En colaboración con la NASA.

## NASA Astronaut



**Astronauts are up to 2 inches taller while they are in space. This is due to lack of spinal compression by gravity.**

Les astronautes sont jusqu'à 5 cm plus grands lorsqu'ils sont dans l'espace. Ceci est dû à l'absence de compression de la colonne vertébrale par la gravité.

La altura de los astronautas aumenta hasta 5 centímetros durante su estancia en el espacio. Ello se debe a que la columna vertebral no sufre la compresión que la gravedad causa sobre ella.

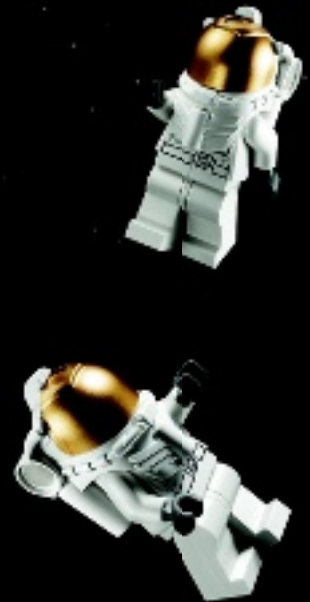



CITY



3365



3366



3367



3368



**LEGO** CITY

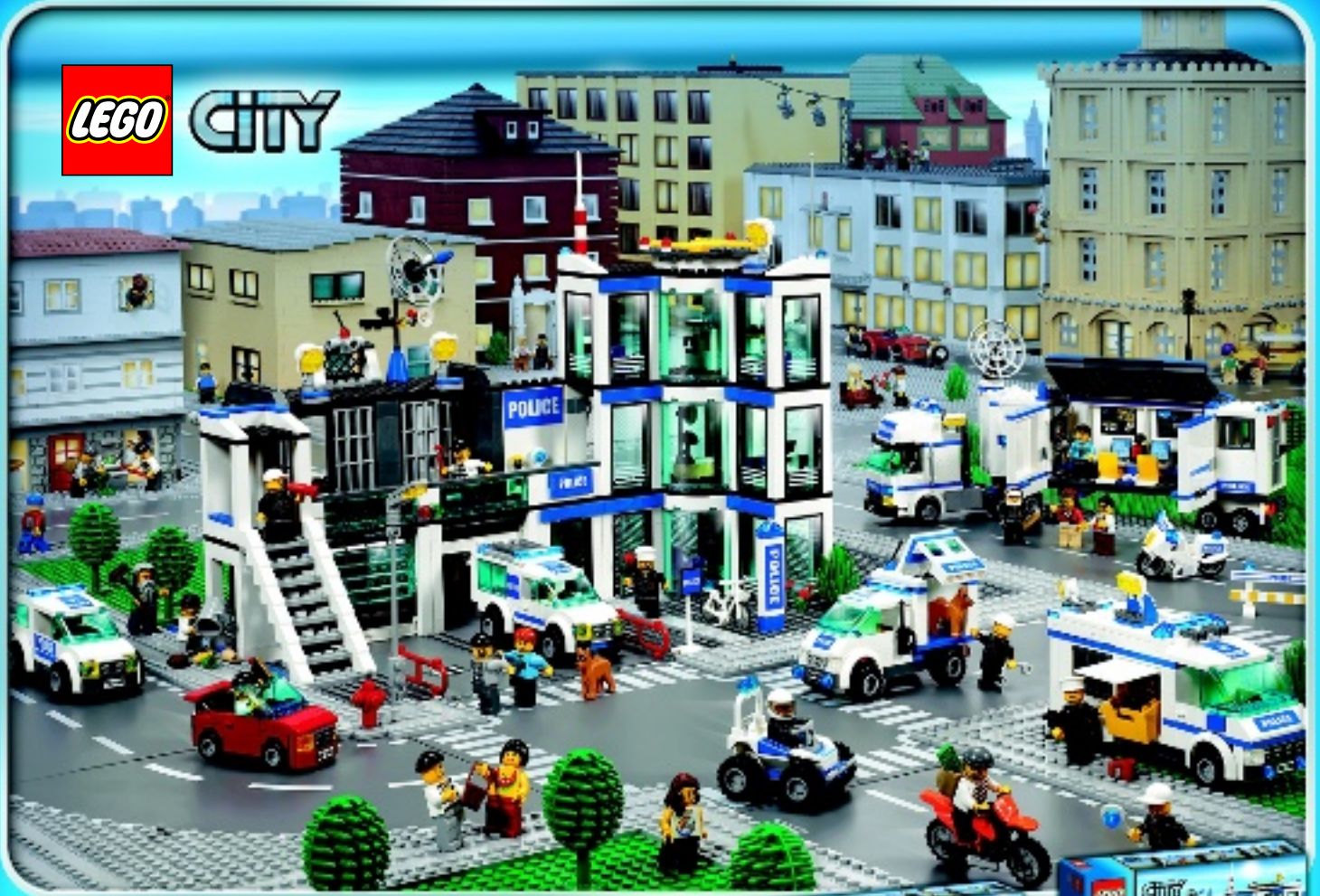

7279



7285



7286



7287



7288



7498



[www.LEGOclub.com](http://www.LEGOclub.com)



LEGO® Club Email

**LEGO club**™

**FREE! GRATIS! GRATUIT!**



LEGO® Club Magazine

**SIGN UP ONLINE!**

**[www.LEGOclub.com](http://www.LEGOclub.com)**



**00800 5346 5555\***



**1-866-534-6258 • 1-877-518-5346**

US & Canada only

Canada seulement

- \* Freephone. Mobile charges may apply.
- \* Numéro sans frais. Des frais peuvent s'appliquer avec les téléphones cellulaires.
- \* Gebührenfrei. Kosten für Anrufe aus Mobilfunknetzen können abweichen.
- \* Gratis telefonnummer vanaf vaste lijn.
- \* Det er et gratis nummer, når du ringer fra fasttelefon.
- \* Det är gratis, när du ringer från en fast telefon.
- \* Numéro sans frais. Des frais peuvent s'appliquer avec les téléphones portables.

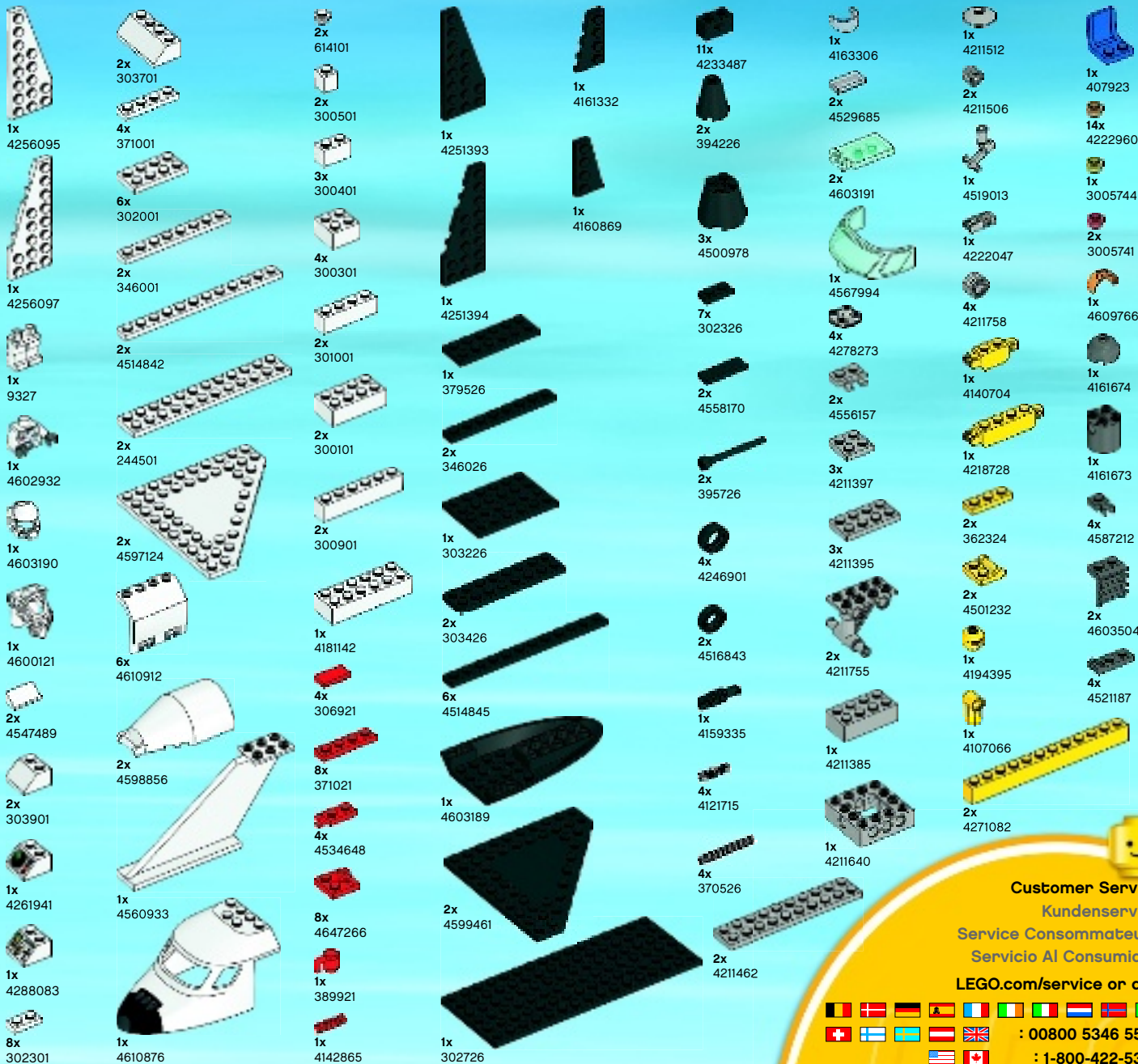

Customer Service

Kundenservice

Service Consommateurs

Servicio Al Consumidor

LEGO.com/service or dial



: 00800 5346 5555

: 1-800-422-5346

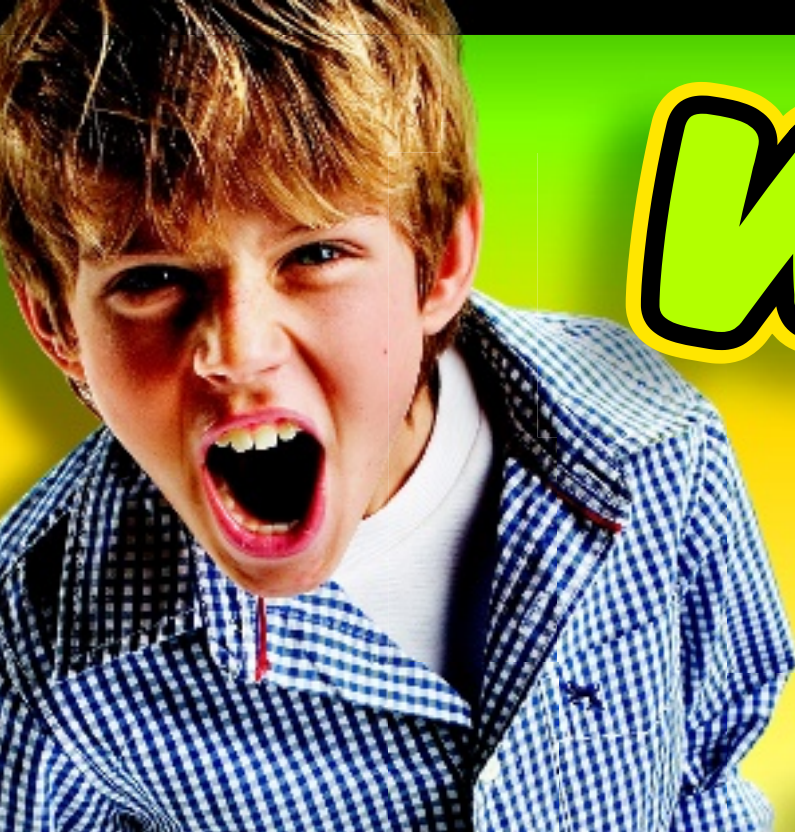

# WIN!

Go to [www.LEGOsurvey.com/product](http://www.LEGOsurvey.com/product)  
to fill out a survey for a chance  
to win a cool LEGO® Product.

No purchase necessary.

Open to all residents where not prohibited.



LEGO.com



## [www.LEGOsurvey.com/product](http://www.LEGOsurvey.com/product)

### GEWINNE! WIN!

Nimm an der Umfrage auf  
[www.LEGOsurvey.com/product](http://www.LEGOsurvey.com/product)  
teil und hab die Chance ein cooles  
LEGO® Produkt zu gewinnen!

Die Teilnahme am Gewinnspiel führt zu keinerlei  
Kaufverpflichtungen. Teilnahme in allen nicht  
ausgeschlossenen Ländern möglich.

Ga naar [www.LEGOsurvey.com/product](http://www.LEGOsurvey.com/product),  
vul een  
enquêteformulier in en maak  
kans op een cool LEGO® product.

Geen aankoopverplichting.  
Iedereen mag deelnemen, uitgezonderd  
ingezetenden van landen waar een  
enquêteverbod geldt.

### GAGNE! 当てよう!

Visite [www.LEGOsurvey.com/product](http://www.LEGOsurvey.com/product)  
pour répondre à un  
questionnaire et avoir une chance de  
gagner un produit LEGO® très cool!

Aucune obligation d'achat.  
Ouvert à tous les résidents des pays  
autorisés.

[www.LEGOsurvey.com/product](http://www.LEGOsurvey.com/product) にアクセスして、  
アンケートにご記入ください。当選者にはレゴ  
製品を差し上げます。

お買い上げの必要はありません

禁止されていない限り、すべての皆様にご利用いただけます。