

DENSO

DENSO SPARK PLUG CATALOG 2020



MOTORSPORTS

Supported by DENSO

TOYOTA GAZOO Racing WEC



LEXUS TEAM SARD SUPER GT GT500 CLASS



SUBARU BRZ GT300



Copyright © STI

YOSHIMURA SUZUKI MOTUL RACING JSB1000



Photo credit: YOSHIMURA JAPAN



Be sure to read this Catalogue & Website

IN NO EVENT SHALL DENSO BE LIABLE FOR ANY LOSSES, EXPENSES OR DAMAGES WHATSOEVER RESULTING FROM ANY OF THE FOLLOWINGS;

- FAILURE TO COMPLY WITH THE WARNING OR PRECAUTIONS DESCRIBED IN THIS CATALOGUE AND WEBSITE,
- ANY USES OTHER THAN THE APPLICABLE USE DESCRIBED IN THIS CATALOGUE AND WEBSITE, and
- ANY TROUBLE NOT ATTRIBUTABLE TO DENSO SPARK PLUGS.

※"Spark plugs" means any type of DENSO's spark plugs, including but not limited to Iridium Power, Iridium TT, Iridium Racing, Iridium Plus, and Iridium Tough, Iridium Long Life, Double Platinum, U-Groove, Resistor, Standard, Nickel TT, Platinum TT, Two-Tops.



WARNING (Prohibited Usage)

- Never use DENSO spark plugs in the engines for any aircraft, including airplanes, helicopters, gliders and drones. The DENSO spark plugs sold are not designed and manufactured for any aircraft: use may result in a plane crash or other accidents due to engine malfunction.
- Never use DENSO spark plugs, listed in this catalogue, in the engines for generator and gas heat pump air conditioning system. The DENSO spark plugs we sell are not designed and manufactured for such use, so that such use may result in accidents, including power generation stop or heat generation stop.
A separate catalogue for DENSO spark plug specifically designed for generators (gas engines) is available. Please contact your DENSO representative for more information.
- Never use DENSO spark plugs for gas burner ignition. The DENSO spark plugs we sell are not designed and manufactured for such use, so that such use may result in ignition failure or equipment damage due to overheating.



WARNING

- Be sure to turn off the engine and disconnect the battery before replacing or adjusting the plugs. Failure to heed this warning may result in a fire, an electric shock and/or bodily harm.



Spark Plug Handing Precautions

- Always refer to the vehicle manufacturer's repair manual for specific installation procedures.
- Carefully read the instructions and precautions on the package, catalogue and website.
- Do not drop spark plugs. This may cause the spark plug to crack internally or the gap to be narrowed, preventing it from functioning correctly.
- If Spark Plug needs to be gapped, bend from the back of the ground strap with appropriate tools. Do not physically adjust gap using the center electrode as leverage. Check gaps with care, not to damage the center electrode. Gap to the vehicle specific manufacturer's recommendation unless otherwise recommended.



Modified Vehicles and Tuning Precautions

- DENSO will not bear any responsibility whatsoever for any trouble arising from mechanically or electronically modified engines or vehicles.
- It is the user's judgement and responsibility to check the specifications required for modified engines, which includes and not limited to, gapping, heat ranges, reach, projection, and/or clearances with valves and/or pistons.



Catalogue & Website Precautions

- Precautions for cross reference and product tables showing other manufacturer's spark plugs:
 - ◆ Use for reference only. Table does not guarantee the performance of spark plugs when installed in the vehicles if plug was specified using cross references. Always check the applications section for DENSO recommended plugs.
 - ◆ The spark plug specifications (construction, material, etc.) differ from one manufacturer to another.
 - ◆ Select a suitable type of spark plug from the vehicle application table. If not listed on the table, please check with your DENSO Representative.
- The contents of the catalogue and website are updated on a regular basis, but they cannot account for daily dynamic changes such as new applications and or OE supersessions. If there is an issue with the information, please contact your DENSO Representative for further assistance.
- Consumption tax and installation fees are not included in the price of the product.
- Some spark plugs on this catalogue and website are manufacturer's genuine parts that listed for reference and cannot be directly sold. Please contact your DENSO representative for further assistance.
- The appearance and specifications of the product are subject to change without prior notice.
- The images of spark plugs indicated in the catalogue and website are conceptual diagrams, and sometimes differ from the actual products.



Precautions for selecting spark plugs.

When selecting an appropriate type of spark plug, check the vehicle manual, the maintenance manual and the application table in this catalog, and select spark plugs with the correct dimensions and heat range.

Know-how concerning spark plug selection

Normal vehicle

- Basically, use a spark plug that has a standard heat range. Note, however, if this type of spark plug is used for traveling at low speed or traveling over short distances, resulting in the occurrence of carbon fouling, it is recommended that you use spark plugs that have a low heat range.
- Do not use a non-resistor type plug in an engine for which a resistor type plug is specified. This may result in engine trouble due to noise accompanying the spark discharge.
- If you install extended type spark plugs (J, QJ, KJ, PKJ, SKJ, VKJ, TJ, etc.) in a non-designated engine, they may interfere with the valves and pistons, causing damage to the engine and the spark plugs.

Selection of the optimum heat range

Heat range	Applications
31	For preventing plug overheat
27	
24	
22	
20	For preventing carbon fouling / oil fouling

Low ← Tuning level → High

Tuned or modified vehicle

- In the case of a tuned or modified vehicle which has a modified engine, or one which uses a muffler, ignition coil, plug cords, turbo unit or commercially available electronic ignition system, or a NOS (*) for example, it is necessary to increase the heat range of the plugs to a value that matches the tuning level. If you do not select the plugs correctly, trouble such as carbon fouling / oil fouling or pre-ignition (a naturally occurring phenomenon in which combustion occurs prior to the emission of a spark from the plug) will occur, which may result in a breakdown of the vehicle.
- (*) NOS: A device which injects nitrous oxide together with gasoline into the air intake in order to increase the engine power
- When using a tuned vehicle or a modified vehicle, select a heat range using your own judgment and at your own responsibility.

When using Iridium Racing plugs

- Iridium Racing plugs are intended for racing and also for tuning up. Set the heat range of the plugs to match the tuning level, based on the heat range of the standard plugs or Iridium Power plugs.
- Generally, a plug that protrudes into the combustion chamber has superior ignition performance, resulting in improved engine performance. On the other hand, this type of plug is liable to be exposed to the high-temperature combustion gas, and also the length of the grounding electrode increases, reducing the heat resistance and durability of the plug. For this reason, the higher the tuning level becomes, the greater is the necessity to use a type of plug that has a recessed electrode.
- Generally, when the tuning level rises, the necessity of using high heat range plugs increases.
- When using Iridium Racing plugs, select them according to your judgment and at your own responsibility.

Using a plug fitted with a terminal nut

If you use a plug fitted with a terminal nut when the terminal nut is loose, the engine is likely to malfunction. If the part No. of the plug includes the notation "R" alongside "Terminal shape" or "NUT," and the plug is used with the terminal nut fitted, securely tighten the nut using pliers, or the like. In the case of a plug whose part No. includes the notation "RC" alongside "Terminal shape" or "NUT," the terminal nut is crimped and will not work loose under normal applications. However, if vibration of the engine and/or the plug cord is severe, the nut may on rare occasions become loose. Keep this possibility in mind, and periodically inspect the nut. If it is loose, re-tighten it securely.

S: Solid (integrated type)



R: Nut type (no crimping)

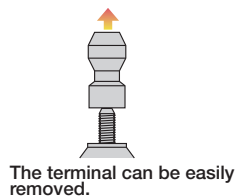

RC: Nut type (with crimping)

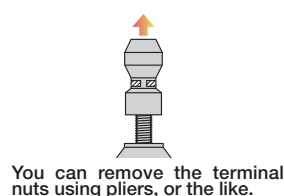

T: Screw type





Precautions to observe when installing the spark plugs

Recommended torque and angle of rotation

It is necessary to install the plugs in the engine using the correct torque. Note that if the torque is too low, the plugs are liable to work loose due to leakage of combustion gas or vibration, resulting in possible damage to the engine and the plugs. Conversely, if the torque is too high, the crimping between the insulator and the housing is liable to become loose, causing the integrity of the seal to be impaired or the mounting screw thread to break.

- 1** Use the correct wrench that matches the hex part of the plug. Take care not to damage the insulator.
- 2** When carrying out this work, take steps to ensure that oil, dust and foreign objects in the vicinity of the cylinder head do not enter the engine.
- 3** Before installing the plug, clean the mounting seat on the engine side, check that there is a gasket, and then insert the plug into the mounting seat.
- 4** When carrying out this work, hold the plug vertically, and then lightly tighten it by hand or by using a plug wrench.
- 5** Next, using a plug wrench, tighten the plug to the recommended torque or the recommended angle indicated in the table below.

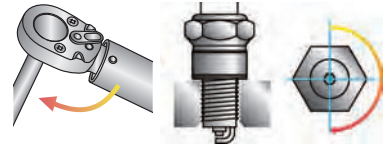

- !** If you tighten the plug to a greater rotation angle or torque than that indicated in the table below, the engine may become damaged or the screw thread of the plug may break, so be careful.
- !** If you apply grease or another screw thread lubricant to the threaded part of the plug, you are liable to tighten the plug to an excessive degree, impairing the integrity of the seal, even if you apply no more than the recommended torque. For this reason, do not coat the plug with screw thread lubricant.
- !** If you apply the plug wrench obliquely, an unreasonable force may be applied to the insulator, causing it to crack, as indicated in the figure below. For this reason, be careful not to hold the wrench obliquely.

Thread Size	Applicable Models	Recommended Torque	Recommended Tightening Angle	
			New Plug	Previously Used
M 8	All Types	8 -10N·m	About 1/3 turn	About 1/12 turn
M10	Types other than the ones shown below	10-15N·m	About 1/3 turn	About 1/12 turn
M10	UFE, IUH, VUH, VNH Types	10-15N·m	About 2/3 turn	About 1/12 turn
M10	Stainless Gasket Type ^(*)	10-15N·m	About 3/4 turn	About 1/12 turn
M12	All Types	15-20N·m	About 1/3 turn	About 1/12 turn
M14	Types other than the ones shown below	20-30N·m	About 1/2 turn	About 1/12 turn
M14	Stainless Gasket Type ^(*)	20-30N·m	About 2/3 turn	About 1/12 turn
M18	All Types	30-40N·m	About 1/4 turn	About 1/12 turn
M14 Taper seat	All Ty	10-20N·m	About 1/16 turn	About 1/16 turn
M14 (Gas)	If the cylinder head material is cast iron	20N·m	-	-
M14 (Gas)	If the cylinder head material is aluminum	N·m	-	-
M18 (Gas)	If the cylinder head material is cast iron	30N·m	-	-

(*)1 VUH27ES, U24FER9S
 (*)2 IK16G, IK20G, IK22G, K20PR-U8S, K20PR-U9S, KJ20DR-M11S, PK22PR-L11S, SK20PR-N9S, SK22PR-M11S, SKJ20DR-M11S, VK16G, VK20G, VK22G

Cracking of the insulator

The plugs of recent engines are installed in deep plug holes, so it may be difficult to notice whether or not you are holding the wrench obliquely when installing or removing the plugs. However, if you turn the wrench in this condition, the head of the insulator may stick, causing an unreasonable force to be applied to it. As a result, the insulator is liable to crack.

*However, the mode of occurrence differs according to the construction and dimensions of the plug holes in the engine, and also the type of wrench used.

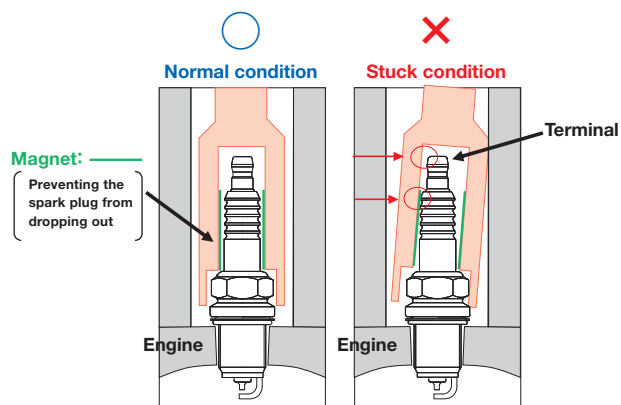



Regarding the spark plug replacement timing

The electrode progressively wears, causing the spark gap to increase, along with the increasing number of spark discharges. When the gap exceeds a certain limit, the sparking performance deteriorates, which may prevent stable ignition of the gas mixture. When this happens, the horsepower of the engine falls, the fuel economy deteriorates and also the quality of the exhaust gas is adversely affected, so it is necessary to replace the plugs. The table below shows our recommended plug replacement timing as a rough guide to the economic life of the plugs. The economic life may be reduced depending upon the vehicle running condition* and the sparking characteristics*.

Rough guide to the recommended replacement interval (economic life) for conventional spark plugs

Automobile	15,000 to 20,000km
Motorcycle	3,000 to 5,000km

Rough guide to the recommended replacement interval (economic life) for platinum plugs, Iridium Tough and Iridium Plus plugs

Automobile	up to 100,000km *1
Motorcycle	There are no settings.

*1: The small engine vehicle, a tuned vehicle or a vehicle that uses a simultaneous ignition coil is often used at high speed. This may cause the life of the plugs to be reduced.

Rough guide to the recommended replacement interval (economic life) of Ni-TT plugs

Automobile	15,000 to 20,000km
Motorcycle	There are no settings.

*Factors which shorten life

- Running condition: High-speed running, high-load running, hill climbing, extended idling (taxi), etc.
- Ignition characteristics: Simultaneous ignition, positive discharge, use of high-energy coil, etc.

Simultaneous ignition system

A simultaneous ignition system is an ignition system in which two plug cords are connected to one coil, as shown in the figure. A normal coil consists of a single coil which provides a high voltage to one plug. Generally, it employs a negative discharge that results in relatively low wear. In contrast, a simultaneous ignition system uses a single coil which must be capable of supplying high voltage to two plugs. A negative discharge occurs at one plug and a positive discharge occurs at the other plug, resulting in the generation of wasteful fire that is unrelated to combustion. For this reason, the electrode at which a positive discharge occurs tends to wear markedly.

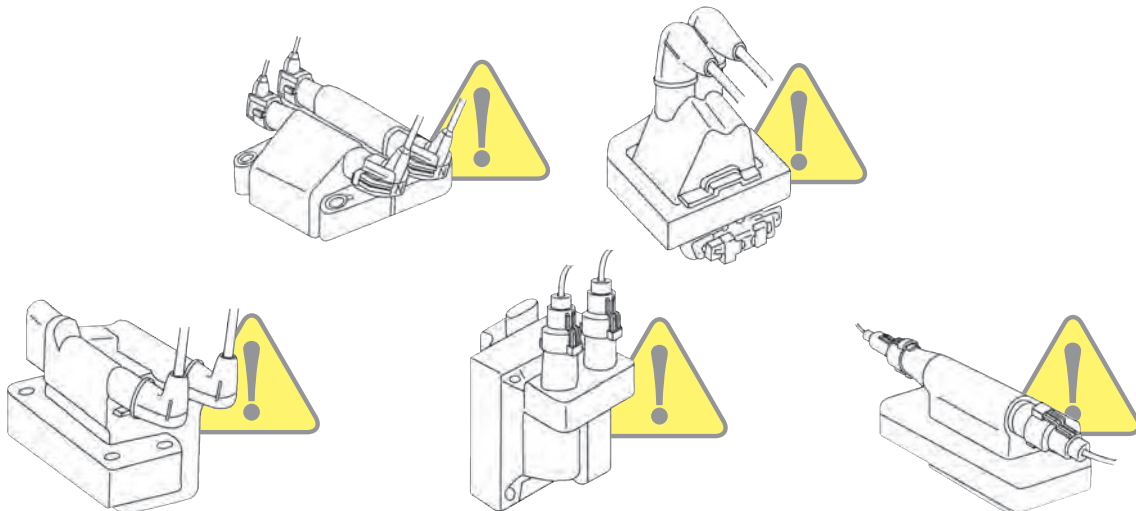

Adjustment of the plug gap

- If the center electrode becomes rounded or the grounding electrode wears unevenly, replace the plug with a new one.
- Do not adjust the gap of a plug that has a thin electrode, such as a platinum plug or an iridium plug, because this may result in damage to the center electrode.

BASIC INFORMATION FOR PLUG (1)

01

The role of spark plugs

DENSO spark plugs ignite your engine.

Gasoline engines generate power from the precision-timing combustion of a fuel-air mixture of gasoline and oxygen. However, gasoline itself is relatively difficult to ignite with the precision timing required for combustion of the fuel-air mixture, even at high temperatures. The role of the spark plug is to create a spark which ignites the fuel. Since the spark plug ignites combustion, the performance of the plug determines the performance of the entire engine. The engine is often likened to the “heart of a vehicle,” and spark plugs have the significant role as the “heart of the engine.”

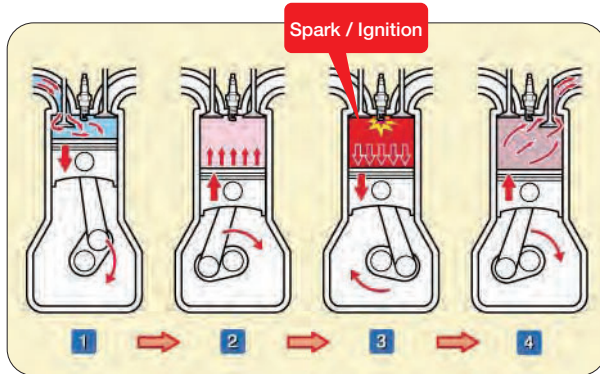

**Spark plugs are
the heart of
your engine!**



02

Spark and Ignition

Generate a strong spark from an electrical discharge between electrodes

When high voltage produced by the ignition system is discharged between the center electrode and ground electrode of the spark plug, the natural insulation between the two electrodes breaks down, current flows as a result of the discharge phenomenon, and an electrical spark is generated.

The energy from this spark triggers the igniting and combustion of the compressed air-fuel mixture. The duration of this discharge is extremely brief (about 1/1,000 of a second) and is extraordinarily complex.

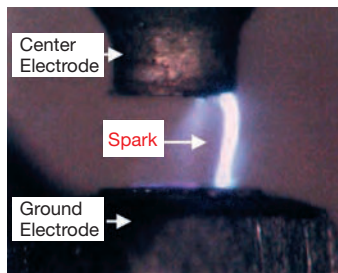

The role of the spark plug is to reliably generate a strong spark between electrodes precisely at each specific moment to create the trigger for combustion of the gaseous mixture.

The spark plug generates a flame kernel from a spark which then ignites the fuel

Igniting the fuel with an electrical spark occurs because fuel particles situated between the electrodes are activated by the discharge spark to trigger a chemical reaction (oxidation), the reaction generates heat, and a flame kernel is formed. This heat ignites the surrounding air-fuel mixture until a flame core is formed that spreads combustion throughout the chamber. However, the electrodes themselves absorb heat which can extinguish the flame kernel, called the “quenching effect.” If the quenching effect between the electrodes is greater than the heat generated by the flame kernel, the flame is extinguished and combustion stops.

If the plug gap is wide, the flame kernel will be larger and the quenching effect is reduced, so reliable ignition can be expected. But if the gap is too wide, a large discharge voltage becomes necessary, the limits of coil performance are exceeded, and discharge becomes impossible.

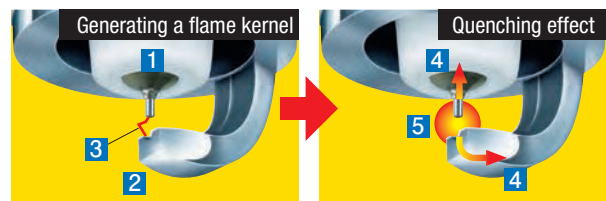

- 1 Center Electrode 2 Ground Electrode 3 Flame kernel
4 Heat absorption 5 Flame propagation

03 How to Choose a Plug

Various circumstances such as engine conditions and driving conditions are rough measures for choosing a plug. For example, if strenuous driving is continued for a long time using normal plugs, the plug will overheat. This is why the idea of a regular plug for a regular car doesn't work. What's important is to inspect the condition of your current plugs, and then choose a plug accordingly.

Heat Range	Application
31	To prevent plug overheat
27	Standard Plugs
24	
22	
20	To prevent carbon fouling/ oil fouling

Low ← Level of Tuning → High

■ The heat range will change with the seasons.

When the air temperature is high, as in the summer, the inlet air temperature becomes higher, increasing the load on the engine. In times like this, it's better to choose a plug with a higher heat range.

■ The more horsepower is increased, the higher the required heat range.

If the horsepower has been increased through tuning, the increase in explosive power leads to an increase in combustion chamber temperature, making pre-ignition more likely; in such cases it is necessary to choose a plug with a higher heat range and a higher level of heat resistance.

Glossary of spark plug terms

What is a spark plug's heat range ?

Spark plug heat dispersal

The degree to which a spark plug disperses the heat it receives is called its "heat range". Spark plugs with a high degree of heat dispersal are called high heat range (cold type) and those with a low degree of heat dispersal are called low heat range (hot type).

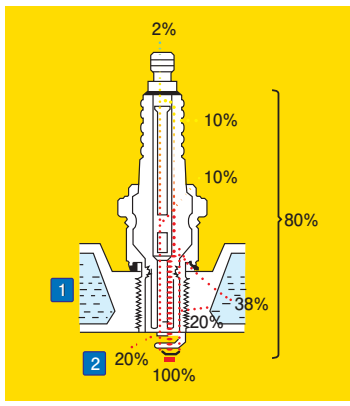

This is largely determined by the temperature of the gas inside the combustion chamber and the spark plug design.

The relationship between the spark plug temperature and vehicle speed and heat range

There are restrictions on the temperatures at which spark plugs can be used: the lower limit is the self-cleaning temperature and the upper limit is the pre-ignition temperature. A spark plug only functions completely when its center electrode temperature is between these temperatures of about 500C and 950C.

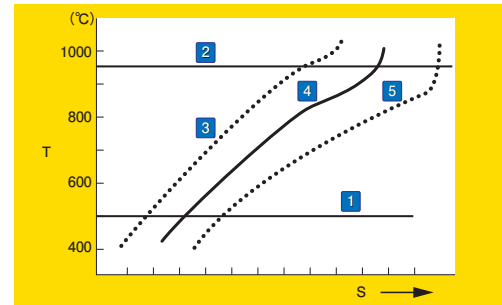

1 Self-cleaning temperature 2 Pre-ignition temperature
3 Low heat range (hot type) spark plugs 4 Standard spark plugs
5 High heat range (cold type) spark plugs
S: Vehicle speed T: Spark plug temperature (°C)

Low heat range and high heat range

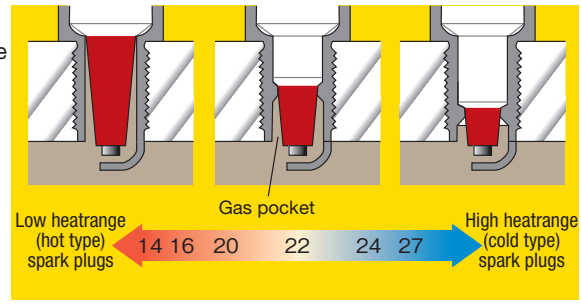

Low heat range plugs have long insulator leg sections and the surface area affected by the flame and the gas pocket capacity are large. Also, since the heat release path from the insulator leg section to the housing is long, heat dispersal is low and the temperature of the center electrode rises easily. On the other hand, high heat range plugs have short insulator legs and the surface area affected by the flame and the gas pocket capacity are small. Also since the heat release path from the insulator leg section to the housing is short, heat dispersal is high and the temperature of the center electrode does not rise easily.





BASIC INFORMATION FOR PLUG (2)

04

Failure Modes of Spark Plugs

Condition	Normal	Carbon fouling	Oil fouling
Appearance			
	When using unleaded gasoline, the base of the insulator often becomes white or gray. The electrode may become slightly burned. When using leaded gasoline, the base of the insulator becomes light brown.	Dried carbon is deposited, covering the insulation base and electrode area.	The base of the insulator and electrode become shiny black, covered with oil or gasoline.
Engine	The engine runs in excellent condition when starting or driving, both at high or low speeds.	Engine startability worsens and "misses" at low speeds. If not corrected, the engine may die often and have poor acceleration. (Nearly 90% of engine trouble from spark plugs is caused by carbon fouling or oil fouling.)	Engine startability worsens and "misses" at low speeds. If not corrected, the engine may die often and have poor acceleration. (Nearly 90% of engine trouble from spark plugs is caused by carbon fouling or oil fouling.)
Causes		<ol style="list-style-type: none"> 1. Inappropriate thermal value 2. Engine idling for a long time, or driving in low temperatures 3. Rich air-fuel mixture 4. Clogged air filter 5. Delay in ignition timing 	<ol style="list-style-type: none"> 1. Oil leakage into the combustion chamber due to frictional wear of the piston rings, valve guides, or cylinder wall. 2. Rich air-fuel mixture
Solve the problem		<ol style="list-style-type: none"> 1 or 2: Use a spark plug with a thermal value that is one level lower, or adjust engine idling 3 to 5: Perform complete readjustment and tune-up 	<ol style="list-style-type: none"> 1. Spark plugs may become wet until the oil flow control becomes normal during pre-conditioning runs with a new engine or an engine immediately after an overhaul. In such cases, simply clean the plug and reinstall it. In other cases, the engine basically requires a complete overhaul. 2. Adjust the carburetor.

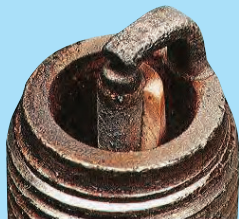
Condition	Overheating	Pre-ignition	Insulator breakage
Appearance			
	The base of the insulator will be burned and become bleach white from the heat. The electrode will also be burned and become white or dark purple. Electrodes will wear out soon.	The electrode will be melted. In extreme cases, the base of the insulator is also melted.	The base of the insulator has a vertical crack. The appearance of the spark plug is similar to problems with overheating or lead fouling.
Engine	Engine horsepower decreases and speed falls when running continuously at high speeds, driving for a long time uphill, or pulling too great a load.	This is caused by overheating. Temperatures in the combustion chamber increase rapidly, destroying not only the spark plug, but the piston head also.	Engine horsepower decreases and speed falls when running continuously at high speeds, driving for a long time uphill, or pulling too great a load.
Causes	<ol style="list-style-type: none"> 1. Inappropriate thermal value of plug 2. Use of low octane gasoline 3. Ignition timing set too early 4. Inappropriate cooling 5. Poor air-fuel mixture 	<ol style="list-style-type: none"> 1. Inappropriate thermal value of plug 2. Use of low octane gasoline 3. Ignition timing set too early 4. Inappropriate cooling 5. Poor air-fuel mixture 	<ol style="list-style-type: none"> 1. Inappropriate thermal value of plug 2. Ignition timing set too early 3. Inappropriate cooling 4. Poor air-fuel mixture
Solve the problem	<ol style="list-style-type: none"> 1. Use a spark plug with a higher thermal value 2. Use higher octane gasoline 3. Adjust the ignition timing 4. Check the cooling system 5. Adjust the carburetor 	<ol style="list-style-type: none"> 1. Use a spark plug with a higher thermal value 2. Use higher octane gasoline 3. Adjust the ignition timing 4. Check the cooling system 5. Adjust the carburetor 	<ol style="list-style-type: none"> 1. Use a spark plug with a higher thermal value 2. Adjust the ignition timing 3. Check the cooling system 4. Adjust the carburetor

The plugs configuration

$\phi 12 \times L26.5 \times \bigcirc 14$
 Thread diameter \times length \times Hex size

Iridium plug

Super ignition, $\phi 12$ long-reach shroud iridium plug

EX. FXE20HE11



- Super Ignition Plug
- The needle-shaped ground electrode of this revolutionary iridium plug features DENSO's own exclusive technology, resulting in an unparalleled reduction of quenching effect.
- Equipped as original parts on Nissan's TIDA and NOTE
- $\phi 12 \times L26.5 \times \bigcirc 14$
- NISSAN

Iridium plug

Super ignition, long-reach iridium plug

EX. FK20HR11



- Super Ignition Plug
- By pairing an ultra-fine 0.55 mm diameter iridium alloy tip on the center electrode with a platinum tip on the ground electrode, this iridium plug will realize a very long lifetime.
- Equipped on Toyota's SIENTA and CROWN as genuine parts since 2003.
- $\phi 14 \times L26.5 \times \bigcirc 16$
- TOYOTA

Iridium plug

Super ignition, iridium plug

EX. FK16R11 · FK16PR11



- Super Ignition Plug
- $\phi 14 \times L19 \times \bigcirc 16$
- TOYOTA
- MAZDA

Iridium plug

Long-reach iridium plug

EX. SK16HR11 · SK20HPR-L11



- $\phi 14 \times L26.5 \times \bigcirc 16$
- Honda / Toyota

Iridium plug

New triple-electrode iridium plug

EX. SK20BR11 · SK20BGR11



- Under normal operating conditions the main electrode sparks, but if it becomes fouled, side electrodes generate the spark to burn off any carbon - this plug is the optimum design for direct fuel-injection engines. Equipped as original parts for 3000 cc direct injection engines (D-4) on TOYOTA's CROWN and other models.
- $\phi 14 \times L19 \times \bigcirc 16$
- TOYOTA

Iridium plug

Iridium plug

EX. SK20R11 · SK16R-P11 · SK20PR-A11 · SK20PR-B11 · SK16PR-E11 · SK20PR-F8 · SKJ16CR-L11 · SKJ16CR-A8



- We developed a 0.7 mm diameter ultra-fine iridium alloy electrode, the first in the world. Ignitability and lifetime have dramatically improved. The SK16R-P11 is equipped as original parts on TOYOTA's CENTURY.
- $\phi 14 \times L19 \times \bigcirc 16$
- TOYOTA / HONDA / MAZDA / MITSUBISHI / HYUNDAI / SUZUKI

Iridium plug

Iridium plug with stainless steel gasket

EX. SK22PR-M11S · SK20PR-L9S



- $\phi 14 \times L19 \times \bigcirc 16$
- HONDA

Iridium plug

Extended shroud iridium plug

EX. SKJ20DR-M11S · SKJ20DR-M11



- $\phi 14 \times L20.5 \times \bigcirc 16$
- HONDA
- SKJ20DR-M11S with stainless steel gasket

Iridium plug

$\phi 12$ long-reach iridium plug

EX. SXU22HR9 · SXU22HDR8 · SXU16HPR9



- $\phi 12 \times L26.5 \times \bigcirc 16$
- DAIHATSU / ISUZU / MITSUBISHI

Iridium plug

$\phi 12$ long-reach iridium plug

EX. ZXE20HR13



- By joining an ultra-fine 0.55 mm diameter iridium alloy tip on center electrode and platinum tip on ground electrode, this iridium plug has realized a very long lifetime.
- $\phi 12 \times L26.5 \times \bigcirc 14$
- NISSAN

Iridium plug

$\phi 0.4$ iridium plug with platinum tip ground electrode

EX. SVK20RZ11 · SVK20RZ8 · VK16PR-Z11 · VK20PR-Z11 · VK22PR-Z11 · VK24PR-Z11 · VK27PR-Z11



- $\phi 14 \times L19 \times \bigcirc 16$
- DAIHATSU / MITSUBISHI / HONDA

Iridium plug

$\phi 0.4$ iridium plug with platinum tip ground electrode

EX. VNH27Z · VNH24Z



- $\phi 10 \times L(6.3 + 12.7) \times \bigcirc 16$
- Honda Motorcycles

Iridium plug

$\phi 0.4$ iridium plug with platinum tip ground electrode

EX. VUH27D · VUH27ES · VUH24D



- $\phi 10 \times L(6.3 + 12.7) \times \bigcirc 16$
- Honda Motorcycles
- VUH27ES with stainless steel gasket

Iridium plug

$\phi 0.4$ iridium plug

EX. IXU22C



- $\phi 12 \times L19 \times \bigcirc 16$
- SUZUKI

Iridium plug

$\phi 0.4$ iridium plug

EX. IUH27D · IUH24D



- Supplied 0.4 mm diameter iridium plugs to Honda Motorcycles for the first time in the world.
- $\phi 10 \times L(6.3 + 12.7) \times \bigcirc 14$
- HONDA Motorcycles CBR900RR

Iridium plug

$\phi 0.4$ iridium plug

EX. IU27D



- $\phi 10 \times L19 \times \bigcirc 16$
- YAMAHA Motorcycles YZFR-1
- SUZUKI GSX1300R B-KING

Platinum plug

Platinum plug

EX. PK20R11

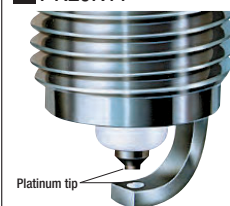

- Platinum is used for both the center and ground electrodes.
- Mileage, drivability, and durability are improved by using a finer center electrode with a platinum tip.
- $\phi 14 \times L19 \times \bigcirc 16$
- TOYOTA / DAIHATSU

Platinum plug

Double-electrode platinum plug

EX. PK20TR11 · PK20PTR-S9

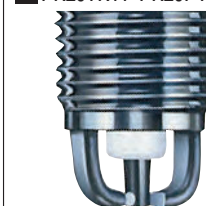

- Platinum tip is mounted on both the center and ground electrodes.
- The double-electrode structure reduces the voltage required for positive discharges.
- $\phi 14 \times L19 \times \bigcirc 16$
- TOYOTA / DAIHATSU

Cars & trucks plugs

Long-reach plug

EX. K20HR-U11 · K16HPR-U11



- $\phi 14 \times L26.5 \times \bigcirc 16$
- TOYOTA

DENSO

AUSTRALIA CHINA INDIA INDONESIA KOREA MALAYSIA PHILIPPINES SAUDIARABIA SINGAPORE TAIWAN THAILAND VIETNAM JAPAN & USA EUROPE MOTOR SMALL CROSS PART ENGINE REFERENCE NUMBER

Cars & trucks plugs
ISO-compatible small hex plug
 EX. K16R-U11 · K16PR-U11

- Compatible with ISO standards
 *SKJ20DR-M11S with stainless steel gasket
- φ14 × L19 × Ø16
- TOYOTA, and others

ISO TYPE

Cars & trucks plugs
Small hex plug
 EX. Q16R-U11 · Q16PR-U11

- By reducing the hex size (16 mm), this plug is lighter in weight.
- φ14 × L19 × Ø16
- TOYOTA, and others

Cars & trucks plugs
Extended shroud plug
 EX. KJ20DR-M11 · KJ20DR-M11S

- φ14 × L19 × Ø16
- HONDA

Cars & trucks plugs
Extended plug
 EX. KJ20CR11 · KJ16CR-U11

- KJ20CR11: no U-Groove
 KJ20CR-U: with U-Groove
- φ14 × L19 × Ø16
- MAZDA, MITSUBISHI

Cars & trucks plugs
Extended plug
 EX. KJ20CR-L11

- The tip of the ground electrode has a taper-cut, and the center electrode is made finer for improved ignitability.
- φ14 × L19 × Ø16
- HONDA

Cars & trucks plugs
Double-electrode semi-surface plug
 EX. W20ETR-S11

- With this new supplementary gap, resistance to fouling is improved.
- φ14 × L19 × Ø20.6
- TOYOTA, DAIHATSU

Cars & trucks plugs
Triple-electrode plug
 EX. K22PB · W20EPB

- Durability is improved with three ground electrodes.
- φ14 × L19 × Ø16 (K22PB)
- AUDI / VW / CITROEN / FIAT / MERCEDES-BENZ / RENAULT

Cars & trucks plugs
φ12 long-reach plug
 EX. XU22HR9

- φ12 × L26.5 × Ø16
- DAIHATSU

Cars & trucks plugs
φ12 plug
 EX. XU22EPR-U

- By reducing the hex size (16 mm), this plug may be used in light vehicles. Thread diameter is 12 mm.
- φ12 × L19 × Ø16
- SUZUKI / MITSUBISHI

Cars & trucks plugs
φ12 long-reach plug with 14 mm hex size
 EX. XE20HR-U9

- φ12 × L26.5 × Ø14
- RENAULT

Cars & trucks plugs
Taper seat plug
 EX. T16EPR-U

- This plug may be installed only in non-Japanese cars and has no gasket.
- φ14 × L17.5 × Ø16
- GM, Ford

Motorcycle plugs
Compact head plug
 EX. W27EMR-C

- Plug with compact insulator head
- φ14 × L19 × Ø20.6
- HONDA / SUZUKI

Motorcycle plugs
φ12 shroud plug
 EX. X24GP-U

- φ12 × L (19 + 3) × Ø18
- HONDA

Motorcycle plugs
φ12 × 19 mm plug
 EX. X24EPR-U

- φ12 × L19 × Ø18
- HONDA / SUZUKI / YAMAHA

Motorcycle plugs
φ10 plug with half-sized threads and stainless steel gasket
 EX. U24FER9S

- φ10 × L (6.3 + 12.7) × Ø16
- HONDA

Motorcycle plugs
φ10 plug with half-sized threads
 EX. U27FER9

- With its wider spark gap of 0.9 mm compared to conventional plugs (0.6 to 0.7 mm), this plug has improved ignitability.
- φ10 × L (6.3 + 12.7) × Ø16
- HONDA

Motorcycle plugs
φ10 double-electrode plug
 EX. U31ETR

- With two ground electrodes, heat resistance is improved.
- φ10 × L19 × Ø16
- KAWASAKI / SUZUKI

Motorcycle plugs
φ10 × 19 mm plug
 EX. U27ESR-N

- Increasing the projection length by 0.5 mm improves resistance to fouling.
- φ10 × L19 × Ø16
- YAMAHA / KAWASAKI / SUZUKI

Motorcycle plugs
φ10 × 12.7 mm plug
 EX. U20FSR-U

- φ10 × L12.7 × Ø16
- HONDA / YAMAHA / SUZUKI

Motorcycle plugs
φ8 plug
 EX. Y27FER-C

- φ8 × L (6.3 + 12.7) × Ø13
- HONDA



WARNING!

Counterfeit auto parts are illegal!

¡Falsificar las piezas de automóviles es un acto ilegal!

伪造汽车零部件是违法的!

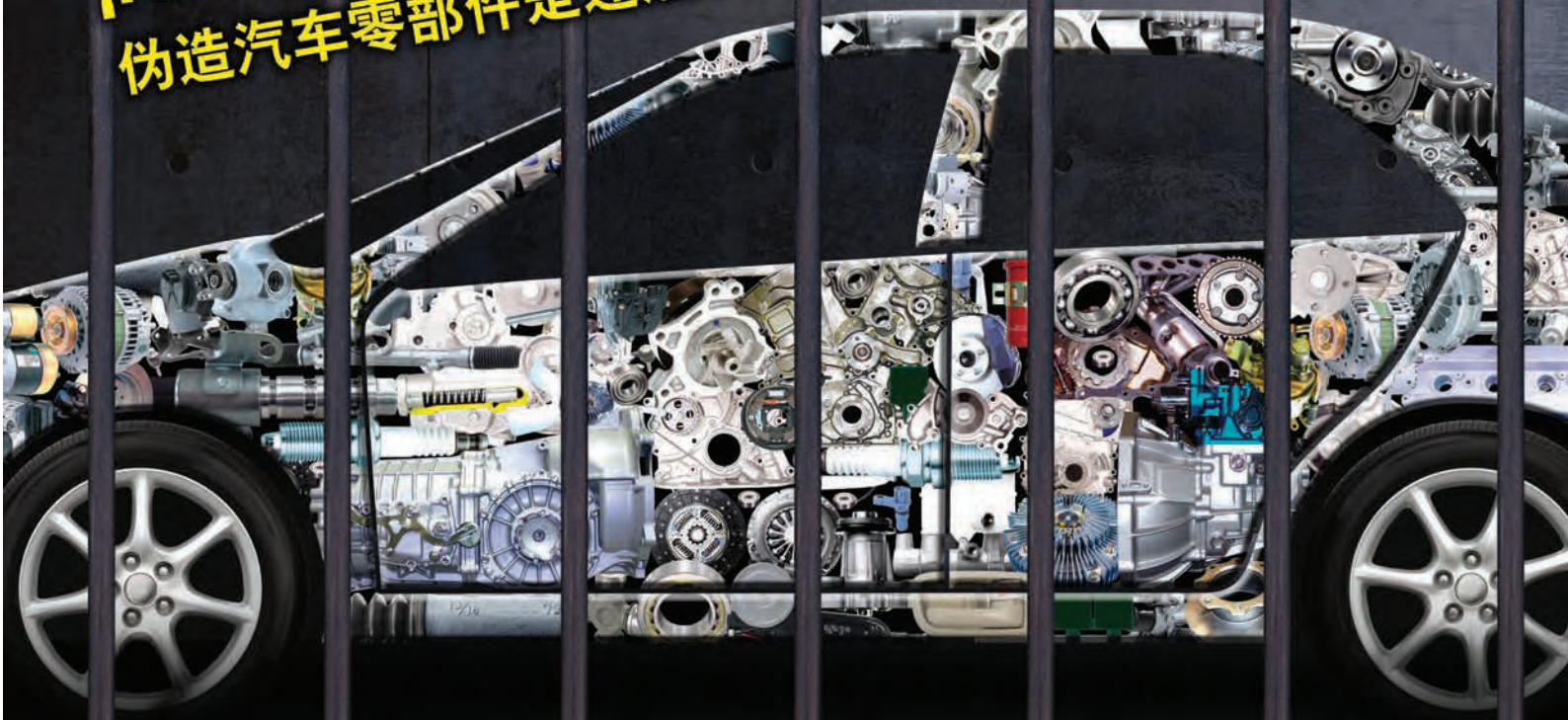

JAPIA

Japan Auto Parts Industries Association

If you find any counterfeit parts, please contact us at "info@japia.or.jp"





Comparison Between Genuine DENSO and Fake Spark Plugs

Comparison of DENSO and Fake

Appearance

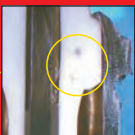

DENSO	Fake	
		Terminal Terminal has a glossy finish.
		Markings Printed wording can be scraped off.
		Housing Poor surface finish.
		Screws & Electrode Poor thread quality and finish.

Section

DENSO	Fake	
		Ceramic Insulator Poorly manufactured ceramic insulator with visible air bubbles trapped within which affect heat dissipation capability.
		Center Electrode A genuine DENSO spark plug has a copper-core center electrode with excellent heat conductivity. A fake DENSO spark plug does not, retaining heat that causes meltdown.



Problems Caused by Fake Spark Plugs

Problem 1
Fuel economy is diminished.



Inconsistent sparking causes incomplete combustion. Unburned fuel forms a black sooty deposit on the spark plug, eventually leading to poor fuel economy and poor start up of the engine.

Problem 2
Engine power drops on uphill roads and highways.

Poor heat dissipation due to the lack of a copper-core center electrode causes pre-ignition. As a result, engine power drops under highway driving or uphill driving conditions.

Problem 3
The plug melts down.

Continued usage of an overheated plug will damage the electrodes.

Why Power Drops and Melting Occurs

DENSO

DENSO plug contains copper core

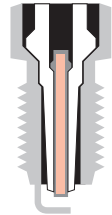
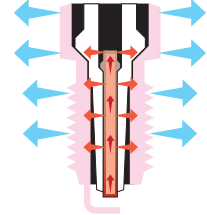
Quick heat dissipation.
Copper is an excellent heat conductor. High temperature heat is quickly dissipated away from the center-electrode to prevent melt down.

Fake

Fake plug is iron only

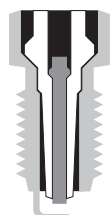
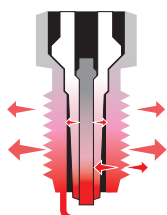
Slow heat dissipation.
Absence of a copper-core center electrode results in poor heat dissipation capability. Prolonged use causes power loss due to excessive heat buildup. This results in melt down of the ground electrode, eventually leading to serious engine damage.

Finally ...



Melt down

TT REVOLUTION

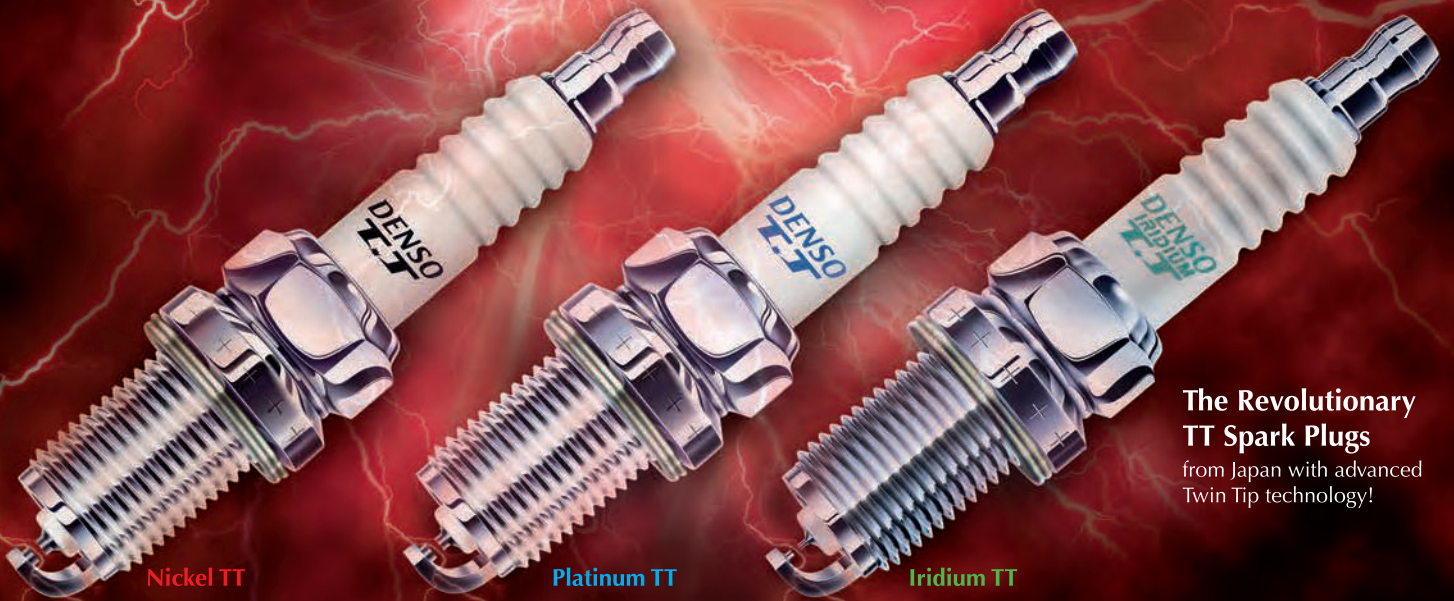

The Revolutionary
TT Spark Plugs
from Japan with advanced
Twin Tip technology!

Nickel TT

Platinum TT

Iridium TT

SPARK UP with the Twin Tip Range.

These spark plugs feature a 'twin tip' – a thin centre and a protruding ground electrode – to give you more sparks and enhanced ignitability! With an overall increased performance at a lower cost, experience a smooth and superior ride anytime, anywhere.

How Twin Tip Works

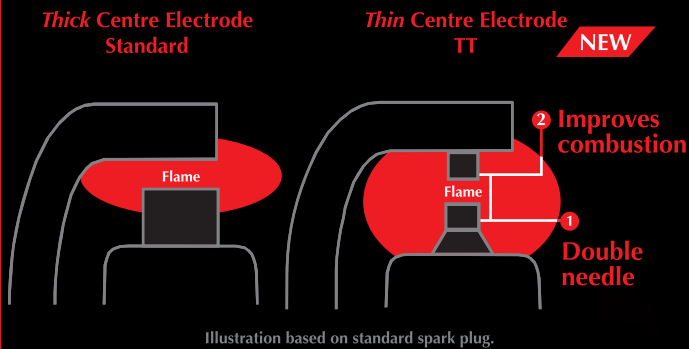

Benefits of Twin Tip

	Nickel TT		
	Platinum TT		
	Iridium TT		

DENSO

www.denso.com.sg

REVOLUTION

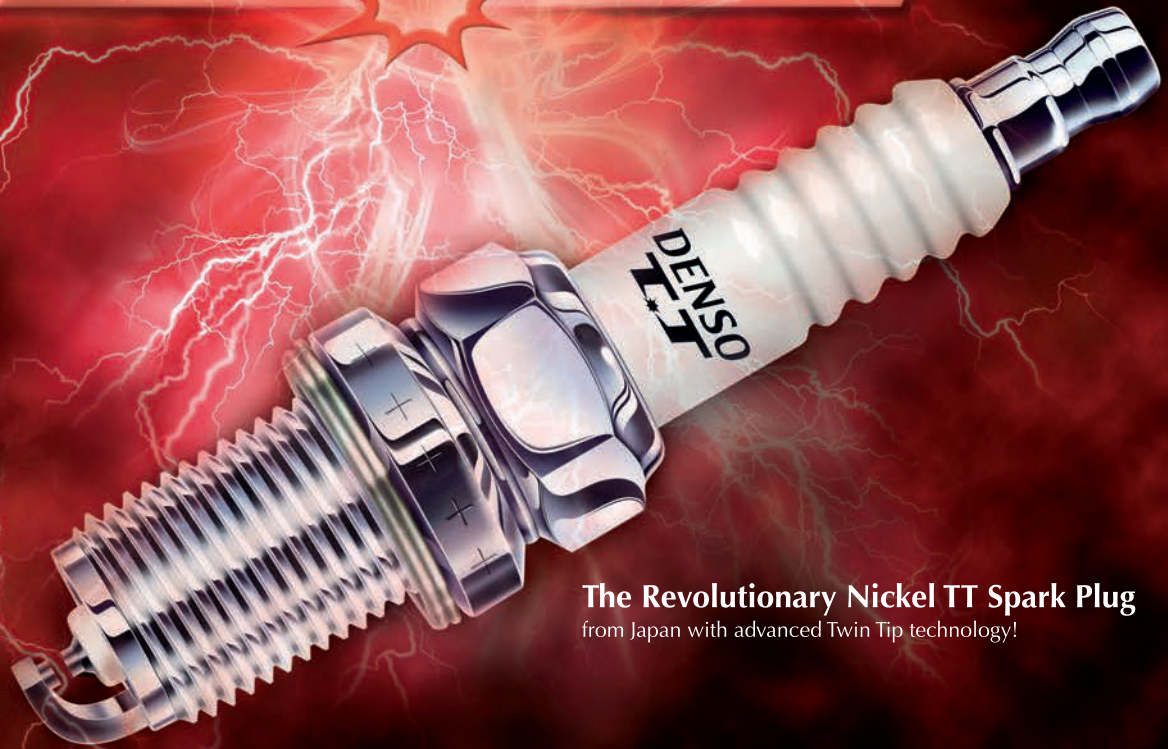

The Revolutionary Nickel TT Spark Plug
from Japan with advanced Twin Tip technology!

SPARK UP. More Savings.

This spark plug features a 'twin tip' – a thin centre and a protruding ground electrode both 1.5mm in diameter – which enhances the ignitability of your car. The faster you start your car, the more petrol you save!

With better performance at a lower cost, experience a smooth and superior ride anytime, anywhere.

How Twin Tip Works

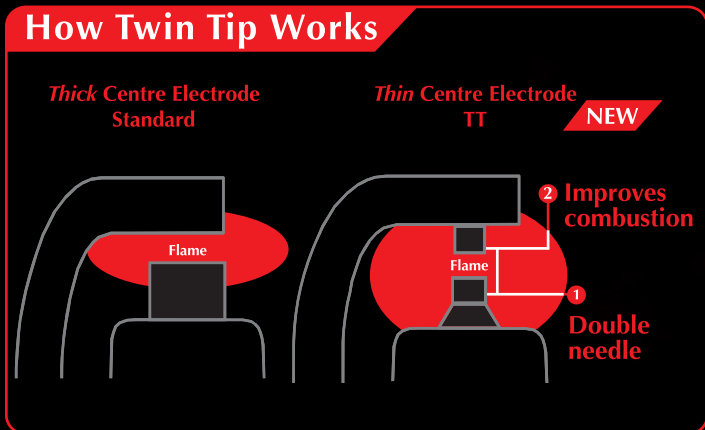

Benefits of Twin Tip



Twin Tip Technology



DENSO

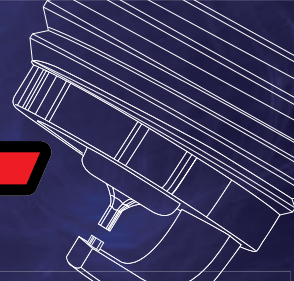

Recommended for anyone who wants a better Nickel spark plug



- 1 Boosting flying sparks and ignitability
 - Thin center electrode (1.5mm)
 - Double Needle structure (a first with nickel)
 - Utilizes nickel alloy featuring new materials
- 2 Model consolidation : Model 290 → Model 16

High ignitability nickel plug impact of thin diameter on both sides of electrode

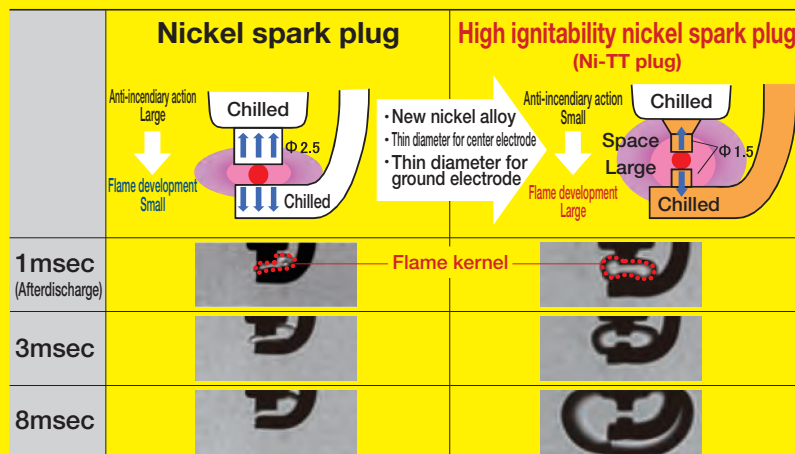

A new nickel alloy achieves thin diameter on both sides of the electrode, improving combustion by boosting flame development

Reasons why the Ni-TT plug can cover for other Nickel plugs

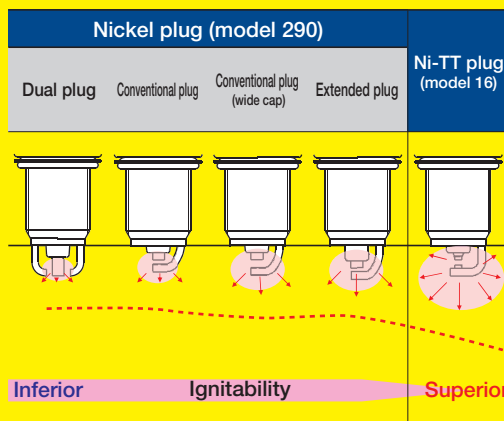

The Ni-TT plug can cover for other standard plugs thanks to its superior ignitability (flame kernel spreads easily).

Improves speed and output

1.1% improvement in torque boosts horsepower by 1.1*1

Improving engine torque means greater dynamism! Facilitates smooth driving even when subjected to a load--such as people or baggage--on top.

Vehicle: 1.5L, four-cylinder Rotation frequency: 3,500rpm (70km/h)

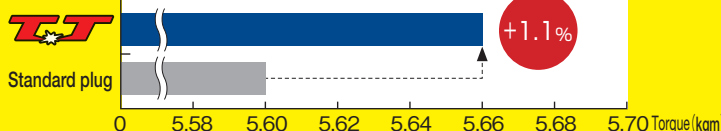

*1Horsepower calculation equation: horsepower=torque X rotation frequency x 0.001396

*All data is provided by DENSO. All references to standard plugs refer to DENSO products.

Improved fuel efficiency

Improves fuel efficiency by 1.2% ! The more you drive, the more economical it is!

Fuel efficiency is boosted by reliable ignitability. Fuel consumption is lowered, and the vehicle can run longer on the same amount of fuel.

Vehicle: 1.5L, 4-cylinder Driving conditions: 10·15 mode

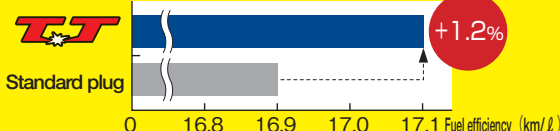

* All data indicated is provided by DENSO. All references to standard plugs refer to DENSO products

Travel distance

Conditions Fuel efficiency is improved by 1.2% by switching to the TT (10,000 km driving/year, fuel efficiency of 16.9 km/ℓ)

【 Conventional plug 】 10,000km÷16.9km= Approximately 591.7 ℓ

【 TT 】 10,000km÷17.1km= Approximately 584.7 ℓ

7-liter difference over 10,000 km, translating to an additional 120 km of travel distance

TYPE	DIA (mm)	REACH (mm)	HEX (mm)	GAP	PROJECTION (mm)	SPARK POSITION (mm)	TERMINAL SHAPE	RESISTOR (kΩ)	TT PLUG DENSO P/N
K16TT	14	19	16	1.0	1.5	3	S	5	267700-7431
K20TT	14	19	16	1.0	1.5	3	S	5	267700-7441
KH16TT	12	26.5	16	1.0	1.5	3	S	5	267700-7451
KH20TT	12	26.5	16	1.0	1.5	3	S	5	267700-7460
Q16TT	14	19	16	1.0	1.5	3	S	5	267700-7471
Q20TT	14	19	16	1.0	1.5	3	S	5	267700-7481
W16TT	14	19	20.6	0.8	1.5	3	RC	5	267700-6301
W20TT	14	19	20.6	0.8	1.5	3	RC	5	267700-6311
W22TT	14	19	20.6	0.8	1.5	3	RC	5	267700-7510
WF20TT	14	12.7	20.6	0.8	1.5	3	RC	5	267700-7500
T16TT	14	17.5	16	1.0	1.5	3	S	5	267700-7820
T20TT	14	17.5	16	1.0	1.5	3	S	5	267700-7830
TV16TT	14	25	16	1.0	1.5	3	S	5	267700-7490
XU22TT	12	19	16	0.8	1.3	2.8	S	5	267700-7080
XUH22TT	12	26.5	16	0.8	1.5	3	S	5	267700-7090
XUH20TTI	12	26.5	16	0.8	1.5	4	S	5	267700-8290

TT REVOLUTION



The Revolutionary Platinum TT Spark Plug from Japan with advanced Twin Tip technology!

SPARK UP. Xtra Boost.

This spark plug features a 'twin tip' – a thin centre and a protruding ground electrode both 1.1mm in diameter – which enhances your engine's efficiency and extends the spark plug's shelf life.

With improved performance at a lower cost, experience a smooth and superior ride anytime, anywhere.

How Twin Tip Works

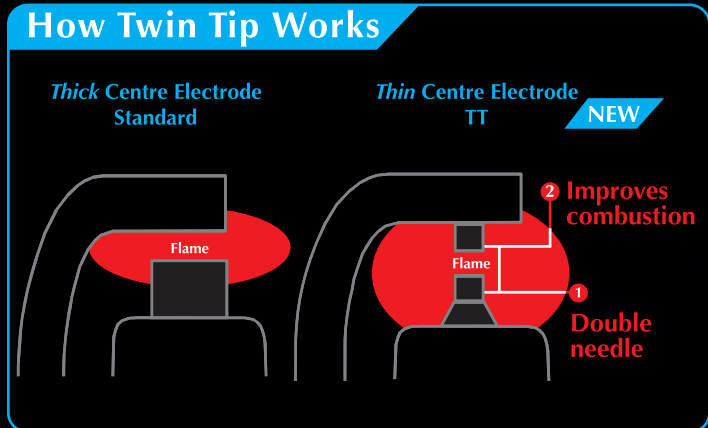

Benefits of Twin Tip



Twin Tip Technology

- Fuel Savings
- Enhanced Speed
- Engine Efficiency
- km **888888** Xtra Mileage



PLATINUM TT



Better Ignitability and Fuel Consumption with Platinum and TT Technology.

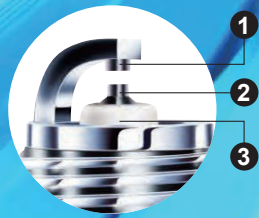

- 1 DENSO Unique "Twin-Tip" Structure
- 2 1.1mm platinum center electrode
- 3 360 Laser welding

High Ignitability Platinum Plug

Conventional Nickel Plug

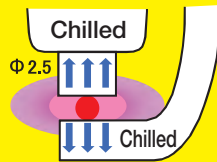

Reduced quenching results in larger flame

Thinner center electrode with Platinum

Platinum TT

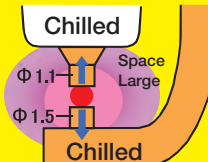

Faster flame propagation for more complete combustion

DENSO's revolutionary Twin-Tip design is a combination of highly durable precious metals-Platinum and Titanium. The center electrode is created using an extremely durable platinum alloy that allows for the reduction of the tip size to 1.1mm in diameter, while maintaining the life of the plug. The Titanium-enhanced alloy on the ground electrode also increases durability, which is critical to minimize tip erosion and achieve the new Twin-Tip design.

Better Ignitability

(A method)
 Engine :1.8L 4cyl(1ZZ-FE)
 engine speed:700rpm
 L.M.L :Lean misfire Limit
 COV :coefficient of variation
 Judgement of L.M.L :COV of combustion pressure exceed 25%

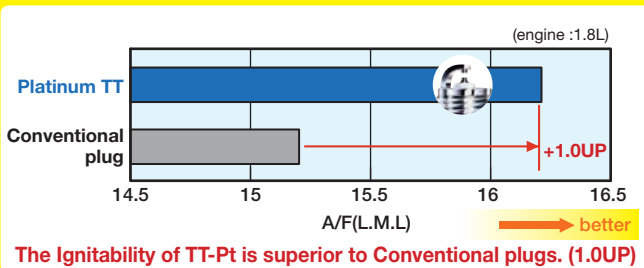

Better Fuel Consumption

Platinum TT is superior to Conventional plugs by 1.5%

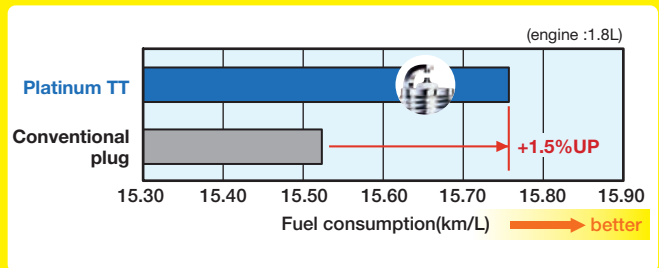

Superior ignitability of the DENSO Platinum TT means more efficient combustion, which yields better engine performance in terms of power and fuel economy. Better mileage, more power, and faster starts, all while reducing carbon emissions are what places the platinum TT heads above the competition. Top performance, total value.



Specifications

Type	DIA (mm)	REACH (mm)	HEX (mm)	GAP (mm)	PROJECTION (mm)	SPARK POSITION (mm)	GROUND ELECTRODE HEIGHT (mm)	TERMINAL SHAPE	RESISTOR (kΩ)	No.	DENSO P/N
PK16TT	14	19	16	1	1.5	3	6.3	Solid	5	PT03	267700-6320
PK20TT	14	19	16	1	1.5	3	6.3	Solid	5	PT04	267700-6330
PK22TT	14	19	16	1	1.5	3	6.3	Solid	5	PT14	267700-7790
PKH16TT	14	26.5	16	1	1.5	3	6.3	Solid	5	PT05	267700-6340
PKH20TT	14	26.5	16	1	1.5	3	6.3	Solid	5	PT06	267700-6350
PQ16TT	14	19	16	1	1.5	3	6.3	Solid	5	PT07	267700-6360
PQ20TT	14	19	16	1	1.5	3	6.3	Solid	5	PT08	267700-6370
PW16TT	14	19	20.6	1	1.5	3	6.3	Solid	5	PT01	267700-6380
PW20TT	14	19	20.6	1	1.5	3	6.3	Solid	5	PT02	267700-6390
PT16TT	14	17.5	16	1	1.5	3	6.3	Solid	5	PT11	267700-7200
PT20TT	14	17.5	16	1	1.5	3	6.3	Solid	5	PT12	267700-7210
PTF16TT	14	11.2	16	1	1.5	3	6.3	Solid	5	PT09	267700-7240
PTF20TT	14	11.2	16	1	1.5	3	6.3	Solid	5	PT10	267700-7250
PTV16TT	14	25	16	1	1.5	3	6.3	Solid	5	PT13	267700-7220



AUSTRALIA | CHINA | INDIA | INDONESIA | KOREA | MALAYSIA | PHILIPPINES | SAUDI ARABIA | SINGAPORE | TAIWAN | THAILAND | VIETNAM | JAPAN | EUROPE & USA | MOTOR CYCLE | SMALL ENGINE | CROSS PART REFERENCE NUMBER

REVOLUTION



The Revolutionary Iridium TT Spark Plug
from Japan with advanced Twin Tip technology!

SPARK UP. Full Throttle.

This spark plug features a 'twin tip' – a thin centre of 0.4mm and a protruding ground electrode of 0.7mm in diameter – which boosts your car's horsepower and torque.

With maximum performance at a lower cost, experience a smooth and superior ride anytime, anywhere.

How Twin Tip Works

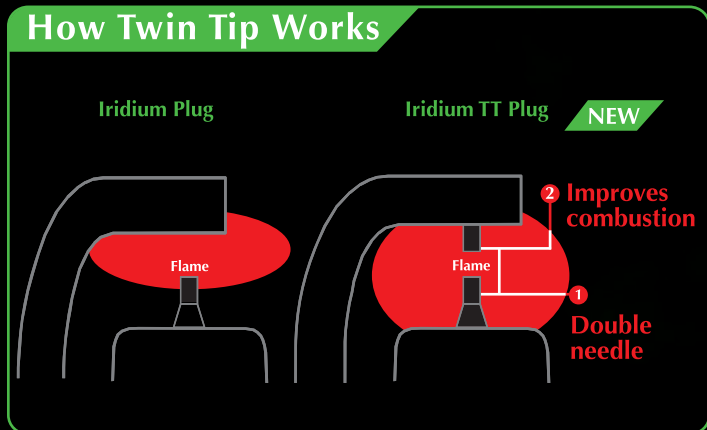

Benefits of Twin Tip



Twin Tip Technology

- Fuel Savings
- Enhanced Speed
- Engine Efficiency
- km **888888** Xtra Mileage



φ 0.4mm DOUBLE NEEDLE

IRIDIUM TT

**0.4mm Iridium,
only at DENSO!**



The world's finest diameter (as of March 2019)
0.4mm
with an iridium center electrode

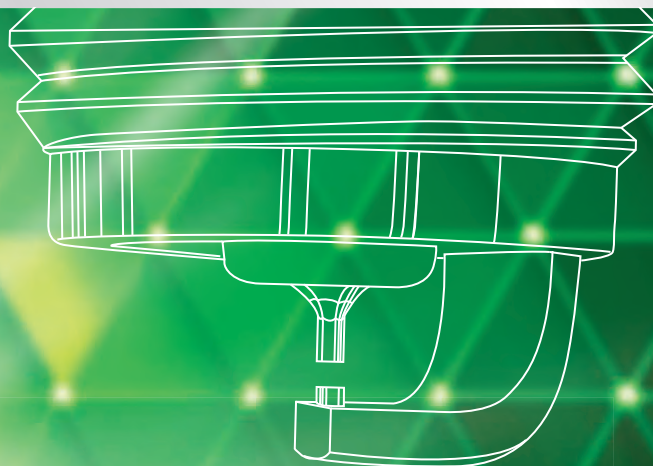

*The Finest TT plug
with improved Acceleration
Economical
and long lasting!*

**φ0.4 mm iridium alloy & φ0.7 mm platinum needle alloy
achieve high performance & high durability**



DENSO has started to sell IRIDIUM TT spark plugs having a φ0.4 mm iridium alloy center electrode and a 0.7 mm needle-type platinum alloy ground electrode.

The quenching effect has been decreased by forming the electrode into a double needle shape. As a result, the flame kernel rapidly develops and the engine's power is drawn out to its maximum potential.



Built-in, Highly Reliable Resistor

All specification types include an embedded, highly reliable, monolithic resistor to eliminate electromagnetic noise interference from all kinds of electronic devices.



360° Laser Welding

The iridium tip is mounted with an "All-around Laser Welding" method that insures high reliability and durability even under the most severe driving conditions.

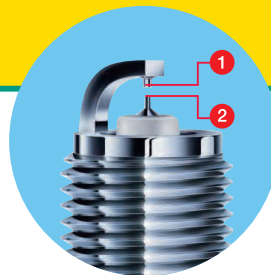

1 φ0.7mm Needle-Shaped Platinum Ground Electrode

In order to maximally prevent quenching effect, the ground electrode needs to be made as small as possible. Traditional ground electrodes could not be made too small without reducing grounding strength or increasing electrode wear. However, we've managed to attach a fine 0.7mm-diameter platinum electrode using a 360° laser welding technique.

2 φ0.4mm Ultra-fine Iridium Center Electrode

Using DENSO's exclusive iridium alloy having a very high melting point, the tip of the center electrode can be shaped very thin and fine, reducing spark voltage requirements and greatly improving ignitability.



DENSO
AUSTRALIA CHINA INDIA INDONESIA KOREA MALAYSIA PHILIPPINES SAUDI ARABIA SINGAPORE TAIWAN THAILAND VIETNAM JAPAN
EUROPE MOTOR SMALL CROSS PART
& USA CYCLE ENGINE REFERENCE NUMBER
21

Flame Growth

The photograph shows flame reflected by the variation in density. Fig. 1 shows the results of studying the influence of electrode shape on flame growth, using the Iridium Spark Plug and IRIDIUM TT.

The photographs indicate that, in the case of the Iridium Spark Plug, the size reduction of the gap (from 1.1 mm to 0.6 mm) interfered with flame growth, while in the case of IRIDIUM TT, flame growth was ample and greater than that of the Iridium Spark Plug in spite of the narrowed spark gap (0.6 mm). These observations show that, as the results of the ignition/firing simulation indicated, a fine ground electrode can reduce required voltage because it enables the spark gap to be narrower, while realizing higher ignitability than the Iridium Spark Plug.

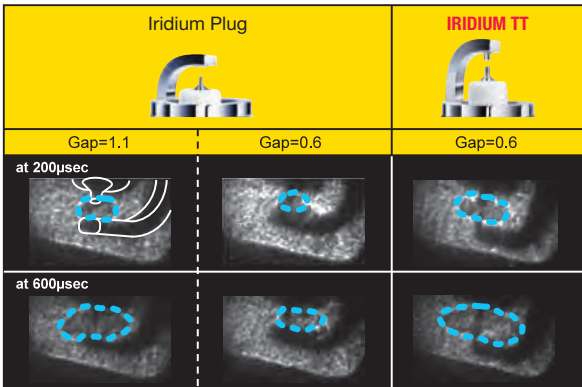

Fig.1 Electrode Shape's Effect to Flame Growth

Higher Ignitability

Fig. 3 shows the results of evaluating how the miniaturized-portion protrusion direction may influence the ignitability of an engine. The evaluation checked idle speed at equal throttle opening with the ISC (idle speed control) turned off. A higher idle speed represents higher ignitability. This figure shows the results of evaluating IRIDIUM TT. This figure shows that IRIDIUM TT are superior to the Iridium Spark Plugs in ignitability.

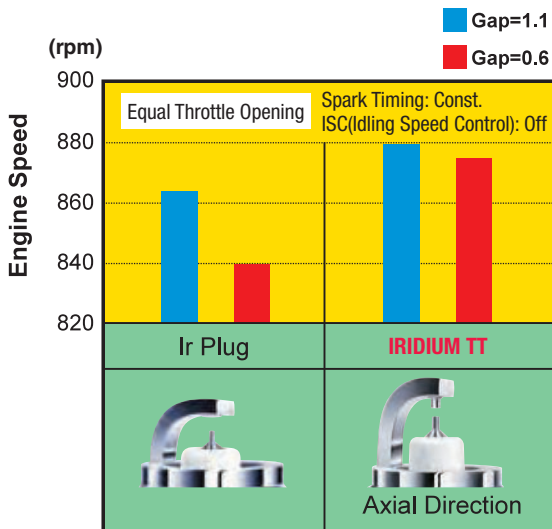

Fig.3 Influence of Miniaturized-Portion Protrusion to Ignitability

Advantages of Fine Ground Electrodes

To lower the required voltage and improve firing performance. The most advanced technology in the world has been employed to enable use of electrode, at 0.4 mm in diameter, in the IRIDIUM TT.

The smaller the electrode the more concentrated the electric potential at the tip of the electrode and the stronger the electric field that affects required voltage and the lower the required voltage. As a result, combustion is good for all types of driving, the engine starts easily, and acceleration improves.

The above shows the strength of electrical field in case certain voltage changes on Iridium plug and IRIDIUM TT.

The more electrical field strength is getting high, the more it becomes easy to fire with low voltage.

*1 FEM(Finite Element Method analysis): General method to measure electrical field strength.

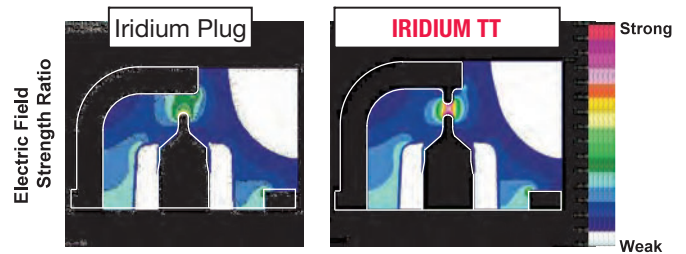

Fig.2 Electric Field Analysis (FEM)

Better fuel efficiency

Fig. 4 shows the results of the examination of combustion variation and fuel consumption, using a 1,800-cc, four-cylinder engine. The evaluation was conducted by turning on the ISC and setting the average engine speed to 800 rpm (idling). The previously specified Type-1 of the IRIDIUM TT was used in this examination. Pmi COV (coefficient of variation) in the diagram shows fluctuation in IMEP (indicated mean effective pressure). As this figure shows, IRIDIUM TT can reduce the Pmi COV approximately 3.1% and accordingly reduce fuel consumption by 2.4%, compared with the Iridium Spark Plug. These advantages are achieved because the miniaturization of the ground electrode enables better ignitability, improving combustion efficiency. Because the IRIDIUM TT is low in combustion variation and enables a reduction in idling speed, further improvement can be expected in fuel efficiency.

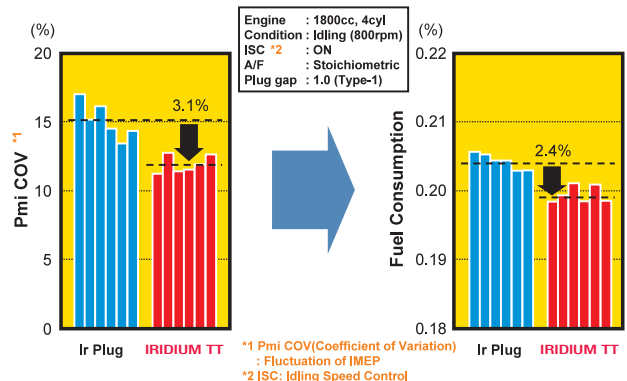
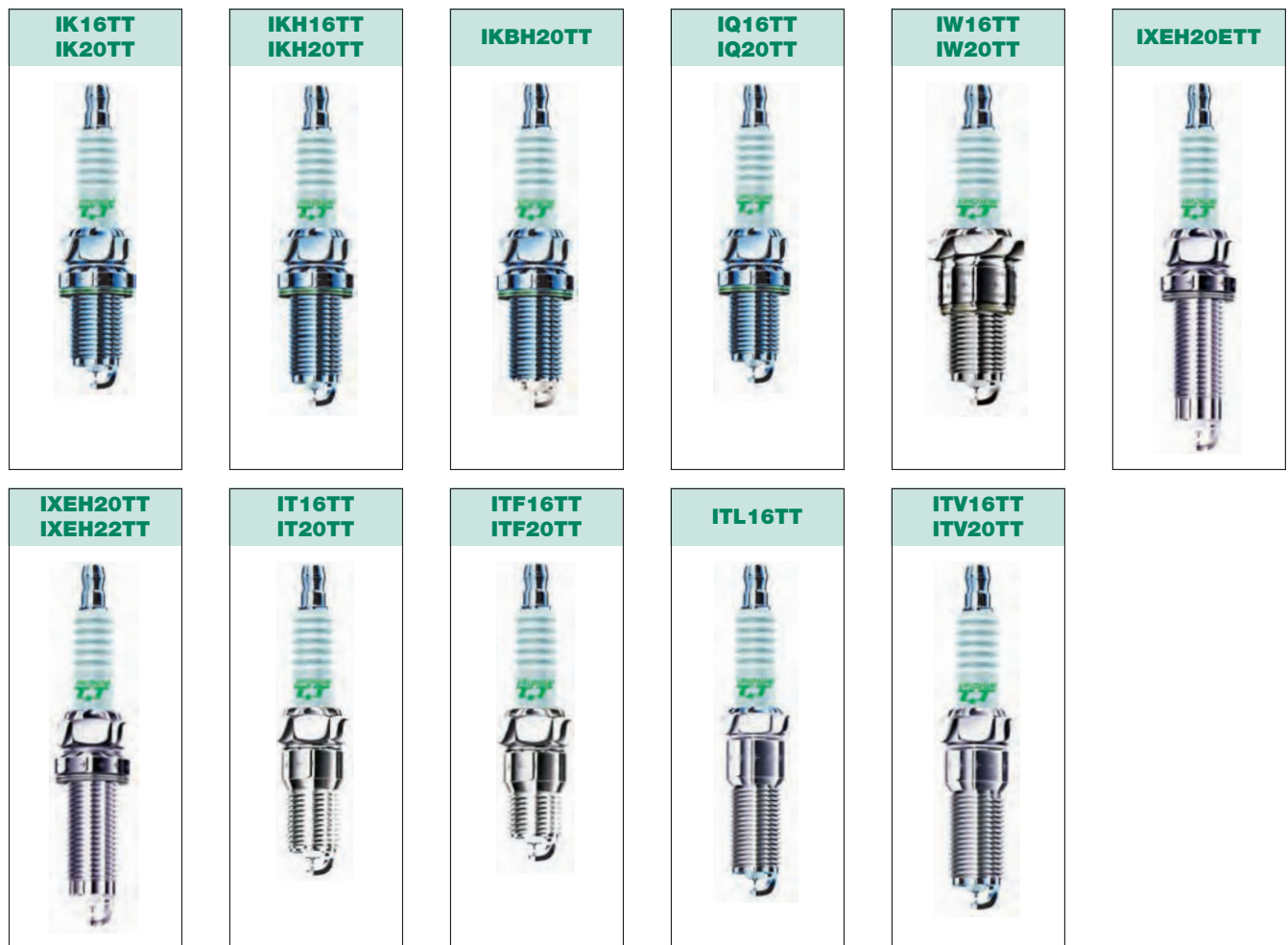

Fig.4 Better Fuel Efficiency

IRIDIUM **TT** Specifications

Type	Spec	DIA (mm)	REACH (mm)	HEX (mm)	GAP (mm)	PROJECTION (mm)	SPARK POSITION (mm)	GROUND ELECTRODE HEIGHT (mm)	TERMINAL SHAPE	RESISTOR (k.Ω)	No.	DENSO P/N
IK16TT	ISO	14	19	16	1	1.5	3	6.2	Solid	5	IT01	267700-8450
IK20TT	ISO	14	19	16	1	1.5	3	6.2	Solid	5	IT02	267700-8530
IKH16TT	ISO	14	26.5	16	1	1.5	3	6.2	Solid	5	IT03	267700-8460
IKH20TT	ISO	14	26.5	16	1	1.5	3	6.2	Solid	5	IT04	267700-8470
IKBH20TT	NEW 3 ELECTRODE	14	26.5	16	1	2.5	4	7.2	Solid	5	IT05	267700-8480
IQ16TT	JIS	14	19	16	1	1.5	3	6.2	Solid	5	IT06	267700-8190
IQ20TT	JIS	14	19	16	1	1.5	3	6.2	Solid	5	IT07	267700-8200
IW16TT		14	19	20.6	1	1.5	3	6.2	Solid	5	IT08	267700-8210
IW20TT		14	19	20.6	1	1.5	3	6.2	Solid	5	IT09	267700-8220
IXEH20ETT	SHROUD 2mm	12	26.5	14	1	2.5 (+shroud 2mm)	4 (+shroud 2mm)	7.1 (+shroud 2mm)	Solid	5	IT10	267700-8490
IXEH20TT		12	26.5	14	1	2.5	4	7.1	Solid	5	IT11	267700-8500
IXEH22TT		12	26.5	14	1	2.5	4	7.1	Solid	5	IT12	267700-8510
IT16TT	TAPER SEAT	14	17.5	16	1	1.5	3	6.2	Solid	5	IT13	267700-8230
IT20TT	TAPER SEAT	14	17.5	16	1	1.5	3	6.2	Solid	5	IT14	267700-8520
ITF16TT	TAPER SEAT	14	11.2	16	1	1.5	3	6.2	Solid	5	IT15	267700-8260
ITF20TT	TAPER SEAT	14	11.2	16	1	1.5	3	6.2	Solid	5	IT16	267700-8270
ITL16TT	TAPER SEAT (INSULATOR Length 56mm)	14	25	16	1	1.5	3	6.2	Solid	5	IT17	267700-8280
ITV16TT	TAPER SEAT (INSULATOR Length 50mm)	14	25	16	1	1.5	3	6.2	Solid	5	IT18	267700-8240
ITV20TT	TAPER SEAT (INSULATOR Length 50mm)	14	25	16	1	1.5	3	6.2	Solid	5	IT19	267700-8250









TT Cross Reference

EUROPE & USA | SMALL MOTOR ENGINE | CROSS REFERENCE NUMBER | PART NUMBER | JAPAN | VIETNAM | THAILAND | TAIWAN | SINGAPORE | SAUDI ARABIA | PHILIPPINES | MALAYSIA | KOREA | INDONESIA | INDIA | CHINA | AUSTRALIA

NGK Ni/Pt/Ir	NGK TYPE	TT	PLATINUM TT	IRIDIUM TT	DENSO
Ni	B5EB11	W16TT	PW16TT	IW16TT	W16EKR-S11
	B6EB	W20TT	PW20TT	IW20TT	W20EKR-S11
	B6EB11	W20TT	PW20TT	IW20TT	W20EKR-S11
	B6EB-L11	W20TT	PW20TT	IW20TT	W20EKR-S11
	B6EFS	T20TT	PT20TT	IT20TT	T20EP-U
	B7EB	W22TT	-	-	W22EKR-S11
	B7EB11	W22TT	-	-	W22EKR-S11
	BCP4ES	Q16TT	PQ16TT	IQ16TT	Q14R-U11
	BCP4ES11	Q16TT	PQ16TT	IQ16TT	Q14R-U11
	BCP5E	Q16TT	PQ16TT	IQ16TT	Q16P-U11
	BCP5E11	Q16TT	PQ16TT	IQ16TT	Q16P-U11
	BCP5ES	Q16TT	PQ16TT	IQ16TT	Q16-U
	BCP5ES11	Q16TT	PQ16TT	IQ16TT	Q16-U11
	BCP5ET	K20TT	PK20TT	IK20TT	K20PBR
	BCP5EY11	Q16TT	PQ16TT	IQ16TT	Q16-U11
	BCP6E	Q20TT	PQ20TT	IQ20TT	Q20P-U
	BCP6E11	Q20TT	PQ20TT	IQ20TT	Q20P-U11
	BCP6ES	Q20TT	PQ20TT	IQ20TT	Q20-U
	BCP6ES11	Q20TT	PQ20TT	IQ20TT	Q20-U11
	BCP6ET	K20TT	PK20TT	IK20TT	K20PBR
	BCP6EY11	Q20TT	PQ20TT	IQ20TT	Q20-U11
	BCPR4ES11	Q16TT	PQ16TT	IQ16TT	Q14R-U11
	BCPR4EY11	Q16TT	PQ16TT	IQ16TT	Q14R-U11
	BCPR5E	Q16TT	PQ16TT	IQ16TT	Q16PR-U
	BCPR5E11	Q16TT	PQ16TT	IQ16TT	Q16PR-U11
	BCPR5ES	Q16TT	PQ16TT	IQ16TT	Q16PR-U
	BCPR5ES11	Q16TT	PQ16TT	IQ16TT	Q16PR-U11
	BCPR5ET	K20TT	PK20TT	IK20TT	K20PBR
	BCPR5EY	-	PQ16TT	IQ16TT	Q16R-U
	BCPR5EY11	Q16TT	PQ16TT	IQ16TT	Q16R-U11
	BCPR5EY-N11	Q16TT	PQ16TT	IQ16TT	Q16PR-U11
	BCPR5EY-N11	Q16TT	PQ16TT	IQ16TT	Q16R-U11
	BCPR6E	Q20TT	PQ20TT	IQ20TT	Q20PR-U
	BCPR6E11	Q20TT	PQ20TT	IQ20TT	Q20PR-U11
	BCPR6ES	Q20TT	PQ20TT	IQ20TT	Q20PR-U
	BCPR6ES11	Q20TT	PQ20TT	IQ20TT	Q20PR-U11
	BCPR6ET	K20TT	PK20TT	IK20TT	K20PBR
	BCPR6EY	Q20TT	PQ20TT	IQ20TT	Q20R-U
	BCPR6EY11	Q20TT	PQ20TT	IQ20TT	Q20R-U11
	BCPR6EY-N11	Q20TT	PQ20TT	IQ20TT	Q20PR-U11
	BCPR6EY-N11	Q20TT	PQ20TT	IQ20TT	Q20R-U11
	BK5E	K16TT	PK16TT	IK16TT	K16P-U
	BK5E11	K16TT	PK16TT	IK16TT	K16P-U11
	BK6E	K20TT	PK20TT	IK20TT	K20P-U
	BK6E11	K20TT	PK20TT	IK20TT	K20PR-U11
BKR4ESA11	-	PK16TT	IK16TT	-	
BKR5E	K16TT	PK16TT	IK16TT	K16PR-U	
BKR5E11	K16TT	PK16TT	IK16TT	K16PR-U11	
BKR5E11	K16TT	PK16TT	IK16TT	K16PR-U11	
BKR5E-E	K16TT	PK16TT	IK16TT	K16PR-UR	
BKR5EK	K20TT	PK20TT	IK20TT	K20TXR	
BKR5EKB11	K16TT	PK16TT	IK16TT	K16TR11	
BKR5EKC	K16TT	PK16TT	IK16TT	K16TNR-S9	
BKR5EKU	K20TT	PK20TT	IK20TT	K20TXR	
BKR5EKUP	K20TT	PK20TT	IK20TT	K20TXR	
BKR5EN	K16TT	PK16TT	IK16TT	K16PR-U	

NGK Ni/Pt/Ir	NGK TYPE	TT	PLATINUM TT	IRIDIUM TT	DENSO
Ni	BKR5EN11	K16TT	PK16TT	IK16TT	K16PR-L11
	BKR5ES	K16TT	PK16TT	IK16TT	K16PR-U
	BKR5ES-11	K16TT	PK16TT	IK16TT	K16PR-U11
	BKR5ESA-11	K16TT	PK16TT	IK16TT	K16PR-U11
	BKR5EY	K16TT	PK16TT	IK16TT	K16R-U
	BKR5EY11	K16TT	PK16TT	IK16TT	K16R-U11
	BKR5EYA	K16TT	PK16TT	IK16TT	K16R-U
	BKR5EYA11	K16TT	PK16TT	IK16TT	K16R-U11
	BKR5EZ	K16TT	PK16TT	IK16TT	K16PR-U
	BKR6E	K20TT	PK20TT	IK20TT	K20PR-U
	BKR6E	K20TT	PK20TT	IK20TT	K20PR-U
	BKR6E11	K20TT	PK20TT	IK20TT	K20PR-U11
	BKR6E-E	K20TT	PK20TT	IK20TT	K20PR-UR
	BKR6EK	K20TT	PK20TT	IK20TT	K20TXR
	BKR6EKB11	K20TT	PK20TT	IK20TT	K20TR11
	BKR6EKC	K20TT	PK20TT	IK20TT	K20TNR
	BKR6EKC-N11	K20TT	PK20TT	IK20TT	K20TNR
	BKR6EKE	K20TT	PK20TT	IK20TT	K20TXR
	BKR6EKU	K20TT	PK20TT	IK20TT	K20TXR
	BKR6EKUB	K20TT	PK20TT	IK20TT	K20TXR
	BKR6EKUE	K20TT	PK20TT	IK20TT	K20TXR
	BKR6EN	K20TT	PK20TT	IK20TT	K20PR-U
	BKR6EN11	K20TT	PK20TT	IK20TT	K20PR-L11
	BKR6EQU	K20TT	PK20TT	IK20TT	K20TXR
	BKR6EQUA	K20TT	PK20TT	IK20TT	K20TXR
	BKR6EQUB	K20TT	PK20TT	IK20TT	K20TXR
	BKR6EQUF	K20TT	PK20TT	IK20TT	K20TXR
	BKR6EQUA	K20TT	PK20TT	IK20TT	K20TXR
	BKR6ES	K20TT	PK20TT	IK20TT	K20PR-U
	BKR6ES11	K20TT	PK20TT	IK20TT	K20PR-U11
	BKR6ESZ-10	K20TT	PK20TT	IK20TT	K20PR-U11
	BKR6ETA10	K20TT	PK20TT	IK20TT	K20PBR
	BKR6ETUB	K20TT	PK20TT	IK20TT	K20PBR-S10
	BKR6EY	K20TT	PK20TT	IK20TT	K20R-U
	BKR6EY11	K20TT	PK20TT	IK20TT	K20R-U11
	BKR6EYA	K20TT	PK20TT	IK20TT	K20R-U
	BKR6EYA11	K20TT	PK20TT	IK20TT	K20R-U11
	BKR6EZ	K20TT	PK20TT	IK20TT	K20PR-U
	BKR6EZB	K20TT	PK20TT	IK20TT	K20PR-U
	BKUR5EK9	K16TT	PK16TT	IK16TT	K16TNR-S9
	BKUR5ET	K16TT	PK16TT	IK16TT	K16TNR-S9
	BKUR5ET10	K16TT	PK16TT	IK16TT	K16TNR-S9
	BKUR5ETC10	K16TT	PK16TT	IK16TT	K16TNR-S9
	BKUR5ETZ10	K16TT	PK16TT	IK16TT	K16TNR-S9
	BKUR6E	K20TT	PK20TT	IK20TT	K20PR-SU9
	BKUR6EK	K20TT	PK20TT	IK20TT	K20TNR-S
	BKUR6EK9	K20TT	PK20TT	IK20TT	K20TNR-S9
	BKUR6ET	K20TT	PK20TT	IK20TT	K20PBR-S10
	BKUR6ET10	K20TT	PK20TT	IK20TT	K20PBR-S10
	BKUR6ETB	K20TT	PK20TT	IK20TT	K20PBR-S10
	BP4E	W16TT	PW16TT	IW16TT	W14EX-U
	BP4EA11	W16TT	PW16TT	IW16TT	W14EX-U11
	BP4EFS	T16TT	PT16TT	IT16TT	T16EPR-U
	BP4ES	W16TT	PW16TT	IW16TT	W14EP-U
	BP4ES	W16TT	PW16TT	IW16TT	W14EX-U
BP4ES11	W16TT	PW16TT	IW16TT	W14EX-U11	

NGK Ni/Pt/Ir	NGK TYPE				DENSO
Ni	BP4ES-L11	W16TT	PW16TT	IW16TT	W14EX-U11
	BP4EY	W16TT	PW16TT	IW16TT	W14EX-U
	BP4EY11	W16TT	PW16TT	IW16TT	W14EX-U11
	BP4FS	—	PTF16TT	ITF16TT	T14PR-U
	BP5E	W16TT	PW16TT	IW16TT	W16EP-U
	BP5EA	W16TT	PW16TT	IW16TT	W14EX-U
	BP5EA11	W16TT	PW16TT	IW16TT	W14EX-U11
	BP5EA-L	W16TT	PW16TT	IW16TT	W16EX-U
	BP5EA-L11	W16TT	PW16TT	IW16TT	W16EX-U11
	BP5EFS	T16TT	PT16TT	IT16TT	T16EPR-U
	BP5EFS-13	T16TT	PT16TT	IT16TT	T16EPR-U15
	BP5EK-A	W16TT	PW16TT	IW16TT	W16ET-S
	BP5EKN	W16TT	PW16TT	IW16TT	W16ET-S
	BP5ES	W16TT	PW16TT	IW16TT	W16EP-U
	BP5ES	W16TT	PW16TT	IW16TT	W16EX-U
	BP5ES11	W16TT	PW16TT	IW16TT	W16EP11
	BP5ES11	W16TT	PW16TT	IW16TT	W16EP-U11
	BP5ES11	W16TT	PW16TT	IW16TT	W16EX-U11
	BP5ES13	W16TT	PW16TT	IW16TT	W16EX-U13
	BP5ES-A	W16TT	PW16TT	IW16TT	W16EP-U
	BP5ES-A	W16TT	PW16TT	IW16TT	W16EX-U
	BP5ESZ	W16TT	PW16TT	IW16TT	W16EP-U
	BP5ET	W16TT	PW16TT	IW16TT	W16EPB10
	BP5ET10	W16TT	PW16TT	IW16TT	W16EPB10
	BP5EY	W16TT	PW16TT	IW16TT	W16EX-U
	BP5EY11	W16TT	PW16TT	IW16TT	W16EX-U11
	BP5FS	—	PTF16TT	ITF16TT	T16P-U
	BP6E	W20TT	PW20TT	IW20TT	W20EP-U
	BP6EA	W20TT	PW20TT	IW20TT	W20EX-U
	BP6EA11	W20TT	PW20TT	IW20TT	W20EX-U11
	BP6EFS	T20TT	PT20TT	IT20TT	T20EP-U
	BP6EFS-13	T20TT	PT20TT	IT20TT	T20EP-U15
	BP6EK	W20TT	PW20TT	IW20TT	W20ETR-L
	BP6EK	W20TT	PW20TT	IW20TT	W20ET-S
	BP6EK-A	W20TT	PW20TT	IW20TT	W20ET-S
	BP6EKN	W20TT	PW20TT	IW20TT	W20ETR-L
	BP6EK-N	W20TT	PW20TT	IW20TT	W20ET-S
	BP6ES	W20TT	PW20TT	IW20TT	W20EP
	BP6ES	W20TT	PW20TT	IW20TT	W20EP-U
	BP6ES	W20TT	PW20TT	IW20TT	W20EX-U
	BP6ES11	W20TT	PW20TT	IW20TT	W20EP11
	BP6ES11	W20TT	PW20TT	IW20TT	W20EPR-U11
	BP6ES11	W20TT	PW20TT	IW20TT	W20EX-U11
	BP6ES13	W20TT	PW20TT	IW20TT	W20EX-U13
	BP6ESZ	W20TT	PW20TT	IW20TT	W20EP-U
	BP6ET	W20TT	PW20TT	IW20TT	W20EPB
	BP6EY	W20TT	PW20TT	IW20TT	W20EX-U
	BP6EY11	W20TT	PW20TT	IW20TT	W20EX-U11
	BP6FS	—	PTF20TT	ITF20TT	T20P-U
	BP6HS	WF20TT	—	—	W20FP-U
BP6HS10	WF20TT	—	—	W20FP-U10	
BP6HSA	WF20TT	—	—	W20FR-L	
BP7E	W22TT	—	—	W22EP-U	
BP7EK-N	W22TT	—	—	W22ETR-L	
BP7ES	W22TT	—	—	W22EP-U	
BP7ES11	W22TT	—	—	W22EP11	



NGK Ni/Pt/Ir	NGK TYPE				DENSO
Ni	BP7ES11	W22TT	—	—	W22EP-U11
	BP7ET	W22TT	—	—	W22EPB
	BP7EY	W22TT	—	—	W22EP-U
	BPR4EFS	—	PT16TT	IT16TT	—
	BPR4ES	W16TT	PW16TT	IW16TT	W14EPR-U
	BPR4ES	W16TT	PW16TT	IW16TT	W14EXR-U
	BPR4ES11	W16TT	PW16TT	IW16TT	W14EXR-U11
	BPR4ES13	W16TT	PW16TT	IW16TT	W14EXR-U13
	BPR4ES-L11	W16TT	PW16TT	IW16TT	W14EXR-U11
	BPR4EY	W16TT	PW16TT	IW16TT	W14EXR-U
	BPR4EY11	W16TT	PW16TT	IW16TT	W14EXR-U11
	BPR4FS	—	PTF16TT	ITF16TT	T14PR-U
	BPR4FS11	—	PTF16TT	ITF16TT	T14PR-U15
	BPR4FS15	—	PTF16TT	ITF16TT	T14PR-U15
	BPR5E	W16TT	PW16TT	IW16TT	W16EPR-U
	BPR5E11	W16TT	PW16TT	IW16TT	W16EPR-U11
	BPR5EA	W16TT	PW16TT	IW16TT	W14EXR-U
	BPR5EA-11	W16TT	PW16TT	IW16TT	W14EXR-U11
	BPR5EA-L	W16TT	PW16TT	IW16TT	W16EXR-U
	BPR5EA-L11	W16TT	PW16TT	IW16TT	W16EXR-U11
	BPR5EF	T16TT	PT16TT	IT16TT	T16EPR-U
	BPR5EFS	T16TT	PT16TT	IT16TT	T16EPR-U
	BPR5EFS13	T16TT	PT16TT	IT16TT	T16EPR-U15
	BPR5EK-A	W16TT	PW16TT	IW16TT	W16ETR-S
	BPR5EKU	W16TT	PW16TT	IW16TT	W16ETR-S
	BPR5ES	W16TT	PW16TT	IW16TT	W16EPR-U
	BPR5ES	W16TT	PW16TT	IW16TT	W16EXR-U
	BPR5ES11	W16TT	PW16TT	IW16TT	W16EPR11
	BPR5ES11	W16TT	PW16TT	IW16TT	W16EXR-U11
	BPR5ES13	W16TT	PW16TT	IW16TT	W16EXR-U13
	BPR5ES-A	W16TT	PW16TT	IW16TT	W16EXR-U
	BPR5EY	W16TT	PW16TT	IW16TT	W16EXR-U
	BPR5EY11	W16TT	PW16TT	IW16TT	W16EXR-U11
	BPR5FS	—	PTF16TT	ITF16TT	T16PR-U
	BPR5FS11	—	PTF16TT	ITF16TT	T16PR-U11
	BPR5FS15	—	PTF16TT	ITF16TT	T16PR-U15
	BPR6E	W20TT	PW20TT	IW20TT	W20EPR-U
	BPR6EFS	T20TT	PT20TT	IT20TT	T20EPR-U
	BPR6EFS13	T20TT	PT20TT	IT20TT	T20EPR-U15
	BPR6EFS15	T20TT	PT20TT	IT20TT	T20EPR-U15
	BPR6EKA	W20TT	PW20TT	IW20TT	W20ET-S
	BPR6EK-N	W20TT	PW20TT	IW20TT	W20ETR-L
	BPR6ES	W20TT	PW20TT	IW20TT	W20EPR-U
	BPR6ES	W20TT	PW20TT	IW20TT	W20EXR-U
	BPR6ES11	W20TT	PW20TT	IW20TT	W20EPR11
	BPR6ES11	W20TT	PW20TT	IW20TT	W20EPR-U11
	BPR6ES11	W20TT	PW20TT	IW20TT	W20EXR-U11
	BPR6ES-13	W20TT	PW20TT	IW20TT	W20EXR-U13
	BPR6EY	W20TT	PW20TT	IW20TT	W20EXR-U
	BPR6EY11	W20TT	PW20TT	IW20TT	W20EXR-U11
BPR6EYZ	W20TT	PW20TT	IW20TT	W20EXR-U	
BPR6FS	—	PTF20TT	ITF20TT	T20PR-U	
BPR6HS	WF20TT	—	—	W20FPR-U	
BPR6HS10	WF20TT	—	—	W20FPR-U10	
BPR6HSA	WF20TT	—	—	W20FR-L	
BPR7E	W22TT	—	—	W22EPR-U	

TT Cross Reference



EUROPE & USA | SMALL MOTOR ENGINE | CROSS REFERENCE NUMBER | JAPAN | VIETNAM | THAILAND | TAIWAN | SINGAPORE | SAUDI ARABIA | PHILIPPINES | MALAYSIA | KOREA | INDONESIA | INDIA | CHINA | AUSTRALIA

NGK Ni/Pt/Ir	NGK TYPE	TT	PLATINUM TT	IRIDIUM TT	DENSO
Ni	BPR7EK-N	W22TT	—	—	W22ETR-L8
	BPR7ES	W22TT	—	—	W22EPR-U
	BPR7ES11	W22TT	—	—	W22EPR-U11
	BPR7EY	W22TT	—	—	W22EPR-U
	BPR7EY-11	W22TT	—	—	W22EPR-U11
	BR5EF	T16TT	PT16TT	IT16TT	T16EPR-U
	BR6EB11	W20TT	PW20TT	IW20TT	W20EKR-S11
	BR6EBL	W20TT	PW20TT	IW20TT	W20EKR-S11
	BR6EB-L11	W20TT	PW20TT	IW20TT	W20EKR-S11
	BR6HSA	WF20TT	—	—	W20FR-L
	BU6EA11	W20TT	PW20TT	IW20TT	W20EP-S11
	BU6EFSZ	T20TT	PT20TT	IT20TT	T20EP-U
	BU7EA11	W22TT	—	—	W22EP-S11
	BUR5EB11	W16TT	PW16TT	IW16TT	W16EKR-S11
	BUR5ET	W20TT	PW20TT	IW20TT	W20EPBR-S
	BUR5ET10	W20TT	PW20TT	IW20TT	W20EPBR-S
	BUR5ETB-10	W20TT	PW20TT	IW20TT	W20EPBR-S
	BUR6EA11	W20TT	PW20TT	IW20TT	W20EPR-S11
	BUR6EB11	W20TT	PW20TT	IW20TT	W20EKR-S11
	BUR6EFSZ	T20TT	PT20TT	IT20TT	T20EPR-U
	BUR6ET	W20TT	PW20TT	IW20TT	W20EPBR-S
	BUR7EA11	W22TT	—	—	W22EP-S11
	DCP7E	XU22TT	—	—	XU22EP-U
	DCPR7E	XU22TT	—	—	XU22EPR-U
	DCPR7EA9	XU22TT	—	—	XU22PR9
	DCPR7E-N	XU22TT	—	—	XU22EPR-U
	DCPR7E-N10	XU22TT	—	—	XU22EPR-U
	FR4	K16TT	PK16TT	IK16TT	K16PR-U
	FR45	K16TT	PK16TT	IK16TT	K16PR-U11
	FR5	K20TT	PK20TT	IK20TT	K20PR-U
	FR5-1	K20TT	PK20TT	IK20TT	KJ20CR-L11
	FR5EI	K16TT	PK16TT	IK16TT	K16PSR-B8
	GR4	W16TT	PW16TT	IW16TT	W14EXR-U
	GR45	W16TT	PW16TT	IW16TT	W14EXR-U11
	GR5	W16TT	PW16TT	IW16TT	W16EXR-U
	LFR5A11	KH16TT	PKH16TT	IKH16TT	K16HPR-U11
	LFR5B	KH16TT	PKH16TT	IKH16TT	K16HPR-U11
	LFR6A11	KH20TT	PKH20TT	IKH20TT	K20HR-U11
	LFR6C11	KH20TT	PKH20TT	IKH20TT	K20HR-U11
	LKR6C	XUH20TTI	—	—	XU20HR9
	LKR6D10E	XUH20TTI	—	—	XU20HR9
	LKR7B	XUH22TT	—	—	XU22HDR9
	LKR7B9	XUH22TT	—	—	XU22HDR9
	LKR7C	XUH22TT	—	—	XU22HR9
	LZFR5C11	KH16TT	PKH16TT	IKH16TT	K16HPR-U11
LZFR5C11G	KH16TT	PKH16TT	IKH16TT	K16HPR-U11	
LZFR6B10E	KH20TT	PKH20TT	IKH20TT	—	
LZKR6B10E	XUH20TTI	—	—	—	
LZKR6B-E	XUH20TTI	—	—	—	
LZTR4A11	—	—	ITL16TT	—	
LZTR4AGP	—	—	ITL16TT	—	
LZTR4AIX13	—	—	ITL16TT	ITL16	
R5673-6	—	PTF20TT	ITF20TT	ITF20	
R5674-6	—	PTF20TT	ITF20TT	ITF20	
SR5	T20TT	PT20TT	IT20TT	T20NR-U11	
TR4	T16TT	PT16TT	IT16TT	T16EPR-U	

NGK Ni/Pt/Ir	NGK TYPE	TT	PLATINUM TT	IRIDIUM TT	DENSO	
Ni	TR4-2	T16TT	PT16TT	IT16TT	T16EPR-U	
	TR5	T20TT	PT20TT	IT20TT	T20EPR-U	
	TR5-1	T20TT	PT20TT	IT20TT	T20EPR-U	
	TR55	T20TT	PT20TT	IT20TT	T20EPR-U15	
	TR5A10	TV16TT	PTV16TT	ITV16TT	T16VR-U10	
	TR5A13	TV16TT	PTV16TT	ITV16TT	T16VR-U10	
	TR5B13	TV16TT	PTV16TT	ITV16TT	T16VR-U10	
	TR6	T20TT	PT20TT	IT20TT	T20EPR-U	
	TR6B10	—	PTV20TT	ITV20TT	—	
	TR6B13	—	PTV20TT	ITV20TT	—	
	UR4	—	PTF16TT	ITF16TT	T16PR-U	
	UR40	—	PTF16TT	ITF16TT	T16PR-U15	
	UR45	—	PTF16TT	ITF16TT	T16PR-U15	
	UR5	—	PTF20TT	ITF20TT	T20PR-U	
	UR5	—	PTF20TT	ITF20TT	T20PR-U11	
	UR55	—	PTF20TT	ITF20TT	T20PR-U15	
	ZF6A11	Q20TT	PQ20TT	IQ20TT	QJ20CR11	
	ZFR5A11	Q16TT	PQ16TT	IQ16TT	QJ16CR11	
	ZFR5C11G	K16TT	PK16TT	IK16TT	KJ16CR-L11	
	ZFR5F	K16TT	PK16TT	IK16TT	KJ16CR	
	ZFR5F11	K16TT	PK16TT	IK16TT	KJ16CR-L11	
	ZFR5F11	K16TT	PK16TT	IK16TT	KJ16CR11	
	ZFR5F11	K16TT	PK16TT	IK16TT	KJ16CR-U11	
	ZFR5J11	K16TT	PK16TT	IK16TT	KJ16CR-L11	
	ZFR5N11	K16TT	PK16TT	IK16TT	KJ16CR-L11	
	ZFR6A11	Q20TT	PQ20TT	IQ20TT	QJ20CR11	
	ZFR6F11	K20TT	PK20TT	IK20TT	KJ20CR-L11	
	ZFR6F11	K20TT	PK20TT	IK20TT	KJ20CR11	
	ZFR6F11	K20TT	PK20TT	IK20TT	KJ20CR-U11	
	ZFR6J11	K20TT	PK20TT	IK20TT	KJ20CR-L11	
	ZFR6K11	K20TT	PK20TT	IK20TT	KJ20DR-M11	
	ZFR6S-Q	K20TT	PK20TT	IK20TT	K20PBR-S10	
	ZFR6U11	K20TT	PK20TT	IK20TT	KJ20CR-L11	
	ZFR6U9	K20TT	PK20TT	IK20TT	KJ20CR-11	
	ZG5A	W16TT	PW16TT	IW16TT	J16CR-U	
	ZGR5A	W16TT	PW16TT	IW16TT	J16CR-U	
	ZGR5C	W16TT	PW16TT	IW16TT	J16CR-U	
	ZGR5E	W16TT	PW16TT	IW16TT	J16CR-U	
	ZKR7A	XU22TT	—	—	XU22EPR-U	
	Pt	BCP5EV	—	PQ16TT	IQ16TT	—
		BCP5EV11	—	PQ16TT	IQ16TT	—
		BCP5EVX	—	PQ16TT	IQ16TT	—
		BCP5EVX11	—	PQ16TT	IQ16TT	—
		BCP6EV	—	PQ20TT	IQ20TT	—
		BCP6EV11	—	PQ20TT	IQ20TT	—
BCP6EVX		—	PQ20TT	IQ20TT	—	
BCP6EVX11		—	PQ20TT	IQ20TT	—	
BCPR5EP11		—	PQ16TT	IQ16TT	PQ16R	
BCPR5EP13		—	PQ16TT	IQ16TT	PQ16R13	
BCPR5EP8		—	PQ16TT	IQ16TT	PQ16R8	
BCPR5EP-N11		—	PQ16TT	IQ16TT	PQ16R-P11	
BCPR5EV		—	PQ16TT	IQ16TT	—	
BCPR5EV11		—	PQ16TT	IQ16TT	—	
BCPR5EVX		—	PQ16TT	IQ16TT	—	
BCPR5EVX11	—	PQ16TT	IQ16TT	—		
BCPR6EP11	—	PQ20TT	IQ20TT	PQ20R		

NGK Ni/Pt/Ir	NGK TYPE				DENSO
	BCPR6EP13	—	PQ20TT	IQ20TT	PQ20R13
	BCPR6EP8	—	PQ20TT	IQ20TT	PQ20R8
	BCPR6EP-N11	—	PQ20TT	IQ20TT	PQ20R-P11
	BCPR6EP-N8	—	PQ20TT	IQ20TT	PQ20R-P8
	BCPR6EV	—	PQ20TT	IQ20TT	—
	BCPR6EV11	—	PQ20TT	IQ20TT	—
	BCPR6EVX	—	PQ20TT	IQ20TT	—
	BCPR6EVX11	—	PQ20TT	IQ20TT	—
	BKR5EGP	—	PK16TT	IK16TT	IK16
	BKR5EKP11	—	PK16TT	IK16TT	PK16TR11
	BKR5EKP13	—	PK16TT	IK16TT	PK16TR13
	BKR5EP11	—	PK16TT	IK16TT	PK16R11
	BKR5EP8	—	PK16TT	IK16TT	PK16R8
	BKR5EQUPA	—	—	IK16TT	—
	BKR5EVX	—	PK16TT	IK16TT	—
	BKR5EVX11	—	PK16TT	IK16TT	—
	BKR5EVXA	—	PK16TT	IK16TT	—
	BKR5EVXA11	—	PK16TT	IK16TT	—
	BKR5EVXA13	—	PK16TT	IK16TT	—
	BKR6EGP	—	PK20TT	IK20TT	IK20
	BKR6EKPA	—	PK20TT	IK20TT	PK20TR11
	BKR6EKP11	—	PK20TT	IK20TT	PK20TR11
	BKR6EP11	—	PK20TT	IK20TT	PK20R11
	BKR6EP13	—	PK20TT	IK20TT	PK20R13
	BKR6EP8	—	PK20TT	IK20TT	PK20R8
	BKR6EP8	—	—	IK20TT	VK20T
	BKR6EP-N8	—	PK20TT	IK20TT	PK20R-P8
	BKR6EVX11	—	PK20TT	IK20TT	—
	BKR6EVXA11	—	PK20TT	IK20TT	—
	BP5EV	—	PW16TT	IW16TT	—
	BP5EVX	—	PW16TT	IW16TT	—
	BP5EVX11	—	PW16TT	IW16TT	—
	BP6EV	—	PW20TT	IW20TT	—
	BP6EVX	—	PW20TT	IW20TT	—
	BP6EVX11	—	PW20TT	IW20TT	—
	BPR5EFVX	—	PT16TT	IT16TT	IT16
	BPR5EGP	—	PW16TT	IW16TT	IW16
	BPR5EP11	—	PW20TT	IW20TT	P16R
	BPR5EP11	—	PW16TT	IW16TT	P16R
	BPR5EP13	—	PW16TT	IW16TT	P16R13
	BPR5EV	—	PW16TT	IW16TT	—
	BPR5EVX	—	PW16TT	IW16TT	—
	BPR5EVX11	—	PW16TT	IW16TT	—
	BPR6EGP	—	PW20TT	IW20TT	IW20
	BPR6EP11	—	PW20TT	IW20TT	VW20
	BPR6EP8	—	PW20TT	IW20TT	VW20
	BPR6EP8	—	PW20TT	IW20TT	VW20T
	BPR6EV	—	IW20TT	IW20TT	IW20
	BPR6EVX	—	IW20TT	IW20TT	IW20
	BPR6EVX11	—	IW20TT	IW20TT	IW20
	FR4BP11	—	PK16TT	IK16TT	IK16
	FR5BP11	—	PK16TT	IK16TT	IK16
	FR5CP	—	PK16TT	IK16TT	IK16
	FR6BP11	—	PK20TT	IK20TT	IK20
	LFR5AP11	—	PKH16TT	IKH16TT	IKH16
	LFR5AQP	—	PKH16TT	IKH16TT	IKH16

Pt

NGK Ni/Pt/Ir	NGK TYPE				DENSO
	LFR5BP11	—	PKH16TT	IKH16TT	IKH16
	LFR5P11	—	PKH16TT	IKH16TT	IKH16
	LFR6AP11	—	PKH20TT	IKH20TT	IKH20
	LFR6AP9	—	PKH20TT	IKH20TT	IKH20
	LFR6AQP	—	PKH20TT	IKH20TT	IKH20
	LFR6BP11	—	PKH20TT	IKH20TT	IKH20
	LTR6AP11	—	PTV20TT	ITV20TT	ITV20
	PFR5A11	—	PQ16TT	IQ16TT	PQ16R
	PFR5B	—	PK16TT	IK16TT	PK16R8
	PFR5B11	—	PK16TT	IK16TT	PK16PR(-L)11
	PFR5B11B	—	PK16TT	IK16TT	PK16R11
	PFR5B11C	—	PK16TT	IK16TT	PK16R11
	PFR5B9	—	PK16TT	IK16TT	PK16R8
	PFR5B-D	—	PK20TT	IK20TT	PK16R8
	PFR5C11	—	PK16TT	IK16TT	PK16R11
	PFR5F11	—	PQ16TT	IQ16TT	PQ16R
	PFR5G11	—	PK16TT	IK16TT	PK16PR(-L)11
	PFR5G11-E	—	PK16TT	IK16TT	PK16PR(-L)11
	PFR5G13-E	—	PK16TT	IK16TT	PK16PR-L11
	PFR5J11	—	PK16TT	IK16TT	PK16PR-P11
	PFR5K11	—	PQ16TT	IQ16TT	PQ16R
	PFR5L11	—	PK16TT	IK16TT	PK16PR(-L)11
	PFR5L13	—	PK16TT	IK16TT	VK16
	PFR5N11	—	PK16TT	IK16TT	PK16PR(-L)11
	PFR5P	—	PK16TT	IK16TT	PK16R8
	PFR5P11	—	PK16TT	IK16TT	PK16PR(-L)11
	PFR5R11	—	PK16TT	IK16TT	PK16PR(-L)11
	PFR6A11	—	PQ20TT	IQ20TT	PQ20R
	PFR6B	—	PK20TT	IK20TT	PK20PR-P8
	PFR6B11	—	PK20TT	IK20TT	PK20PR11
	PFR6B11B	—	PK20TT	IK20TT	PK20R11
	PFR6B9	—	PK20TT	IK20TT	PK20PR-P8
	PFR6B-D	—	PK20TT	IK20TT	PK20R8
	PFR6C11	—	PK20TT	IK20TT	PK20R11
	PFR6E	—	PK20TT	IK20TT	PK20PR-P8
	PFR6G11	—	PK20TT	IK20TT	PK20PR11
	PFR6G11	—	PK20TT	IK20TT	PK20PR-L11
	PFR6G11-E	—	PK20TT	IK20TT	PK20PR11
	PFR6G11-E	—	PK20TT	IK20TT	PK20PR-L11
	PFR6G13	—	PK20TT	IK20TT	PK20PR-L13
	PFR6G13E	—	PK20TT	IK20TT	PK20PR-L13
	PFR6H10	—	PQ20TT	IQ20TT	PQ20R
	PFR6J	—	PK20TT	IK20TT	PK20PR-P8
	PFR6J11	—	PK20TT	IK20TT	PK20PR-P11
	PFR6J13	—	PK20TT	IK20TT	PK20PR-L13
	PFR6K11	—	PQ20TT	IQ20TT	PQ20R
	PFR6L13	—	PK20TT	IK20TT	PK20PR-L13
	PFR6N11	—	PK20TT	IK20TT	PK20PR-L11
	PFR6P11	—	PK20TT	IK20TT	PK20PR(-L)11
	PFR6R11	—	PK20TT	IK20TT	PK20PR-L11
	PFR6T10	—	PK20TT	IK20TT	PK20PR-L11
	PFR6T10G	—	PK20TT	IK20TT	PK20PR-L11
	PFR6T-G	—	PK20TT	IK20TT	PK20PR-P8
	PFR6U11G	—	PK20TT	IK20TT	PK20PR-L11
	PFR6V10D	—	PK20TT	IK20TT	VK20T
	PFR6X11	—	PK20TT	IK20TT	PK20PR-L11



Pt



TT Cross Reference

EUROPE & USA | SMALL MOTOR ENGINE | CROSS REFERENCE NUMBER | JAPAN | VIETNAM | THAILAND | TAIWAN | SINGAPORE | SAUDI ARABIA | PHILIPPINES | MALAYSIA | KOREA | INDONESIA | INDIA | CHINA | AUSTRALIA

NGK Ni/Pt/Ir	NGK TYPE	TT	PLATINUM TT	IRIDIUM TT	DENSO
Pt	PGR5A	—	PW16TT	IW16TT	P16PR8
	PGR5A11	—	PW16TT	IW16TT	P16PR11
	PGR6A	—	PW20TT	IW20TT	P20PR8
	PGR6A	—	PW20TT	IW20TT	P20R8
	PGR6A	—	PW20TT	IW20TT	P20PR8
	PGR6A	—	PW20TT	IW20TT	P20R8
	PGR6A11	—	PW20TT	IW20TT	VW20
	PGR6A-D	—	PW20TT	IW20TT	VW20
	PGR6B	—	PW20TT	IW20TT	VW20
	PLFR4A11	—	PKH16TT	IKH16TT	VKH16
	PLFR5A11	—	PKH16TT	IKH16TT	VKH16
	PLFR5A11D	—	PKH16TT	IKH16TT	VKH16
	PLFR6A11	—	PKH20TT	IKH20TT	VKH20
	PLFR6A9	—	PKH20TT	IKH20TT	VKH20
	PLTR6A10G	—	PTV20TT	ITV20TT	ITV20
	PLZFR5B-13G	—	PKH16TT	IKH16TT	VKH16
	PLZFR6A-11S	—	PKH20TT	IKH20TT	VKH20
	PLZKAR6A11	—	—	IXEH20TT	FXE20HR11
	PLZTR5A13	—	—	ITL16TT	—
	PTR4B15	—	PT16TT	IT16TT	PT16EPR-L13
	PTR4G15	—	PT16TT	IT16TT	PT16EPR-L13
	PTR5A10	—	PTV16TT	ITV16TT	PT16VR10
	PTR5A13	—	PTV16TT	ITV16TT	PT16VR13
	PTR5C13	—	PT16TT	IT16TT	PT16EPR-L13
	PTR6D13G	—	PT20TT	IT20TT	VT20
	PTR6E13	—	PT20TT	IT20TT	VT20
	PTR6F13	—	PT20TT	IT20TT	VT20
	PZFR5E11	—	PK16TT	IK16TT	SKJ16CR-L11
	PZFR5F	—	PK16TT	IK16TT	PKJ16CR8
	PZFR5F11	—	PK16TT	IK16TT	SKJ16CR-L11
	PZFR5F13	—	PK16TT	IK16TT	PKJ16CR-L13
	PZFR5J11	—	PK16TT	IK16TT	SKJ16CR-L11
	PZFR6E11	—	PK20TT	IK20TT	PKJ20CR-L11
	PZFR6F11	—	PK20TT	IK20TT	PKJ20CR-L11
	PZFR6J11	—	PK20TT	IK20TT	PKJ20CR-L11
	PZTR5A15	—	PT16TT	IT16TT	PT16EPR-L13
	TR4VX	—	PT16TT	IT16TT	IT16
	TR5-1VX	—	PT20TT	IT20TT	IT20
	TR55-1VX	—	PT20TT	IT20TT	IT20
	TR55VX	—	PT20TT	IT20TT	IT20
	TR5BP12	—	PTV16TT	ITV16TT	ITV16
	TR5VX	—	PT20TT	IT20TT	IT20
	TR6AP13	—	PT20TT	IT20TT	IT20
	TR6AP13E	—	PT20TT	IT20TT	IT20
	TR6GP	—	PT20TT	IT20TT	IT20
UR45VX	—	PTF16TT	ITF16TT	ITF16	
UR4VX	—	PTF16TT	ITF16TT	ITF16	
UR55VX	—	PTF20TT	ITF20TT	—	
UR5VX	—	PTF20TT	ITF20TT	—	
UR6VX	—	PTF20TT	ITF20TT	—	
YR55VX	—	PTF20TT	ITF20TT	—	
YR5VX	—	PTF20TT	ITF20TT	—	
ZFR5AP	—	PK16TT	IK16TT	IK16	
ZFR5FGP	—	PK16TT	IK16TT	IK16	
ZFR5LP13G	—	PK16TT	IK16TT	—	
Ir	BCPR5EIX11	—	—	IQ16TT	IQ16

NGK Ni/Pt/Ir	NGK TYPE	TT	PLATINUM TT	IRIDIUM TT	DENSO
Ir	BCPR5EIX11P	—	—	IQ16TT	VQ16
	BCPR6EIX11	—	—	IQ20TT	IQ20
	BCPR6EIX11P	—	—	IQ20TT	VQ20
	BKR4EIX	—	—	IK16TT	IK16
	BKR5EIX	—	—	IK16TT	IK16
	BKR5EIX11	—	—	IK16TT	IK16
	BKR5EIX11P	—	—	IK16TT	VK16
	BKR5EIXP	—	—	IK16TT	VK16
	BKR6EIX	—	—	IK20TT	IK20
	BKR6EIX	—	—	IK20TT	VK20T
	BKR6EIX11	—	—	IK20TT	IK20
	BKR6EIX11P	—	—	IK20TT	VK20
	BPR5EFIX13P	—	—	IT16TT	VT16
	BPR5EIX	—	—	IW16TT	IW16
	BPR5EIX11	—	—	IW16TT	IW16
	BPR5EIX11-P	—	—	IW16TT	VW16
	BPR5EIX-P	—	—	IW16TT	VW16
	BPR6EFIX10	—	—	IT20TT	IT20
	BPR6EFIX13P	—	—	IT20TT	VT20
	BPR6EIX	—	—	IW20TT	IW20
	BPR6EIX(LPG)	—	—	IW20TT	VW20T
	BPR6EIX11	—	—	IW20TT	IW20
	BPR6EIX11-P	—	—	IW20TT	VW20
	BPR6EIX-P	—	—	IW20TT	VW20
	DF5A11A	—	—	IK16TT	FK16PR11
	DF5B11A	—	—	IKH16TT	FK16HR11
	DF6H11A	—	—	IXEH20ETT	FXE20HE11
	DF6H11A	—	—	IXEH20ETT	VFXEH20E
	DF6H11B	—	—	IXEH20TT	FXE20HR11
	DF6H11B	—	—	IXEH20TT	VFXEH20
	DF7H11B	—	—	IXEH22TT	FXE22HR11
	DF7H11B	—	—	IXEH22TT	VFXEH22
	DFH6B11A	—	—	IKBH20TT	FK20HBR11
	DFH6B11A	—	—	IKBH20TT	VFKBH20
	DILFR5A	—	—	IK16TT	—
	DILFR5A11	—	—	IK16TT	FK16HR11
	DILFR5A11D	—	—	IK16TT	FK16HR11
	DILFR5E11	—	—	IK16TT	FK16HR11
	DILFR6D11	—	—	IK20TT	FK20HR11
	DILFR6F11G	—	—	IK20TT	—
	DILFR6J11	—	—	IK20TT	—
	DILKAR6A11	—	—	IXEH20TT	FXE20HR11
	DILKAR7B11	—	—	IXEH22TT	—
	DILKAR7F8	—	—	IXEH22TT	FC20HPR8
	DILZKAR6A11	—	—	IXEH20ETT	FXE20HE11
DILZKR7B11	—	—	IXEH22TT	—	
GR4IX	—	—	IW16TT	IW16	
GR5AI10	—	—	IW16TT	IW16	
GR5IX	—	—	IW16TT	IW16	
HAMP-FR5C11G	—	—	IK16TT	HAMP-IK16F	
HAMP-FR6C11G	—	—	IK20TT	HAMP-IK20F	
HAMP-FR6D11G	—	—	IQ20TT	HAMP-IQ20F	
HAMP-ZFR5F11G	—	—	IK16TT	HAMP-IK16FJ	
HAMP-ZFR6F11G	—	—	IK20TT	HAMP-IK20FJ	
HAMP-ZFR6K11G	—	—	IK20TT	HAMP-IKD20F	
IFR5A11	—	—	IK16TT	SK16R11	

NGK Ni/Pt/Ir	NGK TYPE				DENSO
Ir	IFR5A-8N	—	—	IK20TT	SK16R-P8
	IFR5D10	—	—	IK16TT	VK16
	IFR5E11	—	—	IK16TT	SK16PR-A11
	IFR5G11	—	—	IK16TT	SK16PR-L11
	IFR5G11K	—	—	IK16TT	SK16PR-L11
	IFR5J11	—	—	IK16TT	VK16
	IFR5L11	—	—	IK16TT	VK16PRZ11
	IFR5N	—	—	IK16TT	VK16
	IFR5N10	—	—	IK16TT	VK16
	IFR6A11	—	—	IK20TT	SK20R11
	IFR6C	—	—	IK20TT	SK20PR-L9
	IFR6D10	—	—	IK20TT	VK20
	IFR6E11	—	—	IK20TT	VK20
	IFR6J11	—	—	IK20TT	SVK20RZ11
	IFR6L11	—	—	IK20TT	VK20PRZ11
	IFR6T11	—	—	IK20TT	SK20R11
	IGR5B10-D	—	—	IW16TT	VW16
	IGR6A11	—	—	IW20TT	VW20
	IGR6B10-D	—	—	IW20TT	VW20T
	ILFR5C11	—	—	IKH16TT	SK16HR11
	ILFR6A	—	—	IKH20TT	VKH20
	ILFR6B	—	—	IKH20TT	VKH20
	ILFR6C	—	—	IKH20TT	VKH20
	ILFR6C11	—	—	IKH20TT	SK20HR11
	ILFR6D11	—	—	IK20TT	FK20HR11
	ILFR6G	—	—	IKH20TT	VKH20
	ILFR6J11K	—	—	IKH20TT	SK20HPR-L11
	ILKAR6C10	—	—	IXEH20TT	VFXEH20
	ILKAR7B11	—	—	IXEH22TT	SC20HR11
	ILKAR7L11	—	—	IXEH22TT	ZC20HPR11
	ILTR5A13G	—	—	ITV16TT	—
	ILTR5B11	—	—	ITL16TT	—
	ILTR5C11	—	—	ITL16TT	—
	ILTR5D	—	—	ITV16TT	—
	ILTR5E11	—	—	ITV16TT	—
	ILTR6A13G	—	—	ITV20TT	—
	ILTR6A8G	—	—	ITV20TT	—
	ILTR6E11	—	—	ITV20TT	—
	ILZFR5B	—	—	IKH16TT	VKH16
	ILZFR6A11	—	—	IKH20TT	VKH20
	ILZFR6C11K	—	—	IKH20TT	VKH20
	ILZFR6D11	—	—	IKH20TT	VKH20
	ILZKAR7A	—	—	IXEH22TT	—
	ILZKAR7A10	—	—	IXEH22TT	FXE22HR11
	ILZKAR7B11	—	—	IXEH22TT	—
	ITR4A15	—	—	IT16TT	VT16
	ITR5F13	—	—	IT16TT	VT16
	ITR6F13	—	—	IT20TT	VT20
	IZFR5F11	—	—	IK16TT	SKJ16CR-L11
	IZFR5K11	—	—	IK16TT	SKJ16DR-M11
IZFR5L11	—	—	IK16TT	SKJ16CR-L11	
IZFR6F11	—	—	IK20TT	VKJ20RZ-M11	
IZFR6H11	—	—	IK20TT	VK20	
IZFR6K11	—	—	IK20TT	SKJ20DR-M11	
IZFR6K13	—	—	IK20TT	SKJ20DR-M13	
LFR5AIX11	—	—	IKH16TT	IKH16	

NGK Ni/Pt/Ir	NGK TYPE				DENSO
Ir	LFR5AIX11P	—	—	IKH16TT	VKH16
	LFR5ARX-11P	—	—	IKH16TT	VFKH16
	LFR6AIX11	—	—	IKH20TT	IKH20
	LFR6AIX11P	—	—	IKH20TT	VKH20
	LFR6AIX-LPG	—	—	IKH20TT	VKH20T
	LKAR6AIX13P	—	—	IXEH20TT	ZXE20HR13
	LTR5BI-13	—	—	ITV16TT	—
	LTR5IX11	—	—	ITV16TT	ITV16
	LTR6AI-9	—	—	ITV20TT	ITV20
	LTR6BI-13	—	—	ITV20TT	—
	LTR6BI-9	—	—	ITV20TT	—
	LTR6BP13	—	—	ITV20TT	ITV20
	LTR6IX11	—	—	ITV20TT	ITV20
	LZFR6AI	—	—	IKH20TT	IKH20
	LZKAR6AP11	—	—	IXEH20TT	FXE20HR11
	SIFR6A11	—	—	IK20TT	VK20
	SILFR6A11	—	—	IKH20TT	VKH20
	SILFR6C11	—	—	IKH20TT	VKH20
	SILTR6A7G	—	—	ITV20TT	—
	SILZKAR7B11	—	—	IXEH22TT	—
	TR4IX	—	—	IT16TT	IT16
	TR5-11X	—	—	IT20TT	IT20
	TR55IX	—	—	IT20TT	IT20
	TR5IX	—	—	IT20TT	IT20
	TR6IX	—	—	IT20TT	IT20
	UR45IX	—	—	ITF16TT	ITF16
	UR4IX	—	—	ITF16TT	ITF16
	UR55IX	—	—	ITF20TT	ITF20
	UR5IX	—	—	ITF20TT	ITF20
	UR6IX	—	—	ITF20TT	ITF20
	YR55IX	—	—	ITF20TT	ITF20
	YR5IX	—	—	ITF20TT	ITF20
	ZFR5FIX11	—	—	IK16TT	IK16
	ZFR5FIX11P	—	—	IK16TT	VK16
	ZFR6FIX11	—	—	IK20TT	IK20
	ZFR6FIX11P	—	—	IK20TT	VK20
	LPG1	—	—	IK20TT	—
	LPG1	—	—	IK20TT	—
	LPG2	—	—	IW20TT	—
	LPG2	—	—	IW20TT	—
LPG3	—	—	IQ20TT	—	
LPG4	—	—	ITV16TT	—	
LPG5	—	—	IT20TT	—	
LPG6	—	—	IK20TT	—	
LPG7	—	—	IKH20TT	—	

High Performance Spark Plug

IRIDIUM POWER®

**0.4mm Iridium,
only at DENSO!**



The world's finest diameter (as of March 2019)
0.4mm
with an iridium center electrode

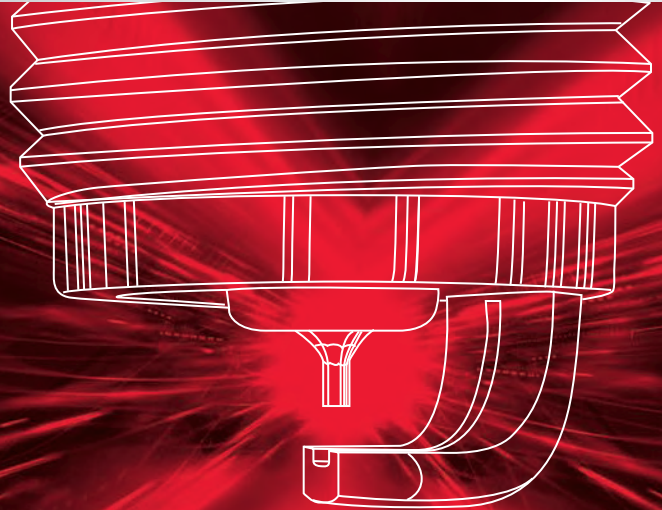

A next-generation plug that draws out engine evolution with a high-performance spark.

Improved acceleration!

Revving up plug performance with 0.4 mm!



Specifications Include Terminal
A terminal nut is attached that fits with most of the world's spark plug cables. Please remove the nut for installations that do not require one. (The terminal nuts on the IWM and IK-G types are solid parts and cannot be removed.)



Built-in, Highly Reliable Resistor
All **IRIDIUM POWER** plugs include a highly reliable, 5,000 ohm monolithic resistor specification to reduce electromagnetic noise that may affect electronic devices. (For all plug types)



Highly Corrosion Resistant, Burnished Nickel Plating
The plug housing is plated with burnished nickel, the same as plugs used for racing. It is highly resistant to corrosion and rust even while touring in continually rainy weather and during motocross events. (Low-heat range types excluded)



360° Laser Welding
The process used to mount the iridium tip is a highly reliable "All-around Laser Welding" process that is able to withstand all kinds of driving conditions. (For all plug types)



1 Projected Center Electrode

In order to improve ignitability, the center electrode protrudes more than with conventional type plugs. This improves both acceleration response time and performance. (Only with: IU31, IUH24, IUH27, IX22, IX24, IX27, IUF22, IUF24, IWF22, IWF24, IWF27, IW24, IW27, IW29, IW31, and IW34)



2 0.4 mm Diameter Ultra-fine Iridium Center Electrode

Using a new iridium alloy with a very high melting point, the tip of the electrode can be made very fine. This enables the reduction of voltage necessary to cause the spark, and greatly improves ignitability. Moreover, the special iridium alloy used was developed by DENSO

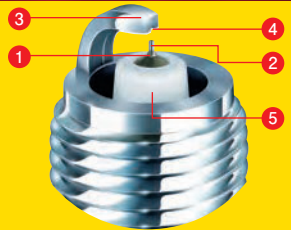

3 Taper-cut Ground Electrode

The tip of the ground electrode is cut to a fine taper to reduce the adverse effects of quenching, which greatly improves fuel ignitability. Also, because of the streamlined, taper-cut shape, the fuel-air mixture spreads more evenly in the gap, resulting in steady, reliable igniting of combustion. (excluding IUF27A, IUF31A, IU24A, IU27A, IU31A, IY24, IY27 & IY31)



4 U-Groove Ground Electrode

The U-shaped groove on the ground electrode insures that the inside surface area is large enough to generate the flame kernel. This shape enables lower voltage needed to cause the spark and results in excellent ignitability without increasing the size of the spark gap. (excluding IUF27A, IUF31A, IU24A and IU31A)



5 Insulator Projection

The projection of the insulator is optimally designed based on each plug's thermal value. This corresponds to requirements unique to thermal value, such as self-cleaning ability at lower thermal values, and heat resistance at higher thermal values. (For all plug types)

Origin of Iridium: DENSO Iridium

A Long Time Ago...



Approximately 50 million years ago an asteroid, some 10km in diameter slammed into what is now Mexico's Yucatan Peninsula near the town of Chicxulub. The resulting dust cloud destroyed most living things and ended the dinosaurs reign on earth. The evidence for this has been known for some time, with the deposits of Iridium-rich clay found at the boundary of Cretaceous and Tertiary deposits (known as the K/T Boundary) all over the world.

On July 2 1992, Alan R. Hildebrand of the Geological Survey of Canada presented a scientific paper to the General Assembly of the Royal Astronomical Society of Canada entitled "The Cretaceous/Tertiary Boundary Impact". Some of his findings are summarized here.

The K/T boundary layer, sometimes known as the iridium bearing clay layer, has a global distribution and consists of at least two layers of impact material.

The upper layer, known as the Fireball layer averages 3mm thickness and represents 1500 cubic kilometers of debris deposited globally with no apparent variation in thickness. The lower layer termed the ejecta layer, averages about 2cm in thickness.

A Major Impact on Earth?

Many scientists believe that the enormous impact put enough dust into the upper atmosphere to darken and hence cool the Earth for several years. This was theorized to result in shutting off global photosynthesis, with the resulting collapse of the global food chain. As a result nothing larger than 25 kg survived the boundary.

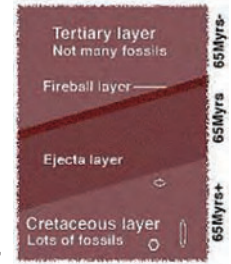

Iridium is found all over the world in the K/T layer and is not an unknown metal (commodity), however; its ability to be used in a manufacture type environment is unique. The current products that use Iridium are cellular telephones (Motorola), sunglasses (Oakley), and now spark plugs (DENSO). The reason for a few companies using this precious metal is its difficulty to be manipulated in a cost-effective manner.

DENSO's experience with Iridium in the development of the complete line of original equipment platinum spark plugs helped in the development of the DENSO Iridium alloy, where the Iridium becomes the primary metal complimented by rhodium (Atomic Symbol: Rh) to increase oxidation wear resistance.

Ignitability That's a Cut Above

With DENSO's very own U-Groove ground electrode for better spark performance.

To increase ignitability, the important point is to let the flame kernel caused by the spark to grow to a large size. Normally, this can be accomplished by widening the spark gap, however this causes spark voltage to increase, which has the opposite effect. **IRIDIUM POWER** uses DENSO very own U-Groove ground electrode to realize a superb ignitability while maintaining spark voltage at low levels.

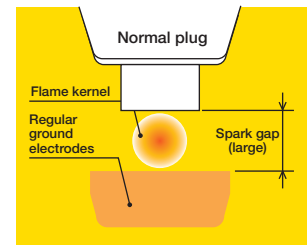
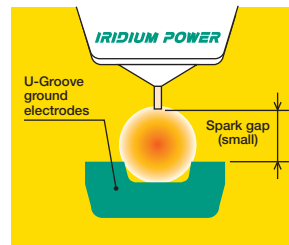

Improved Horse Power (1)

Get more power with an optimal fuel cycle.

IRIDIUM POWER has a low required voltage and a high ignitability, resulting in less misfiring and no spark, the outcome being a dramatic improvement in combustion. Engine output is thus increased. The findings of a bench test using a motorcycle engine to show the improved combustion from **IRIDIUM POWER** is shown on the below. Compared to normal plugs, a 0.5ps (1.4%) improvement is seen in output at 110 km/h.

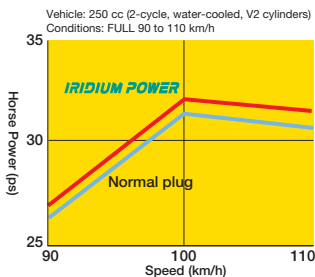

Plug	Horse Power (ps)	110 (km/h)
IRIDIUM POWER	31.50	32
Normal plug	31.06	

Data: In-Company Comparison

1.4% up!

Improved Acceleration

Increased response and acceleration performance.

IRIDIUM POWER best demonstrates its performance improvement during acceleration. **IRIDIUM POWER** has a 0.4 mm diameter iridium center electrode and a specially shaped ground electrode. These features combine to achieve higher ignitability and require lower spark voltage than ever before. This enables high-response driving with fewer misfires than under higher required voltage spark conditions, and fewer misfires when ignitability is difficult. As a result, acceleration improves in comparison with normal plugs.

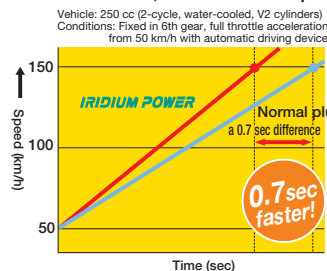

Data: In-Company Comparison

Plug	Center Electrode Dia. (mm)	Mileage (m)
IRIDIUM POWER	0.4 dia.	805
Normal plug	2.5 dia.	799

Good (800-810 m range)
6m longer!
A 6 m difference

Improved Horse Power (2)

The 0.4mm center electrode increases output under various driving conditions.

The power produced by the 0.4mm dia. iridium center electrode is **IRIDIUM POWER** unmatched by other plugs. The graph below compares the resulting power when **IRIDIUM POWER** is installed compared to other high performance plugs. Using a 0.4mm dia. fine center electrode, there is more power compared to 0.8mm and 2.5 mm dia. plugs. This is what makes the difference in acceleration and in your lap time.

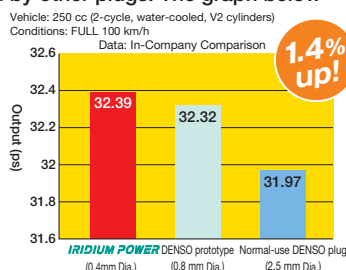

Improved Fuel Mileage

Even during idling ignition is assured, with less fuel consumption.

The good ignitability from the fine electrode (0.4 mm) of **IRIDIUM POWER** draws out much more performance from the engine. Comparing a normal plug (W20FS-U) with an **IRIDIUM POWER** (IW22) on a 2-cycle 50cc engine, fuel consumption improved from 41.74 km/L → 43.69 km/L, an improvement of about 5%.

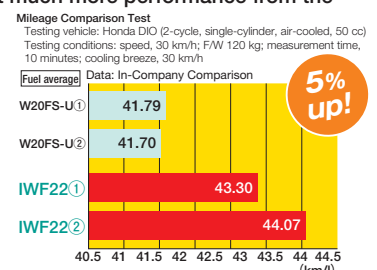

IRIDIUM POWER® lineup

IKH series

IKH16. IKH20. IKH22
IKH24. IKH27

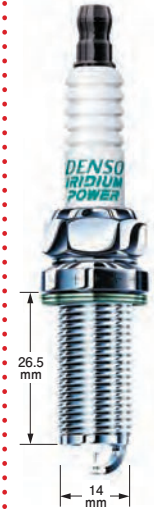

- φ14 mm × L26.5 mm length long reach type.
- For Subaru 3 Liter, Nissan, Peugeot, Citroen, and Yamaha Marine.
- IRIDIUM TOUGH** VKH16, VKH20, and VKH22 are also on sale.

IK series

IK16. IK20. IK22. IK24. IK27.
IK31. IK34



- Mainly used for cars. ISO type.
- φ14 mm × L19 mm length type.
- IK22 and above are for tuned engines, with a spark gap of 0.8 mm.
- IK16G, IK20G, and IK22G have a solid, stainless steel gasket (mainly used with Honda engines).
- IRIDIUM TOUGH** VK16, VK20, and VK22 are also on sale at the same time.
- IK□L is extended type (spark position 5 mm)

IK-L series

IK16L. IK20L



- φ14 mm X L19 mm X Hex 16mm.
- Extended Type The spark position is longer than IK20 by 2mm.
- KJ16CR-L11 / KJ16CR are substituted by IK16L
- KJ20CR-L11 / KJ20CR11 are substituted by IK20L (see this catalog for more substitution)

IK-G series

IK16G. IK20G. IK22G



- Mainly used for cars. ISO type.
- φ14 mm X L19 mm length type.
- IK22 and above are for tuned engines with a spark gap of 0.8 mm.
- IK16G, IK20G, and IK22G have a solid, stainless steel gasket (mainly used with Honda engines).
- IRIDIUM TOUGH** VK16G, VK20G, VK22G are also on sale at the same time.

IQ series

IQ16. IQ20. IQ22. IQ24.
IQ27. IQ31. IQ34

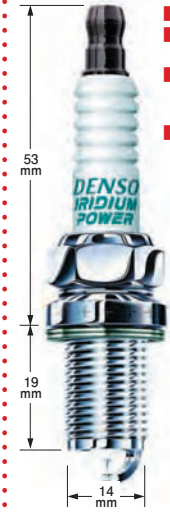

- Mainly used for cars.
- φ14 mm × L19 mm length type.
- IQ22 and above are for tuned engines, with a spark gap of 0.8 mm.
- IRIDIUM TOUGH** VQ16, VQ20, and VQ22 are also on sale.

IW series

IW16. IW20. IW22. IW24.
IW27. IW29. IW31. IW34



- φ14 mm × L19 mm length fully threaded type.
- IW16 to 22 are focused on ignitability with a 1.5 mm projection, whereas IW24 to 34 are focused on heat resistance with a projection of -1.5 mm.
- The spark position of IW24 to 34 is projected 0.5mm compared to normal (1.0 → 1.5 mm).
- Equipped with 0.4 mm diameter iridium center electrode for improved ignitability.
- IRIDIUM TOUGH** VW16, VW20, and VW22 are also on sale.

IWM series

IWM24. IWM27. IWM31

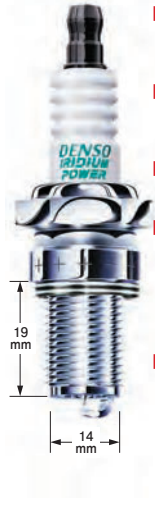

- This type has a gasket face height shortened by approximately 10 mm from the IW Type.
- The **IRIDIUM POWER** version of the IWM01-□ Iridium Racing plugs.
- Sold as street-use plugs for 2-cycle 250cc sports bikes.
- For Honda NSR250, Yamaha T2250R, Suzuki RGV250T (Gamma), Aprilia RS250, KTM260, 300, and 380 ('99 and later).
- Can also be used for water cooled kart engines.

IWF series

IWF16. IWF20.
IWF22. IWF24. IWF27



- φ14 mm × L12.7 mm length short reach type.
- IWF27 utilizes the heat resistance of the iridium electrode to extend the spark position 0.5 mm (1.0 → 1.5 mm)
- Harnessing the low required voltage of the 0.4mm dia. iridium, the gap is wider than in standard types (0.7 → 0.8 mm). Ignitability is increased even further.

ITV series

ITV16. ITV20. ITV22. ITV24.
ITV27

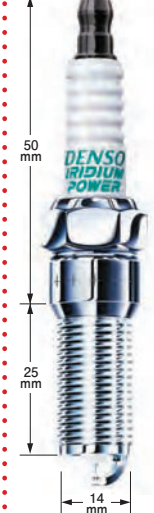

- φ14 mm × L25.0 mm length tapered seat, long reach type.
- For the Ford Focus, Mondeo, Escape, Chevrolet Blazer and Mazda Tribute.

ITL series

ITL16. ITL20



- φ14 mm × L25.0 mm length tapered seat, long reach type.
- Designed so that the head of the plug is 6 mm higher than in the ITV.
- Use with Chrysler's PT Cruiser, Voyager, Dodge, Magnum for 2005 model years and later.

IT series

IT16. IT20. IT22. IT24. IT27



- φ14 mm × L17.5 mm length tapered seat type.
- For use with GM, Ford, Citroen, Jaguar, Peugeot, Volvo, Mercedes-Benz, Lancia, Renault, Audi, and Mazda.
- IRIDIUM TOUGH** VT16, VT20 are also on sale.

ITF series

ITF16. ITF20. ITF22. ITF24.
ITF27



- φ14 mm × L11.2 mm length tapered seat type.
- For use with GM and Ford.

IXUH series

IXUH22. IXUH20I. IXUH22I



- φ12 mm × L26.5 mm length fully threaded type.
- The insulator is fully projected (1.5 mm), creating greater heat range and greater ignitability.
- 16 mm Hex
- Application: BMW Mercedes Benz Honda Mitsubishi Mazda Subaru Suzuki Daihatsu.
- IRIDIUM TOUGH** VXUH22, VXUH20I, VXUH22I are also on sale.

IXU series

IXU22. IXU24. IXU27. IXU22I



- φ12 mm × L19 mm length fully threaded type.
- The insulator is fully projected (1.5 mm), creating a wide heat range and greater ignitability.
- 16 mm Hex
- For use with small cars and imported motorcycles such as Ducati.
- IRIDIUM TOUGH** VXU20, VXU22, VXU24, VXU22I are also on sale.

IX series

IX22. IX24. IX27

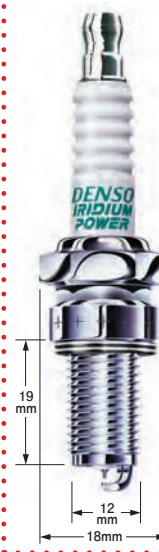

- φ12 mm × L19 mm length fully threaded type.
- Using the high heat resistance of the iridium electrode, the spark position is projected 0.4 mm more than in standard types. (1.6 → 2.0 mm)
- Harnessing the low required voltage of the 0.4 mm dia. iridium the gap is wider than in the standard types (0.7 → 0.8 mm). A further increase in ignitability.
- 18 mm Hex

IX-B series

IX22B. IX24B. IX27B



- φ12 mm × L19 mm length fully threaded type.
- Compared to the IX type, the insulator projection is extended 0.9 mm (0.6 → 1.5 mm), resulting in a wider heat range.
- The spark position is projected 0.8 mm more than the IX type. (2.0 → 2.8 mm)
- 18 mm Hex

IXG series

IXG24. IXG27



- The Iridium Power versions of the 2 mm shroud type plugs (X24/27GPU) used by Honda.
- Applicable to CB400SS. An expansion of applications is planned.
- Applicable to Honda CB400SS, XR400RR, CL400/RS, XLR250R, CBX250S, FTR250, CBX400F, XR250R.

IU series

IU20. IU22. IU24. IU27. IU31. IU22D. IU24D. IU27D



- φ10 mm × L19 mm length fully threaded type.
- Harnessing the low required voltage of the 0.4 mm iridium center electrode, the spark gap is wider than in normal type. A further increase in ignitability. (0.8 → 0.9 mm)
- For motorcycles such as Yamaha and Kawasaki, also for Ferrari, Maserati, and Alfa Romeo.

IU-A series

IU24A. IU27A. IU31A



- φ10 mm × L19 mm length fully threaded slant ground electrode type.
- Harnessing the low required voltage of the 0.4 mm dia. iridium, the gap is wider than in normal type (0.7 → 0.9 mm). Ignitability is greatly increased.
- By making this a single electrode, the spark location is stabilized compared to in normal types (double ground electrode), securing an ideal combustion condition.

IUH series

IUH24. IUH27



- φ10 mm × L19 mm length half-threaded type.
- Using the high heat resistance of the iridium electrode, the spark position is extended 0.4 mm compared to standard types (1.6 → 2.0 mm)
- Use only with Honda

IUF series

IUF22. IUF24. IUF14-UB



- φ10 mm × L12.7 mm length short reach type.
- Using the high heat resistance of the iridium, the spark position is extended 0.4 mm compared to standard types (1.6 → 2.0 mm)
- Harnessing the low required voltage of the 0.4 mm dia. iridium, the spark gap is wider than in normal types (0.7 → 0.8 mm). Ignitability is greatly increased.

IUF-A series

IUF27A. IUF31A



- φ10 mm × L12.7 mm length short type.
- Ideal for Gorilla/ Monkey Racing.
- The ground electrode has a slant shape, reducing the thermal stress on it.

IY series

IY24. IY27. IY31

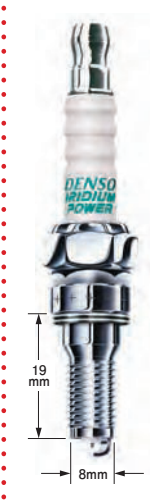

- φ8 mm × L19 mm length tapered seat, half thread type.
- The world's first 8 mm thread diameter iridium plug.
- Can be used with Honda Smart Dio ('04-), VFR400, RVF400, Kitaco Monkey Head, and NR750.

IRIDIUMPOWER® Specifications

TYPE	APPLICATION	SPEC	DIA. (mm)	REACH (mm)	HEX (mm)	GAP (mm)	PROJECTION (mm)	SPARK POSITION (mm)	GROUND ELECTRODE HEIGHT (mm)	TERMINAL SHAPE	RESISTOR (kΩ)	No.	IRIDIUM POWER	IRIDIUM POWER
													ONE PC BOX	2pcs BLISTER PACK
													DENSO P/N	DENSO P/N
IQ16	Automobile	Old JIS (Installing height=K type+2mm)	14	19	16	1.1	1.5	3.0	5.5	S	5	I01	067700-8701	100676-3380
IQ20	Automobile	Old JIS (Installing height=K type+2mm)	14	19	16	1.1	1.5	3.0	5.5	S	5	I02	067700-8711	100676-3390
IQ22	Automobile	Old JIS (Installing height=K type+2mm)	14	19	16	0.8	1.5	3.0	5.2	S	5	I13	067700-8481	100676-3480
IQ24	Automobile	Old JIS (Installing height=K type+2mm)	14	19	16	0.8	1.5	3.0	5.2	S	5	I14	067700-8491	100676-3490
IQ27	Automobile	Old JIS (Installing height=K type+2mm)	14	19	16	0.8	1.5	3.0	5.2	S	5	I15	067700-8502	
IQ31	Automobile	Old JIS (Installing height=K type+2mm)	14	19	16	0.8	-0.5	1.0	3.2	S	5	I23	067700-9231	
IQ34	Automobile	Old JIS (Installing height=K type+2mm)	14	19	16	0.8	-0.5	1.0	3.2	S	5	I24	067700-9601	
IK16	Automobile		14	19	16	1.1	1.5	3.0	5.5	S	5	I03	067700-8681	100676-3360
IK20	Automobile		14	19	16	1.1	1.5	3.0	5.5	S	5	I04	067700-8691	100676-3370
IK22	Automobile		14	19	16	0.8	1.5	3.0	5.2	S	5	I10	067700-8431	100676-3450
IK24	Automobile		14	19	16	0.8	1.5	3.0	5.2	S	5	I11	067700-8461	100676-3460
IK27	Automobile		14	19	16	0.8	1.5	3.0	5.2	S	5	I12	067700-8472	100676-3470
IK31	Automobile		14	19	16	0.8	-0.5	1.0	3.2	S	5	I21	067700-9221	
IK34	Automobile		14	19	16	0.8	-0.5	1.0	3.2	S	5	I22	067700-9591	
IK16G	Automobile	SUS Gasket	14	19	16	1.1	1.5	3.0	5.5	S	5	I51	267700-5611	
IK20G	Automobile	SUS Gasket	14	19	16	1.1	1.5	3.0	5.5	S	5	I52	267700-5621	
IK22G	Automobile	SUS Gasket	14	19	16	0.8	1.5	3.0	5.2	S	5	I48	267700-5661	100676-5350
IK16L	Automobile	EXTENDED	14	19	16	1.1	2.5	5.0	7.8	RC	5	I57	267700-5121	
IK20L	Automobile	EXTENDED	14	19	16	1.1	2.5	5.0	7.8	RC	5	I58	267700-5131	
IKH16	Automobile		14	26.5	16	1.1	1.5	3.0	5.5	S	5	I43	267700-3661	100676-5160
IKH20	Automobile		14	26.5	16	1.1	1.5	3.0	5.5	S	5	I44	267700-3671	100676-5140
IKH22	Automobile		14	26.5	16	0.8	1.5	3.0	5.2	S	5	I45	267700-2651	100676-5170
IKH24	Automobile		14	26.5	16	0.8	1.5	3.0	5.2	S	5	I46	267700-4281	100676-5180
IKH27	Automobile		14	26.5	16	0.8	1.5	3.0	5.2	S	5	I47	267700 4291	
IW16	Automobile		14	19	20.6	1.1	1.5	3.0	5.5	RC	5	I05	067700-8651	100676-3400
IW20	Automobile		14	19	20.6	1.1	1.5	3.0	5.5	RC	5	I06	067700-8661	100676-3410
IW22	Automobile		14	19	20.6	0.8	1.5	3.0	5.2	RC	5	I07	067700-8671	100676-3420
IW24	Motorcycle		14	19	20.6	0.7	-0.5	1.5	3.6	RC	5	I16	067700-8891	
IW27	Motorcycle		14	19	20.6	0.7	-0.5	1.5	3.6	RC	5	I17	067700-8901	
IW29	Racing Kart		14	19	20.6	0.7	-0.5	1.5	3.6	RC	5	I18	067700-8911	
IW31	Racing Kart		14	19	20.6	0.7	-0.5	1.5	3.6	RC	5	I19	067700-8921	
IW34	Racing Kart		14	19	20.6	0.7	-0.5	1.5	3.6	RC	5	I20	067700-8931	
IWM24	Motorcycle	Compact insulator head	14	19	20.6	0.8	-1.5	0.5	2.7	S	5	I91	267700-2891	
IWM27	Motorcycle	Compact insulator head	14	19	20.6	0.8	-1.5	0.5	2.7	S	5	I92	267700-2901	
IWM31	Motorcycle	Compact insulator head	14	19	20.6	0.8	-1.5	0.5	2.7	S	5	I93	267700-2911	
IWF16	Motorcycle		14	12.7	20.6	0.8	1.5	3.0	5.2	R	5	I59	267700-5001	
IWF20	Motorcycle		14	12.7	20.6	0.8	1.5	3.0	5.2	R	5	I78	267700-5011	
IWF22	Motorcycle		14	12.7	20.6	0.8	-0.5	1.5	3.7	R	5	I79	067700-9411	
IWF24	Motorcycle		14	12.7	20.6	0.8	-0.5	1.5	3.7	R	5	I80	067700-9421	
IWF27	Motorcycle		14	12.7	20.6	0.8	-0.5	1.5	3.7	R	5	I81	067700-9431	
ITV16	Automobile	Taper Seat(Insulator Length 50mm)	14	25	16	1.1	1.5	3.0	5.5	S	5	I38	267700-3701	100676-5200
ITV20	Automobile	Taper Seat(Insulator Length 50mm)	14	25	16	1.1	1.5	3.0	5.5	S	5	I39	267700-3711	100676-5210
ITV22	Automobile	Taper Seat(Insulator Length 50mm)	14	25	16	0.8	1.5	3.0	5.2	S	5	I40	267700-2501	
ITV24	Automobile	Taper Seat(Insulator Length 50mm)	14	25	16	0.8	-0.5	1.0	3.2	S	5	I41	267700-2511	
ITV27	Automobile	Taper Seat(Insulator Length 50mm)	14	25	16	0.8	-0.5	1.0	3.2	S	5	I42	267700-2521	
ITL16	Automobile	Taper Seat(Insulator Length 56mm)	14	25	16	1.1	1.5	3.0	5.5	S	5	I49	267700-4981	
ITL20	Automobile	Taper Seat(Insulator Length 56mm)	14	25	16	1.1	1.5	3.0	5.5	S	5	I50	267700-4991	
IT16	Automobile	TAPER SEAT	14	17.5	16	1.1	1.5	3.0	5.5	S	5	I25	267700-0611	100676-3610
IT20	Automobile	TAPER SEAT	14	17.5	16	1.1	1.5	3.0	5.5	S	5	I26	267700-0621	100676-3620
IT22	Automobile	TAPER SEAT	14	17.5	16	0.8	1.5	3.0	5.2	S	5	I27	267700-0631	
IT24	Automobile	TAPER SEAT	14	17.5	16	0.8	-0.5	1.0	3.2	S	5	I28	267700-0641	
IT27	Automobile	TAPER SEAT	14	17.5	16	0.8	-0.5	1.0	3.2	S	5	I29	267700-0651	
ITF16	Automobile	TAPER SEAT	14	11.2	16	1.1	1.5	3.0	5.5	S	5	I30	267700-0661	
ITF20	Automobile	TAPER SEAT	14	11.2	16	1.1	1.5	3.0	5.5	S	5	I31	267700-0671	
ITF22	Automobile	TAPER SEAT	14	11.2	16	0.8	1.5	3.0	5.2	S	5	I32	267700-0681	
ITF24	Automobile	TAPER SEAT	14	11.2	16	0.8	-0.5	1.0	3.2	S	5	I33	267700-0691	
ITF27	Automobile	TAPER SEAT	14	11.2	16	0.8	-0.5	1.0	3.2	S	5	I34	267700-0701	
IXU22	Automobile		12	19	16	0.9	1.3	2.8	5.0	RC	5	I08	067700-8722	100676-3430
IXU24	Automobile		12	19	16	0.9	1.3	2.8	5.0	RC	5	I09	067700-8732	100676-3440
IXU27	Motorcycle		12	19	16	0.9	1.3	2.8	5.0	RC	5	I37	067700-8602	100676-3820
IXU22I	Automobile		12	19	16	0.9	1.3	3.5	5.7	S	5	I51	267700-8431	
IXUH22	Automobile		12	26.5	16	0.9	1.5	3.0	5.2	S	5	I53	267700-6451	
IXUH20I	Automobile		12	26.5	16	0.9	1.5	4.0	6.2	S	5	I54	267700-8171	
IXUH22I	Automobile		12	26.5	16	0.9	1.5	4.0	6.2	S	5	I56	267700-7371	

TYPE	APPLICATION	SPEC	DIA.	REACH	HEX	GAP	PROJECTION	SPARK POSITION	GROUND ELECTRODE HEIGHT	TERMINAL SHAPE	RESISTOR (Ω)	No.	IRIDIUM POWER	IRIDIUM POWER
													ONE PC BOX	2pcs BLISTER PACK
													DENSO P/N	DENSO P/N
IX22	Motorcycle		12	19	18	0.8	0.6	2.0	4.1	R	5	I71	067700-9351	
IX24	Motorcycle		12	19	18	0.8	0.6	2.0	4.1	R	5	I72	067700-9361	
IX27	Motorcycle		12	19	18	0.8	0.6	2.0	4.1	R	5	I73	067700-9371	
IX22B	Motorcycle		12	19	18	0.9	1.5	2.8	5.0	R	5	I75	067700-9381	
IX24B	Motorcycle		12	19	18	0.9	1.5	2.8	5.0	R	5	I76	067700-9391	
IX27B	Motorcycle		12	19	18	0.9	1.5	2.8	5.0	R	5	I77	067700-9401	
IXG24	Motorcycle	SHROUD	12	21.8	18	0.7	0.7	2.0	4.1	R	5	I94	267700-2921	
IXG27	Motorcycle	SHROUD	12	21.8	18	0.7	0.7	2.0	4.1	R	5	I95	267700-2931	
IU20	Motorcycle		10	19	16	0.9	-0.5	0.7	2.6	R	5	I60	267700-5021	
IU22	Motorcycle		10	19	16	0.9	-0.5	0.7	2.6	R	5	I61	067700-9262	
IU24	Motorcycle		10	19	16	0.9	-0.5	0.7	2.6	R	5	I62	067700-9272	
IU27	Motorcycle		10	19	16	0.9	-0.5	0.7	2.6	R	5	I63	067700-9282	
IU31	Motorcycle		10	19	16	0.9	-0.5	0.7	2.6	R	5	I64	067700-9292	
IU24A	Motorcycle	SLANT GROUND ELECTRODE	10	19	16	0.9	-0.5	1.0	2.9	R	5	I65	067700-9302	
IU27A	Motorcycle	SLANT GROUND ELECTRODE	10	19	16	0.9	-0.5	1.0	2.9	R	5	I66	067700-9312	
IU31A	Motorcycle	SLANT GROUND ELECTRODE	10	19	16	0.9	-0.5	1.0	2.9	R	5	I67	067700-9321	
IU22D	Motorcycle	NON U-GROOVE	10	19	16	0.9	0.5	2.0	4.0	T	5	-	267700-0830	
IU24D	Motorcycle	NON U-GROOVE	10	19	16	0.9	0.5	2.0	4.0	T	5	I103	267700-0840	
IU27D	Motorcycle	NON U-GROOVE	10	19	16	0.9	0.5	2.0	4.0	T	5	I90	267700-0850	
IUH24	Motorcycle	HALF THREAD	10	19	16	0.9	0.6	2.0	3.9	R	5	I68	067700-9331	
IUH27	Motorcycle	HALF THREAD	10	19	16	0.9	0.6	2.0	3.9	R	5	I69	067700-9341	
IUF22	Motorcycle		10	12.7	16	0.8	0.6	2.0	3.8	R	5	I83	067700-9481	
IUF24	Motorcycle		10	12.7	16	0.8	0.6	2.0	3.8	R	5	I84	067700-9491	
IUF27A	Motorcycle	SLANT GROUND ELECTRODE	10	12.7	16	0.9	-0.5	1.0	2.9	R	5	I85	067700-9701	
IUF31A	Motorcycle	SLANT GROUND ELECTRODE	10	12.7	16	0.9	-0.5	1.0	2.9	R	5	I86	067700-9711	
IY24	Motorcycle	HALF THREAD	8	19	13	0.7	0.6	1.4	2.9	R	5	I100	267700-4491	
IY27	Motorcycle	HALF THREAD	8	19	13	0.7	0.6	1.4	2.9	R	5	I101	267700-4501	
IY31	Motorcycle	HALF THREAD	8	19	13	0.7	-0.5	0.5	2.0	R	5	I102	267700-4511	

0.4mm diameter IRIDIUM PLUG

TYPE	APPLICATION	SPEC	DIA.	REACH	HEX	GAP	PROJECTION	SPARK POSITION	GROUND ELECTRODE HEIGHT	TERMINAL SHAPE	RESISTOR (Ω)	No.	IRIDIUM	IRIDIUM
													ONE PC BOX	2pcs BLISTER PACK
													DENSO P/N	DENSO P/N
IK24C11	Motorcycle		14	19	16	1.1	1.5	3.0	5.7	S	5	I35	067700-9550	
IK27C11	Motorcycle		14	19	16	1.1	0.5	2.0	4.7	S	5	I36	067700-9520	
IXU22C	Automobile	NON U-GROOVE	12	19	16	0.8	1.3	2.8	4.9	S	5	-	267700-5170	
IXU22HPR	Automobile	NON U-GROOVE	12	26.5	16	0.8	1.5	3.0	5.1	S	5	I74	267700-7170	
IU31D	Motorcycle	NON U-GROOVE	10	19	16	0.9	-0.5	1.0	3.0	T	5	-	267700-0860	
IUH24D	Motorcycle	HALF THREAD	10	19	16	0.9	0.6	2.0	4.0	T	5	I87	067700-9560	
IUH27D	Motorcycle	HALF THREAD	10	19	16	0.9	0.6	2.0	4.0	T	5	I88	067700-9570	
IUF14-UB	MARINE		10	12.7	16	0.7	0.6	1.6	3.3	S	5	I89	267700-0540	
VK16PR-Z11	Motorcycle	GROUND ELEC. Pt.&TAPERCUT	14	19	16	1.1	1.5	3.0	5.7	S	5	V28	267700-1840	
VK20PR-Z11	Motorcycle	GROUND ELEC. Pt.&TAPERCUT	14	19	16	1.1	1.5	3.0	5.7	S	5	V15	267700-1850	
VK22PR-Z11	Motorcycle	GROUND ELEC. Pt.&TAPERCUT	14	19	16	1.1	1.5	3.0	5.7	S	5	V29	267700-1860	
VK24PR-Z11	Motorcycle	GROUND ELEC. Pt.&TAPERCUT	14	19	16	1.1	1.5	3.0	5.7	S	5	V16	267700-1870	
VK27PR-Z11	Motorcycle	GROUND ELEC. Pt.&TAPERCUT	14	19	16	1.1	0.5	2.0	4.7	S	5	V30	267700-2050	
VKJ20RZ-M11	Motorcycle	GROUND ELEC. Pt.&TAPERCUT	14	19	16	1.1	3.0	5.0	7.7	S	5	V33	267700-1970	
SVK20RZ8	Automobile	GROUND ELEC. Pt.&TAPERCUT	14	19	16	0.8	1.5	3.5	5.7	S	5	S18	067700-9740	
SVK20RZ11	Automobile	GROUND ELEC. Pt.&TAPERCUT	14	19	16	1.1	1.5	3.5	6.0	S	5	S52	067700-8620	
VX20BC	Motorcycle	GROUND ELEC. Pt.	12	19	18	0.9	1.5	2.8	5.0	T	5	V34	067700-9830	
VX22BC	Motorcycle	GROUND ELEC. Pt.	12	19	18	0.9	1.5	2.8	5.0	T	5	V14	067700-9720	
VUH24D	Motorcycle	HALF THREAD,Ground Elec. Pt.&TAPERCUT	10	19	16	0.9	0.6	2.0	4.0	T	5	V26	267700-2011	
VUH27D	Motorcycle	HALF THREAD,Ground Elec. Pt.&TAPERCUT	10	19	16	0.9	0.6	2.0	4.0	T	5	V27	267700-1931	
VUH24ES	Motorcycle	HALF THREAD,Ground Elec. Pt.&TAPERCUT,SUS GASKET	10	19	16	0.9	0.6	2.0	4.0	T	5	V57	267700-6130	
VUH27ES	Motorcycle	HALF THREAD,Ground Elec. Pt.&TAPERCUT,SUS GASKET	10	19	16	0.9	0.6	2.0	4.0	T	5	V42	267700-4770	
VNH24Z	Motorcycle	HALF THREAD,Ground Elec. Pt.&TAPERCUT	10	19	16	0.9	0.6	2.0	4.0	S	5	V32	267700-2060	
VNH27Z	Motorcycle	HALF THREAD,Ground Elec. Pt.&TAPERCUT	10	19	16	0.9	0.6	2.0	4.0	S	5	V31	267700-2070	
VNH27ZB	Motorcycle	HALF THREAD,Ground Elec. Pt.&TAPERCUT	10	19	16	0.9	0.6	2.0	4.0	S	5	-	267700-1920	

Spark gap example For a 1.1 mm gap, set from 1.0 to 1.1 mm.
 Insulator projection Length from edge of side housing to top of insulator.
 Spark position The plus (+) direction is the distance from the edge to the piston head.
 Ground electrode height Length from edge of side housing to top of center electrode.
 The plus (+) direction is the distance from the edge to the piston head.
 The plus (+) direction is the distance from the edge to the piston head.
 Terminal shapes S: solid terminal, R: removable, RC: crimped nut, T: threaded
 Note: Please purchase plugs equipped as original parts at stores that sell original parts.



High Performance Spark Plug

IRIDIUM TOUGH®



Iridium alloy fine center electrode

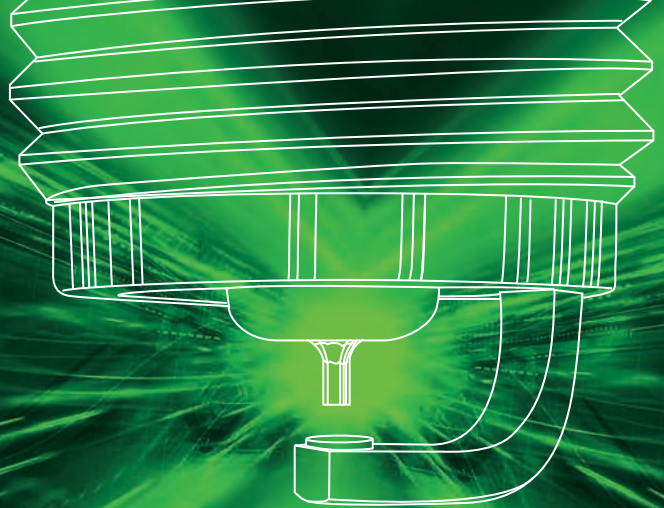

Lasting high performance, long life and high response

Economical and long lasting!

Fine diameter iridium alloy and platinum-tipped ground electrode achieve high durability!



Resistor
Noise Reduction
5kΩ

Built-in, Highly Reliable Resistor
All specification types include an embedded, highly reliable, monolithic resistor to eliminate electromagnetic noise interference from all kinds of electronic devices.



Highly Corrosion Resistant, Burnished Nickel Plating
The insulator housing is plated with burnished nickel the same as racing plugs, resulting in high corrosion resistance. (VKA and VKB excluded)



LASER WELDING
360° Laser Welding
The iridium tip is mounted with an "All-around Laser Welding" method that insures high reliability and durability even under the most severe driving conditions.

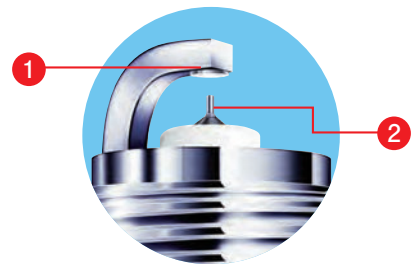

1 Platinum-tipped Ground Electrode

The ground electrode has a platinum tip, from DENSO's experience with platinum plugs. This greatly moderates electrode wear and insures high durability.

2 Fine Diameter Ultra-fine Iridium Center Electrode

Using DENSO's exclusive iridium alloy having a very high melting point, the tip of the center electrode can be shaped very thin and fine, reducing spark voltage requirements and greatly improving ignitability.

IRIDIUM TOUGH® is recommended for the following user.



For long distance and heavy-use drivers.

Because of its long lifetime, recommended to drivers for long driving.

By greatly minimizing electrode wear, DENSO improved mileage and extended the plug's useful life. Longevity provides you with peace of mind and safety when using **IRIDIUM TOUGH®**.

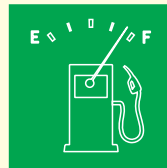

For drivers that care about mileage.

As I drive every day, so I want less fuel consumption.

If you use your car on a daily basis, you may be concerned about fuel consumption. **IRIDIUM TOUGH®** is one solution.

High Durability



Comparison of Durability

In-Company Comparison (Data for positive and negative discharging vehicle)

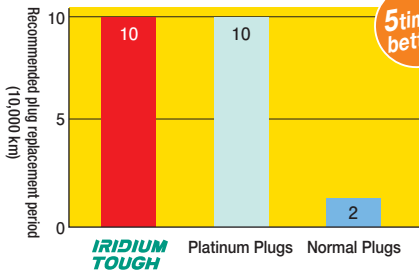

5 times better!

- * From taxi monitoring test results. Displacement is mainly 2000 cc.
- * Depending on the driving conditions there will be differences in endurance.
- * The service lifetime of Iridium Tough will depend on operating conditions and the vehicles it is installed on. (Service lifetime may become shorter depending on the vehicle's ignition system.)

Improved Mileage



The difference in mileage

In-Company Comparison

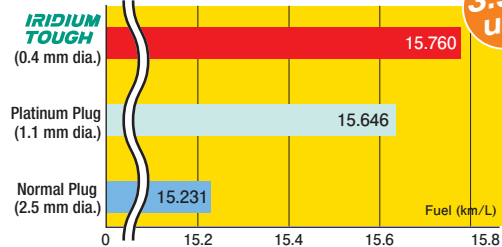

3.5% up!

Vehicle: 2000cc, 6 cyl, 4 cycle
Driving Conditions: 60km/h on set ground

Improved Ignitability



Realizing high ignition performance with a fine diameter electrode.

Comparison of Flame Spread

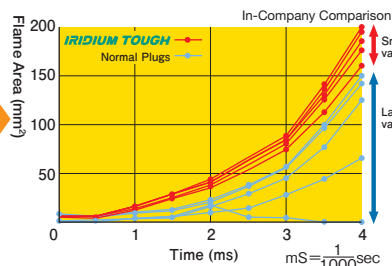
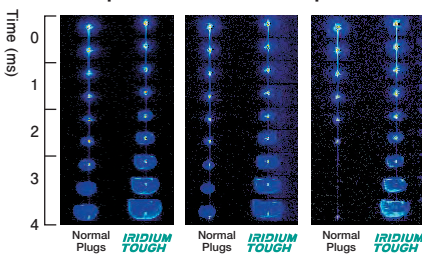

Promotion of Flame Kernel Growth

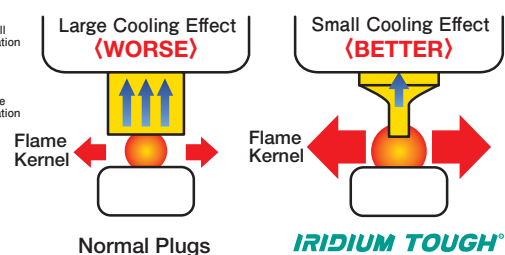

If the electrode dia. is fine, the cooling effect on the flame kernel is smaller.

Improved Acceleration



Stable ignitability improves acceleration

The difference in acceleration

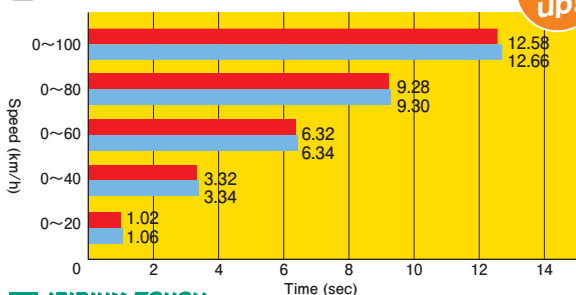

0.6% up!

Vehicle: 2000cc, 4 cyl, 4-cycle
Driving conditions: Creeping (2nd) → Full throttle (100km/h)

* The data shown is from internal studies. Also, the "Normal Plug" referred to here is a DENSO product.

Comparison of Combustion Pressure

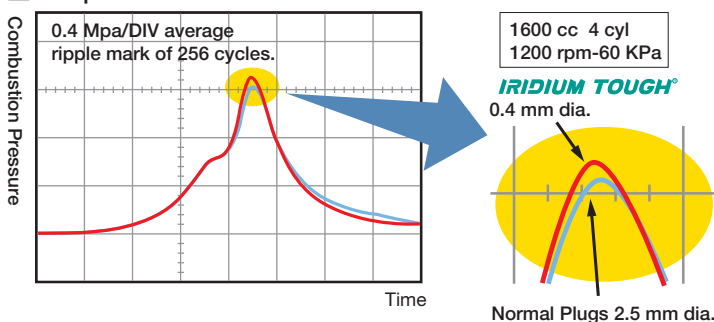

IRIDIUM TOUGH will increase combustion pressure and engine output.

IRIDIUM TOUGH® Specifications

TYPE	APPLICATION	SPEC	DIA. (mm)	REACH (mm)	HEX (mm)	GAP (mm)	PROJECTION (mm)	SPARK POSITION (mm)	GROUND ELECTRODE HEIGHT (mm)	TERMINAL SHAPE	RESISTOR (KΩ)	No.	IRIDIUM TOUGH® ONE PC BOX	IRIDIUM TOUGH® 2pcs BLISTER PACK
													DENSO P/N	DENSO P/N
VQ16	Automobile	JIS	14	19	16	1.1	1.5	3.0	5.7	S	5	V01	267700-0741	100676-3740
VQ20	Automobile	JIS	14	19	16	1.1	1.5	3.0	5.7	S	5	V02	267700-0751	100676-3750
VQ22	Automobile	JIS	14	19	16	0.8	1.5	3.0	5.4	S	5	V13	267700-0761	100676-3760
VK16	Automobile	ISO	14	19	16	1.1	1.5	3.0	5.7	S	5	V03	267700-0711	100676-3710
VK20	Automobile	ISO	14	19	16	1.1	1.5	3.0	5.7	S	5	V04	267700-0721	100676-3720
VK22	Automobile	ISO	14	19	16	0.8	1.5	3.0	5.4	S	5	V10	267700-0731	100676-3730
VK16G	Automobile	SUS GASKET	14	19	16	1.1	1.5	3.0	5.7	S	5	V40	267700-5631	
VK20G	Automobile	SUS GASKET	14	19	16	1.1	1.5	3.0	5.7	S	5	V41	267700-5641	
VK22G	Automobile	SUS GASKET	14	19	16	0.8	1.5	3.0	5.4	S	5	V36	267700-5671	100676-5340
VK20Y	Automobile		14	19	16	0.8	1.5	3.0	5.4	S	5	V20	267700-3721	100676-3950
VKA16	Automobile	NEW 3 ELECTRODE SHROUD	14	22	16	1.1	2.5	4.0	6.5	S	5	V22	267700-5031	100676-5360
VKA20	Automobile	NEW 3 ELECTRODE SHROUD	14	22	16	1.1	2.5	4.0	6.5	S	5	V23	267700-5041	100676-5370
VKB16	Automobile	NEW 3 ELECTRODE	14	19	16	1.1	2.5	4.0	6.5	S	5	V24	267700-5051	100676-5380
VKB20	Automobile	NEW 3 ELECTRODE	14	19	16	1.1	2.5	4.0	6.5	S	5	V25	267700-5061	100676-5390
VFK16	Automobile	DOUBLE NEEDLE Ir & Pt ELEC.	14	19	16	1.1	1.5	3.0	6.5	S	5	V47	267700-9151	
VFK20F	Automobile	DOUBLE NEEDLE Ir & Pt ELEC. COPPER CORE GROUND ELEC.	14	19	16	1.1	1.5	3.0	6.5	S	5	V48	267700-9161	
VFKB16	Automobile	NEW 3 ELECTRODE, DOUBLE NEEDLE IRIIDIUM, PLATINUM	14	19	16	0.8	2.5	4.0	7.0	S	5	V64	267700-9271	
VFKH16	Automobile	DOUBLE NEEDLE Ir & Pt ELEC.	14	26.5	16	1.1	2.5	4.0	7.3	S	5	V54	267700-7411	
VFKH20	Automobile	DOUBLE NEEDLE Ir & Pt ELEC.	14	26.5	16	1.1	2.5	4.0	7.3	S	5	V55	267700-7421	
VFKBH20	Automobile	NEW 3 ELECTRODE, DOUBLE NEEDLE IRIIDIUM, PLATINUM	14	26.5	16	1.1	2.5	4.0	7.1	S	5	V43	267700-7661	
VKH16	Automobile		14	26.5	16	1.1	1.5	3.0	5.7	S	5	V17	267700-3681	100676-5250
VKH20	Automobile		14	26.5	16	1.1	1.5	3.0	5.7	S	5	V18	267700-3691	100676-5150
VKH20Y	Automobile		14	26.5	16	0.8	1.5	3.0	5.4	S	5	V39	267700-4541	100676-5260
VKH22	Automobile		14	26.5	16	0.8	1.5	3.0	5.4	S	5	V19	267700-2681	100676-5270
VW16	Automobile		14	19	20.6	1.1	1.5	3.0	5.5	S	5	V05	267700-0771	100676-3770
VW20	Automobile		14	19	20.6	1.1	1.5	3.0	5.5	S	5	V06	267700-0781	100676-3780
VW22	Automobile		14	19	20.6	0.8	1.5	3.0	5.2	S	5	V07	267700-0791	100676-3790
VT16	Automobile	TAPER SEAT	14	17.5	16	1.1	1.5	3.0	5.5	S	5	V21	267700-2811	100676-5280
VT20	Automobile	TAPER SEAT	14	17.5	16	1.1	1.5	3.0	5.5	S	5	V38	267700-4481	100676-5290
VXU20	Automobile		12	19	16	1.1	1.5	3.0	5.4	S	5	V49	267700-9141	
VXU22	Automobile		12	19	16	0.9	1.3	2.8	5.0	RC	5	V08	267700-0801	100676-3800
VXU24	Automobile		12	19	16	0.9	1.3	2.8	5.0	RC	5	V09	267700-0811	100676-3810
VXU22I	Automobile		12	19	16	0.9	1.3	3.5	5.7	S	5	V51	267700-8441	
VXUH22	Automobile		12	26.5	16	0.9	1.5	3.0	5.2	S	5	V11	267700-6461	
VXUH20I	Automobile		12	26.5	16	0.9	1.5	4.0	6.2	S	5	V50	267700-8161	
VXUH22I	Automobile		12	26.5	16	0.9	1.5	4.0	6.2	S	5	V56	267700-7381	
VXUHC22G	Automobile	SUS GASKET SHROUD	12	28	16	0.8	2.0	3.5	5.6	S	5	V52	267700-8671	
VFXUHC22FG	Automobile	DOUBLE NEEDLE Ir & Pt ELEC, SUS GASKET SHROUD	12	28	16	1.1	2.0	3.5	5.7	S	5	V53	267700-8681	
VCH16	Automobile		12	26.5	14	1.1	2.5	4.0	6.4	S	5	V58	267700-9211	
VCH20	Automobile		12	26.5	14	1.1	2.5	4.0	6.4	S	5	V37	267700-7671	
VFCH16	Automobile	DOUBLE NEEDLE Ir & Pt ELECTRODE	12	26.5	14	0.8	2.5	4.0	6.8	S	5	V65	267700-9281	
VDCH22F	Automobile	DOUBLE NEEDLE Ir & Pt ELECTRODE	12	26.5	14	0.9	3	3.0	6.0	S	5	V63	267700-9291	
VDKH22F	Automobile	DOUBLE NEEDLE Ir & Pt ELECTRODE	14	26.5		0.9	3	3.0	6.3	S	5	V62	267700-8751	
VXEBH27	Automobile	NEW 3 & COPPER CORE GROUND ELEC.	12	26.5	14	0.8	2	3.5	5.6	S	5	V86	267700-9171	
VXEHC24G	Automobile	SUS GASKET SHROUD 1.5mm	12	28	14	0.8	2	3.0	5.7	S	5	V60	267700-9231	
VFXEH20E	Automobile	DOUBLE NEEDLE Ir & Pt ELECTRODE, SHROUD 2mm	12	28.5	14	1.1	2.5	4.0	7.2	S	5	V44	267700-7631	
VFXEH22	Automobile	DOUBLE NEEDLE Ir & Pt ELECTRODE	12	26.5	14	1.1	2.5	4.0	7.2	S	5	V46	267700-7651	
VFXEH20	Automobile	DOUBLE NEEDLE Ir & Pt ELECTRODE	12	26.5	14	1.1	2.5	4.0	7.2	S	5	V45	267700-7641	
VFXEHC22G	Automobile	DOUBLE NEEDLE Ir & Pt ELECTRODE, SHROUD 1.5mm	12	28	14	0.8	2	3.5	6.4	S	5	V59	267700-9221	
VSUEH22	Automobile	M10x26.5	10	26.5	14	0.7	3	1.5	4.8	S	5	V61	267700-9241	

Spark gap example For a 1.1 mm gap, set from 1.0 to 1.1 mm.
 Insulator projection Length from edge of side housing to top of insulator. The plus (+) direction is the distance from the edge to the piston head.
 Spark position Length from edge of side housing to top of center electrode. The plus (+) direction is the distance from the edge to the piston head.
 Ground electrode height Length from edge of side housing to top of ground electrode. The plus (+) direction is the distance from the edge to the piston head.
 Terminal shapes S: solid terminal, R: removable, RC: crimped nut, T: threaded

IRIDIUM TOUGH® lineup



VFKH series

VFKH16 · VFKH20

- World's first $\phi 0.4$ mm Double needle Iridium Tough.
- DENSO OEM needle technology used by Iridium Tough plugs on the market.
- Both electrodes are needle-shaped for better ignitability and wider heat range, coaxing the maximum power possible from your engine.
- $\phi 14 \times L26.5 \times \circ 16$.
- For Toyota, Lexus and Subaru



VFKBH series

VFKBH20

- World's first $\phi 0.4$ mm new-3 electrode double needle Iridium Tough.
- DENSO OEM needle technology used by Iridium Tough plugs on the market.
- Both electrodes are needle-shaped for better ignitability and wider heat range, coaxing the maximum power possible from your engine.
- $\phi 14 \times L26.5 \times \circ 16$.
- For Lexus, Toyota



VFXEH series

VFXEH20 · VFXEH22

- World's first $\phi 0.4$ mm double needle Iridium Tough.
- DENSO OEM needle technology used by Iridium Tough plugs on the market.
- Both electrodes are needle-shaped for better ignitability and wider heat range, coaxing the maximum power possible from your engine.
- $\phi 12 \times L26.5 \times \circ 14$.
- For Nissan, AMG Mercedes, Renault, Peugeot, Citroen



VFXEH-E series

VFXEH20E

- World's first $\phi 0.4$ mm double needle Iridium Tough.
- DENSO OEM needle technology used by Iridium Tough plugs on the market.
- Both electrodes are needle-shaped for better ignitability and wider heat range, coaxing the maximum power possible from your engine.
- $\phi 12 \times L28.5 \times \circ 14$ (2mm shroud).
- For Nissan, Mazda, Mitsubishi, Mitsuoka



VKH series

VKH16 · VKH20 · VKH22 · VKH20Y

- For Subaru
- For Peugeot
- For Citroen
- For NISSAN
- For Renault
- For Mitsubishi
- For TOYOTA
- For ISUZU
- For Mercedes Benz, and others
- Thread length: 26.5 mm



VK series

VK16 · VK20 · VK22 · VK20Y · VK16G · VK20G · VK22G

- Mainly for automobiles and trucks
- ISO-compatible small plug
- $\phi 14 \times L19 \times \circ 16$.
- VK20Y has a gap of 0.8 and is mainly for use with turbo engine vehicles.
- VK16G, VK20G, and VK22G have a stainless steel gasket.



VQ series

VQ16 · VQ20 · VQ22

- Mainly for automobiles and trucks
- JIS-type Small plug
- $\phi 14 \times L19 \times \circ 16$.
- VQ22 can be used for upgrading performance if the gap is set to 0.8.



VKA series

VKA16 · VKA20

- Corresponding to SK16BGR11, SK20BGR11 and PK20GR8
- Shroud-type
- Thread length: 22 mm
- For TOYOTA D4 engine
- For Mitsubishi GDI engine



VKB series

VKB16 · VKB20

- Corresponding to SK16BR11 and SK20BR11
- Thread length: 19 mm
- For TOYOTA D4 engine
- For Mitsubishi GDI engine



VW series

VW16 · VW20 · VW22

- Mainly for automobiles and trucks
- $\phi 14 \times L19 \times \circ 20.6$.



VT series

VT16 · VT20

- For Mercedes Benz
- For MAZDA
- For Ford and GM
- Tapered seat



VXUH series

VXUH22 · VXUH20I · VXUH21I

- $\phi 12 \times L26.5 \times \circ 16$.
- Application: BMW, Mercedes Benz, Honda, Mitsubishi, Mazda, Subaru, Suzuki, Daihatsu.
- IRIDIUM POWER IXUH22 is on sale.



VXU series

VXU20 · VXU22 · VXU24 · VXU21I

- Applicable for light vehicles
- $\phi 12 \times L19 \times \circ 16$.
- By fully projecting the insulator (1.5 mm), the heat range is widened and ignitability is improved.



VCH series

VCH16 · VCH20

- Insulator Projection is 2.5mm
- Spark position is 4.0mm
- For Toyota
- $\phi 12 \times L26.5 \times \circ 14$.



VFK series

VFK16 · VFK20F

- For Toyota, Honda, Mazda
- Thread length: 19mm

DENSO

AUSTRALIA

CHINA

INDIA

INDONESIA

KOREA

MALAYSIA

PHILIPPINES

SAUDI ARABIA

SINGAPORE

TAIWAN

THAILAND

VIETNAM

JAPAN

& USA

EUROPE

MOTOR

SMALL

CROSS

PART

ENGINE REFERENCE NUMBER

VXEBH series**VXEBH27**

- For Toyota 86, Subaru BRZ
- World first $\phi 0.4$ mm new 3elect road.
- $\phi 12 \times L26.5 \times \phi 14$.

**VFXUHC series****VFXUHC22FG**

- Corresponding to DXU22HCR-D11S (DENSO)
- Corresponding to DILZKR7B11GS (NGK)
- Shroud-type
- 28 mm reach (base length)
- For Honda Odyssey RB3/4 (except Absolute)

**VXUHC series****VXUHC22G**

- Corresponding to SXU22HCR8S (DENSO)
- Corresponding to ILZKR7B8S (NGK)
- Shroud-type
- 28 mm reach (base length)
- For Honda N BOX series (until October 2013)

**VFXEHC series****VFXEHC22G**

- $\phi 12 \times L28 \times \phi 14$ mm (1.5 mm shroud)
- Center electrode $\phi 0.4$ mm double needle Iridium Tough
- Corresponding to DXE22HCR11S (DENSO)
- Corresponding to DILZKAR7C11S (NGK) and ILZKAR7E11S (NGK)
- For Honda

**VXEHC series****VXEHC24G**

- $\phi 12 \times L28 \times \phi 14$ mm (1.5 mm shroud)
- Corresponding to SXE24HCR8S (DENSO)
- Corresponding to ILZKAR8F8S (NGK) and ILZKAR8H8S (NGK)
- For Honda

**VFKB series****VFKB16**

- $\phi 14 \times L19 \times \phi 16$ mm
- Center electrode $\phi 0.4$ mm double needle Iridium Tough
- Corresponding to FK16BR-AL8 (DENSO)
- For Toyota

**VFCH series****VFCH16**

- $\phi 12 \times L26.5 \times \phi 14$ mm
- Center electrode $\phi 0.4$ mm double needle Iridium Tough
- Corresponding to FC16HR8 and FC16HR-C9 (DENSO)
- For Toyota

**VDKH series****VDKH22F**

- $\phi 14 \times L26.5 \times \phi 16$ mm
- Center electrode $\phi 0.7$ mm double needle Iridium Tough
- Corresponding to DILFR7K9G
- For Lexus NX200t 2000 cc (8AR-FTC, T/C) and others

**VDCH series****VDCH22F**

- $\phi 12 \times L26.5 \times \phi 14$ mm
- Center electrode $\phi 0.7$ mm double needle Iridium Tough
- Corresponding to DILKAR8J9G
- For Toyota Auris 1200 cc (8NR-FTS, T/C) and others

**VSUEH series****VSUEH22**

- $\phi 10 \times L26.5 \times \phi 14$ mm
- Center electrode $\phi 0.7$ mm Iridium Tough
- Corresponding to ILMAR7AR and LMAR7CI-8
- For Suzuki (R06A engine)



High Performance Spark Plug **IRIDIUM PLUS**



Next Generation
High Performance Plugs
for Taxi

Economical!

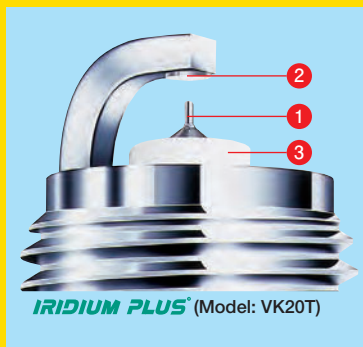

1 Fine Diameter Ultra-fine Iridium Alloy Center Electrode

2 Platinum-tipped Ground Electrode

The ground electrode has a platinum tip, from DENSO's experience with platinum plugs. This greatly moderates electrode wear and insures high durability.

3 High Strength Insulator

Using a high strength ceramic insulator for LPG engines improves strength by 20% over conventional insulators.

IRIDIUM PLUS Specifications

TYPE	APPLICATION	SPEC	DIA. (mm)	REACH (mm)	HEX (mm)	GAP (mm)	PROJECTION (mm)	SPARK POSITION (mm)	GROUND ELECTRODE HEIGHT (mm)	TERMINAL SHAPE	RESISTOR (kΩ)	No.	IRIDIUM PLUS [®]
													ONE PC BOX
													DENSO P/N
VK20T	For LPG For LPG		14	19	16	0.8	1.5	3.0	5.4	S	5	-	067700-9540
VW20T	For LPG For LPG		14	19	20.6	0.8	1.5	3.0	5.4	S	5	-	067700-9240
VKH20T	For LPG For LPG		14	26.5	16	0.8	2.5	4.0	6.2	S	5	-	267700-7760
VDKH16T	For LPG For LPG		14	26.5	16	0.8	1.5	3.0	6.2	S	5	-	267700-8920

Next Generation High Performance Plugs for Taxi

Economical spark plug with high durability, mileage, and acceleration performance.

Excellent Durability

Realizing astounding life and durability with platinum ground electrodes.

By welding a platinum tip to the ground electrode, wear has been controlled to a significant extent in the **IRIDIUM PLUS**. In addition to acceleration performance, the life and durability of this plug has been increased to that of a platinum plug.

Durability Comparison

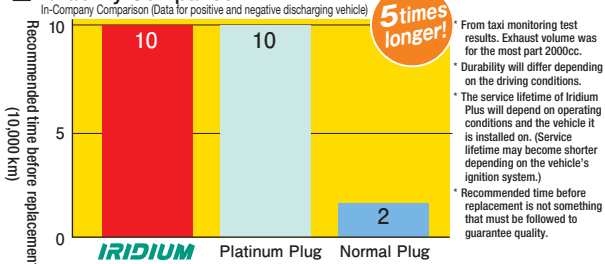

* The data shown is from internal studies. Also, the "Normal Plug" and "Platinum Plug" referred to here are DENSO products.

Improved Mileage

Less fuel consumption with a fine diameter center electrode.

Even during idling, when it is easy for ignition to degrade, **IRIDIUM PLUS** reduces mis-sparking and stabilizes idling speed. This results in a quieter engine and improved fuel consumption.

Fuel Consumption Comparison

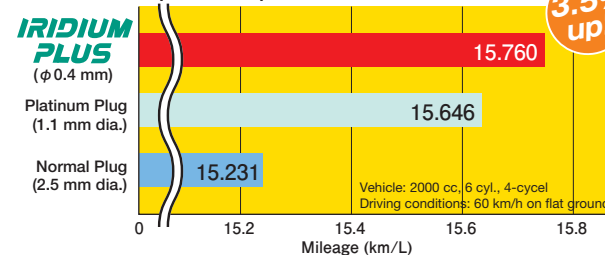

* The data shown is from internal studies. Also, the "Regular Plug" and "Platinum Plug" referred to here are DENSO products.

Improved Acceleration

Through steady ignitability, acceleration performance is greatly improved.

IRIDIUM PLUS, through its fine diameter iridium center electrode, has realized high ignition performance and low spark voltage at levels heretofore unseen. Because of this, there is less non-firing under high spark voltage conditions and fewer misfires under conditions where ignition is difficult, permitting operation with a high level of response under a variety of conditions. As a result, acceleration has been improved.

Acceleration comparison

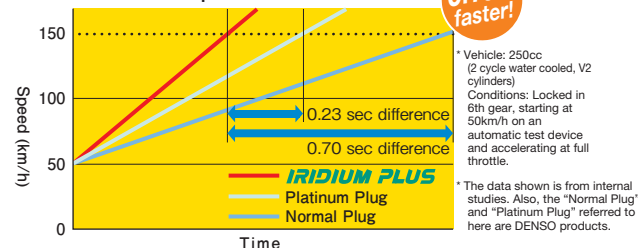

DENSO
 AUSTRALIA CHINA INDIA INDONESIA KOREA MALAYSIA PHILIPPINES SAUDI ARABIA SINGAPORE TAIWAN THAILAND VIETNAM JAPAN & USA EUROPE MOTOR SMALL CROSS PART
 ENGINE REFERENCE NUMBER

High Performance Spark Plug

IRIDIUM RACING®

**0.4mm Iridium,
only at DENSO!**



The world's finest diameter (as of March 2019)
0.4mm
with an iridium center electrode

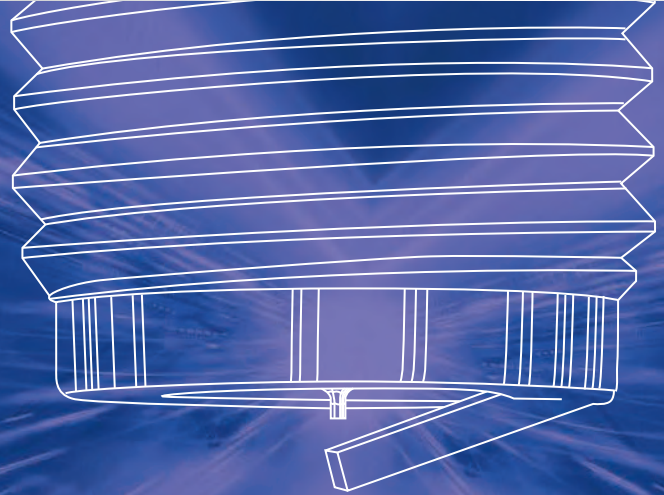

**Unbeatable spark technology
fine-tuned for racing**

- Specifications Include Terminal**
Included with the plug comes with a terminal nut compatible to the Nology Hot Wire and most plug cords around the world. Please remove for vehicle types that do not require terminals. (Some plugs have solid terminals. Please refer to the list.)
- Built-in, Highly Reliable Resistor**
All IRIDIUM RACING plugs specify a resistor, and contain a highly reliable monolithic-type resistor that blocks noise that may affect electronic devices. (IW06 has no resistor.)
- Highly Corrosion Resistant, Burnished Nickel Plating**
Burnished nickel plating on the housing, a high level of corrosion resistance has been realized. Also, because the amount on the threads is low, the damage to the female thread in the cylinder is reduced.
- 0.4 mm Diameter Ultra-Fine Iridium Center Electrode**
The center electrode tip is able to be made fine using a new iridium alloy with a high melting point. The required voltage is reduced, and ignitability is improved greatly.

1 All-platinum Ground Electrode

Compared to the nickel alloy used in conventional spark plugs, the high melting point of platinum will reduce such problems as ground electrode melting and wear. Also, the 0.8mm platinum alloy is welded on and gapped without any bending, reducing residual stress and increasing durability.

2 Insulators for Racing

By using a new, strengthened insulator which was developed during numerous and repeated testing during racing trials, strength is improved by 20%.

3 Spark Cleaning Pocket

Between the center electrode and the insulator, a small pocket has been opened around the tip clearance. When there is carbon fouling or deposition, this part will discharge and burn off the carbon, restoring electrical resistance. This technology is patented by DENSO (Japan Patent No. 2727558).

4 Silicone Oil Coating

During the start of the race, non-starting from carbon fouling and carbon deposits can be fatal. To stop this, the insulator has been coated with a silicone coating. Using the water repellency of silicone, the insulator surface is isolated from moisture and carbon, preventing a decrease in resistance.

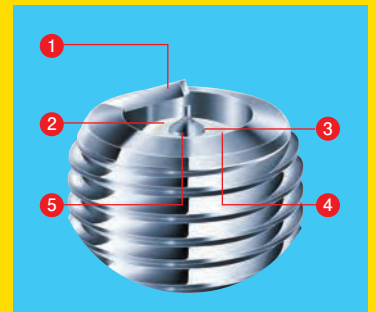

5 360° Laser Welding

The process used to join the iridium tip is a highly reliable "All-around Laser Welding" process that is able to withstand various kinds of driving conditions.



IRIDIUM RACING is recommended for the following user.

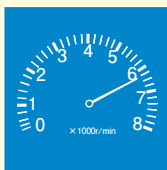

Improve acceleration and engine power with IRIDIUM RACING

Reliability and durability, backed by the racing results of major drivers such as Sorberg, Stoner & Koyama

It's the age of iridium electrodes. Discover more acceleration with 0.4 mm DENSO Racing Plugs. DENSO would like you to try the 0.4 mm IRIDIUM RACING advantage. Use IRIDIUM RACING and experience a ride like never before.

Improved Acceleration



Unbeatable acceleration performance on the circuit.

With an ultra-fine, 0.4 mm diameter center electrode, IRIDIUM RACING plugs are the realization of superb ignition performance and required voltage at unparalleled levels. Misfires have been controlled and will allow you to have steadily high levels of response and increased acceleration.

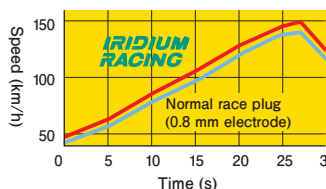

0.3% faster!

* The data shown is from internal studies. Also, the "Regular Racing Plug" referred to here is a DENSO product.

Vehicle: 250 cc (2-cycle water cooled, 2 cylinder) Conditions: WOT 60 to 129 km/h (locked in 6th gear)

Improved Horse Power



More power with an ideal combustion cycle.

Through superb ignitability and required voltage, non-firing and misfires under a variety of conditions has been greatly reduced. As a result, combustion conditions have improved dramatically, increasing engine output.

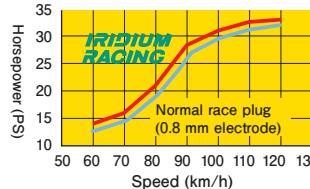

1.3% up!

* The data shown is from internal studies. Also, the "Regular Racing Plug" referred to here is a DENSO product.

Vehicle: 250 cc (2-cycle water cooled, 2 cylinder) Conditions: WOT 60 to 120 km/h (locked in 4th gear)

How to Choose a Racing Plug

Warning: On choosing the right racing plug

- Generally, electrodes that project into the combustion chamber have better ignitability and have better performance. However, because of more exposure to high temperature combustion gases and because ground electrode becomes longer, heat resistance and durability decrease. The higher the level of tuning, the greater the need is to use a less projecting type.
- As the level of tuning is increased, so does the need for higher heat range.

Overall Shape

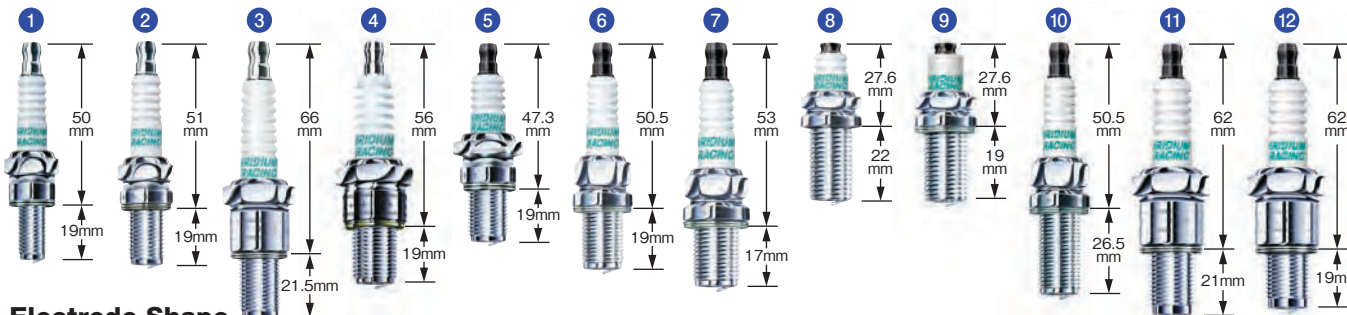

Electrode Shape



Identifying IRIDIUM RACING (Stamped into the Center of the Housing)

Variety	Thread Size	Intermediate Number (Overall Size)	Intermediate Number (Electrode Shape)	Heat Range
I : Iridium	U: 10 mm XU: 12 mm A: 14 mm AE: 14 mm K: 14 mm KH: 14 mm Q: 14 mm RE: 14 mm RL: 14 mm RT: 14 mm W: 14 mm WM: 14 mm	0	1 : Slant ground electrode or surface gap plug. 2 : Flat ground electrode	24 27 29 31 32 34 35

(Exception) IRE01 has a flat ground electrode.

DENSO	TYPE	Figure Electrode	Cross Reference
IU01-□	U-E	1 A	R0373A, R0379A, R016
RU01-□*	U-E (SURFACE)	1 C	R0045J, R0045Q
IXU01-□	XU-E	2 A	R216, R2525
IRE01-□	ROTARY ENGINE	3 B	R6725
IW01-□	W-E	4 A	R6385P, R7379, R6918B
IW06-□	W-E (NON-RESISTOR)	4 A	B-EGP, R4630A
IWM01-□	W-EM	5 A	R5184, R6179AP
IK01-□	ISO (SLANT ELECT)	6 A	R7116, R7117
IK02-□	ISO (STRAIGHT ELECT)	6 B	R7279, R7118, R7119
IQ01-□	SLANT ELECT	7 A	R7236, R7237
IQ02-□	STRAIGHT ELECT	7 B	R7238, R7239
IA01-□	FOR DETONATION COUNTER	8 A	R7282A, R6120A
IAE01-□	FOR W/OUT DETONATION COUNTER	9 A	R7282, R6120
IKH01-□	K-LONGREACH	10 A	R7438
IRL01-□	ROTARY ENGINE RX8	11 A	R7440A-L
IRT01-□	ROTARY ENGINE RX8	12 A	R7440B-L

RU01-□ are surface gap plugs, not ones with iridium center electrode and all-platinum ground electrodes. □ : indicate's the heat range.

IRIDIUM RACING is ideal for racing and tuned-up engines; please choose one based on the heat range of the standard plug or IRIDIUM POWER plugs used currently that is suited to your level of tuning.

IRIDIUM RACING® Specifications

TYPE	APPLICATION	SPEC	DIA. (mm)	REACH (mm)	HEX (mm)	GAP (mm)	PROJECTION (mm)	SPARK POSITION (mm)	GROUND ELECTRODE HEIGHT (mm)	TERMINAL SHAPE	RESISTOR (kΩ)	No.	IRIDIUM RACING ONE PC BOX
													DENSO P/N
IK01-24	Automobile	ISO(SLANT ELEC.)	14	19	16	0.7	-1.0	0.5	2.0	S	5	R01	267700-1311
IK01-27	Automobile	ISO(SLANT ELEC.)	14	19	16	0.7	-1.0	0.5	2.0	S	5	R02	267700-1321
IK01-31	Automobile	ISO(SLANT ELEC.)	14	19	16	0.7	-1.0	0.5	2.0	S	5	R03	267700-1331
IK01-34	Automobile	ISO(SLANT ELEC.)	14	19	16	0.7	-1.0	0.5	2.0	S	5	R42	267700-1341
IK02-24	Automobile	ISO(STRAIGHT ELEC.)	14	19	16	0.7	-2.3	-0.8	0.7	S	5	R04	267700-1361
IK02-27	Automobile	ISO(STRAIGHT ELEC.)	14	19	16	0.7	-2.3	-0.8	0.7	S	5	R05	267700-1371
IK02-31	Automobile	ISO(STRAIGHT ELEC.)	14	19	16	0.7	-2.3	-0.8	0.7	S	5	R06	267700-1381
IKH01-24	Automobile	LONG REACH	14	26.5	16	0.7	-1.0	0.5	2.0	S	5	R49	267700-4451
IKH01-27	Automobile	LONG REACH	14	26.5	16	0.7	-1.0	0.5	2.0	S	5	R50	267700-4461
IKH01-31	Automobile	LONG REACH	14	26.5	16	0.7	-1.0	0.5	2.0	S	5	R51	267700-4471
IQ01-24	Automobile	SLANT ELEC.	14	19	16	0.7	-1.0	0.5	2.0	S	5	R07	267700-1411
IQ01-27	Automobile	SLANT ELEC.	14	19	16	0.7	-1.0	0.5	2.0	S	5	R08	267700-1421
IQ01-31	Automobile	SLANT ELEC.	14	19	16	0.7	-1.0	0.5	2.0	S	5	R09	267700-1431
IQ01-34	Automobile	SLANT ELEC.	14	19	16	0.7	-1.0	0.5	2.0	S	5	R43	267700-1441
IQ02-24	Automobile	STRAIGHT ELEC.	14	19	16	0.7	-2.3	-0.8	0.7	S	5	R10	267700-1461
IQ02-27	Automobile	STRAIGHT ELEC.	14	19	16	0.7	-2.3	-0.8	0.7	S	5	R11	267700-1471
IQ02-31	Automobile	STRAIGHT ELEC.	14	19	16	0.7	-2.3	-0.8	0.7	S	5	R12	267700-1481
IW01-24	Motorcycle	W-E	14	19	20.6	0.6	-1.5	0.0	1.6	RC	5	R13	267700-1111
IW01-27	Motorcycle	W-E	14	19	20.6	0.6	-1.5	0.0	1.6	RC	5	R14	267700-1121
IW01-29	Racing Kart	W-E	14	19	20.6	0.6	-1.5	0.0	1.6	RC	5	R15	267700-1131
IW01-31	Racing Kart	W-E	14	19	20.6	0.6	-1.5	0.0	1.6	RC	5	R16	267700-1141
IW01-32	Racing Kart	W-E	14	19	20.6	0.6	-1.5	0.0	1.6	RC	5	R17	267700-1151
IW01-34	Racing Kart	W-E	14	19	20.6	0.6	-1.5	0.0	1.6	RC	5	R18	267700-1161
IW06-27	Automobile	W-E NON RESISTOR	14	19	20.6	0.6	-1.5	0.0	1.6	S	0	R44	067600-1811
IW06-31	Automobile	W-E NON RESISTOR	14	19	20.6	0.6	-1.5	0.0	1.6	S	0	R45	067600-1821
IW06-34	Automobile	W-E NON RESISTOR	14	19	20.6	0.6	-1.5	0.0	1.6	S	0	R46	067600-1831
IRE01-27	Rotary Engine	ROTARY ENGINE	14	21.5	20.6	0.7	-2.2	-0.7	0.8	RC	5	R19	267700-1521
IRE01-31	Rotary Engine	ROTARY ENGINE	14	21.5	20.6	0.7	-2.2	-0.7	0.8	RC	5	R20	267700-1531
IRE01-32	Rotary Engine	ROTARY ENGINE	14	21.5	20.6	0.7	-2.2	-0.7	0.8	RC	5	R21	267700-1541
IRE01-34	Rotary Engine	ROTARY ENGINE	14	21.5	20.6	0.7	-2.2	-0.7	0.8	RC	5	R22	267700-1551
IRE01-35	Rotary Engine	ROTARY ENGINE	14	21.5	20.6	0.7	-2.2	-0.7	0.8	RC	5	R41	267700-1561
IRL01-27	Rotary Engine	ROTARY RX8(LEADING)	14	21	20.6	1.1	-2.5	-0.5	1.6	S	5	R54	267700-4821
IRL01-31	Rotary Engine	ROTARY RX8(LEADING)	14	21	20.6	1.1	-2.5	-0.5	1.6	S	5	R55	267700-4831
IRT01-31	Rotary Engine	ROTARY RX8(TRAILING)	14	19	20.6	1.1	-2.5	-0.5	1.6	S	5	R52	267700-4841
IRT01-34	Rotary Engine	ROTARY RX8(TRAILING)	14	19	20.6	1.1	-2.5	-0.5	1.6	S	5	R53	267700-4851
IA01-31	Motorcycle	WITH DETONATION COUNTER	14	22	16	0.6	-1.0	0.5	1.9	S	5	R23	267700-1261
IA01-32	Motorcycle	WITH DETONATION COUNTER	14	22	16	0.6	-1.0	0.5	1.9	S	5	R24	267700-1271
IA01-34	Motorcycle	WITH DETONATION COUNTER	14	22	16	0.6	-1.0	0.5	1.9	S	5	R25	267700-1281
IAE01-32	Motorcycle	W/OUT DETONATION COUNTER	14	19	16	0.6	-1.3	0.5	2.1	S	5	R47	267700-2941
IAE01-34	Motorcycle	W/OUT DETONATION COUNTER	14	19	16	0.6	-1.3	0.5	2.1	S	5	R48	267700-2951
IWM01-29	Motorcycle	W-EM	14	19	20.6	0.6	-1.5	0.0	1.6	S	5	R26	267700-1211
IWM01-31	Motorcycle	W-EM	14	19	20.6	0.6	-1.5	0.0	1.6	S	5	R27	267700-1221
IWM01-32	Motorcycle	W-EM	14	19	20.6	0.6	-1.5	0.0	1.6	S	5	R28	267700-1231
IWM01-34	Motorcycle	W-EM	14	19	20.6	0.6	-1.5	0.0	1.6	S	5	R29	267700-1241
IXU01-24	Motorcycle	XU-E	12	19	16	0.6	-1.5	0.0	1.4	R	5	R30	267700-1061
IXU01-27	Motorcycle	XU-E	12	19	16	0.6	-1.5	0.0	1.4	R	5	R31	267700-1071
IXU01-31	Motorcycle	XU-E	12	19	16	0.6	-1.5	0.0	1.4	R	5	R32	267700-1081
IXU01-34	Motorcycle	XU-E	12	19	16	0.6	-1.5	0.0	1.4	R	5	R33	267700-1091
IU01-24	Motorcycle	U-E	10	19	16	0.6	-1.8	-0.3	1.2	R	5	R34	267700-1011
IU01-27	Motorcycle	U-E	10	19	16	0.6	-1.8	-0.3	1.2	R	5	R35	267700-1021
IU01-31	Motorcycle	U-E	10	19	16	0.6	-1.8	-0.3	1.2	R	5	R36	267700-1031
IU01-34	Motorcycle	U-E	10	19	16	0.6	-1.8	-0.3	1.2	R	5	R37	267700-1041
*RU01-27	Motorcycle	U-E(SURFACE)	10	19	16	1.1	-0.2	0.0	0.0	R	5	R38	267700-1571
*RU01-31	Motorcycle	U-E(SURFACE)	10	19	16	1.1	-0.2	0.0	0.0	R	5	R39	267700-1581
*RU01-34	Motorcycle	U-E(SURFACE)	10	19	16	1.1	-0.2	0.0	0.0	R	5	R40	267700-1591

* These plugs do not have iridium electrodes.

Spark gap example For a 1.1 mm gap, set from 1.0 to 1.1 mm.

Insulator projection Length from edge of side housing to top of insulator. The plus (+) direction is the distance from the edge to the piston head.

Spark position Length from edge of side housing to top of center electrode. The plus (+) direction is the distance from the edge to the piston head.

Ground electrode height Length from edge of side housing to top of ground electrode. The plus (+) direction is the distance from the edge to the piston head.

Terminal shapes S: solid terminal, R: removable, RC: crimped nut, T: threaded

IRIDIUM RACING® CROSS REFERENCE

DENSO			NGK					
IRIDIUM POWER	IRIDIUM RACING	FIGURE	DIA. (mm)	REACH (mm)	HEX (mm)	RESISTOR	FIGURE	TYPE
IW□		4 D	14	19	20.6		BP-E	R4304A-□
	IW01/IW06-□ (Note 1)	4 A	14	19	20.6		B-E	B□EGP
IW□		4 D	14	19	20.6		B-E	B□EGV
IW□		4 D	14	19	20.6		B-E	R4118S-□
	IW01/IW06-□ (Note 1)	4 A	14	19	20.6		B-E	R4630A-□
	IW01/IW06-□ (Note 1)	4 A	14	19	20.6	R	B-E	R6252K-□
	IW01/IW06-□ (Note 1)	4 A	14	19	20.6	R	B-E	R6918B-□
	IW01/IW06-□ (Note 1)	4 A	14	19	20.6	R	B-E	R6918C-□
IW□		4 D	14	19	20.6	R	B-E	R6021E-□
	IW01/IW06-□ (Note 1)	4 A	14	19	20.6	R	B-E	R6385-□P
	IW01/IW06-□ (Note 1)	4 A	14	19	20.6	R	B-E	R7376-□(Ir)
			14	19	20.6		B-E SEMISURFACE	R5649-□
			14	19	20.6	R	B-E SEMISURFACE	R6712-□
	IWM01-□	5 A	14	19	20.6		B-E COMPACT	R5184-□
			14	19	20.6	R	B-E COMPACT	R5300A-□
			14	19	20.6	R	B-E COMPACT	R5300N-□
			14	19	20.6	R	B-E COMPACT	R5540F-□
	IWM01-□	5 A	14	19	20.6	R	B-E COMPACT	R6179A-□P
			14	22	20.6	R	B-E COMPACT	R6179C-□PA
			14	22	20.6	R	B-E	R7376B(Ir)
	IA01-□	8 A	14	22	16	R	BC-E COMPACT	R6120A-□
	IA01-□	8 A	14	22	16	R	BC-E COMPACT	R7282A-□ (Ir)
	IAE01-□	9 A	14	19	16	R	BC-E COMPACT	R6120-□
	IAE01-□ (Note 2)	9 A	14	19	16	R	BC-E COMPACT	R6120C-□
	IAE01-□ (Note 2)	9 A	14	19	16	R	BC-E COMPACT	R6120M-□
	IAE01-□	9 A	14	19	16	R	BC-E COMPACT	R7282-□(Ir)
	IAE01-□ (Note 2)	9 A	14	19	16	R	BC-E COMPACT	R7282C-□(Ir)
	IAE01-□ (Note 2)	9 A	14	19	16	R	BC-E COMPACT	R7282M-□(Ir)
IK□		6 D	14	19	16	R	BK-E ISO	R6888A-□
IK□		6 D	14	19	16		BK-E ISO	R7112-□
IK□		6 D	14	19	16	R	BK-E ISO	R7113-□
IK□		6 D	14	19	16	R	BK-E ISO	R7433-□(Ir)
IK□		6 D	14	19	16		BK-E ISO	R7114-□
IK□		6 D	14	19	16		BK-E ISO	R7115-□
	IK01-□	6 A	14	19	16		BK-E ISO	R7116-□
	IK01-□	6 A	14	19	16	R	BK-E ISO	R7117-□
	IK02-□	6 B	14	19	16		BK-E ISO	R7118-□
	IK02-□	6 B	14	19	16	R	BK-E ISO	R7119-□
	IK01-□	6 A	14	19	16	R	BK-E ISO	R7434-□(Ir)
	IK02-□	6 B	14	19	16	R	BK-E ISO	R7279-□(Ir)
			14	19	16	R	BK-E SEMISURFACE	R6601-□
			14	19	16		BK-E SEMISURFACE	R6711-□
IQ□		7 D	14	19	16	R	BCP-E	R7435-□(Ir)
IQ□		7 D	14	19	16		BCP-E	R7232-□
IQ□		7 D	14	19	16	R	BCP-E	R7233-□
IQ□		7 D	14	19	16		BC-E	R7234-□
IQ□		7 D	14	19	16	R	BC-E	R7235-□
	IQ01-□	7 A	14	19	16		BC-E	R7236-□
	IQ01-□	7 A	14	19	16	R	BC-E	R7237-□
	IQ02-□	7 B	14	19	16		BC-E	R7238-□
	IQ02-□	7 B	14	19	16	R	BC-E	R7239-□
	IQ01-□	7 A	14	19	16	R	BC-E	R7436-□(Ir)
			14	19	16		BC-E SEMISURFACE	R5883-□
			14	19	16	R	BC-E SEMISURFACE	R6690-□
IKH□		10 D	14	26.5	16	R	LFR	R7437-□(Ir)
	IKH01-□	10 A	14	26.5	16	R	LFR	R7438-□(Ir)
IWF□		- D	14	12.7	20.6		B-H	R5525-□
			14	12.7	20.6		B-H	R5530-□
	IRE01-□	3 B	14	21.5	20.6	R	ROTARY	R6725-□
	IRE01-□	3 B	14	21.5	20.6	R	ROTARY	R7420-□(Ir)
			14	21.5	20.6		ROTARY, SURFACE	T813J-N13
	IRL01-□	11 A	14	21	20.6	R	ROTARY RX-8(L)	R7440A-□L(Ir)
	IRT01-□	12 A	14	19	20.6	R	ROTARY RX-8(T)	R7440B-□T(Ir)
	IXU01-□ (Note 3)	2 A	12	19	18		D-E	R216-□
IX□ (Note 3)	IXU01-□ (Note 3)	2 D, 2 A	12	19	18		D-E	R217-□
			12	21	18		D-Z	R2188-□
			12	19	16	R	DC-E SEMISURFACE	R2349-□
	IXU01-□ (Note 3)	2 A	12	19	16	R	DC-E	R2525-□
			12	19	16		DC-E SEMISURFACE	R2430-□
IU□A	IU01-□	1 A	10	19	16		C-E	R016-□
	IU01-□	1 E	10	19	16		C-E	R017-□
	IU01-□	1 A	10	19	16		C-E	R0373A-□(Ir)
			10	19	16		C-E SEMISURFACE	R0045G-□
	RU01-□	1 C	10	19	16		C-E SEMISURFACE	R0045J-□
	RU01-□	1 C	10	19	16	R	C-E SEMISURFACE	R0045Q-□
	IU01-□	1 A	10	19	16	R	C-EH HALF THREAD	R0379A-10(Ir), R0409B-□
IUF□(A)		- D, - E	10	12.7	16		C-H	R0161-□
IY□		- D	8	19	12.7	R	E-EH SEMISURFACE	R847-□

Overall shape

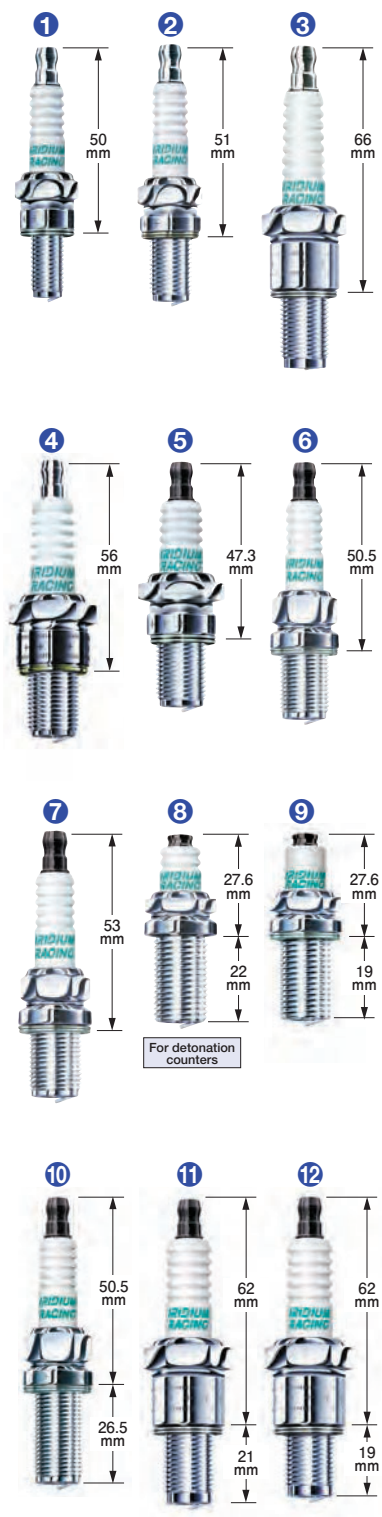

Electrode shape

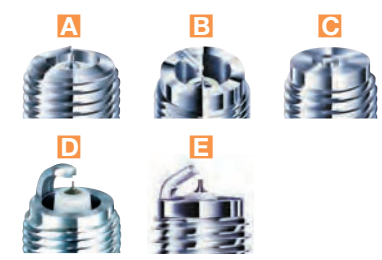

(Note 1) IW06 is a non resistor type
 (Note 2) Remove the gasket with nippers before use
 (Note 3) IX □ B and IX □ is different from IXU01- □ only in the hex size (18 mm or 16 mm), and are otherwise interchangeable in terms of installation.
 (□) show the heat range.

DENSO
 AUSTRALIA | CHINA | INDIA | INDONESIA | KOREA | MALAYSIA | PHILIPPINES | SAUDI ARABIA | SINGAPORE | TAIWAN | THAILAND | VIETNAM | JAPAN & USA | EUROPE MOTOR SMALL ENGINE | CROSS REFERENCE PART NUMBER



Q&A about Plug Performance

Q.1

Will output and torque increase if I use **IRIDIUM POWER**?

A These are chassis dynamo test results comparing a Vitz 1300 using **IRIDIUM POWER** and another which uses Normal plugs are shown below. With the normal plugs, the output is 98.2PS, while torque is 14.8 kgf; when this was changed to the **IRIDIUM POWER**, the output was 99.3PS, while torque was 15.2 kgf. (This is approximately a 1.5% improvement in output.)

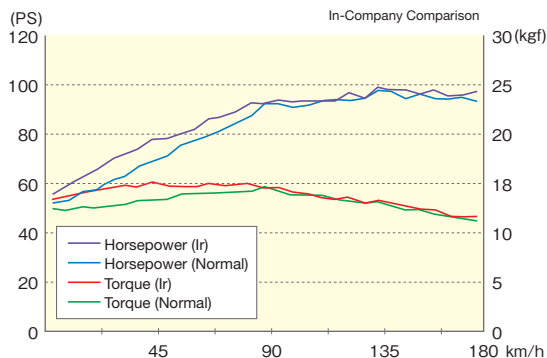

Q.2

Is there a standard for differentiating the uses of **IRIDIUM POWER** and **IRIDIUM RACING**?

A **IRIDIUM RACING** uses a platinum tip for the ground electrode and a high strength fine insulator for racing. Also, there is a silicone coating on the insulator giving it an increased resistance to carbon fouling. However, because of the withdrawn spark position, the **IRIDIUM POWER** has the high ignitability of the two. Instead, because of the "extension" in engine revolution felt by many at high revolutions, it is popular with customers who race. Choose "**IRIDIUM POWER**" for response and "**IRIDIUM RACING**" for high revolutions. **IRIDIUM RACING** is particularly popular on the circuit scene.

Q.3

How does the engine respond to changed settings?

A We sometimes hear that "**IRIDIUM POWER** is too sensitive to setting changes." However, the flip side to sensitivity is that "the response to setting changes is fast and easier," and during races, we hear that it makes setting changes easier. If **IRIDIUM POWER** is used, it should become possible to draw out more performance from your vehicle.



Q.4

Will my exhaust emissions be cleaner if I put on **IRIDIUM POWER**?

A Improved combustion efficiency will clean your exhaust emission! Fuel consumption will improve too! With the superior ignitability of ultra-thin electrodes (0.4 mm), combustion efficiency will be improved.

- Cleaner Exhaust Emissions
CO and CO₂ levels will decrease in the "EURO III" emissions test to be implemented in the feature.
- Improved Mileage
A great bonus for long-distance drivers.
Even for those who are concerned about the environment, we recommend Iridium Power.

■ Iridium Plug Motorcycle Emissions Comparison Test
Test Vehicle: CBR250
Test Conditions: EURO III
Test Equipment: MEXA-7400, CVS 7100
Tested Plugs: U24FER9 (Ni Plug) Gap: 0.85
IUH24 (Ir Plug) Gap: 0.85

● EURO III Test Pattern (In-Company Comparison)

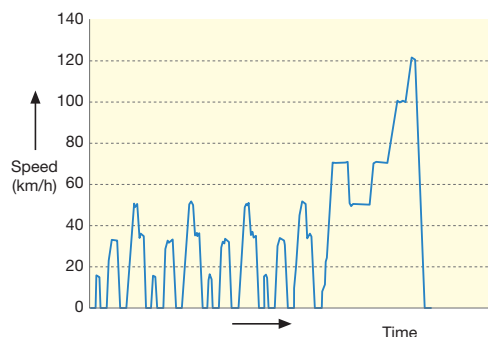

● CO (g/km) (In-Company Comparison)

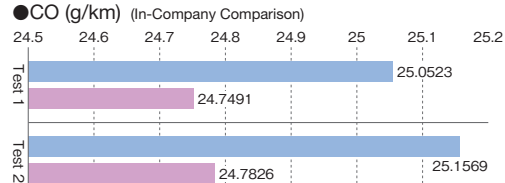

● CO₂ (g/km) (In-Company Comparison)

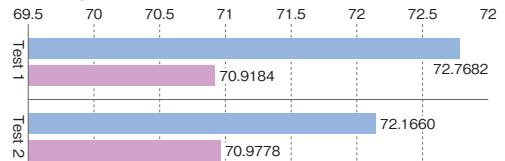

● Fuel Consumption (km/L) (In-Company Comparison)

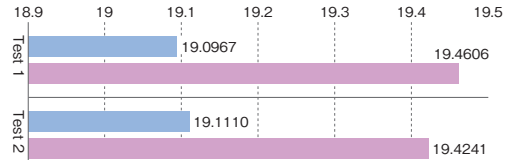



Q&A about Plug Performance

Q.5

Can I replace my double, triple, or quadruple electrode plugs to **IRIDIUM POWER** or **IRIDIUM TOUGH**?

A This is possible. The reason: because of the fine center electrode in Iridium Power and Iridium Tough plugs, they have a lower spark voltage compared to double, triple, and quadruple electrode plugs. Please refer to the Standard Resistor Model Quick Chart.

Spark Voltage

The thinner the electrode is, the stronger the electrical field is. Because the electrical field affects spark voltage, a thinner electrode lowers spark voltage. If each type of electrode shape is modeled as shown below, Iridium Tough has a lower voltage than double electrode plugs.

		IRIDIUM TOUGH	Double electrode plug	Normal Plug
Plug				
Electrode model	Ground			
	Center			
Required voltage		Low		High

Ignitability

The more the contact area between the flame kernel and the electrode is minimized, the smaller the cooling action from the electrodes and the better ignitability is. Because of the fine center electrode, the contact area between the flame kernel and the electrode is small, resulting in excellent ignitability.

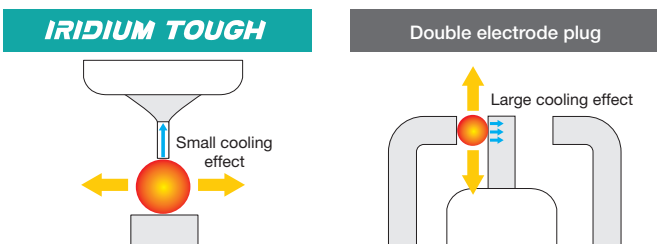

Service lifetime of plugs

The service lifetime of a spark plug may be shortened due to driving conditions or ignition properties when used in a vehicle equipped with a simultaneous ignition system (plus-minus discharge and D-DL methods). Please ask your dealer to check if your vehicle is equipped with a simultaneous ignition system. The simultaneous ignition system fires the plug at the top dead center point not only of the compression stroke, but also the exhaust stroke.



Q.6

What kind of vehicles are surface gap plugs used for?

A These are plugs developed for racing, and there are many people who use these plugs in the All-Japan Road Race Championship JSB1000 class and in drag racing. Because the ground electrode is gone, there are the following advantages and disadvantages.

Advantages

- [1] When the engine is tuned so that the compression ratio is increased, these can avoid interference with the piston.
- [2] Because there are no excess projections into the combustion chamber, the combustion efficiency at high revolutions is improved.
- [3] Difficulties due to the ground electrode can be prevented.

Disadvantages

- [1] The ignitability becomes worse, and thus feeling and response at low and mid-revolutions deteriorates.
- [2] For peak engine characteristics demanded under the most severe operating conditions. In the popular ST600 class, many drivers use a plug with a ground electrode.

Q.7

How is the compatibility with plug cords such as Nology?

A There are no particular issues with compatibility. In fact, there are some cord manufacturers who sell products "especially for iridium plugs."

Q.8

When changing plugs, is there any need to change the settings?

A For normal vehicles, there is no need to change the settings. It is advisable to reset vehicles with modified exhaust systems, though in most cases adjusting the air screw is sufficient. (Except for racing carburetors such as FCRs)

Q.9

Is there a way to tell them apart when replacing them?

A This can be done by confirming the level of wear (the gap width) on the ground electrode. DENSO's Iridium electrodes are different from conventional products in that their center electrodes hardly wear, and because of this it is better to check for wear on the ground electrode.

Q.10

The vehicle seems to be running worse now that I've installed them?

A In most cases there is a problem with the vehicle. Scooters are often run for long periods of time without maintenance, and it is common to see them with richer fuel-air mixtures from dirty air cleaners. Our investigations have found that these vehicles tend to be susceptible to carbon fouling, and when replacing plugs also remember to inspect and clean the air cleaner. The effectiveness of the change should become even more apparent.

Q&A about Tuning Cars

Q.1

I have a 4AG engine NA tuned, with a Solex 44 dia. carburetor installed, giving a 200PS output. Which plug is good for a car such as this?

A DENSO has **IRIDIUM POWER** and **IRIDIUM RACING** to meet the needs of tuned and racing engines. For the engine described in the question, the right plug should be around **IRIDIUM POWER** 1K (IQ) 22, 24, or 27. Here is an introduction to using the different types of the Iridium Series on racing engines.

■ **IRIDIUM POWER**: NA Tuned (Short distance racing), Turbo tuned where a regular turbine has been tuned to increase the boost.

■ **IRIDIUM RACING** (01 Type): The 01 Type is usually called the slant ground electrode type. If your car is turbo tuned where the turbine has been replaced and the boost pressure is above 1.2 to 1.3 kg/cm², an **IRIDIUM RACING** 01 type is needed. Also, if a NA tuned engine with comparatively high vibration (4 cylinders) is to be raced over long distances, switching to this type can increase the reliability of the ground electrodes.

■ **IRIDIUM RACING** (02 Type): The 02 type (flat ground type) is appropriate for higher output engines than the 01 type, but because the spark position is withdrawn compared to the 01 type, only consider this plug for racing applications.

Q.2

I drive a GT-R tuned to 850HP. Would it be okay to install 0.4 mm dia. Iridium Power series plugs?

A The DENSO Iridium Series have the world's thinnest 0.4 mm iridium center electrodes, but because the durability of the iridium alloy developed by DENSO is higher than even platinum, which has in the past been said to be the most durable, it can be said that it's the best plug for tuned engines. Specifically, it has the following advantages:

- [1] Iridium alloy has a melting point and hardness above that of platinum, even turbo, with its high combustion temperature, can be used with confidence. Also, even when used with powerful ignition systems such as MSD and MDI, these plugs are even more reliable than platinum racing plugs.
- [2] The issue for high boost engines is that misfiring that occurs at high revolutions. The fine electrodes of the Iridium series require a lower voltage, allowing the energy generated by the coil to be sparked without losses. It can be said the 0.4 mm dia. DENSO **IRIDIUM POWER** series are a strong ally of tuned high-boost turbo systems.

Q.3

What is the optimum heat range for a tuned up Golf4 GTI 1.8L Turbo?
(Tuning: Turbine Changed, High Volume Injector Installed, and ROM Adjusted to give an output of 200PS from 150PS.)

A It's difficult to give a heat range based on going from 150PS to 200PS alone, and it's best if you judge the condition of your current plugs and judge for yourself, but as a general rule, for boost pressures between 1.0 and 1.2 kg/cm², an IK24 should be sufficient. During the winter, IK22 should improve starting and low speed feel. The heat range is different depending on how the engine has been tuned and how it's used; using an increase in heat range of 1 or 2 as a starting point, decide on a heat range, always looking at the condition of your current plugs.

Q.4

Can an **IRIDIUM POWER** be installed on an RX-7 (SA22C Turbo Model)?

A In the rotary engines in some old Mazda's on the T (Trailing) side there is a plug, the terminal nut for which must be removed. In others, the removal of the T side plug terminal nut is necessary as in the Cosmo (HB22S). DENSO has **IRIDIUM RACING** for rotary engines, with a variety of heat ranges from #27 to #35. **IRIDIUM RACING** for Rotary Engines come standard with terminal nuts.

Q.5

The plugs of racing karts are susceptible to carbon fouling, but how does **IRIDIUM POWER** do in this case?

A We frequently hear that **IRIDIUM POWER** is resistant to carbon fouling compared to plugs from other companies. However, there is no way that they are a 100% solution, and it's good to know these techniques to prevent carbon fouling.

- [1] When rolling in the race, close the carburetor's low needle or pinch the fuel pipe with your hand to prevent excess fuel from entering the engine.
- [2] By pumping the accelerator during rolling, a rich fuel air mixture goes into the engine, making it easier for carbon fouling to occur. Operate the accelerator gently.
- [3] If carbon fouling happens while running with the throttle fully open, this could mean that the heat range is too low or that the fuel mix is too rich. Consult with a kart shop to find the optimum setting.

Q.6

Please advise us about selecting a plug for upgraded turbo engine vehicles.

A The following suggestions are only guidelines. First, regarding thermal value, if the boost pressure is 1.4 or lower, please choose No. 24. For thermal values of 1.5 or above, we recommend using No. 27. Thermal value may vary depending on the engine type and tuning, so please decide after checking the burned condition of the plugs.

Next, regarding the type of plug, if the boost pressure is 1.7 or lower, either **IRIDIUM POWER** or **IRIDIUM RACING** can be used. As a guideline, if you often drive with lower speeds or in town, **IRIDIUM POWER** is recommended since it is resistant to carbon fouling. If you are racing in 400-meter runs or often drive at high speeds, we recommend **IRIDIUM RACING**. When the boost pressure exceeds 1.7, it causes misfiring at high rpm. In such cases, it is necessary to use **IRIDIUM RACING**.

Q&A about Motorcycles

Q.1 How is the compatibility with trial Motorcycle?

A The “IW series” is well suited for most trial vehicles. Though these vehicles frequently use a low heat range, the heat ranges available for **IRIDIUM POWER** starts with IW16, so choose one that matches the type of driving you do. Better accelerator response and torque can be expected with **IRIDIUM POWER**, which has excellent ignitability. Recently, with downsizing of the space to install plugs in trial vehicles, demand for miniature plugs is increasing. In these cases, try the IK types. However, the space between the plug cable and the insulator will require waterproofing.

Q.2 What is the difference in the life of an **IRIDIUM POWER** used under 2-cycle conditions and one used under 4-cycle conditions?

A ●In 4-cycle engines, a spark is produced for every 2 revolutions of the crankshaft, resulting in explosion and combustion in the engine. ●In 2-cycle engines, a spark is produced for each revolution of the crankshaft, resulting in explosion and engine combustion in the engine. This simple comparison may lead you to conclude that 2-cycle engines simply have twice the wear; however wear is made up of not only wear from sparking, but also wear from high temperatures (oxidation). Thus, the amount of wear depends on the driving conditions of the vehicle, how the rotations of the engine are applied (that is, how the shift is used), and whether the resulting combustion temperature is high or low.

2-cycle engines have a higher level of electrode wear. This electrode wear is estimated at approximately 1.5 to 2 times that of 4-cycle engines, and plug life is also shorter with 2-cycle engines. Iridium has a high melting point; however, it will undergo wear from sparking and wear from high temperatures (oxidation). To our knowledge, 2-cycle engines are only found in 2-wheel vehicles, our recommended value in this catalog for lifetime is 3000 to 5000km. (This value is based on a variety of conditions, and, racing use may require even more frequent replacement.) From the above, it is recommended that plugs for 2-cycle engines be replaced about every 3000km. However, the condition of wear depends on operating conditions and the typical engine rpms, so it is also possible to take out the plugs occasionally to confirm the amount of electrode wear and judge when the best time is to replace the plug.

Q.3 Is it true that installation on Ducati watercooled 4-valve engines is not possible?

A Since the 996R, the interior of the Testastretta (narrow head) engine’s plug holes have been very narrowly machined, and with regular plug wrenches, the socket OD hits the wall and thus the plugs cannot be fully tightened. (Not possible with a 21.5mm OD) In this case, a thin-wall plug wrench is required. [We recommend the “NB3-16SP (nepros)” or the “B3A-16SP” by KTC.]

Q.4 The terminal on the end of the plug is frequently unnecessary on motorcycle, so why is this included with all types?

A **IRIDIUM POWER** comes standard with a plug terminal (not including combined types). This is because some of the other companies’ plug cords require a terminal, and at DENSO we decide our product specifications keeping in mind every customer.

Q.5 I see that **IRIDIUM TOUGH** plugs, such as VUH27D and VK24PRZ11, are available for Honda vehicles. Will they last 100,000 km? Also, can **IRIDIUM POWER** be substituted here?

A Plugs for motorcycle vehicles with a “V” in the part number have a platinum tip welded to the ground electrode, the same as in 4-wheel vehicles. They have more durability than Iridium Power, but do last 100,000 km. Thus we do not offer them as Iridium Tough products. You can choose the Iridium Power plug for those vehicle types with a compatible Iridium Power plug shown in the Model Chart; however, please understand that it will be not as durable.

Q.6 I installed **IRIDIUM POWER** on to my motor cycle vehicle. Sometimes when I start it, there is a loud, explosive “pop.” With regular plugs this did not happen. Why is the reason for this?

A A loud explosive “pop” pop sound can have the following two causes:

- (1) An afterfiring muffler
 - (2) Backfiring due to blowback from the carburetor
- If it is the same vehicle and these symptoms were not there before changing to the new plugs, the reason for this is (1) afterfiring. The causes of afterfiring are:
- (1) An abnormally elevated intake pressure, the combustion becomes unsteady (during engine brake)
 - (2) A problem with an ignition device (improper ignition timing, misfiring)
 - (3) The fuel-air mixture is too rich (problem with the carburetor, too much choke)
 - (4) The valve timing is off

If the problem is during starting, (2), (3), or (4) are thought to be the reason. A specific example for (2) is “ignition timing that is off” and specific examples for (3) include “a dirty air cleaner” and “pulling the choke too much.”

We often hear that Iridium plugs improve ignitability so much that people “don’t have to pull the choke to start the engine.” If you are pulling the choke to full, try pulling it to the “halfway” point and see if this solves the problem.



AUSTRALIA CAR

▶ Spark plug color codes: ■ for Iridium Tough and Iridium Plugs and Iridium TT, ■ for Iridium Power, ■ for Iridium Racing and Two Tops Plugs, ■ for Platinum Plugs and Platinum TT, and black for general spark plugs.

DENSO	Model	Engine Size	Engine Code	Specification	From To	DENSO					QTY
							TJ	Iridium	Iridium Power	Iridium Tough	
ALFA ROMEO											
AUSTRALIA	33	1.5L 4Cyl 8V	AR 30143,AR 30504	905	83-87	W22ES-U	-	-	-	-	4
				905	84-89	W22ES-U	-	-	-	-	4
		1.7L 4Cyl 8V	AR 30550	905	86-89	W22ES-U	-	-	-	-	4
		1.7L 4Cyl 16V	AR 30747	907A	90-92	IK20TT	K20TT	IK20TT	-	VK20Y	4
		1.7L 4Cyl 8V	AR 30736,AR 30737	907A	90-94	W22EPR-U	W22TT	-	IW22	VW22	4
CHINA	75	2.0L 4Cyl 8V	AR 06166,AR 06224	162B	87-92	K20PR-U	K20TT	IK20TT	-	VK20Y	4
		3.0L 6Cyl 12V	AR 06124	162B	88-92	W20ES-U	-	-	-	-	6
INDIA	147	2.0L 4Cyl 16V	AR 32310	937 Twin Spark	01-10	IK20 / IU22	K20TT / -	IK20TT / -	IK20 / IU22	VK20 / -	8
		3.2L 6Cyl 24V	932 A.000	937 GTA	03-10	IK20TT	K20TT	IK20TT	-	VK20Y	6
INDONESIA	156	2.5L 6Cyl 24V	AR 32401	932	99-02	K20PBR-S10	K20TT	IK20TT	IK20	VK20	6
		2.0L 4Cyl 16V	AR 32301,AR 32310	932 Twin Spark	99-02	IK20 / IU22	K20TT / -	IK20TT / -	IK20 / IU22	VK20 / -	8
			AR 32310,AR 32301	932 Twin Spark	00-02	IK20 / IU22	K20TT / -	IK20TT / -	IK20 / IU22	VK20 / -	8
		2.5L 6Cyl 24V	AR 32405	932	00-05	IK20TT	K20TT	IK20TT	-	VK20Y	6
		3.2L 6Cyl 24V	932 A.000	932 GTA	02-05	IK20TT	K20TT	IK20TT	-	VK20Y	6
KOREA	159	2.0L 4Cyl 16V	937 A1.000	932 JTS	02-06	IK20	K20TT	IK20TT	IK20	VK20	4
		3.2L 6Cyl 24V	939 A.000	939 JTS	05-11	IK16	K16TT	IK16TT	IK16	VK16	6
		2.2L 4Cyl 16V	939 A5.000	939 JTS	06-11	IK16	K16TT	IK16TT	IK16	VK16	4
MALAYSIA	164	1.8L 4Cyl 16V	939 B1.000	939 Turbo	09-12	IXEH20TT	-	IXEH20TT	-	VCH20	4
		3.0L 6Cyl 12V	AR 06412	164	89-92	W20EP-U	W20TT	IW20TT	IW20	VW20	6
PHILIPPINES	166	AR 06430,AR 64301		164	90-92	IW20TT	W20TT	IW20TT	IW20	VW20	6
		3.0L 6Cyl 24V	AR 34302,AR 34301	936	99-04	IK20TT	K20TT	IK20TT	-	VK20Y	6
SAUDI ARABIA	4C	1.8L 4Cyl 16V	960 A1.000	960 Turbo	13-	IXEH20TT	-	IXEH20TT	-	VCH20	4
		4C SPIDER	1.8L 4Cyl 16V	960 A1.000	961 Turbo	14-	IXEH20TT	-	IXEH20TT	-	VCH20
SINGAPORE	BRERA	3.2L 6Cyl 24V	939 A.000	939 JTS	06-11	IK16	K16TT	IK16TT	IK16	VK16	6
		2.2L 4Cyl 16V	939 A5.000	939 JTS	06-11	IK16	K16TT	IK16TT	IK16	VK16	4
TAIWAN	GIULIETTA	2.0L 4Cyl 8V	AR 01699	116 Turbo	83-84	W22ES-U	-	-	-	-	4
		1.8L 4Cyl 16V	940 A1.000	940	10-	IXEH20TT	-	IXEH20TT	-	VCH20	4
			940 A2.000	940	10-	IXU27	-	-	IXU27	-	4
		1.4L 4Cyl 16V	940 B7.000,198 A4.000	940	10-	IXU27	-	-	IXU27	-	4
			940 C2.000,940 A2.000	940	14-	IXU27	-	-	IXU27	-	4
1.8L 4Cyl 16V	960 A1.000,940 B2.000	940	15-	IXEH20TT	-	IXEH20TT	-	VCH20	4		
THAILAND	GT	3.2L 6Cyl 24V	936 A.000	937 GTA	04-10	IK20TT	K20TT	IK20TT	-	VK20Y	6
		2.0L 4Cyl 16V	932 A2.000,937 A1.000	937 JTS	05-10	IK20	K20TT	IK20TT	IK20	VK20	4
VIETNAM	GTV	2.0L 4Cyl 16V	AR 32301	916 Twin Spark	97-03	IK20TT / IU22	-	IK20TT / IU22	IK20 / IU22	VK20 / IU22	8
		3.0L 6Cyl 24V	AR 16102	916	98-00	IK20TT	K20TT	IK20TT	-	VK20Y	6
		2.0L 4Cyl 16V	AR 32310,AR 16201	916 Twin Spark	98-05	IK20 / IU22	K20TT / -	IK20TT / -	IK20 / IU22	VK20 / -	8
JAPAN	MITO	1.4L 4Cyl 16V	198 A4.000	955	08-	IXU27	-	-	IXU27	-	4
			199 A8.000	955	08-	IXU27	-	-	IXU27	-	4
		3.0L 6Cyl 12V	940 A2.000	955 Turbo	09-	IXU27	-	-	IXU27	-	4
			955 A2.000,955 A7.000	955 Turbo	09-	IXU27	-	-	IXU27	-	4
		AR 16101	916	95-05	IK20TT	K20TT	IK20TT	-	VK20Y	6	
EUROPE & USA	SPIDER	AR 32301	916 Twin Spark	98-00	IK20TT / IU22	-	IK20TT / IU22	IK20 / IU22	VK20 / IU22	8	
		AR 16201,AR 32310	916 Twin Spark	98-05	IK20 / IU22	K20TT / -	IK20TT / -	IK20 / IU22	VK20 / -	8	
		3.2L 6Cyl 24V	939 A.000	939 JTS	06-11	IK20TT	K20TT	IK20TT	-	VK20Y	6
		2.2L 4Cyl 16V	939 A5.000	939 JTS	06-11	IK16	K16TT	IK16TT	IK16	VK16	4
MOTOR CYCLE	ASTON MARTIN	3.2L 6Cyl 24V	AJ6HT		94-03	K22PR-U	-	-	IK22	VK22	6
			6.0L 12Cyl 48V	AM2		99-03	IT16	T16TT	IT16TT	IT16	VT16
		6.0L 12Cyl 48V	AM3		04-12	IT20	T20TT	IT20TT	IT20	VT20	12
AM11			12-16	IT20	T20TT	IT20TT	IT20	VT20	12		
SMALL ENGINE	DBS	6.0L 12Cyl 48V	AM4R9		07-	IT20	T20TT	IT20TT	IT20	VT20	12
		RAPIDE	6.0L 12Cyl 48V	AM16,AM4R9		10-13	IT20	T20TT	IT20TT	IT20	VT20
CROSS REFERENCE	VANQUISH	6.0L 12Cyl 48V	AM 702	R2	01-07	IT20TT	T20TT	IT20TT	IT20	VT20	12
		80	2.0L 4Cyl 8V	3A	89, 89Q, 8A, B3	88-90	W20EPB	W20TT	IW20TT	IW20	VW20
PART NUMBER	AUDI	2.3L 5Cyl 10V	ABK	8C2, B4	91-94	W20EPBR-S	W20TT	IW20TT	IW20	VW20	4
			NG	8C2, B4	92-93	IW16	W16TT	IW16TT	IW16	VW16	5
		2.6L 6Cyl 12V	ABC	8C2, B4	93-94	K20PBR-S10	K20TT	IK20TT	IK20	VK20	6
			ABC	8C2, B4 Quattro	93-94	K20PBR-S10	K20TT	IK20TT	IK20	VK20	6
		90	2.3L 5Cyl 10V	NG	89, 89Q, 8A, B3	87-91	IW16	W16TT	IW16TT	IW16	VW16
100	2.3L 5Cyl 10V	NF	44, 44Q, C3	86-90	IW16	W16TT	IW16TT	IW16	VW16	5	
	2.8L 6Cyl 12V	AAH	4A2, C4	90-94	K20PBR-S10	K20TT	IK20TT	IK20	VK20	6	
		AAH	4A2, C4 Quattro	90-94	K20PBR-S10	K20TT	IK20TT	IK20	VK20	6	
2.6L 6Cyl 12V	ABC	4A2, C4	93-94	K20PBR-S10	K20TT	IK20TT	IK20	VK20	6		
A1	1.4L 4Cyl 16V	CNVA,CAXA	8X1, 8XK	10-15	IK20L	-	-	IK20L	-	4	
		CTJA,CTHG,CAVG	8X1, 8XK	11-15	VKA20	-	-	-	VKA20	4	
		CAXA,CNVA	8XA, 8XF	11-15	IK20L	-	-	IK20L	-	4	

Model	Engine Size	Engine Code	Specification	From To	DENSO					QTY	
AUDI											
A1	1.4L 4Cyl 16V	CTHG,CAVG,CTJA	8XA, 8XF	11-15	VKA20	-	-	-	VKA20	4	
		DAJB	8X1, 8XK	15-18	VKH22	-	-	IKH22	VKH22	4	
	1.8L 4Cyl 16V	DAJB	8XA, 8XF	15-18	VKH22	-	-	IKH22	VKH22	4	
A3	1.6L 4Cyl 8V	AEH,APF,AKL	8L1	97-03	K20PBR-S10	K20TT	IK20TT	IK20	VK20	4	
		AGN,APG	8L1	97-03	K20PBR-S10	K20TT	IK20TT	IK20	VK20	4	
		ARZ,AUM,AQA,AGU	8L1	98-03	IK20TT	K20TT	IK20TT	-	VK20Y	4	
	1.8L 4Cyl 20V	AMK,APY	8L1 Quattro	99-02	IK20TT	K20TT	IK20TT	-	VK20Y	4	
		BAM	8L1 Quattro	01-03	IK20TT	K20TT	IK20TT	-	VK20Y	4	
	2.0L 4Cyl 16V			8P1	03-08	VKA16	-	-	-	VKA16	4
	1.6L 4Cyl 8V	BSF,BGU,BSE	8P1	03-12	K20PBR-S10	K20TT	IK20TT	IK20	VK20	4	
	2.0L 4Cyl 16V	CAWB,AXX,CCZA,BWA	8P1	04-12	IK22	-	-	IK22	VK22	4	
		BWA,AXX,CCZA	8P1 Quattro	04-12	IK22	-	-	IK22	VK22	4	
	1.8L 4Cyl 16V	BYT,CDAA,BZB	8P1	06-12	IK22	-	-	IK22	VK22	4	
	2.0L 4Cyl 16V	CDLC,BZC	8P1 Quattro	07-12	IK22	-	-	IK22	VK22	4	
	1.4L 4Cyl 16V	CAXC,CMSA	8PA	07-13	IK20L	-	-	IK20L	-	4	
	2.0L 4Cyl 16V	CCZA,CAWB	8P7	08-13	IK22	-	-	IK22	VK22	4	
		CDAABZB	8P7	08-13	IK22	-	-	IK22	VK22	4	
	1.8L 4Cyl 16V	CJSA	8V1, 8VK	12-	VKH22	-	-	IKH22	VKH22	4	
		CJSB	8V1, 8VK Quattro	12-	VKH22	-	-	IKH22	VKH22	4	
	1.4L 4Cyl 16V	CPTA	8V1, 8VK	13-	IK20L	-	-	IK20L	-	4	
	2.0L 4Cyl 16V	CJXB	8V1, 8VK Quattro	13-	VKH22	-	-	IKH22	VKH22	4	
	1.8L 4Cyl 16V	CJSA,CJSB	8V7, 8VE	13-	VKH22	-	-	IKH22	VKH22	4	
	1.4L 4Cyl 16V	CPTA	8VA, 8VF	13-	IK20L	-	-	IK20L	-	4	
	1.8L 4Cyl 16V	CJSB,CJSA	8VS, 8VM	13-	VKH22	-	-	IKH22	VKH22	4	
	1.4L 4Cyl 16V	CPTA	8VS, 8VM	13-	IK20L	-	-	IK20L	-	4	
	1.8L 4Cyl 16V	CJSB	8VS, 8VM Quattro	13-	VKH22	-	-	IKH22	VKH22	4	
	2.0L 4Cyl 16V	CJXB	8VS, 8VM Quattro	13-	VKH22	-	-	IKH22	VKH22	4	
	1.4L 4Cyl 16V	CZEA	8V1, 8VK	14-	IK20L	-	-	IK20L	-	4	
	2.0L 4Cyl 16V	CJXF	8V1, 8VK Quattro	14-	VKH22	-	-	IKH22	VKH22	4	
	1.8L 4Cyl 16V	CJSB	8V7, 8VE Quattro	14-	VKH22	-	-	IKH22	VKH22	4	
	2.0L 4Cyl 16V	CJXF	8V7, 8VE Quattro	14-	VKH22	-	-	IKH22	VKH22	4	
	1.4L 4Cyl 16V	CZEA	8VA, 8VF	14-	IK20L	-	-	IK20L	-	4	
		CZEA	8VS, 8VM	14-	IK20L	-	-	IK20L	-	4	
	2.0L 4Cyl 16V	CJXF	8VS, 8VM Quattro	14-	VKH22	-	-	IKH22	VKH22	4	
A4	1.8L 4Cyl 20V	ADR,AVV,ARG,APT	8D2, B5	95-00	K20PBR-S10	K20TT	IK20TT	IK20	VK20	4	
		APT,ADR,ARG	8D2, B5 Quattro	95-00	K20PBR-S10	K20TT	IK20TT	IK20	VK20	4	
		ABC	8D2, B5	95-98	K20PBR-S10	K20TT	IK20TT	IK20	VK20	6	
	2.6L 6Cyl 12V	ABC	8D2, B5 Quattro	95-98	K20PBR-S10	K20TT	IK20TT	IK20	VK20	6	
		ABC	8D5, B5	95-98	K20PBR-S10	K20TT	IK20TT	IK20	VK20	6	
		ABC	8D5, B5 Quattro	95-98	K20PBR-S10	K20TT	IK20TT	IK20	VK20	6	
	1.8L 4Cyl 20V	ANB,ARK,AEB,APU,AWT	8D2, B5	96-00	IK20TT	K20TT	IK20TT	-	VK20Y	4	
		ANB,ARK,AEB,AWT,APU	8D2, B5 Quattro	96-00	IK20TT	K20TT	IK20TT	-	VK20Y	4	
		AJL	8D2, B5 Quattro	97-00	IK20TT	K20TT	IK20TT	-	VK20Y	4	
	2.7L 6Cyl 30V	AGB,AZB	8D2, B5 Quattro	97-01	IK20TT	K20TT	IK20TT	-	VK20Y	6	
	2.8L 6Cyl 30V		8D2, B5 Quattro	97-01	K20TXR	K20TT	IK20TT	IK20	VK20	6	
	2.4L 6Cyl 30V	ARJ,AML,APS,AGA,ALF	8D5, B5	97-01	K20TXR	K20TT	IK20TT	IK20	VK20	6	
	2.7L 6Cyl 30V	AGB,AZB	8D5, B5 Quattro	97-01	IK20TT	K20TT	IK20TT	-	VK20Y	6	
	2.4L 6Cyl 30V	APS,AGA,AML,ALF,ARJ	8D2, B5	98-00	K20TXR	K20TT	IK20TT	IK20	VK20	6	
		AML,ALF,ARJ,AGA,APS	8D2, B5 Quattro	98-00	K20TXR	K20TT	IK20TT	IK20	VK20	6	
	1.8L 4Cyl 20V	AJL	8D5, B5	99-01	IK20TT	K20TT	IK20TT	-	VK20Y	4	
		ANB,ARK,AEB,APU,AWT	8D5, B5	99-01	IK20TT	K20TT	IK20TT	-	VK20Y	4	
	2.7L 6Cyl 30V	AZR,ASJ	8D5, B5 Quattro	00-01	VK22	-	-	IK22	VK22	6	
	3.0L 6Cyl 30V	ASN	8E2, B6 Quattro	00-04	K20TXR	K20TT	IK20TT	IK20	VK20	6	
	1.8L 4Cyl 20V	AVJ	8E2, B6	01-02	IK20TT	K20TT	IK20TT	-	VK20Y	4	
		AVJ	8E2, B6 Quattro	01-02	IK20TT	K20TT	IK20TT	-	VK20Y	4	
	2.0L 4Cyl 20V	ALT	8E2, B6	01-04	IK16	K16TT	IK16TT	IK16	VK16	4	
	3.0L 6Cyl 30V	BBJ	8E2, B6	01-04	K20TXR	K20TT	IK20TT	IK20	VK20	6	
	2.0L 4Cyl 20V	ALT	8E5, B6	01-04	IK16	K16TT	IK16TT	IK16	VK16	4	
	2.4L 6Cyl 30V	BDV	8E2, B6	02-04	K20TXR	K20TT	IK20TT	IK20	VK20	6	
		BFB	8E2, B6	02-04	IK20TT	K20TT	IK20TT	-	VK20Y	4	
		BEX	8E2, B6 Quattro	02-04	IK20TT	K20TT	IK20TT	-	VK20Y	4	
		BFB	8E2, B6 Quattro	02-04	IK20TT	K20TT	IK20TT	-	VK20Y	4	
		BFB	8E5, B6	02-04	IK20TT	K20TT	IK20TT	-	VK20Y	4	
	3.0L 6Cyl 30V	ASN	8H7, B6, 8HE, B7	02-05	K20TXR	K20TT	IK20TT	IK20	VK20	6	
	1.8L 4Cyl 20V	BFB	8H7, B6, 8HE, B7	02-09	IK20TT	K20TT	IK20TT	-	VK20Y	4	
	4.2L 8Cyl 40V	BBK	8E2, B6 Quattro	03-04	K20TXR	K20TT	IK20TT	IK20	VK20	8	
3.0L 6Cyl 30V	BBJ	8EC, B7 Quattro	04-06	K20TXR	K20TT	IK20TT	IK20	VK20	6		

DENSO
 AUSTRALIA
 CHINA
 INDIA
 INDONESIA
 KOREA
 MALAYSIA
 PHILIPPINES
 SAUDI ARABIA
 SINGAPORE
 TAIWAN
 THAILAND
 VIETNAM
 JAPAN
 EUROPE
 MOTOR & USA
 CYCLE
 SMALL ENGINE
 CROSS REFERENCE
 PART NUMBER

DENSO	9	14	16	20	22	24	27	29	31	32	34	35	DENSO	9	14	16	20	22	24	27	29	31	32	DENSO	9	14	16	20	22	24	27	31
NGK	2	4	5	6	7	8	9	9.5	10	10.5	11	11.5	CHAMPION	18	16,14	12,11	10,9	8,7	6,63,61	4,59	57	55	53	BOSCH	10	9	8	7,6	5	4	3	2



AUSTRALIA CAR

▶ Spark plug color codes: ■ for Iridium Tough and Iridium Plugs and Iridium TT, ■ for Iridium Power, ■ for Iridium Racing and Two Tops Plugs, ■ for Platinum Plugs and Platinum TT, and black for general spark plugs.

DENSO
AUSTRALIA
CHINA
INDIA
INDONESIA
KOREA
MALAYSIA
PHILIPPINES
SAUDI ARABIA
SINGAPORE
TAIWAN
THAILAND
VIETNAM
JAPAN
EUROPE & USA
MOTOR CYCLE
SMALL ENGINE
CROSS REFERENCE
PART NUMBER

Model	Engine Size	Engine Code	Specification	From To	DENSO					QTY
AUDI										
A4										
	2.0L 4Cyl 20V	ALT	8EC, B7	04-08	IK16	K16TT	IK16TT	IK16	VK16	4
	1.8L 4Cyl 20V	BFB	8EC, B7	04-08	IK20TT	K20TT	IK20TT	-	VK20Y	4
	2.0L 4Cyl 16V	BGB,BWE	8EC, B7	04-08	IK22	-	-	IK22	VK22	4
	1.8L 4Cyl 20V	BFB	8EC, B7 Quattro	04-08	IK20TT	K20TT	IK20TT	-	VK20Y	4
	2.0L 4Cyl 16V	BWE,BGB	8EC, B7 Quattro	04-08	IK22	-	-	IK22	VK22	4
	2.0L 4Cyl 20V	ALT	8ED, B7	04-08	IK16	K16TT	IK16TT	IK16	VK16	4
	1.8L 4Cyl 20V	BFB	8ED, B7	04-08	IK20TT	K20TT	IK20TT	-	VK20Y	4
	2.0L 4Cyl 16V	BWT,BWE,BGB	8ED, B7 Quattro	04-08	IK22	-	-	IK22	VK22	4
	3.2L 6Cyl 24V	AUK	8EC, B7 Quattro	05-08	IK22	-	-	IK22	VK22	6
	4.2L 8Cyl 32V	BNS	8EC, B7 Quattro	05-08	IK22	-	-	IK22	VK22	8
	4.2L 8Cyl 32V	BNS	8ED, B7 Quattro	05-08	IK22	-	-	IK22	VK22	8
	4.2L 8Cyl 40V	BBK	8H7, B6, 8HE, B7 Quattro	05-09	K20TXR	K20TT	IK20TT	IK20	VK20	8
	3.2L 6Cyl 24V	AUK	8H7, B6, 8HE, B7	06-09	IK22	-	-	IK22	VK22	6
	2.0L 4Cyl 16V	BWE	8H7, B6, 8HE, B7	06-09	IK22	-	-	IK22	VK22	4
	4.2L 8Cyl 32V	BNS	8H7, B6, 8HE, B7 Quattro	06-09	IK22	-	-	IK22	VK22	8
	1.8L 4Cyl 16V	CABB,CDHB	8K2, B8	07-12	IK22	-	-	IK22	VK22	4
	3.2L 6Cyl 24V	CALA	8K2, B8 Quattro	07-12	IK20TT	K20TT	IK20TT	IK20	VK20	6
	1.8L 4Cyl 16V	CDHB,CABB	8K5, B8	07-12	IK22	-	-	IK22	VK22	4
	2.0L 4Cyl 16V	CFKA,CAEA,CDNB	8K2, B8	08-15	IK22	-	-	IK22	VK22	4
	3.0L 6Cyl 24V	CDNC,CPMA	8K2, B8 Quattro	08-15	IK22	-	-	IK22	VK22	4
	3.0L 6Cyl 24V		8K2, B8 Quattro	08-15	IK24	-	-	IK24	-	6
	2.0L 4Cyl 16V	CDNB,CFKA	8K5, B8	08-15	IK22	-	-	IK22	VK22	4
	2.0L 4Cyl 16V	CAEB,CDNC	8K5, B8 Quattro	08-15	IK22	-	-	IK22	VK22	4
	3.0L 6Cyl 24V		8K5, B8 Quattro	08-15	IK24	-	-	IK24	-	6
	1.8L 4Cyl 16V	CJEB	8K2, B8	11-15	VKH22	-	-	IKH22	VKH22	4
	1.8L 4Cyl 16V	CJEB	8K5, B8	11-15	VKH22	-	-	IKH22	VKH22	4
	2.0L 4Cyl 16V	CNCD	8K2, B8 Quattro	13-15	VKH22	-	-	IKH22	VKH22	4
	2.0L 4Cyl 16V	CNCD	8K5, B8 Quattro	13-15	VKH22	-	-	IKH22	VKH22	4
A5										
	3.2L 6Cyl 24V	CALA	8T3	07-12	IK20TT	K20TT	IK20TT	IK20	VK20	6
	3.2L 6Cyl 24V	CALA	8T3 Quattro	07-12	IK20TT	K20TT	IK20TT	IK20	VK20	6
	4.2L 8Cyl 32V	CAUA	8T3 Quattro	07-12	VKB20	-	-	-	VKB20	8
	1.8L 4Cyl 16V	CABD,CJEB	8T3	07-17	VKH22	-	-	IKH22	VKH22	4
		CDNC,CAEB	8T3 Quattro	08-17	IK22	-	-	IK22	VK22	4
	2.0L 4Cyl 16V	CAEA,CDNB	8F7	09-12	IK22	-	-	IK22	VK22	4
		CDNB	8TA	09-14	IK22	-	-	IK22	VK22	4
		CAEB,CPMA,CDNC	8F7 Quattro	09-17	IK22	-	-	IK22	VK22	4
	3.0L 6Cyl 24V		8F7 Quattro Supercharged	09-17	IK24	-	-	IK24	-	6
	2.0L 4Cyl 16V	CDNC,CAEB	8TA Quattro	09-17	IK22	-	-	IK22	VK22	4
	3.0L 6Cyl 24V		8TA Quattro Supercharged	10-17	IK24	-	-	IK24	-	6
	1.8L 4Cyl 16V	CJEB,CABD	8F7	11-16	VKH22	-	-	IKH22	VKH22	4
	3.0L 6Cyl 24V	CRED,CHMB,CMUA	8T3 Quattro	11-17	IK24	-	-	IK24	-	6
			8T3 Quattro	11-17	IK24	-	-	IK24	-	6
	1.8L 4Cyl 16V	CJEB	8TA	11-17	VKH22	-	-	IKH22	VKH22	4
	2.0L 4Cyl 16V	CNCD	8F7 Quattro	13-16	VKH22	-	-	IKH22	VKH22	4
	2.0L 4Cyl 16V	CNCD	8TA Quattro	13-16	VKH22	-	-	IKH22	VKH22	4
A6										
	2.6L 6Cyl 12V	ABC	4A2, C4	94-97	K20PBR-S10	K20TT	IK20TT	IK20	VK20	6
		ACK	4A2, C4	95-97	K20TXR	K20TT	IK20TT	IK20	VK20	6
	2.8L 6Cyl 30V		4B2, C5	97-02	K20TXR	K20TT	IK20TT	IK20	VK20	6
			4B2, C5 Quattro	97-02	K20TXR	K20TT	IK20TT	IK20	VK20	6
			4B5, C5 Quattro	97-02	K20TXR	K20TT	IK20TT	IK20	VK20	6
	2.4L 6Cyl 30V	ARJ,AML,APS,AGA,ALF	4B2, C5	97-04	K20TXR	K20TT	IK20TT	IK20	VK20	6
		AML,ARJ,ALF,AGA,APS	4B2, C5 Quattro	97-05	K20TXR	K20TT	IK20TT	IK20	VK20	6
		BDV	4B2, C5	01-05	K20TXR	K20TT	IK20TT	IK20	VK20	6
	2.7L 6Cyl 30V	BES,ARE	4B2, C5 Quattro	02-04	IK20TT	K20TT	IK20TT	-	VK20Y	6
	3.0L 6Cyl 30V	ASN	4B2, C5 Quattro	02-05	K20TXR	K20TT	IK20TT	IK20	VK20	6
		BCY	4B2, C5 Quattro	02-05	VK22	-	-	IK22	VK22	8
	4.2L 8Cyl 40V	BCY	4B5, C5 Quattro	02-05	VK22	-	-	IK22	VK22	8
		BAT	4F2, C6 Quattro	04-06	K20TXR	K20TT	IK20TT	IK20	VK20	8
	3.0L 6Cyl 30V	BBJ	4F2, C6 Quattro	04-06	K20TXR	K20TT	IK20TT	IK20	VK20	6
	2.4L 6Cyl 24V	BDW	4F2, C6	04-08	IK20TT	K20TT	IK20TT	IK20	VK20	6
		AUK	4F2, C6 Quattro	05-08	IK22	-	-	IK22	VK22	6
	3.2L 6Cyl 24V	AUK	4F5, C6 Quattro	05-08	IK22	-	-	IK22	VK22	6
		AUK,BKH	4F2, C6	05-09	IK22	-	-	IK22	VK22	6
	2.0L 4Cyl 16V	BPJ	4F2, C6	05-11	IK22	-	-	IK22	VK22	4
		BPJ	4F5, C6	05-11	IK22	-	-	IK22	VK22	4
	5.2L 10Cyl 40V	BXA	4F2, C6 Quattro	06-11	VKB20	-	-	-	VKB20	10
	2.8L 6Cyl 24V	BDX	4F2, C6 Quattro	07-08	IK20TT	K20TT	IK20TT	IK20	VK20	6



Model	Engine Size	Engine Code	Specification	From To	DENSO					QTY
AUDI										
A6	5.0L 10Cyl 40V	BUH	4F5, C6 Quattro	08-10	IK20TT	K20TT	IK20TT	-	VK20Y	10
	3.0L 6Cyl 24V	CAJA	4F2, C6 Quattro	08-11	IK24	-	-	IK24	-	6
	2.8L 6Cyl 24V	CCEA	4F2, C6 Quattro	08-11	IK20TT	K20TT	IK20TT	IK20	VK20	6
		CHVA	4G2, 4GC, C7 Quattro	10-15	IK20TT	K20TT	IK20TT	IK20	VK20	6
	2.0L 4Cyl 16V	CDNB	4G2, 4GC, C7	11-	IK22	-	-	IK22	VK22	4
A7	3.0L 6Cyl 24V	CGWB,CHMA	4GA, 4GF Quattro	10-12	IK24	-	-	IK24	-	6
A8	4.2L 8Cyl 32V	ABZ,AKG	4D2, 4D8 Quattro	95-00	T20EPR-U	T20TT	IT20TT	IT20	VT20	8
	3.7L 8Cyl 32V	AEW	4D2, 4D8	97-98	T20EPR-U	T20TT	IT20TT	IT20	VT20	8
	4.2L 8Cyl 40V	AQF,AUW,AUX	4D2, 4D8 Quattro	00-05	K20TXR	K20TT	IK20TT	IK20	VK20	8
	3.7L 8Cyl 40V	BFL	4E2, 4E8 Quattro	03-06	K20TXR	K20TT	IK20TT	IK20	VK20	8
	4.2L 8Cyl 40V	BFM	4E2, 4E8 Quattro	03-10	K20TXR	K20TT	IK20TT	IK20	VK20	8
	3.2L 6Cyl 24V	BPK	4E2, 4E8	05-10	IK22	-	-	IK22	VK22	6
	6.0L 12Cyl 48V	BHT	4E2, 4E8 Quattro	05-10	IK20TT	K20TT	IK20TT	IK20L	-	12
	3.2L 6Cyl 24V	BPK	4E2, 4E8 Quattro	05-10	IK22	-	-	IK22	VK22	6
	5.2L 10Cyl 40V	BSM	4E2, 4E8 Quattro	06-10	VKB20	-	-	-	VKB20	10
	4.2L 8Cyl 32V	CDRA	4H Quattro	09-	VKB20	-	-	-	VKB20	8
ALLROAD										
ALLROAD	2.7L 6Cyl 30V	BES,ARE	4BH, C5 Quattro	01-05	IK20TT	K20TT	IK20TT	-	VK20Y	6
	4.2L 8Cyl 40V	BAS	4BH, C5 Quattro	02-05	K20TXR	K20TT	IK20TT	IK20	VK20	8
CABRIOLET										
Q3	2.6L 6Cyl 12V	ABC	8G7, B4	93-00	K20PBR-S10	K20TT	IK20TT	IK20	VK20	6
	2.0L 4Cyl 16V	CCZC	8UB, 8UG Quattro	11-	IK22	-	-	IK22	VK22	4
		CPSA	8UB, 8UG Quattro	11-	IK22	-	-	IK22	VK22	4
Q5	2.0L 4Cyl 16V	CULB	8UB, 8UG Quattro	14-	VKH22	-	-	IKH22	VKH22	4
	2.0L 4Cyl 16V	CAEB,CDNC,CPMA	8RB Quattro	08-	IK22	-	-	IK22	VK22	4
	3.2L 6Cyl 24V	CALB	8RB Quattro	08-	IK20TT	K20TT	IK20TT	IK20	VK20	6
Q7	2.0L 4Cyl 16V	CNCD	8RB Quattro	12-	VKH22	-	-	IKH22	VKH22	4
	4.2L 8Cyl 32V	BAR	4LB Quattro	06-10	VKB20	-	-	-	VKB20	8
R8	3.0L 6Cyl 24V	CJTB,CJWB,CTWA,CNAA	4LB Quattro	10-15	IK24	-	-	IK24	-	6
	4.2L 8Cyl 32V	BYH	422, 423 Quattro	07-10	IK22	-	-	IK22	VK22	8
	5.2L 10Cyl 40V	BUJ,CTYA	422, 423 Quattro	09-15	IK22	-	-	IK22	VK22	10
	4.2L 8Cyl 32V	CNDA	422, 423 Quattro	10-15	IK22	-	-	IK22	VK22	8
	5.2L 10Cyl 40V	CTYA,BUJ	427, 429 Quattro	10-15	IK22	-	-	IK22	VK22	10
TT	1.8L 4Cyl 20V	CTPA	422, 423 Quattro	12-15	IK22	-	-	IK22	VK22	10
		AUQ,ATC,APP,AJQ	8N3	98-06	IK20TT	K20TT	IK20TT	-	VK20Y	4
		APX,BAM	8N3 Quattro	99-06	IK20TT	K20TT	IK20TT	-	VK20Y	4
		AUQ,ATC,APP,AJQ	8N9	99-06	IK20TT	K20TT	IK20TT	-	VK20Y	4
		APX,BAM	8N9 Quattro	99-06	IK20TT	K20TT	IK20TT	-	VK20Y	4
	3.2L 6Cyl 24V	AUM	8N3	02-06	IK20TT	K20TT	IK20TT	-	VK20Y	4
		BHE	8N3 Quattro	04-06	IK20TT	K20TT	IK20TT	-	VK20Y	6
	1.8L 4Cyl 20V	BVR	8N3	05-06	IK20TT	K20TT	IK20TT	-	VK20Y	4
		BVR	8N9	05-06	IK20TT	K20TT	IK20TT	-	VK20Y	4
	2.0L 4Cyl 16V	BWA	8J3	06-10	IK22	-	-	IK22	VK22	4
		BWA	8J9	07-10	IK22	-	-	IK22	VK22	4
	1.8L 4Cyl 16V	CDA A	8J3	08-14	IK22	-	-	IK22	VK22	4
	2.0L 4Cyl 16V	CDLB	8J3 Quattro	08-14	IK22	-	-	IK22	VK22	4
		CDLB	8J9 Quattro	08-14	IK22	-	-	IK22	VK22	4
	2.5L 5Cyl 20V	CEPA	8J3 Quattro	09-14	VKH22	-	-	IKH22	VKH22	5
	2.0L 4Cyl 16V	CESA	8J3	10-14	IK22	-	-	IK22	VK22	4
		CETA,CESA	8J3 Quattro	10-14	IK22	-	-	IK22	VK22	4
		CESA	8J9	10-14	IK22	-	-	IK22	VK22	4
		CHHC	FV3	14-	VKH22	-	-	IKH22	VKH22	4
		CHHC	FV3 Quattro	14-	VKH22	-	-	IKH22	VKH22	4
CJXF		FV3 Quattro	15-	VKH22	-	-	IKH22	VKH22	4	
CJXF		FV3 Quattro	15-	VKH22	-	-	IKH22	VKH22	4	
BMW										
1 Series	1.6L 4Cyl 16V	N45 B16	E87 116 i	03-11	K20TXR	K20TT	IK20TT	IK20	VK20	4
	2.0L 4Cyl 16V	N46 B20	E87 120 i	03-11	IK20TT	K20TT	IK20TT	IK20	VK20	4
	3.0L 6Cyl 24V	N52 B30	E87 130 i	05-12	IKH20TT	KH20TT	IKH20TT	IKH20	VKH20	6
	2.0L 4Cyl 16V	N46 B20	E87 118 i	06-11	IK20TT	K20TT	IK20TT	IK20	VK20	4
	3.0L 6Cyl 24V	N52 B30	E82 125 i	07-13	IKH20TT	KH20TT	IKH20TT	IKH20	VKH20	6
		N52 B30	E88 125 i	08-13	IKH20TT	KH20TT	IKH20TT	IKH20	VKH20	6
	1.6L 4Cyl 16V	N13 B16	F20 116 i	10-	IXUH22	-	-	IXUH22	VXUH22	4
		N13 B16	F20 118 i	10-	IXUH22	-	-	IXUH22	VXUH22	4
3 Series	2.3L 6Cyl 12V	M20 B23	E21 323 i	79-83	W16EP-U	W16TT	IW16TT	IW16	VW16	6
	1.8L 4Cyl 8V	M10 B18	E30 318 i	82-87	W16EP-U	W16TT	IW16TT	IW16	VW16	4
	2.0L 6Cyl 12V	M20 B20	E30 320 i	82-91	J16CR-U	W16TT	IW16TT	IW16	VW16	6
	2.3L 6Cyl 12V	M20 B23	E30 323 i	83-86	W16EP-U	W16TT	IW16TT	IW16	VW16	6
	1.8L 4Cyl 8V	M10 B18	E30 316	83-90	W16EP-U	W16TT	IW16TT	IW16	VW16	4
	2.5L 6Cyl 12V	M20 B25	E30 325 i	83-93	J16CR-U	W16TT	IW16TT	IW16	VW16	6

DENSO
 AUSTRALIA
 CHINA
 INDIA
 INDONESIA
 KOREA
 MALAYSIA
 PHILIPPINES
 SAUDI ARABIA
 SINGAPORE
 TAIWAN
 THAILAND
 VIETNAM
 JAPAN
 & USA
 EUROPE
 MOTOR
 CYCLE
 SMALL
 ENGINE
 REFERENCE
 NUMBER
53

DENSO	9	14	16	20	22	24	27	29	31	32	34	35	DENSO	9	14	16	20	22	24	27	29	31	32	DENSO	9	14	16	20	22	24	27	31
NGK	2	4	5	6	7	8	9	9.5	10	10.5	11	11.5	CHAMPION	18	16,14	12,11	10,9	8,7	6,63,61	4,59	57	55	53	BOSCH	10	9	8	7,6	5	4	3	2



AUSTRALIA CAR

▶ Spark plug color codes: ■ for Iridium Tough and Iridium Plugs and Iridium TT, ■ for Iridium Power, ■ for Iridium Racing and Two Tops Plugs, ■ for Platinum Plugs and Platinum TT, and black for general spark plugs.

DENSO**AUSTRALIA****CHINA****INDIA****INDONESIA****KOREA****MALAYSIA****PHILIPPINES****SAUDI ARABIA****SINGAPORE****TAIWAN****THAILAND****VIETNAM****JAPAN****EUROPE & USA****MOTOR CYCLE****SMALL ENGINE****CROSS REFERENCE****PART NUMBER**

Model	Engine Size	Engine Code	Specification	From To	DENSO					QTY
BMW										
3 Series										
1.8L 4Cyl 8V	M40 B18	M40 B18	E30 318 i	87-91	KJ16CR-L11	K16TT	IK16TT	IK16	VK16	4
		M40 B18	E36 318 i	90-93	K20TXR	K20TT	IK20TT	IK20	VK20	4
2.0L 6Cyl 24V	M52 B20		E36 320 i	91-95	K20TXR	K20TT	IK20TT	IK20	VK20	6
2.5L 6Cyl 24V	M50 B25		E36 325 i	91-99	K20TXR	K20TT	IK20TT	IK20	VK20	6
3.0L 6Cyl 24V	S50 B30		E36 M3	92-95	VXU22	XU22TT	-	IXU22	VXU22	6
1.8L 4Cyl 8V	M43 B18		E36 318 i	92-98	K20TXR	K20TT	IK20TT	IK20	VK20	4
1.8L 4Cyl 16V	M42 B18		E36 318 is	92-98	K20TXR	K20TT	IK20TT	IK20	VK20	4
1.6L 4Cyl 8V	M43 B16		E36 316 i	95-00	K20TXR	K20TT	IK20TT	IK20	VK20	4
1.9L 4Cyl 16V	M44 B19	M44 B19	E36 318 ti	95-00	K20TXR	K20TT	IK20TT	IK20	VK20	4
		M44 B19	E36 318 is	95-99	K20TXR	K20TT	IK20TT	IK20	VK20	4
2.8L 6Cyl 24V	M52 B28		E36 328 i	95-99	K20TXR	K20TT	IK20TT	IK20	VK20	6
3.2L 6Cyl 24V	S50 B32		E36 M3	95-99	VXU22	XU22TT	-	IXU22	VXU22	6
2.5L 6Cyl 24V	M52 B25		E36 323 i	96-98	K20TXR	K20TT	IK20TT	IK20	VK20	6
1.9L 4Cyl 8V	M43 B19		E36 316 i	98-00	K20TXR	K20TT	IK20TT	IK20	VK20	4
2.0L 6Cyl 24V	M52 B20		E46 320 i	98-00	K20TXR	K20TT	IK20TT	IK20	VK20	6
2.5L 6Cyl 24V	M52 B25		E46 323 i	98-00	K20TXR	K20TT	IK20TT	IK20	VK20	6
1.9L 4Cyl 8V	M43 B19		E46 318 i	98-01	K20TXR	K20TT	IK20TT	IK20	VK20	4
2.8L 6Cyl 24V	M52 B28		E46 328 i	98-05	K20TXR	K20TT	IK20TT	IK20	VK20	6
2.5L 6Cyl 24V	M52 B25		E46 323 Ci	99-00	K20TXR	K20TT	IK20TT	IK20	VK20	6
2.8L 6Cyl 24V	M52 B28		E46 328 Ci	99-06	K20TXR	K20TT	IK20TT	IK20	VK20	6
2.2L 6Cyl 24V	M54 B22		E46 320 i	00-05	K20TXR	K20TT	IK20TT	IK20	VK20	6
2.5L 6Cyl 24V	M54 B25		E46 325 i	00-05	K20TXR	K20TT	IK20TT	IK20	VK20	6
3.0L 6Cyl 24V	M54 B30		E46 330 i	00-05	K20TXR	K20TT	IK20TT	IK20	VK20	6
2.2L 6Cyl 24V	M54 B22		E46 320 Ci	00-06	K20TXR	K20TT	IK20TT	IK20	VK20	6
2.5L 6Cyl 24V	M54 B25		E46 325 Ci	00-06	K20TXR	K20TT	IK20TT	IK20	VK20	6
3.0L 6Cyl 24V	M54 B30		E46 330 Ci	00-06	K20TXR	K20TT	IK20TT	IK20	VK20	6
3.2L 6Cyl 24V	S54 B32		E46 M3	00-06	IXU24	-	-	IXU24	VXU24	6
1.8L 4Cyl 16V	N46 B18	N46 B18	E46 316 ti	01-05	K20TXR	K20TT	IK20TT	IK20	VK20	4
2.0L 4Cyl 16V		N42 B20	E46 318 i	01-05	K20TXR	K20TT	IK20TT	IK20	VK20	4
2.5L 6Cyl 24V	M54 B25	N46 B20	E46 318 ti	02-04	K20TXR	K20TT	IK20TT	IK20	VK20	4
		M54 B25	E46 325 ti	02-05	K20TXR	K20TT	IK20TT	IK20	VK20	6
3.0L 6Cyl 24V	N52 B30		E90 330 i	04-07	IKH20TT	KH20TT	IKH20TT	IKH20	VKH20	6
2.0L 4Cyl 16V	N52	N46 B20	E90 320 i	04-11	IK20TT	K20TT	IK20TT	IK20	VK20	4
2.5L 6Cyl 24V		N52	E90 323 i	05-07	IKH20TT	KH20TT	IKH20TT	IKH20	VKH20	6
		N52 B25	E92 325 i	05-10	IKH20TT	KH20TT	IKH20TT	IKH20	VKH20	6
		N52 B25	E90 325 i	05-11	IKH20TT	KH20TT	IKH20TT	IKH20	VKH20	6
3.0L 6Cyl 24V	N52 B25	N52 B25	E91 323 i	06-07	IKH20TT	KH20TT	IKH20TT	IKH20	VKH20	6
		N53 B30	E90 330 i	07-11	VKH20Y	-	-	-	VKH20Y	6
2.5L 6Cyl 24V	N52 B25		E93 325 i	07-13	IKH20TT	KH20TT	IKH20TT	IKH20	VKH20	6
5 Series										
2.0L 4Cyl 8V	M10 B20		E12 520 i	72-79	W20EP-U	W20TT	IW20TT	IW20	VW20	4
2.5L 6Cyl 12V	M20 B25		E34 525 i	88-90	J16CR-U	W16TT	IW16TT	IW16	VW16	6
3.6L 6Cyl 24V	S38 B36		E34 M5	88-92	XU20EPR-U	-	-	-	VXU20	6
3.4L 6Cyl 12V	M30 B34		E34 535 i	88-93	J16CR-U	W16TT	IW16TT	IW16	VW16	6
2.5L 6Cyl 24V	M50 B25		E34 525 i	89-97	K20TXR	K20TT	IK20TT	IK20	VK20	6
2.0L 6Cyl 24V	M50 B20		E34 520 i	90-95	K20TXR	K20TT	IK20TT	IK20	VK20	6
3.0L 8Cyl 32V	M60 B30		E34 530 i	92-95	K20TXR	K20TT	IK20TT	IK20	VK20	8
4.0L 8Cyl 32V	M60 B40		E34 540 i	92-95	K20TXR	K20TT	IK20TT	IK20	VK20	8
2.8L 6Cyl 24V	M52 B28		E39 528 i	95-00	K20TXR	K20TT	IK20TT	IK20	VK20	6
2.5L 6Cyl 24V	M52 B25		E39 523 i	96-00	K20TXR	K20TT	IK20TT	IK20	VK20	6
2.0L 6Cyl 24V	M52 B20		E39 520 i	96-03	K20TXR	K20TT	IK20TT	IK20	VK20	6
3.5L 8Cyl 32V	M62 B35		E39 535 i	96-03	K20TXR	K20TT	IK20TT	IK20	VK20	8
4.4L 8Cyl 32V	M62 B44		E39 540 i	96-03	K20TXR	K20TT	IK20TT	IK20	VK20	8
4.9L 8Cyl 32V	S62 B50		E39 M5	99-03	K20TXR	K20TT	IK20TT	IK20	VK20	8
2.5L 6Cyl 24V	M54 B25		E39 525 i	00-03	K20TXR	K20TT	IK20TT	IK20	VK20	6
3.0L 6Cyl 24V	M54 B30	M54 B30	E39 530 i	00-04	K20TXR	K20TT	IK20TT	IK20	VK20	6
		M54 B30	E60 530 i	03-05	K20TXR	K20TT	IK20TT	IK20	VK20	6
2.5L 6Cyl 24V	M54 B25		E60 525 i	03-10	K20TXR	K20TT	IK20TT	IK20	VK20	6
4.4L 8Cyl 32V	N62 B44		E60 545 i	03-10	K20TXR	K20TT	IK20TT	IK20	VK20	8
3.0L 6Cyl 24V	N52 B30	N52 B30	E60 530 i	04-07	IKH20TT	KH20TT	IKH20TT	IKH20	VKH20	6
		N52 B30	E61 530 i	04-07	IKH20TT	KH20TT	IKH20TT	IKH20	VKH20	6
2.5L 6Cyl 24V	N52 B25		E60 525 i	04-09	IKH20TT	KH20TT	IKH20TT	IKH20	VKH20	6
4.0L 8Cyl 32V	N62 B40		E60 540 i	05-10	IK20TT	K20TT	IK20TT	IK20	VK20	8
4.8L 8Cyl 32V	N62 B48		E60 550 i	05-10	IK20TT	K20TT	IK20TT	IK20	VK20	8
3.0L 6Cyl 24V	N53 B30		E60 530 i	06-09	IKH20TT	KH20TT	IKH20TT	IKH20	VKH20	6
2.5L 6Cyl 24V	N52 B25		E60 523 i	07-10	IKH20TT	KH20TT	IKH20TT	IKH20	VKH20	6
3.0L 6Cyl 24V	N53 B30		E61 530 i	07-10	IKH20TT	KH20TT	IKH20TT	IKH20	VKH20	6
6 Series										
4.4L 8Cyl 32V	N62 B44		E63 645 Ci	04-09	K20TXR	K20TT	IK20TT	IK20	VK20	8



Model	Engine Size	Engine Code	Specification	From To	DENSO	TJ	IRIDIUM	IRIDIUM POWER	IRIDIUM TOUGH	QTY
BMW										
6 Series	4.4L 8Cyl 32V	N62 B44	E64 645 Ci	04-09	K20TXR	K20TT	IK20TT	IK20	VK20	8
	4.8L 8Cyl 32V	N62 B48	E63 650 i	05-09	IK20TT	K20TT	IK20TT	IK20	VK20	8
		N62 B48	E64 650 i	05-09	IK20TT	K20TT	IK20TT	IK20	VK20	8
7 Series	3.2L 6Cyl 12V	M30 B32	E23 733 i	78-83	W16EP-U	W16TT	IW16TT	IW16	VW16	6
	3.4L 6Cyl 12V	M30 B34	E32 735 i,iL	88-92	J16CR-U	W16TT	IW16TT	IW16	VW16	6
	5.0L 12Cyl 24V	M70 B50	E32 750 i,iL	88-94	KJ16CR-L11	K16TT	IK16TT	IK16	VK16	12
	3.0L 6Cyl 12V	M30 B30	E32 730 i,iL	90-93	J16CR-U	W16TT	IW16TT	IW16	VW16	6
	3.0L 8Cyl 32V	M60 B30	E32 730 i,iL	92-94	J16CR-U	W16TT	IW16TT	IW16	VW16	8
	4.0L 8Cyl 32V	M60 B40	E32 740 i,iL	92-94	K20TXR	K20TT	IK20TT	IK20	VK20	8
	3.0L 8Cyl 32V	M60 B30	E38 730 i, iL	94-01	K20TXR	K20TT	IK20TT	IK20	VK20	8
	5.4L 12Cyl 24V	M73 B54	E38 750 i, iL	94-01	K20TXR	K20TT	IK20TT	IK20	VK20	12
	4.0L 8Cyl 32V	M60 B40	E38 740 i, iL	94-96	K20TXR	K20TT	IK20TT	IK20	VK20	8
	4.4L 8Cyl 32V	M62 B44	E38 740 i, iL	96-01	K20TXR	K20TT	IK20TT	IK20	VK20	8
	3.5L 8Cyl 32V	M62 B35	E38 735 i, iL	98-98	K20TXR	K20TT	IK20TT	IK20	VK20	8
	3.6L 8Cyl 32V	N62 B36	E65, E66, E67 735 i, Li	02-05	K20TXR	K20TT	IK20TT	IK20	VK20	8
	4.4L 8Cyl 32V	N62 B44	E65, E66, E67 745 i, Li	02-08	K20TXR	K20TT	IK20TT	IK20	VK20	8
	6.0L 12Cyl 48V	N73 B60	E65, E66, E67 760 i, Li	03-08	K20TXR	K20TT	IK20TT	IK20	VK20	12
	4.0L 8Cyl 32V	N62 B40	E65, E66, E67 740 i, Li	05-05	IK20TT	K20TT	IK20TT	IK20	VK20	8
4.8L 8Cyl 32V	N62 B48	E65, E66, E67 750 i, Li	05-05	IK20TT	K20TT	IK20TT	IK20	VK20	8	
8 Series	5.0L 12Cyl 24V	M70 B50	E31 850 i,Ci	90-95	KJ16CR-L11	K16TT	IK16TT	IK16	VK16	12
	4.0L 8Cyl 32V	M60 B40	E31 840 i	93-96	K20TXR	K20TT	IK20TT	IK20	VK20	8
	4.4L 8Cyl 32V	M62 B44	E31 840 Ci	96-99	K20TXR	K20TT	IK20TT	IK20	VK20	8
X1	2.0L 4Cyl 16V	N46 B20	E84 sDrive 18 i	10-15	IK20TT	K20TT	IK20TT	IK20	VK20	4
	3.0L 6Cyl 24V	N52 B30	E84 xDrive 25 i	10-15	IKH20TT	KH20TT	IKH20TT	IKH20	VKH20	6
X3	2.5L 6Cyl 24V	M54 B25	E83 2.5 i	04-11	K20TXR	K20TT	IK20TT	IK20	VK20	6
	3.0L 6Cyl 24V	M54 B30	E83 3.0 i xDrive	04-11	K20TXR	K20TT	IK20TT	IK20	VK20	6
	2.5L 6Cyl 24V	N52 B25	E83 2.5 si	06-11	IKH20TT	KH20TT	IKH20TT	IKH20	VKH20	6
	3.0L 6Cyl 24V	N52 B30	E83 3.0 si	06-11	IKH20TT	KH20TT	IKH20TT	IKH20	VKH20	6
X5	3.0L 6Cyl 24V	M54 B30	E53 3.0 i	00-06	K20TXR	K20TT	IK20TT	IK20	VK20	6
	4.4L 8Cyl 32V	M62 B44	E53 4.4 i	01-03	K20TXR	K20TT	IK20TT	IK20	VK20	8
	4.6L 8Cyl 32V	M62 B46	E53 4.6 is	02-03	K20TXR	K20TT	IK20TT	IK20	VK20	8
	4.4L 8Cyl 32V	N62 B44	E53 4.4 i	03-06	K20TXR	K20TT	IK20TT	IK20	VK20	8
	4.8L 8Cyl 32V	N62 B48	E53 4.8 is	04-06	IK20TT	K20TT	IK20TT	IK20	VK20	8
	3.0L 6Cyl 24V	N52 B30	E70 3.0 si	06-08	IKH20TT	KH20TT	IKH20TT	IKH20	VKH20	6
	4.8L 8Cyl 32V	N62 B48	E70 4.8 i xDrive	07-08	IK20TT	K20TT	IK20TT	IK20	VK20	8
X6	3.0L 6Cyl 24V	N54 B30	E71, E72 xDrive 35 i	07-14	IK20TT	K20TT	IK20TT	IK20	VK20	6
Z3	2.8L 6Cyl 24V	M52 B28	E36 2.8 i	97-00	K20TXR	K20TT	IK20TT	IK20	VK20	6
	1.9L 4Cyl 16V	M44 B19	E36 1.9 i	97-99	K20TXR	K20TT	IK20TT	IK20	VK20	4
	2.0L 6Cyl 24V	M52 B20	E36 2.0 i	99-00	K20TXR	K20TT	IK20TT	IK20	VK20	6
	2.2L 6Cyl 24V	M54 B22	E36 2.2 i	00-02	K20TXR	K20TT	IK20TT	IK20	VK20	6
	3.0L 6Cyl 24V	M54 B30	E36 3.0 i	00-03	K20TXR	K20TT	IK20TT	IK20	VK20	6
Z4	2.5L 6Cyl 24V	M54 B25	E85 2.5 i	03-06	K20TXR	K20TT	IK20TT	IK20	VK20	6
	3.0L 6Cyl 24V	M54 B30	E85 3.0 i	03-06	K20TXR	K20TT	IK20TT	IK20	VK20	6
	2.5L 6Cyl 24V	N52 B25	E85 2.5 si	05-09	IKH20TT	KH20TT	IKH20TT	IKH20	VKH20	6
		N52 B30	E85 3.0 si	06-08	IKH20TT	KH20TT	IKH20TT	IKH20	VKH20	6
	3.0L 6Cyl 24V	N52 B30	E86 3.0 si	06-09	IKH20TT	KH20TT	IKH20TT	IKH20	VKH20	6
		N52 B25	E89 sDrive 23 i	09-	IKH20TT	KH20TT	IKH20TT	IKH20	VKH20	6
3.0L 6Cyl 24V	N52 B30	E89 sDrive 30 i	09-	IKH20TT	KH20TT	IKH20TT	IKH20	VKH20	6	
CHERY										
J11	2.0L 4Cyl 16V	SQR484F		06-	IK22	-	-	IK22	VK22	4
CHEVROLET										
CAMARO	5.7L 8Cyl 16V			67-69	W16EXR-U	W16TT	IW16TT	IW16	VW16	8
	4.1L 6Cyl 12V	L22		74-79	T16PR-U	-	ITF16TT	ITF16	-	6
	2.8L 6Cyl 12V	LE2	FP_	84-89	T20PR-U	-	ITF20TT	ITF20	-	6
	3.4L 6Cyl 12V	L32		92-98	T20PR-U	-	ITF20TT	ITF20	-	6
	3.8L 6Cyl 12V	L36		95-97	T20PR-U	-	ITF20TT	ITF20	-	6
	6.2L 8Cyl 16V	LSA		11-	IT20TT	T20TT	IT20TT	IT20	VT20	8
SILVERADO 1500	5.3L 8Cyl 16V	LM7		03-07	IT16TT	T16TT	IT16TT	IT16	VT16	8
SILVERADO 2500	5.3L 8Cyl 16V	LM7		98-00	IT16TT	T16TT	IT16TT	IT16	VT16	8
TAHOE	4.8L 8Cyl 16V	LR4	B2W	00-06	T20EPR-U15	T20TT	IT20TT	IT20	VT20	8
	5.3L 8Cyl 16V	L59	B2W	02-06	T20EPR-U15	T20TT	IT20TT	IT20	VT20	8
CHRYSLER										
300 C	3.5L 6Cyl 24V	EEG	LX, LE	04-10	IK16	K16TT	IK16TT	IK16	VK16	6
	5.7L 8Cyl 16V	EZH,EZD,EZB	LX, LE	04-10	ITL16	-	ITL16TT	ITL16	-	8
		EZH,EZB,EZD	LX, LE	05-08	ITL16	-	ITL16TT	ITL16	-	8
	3.5L 6Cyl 24V	EGG	LX, LE	05-12	IK16	K16TT	IK16TT	IK16	VK16	6
6.1L 8Cyl 16V	ESF	SRT8	05-12	ITL16	-	ITL16TT	ITL16	-	16	

DENSO

AUSTRALIA

CHINA

INDIA

INDONESIA

KOREA

MALAYSIA

PHILIPPINES

SAUDI ARABIA

SINGAPORE

TAIWAN

THAILAND

VIETNAM

JAPAN

EUROPE

MOTOR

SMALL

ENGINE

REFERENCE

NUMBER

DENSO	9	14	16	20	22	24	27	29	31	32	34	35	DENSO	9	14	16	20	22	24	27	29	31	32	DENSO	9	14	16	20	22	24	27	31
NGK	2	4	5	6	7	8	9	9.5	10	10.5	11	11.5	CHAMPION	18	16,14	12,11	10,9	8,7	6,63,61	4,59	57	55	53	BOSCH	10	9	8	7,6	5	4	3	2



AUSTRALIA CAR

▶ Spark plug color codes: ■ for Iridium Tough and Iridium Plugs and Iridium TT, ■ for Iridium Power, ■ for Iridium Racing and Two Tops Plugs, ■ for Platinum Plugs and Platinum TT, and black for general spark plugs.

DENSO**AUSTRALIA****CHINA****INDIA****INDONESIA****KOREA****MALAYSIA****PHILIPPINES****SAUDI ARABIA****SINGAPORE****TAIWAN****THAILAND****VIETNAM****JAPAN****EUROPE & USA****MOTOR CYCLE****SMALL ENGINE****CROSS REFERENCE****PART NUMBER**

Model	Engine Size	Engine Code	Specification	From To	DENSO					QTY
CHRYSLER										
300 C	3.6L 6Cyl 24V	ERB		11-	VXUHC22G	-	-	-	VXUHC22G	6
CROSSFIRE	3.2L 6Cyl 18V	EGX		03-08	IK20TT	K20TT	IK20TT	IK20	VK20	12
		EGZ	SRT-6	04-07	IK20TT	K20TT	IK20TT	IK20	VK20	12
GRAND VOYAGER	3.8L 6Cyl 12V	EGL	RT	07-	ITL16	-	ITL16TT	ITL16	-	6
NEON	2.0L 4Cyl 16V	420H	PL	94-99	K20PR-U	K20TT	IK20TT	-	VK20Y	4
		420H,ECB		99-02	K20PR-U	K20TT	IK20TT	-	VK20Y	4
PT CRUISER	2.0L 4Cyl 16V	ECC	PT_	00-04	ITL16	-	ITL16TT	ITL16	-	4
		EDZ		04-08	ITL16	-	ITL16TT	ITL16	-	4
		EDZ	PT_	04-10	ITL16	-	ITL16TT	ITL16	-	4
SEBRING	2.4L 4Cyl 16V	EDG,ED3	JS	07-10	KJ16CR-L11	K16TT	IK16TT	IK16L	-	4
	2.7L 6Cyl 24V	EER	JS	07-10	ITL16	-	ITL16TT	ITL16	-	6
VOYAGER / GRAND VOYAGER	3.3L 6Cyl 12V	R00	GS	95-01	IW16TT	W16TT	IW16TT	IW16	VW16	6
		EGA	RG, RS	00-08	ITL16	-	ITL16TT	ITL16	-	6
		EGA,EGM	RG, RS	00-08	ITL16	-	ITL16TT	ITL16	-	6
CITROEN										
2 CV	0.6L 2Cyl 4V	M28		75-81	W20FS-U	WF20TT	-	IWF20	-	2
AX	1.4L 4Cyl 8V	KDY	ZA_	91-93	IQ20	Q20TT	IQ20TT	IQ20	VQ20	4
BERLINGO	1.4L 4Cyl 8V	KFW	M_	99-03	K20PR-U	K20TT	IK20TT	-	VK20Y	4
		NFR	B9	08-	K20HR-U11	KH20TT	IKH20TT	IKH20	VKH20	4
		NFU	B9	08-	K20HR-U11	KH20TT	IKH20TT	IKH20	VKH20	4
BX	1.6L 4Cyl 8V	XU52C	XB_	82-92	T20EP-U	T20TT	IT20TT	IT20	VT20	4
		150C	XB_	83-93	T20EP-U	T20TT	IT20TT	IT20	VT20	4
	1.6L 4Cyl 8V	171D	XB_	85-94	Q20P-U	Q20TT	IQ20TT	IQ20	VQ20	4
		180Z	XB_	86-94	Q22PRU	-	-	IQ22	VQ22	4
	1.9L 4Cyl 8V	D2A	XB_	86-94	IQ20	Q20TT	IQ20TT	IQ20	VQ20	4
		DFZ	XB_	86-94	IQ20	Q20TT	IQ20TT	IQ20	VQ20	4
	1.6L 4Cyl 8V	DKZ	XB_	87-94	IQ20	Q20TT	IQ20TT	IQ20	VQ20	4
		BAY	XB_	88-93	T20EP-U	T20TT	IT20TT	IT20	VT20	4
	1.9L 4Cyl 16V	DFW	XB_	88-93	IQ22	-	-	IQ22	VQ22	4
	1.6L 4Cyl 8V	B1E	XB_	88-94	T20EP-U	T20TT	IT20TT	IT20	VT20	4
1.9L 4Cyl 8V	DDZ	XB_	88-94	IQ20	Q20TT	IQ20TT	IQ20	VQ20	4	
C2	1.6L 4Cyl 16V	NFU	JM_	04-08	K20HR-U11	KH20TT	IKH20TT	IKH20	VKH20	4
C3	1.4L 4Cyl 8V	KFV	FC_, FN_	02-10	K20PR-U	K20TT	IK20TT	-	VK20Y	4
		NFU	FC_, FN_	03-10	K20HR-U11	KH20TT	IKH20TT	IKH20	VKH20	4
		1.2L 3Cyl 12V	HMZ	SC_	12-	IXEH20TT	-	IXEH20TT	-	VFXEH20
C4	2.0L 4Cyl 16V	RFK	LA_	04-09	K20HR-U11	KH20TT	IKH20TT	IKH20	VKH20	4
		NFU	LA_	05-09	K20HR-U11	KH20TT	IKH20TT	IKH20	VKH20	4
	1.6L 4Cyl 16V	NFU	LC_	05-09	K20HR-U11	KH20TT	IKH20TT	IKH20	VKH20	4
		RFJ	LC_	05-09	K16HPR-U11	KH16TT	IKH16TT	IKH16	VKH16	4
	1.6L 4Cyl 16V	5FS	B7	09-	VXUH22	-	-	IXUH22	VXUH22	4
		5FV	B7	09-	VXUH22	-	-	IXUH22	VXUH22	4
C4 Grand Picasso	2.0L 4Cyl 16V	RFJ	UA_	06-	K16HPR-U11	KH16TT	IKH16TT	IKH16	VKH16	4
C4 Picasso	2.0L 4Cyl 16V	RFJ	UD_	07-09	K16HPR-U11	KH16TT	IKH16TT	IKH16	VKH16	4
C5	2.0L 4Cyl 16V	RFN	DC_	01-04	K16HPR-U11	KH16TT	IKH16TT	IKH16	VKH16	4
		3.0L 6Cyl 24V	XFX	DC_	01-04	IKH16TT	KH16TT	IKH16TT	IKH16	VKH16
	2.0L 4Cyl 16V	RFN	DE_	01-04	K16HPR-U11	KH16TT	IKH16TT	IKH16	VKH16	4
		RFJ	RE_	04-16	K16HPR-U11	KH16TT	IKH16TT	IKH16	VKH16	4
	2.0L 4Cyl 16V	RFJ	RC_	04-	K20HR-U11	KH20TT	IKH20TT	IKH20	VKH20	4
		RFJ	RD_	08-	K16HPR-U11	KH16TT	IKH16TT	IKH16	VKH16	4
C6	3.0L 6Cyl 24V	XFV	TD_	06-12	IKH16TT	KH16TT	IKH16TT	IKH16	VKH16	6
DS4	1.6L 4Cyl 16V	5FU		11-15	VXUH22	-	-	IXUH22	VXUH22	4
		5FV		11-15	VXUH22	-	-	IXUH22	VXUH22	4
DS5	1.6L 4Cyl 16V	5FV		11-15	VXUH22	-	-	IXUH22	VXUH22	4
XANTIA	2.0L 4Cyl 8V	RFX	X1_, X2_	94-03	K20PR-U	K20TT	IK20TT	-	VK20Y	4
		RFV	X1_, X2_	95-03	K20PR-U	K20TT	IK20TT	-	VK20Y	4
	2.0L 4Cyl 8V	RFX	X1_, X2_	95-03	K20TXR	K20TT	IK20TT	IK20	VK20	4
		RGX	X1_, X2_	95-03	K20PR-U	K20TT	IK20TT	-	VK20Y	4
	3.0L 6Cyl 24V	XFZ	X1_, X2_	97-03	K20PR-U	K20TT	IK20TT	-	VK20Y	6
XM	3.0L 6Cyl 12V	UFZ	Y3	91-94	K20PBR-S10	K20TT	IK20TT	-	VK20Y	6
		UFZ	Y4	94-00	K20PBR-S10	K20TT	IK20TT	-	VK20Y	6
	3.0L 6Cyl 24V	UKZ	Y4	94-00	K20PBR-S10	K20TT	IK20TT	-	VK20Y	6
		XFZ	Y4	97-00	K20TXR	K20TT	IK20TT	IK20	VK20	6
XSARA	1.8L 4Cyl 16V	LFY	N1	97-00	K20TXR	K20TT	IK20TT	IK20	VK20	4
	1.8L 4Cyl 8V	LFZ	N1	98-00	K20TXR	K20TT	IK20TT	IK20	VK20	4
	2.0L 4Cyl 16V	RFV	N1	98-00	K20PR-U	K20TT	IK20TT	-	VK20Y	4
	1.6L 4Cyl 8V	NFZ	N1	00-00	K20PR-U	K20TT	IK20TT	-	VK20Y	4
	2.0L 4Cyl 16V	RFN	NO	00-05	K16HPR-U11	KH16TT	IKH16TT	IKH16	VKH16	4

Model	Engine Size	Engine Code	Specification	From To	DENSO					QTY
CITROEN										
XSARA	2.0L 4Cyl 16V	RFN	N1	01-03	K16HPR-U11	KH16TT	IKH16TT	IKH16	VKH16	4
	1.6L 4Cyl 16V	NFU	N0	01-05	K20HR-U11	KH20TT	IKH20TT	IKH20	VKH20	4
	2.0L 4Cyl 16V	RFS	N0	01-05	K20PR-U	K20TT	IK20TT	-	VK20Y	4
DAEWOO										
1.5i	1.5L 4Cyl 8V	G15MF	1C4	94-95	W20EPR-U	W20TT	IW20TT	IW20	VW20	4
CIELO	1.5L 4Cyl 16V	A15MF		95-97	K20PR-U11	K20TT	IK20TT	IK20	VK20	4
	1.5L 4Cyl 8V	G15MF		95-97	W20EPR-U	W20TT	IW20TT	IW20	VW20	4
CIELO LOAD RUNNER	1.5L 4Cyl 8V	G15MF		96-97	W20EPR-U	W20TT	IW20TT	IW20	VW20	4
ESPERO	2.0L 4Cyl 8V	C20LE	KLEJ	95-97	W20EPR-U	W20TT	IW20TT	IW20	VW20	4
KALOS	1.5L 4Cyl 8V	F15S	KLAS	03-04	W20EPR-U	W20TT	IW20TT	IW20	VW20	4
LACETTI	1.8L 4Cyl 16V	T18SED	J200	03-04	K20TXR	K20TT	IK20TT	IK20	VK20	4
LANOS	1.5L 4Cyl 8V	A15SMS	KLAT	97-03	W20EPR-U	W20TT	IW20TT	IW20	VW20	4
	1.6L 4Cyl 16V	A16DMS	KLAT	97-03	K20PR-U11	K20TT	IK20TT	IK20	VK20	4
LEGANZA	2.0L 4Cyl 16V	X 20 SED	KLAV	97-99	K20TXR	K20TT	IK20TT	IK20	VK20	4
	2.2L 4Cyl 16V	T22SED	KLAV	99-04	K20TXR	K20TT	IK20TT	IK20	VK20	4
MATIZ	0.8L 3Cyl 6V	F8CV	M100, M150	98-04	W16EXR-U11	W16TT	IW16TT	IW16	VW16	3
MUSSO	3.2L 6Cyl 24V	M 104.992	FJ	98-02	Q16-U	Q16TT	IQ16TT	IQ16	VQ16	6
NUBIRA	1.6L 4Cyl 16V	A16DMS	J100,J150	97-00	K20PR-U11	K20TT	IK20TT	IK20	VK20	4
		A16DMS	J100,J151	97-00	K20PR-U11	K20TT	IK20TT	IK20	VK20	4
	2.0L 4Cyl 16V	A16DMS	J100,J152	97-00	K20PR-U11	K20TT	IK20TT	IK20	VK20	4
		X 20 SED	J100,J153	98-03	K20TXR	K20TT	IK20TT	IK20	VK20	4
TACUMA	2.0L 4Cyl 16V	T20SED	U100	00-04	K20TXR	K20TT	IK20TT	IK20	VK20	4
DAIHATSU										
APPLAUSE	1.6L 4Cyl 16V	HD-E	A101, A111	89-97	K20PR-U11	K20TT	IK20TT	IK20	VK20	4
		HD-E	A101	97-00	K20TNR-S	K20TT	IK20TT	IK20	VK20	4
CHARADE	1.0L 3Cyl 6V	CB 22, CB 20	G10	80-83	W16EXRU	W16TT	IW16TT	IW16	VW16	3
		CB 20, CB 22	G11, G30	83-87	W16EXRU	W16TT	IW16TT	IW16	VW16	3
		CB 23	G100, G101, G102	87-93	W16EXRU	W16TT	IW16TT	IW16	VW16	3
	1.3L 4Cyl 16V	HCE	G100, G101, G102	88-93	K20PR-U11	K20TT	IK20TT	IK20	VK20	4
		HCE	G102	88-93	K20PR-U11	K20TT	IK20TT	IK20	VK20	4
		HC,HCE	G200, G202, G200	93-98	K20PR-U11	K20TT	IK20TT	IK20	VK20	4
1.5L 4Cyl 16V	HEEG,HEE	G200, G202, G200	97-00	K20PR-U11	K20TT	IK20TT	IK20	VK20	4	
	HEE	G203	97-00	K20PR-U11	K20TT	IK20TT	IK20	VK20	4	
CHARADE CENTRO	0.7L 3Cyl 6V	EF-SE	L501	94-98	K20PR-U11	K20TT	IK20TT	IK20	VK20	3
COPEN	0.7L 4Cyl 16V	JB,JB-DET	L880	03-06	IK20TT	K20TT	IK20TT	IK20	VK20	4
CUORE	1.0L 3Cyl 12V	EJ-DE,EJ-VE	L701	00-02	K16PR-U11	K16TT	IK16TT	IK16	VK16	3
FEROZA Hard Top	1.6L 4Cyl 16V	HD-E	F300,F310	88-99	K20PR-U11	K20TT	IK20TT	IK20	VK20	4
FEROZA Soft Top	1.6L 4Cyl 16V	HD-E	F300	88-96	K20PR-U11	K20TT	IK20TT	IK20	VK20	4
HANDI	0.7L 3Cyl 12V	EF-EL	L500	95-98	W20EXR-U	W20TT	IW20TT	IW20	VW20	3
	1.0L 3Cyl 12V	EJ-DE	L701	98-00	W20EX-U	W20TT	IW20TT	IW20	VW20	3
MIRA	0.7L 3Cyl 12V	EF-EL	L200,L201	90-94	QL22TR-S	-	-	-	-	3
	0.8L 3Cyl 6V	ED 10 K	L201, L200	90-94	W20EXR-U	W20TT	IW20TT	IW20	VW20	3
MOVE	0.8L 3Cyl 6V	ED 20	L601	97-99	W20EXR-U11	W20TT	IW20TT	IW20	VW20	3
PYZAR	1.5L 4Cyl 16V	HEEG	G303	97-98	K20PR-U11	K20TT	IK20TT	IK20	VK20	4
	1.6L 4Cyl 16V	HDEP	G301	98-00	K20PR-U11	K20TT	IK20TT	IK20	VK20	4
SIRION	1.0L 3Cyl 12V	EJ-DE	M100	98-00	K16PR-U11	K16TT	IK16TT	IK16	VK16	3
		EJ-VE	M100	00-05	IK16	K16TT	IK16TT	IK16	VK16	3
	1.3L 4Cyl 16V	K3-VE2	M101	00-05	K20R-U11	K20TT	IK20TT	IK20	VK20	4
TERIOS	1.3L 4Cyl 16V	K3-VE	M301	05-06	IK20TT	K20TT	IK20TT	IK20	VK20	4
		HC-EJ	J100	97-00	K20TNR-S	K20TT	IK20TT	IK20	VK20	4
YRV	1.3L 4Cyl 16V	K3-VE	J102	00-06	K20PR-U11	K20TT	IK20TT	IK20	VK20	4
		K3-VE	M201	01-05	K20R-U11	K20TT	IK20TT	IK20	VK20	4
DODGE										
AVENGER	2.7L 6Cyl 24V	EER	JS	07-10	ITL16	-	ITL16TT	ITL16	-	6
	2.0L 4Cyl 16V	ECN	JS	07-	K20PR-U11	K20TT	IK20TT	IK20	VK20	4
	2.4L 4Cyl 16V	EDG	JS	07-	IK16TT	K16TT	IK16TT	IK16	VK16	4
CALIBER	1.8L 4Cyl 16V	EBA		06-09	KJ16CR-L11	K16TT	IK16TT	IK16L	-	4
	2.0L 4Cyl 16V	ECN		06-	KJ16CR-L11	K16TT	IK16TT	IK16L	-	4
	2.4L 4Cyl 16V	ED3		06-	KJ16CR-L11	K16TT	IK16TT	IK16L	-	4
JOURNEY	2.7L 6Cyl 24V	EER	JC	09-	ITL16	-	ITL16TT	ITL16	-	6
	3.6L 6Cyl 24V	ERB	JC	11-15	VXUHC22G	-	-	-	VXUHC22G	6
NITRO	3.7L 6Cyl 12V	EKG		07-12	IK20TT	K20TT	IK20TT	IK20L	-	6
FERRARI										
360	3.6L 8Cyl 40V	F 131 B40	F131	99-05	IU24	-	-	IU24	-	8
		F 131 B44	F131	02-05	IU24	-	-	IU24	-	8
			F131	03-05	IU24	-	-	IU24	-	8

DENSO
 AUSTRALIA
 CHINA
 INDIA
 INDONESIA
 KOREA
 MALAYSIA
 PHILIPPINES
 SAUDI ARABIA
 SINGAPORE
 TAIWAN
 THAILAND
 VIETNAM
 JAPAN
 EUROPE
 MOTOR CYCLE
 SMALL ENGINE
 CROSS REFERENCE
 PART NUMBER

DENSO	9	14	16	20	22	24	27	29	31	32	34	35	DENSO	9	14	16	20	22	24	27	29	31	32	DENSO	9	14	16	20	22	24	27	31
NGK	2	4	5	6	7	8	9	9.5	10	10.5	11	11.5	CHAMPION	18	16,14	12,11	10,9	8,7	6,63,61	4,59	57	55	53	BOSCH	10	9	8	7,6	5	4	3	2



Model	Engine Size	Engine Code	Specification	From To	DENSO					QTY
FORD										
FAIRLANE	4.0L 6Cyl 24V	BARRA 190	BF	05-07	IK20TT	K20TT	IK20TT	IK20	VK20	6
FAIRMONT	4.1L 6Cyl 12V	250ci	XA, XB, XC (Xflow head)	72-79	MA16PR-U	-	-	-	-	6
FALCON	5.8L 8Cyl 16V	351ci	XW WINDSOR / CLEVELAND	69-71	T16PR-U / T20P-U	-	ITF16TT / ITF20TT	ITF16 / ITF20	-	8
		351ci CLEVELAND	XY	70-72	T20P-U / T16P-U	-	ITF20TT / ITF16TT	ITF20 / ITF16	-	8
	3.3L 6Cyl 12V	200ci	XA, XB, XC	72-79	MA16PR-U	-	-	-	-	6
	4.9L 8Cyl 16V	351ci CLEVELAND	XA, XB, XC	72-79	T20P-U / T16P-U	-	ITF20TT / ITF16TT	ITF20 / ITF16	-	8
	5.8L 8Cyl 16V	351ci CLEVELAND	XA, XB, XC	72-79	T20P-U / T16P-U	-	ITF20TT / ITF16TT	ITF20 / ITF16	-	8
	4.1L 6Cyl 12V	250ci	XA, XB, XC (Xflow head)	72-79	MA16PR-U	-	-	-	-	6
	3.3L 6Cyl 12V	200ci	XF	86-90	J16AR-U11	-	-	-	-	6
	4.1L 6Cyl 12V	250ci	XF (Alloy head)	86-93	J16AR-U11	-	-	-	-	6
	3.2L 6Cyl 12V		EA	88-88	J16AR-U11	-	-	-	-	6
	3.9L 6Cyl 12V		EA	88-91	J16AR-U11	-	-	-	-	6
			EB	91-92	J16AR-U11	-	-	-	-	6
	5.0L 8Cyl 16V	MNG	EB (Inc XR8)	91-93	T16PR-U15	-	ITF16TT	ITF16	-	8
		MNG	EB	92-93	T16PR-U15	-	ITF16TT	ITF16	-	8
	4.0L 6Cyl 12V		EB	92-93	J16AR-U11	-	-	-	-	6
	5.0L 8Cyl 16V		EB GT	92-93	T20EPR-U	T20TT	IT20TT	IT20	VT20	8
	4.0L 6Cyl 12V		EB XR6	92-93	W20EXR-U11	W20TT	IW20TT	IW20	VW20	6
	5.0L 8Cyl 16V	MNG	ED	93-94	T16PR-U15	-	ITF16TT	ITF16	-	8
	4.0L 6Cyl 12V		ED	93-94	J16AR-U11	-	-	-	-	6
	5.0L 8Cyl 16V	MNG	ED (Inc XR8)	93-94	T16PR-U15	-	ITF16TT	ITF16	-	8
	4.0L 6Cyl 12V		ED XR6	93-94	W20EXR-U11	W20TT	IW20TT	IW20	VW20	6
	5.0L 8Cyl 16V		ED XR8	93-94	T16PR-U15	-	ITF16TT	ITF16	-	8
	4.0L 6Cyl 12V		XG	93-96	J16AR-U11	-	-	-	-	6
	5.0L 8Cyl 16V	MNG	EF	94-96	T16PR-U15	-	ITF16TT	ITF16	-	8
	4.0L 6Cyl 12V	YTR	EF	94-96	W16EXR-U11	W16TT	IW16TT	IW16	VW16	6
	5.0L 8Cyl 16V	MNG	EF (Inc XR8)	94-96	T16PR-U15	-	ITF16TT	ITF16	-	8
	4.0L 6Cyl 12V		EF XR6	94-96	W20EXR-U11	W20TT	IW20TT	IW20	VW20	6
	5.0L 8Cyl 16V		EF XR8	94-96	T16PR-U15	-	ITF16TT	ITF16	-	8
	4.0L 6Cyl 12V		EF	95-96	W16EXR-U11	W16TT	IW16TT	IW16	VW16	6
	5.0L 8Cyl 16V	MNG	XH XR8	96-97	T16PR-U15	-	ITF16TT	ITF16	-	8
		MNG	EL	96-98	T16PR-U15	-	ITF16TT	ITF16	-	8
	4.0L 6Cyl 12V	YTR	EL	96-98	W16EXR-U11	W16TT	IW16TT	IW16	VW16	6
	5.0L 8Cyl 16V		EL GT	96-98	T20PR-U	-	ITF20TT	ITF20	-	8
	4.0L 6Cyl 12V	YTR	EL XR6	96-98	W20EXR-U11	W20TT	IW20TT	IW20	VW20	6
	5.0L 8Cyl 16V		EL XR8	96-98	T20PR-U	-	ITF20TT	ITF20	-	8
	4.0L 6Cyl 12V		XH	96-99	W16EXR-U11	W16TT	IW16TT	IW16	VW16	6
			XH XR6	96-99	W20EXR-U11	W20TT	IW20TT	IW20	VW20	6
5.0L 8Cyl 16V		XH XR8	97-99	T16PR-U15	-	ITF16TT	ITF16	-	8	
4.0L 6Cyl 12V	YTR	AU	98-00	W20EXR-U	W20TT	IW20TT	IW20	VW20	6	
	YTR	AU I	98-00	IW16TT	W16TT	IW16TT	IW16	VW16	6	
5.0L 8Cyl 16V	MNJ	AU	98-02	IT20	T20TT	IT20TT	IT20	VT20	8	
		AU XR8	98-02	IT20	T20TT	IT20TT	IT20	VT20	8	
4.0L 6Cyl 12V		AU I, AU II XR-6 (-10/01)	98-02	W20EXR-U11	W20TT	IW20TT	IW20	VW20	6	
	YTR	AU I	99-00	W16EXR-U11	W16TT	IW16TT	IW16	VW16	6	
	YTR	AU II, III	00-02	IW16TT	W16TT	IW16TT	IW16	VW16	6	
		AU LPG	00-02	IW16TT	W16TT	IW16TT	IW16	VW16	6	
		AU II, AU III XR-6 (2000-) (inc LPG)	00-02	IW16TT	W16TT	IW16TT	IW16	VW16	6	
	YTR	AU LPG	02-02	IW16TT	W16TT	IW16TT	IW16	VW16	6	
4.0L 6Cyl 24V	BARRA 182	BA	02-05	IK16	K16TT	IK16TT	IK16	VK16	6	
	BARRA 156	BA E-Gas (-10/04)/(10/04-)	02-05	IK16TT / IK20TT	-	IK16TT / IK20TT	IK16 / IK20	VK16 / VK20	6	
	BARRA 240T	BA Turbo XR6	02-05	IK16	K16TT	IK16TT	IK16	VK16	6	
	BARRA 245T	BA Turbo XR6	02-05	IK16	K16TT	IK16TT	IK16	VK16	6	
	BARRA 182	BA XR6	02-05	IK16	K16TT	IK16TT	IK16	VK16	6	
5.4L 8Cyl 32V	Boss 260	BA XR8	02-05	IT20	T20TT	IT20TT	IT20	VT20	8	
4.0L 6Cyl 24V	BARRA 156	BF	05-08	VK20Y	-	-	-	VK20Y	6	
	BARRA 190	BF	05-08	IK20TT	K20TT	IK20TT	IK20	VK20	6	
	BARRA 245T	BF Turbo XR6	05-08	VK20Y	-	-	-	VK20Y	6	
	BARRA 190	BF XR6	05-08	IK20TT	K20TT	IK20TT	IK20	VK20	6	
5.4L 8Cyl 32V	Boss 260	BF XR8	05-08	IT20	T20TT	IT20TT	IT20	VT20	8	
4.0L 6Cyl 24V	BARRA 156	FG	08-14	VK20Y	-	-	-	VK20Y	6	
	BARRA 195	FG	08-14	IK20TT	K20TT	IK20TT	IK20	VK20	6	
	BARRA 195	FG G6/XR6	08-14	IK20TT	K20TT	IK20TT	IK20	VK20	6	
	BARRA 270T	FG Turbo XR6	08-14	VK20Y	-	-	-	VK20Y	6	
	BARRA 270T	FG Turbo XR6/G6	08-14	VK20Y	-	-	-	VK20Y	6	
	BARRA 270T	FG Turbo XR6/G6	08-14	IK20TT	K20TT	IK20TT	IK20	VK20	6	

DENSO	9	14	16	20	22	24	27	29	31	32	34	35	DENSO	9	14	16	20	22	24	27	31	32	DENSO	9	14	16	20	22	24	27	31	
NGK	2	4	5	6	7	8	9	9.5	10	10.5	11	11.5	CHAMPION	18	16,14	12,11	10,9	8,7	6,6,3,61	4,59	57	55	53	BOSCH	10	9	8	7,6	5	4	3	2

DENSO

AUSTRALIA

CHINA

INDIA

INDONESIA

KOREA

MALAYSIA

PHILIPPINES

SAUDI ARABIA

SINGAPORE

TAIWAN

THAILAND

VIETNAM

JAPAN

& USA

EUROPE

MOTOR

SMALL

ENGINE

REFERENCE NUMBER



AUSTRALIA CAR

▶ Spark plug color codes: ■ for Iridium Tough and Iridium Plugs and Iridium TT, ■ for Iridium Power, ■ for Iridium Racing and Two Tops Plugs, ■ for Platinum Plugs and Platinum TT, and black for general spark plugs.

DENSO	Model	Engine Size	Engine Code	Specification	From To	DENSO	DENSO				QTY				
AUSTRALIA	FORD FALCON	4.0L 6Cyl 24V	BARRA 195	FG XR6	08-14	IK20TT	K20TT	IK20TT	IK20	VK20	6				
		5.4L 8Cyl 32V	Boss 290	FG XR8	08-14	IT20	T20TT	IT20TT	IT20	VT20	8				
		4.0L 6Cyl 24V	BARRA 198	FG G6/XR6/G6E	10-14	IK20TT	K20TT	IK20TT	IK20	VK20	6				
		FG		11-14	IK20TT	K20TT	IK20TT	IK20	VK20	6					
		2.0L 4Cyl 16V	4.0L 6Cyl 24V	FG X	14-	ITV20	-	ITV20TT	ITV20	-	4				
		BARRA 270T		FG X Turbo XR6	14-	VK20Y	-	-	-	VK20Y	6				
		BARRA 195		FG X Turbo XR6/G6	14-	IK20TT	K20TT	IK20TT	IK20	VK20	6				
		BARRA 195		FG X XR6	14-	IK20TT	K20TT	IK20TT	IK20	VK20	6				
		CHINA	FORD FESTIVA	1.3L 4Cyl 8V	B3	WA	91-94	W16EPR-U11	W16TT	IW16TT	IW16	VW16	4		
				WB		94-97	W16EPR-U11	W16TT	IW16TT	IW16	VW16	4			
WD	97-97			W16EPR-U11		W16TT	IW16TT	IW16	VW16	4					
1.5L 4Cyl 16V	B5 (16 V)			WD	97-97	K20PR-U11	K20TT	IK20TT	IK20	VK20	4				
1.3L 4Cyl 8V	B3			WF	98-01	W16EPR-U11	W16TT	IW16TT	IW16	VW16	4				
1.5L 4Cyl 8V	B5 (8 V)			WF	98-01	K20PR-U11	K20TT	IK20TT	IK20	VK20	4				
INDIA	FORD FIESTA			1.6L 4Cyl 16V	FYJB,FYJA	WP, WQ	04-08	ITV16TT	TV16TT	ITV16TT	ITV16	-	4		
				2.0L 4Cyl 16V	N4JB	WP, WQ XR4	07-09	IT20TT	T20TT	IT20TT	IT20	VT20	4		
				1.6L 4Cyl 16V	HXJA	WS	08-10	ITV16TT	TV16TT	ITV16TT	ITV16	-	4		
				1.4L 4Cyl 16V	SPJA	WS	09-10	ITV16TT	TV16TT	ITV16TT	ITV16	-	4		
		1.6L 4Cyl 16V	HXJA	WT	10-12	ITV16TT	TV16TT	ITV16TT	ITV16	-	4				
		1.5L 4Cyl 16V		WZ	13-	ITV20	-	ITV20TT	ITV20	-	4				
		INDONESIA	FORD FOCUS	2.0L 4Cyl 16V	EDDB	LR	02-05	ITV16TT	TV16TT	ITV16TT	ITV16	-	4		
				1.8L 4Cyl 16V	EYDE	LR	02-05	ITV16TT	TV16TT	ITV16TT	ITV16	-	4		
				LR		03-05	ITV20	-	ITV20TT	ITV20	-	4			
				2.0L 4Cyl 16V	AODB,AODE	LS, LT	05-09	IT20TT	T20TT	IT20TT	IT20	VT20	4		
AODE,AODB	LT			05-09	IT20TT	T20TT	IT20TT	IT20	VT20	4					
2.5L 5Cyl 20V	HYDA			LT XR5 Turbo	06-08	VKH20Y	-	-	-	VKH20Y	5				
2.0L 4Cyl 16V	AODB,AODE			LV	09-11	IT20TT	T20TT	IT20TT	IT20	VT20	4				
AODE,AODB	LV			09-11	IT20TT	T20TT	IT20TT	IT20	VT20	4					
2.5L 5Cyl 20V	HYDA			LV XR5 Turbo	09-11	VKH20Y	-	-	-	VKH20Y	5				
JZDA	LV RS Turbo			10-10	VKH20Y	-	-	-	VKH20Y	5					
MALAYSIA	FORD FOCUS	2.0L 4Cyl 16V	MGDA	LW	11-15	ITV20	-	ITV20TT	ITV20	-	4				
		1.6L 4Cyl 16V	PNDA	LW	11-15	ITV16	TV16TT	ITV16TT	ITV16	-	4				
		5.4L 8Cyl 32V	GT	TA, TB	03-	T20EPR-U	T20TT	IT20TT	IT20	VT20	8				
				TA, TB	99-03	T16EPR-U	T16TT	IT16TT	IT16	VT16	4				
		PHILIPPINES	FORD KUGA	2.5L 5Cyl 20V	HYDB	TE	11-14	IKH20TT	KH20TT	IKH20TT	IKH20	VKH20	5		
				2.0L 4Cyl 16V	R9MB,R9MA	TF EcoBoost	14-16	ITV20	-	ITV20TT	ITV20	-	4		
				SAUDI ARABIA	FORD LASER	1.6L 4Cyl 8V	B6 (8 V)	KE	87-90	W16EPR-U11	W16TT	IW16TT	IW16	VW16	4
						KE		87-90	W16EPR-U11	W16TT	IW16TT	IW16	VW16	4	
						1.6L 4Cyl 16V	B6 (SOHC 16 V)	KF	90-91	K16PR-U11	K16TT	IK16TT	IK16	VK16	4
						KF		90-91	K16PR-U11	K16TT	IK16TT	IK16	VK16	4	
1.8L 4Cyl 16V	BP (SOHC)					KF TX3	90-91	K20PR-U11	K20TT	IK20TT	IK20	VK20	4		
KH						91-94	K16PR-U11	K16TT	IK16TT	IK16	VK16	4			
1.6L 4Cyl 16V	B6 (SOHC 16 V)					KH	91-94	K16PR-U11	K16TT	IK16TT	IK16	VK16	4		
KH						91-94	K16PR-U11	K16TT	IK16TT	IK16	VK16	4			
1.8L 4Cyl 16V	BP (DOHC)	KH	92-94			K20PR-U11	K20TT	IK20TT	IK20	VK20	4				
KJ, KL		94-99	K16PR-U11			K16TT	IK16TT	IK16	VK16	4					
1.6L 4Cyl 16V	B6 (DOHC 16 V)	KJ, KL	94-99	K20PR-U11	K20TT	IK20TT	IK20	VK20	4						
KN		99-01	K20PR-U11	K20TT	IK20TT	IK20	VK20	4							
1.8L 4Cyl 16V	BP (DOHC)	KN	99-99	K16PR-U11	K16TT	IK16TT	IK16	VK16	4						
KN		00-01	KJ16CR-L11	K16TT	IK16TT	IK16L	-	4							
SINGAPORE	FORD LASER	1.6L 4Cyl 16V	ZM	KN	00-01	KJ16CR-L11	K16TT	IK16TT	IK16L	-	4				
		KN		00-01	KJ16CR-L11	K16TT	IK16TT	IK16L	-	4					
		1.8L 4Cyl 16V	FP	KQ	01-02	K16PR-U11	K16TT	IK16TT	IK16	VK16	4				
		1.6L 4Cyl 16V	ZM	KQ	01-02	KJ16CR-L11	K16TT	IK16TT	IK16L	-	4				
		1.8L 4Cyl 16V	FP	KQ, KN III	01-02	K16PR-U11	K16TT	IK16TT	IK16	VK16	4				
		2.0L 4Cyl 16V	FS	KQ, KN III	01-02	KJ16CR-L11	K16TT	IK16TT	IK16L	-	4				
		1.6L 4Cyl 16V	ZM	KQ, KN III	01-02	KJ16CR-L11	K16TT	IK16TT	IK16L	-	4				
		SINGAPORE	FORD LTD	5.8L 8Cyl 16V	351ci	P_	73-79	T20P-U	-	ITF20TT	ITF20	-	8		
				351ci	FC	79-82	T16PR-U	-	ITF16TT	ITF16	-	8			
				4.1L 6Cyl 12V	250ci	FC (-07/80) / (07/80-)	79-82	T16P-U / W16EPR-U	-	ITF16TT / IW16TT	ITF16 / IW16	-	6		
5.8L 8Cyl 16V	351ci			FD	82-84	T16PR-U	-	ITF16TT	ITF16	-	8				
4.1L 6Cyl 12V				FE	86-88	J16AR-U11	-	-	-	-	6				
3.9L 6Cyl 12V				DA	88-91	J16AR-U11	-	-	-	-	6				
5.0L 8Cyl 16V	MNG			DC	91-95	T16PR-U15	-	ITF16TT	ITF16	-	8				
3.9L 6Cyl 12V				DC	91-95	J16AR-U11	-	-	-	-	6				
5.0L 8Cyl 16V	MNG			DF	95-96	T16PR-U15	-	ITF16TT	ITF16	-	8				
4.0L 6Cyl 12V				DF	95-96	W16EXR-U11	W16TT	IW16TT	IW16	VW16	6				
5.0L 8Cyl 16V	MNG	DL	96-99	T16PR-U15	-	ITF16TT	ITF16	-	8						
TAIWAN	FORD LASER	1.6L 4Cyl 8V	B6 (8 V)	KE	87-90	W16EPR-U11	W16TT	IW16TT	IW16	VW16	4				
		KE		87-90	W16EPR-U11	W16TT	IW16TT	IW16	VW16	4					
		1.6L 4Cyl 16V	B6 (SOHC 16 V)	KF	90-91	K16PR-U11	K16TT	IK16TT	IK16	VK16	4				
		KF		90-91	K16PR-U11	K16TT	IK16TT	IK16	VK16	4					
		1.8L 4Cyl 16V	BP (SOHC)	KF TX3	90-91	K20PR-U11	K20TT	IK20TT	IK20	VK20	4				
		KH		91-94	K16PR-U11	K16TT	IK16TT	IK16	VK16	4					
		1.6L 4Cyl 16V	B6 (SOHC 16 V)	KH	91-94	K16PR-U11	K16TT	IK16TT	IK16	VK16	4				
		KH		91-94	K16PR-U11	K16TT	IK16TT	IK16	VK16	4					
		1.8L 4Cyl 16V	BP (DOHC)	KH	92-94	K20PR-U11	K20TT	IK20TT	IK20	VK20	4				
		KJ, KL		94-99	K16PR-U11	K16TT	IK16TT	IK16	VK16	4					
1.6L 4Cyl 16V	B6 (DOHC 16 V)	KJ, KL	94-99	K20PR-U11	K20TT	IK20TT	IK20	VK20	4						
KN		99-01	K20PR-U11	K20TT	IK20TT	IK20	VK20	4							
1.8L 4Cyl 16V	BP (DOHC)	KN	99-99	K16PR-U11	K16TT	IK16TT	IK16	VK16	4						
KN		00-01	KJ16CR-L11	K16TT	IK16TT	IK16L	-	4							
THAILAND	FORD LASER	1.6L 4Cyl 16V	ZM	KN	00-01	KJ16CR-L11	K16TT	IK16TT	IK16L	-	4				
		KN		00-01	KJ16CR-L11	K16TT	IK16TT	IK16L	-	4					
		1.8L 4Cyl 16V	FP	KQ	01-02	K16PR-U11	K16TT	IK16TT	IK16	VK16	4				
		1.6L 4Cyl 16V	ZM	KQ	01-02	KJ16CR-L11	K16TT	IK16TT	IK16L	-	4				
		1.8L 4Cyl 16V	FP	KQ, KN III	01-02	K16PR-U11	K16TT	IK16TT	IK16	VK16	4				
		2.0L 4Cyl 16V	FS	KQ, KN III	01-02	KJ16CR-L11	K16TT	IK16TT	IK16L	-	4				
		1.6L 4Cyl 16V	ZM	KQ, KN III	01-02	KJ16CR-L11	K16TT	IK16TT	IK16L	-	4				
		VIETNAM	FORD LASER	1.6L 4Cyl 8V	B6 (8 V)	KE	87-90	W16EPR-U11	W16TT	IW16TT	IW16	VW16	4		
				KE		87-90	W16EPR-U11	W16TT	IW16TT	IW16	VW16	4			
				1.6L 4Cyl 16V	B6 (SOHC 16 V)	KF	90-91	K16PR-U11	K16TT	IK16TT	IK16	VK16	4		
KF	90-91			K16PR-U11		K16TT	IK16TT	IK16	VK16	4					
1.8L 4Cyl 16V	BP (SOHC)			KF TX3	90-91	K20PR-U11	K20TT	IK20TT	IK20	VK20	4				
KH				91-94	K16PR-U11	K16TT	IK16TT	IK16	VK16	4					
1.6L 4Cyl 16V	B6 (SOHC 16 V)			KH	91-94	K16PR-U11	K16TT	IK16TT	IK16	VK16	4				
KH				91-94	K16PR-U11	K16TT	IK16TT	IK16	VK16	4					
1.8L 4Cyl 16V	BP (DOHC)			KH	92-94	K20PR-U11	K20TT	IK20TT	IK20	VK20	4				
KJ, KL				94-99	K16PR-U11	K16TT	IK16TT	IK16	VK16	4					
1.6L 4Cyl 16V	B6 (DOHC 16 V)	KJ, KL	94-99	K20PR-U11	K20TT	IK20TT	IK20	VK20	4						
KN		99-01	K20PR-U11	K20TT	IK20TT	IK20	VK20	4							
1.8L 4Cyl 16V	BP (DOHC)	KN	99-99	K16PR-U11	K16TT	IK16TT	IK16	VK16	4						
KN		00-01	KJ16CR-L11	K16TT	IK16TT	IK16L	-	4							
EUROPE & USA	FORD LASER	1.6L 4Cyl 16V	ZM	KN	00-01	KJ16CR-L11	K16TT	IK16TT	IK16L	-	4				
		KN		00-01	KJ16CR-L11	K16TT	IK16TT	IK16L	-	4					
		1.8L 4Cyl 16V	FP	KQ	01-02	K16PR-U11	K16TT	IK16TT	IK16	VK16	4				
		1.6L 4Cyl 16V	ZM	KQ	01-02	KJ16CR-L11	K16TT	IK16TT	IK16L	-	4				
		1.8L 4Cyl 16V	FP	KQ, KN III	01-02	K16PR-U11	K16TT	IK16TT	IK16	VK16	4				
		2.0L 4Cyl 16V	FS	KQ, KN III	01-02	KJ16CR-L11	K16TT	IK16TT	IK16L	-	4				
		1.6L 4Cyl 16V	ZM	KQ, KN III	01-02	KJ16CR-L11	K16TT	IK16TT	IK16L	-	4				
		EUROPE & USA	FORD LTD	5.8L 8Cyl 16V	351ci	P_	73-79	T20P-U	-	ITF20TT	ITF20	-	8		
				351ci	FC	79-82	T16PR-U	-	ITF16TT	ITF16	-	8			
				4.1L 6Cyl 12V	250ci	FC (-07/80) / (07/80-)	79-82	T16P-U / W16EPR-U	-	ITF16TT / IW16TT	ITF16 / IW16	-	6		
5.8L 8Cyl 16V	351ci			FD	82-84	T16PR-U	-	ITF16TT	ITF16	-	8				
4.1L 6Cyl 12V				FE	86-88	J16AR-U11	-	-	-	-	6				
3.9L 6Cyl 12V				DA											



Model	Engine Size	Engine Code	Specification	From To	DENSO					QTY	
FORD											
LTD	4.0L 6Cyl 12V		DL	96-99	W16EXR-U11	W16TT	IW16TT	IW16	VW16	6	
	5.0L 8Cyl 16V	MNJ	AU	99-02	IT20	T20TT	IT20TT	IT20	VT20	8	
	4.0L 6Cyl 12V		AU	99-02	IW16TT	W16TT	IW16TT	IW16	VW16	6	
MAVERICK	4.2L 6Cyl 12V	TB42	DA	88-94	W16EPR-U	W16TT	IW16TT	IW16	VW16	6	
MONDEO	2.0L 4Cyl 16V	NGA	HA, HB	95-00	ITV16TT	TV16TT	ITV16TT	ITV16	-	4	
	2.0L 4Cyl 16V	NGA	HB, HC, HA	95-98	ITV16TT	TV16TT	ITV16TT	ITV16	-	4	
	2.5L 6Cyl 24V	SEA	HD, HE	00-01	IT16TT	T16TT	IT16TT	IT16	VT16	6	
	2.0L 4Cyl 16V		HD, HE	00-01	IT20TT	T20TT	IT20TT	IT20	VT20	4	
	2.0L 4Cyl 16V		HE	00-01	IT20TT	T20TT	IT20TT	IT20	VT20	4	
	2.3L 4Cyl 16V	SEBA	MA, MB, MC	07-10	ITV16	TV16TT	ITV16TT	ITV16	-	4	
	2.3L 4Cyl 16V	SEBA	MA, MB	07-15	ITV16	TV16TT	ITV16TT	ITV16	-	4	
	2.5L 5Cyl 20V	HUBA	MA, MB, MC XR5 Turbo	07-15	VKH20Y	-	-	-	VKH20Y	5	
	2.3L 4Cyl 16V	SEBA	MB, MC	09-15	ITV16	TV16TT	ITV16TT	ITV16	-	4	
	2.0L 4Cyl 16V	R9CH,R9CF,R9CB	MD EcoBoost	14-	ITV20	-	ITV20TT	ITV20	-	4	
	TNCD,TNCF	MD EcoBoost	14-	ITV20	-	ITV20TT	ITV20	-	4		
	TNCF,TNCD	MD EcoBoost	14-	ITV20	-	ITV20TT	ITV20	-	4		
MUSTANG	4.9L 8Cyl 16V			93-95	T16PR-U	-	ITF16TT	ITF16	-	8	
	3.8L 6Cyl 12V			93-99	IT16TT	T16TT	IT16TT	IT16	VT16	6	
	4.6L 8Cyl 16V			95-99	IT16TT	T16TT	IT16TT	IT16	VT16	8	
	4.6L 8Cyl 32V			95-99	IT16TT	T16TT	IT16TT	IT16	VT16	8	
	4.6L 8Cyl 16V			99-00	IT20	T20TT	IT20TT	IT20	VT20	8	
	4.6L 8Cyl 32V			99-03	IT20	T20TT	IT20TT	IT20	VT20	8	
	4.0L 6Cyl 12V			04-	T20EPR-U15	T20TT	IT20TT	IT20	VT20	6	
	2.3L 4Cyl 16V		FM EcoBoost	14-	ITV20	-	ITV20TT	ITV20	-	4	
	PROBE	2.5L 6Cyl 24V	KL-ZE	ST, SU, SV	94-98	KJ16CR-L11	K16TT	IK16TT	IK16L	-	6
	RAIDER	2.6L 4Cyl 12V	G6	UV	91-97	KJ20CR-L11	K20TT	IK20TT	IK20L	-	4
RANGER	2.5L 4Cyl 16V	GBVAK,GBVAF,GBVAL	PX	11-	ITV20	-	ITV20TT	ITV20	-	8	
	2.5L 4Cyl 16V	GBVAL,GBVAK,GBVAF	PX	11-	ITV20	-	ITV20TT	ITV20	-	8	
SPECTRON	1.8L 4Cyl 12V	F8 (12 V)		84-89	W16EPR-U	W16TT	IW16TT	IW16	VW16	4	
	2.0L 4Cyl 8V	FE		86-90	W16EPR-U	W16TT	IW16TT	IW16	VW16	4	
TAURUS	3.0L 6Cyl 24V		DN, DP	96-98	IT16TT	T16TT	IT16TT	IT16	VT16	6	
TELSTAR	2.0L 4Cyl 8V	FE	AT TX5	87-89	W16EP-U11	W16TT	IW16TT	IW16	VW16	4	
		F2T	AT TX5 Turbo	87-89	IQ20	Q20TT	IQ20TT	IQ20	VQ20	4	
	2.2L 4Cyl 12V	F2 (12 V)	AV TX5	90-92	W16EP-U11	W16TT	IW16TT	IW16	VW16	4	
		F2T	AV TX5 Turbo	90-92	KJ20CR-L11	K20TT	IK20TT	IK20L	-	4	
	2.0L 4Cyl 16V	FS	AX	92-94	K16PR-U11	K16TT	IK16TT	IK16	VK16	4	
	2.0L 4Cyl 16V	FS	AX TX5	92-94	K16PR-U11	K16TT	IK16TT	IK16	VK16	4	
	2.5L 6Cyl 24V	KL-ZE	AX	92-95	KJ16CR-L11	K16TT	IK16TT	IK16L	-	6	
	2.0L 4Cyl 16V	FS	AY	94-96	K16PR-U11	K16TT	IK16TT	IK16	VK16	4	
	TERRITORY		BARRA 182	SX, SY	04-06	IK16	K16TT	IK16TT	IK16	VK16	6
		4.0L 6Cyl 24V	BARRA 190	SX, SY	04-11	IK20TT	K20TT	IK20TT	IK20	VK20	6
		BARRA 245T	SX, SY Turbo	06-11	VK20Y	-	-	-	VK20Y	6	
			SZ	11-	IK20TT	K20TT	IK20TT	IK20	VK20	6	
TICKFORD TE 50	5.0L 8Cyl 16V		AU I	99-00	IT16TT	T16TT	IT16TT	IT16	VT16	8	
			AU II	00-01	IT16TT	T16TT	IT16TT	IT16	VT16	8	
	5.6L 8Cyl 16V		AU III	01-02	IT16TT	T16TT	IT16TT	IT16	VT16	8	
TICKFORD TL 50	5.0L 8Cyl 16V		AU I	99-00	IT16TT	T16TT	IT16TT	IT16	VT16	8	
			AU II	00-01	IK20TT	K20TT	IK20TT	IK20	VK20	8	
	5.6L 8Cyl 16V		AU III	01-02	IT16TT	T16TT	IT16TT	IT16	VT16	8	
TICKFORD TS 50	5.0L 8Cyl 16V		AU I	99-00	IQ16TT	Q16TT	IQ16TT	IQ16	VQ16	8	
			AU II	00-01	IQ16TT	Q16TT	IQ16TT	IQ16	VQ16	8	
	5.6L 8Cyl 16V		AU III	01-02	IQ16TT	Q16TT	IQ16TT	IQ16	VQ16	8	
TRANSIT	2.0L 4Cyl 8V	NSF,NSG	VE, VF, VG	94-00	IK22	-	-	IK22	VK22	4	
		E5FA	VH, VJ	00-06	IK20TT	K20TT	IK20TT	IK20	VK20	4	
	2.3L 4Cyl 16V	E5FA,E5FC	VH, VJ	00-06	IK20TT	K20TT	IK20TT	IK20	VK20	4	
		GZFA	VM	06-08	IT20TT	T20TT	IT20TT	IT20	VT20	4	
GREAT WALL											
SA220	2.2L 4Cyl 8V	491Q-E		09-	W20EPR-U	W20TT	IW20TT	IW20	VW20	4	
V240	2.4L 4Cyl 16V	4G69-S4N		09-	K20PR-U11	K20TT	IK20TT	IK20	VK20	4	
X240	2.4L 4Cyl 16V	4G69-S4N		10-13	K20PR-U11	K20TT	IK20TT	IK20	VK20	4	
HOLDEN											
ADVENTRA	5.7L 8Cyl 16V	LS1	VY	03-04	IT16TT	T16TT	IT16TT	IT16	VT16	8	
		LS1	VZ	04-07	IT16TT	T16TT	IT16TT	IT16	VT16	8	
	3.6L 6Cyl 24V	LY7,H7	VZ	05-06	ITV20	-	ITV20TT	ITV20	-	6	
APOLLO	2.0L 4Cyl 16V	3S-FC	JK	89-91	K16R-U11	K16TT	IK16TT	IK16	VK16	4	
		3S-FE	JK	89-91	K16R-U11	K16TT	IK16TT	IK16	VK16	4	
		3S-FE	JL	91-93	K16R-U11	K16TT	IK16TT	IK16	VK16	4	

DENSO AUSTRALIA CHINA INDIA INDONESIA KOREA MALAYSIA PHILIPPINES SAUDIARABIA SINGAPORE TAIWAN THAILAND VIETNAM JAPAN & USA EUROPE MOTOR SMALL CROSS PART ENGINE REFERENCE NUMBER

DENSO	9	14	16	20	22	24	27	29	31	32	34	35	DENSO	9	14	16	20	22	24	27	31	32	DENSO	9	14	16	20	22	24	27	31	
NGK	2	4	5	6	7	8	9	9.5	10	10.5	11	11.5	CHAMPION	18	16,14	12,11	10,9	8,7	6,6.3,6.1	4,59	57	55	53	BOSCH	10	9	8	7.6	5	4	3	2



AUSTRALIA CAR

▶ Spark plug color codes: ■ for Iridium Tough and Iridium Plugs and Iridium TT, ■ for Iridium Power, ■ for Iridium Racing and Two Tops Plugs, ■ for Platinum Plugs and Platinum TT, and black for general spark plugs.

Model	Engine Size	Engine Code	Specification	From To	DENSO	DENSO				QTY	
						IRIDIUM TT	IRIDIUM RACING	IRIDIUM POWER	IRIDIUM TOUGH		
HOLDEN APOLLO	3.0L 6Cyl 24V	3VZ-FE	JM	93-95	IK20TT	K20TT	IK20TT	IK20	VK20	6	
	2.2L 4Cyl 16V	5S-FE	JM	93-95	IK20TT	K20TT	IK20TT	IK20	VK20	4	
	3.0L 6Cyl 24V	3VZ-FE	JP	95-97	IK20TT	K20TT	IK20TT	IK20	VK20	6	
	2.2L 4Cyl 16V	5S-FE	JP	95-97	IK20TT	K20TT	IK20TT	IK20	VK20	4	
ASTRA	1.6L 4Cyl 8V	C 16 SE	TR	95-98	K20TXR	K20TT	IK20TT	IK20	VK20	4	
	2.0L 4Cyl 16V	X 20 XEV	TR	95-98	K20TXR	K20TT	IK20TT	IK20	VK20	4	
		C 18 CEL	TR	96-98	K20TXR	K20TT	IK20TT	IK20	VK20	4	
	1.8L 4Cyl 16V	X 18 XE1	TS	98-00	K20TXR	K20TT	IK20TT	IK20	VK20	4	
		Z 18 XE	TS	00-04	K20TXR	K20TT	IK20TT	IK20	VK20	4	
	2.2L 4Cyl 16V	Z 22 SE	TS	00-06	ITV20	-	ITV20TT	ITV20	-	4	
	2.0L 4Cyl 16V	Z 20 LER, Z 20 LET	TS Turbo	02-04	K20TXR	K20TT	IK20TT	IK20	VK20	4	
		Z 20 LET	TS Turbo	03-04	K20TXR	K20TT	IK20TT	IK20	VK20	4	
	1.8L 4Cyl 16V	Z 18 XE	AH	05-08	KJ16CR-L11	K16TT	IK16TT	IK16	VK16	4	
	2.2L 4Cyl 16V	Z 22 YH	AH	06-10	K20PBR-S10	K20TT	IK20TT	IK20	VK20	4	
2.0L 4Cyl 16V	Z 20 LER	AH Turbo	06-10	IK20TT	K20TT	IK20TT	-	VK20Y	4		
1.8L 4Cyl 16V	Z 18 XER	AH	07-10	KJ16CR-L11	K16TT	IK16TT	IK16	VK16	4		
BARINA	1.3L 4Cyl 8V	G13BA	MF	89-91	W20EP-U	W20TT	IW20TT	IW20	VW20	4	
		G13BA	MH	91-94	W20EP-U	W20TT	IW20TT	IW20	VW20	4	
	1.2L 4Cyl 8V	C 12 NZ	SB Large hex / Small hex	94-97	W16EPR-U / K20TXR	W16TT / K20TT	IW16TT / IK20TT	IW16 / IK20	- / VK20	4	
	1.4L 4Cyl 8V	C 14 NZ	SB Large hex / Small hex	94-97	W20EPR-U / K20TXR	W20TT / K20TT	IW20TT / IK20TT	IW20 / IK20	VW20T / VK20	4	
	1.6L 4Cyl 16V	X 16 XE	SB	94-98	K20TXR	K20TT	IK20TT	IK20	VK20	4	
	1.4L 4Cyl 8V	C 14 SE	SB	97-01	K20TXR	K20TT	IK20TT	IK20	VK20	4	
	1.4L 4Cyl 16V	X 14 XE, Z 14 XE	XC	00-05	K20TXR	K20TT	IK20TT	IK20	VK20	4	
	1.8L 4Cyl 16V	Z 18 XE	XC	00-05	K20TXR	K20TT	IK20TT	IK20	VK20	4	
	1.4L 4Cyl 16V	Z 14 XEP	XC	04-05	KJ16CR-L11	K16TT	IK16TT	IK16L	-	4	
	1.6L 4Cyl 16V	F16D3	TK	05-12	K20PR-U11	K20TT	IK20TT	IK20	VK20	4	
		F16D4	TM	11-	KJ20CR-L11	K20TT	IK20TT	IK20L	-	4	
	1.4L 4Cyl 16V	A 14 NET	TM Turbo	13-	VK22	-	-	IK22	VK22	4	
	BARINA SPARK	1.2L 4Cyl 16V	B12D1	MJ	10-15	XU22EPR-U	XU22TT	-	IXU22	VXU22	4
			B12D2	MJ	10-15	XU22EPR-U	XU22TT	-	IXU22	VXU22	4
CALAIS	3.8L 6Cyl 12V	L36	VS	95-97	T20EPR-U15	T20TT	IT20TT	IT20	VT20	6	
		L36	VT	97-00	T20EPR-U15	T20TT	IT20TT	IT20	VT20	6	
		L67	VT Supercharged	97-00	T20EPR-U15	T20TT	IT20TT	IT20	VT20	6	
	5.0L 8Cyl 16V		VT	97-99	T20EPR-U	T20TT	IT20TT	IT20	VT20	8	
	5.7L 8Cyl 16V	LS1	VT	99-00	IT16TT	T16TT	IT16TT	IT16	VT16	8	
	3.8L 6Cyl 12V	L36	VX	00-02	T20EPR-U15	T20TT	IT20TT	IT20	VT20	6	
	5.7L 8Cyl 16V	LS1	VX	00-02	IT16TT	T16TT	IT16TT	IT16	VT16	8	
	3.8L 6Cyl 12V	L67	VX Supercharged	00-02	T20EPR-U15	T20TT	IT20TT	IT20	VT20	6	
		L36	VY	02-04	T20EPR-U15	T20TT	IT20TT	IT20	VT20	6	
	3.8L 6Cyl 12V	L67	VY Supercharged	02-04	T20EPR-U15	T20TT	IT20TT	IT20	VT20	6	
		5.7L 8Cyl 16V	LS1	VY (-07/03) / VY II (08/03-)	03-04	IT16TT	T16TT	IT16TT	IT16	VT16	8
	3.6L 6Cyl 24V	HV	VZ	04-06	ITV20	-	ITV20TT	ITV20	-	6	
	5.7L 8Cyl 24V		VZ	04-06	IT16TT	T16TT	IT16TT	IT16	VT16	8	
	6.0L 8Cyl 16V	L98	VE	06-13	IT16TT	T16TT	IT16TT	IT16	VT16	8	
	3.6L 6Cyl 24V	LY7	VE	06-13	ITV20	-	ITV20TT	ITV20	-	6	
		LLT	VE	08-13	ITV20	-	ITV20TT	ITV20	-	6	
	6.0L 8Cyl 16V	L76	VE	09-13	IT16TT	T16TT	IT16TT	IT16	VT16	8	
		L77	VF	13-15	IT16TT	T16TT	IT16TT	IT16	VT16	8	
	3.6L 6Cyl 24V	LFX	VF	13-	ITV20	-	ITV20TT	ITV20	-	6	
	6.2L 8Cyl 16V	LS3	VF	15-	IT16TT	T16TT	IT16TT	IT16	VT16	8	
CALIBRA	2.0L 4Cyl 8V	C 20 NE	YE	91-95	W16EPR-U	W16TT	IW16TT	IW16	VW16	4	
	2.0L 4Cyl 16V	C 20 XE	YE	91-95	K20PR-U	K20TT	IK20TT	-	VK20Y	4	
		C 20 LET	YE Turbo	92-97	KJ20CR-L11	K20TT	IK20TT	IK20L	-	4	
2.5L 6Cyl 24V	X 25 XE, C 25 XE	YE	95-97	K20TXR	K20TT	IK20TT	IK20	VK20	6		
CAPRICE	5.0L 8Cyl 16V	GMH 308 (Red)	VQ	90-93	T20EPR-U	T20TT	IT20TT	IT20	VT20	8	
	3.8L 6Cyl 12V	L27	VR	94-95	T20EPR-U15	T20TT	IT20TT	IT20	VT20	6	
	5.0L 8Cyl 16V		VR	94-95	T20EPR-U	T20TT	IT20TT	IT20	VT20	8	
	3.8L 6Cyl 12V	L36	VS	95-98	T20EPR-U15	T20TT	IT20TT	IT20	VT20	6	
	5.0L 8Cyl 16V		VS	95-99	T20EPR-U	T20TT	IT20TT	IT20	VT20	8	
	3.8L 6Cyl 12V	L36	VS Supercharged	96-99	T20EPR-U15	T20TT	IT20TT	IT20	VT20	6	
		L67	WH Supercharged	99-01	T20EPR-U15	T20TT	IT20TT	IT20	VT20	6	
	3.8L 6Cyl 12V	L36	WH	99-03	T20EPR-U15	T20TT	IT20TT	IT20	VT20	6	
		5.7L 8Cyl 16V	LS1	WH	99-03	IT16TT	T16TT	IT16TT	IT16	VT16	8
	3.8L 6Cyl 12V	L36	WK	03-04	T20EPR-U15	T20TT	IT20TT	IT20	VT20	6	
	5.7L 8Cyl 16V	LS1	WK	03-04	IT16TT	T16TT	IT16TT	IT16	VT16	8	
	3.8L 6Cyl 12V	L67	WK Supercharged	03-04	T20EPR-U15	T20TT	IT20TT	IT20	VT20	6	
	5.7L 8Cyl 16V	LS1	WL	04-06	IT16TT	T16TT	IT16TT	IT16	VT16	8	



Model	Engine Size	Engine Code	Specification	From To	DENSO					QTY	
HOLDEN											
CAPRICE	3.6L 6Cyl 24V	LY7,H7	WL	04-06	ITV20	-	ITV20TT	ITV20	-	6	
		L76	WM	06-13	IT16TT	T16TT	IT16TT	IT16	VT16	8	
	6.0L 8Cyl 16V	L76,LS2	WM	06-13	IT16TT	T16TT	IT16TT	IT16	VT16	8	
		LWR	WM	06-13	ITV20	-	ITV20TT	ITV20	-	6	
	3.6L 6Cyl 24V	LY7,H7	WM	06-13	ITV20	-	ITV20TT	ITV20	-	6	
		LFX,LLT	WM	09-13	ITV20	-	ITV20TT	ITV20	-	6	
	6.0L 8Cyl 16V	L76	WN	13-	IT16TT	T16TT	IT16TT	IT16	VT16	8	
	3.6L 6Cyl 24V	LFX	WN	13-	ITV20	-	ITV20TT	ITV20	-	6	
			WN	13-	ITV20	-	ITV20TT	ITV20	-	6	
	6.2L 8Cyl 16V	LS3	WN	15-	IT16TT	T16TT	IT16TT	IT16	VT16	8	
CAPTIVA	3.2L 6Cyl 24V	LU1,Z 32 SEE	CG	06-08	ITV20	-	ITV20TT	ITV20	-	6	
		Z 32 SEE,LU1	CG	08-11	ITV20	-	ITV20TT	ITV20	-	6	
	2.4L 4Cyl 16V	Z 24 XED	CG	09-11	K20TXR	K20TT	IK20TT	IK20	VK20	4	
CAPTIVA 5	2.4L 4Cyl 16V		CG	16-	ITV16	TV16TT	ITV16TT	ITV16	-	4	
		LE5,A 24 XE	CG5	11-12	ITV16	TV16TT	ITV16TT	ITV16	-	4	
CAPTIVA 7	2.4L 4Cyl 16V	A 24 XE,LE5	CG7	11-	ITV16	TV16TT	ITV16TT	ITV16	-	4	
		LE9,A 24 XE	CG7	11-	ITV16	TV16TT	ITV16TT	ITV16	-	4	
CAPTIVA 7	3.0L 6Cyl 24V	LF1	CG7	11-13	ITV20	-	ITV20TT	ITV20	-	6	
	2.4L 4Cyl 16V	LE5,A 24 XE	CG7	12-	ITV16	TV16TT	ITV16TT	ITV16	-	4	
	3.0L 6Cyl 24V		CG7	12-	ITV20	-	ITV20TT	ITV20	-	6	
	COLORADO	3.6L 6Cyl 24V	LCA (H9)	RC	08-12	ITV20	-	ITV20TT	ITV20	-	6
		2.4L 4Cyl 16V	Y 24 SE	RC	08-12	W20EPR-U11	W20TT	IW20TT	IW20	VW20	4
COMBO	1.4L 4Cyl 8V	C 14 NZ	SB	96-97	K20TXR	K20TT	IK20TT	IK20	VK20	4	
		C 14 SE	SB	97-02	K20TXR	K20TT	IK20TT	IK20	VK20	4	
	1.6L 4Cyl 8V	Z 16 SE	XC	02-05	K20TXR	K20TT	IK20TT	IK20	VK20	4	
	1.4L 4Cyl 16V	Z 14 XEP	XC	05-12	KJ16CR-L11	K16TT	IK16TT	IK16L	-	4	
COMMODORE	2.8L 6Cyl 12V	GMH 285 (Blue)	VH	81-84	T20EPR-U15	T20TT	IT20TT	IT20	VT20	6	
	3.3L 6Cyl 12V	GMH 202 (Black)	VK	84-86	T20EPR-U15	T20TT	IT20TT	IT20	VT20	6	
	4.9L 8Cyl 16V		VL	86-87	T20EPR-U	T20TT	IT20TT	IT20	VT20	8	
	3.8L 6Cyl 12V	L27	VG	88-91	T20EPR-U15	T20TT	IT20TT	IT20	VT20	6	
			VG	88-91	T20EPR-U	T20TT	IT20TT	IT20	VT20	8	
	5.0L 8Cyl 16V	GMH 308 (Red)	VN	88-91	T20EPR-U	T20TT	IT20TT	IT20	VT20	8	
			VN	88-91	T20EPR-U	T20TT	IT20TT	IT20	VT20	8	
	3.8L 6Cyl 12V	L27	VP	91-93	T20EPR-U15	T20TT	IT20TT	IT20	VT20	6	
		L27,LN3	VP	91-93	T20EPR-U15	T20TT	IT20TT	IT20	VT20	6	
	5.0L 8Cyl 16V		VP	91-93	T20EPR-U	T20TT	IT20TT	IT20	VT20	8	
	3.8L 6Cyl 12V	L27	VR	93-95	T20EPR-U15	T20TT	IT20TT	IT20	VT20	6	
	5.0L 8Cyl 16V		VR	93-95	T20EPR-U	T20TT	IT20TT	IT20	VT20	8	
	3.8L 6Cyl 12V	L36	VS	95-00	T20EPR-U15	T20TT	IT20TT	IT20	VT20	6	
	5.0L 8Cyl 16V		VS	95-00	T20EPR-U	T20TT	IT20TT	IT20	VT20	8	
	3.8L 6Cyl 12V	L67	VS Supercharged	95-97	T20EPR-U15	T20TT	IT20TT	IT20	VT20	6	
		L67	VT Supercharged	97-00	T20EPR-U15	T20TT	IT20TT	IT20	VT20	6	
		L36	VT	97-02	T20EPR-U15	T20TT	IT20TT	IT20	VT20	6	
	5.0L 8Cyl 16V		VT	97-02	T20EPR-U	T20TT	IT20TT	IT20	VT20	8	
	5.7L 8Cyl 16V	LS1	VT	99-00	IT16TT	T16TT	IT16TT	IT16	VT16	8	
	3.8L 6Cyl 12V	L36	VU	00-02	T20EPR-U15	T20TT	IT20TT	IT20	VT20	6	
	5.7L 8Cyl 16V	LS1	VU	00-02	IT16TT	T16TT	IT16TT	IT16	VT16	8	
	3.8L 6Cyl 12V	L36	VX	00-02	T20EPR-U15	T20TT	IT20TT	IT20	VT20	6	
	5.7L 8Cyl 16V	LS1	VX	00-02	IT16TT	T16TT	IT16TT	IT16	VT16	8	
	3.8L 6Cyl 12V	L67	VX Supercharged	00-02	T20EPR-U15	T20TT	IT20TT	IT20	VT20	6	
			VU	01-02	T20EPR-U15	T20TT	IT20TT	IT20	VT20	6	
	3.8L 6Cyl 12V	L36	VY	02-04	T20EPR-U15	T20TT	IT20TT	IT20	VT20	6	
			VY	02-04	T20EPR-U15	T20TT	IT20TT	IT20	VT20	6	
	5.7L 8Cyl 16V	LS1	VY (-07/03) / VYII (08/03-)	02-04	IT16TT	T16TT	IT16TT	IT16	VT16	8	
	3.8L 6Cyl 12V	L67	VY Supercharged	02-04	T20EPR-U15	T20TT	IT20TT	IT20	VT20	6	
	3.6L 6Cyl 24V	HB,LE0	VZ	04-06	ITV20	-	ITV20TT	ITV20	-	6	
	5.7L 8Cyl 16V	LS1	VZ	04-06	IT16TT	T16TT	IT16TT	IT16	VT16	8	
	3.6L 6Cyl 24V	LE0,HB	VZ	04-07	ITV20	-	ITV20TT	ITV20	-	6	
		LY7,H7	VZ	04-07	ITV20	-	ITV20TT	ITV20	-	6	
	6.0L 8Cyl 16V	LS2,L76	VZ	05-07	IT16TT	T16TT	IT16TT	IT16	VT16	8	
	3.6L 6Cyl 24V	HB,LE0	VE	06-13	ITV20	-	ITV20TT	ITV20	-	6	
	6.0L 8Cyl 16V	L76	VE	06-13	IT16TT	T16TT	IT16TT	IT16	VT16	8	
		L98	VE	06-13	IT16TT	T16TT	IT16TT	IT16	VT16	8	
	3.6L 6Cyl 24V	LE0,HB,LW2	VE	06-13	ITV20	-	ITV20TT	ITV20	-	6	
		LW2	VE	06-13	ITV20	-	ITV20TT	ITV20	-	6	
		LY7,H7	VE	06-13	ITV20	-	ITV20TT	ITV20	-	6	
HN,LE0,LW2,HB		VE	07-13	ITV20	-	ITV20TT	ITV20	-	6		
LE0,HB		VE	07-13	ITV20	-	ITV20TT	ITV20	-	6		

DENSO
 AUSTRALIA
 CHINA
 INDIA
 INDONESIA
 KOREA
 MALAYSIA
 PHILIPPINES
 SAUDI ARABIA
 SINGAPORE
 TAIWAN
 THAILAND
 VIETNAM
 JAPAN
 EUROPE
 MOTOR & USA
 CYCLE
 SMALL
 ENGINE
 REFERENCE
 PART NUMBER

DENSO	9	14	16	20	22	24	27	29	31	32	34	35	DENSO	9	14	16	20	22	24	27	29	31	32	DENSO	9	14	16	20	22	24	27	31
NGK	2	4	5	6	7	8	9	9.5	10	10.5	11	11.5	CHAMPION	18	16,14	12,11	10,9	8,7	6,63,61	4,59	57	55	53	BOSCH	10	9	8	7,6	5	4	3	2

**DENSO****AUSTRALIA****CHINA****INDIA****INDONESIA****KOREA****MALAYSIA****PHILIPPINES****SAUDI ARABIA****SINGAPORE****TAIWAN****THAILAND****VIETNAM****JAPAN****EUROPE & USA****SMALL ENGINE****CROSS REFERENCE****PART NUMBER**

Model	Engine Size	Engine Code	Specification	From To	DENSO					QTY
HOLDEN										
COMMODORE										
	3.6L 6Cyl 24V	LW2,LE0,HN	VE	07-13	ITV20	-	ITV20TT	ITV20	-	6
	6.0L 8Cyl 16V	L98,LS2	VE	08-13	IT16TT	T16TT	IT16TT	IT16	VT16	8
	3.6L 6Cyl 24V	LE0,LW2,HB	VE	08-13	ITV20	-	ITV20TT	ITV20	-	6
		H7,LY7	VE	09-13	ITV20	-	ITV20TT	ITV20	-	6
	3.0L 6Cyl 24V	LF1,LFW	VE	09-13	ITV20	-	ITV20TT	ITV20	-	6
		LFW,LF1	VE	09-13	ITV20	-	ITV20TT	ITV20	-	6
	3.6L 6Cyl 24V	LFX,LLT	VE	09-13	ITV20	-	ITV20TT	ITV20	-	6
	3.0L 6Cyl 24V	LF1	VE	10-13	ITV20	-	ITV20TT	ITV20	-	6
	3.6L 6Cyl 24V	LWR	VE	12-13	ITV20	-	ITV20TT	ITV20	-	6
	3.0L 6Cyl 24V	LFW	VF	13-14	ITV20	-	ITV20TT	ITV20	-	6
	6.0L 8Cyl 16V	L77	VF SS, SS-V	13-15	IT16TT	T16TT	IT16TT	IT16	VT16	8
	3.0L 6Cyl 24V	LF1	VF	13-	ITV20	-	ITV20TT	ITV20	-	6
		LF1,LFW	VF	13-	ITV20	-	ITV20TT	ITV20	-	6
	3.6L 6Cyl 24V	LFX	VF	13-	ITV20	-	ITV20TT	ITV20	-	6
		LWR	VF	13-	ITV20	-	ITV20TT	ITV20	-	6
	6.2L 8Cyl 16V	LY7	VF	13-	ITV20	-	ITV20TT	ITV20	-	6
		LS3	VF SS, SS-V	15-	IT16TT	T16TT	IT16TT	IT16	VT16	8
CREWMAN										
	3.8L 6Cyl 12V	L36	VY	03-04	T20EPR-U15	T20TT	IT20TT	IT20	VT20	6
	5.7L 8Cyl 16V	LS1	VY	03-04	IT16TT	T16TT	IT16TT	IT16	VT16	8
		LS1	VZ	04-06	IT16TT	T16TT	IT16TT	IT16	VT16	8
	3.6L 6Cyl 24V	HB,LE0	VZ	04-07	ITV20	-	ITV20TT	ITV20	-	6
	6.0L 8Cyl 16V	LS2,L76	VZ SS, SS-V	05-06	IT16TT	T16TT	IT16TT	IT16	VT16	8
CRUZE										
	1.5L 4Cyl 16V	M15A	YG	02-06	K16PR-U11	K16TT	IK16TT	IK16	VK16	4
	1.8L 4Cyl 16V	F18D	JG	09-11	KJ20CR-L11	K20TT	IK20TT	IK20L	-	4
		F18D	JH	11-16	KJ20CR-L11	K20TT	IK20TT	IK20L	-	4
	1.4L 4Cyl 16V	A 14 NET	JH Turbo	11-16	VK22	-	-	IK22	VK22	4
	1.6L 4Cyl 16V	A 16 LET	JH	13-16	KJ20CR-L11	K20TT	IK20TT	IK20L	-	4
EPICA										
	2.0L 6Cyl 24V	X 20 D1	EP	07-08	IK20TT	K20TT	IK20TT	IK20	VK20	6
	2.5L 6Cyl 24V	X 25 D1	EP	07-11	IK20TT	K20TT	IK20TT	IK20	VK20	6
FRONTERA										
	2.0L 4Cyl 8V	X 20 SE	UES	95-99	K20TXR	K20TT	IK20TT	IK20	VK20	4
	3.2L 6Cyl 24V	6VD1	UES	98-04	IK16TT	K16TT	IK16TT	IK16	VK16	6
	2.2L 4Cyl 16V	X 22 SE	UES	99-02	IK16TT	K16TT	IK16TT	IK16	VK16	4
JACKAROO / MONTEREY										
	2.6L 4Cyl 8V	4ZE1	UBS	88-92	W20EPR-U11	W20TT	IW20TT	IW20	VW20	4
	3.2L 6Cyl 24V	6VD1	UBS	92-98	K20PR-U11	K20TT	IK20TT	IK20	VK20	6
	3.5L 6Cyl 24V	6VE1	UBS	98-04	IK16TT	K16TT	IK16TT	IK16	VK16	6
MALIBU										
	2.4L 4Cyl 16V	LE9	V300	13-	ITV16	TV16TT	ITV16TT	ITV16	-	4
MONARO										
	5.0L 8Cyl 16V	308ci	HZ	77-80	T16P-U	-	ITF16TT	ITF16	-	8
	3.8L 6Cyl 12V	L67	V2	01-03	T20EPR-U15	T20TT	IT20TT	IT20	VT20	6
		LS1	V2	01-04	IT16TT	T16TT	IT16TT	IT16	VT16	8
	5.7L 8Cyl 16V	LS1	VZ	04-06	IT16TT	T16TT	IT16TT	IT16	VT16	8
		LS1	VZ	04-06	IT16TT	T16TT	IT16TT	IT16	VT16	8
NOVA										
	1.4L 4Cyl 16V	6A-FC	LF	91-92	QJ16AR-U	-	-	-	-	4
		4A-FC	LF	91-94	QJ16AR-U	-	-	-	-	4
	1.6L 4Cyl 16V	4A-FE	LF	91-94	K16PR-U	K16TT	IK16TT	IK16	VK16	4
		7A-FE	LF	92-94	K16R-U	K16TT	IK16TT	IK16	VK16	4
	1.6L 4Cyl 16V	4A-FE	LG	94-97	K16R-U	K16TT	IK16TT	IK16	VK16	4
	1.8L 4Cyl 16V	7A-FE	LG	94-97	K16R-U	K16TT	IK16TT	IK16	VK16	4
ONE TONNER										
	3.8L 6Cyl 12V	L36	VY	03-04	T20EPR-U15	T20TT	IT20TT	IT20	VT20	6
	3.6L 6Cyl 24V	HB,LE0	VZ	04-05	ITV20	-	ITV20TT	ITV20	-	6
RODEO										
	1.6L 4Cyl 8V	G161-Z	KB	78-85	W20EP-U	W20TT	IW20TT	IW20	VW20	4
	1.8L 4Cyl 8V	G180Z	KB	82-83	W20EP-U	W20TT	IW20TT	IW20	VW20	4
	2.0L 4Cyl 8V	G200Z	KB	83-87	W20EP-U	W20TT	IW20TT	IW20	VW20	4
	2.3L 4Cyl 8V	4ZD1	KB	85-88	W20EP-U	W20TT	IW20TT	IW20	VW20	4
	2.6L 4Cyl 8V	4ZE1	TF	88-98	W20EPR-U11	W20TT	IW20TT	IW20	VW20	4
	2.3L 4Cyl 8V	4ZD1	TF	91-03	W20EPR-U11	W20TT	IW20TT	IW20	VW20	4
	3.2L 6Cyl 24V	6VD1	TF	98-03	IK16TT	K16TT	IK16TT	IK16	VK16	6
	2.2L 4Cyl 8V	C 22 NE	TF	98-03	W20EPR-U11	W20TT	IW20TT	IW20	VW20	4
	3.5L 6Cyl 24V	6VE1	RA	03-05	IK16TT	K16TT	IK16TT	IK16	VK16	6
	2.4L 4Cyl 8V	C 24 SE	RA	03-08	W20EPR-U11	W20TT	IW20TT	IW20	VW20	4
	3.6L 6Cyl 24V	LCA (H9)	RA	06-08	ITV20	-	ITV20TT	ITV20	-	6
SHUTTLE										
	2.0L 4Cyl 8V	4ZC1	WFR	83-91	W20EP-U	W20TT	IW20TT	IW20	VW20	4
STATESMAN										
	5.0L 8Cyl 16V	GMH 308 (Blue)	WB	80-85	T16PR-U15	-	ITF16TT	ITF16	-	8
	3.8L 6Cyl 12V	L27	VQ (-10/91) / VQ II (10/91-)	90-93	T16EPR-U15 / T20EPR-U15	T16TT / T20TT	IT16TT / IT20TT	IT16 / IT20	VT16 / VT20	6
	5.0L 8Cyl 16V	GMH 308 (Red)	VQ	90-94	T20EPR-U	T20TT	IT20TT	IT20	VT20	8
	3.8L 6Cyl 12V	L27	VR	94-95	T20EPR-U15	T20TT	IT20TT	IT20	VT20	6
	5.0L 8Cyl 16V		VR	94-95	T20EPR-U	T20TT	IT20TT	IT20	VT20	8
	3.8L 6Cyl 12V	L36,LN3	VS	95-98	T20EPR-U15	T20TT	IT20TT	IT20	VT20	6
	5.0L 8Cyl 16V		VS	95-99	T20EPR-U	T20TT	IT20TT	IT20	VT20	8



Model	Engine Size	Engine Code	Specification	From To	DENSO	TJ	IRIDIUM	IRIDIUM POWER	IRIDIUM TOUGH	QTY
HOLDEN										
STATESMAN										
3.8L 6Cyl 12V	L67	VS Supercharged	96-99	T20EPR-U15	T20TT	IT20TT	IT20	VT20	6	
	L36	WH	99-03	T20EPR-U15	T20TT	IT20TT	IT20	VT20	6	
5.7L 8Cyl 16V	LS1	WH	99-03	IT16TT	T16TT	IT16TT	IT16	VT16	8	
3.8L 6Cyl 12V	L67	WH Supercharged	01-03	T20EPR-U15	T20TT	IT20TT	IT20	VT20	6	
	L36	WK	03-04	T20EPR-U15	T20TT	IT20TT	IT20	VT20	6	
5.7L 8Cyl 16V	LS1	WK	03-04	IT16TT	T16TT	IT16TT	IT16	VT16	8	
3.8L 6Cyl 12V	L67	WK Supercharged	03-04	T20EPR-U15	T20TT	IT20TT	IT20	VT20	6	
SUBURBAN										
5.7L 8Cyl 16V		1500	98-00	IT20	T20TT	IT20TT	IT20	VT20	8	
TIGRA										
1.8L 4Cyl 16V	Z 18 XE	XC	05-07	K20TXR	K20TT	IK20TT	IK20	VK20	4	
TRAX										
1.8L 4Cyl 16V	F18D4,2H0	TJ	13-	KJ20CR-L11	K20TT	IK20TT	IK20L	-	4	
1.4L 4Cyl 16V	A 14 NET	TJ	14-	VK22	-	-	IK22	VK22	4	
VECTRA										
2.0L 4Cyl 16V	C 20 SEL	JR	97-98	K20TXR	K20TT	IK20TT	IK20	VK20	4	
2.5L 6Cyl 24V	X 25 XE	JR	97-98	K20TXR	K20TT	IK20TT	IK20	VK20	6	
	X 25 XE	JS	98-02	K20TXR	K20TT	IK20TT	IK20	VK20	6	
2.2L 4Cyl 16V	C 22 SEL	JS	98-03	K20TXR	K20TT	IK20TT	IK20	VK20	4	
2.6L 6Cyl 24V	Y 26 SE	JS	00-02	K20TXR	K20TT	IK20TT	IK20	VK20	6	
2.2L 4Cyl 16V	Z 22 SE	ZC	02-06	ITV20	-	ITV20TT	ITV20	-	4	
3.2L 6Cyl 24V	Z 32 SE	ZC	02-06	K20TXR	K20TT	IK20TT	IK20	VK20	6	
VIVA										
1.8L 4Cyl 16V	F18D3	JF	05-09	K20PBR-S10	K20TT	IK20TT	IK20	VK20	4	
ZAFIRA										
2.2L 4Cyl 16V	Z 22 SE	TT	01-06	ITV20	-	ITV20TT	ITV20	-	4	
HONDA										
ACCORD										
2.0L 4Cyl 12V	A20A3	CA	87-89	W20EXR-U11	W20TT	IW20TT	IW20	VW20	4	
	F22A9,F22A6	CB	89-90	KJ16CR-L11	K16TT	IK16TT	IK16L	-	4	
2.2L 4Cyl 16V	F22A6	CB, CC	92-93	KJ16CR-L11	K16TT	IK16TT	IK16L	-	4	
	F22B1	CD	93-97	KJ16CR-L11	K16TT	IK16TT	IK16L	-	4	
3.0L 6Cyl 24V	F22B1	CE	95-96	KJ16CR-L11	K16TT	IK16TT	IK16L	-	4	
	J30A1	CK	97-03	KJ16CR-L11	K16TT	IK16TT	IK16L	-	6	
2.3L 4Cyl 16V	F23A1	CG	97-99	KJ16CR-L11	K16TT	IK16TT	IK16L	-	4	
	F23A1,F23Z5	CK	00-03	KJ16CR-L11	K16TT	IK16TT	IK16L	-	4	
2.4L 4Cyl 16V	K24A2,K24A4	CM	02-05	KJ20DR-M11	K20TT	IK20TT	IK20	VK20	4	
3.0L 6Cyl 24V	J30A4	CM	03-07	KJ20DR-M11	K20TT	IK20TT	IK20	VK20	6	
2.4L 4Cyl 16V	K24A4	CM	06-08	KJ20DR-M11	K20TT	IK20TT	IK20	VK20	4	
3.5L 6Cyl 24V	J35Z2	CP	07-12	VXUHC22G	-	-	-	VXUHC22G	6	
	K24Z2	CP	08-	VXUHC22G	-	-	-	VXUHC22G	4	
2.4L 4Cyl 16V	K24W	CR, CU	13-	IXEH22TT	-	IXEH22TT	-	VFXEH22	4	
	J35Z2	CR, CU	16-	VXUHC22G	-	-	-	VXUHC22G	6	
ACCORD EURO										
2.4L 4Cyl 16V	K24A,K24A3	CL	03-08	IK20TT	K20TT	IK20TT	IK20	VK20	4	
	K24Z3	CU	08-15	VFXUHC22FG	-	-	-	VFXUHC22FG	4	
BEAT										
0.7L 3Cyl 12V	E07A	PP_	91-96	K20PR-U11	K20TT	IK20TT	IK20	VK20	3	
CITY										
1.5L 4Cyl 16V	L15A7	GM26	09-14	IK20TT	K20TT	IK20TT	IK20	VK20	4	
	L15A7	GM65	14-	IK20TT	K20TT	IK20TT	IK20	VK20	4	
CIVIC										
1.3L 4Cyl 8V	EN1	WC	79-83	W16EXRU	W16TT	IW16TT	IW16	VW16	4	
1.5L 4Cyl 8V	EW2	AM, AK, AU	83-84	W20EX-U11	W20TT	IW20TT	IW20	VW20	4	
	EW2	AN, AR	84-87	W20EX-U11	W20TT	IW20TT	IW20	VW20	4	
1.5L 4Cyl 16V	D15B4	EC, ED, EE	87-93	IQ16	Q16TT	IQ16TT	IQ16	VQ16	4	
	D15B4	ED	87-93	IQ16	Q16TT	IQ16TT	IQ16	VQ16	4	
1.3L 4Cyl 16V	D13B2	EG	91-93	K20PR-U11	K20TT	IK20TT	IK20	VK20	4	
1.6L 4Cyl 16V	D16A8	EG	91-93	K20PR-L11	K20TT	IK20TT	IK20	VK20	4	
	D16A8	EG, EH	91-93	K20PR-L11	K20TT	IK20TT	IK20	VK20	4	
1.5L 4Cyl 16V	D15	EG	91-95	K20PR-U11	K20TT	IK20TT	IK20	VK20	4	
1.6L 4Cyl 16V	D16A9,D16Y1	EG	93-95	K20PR-U11	K20TT	IK20TT	IK20	VK20	4	
1.5L 4Cyl 16V	D15B2,D15B7,D15Z1	EG, EH	93-95	KJ16CR-L11	K16TT	IK16TT	IK16L	-	4	
	D15B7	EG, EH	93-95	KJ16CR-L11	K16TT	IK16TT	IK16L	-	4	
1.6L 4Cyl 16V	D16A7	EG, EH	93-95	K20PR-L11	K20TT	IK20TT	IK20	VK20	4	
	D16Y1,D16Z6	EG, EH	93-95	K20PR-U11	K20TT	IK20TT	IK20	VK20	4	
1.6L 4Cyl 16V	D16Y7	EJ	94-95	KJ16CR-L11	K16TT	IK16TT	IK16L	-	4	
	D16Y6,D16Y8	EJ, EK	95-00	K16PR-U11	K16TT	IK16TT	IK16	VK16	4	
1.7L 4Cyl 16V	B16A2	EJ, EK	95-98	K20PR-L11	K20TT	IK20TT	IK20	VK20	4	
	D16Y8	EJ, EM1	96-99	K16PR-U11	K16TT	IK16TT	IK16	VK16	4	
1.7L 4Cyl 16V	B16A2	EJ, EM1	99-00	K20PR-L11	K20TT	IK20TT	IK20	VK20	4	
	D17A6	ES, ET	00-06	KJ20CR-L11	K20TT	IK20TT	IK20L	-	4	
1.3L 4Cyl 16V	D17A6	EU, EP, EV	00-06	KJ20CR-L11	K20TT	IK20TT	IK20L	-	4	
	LDA1	ES, ET	04-05	IK16TT	K16TT	IK16TT	IK16	VK16	8	
1.8L 4Cyl 16V	R18A1,R18A2	FD, FA	05-12	IK20TT	K20TT	IK20TT	IK20G	VK20G	4	
	R18A2	FN, FK	05-	IK20TT	K20TT	IK20TT	IK20G	VK20G	4	
2.0L 4Cyl 16V	K20Z2,K20A3	FD, FA	06-12	IK20TT	K20TT	IK20TT	IK20	VK20	4	
1.3L 4Cyl 8V	LDA2	FD, FA	06-12	IKH20TT	KH20TT	IKH20TT	IKH20	VKH20	8	

DENSO
 AUSTRALIA
 CHINA
 INDIA
 INDONESIA
 KOREA
 MALAYSIA
 PHILIPPINES
 SAUDI ARABIA
 SINGAPORE
 TAIWAN
 THAILAND
 VIETNAM
 JAPAN
 EUROPE
 MOTOR & USA
 SMALL ENGINE
 CROSS REFERENCE
 PART NUMBER

DENSO	9	14	16	20	22	24	27	29	31	32	34	35	DENSO	9	14	16	20	22	24	27	29	31	32	DENSO	9	14	16	20	22	24	27	31
NGK	2	4	5	6	7	8	9	9.5	10	10.5	11	11.5	CHAMPION	18	16,14	12,11	10,9	8,7	6,63,61	4,59	57	55	53	BOSCH	10	9	8	7,6	5	4	3	2



AUSTRALIA CAR

▶ Spark plug color codes: ■ for Iridium Tough and Iridium Plugs and Iridium TT, ■ for Iridium Power, ■ for Iridium Racing and Two Tops Plugs, ■ for Platinum Plugs and Platinum TT, and black for general spark plugs.

PART NUMBER	CROSS REFERENCE	SMALL ENGINE	MOTOR CYCLE	EUROPE & USA	JAPAN	VIETNAM	THAILAND	TAIWAN	SINGAPORE	SAUDI ARABIA	PHILIPPINES	MALAYSIA	KOREA	INDONESIA	INDIA	CHINA	AUSTRALIA	Model	Engine Size	Engine Code	Specification	From To	DENSO			IRIDIUM POWER	IRIDIUM TOUGH	QTY					
																		HONDA															
																		HONDA															
																		CIVIC	2.0L 4Cyl 16V	K20Z4	FN Type R	11-12	VK22G	-	-	IK22G	VK22G	4					
																			1.8L 4Cyl 16V	R18Z1,R18Z4	FB, FG	12-14	VFXUHC22FG	-	-	-	VFXUHC22FG	4					
																			1.5L 4Cyl 16V		FB, FG	12-14	IKH20TT	KH20TT	IKH20TT	IKH20	VFKH20	4					
																			1.8L 4Cyl 16V	R18Z4	FK	13-14	VFXUHC22FG	-	-	-	VFXUHC22FG	4					
																			1.5L 4Cyl 16V	L15B7	FC1 RS Turbo	16-	VXEHC24G	-	-	-	VXEHC24G	4					
																			1.8L 4Cyl 16V	R18Z1	FC6	16-	VXUHC22G	-	-	-	VXUHC22G	4					
																		CONCERTO	1.6L 4Cyl 16V	D16Z4,D16A8	HW	89-93	IQ20	Q20TT	IQ20TT	IQ20	VQ20	4					
																		CR-V	2.0L 4Cyl 16V	B20B	RD	97-00	KJ16CR-L11	K16TT	IK16TT	IK16L	-	4					
																				B20Z1	RD	99-02	KJ20CR-L11	K20TT	IK20TT	IK20L	-	4					
																				K24A1	RD	01-06	KJ20DR-M11	K20TT	IK20TT	IK20	VK20	4					
																				K24A1	RE	07-12	KJ20DR-M11	K20TT	IK20TT	IK20	VK20	4					
																				K24Z1	RE	07-	KJ20DR-M11	K20TT	IK20TT	IK20	VK20	4					
																				K24Z9	RM	12-18	KJ20DR-M11	K20TT	IK20TT	IK20	VK20	4					
																		CRX	1.6L 4Cyl 16V	D16A9,D16A8	ED, EE	87-92	IQ20	Q20TT	IQ20TT	IQ20	VQ20	4					
																		CR-Z	1.5L 4Cyl 16V	LEA1	ZF	10-	IK20TT	K20TT	IK20TT	-	VFK20F	4					
																		HR-V	1.6L 4Cyl 16V	D16W1	GH	99-02	KJ16CR-L11	K16TT	IK16TT	IK16L	-	4					
																			1.8L 4Cyl 16V	R18Z9,R18ZF	RU	15-	VXUHC22G	-	-	-	VXUHC22G	4					
																		INSIGHT	1.0L 3Cyl 12V	ECA1	ZE18	01-04	IKH20TT	KH20TT	IKH20TT	IKH20	VKH20	3					
																			1.3L 4Cyl 8V	LDA3	ZE28 Twin spark	09-	IKH20TT	KH20TT	IKH20TT	IKH20	VFKH20	8					
																		INTEGRA		B18A1	DA	89-93	IQ16	Q16TT	IQ16TT	IQ16	VQ16	4					
																			1.8L 4Cyl 16V	B18B1	DC2, DC4	93-01	KJ16CR-L11	K16TT	IK16TT	IK16L	-	4					
																				B18B2	DC2, DC4	93-01	KJ16CR-L11	K16TT	IK16TT	IK16L	-	4					
																				B18C2	DC2, DC4	93-99	K20PR-L11	K20TT	IK20TT	IK20	VK20	4					
																				B18C6	DC2, DC4 Type-R	99-01	VK22G	-	-	IK22G	VK22G	4					
																				K20A2	DC5	01-04	VK22G	-	-	IK22G	VK22G	4					
																				K20A3	DC5	01-06	KJ20DR-M11	K20TT	IK20TT	IK20	VK20	4					
																				K20Z1	DC5 Type-S	04-07	VK22G	-	-	IK22G	VK22G	4					
																		JAZZ	1.3L 4Cyl 8V	L13A1	GD_, GE3, GE2	02-08	K20PR-U11	K20TT	IK20TT	IK20	VK20	8					
																				L15A	GD_, GE3, GE2	02-08	IK20TT	K20TT	IK20TT	IK20	VK20	4					
																				L13Z1	GE	08-11	IK20TT	K20TT	IK20TT	IK20	VK20	4					
																				L15A7,L15A3	GE	08-	IK20TT	K20TT	IK20TT	IK20	VK20	4					
																				LDA3	GE	11-	IKH20TT	KH20TT	IKH20TT	IKH20	VFKH20	4					
																				L15Z2,L15A	GF	14-	IK20TT	K20TT	IK20TT	-	VFK20F	4					
																		LEGEND	2.5L 6Cyl 24V	C25A1	HS, KA	86-87	IQ20	Q20TT	IQ20TT	IQ20	VQ20	6					
																				C27A1	HS, KA	87-91	IQ20	Q20TT	IQ20TT	IQ20	VQ20	6					
																				C27A1	KA3	87-91	IQ20	Q20TT	IQ20TT	IQ20	VQ20	6					
																				C32A2	KA7	91-96	IK20TT	K20TT	IK20TT	IK20	VK20	6					
																				C32A2	KA8	91-96	IK20TT	K20TT	IK20TT	IK20	VK20	6					
																				C35A2	KA9	96-01	IK20TT	K20TT	IK20TT	IK20	VK20	6					
																				J35A8,C35A8	KB	06-13	IK20TT	K20TT	IK20TT	IK20	VK20	6					
																				J37A2	KB	08-13	VXUHC22G	-	-	-	VXUHC22G	6					
																		MDX	3.5L 6Cyl 24V	J35A5	YD	03-07	IK16TT	K16TT	IK16TT	IK16	VK16	6					
																		NSX	3.0L 6Cyl 24V	C30A3	NA	90-05	IK20TT	K20TT	IK20TT	IK20	VK20	6					
																				C30A4	NA	90-05	IK20TT	K20TT	IK20TT	IK20	VK20	6					
																				C32B2	NA	97-05	IK20TT	K20TT	IK20TT	IK20	VK20	6					
																		ODYSSEY	2.2L 4Cyl 16V	F22B8	RA	95-97	KJ16CR-L11	K16TT	IK16TT	IK16L	-	4					
																				F23A7	RA	98-04	KJ20CR-L11	K20TT	IK20TT	IK20L	-	4					
																				J30A	RA	00-04	KJ16CR-L11	K16TT	IK16TT	IK16L	-	6					
																				K24A5	RB	04-09	IK20TT	K20TT	IK20TT	IK20	VK20	4					
																				K24A	RB	09-13	VXUHC22G	-	-	-	VXUHC22G	4					
																				K24W	RC	13-	IXEH22TT	-	IXEH22TT	-	VFXEH22	4					
																		PRELUDE	1.6L 4Cyl 8V	EL14,EL	SN	78-82	W16EXRU	W16TT	IW16TT	IW16	VW16	4					
																				ET2,ET3	AB	83-85	W20EX-U11	W20TT </									

Model	Engine Size	Engine Code	Specification	From To	DENSO					QTY
HSV										
CLUBSPORT	5.7L 8Cyl 16V	LS1	VY	02-04	IT16TT	T16TT	IT16TT	IT16	VT16	8
	6.0L 8Cyl 16V	LS2,L76	VZ	04-06	IT16TT	T16TT	IT16TT	IT16	VT16	8
	6.2L 8Cyl 16V	LS3	VE	08-13	IT16TT	T16TT	IT16TT	IT16	VT16	8
LS3		VF	13-	IT16TT	T16TT	IT16TT	IT16	VT16	8	
COMMODORE	5.0L 8Cyl 16V		VL	88-89	T20EPR-U	T20TT	IT20TT	IT20	VT20	8
			VN	89-91	T20EPR-U	T20TT	IT20TT	IT20	VT20	8
GRANGE	5.7L 8Cyl 16V	LS1	WH	00-03	IT16TT	T16TT	IT16TT	IT16	VT16	8
	6.2L 8Cyl 16V	LS3	WM	08-10	IT16TT	T16TT	IT16TT	IT16	VT16	8
GTO	5.7L 8Cyl 16V	LS1	V2	01-03	IT16TT	T16TT	IT16TT	IT16	VT16	8
GTS			VX	00-01	IT16TT	T16TT	IT16TT	IT16	VT16	8
	5.7L 8Cyl 16V		V2	01-04	IT16TT	T16TT	IT16TT	IT16	VT16	8
		LS1	VY	02-04	IT16TT	T16TT	IT16TT	IT16	VT16	8
	6.0L 8Cyl 16V	LS2	VE	06-08	IT16TT	T16TT	IT16TT	IT16	VT16	8
	6.2L 8Cyl 16V	LS3	VE	08-13	IT16TT	T16TT	IT16TT	IT16	VT16	8
		LSA	VF	13-	IT20TT	T20TT	IT20TT	IT20	VT20	8
MALOO	5.0L 8Cyl 16V		VS	95-00	T20EPR-U	T20TT	IT20TT	IT20	VT20	8
	6.0L 8Cyl 16V	L76,LS2	VZ	04-07	IT16TT	T16TT	IT16TT	IT16	VT16	8
		LS2	VE	07-08	IT16TT	T16TT	IT16TT	IT16	VT16	8
	6.2L 8Cyl 16V	LS3	VE	08-13	IT16TT	T16TT	IT16TT	IT16	VT16	8
		LSA	VF	13-	IT20TT	T20TT	IT20TT	IT20	VT20	8
SENATOR	5.7L 8Cyl 16V	LS1	VY	02-03	IT16TT	T16TT	IT16TT	IT16	VT16	8
	6.0L 8Cyl 16V	LS2,L76	VZ	04-06	IT16TT	T16TT	IT16TT	IT16	VT16	8
		LS2	VE	06-08	IT16TT	T16TT	IT16TT	IT16	VT16	8
	6.2L 8Cyl 16V	LS3	VE	08-13	IT16TT	T16TT	IT16TT	IT16	VT16	8
		LS3	VF	13-	IT16TT	T16TT	IT16TT	IT16	VT16	8
W427	7.0L 8Cyl 16V	LS7	VE	08-13	IT16TT	T16TT	IT16TT	IT16	VT16	8
HUMMER										
HUMMER	6.0L 8Cyl 16V	LQ4		02-	IT16TT	T16TT	IT16TT	IT16	VT16	8
	6.2L 8Cyl 16V	L92		04-	IT16TT	T16TT	IT16TT	IT16	VT16	8
	3.7L 6Cyl 24V	LLR		06-	ITL16	-	ITL16TT	ITL16	-	5
HYUNDAI										
ACCENT	1.5L 4Cyl 16V	G4ECX	LC	00-02	K16PR-U11	K16TT	IK16TT	IK16	VK16	4
		G4EC-G	LC	00-03	K16PR-U11	K16TT	IK16TT	IK16	VK16	4
		G4ED-G	LC	03-06	K16PR-U11	K16TT	IK16TT	IK16	VK16	4
	1.6L 4Cyl 16V	G4ED	MC	06-09	K16PR-U11	K16TT	IK16TT	IK16	VK16	4
		G4FC	RB	10-	IXUH20I	-	-	IXUH20I	VXUH20I	4
	1.4L 4Cyl 16V	G4LC	RB	10-	IXUH20I	-	-	IXUH20I	VXUH20I	4
	1.6L 4Cyl 16V	G4FD	RB	11-	IXUH20I	-	-	IXUH20I	VXUH20I	4
COUPE	2.0L 4Cyl 16V	G4GF	RD	96-02	K16PR-U11	K16TT	IK16TT	IK16	VK16	4
	1.8L 4Cyl 16V	G4GM	RD	96-02	K16PR-U11	K16TT	IK16TT	IK16	VK16	4
ELANTRA	1.8L 4Cyl 16V	G4GB,G4BB	XD	00-03	K16PR-U11	K16TT	IK16TT	IK16	VK16	4
		G4GC	XD	00-06	K16PR-U11	K16TT	IK16TT	IK16	VK16	4
	2.0L 4Cyl 16V	G4GC	HD	06-11	K16PR-U11	K16TT	IK16TT	IK16	VK16	4
		G4NB	MD, UD	10-15	IXUH20I	-	-	IXUH20I	VXUH20I	4
2.0L 4Cyl 16V	G4NA	AD	15-	VXUHC22G	-	-	-	VXUHC22G	4	
ELANTRA LAVITA	1.8L 4Cyl 16V	G4GB-G	FC	01-04	K16PR-U11	K16TT	IK16TT	IK16	VK16	4
EXCEL	1.5L 4Cyl 8V	G4DJ,G15B	X-2	90-95	W20EPR-U	W20TT	IW20TT	IW20	VW20	4
		G4DJ	X-2	91-94	W20EPR-U	W20TT	IW20TT	IW20	VW20	4
	1.5L 4Cyl 12V	G4EK	X-3	94-00	K16PR-U11	K16TT	IK16TT	IK16	VK16	4
	1.5L 4Cyl 16V	G4ER	X-3	95-00	K16PR-U11	K16TT	IK16TT	IK16	VK16	4
GETZ	1.5L 4Cyl 16V	G4ER,G4EC-G	TB	02-05	K16PR-U11	K16TT	IK16TT	IK16	VK16	4
	1.3L 4Cyl 12V	G4EA	TB	03-05	K16PR-U11	K16TT	IK16TT	IK16	VK16	4
	1.6L 4Cyl 16V	G4ED-G	TB	05-06	K16PR-U11	K16TT	IK16TT	IK16	VK16	4
	1.4L 4Cyl 16V	G4EE	TB	05-10	K16PR-U11	K16TT	IK16TT	IK16	VK16	4
GRANDEUR	3.0L 6Cyl 24V	G6CT-G	XG	99-04	IK16TT	K16TT	IK16TT	IK16	VK16	6
	3.8L 6Cyl 24V	G6DA	TG	05-11	IK16TT	K16TT	IK16TT	IK16	VK16	6
i20	1.6L 4Cyl 16V	G4FC	PB, PBT	08-12	IXUH20I	-	-	IXUH20I	VXUH20I	4
	1.4L 4Cyl 16V	G4FA	PB, PBT	08-15	IXUH20I	-	-	IXUH20I	VXUH20I	4
i30	1.6L 4Cyl 16V	G4FC	FD	07-11	IXUH20I	-	-	IXUH20I	VXUH20I	4
	2.0L 4Cyl 16V	G4GC,G4GC-G	FD	07-12	K16PR-U11	K16TT	IK16TT	IK16	VK16	4
	1.6L 4Cyl 16V	G4FD	GD	11-	IXUH20I	-	-	IXUH20I	VXUH20I	4
	1.8L 4Cyl 16V	G4NB	GD	12-	VXUHC22G	-	-	-	VXUHC22G	4
		G4NC	GD	13-17	VXUHC22G	-	-	-	VXUHC22G	4
			PDE, PD	16-	VXUHC22G	-	-	-	VXUHC22G	4
i40	2.0L 4Cyl 16V	G4NC	VF	11-	VXUHC22G	-	-	-	VXUHC22G	4
i45	2.4L 4Cyl 16V	G4KJ	YF	09-14	FXU16HR11	-	-	-	-	4

DENSO	9	14	16	20	22	24	27	29	31	32	34	35	DENSO	9	14	16	20	22	24	27	29	31	32	DENSO	9	14	16	20	22	24	27	31
NGK	2	4	5	6	7	8	9	9.5	10	10.5	11	11.5	CHAMPION	18	16,14	12,11	10,9	8,7	6,63,61	4,59	57	55	53	BOSCH	10	9	8	7,6	5	4	3	2

DENSO
 AUSTRALIA
 CHINA
 INDIA
 INDONESIA
 KOREA
 MALAYSIA
 PHILIPPINES
 SAUDI ARABIA
 SINGAPORE
 TAIWAN
 THAILAND
 VIETNAM
 JAPAN
 & USA
 EUROPE
 MOTOR
 SMALL
 ENGINE
 REFERENCE
 NUMBER
67



AUSTRALIA CAR

▶ Spark plug color codes: ■ for Iridium Tough and Iridium Plugs and Iridium TT, ■ for Iridium Power, ■ for Iridium Racing and Two Tops Plugs, ■ for Platinum Plugs and Platinum TT, and black for general spark plugs.

DENSO	Model	Engine Size	Engine Code	Specification	From To	DENSO	DENSO				QTY
	HYUNDAI										
	i45	2.0L 4Cyl 16V	G4KD	YF	11-14	K16HPR-U11	KH16TT	IKH16TT	IKH16	VKH16	4
	iLoad	2.4L 4Cyl 16V	G4KC	TQ	08-	IKH16TT	KH16TT	IKH16TT	IKH16	VKH16	4
	iMAX	2.4L 4Cyl 16V	G4KC	TQ	08-	IKH16TT	KH16TT	IKH16TT	IKH16	VKH16	4
	ix35	2.0L 4Cyl 16V	G4KD	LM	10-	K16HPR-U11	KH16TT	IKH16TT	IKH16	VKH16	4
		2.4L 4Cyl 16V	G4KE	LM	10-	K16HPR-U11	KH16TT	IKH16TT	IKH16	VKH16	4
		2.0L 4Cyl 16V	G4NC	LM	13-	VXUHC22G	-	-	-	VXUHC22G	4
	LANTRA	1.6L 4Cyl 16V	G4CR	J-1	91-95	W20EPR-U11	W20TT	IW20TT	IW20	VW20	4
		1.8L 4Cyl 16V	G4CN	J-1	92-95	W20EPR-U11	W20TT	IW20TT	IW20	VW20	4
		2.0L 4Cyl 16V	G4GF	J-2	95-00	K16PR-U11	K16TT	IK16TT	IK16	VK16	4
		1.8L 4Cyl 16V	G4GM	J-2	95-00	K16PR-U11	K16TT	IK16TT	IK16	VK16	4
	S COUPE	1.5L 4Cyl 8V	G15B,G4DJ	SLC	90-91	W20EPR-U11	W20TT	IW20TT	IW20	VW20	4
		1.5L 4Cyl 12V	G4EK	SLC	91-96	K16PR-U11	K16TT	IK16TT	IK16	VK16	4
			G4EK-TC	SLC Turbo	92-96	K20PR-U	K20TT	IK20TT	-	VK20Y	4
	SANTA FE	2.7L 6Cyl 24V	G6EA	SM	00-06	IKH16TT	KH16TT	IKH16TT	IKH16	VKH16	6
		2.4L 4Cyl 16V	G4JS-G	SM	01-03	IW16TT	W16TT	IW16TT	IW16	VW16	4
		2.7L 6Cyl 24V	G6EA	CM	06-09	IKH16TT	KH16TT	IKH16TT	IKH16	VKH16	6
		3.3L 6Cyl 24V	G6DB	CM	07-09	IK16TT	K16TT	IK16TT	IK16	VK16	6
		3.5L 6Cyl 24V	G6DC	CM	11-12	VXUHC22G	-	-	-	VXUHC22G	6
		2.4L 4Cyl 16V	G4KJ	DM	12-15	FXU16HR11	-	-	-	-	4
		3.3L 6Cyl 24V	G6DF	DM	14-	VXUHC22G	-	-	-	VXUHC22G	6
		SONATA	2.4L 4Cyl 8V	G4CS	Y-2	89-92	W20EPR-U11	W20TT	IW20TT	IW20	VW20
	3.0L 6Cyl 12V		G6AT	Y-2	90-93	W20EPR-U11	W20TT	IW20TT	IW20	VW20	6
	2.0L 4Cyl 16V		G4CP-D	Y-3	93-98	W20EPR-U11	W20TT	IW20TT	IW20	VW20	4
	3.0L 6Cyl 12V		G6AT	Y-3	93-98	W20EPR-U11	W20TT	IW20TT	IW20	VW20	6
	2.0L 4Cyl 16V		G4JP-G	EF	98-00	IW16TT	W16TT	IW16TT	IW16	VW16	4
	2.5L 6Cyl 24V		G6BV	EF	98-01	IK16TT	K16TT	IK16TT	IK16	VK16	6
	2.7L 6Cyl 24V		G6BA-G	EF	01-04	IK16TT	K16TT	IK16TT	IK16	VK16	6
	2.4L 4Cyl 16V		G4JS	EF	01-05	IW16TT	W16TT	IW16TT	IW16	VW16	4
	2.7L 6Cyl 24V		G6BA-Y	EF	01-05	IK16TT	K16TT	IK16TT	IK16	VK16	6
	2.4L 4Cyl 16V		G4KC	NF	05-08	K16PR-U11	K16TT	IK16TT	IK16	VK16	4
	3.3L 6Cyl 24V		G6DB	NF	05-10	IK16TT	K16TT	IK16TT	IK16	VK16	6
			G4KE	NF	08-10	K16HPR-U11	KH16TT	IKH16TT	IKH16	VKH16	4
			G4KJ	LF	14-	FXU16HR11	-	-	-	-	4
	TERRACAN	3.5L 6Cyl 24V	G6CU	HP	01-07	IK16TT	K16TT	IK16TT	IK16	VK16	6
	TIBURON	2.7L 6Cyl 24V	G6BA-G	GK	01-09	IK16TT	K16TT	IK16TT	IK16	VK16	6
		2.0L 4Cyl 16V	G4GC-G	GK	02-04	K16PR-U11	K16TT	IK16TT	IK16	VK16	4
	TUCSON	2.0L 4Cyl 16V	G4GC	JM	04-10	K16PR-U11	K16TT	IK16TT	IK16	VK16	4
		2.7L 6Cyl 24V	G6BA-G	JM	04-10	IK16TT	K16TT	IK16TT	IK16	VK16	6
		2.0L 4Cyl 16V	G4NA	TL	15-	VXUHC22G	-	-	-	VXUHC22G	4
	G4NC		TL	15-	VXUHC22G	-	-	-	VXUHC22G	4	
	VELOSTER	1.6L 4Cyl 16V	G4FD	FS	11-	IXUH20I	-	-	IXUH20I	VXUH20I	4
	INFINITI										
	FX	5.0L 8Cyl 32V	VK50VE		08-	IXEH22TT	-	IXEH22TT	-	VFXEH22	8
		3.7L 6Cyl 24V	VQ37VHR		08-	FXE24HR11	-	-	-	-	6
	G	3.7L 6Cyl 24V	VQ37VHR		10-	FXE24HR11	-	-	-	-	6
	QX70	5.0L 8Cyl 32V	VK50VE		13-	IXEH22TT	-	IXEH22TT	-	VFXEH22	8
	JAGUAR										
	S-TYPE	4.0L 8Cyl 32V	AJ-V8	X200	99-02	IK16TT	K16TT	IK16TT	IK16	VK16	8
		3.0L 6Cyl 24V	FB,AJ-V6	X200	99-07	IT20	T20TT	IT20TT	IT20	VT20	6
		4.2L 8Cyl 32V	AJ8FT	X200	02-07	IK16TT	K16TT	IK16TT	IK16	VK16	8
		2.5L 6Cyl 24V	JB (AJ-V6),AJ25	X200	02-07	IT20	T20TT	IT20TT	IT20	VT20	6
	XF	3.0L 6Cyl 24V	AJ6WG	X250	08-15	IT20	T20TT	IT20TT	IT20	VT20	6
		4.2L 8Cyl 32V	SV82G	X250	08-15	IK16TT	K16TT	IK16TT	IK16	VK16	8
			SV8TS	X250 Kompressor	08-15	IK16TT	K16TT	IK16TT	IK16	VK16	8
		5.0L 8Cyl 32V	508PN	X250	09-15	IK16TT	K16TT	IK16TT	IK16	VK16	8
	508PS		X250 Kompressor	09-15	IK16TT	K16TT	IK16TT	IK16	VK16	8	
	XJ	4.0L 6Cyl 24V	9EPCNA	XJ40, XJ81	89-94	IQ20	Q20TT	IQ20TT	IQ20	VQ20	6
		3.2L 6Cyl 24V	9BPMNA	XJ40, XJ81	90-94	IQ20	Q20TT	IQ20TT	IQ20	VQ20	6
		6.0L 12Cyl 48V	8C (92-94)	XJ40, XJ81	93-94	T22EP-U	-	-	IT22	-	12
		4.0L 6Cyl 24V	9KPDRB	X300, X330 R Supercharged	94-97	IQ20	Q20TT	IQ20TT	IQ20	VQ20	6
		4.0L 8Cyl 32V	BC	X308	97-03	IQ20	Q20TT	IQ20TT	IQ20	VQ20	8
		3.2L 8Cyl 32V		X308	97-03	IK16TT	K16TT	IK16TT	IK16	VK16	8
		4.2L 8Cyl 32V	AJ8FT	X350	03-09	IK16TT	K16TT	IK16TT	IK16	VK16	8
		3.6L 8Cyl 32V	RG (AJ-V8)	X350	03-09	IK16TT	K16TT	IK16TT	IK16	VK16	8
	5.0L 8Cyl 32V	508PN	X351	09-	IK16TT	K16TT	IK16TT	IK16	VK16	8	
		508PS	X351	09-	IK16TT	K16TT	IK16TT	IK16	VK16	8	
	XJS	5.3L 12Cyl 24V	8S (86-88)		85-92	T22EP-U	-	-	IT22	-	12

Model	Engine Size	Engine Code	Specification	From To	DENSO					QTY
JAGUAR										
XJS	5.3L 12Cyl 24V	V 12 (90-93, 197KW)		86-89	T22EP-U	-	-	IT22	-	12
	6.0L 12Cyl 48V	8C (92-94)		91-93	T22EP-U	-	-	IT22	-	12
	4.0L 6Cyl 24V	9EPCNA		91-94	IQ20	Q20TT	IQ20TT	IQ20	VQ20	6
	6.0L 12Cyl 48V	8D		93-96	T22EP-U	-	-	IT22	-	12
XJSC	5.3L 12Cyl 24V	8S (86-88)	X27	85-92	T22EP-U	-	-	IT22	-	12
		V 12 (90-93, 197KW)	X27	86-88	T22EP-U	-	-	IT22	-	12
	4.0L 6Cyl 24V	9EPCNA	X27	91-94	IQ20	Q20TT	IQ20TT	IQ20	VQ20	6
	6.0L 12Cyl 48V	8D	X27	93-96	T22EP-U	-	-	IT22	-	12
	4.0L 6Cyl 24V	9LPFRB	X27	94-96	IQ20	Q20TT	IQ20TT	IQ20	VQ20	6
XK	4.2L 8Cyl 32V	AJ8FT	X150 XK8	06-14	IK16TT	K16TT	IK16TT	IK16	VK16	8
		SV8TS	X150 XKR	06-14	IK16TT	K16TT	IK16TT	IK16	VK16	8
	5.0L 8Cyl 32V	508PN	X150	09-14	IK16TT	K16TT	IK16TT	IK16	VK16	8
XK 8	4.0L 8Cyl 32V	CC,CE	X100	96-02	IK16TT	K16TT	IK16TT	IK16	VK16	8
		AJ26,AJ27	X100	96-05	IK16TT	K16TT	IK16TT	IK16	VK16	8
	4.2L 8Cyl 32V	AJ8FT	X100	02-05	IK16TT	K16TT	IK16TT	IK16	VK16	8
X-TYPE	3.0L 6Cyl 24V	AJ-V6	X400	01-08	IT20	T20TT	IT20TT	IT20	VT20	6
	2.5L 6Cyl 24V	XB (AJ-V6)	X400	01-09	IT20	T20TT	IT20TT	IT20	VT20	6
	2.1L 6Cyl 24V	YB (AJ-V6)	X400	02-09	IT20	T20TT	IT20TT	IT20	VT20	6
JEEP										
CHEROKEE	4.0L 6Cyl 12V	MX	XJ	99-01	KJ20CR-L11	K20TT	IK20TT	IK20L	-	6
	3.7L 6Cyl 12V	EKG	KJ	01-08	KJ16CR-L11	K16TT	IK16TT	IK16L	-	6
	2.4L 4Cyl 16V	ED1	KJ	04-08	ITL16	-	ITL16TT	ITL16	-	4
	3.7L 6Cyl 12V	EKG	KK	08-	KJ20CR-L11	K20TT	IK20TT	IK20L	-	6
	2.4L 4Cyl 16V	ED6	KL	13-	IKH16TT	KH16TT	IKH16TT	IKH16	VKH16	4
	3.2L 6Cyl 24V	EHB	KL	13-	VXUHC22G	-	-	-	VXUHC22G	6
COMMANDER	4.7L 8Cyl 16V	EVA	XK, XH	05-10	IK20TT	K20TT	IK20TT	IK20L	-	8
	5.7L 8Cyl 16V	EZB	XK, XH	05-10	ITL16	-	ITL16TT	ITL16	-	8
COMPASS	2.4L 4Cyl 16V	ED3	MK49	06-	KJ16CR-L11	K16TT	IK16TT	IK16L	-	4
	2.0L 4Cyl 16V	ECN	MK49	11-17	KJ16CR-L11	K16TT	IK16TT	IK16L	-	4
GRAND CHEROKEE	4.0L 6Cyl 12V	S01	ZJ	95-99	KJ20CR-L11	K20TT	IK20TT	IK20L	-	6
		ERH	WJ, WG	99-05	IK16	K16TT	IK16TT	IK16	VK16	6
	4.7L 8Cyl 16V	EVA	WJ, WG	99-05	KJ20CR-L11	K20TT	IK20TT	IK20L	-	8
		EVC	WJ, WG	01-05	VK22	-	-	IK22	VK22	8
	3.7L 6Cyl 12V	EKG	WH, WK	04-10	KJ20CR-L11	K20TT	IK20TT	IK20L	-	6
	4.7L 8Cyl 16V	EVA	WH, WK	05-10	KJ20CR-L11	K20TT	IK20TT	IK20L	-	8
	5.7L 8Cyl 16V	EZB	WH, WK	05-10	ITL16TT / IKH16TT	-	ITL16TT / IKH16TT	ITL16 / IKH16	-	16
	6.1L 8Cyl 16V	ESF	WH, WK SRT8	06-10	ITL16	-	ITL16TT	ITL16	-	8
	5.7L 8Cyl 16V	EZD,EZH	WH, WK Hemi 345 (Twin Spark)	09-10	ITL16	-	ITL16TT	ITL16	-	16
	3.6L 6Cyl 24V	ERB	WK, WK2	10-	VXUH22I	-	-	IXUH22I	VXUH22I	6
	5.7L 8Cyl 16V	EZH	WK, WK2	10-	ITL16	-	ITL16TT	ITL16	-	16
PATRIOT	2.4L 4Cyl 16V	ED3	MK74	08-	IK16TT	K16TT	IK16TT	IK16L	-	4
	2.0L 4Cyl 16V	ECN	MK74	11-	KJ16CR-L11	K16TT	IK16TT	IK16L	-	4
RENEGADE	1.4L 4Cyl 16V	55263624,EAM	BU, B1	14-	IXU27	-	-	IXU27	-	4
	1.6L 4Cyl 16V	EJH,55263842	BU, B1	14-	IXU27	-	-	IXU27	-	4
	2.4L 4Cyl 16V	ED6	BU, B1	15-	IKH16TT	KH16TT	IKH16TT	IKH16	VKH16	4
WRANGLER	4.0L 6Cyl 12V	M400L	YJ, SJ_	86-90	KJ20CR-L11	K20TT	IK20TT	IK20L	-	6
		S01	TJ	96-07	KJ20CR-L11	K20TT	IK20TT	IK20L	-	6
	3.8L 6Cyl 12V	ERH	TJ	03-07	KJ20CR-L11	K20TT	IK20TT	IK20L	-	6
		EGT	JK	07-	ITL16	-	ITL16TT	ITL16	-	6
	3.6L 6Cyl 24V	ERB	JK	11-	VXUHC22G	-	-	-	VXUHC22G	6
KIA										
CARENS	1.8L 4Cyl 16V	T8	FC	00-02	K20PR-U	K20TT	IK20TT	-	VK20Y	4
CARNIVAL / GRAND CARNIVAL	2.5L 6Cyl 24V	KV6	UP	99-01	IK20TT	K20TT	IK20TT	IK20	VK20	6
	3.3L 6Cyl 24V	G6DH	YP	14-	VXUHC22G	-	-	-	VXUHC22G	6
	2.7L 6Cyl 24V	G6EA	VQ	06-09	IKH16TT	KH16TT	IKH16TT	IKH16	VKH16	6
	3.8L 6Cyl 24V	G6DA	VQ	06-	IK16TT	K16TT	IK16TT	IK16	VK16	6
	3.5L 6Cyl 24V	G6DC	VQ	10-	VXUHC22G	-	-	-	VXUHC22G	6
CERATO	2.0L 4Cyl 16V	G4GC	LD	04-09	K16PR-U11	K16TT	IK16TT	IK16	VK16	4
	1.6L 4Cyl 16V	G4FC	TD	09-	XU22HDR9	XUH22TT	-	IXUH22I	VXUH22I	4
	2.0L 4Cyl 16V	G4KD	TD	09-	K16HPR-U11	KH16TT	IKH16TT	IKH16	VKH16	4
	1.8L 4Cyl 16V	G4NB	YD	13-	VXUHC22G	-	-	-	VXUHC22G	4
		G4NC	YD	13-	VXUHC22G	-	-	-	VXUHC22G	4
	2.0L 4Cyl 16V			13-	VXUHC22G	-	-	-	VXUHC22G	4
	1.8L 4Cyl 16V			15-	VXUHC22G	-	-	-	VXUHC22G	4
2.0L 4Cyl 16V	G4NA	YD	16-	VXUHC22G	-	-	-	VXUHC22G	4	
CERATO KOUP	2.0L 4Cyl 16V	G4KD	TD	09-13	K16HPR-U11	KH16TT	IKH16TT	IKH16	VKH16	4
CREDOS	2.0L 4Cyl 16V	FE (16V)	K9A	98-01	K20PR-U11	K20TT	IK20TT	IK20	VK20	4

DENSO	9	14	16	20	22	24	27	29	31	32	34	35	DENSO	9	14	16	20	22	24	27	29	31	32	DENSO	9	14	16	20	22	24	27	31
NGK	2	4	5	6	7	8	9	9.5	10	10.5	11	11.5	CHAMPION	18	16,14	12,11	10,9	8,7	6,63,61	4,59	57	55	53	BOSCH	10	9	8	7,6	5	4	3	2

DENSO
 AUSTRALIA
 CHINA
 INDIA
 INDONESIA
 KOREA
 MALAYSIA
 PHILIPPINES
 SAUDI ARABIA
 SINGAPORE
 TAIWAN
 THAILAND
 VIETNAM
 JAPAN
 EUROPE
 MOTOR & USA
 CYCLE
 SMALL ENGINE
 CROSS REFERENCE
 PART NUMBER



AUSTRALIA CAR

▶ Spark plug color codes: ■ for Iridium Tough and Iridium Plugs and Iridium TT, ■ for Iridium Power, ■ for Iridium Racing and Two Tops Plugs, ■ for Platinum Plugs and Platinum TT, and black for general spark plugs.

DENSO	Model	Engine Size	Engine Code	Specification	From To	DENSO	Iridium				QTY
KIA	MAGENTIS	2.7L 6Cyl 24V	G6EA	MG	06-08	IKH16TT	KH16TT	IKH16TT	IKH16	VKH16	6
		2.4L 4Cyl 16V	G4KC	MG (-09/08) / (-09/08-)	06-09	K16PR-U11 / K16HPR-U11	K16TT / KH16TT	IK16TT / IKH16TT	IK16 / IKH16	VK16 / VKH16	4
MENTOR	1.5L 4Cyl 8V	B5	FA	96-97	K20PR-U11	K20TT	IK20TT	IK20	VK20	4	
		ZY-VE, BFD	FB	97-01	K20PR-U11	K20TT	IK20TT	IK20	VK20	4	
MENTOR / SHUMA	1.5L 4Cyl 16V	BFD, ZY-VE	FB	97-01	K20PR-U11	K20TT	IK20TT	IK20	VK20	4	
		1.8L 4Cyl 16V	T8	FB	97-01	K20PR-U	K20TT	IK20TT	-	VK20Y	4
OPTIMA	2.5L 6Cyl 24V	G6BV	GD, MS	01-03	IK16TT	K16TT	IK16TT	IK16	VK16	6	
		G6BA	GD, MS	04-06	IK16TT	K16TT	IK16TT	IK16	VK16	6	
	2.4L 4Cyl 16V	G4KJ	TF	11-	FXU16HR11	-	-	-	-	4	
		G4KJ	JF	15-	FXU16HR11	-	-	-	-	4	
RIO	1.5L 4Cyl 16V	A5D	BC	00-05	K20PR-U	K20TT	IK20TT	-	VK20Y	4	
		G4ED	JB	05-12	K16PR-U11	K16TT	IK16TT	IK16	VK16	4	
	1.4L 4Cyl 16V	G4EE	JB	05-12	K16PR-U11	K16TT	IK16TT	IK16	VK16	4	
		G4FA	UB	11-	IXUH20I	-	-	IXUH20I	VXUH20I	4	
RONDO	1.6L 4Cyl 16V	G4FD	UB	11-	IXUH20I	-	-	IXUH20I	VXUH20I	4	
		G4FC	UB	12-	IXUH20I	-	-	IXUH20I	VXUH20I	4	
	2.0L 4Cyl 16V	G4KA	UN	08-13	K16PR-U11	K16TT	IK16TT	IK16	VK16	4	
		G4NC	RP	15-	VXUHC22G	-	-	-	VXUHC22G	4	
SORENTO	3.5L 6Cyl 24V	G6CU	BL	02-09	IK16TT	K16TT	IK16TT	IK16	VK16	6	
	3.3L 6Cyl 24V	G6DB	BL	07-09	IK16TT	K16TT	IK16TT	IK16	VK16	6	
	2.4L 4Cyl 16V	G4KE	XM	09-15	K16HPR-U11	KH16TT	IKH16TT	IKH16	VKH16	4	
	3.5L 6Cyl 24V	G6DC	XM	09-	VXUHC22G	-	-	-	VXUHC22G	6	
	2.4L 4Cyl 16V	G4KJ	XM	12-15	FXU16HR11	-	-	-	-	4	
	3.3L 6Cyl 24V		UM	15-	VXUHC22G	-	-	-	VXUHC22G	6	
SOUL	1.6L 4Cyl 16V	G4FC	AM	09-14	IXUH20I	-	-	IXUH20I	VXUH20I	4	
		G4FG	AM	09-14	IXUH20I	-	-	IXUH20I	VXUH20I	4	
SPECTRA SPORTAGE	2.0L 4Cyl 16V	G4NA	PS	14-	VXUHC22G	-	-	-	VXUHC22G	4	
	1.8L 4Cyl 16V	T8	FB	01-04	K20PR-U	K20TT	IK20TT	-	VK20Y	4	
		2.0L 4Cyl 16V	FE (16V)	K00	96-04	K20PR-U11	K20TT	IK20TT	IK20	VK20	4
	2.7L 6Cyl 24V	G6BA	KM	05-07	IK16TT	K16TT	IK16TT	IK16	VK16	6	
		2.0L 4Cyl 16V	G4GC	KM	07-	K16PR-U11	K16TT	IK16TT	IK16	VK16	4
	2.4L 4Cyl 16V	G4KD	SL	10-15	K16HPR-U11	KH16TT	IKH16TT	IKH16	VKH16	4	
		G4KE	SL	10-15	K16HPR-U11	KH16TT	IKH16TT	IKH16	VKH16	4	
	2.0L 4Cyl 16V	G4NC	SL	14-	VXUHC22G	-	-	-	VXUHC22G	4	
		G4NA	QL, QLE	15-	VXUHC22G	-	-	-	VXUHC22G	4	
	2.4L 4Cyl 16V	G4NA	QL, QLE	16-	IKH16TT	KH16TT	IKH16TT	-	VFKH16	4	
LAMBORGHINI											
COUNTACH	4.0L 12Cyl 24V		LP400	74-82	IW24	-	-	IW24	-	12	
		GALLARDO	5.0L 10Cyl 40V	L 510	03-	IK22	-	-	IK22	VK22	10
GALLARDO SPYDER	5.0L 10Cyl 40V			05-	IK22	-	-	IK22	VK22	10	
				10-13	IK22	-	-	IK22	VK22	10	
LAND ROVER											
90	2.5L 4Cyl 8V	17 H	LDV	85-90	W16EPR-U	W16TT	IW16TT	IW16	VW16	4	
		110/127	3.5L 8Cyl 16V	15G	LDH	83-90	W16EXRU	W16TT	IW16TT	IW16	8
	88/109	2.3L 4Cyl 8V	10 H, 11H	LR	63-86	W20ESR-U	-	-	-	-	4
			11H, 10 H	LR	63-86	W20ESR-U	-	-	-	-	4
DISCOVERY	3.5L 8Cyl 16V	22 D	LJ	89-94	W16EPR-U	W16TT	IW16TT	IW16	VW16	8	
		36 D, 35 D	LJ	93-98	W20EPR-U	W20TT	IW20TT	IW20	VW20	8	
	4.0L 8Cyl 16V	94 D, 56 D, 35 D	L318	98-04	IK16	K16TT	IK16TT	IK16	VK16	8	
		4.0L 6Cyl 24V	406PN	L319	04-09	IT16	T16TT	IT16TT	IT16	VT16	6
	4.4L 8Cyl 32V	448PN	L319	04-09	K20TXR	K20TT	IK20TT	IK20	VK20	8	
		5.0L 8Cyl 32V	508PN	L319	09-	IK20TT	K20TT	IK20TT	IK20	VK20	8
FREELANDER	1.8L 4Cyl 16V	18 K4F	L314	98-00	IK20TT	K20TT	IK20TT	IK20	VK20	4	
	2.5L 6Cyl 24V	25 K4F	L314	00-06	IK20TT	K20TT	IK20TT	IK20	VK20	6	
FREELANDER 2	3.2L 6Cyl 24V	B 6324 S	L359	06-14	VKH20Y	-	-	-	VKH20Y	6	
RANGE ROVER	3.9L 8Cyl 16V	42 D	P38A	94-02	W20EXR-U	W20TT	IW20TT	IW20	VW20	8	
		4.6L 8Cyl 16V	46 D	P38A	94-02	W20EXR-U	W20TT	IW20TT	IW20	VW20	8
	4.0L 8Cyl 16V	42 D	P38A	95-02	W20EXR-U	W20TT	IW20TT	IW20	VW20	8	
		60 D	P38A	98-02	IK20TT	K20TT	IK20TT	IK20	VK20	8	
	4.4L 8Cyl 32V	M62 B44	L322	02-05	K20TXR	K20TT	IK20TT	IK20	VK20	8	
	4.2L 8Cyl 32V	428PS	L322	05-12	IK16TT	K16TT	IK16TT	IK16	VK16	8	
	4.4L 8Cyl 32V	448PN	L322	05-12	IK16TT	K16TT	IK16TT	IK16	VK16	8	
		5.0L 8Cyl 32V	508PS	L405	12-	IXEH20TT	-	IXEH20TT	-	VFXEH20	8
	RANGE ROVER SPORT	4.2L 8Cyl 32V	428PS	L320	05-13	IK16TT	K16TT	IK16TT	IK16	VK16	8
		4.4L 8Cyl 32V	448PN	L320	05-13	IK16TT	K16TT	IK16TT	IK16	VK16	8
5.0L 8Cyl 32V		508PS	L320	09-13	IXEH20TT	-	IXEH20TT	-	VFXEH20	8	



Model	Engine Size	Engine Code	Specification	From To	DENSO	TJ	IRIDIUM	IRIDIUM POWER	IRIDIUM TOUGH	QTY
LEXUS										
CT200h	1.8L 4Cyl 16V	2ZR-FXE	ZWA10	10-	SC16HR11	-	IXEH20TT	-	VCH16	4
ES300	3.0L 6Cyl 24V	3VZ-FE	VCV10	91-96	IK20TT	K20TT	IK20TT	IK20	VK20	6
		1MZ-FE	MCV20	98-01	IK20	K20TT	IK20TT	IK20	VK20	6
		1MZ-FE	MCV30	01-08	IK20	K20TT	IK20TT	IK20	VK20	6
ES300h	2.5L 4Cyl 16V	2AR-FXE	AVV60	12-	FK16HR-A8	-	-	-	-	4
ES350	3.5L 6Cyl 24V	2GR-FE	GSV60	12-	IKH20TT	KH20TT	IKH20TT	-	VFKH20	6
GS250	2.5L 6Cyl 24V	4GR-FSE	GRL11	12-	IKBH20TT	-	IKBH20TT	-	VFKBH20	6
GS300	3.0L 6Cyl 24V	2JZ-GE	JZS160	97-04	IK20TT	K20TT	IK20TT	IK20	VK20	6
		3GR-FSE	GRS190	05-11	IKBH20TT	-	IKBH20TT	-	VFKBH20	6
GS300h	2.5L 4Cyl 16V	2AR-FSE	AWL10	13-	IKBH20TT	-	IKBH20TT	-	VFKBH20	4
GS350	3.5L 6Cyl 24V	2GR-FSE	GRL10	08-	IKBH20TT	-	IKBH20TT	-	VFKBH20	6
GS430	4.3L 8Cyl 32V	3UZ-FE	UZS190	05-08	IK20TT	K20TT	IK20TT	IK20	VK20	8
GS450h	3.5L 6Cyl 24V	2GR-FSE	GWS191	06-11	IKBH20TT	-	IKBH20TT	-	VFKBH20	6
		2GR-FXE	GWL10	12-	IKH20TT	KH20TT	IKH20TT	-	VFKH20	6
GS460	4.6L 8Cyl 32V	1UR-FSE	URS190	07-11	IKBH20TT	-	IKBH20TT	-	VFKBH20	8
IS C250	2.5L 6Cyl 24V	4GR-FSE	GSE20	09-14	IKBH20TT	-	IKBH20TT	-	VFKBH20	6
IS F	5.0L 8Cyl 32V	2UR-GSE	USE20	07-13	IKBH20TT	-	IKBH20TT	-	VFKBH20	8
IS200	2.0L 6Cyl 24V	1G-FE	GXE10	99-05	IK20TT	K20TT	IK20TT	IK20	VK20	6
IS200t	2.0L 4Cyl 16V	8AR-FTS	ASE30	15-	VDKH22F	-	-	-	VDKH22F	4
IS250	2.5L 6Cyl 24V	4GR-FSE	GSE20	05-13	IKBH20TT	-	IKBH20TT	-	VFKBH20	6
		4GR-FSE	GSE30	13-	IKBH20TT	-	IKBH20TT	-	VFKBH20	6
IS300	3.0L 6Cyl 24V	2JZ-GE	JCE10	01-05	IK20TT	K20TT	IK20TT	IK20	VK20	6
IS350	3.5L 6Cyl 24V	2GR-FSE	GSE21	08-13	IKBH20TT	-	IKBH20TT	-	VFKBH20	6
		2GR-FSE	GSE30	13-	IKBH20TT	-	IKBH20TT	-	VFKBH20	6
LS400	4.0L 8Cyl 32V	1UZ-FE	UCF10	89-95	IK20TT	K20TT	IK20TT	IK20	VK20	8
		1UZ-FE	UCF20	94-00	IK20TT	K20TT	IK20TT	-	VK20Y	8
LS430	4.3L 8Cyl 32V	3UZ-FE	UCF30	00-06	IK20TT	K20TT	IK20TT	IK20	VK20	8
LS460	4.6L 8Cyl 32V	1UR-FSE	USF40	06-	IKBH20TT	-	IKBH20TT	-	VFKBH20	8
LS600h	5.0L 8Cyl 32V	2UR-FSE	UVF45	13-	IKBH20TT	-	IKBH20TT	-	VFKBH20	8
LX470	4.7L 8Cyl 32V	2UZ-FE	UZJ100	98-08	IK20TT	K20TT	IK20TT	IK20	VK20	8
LX570	5.7L 8Cyl 32V	3UR-FE	URJ201	07-	IKH20TT	KH20TT	IKH20TT	IKH20	VKH20	8
NX200t	2.0L 4Cyl 16V	8AR-FTS	AGZ10	14-	VDKH22F	-	-	-	VDKH22F	4
		8AR-FTS	AGZ15	14-	VDKH22F	-	-	-	VDKH22F	4
NX300h	2.5L 4Cyl 16V	2AR-FXE	AYZ10	14-	FK16HR-A8	-	-	-	-	4
		2AR-FXE	AYZ15	14-	FK16HR-A8	-	-	-	-	4
RC350	3.5L 6Cyl 24V	2GR-FSE	GSC10	14-	IKBH20TT	-	IKBH20TT	-	VFKBH20	6
RCF	5.0L 8Cyl 32V	2UR-GSE	USC10	14-	IKBH20TT	-	IKBH20TT	-	VFKBH20	8
RX270	2.7L 4Cyl 16V	1AR-FE	AGL10	08-15	IKH16TT	KH16TT	IKH16TT	IKH16	VKH16	4
RX300	3.0L 6Cyl 24V	1MZ-FE	MCU15	00-03	IK20	K20TT	IK20TT	IK20	VK20	6
RX330	3.3L 6Cyl 24V	3MZ-FE	MCU38	03-08	IK20TT	K20TT	IK20TT	IK20	VK20	6
RX350	3.5L 6Cyl 24V	2GR-FE	GGL15	06-08	IKH20TT	KH20TT	IKH20TT	-	VFKH20	6
		2GR-FE,2GR-FXE	GRL10	08-15	IKH20TT	KH20TT	IKH20TT	-	VFKH20	6
RX400h	3.3L 6Cyl 24V	3MZ-FE	MHU38	06-08	IK20TT	K20TT	IK20TT	IK20	VK20	6
RX450h	3.5L 6Cyl 24V	2GR-FXE	GYL15	08-15	IKH20TT	KH20TT	IKH20TT	-	VFKH20	6
SC430	4.3L 8Cyl 32V	3UZ-FE	UZZ40	01-10	IK20TT	K20TT	IK20TT	IK20	VK20	8
LOTUS										
ELAN	1.6L 4Cyl 16V	4XE1-T	Turbo	89-95	K20PR-U	K20TT	IK20TT	-	VK20Y	4
ELISE	1.8L 4Cyl 16V	18 K4F		95-05	IK20TT	K20TT	IK20TT	IK20	VK20	4
		2ZZ-GE		02-	IK20TT	K20TT	IK20TT	IK20	VK20	4
		1ZZ-FE		03-	IXEH20TT	-	IXEH20TT	-	VCH20	4
		1ZR-FAE		07-	IXEH20TT	-	IXEH20TT	-	VCH20	4
ESPRIT	2.2L 4Cyl 16V	910 S	Turbo	89-96	IW20	W20TT	IW20TT	IW20	VW20	4
		618	Turbo	96-03	K20TNR-S	K20TT	IK20TT	IK20	VK20	4
EUROPA S	2.0L 4Cyl 16V	Z 20 LER	Turbo	06-	IK20TT	K20TT	IK20TT	IK20	VK20	4
EVORA	3.5L 6Cyl 24V	2GR-FE		09-16	IKH20TT	KH20TT	IKH20TT	-	VFKH20	6
EXIGE	1.8L 4Cyl 16V	2ZZ-GE	SCC_	01-08	IK20TT	K20TT	IK20TT	IK20	VK20	4
		2ZZ-GE	SCC_	06-12	VK22	-	-	IK22	VK22	4
		2ZZ-GE	Supercharged	06-12	VK22	-	-	IK22	VK22	4
		2GR-FE	Supercharged	12-	IKH20TT	KH20TT	IKH20TT	-	VFKH20	6
MASERATI										
3200 GT	3.2L 8Cyl 32V	AM 585	Biturbo	98-02	IU24	-	-	IU24	-	8
4200 GT	4.2L 8Cyl 32V	M 138		02-07	IU24	-	-	IU24	-	8
4200 GT SPYDER	4.2L 8Cyl 32V	M 138		01-	IU24	-	-	IU24	-	8
BITURBO	2.5L 6Cyl 18V			82-87	W24EP-U	-	-	IW24	-	6
	2.5L 6Cyl 12V	453		83-86	W24EP-U	-	-	IW24	-	6
	2.0L 6Cyl 18V	471		87-88	W24EPR-U	-	-	IW24	-	6

DENSO AUSTRALIA CHINA INDIA INDONESIA KOREA MALAYSIA PHILIPPINES SAUDI ARABIA SINGAPORE TAIWAN THAILAND VIETNAM JAPAN & USA EUROPE MOTOR SMALL ENGINE REFERENCE NUMBER PART

DENSO	9	14	16	20	22	24	27	29	31	32	34	35	DENSO	9	14	16	20	22	24	27	31	32	DENSO	9	14	16	20	22	24	27	31	
NGK	2	4	5	6	7	8	9	9.5	10	10.5	11	11.5	CHAMPION	18	16,14	12,11	10,9	8,7	6,63,61	4,59	57	55	53	BOSCH	10	9	8	7,6	5	4	3	2

Model	Engine Size	Engine Code	Specification	From To	DENSO					QTY	
MAZDA											
B-SERIE BRAVO	2.6L 4Cyl 12V	G6Y1	UN	99-06	KJ16CR-L11	K16TT	IK16TT	IK16L	-	4	
		JK26	UN	99-06	KJ16CR-L11	K16TT	IK16TT	IK16L	-	4	
	4.0L 6Cyl 12V	1V	MJ	05-06	IT16	T16TT	IT16TT	IT16	VT16	6	
CX-3	2.0L 4Cyl 16V	PE-VPS	DK	15-	IXEH20TT	-	IXEH20TT	-	VCH20	4	
		PEX0	DK	15-	IXEH20TT	-	IXEH20TT	-	VCH20	4	
CX-5	2.0L 4Cyl 16V	PEY5,PEY4	KE,KF	12-18	IXEH20TT	-	IXEH20TT	-	-	4	
	2.5L 4Cyl 16V	PYY1	KE,KF	13-	IXEH20TT	-	IXEH20TT	-	VCH20	4	
CX-7	2.3L 4Cyl 16V	L3-VDT	ER Turbo	06-14	ITV20	-	ITV20TT	ITV20	-	4	
	2.5L 4Cyl 16V	L5-VE	ER	09-13	ITV16	TV16TT	ITV16TT	ITV16	-	4	
CX-9	3.7L 6Cyl 24V	CAY6,CA,CAY5,CAY1	TB	07-	ITV20	-	ITV20TT	ITV20	-	6	
		CAY6,CAY1,CAY5	TB	07-	ITV20	-	ITV20TT	ITV20	-	6	
E1400	1.5L 4Cyl 8V	E5	SR2	84-88	W16EXR-U11	W16TT	IW16TT	IW16	VW16	4	
E1800	1.8L 4Cyl 12V	F8 (12V)	SR2	84-88	W16EP-U	W16TT	IW16TT	IW16	VW16	4	
E1800i	1.8L 4Cyl 8V	F8 (8V)	SG, SK	03-06	K16PR-U11	K16TT	IK16TT	IK16	VK16	4	
E2000	2.0L 4Cyl 8V	FE (8V)	SR2	84-90	W16EP-U	W16TT	IW16TT	IW16	VW16	4	
		FE61,FE60,FE (8V)	SR2	91-03	W16EP-U	W16TT	IW16TT	IW16	VW16	4	
		FE (8V)	SG, SK	04-06	K16PR-U11	K16TT	IK16TT	IK16	VK16	4	
FAMILIA	1.8L 4Cyl 16V	BP Turbo	BG Turbo	90-92	K20PR-U11	K20TT	IK20TT	IK20	VK20	4	
		BP Turbo	BG Turbo	93-94	IK20	K20TT	IK20TT	IK20	VK20	4	
MPV	3.0L 6Cyl 18V	JE94	LV	96-99	K16PR-U11	K16TT	IK16TT	IK16	VK16	6	
	2.5L 6Cyl 24V	GY-DE	LW	99-02	IT20	T20TT	IT20TT	IT20	VT20	6	
	3.0L 6Cyl 24V	AJ	LW	02-06	IT20	T20TT	IT20TT	IT20	VT20	6	
MX-5	1.6L 4Cyl 16V	B64F	NA	89-93	K20PR-U11	K20TT	IK20TT	IK20	VK20	4	
		BPF1,BP (DOHC)	NA	93-98	K16PR-U11	K16TT	IK16TT	IK16	VK16	4	
		BP-ZE	NB	98-05	K16PR-U11	K16TT	IK16TT	IK16	VK16	4	
		BPD	NB	00-05	K16PR-U11	K16TT	IK16TT	IK16	VK16	4	
		BP-ZE,BPD	NB	00-05	K16PR-U11	K16TT	IK16TT	IK16	VK16	4	
		BP Turbo	NB Turbo	02-02	K16PR-U11	K16TT	IK16TT	IK16	VK16	4	
		BP4W	NB	02-05	K16PR-U11	K16TT	IK16TT	IK16	VK16	4	
	BP Turbo	NB Turbo	02-05	IK16TT	K16TT	IK16TT	-	VFK16	4		
	2.0L 4Cyl 16V		NC	05-14	ITV20	-	ITV20TT	ITV20	-	4	
1.5L 4Cyl 16V	P5-VPR	ND	15-	IXEH20TT	-	IXEH20TT	-	VCH20	4		
2.0L 4Cyl 16V	PEX6,PEX4	ND	15-	IXEH20TT	-	IXEH20TT	-	VCH20	4		
MX-6	2.2L 4Cyl 12V	F2T	GD Turbo	87-91	IQ20	Q20TT	IQ20TT	IQ20	VQ20	4	
	2.5L 6Cyl 24V	KL	GE	91-97	KJ16CR-L11	K16TT	IK16TT	IK16L	-	6	
PREMACY	1.9L 4Cyl 16V	FP	CP	01-02	K16PR-U11	K16TT	IK16TT	IK16	VK16	4	
	2.0L 4Cyl 16V	FS7E,FS7G	CP	02-03	KJ16CR-L11	K16TT	IK16TT	IK16L	-	4	
RX 7	1.3L 2Cyl 2V	RE13B	FD Twin Turbo	92-96	IRE01-27	-	-	-	-	4	
	1.1L 2Rotor	12A	SA	79-86	IRE01-27	-	-	-	-	4	
	1.3L 2Rotor	RE13B	FC Leading / trailing	85-89	IRE01-27 / IRE01-31	-	-	-	-	2 each	
RE13B		FC Turbo Leading / trailing	87-91	IRE01-27 / IRE01-31	-	-	-	-	2 each		
RX-8	1.3L 2Rotor	13B-MSP	SE17 Leading / trailing	03-12	L) IRL01-27 T) IRT01-31	-	-	-	-	2 each	
TELSTAR	2.0L 4Cyl 8V	FE (8V)	GC	83-87	W16EPR-U	W16TT	IW16TT	IW16	VW16	4	
		FET	GC Turbo	86-87	W20EPR-U11	W20TT	IW20TT	IW20	VW20	4	
	2.2L 4Cyl 12V	F2	GD	87-91	KJ20CR-L11	K20TT	IK20TT	IK20L	-	4	
TRIBUTE	3.0L 6Cyl 24V	AJ	EP	00-07	IT16TT	T16TT	IT16TT	IT16	VT16	6	
	2.0L 4Cyl 16V	YF	EP	01-04	ITV16TT	TV16TT	ITV16TT	ITV16	-	4	
	2.3L 4Cyl 16V	L3-VE	EP	04-08	IT16 / ITV16	-	ITV16TT / ITV16TT	IT16 / ITV16	VT16 / -	4	
MERCEDES-BENZ											
A-CLASS	1.4L 4Cyl 8V	M 166.940	A 140 W168	97-04	IK16	K16TT	IK16TT	IK16	VK16	4	
	1.6L 4Cyl 8V	M 166.960	A 160 W168	97-04	IK16	K16TT	IK16TT	IK16	VK16	4	
	1.9L 4Cyl 8V	M 166.990	A 190 W168	99-04	IK16	K16TT	IK16TT	IK16	VK16	4	
	1.5L 4Cyl 8V	M 266.920	A 150 W169	04-12	K20PR-U	K20TT	IK20TT	-	VK20Y	4	
	1.7L 4Cyl 8V	M 266.940	A 170 W169	04-12	K20PR-U	K20TT	IK20TT	-	VK20Y	4	
	2.0L 4Cyl 8V	M 266.960	A 200 W169	04-12	K20PR-U	K20TT	IK20TT	-	VK20Y	4	
		M 266.980	A 200 TURBO W169	05-12	K20PR-U	K20TT	IK20TT	-	VK20Y	4	
	1.7L 4Cyl 8V	M 266.940	A 180 W169	09-12	K20PR-U11	K20TT	IK20TT	IK20	VK20	4	
	B-CLASS	2.0L 4Cyl 8V	M 266.980	B 200 TURBO W245	05-11	K20PR-U	K20TT	IK20TT	-	VK20Y	4
			M 266.960	B 200 W245	05-11	K20PR-U	K20TT	IK20TT	-	VK20Y	4
1.7L 4Cyl 8V	M 266.940	B 180 W245	09-11	K20PR-U	K20TT	IK20TT	-	VK20Y	4		
C-CLASS	1.8L 4Cyl 16V	M 111.921,M 111.920	C 180 W202	93-00	K20PR-U / IK16	K20TT / K16TT	IK20TT / IK16TT	- / IK16	VK20Y / VK16	4	
	2.8L 6Cyl 24V	M 104.941	C 280 W202	93-00	K20PR-U	K20TT	IK20TT	-	VK20Y	6	
	2.2L 4Cyl 16V	M 111.961	C 220 W202	94-00	K20PR-U	K20TT	IK20TT	-	VK20Y	4	
	2.0L 4Cyl 16V	M 111.941,M 111.945	C 200 W202	96-00	K20PR-U	K20TT	IK20TT	-	VK20Y	4	
	2.3L 4Cyl 16V	M 111.974	C 230 W202	96-97	IQ20	Q20TT	IQ20TT	IQ20	VQ20	4	
2.4L 6Cyl 18V	M 112.910	C 240 T S202	97-00	IK16TT	K16TT	IK16TT	IK16	VK16	12		

DENSO	9	14	16	20	22	24	27	29	31	32	34	35	DENSO	9	14	16	20	22	24	27	29	31	32	DENSO	9	14	16	20	22	24	27	31
NGK	2	4	5	6	7	8	9	9.5	10	10.5	11	11.5	CHAMPION	18	16,14	12,11	10,9	8,7	6,63,61	4,59	57	55	53	BOSCH	10	9	8	7,6	5	4	3	2

DENSO
 AUSTRALIA
 CHINA
 INDIA
 INDONESIA
 KOREA
 MALAYSIA
 PHILIPPINES
 SAUDI ARABIA
 SINGAPORE
 TAIWAN
 THAILAND
 VIETNAM
 JAPAN
 EUROPE
 MOTOR & USA
 CYCLE
 SMALL ENGINE
 CROSS REFERENCE
 PART NUMBER



AUSTRALIA CAR

▶ Spark plug color codes: ■ for Iridium Tough and Iridium Plugs and Iridium TT, ■ for Iridium Power, ■ for Iridium Racing and Two Tops Plugs, ■ for Platinum Plugs and Platinum TT, and black for general spark plugs.

DENSO**AUSTRALIA****CHINA****INDIA****INDONESIA****KOREA****MALAYSIA****PHILIPPINES****SAUDI ARABIA****SINGAPORE****TAIWAN****THAILAND****VIETNAM****JAPAN****EUROPE****& USA****MOTOR****CYCLE****SMALL****CROSS****REFERENCE****PART****NUMBER**

Model	Engine Size	Engine Code	Specification	From To	DENSO					QTY
MERCEDES-BENZ										
C-CLASS										
2.4L 6Cyl 18V	M 112.910	C 240 W202	97-00	IK16TT	K16TT	IK16TT	IK16	VK16	12	
2.8L 6Cyl 18V	M 112.920	C 280 W202	97-00	IK16TT	K16TT	IK16TT	IK16	VK16	12	
4.3L 8Cyl 24V	M 113.944	C 43 AMG W202	97-00	IK16TT	K16TT	IK16TT	IK16	VK16	16	
	M 113.944	C 43 AMG S202	97-01	IK16TT	K16TT	IK16TT	IK16	VK16	16	
2.0L 4Cyl 16V	M 111.956	C 200 T Kompressor S202	00-01	IK20TT	K20TT	IK20TT	IK20	VK20	4	
	M 111.951	C 180 W203	00-02	IK20TT	K20TT	IK20TT	IK20	VK20	4	
2.6L 6Cyl 18V	M 111.955	C 200 Kompressor W203	00-02	IK20TT	K20TT	IK20TT	IK20	VK20	4	
	M 112.912	C 240 W203	00-07	IK16TT	K16TT	IK16TT	IK16	VK16	12	
3.2L 6Cyl 18V	M 112.946	C 320 W203	00-07	IK16TT	K16TT	IK16TT	IK16	VK16	12	
	M 111.951	C 180 CL203	01-02	IK20TT	K20TT	IK20TT	IK20	VK20	4	
2.0L 4Cyl 16V	M 111.955	C 200 Kompressor CL203	01-02	IK20TT	K20TT	IK20TT	IK20	VK20	4	
	M 111.955	C 200 Kompressor S203	01-02	IK20TT	K20TT	IK20TT	IK20	VK20	4	
3.2L 6Cyl 18V	M 112.961	C 32 AMG Kompressor W203	01-07	IK20TT	K20TT	IK20TT	IK20	VK20	12	
	M 271.946	C 180 Kompressor W203	02-07	IKH20TT	KH20TT	IKH20TT	IKH20	VKH20	4	
1.8L 4Cyl 16V	M 271.940	C 200 Kompressor S203	02-07	IKH20TT	KH20TT	IKH20TT	IKH20	VKH20	4	
	M 271.940	C 200 Kompressor W203	02-07	IKH20TT	KH20TT	IKH20TT	IKH20	VKH20	4	
5.4L 8Cyl 24V	M 271.940	C 200 Kompressor CL203	02-08	IKH20TT	KH20TT	IKH20TT	IKH20	VKH20	4	
	M 271.940	C 220 CL203	02-08	IKH20TT	KH20TT	IKH20TT	IKH20	VKH20	4	
1.8L 4Cyl 16V	M 271.948	C 230 Kompressor CL203	02-08	IKH20TT	KH20TT	IKH20TT	IKH20	VKH20	4	
	M 113.988	C 55 AMG W203	04-07	IK16TT	K16TT	IK16TT	IK16	VK16	16	
1.8L 4Cyl 16V	M 271.946	C 180 Kompressor CL203	04-08	IKH20TT	KH20TT	IKH20TT	IKH20	VKH20	4	
	M 272.920	C 230 S203	05-07	VXUH22I	-	-	IXUH22I	VXUH22I	6	
2.5L 6Cyl 24V	M 272.920	C 230 W203	05-07	VXUH22I	-	-	IXUH22I	VXUH22I	6	
	M 272.940	C 280 W203	05-07	VXUH22I	-	-	IXUH22I	VXUH22I	6	
3.0L 6Cyl 24V	M 272.960	C 350 W203	05-07	IK16TT	K16TT	IK16TT	IK16	VK16	6	
2.5L 6Cyl 24V	M 272.920	C 230 CL203	05-08	VXUH22I	-	-	IXUH22I	VXUH22I	6	
	M 271.950	C 200 Kompressor S204	07-14	VXUH22	-	-	IXUH22	VXUH22	4	
1.8L 4Cyl 16V	M 271.950	C 200 Kompressor W204	07-14	VXUH22	-	-	IXUH22	VXUH22	4	
	M 271.820,M 271.860	C 200 S204	07-14	VXUH22	-	-	IXUH22	VXUH22	4	
2.5L 6Cyl 24V	M 271.860,M 271.820	C 200 W204	07-14	VXUH22I	-	-	IXUH22I	VXUH22I	4	
	M 272.921	C 230 S204	07-14	VXUH22I	-	-	IXUH22I	VXUH22I	6	
3.0L 6Cyl 24V	M 272.921	C 230 W204	07-14	VXUH22I	-	-	IXUH22I	VXUH22I	6	
	M 272.947	C 280 W204	07-14	VXUH22I	-	-	IXUH22I	VXUH22I	6	
3.5L 6Cyl 24V	M 272.961	C 350 W204	07-14	VXUH22I	-	-	IXUH22I	VXUH22I	6	
6.2L 8Cyl 32V	M 156.985	C 63 AMG S204	08-14	IXEH22TT	-	IXEH22TT	-	VFXEH22	8	
	M 271.860	C 250 S204	09-14	VXUH22	-	-	IXUH22	VXUH22	4	
1.8L 4Cyl 16V	M 271.860	C 250 W204	09-14	VXUH22I	-	-	IXUH22I	VXUH22I	4	
	M 272.947	C 300 W204	09-14	VXUH22I	-	-	IXUH22I	VXUH22I	6	
1.8L 4Cyl 16V	M 271.820	C 180 C204	11-	VXUH22	-	-	IXUH22	VXUH22	4	
	M 271.860	C 250 C204	11-	VXUH22	-	-	IXUH22	VXUH22	4	
3.5L 6Cyl 24V	M 276.957	C 350 C204	11-	VXUH22I	-	-	IXUH22I	VXUH22I	6	
6.2L 8Cyl 32V	M 156.985	C 63 AMG C204	11-	IXEH22TT	-	IXEH22TT	-	VFXEH22	8	
1.6L 4Cyl 16V	M 274.910	C 180 C204	13-	VXUH22I	-	-	IXUH22I	VXUH22I	4	
CLC-CLASS										
1.8L 4Cyl 16V	M 271.957	CLC 200 Kompressor CL203	08-11	VXUH22	-	-	IXUH22	VXUH22	4	
CLK										
2.3L 4Cyl 16V	M 111.975,M 111.973	230 Kompressor C208	97-00	K20PBR-S10	K20TT	IK20TT	IK20	VK20	4	
2.0L 4Cyl 16V	M 111.945	200 C208	97-02	K20PR-U	K20TT	IK20TT	-	VK20Y	4	
3.2L 6Cyl 18V	M 112.940	320 C208	97-02	IK16TT	K16TT	IK16TT	IK16	VK16	12	
2.3L 4Cyl 16V	M 111.975,M 111.973	230 Kompressor A208	98-00	K20PBR-S10	K20TT	IK20TT	IK20	VK20	4	
2.0L 4Cyl 16V	M 111.941,M 111.945	200 A208	98-02	K20PR-U	K20TT	IK20TT	-	VK20Y	4	
3.2L 6Cyl 18V	M 112.940	320 A208	98-02	IK16TT	K16TT	IK16TT	IK16	VK16	12	
4.3L 8Cyl 24V	M 113.943	430 A208	98-02	IK16TT	K16TT	IK16TT	IK16	VK16	16	
	M 113.943	430 C208	98-02	IK16TT	K16TT	IK16TT	IK16	VK16	16	
5.4L 8Cyl 24V	M 113.981,M 113.984	55 AMG C208	99-02	IK16TT	K16TT	IK16TT	IK16	VK16	16	
2.0L 4Cyl 16V	M 111.956	200 Kompressor A208	00-02	IK20TT	K20TT	IK20TT	IK20	VK20	4	
	M 111.956	200 Kompressor C208	00-02	IK20TT	K20TT	IK20TT	IK20	VK20	4	
2.3L 4Cyl 16V	M 111.982	230 Kompressor A208	00-02	IK20TT	K20TT	IK20TT	IK20	VK20	4	
	M 111.982	230 Kompressor C208	00-02	IK20TT	K20TT	IK20TT	IK20	VK20	4	
2.6L 6Cyl 18V	M 112.912	240 C209	02-09	IK16TT	K16TT	IK16TT	IK16	VK16	6	
3.2L 6Cyl 18V	M 112.955	320 C209	02-09	IK16TT	K16TT	IK16TT	IK16	VK16	12	
5.0L 8Cyl 24V	M 113.968	500 C209	02-09	IK16TT	K16TT	IK16TT	IK16	VK16	16	
5.4L 8Cyl 24V	M 113.987	55 AMG C209	02-09	IK20TT	K20TT	IK20TT	IK20	VK20	16	
2.6L 6Cyl 18V	M 112.912	CLK 240 A209	03-10	IK16TT	K16TT	IK16TT	IK16	VK16	6	
3.2L 6Cyl 18V	M 112.955	CLK 320 A209	03-10	IK16TT	K16TT	IK16TT	IK16	VK16	12	
5.0L 8Cyl 24V	M 113.968	CLK 500 A209	03-10	IK16TT	K16TT	IK16TT	IK16	VK16	16	
5.5L 8Cyl 24V	M 113.987	CLK 55 AMG A209	03-10	IK20TT	K20TT	IK20TT	IK20	VK20	16	
1.8L 4Cyl 16V	M 271.940	200 Kompressor C209	04-09	IKH20TT	KH20TT	IKH20TT	IKH20	VKH20	4	
3.0L 6Cyl 24V	M 272.940	280 C209	05-09	VXUH22I	-	-	IXUH22I	VXUH22I	6	

Model	Engine Size	Engine Code	Specification	From To	DENSO					QTY
MERCEDES-BENZ										
CLK	3.5L 6Cyl 24V	M 272.960	350 C209	05-09	VXUH22I	-	-	IXUH22I	VXUH22I	6
	1.8L 4Cyl 16V	M 271.940	CLK 200 Kompressor A209	05-10	IKH20TT	KH20TT	IKH20TT	IKH20	VKH20	4
	3.0L 6Cyl 24V	M 272.940	CLK 280 A209	05-10	VXUH22I	-	-	IXUH22I	VXUH22I	6
	3.5L 6Cyl 24V	M 272.960	CLK 350 A209	05-10	VXUH22I	-	-	IXUH22I	VXUH22I	6
	1.8L 4Cyl 16V	M 271.955	200 Kompressor C209	06-09	VXUH22	-	-	IXUH22	VXUH22	4
	5.5L 8Cyl 32V	M 273.965	500 C209	06-09	VXUH22I	-	-	IXUH22I	VXUH22I	16
	6.2L 8Cyl 32V	M 156.982	63 AMG C209	06-09	IXEH22TT	-	IXEH22TT	-	VFXEH22	8
	1.8L 4Cyl 16V	M 271.955	CLK 200 Kompressor A209	06-10	VXUH22	-	-	IXUH22	VXUH22	4
	5.5L 8Cyl 32V	M 273.967	CLK 500 A209	06-10	VXUH22I	-	-	IXUH22I	VXUH22I	16
	6.2L 8Cyl 32V	M 156.982	CLK 63 AMG A209	06-10	IXEH22TT	-	IXEH22TT	-	VFXEH22	8
CLS	3.5L 6Cyl 24V	M 272.964	CLS 350 C219	05-10	VXUH22I	-	-	IXUH22I	VXUH22I	6
	5.0L 8Cyl 24V	M 113.967	CLS 500 C219	05-10	IK16TT	K16TT	IK16TT	IK16	VK16	16
	5.4L 8Cyl 24V	M 113.990	CLS 55 AMG C219	05-10	IKH20TT	KH20TT	IKH20TT	IKH20	VKH20	16
	5.5L 8Cyl 32V	M 273.960	CLS 500 C219	06-10	VXUH22I	-	-	IXUH22I	VXUH22I	8
	6.2L 8Cyl 32V	M 156.983	CLS 63 AMG C219	06-10	IXEH22TT	-	IXEH22TT	-	VFXEH22	8
5.5L 8Cyl 32V	M 157.981,M 157.980	CLS 63 AMG C218	11-	IXEH22TT	-	IXEH22TT	-	VFXEH22	8	
COUPE	3.0L 6Cyl 12V	M 103.983	300 CE C124	87-93	T20EP-U	T20TT	IT20TT	IT20	VT20	6
		M 103.983	300 CE C124	88-90	T16EPR-U	T16TT	IT16TT	IT16	VT16	6
	3.0L 6Cyl 24V	M 104.980	300 CE C124	90-93	Q16-U	Q16TT	IQ16TT	IQ16	VQ16	6
E190	2.0L 4Cyl 8V	M 102.961,M 102.962	W201	82-93	T20EP-U	T20TT	IT20TT	IT20	VT20	4
		M 102.962	W201	85-93	T20EP-U	T20TT	IT20TT	IT20	VT20	4
	2.3L 4Cyl 8V	M 102.985	W201	86-91	T20EP-U	T20TT	IT20TT	IT20	VT20	4
E-CLASS	2.2L 4Cyl 16V	M 111.960	E 220 W124	93-95	IQ20	Q20TT	IQ20TT	IQ20	VQ20	4
	2.8L 6Cyl 24V	M 104.942	E 280 W124	93-95	IQ20	Q20TT	IQ20TT	IQ20	VQ20	6
	3.2L 6Cyl 24V	M 104.992	E 320 W124	93-95	IQ20	Q20TT	IQ20TT	IQ20	VQ20	6
	2.2L 4Cyl 16V	M 111.960	E 220 T S124	93-96	IQ20	Q20TT	IQ20TT	IQ20	VQ20	4
		M 111.960	E 220 C124	93-97	IQ20	Q20TT	IQ20TT	IQ20	VQ20	4
	3.2L 6Cyl 24V	M 104.992	E 320 C124	93-97	IQ20	Q20TT	IQ20TT	IQ20	VQ20	6
	2.2L 4Cyl 16V	M 111.960	E 220 A124	93-98	IQ20	Q20TT	IQ20TT	IQ20	VQ20	4
	3.2L 6Cyl 24V	M 104.992	E 320 A124	93-98	IQ20	Q20TT	IQ20TT	IQ20	VQ20	6
	3.2L 6Cyl 18V	M 112.941	E 320 T S210	96-03	IK16TT	K16TT	IK16TT	IK16	VK16	12
	3.2L 6Cyl 24V	M 104.995	E 320 W210	96-97	IQ20	Q20TT	IQ20TT	IQ20	VQ20	6
	2.3L 4Cyl 16V	M 111.970	E 230 W210	96-98	Q16-U	Q16TT	IQ16TT	IQ16	VQ16	4
	2.4L 6Cyl 18V	M 112.911	E 240 W210	97-00	IK16TT	K16TT	IK16TT	IK16	VK16	6
	3.2L 6Cyl 18V	M 112.941	E 320 W210	97-02	IK16TT	K16TT	IK16TT	IK16	VK16	12
	4.3L 8Cyl 24V	M 113.940	E 430 W210	97-02	IK16TT	K16TT	IK16TT	IK16	VK16	16
	5.4L 8Cyl 24V	M 113.980	E 55 AMG W210	97-02	IK16TT	K16TT	IK16TT	IK16	VK16	16
	2.4L 6Cyl 18V	M 112.911	E 240 T S210	97-03	IK16TT	K16TT	IK16TT	IK16	VK16	6
	2.8L 6Cyl 18V	M 112.921	E 280 W210	98-02	IK16TT	K16TT	IK16TT	IK16	VK16	12
	2.0L 4Cyl 16V	M 111.957	E 200 Kompressor W210	00-02	IK20TT	K20TT	IK20TT	IK20	VK20	4
	2.6L 6Cyl 18V	M 112.914	E 240 W210	00-02	IK16TT	K16TT	IK16TT	IK16	VK16	6
		M 112.914	E 240 T S210	00-03	IK16TT	K16TT	IK16TT	IK16	VK16	6
	3.2L 6Cyl 18V	M 112.949	E 320 W211	02-08	IK16TT	K16TT	IK16TT	IK16	VK16	12
	5.0L 8Cyl 24V	M 113.967	E 500 W211	02-08	IK16TT	K16TT	IK16TT	IK16	VK16	16
	5.5L 8Cyl 24V	M 113.990	E 55 AMG Kompressor W211	02-08	IKH20TT	KH20TT	IKH20TT	IKH20	VKH20	8
	2.6L 6Cyl 18V	M 112.913,M 112.917	E 240 W211	03-08	IK16TT	K16TT	IK16TT	IK16	VK16	6
		M 112.913	E 240 T S211	03-09	IK16TT	K16TT	IK16TT	IK16	VK16	6
	3.2L 6Cyl 18V	M 112.949	E 320 T S211	03-09	IK16TT	K16TT	IK16TT	IK16	VK16	12
	5.0L 8Cyl 24V	M 113.967	E 500 T S211	03-09	IK16TT	K16TT	IK16TT	IK16	VK16	8
	5.4L 8Cyl 24V	M 113.990	E 55 T AMG Kompressor S211	03-09	IKH20TT	KH20TT	IKH20TT	IKH20	VKH20	16
	1.8L 4Cyl 16V	M 271.941	E 200 Kompressor W211	04-08	IKH20TT	KH20TT	IKH20TT	IKH20	VKH20	4
	3.0L 6Cyl 24V	M 272.943	E 280 W211	05-08	VXUH22I	-	-	IXUH22I	VXUH22I	6
	3.5L 6Cyl 24V	M 272.964	E 350 W211	05-08	VXUH22I	-	-	IXUH22I	VXUH22I	6
	3.0L 6Cyl 24V	M 272.943	E 280 T S211	05-09	VXUH22I	-	-	IXUH22I	VXUH22I	6
	3.5L 6Cyl 24V	M 272.964	E 350 T S211	05-09	VXUH22I	-	-	IXUH22I	VXUH22I	6
	1.8L 4Cyl 16V	M 271.956	E 200 Kompressor W211	06-08	VXUH22	-	-	IXUH22	VXUH22	4
	5.5L 8Cyl 32V	M 273.960	E 500 W211	06-08	VXUH22I	-	-	IXUH22I	VXUH22I	8
6.2L 8Cyl 32V	M 156.983	E 63 AMG W211	06-08	IXEH22TT	-	IXEH22TT	-	VFXEH22	8	
5.5L 8Cyl 32V	M 273.960	E 500 T S211	06-09	VXUH22I	-	-	IXUH22I	VXUH22I	8	
6.2L 8Cyl 32V	M 156.983	E 63 AMG S211	06-09	IXEH22TT	-	IXEH22TT	-	VFXEH22	8	
1.8L 4Cyl 16V	M 271.820,M 271.860	E 200 W212	09-	VXUH22	-	-	IXUH22	VXUH22	4	
	M 271.860	E 250 C207	09-	VXUH22	-	-	IXUH22	VXUH22	4	
	M 271.860	E 250 W212	09-	VXUH22	-	-	IXUH22	VXUH22	4	
3.5L 6Cyl 24V	M 272.980	E 350 S212	09-	VXUH22I	-	-	IXUH22I	VXUH22I	6	
	M 272.980	E 350 W212	09-	VXUH22I	-	-	IXUH22I	VXUH22I	6	
5.5L 8Cyl 32V	M 273.966	E 500 C207	09-	VXUH22I	-	-	IXUH22I	VXUH22I	8	
	M 273.971	E 500 W212	09-	VXUH22I	-	-	IXUH22I	VXUH22I	8	

DENSO	9	14	16	20	22	24	27	29	31	32	34	35	DENSO	9	14	16	20	22	24	27	29	31	32	DENSO	9	14	16	20	22	24	27	31
NGK	2	4	5	6	7	8	9	9.5	10	10.5	11	11.5	CHAMPION	18	16,14	12,11	10,9	8,7	6,63,61	4,59	57	55	53	BOSCH	10	9	8	7,6	5	4	3	2

DENSO
 AUSTRALIA
 CHINA
 INDIA
 INDONESIA
 KOREA
 MALAYSIA
 PHILIPPINES
 SAUDI ARABIA
 SINGAPORE
 TAIWAN
 THAILAND
 VIETNAM
 JAPAN
 EUROPE
 MOTOR & USA
 CYCLE
 SMALL ENGINE
 CROSS REFERENCE
 PART NUMBER



AUSTRALIA CAR

▶ Spark plug color codes: ■ for Iridium Tough and Iridium Plugs and Iridium TT, ■ for Iridium Power, ■ for Iridium Racing and Two Tops Plugs, ■ for Platinum Plugs and Platinum TT, and black for general spark plugs.

PART NUMBER	CROSS REFERENCE	SMALL ENGINE	MOTOR CYCLE	EUROPE & USA	JAPAN	VIETNAM	THAILAND	TAIWAN	SINGAPORE	SAUDI ARABIA	PHILIPPINES	MALAYSIA	INDONESIA	INDIA	CHINA	AUSTRALIA	DENSU	Model	Engine Size	Engine Code	Specification	From To	DENSO					QTY
																		Model	Engine Size	Engine Code	Specification	From To	DENSO					QTY
MERCEDES-BENZ																												
E-CLASS																												
																		6.2L 8Cyl 32V	M 156.985	E 63 AMG W212	09-	IXEH22TT	-	IXEH22TT	-	VFXEH22	8	
																		1.8L 4Cyl 16V	M 271.860	E 250 A207	10-	VXUH22	-	-	-	IXUH22	VXUH22	4
																		5.5L 8Cyl 32V	M 273.966	E 500 A207	10-	VXUH22I	-	-	-	IXUH22I	VXUH22I	8
G-CLASS																												
																		5.5L 8Cyl 24V	M 113.993	G 55 AMG W463	08-	IKH20TT	KH20TT	IKH20TT	IKH20	VKH20	16	
GL-CLASS																												
																		4.7L 8Cyl 32V	M 273.923	GL 450 X164	06-	VXUH22I	-	-	-	IXUH22I	VXUH22I	8
																		5.5L 8Cyl 32V	M 273.963	GL 500 X164	06-	VXUH22I	-	-	-	IXUH22I	VXUH22I	8
KOMBI																												
																		3.0L 6Cyl 12V	M 103.983	300 TE S124	86-89	T16EPR-U	T16TT	IT16TT	IT16	VT16	6	
																			M 103.983	300 TE S124	86-92	T20EP-U	T20TT	IT20TT	IT20	VT20	6	
																		3.2L 6Cyl 24V	M 104.992	320 TE S124	92-93	IQ20	Q20TT	IQ20TT	IQ20	VQ20	6	
MB100																												
																		2.3L 4Cyl 16V	2.3 i	KPA	99-05	Q16-U	Q16TT	IQ16TT	IQ16	VQ16	4	
MB140																												
																		2.3L 4Cyl 16V	2.3 i	KPA	99-05	Q16-U	Q16TT	IQ16TT	IQ16	VQ16	4	
M-CLASS																												
																		3.2L 6Cyl 18V	M 112.942	ML 320 W163	98-03	IK16TT	K16TT	IK16TT	IK16	VK16	6	
																		4.3L 8Cyl 24V	M 113.942	ML 430 W163	99-01	IK16TT	K16TT	IK16TT	IK16	VK16	8	
																		5.4L 8Cyl 24V	M 113.981	ML 55 AMG W163	00-05	IK16TT	K16TT	IK16TT	IK16	VK16	16	
																		5.0L 8Cyl 24V	M 113.965, M 113.964	ML 500 W163	01-05	IK16TT	K16TT	IK16TT	IK16	VK16	16	
																		3.7L 6Cyl 18V	M 112.970	ML 350 W163	02-05	IK16TT	K16TT	IK16TT	IK16	VK16	12	
																		3.5L 6Cyl 24V	M 272.967	ML 350 W164	05-11	VXUH22I	-	-	-	IXUH22I	VXUH22I	12
																		5.0L 8Cyl 24V	M 113.964	ML 500 W164	05-11	IK16TT	K16TT	IK16TT	IK16	VK16	16	
																		5.5L 8Cyl 32V	M 273.963	ML 500 W164	05-11	VXUH22I	-	-	-	IXUH22I	VXUH22I	16
																		6.2L 8Cyl 32V	M 156.980	ML 63 AMG W164	06-11	IXEH22TT	-	IXEH22TT	-	VFXEH22	8	
																		3.5L 6Cyl 24V	M 276.955	ML 350 W166	11-15	VXUH22I	-	-	-	IXUH22I	VXUH22I	6
																		5.5L 8Cyl 32V	M 157.982	ML 63 AMG W166	11-15	VXUH22I	-	-	-	IXUH22I	VXUH22I	16
R-CLASS																												
																		3.5L 6Cyl 24V	M 272.967	R 350 W251, V251	06-	VXUH22I	-	-	-	IXUH22I	VXUH22I	6
																		5.0L 8Cyl 24V	M 113.971	R 500 W251, V251	06-	IK16TT	K16TT	IK16TT	IK16	VK16	8	
																		6.2L 8Cyl 32V	M 156.980	R 63 AMG W251, V251	06-	IXEH22TT	-	IXEH22TT	-	VFXEH22	8	
																		5.5L 8Cyl 32V	M 273.963	R 500 W251, V251	07-	VXUH22I	-	-	-	IXUH22I	VXUH22I	8
S-CLASS																												
																		3.0L 6Cyl 12V	M 103.981	300 SE, SEL W126	85-91	T20EP-U	T20TT	IT20TT	IT20	VT20	6	
																		4.1L 8Cyl 16V	M 116.965	420 SE, SEL W126	85-91	W20EP-U	W20TT	IW20TT	IW20	VW20	8	
																		5.5L 8Cyl 16V	M 117.968	560 SE, SEL W126	85-91	W20EP-U	W20TT	IW20TT	IW20	VW20	8	
																		4.2L 8Cyl 32V	M 119.971	400 SE, SEL W140	91-98	IQ20	Q20TT	IQ20TT	IQ20	VQ20	8	
																		3.2L 6Cyl 24V	M 104.994, M 104.990	300 SE, SEL W140	92-93	IQ20	Q20TT	IQ20TT	IQ20	VQ20	6	
																		5.0L 8Cyl 32V	M 119.970	SEC/CL 500 C140	92-99	IQ20	Q20TT	IQ20TT	IQ20	VQ20	8	
																		4.2L 8Cyl 32V	M 119.971	S 420 W140	93-98	IQ20	Q20TT	IQ20TT	IQ20	VQ20	8	
																		5.0L 8Cyl 32V	M 119.970, M 119.980	S 500 W140	93-98	IQ20	Q20TT	IQ20TT	IQ20	VQ20	8	
																		6.0L 12Cyl 48V	M 120.982, M 120.980	S 600 W140	93-98	K20PR-U	K20TT	IK20TT	-	VK20Y	12	
																		2.8L 6Cyl 24V	M 104.944	S 280 W140	95-98	IQ20	Q20TT	IQ20TT	IQ20	VQ20	6	
																		3.2L 6Cyl 18V	M 112.944	S 320 W220	98-05	IK16TT	K16TT	IK16TT	IK16	VK16	6	
																			M 137.970	CL 600 C215	99-06	IK16TT	K16TT	IK16TT	IK16	VK16	24	
																		5.8L 12Cyl 36V	M 137.970	S 600 W220	00-05	IK20TT	K20TT	IK20TT	IK20	VK20	12	
																		5.0L 8Cyl 24V	M 113.960	CL 500 C215	00-06	IK16TT	K16TT	IK16TT	IK16	VK16	8	
																			M 113.991	S 55 AMG Kompressor W220	02-05	IKH20TT	KH20TT	IKH20TT	IKH20	VKH20	16	
																			M 113.991	CL 55 AMG Kompressor C215	02-06	IKH20TT	KH20TT	IKH20TT	IKH20	VKH20	16	
																			M 275.950	CL 600 C215	02-06	VK20Y	-	-	-	VK20Y	24	
																		3.7L 6Cyl 18V	M 112.972	S 350 W220	03-05	IK16TT	K16TT	IK16TT	IK16	VK16	12	
																		4.3L 8Cyl 24V	M 113.941	S 430 W220	03-05	IK16TT	K16TT	IK16TT	IK16	VK16	8	
																		5.0L 8Cyl 24V	M 113.960, M 113.966	S 500 W220	03-05	IK16TT	K16TT	IK16TT	IK16	VK16	16	
																		5.5L 12Cyl 36V	M 275.950	S 600 W220	03-05	VK20Y	-	-	-	VK20Y	24	
																			M 275.980	CL 65 AMG C215	03-06	VK20Y	-	-	-	VK20Y	24	
																			M 275.980	S 63 AMG W220	04-05	VK20Y	-	-	-	VK20Y	24	
																		3.5L 6Cyl 24V	M 272.965	S 350 W221	05-13	VXUH22I	-	-	-	IXUH22I	VXUH22I	12
																		4.7L 8Cyl 32V	M 273.922	S 450 W221	05-13	VXUH22I	-	-	-	IXUH22I	VXUH22I	8
																		5.5L 8Cyl 32V	M 273.961	S 500 W221	05-13	VXUH22I	-	-	-	IXUH22I	VXUH22I	8
																		5.5L 12Cyl 36V	M 275.953	S 600 W221	05-13	VK20Y	-	-	-	VK20Y	24	
																		6.0L 12Cyl 36V	M 275.982	S 63 AMG W221	05-13	VK20Y	-	-	-	VK20Y	24	
																		5.5L 8Cyl 32V	M 273.961	CL 500 C216	06-13	VXUH22I	-	-	-	IXUH22I	VXUH22I	8

Model	Engine Size	Engine Code	Specification	From To	DENSO					QTY
MERCEDES-BENZ										
SL										
4.9L 8Cyl 16V	M 117.960,M 117.964	500 SL R107	86-89	W20EX-U	W20TT	IW20TT	IW20	VW20	8	
	M 117.964	500 SL R107	86-89	W20EX-U	W20TT	IW20TT	IW20	VW20	8	
5.0L 8Cyl 32V	M 119.972,M 119.960	500 SL R129	89-92	IQ20	Q20TT	IQ20TT	IQ20	VQ20	8	
	M 119.972,M 119.982	500 R129	92-01	IQ20	Q20TT	IQ20TT	IQ20	VQ20	8	
6.0L 12Cyl 48V	M 120.981,M 120.983	600 R129	92-01	K20PR-U	K20TT	IK20TT	-	VK20Y	12	
2.8L 6Cyl 24V	M 104.943	280 R129	93-01	IQ20	Q20TT	IQ20TT	IQ20	VQ20	6	
3.2L 6Cyl 18V	M 112.943	320 R129	98-01	IK16TT	K16TT	IK16TT	IK16	VK16	6	
5.5L 8Cyl 24V	M 113.992	55 AMG Kompressor R230	02-12	IKH20TT	KH20TT	IKH20TT	IKH20	VKH20	16	
3.7L 6Cyl 18V	M 112.973	350 R230	03-12	IK16TT	K16TT	IK16TT	IK16	VK16	12	
5.0L 8Cyl 24V	M 113.963	500 R230	03-12	IK16TT	K16TT	IK16TT	IK16	VK16	8	
5.5L 12Cyl 36V	M 275.951	600 R230	03-12	VK20Y	-	-	-	VK20Y	24	
6.0L 12Cyl 36V	M 275.981	65 AMG R230	04-12	VK20Y	-	-	-	VK20Y	24	
3.5L 6Cyl 24V	M 272.966	350 R230	06-12	VXUH22I	-	-	IXUH22I	VXUH22I	6	
5.5L 8Cyl 32V	M 273.965	500 R230	06-12	VXUH22I	-	-	IXUH22I	VXUH22I	16	
5.4L 8Cyl 24V	M 113.995	55 AMG R230	06-12	IKH20TT	KH20TT	IKH20TT	IKH20	VKH20	16	
5.5L 12Cyl 36V	M 275.954	600 R230	06-12	VK20Y	-	-	-	VK20Y	24	
6.2L 8Cyl 32V	M 156.981	63 AMG R230	08-12	IXEH22TT	-	IXEH22TT	-	VFXEH22	8	
SLK										
2.3L 4Cyl 16V	M 111.973	230 Kompressor R170	96-00	K20PBR-S10	K20TT	IK20TT	IK20	VK20	4	
2.0L 4Cyl 16V	M 111.946	200 R170	97-00	IK16	K16TT	IK16TT	IK16	VK16	4	
2.3L 4Cyl 16V	M 111.983	230 Kompressor R170	00-00	IK20TT	K20TT	IK20TT	IK20	VK20	4	
2.0L 4Cyl 16V	M 111.958	200 Kompressor R170	00-04	IK20TT	K20TT	IK20TT	IK20	VK20	4	
3.2L 6Cyl 18V	M 112.947	320 R170	00-04	IK16TT	K16TT	IK16TT	IK16	VK16	12	
1.8L 4Cyl 16V	M 271.944	200 Kompressor R171	04-11	IKH20TT	KH20TT	IKH20TT	IKH20	VKH20	4	
3.5L 6Cyl 24V	M 272.963	350 R171	04-11	VXUH22I	-	-	IXUH22I	VXUH22I	6	
3.0L 6Cyl 24V	M 272.942	280 R171	05-11	VXUH22I	-	-	IXUH22I	VXUH22I	6	
5.5L 8Cyl 24V	M 113.989	55 AMG R171	05-11	IK20TT	K20TT	IK20TT	IK20	VK20	16	
1.8L 4Cyl 16V	M 271.954	200 Kompressor R171	08-11	VXUH22	-	-	IXUH22	VXUH22	4	
3.0L 6Cyl 24V	M 272.942	300 R171	09-11	VXUH22I	-	-	IXUH22I	VXUH22I	6	
1.8L 4Cyl 16V	M 271.861,M 271.860	200 R172	11-	VXUH22	-	-	IXUH22	VXUH22	4	
	M 271.860,M 271.861	250 R172	11-	VXUH22	-	-	IXUH22	VXUH22	4	
VIANO										
3.7L 6Cyl 18V	M 112.976	W639	04-	IK16TT	K16TT	IK16TT	IK16	VK16	6	
VITO										
2.0L 4Cyl 16V	M 111.948,M 111.950	638	98-03	IK16	K16TT	IK16TT	IK16	VK16	4	
VITO / MIXTO										
3.2L 6Cyl 18V	M 112.951	W639	04-05	IK16TT	K16TT	IK16TT	IK16	VK16	6	
MG										
MG 6										
1.8L 4Cyl 16V	18N4TI		10-	IK16TT	K16TT	IK16TT	IK16	VK16	4	
MG TF										
1.8L 4Cyl 16V	18 K4F		02-09	IK20TT	K20TT	IK20TT	IK20	VK20	4	
	18 K4K		02-09	IK20TT	K20TT	IK20TT	IK20	VK20	4	
MG ZR										
1.8L 4Cyl 16V	18 K4K		01-05	IK20TT	K20TT	IK20TT	IK20	VK20	4	
MG ZS										
2.5L 6Cyl 24V	25 K4F		01-05	IK20TT	K20TT	IK20TT	IK20	VK20	6	
MG ZT										
2.5L 6Cyl 24V	25 K4F		01-05	IK20TT	K20TT	IK20TT	IK20	VK20	6	
4.6L 8Cyl 16V	99W		03-05	IT20TT	T20TT	IT20TT	IT20	VT20	8	
MGB										
1.8L 4Cyl 8V			62-80	W20EP-U	W20TT	IW20TT	IW20	VW20	4	
MGF										
1.8L 4Cyl 16V	18 K4F	RD	95-02	IK20TT	K20TT	IK20TT	IK20	VK20	4	
	18 K4K	RD	95-02	IK20TT	K20TT	IK20TT	IK20	VK20	4	
MIDGET										
1.3L 4Cyl 8V	12 H		67-74	W20EP-U	W20TT	IW20TT	IW20	VW20	4	
MINI										
MINI										
1.6L 4Cyl 16V	W10 B16 A	Cooper R50, R53	01-06	K20TXR	K20TT	IK20TT	IK20	VK20	4	
	W11 B16 A	Cooper S R50, R53	02-06	K20TXR	K20TT	IK20TT	IK20	VK20	4	
	W11 B16 A	Works R50, R53	03-06	K20TXR	K20TT	IK20TT	IK20	VK20	4	
	W10 B16 A	Cooper R52	04-07	K20TXR	K20TT	IK20TT	IK20	VK20	4	
	W11 B16 A	Cooper S R52	04-07	K20TXR	K20TT	IK20TT	IK20	VK20	4	
	N14 B16 A,N14 B16 AB	Cooper S R56	06-10	IXUH22	-	-	IXUH22	VXUH22	4	
	N12 B16 A	Cooper R56	06-12	IXUH22	-	-	IXUH22	VXUH22	4	
	N16 B16 A	Cooper R58	10-15	IXUH22	-	-	IXUH22	VXUH22	4	
	N16 B16 A	Cooper R59	11-15	IXUH22	-	-	IXUH22	VXUH22	4	
MINI CLUBMAN										
1.6L 4Cyl 16V	N16 B16 A,N12 B16 A	Cooper R55	07-14	IXUH22	-	-	IXUH22	VXUH22	4	
	N14 B16 AB	Cooper S R55	07-14	IXUH22	-	-	IXUH22	VXUH22	4	
MITSUBISHI										
380										
3.8L 6Cyl 24V	6G75	DB	05-08	IK16	K16TT	IK16TT	IK16	VK16	6	
3000 GT										
3.0L 6Cyl 24V	6G72 (DOHC 24V)	Z16A	92-98	IK20TT	K20TT	IK20TT	IK20	VK20	6	
ASX										
2.0L 4Cyl 16V	4B11	XA,XB,XC	10-	IK20	K20TT	IK20TT	IK20	VK20	4	
CHALLENGER										
3.0L 6Cyl 24V	6G72 (SOHC 24V)	PA	98-07	IK20TT	K20TT	IK20TT	IK20	VK20	6	
COLT										
1.6L 4Cyl 8V	4G32	RC	84-86	W16EP-U	W16TT	IW16TT	IW16	VW16	4	
1.4L 4Cyl 8V	4G33	RC	84-86	W16EP-U	W16TT	IW16TT	IW16	VW16	4	
1.6L 4Cyl 8V	4G32	RD,RE	86-90	W20EP-U	W20TT	IW20TT	IW20	VW20	4	
1.4L 4Cyl 8V	4G33	RD,RE	86-90	W20EP-U	W20TT	IW20TT	IW20	VW20	4	
1.5L 4Cyl 16V	4G15 (16V)	RG	04-06	IKH16TT	KH16TT	IKH16TT	IKH16	VKH16	4	

DENSO	9	14	16	20	22	24	27	29	31	32	34	35	DENSO	9	14	16	20	22	24	27	29	31	32	DENSO	9	14	16	20	22	24	27	31
NGK	2	4	5	6	7	8	9	9.5	10	10.5	11	11.5	CHAMPION	18	16,14	12,11	10,9	8,7	6,63,61	4,59	57	55	53	BOSCH	10	9	8	7,6	5	4	3	2

DENSO AUSTRALIA CHINA INDIA INDONESIA KOREA MALAYSIA PHILIPPINES SAUDIARABIA SINGAPORE TAIWAN THAILAND VIETNAM JAPAN & USA EUROPE MOTOR SMALL ENGINE REFERENCE NUMBER PART



AUSTRALIA CAR

▶ Spark plug color codes: ■ for Iridium Tough and Iridium Plugs and Iridium TT, ■ for Iridium Power, ■ for Iridium Racing and Two Tops Plugs, ■ for Platinum Plugs and Platinum TT, and black for general spark plugs.

DENSO**AUSTRALIA****CHINA****INDIA****INDONESIA****KOREA****MALAYSIA****PHILIPPINES****SAUDI ARABIA****SINGAPORE****TAIWAN****THAILAND****VIETNAM****JAPAN****EUROPE & USA****MOTOR CYCLE****SMALL ENGINE****CROSS REFERENCE****PART NUMBER**

Model	Engine Size	Engine Code	Specification	From To	DENSO					QTY
MITSUBISHI										
COLT		4G15T	RG Turbo	06-08	VKH20Y	-	-	-	VKH20Y	4
	1.5L 4Cyl 16V	4A91	RG	06-12	IKH20TT	KH20TT	IKH20TT	IKH20	VKH20	4
		4G15T	RG Ralliart Turbo	06-12	VKH20Y	-	-	-	VKH20Y	4
EXPRESS	2.0L 4Cyl 8V	G63B	SF,SG,SH,SJ,WA	86-94	W20EX-U	W20TT	IW20TT	IW20	VW20	4
	2.4L 4Cyl 8V	G64B,4G64 (8V)	SF,SG,SH,SJ,WA	86-94	W20EX-U	W20TT	IW20TT	IW20	VW20	4
	2.0L 4Cyl 8V	4G63 (SOHC 8V)	SF,SG,SH,SJ,WA	94-03	K16PR-U11	K16TT	IK16TT	IK16	VK16	4
	2.4L 4Cyl 16V	4G64 (16V)	SF,SG,SH,SJ,WA	94-13	K16PR-U11	K16TT	IK16TT	IK16	VK16	4
	2.0L 4Cyl 16V	4G63 (SOHC 16V)	SF,SG,SH,SJ,WA	03-06	K16PR-U11	K16TT	IK16TT	IK16	VK16	4
FTO	2.0L 6Cyl 24V	6A12 (DOHC)	DE_A	94-01	K20PR-U11	K20TT	IK20TT	IK20	VK20	6
		6A12 (MIVEC)	DE_A	94-01	IK22	-	-	IK22	VK22	6
GALANT	2.0L 4Cyl 16V	4G63 (DOHC 16V)	HG,HH	88-92	W20EPRU11	W20TT	IW20TT	IW20	VW20	4
	2.0L 4Cyl 8V	4G63 (SOHC 8V)	HG,HH	89-92	W20EPR-U11	W20TT	IW20TT	IW20	VW20	4
	2.0L 4Cyl 16V	4G63-T (DOHC 16V)	HG,HH VR4 Turbo 4WD	90-93	W20EPR-U	W20TT	IW20TT	IW20	VW20	4
	2.0L 6Cyl 24V	6A12	HJ	92-96	IK20TT	K20TT	IK20TT	IK20	VK20	6
	2.0L 4Cyl 16V	4G63 (SOHC 16V)	HJ	93-95	K16PR-U11	K16TT	IK16TT	IK16	VK16	4
	2.5L 6Cyl 24V	6A13TT	EA_	96-02	IK20TT	K20TT	IK20TT	-	VK20Y	6
GRANDIS	2.4L 4Cyl 16V	4G69	BA	04-10	IKH20	KH20TT	IKH20TT	IKH20	VKH20	4
GTO		6G72 (DOHC 24V)	Z1_A	89-96	IK20TT	K20TT	IK20TT	IK20	VK20	6
	3.0L 6Cyl 24V	6G72 (DOHC 24V),6G72T	Z1_A Turbo	92-96	IK20TT	K20TT	IK20TT	IK20	VK20	6
		6G72T	Z1_A Turbo	96-00	IK20TT	K20TT	IK20TT	IK20	VK20	6
L300 STARWAGON	1.6L 4Cyl 8V	4G32	SA,SB,SC,SD,SE	80-84	W16EPR-U	W16TT	IW16TT	IW16	VW16	4
	1.8L 4Cyl 8V	4G62	SA,SB,SC,SD,SE	81-86	W16EP-U	W16TT	IW16TT	IW16	VW16	4
	2.0L 4Cyl 8V	G63B,4G63 (SOHC 8V)	SA,SB,SC,SD,SE	84-86	W16EP-U	W16TT	IW16TT	IW16	VW16	4
LANCER	1.5L 4Cyl 8V	4G15 (8V)	CA,CB	88-90	W20EP-U	W20TT	IW20TT	IW20	VW20	4
	1.5L 4Cyl 12V	4G15 (12V)	CA,CB	88-92	W20EPRU11	W20TT	IW20TT	IW20	VW20	4
	1.6L 4Cyl 16V	4G61	CA,CB	90-92	W20EPRU11	W20TT	IW20TT	IW20	VW20	4
	1.8L 4Cyl 16V	4G93 (SOHC 16V)	CC,CE	92-03	K16PR-U11	K16TT	IK16TT	IK16	VK16	4
	2.0L 4Cyl 16V	4G63 Turbo	CC EVO I Turbo	92-93	W20EP-U	W20TT	IW20TT	IW20	VW20	4
	1.5L 4Cyl 12V	4G15 (12V)	CC	92-96	W20EPRU11	W20TT	IW20TT	IW20	VW20	4
	1.6L 4Cyl 16V	4G92 (SOHC 16V)	CC	92-96	K16PR-U11	K16TT	IK16TT	IK16	VK16	4
	1.8L 4Cyl 16V	4G93 (SOHC 16V)	CC	92-96	K16PR-U11	K16TT	IK16TT	IK16	VK16	4
		4G93T	CC GSR Turbo AWD	92-96	K20PR-U	K20TT	IK20TT	-	VK20Y	4
	2.0L 4Cyl 16V	4G63 Turbo	CC EVO II Turbo	94-95	W22EP-U	W22TT	-	IW22	VW22	4
		4G63 Turbo	CC EVO III Turbo	95-96	W22EP-U	W22TT	-	IW22	VW22	4
	1.8L 4Cyl 16V	4G93 (SOHC 16V)	CE	95-97	K16PR-U11	K16TT	IK16TT	IK16	VK16	4
	1.5L 4Cyl 12V	4G15 (12V)	CE	96-03	W16EPR-U11	W16TT	IW16TT	IW16	VW16	4
	1.8L 4Cyl 16V	4G93 (SOHC 16V)	CJ_A, CE	96-04	K16PR-U11	K16TT	IK16TT	IK16	VK16	4
		4G63 Turbo	CE EVO VII	98-98	VW22	-	-	IW22	VW22	4
	2.0L 4Cyl 16V	4G94 (GDI)	CG,CH,CJ	03-05	K16PR-U11	K16TT	IK16TT	IK16	VK16	4
		4G63 Turbo	CZ,CJ EVO VIII	03-07	VW22	-	-	IW22	VW22	4
		4G94	CG,CH,CJ	05-06	K16PR-U11	K16TT	IK16TT	IK16	VK16	4
	2.4L 4Cyl 16V	4G69	CG,CH,CJ	05-08	IKH20	KH20TT	IKH20TT	IKH20	VKH20	4
		4G94	CH	05-08	K16PR-U11	K16TT	IK16TT	IK16	VK16	4
	2.0L 4Cyl 16V	4G63 Turbo	CG,CH,CJ EVO IX	07-13	VKH22	-	-	IKH22	VKH22	4
		4B11	CG,CH,CJ	07-	IK20	K20TT	IK20TT	IK20	VK20	4
		4B11	CJ,CF	07-	IK20	K20TT	IK20TT	IK20	VK20	4
		4B11	CJ,CY, CF	07-	IK20	K20TT	IK20TT	IK20	VK20	4
	2.4L 4Cyl 16V	4B12	CJ,CF	08-	K16TT	K16TT	IK16TT	IK16	VK16	4
		4B12	CJ,CY, CF	08-	K16TT	K16TT	IK16TT	IK16	VK16	4
MAGNA		4G54	TM	87-89	W20EP-U	W20TT	IW20TT	IW20	VW20	4
	2.6L 4Cyl 8V	4G54	TP	89-91	W20EP-U	W20TT	IW20TT	IW20	VW20	4
		4G54	TR	91-94	W20EP-U	W20TT	IW20TT	IW20	VW20	4
	3.0L 6Cyl 12V	6G72 (SOHC 12V)	TR	91-94	W20EPRU11	W20TT	IW20TT	IW20	VW20	6
	2.6L 4Cyl 8V	4G54	TS	94-96	W20EP-U	W20TT	IW20TT	IW20	VW20	4
	3.0L 6Cyl 12V	6G72 (SOHC 12V)	TS	94-96	W20EPRU11	W20TT	IW20TT	IW20	VW20	6
	2.6L 4Cyl 8V	4G54	TE	96-97	W20EP-U	W20TT	IW20TT	IW20	VW20	4
	2.4L 4Cyl 16V	4G64 (16V)	TE	96-97	K16PR-U11	K16TT	IK16TT	IK16	VK16	4
	3.0L 6Cyl 24V	6G72 (SOHC 24V)	TE (Front bank / Rear Bank)	96-97	K20PR-U11 / IK20TT	K20TT / -	IK20TT / IK20TT	IK20 / IK20	VK20 / VK20	6
	2.4L 4Cyl 16V	4G64 (16V)	TF	97-99	K16PR-U11	K16TT	IK16TT	IK16	VK16	4
	3.0L 6Cyl 24V	6G72 (SOHC 24V)	TF (Front bank / Rear Bank)	97-99	K20PR-U11 / IK20TT	K20TT / -	IK20TT / IK20TT	IK20 / IK20	VK20 / VK20	6
	3.5L 6Cyl 24V	6G74 (SOHC 24V)	TH	99-00	K16PR-U11 / IK16TT	K16TT / -	IK16TT / IK16TT	IK16 / IK16	VK16 / VK16	6
	3.0L 6Cyl 24V	6G72 (SOHC 24V)	TH (Front bank / Rear Bank)	99-00	K20PR-U11 / IK20TT	K20TT / -	IK20TT / IK20TT	IK20 / IK20	VK20 / VK20	6
	3.5L 6Cyl 24V	6G74 (SOHC 24V)	TH (Front bank / Rear Bank)	99-00	K16PR-U11 / IK16TT	K16TT / -	IK16TT / IK16TT	IK16 / IK16	VK16 / VK16	6
	3.0L 6Cyl 24V	6G72 (SOHC 24V)	TJ (Front bank / Rear Bank)	00-03	K20PR-U11 / IK20TT	K20TT / -	IK20TT / IK20TT	IK20 / IK20	VK20 / VK20	6
		6G74 (SOHC 24V)	TJ (Front bank / Rear Bank)	00-03	K16PR-U11 / IK16TT	K16TT / -	IK16TT / IK16TT	IK16 / IK16	VK16 / VK16	6
	3.5L 6Cyl 24V	6G74 (SOHC 24V)	TJ VR-X	01-03	K16PR-U11 / IK16TT	K16TT / -	IK16TT / IK16TT	IK16 / IK16	VK16 / VK16	6
		6G74 (SOHC 24V)	TJ Ralliart (Front bank/Rear Bank)	02-03	K20PR-U11 / IK20TT	K20TT / -	IK20TT / IK20TT	IK20 / IK20	VK20 / VK20	6



Model	Engine Size	Engine Code	Specification	From To	DENSO	TJ	IRIDIUM	IRIDIUM POWER	IRIDIUM TOUGH	QTY
MITSUBISHI										
MAGNA										
3.5L 6Cyl 24V	6G74 (SOHC 24V)	TJ VR-X (Front bank / Rear Bank)	02-03	K20PR-U11 / IK20TT	K20TT / -	IK20TT / IK20TT	IK20 / IK20	VK20 / VK20	6	
	6G74 (SOHC 24V)	TW (Front bank / Rear Bank)	03-05	K16PR-U11 / IK16TT	K16TT / -	IK16TT / IK16TT	IK16 / IK16	VK16 / VK16	6	
	6G74 (SOHC 24V)	TW VR-X (Front bank / Rear Bank)	03-05	K16PR-U11 / IK16TT	K16TT / -	IK16TT / IK16TT	IK16 / IK16	VK16 / VK16	6	
MIRAGE										
1.5L 4Cyl 8V	G15B	RC	83-88	W20EPR-U11	W20TT	IW20TT	IW20	VW20	4	
1.5L 4Cyl 16V	4G15 (16V)	CE	96-04	W16EPR-U11	W16TT	IW16TT	IW16	VW16	4	
1.5L 4Cyl 12V	4G15 (12V)	CE	96-99	W16EPR-U11	W16TT	IW16TT	IW16	VW16	4	
1.2L 3Cyl 12V	3A92	LA	12-	IKH16TT	KH16TT	IKH16TT	-	VFKH16	3	
NIMBUS										
1.8L 4Cyl 8V	4G37	UA,UB,UC	84-85	W20EP-U	W20TT	IW20TT	IW20	VW20	4	
	G37B	UA,UB,UC	85-87	W20EP-U	W20TT	IW20TT	IW20	VW20	4	
2.0L 4Cyl 8V	4G63 (SOHC 8V)	UA,UB,UC	87-92	W20EP-U	W20TT	IW20TT	IW20	VW20	4	
2.4L 4Cyl 16V	4G64 (16V)	UF	92-98	K16PR-U11	K16TT	IK16TT	IK16	VK16	4	
	4G64 (16V)	UG	98-04	K16PR-U11	K16TT	IK16TT	IK16	VK16	4	
OUTLANDER										
2.4L 4Cyl 16V	4G64 (16V)	ZE,ZF	03-04	K16PR-U	K16TT	IK16TT	IK16	VK16	4	
	4G69	ZE,ZF	04-06	IKH20	KH20TT	IKH20TT	IKH20	VKH20	4	
	4B12	ZG,ZH	06-12	K16TT	K16TT	IK16TT	IK16	VK16	4	
3.0L 6Cyl 24V	6B31	ZG,ZH	06-12	VXUH22I	-	-	IXUH22I	VXUH22I	6	
2.0L 4Cyl 16V	4J11	ZJ,ZL	12-	IXUH20I	-	-	IXUH20I	VXUH20I	4	
2.4L 4Cyl 16V	4J12,4B12	ZJ,ZL	12-	IXUH20I	-	-	IXUH20I	VXUH20I	4	
PAJERO										
2.6L 4Cyl 8V	4G54	NA,NB,NC,ND,NE,NG	83-87	W16EP-U	W16TT	IW16TT	IW16	VW16	4	
	4G54	NA,NB,NC,ND,NE,NG	86-91	W20EP-U	W20TT	IW20TT	IW20	VW20	4	
3.0L 6Cyl 12V	6G72 (SOHC 12V)	NA,NB,NC,ND,NE,NG	88-91	W16EPR-U11	W16TT	IW16TT	IW16	VW16	6	
2.6L 4Cyl 8V	4G54	NH,NJ,NK,NL	91-93	W16EP-U	W16TT	IW16TT	IW16	VW16	4	
3.0L 6Cyl 12V	6G72 (SOHC 12V)	NH,NJ,NK,NL	91-97	W16EPR-U11	W16TT	IW16TT	IW16	VW16	6	
3.5L 6Cyl 24V	6G74	NH,NJ,NK,NL	95-00	IK16TT	K16TT	IK16TT	IK16	VK16	6	
	6G74 (DOHC 24V)	NM,NP	00-07	IK16TT	K16TT	IK16TT	IK16	VK16	6	
3.8L 6Cyl 24V	6G75	NS,NT,NW	06-13	VK20Y	-	-	-	VK20Y	6	
SIGMA										
1.6L 4Cyl 8V	4G32	GJ, GK, GN	82-85	W16EP-U	W16TT	IW16TT	IW16	VW16	4	
STARWAGON										
2.4L 4Cyl 8V	4G64 (8V)	SF,SG,SH,SJ,WA	86-94	W20EX-U	W20TT	IW20TT	IW20	VW20	4	
2.0L 4Cyl 8V	4G63 (SOHC 8V)	SF,SG,SH,SJ,WA	86-97	W20EX-U	W20TT	IW20TT	IW20	VW20	4	
2.0L 4Cyl 16V	4G63 (SOHC 16V)	SF,SG,SH,SJ,WA	94-04	K16PR-U11	K16TT	IK16TT	IK16	VK16	4	
2.4L 4Cyl 16V	4G64 (16V)	SF,SG,SH,SJ,WA	94-04	K16PR-U11	K16TT	IK16TT	IK16	VK16	4	
TRITON										
2.6L 4Cyl 8V	4G54	ME,MF,MG,MH,MJ	86-96	W20EP-U	W20TT	IW20TT	IW20	VW20	4	
3.0L 6Cyl 12V	6G72 (SOHC 12V)	ME,MF,MG,MH,MJ	90-96	W16EP-U11	W16TT	IW16TT	IW16	VW16	6	
2.4L 4Cyl 16V	4G64 (16V)	MK	96-06	K16PR-U11	K16TT	IK16TT	IK16	VK16	4	
3.0L 6Cyl 24V	6G72 (SOHC 24V)	MK	96-06	IK20TT	K20TT	IK20TT	IK20	VK20	6	
2.4L 4Cyl 16V	4G64 (16V)	ML,MN	05-15	K16PR-U11	K16TT	IK16TT	IK16	VK16	4	
3.5L 6Cyl 24V	6G74 (SOHC 24V)	ML,MN	06-09	IK20TT	K20TT	IK20TT	IK20	VK20	6	
2.4L 4Cyl 16V	4G64 (16V)	MQ	14-	K16PR-U11	K16TT	IK16TT	IK16	VK16	4	
VERADA										
3.0L 6Cyl 12V	6G72 (SOHC 12V)	KS	94-97	W20EPRU11	W20TT	IW20TT	IW20	VW20	6	
3.5L 6Cyl 24V	6G72 (SOHC 24V)	KS	94-97	W20EPRU11	W20TT	IW20TT	IW20	VW20	6	
	6G74 (SOHC 24V)	KE (Front bank / Rear Bank)	96-97	K16PR-U11 / IK16TT	K16TT / -	IK16TT / IK16TT	IK16 / IK16	VK16 / VK16	6	
	6G74 (SOHC 24V)	KF	97-99	K16PR-U11 / IK16TT	K16TT / -	IK16TT / IK16TT	IK16 / IK16	VK16 / VK16	6	
	6G74 (SOHC 24V)	KF (Front bank / Rear Bank)	97-99	K16PR-U11 / IK16TT	K16TT / -	IK16TT / IK16TT	IK16 / IK16	VK16 / VK16	6	
	6G74 (SOHC 24V)	KH (Front bank / Rear Bank)	99-00	K16PR-U11 / IK16TT	K16TT / -	IK16TT / IK16TT	IK16 / IK16	VK16 / VK16	6	
	6G74 (SOHC 24V)	KJ (Front bank / Rear Bank)	00-03	K16PR-U11 / IK16TT	K16TT / -	IK16TT / IK16TT	IK16 / IK16	VK16 / VK16	6	
	6G74 (SOHC 24V)	KL	03-04	K16PR-U11 / IK16TT	K16TT / -	IK16TT / IK16TT	IK16 / IK16	VK16 / VK16	6	
	6G74 (SOHC 24V)	KL (Front bank / Rear Bank)	03-04	K16PR-U11 / IK16TT	K16TT / -	IK16TT / IK16TT	IK16 / IK16	VK16 / VK16	6	
	6G74 (SOHC 24V)	KW (Front bank / Rear Bank)	04-05	K16PR-U11 / IK16TT	K16TT / -	IK16TT / IK16TT	IK16 / IK16	VK16 / VK16	6	
MORRIS										
MINI										
0.8L 4Cyl 8V		850	60-79	W20EP-U	W20TT	IW20TT	IW20	VW20	4	
1.0L 4Cyl 8V		Cooper	61-67	W20EP-U	W20TT	IW20TT	IW20	VW20	4	
1.3L 4Cyl 8V		1.3	62-69	W20EP-U	W20TT	IW20TT	IW20	VW20	4	
1.0L 4Cyl 8V		1000	69-80	W20EP-U	W20TT	IW20TT	IW20	VW20	4	
0.9L 4Cyl 8V		0.9	55-62	W20ES-U	-	-	-	-	4	
MINOR										
NISSAN										
180 SX										
1.8L 4Cyl 16V	CA18DE	S13	88-92	IQ20TT	Q20TT	IQ20TT	IQ20	VQ20	4	
	CA18DT	S13 Turbo	88-92	IQ20TT	Q20TT	IQ20TT	IQ20	VQ20	4	
	CA18DET	S13 Turbo	89-92	IQ20TT	Q20TT	IQ20TT	IQ20	VQ20	4	
2.0L 4Cyl 16V	SR20DE	S13	91-94	IK20TT	K20TT	IK20TT	IK20	VK20	4	
	SR20DET	S13 Turbo	91-94	IK20TT	K20TT	IK20TT	-	VK20Y	4	
2.0L 4Cyl 16V	SR20DET	S14 Turbo	94-96	IK20TT	K20TT	IK20TT	-	VK20Y	4	
	SR20DET	S15 Turbo	00-03	IK20TT	K20TT	IK20TT	-	VK20Y	4	
200 SX										
300 ZX										
3.0L 6Cyl 12V	VG30E	Z31	84-87	IQ20	Q20TT	IQ20TT	IQ20	VQ20	6	
	VG30ET	Z31 Turbo	87-90	IQ20	Q20TT	IQ20TT	IQ20	VQ20	6	
3.0L 6Cyl 24V	VG30DE	Z32	89-97	K20R-U	K20TT	IK20TT	-	VK20Y	6	
	VG30DETT	Z32 Twin Turbo	89-97	IK20TT	K20TT	IK20TT	IK20	VK20	6	
3.5L 6Cyl 24V	VQ35DE	Z33	03-09	IKH16TT	KH16TT	IKH16TT	IKH16	VKH16	6	

DENSO AUSTRALIA CHINA INDIA INDONESIA KOREA MALAYSIA PHILIPPINES SAUDIARABIA SINGAPORE TAIWAN THAILAND VIETNAM JAPAN EUROPE MOTOR & USA SMALL ENGINE REFERENCE NUMBER PART

DENSO	9	14	16	20	22	24	27	29	31	32	34	35	DENSO	9	14	16	20	22	24	27	29	31	32	DENSO	9	14	16	20	22	24	27	31
NGK	2	4	5	6	7	8	9	9.5	10	10.5	11	11.5	CHAMPION	18	16,14	12,11	10,9	8,7	6,63,61	4,59	57	55	53	BOSCH	10	9	8	7,6	5	4	3	2

Model	Engine Size	Engine Code	Specification	From To	DENSO					QTY
NISSAN										
PINTARA	2.4L 4Cyl 12V	KA24E	U12	89-92	K16GPR-U11	-	-	-	-	4
	2.0L 4Cyl 8V	CA20E	U12 twin spark. (In / ex)	89-92	Q20PR-U11 / Q16PR-U11	Q20TT / Q16TT	IQ20TT / IQ16TT	IQ20 / IQ16	- / -	4
PRAIRIE	1.5L 4Cyl 8V	E15S	M10, NM10	82-86	W16EP-U	W16TT	IW16TT	IW16	VW16	4
PULSAR	1.5L 4Cyl 8V	E15	N10	81-82	W16EP-U	W16TT	IW16TT	IW16	VW16	4
		E15	N12	83-86	W16EP-U	W16TT	IW16TT	IW16	VW16	4
	1.3L 4Cyl 8V	E13	N12	83-87	W16EP-U	W16TT	IW16TT	IW16	VW16	4
	1.6L 4Cyl 8V	E16	N12	86-87	W16EPR-U11	W16TT	IW16TT	IW16	VW16	4
		16LF	N13	87-91	W20EPR-U11	W20TT	IW20TT	IW20	VW20	4
	1.8L 4Cyl 8V	18LE	N13	87-91	W20EPR-U11	W20TT	IW20TT	IW20	VW20	4
	1.6L 4Cyl 16V	GA16DE	N14	91-95	K16PR-U11	K16TT	IK16TT	IK16	VK16	4
	2.0L 4Cyl 16V	SR20DE	N14	91-95	IK16TT	K16TT	IK16TT	IK16	VK16	4
	1.6L 4Cyl 16V	GA16DE	N15	95-00	K20PR-U11	K20TT	IK20TT	IK20	VK20	4
	2.0L 4Cyl 16V	SR20DE	N15	95-01	IK20TT	K20TT	IK20TT	IK20	VK20	4
	1.6L 4Cyl 16V	QG16DE	N16	00-03	K16PR-U	K16TT	IK16TT	IK16	VK16	4
		QG18DE	N16	00-06	K16PR-U / K16HPR-U11	K16TT / KH16TT	IK16TT / IKH16TT	IK16 / IKH16	VK16 / VKH16	4
MRA8DE		B17	12-	IXEH20TT	-	IXEH20TT	-	VFXEH20	4	
QASHQAI	2.0L 4Cyl 16V	MRA8DE	C12 Turbo	13-	IXEH20TT	-	IXEH20TT	-	VFXEH20	4
		MR20DD	J11	14-	IXEH20TT	-	IXEH20TT	-	VFXEH20	4
S-CARGO	1.5L 4Cyl 8V	E15S	G20	89-94	W16EPR-U11	W16TT	IW16TT	IW16	VW16	4
SERENA	2.0L 4Cyl 16V	SR20DE	C23	92-95	K16PR-U	K16TT	IK16TT	IK16	VK16	4
SKYLINE	2.4L 6Cyl 12V	L24	C210	78-81	W20EP-U	W20TT	IW20TT	IW20	VW20	6
		L24E	R30	81-86	W20EPRU11	W20TT	IW20TT	IW20	VW20	6
	2.0L 6Cyl 24V	RB20DE	R31	85-90	IQ16TT	Q16TT	IQ16TT	IQ16	VQ16	6
		RB20DET	R31 Turbo	85-90	IQ20TT	Q20TT	IQ20TT	IQ20	VQ20	6
	3.0L 6Cyl 12V	RB30E	R31	86-90	IQ20	Q20TT	IQ20TT	IQ20	VQ20	6
	2.0L 6Cyl 24V	RB20DE	R32	89-93	IQ20TT	Q20TT	IQ20TT	IQ20	VQ20	6
	2.0L 6Cyl 12V	RB20E	R32	89-93	IQ16	Q16TT	IQ16TT	IQ16	VQ16	6
	2.5L 6Cyl 24V	RB25DE	R32	89-93	IQ16	Q16TT	IQ16TT	IQ16	VQ16	6
	2.0L 6Cyl 24V	RB20DET	R32 Turbo	89-93	IQ20TT	Q20TT	IQ20TT	IQ20	VQ20	6
	2.6L 6Cyl 24V	RB26DETT	R32 Twin Turbo	89-95	IQ20TT	Q20TT	IQ20TT	IQ20	VQ20	6
	2.0L 6Cyl 12V	RB20E	R33	93-98	IQ16	Q16TT	IQ16TT	IQ16	VQ16	6
	2.5L 6Cyl 24V	RB25DE	R33	93-98	IK16TT	K16TT	IK16TT	IK16	VK16	6
		RB25DET	R33 Turbo	94-00	IK16TT	K16TT	IK16TT	IK16	VK16	6
	2.6L 6Cyl 24V	RB26DETT	R33 Twin Turbo	94-99	IQ20TT	Q20TT	IQ20TT	IQ20	VQ20	6
	2.0L 6Cyl 24V	RB20DE	R34	98-00	IQ20TT	Q20TT	IQ20TT	IQ20	VQ20	6
	2.5L 6Cyl 24V	RB25DEH	R34	98-00	IK16TT	K16TT	IK16TT	IK16	VK16	6
		RB25DET	R34 Turbo	98-06	IK20TT	K20TT	IK20TT	IK20	VK20	6
	2.6L 6Cyl 24V	RB26DETT	R34 Twin Turbo	99-08	IQ20TT	Q20TT	IQ20TT	IQ20	VQ20	6
	3.5L 6Cyl 24V	VQ35DE	V35	01-07	IKH16TT	KH16TT	IKH16TT	IKH16	VKH16	6
	2.5L 6Cyl 24V	VQ25DD	V35	06-07	IKH16	KH16TT	IKH16TT	IKH16	VKH16	6
	3.0L 6Cyl 24V	VQ30DD	V35	06-07	IKH16	KH16TT	IKH16TT	IKH16	VKH16	6
	STAGEA	2.0L 6Cyl 12V	RB20E	WC34	96-01	IQ16	Q16TT	IQ16TT	IQ16	VQ16
2.5L 6Cyl 24V		RB25DE	WC34	96-01	IK16TT	K16TT	IK16TT	IK16	VK16	6
3.0L 6Cyl 24V		VQ30DD	M35	01-03	IKH16	KH16TT	IKH16TT	IKH16	VKH16	6
2.5L 6Cyl 24V		VQ25DD	M35	01-07	IKH16	KH16TT	IKH16TT	IKH16	VKH16	6
3.5L 6Cyl 24V	VQ35DE	M35	06-07	IKH16TT	KH16TT	IKH16TT	IKH16	VKH16	6	
TERRANO II										
TIIDA	1.8L 4Cyl 16V	MR18DE	C11	06-13	IXEH20TT	-	IXEH20TT	-	VFXEH20	4
		MR18DE	SC11	06-13	IXEH20TT	-	IXEH20TT	-	VFXEH20	4
URVAN	2.0L 4Cyl 8V	Z20	E23	82-98	W16EP-U	W16TT	IW16TT	IW16	VW16	4
	2.4L 4Cyl 8V	Z24i	E24	87-93	W20EP-U	W20TT	IW20TT	IW20	VW20	4
VANETTE	2.0L 4Cyl 8V	Z20S	C120, C20	82-87	W20EP-U	W20TT	IW20TT	IW20	VW20	4
X-TRAIL	2.5L 4Cyl 16V	QR25DE	T30	01-07	K16HPR-U11	KH16TT	IKH16TT	IKH16	VKH16	4
		QR25DE	T31	07-14	IXEH20TT	-	IXEH20TT	-	VFXEH20	4
	2.0L 4Cyl 16V	MR20DE	T31	08-14	IXEH20TT	-	IXEH20TT	-	VFXEH20	4
	2.5L 4Cyl 16V	QR25DE	T32	13-	IXEH20TT	-	IXEH20TT	-	VFXEH20	4
QR25DE		T32	13-	IXEH20ETT	-	IXEH20ETT	-	VFXEH20E	4	
OPEL										
ASTRA	1.4L 4Cyl 16V	A 14 NET	P10 Turbo	12-13	VK22	-	-	IK22	VK22	4
	1.6L 4Cyl 16V	A 16 LET	P10 Turbo	12-13	KJ20CR-L11	K20TT	IK20TT	IK20L	-	4
	1.4L 4Cyl 16V	B 14 NET,A 14 NET	P10 Turbo	12-13	VK22	-	-	IK22	VK22	4
	1.6L 4Cyl 16V	A 16 LET		12-13	KJ20CR-L11	K20TT	IK20TT	IK20L	-	4
	1.4L 4Cyl 16V	B 14 NET,A 14 NET		12-13	VK22	-	-	IK22	VK22	4
CORSA	1.4L 4Cyl 16V	A 14 XER	S07	12-13	KJ20CR-L11	K20TT	IK20TT	IK20L	-	4
	1.6L 4Cyl 16V		S07 Turbo	12-13	KJ20CR-L11	K20TT	IK20TT	IK20L	-	4
INSIGNIA	2.0L 4Cyl 16V	A 20 NFT	G09 Turbo	12-17	ITV16	TV16TT	ITV16TT	ITV16	-	4

DENSO AUSTRALIA CHINA INDIA INDONESIA KOREA MALAYSIA PHILIPPINES SAUDIARABIA SINGAPORE TAIWAN THAILAND VIETNAM JAPAN & USA EUROPE MOTOR SMALL ENGINE REFERENCE NUMBER PART CYCLE

DENSO	9	14	16	20	22	24	27	29	31	32	34	35	DENSO	9	14	16	20	22	24	27	29	31	32	DENSO	9	14	16	20	22	24	27	31
NGK	2	4	5	6	7	8	9	9.5	10	10.5	11	11.5	CHAMPION	18	16,14	12,11	10,9	8,7	6,63,61	4,59	57	55	53	BOSCH	10	9	8	7,6	5	4	3	2

Model	Engine Size	Engine Code	Specification	From To	DENSO					QTY		
PEUGEOT												
407	2.2L 4Cyl 16V	3FZ	6E_	04-11	K16HPR-U11	KH16TT	IKH16TT	IKH16	VKH16	4		
		XFV	6E_	04-11	IKH16TT	KH16TT	IKH16TT	IKH16	VKH16	6		
	3.0L 6Cyl 24V	XFV	6D_	04-	IKH16TT	KH16TT	IKH16TT	IKH16	VKH16	6		
		XFV	6C_	06-11	IKH16TT	KH16TT	IKH16TT	IKH16	VKH16	6		
505	2.2L 4Cyl 8V	851	551D GTI	85-86	T20EP-U	T20TT	IT20TT	IT20	VT20	4		
		851	551D	86-93	T20EP-U	T20TT	IT20TT	IT20	VT20	4		
508	1.6L 4Cyl 16V	5FV	8D_	10-	VXUH22	-	-	IXUH22	VXUH22	4		
605	3.0L 6Cyl 12V	UFZ	6B	94-96	K20PBR-S10	K20TT	IK20TT	-	VK20Y	6		
607	3.0L 6Cyl 24V	XFX	9D, 9U	00-09	IKH16TT	KH16TT	IKH16TT	IKH16	VKH16	6		
4008	2.0L 4Cyl 16V	4B11		12-	VK20Y	-	-	-	VK20Y	4		
508 SW	1.6L 4Cyl 16V	5FV	8E_	10-	VXUH22	-	-	IXUH22	VXUH22	4		
PARTNER	1.6L 4Cyl 16V	NFR		08-	IKH20TT	KH20TT	IKH20TT	IKH20	VKH20	4		
PORSCHE												
911	3.6L 6Cyl 12V	M 64.01	964 Carrera 4	88-93	IK22	-	-	IK22	VK22	6		
		M 64.01, M 64.02	964 Carrera	89-93	IK22	-	-	IK22	VK22	6		
		M 64.02, M 64.01	964 Carrera	89-94	IK22	-	-	IK22	VK22	6		
		M 64	993 Carrera	93-97	IK22	-	-	IK22	VK22	6		
		M 64.05	993 Carrera 4	94-95	IK22	-	-	IK22	VK22	6		
	3.8L 6Cyl 12V	M 64.20	993 Carrera RS	95-97	IK22	-	-	IK22	VK22	6		
		M 64.60	993 Turbo 4	95-97	K20TXR	K20TT	IK20TT	IK20	VK20	6		
	3.6L 6Cyl 12V	M 96.01, M 96.04	996 Carrera	97-01	K20TXR	K20TT	IK20TT	IK20	VK20	6		
		M 96.01, M 96.04	996 Carrera 4	97-01	K20TXR	K20TT	IK20TT	IK20	VK20	6		
	3.6L 6Cyl 24V	M 96.76	996 GT3	99-05	K20TXR	K20TT	IK20TT	IK20	VK20	6		
		M 96.70	996 Turbo 4	00-05	IK22	-	-	IK22	VK22	6		
		M 96.03	996	01-05	K20TXR	K20TT	IK20TT	IK20	VK20	6		
		M 96.03	996 Carrera	01-05	K20TXR	K20TT	IK20TT	IK20	VK20	6		
		M 96.03	996 Carrera 4	01-05	K20TXR	K20TT	IK20TT	IK20	VK20	6		
		M 96.70	996 GT2	01-05	IK22	-	-	IK22	VK22	6		
		M 96.79	996 GT3	03-05	IK22	-	-	IK22	VK22	5		
		M 96.70	996 Turbo 4S	03-05	IK22	-	-	IK22	VK22	6		
		M 96.05	997 Carrera	04-08	IK22	-	-	IK22	VK22	6		
		M 97.01	997 Carrera 4S	04-08	IK22	-	-	IK22	VK22	6		
	3.8L 6Cyl 24V	M 97.01	997 Carrera S	04-08	IK22	-	-	IK22	VK22	6		
		M 97.76	997 GT3	06-09	IK22	-	-	IK22	VK22	6		
	928	5.0L 8Cyl 32V	M 28.41, M 28.42	S, S4	86-91	W20EPR-U	W20TT	IW20TT	IW20	VW20	8	
M 28.49, M 28.50			5.4 GTS	91-95	W20EPB	W20TT	IW20TT	IW20	VW20	8		
944	2.5L 4Cyl 8V	M 44.52	Turbo	87-91	W20EPR-U	W20TT	IW20TT	IW20	VW20	4		
		M 44.41		88-91	W22EPR-U	W22TT	-	IW22	VW22	4		
968	3.0L 4Cyl 8V	M 44.43, M 44.44		91-95	K20PBR-S10	K20TT	IK20TT	-	VK20Y	4		
BOXSTER												
BOXSTER	2.5L 6Cyl 24V	M 96.20	986	96-99	K20TXR	K20TT	IK20TT	IK20	VK20	6		
	2.7L 6Cyl 24V	M 96.22	986	99-02	K20TXR	K20TT	IK20TT	IK20	VK20	6		
	3.2L 6Cyl 24V	M 96.21	986 S	99-02	K20TXR	K20TT	IK20TT	IK20	VK20	6		
	2.7L 6Cyl 24V	M 96.23	986	02-04	K20TXR	K20TT	IK20TT	IK20	VK20	6		
	3.2L 6Cyl 24V	M 96.24	986 S	02-04	K20TXR	K20TT	IK20TT	IK20	VK20	6		
	2.7L 6Cyl 24V	M 96.25	987	04-06	IK22	-	-	IK22	VK22	6		
	3.2L 6Cyl 24V	M 96.26	987 S	04-06	IK22	-	-	IK22	VK22	6		
	2.7L 6Cyl 24V	M 97.20	987	06-09	IK22	-	-	IK22	VK22	6		
	3.4L 6Cyl 24V	M 97.21	987 S	06-09	IK22	-	-	IK22	VK22	6		
	2.9L 6Cyl 24V	MA1.20	987	09-11	IK22	-	-	IK22	VK22	6		
	3.4L 6Cyl 24V	MA1.21	987 S	09-11	IK22	-	-	IK22	VK22	6		
		MA1.21	987	10-11	IK22	-	-	IK22	VK22	6		
		M 48.00	9PA S	02-07	K20TXR	K20TT	IK20TT	IK20	VK20	8		
	4.5L 8Cyl 32V	M 48.50	9PA Turbo	02-07	VK22	-	-	IK22	VK22	8		
		M 48.01	9PA GTS	07-10	VK22	-	-	IK22	VK22	8		
M 48.01		9PA S	07-10	VK22	-	-	IK22	VK22	8			
M 48.51		9PA Turbo S	07-10	VK22	-	-	IK22	VK22	8			
4.8L 8Cyl 32V		M 48.02	92A S	10-	VK22	-	-	IK22	VK22	8		
		M 48.52	92A Turbo	10-	VK22	-	-	IK22	VK22	8		
		M 48.02	92A GTS	12-	VK22	-	-	IK22	VK22	8		
		M 48.52	92A Turbo S	12-	VK22	-	-	IK22	VK22	8		
CAYENNE												
CAYENNE	4.5L 8Cyl 32V	M 48.00	9PA S	02-07	K20TXR	K20TT	IK20TT	IK20	VK20	8		
		M 48.50	9PA Turbo	02-07	VK22	-	-	IK22	VK22	8		
		M 48.01	9PA GTS	07-10	VK22	-	-	IK22	VK22	8		
	4.8L 8Cyl 32V	M 48.01	9PA S	07-10	VK22	-	-	IK22	VK22	8		
		M 48.51	9PA Turbo S	07-10	VK22	-	-	IK22	VK22	8		
		M 48.02	92A S	10-	VK22	-	-	IK22	VK22	8		
		M 48.52	92A Turbo	10-	VK22	-	-	IK22	VK22	8		
		M 48.02	92A GTS	12-	VK22	-	-	IK22	VK22	8		
		M 48.52	92A Turbo S	12-	VK22	-	-	IK22	VK22	8		
		CAYMAN										
		CAYMAN	3.4L 6Cyl 24V	M 97.21	987 S	05-09	IK22	-	-	IK22	VK22	6
			2.7L 6Cyl 24V	M 97.20	987	06-09	IK22	-	-	IK22	VK22	6
			2.9L 6Cyl 24V	MA1.20	987	09-12	IK22	-	-	IK22	VK22	6
			3.4L 6Cyl 24V	MA1.21	987 S	09-13	IK22	-	-	IK22	VK22	6
				MA1.21	987 R	10-12	IK22	-	-	IK22	VK22	6
2.7L 6Cyl 24V	MA1.22		981	13-	IK22	-	-	IK22	VK22	6		
3.4L 6Cyl 24V	MA1.23		981 S	13-	IK22	-	-	IK22	VK22	6		

DENSO
 AUSTRALIA
 CHINA
 INDIA
 INDONESIA
 KOREA
 MALAYSIA
 PHILIPPINES
 SAUDI ARABIA
 SINGAPORE
 TAIWAN
 THAILAND
 VIETNAM
 JAPAN
 EUROPE
 MOTOR & USA
 CYCLE
 SMALL
 ENGINE
 REFERENCE
 NUMBER
83

DENSO	9	14	16	20	22	24	27	29	31	32	34	35	DENSO	9	14	16	20	22	24	27	29	31	32	DENSO	9	14	16	20	22	24	27	31
NGK	2	4	5	6	7	8	9	9.5	10	10.5	11	11.5	CHAMPION	18	16,14	12,11	10,9	8,7	6,63,61	4,59	57	55	53	BOSCH	10	9	8	7,6	5	4	3	2



Model	Engine Size	Engine Code	Specification	From To	DENSO	TJ	IRIDIUM	IRIDIUM POWER	IRIDIUM TOUGH	QTY
SAAB										
900	2.0L 4Cyl 8V	B201XC,B 20	AC4, AM4	82-88	W20EP-U	W20TT	IW20TT	IW20	VW20	4
	2.0L 4Cyl 16V	B202XL	AC4, AM4 Turbo	84-93	IQ20	Q20TT	IQ20TT	IQ20	VQ20	4
	2.0L 4Cyl 8V	B201	AC4, AM4	85-90	W20EP-U	W20TT	IW20TT	IW20	VW20	4
	2.0L 4Cyl 16V	B202XL	Turbo	85-94	IQ20	Q20TT	IQ20TT	IQ20	VQ20	4
	2.0L 4Cyl 8V	B201XL	AC4, AM4 Turbo	86-91	W22EP-U	W22TT	-	IW22	VW22	4
	2.0L 4Cyl 16V	B202I	AC4, AM4	89-93	IQ16	Q16TT	IQ16TT	IQ16	VQ16	4
	2.1L 4Cyl 16V	B212I	AC4, AM4	90-93	IQ16	Q16TT	IQ16TT	IQ16	VQ16	4
		B212I		90-94	IQ16	Q16TT	IQ16TT	IQ16	VQ16	4
	2.0L 4Cyl 16V	B202S	AC4, AM4 Turbo	91-93	Q22PR-U	-	-	IQ22	VQ22	4
		B206I		93-94	Q16-U	Q16TT	IQ16TT	IQ16	VQ16	4
		B204L	Turbo	93-98	IQ22	-	-	IQ22	VQ22	4
	2.3L 4Cyl 16V	B234I		93-98	IQ20	Q20TT	IQ20TT	IQ20	VQ20	4
	2.5L 6Cyl 24V	B258I		93-98	K20TXR	K20TT	IK20TT	IK20	VK20	6
	2.0L 4Cyl 16V	B204I		94-98	IQ22	-	-	IQ22	VQ22	4
9000	2.3L 4Cyl 16V	B234L	Turbo	90-98	IQ22	-	-	IQ22	VQ22	4
		B234I		90-98	IQ22	-	-	IQ22	VQ22	4
		B234E		93-98	IQ22	-	-	IQ22	VQ22	4
		B234R		93-98	IQ22	-	-	IQ22	VQ22	4
	3.0L 6Cyl 24V	B308I		95-97	K20TXR	K20TT	IK20TT	IK20	VK20	6
9-3	2.0L 4Cyl 16V	B205L,B205E,B204L	YS3D Turbo	98-02	IQ20	Q20TT	IQ20TT	IQ20	VQ20	4
	2.3L 4Cyl 16V	B234I	YS3D	98-03	IQ22	-	-	IQ22	VQ22	4
	2.0L 4Cyl 16V	B204E	YS3D Turbo	98-03	VK22	-	-	IK22	VK22	4
		B205E,B204L,B205L	YS3D Turbo	98-03	IQ20	Q20TT	IQ20TT	IQ20	VQ20	4
	2.3L 4Cyl 16V	B235R	YS3D Turbo	98-03	IQ22	-	-	IQ22	VQ22	4
	2.0L 4Cyl 16V	B204R	YS3D Turbo	99-01	VK22	-	-	IK22	VK22	4
		B205E	YS3D Turbo	99-03	IQ22	-	-	IQ22	VQ22	4
		B205R	YS3D Turbo	01-03	IQ20TT	Q20TT	IQ20TT	IQ20	VQ20	4
		B207E	YS3F	02-15	IK20TT	K20TT	IK20TT	IK20	VK20	4
		B207L	YS3F	02-15	IK20TT	K20TT	IK20TT	IK20	VK20	4
		B207R	YS3F	02-15	IK20TT	K20TT	IK20TT	IK20	VK20	4
9-5	2.0L 4Cyl 16V	B205E	YS3E	99-09	IQ22	-	-	IQ22	VQ22	4
	2.3L 4Cyl 16V	B235E	YS3E	99-09	IQ20	Q20TT	IQ20TT	IQ20	VQ20	4
	3.0L 6Cyl 24V	B308E	YS3E	99-09	K22PR-U	-	-	IK22	VK22	6
	2.3L 4Cyl 16V	B235R	YS3E Turbo	01-09	IQ20TT	Q20TT	IQ20TT	IQ20	VQ20	4
		B235L	YS3E Turbo	03-09	IQ20	Q20TT	IQ20TT	IQ20	VQ20	4
	2.0L 4Cyl 16V	A 20 NHT	YS3G Turbo	10-12	ITV16	TV16TT	ITV16TT	ITV16	-	4
SKODA										
FABIA	1.4L 4Cyl 16V	CAVE,CTHE	542, 5J, 5J	10-14	VKA20	-	-	-	VKA20	4
		CAVE,CTHE	545, 5J, 5J	10-14	VKA20	-	-	-	VKA20	4
OCTAVIA	2.0L 4Cyl 16V	BVZ,BLR,BVY,BLY	1Z3	04-08	VKA16	-	-	-	VKA16	4
		BLR,BVY,BLY,BVZ	1Z5	04-08	VKA16	-	-	-	VKA16	4
	1.6L 4Cyl 8V	BSE,CMXA,BGU,BSF,CCSA	1Z3	04-13	K20PBR-S10	K20TT	IK20TT	IK20	VK20	4
		BSE,CMXA,BGU,CCSA,BSF	1Z5	04-13	K20PBR-S10	K20TT	IK20TT	IK20	VK20	4
	2.0L 4Cyl 16V	CCZA,BWA	1Z5	05-13	IK22	-	-	IK22	VK22	4
	1.8L 4Cyl 16V	BZB,CDAA	1Z3	07-13	IK22	-	-	IK22	VK22	4
		CDAA,BZB	1Z5	07-13	IK22	-	-	IK22	VK22	4
	2.0L 4Cyl 16V	BWA,CCZA	1Z3	08-13	IK22	-	-	IK22	VK22	4
	1.4L 4Cyl 16V	CAXA	1Z3	08-13	IK20L	-	-	IK20L	-	4
		CAXA	1Z5	08-13	IK20L	-	-	IK20L	-	4
ROOMSTER SUPERB	1.6L 4Cyl 16V	BTS,CFNA	5J	08-15	VKA20	-	-	IK20L	VKA20	4
	1.8L 4Cyl 16V	CDAA,BZB	3T4	08-15	IK22	-	-	IK22	VK22	4
CDAA		3T5	09-15	IK22	-	-	IK22	VK22	4	
YETI	1.8L 4Cyl 16V	CDAA	5L	09-17	IK22	-	-	IK22	VK22	4
		CDAB	5L	09-17	VK22	-	-	IK22	VK22	4
	1.4L 4Cyl 16V	CAXA	5L	10-15	IK20L	-	-	IK20L	-	4
SMART										
CITY-COUPE	0.6L 3Cyl 6V		450	01-04	K20TXR	K20TT	IK20TT	IK20	VK20	3
		M 160.910	450	02-04	K20TXR	K20TT	IK20TT	IK20	VK20	3
FORFOUR	1.3L 4Cyl 16V	M 135.930	454	04-06	K20HR-U11	KH20TT	IKH20TT	IKH20	VKH20	4
		M 135.950	454	04-06	K20HR-U11	KH20TT	IKH20TT	IKH20	VKH20	4
	1.5L 4Cyl 16V	M 122.950	454 BRABUS	05-06	VKH20Y	-	-	-	VKH20Y	4
FORTWO	1.0L 3Cyl 12V	M 132.910	451	07-	XU22HDR9	XUH22TT	-	IXUH22I	VXUH22I	3
		M 132.930	451 Turbo	07-	XU22HDR9	XUH22TT	-	IXUH22I	VXUH22I	3
SSANGYONG										
ACTYON	2.3L 4Cyl 16V	G23D		07-08	K16PR-U	K16TT	IK16TT	IK16	VK16	4
CHAIRMAN	3.2L 6Cyl 24V	M 104.992	HT_	05-07	IK16	K16TT	IK16TT	IK16	VK16	6
KORANDO	3.2L 6Cyl 24V	M 104.995	KJ	96-02	IQ16	Q16TT	IQ16TT	IQ16	VQ16	6

DENSO
 AUSTRALIA
 CHINA
 INDIA
 INDONESIA
 KOREA
 MALAYSIA
 PHILIPPINES
 SAUDI ARABIA
 SINGAPORE
 TAIWAN
 THAILAND
 VIETNAM
 JAPAN
 EUROPE
 MOTOR & USA
 CYCLE
 SMALL ENGINE
 CROSS REFERENCE
 PART NUMBER

DENSO	9	14	16	20	22	24	27	29	31	32	34	35	DENSO	9	14	16	20	22	24	27	29	31	32	DENSO	9	14	16	20	22	24	27	31
NGK	2	4	5	6	7	8	9	9.5	10	10.5	11	11.5	CHAMPION	18	16,14	12,11	10,9	8,7	6,6.3,6.1	4,5,9	5,7	5,5	5,3	BOSCH	10	9	8	7,6	5	4	3	2



AUSTRALIA CAR

▶ Spark plug color codes: ■ for Iridium Tough and Iridium Plugs and Iridium TT, ■ for Iridium Power, ■ for Iridium Racing and Two Tops Plugs, ■ for Platinum Plugs and Platinum TT, and black for general spark plugs.

DENSO

AUSTRALIA

CHINA

INDIA

INDONESIA

KOREA

MALAYSIA

PHILIPPINES

SAUDI ARABIA

SINGAPORE

TAIWAN

THAILAND

VIETNAM

JAPAN

EUROPE & USA

MOTOR CYCLE

SMALL ENGINE

CROSS REFERENCE

PART NUMBER

Model	Engine Size	Engine Code	Specification	From To	DENSO					QTY
SSANGYONG										
KORANDO	2.3L 4Cyl 16V	M 111.970	KJ	98-98	K16PR-U	K16TT	IK16TT	IK16	VK16	4
	2.0L 4Cyl 16V	G20	CK	12-	VXUHC22G	-	-	-	VXUHC22G	4
KYRON	3.2L 6Cyl 24V	G32D		08-12	IQ16	Q16TT	IQ16TT	IQ16	VQ16	6
MUSSO	3.2L 6Cyl 24V	M 104.992	FJ	96-98	K16PR-U	K16TT	IK16TT	IK16	VK16	6
	2.3L 4Cyl 16V	M 111.970	FJ	96-98	K16PR-U	K16TT	IK16TT	IK16	VK16	4
REXTON	3.2L 6Cyl 24V	G32D	GAB_	03-06	K16PR-U	K16TT	IK16TT	IK16	VK16	6
STAVIC	3.2L 6Cyl 24V			05-07	IQ16	Q16TT	IQ16TT	IQ16	VQ16	6
SUBARU										
BRUMBY	1.8L 4Cyl 8V	EA81	AS_	81-86	W20EP-U	W20TT	IW20TT	IW20	VW20	4
BRZ	2.0L 4Cyl 16V	FA20D	Z1	12-	VXEBH27	-	-	-	VXEBH27	4
FIORI	0.8L 4Cyl 8V	EN08		89-92	K20PR-U	K20TT	IK20TT	-	VK20Y	4
FORESTER	2.0L 4Cyl 16V	EJ202	SF,SF5	97-02	K20PR-U11	K20TT	IK20TT	IK20	VK20	4
		EJ205	SF,SF5	98-02	IK20TT	K20TT	IK20TT	-	VK20Y	4
2.5L 4Cyl 16V	EJ251	SG	02-05	K20PR-U11	K20TT	IK20TT	IK20	VK20	4	
	EJ25	SG,SG9	02-05	K20PR-U11	K20TT	IK20TT	IK20	VK20	4	
2.0L 4Cyl 16V	EJ201	SG	02-08	K20PR-U11	K20TT	IK20TT	IK20	VK20	4	
	EJ205	SG	02-08	IK20TT	K20TT	IK20TT	-	VK20Y	4	
2.5L 4Cyl 16V	EJ255	SG,SG9	05-08	IKH20TT	KH20TT	IKH20TT	IKH20	VKH20	4	
	EJ25D	SG,SG9	05-08	K20PR-U11	K20TT	IK20TT	IK20	VK20	4	
	EJ255	SH,SH9	08-13	K20PR-U11	K20TT	IK20TT	IK20	VK20	4	
	EJ25	SH,SH9	09-13	K20PR-U11	K20TT	IK20TT	IK20	VK20	4	
2.5L 4Cyl 16V	FB25	SH	11-13	IXEH22TT	-	IXEH22TT	-	VFXEH22	4	
	EJ255	SH,SH9 Turbo	11-13	VKH20Y	-	-	-	VKH20Y	4	
	FB20	SJ	13-	IXEH22TT	-	IXEH22TT	-	VFXEH22	4	
2.5L 4Cyl 16V	FB25	SJ,SJ9	14-	IXEH22TT	-	IXEH22TT	-	VFXEH22	4	
IMPREZA	2.0L 4Cyl 16V	EJ20 (Turbo)	GC,GC8 WRX	92-98	IK20TT	K20TT	IK20TT	-	VK20Y	4
	1.8L 4Cyl 16V	EJ18E,EJ18	GC,GC6	93-96	K20PR-U11	K20TT	IK20TT	IK20	VK20	4
1.8L 4Cyl 16V	EJ18	GF,GF6	93-96	K20PR-U11	K20TT	IK20TT	IK20	VK20	4	
	EJ16	GC,GC3	93-98	K20PR-U11	K20TT	IK20TT	IK20	VK20	4	
2.0L 4Cyl 16V	EJ20 (Turbo)	GF,GF8 WRX	94-98	IK20TT	K20TT	IK20TT	-	VK20Y	4	
	EJ20E	GFC	95-00	K20PR-U11	K20TT	IK20TT	IK20	VK20	4	
1.8L 4Cyl 16V	EJ18E	GC,GC5	95-96	K20PR-U11	K20TT	IK20TT	IK20	VK20	4	
	EJ18E	GF,GF5	95-96	K20PR-U11	K20TT	IK20TT	IK20	VK20	4	
2.0L 4Cyl 16V	EJ20E	GC,GC7	96-98	K20PR-U11	K20TT	IK20TT	IK20	VK20	4	
	EJ20E,EJ201	GC,GC7	96-98	K20PR-U11	K20TT	IK20TT	IK20	VK20	4	
2.0L 4Cyl 16V	EJ20E,EJ201	GF,GF8	96-98	K20PR-U11	K20TT	IK20TT	IK20	VK20	4	
	EJ161	GC,GC3	97-00	K20PR-U11	K20TT	IK20TT	IK20	VK20	4	
1.6L 4Cyl 16V	EJ161	GF,GF3	97-00	K20PR-U11	K20TT	IK20TT	IK20	VK20	4	
	EJ201	GC	98-00	K20PR-U11	K20TT	IK20TT	IK20	VK20	4	
2.0L 4Cyl 16V	EJ205	GC,GC8 WRX	98-00	IK20TT	K20TT	IK20TT	-	VK20Y	4	
	EJ20E,EJ201	GF	98-00	K20PR-U11	K20TT	IK20TT	IK20	VK20	4	
2.0L 4Cyl 16V	EJ205	GF,GF8 WRX	98-00	IK20TT	K20TT	IK20TT	-	VK20Y	4	
	EJ22E	GFC	98-00	K20PR-U11	K20TT	IK20TT	IK20	VK20	4	
1.6L 4Cyl 8V		GC,GC7	98-98	K20PR-U11	K20TT	IK20TT	IK20	VK20	4	
2.0L 4Cyl 16V	EJ201	GC,GC8	99-00	K20PR-U11	K20TT	IK20TT	IK20	VK20	4	
	EJ201	GD,GD9	99-07	K20PR-U11	K20TT	IK20TT	IK20	VK20	4	
2.0L 4Cyl 16V	EJ201	GG	00-02	K20PR-U11	K20TT	IK20TT	IK20	VK20	4	
	EJ205	GG,GGA WRX	00-02	IK20TT	K20TT	IK20TT	-	VK20Y	4	
2.0L 4Cyl 16V	EJ205	GD,GDA WRX	00-05	IK20TT	K20TT	IK20TT	-	VK20Y	4	
	EJ251	GD,GDE	01-05	K20PR-U11	K20TT	IK20TT	IK20	VK20	4	
2.0L 4Cyl 16V	EJ207	GD,GDB WRX Sti	02-05	IK20TT	K20TT	IK20TT	-	VK20Y	4	
2.5L 4Cyl 16V	EJ25	GDA,GGA	02-05	K20PR-U11	K20TT	IK20TT	IK20	VK20	4	
2.0L 4Cyl 16V	EJ205	GG WRX	05-06	IK20TT	K20TT	IK20TT	-	VK20Y	4	
2.5L 4Cyl 16V	EJ257	GD	05-07	VKH20Y	-	-	-	VKH20Y	4	
	EJ257	GD WRX Sti	05-07	VKH20Y	-	-	-	VKH20Y	4	
2.0L 4Cyl 16V	EJ204	GD,GD9	05-07	IKH20TT	KH20TT	IKH20TT	IKH20	VKH20	4	
	EJ257	GD,GDF WRX Sti	05-07	VKH20Y	-	-	-	VKH20Y	4	
2.5L 4Cyl 16V	EJ255	GD,GDG WRX	05-07	VKH20Y	-	-	-	VKH20Y	4	
	EJ204	GG,GG9	05-07	IKH20TT	KH20TT	IKH20TT	IKH20	VKH20	4	
2.5L 4Cyl 16V	EJ255	GG,GGG WRX	05-08	VKH20Y	-	-	-	VKH20Y	4	
	EJ255	GE,GH,GR,GHE WRX	07-11	VKH20Y	-	-	-	VKH20Y	4	
2.0L 4Cyl 16V	EJ255	GE,GH,GR,GRE WRX	08-11	VKH20Y	-	-	-	VKH20Y	4	
	EJ204	GE,GH,GR,GH7	08-12	IKH20TT	KH20TT	IKH20TT	IKH20	VKH20	4	
2.5L 4Cyl 16V	EJ257	GE,GH,GR,GRF WRX Sti	08-13	VKH20Y	-	-	-	VKH20Y	4	
2.0L 4Cyl 16V	EJ204	GR,GE7	08-16	IKH20TT	KH20TT	IKH20TT	IKH20	VKH20	4	
2.5L 4Cyl 16V	EJ257	GE,GH,GR,GRE WRX	11-13	VKH20Y	-	-	-	VKH20Y	4	
2.0L 4Cyl 16V	FB20B	GJ,GJ7	11-16	IXEH22TT	-	IXEH22TT	-	VFXEH22	4	



Model	Engine Size	Engine Code	Specification	From To	DENSO	TJ	IRIDIUM	IRIDIUM POWER	IRIDIUM TOUGH	QTY
SUBARU										
IMPREZA	2.5L 4Cyl 16V	EJ257	GR,GVE WRX	11-16	VKH20Y	-	-	-	VKH20Y	4
		EJ257	GR,GVF WRX Sti	11-16	VKH20Y	-	-	-	VKH20Y	4
	2.0L 4Cyl 16V	FB20	GP,GP7	12-16	IXEH22TT	-	IXEH22TT	-	VFXEH22	4
LEONE										
LIBERTY										
1.8L 4Cyl 8V	EA82			84-90	W20EP-U	W20TT	IW20TT	IW20	VW20	4
2.2L 4Cyl 16V	EJ22	BC,BC6		89-94	K20PR-U11	K20TT	IK20TT	IK20	VK20	4
	EJ22	BF,BF6		89-94	K20PR-U11	K20TT	IK20TT	IK20	VK20	4
2.0L 4Cyl 16V	EJ20-GN	BC,BC5		91-94	IK20TT	K20TT	IK20TT	-	VK20Y	4
	EJ20-GN	BF,BF5		91-94	IK20TT	K20TT	IK20TT	-	VK20Y	4
2.2L 4Cyl 16V	EJ22	BD,BD6		94-95	K20PR-U11	K20TT	IK20TT	IK20	VK20	4
	EJ22 EMPI	BG,BG7		94-96	K20PR-U11	K20TT	IK20TT	IK20	VK20	4
	EJ22	BD,BD6/BD7		94-98	K20PR-U11	K20TT	IK20TT	IK20	VK20	4
	EJ22	BG,BG6/BG7		94-98	K20PR-U11	K20TT	IK20TT	IK20	VK20	4
	EJ22 EMPI	BD,BD7		94-99	K20PR-U11	K20TT	IK20TT	IK20	VK20	4
	EJ25	BD,BD9		96-98	K20PR-U11	K20TT	IK20TT	IK20	VK20	4
2.5L 4Cyl 16V	EJ25D	BG,BG9		96-98	K20PR-U11	K20TT	IK20TT	IK20	VK20	4
2.0L 4Cyl 16V	EJ201	BE,BE5		98-03	K20PR-U11	K20TT	IK20TT	IK20	VK20	4
2.5L 4Cyl 16V	EJ25	BE,BE9		98-03	K20PR-U11	K20TT	IK20TT	IK20	VK20	4
2.0L 4Cyl 16V	EJ201	BH,BH5		98-03	K20PR-U11	K20TT	IK20TT	IK20	VK20	4
2.5L 4Cyl 16V	EJ25	BH,BH9		98-03	K20PR-U11	K20TT	IK20TT	IK20	VK20	4
2.0L 4Cyl 16V	EJ202	BL,BL5		03-05	IK16TT	K16TT	IK16TT	IK16	VK16	4
	EJ202	B13_,BP,BP5		03-06	IK16TT	K16TT	IK16TT	IK16	VK16	4
	EJ20 (Turbo)	B13_,BP,BP5 Turbo		03-06	IKH20TT	KH20TT	IKH20TT	IKH20	VKH20	4
2.5L 4Cyl 16V	EJ25	B13_,BP,BP9		03-06	IK16TT	K16TT	IK16TT	IK16	VK16	4
2.0L 4Cyl 16V	EJ20 (Turbo)	BL,BL5 Turbo		03-06	IKH20TT	KH20TT	IKH20TT	IKH20	VKH20	4
2.5L 4Cyl 16V	EJ25	BL,BL9		03-09	IK16TT	K16TT	IK16TT	IK16	VK16	4
3.0L 6Cyl 24V	EZ30	B13_,BP,BPE		04-07	IKH20TT	KH20TT	IKH20TT	IKH20	VKH20	6
	EZ30	BL,BLE		04-07	IKH20TT	KH20TT	IKH20TT	IKH20	VKH20	6
2.0L 4Cyl 16V	EJ20X	B13_,BP,BP5		05-07	IK16TT	K16TT	IK16TT	IK16	VK16	4
	EJ204	BL		05-09	IKH20TT	KH20TT	IKH20TT	IKH20	VKH20	4
2.5L 4Cyl 16V	EJ25DET	B13_,BP,BP9		06-09	VKH20Y	-	-	-	VKH20Y	4
	EJ25DET	B13_,BP,BP9 Sti		06-09	VKH20Y	-	-	-	VKH20Y	4
	EJ25DET	BL,BL9		06-09	VKH20Y	-	-	-	VKH20Y	4
	EJ25DET,EJ255	BL,BL9 Sti		06-09	VKH20Y	-	-	-	VKH20Y	4
	EJ25	BP,BP9		08-09	IK16TT	K16TT	IK16TT	IK16	VK16	4
	EJ253	BM,BM9		09-14	IK20TT	K20TT	IK20TT	IK20	VK20	4
3.6L 6Cyl 24V	EZ36D	BM,BMF		09-14	IKH20TT	KH20TT	IKH20TT	IKH20	VKH20	6
	EJ253	BR,BR9		09-14	IK20TT	K20TT	IK20TT	IK20	VK20	4
	EJ255	BM,BM9		10-14	VKH20Y	-	-	-	VKH20Y	4
2.5L 4Cyl 16V	EJ255	BR,BR9		10-14	VKH20Y	-	-	-	VKH20Y	4
	FB25,FB25A,FB25B	BM		12-14	IXEH22TT	-	IXEH22TT	-	VFXEH22	4
	FB25	BR,BRM		12-14	IXEH22TT	-	IXEH22TT	-	VFXEH22	4
	FB25	BM,BN9		13-	IXEH22TT	-	IXEH22TT	-	VFXEH22	4
	FB25	BN,BN9		15-	IXEH22TT	-	IXEH22TT	-	VFXEH22	4
	3.6L 6Cyl 24V	EZ36D	BN,BNF		15-	IKH20TT	KH20TT	IKH20TT	IKH20	VKH20
LIBERTY OUTBACK										
2.5L 4Cyl 16V	EJ25	BH,BH9		00-03	K20PR-U11	K20TT	IK20TT	IK20	VK20	4
3.0L 6Cyl 24V	EZ30	BH,BHE		00-03	IKH20TT	KH20TT	IKH20TT	IKH20	VKH20	6
OUTBACK										
2.5L 4Cyl 16V	EJ25D	BP,BP9		03-07	IK16TT	K16TT	IK16TT	IK16	VK16	4
3.0L 6Cyl 24V	EZ30	BP,BPE		03-09	IKH20TT	KH20TT	IKH20TT	IKH20	VKH20	6
2.5L 4Cyl 16V	EJ251	BP,BP9		08-09	IK16TT	K16TT	IK16TT	IK16	VK16	4
	EJ253	BR,BR9		09-15	IK20TT	K20TT	IK20TT	IK20	VK20	4
3.6L 6Cyl 24V	EZ36D	BR,BRF		09-15	IKH20TT	KH20TT	IKH20TT	IKH20	VKH20	6
2.5L 4Cyl 16V	EJ253	BR,BRM		12-15	IK20TT	K20TT	IK20TT	IK20	VK20	4
	FB25	BS,BS9		14-	IXEH22TT	-	IXEH22TT	-	VFXEH22	4
3.6L 6Cyl 24V	EZ36D	BS,BSF		14-	IKH20TT	KH20TT	IKH20TT	IKH20	VKH20	6
SVX										
TRIBECA										
3.3L 6Cyl 24V	EG33 DOHC	CX		92-97	IK20TT	K20TT	IK20TT	IK20	VK20	6
3.0L 6Cyl 24V	EZ30	B9		06-07	IKH20TT	KH20TT	IKH20TT	IKH20	VKH20	6
3.6L 6Cyl 24V	EZ36D	B9		07-	VKH20Y	-	-	-	VKH20Y	6
2.5L 4Cyl 16V	EJ257	GJ,FKH (V1) WRX Sti		14-	VKH20Y	-	-	-	VKH20Y	4
2.0L 4Cyl 16V	FB20B	GP7		11-17	IXEH22TT	-	IXEH22TT	-	VFXEH22	4
SUZUKI										
ALTO										
1.0L 4Cyl 16V	G10BB	EF		96-98	W16EXR-U	W16TT	IW16TT	IW16	VW16	4
1.0L 3Cyl 12V	K10B	GF		09-	VXU20	-	-	-	VXU20	3
1.6L 4Cyl 16V	G16A (16V)	GD		05-	K20PR-U	K20TT	IK20TT	-	VK20Y	4
APV										
BALENO										
1.6L 4Cyl 16V	G16B	EG		95-02	K20PR-U	K20TT	IK20TT	-	VK20Y	4
1.8L 4Cyl 16V	J18A	EG		96-01	K20PR-U11	K20TT	IK20TT	IK20	VK20	4
1.0L 3Cyl 12V	K10C	FW, EW		16-	IXUH20I	-	-	IXUH20I	VXUH20I	3
1.4L 4Cyl 16V		FW, EW		16-	IXUH20I	-	-	IXUH20I	VXUH20I	4

DENSO

AUSTRALIA

CHINA

INDIA

INDONESIA

KOREA

MALAYSIA

PHILIPPINES

SAUDI ARABIA

SINGAPORE

TAIWAN

THAILAND

VIETNAM

JAPAN

EUROPE

MOTOR & USA

CYCLE

SMALL ENGINE

CROSS REFERENCE

PART NUMBER

DENSO	9	14	16	20	22	24	27	29	31	32	34	35	DENSO	9	14	16	20	22	24	27	29	31	32	DENSO	9	14	16	20	22	24	27	31
NGK	2	4	5	6	7	8	9	9.5	10	10.5	11	11.5	CHAMPION	18	16,14	12,11	10,9	8,7	6,6,3,61	4,59	57	55	53	BOSCH	10	9	8	7,6	5	4	3	2



AUSTRALIA CAR

▶ Spark plug color codes: ■ for Iridium Tough and Iridium Plugs and Iridium TT, ■ for Iridium Power, ■ for Iridium Racing and Two Tops Plugs, ■ for Platinum Plugs and Platinum TT, and black for general spark plugs.

PART NUMBER	CROSS REFERENCE	SMALL ENGINE	MOTOR CYCLE	EUROPE & USA	JAPAN	VIETNAM	THAILAND	TAIWAN	SINGAPORE	SAUDI ARABIA	PHILIPPINES	MALAYSIA	KOREA	INDONESIA	INDIA	CHINA	AUSTRALIA	DENSO	From To	Specification	Engine Code	Engine Size	Model	DENSO				QTY	
																								IRIDIUM TOUGH	IRIDIUM POWER	IRIDIUM RACING	IRIDIUM TT		
SUZUKI																													
CAPPUCINO																													
																			92-95	EA11	F6A	0.7L 3Cyl 12V	CAPPUCINO	IXU22	XU22TT	-	IXU22	VXU22	3
																			95-98	EA21	F6A	0.7L 3Cyl 12V	CAPPUCINO	IXU22	XU22TT	-	IXU22	VXU22	3
CARRY																													
																			99-05	FD	G13BB	1.3L 4Cyl 16V	CARRY	K20PR-U	K20TT	IK20TT	-	VK20Y	4
																			00-05	FD, DA5_T, DA6_T	G13BB	1.3L 4Cyl 16V	CARRY	K20PR-U	K20TT	IK20TT	-	VK20Y	4
CELERIO																													
																			14-	LF	K10B	1.0L 3Cyl 12V	CELERIO	VXU20	-	-	-	VXU20	3
CULTUS																													
																			91-96	SF413	G13BA	1.3L 4Cyl 8V	CULTUS	W20EP-U	W20TT	IW20TT	IW20	VW20	4
GRAND VITARA																													
																			98-03	GT	J20A	2.0L 4Cyl 16V	GRAND VITARA	K20PR-U11	K20TT	IK20TT	IK20	VK20	4
																			05-15	JT, TE, TD	J20A	2.0L 4Cyl 16V	GRAND VITARA	K20PR-U11	K20TT	IK20TT	IK20	VK20	4
																			05-15	JT, TE, TD	M16A	1.6L 4Cyl 16V	GRAND VITARA	IK20TT	K20TT	IK20TT	IK20	VK20	4
																			08-15	JT, TE, TD	N32A	3.2L 6Cyl 24V	GRAND VITARA	ITV20	-	ITV20TT	ITV20	-	6
																			08-	JT, TE, TD	J24B	2.4L 4Cyl 16V	GRAND VITARA	IKH20TT	KH20TT	IKH20TT	IKH20	VKH20	4
GRAND VITARA (INC XL-7)																													
																			98-03	FT, HT	J20A	2.0L 4Cyl 16V	GRAND VITARA (INC XL-7)	K20PR-U11	K20TT	IK20TT	IK20	VK20	4
																			98-05	FT, HT	G16B	1.6L 4Cyl 16V	GRAND VITARA (INC XL-7)	K20PR-U11	K20TT	IK20TT	IK20	VK20	4
																			98-05	FT, HT	H 25 A	2.5L 6Cyl 24V	GRAND VITARA (INC XL-7)	IK16TT	K16TT	IK16TT	IK16	VK16	6
																			01-03	FT, HT	H 27 A	2.7L 6Cyl 24V	GRAND VITARA (INC XL-7)	K20PR-U11	K20TT	IK20TT	IK20	VK20	6
IGNIS																													
																			00-05	FH	M13A	1.3L 4Cyl 16V	IGNIS	K20PR-U11	K20TT	IK20TT	IK20	VK20	4
																			03-05	FH	M15A	1.5L 4Cyl 16V	IGNIS	IK20TT	K20TT	IK20TT	IK20	VK20	4
JIMNY																													
																			98-17	SN	G13BB	1.3L 4Cyl 16V	JIMNY	K20PR-U	K20TT	IK20TT	-	VK20Y	4
																			00-17	SN	M13A	1.3L 4Cyl 16V	JIMNY	K20PR-U	K20TT	IK20TT	-	VK20Y	4
KIZASHI																													
																			10-	FR	J24B	2.4L 4Cyl 16V	KIZASHI	IKH20TT	KH20TT	IKH20TT	IKH20	VKH20	4
LIANA																													
																			01-04	ER, RH_	M16A	1.6L 4Cyl 16V	LIANA	K20PR-U11	K20TT	IK20TT	IK20	VK20	4
																			01-04	ER, RH_	M16A	1.6L 4Cyl 16V	LIANA	K20PR-U11	K20TT	IK20TT	IK20	VK20	4
																			04-07	ER, RH_	M18A	1.8L 4Cyl 16V	LIANA	K20PR-U11	K20TT	IK20TT	IK20	VK20	4
																			04-07	ER, RH_	M18A	1.8L 4Cyl 16V	LIANA	K20PR-U11	K20TT	IK20TT	IK20	VK20	4
S-CROSS																													
																			13-	JY	M16A	1.6L 4Cyl 16V	S-CROSS	IKH20TT	KH20TT	IKH20TT	IKH20	VKH20	4
SIERRA																													
																			81-00	SJ	F10A	1.0L 4Cyl 8V	SIERRA	W16EP-U	W16TT	IW16TT	IW16	VW16	4
																			81-91	SJ410	F10A	1.0L 4Cyl 8V	SIERRA	W16EP-U	W16TT	IW16TT	IW16	VW16	4
																			84-04	SJ	G13A	1.0L 4Cyl 8V	SIERRA	W16EP-U	W16TT	IW16TT	IW16	VW16	4
																			84-90	SJ413	G13A	1.3L 4Cyl 8V	SIERRA	W16EP-U	W16TT	IW16TT	IW16	VW16	4
																			89-99	SJ	G13BA	1.3L 4Cyl 8V	SIERRA	W20EP-U	W20TT	IW20TT	IW20	VW20	4
SWIFT																													
																			84-89	AA	G13A	1.3L 4Cyl 8V	SWIFT	W20EP-U	W20TT	IW20TT	IW20	VW20	4
																			85-89	AA	G10,G10A	1.0L 3Cyl 6V	SWIFT	W20EP-U	W20TT	IW20TT	IW20	VW20	3
																			85-89	AA	G13B	1.0L 3Cyl 6V	SWIFT	W20EP-U	W20TT	IW20TT	IW20	VW20	4
																			89-00	EA, MA	G13B	1.3L 4Cyl 16V	SWIFT	W20EPR-U	W20TT	IW20TT	IW20	VW20	4
																			89-91	AH, AJ	G16B	1.6L 4Cyl 16V	SWIFT	K20R-U	K20TT	IK20TT	-	VK20Y	4
																			89-95	AH, AJ	G16B	1.6L 4Cyl 16V	SWIFT	K20PR-U	K20TT	IK20TT	-	VK20Y	4
																			89-95	EA, MA	G10A	1.0L 3Cyl 6V	SWIFT	W20EP-U	W20TT	IW20TT	IW20	VW20	3
																			90-95	AH, AJ	G13B	1.3L 4Cyl 16V	SWIFT	W20EPR-U	W20TT	IW20TT	IW20	VW20	4
																			94-00	EA, MA	G13B	1.3L 4Cyl 8V	SWIFT	W20EP-U	W20TT	IW20TT	IW20	VW20	4
																			95-05	EA, MA	G10A	1.0L 3Cyl 6V	SWIFT	K20R-U	K20TT	IK20TT	-	VK20Y	3
																			05-11	MZ, EZ	M15A	1.5L 4Cyl 16V	SWIFT	K20PR-U11	K20TT	IK20TT	IK20	VK20	4
																			06-11	MZ, EZ	M16A	1.6L 4Cyl 16V	SWIFT	K20PR-U11	K20TT	IK20TT	IK20	VK20	4
																			11-	FZ, NZ	K14B	1.4L 4Cyl 16V	SWIFT	XU20EPR-U	-	-	-	VXU20	4
																			12-	FZ, NZ	M16A	1.6L 4Cyl 16V	SWIFT	IKH20TT	KH20TT	IKH20TT	IKH20	VKH20	4
SX4																													
																			06-	EY, GY	J20A	2.0L 4Cyl 16V	SX4	K20PR-U11	K20TT	IK20TT	IK20	VK20	4
																			07-10	GY	J20A	2.0L 4Cyl 16V	SX4	K20PR-U11	K20TT	IK20TT	IK20	VK20	4
																			10-	EY, GY	J20B	2.0L 4Cyl 16V	SX4	K16HPR-U11	KH16TT	IKH16TT	IKH16	VKH16	4
																			10-	GY	J20B	2.0L 4Cyl 16V	SX4	K16HPR-U11	KH16TT	IKH16TT	IKH16	VKH16	4
VITARA																													
																			88-95	ET, TA	G16A (8V)	1.6L 4Cyl 8V	VITARA	W20EP-U	W20TT	IW20TT	IW20	VW20	4
																			94-99	ET, TA	G16B	1.6L 4Cyl 16V	VITARA	K20PR-U	K20TT	IK20TT	-	VK20Y	4
																			95-98	ET, TA	H 20 A	2.0L 6Cyl 24V	VITARA	K20PR-U	K20TT	IK20TT	-	VK20Y	6
																			97-00	ET, TA	J20A	2.0L 4Cyl 16V	VITARA	K20PR-U	K20TT	IK20TT	-	VK20Y	4
																			99-02	ET, TA	G16B	1.6L 4Cyl 16V	VITARA	K20PR-U11	K20TT	IK20TT	IK20		

Model	Engine Size	Engine Code	Specification	From To	DENSO					QTY
TOYOTA										
AURION	3.5L 6Cyl 24V	2GR-FE	GSV50	11-	IKH20TT	KH20TT	IKH20TT	-	VFKH20	6
AVALON	3.0L 6Cyl 24V	1MZ-FE	MCX10	95-06	IK20	K20TT	IK20TT	IK20	VK20	6
AVENSIS VERSO	2.0L 4Cyl 16V	1AZ-FE	ACM20	01-03	IK20TT	K20TT	IK20TT	IK20	VK20	4
	2.4L 4Cyl 16V	2AZ-FE	ACN21	01-11	IK20TT	K20TT	IK20TT	IK20	VK20	4
	2.4L 4Cyl 16V	2AZ-FE	ACM21	03-07	IK20TT	K20TT	IK20TT	IK20	VK20	4
CALDINA	2.0L 4Cyl 16V	3S-GTE	ST215	00-01	IK20TT	K20TT	IK20TT	-	VK20Y	4
CAMRY	2.0L 4Cyl 16V	3S-FE	SV21	87-93	Q16R-U11	Q16TT	IQ16TT	IQ16	VQ16	4
	2.5L 6Cyl 24V	2VZ-FE	VZV21	88-93	IQ20TT	Q20TT	IQ20TT	IQ20	VQ20	6
	2.0L 4Cyl 16V	3S-FC	SV22	89-91	K16R-U11	K16TT	IK16TT	IK16	VK16	4
	3.0L 6Cyl 24V	3VZ-FE	_V1_	92-97	Q20R-U11	Q20TT	IQ20TT	IQ20	VQ20	6
	2.2L 4Cyl 16V	5S-FE	SXV10/SDV10	92-97	IK20TT	K20TT	IK20TT	IK20	VK20	4
		3VZ-FE	VCV10	93-94	Q20R-U11	Q20TT	IQ20TT	IQ20	VQ20	6
	3.0L 6Cyl 24V	3VZ-FE	VDV10	96-01	Q20R-U11	Q20TT	IQ20TT	IQ20	VQ20	6
		1MZ-FE	MCV20	97-02	IK20	K20TT	IK20TT	IK20	VK20	6
	2.2L 4Cyl 16V	5S-FE	SXV20	97-02	IK20	K20TT	IK20TT	IK20	VK20	4
	2.4L 4Cyl 16V	2AZ-FE	ACV36	02-06	K20R-U11	K20TT	IK20TT	IK20	VK20	4
	3.0L 6Cyl 24V	1MZ-FE	MCV36	02-06	IK20	K20TT	IK20TT	IK20	VK20	6
	2.4L 4Cyl 16V	2AZ-FE	ACV40	06-11	IK20TT	K20TT	IK20TT	IK20	VK20	4
		2AZ-FXE	AHV40	09-11	IK20TT	K20TT	IK20TT	IK20	VK20	4
	2.5L 4Cyl 16V	2AR-FE	ASV50	11-17	IKH16TT	KH16TT	IKH16TT	IKH16	VKH16	4
	2JM,2AR-FXE	AVV50	11-17	FK16HR-A8	-	-	-	-	4	
CELICA	1.6L 4Cyl 8V	2T-C	TA22	71-76	W16EXRU	W16TT	IW16TT	IW16	VW16	4
	2.0L 4Cyl 8V	18R	RA23,RA28	73-77	W16EXRU	W16TT	IW16TT	IW16	VW16	4
	1.6L 4Cyl 8V	2T-G	TA4C	80-81	W16EXRU	W16TT	IW16TT	IW16	VW16	4
	2.0L 4Cyl 8V	21R-U	RA60	81-83	W16EXR-U	W16TT	IW16TT	IW16	VW16	4
	2.8L 6Cyl 12V	5M-GE	MA61	81-85	IW16TT	W16TT	IW16TT	IW16	VW16	6
	2.0L 4Cyl 8V	21R-C	RA61	82-85	W16EXR-U	W16TT	IW16TT	IW16	VW16	4
		2S-C	SA63	83-84	W16EXR-U	W16TT	IW16TT	IW16	VW16	4
	2.4L 4Cyl 8V	22REC	RA65	84-85	W16EXR-U	W16TT	IW16TT	IW16	VW16	4
		3S-GEL	ST162	85-89	IQ16TT	Q16TT	IQ16TT	IQ16	VQ16	4
		3S-GELC	ST162	85-89	Q20R-U11	Q20TT	IQ20TT	IQ20	VQ20	4
	2.0L 4Cyl 16V	3S-GEL,3S-GELC	_T16_	86-89	Q20R-U11	Q20TT	IQ20TT	IQ20	VQ20	4
		3S-FE	ST162	87-89	Q16R-U11	Q16TT	IQ16TT	IQ16	VQ16	4
		3S-GE	ST182	89-93	IK20TT	K20TT	IK20TT	-	VK20Y	4
	2.2L 4Cyl 16V	5S-FE	ST184	89-94	K16R-U11	K16TT	IK16TT	IK16	VK16	4
		3S-GTE	ST185	90-92	IK20TT	K20TT	IK20TT	-	VK20Y	4
	2.0L 4Cyl 16V	3S-GE	ST183	90-93	IK20TT	K20TT	IK20TT	-	VK20Y	4
		3S-GE	ST202	93-99	IK20TT	K20TT	IK20TT	-	VK20Y	4
	3S-GTE	ST205	94-95	IK20TT	K20TT	IK20TT	-	VK20Y	4	
2.2L 4Cyl 16V	5S-FE	ST204	94-99	IK20TT	K20TT	IK20TT	IK20	VK20	4	
1.8L 4Cyl 16V	2ZZ-GE	ZZT231	99-06	IK20TT	K20TT	IK20TT	IK20	VK20	4	
CHASER	2.5L 6Cyl 24V	1JZ-GTE	JZX90 Turbo	92-96	IK20TT	K20TT	IK20TT	-	VK20Y	6
		1JZ-GE	JZX90,JZX93	92-96	IK16	K16TT	IK16TT	IK16	VK16	6
C-HR	1.2L 4Cyl 16V	8NR-FTS	NGX10	17-	VDCH22F	-	-	-	VDCH22F	4
		8NR-FTS	NGX50	17-	VDCH22F	-	-	-	VDCH22F	4
COASTER	2.4L 4Cyl 8V	22R	_B2_,_B3_	82-89	W16EXRU	W16TT	IW16TT	IW16	VW16	4
	2.7L 4Cyl 16V	2TR-FE	_B4_,_B5_	07-	IKH20TT	KH20TT	IKH20TT	IKH20	VKH20	4
COROLLA	1.2L 4Cyl 8V	3K-C,3K-H,3K-B	KE20,KE25,KE30	70-80	W16EXRU	W16TT	IW16TT	IW16	VW16	4
		3K-H,3K-C,3K-B,3K	KE25,KE30,KE36	75-79	W16EXRU	W16TT	IW16TT	IW16	VW16	4
		3K-C,3K-H,3K-B	KE35	75-80	W16EXRU	W16TT	IW16TT	IW16	VW16	4
	1.3L 4Cyl 8V	4K-C	KE55	78-81	W16EXRU	W16TT	IW16TT	IW16	VW16	4
		4K	KE70	81-85	W16EXRU	W16TT	IW16TT	IW16	VW16	4
	1.6L 4Cyl 8V	4A-C	AE71	83-85	W16EXRU	W16TT	IW16TT	IW16	VW16	4
		4A-C	AE86	83-85	W16EXR-U	W16TT	IW16TT	IW16	VW16	4
	1.3L 4Cyl 8V	2A	AE80	85-89	W16EXRU	W16TT	IW16TT	IW16	VW16	4
	1.6L 4Cyl 8V	4A-LC	AE82	85-89	W16EX-U11	W16TT	IW16TT	IW16	VW16	4
	1.6L 4Cyl 16V	4A-GEC,4A-GELC	AE82	86-89	IQ16TT	Q16TT	IQ16TT	IQ16	VQ16	4
	1.6L 4Cyl 20V	4A-GE (20V)	AE92	87-91	IK20TT	K20TT	IK20TT	-	VK20Y	4
	1.6L 4Cyl 16V	4A-FE	AE95	88-95	Q16R-U	Q16TT	IQ16TT	IQ16	VQ16	4
	1.4L 4Cyl 16V	6A-FC	AE90	89-92	QJ16AR-U	-	-	-	-	4
		4A-F	AE92	89-94	Q16R-U11	Q16TT	IQ16TT	IQ16	VQ16	4
	1.6L 4Cyl 16V	4A-FE	AE92	91-94	Q16R-U	Q16TT	IQ16TT	IQ16	VQ16	4
		4A-GE	AE92,AE93	91-94	IK20TT	K20TT	IK20TT	-	VK20Y	4
	1.6L 4Cyl 20V	4A-GE (20V)	AE101	91-98	K16R-U11	K16TT	IK16TT	IK16	VK16	4
	1.6L 4Cyl 16V	4A-FE	AE101	91-99	K16R-U11	K16TT	IK16TT	IK16	VK16	4
	1.8L 4Cyl 16V	7A-FE	AE96	92-94	K16R-U	K16TT	IK16TT	IK16	VK16	4
	7A-FE	AE102	94-99	K16R-U	K16TT	IK16TT	IK16	VK16	4	

DENSO	9	14	16	20	22	24	27	29	31	32	34	35	DENSO	9	14	16	20	22	24	27	29	31	32	DENSO	9	14	16	20	22	24	27	31
NGK	2	4	5	6	7	8	9	9.5	10	10.5	11	11.5	CHAMPION	18	16,14	12,11	10,9	8,7	6,6.3,6.1	4,5,9	5,7	5,5	5,3	BOSCH	10	9	8	7,6	5	4	3	2

DENSO
 AUSTRALIA
 CHINA
 INDIA
 INDONESIA
 KOREA
 MALAYSIA
 PHILIPPINES
 SAUDI ARABIA
 SINGAPORE
 TAIWAN
 THAILAND
 VIETNAM
 JAPAN
 & USA
 EUROPE
 MOTOR
 CYCLE
 SMALL
 ENGINE
 REFERENCE
 NUMBER



AUSTRALIA CAR

▶ Spark plug color codes: ■ for Iridium Tough and Iridium Plugs and Iridium TT, ■ for Iridium Power, ■ for Iridium Racing and Two Tops Plugs, ■ for Platinum Plugs and Platinum TT, and black for general spark plugs.

DENSO
AUSTRALIA
CHINA
INDIA
INDONESIA
KOREA
MALAYSIA
PHILIPPINES
SAUDI ARABIA
SINGAPORE
TAIWAN
THAILAND
VIETNAM
JAPAN
EUROPE & USA
SMALL ENGINE
CROSS REFERENCE
PART NUMBER

Model	Engine Size	Engine Code	Specification	From To	DENSO					QTY	
TOYOTA											
COROLLA	1.6L 4Cyl 20V	4A-GE (20V)	AE111	98-00	IK20TT	K20TT	IK20TT	-	VK20Y	4	
		7A-FE	AE112	98-02	K20R-U11	K20TT	IK20TT	IK20	VK20	4	
		1ZZ-FE	ZZE122	01-07	K16R-U11	K16TT	IK16TT	IK16	VK16	4	
	1.8L 4Cyl 16V	2ZZ-GE	ZZE123	03-07	IK20TT	K20TT	IK20TT	IK20	VK20	4	
		2ZR-FE	ZRE152	06-12	IXEH20TT	-	IXEH20TT	-	VCH20	4	
		2ZR-FE,2ZR-FAE	ZZE152	06-12	IXEH20TT	-	IXEH20TT	-	VCH20	4	
	2.0L 4Cyl 16V	3ZR-FE	ZRE143	10-12	IXEH20TT	-	IXEH20TT	-	VCH20	4	
		2ZR-FE,2ZR-FAE	ZRE182	12-	IXEH20TT	-	IXEH20TT	-	VCH20	4	
	1.8L 4Cyl 16V	2ZR-FXE	ZWE186	12-	IXEH20TT	-	IXEH20TT	-	VCH20	4	
		2ZR-FBE,2ZR-FE	ZRE172	14-	IXEH20TT	-	IXEH20TT	-	VCH20	4	
CORONA											
2.0L 4Cyl 8V	18R	RT118	75-79	W16EXRU	W16TT	IW16TT	IW16	VW16	4		
	18R	RT104	76-79	W16EXRU	W16TT	IW16TT	IW16	VW16	4		
	1.9L 4Cyl 8V	1X	XT130	79-83	T16EPR-U	T16TT	IT16TT	IT16	VT16	4	
		18R-C	RT132	80-81	W16EXRU	W16TT	IW16TT	IW16	VW16	4	
	2.0L 4Cyl 8V	21R-C	RT133	82-83	W16EXR-U	W16TT	IW16TT	IW16	VW16	4	
		2S-C	ST141	83-87	W16EXR-U	W16TT	IW16TT	IW16	VW16	4	
	2.4L 4Cyl 8V	22RE	RT142	84-87	W16EXR-U	W16TT	IW16TT	IW16	VW16	4	
	2.0L 4Cyl 16V	3S-FE	ST191	92-97	K20R-U11	K20TT	IK20TT	IK20	VK20	4	
	CORSA										
	1.5L 4Cyl 16V	5E-FE	EL43	90-94	K16R-U11	K16TT	IK16TT	IK16	VK16	4	
CRESSIDA											
2.6L 6Cyl 12V	4M	MX32	77-80	W16EXRU	W16TT	IW16TT	IW16	VW16	6		
	5M-E	MX62	81-84	W16EXR-U	W16TT	IW16TT	IW16	VW16	6		
		MX73	84-88	W16EXR-U	W16TT	IW16TT	IW16	VW16	6		
3.0L 6Cyl 24V	7M-GE	MX83	88-93	IQ16TT	Q16TT	IQ16TT	IQ16	VQ16	6		
CROWN											
2.6L 6Cyl 12V	4M	MS85	75-79	W16EXRU	W16TT	IW16TT	IW16	VW16	6		
	5M-E,5M	MS112	80-83	W14EXR-U	W16TT	IW16TT	IW16	VW16	6		
		5M-GE	MS112	84-85	W16EXR-U	W16TT	IW16TT	IW16	VW16	6	
ECHO											
1.3L 4Cyl 16V	2NZ-FE	NCP10	99-05	K16R-U11	K16TT	IK16TT	IK16	VK16	4		
	1NZ-FE	NCP12	99-05	K16R-U	K16TT	IK16TT	IK16	VK16	4		
		1NZ-FE	NCP13	01-05	K16R-U	K16TT	IK16TT	IK16	VK16	4	
FJ CRUISER											
4.0L 6Cyl 24V	1GR-FE	GSJ15	10-	IKH20TT	KH20TT	IKH20TT	IKH20	VKH20	6		
GRANVIA											
3.4L 6Cyl 24V	5VZ-FE	VCH10	95-04	K16TR11	K16TT	IK16TT	IK16	VK16	6		
	5VZ-FE	VCH16	97-04	K16TR11	K16TT	IK16TT	IK16	VK16	6		
HIACE											
1.6L 4Cyl 8V	12R	RH20-30	77-83	W16EXRU	W16TT	IW16TT	IW16	VW16	4		
2.0L 4Cyl 8V	18R	RH25-32	77-83	W16EXRU	W16TT	IW16TT	IW16	VW16	4		
1.6L 4Cyl 8V	12R	RH11	77-85	W16EXRU	W16TT	IW16TT	IW16	VW16	4		
2.0L 4Cyl 8V	3Y	YH6_,YN5	82-89	W16EXRU	W16TT	IW16TT	IW16	VW16	4		
1.8L 4Cyl 8V	2Y	YN5_	82-89	W16EXRU	W16TT	IW16TT	IW16	VW16	4		
2.0L 4Cyl 8V	3Y	H5G	85-89	W16EXRU	W16TT	IW16TT	IW16	VW16	4		
	4Y	YN7_	86-89	W16EXRU	W16TT	IW16TT	IW16	VW16	4		
4Y		YH5_,YN6_	87-89	W16EXRU	W16TT	IW16TT	IW16	VW16	4		
2.4L 4Cyl 8V	2RZ-E	RZH10	89-04	IW16TT	W16TT	IW16TT	IW16	VW16	4		
2.7L 4Cyl 16V	2TR-FE	TRH201,TRH221	05-	IKH20TT	KH20TT	IKH20TT	IKH20	VKH20	4		
HIACE / COMMUTER											
2.7L 4Cyl 16V	2TR-FE	TRH223	05-	IKH20TT	KH20TT	IKH20TT	IKH20	VKH20	4		
HIACE SBV											
2.4L 4Cyl 8V	2RZ-E	RCH12,RCH22	95-03	IW16TT	W16TT	IW16TT	IW16	VW16	4		
	2RZ-E	RZH10	95-04	IW16TT	W16TT	IW16TT	IW16	VW16	4		
HILUX											
1.6L 4Cyl 8V	12R	RN3_,RN4_	78-83	W16EXRU	W16TT	IW16TT	IW16	VW16	4		
	18R	RN3_,RN4_	79-83	W16EXRU	W16TT	IW16TT	IW16	VW16	4		
2.0L 4Cyl 8V	3Y	YN57	83-87	W16EXRU	W16TT	IW16TT	IW16	VW16	4		
1.6L 4Cyl 8V	1Y	YN58	83-87	W16EXRU	W16TT	IW16TT	IW16	VW16	4		
1.8L 4Cyl 8V	2Y	YN58	83-88	W16EXRU	W16TT	IW16TT	IW16	VW16	4		
2.2L 4Cyl 8V	4Y	YN106,YN58	83-89	W16EXRU	W16TT	IW16TT	IW16	VW16	4		
1.8L 4Cyl 8V	2Y,2Y-C	YN58	83-89	W16EXRU	W16TT	IW16TT	IW16	VW16	4		
2.4L 4Cyl 8V	22R	RN105,RN110	88-97	W16EXR-U	W16TT	IW16TT	IW16	VW16	4		
	22R	RN85,RN90	88-97	W16EXR-U	W16TT	IW16TT	IW16	VW16	4		
1.8L 4Cyl 8V	2Y	YN85,YN90	88-97	W16EXRU	W16TT	IW16TT	IW16	VW16	4		
2.7L 4Cyl 16V	3RZ-FE	RZN169,RZN174	97-02	K16R-U	K16TT	IK16TT	IK16	VK16	4		
2.0L 4Cyl 8V	1RZ-E	RZN147	97-05	W16EXR-U	W16TT	IW16TT	IW16	VW16	4		
2.7L 4Cyl 16V	3RZ-FE	RZN149,RZN154	97-05	K16R-U	K16TT	IK16TT	IK16	VK16	4		
3.4L 6Cyl 24V	5VZ-FE	VZN1_	01-05	K16TR11	K16TT	IK16TT	IK16	VK16	6		
	5VZ-FE	VZN167,VZN172	02-05	K16TR11	K16TT	IK16TT	IK16	VK16	6		
4.0L 6Cyl 24V	1GR-FE	GGN15	05-	K20HR-U11	KH20TT	IKH20TT	IKH20	VKH20	6		
	1GR-FE	GGN25	05-	K20HR-U11	KH20TT	IKH20TT	IKH20	VKH20	6		
2.7L 4Cyl 16V	2TR-FE	TGN16	05-	IKH20TT	KH20TT	IKH20TT	IKH20	VKH20	4		
4.0L 6Cyl 24V	1GR-FE	GGN120	15-	K20HR-U11	KH20TT	IKH20TT	IKH20	VKH20	6		
	1GR-FE	GGN125	15-	K20HR-U11	KH20TT	IKH20TT	IKH20	VKH20	6		
2.7L 4Cyl 16V	2TR-FE	TGN121	15-	IKH20TT	KH20TT	IKH20TT	IKH20	VKH20	4		
HILUX SURF											
3.0L 6Cyl 12V	3VZ-E	VZN_	89-95	K16R-U	K16TT	IK16TT	IK16	VK16	6		



Model	Engine Size	Engine Code	Specification	From To	DENSO					QTY
TOYOTA										
KLUGER	3.3L 6Cyl 24V	3MZ-FE	GSU40R	03-07	IK20TT	K20TT	IK20TT	IK20	VK20	6
		3MZ-FE	MCU28R	03-07	IK20TT	K20TT	IK20TT	IK20	VK20	6
	3.5L 6Cyl 24V	2GR-FE	GSU40R	07-14	IKH20TT	KH20TT	IKH20TT	-	VFKH20	6
		2GR-FE	GSU45R	07-14	IKH20TT	KH20TT	IKH20TT	-	VFKH20	6
		2GR-FE	GSU50R	14-	IKH20TT	KH20TT	IKH20TT	-	VFKH20	6
		2GR-FE	GSU55R	14-	IKH20TT	KH20TT	IKH20TT	-	VFKH20	6
LAND CRUISER										
3.9L 6Cyl 12V	F			60-68	W16EP-U	W16TT	IW16TT	IW16	VW16	6
	F			69-84	W16EXRU	W16TT	IW16TT	IW16	VW16	6
4.2L 6Cyl 12V	2F	FJ45		72-84	W14EXR-U	W16TT	IW16TT	IW16	VW16	6
	2F			72-84	W14EXR-U	W16TT	IW16TT	IW16	VW16	6
4.0L 6Cyl 12V	3F	FJ62		84-87	W14EXR-U	W16TT	IW16TT	IW16	VW16	6
	3F	FJ70,FJ73,FJ75		85-92	W14EXR-U	W16TT	IW16TT	IW16	VW16	6
	3F-E	FJ62		87-90	W16EXR-U11	W16TT	IW16TT	IW16	VW16	6
4.5L 6Cyl 24V	1FZ-FE	_J1_		98-07	K16TR11	K16TT	IK16TT	IK16	VK16	6
	1FZ-FE	FZJ105		98-07	K16TR11	K16TT	IK16TT	IK16	VK16	6
4.7L 8Cyl 32V	2UZ-FE	UZJ100		98-07	IK20TT	K20TT	IK20TT	IK20	VK20	8
	2UZ-FE	UZJ200		07-	IK20TT	K20TT	IK20TT	IK20	VK20	8
4.6L 8Cyl 32V	1UR-FE	URJ202		10-	IKH20TT	KH20TT	IKH20TT	IKH20	VKH20	8
LAND CRUISER PRADO										
2.7L 4Cyl 16V	3RZ-FE	RZJ95		96-02	K16R-U	K16TT	IK16TT	IK16	VK16	4
3.4L 6Cyl 24V	5VZ-FE	VZJ90,VZJ95		96-03	K16TR11	K16TT	IK16TT	IK16	VK16	6
2.7L 4Cyl 16V	2TR-FE	TRJ120		03-04	IKH20TT	KH20TT	IKH20TT	IKH20	VKH20	4
4.0L 6Cyl 24V	1GR-FE	GRJ120		03-09	K20HR-U11	KH20TT	IKH20TT	IKH20	VKH20	6
	1GR-FE	GRJ125		09-	IKH20TT	KH20TT	IKH20TT	IKH20	VKH20	6
	1GR-FE	GRJ150		10-	IKH16TT	KH16TT	IKH16TT	IKH16	VKH16	6
LEXCEN										
3.8L 6Cyl 12V	L36	VN, VP		89-93	T20EPR-U15	T20TT	IT20TT	IT20	VT20	6
	L36	VP		91-93	T20EPR-U15	T20TT	IT20TT	IT20	VT20	6
	L36	VR		93-95	T20EPR-U15	T20TT	IT20TT	IT20	VT20	6
	L36	VS, VR		93-97	T20EPR-U15	T20TT	IT20TT	IT20	VT20	6
	L36	VS		95-97	T20EPR-U15	T20TT	IT20TT	IT20	VT20	6
LITEACE										
1.3L 4Cyl 8V	4K-C,4K	KM20		79-86	W16EXRU	W16TT	IW16TT	IW16	VW16	4
1.8L 4Cyl 8V	2Y	YM21		84-85	W16EXR-U	W16TT	IW16TT	IW16	VW16	4
1.5L 4Cyl 8V	5K	KM31,KM36		86-92	W16EXRU	W16TT	IW16TT	IW16	VW16	4
1.8L 4Cyl 8V	2Y	YM30,YM35		86-92	IW16TT	W16TT	IW16TT	IW16	VW16	4
MARK II										
2.5L 6Cyl 24V	1JZ-GTE	JZX110		92-96	IK20TT	K20TT	IK20TT	-	VK20Y	6
3.0L 6Cyl 24V	2JZ-GE	JZX91		92-96	IK16TT	K16TT	IK16TT	IK16	VK16	6
	2JZ-GE	JZX101		96-01	IK16TT	K16TT	IK16TT	IK16	VK16	6
MR 2										
1.6L 4Cyl 16V	4A-GZE	AW11 Supercharged		86-89	IQ20TT	Q20TT	IQ20TT	IQ20	VQ20	4
	4A-GELC	AW11		87-90	IQ16TT	Q16TT	IQ16TT	IQ16	VQ16	4
2.0L 4Cyl 16V	3S-GE	SW20		89-00	IK20TT	K20TT	IK20TT	-	VK20Y	4
	3S-GTE	SW20 Turbo		89-99	IK20TT	K20TT	IK20TT	-	VK20Y	4
1.8L 4Cyl 16V	1ZZ-FE	ZZW30		99-06	K16R-U11	K16TT	IK16TT	IK16	VK16	4
NOAH/VOXY										
2.0L 4Cyl 16V	1AZ-FSE	AZR60		01-07	VKA20	-	-	-	VKA20	4
	1AZ-FSE	AZR65		01-07	VKA20	-	-	-	VKA20	4
PASEO										
1.5L 4Cyl 16V	5E-FE	EL44		91-95	K16R-U11	K16TT	IK16TT	IK16	VK16	4
	5E-FE	EL54		95-99	K16TR11	K16TT	IK16TT	IK16	VK16	4
PORTE										
1.3L 4Cyl 16V	2NZ-FE	NNP10		04-12	K16R-U11	K16TT	IK16TT	IK16	VK16	4
1.5L 4Cyl 16V	1NZ-FE	NNP11		04-12	K16R-U11	K16TT	IK16TT	IK16	VK16	4
PRIUS										
1.5L 4Cyl 16V	1NZ-FXE	NHW11		00-03	IK16TT	K16TT	IK16TT	IK16	VK16	4
	1NZ-FXE	NHW20		03-09	IK16TT	K16TT	IK16TT	IK16	VK16	4
1.8L 4Cyl 16V	2ZR-FXE	ZVW30		09-	IXEH20TT	-	IXEH20TT	-	VCH20	4
	2ZR-FXE	ZVW50		15-	IXEH20TT	-	IXEH20TT	-	VCH20	4
PRIUS C										
1.5L 4Cyl 16V	1NZ-FXE	NHP10		11-	IK16TT	K16TT	IK16TT	IK16	VK16	4
PRIUS V										
1.8L 4Cyl 16V	2ZR-FXE	ZVW40		11-	IXEH20TT	-	IXEH20TT	-	VCH20	4
RAV 4										
2.0L 4Cyl 16V	3S-FE	SA10		94-00	K20R-U11	K20TT	IK20TT	IK20	VK20	4
	1AZ-FE	ACA20,ACA21		00-03	IK20TT	K20TT	IK20TT	IK20	VK20	4
2.4L 4Cyl 16V	2AZ-FE	ACA22,ACA23		03-05	IK20TT	K20TT	IK20TT	IK20	VK20	4
	2AZ-FE	ACR38		05-12	IK20TT	K20TT	IK20TT	IK20	VK20	4
	2AZ-FE	ACA33		05-13	IK20TT	K20TT	IK20TT	IK20	VK20	4
3.5L 6Cyl 24V	2GR-FE	GSA33		07-12	IKH20TT	KH20TT	IKH20TT	-	VFKH20	6
2.5L 4Cyl 16V	2AR-FE	ASA44		12-	IKH16TT	KH16TT	IKH16TT	IKH16	VKH16	4
2.0L 4Cyl 16V	3ZR-FE	ZSA42		12-	IXEH20TT	-	IXEH20TT	-	VCH20	4
REGIUS										
2.4L 4Cyl 8V	2RZ-E	RZH103		89-95	IW16TT	W16TT	IW16TT	IW16	VW16	4
	2RZ-E	RZH12		95-05	IW16TT	W16TT	IW16TT	IW16	VW16	4
RUkus										
2.4L 4Cyl 16V	2AZ-FE	AZE151		10-	IK20TT	K20TT	IK20TT	IK20	VK20	4
SERA										
1.5L 4Cyl 16V	5E-FHE	EXY10		90-95	K20R-U11	K20TT	IK20TT	IK20	VK20	4
SOARER										
2.5L 6Cyl 24V	1JZ-GTE	JZZ30		90-00	IK20TT	K20TT	IK20TT	-	VK20Y	6
3.0L 6Cyl 24V	2JZ-GE	JZZ31		90-00	IK16TT / IK20TT	IK16TT / K20TT	IK16TT / IK20TT	IK16 / IK20	VK16 / VK20	6

DENSO	9	14	16	20	22	24	27	29	31	32	34	35	DENSO	9	14	16	20	22	24	27	31	DENSO	9	14	16	20	22	24	27	31		
NGK	2	4	5	6	7	8	9	9.5	10	10.5	11	11.5	CHAMPION	18	16,14	12,11	10,9	8,7	6,6.3,6.1	4,5,9	5,7	5,5	5,3	BOSCH	10	9	8	7,6	5	4	3	2

DENSO
 AUSTRALIA
 CHINA
 INDIA
 INDONESIA
 KOREA
 MALAYSIA
 PHILIPPINES
 SAUDI ARABIA
 SINGAPORE
 TAIWAN
 THAILAND
 VIETNAM
 JAPAN
 EUROPE
 MOTOR & USA
 CYCLE
 SMALL ENGINE
 CROSS REFERENCE
 PART NUMBER



Model	Engine Size	Engine Code	Specification	From To	DENSO	TJ	IRIDIUM	IRIDIUM POWER	IRIDIUM TOUGH	QTY
VOLVO										
C70	2.5L 5Cyl 20V	B 5254 T3	542	06-07	VKH20Y	-	-	-	VKH20Y	5
	2.4L 5Cyl 20V	B 5244 S4	542	06-09	K20HR-U11	KH20TT	IKH20TT	IKH20	VKH20	5
	2.5L 5Cyl 20V	B 5254 T7	542	07-09	IKH20TT	KH20TT	IKH20TT	IKH20	VKH20	5
S40	2.0L 4Cyl 16V	B 4204 S	644	95-99	K20PBR-S10	K20TT	IK20TT	IK20	VK20	4
	1.9L 4Cyl 16V	B 4194 T2,B 4194 T	644	97-00	IK20TT	K20TT	IK20TT	-	VK20Y	4
		B 4204 S,B 4204 S2	644	97-03	K20PBR-S10	K20TT	IK20TT	IK20	VK20	4
	2.0L 4Cyl 16V	B 4204 T	644	97-03	IK20TT	K20TT	IK20TT	-	VK20Y	4
		B 4184 S2	644	99-03	K20PBR-S10	K20TT	IK20TT	IK20	VK20	4
	2.0L 4Cyl 16V	B 4204 T2,B 4204 T3	644	00-01	IK20TT	K20TT	IK20TT	-	VK20Y	4
		B 4204 T5	644	00-03	IK20TT	K20TT	IK20TT	-	VK20Y	4
	2.0L 4Cyl 16V	B 4204 T3	644	01-03	IK20TT	K20TT	IK20TT	-	VK20Y	4
		B 5254 T3	544	04-07	VKH20Y	-	-	-	VKH20Y	5
	2.4L 5Cyl 20V	B 5244 S4	544	04-12	K20HR-U11	KH20TT	IKH20TT	IKH20	VKH20	5
2.5L 5Cyl 20V	B 5254 T7	544	07-12	IKH20TT	KH20TT	IKH20TT	IKH20	VKH20	5	
S60	2.3L 5Cyl 20V	B 5234 T3	384	01-10	IK20TT	K20TT	IK20TT	-	VK20Y	5
	2.4L 5Cyl 20V	B 5244 S	384	01-10	K20PBR-S10	K20TT	IK20TT	IK20	VK20	5
		B 5244 T3	384	01-10	IK20TT	K20TT	IK20TT	-	VK20Y	5
	2.5L 5Cyl 20V	B 5254 T2	384	02-10	IK20	K20TT	IK20TT	IK20	VK20	5
		B 5254 T4	384	03-10	VKH20Y	-	-	-	VKH20Y	5
S70	2.3L 5Cyl 20V	B 5234 T3	874	97-00	IK22	-	-	IK22	VK22	5
	2.4L 5Cyl 20V	B 5244 S,B 5254 S	874	97-00	K20PBR-S10	K20TT	IK20TT	IK20	VK20	5
	2.4L 5Cyl 10V	B 5252 FS	874	97-99	K20PBR-S10	K20TT	IK20TT	IK20	VK20	5
	2.4L 5Cyl 20V	B 5244 T,B 5254 T	874 Turbo	99-00	IKH20TT	KH20TT	IKH20TT	IKH20	VKH20	5
S80	2.8L 6Cyl 24V	B 6284 T	184	98-06	IK22	-	-	IK22	VK22	6
	2.9L 6Cyl 24V	B 6304 S3	184	98-06	K20PBR-S10	K20TT	IK20TT	IK20	VK20	6
		B 6294 S	184	99-06	K20PBR-S10	K20TT	IK20TT	IK20	VK20	6
	3.0L 6Cyl 24V	B 6294 S2	184	01-06	K20PBR-S10	K20TT	IK20TT	IK20	VK20	6
		B 6294 T	184	01-06	IK20TT	K20TT	IK20TT	-	VK20Y	6
	2.5L 5Cyl 20V	B 5254 T2	184	03-06	IK20	K20TT	IK20TT	IK20	VK20	5
	4.4L 8Cyl 32V	B 8444 S	124	06-12	IK20TT	K20TT	IK20TT	IK20	VK20	8
	3.0L 6Cyl 24V	B 6304 T2	124	07-10	IKH20TT	KH20TT	IKH20TT	IKH20	VKH20	6
	3.2L 6Cyl 24V	B 6324 S	124	07-10	VKH20Y	-	-	-	VKH20Y	6
	S90	2.9L 6Cyl 24V	B 6304 GS	964	97-98	K20PR-U	K20TT	IK20TT	-	VK20Y
V40		B 4204 S,B 4204 S2	645	95-04	K20PBR-S10	K20TT	IK20TT	IK20	VK20	4
	B 4204 S	645	95-99	K20PBR-S10	K20TT	IK20TT	IK20	VK20	4	
1.9L 4Cyl 16V	B 4194 T2,B 4194 T	645	97-00	IK20TT	K20TT	IK20TT	-	VK20Y	4	
2.0L 4Cyl 16V	B 4204 T	645	97-00	IK20TT	K20TT	IK20TT	-	VK20Y	4	
1.8L 4Cyl 16V	B 4184 S2	645	99-04	K20PBR-S10	K20TT	IK20TT	IK20	VK20	4	
	B 4204 T2	645	99-04	IK20TT	K20TT	IK20TT	-	VK20Y	4	
	B 4204 T5	645	00-04	IK20TT	K20TT	IK20TT	-	VK20Y	4	
V50	2.5L 5Cyl 20V	B 5254 T3	545	04-07	VKH20Y	-	-	-	VKH20Y	5
	2.4L 5Cyl 20V	B 5244 S4	545	04-10	K20HR-U11	KH20TT	IKH20TT	IKH20	VKH20	5
	2.5L 5Cyl 20V	B 5254 T7	545	07-10	VKH20Y	-	-	-	VKH20Y	5
V70	2.4L 5Cyl 10V	B 5252 FS	875, 876	95-00	K20PBR-S10	K20TT	IK20TT	IK20	VK20	5
			875, 876	95-00	K20PBR-S10	K20TT	IK20TT	IK20	VK20	5
	2.4L 5Cyl 20V	B 5254 T,B 5244 T	875, 876 Turbo	96-00	IK22	-	-	IK22	VK22	5
		B 5234 T3	875, 876	97-00	IK20	K20TT	IK20TT	IK20	VK20	5
		B 5234 T3	285	99-08	IK20	K20TT	IK20TT	IK20	VK20	5
	2.4L 5Cyl 20V	B 5244 T3	285	99-08	IK20TT	K20TT	IK20TT	-	VK20Y	5
		B 5244 S	285	00-08	K20PBR-S10	K20TT	IK20TT	IK20	VK20	5
		B 5244 S2	285	00-08	K20PBR-S10	K20TT	IK20TT	IK20	VK20	5
	2.5L 5Cyl 20V	B 5254 T2	285	01-08	IK20	K20TT	IK20TT	IK20	VK20	5
		B 5254 T4	285	03-07	IKH20TT	KH20TT	IKH20TT	IKH20	VKH20	5
3.0L 6Cyl 24V	B 6304 T2	135	07-10	VKH20Y	-	-	-	VKH20Y	6	
XC60	3.0L 6Cyl 24V	B 6304 T2	DZ	08-10	VKH20Y	-	-	-	VKH20Y	6
		B 6304 T4	DZ	10-15	IKH20TT	KH20TT	IKH20TT	IKH20	VFKH20	6
	3.2L 6Cyl 24V	B 6324 S5	DZ	10-15	IKH20TT	KH20TT	IKH20TT	IKH20	VFKH20	6
XC70	3.2L 6Cyl 24V	B 6324 S	BZ	07-11	VKH20Y	-	-	-	VKH20Y	6
XC70 CROSS COUNTRY	2.4L 5Cyl 20V	B 5244 T3	295	00-02	IK20TT	K20TT	IK20TT	-	VK20Y	5
	2.5L 5Cyl 20V	B 5254 T2	295	03-04	IK20	K20TT	IK20TT	IK20	VK20	5
XC90	2.5L 5Cyl 20V	B 5254 T2	275	02-14	IK20	K20TT	IK20TT	IK20	VK20	5
	2.9L 6Cyl 24V	B 6294 T	275	03-06	IK20	K20TT	IK20TT	IK20	VK20	6
	4.4L 8Cyl 32V	B 8444 S	275	05-10	IK20TT	K20TT	IK20TT	IK20	VK20	8
	3.2L 6Cyl 24V	B 6324 S	275	06-10	VKH20Y	-	-	-	VKH20Y	6
B 6324 S5		275	10-12	IKH20TT	KH20TT	IKH20TT	IKH20	VFKH20	6	
VW										
AMAROK	2.0L 4Cyl 16V	CFPA		10-	IK22	-	-	IK22	VK22	4

DENSO

AUSTRALIA

CHINA

INDIA

INDONESIA

KOREA

MALAYSIA

PHILIPPINES

SAUDI ARABIA

SINGAPORE

TAIWAN

THAILAND

VIETNAM

JAPAN

& USA

EUROPE

MOTOR

SMALL

ENGINE

REFERENCE NUMBER

DENSO	9	14	16	20	22	24	27	29	31	32	34	35	DENSO	9	14	16	20	22	24	27	29	31	32	DENSO	9	14	16	20	22	24	27	31
NGK	2	4	5	6	7	8	9	9.5	10	10.5	11	11.5	CHAMPION	18	16,14	12,11	10,9	8,7	6,63,61	4,59	57	55	53	BOSCH	10	9	8	7,6	5	4	3	2







AUSTRALIA CAR

▶ Spark plug color codes: ■ for Iridium Tough and Iridium Plugs and Iridium TT, ■ for Iridium Power, ■ for Iridium Racing and Two Tops Plugs, ■ for Platinum Plugs and Platinum TT, and black for general spark plugs.

DENSO
AUSTRALIA
CHINA
INDIA
INDONESIA
KOREA
MALAYSIA
PHILIPPINES
SAUDI ARABIA
SINGAPORE
TAIWAN
THAILAND
VIETNAM
JAPAN
EUROPE & USA
MOTOR CYCLE
SMALL ENGINE
CROSS REFERENCE
PART NUMBER

Model	Engine Size	Engine Code	Specification	From To	DENSO					QTY	
VW											
AMAROK	2.0L 4Cyl 16V	CFPA	S1B	11-	IK22	-	-	IK22	VK22	4	
BEETLE	2.0L 4Cyl 8V	BDC,BEV,BGD,AZJ	9C1, 1C1	98-10	IK16TT	K16TT	IK16TT	IK16L	-	4	
			1Y7	02-10	IK16TT	K16TT	IK16TT	IK16L	-	4	
	1.6L 4Cyl 8V	BFS,AYD	9C1, 1C1	02-10	K20PBR-S10	K20TT	IK20TT	IK20	VK20	4	
	1.8L 4Cyl 20V		9C1, 1C1	02-10	IK20TT	K20TT	IK20TT	-	VK20Y	4	
	1.4L 4Cyl 16V	CTHD,CAVD,CNWA,CTKA	5C1, 5C2	11-	IK20TT	K20TT	IK20TT	-	VK20Y	4	
BORA	2.3L 5Cyl 10V	AGZ	1J2	99-05	K20TXR	K20TT	IK20TT	IK20	VK20	5	
	2.0L 4Cyl 8V		1J2	99-05	K20PBR-S10	K20TT	IK20TT	IK20	VK20	4	
	2.3L 5Cyl 20V	AQN	1J2	00-05	IK16TT	K16TT	IK16TT	IK16L	-	5	
	2.8L 6Cyl 24V	AUE,AQP,BDE	1J2	01-05	IK16TT	K16TT	IK16TT	IK16L	-	6	
CADDY	1.6L 4Cyl 8V	BSE,BSF,BGU		04-15	K20PBR-S10	K20TT	IK20TT	IK20	VK20	4	
EOS	2.0L 4Cyl 16V	CAWB,CCZA,BWA	1F7, 1F8	07-15	IK22	-	-	IK22	VK22	4	
		CCZB	1F7, 1F8	09-15	IK22	-	-	IK22	VK22	4	
GOLF		JH	MK I 155	83-93	W20EPB	W20TT	IW20TT	IW20	VW20	4	
	1.8L 4Cyl 8V	GU,GX	MK II 19E,1G1	84-91	W20EPBR-S	W20TT	IW20TT	IW20	VW20	4	
		ACC,ABS,ADZ	MK III 1H1	91-97	W20EPBR-S	W20TT	IW20TT	IW20	VW20	4	
		AGG,2E,ADY,AKR	MK III 1E7	93-98	W20EPBR-S	W20TT	IW20TT	IW20	VW20	4	
	2.8L 6Cyl 12V	AAA	MK III 1H1	94-97	K20TXR	K20TT	IK20TT	IK20	VK20	6	
		ABA,AKR,ADY,2E,AGG	MK III 1H1	94-97	W20EPBR-S	W20TT	IW20TT	IW20	VW20	4	
	2.0L 4Cyl 8V	AZG,APK,BER,AQY,AZJ	MK IV 1J1	97-04	K20PBR-S10	K20TT	IK20TT	IK20	VK20	4	
	1.6L 4Cyl 8V	AKL,AEH,APF	MK IV 1J1	98-01	K20PBR-S10	K20TT	IK20TT	IK20	VK20	4	
		AWF,AGG,ATU,AWG,AKR		98-02	K20PBR-S10	K20TT	IK20TT	IK20	VK20	4	
	1.8L 4Cyl 20V	BAF,AGN	MK IV 1J1	98-99	K20PBR-S10	K20TT	IK20TT	IK20	VK20	4	
		AWD,AGU,ARZ,AQA,AUM	MK IV 1J1	99-04	IK20TT	K20TT	IK20TT	-	VK20Y	4	
	1.6L 4Cyl 8V	AVU,BJH,BFQ	MK IV 1J1	00-04	K20PBR-S10	K20TT	IK20TT	IK20	VK20	4	
		BSE,CCSA,BGU,BSF	MK V 1K1	04-08	K20PBR-S10	K20TT	IK20TT	IK20	VK20	4	
	2.0L 4Cyl 16V		MK V 1K1	04-08	VKA16	-	-	-	VKA16	4	
	1.4L 4Cyl 16V	BLG	MK V 1K1	05-08	IK20L	-	-	IK20L	-	4	
		BWA,AXX,CAWB	MK V 1K1	05-09	IK22	-	-	IK22	VK22	4	
	2.0L 4Cyl 16V	BYD	MK V 1K1	06-08	IK22	-	-	IK22	VK22	4	
		CAXA	MK VI 5K1	08-12	IK20L	-	-	IK20L	-	4	
	1.4L 4Cyl 16V	CNWA,CTKA,CAVD,CTHD	MK VI 5K1 Chargerd	08-12	IK20TT	K20TT	IK20TT	-	VK20Y	4	
		CCZB	MK VI 5K1	09-12	IK22	-	-	IK22	VK22	4	
	2.0L 4Cyl 16V	CDLC,CRZA	MK VI 5K1	09-13	IK22	-	-	IK22	VK22	4	
		CAXA	MK VI AJ5	09-13	IK20L	-	-	IK20L	-	4	
	1.4L 4Cyl 16V	CTKA,CNWA,CTHD,CAVD	MK VI AJ5 Chargerd	09-13	IK20TT	K20TT	IK20TT	-	VK20Y	4	
		CTKA,CAVD,CNWA,CTHD	MK VI 517	11-	IK20TT	K20TT	IK20TT	-	VK20Y	4	
	2.0L 4Cyl 16V	CHHA	MK VII	13-	VKH22	-	-	IKH22	VKH22	4	
		CJXB	MK VII	13-	VKH22	-	-	IKH22	VKH22	4	
	2.0L 4Cyl 16V	CNTC,CHHB,CXCB,CXDA	MK VII	13-	VKH22	-	-	IKH22	VKH22	4	
CJSB		BA5, BV5	14-	VKH22	-	-	IKH22	VKH22	4		
JETTA	2.0L 4Cyl 16V	BVY,BLY,BVZ,BLR	1K2	05-10	VKA16	-	-	-	VKA16	4	
			1K2	05-10	IK22	-	-	IK22	VK22	4	
	1.4L 4Cyl 16V	CAVD	1K2 Chargerd	08-10	IK20TT	K20TT	IK20TT	-	VK20Y	4	
	2.0L 4Cyl 16V	CBFA,CCTA,CCZA	162, 163	10-	IK22	-	-	IK22	VK22	4	
	1.4L 4Cyl 16V	CAVD,CTHD	162, 163	11-	IK20TT	K20TT	IK20TT	-	VK20Y	4	
MULTIVAN	2.0L 4Cyl 16V	CJKA		11-15	VK22	-	-	IK22	VK22	4	
	2.0L 4Cyl 8V	AGG,2E,ADY	3A2, 35I	90-96	W20EPBR-S	W20TT	IW20TT	IW20	VW20	4	
		AAA	3A2, 35I	91-96	K20TXR	K20TT	IK20TT	IK20	VK20	6	
	2.8L 6Cyl 30V	APR,ALG,ACK,AQD,AHA	3B2	96-00	K20TXR	K20TT	IK20TT	IK20	VK20	6	
	1.8L 4Cyl 20V	ANB,APU,AEB	3B5	97-00	IK20TT	K20TT	IK20TT	-	VK20Y	4	
		APR,ACK,AQD,AHA	3B5	97-00	K20TXR	K20TT	IK20TT	IK20	VK20	6	
	1.8L 4Cyl 20V	ADR,APT,ARG	3B2	98-00	K20PBR-S10	K20TT	IK20TT	IK20	VK20	4	
		ANB,APU,AEB	3B2	98-00	IK20TT	K20TT	IK20TT	-	VK20Y	4	
	2.8L 6Cyl 30V	APR,AHA,ACK	3B2	98-00	K20TXR	K20TT	IK20TT	IK20	VK20	6	
		AMX,ATQ	3B3	00-05	K20TXR	K20TT	IK20TT	IK20	VK20	6	
	1.8L 4Cyl 20V	AWL,AWT	3B3	00-05	IK20TT	K20TT	IK20TT	-	VK20Y	4	
	2.3L 5Cyl 20V	AZX	3B3	00-05	IK16TT	K16TT	IK16TT	IK16L	-	5	
	1.8L 4Cyl 20V	AWT	3B6	00-05	IK20TT	K20TT	IK20TT	-	VK20Y	4	
	4.0L 8Cyl 32V	BDN	3B3	03-04	K20TXR	K20TT	IK20TT	IK20	VK20	8	
		2.0L 4Cyl 16V		3C2	05-10	IK22	-	-	IK22	VK22	4
				3C5	05-10	IK22	-	-	IK22	VK22	4
		1.8L 4Cyl 16V	BZB,CDA	3C2	07-10	IK22	-	-	IK22	VK22	4
			BZB,CDA	3C5	07-11	IK22	-	-	IK22	VK22	4
			CDA	3C_(365)	10-14	IK22	-	-	IK22	VK22	4
		CJSA,CJSC	3G2 (B8)	15-	VKH22	-	-	IKH22	VKH22	4	
CJSA,CJSC	3G5 (B8)	15-	VKH22	-	-	IKH22	VKH22	4			

Model	Engine Size	Engine Code	Specification	From To	DENSO					QTY
VW										
POLO	1.6L 4Cyl 8V	AEE,AEA	6N1	96-99	W20EPBR-S	W20TT	IW20TT	IW20	VW20	4
		APE,AUA,AHW	6N2	00-01	K20PBR-S10	K20TT	IK20TT	IK20	VK20	4
	1.4L 4Cyl 16V	AUA,BKY,BBY	9N_	01-08	K20PBR-S10	K20TT	IK20TT	IK20	VK20	4
		BBZ,AUB	9N_	01-08	K20PBR-S10	K20TT	IK20TT	IK20	VK20	4
	1.6L 4Cyl 8V	BCD	9N4	05-06	VKA20	-	-	IK20L	VKA20	4
	1.8L 4Cyl 20V	BJX	9N_	05-09	IK20TT	K20TT	IK20TT	-	VK20Y	4
	1.6L 4Cyl 16V	BTS	9N_	06-09	VKA20	-	-	IK20L	VKA20	4
		BUD	9N_	06-09	VKA20	-	-	IK20L	VKA20	4
	1.4L 4Cyl 16V	CGGB		09-14	KJ16CR-L11	K16TT	IK16TT	IK16L	-	4
		CTHE,CAVE		10-	IK20TT	K20TT	IK20TT	-	VK20Y	4
1.8L 4Cyl 16V	DAJB,DAJA		14-	VKH22	-	-	IKH22	VKH22	4	
SCIROCCO	2.0L 4Cyl 16V	CDLC	137, 138	09-17	IK22	-	-	IK22	VK22	4
TIGUAN	2.0L 4Cyl 16V	CAWB,CCTA,CCZA	5N_	07-	IK22	-	-	IK22	VK22	4
		CCZC,CAWA	5N_	07-	IK22	-	-	IK22	VK22	4
	1.4L 4Cyl 16V	BWK,CTHA,CAVA	5N_	08-	IK20TT	K20TT	IK20TT	-	VK20Y	4
		CAVD,CTHD	5N_	11-	IK20TT	K20TT	IK20TT	-	VK20Y	4
	2.0L 4Cyl 16V	CCZB	5N_	11-16	IK22	-	-	IK22	VK22	4
		CCZD	5N_	11-16	IK22	-	-	IK22	VK22	4
		CHHB	AD1, BT1	16-	VKH22	-	-	IKH22	VKH22	4
		CZPA	AD1, BT1	16-	VKH22	-	-	IKH22	VKH22	4
TOUAREG	4.2L 8Cyl 40V	AXQ	7LA, 7L6, 7L7	03-06	K20TXR	K20TT	IK20TT	IK20	VK20	8
TRANSPORTER	2.5L 5Cyl 10V	AEU,AAF,AEN,ACU		92-03	W20EPB	W20TT	IW20TT	IW20	VW20	5
	2.0L 4Cyl 8V	AAC		93-03	W20EPBR-S	W20TT	IW20TT	IW20	VW20	4
		ACU,AEU,AEN,AAF		94-97	W20EPBR-S	W20TT	IW20TT	IW20	VW20	5
	2.5L 5Cyl 10V	AET,APL,AVT		95-03	W20EPBR-S	W20TT	IW20TT	IW20	VW20	5
		APL,AVT,AET		97-03	W20EPBR-S	W20TT	IW20TT	IW20	VW20	5
		AVT,AET,APL		97-03	W20EPBR-S	W20TT	IW20TT	IW20	VW20	5
	2.0L 4Cyl 8V	AXA		03-15	K20PBR-S10	K20TT	IK20TT	IK20	VK20	4
TRANSPORTER / CARAVELLE	2.1L 4Cyl 8V	MV		85-92	W20ES-U	-	-	-	-	4
	2.5L 5Cyl 10V	AEU,AEN,AAF,ACU		94-97	W20EPBR-S	W20TT	IW20TT	IW20	VW20	5
		APL,AET,AVT		97-03	W20EPBR-S	W20TT	IW20TT	IW20	VW20	5
	2.8L 6Cyl 24V	AMV		00-03	IK16TT	K16TT	IK16TT	IK16L	-	6
2.0L 4Cyl 8V	AXA		03-15	K20PBR-S10	K20TT	IK20TT	IK20	VK20	4	
VENTO	2.0L 4Cyl 8V	AGG,2E,ADY,AKR	1H2	95-97	W20EPBR-S	W20TT	IW20TT	IW20	VW20	4

DENSO
 AUSTRALIA
 CHINA
 INDIA
 INDONESIA
 KOREA
 MALAYSIA
 PHILIPPINES
 SAUDI ARABIA
 SINGAPORE
 TAIWAN
 THAILAND
 VIETNAM
 JAPAN
 EUROPE
 MOTOR
 CYCLE
 SMALL
 ENGINE
 REFERENCE
 NUMBER

DENSO	9	14	16	20	22	24	27	29	31	32	34	35	DENSO	9	14	16	20	22	24	27	29	31	32	DENSO	9	14	16	20	22	24	27	31
NGK	2	4	5	6	7	8	9	9.5	10	10.5	11	11.5	CHAMPION	18	16,14	12,11	10,9	8,7	6,63,61	4,59	57	55	53	BOSCH	10	9	8	7,6	5	4	3	2



DENSO	车种	车型	发动机型式	DENSO	IRIDIUM	IRIDIUM		PLATINUM	
						IRIDIUM	PLATINUM	PLATINUM	IRIDIUM
	华晨汽车								
	中华	2.0L	4G63S4M	K16PR-U11	IK16	IK16TT	PK16TT	K16TT	
		2.4L	4G63S4M	K16PR-U11	IK16	IK16TT	PK16TT	K16TT	
		1.5L	BM15L	K20HR-U11	IKH20	IKH20TT	PKH20TT	KH20TT	
		1.5T	BM15T	K20HR-U11	IKH20	IKH20TT	PKH20TT	KH20TT	
		1.6L	4A92S	K20HR-U11	IKH20	IKH20TT	PKH20TT	KH20TT	
	尊驰	1.8L	4G93	K20PR-U11	IK20	IK20TT	PK20TT	K20TT	
		1.8T	BL18T	K22PR-U	IK22	-	PK22TT	-	
		2.0L	4G63S4M	K16PR-U11	IK16	IK16TT	PK16TT	K16TT	
		2.4L	4G63S4M	K16PR-U11	IK16	IK16TT	PK16TT	K16TT	
	骏捷	1.6L	4G18	K16PR-U11	IK16	IK16TT	PK16TT	K16TT	
		1.8L	4G93	K20PR-U11	IK20	IK20TT	PK20TT	K20TT	
		1.8T	BL18T	K22PR-U	IK22	-	PK22TT	K16TT	
		2.0L	4G63S4M	K16PR-U11	IK16	IK16TT	PK16TT	K16TT	
		1.6L	BL16L	K16PR-U11	IK16	IK16TT	PK16TT	K16TT	
		1.8L	BL18L	K20PR-U11	IK20	IK20TT	PK20TT	K20TT	
		1.8T	BL18L	K22PR-U	IK22	-	PK22TT	-	
		1.5L	4A15	XU22EPR-U	IXU22	-	-	XU22TT	
	骏捷CROSS	1.6L	4G18S	K16PR-U11	IK16	IK16TT	PK16TT	K16TT	
	骏捷	1.5L	4A91S	K16PR-U11	IK16	IK16TT	PK16TT	K16TT	
	骏捷FRV	1.3L	4G13S	K16PR-U11	IK16	IK16TT	PK16TT	K16TT	
		1.3L	4A13	XU22EPR-U	IXU22	-	-	XU22TT	
		1.5L	4A91S	K16PR-U11	IK16	IK16TT	PK16TT	K16TT	
		1.6L	4G18S	K16PR-U11	IK16	IK16TT	PK16TT	K16TT	
	骏捷FSV	1.5L	4A15	XU22EPR-U	IXU22	-	-	XU22TT	
		1.5L	4A91S	K16PR-U11	IK16	IK16TT	PK16TT	K16TT	
		1.6L	4G18S	K16PR-U11	IK16	IK16TT	PK16TT	K16TT	
	骏捷Wagon	1.8L	4G93	K20PR-U11	IK20	IK20TT	PK20TT	K20TT	
		1.8T	BL18T	K22PR-U	IK22	-	PK22TT	-	
		2.0L	4G63S4M	K16PR-U11	IK16	IK16TT	PK16TT	K16TT	
		2.0L	BL20L	K16PR-U11	IK16	IK16TT	PK16TT	K16TT	
	酷宝	1.8MT	4G93	K20PR-U11	IK20	IK20TT	PK20TT	K20TT	
		1.8T	BL18T	K22PR-U	IK22	-	PK22TT	-	
	阁瑞斯	2.0L	4G20D4L	K16PR-U11	IK16	IK16TT	PK16TT	K16TT	
		2.4L	4RB2	K20PR-U	IK20	IK20TT	PK20TT	K20TT	
		2.7L	2TR	K16R-U	IK16	IK16TT	PK16TT	K16TT	
	比亚迪								
	F0	1.0L3	BYD371DA	K20HR-U11	IKH20	IKH20TT	PKH20TT	KH20TT	
	F3	1.5L	三菱4G15S	K16PR-U11	IK16	IK16TT	PK16TT	K16TT	
		1.5L	BYD473QE	K20PR-U	IK20	IK20TT	PK20TT	K20TT	
		1.5T	BYD476ZQA	K20PR-U11	IK20	IK20TT	PK20TT	K20TT	
		1.6L	DA4G18	K16PR-U11	IK16	IK16TT	PK16TT	K16TT	
		1.8L	BYD483QA	K16PR-U11	IK16	IK16TT	PK16TT	K16TT	
		1.0L DM	371QA	K20HR-U11	IKH20	IKH20TT	PKH20TT	KH20TT	
	F3R	1.5L	4G15S	K16PR-U11	IK16	IK16TT	PK16TT	K16TT	
		1.5L	BYD473QB	K20PR-U	IK20	IK20TT	PK20TT	K20TT	
		1.6L	DA4G18	K16PR-U11	IK16	IK16TT	PK16TT	K16TT	
	G3	1.5L	4G15S	K16PR-U11	IK16	IK16TT	PK16TT	K16TT	
		1.8L	483QA	K16PR-U11	IK16	IK16TT	PK16TT	K16TT	
		1.5L	473QE	K20PR-U	IK20	IK20TT	PK20TT	K20TT	
	G3R	1.5L	473QD	K20PR-U	IK20	IK20TT	PK20TT	K20TT	
		1.8L	483QA	K16PR-U11	IK16	IK16TT	PK16TT	K16TT	
	L3	1.8L	BYD483QA	K16PR-U11	IK16	IK16TT	PK16TT	K16TT	
		1.5L	473QB/QE	K20PR-U	IK20	IK20TT	PK20TT	K20TT	
	速锐	1.5L	BYD473QE	K20PR-U	IK20	IK20TT	PK20TT	K20TT	
		1.5T	BYD476ZQA	K20PR-U11	IK20	IK20TT	PK20TT	K20TT	
	思锐	1.5T	BYD476ZQA	K20PR-U11	IK20	IK20TT	PK20TT	K20TT	
	G5	1.5T	476ZQA	K20PR-U11	IK20	IK20TT	PK20TT	K20TT	
	F6	1.8L	BYD483QA	K16PR-U11	IK16	IK16TT	PK16TT	K16TT	
		2.0L	BYD483QB	K16PR-U11	IK16	IK16TT	PK16TT	K16TT	
		2.4L	4G69S4M	KJ20CR-L11	IK20L	IK20TT	PK20TT	K20TT	
	M6	2.0L	BYD483QB	K16PR-U11	IK16	IK16TT	PK16TT	K16TT	
		2.4L	4G69S4M	KJ20CR-L11	IK20L	IK20TT	PK20TT	K20TT	
		2.4L	BYD488QA	K16PR-U11	IK16	IK16TT	PK16TT	K16TT	
	G6	1.5T	BYD476ZQA	K20PR-U11	IK20	IK20TT	PK20TT	K20TT	
		2.0L	BYD483QB	K20PR-U11	IK20	IK20TT	PK20TT	K20TT	
	S6	1.5T	BYD476ZQA	K20PR-U11	IK20	IK20TT	PK20TT	K20TT	
		2.0L	BYD483QB	K16PR-U11	IK16	IK16TT	PK16TT	K16TT	



车种	车型	发动机型式	DENSO	IRIDIUM	IRIDIUM	PLATINUM	TT
比亚迪							
S6	2.4L	4G69	KJ20CR-L11	IK20L	IK20TT	PK20TT	K20TT
	2.4L	BYD488QB	K16PR-U11	IK16	IK16TT	PK16TT	K16TT
S7	1.5T	BYD476ZQA	K20PR-U11	IK20	IK20TT	PK20TT	K20TT
	2.0T	BYD487ZQA	K20HR-U11	IKH20	IKH20TT	PKH20TT	KH20TT
S8	2.0L	BYD483QB	K16PR-U11	IK16	IK16TT	PK16TT	K16TT
秦	1.5T	BYD476ZQA	K20PR-U11	IK20	IK20TT	PK20TT	K20TT
唐	2.0T	BYD487ZQA	K20HR-U11	IKH20	IKH20TT	PKH20TT	KH20TT
宋	1.5T	BYD476ZQA	K20PR-U11	IK20	IK20TT	PK20TT	K20TT
	2.0T	BYD487QA	K20HR-U11	IKH20	IKH20TT	PKH20TT	KH20TT
元	1.5L	BYD473QE	K20PR-U	IK20	IK20TT	PK20TT	K20TT
	1.5T	BYD476ZQA	K20PR-U11	IK20	IK20TT	PK20TT	K20TT
昌河汽车							
北斗星	1.0L	DA465Q	W16EX-U	IW16	IW16TT	PW16TT	-
	1.1L	DA465Q	W16EX-U	IW16	IW16TT	PW16TT	-
	1.4L	K14B	XU22EPR-U	IXU22	-	-	XU22TT
	1.0L	K10A	XU22EPR-U	IXU22	-	-	XU22TT
	1.2L	K12A	XU22EPR-U	IXU22	-	-	XU22TT
浪迪	1.4L	K14B-A	XU22EPR-U	IXU22	-	-	XU22TT
	1.2L	K12B-A	XU22EPR-U	IXU22	-	-	XU22TT
利亚纳	1.4L	K14B-C	XU22EPR-U	IXU22	-	-	XU22TT
	1.4L	K14B-G	XU22EPR-U	IXU22	-	-	XU22TT
	1.6L	M16A	K20PR-U11	IK20	IK20TT	PK20TT	K20TT
利亚纳A6	1.4L	K14B-G	XU22EPR-U	IXU22	-	-	XU22TT
	1.5L	4G15M	K20HR-U11	IKH20	IKH20TT	PKH20TT	KH20TT
派喜 爱迪尔	1.4L	K14B-B	XU22EPR-U	IXU22	-	-	XU22TT
	1.05L	DA465Q	W20EXR-U11	IW20	IW20TT	PW20TT	-
	1.0L	DA465Q-2	W20EXR-U11	IW20	IW20TT	PW20TT	-
	1.4L	K14B	XU22EPR-U	IXU22	-	-	XU22TT
福瑞达	1.0L	DA465QAF1	W20EXR-U11	IW20	IW20TT	PW20TT	-
	1.1L	DA465QE-1A/FU	W20EXR-U11	IW20	IW20TT	PW20TT	-
	1.5L	BJ415B	K20PR-U	IK20	IK20TT	PK20TT	K20TT
长安铃木							
奥拓	1.0L	JL368Q3	W16EX-U	IW16	IW16TT	PW16TT	-
	1.0L	K10B	XU22EPR-U	IXU22	-	-	XU22TT
羚羊	1.0L	JL472Q1	W16EXR-U	IW16	IW16TT	PW16TT	-
	1.3L	JL474Q1	K16R-U	IK16	IK16TT	PK16TT	K16TT
	1.3L	G13B	K20PR-U	IK20	IK20TT	PK20TT	K20TT
天语SX4	1.6L	M16A	K20PR-U11	IK20	IK20TT	PK20TT	K20TT
	1.8L	M18A	K20PR-U11	IK20	IK20TT	PK20TT	K20TT
	1.6L	CAS16	K16HPR-U11	IKH16	IKH16TT	PKH16TT	KH16TT
启悦 雨燕	1.6L	G-INNOTEK	K16HPR-U11	IKH16	IKH16TT	PKH16TT	KH16TT
	1.3L	G13B	K20PR-U	IK20	IK20TT	PK20TT	K20TT
	1.5L	M15A	K20PR-U11	IK20	IK20TT	PK20TT	K20TT
进口铃木							
吉姆尼	1.3L	M13A	K16R-U	IK16	IK16TT	PK16TT	K16TT
维特拉	2.0L	J20A	K16R-U	IK16	IK16TT	PK16TT	K16TT
	2.4L	J24B	K20HR-U11	IKH20	IKH20TT	PKH20TT	KH20TT
	3.2L	N32A	-	ITV16	ITV16TT	PTV16TT	TV16TT
凯泽西	2.4L	J24B	K20HR-U11	IKH20	IKH20TT	PKH20TT	KH20TT
速翼特Swift sport	1.6L	M16A	K20PR-U11	IK20	IK20TT	PK20TT	K20TT
	1.6L CVT	M16A	K20PR-U11	IK20	IK20TT	PK20TT	K20TT
长安汽车/CHANGAN							
长安之星	1.0L	JL465QE	W20EXR-U	IW20	IW20TT	PW20TT	-
	1.3L	JL465QK/JL474QH	K20PR-U	IK20	IK20TT	PK20TT	K20TT
长安之星2	1.0L	JL466Q8	W20EXR-U	IW20	IW20TT	PW20TT	-
	1.3L	JL465QK/JL474QH	K20PR-U	IK20	IK20TT	PK20TT	K20TT
长安之星9	1.5L	4G15S	K16PR-U11	IK16	IK16TT	PK16TT	K16TT
长安星光	1.3L	JL474Q7	K20PR-U	IK20	IK20TT	PK20TT	K20TT
	1.0L	MPI	W20EXR-U	IW20	IW20TT	PW20TT	-
	1.5L	4G15S	K16PR-U11	IK16	IK16TT	PK16TT	K16TT
长安睿行 奔奔	1.0L	JL466Q2	K20PR-U	IK20	IK20TT	PK20TT	K20TT
	1.3L	JL474Q2	K20PR-U	IK20	IK20TT	PK20TT	K20TT
	1.0L	C10	XU22EPR-U	IXU22	-	-	XU22TT
	1.4L	JL473Q1	XU22EPR-U	IXU22	-	-	XU22TT
CX20	1.3L	JL474QL	K20PR-U11	IK20	IK20TT	PK20TT	K20TT
	1.4L	JL473Q1	XU22EPR-U	IXU22	-	-	XU22TT
CX30	1.6L	JL475QK	K20PR-U11	IK20	IK20TT	PK20TT	K20TT

DENSO
 AUSTRALIA CHINA
 INDIA
 INDONESIA KOREA MALAYSIA PHILIPPINES SAUDIARABIA SINGAPORE TAIWAN THAILAND VIETNAM JAPAN & USA
 EUROPE MOTOR SMALL CROSS PART
 CYCLE ENGINE REFERENCE NUMBER

DENSO	9	14	16	20	22	24	27	29	31	32	34	35	DENSO	9	14	16	20	22	24	27	29	31	32	DENSO	9	14	16	20	22	24	27	31
NGK	2	4	5	6	7	8	9	9.5	10	10.5	11	11.5	CHAMPION	18	16,14	12,11	10,9	8,7	6,63,61	4,59	57	55	53	BOSCH	10	9	8	7,6	5	4	3	2



DENSO

CHINA AUSTRALIA

INDIA

INDONESIA

KOREA

PHILIPPINES

SAUDI ARABIA

SINGAPORE

TAIWAN

THAILAND

VIETNAM

JAPAN



EUROPE & USA

MOTOR CYCLE

SMALL ENGINE

CROSS REFERENCE

车种	车型	发动机型式	DENSO	IRIDIUM			
长安汽车/CHANGAN							
CX30	2.0L	JL486Q2	K20PR-U11	IK20	IK20TT	PK20TT	K20TT
CM8	1.3L	JL474Q7	K20PR-U	IK20	IK20TT	PK20TT	K20TT
悦翔	1.5L	JL475Q7	K20PR-U	IK20	IK20TT	PK20TT	K20TT
	1.3L	JL474QAF	K20PR-U	IK20	IK20TT	PK20TT	K20TT
	1.5L	JL478QCA	XE20HR-U9	-	IXEH20ETT	-	-
	1.6L	JL478QEA	XE20HR-U9	-	IXEH20ETT	-	-
志翔	1.6L	JL486Q2	K20PR-U	IK20	IK20TT	PK20TT	K20TT
	2.0L	JL486Q2	K20PR-U	IK20	IK20TT	PK20TT	K20TT
逸动EADO	1.6L	JL478QEB	XE20HR-U9	-	IXEH20ETT	-	-
	1.5T	JA476ZQCA	XE20HR-U9	-	IXEH20ETT	-	-
逸动XT致尚XT	1.5T	JA476ZQCA	XE20HR-U9	-	IXEH20ETT	-	-
	1.6L	JL478QEA	XE20HR-U9	-	IXEH20ETT	-	-
CS35	1.6L	JL478QEE	XE20HR-U9	-	IXEH20ETT	-	-
CS75	1.8T	JL486ZQ2	K20PR-U	IK20	IK20TT	PK20TT	K20TT
	2.0L	JL486Q5	K20PR-U	IK20	IK20TT	PK20TT	K20TT
欧诺	1.3L	JL474QAD	K20PR-U	IK20	IK20TT	PK20TT	K20TT
	1.5L	4G15	K16PR-U11	IK16	IK16TT	PK16TT	K16TT
	1.5L	4G15V	K16PR-U11	IK16	IK16TT	PK16TT	K16TT
睿骋RAETON	1.8T	JL486ZQ2	K20PR-U	IK20	IK20TT	PK20TT	K20TT
	2.0L	JL486Q5	K20PR-U	IK20	IK20TT	PK20TT	K20TT
睿行	1.5L	4G15S	K16PR-U11	IK16	IK16TT	PK16TT	K16TT
奇瑞汽车							
A1	1.0L	SQR371F	K20PR-U	IK20	IK20TT	PK20TT	K20TT
	1.3L	SQR473F	K20PR-U	IK20	IK20TT	PK20TT	K20TT
A3	1.6L	SQR481F	K20PR-U	IK20	IK20TT	PK20TT	K20TT
	1.8L	SQR481FC	K20PR-U	IK20	IK20TT	PK20TT	K20TT
	2.0L	SQR484F	K20PR-U	IK20	IK20TT	PK20TT	K20TT
	1.6L	E4G16	-	IXUH22	-	-	XUH22TT
A5	1.5L	SQR477F	K20PR-U	IK20	IK20TT	PK20TT	K20TT
	1.6L	SQR481F	K20PR-U	IK20	IK20TT	PK20TT	K20TT
	1.8L	SQR481FC	K20PR-U	IK20	IK20TT	PK20TT	K20TT
	2.0L	SQR484F	K20PR-U	IK20	IK20TT	PK20TT	K20TT
E5	1.5L	SQR477F	K20PR-U	IK20	IK20TT	PK20TT	K20TT
	1.8L	SQR481FC	K20PR-U	IK20	IK20TT	PK20TT	K20TT
东方之子	2.0L	4G63S4M	K16PR-U	IK16	IK16TT	PK16TT	K16TT
	2.4L	4G64S4M	K16PR-U	IK16	IK16TT	PK16TT	K16TT
	1.8L	SQR481FC	K16PR-U	IK16	IK16TT	PK16TT	K16TT
	2.0L	SQR484F	K16PR-U	IK16	IK16TT	PK16TT	K16TT
风云	1.6L	SQR480	K20PR-U	IK20	IK20TT	PK20TT	K20TT
	1.5L	SQR477F	K20PR-U	IK20	IK20TT	PK20TT	K20TT
QQ3	0.8L	SQR372	K20PR-U	IK20	IK20TT	PK20TT	K20TT
	1.1L	SQR465	K20PR-U	IK20	IK20TT	PK20TT	K20TT
	1.0L	SQR472	K20PR-U	IK20	IK20TT	PK20TT	K20TT
	1.1L	SQR472	K20PR-U	IK20	IK20TT	PK20TT	K20TT
QQ6	1.1L	SQR472F	K20PR-U	IK20	IK20TT	PK20TT	K20TT
	1.3L	SQR473F	K20PR-U	IK20	IK20TT	PK20TT	K20TT
QQ3	1.0L	SQR473F	K20PR-U	IK20	IK20TT	PK20TT	K20TT
QQme	1.3L	SQR473F	K20PR-U	IK20	IK20TT	PK20TT	K20TT
旗云 老款	1.3L	SQR475E	K16PR-U	IK16	IK16TT	PK16TT	K16TT
	1.6L	TRITEC	K20PR-U	IK20	IK20TT	PK20TT	K20TT
	1.0L	SQR472	K20PR-U	IK20	IK20TT	PK20TT	K20TT
旗云1	1.3L	SQR473F	K20PR-U	IK20	IK20TT	PK20TT	K20TT
	1.5L	SQR477F	K16PR-U	IK16	IK16TT	PK16TT	K16TT
旗云2	1.6L	SQR480	K20PR-U	IK20	IK20TT	PK20TT	K20TT
	1.8L	SQR481FC	K16PR-U	IK16	IK16TT	PK16TT	K16TT
	2.0L	SQR484F	K20PR-U	IK20	IK20TT	PK20TT	K20TT
	1.8L	SQR481FC	K16PR-U	IK16	IK16TT	PK16TT	K16TT
旗云5	1.8L	SQR481FC	K16PR-U	IK16	IK16TT	PK16TT	K16TT
V5	2.0L	SQR484F	K16PR-U	IK16	IK16TT	PK16TT	K16TT
	2.4L	4G64S4M	K16PR-U	IK16	IK16TT	PK16TT	K16TT
	1.6L	SQR481F	K20PR-U	IK20	IK20TT	PK20TT	K20TT
瑞虎	2.0L	4G64S4M	K20PR-U	IK20	IK20TT	PK20TT	K20TT
	2.4L	4G64S4M	K20PR-U	IK20	IK20TT	PK20TT	K20TT
	1.6L	SQR481FG	K20PR-U	IK20	IK20TT	PK20TT	K20TT
	1.6L	SQRE4G16	-	IXUH22	-	-	XUH22TT
	1.8L	SQR481FC	K20PR-U	IK20	IK20TT	PK20TT	K20TT
	2.0L	SQR484F	K20PR-U	IK20	IK20TT	PK20TT	K20TT
	2.0L	SQR481A	K20PR-U	IK20	IK20TT	PK20TT	K20TT
瑞麒G5	2.0TGDI	SQR481A	K20PR-U	IK20	IK20TT	PK20TT	K20TT

车种	车型	发动机型式	DENSO	IRIDIUM			
奇瑞汽车							
瑞麒G5	2.0TCI	SQR484B	K20PR-U	IK20	IK20TT	PK20TT	K20TT
瑞麒G6	2.0TSI	SQRE4T20	K22PR-U	IK22	-	PK22TT	-
	3.0L	V6	K20PR-U	IK20	IK20TT	PK20TT	K20TT
威麟V5	1.8L	SQR481FC	K20PR-U	IK20	IK20TT	PK20TT	K20TT
	1.9T	SQR484F	K20PR-U	IK22	-	PK20TT	-
	2.0L	SQR484F	K20PR-U	IK20	IK20TT	PK20TT	K20TT
威麟H5	2.0T	SQR484B	K22PR-U	IK22	-	PK22TT	-
威麟X5	2.0T	SQR481A	K22PR-U	IK22	-	PK22TT	-
瑞麒M5	1.3L	SQR473F	K20PR-U	IK20	IK20TT	PK20TT	K20TT
瑞麒M1	1.0L	SQR472FB	K20PR-U	IK20	IK20TT	PK20TT	K20TT
	1.3L	SQR473F	K20PR-U	IK20	IK20TT	PK20TT	K20TT
瑞麒X1	1.3L	SQR473F	K20PR-U	IK20	IK20TT	PK20TT	K20TT
观致汽车/QOROS							
观致3	1.6T L4	SQRE4T16	-	IXUH22	-	-	XUH22TT
观致3 SUV	1.6T	SQRE4T16	-	IXUH22	-	-	XUH22TT
观致5 SUV	1.6T	SQRE4T16	-	IXUH22	-	-	XUH22TT
东风风行							
风行	2.0L	4G63	K16R-U	IK16L	IK16TT	PK16TT	K16TT
	2.0L	东风EQ491	MA20PR-U	-	-	-	XUH22TT
	2.4L	4G64	K16PR-U	IK16L	IK16TT	PK16TT	K16TT
景逸	1.5L	4A91S	K20HR-U11	IKH20	IKH20TT	PKH20TT	KH20TT
	1.8L	4G93	K20PR-U	IK20	IK20TT	PK20TT	K20TT
	1.8L	4G93M	K20PR-U	IK20	IK20TT	PK20TT	K20TT
	1.8T	18K4G	K22PR-U	IK22	-	PK22TT	-
	1.6L	4A92	K20HR-U11	IKH20	IKH20TT	PKH20TT	KH20TT
菱智	2.0L	4G63	K16R-U	IK16	IK16TT	PK16TT	K16TT
	2.4L	4G64	K16R-U	IK16	IK16TT	PK16TT	K16TT
	2.0L	4G94	K16R-U	IK16	IK16TT	PK16TT	K16TT
	2.4L	4G69	K16R-U	IK16	IK16TT	PK16TT	K16TT
东风风神							
风神S30	1.6L	TU5JP4	K16HPR-U11	IKH16	IKH16TT	PKH16TT	KH16TT
风神H30	1.6L	TU5JP4	K16HPR-U11	IKH16	IKH16TT	PKH16TT	KH16TT
	1.6L	HR16DE	XE20HR-U9	-	IXEH20ETT	-	-
风神A60	1.6L	HR16DE	XE20HR-U9	-	IXEH20ETT	-	-
	2.0L	MR20DE	XE20HR-U9	-	IXEH20ETT	-	-
风神AX7	2.0L	RFN 10LH3X	K16HPR-U11	IKH16	IKH16TT	PKH16TT	KH16TT
	2.3L	3FY 10XP01	K16HPR-U11	IKH16	IKH16TT	PKH16TT	KH16TT
东风雪铁龙							
富康ZX	1.6L	TU5JPK	K20HR-U11	IKH20	IKH20TT	PKH20TT	KH20TT
	1.4L	TU3JPK	K20PR-U	IK20	IK20TT	PK20TT	K20TT
	1.6L	N6A 10FX3A	K20HR-U11	IKH20	IKH20TT	PKH20TT	KH20TT
爱丽舍	1.6L	TU5JP/K	K20HR-U11	IKH20	IKH20TT	PKH20TT	KH20TT
	1.6L	TU3	K20HR-U11	IKH20	IKH20TT	PKH20TT	KH20TT
经典爱丽舍	1.4L	TU5JP4	K20PR-U	IK20	IK20TT	PK20TT	K20TT
全新爱丽舍	1.6L	N6A 10 xA3A	K20HR-U11	IKH20	IKH20TT	PKH20TT	KH20TT
毕加索	1.6L	EC5	K20HR-U11	IKH20	IKH20TT	PKH20TT	KH20TT
	1.6L	TU5JP4/L4	K20HR-U11	IKH20	IKH20TT	PKH20TT	KH20TT
	2.0L	EW10J4	K16HPR-U11	IKH16	IKH16TT	PKH16TT	KH16TT
赛纳	1.6L	TU5JP4	K20HR-U11	IKH20	IKH20TT	PKH20TT	KH20TT
	2.0L	EW10J4	K16HPR-U11	IKH16	IKH16TT	PKH16TT	KH16TT
C2	1.4L	TU3AF	K20PR-U	IK20	IK20TT	PK20TT	K20TT
	1.6L	TU5JP4	K20HR-U11	IKH20	IKH20TT	PKH20TT	KH20TT
C3-XR	1.6L		K20HR-U11	IKH20	IKH20TT	PKH20TT	KH20TT
C4L	1.6L	L4	K20HR-U11	IKH20	IKH20TT	PKH20TT	KH20TT
	1.6THP	EP6CDTM进口	-	IXUH22	-	-	XUH22TT
	1.6THP	EP6FDTM国产	-	IXUH22	-	-	XUH22TT
	1.8L		K20HR-U11	IKH20	IKH20TT	PKH20TT	KH20TT
	1.8L	EC8	K20HR-U11	IKH20	IKH20TT	PKH20TT	KH20TT
世嘉	1.6L	N6A	K20HR-U11	IKH20	IKH20TT	PKH20TT	KH20TT
	2.0L	RFN 10LH3X	K16HPR-U11	IKH16	IKH16TT	PKH16TT	KH16TT
	1.6L	N6A 10 xA3A	K20HR-U11	IKH20	IKH20TT	PKH20TT	KH20TT
	1.6L	NFP	K20HR-U11	IKH20	IKH20TT	PKH20TT	KH20TT
	2.0L	EW10A	K16HPR-U11	IKH16	IKH16TT	PKH16TT	KH16TT
C4世嘉	1.6L		K20HR-U11	IKH20	IKH20TT	PKH20TT	KH20TT
凯旋	2.0L	RFN 10LH3X	K16HPR-U11	IKH16	IKH16TT	PKH16TT	KH16TT
C5	2.0L	RFN 10LH3X	K16HPR-U11	IKH16	IKH16TT	PKH16TT	KH16TT
	2.3L	3FY 10XP01	K16HPR-U11	IKH16	IKH16TT	PKH16TT	KH16TT

DENSO
 AUSTRALIA CHINA
 INDIA
 INDONESIA KOREA MALAYSIA PHILIPPINES SAUDIARABIA SINGAPORE TAIWAN THAILAND VIETNAM JAPAN & USA
 EUROPE MOTOR SMALL CROSS PART
 ENGINE REFERENCE NUMBER

DENSO	9	14	16	20	22	24	27	29	31	32	34	35	DENSO	9	14	16	20	22	24	27	29	31	32	DENSO	9	14	16	20	22	24	27	31
NGK	2	4	5	6	7	8	9	9.5	10	10.5	11	11.5	CHAMPION	18	16,14	12,11	10,9	8,7	6,63,61	4,59	57	55	53	BOSCH	10	9	8	7,6	5	4	3	2



DENSO

CHINA AUSTRALIA

INDIA

INDONESIA

KOREA

MALAYSIA

PHILIPPINES

SAUDI ARABIA

SINGAPORE

TAIWAN

车种	车型	发动机型式	DENSO	IRIDIUM			
东风雪铁龙							
C5	3.0L	10FJ5P XFV	K16HPR-U11	IKH16	IKH16TT	PKH16TT	KH16TT
进口雪铁龙							
C4毕加索	2.0L	RFJ	K16HPR-U11	IKH16	IKH16TT	PKH16TT	KH16TT
C4	2.0L		K16HPR-U11	IKH16	IKH16TT	PKH16TT	KH16TT
C6	3.0L	XFV	K16HPR-U11	IKH16	IKH16TT	PKH16TT	KH16TT
东风标致							
307	1.6L	TU5JP4	K20HR-U11	IKH20	IKH20TT	PKH20TT	KH20TT
	1.6L	N6A 10XA3A	K20HR-U11	IKH20	IKH20TT	PKH20TT	KH20TT
	1.6L	EC5	K20HR-U11	IKH20	IKH20TT	PKH20TT	KH20TT
	1.6L	N6A 10XA3A PSA	K20HR-U11	IKH20	IKH20TT	PKH20TT	KH20TT
	2.0L	EW10J4 99kw	K16HPR-U11	IKH16	IKH16TT	PKH16TT	KH16TT
	2.0L	EW10J4 108kw	K16HPR-U11	IKH16	IKH16TT	PKH16TT	KH16TT
	2.0L	RFN 10LH3X	K16HPR-U11	IKH16	IKH16TT	PKH16TT	KH16TT
206	1.4L	TU3AF	K20PR-U	IK20	IK20TT	PK20TT	K20TT
	1.6L	TU5JP4	K20HR-U11	IKH20	IKH20TT	PKH20TT	KH20TT
207	1.4L	TU3AF	K20PR-U	IK20	IK20TT	PK20TT	K20TT
	1.6L	TU5JP4	K20HR-U11	IKH20	IKH20TT	PKH20TT	KH20TT
老款308	1.6L	N6A 10XA3A	K20HR-U11	IKH20	IKH20TT	PKH20TT	KH20TT
	2.0L	RFN 10LH3X	K16HPR-U11	IKH16	IKH16TT	PKH16TT	KH16TT
新款308	1.6L	NFP	K20HR-U11	IKH20	IKH20TT	PKH20TT	KH20TT
	2.0L	RFN 10LH3X	K16HPR-U11	IKH16	IKH16TT	PKH16TT	KH16TT
308S	1.6L	EC5	K20HR-U11	IKH20	IKH20TT	PKH20TT	KH20TT
	1.6T	EP6	-	IXUH22	-	-	XUH22TT
老款408	1.6L	N6A 10XA3A	K20HR-U11	IKH20	IKH20TT	PKH20TT	KH20TT
	2.0L	EW10A	K16HPR-U11	IKH16	IKH16TT	PKH16TT	KH16TT
新款408	1.6L	NFP	K20HR-U11	IKH20	IKH20TT	PKH20TT	KH20TT
	2.0L	RFN 10LH3X	K16HPR-U11	IKH16	IKH16TT	PKH16TT	KH16TT
	1.6T	EP6FDTM国产	-	IXUH22	-	-	XUH22TT
	1.8L	EC8	K20HR-U11	IKH20	IKH20TT	PKH20TT	KH20TT
508	2.0L	RFN 10LH3X	K16HPR-U11	IKH16	IKH16TT	PKH16TT	KH16TT
	2.3L	3FY 10XP01	K16HPR-U11	IKH16	IKH16TT	PKH16TT	KH16TT
	1.6T	-	-	IXUH22	-	-	XUH22TT
	1.8T	-	-	IXUH22	-	-	XUH22TT
	2.0L	EW10A	K16HPR-U11	IKH16	IKH16TT	PKH16TT	KH16TT
2008	1.6THP	-	-	IXUH22	-	-	XUH22TT
3008	1.6T	EP6CDTM进口	-	IXUH22	-	-	XUH22TT
	1.6T	EP6FDTM国产	-	IXUH22	-	-	XUH22TT
	2.0L	RFN 10LH3X	K16HPR-U11	IKH16	IKH16TT	PKH16TT	KH16TT
进口标致							
206CC	1.6L	KFX(TU3JP4)	K20HR-U11	IKH20	IKH20TT	PKH20TT	KH20TT
207CC	1.6T	EP6DT	-	IXUH22	-	-	XUH22TT
	1.6L	EP6C	K20HR-U11	IKH20	IKH20TT	PKH20TT	KH20TT
308CC308SW	1.6T	EP6DT	-	IXUH22	-	-	XUH22TT
	1.6T	EP6CDTM	-	IXUH22	-	-	XUH22TT
进口3008	1.6THP	EP6CDT	-	IXUH22	-	-	XUH22TT
进口4008	2.0L	4B11	K16HPR-U11	IKH16	IKH16TT	PKH16TT	KH16TT
进口RCZ	1.6T	EP6CDT	-	IXUH22	-	-	XUH22TT
一汽奥迪							
奥迪 A6L AUDI A6L	2.8L V6	CCEA	-	VKB20	-	-	-
	2.8L V6	BDX	K20R-U	IK20	IK20TT	PK20TT	K20TT
	4.2L V8(2006.5~)	BVJ	-	VKB20	-	-	-
	3.2L V6	AUK	-	IK22	-	-	-
	4.2L V8(2005~)	BVJ	-	VKB20	-	-	-
	2.4L V6	BDW	K20R-U	IK20	IK20TT	PK20TT	K20TT
奥迪 A6 AUDI A6	2.8L V6	APS/ATX	K20TXR	IK20	IK20TT	PK20TT	K20TT
	2.4L V6	APS/ATX	K20TXR	IK20	IK20TT	PK20TT	K20TT
	1.8T(2004~)	AWL	PK20PR-P8	IK20	IK20TT	PK20TT	K20TT
	1.8T(1999~)	AWL	PK20PR-P8	IK20	IK20TT	PK20TT	K20TT
	1.8L	ANQ	K20PBR-S10	IK20	IK20TT	PK20TT	K20TT
奥迪 A4 AUDI A4	2.0T	BWE	PK20PR-P8	IK20	IK20TT	PK20TT	K20TT
	3.0L V6	BBJ	K20TXR	IK20	IK20TT	PK20	K20TT
	2.4L V6	BDV	K20TXR	IK20	IK20TT	PK20	K20TT
	1.8T	BFB	PK20PR-P8	IK20	IK20TT	PK20TT	K20TT
奥迪							
Q7	4.2L	BAR	-	VKB20	-	-	-
	3.6L	BHK	-	IXUH22I	-	-	XUH22TT1
A8	6.0L	BHT	-	IXUH22I	-	-	XUH22TT1

车种	车型	发动机型式	DENSO	IRIDIUM			
奥迪							
A8	4.2L	BVJ	-	VKB20	-	-	-
	4.2L	BFM	K20TXR	IK20	IK20TT	PK20TT	K20TT
	3.2L	BPK	PKJ20CR-L11	IK20L	IK20TT	PK20TT	K20TT
	2.8L	AMX	K20TXR	IK20	IK20TT	PK20TT	K20TT
一汽大众							
捷达	1.6L	ATK\AHP	K20PR-U	IK20	IK20TT	PK20TT	K20TT
	1.6L	ABX/ACR	K20PR-U	IK20	IK20TT	PK20TT	K20TT
	1.6L		K20TXR	IK20	IK20TT	PK20TT	K20TT
	1.4TSI		K20TXR	IK20	IK20TT	PK20TT	K20TT
	1.8TSI		-	IK22	-	PK22TT	-
	1.4L	EA211	XU22EPR-U	IXU22	-	-	XU22TT
	1.6L	EA211	XU22EPR-U	IXU22	-	-	XU22TT
宝来	1.6L	L4	K20PBR-S10	IK20	IK20TT	PK20TT	K20TT
	1.8L	BAF	K20PR-U	IK20	IK20TT	PK20TT	K20TT
	1.8T	L4	K22PR-U	IK22	-	PK22TT	-
	1.6L	SMFi	K20PBR-S10	IK20	IK20TT	PK20TT	K20TT
	1.8L	SMFi	K20PR-U	IK20	IK20TT	PK20TT	K20TT
	2.0L	L4	K20PR-U	IK20L	IK20TT	PK20TT	K20TT
	1.4TSI	EA111	K20R-U	IK20	IK20TT	PK20TT	K20TT
	1.6L	EA111	KJ20DR-M11	IK20L	IK20TT	PK20TT	K20TT
高尔夫4	1.6L	SEFI 2V	K20PBR-S10	IK20	IK20TT	PK20TT	K20TT
	1.8L5V	SEFI	K20PBR-S10	IK20	IK20TT	PK20TT	K20TT
	2.0L	SEFI	K20PR-U	IK20	IK20TT	PK20TT	K20TT
	2.0L	EA113	K20PR-U	IK20	IK20TT	PK20TT	K20TT
高尔夫6	1.4TSI	CFB	K20TXR	IK20	IK20TT	PK20TT	K20TT
	1.6L	EA111	KJ20DR-M11	IK20L	IK20TT	PK20TT	K20TT
	2.0TSI	CCZB	-	IK24	-	-	-
	2.0TSI	CDLC,CDLA	-	IK24	-	-	-
高尔夫7	1.2TSI(2013-)	EA211	XU22EPR-U	IXU22	-	-	XU22TT
	1.4TSI(2013-)	EA211	XU22EPR-U	IXU22	-	-	XU22TT
	1.6L(2013-)	EA211	XU22EPR-U	IXU22	-	-	XU22TT
	2.0TSI(2013-)	CHHB,CHHA	-	IKH24	-	-	-
	2.0TSI 进口(2013-)	CJXB,CJXD,CJXC	-	IKH24	-	-	-
开迪	1.6L	BRY	KJ20DR-M11	IK20L	IK20TT	PK20TT	K20TT
速腾1代	1.4TSI	EA111	K20R-U	IK20	IK20TT	PK20TT	K20TT
	1.6L	EA113	K20PR-U	IK20	IK20TT	PK20TT	K20TT
	1.8T	BPL	K20R-U	IK20	IK20TT	PK20TT	K20TT
	2.0L	L4	KJ20DR-M11	IK20L	IK20TT	PK20TT	K20TT
速腾2代	1.8TSI	EA888	VK22	IK22	-	PK22TT	-
	2.0TSI	EA888	VK24PR-Z11	IK24	-	-	-
	1.4TSI	EA111	KJ20DR-M11	IK20L	IK20TT	PK20TT	K20TT
	1.6L	EA111	KJ20DR-M11	IK20L	IK20TT	PK20TT	K20TT
速腾2.5代小改引擎升级	1.4T 230TSI 96kw	EA211	XU22EPR-U	IXU22	-	-	XU22TT
	1.4T 280TSI 110kw	EA211	XU22EPR-U	IXU22	-	-	XU22TT
	1.6L 81kw	EA211	XU22EPR-U	IXU22	-	-	XU22TT
迈腾 (底盘B6)	1.4TSI(2007-2011)	EA111/CFB	K20TXR	IK20	IK20TT	PK20TT	K20TT
	1.8TSI(2007-2011)	EA888/BYJ	VK22	IK22	-	PK22TT	-
	2.0TSI(2007-2011)	EA888/CBL	VK24PR-Z11	IK24	-	-	-
	2.0L(2007-2011)	BJZ	KJ16CR-L11	IK16L	IK16TT	PK16TT	K16TT
迈腾 (底盘B7L)	1.4TSI	EA111	K20TXR	IK20	IK20TT	PK20TT	K20TT
	1.8TSI	EA888	VK22	IK22	-	PK22TT	-
	2.0TSI	EA888	VK24PR-Z11	IK24	-	-	-
	3.0FSI V6	CNGA	KJ16CR-L11	IK16L	IK16TT	PK16TT	K16TT
CC	1.8TSI	EA888	-	IK22	-	PK22TT	-
	2.0TSI	EA888	-	IK24	-	-	-
	3.0FSI V6	CNGA	KJ16CR-L11	IK16L	IK16TT	PK16TT	K16TT
进口大众							
途锐	4.2L	BAR	VKB20	VKB20	-	-	-
	3.2L	BRJ	XU22EPR-U	IXU22	-	-	XU22TT
辉腾	6.0L	BAN,BAP,BRN	PKJ20CR-L11	IK20L	IK20TT	PK20TT	K20TT
	4.2L	BGH	K20TXR	IK20	IK20TT	PK20TT	K20TT
	3.2L	BRK	XU22EPR-U	IXU22	-	-	XU22TT
迈腾	3.2L	FSI	XU22EPR-U	IXU22	-	-	XU22TT
尚酷3代 (底盘1K8)	1.4TSI	CAXA, CMSB	K22PR-U	IK22	-	PK22TT	-
	1.4TSI 双涡轮	CAVD, CNWA, CTHD, CTKA	K22PR-U	IK22	-	PK22TT	-
	2.0TSI	CAWB	VK24PR-Z11	IK24	-	-	-
	2.0TSI GTI	CCZB	VK24PR-Z11	IK24	-	-	-

DENSO
 AUSTRALIA CHINA
 INDIA
 INDONESIA KOREA MALAYSIA PHILIPPINES SAUDIARABIA SINGAPORE TAIWAN THAILAND VIETNAM JAPAN
 EUROPE MOTOR SMALL ENGINE REFERENCE NUMBER
 CROSS PART

DENSO	9	14	16	20	22	24	27	29	31	32	34	35	DENSO	9	14	16	20	22	24	27	29	31	32	DENSO	9	14	16	20	22	24	27	31
NGK	2	4	5	6	7	8	9	9.5	10	10.5	11	11.5	CHAMPION	18	16,14	12,11	10,9	8,7	6,63,61	4,59	57	55	53	BOSCH	10	9	8	7,6	5	4	3	2

**DENSO****CHINA AUSTRALIA****INDIA****INDONESIA****KOREA****MALAYSIA****PHILIPPINES****SAUDI ARABIA****SINGAPORE****TAIWAN****THAILAND****VIETNAM****JAPAN****EUROPE & USA****SMALL MOTOR ENGINE****CYCLE****REFERENCE****CROSS****PART NUMBER**

车种	车型	发动机型式	DENSO	IRIDIUM				
进口大众								
尚酷3代 (底盘1K8)	2.0TSI R	CDLC/CDLA	VK24PR-Z11	IK24	-	-	-	
甲壳虫 (老款)	1.6L	AWH,ADY,BFS	K20PR-U	IK20	IK20TT	PK20TT	K20TT	
	1.8T	BAM,AUQ	K22PR-U	IK22	-	PK22TT	-	
	2.0L	AEG,PK,QY,ZJ	K20PR-U	IK20	IK20TT	PK20TT	K20TT	
甲壳虫 (底盘5C)	1.2TSI(2011-)	CBZB	VK20Y	IK20	IK20TT	PK20TT	K20TT	
	1.4TSI(2011-)	CAVD,CTHD,CTKA	VK20Y	IK20	IK20TT	PK20TT	K20TT	
	1.8TSI(2011-)	CPKA,CPRA	VK22	IK22	-	PK22TT	-	
	2.0TSI(2011-)	CBFA,CCTA,CCZA	VK22	IK22	-	PK22TT	-	
	2.0TSI EA888引擎(2011-)	CPLA,CPPA	-	IKH24	-	-	-	
EOS	2.0TFSI 敞篷	CCZB	K22PR-U	IK22	-	PK22TT	-	
新夏朗7N	1.4TFSI(2010-)	CAVA	K22PR-U	IK22	-	PK22TT	-	
	1.8TSI(2010-)	CDAA	K22PR-U	IK22	-	PK22TT	-	
	2.0TFSI(2010-)	CCZA	K22PR-U	IK22	-	PK22TT	-	
迈特威	2.0TSI	CJKB	K22PR-U	IK22	-	PK22TT	-	
上海大众								
桑塔纳	1.6L	AYF	W16EXR-U	IW16	IW16TT	PW16TT	-	
	1.8L Gli	AFE AYF	W16EXR-U	IW16	IW16TT	PW16TT	-	
	1.8L Gli	AYJ	K16PR-U	IK16	IK16TT	PK16TT	K16TT	
桑塔纳2000	1.8L	AJP/AFB	W16EXR-U	IW16	IW16TT	PW16TT	-	
	1.8L	AYJ	K16PR-U	IK16	IK16TT	PK16TT	K16TT	
桑塔纳3000	1.8L	AYJ BKU BKT	K16PR-U	IK16	IK16TT	PK16TT	K16TT	
	2.0L	BTL	K16PR-U	IK16	IK16TT	PK16TT	K16TT	
桑坦纳志俊	1.8L	BKT	K16PR-U	IK16	IK16TT	PK16TT	K16TT	
	2.0L	BNL	K16PR-U	IK16	IK16TT	PK16TT	K16TT	
	1.6L	BWH	K16PR-U	IK16	IK16TT	PK16TT	K16TT	
新桑塔纳	1.4L	EA211	XU22EPR-U	IXU22	-	-	XU22TT	
	1.6L	EA211	XU22EPR-U	IXU22	-	-	XU22TT	
桑塔纳浩纳	1.4T	EA211	XU22EPR-U	IXU22	-	-	XU22TT	
	1.6L	EA211	XU22EPR-U	IXU22	-	-	XU22TT	
桑塔纳尚纳	1.4L	EA211	XU22EPR-U	IXU22	-	-	XU22TT	
	1.4T	EA211	XU22EPR-U	IXU22	-	-	XU22TT	
	1.6L	EA211	XU22EPR-U	IXU22	-	-	XU22TT	
帕萨特B5	1.8L	ANQ	K20TXR	IK20	IK20TT	PK20TT	K20TT	
	1.8T	AWL	K22PR-U	IK22	-	PK22TT	-	
	2.0L	BFF BNF	KJ20DR-M11	IK20L	IK20TT	PK20TT	K20TT	
	2.8V6	BBG	K20TXR	IK20	IK20TT	PK20TT	K20TT	
帕萨特领驭B5+	1.8T	BGC	K22PR-U	IK22	-	PK22TT	-	
	2.0L	BNL	KJ20DR-M11	IK20L	IK20TT	PK22TT	K20TT	
	2.8V6	BBG	K20TXR	IK20	IK20TT	PK20TT	K20TT	
帕萨特B7	1.4TSI	EA111/CFB	K20R-U	IK20	IK20TT	PK20TT	K20TT	
	1.8TSI	EA888/CEA	VK24PR-Z11	IK24	-	-	-	
	2.0TSI	EA888/CGM	VK24PR-Z11	IK24	-	-	-	
	3.0L	V6 DSG	VXUH22	IXUH22	-	-	XUH22TT	
帕萨特B7+7.5代	1.4T 280TSI	EA211	XU22EPR-U	IXU22	-	-	XU22TT	
	1.8T 330TSI	3代EA888	-	IKH24	-	-	-	
	2.0T 380TSI	3代EA888	-	IKH24	-	-	-	
凌渡	1.4T 230TSI 96kw	EA211	XU22EPR-U	IXU22	-	-	XU22TT	
	1.4T 280TSI 110kw	EA211	XU22EPR-U	IXU22	-	-	XU22TT	
	1.8T 330TSI 132kw	3代EA888	-	IKH24	-	-	-	
四眼老波罗	1.4L	BCC	K20R-U	IK20	IK20TT	PK20TT	K20TT	
	1.6L	BCD	K20R-U	IK20	IK20TT	PK20TT	K20TT	
劲情劲取	1.4L(2007-2010)	BMG	KJ20DR-M11	IK20L	IK20TT	PK20TT	K20TT	
	1.6L(2007-2010)	BMH	KJ20DR-M11	IK20L	IK20TT	PK20TT	K20TT	
	1.6L(2007-2010)	HLD	KJ20DR-M11	IK20L	IK20TT	PK20TT	K20TT	
	1.4L(2007-2010)	EA111	KJ20DR-M11	IK20L	IK20TT	PK20TT	K20TT	
	1.6L(2007-2010)	EA111	KJ20DR-M11	IK20L	IK20TT	PK20TT	K20TT	
波罗	1.4L(2011-2013)	EA111	KJ20DR-M11	IK20L	IK20TT	PK20TT	K20TT	
	1.6L(2011-2013)	EA111	KJ20DR-M11	IK20L	IK20TT	PK20TT	K20TT	
	1.4T(2011-2013)	EA111	K20TXR	IK20	IK20TT	PK20TT	K20TT	
波罗引擎升级	1.4L(2014-2016)	EA211	XU22EPR-U	IXU22	-	-	XU22TT	
	1.4TSI(2014-2016)	EA211	XU22EPR-U	IXU22	-	-	XU22TT	
	1.6L(2014-2016)	EA211	XU22EPR-U	IXU22	-	-	XU22TT	
高尔朗逸 1代	1.6L	BHJ	W16EXR-U	IW16	IW16TT	PW16TT	-	
	1.6L	CDE	KJ20DR-M11	IK20L	IK20TT	PK20TT	K20TT	
	1.6L	CLS,CPJ	KJ20DR-M11	IK20L	IK20TT	PK20TT	K20TT	
	1.6L	CFN/EA111	KJ20DR-M11	IK20L	IK20TT	PK20TT	K20TT	
	1.4TSI	EA111	K20TXR	IK20	IK20TT	PK20TT	K20TT	



车种	车型	发动机型式	DENSO	IRIDIUM	IRIDIUM	PLATINUM	TT
上海大众							
朗逸 1代	2.0L	EA113	KJ20DR-M11	IK20L	IK20TT	PK20TT	K20TT
朗逸 改款引擎升级	1.2TSI	EA211	XU22EPR-U	IXU22	-	-	XU22TT
	1.4L	EA111	KJ20DR-M11	IK20L	IK20TT	PK20TT	K20TT
	1.4T	EA211	XU22EPR-U	IXU22	-	-	XU22TT
	1.4T 230TSI	EA211	XU22EPR-U	IXU22	-	-	XU22TT
	1.6L	EA111	KJ20DR-M11	IK20L	IK20TT	PK20TT	K20TT
	1.6L	EA211	XU22EPR-U	IXU22	-	-	XU22TT
朗行	1.4T	EA211	XU22EPR-U	IXU22	-	-	XU22TT
	1.4T 230TSI	EA211	XU22EPR-U	IXU22	-	-	XU22TT
	1.6L	EA211	XU22EPR-U	IXU22	-	-	XU22TT
朗境	1.4T	EA211	XU22EPR-U	IXU22	-	-	XU22TT
	1.4T 230TSI	EA211	XU22EPR-U	IXU22	-	-	XU22TT
	1.6L	EA211	XU22EPR-U	IXU22	-	-	XU22TT
老途安	2.0L	EA113	KJ20DR-M11	IK20L	IK20TT	PK20TT	K20TT
	1.8T	EA113	K22PR-U	IK22	-	PK22TT	-
途安小改	1.4TSI	EA111	K20TXR	IK20	IK20TT	PK20TT	K20TT
途安L	1.4T 280TSI 110kw	EA211	XU22EPR-U	IXU22	-	-	XU22TT
	1.8T 330TSI 132kw	3代EA888	-	IKH24	-	-	-
途观(5N)	1.4TSI	CAVD, CTHD	K20TXR	IK20	IK20TT	PK20TT	K20TT
	1.8TSI	CEA	VK24PR-Z11	IK24	-	-	-
	2.0TSI	CGM	VK24PR-Z11	IK24	-	-	-
途观(ADI)引擎升级	1.4TSI 230/280TSI	EA211	XU22EPR-U	IXU22	-	-	XU22TT
	1.8TSI 300TSI	3代EA888	-	IKH24	-	-	-
	2.0TSI 330TSI	3代EA888	-	IKH24	-	-	-
上海大众斯柯达							
晶锐1	1.4L(2004-2014)	BMG	KJ20DR-M11	IK20L	IK20TT	PK20TT	K20TT
	1.6L(2004-2014)	BMH	KJ20DR-M11	IK20L	IK20TT	PK20TT	K20TT
	1.4L(2004-2014)	EA111	KJ20DR-M11	IK20L	IK20TT	PK20TT	K20TT
	1.6L(2004-2014)	EA111	KJ20DR-M11	IK20L	IK20TT	PK20TT	K20TT
晶锐2	1.4L(2015-)	EA211	XU22EPR-U	IXU22	-	-	XU22TT
	1.6L(2015-)	EA211	XU22EPR-U	IXU22	-	-	XU22TT
昕锐Rapid	1.4L	EA211	XU22EPR-U	IXU22	-	-	XU22TT
	1.6L	EA211	XU22EPR-U	IXU22	-	-	XU22TT
昕动Rapid	1.4T	EA211	XU22EPR-U	IXU22	-	-	XU22TT
	1.4T 230TSI	EA211	XU22EPR-U	IXU22	-	-	XU22TT
	1.6L	EA211	XU22EPR-U	IXU22	-	-	XU22TT
	1.4L	EA211	XU22EPR-U	IXU22	-	-	XU22TT
明锐I代 Octavia	1.6L(2007-2014)	EA111	KJ20DR-M11	IK20L	IK20TT	PK20TT	K20TT
	1.8T(2007-2014)	CEA	K22PR-U	IK22	-	PK22TT	-
	1.8TSI(2007-2014)	EA888	K22PR-U	IK22	-	PK22TT	-
	2.0L(2007-2014)	MPI	KJ20DR-M11	IK20L	IK20TT	PK20TT	K20TT
	2.0T(2007-2014)	EA888	VK24PR-Z11	IK24	-	-	-
	1.4TSI(2007-2014)	EA111	K20TXR	IK20	IK20TT	PK20TT	K20TT
明锐I代经典版	1.4TSI(2015)	EA111	KJ20DR-M11	IK20L	IK20TT	PK20TT	K20TT
	1.6L(2015)	EA111	KJ20DR-M11	IK20L	IK20TT	PK20TT	K20TT
明锐II代Octavia II	1.4TSI(2015)	EA211	XU22EPR-U	IXU22	-	-	XU22TT
	1.4T 280TSI(2015)	EA211	XU22EPR-U	IXU22	-	-	XU22TT
	1.6L(2015)	EA211	XU22EPR-U	IXU22	-	-	XU22TT
昊锐Superb	1.8TSI	EA888	K22PR-U	IK22	-	PK22TT	-
	2.0TSI	EA888	K22PR-U	IK22	-	PK22TT	-
	1.4TSI	EA111	K20TXR	IK20	IK20TT	PK20TT	K20TT
速派	1.4TSI	EA111	K20TXR	IK20	IK20TT	PK20TT	K20TT
	1.8TSI	EA888	K22PR-U	IK22	-	PK22TT	-
	2.0TSI	EA888	K22PR-U	IK22	-	PK22TT	-
新速派引擎升级	1.4TSI 280TSI	EA211	XU22EPR-U	IXU22	-	-	XU22TT
	1.8TSI 330TSI	3代EA888	-	IKH24	-	-	-
	2.0TSI 380TSI	3代EA888	-	IKH24	-	-	-
野帝Yeti	1.4TSI	EA211	XU22EPR-U	IXU22	-	-	XU22TT
	1.6L	EA211	XU22EPR-U	IXU22	-	-	XU22TT
	1.8TSI	EA888	K22PR-U	IK22	-	PK22TT	-
一汽马自达							
马自达6	2.0L	L4 99kw	T20EPR-U	IT20	IT20TT	PT20TT	T20TT
	2.3L	L4 119kw	T20EPR-U	IT20	IT20TT	PT20TT	T20TT
	2.0L	LFX 108kw	-	ITV16	ITV16TT	PTV16TT	TV16TT
	2.3L	L3X 120kw	-	ITV16	ITV16TT	PTV16TT	TV16TT
马自达3	2.0L	LF 110kw	-	ITV16	ITV16TT	PTV16TT	TV16TT
马自达5	2.0L	LF-DE	-	ITV16	ITV16TT	PTV16TT	TV16TT

DENSO
AUSTRALIA CHINA
INDIA
INDONESIA KOREA
MALAYSIA PHILIPPINES SAUDI ARABIA SINGAPORE
TAIWAN THAILAND VIETNAM JAPAN
EUROPE MOTOR & USA
CYCLE SMALL ENGINE
CROSS PART
REFERENCE NUMBER

DENSO	9	14	16	20	22	24	27	29	31	32	34	35	DENSO	9	14	16	20	22	24	27	29	31	32	DENSO	9	14	16	20	22	24	27	31
NGK	2	4	5	6	7	8	9	9.5	10	10.5	11	11.5	CHAMPION	18	16,14	12,11	10,9	8,7	6,63,61	4,59	57	55	53	BOSCH	10	9	8	7,6	5	4	3	2

**DENSO****CHINA AUSTRALIA****INDIA****INDONESIA****KOREA****MALAYSIA****PHILIPPINES****SAUDI ARABIA****SINGAPORE****TAIWAN****THAILAND****VIETNAM****JAPAN****EUROPE****& USA****SMALL MOTOR****ENGINE****CROSS****PART NUMBER REFERENCE**

车种	车型	发动机型式	DENSO	IRIDIUM				
一汽马自达								
CX-5	2.0L	PE	VFXEH20	VCH20	IXEH20ETT	-	-	
MX-5	2.0L	LFN 118kw	-	ITV16	ITV16TT	PTV16TT	TV16TT	
睿翼	2.0L	LF 108kw	-	ITV16	ITV16TT	PTV16TT	TV16TT	
	2.5L L4	L5 124kw	-	ITV16	ITV16TT	PTV16TT	TV16TT	
阿特兹ATENZA	2.0L	PE 116kw	VFXEH20	-	IXEH20ETT	-	-	
	2.5L L4	PY 141kw	VFXEH20	-	IXEH20ETT	-	-	
CX-4	2.0L		VFXEH20	-	IXEH20ETT	-	-	
	2.5L L4		VFXEH20	-	IXEH20ETT	-	-	
CX-7	2.5L L4	L5 120kw	VFXEH20	-	IXEH20ETT	-	-	
长安马自达								
马自达3	2.0L	LF	T20EPR-U	IT20	IT20TT	PT20TT	-	
	1.6L	Z6V 79kw	K16PR-U11	IK16	IK16TT	PK16TT	K16TT	
	2.0L	LF 110kw	-	ITV16	ITV16TT	PTV16TT	TV16TT	
马自达3星骋	1.6L	Z6 79kw	K16PR-U11	IK16	IK16TT	PK16TT	K16TT	
	2.0L	LF 110kw	-	ITV16	ITV16TT	PTV16TT	TV16TT	
昂克赛拉Axela	1.5L	Dual S-VT 86kw	VFXEH20	-	IXEH20ETT	-	-	
	2.0L	PY 116kw	VFXEH20	-	IXEH20ETT	-	-	
马自达2/劲翔	1.3L	ZJ-VR	K16PR-U11	IK16	IK16TT	PK16TT	K16TT	
	1.5L	ZY-VE	K16PR-U11	IK16	IK16TT	PK16TT	K16TT	
CX-5	2.0L	PE 114kw	-	-	IXEH20ETT	-	-	
	2.5L	PY 144kw	-	-	IXEH20ETT	-	-	
一汽奔腾								
奔腾	1.6L	BWH	K20PR-U	IK20	IK20TT	PK20TT	K20TT	
	1.8L	CA4GD5	-	ITV20	ITV20TT	PTV20TT	-	
	1.8L	CA4GC	-	ITV20	ITV20TT	PTV20TT	-	
	2.0L	LFX	-	ITV16	ITV16TT	PTV16TT	TV16TT	
	2.3L	L3-VE	-	ITV16	ITV16TT	PTV16TT	TV16TT	
	1.8T	CA4GC18T	-	ITV20	ITV20TT	PTV20TT	-	
	2.0L	CA4GD1	-	ITV20	ITV20TT	PTV20TT	-	
	2.3L	CA4GD3	-	ITV16	ITV16TT	PTV16TT	-	
2.0T	CA4GC20T	-	ITV20	ITV20TT	PTV20TT	-		
一汽红旗								
红旗新明仕	1.8L	QG18DE	K16PR-U11	IK16	IK16TT	PK16TT	K16TT	
	1.8L	CA4GE/74	K16PR-U11	IK16	IK16TT	PK16TT	K16TT	
红旗世纪星	1.8L	QG18DE	K16PR-U11	IK16	IK16TT	PK16TT	K16TT	
	2.4L	APS	K20TXR	IK20	IK20TT	PK20TT	K20TT	
	2.0L	VG20E	Q16PR-U11	IQ16	IQ16TT	PQ16TT	Q16TT	
红旗明仕	1.8L/2.0L/2.2L	CA4GE/74	K16PR-U11	IK16	IK16TT	PK16TT	K16TT	
	1.8L/2.0L/2.2L	CA488-3B2	W20EPB	IW20	IW20TT	PW20TT	-	
	1.8L/2.0L/2.2L	CA488-3	W20EPB	IW20	IW20TT	PW20TT	-	
	2.0L	VG20E	Q16PR-U11	IQ16	IQ16TT	PQ16TT	Q16TT	
	1.8L	AHP	W20EPB	IW20	IW20TT	PW20TT	-	
一汽吉林								
森雅	1.3L	K3-VE3	XU22EPR-U	IXU22	-	-	XU22TT	
	1.5L	3SZ-VE2	XU22EPR-U	IXU22	-	-	XU22TT	
森雅 M80	1.3L	K3-VE3	XU22EPR-U	IXU22	-	-	XU22TT	
	1.5L	3SZ-VE2	XU22EPR-U	IXU22	-	-	XU22TT	
一汽丰田								
威驰	1.3L(2003-2007)	8A-FE	-	IK16	IK16TT	PK16TT	K16TT	
	1.5L(2003-2007)	5A-FE	-	IK16	IK16TT	PK16TT	K16TT	
	1.3L(2003-2007)	2SZ-FE	XU22EPR-U	IXU22	-	-	XU22TT	
	1.5L(2003-2007)	3SZ-FE	XU22EPR-U	IXU22	-	-	XU22TT	
	1.3L(2008-2013)	2NZ-FE	-	IXU22	-	-	XU22TT	
	1.6L(2008-2013)	1ZR-FE	SC20HR11	VCH20	-	-	-	
	1.3L(2014-2016)	4NR-FE	SC20HR11	-	IXEH20ETT	-	-	
	1.5L(2014-2016)	5NR-FE	SC20HR11	-	IXEH20ETT	-	-	
	花冠	1.8L	1ZZ-FE	-	IK16	IK16TT	PK16TT	K16TT
1.6L		1ZR-FE	SC20HR11	VCH20	IXEH20ETT	-	-	
卡罗拉	1.6L	1ZR-FE	SC20HR11	VCH20	IXEH20ETT	-	-	
	1.8L	2ZR-FE	SC20HR11	VCH20	IXEH20ETT	-	-	
	2.0L	3ZR-FE	SC20HR11	VCH20	IXEH20ETT	-	-	
锐志	3.0L	3GR-FE	FK20HR11	VFKH20	IKH20TT	PKH20TT	KH20TT	
	2.5L	5GR-FE	FK20HR11	VFKH20	IKH20TT	PKH20TT	KH20TT	
皇冠	2.5L	5GR-FE	FK20HR11	VFKH20	IKH20TT	PKH20TT	KH20TT	
	3.0L	3GR-FE	FK20HR11	VFKH20	IKH20TT	PKH20TT	KH20TT	
	4.3L	3UZ-FE	SK20HR11	IKH20	IKH20TT	PKH20TT	KH20TT	
	2.0T	8AR-FTS	FK20HR11	-	IKH20TT	-	KH20TT	

车种	车型	发动机型式	DENSO	IRIDIUM			
一汽丰田							
普锐斯	1.5L	1NE-FXE	K16R-U11	IK16	IK16TT	PK16TT	K16TT
	1.8L	5ZR-FXE	SK16R11	-	IXEH20ETT	-	-
RVA4	2.0L	1AZ-FE	SK20R11	IK20	IK20TT	PK20TT	K20TT
	2.4L	2AZ-FE	SK20R11	IK20	IK20TT	PK20TT	K20TT
	2.0L	6ZR-FE	-	-	IXEH20ETT	-	-
	2.5L L4	5AR-FE	-	-	IKH20TT	-	KH20TT
普拉多/霸道国产PRADO	2700L4	2TR-FE	K20HR-U11	IKH20	IKH20TT	PKH20TT	KH20TT
	3500V6	7GR-FKS	K20HR-U11	IKH20	IKH20TT	PKH20TT	KH20TT
	4000V6	1GR-FE	K20HR-U11	IKH20	IKH20TT	PKH20TT	KH20TT
陆地巡洋舰/兰德酷路泽 LandCruiser	4.0L V6	1GR-FE	SK20R11	IK20	IK20TT	PK20TT	K20TT
	4.5L V6	1FZ-FE	K16TR11	IK16	IK16TT	PK16TT	K16TT
	4.6L V8	1UR-FE	K20HR-U11	IKH20	IKH20TT	PKH20TT	KH20TT
	4.7L V8	2UZ-FE	SK20R11	IK20	IK20TT	PK20TT	K20TT
广汽丰田							
6代凯美瑞	2.0L	1AZ-FE	SK20R11	IK20	IK20TT	PK20TT	K20TT
	2.4L	2AZ-FE	SK20R11	IK20	IK20TT	PK20TT	K20TT
7代凯美瑞	2.0L	1AZ-FE	SK20R11	IK20	IK20TT	PK20TT	K20TT
	2.5L	5AR-FE	SK20HR11	-	IKH20TT	-	KH20TT
	2.5L 混动	4AR-FXE	SK20HR11	-	IKH20TT	-	KH20TT
7.5代中改款凯美瑞	2.0L	6AR-FSE	SK20HR11	-	IKH20TT	-	KH20TT
	2.5L	5AR-FE	SK20HR11	-	IKH20TT	-	KH20TT
	2.5L 混动	4AR-FXE	SK20HR11	-	IKH20TT	-	KH20TT
雅力士Yaris	1.3L	2NZ	SK16R11	IK16	IK16TT	PK16TT	K16TT
	1.6L	4ZR	XU22EPR-U	IXU22	-	-	XU22TT
	1.6L	1ZR	SC20HR11	-	IXEH20ETT	-	-
致炫Yaris L	1.3L	6NR-FE	SC20HR11	-	IXEH20ETT	-	-
	1.5L	7NR-FE	SC20HR11	-	IXEH20ETT	-	-
雷凌Levin	1.6L	1ZR,4ZR	SC20HR11	-	IXEH20ETT	-	-
	1.8L	2ZR,7ZR	SC20HR11	-	IXEH20ETT	-	-
	1.8L	8ZR-FXE	SC20HR11	-	IXEH20ETT	-	-
汉兰达	2.7L L4	1AR-FE	SK16HR11	IKH16	IKH16TT	PKH16TT	KH16TT
	2.7L L4	3AR-FE	SK16HR11	IKH16	IKH16TT	PKH16TT	KH16TT
	3.5L V6	2GR-FE	FK20HR11	IKH20	IKH20TT	PKH20TT	KH20TT
逸致EZ	1.6L	1ZR-FE	SC20HR11	-	IXEH20ETT	-	-
	1.8L	2ZR-FE	SC20HR11	-	IXEH20ETT	-	-
	2.0L	3ZR-FE	SC20HR11	-	IXEH20ETT	-	-
天津一汽							
夏利	1.1L	TJ378	W16EXR-U11	IW16	IW16TT	PW16TT	-
	1.0L	TJ378	W16EXR-U11	IW16	IW16TT	PW16TT	-
	1.3L	8A-FE	K16R-U	IK16	IK16TT	PK16TT	K16TT
	1.0L	CA3GA2+	K20R-U	IK20	IK20TT	PK20TT	K20TT
	1.3L	CA4GA1	K20R-U	IK20	IK20TT	PK20TT	K20TT
	1.4L	CA3GA2	K20R-U	IK20	IK20TT	PK20TT	K20TT
	1.0L	3GA2	K20R-U	IK20	IK20TT	PK20TT	K20TT
	1.0L	TJ376QE	W16EXR-U11	IW16	IW16TT	PW16TT	-
	1.1L	TJ378QE	K20R-U	IK20	IK20TT	PK20TT	K20TT
	1.4L	4GBI	K20R-U	IK20	IK20TT	PK20TT	K20TT
威姿	1.0L	CA3GA2	K20R-U	IK20	IK20TT	PK20TT	K20TT
	1.3L	8A EFI	K16R-U	IK16	IK16TT	PK16TT	K16TT
威志Vitz	1.3L两厢	8A+	K16R-U	IK16	IK16TT	PK16TT	K16TT
	1.5L两厢	5A+	K20R-U	IK20	IK20TT	PK20TT	K20TT
威志V2	1.3L	CA4GA1	K20R-U	IK20	IK20TT	PK20TT	K20TT
威乐	1.5L	5A-FE	K20R-U	IK20	IK20TT	PK20TT	K20TT
	1.3L	8A	K16R-U	IK16	IK16TT	PK16TT	K16TT
	1.6L	CA4GBE	K20R-U	IK20	IK20TT	PK20TT	K20TT
雅酷	1.3L	8A-FE	K16R-U	IK16	IK16TT	PK16TT	K16TT
进口丰田							
佳美	2.4L L4	2AZ-FE	K20R-U11	IK20	IK20TT	PK20TT	K20TT
子弹头/大霸王	2.4L	2TZFE	PK16R11	IK16	IK16TT	PK16TT	K16TT
进口RAV4	2.0L L4	1AZ-FE	SK20R11	IK20	IK20TT	PK20TT	K20TT
	2.4L L4	2AZ-FE	K20R-U11	IK20	IK20TT	PK20TT	K20TT
	3.5L V6	2GR-FE	K20HR-U11	IKH20	IKH20TT	PKH20TT	KH20TT
皇冠	2.2L	4Y	W16EXR-U	IW16	IW16TT	PW16TT	-
	2.0L	3Y	W16EXR-U	IW16	IW16TT	PW16TT	-
	2.8L	5M	W16EXR-U	IW16	IW16TT	PW16TT	-
杰路驰Zelas	2.5L L4	2AR-FE	K20HR-U11	IKH20	IKH20TT	PKH20TT	KH20TT
塞纳Sienna	3.5L V6	2GR-FE	-	-	IKH20TT	-	KH20TT

DENSO
 AUSTRALIA CHINA INDIA INDONESIA KOREA MALAYSIA PHILIPPINES SAUDIARABIA SINGAPORE TAIWAN THAILAND VIETNAM JAPAN & USA EUROPE MOTOR CYCLE SMALL ENGINE REFERENCE NUMBER

DENSO	9	14	16	20	22	24	27	29	31	32	34	35	DENSO	9	14	16	20	22	24	27	29	31	32	DENSO	9	14	16	20	22	24	27	31
NGK	2	4	5	6	7	8	9	9.5	10	10.5	11	11.5	CHAMPION	18	16,14	12,11	10,9	8,7	6,63,61	4,59	57	55	53	BOSCH	10	9	8	7,6	5	4	3	2



DENSO

AUSTRALIA

CHINA

INDIA

INDONESIA

KOREA

MALAYSIA



PHILIPPINES

SAUDI ARABIA

SINGAPORE

TAIWAN

车种	车型	发动机型式	DENSO	IRIDIUM			
进口丰田							
普瑞维亚Previa	2.4L L4	2TZ-FE	K16R-U11	IK16	IK16TT	PK16TT	K16TT
	2.4L	2AZ-FE	K20R-U11	IK20	IK20TT	PK20TT	K20TT
	2.4L L4	2AZ-FE	K20R-U11	IK20	IK20TT	PK20TT	K20TT
	3.5L V6	2GR-FE	-	-	IKH20TT	-	KH20TT
爱尔法Alphard	2.4L	2AZ-FE	K20R-U11	IK20	IK20TT	PK20TT	K20TT
	3.5L	2GR-FE	-	-	IKH20TT	-	KH20TT
Fortuner	2.7L L4	2TR-FE	-	IKH20	IKH20TT	PKH20TT	KH20TT
普拉多/霸道中东进口版PRADO	2700 L4	3RZ-FE	K16R-U11	IK16	IK16TT	PK16TT	K16TT
	2700 L4	2TR-FE	K20HR-U11	IKH20	IKH20TT	PKH20TT	KH20TT
	3400 V6	5VZ-FE	K16R-U11	IK16	IK16TT	PK16TT	K16TT
	3500 V6	7GR-FKS	K20HR-U11	IKH20	IKH20TT	PKH20TT	KH20TT
	4000 V6	1GR-FE	K20HR-U11	IKH20	IKH20TT	PKH20TT	KH20TT
陆地巡洋舰/兰德酷路泽 LandCruiser中东进口版	4.7L V8	2UZ-FE	-	IK20	IK20TT	PK20TT	K20TT
	5.7L V8	3UR-FE 284kw	K20HR-U11	IKH20	IKH20TT	PKH20TT	KH20TT
	4.0L V6	1GR-FE	K20HR-U11	IKH20	IKH20TT	PKH20TT	KH20TT
	4.6L V8	1UR-FE	K20HR-U11	IKH20	IKH20TT	PKH20TT	KH20TT
FJ酷路泽	4.0L V6	1GR-FE	K20HR-U11	IKH20	IKH20TT	PKH20TT	KH20TT
红杉	5700 V8	3UR-FE	K20HR-U11	IKH20	IKH20TT	PKH20TT	KH20TT
坦途/Tundra	4.7L V8	2UZ-FE	-	IK20	IK20TT	PK20TT	K20TT
	5.7L V8	3UR-FE	K20HR-U11	IKH20	IKH20TT	PKH20TT	KH20TT
南汽菲亚特							
派力奥	1.3L	188A4000	K16PR-U	IK16	IK16TT	PK16TT	K16TT
	1.3L	188A5000	XU22EPR-U	IXU22	-	-	XU22TT
	1.5L	178E5027	K16PR-U	IK16	IK16TT	PK16TT	K16TT
西耶那	1.3L	188A4000	K20PR-U11	IK20	IK20TT	PK20TT	K20TT
	1.3L	188A5000	XU22EPR-U	IXU22	-	-	XU22TT
	1.5L	178E5027	K16PR-U	IK16	IK16TT	PK16TT	K16TT
周末风	1.3L	188A5000	XU22EPR-U	IXU22	-	-	XU22TT
	1.5L	178E5027	K16PR-U	IK16	IK16TT	PK16TT	K16TT
派朗	1.7L	311A1027	K16PR-U	IK16	IK16TT	PK16TT	K16TT
广汽菲亚特							
菲翔Viaggio	1.4T 88kw	1.4T-JET	-	IXU27	-	-	-
	1.4T 110kw	1.4T-JET	-	IXU27	-	-	-
致悦Ottimo	1.4T	1.4T-JET	-	IXU27	-	-	-
	1.T运动版	1.4T-JET	-	IXU27	-	-	-
进口菲亚特							
博悦Bravo	1.4T	1.4T-JET	-	IXU27	-	-	-
菲亚特500	1.4L	169A3000	XU22EPR-U	IXU22	-	-	XU22TT
领雅Linea	1.4T	1.4T-JET	-	IXU27	-	-	-
朋多Punto	1.4L	199A6000	XU22EPR-U	IXU22	-	-	XU22TT
菲跃Freemont	2.4L L4	ED3	K16PR-U	IK16	IK16TT	PK16TT	K16TT
	3.6L V6	ERB	-	IKH22	-	-	-
长安福特							
嘉年华	1.6L	JL482QA	-	ITV16	ITV16TT	PTV16TT	TV16TT
	1.3L	ZJ	K16PR-U11	IK16	IK16TT	PK16TT	K16TT
	1.5L	ZY	-	IK20	IK20TT	PK20TT	K20TT
	1.5L	CAF479Q0	-	ITV20	ITV20TT	PTV20TT	-
福睿斯	1.5L	CAF479Q1	-	ITV20	ITV20TT	PTV20TT	-
福克斯	1.8L(2005-2008)	Duratec-HE	T20EPR-U	IT20	IT20TT	PT20TT	T20TT
	2.0L(2005-2008)	Duratec-HE	T20EPR-U	IT20	IT20TT	PT20TT	T20TT
	1.8L(2009-2010)	Duratec-HE	T20EPR-U	IT20	IT20TT	PT20TT	T20TT
	2.0L(2009-2010)	Duratec-HE	T20EPR-U	IT20	IT20TT	PT20TT	T20TT
	1.8L(2011)	CAF483Q0	T20EPR-U	IT20	IT20TT	PT20TT	T20TT
	2.0L(2011)	CAF488Q1	T20EPR-U	IT20	IT20TT	PT20TT	T20TT
	1.6L(2012-2014)	Ti-VCT C6	-	ITV20	ITV20TT	PTV20TT	-
	1.8L经典版(2012-2014)	CAF483Q0	T20EPR-U	IT20	IT20TT	PT20TT	T20TT
	2.0L(2012-2014)	GDI	-	ITV20	ITV20TT	PTV20TT	-
	2.0T(2012-2014)	-	-	ITV22	-	-	-
蒙迪欧	2.0L(2003-2007)	CAF488Q1	T20EPR-U	IT20	IT20TT	PT20TT	T20TT
	2.5V6(2003-2007)	CAF488Q0	T20EPR-U	IT20	IT20TT	PT20TT	T20TT
	2.0T(2013)	GTDi240	-	ITV22	-	-	-
致胜	2.0L	CAF488Q2	-	ITV20	ITV20TT	PTV20TT	-
	2.3L	L3	-	ITV20	ITV20TT	PTV20TT	-
	2.0T	Ecoboost	-	ITV22	-	PTV20TT	-
翼搏	1.5L	CAF479Q0	-	ITV20	ITV20TT	PTV20TT	-
翼虎	1.6T	GTDI240	-	ITV22	-	-	-
	2.0T	CAF488WQ2	-	ITV22	-	-	-

车种	车型	发动机型式	DENSO	IRIDIUM			
长安福特							
S-MAX	2.3L	Duratec-HE	-	ITV20	ITV20TT	PTV20TT	-
锐界	2.0T		-	ITV22	-	PTV20TT	-
	3.5L		-	ITV22	-	PTV20TT	-
吉利汽车							
美日	1.3L	MR479Q	K16R-U11	IK16	IK16TT	PK16TT	K16TT
	1.3L	8A-FE	K16R-U11	IK16	IK16TT	PK16TT	K16TT
自由舰	1.5L	MR479QA	K20PR-U	IK20	IK20TT	PK20TT	K20TT
	1.3L	MR749Q	K16R-U	IK16	IK16TT	PK16TT	K16TT
	1.6L	MR481QA	K20PR-U	IK20	IK20TT	PK20TT	K20TT
豪情	1.3L	8A-FE	K16R-U11	IK16	IK16TT	PK16TT	K16TT
	1.0L	JL376QE	W16EXR-U	IW16	IW16TT	PW16TT	-
	1.3L	MR479Q	K16R-U11	IK16	IK16TT	PK16TT	K16TT
优利欧	1.3L	MR479Q	K16R-U11	IK16	IK16TT	PK16TT	K16TT
	1.0L	JL376QE	W16EXR-U	IW16	IW16TT	PW16TT	-
远景	1.8L	JL4G18	K20PR-U	IK20	IK20TT	PK20TT	K20TT
	1.5L	JL4G15D	K20PR-U	IK20	IK20TT	PK20TT	K20TT
海景	1.5L	JL4G15D	K20PR-U	IK20	IK20TT	PK20TT	K20TT
	1.8L	JL4G18	K20PR-U	IK20	IK20TT	PK20TT	K20TT
金刚	1.5L	MR479QA	K20PR-U	IK20	IK20TT	PK20TT	K20TT
	1.6L	MR481QA	K20PR-U	IK20	IK20TT	PK20TT	K20TT
	1.8L	MR481QA	K20PR-U	IK20	IK20TT	PK20TT	K20TT
	1.5L	JLB-4G15	K20PR-U	IK20	IK20TT	PK20TT	K20TT
	1.5L	MR479QN	K20PR-U	IK20	IK20TT	PK20TT	K20TT
金鹰	1.5L	MR479QA	K20PR-U	IK20	IK20TT	PK20TT	K20TT
美人豹	1.3L	MR479Q	K20PR-U	IK20	IK20TT	PK20TT	K20TT
	1.5L	MR479QA	K20PR-U	IK20	IK20TT	PK20TT	K20TT
	1.8L	MR481QA	K20PR-U	IK20	IK20TT	PK20TT	K20TT
熊猫	1.3L	MR479QA	K20PR-U	IK20	IK20TT	PK20TT	K20TT
	1.0L	JL3G10	K20HR-U11	IKH20	IKH20TT	PKH20TT	KH20TT
	1.5L	L4	K20PR-U	IK16	IK16TT	PK16TT	K16TT
全球鹰	1.3L	MR479Q	K20PR-U	IK20	IK20TT	PK20TT	K20TT
	1.5L	MR479QN	K20PR-U	IK20	IK20TT	PK20TT	K20TT
	1.8L	JL4G18	K20PR-U	IK20	IK20TT	PK20TT	K20TT
	2.0L	JL δ-4G20	K20HR-U11	IKH20	IKH20TT	PKH20TT	KH20TT
	2.0L	JLD-4G20	K20PR-U	IK20	IK20TT	PK20TT	K20TT
	2.4L	JLD-4G24	K20PR-U	IK20	IK20TT	PK20TT	K20TT
吉利帝豪							
经典帝豪EC7	1.5L	JL γ-4G15	K20HR-U11	IKH20	IKH20TT	PKH20TT	KH20TT
	1.5L	JL4G15	K20PR-U	IK20	IK20TT	PK20TT	K20TT
	1.8L L4	JL4G18	K20PR-U	IK20	IK20TT	PK20TT	K20TT
	1.8L	JL γ-4G18	K20HR-U11	IKH20	IKH20TT	PKH20TT	KH20TT
新帝豪 帝豪EC8	1.5L	JL4G15	K20PR-U	IK20	IK20TT	PK20TT	K20TT
	2.0L	JL δ-4G20	K20HR-U11	IKH20	IKH20TT	PKH20TT	KH20TT
	2.0L	4G63S4N	K20HR-U11	IKH20	IKH20TT	PKH20TT	KH20TT
	2.4L	JL δ-4G24	K20HR-U11	IKH20	IKH20TT	PKH20TT	KH20TT
博瑞GC9	2.4L L4	JLD-4G24	K20PR-U	IK20	IK20TT	PK20TT	K20TT
博越	2.0L L4	JLD-4G20	K20PR-U	IK20	IK20TT	PK20TT	K20TT
吉利英伦							
SC3	1.3L	MR479Q	K20PR-U	IK20	IK20TT	PK20TT	K20TT
英伦C5	1.5L	JLB-4G15	K20PR-U	IK20	IK20TT	PK20TT	K20TT
SC5-RV	1.5L	MR479QA	K20PR-U	IK20	IK20TT	PK20TT	K20TT
SC6	1.5L	MR479QN	K20PR-U	IK20	IK20TT	PK20TT	K20TT
GC7	1.5L	JL4G15D	K20PR-U	IK20	IK20TT	PK20TT	K20TT
	1.5L	JL γ 4G15	K20HR-U11	IKH20	IKH20TT	PKH20TT	KH20TT
	1.8L	JL4G18	K20PR-U	IK20	IK20TT	PK20TT	K20TT
SX7	1.8L	JL γ 4G18	K20HR-U11	IKH20	IKH20TT	PKH20TT	KH20TT
	1.8L	JL4G18	K20PR-U	IK20	IK20TT	PK20TT	K20TT
	2.0L	JLD-4G20	K20PR-U	IK20	IK20TT	PK20TT	K20TT
TX4英伦出租车	2.4L	JLD-4G24	K20PR-U	IK20	IK20TT	PK20TT	K20TT
	2.4L	4G69S4N	K16PR-U11	IK16	IK16TT	PK16TT	K16TT
华普汽车							
海域	1.3L	HJL479Q	-	IK16	IK16TT	PK16TT	K16TT
	1.5L	JL479Q	-	IK16	IK16TT	PK16TT	K16TT
海迅	1.5L	JL481Q	-	IK16	IK16TT	PK16TT	K16TT
海尚	海尚	JL481Q	-	IK16	IK16TT	PK16TT	K16TT
海锋	海锋	JL479Q4	-	IK16	IK16TT	PK16TT	K16TT
海悦	海悦	JL479QA	-	IK16	IK16TT	PK16TT	K16TT

DENSO
 AUSTRALIA CHINA
 INDIA
 INDONESIA KOREA
 MALAYSIA PHILIPPINES SAUDI ARABIA SINGAPORE
 TAIWAN THAILAND VIETNAM
 JAPAN & USA
 EUROPE MOTOR SMALL ENGINE REFERENCE NUMBER
 CROSS PART

DENSO	9	14	16	20	22	24	27	29	31	32	34	35	DENSO	9	14	16	20	22	24	27	29	31	32	DENSO	9	14	16	20	22	24	27	31
NGK	2	4	5	6	7	8	9	9.5	10	10.5	11	11.5	CHAMPION	18	16,14	12,11	10,9	8,7	6,63,61	4,59	57	55	53	BOSCH	10	9	8	7,6	5	4	3	2



DENSO

CHINA AUSTRALIA

INDIA

INDONESIA

KOREA

MALAYSIA

PHILIPPINES

SAUDI ARABIA

SINGAPORE

TAIWAN

THAILAND

VIETNAM

JAPAN

EUROPE & USA

MOTOR CYCLE

SMALL ENGINE

CROSS REFERENCE

车种	车型	发动机型式	DENSO	IRIDIUM	IRIDIUM TT	PLATINUM	TT
华普汽车							
海景	海景	JL4G18	-	IK16	IK16TT	PK16TT	K16TT
上海通用							
赛欧	1.6L	SOHC L01	W20EXR-U	IW20	IW20TT	PW20TT	-
凯越	1.6L(2004-2007)	F16D3D	K20PR-U11	IK20	IK20TT	PK20TT	K20TT
	1.8L(2004-2007)	T18SED	K20PR-U11	IK20	IK20TT	PK20TT	K20TT
	1.6L(2004-2007)	F16D3	K20PR-U11	IK20	IK20TT	PK20TT	K20TT
新凯越	1.6L(2008-2015)	F16D3	K20PR-U11	IK20	IK20TT	PK20TT	K20TT
	1.8L(2008-2015)	T18SED	K20PR-U11	IK20	IK20TT	PK20TT	K20TT
	1.5L(2008-2015)	L2B	XU22EPR-U	IXU22	-	-	XU22TT
老君威	2.0L(2002-2007)	L34	K20PR-U11	IK20	IK20TT	PK20TT	K20TT
	2.5L(2002-2007)	LB8	T16EPR-U	IT16	IT16TT	PT16TT	T16TT
	3.0L(2002-2007)	LW9	T16EPR-U	IT16	IT16TT	PT16TT	T16TT
新君威	2.0L(2009-2015)	ECO TEC	-	ITV16	ITV16TT	PTV16TT	TV16TT
	2.4L(2009-2015)	ECO TEC	-	ITV16	ITV16TT	PTV16TT	TV16TT
	1.6T(2009-2015)	Turbo	KJ20CR-L11	IK20L	IK20TT	PK20TT	K20TT
	2.0T(2009-2015)	Turbo DI	-	ITV20	ITV20TT	PTV20TT	-
老君越	2.4L(2006-2008)	LE5	-	ITV16	ITV16TT	PTV16TT	TV16TT
	3.0L(2006-2008)	LZD	-	ITV16	ITV16TT	PTV16TT	TV16TT
	2.4L(2009-2014)	ECOTEC	-	ITV16	ITV16TT	PTV16TT	TV16TT
新君越	3.0L(2009-2014)	SIDI	-	ITV16	ITV16TT	PTV16TT	TV16TT
	2.0T(2009-2014)	Turbo DI	-	ITV20	ITV20TT	PTV20TT	-
	2.0T L4(2016)		-	ITV20	ITV20TT	-	-
	2.5L(2001-2005)	V6	T16EPR-U	IT16	IT16TT	PT16TT	T16TT
老GL8	3.0L(2001-2005)	LW9	T16EPR-U	IT16	IT16TT	PT16TT	T16TT
	2.5L	LB8	T16EPR-U	IT16	IT16TT	PT16TT	T16TT
GL8陆尊	3.0L	LZC	T16EPR-U	IT16	IT16TT	PT16TT	T16TT
	2.4L	LE5	-	ITV16	ITV16TT	PTV16TT	TV16TT
GL8天尊	3.0L	LFW	-	ITV16	ITV16TT	PTV16TT	TV16TT
	1.6L	ECOTEC	KJ20CR-L11	IK20L	IK20TT	PK20TT	K20TT
英朗	1.6T	Turbo	KJ20CR-L11	IK20L	IK20TT	PK20TT	K20TT
	1.8L	D-VVT Eco	KJ20CR-L11	IK20L	IK20TT	PK20TT	K20TT
	1.4T		-	-	IXEH22TT	-	-
	1.5L		-	IXUH22	-	-	XUH22TT
昂科拉	1.4T	A14NET(LUJ)	-	IK22	-	PK22TT	-
	1.4TGL	LFF	-	IK22	-	PK22TT	-
昂科威	2.0T	LTG	-	ITV20	ITV20TT	PTV20TT	-
昂科雷	3.6L V6	LLT	-	ITV20	ITV20TT	PTV20TT	-
荣御	2.8L V6	Alloytec	-	ITV20	ITV20TT	PTV20TT	-
	3.6L V6	Alloytec	-	ITV20	ITV20TT	PTV20TT	-
	2.8L V6	Alloytec	-	ITV20	ITV20TT	PTV20TT	-
林荫大道	3.6L V6	AlloyTec	-	ITV20	ITV20TT	PTV20TT	-
	3.0L V6	AlloyTec	-	ITV20	ITV20TT	PTV20TT	-
	3.0L V6	AlloyTec	-	ITV20	ITV20TT	PTV20TT	-
进口凯迪拉克/CADILLAC							
进口ATS	2.0T	LTG	-	ITV20	ITV20TT	PTV20TT	-
进口CTS 1代	2.8L V6	LP1	-	ITV20	ITV20TT	PTV20TT	-
	3.6L V6	LY7	-	ITV20	ITV20TT	PTV20TT	-
进口CTS 2代	2.8L V6	LY7	-	ITV20	ITV20TT	PTV20TT	-
	3.6L V6	LY7	-	ITV20	ITV20TT	PTV20TT	-
	3.0L V6	SIDI	-	ITV20	ITV20TT	PTV20TT	-
	6.2T V8	LSV V8-378	-	IT20	IT20TT	PT20TT	T20TT
	2.0T L4	LTG	-	ITV20	ITV20TT	PTV20TT	-
XLR	4.6L V8	LH2	T16EPR-U	IT16	IT16TT	PT16TT	-
SRX 1代	3.6L V6	LY7	-	ITV20	ITV20TT	PTV20TT	-
	4.6L V8	LH2	T16EPR-U	IT16	IT16TT	PT16TT	T16TT
SRX 2代	3.0L V6 198kw	LF1	-	ITV20	ITV20TT	PTV20TT	-
	3.0L V6 199kw	LFW	-	ITV20	ITV20TT	PTV20TT	-
	3.6L	LY7	-	ITV20	ITV20TT	PTV20TT	-
凯雷德Escalade	6.2LV8	VORTEC IV L92	-	IT20	IT20TT	PT20TT	T20TT
	6.0L V8 Hybrid	Vortec6000	-	IT16	IT16TT	PT16TT	T16TT
上汽通用凯迪拉克/CADILLAC							
国产CTS 1代	2.8L V6	LP1	-	ITV20	ITV20TT	PTV20TT	-
	3.6L V6	LY7	-	ITV20	ITV20TT	PTV20TT	-
国产SLS赛威	2.8L V6		-	ITV20	ITV20TT	PTV20TT	-
	3.0L V6	SIDI	-	ITV20	ITV20TT	PTV20TT	-
	3.6L V6	LY7	-	ITV20	ITV20TT	PTV20TT	-
	4.6L V8	D-VVT ETC	T16EPR-U	IT16	IT16TT	PT16TT	T16TT
	2.0T	LNF	-	ITV20	ITV20TT	PTV20TT	-

车种	车型	发动机型式	DENSO	IRIDIUM			
上汽通用凯迪拉克/CADILLAC							
国产ATS-L	2.0T	LTG 169kw	-	ITV20	ITV20TT	PTV20TT	-
	2.0T	LTG 205kw	-	ITV20	ITV20TT	PTV20TT	-
国产XTS	2.0T	LTG	-	ITV20	ITV20TT	PTV20TT	-
	3.6L V6	LY7	-	ITV20	ITV20TT	PTV20TT	-
国产CT6	2.0T	LTG	-	ITV20	ITV20TT	PTV20TT	-
	3.0T V6	LGW	-	ITV20	ITV20TT	PTV20TT	-
悍马/Hummer							
悍马H3Hummer	3.5L L5	L52	-	ITV16	ITV16TT	PTV16TT	TV16TT
	3.7L L5		-	ITV16	ITV16TT	PTV16TT	TV16TT
	5.3L V8		-	IT16	IT16TT	PT16TT	T16TT
悍马H2Hummer	6.0L V8	Vortec6000	-	IT16	IT16TT	PT16TT	T16TT
	6.2L V8	VORTEC IV L92	-	IT16	IT16TT	PT16TT	T16TT
上海通用雪佛兰							
赛欧	1.6L	L4	W20EXR-U	IW20	IW20TT	PW20TT	-
	1.2L	LMU	XU22EPR-U	IXU22	-	-	XU22TT
	1.4L	LCU	XU22EPR-U	IXU22	-	-	XU22TT
赛欧3	1.3L	LEW	-	IXUH22	-	-	XUH22TT
	1.5L	L2B	-	IXUH22	-	-	XUH22TT
爱唯欧	1.4L	LCU	XU22EPR-U	IXU22	-	-	XU22TT
	1.6L	Ecotec	KJ20CR-L11	IK20L	IK20TT	PK20TT	K20TT
乐骋	1.4L	L95	K20PR-U11	IK20	IK20TT	PK20TT	K20TT
	1.6L	L95	K20PR-U11	IK20	IK20TT	PK20TT	K20TT
	1.2L	B12	XU22EPR-U	IXU22	-	-	XU22TT
乐风	1.4L	L95	K20PR-U11	IK20	IK20TT	PK20TT	K20TT
	1.6L	F16D3	K20PR-U11	IK20	IK20TT	PK20TT	K20TT
	1.2L	B12	XU22EPR-U	IXU22	-	-	XU22TT
乐风RV	1.5L	L2B	-	IXUH22	-	-	XUH22TT
老景程	2.0L	T20SED	K20TNR	IK20	IK20TT	PK20TT	K20TT
景程改款	2.0L	L34	K20TNR	IK20	IK20TT	PK20TT	K20TT
	1.8L	2H0	K20TNR	IK20L	IK20TT	PK20TT	K20TT
	1.6L	LDE	KJ20CR-L11	IK20L	IK20TT	PK20TT	K20TT
科鲁兹 1代	1.8L	2H0	KJ20CR-L11	IK20L	IK20TT	PK20TT	K20TT
	1.6T	LLU	KJ20CR-L11	IK20L	IK20TT	PK20TT	K20TT
	1.6L	LDE	KJ20CR-L11	IK20L	IK20TT	PK20TT	K20TT
科鲁兹 1代小改	1.6T	LLU	KJ20CR-L11	IK20L	IK20TT	PK20TT	K20TT
	1.6L	LDE	KJ20CR-L11	IK20L	IK20TT	PK20TT	K20TT
创酷	1.4T	Ecotec	-	-	IXEH22TT	-	-
迈锐宝 1代	1.6T	LLU	KJ20CR-L11	IK20L	IK20TT	PK20TT	K20TT
	2.0L	LTD	-	ITV16	ITV16TT	PTV16TT	TV16TT
	2.4L	LAF	-	ITV16	ITV16TT	PTV16TT	TV16TT
迈锐宝 1代改款	1.6T	LLU	KJ20CR-L11	IK20L	IK20TT	PK20TT	K20TT
	2.0L	LTD	-	ITV16	ITV16TT	PTV16TT	TV16TT
	2.4L	LAF	-	ITV16	ITV16TT	PTV16TT	TV16TT
进口雪佛兰							
科帕奇	2.4L	L4 DOHC	K20TNR	IK20	IK20TT	PK20TT	K20TT
	3.2L	HFV6	K20TNR	IK20	IK20TT	PK20TT	K20TT
	3.2L	V6	K20TNR	IK20	IK20TT	PK20TT	K20TT
科迈罗	3.6L	LLT	-	ITV20	ITV20TT	PTV20TT	-
科帕奇	3.2L	LU1	K20TNR	IK20	IK20TT	PK20TT	K20TT
科迈罗	3.6L限量版		-	ITV20	ITV20TT	PTV20TT	-
上汽通用五菱							
五菱之光	1.3L	LJ474QE2	K20PR-U	IK20	IK20TT	PK20TT	K20TT
	1.1L	LJ465QE5	K20PR-U	IW20	IW20TT	PW20TT	-
乐驰SPARK	0.8L	F8CV	W16EXR-U11	IW16	IW16TT	PW16TT	-
	1.0L	B10S1	W16EXR-U11	IW16	IW16TT	PW16TT	-
	1.0L	LMU	XU22EPR-U	IXU22	-	-	XU22TT
	1.2L	LMU	XU22EPR-U	IXU22	-	-	XU22TT
	1.5L	L2C	XU22EPR-U	IXU22	-	-	XU22TT
五菱宏光	1.2L	LMU	XU22EPR-U	IXU22	-	-	XU22TT
	1.4L	LCU	XU22EPR-U	IXU22	-	-	XU22TT
五菱鸿途	1.1L	LXA	W20EXR-U11	IW20	IW20TT	PW20TT	-
	1.2L	LAQ	XU22EPR-U	IXU22	-	-	XU22TT
五菱荣光	1.2L	LAQ	XU22EPR-U	IXU22	-	-	XU22TT
	1.5L	L2C	XU22EPR-U	IXU22	-	-	XU22TT
上汽荣威/名爵汽车							
荣威950	2.0L		-	ITV16	ITV16TT	PTV16TT	TV16TT
	2.4L		-	ITV16	ITV16TT	PTV16TT	TV16TT
	3.0L		-	ITV16	ITV16TT	PTV16TT	TV16TT

DENSO
 AUSTRALIA CHINA
 INDIA
 INDONESIA KOREA
 MALAYSIA PHILIPPINES SAUDI ARABIA SINGAPORE
 TAIWAN THAILAND VIETNAM JAPAN
 EUROPE MOTOR SMALL CROSS PART
 CYCLE ENGINE REFERENCE NUMBER

DENSO	9	14	16	20	22	24	27	29	31	32	34	35	DENSO	9	14	16	20	22	24	27	29	31	32	DENSO	9	14	16	20	22	24	27	31
NGK	2	4	5	6	7	8	9	9.5	10	10.5	11	11.5	CHAMPION	18	16,14	12,11	10,9	8,7	6,63,61	4,59	57	55	53	BOSCH	10	9	8	7,6	5	4	3	2

**DENSO****CHINA AUSTRALIA****INDIA****INDONESIA****KOREA****PHILIPPINES MALAYSIA****SAUDI ARABIA****SINGAPORE****TAIWAN****THAILAND VIETNAM****JAPAN****EUROPE****USA****MOTOR****CYCLE****SMALL****ENGINE****CROSS****REFERENCE****PART****NUMBER**

车种	车型	发动机型式	DENSO	IRIDIUM	IRIDIUM	PLATINUM	TT
上汽荣威/名爵汽车							
荣威750	1.8T	Kavachi	K22PR-U	IK22	-	PK22TT	-
	2.5 V6		K20R-U	IK20	IK20TT	PK20TT	K20TT
荣威550	1.8L	L4	K20R-U	IK20	IK20TT	PK20TT	K20TT
	1.8T	18K4G	K22PR-U	IK22	-	PK22TT	-
荣威350	1.5L	15S4U	K20R-U	IK20	IK20TT	PK20TT	K20TT
荣威W5	1.8T		K22PR-U	IK22	-	PK22TT	-
名爵3MG3	1.4L	L4	K20R-U	IK20	IK20TT	PK20TT	K20TT
	1.8L	L4	K20R-U	IK20	IK20TT	PK20TT	K20TT
	1.3L	13S4F	K20R-U	IK20	IK20TT	PK20TT	K20TT
	1.5L	15S4U	K20R-U	IK20	IK20TT	PK20TT	K20TT
名爵5MG5	1.5L	15N4S4	K20R-U	IK20	IK20TT	PK20TT	K20TT
	1.5T	15S4G	K22PR-U	IK22	-	PK22TT	-
	1.8L	18K4C	K20R-U	IK20	IK20TT	PK20TT	K20TT
名爵6MG6	1.8T	L4	K22PR-U	IK22	-	PK22TT	-
	1.8L	DVVT	K20R-U	IK20	IK20TT	PK20TT	K20TT
名爵7MG7	1.8T	18N4T1	K22PR-U	IK22	-	PK22TT	-
MG TF	2.5L	V6	K20R-U	IK20	IK20TT	PK20TT	K20TT
	1.8L	L4	K20R-U	IK20	IK20TT	PK20TT	K20TT
长城汽车							
赛弗	2.2L	491QE	W16EXR-U	IW16	IW16TT	PW16TT	-
赛骏	2.2L	491QE	W16EXR-U	IW16	IW16TT	PW16TT	-
赛影	2.2L	GW491QE	W16EXR-U	IW16	IW16TT	PW16TT	-
哈弗M1	1.3L	GW4G13(VVT)	K16PR-U11	IK16	IK16TT	PK16TT	K16TT
哈弗M2	1.5L	GW4G15(VVT)	K16PR-U11	IK16	IK16TT	PK16TT	K16TT
哈弗M4	1.5L	GW4G15(VVT)	K16PR-U11	IK16	IK16TT	PK16TT	K16TT
哈弗H1	1.5L	GW4G15	K16PR-U11	IK16	IK16TT	PK16TT	K16TT
哈弗H2	1.5T	GW4G15B	K22PR-U	IK22	-	PK22TT	-
哈弗H3	2.0L	4G63S4M	K16PR-U11	IK16	IK16TT	PK16TT	K16TT
	2.4L	4G69S4M	K16PR-U11	IK16	IK16TT	PK16TT	K16TT
哈弗H5	2.0L	4G63S4M	K16PR-U11	IK16	IK16TT	PK16TT	K16TT
	2.4L	4G69S4N	K16PR-U11	IK16	IK16TT	PK16TT	K16TT
哈弗H6	1.5T		K22PR-U	IK22	-	PK22TT	-
	2.0L	4G63S4M	K16R-U11	IK16	IK16TT	PK16TT	K16TT
	2.4L	4G69S4M	K20HR-U11	IKH20	IKH20TT	PKH20TT	KH20TT
精灵	1.3L	GW4G13(VVT)	K16PR-U11	IK16	IK16TT	PK16TT	K16TT
	1.3L	GW413EF	K16PR-U11	IK16	IK16TT	PK16TT	K16TT
炫丽	1.3L	GW4G13(VVT)	K16PR-U11	IK16	IK16TT	PK16TT	K16TT
酷熊	1.5L	GW4G15(VVT)	K16PR-U11	IK16	IK16TT	PK16TT	K16TT
	2.4L	4G69	K20HR-U11	IKH20	IKH20TT	PKH20TT	KH20TT
腾翼	2.0L	4G63	K20HR-U11	IKH20	IKH20TT	PKH20TT	KH20TT
	1.5T	GW4G15T	K22PR-U	IK22	-	PK22TT	-
	1.5L	GW4G15(VVT)	K16PR-U11	IK16	IK16TT	PK16TT	K16TT
凌傲	1.3L	GW4G13(VVT)	K16PR-U11	IK16	IK16TT	PK16TT	K16TT
	1.5L	GW4G15(VVT)	K16PR-U11	IK16	IK16TT	PK16TT	K16TT
嘉誉	2.0L	4G69	K20HR-U11	IKH20	IKH20TT	PKH20TT	KH20TT
	2.4L	4G64	K16PR-U11	IK16	IK16TT	PK16TT	K16TT
哈飞							
中意	1.1L	DA465Q	W16EXR-U	IW16	IW16TT	PW16TT	-
民意	1.0L	DA465Q	W16EXR-U	IW16	IW16TT	PW16TT	-
赛马	1.3L	DA471Q	K16PR-U11	IK16	IK16TT	PK16TT	K16TT
	1.5L	4G15S	K16PR-U11	IK16	IK16TT	PK16TT	K16TT
	1.6L	DA476Q	K16PR-U11	IK16	IK16TT	PK16TT	K16TT
	1.6L	DA4G18	K16PR-U11	IK16	IK16TT	PK16TT	K16TT
赛豹	2.0L	4G94	K16PR-U11	IK16	IK16TT	PK16TT	K16TT
	1.6L	DA476Q	K16PR-U11	IK16	IK16TT	PK16TT	K16TT
	1.8L	4G93	K16PR-U11	IK16	IK16TT	PK16TT	K16TT
路宝	1.0L	DAK10A	K16PR-U11	IK16	IK16TT	PK16TT	K16TT
	1.1L	DA468Q	XU22EPR-U	IXU22	-	-	XU22TT
	1.3L	DA471QL	K16PR-U11	IK16	IK16TT	PK16TT	K16TT
	1.0L	DA465Q-2	W20EXR-U	IW20	IW20TT	PW20TT	-
海南马自达/海马汽车							
福美来	1.6L	ZM-II	KJ20CR-L11	IK20L	IK20TT	PK20TT	K20TT
	1.6L	TRITEC	K20PR-U11	IK20	IK20TT	PK20TT	K20TT
	1.8L	HM483Q	K16PR-U11	IK16	IK16TT	PK16TT	K16TT
	1.6L	HA-VVT-1.6	K16PR-U11	IK16	IK16TT	PK16TT	K16TT
福美来M5	1.6L	HM474Q-C	K20PR-U11	IK20	IK20TT	PK20TT	K20TT



车种	车型	发动机型式	DENSO	IRIDIUM	IRIDIUM	PLATINUM	TT
海南马自达/海马汽车							
海福星	1.6L	4G18	K16PR-U11	IK16	IK16TT	PK16TT	K16TT
	1.8L	483Q	K16PR-U11	IK16	IK16TT	PK16TT	K16TT
	1.5L	4A91S	K20HR-U11	IKH20	IKH20TT	PKH20TT	KH20TT
海马2	1.3L	4A90S	K20HR-U11	IKH20	IKH20TT	PKH20TT	KH20TT
	1.3L	HM474Q-BAJ	K20PR-U11	IK20	IK20TT	PK20TT	K20TT
	1.5L	4A91S	K20HR-U11	IKH20	IKH20TT	PKH20TT	KH20TT
	1.5L	HM474Q	K20PR-U11	IK20	IK20TT	PK20TT	K20TT
海马3	1.6L	HM483Q	K16PR-U11	IK16	IK16TT	PK16TT	K16TT
	1.6L	479Q-A	KJ20CR-L11	IK20L	IK20TT	PK20TT	K20TT
	1.6L	TRITEC	K20PR-U11	IK20	IK20TT	PK20TT	K20TT
海马7	2.0L	HM484Q	KJ20CR-L11	IK20L	IK20TT	PK20TT	K20TT
普力马	1.8L	HM483Q	K16PR-U11	IK16	IK16TT	PK16TT	K16TT
	1.6L	HA-VVT-1.6	K16PR-U11	IK16	IK16TT	PK16TT	K16TT
丘比特	1.3L	4A90S	K16PR-U11	IK16	IK16TT	PK16TT	K16TT
	1.3L	HA-1.3	K16PR-U11	IK16	IK16TT	PK16TT	K16TT
	1.5L	4A91S	K20HR-U11	IKH20	IKH20TT	PKH20TT	KH20TT
欢动	1.6L	HA-VVT-1.6	K16PR-U11	IK16	IK16TT	PK16TT	K16TT
	1.8L	HM483Q	K16PR-U11	IK16	IK16TT	PK16TT	K16TT
骑士	1.5L	4A91S	K20HR-U11	IKH20	IKH20TT	PKH20TT	KH20TT
	2.0L	484Q	K16PR-U11	IK16	IK16TT	PK16TT	K16TT
海马3	1.8L	HM483Q	K16PR-U11	IK16	IK16TT	PK16TT	K16TT
广州本田							
飞度	1.3L三厢	L13A3	K20PR-U11	IK20	IK20TT	PK20TT	K20TT
	1.5L三厢	L15A1	KJ20CR-L11	IK20L	IK20TT	PK20TT	K20TT
	1.3L二厢	L13A3	K20PR-U11	IK20	IK20TT	PK20TT	K20TT
	1.5L二厢	L15A1	KJ20CR-L11	IK20L	IK20TT	PK20TT	K20TT
	1.3L	L13Z1	SKJ20DR-M13	IK20L	IK20TT	PK20TT	K20TT
	1.5L	L15A7	SKJ20DR-M13	IK20L	IK20TT	PK20TT	K20TT
	1.5L	L15B2	-	-	IXEH22TT	-	-
思迪	1.3L	L13A3	K20PR-U11	IK20	IK20TT	PK20TT	K20TT
	1.5L	L15A1	SKJ20DR-M13	IK20L	IK20TT	PK20TT	K20TT
锋范	1.5L	L15A7	SKJ20DR-M13	IK20L	IK20TT	PK20TT	K20TT
	1.8L	R18A1	SKJ20DR-M11S	IK20G	IK20TT	PK20TT	K20TT
	1.5L	L15B2	-	-	IXEH22TT	-	-
理念	1.3L	L13A3	K20PR-U11	IK20	IK20TT	PK20TT	K20TT
	1.5L	L15A1	SKJ20DR-M13	IK20L	IK20TT	PK20TT	K20TT
凌派	1.8L	R18Z5	-	IXUH22	-	-	XUH22TT
缤智	1.5L	L15B2	-	-	IXEH22TT	-	-
	1.8L	R18Z7	-	IXUH22	-	-	XUH22TT
六代雅阁	2.0L	K20A7	KJ16CR-L11	IK16L	IK16TT	PK16TT	K16TT
	2.3L CG5	F23A1	KJ16CR-L11	IK16L	IK16TT	PK16TT	K16TT
	30.L CG1	J30A4	KJ16CR-L11	IK16L	IK16TT	PK16TT	K16TT
七代雅阁	2.0L	K20A7	KJ20DR-M11	IK20L	IK20TT	PK20TT	K20TT
	2.4L	K24Z2/K24A8	KJ20DR-M11	IK20L	IK20TT	PK20TT	K20TT
	3.0L	J30A4	KJ20DR-M11	IK20L	IK20TT	PK20TT	K20TT
八代雅阁	2.0L	R20A3	KJ20CR-L11	IK20L	IK20TT	PK20TT	K20TT
	2.4L	K24Z2	SXU22HCR11	IXUH22	-	-	XUH22TT
	3.5L	J35Z2	SC20HR11	-	IXEH20ETT	-	-
九代雅阁	2.0L	R20Z4	-	IXUH22	-	-	XUH22TT
	2.4L	K24W5	-	-	IXEH22TT	-	-
	3.0L	J30A5	-	IXUH22	-	-	XUH22TT
奥德赛2代	2.3L	F23Z4	KJ16CR-L11	IK16L	IK16TT	PK16TT	K16TT
	3.0L	F23Z4	KJ16CR-L11	IK16L	IK16TT	PK16TT	K16TT
奥德赛3代	2.4L	K24A6	SKJ20DR-M11S	IK20L	IK20TT	PK20TT	K20TT
奥德赛4代	2.4L	K24A2	SXU22HCR11	IXUH22	-	-	XUH22TT
奥德赛5代	2.4L	K24W5	-	-	IXEH22TT	-	-
歌诗图	2.4L	K24Y3	-	IXUH22	-	-	XUH22TT
	3.0L	J30A7	-	IXUH22	-	-	XUH22TT
	3.5L	J35Z2	SXU22HCR11	IXUH22	-	-	XUH22TT
东风本田							
八代思域	1.3L Hybrid	LDA2	SK20HR11	VKH20	IKH20TT	PKH20TT	KH20TT
	1.8L	R18A1	SKJ20DR-M11S	IK20G	IK20TT	-	K20TT
九代思域	1.8L	R18Z2	-	IXUH22	-	-	XUH22TT
	2.0L	R20A6	-	IXUH22	-	-	XUH22TT
	2.0L Hybrid	R20A6	-	IXUH22	-	-	XUH22TT
九代中改款思域(9.5代)	1.8L	R18Z2	-	IXUH22	-	-	XUH22TT
	2.4L	K24Z7	-	IXUH22	-	-	XUH22TT

DENSO
 AUSTRALIA CHINA
 INDIA
 INDONESIA KOREA
 MALAYSIA PHILIPPINES SAUDI ARABIA SINGAPORE
 TAIWAN THAILAND VIETNAM JAPAN
 EUROPE MOTOR & USA
 SMALL ENGINE
 CROSS REFERENCE PART NUMBER

DENSO	9	14	16	20	22	24	27	29	31	32	34	35	DENSO	9	14	16	20	22	24	27	29	31	32	DENSO	9	14	16	20	22	24	27	31
NGK	2	4	5	6	7	8	9	9.5	10	10.5	11	11.5	CHAMPION	18	16,14	12,11	10,9	8,7	6,63,61	4,59	57	55	53	BOSCH	10	9	8	7,6	5	4	3	2



DENSO	车种	车型	发动机型式	DENSO	IRIDIUM	IRIDIUM		PLATINUM		TT
						IXUH22	IXEH22TT	PKH20TT	PK20TT	
	东风本田									
	思铭	1.8L	R18A1	K20PR-U11	IK20G	IK20TT	-	-	-	K20TT
	杰德	1.8L	R18Z6	-	IXUH22	-	-	-	-	XUH22TT
	哥瑞 Greiz	1.5L	L15B5 地球梦引擎	-	-	IXEH22TT	-	-	-	-
	CR-V 1代	2.0L	RD5	KJ20DR-M11	IK20L	IK20TT	PK20TT	PK20TT	PK20TT	K20TT
		2.4L	RD5	KJ20DR-M11	IK20L	IK20TT	PK20TT	PK20TT	PK20TT	K20TT
	CR-V 2代	2.0L	K20A1	SKJ20DR-M11S	IK20L	IK20TT	PK20TT	PK20TT	PK20TT	K20TT
		2.4L	K24Z1	SKJ20DR-M11S	IK20L	IK20TT	PK20TT	PK20TT	PK20TT	K20TT
		2.0L	i-VTEC	K20PR-U11	IK20G	IK20TT	-	-	-	K20TT
		2.4L	i-VTEC	K20PR-U11	IK20G	IK20TT	-	-	-	K20TT
	CR-V 3代	2.0L	R20A7	-	IXUH22	-	-	-	-	XUH22TT
		2.4L	K24Z8	-	IXUH22	-	-	-	-	XUH22TT
		2.4L	K24V6 地球梦引擎	-	IXUH22	-	-	-	-	XUH22TT
	XR-V	1.5L	L15B5	-	-	IXEH22TT	-	-	-	-
		1.8L	R18ZA	-	IXUH22	-	-	-	-	XUH22TT
	思铂睿	2.0L	R20A4	K20PR-U11	IK20G	IK20TT	-	-	-	K20TT
		2.0L	R20Z8	-	IXUH22	-	-	-	-	XUH22TT
		2.4L	K24Z5	SXU22HCR11	IXUH22	-	-	-	-	XUH22TT
		2.4L	K24V4	-	IXUH22	-	-	-	-	XUH22TT
		2.4L	K24Z5	-	IXUH22	-	-	-	-	XUH22TT
	艾力绅	2.4L	K24Z5	-	IXUH22	-	-	-	-	XUH22TT
	北京汽车									
	E系列	1.3L	4A90M	K20HR-U11	IKH20	IKH20TT	PKH20TT	PKH20TT	PKH20TT	KH20TT
		1.5L	4A91S	K20HR-U11	IKH20	IKH20TT	PKH20TT	PKH20TT	PKH20TT	KH20TT
	北京现代									
	索纳塔EF	2.0L	G4GC	K16PR-U11	IK16	IK16TT	PK16TT	PK16TT	PK16TT	K16TT
		2.5L	G6BV	K16PR-U11	IK16	IK16TT	PK16TT	PK16TT	PK16TT	K16TT
		2.7L	G6BA	K16PR-U11	IK16	IK16TT	PK16TT	PK16TT	PK16TT	K16TT
	索纳塔八	2.0L	G4KD	K16HPR-U11	IKH16	IKH16TT	PKH16TT	PKH16TT	PKH16TT	KH16TT
		2.4L	G4KE	K16HPR-U11	IKH16	IKH16TT	PKH16TT	PKH16TT	PKH16TT	KH16TT
		2.0L	G4NA	-	IXUH22	-	-	-	-	XUH22TT
	索纳塔九	1.6T 双离合	γ G4FJ	-	IXUH22	-	-	-	-	XUH22TT
		2.0L	G4KD	-	IXUH22	-	-	-	-	XUH22TT
		2.4L	G4KJ	-	IXUH22	-	-	-	-	XUH22TT
	伊兰特	1.6L	G4ED	K20PR-U11	IK20	IK20TT	PK20TT	PK20TT	PK20TT	K20TT
		1.8L	G4GB	K16PR-U11	IK16	IK16TT	PK16TT	PK16TT	PK16TT	K16TT
		1.6L	G4FG	-	IXUH22	-	-	-	-	XUH22TT
		1.8L	G4NB	-	IXUH22	-	-	-	-	XUH22TT
	悦动	1.6L	a-CVVT/G4ED	K16PR-U11	IK16	IK16TT	PK16TT	PK16TT	PK16TT	K16TT
		1.8L	β-DOHC/G4GB	K16PR-U11	IK16	IK16TT	PK16TT	PK16TT	PK16TT	K16TT
		1.6L	γ-CVVT/G4FC	-	IXUH22	-	-	-	-	XUH22TT
	御翔	2.0L	G4KA	K16PR-U11	IK16	IK16TT	PK16TT	PK16TT	PK16TT	K16TT
		2.4L	G4KC/G4KE	K16PR-U11	IK16	IK16TT	PK16TT	PK16TT	PK16TT	K16TT
	领翔	2.0L	G4KD	K16HPR-U11	IKH16	IKH16TT	PKH16TT	PKH16TT	PKH16TT	KH16TT
		2.4L	G4KE	K16HPR-U11	IKH16	IKH16TT	PKH16TT	PKH16TT	PKH16TT	KH16TT
	名驭	1.8L	G4GB	K16PR-U11	IK16	IK16TT	PK16TT	PK16TT	PK16TT	K16TT
		2.0L	G4GC	K16PR-U11	IK16	IK16TT	PK16TT	PK16TT	PK16TT	K16TT
	名图MISTRA	1.8L	G4NB	-	IXUH22	-	-	-	-	XUH22TT
		2.0L	G4NA	-	IXUH22	-	-	-	-	XUH22TT
	雅绅特	1.4L	G4EE	K16PR-U11	IK16	IK16TT	PK16TT	PK16TT	PK16TT	K16TT
		1.6L	G4ED(CVVT)	K16PR-U11	IK16	IK16TT	PK16TT	PK16TT	PK16TT	K16TT
	瑞纳	1.4L	G4FA	-	IXUH22	-	-	-	-	XUH22TT
		1.6L	G4FC	-	IXUH22	-	-	-	-	XUH22TT
	瑞奕	1.4L	-	-	IXUH22	-	-	-	-	XUH22TT
		1.6L	-	-	IXUH22	-	-	-	-	XUH22TT
	朗动	1.6L	G4FG	-	IXUH22	-	-	-	-	XUH22TT
		1.8L	G4NB	-	IXUH22	-	-	-	-	XUH22TT
	i30	1.6L	G4FC, γ-CVVT	-	IXUH22	-	-	-	-	XUH22TT
		2.0L	G4GC, β-CVVT	-	IXUH22	-	-	-	-	XUH22TT
	ix25	1.6L	G4FG	-	IXUH22	-	-	-	-	XUH22TT
		2.0L	G4NA	-	IXUH22	-	-	-	-	XUH22TT
	ix35 1代	2.0L	G4KD	K16HPR-U11	IKH16	IKH16TT	PKH16TT	PKH16TT	PKH16TT	KH16TT
		2.4L	G4KC	K16HPR-U11	IKH16	IKH16TT	PKH16TT	PKH16TT	PKH16TT	KH16TT
	ix35 2代	2.0L	G4NA	-	IXUH22	-	-	-	-	XUH22TT
		2.4L	G4KE	-	IXUH22	-	-	-	-	XUH22TT
	途胜1代	2.0L	G4GC	K16PR-U11	IK16	IK16TT	PK16TT	PK16TT	PK16TT	K16TT
		2.7L	G6BA	K16PR-U11	IK16	IK16TT	PK16TT	PK16TT	PK16TT	K16TT
	途胜3代	1.6T DCT	1.6 Gamma T-Gdi	-	IXUH22	-	-	-	-	XUH22TT
		2.0L	2.0 Nu Gdi	-	IXUH22	-	-	-	-	XUH22TT

车种	车型	发动机型式	DENSO	IRIDIUM			
北京现代 国产新胜达Santa	2.0T	G4KH	-	IXUH22	-	-	XUH22TT
	2.4L	G4KJ	-	IXUH22	-	-	XUH22TT
华泰汽车 圣达菲	2.7L	G6BA	K16PR-U11	IK16	IK16TT	PK16TT	K16TT
	1.8T	18K4G	K22PR-U	IK22	-	PK22TT	-
	2.0L	4G63S4M	K20PR-U11	IK20	IK20TT	PK20TT	K20TT
特拉卡	2.4L	4G64	K16PR-U11	IK16	IK16TT	PK16TT	K16TT
进口现代 酷派	2.0L	G4GC	K16PR-U11	IK16	IK16TT	PK16TT	K16TT
	2.0L	DOHC	K16PR-U11	IK16	IK16TT	PK16TT	K16TT
	2.7 V6	G6BA	K16PR-U11	IK16	IK16TT	PK16TT	K16TT
劳恩斯酷派	2.0T	G4KF	-	IKH24	-	-	-
	3.8L	D-CVVT	-	IKH22	-	-	-
胜达	2.7L	G6EA	K16HPR-U11	IKH16	IKH16TT	PKH16TT	KH16TT
	2.7L	V6	K16HPR-U11	IKH16	IKH16TT	PKH16TT	KH16TT
	2.0L		K16HPR-U11	IKH16	IKH16TT	PKH16TT	KH16TT
	2.4L	θ II	K16HPR-U11	IKH16	IKH16TT	PKH16TT	KH16TT
	2.0T	G4KH	-	IXUH22	-	-	XUH22TT
	2.4L	G4KE	-	IXUH22	-	-	XUH22TT
飞思Veloster	1.6L		-	-	-	-	
美佳MATRIX	1.6L L4	G4ED	K16PR-U11	IK16	IK16TT	PK16TT	K16TT
	1.8L L4	G6GB	K16PR-U11	IK16	IK16TT	PK16TT	K16TT
维拉克斯	3.8L V6	G6DA	K16PR-U11	IK16	IK16TT	PK16TT	K16TT
雅科仕Equus	3.8GDi V6	G6CU	K16PR-U11	IK16	IK16TT	PK16TT	K16TT
雅科仕	3.5L	G6CU	K16PR-U11	IK16	IK16TT	PK16TT	K16TT
	4.5L		K16PR-U11	IK16	IK16TT	PK16TT	K16TT
	3.8L	V6 λ	K16PR-U11	IK16	IK16TT	PK16TT	K16TT
	4.6L	V8 τ	K16PR-U11	IK16	IK16TT	PK16TT	K16TT
雅尊	2.4L		K16PR-U11	IK16	IK16TT	PK16TT	K16TT
	2.7L	G6EA	K16PR-U11	IK16	IK16TT	PK16TT	K16TT
	3.3L	G6D8	K16PR-U11	IK16	IK16TT	PK16TT	K16TT
东风悦达起亚 千里马	1.3L	LS SOHC	K16PR-U11	IK16	IK16TT	PK16TT	K16TT
	1.6L	LS SOHC	K16PR-U11	IK16	IK16TT	PK16TT	K16TT
锐欧	1.4L	DOHC	K16PR-U11	IK16	IK16TT	PK16TT	K16TT
	1.6L	CVVT	K20PR-U11	IK20	IK20TT	PK20TT	K20TT
赛拉图	1.6L	CVVT L4	K20PR-U11	IK20	IK20TT	PK20TT	K20TT
	1.8L	CVVT L4	K16PR-U11	IK16	IK16TT	PK16TT	K16TT
	1.6L	DOHC L4	K20PR-U11	IK20	IK20TT	PK20TT	K20TT
远舰	1.8L	G4GB	K16PR-U11	IK16	IK16TT	PK16TT	K16TT
	2.0L	DOHC L4	K16PR-U11	IK16	IK16TT	PK16TT	K16TT
嘉华	3.5L	G6CU	K16PR-U11	IK16	IK16TT	PK16TT	K16TT
	2.7L	DOHC	K16PR-U11	IK16	IK16TT	PK16TT	K16TT
福瑞迪	1.6L	1.6 γ	-	IXUH22	-	-	-
	2.0L	CVVT	-	IXUH22	-	-	XUH22TT
	1.6L	G4FC	-	IXUH22	-	-	XUH22TT
秀尔	1.6L	G4FC	-	IXUH22	-	-	XUH22TT
	2.0L	G4GC	K16PR-U11	IK16	IK16TT	PK16TT	K16TT
K2	1.4L	G4FA	-	IXUH22	-	-	XUH22TT
	1.6L	G4FC	-	IXUH22	-	-	XUH22TT
K3	1.6L	G4FG	-	IXUH22	-	-	XUH22TT
	1.8L	G4NB	-	IXUH22	-	-	XUH22TT
K3S	1.6L	G4FG	-	IXUH22	-	-	XUH22TT
K4	1.6T		-	IXUH22	-	-	XUH22TT
	1.8L		-	IXUH22	-	-	XUH22TT
	2.0L		-	IXUH22	-	-	XUH22TT
K5 1代	2.0L	G4KD 121kw	K16HPR-U11	IKH16	IKH16TT	PKH16TT	KH16TT
	2.4L	G4KE	K16HPR-U11	IKH16	IKH16TT	PKH16TT	KH16TT
K5 1.5代小改款	2.0L	G4NA 119kw	-	IXUH22	-	-	XUH22TT
	2.0T		-	IXUH22	-	-	XUH22TT
	2.4L	G4KE	-	IXUH22	-	-	XUH22TT
K5 2代	1.6T		-	IXUH22	-	-	XUH22TT
	2.0L		-	IXUH22	-	-	XUH22TT
	2.0T		-	IXUH22	-	-	XUH22TT
狮跑	2.0L	G4GC	K16PR-U11	IK16	IK16TT	PK16TT	K16TT
	2.7L	G6BA	K16PR-U11	IK16	IK16TT	PK16TT	K16TT
智跑	2.0L	G4KD	K16HPR-U11	IKH16	IKH16TT	PKH16TT	KH16TT

DENSO
 AUSTRALIA CHINA
 INDIA
 INDONESIA KOREA MALAYSIA PHILIPPINES SAUDI ARABIA SINGAPORE TAIWAN THAILAND VIETNAM JAPAN & USA
 EUROPE MOTOR SMALL CROSS PART
 CYCLE ENGINE REFERENCE NUMBER

DENSO	9	14	16	20	22	24	27	29	31	32	34	35	DENSO	9	14	16	20	22	24	27	29	31	32	DENSO	9	14	16	20	22	24	27	31
NGK	2	4	5	6	7	8	9	9.5	10	10.5	11	11.5	CHAMPION	18	16,14	12,11	10,9	8,7	6,63,61	4,59	57	55	53	BOSCH	10	9	8	7,6	5	4	3	2

车种	车型	发动机型式	DENSO	IRIDIUM			
北汽克莱斯勒吉普							
切诺基	2.5L L4	C498QA1	KJ16CR-L11	IK16L	IK16TT	PK16TT	K16TT
	4.0L V6	C698QA1	KJ16CR-L11	IK16L	IK16TT	PK16TT	K16TT
	4.7L V8	C8V93Q	KJ16CR-L11	IK16L	IK16TT	PK16TT	K16TT
进口克莱斯勒							
进口克莱斯勒	2.4L 16V	EDZ	-	ITL20	-	-	-
	2.4 GT Turbo	EDV/EDT	-	ITL20	-	-	-
道奇	2.7L V6	EER	-	ITL20	-	PTV16TT	-
	2.4L		KJ16CR-L11	IK16L	IK16TT	PK16TT	K16TT
	3.6L		-	IKH22	-	-	-
	2.0L 16V CVT	ECN	-	IK20L	IK20TT	-	K20TT
JEEP 吉普							
指挥官HEMI	4.7L V8	EV	KJ16CR-L11	IK16L	IK16TT	PK16TT	K16TT
	5.7L V8	EZ	-	ITL20	-	-	-
老款指南者Compass	2.0L	A	KJ20CR-L11	IK20L	IK20TT	-	K20TT
	2.4L	B	KJ20CR-L11	IK20L	IK20TT	-	K20TT
新款指南者 Compass	2.0L	A	KJ20CR-L11	IK20L	IK20TT	-	K20TT
	2.4L	B	KJ20CR-L11	IK20L	IK20TT	-	K20TT
自由客Patriot	2.0L	16V	KJ20CR-L11	IK20L	IK20TT	-	K20TT
	2.4L	16V	KJ20CR-L11	IK20L	IK20TT	-	K20TT
牧马人3代	3.6L	V6	-	IXUH22	-	-	XUH22TT
	3.8L(1999-2005)	V6	-	ITL20	-	-	-
大切诺基 2代	4.0L(1999-2005)	WJ WG	KJ16CR-L11	IK16L	IK16TT	PK16TT	K16TT
	4.7L V8(1999-2005)	WJ WG	-	IK20	IK20TT	PK20TT	K20TT
	4.7L V8 H.O.(1999-2005)	WJ WG	-	IK20	IK20TT	PK20TT	K20TT
大切诺基3代	4.7L V8 H.O.(2005-2010)	EVA-231	-	ITL20	-	-	-
	5.7L V8 HEMI(2005-2010)	EZD,EZH	-	ITL20	-	-	-
	6.1L V8 HEMI-SRT8(2005-2010)	ESF	-	ITL20	-	-	-
大切诺基4代	5.7L V8(2010-)	HEMI	K20HR-U11	IKH20	IKH20TT	PKH20TT	KH20TT
	6.4L V8(2010-)	SRT	-	ITL20	-	-	-
东南汽车							
富利卡	2.0L\2.4L	4G63S4M	K16PR-U11	IK16	IK16TT	PK16TT	K16TT
	2.0L	东风EQ491	MA20PR-U	-	-	-	-
得利卡	2.0L\2.4L	4G63S4M	K16R-U11	IK16	IK16TT	PK16TT	K16TT
	2.0L	东风EQ491	MA20PR-U	-	-	-	-
菱利	1.3L	L4	K16PR-U11	IK16	IK16TT	PK16TT	K16TT
	1.6L	L4	K16PR-U11	IK16	IK16TT	PK16TT	K16TT
菱帅	1.6L	DA4G18	K16PR-U11	IK16	IK16TT	PK16TT	K16TT
	1.6L	4G64	K16PR-U11	IK16	IK16TT	PK16TT	K16TT
菱悦	1.5L	4G15M	K20R-U	IK20	IK20TT	PK20TT	K20TT
	1.5L	4A91	K16HPR-U11	IKH16	IKH16TT	PKH16TT	KH16TT
菱绅	2.4L	4G64S4M	K16PR-U11	IK16	IK16TT	PK16TT	K16TT
	2.4L	4G69	K16PR-U11	IK16	IK16TT	PK16TT	K16TT
东南三菱							
蓝瑟/LANCER	1.6L	DA4G18	K16PR-U11	IK16	IK16TT	PK16TT	K16TT
翼神	1.6L	4A92	K20HR-U11	IKH20	IKH20TT	PKH20TT	KH20TT
	1.8L	4B10	K20R-U	IK20	IK20TT	PK20TT	K20TT
	2.0L	4B11	K20R-U	IK20	IK20TT	PK20TT	K20TT
	2.0T		-	IKH24	-	-	-
戈蓝	2.0L	4G63S4N	K20PR-U11	IK20	IK20TT	PK20TT	K20TT
	2.4L	4G69S4N	K20HR-U11	IKH20	IKH20TT	PKH20TT	KH20TT
君阁	2.0L	4G63S4N	K20HR-U11	IKH20	IKH20TT	PKH20TT	KH20TT
东南劲炫	2.0L	4B11	K20R-U	IK20	IK20TT	PK20TT	K20TT
广汽三菱							
劲炫ASX	1.6L	4A92	K20HR-U11	IKH20	IKH20TT	PKH20TT	KH20TT
	2.0L	4B11	K20R-U	IK20	IK20TT	PK20TT	K20TT
帕杰罗V73/V77	3.0L	6G72 133kw	K20PR-U11	IK20	IK20TT	PK20TT	K20TT
	3.8L	6G75	K20R-U	IK20	IK20TT	PK20TT	K20TT
帕杰罗劲畅	2.4L	4G64S4M	K16PR-U11	IK16	IK16TT	PK16TT	K16TT
	3.0L	6B31	-	IXUH22	-	-	XUH22TT
长丰三菱猎豹							
猎豹	3.0L V6	6G72	W16ERP11	IW16	IW16TT	PW16TT	-
	2.4L	4G64S4M	K16PR-U11	IK16	IK16TT	PK16TT	K16TT
	2.0L	4G94	K20PR-U11	IK20	IK20TT	PK20TT	K20TT
飞腾	1.5L	4G15	-	IXUH22	-	-	XUH22TT
	2.0L	4G94	K20PR-U11	IK20	IK20TT	PK20TT	K20TT
北汽三菱							
速跑	2.4L	4G64S4M	K16PR-U11	IK16	IK16TT	PK16TT	K16TT

DENSO

AUSTRALIA CHINA

INDIA

INDONESIA

KOREA

MALAYSIA

PHILIPPINES

SAUDIARABIA

SINGAPORE

TAIWAN

THAILAND

VIETNAM

JAPAN

EUROPE

MOTOR

SMALL

CROSS

REFERENCE

PART NUMBER

DENSO	9	14	16	20	22	24	27	29	31	32	34	35	DENSO	9	14	16	20	22	24	27	29	31	32	DENSO	9	14	16	20	22	24	27	31
NGK	2	4	5	6	7	8	9	9.5	10	10.5	11	11.5	CHAMPION	18	16,14	12,11	10,9	8,7	6,63,61	4,59	57	55	53	BOSCH	10	9	8	7,6	5	4	3	2



DENSO

CHINA AUSTRALIA

INDIA

INDONESIA

KOREA

PHILIPPINES MALAYSIA

SAUDI ARABIA

SINGAPORE

TAIWAN

THAILAND

VIETNAM

JAPAN

EUROPE & USA



MOTOR CYCLE

SMALL ENGINE

CROSS REFERENCE

PART NUMBER

车种	车型	发动机型式	DENSO	IRIDIUM	IRIDIUM TT	PLATINUM	TT
北汽三菱							
速跑	3.0L	6G72	K16PR-U11	IK16	IK16TT	PK16TT	K16TT
欧蓝德	2.4L	4G64	K16R-U11	IK16	IK16TT	PK16TT	K16TT
	2.4L	4G69	K20HR-U11	IKH20	IKH20TT	PKH20TT	KH20TT
	3.0L	6B31(MIVEC)	-	IXUH22	-	-	XUH22TT
三菱/MISTUBISHI							
帕杰罗Pajero	3.0L	6G72	K16PR-U11	IK16	IK16TT	PK16TT	K16TT
	2.4L	4G64	K16PR-U11	IK16	IK16TT	PK16TT	K16TT
	3.0L	6G74	K16PR-U11	IK16	IK16TT	PK16TT	K16TT
	3.0L	6G73	K16PR-U11	IK16	IK16TT	PK16TT	K16TT
	3.8L	6G75	-	IK20	IK20TT	PK20TT	K20TT
欧蓝德EXOutlander	2.0L	4B11	K20R-U	IK20	IK20TT	PK20TT	K20TT
	3.0L	1113L	-	IXUH22	-	-	XUH22TT
	3.0L	6B31	-	IXUH22	-	-	XUH22TT
格蓝迪Grandis	2.4L	4G64	K16R-U	IK16	IK16TT	PK16TT	K16TT
	2.4L	4G69	K20HR-U11	IKH20	IKH20TT	PKH20TT	KH20TT
东风日产							
蓝鸟	U13	SR20DE	W16EXR-U	IW16	IW16TT	PW16TT	-
	2.0L	SR20DE	W16EXR-U	IW16	IW16TT	PW16TT	-
	2.0L	Z18S/Z18E	W16EXR-U	IW16	IW16TT	PW16TT	-
阳光	2.0L	SR20DE	K16PR-U	IK16	IK16TT	PK16TT	K16TT
	1.5L	HR15DE	FXE20HR11	-	IXEH20ETT	-	-
骐达/颐达	1.6L	HR16DE	FXE20HR11	-	IXEH20ETT	-	-
	1.6T	MR16DDT	-	-	IXEH22TT	-	-
骊威	1.6L	HR16DE	XE20HR-U9	-	IXEH20ETT	-	-
	1.8L	MR18DE	XE20HR-U9	-	IXEH20ETT	-	-
轩逸	2.0L	MR20	FXE20HR11	-	IXEH20ETT	-	-
	1.6L	HR16	FXE20HR11	-	IXEH20ETT	-	-
骏逸	1.8L	MR18	XE20HR-U9	-	IXEH20ETT	-	-
	1.8L	MR18	XE20HR-U9	-	IXEH20ETT	-	-
一代天籁 J31	2.3L	VQ23DE	K16HPR-U11	IKH16	IKH16TT	PKH16TT	KH16TT
	3.5L	VQ35DE	K16HPR-U11	IKH16	IKH16TT	PKH16TT	KH16TT
	2.0L	QR20	K16HPR-U11	IKH16	IKH16TT	PKH16TT	KH16TT
二代天籁 J32	2.0L	MR20DE	-	-	IXEH22TT	-	-
	2.5L	VQ25DE	-	-	IXEH22TT	-	-
	3.5L	VQ35DE	-	-	IXEH22TT	-	-
新世代天籁L33	2.0L	MR20DE	FXE20HR11	VFXEH20	IXEH22TT	-	-
	2.5L	QR25DE	FXE20HR11	VFXEH20	IXEH22TT	-	-
老逍客	1.6L	HR16DE	FXE20HR11	VFXEH20	IXEH20ETT	-	-
	2.0L	MR20DE	FXE20HR11	VFXEH20	IXEH20ETT	-	-
新逍客	2.0L	MR20	XE20HR-U9	-	IXEH20ETT	-	-
老奇骏	2.0L	MR20DE	FXE22HR11	VFXEH22	IXEH20ETT	-	-
	2.5L	QR25DE	FXE22HR11	VFXEH22	IXEH20ETT	-	-
	2.0L	MR20	XE20HR-U9	-	IXEH20ETT	-	-
	2.5L	QR25	XE20HR-U9	-	IXEH20ETT	-	-
新奇骏	2.0L	MR20dd	XE20HR-U9	-	IXEH20ETT	-	-
	2.5L	QR25	XE20HR-U9	-	IXEH20ETT	-	-
玛驰	1.5L	HR15DE	FXE20HR11	VFXEH20	IXEH20ETT	-	
郑州日产							
帕拉丁	2.4L	KA24	K16PR-U	IK16	IK16TT	PK16TT	K16TT
	3.3L	VG33	K16PR-U11	IK16	IK16TT	PK16TT	K16TT
皮卡	2.4L	KA24	W16EXR-U	IW16	IW16TT	PW16TT	-
御轩	2.5L/2.0L	QR25N/10LH3X	K16HPR-U11	IKH16	IKH16TT	PKH16TT	KH16TT
NV200	1.6L	HR16	XE20HR-U9	-	IXEH20ETT	-	-
进口日产							
西玛	4.5L	VK45DE	K16HPR-U11	IKH16	IKH16TT	PKH16TT	KH16TT
风雅	3.5L	VQ35DE	K16HPR-U11	IKH16	IKH16TT	PKH16TT	KH16TT
途乐		TB42E	W16EPR-U	IW16	IW16TT	PW16TT	-
水星		VG30E	W16EXR-U	IW16	IW16TT	PW16TT	-
楼兰MURANO	3.5L	VQ35DE	-	-	IXEH22TT	-	-
	2.5L	QR25	XE20HR-U9	-	IXEH20ETT	-	-
	2.5T	QR25	-	-	IXEH22TT	-	-
雷诺/Renault							
风朗	2.0L	M4R714	XE20HR-U9	-	IXEH20ETT	-	-
纬度LATITUDE	2.0L	M4R746	XE20HR-U9	-	IXEH20ETT	-	-
	2.5L		XE20HR-U9	-	IXEH20ETT	-	-
梅甘娜3代MEGANE	2.0L	F4R	K20PR-U	IK20	IK20TT	PK20TT	K20TT
	2.0T	F4R870	K20R-U	IK20	IK20TT	PK20TT	K20TT
拉古娜LAGUNA	2.0L	F4R	K20PR-U	IK20	IK20TT	PK20TT	K20TT



车种	车型	发动机型式	DENSO	IRIDIUM			
雷诺/Renault							
拉古娜LAGUNA	2.0T	F4RJ813	K20R-U	IK20	IK20TT	PK20TT	K20TT
风景	2.0L	F4R	K20PR-U	IK20	IK20TT	PK20TT	K20TT
科雷傲KOLEOS	2.5L	2TRA7	FXE20HR11	VFXE20	IXEH20TT	-	-
	2.0L		XE20HR-U9	-	IXEH20ETT	-	-
塔利斯曼Talisman	2.5L	VQ25DE	XE20HR-U9	-	IXEH20ETT	-	-
	3.5L	VQ35DE	XE20HR-U9	-	IXEH20ETT	-	-
纳智捷(东风裕隆)							
纳5	1.8T	G18TG	FXE24HR11	-	-	-	-
	2.0T	G20TE	K20PR-U11	IK20	IK20TT	PK20TT	K20TT
	2.0T	G20TG	FXE24HR11	-	-	-	-
优6	1.8T	G18TE	K20PR-U11	IK20	IK20TT	PK20TT	K20TT
	1.8T	GPK 138kw	FXE24HR11	-	-	-	-
	2.0T	G20TE	K20PR-U11	IK20	IK20TT	PK20TT	K20TT
大7 SUV	2.0T	GPK 138kw	FXE24HR11	-	-	-	-
	2.0T	G20TE 120kw	K20PR-U11	IK20	IK20TT	PK20TT	K20TT
	2.2T	G22TG 131kw	K20PR-U11	IK20	IK20TT	PK20TT	K20TT
大7 MPV	2.2T	G22TG 138kw	K20PR-U11	IK20	IK20TT	PK20TT	K20TT
	2.2T	G22TG 148kw	K20PR-U11	IK20	IK20TT	PK20TT	K20TT
	2.0T	G20TE 125kw	K20PR-U11	IK20	IK20TT	PK20TT	K20TT
CEO	MPV 2.0T L4	GPK 138kw	FXE24HR11	-	-	-	
CEO	MPV 2.2T L4	G22TG 148kw	K20PR-U11	IK20	IK20TT	PK20TT	K20TT
CEO	MASTER CEO 2.2T	G22TG 131kw	K20PR-U11	IK20	IK20TT	PK20TT	K20TT
广汽传祺							
传祺GA3	1.6L	4B16K1	K20R-U	IK20	IK20TT	PK20TT	K20TT
传祺GA3S	1.6L	4B16K1	K20R-U	IK20	IK20TT	PK20TT	K20TT
传祺GA5	2.0L	4B20K2	K20R-U	IK20	IK20TT	PK20TT	K20TT
	1.8L	4B18K1	K20R-U	IK20	IK20TT	PK20TT	K20TT
	1.8T	4B18M1	SXU22HCR11	IXUH22	-	-	XUH22TT
传祺GA6	1.6T	4B16M1	SXU22HCR11	IXUH22	-	-	XUH22TT
	1.8T	4B18M1	SXU22HCR11	IXUH22	-	-	XUH22TT
传祺GS5	2.0L	4B20K2	K20R-U	IK20	IK20TT	PK20TT	K20TT
	1.8T	4B18M1	SXU22HCR11	IXUH22	-	-	XUH22TT
双环汽车							
来宝SRV	2.0L	EQ491i	W16EXR-U	IW16	IW16TT	PW16TT	-
	2.0L	4G63	-	IK16	IK16TT	PK16TT	K16TT
	2.2L	JM491Q-ME	W16EXR-U	IW16	IW16TT	PW16TT	-
	2.4L	4G64	-	IK16	IK16TT	PK16TT	K16TT
SCEO	2.4L	4G64	-	IK16	IK16TT	PK16TT	K16TT
小贵族	1.0L	DA468QA	XU22EPR-U	IXU22	-	-	XU22TT
	1.1L	DA468QA	XU22EPR-U	IXU22	-	-	XU22TT
永源汽车							
飞碟UFO	1.6L	4G18S	K16PR-U11	IK16	IK16TT	PK16TT	K16TT
	2.0L	4G63S4M	K16PR-U11	IK16	IK16TT	PK16TT	K16TT
	2.4L	4G64S4M	K16PR-U11	IK16	IK16TT	PK16TT	K16TT
众泰汽车							
Z200	1.5L	4A91S	K20HR-U11	IKH20	IKH20TT	PKH20TT	KH20TT
	1.3L	4A90M	K16PR-U11	IK16	IK16TT	PK16TT	K16TT
M300	1.6L	4G18	K20PR-U11	IK20	IK20TT	PK20TT	K20TT
5008	1.3L	4G13S1	K20PR-U11	IK20	IK20TT	PK20TT	K20TT
	1.5L	4G15	K20PR-U11	IK20	IK20TT	PK20TT	K20TT
2008	1.3L	4G13	K16PR-U11	IK16	IK16TT	PK16TT	K16TT
	1.5L	4G15S	K16PR-U11	IK16	IK16TT	PK16TT	K16TT
	1.6L	4G18	K16PR-U11	IK16	IK16TT	PK16TT	K16TT
朗悦	1.6L	4G18	K20PR-U11	IK20	IK20TT	PK20TT	K20TT
朗俊	1.3L	4G13S1	K20PR-U11	IK20	IK20TT	PK20TT	K20TT
朗朗	1.3L	4A90M	K16PR-U11	IK16	IK16TT	PK16TT	K16TT
	1.5L	4A91S	K20HR-U11	IKH20	IKH20TT	PKH20TT	KH20TT
福田汽车							
迷迪	1.3L	4G13S	K16PR-U11	IK16	IK16TT	PK16TT	K16TT
	1.6L	4G18S	K16PR-U11	IK16	IK16TT	PK16TT	K16TT
雷克萨斯/LEXUS							
CT	1.8T	2ZR-FXE	-	-	IXEH20ETT	-	-
	F-Sport	2ZR-FXE	-	-	IXEH20ETT	-	-
ES300	ES300(1996-2008)		-	IQ20	IQ20TT	PQ20TT	Q20TT
	2.4L(2009)	2AZ-FE	-	IK20	IK20TT	PK20TT	K20TT
	3.5L(2009)	2GR-FE	-	IKH20	IKH20TT	-	KH20TT

DENSO
 AUSTRALIA CHINA
 INDIA
 INDONESIA KOREA
 MALAYSIA PHILIPPINES SAUDIARABIA SINGAPORE TAIWAN THAILAND VIETNAM JAPAN
 EUROPE MOTOR & USA
 SMALL ENGINE REFERENCE NUMBER
 CROSS PART

DENSO	9	14	16	20	22	24	27	29	31	32	34	35	DENSO	9	14	16	20	22	24	27	29	31	32	DENSO	9	14	16	20	22	24	27	31
NGK	2	4	5	6	7	8	9	9.5	10	10.5	11	11.5	CHAMPION	18	16,14	12,11	10,9	8,7	6,63,61	4,59	57	55	53	BOSCH	10	9	8	7,6	5	4	3	2

**DENSO****CHINA AUSTRALIA****INDIA****INDONESIA****KOREA****MALAYSIA****PHILIPPINES****SAUDI ARABIA****SINGAPORE****TAIWAN****THAILAND****VIETNAM****JAPAN****EUROPE & USA****MOTOR CYCLE****SMALL ENGINE****CROSS REFERENCE****PART NUMBER**

车种	车型	发动机型式	DENSO	IRIDIUM				
雷克萨斯/LEXUS								
GS 2代	GS300 T3	2JZ-GE	-	IK20	IK20TT	PK20TT	K20TT	
	GS300	2JZ-GE	SK20R11	IK20	IK20TT	PK20TT	K20TT	
	GS430 V8	3UZ-FE	SK20R11	IK20	IK20TT	PK20TT	K20TT	
GS 3代	GS300	3GR-FSE	-	IKH20	IKH20TT	-	KH20TT	
	GS430 4.3L V8	3UZ-FE	-	IKH20	IKH20TT	-	KH20TT	
	GS450h 3.5L V6	2GR-FSE	-	IKH20	IKH20TT	-	KH20TT	
	GS460	1UR-FSE	-	IKH20	IKH20TT	-	KH20TT	
GS 4代	GS250 2.5L V6	4GR-FSE	-	IKH20	IKH20TT	-	KH20TT	
	GS300h 2.5L V6	2AR-FSE	-	IKH20	IKH20TT	-	KH20TT	
	GS350	2GR-FSE	FK20HBR11	IKH20	IKBH20TT	-	KH20TT	
	GS450h 3.5L V6	2GR-FXE	FK20HBR11	IKH20	IKBH20TT	-	KH20TT	
GX	GX 460	1UR-FE	-	IKH20	IKH20TT	-	KH20TT	
IS 1代	IS200 2.0L(2001-2005)	1G-FE	-	IK20	IK20TT	PK20TT	K20TT	
	IS200 Compressor(2001-2005)	1GE-FEC	-	IK20	IK20TT	PK20TT	K20TT	
	IS300(2001-2005)	2JZ-GE	-	IK20	IK20TT	PK20TT	K20TT	
IS 2代	IS250 2.5L V6	4GR-FSE	FK20HBR11	IKH20	IKBH20TT	-	KH20TT	
IS 3代	IS250 2.5L V6(2013-)	4GR-FSE	FK20HBR11	IKH20	IKBH20TT	-	KH20TT	
	IS300h 2.5L V6(2013-)	2AR-FSE	-	IKH20	IKH20TT	-	KH20TT	
LS 3代	LS430 4.3L(2003)	3UZ-FE	-	IK20	IK20TT	-	K20TT	
LS 4代	LS460 4.6L V8	1UR-FSE	-	IKH20	IKH20TT	-	KH20TT	
	LS460 AWD 4.6L V8(2006-)	1UR-FSE	-	IKH20	IKH20TT	-	KH20TT	
	LS600h 5.0L V8(2006-)	2UR-FSE	-	IKH20	IKH20TT	-	KH20TT	
LX470	LX470 4.7L V8	2UZ-FE	-	IK20	IK20TT	-	K20TT	
LX570	LX570 5.7L V8	3UZ-FE	-	IKH20	IKH20TT	-	KH20TT	
RX 2代	RX300 3.0 V6(2003-2008)	1MZ-FE	-	IK20	IK20TT	-	K20TT	
	RX350 3.5 V6(2003-2008)	2GR-FE	-	IKH20	IKH20TT	-	KH20TT	
	RX400h 3.3L V6(2003-2008)	3MZ-FE	-	IK20	IK20TT	PK20TT	K20TT	
RX 3代	RX270 2.7L(2009-)	1AR-FE	-	IKH20	IKH20TT	-	KH20TT	
	RX350 3.5 V6(2009-)	2GR-FXE	-	IKH20	IKH20TT	-	KH20TT	
	RX350h(2009-)	2GR-FXE	-	IKH20	IKH20TT	-	KH20TT	
	RX450h (Hybrid)(2009-)	2GR-FXE	-	IKH20	IKH20TT	-	KH20TT	
SC430	SC430 4.3L V8(2009-)	3UZ-FE	-	IK20	IK20TT	-	K20TT	
英菲尼迪/INFINITI								
G	G35 3.5L V6	VQ35DE/VQ35HR	FK16HR11	IKH16	IKH16TT	PKH16TT	KH16TT	
	G35 3.5L V6 双进气	VQ35DE/VQ35HR	FXE22HR11	-	IXEH22TT	-	-	
	G25 2.5L V6 双进气	VQ25HR	FXE22HR11	-	IXEH22TT	-	-	
	G37 3.7L V6 双进气	VQ37HR	FXE24HR11	-	-	-	-	
M	M25 2.5L V6	VQ25HR	-	-	IXEH22TT	-	-	
	M25L 2.5L V6	VQ25HR	-	-	IXEH22TT	-	-	
	M35 3.5L V6 双进气	VQ35DE	-	IKH16	IKH16TT	PKH16TT	KH16TT	
	M35 3.7L V6 双进气	VQ35DE	FXE24HR11	-	-	-	-	
	M35L 3.7L V6 双进气	VQ35DE	FXE24HR11	-	-	-	-	
	M37 3.7L V6 双进气	VQ37HR	FXE24HR11	-	-	-	-	
EX	EX25 2.5L V6 双进气	VQ25HR	-	-	IXEH22TT	-	-	
	EX35 3.5L V6 双进气	VQ35HR	FXE24HR11	-	-	-	-	
	EX37 3.7L V6 双进气	VQ37VHR	FXE24HR11	-	-	-	-	
FX	FX35 3.5L 双进气	VQ35DE	-	IKH16	IKH16TT	PKH16TT	KH16TT	
	FX37 3.7L 双进气	VQ37HR	FXE24HR11	-	-	-	-	
	FX45 4.5L 双进气	VK45DE	-	IKH16	IKH16TT	PKH16TT	KH16TT	
	FX50 5.0L 双进气	VK50VE	FXE24HR11	-	IXEH22TT	-	-	
JX	JX35 3.5L V6	VQ35 204kw	FXE24HR11	-	-	-	-	
进口QX50(原FX)	QX50 2.5L V6	VQ25HR	FXE22HR11	-	IXEH22TT	-	-	
	QX50 3.7L V6	VQ37VHR	FXE24HR11	-	-	-	-	
进口Q50	Q50 3.5L V6	VQ35HR 235kw	FXE24HR11	-	-	-	-	
	Q50 3.7L V6	VQ37HR	FXE24HR11	-	-	-	-	
Q60 敞篷	Q60 3.7L V6	VQ37VHR 258kw	FXE24HR11	-	-	-	-	
Q60S 硬顶	Q60S 3.7L V6	VQ37VHR 258kw	FXE24HR11	-	-	-	-	
进口Q70L	Q70L 2.5L V6	VQ25HR	FXE22HR11	-	IXEH22TT	-	-	
	Q70L 3.5L V6	VQ35HR	FXE24HR11	-	-	-	-	
QX50	QX50 2.5L V6	VQ25HR 173kw	FXE22HR11	-	IXEH22TT	-	-	
	QX50 3.7L V6	VQ37VHR 258kw	FXE24HR11	-	-	-	-	
QX60/JX35	QX60 3.5L V6	VQ35	FXE24HR11	-	-	-	-	
	QX70	QX70 3.5L V6	VQ35	FXE24HR11	-	-	-	
QX70	QX70 3.7L V6	VQ37	FXE24HR11	-	-	-	-	
	QX70 5.0L V8	VK50	FXE22HR11	-	IXEH22TT	-	-	
QX56	QX56 5.6L V8	VK56 324kw	FXE22HR11	-	IXEH22TT	-	-	
QX80	QX80 5.6L V8	VK56 324kw	FXE22HR11	-	IXEH22TT	-	-	

车种	车型	发动机型式	DENSO	IRIDIUM			
英菲尼迪/INFINITI							
QX80	QX80 5.6L V8	VK56 293kw	FXE22HR11 -	-	IXEH22TT -	-	-
东风英菲尼迪/INFINITI							
国产QX50	QX50 2.5L V6	VQ25HR 173kw	FXE22HR11 -	-	IXEH22TT -	-	-
日产/NISSAN							
风度Cefiro	A31/32	VQ30DE	PK16PR(-L)11	IK16	IK16TT	PK16TT	K16TT
	A32	VQ20DE	VFK16	IK16	IK16TT	PK16TT	K16TT
	A33	VQ30DE	VFK16	IK16	IK16TT	PK16TT	K16TT
公爵王Cedric	S30	VG30S	VFK20F	IK20	IK20TT	PK20TT	K20TT
	SY31	VG20S/VG30S	VFK20F	IK20	IK20TT	PK20TT	K20TT
	WY3C	VG30S	VFK20F	IK20	IK20TT	PK20TT	K20TT
西玛Cima	VK45DE 4.5L	VK45DE	VFKH16	IKH16	IKH16TT	PKH16TT	KH16TT
斯巴鲁/SUBARU							
森林人SF 97-02	SF 2.0	EJ20	VK20Y	IK22	-	PK22TT	-
	SF 2.0 S-Turbo	EJ20G	VK20Y	IK22	-	PK22TT	-
森林人SG 02-07	SG 2.0L	EJ20	PK16PR(-L)11	IK16	IK16TT	PK16TT	K16TT
	SG 2.5T	EJ25	-	IKH20	IKH20TT	PKH20TT	KH20TT
	SG 2.5T	EJ25	VKH22	IKH22	-	-	-
森林人SH 08-10	SH 2.0L	EJ20	-	IK20	IK20TT	PK20TT	K20TT
	SH 2.5L	EJ25	VKH20	IKH20	IKH20TT	PKH20TT	KH20TT
	SH 2.5T	EJ25	VKH20Y	IKH20	IKH20TT	-	KH20TT
森林人SI 11-	SI 2.0L	FB20	-	-	IXEH22TT	-	-
	SI 2.5L	FB25	-	-	IXEH22TT	-	-
森林人SJ 13-	SJ 2.0L	FB20	-	-	IXEH22TT	-	-
	SJ 2.5L	FB25	-	-	IXEH22TT	-	-
翼豹2代 -07	2.0 WRX	EJ20T	-	IK22	-	PK22TT	-
翼豹3代	2.0L	EJ20	-	IKH20	IKH20TT	PKH20TT	KH20TT
翼豹3代 08-	2.5T	H4	-	IKH22	IKH20TT	-	KH20TT
翼豹4代 13-	2.0R	FB20	-	-	IXEH22TT	-	-
力狮II 98-04	2.0i	EJ20-E	-	IK22	-	PK22TT	-
	2.5i	EJ25D	-	IK22	-	PK22TT	-
力狮III Legacy 03-09	2.0i 16V	EJ20	-	IK22	-	PK22TT	-
	2.5i 16V	EJ25	-	IK22	-	PK22TT	-
	3.0i 24V	EZ30	-	IKH20	IKH20TT	PKH20TT	KH20TT
力狮 IV	2.0i(2009-)	EJ20	-	IKH20	IKH20TT	PKH20TT	KH20TT
	2.5i(2009-)	EJ25	-	IKH20	IKH20TT	PKH20TT	KH20TT
	2.5GT(2009-)	EJ255	-	IKH22	IKH20TT	-	KH20TT
力狮 V	2.0i(2012-)	FA20	-	-	IXEH22TT	-	-
	2.5i(2012-)	FB25	VFXEH22	-	IXEH22TT	-	-
傲虎II	2.5L(2004-2009)	EJ25	PK16PR(-L)11	IK16	IK16TT	PK16TT	K16TT
	3.0L 36V(2004-2009)	EZ30	-	IKH20	IKH20TT	PKH20TT	KH20TT
傲虎III	2.5i(2009-2014)	EJ25	-	IKH20	IKH20TT	PKH20TT	KH20TT
驰腾Tribeca	3.0L 24V	EZ30	-	IKH20	IKH20TT	PKH20TT	KH20TT
	3.6R V6	EZ36	-	IKH20	IKH20TT	PKH20TT	KH20TT
驰腾	2.5T	EJ25	VKH20Y	-	IKH20TT	PKH20TT	KH20TT
XV	XV 2.0i(2012-)	FB20	VFXEH22	-	IXEH22TT	-	-
BRZ	2.0i 16V(2012-)	FA20	VXEBH27	-	-	-	-
宝马							
X5	4.8iS	N62 B48	-	IK20	IK20TT	PK20TT	K20TT
	4.4i	N62 B44	K20TXR	IK20	IK20TT	PK20TT	K20TT
	3.0i	M62 B30	K20TXR	IK20	IK20TT	PK20TT	K20TT
X3	3.0L	M54 B30	K20TXR	IK20	IK20TT	PK20TT	K20TT
	2.5L	M54 B25	K20TXR	IK20	IK20TT	PK20TT	K20TT
7系	750LI	N62 B50	-	IK20	IK20TT	PK20TT	K20TT
	740LI	N62 B40	-	IK20	IK20TT	PK20TT	K20TT
740i	4.0L	448S	K20TXR	IK20	IK20TT	PK20TT	K20TT
530i	3.0L	308S	K20TXR	IK20	IK20TT	PK20TT	K20TT
528i	2.8L	286S	K20TXR	IK20	IK20TT	PK20TT	K20TT
320i	2.0L	206S	K20TXR	IK20	IK20TT	PK20TT	K20TT
华晨宝马							
宝马5系	2.0L	N52	K20TXR	IK20	IK20TT	PK20TT	K20TT
	3.0L(L6)	N54	K20TXR	IK20	IK20TT	PK20TT	K20TT
	2.5L(L6)	M54	K20TXR	IK20	IK20TT	PK20TT	K20TT
	2.2L(L6)	M54	K20TXR	IK20	IK20TT	PK20TT	K20TT
宝马3系	2.5L(L6)	N52	K20TXR	IK20	IK20TT	PK20TT	K20TT
	2.5L(L6)	M54	K20TXR	IK20	IK20TT	PK20TT	K20TT
	2.0L	N46	-	IK20	IK20TT	PK20TT	K20TT

DENSO

AUSTRALIA CHINA

INDIA

INDONESIA

KOREA

MALAYSIA

PHILIPPINES

SAUDIARABIA

SINGAPORE

TAIWAN

THAILAND

VIETNAM

JAPAN

& USA

EUROPE

MOTOR



SMALL

CROSS

PART

**DENSO****CHINA AUSTRALIA****INDIA****INDONESIA****KOREA****MALAYSIA****PHILIPPINES****SAUDI ARABIA****SINGAPORE****TAIWAN****THAILAND****VIETNAM****JAPAN****EUROPE****SMALL MOTOR & USA****ENGINE CYCLE****CROSS REFERENCE****PART NUMBER**

车种	车型	发动机型式	DENSO	IRIDIUM				
MINI								
Mini Onell .Clubman .Countryman	1.6(2007-)	N16 B16A	-	IXUH22	-	-	-	XUH22TT
Mini Cooper II, Cabrio,clubman, Countnman,Roadster	1.6(2006-)	N12 B16A	-	IXUH22	-	-	-	XUH22TT
	1.6(2006-)	N16 B16A	-	IXUH22	-	-	-	XUH22TT
	1.6 John Cooper(2006-)	N14 B16	-	IXUH22	-	-	-	XUH22TT
	1.6 S Turbo(2006-)	N14 B16A	-	IXUH22	-	-	-	XUH22TT
	1.6 S Turbo(2006-)	N18 B16A	-	IXUH22	-	-	-	XUH22TT
奔驰								
SLK230 GF-170447	2.3L	170	K16TNR-S9	IK16	IK16TT	PK16TT	K16TT	
S600 E-140076	6.0L	M120	W16EPR-U	IW16	IW16TT	PW16TT	-	
S600	6.0L	M275	-	VK20Y	IK20TT	-	-	
S500	5.0L	M273	-	IXUH22	-	-	-	XUH22TT
S350	3.5L	M272	-	IXUH22	-	-	-	XUH22TT
MB100 M161E2.3	2.3L	M161	W20EPR-U	IW20	IW20TT	PW20TT	-	
北京奔驰								
奔驰 C280 BENS	3.0L V6	M272	-	IXUH22	-	-	-	XUH22TT
奔驰 C230 BENS	2.5L V6	M272	-	IXUH22	-	-	-	XUH22TT
奔驰 C200K BENS	1.8T	M271	-	IKH20	IKH20TT	PKH20TT	-	
C180K	1.6T	-	-	IXUH22	-	-	-	XUH22TT
E500	5.0L V8	M11	PK16PR(-L)11	IK16	IK16TT	PK16TT	-	
E350	3.5L V6	M272	-	IXUH22	-	-	-	XUH22TT
E280	3.0L V6	M272 940	-	IXUH22	-	-	-	XUH22TT
E230	2.5L V6	-	-	IXUH22	-	-	-	XUH22TT
E200K	1.8L	-	K20HR-U11	IKH20	IKH20TT	PKH20TT	KH20TT	
GLK300	3.0L	-	IXUH22	-	-	-	-	
SMART								
SMART Fortwo	1.0(2007-)	M 132	-	IXUH22	-	-	-	XUH22TT
	1.0 Turbo(2007-)	M 132	-	IXUH22	-	-	-	XUH22TT
	1.0 Brabus Turbo(2007-)	M 132	-	IXUH22	-	-	-	XUH22TT
	1.0 Brabus ultimate 120(2007-)	M 132	-	IXUH22	-	-	-	XUH22TT
保时捷								
卡宴	3.6L	M55	-	VXUH22I	-	-	-	
	3.2L	BFD	-	IXU22	-	-	-	
帕纳梅拉Panamera	3.0TS Hybrid(2009-)	MCG.EA/FA	-	IK20L	IK20TT	PK20TT	K20TT	
沃尔沃汽车								
进口C30	进口C30 2.0i(2010-2013)	B 4204 S3 / B 4204 S4	-	IT20	IT20TT	PT20TT	T20TT	
	进口C30 2.4i(2008-2010)	B 5254 T3	-	IKH20	IKH20TT	PKH20TT	KH20TT	
长安S40 II	S40 2.0i(2009-2012)	B 4204 S3	-	IT20	IT20TT	PT20TT	T20TT	
	S40 2.4i(2006-2007)	B 5244 S5	-	IKH20	IKH20TT	PKH20TT	KH20TT	
长安S40 II 04-	S40 2.5 T5(2006-2009)	B 5254 T3	-	IKH20	IKH20TT	PKH20TT	KH20TT	
进口S60 II	S60 1.6 T4(2012-2013)	B 4164 T	-	ITV20	ITV20TT	PTV20TT	-	
	S60 2.0 T(2011-2013)	B 4204 T6 福特引擎	-	ITV20	ITV20TT	PTV20TT	-	
	S60 2.0 T5(2012)	B 4204 T7 福特引擎	-	ITV20	ITV20TT	PTV20TT	-	
	S60 2.0 T5(2013)	B 4204 T 沃尔沃引擎	-	ITV20	ITV20TT	PTV20TT	-	
	S60 2.0 T5(2013-2014)	B 4204 T9 沃尔沃引擎	-	ITV20	ITV20TT	PTV20TT	-	
	S60 2.0 T6(2014-2015)	B 4204 T11	-	ITV20	ITV20TT	PTV20TT	-	
	S60 3.0 T6(2011-2015)	B 6304 T4	-	IKH20	IKH20TT	PKH20TT	KH20TT	
进口V60	V60 2.0 T5(2013-2014)	B 4204 T9 沃尔沃引擎	-	ITV20	ITV20TT	PTV20TT	-	
	V60 2.0 T6(2014-2015)	B 4204 T11 福特引擎	-	ITV20	ITV20TT	PTV20TT	-	
	V60 3.0 T6(2012-2015)	B 6304 T4	-	IKH20	IKH20TT	PKH20TT	KH20TT	
亚太S60L	S60L 2.0 T(2014-2015)	B 4204 T 沃尔沃引擎	-	ITV20	ITV20TT	PTV20TT	-	
	S60L 2.0 T5(2014-2015)	B 4204 T9 沃尔沃引擎	-	ITV20	ITV20TT	PTV20TT	-	
	S60L 2.0T6 E驱混动(2015)	-	-	ITV20	ITV20TT	PTV20TT	-	
	S60L 2.0T4(2016)	B4204T19	-	ITV20	ITV20TT	PTV20TT	-	
	S60L 2.0 T5(2016)	B 4204 T11	-	ITV20	ITV20TT	PTV20TT	-	
S80	2.4 20V(1998-2005)	B 5244 S	-	IK20	IK20TT	-	K20TT	
	2.5 T (1998-2005)	B 5254 T2	-	IK20	IK20TT	-	K20TT	
	2.9 T6(1998-2005)	B6294 T	-	IK20	IK20TT	-	K20TT	
	3.0 T6(1998-2005)	B 6304 T2	-	IK20	IK20TT	-	K20TT	
长安S80LII	S80L 2.0 T(2011-2012)	B 4204 T6 4缸	-	IKH20	IKH20TT	-	KH20TT	
	S80L 2.0 T5(2014)	B 4204 T9 沃尔沃引擎 5缸	-	IKH20	IKH20TT	-	KH20TT	
	S80L 2.5 T(2009-2010)	B 5254 T6, B 5254 T8	-	IKH20	IKH20TT	-	KH20TT	
	S80L 3.0 T6(2009-2015)	B 6304 T2	-	IKH20	IKH20TT	-	KH20TT	
	进口S80 4.4i(2006-2008)	B 8444 S	-	IK20	IK20TT	-	K20TT	
进口V40 II	V40 1.6 T4(2015)	D 4164 T	-	ITV20	ITV20TT	PTV20TT	-	
	V40 2.0 T4 /Cross	B5204 T8	-	ITV20	ITV20TT	PTV20TT	-	
	V40 2.0 T5 /Cross(2013-2015)	B5204 T9	-	ITV20	ITV20TT	PTV20TT	-	
	V40 2.0T(2016)	B4204T19	-	ITV20	ITV20TT	PTV20TT	-	

车种	车型	发动机型式	DENSO	IRIDIUM			
沃尔沃汽车							
进口V40 II	V40 2.0 T4(2016)	B4204T19	-	ITV20	ITV20TT	PTV20TT	-
进口XC60	XC60 2.0 T(2011)	B 4204 T6 沃尔沃引擎	-	ITV20	ITV20TT	PTV20TT	-
	XC60 2.0 T5(2012-2015)	B 4204 T7 福特引擎	-	ITV20	ITV20TT	PTV20TT	-
	XC60 2.0 T5(2014-2015)	B 4204 T11 沃尔沃引擎	-	ITV20	ITV20TT	PTV20TT	-
	XC60 3.0 T6(2009-2010)	B 6304 T2	-	IKH20	IKH20TT	-	KH20TT
	XC60 3.0 T6(2010-2015)	B 6304 T4	-	IKH20	IKH20TT	-	KH20TT
XC90/XC90 Sport	2.5 T	D 5244 T11	-	IK20	IK20TT	-	K20TT
	3.2	B 6324 S	-	IKH20	IKH20TT	-	KH20TT
	3.2 AWD	-	-	IKH20	IKH20TT	-	KH20TT
	4.4 V8	B 8444 S	-	IK20	IK20TT	-	K20TT
捷豹/JAGUAR							
S-Type(CCX)	3.0 V6(1999-2008)	AJ-V6	-	IT20	IT20TT	PT20TT	T20TT
	4.0 V8(1999-2008)	AJ-28	-	IK16	IK16TT	PK16TT	K16TT
	4.2 V8(1999-2008)	AJ-V8	-	IT20	IT20TT	PT20TT	T20TT
	4.2 V8 R(1999-2008)	AJ34 SC	-	IT20	IT20TT	PT20TT	T20TT
X-Type(CF1)	2.0 V6(2001-2009)	AJ20	-	IT20	IT20TT	PT20TT	T20TT
	2.5 V6(2001-2009)	AJ25	-	IT20	IT20TT	PT20TT	T20TT
	3.0 V6(2001-2009)	AJ30	-	IT20	IT20TT	PT20TT	T20TT
捷豹XF	XF 2.0T(2013)	204PT	-	ITV22	-	-	-
	XF 3.0 V6(2008-2012)	AJ-V6	-	IT20	IT20TT	PT20TT	T20TT
	XF 3.0T V6 SC (2013)	-	-	IT20	IT20TT	PT20TT	T20TT
	XF 4.2T V8(2009-2010)	AJ34 KG	-	IK16	IK16TT	PK16TT	K16TT
	XF 5.0 V8(2009)	HP385	-	IK16	IK16TT	PK16TT	K16TT
	XFR 5.0T V8(2009)	HP510	-	IK16	IK16TT	PK16TT	K16TT
XJ/XJR(X300)	XJ6 3.2 V6(1994-2003)	9JPGRB	-	IK20	IK20TT	PK20TT	K20TT
	XJ8 3.2 V8(1994-2003)	AJ-V8	-	IK20	IK20TT	PK20TT	K20TT
	XJ8 4.0(1994-2003)	AJ27	-	IK20	IK20TT	PK20TT	K20TT
	XJR8 4.0T(1994-2003)	AJ27 SC	-	IK20	IK20TT	PK20TT	K20TT
XJ/XJR (X350)	XJ6 3.0 V6(2003-2010)	AJ-V6	-	IT20	IT20TT	PT20TT	T20TT
	XJ8 3.5 V8(2003-2010)	AJV8	-	IK16	IK16TT	PK16TT	K16TT
	XJ8 4.2 V8(2003-2010)	AJ34	-	IK16	IK16TT	PK16TT	K16TT
	XJ8 4.2T V8(2003-2010)	AJ34	-	IK20	IK20TT	PK20TT	K20TT
	XJ8 4.2T V8(2003-2010)	-	-	IK20	IK20TT	PK20TT	K20TT
XJ/XJR(X351)	XJL 2.0T(2013)	HP241	-	ITV22	-	-	-
	XJL 3.0L V6(2010-)	-	-	IT20	IT20TT	PT20TT	T20TT
	XJL 3.0T(2013)	-	-	IT20	IT20TT	PT20TT	T20TT
	XJL 5.0L V8(2010-)	AJ-V8 Gen III	-	IK16	IK16TT	PK16TT	K16TT
	XJL 5.0T V8	-	-	IK20	IK20TT	PK20TT	K20TT
捷豹XK J43	XK8 4.2L(2006-2014)	219KW	-	IK16	IK16TT	PK16TT	K16TT
	XKR 4.2T(2006-2014)	306/313KW	-	IK20	IK20TT	PK20TT	K20TT
	XK 5.0L(2006-2014)	283KW	-	IK16	IK16TT	PK16TT	K16TT
	XKR 5.0T(2006-2014)	375/405KW	-	IK20	IK20TT	PK20TT	K20TT
路虎							
发现者2	4.0 V8(1998-2004)	-	-	IK20G	IK20TT	PK20TT	K20TT
发现者3	4.0 V6(2004-2009)	161KW	-	IT20	IT20TT	PT20TT	T20TT
	4.0 V6(2004-2009)	406PN 156KW	-	IK20G	IK20TT	PK20TT	K20TT
	4.4 V8(2004-2009)	AJ34,L319	-	IK16	IK16TT	PK16TT	K16TT
发现者4	4.0 V6(2009-)	406PN	-	IK20G	IK20TT	PK20TT	K20TT
	5.0 V8(2009-)	AJ133	-	IK20	IK20TT	PK20TT	K20TT
神行者1	1.8i(1998-)	18 K4F	-	IK20	IK20TT	PK20TT	K20TT
	1.8i 16V(1998-)	18 K4F	-	IK20	IK20TT	PK20TT	K20TT
	2.5 V6(1998-)	25 K4F	-	IK20	IK20TT	PK20TT	K20TT
神行者2	2.0T Si4(2007-)	204PT	-	ITV22	-	-	-
	3.2(2007-)	B 6324 S	-	-	IKH20TT	-	KH20TT
揽胜2	4.0(1994-2002)	42D(185) - E97	-	IK20G	IK20TT	PK20TT	K20TT
	4.6(1994-2002)	46D(224)	W16EXR-U	IW16	IW16TT	PW16TT	-
揽胜3	4.2 V8 (2002-2012)	AJ34	-	IK16	IK16TT	PK16TT	K16TT
	4.4 V8(2002-2012)	M 62 B44	K20TXR	IK20	IK20TT	PK20TT	K20TT
	4.4 V8(2002-2012)	AJ34	-	IK16	IK16TT	PK16TT	K16TT
	5.0 V8 (2002-2012)	-	-	-	IXEH22TT	-	-
揽胜4	3.0T V6(2014-2016)	306PS	-	-	IXEH22TT	-	-
	5.0L V8(2013)	508PS	-	-	IXEH22TT	-	-
	5.0T V8(2013-2016)	508PS	-	-	IXEH22TT	-	-
揽胜运动版1	4.2T V8(2006)	AJ34	-	IK16	IK16TT	PK16TT	K16TT
	4.4L V8(2005)	AJ34	-	IK16	IK16TT	PK16TT	K16TT
	5.0L V8(2010-2011)	HP375	-	-	IXEH22TT	-	-
	5.0T V8 375KW(2010-2011)	HP510	-	-	IXEH22TT	-	-

DENSO
 AUSTRALIA CHINA
 INDIA
 INDONESIA KOREA
 MALAYSIA PHILIPPINES SAUDI ARABIA SINGAPORE TAIWAN THAILAND VIETNAM JAPAN & USA
 EUROPE MOTOR SMALL PART
 CYCLE ENGINE REFERENCE NUMBER

DENSO	9	14	16	20	22	24	27	29	31	32	34	35	DENSO	9	14	16	20	22	24	27	29	31	32	DENSO	9	14	16	20	22	24	27	31
NGK	2	4	5	6	7	8	9	9.5	10	10.5	11	11.5	CHAMPION	18	16,14	12,11	10,9	8,7	6,63,61	4,59	57	55	53	BOSCH	10	9	8	7,6	5	4	3	2



DENSO

车种	车型	发动机型式	DENSO	IRIDIUM			
路虎							
揽胜运动版2	2.0T(2016)		-	ITV22	-	-	-
	3.0T V6(2014-2016)	30HD0D	-	-	IXEH22TT	-	-
	3.0T V6(2016)		-	-	IXEH22TT	-	-
	5.0T V8(2014-2015)		-	-	IXEH22TT	-	-
	5.0T V8 SVR(2016)		-	-	IXEH22TT	-	-
揽胜极光	2.0T(2011-)	204PT	-	ITV22	-	-	-
玛莎拉蒂							
Ghibli吉博力	吉博力 3.0T(2014)	M156	-	-	-	-	-
	吉博力S 3.0T(2014)	M156	-	-	-	-	-
总裁Quattroporte	总裁 4.2L(2008-2010)	M139, V8	-	IU24	-	-	-
	总裁 3.0T(2013-2015)	M156C	-	IU24	-	-	-
GT	GT 4.2L(2009)	M139P, V8	-	IU24	-	-	-

CHINA AUSTRALIA

INDIA INDONESIA KOREA MALAYSIA PHILIPPINES SINGAPORE THAILAND VIETNAM

- 注:
- 1、在安装火花塞时请确认与原车火花塞尺寸一致;
 - 2、在安装时请严格按照火花塞标准力矩安装;
 - 3、如出现点火不良可根据具体情况适当调节火花塞间隙;
 - 4、奔驰新款双点火发动机不适合使用钛金火花塞;
 - 5、火花塞热值可根据环境、季节、驾驶习惯、发动机改装、涡轮增压等适当提高一级热值;
 - 6、高协调性发动机请直接使用长寿命火花塞。



CHINA MOTORCYCLE

车种	CC	DENSO		
Piaggio 霸伏		W20FP-U	IWF20	-
Tomos		W20FP-U	IWF20	-
天津富士达				
CB125	125	X24EP-U/U9	IX24B	IXU01-□
金城				
AJ50	50	W20FP-U	IWF20	-
JC70	70	U22FS-U	IUF22	-
JC90-B	90	U22FS-U	IUF22	-
AX100	100	W20EP-U	IW20	IW01-□
FD100	100	U22FS-U	IUF22	-
JC100	100	W20FP-U	IWF20	-
JC150	150	U22FS-U	IUF22	-
金鸟				
TN36L		W20FP-U	IWF20	-
木兰				
AG50	50	W20FP-U	IWF20	-
QM50QW-A	50	W20FP-U	IWF20	-
建设摩托				
JS50	50	W20FP-U	IWF20	-
JY55	55	W20FP-U	IWF20	-
JS60	60	W20FP-U	IWF20	-
CY80	80	W20FP-U	IWF20	-
JS90	90	U22FS-U	IUF22	-
JS100	100	U22FS-U	IUF22	-
JS125	125	X24EP-U/U9	IX24B	IXU01-□
SR125	125	X24EP-U/U9	IX24B	IXU01-□
JY150	150	X24EP-U/U9	IX24B	IXU01-□
SR150	150	X24EP-U/U9	IX24B	IXU01-□
SRZ150	150	X24EP-U/U9	IX24B	IXU01-□
建设雅马哈				
YBR125(天剑)	125	U22FS-U	IUF22	-
SR150(劲豹)	150	X24ES-U	IX24	IXU01-□
SRZ150(劲飙)	150	X24ES-U	IX24	IXU01-□
SRV200(劲龙)		X24ES-U	IX24	IXU01-□
JYM250		X24ES-U	IX24	IXU01-□
YA90		W22FP-U	IWF22	-
ZY100T-3(丽鹰100)		U20FS-U	IUF22	-
幸福摩托				
XF50Q	50	W20FP-U	IWF20	-
XF90T	90	W20FP-U	IWF20	-
XF125	125	X24EP-U/U9	IX24B	IXU01-□
XF150	150	X24EP-U/U9	IX24B	IXU01-□

车种	CC	DENSO		
广州五羊				
WH100T-H(喜悦100)	100	U22FS-U	IUF22	-
SCR110(佳御)	110	U22FS-U	IUF22	-
优悦	110	U22FS-U	IUF22	-
WH125(锋芒125)	125	X24EP-U/U9	IX24B	IXU01-□
WH125(追影125)	125	X24EP-U/U9	IX24B	IXU01-□
WH125(CG125)	125	X24EP-U/U9	IX24B	IXU01-□
WH125-F	125	X24EP-U/U9	IX24B	IXU01-□
WH125-H(新概念)	125	X24EP-U/U9	IX24B	IXU01-□
WH125T(追梦125)	125	X24EP-U/U9	IX24B	IXU01-□
GZ125	125	X24EP-U/U9	IX24B	IXU01-□
WY125	125	X24EP-U/U9	IX24B	IXU01-□
三阳 DUKE				
50 丐L5H	50	W20FP-U	IWF20	-
125-5P(A125)	125	U22FS-U	IUF22	-
125RD/RS	125	X24EP-U/U9	IX24B	IXU01-□
重庆力帆				
LF125	125	U22FS-U	IUF22	-
LF125T	125	U22FS-U	IUF22	-
LX125	125	X24EP-U/U9	IX24B	IXU01-□
新大洲				
XDZ35LL	35	W20FP-U	IWF20	-
XDZ50	50	W20FP-U	IWF20	-
XDZ 丐80T	80	W20FP-U	IWF20	-
XDZ 丐90T	90	W20FP-U	IWF20	-
XDZ125	125	U22FS-U	IUF22	-
新大洲本田				
SDH100-21(太阳风)	100	U20FS-U	IUF22	-
SDH100-41(威武)	100	U20FS-U	IUF22	-
SDH100-42(威胜)	100	U22FS-U	IUF22	-
SDH125T-2D	125	U22FS-U	IUF22	-
SDH125T-8D(白马王子)	125	U22FS-U	IUF22	-
SDH125T-21(新生代)	125	U22FS-U	IUF22	-
SDH125T-22(E彩)	125	U22FS-U	IUF22	-
SDH125T-7B(新火鹰)	125	U22FS-U	IUF22	-
SDH125-2(新概念)	125	U20ESR-N	IU20	-
SDH125(万里行)	125	X24EP-U/U9	IX24B	IXU01-□
SDH125-39(新锋锐)	125	X24EP-U/U9	IX24B	IXU01-□
SDH125-7(神雕)	125	X24EP-U/U9	IX24B	IXU01-□
SDH125-42(威猛)	125	X24EP-U/U9	IX24B	IXU01-□
DNH125-46(锐箭)	125	X24EP-U/U9	IX24B	IXU01-□
SDH125-38(超影)	125	X24ES-U	IX24	IXU01-□
SDH125-40(稳重)	125	X24ES-U	IX24	IXU01-□
SDH100-6G(火龙驹)	100	U20FS-U	IUF22	-
SDH150(战鹰)	150	U24ES-N	IU24	IU01-□



车种	CC	DENSO	IRIDIUM POWER	IRIDIUM RACING
常州光阳				
CK100T-A	100	U22FS-U	IUF22	-
南方				
NF50Q	50	W20FP-U	IWF20	-
NF55	55	W20FP-U	IWF20	-
NF90	90	W20FP-U	IWF20	-
NF125	125	W20FP-U	IWF20	-
捷达				
JD90	90	U22FS-U	IUF22	-
JD125	125	X24EP-U/U9	IX24B	IXU01-□
春兰				
CL125	125	U22FS-U	IUF22	-
光阳				
FREEWAY50	50	W20FP-U	IWF20	-
CB125	125	X24EP-U/U9	IX24B	IXU01-□
EY6125	125	X24EP-U/U9	IX24B	IXU01-□
光阳豪迈				
125(GY6)	125	U20FS-U	IUF22	-
光阳名流				
CH100	100	U20FS-U	IUF22	-
北方易初				
DY50	50	W20FP-U	IWF20	-
DY70	70	U22FS-U	IUF22	-
DY90	90	U22FS-U	IUF22	-
DY100	100	U22FS-U	IUF22	-
本田 HONDA				
NJ50	50	W20FP-U	IWF20	-
PA50	50	W20FP-U	IWF20	-
PC50	50	U22FS-U	IUF22	-
SK50	50	W20FP-U	IWF20	-
SZ50	50	W20FP-U	IWF20	-
XL50	50	U22FS-U	IUF22	-
NH60	60	W20FP-U	IWF20	-
AT70	70	U22FS-U	IUF22	-
C70	70	U22FS-U	IUF22	-
CA70	70	U22FS-U	IUF22	-
CD70	70	U22FS-U	IUF22	-
CL70	70	U22FS-U	IUF22	-
CM70	70	U22FS-U	IUF22	-
CD90	90	U22FS-U	IUF22	-
CD90D	90	U22FS-U	IUF22	-
H100S	100	W20FP-U	IWF20	-
WIN100	100	U22FS-U	IUF22	-
XL100S	100	U22FS-U	IUF22	-
CB125T	125	U22FS-U	IUF22	-
CHA125	125	U22FS-U	IUF22	-
CJ125	125	U22FS-U	IUF22	-
CM125	125	U22FS-U	IUF22	-
宗申				
ZS125	125	X24EP-U/U9	IX24B	IXU01-□
ZS125T	125	U24ES-N	IU24	IU01-□
ZS100	100	U22FS-U	IUF22	-
嘉陵				
CJ50	50	W20FP-U	IWF20	-
JH70	70	U22FS-U	IUF22	-
JH90	90	U22FS-U	IUF22	-
JH125	125	X24EP-U/U9	IX24B	IXU01-□
JH145	145	X24EP-U/U9	IX24B	IXU01-□
JH150	150	X24ES-U	IX24	IXU01-□
JH600	400	-	IU24	IU01-□
嘉陵本田				
CB125T	125	U22FS-U	IUF22	-
CB125X(锐影)	125	U20FS-U	IUF22	-
CH125(大鲨)	125	X22EP-U9	IX22B	IXU01-□
CG125	125	X24EP-U/U9	IX24B	IXU01-□
CM125	125	U20FS-U	IUF22	-
雅马哈 YAMAHA				
CY50	50	W20FP-U	IWF20	-

车种	CC	DENSO	IRIDIUM POWER	IRIDIUM RACING
雅马哈 YAMAHA				
V50	50	W20FP-U	IWF20	-
YA50	50	W20FP-U	IWF20	-
YB50	50	W20FP-U	IWF20	-
T80	80	U22FS-U	IUF22	-
YA90	90	W20FP-U	IWF20	-
DX100	100	W20FP-U	IWF20	-
YB100	100	W20FP-U	IWF20	-
YFM100T	100	U22FS-U	IUF22	-
C125B	125	U22FS-U	IUF22	-
CX125	125	U22FS-U	IUF22	-
XC125U/W	125	U22FS-U	IUF22	-
兰翔				
LX50T	50	W20FP-U	IWF20	-
凯基助动车				
KJ50ZL	50	W20FP-U	IWF20	-
济南轻骑				
T151FMI	100	U22ES-N	IU22	IU01-□
K157FMI	125	X24ES-U	IX24	IXU01-□
157FMI	125	X24ES-U	IX24	IXU01-□
QM125	125	X24EP-U/U9	IX24B	IXU01-□
QM125T	125	X24EP-U/U9	IX24B	IXU01-□
轻骑铃木				
AG50	50	W20FP-U	IWF20	-
QM50Q-2B	50	W20FP-U	IWF20	-
ST50	50	W20FP-U	IWF20	-
TB50	50	W20FP-U	IWF20	-
K90	90	W20FP-U	IWF20	-
QS90	90	W20FP-U	IWF20	-
QM100	100	W20FP-U	IWF20	-
QS100	100	W20FP-U	IWF20	-
QX100	100	W20EP-U	IW20	IW01-□
QS110(赛驰)	110	U20FS-U	IUF22	-
QS125(悠E)	125	U20ESR-N	IU20	IU01-□
GS125(铃木王)	125	U22ES-N	IU22	IU01-□
GSX125-3/3A(骏威)	125	U22ES-N	IU22	IU01-□
QS125(风飙)	125	U24ES-N	IU24	IU01-□
GT125(骏驰)	125	U20FS-U	IUF22	-
QS125T-2(丽彩)	125	U20ESR-N	IU20	-
QS150(超人)	150	U20ESR-N	IU20	IU01-□
GZ150(新风暴)	150	U22ES-N	IU22	IU01-□
GSX150(骏威)	150	U22ES-N	IU22	IU01-□
钱江				
QJ125	125	X24EP-U/U9	IX24B	IXU01-□
铃木刃				
A50	50	W20FP-U	IWF20	-
AG50	50	W20FP-U	IWF20	-
A80	80	W20FP-U	IWF20	-
K90	90	W20FP-U	IWF20	-
A100	100	W20FP-U	IWF20	-
AG100	100	W20FP-U	IWF20	-
AX100	100	W20FP-U	IWF20	-
DR100	100	X24EP-U/U9	IX24B	IXU01-□
RC100	100	W20FP-U	IWF20	-
SP100	100	X24EP-U/U9	IX24B	IXU01-□
DF125	125	X24EP-U/U9	IX24B	IXU01-□
DR125	125	X24EP-U/U9	IX24B	IXU01-□
GN125	125	X24EP-U/U9	IX24B	IXU01-□
GS125	125	X24EP-U/U9	IX24B	IXU01-□
S125	125	W20FP-U	IWF20	-
SP125	125	X24EP-U/U9	IX24B	IXU01-□
长春铃木				
AR100	100	W20EP-U	IW20	IW01-□
AX100	100	W20EP-U	IW20	IW01-□
隆鑫摩托				
HY50QT	50	W14FP-UL	-	-
LX90	90	U22FS-U	IUF22	-
LX125	125	X24ES-U	IX24	IXU01-□

DENSO

AUSTRALIA CHINA

INDIA

INDONESIA KOREA

MALAYSIA

PHILIPPINES SAUDIARABIA

SINGAPORE

TAIWAN THAILAND

VIETNAM

JAPAN

& USA

EUROPE MOTOR

CYCLE

SMALL

ENGINE

REFERENCE

NUMBER

DENSO	9	14	16	20	22	24	27	29	31	32	34	35	DENSO	9	14	16	20	22	24	27	29	31	32	DENSO	9	14	16	20	22	24	27	31
NGK	2	4	5	6	7	8	9	9.5	10	10.5	11	11.5	CHAMPION	18	16,14	12,11	10,9	8,7	6,63,61	4,59	57	55	53	BOSCH	10	9	8	7,6	5	4	3	2



DENSO

车种	CC	DENSO	IRIDIUM POWER	IRIDIUM RACING
隆鑫摩托				
CY80	80	W22EP-U	IW22	-
AX100	100	W20EP-U	IW20	IW01-□
望江摩托				
WJ100	100	U22FS-U	IUF22	-
WJ125	125	X24ES-U	IX24	IXU01-□
大江摩托				
DJ100	100	U22FS-U	IUF22	-

车种	CC	DENSO	IRIDIUM POWER	IRIDIUM RACING
大江摩托				
DJ125	125	X24ES-U	IX24	IXU01-□
DJ150	150	X24ES-U	IX24	IXU01-□
银刚科技				
YG100	100	U22FS-U	IUF22	-
YG125	125	X24ES-U	IX24	IXU01-□
YG150	150	X24ES-U	IX24	IXU01-□

CHINA AUSTRALIA

INDIA

INDONESIA

KOREA

MALAYSIA

PHILIPPINES

SAUDI ARABIA

SINGAPORE

TAIWAN

THAILAND

VIETNAM

JAPAN

EUROPE & USA

MOTOR CYCLE

SMALL ENGINE

CROSS REFERENCE

PART NUMBER



MODEL	DENSO	TJ	IRIDIUM POWER
TOYOTA KIRLOS KAR MOTORS LTD			
QUALIS	-	W16TT	-
COROLLA	-	K16TT	IK16
INNOVA	-	KH20TT	-
ETIOS 1.2, 1.5, ETIOS LIVA 1.2/1.5	-	KH20TT	-
HONDA CARS INDIA LTD			
ACCORD (MODEL UPTO JUL-2003)	-	K16TT	IK16
CITY 1.3/1.5 (MODEL UP TO SEPTEMBER, 2008), BRIO, AMAZE	-	K20TT	IK20
CITY<NEW> (2008.10~), JAZZ	-	-	IK20
CIVIC 1.6/1.8i, 2.0i	-	-	IK20
ACCORD 2.4i/3.0i (AUG-2003 ONWARDS), CR-V	-	K20TT	IK20
HYUNDAI MOTOR INDIA LTD			
SONATA 2.4, EMBARA, ACCENT 1.5i/1.6i, ELANTRA, GETZ 1.3i, SANTRO 1.1i, VERNA 1.6, i10 1.1 L, EON (MODEL UPTO 2013)	K16PR-U11	K16TT	IK16
SONATA 2.0/2.4, SONATA GOLD	-	W20TT	IW20
i10/i20 (KAPPA ENGINE), EON (MODEL FROM 2014), GRAND i10, i20 ELITE, XCENT	-	XUH20TTI	-
MARUTI SUZUKI INDIA LTD			
ALL CARB MODEL-GYPSY 1.3, ZEN 1.0, MARUTI 800, OMNI 0.8, OMNI 0.8 (MPFI), MARUTI 1000	W16EPR-U	W16TT	-
ALL CARB MODEL	-	W16TT	-
VERSA 1.3i, GYPSY KING 1.3i, SX4, SWIFT 1.3i, BALENO 1.6 (BS II, III), ZEN 1.0i 16V, ESTEEM 1.3 (MPFI), EECO	K20PR-U	K20TT	IK20
GRAND VITARA 1.6/2.0/2.7	-	K20TT	IK20
ALTO 800/12V, ALTO 1.1i16V, MARUTI 800i 12V, WAGON-R 1.1i, ZEN ESTILLO, ALTO 0.8i 12V	XU22EPR-U	XU22TT	IXU22
A STAR, RITZ, WAGON R (K- SERIES ENGINE), ALTO K-10, SWIFT (BEFORE OCT-2014), SWIFT DZIRE (BEFORE FEB-2015), ERTIGA (K- SERIES ENGINE), CELERIO, WAGON R STINGRAY	-	XU22TT	IXU22
ESTEEM 1.3 (CARBURETOR MODEL)	W20EPR-U	W20TT	IW20
TATA MOTORS LTD			
INDICA 1.4/ 1.4i, INDICA XETA, INDIGO 1.4i, INDIGO MARINA, INDIGO XL, NANO	K20PR-U	K20TT	IK20
INDICA VISTA, INDIGO MANZA	XU22EPR-U	XU22TT	IXU22
FIAT INDIA AUTOMOBILES LTD			
ADVENTURE, PALIO 1.6i.e, SIENA 1.6i.e	-	K16TT	IK16
UNO 1.0i/1.2,	K20PR-U	K20TT	IK20
PALIO 1.2i.e, STILE 1.1i, SPORT, SIENA 1.2i	XU22EPR-U	XU22TT	IXU22
LINEA 1.4L, GRANDE PUNTO 1.2L/ 1.4 L, PUNTO EVO	XU22EPR-U	XU22TT	IXU22
FORD INDIA PVT. LTD			
IKON 1.3i	T20EPR-U	T20TT	IT20
FIESTA 1.4/1.6, FUSION 1.6, IKON 1.6i-8V, FIGO, FIESTA CLASSIC	T16VR-U10	TV16TT	ITV16
SKODA AUTO INDIA PVT. LTD			
SUPERB 2.8 AZM, OCTAVIA 1.8/2.0	-	K20TT	IK20
BMW			
740i / 740Li / 320i	-	-	IK20
RENAULT			
Kwid	XU22EPR-U	XU22TT	IXU22
LAND ROVER			
DISCOVERY III 4.4 4x4 (04-09), RANGE ROVER SPORT (05-) 4.2 4x4 & 4.4 4x4	-	-	IK16
DISCOVERY IV (09-) 5.0 V8 4x4, FREELANDER (98-06) 1.8, 1.8i, 2.5	-	-	IK20
FREELANDER 2 (06-) 2.0 Si4 4x4, RANGE ROVER EVOQUE 2.0 4x4	-	-	ITV22
GENERAL MOTORS INDIA PVT. LTD			
ASTRA 1.6i, CORSA 1.6i,	-	W16TT	-
SPARK 1.0, UVA 1.2	-	W16TT	-
OPTRA 1.8,	K20PR-U	K20TT	IK20
AVEO 1.4/1.6, OPTRA 1.6, SRV	-	K20TT	IK20
BEAT	XU22EPR-U	XU22TT	IXU22
CORSA 1.4i, SWING 1.4, SAIL 1.4	-	W20TT	IW20
MITSUBISHI MOTORS			
LANCER 1.5/1.8	-	W16TT	-
CEDIA 2.0	K16PR-U11	K16TT	IK16
HINDUSTAN MOTORS LTD			
AMBASSADOR 1.5/1.8	-	W16TT	-

DENSO
 AUSTRALIA
 CHINA
 INDIA
 INDONESIA
 KOREA
 MALAYSIA
 PHILIPPINES
 SAUDI ARABIA
 SINGAPORE
 TAIWAN
 THAILAND
 VIETNAM
 JAPAN
 EUROPE
 MOTOR
 CYCLE
 SMALL
 ENGINE
 REFERENCE
 NUMBER
 PART

DENSO	9	14	16	20	22	24	27	29	31	32	34	35	DENSO	9	14	16	20	22	24	27	29	31	32	DENSO	9	14	16	20	22	24	27	31
NGK	2	4	5	6	7	8	9	9.5	10	10.5	11	11.5	CHAMPION	18	16,14	12,11	10,9	8,7	6,63,61	4,59	57	55	53	BOSCH	10	9	8	7,6	5	4	3	2



▶ Spark plug color codes: ■ for Iridium Tough and Iridium Plugs and Iridium TT, ■ for Iridium Power, ■ for Iridium Racing and Two Tops Plugs, ■ for Platinum Plugs and Platinum TT, and black for general spark plugs.

DENSO

MODEL	DENSO		
DAEWOO MOTORS			
MATIZ	-	W16TT	-

AUSTRALIA

CHINA

INDONESIA

INDONESIA

INDONESIA

INDONESIA

INDONESIA

INDONESIA

INDONESIA

INDONESIA

INDONESIA

INDONESIA

INDONESIA

INDONESIA

INDONESIA

INDONESIA

INDONESIA

INDONESIA



MODEL	DENSO	IRIDIUM POWER
BAJAJ		
AVENGER		IU24D
BOXER (AT/CT)		IUF22
BYK		IUF22
CALIBER (ALL MODELS)		IUF22
CHAMPION		IUF22
CNG-3-WHEELER		IWF20
CT 100DX		IUF22
DISCOVER 100/125/150 DTSI (ALL NEW MODELS)		IUF22
DISCOVER 100M		IUF22
DISCOVER 115		IUF22
DISCOVER 125 DTSI (OLD MODELS)		IU24D
DISCOVER 135 DTSI		IU24D
ELIMINATOR		IU24D
FUSION		IUF22
KTM DUKE		IU24D
LEGEND NXT		IUF22
M80-4S		IUF22
PLATINA 100CC		IUF22
PLATINA 125CC		IU24D
PULSAR 135 CC DTSI		IUF22
PULSAR 150/180/200		IU24D
PULSAR 200 NS (LEFT HAND & RIGHT HAND SIDE)		IU24D
PULSAR 220 (LEFT SIDE)		IU24D
PULSAR 220 (RIGHT SIDE)		IU24D
WIND		IUF22
XCD 135 DTSI		IU24D
XCD125 DTSI		IU24D
ENFIELD		
BULLET LB 350 MACHISMO		IW22
BULLET LB 500 MACHISMO		IW27
BULLET STD 350		IWF20
BULLET UCE 350 THUNDERBIRD (TWIN SPARK PLUG)		IW16
BULLET UCE 350 THUNDERBIRD (TWIN)		IU22D
HERO		
ACHIEVER		IU24D
AMBITION		IX24B
CBZ- STAR		IX24B
CBZ XTREME		IU24D
CBZ-GOLD		IX24B
CD (ALL MODELS)		IUF22
GLAMOUR		IU20
GLAMOUR FI		IU20
HF DAWN		IUF22
HF- DELUXE ECO		IUF22
HF-DELUXE		IUF22
HUNK		IU24D
IGNITOR		IU20
IMPULSE		IU24D
JOY		IUF22
KARIZMA		IX24B
KARIZMA-ZMR		IX24B
MAESTRO (SCOOTER)		IU22D
PASSION (ALL MODELS)		IUF22
PASSION PRO X		IU22D
PLEASURE		IUF22
SPLENDOR (ALL MODELS)		IUF22
STREET		IUF22
STREET SMART		IUF22
SUPER SPLENDOR		IU20
XTREME		IU24D
XTREME SPORT		IU24D
HONDA		
ACTIVA (MODEL FROM MARCH'09 UP TO JAN'13)		IU22D
ACTIVA (MODEL UP TO FEB'2009)		IUF22
AVIATOR		IUF22
CB SHINE		IU22D
CB TRIGGER		IU24D
CB TWISTER		IU22D

DENSO

AUSTRALIA CHINA INDIA INDONESIA KOREA MALAYSIA PHILIPPINES SAUDIARABIA SINGAPORE TAIWAN THAILAND VIETNAM JAPAN EUROPE MOTOR & USA CYCLE SMALL ENGINE CROSS PART REFERENCE NUMBER



DENSO		DENSO	IRIDIUM POWER
HONDA			
CB UNICORN			
			IU24D
CB UNICORN (160CC)			
			IU24D
CBF STUNNER			
			IU22D
CBR150R			
			IU24
CBR250R			
			IU24
DIO (MODEL AFTER APR'12)			
			IU22D
DIO (MODEL UP TO MARCH 2012)			
			IUF22
DREAM CD 110			
			IU22D
DREAM NEO			
			IU22D
DREAM YUGA			
			IU22D
ETERNO			
			IUF22
SHINE			
			IU22D
UNICORN			
			IU24D
UNICORN DAZZLER			
			IU24D
KINETIC			
BOSS			
			IUF22
GF (ALL MODELS)			
			IU22
NOVA (ALL MODELS)			
			IUF22
VELOCITY			
			IUF22
LML			
BEAMER			
			IU24
FREEDOM			
			IU24
GRAPTOR			
			IU24
SCOOTERS			
			IW16
M&M			
CENTURO			
			IUF22
CENTURO ROCKSTAR			
			IUF22
DURO			
			IUF22
FLYTE			
			IUF22
PANTERO			
			IUF22
RODEO			
			IUF22
SUZUKI			
ACCESS 125			
			IUF22
GIXXER			
			IU20
SWISH 125			
			IUF22
TVS			
APACHE (ALL MODELS)			
			IU22
CENTRA			
			IU22
FIERO (ALL MODELS)			
			IU22
FLAME			
			IU22
JUPITER			
			IU24D
PEP PLUS			
			IUF22
PHEONIX			
			IU24D
RTR 160			
			IU22
SAMURAI			
			IWF22
SCOOTY PEP			
			IUF22
SHAOLIN			
			IWF22
SHOGUN			
			IWF22
SPORT			
			IUF22
STAR (ALL MODELS)			
			IUF22
STAR CITY			
			IUF22
STAR CITY PLUS			
			IU24D
SUPER HD 2-STROKE			
			IWF22
VICTOR 110			
			IUF22
VICTOR EDGE 125			
			IU22
VICTOR GLX 125			
			IU22
ZEST 110			
			IU24D
YAMAHA			
ALPHA (MODEL UP TO FEB'2015)			
			IUF22
CRUX (ALL MODELS)			
			IX22B
ENTICER			
			IUF22
FAZAR (ALL MODELS)			
			IUF22
FZ (ALL MODELS)			
			IU24D
G5			
			IX22B
GLADIATOR			
			IUF22
LIBERO (ALL MODELS)			
			IX22B
RAY			
			IUF22
RAY-Z			
			IUF22



MODEL	DENSO	IRIDIUM POWER
YAMAHA		
RX100		IWF22
RX135		IWF22
RX-Z		IWF22
SS 125		IUF22
SZ-RR 2.0		IU24D
SZ-S		IU24D
YBR 110		IUF22
YBX		IUF22
YD		IUF22
YZF R15		IU24
YZF R15 2.0		IU24

DENSO

AUSTRALIA CHINA

INDIA

INDONESIA

KOREA

MALAYSIA

PHILIPPINES

SAUDIARABIA

SINGAPORE

TAIWAN

THAILAND

VIETNAM

JAPAN

EUROPE

& USA

MOTOR

SMALL

CROSS

PART

ENGINE REFERENCE NUMBER



DENSO

MODEL	ENGINE	DENSO				
AMC						
CJ5, CJ6, CJ7	J5R-800	J16HR-U10	-	-	-	-
AUDI						
A3, A4, A5, A6, A8	ABC	K20PBR-S10	IK20TT	K20TT	IK20	VK20
Q5		K20PBR-S10	IK20TT	K20TT	IK20	VK20
TT		K20PBR-S10	IK20TT	K20TT	IK20	VK20
BMW						
318i '84-'85, 325i, 523 '87-'92		W16EXR-U	IW16TT	W16TT	IW16	VW16
318i '91-'99, 325i '93-'05		K20TXR	IK20TT	K20TT	IK20	VK20
325i '06, 328i, 520i '07-'09		K20HR-U11	IKH20TT	KH20TT	IKH20	VKH20
328i, 520i '96-'00,		K20TXR	IK20TT	K20TT	IK20	VK20
520i, 523i		K20TXR	IK20TT	K20TT	IK20	VK20
730i V8, 740i V8, 740iL V8		K20TXR	IK20TT	K20TT	IK20	VK20
CHEVROLET						
AVEO 1.5L	E-TEC II	W20EXR-U	IW20TT	W20TT	IW20	VW20
CAPTIVA	ECOTEC	W20EXR-U	IW20TT	W20TT	IW20	VW20
KALOS	F14D3	K20PR-U11	IK20TT	K20TT	IK20	VK20
SPARK 1.8L	S-TEC II	W16EXR-U	IW16TT	W16TT	IW16	VW16
	LS-TECH	XU22PR9	-	XU22TT	IXU22	VXU22
SPIN		XU22PR9	-	XU22TT	IXU22	VXU22
TAVERA 2.2L, NEW BLAZER 2.2L		K16PR-U	IK16TT	K16TT	IK16	VK16
ZAFIRA 1.8L		K16PR-U	IK16TT	K16TT	IK16	VK16
CHRYSLER						
CHEROKEE 2.5L	KENOSHA	KJ16CR-L11	IK16TT	K16TT	IK16L	-
CHEROKEE COUNTRY	KENOSHA	KJ16CR-L11	IK16TT	K16TT	IK16L	-
CHEROKEE LIMITED (+) (XJ)	KENOSHA	KJ16CR-L11	IK16TT	K16TT	IK16L	-
CHEROKEE SPORT	KENOSHA	KJ16CR-L11	IK16TT	K16TT	IK16L	-
GRAND CHEROKEE (ZJ)	KENOSHA	KJ16CR-L11	IK16TT	K16TT	IK16L	-
WRANGLER (YJ)	KENOSHA	KJ16CR-L11	IK16TT	K16TT	IK16L	-
CITROEN						
BX 19 GTi		Q20P-U	IQ20TT	Q20TT	IQ20	VQ20
CX Pallas, DYANE, PFAF		W20FP-U	-	WF20TT	IWF20	-
GS, GS Pallas, CHIC		W20EX-U	IW20TT	W20TT	IW20	VW20
VAN CLUB 1220, COTTAGE		W20EX-U	IW20TT	W20TT	IW20	VW20
DAEWOO						
ESPIRO, NEXIA, MATIZ		W16EXR-U	IW16TT	W16TT	IW16	VW16
DAIHATSU						
AYLA	1KR-FE	XU20HR9	-	XUH20TTI	IXUH20	VXUH20
CERIA	ED-10	W20EX-U	IW20TT	W20TT	IW20	VW20
CHARADE 1.0 CX	CB-23	W16EX-U	IW16TT	W16TT	IW16	VW16
CHARADE 1.0, XG	CB-41	W16EX-U	IW16TT	W16TT	IW16	VW16
CHARADE TURBO 1.0	CB-60	W16EX-U	IW16TT	W16TT	IW16	VW16
CHARMANT	4A	W16EX-U	IW16TT	W16TT	IW16	VW16
CLASSY, WINNER	HL-C	K20PR-U11	IK20TT	K20TT	IK20	VK20
ESPASS 1.5 (EFI)	HC-E	K20TNR-S	IK20TT	K20TT	IK20	VK20
ESPASS 1.6	HD	K20P-U	IK20TT	K20TT	IK20	VK20
FELLOW MAX	ZM	W20EP-U	IW20TT	W20TT	IW20	VW20
FEROZA, TARUNA	HD-C	K20PR-U11	IK20TT	K20TT	IK20	VK20
GRAND MAX	K3/3SZ	XU22PR9	-	XU22TT	IXU22	VXU22
HIJET 1000, ZEBRA 1.0	CB-41	W16EX-U	IW16TT	W16TT	IW16	VW16
HIJET 55 WIDE	AB-20	W16EX-U	IW16TT	W16TT	IW16	VW16
HIJET S38P	ZM	W20EP-U	IW20TT	W20TT	IW20	VW20
LUXIO	3SZ	XU22PR9	-	XU22TT	IXU22	VXU22
SIRION		K20PR-U11	IK20TT	K20TT	IK20	VK20
TARUNA (EFI)	AD-E	K20TNR-S	IK20TT	K20TT	IK20	VK20
TERIOS		XU22PR9	-	XU22TT	IXU22	VXU22
XENIA 1.0	EJ-DE	K16PR-U11	IK16TT	K16TT	IK16	VK16
XENIA VVTi		XU22PR9	-	XU22TT	IXU22	VXU22
XENIA<NEW>		SC16HR11	-	-	-	-
YRV	K3-VE	K20R-U11	IK20TT	K20TT	IK20	VK20
ZEBRA 1.3, ESPASS 1.3	HC	K20P-U	IK20TT	K20TT	IK20	VK20
FORD						
CHALLENGE/BRILLIANT 2.0L	FS	K16PR-U	IK16TT	K16TT	IK16	VK16
ESCAPE 2.0L		PT16VR10	ITV16TT	-	ITV16	-
EVEREST		T20EPR-U15	IT20TT	T20TT	IT20	VT20
FIESTA		T20EPR-U15	IT20TT	T20TT	IT20	VT20
FOCUS		-	IT20TT	-	IT20	VT20
LASER 1.3L	E3	W20EP-U	IW20TT	W20TT	IW20	VW20

CHINA AUSTRALIA

INDIA

INDONESIA

KOREA

PHILIPPINES MALAYSIA

SAUDI ARABIA

SINGAPORE

TAIWAN

THAILAND

VIETNAM

JAPAN





EUROPE & USA

MOTOR CYCLE

SMALL ENGINE

CROSS REFERENCE

PART NUMBER

MODEL	ENGINE	DENSO				
FORD						
LASER 1.5L	E5	W20EP-U	IW20TT	W20TT	IW20	VW20
LASER CHAM 1.8L	BP	K20PR-U	IK20TT	K20TT	IK20	VK20
LASER GALA 1.6L	B6	K20PR-U	IK20TT	K20TT	IK20	VK20
LASER GHIA 1.6L <NEW>	B6	K16PR-U	IK16TT	K16TT	IK16	VK16
LASER GHIA 1.8L <NEW>	BP	K16PR-U	IK16TT	K16TT	IK16	VK16
LASER SONIC 1.3L	B3	K20PR-U	IK20TT	K20TT	IK20	VK20
LINX 1.8L		K20PR-U11	IK20TT	K20TT	IK20	VK20
RANGER		T20EPR-U15	IT20TT	T20TT	IT20	VT20
TELSTAR GRAND	FE	Q20PR-U	IQ20TT	Q20TT	IQ20	VQ20
TELSTAR THUNDER	FE	Q20PR-U	IQ20TT	Q20TT	IQ20	VQ20
HOLDEN						
CALLAIS		Q20P-U	IQ20TT	Q20TT	IQ20	VQ20
GEMINI, CAMIRA, TORANA 1.3L		W20EX-U	IW20TT	W20TT	IW20	VW20
HONDA						
ACCORD 3.5		SXU22HCR11S	-	-	-	-
ACCORD CIELO	SV4	KJ20CR-L11	IK20TT	K20TT	IK20L	-
ACCORD ELEGEND	JHM	W20EXR-U11	IW20TT	W20TT	IW20	VW20
ACCORD EXECUTIVE 1.6L	SA6	W20EXR-U11	IW20TT	W20TT	IW20	VW20
ACCORD MAESTRO	SM4	KJ16CR-L11	IK16TT	K16TT	IK16L	-
ACCORD PRESTIGE	SE3	W20EXR-U11	IW20TT	W20TT	IW20	VW20
ACCORD VTI	SB6	KJ20CR-L11	IK20TT	K20TT	IK20L	-
ACCORD	NP2	-	IXEH22TT	-	-	VCH20
BRIO/BRIO SATYA	L13A/L12B	K20PR-U11	IK20TT	K20TT	IK20	VK20
CITY	SX8	K16PR-U11	IK16TT	K16TT	IK16	VK16
CITY <NEW>		K20PR-U11	IK20TT	K20TT	IK20	VK20
CIVIC EXCELLENT 1.3L, 1.5L	JHM	W20EXR-U11	IW20TT	W20TT	IW20	VW20
CIVIC FACELIFT 2.0		K20PR-U	IK20TT	K20TT	IK20	VK20
CIVIC FERIO, JM	SO4	K16PR-U11	IK16TT	K16TT	IK16	VK16
CIVIC GENIO, ESTILO	SR3/SR4	K20PR-U11	IK20TT	K20TT	IK20	VK20
CIVIC GRAND	SH3/SH4	K16PR-U11	IK16TT	K16TT	IK16	VK16
CIVIC WONDER	SB3/SB4	W20EXR-U11	IW20TT	W20TT	IW20	VW20
CRV		SKJ20DR-M11	IK20TT	-	IK20L	-
FIT		K20PR-U11	IK20TT	K20TT	IK20	VK20
FREED		K20PR-U11	IK20TT	K20TT	IK20	VK20
HRV		-	-	-	-	-
JAZZ		K20PR-U11	IK20TT	K20TT	IK20	VK20
JAZZ RS		SKJ20DR-M11	IK20TT	-	IK20L	-
MOBILIO	L15A1	-	-	-	-	-
ODDYSEY		KJ16CR-L11	IK16TT	K16TT	IK16L	-
STREAM 1.7		KJ20CR-L11	IK20TT	K20TT	IK20L	-
STREAM 2.0		KJ20DR-M11	IK20TT	K20TT	IK20L	-
HYUNDAI						
ACCENT 1.5		K16R-U11	IK16TT	K16TT	IK16	VK16
ACCENT, CAKRA		Q20PR-U	IQ20TT	Q20TT	IQ20	VQ20
ATOZ		K20PR-U	IK20TT	K20TT	IK16	VK16
AVEGA		K16PR-U11	IK16TT	K16TT	IK16	VK16
AVEGA <GRAND>		-	-	-	IXUH22I	VXUH22I
COUPE 1.5i		K20PR-U11	IK20TT	K20TT	IK20	VK20
ELANTRA, NENGGALA		W20EPR-U	IW20TT	W20TT	IW20	VW20
EXEL 1.5i		K20PR-U11	IK20TT	K20TT	IK20	VK20
GETZ		K16PR-U11	IK16TT	K16TT	IK16	VK16
MATRIX		K16R-U11	IK16TT	K16TT	IK16	VK16
MATRIX 1600cc		K20PR-U	IK20TT	K20TT	IK20	VK20
SANTA FE		PK16PR-L11	IK16TT	-	IK16	VK16
SONATA		W20EPR-U11	IW20TT	W20TT	IW20	VW20
TRAJET 2.0		W20EXR-U	IW20TT	W20TT	IW20	VW20
TUCSON		K16PR-U11	IK16TT	K16TT	IK16	VK16
VERNA		K16PR-U11	IK16TT	K16TT	IK16	VK16
ISUZU						
TROOPER 3,2L		K20PR-U11	IK20TT	K20TT	IK20	VK20
TROOPER 3,5L		PK16PR11	IK16TT	-	IK16	VK16
KIA						
CARENS 1.8/2.0 (DOHC)		K20PR-U	IK20TT	K20TT	IK20	VK20
CARNIVAL GSL 2.5 (DOHC)		K20PR-U11	IK20TT	K20TT	IK20	VK20
CARNIVAL LPG 2.5 (DOHC)		K20PR-U	IK20TT	K20TT	IK20	VK20
PICANTO 1.0		K16PR-U	IK16TT	K16TT	IK16	VK16
PICANTO (NEW)		XU20HR9	-	XUH22TT	IXUH20I	VXUH20I

DENSO
 AUSTRALIA CHINA INDIA INDONESIA KOREA MALAYSIA PHILIPPINES SAUDIARABIA SINGAPORE TAIWAN THAILAND VIETNAM JAPAN & USA EUROPE MOTOR SMALL PART CROSS ENGINE REFERENCE NUMBER

DENSO	9	14	16	20	22	24	27	29	31	32	34	35	DENSO	9	14	16	20	22	24	27	29	31	32	DENSO	9	14	16	20	22	24	27	31
NGK	2	4	5	6	7	8	9	9.5	10	10.5	11	11.5	CHAMPION	18	16,14	12,11	10,9	8,7	6,63,61	4,59	57	55	53	BOSCH	10	9	8	7,6	5	4	3	2



PART NUMBER	CROSS REFERENCE	ENGINE	DENSO	DENSO			DENSO	
				IRIDIUM TT	IRIDIUM RACING	IRIDIUM POWER	IRIDIUM TOUGH	IRIDIUM TOUGH
KIA								
		RIO 1.5, SHUMA 1.8, SPECTRA 1.8	K20PR-U	IK20TT	K20TT	IK20	VK20	
		SEDONA 2.5	K16PR-U11	IK16TT	K16TT	IK16	VK16	
		SEDONA 2.9	K16PR-U11	IK16TT	K16TT	IK16	VK16	
		SORENTO	K16PR-U11	IK16TT	K16TT	IK16	VK16	
		SPORTAGE 2.0 (DOHC)	K20PR-U11	IK20TT	K20TT	IK20	VK20	
		SPORTAGE 2.0 (SOHC)	K16PR-U	IK16TT	K16TT	IK16	VK16	
		VISTO	K16PR-U11	IK16TT	K16TT	IK16	VK16	
LAND-ROVER								
		DEFENDER 3.9L	W16EPR-U	IW16TT	W16TT	IW16	VW16	
		DISCOVERY 3.9L	W16EPR-U	IW16TT	W16TT	IW16	VW16	
		FREE LANDER 1.8L	W16EPR-U	IW16TT	W16TT	IW16	VW16	
		RANGE ROVER 4.0L, 4.6L <NEW>	W16EPR-U	IW16TT	W16TT	IW16	VW16	
		RANGE ROVER CLASSIC 3.9L	W16EPR-U	IW16TT	W16TT	IW16	VW16	
MAZDA								
		323 ELITE	E3	W16EX-U	IW16TT	W16TT	IW16	VW16
		323 INTERPLAY	B6N	K16PR-U	IK16TT	K16TT	IK16	VK16
		626 ('87)	FE	Q20PR-U	IQ20TT	Q20TT	IQ20	VQ20
		626 CAPELLA ('89)	FE	Q20PR-U	IQ20TT	Q20TT	IQ20	VQ20
		626 COUPE MX6	FE	Q20PR-U	IQ20TT	Q20TT	IQ20	VQ20
		808, 616, 929		W16EX-U	IW16TT	W16TT	IW16	VW16
		ASTINA (DOHC)	BP	K16PR-U11	IK16TT	K16TT	IK16	VK16
		B600		W20EP-U	IW20TT	W20TT	IW20	VW20
		BIANTE	LF-VD	-	ITV16TT	-	ITV16	-
		BT-50	MZ-DE	-	ITV20TT	-	ITV20	-
		CRONOS 2.0L	FSN	K16PR-U11	IK16TT	K16TT	IK16	VK16
		CRONOS 2.5L	KL	K16PR-U11	IK16TT	K16TT	IK16	VK16
		CX-7	MZR 2.3	-	ITV20TT	-	ITV20	-
		CX-9	MZI 3.7	-	ITV20TT	-	ITV20	-
		E 2000	FE	Q20PR-U	IQ20TT	Q20TT	IQ20	VQ20
		FAMILIA	BPD	K16PR-U11	IK16TT	K16TT	IK16	VK16
		H 1000, 2000, 3000		W16EX-U	IW16TT	W16TT	IW16	VW16
		LANTIS	BPG	K16PR-U11	IK16TT	K16TT	IK16	VK16
		MAZDA 2		PT16EPR-L13	IT16TT	-	IT20	VT20
		MAZDA 2 (2009 -)	MZR 1.5	K16PR-U11	IK16TT	K16TT	IK16	VK16
		MAZDA 6		PT16EPR-L13	IT16TT	-	IT20	VT20
		MAZDA 8	L3VE	-	ITV16TT	-	ITV16	-
		MR 90, VAN TREND	UCN	W16EX-U	IW16TT	W16TT	IW16	VW16
		RX-8	RENEISIS	-	-	-	-	-
		VX-1	K14B	XU20EPR-U	-	-	IXU20	VXU20
MERCEDES BENZ								
		180, 190	M 102	W16EP-U	IW16TT	W16TT	IW16	VW16
		200 (W123)	M 102	W20EP-U	IW20TT	W20TT	IW20	VW20
		200, 230	M 115	W16EX-U	IW16TT	W16TT	IW16	VW16
		200E (W124)	M 103	T20EP-U	IT20TT	T20TT	IT20	VT20
		230 (W123)	M 102	W20EP-U	IW20TT	W20TT	IW20	VW20
		230 S	M 115	W20EX-U	IW20TT	W20TT	IW20	VW20
		230E (W124)	M 103	T20EP-U	IT20TT	T20TT	IT20	VT20
		250, 250 S	M 123	W20EX-U	IW20TT	W20TT	IW20	VW20
		280 (W123)	M 110	W20EP-U	IW20TT	W20TT	IW20	VW20
		280, 280 S, 280 E	M 110	W20EP-U	IW20TT	W20TT	IW20	VW20
		280E (W123)	M 102	W20EP-U	IW20TT	W20TT	IW20	VW20
		300 SEL	M 104	K20P-U	IK20TT	K20TT	IK20	VK20
		300E (W124)	M 103	T20EP-U	IT20TT	T20TT	IT20	VT20
		C180, C200, C230	M 111	Q16P-U11	IQ16TT	Q16TT	IQ16	VQ16
		E220, E230 (W210)	M 111	Q16P-U11	IQ16TT	Q16TT	IQ16	VQ16
		E320 (W124), S320	M 104	Q16P-U11	IQ16TT	Q16TT	IQ16	VQ16
		E320 (W210)	M 104	Q16P-U11	IQ16TT	Q16TT	IQ16	VQ16
		JEEP 280 GE	M 110	W20EP-U	IW20TT	W20TT	IW20	VW20
		JEEP 300 GE	M 104	Q16P-U11	IQ16TT	Q16TT	IQ16	VQ16
MITSUBISHI								
		COLT L300	4G32	W20EP-U	IW20TT	W20TT	IW20	VW20
		COLT T120 SS	4G17	W20EP-U	IW20TT	W20TT	IW20	VW20
		DAN GAN 1.5L	4G15	W22EP-U	-	W22TT	IW22	VW22
		DAN GAN 1.5L SOHC	4G15	W22EP-U	-	W22TT	IW22	VW22
		DAN GAN 1.6L DOHC	4G61	W20EP-U	IW20TT	W20TT	IW20	VW20
		DAN GAN 1.8L DOHC	4G67	W16EP-U	IW16TT	W16TT	IW16	VW16
		ETERNA ('87) 2.0L	4G63	W20EP-U	IW20TT	W20TT	IW20	VW20



MODEL	ENGINE	DENSO	IRIDIUM U	TJ	IRIDIUM POWER	IRIDIUM TOUGH
MITSUBISHI						
ETERNA 2.0L DOHC	4G63	W22EP-U	-	W22TT	IW22	VW22
ETERNA 2.0L SOHC	4G63	W20EP-U	IW20TT	W20TT	IW20	VW20
GALANT II 1.8L	4G37	K20P-U	IK20TT	K20TT	IK20	VK20
GALANT SIGMA 1.6L YC	4G32	W20EP-U	IW20TT	W20TT	IW20	VW20
GALANT SIGMA 1.6L YD	4G32	W20EP-U	IW20TT	W20TT	IW20	VW20
GALANT SIGMA 2.0L YC	4G52	W20EP-U	IW20TT	W20TT	IW20	VW20
GALANT SIGMA 2.0L YD	4G63	W20EP-U	IW20TT	W20TT	IW20	VW20
GALANT ST 2.5L	6A13	K20PR-U	IK20TT	K20TT	IK20	VK20
GALANT V6 2.0L	6A12	K16P-U	IK16TT	K16TT	IK16	VK16
GALANT VR 2.0L	4G63	K20PR-U	IK20TT	K20TT	IK20	VK20
GRANDIS	4G69	IKH20	IKH20TT	-	IKH20	VKH20
JET STAR	U21	W16EX-U	IW16TT	W16TT	IW16	VW16
KUDA 1.6L	4G18	W16EP-U	IW16TT	W16TT	IW16	VW16
LANCER EX 2.0 GT <NEW>		PQ16R	IQ16TT	-	IQ16	VQ16
LANCER GLX, SEI 1.6L	4G92	W20EP-U	IW20TT	W20TT	IW20	VW20
LANCER LA 1.4L	4G33	W20EP-U	IW20TT	W20TT	IW20	VW20
LANCER LA 1.6L	3G32	W20EP-U	IW20TT	W20TT	IW20	VW20
LANCER SL 1.4L	4G33	W20EP-U	IW20TT	W20TT	IW20	VW20
LE-DAN GAN 1.5L SOHC	4G15	K16P-U	IK16TT	K16TT	IK16	VK16
LE-DAN GAN 1.6L SOHC	4G92	K20P-U	IK20TT	K20TT	IK20	VK20
LE-DAN GAN 1.8L DOHC	4G93	W16EP-U	IW16TT	W16TT	IW16	VW16
MAVEN	4G15	K20PR-U	IK20TT	K20TT	IK20	VK20
MIRAGE	3A92	K16PR-U	IK16TT	K16TT	IK16	VK16
OUTLANDER		FXE20HR-11	IXEH20TT	-	-	VFXEH20
PAJERO	4G72	W20EP-U	IW20TT	W20TT	IW20	VW20
NISSAN						
CEFIRO	RB20E	Q20PR-U11	IQ20TT	Q20TT	IQ20	VQ20
DATSUN GO/GO+	HR12DE	-	-	-	-	-
EVALIA		FXE20HR-11	IXEH20TT	-	-	VFXEH20
GENESIS	GA16CE	Q20PR-U	IQ20TT	Q20TT	IQ20	VQ20
INFINITY	VQ30	K20PR-U	IK20TT	K20TT	IK20	VK20
JUKE, EVALIA	HR15DE	FXE20HR-11	IXEH20TT	-	-	VFXEH20
LAUREL	L 20 B	W20EP-U	IW20TT	W20TT	IW20	VW20
LIVINA, GRAND LIVINA, LIVINA X-GEAR	HR15DE	FXE20HR-11	IXEH20TT	-	-	VFXEH20
MARCH	HR12DE	VFXEH20	IXEH20TT	-	-	VFXEH20
MURANO, ELGRAND	VQ35DE	VKH16	IKH20TT	-	IKH16	VKH16
N 1400, 120 J, 160 J, 180 B		W16EX-U	IW16TT	W16TT	IW16	VW16
N 260C, 280C, 1600 (SSS)		W20EX-U	IW20TT	W20TT	IW20	VW20
PATROL (4 Sil.-Carburator)	TB42S	W20EP-U	IW20TT	W20TT	IW20	VW20
PATROL (6 Sil.-Injection)	TB24	W20EP-U	IW20TT	W20TT	IW20	VW20
PICK UP 800, 1500, 1600 SENA		W16EX-U	IW16TT	W16TT	IW16	VW16
SENTRA	E16	W20EP-U	IW20TT	W20TT	IW20	VW20
	GA16S	Q20P-U11	IQ20TT	Q20TT	IQ20	VQ20
SENTRA COUPE	CA16DE	Q20PR-U11	IQ20TT	Q20TT	IQ20	VQ20
SERENA 2.0L	5R20	Q20PR-U	IQ20TT	Q20TT	IQ20	VQ20
STANZA 1.6L	CA 16	W16EP-U	IW16TT	W16TT	IW16	VW16
TEANA <NEW>	VQ25DE	FXE20HR-11	IXEH20TT	-	-	VFXEH20
TERRANO	Z24	W20EP-U	IW20TT	W20TT	IW20	VW20
X-TRAIL	MR20DD	FXE20HR-11	IXEH20TT	-	-	VFXEH20
X-TRAIL 2.5	QR25DE	K16HPR-U11	IKH16TT	KH16TT	IKH16	VKH16
X-TRAIL <NEW>		-	-	-	-	-
OPEL						
ADMIRAL		W20FP-U _s	-	WF20TT	IWF20	-
BLAZER 2.2i DOHC	SEC/DOHC	K20TXR	IK20TT	K20TT	IK20	VK20
BLAZER 2.2i SOHC	NEC/SOHC	K20TXR	IK20TT	K20TT	IK20	VK20
KADETT 1.3L		W16EX-U	IW16TT	W16TT	IW16	VW16
KAPTAIN		W20FP-U _s	-	WF20TT	IWF20	-
OPTIMA CDX, CDX A 1.8i, CLUB	SE OHC II	W16EPR-U	IW16TT	W16TT	IW16	VW16
OPTIMA GLS 1.8i	SE OHC II	W16EPR-U	IW16TT	W16TT	IW16	VW16
OPTIMA SPORT 1.8L	SE OHC II	W16EPR-U	IW16TT	W16TT	IW16	VW16
OPTIMA SPORT 2.0L	NE OHC II	K20TXR	IK20TT	K20TT	IK20	VK20
REKORD E 1.7L		W20FP-U _s	-	WF20TT	IWF20	-
REKORD E 1.9L		W20FP-U _s	-	WF20TT	IWF20	-
TROOPER HIGH ROOF	ZDI/SOHC	W20EX-U	IW20TT	W20TT	IW20	VW20
VECTRA CD 2.0i	NE OHC II	K20TXR	IK20TT	K20TT	IK20	VK20
PEUGEOT						
304 S ('75)	XL5	W24EP-U	-	-	IW24	VW24

DENSO
 AUSTRALIA CHINA INDIA INDONESIA KOREA MALAYSIA PHILIPPINES SAUDI ARABIA SINGAPORE TAIWAN THAILAND VIETNAM JAPAN & USA EUROPE MOTOR SMALL ENGINE REFERENCE NUMBER PART

DENSO	9	14	16	20	22	24	27	29	31	32	34	35	DENSO	9	14	16	20	22	24	27	29	31	32	DENSO	9	14	16	20	22	24	27	31
NGK	2	4	5	6	7	8	9	9.5	10	10.5	11	11.5	CHAMPION	18	16,14	12,11	10,9	8,7	6,63,61	4,59	57	55	53	BOSCH	10	9	8	7,6	5	4	3	2



PART NUMBER	CROSS REFERENCE	SMALL ENGINE	MOTOR CYCLE	EUROPE & USA	JAPAN	VIETNAM	THAILAND	TAIWAN	SINGAPORE	SAUDJARABIA	PHILIPPINES	MALAYSIA	KOREA	INDONESIA	INDIA	CHINA	AUSTRALIA	DENSU	SPARK PLUGS					
																			IRIDIUM TT	IRIDIUM RACING	IRIDIUM POWER	IRIDIUM TOUGH		
PEUGEOT																								
306																		XU7	K20TXR	IK20TT	K20TT	IK20	VK20	
307 1.6 XS																				K20HR-U11	IKH20TT	KH20TT	IKH20	VKH20
404 Carburator																				W20EP-U	IW20TT	W20TT	IW20	VW20
405 SR																			XU92C	Q22PR-U	-	-	IQ22	VQ22
405 Sri																			XU9J2	Q22PR-U	-	-	IQ22	VQ22
406																			XU10	K20TXR	IK20TT	K20TT	IK20	VK20
504 Carburator																			XLJ	W20EP-U	IW20TT	W20TT	IW20	VW20
505 GR <OLD>																			Xni	W20EP-U	IW20TT	W20TT	IW20	VW20
505 GTI																			2DJ5	T20EP-U	IT20TT	T20TT	IT20	VT20
506 GR <NEW>																			XNiA	W20EP-U	IW20TT	W20TT	IW20	VW20
604																				T20EP-U	IT20TT	T20TT	IT20	VT20
605																			XU10	K20TXR	IK20TT	K20TT	IK20	VK20
807																				K16HPR-U11	IKH16TT	KH16TT	IKH16	VKH16
RENAULT																								
12 TL/SL, 15 TL																				W20EP-U	IW20TT	W20TT	IW20	VW20
16 TL, 18 TL, 21 TL																				W20EP-U	IW20TT	W20TT	IW20	VW20
CLIO 1.4, SCENIC 1.9																				K20PR-U	IK20TT	K20TT	IK20	VK20
KANGOO 1.4																				K16PR-U	IK16TT	K16TT	IK16	VK16
SSANGYONG																								
SG 320																			M104	Q16P-U11	IQ16TT	Q16TT	IQ16	VQ16
SUZUKI																								
APV, APV ARENA																				K20PR-U	IK20TT	K20TT	IK20	VK20
BALENO, AERIO																			G16A	K20PR-U11	IK20TT	K20TT	IK20	VK20
CARRY 1.3 FUTURA																			G13C	W16EX-U	IW16TT	W16TT	IW16	VW16
CARRY 1.6 FUTURA																			G16C	W16EX-U	IW16TT	W16TT	IW16	VW16
CARRY ST 100																			F10A	W16EX-U	IW16TT	W16TT	IW16	VW16
CARRY ST 20																			LJ50	W16FP-U _s	-	-	IWF16	-
ERTIGA																			K14B	XU20EPR-U	-	-	IXU20	VXU20
ESCUDO, SIDE KICK																			G16A	W20EX-U	IW20TT	W20TT	IW20	VW20
ESTEEM 1.3 (SOHC)																			G13B	W20EP-U	IW20TT	W20TT	IW20	VW20
ESTEEM 1.6 GT (SOHC)																			G13A	K20P-U	IK20TT	K20TT	IK20	VK20
FORSA AMENITY SF 413																			G13C	W20EP-U	IW20TT	W20TT	IW20	VW20
FORSA SA 410																			F10A	W16EX-U	IW16TT	W16TT	IW16	VW16
GRAND ESCUDO																			J20A	K20PR-U11	IK20TT	K20TT	IK20	VK20
GRAND VITARA																				K20PR-U11	IK20TT	K20TT	IK20	VK20
JIMNY																			F8A	W16EX-U	IW16TT	W16TT	IW16	VW16
KARIMUN																			F10A	W16EX-U	IW16TT	W16TT	IW16	VW16
KARIMUN ESTILO																				XU22PR9	-	XU22TT	IXU22	VXU22
KARIMUN WAGON R																				-	-	IXU22	VXU22	
SUPER JIMNY, KATANA SJ 410V, GX																			F10A	W16EX-U	IW16TT	W16TT	IW16	VW16
SWIFT SA 310																			G10	W16EX-U	IW16TT	W16TT	IW16	VW16
SWIFT <NEW>																				-	-	IXU22	VXU22	
SX4																				K20PR-U11	IK20TT	K20TT	IK20	VK20
VITARA SE 416																			G16A	W20EX-U	IW20TT	W20TT	IW20	VW20
WAGON R																			K10B	XU20EPR-U	-	-	IXU20	VXU20
XL-7																				K20PR-U11	IK20TT	K20TT	IK20	VK20
TIMOR-KIA																								
CARNIVAL																				K20PR-U11	IK20TT	K20TT	IK20	VK20
S515																			B5	W16EPR-U11	IW16TT	W16TT	IW16	VW16
S515i																			B5	K16PR-U11	IK16TT	K16TT	IK16	VK16
TOYOTA																								
AGYA																			1KR-FE	XU20HR9	-	XUH20TTI	IXUH20	VXUH20
ALPHARD 3.0																			IMZ-FE	SK20R11	IK20TT	-	IK20	VK20
ALPHARD 3.5 <NEW>																			2GR-FE	FK20HR11	IKBH20TT	-	-	VFKBH20
ALTIS																			ZZ	K16R-U11	IK16TT	K16TT	IK16	VK16
ALL NEW ALTIS																			2ZR-FE	SC20HR11	-	-	-	VCH20
AVANZA																			NR	XU22PR9	-	XU22TT	IXU22	VXU22
AVANZA 1.3																			K3-DE	K20PR-U	IK20TT	K20TT	IK20	VK20
AVANZA VVTI																				XU22PR9	-	XU22TT	IXU22	VXU22
AVANZA<NEW>																				SC16HR11	-	-	-	-
CAMRY GLX 2.2L																			5S-FE	K20TR11	IK20TT	K20TT	IK20	VK20
CAMRY GRAND 3.0L																			1MZ-FE	K20TR11	IK20TT	K20TT	IK20	VK20
CAMRY<NEW>																			2AR-FE	SK20R11	IK20TT	-	IK20	VK20
COROLLA AE 101/111																			4A-FE	K16R-U11	IK16TT	K16TT	IK16	VK16
COROLLA AE 112																			7A	K20R-U	IK20TT	K20TT	IK20	VK20
COROLLA AE 80																			2A	W16EX-U	IW16TT	W16TT	IW16	VW16
COROLLA AE 92																			4A	Q16R-U	IQ16TT	Q16TT	IQ16	VQ16



MODEL	ENGINE	DENSO	IRIDIUM U	TJ	IRIDIUM POWER	IRIDIUM TOUGH
TOYOTA						
COROLLA AE 92 GTI	4A-FE	K16R-U11	IK16TT	K16TT	IK16	VK16
COROLLA EE 80/90/100	2E	W20EXR-U	IW20TT	W20TT	IW20	VW20
CORONA AT 151	4A	W16EX-U	IW16TT	W16TT	IW16	VW16
CORONA AT 171	4A	Q16R-U	IQ16TT	Q16TT	IQ16	VQ16
CORONA AT 190	4A	K16R-U11	IK16TT	K16TT	IK16	VK16
CORONA RX 60	21R	W16EXR-U	IW16TT	W16TT	IW16	VW16
CORONA ST 191	3S-FE	K20R-U11	IK20TT	K20TT	IK20	VK20
CRESSIDA GX 71	1G	W20EXR-U	IW20TT	W20TT	IW20	VW20
CROWN GS 131	1G-E	K20R-U11	IK20TT	K20TT	IK20	VK20
CROWN JZS 133	2G-FE	K20R-U	IK20TT	K20TT	IK20	VK20
CROWN MS 111/122	5M	W16EXR-U	IW16TT	W16TT	IW16	VW16
ETIOS		K16HRU11	IK16TT	KH16TT	IKH16	VKH16
FORTUNER 2.7	3-2TR-FE	SK20HR11	IK20TT	-	IKH20	VKH20
INNOVA		K20HRU11	IKH20TT	KH20TT	IKH20	VKH20
KIJANG 2.0 L	1RZ-E	W16EXR-U	IW16TT	W16TT	IW16	VW16
KIJANG KF 20	4K	W16EX-U	IW16TT	W16TT	IW16	VW16
KIJANG KF 21	5K	W16EX-U	IW16TT	W16TT	IW16	VW16
KIJANG KF 40/50	5K	W16EX-U	IW16TT	W16TT	IW16	VW16
KIJANG KF 42/52	7K	W16EX-U	IW16TT	W16TT	IW16	VW16
KIJANG KF 60/70/80	7K	W16EX-U	IW16TT	W16TT	IW16	VW16
KIJANG KF 72/82 (Carburator)	7K	W16EX-U	IW16TT	W16TT	IW16	VW16
KIJANG KF 72/82 (EFI)	7K-E	W16EXR-U11	IW16TT	W16TT	IW16	VW16
LAND CRUISER FJ 40	2F	W14EX-U	IW16TT	W16TT	IW16	VW16
PREVIA		PK20R11	IK20TT	-	IK20	VK20
RAV4 2.4, ALPHARD 2.4	2AZ-FE	K20RU11	IK20TT	K20TT	IK20	VK20
RUSH	3SZ	XU22PR9	-	XU22TT	IXU22	VXU22
SOLUNA	5A-FE	K16R-U11	IK16TT	K16TT	IK16	VK16
STARLET EP 70/80	1E	W16EXR-U	IW16TT	W16TT	IW16	VW16
STARLET EP 71/81	2E	W20EXR-U	IW20TT	W20TT	IW20	VW20
TOYOTA 86		ZXE27HBR8	-	-	-	-
VELLFIRE 2.4 <NEW>	2AZ-FE	SK16R11	IK16TT	-	IK16	VK16
VIOS / ALL NEW VIOS	1NZ-FE	K16R-U	IK16TT	K16TT	IK16	VK16
YARIS / ALL NEW YARIS	1NZ-FE	K16R-U	IK16TT	K16TT	IK16	VK16
VOLKSWAGEN						
BEETLE, COMBI, MITRA		W16FP-U _s	-	-	IWF16	-
CARAVELLE GL 2.5	AAF, ACU	W20EPBR-S	IW20TT	-	IW20	VW20
CARAVELLE GL 2.8	AET	W20EPBR-S	IW20TT	-	IW20	VW20
GOLF S/LS, PASSAT		W20EX-U	IW20TT	W20TT	IW20	VW20
SAFARI, GURSEL		W16FP-U _s	-	-	IWF16	-
V 1200, V 1300, V 1500		W16FP-U _s	-	-	IWF16	-
V 1302, V 1303		W16FP-U _s	-	-	IWF16	-
VOLVO						
240, 245	B230E	W16EPR-U	IW16TT	W16TT	IW16	VW16
340 GL, 244 PL/GL	B23A	W16EPR-U	IW16TT	W16TT	IW16	VW16
740 GLE	B230E	W16EPR-U	IW16TT	W16TT	IW16	VW16
740 TI	B230GT	W20EPR-U	IW20TT	W20TT	IW20	VW20
850 GTL, S70 GTL	B5254S	Q20PR-U	IQ20TT	Q20TT	IQ20	VQ20
960 2.3 TURBO	B230GT	W20EPR-U	IW20TT	W20TT	IW20	VW20
960 3.0/EXECUTIVE	B6304G	W20EPR-U	IW20TT	W20TT	IW20	VW20
S70 T5	B5254T	Q22PR-U	-	-	IQ22	VQ22
V70	B5254S	Q20PR-U	IQ20TT	Q20TT	IQ20	VQ20

DENSO

AUSTRALIA CHINA

INDIA

INDONESIA

KOREA

MALAYSIA

PHILIPPINES

SAUDI ARABIA

SINGAPORE

TAIWAN

THAILAND

VIETNAM

JAPAN

& USA

EUROPE

MOTOR

SMALL

CROSS

PART

INDONESIA | MOTORCYCLE |



MODEL	DENSO	IRIDIUM POWER	IRIDIUM RACING
BAJAJ			
PULSAR 180 DTSi	U27ESR-N	IU27	IU01-□
PULSAR 200 DTS-Fi	U27ESR-N	IU27	IU01-□
PULSAR 220 DTS-i	U24ESR-N	IU24	IU01-□
PULSAR XCD 125	U27ESR-N	IU27	IU01-□
HONDA			
ASTREA GRAND, WIN, SUPRA SERIES	U22FS-U	IUF22	-
BEAT (KVY)	U24EPR9	IU24	IU01-□
BEAT NEW Fi	U27EPR9	IU27	IU01-□
BLADE (KWB), BLADE NEW (K07A)	U20EPR9S	IU20	IU01-□
C700M, C800M, ASTREA 800, C700	U20FS-U	IUF22	-

DENSO	9	14	16	20	22	24	27	29	31	32	34	35	DENSO	9	14	16	20	22	24	27	29	31	32	DENSO	9	14	16	20	22	24	27	31
NGK	2	4	5	6	7	8	9	9.5	10	10.5	11	11.5	CHAMPION	18	16,14	12,11	10,9	8,7	6,63,61	4,59	57	55	53	BOSCH	10	9	8	7,6	5	4	3	2



DENSO

AUSTRALIA

CHINA

INDIA

INDONESIA

KOREA

MALAYSIA

PHILIPPINES

SAUDI ARABIA

SINGAPORE

TAIWAN

THAILAND

VIETNAM

JAPAN

EUROPE & USA

MOTOR CYCLE

SMALL ENGINE

CROSS REFERENCE PART NUMBER

MODEL	DENSO	IRIDIUM POWER	IRIDIUM RACING
HONDA			
C800, ASTREA STAR, ASTREA PRIMA	U22FS-U	IUF22	-
C90, S90Z	X20FS-U	-	-
CB125S, CG125, CB200, MINICAR	X22EP-U	IX22B	IXU01-□
CB150	U27EPR9	IU27	IU01-□
CBR 150 (K15A), CBR 150 Fi	U27EPR9	IU27	IU01-□
CBR 250	-	IU24	-
CITY SPORT 1	U24ESR-N	IU24	IU01-□
GL 100, GL MAX, GL PRO (CDI), CBX 650	X24EP-U9	IX24B	IXU01-□
GL MAX NEO TECH, KCJA (TIGER)	X24EP-U9	IX24B	IXU01-□
GL MAX, GL PRO (PLATINA)	X24EP-U	IX24B	IXU01-□
GL100K, GL125, XL125R, CB750K	X24EP-U	IX24B	IXU01-□
KARINA 125, KARISMA 125	U20EPR9	IU20	IU01-□
MEGA PRO, GL PRO NEO TECH	X24EP-U9	IX24B	IXU01-□
MEGA PRO (KYEA)	U24EPR9	IU24	IU01-□
MEGA PRO Fi	U27EPR9	IU27	IU01-□
NSR 150	W24ES-U	IW24	IW01-□
PCX	U22EPR9	IU22	IU01-□
REVO	U22FS-U	IUF22	-
REVO ABSOLUT, REVO MATIC, REVO NEW	U20EPR9S	IU20	IU01-□
S110, CG110, CB100, CB125	X22EP-U	IX22B	IXU01-□
SCOOPY	U24EPR9	IU24	IU01-□
SCOOPY Fi	U27EPR9	IU27	IU01-□
SONIC 125	U24ESR-N	IU24	IU01-□
SONIC 150	U27EPR9	IU27	IU01-□
SPACY, SPACY HELM IN	U24EPR9	IU24	IU01-□
SPACY Fi	U27EPR9	IU27	IU01-□
SUPRA X 125, SUPRA X PGMFI	U20EPR9	IU20	IU01-□
SUPRA X HELM IN 125, HELM IN 125Fi	U20EPR9	IU20	IU01-□
TA 200 (PHANTOM)	X24EPR-U9	IX24B	IXU01-□
VARIO (KVB)	U22FER9	IUH24	IU01-□
VARIO PGMFI 125 NEW	U22EPR9	IU22	IU01-□
VARIO 110, 150	U27EPR9	IU27	IU01-□
VERZA	U27EPR9	IU27	IU01-□
KANZEN			
SPECTRA 110, PESONA 5	U16FS-U	-	-
SCUDETO 125	U22FS-U	IUF22	-
K-CROSS 125	X24EP-U9	IX24B	IXU01-□
KAWASAKI			
BLITZ 125, EDGE	U20FS-U	IUF22	-
ELIMINATOR 175	U24ESR-N	IU24	IU01-□
KAZE 110	U20FS-U	IUF22	-
KLX 150S, KLX 250S, D TRACKER	U22FSR-U	IUF22	-
MERCY 200	W22EP-U	IW22	IW01-□
NINJA 150	W24ES-U	IW24	IW01-□
NINJA 250	U24ESR-N	IU24	IU01-□
NINJA RR 150	W27ES-U	IW27	IW01-□
ZONE R, ZX 130, ATHLETE	U20FS-U	IUF22	-
KYMCO			
EASY 100	U22FS-U	IUF22	-
VISA	U22FS-U	IUF22	-
METICA 125	U22FSR-U	IUF22	-
SPIKE 120	U22FS-U	IUF22	-
TREND 125	U22FSR-U	IUF22	-
LIBERO 110	U22FS-U	IUF22	-
FREE MX, LX	U22FSR-U	IUF22	-
SUZUKI			
ARASHI	U20FS-U	IUF22	-
COOL (110)	W24ES-U	IW24	IW01-□
FXR150	U24ESR-N	IU24	IU01-□
GSX750	X24EP-U	IX24B	IXU01-□
HAYATE	U20FS-U	IUF22	-
NEX	U20FS-U	IUF22	-
NEX FI, NEX AT NEW	U22EPR9	IU22	IU01-□
RAIDER (125)	U24ES-N	IU24	IU01-□
RC100, CRYSTAL RC80/100DK	W22FP-U _s	IWF22	-
RC110 CDN/CSD, TRS, TRZ	W24FP-U _s	IWF24	-
RGR, SATRIA RU120	W24ES-U	IW24	IW01-□



MODEL	DENSO	IRIDIUM POWER	IRIDIUM RACING
SUZUKI			
SATRIA F 150, NEW SATRIA	U24ESR-N	IU24	IU01-□
SHOGUN FD110	U20FS-U	IUF22	-
SHOGUN Hyper Injection Fi <NEW>	U20FS-U	IUF22	-
SHOGUN SC231 (125), SHOGUN AXELO	U20FS-U	IUF22	-
SKYWAVE 125	U20FSR-U	IUF22	-
SMASH (110), SMASH <NEW>	U20FS-U	IUF22	-
SPIN, SKYDRAVE	U20FS-U	IUF22	-
THUNDER EN125	U24ESR-N	IU24	IU01-□
THUNDER GSX250	X24ES-U	IX24	IXU01-□
TITAN	U20FS-U	IUF22	-
TITAN NEXT	U24EPR9	IU24	IU01-□
TS100, TS125 ('78~), GT250, GT380	W22EP-U	IW22	IW01-□
TVS			
NEO 110CC	U22ESR-N	IU22	IU01-□
NEO X3i	U22ESR-N	IU22	IU01-□
VESPA/PIAGIO			
CORSA, PK125	W20FP-U _s	IWF20	-
DNA 180	U27ESR-N	IU27	IU01-□
EXCLUSIVE 150, EXCEL 150	W14EX-U	IW16	IW01-□
P150X, P150S, PX150E	W9FP-UL	-	-
PT100TS, SUPER, SPRINT	W9FP-UL	-	-
PX150XE, PX150SE, P200XE, EXCEL	W14EX-U	IW16	IW01-□
X9 180	U27ESR-N	IU27	IU01-□
YAMAHA			
BYSON	U24EPR9	IU24	IU01-□
CRYPTON	U22FS-U	IUF22	-
F1ZR, SIGMA	W22FP-U _s 10	IWF22	-
FINO	U22FS-U	IUF22	-
FINO FI	U20FSR-U	IUF22	-
FORCE	U20FSR-U	IUF22	-
GLIDE	W22FPR-U	IWF22	-
JUPITER	U22FS-U	IUF22	-
JUPITER Z1 Fi	U20FSR-U	IUF22	-
JUPITER MX	U24EPR9	IU24	IU01-□
JUPITER MX-KING	U24ESR-N	IU24	IU01-□
L2S, XT80, L2 Super	W22FP-U _s	IWF22	-
LEXAM	U20FS-U	IUF22	-
MAJESTY	U22ES-N	IU22	IU01-□
MIO, MIO SOUL, MIO SPORTY	U22FS-U	IUF22	-
MIO Fi, MIO SOUL Fi, MIO J, MIO GT	U20FSR-U	IUF22	-
N-MAX	U24EPR9	IU24	IU01-□
NOUVO	U22FSR-U	IUF22	-
RX-K ('96~)	W24FPR-U10	IWF24	-
RX-Z, RZ-R	W24ES-U	IW24	IW01-□
SCORPIO Z <NEW>	X24ES-U	IX24	-
SCORPIO, SCORPIO Z	X24EP-U	IX24B	IXU01-□
TOUCHS	W24ESR-U	IW24	IW01-□
V100(3AY) ALVA IIR, V110(3XA) FORCE 1	W22FP-U _s 10	IWF22	-
VEGA	U22FS-U	IUF22	-
VEGA ZR	U20FS-U	IUF22	-
VIXION, VIXION NEW	U24ESR-N	IU24	IU01-□
XEON, XEON Fi	U22ESR-N	IU22	IU01-□
Y125Z, TIARA	W24ES-U	IW24	IW01-□
YT 115, RX-S, RX-K	W24FP-U _s 10	IWF24	-

DENSO
 AUSTRALIA
 CHINA
 INDIA
 INDONESIA
 KOREA
 MALAYSIA
 PHILIPPINES
 SAUDI ARABIA
 SINGAPORE
 TAIWAN
 THAILAND
 VIETNAM
 JAPAN
 EUROPE
 MOTOR CYCLE
 SMALL ENGINE
 CROSS REFERENCE
 PART NUMBER

DENSO	9	14	16	20	22	24	27	29	31	32	34	35
NGK	2	4	5	6	7	8	9	9.5	10	10.5	11	11.5

DENSO	9	14	16	20	22	24	27	29	31	32
CHAMPION	18	16,14	12,11	10,9	8,7	6,63,61	4,59	57	55	53

DENSO	9	14	16	20	22	24	27	31
BOSCH	10	9	8	7,6	5	4	3	2



MODEL	DENSO	IRIDIUM	TT	IRIDIUM POWER	IRIDIUM TOUGH
HYUNDAI					
EQUUS GDI	-	-	-	IXUH22I	VXUH22I
EXCEL / EXCEL <NEW>	W20EP-U11	IW20TT	W20TT	IW20	VW20
EXCEL VAN	W20EP-U11	IW20TT	W20TT	IW20	VW20
GALLOPER SOHC (3.0)	W16EPR-U11	IW16TT	W16TT	IW16	VW16
GALLOPER SOHC LPG (3.0)	W16EPR-U	IW16TT	-	-	VW20T
GENESIS (3.3/3.8)	VK16	IK16TT	-	IK16	VK16
GENESIS (3.3/3.8) 2010	-	-	-	IXUH22	VXUH22
GENESIS (3.3/3.8) 2014	-	-	-	IXUH22	VXUH22
GENESIS COUPE (3.8)	-	-	-	IXUH22	VXUH22
GENESIS COUPE TURBO (2.0)	-	-	-	IKH22	VKH20Y
GENESIS GDI	-	-	-	IXUH22I	VXUH22I
GRACE	W20EP-U11	IW20TT	W20TT	IW20	VW20
GRACE LPG	W20EPR-U	IW20TT	-	-	VW20T
GRANDEUR (2.0) <NEW>	W20EP-U11	IW20TT	W20TT	IW20	VW20
GRANDEUR (2.4)	W20EP-U11	IW20TT	W20TT	IW20	VW20
GRANDEUR DOHC (3.3)	-	IK16TT	-	IK16	VK16
GRANDEUR DOHC (V6 2.5/3.0/3.5)	PK16PR-P11	IK16TT	-	IK16	VK16
GRANDEUR SOHC (3.0)	W16EPR-U11	IW16TT	W16TT	IW16	VW16
GRANDEUR TAXI (2.0)	W20EP-U	IW20TT	-	-	VW20T
GRANDEUR TAXI (2.4) <NEW>	W20EPR-U	IW20TT	-	-	VW20T
GRANDEUR TAXI (3.0) <NEW>	W16EPR-U	IW16TT	-	-	VW20T
GRANDEUR TG (2.4/3.3/3.8)	VK16	IK16TT	-	IK16	VK16
GRANDEUR TG (2.7)	-	IKH16TT	-	IKH16	VKH20T
GRANDEUR HG (2.4)	-	-	-	IXUH22I	VXUH22I
GRANDEUR HG (3.0/3.3)	-	-	-	IXUH22I	VXUH22I
GRANDEUR XG DOHC (V6 2.0/2.5/3.0)	PK16PR-P11	IK16TT	-	IK16	VK16
I-30 2012	-	-	-	IXUH22I	VXUH22I
I-30 (1.6/2.0)	KJ16CR-U11	IK16TT	K16TT	IK16L	VK16
I-30 (1.6/2.0) 2009MY 2nd half	-	-	-	IXUH22	VXUH22
I-40	-	-	-	IXUH22I	VXUH22I
LAVITA	K16PR-U11	IK16TT	K16TT	IK16	VK16
LF SONATA (2.0 / 2.4)	-	-	-	IXUH22I	VXUH22I
LIBERO SOHC LPG (3.0)	W16EPR-U	IW16TT	-	-	VW20T
MARCIA (2.0)	W20EP-U11	IW20TT	W20TT	IW20	VW20
MARCIA (2.5)	-	IK16TT	-	IK16	VK16
NF SONATA DOHC (2.0/2.4)	K16PR-U11	IK16TT	K16TT	IK16	VK16
NF SONATA DOHC (3.3)	IK16	IK16TT	-	IK16	VK16
NF SONATA TRANSFORM	-	IKH16TT	-	IKH16	VKH16
PORTER LPG	W20EPR-U	IW20TT	-	-	VW20T
PRESTO	W20EPR-U	IW20TT	W20TT	IW20	VW20
SANTAFE DOHC (2.0)	W20EPR-U11	IW20TT	W20TT	IW20	VW20
SANTAFE DOHC (V6 2.7)	PK16PR-P11	IK16TT	-	IK16	VK16
SANTAFE LPG (V6 2.7)	K20PR-U	IK20TT	-	-	VK20T
SANTAMO	W20EP-U11	IW20TT	W20TT	IW20	VW20
SANTAMO LPG	W20EPR-U	IW20TT	-	-	VW20T
SCOOP N/A	K16PR-U11	IK16TT	K16TT	IK16	VK16
SCOOP TURBO	K20PR-U	IK20TT	K20TT	IK20	VK20
SONATA I, II, III	W20EP-U11	IW20TT	W20TT	IW20	VW20
SONATA TAXI	W20EP-U	IW20TT	-	-	VW20T
SONATA TAXI <NEW>	W20EPR-U	IW20TT	-	-	VW20T
STAREX	W20EP-U11	IW20TT	W20TT	IW20	VW20
STAREX LPG	W20EPR-U	IW20TT	-	-	VW20T
STAREX SOHC LPG (3.0)	W16EPR-U	IW16TT	-	-	VW20T
STELLA	W16EPR-U	IW16TT	W16TT	IW16	VW16
STELLA TAXI LPG	W20EPR-U	IW20TT	-	-	VW20T
TARJET XG DOHC (2.0)	-	IK20TT	-	IK20	VK20
TERRACAN (V6 3.5)	K16PR-U11	IK16TT	K16TT	IK16	VK16
TIBURON	K16PR-U11	IK16TT	K16TT	IK16	VK16
TRAJET XG (V6 2.7)	PK16PR-P11	IK16TT	-	IK16	VK16
TRAJET XG LPG (V6 2.7)	K20PR-U	IK20TT	-	-	VK20T
TUCSON (2.0)	-	IK16TT	-	IK16	VK16
TUCSON IX (2.0)	-	IKH16TT	-	IKH16	VKH16
TUSCANI	K16PR-U11	IK16TT	K16TT	IK16	VK16
VELOSTER & TURBO	-	-	-	IXUH22I	VXUH22I
VERACRUZ GASOLINE (3.8)	PK16PR-P11	IK16TT	-	IK16	VK16
VERNA / VERNA <NEW>	K16PR-U11	IK16TT	K16TT	IK16	VK16
YF SONATA 2012	-	-	-	IXUH22I	VXUH22I

DENSO
 AUSTRALIA
 CHINA
 INDIA
 INDONESIA
 KOREA
 MALAYSIA
 PHILIPPINES
 SAUDI ARABIA
 SINGAPORE
 TAIWAN
 THAILAND
 VIETNAM
 JAPAN
 EUROPE
 MOTOR & USA
 CYCLE
 SMALL ENGINE
 CROSS REFERENCE
 PART NUMBER

DENSO	9	14	16	20	22	24	27	29	31	32	34	35	DENSO	9	14	16	20	22	24	27	29	31	32	DENSO	9	14	16	20	22	24	27	31
NGK	2	4	5	6	7	8	9	9.5	10	10.5	11	11.5	CHAMPION	18	16,14	12,11	10,9	8,7	6,63,61	4,59	57	55	53	BOSCH	10	9	8	7,6	5	4	3	2



PART NUMBER	CROSS REFERENCE	SMALL ENGINE	MOTOR CYCLE	EUROPE & USA	JAPAN	VIETNAM	THAILAND	TAIWAN	SINGAPORE	SAUDI ARABIA	PHILIPPINES	MALAYSIA	KOREA	INDONESIA	INDIA	CHINA	AUSTRALIA	MODEL	DENSO	IRIDIUM TT	IRIDIUM RACING	IRIDIUM POWER	IRIDIUM TOUGH
																		HYUNDAI					
																		YF SONATA LPI (2.0) 2010MY	-	IK20TT	-	-	VK20T
																		YF SONATA (2.0) 2010MY	-	IKH16TT	-	IKH16	VKH16
																		KIA					
																		AVELLA (1.3)	W16EX-U11	IW16TT	W16TT	IW16	VW16
																		AVELLA DELTA (1.3)	W16EX-U11	IW16TT	W16TT	IW16	VW16
																		AVELLA DELTA SOHC (1.5)	W16EPR-U11	IW16TT	W16TT	IW16	VW16
																		AVELLA DOHC (1.5)	K20PR-U11	IK20TT	K20TT	IK20	VK20
																		AVELLA SOHC (1.5)	W16EP-U11	IW16TT	W16TT	IW16	VW16
																		CAPITAL GLX/SLX	W16EP-U11	IW16TT	W16TT	IW16	VW16
																		CAPITAL DOHC (1.5)	Q20P-U11	IQ20TT	Q20TT	IQ20	VQ20
																		CAPITAL SOHC (1.8)	W16EPR-U	IW16TT	W16TT	IW16	VW16
																		CAPITAL TAXI LPG	W20EP-U	IW20TT	-	-	VW20T
																		CARENS <NEW>	-	IK20TT	-	-	VK20T
																		CARENS DOHC (1.8)	K20PR-U	IK20TT	K20TT	IK20	VK20
																		CARENS DOHC LPG (1.8/2.0)	K20PR-U	IK20TT	-	-	VK20T
																		CARNIVAL GSL DOHC (2.5)	PK20PR-P11	IK20TT	-	IK20	VK20
																		CARNIVAL I, II DOHC LPG (2.5)	K20PR-U	IK20TT	-	-	VK20T
																		CARSTAR	W20EP-U11	IW20TT	W20TT	IW20	VW20
																		CARSTAR LPG	W20EPR-U	IW20TT	-	-	VW20T
																		CERATO DOHC (1.5)	K16PR-U11	IK16TT	K16TT	IK16	VK16
																		CERATO DOHC (1.6)	K16PR-U11	IK16TT	K16TT	IK16	VK16
																		CERATO DOHC (2.0)	K16PR-U11	IK16TT	K16TT	IK16	VK16
																		CONCORD DOHC (2.0)	Q20P-U11	IQ20TT	Q20TT	IQ20	VQ20
																		CONCORD SOHC (1.8)	W20EP-U	IW20TT	W20TT	IW20	VW20
																		CONCORD SOHC (2.0)	W16EPR-U	IW16TT	W16TT	IW16	VW16
																		CONCORD TAXI DOHC (2.0)	W20EP-U	IW20TT	-	-	VW20T
																		CREDOS DOHC (1.8)	K16PR-U	IK16TT	K16TT	IK16	VK16
																		CREDOS DOHC (2.0)	K20PR-U11	IK20TT	K20TT	IK20	VK20
																		CREDOS SOHC (2.0)	W16EPR-U	IW16TT	W16TT	IW16	VW16
																		CREDOS TAXI DOHC (1.8/2.0)	K20PR-U	IK20TT	-	-	VK20T
																		ELAN	K20PR-U	IK20TT	K20TT	IK20	VK20
																		ENTERPRISE (2.5/3.0/3.6)	KJ16CR-U11	IK16TT	K16TT	IK16L	VK16
																		FORTE GDI (1.6) 2010	-	-	-	IXUH22	VXUH22
																		FORTE HYBRID LPI 2009	-	-	-	IXUH22	VXUH22
																		FORTE (1.6)	-	IKH16TT	-	IKH16	VKH16
																		FORTE (1.6) 2010	-	-	-	IXUH22	VXUH22
																		FORTE (2.0) 2010	-	IKH16TT	-	IKH16	VKH16
																		GRAND CARNIVAL LPG	-	IKH20TT	-	-	VKH20T
																		K3 GDI/COUPE/COUPE TURBO	-	-	-	IXUH22I	VXUH22I
																		K5 (2.0) 2011	-	IKH16TT	-	IKH16	VKH16
																		K5 GDI 2012	-	-	-	IXUH22I	VXUH22I
																		K5 LPI (2.0) 2011	-	IK20TT	-	-	VK20T
																		K7 (2.7)	-	IKH16TT	-	IKH16	VKH16
																		K7 GDI	-	-	-	IXUH22I	VXUH22I
																		K7 LPI (2.7)	-	-	-	IKH22	VKH20T
																		K9 GDI	-	-	-	IXUH22I	VXUH22I
																		LOTZE INNOVATION ~2010	-	IKH16TT	-	IKH16	VKH16
																		LOTZE (1.8/2.0/2.4)	K16PR-U11	IK16TT	K16TT	IK16	VK16
																		LOTZE ADVANCE Theta1 Engine	-	IK16TT	-	IK16	VK16
																		LOTZE ADVANCE Theta2 Engine	-	IKH16TT	-	IKH16	VKH16
																		MOHAVE	-	-	-	IXUH22	VXUH22
																		MORNING (1.0) 2010 <NEW>	-	IK16TT	-	IK16	VK16
																		MORNING <ALL NEW>	-	-	-	IXUH22I	VXUH22I
																		MORNING SOHC (1.0)	K16PR-U11	IK16TT	K16TT	IK16	VK16
																		OPIRUS (2.7/3.0/3.3/3.5/3.8)	PK16PR-P11	IK16TT	-	IK16	VK16
																		OPIRUS LPG	-	IK20TT	-	-	VK20T
																		OPIRUS LPG 2006MY	-	-	-	IKH22	VKH20T
																		OPTIMA Beta Engine DOHC (1.8/2.0)	K16PR-U11	IK16TT	K16TT	IK16	VK16
																		OPTIMA Sirius Engine DOHC (1.8/2.0)	W20EPR-U11	IW20TT	W20TT	IW20	VW20
																		OPTIMA TAXI DOHC (2.0) Beta Engine	K20PR-U	IK20TT	-	-	VK20T
																		PARKTOWN DOHC (1.8)	K16PR-U	IK16TT	K16TT	IK16	VK16
																		POTENTIA DOHC (2.0)	K20PR-U11	IK20TT	K20TT	IK20	VK20
																		POTENTIA DOHC (2.2)	KJ20CR-U11	IK16TT	K20TT	IK20L	VK20
																		POTENTIA DOHC (V6 3.0)	KJ16CR-U11	IK16TT	K16TT	IK16L	VK16
																		POTENTIA TAXI DOHC (2.0)	K20PR-U	IK20TT	-	-	VK20T
																		PRIDE	W16EP-U11	IW16TT	W16TT	IW16	VW16



MODEL	DENSO	IRIDIUM	TJ	IRIDIUM POWER	IRIDIUM TOUGH
KIA					
PRIDE DOHC (1.4) <NEW>	K16PR-U11	IK16TT	K16TT	IK16	VK16
PRIDE DOHC (1.6) <NEW>	K16PR-U11	IK16TT	K16TT	IK16	VK16
PRIDE GDI <ALL NEW>	-	-	-	IXUH22I	VXUH22I
RAY	-	-	-	IXUH22I	VXUH22I
RIO DOHC (1.5/1.6)	K20PR-U	IK20TT	K20TT	IK20	VK20
RIO SOHC (1.3/1.5)	W16EXR-U	IW16TT	W16TT	IW16	VW16
ROCSTAR SOHC (1.8)	W20EP-U	IW20TT	W20TT	IW20	VW20
SEPHIA I DOHC (1.5)	K20PR-U11	IK20TT	K20TT	IK20	VK20
SEPHIA I SOHC (1.5)	W16EP-U11	IW16TT	W16TT	IW16	VW16
SEPHIA II (1.8)	K20PR-U	IK20TT	K20TT	IK20	VK20
SEPHIA II DOHC (1.5)	K20PR-U11	IK20TT	K20TT	IK20	VK20
SEPHIA II SOHC (1.5)	W16EXR-U	IW16TT	W16TT	IW16	VW16
SEPHIAREO DOHC	K20PR-U11	IK20TT	K20TT	IK20	VK20
SEPHIAREO SOHC (1.5)	W16EP-U11	IW16TT	W16TT	IW16	VW16
SHUMA DOHC (1.5)	K20PR-U11	IK20TT	K20TT	IK20	VK20
SHUMA SOHC (1.5)	W16EXR-U	IW16TT	W16TT	IW16	VW16
SORENTO DOHC (V6 3.5)	-	IK16TT	-	IK16	VK16
SOUL (1.6)	-	IK16TT	-	IK16	VK16
SOUL (2.0)	-	IK16TT	-	IXUH22	VXUH22
SPECTRA DOHC (1.5/1.8)	K20PR-U	IK20TT	K20TT	IK20	VK20
SPECTRA SOHC (1.5)	W16EXR-U	IW16TT	W16TT	IW16	VW16
SPECTRAWING DOHC (1.5/1.8)	K20PR-U	IK20TT	K20TT	IK20	VK20
SPORTAGE DOHC (2.0)	K20PR-U11	IK20TT	K20TT	IK20	VK20
SPORTAGE R GDI TURBO	-	-	-	IXUH22I	VXUH22I
SPORTAGE R Theta2	-	IKH16TT	-	IKH16	VKH16
SPORTAGE SOHC (2.0)	K16PR-U	IK16TT	K16TT	IK16	VK16
TOWNER VAN/TRUCK/MINI BUS	W16EX-U	IW16TT	W16TT	IW16	VW16
TOWNER LPG	W20EX-U	IW20TT	-	-	VW20T
VESTA LPG	W20EP-U	IW20TT	-	-	VW20T
VISTO	K16PR-U11	IK16TT	K16TT	IK16	VK16
WIDEBONGO LPG	W20EP-U	IW20TT	-	-	VW20T
Renault Samsung					
QM5 (2.5)	FXE20HR11	IXEH20TT	-	-	VFXEH20
SM3 (1.6) <NEW>	IKH16	IKH16TT	-	IKH16	VKH16
SM3(1.5/1.6)	K16PR-U11	IK16TT	K16TT	IK16	VK16
SM3(1.6) 2010 <NEW>	FXE20HR11	IXEH20TT	-	-	VFXEH20
SM5 (2.0/2.5) <ALL NEW>	FXE20HR11	IXEH20TT	-	-	VFXEH20
SM5 <NEW>	K16PR-U11	IK16TT	K16TT	IK16	VK16
SM5 Impression <NEW>	FXE20HR11	IXEH20TT	-	-	VFXEH20
SM5 LPG <NEW>	K20PR-U	IK20TT	-	-	VK20T
SM5 TAXI	K20PR-U	IK20TT	-	-	VK20T
ALL NEW SM5 LPLI	-	IXEH22TT	-	-	VFXEH22
SM520/SM520V	K16PR-U11	IK16TT	K16TT	IK16	VK16
SM525/SM525V	K16PR-U11	IK16TT	K16TT	IK16	VK16
SM7 <ALL NEW>	FXE22HR11	IXEH22TT	-	-	VFXEH22
SM7 DOHC (V6 2.3)	VKH16	IKH16TT	-	IKH16	VKH16
SM7 DOHC (V6 3.5)	VKH16	IKH16TT	-	IKH16	VKH16
SM7 New Art	-	IKH16TT	-	IKH16	VKH16
ALL NEW SM7 (2.5/3.5)	-	-	-	-	VFXEH22
SSANGYONG					
Chairman (2.3/2.8/3.2)	-	IK16TT	-	IK16	VK16
Chairman Limousine	-	IK16TT	-	IK16	VK16
Chairman W (3.6/5.0)	-	IK16TT	-	IK16	VK16
Chairman W Limousine (3.6/5.0)	-	IK16TT	-	IK16	VK16
ISTANA LPG	K20PR-U	IK20TT	-	-	VK20T
KORANDO	K16PR-U	IK16TT	K16TT	IK16	VK16
TIVOLI	-	-	-	IXUH22I	VXUH22I
MUSSO	K16PR-U	IK16TT	K16TT	IK16	VK16

DENSO

AUSTRALIA CHINA INDIA INDONESIA KOREA MALAYSIA PHILIPPINES SAUDIARABIA SINGAPORE TAIWAN THAILAND VIETNAM JAPAN EUROPE MOTOR & USA CYCLE SMALL CROSS PART ENGINE REFERENCE NUMBER

DENSO	9	14	16	20	22	24	27	29	31	32	34	35
NGK	2	4	5	6	7	8	9	9.5	10	10.5	11	11.5

DENSO	9	14	16	20	22	24	27	29	31	32
CHAMPION	18	16,14	12,11	10,9	8,7	6,63,61	4,59	57	55	53

DENSO	9	14	16	20	22	24	27	31
BOSCH	10	9	8	7,6	5	4	3	2



PART NUMBER	CROSS REFERENCE	SMALL ENGINE	MOTOR CYCLE	EUROPE & USA	JAPAN	VIETNAM	THAILAND	TAIWAN	SINGAPORE	SAUDI ARABIA	PHILIPPINES	MALAYSIA	KOREA	INDONESIA	INDIA	CHINA	AUSTRALIA	DENSO	IRIDIUM POWER	IRIDIUM RACING	
DENSO																					
Asea																					
																			W14FP-UL	IWF16	-
DaeDong																					
																			W14F-U	-	-
																			W20FP-U	IWF20	-
																			W14P-U	-	-
																			W14P-U	-	-
																			W14P-U	-	-
																			W14F-U	-	-
DaeHeung																					
																			W22S-U	-	-
																			W20FS-U	IWF22	-
																			W14F-U	-	-
																			W14M-U	-	-
DaeLim																					
																			W24FS-U	IWF24	-
																			U20FS-U	IUF22	-
																			U22FS-U	IUF22	-
																			U24FE9	IUH24	IU01-□
																			X24ES-U	IX24	IXU01-□
																			U24FE9	IUH24	IU01-□
																			W20FS-U	IWF22	-
																			U24FE9	IUH24	IU01-□
																			W24FS-U	IWF24	-
																			W24FS-U	IWF24	-
																			W20FP-U	IWF20	-
HyoSung																					
																			W22FP-U	IWF22	-
																			U24ES-N	IU24	IU01-□
																			U24ES-N	IU24	IU01-□
																			W22FP-U	IWF22	-
																			X24ES-U	IX24	IXU01-□
																			U24FE9	IUH24	IU01-□
																			U24ESR-N	IU24	IU01-□
																			X24ES-U	IX24	IXU01-□
																			U24ESR-N	IU24	IU01-□
																			W20FP-U	IWF20	-
																			W20FP-U	IWF20	-
																			W22FP-U	IWF22	-
																			W24FS-U	IWF24	-
																			U24ES-N	IU24	IU01-□
KeYang																					
																			W20M-U	-	-
																			W20M-U	-	-



MAKER	From-Till	DENSO	IRIDIUM TJ	TJ	IRIDIUM POWER	IRIDIUM TOUGH
ALFA ROMEO						
145, 146	97 -	PK20TR11+IU22	IK20TT+N/A	-	IK20+IU22	VK20+IU22
147 2.0 Twin Spark	00 -	PK20TR11+IU22	IK20TT+N/A	-	IK20+IU22	VK20+IU22
147 GTA 3.2	02 -	PK20PR-P8	IK20TT	-	IK20	VK20Y
149 1.4 Turbo MultiAir	10 -	IXU27	-	-	IXU27	-
156 2.0 (16V)	97 - 01	K20PR-U	IK20TT	K20TT	IK20	VK20
156 GTA 3.2	02 -	VK22	-	-	IK22	VK22
156 JTS 2.0	01 -	K20PR-U	IK20TT	K20TT	IK20	VK20
159 2.0 (16V) Twin Spark	97 - 01	PK20TR11+IU22	IK20TT+N/A	-	IK20+IU22	VK20+IU22
159 2.2	08 -	-	IK16TT	-	IK16	VK16
159 GTA 3.2	02 -	PK20PR-P8	IK20TT	-	IK20	VK20Y
159 JTS 2.0	01 -	PK20TR11	IK20TT	-	IK20	VK20
164 3.0 V6 24V, Q4	97 - 01	PK20PR-P8	IK20TT	-	IK20	VK20Y
166 2.0 (16V) Twin Spark	98 - 02	PK20TR11+IU22	IK20TT+N/A	-	IK20+IU22	VK20+IU22
Brera 2.2, Spider 2.2	06 -	-	IK16TT	-	IK16	VK16
GT 2.0, GTV 2.0, (JTS) 16V	03 -	PK20TR11	IK20TT	-	IK20	VK20
Mito 1.4 MultiAir (105CV)	09 -	XU22EPR-U	-	XU22TT	IXU22	VXU22
Mito 1.4 Turbo MultiAir (135 CV, 170 CV)	09 -	IXU27	-	-	IXU27	-
Spider 1.8, 2.0 (16V) Twin Spark	98 - 02	PK20TR11+IU22	IK20TT+N/A	-	IK20+IU22	VK20+IU22
Spider 2.0, 16v (JTS)	03 -	PK20TR11	IK20TT	-	IK20	VK20
Spider 3.0, 3.2 V6 (24V)	03 -	PK20PR-P8	IK20TT	-	IK20	VK20Y
AUDI						
A3 (8P1) 2.0	04 -	VK20	IK20TT	-	IK20	VK20
A4 1.6, 1.8	98 -	K20PBR-S10	IK20TT	K20TT	IK20	VK20
A4 1.6, 1.8 (Turbo)	98 -	PK20PR-P8	IK20TT	-	-	VK20Y
A4 1.8T, 2.0T	06 -	VK20	IK20TT	-	IK20	VK20
A5 1.8T(CABD, CDHB)	07 -	VK22	-	-	IK22	VK22
A5 4.2 (CAUA)	07 -	VKB20	-	-	-	VKB20
A6 1.8 (AJL, AFY, AJB, AQF, ARH)	98 -	K20PBR-S10	IK20TT	K20TT	IK20	VK20
A6 2.0, 3.0	05 -	VK20	IK20TT	-	IK20	VK20
A6 2.8, 3.0L (ACK, AEJ, AGE, AHA, APR)	97 -	K20TXR	IK20TT	K20TT	IK20	VK20
A8 L3.0 (ASN, BBJ)	01 -	K20TXR	IK20TT	K20TT	IK20	VK20
Q5 2.0 TFSI (CDNA, CDNB, CDNC, CAEB)	08 -	VK20	IK20TT	-	IK20	VK20
Q7 4.2 (BAR)	06 -	VKB20	-	-	-	VKB20
Quattro 80, 90, 100	90 - 99	W20EPB	IW20TT	W20TT	IW20	VW20
R8 4.2 V8, 5.2 V10	07 - 12	VK22	-	-	IK22	VK22
S3 2.0 (CDL)	09 -	VK22	-	-	IK22	VK22
TT/TTs Coupe 1.8 Turbo	98 -	PK20PR-P8	IK20TT	-	-	VK20Y
TT/TTs Coupe 2.0 (CDMA, CESA, CETA)	10 -	VK22	-	-	IK22	VK22
BMW						
116i (B16)	04 -	K20TXR	IK20TT	K20TT	IK20	VK20
3 Series - E36	91 - 98	K20TXR	IK20TT	K20TT	IK20	VK20
3 Series - E46	98 - 05	K20TXR	IK20TT	K20TT	IK20	VK20
3 Series - E90, E91	05 -	VK20	IK20TT	-	IK20	VK20
5 Series - E34, E39	95 - 03	K20TXR	IK20TT	K20TT	IK20	VK20
5 Series - E60 (523i, 525i, 530i)	05 -	-	IKH20TT	-	IKH20	VKH20
5 Series - E60, E61	03 -	K20TXR	IK20TT	K20TT	IK20	VK20
6 Series - E63	04 -	K20TXR	IK20TT	K20TT	IK20	VK20
7 Series - E32	01 -	K20TXR	IK20TT	K20TT	IK20	VK20
7 Series - E38	94 - 01	K20TXR	IK20TT	K20TT	IK20	VK20
7 Series - E65, E66	01 -	K20TXR	IK20TT	K20TT	IK20	VK20
X5 3.0 - E53	99 -	K20TXR	IK20TT	K20TT	IK20	VK20
Z3 - E367, E368	94 - 02	K20TXR	IK20TT	K20TT	IK20	VK20
Z3 - M43, M44, M45	95 -	K20TXR	IK20TT	K20TT	IK20	VK20
Z4 - M54	03 -	K20TXR	IK20TT	K20TT	IK20	VK20
Z4 - E85 (N46 B20)	04 -	VK20	IK20TT	-	IK20	VK20
Z8 - E52	03 -	K20TXR	IK20TT	K20TT	IK20	VK20
CHEVROLET						
Aveo 1.5	04 -	W20EPR-U	IW20TT	W20TT	IW20	VW20
Captiva SUV 2.4	06 -	K20TXR	IK20TT	K20TT	IK20	VK20
Epica 2.0	09 -	K20TXR	IK20TT	K20TT	IK20	VK20
Nabira 1.8	04 -	K20TXR	IK20TT	K20TT	IK20	VK20
Nabira 2.2	04 -	ITV20	ITV20TT	-	ITV20	-
Optra 1.6, 5	04 -	K20PR-U11	IK20TT	K20TT	IK20	VK20
Optra 1.8	04 -	K20TXR	IK20TT	K20TT	IK20	VK20
Spark 0.8	05 -	W16EPR11	IW16TT	W16TT	IW16	VW16
CHERY						
A160 1.6	04 -	K20PR-U	IK20TT	K20TT	IK20	VK20

DENSO

AUSTRALIA CHINA INDIA INDONESIA KOREA MALAYSIA PHILIPPINES SAUDI ARABIA SINGAPORE TAIWAN THAILAND VIETNAM JAPAN & USA EUROPE MOTOR CYCLE SMALL ENGINE CROSS PART REFERENCE NUMBER

DENSO	9	14	16	20	22	24	27	29	31	32	34	35	DENSO	9	14	16	20	22	24	27	29	31	32	DENSO	9	14	16	20	22	24	27	31
NGK	2	4	5	6	7	8	9	9.5	10	10.5	11	11.5	CHAMPION	18	16,14	12,11	10,9	8,7	6,63,61	4,59	57	55	53	BOSCH	10	9	8	7,6	5	4	3	2



▶ Spark plug color codes: ■ for Iridium Tough and Iridium Plugs and Iridium TT, ■ for Iridium Power, ■ for Iridium Racing and Two Tops Plugs, ■ for Platinum Plugs and Platinum TT, and black for general spark plugs.

DENSO
AUSTRALIA
CHINA
INDIA
INDONESIA
KOREA
MALAYSIA
PHILIPPINES
SAUDI ARABIA
SINGAPORE
TAIWAN
THAILAND
VIETNAM
JAPAN
EUROPE & USA
MOTOR CYCLE
SMALL ENGINE
CROSS REFERENCE
PART NUMBER

MAKER	From-Till	DENSO	IRIDIUM TT	IRIDIUM RACING	IRIDIUM POWER	IRIDIUM TOUGH
CHERY						
Estar 2.4	03 - 06	K20PR-U11	IK20TT	K20TT	IK20	VK20
QQ 0.8	03 -	K20PR-U	IK20TT	K20TT	IK20	VK20
Tiggo 1.6	09 -	K20PR-U	IK20TT	K20TT	IK20	VK20
CITREON						
Belingo II 1.4	96 -	K20PR-U11	IK20TT	K20TT	IK20	VK20
C2, C3 1.6	03 -	K16HPR-U11	IKH16TT	KH16TT	IKH16	VKH16
C4, Coupe 1.6	04 -	K16HPR-U11	IKH16TT	KH16TT	IKH16	VKH16
C5 1.8, 2.0 16V	02 -	K16HPR-U11	IKH16TT	KH16TT	IKH16	VKH16
C8 2.0i 16V	02 -	K16HPR-U11	IKH16TT	KH16TT	IKH16	VKH16
Evasion 2.0	94 - 02	K20TXR	IK20TT	K20TT	IK20	VK20
Xsara Picasso	05 -	K16HPR-U11	IKH16TT	KH16TT	IKH16	VKH16
Xsara Picasso 1.6, 1.8, 2.0	97 -	K20TXR	IK20TT	K20TT	IK20	VK20
ZX 1.9i, 2.0i	92 - 97	K20PR-U	IK20TT	K20TT	IK20	VK20
DAIHATSU						
Esperi	96 -	W16EX-U	IW16TT	W16TT	IW16	VW16
Ferosa / Ascend	92 - 97	K20PR-U11	IK20TT	K20TT	IK20	VK20
GrandMax	10 -	XU22PR9	-	XU22TT	IXU22	VXU22
Hijet City Van II	00 -	K20P-U	IK20TT	K20TT	IK20	VK20
FIAT						
Coupe 2.0V Turbo	97 -	K20TXR	IK20TT	K20TT	IK20	VK20
Grande Punto 1.4	06 -	XU22EPR-U	-	XU22TT	IXU22	VXU22
Multipla 1.6	99 - 05	K20TXR	IK20TT	K20TT	IK20	VK20
Punto 1.3 (Speedgear)	00 -	K20PR-U	IK20TT	K20TT	IK20	VK20
Stilo 1.6, 1.8, 2.4	01 -	K20PR-U	IK20TT	K20TT	IK20	VK20
Ulysse 2.0 (A)16v, Emotion	97 -	K20PR-U	IK20TT	K20TT	IK20	VK20
FORD						
Econovan 2.0 (V193)	03 -	K16PR-U11	IK16TT	K16TT	IK16	VK16
Econovan, Spectron VAN	97 - 02	W16EX-U	IW16TT	W16TT	IW16	VW16
Escape 2.3 L	01 -	VT20	IT20TT	-	IT20	VT20
Fiesta 1.4, 1.6	10 -	ITV22	-	-	ITV22	-
Focus 1.8, 2.0L ZETEC, Escape 2.0	02 -	PT16VR13	ITV16TT	-	ITV16	-
Focus I 1.8 (ZETEC)	98 - 05	ITV16	ITV16TT	-	ITV16	-
Focus II 2.0	05 -	PT16EPR-L13	IT16TT	-	IT16	VT16
Focus III 2.0	07 -	VT20	IT20TT	-	IT20	VT20
Lynx 1.6, RS 2.0, Ranger 2.0	98 -	KJ16CR11	IK16TT	K16TT	IK16L	VK16
Mondeo 2.0 EcoBoost	10 -	ITV20	ITV20TT	-	ITV20	-
Ranger 2.0	00 -	T16EPR-U	IT16TT	T16TT	IT16	VT16
S-Max 2.0 EcoBoost	10 -	ITV20	ITV20TT	-	ITV20	-
Telstar 1.8, 2.0	92 - 97	K20PR-U11	IK20TT	K20TT	IK20	VK20
HONDA						
Accord 2.0 Vti	05 - 08	KJ20DR-M11	IK20TT	K20TT	IK20L	VK20
Accord 2.0, 2.2	01 - 05	KJ20CR11	IK20TT	K20TT	IK20L	VK20
Accord 2.0 i-VTEC	08 - 13	IK20G	IK20TT	-	IK20G	VK20G
	13 -	SXU22HCR11S	-	-	-	VXUHC22G
Accord 2.4 i-VTEC	05 - 08	KJ20DR-M11	IK20TT	K20TT	IK20L	VK20
	08 - 13	IK20G	-	-	-	VXUHC22G
	13 -	VCH20	-	-	-	VCH20
Accord 3.0 V6	05 -	KJ20DR-M11	IK20TT	K20TT	IK20L	VK20
BRV 1.5 i-VTEC	15 -	VFK20F	IK20TT	-	-	VFK20F
City 1.3, 1.5 Type Z	98 - 01	K20PR-U11	IK20TT	K20TT	IK20	VK20
City 1.5 i-DSI	03 - 09	K20PR-U11	IK20TT	K20TT	IK20	VK20
City 1.5 VTEC	05 -	SKJ20DR-M13	IK20TT	-	IK20L	VK20
City 1.5 i-VTEC	09 - 13	SKJ20DR-M13	IK20TT	-	IK20L	VK20
	13 -	VFK20F	IK20TT	-	-	VFK20F
City 1.5 i-Vtec Hybrid i-DCD	17 -	-	IXEH22TT	-	-	VFXEHC22G
Civic (1.7, 2.0 VTEC)	00 - 05	KJ20CR-L11	IK20TT	K20TT	IK20L	VK20
Civic 1.5, 1.6	92 - 95	K20PR-U11	IK20TT	K20TT	IK20	VK20
Civic UH 1.8, 2.0 i-VTEC	06 - 12	SKJ20DR-M11	IK20TT	-	IK20L	VK20
Civic 1.8, 2.0 i-VTEC (Earth Dream)	13 -	SXU22HCR11S	-	-	-	VXUHC22G
Civic 1.3i Hybrid	06 -	SK20HPR-L11	IKH20TT	-	IKH20	VKH20
Civic Type R 2.0 FD2R	08 - 11	SK22PR-M11S	-	-	IK22G	VK22G
Civic Type R 2.0 FK2, FK8	16 -	SXU22HCR11S	-	-	-	VXEHC24G
Civic 1.8 Earth Dream	16 -	SXU22HCR11S	-	-	-	VXUHC22G
Civic 1.5 Turbo	16 -	-	-	-	-	VXEHC24G
CRV 1st Gen 2.0 16V	97 - 01	KJ20CR-L11	IK20TT	K20TT	IK20L	VK20
CRV 2nd Gen 2.0 i-VTEC	02 - 06	KJ20DR-M11	IK20TT	K20TT	IK20L	VK20
CRV 3rd Gen 2.0 i-VTEC	07 - 12	IK20G	IK20TT	-	IK20G	VK20G



MAKER	From-Till	DENSO	IRIDIUM	TJ	IRIDIUM POWER	IRIDIUM TOUGH
HONDA						
CRV 2.0/2.4	13 - 17	SXU22HCR11S	-	-	-	VXUHC22G
CRV 1.5 Turbo	17 -	SXU22HCR11S	-	-	-	VXEHC24G
CRZ 1.5i Hybrid	10 -	SKJ20DR-M13	IK20TT	-	IK20L	VK20
Freed 1.5 i-VTEC	10 -	SKJ20DR-M13	IK20TT	-	IK20L	VK20
HRV 1.8	10 -	SXU22HCR11S	-	-	-	VXUHC22G
Insight 1.3i Hybrid	09 -	VFKH20	IKH20TT	-	-	VFKH20
Jazz 1.3i Hybrid	10 - 13	VFKH20	IKH20TT	-	-	VFKH20
Jazz 1.5 I-DSI, 1.4 i-DSI	02 -	K20PR-U11	IK20TT	K20TT	IK20	VK20
Jazz 1.5 VTEC	05 - 08	SKJ20DR-M13	IK20TT	-	IK20L	VK20
Jazz 1.5 i-VTEC	08 -	SKJ20DR-M13	IK20TT	-	IK20L	VK20
	14 -	VFK20F	IK20TT	-	-	VFK20F
Jazz 1.5 i-Vtec Hybrid i-DCD	17 -	-	IXEH22TT	-	-	VFXEHC22G
Odyssey 2.4L i-VTEC	05 -	SKJ20DR-M11	IK20TT	-	IK20L	VK20
Stream 1st Gen 1.7, 2.0	01 - 07	KJ20DR-M11	IK20TT	K20TT	IK20L	VK20
Stream 2nd Gen 1.8	07 -	VK20	IK20TT	-	IK20	VK20
HYUNDAI INOKOM						
Accent 1.5	99 - 06	K20PR-U11	IK20TT	K20TT	IK20	VK20
Accent 1.6	06 -	K16PR-U11	IK16TT	K16TT	IK16	VK16
Atos 1.1	97 -	K16PR-U	IK16TT	K16TT	IK16	VK16
Coupe 2.0i	01 -	K16PR-U11	IK16TT	K16TT	IK16	VK16
Elantra 1.6, 1.8	01 - 06	K20PR-U	IK20TT	K20TT	IK20	VK20
Elantra 2.0	07 -	K20PR-U11	IK20TT	K20TT	IK20	VK20
Getz 1.3, 1.6	02 -	K16PR-U	IK16TT	K16TT	IK16	VK16
Grandeur XG 3.0, 250 V6	01 -	PK16PR-L11	IK16TT	-	IK16	VK16
i10 1.1	08 -	K20PR-U11	IK20TT	K20TT	IK20	VK20
i30 1.6	07 -	K20PR-U11	IK20TT	K20TT	IK20	VK20
i40 2.0 GDI VF	11 -	-	-	-	-	-
Matrix 1.6	01 -	K16PR-U11	IK16TT	K16TT	IK16	VK16
NF 2.4	05 -	K16PR-U11	IK16TT	K16TT	IK16	VK16
NF 2.7	05 -	PK16PR-L11	IK16TT	-	IK16	VK16
Permas Van 2.0	-	W16EX/P-U	IW16TT	W16TT	IW16	VW16
Permas Van 2.2	-	T16EPR-U	IT16TT	T16TT	IT16	VT16
Santa FE 2.4	01 - 06	P16PR11	IW16TT	-	IW16	VW16
Sonata (NF) 2.4	06 -	K16PR-U11	IK16TT	K16TT	IK16	VK16
Sonata (NF) 2.7	05 -	VK20	IK20TT	-	IK20	VK20
Sonata 2.0, 2.4	10 -	W20EXR-U	IW20TT	W20TT	IW20	VW20
Trajt 2.0GL / GLS	00 -	W20EXR-U11	IW20TT	W20TT	IW20	VW20
Tucson 2.0	05 -	K16PR-U11	IK16TT	K16TT	IK16	VK16
Tucson 2.0/ 2.4	11 -	K16HPR-U11	IKH16TT	K16TT	IKH16	VKH16
ISUZU						
Pick-Up	-	K20PR-U11	IK20TT	K20TT	IK20	VK20
Trooper V6 24V	95 -	K20PR-U11	IK20TT	K20TT	IK20	VK20
Van	-	K20PR-U11	IK20TT	K20TT	IK20	VK20
JAGUAR						
XJ8 4.2 SE, XJR8	97 - 03	K20PR-U	IK20TT	K20TT	IK20	VK20
X-Type 3.0 SE (AJ-V6)	01 -	K20PR-U	IK20TT	K20TT	IK20	VK20
JEEP CHEROKEE						
Jeep 2.5L	94 -	K16PR-U	IK16TT	K16TT	IK16	VK16
Jeep 4	94 -	K20PR-U	IK20TT	K20TT	IK20	VK20
LAND ROVER						
Range Rover 4.4 V8	02 - 05	K20TXR	IK20TT	K20TT	IK20	VK20
LEXUS						
IS/GS 250	06 - 16	FK20HBR11	IKBH20TT	-	-	VFKBH20
LS460L	07 -	FK20HBR11	IKBH20TT	-	-	VFKBH20
LX570	16 -	-	IKH20TT	-	IKH20	VKH20
RX350	07 -	FK20HR11	IKH20TT	-	-	VFKH20
RX450h	09 -	-	IKBH20TT	-	-	VFKBH20
IS/GS/RX/NX 200t	15 -	-	-	-	-	VDKH22F
LOTUS						
Elise 1.8	95 -	VK20	IK20TT	-	IK20	VK20
Europa Special	-	W22EP-U	-	-	IW22	VW22
MAZDA						
Mazda 2 1.5 SkyActiv	15 -	VCH20	IXEH20TT	-	-	VCH20
Mazda 2 1.5 (ZY-VE)	09 - 14	K16PR-U11	IK16TT	K16TT	IK16	VK16
Mazda 2 1.5	10 -	VK16	IK16TT	-	IK16	VK16
323 Astina	95 -	K20PR-U11	IK20TT	K20TT	IK20	VK20
Bongo Van	-	W16EP-U/W16EX-U	IW16TT	W16TT	IW16	VW16

DENSO

AUSTRALIA CHINA

INDIA

INDONESIA

KOREA

MALAYSIA

PHILIPPINES SAUDI ARABIA SINGAPORE

TAIWAN

THAILAND

VIETNAM

JAPAN

EUROPE

MOTOR CYCLE

SMALL ENGINE

CROSS REFERENCE

PART NUMBER

DENSO	9	14	16	20	22	24	27	29	31	32	34	35	DENSO	9	14	16	20	22	24	27	29	31	32	DENSO	9	14	16	20	22	24	27	31
NGK	2	4	5	6	7	8	9	9.5	10	10.5	11	11.5	CHAMPION	18	16,14	12,11	10,9	8,7	6,63,61	4,59	57	55	53	BOSCH	10	9	8	7,6	5	4	3	2



DENSO

MAKER	From-Till	DENSO	IRIDIUM	IRIDIUM	IRIDIUM POWER	IRIDIUM TOUGH
MAZDA						
Lantis 1.6, 626 2.0	95 -	K20PR-U11	IK20TT	K20TT	IK20	VK20
Mazda 3 2.0 SkyActiv	14 -	VCH20	IXEH20TT	-	-	VCH20
Mazda 3 2.0	04 -	VT16	IT16TT	-	IT16	VT16
Mazda 3 1.6	09 -	VK16	IK16TT	-	IK16	VK16
Mazda 5 2.0 MPV	06 -	VT20	IT20TT	-	IT20	VT20
Mazda 6 2.0, 2.5 SkyActiv	13 -	VCH20	IXEH20TT	-	-	VCH20
Mazda 6 2.0	04 -	-	ITV16TT	-	ITV16	-
CX-3 2.0 SkyActiv	15 -	VCH20	IXEH20TT	-	-	VCH20
CX-5 2.0, 2.5 Sky Activ	12 -	VCH20	IXEH20TT	-	-	VCH20
CX-7 2.3	09 -	ITV20	ITV20TT	-	ITV20	-
Premacy 1.8L	99 -	K16PR-U11	IK16TT	K16TT	IK16	VK16
MERCEDES BENZ						
190E, 200, 230, 300 (123, 124, 126 Model)	-	T20EP-U	IT20TT	T20TT	IT20	VT20
B200T 2.0 (M266)	05 -	VK20	IK20TT	-	IK20	VK20
C Class 180K 1.8 (M271) (W203)	02 - 07	VXUH22	-	-	IXUH22	VXUH22
C Class 200, 220 (M111)	98 -	K16P-U	IK16TT	K16TT	IK16	VK16
C Class 200K, E200K 2.0 (M111) (W203) (W210)	00 - 02	VK20	IK20TT	-	IK20	VK20
C Class 230K 2.3 (M271) (W203)	04 - 05	VKH20	IKH20TT	-	IKH20	VKH20
C-180K, C200K, E200K, (M271, M203)	02 -	VKH20	IKH20TT	-	IKH20	VKH20
E200, E230, E240 (M111, M104, M119)	96 -	K16PR-U	IK16TT	K16TT	IK16	VK16
E200, E230, S280, S320L (M111)	98 -	K16TNR-S9	IK16TT	K16TT	IK16	VK16
E200K 2.0 (M271) (W211)	02 - 06	VKH20	IKH20TT	-	IKH20	VKH20
E240K, S280 (W211)	04 -	PK16PR(-L)11	IK16TT	-	IK16	VK16
S320 (W220), 350L (V220)	03 -	PK16PR(-L)11	IK16TT	-	IK16	VK16
SLK200, SLK350	06 -	PK16PR(-L)11	IK16TT	-	IK16	VK16
MINI						
Cooper 1.6	02 -	K20TXR	IK20TT	K20TT	IK20	VK20
Cooper S 1.6	02 -	K20TXR	IK20TT	K20TT	IK20	VK20
Mini Cooper, One 1.6	02 -	K20TXR	IK20TT	K20TT	IK20	VK20
MITSUBISHI						
Airtrek 2.0	01 -	K20PR-U11	IK20TT	K20TT	IK20	VK20
Airtrek 2.0 Turbo	02 -	P20R8	IW20TT	-	IW20	VW20
ASX 2.0	10 -	-	IK20TT	-	IK20	VK20Y
Colt 1.5L (4A91)	03 -	VKH20	IKH20TT	-	IKH20	VKH20
Colt 1.6 (4G92)	96 -	K20PR-U11	IK20TT	K20TT	IK20	VK20
Grandis 2.4L	04 -	IKH20	IKH20TT	-	IKH20	VKH20
Lancer 1.6L	03 -	K16PR-U11	IK16TT	K16TT	IK16	VK16
Lancer, Evo-V, VI	04 -	P22PR8	-	-	IW22	VW22
Lancer 2.0	10 -	-	IK20TT	-	IK20	VK20Y
Lancer Evo X	10 -	-	-	-	-	-
Outlander 2.4L	03 -	IKH20	IKH20TT	-	IKH20	VKH20
Pajero 2.0	82 - 88	W20EX-U11	IW20TT	W20TT	IW20	VW20
Pajero 2.4	96 - 00	K16PR-U11	IK16TT	K16TT	IK16	VK16
Storm V6 3.0	00 -	PK20PR-P11	IK20TT	-	IK20	VK20
NAZA / KIA						
Bestari 206 1.4	06 -	K20TXR	IK20TT	K20TT	IK20	VK20
Carens 1.8	01 -	K20PR-U11	IK20TT	K20TT	IK20	VK20
Carnival V6 2.5	01 - 06	PK20PR-L11	IK20TT	-	IK20	VK20
Cerato K3 1.6	13 -	-	-	-	IXUH20I	VXUH20I
Cerato K3 2.0	13 -	K16HPR-U11	IKH16TT	KH16TT	IKH16	VKH16
Citra 2.0	02 -	K20PR-U11	IK20TT	K20TT	IK20	VK20
Citra II Rondo 2.0	08 -	K20PR-U11	IK20TT	K20TT	IK20	VK20
Forte 1.6	10 -	-	-	-	IXUH22I	VXUH22I
Forte 2.0	10 -	K16HPR-U11	IKH16TT	KH16TT	IKH16	VKH16
Forte Koup 2.0i CVVT	10 -	K16HPR-U11	IKH16TT	KH16TT	IKH16	VKH16
K5 2.0	11 -	-	-	-	-	-
Optima 2.0	03 -	K20PR-U11	IK20TT	K20TT	IK20	VK20
Picanto 1.1	04 -	K16PR-U11	IK16TT	K16TT	IK16	VK16
Picanto 1.2	11 -	-	-	-	IXUH20I	VXUH20I
Ria 2.5 V6	01 - 06	PK20PR-L11	IK20TT	-	IK20	VK20
Rio 1.4	03 -	K16PR-U11	IK16TT	K16TT	IK16	VK16
Rio/ Rio Sedan 1.4	11 -	-	-	-	IXUH20I	VXUH20I
Sephia 1.5 / 1.6	01 -	K20PR-U11	IK20TT	K20TT	IK20	VK20
Sorento V6 3.5	02 -	K20PR-U11	IK20TT	K20TT	IK20	VK20
Sorento XM	09 -	K16HPR-U11	IKH16TT	K16TT	IK16	VK16
Spectra 1.6	01 -	K20PR-U11	IK20TT	K20TT	IK20	VK20
Spectra 5	-	K20PR-U11	IK20TT	K20TT	IK20	VK20

CHINA AUSTRALIA INDIA INDONESIA KOREA MALAYSIA PHILIPPINES SAUDI ARABIA SINGAPORE TAIWAN THAILAND VIETNAM JAPAN EUROPE & USA SMALL ENGINE CROSS REFERENCE PART NUMBER



MAKER	From-Till	DENSO	IRIDIUM I	TJ	IRIDIUM POWER	IRIDIUM TOUGH
NAZA / KIA						
Sportage R	-	K20PR-U11	IK20TT	K20TT	IK20	VK20
Sportage 2.0 4x4	10 -	K16HPR-U11	IKH16TT	KH16TT	IKH16	VKH16
Suria	-	K16PR-U	IK16TT	K16TT	IK16	VK16
Sutera 1.1	06 -	PK16PR-L11	IK16TT	-	IK16	VK16
NISSAN						
350Z	03 -	VKH16	IKH16TT	-	IKH16	VKH16
AD Resort 1.6SLX	90 - 97	K20PR-U	IK20TT	K20TT	IK20	VK20
Almera 1.5	13 -	FXE20HR-11	IXEH20TT	-	-	VFXEH20
Altima 2.0, BLUEBIRD 2.0	00 -	Q20PR-U	IQ20TT	Q20TT	IQ20	VQ20
Bluebird 2.0	00 -	K20PR-U	IK20TT	K20TT	IK20	VK20
Cefiro 2.0i V6 24V (A33)	00 -	VK20	IK20TT	-	IK20	VK20
Cefiro 2.0i, 3.0i	97 - 01	PK20PR11	IK20TT	-	IK20	VK20Y
Grand Livina 1.6, 1.8	07 -	FXE20HR-11	IXEH20TT	-	-	VFXEH20
Latio 1.6, 1.8	07 -	FXE20HR-11	IXEH20TT	-	-	VFXEH20
Livina X-GEAR	11 -	FXE20HR-11	IXEH20TT	-	-	VFXEH20
March Micra 1.0	00 -	W16EX-U	IW16TT	W16TT	IW16	VW16
March Micra 1.4 <NEW>	02 -	VKH20	IKH20TT	-	IKH20	VKH20
Murano 2.5	04 - 09	K16HPR-U11	IKH16TT	-	IKH16	VKH16
Sentra 1.5, 1.6i (N13)	88 - 91	Q20-U	IQ20TT	Q20TT	IQ20	VQ20
Sentra 1.6 (B13)	91 - 95	K16PR-U	IK16TT	K16TT	IK16	VK16
Sentra 1.6 (B14)	95 - 01	K16PR-U11	IK16TT	K16TT	IK16	VK16
Sentra 1.6, 1.8 (N16)	00 -	K16PR-U	IK16TT	K16TT	IK16	VK16
Serena 1.6, 2.0i	01 -	K16PR-U11	IK16TT	K16TT	IK16	VK16
Skyline 2.5GTR R34 (RB26DETT)	01 -	VQ22	-	-	IQ22	VQ22
Sunny 1.6i	86 -	W16EX-U11	IW16TT	W16TT	IW16	VW16
Sunny 120Y (B11), 130Y (B12)	94 -	W16EX-U	IW16TT	W16TT	IW16	VW16
SYLPHY 2.0	08 -	FXE20HR-11	IXEH20TT	-	-	VFXEH20
Teana 2.0	11 -	FXE20HR-11	IXEH20TT	-	-	VFXEH20
Teana 2.5 V6	11 -	FXE20HR-11	IXEH20TT	-	-	VFXEH20
Terrano	86 - 95	W16EX-U	IW16TT	W16TT	IW16	VW16
Vanette C20, C22	93 -	W16EX-U	IW16TT	W16TT	IW16	VW16
X-Trail 2.0, 2.5	03 - 14	K16HPR-U11	IKH16TT	KH16TT	IKH16	VKH16
X-Trail 2.0	15 -	-	IXEH20TT	-	-	VFXEH20
OPEL						
Astra 1.6i	93 -	K16PR-U	IK16TT	K16TT	IK16	VK16
Astra 2.0i, GSi 16V	95 -	K20PR-U	IK20TT	K20TT	IK20	VK20
Frontera 4WD 2.2 ECOTEC	95 -	K16PR-U	IK16TT	K16TT	IK16	VK16
Vectra 1.8, 2.0i ECOTEC	95 -	K20PR-U	IK20TT	K20TT	IK20	VK20
PERODUA						
Alza 1.5	10 -	XU22PR9	-	XU22TT	IXU22	VXU22
Aruz 1.5	18 -	-	-	-	-	VCH16
Axia 1.0	14 -	XU20HR9	-	-	IXUH20I	VXUH20I
Bezza 1.0	16 -	XU20HR9	-	-	IXUH20I	VXUH20I
Bezza 1.3	16 -	SC16HR11	-	-	-	VCH16
Kancil 850Ezi	00 -	K16PR-U11	IK16TT	K16TT	IK16	VK16
Kancil EX, GX, EZ660	09 -	W16EX-U	IW16TT	W16TT	IW16	VW16
Kancil EX, GX, EZ850	94 -	W20EX-U	IW20TT	W20TT	IW20	VW20
Kelisa, Kenari, Myvi 1.0	98 -	K16PR-U11	IK16TT	K16TT	IK16	VK16
Kembara 1.3	96 -	K20TNR-S	IK20TT	K20TT	IK20	VK20
Myvi 1.3 Lagi Best, Icon	07 - 17	XU22PR9	-	XU22TT	IXU22	VXU22
Myvi 1.3 (Old), Kembara DVVT	05 - 06	K20R-U11	IK20TT	K20TT	IK20	VK20
New Myvi 1.3, 1.5	17 -	SC16HR11	-	-	-	VCH16
Nautica 1.5	07 -	XU22EPR-U	-	XU22TT	IXU22	VXU22
Rusa 1.3, 1.6	00 -	K20P-U	IK20TT	K20TT	IK20	VK20
ViVa 0.66	06 -	K20PR-U	IK20TT	K20TT	IK20	VK20
ViVa 1.0, 0.85	06 -	K16PR-U11	IK16TT	K16TT	IK16	VK16
PEUGEOT						
206, 206CC	00 -	K20TXR	IK20TT	K20TT	IK20	VK20
207 CC 1.6	06 -	-	IKH16TT	-	IKH16	VKH16
306 1.8i	97 - 03	K20TXR	IK20TT	K20TT	IK20	VK20
307 1.6i	00 - 03	K20TXR	IK20TT	K20TT	IK20	VK20
308 (T7)	07 -	K20PR-U	IK20TT	K20TT	IK20	VK20
405 SR, Sri	92 - 97	K20TXR	IK20TT	K20TT	IK20	VK20
406 2.0i	95 - 04	K20TXR	IK20TT	K20TT	IK20	VK20
407 (D2)	04 -	-	IKH16TT	-	IKH16	VKH16
607 2.2i	00 -	-	IKH16TT	-	IKH16	VKH16
807 2.0i	02 -	-	IKH16TT	-	IKH16	VKH16

DENSO

AUSTRALIA CHINA INDIA INDONESIA KOREA MALAYSIA PHILIPPINES SAUDIARABIA SINGAPORE TAIWAN THAILAND VIETNAM JAPAN & USA EUROPE MOTOR CYCLE SMALL ENGINE CROSS PART REFERENCE NUMBER

DENSO	9	14	16	20	22	24	27	29	31	32	34	35	DENSO	9	14	16	20	22	24	27	29	31	32	DENSO	9	14	16	20	22	24	27	31
NGK	2	4	5	6	7	8	9	9.5	10	10.5	11	11.5	CHAMPION	18	16,14	12,11	10,9	8,7	6,63,61	4,59	57	55	53	BOSCH	10	9	8	7,6	5	4	3	2



DENSO

MAKER	From-Till	DENSO	IRIDIUM	TT	IRIDIUM POWER	IRIDIUM TOUGH
PORSCHE						
911 (996)	97 - 04	VK20	IK20TT	-	IK20	VK20
Boxster (986)	96 -	IK22	-	-	IK22	VK22
Cayenne (9PA)	02 -	K20PBR-S10	IK20TT	K20TT	IK20	VK20
Cayman	05 -	IK22	-	-	IK22	VK22
PROTON						
Arena 1.5L	99 -	W16EX-U	IW16TT	W16TT	IW16	VW16
X70 1.8 TGD <i>i</i>	18 -	-	IK20TT	-	IK20	VK20
Exora 1.6 CPS MPV	09 -	T20EPR-U	IT20TT	T20TT	IT20	VT20
Exora Bold 1.6 CFE Turbo	11 -	-	IXEH22TT	-	-	-
Gen 2 1.3 <i>i</i>	05 -	T20EPR-U	IT20TT	T20TT	IT20	VT20
Gen 2 1.6 <i>i</i>	04 -	T20EPR-U	IT20TT	T20TT	IT20	VT20
Iswara 1.3 , 1.5	92 -	W16EX-U	IW16TT	W16TT	IW16	VW16
Iriz 1.3, 1.6 VVT	14 -	-	IXEH22TT	-	-	-
Juara 1.1	00 - 04	XU22EPR-U	-	XU22TT	IXU22	VXU22
Perdana 2.0 <i>i</i> V6	94 - 01	K20PR-U11	IK20TT	K20TT	IK20	VK20
Perdana 2.0 <i>i</i> V6 24V	98 - 13	PK20PR-P11	IK20TT	-	IK20	VK20
Persona 1.6L	04 -	T20EPR-U	IT20TT	T20TT	IT20	VT20
New Persona 1.6 VVT	16 -	-	IXEH22TT	-	-	-
Preve 1.6 Campro (Non-Turbo)	12 -	T20EPR-U	IT20TT	T20TT	IT20	VT20
Preve 1.6 CFE Turbo	12 -	-	IXEH22TT	-	-	-
Putra 1.8 <i>i</i>	96 - 00	K16PR-U	IK16TT	K16TT	IK16	VK16
Saga 1.3 , 1.5	85 - 92	W16EX-U	IW16TT	W16TT	IW16	VW16
Saga BLM, FL, FLX	08 - 16	T20EPR-U	IT20TT	T20TT	IT20	VT20
Saga 1.3 VVT	16 -	-	IXEH22TT	-	-	-
Satria 1.3	96 -	W16EX-U	IW16TT	W16TT	IW16	VW16
Satria 1.5	96 -	W16EX-U	IW16TT	W16TT	IW16	VW16
Satria 1.6 <i>i</i>	96 -	K16PR-U	IK16TT	K16TT	IK16	VK16
Satria 1.8 GT <i>i</i> 16V	99 - 06	K20PR-U11	IK20TT	K20TT	IK20	VK20
Satria Neo 1.3	06 -	T20EPR-U	IT20TT	T20TT	IT20	VT20
Satria Neo 1.6	06 -	T20EPR-U	IT20TT	T20TT	IT20	VT20
Savvy 1.2	05 -	XE20HR-U9	IXEH20TT	-	-	VFXEH20
Tiara 1.1 GL 8V	95 - 00	K16PR-U	IK16TT	K16TT	IK16	VK16
Waja 1.6 <i>i</i>	99 - 06	K20PR-U11	IK20TT	K20TT	IK20	VK20
Waja Campro CPS 1.6 <i>i</i>	06 -	T20EPR-U	IT20TT	T20TT	IT20	VT20
Waja 1.8 <i>i</i>	01 -	K20PR-U11	IK20TT	K20TT	IK20	VK20
Wira 1.3 , 1.5	93 - 01	W16EX-U	IW16TT	W16TT	IW16	VW16
	00 -	W16EX-U	IW16TT	W16TT	IW16	VW16
Wira 1.6 , 1.8	00 -	K20PR-U11	IK20TT	K20TT	IK20	VK20
Wira 1.6 Xli , 1.8EX <i>i</i>	95 -	K16PR-U	IK16TT	K16TT	IK16	VK16
RENAULT						
19 Cabrio 1.8 <i>i</i>	92 - 95	W16EXR-U11	IW16TT	W16TT	IW16	VW16
Clio III 1.4	05 -	K16PR-U	IK16TT	K16TT	IK16	VK16
Espace III (JEO) 2.0	96 - 02	K16PR-U	IK16TT	K16TT	IK16	VK16
Kangoo 1.4 <i>i</i>	97 -	K16PR-U	IK16TT	K16TT	IK16	VK16
Laguna 1.8RT, 2.0RXE	94 -	W16EX-U	IW16TT	W16TT	IW16	VW16
Megane 1.6 <i>i</i> , Scenic 1.6 <i>i</i>	96 -	K16PR-U	IK16TT	K16TT	IK16	VK16
Megane 2.0 <i>i</i> , Scenic 2.0 <i>i</i>	96 -	W16EXR-U	IW16TT	W16TT	IW16	VW16
Traffic 2.2	-	T20EP-U	IT20TT	T20TT	IT20	VT20
SKODA						
Fabia	99 -	-	IK20TT	-	IK20	VK20
Octavia (1U25)	96 - 04	-	IK16TT	-	IK16	VK16
Octavia (1Z35)	04 -	-	IK16TT	-	IK16	VK16
Superb	04 -	-	IK16TT	-	IK16	VK16
SSANGYONG						
Actyon	06 -	K16PR-U	IK16TT	K16TT	IK16	VK16
Chairman 2.3 DOHC	97 -	K16PR-U11	IK16TT	K16TT	IK16	VK16
Chairman 2.8, 3.2 DOHC	03 -	K16TNR-S9	IK16TT	K16TT	IK16	VK16
Kyron	05 -	K16PR-U	IK16TT	K16TT	IK16	VK16
Rexton RX280, RX320S	03 -	K16PR-U	IK16TT	K16TT	IK16	VK16
SUBARU						
Forester 2.0 <i>i</i>	97 -	K20PR-U11	IK20TT	K20TT	IK20	VK20
Forester 2.0 <i>i</i> p	16 -	VFXEH22	IXEH22TT	-	-	VFXEH22
Impreza 1.6 , 1.8	92 - 96	K20PR-U11	IK20TT	K20TT	IK20	VK20
Impreza 2.0 4WD Outback	00 -	K20PR-U11	IK20TT	K20TT	IK20	VK20
Impreza 2.0 4WD Turbo	92 - 00	K20PR-U11	IK20TT	K20TT	IK20	VK20
Impreza WRX 2.0 CVT	14 -	VFXEH22	IXEH22TT	-	-	VFXEH22
Impreza WRX ST <i>i</i> 2.5 6-MT	14 -	VKH20Y	IKH20TT	-	-	VKH20Y



MAKER	From-Till	DENSO	IRIDIUM I	TJ	IRIDIUM POWER	IRIDIUM TOUGH
SUBARU						
Legacy 2.0 , 2.2	04 -	K20PR-U11	IK20TT	K20TT	IK20	VK20
Libero 1.2i, 1.2, 4WD	95 -	K16PR-U11	IK16TT	K16TT	IK16	VK16
XV 2.0	12 -	VFXEH22	IXEH22TT	-	-	VFXEH22
SUZUKI						
Alto 1.0	11 -	W16EPR-U	IW16TT	K16TT	IW16	VW16
APV 1.6	-	K20PR-U	IK20TT	K20TT	IK20	VK20
ERV 1.3	-	K20PR-U	IK20TT	K20TT	IK20	VK20
Grand Vitara	-	K20PR-U11	IK20TT	K20TT	IK20	VK20
Jimny 1.3	-	K16PR-U11	IK16TT	K16TT	IK16	VK16
Swift 1.5	04 -	K20PR-U11	IK20TT	K20TT	IK20	VK20
Swift Sport 1.6	05 - 11	VK20	IK20TT	-	IK20	VK20
SX4 1.6	07 -	VK20	IK20TT	-	IK20	VK20
Vitara 1.6i , 2.0i	97 - 02	K20PR-U11	IK20TT	K20TT	IK20	VK20
Vitara 2.0 GLX	04 -	K20PR-U11	IK20TT	K20TT	IK20	VK20
TOYOTA						
GT 86	12 -	ZXE27HBR8	-	-	-	VXEBH27
Alphard 2.4	02 - 08	K20R-U11	IK20TT	K20TT	IK20	VK20
	08 - 15	SK20R11	IK20TT	-	IK20	VK20
Alphard 2.5	15 -	SK16HR11	IKH16TT	-	IKH16	VKH16
Alphard 3.0	02 - 08	SK20R11	IK20TT	-	IK20	VK20
Alphard 3.5 V6	08 -	FK20HR11	IKH20TT	-	-	VFKH20
Altis 1.8E, 1.8G, 2.0V Dual VVT-i	16 -	SC20HR11	-	-	-	VCH20
	14 - 16	SC20HR11	-	-	-	VCH20
Altis 1.6E, 1.8G, 2.0V Dual VVT-i	10 - 14	SC20HR11	-	-	-	VCH20
Altis 1.6 , 1.8 VVT-i	03 - 10	K16R-U11	IK16TT	K16TT	IK16	VK16
Avanza 1.3	04 - 06	K20R-U11	IK20TT	K20TT	IK20	VK20
Avanza 1.3 , 1.5	06 - 15	XU22PR9	-	XU22TT	IXU22	VXU22
Avanza 1.3, 1.5 (Dual-VVTi)	15 -	SC16HR11	-	-	-	VCH16
Caldina 1.8 (1ZZ-FE)	02 -	K16R-U11	IK16TT	K16TT	IK16	VK16
Caldina 1.8 (7A-FE)	96 - 02	PK16TR13	IK16TT	-	IK16	VK16
Caldina 2.0 (1AZ-FSE D-4)	02 -	SK20BGR11	-	-	-	VKA20
Caldina 2.0 (3S-FE)	92 - 96	K20R-U11	IK20TT	K20TT	IK20	VK20
	96 - 02	K20TR11	IK20TT	K20TT	IK20	VK20
Caldina 2.0 (3S-GTE T/C)	97 - 02	PK20R8	IK20TT	-	-	VK20Y
Caldina 2.0 ST246W (3S-GTE T/C)	02 -	SK20R8	IK20TT	-	-	VK20Y
Camry 2.5 ASV70R	18 -	-	IKH16TT	-	-	VFKH16
Camry 2.5 AVV50 Hybrid	15 -	FK16HR-A8	IKH16TT	-	-	VFKH16
Camry 2.0E, 2.0G VVTi-W	15 -	FK16HBR-J8	IKBH20TT	-	-	VFKBH20
Camry 2.5V ACV50	12 - 15	SK16HR11	IKH16TT	-	IKH16	VKH16
Camry 2.0E, 2.0G ACV50	12 - 15	SK20R11	IK20TT	-	IK20	VK20
Camry 2.0 E VVTI ACV30	02 - 06	SK20R11	IK20TT	-	IK20	VK20
Camry 2.0E . 2.0G, 2.4V ACV40	06 - 12	SK20R11	IK20TT	-	IK20	VK20
Camry 2.2i Sedan	92 - 00	PK20TR11	IK20TT	-	IK20	VK20
Camry 2.4 V VVTI	92 - 00	SK20R11	IK20TT	-	IK20	VK20
Camry SXV10	-	K20R-U11	IK20TT	K20TT	IK20	VK20
Camry SXV20	-	PK20TR11	IK20TT	-	IK20	VK20
CH-R 1.8	18 -	-	IXEH20TT	-	-	VCH20
CH-R 1.2 Turbo	18 -	-	IXEH22TT	-	-	VDCH22F
Celica 2.0i, 2.2i	93 -	K16R-U11	IK16TT	K16TT	IK16	VK16
Corolla (EE111)	-	K16R-U	IK16TT	K16TT	IK16	VK16
Corolla 1.3i (AE80 , 82)	97 - 99	W16EX-U	IW16TT	W16TT	IW16	VW16
Corolla 1.6i (AE101)	94 - 97	K16R-U11	IK16TT	K16TT	IK16	VK16
Corolla 1.6i (AE111)	97 - 02	K20R-U	IK20TT	K20TT	IK20	VK20
Corolla 1.6i (AE92)	96 - 02	Q16R-U	IQ16TT	Q16TT	IQ16	VQ16
Corona (ST171R)	-	Q20R-U11	IQ20TT	Q20TT	IQ20	VQ20
Corona (TT132), 1.6XLI(AT151)	-	W16EX-U	IW16TT	W16TT	IW16	VW16
Estima 2.4 (2AZ-FE)	00 - 06	K20R-U11	IK20TT	K20TT	IK20	VK20
	06 -	SK20R11	IK20TT	-	IK20	VK20
Estima 2.4, 3.0	98 - 05	SK20R11	IK20TT	-	IK20	VK20
Estima 2.5	93 - 97	PK16R11	IK16TT	-	IK16	VK16
Estima 3.0 (1MZ-FE)	00 - 06	SK20R11	IK20TT	-	IK20	VK20
Estima 3.5 (2GR-FE)	06 -	FK20HR11	IKH20TT	-	-	VFKH20
Fortuner 2.7 Dual VVT-i	16 -	FK20HR-A8	IKH20TT	-	-	VFKH20
Fortuner 2.7	05 -	K20HR-U11	IKH20TT	KH20TT	IKH20	VKH20
Harrier ZSU60/65W 2.0	14 -	-	IXEH20TT	-	-	VCH20
Harrier ASU60/65W 2.0 Turbo	18 -	-	-	-	-	VDKH22F
Harrier 2.4	00 - 03	K20R-U11	IK20TT	K20TT	IK20	VK20

DENSO

AUSTRALIA CHINA

INDIA

INDONESIA

KOREA

MALAYSIA

PHILIPPINES

SAUDI ARABIA

SINGAPORE

TAIWAN

THAILAND

VIETNAM

JAPAN

EUROPE

MOTOR & USA

CYCLE

SMALL

ENGINE

CROSS

PART

REFERENCE NUMBER

DENSO	9	14	16	20	22	24	27	29	31	32	34	35	DENSO	9	14	16	20	22	24	27	29	31	32	DENSO	9	14	16	20	22	24	27	31
NGK	2	4	5	6	7	8	9	9.5	10	10.5	11	11.5	CHAMPION	18	16,14	12,11	10,9	8,7	6,63,61	4,59	57	55	53	BOSCH	10	9	8	7,6	5	4	3	2



DENSO

MAKER	From-Till	DENSO	IRIDIUM TT	IRIDIUM RACING	IRIDIUM POWER	IRIDIUM TOUGH
TOYOTA						
Harrier 3.0i 24V	98 -	SK20R11	IK20TT	-	IK20	VK20
Hiace (2R, 2Y, 3Y, 1RZ)	-	W16EX-U	IW16TT	W16TT	IW16	VW16
Hilux 1.8, 2.2, 2.4	88 - 94	W16EXR-U11	IW16TT	W16TT	IW16	VW16
Innova 2.0 Dual VVT-i	16 -	FK20HBR-TJ8	IKBH20TT	-	-	VFKBH20
Innova 2.0	05 -	K20HR-U11	IKH20TT	KH20TT	IKH20	VKH20
Land Cruiser (Prado) 2.7	97 - 02	K16R-U	IK16TT	K16TT	IK16	VK16
	02 - 04	K16R-U11	IK16TT	K16TT	IK16	VK16
	04 - 07	SK20HR-11	IKH20TT	-	IKH20	VKH20
Land Cruiser (Prado) 2.7i 16V	96 -	K20R-U	IK20TT	K20TT	IK20	VK20
Land Cruiser (Prado) 3.4i 24V	96 -	K16TR11	IK16TT	K16TT	IK16	VK16
Land Cruiser 4.7 (LC100, LC200)	-	SK20R11	IK20TT	-	IK20	VK20
Land Cruiser II 2.4	88 - 96	W16EP-U	IW16TT	W16TT	IW16	VW16
Liteace (KM36)	-	W16EX-U	IW16TT	W16TT	IW16	VW16
Liteace (YM30, 31, 35)	-	W16EX-U	IW16TT	W16TT	IW16	VW16
Liteace 1.5, 1.8	83 - 92	W16EX-U	IW16TT	W16TT	IW16	VW16
MR2 1.6 (AW11), 2.0GTI	93 -	K20R-U11	IK20TT	K20TT	IK20	VK20
MR2 2.0 (S-GE)	89 - 97	PK20R8	IK20TT	-	IK20	VK20Y
	97 - 99	PK20R11	IK20TT	-	IK20	VK20
MR2 2.0 (S-GTE T/C)	89 - 99	PK20R8	IK20TT	-	-	VK20Y
Prius C 1.5	11 -	SK16R11	IK16TT	-	IK16	VK16
Prius 1.8	09 -	SC20HR11	-	-	-	VCH20
Rav 4 2.0i 16V	94 - 00	K20R-U11	IK20TT	K20TT	IK20	VK20
Rush 1.5 Dual VVT-i	18 -	SC16HR11	-	-	-	VCH16
Rush 1.5	06 -	XU22PR9	-	XU22TT	IXU22	VXU22
Sienta 1.5 Dual VVT-i	16 -	SC16HR11	-	-	-	VCH16
Unser 1.8	99 - 04	W16EXR-U11	IW16TT	W16TT	IW16	VW16
Vellfire 2.4	09 - 15	SK20R11	IK20TT	-	IK20	VK20
Vellfire 2.5	15 -	SK16HR11	IKH16TT	-	IKH16	VKH16
Vellfire 3.5 V6	09 -	FK20HR11	IKH20TT	-	-	VFKH20
Vios 1.5J, 1.5E, 1.5G, 1.5GX, TRD (Dual VVTi)	16 -	SC16HR11	-	-	-	VCH16
Vios 1.5J, 1.5E, 1.5G, TRD	10 - 16	K16R-U11	IK16TT	K16TT	IK16	VK16
Vios 1.5E, 1.5G	03 - 07	K16R-U11	IK16TT	K16TT	IK16	VK16
Wish 1.8 (Japan)	03 - 09	K16R-U11	IK16TT	K16TT	IK16	VK16
Wish 2.0 (Japan)	03 - 09	SK20BGR11	-	-	-	VKA20
Wish 2.0 (Thailand)	04 - 09	SK20R11	IK20TT	-	IK20	VK20
Yaris 1.5 Dual VVT-i	19 -	-	-	-	-	-
Yaris 1.5	06 - 09	K16R-U11	IK16TT	K16TT	IK16	VK16
VOLKSWAGEN						
Beetle	-	SC16HR11	-	-	-	VCH16
Beetle (New) 1.6	02 -	K20PBR-S10	IK20TT	K20TT	IK20	VK20
Beetle (New) 2.0	02 -	VK20	IK20TT	-	IK20	VK20
EOS 2.0	06 -	VK20	IK20TT	-	IK20	VK20
Golf	-	W16EX-U	IW16TT	W16TT	IW16	VW16
Golf V 1.6	07 -	K20PBR-S10	IK20TT	K20TT	IK20	VK20
Golf V GTI 2.0	05 -	VK20	IK20TT	-	IK20	VK20
Golf VI 1.6	08 -	VK20	IK20TT	-	IK20	VK20
Jetta 1.6	05 - 08	K20PBR-S10	IK20TT	K20TT	IK20	VK20
Jetta 2.0 FSI	05 -	VK20	IK20TT	-	IK20	VK20
Passat 2.8 V6	-	K20PBR-S10	IK20TT	K20TT	IK20	VK20
Polo 1.4 FSI	06 -	K20PBR-S10	IK20TT	K20TT	IK20	VK20
Polo Sedan 1.6 MPI	06 -	VK16	IK16TT	-	IK16	VK16
Polo GTI 1.8 TURBO	06 -	VK20	IK20TT	-	IK20	VK20
Tiguan 2.0	07 -	VK20	IK20TT	-	IK20	VK20
Touareg (7LA) 3.6 V6 FSI	02 - 06	VUX22	-	-	IXU22	VXU22
VOLVO						
740 2.3i	90 - 95	W20EX-U	IW20TT	W20TT	IW20	VW20
850 2.5 GLT	93 - 97	W20EX-U	IW20TT	W20TT	IW20	VW20
850 2.5GLE	92 - 97	K20PR-U	IK20TT	K20TT	IK20	VK20
940 2.3, 2.3T	91 - 97	W20EX-U	IW20TT	W20TT	IW20	VW20
960 2.4, 3.0	94 - 97	PK20PR-P8	IK20TT	-	IK20	VK20Y

CHINA AUSTRALIA

INDIA

INDONESIA

KOREA

IMALAYSIA

PHILIPPINES

SAUDJARABIA

SINGAPORE

TAIWAN

THAILAND

VIETNAM

JAPAN

EUROPE & USA

MOTOR CYCLE

SMALL ENGINE

CROSS REFERENCE

PART NUMBER

150



MODEL	DENSO	IRIDIUM POWER
APRILIA		
ETV CapoNord, RST Futura	XU27EPR-U	IXU27
MX50, SR50 Street	W27ESR-U	IW27
Pegaso 650, Moto 6.5	X24ES-U	IX24
RSV1000R, Tuono 1000R	XU27EPR-U	IXU27
RX 250	W31ES-U	IW31
RX125, Strada 125, RS125	W27ESR-U/W27ES-U	IW27
SR50, Rally 50	W24ES-U _s	IW24
Tuareg Rally 250	W27ES-U	IW27
BMW		
F650, F650CS, F650GS	X24ES-U	IX24
GS80, R80/7, R80G, R80S	W20EP-U _s	IW20
K100, K100RS, K100RT	X22ES-U	IX22
K1200GT	XU22EPR-U	IXU22
K75C, K75S	X22ES-U	IX22
R1100GS/RS	K22PB	IK22
R1100S Boxer Cup	K22TNR	IK22
R75/5, R75/6, R75/7	W20EP-U _s	IW20
CAGIVA		
125, Mito 125, ST125	W27ES-U	IW27
City, Scooter(D)	W24FP-U _s	IWF24
Elefant 750	X24EPR-U9	IX24B
Elefant 900	X27EPR-U9	IX27B
Mito SP 125	IW29	IW29
MX250, MXR250	IW27	IW27
Raptor, V-Raptor	U24ESR-N	IU24
SS250, SST250, SX250	W24ES-U _s	IW24
V-Raptor, X-tra Raptor	U24ETR	IU24A
COMEL/JRD		
Admiral RD-150R	U20FS-U	IUF22
Comet Acerr, Swng, Maxx	U20FS-U	IUF22
Manja GS5, Manja II, III	U20FS-U	IUF22
Monyet, Summer, Manja Sport	U20FS-U	IUF22
Quest 125R, Cyclone 150	U20FS-U	IUF22
Rainbow RB125, RC125, Snow 125R	U20FS-U	IUF22
Storm 125Z, Turbulence 125	U20FS-U	IUF22
Traveller 150, Harimau 150	U20FS-U	IUF22
DEMAK		
All Scooter Series	U20FS-U	IUF22
Smart 110, Smart-R 125	U20FS-U	IUF22
Sparks, Matrix	U20FS-U	IUF22
DUCATI		
600SS, Monster	X27EPR-U9	IX27B
800 Sport, Monster 800	XU24EPR-U	IXU24
900SS, Monster	XU24EPR-U	IXU24
916 SPI, Strada	IX27	IX27
HONDA		
CBR 250R	IU24	IU24
CBR 150R	U24ESR-N	IU24
CBR 500F, CB500X, CBR500 RR	U24EPR9	IU24D
AirBlade 125	U22EPR9	IU22D
C70, C86, C90, FAME	U20FS-U	IUF22
CB100, GL100, GL125, GL145	X22ES-U	IX22
Click 110	U22FER9/U24FER9	IUH24
Dream, Wave	U20FS-U	IUF22
EX5, EX5 Class, EX5 Class I	U20FS-U	IUF22
EX5 110 (New)	U20EPR9	IU20
Future 125	U20EPR9	IU20
Icon 110	U24EPR9	IU24D
GL1200 Goldwing	X24EP-U9	IX24B
Hurricane	W20ES-U _s	-
NX105	W20EP-U _s	IW20
PCX 150	U22EPR9	IU22D
RS150 R	-	IU24D
Raider, NSR150R	W24ES-U _s	IW24
Spacy 110	U24EPR9	IU24D
VT600, GL1500 Goldwing	X22EP-U9	IX22B
Wave DASH Repsol	U20EPR9	IU20

MODEL	DENSO	IRIDIUM POWER
HONDA		
Wave 125	U20EPR9	IU20
KAWASAKI		
1400GTR	IU27D	IU27D
AXM100, AN90 (Honey)	U20FS-U	IUF22
Eliminator 250	U22FS-U	IUF22
ER-6N/F	IU27D	IU27D
K1 Sports, K1 155	W22FP-U _s	IWF22
KR150, KRR150	W24ES-U _s	IW24
KR150/A, KRR150, Victor	W24EP-U _s	IW24
KR150/H/J, KRZ, Serpico	W27ES-U	IW27
Ninja	W24EP-U _s	IW24
Ninja 1000RX	X24ES-U	IX24
Ninja ZX-6R, ZXR250, ZX-9R	U27ESR-N	IU27
Ninja ZX-7, ZX-7R, ZX-7RR	U27ESR-N	IU27
RR100 Ninja, Victor 150	W24ES-U _s	IW24
Ninja 250/250R	U24ESR-N	IU24
Serpico 150, KRZ150, KRX150	W27ES-U	IW27
Versys 1000	IU27D	IU27D
VN800/A/B, Vulcan 800	U22ESR-N	IU22
Vulcan 1500	X22EP-U9	IX22B
Vulcan 500	X27ES-U	IX27
ZX500, ZZ-R500, ZZ-R1100	U27ESR-N	IU27
ZXR250	U27ESR-N	IU27
ZZR250, Eliminator 250	U24FS-U	IUF24
Z1000, ZX-10R, ZZ-R1400	IU27D	IU27D
MODENAS		
Ceria, Karisma, Kristar, Ace 115	U22FS-U	IUF22
Dinamik	W27ES-U	IW27
Elegan 150, Passion	U24ESR-N	IU24
Jaguh	U24ES-N	IU24
Kriss, Kriss 2, Kriss SE, Kriss SG	U20FS-U	IUF22
Ninja KRR ZX150	W27ESR-U	IW27
X-Cite, GT128, MR1	U20FS-U	IUF22
MOTO-GUZZI		
1100 Sport, California 1100	W20EP-U _s	IW20
125 Custom, 125TT	W27ES-U	IW27
Breva Naked, Nevada Classic 750	W24ESR-U	IW24
Nevada	W24EP-U _s	IW24
Stornello 125, Tuttoterrano 125T	W22ES-U _s	-
MZ		
125 SM/SX	U24ESR-N	IU24
Classic 120, Perintis 120	U22FS-U	IUF22
Mantizz 125, Moskito 125	U22FS-U	IUF22
NAZA BIKES		
Blade 250, Cruise 250	U24ESR-N	IU24
Blitz 150	U24ESR-N	IU24
Gemilang I, II 150	U22FS-U	IUF22
NZ 125R, Flash 125	U22FS-U	IUF22
Prisma 110	U20FS-U	IUF22
Prisma 125, Symphony 125	U20FS-U	IUF22
GTR 150, 170	X22EP-U9	IX22B
NITRO		
Baby Star	W22FP-U _s	IWF22
Bintang I & II, Royal I & II	U22FS-U	IUF22
City Star, Super Star	U22FS-U	IUF22
Dealim Daystar, Roadwin	U24FER9	IUH24
Golden Star, City Jumbo	U22FS-U	IUF22
Grand Slam, Rambo, Ranger I & II	X24ES-U	IX24
Grand, 150cc Super Grand	U22FS-U	IUF22
Impala, Super Impala I, II, III	U22FS-U	IUF22
NX5, Power, Energy, Striker	U22FS-U	IUF22
Silver Star, 250cc Winstar	U22FS-U	IUF22
Sonic, Janggo, Action Air	U22FS-U	IUF22
Summer Star, 150cc Megastar	U22FS-U	IUF22
Supreme Grand, 125cc Star	U22FS-U	IUF22
Windstar I, II, III & X	X24ES-U	IX24

DENSO	9	14	16	20	22	24	27	29	31	32	34	35	DENSO	9	14	16	20	22	24	27	29	31	32	DENSO	9	14	16	20	22	24	27	31
NGK	2	4	5	6	7	8	9	9.5	10	10.5	11	11.5	CHAMPION	18	16,14	12,11	10,9	8,7	6,63,61	4,59	57	55	53	BOSCH	10	9	8	7,6	5	4	3	2



DENSO

MODEL	DENSO	IRIDIUM POWER
SUZUKI		
Belang 150	U24ESR-N	IU24
Best 110	W24FP-U _s	IWF24
FD110, FX110, GSX110, Smash, Smash Revo	U20FS-U	IUF22
FX125, VR125, VS125	U24ESR-N	IU24
FX150	U24ESR-N	IU24
RC100, Scooter V100	W22FP-U _s	IWF22
RC80, FR80,	W22FP-U _s	IWF22
RG Sport	W24EP-U _s	IW24
RGV120	W24EP-U _s	IW24
SkyDrive	U20FS-U	IUF22
Step 125	U20FS-U	IUF22
TR-S	W24FP-U _s	IWF24
TRS118, PR110 (Best)	W22FP-U _s	IWF22
TXR150, RG Sport 110	W24EP-U _s	IW24
V100 Scooter	W22FP-U _s	IWF22
VS125, FX125, FX150	U24ESR-N	IU24
VESPA		
125/P125X/Super/Primavera	W14FP-UL	IWF16
125GT, 125GTR	W14FP-UL	IWF16
150 Super, Sprint	W14FP-UL	IWF16
200 RALLY	W20ES-U _s	-
P150S, P150X	W14FP-UL	IWF16
YAMAHA		
AT115 Nouvo	U22FSR-U	IUF22
Bolt 900	U22EPR9	IU22D
Ego S115	U22FS-U	IUF22
Ego LC125	U22FS-U	IUF22
FZ 150	U24ESR-N	IU24

MODEL	DENSO	IRIDIUM POWER
YAMAHA		
Legenda 110	U22FS-U	IUF22
MT-07	-	-
MT-09	U27EPR9	IU27D
NMAX 155	U24EPR9	IU24D
Nouvo AT 135LC	U22ESR-N	IU22
RS125R, RXS115, Y100	W22FP-U _s	IWF22
RX100	W22FP-U _s	IWF22
RX135Z	W24EP-U _s	IW24
RXS115	W24FP-U _s	IWF24
SPORT (II), SS(II)	W22FP-U _s 10	IWF22
SRE100, SRX100, SR-Lagenda	U22FS-U	IUF22
TZR125, TZR250A, TZM150	W27ES-U	IW27
TZR250/A	W27ESR-U	IW27
Virago	W22EPR-U	IW22
Virago XV 535, 250	W22FP-U _s	IWF22
XJ6 Diversion/F	U27ESR-N	IU27
XV250A/AC	U20FS-U	IUF22
XV535S	W22EPR-U	IW22
XVS650 Drag Star	X22EP-U9	IX22B
XVZ 13/AJ Royal Star	X22EP-U9	IX22B
Y100, SS110	W22FP-U _s 10	IWF22
Y125Z, Y125ZR, RZX135	W24ES-U _s	IW24
Y135 LC	U24EPR9	IU24D
Y15ZR	U24ESR-N	IU24
Y70	W20FP-U _s	IWF20
YP250K/L/C/R, Majesty	X24ES-U	IX24
YZF-R25	U27ESR-N	IU27

AUSTRALIA
CHINA
INDIA
INDONESIA
KOREA
MALAYSIA
PHILIPPINES
SAUDI ARABIA
SINGAPORE
TAIWAN
THAILAND
VIETNAM
JAPAN
EUROPE & USA
SMALL MOTOR CYCLE
ENGINE
CROSS REFERENCE
PART NUMBER



MODEL	ENGINE	YEAR	DENSO	IRIDIUM	TJ	IRIDIUM POWER	IRIDIUM TOUGH
AUDI							
A3 1.8 TFSI	BZB	2007 - 2008	-	IK20TT	-	IK20	VK20
A4 1.8 T	AMB/AVJ/BEX/BFB	2000 -	-	IK20TT	-	IK20	VK20
A4 1.8 T Quattro	AVJ/BEX/BFB	2000 -	-	IK20TT	-	IK20	VK20
A4 1.8 TFSI	CABA/CABB/CDHA/CDHB	2007 -	-	IK20TT	-	IK20	VK20
A5 3.2 FSI Quattro	CALA	2007	-	IK20TT	-	IK20	VK20
A6 2.4 Quattro	BDW	2005	-	IK20TT	-	IK20	VK20
A6 2.8 FSI Quattro	BDX	2001	-	IK20TT	-	IK20	VK20
Q5 2.0	CDN		VK22	-	-	IK22	VK22
Q5 3.2	CAL		PK20PR-L11	IK20TT	-	IK20	VK20
R8 5.2	BUJ		VK22	-	-	IK22	VK22
TT Coupe 2.0	BWA / CCZ		VK22	-	-	IK22	VK22
BMW							
116i (E 87) 1.6	N45 B16A	2004	K20PBR-S10	IK20TT	K20TT	IK20	VK20
118i (E 87)	N46 B20B	2004 - 2007	-	IK20TT	-	IK20	VK20
316i (E 30) (E 46)	16 4E 1/2/3	1988 - 2002	K20TXR	IK20TT	K20TT	IK20	VK20
316i (E 46)	N40 B16A / N45 B16A	2002 - 2006	K20TXR	IK20TT	K20TT	IK20	VK20
316i (E 90)	N45 B16A	2005	K20PBR-S10	IK20TT	K20TT	IK20	VK20
318i (E 30)	18 4E 1	1987 - 1991	K20TXR	IK20TT	K20TT	IK20	VK20
	18 4E B / 18 4K A	1983 - 1987	W16EPR-U	IW16TT	W16TT	IW16	VW16
318i(E36)(E 46)	18 4E1/ 4E2 / 19 4E1	1990 - 2001	K20TXR	IK20TT	K20TT	IK20	VK20
318i(E46)	N42 B20A	2001 - 2005	K20TXR	IK20TT	K20TT	IK20	VK20
318i(E90)	N46 B20	2005	-	IK20TT	-	IK20	VK20
320i(E30)	20 6E B/E/Z/ 20 6K A	1982 - 1991	-	IW16TT	-	IW16	VW16
320i(E36)(E 46)	20 6S 1/2/3/A	1990 - 2005	K20TXR	IK20TT	K20TT	IK20	VK20
320i(E90)	N46 B20	2005	-	IK20TT	-	IK20	VK20
323i(E30)	23 6E B/C/W	1982 - 1986	-	IW16TT	-	IW16	VW16
323i(E36)(E 46)	24 6S 2 / 25 6S 4	1996 - 2000	K20TXR	IK20TT	K20TT	IK20	VK20
323i(E90)	N52 B25	2005	-	IK20TT	-	IK20	VK20
325i(E30)	25 6E 1/2 /25 6K 1	1985 - 1991	-	IW16TT	-	IW16	VW16
325i(E36)(E 46)	25 6S 1/2/5	1990 - 2005	K20TXR	IK20TT	K20TT	IK20	VK20
325i(E90)	N52 B25	2005	-	IK20TT	-	IK20	VK20
520i(E34)	20 6E E/K A	1988 - 1990	-	IW16TT	-	IW16	VW16
520i(E34)(E 39)	20 6S 1/2/3/4	1989 - 2003	K20TXR	IK20TT	K20TT	IK20	VK20
520i(E60)	N46 B20B	2007	-	IK20TT	-	IK20	VK20
525i(E34)	25 6K 1/2	1989 - 1995	K20TXR	IK20TT	K20TT	IK20	VK20
	25 6K1	1988 - 1990	-	IW16TT	-	IW16	VW16
525i (E 34) (E 39) (E 60)	25 6S 1/2/5	1990 - 2005	K20TXR	IK20TT	K20TT	IK20	VK20
630i (E 63)	N52 B30	2004	-	IK20TT	-	IK20	VK20
650i (E 63)	N62 B48B	2005	-	IK20TT	-	IK20	VK20
730i 3.0	M30B30		J16CR-U	IW16TT	W16TT	IW16	VW16
760Li 6.0	N73B60A		VK20	IK20TT	-	IK20	VK20
X1 sDrive 18i 2.0	N46B20B		VK20	IK20TT	-	IK20	VK20
X3 2.0i (E 83)	N46B20B	2005 - 2008	-	IK20TT	-	IK20	VK20
X3 2.5i (E 83)	25 6S 5	2004 - 2006	K20TXR	IK20TT	K20TT	IK20	VK20
X3 2.5si (E 83)	N52 B25	2006 - 2008	-	IK20TT	-	IK20	VK20
X3 xDrive20i 2.0 (E 83)	B46 B20B	2008	-	IK20TT	-	IK20	VK20
X3 xDrive20i 2.5 (E 83)	N52 B25	2008	-	IK20TT	-	IK20	VK20
X5 3.0i (E 53)	30 6S 3	1999 - 2006	K20TXR	IK20TT	K20TT	IK20	VK20
X5 3.0si (E 70)	N52 B30	2006 - 2008	-	IK20TT	-	IK20	VK20
X5 4.8i (E 70)	N62 B48B	2006 - 2008	-	IK20TT	-	IK20	VK20
X5 xDrive30i 3.0 (E 70)	N52 B30	2008	-	IK20TT	-	IK20	VK20
X5 xDrive48i 4.8 (E 70)	N62 B48B	2008	-	IK20TT	-	IK20	VK20
Z3 1.9 Roadster	19 4S 1	1995 - 1998	K20TXR	IK20TT	K20TT	IK20	VK20
Z3 2.8 Roadster	28 6S 1/2	1996 - 2000	K20TXR	IK20TT	K20TT	IK20	VK20
Z3 3.0 Roadster	30 6S 3	2000 - 2002	K20TXR	IK20TT	K20TT	IK20	VK20
Z4 sDrive 30i 3.0	N52 B30	2009	-	IK20TT	-	IK20	VK20
CHANA							
Benni 1.3 De Luxe	JL474Q2		K20PR-U11	IK20TT	K20TT	IK20	VK20
CHERRY							
A1 1.3	SQR473		K20PR-U11	IK20TT	K20TT	IK20	VK20
A5 1.6	SQR481F	2006	K16PR-U11	IK16TT	K16TT	IK16	VK16
Cowin 1.6	SQR480ED	2006	K16PR-U11	IK16TT	K16TT	IK16	VK16
Eastar 2.0	SQR484F	2008	K16PR-U11	IK16TT	K16TT	IK16	VK16
Karry 1.6	SQR480ED	2008	K16PR-U11	IK16TT	K16TT	IK16	VK16
QQ3 0.8	SQR372	2006	K16PR-U11	IK16TT	K16TT	IK16	VK16
QQ3 1.1	SQR472F	2006	W16EP-U	IW16TT	W16TT	IW16	VW16
Tiggo 1.6	SQR481F	2006	K16PR-U11	IK16TT	K16TT	IK16	VK16

DENSO

AUSTRALIA CHINA

INDIA

INDONESIA

KOREA

MALAYSIA

PHILIPPINES

SAUDI ARABIA

SINGAPORE

TAIWAN

THAILAND

VIETNAM

JAPAN

& USA

EUROPE

MOTOR

SMALL

CROSS

PART

ENGINE REFERENCE NUMBER

DENSO	9	14	16	20	22	24	27	29	31	32	34	35	DENSO	9	14	16	20	22	24	27	29	31	32	DENSO	9	14	16	20	22	24	27	31
NGK	2	4	5	6	7	8	9	9.5	10	10.5	11	11.5	CHAMPION	18	16,14	12,11	10,9	8,7	6,63,61	4,59	57	55	53	BOSCH	10	9	8	7,6	5	4	3	2



▶ Spark plug color codes: for Iridium Tough and Iridium Plugs and Iridium TT, for Iridium Power, for Iridium Racing and Two Tops Plugs, for Platinum Plugs and Platinum TT, and black for general spark plugs.

PART NUMBER	CROSS REFERENCE	SMALL ENGINE	MOTOR CYCLE	EUROPE & USA	JAPAN	VIETNAM	THAILAND	TAIWAN	SINGAPORE	SAUDI ARABIA	HONDA	PHILIPPINES	MALAYSIA	KOREA	INDONESIA	INDIA	CHINA	AUSTRALIA	DENSO	YEAR	ENGINE	MODEL	DENSO											
CHERRY																							V5 2.0	SQR481F	2006	K16PR-U11	IK16TT	K16TT	IK16	VK16				
CHEVROLET																							Aveo 1.2		2002	W16EP-U	IW16TT	W16TT	IW16	VW16				
Aveo Sedan 1.4/1.4L																										K16PR-U11	IK16TT	K16TT	IK16	VK16				
Aveo 1.5																									2002	W16EP-U	IW16TT	W16TT	IW16	VW16				
Captiva 2.4																							RA420 / Z24	2006	K20TXR	IK20TT	K20TT	IK20	VK20					
Cruze 1.8 L/LS/LT																							F18D4	2009 -	KJ20CR-L11	IK20TT	K20TT	IK20L	VK20					
Matiz 1.0																								1999 - 2000	W16EP-U	IW16TT	W16TT	IW16	VW16					
Optra 1.6																								2002	K16PR-U11	IK16TT	K16TT	IK16	VK16					
Orlando LT 1.8																							2HD	2011 -	KJ20CR-L11	IK20TT	K20TT	IK20L	VK20					
Sonic 1.4																							14XER	2012 -	KJ16CR-11	IK16TT	K16TT	IK16L	VK16					
Spark 1.0																								2007 - 2010	W16EP-U	IW16TT	W16TT	IW16	VW16					
Spark 1.2																							L4	2011 -	XU24EPR-U	-	-	IXU24	VXU24					
Suburban 5.3																							Vortec	2000 -	T16PR-U	IT16TT	T16TT	IT16	VT16					
Tahoe 5.3																							Vortec	2000 -	T16PR-U	IT16TT	T16TT	IT16	VT16					
FORD																							E-150 4.6	Triton	1997	T20NR-U11	IT20TT	T20TT	IT20	VT20				
Expedition 4.6																							Modular	1997 - 2006	T20NR-U11	IT20TT	T20TT	IT20	VT20					
Expedition 5.4																							Triton	1997 -	T20NR-U11	IT20TT	T20TT	IT20	VT20					
Explorer 4.0																							Cologne	1995 - 2009	-	IT16TT	-	IT16	VT16					
F 150 4.2																							Essex / Triton	1997 - 2004	T20NR-U11	IT20TT	T20TT	IT20	VT20					
Fiesta 1.5																							Duratec He	2004 -	VT20	IT20TT	-	IT20	VT20					
Focus 1.6																							Duratec	2011 -	T16VR-U10	ITV16TT	TV16TT	ITV16	-					
Focus 2.0																							Duratec He Spi	2009 -	VT20	IT20TT	-	IT20	VT20					
Lynx 1.3																								1999 - 2004	K16PR-U11	IK16TT	K16TT	IK16	VK16					
Lynx 1.6																								1999 - 2004	K16PR-U11	IK16TT	K16TT	IK16	VK16					
Lynx 2.0 RS																								2003 - 2004	K16PR-U11	IK16TT	K16TT	IK16	VK16					
Mustang 3.7																							Duratec V6	2012 -	ITV20	ITV20TT	-	ITV20	-					
Mustang 5.0																							Coyote V8	2011 -	ITV20	ITV20TT	-	ITV20	-					
HONDA																							Accord 2.0	F20	1994 - 2002	K16PR-U11	IK16TT	K16TT	IK16	VK16				
Accord 2.0																							K20A	2003 - 2007	K16PR-U11	IK16TT	K16TT	IK16	VK16					
Accord 2.2																							F22A	1990 - 1997	K16PR-U11	IK16TT	K16TT	IK16	VK16					
Accord 2.3																							F23A	1998 - 2002	K16PR-U11	IK16TT	K16TT	IK16	VK16					
Accord 2.4																							K24	2003	K16PR-U11	IK16TT	K16TT	IK16	VK16					
Accord 2.4S																							K24A		KJ20CR-L11	IK20TT	K20TT	IK20L	VK20					
Accord 3.0																							J30A	2003 - 2007	K16PR-U11	IK16TT	K16TT	IK16	VK16					
Accord 3.5																							J35Z2	2008	K16PR-U11	IK16TT	K16TT	IK16	VK16					
Accord 3.5 SV																							J35Z	2009 -	DXU22HCR-D11S	-	-	-	-					
Brio																							L13A	2014	K16PR-U11	IK16TT	K16TT	IK16	VK16					
City 1.3																							3A152/152T/D13B/L13A	1996 -	K16PR-U11	IK16TT	K16TT	IK16	VK16					
City 1.5																							D15B/L15A	1996 -	K16PR-U11	IK16TT	K16TT	IK16	VK16					
Civic 1.3																							D13B2	1992 - 1995	K16PR-U11	IK16TT	K16TT	IK16	VK16					
Civic 1.5																							D15/D15Z4/D15Z6	1992 - 2005	K16PR-U11	IK16TT	K16TT	IK16	VK16					
Civic 1.6																							D16/D16W7/D16Y7	1992 - 2005	K16PR-U11	IK16TT	K16TT	IK16	VK16					
Civic 1.6 SiR																							B16A2	1996 - 2000	K16PR-U11	IK16TT	K16TT	IK16	VK16					
Civic 1.8																							R18A1	2006	K16PR-U11	IK16TT	K16TT	IK16	VK16					
Civic 2.0																							K20A/K20Z2	2004 -	K16PR-U11	IK16TT	K16TT	IK16	VK16					
CR-V 2.0																							B20Z/K20A/R20A	1996 -	K16PR-U11	IK16TT	K16TT	IK16	VK16					
CR-V 2.4																							K24A/K24Z	2002 -	K16PR-U11	IK16TT	K16TT	IK16	VK16					
CRZ																							ZF1	2013 -	DK20PR-D13	IK20TT	-	-	VFK20F					
HR-V 1.6																							D16	2000 - 2002	K16PR-U11	IK16TT	K16TT	IK16	VK16					
Jazz 1.3																							L13A	2004 -	K16PR-U11	IK16TT	K16TT	IK16	VK16					
Jazz 1.5																							L15A	2004 -	K16PR-U11	IK16TT	K16TT	IK16	VK16					
Odyssey 2.2																							F22B	1995 - 1998	K16PR-U11	IK16TT	K16TT	IK16	VK16					
Odyssey 3.5																							J35A7	2012 -	DXU22HCR-D11S	-	-	-	-					
Pilot 3.5																							J35Z4	2012 -	DXU22HCR-D11S	-	-	-	-					
HYUNDAI																							Accent 1.4 GL			K16PR-U11	IK16TT	K16TT	IK16	VK16				
Accent 1.6 GLS A/T																								2011	PK16PR11	IK16TT	-	IK16	VK16					
Azera 3.0																							G6DB	2006 -	SK16PR-L11	IK16TT	-	IK16	VK16					
Elantra 1.6 GL																										K16PR-U11	IK16TT	K16TT	IK16	VK16				
Elantra 1.8 GLS																							G4GB			K16PR-U11	IK16TT	K16TT	IK16	VK16				
Eon 0.8																							Epsilon	2012 -	VXUH22	-	-	IXUH22	VXUH22					
Genesis 2.0 Coupe																							Lambda	2008 -	-	IK20TT	-	IK20	VK20					
Genesis 3.8 Coupe																							Lambda	2008	VK16	IK16TT	-	IK16	VK16					
Genesis Sedan																								2009 -		K16PR-U11	IK16TT	K16TT	IK16	VK16				



MODEL	ENGINE	YEAR	DENSO				
HYUNDAI							
Getz 1.1		2002	K16PR-U11	IK16TT	K16TT	IK16	VK16
Getz 1.4		2002	K16PR-U11	IK16TT	K16TT	IK16	VK16
i10 1.1		2007	K16PR-U11	IK16TT	K16TT	IK16	VK16
i10 1.2 / 1.2 GLS		2007	K16PR-U11	IK16TT	K16TT	IK16	VK16
i30 1.6		2007	K16PR-U11	IK16TT	K16TT	IK16	VK16
Matrix 1.6	G4EP	2001 - 2004	K16PR-U11	IK16TT	K16TT	IK16	VK16
Santa Fe Theta II 2.4	Theta II		-	IW16TT	-	IW16	VW16
Santa Fe		2007	VKH16	IKH16TT	-	IKH16	VKH16
Sonata 2.0		2002 - 2005	K16PR-U11	IK16TT	K16TT	IK16	VK16
Sonata 2.4 GLS / GLS Premium			SK16PR-A11	IK16TT	-	IK16	VK16
Sonata 2.4		2004	K16PR-U11	IK16TT	K16TT	IK16	VK16
Sonata 3.0	G6T	2001 - 2005	P16PR11	IW16TT	-	IW16	VW16
Tucson 2.0 Theta II GL/GLS	Theta II		PK20PR-L11	IK20TT	-	IK20	VK20
Tucson 2.0		2004	K16PR-U11	IK16TT	K16TT	IK16	VK16
Tucson 2.4 Theta II / II Premium	Theta II		-	IW16TT	-	IW16	VW16
Veloster GDI Turbo 1.6			-	IW16TT	-	IW16	VW16
KIA							
Avella 1.3	B3	1994 - 1999	W16EP-U	IW16TT	W16TT	IW16	VW16
Avella 1.5	B5	1994 - 1999	W16EP-U	IW16TT	W16TT	IW16	VW16
Carens 2.0	G4KA	2006	K16PR-U11	IK16TT	K16TT	IK16	VK16
Forte Sedan 2.0		2011	W14EX-U	IW16TT	W16TT	IW16	VW16
Optima Ex 2.4	THETA II	2011 -	FK16HR-11	IKH16TT	-	-	VFKH16
Picanto 1.0 / 1.2	KAPPA	2004 -	XU20HR-9	-	XUH20TTI	IXUH20I	VXUH20I
Picanto 1.1 LX/DLX	Epsilon	2004	K16PR - U11	IK16TT	K16TT	IK16	VK16
Pride 1.1	B1	1987 - 2000	W16EP-U	IW16TT	W16TT	IW16	VW16
Pride 1.3	B3	1987 - 2000	W16EP-U	IW16TT	W16TT	IW16	VW16
Rio 1.2 LX/SLX	1.2 KAPPA	2011 -	XU20HR-9	-	XUH20TTI	IXUH20I	VXUH20I
Rio 1.3	A3E	2000 - 2006	W16EP-U	IW16TT	W16TT	IW16	VW16
Rio 1.4		2006	K16PR-U11	IK16TT	K16TT	IK16	VK16
Rio 1.6		2000 - 2006	K16PR-U11	IK16TT	K16TT	IK16	VK16
Soul 1.6 LX	G4FC	2010 -	-	-	-	IXUH22I	VXUH22I
Soul 2.0 EX		2009	K16PR-U11	IK16TT	K16TT	IK16	VK16
Sorento 2.4 LX GAS	G4KE	2009 -	K16HPR-U11	IKH16TT	KH16TT	IKH16	VKH16
Sportage 2.0 G		1993	K16PR-U11	IK16TT	K16TT	IK16	VK16
MAZDA							
323 1.6	E5	1989	K16PR-U	IK16TT	K16TT	IK16	VK16
323 1.8	B6	1989	K16PR-U	IK16TT	K16TT	IK16	VK16
626 2.0	FE	1990	K16PR-U	IK16TT	K16TT	IK16	VK16
E2000 2.0	FE	1995	W16EP-U	IW16TT	W16TT	IW16	VW16
Mazda 2 1.5	ZY-VE	2007 -	SK16PR-A11	IK16TT	-	IK16	VK16
Mazda 3 1.6 S/V/Hatchback	MZR	2004	K16PR-U11	IK16TT	K16TT	IK16	VK16
Mazda 3 2.0	MZR	2004	-	IT20TT	-	IT20	VT20
Mazda 6 2.5	MZR	2007	-	IT20TT	-	IT20	VT20
Miata (MX-5) 1.6	B6P/B6-ZE	1989 - 2005	K16PR-U11	IK16TT	K16TT	IK16	VK16
Miata (MX-5) 1.8	BP/BP-Z3	1989 - 2005	K16PR-U11	IK16TT	K16TT	IK16	VK16
Miata (MX-5) 2.0	MZR	2006	-	IT20TT	-	IT20	VT20
MERCEDEZ - BENZ							
C 180 (202)	M111.920/921	1993 - 2000	K16P-U11	IK16TT	K16TT	IK16	VK16
C 230 (202)	M111.974	1996 - 1997	K16P-U11	IK16TT	K16TT	IK16	VK16
C 230 (203) (204)	M272.920/921	2005 -	-	-	-	IXUH22	VXUH22
C 280 (202)	M111.941	1993 - 1997	K16P-U11	IK16TT	K16TT	IK16	VK16
C 300 (204)	M272.947/948	2007	-	-	-	IXUH22	VXUH22
C 350 (204)	M272.961	2007	-	-	-	IXUH22	VXUH22
E 200 (124)	M111.94	1993 - 1995	K16P-U11	IK16TT	K16TT	IK16	VK16
E 220 (124)	M111.96	1993 - 1995	K16P-U11	IK16TT	K16TT	IK16	VK16
E 230 (211)	M272.922	2007	-	-	-	IXUH22	VXUH22
E 280 (124)	M104.942	1993 - 1995	K16P-U11	IK16TT	K16TT	IK16	VK16
E 280 (211)	M272.943	2005	-	-	-	IXUH22	VXUH22
E 320 (124)	M104.992	1993 - 1995	K16P-U11	IK16TT	K16TT	IK16	VK16
E 350 (211)	M272.964	2005	-	-	-	IXUH22	VXUH22
MITSUBISHI							
Adventure 2.0	4G63	1997	K16PR-U11	IK16TT	K16TT	IK16	VK16
Asx 2.0	4B11	2010 -	-	IK20TT	-	IK20	VK20Y
Eclipse 2.4	4G64	2000 - 2005	K16PR-U11	IK16TT	K16TT	IK16	VK16
Fuzion 2.4	4G64	2005	K16PR-U11	IK16TT	K16TT	IK16	VK16
Galant 1.8	4G93	1992 - 1998	K16PR-U11	IK16TT	K16TT	IK16	VK16
Galant 2.0	4G63	1992 - 2002	K16PR-U	IK16TT	K16TT	IK16	VK16

DENSO
 AUSTRALIA CHINA INDIA INDONESIA KOREA MALAYSIA PHILIPPINES SAUDIARABIA SINGAPORE TAIWAN THAILAND VIETNAM JAPAN & USA EUROPE MOTOR CYCLE SMALL ENGINE CROSS PART REFERENCE NUMBER

DENSO	9	14	16	20	22	24	27	29	31	32	34	35	DENSO	9	14	16	20	22	24	27	29	31	32	DENSO	9	14	16	20	22	24	27	31
NGK	2	4	5	6	7	8	9	9.5	10	10.5	11	11.5	CHAMPION	18	16,14	12,11	10,9	8,7	6,63,61	4,59	57	55	53	BOSCH	10	9	8	7,6	5	4	3	2



▶ Spark plug color codes: for Iridium Tough and Iridium Plugs and Iridium TT, for Iridium Power, for Iridium Racing and Two Tops Plugs, for Platinum Plugs and Platinum TT, and black for general spark plugs.

PART NUMBER	CROSS REFERENCE	SMALL ENGINE	MOTOR CYCLE	EUROPE & USA	JAPAN	VIETNAM	THAILAND	TAIWAN	SINGAPORE	SAUDI ARABIA	PHILIPPINES	MALAYSIA	KOREA	INDONESIA	INDIA	CHINA	AUSTRALIA	DENSO	YEAR	ENGINE	MODEL	SPARK PLUGS							
																						IRIDIUM	IRIDIUM RACING	IRIDIUM POWER	IRIDIUM TOUGH				
MITSUBISHI																													
																						Galant 2.0	4G63/6A12	1996 - 2006	K16PR-U11	IK16TT	K16TT	IK16	VK16
																						Galant 2.4	4G69	2004	K16PR-U11	IK16TT	K16TT	IK16	VK16
																						Galant 2.5	6A13	1996 - 2006	K16PR-U11	IK16TT	K16TT	IK16	VK16
																						Galant GT 3.8	6G75		-	IK20TT	-	IK20	VK20
																						Grandis 2.4	4G69	2003	K16PR-U11	IK16TT	K16TT	IK16	VK16
																						L300 2.0	4G63	1989	W16EP-U	IW16TT	W16TT	IW16	VW16
																						L300 Exceed 2.0	4G63	2001 - 2004	K16PR-U	IK16TT	K16TT	IK16	VK16
																						L400 Space Gear 2.4	4G64	2000 -	K16PR-U11	IK16TT	K16TT	IK16	VK16
																						Lancer 1.3	4G13	1988 - 2002	W16EP-U	IW16TT	W16TT	IW16	VW16
																						Lancer 1.5	4G15	1988 - 2002	W16EP-U	IW16TT	W16TT	IW16	VW16
																						Lancer 1.6	4G18	2002 -	K16PR-U11	IK16TT	K16TT	IK16	VK16
																							4G92	1988 - 2002	K16PR-U	IK16TT	K16TT	IK16	VK16
																						Lancer 2.0	4B11	2008	K16PR-U11	IK16TT	K16TT	IK16	VK16
																						Mirage G4 GX	3A92	2016	IKH16	IKH16TT	-	IKH16	VKH16
																						Mirage G4 GLX M/T / CVT	3A92	2016	IKH16	IKH16TT	-	IKH16	VKH16
																						Mirage G4 GLS M/T / CVT	3A92	2016	IKH16	IKH16TT	-	IKH16	VKH16
																						Mirage 1.2 Mivec GLX M/T / CVT	3A92	2016	IKH16	IKH16TT	-	IKH16	VKH16
																						Mirage 1.2 Mivec GLS M/T / CVT	3A92	2016	IKH16	IKH16TT	-	IKH16	VKH16
																						Mirage GLX/GLS 1.2	JC08	2013 -	IKH16	IKH16TT	-	IKH16	VKH16
																						Montero Sport GLS 4X2 3.0	6B31	2012 -	SXU22HDR8	-	-	IXUH22	VXUH22
																						Outlander	4B12/4G69	2003	K16PR-U11	IK16TT	K16TT	IK16	VK16
																							4G64	2003 - 2006	K16PR-U	IK16TT	K16TT	IK16	VK16
																						Outlander SE 2.4	4B12 FI	2009 -	IKH20	IKH20TT	-	IKH20	VKH20
																						Pajero 3.0	6G72	1991 -	K16PR-U	IK16TT	K16TT	IK16	VK16
																						Pajero 3.5	6G74	1993 - 1999	K16PR-U	IK16TT	K16TT	IK16	VK16
																						Pajero 3.8	6G75	1999 -	K16PR-U	IK16TT	K16TT	IK16	VK16
																						Space Wagon 1.6	4G63/4G93	1992 - 1997	K16PR-U	IK16TT	K16TT	IK16	VK16
NISSAN																													
																						350Z 3.5	VQ35DE	2004	K16HPR-U11	IKH16TT	KH16TT	IKH16	VKH16
																						Altima 2.5L SV CVT	QR25DE		FXE20HR11	IXEH20TT	-	-	VFXEH20
																						Altima 3.5L SL CVT	VQ35DE		K16HPR-U11	IKH16TT	KH16TT	IKH16	VKH16
																						Bluebird 2.0	CA20	1989 - 1994	K16PR-U11	IK16TT	K16TT	IK16	VK16
																						Cedric 3.0	VG30	1987 - 1991	K16PR-U11	IK16TT	K16TT	IK16	VK16
																						Cefiro 2.0	VQ20DE	1995 - 2003	-	IK20TT	-	IK20	VK20
																						Cefiro 2.5	VQ25DE	1995 - 1998	-	IK20TT	-	IK20	VK20
																						Cefiro 3.0	VQ30DE	1995 -	-	IK20TT	-	IK20	VK20
																						Grand Livina 1.8	MR18DE	2007	K16HPR-U11	IKH16TT	KH16TT	IKH16	VKH16
																						Juke	HR16DE	2016 -	FXE20HR11	IXEH20TT			VFXEH20
																						Maxima 2.0	CA20	1989 - 1994	K16PR-U	IK16TT	K16TT	IK16	VK16
																						Murano Z51 3.5	VQ35DE	2007 -	K16HPR-U11	IKH16TT	KH16TT	IKH16	VKH16
																						Patrol 4.5	TB45E	1997 - 2004	W16EP-U	IW16TT	W16TT	IW16	VW16
																						Patrol 4.8	TB48DE	2004	K16HPR-U11	IKH16TT	KH16TT	IKH16	VKH16
																						Patrol Royale 5.6	VK56DE	2012 -	FK16HR-11	IKH16TT	-	-	VFKH16
																						Sentra 1.3/FE/LEC	QG13DE/GA13DS	1991 -	K16PR-U	IK16TT	K16TT	IK16	VK16
																						Sentra 1.4	GA14DE/DS	1992 - 2000	K16PR-U	IK16TT	K16TT	IK16	VK16
																						Sentra 1.6 / California	GA16DE	1985 -	K16PR-U	IK16TT	K16TT	IK16	VK16
																						Sentra 1.8	QG18DE	2000 - 2006	K16PR-U	IK16TT	K16TT	IK16	VK16
																						Sentra 2.0	QR20DE	2003	K16HPR-U11	IKH16TT	KH16TT	IKH16	VKH16
																							SR20DE	1999 - 2005	K16PR-U11	IK16TT	K16TT	IK16	VK16
																						Sentra 2.5	QR25DE	2005	K16HPR-U11	IKH16TT	KH16TT	IKH16	VKH16
																						Silvia 2.0	SR20DE	1993 - 2001	K16HPR-U11	IKH16TT	K16TT	IK16	VK16
																						Teana 2.3	VQ23DE	2007	K16HPR-U11	IKH16TT	KH16TT	IKH16	VKH16
																						Vanette 2.0	Z20	1994 - 1999	W16EP-U	IW16TT	W16TT	IW16	VW16
																						Verita 1.3	CG13DE	2000 - 2003	K16PR-U11	IK16TT	K16TT	IK16	VK16
																						X-Trail 2.0	QR20DE	2001	K16HPR-U11	IKH16TT	KH16TT	IKH16	VKH16
																						X-Trail 2.5	QR25DE	2001	K16HPR-U11	IKH16TT	KH16TT	IKH16	VKH16
PORSCHE																													
																						911 3.4		1997 - 2001	K20PBR-S10	IK20TT	K20TT	IK20	VK20
																						911 3.6		1989 - 1997	K22PBR-S	-	-	IK22	VK22
																							2004		-	-	IK22	VK22	
																								1999 - 2001	K20TR11	IK20TT	K20TT	IK20	VK20



MODEL	ENGINE	YEAR	DENSO	IRIDIUM	TJ	IRIDIUM POWER	IRIDIUM TOUGH
PORSCHE							
Boxster 3.2		1999 – 2004	K20PBR-S10	IK20TT	K20TT	IK20	VK20
		2004 – 2006	-	-	-	IK22	VK22
Boxster 3.4		2006	-	-	-	IK22	VK22
Boxster 3.4 S		2009	-	-	-	IKH22	VKH22
Cayenne 4.5		2002	K20PBR-S10	IK20TT	K20TT	IK20	VK20
Cayenne 4.8 GTS/S/Turbo		2007	-	-	-	IKH22	VKH22
Cayman 2.7		2006	-	-	-	IK22	VK22
Cayman 2.9		2009	-	-	-	IKH22	VKH22
Cayman S 3.4		2005 – 2009	-	-	-	IK22	VK22
		2009	-	-	-	IKH22	VKH22
Panamera 4.8 4S/S/Turbo		2009	-	-	-	IKH22	VKH22
PROTON							
Wira 1.3		1993	W16EP-U	IW16TT	W16TT	IW16	VW16
Wira 1.5		1993	W16EP-U	IW16TT	W16TT	IW16	VW16
Wira 1.6		1993	K16PR-U	IK16TT	K16TT	IK16	VK16
SUBARU							
Forester 2.0	EJ20	1997 – 2005	K16PR-U11	IK16TT	K16TT	IK16	VK16
Forester 2.5	EJ251	2002	K16PR-U11	IK16TT	K16TT	IK16	VK16
Impreza 1.6	EJ16/EJ16E/EJ16J/EJ161	1993 –	-	IK20TT	-	IK20	VK20
Impreza 1.8	EJ18E	1993 – 1997	-	IK20TT	-	IK20	VK20
Impreza 2.0	EJ201/EJ20E	1995 – 2000	-	IK20TT	-	IK20	VK20
	EJ201/EJ205	2000 –	K16PR-U11	IK16TT	K16TT	IK16	VK16
Impreza 2.5	EJ251	2001 – 2005	K16PR-U11	IK16TT	K16TT	IK16	VK16
SUZUKI							
Alto 0.8	F8D	2004	W16EP-U	IW16TT	W16TT	IW16	VW16
APV 1.6	G16A	2004	K16PR-U	IK16TT	K16TT	IK16	VK16
Bravo 1.0	F10A	1988	W16EP-U	IW16TT	W16TT	IW16	VW16
Carry 0.6	F6A	1988	XU22EPR-U	-	XU22TT	IXU22	VXU22
Carry 0.8	F8A	1988	W16EP-U	IW16TT	W16TT	IW16	VW16
Carry 1.0	F10A	1988	W16EP-U	IW16TT	W16TT	IW16	VW16
Celerio A+ Compact M/T / CVT	K10B	2016 –	XU20EPR-U	-	-	-	VXU20
Celerio GL/GA 1.0	K10B	2010 –	XU20EPR-U	-	-	-	VXU20
Ciaz GL / GLX	K14B	2016 –	XU20EPR-U	-	-	-	VXU20
Ertiga	K14B	2016 –	XU20EPR-U	-	-	-	VXU20
Esteem 1.6	G16B	1988	K16PR-U	IK16TT	K16TT	IK16	VK16
Grand Vitara 2.0	J20A	1999 –	K16PR-U11	IK16TT	K16TT	IK16	VK16
Grand Vitara 2.4	J24A	2006 –	K16PR-U11	IK16TT	K16TT	IK16	VK16
Grand Vitara 2.5	H25A	1999 – 2005	K16PR-U11	IK16TT	K16TT	IK16	VK16
Grand Vitara 2.7	H27A	2002 – 2006	K16PR-U11	IK16TT	K16TT	IK16	VK16
Grand Vitara Special Edition	J24B	2016 –	VK20	IK20TT	-	IK20	VK20
Jimny 1.3	M13A	1998	K16PR-U11	IK16TT	K16TT	IK16	VK16
Kizashi / Kizashi 2.4L	J24B	2011 –	VK20	IK20TT	-	IK20	VK20
Samurai 1.3	G13A/G13B	1984 – 2004	W16EP-U	IW16TT	W16TT	IW16	VW16
Super Carry 1.0	F10A`	1988	W16EP-U	IW16TT	W16TT	IW16	VW16
Swift 1.2	K12M	2016 –	XU20EPR-U	-	-	-	VXU20
Swift 1.4	K14B	2011 –	XU20EPR-U	-	-	-	VXU20
Swift 1.5	M15A	2004	K16PR-U11	IK16TT	K16TT	IK16	VK16
Swift Dzire 1.2	K12B	2012 –	ZXU20PR-11	-	-	-	VXU20
SX4 1.6	M16A	2007 – 2009	K16PR-U11	IK16TT	K16TT	IK16	VK16
Vitara 1.6	G16A	1999 – 2004	K16PR-U	IK16TT	K16TT	IK16	VK16
Vitara 2.0	J20A	1998 – 2002	K16PR-U11	IK16TT	K16TT	IK16	VK16
TOYOTA							
86	FA20		VXEBH27				VXEBH27
Alphard 3.5 V6	2GR-FE		-	IKH20TT	-	IKH20	VKH20
Avanza 1.3	K3-VE	2006	XU22EPR-U	-	XU22TT	IXU22	VXU22
Avanza 1.5	3SZ-VE	2006	XU22EPR-U	-	XU22TT	IXU22	VXU22
Avanza 1.3 E / J	1NR-VE		SC16HR11	-	-	-	VCH16
Avanza 1.5 G	2NR-VE		SC16HR11	-	-	-	VCH16
Camry 2.0	3S-FE	1994 – 1998	K16PR-U11	IK16TT	K16TT	IK16	VK16
Camry 2.2	5S-FE	1996 – 2002	K20TXR-U	IK20TT	K20TT	IK20	VK20
Camry 2.4	2AZ-FE	2002 –	K16PR-U11	IK16TT	K16TT	IK16	VK16
Camry 3.0	1MZ-FE	2004	SK20R11	IK20TT	-	IK20	VK20
Camry 2.5 V / S / G	2AR-FE		K16HPR-U11	IKH16TT	KH16TT	IKH16	VKH16
Camry 3.5	2GR-FE	2006	-	IKH20TT	-	IKH20	VKH20
Corolla 1.3	2E	1987 –	W16EP-U	IW16TT	W16TT	IW16	VW16
Corolla 1.6	4A-F	1987 – 1992	QJ16AR-U	-	-	-	-
	4A-FE	1992 – 2001	K16PR-U11	IK16TT	K16TT	IK16	VK16

DENSO
 AUSTRALIA CHINA INDIA INDONESIA KOREA MALAYSIA PHILIPPINES SAUDI ARABIA SINGAPORE TAIWAN THAILAND VIETNAM JAPAN & USA EUROPE MOTOR SMALL CROSS PART
 CYCLE ENGINE REFERENCE NUMBER

DENSO	9	14	16	20	24	27	29	31	32	34	35	DENSO	9	14	16	20	22	24	27	29	31	32	DENSO	9	14	16	20	22	24	27	31	
NGK	2	4	5	6	7	8	9	9.5	10	10.5	11	11.5	CHAMPION	18	16,14	12,11	10,9	8,7	6,63,61	4,59	57	55	53	BOSCH	10	9	8	7,6	5	4	3	2



PHILIPPINES CAR

▶ Spark plug color codes: ■ for Iridium Tough and Iridium Plugs and Iridium TT, ■ for Iridium Power, ■ for Iridium Racing and Two Tops Plugs, ■ for Platinum Plugs and Platinum TT, and black for general spark plugs.

DENSO

MODEL	ENGINE	YEAR	DENSO	IRIDIUM TT	IRIDIUM RACING	IRIDIUM POWER	IRIDIUM TOUGH
TOYOTA							
Corolla 1.8	7A-FE	1999 - 2001	K16PR-U11	IK16TT	K16TT	IK16	VK16
Corolla Altis 1.6	3ZZ-FE	2001 -	K16PR-U11	IK16TT	K16TT	IK16	VK16
Corolla Altis 1.8	1ZZ-FE	2001 - 2008	K16PR-U11	IK16TT	K16TT	IK16	VK16
Corona 2.0	3S-F/FE	1987 - 1998	K16PR-U11	IK16TT	K16TT	IK16	VK16
Crown 2.0	1G-FE	1987 - 1995	K16PR-U	IK16TT	K16TT	IK16	VK16
Crown 2.2	4Y	1987 - 1991	W16EP-U	IW16TT	W16TT	IW16	VW16
Crown 2.8	5M	1983 - 1991	W16EP-U	IW16TT	W16TT	IW16	VW16
Echo 1.3	2NZ-FE	1999 - 2005	K16PR-U11	IK16TT	K16TT	IK16	VK16
Echo 1.5	1NZ-FE	1999 - 2005	K16PR-U11	IK16TT	K16TT	IK16	VK16
FJ Cruiser	1GR-FE		K20HR-U11	IKH20TT	KH20TT	IKH20	VKH20
Fortuner 2.7	2TR-FE	2005	K16HPR-U11	IKH16TT	KH16TT	IKH16	VKH16
Hiace 2.0	1RZ	1989 - 2004	W16EP-U	IW16TT	W16TT	IW16	VW16
Hilux 2.7	2TR-FE	2005	K16HPR-U11	IKH16TT	KH16TT	IKH16	VKH16
Innova 2.0	1TR-FE	2004	K16HPR-U11	IKH16TT	KH16TT	IKH16	VKH16
Liteace 1.5	5K	1985 - 1998	W16EP-U	IW16TT	W16TT	IW16	VW16
Land Cruiser Prado 4.0L A/T	1GR-FE		K20HR-U11	IKH20TT	KH20TT	IKH20	VKH20
Previa 2.0	2TZ-FE	1993 - 2000	K16PR-U	IK16TT	K16TT	IK16	VK16
Previa 2.4	2AZ-FE	2003 -	SK20R11	IK20TT	-	IK20	VK20
Prius Hybrid 1.8	2ZR-FXE		SC20HR11	-	-	-	VCH20
RAV4 1.8	1ZZ-FE	2001 - 2005	K16PR-U11	IK16TT	K16TT	IK16	VK16
RAV4 2.0	1AZ-FE	2001 - 2005	K16PR-U11	IK16TT	K16TT	IK16	VK16
	3S-FE	1996 - 2000	XU22EPR-U	-	XU22TT	IXU22	VXU22
Revo 1.8	7K-E	1998 - 2005	W16EP-U	IW16TT	W16TT	IW16	VW16
Revo 2.0	1RZ-E	1998 - 2005	W16EP-U	IW16TT	W16TT	IW16	VW16
Tamaraw FX 1.5	5K	1986 - 1992	W16EX-U	IW16TT	W16TT	IW16	VW16
Tamaraw FX 1.8	7K	1992 - 1996	W16EX-U	IW16TT	W16TT	IW16	VW16
Vios 1.3	2NZ-FE	2003 -	K16PR-U11	IK16TT	K16TT	IK16	VK16
Vios 1.5	1NZ-FE	2003 -	K16PR-U11	IK16TT	K16TT	IK16	VK16
Vios 1.3	2NR-SE	2016 -	SC16HR11	-	-	-	VCH16
Vios 1.5	1NR-SE	2016 -	SC16HR11	-	-	-	VCH16
Wigo 1.0	1NZ-FE	2014	XU20HR-9	-	XUH20TTI	IXUH20I	VXUH20I
Yaris 1.5	1NZ-FE	2006	K16PR-U11	IK16TT	K16TT	IK16	VK16
VOLKSWAGEN							
New Beetle 1.6	AWH	1999 - 2000	XU22EPR-U	-	XU22TT	IXU22	VXU22
	AYD/BFS	2000 -	XU22EPR-U	-	XU22TT	IXU22	VXU22
VOLVO							
850 2.0	B5202S	1994 - 1996	K20PBR-S10	IK20TT	K20TT	IK20	VK20
850 2.5	B5254S	1991 - 1997	K20PBR-S10	IK20TT	K20TT	IK20	VK20
S60 2.0 T	B5204T5	2000 - 2004	PK20PR-P8	IK20TT	-	-	VK20Y
	B5204T5	2004	-	IKH20TT	-	-	VKH20
S80 2.5 T	B5254T6	2006 - 2009	-	IKH20TT	-	-	VKH20
XC60 2.9 T6	B6304T2	2009	-	IKH20TT	-	-	VKH20
XC70 2.3 T	B5234T7	2002 - 2004	PK20PR-P8	IK20TT	-	-	VK20Y
XC70 2.5 T	B5254T2	2002 - 2007	PK20PR-P8	IK20TT	-	-	VK20Y
XC70 3.2 AWD	B6324S	2007	-	IKH20TT	-	IKH20	VKH20
XC90 2.5 T	B6254T2	2003	PK20PR-P8	IK20TT	-	-	VK20Y
XC90 2.9 T6	B6294T	2003 - 2006	PK20PR-P8	IK20TT	-	-	VK20Y
XC90 3.2 AWD	B6324S	2006	-	IKH20TT	-	IKH20	VKH20

PART NUMBER CROSS REFERENCE SMALL MOTOR ENGINE CYCLE EUROPE & USA



PHILIPPINES MOTORCYCLE

MAKER	DENSO	IRIDIUM POWER	IRIDIUM RACING	MAKER	DENSO	IRIDIUM POWER	IRIDIUM RACING
AEON ATVS							
Cobra 220	U22FSR-U	IUF22	-	EURO MOTORS			
New Sport 180cc	U22FS-U	IUF22	-	Absolute 150	U22FS-U	IUF22	-
Overland 180cc	U22FS-U	IUF22	-	BE 125	U22FS-U	IUF22	-
BMW							
F800 R/S	XU24EPR-U	IXU24	IXU01-□	Chic 70	U22FS-U	IUF22	-
F800 ST	XU24EPR-U	IXU24	IXU01-□	EM 50 QT	U22FS-U	IUF22	-
G650 Xchallenge	-	IX24	IXU01-□	Euro Eagle 125	U22FS-U	IUF22	-
K1200 GT	X22EPR-U9	IX22B	IXU01-□	Euro Space 100	U22FS-U	IUF22	-
R1200 GS	XU24EPR-U	IXU24	IXU01-□	HONDA			
R1200 RT	XU24EPR-U	IXU24	IXU01-□	AME 100	U20FSR-U	IUF22	-
R1200 S	XU24EPR-U	IXU24	IXU01-□	BeAt	U24EPR9	IU24	-
R1200 ST	XU24EPR-U	IXU24	IXU01-□	Bravo	U20FS-U	IUF22	-
				C 70	U22FS-U	IUF22	-
				CB110	U22EPR9	IU22	IU01-□
				CB 125 CL	U20EPR-9	IU20	-



MAKER	DENSO	IRIDIUM POWER	IRIDIUM RACING	MAKER	DENSO	IRIDIUM POWER	IRIDIUM RACING
HONDA				KAWASAKI			
CB400F/SF/SB/VTEC	U24FER9	IUH24	IU01-□	AR-80 (K)	W24EP-U	IW24	IW01-□
CBF 110	U24ESR-N	IU24	-	Aura Classic (AN110)	U20FS-U	IUF22	-
CBR 150R	U24ESR-N	IU24	-	Aura Nexus (AN112)	U20FS-U	IUF22	-
CBR1000RR	X24EPR-U9	IX24B	IXU01-□	Aura Nexus (AN125)	U20FS-U	IUF22	-
CBR400F I . II /AF/T	X24ES-U	IX24	IXU01-□	Bajaj BYK 100	U22FS-U	IUF22	-
CBR600F/FS/F4I/RR	U27FER9	IUH27	IU01-□	Bajaj Caliber 115	U22FS-U	IUF22	-
CBR900RR	U27FER9	IUH27	IU01-□	Bajaj CT 100	U22FS-U	IUF22	-
CG 125	X24ES-U	IX24	IXU01-□	Bajaj Wind 125	U22FS-U	IUF22	-
CR125R	W27ESR-V	IW27	IW01-□	Barako 175 (Electric/Kick)	U24ES-N	IU24	IU01-□
CRF150R/EXPERT	U24FER9	IUH24	IU01-□	BC 125	U24ESR-N	IU24	IU01-□
CRF250R	VUH24D	IUH24	IU01-□	Boxer CT-150	U22FSR-U	IUF22	-
CRF450R	VK24PRZ11	IK24	IK01-□	Curve	U22FSR-U	IUF22	-
Dream (C100)	U22FS-U	IUF22	-	CT100	U22FS-U	IUF22	-
Dream 125 (AND125)	U20EPR9	IU20	IU01-□	DH-140 (KC138) Brutus	W22FS-U	IWF22	-
G200/G300	W14FR-U	-	-	D-Tracker	U22FSR-U	IUF22	-
GL 125	X24EPR-U9	IX24B	IXU01-□	Discover 100	U22FSR-U	IUF22	-
GX340/340KI/GX160	W20EP-U11	IW20	IW01-□	Eliminator (BN175)	U24ES-N	IU24	IU01-□
Scoopy	U24EPR9	IU24	-	Fury 125	U20FS-U	IUF22	-
SR 125	X24ES-U	IX24	IXU01-□	GPZ1100	U27ETR	IU27A	IU01-□
TMS 125	X24ES-U	IX24	IXU01-□	GPZ900R	X27ES-U	IX27	IXU01-□
TMX 125	X24EP-U9	IX24B	IXU01-□	HD-III (KC125)	W22FP-U	IWF22	-
TMX 125 ST	X24EP-U9	IX24B	IXU01-□	HD- I , II , III , X (KC100)	W22FP-U	IWF22	-
TMX 155 CDI	X24EP-U9	IX24B	IXU01-□	KDX-125	W24ESR-U	IW24	IW01-□
TMX 155 CP	X24ES-U	IX24	IXU01-□	KE 100	W24ES-U	IW24	IW01-□
TMX 155 RT	X24EP-U9	IX24B	IXU01-□	KE 125	W24ES-U	IW24	IW01-□
Tmx Supremo	U24EPR9	IU24A	IU01-24	KLX-150	U22FSR-U	IUF22	-
VFR400R/K/Z	U24FER9	IUH24	IU01-□	KMX 125	W24ES-U	IW24	IW01-□
VTR1000	X24EPR-U9	IX24B	IXU01-□	KR 150SSR	W27ES-U	IW27	IW01-□
Wave 100	U20FS-U	IUF22	-	KSR 110	U20FS-U	IUF22	-
Wave 100R	U22FS-U	IUF22	-	KX-125	W27ESR	IW27	IW01-□
Wave 110 (NF110)	U20FS-U	IUF22	-	KX-250F	U24ESR-N	IU24	IU01-□
Wave 110 ALPHA	U20FS-U	IUF22	-	KX-450F	-	IU24	IU01-□
Wave 125 (ANF125)	U20EPR9	IU20	IU01-□	Leo Star (AS120)	W24EP-U	IW24	IW01-□
Wave 125S	U24ES-N	IU24	IU01-□	Neo Max	U20FS-U	IUF22	-
Wave Alpha (NF100)	U20FS-U	IUF22	-	Ninja 250	U24ESR-N	IU24	IU01-24
Wave Dash	U22EPR9	IU22	IU01-□	Rouser 135	U20FSR-U	IUF22	-
XL 100	X24ES-U	IX24	IXU01-□	Rouser 180	U27ESR-N	IU27	IU01-27
XL 125	X24ES-U	IX24	IXU01-□	Wind 125 (BR125)	U22FS-U	IUF22	-
XL 185	X24ES-U	IX24	IXU01-□	ZEPHYR 1100	U27ESR-N	IU27	IU01-□
XLR 200	X24EPR-U9	IX24B	IXU01-□	ZEPHYR 750	X27ESR-U	IX27	IXU01-□
XR 200	X24EPR-U9	IX24B	IXU01-□	Zone 125	U20FS-U	IUF22	-
XRM 110	U20FS-U	IUF22	-	ZX-10R Ninja	U27ESR-N	IU27	IU01-□
XRM 125	U20EPR9	IU20	IU01-□	ZX130B/C	U20FS-U	IUF22	-
XRM 125 DS / RS / MOTARD	U20EPR-9	IU20	-	ZX-6R/RR/ZX-7RR	U27ESR-N	IU27	IU01-□
XR 125L	X27EPR-U9	IX27B	IXU01-27	ZX-9R/ZXR400/R	U27ETR	IU27A	IU01-□
Zoomer-X	U24EPR-9	IU24A	IU01-24	ZZ-R1100	U27ESR-N	IU27	IU01-□
JIANSHE				KTM			
Apache	X24ES-U	IX24	IXU01-□	530 EXC-R	XU24EPR-U	IXU24	IXU01-□
Blitz	U22FS-U	IUF22	-	950 Supermoto	U24ETR	IU24A	IU01-□
Broncho 125	X24ES-U	IX24	IXU01-□	KYMCO			
Cougar 100	U22FS-U	IUF22	-	Active 110	U22FS-U	IUF22	-
CP 125	U22FS-U	IUF22	-	Agility 125 RS	U22FSR-U	IUF22	-
CP 150	U22FS-U	IUF22	-	AXR 110	U22FS-U	IUF22	-
Dagger	U22FS-U	IUF22	-	Cevira 110	U22FS-U	IUF22	-
Dash 110	U22FS-U	IUF22	-	CG 150	X24ESR-U	IX24	IXU01-□
Evolution	U22FS-U	IUF22	-	Dink 150	X22EPR-U9	IX22B	IXU01-□
Intense 110	U22FS-U	IUF22	-	Dink 200i	X22EPR-U9	IX22B	-
Intense 125	U22FS-U	IUF22	-	Free LX 115	U22FSR-U	IUF22	-
Legacy 100	U22FS-U	IUF22	-	Grand Dink 250	X22EPR-U9	IX22B	IXU01-□
Monark 125	X24ES-U	IX24	IXU01-□	Jetix 125	U22FSR-U	IUF22	-
Monark Hunk	X24ES-U	IX24	IXU01-□	Kargador 150	X24ESR-U	IX24	IXU01-□
Prodigy 110	U22FS-U	IUF22	-	K-Pipe 125	U22FSR-U	IUF22	-
Stag 155	X24ES-U	IX24	IXU01-□	Like 125	U22FSR-U	IUF22	-
Stag 50	U22FS-U	IUF22	-	Spike 125	U22FSR-U	IUF22	-
V-150	X24ES-U	IX24	IXU01-□	Stryker 150	X24ESR-U	IX24	IXU01-□
Vision 150	X24ES-U	IX24	IXU01-□	Super 8 125	U22FSR-U	IUF22	-
XVR 150	X24ES-U	IX24	IXU01-□	Topboy 100	W24FR-L	IWF24	-

DENSO
 AUSTRALIA CHINA INDIA INDONESIA KOREA MALAYSIA PHILIPPINES SAUDI ARABIA SINGAPORE TAIWAN THAILAND VIETNAM JAPAN & USA EUROPE MOTOR CYCLE SMALL ENGINE REFERENCE NUMBER PART

DENSO	9	14	16	20	22	24	27	29	31	32	34	35	DENSO	9	14	16	20	22	24	27	29	31	32	DENSO	9	14	16	20	22	24	27	31
NGK	2	4	5	6	7	8	9	9.5	10	10.5	11	11.5	CHAMPION	18	16,14	12,11	10,9	8,7	6,63,61	4,59	57	55	53	BOSCH	10	9	8	7,6	5	4	3	2



MAKER	DENSO	IRIDIUM POWER	IRIDIUM RACING	MAKER	DENSO	IRIDIUM POWER	IRIDIUM RACING
SUZUKI				YAMAHA			
Raider 150 (FU150)	U24ESR-N	IU24	IU01-□	Crypton R/S	U22FSR-U	IUF22	-
Raider J/R	U20FS-U	IUF22	-	Crypton Z	U20FS-U	IUF22	-
Raider J 110 PRO	U20FS-U	IUF22	-	DT 125	W24ES-U	IW24	IW01-□
RC 110	W24FP-U	IWF24	-	DT100	-	-	-
RF600	U27ESR-N	IU27	IU01-□	FORCE ONE	-	-	-
RM125	W24ESR-V	IW24	IW01-□	FZ16	U24EPR9	IU24	IU01-□
RM250	W24ESR-V	IW24	IW01-□	L2GF/DX	W22FS-U	IWF22	-
SC 110	W24FP-U	IWF24	-	LB80	W20FS-U	IWF20	-
Shogun 110 (FD110XSD)	U20FS-U	IUF22	-	Mio Sporty/Mio Soul	U22FS-U	IUF22	-
Shogun 125 (FD125XSD)	U20FS-U	IUF22	-	Mio Fino	U22FS-U	IUF22	-
ShogunPro 125 (FD125XRM)	U20FS-U	IUF22	-	Mio 125 / Mio 125 MXi	U22ESR-N	IU22	-
Skydrive 125	U20FS-U	IUF22	-	Mio Fino FI	U20FSR-U	IUF22	-
Smash 110 (FD110XCD)	U20FS-U	IUF22	-	Nouvo/Nouvo Z	U22FSR-U	IUF22	-
Smash 115	U22FS-U	IUF22	-	PW50 (3PTP)	W14FPR-UL	IWF16	-
SS 100	W22FP-U	IWF22	-	RS 100T	W20FP-U	IWF20	-
Step 125	U20FS-U	IUF22	-	RS 110F	X22EPR-U9	IX22B	-
TS 100	W24ES-U	IW24	IW01-□	RS125GE	-	-	-
TS 125 (ER)	W24ES-U	IW24	IW01-□	RX100	-	-	-
TS 185	W22EP-U	IW22	IW01-□	RXT 135	W24FP-U	IWF24	-
TSR 125	W24ES-U	IW24	IW01-□	Sniper MX	U24EPR9	IU24	IU01-□
Thunder 125	U20EPR-9	IU20	-	Sniper T 135	U24EPR9	IU24	IU01-□
VS 800/GL	X24EPR-U9	IX24B	IXU01-□	STX 125	U22FS-U	IUF22	-
X 3 (GP 100)	W22FS-U	IWF22	-	SZ16	U24EPR-9	IU24D	IU01-24
X 4 (GP 125)	W22FS-U	IWF22	-	T105E	U22FS-U	IUF22	-
SYM				V110E (4US1)	W22FP-U10	IWF22	-
Angel	U22FS-U	IUF22	-	V110E (F1ZR/3AX2)	W22FP-U10	IWF22	-
Attila	U22FS-U	IUF22	-	Vega	U20FS-U	IU22	IU01-□
Blaze 150	X24ES-U	IX24	IXU01-□	Vega Force	U20FS-U	IU22	IU01-□
Bonus	U22FS-U	IUF22	-	VMX1200	X24EPR-U9	IX24B	IXU01-□
Didi 50	W24FR-L	IWF24	-	X1	U20FS-U	IUF22	-
Fighter 150	U24ESR-N	IU24	IU01-□	XJR1200	X24EPR-U9	IX24B	IXU01-□
GTS 250	U24ESR-N	IU24	IU01-□	XJR400	U27ESR-N	IU27	IU01-□
Jet 100	W24FR-L	IWF24	-	XT 225	X24ESR-U	IX24	IXU01-□
Jet Alpha (2 Stroke)	W20FR-L	IWF20	-	XTZ 125	U20FSR-U	IUF22	-
Jet Euro	W24FR-L	IWF24	-	YA90 (4DM3)	W22FP-U10	IWF22	-
Joyride 200	U24ESR-N	IU24	IU01-□	YZ125	-	IW27	IW01-□
Jet 4 125	U22FS-U	IUF22	-	YZ250F	U24ESR-N	IU24	IU01-□
Jet Power 125	U22FS-U	IUF22	-	YZ400F	U24ESR-N	IU24	IU01-□
Magic RR	U22FS-U	IUF22	-	YZF-R1	U27ETR	IU27A	IU01-□
Radar X 125	U22FS-U	IUF22	-	YZF-R6	U31ETR	IU31A	IU01-□
RV 1	U22FS-U	IUF22	-	ZONGSHEN			
RV 1-2 Sports 110	U22FS-U	IUF22	-	Badger (ZS150-27)	X24ES-U	IX24	IXU01-□
Shark/Excell	U24ESR-N	IU24	IU01-□	Buggy (ZS150T-7)	U22FS-U	IUF22	-
Star 110	U22FS-U	IUF22	-	Caravan (ZS125-2)	X24ES-U	IX24	IXU01-□
Star X	U22FS-U	IUF22	-	Chase (ZS125-18A)	U22FS-U	IUF22	-
Wolf 125	X24ESR-U	IX24	IXU01-24	Chase (ZS125-18B)	U22FS-U	IUF22	-
TIGER				Excel (ZS125-31)	X24ES-U	IX24	IXU01-□
Boxer 200E	X24ES-U	IX24	IXU01-□	Glide (ZS125-26)	U22FS-U	IUF22	-
Bulldog 150	X24ES-U	IX24	IXU01-□	Hornet (ZS125T-30)	U22FS-U	IUF22	-
Bulldog 200	X24ES-U	IX24	IXU01-□	Icon 125 (ZS125T-7)	U22FS-U	IUF22	-
CX135A	U22FS-U	IUF22	-	Loadstar (ZS150-6)	X24ES-U	IX24	IXU01-□
CX135SE	U22FS-U	IUF22	-	Manta (ZS110-9B)	U22FS-U	IUF22	-
CX135SM	U22FS-U	IUF22	-	Nova (ZS110-12)	U22FS-U	IUF22	-
Matrix 115E	U22FS-U	IUF22	-	Nova (ZS110-18)	U22FS-U	IUF22	-
Matrix 115R	U22FS-U	IUF22	-	Ranger (ZS250)	U22FS-U	IUF22	-
Smart 125	U22FS-U	IUF22	-	Sleek (ZS125T-8)	U22FS-U	IUF22	-
Smart 135A	U22FS-U	IUF22	-	Sprint (ZS150T-8)	U22FS-U	IUF22	-
Smart 135SE	U22FS-U	IUF22	-	Trojan (ZS150-15)	X24ES-U	IX24	IXU01-□
YAMAHA				Trump (ZS150GY)	X24ES-U	IX24	IXU01-□
CR50Z (3WN2)	W22FP-U10	IWF22	-	Trump (ZS200GY)	X24ES-U	IX24	IXU01-□
CR90Z (3XR2)	W22FP-U10	IWF22	-	Tycoon (ZS200)	X22EPR-U9	IX22B	IXU01-□

DENSO
 AUSTRALIA CHINA INDIA INDONESIA KOREA MALAYSIA PHILIPPINES SAUDI ARABIA SINGAPORE TAIWAN THAILAND VIETNAM JAPAN & USA EUROPE MOTOR CYCLE SMALL ENGINE CROSS PART REFERENCE NUMBER

DENSO	9	14	16	20	22	24	27	29	31	32	35	DENSO	9	14	16	20	22	24	27	29	31	32	DENSO	9	14	16	20	22	24	27	31	
NGK	2	4	5	6	7	8	9	9.5	10	10.5	11	11.5	CHAMPION	18	16,14	12,11	10,9	8,7	6,63,61	4,59	57	55	53	BOSCH	10	9	8	7,6	5	4	3	2



DENSO

AUSTRALIA

CHINA

INDIA

INDONESIA

KOREA

MALAYSIA

PHILIPPINES

SAUDI ARABIA

SINGAPORE

TAIWAN

THAILAND

VIETNAM

JAPAN

EUROPE

MOTOR & USA

SMALL ENGINE

CROSS REFERENCE

MODEL	ENGINE	YEAR	DENSO	IRIDIUM TT	IRIDIUM RACING	IRIDIUM POWER	IRIDIUM TOUGH
BUICK							
ROADMASTER	5000 <E>	1991	T14PR-U	ITF16TT	-	ITF16	-
	5700 <7>	1992 - 1993	T16PR-U	ITF16TT	-	ITF16	-
CHEVROLET							
CAPRICE	4300<Z>	1990	T14PR-U	ITF16TT	-	ITF16	-
	4300<Z>	1992 - 1993	T16PR-U	ITF16TT	-	ITF16	-
	5000<E>	1990 - 1993	T14PR-U	ITF16TT	-	ITF16	-
	5000<Y>	1990	K16PR-U11	IK16TT	K16TT	IK16	VK16
	5700<7>	1990 - 1992	T16PR-U	ITF16TT	-	ITF16	-
	5700<P>	1984 - 1990	T16EPR-U15	IT16	T16TT	IT16	VT16
		2007 - 2011	-	-	-	-	-
LUMINA		2007 - 2011	-	-	-	-	
FORD							
CROWN VICTORIA	5800 <G>	1990 - 1991	T14PR-U	ITF16TT	-	ITF16	-
	4600 <W>	1992 - 1995	T16EPR-U15	IT16	T16TT	IT16	VT16
	5700 <7>	1993	T16EPR-U15	IT16	T16TT	IT16	VT16
GMC							
SUBURBAN	5700 <K>	1990 - 1993	T16PR-U	ITF16TT	-	ITF16	-
	5700 <K>	1994 - 1995	T20PR-U	ITF20	-	ITF20	-
	7400 <K>	1990 - 1995	T16PR-U	ITF16TT	-	ITF16	-
HONDA							
ACCORD	2300ZVTI	1998 -	KJ16CR-L11	IK16TT	K16TT	IK16L	-
	2200MPI	1996 - 1997	KJ20CR-L11	IK20TT	K20TT	IK20L	-
	2200MPI	1995	KJ16CR-L11	IK16TT	K16TT	IK16L	-
	2000MPI	1996 - 1997	KJ20CR-L11	IK20TT	K20TT	IK20L	-
	2000MPI	1995	KJ16CR-L11	IK16TT	K16TT	IK16L	-
	2000DOHC	-	Q20PR-U11	IQ20TT	Q20TT	IQ20	VQ20
		2006 - 2007	KJ20CR-L11	IK20TT	K20TT	IK20L	-
	2011	SXU22HCR11S	-	-	-	-	
CITY CIVIC	1300	1998 - 1999	K16PR-U11	IK16TT	K16TT	IK16	VK16
	1600	1992 - 1994	K20PR-U11	IK20TT	K20TT	IK20	VK20
	1600 MPI	1996 -	K16PR-U11	IK16TT	K16TT	IK16	VK16
	1600 MPI	1996 - 1998	K16PR-U11	IK16TT	K16TT	IK16	VK16
	1500	1990 - 1991	Q20PR-U11	IQ20TT	Q20TT	IQ20	VQ20
	1300	1988 - 1991	Q20PR-U11	IQ20TT	Q20TT	IQ20	VQ20
	1300	1984 - 1987	W20EXR-U11	IW20TT	W20TT	IW20	VW20
	2007 - 2011	SKJ20DR-M11S	-	-	IK20G	VK20G	
LEGEND ODYSSEY	3500	1996 - 1998	K20PR-U11	IK20TT	K20TT	IK20	VK20
		1997 - 1999	KJ20CR-L11	IK20TT	K20TT	IK20L	-
		1997 - 1999	KJ16CR-L11	IK16TT	K16TT	IK16L	-
PRELUDE	2200 MPI	1995 - 1998	KJ20CR-L11	IK20TT	K20TT	IK20L	-
	2000	1992	Q20PR-U11	IQ20TT	Q20TT	IQ20	VQ20
HYUNDAI							
ACCENT	1500 SOHC	-	K16PR-U	IK16TT	K16TT	IK16	VK16
	1300 SOHC	-	K16PR-U11	IK16TT	K16TT	IK16	VK16
		2006 - 2011	K16PR-U11	IK16TT	K16TT	IK16	VK16
		2012 -	-	IK16TT	-	IK16	VK16
ELANTRA		2006 - 2011	K16PR-U11	IK16TT	K16TT	IK16	VK16
		2012 -	-	IK16TT	-	IK16	VK16
SONATA	2000 DOHC	-	W20EPR-U	IW20TT	W20TT	IW20	VW20
	2500 V6	-	W16EPR-U	IW16TT	W16TT	IW16	VW16
	2400	2006 - 2011	K16PR-U11	IK16TT	K16TT	IK16	VK16
	3000 V6	2006 - 2011	K16PR-U	IK16TT	K16TT	IK16	VK16
KIA							
CREDOS	1800 LPG	-	K20PR-U	IK20TT	K20TT	IK20	VK20
	2000 LPG	-	K20PR-U	IK20TT	K20TT	IK20	VK20
SEPHIA	1500	-	K20PR-U	IK20TT	K20TT	IK20	VK20
	1500	-	K20PR-U11	IK20TT	K20TT	IK20	VK20
SPORTAGE	2000	-	K20PR-U11	IK20TT	K20TT	IK20	VK20
	2000	-	W20EPR-U11	IW20TT	W20TT	IW20	VW20
TOWNER	800	-	W16EX-U	IW16TT	W16TT	IW16	VW16
LEXUS							
LEXUS IS 300	3000<3VZ-FE>	1990	PQ20R	IQ20TT	-	IQ20	VQ20
	3000<1MZ-FE>	1999	PK20TR11	IK20TT	-	IK20	VK20
LEXUS LS 400	4000<1UZ-FE>	1990	PK20R11	IK20TT	-	IK20	VK20
LEXUS LS 700	4000<2UZ-FE>	1998	K20R-U	IK20TT	K20TT	IK20	VK20
MAZDA							
CAPELLA	1600 <F6>	-	W16EPR-U	IW16TT	W16TT	IW16	VW16



MODEL	ENGINE	YEAR	DENSO	IRIDIUM U	TJ	IRIDIUM POWER	IRIDIUM TOUGH
MAZDA							
CAPELLA	1800<F8>	- 1989	W16EPR-U	IW16TT	W16TT	IW16	VW16
	2000<FE>	-	W16EPR-U	IW16TT	W16TT	IW16	VW16
	2000DOHC <FE>	-	K20PR-U	IK20TT	K20TT	IK20	VK20
	2500<KL-ZE>	1998	KJ16CR11	IK16TT	K16TT	IK16L	-
FAMILIA 323							
	1300CARB. <B3>	1990 - 1992	K16PR-U	IK16TT	K16TT	IK16	VK16
	1300<B3>	- 1989	K16PR-U	IK16TT	K16TT	IK16	VK16
	1300<B3E>	1992 -	W16EPR-U11	IW16TT	W16TT	IW16	VW16
	1600<E6>	-	W16EPR-U11	IW16TT	W16TT	IW16	VW16
	1600<B6D>	1992 -	K16PR-U	IK16TT	K16TT	IK16	VK16
	1300	-	K20PR-U	IK20TT	K20TT	IK20	VK20
	1600	-	K20PR-U	IK20TT	K20TT	IK20	VK20
LUCE 929							
	2000<FE>	-	W16EPR-U	IW16TT	W16TT	IW16	VW16
	2200<F2>	-	Q20PR-U	IQ20TT	Q20TT	IQ20	VQ20
MPV							
	3000EGI <JE>	1995	KJ16CR11	IK16TT	K16TT	IK16L	-
	3000EGI <JE>	1998 - 1999	QJ20CR11	IQ20TT	Q20TT	IQ20	VQ20
	1600<Z6D>	1992	K16PR-U	IK16TT	K16TT	IK16	VK16
MERCURY							
G-MARQUIS							
	5800 <G>	1990 - 1991	T14PR-U	ITF16TT	-	ITF16	-
	4600 <W>	1992 - 1995	T16EPR-U15	IT16	T16TT	IT16	VT16
MITSUBISHI							
CANTER							
	2400 <T207,T217>	-	W20EP-U	IW20TT	W20TT	IW20	VW20
		2006 - 2011	K16P-U	IK16TT	K16TT	IK16	VK16
GALANT LAMPADA							
	1600 <4G32>	-	W16EP-U	IW16TT	W16TT	IW16	VW16
	1500 <4G15>	1992 - 1996	W16EP-U	IW16TT	W16TT	IW16	VW16
	1500 <4G15>	-	W20EP-U	IW20TT	W20TT	IW20	VW20
	1300 <4G13>	-	W20EP-U	IW20TT	W20TT	IW20	VW20
	2600/2000/1600	-	W16EP-U	IW16TT	W16TT	IW16	VW16
GALANT -SIGMA							
	2000 <4G63>	-	W22EP-U	-	W22TT	IW22	VW22
	1600 <4G32>	-	W20EP-U	IW20TT	W20TT	IW20	VW20
LANCER							
	1600 T <4G32>	1985	W22EP-U	-	W22TT	IW22	VW22
	1500 <4G15>	1985	W20EP-U	IW20TT	W20TT	IW20	VW20
	1300 <4G13>	1985	W20EP-U	IW20TT	W20TT	IW20	VW20
		2006 - 2011	K16P-U	IK16TT	K16TT	IK16	VK16
PAJERO							
		2006 - 2011	K16P-U	IK16TT	K16TT	IK16	VK16
NISSAN							
300EX							
	3000 <VG30>	1996	Q20R-U11	IQ20TT	Q20TT	IQ20	VQ20
ALTIMA							
	2000 <SR20-DE>	1995	K20R-U	IK20TT	K20TT	IK20	VK20
		2007 - 2010	VKH20	IKH20TT	-	IKH20	VKH20
BLUEBIRD							
CEDRIC							
	1800 <CA18S>	1994	Q16-U	IQ16TT	Q16TT	IQ16	VQ16
	2000 <CA20S>	-	Q16-U	IQ16TT	Q16TT	IQ16	VQ16
	3000 <VG30E>	-	Q20-U11	IQ20TT	Q20TT	IQ20	VQ20
	3000 <VG30S>	1985 -	Q20-U11	IQ20TT	Q20TT	IQ20	VQ20
	3000 <VG30S>	-	Q20-U11	IQ20TT	Q20TT	IQ20	VQ20
	3000 <VQ30DE>	-	PK16PR11	IK16TT	-	IK16	VK16
INFINITI							
MAXIMA							
	4100 <VH41-DE>	1998	PK16R11	IK16TT	-	IK16	VK16
PATH FINDER							
	3300 <VG33E>	1998	W16EPR-U11	IW16TT	W16TT	IW16	VW16
PATROL							
	2800 <L28>	-	W16EP-U11	IW16TT	W16TT	IW16	VW16
	4000 <P40>	-	W16EP-U11	IW16TT	W16TT	IW16	VW16
	3000 <RB30S>	-	K20PR-U	IK20TT	K20TT	IK20	VK20
	4200 <TB42,TB42S>	-	W16EP-U	IW16TT	W16TT	IW16	VW16
PICK UP							
	2000 <Z20>	1985	W20EP-U	IW20TT	W20TT	IW20	VW20
	2400 <Z24>	1990	W20EP-U	IW20TT	W20TT	IW20	VW20
PRIMERA							
	2000 <SR20-DE>	1998	K16R-U11	IK16TT	K16TT	IK16	VK16
SAFARI							
	4500 <TB45E>	1998	W16EPR-U11	IW16TT	W16TT	IW16	VW16
SUNNY							
	1600 <GA16S>	-	Q20-U	IQ20TT	Q20TT	IQ20	VQ20
	1300,1500 <E13>,<E15>	-	W20EP-U	IW20TT	W20TT	IW20	VW20
		2007 - 2010	K16HPR-U11	IKH16TT	KH16TT	IKH16	VKH16
URVAN							
	2000 <Z20>	1985	W16EP-U	IW16TT	W16TT	IW16	VW16
	2400 <Z24>	1990	W16EP-U	IW16TT	W16TT	IW16	VW16
X							
	2000,2400 <Z20>,<Z24>	-	W16EPR-U	IW16TT	W16TT	IW16	VW16
SUBARU							
LEGACY							
	2000	-	K20PR-U	IK20TT	K20TT	IK20	VK20
	2500	-	K20PR-U	IK20TT	K20TT	IK20	VK20
SUZUKI							
CULTUS-SWIFT							
	1300	-	W20EP-U	IW20TT	W20TT	IW20	VW20
	1600	1995	W20EPR-U11	IW20TT	W20TT	IW20	VW20

DENSO
 AUSTRALIA CHINA INDIA INDONESIA KOREA MALAYSIA PHILIPPINES SAUDI ARABIA SINGAPORE TAIWAN THAILAND VIETNAM JAPAN & USA EUROPE MOTOR CYCLE SMALL ENGINE CROSS PART REFERENCE NUMBER

DENSO	9	14	16	20	22	24	27	29	31	32	34	35	DENSO	9	14	16	20	22	24	27	29	31	32	DENSO	9	14	16	20	22	24	27	31
NGK	2	4	5	6	7	8	9	9.5	10	10.5	11	11.5	CHAMPION	18	16,14	12,11	10,9	8,7	6,63,61	4,59	57	55	53	BOSCH	10	9	8	7,6	5	4	3	2



DENSO

AUSTRALIA

CHINA

INDIA

INDONESIA

KOREA

MALAYSIA

PHILIPPINES

SAUDI ARABIA

SINGAPORE

TAIWAN

THAILAND

VIETNAM

JAPAN

EUROPE

MOTOR & USA

CYCLE

SMALL ENGINE

CROSS REFERENCE

PART NUMBER

MODEL	ENGINE	YEAR	DENSO				
TOYOTA CAMRY	3000<3VX-FE>	1996	Q20R-U11	IQ20TT	Q20TT	IQ20	VQ20
	2200<5S-FE>	1998 - 1999	K20TR11	IK20TT	K20TT	IK20	VK20
	2200<5S-FE>	- 1996	K20R-U11	IK20TT	K20TT	IK20	VK20
	2400	2007 - 2011	SK20R11	IK20TT	-	IK20	VK20
	2500<2AR-FE>	2011 -	SK16HR11	IKH16TT	-	IKH16	VKH16
	3000V6	2007 - 2011	SK20R11	IK20TT	-	IK20	VK20
	3000V6	2002 - 2006	PK20TR11	IK20TT	-	IK20	VK20
COROLLA	1600<4A-F>	- 1989	Q16R-U	IQ16TT	Q16TT	IQ16	VQ16
	1600<4A-FE>	-	Q16R-U	IQ16TT	Q16TT	IQ16	VQ16
	1600<4A-FE>	1996 - 1998	K16R-U11	IK16TT	K16TT	IK16	VK16
	1300<2E>	1999	W20EXR-U	IW20TT	W20TT	IW20	VW20
	1300<4K>	1987 -	W16EX-U	IW16TT	W16TT	IW16	VW16
	1300<2E>	1996 - 1998	W20EXR-U	IW20TT	W20TT	IW20	VW20
	1300<4E-FE>	1998	K16R-U11	IK16TT	K16TT	IK16	VK16
CORONA	2000 <3S-F,3S-FE>	-	Q20R-U11	IQ20TT	Q20TT	IQ20	VQ20
	1800 <1S>	-	W16EXR-U	IW16TT	W16TT	IW16	VW16
	1600 <4A-F>	-	Q16R-U	IQ16TT	Q16TT	IQ16	VQ16
	2000 <18R>	-	W16EX-U/W14EX-U	IW16TT	W16TT	IW16	VW16
CORONA MK2	2800 <5M-GE>	1980 - 1985	W20EXR-U	IW20TT	W20TT	IW20	VW20
	2400 <22R>	-	W16EXR-U	IW16TT	W16TT	IW16	VW16
	2000 <1G-E>	-	W20EXR-U	IW20TT	W20TT	IW20	VW20
	2000 <18R>	- 1980	W16EX-U/W14EX-U	IW16TT	W16TT	IW16	VW16
	2000 <21R>	1980 - 1985	W16EXR-U	IW16TT	W16TT	IW16	VW16
CROWN	3000 <2JZ-GE>	1996	K20R-U	IK20TT	K20TT	IK20	VK20
	2800 <5M>	1983 -	W16EXR-U	IW16TT	W16TT	IW16	VW16
	2800 <5M-E>	- 1983	W20EXR-U	IW20TT	W20TT	IW20	VW20
	2800 <5M-GE>	1986 -	W16EXR-U	IW16TT	W16TT	IW16	VW16
DYNA	2000 <5R>	1983 - 1984	W16EX-U	IW16TT	W16TT	IW16	VW16
	2000 <5R>	1980 - 1982	W16EX-U/W14EX-U	IW16TT	W16TT	IW16	VW16
	2400 <22R>	-	W16EX-U	IW16TT	W16TT	IW16	VW16
FJ CRUISER		2007 - 2010	K16TR11	IK16TT	K16TT	IK16	VK16
		2008 - 2010	K20HR-U11	IKH20TT	KH20TT	IKH20	VKH20
HIACE	2000 <1RZ>	1999	W16EX-U	IW16TT	W16TT	IW16	VW16
	2400 <2RZ>	1999	W16EX-U	IW16TT	W16TT	IW16	VW16
	1600 <12R>	1983	W16EX-U/W14EX-U	IW16TT	W16TT	IW16	VW16
	2000 <18R>	1983	W16EX-U/W14EX-U	IW16TT	W16TT	IW16	VW16
	2400 <22R>	1985	W16EX-U	IW16TT	W16TT	IW16	VW16
		2007 - 2010	K20HR-U11	IKH20TT	KH20TT	IKH20	VKH20
HILUX	1600 <1Y>	-	W16EX-U	IW16TT	W16TT	IW16	VW16
	1800 <2Y>	- 1997	W16EX-U	IW16TT	W16TT	IW16	VW16
	2700 <3RZ-FE>	1998 - 1999	K16R-U	IK16TT	K16TT	IK16	VK16
	2000 <3Y>	- 1997	W16EX-U	IW16TT	W16TT	IW16	VW16
	2000 <18R>	-	W16EX-U/W14EX-U	IW16TT	W16TT	IW16	VW16
	2400 <22R>	- 1997	W16EXR-U	IW16TT	W16TT	IW16	VW16
LAND CRUISER	4500 <1FZ-FE>	- 1999	K16R-U	IK16TT	K16TT	IK16	VK16
	4200 <2F>	1981	W14EX-U	IW16TT	W16TT	IW16	VW16
	4000 <3F>	-	W14EX-U	IW16TT	W16TT	IW16	VW16
		2007 - 2008	K20R-U11	IK20TT	K20TT	IK20	VK20
		2009 - 2010	SK20HR11	IKH20TT	-	IKH20	VKH20
LAND CRUISER WAGON	4500 <1FZ-FE>	1999	K16TR11	IK16TT	K16TT	IK16	VK16
	4700 <2UZ-FE>	1999	K20R-U	IK20TT	K20TT	IK20	VK20
PRADO	2700 <3RZ-F>	1997 - 1999	K16R-U	IK16TT	K16TT	IK16	VK16
	2700 <3RZ-FE>	1997 - 1999	K16R-U	IK16TT	K16TT	IK16	VK16
	3400 <5VZ-FE>	1997 - 1999	K16TR11	IK16TT	K16TT	IK16	VK16
PREVIA		2010	K20HR-U11	IKH20TT	KH20TT	IKH20	VKH20
	2400 <2TZ-FE>	1998	PK16R11	IK16TT	-	IK16	VK16
RAV 4	2000 <3S-FE>	1998 - 1999	K20R-U11	IK20TT	K20TT	IK20	VK20
		2008	SK20R11	IK20TT	-	IK20	VK20
SEQUOIA		2010	SK20HR11	IKH20TT	-	IKH20	VKH20
TERCEL	1500 <2E>	1986 - 1982	W16EXR-U	IW16TT	W16TT	IW16	VW16
	1300 <3E>	1999	W20EXR-U	IW20TT	W20TT	IW20	VW20





MODEL	YEAR	VEHICLE CODE	ENGINE	DENSO	IRIDIUM	TJ	IRIDIUM POWER	IRIDIUM TOUGH	QTY
ALFA ROMEO									
147 GTA 3.2	04'-	937AXL	-	PK20PR-P8	IK20TT	-	IK20	VK20Y	6
147 Twin Spark 1.6/2.0	00'-	937AB	-	-	IK20TT+N/A	-	IK20+IU22	VK20+N/A	4
156 Twin Spark 2.0	98'-	932B2	-	-	IK20TT+N/A	-	IK20+IU22	VK20+N/A	4
156 V6 2.5	98'-	932A1	-	-	IK20TT	-	IK20	VK20	6
156 GTA 3.2	04'-	932BXB	932A	PK20PR-P8	IK20TT	-	IK20	VK20Y	6
159 2.2	06'-	-	939A5	-	IW16TT	-	IK16	VK16	4
159 3.2	06'-	93922	939A	PT16VR13	ITV16TT	-	ITV16	-	6
166 V6 3.0	99'-	936A1	-	-	IK20TT	-	IK20	VK20	6
Brera 2.2	07'-	93922S	939A5	-	IW16TT	-	IK16	VK16	4
Brera 3.2	07'-	93932S	939A	PT16VR13	ITV16TT	-	ITV16	-	6
GT 2.0	04'-	93270L	937A1	-	IK20TT	-	IK20	VK20	4
GT 3.2	04'-	93732L	936A	-	IK20TT	-	IK20	VK20	6
Spider 2.2	06'-	-	939A5	-	IW16TT	-	IK16	VK16	4
Spider 3.2	06'-	-	939A	-	ITV16TT	-	ITV16	-	6
AUDI									
A3 1.6	97'-	-	AKL	K20PBR-S10	IK20TT	K20TT	IK20	VK20	4
A3 1.8	07'-	-	CDA	PK20PR-P8	IK20TT	-	-	VK20Y	4
A3 S3 2.0	06'-	-	-	-	-	-	-	VKA16	4
A4 1.8T	99'-	-	APU	K22PBR-S	-	-	IK22	VK22	4
	01'-	-	AMB	-	-	-	IK22	VK22	4
	06'-	-	BFB	-	-	-	IK22	VK22	4
A4 2.0	01'-	-	ALT	-	IW16TT	-	IK16	VK16	4
	07'-	-	BFB	-	-	-	-	VK20Y	4
A6 1.8T	99'-	-	AJL/AQC	K20PBR-S10	IK20TT	K20TT	IK22	VK20Y	4
A6 2.0	06'-	-	BPJ	PK20PR-P8	IK20TT	-	-	VK20Y	4
A6 2.4	99'-	-	APS	K20TXR	IK20TT	K20TT	IK20	VK20	6
Q7 3.6	07'-	-	BHK	-	-	-	IXU22	VXU22	6
Q7 4.2	06'-	-	BAR	-	-	-	-	VKB20	8
R8 4.2	07'-	-	BYH	-	-	-	-	VKB20	8
TT 2.0T	07'-	-	BWA	-	-	-	IK22	VK22	4
TT 3.2	07'-	-	BUB	-	-	-	IXU22	VXU22	6
BMW									
118i 2.0	05'-	-	N46	-	IK20TT	-	IK20	VK20	4
120i 2.0	07'-	-	N46	-	IK20TT	-	IK20	VK20	4
130i 3.0	07'-	-	N52	-	IKH20TT	-	IKH20	VKH20	6
135i 3.0	07'-	-	N54	-	-	-	-	-	6
318iS 1.9	97'-	-	M44	K20TXR	IK20TT	K20TT	IK20	VK20	4
318i 2.0 Valvetronic	01'-	-	N42	-	IK20TT	-	IK20	VK20	4
320i 2.0	92'-	-	M52	K20TXR	IK20TT	K20TT	IK20	VK20	6
	05'-	-	N46	-	IK20TT	-	IK20	VK20	4
320i 2.2	00'-	-	M54	-	IK20TT	-	IK20	VK20	6
323i 2.5	05'-	-	N52	-	IKH20TT	-	IKH20	VKH20	6
325i 2.5	00'-	-	M54	-	IK20TT	-	IK20	VK20	6
	05'-	-	N52	-	IKH20TT	-	IKH20	VKH20	6
328i 2.8	95'-	-	M52	K20TXR	IK20TT	K20TT	IK20	VK20	6
330i 3.0	01'-	-	M54	-	IK20TT	-	IK20	VK20	6
335i 3.0	06'-	-	N54	-	-	-	-	-	6
520i 2.0	96'-	-	M52	K20TXR	IK20TT	K20TT	IK20	VK20	6
523i 2.5	06'-	-	N52	-	IKH20TT	-	IKH20	VKH20	6
525i 2.5	00'-	-	M54	-	IK20TT	-	IK20	VK20	6
528i 2.8	96'-	-	M52	K20TXR	IK20TT	K20TT	IK20	VK20	6
530i 3.0	01'-	-	M54	-	IK20TT	-	IK20	VK20	6
545i 4.4	03'-	-	N62	-	IK20TT	-	IK20	VK20	8
630i 3.0	05'-	-	N52	-	IKH20TT	-	IKH20	VKH20	6
645Ci 4.4	04'-	-	N62	-	IK20TT	-	IK20	VK20	8
650i 4.8	05'-	-	N62	-	IK20TT	-	IK20	VK20	8
735i 3.5	02'-	-	N62	-	IK20TT	-	IK20	VK20	8
740Li 4.0	05'-	-	N62	-	IK20TT	-	IK20	VK20	8
745i 4.4	02'-	-	N62	-	IK20TT	-	IK20	VK20	8
750Li 4.8	05'-	-	N62	-	IK20TT	-	IK20	VK20	8
760Li 6.0	03'-	-	N73	-	IK20TT	-	IK20	VK20	12
M3 3.2	00'-	-	S54	-	-	-	IXU24	VXU24	6
M6 5.0	05'-	-	S85	-	-	-	-	-	10
X3 2.5	04'-	-	256S	-	IK20TT	-	IK20	VK20	6
	06'-	-	N52	-	IKH20TT	-	IKH20	VKH20	6
X5 3.0	04'-	-	306S	-	IK20TT	-	IK20	VK20	6
X5 4.8	05'-	-	N62	-	IK20TT	-	IK20	VK20	8

DENSO
 AUSTRALIA CHINA INDIA INDONESIA KOREA MALAYSIA PHILIPPINES SAUDI ARABIA SINGAPORE TAIWAN THAILAND VIETNAM JAPAN & USA EUROPE MOTOR SMALL PART CROSS REFERENCE NUMBER

DENSO	9	14	16	20	22	24	27	29	31	32	34	35	DENSO	9	14	16	20	22	24	27	29	31	32	DENSO	9	14	16	20	22	24	27	31
NGK	2	4	5	6	7	8	9	9.5	10	10.5	11	11.5	CHAMPION	18	16,14	12,11	10,9	8,7	6,63,61	4,59	57	55	53	BOSCH	10	9	8	7,6	5	4	3	2



PART NUMBER	CROSS REFERENCE	MOTOR ENGINE CYCLE	EUROPE & USA	JAPAN	VIETNAM	THAILAND	TAIWAN	SINGAPORE	SAUDI ARABIA	PHILIPPINES	MALAYSIA	KOREA	INDONESIA	INDIA	CHINA	AUSTRALIA	DENSO	SPARK PLUGS				QTY	
																		IRIDIUM TT	IRIDIUM RACING	IRIDIUM POWER	IRIDIUM TOUGH		
DENSO																							
BMW																							
Z4 2.5	03'-	-															M54	-	IK20TT	-	IK20	VK20	6
Z4 3.0	03'-	-															M54	-	IK20TT	-	IK20	VK20	6
CHANA																							
Benni 1.3	07'-	-															JL474Q2	K20PR-U11	IK20TT	K20TT	IK20	VK20	4
CHERY																							
A1 1.3	08'-	DB12B															SQR473	K20PR-U11	IK20TT	K20TT	IK20	VK20	4
A168 1.6	07'-	DA11A															SQR480	K20PR-U11	IK20TT	K20TT	IK20	VK20	4
A5 1.6	07'-	-															SQR481	K20PR-U11	IK20TT	K20TT	IK20	VK20	4
A5 2.0	07'-	DC24B															SQR484	K20PR-U11	IK20TT	K20TT	IK20	VK20	4
QQ 0.8	07'-	-															SQR372	K20PR-U11	IK20TT	K20TT	IK20	VK20	4
QQ 1.1	07'-	-															DA456Q	W16EPR-U	IW16TT	W16TT	IW16	VW16	4
T11 1.6	08'-	DB11B															SQR481	K20PR-U11	IK20TT	K20TT	IK20	VK20	4
T11 2.0	08'-	DB14B															SQR484	K20PR-U11	IK20TT	K20TT	IK20	VK20	4
V5 2.4	07'-	DB24B															4G64	K16PR-U11	IK16TT	K16TT	IK16	VK16	4
CHEVROLET (DAEWOO)																							
Aveo 1.4	04'-	-															714B	K20PR-U11	IK20TT	K20TT	IK20	VK20	4
Captiva 2.4	07'-	CD26															Z24	K20TXR	IK20TT	K20TT	IK20	VK20	4
Epica 2.0	06'-	LA69															X20D	-	IK20TT	-	IK20	VK20	4
Optra 1.6	03'-	-															E4H	K20PR-U11	IK20TT	K20TT	IK20	VK20	4
	05'-	-															F16D	K20PR-U11	IK20TT	K20TT	IK20	VK20	4
Spark 0.8	06'-	KA48															A08S	W16EXR-U11	IW16TT	W16TT	IW16	VW16	4
Spark 1.0	06'-	KF48															B10S	W16EXR-U11	IW16TT	W16TT	IW16	VW16	4
Vivant 1.6	02'-	-															A16D	K20PR-U11	IK20TT	K20TT	IK20	VK20	4
Vivant 2.0	02'-	-															T20SED	K20TXR	IK20TT	K20TT	IK20	VK20	4
CHRYSLER																							
300C 3.5	04'-	-															-	-	IW16TT	-	IK16	VK16	6
Crossfire 3.2	03'-	-															112	-	IW16TT	-	IK16	VK16	12
Grand Voyager SE 3.3	01'-	RG33L															-	-	ITL16TT	-	ITL16	-	6
PT Cruiser 2.0	00'-	PT2K20															T,G	-	ITL16TT	-	ITL16	-	4
PT Cruiser 2.4	04'-	PT2K24															S	-	ITL16TT	-	ITL16	-	4
Sebring 2.4	01'-	-															-	-	ITL16TT	-	ITL16	-	4
CITROEN																							
C1 1.0	05'-	-															1KR-FE	K20HR-U11	IKH20TT	-	IKH20	VKH20	4
C3 1.4	02'-	FCKFVE															KFV	K20PR-U	IK20TT	K20TT	IK20	VK20	4
C3 1.6	02'-	FCNFUC															NFU	-	IKH20TT	-	IKH20	VKH20	4
C4 1.6	05'-	LCNFUF															NFU	-	IKH20TT	-	IKH20	VKH20	4
C5 2.0	01'-	DCRFNE															RFN	K16HPR-U11	IKH16TT	KH16TT	IKH16	VKH16	4
	05'-	RCRFJF															RFJ	K20HR-U11	IKH20TT	KH20TT	IKH20	VKH20	4
C5 3.0	01'-	DCXFXF															XFX	K16HPR-U11	IKH16TT	KH16TT	IKH16	VKH16	6
	06'-	-															XVF	-	IKH16TT	-	IKH16	VKH16	6
C6 3.0	04'-	-															XFU	-	IKH16TT	-	IKH16	VKH16	6
Grand C4 2.0	06'-	-															RFJ	K16HPR-U11	IKH16TT	KH16TT	IKH16	VKH16	4
Xsara 1.4	97'-	N1KFWB															KFW	K20TXR	IK20TT	K20TT	IK20	VK20	4
Xsara 1.6	99'-	N1NFUN															NFU	K20TXR	IK20TT	K20TT	IK20	VK20	4
DAEWOO																							
Kalos 1.5	03'-	-															A13B	W20EXR-U11	IW20TT	W20TT	IW20	VW20	4
Lanos 1.5	97'-	-															A15B	W20EXR-U11	IW20TT	W20TT	IW20	VW20	4
Lanos 1.6	97'-	-															A16D	K20PR-U11	IK20TT	K20TT	IK20	VK20	4
Leganza 2.0	97'-	-															X20SED	K20TXR	IK20TT	K20TT	IK20	VK20	4
Leganza 2.2	98'-	-															T22SED	K20TXR	IK20TT	K20TT	IK20	VK20	4
Nubira 1.6	97'-	-															ZE1K	K20PR-U11	IK20TT	K20TT	IK20	VK20	4
Tacuma 1.6	02'-	-															A16D	K20PR-U11	IK20TT	K20TT	IK20	VK20	4
Tacuma 2.0	02'-	-															T20SED	K20TXR	IK20TT	K20TT	IK20	VK20	4
DAIHATSU																							
Charade 1.0	90'-93'	G100															CB	W16EX-U	IW16TT	W16TT	IW16	VW16	3
	93'-	G202															CB	W16EX-U	IW16TT	W16TT	IW16	VW16	3
Charade 1.3	90'-93'	G102															HC-E	K20PR-U11	IK20TT	K20TT	IK20	VK20	4
	93'-	G200															HC-E	K20PR-U11	IK20TT	K20TT	IK20	VK20	4
Extol 1.3	00'-	S221V															K3-VE	K20R-U11	IK20TT	K20TT	IK20	VK20	4
Gran Move 1.5	97'-98'	G303G															HE-EG	K20PR-U11	IK20TT	K20TT	IK20	VK20	4
Gran Move 1.6	98'-03'	G301G															HD-EP	K20PR-U11	IK20TT	K20TT	IK20	VK20	4
Hijet 0.66	95'-97'	S100															EF-NS	W16DTR-S	-	-	-	-	3
	99'-00'	S200V															EF-SE	K20PR-U11	IK20TT	K20TT	IK20	VK20	3
Hijet 1.0	90'-95'	S85															CB	W16EX-U	IW16TT	W16TT	IW16	VW16	3
Materia 1.5	07'-	M402															3SZ-VE	XU22EPR-U	-	XU22TT	IXU22	VXU22	4
Move 0.85	97'-99'	L601															ED	W16EXR-U11	IW16TT	W16TT	IW16	VW16	3
Move 1.0	99'-00'	L901															EJ-DE	K16PR-U11	IK16TT	K16TT	IK16	VK16	3

MODEL	YEAR	VEHICLE CODE	ENGINE	DENSO					QTY
DAIHATSU									
Sirion 1.0	98'-02'	M100S	EJ-DE	K16PR-U11	IK16TT	K16TT	IK16	VK16	3
Sirion 1.3	05'-07'	M301	K3-VE	K20R-U11	IK20TT	K20TT	IK20	VK20	4
	07'-	M301	K3-VE	XU22EPR-U	-	XU22TT	IXU22	VXU22	4
Sirion 1.5	07'-	M303	3SZ-VE	XU22EPR-U	-	XU22TT	IXU22	VXU22	4
Terios 1.5	06'-	J200/210	3SZ-VE	XU22EPR-U	-	XU22TT	IXU22	VXU22	4
Terios 7-Seater 1.5	08'-	F700	3SZ-VE	XU22EPR-U	-	XU22TT	IXU22	VXU22	4
YRV 1.3	00'-	M201G	K3-VE	K20R-U11	IK20TT	K20TT	IK20	VK20	4
YRV Turbo 1.3	02'-	M201G	K3-VET	PK20PTR-S9	IK20TT	-	IK20L	-	4
DAIHATSU (PI)									
Copen 0.66	07'-	L880K	JB-DET	SVK20RZ8	IK20TT	-	IK20	VK20Y	4
Hijet 0.66	04'-	S320V	EF	K20PR-U11	IK20TT	K20TT	IK20	VK20	3
DONGFENG									
Star 1.3	07'-	EQ6380LF	EQ474i	K20PR-U11	IK20TT	K20TT	IK20	VK20	4
FIAT									
500 1.2	07'-	-	169A4	XU22EPR-U	-	XU22TT	IXU22	VXU22	4
500 1.4	07'-	-	169A3	XU22EPR-U	-	XU22TT	IXU22	VXU22	4
Bravo 1.4	07'-	-	198A	XU22EPR-U	-	XU22TT	IXU22	VXU22	4
Croma 1.8	05'-	-	939A	KJ16CR-L11	IK16TT	K16TT	IK16L	-	4
Croma 2.2	05'-	-	194A	-	ITV16TT	-	ITV16	-	4
Grande Punto 1.4	06'-	-	350A1	XU22EPR-U	-	XU22TT	IXU22	VXU22	4
Panda 1.2	05'-	-	188A4	XU22EPR-U	-	XU22TT	IXU22	VXU22	4
Panda 1.3	03'-	-	188A4	K16PR-U	IK16TT	K16TT	IK16	VK16	4
Punto 1.3	03'-	-	188A4	K16PR-U	IK16TT	K16TT	IK16	VK16	4
Ulysse 2.0	02'-	-	RFN	K16HPR-U11	IKH16TT	-	IKH16	VKH16	4
FORD									
Escape 2.0	02'-	ED75RAA	-	PT16VR13	ITV16TT	-	ITV16	-	4
Fiesta 1.4	03'-	WF0HXX	-	PT16VR13	ITV16TT	-	ITV16	-	4
Fiesta 1.6	04'-	WF0FYJ	-	PT16VR13	ITV16TT	-	ITV16	-	4
Focus 1.6	98'-	WF0FXX	-	PT16VR13	ITV16TT	-	ITV16	-	4
	05'-	WF05XX	-	-	ITV16TT	-	ITV16	-	4
Galaxy 2.3	98'-	WF0GXX	-	-	IK20TT	-	IK20	VK20	4
Ka 1.3	97'-	WF0BXX	-	T20EPR-U	IT20TT	T20TT	IT20	VT20	4
Laser 1.3/1.6	98'-	BJ	-	KJ16CR-L11	IK16TT	K16TT	IK16L	-	4
Laser Tierra 1.6	04'-	BVPP	-	KJ16CR-L11	IK16TT	K16TT	IK16L	-	4
Mondeo 2.0	97'-	WF0FZZ	-	PT16VR13	ITV16TT	-	ITV16	-	4
	00'-	WF04XX	-	T20EPR-U	IT20TT	T20TT	IT20	VT20	4
	05'-	WF04XX	-	-	IT20TT	-	IT20	VT20	4
Mondeo 2.3	07'-	WF0GXX	-	-	ITV16TT	-	ITV16	-	4
S-Max 2.3	06'-	-	AOWA	-	IT20TT	-	IT20	VT20	4
GEELY									
CK 1.5	06'-	-	MR479QA	K16PR-U11	IK16TT	K16TT	IK16	VK16	4
MK 1.5	06'-	-	MR479QA	K16PR-U11	IK16TT	K16TT	IK16	VK16	4
HAFEI									
Lobo 1.1	07'-	-	DA468	K16PR-U	IK16TT	K16TT	IK16	VK16	4
Minz 1.1	07'-	-	DA465	K16PR-U11	IK16TT	K16TT	IK16	VK16	4
Minz 1.3	07'-	-	DA471	K16PR-U11	IK16TT	K16TT	IK16	VK16	4
HONDA									
Accord 2.0	97'-	CF3	F20B	KJ20CR-L11	IK16TT	K20TT	IK20L	-	4
	02'-	CL7	K20A	KJ20DR-M11	IK16TT	K20TT	IK20L	-	4
	08'-	CP1	R20A	KJ20DR-M11	IK16TT	K20TT	IK20L	-	4
	13'-	CR1	R20Z	-	-	-	-	VXUHC22G	4
Accord 2.4	02'-	CL9	K24A	KJ20CR-L11	IK16TT	K20TT	IK20L	-	4
	08'-	CP2	K24Z	SKJ20DR-M11	IK20TT	-	IK20L	-	4
	13'-	CR2	K24W	-	-	-	-	-	4
Accord 3.5	07'-	CP3	J35Z	SXU22HCR11	-	-	IXUH22	VXUH22	6
City i-DSI T-Spark 1.5	02'-	GD8	L15A	K20PR-U11	IK20TT	K20TT	IK20	VK20	8
City Vtec 1.5	05'-	GD8	L15A1	SKJ20DR-L13	IK20TT	-	IK20L	-	4
	13'-	GM6	L15Z	-	IK20TT	-	-	VFK20F	4
Civic 1.6	12'-	FB1	R16B	-	-	-	-	VXUHC22G	4
Civic IMA 1.5	12'-	FB4	LEA2	-	-	-	-	-	4
Civic Turbo 1.5	16'-	FC1	L15B7	-	-	-	-	-	4
Civic 1.6	16'-	FC5	R16B6	-	-	-	-	-	4
Civic Hybrid IMA 1.3	07'-	FD3	LDA	SK20HPR-L11	IKH20TT	-	IKH20	VKH20	8
Civic Vtec SOHC 1.5	01'-	ES8	D15B	KJ16CR-L11	IK16TT	K16TT	IK16L	-	4
Civic Vtec SOHC 1.6	03'-	ES5	D16B	KJ16CR-L11	IK16TT	K16TT	IK16L	-	4
Civic Vtec SOHC 1.7	01'-	ES1	D17A	KJ20CR-L11	IK16TT	K20TT	IK20L	-	4
Civic Vti 1.8	05'-	FD1	R18A1	SKJ20DR-M11S	-	-	IK20L	-	4

DENSO
 AUSTRALIA
 CHINA
 INDIA
 INDONESIA
 KOREA
 MALAYSIA
 PHILIPPINES
 SAUDI ARABIA
 SINGAPORE
 TAIWAN
 THAILAND
 VIETNAM
 JAPAN
 & USA
 EUROPE
 MOTOR
 CYCLE
 SMALL
 ENGINE
 CROSS
 REFERENCE
 PART
 NUMBER

DENSO	9	14	16	20	22	24	27	29	31	32	34	35	DENSO	9	14	16	20	22	24	27	29	31	32	DENSO	9	14	16	20	22	24	27	31
NGK	2	4	5	6	7	8	9	9.5	10	10.5	11	11.5	CHAMPION	18	16,14	12,11	10,9	8,7	6,63,61	4,59	57	55	53	BOSCH	10	9	8	7,6	5	4	3	2



DENSO
AUSTRALIA
CHINA
INDIA
INDONESIA
KOREA
MALAYSIA
PHILIPPINES
SAUDI ARABIA
SINGAPORE
TAIWAN
THAILAND
VIETNAM
JAPAN
EUROPE & USA
MOTOR CYCLE
SMALL ENGINE
CROSS REFERENCE
PART NUMBER

MODEL	YEAR	VEHICLE CODE	ENGINE	DENSO	IRIDIUM TT	IRIDIUM RACING	IRIDIUM POWER	IRIDIUM TOUGH	QTY
HONDA									
Civic Si 2.0	05'-	FD2	K20Z	SKJ20DR-M11	IK20TT	-	IK20L	-	4
Civic 3DR TypeR 2.0	07'-	FN2	K20Z	SKJ20DR-M11	IK20TT	-	IK20L	-	4
CR-V 2.0	01'-	RD5	K20A	KJ20DR-M11	IK16TT	K20TT	IK20L	-	4
	07'-	RE2	R20A	KJ20DR-M11	IK16TT	K20TT	IK20L	-	4
CR-V 2.4	07'-	RE4	K24Z	SKJ20DR-M11	IK20TT	-	IK20L	-	4
	14'-	RM3	K24Z	-	-	-	-	-	4
CR-Z 1.5	11'-	ZF1	LEA1	DK20PR-D13	IK20TT	-	-	VFK20F	4
Freed 1.5	10'-	GB3	L15A	-	IK20TT	-	IK20L	-	4
HR-V 1.5	13'-	RU1	L15Z	-	IK20TT	-	-	VFK20F	4
Integra TypeR 2.0	01'-	DC5	K20A	SK22PR-M11	-	-	IK22G	VK22G	4
Jazz 1.3	07'-	GE6	L13Z	SKJ20DR-M13	IK20TT	-	IK20L	-	4
Jazz i-DSI T-Spark 1.4	02'-	GD1	L13A	K20PR-U11	IK20TT	K20TT	IK20	VK20	8
Jazz 1.5	07'-	GE8	L15A	SKJ20DR-M13	IK20TT	-	IK20L	-	4
Jazz i-vtec 1.3	13'-	GK3	L13B	DXE22HCR11S	-	-	-	VFXEHC22G	4
Jazz RS i-vtec 1.5	13'-	GK5	L15B	DXE22HCR11S	-	-	-	VFXEHC22G	4
Mobilio RS i-vtec 1.5	14'-	DD4	L15Z	-	IK20TT	-	-	VFK20F	4
Odyssey 2.3	00'-	RA6	F23A	KJ16CR-L11	IK16TT	K16TT	IK16L	-	4
Odyssey 2.4	03'-	RB1/2	K24A	SKJ20DR-M11	IK20TT	-	IK20L	-	4
	08'-	RB3	K24Z	SKJ20DR-M11	IK20TT	-	IK20L	-	4
Odyssey 2.4 (Except Absolute)	08'-11'	RB3	K24A	DXU22HCR-D11S	-	-	-	VXUHC22G	4
Odyssey (Except Absolute) 2.4	13'-	RC1	K24W	SXE22HQR11S	-	-	-	-	4
Odyssey 3.0	00'-	RA8	J30A	KJ16CR-L11	IK16TT	K16TT	IK16L	-	4
S2000 2.0	03'-	AP1	F20C	PK22PR-L11S	-	-	IK22G	VK22G	4
S2000 2.2	06'-	AP2	F22C	PK22PR-L11S	-	-	IK22G	VK22G	4
Stream Vtec SOHC 1.7	00'-	RN1	D17A	KJ20CR-L11	IK16TT	K20TT	IK20L	-	4
Stream RSZ 1.8	07'-	RN6	R18A	KJ20DR-M11	IK16TT	K20TT	IK20L	-	4
Stream i-vtec DOHC 2.0	00'-	RN3	K20A	KJ20DR-M11	IK16TT	K20TT	IK20L	-	4
HONDA (PI)									
Acty 0.66	99'-	HH51	E07Z	SK20PR-L9	IK20TT	-	IK20	VK20	3
Airwave 1.5	05'-	GJ1	L15A	SKJ20DR-M13	IK20TT	-	IK20L	-	4
Civic Type-R 2.0	-	-	-	-	-	-	-	-	4
Crossroad 1.8	07'-	RT1	R18A	KJ20DR-M11	IK16TT	K20TT	IK20L	-	4
CR-Z Hybrid 1.5	12'-	ZF2	LEA-MF6	SKJ20DR-M13	IK20TT	-	IK20L	VK20	4
Edix 1.7	04'-	BE1	D17A	KJ20CR-L11	IK16TT	K20TT	IK20L	-	4
ElySION 2.4	04'-	RR1/2	K24A	SKJ20DR-M11	IK20TT	-	IK20L	-	4
ElySION 3.0	04'-	RR3/4	J30A	SKJ20DR-M11	IK20TT	-	IK20L	-	6
Fit 1.3	13'-	GK3	L13B	DXE22HCR11S	-	-	-	VFXEHC22G	4
Fit i-Vtec 1.3	07'-	GE6	L13A	SKJ20DR-M13	IK20TT	-	IK20L	-	4
Fit Vtec 1.5	02'-	GD3	L15A	SKJ20DR-M11	IK20TT	-	IK20L	-	4
Fit Hybrid 1.5	13'-	GP5/GP6	LEB-H1	DXE22HCR11S	-	-	-	VFXEHC22G	4
Freed 1.5	08'-	GB3	L15A	SKJ20DR-M13	IK20TT	-	IK20L	-	4
Grace 1.5	15'-	GM6/9	L15B	DXE22HCR11S	-	-	-	VFXEHC22G	4
Insight Hybrid 1.3	09'-	ZE2	LDA	SK20HPR-L11	IKH20TT	-	IKH20	VKH20	8
Jade 1.5	15'-	FR4	LEB-H1	DXE22HCR11S	-	-	-	VFXEHC22G	4
Jade Hybrid 1.5	-	-	-	-	-	-	-	-	4
Mobilio 1.5	02'-	GB1	L15A	K20PR-U11	IK20TT	K20TT	IK20	VK20	8
Odyssey (Absolute) 2.4	08'-11'	RB3	K24A	SXU22HCR11S	-	-	-	VXUHC22G	4
	13'-	RC1	K24W	DXE22HQR-D11S	-	-	-	-	4
Shuttle 1.5	15'-	GK8	L15B	DXE22HCR11S	-	-	-	VFXEHC22G	4
Shuttle Hybrid 1.5	15'-	GP8	LEB-H1	DXE22HCR11S	-	-	-	VFXEHC22G	4
Stepwagon 2.0	01'-	RF3/4	K20A	KJ20DR-M11	IK16TT	K20TT	IK20L	-	4
	05'-	RG1	K20A	KJ20DR-M11	IK16TT	K20TT	IK20L	-	4
Stepwagon 2.4	03'-	RF7/8	K24A	KJ20DR-M11	IK16TT	K20TT	IK20L	-	4
Stream RSZ 1.8	07'-	RN6	R18A	KJ20DR-M11	IK16TT	K20TT	IK20L	-	4
VeZel 1.5	14'-	RU1	L15B	DXE22HCR11S	-	-	-	VFXEHC22G	4
VeZel Hybrid 1.5	14'-	RU3	LEB-H1	DXE22HCR11S	-	-	-	VFXEHC22G	4
HYUNDAI									
Accent 1.3/1.5	00'-	CH41	-	K16PR-U11	IK16TT	K16TT	IK16	VK16	4
Atos Prime 1.0	01'-	AH51	-	K16PR-U11	IK16TT	K16TT	IK16	VK16	4
Avante 1.6	06'-	DU41	-	KJ16CR-L11	IK16TT	K16TT	IK16L	-	4
	08'-	DU41	-	-	-	-	IXUH22	VXUH22	4
Azera 3.3	05'-	FC41D	-	SK16PR-L11	IK16TT	-	IK16	VK16	6
Coupe 1.6	97'-	JG3R	-	K16PR-U11	IK16TT	K16TT	IK16	VK16	4
Coupe 1.8	02'-	HN61	-	K16PR-U11	IK16TT	K16TT	IK16	VK16	4
Coupe 2.0	96'-	JG3F	-	K20PR-U11	IK20TT	K20TT	IK20	VK20	4
	02'-	HN61	-	K16PR-U11	IK16TT	K16TT	IK16	VK16	4
Elantra 1.6	00'-	DN41	-	K16PR-U11	IK16TT	K16TT	IK16	VK16	4

MODEL	YEAR	VEHICLE CODE	ENGINE	DENSO	IRIDIUM	TJ	IRIDIUM POWER	IRIDIUM TOUGH	QTY
HYUNDAI									
Getz 1.1	05 ⁻	BT51G	-	K16PR-U11	IK16TT	K16TT	IK16	VK16	4
Getz 1.3	03 ⁻	BU51H	-	K16PR-U11	IK16TT	K16TT	IK16	VK16	4
Getz 1.4	05 ⁻	BU51D	-	K16PR-U11	IK16TT	K16TT	IK16	VK16	4
Getz 1.6	03 ⁻	BU51B	-	K16PR-U11	IK16TT	K16TT	IK16	VK16	4
Grandeur 3.0	98 ⁻	FU41	-	PK16PR11	IK16TT	-	IK16	VK16	6
i 30 1.6	08 ⁻	DC5	-	KJ16CR-L11	IK16TT	K16TT	IK16L	-	4
Matrix 1.6/1.8	01 ⁻	PN81C/81D	-	K16PR-U11	IK16TT	K16TT	IK16	VK16	4
Santa Fe 2.4	00 ⁻	SC81B	-	W20EXR-U11	IW20TT	W20TT	IW20	VW20	4
Santa Fe 2.7	00 ⁻	SC81D	-	PK16PR11	IK16TT	-	IK16	VK16	6
	06 ⁻	SH81D	-	-	IKH16TT	-	IKH16	VKH16	6
Sonata 2.0	98 ⁻	EN41	-	W20EXR-U11	IW20TT	W20TT	IW20	VW20	4
Sonata 2.0 H-matic	01 ⁻	EN41	-	W20EXR-U11	IW20TT	W20TT	IW20	VW20	4
Sonata 2.0	06 ⁻	EU41B	-	K16PR-U11	IK16TT	K16TT	IK16	VK16	4
Sonata 2.4	05 ⁻	EU41C	-	K16PR-U11	IK16TT	K16TT	IK16	VK16	4
Terracan 3.5	05 ⁻	NM81C	-	PK16PR-L11	IK16TT	-	IK16	VK16	6
Trajeta 2.0	98 ⁻	MH81A	-	W20EXR-U11	IW20TT	W20TT	IW20	VW20	4
Trajeta 2.7	98 ⁻	MH81C	-	PK16PR11	IK16TT	-	IK16	VK16	6
Tucson 2.0	04 ⁻	JN81V	-	K16PR-U11	IK16TT	K16TT	IK16	VK16	4
Tucson 2.7	04 ⁻	JN81D	-	PK16PR11	IK16TT	-	IK16	VK16	6
Tuscani 2.0	03 ⁻	HM61D	-	K16PR-U11	IK16TT	K16TT	IK16	VK16	4
Tuscani 2.7	03 ⁻	HM61F	-	PK16PR11	IK16TT	-	IK16	VK16	6
Verna 1.4	05 ⁻	CM41A	-	K16PR-U11	IK16TT	K16TT	IK16	VK16	4
Verna 1.6	05 ⁻	CN41C	-	K16PR-U11	IK16TT	K16TT	IK16	VK16	4
JAGUAR									
S Type 3.0	00 ⁻	J01	FB	-	IT20TT	-	IT20	VT20	6
X Type 2.1/2.5/3.0	02 ⁻	J51	YB/WB/XB	-	IT20TT	-	IT20	VT20	6
XJ6 3.0	05 ⁻	J71VA	-	-	IT16TT	-	IT16	VT16	6
XJ8 3.5	04 ⁻	J72RA	-	-	IW16TT	-	IK16	VK16	8
XJ8 4.2	04 ⁻	J72SA	-	-	IW16TT	-	IK16	VK16	8
XJR 4.2	03 ⁻	J413A	-	-	IW16TT	-	IK16	VK16	8
XK8 4.0	96 ⁻	J	NB	-	IK20TT	-	IK20	VK20	8
JEEP									
Cherokee 3.7	01 ⁻	KJ37	K	KJ20CR-L11	IK16TT	K20TT	IK20L	-	6
Crossfire 3.2	03 ⁻	ZH32	-	-	IW16TT	-	IK16	VK16	12
Grand Cherokee 4.7	99 ⁻	WJ47	661	K16R-U11	IK16TT	K16TT	IK16	VK16	8
Wrangler Sport 4.0	99 ⁻	TJ40S	-	KJ16CR-L11	IK16TT	K16TT	IK16L	-	6
KIA									
Carens 1.8	00 ⁻	FC52	-	K20PR-U	IK20TT	K20TT	IK20	VK20	4
Carens II 2.0	03 ⁻	FC52	-	K20PR-U	IK20TT	K20TT	IK20	VK20	4
	06 ⁻	FG52	-	K20PR-U	IK20TT	K20TT	IK20	VK20	4
Carnival 2.5	01 ⁻	MA75	-	PK20PR-L11	IK20TT	-	IK20	VK20	6
Cerato 1.6	04 ⁻	FE22	-	K20PR-U11	IK20TT	K20TT	IK20	VK20	4
	08 ⁻	FG22	-	K20PR-U11	IK20TT	K20TT	IK20	VK20	4
Cerato Forte 1.6	08 ⁻	FH22	-	-	-	-	IXUH22	VXUH22	4
Magentis 2.0	03 ⁻	GD22	-	W20EXR-U11	IW20TT	W20TT	IW20	VW20	4
	05 ⁻	GE22	-	K16PR-U11	IK16TT	K16TT	IK16	VK16	4
Optima 2.0	00 ⁻	GD22	-	W20EXR-U11	IW20TT	W20TT	IW20	VW20	4
Picanto 1.1	04 ⁻	BA24	-	K20PR-U11	IK20TT	K20TT	IK20	VK20	4
Rio 1.3	00 ⁻	DC22	-	W16EXR-U11	IW16TT	W16TT	IW16	VW16	4
Rio 1.4	05 ⁻	DE22	-	K16PR-U11	IK16TT	K16TT	IK16	VK16	4
Rio 1.5	00 ⁻	DC22	-	K20PR-U	IK20TT	K20TT	IK20	VK20	4
Rio 1.6	05 ⁻	DE22	-	K16PR-U11	IK16TT	K16TT	IK16	VK16	4
Sorento 3.5	04 ⁻	JC52	-	PK16PR11	IK16TT	-	IK16	VK16	6
Spectra 1.5	00 ⁻	FB22	-	K20PR-U	IK20TT	K20TT	IK20	VK20	4
Sportage 2.0	04 ⁻	JE55	-	K16PR-U11	IK16TT	K16TT	IK16	VK16	4
	07 ⁻	ET41	-	K16PR-U	IK16TT	K16TT	IK16	VK16	4
LEXUS									
ES300 3.0	01 ⁻	MCV30	1MZ-FE	PK16R11	IK16TT	-	IK16	VK16	6
GS450h 3.5	06 ⁻	GWA191	2GR-FSE	FK20HBR11	IKBH20TT	-	-	VFKBH20	6
IS200 2.0	98 ⁻	GXE10	1G-FE	SK20R11	IK20TT	-	IK20	VK20	4
IS250 2.5	05 ⁻	GSE25	4GR-FSE	FK20HBR11	IKBH20TT	-	-	VFKBH20	6
LS430 4.3	00 ⁻	UCF30/31	3UZ-FE	SK20R11	IK20TT	-	IK20	VK20	6
LS460 4.6	06 ⁻	USF40	1UR-FSE	FK20HBR11	IKBH20TT	-	-	VFKBH20	8
LS600hL 5.0	07 ⁻	UVF46	2UR-FSE	FK20HBR11	IKBH20TT	-	-	VFKBH20	8
RX300 3.0	03 ⁻	MCU35	1MZ-FE	SK20R11	IK20TT	-	IK20	VK20	6
RX350 3.5	06 ⁻	GSU35	2GR-FE	FK20HR11	IKH20TT	-	-	VFKH20	6
RX400h 3.3	05 ⁻	JHW31	3MZ-FE	SK20R11	IK20TT	-	IK20	VK20	6





DENSO

AUSTRALIA CHINA INDIA INDONESIA KOREA MALAYSIA PHILIPPINES SAUDI ARABIA SINGAPORE TAIWAN THAILAND VIETNAM JAPAN & USA EUROPE MOTOR CYCLE SMALL ENGINE REFERENCE NUMBER PART

DENSO	9	14	16	20	22	24	27	29	31	32	34	35	DENSO	9	14	16	20	22	24	27	29	31	32	DENSO	9	14	16	20	22	24	27	31
NGK	2	4	5	6	7	8	9	9.5	10	10.5	11	11.5	CHAMPION	18	16,14	12,11	10,9	8,7	6,63,61	4,59	57	55	53	BOSCH	10	9	8	7,6	5	4	3	2



PART NUMBER	CROSS REFERENCE	SMALL ENGINE	MOTOR CYCLE	EUROPE & USA	JAPAN	VIETNAM	THAILAND	TAIWAN	SINGAPORE	SAUDI ARABIA	PHILIPPINES	MALAYSIA	KOREA	INDONESIA	INDIA	CHINA	AUSTRALIA	DENSO	SPARK PLUGS				QTY		
																			IRIDIUM TT	IRIDIUM RACING	IRIDIUM POWER	IRIDIUM TOUGH			
DENSO																									
LEXUS																									
	RX450h 3.5	06'-	JBC11	2GR-FE	FK20HR11	IKH20TT	-	-	-	-	-	-	-	-	-	-	-	VFKH20	6						
	SC430 4.3	01'-	VZZ40	3UZ-FE	SK20R11	IK20TT	-	-	-	-	-	-	-	-	-	-	-	IK20	VK20	6					
MASERATI																									
	Coupe 4.2	02'-	MCP	M138	-	-	-	-	-	-	-	-	-	-	-	-	-	IU24	-	8					
	Spyder 4.2	02'-	SPY	M138	-	-	-	-	-	-	-	-	-	-	-	-	-	IU24	-	8					
MAZDA																									
	323 1.3	99'-	BVY11	QG13DE	KJ16CR-L11	IK16TT	K16TT	IK16L	-	-	-	-	-	-	-	-	-	-	-	4					
	323 1.6	99'-	BJ	B6DE	KJ16CR-L11	IK16TT	K16TT	IK16L	-	-	-	-	-	-	-	-	-	-	-	4					
	5 2.0	13'-	CWFFW	PE-VPS	ZC20HPR11	-	-	-	-	-	-	-	-	-	-	-	-	-	VCH20	4					
	626 2.0	97'-99'	GA07	-	PKJ16CR8	-	-	-	-	-	-	-	-	-	-	-	-	-	IK16L	-	4				
	Biante 2.0	09'-	CCEFW	LF-VDS	-	-	-	-	-	-	-	-	-	-	-	-	-	-	-	ITV20	4				
		13'-	CCFFW	PE-VPS	ZC20HPR11	-	-	-	-	-	-	-	-	-	-	-	-	-	-	-	VCH20	4			
	CX-5 2.0	12'-	KEEAW/KEEFW	PE-VPS	ZC20HPR11	-	-	-	-	-	-	-	-	-	-	-	-	-	-	VCH20	4				
	CX-5 2.5	13'-	KE5AW/KE5FW	PY-VPS	ZC20HPR11	-	-	-	-	-	-	-	-	-	-	-	-	-	-	VCH20	4				
	CX-7 2.3	07'-	ER3P	L3-VDT	-	-	-	-	-	-	-	-	-	-	-	-	-	-	ITV20TT	ITV20	-	4			
	Mazda 21.5	04'-	DY10	ZY3	K16PR-U11	IK16TT	K16TT	IK16	VK16	-	-	-	-	-	-	-	-	-	-	IK16	VK16	4			
		07'-	DE10	ZY	-	-	IW16TT	-	-	-	-	-	-	-	-	-	-	-	-	-	IK16	VK16	4		
	Mazda 31.6	04'-	6BK	Z6	K16PR-U11	IK16TT	K16TT	IK16	VK16	-	-	-	-	-	-	-	-	-	-	IK16	VK16	4			
	Mazda 32.0	07'-	6BL	LF	-	-	-	-	-	-	-	-	-	-	-	-	-	-	-	IT20TT	IT20	VT20	4		
	Mazda 52.0	05'-	CREW	LF-DE	-	-	-	-	-	-	-	-	-	-	-	-	-	-	-	IT16TT	IT16	VT16	4		
		03'-	GG12/14	LF-DE	-	-	-	-	-	-	-	-	-	-	-	-	-	-	-	-	IT20TT	IT20	VT20	4	
		05'-	GG10	LF-DE	-	-	-	-	-	-	-	-	-	-	-	-	-	-	-	-	ITV16TT	ITV16	-	4	
	Mazda 62.0	08'-	GH10	LF-DE	-	-	-	-	-	-	-	-	-	-	-	-	-	-	-	-	ITV20TT	ITV20	-	4	
		03'-	GG12/14	L3-VE	-	-	-	-	-	-	-	-	-	-	-	-	-	-	-	-	IT20TT	IT20	VT20	4	
	Mazda 62.3	03'-	GG12/14	L3-VE	-	-	-	-	-	-	-	-	-	-	-	-	-	-	-	IT20TT	IT20	VT20	4		
	MPV 3.0	02'-	LWFW	AJ	-	-	-	-	-	-	-	-	-	-	-	-	-	-	-	IT20TT	IT20	VT20	6		
	MX-5 1.6	98'-	NB6C	B6-ZE	KJ16CR-L11	IK16TT	K16TT	IK16L	-	-	-	-	-	-	-	-	-	-	-	IK16TT	K16TT	IK16L	-	4	
	MX-5 1.8	93'-98'	NA8C	BP-ZE	KJ16CR-L11	IK16TT	K16TT	IK16L	-	-	-	-	-	-	-	-	-	-	-	IK16TT	K16TT	IK16L	-	4	
		98'-	NB8C	BP-ZE	KJ16CR-L11	IK16TT	K16TT	IK16L	-	-	-	-	-	-	-	-	-	-	-	-	IK16TT	K16TT	IK16L	-	4
	MX-5 2.0	05'-	NC	LF-DE	-	-	-	-	-	-	-	-	-	-	-	-	-	-	-	IT20TT	IT20	VT20	4		
	Premacy 1.8	02'-	CP12	FP-DE	KJ16CR-L11	IK16TT	K16TT	IK16L	-	-	-	-	-	-	-	-	-	-	-	IK16TT	K16TT	IK16L	-	4	
	Premacy 2.0	00'-	CP25	FS-DE	KJ16CR-L11	IK16TT	K16TT	IK16L	-	-	-	-	-	-	-	-	-	-	-	IK16TT	K16TT	IK16L	-	4	
	RX-8 1.3	04'-	JM2SE	13B-MSP	Leading	-	-	-	-	-	-	-	-	-	-	-	-	-	-	-	-	IRL01-27	-	2	
		04'-	JM2SE	13B-MSP	Trailing	-	-	-	-	-	-	-	-	-	-	-	-	-	-	-	-	-	IRT01-31	-	2
MERCEDES-BENZ																									
	200E 2.0	86'-93'	W124	102	T20EPR-U	IT20TT	T20TT	IT20	VT20	-	-	-	-	-	-	-	-	-	-	IT20TT	T20TT	IT20	VT20	4	
	A160 1.6	98'-	W168	166	K20PBR-S10	IK20TT	K20TT	IK20	VK20	-	-	-	-	-	-	-	-	-	-	IK20TT	K20TT	IK20	VK20	4	
	A170 1.7	06'-	W169	266	K20PR-U	IK20TT	K20TT	IK20	VK20	-	-	-	-	-	-	-	-	-	-	IK20TT	K20TT	IK20	VK20	4	
	A190 1.9	99'-	W168	166	K20PBR-S10	IK20TT	K20TT	IK20	VK20	-	-	-	-	-	-	-	-	-	-	IK20TT	K20TT	IK20	VK20	4	
	A200 Turbo 2.0	06'-	W169	266M20	-	-	-	-	-	-	-	-	-	-	-	-	-	-	-	IK20TT	-	IK20	VK20	4	
	B170 1.7	06'-	W245	266	K20PR-U	IK20TT	K20TT	IK20	VK20	-	-	-	-	-	-	-	-	-	-	IK20TT	K20TT	IK20	VK20	4	
	B200 2.0	06'-	W245	266M20	K20PR-U	IK20TT	K20TT	IK20	VK20	-	-	-	-	-	-	-	-	-	-	IK20TT	K20TT	IK20	VK20	4	
	C180 Komp 1.8	05'-	W203	271	-	-	-	-	-	-	-	-	-	-	-	-	-	-	-	IKH20TT	-	IKH20	VKH20	4	
	C200 Komp 1.8	02'-	W203	271	-	-	-	-	-	-	-	-	-	-	-	-	-	-	-	IKH20TT	-	IKH20	VKH20	4	
	C200 Komp. 1.8	07'-	W204	271	-	-	-	-	-	-	-	-	-	-	-	-	-	-	-	-	-	-	-	4	
	C200 Komp 2.0	00'-	W203	111	-	-	-	-	-	-	-	-	-	-	-	-	-	-	-	IK20TT	-	IK20	VK20	4	
	C230 2.5	06'-	W203	272M25	-	-	-	-	-	-	-	-	-	-	-	-	-	-	-	-	-	IXUH22	VXUH22	6	
	C240 2.6	00'-	W203	112M26	-	-	-	-	-	-	-	-	-	-	-	-	-	-	-	IW16TT	-	IK16	VK16	12	
	C280 3.0	05'-	W203	272M30	-	-	-	-	-	-	-	-	-	-	-	-	-	-	-	-	-	IXUH22	VXUH22	6	
	CL500 5.5	06'-	W216	273	-	-	-	-	-	-	-	-	-	-	-	-	-	-	-	-	-	IXUH22	VXUH22	16	
	CL600 5.5	06'-	W215	275	-	-	-	-	-	-	-	-	-	-	-	-	-	-	-	-	-	IK22	VK22	24	
	CLK200 1.8	03'-	W209	271	-	-	-	-	-	-	-	-	-	-	-	-	-	-	-	IKH20TT	-	IKH20	VKH20	4	
	CLK200 Komp. 1.8	06'-	W209	271	-	-	-	-	-	-	-	-	-	-	-	-	-	-	-	-	-	-	-	4	
	E200 Komp 1.8	03'-	W211	271	-	-	-	-	-	-	-	-	-	-	-	-	-	-	-	-	IKH20TT	-	IKH20	VKH20	4
		06'-	W211	271	-	-	-	-	-	-	-	-	-	-	-	-	-	-	-	-	IKH20TT	-	IKH20	VKH20	4
	E200 Komp NGT 1.8	06'-	W211	271	-	-	-	-	-	-	-	-	-	-	-	-	-	-	-	IKH20TT	-	IKH20	VKH20	4	
	E200 Komp 2.0	00'-	W210	111	-	-	-	-	-	-	-	-	-	-	-	-	-	-	-	IK20TT	-	IK20	VK20	4	
	E240 2.4	00'-	W210	112	-	-	-	-	-	-	-	-	-	-	-	-	-	-	-	IW16TT	-	IK16	VK16	12	
	E240 2.6	03'-	W211	112	-	-	-	-	-	-	-	-	-	-	-	-	-	-	-	IW16TT	-	IK16	VK16	12	
	E280 3.0	05'-	W211	272	-	-	-	-	-	-	-	-	-	-	-	-	-	-	-	-	-	IXUH22	VXUH22	6	
	E320 3.2	00'-	W210	112	-	-	-	-	-	-	-	-	-	-	-	-	-	-	-	IW16TT	-	IK16	VK16	12	
		03'-	W211	112	-	-	-	-	-	-	-	-	-	-	-	-	-	-	-	-	IW16TT	-	IK16	VK16	12
	E350 3.5	05'-	W211	272	-	-	-	-	-	-	-	-	-	-	-	-	-	-	-	-	-	IXUH22	VXUH22	6	
	ML350 3.5	05'-	W164	272	-	-	-	-	-	-	-	-	-	-	-	-	-	-	-	-	-	IXUH22	VXUH22	6	
	ML500 5.0	05'-	W164	113	-	-	-	-	-	-	-	-	-	-	-	-	-	-	-	IW16TT	-	IK16	VK16	16	
	R350L 3.5	06'-	W251	272	-	-	-	-	-	-	-	-	-	-	-	-	-	-	-	-	-	IXUH22	VXUH22	6	
	S320 3.2	98'-	W220	112	-	-	-	-	-	-	-	-	-	-	-	-	-	-	-	IW16TT	-	IK16	VK16	12	
	S350 3.5	05'-	W221	272	-	-	-	-	-	-	-	-	-	-	-	-	-	-	-	-	-	IXUH22	VXUH22	6	

MODEL	YEAR	VEHICLE CODE	ENGINE	DENSO					QTY
MERCEDES-BENZ									
S500 5.5	05'-	W221	273	-	-	-	IXUH22	VXUH22	8
S600L 5.5	06'-	W221	275	-	-	-	IK22	VK22	24
SL350 3.5	06'-	W230	272	-	-	-	-	-	6
SLK200 Komp. 1.8	06'-	W171	271	-	IKH16TT	-	IKH16	VKH16	4
SLK280 3.0	05'-	W171	272M30	-	-	-	IXUH22	VXUH22	6
SLK350 3.5	04'-	W171	272	-	-	-	-	-	6
MINI									
Cooper 1.6	04'-	RF16	-	-	IK20TT	-	IK20	VK20	4
Cooper S 1.6	02'-	RE16	-	-	IK20TT	-	IK20	VK20	4
	02'-	RH16	-	-	IK20TT	-	IK20	VK20	4
Cooper S Clubman 1.6	07'-	MM16	-	-	-	-	IXUH22	VXUH22	4
Cooper S Turbo 1.6	07'-	MF16	-	-	-	-	IXUH22	VXUH22	4
One 1.4	02'-	RA16	-	-	IK20TT	-	IK20	VK20	4
MITSUBISHI									
Airtrek 2.0	01'-	CU2W	4G63	K20PR-U11	IK20TT	K20TT	IK20	VK20	4
Airtrek Turbo 2.0	01'-	CU2W	4G63(TC)	P20PR8	IW20TT	-	IW20	VW20	4
Chariot 2.4	00'-	N84W	4G64	-	-	-	-	VKA20	4
Colt 1.5	03'-	Z27A	4G15	K16HPR-U11	IKH16TT	KH16TT	IKH16	VKH16	4
Colt Plus 1.5	04'-	Z27W	4G15	K16HPR-U11	IKH16TT	KH16TT	IKH16	VKH16	4
Colt Turbo Version-R 1.5	05'-	Z27A	4G15	-	IKH20TT	-	IKH20	VKH20	4
Delica 2.4	07'-	CV5W	4B12	-	IW16TT	-	IK16	VK16	4
Dion GDI 1.8T	02'-	CR5W	4G93	-	-	-	-	VKA20	4
Dion GDI 2.0	00'-	CR9W	4G63	-	-	-	-	VKA16	4
Galant Mivec 2.0	96'-	EA/EC	6A12	K20PR-U11	IK20TT	K20TT	IK20	VK20	4
Galant GDI 2.0	00'-	EA7A	4G94	-	-	-	-	VKA16	4
Galant Turbo 2.5	96'-	EA/EC	6A13	-	-	-	IK22	VK22	4
Grandis 2.4	03'-	NA4W	4G69	-	IKH20TT	-	IKH20	VKH20	4
i 0.6	06'-	HA1W	3B20	SXU22HDR9	-	-	IXUH22	VXUH22	3
Lancer GL 1.3	96'-99'	CK1A	4G13	W16EXR-U11	IW16TT	W16TT	IW16	VW16	4
Lancer MX 1.5	98'-99'	CK2A	4G15	K20PR-U11	IK20TT	K20TT	IK20	VK20	4
Lancer GDI 1.5	00'-	CS2A	4G15	-	-	-	-	VKA16	4
Lancer EX 1.5	07'-	CY2A	4A91	-	IKH20TT	-	IKH20	VKH20	4
Lancer Mivec MR 1.6	96'-99'	CK4A	4G92	K22TMR11	-	-	IK22	VK22	4
Lancer GLXi 1.6	96'-99'	CK4A	4G92	K20PR-U11	IK20TT	K20TT	IK20	VK20	4
	00'-	CS3A	4G92	K20PR-U11	IK20TT	K20TT	IK20	VK20	4
Lancer 1.6	06'-	CS3A	4G18	K20PR-U11	IK20TT	K20TT	IK20	VK20	4
Lancer EX 2.0	07'-	CY4A	4B11	K20PSR-B8	IK20TT	K20TT	IK20	VK20	4
Lancer Evolution X 2.0	08'-	CZ4A	4B11	-	-	-	-	-	4
Outlander 2.4	04'-	CU5W	4G93	-	IKH20TT	-	IKH20	VKH20	4
	06'-	CW5W	4B12	K16PSR-B8	IK16TT	K16TT	IK16	VK16	4
Pajero 3.0	07'-	V93W	6G72TG	-	IK20TT	-	IK20	VK20	6
Pajero 3.8	06'-	V97W	6G75	-	IK20TT	-	IK20	VK20	6
MITSUBISHI (PI)									
eK Wagon 0.66	06'-	H82W	3G83	KJ16CR-L11	IK16TT	K16TT	IK16L	-	3
Lancer Evolution V2.0	98'-99'	CP9A	4G63	P22PR8	-	-	IW22	VW22	4
Lancer Evolution VI2.0	99'-00'	CP9A	4G63	P22PR8	-	-	IW22	VW22	4
Lancer Evolution VII2.0	01'-03'	CT9A	4G63	-	-	-	IW22	VW22	4
Lancer Evolution VIII2.0	03'-	CT9A	4G63	-	-	-	IW22	VW22	4
Lancer Evolution IX2.0	05'-	CT9A	4G63	-	-	-	IKH22	VKH22	4
Lancer Evolution X2.0	08'-	CZ4A	4B11	-	-	-	-	-	4
NAZA									
Sutera 1.1	08'-	-	DA468Q6	K20PR-U11	IK20TT	K20TT	IK20	VK20	4
NISSAN									
350Z 3.5	03'-	Z33	VQ35DE	-	IKH16TT	-	IKH16	VKH16	6
Almera 1.5	14'-	N17	HR15	FXE20HE11	IXEH20ETT	-	-	VFXEH20E	4
Cefiro 2.0	98'-	A32	VQ20DE	K16PR-U11	IK16TT	K16TT	IK16	VK16	4
	03'-	J31	QR20DE	K16HPR-U11	IKH16TT	KH16TT	IKH16	VKH16	4
Cefiro 2.3	03'-	J31	QR 23DE	K16HPR-U11	IKH16TT	KH16TT	IKH16	VKH16	6
Cefiro 3.0	98'-	A32	VQ30DE	K16PR-U11	IK16TT	K16TT	IK16	VK16	6
Elgrand 2.5	04'-	ME51	VQ25DE	-	IKH16TT	-	IKH16	VKH16	6
Elgrand Star 2.5	13'-	E52	QR25DE	FXE20HR11	IXEH20TT	-	-	VFXEH20	4
Lafesta 2.0	04'-	B30	MR20DE	ZXE20HR13	IXEH20TT	-	-	VFXEH20	4
Latio 1.5	04'-	SC11	HR15DE	FXE20HE11	IXEH20ETT	-	-	VFXEH20E	4
March 1.0	92'-	K11	CG10DE	K16PR-U11	IK16TT	K16TT	IK16	VK16	4
March 1.2	03'-	AK12	CR12DE	K16HPR-U11	IKH16TT	KH16TT	IKH16	VKH16	4
March 1.4	03'-	BK12	CR14DE	K16HPR-U11	IKH16TT	KH16TT	IKH16	VKH16	4
Murano 2.5	04'-	Z50	QR25DE	K16HPR-U11	IKH16TT	KH16TT	IKH16	VKH16	4

DENSO
 AUSTRALIA CHINA INDIA INDONESIA KOREA MALAYSIA PHILIPPINES SAUDI ARABIA SINGAPORE TAIWAN THAILAND VIETNAM JAPAN & USA EUROPE MOTOR CYCLE SMALL ENGINE CROSS PART REFERENCE NUMBER

DENSO	9	14	16	20	22	24	27	29	31	32	34	35	DENSO	9	14	16	20	22	24	27	29	31	32	DENSO	9	14	16	20	22	24	27	31
NGK	2	4	5	6	7	8	9	9.5	10	10.5	11	11.5	CHAMPION	18	16,14	12,11	10,9	8,7	6,63,61	4,59	57	55	53	BOSCH	10	9	8	7,6	5	4	3	2



PART NUMBER	CROSS REFERENCE	SMALL ENGINE	MOTOR CYCLE	EUROPE & USA	VIETNAM	THAILAND	TAIWAN	SINGAPORE	SAUDARABIA	PHILIPPINES	MALAYSIA	KOREA	INDONESIA	INDIA	CHINA	AUSTRALIA	MODEL	YEAR	VEHICLE CODE	ENGINE	DENSO	IRIDIUM TT	IRIDIUM RACING	IRIDIUM POWER	IRIDIUM TOUGH	QTY
																	NISSAN									
																	Murano 3.5	04'-	Z50	VQ35DE	-	IKH16TT	-	IKH16	VKH16	6
																	Note 1.2	12'-	E12	HR12DE	FXE20HR11	IXEH20TT	-	-	VFXEH20	4
																	Prairie 2.0	02'-	RM12	QR20DE	K16HPR-U11	IKH16TT	KH16TT	IKH16	VKH16	4
																	Presage 2.5	04'-	U31	QR25DE	K16HPR-U11	IKH16TT	KH16TT	IKH16	VKH16	4
																	Primera 1.8	03'-	P/WP12	SR20DE	K16HPR-U11	IKH16TT	KH16TT	IKH16	VKH16	4
																	Qashqai 1.2	15'-	J11	HRA2	FXE20HR11	IXEH20TT	-	-	VFXEH20	4
																	Qashqai 2.0	08'-	KJ10	MR20DE	FXE20HR11	IXEH20TT	-	-	VFXEH20	4
																	Sunny 1.5	98'-	B14	GA15DE	K20PR-U11	IK20TT	K20TT	IK20	VK20	4
																		00'-	N16	QG15DE	K16PR-U11	IK16TT	K16TT	IK16	VK16	4
																	Sunny 1.6	98'-	B14	GA16DE	K20PR-U11	IK20TT	K20TT	IK20	VK20	4
																		00'-	N16	QG16DE	K16PR-U11	IK16TT	K16TT	IK16	VK16	4
																		03'-	N16	QG16DE	K16HPR-U11	IKH16TT	-	IKH16	VKH16	4
																	Sylphy 1.5	06'-	G11	HR15DE	FXE20HE11	IXEH20ETT	-	-	VFXEH20E	4
																	Sylphy 1.8	12'-	TB17	MRA8DE	FXE20HR11	IXEH20TT	-	-	VFXEH20	4
																	Sylphy 2.0	06'-	KG11	MR20DE	ZXE20HR13	IXEH20TT	-	-	VFXEH20	4
																	Teana 2.0	08'-	DUJ32	MR20DE	ZXE20HR13	IXEH20TT	-	-	VFXEH20	4
																	Teana 2.5	08'-	BUJ32	VQ25DE	FXE20HR11	IXEH20TT	-	-	VFXEH20	6
																		14'-	L33	QR25DE	FXE20HE11	IXEH20ETT	-	-	VFXEH20E	4
																	Teana 3.5	08'-	PJ32	VQ35DE	FXE22HR11	IXEH22TT	-	-	VFXEH22	6
																	X-Trail 2.0	13'-	T32	MR20DD	-	-	-	-	4	
																	X-Trail 2.5	01'-	JN1	QR25DE	K16HPR-U11	IKH16TT	-	IKH16	VKH16	4
																	NISSAN (PI)									
																	Cube 1.3	98'-	Z10	CG13DE	K16PR-U11	IK16TT	K16TT	IK16	VK16	4
																	Cube 1.4	02'-	BZ11	CR14DE	-	IKH16TT	-	IKH16	VKH16	4
																	Dualis 2.0	07'-	KJ10	MR20DE	FXE20HR11	IXEH20TT	-	-	VFXEH20	4
																	GT-R 3.8	08'-	R35	VR38	-	-	-	-	8	
																	Serena 2.0	12'-	HC26	MR20DD	-	-	-	-	4	
																	Skyline 2.5	06'-	V36	VQ25HR	FXE22HR11	IXEH22TT	-	-	VFXEH22	6
																	OPEL									
																	Astra 1.6	00'-	XK161	X/Z16	K20TXR	IK20TT	K20TT	IK20	VK20	4
																		04'-	-	Z16XE	KJ16CR-L11	IK16TT	K16TT	IK16L	-	4
																	Astra 1.8	04'-	-	Z18XE	KJ16CR-L11	IK16TT	K16TT	IK16L	-	4
																	Astra 2.0	04'-	-	Z20LEL	KJ16CR-L11	IK16TT	K16TT	IK16L	-	4
																	Astra 2.2	00'-	XK220	Z22	-	ITV20TT	-	ITV20	-	4
																	Corsa 1.2	00'-	-	Z12XE	K20TXR	IK20TT	K20TT	IK20	VK20	4
																	Meriva 1.6	04'-	X01Z16	Z162	K20TXR	IK20TT	K20TT	IK20	VK20	4
																	Omega 2.0	96'-00'	XF200	X20	K20TXR	IK20TT	K20TT	IK20	VK20	4
																	Omega 2.2	00'-	XF220	X22	K20TXR	IK20TT	K20TT	IK20	VK20	4
																	Vectra 2.0	95'-00'	XH	X20	K20TXR	IK20TT	K20TT	IK20	VK20	4
																	Vectra 2.2	03'-	Z02	Z22	-	ITV20TT	-	ITV20	-	4
																	Zafira 1.8	00'-	XM180	Z18	K20TXR	IK20TT	K20TT	IK20	VK20	4
																		05'-	-	Z18XEP	KJ16CR-L11	IK16TT	K16TT	IK16L	-	4
																	PERODUA									
																	Kancil 0.66	98'-	L201	ED	W16EXR-U11	IW16TT	W16TT	IW16	VW16	3
																	Kelisa 1.0	01'-	L701	EJ-DE	K16PR-U11	IK16TT	K16TT	IK16	VK16	3
																	Kembara 1.3	00'-	J104	HCE	K20PR-U11	IK20TT	K20TT	IK20	VK20	4
																	Kenari 1.0	06'-	L901	EJ-DE	K16PR-U11	IK16TT	K16TT	IK16	VK16	3
																	Myvi 1.3	08'-	M301	K3-VE	K20R-U11	IK20TT	K20TT	IK20	VK20	4
																	Viva 1.0	08'-	L251S	EJ-VE	K16PR-U11	IK16TT	K16TT	IK16	VK16	3
																	PEUGEOT									
																	1007 1.6	06'-	A8NFU	-	K16HPR-U11	IKH16TT	KH16TT	IKH16	VKH16	4
																	107 1.0	05'-	-	1KR-FE	K20HR-U11	IKH20TT	KH20TT	IKH20	VKH20	4
																	206 1.4	01'-	-	KFW	K20PR-U	IK20TT	K20TT	IK20	VK20	4
																	206 1.6	01'-	-	NFU	K20HR-U11	IKH20TT	KH20TT	IKH20	VKH20	4
																	206 2.0	02'-	-	RFN	K20HR-U11	IKH20TT	KH20TT	IKH20	VKH20	4
																	206CC 2.0	02'-	M206CC	RFR	K16HPR-U11	IKH16TT	KH16TT	IKH16	VKH16	4
																	307 1.6	02'-	T5***	NFU	K20HR-U11	IKH20TT	KH20TT	IKH20	VKH20	4
																	307CC 2.0	06'-	-	-	K20HR-U11	IKH20TT	KH20TT	IKH20	VKH20	4
																	406 2.0	96'-99'	D8BR	RFR	K20TXR	IK20TT	K20TT	IK20	VK20	4
																		00'-	D9BR	RFR	K16HPR-U11	IKH16TT	KH16TT	IKH16	VKH16	4
																	407 2.0/2.2	05'-	-	-	-	IKH16TT	-	IKH16	VKH16	4
																	407 3.0	04'-	-	ES9A	K16HPR-U11	IKH16TT	KH16TT	IKH16	VKH16	6
																	607 3.0	01'-	Z8	XFX	-	IKH16TT	-	IKH16	VKH16	6
																	PROTON									
																	GEN-2 1.3	06'-	CM3	S4PE	T20EPR-U	IT20TT	T20TT	IT20	VT20	4
																	GEN-2 1.6	04'-	CM6	S4PH	T20EPR-U	IT20TT	T20TT	IT20	VT20	4
																	Persona 1.6	07'-	CM6	S4PH	T20EPR-U	IT20TT	T20TT	IT20	VT20	4

MODEL	YEAR	VEHICLE CODE	ENGINE	DENSO	IRIDIUM	IRIDIUM	IRIDIUM POWER	IRIDIUM TOUGH	QTY
PROTON									
Saga 1.3	08'-	BT3	S4PE	T20EPR-U	IT20TT	T20TT	IT20	VT20	4
Savvy 1.2	06'-	BT2	D4FA	ZXE20HR13	IXEH20TT	-	-	VFXEH20	4
Waja 1.6	00'-	CF1	4G18	K20PR-U11	IK20TT	K20TT	IK20	VK20	4
Wira 1.3/1.5	94'-	C96/97	4G13/4G15	W16EX-U	IW16TT	W16TT	IW16	VW16	4
Wira 1.6	94'-	C99	4G92	K16PR-U	IK16TT	K16TT	IK16	VK16	4
RENAULT									
Clio 8v 1.4	00'-	BB0C/BB0S	E7J	K20TXR	IK20TT	K20TT	IK20	VK20	4
Clio 16v 1.4	02'-	BB13	K4J	K20TXR	IK20TT	K20TT	IK20	VK20	4
Clio 1.6	05'-	-	K4M	Q20PR-U	IQ20TT	Q20TT	IQ20	VQ20	4
Grand Espace 2.0T	02'-	JK0B	F4R	K20TXR	IK20TT	K20TT	IK20	VK20	4
	05'-	JK0A	F4R	K20PSR-B8	IK20TT	K20TT	-	VK20Y	4
Laguna 16v 2.0	02'-	BG0W	F4R	K20TXR	IK20TT	K20TT	IK20	VK20	4
Megane 16v 5dr 1.6	02'-	BM0J	K4M	K20TXR	IK20TT	K20TT	IK20	VK20	4
Megane Classis 16v 1.6	02'-	LM0C/LM0J	K4M	K20TXR	IK20TT	K20TT	IK20	VK20	4
Megane Scenic 8v 1.6	00'-	JA0F	K7M	K20TXR	IK20TT	K20TT	IK20	VK20	4
Megane Scenic 16v 1.6	02'-	JM0J/JA04/JA11	K4M	K20TXR	IK20TT	K20TT	IK20	VK20	4
Megane Scenic 16v 2.0	02'-	JM1N	F4R	K20TXR	IK20TT	K20TT	IK20	VK20	4
SAAB									
9-3 2.0T	98'-01'	-	B204E	-	-	-	IQ22	VQ22	4
	04'-	-	B207E	-	IK20TT	-	IK20	VK20	4
9-3 Aero 2.3	98'-01'	-	B235E	-	-	-	IK22	VK22	4
9-3 Aero 2.8	06'-	-	B284E	-	-	-	IK22	VK22	4
9-5 Aero 2.0	97'-	-	B205E	Q20PR-U11	IQ20TT	Q20TT	IQ20	VQ20	4
9-5 2.0T	04'-	-	B205E	Q22PR-U11	-	-	IQ22	VQ22	4
9-5 2.3T	97'-	-	B235E	-	-	-	IQ22	VQ22	4
	04'-	-	B235R	PK20PR11	IK20TT	-	IK20	VK20	4
9-5 3.0	99'-	-	B308E	-	-	-	IK22	VK22	6
SKODA									
Fabia 1.4	99'-	-	AUA/ANE	K20PBR-S10	IK20TT	K20TT	IK20	VK20	4
	00'-	-	AME/BBY	K20PBR-S10	IK20TT	K20TT	IK20	VK20	4
Octavia 1.6	98'-	-	AEH/AKL	K20PBR-S10	IK20TT	K20TT	IK20	VK20	4
	06'-	-	BSE	K20PBR-S10	IK20TT	K20TT	IK20	VK20	4
Octavia 1.8T	98'-	-	AGH	K20PBR-S10	IK20TT	K20TT	IK20	VK20	4
Octavia 2.0	06'-	-	BWA	PK20PR-P8	IK20TT	-	-	VK20Y	4
Roomster 1.6	08'-	-	BTS	K20PBR-S10	IK20TT	K20TT	IK20	VK20	4
Superb 1.8T	02'-	-	AWT	PK20PR-P8	IK20TT	-	-	VK20Y	4
	06'-	-	CDA	PK20PR-P8	IK20TT	-	-	VK20Y	4
SSANGYONG									
Actyon 2.3	06'-	D0B16S7P	-	K16PBR-S10	IK16TT	K16TT	IK16	VK16	4
Chairman CM500S 2.8	04'-	R1C17S6P	-	T20EPR-U	IT20TT	T20TT	IT20	VT20	4
Rexton 2.3	05'-	-	-	K16PR-U11	IK16TT	K16TT	IK16	VK16	4
Rexton 2.8	05'-	-	-	K16PR-U11	IK16TT	K16TT	IK16	VK16	4
Rexton 3.2	05'-	-	-	K16PR-U11	IK16TT	K16TT	IK16	VK16	4
Stavic 3.2	05'-	V0B19S8P	-	K16PR-U	IK16TT	K16TT	IK16	VK16	4
SUBARU									
BRZ 2.0	12'-	ZC6	FA20	ZXE27HBR8	-	-	-	VXEBH27	4
Exiga 2.0	08'-	YA5	EJ20D	-	-	-	-	VKH20Y	4
Forester 2.0	02'-	SG5	EJ20	PK20PR-P8	IK20TT	-	-	VK20Y	4
	07'-	SH5	EJ20D	-	-	-	-	VKH20Y	4
Forester L 2.0	13'-	SJ5	FB20	-	IXEH22TT	-	-	VFXEH22	4
Forester XT 2.0	00'-	SG5/SF5	EJ20T	PK22PR-P8	IK22TT	-	IK22	VK22	4
	12'-	SJG	FA20	-	-	-	-	-	4
Forester XT 2.5	04'-	SG9	EJ25T	-	-	-	IKH22	VKH22	4
Impreza 4Dr 1.5	08'-	GE3	EL15D	FK20HR11	IKH20TT	-	-	VFKH20	4
Impreza 5Dr 1.5	07'-	GH3	EL15D	FK20HR11	IKH20TT	-	-	VFKH20	4
Impreza GL 1.6	93'-00'	GC3	EJ16	K20PR-U11	IK20TT	K20TT	IK20	VK20	4
Impreza TS GL 1.6	00'-	GD4	EJ16	K20PR-U11	IK20TT	K20TT	IK20	VK20	4
Impreza 1.6	05'-	GD5	EJ161	K20PR-U11	IK20TT	K20TT	IK20	VK20	4
Impreza S-GT 2.0	07'-	GRB	EJ20D	-	-	-	-	VKH20Y	4
Impreza 2.0	07'-	GH8	EJ20D	-	-	-	-	VKH20Y	4
	08'-	GH7	EJ20	PK16PR11	IK16TT	-	IK16	VK16	4
	13'-	GP7	FB20	-	IXEH22TT	-	-	VFXEH22	4
	94'-	GC8	EJ20T	PK22PR8	IK22TT	-	IK22	VK22	4
Impreza WRX 2.0	01'-	GDAK	EJ20T	PK22PR8	IK22TT	-	IK22	VK22	4
	06'-	GDA	EJ20D	PK20PR-P8	IK20TT	-	-	VK20Y	4
	05'-	GDGK	EJ255	-	IKH20TT	-	IKH20	VKH20	4
Legacy 2.0	98'-	BH5	EJ20T	K20PR-U11	IK20TT	K20TT	IK20	VK20	4





DENSO
 AUSTRALIA CHINA INDIA INDONESIA KOREA MALAYSIA PHILIPPINES SAUDI ARABIA SINGAPORE TAIWAN THAILAND VIETNAM JAPAN & USA EUROPE MOTOR SMALL PART CROSS REFERENCE NUMBER

DENSO	9	14	16	20	22	24	27	29	31	32	34	35	DENSO	9	14	16	20	22	24	27	29	31	32	DENSO	9	14	16	20	22	24	27	31
NGK	2	4	5	6	7	8	9	9.5	10	10.5	11	11.5	CHAMPION	18	16,14	12,11	10,9	8,7	6,63,61	4,59	57	55	53	BOSCH	10	9	8	7,6	5	4	3	2



▶ Spark plug color codes: ■ for Iridium Tough and Iridium Plugs and Iridium TT, ■ for Iridium Power, ■ for Iridium Racing and Two Tops Plugs, ■ for Platinum Plugs and Platinum TT, and black for general spark plugs.

PART NUMBER	CROSS REFERENCE	SMALL ENGINE	MOTOR CYCLE	EUROPE & USA	JAPAN	VIETNAM	THAILAND	TAIWAN	SINGAPORE	SAUDI ARABIA	PHILIPPINES	MALAYSIA	KOREA	INDONESIA	INDIA	CHINA	AUSTRALIA	MODEL	YEAR	VEHICLE CODE	ENGINE	DENSO	IRIDIUM TT		IRIDIUM POWER		IRIDIUM TOUGH		QTY
																		IRI	TT	IRI	IRI	IRI	IRI	IRI	IRI	IRI	IRI	IRI	IRI
SUBARU																													
																		Legacy 2.0	04'-	BL5	EJ20	-	IKH20TT	-	IKH20	VKH20	4		
																		Legacy 2.5	07'-	BL9	EJ25	-	IW16TT	-	IK16	VK16	4		
																		Outback 3.0	07'-	BPE	EZ30	-	IKH20TT	-	IKH20	VKH20	6		
																		R1 0.66	06'-	RJ1	EN07	-	-	-	IXUH22	VXUH22	4		
																		R2 0.66	06'-	RC1	EN07	-	-	-	IXUH22	VXUH22	4		
																		Tribeca 3.0	07'-	WXE	EZ30U	-	IKH20TT	-	IKH20	VKH20	6		
																		XV 1.6	13'-	GP3	FB16	-	IXEH22TT	-	-	VFXEH22	4		
SUZUKI																													
																		APV 1.6	05'-	GC416V	G16A	K20PR-U	IK20TT	K20TT	IK20	VK20	4		
																		Grand Vitara 2.0	05'-	JB420W	J20A	K20PR-U11	IK20TT	K20TT	IK20	VK20	4		
																		Grand Vitara 2.5	03'-	SQ625	H25A	K20PR-U11	IK20TT	K20TT	IK20	VK20	6		
																		Grand Vitara 2.7	05'-	JD94A	H27A	K20PR-U11	IK20TT	K20TT	IK20	VK20	6		
																		Ignis 1.3	02'-	RG413	M13A	K16PR-U11	IK16TT	K16TT	IK16	VK16	4		
																		Ignis Sport 1.5	03'-	RG415	M15A	SK16PR-A11	IK16TT	-	IK16	VK16	4		
																		Jimny 1.3	98'-00'	SN413	G13B	K20PR-U	IK20TT	K20TT	IK20	VK20	4		
																			00'-	SN413	M13A	K16PR-U11	IK16TT	K16TT	IK16	VK16	4		
																		Liana 1.3	02'-	RH413	M13A	K16PR-U11	IK16TT	K16TT	IK16	VK16	4		
																		Liana 1.6	02'-	RH416	M16A	K20PR-U11	IK20TT	K20TT	IK20	VK20	4		
																		Swift 1.0	90'-	AA44	G10	W16EXR-U11	IW16TT	W16TT	IW16	VW16	4		
																		Swift 1.3	07'-	ZC11S	M13A	-	IK20TT	-	IK20	VK20	4		
																		Swift Gti 1.3	90'-	AA34	G13B	-	-	-	IW22	VW22	4		
																		Swift 1.5	04'-	HT81S	M15A	-	IK20TT	-	IK20	VK20	4		
																			06'-	ZC21S	M15A	-	IK20TT	-	IK20	VK20	4		
																		Swift Sport 1.6	05'-	ZC31S	M16A	-	IK20TT	-	IK20	VK20	4		
																		SX4 1.6	06'-	YA21S	M16A	-	IK20TT	-	IK20	VK20	4		
																		Vitara 1.6	95'-	SE416	G16B	K20PR-U	IK20TT	K20TT	IK20	VK20	4		
																		WagonR 0.66	00'-	SP306	F6A	XU22EPR-U	-	XU22TT	IXU22	VXU22	4		
																		WagonR Plus 1.0	99'-	MA63S	K10A	XU22EPR-U	-	XU22TT	IXU22	VXU22	4		
SUZUKI (PI)																													
																		Every 0.66	07'-	DA64V	K6A	XU22EPR-U	-	XU22TT	IXU22	VXU22	3		
																		Lapin 0.66	03'-	HE21S	K6A	-	-	-	IXU22	VXU22	3		
																		Swift 1.2	07'-	ZC71S	K12B	ZXU20PR11	-	-	-	VXU20	4		
TOYOTA																													
																		Allion 1.5	07'-07'	NZT260	1NZ-FE	FK20HR11	IKH20TT	-	-	VFKH20	4		
																			07'-14'	NZT260	1NZ-FE	FK16HR11	IKH16TT	-	-	VFKH16	4		
																		Alphard 2.4	09'-	ANH20R	2AZ-FE	SK20R11	IK20TT	-	IK20	VK20	4		
																		Alphard 2.5	15'-	AGH30R	2AR-FE	SK16HR11	VKH16	-	IKH16	VKH16	4		
																		Altis 1.6	10'-13'	ZRE141R	1ZR-FE	SC20HR11	IXEH22TT	-	-	VCH20	4		
																			13'-	ZRE171R	1ZR-FE	SC20HR11	IXEH22TT	-	-	VCH20	4		
																		Avanza 1.5	11'-	F652RM	3SZ-VE	XU22PR9	-	-	IXU22	VXU22	4		
																		Camry 2.0	02'-	ACV31	1AZ-FE	SK20R11	IK20TT	-	IK20	VK20	4		
																			06'-	ACV41	1AZ-FE	SK20R11	IK20TT	-	IK20	VK20	4		
																		Camry 2.2	96'-02'	SXV20	5S-FE	K20TR11	IK20TT	K20TT	IK20L	-	4		
																		Camry 2.4	02'-	ACV30	2AZ-FE	SK20R11	IK20TT	-	IK20	VK20	4		
																			06'-	ACV40	2AZ-FE	SK20R11	IK20TT	-	IK20	VK20	4		
																		Camry 2.5	12'-	ASV50R	2AR-FE	SK16HR11	IKH16TT	-	-	VKH16	4		
																		Camry Hybrid 2.0	12'-	ACV51R	1AZ-FE	SK16R11	IK16TT	-	-	VK16	4		
																		Camry Hybrid 2.5	11'-	AVV50R	2AR-FXE	FK16HR-A8	IKH16TT	-	-	VFKH16	4		
																		Corolla 1.3	92'-97'	EE101	4E-FE	K16R-U11	IK16TT	K16TT	IK16	VK16	4		
																			97'-01'	EE111	4E-FE	K16TR11	IK16TT	K16TT	IK16L	-	4		
																		Corolla 1.5	01'-03'	NZE121	1NZ-FE	K16R-U11	IK16TT	K16TT	IK16	VK16	4		
																		Corolla 1.6	92'-97'	AE101	4A-FE	K16R-U11	IK16TT	K16TT	IK16	VK16	4		
																			01'-03'	ZZE121	3ZZ-FE	K16R-U11	IK16TT	K16TT	IK16	VK16	4		
																		Corolla Altis 1.6	03'-	ZZE121	3ZZ-FE	K16R-U11	IK16TT	K16TT	IK16	VK16	4		
																			08'-	ZZE141	3ZZ-FE	K16R-U11	IK16TT	K16TT	IK16	VK16	4		
																		Corolla Altis 1.8	03'-	ZZE122	1ZZ-FE	K16R-U11	IK16TT	K16TT	IK16	VK16	4		
																			08'-	ZZE142	1ZZ-FE	K16R-U11	IK16TT	K16TT	IK16	VK16	4		
																		Corolla Axio 1.5	06'-07'	NZE141/144	1NZ-FE	FK20HR11	IKH20TT	-	-	VFKH20	4		
																			07'-	NZE141/144	1NZ-FE	FK16HR11	IKH16TT	-	-	VFKH16	4		
																		Corona CD 1.6	89'-	AT171	4A-F	QJ16AR-U	-	-	-	-	4		
																		Corona 1.6	92'-	AT190	4A-FE	K20R-U	IK20TT	K20TT	IK20	VK20	4		
																			96'-	AT210	4A-FE	PK16TR13	IK16TT	-	IK16	VK16	4		
																		Corona 2.0	92'-	ST191	3S-FE	K20R-U11	IK20TT	K20TT	IK20	VK20	4		
																			96'-	ST210	3S-FE	K20TR11	IK20TT	K20TT	IK20L	-	4		
																		Estima 2.4	12'-	ACR50W/55W	2AZ-FE	SK16R11	IK16TT	-	IK16	VK16	4		
																		Fortuner 2.7	05'-	TGN51	2TR-FE	SK20HR11	IKH20TT	-	IKH20	VKH20	4		
																			07'-	TGN61	2TR-FE	SK20HR11	IKH20TT	-	IKH20	VKH20	4		

MODEL	YEAR	VEHICLE CODE	ENGINE	DENSO					QTY
TOYOTA									
Picnic 2.0	96'-	SXM10	3S-FE	K20TR11	IK20TT	K20TT	IK20L	-	4
	01'-	ACM20	3S-FE	K20R-U11	IK20TT	K20TT	IK20	VK20	4
Previa 2.4	00'-	ACR30	2AZ-FE	K20R-U11	IK20TT	K20TT	IK20	VK20	4
	06'-	ACR50	2AZ-FE	K20R-U11	IK20TT	K20TT	IK20	VK20	4
	12'-	ACR50R	2AZ-FE	SK16R11	IK16TT	-	IK16	VK16	4
Prius Hybrid 1.5	05'-	NHW20	1NZ-FXE	SK16R11	IK16TT	-	IK16	VK16	4
Prius C 1.5	11'-	NHP10R	1NZ-FXE	FK16R-A8	IK16TT	-	-	VFK16	4
Prius Hybrid 1.8	09'-	ZVW30	2ZR-FXE	SC20HR11	-	-	-	VCH20	4
Prius Gen 3 1.8	11'-	ZVW30R	2ZR-FXE	SC20HR11	-	-	-	VCH20	4
Prius Gen 4 1.8	15'-	ZVW50R	2ZR-FXE	FC16HR-C9	IXEH20TT	-	-	VFCH16	4
RAV4 2.0	00'-	ACA21	1AZ-FSE	SK20BGR11	-	-	-	VKA20	4
	13'-	ZSA44R	3ZR-FAE	SC20HR11	-	-	-	VCH20	4
RAV4 2.4	06'-	ACA33	2AZ-FE	K20R-U11	-	K20TT	IK20	VK20	4
Royal Crown 3.0	04'-	GRS182	3GR-FSE	FK20HBR11	IKBH20TT	-	-	VFKBH20	6
Soluna 1.5	96'-	AL50	5A-FE	K16R-U11	IK16TT	K16TT	IK16	VK16	4
Vellfire 2.5	15'-	AGH30R	2AR-FE	SK16HR11	IK1H6TT	-	IKH16	VKH16	4
Vios 1.5	03'-	NCP42	1NZ-FE	K16R-U	IK16TT	K16TT	IK16	VK16	4
	07'-	NCP43	1NZ-FE	K16R-U	IK16TT	K16TT	IK16	VK16	4
Wish 1.8	06'-	ZNE10	1ZZ-FE	K16R-U11	IK16TT	K16TT	IK16	VK16	4
Vios 1.5	13'-	NCP150R	1NZ-FE	K16R-U	IK16TT	K16TT	IK16	VK16	4
Yaris 1.5	06'-	NCP91	1NZ-FE	K16R-U11	IK16TT	K16TT	IK16	VK16	4
TOYOTA (PI)									
86	12'-	ZN6	FA20	ZXE27HBR8	-	-	-	VXEBH27	4
Allion 1.5	01'-	NZT240	1NZ-FE	K16R-U11	IK16TT	K16TT	IK16	VK16	4
	14'-	NZT260	1NZ-FE	FK16HR11	IKH16TT	-	-	VFKH16	4
Allion 1.8	01'-	ZZT240	1ZZ-FE	K16R-U11	IK16TT	K16TT	IK16	VK16	4
Alphard 2.4	02'-	ANH10	2AZ-FE	K20R-U11	IK20TT	K20TT	IK20	VK20	4
	12'-	ANH20W/25W	2AZ-FE	SK16R11	VK16	-	IK16	VK16	4
Alphard 2.5	15'-	AGH30R	2AR-FE	SK16HR11	VKH16	-	IKH16	VKH16	4
Alphard 3.0	02'-	MNH10	1MZ-FE	SK20R11	IK20TT	-	IK20	VK20	6
Alphard 3.5	15'-	GGH30R	2GR-FE	FK20HR11	IKH20TT	-	-	VFKH20	6
Alphard Hybrid 2.4	04'-	ATH10W	2AZ-FXE	SK20R11	IK20TT	-	IK20	VK20	4
Altezza 2.0	99'-	SXE10	3S-GE	SK20R11	IK20TT	-	IK20	VK20	4
Aqua Hybrid 1.5	13'-	NHP10	1NZ-FXE	FK16R-AL8	IK16TT	-	-	VFK16	4
Auris 1.5	07'-	NZE15	1NZ-FE	FK20HR11	IKH20TT	-	-	VFKH20	4
Auris 1.6	12'-	ZRE185R	1ZR-FAE	SC20HR11	IXEH22TT	-	-	VCH20	4
Axio 1.5	07'-	NZE121	1NZ-FE	FK20HR11	IKH20TT	-	-	VFKH20	4
	15'-	NZE161	1NZ-FE	FK16HR11	IKH16TT	-	-	VFKH16	4
	15'-	NRE161G	2NR-FKE	FC16HR8	IXEH20TT	-	-	VFCH16	4
bB 1.3	06'-	QNC20	K3-VE	SVK20RZ11	IK20TT	-	IK20	VK20	4
Belta 1.3	06'-	SCP92	2SZ-FE	SK16HR11	IKH16TT	-	IKH16	VKH16	4
Caldina 1.8	02'-	ZZT241W	1ZZ-FE	K16R-U11	IK16TT	K16TT	IK16	VK16	4
Camry 2.4	06'-	ACV40	2AZ-FE	K20R-U11	IK20TT	K20TT	IK20	VK20	4
Celica 1.8	99'-	ZZT230	1ZZ-FE	K16R-U11	IK16TT	K16TT	IK16	VK16	4
	99'-	ZZT231	2ZZ-GE	SK20R11	IK20TT	-	IK20	VK20	4
Crown 2.5	04'-	GRS180	4GR-FSE	FK20HBR11	IKBH20TT	-	-	VFKBH20	6
Esquire 2.0	14'-	ZRR80	3ZR-FAE	SC20HR11	IXEH22TT	-	-	VCH20	4
Estima 2.4	00'-	ACR30	2AZ-FE	K20R-U11	IK20TT	K20TT	IK20	VK20	4
	06'-	ACR50	2AZ-FE	K20R-U11	IK20TT	K20TT	IK20	VK20	4
Estima Hybrid 2.4	07'-	AHR20W	2AZ-FXE	SK20R11	IK20TT	-	IK20	VK20	4
Fielder 1.5	06'-	NZE141	1NZ-FE	FK20HR11	IKH20TT	-	-	VFKH20	4
	12'-	NRE161G	1NZ-FE	FK16HR11	IKH16TT	-	-	VFKH16	4
	15'-	NRE161G	2NR-FKE	FC16HR8	IXEH20TT	-	-	VFCH16	4
Fj Cruiser 4.0	10'-	GSJ15W	1GR-FE	SK20HR11	IKH20TT	-	IKH20	VKH20	6
Harrier 2.0	13'-	ZSU60W	3ZR-FE	SC20HR11	IXEH22TT	-	-	VCH20	4
Harrier 2.4	00'-	ACU10	2AZ-FE	K20R-U11	IK20TT	K20TT	IK20	VK20	4
	03'-	ACU30	2AZ-FE	K20R-U11	IK20TT	K20TT	IK20	VK20	4
Harrier Hybrid 2.5	14'-	AVU65W	2AR-FXE	FK16HR-A8	IKH16TT	-	-	VFKH16	4
Harrier HV 3.3	05'-	MHU38	3MZ-FE	SK20R11	IK20TT	-	IK20	VK20	6
Ipsum 2.0	96'-	SXM10	3S-FE	K20TR11	IK20TT	K20TT	IK20L	-	4
Ipsum 2.4	01'-	ACM21	2AZ-FE	K20R-U11	IK20TT	K20TT	IK20	VK20	4
Iq 1.0	08'-	KGJ10	1KR-FE	SK16HR11	IKH16TT	-	IKH16	VKH16	3
ISIS 1.8	04'-	ZNM10G	1ZZ-FE	K16R-U11	IK16TT	K16TT	IK16	VK16	4
IST 1.3	02'-	NCP60	2NZ-FE	K16R-U11	IK16TT	K16TT	IK16	VK16	4
Land Cruiser 4.6	09'-	URJ202W	1UR-FE	SK20HR11	IKH20TT	-	IKH20	VKH20	6
Mark X 2.5	04'-	GRX120	4GR-FSE	FK20HBR11	IKBH20TT	-	-	VFKBH20	6
Mark X Zio 2.4	07'-	ANA10	2AZ-FE	SK20R11	IK20TT	-	IK20	VK20	4

DENSO
 AUSTRALIA CHINA INDIA INDONESIA KOREA MALAYSIA PHILIPPINES SAUDI ARABIA SINGAPORE TAIWAN THAILAND VIETNAM JAPAN & USA EUROPE MOTOR CYCLE SMALL ENGINE REFERENCE NUMBER PART

DENSO	9	14	16	20	22	24	27	29	31	32	34	35	DENSO	9	14	16	20	22	24	27	29	31	32	DENSO	9	14	16	20	22	24	27	31
NGK	2	4	5	6	7	8	9	9.5	10	10.5	11	11.5	CHAMPION	18	16,14	12,11	10,9	8,7	6,63,61	4,59	57	55	53	BOSCH	10	9	8	7,6	5	4	3	2



PART NUMBER	CROSS REFERENCE	SMALL ENGINE	MOTOR CYCLE	EUROPE & USA	JAPAN	VIETNAM	THAILAND	TAIWAN	SINGAPORE	SAUDI ARABIA	PHILIPPINES	MALAYSIA	KOREA	INDONESIA	INDIA	CHINA	AUSTRALIA	DENSO	IRIDIUM				QTY					
																			IRIDIUM TT	IRIDIUM RACING	IRIDIUM POWER	IRIDIUM TOUGH						
TOYOTA (PI)																												
																				IK16TT	K16TT	IK16	VK16	4				
																				SC20HR11	IXEH22TT	-	-	VCH20	4			
																				SK20HR11	IKH20TT	-	IKH20	VKH20	3			
																				SVK20RZ11	IK20TT	-	IK20	VK20	4			
																				XU22EPR-U	-	XU22TT	IXU22	VXU22	4			
																				K16R-U11	IK16TT	K16TT	IK16	VK16	4			
																				SK20HR11	IKH20TT	-	IKH20	VKH20	4			
																				SK20HR11	IKH20TT	-	IKH20	VKH20	4			
																				K20HR-U11	IKH20TT	KH20TT	IKH20	VKH20	6			
																				K16R-U11	IK16TT	K16TT	IK16	VK16	4			
																				SC20HR11	-	-	-	VCH20	4			
																				ZVW30	2ZR-FXE	SC20HR11	-	-	VCH20	4		
																				ZVW40W	2ZR-FXE	SC20HR11	-	-	VCH20	4		
																				K16R-U11	IK16TT	K16TT	IK16	VK16	4			
																				K16R-U11	IK16TT	K16TT	IK16	VK16	4			
																				K16R-U11	IK16TT	K16TT	IK16	VK16	4			
																				XU22EPR-U	-	XU22TT	IXU22	VXU22	4			
																				FK20HR11	IKH20TT	-	-	VFKH20	4			
																				FC16HR8	IXEH20TT	-	-	VFCH16	4			
																				NSP170G	2NR-FKE	FC16HR8	IXEH20TT	-	VFCH16	4		
																				NHP170	2NR-FKE	FC16HR8	IXEH20TT	-	VFCH16	4		
																				S402M	3SZ-VE	XU22PR9	-	XU22TT	IXU22	VXU22	4	
																				ACA33	2AZ-FE	SK20R11	IK20TT	-	IK20	VK20	4	
																				GSA33	2GR-FE	FK20HR11	IKH20TT	-	-	VFKH20	6	
																				ANH20W	2AZ-FE	SK20R11	IK20TT	-	IK20	VK20	4	
																				AGH30R	2AR-FE	SK16HR11	IKH20TT	-	IKH20	VKH16	4	
																				GGH20W	2GR-FE	FK20HR11	IKH20TT	-	-	VFKH20	6	
																				KSP90	1KR-FE	SK20HR11	IKH20TT	-	IKH20	VKH20	3	
																				SCP90	2SZ-FE	SK16HR11	IKH16TT	-	IKH16	VKH16	4	
																				ZZE136/138	1ZZ-FE	SK16R11	IK16TT	-	IK16	VK16	4	
																				AZR60	1AZ-FSE	SK20BGR11	-	-	-	VKA20	4	
																				ZRR80R	3ZR-FAE	SC20HR11	-	-	-	VCH20	4	
																				NCP75	1NZ-FE	K16R-U11	IK16TT	K16TT	IK16	VK16	4	
																				MCV20	1MZ-FE	SK20R11	IK20TT	-	IK20	VK20	6	
																				MCV30	1MZ-FE	SK20R11	IK20TT	-	IK20	VK20	6	
																				ZNE10	1ZZ-FE	K16R-U11	IK16TT	K16TT	IK16	VK16	4	
																				ZGE20	2ZR-FAE	SC20HR11	-	-	-	VCH20	4	
VOLKSWAGEN																												
																				-	AYD/BFS	K20PBR-S10	IK20TT	K20TT	IK20	VK20	4	
																				-	AWU	-	-	-	IK22	VK22	4	
																				-	AQY	K20PBR-S10	IK20TT	K20TT	IK20	VK20	4	
																				-	AEE	K20PBR-S10	IK20TT	K20TT	IK20	VK20	4	
																				-	AEH	K20PBR-S10	IK20TT	K20TT	IK20	VK20	4	
																				-	AEH	K20PBR-S10	IK20TT	K20TT	IK20	VK20	4	
																				-	BAG	K20PBR-S10	IK20TT	K20TT	IK20	VK20	4	
																				-	AXW	K20PBR-S10	IK20TT	K20TT	IK20	VK20	4	
																				-	AGU	K22PBR-S	-	-	-	IK22	VK22	4
																				-	AXX	-	-	-	-	VK20Y	4	
																				-	BUB	-	-	-	IXU22	VXU22	6	
																				-	BLX	-	-	-	-	VKA16	4	
																				-	BWA	-	-	-	IK22	VK22	4	
																				-	APT	K20PBR-S10	IK20TT	K20TT	IK20	VK20	4	
																				-	BZB	-	-	-	-	-	4	
																				-	AZM	K20PBR-S10	IK20TT	K20TT	IK20	VK20	4	
																				-	ACK	K22PBR-S	-	-	-	IK22	VK22	6
																				-	BBG	K22PBR-S	-	-	-	IK22	VK22	6
																				-	BKY	KJ20CR-L11	IK16TT	K20TT	IK20L	-	-	4
																				-	BUD	-	-	-	-	VKA20	4	
																				-	AZZ	-	-	-	IXU22	VXU22	6	
																				-	BMV	-	-	-	IXU22	VXU22	6	
																				-	BHK	-	-	-	IXUH22	VXUH22	6	
																				-	BLG	-	-	-	IK22	VK22	4	
VOLVO																												
																				-	B4204	K20TXR	IK20TT	K20TT	IK20	VK20	4	
																				-	B5254	-	-	-	IKH22	VKH22	5	
																				-	-	K20PR-U	IK20TT	K20TT	IK20	VK20	5	
																				-	B5254T3	-	IKH20TT	-	IKH20	VKH20	5	
																				-	-	K20PBR-S10	IK20TT	K20TT	IK20	VK20	4	

MODEL	YEAR	VEHICLE CODE	ENGINE	DENSO			IRIDIUM POWER	IRIDIUM TOUGH	QTY
VOLVO									
S40 2.4i	04'-	-	B5244S4	-	-	-	IKH22	VKH22	5
S40 T4 1.9	98'-	-	B4194	K20PR-U11	IK20TT	K20TT	IK20	VK20	4
S40 T5 2.5	04'-	-	B5254T3	-	-	-	IKH22	VKH22	5
S60 2.0T	04'-	-	B5204T5	K20PBR-S10	IK20TT	K20TT	IK20	VK20	5
S60 T5 2.3	01'-	-	B5234	-	-	-	IK22	VK22	5
S60 T5 2.4	04'-	-	B5244T	-	-	-	IK22	VK22	4
S60R 2.5	03'-	-	B5254T4	-	-	-	IKH22	VKH22	5
S80 2.0T	99'-	-	B5204T2	K20PBR-S10	IK20TT	K20TT	IK20	VK20	5
S80 2.4	01'-	-	B5244S2	K20PR-U	IK20TT	K20TT	IK20	VK20	5
S80 2.5T	04'-	-	B5254T5	-	-	-	IKH22	VKH22	5
S80 T6 2.8	02'-	-	B6284T	-	-	-	IK22	VK22	6
V50 2.0	04'-	-	B5254T3	-	-	-	IKH22	VKH22	5
V50 2.4i	04'-	-	B5244S4	-	-	-	IKH22	VKH22	5
V50 T5 2.5	04'-	-	B5254	-	IKH20TT	-	IKH20	VKH20	5
V70 2.0T	04'-	-	B5204T5	K20PBR-S10	IK20TT	K20TT	IK20	VK20	5
V70 T5 2.4	02'-	-	B5234T3	-	-	-	IK22	VK22	5
V70 2.5T	03'-	-	B5254T	-	IKH20TT	-	IKH20	VKH20	5
V70R 2.5	03'-	-	B5254T4	-	-	-	IKH22	VKH22	5
XC70 2.5T	02'-	-	B5254T2	-	-	-	IK22	VK22	5
XC90 2.5T	03'-	-	B5254T2	-	-	-	IK22	VK22	5
XC90 3.2	06'-	-	B6324	-	IKH20TT	-	IKH20	VKH20	6
XC90 4.4	06'-	-	B8444	-	-	-	-	VK20Y	5
XC90 T6 2.9	03'-	-	B6294T	-	-	-	IK22	VK22	6
WULING									
Journey 1.1	08'-	-	LJ465Q3	W16EXR-U11	IW16TT	W16TT	IW16	VW16	4
Sunshine 1.1	08'-	-	LJ465Q3	W16EXR-U11	IW16TT	W16TT	IW16	VW16	4
ZOTYE									
Trex 1.6	07'-	RX6400	DA4G18	K16PR-U11	IK16TT	K16TT	IK16	VK16	4

DENSO
 AUSTRALIA CHINA INDIA INDONESIA KOREA MALAYSIA PHILIPPINES SAUDIARABIA SINGAPORE
 TAIWAN THAILAND VIETNAM JAPAN & USA EUROPE MOTOR CYCLE SMALL CROSS PART
 ENGINE REFERENCE NUMBER

SINGAPORE MOTORCYCLE

MODEL	ENGINE CC	YEAR	DENSO	IRIDIUM POWER	IRIDIUM RACING	QTY
ADIVA						
AD200	200		-	-	-	-
APRILLA						
Atlantic 200	200	2003 -	U24ESR-NB	IU24	IU01-□	1
ETV1000 Capo Nord	1000	2001 -	XU27EPR-U	IXU27	IXU01-□	4
Pegaso 650	650	1990 -	-	IX24	-	1
RS125 (12bhp restricted engine)	125		W24ESR-U	IW24	IW01-□	1
RS125 (35bhp unrestricted engine)	125		-	IW31	IW01-□	1
RS250	250	1994 -	W27EMR-C	IW27	IW01-□	2
RSV1000R	1000	2001 -	XU27EPR-U	IXU27	IXU01-□	2 / 4
RSV4	1000	2009 -	U27ESR-NB	IU27	IU01-□	4
Scarabeo 200	200	2000 -	U24ESR-NB	IU24	IU01-□	1
SHIVER 750	750	2009 -	-	IU24A	IU01-□	2
SMV 750 Dorsoduro	750	2007 -	-	IU24A	IU01-□	2
Sportcity 250	250	2004 -	U24ESR-NB	IU24	IU01-□	1
SXV 4.5	450	2006 - 2008	U24ESR-NB	IU24	IU01-□	2
		2009 -	-	IU24A	IU01-□	2
Tuono 1000	1000	2004 -	XU27EPR-U	IXU27	IXU01-□	4
Mojito Custom 125	125	2005 -	-	IU22	IU01-□	-
BAJAJ						
Avenger DTS-i	200		U27ESR-N	IU27	IU01-□	-
Pulsar DTS-i 180	180		U27ESR-N	IU27	IU01-□	-
Pulsar DTS-i 200	200		U27ESR-N	IU27	IU01-□	-
Chetak 150	150	2001 -	W16FPR-U	IWF16	-	-
BMW						
C1 Executive	125	2000 - 2004	U24ESR-NB	IU24	IU01-□	-
F 800 R / GS / S / ST	800	2005 -	XU24EPR-U	IXU24	IXU01-□	-
F650CS, GS, GS Dakar	650	2002 - 2005	-	IX24	-	-
F650GS (Twin cylinder 798cc)	800	2011 -	XU24EPR-U	IXU24	IXU01-□	-
HP2 Sport	1170	2008 -	-	-	-	-

DENSO	9	14	16	20	22	24	27	29	31	32	34	35	DENSO	9	14	16	20	22	24	27	29	31	32	DENSO	9	14	16	20	22	24	27	31
NGK	2	4	5	6	7	8	9	9.5	10	10.5	11	11.5	CHAMPION	18	16,14	12,11	10,9	8,7	6,63,61	4,59	57	55	53	BOSCH	10	9	8	7,6	5	4	3	2



MODEL	ENGINE CC	YEAR	DENSO	IRIDIUM POWER	IRIDIUM RACING	QTY
HONDA						
CB1100SF-Y X-11	1100	1999 -	-	IUH24	IU01-□	-
CB175	175		-	-	-	-
CB919 Hornet	900		-	-	-	-
CBF150	150		-	-	-	-
CBR1000 XX	1000		-	-	-	-
CBR1100	1100	1996 -	-	IUH27	IU01-□	-
CBR1100 K1 Blackbird	1100	- 2001	IUH27D	IUH27	IU01-□	-
CBR1100 K2 Blackbird	1100	2002 -	VUH27D	IUH27	IU01-□	-
CBR125R	125	2004 -	U24ESR-NB	IU24	IU01-□	-
CBR150R	150		-	-	-	-
CBR400	400		-	-	-	-
CBR400 RR	400		-	-	-	-
CBR600	400		-	-	-	-
CBR919	900		-	-	-	-
CBX250 Twister	250	1984 - 1986	X24EPR-U9	IX24B	-	-
CG Titan	125		-	-	-	-
Chaly	70		-	-	-	-
Click 110	110		U22FER9/U24FER9	IUH24	IU01-□	-
EX5. Dream, Wave	100		U20FS-U/U22FS-U	IUF22	-	-
GL1500SEW Goldwing	1500		X22EPR-U9	IX22B	-	-
Hornet	250		-	-	-	-
	600	1998 -	U27FER9	IUH27	IU01-□	-
Nice125 RS	125		-	-	-	-
NSR150 SP	150		W24ES-U	IW24	IW01-□	-
NSR250	250		-	-	-	-
NT650 Deauville	650	1998 - 2005	X24EPR-U9	IX24B	-	-
RVF400	400		-	-	-	-
Shadow	400		-	-	-	-
	600		-	-	-	-
Silver Wing 400	400		-	-	-	-
Sonic 125	125		-	-	-	-
ST1100	1100		U24FE9	IUH24	IU01-□	-
ST1300	1260	2002 -	U22FER9	-	IU01-□	-
STX1300	1300		-	-	-	-
Supra X	125		-	-	-	-
TA150 Phantom	150		-	-	-	-
TA200 Phantom	200		-	-	-	-
Valkyrie			-	-	-	-
VFR1200	1137	2010 -	-	-	-	-
VFR800	800	1997 - 2002	U27FER9	IUH27	IU01-□	-
		2002 -	VNH27Z	-	-	-
VLX Steed	400		-	-	-	-
VT-1300 Fury	1300	2003 -	XU20EPR-U	IXU22	-	-
VT600 Shadow	600		X24EPR-U9	IX24B	-	-
VTR1000 SP1	1000	2000 - 2001	IK27C11	IK27	IK01-□	-
VTR1000 SP2	1000	2002 -	VK27PRZ11	IK27	IK01-□	-
WAVE 125	125		U20EPR9	IU20	-	-
XL1000 Varadero	1000	1998 - 2002	-	IX27B	-	-
		2003 -	-	IX24B	-	-
XL125	125	2001 -	U24FE9	IUH24	IU01-□	-
XL200	250		-	-	-	-
XL250	250		X24ES-U	IX24	-	-
XLR200	200		-	-	-	-
XR125	125	2003 -	X24EPR-U9	IX24B	-	-
XR150 SM	125		-	-	-	-
XR200	200		X24ESR-U	IX24	-	-
XR400	400		X24GPR-U	IXG24	-	-
XR650	650		K22PR-U11	IK22	IK01-□	-
XR750 Africa Twin	750	1990 - 2003	X24EPR-U9	IX24B	-	-
C70C/E	70	1982 - 1986	U22FSR-U	IUF22	-	-
CB400 Super 4 F1, F2	400		X24ES-U	IX24	-	4
CB750 Nighthawk (DOHC)	750		X27ESR-U	IX27	-	4
XR600R-V	600		X24EPR-U9	IX24B	-	-
HUSQVARNA						
SM125	125	1998 -	W27ESR-V	IW27	IW01-□	-
SM350	350		-	-	-	-
SM450	450	2003 -	U24ESR-NB	IU24	IU01-□	-

DENSO
 AUSTRALIA CHINA INDIA INDONESIA KOREA MALAYSIA PHILIPPINES SAUDIARABIA SINGAPORE TAIWAN THAILAND VIETNAM JAPAN & USA EUROPE MOTOR CYCLE SMALL ENGINE REFERENCE PART NUMBER

DENSO	9	14	16	20	22	24	27	29	31	32	34	35	DENSO	9	14	16	20	22	24	27	29	31	32	DENSO	9	14	16	20	22	24	27	31
NGK	2	4	5	6	7	8	9	9.5	10	10.5	11	11.5	CHAMPION	18	16,14	12,11	10,9	8,7	6,63,61	4,59	57	55	53	BOSCH	10	9	8	7,6	5	4	3	2



MODEL	ENGINE CC	YEAR	DENSO	IRIDIUM POWER	IRIDIUM RACING	QTY
MV AGUSTA						
Brutale 910S	1000		-	-	-	-
F4 1000R	1000		-	-	-	-
F4 1000S M	1000		-	-	-	-
PGO						
G-Max 150	150		-	-	-	-
G-Max 200	200		-	-	-	-
PIAGGIO						
Fly 150	150		-	-	-	-
MP3 400ie	400		-	-	-	-
Runner 180	180		-	-	-	-
ST200 Runner	200		-	-	-	-
VXR200 Runner	200		-	-	-	-
X Evo 400	400		-	-	-	-
X8 200	200		-	-	-	-
X9 180 EVO	180		-	-	-	-
X9 250 EVO	250		-	-	-	-
RIEJU						
Marathon Pro 125	125		-	-	-	-
RS2 Pro 125	125		-	-	-	-
SMX 125 Pro Supermotard	125		-	-	-	-
SACHS						
Madass 125	125		-	-	-	-
SUZUKI						
Boulevard 400	400		-	-	-	-
DL1000 V-Strom	1000	2002 – 2008	U24ETR	IU24A	IU01-□	-
DR125 SM	125	2008 –	U24ESR-NB	IU24	IU01-□	-
EN125	125		X24ES-U	IX24	-	-
FD110	110		U20FS-U	IUF22	-	-
GN125	125	1993 – 2001	X24ES-U	IX24	-	-
GS125	125		X24ESR-U	IX24	-	-
GS400	400		W24ES-U	IW24	IW01-□	-
GSR400	400		-	-	-	-
GSR600	600	2006 –	U27ESRN	IU27	IU01-□	-
GSX650F Bandit S	650	2008 – 09	U24ESR-NB	IU24	IU01-□	-
GSX-R 1000	1000	2001 – 2006	U27ESRN	IU27	IU01-□	-
GSX-R1300 Hayabusa K8	1340	2008 –	IU27D	IU27	IU01-□	-
GSX-R400	400		-	IUF24	-	-
GSX-R400RR	400		-	-	-	-
GSX-R600	600	1997 – 2006	U27ESRN	IU27	IU01-□	-
		2008 – 2009	-	-	-	-
GSX-R750	750	2008 – 2009	-	-	-	-
		2006 –	U27ESRN	IU27	IU01-□	-
Impulse 400	400		-	-	-	-
Katana 125	125		-	-	-	-
M109R	1800		-	-	-	-
RGV250	250	1992 – 1996	W27EMR-C	IW27	IW01-□	-
RMX250	250	1994 – 1999	-	IW27	IW01-□	-
RV125	125	2003 –	U24ESR-NB	IU24	IU01-□	-
Smash 110	110		U20FS-U	IUF22	-	-
TL1000S	1000	1998 – 2001	U24ETR	IU24A	IU01-□	-
		1997 –	U27ESRN	IU27	IU01-□	-
VS400 Intruder	400		-	-	-	-
XFR650 Freewind	650		-	-	-	-
AN250 W, X, Y, K1-K3 Burgman	250	- 2003	U24ETR	IU24A	IU01-□	-
AN250 K4-K5 Burgman	250	2004 –	U22ETR	IU24A	IU01-□	-
AN400 X, Y, K1-K6 Burgman	400	1999 – 2007	U22ESR-N	IU22	IU01-□	-
AN400 K7-K8 Burgman	400	2007 –	U22ESR-N	IU22	IU01-□	-
DR200SE	200	1996 – 2009	X24ESR-U	IX24	-	-
DR-Z400	400	1980 – 2007	U24ESR-NB	IU24	IU01-□	-
GSX-R1000R	1000	2007 – 2008	IU27D	IU27	IU01-□	-
GSX-R1100 W-P, R, S, T	1100	1993 – 1996	U27ESRN	IU27	IU01-□	-
GSX1300R X, Y, K1-K5 Hayabusa	1300	1997 – 2007	U27ESRN	IU27	IU01-□	-
GSX600FJ	600		X27ESR-U	IX27	-	-
GSX600F	600	1998 – 2006	U27ETR	IU27A	IU01-□	-
VZ800	800	2006 – 2008	X22EPR-U9	IX22B	-	-
VZR1800 C1800R/RT Intruder	1800	2006 –	-	IU24	IU01-□	-

DENSO
 AUSTRALIA
 CHINA
 INDIA
 INDONESIA
 KOREA
 MALAYSIA
 PHILIPPINES
 SAUDI ARABIA
 SINGAPORE
 TAIWAN
 THAILAND
 VIETNAM
 JAPAN
 EUROPE
 MOTOR CYCLE
 SMALL ENGINE
 CROSS REFERENCE
 PART NUMBER

DENSO	9	14	16	20	22	24	27	29	31	32	34	35
NGK	2	4	5	6	7	8	9	9.5	10	10.5	11	11.5
DENSO	9	14	16	20	22	24	27	29	31	32		
CHAMPION	18	16,14	12,11	10,9	8,7	6,63,61	4,59	57	55	53		
DENSO	9	14	16	20	22	24	27	29	31	32		
BOSCH	10	9	8	7,6	5	4	3	2				



MODEL	ENGINE CC	YEAR	DENSO	IRIDIUM POWER	IRIDIUM RACING	QTY
YAMAHA						
YZF R15	150		-	-	-	-
YZF R6	600		U31ETR	IU31A	IU01-□	-
FZ6-S	600	2004 -	U27ETR	IU27A	IU01-□	-
XP500 TMAX	500		U22ESR-N	IU22	IU01-□	-

DENSO

AUSTRALIA

CHINA

INDIA

INDONESIA

KOREA

MALAYSIA

PHILIPPINES

SAUDI ARABIA

SINGAPORE

TAIWAN

THAILAND

VIETNAM

JAPAN

EUROPE

& USA

MOTOR

SMALL

CROSS

PART

ENGINE

REFERENCE

NUMBER

DENSO	9	14	16	20	22	24	27	29	31	32	34	35
NGK	2	4	5	6	7	8	9	9.5	10	10.5	11	11.5

DENSO	9	14	16	20	22	24	27	29	31	32
CHAMPION	18	16,14	12,11	10,9	8,7	6,63,61	4,59	57	55	53

DENSO	9	14	16	20	22	24	27	31
BOSCH	10	9	8	7,6	5	4	3	2



▶ Spark plug color codes: ■ for Iridium Tough and Iridium Plugs and Iridium TT, ■ for Iridium Power, ■ for Iridium Racing and Two Tops Plugs, ■ for Platinum Plugs and Platinum TT, and black for general spark plugs.

DENSO

AUSTRALIA

CHINA

INDIA

INDONESIA

KOREA

MALAYSIA

PHILIPPINES

SAUDI ARABIA

SINGAPORE

TAIWAN

THAILAND

VIETNAM

JAPAN

EUROPE & USA

MOTOR CYCLE

SMALL ENGINE

CROSS REFERENCE

PART NUMBER

車型	年份	一般	白金				鈦合金性能型	鈦合金耐久型
ALFA ROMIO								
145 2.0L	1996.08 -	-	-	IK20TT+N/A	-	-	IK20+IU22	-
146 1.6 TS	1996.11 -	-	PK20TR11	-	-	-	IU22	-
146 2.0 Ti	1996.11 -	-	PK20TR11	-	-	-	IU22	-
147 1.6TS/2.0TS	2001 -2004	-	-	IK20TT+N/A	-	-	IK20+IU22	-
147 3.2 GTA	2002.11	-	PK20PR-P8	IK20TT	-	-	IK20	VK20Y
156 1.8TS/2.0TS	1997 -2002	-	-	IK20TT+N/A	-	-	IK20+IU22	-
156 2.5L/V6	1997 -2002	-	PK20PR-P8	IK20TT	-	-	IK20	VK20Y
159 1.9 JTDM / 2.4 JTDM / 3.2 JTS		-	-	IK16TT	-	-	IK16	-
166 2.5/3.0L	1998.11	-	PK20PR-P8	IK20TT	-	-	IK20	VK20Y
GTV 3.0L	1996.11	-	PK20PR-P8	IK20TT	-	-	IK20	VK20Y
SPIDER 3.0/3.2	1998.06	-	PK20PR-P8	IK20TT	-	-	IK20	VK20Y
BRERA 2.2	2006 -	-	-	IK16TT	-	-	IK16	VK16
BRERA 3.2	2006 -	-	-	ITV16TT	-	-	ITV16	-
AUDI								
A2 1.4 (BBY)	2002.5 -2006	K20PBR510	-	IK20TT	-	-	IK20	VK20
A2 1.6 (AUA)(BBY)	1997 -2001	K20PBR510	-	IK20TT	-	-	IK20	VK20
A3 1.4 TFSi	2007 -2012	SKJ20CR-A8	PKJ20CR8	-	-	-	-	-
A3 1.6L	1996 -2003	-	PKJ16CRL11	IK16TT	-	-	IK16L	VK16
A3 1.6 (AEH)(AKL)(APF)	1996.06 -2000.08	K20PBR510	-	IK20TT	-	-	IK20	VK20
A3 1.8L / 1.8T	1998 -2003	K20PBR510	-	IK20TT	-	-	IK20	VK20
A3 1.8L	1998 -2003	K20PBR510	-	IK20TT	K20TT	-	IK20	VK20
A3 1.8T	1998 -2003	K20PBR510	-	IK20TT	K20TT	-	IK20	VK20
A3 2.0L FSI	2002.08 -	-	-	-	-	-	-	VKA16
A3 2.0L TFSI	2004.09 -	-	PK20PR-P8	IK20TT	-	-	IK20	VK20Y
A3 1.8/2.0 TFSI L4 DOHC 16V TURBO (CDA)	2006 -	PK20PR-P8	-	IK20TT	-	-	IK20	VK20Y
A3 3.2L	2003.07 -	-	-	-	-	-	IXU22	VXU22
A4 1.8L	1995 -2001	K20PBR510	-	IK20TT	K20TT	-	IK20	VK20
	1996 -2001	-	PK20PR-P8	IK20TT	-	-	IK20	VK20Y
	2008 -	-	-	-	-	-	IK22	VK22
A4 1.8T	1995 -2001	K20PBR510	-	IK20TT	K20TT	-	IK20	VK20
A4 1.8T AVAVT	2004 -2005	K20PBR510	-	IK20TT	K20TT	-	IK20	VK20
A4 2.0L	2002 -2005	-	-	IK16TT	-	-	IK16	VK16
A4 2.4L	1995 -2001	K20TXR	-	IK20TT	K20TT	-	IK20	VK20
A4 2.8L	1994 -2001	K20PBR510	-	IK20TT	K20TT	-	IK20	VK20
A4 3.0L	2002 -2005	K20TXR	-	IK20TT	K20TT	-	IK20	VK20
A6 2.4L/2.4L	1998 -2005	K20TXR	-	IK20TT	K20TT	-	IK20	VK20
A6 3.0L	2001 -2003	K20TXR	-	IK20TT	K20TT	-	IK20	VK20
A6 4.2L QUATTRO	2004.09 -	K20PBR-S10	-	IK20TT	K20TT	-	IK20	VK20
A8 2.8L 12V	1994 -2002	K20PBR510	-	IK20TT	K20TT	-	IK20	VK20
A8 2.8L 30V	1999 -2003	K20PBR510	-	IK20TT	K20TT	-	IK20	VK20
A8 3.7L	2004 -2005	K20TXR	-	IK20TT	K20TT	-	IK20	VK20
A8L 4.2L	2003 -2005	K20TXR	-	IK20TT	K20TT	-	IK20	VK20
RS6 4.2L	2002.07 -	-	-	-	-	-	IK22	VK22
S3 1.8L	1998.11 -	-	PK20PR-P8	IK20TT	-	-	IK20	VK20Y
S4 2.7L	1997.10 -	-	PK20PR-P8	IK20TT	-	-	IK20	VK20Y
S4 4.2L	2003.03 -	K20TXR	-	IK20TT	K20TT	-	IK20	VK20
TT 1.8T	1998.07 -	-	PK20PR-P8	IK20TT	-	-	IK20	VK20Y
TT 1.8T ROADSTER	2005.09 -	-	PK20PR-P8	IK20TT	-	-	IK20	VK20Y
TT 3.2L COUPE	2003.07 -	-	-	-	-	-	IXU22	VXU22
BENZ								
A160 (W168) (M166)	1997.10 -	K16TNR-S9	-	IK16TT	-	-	IK16	VK16
A190 (W168) (M166)	1998 -	-	-	IK16TT	-	-	IK16	VK16
B170 (W245) 1.7 (M266)	2005.4 -	K20PR-U	-	IK20TT	-	-	IK20	VK20Y
B180 1.7 L4 DOHC 8V	2006 -	K20PR-U	-	IK20TT	-	-	IK20	VK20Y
B200T 2.0 L4 DOHC 16V	2006 -	K20PR-U	-	IK20TT	-	-	IK20	VK20Y
B200T (W245) 2.0 (M266)	2005.04 -	K20PR-U	-	IK20TT	-	-	IK20	VK20Y
C180 CLASSIC/AVANTGRADE (M271)		-	-	-	-	-	IXUH22	VXUH22
C180 1.8L	1993 -2000	K16PR-U11	PK16PR11	IK16TT	K16TT	-	IK16	VK16
	1998 -2004	-	-	IK16TT	-	-	IK16	VK16
C180K 1.8L	2000 -2005	-	-	IK16TT	-	-	IK16	VK16
C200 2.0L	1996 -2000	K16PR-U11	PK16PR11	IK16TT	K16TT	-	IK16	VK16
	1993 -1998	K16PR-U11	PK16PR11	IK16TT	K16TT	-	IK16	VK16
C200K 1.8L	2000 -2005	-	-	IK16TT	-	-	IK16	VK16
C200K 2.0L	1998 -2004	-	-	IK16TT	-	-	IK16	VK16
C230 2.3L	1996 -2000	K16PR-U11	PK16PR11	IK16TT	K16TT	-	IK16	VK16
C230K 2.0L	2000 -2005	-	-	IK16TT	-	-	IK16	VK16
C230K 2.3L	1995 -2000	K16PR-U11	PK16PR11	IK16TT	K16TT	-	IK16	VK16



車型	年份	一般	白金	IRIDIUM	TJ	鈦合金性能型	鈦合金耐久型
BENZ							
C240 2.4L	1998	-2000	-	-	IK16TT	-	IK16 VK16
C240 2.6L	2000	-2005	-	-	IK16TT	-	IK16 VK16
	2000	-2005	-	-	IK16TT	-	IK16 VK16
C280 2.8L	1997	-2001	-	-	IK16TT	-	IK16 VK16
C320 3.2L	2000	-2005	-	-	IK16TT	-	IK16 VK16
C320 AMG K 3.2L	2000	-2005	-	-	IK16TT	-	IK16 VK16
C350 (W203) 3.5 (M272)	2004.12	-	-	-	-	-	IXUH22 VXUH22
C55 AMG (W203) 5.4 V8 (M113)	2004.2	-	-	-	IK20TT	-	IK20 VK20
C63 AMG ESTATE 6.2 V8 SOHC 32V (M156)	2007	-	FXE22HR11	-	-	-	VFXEH22
C63 AMG M 156.985 6.2 V8	2007.8	-	FXE22HR11	-	-	-	VFXEH22
CL500 (W140) 5.0 V8 (M113)	2000.9	-2007	-	-	IK16TT	-	IK16 VK16
CL500 (W212) 5.5 V8 DOHC 32V	2007	-	SXU22HDR8	-	-	-	IXUH22 VXUH22
CL600 (W212) 5.6 V12 DOHC 36V TURBO	2007	-	-	-	IK20TT	-	IK20 VK20Y
CL63 AMG (W212) 6.2 V8 DOHC 32V	2007	-	-	-	IK20TT	-	IK20 VK20Y
CLK 200 Kompressor (W208) (M111)	1997.7	-2002	K20PBR-S10	-	IK20TT	-	IK20 VK20
	2000.6	-2002	-	-	IK20TT	-	IK20 VK20
CLK 200K 1.8 (M271)	2003.2	-	-	-	-	-	VKH20Y
CLK 230 Kompressor (W208) (M111)	1997.6	-2000.2	K20PBR-S10	-	IK20TT	-	IK20 VK20
	2000.3	-	-	-	IK20TT	-	IK20 VK20
CLK 240 ELEGANCE (W209) (M112)	2003.2	-	-	-	IK16TT	-	IK16 VK16
CLK 240 (209) M112.912	2003.2	-	-	PK16PR(-L)11	IK16TT	-	IK16 VK16
CLK 280 3.0 V6 (M272)	2006.5	-	SXU22HDR8	-	-	-	IXUH22 VXUH22
CLK 320 (W208) (M112)	1997.6	-2002	-	-	IK16TT	-	IK16 VK16
CLK 320 (W209) (M112)	2003.3	-	-	-	IK16TT	-	IK16 VK16
CLK320 ADVANTAGE (W209) 3.2 V6 (M112)	2003.2	-	-	-	IK16TT	-	IK16 VK16
CLS350 (W219) 3.5 V6 (M272)	2004.10	-	SXU22HDR8	-	-	-	IXUH22 VXUH22
CLS500 5.0 V8 SOHC 32V	2006	-2010	SXU22HDR8	-	-	-	IXUH22 VXUH22
CLS500 (W219) 5.0 V8 (M113)	2006	-	-	PK16PR(-L)11	IK16TT	-	IK16 VK16
CLS55 AMG (W219) 5.5 V8 (M113)	2005.1	-	-	-	-	-	VKH20Y
CLS63AMG (M156) 6.2 V8	2006.5	-	FXE22HR11	-	-	-	VFXEH22
E200 2.0L	1992	-1995	K16PR-U11	PK16PR11	IK16TT	K16TT	IK16 VK16
E200/E200 T 2.0L	1999	-2002	K16PR-U11	PK16PR11	IK16TT	K16TT	IK16 VK16
E200K 1.8L	2003	-2005	-	-	IKH20TT	-	IKH20 VKH20
E200K 2.0L	1997	-2003	K16PR-U11	PK16PR11	IK16TT	K16TT	IK16 VK16
E200 CGI 1.8 L4 DOHC 16V TURBO	2009	-	-	-	-	-	VKH20Y
E220 2.2L	1992	-1995	K16PR-U11	PK16PR11	IK16TT	K16TT	IK16 VK16
E230/E230T 2.3L	1995	-1997	K16PR-U11	PK16PR11	IK16TT	K16TT	IK16 VK16
E240/E240T 2.4L	1998	-2003	-	-	IK16TT	-	IK16 VK16
E240/E240T 2.6L	2000	-2003	-	-	IK16TT	-	IK16 VK16
E250 CGI COUPE/ESTATE 2.2 L4 DOHC 16V TURBO	2009	-	SXU22HDR8	-	-	-	IXUH22 VXUH22
E280 2.8L	1995	-1997	K16PR-U11	PK16PR11	IK16TT	K16TT	IK16 VK16
E280/E280T 2.8L	1997	-2003	-	-	IK16TT	-	IK16 VK16
E300 3.0L	1992	-1995	K16PR-U11	PK16PR11	IK16TT	K16TT	IK16 VK16
E320 3.2L	1995	-1997	K16PR-U11	PK16PR11	IK16TT	K16TT	IK16 VK16
	1992	-1995	K16PR-U11	PK16PR11	IK16TT	K16TT	IK16 VK16
	2003	-2005	-	-	IK16TT	-	IK16 VK16
E320/E320T 3.2L	1997	-2003	-	-	IK16TT	-	IK16 VK16
E430/E430T 4.3L	1997	-2002	-	-	IK16TT	-	IK16 VK16
E500 5.0L	2003	-2005	-	-	IK16TT	-	IK16 VK16
S280 2.8L	1992	-1998	K16R-U11	PK16R11	IK16TT	K16TT	IK16 VK16
	1998	-2005	-	-	IK16TT	-	IK16 VK16
S320 3.2L	1992	-1998	K16R-U11	PK16R11	IK16TT	K16TT	IK16 VK16
	1998	-2003	-	-	IK16TT	-	IK16 VK16
S350 3.7L	2003	-2005	-	-	IK16TT	-	IK16 VK16
S430 4.3L	1998	-2005	-	-	IK16TT	-	IK16 VK16
S500 5.0L	1998	-2005	-	-	IK16TT	-	IK16 VK16
SL280 2.8L	1993	-1997	K16R-U11	PK16R11	IK16TT	K16TT	IK16 VK16
	2003	-	-	-	IK16TT	-	IK16 VK16
SL300 3.0L	1993	-1997	K16R-U11	PK16R11	IK16TT	K16TT	IK16 VK16
SL320 3.2L	1997	-2002	K16R-U11	PK16R11	IK16TT	K16TT	IK16 VK16
	1993	-1997	K16R-U11	PK16R11	IK16TT	K16TT	IK16 VK16
	1998	-2003	-	PK16PR11	IK16TT	-	IK16 VK16
BMW							
116i 1.6L	2005.03	-	K20TXR	-	IK20TT	K20TT	IK20 VK20
118i 2.0L	2005.03	-	-	-	IK20TT	-	IK20 VK20
120i 2.0L	2004.09	-	-	-	-	-	-
318iS 1.9L	1998	-2001	K20TXR	-	IK20TT	K20TT	IK20 VK20

DENSO
 AUSTRALIA
 CHINA
 INDIA
 INDONESIA
 KOREA
 MALAYSIA
 PHILIPPINES
 SAUDI ARABIA
 SINGAPORE
 TAIWAN
 THAILAND
 VIETNAM
 JAPAN
 EUROPE
 MOTOR & USA
 CYCLE
 SMALL ENGINE
 CROSS REFERENCE
 PART NUMBER

DENSO	9	14	16	20	22	24	27	29	31	32	34	35	DENSO	9	14	16	20	22	24	27	29	31	32	DENSO	9	14	16	20	22	24	27	31
NGK	2	4	5	6	7	8	9	9.5	10	10.5	11	11.5	CHAMPION	18	16,14	12,11	10,9	8,7	6,63,61	4,59	57	55	53	BOSCH	10	9	8	7,6	5	4	3	2



▶ Spark plug color codes: ■ for Iridium Tough and Iridium Plugs and Iridium TT, ■ for Iridium Power, ■ for Iridium Racing and Two Tops Plugs, ■ for Platinum Plugs and Platinum TT, and black for general spark plugs.

DENSO**CHINA AUSTRALIA****INDIA****INDONESIA****KOREA****PHILIPPINES MALAYSIA****SAUDI ARABIA****SINGAPORE****TAIWAN****THAILAND****VIETNAM****JAPAN****EUROPE & USA****MOTOR CYCLE****SMALL ENGINE****CROSS REFERENCE****PART NUMBER**

車型	年份	一般	白金				鉦合金性能型	鉦合金耐久型
BMW								
318Ti 2.0L	2001 -2005	K20TXR	-	IK20TT	K20TT	IK20	VK20	
320i 2.2L	2000 -2005	K20TXR	-	IK20TT	K20TT	IK20	VK20	
323i 2.5L	1998 -2001	K20TXR	-	IK20TT	K20TT	IK20	VK20	
325i 2.5L	2000 -2005	K20TXR	-	IK20TT	K20TT	IK20	VK20	
328i 2.8L	1998 -2001	K20TXR	-	IK20TT	K20TT	IK20	VK20	
330i 3.0L	2000 -2005	K20TXR	-	IK20TT	K20TT	IK20	VK20	
520i 2.0L/2.2L	1996 -2003	K20TXR	-	IK20TT	K20TT	IK20	VK20	
520i 2.2L	2004 -2005	K20TXR	-	IK20TT	K20TT	IK20	VK20	
523i/525i 2.5L	1996 -2003	K20TXR	-	IK20TT	K20TT	IK20	VK20	
525i 2.5L	2004 -2005	K20TXR	-	IK20TT	K20TT	IK20	VK20	
528i 2.8L/530 3.0L	1996 -2003	K20TXR	-	IK20TT	K20TT	IK20	VK20	
530i 3.0L	2004 -2005	K20TXR	-	IK20TT	K20TT	IK20	VK20	
540i 4.4L	2004 -2005	K20TXR	-	IK20TT	K20TT	IK20	VK20	
545i 4.4L	2003.11 -	-	-	IK20TT	-	IK20	VK20	
630i 3.0L	2005.01 -	-	-	IKH20TT	-	IKH20	VKH20	
633CSi/635CSi	1982 -	J16CR-U	-	IW16TT	-	IW16	VW16	
645 Ci CABRIOLET 4.4L	2004.02 -	-	-	IK20TT	-	IK20	VK20	
650i 4.8L	-	-	-	IK20TT	-	IK20	VK20	
730i 3.0L	2002 -2005	K20TXR	-	IK20TT	K20TT	IK20	VK20	
-	1994 -2001	K20TXR	-	IK20TT	K20TT	IK20	VK20	
735i 3.5L	1994 -2001	K20TXR	-	IK20TT	K20TT	IK20	VK20	
735i 3.6L	2002 -2005	K20TXR	-	IK20TT	K20TT	IK20	VK20	
740i 4.0L	1994 -2001	K20TXR	-	IK20TT	K20TT	IK20	VK20	
740i 4.4L	1994 -2002	K20TXR	-	IK20TT	K20TT	IK20	VK20	
745i 4.4L	2002 -2005	K20TXR	-	IK20TT	K20TT	IK20	VK20	
760Li 6.0L	2002 -2005	K20TXR	-	IK20TT	K20TT	IK20	VK20	
840Ci 4.0L/4.4L	1994.01 -	K20TXR	-	IK20TT	K20TT	IK20	VK20	
850i/Ci/CSi 5.0L	1990 -	KJ16CR-L11	-	IK16TT	K16TT	IK16	VK16	
M3 2.3/2.5L	1986 -1991	-	-	-	-	IX22	-	
M3 3.0/3.2L	1992 -2000	-	-	-	-	IXU22	VXU22	
M3 3.2L	2000.06 -	-	-	-	-	IXU24	VXU24	
-	2003.09 -	-	-	-	-	IXU24	VXU24	
M5 5.0L	2000.11 -	-	-	IK20TT	-	IK20	VK20	
M5 TOURING 3.8L	1996 -	XU22EPR-U	-	-	XU22TT	IXU22	VXU22	
X5 3.0/4.4/4.6/4.8L	1999 -	K20TXR	-	IK20TT	K20TT	IK20	VK20	
Z3 1.9/2.0/2.2/2.8L	1996 -	K20TXR	-	IK20TT	K20TT	IK20	VK20	
Z4 2.2/2.5/3.0L	2003 -	-	-	IK20TT	-	IK20	VK20	
Z8 5.0L	1999.10 -	K20TXR	-	IK20TT	K20TT	IK20	VK20	
BUICK								
PARK AVENUE 3.8L	1995 -	-	PT16EPR-L13	IT16TT	-	IT16	VT16	
REGAL 3.1L	1996 -2004	-	-	IT16TT	-	IT16	VT16	
RENDEZVOUS 3.4L	2000 -2004	-	-	IT16TT	-	IT16	VT16	
CHEVROLET GM								
CORVETTE	1990 -	K20PR-U11	-	IK20TT	-	IK20	VK20	
CADILLAC								
CTS 2.6/3.2L	2004 -	-	-	IK20TT	-	IK20	VK20	
CTS 2.8/3.6L	2004 -	-	-	ITV20TT	-	ITV20	-	
DEVILLE DHS 4.6L	2003 -	-	-	IT20TT	-	IT20	VT20	
DTS 4.6L	2006 -	-	PT16EPR-L13	IT16TT	-	IT16	VT16	
SEVILLE 4.6L	2003 -	-	-	IT20TT	-	IT20	VT20	
SRX 3.6L	2004 -	-	-	ITV20TT	-	ITV20	-	
SRX 4.6L	2004 -	-	PT16EPR-L13	IT16TT	-	IT16	VT16	
STS 3.6L	2005 -	-	-	ITV20TT	-	ITV20	-	
STS 4.6L	2005 -	-	PT16EPR-L13	IT16TT	-	IT16	VT16	
XLR 4.6L	2004 -	-	PT16EPR-L13	IT16TT	-	IT16	VT16	
CHRYSLER								
300C 2.7L	2005 -	-	-	ITL16TT	-	ITL16	-	
300C 3.5L	2005 -	-	-	IK16TT	-	IK16	VK16	
300M 3.5L	2000 -	-	-	IK16TT	-	IK16	VK16	
CHEROKEE 2.5L/4.0L	1997 -2002	KJ16CR-L11	PKJ16CR-L11	IK16TT	K16TT	IK16L	VK16	
CONCORDE 3.5	2003 -	-	-	IK16TT	-	IK16	VK16	
CROSSFIRE 3.2L	2003.12 -	-	-	IK16TT	-	IK16	VK16	
NEON 2.0L	1999 -	K20PR-U	PK20PR11	IK20TT	K20TT	IK20	VK20	
NEW YORKER 3.3L	1989 -	W16EXR-U11	-	IW16TT	W16TT	IW16	VW16	
PACIFICA 3.5L	2003 -	-	-	IK16TT	-	IK16	VK16	
PT CRUISER 2.0L/2.4L	2001 -2004	-	-	ITL16TT	-	ITL16	-	
PT CRUISER 2.4L	2005.02 -	-	-	ITL20TT	-	ITL20	-	



車型	年份	一般	白金	IRIDIUM	TJ	鍍合金性能型	鍍合金耐久型	
CHRYSLER								
SEBRING CONVERTIBLEB 2.7L	2003	-	-	ITL20TT	-	ITL20	-	
STRATUS 2.5L	1995	-	-	IK16TT	-	IK16	VK16	
TOWM&COUNTRY 3.3L	1996	-2004	-	ITL16TT	-	ITL16	-	
VIPER GTS 8.0L	1999.10	-	KJ16CR-L11	PKJ16CR-L11	IK16TT	K16TT	IK16L	VK16
VOYAGER 3.3L	1997	-2001	-	-	IW16TT	-	IW16	VW16
	2001	-	-	-	ITL16TT	-	ITL16	-
VOYAGER 3.8L	1999	-	-	-	IW16TT	-	IW16	VW16
WRANGLER 4.0L	1990	-2001	KJ16CR-L11	PKJ16CR-L11	IK16TT	K16TT	IK16L	VK16
WRANGLER 4.3L	1988	-	K16PR-U	-	IK16TT	K16TT	IK16	VK16
CITROEN								
C2 VTR 1.6L			K20HPR-U11	-	IKH20TT	KH20TT	IKH20	VKH20
C3 1.6L	2002	-2005	K20HPR-U11	-	IKH20TT	KH20TT	IKH20	VKH20
C5 2.0L SX	2001.04	-	K16HPR-U11	-	IKH16TT	KH16TT	IKH16	VKH16
C5 3.0L	2001.04	-	-	-	IKH16TT	-	IKH16	VKH16
C8 2.0L	2002.06	-	K16HPR-U11	-	IKH16TT	KH16TT	IKH16	VKH16
PLURIEL 1.6L	2002	-2005	K20HR-U11	-	IKH20TT	KH20TT	IKH20	VKH20
SAXO 1.4L SX	1996.04	-	K20TXR	-	IK20TT	K20TT	IK20	VK20
SAXO 1.6LSX/1.6VTS	1996.04	-	K20TXR	-	IK20TT	K20TT	IK20	VK20
XANTIA 2.0L	1995.06	-	K20TXR	-	IK20TT	K20TT	IK20	VK20
XSARA 2.0L PICASSO	2000.09	-	K16HPR-U11	-	IKH16TT	KH16TT	IKH16	VKH16
XSARA N7 1.6L	1997.09	-	K20HPR-U11	-	IKH20TT	KH20TT	IKH20	VKH20
XSARA VTS 2.0L	1997.09	-	K20PR-U	PK20PR11	IK20TT	K20TT	IK20	VK20
DAIHATSU								
COPEN 1.3L	2006	-	SVK20RZ11	-	IK20TT	-	IK20	VK20
NEW CHARADE 1.3L	1995.05		K20PR-U11	PK20PR11	IK20TT	K20TT	IK20	VK20
SIRION 1.0L	1997	-2000	K16PR-U11	PK16PR11	IK16TT	K16TT	IK16	VK16
SIRION 1.3L	2000	-2005	K16R-U11	PK16R11	IK16TT	K16TT	IK16	VK16
SKYWING 1.0L	1989	-	W16EPR-U	-	IW16TT	W16TT	IW16	VW16
SOCIAL 1.3L	1992.04		K20PR-U11	PK20PR11	IK20TT	K20TT	IK20	VK20
TERIOS 1.3L	2000	-2005	K20R-U11	PK20R11	IK20TT	K20TT	IK20	VK20
TERIOS 1.5L			K20R-U11	PK20R11	IK20TT	K20TT	IK20	VK20
金好載 1.0L	1990	-	W16EPRU	-	IW16TT	W16TT	IW16	VW16
穩賺 1.0L	1993	-	W16EPRU	-	IW16TT	W16TT	IW16	VW16
DAWOOD/FORMOSA								
MAGNUS 2.0L	2000.12		K16PR-U11	PK16PR11	IK16TT	K16TT	IK16	VK16
LANOS 1.6L	1998	-2003	K20PR-U11	PK20PR11	IK20TT	K20TT	IK20	VK20
LEGAZA 2.0L	1998	-2003	K20TXR	-	IK20TT	K20TT	IK20	VK20
MATIZ 0.8L	2004	-	W16EXR-U11	-	IW16TT	W16TT	IW16	VW16
MATIZ 1.0L	2004	-	K20TXR	-	IK20TT	K20TT	IK20	VK20
NUBIRA 1.6L	1998	-2003	K20PR-U11	PK20PR11	IK20TT	K20TT	IK20	VK20
TUCUMA 2.0L			K20TXR	-	IK20TT	K20TT	IK20	VK20
FIAT								
BARCETTA 1.8L	2000	-	K20PR-U	PK20PR11	IK20TT	K20TT	IK20	VK20
BRAVA 1.2L	1999	-	XU24EPR-U	-	-	-	IXU24	VXU24
BRAVO 1.6L	1995	-2002	K16PR-U	PK16PR11	IK16TT	K16TT	IK16	VK16
COUPE 2.0L	1996	-2001	K20PBR-S10	-	IK20TT	K20TT	IK20	VK20
IDEA 1.4	2005	-	XU22EPR-U	-	-	XU22TT	IXU22	VXU22
MAREA 1.6L	1995	-2002	K16PR-U	PK16PR11	IK16TT	K16TT	IK16	VK16
PANDA 1.3	2003	-2004	K16PR-U	PK16PR11	IK16TT	K16TT	IK16	VK16
	2004.10	-	XU22EPR-U	-	-	XU22TT	IXU22	VXU22
PUNTO 1.2L	2005.02	-	XU22EPR-U	-	-	XU22TT	IXU22	VXU22
	2000.09	-	XU24EPR-U	-	-	-	IXU24	VXU24
PUNTO 1.4L	2004	-	XU22EPR-U	-	-	XU22TT	IXU22	VXU22
PUNTO 1.4L TURBO	1993	-1999	K20PBR	-	IK20TT	K20TT	IK20	VK20
PUNTO 1.8/1.9L	2002.09	-	K20PR-U	PK20PR11	IK20TT	K20TT	IK20	VK20
PUNTO 1.8L	2000.09	-	K20TNR	-	IK20TT	K20TT	IK20	VK20
STILO 1.8L/2.4L	2001.09	-	K20PR-U	PK20PR11	IK20TT	K20TT	IK20	VK20
FORD								
ACTIVA 1.6L			K16PR-U11	PK16PR11	IK16TT	K16TT	IK16	VK16
ALL NEW LIATA 1.6/1.8L	1998	-	K20PR-U11	PK20PR11	IK20TT	K20TT	IK20	VK20
AZTEC 1.6/1.8L	1995	-	K20PR-U11	PK20PR11	IK20TT	K20TT	IK20	VK20
ECOSPORT	2013.11		-	-	ITV20TT	-	ITV20	-
ESCAPE 2.0L	2001	-2004	-	PT16VR13	ITV16TT	-	ITV16	-
ESCAPE 2.3L	2006.06	-	-	-	ITV16TT	-	ITV16	-
	2004	-2006.06	-	-	IT20TT	-	IT20	VT20
ESCAPE 3.0L	2004.05		T16EPR-U15	-	IT16TT	-	IT16	VT16
FESTIVA VIVID 1.3/1.5L	1996	-2001	W16EX-U11	-	IW16TT	W16TT	IW16	VW16

DENSO AUSTRALIA CHINA INDIA INDONESIA KOREA MALAYSIA PHILIPPINES SAUDIARABIA SINGAPORE TAIWAN THAILAND VIETNAM JAPAN & USA EUROPE MOTOR SMALL ENGINE REFERENCE NUMBER PART

DENSO	9	14	16	20	22	24	27	29	31	32	34	35	DENSO	9	14	16	20	22	24	27	29	31	32	DENSO	9	14	16	20	22	24	27	31
NGK	2	4	5	6	7	8	9	9.5	10	10.5	11	11.5	CHAMPION	18	16,14	12,11	10,9	8,7	6,63,61	4,59	57	55	53	BOSCH	10	9	8	7,6	5	4	3	2



▶ Spark plug color codes: ■ for Iridium Tough and Iridium Plugs and Iridium TT, ■ for Iridium Power, ■ for Iridium Racing and Two Tops Plugs, ■ for Platinum Plugs and Platinum TT, and black for general spark plugs.

DENSO

車型	年份	一般	白金	鉑合金性能型	鉑合金耐久型
FORD					
FIESTA 1.4 DOHC 16V	2010	-	PT16VR13	ITV16TT	ITV16
FIESTA 1.6 DOHC 16V	2010	-	PT16VR13	ITV16TT	ITV16
FIESTA 1.5L	2014	-	-	ITV20TT	ITV20
FOCUS 1.8L	2004.11	-	-	IK16TT	IK16
FOCUS 2.0L	2004.12	-	-	IT20TT	IT20
	1998 -2004	-	PT16VR13	ITV16TT	ITV16
	2003.06	-	-	IT20TT	IT20
FOCUS 1.6L	2015	-	-	ITV16TT	ITV16
FOCUS 2.0L	2015	-	-	ITV20TT	ITV20
FREESTAR 4.2L V6		-	-	IT20TT	IT20
i-MAX 2.0L	2007	-	-	IT20TT	IT20
KUGA 2.0L	2013	-	-	ITV20TT	ITV20
LXION MAV 2.0		K16PR-U11	PK16PR11	IK16TT	IK16
MAV 1.8/2.0L	2004.05	K16PR-U11	PK16PR11	IK16TT	IK16
MUSTANG 3.7L	2012	-	-	ITV20TT	ITV20
METROSTAR 2.0L	2002 -2005	-	-	IT20TT	IT20
METROSTAR 2.5L	2003.1	-	PT20VR13	ITV20TT	ITV20
MONDEO 1.8/2.0/2.5L	1998	-	PT16VR13	ITV16TT	ITV16
NEW MONDEO	2008	-	-	ITL20TT	ITL20
MONDEO ECOBOOST 2.0L	2011	-	-	ITV20TT	ITV20
MONDEO Duratec-HEV 2.0L	2015	-	-	ITV16TT	ITV16
NEW TELSTAR 1.8/2.0L	1992	K16PR-U11	PK16PR11	IK16TT	IK16
PR-Z 1.0L		K20PR-U	PK20PR11	IK20TT	IK20
RS MONDEO 2.5L	2003.11	-	PT20VR13	ITV20TT	ITV20
SCORPIO 2.0/2.3L	1995	-	-	IK20TT	IK20
TAURUS 3.0L	1994	T16EPR-U	-	IT16TT	IT16
TELSTAR 1.8/2.0L		W16EXR-U	-	IW16TT	IW16
TIERRA 1.6L	2003.05	KJ16CR-11	PKJ16CR-L11	IK16TT	IK16L
TIERRA 1.8L	1998 -2005	K16PR-U11	PK16PR11	IK16TT	IK16
TIERRA 2.0L	2001	K16PR-U11	PK16PR11	IK16TT	IK16
TX5 2.0L	1992	K20PR-U11	PK20PR11	IK20TT	IK20
VIVID 1.3L		W16EX-U11	-	IW16TT	IW16
WINDSTAR 3.0L	1994	T16EPR-U	-	IT16TT	IT16
好幫手 1.0L	2000 -2005	K16PR-U	PK16PR11	IK16TT	IK16
載卡多 2.0L	1998 -2005	K16PR-U11	PK16PR11	IK16TT	IK16
HONDA					
ACCORD 2.0L/3.0L	1998 -2003	KJ16CR-L11	PKJ16CR-L11	IK16TT	IK16L
	2005.06	KJ20DR-M11	-	IK20TT	IK20
ACCORD 2.0L	2008	SKJ20DR-M11S	-	IK20TT	IK20G
ACCORD 2.4L	2008	SXU22HCR11S	-	-	VXUHC22G
ACCORD 3.5L	2008	SXU22HCR11	-	-	IXUH22I
ACCORD	2013	DXE22HQR-D11S	-	-	-
ACCORD 2.0L	2017	-	-	-	-
CITY 1.5L	1996 -2002	W16EX-U11	-	IW16TT	IW16
	2015	DK20PR-D13	-	-	VFK20F
CIVIC 1.5L(五代)	1996	K20PR-U11	PK20PR11	IK20TT	IK20
CIVIC 1.5L(五代)VTEC		KJ16CR-L11	PKJ16CR-L11	IK16TT	IK16L
CIVIC 1.5L(六代)	1994	K20PR-U11	PK20PR11	IK20TT	IK20
CIVIC 1.5L(六代)VTEC		KJ16CR-L11	PKJ16CR-L11	IK16TT	IK16L
CIVIC 1.8L(八代)	2006	SKJ20DR-M11S	-	IK20TT	IK20G
CIVIC 2.0L(八代)	2006	SKJ20DR-M11	-	IK20TT	IK20L
CIVIC 1.8L	2012	SXU22HCR11S	-	-	VXUHC22G
CRV 2.0L(1代)	1998 -2002	KJ16CR-L11	PKJ16CR-L11	IK16TT	IK16L
CRV 2.0L(2代)	2005.01	KJ20CR-L11	PKJ20CR-L11	IK20TT	IK20
CRV 2.0L(3代)		KJ20DR-M11	-	IK20TT	IK20
CRV 2.4L	2007.01	KJ20DR-M11	-	IK20TT	IK20
CRV 2.0L	2010 -2011	SKJ20DR-M11S	-	IK20TT	IK20G
CRV 2.4L	2010	KJ20DR-M11	-	IK20TT	IK20
CRV 2.0L	2012	SXU22HCR11S	-	-	VXUHC22G
HR-V 1.8L	2016	SXU22HCR11S	-	-	VXUHC22G
CRZ 1.5L	2012	DK20PR-D13	-	-	VFK20F
	2013	SKJ20DR-M13	-	IK20TT	IK20
FERIO 喜美(7代)	2001 -2004	KJ20CR-L11	PKJ20CR-L11	IK20TT	IK20
FIT 1.5	2008	SKJ20DR-M13	-	IK20TT	IK20L
	2014	DK20PR-D13	-	-	VFK20F
INSIGHT 1.4L	2010	-	-	-	VFKH20
	2012	-	-	-	VFKH20



車型	年份	一般	白金	IRIDIUM	TJ	鍍合金性能型	鍍合金耐久型	
HONDA								
LEGEND 3.5L	2007	-	SKJ20DR-M11	-	IK20TT	IK20	VK20	
ODYSSEY 2.4L	2015	-	SXE22HQR11S	-	-	-	-	
HYUNDAI								
ACCENT 1.5L	1995	-	K16PR-U11	PK16PR11	IK16TT	K16TT	IK16	VK16
ATOS PRIME1.0L	1998	-2004	K16PR-U11	PK16PR11	IK16TT	K16TT	IK16	VK16
COUPE 1.8L	2002	-2004	K16PR-U11	PK16PR11	IK16TT	K16TT	IK16	VK16
COUPE 2.0L	2002	-2004	K20PR-U11	PK20PR11	IK20TT	K20TT	IK20	VK20
ELANTRA 1.6/1.8L	1996	-	W20EXR-U11	-	IW20TT	W20TT	IW20	VW20
ELANTRA 1.6L	2002.09	-	K16PR-U	PK16PR11	IK16TT	K16TT	IK16	VK16
ELANTRA 1.8L	2002.09	-	K16PR-U	PK16PR11	IK16TT	K16TT	IK16	VK16
GETZ 1.3L	-	-	K16PR-U11	PK16PR11	IK16TT	K16TT	IK16	VK16
LEGANZA 2.0L	1997	-	K20TXR	-	IK20TT	K20TT	IK20	VK20
MATRIX 1.6L	2003.06	-	K16PR-U11	PK16PR11	IK16TT	K16TT	IK16	VK16
MATRIX 1.8L	2003.06	-	K16PR-U11	PK16PR11	IK16TT	K16TT	IK16	VK16
SANTA 2.7L	2000	-2004	-	PK16PR-L11	IK16TT	-	IK16	VK16
SONATA 2.0L	1993	-	W20EXR-U11	-	IW20TT	W20TT	IW20	VW20
TARJET 2.0L	1999	-2004	-	PK20PR-L11	IK20TT	-	IK20	VK20
TARJET 2.7L	2000.07	-	-	PK16PR-L11	IK16TT	-	IK16	VK16
TUCSON 2.0L	-	-	K16PR-U11	PK16PR11	IK16TT	K16TT	IK16	VK16
XG 2.0L	2000	-2005	-	PK16PR-L11	IK16TT	-	IK16	VK16
IX30	2007	-	-	-	-	-	IXUH22I	VXUH22I
IX35	2009	-	K16HPR-U11	-	IKH16TT	KH16TT	IKH16	VKH16
INFINITI								
FX35 3.5L/4.5L	2004	-2005	-	-	IKH16TT	-	IKH16	VKH16
G35 3.5L	2002	-	-	-	IKH16TT	-	IKH16	VKH16
M35 3.5L	2006	-	-	-	IKH16TT	-	IKH16	VKH16
Q45 4.1L/4.5L	1989	-1997	-	PK16PR-L11	IK16TT	-	IK16	VK16
QX4 3.3L	1997	-2003	-	PK16PR11	IK16TT	-	IK16	VK16
ISUZU								
RODEO 3.5L	-	-	-	PK16PR-L11	IK16TT	-	IK16	VK16
TROOPER 3.5L	-	-	-	PK20PR11	IK20TT	-	IK20	VK20
JAGUAR								
DAIMLER 4.0L	-	-	K16P-U	-	IK16TT	K16TT	IK16	VK16
SOVEREIGN 3.2L	-	-	K20PR-U	PK20PR11	IK20TT	K20TT	IK20	VK20
S-TYPE 2.5L/3.0L	2003	-2005	-	PT16EPR-L13	IT16TT	-	IT16	VT16
XJ8 3.2L	1998.09	-	-	PK16PR-L11	IK16TT	-	IK16	VK16
XJ8 3.5L/4.2L	2003.03	-	-	-	IK16TT	-	IK16	VK16
XJ8L 3.5L/4.2L	2003.03	-	-	-	IK16TT	-	IK16	VK16
XK 4.2L	2006.05	-	-	-	IK16TT	-	IK16	VK16
XK8 4.0L	1997.09	-	-	-	IK16TT	-	IK16	VK16
XK8 4.2L	2002.09	-	-	-	IK16TT	-	IK16	VK16
XKR 4.2L	2002.09	-	-	-	IK16TT	-	IK16	VK16
X-TYPE 2.1L/2.5L/3.0L	2001	-2005	-	PK16PR11	IK16TT	-	IK16	VK16
KIA								
CARENS 1.8L	1999	-2004	K20PR-U	PK20PR11	IK20TT	K20TT	IK20	VK20
EURO-CARENS2.0	-	-	K20PR-U	PK20PR11	IK20TT	K20TT	IK20	VK20
CARNIVAL 2.5L	1999	-2005	-	PK20PR-L11	IK20TT	-	IK20	VK20
EURO STAR 1.1L	-	-	K16PR-U11	PK16PR11	IK16TT	K16TT	IK16	VK16
JOICE 2.0L	-	-	W20EXR-U11	-	IW20TT	W20TT	IW20	VW20
RIO 1.3L	2000	-2003	W16EXR-U11	-	IW16TT	W16TT	IW16	VW16
RIO 1.5L	2000	-2003	K20PR-U11	PK20PR11	IK20TT	K20TT	IK20	VK20
SEPHIA 1.6L	1994	-1999	W20EPR-U11	-	IW20TT	W20TT	IW20	VW20
SHUMA 1.8L	-	-	K20PR-U	PK20PR11	IK20TT	K20TT	IK20	VK20
SORENTO 3.5L	-	-	-	PK16PR-L11	IK16TT	-	IK16	VK16
SPORTAGE 2.0L	1995	-2003	K20PR-U11	PK20PR11	IK20TT	K20TT	IK20	VK20
LANDROVER								
DISCOVERY 4.0L	1998	-2004	-	PK16PRL11	IK16TT	-	IK16	VK16
FREELANDER 1.8L/2.5L	1997	-2003	-	PK20PR11	IK20TT	-	IK20	VK20
RANGE ROVER 4.4L	2004	-2005	-	PK20PR11	IK20TT	-	IK20	VK20
LEXUS								
CT200h	2011	-	SC20HR11	-	-	-	-	VCH20
ES 300/330	2003.05	-	SK20R11	-	IK20TT	-	IK20	VK20
ES 350	2006	-	FK20HR11	-	IKH20TT	-	-	VFKH20
ES250	2012.06	-	SK16HR11	-	IKH16TT	-	IKH16	VKH16
ES350	2012.06	-	FK20HR11	-	IKH20TT	-	-	VFKH20
ES300H	2012.06	-	FK16HR-A8	-	IKH16TT	-	-	-
GS 300/430	2005.01	-	FK20HBR11	-	IKBH20TT	-	-	VFKBH20

DENSO

AUSTRALIA

CHINA

INDIA

INDONESIA

KOREA

MALAYSIA

PHILIPPINES

SAUDIARABIA

SINGAPORE

TAIWAN

THAILAND

VIETNAM

JAPAN

& USA

EUROPE

MOTOR

CYCLE

SMALL

ENGINE

REFERENCE NUMBER

DENSO	9	14	16	20	22	24	27	29	31	32	34	35	DENSO	9	14	16	20	22	24	27	29	31	32	DENSO	9	14	16	20	22	24	27	31
NGK	2	4	5	6	7	8	9	9.5	10	10.5	11	11.5	CHAMPION	18	16,14	12,11	10,9	8,7	6,63,61	4,59	57	55	53	BOSCH	10	9	8	7,6	5	4	3	2



▶ Spark plug color codes: ■ for Iridium Tough and Iridium Plugs and Iridium TT, ■ for Iridium Power, ■ for Iridium Racing and Two Tops Plugs, ■ for Platinum Plugs and Platinum TT, and black for general spark plugs.

DENSO

AUSTRALIA

CHINA

INDIA

INDONESIA

KOREA

MALAYSIA

PHILIPPINES

SAUDI ARABIA

SINGAPORE

TAIWAN

THAILAND

VIETNAM

JAPAN

EUROPE & USA

MOTOR CYCLE

SMALL ENGINE

CROSS REFERENCE

PART NUMBER

車型	年份	一般	白金	IRIDIUM		T-T		鈦合金性能型	鈦合金耐久型
LEXUS									
GS250/350	2012	-	FK20HBR11	-	IKBH20TT	-	-	VFKBH20	
GS450h	2012	-	FK20HBR8	-	IKBH20TT	-	-	VFKBH20	
GS300h	2013.09		FK20HBR8	-	IKBH20TT	-	-	VFKBH20	
IS 200/300	2003.05		SK20RP11	-	IK20TT	-	IK20	VK20	
IS 250	2005.10		FK20HBR11	-	IKBH20TT	-	-	VFKBH20	
IS300h	2013.04		FK20HBR8	-	IKBH20TT	-	-	VFKBH20	
LS400	1998	-	-	PK20R11	IK20TT	-	IK20	VK20	
LS430	2000	-	-	PK20R11	IK20TT	-	IK20	VK20	
LS470	2000	-	-	PK20R11	IK20TT	-	IK20	VK20	
LS460/600h	2006	-	FK20HBR11	-	IKBH20TT	-	-	VFKBH20	
NX200T	2014.07		-	-	-	-	-	VDKH22F	
NX300h	2014.07		FK16HR-A8	-	IKH16TT	-	-	-	
RX300	1998	-2003	-	PK20R11	IK20TT	-	IK20	VK20	
RX330	2003	-	SK20R11	-	IK20TT	-	IK20	VK20	
RX270/350	2012	-	FK20HBR11	-	IKBH20TT	-	-	VFKBH20	
RX450h	2012	-	FK20HR11	-	IKH20TT	-	-	VFKH20	
RX400H Hybrid	2006	-2008	SK20R11	-	IK20TT	-	IK20	VK20	
SC430	2001	-	SK20R11	-	IK20TT	-	IK20	VK20	
LUXGEN									
LUXGEN7 SUV 2.2L	2010		K16HPR-U11	-	IKH16TT	KH16TT	IKH16	VKH16	
LUXGEN7 MVP/CEO 2.2L	2010		K16HPR-U11	-	IKH16TT	KH16TT	IKH16	VKH16	
MAZDA									
323 1.3/1.6L	1993.05	-	K16CR-L11	PKJ16CR-L11	IK16TT	K16TT	IK16L	VK16	
323 ISAMU 1.6L	2004.12		K16PR-U11	PK16PR11	IK16TT	K16TT	IK16	VK16	
CAPELLA 626 2.0L	1997	-2002	KJ16CR11	-	IK16TT	K16TT	IK16	VK16	
CX5 2.0 SKYACTIV-G	2013	-	-	-	IXEH22TT	-	-	VFXEH22	
CX7 2.3	2009	-	-	-	ITV20TT	-	ITV20	-	
CX9 3.8 V6			-	-	-	-	ITV22	-	
MAZDA 2 1.5L	2007	-	-	-	IK16TT	-	IK16	VK16	
MAZDA 3 1.6L	2004.06		-	-	IK16TT	-	IK16	VK16	
MAZDA 3 2.0L	2004.06		-	-	IT16TT	-	IT16	VT16	
	2007.03		-	-	ITV16TT	-	ITV16	-	
MAZDA 3	2013	-	-	-	IXEH22TT	-	-	VCH20	
MAZDA 5 2.0L	2005.11	-	-	-	IT16TT	-	IT16	VT16	
	2011	-	-	-	ITV16TT	-	ITV16	-	
MAZDA 6 2.0/2.3L	2005		-	PT20EPR-L13	IT20TT	-	IT20	VT20	
MAZDA 6 2.3L	2006.06		-	-	ITV16TT	-	ITV16	-	
MAZDA 6 2.0 SKYACTIV-G	2013	-	-	-	IXEH22TT	-	-	VFXEH22	
MILLENNIA 2.3/2.5L	1994	-	KJ16CR-L11	PKJ16CR-L11	IK16TT	K16TT	IK16L	VK16	
MPV 2.5L	1996.06	-	-	-	IT20TT	-	IT20	VT20	
MPV 3.0L	2002	-	-	-	IT20TT	-	IT20	VT20	
MX-5 1.8L	1990	-	-	-	IT20TT	-	IT20	VT20	
MX-6 1.8/2.0L	1992	-	-	-	IT20TT	-	IT20	VT20	
OSHYARE 3.0L 2WD	2003.07		-	PT20EPR-L13	IT20TT	-	IT20	VT20	
PREMACY 2.0L	2003	-	K16PR-U11	PK16PR11	IK16TT	K16TT	IK16	VK16	
PROTEGE 1.6L			KJ16CR-11	PKJ16CR-L11	IK16TT	K16TT	IK16L	VK16	
PROTEGE 1.8/2.0L	1998	-2005	K16PR-U11	PK16PR11	IK16TT	K16TT	IK16	VK16	
TRIBUTE 2.0L	2001	-2004	-	PT16VR13	ITV16TT	-	ITV16	-	
TRIBUTE 2.3L	2006.06	-	-	-	ITV16TT	-	ITV16	-	
	2004	-2006.06	-	-	IT20TT	-	IT20	VT20	
TRIBUTE 3.0L	2004.05	-	T16EPR-U15	-	IT16TT	-	IT16	VT16	
MINI									
COOPER 1.6L	2002	-	K20TXR	-	IK20TT	K20TT	IK20	VK20	
COOPER S 1.6L	2002	-	K20TXR	-	IK20TT	K20TT	IK20	VK20	
ONE 1.6L	2002	-	K20TXR	-	IK20TT	K20TT	IK20	VK20	
MITSUBISHI									
CHALLENGER 3.0L	1998	-2004	-	PK20PR-P11	IK20TT	-	IK20	VK20	
COLT PLUS 1.6L	2007	-	K20PR-U11	PK20PR11	IK20TT	K20TT	IK20	VK20	
DIAMANTE 3.0/3.5L	1997	-	-	PK16PR-P11	IK16TT	-	IK16	VK16	
ECLIPSE 2.0L TURBO	1996	-	K20PR-U11	PK20PR11	IK20TT	K20TT	IK20	VK20	
FRECCA 1.6/2.0L	1999	-2005	K16PR-U11	PK16PR11	IK16TT	K16TT	IK16	VK16	
GALANT 2.0L	1998	-2004	-	PK20PR11	IK20TT	-	IK20	VK20	
GALANT 2.4L	1993.09	-	-	-	IKH20TT	-	IKH20	VKH20	
GLOBAL LANCER 1.6/1.8L	2001	-2005	K16PR-U11	PK16PR11	IK16TT	K16TT	IK16	VK16	
GRUNDER 2.4L	2004.12		-	-	IKH20TT	-	IKH20	VKH20	
INSPIRE 2.4L			K16PR-U11	PK16PR11	IK16TT	K16TT	IK16	VK16	
LANCER 1.6L	1996	-2001	K16PR-U11	PK16PR11	IK16TT	K16TT	IK16	VK16	



車型	年份	一般	白金	IRIDIUM	TJ	鍍合金性能型	鍍合金耐久型
MITSUBISHI							
LANCER FORTIS 1.8L/io 2.0L		K20PSR-B8	-	IK20TT	K20TT	IK20	VK20
LIBERO 1.6L	1994.07 -	K16PR-U11	PK16PR11	IK16TT	K16TT	IK16	VK16
MAGIC 1.6L	2000 -2005	K16PR-U11	PK16PR11	IK16TT	K16TT	IK16	VK16
OUTLANDER 2.4	2003.05 -	-	-	IKH20TT	-	IKH20	VKH20
PAJERO 3.5L	1998 -2004	-	-	IK16TT	-	IK16	VK16
PAJERO 3.8L	2005 -	-	-	IK20TT	-	IK20	VK20
PAJERO PININ 1.8L	2002 -	K16PR-U11	PK16PR11	IK16TT	K16TT	IK16	VK16
SAVRIN 2.0L	2002 -2005	W20EXR-U11	-	IW20TT	W20TT	IW20	VW20
SAVRIN 2.4L		-	-	IKH20TT	-	IKH20	VKH20
SPACE GEAR 2.4L	2002 -2004	K16PR-U11	PK16PR11	IK16TT	K16TT	IK16	VK16
VERYCA 1.2L	2000 -2005	K16PR-U11	PK16PR11	IK16TT	K16TT	IK16	VK16
VERYCA 1.6L	1999 -	K16PR-U11	PK16PR11	IK16TT	K16TT	IK16	VK16
VIRAGE 1.8L	1996 -2001	K20PR-U11	PK20PR11	IK20TT	K20TT	IK20	VK20
VIRAGE io 1.8L	2001 -2005	K20PR-U11	PK20PR11	IK20TT	K20TT	IK20	VK20
ZINGER 2.4L		K16PR-U11	PK16PR11	IK16TT	K16TT	IK16	VK16
威力 1.1L		XU22EPR-U	-	-	XU22TT	IXU22	VXU22
威力 1.2L		K16PR-U11	PK16PR11	IK16TT	K16TT	IK16	VK16
得力卡 2.0L		K16PR-U11	PK16PR11	IK16TT	K16TT	IK16	VK16
得力卡 2.4L		K16PR-U11	PK16PR11	IK16TT	K16TT	IK16	VK16
得力卡 2.5L		K16PR-U11	PK16PR11	IK16TT	K16TT	IK16	VK16
NISSAN							
350Z	2003 -	-	-	IKH16TT	-	IKH16	VKH16
AD RESORT 1.6L		K16PR-U11	PK16PR11	IK16TT	K16TT	IK16	VK16
ALL NEW SENTRA 1.6L/1.8L	1995.03 -	K16PR-U11	PK16PR11	IK16TT	K16TT	IK16	VK16
ALL NEW SENTRA M1 2.0L	2003 -2005	K16HPR-U11	-	IKH16TT	KH16TT	IKH16	VKH16
ALTIMA 2.4L	1998 -	-	PK16PR-L11	IK16TT	-	IK16	VK16
AREX 1.8L		K16PR-U11	PK16PR11	IK16TT	K16TT	IK16	VK16
CEFIRO 2.0L/3.0L	1996 -2005	-	PK16PR-L11	IK16TT	-	IK16	VK16
CEFIRO 3.5L	2003 -2005	-	-	IKH16TT	-	IKH16	VKH16
LIVINA 1.8L	2007	FXE20HR11	-	IXEH20TT	-	-	VFXEH20
MARCH 1.3L	1993 -	K16PR-U11	PK16PR11	IK16TT	K16TT	IK16	VK16
MAXIMA 2.0L		-	PK16PR-L11	IK16TT	-	IK16	VK16
MURANO 3.5L	2006 -	-	-	IKH16TT	-	IKH16	VKH16
NRV		K16PR-U11	PK16PR11	IK16TT	K16TT	IK16	VK16
PRIMERA 2.0L	1992.11 -	-	PK16PR-L11	IK16TT	-	IK16	VK16
QRV 2.0L	2001 -2005	K16R-U11	PK16R11	IK16TT	K16TT	IK16	VK16
QUEST 3.0L	1993 -	K16R-U	PK16R11	IK16TT	K16TT	IK16	VK16
QUEST 3.3L	2002	-	-	IK20TT	-	IK20	VK20
QUEST 3.5L	2005	-	-	IKH16TT	-	IKH16	VKH16
ROGUE 2.5L	2010	FXE22HR11	-	IXEH22TT	-	-	VFXEH22
SERENA 2.5L	2001.09	K16R-U11	PK16R11	IK16TT	K16TT	IK16	VK16
SUPER MARCH 1.3L	2004.12	K16PR-U11	PK16PR11	IK16TT	K16TT	IK16	VK16
SYLPHY 2.0L	2007	FXE20HR11	-	IXEH20TT	-	-	VFXEH20
TEANA 2.0L/2.3L/3.5L	2004.09	-	-	IKH16TT	-	IKH16	VKH16
TEANA 2.0L/2.5L	2010	FXE20HR11	-	IXEH20TT	-	-	VFXEH20
TEANA 3.5L	2010	FXE22HR11	-	IXEH22TT	-	-	VFXEH22
TIIDA 1.6L/1.8L	2007	FXE20HR11	-	IXEH20TT	-	-	VFXEH20
BIG TIIDA 1.6L	2013	FXE20HR11	-	IXEH20TT	-	-	VFXEH20
VERITA 1.3L	2005.07	K16PR-U11	PK16PR11	IK16TT	K16TT	IK16	VK16
X-TRAIL 2.0L/2.5L	2004.05	K16HPR-U11	-	IKH16TT	KH16TT	IKH16	VKH16
OPEL							
ASTRA 1.6L		K20PR-U	-	IK20TT	K20TT	IK20	VK20
ASTRA-G 1.8L	2001 -2005	K20TXR	-	IK20TT	K20TT	IK20	VK20
CORSA 1.2L	2002 -2005	K20TXR	-	IK20TT	K20TT	IK20	VK20
CORSA 1.4L	1995 -2003	K20TXR	-	IK20TT	K20TT	IK20	VK20
CORSA 1.8L	2004 -2005	K20TXR	-	IK20TT	K20TT	IK20	VK20
OMEGA-B 2.0L	1995 -2000	K20TXR	-	IK20TT	K20TT	IK20	VK20
OMEGA-B 2.5L	1995 -2000	K20TXR	-	IK20TT	K20TT	IK20	VK20
OMEGA-B 3.0L	1995 -2000	K20TXR	-	IK20TT	K20TT	IK20	VK20
TIGRA 1.4L	1995 -1998	K20TXR	-	IK20TT	K20TT	IK20	VK20
TIGRA 1.6L	1995 -1998	K20TXR	-	IK20TT	K20TT	IK20	VK20
VECTRA-B 1.8L	1997 -2000	K20TXR	-	IK20TT	K20TT	IK20	VK20
VECTRA-B 2.0L	1996 -1997	K20TXR	-	IK20TT	K20TT	IK20	VK20
VECTRA-C 2.2L	2004 -2005	-	-	ITV20TT	-	ITV20	-
PEUGEOT							
106 1.4L		K20TXR	-	IK20TT	K20TT	IK20	VK20
206 1.4L	1998.09 -1999.12	K20TXR	-	IK20TT	K20TT	IK20	VK20

DENSO
 AUSTRALIA
 CHINA
 INDIA
 INDONESIA
 KOREA
 MALAYSIA
 PHILIPPINES
 SAUDI ARABIA
 SINGAPORE
 TAIWAN
 THAILAND
 VIETNAM
 JAPAN
 EUROPE
 MOTOR
 & USA
 CYCLE
 SMALL
 ENGINE
 REFERENCE
 NUMBER
 PART

DENSO	9	14	16	20	24	27	29	31	32	34	35	DENSO	9	14	16	20	22	24	27	29	31	32	DENSO	9	14	16	20	22	24	27	31	
NGK	2	4	5	6	7	8	9	9.5	10	10.5	11	11.5	CHAMPION	18	16,14	12,11	10,9	8,7	6,63,61	4,59	57	55	53	BOSCH	10	9	8	7,6	5	4	3	2



▶ Spark plug color codes: ■ for Iridium Tough and Iridium Plugs and Iridium TT, ■ for Iridium Power, ■ for Iridium Racing and Two Tops Plugs, ■ for Platinum Plugs and Platinum TT, and black for general spark plugs.

DENSO
AUSTRALIA
CHINA
INDIA
INDONESIA
KOREA
MALAYSIA
PHILIPPINES
SINGAPORE
TAIWAN
THAILAND
VIETNAM
EUROPE & USA
MOTOR CYCLE
SMALL ENGINE
CROSS REFERENCE
PART NUMBER

車型	年份	一般	白金				鉦合金性能型	鉦合金耐久型
PEUGEOT								
206 1.4L	2001.01 -	K20PR-U	PK20PR11	IK20TT	K20TT	IK20	VK20	
206 1.6L	1998 -2005	K20TXR	-	IK20TT	K20TT	IK20	VK20	
	2000.01	K20PR-U	PK20PR11	IK20TT	K20TT	IK20	VK20	
206 CC 2.0L	2000.10 -	K16HPR-U11	-	IKH16TT	KH16TT	IKH16	VKH16	
206 SW 1.6L	2001.03	K20HPR-U11	-	IKH20TT	KH20TT	IKH20	VKH20	
306 2.0L	1998.12	K20TXR	-	IK20TT	K20TT	IK20	VK20	
307 1.6L	2001 -2005	K20HPR-U11	-	IKH20TT	KH20TT	IKH20	VKH20	
307 2.0L	2001 -2005	K16HPR-U11	-	IKH16TT	KH16TT	IKH16	VKH16	
307 SW 2.0L	2001.04 -	K16HPR-U11	-	IKH16TT	KH16TT	IKH16	VKH16	
406 2.0L	1995.10 -	K20TXR	-	IK20TT	K20TT	IK20	VK20	
406 3.0L	1996.10 -	K20TXR	-	IK20TT	K20TT	IK20	VK20	
407 2.2L	2005.06	-	-	IKH16TT	-	IKH16	VKH16	
407 3.0L	2005.06	-	-	IKH16TT	-	IKH16	VKH16	
407 SW 2.2L	2005.06	-	-	IKH16TT	-	IKH16	VKH16	
407SW 3.0L	2005.06	-	-	IKH16TT	-	IKH16	VKH16	
607 2.2L	2000.05 -	K16HPR-U11	-	IKH16TT	KH16TT	IKH16	VKH16	
607 3.0L	2000.05 -	-	-	IKH16TT	-	IKH16	VKH16	
807 2.2L	2004 -2005	K16HPR-U11	-	IKH16TT	KH16TT	IKH16	VKH16	
RENAULT								
CLIO 1.4L	2002 -2004	K16PRTU11	-	IK16TT	-	IK16	VK16	
CLIO RS 2.0L	2002 -2004	K20TXR	-	IK20TT	K20TT	IK20	VK20	
ESPACE 2.0L		W16EXR-U	-	IW16TT	W16TT	IW16	VW16	
LAGUNA 2.0L	2002 -2004	K20TXR	-	IK20TT	K20TT	IK20	VK20	
LAGUNA 3.0L	2001 -2004	-	-	IK20TT	-	IK20	VK20	
MAGANE 2.0L	2004.03 -	-	PK22PR8	-	-	IK22	VK22	
SAFRANE 2.5L		Q20R-U	PQ20R	IQ20TT	Q20TT	IQ20	VQ20	
SCENIC 1.6L	1999 -2004	K20TXR	-	IK20TT	K20TT	IK20	VK20	
SCENIC 2.0L	1999 -2004	K20PR-U	PK20PR11	IK20TT	K20TT	IK20	VK20	
SAAB								
900 2.5L	1993 -1998	K20TXR	-	IK20TT	K20TT	IK20	VK20	
900 TURBO 2.0L	1993 -1998	Q22PR-U11	-	-	-	IQ22	VQ22	
900 TURBO 2.3L	1993 -1998	Q22PR-U11	-	-	-	IQ22	VQ22	
9000 2.5/3.0L	1994 -1998	K20TXR	-	IK20TT	K20TT	IK20	VK20	
9000 TURBO 2.0L	1994 -1998	Q22PR-U	-	-	-	IQ22	VQ22	
9000 TURBO 2.3L	1994 -1998	Q22PR-U	-	-	-	IQ22	VQ22	
9-3 AERO TURBO 2.0L	2000 -	-	PK20PR11	IK20TT	-	IK20	VK20	
	1998 -2000	-	PK22PR11	-	-	IK22	VK22	
9-3 AERO TURBO 2.3L	2001 -2002	-	PK20PR11	IK20TT	-	IK20	VK20	
9-3 TURBO 2.3L	2000 -	-	PK22PR11	-	-	IK22	VK22	
9-3SS TURBO 2.0L	2003 -	-	PK20PR-L11	IK20TT	-	IK20	VK20	
9-5 AERO TURBO 2.3L	2000 -	-	PK20PR11	IK20TT	-	IK20	VK20	
	1998 -2000	-	PK22PR11	-	-	IK22	VK22	
9-5 EP TURBO 2.0L	1998 -2000	-	PK22PR11	-	-	IK22	VK22	
SKODA								
FABIA 1.2L	2007 -	KJ20DR-M11	-	IK20TT	-	IK20	VK20	
FABIA 1.4L	2007 -	KJ16CR-L11/ K16GPR-U11	-	-	-	-	VKA16	
OCTAVIA 1.6L		K20PBR-S10	-	IK20TT	K20TT	IK20	VK20	
OCTAVIA 1.8L	2010 -	-	-	-	-	IK22	VK22	
OCTAVIA TURBO 1.8	2009 -	-	-	-	-	IK22	VK22	
OCTAVIA 2.0L	2004 -2010	-	-	-	-	-	VKA16	
SUPRB 1.8L TURBO	2001 -2008	-	PK20PR-P8	IK20TT	-	IK20	VK20Y	
SUPRB 2.8L	2001 -2008	K20TXR	-	IK20TT	K20TT	IK20	VK20	
SUPERB V6 3.6		K20TXR	-	IK20TT	K20TT	IK20	VK20	
YETI 1.2	2009 -	-	-	-	-	IK22	VK22	
SUBARU								
BRZ 2.0L	2012.3 -	ZXE27HBR8	-	-	-	-	VXEBH27	
CASABLANCA 1.8L	1998 -2003	K20PR-U11	PK20PR11	IK20TT	K20TT	IK20	VK20	
FORESTER 2.0L	2000 -2005	-	PK20PR11	IK20TT	-	IK20	VK20	
FORESTER 2.0L TURBO	2000 -2005	-	-	-	-	IK22	VK20Y	
FORESTER 2.5L	2000 -2005	-	PK20PR11	IK20TT	-	IK20	VK20	
FORESTER 2.5L TURBO	2000 -2005	-	-	-	-	IKH22	VKH22	
FORESTER 2.0L FB20(DOHC)	2010 -2012	-	-	IXEH22TT	-	-	VFXEH22	
FORESTER 2.0L FB20	2012 -2013	-	-	IXEH22TT	-	-	VFXEH22	
	2013 -	-	-	IXEH22TT	-	-	VFXEH22	
IMPREZA 1.8L	1998 -2005	K20PR-U11	PK20PR11	IK20TT	K20TT	IK20	VK20	
IMPREZA 2.0L	1998 -2004	K20PR-U11	PK20PR11	IK20TT	K20TT	IK20	VK20	



車型	年份	一般	白金	IRIDIUM	TJ	鍍合金性能型	鍍合金耐久型
SUBARU							
IMPREZA GT 2.0L TURBO	1998 -2005	-	-	-	-	IK22	VK22
IMPREZA WRX 2.5L TURBO	2006 -	-	-	IKH20TT	-	IKH20	VKH20
IMPREZA 1.6L FB16	2011 -2013	-	-	IXEH22TT	-	-	VFXEH22
	2013 -	-	-	IXEH22TT	-	-	VFXEH22
IMPREZA XV HYBRID 2.0L FB20	2013 -	-	-	IXEH22TT	-	-	VFXEH22
LEGACY 2.0L	1999 -2003	K20PR-U11	PK20PR11	IK20TT	K20TT	IK20	VK20
LEGACY 2.2L	1995 -1998	K20PR-U11	PK20PR11	IK20TT	K20TT	IK20	VK20
LEGACY 2.5L	1999 -2003	K20PR-U11	PK20PR11	IK20TT	K20TT	IK20	VK20
LEGACY 2.5L FB25	2012 -	-	-	IXEH22TT	-	-	VFXEH22
OUTBACK 2.5L	1999 -2003	K20PR-U11	PK20PR11	IK20TT	K20TT	IK20	VK20
OUTBACK 3.0L	2005.02 -	-	-	IKH20TT	-	IKH20	VKH20
SUZUKI							
ALTO 1.0 (K10B)	2009 -	ZXU20PR11	-	-	-	-	-
CARRY 1.3L	2000 -2005	K20PR-U	PK20PR11	IK20TT	K20TT	IK20	VK20
CULTUS 1.3L	1993 -1999	W20EPR-U	-	IW20TT	W20TT	IW20	VW20
ESCUDO 1.6	2001 -2005	W16EXR-U	-	IW16TT	W16TT	IW16	VW16
ESCUDO 1.6L	1993 -2001	K20PR-U	PK20PR11	IK20TT	K20TT	IK20	VK20
ESTEEN 1.6L	1995 -2002	K20PR-U	PK20PR11	IK20TT	K20TT	IK20	VK20
EVERY 1.3L	2000 -2005	K20PR-U	PK20PR11	IK20TT	K20TT	IK20	VK20
GRAND VITARA 2.0L/2.5L/2.7L	1999 -2005	K20PR-U11	PK20PR11	IK20TT	K20TT	IK20	VK20
IGNIS 1.3L	2001 -2004	K20PR-U11	PK20PR11	IK20TT	K20TT	IK20	VK20
JIMNY 1.3L	2001 -2005	K20PR-U	PK20PR11	IK20TT	K20TT	IK20	VK20
		K20PR-U11	PK20PR11	IK20TT	K20TT	IK20	VK20
LANDY 1.3L	2000 -2005	K20PR-U	PK20PR11	IK20TT	K20TT	IK20	VK20
LIANA 1.6L	2004 -2005	K20PR-U11	PK20PR11	IK20TT	K20TT	IK20	VK20
SOLIO 1.3L	2002 -2005	K20PR-U11	PK20PR11	IK20TT	K20TT	IK20	VK20
SWIFT 1.2(K12B)	2014 -	ZXU20PR11	-	-	-	-	VXU20
SWIFT 1.4L(K14B)	2011.04	-	-	IKH20TT	-	IKH20	VKH20
SWIFT 1.5L	2005.1	K20PR-U11	PK20PR11	IK20TT	K20TT	IK20	VK20
SWIFT 1.6L(ZC32S)	2012.03	-	-	IKH20TT	-	IKH20	VKH20
SWIFT 1.6L SPORT	2013 -2015	-	-	IKH20TT	-	IKH20	VKH20
SX4 4D 1.6 (M16A)	2006 -2011	SVK20RZ11	-	IK20TT	-	IK20	VK20
SX4 5D 1.6 (M16A)	2006 -2011	SVK20RZ11	-	IK20TT	-	IK20	VK20
SX4 1.6L (M16A)	2011 -2014	K16HPR-U11	-	IKH16TT	KH16TT	IKH16	VKH16
VITARA 1.6L	1993 -2001	K20PR-U	PK20PR11	IK20TT	K20TT	IK20	VK20
	2001 -2005	W16EXR-U	-	IW16TT	W16TT	IW16	VW16
TOBE							
M car 1.3L	2010	K16R-U	PK16R11	IK16TT	K16TT	IK16	VK16
TOYOTA							
ALPHARD	2010	SK20R11	-	IK20TT	-	IK20	VK20
ALPHARD 3.5L	2015 -	FK20HR11	-	IKH20TT	-	-	VFKH20
AVALON 3.0L	1994.09	K20R11	PK20R11	IK20TT	K20TT	IK20	VK20
	1995.08	K20TR11	PK20TR11	IK20TT	K20TT	IK20	VK20
CAMRY 2.0L	1988.07	Q16R-U11	PQ16R	IQ16TT	Q16TT	IQ16	VQ16
	2004.09	SK20R11	-	IK20TT	-	IK20	VK20
CAMRY 2.2L	1991.09	K20R-U11	PK20R11	IK20TT	K20TT	IK20	VK20
CAMRY 2.5L	1989.09	-	PQ20R	IQ20TT	Q20TT	IQ20	VQ20
CAMRY 3.0L	2004.09	SK20R11	-	IK20TT	-	IK20	VK20
CAMRY 3.0L V6	1993.09	K20R-U11	PK20R11	IK20TT	K20TT	IK20	VK20
	1995.08	K20TR11	PK20TR11	IK20TT	K20TT	IK20	VK20
	1991.09	-	PQ20R	IQ20TT	Q20TT	IQ20	VQ20
CAMRY 2.5L	2011.12	SK16HR11	-	IKH16TT	-	IKH16	VKH16
NEW CAMRY 2.0/2.4	2006.06	SK20R11	-	IK20TT	-	IK20	VK20
NEW CAMRY 3.5	2006.06	FK20HR11	-	IKH20TT	-	-	VFKH20
CAMRY HYBRID 2.5G/2.5V	2012.02	FK16HR-A8	-	IKH16TT	-	-	-
CAMRY 2.0	2015 -	FK16HBRJ8	-	-	-	-	-
CELICA 2.2L	1993.09	K20R-U11	PK20R11	IK20TT	K20TT	IK20	VK20
COROLLA 1.6/1.8L	1992.09	K16R-U	PK16R11	IK16TT	K16TT	IK16	VK16
	1988.09	Q16R-U11	PQ16R	IQ16TT	Q16TT	IQ16	VQ16
COROLLA ALTIS 1.6L	2003.1	K16R-U11	PK16R11	IK16TT	K16TT	IK16	VK16
COROLLA ALTIS 1.8L	2003.1	K16R-U11	PK16R11	IK16TT	K16TT	IK16	VK16
COROLLA ALTIS 1.8	2013.1	SC20HR11	-	-	-	-	VCH20
COROLLA ALTIS 2.0	2008.11	SC20HR11	-	-	-	-	VCH20
COROLLA ALTIS 1.8	2008.11 -	SC20HR11	-	-	-	-	VCH20
COROLLA X	2015 -	SC16HR11	-	-	-	-	VCH16
CORONA 1.6L	1991.04	Q16R-U	PQ16R	IQ16TT	Q16TT	IQ16	VQ16
	1989.02	QJ16AR-U	-	IQ16TT	-	IQ16	VQ16

DENSO
AUSTRALIA CHINA
INDIA
INDONESIA
KOREA
MALAYSIA
PHILIPPINES
SAUDI ARABIA
SINGAPORE
TAIWAN
THAILAND
VIETNAM
JAPAN
& USA
EUROPE
MOTOR
CYCLE
SMALL
ENGINE
REFERENCE
NUMBER
PART

DENSO	9	14	16	20	22	24	27	29	31	32	34	35	DENSO	9	14	16	20	22	24	27	29	31	32	DENSO	9	14	16	20	22	24	27	31
NGK	2	4	5	6	7	8	9	9.5	10	10.5	11	11.5	CHAMPION	18	16,14	12,11	10,9	8,7	6,63,61	4,59	57	55	53	BOSCH	10	9	8	7,6	5	4	3	2



▶ Spark plug color codes: ■ for Iridium Tough and Iridium Plugs and Iridium TT, ■ for Iridium Power, ■ for Iridium Racing and Two Tops Plugs, ■ for Platinum Plugs and Platinum TT, and black for general spark plugs.

DENSO**CHINA AUSTRALIA****INDIA****INDONESIA****KOREA****MALAYSIA****PHILIPPINES****SAUDI ARABIA****SINGAPORE****TAIWAN****THAILAND****VIETNAM****JAPAN****EUROPE & USA****MOTOR CYCLE****SMALL ENGINE****CROSS REFERENCE****PART NUMBER**

車型	年份	一般	白金				鈦合金性能型	鈦合金耐久型
TOYOTA								
CORONA 2.0L	1989.02	Q20R-U11	PQ20R	IQ20TT	Q20TT	IQ20	VQ20	
EXSIOR 1.6L	1993.1	K20R-U11	PK20R11	IK20TT	K20TT	IK20	VK20	
EXSIOR 2.0L	1993.1	K20R-U11	PK20R11	IK20TT	K20TT	IK20	VK20	
GOA CAMRY 2.2L	1996.07	-	PK20TR11	IK20TT	-	IK20	VK20	
GOA CAMRY 3.0L V6	1996.07	-	PK20TR11	IK20TT	-	IK20	VK20	
GOA COROLLA 1.8L	1999.08	SK16R11	-	IK16TT	-	IK16	VK16	
GOA COROLLA 1.8L	1997.08	K16TR11	PK16TR11	IK16TT	K16TT	IK16	VK16	
HIACE SOLEMIO 2.7L	1999.06	SK16R-P8	-	IK16TT	-	IK16	VK16	
INNOVA 2.7L	2007.06	SK20HR11	-	IKH20TT	-	IKH20	VKH20	
PREMIO 1.6L	1997.1	K16R-U	PK16R11	IK16TT	K16TT	IK16	VK16	
PREMIO 2.0L	1997.1	-	PK20TR11	IK20TT	-	IK20	VK20	
PREVIA	2000.02	K20R-U11	PK20R11	IK20TT	K20TT	IK20	VK20	
PREVIA 3.5	2000.02	FK20HR11	-	IKH20TT	-	-	VFKH20	
RAV 4	1997.09	-	PK20TR11	IK20TT	-	IK20	VK20	
	1995.11	-	PK20R11	IK20TT	-	IK20	VK20	
	2008.08	SK20R11	-	IK20TT	-	IK20	VK20	
SURF 2.4L	1999.11	-	P16R	IW16TT	-	IW16	VW16	
TERCEL 1.3L	1995.11	K16R-U	PK16R11	IK16TT	K16TT	IK16	VK16	
TERCEL 1.5L	1995.11	K16R-U	PK16R11	IK16TT	K16TT	IK16	VK16	
VIOS 1.5L	2003.03	K16R-U	PK16R	IK16TT	K16TT	IK16	VK16	
VIOS 1.5	2008.01	SK16R11	-	IK16TT	-	IK16	VK16	
	2014.12	SK16R11	-	IK16TT	-	IK16	VK16	
WISH 2.0L	2004.09	SK20R11	-	IK20TT	-	IK20	VK20	
WISH 2.0	2009.11	SC20HR11	-	-	-	-	VCH20	
YARIS	2006.11	K16R-U	-	IK16TT	K16TT	IK16	VK16	
	2014	SK16R11	-	IK16TT	-	IK16	VK16	
SIENNA 3.5L	2016	FK20HR11	-	IK20TT	-	-	VFKH20	
SIENTA 1.5L & 1.8L	2016	SC16HR11	-	-	-	-	VCH16	
ZACE 1.5L	1992.05	J16B-U11	-	-	-	-	-	
	1996.03	W16EX-U	-	IW16TT	W16TT	IW16	VW16	
ZACE 1.8L	2003.1	-	P16R8 (PW16TT)	IW16TT	-	IW16	VW16	
ZACE 2.4L	2003.1	-	P16R	IW16TT	-	IW16	VW16	
LAND CRUISE PRADO	2009.09	SK20HR11	-	IKH20TT	-	IKH20	VKH20	
PRIUS	2005.07 - 2009.03	SK16R11	-	IK16TT	-	IK16	VK16	
	2010.12 -	SC20HR11	-	-	-	-	VCH20	
GT86		ZXE27HBR8	-	-	-	-	VXEBH27	
VOLKSWAGEN								
BEETLE 1.6L	2001 - 2005	K20PBR510	-	IK20TT	K20TT	IK20	VK20	
BEETLE 1.8T	2001 - 2005	K20PBR510	-	IK20TT	K20TT	IK20	VK20	
BEETLE 2.0L	2000 - 2002	K20PBR510	-	IK20TT	K20TT	IK20	VK20	
BORA 1.6L	2001 - 2005	K20PBR510	-	IK20TT	K20TT	IK20	VK20	
BORA 2.0L	2000 - 2002	K20PBR510	-	IK20TT	K20TT	IK20	VK20	
BORA 2.3L	2000.09 -	-	PKJ16CR-L11	IK16TT	-	IK16L	VK16	
	2001 - 2002	-	PKJ16CRL11	IK16TT	-	IK16L	VK16	
GOLF 1.6L	1999 - 2005	K20PBR510	-	IK20TT	K20TT	IK20	VK20	
GOLF 2.0L	2000 - 2002	K20PBR510	-	IK20TT	K20TT	IK20	VK20	
GOLF 2.3L	2001 - 2003	-	PKJ16CRL11	IK16TT	-	IK16L	VK16	
GOLF GLI 1.8L	1996 - 2000	W20EPBRS	-	IW20TT	W20TT	IW20	VW20	
GOLF GLI 2.0L	1996 - 1999	W20EPBRS	-	IW20TT	W20TT	IW20	VW20	
GOLF GTI 1.8L	2000 - 2004	K20PBR510	-	IK20TT	K20TT	IK20	VK20	
GOLF R32 3.2L	2002.06 -	-	-	-	-	IXU22	VXU22	
LUPO 1.4L	2000 - 2005	K20PBR510	-	IK20TT	K20TT	IK20	VK20	
LUPO GTI 1.6L	2003 - 2005	K20PBR510	-	IK20TT	K20TT	IK20	VK20	
PASSAT 1.8L	1998 - 2001	K20PBR510	-	IK20TT	K20TT	IK20	VK20	
PASSAT 1.8T	2001 - 2005	W20EPBRS	-	IW20TT	W20TT	IW20	VW20	
	1998 - 2001	-	PKJ16CRL11	IK16TT	-	IK16L	VK16	
PASSAT 2.0L	1996 - 1999	W16ETRS	-	IW16TT	W16TT	IW16	VW16	
PASSAT B5 2.3L	2000 - 2001	K20TXR	-	IK20TT	K20TT	IK20	VK20	
PASSAT GP 2.0L	2001 - 2005	K20PBR510	-	IK20TT	K20TT	IK20	VK20	
PASSAT GP 2.3L	2002 - 2004	K20TXR	-	IK20TT	K20TT	IK20	VK20	
PASSAT GP 2.8L	1999 - 2004	K20PBR510	-	IK20TT	K20TT	IK20	VK20	
PASSAT W8 4.0L	2002 - 2003	K20TXR	-	IK20TT	K20TT	IK20	VK20	
PHAETON 3.2L	2002.05 -	-	-	-	-	IXU22	VXU22	
POLO 1.4L	1999.10 -	K20PBR-S10	-	IK20TT	K20TT	IK20	VK20	
	1995.07 -	W20EPBRS	-	IW20TT	W20TT	IW20	VW20	
	2005.08 -	PK20PR-P8	-	IK20TT	-	IK20	VK20Y	
POLO 1.6L	1999.10 -	K20PBR-S10	-	IK20TT	K20TT	IK20	VK20	



車型	年份	一般	白金	IRIDIUM	TJJ	鈦合金性能型	鈦合金耐久型
VOLKSWAGEN							
POLO 1.6L	1999.04-	W20EPBRS	-	IW20TT	W20TT	IW20	VW20
SHARAN 2.8L	2000.04-	-	PKJ16CR-L11	IK16TT	-	IK16L	VK16
T-4 2.0L	1992 -	W20EPBRS	-	IW20TT	W20TT	IW20	VW20
T-4 2.8L	1998 -	K20TXR	-	IK20TT	K20TT	IK20	VK20
T5 2.3L		-	PKJ16CR-L11	IK16TT	-	IK16L	VK16
TOUAREG 3.2L	2004.05-	-	-	-	-	IXU22	VXU22
TOUAREG 4.2L	2003.04	K20TXR	-	IK20TT	K20TT	IK20	VK20
VENTO 1.8L	1996 -1998	W20EPBRS	-	IW20TT	W20TT	IW20	VW20
VENTO 2.0L	1996 -1999	W20EPBRS	-	IW20TT	W20TT	IW20	VW20
VOLVO							
70XC 2.3T	2001 -2005	-	-	-	-	IK22	VK22
850 2.3T	1993 -1995	-	-	-	-	IK22	VK22
850 2.4L	1993 -1996	K20PR-U	PK20PR11	IK20TT	K20TT	IK20	VK20
940 2.3L	1990 -1997	W20EPR-U	-	IW20TT	W20TT	IW20	VW20
960 2.5L	1995 -1997	-	-	IK20TT	-	IK20	VK20
C70 2.3T	1997 -2002	-	-	-	-	IK22	VK22
C70 2.4T	2004 -2005	-	-	-	-	IK22	VK22
S40 1.8L	1996 -1999	K20PBR	-	IK20TT	K20TT	IK20	VK20
S40 1.9T	2000 -	-	-	-	-	IK22	VK22
S40 2.0L	2000 -2005	K20PBR	-	IK20TT	K20TT	IK20	VK20
S40 2.0T	2000 -2005	-	-	-	-	IK22	VK22
	1998 -1999	-	-	-	-	IK22	VK22
S40 2.4L	2004 -2005	-	-	-	-	IKH22	VKH22
S40 2.5T	2004 -2005	-	-	-	-	IKH22	VKH22
S60 2.0T	2000 -2005	-	-	-	-	IK22	VK22
S60 T5 2.3L	2000 -2005	-	-	-	-	IK22	VK22
S60R 2.5T	2004 -2005	-	-	-	-	IKH22	VKH22
S70 2.0L	1997 -1999	-	-	IK20TT	-	IK20	VK20
S70 2.0T	1997 -1998	-	-	-	-	IK22	VK22
S70 2.3T	1997 -2001	-	-	-	-	IK22	VK22
S70 2.5L	1997 -1998	-	-	IK20TT	-	IK20	VK20
S80 2.5L	1998 -2004	-	-	IK20TT	-	IK20	VK20
S80 T5 2.0L	2004 -	-	-	IK20TT	-	IK20	VK20
S80 T6 2.8L	1998 -2004	-	-	-	-	IK22	VK22
S80 T6 3.0L	1998 -2004	-	-	-	-	IK22	VK22
S90 2.5L	1997 -1998	-	-	IK20TT	-	IK20	VK20
S90 3.0L	1997 -1998	-	-	IK20TT	-	IK20	VK20
V40 1.8L	1996 -1999	K20PBR	-	IK20TT	K20TT	IK20	VK20
V40 2.0L	2000 -2005	K20PBR	-	IK20TT	K20TT	IK20	VK20
V40 2.0T	2000 -2005	-	-	-	-	IK22	VK22
V50 2.5T	2004 -2005	-	-	-	-	IKH22	VKH22
V70 2.0L	1997 -1999	-	-	IK20TT	-	IK20	VK20
V70 2.0T	1997 -2005	-	-	-	-	IK22	VK22
V70 2.3T	2001 -2005	-	-	-	-	IK22	VK22
	1997 -2001	-	-	-	-	IK22	VK22
V70 2.5T	2004 -2005	-	-	-	-	IK22	VK22
V70R 2.5T	2004 -2005	-	-	-	-	IKH22	VKH22
V7XC 2.4L	2002 -	-	-	-	-	IK22	VK22
XC70 2.5T	2002.09-	-	-	-	-	IK22	VK22
XC90 2.5T	2003 -2005	-	-	-	-	IK22	VK22
XC90 4.5L	2004.11	-	-	-	-	IK22	VK22
XC90 T6 3.0L	2003 -2005	-	-	-	-	IK22	VK22

DENSO

AUSTRALIA CHINA

INDIA

INDONESIA

KOREA

MALAYSIA

PHILIPPINES

SAUDIARABIA

SINGAPORE

TAIWAN

THAILAND

VIETNAM

JAPAN

EUROPE

MOTOR

SMALL

CROSS

PART

DENSO	9	14	16	20	22	24	27	29	31	32	34	35
NGK	2	4	5	6	7	8	9	9.5	10	10.5	11	11.5

DENSO	9	14	16	20	22	24	27	29	31	32
CHAMPION	18	16,14	12,11	10,9	8,7	6,63,61	4,59	57	55	53

DENSO	9	14	16	20	22	24	27	31
BOSCH	10	9	8	7,6	5	4	3	2



DENSO

CHINA AUSTRALIA

INDIA

INDONESIA

KOREA

PHILIPPINES MALAYSIA

SINGAPORE SAUDARABIA

TAIWAN

THAILAND

VIETNAM

JAPAN

EUROPE & USA

CYCLE

SMALL MOTOR ENGINE

CROSS REFERENCE

PART NUMBER

MODEL	DENSO	IRIDIUM POWER	IRIDIUM RACING
HARTFORD			
MAGIC 125	U22FSR-U	IUF22	-
VR 125/150/200	X24ESR-U	IX24	IXU01-□
雲豹 125/150/200	X24ESR-U	IX24	IXU01-□
KYMCO			
4V三冠王 125	U22ES-N	IU22	IU01-□
	U22ESR-N	IU22	IU01-□
AIR 150	U22ESR-N	IU22	IU01-□
A博士 150	U22ES-N	IU22	IU01-□
CHERRY 100Fi	U22FSR-U	IUF22	-
CHERRY 50/100	U22FS-U	IUF22	-
DINK 頂客 150	U22ES-N	IU22	IU01-□
DINK 頂客 180/180 Fi	X20EPR-U9	-	-
DINK 頂客 180/300	X20EPR-U9	-	-
DINK 頂客 250	X22EPR-U9	IX22B	IXU01-□
EASY 100 Fi	U22FSR-U	IUF22	-
EASY 4U 50/100	U20FS-U	IUF22	-
Ego 125	X22EP-U9	IX22B	IXU01-□
Ego 250	X22EPR-U9	IX22B	IXU01-□
G6 125/150	U22ESR-N	IU22	IU01-□
GOING 100/50	W24FR-L	IWF24	-
GP 125 Fi(M2)	U20FS-U	IUF22	-
GP 125 Fi(M3A)	U22ESR-N	IU22	IU01-□
HIPSTER 勁暴 150	X24ES-U	IX24	IXU01-□
IDOL 100	W20FR-L	IWF20	-
IDOL 50	W24FR-L	IWF24	-
J-POP 50/70/100	U20FSR-U	IUF22	-
JR 100	U20FS-U	IUF22	-
JR 100 Fi	U20FSR-U	IUF22	-
KIWI 50/70/100	U20FS-U	IUF22	-
KTR 125/150/150Fi	U22ESR-N	IU22	IU01-□
KTR 150 Fi	U22ESR-N	IU22	IU01-□
KTR 150/125	U22ESR-N	IU22	IU01-□
MANBOY 90	W20FR-L	IWF20	-
MANY 50/100/110 Fi	U22ESR-N	IU22	IU01-□
MAXXER 300	X22EPR-U9	IX22B	IXU01-□
MONGOOSE 90	U20FS-U	IUF22	-
MXER 150	X24ESR-U	IX24	IXU01-□
MXU 150	X24ESR-U	IX24	IXU01-□
MXU 250/300	X22EPR-U9	IX22B	IXU01-□
Myroad 700	U24ESR-N	IU24	IU01-□
Nikita 300Fi	U22ESR-N	IU22	IU01-□
NSR150	W24ES-U	IWF24	IWF01-□
QUANNON 150 Fi	U22ESR-N	IU22	IU01-□
Racing 125/150 Fi	U22ESR-N	IU22	IU01-□
Racing King 125/180 Fi	U22ESR-N	IU22	IU01-□
SHADOW 300i	U22ESR-N	IU22	IU01-□
SO EASY 100Fi	U22FSR-U	IUF22	-
STRYKER 150	X24ESR-U	IX24	IXU01-□
TECHNO 150	U20FS-U	IUF22	-
TECHNO GT 125	U22ESR-N	IU22	IU01-□
TOPBOY 100	W20FR-L	IWF20	-
V1 125 Fi	U22ESR-N	IU22	IU01-□
V1 150 Fi	U22FSR-U	IUF22	-
VENOX 250	U24ESR-N	IU24	IU01-□
VENOX 250Fi	U24ESR-N	IU24	IU01-□
VJR 110	U22ESR-N	IU22	IU01-□
VJR 50/100 FI	U22ESR-N	IU22	IU01-□
VP 125	U22ESR-N	IU22	IU01-□
XCITING 250/500	U22ESR-N	IU22	IU01-□
XCITING R 250Fi	X20EPR-U9	-	-
XCTING 400/500	U22ESR-N	IU22	IU01-□
X-MODE 100 KDI	KJ20CR-L11	IK20L	IK01-□
YOUNG UP90	W20FR-L	IWF20	-
ZAP 50	W24FR-L	IWF24	-
三冠王 125 Fi	U20FSR-U	IUF22	-
三冠王 125/150	U22FSR-U	IUF22	-
小如意 125	U20FS-U	IUF22	-

MODEL	DENSO	IRIDIUM POWER	IRIDIUM RACING
KYMCO			
小奔騰 V-LINK 125	U22ESR-N	IU22	IU01-□
名流 150	U22ES-N	IU22	IU01-□
奔馳 125	U20FS-U	IUF22	-
奔騰 125	U20FS-U	IUF22	-
奔騰 G4 SR 125 Fi(M2)	U20FS-U	IUF22	-
奔騰 G4 SR 125(M3A)	U22ESR-N	IU22	IU01-□
奔騰 G4 SR125	U22ESR-N	IU22	IU01-□
奔騰 G5 125	U22ESR-N	IU22	IU01-□
奔騰 G5 125/150 Fi	U22ESR-N	IU22	IU01-□
金勇 125/150	X22ES-U	IX22	IXU01-□
金牌 125	U20FS-U	IUF22	-
金牌 125 Fi	U22ESR-N	IU22	IU01-□
金牌 150	U22FSR-U	IUF22	-
金翔鶴 100	W20FR-L	IWF20	-
金豪美 50	W24FR-L	IWF24	-
勁 150	X22ES-U	IX22	IXU01-□
勁多利 150Fi	U22ESR-N	IU22	IU01-□
得意 100	U20FS-U	IUF22	-
頂尖豪邁 125	U20FS-U	IUF22	-
翔羚 100	W20FR-L	IWF20	-
搜索者 150	X24ESR-U	IX24	IXU01-□
新翔鶴 100	W20FR-L	IWF20	-
新翔鶴 50	W24FR-L	IWF24	-
豪爽 150	U20FS-U	IUF22	-
豪漢 150/125	U20FS-U	IUF22	-
豪邁 125	U20FS-U	IUF22	-
豪邁 50	U20FS-U	IUF22	-
豪邁如意 125	U20FS-U	IUF22	-
鐵克諾 150	U20FS-U	IUF22	-
鐵克諾 GT 125 Fi	U22ESR-N	IU22	IU01-□
鐵漢 150	X22ES-U	IX22	IXU01-□
PGO			
BUBU 100	U22FS-U	IUF22	-
BUBU 125	U22FS-U	IUF22	-
CHARGE 噴射王 125	U22ESR-N	IU22	IU01-□
COMET 50	W20FP-U	IWF20	-
G-MAX 125/150	U22FSR-U	IUF22	-
G-MAX 150(水冷)/200/220	U22ESR-N	IU22	IU01-□
HOT 100	W20FP-U	IWF20	-
HOT 90/50	W20FP-U	IWF20	-
I BUBU 125	U20FSR-U	IUF22	-
I-CHARGE 125	U22FS-U	IUF22	-
J BUBU 115	U22ESR-N	IU22	IU01-□
MY BUBU 125/100	U22FS-U	IUF22	-
PMX 90/50	W20FP-U	IWF20	-
SUPPORT 50	W20FP-U	IWF20	-
TIGRA 125/150/150 ABS	U22ESR-N	IU22	IU01-□
TORNADO 90/50	W20FP-U	IWF20	-
X-HOT 125	U22FSR-U	IUF22	-
X-HOT S 150	U22ESR-N	IU22	IU01-□
YOUNG BUBU 125	U22FSR-U	IUF22	-
大驛 150/125	U22FS-U	IUF22	-
快活 110	W20FP-U	IWF20	-
恰吉 125	U22FS-U	IUF22	-
馬路秀 90/50	W20FP-U	IWF20	-
SUZUKI			
ADDRESS V 125	U20FSR-U	IUF22	-
ADRESS V 125	U20FSR-U	IUF22	-
AH 125 TD	U24ESR-N	IU24	IU01-□
AN 250/400	U22ESR-N	IU22	IU01-□
BURGMAN 650	U24ESR-N	IU24	IU01-□
CHOINORI 50	U20FSR-U	IUF22	-
DAO 100	U22ES-N	IU22	IU01-□
GS 150 R	X24ESR-U	IX24	IXU01-□
GSX 1300 R 隼	U27ESR-N	IU27	IU01-□
JAJA 50	W20FP-U	IWF20	-
NEX 125	U20FSR-U	IUF22	-







MODEL	DENSO	IRIDIUM POWER	IRIDIUM RACING	MODEL	DENSO	IRIDIUM POWER	IRIDIUM RACING
SUZUKI				SYM			
RG 125 R	W24EP-U	IW24	IW01-□	RS21 150	U22ES-N	IU22	IU01-□
RG 50 R	W24EP-U	IW24	IW01-□	RS21 150 EFi	U22ESR-N	IU22	IU01-□
SV 1000/S	U22ESR-N	IU22	IU01-□	RV 150	U22ES-N	IU22	IU01-□
SWING 125	U22ES-N	IU22	IU01-□	RV 150/180/250	U22ESR-N	IU22	IU01-□
TU 250 G	X24ESR-U	IX24	IXU01-□	RV 180 EFi	U20FSR-U	IUF22	-
UT 125	U20FSR-U	IUF22	-	RX110	U20FSR-U	IUF22	-
UZ 125	U20FSR-U	IUF22	-	RX110/EFi	U22FSR-U	IUF22	-
X5-D(蛋蛋車)	U20FSR-U	IUF22	-	T1	X22EPR-U9	IX22B	IXU01-□
XR 125	U22ES-N	IU22	IU01-□	tini 100	U22FSR-U	IUF22	-
XZR 100/125	U22ES-N	IU22	IU01-□	WOO 100	U20FSR-U	IUF22	-
X星艦 125	U22ES-N	IU22	IU01-□	WOWOW 100	U20FSR-U	IUF22	-
X星艦 125(噴射)	U22ESR-N	IU22	IU01-□	X'PRO 125R EFi	U22FSR-U	IUF22	-
天箭 50	W20FP-U	IWF20	-	X'PRO125/100/50	U20FS-U	IUF22	-
幻象 50	W20FP-U	IWF20	-	Z1 125	U22FSR-U	IUF22	-
幻象星艦 125	U22ES-N	IU22	IU01-□	心情100	U20FSR-U	IUF22	-
快樂星艦 100	U22ES-N	IU22	IU01-□	心情125	U20FS-U	IUF22	-
金贏家 100	W20FP-U	IWF20	-	來電100	U20FS-U	IUF22	-
青蜂 50	W20FP-U	IWF20	-	金旺100/90/80	U20FS-U	IUF22	-
勇力 125	W20FP-U	IWF20	-	金發財 125 EFi	U22FSR-U	IUF22	-
星河 100	U22ES-N	IU22	IU01-□	阿帝拉125	U20FS-U	IUF22	-
飛翔星艦 150	U22ES-N	IU22	IU01-□	活力心情125	U20FSR-U	IUF22	-
清雲 100	W20FP-U	IWF20	-	迪迪50	W24FR-L	IWF24	-
莎比亞 100	W20FP-U	IWF20	-	迪飛125	W20FP-U	IWF20	-
莎比亞 50	W20FP-U	IWF20	-	迪爵125	U20FS-U	IUF22	-
晶鑽 100	U22ES-N	IU22	IU01-□	風 100/50	U20FS-U	IUF22	-
開朗 90	W20FP-U	IWF20	-	風 100/50 EFi	U20FSR-U	IUF22	-
雄獅 125	W20FP-U	IWF20	-	風尚50	W24FR-L	IWF24	-
愛神 50	W20FP-U	IWF20	-	風動100	W20FR-L	IWF20	-
新象 50	W20FP-U	IWF20	-	風動50	W24FR-L	IWF24	-
新貴 50	W20FP-U	IWF20	-	風梭110	W20FP-U	IWF20	-
新潮流 50	W20FP-U	IWF20	-	風速125	W20FP-U	IWF20	-
極速星艦 150	U22ES-N	IU22	IU01-□	風雲125	U20FS-U	IUF22	-
雷霆 125	W20FP-U	IWF20	-	飛馳100	W20FR-L	IWF20	-
銀河 GSR 125/150	U22ES-N	IU22	IU01-□	飛馳50	W24FR-L	IWF24	-
歐風 100	W20FP-U	IWF20	-	悍將 125	U22ES-N	IU22	IU01-□
歐風 50	W20FP-U	IWF20	-	悍將 F1 125	U22ES-N	IU22	IU01-□
遨遊星艦 125	U22ES-N	IU22	IU01-□	悍將 4V 150	U22ESR-N	IU22	IU01-□
駿 50	W20FP-U	IWF20	-	悍將 FIGHTER 125 EFi	U22ESR-N	IU22	IU01-□
麗仕 50	W20FPR-U	IWF20	-	捍衛巡戈125	U20FS-U	IUF22	-
鐵拳 TEKKEN 125	U20FSR-U	IUF22	-	高手100	U20FSR-U	IUF22	-
霹靂星艦 125/150	U22ES-N	IU22	IU01-□	高手125	U20FSR-U	IUF22	-
SYM				VESPA			
4V 悍將 125/150 EFi	U22ES-N	IU22	IU01-□	ET-8 80	U22ES-N	IU22	IU01-□
4V 悍將 150ZR/DX	U22ES-N	IU22	IU01-□	PX150E	W20EP-U	IW20	IW01-□
CHA CHA 50	W24FR-L	IWF24	-	T5 50	W20EP-U	IW20	IW01-□
CHA CHA100/90	W20FR-L	IWF20	-	速飛樂80	W24ES-U	IW24	IW01-□
DIO100	W20FR-L	IWF20	-	YAMAHA			
DIO50	W24FR-L	IWF24	-	BIANCO 125	U22ESR-N	IU22	IU01-□
FIDDLE50	W24FR-L	IWF24	-	BW'S 100/50	W20FP-U10	IWF20	-
GR 125	U22FSR-U	IUF22	-	BW'S 125 FI	U22ESR-N	IU22	IU01-□
GT 125 EFi/150 EFi	U22FSR-U	IUF22	-	BW'S 125 X Fi	U22ESR-N	IU22	IU01-□
GTS 300i	U24ESR-N	IU24	IU01-□				
HUSKY150	X22ES-U	IX22	IXU01-□				
IRX 115	U22ESR-N	IU22	IU01-□				
JET POWER 125 EFi	U22ESR-N	IU22	IU01-□				
JET100	W20FR-L	IWF20	-				
JET50	W24FR-L	IWF24	-				
MAXSYM 400i	U24ESR-N	IU24	IU01-□				
Mii 110	U22FSR-U	IUF22	-				
MIO 100/50	U20FS-U	IUF22	-				
NEW FIGHTER 150 EFi	U22ESR-N	IU22	IU01-□				
PARTY100/50	U20FS-U	IUF22	-				
R1 100/50	U20FS-U	IUF22	-				
R1 125	U22ES-N	IU22	IU01-□				
R1 150	U20FSR-U	IUF22	-				
R1-2 100	U20FS-U	IUF22	-				
R1Z125精裝版/噴射	U20FSR-U	IUF22	-				

DENSO
 AUSTRALIA CHINA INDIA INDONESIA KOREA MALAYSIA PHILIPPINES SAUDIARABIA SINGAPORE TAIWAN THAILAND VIETNAM JAPAN & USA EUROPE MOTOR CYCLE SMALL ENGINE REFERENCE NUMBER PART

DENSO	9	14	16	20	22	24	27	29	31	32	DENSO	9	14	16	20	22	24	27	31	32	DENSO	9	14	16	20	22	24	27	31			
NGK	2	4	5	6	7	8	9	9.5	10	10.5	11	11.5	CHAMPION	18	16,14	12,11	10,9	8,7	6,63,61	4,59	57	55	53	BOSCH	10	9	8	7,6	5	4	3	2



PART NUMBER	CROSS REFERENCE	SMALL ENGINE	MOTOR CYCLE	EUROPE & USA	JAPAN	VIETNAM	THAILAND	TAIWAN	SINGAPORE	SAUDI ARABIA	PHILIPPINES	MALAYSIA	INDONESIA	INDIA	CHINA	AUSTRALIA	DENSPO	IRIDIUM		
																		POWER	RACING	
YAMAHA																				
																		U20FS-U	IUF22	-
																		U20FSR-U	IUF22	-
																		U20FSR-U	IUF22	-
																		U22ESR-N	IU22	IU01-□
																		U22ESR-N	IU22	IU01-□
																		U22ESR-N	IU22	IU01-□
																		U22ESR-N	IU22	IU01-□
																		X24ES-U	IX24	IXU01-□
																		U20ESR-N	IU20	IU01-□
																		U20FS-U	IUF22	-
																		U20FS-U	IUF22	-
																		U22ES-N	IU22	IU01-□
																		U22ES-N	IU22	IU01-□
																		W20FP-U10	IWF20	-
																		U22ES-N	IU22	IU01-□
																		U22ES-N	IU22	IU01-□
																		U20ESR-N	IU20	IU01-□
																		W20FP-U10	IWF20	-
																		U22ES-N	IU22	IU01-□
																		U22ES-N	IU22	IU01-□
																		U22ES-N	IU22	IU01-□
																		W20FP-U10	IWF20	-
																		W20FP-U10	IWF20	-
																		W20FP-U	IWF20	-
																		U22ES-N	IU22	IU01-□
																		U22ES-N	IU22	IU01-□
																		W20FP-U	IWF20	-
																		W24EP-U	IW24	IW01-□
																		W20FP-U10	IWF20	-
																		U22ES-N	IU22	IU01-□
																		W20FP-U10	IWF20	-
																		X24ES-U	IX24	IXU01-□
																		U22ES-N	IU22	IU01-□

MODEL	YEAR	CODE	DENSO				
Alfa Romeo							
156			-	-	-	IU22	-
Audi							
80			K20PBR-S10	IK20TT	K20TT	IK20	VK20
100			K20PBR-S10	IK20TT	K20TT	IK20	VK20
A3			K20PBR-S10	IK20TT	K20TT	IK20	VK20
A4 1.8			K20PBR-S10	IK20TT	K20TT	IK20	VK20
A4 2.4			K20PBR-S10	IK20TT	K20TT	IK20	VK20
A6			K20PBR-S10	IK20TT	K20TT	IK20	VK20
Benz							
C180	05	W203	-	IKH20TT	-	IKH20	VKH20
C220	94		Q16PR-U	IQ16TT	Q16TT	IQ16	VQ16
E230	96		Q16PR-U	IQ16TT	Q16TT	IQ16	VQ16
E280	96		Q16PR-U	IQ16TT	Q16TT	IQ16	VQ16
S280	94		Q16PR-U	IQ16TT	Q16TT	IQ16	VQ16
S320	94		Q16PR-U	IQ16TT	Q16TT	IQ16	VQ16
S500	94		Q16PR-U	IQ16TT	Q16TT	IQ16	VQ16
SLK230	99		K20PBR-S10	IK20TT	K20TT	IK20	VK20
BMW							
318i (E36,46,90)			K20TXR	IK20TT	K20TT	IK20	VK20
325i (E36,46)			K20TXR	IK20TT	K20TT	IK20	VK20
520i (E34,39)			K20TXR	IK20TT	K20TT	IK20	VK20
525i (E34,39,60)			K20TXR	IK20TT	K20TT	IK20	VK20
X1 s Drive 18i2.0			K20TXR	IK20TT	K20TT	IK20	VK20
X3 2.0 i (E83)	05-08		-	IK20TT	-	IK20	VK20
X3 2.5 i (E83)	04-06		K20TXR	IK20TT	K20TT	IK20	VK20
X5 3.0 i (E53)	99-06		K20TXR	IK20TT	K20TT	IK20	VK20
Chevrolet							
Aveo 1.5	08		-	IK16TT	K16TT	IK16	VK16
Captiva	08		-	IK20TT	-	IK20	VK20
Cruze 1.5	11		-	IK16TT	-	IK16	VK16
Optra 1.6			-	IK16TT	K16TT	IK16	VK16
Optra 1.8			K20TXR	IK20TT	K20TT	IK20	VK20
Sonic 1.5	13		-	IK16TT	-	IK16	VK16
Zafira 1.8			K20TXR	IK20TT	K20TT	IK20	VK20
Zafira 2.2			-	ITV16TT	TV16TT	ITV16	-
Chrysler							
Cherokee 2.5	93		QJ16AR-U	IQ16TT	Q16TT	IQ16	VQ16
Cherokee 4.0	90		KJ16CR-L11	IK16TT	K16TT	IK16L	-
Grand Cherokee 4.0	95		KJ16CR-L11	IK16TT	K16TT	IK16L	-
Grand Cherokee 4.7			K16R-U11	IK16TT	K16TT	IK16	VK16
Neon	94		K20PR-U	IK20TT	K20TT	IK20	VK20
Daewoo							
Ceilo			W20EPR-U	IW20TT	W20TT	IW20	VW20
Espero			W20EPR-U	IW20TT	W20TT	IW20	VW20
Fantasy			W20EPR-U	IW20TT	W20TT	IW20	VW20
Nexia			W16EPR-U	IW16TT	W16TT	IW16	VW16
Racer			W16EPR-U	IW16TT	W16TT	IW16	VW16
Daihatsu							
Applause			K20PR-U11	IK20TT	K20TT	IK20	VK20
Charade			K20PR-U11	IK20TT	K20TT	IK20	VK20
Mira			W20EX-U	IW20TT	W20TT	IW20	VW20
Ferrari							
308			-	-	-	IW24	-
348			-	-	-	IX24	-
360 Modena			-	-	-	IU24	-
456 GT, 456M GT			-	-	-	IXU27	-
512TR			-	-	-	IXU27	-
550 Maranello			-	-	-	IXU27	-
F355			-	-	-	IU22	-
Fiat							
Punto			Q20PR-U11	IQ20TT	Q20TT	IQ20	VQ20
Tempra			W22EPR-U	-	W22TT	IW22	VW22
Ford							
Aspire			W16EX-U	IW16TT	W16TT	IW16	VW16
Ecosport	15	14	-	-	-	-	-
ESCAPE 2.0L	01-04		-	ITV20TT	-	ITV20	VT20
Escort			W20EX-U	IW20TT	W20TT	IW20	VW20

DENSO

AUSTRALIA

CHINA

INDIA

INDONESIA

KOREA

MALAYSIA

PHILIPPINES

SAUDI ARABIA

SINGAPORE

TAIWAN

THAILAND

VIETNAM

JAPAN

EUROPE

MOTOR

SMALL

CROSS

PART





ENGINE REFERENCE NUMBER

DENSO	9	14	16	20	22	24	27	29	31	32	34	35	DENSO	9	14	16	20	22	24	27	29	31	32	DENSO	9	14	16	20	22	24	27	31
NGK	2	4	5	6	7	8	9	9.5	10	10.5	11	11.5	CHAMPION	18	16,14	12,11	10,9	8,7	6,63,61	4,59	57	55	53	BOSCH	10	9	8	7,6	5	4	3	2



▶ Spark plug color codes: ■ for Iridium Tough and Iridium Plugs and Iridium TT, ■ for Iridium Power, ■ for Iridium Racing and Two Tops Plugs, ■ for Platinum Plugs and Platinum TT, and black for general spark plugs.

PART NUMBER	CROSS REFERENCE	SMALL ENGINE	MOTOR CYCLE	EUROPE & USA	JAPAN	VIETNAM	THAILAND	TAIWAN	SINGAPORE	SAUDI ARABIA	PHILIPPINES	MALAYSIA	KOREA	INDONESIA	INDIA	CHINA	AUSTRALIA	DENSO	SPARK PLUGS					
																			IRIDIUM TT	IRIDIUM RACING	IRIDIUM POWER	IRIDIUM TOUGH		
Ford																								
																		W16EX-U	IW16TT	W16TT	IW16	VW16		
																		-	ITV20TT	-	ITV20	-		
																		T20EPR-U15	IT20TT	T20TT	IT20	VT20		
																		98-01	BJ8	K16PR-U11	IK16TT	K16TT	IK16	VK16
																		01-05	PE1	KJ16CR-11	IK16TT	K16TT	IK16L	-
																		01-05	PE1	K20PR-U11	IK20TT	K20TT	IK20	VK20
																				PT16VR13	ITV16TT	TV16TT	ITV16	-
																				K20PR-U	IK20TT	K20TT	IK20	VK20
																		01-05	PE1	K16PR-U11	IK16TT	K16TT	IK16	VK16
HONDA																								
																		90-93, 94-97	CB3,CD5,CD7	KJ16CR-L11	IK16TT	K16TT	IK16L	-
																		98-02	CG5,CF8	KJ16CR-L11	IK16TT	K16TT	IK16L	-
																		08		SKJ20DR-M11S	IK20TT	-	IK20G	VK20G
																		15	R20A3 I4	SKJ20DR-M11S	IK20TT	-	IK20G	VK20G
																		15	R20A3 I4	SKJ20DR-M11S	IK20TT	-	IK20G	VK20G
																		08		-	-	-	-	-
																		15	K24W I4	SXU22HCR11S	-	-	-	VXUHC22G
																		08		-	-	XUH22TT	-	VXUH22I
																		03-07	CM5,CM6	SKJ20DR-M11	IK20TT	-	IK20	VK20
																		16	L12B i-VTEC I4	SKJ20DR-M11	IK20TT	-	IK20	VK20
																		16	L12B i-VTEC I4	SKJ20DR-M11	IK20TT	-	IK20	VK20
																		16	L15Z1 i-VTEC I4	SKJ20DR-M11S	IK20TT	-	IK20G	VK20G
																		08	HRHGM	SKJ20DR-M13	IK20TT	-	IK20	VK20
																		15		VFK20F	IK20TT	-	-	VFK20F
																		96-99		K16PR-U11	IK16TT	K16TT	IK16	VK16
																		96-99		K16PR-U11	IK16TT	K16TT	IK16	VK16
																				K16PR-U11	IK16TT	K16TT	IK16	VK16
																		05		K16PR-U11	IK16TT	K16TT	IK16	VK16
																		92-95		K16PR-U11	IK16TT	K16TT	IK16	VK16
																		96-00		K16PR-U11	IK16TT	K16TT	IK16	VK16
																		14	FD	SKJ20DR-M11	IK20TT	-	IK20	VK20
																		15		SXU22HCR11S	-	-	-	VXUHC22G
																		93-96	EG(3door)	K20PR-U11	IK20TT	K20TT	IK20	VK20
																		01-06	ESI	KJ20CR-L11	IK20TT	K20TT	IK20L	-
																		03,06	ET1	KJ20CR-L11	IK20TT	K20TT	IK20L	-
																		04	RD7	KJ20CR-L11	IK20TT	K20TT	IK20L	-
																		07		SKJ20DR-M11	IK20TT	-	IK20	VK20
																		96-03	RD1,RD5	KJ20CR-L11	IK20TT	K20TT	IK20L	-
																		15		SXU22HCR11S	-	-	-	VXUHC22G
																		15	L15Z6 I4	-	-	-	-	-
																				SKJ20DR-M13	IK20TT	-	IK20	VK20
																				KJ16CR-L11	IK16TT	K16TT	IK16L	-
																		03	GD3	K16PR-U11	IK16TT	K16TT	IK16	VK16
																		07	MRHGE	SKJ20DR-M13	IK20TT	-	IK20	VK20
																		15	L15A I4	SKJ20DR-M13	IK20TT	-	IK20	VK20
																		96-00		PK20PR-L11	IK20TT	K20TT	IK20	VK20
																		15	L15Z1 i-VTEC I4	-	-	-	-	-
																				PK20PR-L11	IK20TT	K20TT	IK20	VK20
																		00		KJ16CR-L11	IK16TT	K16TT	IK16L	-
																		95-98		KJ16CR-L11	IK16TT	K16TT	IK16L	-
																		92-96		KJ16CR-L11	IK16TT	K16TT	IK16L	-
																		97-01		KJ20CR-L11	IK20TT	K20TT	IK20L	-
																		01	LA-RA3	-	IK20TT	K20TT	IK20	VK20
																				K20PR-L11	IK20TT	K20TT	IK20	VK20
Hyundai																								
																				K16PR-U11	IK16TT	K16TT	IK16	VK16
																				W20EPR-U11	IW20TT	W20TT	IW20	VW20
																				W20EPR-U11	IW20TT	W20TT	IW20	VW20
																				-	IW16TT	W16TT	IW16	VW16
																				-	IK16TT	K16TT	IK16	VK16
																				K16PR-U11	IK16TT	K16TT	IK16	VK16
																				K20PR-U11	IK20TT	K20TT	IK20	VK20
																				W20EPR-U11	IW20TT	W20TT	IW20	VW20
																				K16PR-U11	IK16TT	K16TT	IK16	VK16
																				K20PR-U11	IK20TT	K20TT	IK20	VK20
																				W20EPR-U11	IW20TT	W20TT	IW20	VW20
																				K16PR-U11	IK16TT	K16TT	IK16	VK16
Isuzu																								
																				K16PR-U11	IK16TT	K16TT	IK16	VK16

MODEL	YEAR	CODE	DENSO				
Kia							
Sephia			W20EPR-U11	IW20TT	W20TT	IW20	VW20
Sportage DOCH 2.0	94		K20PR-U11	IK20TT	K20TT	IK20	VK20
Sportage SOCH 2.0	94		K16PR-U11	IK16TT	K16TT	IK16	VK16
Lamborghini							
Gallardo			-	-	-	IK27	-
Murcielago			-	-	-	IXU27	-
Land Rover							
623	94		KJ20CR-L11	IK20TT	K20TT	IK20L	-
820	94		K20PR-U	IK20TT	K20TT	IK20	VK20
Discovery MPI	94		W20EPR-U	IW20TT	W20TT	IW20	VW20
Discovery V8	94		W20EPR-U	IW20TT	W20TT	IW20	VW20
Freelander	01		-	IK20TT	K20TT	IK20	VK20
Range Rover 4.6	99		P20PR8	IW20TT	W20TT	IW20	VW20
Lexus							
ES300	96		PK20TR11	IK20TT	K20TT	IK20	VK20
	01		-	IK20TT	K20TT	IK20	VK20
GS300	97		PK20TR11	IK20TT	K20TT	IK20	VK20
	00		-	IK20TT	K20TT	IK20	VK20
	05		PK20TR11	IK20TT	K20TT	IK20	VK20
IS300	99		-	IK20TT	K20TT	IK20	VK20
LS400	96		PK20R11	IK20TT	K20TT	IK20	VK20
LS430	01		-	IK20TT	K20TT	IK20	VK20
RX300			-	IK20TT	K20TT	IK20	VK20
Maserati							
3200GT/GTA			-	-	-	IU24	-
Quattroporte			-	-	-	IU24	-
Mazda							
929			KJ16CR-L11	IK16TT	K16TT	IK16L	-
323 Astina			K20PR-U11	IK20TT	K20TT	IK20	VK20
323 Protégé 1.6			KJ16CR-L11	IK16TT	K16TT	IK16L	-
323 Protégé 1.8 2.0			KJ16CR-L11	IK16TT	K16TT	IK16L	-
323 Sedan			K16PR-U11	IK16TT	K16TT	IK16	VK16
626 Cronos			K20PR-U11	IK20TT	K20TT	IK20	VK20
CX5 2.0	12		ZC20H-PR11	-	-	-	VCH20
CX5 2.5	12		ZC20H-PR12	-	-	-	VCH20
Lantis			K20PR-U11	IK20TT	K20TT	IK20	VK20
Mazda 2 1.5	15		ZC20H-PR11	-	-	-	VCH20
Mazda 3 1.6	05	MZR16DE	K16PR-U11	IK16TT	K16TT	IK16	VK16
	15		ZC20H-PR11	-	-	-	VCH20
Mazda 3 2.0	05	MZR20DE	-	IT16TT	T16TT	IT16	VT16
MX5			K16PR-U11	IK16TT	K16TT	IK16	VK16
Tribute 2.0	03		PT16VR13	ITV16TT	TV16TT	ITV16	-
Tribute 3.0	03		-	IT16TT	T16TT	IT16	VT16
Mini							
Cooper 1.6	04	RF16	-	IK20TT	-	IK20	VK20
Cooper S 1.6	02	RE16,RH16	-	IK20TT	-	IK20	VK20
Mitsubishi							
Cedia CNG	08		K20PR-U11	IK20TT	K20TT	IK20	VK20
Champ I II III	87-95	CA1A,CB1A,CB2A	W16EX-U	IW16TT	W16TT	IW16	VW16
Galant		E33	W20EPR-U11	IW20TT	W20TT	IW20	VW20
Lancer	90, 91-99	E-CAR,CK2A	W16EX-U	IW16TT	W16TT	IW16	VW16
	91-96, 96-99	CB4A/E-CAR,CK4A	K20PR-U11	IK20TT	K20TT	IK20	VK20
Lancer cedia	01-03	CS3A	K16PR-U11	IK16TT	K16TT	IK16	VK16
Lancer EX	01-03	CK5A,CS5A	K20PR-U11	IK20TT	K20TT	IK20	VK20
		MIVEC II	-	IK20TT	K20TT	IK20	VK20Y
New lancer	03		K16PR-U11	IK16TT	K16TT	IK16	VK16
	07	CS9A,E55A,E75A	K20PR-U11	IK20TT	K20TT	IK20	VK20
Mirage	14	A92 I3	FK16HR-A8	IKH16TT	-	-	VFKH16
	15	A92 I3	FK16HR-A9	IKH16TT	-	-	VFKH16
Attrage	14	A92 I3	FK16HR-A10	IKH16TT	-	-	VFKH16
	15	A92 I3	FK16HR-A11	IKH16TT	-	-	VFKH16
Pajero	08		-	IK16TT	K16TT	IK16	VK16
Pajero 3.0i			W16EPR-U11	IW16TT	W16TT	IW16	VW16
Pajero 3.5i			-	IK16TT	K16TT	IK16	VK16
Space Wagon 2.4	04	XP	-	IKH20TT	KH20TT	IKH20	VKH20





DENSO

AUSTRALIA CHINA INDIA INDONESIA KOREA MALAYSIA PHILIPPINES SAUDIARABIA SINGAPORE TAIWAN THAILAND VIETNAM JAPAN & USA EUROPE MOTOR CYCLE SMALL ENGINE CROSS PART REFERENCE NUMBER

DENSO	9	14	16	20	22	24	27	29	31	32	34	35	DENSO	9	14	16	20	22	24	27	29	31	32	DENSO	9	14	16	20	22	24	27	31
NGK	2	4	5	6	7	8	9	9.5	10	10.5	11	11.5	CHAMPION	18	16,14	12,11	10,9	8,7	6,63,61	4,59	57	55	53	BOSCH	10	9	8	7,6	5	4	3	2



PART NUMBER	CROSS REFERENCE	SMALL ENGINE	MOTOR CYCLE	EUROPE & USA	VIETNAM	THAILAND	TAIWAN	SINGAPORE	SAUDI ARABIA	PHILIPPINES	MALAYSIA	KOREA	INDONESIA	INDIA	CHINA	AUSTRALIA	DENSO	DENSO				
																		IRIDIUM TT	IRIDIUM RACING	IRIDIUM POWER	IRIDIUM TOUGH	
MODEL	YEAR	CODE																				
Mitsubishi																						
Triton																	CNG.BENZINE	K16PR-U11	IK16TT	K16TT	IK16	VK16
Ultima																		K20P-U, K20PR-U	IK20TT	K20TT	IK20	VK20
Xedia 1.6	02																CS3	K16PR-U11	IK16TT	K16TT	IK16	VK16
Xedia 1.8	02																CS4	K16PR-U11	IK16TT	K16TT	IK16	VK16
Nissan																						
200SX	92																S13	Q20PR-U11	IQ20TT	Q20TT	IQ20	VQ20
	95																S14	-	IK20TT	K20TT	IK20	VK20
300ZX	93																Z32	-	IK20TT	K20TT	IK20	VK20
350Z	06																	VKH16	IKH16TT	-	IKH16	VKH16
Almera 1.2	10																	FXE20HE11	IXEH20ETT	-	-	VFXEH20E
Bluebird	93																U13	K16PR-U11	IK16TT	K16TT	IK16	VK16
Cefiro 12V	90																A31	Q16R-U11	IQ16TT	Q16TT	IQ16	VQ16
Cefiro 2.0	95-00																A32,A33	PK16PR(-L)11	IK16TT	K16TT	IK16	VK16
Cefiro 24V	93																A31	PQ16R	IQ16TT	Q16TT	IQ16	VQ16
Cefiro 3.0	00																A32,A33	PK20PR11	IK20TT	K20TT	IK20	VK20
March 1.2																		FXE20HR11	IXEH20TT	-	-	VFXEH20
New Teana 2.0	09																J32	-	-	-	-	-
New Teana 2.5	09																J32	FXE20HR11	IXEH20TT	-	-	VFXEH20
NV-B 1.8LX,SLX'96																	Y10	K20PR-U	IK20TT	K20TT	IK20	VK20
NX coupe																	GB13	K16PR-U	IK16TT	K16TT	IK16	VK16
Presia	93																R10	K16PR-U11	IK16TT	K16TT	IK16	VK16
	95																R11	K16PR-U11	IK16TT	K16TT	IK16	VK16
Primera	97																P11	K16PR-U11	IK16TT	K16TT	IK16	VK16
Sylphy 1.6	15																HR16DE I4	FXE20HR11	IXEH20TT	-	-	VFXEH20
Juke 1.6	15																HR16DE I4	FXE20HR11	IXEH20TT	-	-	VFXEH20
Note1.2	15																HR12DE I3	FXE20HR11	IXEH20TT	-	-	VFXEH20
Serena	92																C23	K20PR-U	IK20TT	K20TT	IK20	VK20
Sunny	82-88																B11	W16EX-U	IW16TT	W16TT	IW16	VW16
	92-94, 95-97																B13,B14	K16PR-U11	IK16TT	K16TT	IK16	VK16
	95-97, 98-00																B14,B15	K20PR-U11	IK20TT	K20TT	IK20	VK20
	98-00																B15	K16PR-U11	IK16TT	K16TT	IK16	VK16
Sunny neo 1.6	01-06																N16E	K16PR-U	IK16TT	K16TT	IK16	VK16
Sunny neo 1.8	01-06																N16E	K20PR-U	IK20TT	K20TT	IK20	VK20
Teana 2.0	06																	K16HPR-U11	IKH16TT	KH16TT	IKH16	VKH16
Teana 2.3	04																	K16HPR-U11	IKH16TT	KH16TT	IKH16	VKH16
Teana 3.0	04																	VKH16	IKH16TT	-	IKH16	VKH16
Teana 2.0	14																MR20DE I4	FXE20HR11	IXEH20TT	-	-	VFXEH20
Teana 2.5	14																QR25DE I4	FXE20HR11	IXEH20TT	-	-	VFXEH20
TIDA 1.6	06																	FXE20HE11	IXEH20ETT	-	-	VFXEH20E
TIDA 1.8	06																	FXE20HR11	IXEH20TT	-	-	VFXEH20
X-Trail	05																T30	VKH16	IKH16TT	-	IKH16	VKH16
X-Trail 2.0	15																MR20DD 143 hp (106 kW) I4	-	-	-	-	
X-Trail 2.5	15																QR25DE170 hp (126 kW) I4	FXE20HR11	IXEH20TT	-	-	VFXEH20
X-Trail 2.0 Hybrid	15																	-	-	-	-	
X-Trail 2.5 Hybrid	15																	-	-	-	-	
Opel																						
Astra																		W20EPR-U	IW20TT	W20TT	IW20	VW20
Calibra																		W16EPR-U	IW16TT	W16TT	IW16	VW16
Commodore																		W20EP-U	IW20TT	W20TT	IW20	VW20
Corsa																		W20EPR-U	IW20TT	W20TT	IW20	VW20
Kadett																		W20EP-U	IW20TT	W20TT	IW20	VW20
Omega																		W16EPR-U	IW16TT	W16TT	IW16	VW16
Vectra																		W16EPR-U	IW16TT	W16TT	IW16	VW16
Peugeot																						
205																		T20EP-U	IT20TT	T20TT	IT20	VT20
305																		T20EP-U	IT20TT	T20TT	IT20	VT20
405																		T20EP-U	IT20TT	T20TT	IT20	VT20
505																		W20EX-U	IW20TT	W20TT	IW20	VW20
605																		K20PBR	IK20TT	K20TT	IK20	VK20
Proton																						
Gen 2																		T20EP-U	IT20TT	T20TT	IT20	VT20
Neo																		-	-	-	-	
Persona CNG																		-	IT20TT	T20TT	IT20	VT20

MODEL	YEAR	CODE	DENSO				
Proton							
Savvy			W20EP-U/ W20EX-U	IW20TT	W20TT	IW20	VW20
Saab							
9000			Q20PR-U11	IQ20TT	Q20TT	IQ20	VQ20
9000I			Q20P-U, Q20PR-U	IQ20TT	Q20TT	IQ20	VQ20
Seat							
Cordoba			K22PB	-	-	IK22	VK22
Subaru							
Impreza			K20PR-U11	IK20TT	K20TT	IK20	VK20
Legacy			K20PR-U11	IK20TT	K20TT	IK20	VK20
WRX			PK22PR8	-	-	IK22	VK22
Suzuki							
APV		G16A	K20PR-U	IK20TT	K20TT	IK20	VK20
CIAZ	15	L I4 K-Series	-	-	-	-	-
Celerio	15	L I4 K-Series	-	-	-	-	-
Ertiga	15	K14B I4	-	-	-	-	-
Carry pick-up		G16A,AP416PUM14058	K20PR-U	IK20TT	K20TT	IK20	VK20
Grand Vitara		J20A,DOHC	K20PR-U11	IK20TT	K20TT	IK20	VK20
Swift		M15A,DOHC VVT	K20PR-U11	IK20TT	K20TT	IK20	VK20
SX4		M16A,VVT	K20PR-U11	IK20TT	K20TT	IK20	VK20
TOYOTA							
ALPHARD 3.5 V6		2GR-FE	-	IKH20TT	-	IKH20	VKH20
Altis 1.6	14		SC20HR11	-	-	-	VCH20
	00	ZZE121	K16R-U11	IK16TT	K16TT	IK16	VK16
	08		K16R-U11	IK16TT	K16TT	IK16	VK16
Altis 1.8	14		SC20HR11	-	-	-	VCH20
	00	ZZE122	K16R-U11	IK16TT	K16TT	IK16	VK16
	08		K16R-U11	IK16TT	K16TT	IK16	VK16
Avanza	04	F600	XU22-PR9	-	XU22TT	IXU22	VXU22
Camry	12		SK16HR11	IKH16TT	-	IKH16	VKH16
	92	SXV10	PK20R11	IK20TT	K20TT	IK20	VK20
	99	SXV20	PK20TR11	IK20TT	K20TT	IK20	VK20
	02	ACV30,31	SK20R11	IK20TT	-	IK20	VK20
	06	ACV40,41	SK20R11	IK20TT	-	IK20	VK20
Camry 2.0 G	15	6AR-FSE	FK16HBR-J8	-	-	-	-
Camry 2.5 E	15	2AR-FE	SK16HR11	IKH16TT	-	IKH20	VKH16
Camry Hybrid	15	2AR-FXE	FK16HR-A8	IKH16TT	-	-	VFKH16
Celica	89	ST184	PK20R8	IK20TT	K20TT	IK20	VK20
	94	ST204	PK20R8	IK20TT	K20TT	IK20	VK20
Celica GT-4	95	ST205	PK20R8	IK20TT	K20TT	IK20	VK20
Corolla	92	EE100	W20EX-U	IW20TT	W20TT	IW20	VW20
	87-92	AE92	Q16R-U11	IQ16TT	Q16TT	IQ16	VQ16
	87-92	AE92 GTI	K20R-U11	IK20TT	K20TT	IK20	VK20
	88-92	EE90	W16EX-U	IW16TT	W16TT	IW16	VW16
	92-95	AE101	K16R-U11	IK16TT	K16TT	IK16	VK16
	93-95	EE101	K16R-U11, K20R-U11	IK16TT/ IK20TT	K16TT/ K20TT	IK16/ IK20	VK16/ VK20
	96-99	AE110	K16R-U11	IK16TT	K16TT	IK16	VK16
Corona	88-92	ST171	Q20R-U11	IQ20TT	Q20TT	IQ20	VQ20
	88-92	AT171	Q16R-U11, QJ16AR-U	IQ16TT	Q16TT	IQ16	VQ16
	93-97	ST191	K20R-U11	IK20TT	K20TT	IK20	VK20
	93-97	AT190	K16R-U11	IK16TT	K16TT	IK16	VK16
Crown	91	JZS133	PK16R11	IK16TT	K16TT	IK16	VK16
	95	JZS155	PK16TR11	IK16TT	K16TT	IK16	VK16
	99	JZS175	PK16TR11	IK16TT	K16TT	IK16	VK16
	00	JZS175	-	IK16TT	K16TT	IK16	VK16
CHR	00	3NR-FE	SC20HR-G11	-	-	-	VCH16
HIACE	00	RZH113	W16EXR-U	IW16TT	W16TT	IW16	-
FORTUNER 2.7	07	2TR-FE	K20HR-U11	IKH20TT	KH20TT	IKH20	VKH20
	15		SK20HR11	IKH20TT	-	IKH20	VKH20
INNOVA 2.0	04		K20HR-U11	IKH20TT	KH20TT	IKH20	VKH20
Sienta	16	2NR-FE	SC16HR11	-	-	-	VCH16
Land cruiser	99	VX100	-	IK20TT	K20TT	IK20	VK20
Prado	96	VZJ95	PK16TR11	IK16TT	K16TT	IK16	VK16
	03	GRJ120	-	IK20TT	K20TT	IK20	VK20
PRIUS 1.8	09	2ZR-FXE(HYBRID)	SC20HR11	-	-	-	VCH20

DENSO
 AUSTRALIA
 CHINA
 INDIA
 INDONESIA
 KOREA
 MALAYSIA
 PHILIPPINES
 SAUDI ARABIA
 SINGAPORE
 TAIWAN
 THAILAND
 VIETNAM
 JAPAN
 EUROPE
 MOTOR
 CYCLE
 SMALL
 ENGINE
 REFERENCE
 NUMBER
 PART

DENSO	9	14	16	20	22	24	27	29	31	32	34	35	DENSO	9	14	16	20	22	24	27	29	31	32	DENSO	9	14	16	20	22	24	27	31
NGK	2	4	5	6	7	8	9	9.5	10	10.5	11	11.5	CHAMPION	18	16,14	12,11	10,9	8,7	6,63,61	4,59	57	55	53	BOSCH	10	9	8	7,6	5	4	3	2



THAILAND CAR

▶ Spark plug color codes: ■ for Iridium Tough and Iridium Plugs and Iridium TT, ■ for Iridium Power, ■ for Iridium Racing and Two Tops Plugs, ■ for Platinum Plugs and Platinum TT, and black for general spark plugs.

DENSO

MODEL	YEAR	CODE	DENSO	IRIDIUM TT	IRIDIUM RACING	IRIDIUM POWER	IRIDIUM TOUGH
TOYOTA							
Rav 4	95	SXA11	PK20R11	IK20TT	K20TT	IK20	VK20
Revo	15		SK20HR11	IKH20TT	-	IKH20	VKH20
Soluna	96-01	AL50	K16R-U11	IK16TT	K16TT	IK16	VK16
Supra (2JGE)	93		PK16TR11	IK16TT	K16TT	IK16	VK16
Supra (2JGTE)	93		PK20TR11	IK20TT	K20TT	IK20	VK20
Vios	02	NCP42	K16R-U11	IK16TT	K16TT	IK16	VK16
	07	NCP93	K16R-U11	IK16TT	K16TT	IK16	VK16
	15	1NZ	SK20HR11	IKH20TT	-	IKH20	VKH20
Yaris	14		SK20HR11	IKH20TT	-	IKH20	VKH20
	06	NCP91	K16R-U11	IK16TT	K16TT	IK16	VK16
	15	3NR-FE	SC16HR11	-	-	-	VCH16
Yaris Ativ	15		SC16HR11	-	-	-	VCH16
Volkswagen							
BEETLE (NEW)1.6	02		K20PBR-S10	IK20TT	K20TT	IK20	VK20
BEETLE (NEW)2.0	02		VK20	IK20TT	-	IK20	VK20
Golf	93		W20EPBR-S	IW20TT	W20TT	IW20	VW20
Passat 1.8	95		W20EPBR-S	IW20TT	W20TT	IW20	VW20
Passat 2.0	98		W20EPBR-S	IW20TT	W20TT	IW20	VW20
Passat 2.3	00		-	IK16TT	K16TT	IK16	VK16
Vento	94		W20EPBR-S	IW20TT	W20TT	IW20	VW20
Volvo							
850	94		Q20PR-U	IQ20TT	Q20TT	IQ20	VQ20
940	90		W20EPR-U	IW20TT	W20TT	IW20	VW20
960 2.4, 3.0 24V	90		Q20PR-U	IQ20TT	Q20TT	IQ20	VQ20
S40	96		K20TXR	IK20TT	K20TT	IK20	VK20
S70	98		-	IK20TT	K20TT	IK20	VK20
S80 2.8	01		-	IK20TT	K20TT	IK20	VK20
S90 2.4			K20PR-U	IK20TT	K20TT	IK20	VK20
S90 3.0	98		K20TXR	IK20TT	K20TT	IK20	VK20
V40	96		K20TXR	IK20TT	K20TT	IK20	VK20
V70	98		-	IK20TT	K20TT	IK20	VK20

CHINA AUSTRALIA

INDIA

INDONESIA

KOREA

PHILIPPINES

SAUDARABIA

SINGAPORE

TAIWAN

THAILAND

VIETNAM

JAPAN

EUROPE & USA

MOTOR CYCLE

SMALL ENGINE

CROSS REFERENCE

PART NUMBER



THAILAND MOTORCYCLE

MODEL	DENSO	IRIDIUM POWER	IRIDIUM RACING	MODEL	DENSO	IRIDIUM POWER	IRIDIUM RACING
BMW				HONDA			
C600/C650GT	-	-	-	C70	U20FS-U	IUF22	-
F800GS/F800R	XU24EPRU	IXU24	IXU01-□	C100 (CDI Ignition)	U22FS-U	IUF22	-
K1600GT/GTL	-	-	-	C100 Old Models	U20FS-U	IUF22	-
R1200GS	-	IXU24	IXU01-□	C90	U20FS-U	IUF22	-
R1200R	XU22EPR-U	IXU22	IXU01-□	C90 Old Models	U16FS-U	-	-
R1200RT	-	IXU24	IXU01-□	C700	U20FS-U	IUF22	-
S1000RR	-	-	-	C700 (CDI Ignition)	U22FS-U	IUF22	-
Ducati				C700 Old Models	U20FS-U	IUF22	-
899PANIGALE	-	-	-	C900	U20FS-U	IUF22	-
DIAVEL	-	-	-	C900 (CDI Ignition)	U22FS-U	IUF22	-
DIAVEL CARBON	-	-	-	C900 CDI Old Models	U20FS-U	IUF22	-
DIAVEL TITANIUM	-	-	-	CB400SF	U24FER9	IUH24	IU01-□
MONSTER821/DARK	XU24EPR-U	IXU24	IXU01-□	CB400SS	-	IU24	IU01-□
MONSTER1200/S/STRPE/R	-	-	-	CB500X	U24FER9	IUH24	IU01-□
MULTISTRADA1200/S	-	-	-	CB650F	U27FER9	IUH27	IU01-□
STREET FIGHTER848	-	-	-	CB1000SF/CB1300SF	X24EPR-U9	IX24B	IXU01-□
HARLEY-DAVIDSON				CB1100EX	-	-	-
ELECTREGLIDE CLASSIC	XU24EPR-U	IXU24	IXU01-□	CBR125	U24ESR-N	IU24	IU01-□
HERITAGE SOFTAIL CLASSIS	XU24EPR-U	IXU24	IXU01-□	CBR150	U24ESR-N	IU24	IU01-□
NIGHT ROD SPECIAL	XU24EPR-U	IXU24	IXU01-□	CBR150R	U24ESR-N	IU24	IU01-□
ROADKING CLASS	XU24EPR-U	IXU24	IXU01-□	CBR250	U24ESR-N	IU24	IU01-□
SOFTAIL DELUX	XU24EPR-U	IXU24	IXU01-□	CBR300F	-	IU24	IU01-□
STREET GLIDE	XU24EPR-U	IXU24	IXU01-□	CBR300R	-	IU24	IU01-□
V-ROD MUSCLE	XU24EPR-U	IXU24	IXU01-□	CBR400RR	U24FER9	IUH24	IU01-□
HONDA				CBR500F	U24FER9	IUH24	IU01-□
AIRBLADE	U22FER9	IUH24	IU01-□	CBR500R	U24FER9	IUH24	IU01-□
AIRBLADE-I	U22EPR9	IU22D	IU01-□	CBR600F/FS/F4I/RR	VUH27ES	-	IU01-□
BEST LS110	W24ES-Us	IW24	IW01-□	CBR650F	U27FER9	IUH27	IU01-□
C50	U16FS-U	-	-	CBR900RR/CBR954RR	VUH27D	IUH27	IU01-□
C65	U16FS-U	-	-	CBR1000F	VUH27ES	-	IU01-□



MODEL	DENSO	IRIDIUM POWER	IRIDIUM RACING	MODEL	DENSO	IRIDIUM POWER	IRIDIUM RACING
HONDA				HONDA			
CBR1000RR	-	VUH27ES	IU01-□	SUPER CLUB	U20FSU	IUF20	-
CBR1100XX	VUH27D	IUH27	IU01-□	TENA	W22EP-U _s	IW22	IW01-□
CG110-125	X24ES-U	IX24	IXU01-□	TG125 (Wing)	X22ES-U	IX22	IXU01-□
CLICK	U22FER9	IUH24	IU01-□	TLM200R	W24ES-U	IW24	IW01-□
CLICK125	U22EPR9	IU22D	IU01-□	TLM220R	W24ESR-U	IW24	IW01-□
CLICK-125I	U22EPR10	IU22D	IU01-□	TLM250R	X24ES-U	IX24	IXU01-□
CLICK-I	U22EPR9	IU22D	IU01-□	TLM260R	W20ES-U	-	IW01-□
CR125R	U24ESR-N	IU24	IU01-□	TLR260	W20ESR-U	-	IW01-□
CR250R	-	IW27	IW01-□	VFR800F	-	-	-
CR800R/R2	IW31	IW31	-	VFR1200F	-	IUH24	VUH27ES
CRF100F	U22FSR-U	IUF22	-	VFR1200X	-	IUH24	VUH27ES
CRF250	U24ESR-N	IU24	IU01-□	VTR1000F	-	IX24B	IXU01-□
CRF250L	U24ESR-N	IU24	IU01-□	VTR1000SP/II	VK27PRZ11	IK27	IK01-□
	-	IU24	IU01-□	WAVE100	U20FS-U	IUF22	-
CRF250M	-	IU24	IU01-□	WAVE110	U20FS-U	IUF22	-
	U24ESR-N	IU24	IU01-□	WAVE110AT	U20EPR9S	IU20	IU01-□
CRF250R	-	IU24	IU01-□	WAVE110-I	U20EPR9S	IU20	IU01-□
CRF450R	VK24PRZ11	IK24	IK01-□	WAVE110-IAT	U20EPR9S	IU20	IU01-□
CTX1300	U22FER9/U24FER9	IUH24	IU01-□	WAVE125	U20EPR9	IU20	IU01-□
CTX700N	-	-	-	WAVE125-I	U20EPR9	IU20	IU01-□
CZ-I	U20EPR9S	IU20	IU01-□	WAVE-I	U20EPR9	IU20	IU01-□
DASH	W22EP-U _s	IW22	IW01-□	WAVE-Z	U16FS-U	-	-
DREAM	U20FS-U	IUF22	-	XL100	X24ES-U	IX24	IXU01-□
DREAM SUPER CUB100	U20EPR9	IU20	IU01-□	XR250/Motard	U24FER9	IUH24	IU01-□
DREAM110	U16FS-U	-	-	XR250R	U27FER9	IUH27	IU01-□
DREAM110i	U20EPR9S	IU20	IU01-□	XR400Motard	X24GPR-U	IXG24/	IXU01-□
DREAM125	U24ESR-N	IU24	IU01-□		X27GPR-U	IXG27	
FIGHTER	W24ES-U _s	IW24	IW01-□	XR500R/XR700R	U20FSR-U	IUF22	-
FORZA300	-	IU24	IU01-□	ZOOMER-X	U24EPR9	IU24D	IU01-□
FSX150	W27ES-U	IW27	IW01-□	JRD			
GL100	X24ES-U	IX24	IXU01-□	QUEST	U20FS-U	IUF22	-
GL-X	X24ES-U	IX24	IXU01-□	SNOW	U20FS-U	IUF22	-
ICON	U24EPR9	IU24D	IU01-□	STROM	U20FS-U	IUF22	-
INTEGRA4	-	-	-	SURT	U20FS-U	IUF22	-
JX110-125	X24ES-U	IX24	IXU01-□	TERNADO	U24ESR-N	IU24	IU01-□
LS125	W24ES-U _s	IW24	IW01-□	KAWASAKI			
MSX125	U20EPR9	IU20	IU01-□	1400GTR	-	IU27D	IU01-□
MTX	W24ES-U _s	IW24	IW01-□	AR125	W24ES-U _s	IW24	IW01-□
N	W24ES-U _s	IW24	IW01-□	AR150	W24ES-U _s	IW24	IW01-□
NICE	U20FS-U	IUF22	-	AX-1	U20FS-U	IUF22	-
NICE125i	U20EPR9	IU20	IU01-□	BOSS	U24ES-N,U24ESR-N	IUH24	IU01-□
NM4	-	-	-	CHEER	U20FS-U	IUF22	-
NOVA	U24ESR-N	IU24	IU01-□	COSMO	W22FP-U _s	IWF22	-
NOVA 4GEAR	W20EP-U _s	IW20	IW01-□	D-TRACKER X	U24ESR-N	IU24	IU01-□
NOVA-SR/RS	W22EP-U _s	IW22	IW01-□	D-TRACKER125	U22FSR-U	IUF22	-
NS	W24ES-U _s	IW24	IW01-□	D-TRACKER250	U24ESR-N	IU24	IU01-□
NSR150	W24ES-U _s	IW24	IW01-□	ER6 n	-	IU27D	IU01-□
NSR150SP/R/RR	W27ES-U	IW27	IW01-□	GTO	W24EP-U _s	IW24	IW01-□
NSR250R/SE/RSP	-	IWM27	-	GTX	W24ES-U _s	IW24	IW01-□
PCX	U22EPR9	IU22D	IU01-□	KAZE	U20FS-U	IUF22	-
PCX150	U22EPR10	IU22D	IU01-□	KAZE125	U20FS-U	IUF22	-
PHANTOM (2cycle)	W27ES-U	IW27	IW01-□	KH100	W22EP-U _s	IW22	IW01-□
PHANTOM200	X24EPR-U9	IX24B	IXU01-□	KH125	W22EP-U _s	IW22	IW01-□
QR500	W14FPR-UL	IWF16	-	KLX110	U20FSR-U	IUF22	-
R	W24ES-U _s	IW24	IW01-□	KLX125	U22FSR-U	IUF22	-
REBEL300	U20FSR-U	IUF22	-	KLX140L	U22FSR-U	IUF22	-
RR	W24ES-U _s	IW24	IW01-□	KLX250	U24ESR-N	IU24	IU01-□
RTL250F	-	IU20	IU01-□	KIX-250L	-	-	-
RTL250R	-	IW20	IW01-□	KR150A	W24EP-U _s	IW24	IW01-□
S90	X20FS-U	-	-	KR150K	W27ES-U	IW27	IW01-□
SCOOPY	U24EPR9	IU24D	IU01-□	KSR	U22FSR-U	IUF22	-
SCOOPY-I	U24EPR9	IU24D	IU01-□	KSRPRO	U20FSR-U	IUF22	-
SMILE	W22EP-U _s	IW22	IW01-□	LEO	W22FP-U _s	IWF22	-
SONIC	U24ESR-N	IU24	IU01-□	LEO STER (AS120)	W24EP-U _s	IW24	IW01-□
SPACYI	U24EPR9	IU24D	IU01-□	M	W27ES-U	IW27	IW01-□
SS-1	X24ES-U	IX24	IXU01-□	MAGIC	U20FS-U	IUF22	-
SUPER	W22EP-U _s	IW22	IW01-□	MAGMUN LC	W24ES-U _s	IW24	IW01-□

DENSO
 AUSTRALIA
 CHINA
 INDIA
 INDONESIA
 KOREA
 MALAYSIA
 PHILIPPINES
 SAUDI ARABIA
 SINGAPORE
 TAIWAN
 THAILAND
 VIETNAM
 JAPAN
 EUROPE
 MOTOR CYCLE
 SMALL ENGINE
 CROSS REFERENCE
 PART NUMBER

DENSO	9	14	16	20	22	24	27	29	31	32	34	35	DENSO	9	14	16	20	22	24	27	29	31	32	DENSO	9	14	16	20	22	24	27	31
NGK	2	4	5	6	7	8	9	9.5	10	10.5	11	11.5	CHAMPION	18	16,14	12,11	10,9	8,7	6,63,61	4,59	57	55	53	BOSCH	10	9	8	7,6	5	4	3	2



MODEL	CC	From	Till	DENSO	IRIDIUM POWER	IRIDIUM RACING
DAELIM						
CITI	100	1998		U20FS-U	IUF22	-
HAESUN						
FG	125			U22FS-U	IUF22	-
KEE WAY	125			U22FS-U	IUF22	-
QUEEN	125			U22ES-N	IU22	IU01-□
SMILE	125			U22FS-U	IUF22	-
VENUS	125			U22ES-N	IU22	IU01-□
HONDA						
@	125/150			U27ESR-N	IU27	IU01-□
AIR BLADE (Carburetor)	110	2007		U22FER9	IUH24	IU01-□
AIR BLADE FI (Fuel Injection)	110			U22EPR9	IU22	IU01-□
AIR BLADE-I (Fuel Injection)	110			U22EPR9	IU22	IU01-□
C50	50	1978	1982	U16FS-U	-	-
C70	70			U20FS-U	IUF22	-
C90, CD90	90	1990	1998	U20FS-U	IUF22	-
CD50	50	1990	1998	U20FS-U	IUF22	-
CLICK	110	2006		U22FER9	IUH24	IU01-□
CLICK-I	110			U22EPR9	IU22	IU01-□
CZ-I	110			U20EPR9S	IU20	IU01-□
DREAM/DREAM II	100			U20FS-U	IUF22	-
DYLAN	125/150	2001		U27FER9	IUH27	IU01-□
EXY	125			U24FER9	IUH24	IU01-□
FUTURE	110	2002		U20FS-U	IUF22	-
FUTURE II	125	2004	2005	U22EPR9	IU22	IU01-□
FUTURE NEO	125	2007		U20EPR9	IU20/IU22 (high speed)	IU01-□
FUTURE NEO FI	125			U20EPR9	IU20/IU22 (high speed)	IU01-□
LEAD	110			U22FER9	IU22	IU01-□
PCX	125			U22EPR9	IU22	IU01-□
SCR	110			U22FER9	IUH24	IU01-□
SH	125/150			U24FER9	IUH24	IU01-□
SPACY	110/125			U20FSR-U	IUF22	-
	100	1995		U20FSR-U	IUF22	-
SUPER DREAM	100	1998		U20FS-U	IUF22	-
WAVE	100			U20FS-U	IUF22	-
	110	2002		U22FS-U	IUF22	-
WAVE 1	100	2006	2006	U20FS-U	IUF22	-
WAVE RS	100	2005		U20FS-U	IUF22	-
WAVE RSV	100			U20FS-U	IUF22	-
WAVE RSX AT FI	110			U20EPR9S	IU20/IU22 (high speed)	IU01-□
WAVE ZX	100	2004	2005	U20FS-U	IUF22	-
WAVE α	100	2001		U20FS-U	IUF22	-
KAWASAKI						
CHEER	110			U20FS-U	IUF22	-
CRISS	110			U20FS-U	IUF22	-
LEO	120	1993		W24EP-U	IW24	IW01-□
NEO - MAX	100	1990		U20FS-U	IUF22	-
NEO - MAX II	100			U20FS-U	IUF22	-
NEON	110			W22FP-U	IWF22	-
PIAGGIO						
BEVERLY	125			U24ESR-NB	IU24	IU01-□
FLY	125			U24ESR-N	IU24	IU01-□
LIBERTY	135			U24ESR-N	IU24	IU01-□
LX	125			U24ESR-N	IU24	IU01-□
	150			U24ESR-N	IU24	IU01-□
LXV	125			U24ESR-N	IU24	IU01-□
PIAGGIO GT	125			U24ESR-N	IU24	IU01-□
ZIP	100			U24ESR-N	IU24	IU01-□

MODEL	CC	From	Till	DENSO	IRIDIUM POWER	IRIDIUM RACING
SUZUKI						
AMITY	125			U24ESR-N	IU24	IU01-□
AN	150	2000		U22ESR-N	IU22	IU01-□
AVENIS	150			U22ESR-N	IU22	IU01-□
BEST	110	2002		U20FS-U	IUF22	-
EPICURO	150			U22ESR-N	IU22	IU01-□
GN	125	2001		X24ES-U	IX24	IXU01-□
HAYATE	125			U20FSR-U	IUF22	-
LOVE	110	1996		U20FS-U	IUF22	-
RG SPORT	110	1996		W24EP-U	IW24	IW01-□
SHOGUN	125	1994		U20FS-U	IUF22	-
SKYDRIVE	125			U20FS-U	IUF22	-
SMASH	110	2002		U20FS-U	IUF22	-
VIVA	110			U20FSR-U	IUF22	-
X-BIKE	125			U20FS-U	IUF22	-
VMEP(SYM)						
AMIGO	110			U20FS-U	IUF22	-
ANGEL	80/100	1998		U20FS-U	IUF22	-
ATTILA	125	2001		U22FS-U	IUF22	-
ATTILA (Victoria, Elizabeth)	125			U20FS-U	IUF22	-
BONUS	125	1996		X22ES-U	IX22	IXU01-□
ELEGANT	100			U20FS-U	IUF22	-
EXCEL, EXCEL II	150			U22ESR-N	IU22	IU01-□
EZ	110			U20FS-U	IUF22	-
GALAXY	110			U20FS-U	IUF22	-
HUSKY	150	1995		X24ES-U	IX24	IXU01-□
MAGIC	100/110	1999		U20FS-U	IUF22	-
POWER	85			U20FS-U	IUF22	-
RS II	100			U20FS-U	IUF22	-
SANDA BOSS	110			U20FS-U	IUF22	-
STAR	110	1995		U20FS-U	IUF22	-
YAMAHA						
CUXI FI	100			U20FSR-U	IUF22	-
EXCITER	135			U24EPR9	IU24	IU01-□
GRAVITA	110			U20FS-U	IUF22	-
JUPITER	110	2004		U20FS-U	IUF22	-
LEXAM	115			U20FS-U	IUF22	-
LUVIAS	125			U22ESR-N	IU22	IU01-□
MIO	115	2004		U22FS-U	IUF22	-
NOUVO	115	2002		U22FSR-U	IUF22	-
NOUVO LX	135			U22ESR-N	IU22	IU01-□
RXZ	135			W24EP-U	IW24	IW01-□
SIRIUS	110			U20FS-U	IUF22	-
TAURUS	125			U20FS-U	IUF22	-



DENSO
 AUSTRALIA CHINA INDIA INDONESIA KOREA MALAYSIA PHILIPPINES SAUDI ARABIA SINGAPORE TAIWAN THAILAND VIETNAM JAPAN & USA EUROPE MOTOR CYCLE SMALL ENGINE REFERENCE NUMBER PART CROSS

DENSO	9	14	16	20	22	24	27	29	31	32	35	DENSO	9	14	16	20	22	24	27	29	31	32	DENSO	9	14	16	20	22	24	27	31	
NGK	2	4	5	6	7	8	9	9.5	10	10.5	11	11.5	CHAMPION	18	16,14	12,11	10,9	8,7	6,63,61	4,59	57	55	53	BOSCH	10	9	8	7,6	5	4	3	2



▶ Spark plug color codes: ■ for Iridium Tough and Iridium Plugs and Iridium TT, ■ for Iridium Power, ■ for Iridium Racing and Two Tops Plugs, ■ for Platinum Plugs and Platinum TT, and black for general spark plugs.

PART NUMBER	CROSS REFERENCE	SMALL ENGINE	MOTOR CYCLE	EUROPE & USA	JAPAN	VIETNAM	THAILAND	TAIWAN	SINGAPORE	SAUDI ARABIA	PHILIPPINES	MALAYSIA	KOREA	INDONESIA	INDIA	CHINA	AUSTRALIA	MODEL	CC	VEHICLE CODE	ENGINE	FROM-TILL	DENSO	GENUINE P/N	DENSO			QTY																	
																		IK20	IK20	IK20	IK20	VK20	VK20	VK20																					
DAIHATSU																			ALTIS	2200	SXV20N/25N	5S-FE	00.3-01.8	PK20TR11	90919-01194	-	-	-	-	-	-	-	-	-	-	-	IK20	VK20	VK20	4					
																				2400	ACV30N/35N	2AZ-FE	01.9-06.1	K20R-U11	90919-01184	K20TT	IK20	IK20	VK20	VK20	4														
																					ACV40N/45N	2AZ-FE	06.1-	SK20R11	90048-51186	-	-	-	-	-	-	-	-	-	-	IK20	VK20	VK20	4						
ALTISHYBRID																				2500	AVV50N	2AR-FXE	12.5-17.7	FK16HR-A8	90919-01259	-	-	-	-	-	-	-	-	-	-	-	-	-	-	VFKH16	4				
																					AXVH70N	A25A-FXS	17.7-	FC16HR-Q8	90919-01289	-	-	-	-	-	-	-	-	-	-	-	-	-	-	-	VFCH16	4			
APPLAUSE																				1600	A101S	HD-E1	97.8-00.3	K20TNR-S	90048-51136	K20TT	IK20	IK20	VK20	VK20	4														
ATRAI																				660	S220V · S230V	EF-DET(DOHC · T/C)	99.1-06.12	K20TNR-S9	90048-51159	K20TT	IK20	IK20	VK20Y	VK20Y	3														
																					S220V · S230V	EF-VE(DOHC)	99.1-	K20PR-U11	90048-51099	K20TT	IK20	IK20	VK20	VK20	3														
ATRAI 7																				1300	S221G · S231G	K3-VE(DOHC)	00.7-	K20R-U11	90048-51163	K20TT	IK20	IK20	VK20	VK20	4														
ATRAI WAGON																					S220G · S230G	EF-DET(DOHC · T/C)	99.6-01.12	K20TNR-S9	90048-51159	K20TT	IK20	IK20	VK20Y	VK20Y	3														
																					S220G · S230G	EF-VE(DOHC)	99.6-01.12	K20PR-U11	90048-51099	K20TT	IK20	IK20	VK20	VK20	3														
																					S220G · S230G	EF-DET(DOHC · T/C)	02.1-05.5	SVK20RZ11	90048-51172	-	-	-	-	-	-	-	-	-	-	IK20	VK20Y	VK20Y	3						
																					S220G · S230G	EF-VE(DOHC)	02.1-06.12	K20TNR-S9	90048-51159	K20TT	IK20	IK20	VK20	VK20	3														
																				660	S320G · S330G	EF-VE(DOHC)	05.5-06.12	K20TNR-S9	90048-51159	K20TT	IK20	IK20	VK20	VK20	3														
																					S320G · S330G	EF-DET(DOHC · T/C)	05.5-07.9	K20TNR-S9	90048-51159	K20TT	IK20	IK20	VK20Y	VK20Y	3														
																					S321G · S331G	KF-DET(DOHC · T/C)	07.9-15.4	SXU22HPR8	90048-51214	-	-	-	-	-	-	-	-	-	-	IXUH22I	VXUH22I	VXUH22I	3						
																					S321G	KF(T/C)	15.4-	SXU22HPR8	90048-51214	-	-	-	-	-	-	-	-	-	-	-	IXUH22I	VXUH22I	VXUH22I	3					
																					S331G	KF(T/C)	15.4-	SXU22HPR8	90048-51214	-	-	-	-	-	-	-	-	-	-	-	IXUH22I	VXUH22I	VXUH22I	3					
BeGO																				1500	J200G · J210G	3SZ-VE	06.1-08.11	SXU22PR9	90048-51188-000	-	-	-	-	-	-	-	-	-	-	-	IXU22I	VXU22I	VXU22I	4					
																					J200G · J210G	3SZ-VE	08.11-10.4	XU22PR9	90048-51197-000	XU22TT	IXU22I	IXU22I	VXU22I	VXU22I	4														
																					J200G · J210G	3SZ-VE	10.4-	SXU22PR9	90048-51188-000	-	-	-	-	-	-	-	-	-	-	-	IXU22I	VXU22I	VXU22I	4					
BOON																				900	M312S	KJ-VET	06.3-	IXU22	-	-	-	-	-	-	-	-	-	-	-	-	IXU22	VXU22	VXU22	4					
																					M300S · M310S	1KR-FE	04.6-10.2	SK20HR11	90919-01191	-	-	-	-	-	-	-	-	-	-	-	-	IKH20	VKH20	VKH20	3				
																					M600S · M610S	1KR-FE	10.2-14.4	SK20HR11	90919-01191	-	-	-	-	-	-	-	-	-	-	-	-	IKH20	VKH20	VKH20	3				
																				1000	M600S	1KR-FE	14.4-	SC16HR11	90919-01275	-	-	-	-	-	-	-	-	-	-	-	-	-	-	-	VCH16	3			
																					M610S	1KR-FE	14.4-	SC16HR11	90919-01275	-	-	-	-	-	-	-	-	-	-	-	-	-	-	-	-	VCH16	3		
																					M700S	1KR-FE	16.4-	-	-	-	-	-	-	-	-	-	-	-	-	-	-	-	-	-	-	VFXEH20	3		
																					M710S	1KR-FE	16.4-	-	-	-	-	-	-	-	-	-	-	-	-	-	-	-	-	-	-	VFXEH20	3		
																				1300	M301S	K3-VE(DOHC)	04.6-06.12	SVK20RZ11	90048-51172	-	-	-	-	-	-	-	-	-	-	-	-	IK20	VK20Y	VK20Y	4				
																					M301S	K3-VE(DOHC)	06.12-07.6	SXU22PR9	90048-51188-000	-	-	-	-	-	-	-	-	-	-	-	-	-	-	-	-	VXU22I	4		
																					M301S	K3-VE(DOHC)	07.6-10.2	XU22PR9	90048-51197-000	XU22TT	IXU22I	IXU22I	VXU22I	VXU22I	4														
																					M601S	1NR-FE	10.2-	SC16HR11	90919-01275	-	-	-	-	-	-	-	-	-	-	-	-	-	-	-	-	VCH16	4		
BOON RUMINAS																				1500	M502G · M512G	3SZ-VE	08.12-	SXU22PR9	90048-51188-000	-	-	-	-	-	-	-	-	-	-	-	-	IXU22I	VXU22I	VXU22I	4				
CAST																				660	LA250S	KF	15.9-	SXU20HPR11	90048-51208	-	-	-	-	-	-	-	-	-	-	-	-	IXUH20I	VXUH20I	VXUH20I	3				
																					LA250S	KF(T/C)	15.9-	SXU22HPR8	90048-51214	-	-	-	-	-	-	-	-	-	-	-	-	IXUH22I	VXUH22I	VXUH22I	3				
																					LA260S	KF	15.9-	SXU20HPR11	90048-51208	-	-	-	-	-	-	-	-	-	-	-	-	IXUH20I	VXUH20I	VXUH20I	3				
																					LA260S	KF(T/C)	15.9-	SXU22HPR8	90048-51214	-	-	-	-	-	-	-	-	-	-	-	-	IXUH22I	VXUH22I	VXUH22I	3				
CHARADE/SOCIAL																				1300	G200S	HC-E	93.1-00.3	K20PR-U11	90048-51099	K20TT	IK20	IK20	VK20	VK20	4														
																				1500	G203S · G213S	HE-EG	93.8-00.3	K20PR-U11	90048-51099	K20TT	IK20	IK20	VK20	VK20	4														
																				1600	G201S	HD-EG	93.8-00.3	K20PR-U11	90048-51099	K20TT	IK20	IK20	VK20	VK20	4														
COO																				1300	M401S · M411S	K3-VE	06.5-10.7	SXU22PR9	90048-51188-000	-	-	-	-	-	-	-	-	-	-	-	-	IXU22I	VXU22I	VXU22I	4				
																					M401S · M411S	K3-VE	10.7-	SXU22PR9	90048-51188-000	-	-	-	-	-	-	-	-	-	-	-	-	-	-	-	-	IXU22I	VXU22I	4	
																				1500	M402S	3SZ-VE	06.5-10.7	SXU22PR9	90048-51188-000	-	-	-	-	-	-	-	-	-	-	-	-	-	IXU22I	VXU22I	VXU22I	4			
																					M402S	3SZ-VE	10.7-	SXU22PR9	90048-51188-000	-	-	-	-	-	-	-	-	-	-	-	-	-	IXU22I	VXU22I	VXU22I	4			
COPEN																				660	L880K	JB-DET(T/C)	02.6-10.8	SK20PR-A8	90048-51182	-	-	-	-	-	-	-	-	-	-	-	-	-	-	-	-	-	VK20Y	4	
																					L880K	JB-DET(T/C)	10.8-12.8	-	-	-	-	-	-	-	-	-	-	-	-	-	-	-	-	-	-	-	-	-	4
																					LA400K	KF(T/C)	14.6-	SXU22HPR8	90048-51214	-	-	-	-	-	-	-	-	-	-	-	-	IXUH22I	VXUH22I	VXUH22I	3				
DELTA																				4100	TYMMC · M3N	15B-FP/NE(CNG)	02.6-	SK20R5-G	90919-01229	-	-	-	-	-	-	-	-	-	-	-	-	-	-	-	-	-	-	4	
DELTA WAGON/VAN																				1500	KR41J	5K-J	96.11-01.11	W16EXR-U	90048-51044-000	W16TT	IW16	IW16	VW16	VW16	4														
																				1800	KR42J	7K-E	98.12-01.11	W16EXR-U11	90048-51091-000	W16TT	IW16	IW16	VW16	VW16	4														
																				2000	SR40N · 50N	3S-FE	96.11-01.11	K20TR11	90919-01198-000	K20TT	IK20	IK20	VK20	VK20	4														
ESSE																				660	L235S/L245S	KF-VE(DOHC)	05.12-	XU20HR9	90048-51212	XUH20TTI	IXUH20I	IXUH20I	VXUH20I	VXUH20I	3														
HIJET																					S200P/C/V/W · S210P/C/V/W	EF-SE(SOHC)	99.1-04.12	K20PR-U11	90048-51099	K20TT	IK20	IK20	VK20	VK20	3														
																					S200P/C/V · S210P/C/V	EF-VE(DOHC)	99.1-04.12	K20PR-U11	90048-51099	K20TT	IK20	IK20	VK20	VK20	3														
																					S200V · S210V	EF-DET(DOHC · T/C)	99.1-04.12	K20TNR-S9	90048-51159	K20TT	IK20	IK20	VK20Y	VK20Y	3														
																					S200V · S210V	EF-VN(CNG)	99.11-	VK22	NDVK22A	-	-	-	-	-	-	-	-	-	-	-	-	IK22	VK22	VK22	3				
																				660	S200P · S210P	EF-SE(SOHC)	04.12-07.12	K20PR-U11	90048-51099	K20TT	IK20	IK20	VK20	VK20	3														
																					S200P · S210P	EF-VE(DOHC)	04.12-07.12	K20PR-U11	90048-51099	K20TT	IK20	IK20	VK20	VK20	3														
																					S201P · S211P · S201C	KF-VE(DOHC)	07.12-14.9	XU20HR9	90048-51212	XUH20TTI	IXUH20I	IXUH20I	VXUH20I	VXUH20I	3														
																					S500P	KF	14.9-	SXU20HPR11	90048-51208	-	-	-	-	-	-	-	-	-	-	-	-	IXUH20I	VXUH20I	VXUH20I	3				
																					S510P	KF	14.9-	SXU20HPR11	90048-51208	-	-	-	-	-	-	-	-	-	-	-	-	IXUH20I	VXUH20I	VXUH20I	3				
HIJET ATRAI																				660	S220V · S230V	EF-DET(DOHC · T/C)	99.1-07.10	K20TNR-S9	90048-51159	K20TT	IK20	IK20	VK20Y	VK20Y	3														
																					S220V · S230V	EF-VE(DOHC)	99.1-07.10	K20PR-U11	90048-51099	K20TT	IK20	IK20	VK20	VK20	3														
HIJET CADDIE																				660	LA700V	KF	16.6-	SXU20HPR11	90048-51208	-	-	-	-	-	-	-	-	-	-	-	-	IXUH20I	VXUH20I	VXUH20I	3				
																					LA700V	KF(T/C)	16.6-	SXU22HPR8	90048-51214	-																			

MODEL	CC	VEHICLE CODE	ENGINE	FROM-TILL	DENSO	GENUINE P/N				QTY
DAIHATSU										
HIJET CARGO/DECKVAN		S200V • S210V	EF-DET(DOHC • T/C)	02.1-04.12	SVK20RZ11	90048-51172	-	IK20	VK20Y	3
		S200V • S210V	EF-VE(DOHC)	02.1-04.12	K20TNR-S9	90048-51159	K20TT	IK20	VK20	3
		S200V • S210V	EF-SE	02.1-04.12	K20PR-U11	90048-51099	K20TT	IK20	VK20	3
		S320V • S330V	EF-VE Rev(CNG)	05.2-07.12	VK22	NDVK22A	-	IK22	VK22	3
		S320V • S330V • S330W	EF-DET(DOHC • T/C)	04.12-07.12	K20TNR-S9	90048-51159	K20TT	IK20	VK20Y	3
		S320V • S330V • S330W	EF-VE(DOHC)	04.12-07.12	K20PR-U11	90048-51099	K20TT	IK20	VK20	3
		S320V • S320W • S330V • S330W	EF-SE	04.12-07.12	K20PR-U11	90048-51099	K20TT	IK20	VK20	3
		S320V • S330V	EF-VE Rev(CNG)	05.2-07.12	VK22	NDVK22A	-	IK22	VK22	3
	660	S321V • S331V	KF-VE(DOHC)	07.12-15.4	XU20HR9	90048-51212	XUH20TTI	IXUH20I	VXUH20I	3
		S321V • S331V	KF-DET(DOHC • T/C)	07.12-15.4	SXU22HPR8	90048-51214	-	IXUH22I	VXUH22I	3
		S321V	KF	15.4-	SXU20HPR11	90048-51208	-	IXUH20I	VXUH20I	3
		S321V	KF(T/C)	15.4-	SXU22HPR8	90048-51214	-	IXUH22I	VXUH22I	3
		S321W	KF	15.4-	SXU20HPR11	90048-51208	-	IXUH20I	VXUH20I	3
		S331V	KF	15.4-	SXU20HPR11	90048-51208	-	IXUH20I	VXUH20I	3
		S331V	KF(T/C)	15.4-	SXU22HPR8	90048-51214	-	IXUH22I	VXUH22I	3
		S331W	KF	15.4-	SXU20HPR11	90048-51208	-	IXUH20I	VXUH20I	3
	S320V(Hybrid)	EF-VE(DOHC)	07.12-	K20PR-U11	90048-51099	K20TT	IK20	VK20	3	
HIJET GRAN CARGO MAX	1300	S221V • S231V	K3-VE(DOHC)	01.7-	K20R-U11	90048-51163	K20TT	IK20	VK20	4
660	L950S • L952S • L962S	JB-DET(T/C)	01.10-05.12	SVK20RZ11	90048-51172	-	IK20	VK20Y	4	
	L952S • L960S	EF-DET(DOHC • T/C)	01.10-05.12	SVK20RZ11	90048-51172	-	IK20	VK20Y	3	
	L950S	EF-DET(DOHC • T/C)	01.10-05.12	K20TNR-S9	90048-51159	K20TT	IK20	VK20Y	3	
	L960S	EF-VE(DOHC)	01.10-05.12	SVK20RZ11	90048-51172	-	IK20	VK20Y	3	
	L950S	EF-VE(DOHC)	01.10-02.5	K20TNR-S9	90048-51159	K20TT	IK20	VK20	3	
	L950S	EF-VE(DOHC)	02.5-05.12	SVK20RZ11	90048-51172	-	IK20	VK20Y	3	
MEBIUS MIDGET II MIRA	1800	ZVW41N	2ZR-FXE	13.4-	SC16HR11	90919-01275	-	-	VCH16	4
660	K100C • K100P	EF-SE	99.9-	K20PR-U11	90048-51099	K20TT	IK20	VK20	3	
	L700S/V • L710S/V	EF-SE	98.10-01.9	K20PR-U11	90048-51099	K20TT	IK20	VK20	3	
	L700S • L710S	EF-DET(DOHC • T/C)	98.10-01.9	K20TNR-S9	90048-51159	K20TT	IK20	VK20Y	3	
	L700S • L710S	EF-VE(DOHC)	98.10-01.9	K20TNR-S9	90048-51159	K20TT	IK20	VK20	3	
	L700V • L710V	EF-VN(CNG)	99.11-01.9	VK22	NDVK22A	-	IK22	VK22	3	
	L700S • L710S	EF-DET(DOHC • T/C)	01.10-02.12	SVK20RZ11	90048-51172	-	IK20	VK20Y	3	
	L700S • L710S	EF-VE(DOHC)	01.10-02.8	K20TNR-S9	90048-51159	K20TT	IK20	VK20	3	
	L700S • L710S	EF-VE(DOHC)	02.8-02.12	SVK20RZ11	90048-51172	-	IK20	VK20Y	3	
	L700S • L710S	EF-SE	01.10-02.12	K20PR-U11	90048-51099	K20TT	IK20	VK20	3	
	L250S • L260S	EF-SE	02.12-06.11	K20PR-U11	90048-51099	K20TT	IK20	VK20	3	
	L250V • L260V	EF-VE(DOHC)	02.12-07.12	K20TNR-S9	90048-51159	K20TT	IK20	VK20	3	
	L250V	EF-VE(DOHC)	04.12-06.11	K20PR-SU9	90048-51183	K20TT	IK20	VK20	3	
	L250S/V • L260S/V	EF-VD(DI • DOHC)	02.12-06.10	ZXU22HBR11	90048-51179	-	-	-	3	
	L250V • L260V	EF-VN(CNG)	02.12-06.10	VK22	NDVK22A	-	IK22	VK22	3	
	L275S • L285S	KF-VE(DOHC)	06.12-	XU20HR9	90048-51212	XUH20TTI	IXUH20I	VXUH20I	3	
	L285S	KF(DOHC • CVT)	11.7-	SXU20HPR11	90048-51208	-	IXUH20I	VXUH20I	3	
	L275S • L285S	KF-DET(DOHC • T/C)	06.12-	SXU22HPR8	90048-51214	-	IXUH22I	VXUH22I	3	
	L275V/285V	KF-VE(DOHC)	07.12-	XU20HR9	90048-51212	XUH20TTI	IXUH20I	VXUH20I	3	
	L275V Rev	KF-VE Rev	08.2-	-	-	-	-	-	3	
	MIRA AVY	660	L250S/260S	EF-DET(DOHC • T/C)	02.12-09.4	K20TNR-S9	90048-51159	K20TT	IK20	VK20Y
		L250S/260S	EF-VE(DOHC)	02.12-04.12	K20TNR-S9	90048-51159	K20TT	IK20	VK20	3
		L250S/260S	EF-VE(DOHC)	04.12-09.4	K20PR-SU9	90048-51183	K20TT	IK20	VK20	3
MIRA GINO	660	L700S/L710S	EF-VE(DOHC)	02.8-04.12	SVK20RZ11	90048-51172	-	IK20	VK20Y	3
		L700S/L710S	EF-DET(DOHC • T/C)	02.8-04.12	SVK20RZ11	90048-51172	-	IK20	VK20Y	3
		L650 • L660S	EF-VE(DOHC)	04.12-08.12	K20PR-SU9	90048-51183	K20TT	IK20	VK20	3
1000	L701S • L711S	EJ-VE	02.8-08.12	K16TNR-S9	90048-51164	K16TT	IK16	VK16	3	
MIRA COCOA	660	L675S • L685S	KF-VE(DOHC)	09.8-11.6	XU20HR9	90048-51212	XUH20TTI	IXUH20I	VXUH20I	3
		L675S	KF	11.6-12.4	XU20HR9	90048-51212	XUH20TTI	IXUH20I	VXUH20I	3
		L675S	KF	12.4-14.8	SXU20HPR11	90048-51208	-	IXUH20I	VXUH20I	3
		L675S	KF	14.8-	SXU20HPR11	90048-51208	-	IXUH20I	VXUH20I	3
		L685S	KF	11.6-	SXU20HPR11	90048-51208	-	IXUH20I	VXUH20I	3
MIRA e:S	660	LA300S	KF	11.9-12.11	SXU20HPR11	90048-51208	-	IXUH20I	VXUH20I	3
		LA310S	KF	11.9-12.11	SXU20HPR11	90048-51208	-	IXUH20I	VXUH20I	3
		LA300S	KF	12.11-14.7	SXU20HPR11	90048-51208	-	IXUH20I	VXUH20I	3
		LA310S	KF	12.11-14.7	SXU20HPR11	90048-51208	-	IXUH20I	VXUH20I	3
		LA300S	KF	14.7-17.5	-	-	-	IXUH20I	VXUH20I	3
		LA310S	KF	14.7-17.5	-	-	-	IXUH20I	VXUH20I	3
		LA350S	KF	17.5-	-	-	-	IXUH20I	VXUH20I	3
	LA360S	KF	17.5-	-	-	-	IXUH20I	VXUH20I	3	
MIRA TOCOT	660	LA550S	KF	18.6-	SXU20HPR11	90048-51208	-	IXUH20I	VXUH20I	3
		LA560S	KF	18.6-	SXU20HPR11	90048-51208	-	IXUH20I	VXUH20I	3
MIRA/CUSTOM	660	L275S.L285S	KF-VE(DOHC)	06.12-10.7	XU20HR9	90048-51212	XUH20TTI	IXUH20I	VXUH20I	3

DENSO
 AUSTRALIA CHINA INDIA INDONESIA KOREA MALAYSIA PHILIPPINES SAUDI ARABIA SINGAPORE TAIWAN THAILAND VIETNAM
 JAPAN
 EUROPE MOTOR & USA
 SMALL ENGINE
 CROSS REFERENCE NUMBER
 PART

DENSO	9	14	16	20	22	24	27	29	31	32	34	35	DENSO	9	14	16	20	22	24	27	29	31	32	DENSO	9	14	16	20	22	24	27	31
NGK	2	4	5	6	7	8	9	9.5	10	10.5	11	11.5	CHAMPION	18	16,14	12,11	10,9	8,7	6,63,61	4,59	57	55	53	BOSCH	10	9	8	7,6	5	4	3	2



DENSO

AUSTRALIA

CHINA

INDIA

INDONESIA

KOREA

MALAYSIA

PHILIPPINES

SAUDI ARABIA

SINGAPORE

TAIWAN

THAILAND

VIETNAM

JAPAN

EUROPE & USA



MOTOR CYCLE

SMALL ENGINE

CROSS REFERENCE

PART NUMBER



MODEL	CC	VEHICLE CODE	ENGINE	FROM-TILL	DENSO	GENUINE P/N				QTY
DAIHATSU										
MIRA/CUSTOM	660	L275S.L285S	KF-DET(DOHC·T/C)	06.12-	SXU22HPR8	90048-51214	-	IXUH22I	VXUH22I	3
		L275S	KF(DOHC)	06.12-	XU20HR9	90048-51212	XUH20TTI	IXUH20I	VXUH20I	3
		L285S(Except CVT)	KF(DOHC)	06.12-	XU20HR9	90048-51212	XUH20TTI	IXUH20I	VXUH20I	3
		L285S(CVT)	KF(DOHC)	06.12-	SXU20HPR11	90048-51208	-	IXUH20I	VXUH20I	3
MOVE CANBUS	660	LA800S	KF	16.9-	-	-	-	IXUH20I	VXUH20I	3
		LA810S	KF	16.9-	-	-	-	IXUH20I	VXUH20I	3
MOVE CONTE/CUSTOM	660	L575S·L585S	KF-VE(DOHC)	08.8-11.6	XU20HR9	90048-51212	XUH20TTI	IXUH20I	VXUH20I	3
		L575S·L585S	KF-DET(DOHC·T/C)	08.8-13.8	SXU22HPR8	90048-51214	-	IXUH22I	VXUH22I	3
		L575S·L585S	KF	11.6-12.9	SXU20HPR11	90048-51208	-	IXUH20I	VXUH20I	3
		L575S·L585S	KF	12.9-	SXU20HPR11	90048-51208	-	IXUH20I	VXUH20I	3
		L575S·L585S	KF(T/C)	13.8-	SXU22HPR8	90048-51214	-	IXUH22I	VXUH22I	3
MOVE LATTE	660	L550S/560S	EF-DET(DOHC·T/C)	04.8-09.12	SK20R11	90048-51186	-	IK20	VK20	3
		L550S·L560S	EF-VE(DOHC)	04.8-08.12	K20PR-SU9	90048-51183	K20TT	IK20	VK20	3
MOVE/CUSTOM	660	L902S	JB-DET(DOHC·T/C)	98.10-01.9	K20TNR	90048-51154-000	K20TT	IK20	VK20	4
		L900S·L910S	EF-DET(DOHC·T/C)	98.10-01.9	K20TNR-S9	90048-51159	K20TT	IK20	VK20Y	3
		L900S·L910S	EF-SE	98.10-01.9	K20PR-U11	90048-51099	K20TT	IK20	VK20	3
		L900S·L910S	EF-VE(DOHC)	98.10-01.9	K20TNR-S9	90048-51159	K20TT	IK20	VK20	3
		L902S·L912S	JB-DET(DOHC·T/C)	01.10-02.10	SVK20RZ11	90048-51172	-	IK20	VK20Y	4
		L910S	EF-DET(DOHC·T/C)	01.10-02.10	SVK20RZ11	90048-51172	-	IK20	VK20Y	3
		L900S	EF-DET(DOHC·T/C)	01.10-02.10	K20TNR-S9	90048-51159	K20TT	IK20	VK20Y	3
		L150S·L160S	EF-VE(DOHC)	02.10-04.12	K20TNR-S9	90048-51159	K20TT	IK20	VK20	3
		L150S(Except CVT)	EF-VE(DOHC)	04.12-06.10	K20PR-SU9	90048-51183	K20TT	IK20	VK20	3
		L150S(CVT)	EF-VE(DOHC)	04.12-06.10	K20TNR-S9	90048-51159	K20TT	IK20	VK20	3
		L160S	EF-VE(DOHC)	04.12-06.10	K20PR-SU9	90048-51183	K20TT	IK20	VK20	3
		L150S·L160S	EF-DET(DOHC·T/C)	02.10-06.10	SVK20RZ11	90048-51172	-	IK20	VK20Y	3
		L152S	JB-DET(DOHC·T/C)	02.10-03.9	SVK20RZ8	90048-51167-000	-	-	VK20Y	4
		L152S	JB-DET(DOHC·T/C)	03.10-06.9	SK20PR-A8	90048-51182	-	-	VK20Y	4
		L175S·L185S	KF-VE(DOHC)	06.10-10.12	XU20HR9	90048-51212	XUH20TTI	IXUH20I	VXUH20I	3
		L175S·L185S	KF-DET(DOHC·T/C)	06.10-10.12	SXU22HPR8	90048-51214	-	IXUH22I	VXUH22I	3
		LA100S	KF	10.12-12.12	SXU20HPR11	90048-51208	-	IXUH20I	VXUH20I	3
		LA110S	KF	10.12-12.12	SXU20HPR11	90048-51208	-	IXUH20I	VXUH20I	3
		LA100S·LA110S	KF(T/C)	10.12-13.8	SXU22HPR8	90048-51214	-	IXUH22I	VXUH22I	3
		LA100S	KF	12.12-14.12	SXU20HPR11	90048-51208	-	IXUH20I	VXUH20I	3
LA110S	KF	12.12-14.12	SXU20HPR11	90048-51208	-	IXUH20I	VXUH20I	3		
LA100S	KF(T/C)	13.8-14.12	SXU22HPR8	90048-51214	-	IXUH22I	VXUH22I	3		
LA110S	KF(T/C)	13.8-14.12	SXU22HPR8	90048-51214	-	IXUH22I	VXUH22I	3		
LA150S	KF	14.12-	SXU20HPR11	90048-51208	-	IXUH20I	VXUH20I	3		
LA150S	KF(T/C)	14.12-	SXU22HPR8	90048-51214	-	IXUH22I	VXUH22I	3		
LA160S	KF	14.12-	SXU20HPR11	90048-51208	-	IXUH20I	VXUH20I	3		
LA160S	KF(T/C)	14.12-	SXU22HPR8	90048-51214	-	IXUH22I	VXUH22I	3		
NAKED	660	L750S·L760S(Cold area)	EF-DET(DOHC·T/C)	99.11-04.4	SVK20RZ11	90048-51172	-	IK20	VK20Y	3
		L750S·L760S	EF-DET(DOHC·T/C)	99.11-04.4	K20TNR-S9	90048-51159	K20TT	IK20	VK20Y	3
		L750S·L760S	EF-VE(DOHC)	99.11-04.4	K20TNR-S9	90048-51159	K20TT	IK20	VK20	3
OPTI/CLASSIC	660	L800S/810S	EF-DET(DOHC·T/C)	98.12-01.9	K20TNR-S9	90048-51159	K20TT	IK20	VK20Y	3
		L800S/810S	EF-VE(DOHC)	98.12-01.10	K20TNR-S9	90048-51159	K20TT	IK20	VK20	3
		L802S	JB-DET(DOHC·T/C)	98.12-02.8	K20TNR	90048-51154-000	K20TT	IK20	VK20	4
		L800S/810S	EF-SE	98.12-02.8	K20PR-U11	90048-51099	K20TT	IK20	VK20	3
		L800S/810S	EF-DET(DOHC·T/C)	01.10-02.8	SVK20RZ11	90048-51172	-	IK20	VK20Y	3
PYZAR	1500	G303G·G313G	HE-EG	96.8-02.8	K20PR-U11	90048-51099	K20TT	IK20	VK20	4
	1600	G301G·G311G	HD-EP	97.9-02.8	K20PR-U11	90048-51099	K20TT	IK20	VK20	4
SONICA STORIA	660	L405S·L415S	KF-DET(DOHC·T/C)	06.6-09.4	SXU22HPR8	90048-51214	-	IXUH22I	VXUH22I	3
	700	M112S(X4)	JC-DET(DOHC·T/C)	98.4-04.1	IK27	NDIK27A	-	IK27	-	4
	1000	M100S·M110S	EJ-DE	98.2-00.5	K16PR-U11	90048-51157	K16TT	IK16	VK16	3
		M100S·M110S	EJ-VE(DOHC)	00.5-04.5	K16TNR-S9	90048-51164	K16TT	IK16	VK16	3
	1300	M101S·M111S	K3-VE2(DOHC)	00.5-04.5	K20R-U11	90048-51163	K20TT	IK20	VK20	4
M101S·M111S		K3-VE(DOHC)	01.12-04.5	K20R-U11	90048-51163	K20TT	IK20	VK20	4	
TANTO EXE/CUSTOM	660	L455S/L465S	KF-VE(DOHC)	09.12-11.7	XU20HR9	90048-51212	XUH20TTI	IXUH20I	VXUH20I	3
		L455S/L465S	KF-DET(DOHC·T/C)	09.12-11.7	SXU22HPR8	90048-51214	-	IXUH22I	VXUH22I	3
		L455S	KF	11.7-12.11	SXU20HPR11	90048-51208	-	IXUH20I	VXUH20I	3
		L455S	KF	12.11-	SXU20HPR11	90048-51208	-	IXUH20I	VXUH20I	3
		L465S	KF	11.7-12.11	SXU20HPR11	90048-51208	-	IXUH20I	VXUH20I	3
		L465S	KF	12.11-	SXU20HPR11	90048-51208	-	IXUH20I	VXUH20I	3
		L455S	KF(T/C)	11.7-12.11	SXU22HPR8	90048-51214	-	IXUH22I	VXUH22I	3
		L455S	KF(T/C)	12.11-	SXU22HPR8	90048-51214	-	IXUH22I	VXUH22I	3
		L465S	KF(T/C)	11.7-12.11	SXU22HPR8	90048-51214	-	IXUH22I	VXUH22I	3
		L465S	KF(T/C)	12.11-	SXU22HPR8	90048-51214	-	IXUH22I	VXUH22I	3
TANTO/CUSTOM	660	L350S·L360S	EF-DET(DOHC·T/C)	03.11-05.6	K20TNR-S9	90048-51159	K20TT	IK20	VK20Y	3

MODEL	CC	VEHICLE CODE	ENGINE	FROM-TILL	DENSO	GENUINE P/N				QTY
DAIHATSU										
TANTO/ CUSTOM		L350S • L360S	EF-DET(DOHC • T/C)	05.6-07.12	SK20R11	90048-51186	-	IK20	VK20	3
		L350S • L360S	EF-VE(DOHC)	03.11-07.12	K20PR-SU9	90048-51183	K20TT	IK20	VK20	3
		L375S • L385S	KF-VE(DOHC)	07.12-11.6	XU20HR9	90048-51212	XUH20TTI	IXUH20I	VXUH20I	3
		L375S	KF	11.6-12.9	SXU20HPR11	90048-51208	-	IXUH20I	VXUH20I	3
		L375S	KF	12.9-13.10	SXU20HPR11	90048-51208	-	IXUH20I	VXUH20I	3
		L375S(Rev)	KF	12.9-13.10	SXU20HPR11	90048-51208	-	IXUH20I	VXUH20I	3
		L385S	KF	11.6-13.10	SXU20HPR11	90048-51208	-	IXUH20I	VXUH20I	3
		L385S	KF	12.9-13.10	SXU20HPR11	90048-51208	-	IXUH20I	VXUH20I	3
	660	L375S • L385S	KF-DET(DOHC • T/C)	07.12-13.10	SXU22HPR8	90048-51214	-	IXUH22I	VXUH22I	3
		LA600S	KF	13.10-19.7	SXU20HPR11	90048-51208	-	IXUH20I	VXUH20I	3
		LA610S	KF	13.10-19.7	SXU20HPR11	90048-51208	-	IXUH20I	VXUH20I	3
		LA600S	KF(T/C)	13.10-19.7	SXU22HPR8	90048-51214	-	IXUH22I	VXUH22I	3
		LA610S	KF(T/C)	13.10-19.7	SXU22HPR8	90048-51214	-	IXUH22I	VXUH22I	3
		LA650S	KF	19.7-	-	-	-	-	-	3
		LA650S	KF(T/C)	19.7-	-	-	-	-	-	3
		LA660S	KF	19.7-	-	-	-	-	-	3
	LA660S	KF(T/C)	19.7-	-	-	-	-	-	3	
TERIOS										
	1300	J100G	HC-EJ	97.3-00.5	K20TNR-S	90048-51136	K20TT	IK20	VK20	4
		J102G • J122G	K3-VET(DOHC • T/C)	00.5-05.12	SVK20RZ8	90048-51167-000	-	-	VK20Y	4
		J102G • J122G	K3-VE(DOHC)	00.5-05.12	K20R-U11	90048-51163	K20TT	IK20	VK20	4
TERIOS LUCIA										
660	J111G • J131G	EF-DEM(DOHC • T/C)	02.1-03.1	K20TNR-S9	90048-51159	K20TT	IK20	VK20Y	3	
TERIOS KID										
660	J111G • J131G	EF-DEM(DOHC • T/C)	98.10-06.8	K20TNR-S9	90048-51159	K20TT	IK20	VK20Y	3	
	J111G • J131G	EF-DET(DOHC • T/C)	98.10-10.8	K20TNR-S9	90048-51159	K20TT	IK20	VK20Y	3	
	J111G • J131G	EF-DET(DOHC • T/C)	10.8-	K20TNR-S9	90048-51159	K20TT	IK20	VK20Y	3	
THOR										
	1000	M900S	1KR-FE	16.11-	-	-	-	-	VFXEH20	3
		M900S	1KR-VET(T/C)	16.11-	-	-	-	-	-	3
		M910S	1KR-FE	16.11-	-	-	-	-	VFXEH20	3
WAKE										
	660	LA700S	KF	14.11-	SXU20HPR11	90048-51208	-	IXUH20I	VXUH20I	3
		LA710S	KF	14.11-	SXU20HPR11	90048-51208	-	IXUH20I	VXUH20I	3
		LA700S	KF(T/C)	14.11-	SXU22HPR8	90048-51214	-	IXUH22I	VXUH22I	3
		LA710S	KF(T/C)	14.11-	SXU22HPR8	90048-51214	-	IXUH22I	VXUH22I	3
YRV										
	1000	M200	EJ-VE(DOHC)	00.8-02.12	K16TNR-S9	90048-51164	K16TT	IK16	VK16	3
	1300	M201G • M211G	K3-VET(DOHC • T/C)	00.8-05.7	SVK20RZ8	90048-51167-000	-	-	VK20Y	4
		M201G • M211G	K3-VE(DOHC)	00.8-05.7	K20R-U11	90048-51163	K20TT	IK20	VK20	4
FORD JAPAN										
ESCAPE										
	2000	EPEW	YF(DOHC)	00.12-03.11	PT16VR13	-	-	ITV16	-	4
	2300	EP3WF	L3(DOHC)	03.11-	VT16	-	-	IT16	VT16	4
	3000	EPFW	AJ(DOHC)	00.12-03.11	VT20	-	-	IT20	VT20	6
FESTIVA MINI WAGON										
	1300	DW3WF	B3 • B3-ME	96.8-01.8	K16PR-U11	BP02 18 110	K16TT	IK16	VK16	4
	1500	DW5WF	B5 • B5-ME	96.8-01.8	K16PR-U11	BP02 18 110	K16TT	IK16	VK16	4
FREDA										
	2000	SGE3F • SGEWF	FE-E	95.6-	K16PR-U11	BP02 18 110	K16TT	IK16	VK16	4
	2500	SG5WF	J5-D	95.6-	K16PR-U11	BP02 18 110	K16TT	IK16	VK16	4
IXION										
	1800	CP8WF	FP-DE(DOHC)	99.4-	K16PR-U11	BP02 18 110	K16TT	IK16	VK16	4
J80, J100										
	1800	SS88MF/RF/WF	F8	90.7-	W16EXR-U13	FEDM 18 110	W16TT	IW16	VW16	4
LASER										
	1300	BJ3PF	B3E	98.12-	K16PR-U11	BP02 18 110	K16TT	IK16	VK16	4
	1500	BJ5PF • BJ5WF	ZL-VE(DOHC)	98.12-	K16PR-U11	BP02 18 110	K16TT	IK16	VK16	4
		BJ5PF • BJ5WF	ZL-DE(DOHC)	98.12-	K16PR-U11	BP02 18 110	K16TT	IK16	VK16	4
	1600	BHA6RF	B6-DE(DOHC)	94.9-	IK16	1UD3 18 110	-	IK16	VK16	4
	1800	BJ8WF	FPD(DOHC)	98.12-	K16PR-U11	BP02 18 110	K16TT	IK16	VK16	4
PROBE										
	2500	1ZVTB	KL(DOHC)	92.9-	KJ16CR11	F288 18 110	K16TT	IK16	VK16	6
SPECTRON										
	1800	SS88MF/RF/WF	F8	90.7-	W16EXR-U13	FEDM 18 110	W16TT	IW16	VW16	4
HONDA										
ACCORD										
	1800	CF3	F18B(VTEC)	97.9-02.9	PKJ16CR-L13	98079-55A5N	-	IK16	VK16	4
		CF3 • CF5	F20B(VTEC)	97.9-02.10	KJ16CR-L11	98079-5515G	K16TT	IK16	VK16	4
		CF4(LEV)	F20B	97.9-00.6	KJ16CR-L11	98079-5515G	K16TT	IK16	VK16	4
		CF4	F20B(VTEC)	97.9-00.6	KJ16CR-L11	98079-5515G	K16TT	IK16	VK16	4
		CF4	F20B(DOHC • VTEC)	97.9-02.10	PKJ20CR-L11	98079-5615N	-	IK20	VK20	4
	2000	CL7/8	K20A(DOHC • i-VTEC)	02.10-	KJ20DR-M11	9807B-5615P	K20TT	IK20	VK20	4
		CL7(EURO R)	K20A(DOHC • i-VTEC)	02.10-	SK22PR-M11S>(*4)	98079-571CV	-	IK22G(*4)	VK22G(*4)	4
		CM1	K20A(DOHC • i-VTEC)	04.10-	KJ20DR-M11	9807B-5615P	K20TT	IK20	VK20	4
		CM1	R20A(SOHC.i-TEC)	11.2-	SKJ20DR-M11S(*4)	9807B-561CW	-	IK20G(*4)	VK20G(*4)	4
		CU1	R20A	11.2-	SKJ20DR-M11S(*4)	12290-R60-U02	-	IK20G(*4)	VK20G(*4)	4
	2200	CL1(EURO R)	H22A(DOHC • VTEC)	00.6-02.10	PKJ20CR-L11	98079-5615N	-	IK20	VK20	4
	2400	CL9	K24A(DOHC • i-VTEC)	02.10-08.12	SKJ20DR-M11	9807B-5615W	-	IK20	VK20	4
		CU2 • CW2	K24A(DOHC • i-VTEC)	08.12-	SXU22HCR11S	12290-R40-A02	-	-	VXUHC22G	4
ACCORD HYBRID										
	2000	CR6	LFA-MF8	13.6-16.5	-	-	-	-	VFXEHC22G	4
		CR7	LFA-H4	16.5-	-	-	-	-	VFXEHC22G	4

(*4)GI means an SUS (stainless steel) gasket. Models without a G (Ex: VK16, etc.) are a steel gasket, so they cannot be used in this vehicle.



DENSO

AUSTRALIA CHINA INDIA INDONESIA KOREA MALAYSIA PHILIPPINES SAUDIARABIA SINGAPORE TAIWAN THAILAND VIETNAM JAPAN & USA EUROPE MOTOR SMALL ENGINE REFERENCE NUMBER PART

MODEL	CC	VEHICLE CODE	ENGINE	FROM-TILL	DENSO	GENUINE P/N				QTY	
HONDA											
EDIX	1700	BE1 • BE2	D17A	04.7-06.11	KJ20CR-L11	98079-5615G	K20TT	IK20	VK20	4	
	2000	BE3 • BE4	K20A	04.7-	KJ20DR-M11	9807B-5615P	K20TT	IK20	VK20	4	
	2400	BE8	K24A	06.11-	KJ20DR-M11	9807B-5615P	K20TT	IK20	VK20	4	
ELEMENT ELYSION	2400	YH2	K24A(DOHC • i-VTEC)	03.4-	SKJ20DR-M11	9807B-5615W	-	IK20	VK20	4	
	2400	RR1 • RR2	K24A(DOHC • i-VTEC)	04.5-	SKJ20DR-M11	9807B-5615W	-	IK20	VK20	4	
		RR1 • RR2(PRESTIGE)	K24A(DOHC • i-VTEC)	07.8-	SKJ20DR-M11	9807B-5615W	-	IK20	VK20	4	
	3000	RR3 • RR4	J30A	04.5-	SKJ20DR-M11	9807B-5615W	-	IK20	VK20	6	
	3500	RR5 • RR6(PRESTIGE)	J35A	06.12-	SKJ20DR-M11	9807B-5615W	-	IK20	VK20	6	
FIT	1300	GD1 • GD2	L13A(i-DSI)	01.6-07.10	K20PR-U11	98079-5615E	K20TT	IK20	VK20	8	
		GE6 • GE7	L13A(i-VTEC)	07.10-13.9	DK20PR-D13	-	-	-	VFK20F	4	
	1300	GP1(HYBRID)	LDA-MF6(SOHC PGM-FI)	10.10-13.9	VFKH20	-	-	-	VFKH20	8	
		GK3	L13B	13.9-	DXE22HCR11S	12290-5R0-004	-	-	VFXEHC22G	4	
		GK4	L13B	13.9-	DXE22HCR11S	12290-5R0-004	-	-	VFXEHC22G	4	
		GD3 • GD4	L15A(VTEC)	02.9-07.10	SKJ20DR-M13	9807B-56A5W	-	IK20	VK20	4	
	1500	GE8 • GE9	L15A(i-VTEC)	07.10-13.9	SKJ20DR-M13	12290-RB1-004	-	IK20	VK20	4	
		GP4(HYBRID)	LEA-MF6	12.5-13.9	DK20PR-D13	12290-RTW-004	-	-	VFK20F	4	
		GK5	L15B	13.9-	DXE22HCR11S	12290-5R0-004	-	-	VFXEHC22G	4	
		GK6	L15B	13.9-	DXE22HCR11S	12290-5R0-004	-	-	VFXEHC22G	4	
		1300	GD6 • GD7	L13A(i-DSI)	02.12-05.10	K20PR-U11	98079-5615E	K20TT	IK20	VK20	8
			GD8 • GD9	L15A(i-DSI)	05.10-	K20PR-U11	98079-5615E	K20TT	IK20	VK20	8
1500	GD8 • GD9	L15A(VTEC)	05.10-	SKJ20DR-M13	9807B-56A5W	-	IK20	VK20	4		
	1500	GP5	LEB-H1	13.9-	DXE22HCR11S	12290-5R0-004	-	-	VFXEHC22G	4	
GP6		LEB-H1	14.1-	DXE22HCR11S	12290-5R0-004	-	-	VFXEHC22G	4		
FIT SHUTTLE	1500	GG7.GG8	L15A(SOHC)	11.6-	SKJ20DR-M13	12290-RB1-004	-	IK20	VK20	4	
FIT SHUTTLE HYBRID	1300	GP2(HYBRID)	LDA-MF6(SOHC)	11.6-13.8	VFKH20	-	-	-	VFKH20	8	
		GP2	LDA-MF6	13.8-	-	-	-	-	VFKH20	8	
FREED	1500	GB3 • GB4	L15A(SOHC • iVTEC)	08.5-16.9	SKJ20DR-M13	12290-RB1-004	-	IK20	VK20	4	
		GP3(HYBRID)	LEA-MF6	11.10-16.9	-	-	-	-	VFKH20	8	
	1500	GP3(SPIKE, HYBRID)	LEA-MF6	11.10-16.9	-	-	-	-	VFKH20	8	
		GB5	L15B	16.9-	DXE22HCR11S	12290-5R0-004	-	-	VFXEHC22G	4	
		GB6	L15B	16.9-	DXE22HCR11S	12290-5R0-004	-	-	VFXEHC22G	4	
FREED HYBRID	1500	GB7	LEB-H1	16.9-	DXE22HCR11S	12290-5R0-004	-	-	VFXEHC22G	4	
		GB8	LEB-H1	16.9-	DXE22HCR11S	12290-5R0-004	-	-	VFXEHC22G	4	
GRACE	1500	GM6	L15B	15.6-	DXE22HCR11S	12290-5R0-004	-	-	VFXEHC22G	4	
		GM9	L15B	15.6-	DXE22HCR11S	12290-5R0-004	-	-	VFXEHC22G	4	
		GM6 Rev	L15B	15.7-	DXE22HCR11S	12290-5R0-004	-	-	VFXEHC22G	4	
GRACE HYBRID	1500	GM4	LEB-H1	14.12-	DXE22HCR11S	12290-5R0-004	-	-	VFXEHC22G	4	
		GM5	LEB-H1	14.12-	DXE22HCR11S	12290-5R0-004	-	-	VFXEHC22G	4	
HORIZON HR-V	3500	UBS26GWH	6VE1	98.3-	PK16PR-L11	98079-5515H	-	IK16	VK16	6	
INSIGHT	1000	ZE1	ECA-MF2(SOHC)	99.11-09.2	VKH20	-	-	IKH20	VKH20	3	
	1300	ZE2	LDA-MF6(i-VTEC+IMA)	09.2-	VFKH20	-	-	-	VFKH20	8	
1500	ZE3	LEA-MF6	11.11-18.12	DK20PR-D13	12290-RTW-004	-	-	VFK20F	4		
	ZE4	LEB-H4	18.12-	-	-	-	-	VFXEHC22G	4		
INSPIRE	2500	UA4	J25A	98.10-03.6	PKJ20CR-L11	98079-5615N	-	IK20	VK20	6	
	3000	UC1	J30A(SOHC • i-VTEC)	03.6-07.12	SKJ20DR-M11	9807B-5615W	-	IK20	VK20	6	
	3200	UA5	J32A(VTEC)	98.10-01.3	SKJ16CR-L11	98079-5515W	-	IK16	VK16	6	
		UA5	J32A(VTEC)	01.4-03.5	PKJ20CR-M11	12290-PGE-A01	-	IK20	VK20	6	
	3500	CP3	J35A(VTEC)	07.12-	SXU22HCR11	12290-R70-A02	-	-	VXUHC22G	6	
INTEGRA	1600	DC1 • DB6 • DB9	ZC(PGM-FI)	93.5-01.7	KJ16CR-L11	98079-5515G	K16TT	IK16	VK16	4	
	1800	DC2 • DB8(TYPE R)	B18C(DOHC • VTEC)	95.10-01.7	PK22PR-L11S(*4)	98079-571CH	-	IK22G(*4)	VK22G(*4)	4	
		DC5(TYPE R)	K20A(i-VTEC)	01.7-03.3	SK22PR-M11S(*4)	98079-571CV	-	IK22G(*4)	VK22G(*4)	4	
	2000	DC5(iS)	K20A(i-VTEC)	01.7-04.9	KJ20DR-M11	9807B-5615P	K20TT	IK20	VK20	4	
		DC5(TYPE R)	K20A(i-VTEC)	03.3-	SK22PR-M11S(*4)	98079-571CV	-	IK22G(*4)	VK22G(*4)	4	
		DC5(TYPE S)	K20A(i-VTEC)	04.9-	KJ20DR-M11	9807B-5615P	K20TT	IK20	VK20	4	
INTEGRA SJ	1500	EK3	D15B(VTEC)	96.3-	KJ20CR-L11	98079-5615G	K20TT	IK20	VK20	4	
		EK3	D15B(HYPER 16V)	99.1-	KJ16CR-L11	98079-5515G	K16TT	IK16	VK16	4	
JADE	1500	FR4	LEB-H1	15.2-	DXE22HCR11S	12290-5R0-004	-	-	VFXEHC22G	4	
		FR5	L15B(T/C)	15.5-	-	-	-	-	VXEHC24G	4	
LAGREAT LEGEND	3500	RL1	J35A(VTEC)	99.6-	KJ16CR-L11	98079-5515G	K16TT	IK16	VK16	6	
3500	KA9	C35A	96.2-04.10	PK16PR-L11	98079-5515H	-	IK16G(*4)	VK16G(*4)	6		
	KB1	J35A	04.10-08.9	SKJ20DR-M11	9807B-5615W	-	IK20	VK20	6		
	KB2	J37A	08.9-	SXU22HCR11S	12290-R40-A02	-	-	VXUHC22G	6		
LEGEND HYBRID LIFE	3500	KC2	JNB	15.2-	-	-	-	VFXUHC22FG	6		
660	JB1 • JB2	E07Z	98.10-03.9	K20PR-U11	98079-5615E	K20TT	IK20	VK20	3		
	JB5 • JB6	P07A(i-DSI)	03.9-08.11	K20PR-U9S(*4)	98079-569CE	-	IK20G(*4)	VK20G(*4)	6		

(*4)GI means an SUS (stainless steel) gasket. Models without a G (Ex: VK16, etc.) are a steel gasket, so they cannot be used in this vehicle.



DENSO
 AUSTRALIA CHINA INDIA INDONESIA KOREA MALAYSIA PHILIPPINES SAUDIARABIA SINGAPORE TAIWAN THAILAND VIETNAM JAPAN & USA EUROPE MOTOR SMALL ENGINE CROSS PART REFERENCE NUMBER

MODEL	CC	VEHICLE CODE	ENGINE	FROM-TILL	DENSO	GENUINE P/N				QTY
HONDA ODYSSEY	2400	RC2(Except ABSOLUTE)	K24W	13.11-	SXE22HQR11S	12290-5B0-Y02	-	-	VCH20	4
		RC1(ABSOLUTE)	K24W	17.11-	DXE22HQR-D11S	12290-5A2-A02	-	-	VFXEH22	4
		RC2(ABSOLUTE)	K24W	17.11-	DXE22HQR-D11S	12290-5A2-A02	-	-	VFXEH22	4
	3000	RA5	J30A(VTEC)	97.10-00.1	KJ16CR-L11	98079-5515G	K16TT	IK16	VK16	6
		RA8 · RA9	J30A(VTEC)	00.1-03.10	KJ16CR-L11	98079-5515G	K16TT	IK16	VK16	6
ODYSSEY HYBRID	2000	RC4	LFA-H4	16.2-	-	-	-	VFXEHC22G	4	
ORTHIA	2000	EL2/3	B20B(DOHC)	99.6-02.1	KJ20CR-L11	98079-5615G	K20TT	IK20	VK20	4
PARTNER	1300	EY6	D13B	96.3-06.3	K16PR-U11	98079-5515E	K16TT	IK16	VK16	4
	1500	EY7	D15B(LEV)	99.6-06.3	KJ16CR-L11	98079-5515G	K16TT	IK16	VK16	4
		GJ3 · GJ4	L15A(i-DSI)	06.3-	K20PR-U11	98079-5615E	K20TT	IK20	VK20	8
1600	EY8 · EY9	D16A	96.3-06.3	KJ16CR-L11	98079-5515G	K16TT	IK16	VK16	4	
PRELUDE	2200	BB5	F22B	96.11-00.8	KJ20CR-L11	98079-5615G	K20TT	IK20	VK20	4
	2200	BB5 · BB7	F22B(DOHC)	96.11-00.8	KJ20CR-L11	98079-5615G	K20TT	IK20	VK20	4
		BB6 · BB8	H22A(DOHC · VTEC)	96.11-00.8	PKJ20CR-L11	98079-5615N	-	IK20	VK20	4
S2000	2000	AP1	F20C(DOHC · VTEC)	99.4-01.8	PK22PR-L11S(*4)	98079-571CH	-	IK22G(*4)	VK22G(*4)	4
		AP1	F20C(DOHC · VTEC)	01.9-05.11	PK22PR-L11S(*4)	98079-571CH	-	IK22G(*4)	VK22G(*4)	4
	2200	AP2	F22C(DOHC)	05.11-09.6	PK22PR-L11S(*4)	98079-571CH	-	IK22G(*4)	VK22G(*4)	4
S660	660	JW5	S07A(T/C)	15.4-	SXE24HCR8S	12290-522-004	-	-	VXEHC24G	3
SABER	2500	UA4	J25A	98.10-	PKJ20CR-L11	98079-5615N	-	IK20	VK20	6
	3200	UA5	J32A	98.10-01.3	SKJ16CR-L11	98079-5515W	-	IK16	VK16	6
		UA5	J32A(VTEC)	01.4-	PKJ20CR-M11	12290-PGE-A01	-	IK20	VK20	6
SHUTTLE	1500	GK8	L15B	15.5-	DXE22HCR11S	12290-5R0-004	-	-	VFXEHC22G	4
		GK9	L15B	15.5-	DXE22HCR11S	12290-5R0-004	-	-	VFXEHC22G	4
SHUTTLE HYBRID	1500	GP7	LEB-H1	15.5-	DXE22HCR11S	12290-5R0-004	-	-	VFXEHC22G	4
		GP8	LEB-H1	15.5-	DXE22HCR11S	12290-5R0-004	-	-	VFXEHC22G	4
S-MX	2000	RH1/2	B20B	99.9-02.1	KJ20CR-L11	98079-5615G	K20TT	IK20	VK20	4
STEPWAGON	1500	RP1	L15B(T/C)	15.4-	-	-	-	-	VXEHC24G	4
		RP2	L15B(T/C)	15.4-	-	-	-	-	VXEHC24G	4
		RP3	L15B(T/C)	15.4-	-	-	-	-	VXEHC24G	4
		RP4	L15B(T/C)	15.4-	-	-	-	-	VXEHC24G	4
	2000	RF1 · RF2	B20B	99.5-01.3	KJ20CR-L11	98079-5615G	K20TT	IK20	VK20	4
		RF3 · RF4 · RF5 · RF6	K20A(DOHC · i-VTEC)	01.4-05.4	KJ20DR-M11	9807B-5615P	K20TT	IK20	VK20	4
		RG1 · RG2	K20A(DOHC · i-VTEC)	05.5-07.11	KJ20DR-M11	9807B-5615P	K20TT	IK20	VK20	4
		RG1 · RG2	K20A(DOHC · i-VTEC)	07.11-09.10	SKJ20DR-M11	9807B-5615W	-	IK20	VK20	4
		RK1 · RK2	R20A	09.10-11.8	SKJ20DR-M11S(*4)	9807B-561CW	-	IK20G(*4)	VK20G(*4)	4
		RK1	R20A	11.8-15.4	SKJ20DR-M11S(*4)	12290-R60-U02	-	IK20G(*4)	VK20G(*4)	4
		RK2	R20A	11.8-15.4	SKJ20DR-M11S(*4)	12290-R60-U02	-	IK20G(*4)	VK20G(*4)	4
		RK3	R20A	11.8-15.4	SKJ20DR-M11S(*4)	12290-R60-U02	-	IK20G(*4)	VK20G(*4)	4
		RK4	R20A	11.8-15.4	SKJ20DR-M11S(*4)	12290-R60-U02	-	IK20G(*4)	VK20G(*4)	4
		RK5 · RK6(SPADA)	R20A	09.10-11.8	SKJ20DR-M11S(*4)	9807B-561CW	-	IK20G(*4)	VK20G(*4)	4
		RK5(SPADA)	R20A	11.8-15.4	SKJ20DR-M11S(*4)	12290-R60-U02	-	IK20G(*4)	VK20G(*4)	4
		RK6(SPADA)	R20A	11.8-15.4	SKJ20DR-M11S(*4)	12290-R60-U02	-	IK20G(*4)	VK20G(*4)	4
	RK7(SPADA)	R20A	11.8-15.4	SKJ20DR-M11S(*4)	12290-R60-U02	-	IK20G(*4)	VK20G(*4)	4	
	2400	RF7 · RF8	K24A(DOHC · i-VTEC)	03.6-05.4	KJ20DR-M11	9807B-5615P	K20TT	IK20	VK20	4
		RG3 · RG4	K24A(DOHC · i-VTEC)	05.5-	KJ20DR-M11	9807B-5615P	K20TT	IK20	VK20	4
	STEPWAGON HYBRID	2000	RP5	LFA-H4	17.9-	-	-	-	VFXEHC22G	4
STREAM	1700	RN1 · RN2	D17A(DOHC · VTEC)	00.10-06.7	KJ20CR-L11	98079-5615G	K20TT	IK20	VK20	4
	1800	RN6/RN7	R18A(SOHC · i-VTEC)	06.7-	KJ20DR-M11S(*4)	9807B-561CP	-	IK20G(*4)	VK20G(*4)	4
		RN3	K20A(DOHC · i-VTEC)	00.10-03.9	SKJ20DR-M13	9807B-56A5W	-	IK20	VK20	4
		RN4(4WD)	K20A(DOHC · i-VTEC)	00.10-03.9	KJ20DR-M11	9807B-5615P	K20TT	IK20	VK20	4
	2000	RN3/4	K20A(DOHC · i-VTEC)	03.9-06.7	KJ20DR-M11	9807B-5615P	K20TT	IK20	VK20	4
		RN5	K20B(DI)	03.5-06.7	-	-	-	-	-	4
		RN8/RN9	R20A(SOHC · i-VTEC)	06.7-	KJ20DR-M11S(*4)	9807B-561CP	-	IK20G(*4)	VK20G(*4)	4
THAT'S	660	JD1 · JD2	E07Z(T/C)	02.2-	SK20PR-L9	98079-5695U	-	IK20	VK20	3
		JD1 · JD2	E07Z	02.2-	K20PR-U11	98079-5615E	K20TT	IK20	VK20	3
TORNEO	1800	CF3	F18B(VTEC)	97.9-02.10	PKJ16CR-L13	98079-55A5N	-	IK16	VK16	4
	2000	CF3 · CF4/5	F20B(VTEC)	97.9-02.10	KJ16CR-L11	98079-5515G	K16TT	IK16	VK16	4
		CF4	F20B(DOHC · VTEC)	97.9-02.10	PKJ20CR-L11	98079-5615N	-	IK20	VK20	4
2200	CL1(EURO R)	H22A(DOHC · VTEC)	00.6-02.10	PKJ20CR-L11	98079-5615N	-	IK20	VK20	4	
VAMOS	660	HM1 · HM2	E07Z	99.6-01.8	SK20PR-L9	98079-5695U	-	IK20	VK20	3
		HM1 · HM2	E07Z(T/C)	00.2-	SK20PR-L9	98079-5695U	-	IK20	VK20	3
		HM1 · HM2	E07Z	01.8-	K20PR-U11	98079-5615E	K20TT	IK20	VK20	3
VAMOS HOBIO	660	HM3 · HM4	E07Z	03.4-	K20PR-U11	98079-5615E	K20TT	IK20	VK20	3
		HM3 · HM4	E07Z(T/C)	03.4-	SK20PR-L9	98079-5695U	-	IK20	VK20	3
	660	HJ1 · HJ2	E07Z	03.4-10.8	SK20PR-L9	98079-5695U	-	IK20	VK20	3
		HJ1	E07Z	10.8-	SK20PR-N9	12290-RV4-004	-	IK20	VK20	3
HJ2	E07Z	10.8-	SK20PR-N9	12290-RV4-004	-	IK20	VK20	3		

(*4)GI means an SUS (stainless steel) gasket. Models without a G (Ex: VK16, etc.) are a steel gasket, so they cannot be used in this vehicle.

DENSO

AUSTRALIA CHINA INDIA INDONESIA KOREA MALAYSIA PHILIPPINES SAUDI ARABIA SINGAPORE TAIWAN THAILAND VIETNAM JAPAN EUROPE MOTOR & USA SMALL ENGINE CROSS PART REFERENCE NUMBER

MODEL	CC	VEHICLE CODE	ENGINE	FROM-TILL	DENSO	GENUINE P/N				QTY	
LEXUS											
LS460L	4600	USF41/46	1UR-FSE	08.8-	FK20HBR11	90919-01249	-	-	VFKBH20	8	
LS500	3400	VXFA50	V35A-FTS(T/C)	17.12-	EC22HPR-D7	90919-01295	-	-	-	6	
		VXFA55	V35A-FTS(T/C)	17.12-	EC22HPR-D7	90919-01295	-	-	-	6	
LS500h	3500	GVF50	8GR-FXS	17.10-	FK20HBR8	90919-01263-79	-	-	VFKBH20	6	
		GVF55	8GR-FXS	17.10-	FK20HBR8	90919-01263-79	-	-	VFKBH20	6	
LS600h	5000	UVF45	2UR-FSE	07.5-	FK20HBR11	90919-01249	-	-	VFKBH20	8	
LS600hL	5000	UVF46	2UR-FSE	07.5-	FK20HBR11	90919-01249	-	-	VFKBH20	8	
LX570	5700	URJ201W	3UR-FE	15.9-	SK20HR11	90919-01191-79	-	IKH20	VKH20	8	
NX200t	2000	AGZ10	8AR-FTS(T/C)	14.7-17.9	VDKH22F	-	-	-	VDKH22F	4	
		AGZ15	8AR-FTS(T/C)	14.7-17.9	VDKH22F	-	-	-	VDKH22F	4	
NX300	2000	AGZ10	8AR-FTS(T/C)	17.9-	VDKH22F	-	-	-	VDKH22F	4	
		AGZ15	8AR-FTS(T/C)	17.9-	VDKH22F	-	-	-	VDKH22F	4	
NX300h	2500	AYZ10	2AR-FXE	14.7-	FK16HR-A8	90919-01259-79	-	-	VFKH16	4	
		AYZ15	2AR-FXE	14.7-	FK16HR-A8	90919-01259-79	-	-	VFKH16	4	
RC200t	2000	ASC10	8AR-FTS(T/C)	15.10-17.11	VDKH22F	-	-	-	VDKH22F	4	
RC300	2000	ASC10	8AR-FTS(T/C)	17.11-	VDKH22F	-	-	-	VDKH22F	4	
RC300h	2500	AVC10	2AR-FSE	14.10-	FK20HBR8	90919-01263	-	-	VFKBH20	4	
RC350	3500	GSC10	2GR-FSE	14.10-17.11	FK20HBR11	90919-01249	-	-	VFKBH20	6	
		GSC10	2GR-FKS	17.11-	FK20HBR8	90919-01263	-	-	VFKBH20	6	
RC F	5000	USC10	2UR-GSE	14.10-	FK20HBR-J8	90919-01279	-	-	VFKBH20	8	
RX200t	2000	AGL20W	8AR-FTS(T/C)	15.10-	VDKH22F	-	-	-	VDKH22F	4	
		AGL25W	8AR-FTS(T/C)	15.10-	VDKH22F	-	-	-	VDKH22F	4	
RX270	2700	AGL10W	1AR-FE	10.8-	SK16HR11	90919-01233	-	IKH16	VKH16	4	
RX300	2000	AGL20W	8AR-FTS(T/C)	17.12-	VDKH22F	-	-	-	VDKH22F	4	
		AGL25W	8AR-FTS(T/C)	17.12-	VDKH22F	-	-	-	VDKH22F	4	
RX350	3500	GGL10W/15W/16W	2GR-FE	09.1-	FK20HR11	90919-01247	-	-	VFKH20	6	
RX450h	3500	GYL10W/15W/16W	2GR-FXE	09.4-15.10	FK20HR11	90919-01247	-	-	VFKH20	6	
		GYL20W	2GR-FXS	15.10-	FK20HBR8	90919-01263-79	-	-	VFKBH20	6	
		GYL25W	2GR-FXS	15.10-	FK20HBR8	90919-01263-79	-	-	VFKBH20	6	
RX450hL	3500	GYL26W	2GR-FXS	17.12-	FK20HBR8	90919-01263-79	-	-	VFKBH20	6	
SC430	4300	UZZ40	3UZ-FE	05.8-	SK20R11	90919-01210	-	IK20	VK20	8	
UX200	2000	MZAA10	M20A-FKS	18.11-	FC20HR-Q8	90919-01297-79	-	-	VFXEH22	4	
UX250h	2000	MZAH10	M20A-FXS	18.11-	FC16HR-Q8	90919-01289-79	-	-	VFCH16	4	
		MZAH15	M20A-FXS	18.11-	FC16HR-Q8	90919-01289-79	-	-	VFCH16	4	
MAZDA											
ATENZA	2000	GGEP · GGES	LF-DE	02.5-05.6	VT20	-	-	IT20	VT20	4	
		GYEW	LF-DE	02.6-05.6	VT20	-	-	IT20	VT20	4	
		GGEP/S · GHEFP/S	LF-VE	05.6-12.11	ITV16	-	-	ITV16	-	4	
		GYEW	LF-VE	05.6-08.1	ITV16	-	-	ITV16	-	4	
		GHEFW	LF-VE	08.1-10.1	ITV16	-	-	ITV16	-	4	
		GHEFW	LF-VD	10.1-	ITV20	-	-	ITV20	-	4	
	GJEFP	PE-VPR	12.11-	ZC20HPR11	PE5S-18-110	-	-	-	VCH20	4	
	GJEFW	PE-VPR	12.11-	ZC20HPR11	PE5S-18-110	-	-	-	VCH20	4	
	2300	GG3P · GG3S	L3-VE	02.5-05.6	VT20	-	-	IT20	VT20	4	
		GY3W	L3-VE	02.6-05.6	VT20	-	-	IT20	VT20	4	
		GG3P · GG3S	L3-VE	05.6-08.1	ITV16	-	-	ITV16	-	4	
		GY3W	L3-VE	05.6-08.1	ITV16	-	-	ITV16	-	4	
	GG3P	L3-VDT(T/C)	05.6-08.1	ITV20	-	-	ITV20	-	4		
	2500	GH5FP/FS/AP/AS	L5-VE	08.1-	ITV16	-	-	ITV16	-	4	
		GH5FW.GH5AW	L5-VE	08.1-	ITV16	-	-	ITV16	-	4	
		GJ5FP	PY-VPR	12.11-	ZC20HPR11	PE5S-18-110	-	-	-	VCH20	4
		GJ5FW	PY-VPR	12.11-	ZC20HPR11	PE5S-18-110	-	-	-	VCH20	4
	AXELA	1500	BK5P	ZY-VE	03.10-06.6	SK16PR-E11	Z601 18 110	-	IK16	VK16	4
BK5P			ZY-VE	06.6-09.6	FK16PR11(*7)	ZYY1 18 110	-	-	VFK16(*7)	4	
BL5FW/FP			ZY-VE	09.6-13.11	FK16PR11(*7)	ZYY1 18 110	-	-	VFK16(*7)	4	
BM5FP		P5-VPS	13.11-	ZC20HPR11	PE5S 18 110	-	-	-	VCH20	4	
BM5AP		P5-VPS	13.11-	ZC20HPR11	PE5S 18 110	-	-	-	VCH20	4	
BM5FS		P5-VPS	13.11-	ZC20HPR11	PE5S 18 110	-	-	-	VCH20	4	
BM5AS		P5-VPS	13.11-	ZC20HPR11	PE5S 18 110	-	-	-	VCH20	4	
1600		BL6FJ	Z6-VE	09.6-	K16PR-U11	BP02 18 110	K16TT	IK16	VK16	4	
		BKEP	LF-DE	03.10-09.6	VT16	-	-	IT16	VT16	4	
		BKEP	LF-VE	06.6-09.6	ITV16	-	-	ITV16	-	4	
		BLEFW/FP	LF-VDS	09.6-	ITV20	-	-	ITV20	-	4	
		BLEAW/AP	LF-VE	09.6-	ITV16	-	-	ITV16	-	4	
	BLFFP	PE-VPS	11.9-12.7	FC20HPR8	PE02 18 110	-	-	-	VCH20	4	
2000	BLFFW	PE-VPS	11.9-12.7	FC20HPR8	PE02 18 110	-	-	-	VCH20	4	
	BLFFP · BLFFW	PE-VPS	12.8-	ZC20HPR11	PE5S 18 110	-	-	-	VCH20	4	

(*7)OEM:ZY5118110(FoMoCo brand) OES:ZYY118110 (Mazda brand)

DENSO

AUSTRALIA CHINA

INDIA

INDONESIA

KOREA

MALAYSIA

PHILIPPINES

SAUDIARABIA

SINGAPORE

TAIWAN

THAILAND

VIETNAM



JAPAN

EUROPE & USA

MOTOR CYCLE

SMALL ENGINE

CROSS REFERENCE PART NUMBER

MODEL	CC	VEHICLE CODE	ENGINE	FROM-TILL	DENSO	GENUINE P/N				QTY
MAZDA DEMIO	1300	DY3W • DY3R	ZJ-VE	02.8-07.7	K16PR-U11	BP02 18 110	K16TT	IK16	VK16	4
		DE3AS • DE3FS	ZJ-VE	07.7-	FK16PR11(*7)	ZYY1 18 110	-	-	VFK16(*7)	4
		DE3FS	ZJ-VEM	07.7-	FK16PR11(*7)	ZYY1 18 110	-	-	VFK16(*7)	4
		DEJFS	P3-VPS	11.6-12.7	FC20HPR8	PE02 18 110	-	-	VCH20	4
		DEJFS	P3-VPS	12.8-	ZC20HPR11	PE5S 18 110	-	-	VCH20	4
		DJ3FS	P3-VPS	14.9-	ZC20HPR11	PE5S 18 110	-	-	VCH20	4
		DJ3AS	P3-VPS	14.12-	ZC20HPR11	PE5S 18 110	-	-	VCH20	4
	1500	DW5W	B5-ME • B5E	96.8-02.8	K16PR-U11	BP02 18 110	K16TT	IK16	VK16	4
		DY5W • DY5R	ZY-VE(Except GREENTAX CAR)	02.8-07.7	K16PR-U11(*10)	BP02 18 110	K16TT	IK16	VK16	4
		DY5W • DY5R	ZY-VE(GREENTAX CAR)	05.10-07.7	FK16PR11(*7)(*10)	ZYY1 18 110	-	-	VFK16	4
		DE5FS	ZY-VE	07.7-	FK16PR11(*7)	ZYY1 18 110	-	-	VFK16(*7)	4
		DJLFS	P5-VPS	15.10-	ZC20HPR11	PE5S-18-110	-	-	VCH20	4
		DJLAS	P5-VPS	18.8-	ZC20HPR11	PE5S-18-110	-	-	VCH20	4
	EUNOS 800	2300	TA3Y/Z/A/P	KJ-ZEM(DOHC)	94.6-03.8	PKJ16CR8	KJ14 18 110	-	IK16	VK16
2500		TA5Y/Z/A/P	KL-ZE(DOHC)	93.10-03.8	K20PR-U11	BP04 18 110	K20TT	IK20	VK20	6
FAMILIA	1200	BVYA12	CR12DE	07.1-	IKH16	-	-	IKH16	VKH16	4
	1300	BJ3P	B3E	98.6-03.8	K16PR-U11	BP02 18 110	K16TT	IK16	VK16	4
		BVY11	QG13DE	99.6-	K16PR-U11	BP02 18 110	K16TT	IK16	VK16	4
		BJ5P • BJ5W	ZL-DE(DOHC)	98.6-03.8	K16PR-U11	BP02 18 110	K16TT	IK16	VK16	4
	1500	BJ5P • BJ5W	ZL-VE(DOHC • S-VT)	98.6-03.8	K16PR-U11	BP02 18 110	K16TT	IK16	VK16	4
		BVIFY11	QG15DE	99.6-02.8	K16PR-U11(*5)	BP02 18 110	K16TT	IK16(*5)	VK16(*5)	4
		BVIFY11	QG15DE	02.8-	K16HPR-U11(*5)	-	-	IKH16(*5)	VKH16(*5)	4
		BWIFY11	QG15DE	99.6-	VK16	1UT4 18 110	-	IK16	VK16	4
		BVY12	HR15DE	07.1-	FXE20HE11	1N24 18 110	-	-	VFXEH20E	4
		NCP160M	1NZ-FE	18.6-	FK16HR11	1M00 18 110	-	-	VFKH16	4
		NCP165M	1NZ-FE	18.6-	FK16HR11	1M00 18 110	-	-	VFKH16	4
		1600	BVZNY12	HR16DE	10.8-	FXE20HR11	-	-	-	VFXEH20
	1800	BJ8W	FP-DE(DOHC)	98.6-03.8	K16PR-U11	BP02 18 110	K16TT	IK16	VK16	4
		BVHNY11	QG18DE	99.6-02.8	K16PR-U11(*5)	BP02 18 110	K16TT	IK16(*5)	VK16(*5)	4
		BVHNY11	QG18DE	02.8-	K16HPR-U11(*5)	-	-	IKH16(*5)	VKH16(*5)	4
		BVGY11	QG18DEN(CNG)	02.8-	IK22	-	-	IK22	VK22	4
		BVJY12	MR18DE	07.1-	FXE20HR11	-	-	-	VFXEH20	4
		2000	BJFP • BJFW	FS-ZE(DOHC)	99.8-03.8	KJ16CR11	F288 18 110	K16TT	IK16	VK16
	FLAIR	660	MJ34S	R06A	12.10-	VSUEH22	-	-	-	VSUEH22
MJ34S			R06A(T/C)	12.10-	VSUEH22	-	-	-	VSUEH22	3
MJ34S			R06A(CVT)	15.9-	ZXU22HPR8	1A15-18-110	-	IXUH22	VXUH22	3
MJ44S			R06A(S-ene CHARGE)	14.8-15.9	VSUEH22	-	-	-	VSUEH22	3
MJ44S			R06A(S-ene CHARGE)	15.9-	ZXU22HPR8	1A15-18-110	-	IXUH22	VXUH22	3
MJ44S			R06A(T/C • S-ene CHARGE)	15.9-	VSUEH22	-	-	-	VSUEH22	3
FLAIR CROSSOVER	660	MS31S	R06A	14.1-	VSUEH22	-	-	-	VSUEH22	3
		MS31S	R06A(T/C)	14.1-	VSUEH22	-	-	-	VSUEH22	3
		MS41S	R06A(S-ene CHARGE)	15.5-	ZXU22HPR8	1A15-18-110	-	IXUH22	VXUH22	3
		MS41S	R06A(T/C • S-ene CHARGE)	15.12-	VSUEH22	-	-	-	VSUEH22	3
FLAIR HYBRID	660	MJ55S	R06A	17.3-	-	-	-	IXUH22I	VXUH22I	3
FLAIR WAGON	660	MM21S	K6A	12.6-13.4	IXU22HPR	1A13 18 110	-	IXUH22	VXUH22	3
		MM21S	K6A(T/C)	12.6-13.4	IXU22HPR	1A13 18 110	-	IXUH22	VXUH22	3
		MM32S	R06A	13.4-15.5	VSUEH22	-	-	-	VSUEH22	3
		MM32S	R06A(T/C)	13.7-15.5	VSUEH22	-	-	-	VSUEH22	3
		MM42S	R06A(S-ene CHARGE)	15.5-18.2	ZXU22HPR8	1A15-18-110	-	IXUH22	VXUH22	3
		MM42S	R06A(T/C • S-ene CHARGE)	15.8-18.2	VSUEH22	-	-	-	VSUEH22	3
FLAIR WAGON HYBRID	660	MM53S	R06A	18.2-	-	-	-	IXUH22I	VXUH22I	3
		MM53S	R06A(T/C)	18.2-	ZXU22HPR8	1A15-18-110	-	IXUH22	VXUH22	3
LAPUTA	660	HP11S	F6A(T/C)	99.3-	W16EPR-U	AZ09 18 110	W16TT	IW16	VW16	3
		HP21S	K6A(DOHC • T/C)	99.11-01.4	IXU22C	1A11 18 110	-	IXU22	VXU22	3
		HP21S	K6A(DOHC • VVT)	00.10-01.3	XU22EPR-U	ZZS2 18 110	XU22TT	IXU22	VXU22	3
		HP22S	K6A(DOHC • T/C)	01.4-	IXU22C	1A11 18 110	-	IXU22	VXU22	3
		HP22S	K6A(DOHC • VVT)	01.4-02.11	XU22EPR-U	ZZS2 18 110	XU22TT	IXU22	VXU22	3
		HP22S	K6A(DOHC • VVT)	02.11-	IXU22C	1A11 18 110	-	IXU22	VXU22	3
M2 (1001)	1600	NA6CE	B6-ZE(DOHC)	92.3-	K22PR-U11	BP06 18 110	-	IK22	VK22	4
MAZDA DRIVING INSTRUCTION CAR	1500	DJLFI	P5-VP	19.5-	ZC20HPR11	-	-	-	VCH20	4
MAZDA3	1500	BP5P	P5-VPS	19.5-	ZC20HPR11	PE5S 18 110	-	-	VCH20	4
	2000	BPFP	PE-VPS	19.7-	ZC20HPR11	PE5S 18 110	-	-	VCH20	4
MILLENNIA	2000	TAFP	KF-ZE(DOHC)	98.7-02.1	K20PR-U11	BP04 18 110	K20TT	IK20	VK20	6
	2300	TA3A/P	KJ-ZEM(DOHC)	94.6-03.8	PKJ16CR8	KJ14 18 110	-	IK16	VK16	6
	2500	TA5A/P	KL-ZE(DOHC)	93.10-03.8	K20PR-U11	BP04 18 110	K20TT	IK20	VK20	6
MPV	2000	LWEW	FS-DE	99.6-02.4	KJ16CR11	F288 18 110	K16TT	IK16	VK16	4



DENSO
 AUSTRALIA
 CHINA
 INDIA
 INDONESIA
 KOREA
 MALAYSIA
 PHILIPPINES
 SAUDI ARABIA
 SINGAPORE
 TAIWAN
 THAILAND
 VIETNAM
 JAPAN
 EUROPE
 MOTOR
 & USA
 CYCLE
 SMALL
 ENGINE
 REFERENCE
 CROSS
 PART
 NUMBER

(*5)The plug reach may be 19mm or 26.5mm even with the same engine and the same vehicle code. Please confirm the plug reach and choose the correct DENSO type. If there is an "H" in DENSO type, it has a reach of 26.5mm. If it doesn't, its reach is 19mm. (*7)OEM:ZY5118110(FoMoCo brand) OES:ZYY118110 (Mazda brand) (*10)If a 4-star GREEN TAX label is affixed to the vehicle's rear window, then FK16PR11, if not F16PR-U11.

**DENSO****AUSTRALIA****CHINA****INDIA****INDONESIA****KOREA****MALAYSIA****PHILIPPINES****SAUDI ARABIA****SINGAPORE****TAIWAN****THAILAND****VIETNAM****JAPAN****EUROPE & USA****MOTOR ENGINE****SMALL ENGINE****CROSS REFERENCE****PART NUMBER**

MODEL	CC	VEHICLE CODE	ENGINE	FROM-TILL	DENSO	GENUINE P/N				QTY	
MAZDA											
MPV	2300	LY3P	L3-VE	06.2-	ITV16	-	-	ITV16	-	4	
		LY3P	L3-VDT(T/C)	06.2-	ITV20	-	-	ITV20	-	4	
		LW3W(Identification number:100001~308378)	L3	02.4-06.12	VT20	-	-	IT20	VT20	4	
		LW3W(Identification number:308379~)	L3	02.4-06.12	VT16	-	-	IT16	VT16	4	
	2500	LW5W	GY-DE	99.6-06.2	IT16	-	-	IT16	VT16	6	
	3000	LWFW	AJ	02.4-06.2	VT16	-	-	IT16	VT16	6	
PREMACY	1800	CP8W	FP-DE(DOHC)	99.3-02.6	K16PR-U11	BP02 18 110	K16TT	IK16	VK16	4	
		CP8W	FP-DE(DOHC)	02.6-05.2	KJ16CR11	F288 18 110	K16TT	IK16	VK16	4	
	2000	CPEW	FS-DE(DOHC)	01.7-02.11	KJ16CR11	F288 18 110	K16TT	IK16	VK16	4	
		CPEW	FS-ZE(DOHC)	02.11-05.2	K16PR-U11	BP02 18 110	K16TT	IK16	VK16	4	
		CREW	LF-DE(DOHC)	05.2-07.9	VT16	-	-	IT16	VT16	4	
		CREW	LF-VE	07.9-10.7	ITV16	-	-	ITV16	-	4	
		CREW	LF-VD(DISI)	07.1-10.7	ITV20	-	-	ITV20	-	4	
		CWEFW	LF-VD(DOHC-DISI)	10.7-12.2	ITV20	-	-	ITV20	-	4	
		CWEFW	LF-VDS(DOHC-DISI)	10.7-12.2	ITV20	-	-	ITV20	-	4	
		CWEAW	LF-VE	10.8-12.2	ITV16	-	-	ITV16	-	4	
		2300	CR3W	L3-VE(DOHC)	05.2-07.2	VT16(*6)	-	-	IT16(*6)	VT16(*6)	4
		CR3W	L3-VE(DOHC)	07.2-	ITV16(*6)	-	-	ITV16(*6)	-	4	
	2000	CWEFW	LF-VD	12.2-	ITV20	-	-	ITV20	-	4	
		CWEFW	LF-VDS	12.2-	-	-	-	ITV20	-	4	
CWEAW		LF-VE	12.2-	ITV16	-	-	ITV16	-	4		
CWFFW		PE-VPS	13.1-	ZC20HPR11	PE5S-18-110	-	-	VCH20	4		
PROCEED LEVANTE	2000	TJ52W • TF52W • TF51W	J20A	97.11-	K20PR-U11	BP04 18 110	K20TT	IK20	VK20	4	
	2500	TJ62W	H25A	98.3-	K20PR-U11	BP04 18 110	K20TT	IK20	VK20	6	
ROADSTER	1500	ND5RC	P5-VP	15.5-	ZC20HPR11	PE5S-18-110	-	-	VCH20	4	
		ND5RC	P5-VPR	15.5-	ZC20HPR11	PE5S-18-110	-	-	VCH20	4	
	1600	NB6C	B6-ZE(DOHC)	98.1-	K16PR-U11	BP02 18 110	K16TT	IK16	VK16	4	
		NB8C	BP-ZE(DOHC)	98.1-00.7	K16PR-U11	BP02 18 110	K16TT	IK16	VK16	4	
	1800	NB8C	BP-VE(DOHC)	00.7-03.12	K16PR-U11	BP02 18 110	K16TT	IK16	VK16	4	
		NB8C	BP-ZET(DOHC • T/C)	03.12-05.8	SK16PR-F8	BP8K 18 110	-	IK16	VK16	4	
	2000	NCEC	LF-VE(DOHC)	05.8-15.5	ITV20	-	-	ITV20	-	4	
		NDERC	PE-VPR	16.12-	ZC20HPR11	PE5S 18 110	-	-	VCH20	4	
	RX-7	ROTARY	FD3S	13B-REW(T/C)	91.11-02.8	-	-	-	-	4	
	RX-8	ROTARY	SE3P	13B-MSP	03.5-	-	-	-	-	EACH 2	
SCRUM	660	DG52V/T • DH52V/T	F6A(DOHC)	99.1-01.8	XU22EPR-U	ZZS2 18 110	XU22TT	IXU22	VXU22	3	
		DG52V/T • DH52V/T	F6A(T/C)	99.1-01.8	W16EPR-U	AZ09 18 110	W16TT	IW16	VW16	3	
		DG52W	F6A(2VALVE • T/C)	99.12-01.8	IW16	1UD0 18 110	-	IW16	VW16	3	
		DG62W	K6A(DOHC • T/C)	01.9-05.9	IXU22C	1A11 18 110	-	IXU22	VXU22	3	
		DG62V/62W/62T	K6A(DOHC)	01.9-05.9	XU22EPR-U	ZZS2 18 110	XU22TT	IXU22	VXU22	3	
		DG63T(Except 4WD AT)	K6A(DOHC)	02.5-13.9	XU22EPR-U	ZZS2 18 110	XU22TT	IXU22	VXU22	3	
		DG63T(4WD AT)	K6A(DOHC)	02.5-13.9	IXU22C	1A11 18 110	-	IXU22	VXU22	3	
		DG64V	K6A(DOHC)	05.9-10.5	IXU22C(*5)	1A11 18 110	-	IXU22(*5)	VXU22(*5)	3	
		DG64V	K6A(DOHC)	10.5-15.3	IXU22HPR(*5)	1A13 18 110	-	IXUH22(*5)	VXUH22(*5)	3	
		DG64W	K6A • K6A(DOHC • T/C)	05.9-10.5	IXU22C(*5)	1A11 18 110	-	IXU22(*5)	VXU22(*5)	3	
	DG64W	K6A(DOHC • T/C)	10.5-15.3	IXU22HPR(*5)	1A13 18 110	-	IXUH22(*5)	VXUH22(*5)	3		
	DG16T	R06A	13.9-15.8	VSUEH22	-	-	-	VSUEH22	3		
	DG17V	R06A	15.3-	VSUEH22	-	-	-	VSUEH22	3		
	DG17W	R06A(T/C)	15.3-	VSUEH22	-	-	-	VSUEH22	3		
DG16T	R06A	15.8-	VSUEH22	-	-	-	VSUEH22	3			
SENTIA SPIANO	3000	HEEP • HEEA	JE-E • JE-ZE	95.10-	KJ16CR11	F288 18 110	K16TT	IK16	VK16	6	
		HF21S	K6A(DOHC)	02.1-03.9	XU22EPR-U	ZZS2 18 110	XU22TT	IXU22	VXU22	3	
	660	HF21S	K6A(DOHC)	03.9-	IXU22C	1A11 18 110	-	IXU22	VXU22	3	
TITAN	4000	WGEAH/EAT • WGTAE	TF(LPG)	94.10-	VK20T(*8)	-	-	-	VK20T(*8)	4	
		WHF5T/5G	TF(CNG)	00.11-	VK22	-	-	-	VK22	4	
TITAN DASH	2000	SYE4T/6T	FE-E	00.10-	K16PR-U11	BP02 18 110	K16TT	IK16	VK16	4	
		SYE6T Rev	FE-C	07.8-	K16PR-U	BP48 18 110	K16TT	IK16	VK16	4	
TRIBUTE	2000	EPEW	YF(DOHC)	00.10-03.12	PT16VR13	-	-	ITV16	-	4	
	2300	EP3W	L3(DOHC)	03.12-	VT20	-	-	IT20	VT20	4	
	3000	EPFW	AJ(DOHC)	00.10-	VT20	-	-	IT20	VT20	6	
VERISA	1500	DC5R • DC5W	ZY-VE	04.6-06.8	K16PR-U11	BP02 18 110	K16TT	IK16	VK16	4	
		DC5W	ZY-VE	06.8-	FK16PR11(*7)	ZYY1 18 110	-	-	VFK16(*7)	4	
	1500	DC5R	ZY-VE	06.8-	K16PR-U11	BP02 18 110	K16TT	IK16	VK16	4	
MITSUBISHI											
AIRTREK	2000	CU2W	4G63(MPI)	01.6-05.10	K20PR-U11	MS851728	K20TT	IK20	VK20	4	
		CU2W	4G63(T/C)	02.6-05.10	P20PR8	-	-	IW20	VW20	4	

(*5)The plug reach may be 19mm or 26.5mm even with the same engine and the same vehicle code. Please confirm the plug reach and choose the correct DENSO type. If there is an "H" in DENSO type, it has a reach of 26.5mm. If it doesn't, its reach is 19mm (*6)SXU22HPR9 replaces. (*7)OEM:ZY5118110(FoMoCo brand) OES:ZY1118110 (Mazda brand) (*8)This is IRIIDIUM PLUS.

MODEL	CC	VEHICLE CODE	ENGINE	FROM-TILL	DENSO	GENUINE P/N				QTY	
MITSUBISHI											
AIRTREK	2400	CU4W	4G64(GDI)	01.6-04.1	VKA16	-	-	-	VKA16	4	
		CU4W	4G64(ECI · MULTI)	03.1-04.1	K16PR-U11	MS851727	K16TT	IK16	VK16	4	
		CU5W	4G69(MIVEC)	04.1-05.10	IKH20	-	-	IKH20	VKH20	4	
ASPIRE	1800	EA1A · EC1A	4G93(GDI)	98.8-00.5	VKA16	-	-	-	VKA16	4	
	2000	EA7A · EC7A	4G94(GDI)	00.5-	VKA16	-	-	-	VKA16	4	
CANTER	2000	FA500A/B/510A/B · FA580B/590B	4G63	96.9-04.2	K16PR-U11	MS851727	K16TT	IK16	VK16	4	
		FB700A · FB700B	4G63	04.2-	K16PR-U	MS851737	K16TT	IK16	VK16	4	
	2400	FA523B · FC563B	4G64(LPG)	96.9-	K20PR-U	MS851738	-	-	VK20T(*8)	4	
	3900	FE73CB/CEB · FE82CEV · FE83CEV	4D33(CNG/LPG)	02.5-	VK22	MZ602042	-	IK22	VK22	4	
CARISMA	1800	DA2A	4G93(GDI)	97.10-	VKA16	-	-	-	VKA16	4	
CHALLENGER	3500	K99W	6G74(GDI)	97.8-	VKA16	-	-	-	VKA16	6	
CHARIOT/ GRANDIS	2400	N84W/94W	4G64(GDI)	97.10-01.4	VKA16	-	-	-	VKA16	4	
		N84W/94W	4G64(GDI)	01.4-03.5	VKA16	-	-	-	VKA16	4	
		NA4W	4G69(SOHC)	03.5-09.4	IKH20	-	-	IKH20	VKH20	4	
COLT	3000	N86W/96W	6G72(GDI)	99.10-02.5	VKA16	-	-	-	VKA16	6	
		Z25A · Z26A	4G19	02.11-04.10	VKH16	-	-	IKH16	VKH16	4	
		Z21A · Z22A	4A90(MIVEC)	04.10-10.6	VKH20	-	-	IKH20	VKH20	4	
COLT PLUS	1300	Z21A	4A90	10.6-	-	-	-	-	VFKH16	4	
		Z22A	4A90	10.6-	-	-	-	-	VFKH16	4	
		Z27A · Z28A	4G15(MIVEC)	02.11-04.10	VKH16	-	-	IKH16	VKH16	4	
	1500	Z23A · Z24A	4G91(MIVEC)	04.10-	VKH20	-	-	IKH20	VKH20	4	
		Z23A/24A	4A91(MIVEC)	04.10-	VKH20	-	-	IKH20	VKH20	4	
		Z27A	4G15(MIVEC · T/C)	04.10-	VKH20Y	-	-	-	VKH20Y	4	
		Z27AG	4G15(MIVEC · T/C)	06.10-	VKH20Y	-	-	-	VKH20Y	4	
DEBONAIR	3000	S22A	6G72	92.10-00.2	W20EPR11	MS851418	-	IW20	VW20	6	
		S22A	6G72(LPG)	92.10-	P20PR11	MS851473	-	-	VW20T(*8)	6	
	3500	S26A · S27A	6G74(DOHC)	92.10-00.2	PK16PR-P11	MS851501	-	IK16	VK16	6	
		P06V · P02T	4G92	94.5-	K16PR-U11	MS851727	K16TT	IK16	VK16	4	
DELICA	1600	BVM20	HR16DE	11.10-	FXE20HR11	-	-	-	VFXEH20	4	
		SK82VM/82TM	F8-E	99.9-	K16PR-U11	MS851727	K16TT	IK16	VK16	4	
	2000	SKE6VM	FE-E	99.9-	K16PR-U11	MS851727	K16TT	IK16	VK16	4	
DELICA D:2	1200	MB15S	K12B(DOHC · VVT)	11.3-13.12	ZXU20PR11	MQ500368	-	-	VXU20	4	
		MB15S	K12B(2WD)	13.12-15.12	ZXU20PR11	MQ500368	-	-	VXU20	4	
		MB15S	K12B(ISS · 2WD)	13.12-15.12	ZXU20HPR11	MQ503107	-	IXUH20I	VXUH20I	4	
		MB15S	K12B(4WD)	13.12-15.12	ZXU20HPR11	MQ503107	-	IXUH20I	VXUH20I	4	
DELICA D:2 HYBRID	1200	MB36S	K12C	15.12-	-	-	-	IXUH20I	VXUH20I	4	
		MB46S	K12C	17.1-	-	-	-	IXUH20I	VXUH20I	4	
DELICA D:3	1600	BM20	HR16DE	11.10-	FXE20HR11	-	-	-	VFXEH20	4	
DELICA D:5	2000	CV2W (2WD)	4J11	11.12-	-	-	-	-	-	4	
		CV4W(2WD)	4B11(MIVEC)	09.12-11.11	-	-	-	-	VFK20F	4	
	2400	CV5W	4B12	07.1-09.12	K16PSR-B8	1822A030	-	IK16	VK16	4	
		CV5W	4B12	09.12-10.1	-	-	-	-	VFK16	4	
		CV5W	4B12	10.1-	-	-	-	-	VFK16	4	
DELICA SPACE GEAR	2400	PA4W · PB4W · PC4W · PD4W	4G64	94.6-04.10	K16PR-U11	MS851727	K16TT	IK16	VK16	4	
	3000	PB6W · PD6W · PF6W	6G72	94.6-04.10	PK20PR-P11	MS851502	-	IK20	VK20	6	
		PD6W	6G72(SOHC)	04.10-07.1	VK20	MZ602041	-	IK20	VK20	6	
DIAMANTE	2500	F31A/41A	6G73(GDI)	99.9-01.9	VKA16	-	-	-	VKA16	6	
		F31A/41A	6G73(GDI)	01.9-02.10	VKA16	-	-	-	VKA16	6	
		F34A	6A13	02.10-	SK20PR-B8	MR984646	-	IK20	VK20	6	
	3000	F36A/46A	6G72(GDI)	97.7-02.10	VKA16	-	-	-	VKA16	6	
DIGNITY	4500	S43A	8A80(GDI)	00.2-01.5	VKB16	-	-	-	VKB16	8	
	3500	BHGY51	VQ35HR	12.7-	FXE22HR11	22401-EW61C	-	-	VFXEH22	6	
DION	1800	CR5W	4G93(GDI · T/C)	02.5-	VKA20	-	-	-	VKA20	4	
		CR9W	4G63(DOHC · GDI)	00.1-02.5	VKA16	-	-	-	VKA16	4	
	2000	CR6W	4G94(DOHC · GDI)	00.7-	VKA16	-	-	-	VKA16	4	
ECLIPSE	2000	D32A	4G63(T/C)	95.6-04.10	W20ETR-L8	MS851792	-	IW20	VW20	4	
		D38A	4G63(T/C)	96.5-04.10	W20ETR-L8	MS851792	-	IW20	VW20	4	
	3000	D53A	6G72(MPI)	04.10-	K20PSR-B8	MN163807	-	IK20	VK20	6	
ECLIPSE CROSS eK ACTIVE	1500	GK1W	4B40(T/C)	18.3-	-	-	-	-	-	4	
		660	H81W	3G83(SOHC)	04.5-08.8	KJ16CR-U11	MD362098	K16TT	IK16	VK16	3
			H81W	3G83(SOHC)	08.8-	KJ20CR-U11	MD358202	K20TT	IK20	VK20	3

DENSO
 AUSTRALIA
 CHINA
 INDIA
 INDONESIA
 KOREA
 MALAYSIA
 PHILIPPINES
 SAUDI ARABIA
 SINGAPORE
 TAIWAN
 THAILAND
 VIETNAM
 JAPAN
 EUROPE
 MOTOR & USA
 SMALL ENGINE
 CROSS REFERENCE
 PART NUMBER

(*8)This is IRIDIUM PLUS.



PART NUMBER	CROSS REFERENCE	SMALL ENGINE	MOTOR CYCLE	EUROPE & USA	JAPAN	VIETNAM	THAILAND	TAIWAN	SINGAPORE	SAUDI ARABIA	PHILIPPINES	MALAYSIA	INDONESIA	KOREA	INDONESIA	INDIA	CHINA	AUSTRALIA	MODEL	CC	VEHICLE CODE	ENGINE	FROM-TILL	DENSO	GENUINE P/N				QTY												
MITSUBISHI																				eK ACTIVE	660	H81W	3G83(T/C)	04.5-	SVK20RZ8	MN122257	-	-	-	VK20Y	3										
eK CLASSY																				660	H81W	3G83(SOHC)	03.5-08.8	KJ16CR-U11	MD362098	K16TT	IK16	VK16	3												
ek CUSTOM																					B11W	3B20(IRIDIUM PLUGS INSTALLED VEHICLES)	13.6-14.6	SXU22HDR8	1822A010	-	-	IXUH22	VXUH22	3											
B11W																					B11W	3B20(Except IRIDIUM PLUGS INSTALLED VEHICLES)	13.6-14.6	XU22HDR9	1822A009	XUH22TT	IXUH22	VXUH22	3												
660																					B11W	3B20(T/C,IRIDIUM PLUGS INSTALLED VEHICLES)	13.6-14.6	SXU22HDR8	1822A010	-	-	IXUH22	VXUH22	3											
B11W																					B11W	3B20(T/C,Except IRIDIUM PLUGS INSTALLED VEHICLES)	13.6-14.6	XU22HDR9	1822A009	XUH22TT	IXUH22	VXUH22	3												
B11W																					B11W	3B20	14.6-17.1	SXU22HDR8	1822A010	-	-	IXUH22	VXUH22	3											
B11W																					B11W	3B20(T/C)	14.6-19.3	SXU22HDR8	1822A010	-	-	IXUH22	VXUH22	3											
B11W																					B11W	3B20	17.1-19.3	-	-	-	-	IXUH20I	VXUH20I	3											
eK SPACE																					B11A	3B20	14.2-16.12	SXU22HDR8	1822A010	-	-	IXUH22	VXUH22	3											
660																					B11A	3B20(T/C)	14.2-	SXU22HDR8	1822A010	-	-	IXUH22	VXUH22	3											
B11A																					B11A	3B20	16.12-	-	-	-	-	IXUH20I	VXUH20I	3											
eK SPORT																					H81W	3G83(SOHC)	02.9-08.8	KJ16CR-U11	MD362098	K16TT	IK16	VK16	3												
H81W																					H81W	3G83(SOHC)	08.8-	KJ20CR-U11	MD358202	K20TT	IK20	VK20	3												
660																					H82W	3G83(SOHC)	06.9-10.8	KJ20CR-U11	MD358202	K20TT	IK20	VK20	3												
H82W																					H82W	3G83(SOHC)	10.8-13.6	KJ16CR-U11	MD362098	K16TT	IK16	VK16	3												
H81W																					H81W	3G83(T/C)	02.9-06.9	SVK20RZ8	MN122257	-	-	VK20Y	3												
H82W																					H82W	3G83(T/C)	06.9-	SVK20RZ8	MN122257	-	-	VK20Y	3												
eK WAGON																					H81W	3G83(SOHC)	01.10-08.8	KJ16CR-U11	MD362098	K16TT	IK16	VK16	3												
H81W																					H81W	3G83(SOHC)	08.8-	KJ20CR-U11	MD358202	K20TT	IK20	VK20	3												
H82W																					H82W	3G83(SOHC)	06.9-10.8	KJ16CR-U11	MD362098	K16TT	IK16	VK16	3												
H82W																					H82W	3G83(SOHC)	10.8-13.6	KJ20CR-U11	MD358202	K20TT	IK20	VK20	3												
H81W																					H81W	3G83(T/C)	02.9-06.9	SVK20RZ8	MN122257	-	-	VK20Y	3												
660																					B11W	3B20(IRIDIUM PLUGS INSTALLED VEHICLES)	13.6-14.6	SXU22HDR8	1822A010	-	-	IXUH22	VXUH22	3											
B11W																					B11W	3B20(Except IRIDIUM PLUGS INSTALLED VEHICLES)	13.6-14.6	XU22HDR9	1822A009	XUH22TT	IXUH22	VXUH22	3												
B11W																					B11W	3B20	14.6-17.1	SXU22HDR8	1822A010	-	-	IXUH22	VXUH22	3											
B11W																					B11W	3B20(T/C)	15.10-19.3	SXU22HDR8	1822A010	-	-	IXUH22	VXUH22	3											
B11W																					B11W	3B20	17.1-19.3	-	-	-	-	IXUH20I	VXUH20I	3											
B33W																					B33W	BR06	19.3-	-	-	-	-	VSUEH22	3												
B36W																					B36W	BR06	19.3-	-	-	-	-	VSUEH22	3												
eK X																					B34W	BR06	19.3-	-	-	-	-	VSUEH22	3												
660																					B35W	BR06(T/C)	19.3-	-	-	-	-	VSUEH22	3												
B37W																					B37W	BR06	19.3-	-	-	-	-	VSUEH22	3												
B38W																					B38W	BR06(T/C)	19.3-	-	-	-	-	VSUEH22	3												
ETERNA SIGMA																				1800	E19A	4G93(LPG)	96.1-	K20PR-U	MS851738	-	-	VK20T(*8)	4												
FTO																				1800	DE2A	4G93	94.10-00.8	K16P-U11	MS851731	-	-	IK16	VK16	4											
2000																					DE3A	6A12(MIVEC)	94.10-00.8	F)K22TMR11 R)VK22	F)MD319586 R)-	-	-	IK22	VK22	EACH 3											
2000																					DE3A	6A12	94.10-00.8	F)K20PR-U11 R)PK20PR-P11	F)MS851728 R)MS851502	F)K20TT R)-	IK20	VK20	EACH 3												
GALANT																				1800	EA1A • EC1A	4G93(GDI)	97.1-00.5	VKA16	-	-	-	VKA16	4												
2000																					EA7A • EC7A	4G94(GDI)	00.5-	VKA16	-	-	-	VKA16	4												
2400																					EA3A • EC3A	4G64(GDI)	98.8-01.4	VKA16	-	-	-	VKA16	4												
EA3A • EC3A																					EA3A • EC3A	4G64(GDI)	01.4-	VKA16	-	-	-	VKA16	4												
2500																					EC5A(VR-4)	6A13(DOHC • T/C)	96.8-00.5	PK20PR-P8	MS851506	-	-	VK20Y	6												
GALANT FORTIS																				1800	CY3A	4B10(MIVEC)	09.12-	-	-	-	-	VFK16	4												
CY6A																					CY6A	4J10	11.10-	-	-	-	-	-	4												
2000																					CY4A	4B11(MIVEC)	07.8-09.12	K20PSR-B8	MN163807	-	-	IK20	VK20	4											
CY4A(RALLIART)																					CY4A(RALLIART)	4B11(T/C)	08.7-11.10	-	-	-	-	-	4												
CY4A																					CY4A	4B11(T/C)	11.10-	-	-	-	-	-	4												
GALANT FORTIS SPORTBACK																				1800	CX3A	4B10(MIVEC)	09.12-	-	-	-	-	VFK16	4												
CX6A																					CX6A	4J10	11.10-	-	-	-	-	-	4												
2000																					CX4A	4B11(MIVEC)	08.12-09.12	K20PSR-B8	MN163807	-	-	IK20	VK20	4											
CX4A																					CX4A	4B11(T/C)	08.12-	IXUH22	-	-	-	IXUH22	VXUH22	4											
CX4A																					CX4A	4B11(T/C)	10.8-	-	-	-	-	-	4												
GALANT SIGMA																				1800	E19A	4G93(LPG)	96.1-	K20PR-U	MS851738	-	-	VK20T(*8)	4												
GRANDIS																				2400	NA4W	4G69(MIVEC)	03.5-	-	-	-	-	-	4												
GTO																				3000	Z16A	6G72	95.6-00.8	F)K20PR-U11 R)PK20PR-P11	F)MS851728 R)MS851502	F)K20TT R)-	IK20	VK20	EACH 3												
Z15A/16A																					Z15A/16A	6G72(DOHC • T/C)	95.6-00.8	F)K20PR-U11 R)PK20PR-P11	F)MS851728 R)MS851502	F)K20TT R)-	IK20	VK20	EACH 3												

(*8)This is IRIDIUM PLUS.





MODEL	CC	VEHICLE CODE	ENGINE	FROM-TILL	DENSO	GENUINE P/N	TT	IRIDIUM POWER	IRIDIUM TOUGH	QTY
MITSUBISHI										
i	660	HA1W	3B20(DOHC)	06.1-09.11	XU22HDR9	1822A009	XUH22T	IXUH22	VXUH22	3
		HA1W	3B20(T/C)	06.1-	SXU22HDR8	1822A010	-	IXUH22	VXUH22	3
		HA1W	3B20(MIVEC)	09.11-	FXU22HR11	1822A061	-	-	-	3
LANCER	1300	CB1A · CK1A	4G13	91.10-	W16EPR11	MS851417	W16TT	IW16	VW16	4
		CK2A · CM2A	4G15(DOHC)	95.10-	K16PR-U11	MS851727	K16TT	IK16	VK16	4
	1500	CS2A	4G15	03.2-	K16PR-U11	MS851727	K16TT	IK16	VK16	4
		CS2W	4G15	05.1-	K16PR-U11	MS851727	K16TT	IK16	VK16	4
	1600	CB4A · CK4A	4G92(DOHC · MIVEC)	92.10-	K22TMR11	MD319586	-	IK22	VK22	4
		CM5A	4G93(DOHC · T/C)	95.10-05.1	K20PR-U	MS851738	K20TT	IK20	VK20	4
	1800	CK6A	6A11	95.10-05.1	F)K20PR-U11 R)PK20PR11	F)MS851728 R)MD322771	F)K20TT R)-	IK20	VK20	EACH 3
		CS5W	4G93(GDI · T/C)	03.2-	VKA20	-	-	-	VKA20	4
		CS5A · CS5W	4G93(GDI)	03.2-	VKA16	-	-	-	VKA16	4
	2000	CS6A	4G94	05.1-	K16PR-U11	MS851727	K16TT	IK16	VK16	4
LANCER CARGO	1200	CVAY12	CR12DE	08.12-	IKH16	-	-	IKH16	VKH16	4
		CS2V	4G15	03.1-08.12	K16PR-U11	MS851727	K16TT	IK16	VK16	4
	1500	CVY12	HR15DE	08.12-13.6	FXE20HE11	22401-ED71B	-	-	VFXEH20E	4
		CVY12	HR15DE	13.6-	FXE20HE11	-	-	-	VFXEH20E	4
	1600	CVZNY12	HR16DE	08.12-	FXE20HR11	-	-	-	VFXEH20	4
	1800	CVJY12	MR18DE	08.12-	FXE20HR11	-	-	-	VFXEH20	4
LANCER CEDIA/ WAGON	1500	CS2A	4G15(GDI)	00.5-03.2	VKA16	-	-	-	VKA16	4
		CS2A	4G15	01.5-03.2	K16PR-U11	MS851727	K16TT	IK16	VK16	4
	1800	CS5A · CS5W	4G93(GDI)	00.5-01.6	VKA16	-	-	-	VKA16	4
		CS5A · CS5W	4G93(GDI)	01.6-03.2	VKA16	-	-	-	VKA16	4
		CS5W	4G93(GDI · T/C)	01.6-03.2	VKA20	-	-	-	VKA20	4
LANCER EVOLUTION	2000	CP9A(EVOVI)	4G63(DOHC · T/C)	99.1-00.1	P22PR8	MD343244	-	IW22	VW22	4
		CP9A(EVOVI · Tommy Makinenn Edition)	4G63(DOHC · T/C)	00.1-01.1	S22PR-A7	MD371435	-	IW22	VW22	4
		CT9A(EVOVII/GTA)	4G63(DOHC · T/C)	01.2-03.1	VW22	MZ602048	-	IW22	VW22	4
	2000	CT9A (EVOVIII)	4G63(DOHC · T/C)	03.1-05.3	VW22	MZ602048	-	IW22	VW22	4
		CT9A (EVOIX)	4G63(DOHC · T/C)	05.3-07.10	VKH22	-	-	IKH22	VKH22	4
		CT9W (WAGON · MT)	4G63(DOHC · T/C)	05.9-	VKH22	-	-	IKH22	VKH22	4
		CT9W (WAGON · AT)	4G63(DOHC · T/C)	05.9-	VW22	MZ602048	-	IW22	VW22	4
		CZ4A (EVOX)	4B11(DOHC · T/C)	07.10-	-	-	-	-	-	4
		CZ4A (EVOX)	4B11(T/C)	10.10-	-	-	-	-	-	4
LEGNUM	1800	EA1W · EC1W	4G93(GDI)	97.1-00.5	VKA16	-	-	-	VKA16	4
	2000	EA4W · EC4W	6A12	96.8-00.5	F)K20PR-U11 R)PK20PR11	F)MS851728 R)MD322771	F)K20TT R)-	IK20	VK20	EACH 3
		EA7W · EC7W	4G94(GDI)	00.5-02.8	VKA16	-	-	-	VKA16	4
	2400	EA3W · EC3W	4G64(GDI)	98.8-01.4	VKA16	-	-	-	VKA16	4
		EA3W · EC3W	4G64(GDI)	01.4-02.8	VKA16	-	-	-	VKA16	4
LIBERO/ CARGO	1300	CB1V	4G13	92.6-02.	W16EPR11	MS851417	W16TT	IW16	VW16	4
		CB2V/CD2V	4G15	92.6-02.	W16EPR11	MS851417	W16TT	IW16	VW16	4
	1500	CB2W	4G15(ECI-MVV)	94.1-00.	W16EPR11	MS851417	W16TT	IW16	VW16	4
		CB4W/5W	4G92	96.10-00.	K16PR-U11	MS851727	K16TT	IK16	VK16	4
	1800	CB5W · CD5W	4G93	92.6-00.	K16PR-U11	MS851727	K16TT	IK16	VK16	4
		CD5W	4G93(DOHC · T/C)	94.1-00.	K20P-U	MS851722	K20TT	IK20	VK20	4
MINICA	660	H42A/42V/47A/47V	3G83(MVV)LEANBURN	98.10-01.10	-	-	-	-	-	3
		H42A/42V/47A/47V	3G83(4VALVE)	01.10-08.8	KJ16CR-U11	MD362098	K16TT	IK16	VK16	3
		H42A/42V/47A/47V	3G83(4VALVE)	08.8-	KJ20CR-U11	MD358202	K20TT	IK20	VK20	3
MINICAB	660	U61T/TP/V · U62T/TP/V	3G83(MVV)LEANBURN	99.1-02.8	-	-	-	-	-	3
		U61T/TP/V · U62T/TP/V	3G83	02.8-	KJ20CR-U11	MD358202	K20TT	IK20	VK20	3
		U61V	3G83(T/C)	11.12-	SVK20RZ8	MN122257	-	-	VK20Y	3
	660	U62V	3G83(T/C)	11.12-	SVK20RZ8	MN122257	-	-	VK20Y	3
		DS16T	R06A	14.2-15.9	VSUEH22	-	-	-	VSUEH22	3
		DS64V	K6A	14.2-15.3	IXU22HPR	MQ504109	-	IXUH22	VXUH22	3
		DS64V	K6A(T/C)	14.2-15.3	IXU22HPR	MQ504109	-	IXUH22	VXUH22	3
		DS17V	R06A	15.3-	VSUEH22	-	-	-	VSUEH22	3
		DS17V	R06A(T/C)	15.3-	VSUEH22	-	-	-	VSUEH22	3
		DS16T	R06A	15.9-	VSUEH22	-	-	-	VSUEH22	3
MINICAB, FUEL	660		(Bi-Fuel)	07.10-	KJ20CR-U11	MD358202	K20TT	IK20	VK20	3
MIRAGE	1000	A05A	3A90	12.8-	FK16HR11	-	-	-	VFKH16	3
		A03A	3A92	14.12-	FK16HR11	-	-	-	VFKH16	3
	1200	A03A	3A92	16.1-	-	-	-	-	VFKH16	3
		CA1A · CB1A · CJ1A · CK1A	4G13	91.10-	W16EPR11	MS851417	W16TT	IW16	VW16	4
	1500	CJ2A · CK2A · CL2A · CM2A	4G15(DOHC)	95.10-	K16PR-U11	MS851727	K16TT	IK16	VK16	4
	1600	CK4A · CJ4A	4G92(MIVEC)	95.10-	K22TMR11	MD319586	-	IK22	VK22	4
1800	CM5A	4G93(DOHC · T/C)	95.10-	K20PR-U	MS851738	K20TT	IK20	VK20	4	

DENSO

AUSTRALIA CHINA INDIA INDONESIA KOREA MALAYSIA PHILIPPINES SAUDIARABIA SINGAPORE TAIWAN THAILAND VIETNAM JAPAN EUROPE MOTOR & USA CYCLE SMALL ENGINE PART CROSS REFERENCE NUMBER

DENSO	9	14	16	20	22	24	27	29	31	32	34	35	DENSO	9	14	16	20	22	24	27	29	31	32	DENSO	9	14	16	20	22	24	27	31
NGK	2	4	5	6	7	8	9	9.5	10	10.5	11	11.5	CHAMPION	18	16,14	12,11	10,9	8,7	6,63,61	4,59	57	55	53	BOSCH	10	9	8	7,6	5	4	3	2

MODEL	CC	VEHICLE CODE	ENGINE	FROM-TILL	DENSO	GENUINE P/N				QTY
MITSUBISHI										
GALUE 2-04	1500	NZE141 Rev • NZE144 Rev	1NZ-FE	08.2-	FK20HR11	90919-01247	-	-	VFKH20	4
	1800	ZRE142 Rev • ZRE144 Rev	2ZR-FE	08.2-	SC16HR11	90919-01275	-	-	VCH16	4
GALUE III	2500	Y50	VQ25HR	07.12-	FXE22HR11	22401-EW61C	-	-	VFXEH22	6
	3000	PY50 • PNY50	VQ35HR	07.12-	FXE22HR11	22401-EW61C	-	-	VFXEH22	6
GALUE CLASSIC	1500	NZE141 • NZE144	1NZ-FE	10.3-	FK16HR11	90919-01243	-	-	VFKH16	4
	1800	ZRE142 • ZRE144	2ZR-FE	10.3-	SC16HR11	90919-01275	-	-	VCH16	4
GALUE CONVERTIBLE	4000	FORD MUSTANG	-	07.4-	IT20	-	-	IT20	VT20	6
	4600	FORD MUSTANG	-	07.4-	-	-	-	-	-	8
GALUE II	2500	MY34	VQ25DD	99.12-05.7	VK16	-	-	IK16	VK16	6
	3000	HY34	VQ30DD	99.12-05.7	VK16	-	-	IK16	VK16	6
GALUE LIMOUSINE S50	2500	Y50 Rev	VQ25HR	08.11-	FXE20HR11	22401-JD01B	-	-	VFXEH20	6
	3500	PY50 Rev • PNY50 Rev	VQ35HR	08.11-	FXE20HR11	22401-JD01B	-	-	VFXEH20	6
GALUE LIMOUSINE S51	3500	PY50 Rev	VQ35HR	08.10-	FXE20HR11	22401-JD01B	-	-	VFXEH20	6
GALUE LIMOUSINE S52	3500	PNY50 Rev	VQ35HR	08.10-	FXE20HR11	22401-JD01B	-	-	VFXEH20	6
HIMIKO	2000	NCEC	LF-VE	08.12-	ITV20	-	-	ITV20	-	4
K-1/K-2	50	-	MC-1E	98.10-	W24FR-L	-	-	IWF24	-	1
LE SEYDE	2000	-	SR20DE(DOHC)	00.11-06.2	K20R-U	-	K20TT	IK20	VK20	4
MC-1	50	MC-1	MC-1E	98.7-	W24FR-L	-	-	IWF24	-	1
MG-TD	2000	TD2000	3S-FE	04.10-	K20R-U11	-	K20TT	IK20	VK20	4
NOUERA	1500	NZE141/141G • NZE144/144G	1NZ-FE	08.7-	FK16HR11	90919-01243	-	-	VFKH16	4
	1800	ZRE142/142G • ZRE144/144G	2ZR-FE	08.7-	SC16HR11	90919-01275	-	-	VCH16	4
	2000	CL7 • CL8	K20A(DOHC • i-VTEC)	04.4-08.7	KJ20DR-M11	9807B-5615P	K20TT	IK20	VK20	4
	2400	CL9	K24A(DOHC • i-VTEC)	04.4-08.7	SKJ20DR-M11	9807B-5615W	-	IK20	VK20	4
OROCHI	3300	MSP1	3MZ-FE	07.6-	SK20R11	90919-01210	-	IK20	VK20	6
OROCHI • KABUTO	3300	-	3MZ-FE	08.9-	SK20R11	90919-01210	-	IK20	VK20	-
RAY	660	AC6P	F6A(DOHC)	99.9-	XU22EPR-U	-	XU22TT	IXU22	VXU22	3
		L700S	EF-VE	02.5-	K20TNR-S9	-	K20TT	IK20	VK20	3
RYOGA	1500	FB15 • FNB15	QG15DE	01.7-	K16PR-U11	-	K16TT	IK16	VK16	4
	1800	P11 • WP11	SR18DE(DOHC)	98.2-01.6	K16R-U11	-	K16TT	IK16	VK16	4
		QB15 Rev	QG18DD(NEO D1)	01.7-	PK16R11	-	-	IK16	VK16	4
	2000	HP11 • HNP11	SR20VE(DOHC)	98.2-01.6	K20PR-U	-	K20TT	IK20	VK20	4
WHP11 • WHNP11		SR20VE(DOHC)	98.2-01.6	K20PR-U	-	K20TT	IK20	VK20	4	
TYPE F	1800	MS01	BP-ZE(DOHC)	97.5-	K16PR-U11	-	K16TT	IK16	VK16	4
VIEWT	1000	K11	CG10DE(DOHC)	93.1-05.9	K16PR-U11	-	K16TT	IK16	VK16	4
	1200	AK12	CR12DE	05.9-	VKH16	-	-	IKH16	VKH16	4
	1300	HK11	CG13DE(DOHC)	93.1-05.9	K16PR-U11	-	K16TT	IK16	VK16	4
	1400	BNK12	CR14DE	05.9-	VKH16	-	-	IKH16	VKH16	4
	1500	YK12	HR15DE	05.9-	FXE20HE11	22401-ED71B	-	-	VFXEH20E	4
	YUGA	1300	AZ10 • Z10	CGA3DE • CG13DE	98-01.10	K16PR-U11	-	K16TT	IK16	VK16
ZERO 1	1800	MS01	BP-ZE(DOHC)	94.1-00.7	K16PR-U11	-	K16TT	IK16	VK16	4
NISSAN										
AD, AD MAX (VAN, WAGON)	1300	VY10	GA13(Rev)LPG	-	K16PR-U11	-	-	-	VK20T(*8)	4
		VY11	QG13DE	99.6-	K16PR-U11	-	K16TT	IK16	VK16	4
		VFY10	GA15 Rev (LPG)	-	K16PR-U11	-	-	-	VK20T(*8)	4
	1500	VFY11	QG15DE	99.6-02.8	K16PR-U11(*5)	-	K16TT	IK16(*5)	VK16(*5)	4
		VFY11	QG15DE	02.8-	K16HPR-U11(*5)	-	-	IKH16(*5)	VKH16(*5)	4
	1800	VHNY11	QG18DE	99.6-02.8	K16PR-U11(*5)	-	K16TT	IK16(*5)	VK16(*5)	4
		VHNY11	QG18DE	02.8-	K16HPR-U11(*5)	-	-	IKH16(*5)	VKH16(*5)	4
		VGY11	QG18DEN(CNG)	00.1-	IK22	-	-	IK22	VK22	4
AD, AD EXPERT	1200	VAY12	CR12DE	07.1-	IKH16	-	-	IKH16	VKH16	4
	1500	VY12	HR15DE	07.1-13.5	FXE20HE11	22401-ED71B	-	-	VFXEH20E	4
		VY12	HR15DE	13.5-16.12	FXE20HE11	-	-	-	VFXEH20E	4
	1600	VZNY12	HR16DE	08.12-16.12	FXE20HR11	22401-JD01B	-	-	VFXEH20	4
	1800	VJY12	MR18DE	07.1-	FXE20HR11	22401-JD01B	-	-	VFXEH20	4
ATLAS	2000	SH2F23 • SH4F23	KA20DE	99.6-07.6	K16PR-U11	-	K16TT	IK16	VK16	4
		SQ1F24 • SQ2F24	QR20DE	07.6-	FXE20HR11	22401-JD01B	-	-	VFXEH20	4
AVENIR/ SALUT	1800	W11	QG18DE	98.8-02.7	K16PR-U11(*5)	-	K16TT	IK16(*5)	VK16(*5)	4
		W11	QG18DE	02.8-	K16HPR-U11(*5)	-	-	IKH16(*5)	VKH16(*5)	4
	2000	PNW11 • PW11	SR20DE	98.8-02.7	K16R-U11	-	K16TT	IK16	VK16	4
		PNW11	SR20DET(T/C)	98.8-02.7	PK20PR-P8	-	-	-	VK20Y	4
BASSARA	2400	JU30 • JNU30	KA24DE	99.11-01.7	K16PR-U11	-	K16TT	IK16	VK16	4
	2500	JTU30 • JTNU30	QR25DE(NEO)	01.8-	K16HPR-U11	-	-	IKH16	VKH16	4
	3000	JHU30	VQ30DE(LEV)	99.11-	VK16	-	-	IK16	VK16	6
Be-1	1000	BK10	MA10	87.1-02.2	W16EX-U11	-	W16TT	IW16	VW16	4
BLUEBIRD	1800	PJ811/910 • KP900 • P910	Z18P(LPG)	79.2-01.8	W20EX-U	-	-	-	VW20T(*8)	8
		PC910	Z18P(LPG)	88.2-01.8	VW20T(*8)	-	-	-	VW20T(*8)	8

(*5)The plug reach may be 19mm or 26.5mm even with the same engine and the same vehicle code. Please confirm the plug reach and choose the correct DENSO type. If there is an "H" in DENSO type, it has a reach of 26.5mm. If it doesn't, its reach is 19mm. (*8)This is IRIDIUM PLUS.

DENSO
 AUSTRALIA CHINA INDIA INDONESIA KOREA MALAYSIA PHILIPPINES SAUDI ARABIA SINGAPORE TAIWAN THAILAND VIETNAM JAPAN & USA EUROPE MOTOR CYCLE SMALL ENGINE CROSS PART REFERENCE NUMBER



MODEL	CC	VEHICLE CODE	ENGINE	FROM-TILL	DENSO	GENUINE P/N	TT	IRIDIUM POWER	IRIDIUM TOUGH	QTY
NISSAN										
DAYZ		B21W	3B20(Except IRIDIUM PLUGS INSTALLED VEHICLES)	13.6-14.7	XU22HDR9	1822A009	XUH22TT	IXUH22	VXUH22	3
		B21W	3B20(T/C,IRIDIUM PLUGS INSTALLED VEHICLES)	13.8-14.7	SXU22HDR8	1822A010	-	IXUH22	VXUH22	3
	660	B21W	3B20(T/C,Except IRIDIUM PLUGS INSTALLED VEHICLES)	13.8-14.7	XU22HDR9	1822A009	XUH22TT	IXUH22	VXUH22	3
		B21W	3B20	14.7-17.1	SXU22HDR8	1822A010	-	IXUH22	VXUH22	3
		B21W	3B20(T/C)	14.7-19.3	SXU22HDR8	1822A010	-	IXUH22	VXUH22	3
		B21W	3B20	17.1-19.3	-	-	-	IXUH20I	VXUH20I	3
		B43W	BR06	19.3-	-	-	-	-	VSUEH22	3
		B46W	BR06	19.3-	-	-	-	-	VSUEH22	3
DAYZ HYBRID	660	B44W	BR06	19.3-	-	-	-	VSUEH22	3	
		B45W	BR06(T/C)	19.3-	-	-	-	VSUEH22	3	
		B47W	BR06	19.3-	-	-	-	VSUEH22	3	
		B48W	BR06(T/C)	19.3-	-	-	-	VSUEH22	3	
DAYZ ROOX	660	B21A	3B20(T/C)	14.2-	SXU22HDR8	1822A010	-	IXUH22	VXUH22	3
		B21A	3B20	14.2-	-	-	-	IXUH20I	VXUH20I	3
DUALIS	2000	J10 • NJ10	MR20DE	07.5-08.5	FXE20HR11	22401-JD01B	-	-	VFXEH20	4
		KJ10 • KNJ10	MR20DE	08.5-	FXE20HR11	22401-JD01B	-	-	VFXEH20	4
ELGRAND	2500	E51 • NE51 • ME51 • MNE51	VQ25DE	04.12-10.8	VKH16	-	-	IKH16	VKH16	6
		TE52 • TNE52	QR25DE	10.8-	FXE20HR11	22401-JD01B	-	-	VFXEH20	4
	3300	ALE50 • ALWE50	VG33E	97.5-00.8	K16PR-U11	-	K16TT	IK16	VK16	6
		3500	APE50 • APWE50 • E51 • NE51	VQ35DE	00.8-10.8	VKH16	-	-	IKH16	VKH16
	PE52 • PNE52		VQ35DE	10.8-	FXE22HR11	22401-EW61C	-	-	VFXEH22	6
EXPERT	1800	VW11 • VNW11	QG18DE	99.6-02.8	K16PR-U11(*5)	-	K16TT	IK16(*5)	VK16(*5)	4
		VW11 • VNW11	QG18DEN(CNG)	00.1-	IK22	-	-	IK22	VK22	4
		VW11 • VNW11	QG18DE	02.8-	K16HPR-U11(*5)	-	-	IKH16(*5)	VKH16(*5)	4
FAIRLADY Z	3000	Z32 • GZ32 • HZ32	VG30DE	89.7-02.7	VK20	-	-	IK20	VK20	6
		CZ32 • GCZ32	VG30DETT(T/C)	89.7-02.7	VK20	-	-	IK20	VK20	6
	3500	Z33 • HZ33	VQ35DE	02.7-07.1	VKH16	-	-	IKH16	VKH16	6
		Z33 • HZ33	VQ35HR	07.1-08.12	FXE22HR11	22401-EW61C	-	-	VFXEH22	6
3700	Z34 • HZ34	VQ37VHR	08.12-	FXE24HR11	22401-JK01D	-	-	-	6	
FUGA	2500	Y50	VQ25DE	04.10-07.12	VKH16	-	-	IKH16	VKH16	6
		Y50	VQ25HR	07.12-09.11	FXE22HR11	22401-EW61C	-	-	VFXEH22	6
		Y51	VQ25HR	09.11-	FXE22HR11	22401-EW61C	-	-	VFXEH22	6
	3500	PY50 • PNY50	VQ35DE	04.10-07.12	VKH16	-	-	IKH16	VKH16	6
		PY50 • PNY50	VQ35HR	07.12-09.11	FXE22HR11	22401-EW61C	-	-	VFXEH22	6
	3700	KY51 • KNY51	VQ37VHR	09.11-	FXE24HR11	22401-JK01D	-	-	-	6
4500	GY50	VK45DE	05.8-09.11	VKH16	-	-	IKH16	VKH16	8	
FUGA HYBRID	3500	HY51	VQ35HR(HYBRID)	10.1-	FXE22HR11	22401-EW61C	-	-	VFXEH22	6
GLORIA	2000	QJY31	NA20P(LPG)	91.6-	VW20T(*8)	-	-	-	VW20T(*8)	4
		CBJY31 • BJY31	VG20P(LPG)	04.1-04.9	PK20PR11	-	-	IK20	VK20T(*8)	6
	2500	ENY34	RB25DET(T/C)	99.6-04.9	VK20	-	-	IK20	VK20	6
		MY34	VQ25DD(NEO-Di)	99.6-01.12	VK16(*5)	-	-	IK16(*5)	VK16(*5)	6
		MY34	VQ25DD(NEO-Di)	02.1-04.9	IKH16(*5)	-	-	IKH16(*5)	VKH16(*5)	6
		HY34	VQ30DET(T/C)	99.6-01.12	VK20	-	-	IK20	VK20	6
	3000	HY34	VQ30DD(NEO-Di)	99.6-01.12	VK16(*5)	-	-	IK16(*5)	VK16(*5)	6
		HY34	VQ30DD(NEO-Di)	02.1-04.9	IKH16(*5)	-	-	IKH16(*5)	VKH16(*5)	6
GT-R	3800	R35	VR38DETT(T/C)	07.12-	VDCH22F	-	-	-	VDCH22F	6
HOMY	3000	KEE24 • AEGE24	VG30E	88.10-89.8	VK20	-	-	IK20	VK20	6
		KEE24 • AEGE24	VG30E	89.9-90.10	VK16	-	-	IK16	VK16	6
		KEE24 • AEGE24 • FEGE24	VG30E	90.10-01.3	VK20	-	-	IK20	VK20	6
JUKE	1500	YF15	HR15DE	10.6-	VFXEH20E	-	-	-	VFXEH20E	4
		F15 • NF15	MR16DDT(T/C)	10.11-14.9	-	-	-	-	-	4
	1600	F15	MR16DDT(T/C)	14.9-	-	-	-	-	-	4
NF15		MR16DDT(T/C)	14.9-	-	-	-	-	-	4	
JUKE NISMO RS	1600	NF15	MR16DDT(T/C)	14.11-	-	-	-	-	4	
KIX	660	H59A	4A30(T/C)	08.11-	SXU22PR-A9	-	-	IXU22	VXU22	4
LAFESTA	2000	B30 • NB30	MR20DE	04.12-05.11	ZXE20HR13	22401-EN215	-	-	VFXEH20	4
		B30 • NB30	MR20DE	05.12-	FXE20HR11	22401-JD01B	-	-	VFXEH20	4
LAFESTA HIGHWAY STAR	2000	CWFEFNN(2WD)	LF-VD(DOHC DISI)	11.6-	ITV20	-	-	ITV20	-	4
		CWFEFNN(2WD)	LF-VDS(DOHC DISI)	11.6-	ITV20	-	-	ITV20	-	4
		CWEAWN(4WD)	LF-VE	11.6-13.3	ITV20	-	-	ITV20	-	4
		CWEAWN	LF-VE	13.3-	ITV16	-	-	ITV16	-	4
		CWFFWN	PE-VPS	13.3-	ZC20HPR11	PE5S 18 110	-	-	VCH20	4
LATIO	1200	N17	HR12DE	12.10-	FXE20HR11	22401-JD01B	-	-	VFXEH20	3
LAUREL	2000	HC35	RB20DE(LEANBURN)	97.6-	VK16	-	-	IK16	VK16	6

DENSO
 AUSTRALIA CHINA INDIA INDONESIA KOREA MALAYSIA PHILIPPINES SAUDIARABIA SINGAPORE TAIWAN THAILAND VIETNAM JAPAN EUROPE MOTOR & USA CYCLE SMALL ENGINE CROSS PART REFERENCE NUMBER



(*5)The plug reach may be 19mm or 26.5mm even with the same engine and the same vehicle code. Please confirm the plug reach and choose the correct DENSO type. If there is an "H" in DENSO type, it has a reach of 26.5mm. If it doesn't, its reach is 19mm. (*8) This is IRIDIUM PLUS.



▶ Spark plug color codes: ■ for Iridium Tough and Iridium Plugs and Iridium TT, ■ for Iridium Power, ■ for Iridium Racing and Two Tops Plugs, ■ for Platinum Plugs and Platinum TT, and black for general spark plugs.



PART NUMBER	CROSS REFERENCE	SMALL ENGINE	MOTOR CYCLE	EUROPE & USA	JAPAN	VIETNAM	THAILAND	TAIWAN	SINGAPORE	SAUDI ARABIA	PHILIPPINES	MALAYSIA	KOREA	INDONESIA	INDIA	CHINA	AUSTRALIA	MODEL	CC	VEHICLE CODE	ENGINE	FROM-TILL	DENSO	GENUINE P/N				QTY
																		NISSAN										
DENSO																		LAUREL	2000	HC35	RB20DE	97.6-	VK16	-	-	IK16	VK16	6
																		2500	GC35 · GNC35	RB25DE	97.6-	VK16	-	-	IK16	VK16	6	
																			GC35 · GCC35	RB25DET(T/C)	97.6-	VK16	-	-	IK16	VK16	6	
LIVERTY LUCINO																		2000	RM12 · RNM12	QR20DE	01.5-04.12	K16HPR-U11	-	-	IKH16	VKH16	4	
																		1500	FN15 · FNN15	GA15DE	95.1-	K16PR-U11	-	-	K16TT	IK16	VK16	4
																			EN15	GA16DE	95.1-	K16PR-U11	-	-	K16TT	IK16	VK16	4
																		1600	JN15(VZ-R)	SR16VE(VVL)	97.9-	K20PR-U	-	-	K20TT	IK20	VK20	4
																			JN15(VZ-R · N1)	SR16VE(VVL)	97.9-	VK22	-	-	IK22	VK22	4	
																		1800	HN15	SR18DE	92.8-	K16R-U	-	-	K16TT	IK16	VK16	4
HN15	SR18DE	98.10-	K16R-U11	-	-	K16TT	IK16	VK16	4																			
LUCINO S-RV																		1500	FN15 · FNN15	GA15DE	96.5-	K16PR-U11	-	-	K16TT	IK16	VK16	4
																		1600	JN15	SR16VE	97.9-	K20PR-U	-	-	K20TT	IK20	VK20	4
																			HNN15(4WD)	SR18DE	96.5-	K16R-U11	-	-	K16TT	IK16	VK16	4
MARCH																		1800	HNN15(2WD)	SR18DE	96.5-	K16R-U	-	-	K16TT	IK16	VK16	4
																		1000	K11 · WK11	CG10DE	92.1-02.2	K16PR-U11	-	-	K16TT	IK16	VK16	4
																			K12	CR10DE	02.3-03.6	IKH16	-	-	IKH16	VKH16	4	
MICRA C+C MOCO																		1200	AK12	CR12DE	02.3-08.7	IKH16	-	-	IKH16	VKH16	4	
																		1300	K13 · NK13	HR12DE	10.7-	FXE20HR11	22401-JD01B	-	-	IKH16	VKH16	4
																			AK11 · ANK11 · WAK11	CGA3DE	99.11-02.2	K16PR-U11	-	-	K16TT	IK16	VK16	4
																		1400	BK12(Except 14S)	CR14DE	02.3-05.8	IKH16	-	-	IKH16	VKH16	4	
																			BNK12	CR14DE	02.9-10.7	IKH16	-	-	IKH16	VKH16	4	
																		1500	BK12(14S)	CR14DE	03.7-05.8	VKH20	-	-	IKH20	VKH20	4	
MURANO																		1500	YK12	HR15DE	05.8-10.7	FXE20HE11	22401-ED71B	-	-	VFXEH20E	4	
																		1600	FHZK12	HR16DE	07.7-	FXE20HR11	22401-JD01B	-	-	VFXEH20	4	
																			MG21S	K6A(T/C)	02.4-06.2	IXU22C	-	-	IXU22	VXU22	3	
																		660	MG21S(4WD)	K6A	02.4-06.2	XU22EPR-U	-	-	XU22TT	IXU22	VXU22	3
																			MG21S(2WD)	K6A	02.4-06.2	IXU22C	-	-	IXU22	VXU22	3	
																			MG22S	K6A(DOHC)	06.2-09.6	IXU22C(*5)	-	-	IXU22(*5)	VXU22(*5)	3	
																			MG22S	K6A(DOHC)	09.6-11.2	IXU22HPR(*5)	09482-00608	-	-	IXUH22(*5)	VXUH22(*5)	3
																			MG22S	K6A(T/C)	06.2-11.2	IXU22C(*5)	-	-	IXU22(*5)	VXU22(*5)	3	
MG33S	R06A	11.2-	VSUEH22	-	-	-	VSUEH22	3																				
NOTE																		2500	TZ50	QR25DE	04.9-08.9	K16HPR-U11	-	-	IKH16	VKH16	4	
																		TNZ51 · TZ51	QR25DE	08.9-	FXE20HR11	22401-JD01B	-	-	VFXEH20	4		
																		3500	PNZ50 · PZ50	VQ35DE	04.9-08.9	VKH16	-	-	IKH16	VKH16	6	
																			PNZ51	VQ35DE	08.9-	FXE22HR11	22401-EW61C	-	-	VFXEH22	6	
																		NOTE e-POWER										
NE12	HR12DDR(S/C)	12.9-	-	-	-	-	-	3																				
1500	E11 · NE11	HR15DE	05.1-12.9	FXE20HE11	22401-ED71B	-	-	VFXEH20E	4																			
	ZE11	HR16DE	08.10-12.9	FXE20HR11	22401-JD01B	-	-	VFXEH20	4																			
1600	E12(Rev)	HR16DE	14.10-	FXE20HE11	-	-	-	VFXEH20E	4																			
	HE12	HR12DE	16.11-	FXE20HR11	-	-	-	VFXEH20	3																			
NT100 CLIPPER																		1200	SNE12	HR12DE	18.7-	FXE20HR11	-	-	VFXEH20	3		
																		660	U71T	3G83	12.1-13.12	KJ20CR-U11	-	-	K20TT	IK20	VK20	3
																			U71TP	3G83	12.1-13.12	KJ20CR-U11	-	-	K20TT	IK20	VK20	3
																		DR16T	U72T	3G83	12.1-13.12	KJ20CR-U11	-	-	K20TT	IK20	VK20	3
																			DR16T	R06A	13.12-15.8	VSUEH22	-	-	-	VSUEH22	3	
NV100 CLIPPER																		660	DR16T	R06A	15.8-	VSUEH22	-	-	-	VSUEH22	3	
																		U71V	3G83	12.1-13.12	KJ20CR-U11	-	-	K20TT	IK20	VK20	3	
																		U71V	3G83(T/C)	12.1-13.12	SVK20RZ8	MN122257	-	-	-	VK20Y	3	
																		U72V	3G83	12.1-13.12	KJ20CR-U11	-	-	K20TT	IK20	VK20	3	
																		U72V	3G83(T/C)	12.1-13.12	SVK20RZ8	MN122257	-	-	-	VK20Y	3	
																		660	DR64V	K6A	13.12-15.3	IXU22HPR	-	-	IXUH22	VXUH22	3	
																			DR64V	K6A(T/C)	13.12-15.3	IXU22HPR	-	-	IXUH22	VXUH22	3	
																			DR64W	K6A(T/C)	13.12-15.3	IXU22HPR	-	-	IXUH22	VXUH22	3	
																			DR17V	R06A	15.3-	VSUEH22	-	-	-	VSUEH22	3	
																		NV150 AD										
1600	VZNY12	HR16DE	16.12-	FXE20HR11	-	-	-	VFXEH20	4																			
1600	M20.VM20	HR16DE	09.5-	XE20HR-U9	-	-	-	VFXEH20	4																			
	VNM20	HR16DE	18.1-	FXE20HR11	-	-	-	VFXEH20	4																			
NV200 VANETTE																		1600	M20	HR16DE	10.12-	XE20HR-U9	-	-	-	VFXEH20	4	
																		2000	VR2E26	QR20DE	12.6-	FXE20HR11	22401-JD01B	-	-	VFXEH20	4	
																			KS2E26	QR25DE	12.6-	FXE20HR11	22401-JD01B	-	-	VFXEH20	4	
NV350 CARAVAN																		2500	KS4E26	QR25DE	12.6-	FXE20HR11	22401-JD01B	-	-	VFXEH20	4	

(*5)The plug reach may be 19mm or 26.5mm even with the same engine and the same vehicle code. Please confirm the plug reach and choose the correct DENSO type. If there is an "H" in DENSO type, it has a reach of 26.5mm. If it doesn't, its reach is 19mm

MODEL	CC	VEHICLE CODE	ENGINE	FROM-TILL	DENSO	GENUINE P/N				QTY
NISSAN										
NV350 CARAVAN	2500	CS4E26	QR25DE	12.7-	FXE20HR11	22401-JD01B	-	-	VFXEH20	4
		DS4E26	QR25DE	12.12-	FXE20HR11	22401-JD01B	-	-	VFXEH20	4
		CS8E26	QR25DE	17.12-	FXE20HE11	22401-ED71B	-	-	VFXEH20E	4
		DS8E26	QR25DE	17.12-	FXE20HE11	22401-ED71B	-	-	VFXEH20E	4
OTTI	660	H91W	3G83(SOHC)	05.6-06.10	KJ16CR-U11	MD362098	K16TT	IK16	VK16	3
		H91W	3G83(T/C)	05.6-06.10	SVK20RZ8	MN122257	-	-	VK20Y	3
		H92W	3G83(SOHC)	06.10-	KJ20CR-U11	-	K20TT	IK20	VK20	3
		H92W	3G83(T/C)	06.10-	SVK20RZ8	MN122257	-	-	VK20Y	3
PINO	660	HC24S	K6A(DOHC)	07.1-	IXU22C	09482-00563	-	IXU22	VXU22	3
PRAIRIE/ LIBERTY	2000	PM12 · PNM12	SR20DE	98.11-01.4	K16R-U11	-	K16TT	IK16	VK16	4
		PNM12	SR20DET(T/C)	99.10-01.4	VK20	-	-	IK20	VK20	4
PRESAGE	2400	U30 · NU30 · HN30	KA24DE	98.6-01.7	K16PR-U11	-	K16TT	IK16	VK16	4
	2500	TU30 · TNU30	QR25DE	01.8-03.6	K16HPR-U11	-	-	IKH16	VKH16	4
		TU31 · TNU31	QR25DE	03.7-06.5	K16HPR-U11	-	-	IKH16	VKH16	4
	3000	HU30	VQ30DE	98.6-03.6	VK16	-	-	IK16	VK16	6
	3500	PU31 · PNU31	VQ35DE	03.7-	VKH16	-	-	IKH16	VKH16	6
PRESEA	1500	R11	GA15DE	95.1-00.8	K16PR-U11	-	K16TT	IK16	VK16	4
	1800	PR11	SR18DE	95.1-00.8	K16R-U	-	K16TT	IK16	VK16	4
	2000	HR11	SR20DE	95.1-00.8	K16R-U	-	K16TT	IK16	VK16	4
PRESIDENT	4500	JHG50 · JG50	VH45DE	93.4-02.8	VK16	-	-	IK16	VK16	8
		PGF50	VK45DE	03.10-10.8	VKH16	-	-	IKH16	VKH16	8
PRIMERA/ WAGON	1800	WQP11 · QP11	QG18DD(NEO-Di)	98.9-01.1	VK16	-	-	IK16	VK16	4
		WQP11 · QP11	QG18DE(LEANBURN)	98.9-01.1	VK16	-	-	IK16	VK16	4
		QP12	QG18DE	02.2-	K16HPR-U11(*5)	-	-	IKH16(*5)	VKH16(*5)	4
	2000	HP11 · HNP11	SR20DE	95.9-01.1	K16R-U11	-	K16TT	IK16	VK16	4
		FHP11 · WHP11 · WHNP11	SR20DE	97.2-01.1	K16R-U11	-	K16TT	IK16	VK16	4
		HP11 · WHP11	SR20VE	97.9-01.1	K20PR-U	-	K20TT	IK20	VK20	4
		TP12 · WTP12 · WTNP12	QR20DE(NEO)	01.1-	K16HPR-U11	-	-	IKH16	VKH16	4
		TNP12	QR20DE	01.8-	K16HPR-U11	-	-	IKH16	VKH16	4
		HP12 · WHP12	SR20VE(NEO VVL)	01.8-03.6	VKH20	-	-	IKH20	VKH20	4
		2500	RP12 · WRP12	QR25DD(NEO-Di)	01.1-	-	-	-	-	-
PULSAR SERIE S-RV	1500	FN15 · FNN15	GA15DE	96.5-	K16PR-U11	-	K16TT	IK16	VK16	4
	1600	JN15	SR16VE	97.9-	K20PR-U	-	K20TT	IK20	VK20	4
	1800	HNN15(4WD)	SR18DE	96.5-	K16R-U11	-	K16TT	IK16	VK16	4
		HNN15(2WD)	SR18DE	96.5-	K16R-U	-	K16TT	IK16	VK16	4
PULSAR/ SERIE	1500	FN15 · FNN15	GA15DE	95.1-	K16PR-U11	-	K16TT	IK16	VK16	4
	1600	EN15	GA16DE	95.1-	K16PR-U11	-	K16TT	IK16	VK16	4
		JN15(VZ-R)	SR16VE(VVL)	97.9-	K20PR-U	-	K20TT	IK20	VK20	4
	1800	JN15(VZ-R · N1)	SR16VE(VVL)	97.9-	VK22	-	-	IK22	VK22	4
		HN14 · HN15 · HNN15	SR18DE	92.8-	K16R-U	-	K16TT	IK16	VK16	4
	HN15	SR18DE	98.10-	K16R-U11	-	K16TT	IK16	VK16	4	
RASHEEN/ FORZA	1500	RFNB14	GA15DE	94.12-00.8	K16PR-U11	-	K16TT	IK16	VK16	4
	1800	RHNB14	SR18DE	97.1-00.8	K16R-U11	-	K16TT	IK16	VK16	4
	2000	RKNB14	SR20DE	98.4-00.8	K16R-U11	-	K16TT	IK16	VK16	4
R'NESSA	2000	N30	SR20DE	97.10-00.1	K16PR-U11	-	K16TT	IK16	VK16	4
		N30	SR20DE	00.1-01.7	PK20PR-P8	-	-	IK20	VK20	4
	2400	NN30	SR20DET(T/C)	97.10-01.7	PK20PR-P8	-	-	-	VK20Y	4
		PNN30	KA24DE	97.10-01.7	K16PR-U11	-	K16TT	IK16	VK16	4
ROOX	660	ML21S	K6A	09.12-	IXU22HPR	09482-00608	-	IXUH22	VXUH22	3
		ML21S	K6A(T/C)	09.12-	IXU22HPR	09482-00608	-	IXUH22	VXUH22	3
SAFARI	4500	WGY61	TB45E	97.10-02.11	W16EPR-U11	-	W16TT	IW16	VW16	6
	4800	WFGY61	TB48DE	02.11-	VKH16	-	-	IKH16	VKH16	6
SERENA	2000	PC24 · PNC24	SR20DE	99.6-01.11	K16R-U11	-	K16TT	IK16	VK16	4
		PC24 · PNC24	SR20DE	99.6-	K16R-U11	-	K16TT	IK16	VK16	4
		TC24 · TNC24	QR20DE(NEO)	01.12-05.5	K16HPR-U11	-	-	IKH16	VKH16	4
		TC24 · TNC24	QR20DE	01.12-	K16HPR-U11	-	-	IKH16	VKH16	4
		C25 · NC25	MR20DE	05.5-05.12	FXE20HR11	22401-JD01B	-	-	VFXEH20	4
		C25 · NC25	MR20DE	05.12-10.11	FXE20HR11	22401-JD01B	-	-	VFXEH20	4
		CC25 · CNC25	MR20DE	06.6-10.11	FXE20HR11	22401-JD01B	-	-	VFXEH20	4
		C26 · NC26 · FC26 · FNC26	MR20DD	10.11-16.8	-	-	-	-	-	4
		FC26 · FNC26 · HC26 · HFC26	MR20DD(HYBRID)	12.8-16.8	-	-	-	-	-	4
		FPC26	MR20DD	15.11-	-	-	-	-	-	4
	FNPC26	MR20DD	15.11-	-	-	-	-	-	4	
	2500	C27	MR20DD	16.8-18.9	DXE22H11CT	22401-5TA1C	-	-	-	4
		C27	MR20DD	18.9-	DXE22H11C	22401-6CT1C	-	-	-	4
		RC24	QR25DE(NEO)	01.12-05.5	K16HPR-U11	-	-	IKH16	VKH16	4
		RC24	QR25DE	01.12-	K16HPR-U11	-	-	IKH16	VKH16	4

DENSO
 AUSTRALIA
 CHINA
 INDIA
 INDONESIA
 KOREA
 MALAYSIA
 PHILIPPINES
 SAUDI ARABIA
 SINGAPORE
 TAIWAN
 THAILAND
 VIETNAM
 JAPAN
 EUROPE
 MOTOR & USA
 CYCLE
 SMALL ENGINE
 CROSS REFERENCE
 PART NUMBER

(*5)The plug reach may be 19mm or 26.5mm even with the same engine and the same vehicle code. Please confirm the plug reach and choose the correct DENSO type. If there is an "H" in DENSO type, it has a reach of 26.5mm. If it doesn't, its reach is 19mm.

MODEL	CC	VEHICLE CODE	ENGINE	FROM-TILL	DENSO	GENUINE P/N				QTY
NISSAN										
VANETTE/LARGO (VAN/TRUCK)	1800	SKP2LN	L8-DE	12.6-	VT16	-	-	IT16	VT16	4
WINGROAD		WFY11	QG15DE	99.5-02.11	K16PR-U11	-	K16TT	IK16	VK16	4
		WFY11	QG15DE	02.11-05.11	K16HPR-U11	-	-	IKH16	VKH16	4
	1500	WFY11	QG15DE(LEANBURN)	99.5-01.9	K16PR-U11	-	K16TT	IK16	VK16	4
		WFY11	QG15DE(LEANBURN)	01.10-05.11	VK16	-	-	IK16	VK16	4
		Y12 · NY12	HR15DE	05.11-	FXE20HE11	22401-ED71B	-	-	VFXEH20E	4
		Y12	HR15DE	14.9-	FXE20HE11	22401-ED71B	-	-	VFXEH20E	4
		WHY11	QG18DE(LEANBURN)	99.6-01.9	VK16	-	-	IK16	VK16	4
	1800	WHNY11	QG18DE	99.6-02.10	K16PR-U11(*5)	-	K16TT	IK16(*5)	VK16(*5)	4
		WHNY11	QG18DE	02.11-05.11	K16HPR-U11(*5)	-	-	IKH16(*5)	VKH16(*5)	4
		JY12	MR18DE	05.11-	FXE20HR11	22401-JD01B	-	-	VFXEH20	4
2000	WPY11	SR20VE(VVL)	99.6-01.9	K20PR-U	-	K20TT	IK20	VK20	4	
	WRY11	QR20DE	01.10-05.11	K16HPR-U11	-	-	IKH16	VKH16	4	
X-TRAIL		PNT30	SR20VET(T/C)	00.11-07.8	VKH20	-	-	IKH20	VKH20	4
		NT30 · T30	QR20DE	00.11-07.8	K16HPR-U11	-	-	IKH16	VKH16	4
	2000	NT31 · T31	MR20DE	07.8-13.12	FXE20HR11	22401-JD01B	-	-	VFXEH20	4
		T32	MR20DD	13.12-	-	-	-	-	-	4
		NT32	MR20DD	13.12-	-	-	-	-	-	4
	2500	TNT31	QR25DE	07.8-13.12	FXE20HR11	22401-JD01B	-	-	VFXEH20	4
X-TRAIL HYBRID	2000	HT32	MR20DD	15.5-	-	-	-	-	-	4
		HNT32	MR20DD	15.5-	-	-	-	-	-	4
SUBARU										
BRZ	2000	ZC6	FA20	12.3-15.4	ZXE27HBR8	22401AA801	-	-	VXEBH27	4
		ZC6	FA20	15.4-	ZXE27HBR8	22401AA801	-	-	VXEBH27	4
CHIFFON		LA600F	KF	16.12-19.7	SXU20HPR11	90048-51208	-	IXUH20I	VXUH20I	3
		LA610F	KF	16.12-19.7	SXU20HPR11	90048-51208	-	IXUH20I	VXUH20I	3
		LA600F	KF(T/C)	16.12-19.7	SXU22HPR8	90048-51214	-	IXUH22I	VXUH22I	3
	660	LA610F	KF(T/C)	16.12-19.7	SXU22HPR8	90048-51214	-	IXUH22I	VXUH22I	3
		LA650F	KF	19.7-	-	-	-	-	-	3
		LA650F	KF(T/C)	19.7-	-	-	-	-	-	3
		LA660F	KF	19.7-	-	-	-	-	-	3
		LA660F	KF(T/C)	19.7-	-	-	-	-	-	3
DEX	1300	M401F · M411F	K3-VE	08.11-10.7	SXU22PR9	90048-51188-000	-	IXU22I	VXU22I	4
		M401F · M411F	K3-VE	10.7-	SXU22PR9	90048-51188-000	-	IXU22I	VXU22I	4
DIAS WAGON		TW1 · TW2	EN07(SOHC)	03.11-09.8	K20PR-U	22401KA150	K20TT	IK20	VK20	4
		TW1 · TW2	EN07(SOHC · S/C)	99.8-09.8	K20PR-U	22401KA150	K20TT	IK20	VK20Y	4
	660	S321N · S331N	KF-DET(DOHC · T/C)	09.9-15.4	SXU22HPR8	90048-51214	-	IXUH22I	VXUH22I	3
		S321N	KF(T/C)	15.4-	SXU22HPR8	90048-51214	-	IXUH22I	VXUH22I	3
		S331N	KF(T/C)	15.4-	SXU22HPR8	90048-51214	-	IXUH22I	VXUH22I	3
EXIGA	2000	YA4/5	EJ20(DOHC)	08.6-	VKH20	SAB330DE2670	-	IKH20	VKH20	4
		YA5	EJ20(DOHC · T/C)	08.6-	VKH20Y	SAB330DE4540	-	-	VKH20Y	4
		YA5(STI)	EJ20(DOHC · T/C)	09.10-10.3	VKH20Y	SAB330DE4540	-	-	VKH20Y	4
		YA9	EJ25(SOHC)	09.12-	VK20	SAB330DE0720	-	IK20	VK20	4
	2500	YAM	FB25	12.7-13.8	-	-	-	-	VFXEH22	4
		YAM	FB25	13.8-	-	-	-	-	VFXEH22	4
FORESTER		SF5	EJ20(DOHC · T/C)	97.2-02.2	PK20PR-P8	-	-	-	-	4
		SF5	EJ20(DOHC · T/C)	97.2-02.2	PK20PR-P8	-	-	-	VK20Y	4
		SF5	EJ20	97.6-00.1	K20PR-U11	22401AA320	K20TT	IK20	VK20	4
		SF5	EJ20	00.1-02.2	PK20PR11	-	-	IK20	VK20	4
		SG5	EJ20(DOHC · T/C)	02.2-07.12	PK20PR-P8	-	-	-	VK20Y	4
		SG5	EJ20	02.2-07.12	PK16PR11	-	-	IK16	VK16	4
	2000	SH5	EJ20	07.12-10.10	VKH20	SAB330DE2670	-	IKH20	VKH20	4
		SH5	EJ20(DOHC · T/C)	07.12-09.1	VKH20Y	SAB330DE4540	-	-	VKH20Y	4
		SHS	EJ20(DOHC · AVCS · T/C)	09.1-	VKH20Y	SAB330DE4540	-	-	VKH20Y	4
		SHJ	FB20(DOHC)	10.10-12.11	-	-	-	-	VFXEH22	4
		SJ5	FB20	12.11-13.10	-	-	-	-	VFXEH22	4
		SJ5	FB20	13.10-18.7	-	-	-	-	VFXEH22	4
		SJG	FA20(T/C)	12.11-18.7	-	-	-	-	-	4
		SKE	FB20(e-BOXER)	18.9-	-	-	-	-	-	4
	2500	SF9	EJ25(DOHC)	98.9-02.2	PK20PR11	-	-	IK20	VK20	4
		SG9	EJ25(DOHC · T/C)	04.2-07.12	VKH20Y	SAB330DE4540	-	-	VKH20Y	4
		SH9	EJ25(DOHC · T/C)	10.10-	VKH20Y	SAB330DE4540	-	-	VKH20Y	4
		SK9	FB25	18.7-	-	-	-	-	-	4
IMPREZA	1500	GC1 · GC2 · GF1 · GF2	EJ15	92.11-00.5	K20PR-U11	22401AA320	K20TT	IK20	VK20	4
		GD2/3 · GG2/3	EJ15	00.8-05.6	PK16PR11	-	-	IK16	VK16	4
		GD2 · GD3 · GG2 · GG3	EJ15(SOHC)	05.6-07.7	PK16PR11	-	-	IK16	VK16	4
		GDC · GDD · GGC · GGD	EL15(DOHC)	05.6-07.7	IKH20	SAB330DE2640	-	IKH20	VKH20	4

(*5)The plug reach may be 19mm or 26.5mm even with the same engine and the same vehicle code. Please confirm the plug reach and choose the correct DENSO type. If there is an "H" in DENSO type, it has a reach of 26.5mm. If it doesn't, its reach is 19mm.

DENSO
 AUSTRALIA CHINA INDIA INDONESIA KOREA MALAYSIA PHILIPPINES SAUDI ARABIA SINGAPORE TAIWAN THAILAND VIETNAM JAPAN & USA EUROPE MOTOR CYCLE SMALL ENGINE CROSS PART REFERENCE NUMBER



DENSO

AUSTRALIA

CHINA

INDIA

INDONESIA

KOREA

MALAYSIA

PHILIPPINES

SAUDI ARABIA

SINGAPORE

TAIWAN

THAILAND

VIETNAM

JAPAN

EUROPE

& USA



MOTOR

SMALL ENGINE

CROSS REFERENCE

PART NUMBER

MODEL	CC	VEHICLE CODE	ENGINE	FROM-TILL	DENSO	GENUINE P/N						QTY	
SUBARU IMPREZA	1500	GH2 • GH3	EL15(DOHC)	07.7-11.12	FK20HR11	22401AA700	-	-	-	-	VFKH20	4	
		GE2 • GE3	EL15(DOHC)	08.10-11.12	FK20HR11	22401AA700	-	-	-	-	VFKH20	4	
		GP2	FB16	11.12-13.11	-	-	-	-	-	-	VFXEH22	4	
		GP3	FB16	11.12-13.11	-	-	-	-	-	-	VFXEH22	4	
		GJ2	FB16	11.12-13.11	-	-	-	-	-	-	VFXEH22	4	
	1600	GJ3	FB16	11.12-13.11	-	-	-	-	-	-	VFXEH22	4	
		GP2	FB16	13.11-16.12	-	-	-	-	-	-	VFXEH22	4	
		GP3	FB16	13.11-16.12	-	-	-	-	-	-	VFXEH22	4	
		GJ2	FB16	13.11-16.12	-	-	-	-	-	-	VFXEH22	4	
		GJ3	FB16	13.11-16.12	-	-	-	-	-	-	VFXEH22	4	
		GT2	FB16	16.12-	-	-	-	-	-	-	VFXEH22	4	
		GT3	FB16	16.12-	-	-	-	-	-	-	VFXEH22	4	
		GK2	FB16	16.12-	-	-	-	-	-	-	VFXEH22	4	
		GK3	FB16	16.12-	-	-	-	-	-	-	VFXEH22	4	
		1800	GC6 • GF6 • GF5 • GFA	EJ18		92.11-00.8	K20PR-U11	22401AA320	K20TT	IK20		VK20	4
	GC8 • GF8		EJ20(T/C)		92.11-00.5	PK20PR-P8	-	-	-	-	VK20Y	4	
	GC8 • GF8		EJ20		98.9-00.5	PK20PR-P8	-	-	-	IK20	VK20	4	
	GD9 • GG9		EJ20(DOHC)		00.5-07.7	KJ20SR11	22401AA610	-	IK20		VK20	4	
	GDA • GGA		EJ20(DOHC • T/C)		00.8-07.7	PK20PR-P8	-	-	-	-	VK20Y	4	
	GDB • GGB		EJ20(DOHC • T/C)		00.10-07.7	VK22	SAB330DE0730	-	IK22		VK22	4	
	GH6 • GH7		EJ20(SOHC)		07.7-11.12	PK16PR11	-	-	-	IK16	VK16	4	
	GH8		EJ20(DOHC • T/C)		07.7-11.12	VKH20Y	SAB330DE4540	-	-	-	VKH20Y	4	
	GRB(WRX STI)		EJ20(DOHC • T/C)		07.10-	VKH20Y	SAB330DE4540	-	-	-	VKH20Y	4	
	GE6 • GE7		EJ20(SOHC)		08.10-	PK16PR11	-	-	-	IK16	VK16	4	
	GH6		EJ20(SOHC)		08.11-11.12	PK16PR11	-	-	-	IK16	VK16	4	
	GVB(WRX STI)		EJ20(DOHC • T/C)		10.7-	VKH20Y	SAB330DE4540	-	-	-	VKH20Y	4	
	2000		GP6	FB20		11.12-13.11	-	-	-	-	-	VFXEH22	4
			GP7	FB20		11.12-13.11	-	-	-	-	-	VFXEH22	4
			GJ6	FB20		11.12-13.11	-	-	-	-	-	VFXEH22	4
		GJ7	FB20		11.12-13.11	-	-	-	-	-	VFXEH22	4	
		GP6	FB20		13.11-16.10	-	-	-	-	-	VFXEH22	4	
		GP7	FB20		13.11-16.10	-	-	-	-	-	VFXEH22	4	
		GJ6	FB20		13.11-16.10	-	-	-	-	-	VFXEH22	4	
		GJ7	FB20		13.11-16.10	-	-	-	-	-	VFXEH22	4	
		GT6	FB20		16.10-	-	-	-	-	-	VDCH22F	4	
GT7		FB20		16.10-	-	-	-	-	-	VDCH22F	4		
GK6		FB20		16.10-	-	-	-	-	-	VDCH22F	4		
GK7		FB20		16.10-	-	-	-	-	-	VDCH22F	4		
GTE		FB20(e-BOXER)		18.10-	-	-	-	-	-	-	4		
2500	GRF(WRX STI)	EJ25		09.2-	VKH20Y	SAB330DE4540	-	IKH20		VKH20Y	4		
	GVF(WRX STI)	EJ25(DOHC • T/C)		09.2-	VKH20Y	SAB330DE4540	-	-	-	VKH20Y	4		
IMPREZA HYBRID	2000	GPE	FB20	15.7-	-	-	-	-	-	VFXEH22	4		
IMPREZA XV HYBRID	2000	GPE	FB20	13.6-	-	-	-	-	-	VFXEH22	4		
JUSTY	1000	M900F	1KR-FE	16.11-	-	-	-	-	-	VFXEH20	3		
		M900F	1KR-VET(T/C)	16.11-	-	-	-	-	-	-	3		
		M910F	1KR-FE	16.11-	-	-	-	-	-	VFXEH20	3		
LEGACY	2000	BE5	EJ20(DOHC)	98.12-03.5	PK20PR-P8	-	-	-	IK20	VK20	4		
		BE5	EJ20(DOHC • T/C)	98.12-03.5	PK20PR-P8	-	-	-	-	VK20Y	4		
		BE5	EJ20(DOHC • T/C)	98.6-03.5	PK20PR-P8	-	-	-	-	VK20Y	4		
		BES(S401 STI)	EJ20(DOHC • T/C)	02.10-	PK20PR-P8	-	-	-	-	VK20Y	4		
		BH5	EJ20(SOHC • LEANBURN)	98.6-00.5	PK20PR11	-	-	-	IK20	VK20	4		
		BH5	EJ20(DOHC)	98.6-01.5	PK20PR-P8	-	-	-	IK20	VK20	4		
		BH5	EJ20(SOHC)	00.5-03.5	PK16PR11	-	-	-	IK16	VK16	4		
		BH5	EJ20(DOHC)	01.5-03.5	KJ20SR11	22401AA610	-	-	IK20	VK20	4		
		BH5	EJ20(DOHC • T/C)	98.6-03.5	PK20PR-P8	-	-	-	-	VK20Y	4		
	2500	BL5 • BP5(2.0GT)	EJ20-R(DOHC • T/C)		03.5-09.5	VKH20Y	SAB330DE4540	-	-	-	VKH20Y	4	
		BL5 • BP5(2.0R)	EJ20-R(DOHC)		03.5-09.5	VKH20	SAB330DE2670	-	IKH20		VKH20	4	
		BL5 • BP5(2.0i)	EJ20I(SOHC)		03.5-09.5	VK16	SAB330DE0710	-	IK16		VK16	4	
		BL5 Rev	EJ204(CNG)		04.5-09.5	VKH22	SAB330DE2680	-	IKH22		VKH22	4	
		BMG	FA20(T/C)		12.5-13.5	-	-	-	-	-	-	4	
		BMG	FA20(T/C)		13.5-14.10	-	-	-	-	-	-	4	
		BRG	FA20(T/C)		12.5-13.5	-	-	-	-	-	-	4	
		BRG	FA20(T/C)		13.5-	-	-	-	-	-	-	4	
		BH9 • BHC	EJ25(DOHC)		99.5-01.5	PK20PR11	-	-	-	IK20	VK20	4	
2500	BE9 • BH9	EJ25(DOHC)		01.5-03.5	KJ20SR11	22401AA610	-	IK20		VK20	4		
	BP9	EJ25(SOHC)		03.10-09.5	VK16	SAB330DE0710	-	IK16		VK16	4		
	BL9	EJ25(SOHC)		07.11-09.5	VK16	SAB330DE0710	-	IK16		VK16	4		

MODEL	CC	VEHICLE CODE	ENGINE	FROM-TILL	DENSO	GENUINE P/N				QTY
SUBARU LEGACY	2500	BL9(S402 STI)	EJ25(DOHC · T/C)	08.6-09.2	VKH20Y	SAB330DE4540	-	-	VKH20Y	4
		BP9(S402 STI)	EJ25(DOHC · T/C)	08.6-09.2	VKH20Y	SAB330DE4540	-	-	VKH20Y	4
		BM9 · BR9	EJ25(SOHC)	09.5-	VK20	SAB330DE0720	-	IK20	VK20	4
		BM9 · BR9	EJ25(DOHC · T/C)	09.5-	VKH20Y	SAB330DE4540	-	-	VKH20Y	4
		BMM	FB25	12.5-14.10	-	-	-	-	VFXEH22	4
		BRM	FB25	12.5-	-	-	-	-	VFXEH22	4
		BN9	FB25	14.10-	-	-	-	-	VFXEH22	4
		BS9	FB25	14.10-	-	-	-	-	VFXEH22	4
		BEE · BHE	EZ30(DOHC)	00.5-03.5	VKH20	SAB330DE2670	-	IKH20	VKH20	6
		BLE · BPE	EZ30(DOHC)	03.9-09.5	VKH20	SAB330DE2670	-	IKH20	VKH20	6
3600	BRF	EZ36(DOHC)	09.5-14.10	VKH20	SAB330DE2670	-	IKH20	VKH20	6	
LEONE	1500	CVFY11	QG15DE	99.6-01	K16PR-U11	22401KA200	K16TT	IK16	VK16	4
	1800	CVHNY11	QG18DE	99.6-01	K16PR-U11	22401KA200	K16TT	IK16	VK16	4
LEVORG	1600	VM4	FB16(T/C)	14.6-	-	-	-	-	-	4
	2000	VMG	FA20(T/C)	14.6-	-	-	-	-	-	4
LUCRA/CUSTOM	660	L455F·L465F	KF-VE(DOHC)	10.4-	XU20HR9	90048-51212	XUH20TTI	IXUH20I	VXUH20I	3
		L455F·L465F	KF-DET(DOHC·T/C)	10.4-	SXU22HPR8	90048-51214	-	IXUH22I	VXUH22I	3
		L455F·L465F	KF-VE(DOHC)	10.4-	XU20HR9	90048-51212	XUH20TTI	IXUH20I	VXUH20I	3
		L455F·L465F	KF-DET(DOHC·T/C)	10.4-12.11	SXU22HPR8	90048-51214	-	IXUH22I	VXUH22I	3
		L455F	KF(T/C)	12.11-	SXU22HPR8	90048-51214	-	IXUH22I	VXUH22I	3
		L465F	KF(T/C)	12.11-	SXU22HPR8	90048-51214	-	IXUH22I	VXUH22I	3
		L455F	KF	11.7-12.11	SXU20HPR11	90048-51208	-	IXUH20I	VXUH20I	3
		L455F	KF	12.11-	SXU20HPR11	90048-51208	-	IXUH20I	VXUH20I	3
		L465F	KF	11.7-12.11	SXU20HPR11	90048-51208	-	IXUH20I	VXUH20I	3
		L465F	KF	12.11-	SXU20HPR11	90048-51208	-	IXUH20I	VXUH20I	3
PLEO PLUS	660	LA300F	KF	12.12-14.7	SXU20HPR11	90048-51208	-	IXUH20I	VXUH20I	3
		LA310F	KF	12.12-14.7	SXU20HPR11	90048-51208	-	IXUH20I	VXUH20I	3
		LA300F	KF	14.7-17.5	-	-	-	IXUH20I	VXUH20I	3
		LA310F	KF	14.7-17.5	-	-	-	IXUH20I	VXUH20I	3
		LA350F	KF	17.5-	-	-	-	IXUH20I	VXUH20I	3
		LA360F	KF	17.5-	-	-	-	IXUH20I	VXUH20I	3
PLEO/CUSTOM	660	L275F·L285F	KF-VE(DOHC)	10.4-	XU20HR9	90048-51212	XUH20TTI	IXUH20I	VXUH20I	3
		L275F·L285F	KF-DET(DOHC · T/C)	10.4-	SXU22HPR8	90048-51214	-	IXUH22I	VXUH22I	3
		L275B·L285B	KF-VE(DOHC)	10.4-	XU20HR9	90048-51212	XUH20TTI	IXUH20I	VXUH20I	3
		L275F·L285F	KF-VE(DOHC · 5door · 4WD)	10.4-	SXU20HPR11	90048-51208	-	IXUH20I	VXUH20I	3
		RA1 · RA2	EN07(SOHC)	98.10-07.6	K16PR-U11	22401KA200	K16TT	IK16	VK16	4
PLEO/NESTA/NICOT	660	RA1 · RA2	EN07(DOHC · S/C)	98.10-07.6	IXU24	SAB330DE8730	-	IXU24	VXU24	4
		RA1 · RA2	EN07(SOHC · S/C)	98.10-07.6	K20PR-U	22401KA150	K20TT	-	VK20Y	4
		RA1 · RA2	EN07(SOHC · M/C)	98.10-07.6	K20PR-U	22401KA150	K20TT	-	VK20Y	4
		RV1 · RV2	EN07(SOHC)	98.10-09.12	K16PR-U11	22401KA200	K16TT	IK16	VK16	4
		RJ1 · RJ2	EN07(SOHC)	05.11-	K16PR-U11	22401KA200	K16TT	IK16	VK16	4
R1	660	RJ1 · RJ2	EN07(DOHC)	05.1-	IXUH22	SAB330DE8740	-	IXUH22	VXUH22	4
		RJ1 · RJ2	EN07(DOHC · S/C)	05.11-	IXU24	SAB330DE8730	-	IXU24	VXU24	4
		RC1 · RC2	EN07(SOHC)	03.12-	K16PR-U11	22401KA200	K16TT	IK16	VK16	4
R2	660	RC1 · RC2	EN07(DOHC)	03.12-	IXUH22	SAB330DE8740	-	IXUH22	VXUH22	4
		RC1 · RC2	EN07(DOHC · S/C)	03.12-	IXU24	SAB330DE8730	-	IXU24	VXU24	4
		TT1/2 · TV1/2 · TW1/2	EN07(SOHC)	99.2-01.8	K16PR-U11	22401KA200	K16TT	IK16	VK16	4
SAMBAR	660	TT1/2 · TV1/2 · TW1/2	EN07(S/C)	99.2-01.8	K20PR-U	22401KA150	K20TT	-	VK20Y	4
		TT1/2 · TV1/2 · TW2	EN07Y(S/C)	01.8-12.4	K20PR-U	22401KA150	K20TT	-	VK20Y	4
		TT1/2 · TV1/2	EN07F/V	01.8-03.11	K16PR-U	-	K16TT	IK16	VK16	4
		TT1/2 · TV1/2 · TW1	EN07F/V	03.11-12.4	K20PR-U	22401KA150/ SAB330DE2340	K20TT	IK20	VK20	4
		S321B	KF	12.4-15.4	XU20HR9	90048-51212	XUH20TTI	IXUH20I	VXUH20I	3
		S321B	KF(T/C)	12.4-15.4	SXU22HPR8	90048-51214	-	IXUH22I	VXUH22I	3
		S331B	KF	12.4-15.4	XU20HR9	90048-51212	XUH20TTI	IXUH20I	VXUH20I	3
		S331B	KF(T/C)	12.4-15.4	SXU22HPR8	90048-51214	-	IXUH22I	VXUH22I	3
		S201J	KF	12.4-14.9	XU20HR9	90048-51212	XUH20TTI	IXUH20I	VXUH20I	3
		S201H	KF	12.4-	XU20HR9	90048-51212	XUH20TTI	IXUH20I	VXUH20I	3
		S211J	KF	12.4-14.9	XU20HR9	90048-51212	XUH20TTI	IXUH20I	VXUH20I	3
		S211H	KF	12.4-	XU20HR9	90048-51212	XUH20TTI	IXUH20I	VXUH20I	3
		S321Q	KF	12.7-15.4	XU20HR9	90048-51212	XUH20TTI	IXUH20I	VXUH20I	3
		S331Q	KF	12.7-15.4	XU20HR9	90048-51212	XUH20TTI	IXUH20I	VXUH20I	3
		S500J	KF	14.9-	SXU20HPR11	90048-51208	-	IXUH20I	VXUH20I	3
		S510J	KF	14.9-	SXU20HPR11	90048-51208	-	IXUH20I	VXUH20I	3
		S321B	KF	15.4-	SXU20HPR11	90048-51208	-	IXUH20I	VXUH20I	3
		S321B	KF(T/C)	15.4-	SXU22HPR8	90048-51214	-	IXUH22I	VXUH22I	3
		S321Q	KF	15.4-	SXU20HPR11	90048-51208	-	IXUH20I	VXUH20I	3

DENSO

AUSTRALIA CHINA

INDIA

INDONESIA

KOREA

MALAYSIA

PHILIPPINES

SAUDI ARABIA

SINGAPORE

TAIWAN

THAILAND

VIETNAM

JAPAN

EUROPE

MOTOR

SMALL

ENGINE



CROSS PART REFERENCE NUMBER

DENSO	9	14	16	20	22	24	27	29	31	32	34	35	DENSO	9	14	16	20	22	24	27	29	31	32	DENSO	9	14	16	20	22	24	27	31
NGK	2	4	5	6	7	8	9	9.5	10	10.5	11	11.5	CHAMPION	18	16,14	12,11	10,9	8,7	6,63,61	4,59	57	55	53	BOSCH	10	9	8	7,6	5	4	3	2



▶ Spark plug color codes: ■ for Iridium Tough and Iridium Plugs and Iridium TT, ■ for Iridium Power, ■ for Iridium Racing and Two Tops Plugs, ■ for Platinum Plugs and Platinum TT, and black for general spark plugs.

PART NUMBER	CROSS REFERENCE	SMALL ENGINE	MOTOR CYCLE	EUROPE & USA	JAPAN	VIETNAM	THAILAND	TAIWAN	SINGAPORE	SAUDI ARABIA	PHILIPPINES	MALAYSIA	KOREA	INDONESIA	INDIA	CHINA	AUSTRALIA	DENSU	MODEL	CC	VEHICLE CODE	ENGINE	FROM-TILL	DENSO	GENUINE P/N	IRIDIUM POWER	IRIDIUM TOUGH	QTY						
																			SUBARU	CC	VEHICLE CODE	ENGINE	FROM-TILL	DENSO	GENUINE P/N	IRIDIUM POWER	IRIDIUM TOUGH	QTY						
																			SUBARU															
																			SAMBAR	660	S331B	KF	15.4-	SXU20HPR11	90048-51208	-	IXUH20I	VXUH20I	3					
																		SAMBAR	660	S331B	KF(T/C)	15.4-	SXU22HPR8	90048-51214	-	IXUH22I	VXUH22I	3						
																		SAMBAR	660	S331Q	KF	15.4-	SXU20HPR11	90048-51208	-	IXUH20I	VXUH20I	3						
																		SAMBAR	660	TT1/2 • TV1/2	EN07(SOHC)	99.2-01.8	-	-	-	-	-	4						
																		SAMBAR	660	TT1/2 • TV1/2	EN07Y(S/C)	01.8-12.4	-	-	-	-	-	4						
																		SAMBAR	660	TT1/2 • TV1/2	EN07L(LPG)/F	01.8-12.4	-	-	-	-	-	4						
																		SAMBAR	660	S201J	KF	12.4-	SXU22HPR8	90048-51214	-	IXUH22I	VXUH22I	3						
																		SAMBAR	660	S201H	KF	12.4-	SXU22HPR8	90048-51214	-	IXUH22I	VXUH22I	3						
																		SAMBAR	660	S211J	KF	12.4-	SXU22HPR8	90048-51214	-	IXUH22I	VXUH22I	3						
																		SAMBAR	660	S211H	KF	12.4-	SXU22HPR8	90048-51214	-	IXUH22I	VXUH22I	3						
																		SAMBAR	660	S331B	KF	12.4-	SXU22HPR8	90048-51214	-	IXUH22I	VXUH22I	3						
																		STELLA/CUSTOM			RN1 • RN2	EN07(DOHC)	06.6-11.5	IXUH22	SAB330DE8740	-	IXUH22	VXUH22	4					
																		STELLA/CUSTOM			RN1 • RN2	EN07(DOHC • S/C)	06.6-11.5	IXU24	SAB330DE8730	-	IXU24	VXU24	4					
																		STELLA/CUSTOM			LA100F • LA110F	KF(DOHC)	11.5-13.1	SXU20HPR11	90048-51208	-	IXUH20I	VXUH20I	3					
																		STELLA/CUSTOM			LA100F. LA110F	KF(DOHC)	11.5-13.1	SXU20HPR11	90048-51208	-	IXUH20I	VXUH20I	3					
																		STELLA/CUSTOM			LA100F	KF(T/C)	11.5-13.1	SXU22HPR8	90048-51214	-	IXUH22I	VXUH22I	3					
																		STELLA/CUSTOM			LA110F	KF(T/C)	11.5-13.1	SXU22HPR8	90048-51214	-	IXUH22I	VXUH22I	3					
																		STELLA/CUSTOM			LA100F. LA110F	KF(DOHC • T/C)	11.8-	SXU22HPR8	90048-51214	-	IXUH22I	VXUH22I	3					
																		STELLA/CUSTOM			LA100F	KF	13.1-14.12	SXU20HPR11	90048-51208	-	IXUH20I	VXUH20I	3					
																		STELLA/CUSTOM			LA110F	KF	13.1-14.12	SXU20HPR11	90048-51208	-	IXUH20I	VXUH20I	3					
																		STELLA/CUSTOM			LA100F	KF(T/C)	13.1-13.8	SXU22HPR8	90048-51214	-	IXUH22I	VXUH22I	3					
																		STELLA/CUSTOM			LA110F	KF(T/C)	13.1-13.8	SXU22HPR8	90048-51214	-	IXUH22I	VXUH22I	3					
																		STELLA/CUSTOM			LA100F	KF(T/C)	13.8-14.12	SXU22HPR8	90048-51214	-	IXUH22I	VXUH22I	3					
																		STELLA/CUSTOM			LA110F	KF(T/C)	13.8-14.12	SXU22HPR8	90048-51214	-	IXUH22I	VXUH22I	3					
																		STELLA/CUSTOM			LA150F	KF	14.12-	SXU20HPR11	90048-51208	-	IXUH20I	VXUH20I	3					
																		STELLA/CUSTOM			LA150F	KF(T/C)	14.12-	SXU22HPR8	90048-51214	-	IXUH22I	VXUH22I	3					
																		STELLA/CUSTOM			LA160F	KF	14.12-	SXU20HPR11	90048-51208	-	IXUH20I	VXUH20I	3					
																		STELLA/CUSTOM			LA160F	KF(T/C)	14.12-	SXU22HPR8	90048-51214	-	IXUH22I	VXUH22I	3					
																		TRAVIQ	1800	XM182	Z18(DOHC)	03.7-04.12	K20TXR	-	K20TT	IK20	VK20	4						
																		TRAVIQ	2200	XM220	Z22(DOHC)	01.8-04.12	ITV20	SAB330DE3715	-	ITV20	-	4						
																		TREZIA	1300	NSP120X	1NR-FE	10.11-14.5	SC16HR11	90919-01275	-	-	VCH16	4						
																		TREZIA	1300	NSP120X	1NR-FKE	14.5-	FC16HR8	90919-01280	-	-	VFCH16	4						
																		TREZIA	1500	NCP120X • NCP125X	1NZ-FE	10.11-	FK16HR11	90919-01243	-	-	VFKH16	4						
																		WRX	2000	VAB	EJ20(T/C)	14.8-	-	-	-	-	4							
																		WRX	2000	VAG	FA20(T/C)	14.8-	-	-	-	-	4							
																		SUZUKI																
																		AERIO	1500	RA21S • RB21S	M15A(DOHC • VVT)	01.1-	SK16PR-A11	09482-00562	-	IK16	VK16	4						
																		AERIO	1800	RC51S • RD51S	M18A(DOHC • VVT)	03.1-	VK16	99000-79K73-K16	-	IK16	VK16	4						
																		ALTO ECO	660	HA35S	R06A	11.12-	VSUEH22	-	-	-	VSUEH22	3						
																		ALTO LAPIN	660	HE21S	K6A(DOHC)	00.12-03.9	XU22EPR-U	09482-00449	XU22TT	IXU22	VXU22	3						
																		ALTO LAPIN	660	HE21S	K6A(DOHC)	03.9-08.11	IXU22C	09482-00563	-	IXU22	VXU22	3						
																		ALTO LAPIN	660	HE21S	K6A(DOHC • T/C)	02.1-08.11	IXU22C	09482-00563	-	IXU22	VXU22	3						
																		ALTO LAPIN	660	HE22S	K6A(DOHC)	08.11-15.6	IXU22HPR(*5)	09482-00608	-	IXUH22(*5)	VXUH22(*5)	3						
																		ALTO LAPIN	660	HE22S	K6A(DOHC • T/C)	08.11-15.6	IXU22HPR(*5)	09482-00608	-	IXUH22(*5)	VXUH22(*5)	3						
																		ALTO LAPIN	660	HE33S	R06A	15.6-	ZXU22HPR8	09482-00633	-	IXUH22	VXUH22	3						
																		ALTO/WORKS			HA22S	K6A(DOHC)	98.10-00.12	XU22EPR-U	09482-00449	XU22TT	IXU22	VXU22	3					
																		ALTO/WORKS			HA22S	K6A(DOHC • T/C)	98.10-00.12	IXU22	99000-79J80-U22	-	IXU22	VXU22	3					
																		ALTO/WORKS			HA22S	K6A(DOHC • LEANBURN)	98.10-01.4	IXU22	99000-79J80-U22	-	IXU22	VXU22	3					
																		ALTO/WORKS			HA12V	F6A(4VALVE)	98.10-00.12	XU22EPR-U	09482-00449	XU22TT	IXU22	VXU22	3					
																		ALTO/WORKS			HA12S	F6A(2VALVE • T/C)	98.10-00.12	W16EPR-U	09482-00468	W16TT	IW16	VW16	3					
																		ALTO/WORKS			HA12S	F6A(4VALVE)	99.10-00.12	XU22EPR-U	09482-00449	XU22TT	IXU22	VXU22	3					
																		ALTO/WORKS			HA23S	K6A(DOHC)	00.12-04.9	XU22EPR-U	09482-00449	XU22TT	IXU22	VXU22	3					
																		ALTO/WORKS	660	HA23S • HA23V	K6A(DOHC)	00.12-04.9	XU22EPR-U	09482-00449	XU22TT	IXU22	VXU22	3						
																		ALTO/WORKS	660	HA23S • HA23V	K6A(LEANBURN)	01.4-04.9	IXU22C	09482-00563	-	IXU22	VXU22	3						
																		ALTO/WORKS	660	HA24S	K6A(DOHC)	04.9-09.12												

MODEL	CC	VEHICLE CODE	ENGINE	FROM-TILL	DENSO	GENUINE P/N				QTY	
SUZUKI CARRY	660	DA63T	K6A(DOHC)	01.9-10.10	IXU22C(*5)	09482-00563	-	IXU22(*5)	VXU22(*5)	3	
		DA63T	K6A(DOHC)	10.10-13.9	IXU22HPR(*5)	09482-00608	-	IXUH22(*5)	VXUH22(*5)	3	
		DA65T	K6A(DOHC)	05.11-10.5	IXU22C(*5)	09482-00563	-	IXU22	VXU22	3	
		DA65T	K6A(DOHC)	10.5-13.9	IXU22HPR(*5)	09482-00608	-	IXUH22(*5)	VXUH22(*5)	3	
		DA16T	R06A	13.9-15.8	VSUEH22	-	-	-	VSUEH22	3	
		DA16T	R06A	15.8-	VSUEH22	-	-	-	VSUEH22	3	
CERVO	660	HG21S	K6A(DOHC • VVT)	06.11-09.5	IXU22C(*5)	09482-00563	-	IXU22(*5)	VXU22(*5)	3	
		HG21S	K6A(DOHC • VVT)	09.5-09.12	IXU22HPR(*5)	09482-00608	-	IXUH22(*5)	VXUH22(*5)	3	
		HG21S	K6A(DOHC • VVT • T/C)	06.11-09.12	IXU22C(*5)	09482-00563	-	IXU22(*5)	VXU22(*5)	3	
CHEVROLET CRUZE	1300	HR51S • HR52S	M13A(DOHC • VVT)	01.11-10.8	•SK16PR-A11	09482-00562	-	IK16	VK16	4	
	1500	HR81S • HR82S	M15A(DOHC • VVT)	01.11-06.5	•SK16PR-A11	09482-00562	-	IK16	VK16	4	
CULTUS WAGON/ CRESCENT WAGON	1500	GC21W	G15A	96.2-02	K20PR-U11	09482-00508	K20TT	IK20	VK20	4	
	1600	GD31W	G16A	96.2-02	K20PR-U11	09482-00508	K20TT	IK20	VK20	4	
	1800	GC41W	J18A	96.2-02	K20PR-U11	09482-00508	K20TT	IK20	VK20	4	
CULTUS/ CRESCENT	1000	AA44S • AB44S	G10	91.7-02	W16EPR-U11	09482-00496	W16TT	IW16	VW16	3	
		AA34S • AF34S	G13B(DOHC)	91.7-02	W22EPR-U	09482-00498	-	IW22	VW22	4	
	1300	AA34S • AB34S • AF34S • AK34S	G13B	91.7-02	K20PR-U11	09482-00508	K20TT	IK20	VK20	4	
		GA11S	G13B	95.1-00.5	K20PR-U11	09482-00508	K20TT	IK20	VK20	4	
	1500	GA21S • GB21S • GC21S • GD21S	G15A	95.1-02	K20PR-U11	09482-00508	K20TT	IK20	VK20	4	
	1600	GB31S • GD31S	G16A	96.2-02	K20PR-U11	09482-00508	K20TT	IK20	VK20	4	
ESCUDO	1400	YEA1S	K14C(T/C)	17.7-	-	-	-	IXUH22I	VXUH22I	4	
		TA02W • TD02W	G16A	97.11-00.4	K20PR-U11	09482-00508	K20TT	IK20	VK20	4	
		TA02W	G16A	00.4-06.6	VK20	99000-79K73-K20	-	IK20	VK20	4	
	1600	TA74W	M16A	06.6-08.6	VK20	99000-79K73-K20	-	IK20	VK20	4	
		YD21S	M16A	15.10-	-	99000-79K73-KH2	-	IKH20	VKH20	4	
		YE21S	M16A	15.10-	-	99000-79K73-KH2	-	IKH20	VKH20	4	
	2000	TA52W • TD52W	J20A	97.11-00.4	K20PR-U11	09482-00508	K20TT	IK20	VK20	4	
		TL52W • TD54W	J20A	00.4-08.6	VK16	99000-79K73-K16	-	IK16	VK16	4	
	2400	TDA4W	J24B	08.6-	VKH20	99000-79K73-KH2	-	IKH20	VKH20	4	
		TD62W	H25A	98.2-00.4	K20PR-U11	09482-00508	K20TT	IK20	VK20	6	
		TD62W	H25A	00.4-05.6	VK16	99000-79K73-K16	-	IK16	VK16	6	
	2700	TD94W	H27A	05.6-08.6	VK20	99000-79K73-K20	-	IK20	VK20	6	
		3200	TDB4W	N32A	08.6-	ITV16	-	-	ITV16	-	6
	EVERY	660	DA52V • DB52V	F6A(4VALVE)	99.1-01.8	XU22EPR-U	09482-00449	XU22TT	IXU22	VXU22	3
			DA52V • DB52V	F6A(2VALVE • T/C)	99.11-01.8	IW16	99000-79J80-W16	-	IW16	VW16	3
DA52V • DB52V			F6A(CNG)	00.5-01.9	IXU27	-	-	IXU27	-	3	
DA62V • DA62W			K6A(DOHC • T/C)	01.9-05.8	IXU22	99000-79J80-U22	-	IXU22	VXU22	3	
DA62V • DA62W			K6A(DOHC)	01.9-07.7	XU22EPR-U	09482-00449	XU22TT	IXU22	VXU22	3	
DA62V			K6A(CNG)	01.11-	IXU27	-	-	IXU27	-	3	
660		DA64V	K6A(DOHC)	05.8-10.5	IXU22C(*5)	09482-00563	-	IXU22(*5)	VXU22(*5)	3	
		DA64V	K6A(DOHC)	10.5-15.2	IXU22HPR(*5)	09482-00608	-	IXUH22(*5)	VXUH22(*5)	3	
		DA64V	K6A(DOHC • T/C)	05.8-10.5	IXU22C(*5)	09482-00563	-	IXU22(*5)	VXU22(*5)	3	
		DA64V	K6A(DOHC • T/C)	10.5-15.2	IXU22HPR(*5)	09482-00608	-	IXUH22(*5)	VXUH22(*5)	3	
		DA17V	R06A	15.2-	VSUEH22	-	-	-	VSUEH22	3	
		DA17V	R06A(T/C)	15.2-	VSUEH22	-	-	-	VSUEH22	3	
EVERY LANDY	1300	DA32W	G13B	01.5-	K20PR-U	09482-00429	K20TT	IK20	VK20	4	
EVERY PLUS	1300	DA32W	G13B(LEV)	99.6-01.5	K20PR-U	09482-00429	K20TT	IK20	VK20	4	
EVERY WAGON	660	DA52W	F6A(T/C)	99.11-01.8	IW16	99000-79J80-W16	-	IW16	VW16	3	
		DA62V • DA62W	K6A(DOHC • T/C)	01.9-05.8	IXU22	99000-79J80-U22	-	IXU22	VXU22	3	
		DA62V • DA62W	K6A(DOHC)	01.9-07.7	XU22EPR-U	09482-00449	XU22TT	IXU22	VXU22	3	
		DA64W	K6A(T/C)	05.8-10.5	IXU22C(*5)	09482-00563	-	IXU22(*5)	VXU22(*5)	3	
		DA64W	K6A(T/C)	10.5-15.2	IXU22HPR(*5)	09482-00608	-	IXUH22(*5)	VXUH22(*5)	3	
		DA17W	R06A(T/C)	15.2-	VSUEH22	-	-	-	VSUEH22	3	
GRAND ESCUDO	2700	TX92W	H27A	00.12-	VK16	99000-79K73-K16	-	IK16	VK16	6	
HUSTLER	660	MR31S	R06A	14.1-15.12	VSUEH22	-	-	VSUEH22	3		
		MR31S	R06A(T/C)	14.1-	VSUEH22	-	-	VSUEH22	3		
		MR41S	R06A(S-ene CHARGE)	15.5-	ZXU22HPR8	09482-00633	-	IXUH22	VXUH22	3	
		MR31S	R06A	15.12-	ZXU22HPR8	09482-00633	-	IXUH22	VXUH22	3	
		MR41S	R06A(T/C • S-ene CHARGE)	15.12-	VSUEH22	-	-	-	VSUEH22	3	
IGNIS	1200	FF21S	K12C	16.2-	-	-	-	IXUH20I	VXUH20I	4	
JIMNY	660	JB23W	K6A(DOHC • T/C)	98.10-02.1	IXU22	99000-79J80-U22	-	IXU22	VXU22	3	
		JB23W	K6A(DOHC • T/C)	02.1-08.6	IXU22C(*5)	09482-00563	-	IXU22(*5)	VXU22(*5)	3	
		JB23W	K6A(DOHC • T/C)	08.6-18.7	IXU22HPR(*5)	09482-00608	-	IXUH22(*5)	VXUH22(*5)	3	
		JB64W	R06A(T/C)	18.7-	ZXU22HPR8	09482-00633	-	IXUH22	VXUH22	3	
JIMNY SIERRA	1300	JB43W	M13A(DOHC)	02.1-12.5	•SK16PR-A11	09482-00562	-	IK16	VK16	4	
		JB43W	M13A	12.5-18.7	SVK20RZ11	-	-	IK20	VK20	4	
	1500	JB74W	K15B	18.7-	ZXU20PR11	09482-00602	-	-	VXU20	4	

DENSO
 AUSTRALIA CHINA INDIA INDONESIA KOREA MALAYSIA PHILIPPINES SAUDI ARABIA SINGAPORE TAIWAN THAILAND VIETNAM
JAPAN
 EUROPE MOTOR & USA SMALL ENGINE PART CROSS REFERENCE NUMBER



(*5)The plug reach may be 19mm or 26.5mm even with the same engine and the same vehicle code. Please confirm the plug reach and choose the correct DENSO type. If there is an "H" in DENSO type, it has a reach of 26.5mm. If it doesn't, its reach is 19mm.



▶ Spark plug color codes: ■ for Iridium Tough and Iridium Plugs and Iridium TT, ■ for Iridium Power, ■ for Iridium Racing and Two Tops Plugs, ■ for Platinum Plugs and Platinum TT, and black for general spark plugs.

PART NUMBER	CROSS REFERENCE ENGINE CYCLE	SMALL MOTOR EUROPE & USA	JAPAN	VIETNAM	THAILAND	TAIWAN	SINGAPORE	SAUDI ARABIA	PHILIPPINES	MALAYSIA	KOREA	INDONESIA	INDIA	CHINA	AUSTRALIA	DENSO	GENUINE P/N			QTY					
																MODEL	CC	VEHICLE CODE	ENGINE		FROM-TILL	GENUINE P/N			
SUZUKI																									
JIMNY WIDE	1300															K20PR-U	09482-00429	K20TT	IK20	VK20	4				
																JB33W	G13B	98.1-00.4	SK16PR-A11	09482-00562	-	IK16	VK16	4	
KEI	660															W16EPR-U	09482-00468	W16TT	IW16	VW16	3				
																HN11S · HN12S	F6A(T/C)	98.1-01.10	XU22EPR-U	09482-00449	-	IXU22	VXU22	3	
																HN21S	K6A(DOHC)	98.10-01.3	IXU22	99000-79J80-U22	-	IXU22	VXU22	3	
																HN21S	K6A(DOHC · T/C)	98.10-01.3	IXU22	99000-79J80-U22	-	IXU22	VXU22	3	
																HN22S	K6A(DOHC · T/C)	01.4-	IXU22	99000-79J80-U22	-	IXU22	VXU22	3	
																HN22S	K6A(DOHC · VVT)	01.4-02.11	XU22EPR-U	09482-00449	-	IXU22	VXU22	3	
																HN22S	K6A(DOHC · VVT)	02.11-	IXU22C	09482-00563	-	IXU22	VXU22	3	
KIZASHI LANDY	2400															J24B	09.10-	VKH20	99000-79K73-KH2	-	IKH20	VKH20	4		
																RE91S · RF91S	M13A(DOHC)	07.1-10.12	FXE20HR11	28800-CY000	-	-	VFXEH20	4	
																SC25 · SNC25	MR20DE	10.12-16.12	-	-	-	-	-	4	
																SC26 · SNC26	MR20DD	12.8-16.12	-	-	-	-	-	4	
LANDYHYBRID	2000															MR20DD	16.12-18.9	DXE22H11CT	11182-52Z00	-	-	-	4		
																SHC26	MR20DD	12.8-16.12	-	-	-	-	-	4	
																SC27	MR20DD	16.12-18.9	DXE22H11CT	11182-52Z00	-	-	-	4	
																SC27	MR20DD	18.9-	DXE22H11CT	11182-52Z02	-	-	-	4	
MR WAGON	660															MR20DD	16.12-18.9	DXE22H11CT	11182-52Z00	-	-	-	4		
																SGC27	MR20DD	16.12-18.9	DXE22H11CT	11182-52Z00	-	-	-	4	
																SGNC27	MR20DD	16.12-18.9	DXE22H11CT	11182-52Z00	-	-	-	4	
																SGC27	MR20DD	18.9-	DXE22H11CT	11182-52Z02	-	-	-	4	
PALETTE	660															MR20DD	18.9-	DXE22H11CT	11182-52Z02	-	-	-	4		
																SGNC27	MR20DD	18.9-	DXE22H11CT	11182-52Z02	-	-	-	4	
																MF21S	K6A(DOHC · T/C)	01.12-06.1	IXU22C	09482-00563	-	IXU22	VXU22	3	
																MF21S	K6A(DOHC · VVT)	01.12-02.4	XU22EPR-U	09482-00449	-	IXU22	VXU22	3	
																MF21S	K6A(DOHC · VVT)	02.4-06.1	IXU22C	09482-00563	-	IXU22	VXU22	3	
																MF22S	K6A(DOHC · VVT)	06.1-09.6	IXU22C(*5)	09482-00563	-	IXU22(*5)	VXU22(*5)	3	
																MF22S	K6A(DOHC · VVT)	09.6-11.1	IXU22HPR(*5)	09482-00608	-	IXUH22(*5)	VXUH22(*5)	3	
																MF22S	K6A(DOHC · T/C)	06.1-11.1	IXU22C(*5)	09482-00563	-	IXU22(*5)	VXU22(*5)	3	
SOLIO	1200															R06A(DOHC · VVT)	11.1-	-	-	-	VSUEH22	3			
																MF33S	R06A(DOHC · VVT)	11.1-	-	-	-	-	VSUEH22	3	
																MF33S	R06A(DOHC · VVT · T/C)	11.1-	-	-	-	-	VSUEH22	3	
																MF33S	R06A(DOHC · VVT · T/C)	11.1-	-	-	-	-	VSUEH22	3	
SOLIO HYBRID	1200															MA15S	K12B(DOHC · VVT)	10.12-13.11	ZXU20PR11	09482-00602	-	-	VXU20	4	
																MA15S	K12B(2WD)	13.11-15.8	ZXU20PR11	09482-00602	-	-	VXU20	4	
																MA15S	K12B(2WD)	13.11-15.8	ZXU20HPR11	09482-00629	-	IXUH20I	VXUH20I	4	
																MA15S	K12B(4WD)	13.11-15.8	ZXU20HPR11	09482-00629	-	IXUH20I	VXUH20I	4	
																MA15S	K12B(4WD)	13.11-15.8	ZXU20HPR11	09482-00629	-	IXUH20I	VXUH20I	4	
																MA26S	K12C	15.8-	-	-	-	IXUH20I	VXUH20I	4	
																MA34S	M13A(DOHC)	04.4-10.12	SK16PR-A11	09482-00562	-	IK16	VK16	4	
																MA36S	K12C	15.8-	-	-	-	IXUH20I	VXUH20I	4	
SPACIA	660															MA46S	K12C	16.11-	-	-	-	IXUH20I	VXUH20I	4	
																MK32S	R06A	13.3-15.5	VSUEH22	-	-	-	VSUEH22	3	
																MK32S	R06A(T/C)	13.3-15.8	VSUEH22	-	-	-	VSUEH22	3	
																MK32S Rev	R06A	15.6-	VSUEH22	-	-	-	VSUEH22	3	
																MK42S	R06A(S-ene CHARGE)	15.5-17.12	ZXU22HPR8	09482-00633	-	IXUH22	VXUH22	3	
																MK42S	R06A(T/C · S-ene CHARGE)	15.8-17.12	VSUEH22	-	-	-	VSUEH22	3	
SPACIAHYBRID	660															R06A	17.12-	-	-	-	IXUH22I	VXUH22I	3		
																MK53S	R06A(T/C)	17.12-	ZXU22HPR8	-	-	-	IXUH22	VXUH22	3
SWIFT	1000															XB32S	K12B(DOHC · VVT)	08.10-	ZXU20PR11	09482-00602	-	-	VXU20	4	
																ZC13S	K10C(T/C)	17.1-	-	-	-	-	IXUH22I	VXUH22I	3
																ZC71S	K12B(DOHC · VVT)	07.5-10.8	ZXU20PR11	09482-00602	-	-	VXU20	4	
																ZC72S · ZD72S	K12B(DOHC · VVT)	10.8-13.7	ZXU20PR11	09482-00602	-	-	VXU20	4	
																ZC72S	K12B	13.7-17.1	ZXU20PR11	09482-00602	-	-	VXU20	4	
																ZC72S	K12B(12V)	13.7-17.1	ZXU20HPR11	09482-00629	-	IXUH20I	VXUH20I	4	
																ZD72S	K12B	13.7-17.1	ZXU20HPR11	09482-00629	-	IXUH20I	VXUH20I	4	
																ZC83S	K12C	17.1-	-	-	-	IXUH20I	VXUH20I	4	
																ZD83S	K12C	17.1-	-	-	-	IXUH20I	VXUH20I	4	
																HT51S	M13A(DOHC)	00.1-04.11	SK16PR-A11	09482-00562	-	IK16	VK16	4	
																ZC11S · ZD11S	M13A(DOHC)	04.11-	VK20	99000-79K73-K20	-	IK20	VK20	4	
																SWIFT SPORTS	1400								
ZC21S · ZD21S	M15A(DOHC · VVT)	04.11-	VK20	99000-79K73-K20	-	IK20	VK20	4																	
SWIFTHYBRID	1200															ZC33S	K14C(T/C)	17.9-	-	-	-	IXUH22I	VXUH22I	4	
																ZC31S	M16A(DOHC)	05.8-10.9	VK20	99000-79K73-K20	-	IK20	VK20	4	
																ZC32S	M16A(DOHC · VVT)	11.12-16.12	VKH20	99000-79K73-KH2	-	IKH20	VKH20	4	
SX4	1500															ZC53S	K12C	17.1-	-	-	-	IXUH20I	VXUH20I	4	
																ZD53S	K12C	17.1-	-	-	-	-	IXUH20I	VXUH20I	4
																ZC43S	K12C	17.7-	-	-	-	-	IXUH20I	VXUH20I	4
SWIFT	2000															YA11S · YB11S · YC11S	M15A(DOHC · VVT)	06.7-09.5	VK20(*5)	99000-79K73-K20	-	IK20(*5)	VK20(*5)	4	
																YA11S · YB11S · YC11S	M15A(DOHC · VVT)	09.5-	VKH20(*5)	99000-79K73-KH2	-	IKH20(*5)	VKH20(*5)	4	
SWIFT	2000															YA41S · YB41S	J20A	06.7-09.4	VK16	99000-79K73-K16	-	IK16	VK16	4	



(*5)The plug reach may be 19mm or 26.5mm even with the same engine and the same vehicle code. Please confirm the plug reach and choose the correct DENSO type. If there is an "H" in DENSO type, it has a reach of 26.5mm. If it doesn't, its reach is 19mm

MODEL	CC	VEHICLE CODE	ENGINE	FROM-TILL	DENSO	GENUINE P/N				QTY		
SUZUKI												
SX4 S-CROSS	1600	YA22S	M16A	15.2-	VKH20	99000-79K73-KH2	-	IKH20	VKH20	4		
		YB22S	M16A	15.2-	VKH20	99000-79K73-KH2	-	IKH20	VKH20	4		
TWIN WAGON R	660	EC22S(HYBRID) · EC22S	K6A(DOHC)	03.1-05.8	IXU22C	09482-00563	-	IXU22	VXU22	3		
	660	MC21S	K6A(DOHC)	98.10-00.12	XU22EPR-U	09482-00449	XU22TT	IXU22	VXU22	3		
		MC21S	K6A(DOHC · T/C)	98.10-00.12	IXU22	99000-79J80-U22	-	IXU22	VXU22	3		
		MC11S	F6A(4VALVE)	98.10-00.12	XU22EPR-U	09482-00449	XU22TT	IXU22	VXU22	3		
		MC11S	F6A(2VALVE · T/C)	98.10-00.12	W16EPR-U	09482-00468	W16TT	IW16	VW16	3		
		MC11S	F6A(CNG)	99.6-	IXU27	-	-	IXU27	-	3		
		MC22S	K6A(DOHC)	00.12-03.9	XU22EPR-U	09482-00449	XU22TT	IXU22	VXU22	3		
		MC22S	K6A(DOHC · T/C)	00.12-03.9	IXU22	99000-79J80-U22	-	IXU22	VXU22	3		
		MC12S	F6A(2VALVE · T/C)	00.12-01.10	W16EPR-U	09482-00468	W16TT	IW16	VW16	3		
		MH21S	K6A(DOHC)	03.9-08.9	IXU22C	09482-00563	-	IXU22	VXU22	3		
		MH21S	K6A(DOHC · T/C)	03.9-08.9	IXU22C	09482-00563	-	IXU22	VXU22	3		
		MH21S	K6A(DOHC · T/C · DI)	03.9-08.9	IXU22C	09482-00563	-	IXU22	VXU22	3		
		MH21S Rev	K6A Rev(CNG)	04.5-	IXU27	-	-	IXU27	-	3		
		MH22S	K6A(DOHC · VVT)	07.4-08.9	IXU22C	09482-00563	-	IXU22	VXU22	3		
		MH23S	K6A(DOHC · VVT)	08.9-12.9	IXU22HPR	09482-00608	-	IXUH22(*5)	VXUH22(*5)	3		
		MH23S	K6A(DOHC · T/C)	08.9-10.8	IXU22HPR	09482-00608	-	IXUH22(*5)	VXUH22(*5)	3		
		MH34S	R06A(Vehicle identification number: up to 500000)	12.9-15.8	VSUEH22	-	-	-	VSUEH22	3		
		MH44S	R06A(Sene CHARGE)	14.8-15.8	VSUEH22	-	-	-	VSUEH22	3		
		MH34S	R06A(Vehicle identification number: starting from 500001)	15.8-17.2	ZXU22HPR8	09482-00633	-	IXUH22	VXUH22	3		
		MH44S	R06A(Sene CHARGE)	15.8-17.2	ZXU22HPR8	09482-00633	-	IXUH22	VXUH22	3		
		MH35S	R06A	17.2-	-	-	-	IXUH22I	VXUH22I	3		
WAGON R HYBRID	660	MH55S	R06A	17.2-	-	-	IXUH22I	VXUH22I	3			
WAGON R PLUS	1000	MA63S	K10A(DOHC)	99.5-00.12	XU22EPR-U	09482-00449	XU22TT	IXU22	VXU22	4		
		MA63S	K10A(DOHC · T/C)	99.5-00.12	IXU22	99000-79J80-U22	-	IXU22	VXU22	4		
WAGON R SOLIO	1000	MA64S	K10A(DOHC)	00.11-02.11	XU22EPR-U	09482-00449	XU22TT	IXU22	VXU22	4		
WAGON R STINGRAY	1300	MA34S	M13A(DOHC)	00.11-05.8	·SK16PR-A11	09482-00562	-	IK16	VK16	4		
		MH22S	K6A(DOHC · VVT)	07.2-08.9	IXU22C	09482-00563	-	IXU22	VXU22	3		
		MH22S	K6A(DOHC · T/C)	07.2-08.9	IXU22C	09482-00563	-	IXU22	VXU22	3		
		MH22S	K6A(DOHC · T/C · DI)	07.2-08.9	IXU22C	09482-00563	-	IXU22	VXU22	3		
		MH23S	K6A(DOHC · VVT)	08.9-12.9	IXU22HPR	09482-00608	-	IXUH22	VXUH22	3		
		MH23S	K6A(DOHC · T/C)	08.9-12.9	IXU22HPR	09482-00608	-	IXUH22	VXUH22	3		
		660	MH34S	R06A	12.9-15.8	VSUEH22	-	-	VSUEH22	3		
			MH34S	R06A(T/C)	12.9-15.8	VSUEH22	-	-	VSUEH22	3		
		MH44S	R06A(Sene CHARGE)	14.8-15.8	VSUEH22	-	-	VSUEH22	3			
		MH44S	R06A(Sene CHARGE)	15.8-17.2	ZXU22HPR8	09482-00633	-	IXUH22	VXUH22	3		
		MH44S	R06A(T/C · Sene CHARGE)	15.8-17.2	VSUEH22	-	-	VSUEH22	3			
		MH35S	R06A	17.2-	-	-	-	IXUH22I	VXUH22I	3		
		WAGON R STINGRAY HYBRID	660	MH55S	R06A	17.2-	-	-	IXUH22I	VXUH22I	3	
				MH55S	R06A(T/C)	17.2-	ZXU22HPR8	09482-00633	-	IXUH22	VXUH22	3
		X-90	1600	LB11S	G16A	95.10-	K20PR-U	09482-00429	K20TT	IK20	VK20	4
		XBEE	1000	MN71S	K10C(T/C)	17.12-	-	-	IXUH22I	VXUH22I	3	
		TOYOTA										
		86	2000	ZN6	FA20	12.4-16.8	ZXE27HBR8	SU003-04931	-	-	VXEBH27	4
				GRMN86-FRSPORT	FA20-GR(GRMN)	16.2-	ZXE27HBR8	SU003-04931	-	-	VXEBH27	4
				ZN6	FA20	16.8-	ZXE27HBR8	SU003-04931	-	-	VXEBH27	4
ALLEX	1500	NZE121·124	1NZ-FE	01.1-04.4	K16R-U11	90919-01164	K16TT	IK16	VK16	4		
		NZE121(2WD,AT)	1NZ-FE	04.4-06.10	FK20HR11	90919-01247	-	-	VFKH20	4		
		NZE124(4WD,AT)	1NZ-FE	04.4-06.10	K16R-U11	90919-01164	K16TT	IK16	VK16	4		
		ZZE122·124	1ZZ-FE	02.9-06.10	K16R-U11	90919-01164	K16TT	IK16	VK16	4		
	1800	ZZE123	2ZZ-GE	01.1-06.10	SK20R11	90919-01210	-	IK20	VK20	4		
		NZT240	1NZ-FE	01.12-07.6	K16R-U11	90919-01164	K16TT	IK16	VK16	4		
ALLION	1500	NZT260	1NZ-FE	07.6-07.9	FK20HR11	90919-01247	-	-	VFKH20	4		
		NZT260	1NZ-FE	07.9-	FK16HR11	90919-01243	-	-	VFKH16	4		
		ZZT240/245	1ZZ-FE	01.12-07.6	K16R-U11	90919-01164	K16TT	IK16	VK16	4		
		ZRT260/265	2ZR-FE	07.6-10.4	SC16HR11	90919-01275	-	-	VCH16	4		
		ZRT260/265	2ZR-FAE	10.4-	SC16HR11	90919-01275	-	-	VCH16	4		
	2000	AZT240	1AZ-FSE(D-4)	01.12-07.6	SK20BGR11	90919-01221	-	-	VKA20	4		
		ZRT261	3ZR-FAE	08.1-	SC16HR11	90919-01275	-	-	VCH16	4		
ALPHARD	2400	ANH10W/15W	2AZ-FE	02.5-08.5	K20R-U11	90919-01184	K20TT	IK20	VK20	4		
		ANH20W/25W	2AZ-FE	08.5-12.6	SK20R11	90919-01210	-	IK20	VK20	4		
		ANH20W	2AZ-FE	12.6-15.1	SK16R11	90919-01240	-	IK16	VK16	4		
		ANH25W	2AZ-FE	12.6-15.1	SK16R11	90919-01240	-	IK16	VK16	4		
		2500	AGH30W	2AR-FE	15.1-	SK16HR11	90919-01233	-	IKH16	VKH16	4	
AGH35W	2AR-FE		15.1-	SK16HR11	90919-01233	-	IKH16	VKH16	4			

(*5)The plug reach may be 19mm or 26.5mm even with the same engine and the same vehicle code. Please confirm the plug reach and choose the correct DENSO type. If there is an "H" in DENSO type, it has a reach of 26.5mm. If it doesn't, its reach is 19mm.

DENSO



AUSTRALIA CHINA INDIA INDONESIA KOREA MALAYSIA PHILIPPINES SAUDI ARABIA SINGAPORE TAIWAN THAILAND VIETNAM JAPAN EUROPE MOTOR & USA CYCLE SMALL ENGINE REFERENCE NUMBER PART

MODEL	CC	VEHICLE CODE	ENGINE	FROM-TILL	DENSO	GENUINE P/N				QTY
TOYOTA										
CAMRY	2500	MCV21	2MZ-FE	99.8-01.8	PK20TR11	90919-01194	-	IK20	VK20	6
CAMRY	2200	SXV20W/25W	5S-FE	96.12-01.7	PK20TR11	90919-01194	-	IK20	VK20	4
GRACIA	2500	MCV21W/25W	2MZ-FE	96.12-01.7	PK20TR11	90919-01194	-	IK20	VK20	6
CAMRY HYBRID	2500	AVV50	2AR-FXE	11.9-17.7	FK16HR-A8	90919-01259	-	-	VFKH16	4
		AXVH70	A25A-FXS	17.7-	FC16HR-Q8	90919-01289	-	-	VFCH16	4
CARINA	1600	AT210	4A-GE/FE	96.8-01.11	SK20R11	90919-01210	-	IK20	VK20	4
	1800	AT211	7A-FE(LEANBURN)	96.8-01.11	PK16TR13	90919-01200	-	IK16	VK16	4
	2000	ST215	3S-FE	96.8-01.11	K20TR11	90919-01198	K20TT	IK20	VK20	4
CARINA ED	2000	ST202/203	3S-FE	96.6-01.11	K20TR11	90919-01198	K20TT	IK20	VK20	4
CAVALIER	2400	TJG00	T2	96.1-00.9	PT16EPR-L13	-	-	IT16	VT16	4
CELICA	1800	ZZT230	1ZZ-FE	99.9-06.4	K16R-U11	90919-01164	K16TT	IK16	VK16	4
		ZZT231	2ZZ-GE	99.9-06.4	SK20R11	90919-01210	-	IK20	VK20	4
CELSIOR	4000	UCF20/21	1UZ-FE	97.7-00.8	SK20R11	90919-01210	-	IK20	VK20	8
	4300	UCF30/31	3UZ-FE	00.8-06.5	SK20R11	90919-01210	-	IK20	VK20	8
CENTURY		GZG50	1GZ-FE	97.4-00.4	SK16R-P11	90919-01209	-	IK16	VK16	12
		GZG50	1GZ-FE	00.4-10.8	SK16R-P11	90919-01219	-	IK16	VK16	12
	5000	GZG50	1GZ-FNE(CNG)	03.1-	SK16R8-PG	90919-01239	-	-	VK20T(*8)	12
		GZG50	1GZ-FE	10.8-	PK16TBR-L11	90919-01260	-	-	-	12
		UWG60	2UR-FSE	18.6-	FK20HBR11	90919-01249	-	-	VFKBH20	8
CHASER	1800	SX100	4S-FE	97.4-	K20TR11	90919-01198	K20TT	IK20	VK20	4
	2000	GX100/105	1G-FE	98.8-00.9	K20R-U11	90919-01184	K20TT	IK20	VK20	6
		JZX100/105	1JZ-GE	96.9-00.9	PK16TR11	90919-01196	-	IK16	VK16	6
	2500	JZX100	1JZ-GTE(T/C)	96.9-00.9	PK20TR11	90919-01194	-	IK20	VK20	6
		JZX101	2JZ-GE	96.9-00.9	PK16TR11	90919-01196	-	IK16	VK16	6
C-HR	1200	NGX50	8NR-FTS(T/C)	16.12-	VDCH22F	-	-	-	VDCH22F	4
		NGX10	8NR-FTS(T/C)	18.5-	VDCH22F	-	-	-	VDCH22F	4
C-HR HYBRID	1800	ZYX10	2ZR-FXE	16.12-18.5	FC16HR-C9	90919-01281	-	-	VFCH16	4
		ZYX10	2ZR-FXE	18.5-	FC16HR-CY9	90919-01298	-	-	VFCH16	4
COASTER	1500	HZB50(HYBRID)	5E-FE	97.8-07	K16TR11	90919-01192	K16TT	IK16	VK16	4
	4100	BZB40/50	1BZ-FPE(LPG)	04.8-	SK20R5-G	90919-01229	-	-	-	4
		BZB50	1BZ-FPE	11.8-	SK20R-B5	90919-01264	-	-	-	4
COMFORT	2000	YXS11	3Y-PE(LPG)	95.12-	P20R8	90919-01147	-	-	VW20T(*8)	4
		TSS13Y	1TR-FE	08.8-	FK20HBR11-T	90919-01255	-	-	VFKBH20	4
		TSS11	1TR-FPE(LPG)	08.8-	SK20HR-GT8	90919-01277	-	-	VKH20T(*8)	4
		TSS11Y	1TR-FPE(LPG)	08.8-	SK20HR-GT8	90919-01277	-	-	VKH20T(*8)	4
COROLLA AXIO	1300	NRE160	1NR-FE	12.5-13.11	SC16HR11	90919-01275	-	-	VCH16	4
		NRE160	1NR-FE	13.11-	SC16HR11	90919-01275	-	-	VCH16	4
		NZE141/144	1NZ-FE	06.10-07.11	FK20HR11	90919-01247	-	-	VFKH20	4
	1500	NZE141/144	1NZ-FE	07.11-	FK16HR11	90919-01243	-	-	VFKH16	4
		NZE161	1NZ-FE	12.5-	FK16HR11	90919-01243	-	-	VFKH16	4
		NZE164	1NZ-FE	12.5-	FK16HR11	90919-01243	-	-	VFKH16	4
		NRE161	2NR-FKE	15.4-17.4	FC16HR8	90919-01280	-	-	VFCH16	4
		NRE161	2NR-FKE	17.4-	FC16HR-Q8	90919-01289	-	-	VFCH16	4
		ZRE142/144	2ZR-FE	06.10-	SC16HR11	90919-01275	-	-	VCH16	4
	COROLLA AXIO HYBRID	1500	NKE165	1NZ-FXE	13.8-14.1	FK16R-AL8	90919-01272	-	-	VFK16
NKE165			1NZ-FXE	14.1-	FK16BR-AL8	90919-01284	-	-	VFKB16	4
COROLLA FIELDER	1500	NZE121G/124G	1NZ-FE	00.8-04.4	K16R-U11(*5)	90919-01164	K16TT	IK16(*5)	VK16(*5)	4
		NZE121G(2WD/MT)	1NZ-FE	04.4-06.10	K16R-U11(*5)	90919-01164	K16TT	IK16(*5)	VK16(*5)	4
		NZE121G(2WD/AT)	1NZ-FE	04.4-06.10	FK20HR11(*5)	90919-01247	-	-	VFKH20(*5)	4
		NZE124G(4WD)	1NZ-FE	04.4-06.10	K16R-U11(*5)	90919-01164	K16TT	IK16(*5)	VK16(*5)	4
		NZE141G/144G	1NZ-FE	06.10-07.11	FK20HR11	90919-01247	-	-	VFKH20	4
		NZE141G/144G	1NZ-FE	07.11-12.5	FK16HR11	90919-01243	-	-	VFKH16	4
		NZE161G	1NZ-FE	12.5-	FK16HR11	90919-01243	-	-	VFKH16	4
		NZE164G	1NZ-FE	12.5-	FK16HR11	90919-01243	-	-	VFKH16	4
		NRE161G	2NR-FKE	15.4-17.4	FC16HR8	90919-01280	-	-	VFCH16	4
	NRE161G	2NR-FKE	17.4-	FC16HR-Q8	90919-01289	-	-	VFCH16	4	
	1800	ZZE122G/124G	1ZZ-FE	00.8-04.4	K16R-U11	90919-01164	K16TT	IK16	VK16	4
		ZZE122G/124G	1ZZ-FE	04.4-06.10	K16R-U11	90919-01164	K16TT	IK16	VK16	4
		ZZE123G	2ZZ-GE	00.8-04.4	SK20R11	90919-01210	-	IK20	VK20	4
		ZZE123G	2ZZ-GE	04.4-06.10	SK20R11	90919-01210	-	IK20	VK20	4
		ZRE142G/144G	2ZR-FE	06.10-12.5	SC16HR11	90919-01275	-	-	VCH16	4
ZRE162G		2ZR-FAE	12.5-	SC16HR11	90919-01275	-	-	VCH16	4	
COROLLA FIELDER HYBRID	1500	NKE165G	1NZ-FXE	13.8-14.1	FK16R-AL8	90919-01272	-	-	VFK16	4
		NKE165G	1NZ-FXE	14.1-	FK16BR-AL8	90919-01284	-	-	VFKB16	4
COROLLA RUMION	1500	NZE151N	1NZ-FE	07.10-	FK16HR11	90919-01243	-	-	VFKH16	4
	1800	ZRE152N/154N	2ZR-FE	07.10-09.12	SC16HR11	90919-01275	-	-	VCH16	4
ZRE152N/154N		2ZR-FAE	09.12-	SC16HR11	90919-01275	-	-	VCH16	4	

DENSO

AUSTRALIA CHINA INDIA INDONESIA KOREA MALAYSIA PHILIPPINES SAUDIARABIA SINGAPORE TAIWAN THAILAND VIETNAM JAPAN EUROPE MOTOR & USA CYCLE SMALL ENGINE CROSS PART REFERENCE NUMBER

(*5)The plug reach may be 19mm or 26.5mm even with the same engine and the same vehicle code. Please confirm the plug reach and choose the correct DENSO type. If there is an "H" in DENSO type, it has a reach of 26.5mm. If it doesn't, its reach is 19mm. (*8)This is IRIDIUM PLUS.

MODEL	CC	VEHICLE CODE	ENGINE	FROM-TILL	DENSO	GENUINE P/N				QTY	
TOYOTA CROWN/MAJESTA	2500	JZS171/171W	1JZ-FSE(D-4)	01.8-03.12	SK20BR11	90919-01226	-	-	VKB20	6	
		GRS180/181	4GR-FSE(D-4)	03.12-08.2	FK20HBR11	90919-01249	-	-	VFKBH20	6	
		GRS200/201	4GR-FSE(D-4)	08.2-12.12	FK20HBR11	90919-01249	-	-	VFKBH20	6	
		GRS210	4GR-FSE	12.12-	FK20HBR11	90919-01249	-	-	VFKBH20	6	
		GRS211	4GR-FSE	12.12-	FK20HBR11	90919-01249	-	-	VFKBH20	6	
	3000	JZS175/175W/177	2JZ-FSE(D-4)	99.9-03.12	SK20BR11	90919-01226	-	-	VKB20	6	
		JKS175(Mild Hybrid)	2JZ-FSE(D-4)+1GM	01.8-	SK20BR11	90919-01226	-	-	VKB20	6	
		JZS179	2JZ-GE	99.9-03.12	PK16TR11	90919-01196	-	IK16	VK16	6	
		GRS182/183	3GR-FSE(D-4)	03.12-08.2	FK20HBR11	90919-01249	-	-	VFKBH20	6	
		GRS202/203	3GR-FSE(D-4)	08.2-12.12	FK20HBR11	90919-01249	-	-	VFKBH20	6	
	3500	GRS184	2GR-FSE(D-4S)	05.10-08.2	FK20HBR11	90919-01249	-	-	VFKBH20	6	
		GRS204	2GR-FSE(D-4S)	08.2-12.12	FK20HBR11	90919-01249	-	-	VFKBH20	6	
		GWS204(Hybrid)	2GR-FSE(D-4S)	08.5-12.12	FK20HBR11	90919-01249	-	-	VFKBH20	6	
		GRS214	2GR-FSE	12.12-	FK20HBR11	90919-01249	-	-	VFKBH20	6	
	4000	UZS151/155/157	1UZ-FE	97.7-01.7	SK20R11	90919-01210	-	IK20	VK20	8	
		UZS171/173/175	1UZ-FE	99.9-04.7	SK20R11	90919-01210	-	IK20	VK20	8	
	4300	UZS186/187	3UZ-FE	04.7-09.3	SK20R11	90919-01210	-	IK20	VK20	8	
		UZS207	3UZ-FE	09.3-	SK20R11	90919-01210	-	IK20	VK20	8	
	4600	URS206	1UR-FSE	09.3-	FK20HBR11	90919-01249	-	-	VFKBH20	8	
	CROWN/MAJESTA HYBRID	2500	AWS210	2AR-FSE	12.12-18.6	FK20HBR8	90919-01263	-	-	VFKBH20	4
			AWS211	2AR-FSE	14.7-18.6	FK20HBR8	90919-01263	-	-	VFKBH20	4
			AWS215	2AR-FSE	14.7-	FK20HBR8	90919-01263	-	-	VFKBH20	4
		3500	AZSH20	A25A-FXS	18.6-	FC16HR-Q8	90919-01289	-	-	VFCH16	4
			AZSH21	A25A-FXS	18.6-	FC16HR-Q8	90919-01289	-	-	VFCH16	4
			GWS214	2GR-FXE	13.9-	FK20HBR8	90919-01263	-	-	VFKBH20	6
GWS224			8GR-FXS	18.6-	FK20HBR8	90919-01263	-	-	VFKBH20	6	
DUET	1000	M100A · M110A	EJ-DE	98.9-00.5	K16PR-U11	-	K16TT	IK16	VK16	3	
		M100A · M110A	EJ-DE	00.5-01.11	K16TNR-S9	90048-51164	K16TT	IK16	VK16	3	
		M100A · M110A	EJ-VE	01.12-04.5	K16TNR-S9	90048-51164	K16TT	IK16	VK16	3	
	1300	M101A · M111A	K3-VE2	00.5-04.5	K20R-U11	90919-01184	K20TT	IK20	VK20	4	
		M101A · M111A	K3-VE	01.12-04.5	K20R-U11	90919-01184	K20TT	IK20	VK20	4	
DYNA	2000	YY101/121/131/201/211	3Y	95.5-01.5	P16R	90919-01115	-	IW16	VW16	4	
		LY161	3Y-P(LPG)	98.5-	P16R	90919-01143	-	-	VW20T(*8)	4	
		RZY220/230	1RZ-E	01.6-03.7	P16R8	90919-01223	-	IW16	VW16	4	
		TRY220/230	1TR-FE	08.1-	FK20HBR11-T	90919-01255	-	-	VFKBH20	4	
	2700	RZU100/100A/140	3RZ-FE	95.5-01.5	K16R-U	90919-01176	K16TT	IK16	VK16	4	
		RZU100/100A/140	3RZ-FE	95.5-	K16R-U	90919-01176	K16TT	IK16	VK16	4	
		RZU100A/H	3RZ-FP(LPG)	95.5-01.5	K16R-U	90919-01176	-	-	VK20T(*8)	4	
		RZU300	3RZ-FPE(LPG)	01.6-03.7	SK16R8-PG	90919-01239	-	-	VK20T(*8)	4	
		BU280K	3RZ-FPE(LPG)	01.6-	K16R-U	90919-01176	-	-	VK20T(*8)	4	
		RZY231H/281H	3RZ-FPE(LPG)	03.7-	SK16R8-PG	90919-01239	-	-	VK20T(*8)	4	
		TRU300/300A/340/500	2TR-FE	07.8-	SK20HR11	90919-01191	-	IKH20	VKH20	4	
		TRC600/TRU600/TRC600A	2TR-FE	11.7-	SK20HR11	90919-01191	-	IKH20	VKH20	4	
		BU102A/102H · BU142	15B-FP(LPG)	97.8-01.5	PK20R8	90919-01180	-	-	VK20T(*8)	4	
		RZU100/100A/100H	15B-FP(LPG)	99.5-01.5	PK20R8	90919-01180	-	-	VK20T(*8)	4	
	4100	XZU301A/302/342/412	15B-FNE(CNG)	01.6-	SK20R5-G	90919-01229	-	-	-	4	
		XZU301	15B-FPE(LPG)	01.6-	PK20R8	90919-01180	-	-	VK20T(*8)	4	
		BZU300/410	1BZ-FNE(CNG)	03.5-	SK20R5-G	90919-01229	-	-	-	4	
		BZU300 · BZU340	1BZ-FPE(LPG)	07.8-	SK20R5	90919-01222	-	-	-	4	
		BZU600	1BZ-FPE(LPG)	11.7-	DK16R-B5	90919-01283	-	-	-	4	
ESQUIRE	2000	ZRR80G	3ZR-FAE	14.10-	SC16HR11	90919-01275	-	-	VCH16	4	
		ZRR85G	3ZR-FAE	14.10-	SC16HR11	90919-01275	-	-	VCH16	4	
ESQUIRE HYBRID	1800	ZWR80G	2ZR-FXE	14.10-	SC16HR11	90919-01275	-	-	VCH16	4	
ESTIMA	2400	TCR10W/11W/20W/21W	2TZ-FZE(S/C)	94.8-00.2	SK20R11	90919-01210	-	IK20	VK20	4	
		ACR30W/40W	2AZ-FE	00.2-06.1	K20R-U11	90919-01184	K20TT	IK20	VK20	4	
	3000	MCR30W/40W	1MZ-FE	00.2-06.1	SK20R11	90919-01210	-	IK20	VK20	6	
		ACR50W/55W	2AZ-FE	06.1-12.5	SK20R11	90919-01210	-	IK20	VK20	4	
		ACR50W	2AZ-FE	12.5-14.9	SK16R11	90919-01240	-	IK16	VK16	4	
	2400	ACR55W	2AZ-FE	12.5-14.9	SK16R11	90919-01240	-	IK16	VK16	4	
		ACR50W	2AZ-FE	14.9-	SK16R11	90919-01240	-	IK16	VK16	4	
		ACR55W	2AZ-FE	14.9-	SK16R11	90919-01240	-	IK16	VK16	4	
	3500	GSR50W/55W	2GR-FE	06.1-	FK20HR11	90919-01247	-	-	VFKH20	6	
	ESTIMA EMINA/LUCIDA	2400	TCR10G/11G/20G/21G	2TZ-FE	92.1-00.2	PK16R11	90919-01168	-	IK16	VK16	4
ESTIMA HYBRID	2400	AHR10W	2AZ-FXE	01.6-06.6	SK20R11	90919-01210	-	IK20	VK20	4	
		AHR20W	2AZ-FXE	06.6-12.5	SK20R11	90919-01210	-	IK20	VK20	4	
		AHR20W	2AZ-FXE	12.5-	SK16R11	90919-01240	-	IK16	VK16	4	
		AHR20W	2AZ-FXE	14.9-	SK16R11	90919-01240	-	IK16	VK16	4	



DENSO

AUSTRALIA CHINA INDIA INDONESIA KOREA MALAYSIA PHILIPPINES SAUDI ARABIA SINGAPORE TAIWAN THAILAND VIETNAM JAPAN EUROPE MOTOR & USA CYCLE SMALL ENGINE CROSS PART REFERENCE NUMBER

(*8)This is IRIDIUM PLUS.

**DENSO****CHINA AUSTRALIA****INDIA****INDONESIA****KOREA****MALAYSIA****PHILIPPINES****SAUDI ARABIA****SINGAPORE****TAIWAN****THAILAND****VIETNAM****JAPAN****EUROPE****USA & CANADA****SMALL ENGINE****CROSS REFERENCE****PART NUMBER**

MODEL	CC	VEHICLE CODE	ENGINE	FROM-TILL	DENSO	GENUINE P/N				QTY	
TOYOTA											
FJ CRUISER	4000	GSJ15W	1GR-FE	10.10-13.7	SK20HR11	90919-01191	-	IKH20	VKH20	6	
		GSJ15W	1GR-FE	13.7-	SK16HR11	90919-01233	-	IKH16	VKH16	6	
FUN CARGO	1300	NCP20	2NZ-FE	99.9-05.10	K16R-U11	90919-01164	K16TT	IK16	VK16	4	
	1500	NCP21/25	1NZ-FE	99.9-05.10	K16R-U11	90919-01164	K16TT	IK16	VK16	4	
GAIA	2000	SXM10G/15G	3S-FE	98.5-02.7	K20TR11	90919-01198	K20TT	IK20	VK20	4	
		ACM10G/15G	1AZ-FSE(D-4)	01.4-04.9	SK20BGR11	90919-01221	-	-	VKA20	4	
GRAND HIACE	3400	VCH10W/16W/22K/28K	5VZ-FE	99.8-05.12	PK16TR11	90919-01196	-	IK16	VK16	6	
GRANVIA	3400	VCH10W/16W/22K/28K	5VZ-FE	97.8-02.5	PK16TR11	90919-01196	-	IK16	VK16	6	
HARRIER	2000	ZSU60W	3ZR-FAE	13.12-	SC16HR11	90919-01275	-	-	VCH16	4	
		ZSU65W	3ZR-FAE	13.12-	SC16HR11	90919-01275	-	-	VCH16	4	
		ASU60W	8AR-FTS(T/C)	17.6-	VDKH22F	-	-	-	VDKH22F	4	
		ASU65W	8AR-FTS(T/C)	17.6-	VDKH22F	-	-	-	VDKH22F	4	
	2200	SXU10W/15W	5S-FE	98.1-03.2	PK20TR11	90919-01194	-	IK20	VK20	4	
		ACU10W/15W	2AZ-FE	00.11-03.2	K20R-U11	90919-01184	K20TT	IK20	VK20	4	
	2400	ACU30W/35W	2AZ-FE	03.2-10.9	K20R-U11	90919-01184	K20TT	IK20	VK20	4	
		ACU30W/35W	2AZ-FE	10.9-	SK20R11	90919-01210	-	IK20	VK20	4	
		ACU30W	2AZ-FE	12.6-	SK16R11	90919-01240	-	IK16	VK16	4	
		ACU35W	2AZ-FE	12.6-	SK16R11	90919-01240	-	IK16	VK16	4	
	3000	MCU10W/15W	1MZ-FE	98.1-03.2	SK20R11	90919-01210	-	IK20	VK20	6	
		MCU30W/31W/35W/36W	1MZ-FE	03.2-05.12	SK20R11	90919-01210	-	IK20	VK20	6	
	3500	GSU30W/35W/GCU31W/36W	2GR-FE	06.1-08.11	FK20HR11	90919-01247	-	-	VFKH20	6	
	HARRIER HV	3300	MHU38W	3MZ-FE	05.3-	SK20R11	90919-01210	-	IK20	VK20	6
HARRIER HYBRID	2500	AVU65W	2AR-FXE	14.1-	FK16HR-A8	90919-01259	-	-	VFKH16	4	
HIACE	1800	KM70/75/80/85	7K-E	99.6-02.8	W16EXR-U11	90919-01091	W16TT	IW16	VW16	4	
		RZH100G/110G/102V/112V/112K/124B	1RZ-E	89.8-03.7	P16R	90919-01115	-	IW16	VW16	4	
		RZH102V/112V/112K/122V/124B	1RZ	89.8-03.7	W16EXR-U	90919-01064	W16TT	IW16	VW16	4	
	2000	TRH102V/112K/112V/122K/124B	1TR-FE	03.7-04.8	SK20HR11	90919-01191	-	IKH20	VKH20	4	
		TRH200K/200V/201K	1TR-FE	04.8-07.8	SK20HR11	90919-01191	-	IKH20	VKH20	4	
		TRH200K/200V/201K	1TR-FE	07.8-08.1	FK20HBR11	90919-01249	-	-	VFKBH20	4	
		TRH200K/200V/201K	1TR-FE	08.1-15.1	FK20HBR11-T	90919-01255	-	-	VFKBH20	4	
		TRH200K	1TR-FE	15.1-17.12	FK20HBR-TJ8	90919-01288	-	-	VFKBH20	4	
		TRH200V	1TR-FE	15.1-17.12	FK20HBR-TJ8	90919-01288	-	-	VFKBH20	4	
		TRH200K	1TR-FE	17.12-	FK20HBR-TJ8	90919-01288	-	-	VFKBH20	4	
		TRH200V	1TR-FE	17.12-	FK20HBR-TJ8	90919-01288	-	-	VFKBH20	4	
		2400	RZH101G/111G/133S/133V	2RZ-E	99.7-04.8	P16R	90919-01115	-	-	VW16	4
			TRH221K/226K/214W/219W	2TR-FE	04.8-12.5	SK20HR11	90919-01191	-	IKH20	VKH20	4
	TRH224W/229W		2TR-FE	05.1-12.5	SK20HR11	90919-01191	-	IKH20	VKH20	4	
	TRH211K/216K/223B/228B		2TR-FE	07.8-12.5	SK20HR11	90919-01191	-	IKH20	VKH20	4	
	TRH211K		2TR-FE	12.5-15.1	SK20HR-A11	90919-01266	-	IKH20	VKH20	4	
	TRH221K		2TR-FE	12.5-15.1	SK20HR-A11	90919-01266	-	IKH20	VKH20	4	
	TRH216K		2TR-FE	12.5-15.1	SK20HR-A11	90919-01266	-	IKH20	VKH20	4	
	TRH226K		2TR-FE	12.5-15.1	SK20HR-A11	90919-01266	-	IKH20	VKH20	4	
	TRH223B		2TR-FE	12.5-15.1	SK20HR-A11	90919-01266	-	IKH20	VKH20	4	
	TRH228B		2TR-FE	12.5-15.1	SK20HR-A11	90919-01266	-	IKH20	VKH20	4	
	2700	TRH224W	2TR-FE	12.5-15.1	SK20HR-A11	90919-01266	-	IKH20	VKH20	4	
		TRH214W	2TR-FE	12.5-15.1	SK20HR-A11	90919-01266	-	IKH20	VKH20	4	
TRH229W		2TR-FE	12.5-15.1	SK20HR-A11	90919-01266	-	IKH20	VKH20	4		
TRH219W		2TR-FE	12.5-15.1	SK20HR-A11	90919-01266	-	IKH20	VKH20	4		
TRH211K		2TR-FE	15.1-	FK20HR-A8	90919-01287	-	-	VFKH20	4		
TRH221K		2TR-FE	15.1-	FK20HR-A8	90919-01287	-	-	VFKH20	4		
TRH216K		2TR-FE	15.1-	FK20HR-A8	90919-01287	-	-	VFKH20	4		
TRH226K		2TR-FE	15.1-	FK20HR-A8	90919-01287	-	-	VFKH20	4		
TRH223B		2TR-FE	15.1-	FK20HR-A8	90919-01287	-	-	VFKH20	4		
TRH228B		2TR-FE	15.1-	FK20HR-A8	90919-01287	-	-	VFKH20	4		
HIACE REGIUS	2000	RCH42V	1RZ-E	97.6-	P16R	90919-01115	-	IW16	VW16	4	
	2700	RCH41W/47W	3RZ-FE	98.8-	SK16R11	90919-01240	-	IK16	VK16	4	
	2000	RZN147/152H/167	1RZ-E	97.9-04.8	W16EXR-U	90919-01064	W16TT	IW16	VW16	4	
		RZN169H/174H/180W/185W	3RZ-FE	95.12-02.11	K16R-U	90919-01176	K16TT	IK16	VK16	4	
	2700	RZN210W/215W	3RZ-FE	02.11-04.8	K16R-U11	90919-01164	K16TT	IK16	VK16	4	
		TRN210W/215W	2TR-FE	04.8-	SK20HR11	90919-01191	-	IKH20	VKH20	4	
	3400	VZN180W/185W	5VZ-FE	95.12-02.11	K16TR11	90919-01192	K16TT	IK16	VK16	6	
VZN210W/215W		5VZ-FE	02.11-05.7	K16TR11	90919-01192	K16TT	IK16	VK16	6		
4000	GRN215W	1GR-FE	05.7-	K20HR-U11	90919-01235	-	IKH20	VKH20	6		

MODEL	CC	VEHICLE CODE	ENGINE	FROM-TILL	DENSO	GENUINE P/N				QTY
TOYOTA										
IPSUM	2000	SXM10G/15G	3S-FE	96.5-01.4	K20TR11	90919-01198	K20TT	IK20	VK20	4
	2400	ACM21W/26W	2AZ-FE	01.5-09.12	K20R-U11	90919-01184	K20TT	IK20	VK20	4
iQ	1000	KGJ10	1KR-FE	08.10-	SK16HR11	90919-01233	-	IKH16	VKH16	3
	1300	NGJ10	1NR-FE	09.8-	SC16HR11	90919-01275	-	-	VCH16	4
ISIS	1800	ZNM10W/10G	1ZZ-FE	04.9-09.9	K16R-U11	90919-01164	K16TT	IK16	VK16	4
		ZGM10G/10W/15G/15W	2ZR-FAE	09.9-	SC16HR11	90919-01275	-	-	VCH16	4
	2000	ANM10W/10G/15W/15G	1AZ-FSE(D-4)	04.9-09.9	SK20BGR11	90919-01221	-	-	VKA20	4
		ZGM11G/11W	3ZR-FAE	09.9-	SC16HR11	90919-01275	-	-	VCH16	4
iST	1300	NCP60	2NZ-FE	02.5-05.5	K16R-U11	90919-01164	K16TT	IK16	VK16	4
		NCP60	2NZ-FE	05.5-	SK16R11	90919-01240	-	IK16	VK16	4
		NCP61/65	1NZ-FE	02.5-07.7	K16R-U11	90919-01164	K16TT	IK16	VK16	4
	1500	NCP110 · NCP115	1NZ-FE	07.7-07.11	FK20HR11	90919-01247	-	-	VFKH20	4
		NCP110 · NCP115	1NZ-FE	07.11-	FK16HR11	90919-01243	-	-	VFKH16	4
	1800	ZSP110	2ZR-FE	07.7-	SC16HR11	90919-01275	-	-	VCH16	4
JPN TAXI	1500	NTP10	1NZ-FXP	17.10-	VDKH16T	-	-	-	VDKH16T	4
KLUGER HV	3300	MHU28W	3MZ-FE	05.3-07.4	SK20R11	90919-01210	-	IK20	VK20	6
KLUGER V/L	2400	ACU20W/25W	2AZ-FE	00.11-07.4	K20R-U11	90919-01184	K20TT	IK20	VK20	4
	3000	MCU20W/25W	1MZ-FE	00.11-07.4	SK20R11	90919-01210	-	IK20	VK20	6
LAND CRUISER	4600	URJ202W	1UR-FE	09.5-	SK20HR11	90919-01191	-	IKH20	VKH20	8
	4700	UZJ100W	2UZ-FE	98.1-07.9	SK20R11	90919-01210	-	IK20	VK20	8
		UZJ200W	2UZ-FE	07.9-	SK20R11	90919-01210	-	IK20	VK20	8
LAND CRUISER PRADO	2700	RZJ90W/95W	3RZ-FE	97.4-02.10	K16R-U	90919-01176	K16TT	IK16	VK16	4
		RZJ120W/125W	3RZ-FE	02.10-04.8	K16R-U11	90919-01164	K16TT	IK16	VK16	4
		TRJ120W/125W	2TR-FE	04.8-07.9	SK20HR11	90919-01191	-	IKH20	VKH20	4
		TRJ150W	2TR-FE	09.9-12.7	SK20HR11	90919-01191	-	IKH20	VKH20	4
		TRJ150W	2TR-FE	12.7-15.6	SK20HR-A11	90919-01266	-	IKH20	VKH20	4
		TRJ150W	2TR-FE	15.6-	FK20HR-A8	90919-01287	-	-	VFKH20	4
	3400	VZJ90W/95W	5VZ-FE	99.6-02.10	PK16TR11	90919-01196	-	IK16	VK16	6
		VZJ120W/121W/125W	5VZ-FE	02.10-09.9	K16TR11	90919-01192	K16TT	IK16	VK16	6
	4000	GRJ120W/121W	1GR-FE	05.7-09.9	K20HR-U11	90919-01235	-	IKH20	VKH20	6
		GRJ150W/151W	1GR-FE	09.9-13.6	K20HR-U11	90919-01235	-	IKH20	VKH20	6
GRJ150W		1GR-FE	13.6-	SK16HR11	90919-01233	-	IKH16	VKH16	6	
GRJ151W		1GR-FE	13.6-	SK16HR11	90919-01233	-	IKH16	VKH16	6	
LAND CRUISER70	4000	GRJ76K	1GR-FE	14.8-	K20HR-U11	90919-01235	-	IKH20	VKH20	6
		GRJ79K	1GR-FE	14.8-	K20HR-U11	90919-01235	-	IKH20	VKH20	6
LITEACE	1500	S412M	3SZ-VE	10.7-	XU22PR9	90048-51197	-	IXU22I	VXU22I	4
		S412U	3SZ-VE	10.7-	XU22PR9	90048-51197	-	IXU22I	VXU22I	4
LITEACE/ NOAH	1500	S402M · S402U	3SZ-VE	08.1-	XU22PR9	90048-51197	-	IXU22I	VXU22I	4
		KR42V	7K-E	98.12-02.8	W16EXR-U11	90919-01091	W16TT	IW16	VW16	4
	1800	KM70/75/80/85	7K-E	99.6-02.8	W16EXR-U11	90919-01091	W16TT	IW16	VW16	4
		KR42V · KM70/75/80/85	7K-E	02.8-07.7	W16EXR-U	90919-01064	W16TT	IW16	VW16	4
		KR52V	7K-E	04.11-07.7	W16EXR-U	90919-01064	W16TT	IW16	VW16	4
2000	SR40G/50G	3S-FE	96.10-07.7	K20TR11	90919-01198	K20TT	IK20	VK20	4	
MARK II	1800	SX100	4S-FE	97.4-	K20TR11	90919-01198	K20TT	IK20	VK20	4
		2000	GX100/105	1G-FE	98.8-00.9	K20R-U11	90919-01184	K20TT	IK20	VK20
	GX110/115		1G-FE	00.10-	K20R-U11	90919-01184	K20TT	IK20	VK20	6
	2500	JZX100/105	1JZ-GE	96.9-00.9	PK16TR11	90919-01196	-	IK16	VK16	6
		JZX100	1JZ-GTE(T/C)	96.9-00.9	PK20TR11	90919-01194	-	IK20	VK20	6
		JZX110	1JZ-GTE(T/C)	00.10-04.10	SK20R-P11	90919-01207	-	IK20	VK20	6
		JZX110	1JZ-FSE(D-4)	00.10-04.10	SK20BR11	90919-01226	-	-	VKB20	6
		JZX115	1JZ-GE	00.10-04.10	SK16R-P11	90919-01219	-	IK16	VK16	6
	3000	JZX101	2JZ-GE	96.9-00.9	PK16TR11	90919-01196	-	IK16	VK16	6
	MARK II QUALIS	2200	SXV20W/25W	5S-FE	97.4-02.1	PK20TR11	90919-01194	-	IK20	VK20
2500		MCV21W/25W	2MZ-FE	97.4-02.1	PK20TR11	90919-01194	-	IK20	VK20	6
3000		MCV20W	1MZ-FE	98.8-02.1	SK20R11	90919-01210	-	IK20	VK20	6
MARK II BLIT	2000	GX110W · GX115W	1G-FE	02.1-04.11	K20R-U11	90919-01184	K20TT	IK20	VK20	6
		JZX110W	1JZ-GTE(T/C)	02.1-04.11	PK20TR11	90919-01194	-	IK20	VK20	6
	2500	JZX115W	1JZ-GE	02.1-04.11	SK16R-P11	90919-01219	-	IK16	VK16	6
MARK X	2500	GRX120/125	4GR-FSE(D-4)	04.11-09.10	FK20HBR11	90919-01249	-	-	VFKBH20	6
		GRX130/135	4GR-FSE(D-4)	09.10-	FK20HBR11	90919-01249	-	-	VFKBH20	6
	3000	GRX121	3GR-FSE(D-4)	04.11-09.10	FK20HBR11	90919-01249	-	-	VFKBH20	6
	3500	GRX133	2GR-FSE(D-4S)	09.10-	FK20HBR11	90919-01249	-	-	VFKBH20	6
		MARK X ZIO	ANA10/15	2AZ-FE	07.9-12.6	SK20R11	90919-01210	-	IK20	VK20
2400	ANA10		2AZ-FE	12.6-	SK16R11	90919-01240	-	IK16	VK16	4
	ANA15		2AZ-FE	12.6-	SK16R11	90919-01240	-	IK16	VK16	4
3500	GGA10	2GR-FE	07.9-	FK20HR11	90919-01247	-	-	VFKH20	6	

DENSO

AUSTRALIA CHINA

INDIA

INDONESIA

KOREA

MALAYSIA

PHILIPPINES

SAUDIARABIA

SINGAPORE

TAIWAN

THAILAND

VIETNAM

JAPAN

EUROPE

MOTOR

& USA

CYCLE

SMALL

ENGINE

CROSS

PART

DENSO	9	14	16	20	22	24	27	29	31	32	34	35	DENSO	9	14	16	20	22	24	27	29	31	32	DENSO	9	14	16	20	22	24	27	31
NGK	2	4	5	6	7	8	9	9.5	10	10.5	11	11.5	CHAMPION	18	16,14	12,11	10,9	8,7	6,63,61	4,59	57	55	53	BOSCH	10	9	8	7,6	5	4	3	2



PART NUMBER	CROSS REFERENCE	SMALL ENGINE	MOTOR CYCLE	EUROPE & USA	JAPAN	VIETNAM	THAILAND	TAIWAN	SINGAPORE	SAUDI ARABIA	PHILIPPINES	MALAYSIA	KOREA	INDONESIA	INDIA	CHINA	AUSTRALIA	DENSO	MODEL	CC	VEHICLE CODE	ENGINE	FROM-TILL	DENSO	GENUINE P/N				QTY						
																			TOYOTA																
																				MR-S	1800	ZZW30	1ZZ-FE	99.10-	K16R-U11	90919-01164	K16TT	IK16	VK16	4					
																				NADIA		SXN10/15/10H/15H	3S-FE	98.8-02.7	K20TR11	90919-01198	K20TT	IK20	VK20	4					
																					2000	SXN10	3S-FSE(D-4)	98.8-01.3	PK20GR8	90919-01208	-	-	VKA20	4					
																						ACN10/10H/15	1AZ-FSE(D-4)	01.4-03.8	SK20BGR11	90919-01221	-	-	VKA20	4					
																						NOAH	AZR60G/65G	1AZ-FSE(D-4)	01.11-07.6	SK20BGR11	90919-01221	-	-	VKA20	4				
																							ZRR70G/75G/75W	3ZR-FE	07.6-10.5	SC16HR11	90919-01275	-	-	VCH16	4				
																							ZRR70G/75G/75W	3ZR-FAE	10.5-14.1	SC16HR11	90919-01275	-	-	VCH16	4				
																							2000	ZRR70W	3ZR-FAE	07.6-14.1	SC16HR11	90919-01275	-	-	VCH16	4			
																							ZRR80G	3ZR-FAE	14.1-	SC16HR11	90919-01275	-	-	VCH16	4				
																							ZRR80W	3ZR-FAE	14.1-	SC16HR11	90919-01275	-	-	VCH16	4				
																							ZRR85G	3ZR-FAE	14.1-	SC16HR11	90919-01275	-	-	VCH16	4				
																							ZRR85W	3ZR-FAE	14.1-	SC16HR11	90919-01275	-	-	VCH16	4				
																							NOAH HYBRID	1800	ZWR80G	2ZR-FXE	14.2-	SC16HR11	90919-01275	-	-	VCH16	4		
																							ZWR80W	2ZR-FXE	16.1-	SC16HR11	90919-01275	-	-	VCH16	4				
																							OPA	1800	ZCT10/15	1ZZ-FE	00.5-05.12	K16R-U11	90919-01164	K16TT	IK16	VK16	4		
																								2000	ACT10	1AZ-FSE(D-4)	00.5-05.12	SK20BGR11	90919-01221	-	-	VKA20	4		
																							ORIGIN	3000	JCG17	2JZ-GE	00.11-01.6	PK16TR11	90919-01196	-	-	IK16	VK16	6	
																							PASSO		KGC10 · KGC15	1KR-FE	04.6-10.2	SK20HR11	90919-01191	-	-	IKH20	VKH20	3	
																								KGC30/KGC35	1KR-FE	10.2-14.4	SK20HR11	90919-01191	-	-	IKH20	VKH20	3		
																								1000	KGC30	1KR-FE	14.4-	SC16HR11	90919-01275	-	-	VCH16	3		
																								KGC35	1KR-FE	14.4-	SC16HR11	90919-01275	-	-	VCH16	3			
																								M700A	1KR-FE	16.4-	-	-	-	-	VFXEH20	3			
																								M710A	1KR-FE	16.4-	-	-	-	-	VFXEH20	3			
																								1300	QNC10	K3-VE	04.6-06.12	SK20PR-A8	90048-51182	-	-	IK20	VK20Y	4	
																								QNC10	K3-VE	06.12-10.2	SXU22PR9	90048-51188-000	-	-	IXU22I	VXU22I	4		
																								NGC30	1NR-FE	10.2-	SC16HR11	90919-01275	-	-	VCH16	4			
																							PASSO SETTE	1500	M502E · M512E	3SZ-VE	08.12-	SXU22PR9	90048-51188-000	-	-	IXU22I	VXU22I	4	
																							PIXIS EPOCH		LA310A	KF	12.5-12.11	SXU20HPR11	90048-51208	-	-	IXUH20I	VXUH20I	3	
																								LA300A	KF	12.11-14.7	SXU20HPR11	90048-51208	-	-	IXUH20I	VXUH20I	3		
																								LA310A	KF	12.11-14.7	SXU20HPR11	90048-51208	-	-	IXUH20I	VXUH20I	3		
																								660	LA300A	KF	14.7-17.5	-	-	-	IXUH20I	VXUH20I	3		
																								LA310A	KF	14.7-17.5	-	-	-	IXUH20I	VXUH20I	3			
																								LA350A	KF	17.5-	-	-	-	IXUH20I	VXUH20I	3			
																								LA360A	KF	17.5-	-	-	-	IXUH20I	VXUH20I	3			
																							PIXIS JOY		LA250A	KF	16.8-	SXU20HPR11	90048-51208	-	-	IXUH20I	VXUH20I	3	
																								660	LA250A	KF(T/C)	16.8-	SXU22HPR8	90048-51214	-	-	IXUH22I	VXUH22I	3	
																								LA260A	KF	16.8-	SXU20HPR11	90048-51208	-	-	IXUH20I	VXUH20I	3		
																								LA260A	KF(T/C)	16.8-	SXU22HPR8	90048-51214	-	-	IXUH22I	VXUH22I	3		
																								PIXIS MEGA		LA700A	KF	15.7-	SXU20HPR11	90048-51208	-	-	IXUH20I	VXUH20I	3
																								660	LA700A	KF(T/C)	15.7-	SXU22HPR8	90048-51214	-	-	IXUH22I	VXUH22I	3	
																								LA710A	KF	15.7-	SXU20HPR11	90048-51208	-	-	IXUH20I	VXUH20I	3		
																								LA710A	KF(T/C)	15.7-	SXU22HPR8	90048-51214	-	-	IXUH22I	VXUH22I	3		
																								PIXIS SPACE		L575A/L585A	KF	11.9-12.9	SXU20HPR11	90048-51208	-	-	IXUH20I	VXUH20I	3
																								660	L585A	KF	11.9-12.9	SXU20HPR11	90048-51208	-	-	IXUH20I	VXUH20I	3	
																								L575A	KF	12.9-	SXU20HPR11	90048-51208	-	-	IXUH20I	VXUH20I	3		
																								L585A	KF	12.9-	SXU20HPR11	90048-51208	-	-	IXUH20I	VXUH20I	3		
																								PIXIS SPACE CUSTOM		L575A	KF	11.9-12.9	SXU20HPR11	90048-51208	-	-	IXUH20I	VXUH20I	3
																									L575A	KF(T/C)	11.9-13.8	SXU22HPR8	90048-51214	-	-	IXUH22I	VXUH22I	3	
																									L585A	KF	11.9-12.9	SXU20HPR11	90048-51208	-	-	IXUH20I	VXUH20I	3	
																									660	L585A	KF(T/C)	11.9-13.8	SXU22HPR8	90048-51214	-	-	IXUH22I	VXUH22I	3
																								L575A	KF	12.9-	SXU20HPR11	90048-51208	-	-	IXUH20I	VXUH20I	3		
																								L575A	KF(T/C)	13.8-	SXU22HPR8	90048-512							



MODEL	CC	VEHICLE CODE	ENGINE	FROM-TILL	DENSO	GENUINE P/N	TT	IRIDIUM POWER	IRIDIUM TOUGH	QTY
TOYOTA										
PLATZ	1300	NCP16	2NZ-FE	99.9-05.11	K16R-U11	90919-01164	K16TT	IK16	VK16	4
	1500	NCP12	1NZ-FE	99.9-05.11	K16R-U11	90919-01164	K16TT	IK16	VK16	4
PORTE	1300	NNP10	2NZ-FE	04.7-12.7	K16R-U11	90919-01164	K16TT	IK16	VK16	4
		NSP140	1NR-FE	12.7-	SC16HR11	90919-01275	-	-	VCH16	4
		NNP11/15	1NZ-FE	04.7-12.7	K16R-U11	90919-01164	K16TT	IK16	VK16	4
	1500	NCP141	1NZ-FE	12.7-	FK16HR11	90919-01243	-	-	VFKH16	4
		NCP145	1NZ-FE	12.7-	FK16HR11	90919-01243	-	-	VFKH16	4
		NSP141	2NR-FKE	15.7-17.12	FC16HR8	90919-01280	-	-	VFCH16	4
		NSP141	2NR-FKE	17.12-	FC16HR-Q8	90919-01289	-	-	VFCH16	4
PREMIO	1500	NZT240	1NZ-FE	01.12-07.6	K16R-U11	90919-01164	K16TT	IK16	VK16	4
		NZT260	1NZ-FE	07.6-07.11	FK20HR11	90919-01247	-	-	VFKH20	4
		NZT260	1NZ-FE	07.11-	FK16HR11	90919-01243	-	-	VFKH16	4
	1800	ZZT240/245	1ZZ-FE	01.12-07.6	K16R-U11	90919-01164	K16TT	IK16	VK16	4
		ZRT260/265	2ZR-FE	07.6-10.4	SC16HR11	90919-01275	-	-	VCH16	4
		ZRT260/265	2ZR-FAE	10.4-	SC16HR11	90919-01275	-	-	VCH16	4
		2000	AZT240	1AZ-FSE(D-4)	01.12-08.1	SK20BGR11	90919-01221	-	-	VKA20
ZRT261	3ZR-FAE	08.1-	SC16HR11	90919-01275	-	-	VCH16	4		
PRIUS	1500	NHW10	1NZ-FXE(HYBRID)	97.12-00.4	K16R-U11	90919-01164	K16TT	IK16	VK16	4
		NHW11 • NHW20	1NZ-FXE(HYBRID)	00.5-	SK16R11	90919-01240	-	IK16	VK16	4
		ZVW30	2ZR-FXE(HYBRID)	09.5-15.12	SC16HR11	90919-01275	-	-	VCH16	4
	1800	ZVW51	2ZR-FXE(HYBRID)	15.12-18.12	FC16HR-C9	90919-01281	-	-	VFCH16	4
		ZVW50	2ZR-FXE(HYBRID)	15.12-18.12	FC16HR-C9	90919-01281	-	-	VFCH16	4
		ZVW55	2ZR-FXE(HYBRID)	15.12-18.12	FC16HR-C9	90919-01281	-	-	VFCH16	4
		ZVW51	2ZR-FXE(HYBRID)	18.12-	FC16HR-CY9	90919-01298	-	-	VFCH16	4
ZVW55	2ZR-FXE(HYBRID)	18.12-	FC16HR-CY9	90919-01298	-	-	VFCH16	4		
PRIUS PHV	1800	ZVW35	2ZR-FXE(HYBRID)	12.1-17.2	SC16HR11	90919-01275	-	-	VCH16	4
		ZVW52	2ZR-FXE(HYBRID)	17.2-17.9	FC16HR-C9	90919-01281	-	-	VFCH16	4
		ZVW52	2ZR-FXE(HYBRID)	17.9-	FC16HR-Q8	90919-01298	-	-	VFCH16	4
PRIUS α	1800	ZVW40W • ZVW41W	2ZR-FXE(HYBRID)	11.5-	SC16HR11	90919-01275	-	-	VCH16	4
PROBOX	1300	NCP50V	2NZ-FE	02.7-10.6	K16R-U11	90919-01164	K16TT	IK16	VK16	4
		NCP50V	2NZ-FE	10.6-14.9	SK16R11	90919-01240	-	IK16	VK16	4
	1500	NSP160V	1NR-FE	14.9-	SC16HR11	90919-01275	-	-	VCH16	4
		NCP51V/55V/58G/59G	1NZ-FE	02.7-10.6	K16R-U11	90919-01164	K16TT	IK16	VK16	4
		NCP51V	1NZ-FE	10.6-14.9	SK16R11	90919-01240	-	IK16	VK16	4
		NCP55V	1NZ-FE	10.6-14.9	SK16R11	90919-01240	-	IK16	VK16	4
		NCP58G	1NZ-FE	10.6-	SK16R11	90919-01240	-	IK16	VK16	4
		NCP59G	1NZ-FE	10.6-	SK16R11	90919-01240	-	IK16	VK16	4
		NCP52V	1NZ-FNE(CNG)	03.4-	SK20R8-G	90919-01190	-	-	VK20T(*8)	4
		NCP160V	1NZ-FE	14.9-	FK16HR11	90919-01243	-	-	VFKH16	4
NCP165V	1NZ-FE	14.9-	FK16HR11	90919-01243	-	-	VFKH16	4		
PROBOX HYBRID	1500	NHP160V	1NZ-FXE	18.12-	FK16BR-AL8	90919-01284	-	-	VFKB16	4
PROGRES	2500	JCG10/15	1JZ-GE	98.5-01.3	PK16TR11	90919-01196	-	IK16	VK16	6
		JCG10/15	1JZ-FSE(D-4)	01.4-07.6	SK20BR11	90919-01226	-	-	VKB20	6
	3000	JCG11	2JZ-GE	98.5-01.3	PK16TR11	90919-01196	-	IK16	VK16	6
		JCG11	2JZ-FSE(D-4)	01.4-07.6	SK20BR11	90919-01226	-	-	VKB20	6
PRONARD RACTIS	3000	MCX20	1MZ-FE	00.4-03.11	SK20R11	90919-01210	-	IK20	VK20	6
		SCP100	2SZ-FE	05.10-	SK16HR11	90919-01233	-	IKH16	VKH16	4
		NSP120/122	1NR-FE	10.12-14.5	SC16HR11	90919-01275	-	-	VCH16	4
	1300	NSP120	1NR-FKE	14.5-	FC16HR8	90919-01280	-	-	VFCH16	4
		NSP122	1NR-FKE	14.5-	FC16HR8	90919-01280	-	-	VFCH16	4
		NCP100(2WD)	1NZ-FE	05.10-07.11	FK20HR11	90919-01247	-	-	VFKH20	4
	1500	NCP100(2WD)	1NZ-FE	07.11-	FK16HR11	90919-01243	-	-	VFKH16	4
		NCP105(4WD)	1NZ-FE	05.10-	K16R-U11	90919-01164	K16TT	IK16	VK16	4
		NCP120/122/125	1NZ-FE	10.11-	FK16HR11	90919-01243	-	-	VFKH16	4
		RAUM	1500	EXZ10/15	5E-FE	97.5-03.5	K16TR11	90919-01192	K16TT	IK16
NCZ20/25	1NZ-FE	03.5-		K16R-U11	90919-01164	K16TT	IK16	VK16	4	
RAV4	1800	ZCA25W/26W	1ZZ-FE	00.5-05.11	K16R-U11	90919-01164	K16TT	IK16	VK16	4
		SXA10W/11W	3S-GE	98.8-00.5	SK20R11	90919-01210	-	IK20	VK20	4
		SXA10C/G/W • 11G/11W • 15G/16G	3S-FE	98.8-00.5	K20R-U11	90919-01184	K20TT	IK20	VK20	4
	2000	ACA20W/21W	1AZ-FSE(D-4)	00.5-05.11	SK20BGR11	90919-01221	-	-	VKA20	4
		MXAA52	M20A-FKS	19.4-	FC20HR-Q8	90919-01297	-	-	-	4
		MXAA54	M20A-FKS	19.4-	FC20HR-Q8	90919-01297	-	-	-	4
		ACA31W/36W	2AZ-FE	05.11-12.12	SK20R11	90919-01210	-	IK20	VK20	4
2400	ACA36W	2AZ-FE	12.12-19.4	SK16R11	90919-01240	-	IK16	VK16	4	
	ACA31W	2AZ-FE	12.12-19.4	SK16R11	90919-01240	-	IK16	VK16	4	
	RAV4 HYBRID	2500	AXAH52	A25A-FXS	19.4-	FC16HR-Q8	90919-01289	-	-	VFCH16
AXAH54	A25A-FXS		19.4-	FC16HR-Q8	90919-01289	-	-	VFCH16	4	

DENSO

AUSTRALIA CHINA

INDIA

INDONESIA

KOREA

MALAYSIA

PHILIPPINES

SAUDI ARABIA

SINGAPORE

TAIWAN

THAILAND

VIETNAM

JAPAN

EUROPE

MOTOR & USA

SMALL

ENGINE

CROSS

REFERENCE

PART

NUMBER



(*8)This is IRIDIUM PLUS.



▶ Spark plug color codes: ■ for Iridium Tough and Iridium Plugs and Iridium TT, ■ for Iridium Power, ■ for Iridium Racing and Two Tops Plugs, ■ for Platinum Plugs and Platinum TT, and black for general spark plugs.

DENSO
AUSTRALIA
CHINA
INDIA
INDONESIA
KOREA
MALAYSIA
PHILIPPINES
SAUDI ARABIA
SINGAPORE
TAIWAN
THAILAND
VIETNAM
JAPAN
EUROPE & USA
MOTOR CYCLE
SMALL ENGINE
CROSS REFERENCE
PART NUMBER

MODEL	CC	VEHICLE CODE	ENGINE	FROM-TILL	DENSO	GENUINE P/N				QTY
TOYOTA										
REGIUS ACE VAN	2000	RZH102V	1RZ-E	99.8-03.7	P16R	90919-01115	-	IW16	VW16	4
		TRH102V/112K/112V/122K/124B	1TR-FE	03.7-04.8	SK20HR11	90919-01191	-	IKH20	VKH20	4
		TRH200K/200V	1TR-FE	04.8-07.8	SK20HR11	90919-01191	-	IKH20	VKH20	4
		TRH200K/200V	1TR-FE	07.8-08.1	FK20HBR11	90919-01249	-	-	VFKBH20	4
		TRH200K/200V	1TR-FE	08.1-15.1	FK20HBR11-T	90919-01255	-	-	VFKBH20	4
		TRH200K	1TR-FE	15.1-17.12	FK20HBR-TJ8	90919-01288	-	-	VFKBH20	4
		TRH200V	1TR-FE	15.1-17.12	FK20HBR-TJ8	90919-01288	-	-	VFKBH20	4
		TRH200K	1TR-FE	17.12-	FK20HBR-TJ8	90919-01288	-	-	VFKBH20	4
		TRH200V	1TR-FE	17.12-	FK20HBR-TJ8	90919-01288	-	-	VFKBH20	4
	2700	TRH211K/216K/221K/226K	2TR-FE	04.8-	SK20HR11	90919-01191	-	IKH20	VKH20	4
		TRH211K	2TR-FE	12.5-15.1	SK20HR-A11	90919-01266	-	IKH20	VKH20	4
		TRH221K	2TR-FE	12.5-15.1	SK20HR-A11	90919-01266	-	IKH20	VKH20	4
		TRH216K	2TR-FE	12.5-15.1	SK20HR-A11	90919-01266	-	IKH20	VKH20	4
		TRH226K	2TR-FE	12.5-15.1	SK20HR-A11	90919-01266	-	IKH20	VKH20	4
		TRH221K	2TR-FE	15.1-	FK20HR-A8	90919-01287	-	-	VFKH20	4
		TRH211K	2TR-FE	15.1-	FK20HR-A8	90919-01287	-	-	VFKH20	4
		TRH226K	2TR-FE	15.1-	FK20HR-A8	90919-01287	-	-	VFKH20	4
		TRH216K	2TR-FE	15.1-	FK20HR-A8	90919-01287	-	-	VFKH20	4
ROOMY	1000	M900A	1KR-FE	16.11-	-	-	-	-	VFXEH20	3
		M900A	1KR-VET(T/C)	16.11-	-	-	-	-	-	3
		M910A	1KR-FE	16.11-	-	-	-	-	VFXEH20	3
RUSH	1500	J200E · J210E	3SZ-VE	06.1-10.4	SXU22PR9	90048-51188-000	-	IXU22I	VXU22I	4
		J200E · J210E	3SZ-VE	10.4-	SXU22PR9	90048-51188-000	-	IXU22I	VXU22I	4
SAI	2400	AZK10	2AZ-FXE	09.10-12.6	SK20R11	90919-01210	-	IK20	VK20	4
		AZK10	2AZ-FXE	12.6-	SK16R11	90919-01240	-	IK16	VK16	4
SIENTA	1500	NCP81G(2WD)	1NZ-FE	03.9-07.11	FK20HR11	90919-01247	-	-	VFKH20	4
		NCP81G(2WD)	1NZ-FE	07.11-15.7	FK16HR11	90919-01243	-	-	VFKH16	4
		NCP85G(4WD)	1NZ-FE	03.9-11.6	K16R-U11	90919-01164	K16TT	IK16	VK16	4
		NCP85G(4WD)	1NZ-FE	11.6-15.7	SK16R11	90919-01240	-	IK16	VK16	4
	NSP170G	2NR-FKE	15.7-18.9	FC16HR8	90919-01280	-	-	VFCH16	4	
	NSP172G	2NR-FKE	15.7-18.9	FC16HR8	90919-01280	-	-	VFCH16	4	
	NCP175G	1NZ-FE	15.7-	FK16HR11	90919-01243	-	-	VFKH16	4	
	NSP170G	2NR-FKE	18.9-	FC16HR-Q8	90919-01289	-	-	VFCH16	4	
	NSP172G	2NR-FKE	18.9-	FC16HR-Q8	90919-01289	-	-	VFCH16	4	
SIENTA HYBRID	1500	NHP170G	1NZ-FXE	15.7-	FK16BR-AL8	90919-01284	-	-	VFKB16	4
SOARER	2500	JZZ30	1JZ-GTE(T/C)	96.8-01.3	PK20TR11	90919-01194	-	IK20	VK20	6
	3000	JZZ31	2JZ-GE	97.8-01.3	PK16TR11	90919-01196	-	IK16	VK16	6
	4000	JZZ30/31/32	1UZ-FE	91.5-01.3	SK20R11	90919-01210	-	IK20	VK20	8
	4300	UZZ40	3UZ-FE	01.4-05.8	SK20R11	90919-01210	-	IK20	VK20	8
SPADE	1300	NCP140	1NR-FE	12.7-	SC16HR11	90919-01275	-	-	VCH16	4
		NCP141	1NZ-FE	12.7-	FK16HR11	90919-01243	-	-	VFKH16	4
		NCP145	1NZ-FE	12.7-	FK16HR11	90919-01243	-	-	VFKH16	4
	1500	NSP141	2NR-FKE	15.7-17.12	FC16HR8	90919-01280	-	-	VFCH16	4
		NSP141	2NR-FKE	17.12-	FC16HR-Q8	90919-01289	-	-	VFCH16	4
SPARKY	1300	S221E · S231E	K3-VE	00.9-03.8	K20R-U11	90919-01184	K20TT	IK20	VK20	4
SPRINTER CARIB	1600	AE111G/114G	4A-FE	95.8-00.8	K16R-U11	90919-01164	K16TT	IK16	VK16	4
		AE111G	4A-GE	96.5-00.8	SK20R11	90919-01210	-	IK20	VK20	4
	1800	AE115G	7A-FE	95.8-00.8	K16R-U11	90919-01164	K16TT	IK16	VK16	4
SPRINTER/MARINO/TRUENO	1300	EE96V/106V	2E · 2E-LJ	87.8-00.8	W16EX-U	90919-01059	W16TT	IW16	VW16	4
		EE111 · EE102V	4E-FE	97.4-00.8	K16TR11	90919-01192	K16TT	IK16	VK16	4
		AE100/100G	5A-FE	91.6-00.8	K16R-U11	90919-01164	K16TT	IK16	VK16	4
	1500	AE110	5A-FE	95.5-00.8	K16R-U11	90919-01164	K16TT	IK16	VK16	4
		EE103V/ 104G	5E-FE	97.4-00.8	K16TR11	90919-01192	K16TT	IK16	VK16	4
		AE111	4A-GE	95.5-00.8	SK20R11	90919-01210	-	IK20	VK20	4
1600	AE109V/111/114	4A-FE	96.5-00.8	K16R-U11	90919-01164	K16TT	IK16	VK16	4	
	AE101	4A-GE	96.5-00.8	SK20R11	90919-01210	-	IK20	VK20	4	
SUCCEED	1500	NCP51V/55V/58G/59G	1NZ-FE	02.7-10.6	K16R-U11	90919-01164	K16TT	IK16	VK16	4
		NCP51V	1NZ-FE	10.6-14.9	SK16R11	90919-01240	-	IK16	VK16	4
		NCP55V	1NZ-FE	10.6-14.9	SK16R11	90919-01240	-	IK16	VK16	4
		NCP58G	1NZ-FE	10.6-	SK16R11	90919-01240	-	IK16	VK16	4
		NCP59G	1NZ-FE	10.6-	SK16R11	90919-01240	-	IK16	VK16	4
		NCP160V	1NZ-FE	14.9-	FK16HR11	90919-01243	-	-	VFKH16	4
		NCP165V	1NZ-FE	14.9-	FK16HR11	90919-01243	-	-	VFKH16	4
SUCCEED HYBRID	1500	NHP160V	1NZ-FXE	18.12-	FK16BR-AL8	90919-01284	-	-	VFKB16	4
SUPRA	2000	DB82	B48(T/C)	19.5-	-	-	-	-	-	4
		DB22	B48(T/C)	19.5-	-	-	-	-	-	4
	3000	JZA80	2JZ-GE	97.8-02.7	PK16TR11	90919-01196	-	IK16	VK16	6

MODEL	CC	VEHICLE CODE	ENGINE	FROM-TILL	DENSO	GENUINE P/N				QTY	
TOYOTA											
SUPRA	3000	JZA80	2JZ-GTE(T/C)	97.8-02.7	PK20TR11	90919-01194	-	IK20	VK20	6	
		DB42	B58(T/C)	19.5-	-	-	-	-	-	6	
TANK	1000	M900A	1KR-FE	16.11-	-	-	-	-	VFXEH20	3	
		M900A	1KR-VET(T/C)	16.11-	-	-	-	-	-	3	
		M910A	1KR-FE	16.11-	-	-	-	-	VFXEH20	3	
TOURING HIACE TOWNACE	2700	RCH41W/47W	3RZ-FE	98.8-	SK16R11	90919-01240	-	IK16	VK16	4	
	1500	S412M	3SZ-VE	10.7-	XU22PR9	90048-51197	-	IXU22I	VXU22I	4	
S412U		3SZ-VE	10.7-	XU22PR9	90048-51197	-	IXU22I	VXU22I	4		
TOWNACE/NOAH	1500	KM51	5K	90.8-	J16B-U11	90919-01117	-	-	-	4	
		KR41V	5K	96.10-	W16EXR-U	90919-01064	W16TT	IW16	VW16	4	
	1800	S402M • S402U	3SZ-VE	08.1-	XU22PR9	90048-51197	-	IXU22I	VXU22I	4	
		YM55/60/65	2Y	95.8-	P16R	90919-01115	-	IW16	VW16	4	
	1800	KR42V	7K-E	98.12-02.8	W16EXR-U11	90919-01091	W16TT	IW16	VW16	4	
		KM70/75/80/85	7K-E	99.6-02.8	W16EXR-U11	90919-01091	W16TT	IW16	VW16	4	
		KM70/75/80/85	7K-E	02.8-	W16EXR-U	90919-01064	W16TT	IW16	VW16	4	
		KR52V	7K-E	04.11-	W16EXR-U	90919-01064	W16TT	IW16	VW16	4	
	2000	SR40G/50G	3S-FE	96.10-01.11	K20TR11	90919-01198	K20TT	IK20	VK20	4	
	TOYOACE										
1500	YY101/121/131/201/211	3Y	95.5-01.5	W16EXR-U	90919-01064	W16TT	IW16	VW16	4		
	YY61/YU60/80	3Y-P(LPG)	98.5-01.5	P16R	90919-01143	-	-	VW20T(*8)	4		
	RZY220/230	1RZ-E	01.6-03.7	P16R8	90919-01223	-	IW16	VW16	4		
	2000	TRY220/230	1TR-FE	03.7-07.8	SK20HR11	90919-01191	-	IKH20	VKH20	4	
		TRY220/230	1TR-FE	07.8-08.1	FK20HBR11	90919-01249	-	-	VFKBH20	4	
		TRY220/230	1TR-FE	08.1-	FK20HBR11-T	90919-01255	-	-	VFKBH20	4	
		TRY220/230	1TR-FE	08.1-	FK20HBR11-T	90919-01255	-	-	VFKBH20	4	
	2700	RZU100/100A/140	3RZ-FE	95.5-01.5	K16R-U	90919-01176	K16TT	IK16	VK16	4	
		RZU100/100A/140	3RZ-FE	95.5-	K16R-U	90919-01176	K16TT	IK16	VK16	4	
		RZU100H/100A	3RZ-FP(LPG)	95.5-01.5	K16R-U	90919-01176	-	-	VK20T(*8)	4	
RZU300		3RZ-FPE(LPG)	01.6-03.7	SK16R8-PG	90919-01239	-	-	VK20T(*8)	4		
BU280K		3RZ-FPE(LPG)	01.6-	K16R-U	90919-01176	-	-	VK20T(*8)	4		
RZY231H/281H		3RZ-FPE(LPG)	03.7-	SK16R8-PG	90919-01239	-	-	VK20T(*8)	4		
RZY231H/281H		3RZ-FPE(LPG)	03.7-	SK16R8-PG	90919-01239	-	-	VK20T(*8)	4		
TRU300/300A/340/500		2TR-FE	07.8-	SK20HR11	90919-01191	-	IKH20	VKH20	4		
TRC600/TRU600/TRC600A		2TR-FE	11.7-	SK20HR11	90919-01191	-	IKH20	VKH20	4		
BU102A/H • BU142		15B-FP(LPG)	97.8-01.5	PK20R8	90919-01180	-	-	VK20T(*8)	4		
4100	RZU100/A/H	15B-FP(LPG)	99.5-01.5	PK20R8	90919-01180	-	-	VK20T(*8)	4		
	XZU301	15B-FPE(LPG)	01.6-	PK20R8	90919-01180	-	-	VK20T(*8)	4		
	XZU301A/302/342/412	15B-FNE(CNG)	01.6-	SK20R5-G	90919-01229	-	-	-	4		
	BZU300 • BZU340	1BZ-FPE(LPG)	07.8-	SK20R5	90919-01222	-	-	-	4		
	BZU600	1BZ-FPE(LPG)	11.7-	DK16R-B5	90919-01283	-	-	-	4		
	TOYOTA DRIVING INSTRUCTION CAR										
VANGUARD	1500	NZE161	1NZ-FE	18.2-	FK16HR11	90919-01243	-	-	VFKH16	4	
		2400	ACA33W	2AZ-FE	07.8-12.6	SK20R11	90919-01210	-	IK20	VK20	4
			ACA38W(2WD)	2AZ-FE	08.8-12.6	SK20R11	90919-01210	-	IK20	VK20	4
			ACA38W	2AZ-FE	12.6-	SK16R11	90919-01240	-	IK16	VK16	4
	ACA33W	2AZ-FE	12.6-	SK16R11	90919-01240	-	IK16	VK16	4		
3500	GSA33W	2GR-FE	07.8-	FK20HR11	90919-01247	-	-	VFKH20	6		
VELLFIRE											
2400	ANH20W/25W	2AZ-FE	08.5-12.6	SK20R11	90919-01210	-	IK20	VK20	4		
	ANH20W	2AZ-FE	12.6-15.1	SK16R11	90919-01240	-	IK16	VK16	4		
	ANH25W	2AZ-FE	12.6-15.1	SK16R11	90919-01240	-	IK16	VK16	4		
	2500	AGH30W	2AR-FE	15.1-	SK16HR11	90919-01233	-	IKH16	VKH16	4	
		AGH35W	2AR-FE	15.1-	SK16HR11	90919-01233	-	IKH16	VKH16	4	
	3500	GGH20W/25W	2GR-FE	08.5-15.1	FK20HR11	90919-01247	-	-	VFKH20	6	
		GGH30W	2GR-FE	15.1-18.1	FK20HR11	90919-01247	-	-	VFKH20	6	
		GGH35W	2GR-FE	15.1-18.1	FK20HR11	90919-01247	-	-	VFKH20	6	
		GGH30W	2GR-FKS	18.1-	FK20HBR8	90919-01263	-	-	VFKBH20	6	
		GGH35W	2GR-FKS	18.1-	FK20HBR8	90919-01263	-	-	VFKBH20	6	
VELLFIRE HYBRID											
2400	ATH20W	2AZ-FXE	11.11-12.6	SK20R11	90919-01237	-	IK20	VK20	4		
	ATH20W	2AZ-FXE	12.6-15.1	SK16R11	90919-01240	-	IK16	VK16	4		
2500	AYH30W	2AR-FXE	15.1-	FK16HR-A8	90919-01259	-	-	VFKH16	4		
VEROSSA											
2000	GX110 • GX115	1G-FE	01.7-04.4	K20R-U11	90919-01184	K20TT	IK20	VK20	6		
	2500	JZX110	1JZ-GTE(T/C)	01.7-04.4	PK20TR11	90919-01194	-	IK20	VK20	6	
JZX110		1JZ-FSE(D-4)	01.7-04.4	SK20BR11	90919-01226	-	-	VKB20	6		
VISTA/ARDEO											
1800	ZZV50/50G	1ZZ-FE	98.7-00.4	K16TR11	90919-01192	K16TT	IK16	VK16	4		
	ZZV50/50G	1ZZ-FE	00.4-03.10	K16R-U11	90919-01164	K16TT	IK16	VK16	4		
2000	SV55/55G	3S-FE	98.7-02.4	K20TR11	90919-01198	K20TT	IK20	VK20	4		
	SV50/50G	3S-FSE(D-4)	98.7-01.7	PK20GR8	90919-01208	-	-	VKA20	4		
	AZV50/50G	1AZ-FSE(D-4)	01.8-03.7	SK20BGR11	90919-01221	-	-	VKA20	4		

(*8)This is IRIDIUM PLUS.

DENSO

AUSTRALIA CHINA INDIA INDONESIA KOREA MALAYSIA PHILIPPINES SAUDI ARABIA SINGAPORE TAIWAN THAILAND VIETNAM JAPAN EUROPE MOTOR & USA CYCLE SMALL ENGINE REFERENCE NUMBER PART



PART NUMBER	CROSS REFERENCE	SMALL ENGINE	MOTOR CYCLE	EUROPE & USA	JAPAN	VIETNAM	THAILAND	TAIWAN	SINGAPORE	SAUDI ARABIA	PHILIPPINES	MALAYSIA	KOREA	INDONESIA	INDIA	CHINA	AUSTRALIA	MODEL	CC	VEHICLE CODE	ENGINE	FROM-TILL	DENSO	GENUINE P/N				QTY				
																		TOYOTA														
																		VISTA/ARDEO	2000	AZV55/55G	1AZ-FSE(D-4)	02.4-03.7	SK20BGR11	90919-01221	-	-	VKA20	4				
																		VITZ		SCP10	1SZ-FE	99.1-05.2	K16R-U	90919-01176	K16TT	IK16	VK16	4				
																				1000	KSP90	1KR-FE	05.2-10.12	SK20HR11	90919-01191	-	IKH20	VKH20	3			
																					KSP130	1KR-FE	10.12-14.4	SK20HR11	90919-01191	-	IKH20	VKH20	3			
																					KSP130	1KR-FE	14.4-	SC16HR11	90919-01275	-	-	VCH16	3			
																					NCP10/15	2NZ-FE	99.8-05.2	K16R-U11	90919-01164	K16TT	IK16	VK16	4			
																					NCP95	2NZ-FE	05.2-	K16R-U11	90919-01164	K16TT	IK16	VK16	4			
																					SCP13(CVT)	2SZ-FE	03.1-05.2	SK16HR11	90919-01233	-	IKH16	VKH16	4			
																					1300	SCP90	2SZ-FE	05.2-10.12	SK16HR11	90919-01233	-	IKH16	VKH16	4		
																					NSP130/135	1NR-FE	10.12-	SC16HR11	90919-01275	-	-	VCH16	4			
																					NSP130	1NR-FKE	14.4-18.5	FC16HR8	90919-01280	-	-	VFCH16	4			
																					NSP130	1NR-FKE	18.5-	FC16HR-Q8	90919-01289	-	-	VFCH16	4			
																					NCP13	1NZ-FE	00.10-05.2	K16R-U11	90919-01164	K16TT	IK16	VK16	4			
																					NCP91	1NZ-FE	05.2-07.11	FK20HR11	90919-01247	-	-	VFKH20	4			
																					1500	NCP91	1NZ-FE	07.11-10.12	FK16HR11	90919-01243	-	-	VFKH16	4		
																					NCP131	1NZ-FE	10.12-	FK16HR11	90919-01243	-	-	VFKH16	4			
																					NCP131	1NZ-FE(T/C-GRMN)	13.9-	VKH20Y	90919-01278	-	-	VKH20Y	4			
																					1800	NSP131	2ZR-FE(S/C-GRMN)	18.6-	VKH20Y	90919-01278	-	-	VKH20Y	4		
																					VITZHYBRID	1500	NHP130	1NZ-FXE	17.1-	FK16BR-AL8	90919-01284	-	-	VFKB16	4	
																					VOLTZ		ZZE136/138	1ZZ-FE	02.8-04.2	SK16R11	90919-01240	-	IK16	VK16	4	
																					1800	ZZE137	2ZZ-GE	02.8-04.2	SK20R11	90919-01210	-	IK20	VK20	4		
																					VOXY		AZR60G/65G	1AZ-FSE(D-4)	01.11-07.6	SK20BGR11	90919-01221	-	-	VKA20	4	
																						ZRR70G/75G/70W/75W	3ZR-FE	07.6-10.4	SC16HR11	90919-01275	-	-	VCH16	4		
																						ZRR70W/75W	3ZR-FAE	07.6-14.1	SC16HR11	90919-01275	-	-	VCH16	4		
																					2000	ZRR80G	3ZR-FAE	14.1-	SC16HR11	90919-01275	-	-	VCH16	4		
																						ZRR80W	3ZR-FAE	14.1-	SC16HR11	90919-01275	-	-	VCH16	4		
																						ZRR85G	3ZR-FAE	14.1-	SC16HR11	90919-01275	-	-	VCH16	4		
																						ZRR85W	3ZR-FAE	14.1-	SC16HR11	90919-01275	-	-	VCH16	4		
																					VOXY HYBRID		ZWR80G	2ZR-FXE	14.2-	SC16HR11	90919-01275	-	-	VCH16	4	
																					1800	ZWR80W	2ZR-FXE	16.1-	SC16HR11	90919-01275	-	-	VCH16	4		
																					WILL CYPHA		1300	NCP70	2NZ-FE	02.10-	K16R-U11	90919-01164	K16TT	IK16	VK16	4
																						1500	NCP75	1NZ-FE	02.10-	K16R-U11	90919-01164	K16TT	IK16	VK16	4	
																					WILL Vi		1300	NCP19	2NZ-FE	00.2-01.12	K16R-U11	90919-01164	K16TT	IK16	VK16	4
																					WILL VS		1500	NZE127	1NZ-FE	02.1-04.4	K16R-U11	90919-01164	K16TT	IK16	VK16	4
																							1800	ZZE127/129	1ZZ-FE	01.4-04.4	K16R-U11	90919-01164	K16TT	IK16	VK16	4
																							ZZE128	2ZZ-GE	01.4-04.4	SK20R11	90919-01210	-	IK20	VK20	4	
																					WINDOM		2500	MCV21	2MZ-FE	96.8-01.7	PK20TR11	90919-01194	-	IK20	VK20	6
																							3000	MCV20	1MZ-FE	99.8-01.7	SK20R11	90919-01210	-	IK20	VK20	6
																								MCV30	1MZ-FE	01.8-	SK20R11	90919-01210	-	IK20	VK20	6
																					WISH		1800	ZNE10G/14G	1ZZ-FE	03.1-09.4	K16R-U11	90919-01164	K16TT	IK16	VK16	4
																								ZGE20G/25G · ZGE20W/25W	2ZR-FAE	09.4-	SC16HR11	90919-01275	-	-	VCH16	4
																							2000	ANE10G/11W	1AZ-FSE(D-4)	03.4-09.4	SK20BGR11	90919-01221	-	-	VKA20	4
																								ZGE21G · ZGE22W	3ZR-FAE	09.4-	SC16HR11	90919-01275	-	-	VCH16	4



MODEL	CC	VEHICLE CODE	ENGINE	FROM-TILL	DENSO		IRIDIUM POWER	IRIDIUM TOUGH	QTY
ABARTH									
500	1400	ABA-312141	312A1(T/C)	09.4 -	IXU27	-	IXU27	-	4
500C	1400	ABA-312142	312A3(T/C)	10.10-	IXU27	-	IXU27	-	4
595/C	1400	ABA-312142	312A3(T/C)	13.1 -	IXU27	-	IXU27	-	4
695 TRIBUTO FERRARI	1400	ABA-312142	312A3(T/C)	10.11-	IXU27	-	IXU27	-	4
EDIZIONE MASERATI	1400	ABA-312142	312A3(T/C)	13.2 -	IXU27	-	IXU27	-	4
GRANDE PUNTO	1400	ABA-199143	199A8(T/C)	09.2 -	IXU27	-	IXU27	-	4
ALFA ROMEO									
145	2000	E-930A5	-	96.8 -	VK20+IU22	-	IK20+IU22	-	EACH4
		GF-930A534	32301	98.10-	VK20+IU22	-	IK20+IU22	-	EACH4
		E-950A534	-	98.10-	VK20+IU22	-	IK20+IU22	-	EACH4
147	1600	ABA/GH-937BXB	32104	04.6 -	VK20+IU22	-	IK20+IU22	-	EACH4
	2000	ABA/GF/GH-937AB	32310	01.10-	VK20+IU22	-	IK20+IU22	-	EACH4
	3200	GH-937AXL	-	03.5 -07	PK20PR-P8	-	IK20	VK20	6
155	2000	E-167A2A	67.201	92.7 -95	K22PR-U	-	IK22	VK22	8
		E-167A2G	67.204	95.8 -98	VK20+IU22	-	IK20+IU22	-	EACH4
		E-167A2E	67.203	95.8 -	W20EPBR-S	-	IW20	VW20	4
		E-167A1E	67.303	95.7 -	W22EPR-U	-	IW22	VW22	6
156	2000	E/GF-932A2	32301	98.4 -02	VK20+IU22	-	IK20+IU22	-	EACH4
		GF-932B2	-	00.6 -	VK20+IU22	-	IK20+IU22	-	EACH4
		GH-932BXW	-	03 -06.4	VK20	-	IK20	VK20	4
		GH-932B2	-	00 -02	VK20+IU22	-	IK20+IU22	-	EACH4
	2500	E/GF-932A1	32401	98.4 -02	VK20	-	IK20	VK20	6
		GF-932B1	-	00.7 -02.7	VK20	-	IK20	VK20	6
		GH-932AC	AR32405	02.7 -06.4	VK20	-	IK20	VK20	6
		GH-932BW	-	03 -06.4	VK20	-	IK20	VK20	6
156GTA	3200	GH-932AXB	932A000	02.7 -06.4	VK20	-	IK20	VK20	6
		GH-932BXB	932A000	03.11-06.4	VK20	-	IK20	VK20	6
156JTS	2000	GH-932AXA	937A1000	02.7 -06.4	VK20	-	IK20	VK20	4
159	2200	GH/ABA-93922	939A5	06.2 -	IK16	-	IK16	VK16	4
	3200	GH/ABA-93932	939A	06.2 -	ITV16	-	ITV16	-	6
164	3000	E-168B	-	93.5 -95	VK20	-	IK20	VK20	6
		E-164B	064.305	93.5 -95	W20EPR-U	-	IW20	VW20	6
		E-164KIC	64304;64308	94.10-	VK20	-	IK20	VK20	6
		E-164K1H	64304	95.6 -	VK20	-	IK20	VK20	6
		E-164K1P	64305	95.6 -	W20EPR-U	-	IW20	VW20	6
		E-164K1G	64304;64308	95.8 -	VK20	-	IK20	VK20	6
166	2500	GF-936A2	-	99.9 -	VK20	-	IK20	VK20	6
	3000	GF/GH-936A1	-	99.9 -08.10	VK20	-	IK20	VK20	6
		GH-936A11	-	03 -08.10	PK20PR-P8	-	IK20	VK20	6
4C	1700	ABA-96018	960A1(T/C)	14.7 -	-	-	-	4	
GIULIA	2000	ABA-95220	55273835(T/C)	17.10-	-	-	-	4	
	2900	ABA-95229	670050436(T/C)	17.10-	-	-	-	6	
GIULIETTA	1400	ABA-940141	940A2(T/C)	14.6 -	IXU27	-	IXU27	-	4
		ABA-940141	940A2(T/C)	17.2 -	-	-	IXU24	-	4
	1700	ABA-940181	940B2(T/C)	15.1 -	-	-	-	-	4
		ABA-94018P	940B2(T/C)	19.1 -	-	-	-	-	4
GT	2000	GH/ABA-93720L	937A1	04 -	VK20	-	IK20	VK20	4
	3200	GH-93732L	936A	04 -	VK20	-	IK20	VK20	6
GTV	2000	E-916C2A	162.02	95.12-97	W22EPR-U	-	IW22	VW22	6
		GH-91626G	-	04.7 -	VK20+IU22	-	IK20+IU22	-	4
	3000	E-916C1	-	97.6 -	VK20	-	IK20	VK20	6
		GF-916C1 · GH-916C1B	16102	00 -03.7	VK20	-	IK20	VK20	6
	3200	GH-916CXB/SXB	-	03.7 -	PK20PR-P8	-	IK20	VK20	6
MITO	1400	ABA-95514P	955A2(T/C)	10.3 -	IXU27	-	IXU27	-	4
		ABA-955141	199A8(T/C)	09.5 -	IXU27	-	IXU27	-	4
		ABA-955143	940A2(T/C)	10.7 -	IXU27	-	IXU27	-	4
		ABA-955142	955A7(T/C)	14.1 -	IXU27	-	IXU27	-	4
		ABA-955142	955A7(T/C)	17.2 -	-	-	IXU24	-	4
SPIDER	2000	E-916S2	16.201	95.11-98	VK20+IU22	-	IK20+IU22	-	EACH4
		GF-916S2	-	96 -98	VK20+IU22	-	IK20+IU22	-	EACH4
		E/GF-916S2B	-	98.12-04.7	VK20+IU22	-	IK20+IU22	-	EACH4
		GH-91620S · GH-91620G	-	04.7 -06.10	VK20+IU22	-	IK20+IU22	-	EACH4
	2200	ABA/GH-93922S	939A5	06.10-	IK16	-	IK16	VK16	4
	3000	GF/GH-916S1B	16105	01.9 -03.7	VK20	-	IK20	VK20	6
	3200	GH-916SXB	-	03.7 -06.10	PK20PR-P8	-	IK20	VK20	6
ABA/GH-93932S	939A	06.10-	ITV16	-	ITV16	-	6		
SPORT WAGON	2000	GF-932B2	-	00.8 -	VK20+IU22	-	IK20+IU22	-	EACH4

T/C=Turbo Charger
S/C=Super Charger

DENSO

AUSTRALIA CHINA

INDIA

INDONESIA

KOREA

MALAYSIA

PHILIPPINES

SAUDI ARABIA

SINGAPORE

TAIWAN

THAILAND

VIETNAM

JAPAN

EUROPE

MOTOR

SMALL

CYCLE

ENGINE

REFERENCE

NUMBER

PART



EUROPE & U.S.A. | CAR

▶ Spark plug color codes: ■ for Iridium Tough and Iridium Plugs and Iridium TT, ■ for Iridium Power, ■ for Iridium Racing and Two Tops Plugs, ■ for Platinum Plugs and Platinum TT, and black for general spark plugs.

DENSO
AUSTRALIA
CHINA
INDIA
INDONESIA
KOREA
MALAYSIA
PHILIPPINES
SAUDI ARABIA
SINGAPORE
TAIWAN
THAILAND
VIETNAM
JAPAN
EUROPE & USA
SMALL MOTOR ENGINE
CROSS REFERENCE
PART NUMBER

MODEL	CC	VEHICLE CODE	ENGINE	FROM-TILL	DENSO		IRIDIUM POWER	IRIDIUM TOUGH	QTY
ALFA ROMEO									
SPORT WAGON	2500	GF-932B1	-	00.8 -	VK20	-	IK20	VK20	6
BRERA	2200	ABA/GH-93922S	939A5	06.4 -	IK16	-	IK16	VK16	4
	3200	ABA/GH-93932S	939A	06.4 -	ITV16	-	ITV16	-	6
AMG MERCEDES									
A45	2000	CBA-176052	133(T/C)	13.7 -	-	-	-	-	4
Mercedes-AMG A45	2000	CBA-176052	133(T/C)	15.11-	-	-	-	-	4
		CBA-176052	133(T/C)	17.7 -	-	-	-	-	4
C280	2800	E-202A28S	-	95.3 -	K16PR-U	K16TT	IK16	VK16	6
		E-C280	-	98.3 -	VK16	-	IK16	VK16	6
C32	3200	GF-203065	112	02 -03	VK20	-	IK20	VK20	12
		GH-203065	112(S/C)	03 -	VK20Y	-	-	VK20Y	12
		GF-203265	112	02 -03	VK20	-	IK20	VK20	12
		GH-203265	112(S/C)	03 -	VK20Y	-	-	VK20Y	12
C36	3600	E-202A36S	-	94.3 -	K20PR-U	K20TT	IK20	VK20	6
		E-202B36S	-	96.11-	K16PR-U	K16TT	IK16	VK16	6
C43	4300	E-C43/C43T	-	97.12-99	VK16	-	IK16	VK16	16
		GF-C43T	-	98.12-	VK16	-	IK16	VK16	16
Mercedes-AMG C43	3000	CBA-205364	276M30(T/C)	16.9 -	-	-	-	-	6
		CBA-205464	276M30(T/C)	16.9 -	-	-	-	-	6
		CBA-205064	276M30(T/C)	16.9 -	-	-	-	-	6
		CBA-205264	276M30(T/C)	16.9 -	-	-	-	-	6
C450	3000	CBA-205064	276M30(T/C)	15.9 -	-	-	-	-	6
		CBA-205264	276M30(T/C)	15.9 -	-	-	-	-	6
C55	5500	GH/DBA-203076/203276	113M55	04.6 -08.4	VK20	-	IK20	VK20	16
C63	6300	CBA-204077	156	07.10-	VFXEH22	-	-	VFXEH22	8
		CBA-204277	156	08.4 -	VFXEH22	-	-	VFXEH22	8
C63 Coupe	6300	CBA-204377	156	11.8 -	FXE22HR11	-	-	VFXEH22	8
C63	6200	ABA-204507	156	13.8 -	FXE22HR11	-	-	VFXEH22	8
Mercedes-AMG C63	4000	CBA-205386	177(T/C)	16.8 -	-	-	-	-	8
		CBA-205387	177(T/C)	16.8 -	-	-	-	-	8
		CBA-205487	177(T/C)	16.9 -	-	-	-	-	8
		CBA-205086	177(T/C)	17.2 -	-	-	-	-	8
		CBA-205087	177(T/C)	17.2 -	-	-	-	-	8
		CBA-205286	177(T/C)	17.2 -	-	-	-	-	8
		CBA-205287	177(T/C)	17.2 -	-	-	-	-	8
		CBA-205487	177(T/C)	17.7 -	-	-	-	-	8
		CBA-205086	177(T/C)	18.7 -	-	-	-	-	8
		CBA-205087	177(T/C)	18.7 -	-	-	-	-	8
		CBA-205487	177(T/C)	18.7 -	-	-	-	-	8
		CBA-205386	177(T/C)	18.7 -	-	-	-	-	8
		CBA-205387	177(T/C)	18.7 -	-	-	-	-	8
		CBA-205286	177(T/C)	18.7 -	-	-	-	-	8
CBA-205287	177(T/C)	18.7 -	-	-	-	-	8		
CL550	4700	CBA-216373	278(T/C)	12.2 -	-	-	-	-	8
CL55	5500	GH-215374	113M55	02.11-	VK16	-	IK16	VK16	16
		-	11398660	01.9 -07.3	VK16	-	IK16	VK16	16
CL63	5500	CBA-216374	157(T/C)	12.2 -	-	-	-	-	8
		-	-	02.3 -07.3	VK20	-	IK20	VK20	24
CL65	6000	CBA-216377	156	07.3 -	VFXEH22	-	-	VFXEH22	8
		-	(T/C)	03.10-07.7	VK20Y	-	-	VK20Y	24
Mercedes-AMG CLA45	2000	ABA-216379	-	07.7 -	VK20Y	-	-	VK20Y	24
		CBA-117352	133(T/C)	15.11-	-	-	-	-	4
		CBA-117952	133(T/C)	15.11-	-	-	-	-	4
		CBA-117352	133(T/C)	17.7 -	-	-	-	-	4
CLK320	3200	E/GF-CLK320	112	98.3 -	VK16	-	IK16	VK16	12
		GF-CLK55	M113E55	00.8 -03.1	VK16	-	IK16	VK16	16
CLK55	5500	GH/DBA-209376	M113E55	03.1 -06.9	VK20	-	IK20	VK20	16
		ABA-209476	113M55	05.9 -06.9	VK16	-	IK16	VK16	16
		ABA-209477	156	06.9 -	VFXEH22	-	-	VFXEH22	8
CLK63	6300	DBA-209377	156	06.9 -	VFXEH22	-	-	VFXEH22	8
		Mercedes-AMG CLS53	3000	CAA-257361	256(T/C)	18.9 -	-	-	-
CLS55	5500	CBA-219376	113M55(S/C)	05.2 -06.9	VKH20	-	-	VKH20Y	16
CLS63	5500	CBA-218374	157(T/C)	12.8 -	-	-	-	-	8
		CBA-218375	157(T/C)	14.10-	-	-	-	-	8
		CBA-218376	157(T/C)	14.10-	-	-	-	-	8
		CBA-218976	157(T/C)	14.10-	-	-	-	-	8

DENSO	9	14	16	20	22	24	27	29	31	32	34	35	DENSO	9	14	16	20	22	24	27	29	31	32	DENSO	9	14	16	20	22	24	27	31
NGK	2	4	5	6	7	8	9	9.5	10	10.5	11	11.5	CHAMPION	18	16,14	12,11	10,9	8,7	6,63,61	4,59	57	55	53	BOSCH	10	9	8	7,6	5	4	3	2



MODEL	CC	VEHICLE CODE	ENGINE	FROM-TILL	DENSO		IRIDIUM POWER	IRIDIUM TOUGH	QTY
AMG MERCEDES									
CLS63	6300	CBA-219377	156	06.9 -	VFXEH22	-	-	VFXEH22	8
Mercedes-AMG E43	3000	CBA-213064	276M30(T/C)	16.10-	-	-	-	-	6
		CBA-213264	276M30(T/C)	16.11-	-	-	-	-	6
E50	5000	E-210A50S	M119E50	96.2 -	K20TXR	K20TT(*5)	IK20	VK20	8
Mercedes-AMG E53	3000	CAA-213061	256(T/C)	18.9 -	-	-	-	-	6
		CAA-238461	256(T/C)	18.9 -	-	-	-	-	6
		CAA-238361	256(T/C)	18.9 -	-	-	-	-	6
		CAA-213261	256(T/C)	18.9 -	-	-	-	-	6
E55	5500	E/GF-E55	11386	97.12 -02.12	VK16	-	IK16	VK16	16
		GF-E55T	11386	98.12-04.7	VK16	-	IK16	VK16	16
		GH/DBA-211076	113M55(S/C)	03 -06.8	VKH20Y	-	-	VKH20Y	16
		GH/DBA-211276	113M55(S/C)	03.11-	VKH20Y	-	-	VKH20Y	16
E63	5500	CBA-212074	157(T/C)	11.11-	-	-	-	-	8
		CBA-212274	157(T/C)	11.11-	-	-	-	-	8
		CBA-212075	157(T/C)	14.10-	-	-	-	-	8
		CBA-212076	157(T/C)	14.10-	-	-	-	-	8
		CBA-212292	157(T/C)	14.10-	-	-	-	-	8
		CBA-212276	157(T/C)	14.10-	-	-	-	-	8
	6300	CBA-211077/211277	156	06.8 -10.1	VFXEH22	-	-	VFXEH22	8
		CBA-212077	-	10.2 -	VFXEH22	-	-	VFXEH22	8
Mercedes-AMG E63	4000	CBA-213089	177(T/C)	17.5 -	-	-	-	-	8
		CBA-213088	177(T/C)	17.8 -	-	-	-	-	8
		CBA-213288	177(T/C)	17.8 -	-	-	-	-	8
		CBA-213289	177(T/C)	17.8 -	-	-	-	-	8
G55L	5500	GF-CLK55	M113E55	00.8 -	VK16	-	IK16	VK16	16
		GH-463243	113M55	03.5 -04.7	VK16	-	IK16	VK16	16
		GH-463270	113M55	04.7 -06.11	VKH20	-	IKH20	VKH20	16
		ABA-463270	113M55	06.11-	VKH20	-	IKH20	VKH20	16
G63	5500	ABA-463272	157(T/C)	12.8 -	-	-	-	8	
Mercedes-AMG G63	4000	ABA-463276	177(T/C)	18.6 -	-	-	-	8	
	5500	ABA-463272	157(T/C)	15.12-	-	-	-	8	
GL63	5500	CBA-166874	157(T/C)	13.4 -	-	-	-	8	
Mercedes-AMG GLA45	2000	CBA-156952	133(T/C)	17.4 -	-	-	-	4	
Mercedes-AMG GLC43	3000	CBA-253964	276M30(T/C)	16.9 -	-	-	-	-	6
		CBA-253364	276M30(T/C)	17.3 -	-	-	-	-	6
Mercedes-AMG GLC63	4000	CBA-253988	177(T/C)	18.1 -	-	-	-	-	8
		CBA-253388	177(T/C)	18.1 -	-	-	-	-	8
		CBA-253989	177(T/C)	18.1 -	-	-	-	-	8
		CBA-253389	177(T/C)	18.1 -	-	-	-	-	8
Mercedes-AMG GLE43	3000	CBA-166064	276M30(T/C)	16.4 -	-	-	-	6	
Mercedes-AMG GLE63	5500	CBA-166074	157(T/C)	15.10-	-	-	-	-	8
		CBA-166074	157(T/C)	16.8 -	-	-	-	-	8
Mercedes-AMG GLS63	5500	CBA-166874	157(T/C)	16.4 -	-	-	-	8	
Mercedes-AMG GT	4000	CBA-190378	178(T/C)	15.5 -	-	-	-	-	8
		CBA-190377	178(T/C)	15.9 -	-	-	-	-	8
		ABA-190379	178(T/C)	17.6 -	-	-	-	-	8
	4000	ABA-190477	178(T/C)	17.8 -	-	-	-	-	8
		ABA-190480	178(T/C)	17.8 -	-	-	-	-	8
		ABA-190380	178(T/C)	17.10-	-	-	-	-	9
		CBA-190377	178(T/C)	17.10-	-	-	-	-	8
		CBA-190378	178(T/C)	17.10-	-	-	-	-	8
		4BA-290689	177(T/C)	19.2 -	-	-	-	-	8
ML55	5500	GF-ML55	11386	00.6 -	VK16	-	IK16	VK16	16
		GF-ML55	113M55	01.10 -02.11	VK16	-	IK16	VK16	16
		GH-163174	113M55	02.11-	VK16	-	IK16	VK16	16
ML63	5500	CBA-166074	157(T/C)	12.6 -	-	-	-	8	
	6300	CBA-164177	-	06.9 -	VFXEH22	-	-	VFXEH22	8
R63	6300	DBA-211077/211277	-	07.2 -	VFXEH22	-	-	VFXEH22	8
		DBA-251077	156	07.2 -	VFXEH22	-	-	VFXEH22	8
S55	5500	GF-S55S/S55SA	11386	99.9 -01.6	VK16	-	IK16	VK16	16
		GF-220073	M113 55	02 -	VK16	-	IK16	VK16	16
		GH-220074	113M55(S/C)	02.11-	VKH20Y	-	-	VKH20Y	16
S55A	5500	GF-S55SA	-	00.4 -	VK16	-	IK16	VK16	16
S55L	5500	GH-220174	113M55(S/C)	03 -	VKH20Y	-	-	VKH20Y	16
		GF-S55L/S55LA	-	99.9 -	VK16	-	IK16	VK16	16
		GF-220173	M113 55	01.6 -	VK16	-	IK16	VK16	16
		GH-220174	113M55	02.11-	VKH20	-	IKH20	VKH20	16

(*5) : It can be used only for a plug with a terminal.

DENSO

AUSTRALIA CHINA INDIA INDONESIA KOREA MALAYSIA PHILIPPINES SAUDI ARABIA SINGAPORE TAIWAN THAILAND VIETNAM JAPAN
EUROPE MOTOR SMALL CROSS PART
CYCLE ENGINE REFERENCE NUMBER



EUROPE & U.S.A. | CAR

▶ Spark plug color codes: ■ for Iridium Tough and Iridium Plugs and Iridium TT, ■ for Iridium Power, ■ for Iridium Racing and Two Tops Plugs, ■ for Platinum Plugs and Platinum TT, and black for general spark plugs.

DENSO

CHINA AUSTRALIA

INDIA

INDONESIA

KOREA

MALAYSIA

PHILIPPINES

SAUDI ARABIA

SINGAPORE

TAIWAN

THAILAND

VIETNAM

JAPAN

EUROPE & USA

MOTOR CYCLE

SMALL ENGINE

CROSS REFERENCE

PART NUMBER

MODEL	CC	VEHICLE CODE	ENGINE	FROM-TILL	DENSO		IRIDIUM POWER	IRIDIUM TOUGH	QTY
AMG MERCEDES									
S63	5500	CBA-222177C	157(T/C)	14.6 -	-	-	-	-	8
		CBA-222178	157(T/C)	14.6 -	-	-	-	-	8
Mercedes-AMG S63	4000	CBA-222187	177(T/C)	17.8 -	-	-	-	-	8
		CBA-222188	177(T/C)	17.8 -	-	-	-	-	8
		CBA-217488	177(T/C)	18.6 -	-	-	-	-	8
		CBA-217388	177(T/C)	18.6 -	-	-	-	-	8
		CBA-217478	157(T/C)	16.6 -	-	-	-	-	8
S63L	6300	CBA-221177	156	07.3 -	VFXEH22	-	-	VFXEH22	8
S65	6000	-	275982	07.1 -	VK20Y	-	-	VK20Y	24
		CBA-222179C	279(T/C)	13.11 -	VK20Y	-	-	VK20Y	12
Mercedes-AMG S65	6000	ABA-222179C	279(T/C)	17.8 -	VK20Y	-	-	VK20Y	12
		ABA-217479	279(T/C)	18.6 -	VK20Y	-	-	VK20Y	24
		ABA-217379C	279(T/C)	18.6 -	VK20Y	-	-	VK20Y	24
S65L	6000	-	275982	06.11 - 07.8	VK20Y	-	-	VK20Y	24
		ABA-221179	(T/C)	03.11 -	VK20Y	-	-	VK20Y	24
SL500	5500	GH-230474	113M55	02.7 -	VK16	-	IK16	VK16	16
SL55	5500	GH-230474	113M55(S/C)	02.7 - 05.8	VKH20Y	-	-	VKH20Y	16
		DBA-230474	113M55(S/C)	05.8 - 08.5	VKH20Y	-	-	VKH20Y	16
SL63	5500	CBA-231474	157(T/C)	12.3 -	-	-	-	-	8
Mercedes-AMG SL63	5500	CBA-231474	157(T/C)	16.6 -	-	-	-	-	8
SL63	6300	CBA-230470	156	08.5 -	VFXEH22	-	-	VFXEH22	8
S63L	5500	CBA-221174	157(T/C)	11.7 -	-	-	-	-	8
SL65	6000	-	-	04.7 - 06.11	VK20Y	-	-	VK20Y	24
		DBA-230472	275981	06.11 -	VK20Y	-	-	VK20Y	24
Mercedes-AMG SLC43	3000	CBA-172466	276M30(T/C)	16.6 -	-	-	-	-	6
SLK32	3200	GF/GH-170466	112	02 -	VK16	-	IK16	VK16	12
SLK55	5500	CBA-171473	113M55(S/C)	04.9 -	VK20	-	IK20	VK20	16
		CBA-172475	152	13.8 -	-	-	-	-	8
SLS	6300	-	M159	10.6 -	-	-	-	-	8
ASTONMARTIN									
DB7 COUPE	3200	E-AM7	-	-99	Q22PR-U	-	IQ22	VQ22	6
DB7 VANTAGE	6000	GF-AMV7	AM2	00.10 -	VT20	-	IT20	VT20	12
DB7 VOLANTE	3200	E-AMC7	-	98 - 99	Q22PR-U	-	IQ22	VQ22	6
DB9	6000	-	AM04	04 -	VT20	-	IT20	VT20	12
VANQUISH	6000	-	AM3	01.10 -	VT20	-	IT20	VT20	12
		-	AM06	04 -	VT20	-	IT20	VT20	12
V8 COUPE	5300	-	-	-	Q20PR-U	-	IQ20	VQ20	8
V8 VANTAGE	5300	-	-	-	IQ24	-	IQ24	-	8
VIRAGE	5300	E-AM689	-	94.5 -	K20PR-U	K20TT	IK20	VK20	8
AUDI									
80	2000	E-8CABK	ABK	92.3 - 96.1	W20EPBR-S	-	IW20	VW20	4
		E-8CNG	NG	92.3 - 96.1	W16ETR-S(*2)	-	IW16	VW16	5
		E-8CABC	ABC	93.10 - 96.1	K20PBR-S10	-	IK20	VK20	6
		E-8CAAH	AAH	92.5 - 96.1	K20PBR-S10	-	IK20	VK20	6
100	2600	E-4AABC	ABC	93.10 - 94.7	K20PBR-S10	-	IK20	VK20	6
		E-4AAAHF	AAH	93.11 - 94.7	K20PBR-S10	-	IK20	VK20	6
A1	1000	DBA-8XCHZ	CHZ(T/C)	15.6 -	-	-	-	-	3
		DBA-8XCAX	CAX(T/C)	11.1 -	-	-	-	-	4
		DBA-8XCPT	CPT(T/C)	14.6 -	VKH22	-	IKH22	VKH22	4
		DBA-8XCZE	CZE(T/C)	15.6 -	-	-	-	-	4
A3	1400	ABA-8PCAX	CAX(T/C)	09.7 -	-	-	-	-	4
		DBA-8PCAX	CAX(T/C)	11.9 -	-	-	-	-	4
		DBA-8VCXS	CXS(T/C)	13.9 -	-	-	-	-	4
		DBA-8VCPT	CPT(T/C)	13.9 -	-	-	-	-	4
		DBA-8VCXSL	CXS(T/C)	14.1 -	-	-	-	-	4
		DBA-8VCPTL	CPT(T/C)	14.1 -	-	-	-	-	4
		DBA-8VCXSL	CXS(T/C)	14.8 -	-	-	-	-	4
		DBA-8VCPTL	CPT(T/C)	14.8 -	-	-	-	-	4
		DBA-8VCXS	CXS(T/C)	14.8 -	-	-	-	-	4
		DBA-8VCPT	CPT(T/C)	14.8 -	-	-	-	-	4
		DLA-8VCUK	CUK(T/C)	15.11 -	-	-	-	-	4
		DBA-8VCXSL	CXS(T/C)	17.1 -	-	-	-	-	4
		DBA-8VCXS	CXS(T/C)	17.1 -	-	-	-	-	4
		1600	GH-8PBGU	BGU	04.2 -	K20PBR-S10	-	IK20	VK20
ABA/GH-8PBSE	BSE		05.7 - 08.9	K20PBR-S10	-	IK20	VK20	4	
1800	E-8LAGN	AGN	97.1 - 98.9	K20PBR-S10	-	IK20	VK20	4	
	GF-8LAGN	AGN	98.9 - 01.3	K20PBR-S10	-	IK20	VK20	4	

(*2) : USE REMOVABLE TYPE



MODEL	CC	VEHICLE CODE	ENGINE	FROM-TILL	DENSO		IRIDIUM POWER	IRIDIUM TOUGH	QTY	
AUDI										
A3										
1800		GF-8LAGU	AGU(T/C)	98.9 -01.3	VK20Y	-	-	VK20Y	4	
		GF/GH-8LAPG	APG	01.4 -03.9	K20PBR-S10	-	IK20	VK20	4	
		E-8LAGU	AGU(T/C)	97.1 -98.8	K22PBR-S	-	IK22	VK22	4	
		GF-8LAQAF	AQA(T/C)	99.9 -03.9	K22PBR-S	-	IK22	VK22	4	
		GF/GH-8LAUQ	AUQ(T/C)	02.4 -03.9	VK20Y	-	-	VK20Y	4	
		ABA-8PBZB	BZB(T/C)	07.8 -08.9	VK20Y	-	-	VK20Y	4	
		ABA-8PCDA	CDA(T/C)	08.9 -	VK22	-	IK22	VK22	4	
		ABA-8VCJSF	CJS(T/C)	13.9 -	VKH22	-	IKH22	VKH22	4	
		ABA-8VCJSL	CJS(T/C)	14.1 -	VKH22	-	IKH22	VKH22	4	
		ABA-8VCJSL	CJS(T/C)	14.8 -	VKH22	-	IKH22	VKH22	4	
		ABA-8VCJSF	CJS(T/C)	14.8 -	VKH22	-	IKH22	VKH22	4	
	2000		GH-8PAXW	AXW	03.9 -05.7	VKA16	-	-	VKA16	4
			GH-8PBLX	BLX	04.10-	VKA16	-	-	VKA16	4
			GH-8PAXX	AXX(T/C)	04.10-06.7	VK20Y	-	-	VK20Y	4
			GH-8PBVY	BVY	06.7 -	VKA16	-	-	VKA16	4
			ABA/GH-8PBWA	BWA(T/C)	06.7 -08.9	VK20Y	-	-	VK20Y	4
			GH-8PBLR	BLR	05.7 -06.7	VKA16	-	-	VKA16	4
			ABA-8PCCZF	CCZ(T/C)	08.9 -	VK22	-	IK22	VK22	4
			ABA-8VCZPL	CZP(T/C)	17.1 -	VKH22	-	IKH22	VKH22	4
			ABA-8VCZPF	CZP(T/C)	17.1 -	VKH22	-	IKH22	VKH22	4
	3200		GH-8PBDBF	BDB	03.12-05.7	-	-	-	-	6
		GH-8PBMJF	BMJ	04.10-06.7	-	-	-	-	6	
		ABA/GH-8PBUBF	BUB	06.7 -	-	-	-	-	6	
A4										
1800	1400	ABA-8WCVN	CVN(T/C)	16.10-	-	-	-	-	4	
		E-8DADR	ADR	95.10-99.6	K20PBR-S10	-	IK20	VK20	4	
		GF-8DADR	ADR	99.6 -99.10	K20PBR-S10	-	IK20	VK20	4	
		GF-8DAPT	APT	99.10-	K20PBR-S10	-	IK20	VK20	4	
		E-8DAEBF	AEB(T/C)	96.2 -99.6	K22PBR-S	-	IK22	VK22	4	
		GF-8DAPUF	APU(T/C)	99.6 -99.11	K22PBR-S	-	IK22	VK22	4	
		GF-8DAJLF	AJL	99.11-	PK20PR-P8	-	-	VK20Y	4	
		GH/GF-8EAMBF	AMB(T/C)	01.11-	VK20Y	-	-	VK20Y	4	
		GH/ABA-8EBFB	BFB(T/C)	06.7 -	VK20Y	-	-	VK20Y	4	
		ABA-8KCAB	CAB(T/C)	08.3 -	VK20Y	-	-	VK20Y	4	
		ABA-8KCDH	CDH(T/C)	08.9 -	VK22	-	IK22	VK22	4	
		GF/GH/ABA-8EALT	ALT	01.5 -08.3	IK16	-	IK16	VK16	4	
		GH-8EBGBF	BGB(T/C)	05.2 -06.3	VK20Y	-	-	VK20Y	4	
		GH/ABA-8EBWFE	BWE(T/C)	06.3 -08.3	VK20Y	-	-	VK20Y	4	
2000		ABA-8KCDNF	CDN(T/C)	09.3 -	VK22(*6)	-	IK22(*6)	VK22(*6)	4	
		DBA-8KCDNF	CDN(T/C)	13.7 -	VKH22(*6)	-	IKH22(*6)	VKH22(*6)	4	
		DBA-8KCDN	CDN(T/C)	11.4 -	VK22(*6)	-	IK22(*6)	VK22(*6)	4	
		DBA-8KCDN	CDN(T/C)	13.7 -	VKH22(*6)	-	IKH22(*6)	VKH22(*6)	4	
		ABA-8KCNCA	CNC(T/C)	14.8 -	VKH22	-	IKH22	VKH22	4	
		ABA-8WCVK	CVK(T/C)	16.2 -	VKH22	-	IKH22	VKH22	4	
		ABA-8WCYRF	CYR(T/C)	16.2 -	VKH22	-	IKH22	VKH22	4	
		ABA-8WCYRA	CYR(T/C)	16.9 -	-	-	IK22	VK22	4	
		ABA-8WCYRA	CYR(T/C)	17.1 -	VKH22	-	IKH22	VKH22	4	
		DBA-8WCYRF	CYR(T/C)	17.1 -	VKH22	-	IKH22	VKH22	4	
		DBA-8WCVK	CVK(T/C)	17.7 -	VKH22	-	IKH22	VKH22	4	
		DBA-8WCYRF	CYR(T/C)	19.1 -	-	-	-	-	4	
		ABA-8WCYRA	CYR(T/C)	19.1 -	-	-	-	-	4	
	2400		E-8DAGA	AGA	98.1 -98.6	K20PBR-S10	-	-	-	6
		E/GF-8DAGAF	AGA	98.6 -	K20TXR	K20TT(*5)	-	-	6	
		GF-8DAPSF	APS	99.6 -	K20PBR-S10	-	-	-	6	
		GF-8DAPS	APS	99.6 -01.10	K20PBR-S10	-	-	-	6	
		GF-8EBDV	BDV	01.11-	VK20	-	-	-	6	
		GH-8HBDV	BDV	02.9 -	K20TXR	K20TT(*5)	IK20	VK20	6	
2600		GH-8EBDV	BDV	02.8 -	K20TXR	K20TT(*5)	IK20	VK20	6	
		E-8DABC	ABC	95.7 -99.5	K20PBR-S10	-	IK20	VK20	6	
2800		E-8DAAHF	AAH	96.1 -99.5	K20PBR-S10	-	IK20	VK20	6	
		E-8DACKF	ACK	96.8 -99.5	K20PBR-S10	-	IK20	VK20	6	
3000		GF-8DAPRF	APR	99.4 -	K20TXR	K20TT(*5)	IK20	VK20	6	
		GH/GF-8EASNF	ASN	01.6 -	K20TXR	K20TT(*5)	IK20	VK20	6	
3200		GH/ABA-8EAUKE	AUK	05.2 -08.3	-	-	-	-	6	
		ABA-8KCALF	CAL	08.3 -	VK20	-	IK20	VK20	6	
A5										
2000		ABA-8TCDNF	CDN(T/C)	09.5 -	VK22	-	IK22	VK22	4	
		ABA-8TCDNL	CDN(T/C)	10.1 -	VK22	-	IK22	VK22	4	
		DBA-8TCDNF	CDN(T/C)	12.1 -	VK22	-	IK22	VK22	4	

DENSO

AUSTRALIA CHINA

INDIA

INDONESIA

KOREA

MALAYSIA

PHILIPPINES

SAUDI ARABIA

SINGAPORE

TAIWAN

THAILAND

VIETNAM

JAPAN

EUROPE & USA

MOTOR CYCLE

SMALL ENGINE

CROSS REFERENCE

PART NUMBER

(*5) : It can be used only for a plug with a terminal. (*6) : The plug reach may be 19mm or 26.5mm even with the same engine and the same vehicle code. Please confirm the plug reach and choose the correct DENSO type. If there is an "H" in DENSO type, it has a reach of 26.5mm. If it doesn't, its reach is 19mm



EUROPE & U.S.A. | CAR

▶ Spark plug color codes: ■ for Iridium Tough and Iridium Plugs and Iridium TT, ■ for Iridium Power, ■ for Iridium Racing and Two Tops Plugs, ■ for Platinum Plugs and Platinum TT, and black for general spark plugs.

DENSO

CHINA AUSTRALIA

INDIA

INDONESIA

KOREA

MALAYSIA

PHILIPPINES

SAUDI ARABIA

SINGAPORE

TAIWAN

THAILAND

VIETNAM

JAPAN

EUROPE & U.S.A.

MOTOR CYCLE

SMALL ENGINE

CROSS REFERENCE

PART NUMBER

MODEL	CC	VEHICLE CODE	ENGINE	FROM-TILL	DENSO		IRIDIUM POWER	IRIDIUM TOUGH	QTY
AUDI									
A5									
2000		DBA-8FCDNF	CDN(T/C)	12.1 -	VK22	-	IK22	VK22	4
		DBA-8TCNDL	CDN(T/C)	12.1 -	VK22	-	IK22	VK22	4
		DBA-F5CYRF	CYR(T/C)	17.4 -	VKH22	-	IKH22	VKH22	4
		DBA-F5CYRL	CYR(T/C)	17.4 -	VKH22	-	IKH22	VKH22	4
		DBA-F5CVKL	CVK(T/C)	17.7 -	VKH22	-	IKH22	VKH22	4
		ABA-F5CYRC	CYR(T/C)	17.9 -	VKH22	-	IKH22	VKH22	4
		DBA-F5CYRL	CYR(T/C)	18.11-	-	-	-	-	4
3200		ABA-8TCALF	CAL	08.2 -	VKH22	-	IKH22	VKH22	6
A6									
1800		ABA-4GCGY	CYG(T/C)	15.7 -	VKH22	-	IKH22	VKH22	4
2000		DAA-4GCHJS	CHJ-EAFA(T/C)	12.9 -	VK22	-	IK22	VK22	4
		DBA-4GCDN	CDN(T/C)	14.2 -	VK22	-	IK22	VK22	4
		ABA-4GCPYS	CYP(T/C)	15.7 -	VKH22	-	IKH22	VKH22	4
2400		E-4BAGAF	AGA	97.9 -98.5	K20PBR-S10	-	IK20	VK20	6
		E-4BAGA/F	AGA	98.5 -99.9	K20TXR	K20TT(*5)	IK20	VK20	6
		GF-4BAPS/F	APS	99.9 -00.10	K20TXR	K20TT(*5)	IK20	VK20	6
		GH/GF-4BBDV	BDV	00.10-04.7	K20TXR	K20TT(*5)	IK20	VK20	6
		GH-4EBDW	BDW	04.9 -	VK20	-	IK20	VK20	6
		GH-4BBDW	BDW	04.7 -	PK20PR-L11	-	IK20	VK20	6
		GH/ABA-4FBDW	BDW	04.7 -	VK20	-	IK20	VK20	6
		E-4AABC	ABC	94.11-97.8	K20PBR-S10	-	IK20	VK20	6
2700		GF-4BAZAF	AZA(T/C)	01.1 -01.11	VK20Y	-	-	VK20Y	6
		GF-4BARES	ARE(T/C)	01.11-02.9	VK20Y	-	-	VK20Y	6
		GF/GH-4BBESS	BES(T/C)	02.9 -	VK20Y	-	-	VK20Y	6
2800		E-4AAAHF	AAH	94.10-97.9	K20PBR-S10	-	IK20	VK20	6
		E-4AACKF	ACK	97.9 -98.5	K20PBR-S10	-	IK20	VK20	6
		E-4BACKF	ACK	98.5 -99.9	K20TXR	K20TT(*5)	IK20	VK20	6
		GF-4BAPRF	APR	99.9 -	K20TXR	K20TT(*5)	IK20	VK20	6
		ABA-4FBDXS	BDX	07.8 -	VK20	-	IK20	VK20	6
		ABA-4FCES	CCE	09.1 -	VK20	-	IK20	VK20	6
		ABA-4GCHVS	CHV	11.8 -	VK20	-	IK20	VK20	6
		DBA-4GCHVS	CHV	13.7 -	VK20	-	IK20	VK20	6
		GF/GH-4BASNF	ASN	01.11-04.7	K20TXR	K20TT(*5)	IK20	VK20	6
		ABA-4FCAJS	(S/C)	09.1 -	IK24	-	IK24	-	6
	ABA-4FCAJA	(S/C)	09.1 -	IK24	-	IK24	-	6	
3000		ABA-4GCGWS	CGW(S/C)	11.8 -	IK24	-	IK24	-	6
		DBA-4GCGWS	CGW(S/C)	13.7 -	IK24	-	IK24	-	6
		DBA-4GCGWB	CGW(S/C)	14.8 -	VK20	-	IK20	VK20	6
		ABA-4GCRES	CRE(S/C)	15.7 -	IK24	-	IK24	-	6
		ABA-4GCREB	CRE(S/C)	15.7 -	IK24	-	IK24	-	6
		AAA-F2DLZF	DLZ(T/C)	19.3 -	-	-	-	-	6
3200		ABA-4FAUKA	AUK	04.7 -	-	-	-	-	8
		ABA-8FCALF	CAL	09.8 -	VK20	-	IK20	VK20	6
4200		GH-4FBATS/4FBATA	BAT	04.7 -06.8	K20PBR-S10	-	IK20	VK20	8
		ABA-4FBVJA	BVJ	06.8 -	VKB20	-	-	VKB20	8
A6 3.2QUATTRO									
3200		GH-4FAUKS	AUK	04.9 -	-	-	-	-	6
		ABA-4FAUKS	AUK	06.9 -	-	-	-	-	6
A6 4.2 QUATTRO									
4200		GH-4FBATS	BAT	04.9 -	K20PBR-S10	-	IK20	VK20	8
		GH-4FBATA	BAT	05.8 -06.8	K20PBR-S10	-	IK20	VK20	8
A6 ALL ROAD									
2700		GF-4BAREF	ARE(T/C)	01.2 -02.8	VK20Y	-	-	VK20Y	6
		GH-4BBESF	BES(T/C)	02.9 -	VK20Y	-	-	VK20Y	6
		GH-4BBASF	BAS	03.11-	K20PBR-S10	-	IK20	VK20	8
A7									
2000		ABA-4GCYPC	CYP(T/C)	15.7 -	VKH22	-	IKH22	VKH22	4
		ABA-4GCGWC	CGW(S/C)	11.5 -	IK24	-	IK24	-	6
3000		DBA-4GCGWC	CGW(S/C)	13.7 -	IK24	-	IK24	-	6
		ABA-4GCREC	CRE(S/C)	15.4 -	IK24	-	IK24	-	6
		AAA-F2DLZS	DLZ(T/C)	18.9 -	-	-	-	-	6
A8									
2000		DAA-4HCHJA	CHJ-EAFA(T/C)	13.2 -	VK22	-	IK22	VK22	4
		DAA-4HCHJA	CHJ(T/C)	14.8 -	-	-	IK22	VK22	4
3000		DBA-4HCGWF	CGW(S/C)	12.9 -	IK24	-	IK24	-	6
		DBA-4HCREP	CGW(S/C)	14.3 -	IK24	-	IK24	-	6
		AAA-F8CZSF	CZS(T/C)	18.10-	-	-	-	-	6
3200		GH/ABA-4EBPKF	BPK	05.8 -	-	-	-	-	6
		E-4DAEW	AEW	96.8 -97.10	T20EPR-U	-	IT20	VT20	8
3700		GF-4DAQG	AQG	99.4 -	VK20	-	IK20	VK20	8
		GH-4EBFLF	BFL	05.8 -	K20TXR	K20TT(*5)	IK20	VK20	8
4000		ABA-4HCEUF	CEU(T/C)	12.9 -	-	-	-	-	8
		ABA-4HCEUL	CEU(T/C)	12.9 -	IKH24	-	IKH24	-	8

(*5) : It can be used only for a plug with a terminal.



MODEL	CC	VEHICLE CODE	ENGINE	FROM-TILL	DENSO		IRIDIUM POWER	IRIDIUM TOUGH	QTY
AUDI									
A8	4000	ABA-4HCTGF	CEU(T/C)	14.3 -	IKH24	-	IKH24	-	8
		ABA-4HCTGL	CEU(T/C)	14.3 -	IKH24	-	IKH24	-	8
		AAA-F8CXYF	CXY(T/C)	18.10-	-	-	-	-	8
		AAA-F8CXYL	CXY(T/C)	18.10-	-	-	-	-	8
	4200	E-4DABZ	ABZ	94.10-99.7	T20EPR-U	-	-	VT20	8
		GF-4DAQF	AQF	99.8 -	K20PBR-S10	-	-	VK20	8
		GH-4EBFML	BFM	04.9 -06.8	K20TXR	K20TT(*5)	-	VK20	8
		GH-4EBFMF	BFM	04.2 -06.8	K20PBR-S10	-	-	VK20	8
		GF/GH-4DAUW	AUW	00.9 -	VK20	-	-	VK20	8
		ABA-4EBVJF/4EBVJL	BVJ	06.8 -	VKB20	-	-	VKB20	8
	6000	GH-4EBHTN	BHT	05.3 -06.12	VKA20	-	-	VKA20	12
		GH/ABA-4EBHTF	BHT	05.3 -	VKA20	-	-	VKA20	12
	6300	ABA-4HCEJL	CEJ	11.6 -	-	-	-	-	12
		ABA-4HCTNL	CTN	14.5 -	-	-	-	-	12
CABRIO	2300	E-8GNGK	NG	92.10-	W20EPB	-	IW20	VW20	5
	2600	E-8GABCK	ABC	94.10-	K20PBR-S10	-	IK20	VK20	6
COUPE	2600	E-8BABC	ABC	93.10-	K20PBR-S10	-	IK20	VK20	6
	2800	E-8BAAH	AAH	92.3 -	K20PBR-S10	-	IK20	VK20	6
Q2	1000	ABA-GACHZ	CHZ(T/C)	17.6 -	-	-	-	3	
	1400	ABA-GACZE	CZE(T/C)	17.6 -	-	-	-	4	
Q3	1400	ABA-8UCHP	CHP(T/C)	14.8 -	-	-	-	4	
		ABA-8UCZD	CZD(T/C)	15.5 -	-	-	-	4	
	2000	ABA-8UCPSF	CPS(T/C)	12.5 -	VK22	-	IK22	VK22	4
		ABA-8UCCZF	CCZ(T/C)	13.8 -	VK22	-	IK22	VK22	4
		ABA-8UCULB	CUL(T/C)	15.5 -	VKH22	-	IKH22	VKH22	4
		ABA-8UCULC	CUL(T/C)	15.5 -	VKH22	-	IKH22	VKH22	4
		ABA-8UCULB	CUL(T/C)	17.9 -	-	-	-	-	4
		ABA-8UCTSF	CTS(T/C)	14.3 -	-	-	-	-	5
	2500	ABA-8UCZGF	CZG(T/C)	15.5 -	-	-	IKH24	-	5
		ABA-8UCZGF	CZG(T/C)	16.8 -	-	-	IKH24	-	5
Q5	2000	ABA-8RCDNF	CDN(T/C)	09.6 -	VK22(*6)	-	IK22(*6)	VK22(*6)	4
		ABA-8RCNCF	CNC(T/C)	12.11-	VKH22(*6)	-	IKH22(*6)	VKH22(*6)	4
		DAA-8RCHJF	CHJ-EAFA(T/C)	13.2 -	VK22	-	IK22	VK22	4
		DBA-FYDAXS	DAX(T/C)	17.10-	VKH22	-	IKH22	VKH22	4
	DBA-FYDAXA	DAX(T/C)	17.10-	VKH22	-	IKH22	VKH22	4	
	3000	ABA-8RCTVF	CTV(S/C)	12.11-	IK24	-	IK24	-	6
3200	ABA-8RCALF	CAL	09.6 -	PK20PR-L11	-	IK20	VK20	6	
Q7	2000	ABA-4MCYRS	CYR(T/C)	16.3 -	VKH22	-	IKH22	VKH22	4
		ABA-4MCYRA	CYR(T/C)	16.3 -	VKH22	-	IKH22	VKH22	4
		ABA-4LCJTS	CJT(S/C)	10.7 -	VK22	-	IK22	VK22	6
	3000	ABA-4MCRES	CRE(S/C)	16.3 -	IK24	-	IK24	-	6
		ABA-4MCREA	CRE(S/C)	16.3 -	IK24	-	IK24	-	6
	3600	ABA-4LBHKS	BHK	07.4 -	-	-	-	6	
4200	ABA-4LBARS	BAR	06.10-	VKB20	-	-	VKB20	8	
R8	5200	ABA-42BUJF	BUJ	09.4 -	-	-	-	10	
		ABA-42BYHF	BYH	07.7 -	-	-	-	8	
	4200	ABA-42CNDF	CND	13.4 -	VK22	-	IK22	VK22	8
		ABA-42CTYF	CTY	13.4 -	VK22	-	IK22	VK22	10
		ABA-4SCSPF	CSP	16.7 -	VK22	-	IK22	VK22	10
		ABA-4SCSPD	CSP	16.7 -	VK22	-	IK22	VK22	10
	5200	ABA-4SDKAF	DKA	18.7 -	VK22	-	IK22	VK22	10
		ABA-4SDKAD	DKA	18.7 -	VK22	-	IK22	VK22	10
RS3	2500	ABA-8VCZGF	CZG(T/C)	15.10-	-	-	IKH24	-	5
		ABA-8VDAZL	DAZ(T/C)	17.7 -	-	-	-	5	
		ABA-8VDAZF	DAZ(T/C)	17.11-	-	-	-	5	
RS4	2900	ABA-8WDECF	DEC(T/C)	19.1 -	-	-	-	6	
	4200	GH/ABA-8EBNSF	BNS	06.9 -	VKB20	-	-	VKB20	8
ABA-8KCFSF		CFS	13.4 -	VK22	-	IK22	VK22	8	
RS5	2900	ABA-F5DECF	DEC(T/C)	17.9 -	-	-	-	6	
	4200	ABA-8TCFSF	CFS	12.8 -	VK22	-	IK22	VK22	8
ABA-8FCFSF		CFS	13.10-	VK22	-	IK22	VK22	8	
RS6	4000	ABA-4GCRDS	CRD(T/C)	13.10-	IKH24	-	IKH24	-	8
		ABA-4GCWUS	CWU(T/C)	15.7 -	IKH24	-	IKH24	-	8
	4200	GH-4BBCYF	BCY	03.12-	VK22	-	IK22	VK22	8
5000	ABA-4FBUHS	BXA(T/C)	09.1 -	VK22	-	IK22	VK22	10	
RS7	4000	ABA-4GCRDC	CRD(T/C)	14.1 -	IKH24	-	IKH24	-	8
		ABA-4GCWUC	CWU(T/C)	15.4 -	IKH24	-	IKH24	-	8

DENSO
 AUSTRALIA CHINA INDIA INDONESIA KOREA MALAYSIA PHILIPPINES SAUDI ARABIA SINGAPORE TAIWAN THAILAND VIETNAM JAPAN
 EUROPE MOTOR SMALL CROSS PART
 CYCLE ENGINE REFERENCE NUMBER

(*5) : It can be used only for a plug with a terminal. (*6) : The plug reach may be 19mm or 26.5mm even with the same engine and the same vehicle code. Please confirm the plug reach and choose the correct DENSO type. If there is an "H" in DENSO type, it has a reach of 26.5mm. If it doesn't, its reach is 19mm



EUROPE & U.S.A. | CAR

▶ Spark plug color codes: ■ for Iridium Tough and Iridium Plugs and Iridium TT, ■ for Iridium Power, ■ for Iridium Racing and Two Tops Plugs, ■ for Platinum Plugs and Platinum TT, and black for general spark plugs.

DENSO

AUSTRALIA

CHINA

INDIA

INDONESIA

KOREA

MALAYSIA

PHILIPPINES

SAUDI ARABIA

SINGAPORE

TAIWAN

THAILAND

VIETNAM

JAPAN

EUROPE & USA

MOTOR CYCLE

SMALL ENGINE

CROSS REFERENCE

PART NUMBER

MODEL	CC	VEHICLE CODE	ENGINE	FROM-TILL	DENSO				QTY	
AUDI										
S1	2000	ABA-8XCWZF	CWZ(T/C)	14.11-	VKH22	-	IKH22	VKH22	4	
S3	1800	GF-8LAMKF	AMK	01.1 -02.1	VK20	-	IK20	VK20	4	
		GF/GH-8LBAMF	BAM(T/C)	02.1 -	VK20Y	-	-	VK20Y	4	
		ABA-8PCDLF	(T/C)	09.2 -	VK22	-	IK22	VK22	4	
	2000	ABA-8VCJXL	CJX(T/C)	14.1 -	VKH22	-	IKH22	VKH22	4	
		ABA-8VCJXL	CJX(T/C)	14.8 -	-	-	-	-	4	
		ABA-8VCJXF	CJX(T/C)	14.8 -	-	-	-	-	4	
		ABA-8VDJHL	DJH(T/C)	17.1 -	-	-	-	-	4	
		ABA-8VDJHF	DJH(T/C)	17.1 -	-	-	-	-	4	
S4	2200	E-4AAAN	AAN	93.1 -	VK22	-	IK22	VK22	5	
		GF-8DAGBF	AGB	99.6 -03.9	VK20	-	IK20	VK20	6	
	2700	GF-8DAZBF	AZB	00.12-	VK20	-	IK20	VK20	6	
		ABA-8KCAKF	(S/C)	09.5 -	IK24	-	IK24	-	6	
		ABA-8KCGWF	CWG(S/C)	12.4 -	IK24	-	IK24	-	6	
		ABA-8WCWGF	CWG(T/C)	16.10-	-	-	-	-	6	
S5	4200	GH/ABA-8EBBKF	BBK	03.9 -08.1	K20PBR-S10	-	IK20	VK20	8	
		ABA-8TCGWF	CGW(S/C)	12.1 -	IK24	-	IK24	-	6	
	3000	ABA-8FCGWF	CGW(S/C)	12.1 -	IK24	-	IK24	-	6	
		ABA-8TCGWL	CGW(S/C)	12.1 -	IK24	-	IK24	-	6	
		ABA-F5CWGF	CWG(T/C)	17.4 -	-	-	-	-	6	
		ABA-F5CWGL	CWG(T/C)	17.4 -	-	-	-	-	6	
		ABA-F5CWGC	CWG(T/C)	17.7 -	-	-	-	-	6	
		4200	ABA-8TCAUF	BBK	08.2 -	VKB20	-	-	VKB20	8
S6	2200	E-4AAAN	AAN	99.1 -	VK22	-	IK22	VK22	5	
		ABA-4GCEUA	CEU(T/C)	12.8 -	IKH24	-	IKH24	-	8	
	4000	ABA-4GCTGA	CTG(T/C)	15.7 -	IKH24	-	IKH24	-	8	
		GF-4BAQJF	AQJ	99.11 -01.11	K20PBR-S10	-	IK20	VK20	8	
	4200	GF/GH-4BANKF	ANK	01.11-06.6	VK20	-	IK20	VK20	8	
		5200	ABA-4FBXAS	BXA	06.6 -	VKB20	-	-	VKB20	10
S7	4000	ABA-4GCEUL	CEU(T/C)	12.8 -	IKH24	-	IKH24	-	8	
		ABA-4GCTGL	CTG(T/C)	15.4 -	IKH24	-	IKH24	-	8	
S8	4000	ABA-4HCGTF	CGT(T/C)	12.8 -	IKH24	-	IKH24	-	8	
		ABA-4HCTFF	CTF(T/C)	14.5 -	IKH24	-	IKH24	-	8	
		ABA-4HDDTF	DDT(T/C)	16.4 -	-	-	IKH24	-	8	
	4200	GF-4DBCS	BCS	00 -	K20PBR-S10	-	IK20	VK20	8	
		GF-4DAYS	AYS	01.1 -	K20PBR-S10	-	IK20	VK20	8	
	5200	ABA-4EBSMF	-	06.6 -	VKB20	-	-	VKB20	10	
SQ5	3000	ABA-8RCTXF	CTX(S/C)	13.10-	IK24	-	IK24	-	6	
		ABA-FYCWGS	CWG(T/C)	17.10-	-	-	-	-	6	
		ABA-FYCWGA	CWG(T/C)	18.12-	-	-	-	-	6	
TT COUPE	1800	GF/GH-8NAPXF	APX(T/C)	99.1 -00.12	VK20Y	-	-	VK20Y	4	
		GF/GH-8NBAMF	BAM(T/C)	00.11-03.9	VK20Y	-	-	VK20Y	4	
		GF/GH-8NAUQ	AUQ(T/C)	01.1 -05.11	VK20Y	-	-	VK20Y	4	
		GH-8NBVR	BVR(T/C)	05.11-	VK20Y	-	-	VK20Y	4	
		ABA-8JCDA	CDA(T/C)	12.1 -	VK22	-	IK22	VK22	4	
		ABA-FVCJS	CJS(T/C)	16.8 -	-	-	-	-	4	
	2000	ABA-8JBWA	BWA(T/C)	06.7 -08.9	VK20Y	-	-	VK20Y	4	
		ABA-8JCCZF	CCZ(T/C)	08.9 -	VK22	-	IK22	VK22	4	
		ABA-8JCES	CES(T/C)	11.7 -	VK22	-	IK22	VK22	4	
		ABA-8JCESF	CES(T/C)	11.7 -	VK22	-	IK22	VK22	4	
		ABA-FVCHH	CHH(T/C)	15.8 -	VKH22	-	IKH22	VKH22	4	
		ABA-FVCHHF	CHH(T/C)	15.8 -	VKH22	-	IKH22	VKH22	4	
		ABA-FVDKZ	DKZ(T/C)	19.5 -	VKH22	-	IKH22	VKH22	4	
		3200	GH-8NBHEF	BHE	03.11-06.7	-	-	-	-	6
			ABA-8JBUBF	BUB	06.7 -	-	-	-	-	6
TT ROADSTER	1800	GF-8NAPXF	APX(T/C)	00.5 -	VK20Y	-	-	VK20Y	4	
		GF/GH-8NAUQ	AUQ(T/C)	01.1 -05.11	VK20Y	-	-	VK20Y	4	
		GF/GH-8NBAMF	BAM(T/C)	01.1 -	VK20Y	-	-	VK20Y	4	
	2000	ABA-8JCESF	CES(T/C)	11.7 -	VK22	-	IK22	VK22	4	
ABA-FVCHHF		CHH(T/C)	15.8 -	VKH22	-	IKH22	VKH22	4		
TTRS COUPE	2500	ABA-8JCEPF	CEP(T/C)	10.1 -	VKH22	-	IKH22	VKH22	5	
		ABA-FVDAZF	DAZ(T/C)	17.5 -	VKH22	-	IKH22	VKH22	5	
TTRS PLUS COUPE	2500	ABA-8JCEPF	CEP(T/C)	13.2 -	VK22	-	IK22	VK22	5	
TTRS ROADSTER	2500	ABA-FVDAZF	DAZ(T/C)	17.5 -	VKH22	-	IKH22	VKH22	5	
TTS COUPE	2000	ABA-8JCDLF	CDL(T/C)	08.9 -	VK20Y	-	-	VK20Y	4	
		ABA-FVCJXF	CJX(T/C)	15.8 -	VKH22	-	IKH22	VKH22	4	
		ABA-FVCJXF	CJX(T/C)	17.9 -	VKH22	-	IKH22	VKH22	4	

DENSO	9	14	16	20	22	24	27	29	31	32	34	35	DENSO	9	14	16	20	22	24	27	29	31	32	DENSO	9	14	16	20	22	24	27	31
NGK	2	4	5	6	7	8	9	9.5	10	10.5	11	11.5	CHAMPION	18	16,14	12,11	10,9	8,7	6,63,61	4,59	57	55	53	BOSCH	10	9	8	7,6	5	4	3	2



MODEL	CC	VEHICLE CODE	ENGINE	FROM-TILL	DENSO	IRIIDIUM POWER	IRIDIUM TOUGH	QTY
AUDI								
V8	4200	E-44ABHL	ABH	92.4 -93.11	T20EPR-U	-	IT20 VT20	8
BENTLEY								
ARNAGE	4400	GF-BL	448	00 -00	K20TXR	K20TT(*5)	IK20 VK20	8
	4500	GF-BL	-	98.6 -00	K20TXR	K20TT(*5)	IK20 VK20	8
		GF-BLC	L410MT	01 -	IK20	-	IK20 VK20	8
	6700	GF-BLE	L410MT	01 -01	IK20	-	IK20 VK20	8
		-	-	-	04.7 -	IW16	-	IW16 VW16
ARNAGE R	6700	GH-BLC	L410MT	02 -	IK16	-	IK16 VK16	8
ARNAGE RL	6700	GH-BLE	L410MT	03 -	IK16	-	IK16 VK16	8
ARNAGE T	6700	GF/GH-BLF	L410MT(T/C)	01.4 -	IK16	-	IK16 VK16	8
AZURE	6700	GF-BK	L410MT	95 -	IK20	-	IK20 VK20	8
		E-BK	-	95.8 -	K16PR-U	K16TT	IK16 VK16	8
BROOKLANDS	6700	E-BET	L410MT	93 -97	IK16	-	IK16 VK16	8
		E-BME	-	93.10-	IW16	-	IW16 VW16	8
		E-BYE	-	93.2 -	IW16	-	IW16 VW16	8
		E-BMF	-	94.4 -97	IW16	-	IW16 VW16	8
		E-BF	-	95.9 -	K16PR-U	K16TT	IK16 VK16	8
		E-BE	-	95.9 -	K16PR-U	K16TT	IK16 VK16	8
CONTINENTAL	6000	-	-	04.6 -	IW16	-	IW16 VW16	8
		E-BYD	-	92.10-	IW16	-	IW16 VW16	8
	6700	E-BYB	-	92.4 -	IW16	-	IW16 VW16	8
		E-BMD	-	94.4 -	IK16	-	IK16 VK16	8
CONTINENTAL R	6700	GF-BB	L410MT	92 -	IK20	-	IK20 VK20	8
		E-BMB	-	93.10-	IW16	-	IW16 VW16	8
CONTINENTAL T	6700	GF-BU	L410MT(T/C)	96 -	IK20	-	IK20 VK20	8
MULSANNE	6700	E-BYF	-	92.10-	IW16	-	IW16 VW16	8
TURBO R	6700	E-BYP	(T/C)	92.4 -	IW16	-	IW16 VW16	8
		E-BYR	(T/C)	92.8 -96	IW16	-	IW16 VW16	8
		E-BMP	(T/C)	93.10-99	IW16	-	IW16 VW16	8
		E-BMR	(T/C)	94.2 -96	IW16	-	IW16 VW16	8
		E-BMT	(T/C)	95.2 -	K16PR-U	K16TT	IK16 VK16	8
		E-BR	(T/C)	95.8 -96	K16PR-U	K16TT	IK16 VK16	8
		E-BP	(T/C)	95.9 -	K16PR-U	K16TT	IK16 VK16	8
BMW								
116i	1600	GH-UF16	N45B16A	05.3 -07.5	K20TXR	K20TT(*5)	IK20 VK20	4
		ABA-UE16	N45B16A	07.5 -	K20TXR	K20TT(*5)	IK20 VK20	4
		LBA-UE16	N43B16A	10.5 -	-	-	-	4
		DBA-1A16	N13B16A(T/C)	11.9 -	-	-	-	4
		DBA-1A16	N13B16A(T/C)	13.8 -	-	-	-	4
118i	1500	DBA-1R15	B38B15A(T/C)	15.9 -	-	-	-	3
		DBA-1R15	B38B15A(T/C)	17.8 -	-	-	-	3
	1600	DBA-1A16	N13B16A(T/C)	15.5 -	-	-	-	4
120i	2000	GH-UF18	N46B20B	05.3 -07.5	VK20	-	IK20 VK20	4
		1600	DBA-1A16	N13B16A(T/C)	11.9 -	-	-	-
	2000	DBA-1A16	N13B16A(T/C)	13.8 -	-	-	-	4
		GH-UF20	N46B20B	04.10-07.5	VK20	-	IK20 VK20	4
		ABA-UD20 · UL20	N46B20B	07.5 -	VK20	-	IK20 VK20	4
130i	3000	LBA-UD20 · UC20 · UM20	N43B20A	10.5 -	-	-	-	4
		DBA-1S20G	B48B20A(T/C)	16.11-	-	-	-	4
		ABA-UF30	N52B30A	05.11-07.5	-	-	-	6
		ABA-UD30	N52B30A	07.5 -	-	-	-	6
135i	3000	ABA-UC35	N54B30A(T/C)	08.2 -10.5	-	-	-	6
		ABA-UC30	N55B30A(T/C)	10.5 -	-	-	-	6
218i	1500	DBA-2A15	B38A15A(T/C)	14.10-	-	-	-	3
		DBA-2D15	B38A15A(T/C)	15.6 -	-	-	-	3
		DBA-2D15	B38A15A(T/C)	17.4 -	-	-	-	3
		DBA-6S15	B38A15A(T/C)	18.6 -	-	-	-	3
		DBA-6V15	B38A15A(T/C)	18.6 -	-	-	-	3
220i	2000	DBA-1J20	N20B20B(T/C)	14.2 -	-	-	-	4
		DBA-2D20	B48A20A(T/C)	15.6 -	-	-	-	4
		DBA-2F20	B48B20A(T/C)	16.9 -	-	-	-	4
		DBA-2D20	B48A20A(T/C)	16.9 -	-	-	-	4
		CBA-6V20	B48A20A(T/C)	18.6 -	-	-	-	4
225i	2000	DBA-2A20	B48A20B(T/C)	14.10-	-	-	-	4
		DBA-2A20	B48A20B(T/C)	17.4 -	-	-	-	4
225xe	1500	DLA-2C15	B38A15A-P160(T/C)	16.1 -	-	-	-	3
		DLA-2C15	B38A15A(T/C)	17.4 -	-	-	-	3

(*5) : It can be used only for a plug with a terminal.

DENSO

AUSTRALIA CHINA INDIA INDONESIA KOREA MALAYSIA PHILIPPINES SAUDIARABIA SINGAPORE TAIWAN THAILAND VIETNAM JAPAN EUROPE MOTOR SMALL CROSS PART & USA CYCLE ENGINE REFERENCE NUMBER



EUROPE & U.S.A. | CAR

▶ Spark plug color codes: ■ for Iridium Tough and Iridium Plugs and Iridium TT, ■ for Iridium Power, ■ for Iridium Racing and Two Tops Plugs, ■ for Platinum Plugs and Platinum TT, and black for general spark plugs.

DENSO

AUSTRALIA

CHINA

INDIA

INDONESIA

KOREA

MALAYSIA

PHILIPPINES

SAUDI ARABIA

SINGAPORE

TAIWAN

THAILAND

VIETNAM

JAPAN

EUROPE & USA

MOTOR CYCLE

SMALL ENGINE

CROSS REFERENCE

PART NUMBER

MODEL	CC	VEHICLE CODE	ENGINE	FROM-TILL	DENSO		IRIDIUM POWER	IRIDIUM TOUGH	QTY
BMW									
316ti	1800	GH-AT18	N42B18A	01.11-	VK20	-	IK20	VK20	4
316ti M Sport	1900	GF-CG19	194S	00 -	VK20	-	IK20	VK20	4
318Ci	2000	GH-BX20	N42B20A	05.4 -	VK20	-	IK20	VK20	4
318i	1500	DBA-8E15	B38B15A(T/C)	16.10-	-	-	-	-	3
	1800	E-CA18D	-	93.11-98.6	K20TXR	-	IK20	VK20	4
	1900	GF/GH-AL19	194E	98.7 -01.10	K20TXR	-	IK20	VK20	4
318i/Ci	2000	GH-AY20	N42B20A	01.10-	VK20	-	IK20	VK20	4
318iS	1800	E-BE18	M42B18	93.3 -96.3	K20TXR	-	IK20	VK20	4
	1900	E-BE19	M44B19	96.4 -99.12	K20TXR	-	IK20	VK20	4
318ti	1800	E-CG18	-	95.1 -96.10	K20TXR	-	IK20	VK20	4
	1900	E-CG19	M44B19	96.11-00	K20TXR	K20TT(*5)	IK20	VK20	4
	2000	GH-AU20	N42B20A	01.11-	VK20	-	IK20	VK20	4
320i		E-BF20	M50B20	92.5 -95	K20TXR	K20TT(*5)	IK20	VK20	6
		GF-AM20		99.7 -00	K20TXR	K20TT(*5)	IK20	VK20	6
		ABA-VA20 · VR20 · WA20	N46B20B	05.4 -10.5	VK20	-	IK20	VK20	4
		LBA-PG20 · KD20 · US20	N43B20A	10.5 -	-	-	-	-	4
		DBA-3B20	N20B20B(T/C)	12.4 -	-	-	-	-	4
	2000	DBA-3X20	N20B20B(T/C)	13.6 -	-	-	-	-	4
		DBA-3X20	N20B20B(T/C)	14.11-	-	-	-	-	4
		DBA-8A20	B48B20A(T/C)	15.9 -	-	-	-	-	4
		DBA-8A20	B48B20A(T/C)	16.5 -	-	-	-	-	4
		DBA-8X20	B48B20A(T/C)	16.10-	-	-	-	-	4
	3BA-5F20	B48B20B(T/C)	19.3 -	-	-	-	-	4	
	2200	GH-AV22	226S	00.11-05.4	VK20	-	IK20	VK20	6
323i	2500	GF-AM25		98.9 -00	K20TXR	K20TT(*5)	IK20	VK20	6
		ABA-VB23	N52B25A	05 -	-	-	-	-	6
325i	2500	E-BJ25	M50B25	93.7 -	K20TXR	K20TT(*5)	IK20	VK20	6
	2500	GH-AV25	256S, M54	00.11-	VK20	-	IK20	VK20	6
		ABA-VB25 · VS25 · VF25	N52B25A	05.4 -10.5	-	-	-	-	6
	3000	LBA-PH25 · UT25 · KE25	N53B30A	10.5 -	-	-	-	-	6
328i	2000	DBA-3A20	N20B20A(T/C)	12.9 -	-	-	-	-	4
		DBA-3X28	N20B20A(T/C)	13.6 -	-	-	-	-	4
		DBA-3X28	N20B20A(T/C)	14.11-	-	-	-	-	4
	2800	E-CD28	M521328	95.6 -99	K20TXR	K20TT(*5)	-	-	6
		E-BK28	M521328	95.6 -99	K20TXR	K20TT(*5)	-	-	6
328i/Ci	2800	GF-AM28		98.7 -00	K20TXR	K20TT(*5)	-	-	6
330i/Ci/Xi	3000	GH-AV30	306S	00.8 -05.4	VK20	-	IK20	VK20	6
330Xi	3000	ABA-VD30	N52B30A	05.10-	-	-	-	-	6
330e	2000	DLA-8E20	B48B20A(T/C)	16.1 -	-	-	-	-	4
330i	2000	DBA-8A20	B48B20B(T/C)	15.9 -	-	-	-	-	4
		DBA-8A20	B48B20B(T/C)	16.5 -	-	-	-	-	4
	3000	ABA-VB30	N52B30A	05.4 -	-	-	-	-	6
335i		ABA-VB35 · VS35 · WB35 · WL35(E92)	N54B30A(T/C)	06.10-10.5	-	-	-	-	6
		ABA-PM35 · UV35 · KG35 · DX35	N55B30A(T/C)	10.5 -	-	-	-	-	6
	3000	DBA-3A30	N55B30A(T/C)	13.4 -	-	-	-	-	6
		DBA-3X30	N55B30A(T/C)	13.6 -	-	-	-	-	6
340i	3000	DBA-8B30	B58B30A(T/C)	15.9 -	-	-	-	-	6
		DBA-8B30	B58B30A(T/C)	16.5 -	-	-	-	-	6
ACTIVE HYBRID 3	3000	DAA-3F30	N55B30A-M230(T/C)	12.7 -	-	-	-	-	6
420i	2000	DBA-3N20	N20B20B(T/C)	14.1 -	-	-	-	-	4
		DBA-4A20	N20B20B(T/C)	14.6 -	-	-	-	-	4
		DBA-4N20	B48B20A(T/C)	16.4 -	-	-	-	-	4
		DBA-4D20	B48B20A(T/C)	16.4 -	-	-	-	-	4
428i	2000	DBA-3N28	N20B20A(T/C)	13.9 -	-	-	-	-	4
		DBA-4A28	N20B20A(T/C)	14.6 -	-	-	-	-	4
430i	2000	DBA-4N20	B48B20B(T/C)	16.4 -	-	-	-	-	4
		DBA-4D20	B48B20B(T/C)	16.4 -	-	-	-	-	4
435i	3000	DBA-3R30	N55B30A(T/C)	13.9 -	-	-	-	-	6
		DBA-4B30	N55B30A(T/C)	14.6 -	-	-	-	-	6
440i	3000	DBA-4P30	B58B30A(T/C)	16.4 -	-	-	-	-	6
		DBA-4E30	B58B30A(T/C)	16.4 -	-	-	-	-	6
523i	2000	DBA-XG20	N20B20B	11.10-	-	-	-	-	4
		DBA-XL20	N20B20B(T/C)	13.9 -	-	-	-	-	4
		DBA-JA20	B48B20A(T/C)	17.2 -	-	-	-	-	4
		DBA-JL10	B48B20A(T/C)	17.6 -	-	-	-	-	4
	2500	DBA-FP25 · MT25	N52B25A	10.7 -	-	-	-	-	6
525i	2500	E-DD25/A	M50B25	96.4 -98.8	K20TXR	K20TT(*5)	IK20	VK20	6

(*5) : It can be used only for a plug with a terminal.



MODEL	CC	VEHICLE CODE	ENGINE	FROM-TILL	DENSO		IRIDIUM POWER	IRIDIUM TOUGH	QTY	
BMW										
525i	2500	E-DD25/A	-	98.8 -99	VK20	-	IK20	VK20	6	
		GF-DM25		98.9 -	K20TXR	K20TT(*5)	IK20	VK20	6	
		GH-DT25	256S	00.11-03.8	VK20	-	IK20	VK20	6	
		GH-DS25/A	256S	00.11-03.8	VK20	-	IK20	VK20	6	
		GH-NA25	256S	03.11-05.6	VK20	-	IK20	VK20	6	
		GH-NG25	25 6S	04.6 -07.6	VK20	-	IK20	VK20	6	
		ABA-NE25	N52B25A	05.6 -07.6	-	-	-	-	6	
		ABA-NL25	N52B25A	05.6 -	-	-	-	-	6	
		ABA-NU25	N52B25A	07.6 -10.5	-	-	-	-	6	
		ABA-PU25	N52B25A	07.6 -	-	-	-	-	6	
528i	2000	DBA-XG28	N20B20A	11.11-	-	-	-	-	4	
		DBA-XL28	N20B20A(T/C)	11.11-	-	-	-	-	4	
		DBA-SZ20	N20B20A(T/C)	13.9 -	-	-	-	-	4	
		DBA-XG28	N20B20A(T/C)	14.6 -	-	-	-	-	4	
		DBA-SZ20	N20B20A(T/C)	14.6 -	-	-	-	-	4	
		DBA-XL28	N20B20A(T/C)	14.6 -	-	-	-	-	4	
	2800	E-DD28/A	M52B28	96.4 -98.6	K20TXR	K20TT(*5)	IK20	VK20	6	
		GF-DP28		98.6 -00	K20TXR	K20TT(*5)	IK20	VK20	6	
		GF-DM28		98.6 -00	K20TXR	K20TT(*5)	IK20	VK20	6	
	3000	DBA-FR30 • MU30	N52B30A	10.5 -	-	-	-	-	6	
530e	2000	CLA-JA20P	B48B20A(T/C)	17.2 -	-	-	-	4		
530i	2000	DBA-JA20	B48B20B(T/C)	17.2 -	-	-	-	-	4	
		DBA-JL20	B48B20B(T/C)	17.6 -	-	-	-	-	4	
	3000	E-HE30	M60B30	93.3 -95	K20TXR	K20TT(*5)	IK20	VK20	8	
		GH-DS30	306S	00.11-03.8	VK20	-	IK20	VK20	6	
		GH-DT30	306S	00.11-03.8	VK20	-	IK20	VK20	6	
		GH-NA30	306S	03.8 -05.6	VK20	-	IK20	VK20	6	
		ABA-NE30	N52B30A	05.6 -07.6	-	-	-	-	6	
		ABA-NL30	N52B30A	05.6 -07.6	-	-	-	-	6	
		ABA-NU30	N52B30A	07.6 -10.5	-	-	-	-	6	
		ABA-PU30/PV30	N52B30A	07.6 -	-	-	-	-	6	
530Xi	3000	ABA-PV30	N52B30A	07.6 -	-	-	-	6		
535i	3000	CBA-SN30	N55B30A(T/C)	09.11-	-	-	-	-	6	
		DBA-SN30	N55B30A(T/C)	12.9 -	-	-	-	-	6	
		DBA-FR35 • MU35	N55B30A(T/C)	10.5 -	-	-	-	-	6	
540i	3000	DBA-JB30	B58B30A(T/C)	17.2 -	-	-	-	-	6	
		DBA-JM30	B58B30A(T/C)	17.6 -	-	-	-	-	6	
	4000	E-HE40	M60B40	93.3 -95.12	K20TXR	K20TT(*5)	IK20	VK20	8	
		ABA-NB40	N62B40A	05.11-07.6	VK20	-	IK20	VK20	8	
	4400	ABA-NW40	N62B40A	07.6 -10.5	VK20	-	IK20	VK20	8	
		E-DE44	M62B44	96.9 -99.8	K20TXR	K20TT(*5)	IK20	VK20	8	
		GF-DN44		99.8 -00	VK20	-	IK20	VK20	8	
		GH-DN44	448S	00.11-	VK20	-	IK20	VK20	8	
		4400	GH-NB44	N62B44A	03.11-	VK20	-	IK20	VK20	8
			ABA-SN44	N63B44A(T/C)	09.11-	-	-	-	-	8
545i	4400	CBA-SN44	N63B44B(T/C)	12.9 -	-	-	-	-	8	
		ABA-FR44 • SP44	N63B44A(T/C)	10.5 -	-	-	-	-	8	
	4400	CBA-KN44	N63B44B(T/C)	13.9 -	-	-	-	-	8	
		CBA-HR44	N63B44B(T/C)	13.9 -	-	-	-	-	8	
		ABA-NB48/NH48	N62B48B	05.11-07.6	VK20	-	IK20	VK20	8	
		ABA-NW48	N62B48B	07.6 -10.5	VK20	-	IK20	VK20	8	
		ABA-PW48	N62B48B	07.6 -	VK20	-	IK20	VK20	8	
		4800	ABA-NW48	N62B48B	07.6 -10.5	VK20	-	IK20	VK20	8
	ABA-PW48		N62B48B	07.6 -	VK20	-	IK20	VK20	8	
	ACTIVE HYBRID 5	3000	DAA-FZ35	N55B30A-M230(T/C)	12.8 -	-	-	-	6	
630i	2000	ABA-JX20S	B48B20B(T/C)	18.8 -	-	-	-	-	4	
		GH-EH30	N52B30A	04.11 -05.10	-	-	-	-	6	
	3000	ABA-EH30	N52B30A	05.10-	-	-	-	-	6	
640i Coupe	3000	DBA-LW30C	N55B30A(T/C)	11.8 -	-	-	-	6		
640i Gran Coupe	3000	DBA-6A30	N55B30A(T/C)	12.6 -	-	-	-	6		
640i Cabriolet	3000	DBA-LW30	N55B30A	12.8 -	-	-	-	6		
640i	3000	DBA-JV30A	B58B30A(T/C)	17.10-	-	-	-	6		
645Ci	4400	GH-EH44/EK44	N62B44A	04.2 -	VK20	-	IK20	VK20	8	
650i Coupe	4400	ABA-LX44C	N63B44A(T/C)	11.8 -	-	-	-	-	8	
		CBA-YM44C	N63B44B(T/C)	12.8 -	-	-	-	-	8	
650i Cabriolet	4400	CBA-YP44	N63B44B(T/C)	12.8 -	-	-	-	8		
650i	4400	CBA-6B44	N63B44B(T/C)	13.8 -	-	-	-	-	8	
		CBA-6B44	N63B44B(T/C)	14.5 -	-	-	-	-	8	
		CBA-YP44	N63B44B(T/C)	15.7 -	-	-	-	-	8	

DENSO
 AUSTRALIA
 CHINA
 INDIA
 INDONESIA
 KOREA
 MALAYSIA
 PHILIPPINES
 SAUDI ARABIA
 SINGAPORE
 TAIWAN
 THAILAND
 VIETNAM
 JAPAN
 EUROPE & USA
 MOTOR CYCLE
 SMALL ENGINE
 CROSS REFERENCE
 PART NUMBER

(*5) : It can be used only for a plug with a terminal.



EUROPE & U.S.A. | CAR

▶ Spark plug color codes: ■ for Iridium Tough and Iridium Plugs and Iridium TT, ■ for Iridium Power, ■ for Iridium Racing and Two Tops Plugs, ■ for Platinum Plugs and Platinum TT, and black for general spark plugs.

DENSO

AUSTRALIA

CHINA

INDIA

INDONESIA

KOREA

MALAYSIA

PHILIPPINES

SAUDI ARABIA

SINGAPORE

TAIWAN

THAILAND

VIETNAM

EUROPE

MOTOR

CYCLE

EUROPE

& USA

SMALL

ENGINE

CROSS

PART

NUMBER

MODEL	CC	VEHICLE CODE	ENGINE	FROM-TILL	DENSO				QTY
BMW									
650i	4400	CBA-YM44C	N63B44B(T/C)	15.7 -	-	-	-	-	8
	4800	ABA-EK48	N62B48B	05.11-	VK20	-	IK20	VK20	8
		ABA-EH48	N62B48B	05.11-	VK20	-	IK20	VK20	8
735i	3500	E-GF35	M62B35	96.5 -99	K20TXR	K20TT(*5)	IK20	VK20	6
		GH-GG35	358S	00.11 -01.10	VK20	-	IK20	VK20	8
	3600	GH-GL36	N62B36A	02.3 -	VK20	-	IK20	VK20	8
740e	2000	DLA-7D20	B48B20B(T/C)	16.10-	-	-	-	4	
740i	3000	ABA-KA30	N54B30A(T/C)	09.3 -	-	-	-	-	6
		DBA-YA30	N55B30A(T/C)	12.9 -	-	-	-	-	6
		DBA-7A30	B58B30A(T/C)	16.10-	-	-	-	-	6
		DBA-7A30	B58B30A(T/C)	17.8 -	-	-	-	-	6
		E-GD40	M60B40	92.11 -94.10	K20TXR	K20TT(*5)	IK20	VK20	8
	4000	E-GF40	M60B40	94.10-96.5	K20TXR	K20TT(*5)	IK20	VK20	8
		ABA-HL40	N62B40A	05.5 -	VK20	-	IK20	VK20	8
	4400	E-GF44	M62B44	96.6 -97	K20TXR	K20TT(*5)	IK20	VK20	8
GH-GG44		448S	00.11-	VK20	-	IK20	VK20	8	
740Li	3000	ABA-KB30	N54B30A(T/C)	09.3 -	-	-	-	-	6
		DBA-YE30	N55B30A(T/C)	12.9 -	-	-	-	-	6
		DBA-7E30	B58B30A(T/C)	16.10-	-	-	-	-	6
		DBA-7E30	B58B30A(T/C)	17.8 -	-	-	-	-	6
740iL	4000	E-GD40L	M60B40	92.11 -94.10	K20TXR	K20TT(*5)	IK20	VK20	8
745i	4400	GH-GL44	-	02.3 -05.5	VK20	-	IK20	VK20	8
745Li	4400	GH-GN44	-	02.6 -	VK20	-	IK20	VK20	8
750i	4400	ABA-KA44	N63B44A(T/C)	09.3 -	-	-	-	-	8
		CBA-YA44	N63B44B(T/C)	12.9 -	-	-	-	-	8
		CBA-YA44	N63B44B(T/C)	14.8 -	-	-	-	-	8
		CBA-7A44	N63B44C(T/C)	17.8 -	-	-	-	-	8
	4800	ABA-HL48	N62B48B	05.5 -	VK20	-	IK20	VK20	8
750Li	4400	ABA-KB44	N63B44A(T/C)	09.3 -	-	-	-	-	8
		CBA-YE44	N63B44B(T/C)	12.9 -	-	-	-	-	8
		CBA-YE44	N63B44B(T/C)	14.8 -	-	-	-	-	8
		CBA-7F44	N63B44C(T/C)	17.8 -	-	-	-	-	8
750iL	5400	E-GK50	M73B54	96.6 -99	KJ16CR-L11	-	-	VKA16	12
		GH-GJ50	5412	00.10-01	VK20	-	IK20	VK20	12
750Li	4800	ABA-HN48	N62B48B	05.5 -	VK20	-	IK20	VK20	8
760Li	6000	GH-GN60	N73B60A	03.3 -06.11	VK20	-	IK20	VK20	12
		ABA-GN60	N73B60A	06.11-	VK20	-	IK20	VK20	12
		ABA-KB60	N74B60A(T/C)	09.7 -	-	-	-	-	12
		CBA-YG60	N74B60A(T/C)	12.9 -	-	-	-	-	12
ACTIVE HYBRID 7	3000	DAA-YA30	N55B30A-M230(T/C)	12.9 -	-	-	-	-	8
	4400	-	-	09.10-	-	-	-	-	8
ACTIVE HYBRID 7L	3000	DAA-YE30	N55B30A-M230(T/C)	12.9 -	-	-	-	8	
840Ci	4000	E-E40	M60B40	94.1 -96	K20TXR	K20TT(*5)	IK20	VK20	8
	4400	E-EF44	M62B44	96.4 -99	K20TXR	K20TT(*5)	IK20	VK20	8
850Ci	5000	E-EG50	M70B50	93.3 -94.12	KJ16CR-L11	-	-	VKA16	12
850CSi	5600	E-850CSi	M70B56	94.3 -96	KJ16CR-L11	-	-	VKA16	12
i3	650	DLA-1Z06	W20K06A	13.11-	-	-	-	-	2
		3LA-8P06	W20K06A	19.2 -	-	-	-	-	2
i8	1500	DLA-2Z15	B38K15A(T/C)	13.11-	-	-	-	-	3
		CLA-2Z15U	B38K15A(T/C)	18.4 -	-	-	-	-	3
L7	5400	GF-L7	5412	98.10-01	VK20	-	IK20	VK20	12
M COUPE	3200	GF-CM32	S50B32	98.10-01	IXU22	-	IXU22	VXU22	6
		GH-CM32	326S4	01.7 -	VXU24	-	IXU24	VXU24	6
M ROADSTER	3200	GF-CK32	S50B32	98.10-01.7	IXU22	-	IXU22	VXU22	6
		GH-CK32	326S4	01.7 -	VXU24	-	IXU24	VXU24	6
		GH-CL32	326S4	01.8 -06.4	VXU24	-	IXU24	VXU24	6
		ABA-BT32	326S4	06.4 -	IXU24	-	IXU24	VXU24	6
M135i	3000	DBA-1B30	N55B30A	12.8 -	-	-	-	6	
M140i	3000	DBA-1S30	B58B30A(T/C)	16.9 -	-	-	-	6	
M235i	3000	DBA-1J30	N55B30A(T/C)	14.2 -	-	-	-	6	
M240i	3000	ABA-2G30G	B58B30A(T/C)	16.9 -	-	-	-	-	6
		DBA-2G30	B58B30A(T/C)	16.9 -	-	-	-	-	6
M2	3000	CBA-1H30	N55B30A(T/C)	16.1 -	-	-	-	-	6
		CBA-1H30G	N55B30A(T/C)	16.10-	-	-	-	-	6
		CBA-2U30	S55B30A(T/C)	18.8 -	-	-	-	-	6
M3	3000	E-M3B	30 6S	92.9 -95.12	-	-	-	-	6
		CBA-3C30	S55B30A(T/C)	14.2 -	-	-	-	-	6

(*5) : It can be used only for a plug with a terminal.



MODEL	CC	VEHICLE CODE	ENGINE	FROM-TILL	DENSO		IRIDIUM POWER	IRIDIUM TOUGH	QTY	
BMW										
M3	3200	E-M3C	326S	96.7 -	IXU22	-	IXU22	VXU22	6	
		GF-BL32	326S	01.1 -	IXU24	-	IXU24	VXU24	6	
		GH-BL32	326S4	02.12-	IXU24	-	IXU24	VXU24	6	
		GH-M3CSL	326S4	03.5 -	VXU24	-	IXU24	VXU24	6	
	4000	ABA-VA40/WD40	S65B40A	07.9 -	-	-	-	-	8	
		CBA-VA40 · WD40	S65B40A	10.5 -	-	-	-	-	8	
M4	3000	CBA-3C30	S55B30A(T/C)	14.2 -	-	-	-	6		
M5	3800	E-M5H(E34)	S38B38(386S)	93 -96	XU22EPR-U	XU22TT	IXU22	VXU22	6	
	4400	ABA-FV44M	S63B44B	11.7 -	-	-	-	-	8	
		ABA-JF44M	S63B44B(T/C)	17.10-	-	-	-	-	8	
	5000	ABA-NB50	-	04.11-	-	-	-	-	10	
		GF/GH-DE50	508S	99.4 -04.11	VK20	-	IK20	VK20	8	
M6	4400	ABA-LZ44M	S63B44B	12.4 -	-	-	-	-	8	
		ABA-LZ44M	S63B44B(T/C)	15.7 -	-	-	-	-	8	
		ABA-6C44M	S63B44B(T/C)	15.7 -	-	-	-	-	8	
	5000	ABA-EH50	S85B50A	05.9 -	-	-	-	-	10	
		ABA-EK50	S85B50A	06.9 -	-	-	-	-	10	
M760Li	6600	CBA-7H66	N74B66B(T/C)	16.10-	-	-	-	12		
M850i	4400	3BA-BC44	N63B44D(T/C)	18.11-	-	-	-	8		
MINI ONE										
	1200	DBA-XM12	B38A12A(T/C)	14.7 -	-	-	-	-	3	
		DBA-XS12	B38A12A(T/C)	14.12-	-	-	-	-	3	
		DBA-XM12	B38A12A(T/C)	16.12-	-	-	-	-	3	
		DBA-XS12	B38A12A(T/C)	16.12-	-	-	-	-	3	
	1400	ABA-ME14	-	07.5 -10.3	-	-	-	-	4	
		DBA-LN15	B38A15A(T/C)	16.4 -	-	-	-	-	3	
	1500	DBA-YS15	B38A15A(T/C)	17.10-	-	-	-	-	3	
		DBA-XR15M	B38A15A(T/C)	18.5 -	-	-	-	-	3	
		DBA-XU15M	B38A15A(T/C)	18.5 -	-	-	-	-	3	
		GH-RA16	-	02.2 -07.2	VK20	-	IK20	VK20	4	
	1600	CBA/DBA-SR16	(98PS)	10.3 -	-	-	-	-	4	
	MINI COOPER									
		1500	DBA-XM15	B38A15A(T/C)	14.4 -	-	-	-	-	3
			DBA-LN15	B38A15A(T/C)	15.11-	-	-	-	-	3
			DBA-WG15	B38A15A(T/C)	16.3 -	-	-	-	-	3
DBA-XM15			B38A15A(T/C)	16.12-	-	-	-	-	3	
DBA-XS15			B38A15A(T/C)	16.12-	-	-	-	-	3	
DBA-XR15M			B38A15A(T/C)	18.5 -	-	-	-	-	3	
DBA-XU15M			B38A15A(T/C)	18.5 -	-	-	-	-	3	
CBA-WJ15M			B38A15A(T/C)	18.5 -	-	-	-	-	3	
1600		GH-RF16	W10B16A	04.9 -07.2	VK20	-	IK20	VK20	4	
		GH-RA16	-	02.2 -07.2	VK20	-	IK20	VK20	4	
		ABA-MF16/ML16	-	07.2 -10.3	-	-	-	-	4	
		ABA-RF16/RH16	-	08.10-09.4	-	K20TT	IK20	VK20	4	
		ABA-MR16	-	09.4 -10.3	-	-	-	-	4	
		CBA/DBA-SU16	(122PS)	10.3 -	-	-	-	-	4	
		CBA/DBA-ZN16	(122PS)	10.3 -	-	-	-	-	4	
CBA/DBA-ZF16	(122PS)	10.3 -	-	-	-	-	4			
2000	DBA-XS15	B38A15A(T/C)	14.10-	-	-	-	-	3		
MINI COOPER Coupe										
	1600	DBA-SX16	N16B16A	11.9 -	-	-	-	-	4	
		CBA-SX16	N16B16A	11.9 -	-	-	-	-	4	
MINI COOPER S										
	1500	DBA-XS20	B48A20A(T/C)	14.10-	-	-	-	-	4	
		CLA-YU15	B38A15A-P160(T/C)	17.7 -	-	-	-	-	3	
	1600	GH-RE16/RH16	(S/C)	02.2 -07.2	VK20	-	IK20	VK20	4	
		ABA-MF16S/MM16/MS16	(T/C)	07.2 -10.3	-	-	-	-	4	
		DBA-SV16/ZP16/ZG16	(184PS)(T/C)	10.3 -	-	-	-	-	4	
	2000	DBA-XM20	B48A20A(T/C)	14.4 -	-	-	-	-	4	
		DBA-LN20	B48A20A(T/C)	15.11-	-	-	-	-	4	
		DBA-WG20	B48A20A(T/C)	16.3 -	-	-	-	-	4	
		DBA-XM20	B48A20A(T/C)	16.12-	-	-	-	-	4	
		DBA-XS20	B48A20A(T/C)	16.12-	-	-	-	-	4	
		CBA-XR20M	B48A20A(T/C)	18.5 -	-	-	-	-	4	
		DBA-XU20M	B48A20A(T/C)	18.5 -	-	-	-	-	4	
		CBA-WJ20M	B48A20F(T/C)	18.5 -	-	-	-	-	4	
	MINI COOPER S Coupe	1600	DBA-SX16S	N18B16A(T/C)	11.9 -	-	-	-	4	
	MINI JOHN COOPER									
	1600	ABA-MFJCW/MMJCW/MSJCW		08.9 -	-	-	-	4		
MINI JOHN COOPER WORKS										
	2000	DBA-LVJCW	B48A20B(T/C)	17.1 -	-	-	-	4		
MINI JOHN COOPER WORKS COUPE										
	1600	ABA-SXJCW	N14B16C(T/C)	11.9 -	-	-	-	4		
		CBA-XDJCW	N18B16C(T/C)	13.1 -	-	-	-	4		

DENSO
 AUSTRALIA CHINA INDIA INDONESIA KOREA MALAYSIA PHILIPPINES SAUDI ARABIA SINGAPORE TAIWAN THAILAND VIETNAM JAPAN
 EUROPE MOTOR SMALL CROSS PART
 CYCLE ENGINE REFERENCE NUMBER



EUROPE & U.S.A. | CAR

▶ Spark plug color codes: ■ for Iridium Tough and Iridium Plugs and Iridium TT, ■ for Iridium Power, ■ for Iridium Racing and Two Tops Plugs, ■ for Platinum Plugs and Platinum TT, and black for general spark plugs.

DENSO

AUSTRALIA

CHINA

INDIA

INDONESIA

KOREA

MALAYSIA

PHILIPPINES

SAUDI ARABIA

SINGAPORE

TAIWAN

THAILAND

VIETNAM

JAPAN

EUROPE

& USA

MOTOR

SMALL ENGINE

CROSS REFERENCE

PART NUMBER

CYCLE

MODEL	CC	VEHICLE CODE	ENGINE	FROM-TILL	DENSO		IRIDIUM POWER	IRIDIUM TOUGH	QTY
BMW									
MINI JOHN COOPER WORKS COUPE	2000	DBA-WHJCW	B48A20B(T/C)	16.3 -	-	-	-	-	4
		DBA-YS20	B48A20B(T/C)	17.5 -	-	-	-	-	4
		CBA-XRJCWM	B48A20B(T/C)	18.5 -	-	-	-	-	4
		CBA-WJJCWM	B48A20B(T/C)	18.5 -	-	-	-	-	4
X1	1500	ABA-JG15	B38A15A(T/C)	17.8 -	-	-	-	-	3
		ABA-VL18	N46B20B	10.4 -	VK20	-	IK20	VK20	4
		DBA-VM20	N20B20A	11.10-	-	-	-	-	4
	2000	CBA-VL18	N46B20B	12.9 -	-	-	-	-	4
		DBA-VL20	N20B20A(T/C)	12.9 -	-	-	-	-	4
		DBA-VM20	N20B20A(T/C)	12.9 -	-	-	-	-	4
		CBA-VL18	N46B20B	15.4 -	-	-	-	-	4
		DBA-VL20	N20B20A(T/C)	15.4 -	-	-	-	-	4
		DBA-VM20	N20B20A(T/C)	15.4 -	-	-	-	-	4
		CBA-JG20	B48A20B(T/C)	17.11-	-	-	-	-	4
		ABA-JG20A	B48A20A(T/C)	18.5 -	-	-	-	-	4
		CBA-JG20	B48A20B(T/C)	18.5 -	-	-	-	-	4
		ABA-VL25	N52B30A	10.4 -	-	-	-	-	6
X2	1500	DBA-YH15	B38A15A(T/C)	18.4 -	-	-	-	-	3
	2000	ABA-YH20	B48A20A(T/C)	18.4 -	-	-	-	-	4
		3BA-YN20	B48A20E(T/C)	19.1 -	-	-	-	-	4
X3	2000	DBA-WX20	N20B20A	12.3 -	-	-	-	-	4
		DBA-WX20	N20B20A(T/C)	14.6 -	-	-	-	-	4
		DBA-TR20	B48B20A(T/C)	17.10-	-	-	-	-	4
	2500	GH-PA25	25 6S	04.7 -06.10	VK20	-	IK20	VK20	6
		ABA-PC25	N52B25A	06.10-11.3	-	-	-	-	6
	3000	GH-PA30	30 6S	04.7 -06.10	VK20	-	IK20	VK20	6
		ABA-PC30	N52B30A	06.10-11.3	-	-	-	-	6
		CBA-WX30	N52B30A	11.3 -	-	-	-	-	6
	DBA-WX35	N55B30A(T/C)	11.3 -	-	-	-	-	6	
X4	2000	DBA-XW20	N20B20A(T/C)	14.8 -	-	-	-	-	4
		CBA-UJ20	B48B20B(T/C)	18.9 -	-	-	-	-	4
		DBA-XW35	N55B30A(T/C)	14.8 -	-	-	-	-	6
	3000	DBA-XW35M	N55B30A(T/C)	16.1 -	-	-	-	-	6
		DBA-XW35	N55B30A(T/C)	16.6 -	-	-	-	-	6
		DBA-XW35M	N55B30A(T/C)	16.6 -	-	-	-	-	6
		CBA-UJ30	B58B30A(T/C)	18.9 -	-	-	-	-	6
X5	2000	CLA-KT20	N20B20A-P251(T/C)	15.9 -	-	-	-	-	4
		CLA-KT20	N20B20A-P251(T/C)	16.3 -	-	-	-	-	4
		CLA-KT20	N20B20A(T/C)	17.5 -	-	-	-	-	4
	3000	GH-FA30	M54	01.1 -03.10	VK20	-	IK20	VK20	6
		GH-FA30N	306S	03.12-07.6	VK20	-	IK20	VK20	6
		ABA-FE30	N52B30A	07.6 -10.5	-	-	-	-	6
		ABA-ZV30S	N55B30A(T/C)	10.5 -	-	-	-	-	6
		DBA-KR30	N55B30A(T/C)	14.10-	-	-	-	-	6
		DBA-KR30S	N55B30A(T/C)	14.10-	-	-	-	-	6
		GH-FB44	448S	00.9 -	K20TXR	K20TT(*5)	IK20	VK20	8
		GH-FB44N	N62B44A	03.12-	VK20	-	IK20	VK20	8
		ABA-ZV44S	N63B44A(T/C)	10.5 -	-	-	-	-	8
	4400	CBA-KR44	N63B44B(T/C)	13.11-	-	-	-	-	8
		CBA-KR44S	N63B44B(T/C)	13.11-	-	-	-	-	8
		GH-FB46	-	02.3 -04.5	VK20	-	IK20	VK20	8
4800	GH-FA48	N62B48A	04.6 -07.6	VK20	-	IK20	VK20	8	
	ABA-FE48	N62B48B	07.6 -10.5	-	-	-	-	8	
X5 M	4400	ABA-GY44	S63B44A(T/C)	09.7 -	-	-	-	-	8
		ABA-KT44	S63B44B(T/C)	14.11-	-	-	-	-	8
		ABA-KT44	S63B44B(T/C)	16.3 -	-	-	-	-	8
		ABA-KT44	S63B44B(T/C)	17.5 -	-	-	-	-	8
X6	3000	ABA-FG30	N54B30A(T/C)	08.6 -10.5	-	-	-	-	6
		ABA-FG35	N55B30A(T/C)	10.5 -	-	-	-	-	6
		DBA-FG35	N55B30A(T/C)	12.6 -	-	-	-	-	6
		DBA-KU30S	N55B30A(T/C)	14.8 -	-	-	-	-	6
		DBA-KU30	N55B30A(T/C)	14.8 -	-	-	-	-	6
		DBA-KU30	N55B30A(T/C)	17.5 -	-	-	-	-	6
	4400	DBA-KU30S	N55B30A(T/C)	17.5 -	-	-	-	-	6
		ABA-FG44	N63B44A(T/C)	08.6 -10.5	-	-	-	-	8
		ABA-FG44	N63B44A(T/C)	12.6 -	-	-	-	-	8
		CBA-KU44S	N63B44B(T/C)	14.8 -	-	-	-	-	8

(*5) : It can be used only for a plug with a terminal.

MODEL	CC	VEHICLE CODE	ENGINE	FROM-TILL	DENSO		IRIDIUM POWER	IRIDIUM TOUGH	QTY
BMW									
X6	4400	CBA-KU44	N63B44B(T/C)	14.8 -	-	-	-	-	8
X6 M	4400	ABA-GZ44	S63B44A(T/C)	09.7 -	-	-	-	-	8
		ABA-KT44	S63B44B(T/C)	14.11-	-	-	-	-	8
		ABA-KT44	S63B44B(T/C)	16.3 -	-	-	-	-	8
		ABA-KT44	S63B44B(T/C)	17.5 -	-	-	-	-	8
		ABA-KT44	S63B44B(T/C)	17.5 -	-	-	-	-	8
Z3	1900	E-CH19	194S	96.9 -99	K20TXR	K20TT(*5)	IK20	VK20	4
	2000	GF-CL20		99.7 -00	K20TXR	K20TT(*5)	IK20	VK20	6
	2200	GH-CN22	M54	00.12-	VK20	-	IK20	VK20	6
		GF-CK28	M52B28	98.4 -00	K20TXR	K20TT(*5)	IK20	VK20	6
		GF-CJ28	M52B28	98.4 -98	K20TXR	K20TT(*5)	IK20	VK20	6
	2800	GF-CK28	M53TUB28	98.10-00	K20TXR	K20TT(*5)	IK20	VK20	6
		GF-CJ28	M53TUB28	98.10-98	K20TXR	K20TT(*5)	IK20	VK20	6
		GF-CH28	286S	98.6 -00	VK20	-	IK20	VK20	6
		GH-CN30	-	00.8 -	K20TXR	K20TT(*5)	IK20	VK20	6
Z4	2000	DBA-LL20	N20B20A(T/C)	13.4 -	-	-	-	-	4
		3BA-HF20	B48B20B(T/C)	19.3 -	-	-	-	-	4
	2200	GH-BT22	226S	03.12-06.4	VK20	-	IK20	VK20	6
		GH-BT25	256S	03.1 -06.4	VK20	-	IK20	VK20	6
	2500	ABA-BU25	N52B25A	06.4 -	-	-	-	-	6
		ABA-LM25	N52B25A	09.5 -	-	-	-	-	6
		GH-BT30	306S	03.5 -06.4	VK20	-	IK20	VK20	6
	3000	ABA-BU30/DU30	N52B30A	06.4 -	-	-	-	-	6
		ABA-LM30	N54B30A(T/C)	09.5 -	-	-	-	-	6
		ABA-LM35	N54B30A(T/C)	10.5 -	-	-	-	-	6
		3BA-HF30	B58B30C(T/C)	19.3 -	-	-	-	-	6
	3200	ABA-BT32/DU32	S54B32	06.4 -	VXU24	-	IXU24	VXU24	6
	Z8	5000	GH-EJ50	508S	99.10-	K20TXR	K20TT(*5)	IK20	VK20
BMW ALPINA									
B3 3.0	3000	E-3E3J	E3J	93.4 -96.2	K20TXR	K20TT(*5)	IK20	VK20	6
		-	E3J	93.4 -96.2	K20TXR	K20TT(*5)	IK20	VK20	6
B3 3.2	3200	E-3E4J	E4J	96.4 -98.9	K20TXR	K20TT(*5)	IK20	VK20	6
		-	E4J	96.4 -99.3	K20TXR	K20TT(*5)	IK20	VK20	6
B3 3.3	3300	GF-3E44	E44	99.3 -00.9	VK20	-	IK20	VK20	6
		GF-3E46	E4/6	00.11-	VK20	-	IK20	VK20	6
B3 3.4	3400	-	-	02.10 -07.10	VK20	-	IK20	VK20	6
B5 4.4	4400	-	-	05.10-	PK22PR8	-	IK22	VK22	8
B6 2.8	2800	-	E42J	96.10 -98.11	K20TXR	K20TT(*5)	IK20	VK20	6
B6 4.4	4400	-	-	05.9 -	PK22PR8	-	IK22	VK22	8
B7 4.4	4400	ABA-TH10/NH10	-	03.10-	PK22PR8	-	IK22	VK22	8
B8 4.0	3900	-	F11	95.1 -98.11	K20TXR	K20TT(*5)	IK20	VK20	8
B8 4.6	4600	E-8F21	F21	95.1 -98.11	K20TXR	K20TT(*5)	IK20	VK20	8
B10 3.2	3200	E-AF43	E43	97.8 -98.12	K20TXR	K20TT(*5)	IK20	VK20	6
B10 3.3	3300	GF-FE45	E45	99.2 -00.9	VK20	-	IK20	VK20	6
		GF-YE47	E4/7	01.2 -	VK20	-	IK20	VK20	6
B10 4.6	4600	E-AF3	F3	97.1 -98.10	K20TXR	K20TT(*5)	IK20	VK20	8
		-	F3	97.8 -99.9	K20TXR	K20TT(*5)	IK20	VK20	8
		-	F4	97.8 -99.9	VK20	-	IK20	VK20	8
B10 V8	4600	GF-AF4	F4	99.1 -	VK20	-	IK20	VK20	8
		GF-JF4	F4	99.12-00.7	VK20	-	IK20	VK20	8
B10 V8 S	4837	GH-EF50	F5	02.3 -03.4	VK20	-	IK20	VK20	8
B12 5.7	5646	E-RD3	D3	95.12-98.8	K20TXR	K20TT(*5)	IK20	VK20	12
		E-PD3	D3	95.12-98.8	K20TXR	K20TT(*5)	IK20	VK20	12
B12 6.0	6000	GF-KD32	D32	99.7 -01.7	VK20	-	IK20	VK20	12
		GF-LD32	D32	99.7 -01.7	VK20	-	IK20	VK20	12
ROADSTER S	3400	(E85)	E5/2	04 -	VK20	-	IK20	VK20	6
ROADSTER V8	4837	GH-GF51(E52)	F5/1	02 -10	VK20	-	IK20	VK20	8
BUICK GM									
PARK AVENUE	3800	E-BC33A	-	95.11-96	PT16EPR-L13	-	IT16	VT16	6
REGAL	3100	E-BA43CW	-	93.11 -95.10	T16EPR-U	-	IT16	VT16	6
		E-BA43C	-	93.11 -95.10	T16EPR-U	-	IT16	VT16	6
		E-BA43CW	-	95.11-96	PT16EPR-L13	-	IT16	VT16	6
		E-BA43CW	-	95.11-96	PT16EPR-L13	-	IT16	VT16	6
		E-BA43C	-	95.11-96	PT16EPR-L13	-	IT16	VT16	6
CADILLAC GM									
ALLANTE	4600	E-AV14K	-	92.8 -	T16EPR-U15	-	IT16	VT16	8
CONCOURS	4600	E/GF-AK44K	-	93.11-	PT16EPR-L13	-	IT16	VT16	8
ATS	2000	ABA-A1SL	1D(T/C)	13.9 -	-	-	ITV16	-	4
		ABA-A1SL	1D(T/C)	16.1 -	-	-	ITV16	-	4

(*5) : It can be used only for a plug with a terminal.

DENSO

AUSTRALIA CHINA INDIA INDONESIA KOREA MALAYSIA PHILIPPINES SAUDIARABIA SINGAPORE TAIWAN THAILAND VIETNAM JAPAN & USA EUROPE MOTOR SMALL ENGINE REFERENCE NUMBER



EUROPE & U.S.A. | CAR

▶ Spark plug color codes: ■ for Iridium Tough and Iridium Plugs and Iridium TT, ■ for Iridium Power, ■ for Iridium Racing and Two Tops Plugs, ■ for Platinum Plugs and Platinum TT, and black for general spark plugs.

DENSO

AUSTRALIA

CHINA

INDIA

INDONESIA

KOREA

MALAYSIA

PHILIPPINES

SAUDI ARABIA

SINGAPORE

TAIWAN

THAILAND

VIETNAM

JAPAN

EUROPE & USA

SMALL MOTOR ENGINE

CROSS REFERENCE

PART NUMBER

MODEL	CC	VEHICLE CODE	ENGINE	FROM-TILL	DENSO		IRIDIUM POWER	IRIDIUM TOUGH	QTY
CADILLAC GM									
ATS-V	3600	ABA-A1SLV	3K(T/C)	16.1 -	-	-	-	-	6
CT6	3600	ABA-O1SL	3L	16.10-	-	-	-	-	6
CTS	2000	ABA-A1LL	1D(T/C)	14.4 -	-	-	ITV16	-	4
	2600	GH-AD32F	2F	03.3 -	VK20	-	IK20	VK20	6
	2800	GH-AD32G	2G	04.11-	ITV16	-	ITV16	-	6
		ABA-X322A	2G	08.1 -	ITV16	-	ITV16	-	6
	3200	GH-AD33G	3G	03.3 -04.11	VK20	-	IK20	VK20	6
		GH-AD33H	3H	04.11-	ITV16	-	ITV16	-	6
3600	ABA-X322B	3H	08.1 -	ITV16	-	ITV16	-	6	
	CTS-V	6200	ABA-X322V	-(S/C)	09.1 -	IT20	-	IT20	VT20
		ABA-A1LLV	6K(S/C)	16.1 -	-	-	-	-	8
DTS	4600	GH/ABA-X272	4K	06.6 -	PT16EPR-L13	-	IT16	VT16	8
DEVILLE	4600	GF/GH-AK64K	4K	99.10-	PT16EPR-L13	-	IT16	VT16	8
ELDORADO	4600	E/GF-AE44K	-	92.9 -	T16EPR-U15	-	IT16	VT16	8
ESCALADE	6000		HO	04.2 -	VT16	-	IT16	VT16	8
	6200		Vortech6200	07.11-	IT20	-	IT20	VT20	8
FLEETWOOD	5700	E-AD25B	-	92.9 -95	T16EPR-U15	-	IT16	VT16	8
SEVILLE	4600	E-AK34K	-	92.9 -97	T16EPR-U15	-	IT16	VT16	8
		E-AK54K	-	97.11 -98.11	PT16EPR-L13	-	IT16	VT16	8
		GF-AK54K	-	98.11 -03.3	PT16EPR-L13	-	IT16	VT16	8
		GH-AK54K	4K	03.3 -	PT16EPR-L13	-	IT16	VT16	8
		SRX	3000	ABA-T166C	2H	13.10-	-	-	ITV16
3600	GH-T265S	3H	04.11-	ITV16	-	ITV16	-	6	
	4600	GH-T265E	4M	04.1 -	PT16EPR-L13	-	IT16	VT16	8
	STS	3600	GH-X295S	3H	05 -	ITV16	-	ITV16	-
ABA-X295S		3H	08.1 -	ITV16	-	ITV16	-	6	
4600	GH/ABA-X295E	4M	04.1 -	PT16EPR-L13	-	IT16	VT16	8	
	STS-V	4400	GH/ABA-X295V	4N(S/C)	06.1 -	PT22EPR10	-	IT22	-
XLR	4600	GH-X215	4M	04.2 -	PT16EPR-L13	-	IT16	VT16	8
XLR-V	4600	ABA-X215V	4N	07.11-	PT16EPR-L13	-	IT16	VT16	8
XT5	3600	ABA-C1UL	3L	17.10-	-	-	-	-	6
CATERHAM									
SUPER SEVEN	1400	Rover K-series	16V	92 -	K20PR-U	K20TT	IK20	VK20	4
		Rover K-series	16V Supersport	92 -	IK22	-	IK22	VK22	4
		Rover K-series	i 16V	95.4 -	K20PR-U	K20TT	IK20	VK20	4
CHEVROLET GM									
ASTRO 2WD	4300	E-CL14G	-	-95.12	T20PR-U11	-	ITF20	-	6
		E-CL14G	-	96.1 -99.12	PT16EPR-L13	-	IT16	VT16	6
		GF/GH-CL14G	-	00.1 -05	PT16EPR-L13	-	IT16	VT16	6
ASTRO 4WD	4300	E-CM14G(S)	-	-95.12	T20PR-U11	-	ITF20	-	6
		E-CM14G(S)	-	96.1 -99.12	PT16EPR-L13	-	IT16	VT16	6
		GF/GH-CM14G	-	00.1 -05	PT16EPR-L13	-	IT16	VT16	6
BLAZER, TRAIL BLAZER	4200	GH-T360/360G · ABA-T360G	4L	01.9 -	ITV16	-	ITV16	-	6
		GH-T370L	4L	03 -07.5	ITV16	-	ITV16	-	6
	4300	E-CT34G	-	95.5 -99.9	PT16EPR-L13	-	IT16	VT16	6
		GF-CT34G	-	99.10-	PT16EPR-L13	-	IT16	VT16	6
	5300	GH-T370V	5F	03.2 -	PTJ16R15	-	IT16	VT16	8
	5700	E-CK15B	-	92.4 -94	T16PR-U	-	ITF16	-	8
CAMARO	3400	E-CF43F	-	93.5 -95	T16PR-U11	-	ITF16	-	6
		E-CF43FK	-	94.1 -95	T16PR-U11	-	ITF16	-	6
		-	LLT	09.12-	ITV20	-	ITV20	-	6
	3800	E-CF43A	-	95.10 -98.10	IT20	-	IT20	VT20	6
		E-CF43AK	-	95.11 -98.10	IT20	-	IT20	VT20	6
		GF-CF43A	3A	98.11-	PT16EPR-L13	-	IT16	VT16	6
		GF-CF43AK	3A	98.11-01	PT16EPR-L13	-	IT16	VT16	6
		E-CF45B	-	93.4 -97.3	T16EPR-U15	-	IT16	VT16	8
		E-CF45BK	-	94.1 -96.9	T16EPR-U15	-	IT16	VT16	8
	5700	E-CF45BK	-	96.10 -98.11	PT16EPR-L13	-	IT16	VT16	8
		E-CF45B	-	97.4 -98.11	PT16EPR-L13	-	IT16	VT16	8
		E-CF45E	-	97.9 -98.11	PT16EPR-L13	-	IT16	VT16	8
		GF-CF45E	-	98.11-	PT16EPR-L13	-	IT16	VT16	8
		6200	-	L99	09.12-	IT20	-	IT20	VT20
	CHEVROLET MW	1000	LA-ME64S	K10A(DOHC)	01.1 -	XU22EPR-U	XU22TT	IXU22	VXU22
1300		LA-ME34S	M13A(DOHC)	01.1 -06.1	IK16	-	IK16	VK16	4
		ABA/DBA-ME34S	M13A(DOHC)	06.1 -	IK16	-	IK16	VK16	4
CORVETTE	5700	E-CY15BK	-	95.11-	IT20	-	IT20	VT20	8
		E-CY15B	-	95.11-	IT20	-	IT20	VT20	8

DENSO	9	14	16	20	22	24	27	29	31	32	34	35	DENSO	9	14	16	20	22	24	27	29	31	32	DENSO	9	14	16	20	22	24	27	31
NGK	2	4	5	6	7	8	9	9.5	10	10.5	11	11.5	CHAMPION	18	16,14	12,11	10,9	8,7	6,63,61	4,59	57	55	53	BOSCH	10	9	8	7,6	5	4	3	2



MODEL	CC	VEHICLE CODE	ENGINE	FROM-TILL	DENSO		IRIDIUM POWER	IRIDIUM TOUGH	QTY
CHEVROLET GM									
CORVETTE	5700	E-CY25E	-	97 -99	IT20	-	IT20	VT20	8
		GF-CY25E	5E	99 -02.3	PT16EPR-L13	-	IT16	VT16	8
		GF-CY25E	5E	02.3 -04	PTJ16R15	-	IT16	VT16	8
		GH-CY25E	5E	02.5 -04	VT16	-	IT16	VT16	8
	6000	GH-X245	5G	05.2 -07.10	VT20	-	IT20	VT20	8
	6200	ABA-X245S	6F	07.10-	VT20	-	IT20	VT20	8
	7000	GH/ABA-X245A	6E	06.11-	VT20	-	IT20	VT20	8
CRUZE	1300	LA-HR51S	M13A	01.11 -03.11	• SK16PR-A11	-	IK16	VK16	4
		UA/DBA/MBA-HR52S	M13A	03.11-10.8	• SK16PR-A11	-	IK16	VK16	4
	1500	LA-HR81S	M15A	01.11 -03.11	• SK16PR-A11	-	IK16	VK16	4
		UA/CBA-HR82S	M15A	03.11-10.8	• SK16PR-A11	-	IK16	VK16	4
SONIC	1600	ABA-KT300	F16	13.11-	KJ16CR-L11	K16TT	IK16	VK16	4
HHR	2200	-	-	07.6 -	ITV16	-	ITV16	-	4
	2400	-	-	07.6 -	ITV16	-	ITV16	-	4
SILVERADO	4800	-	-	10.4 -	IT20	-	IT20	VT20	8
TAHOE	5300	-	Vortech5.3 V8	08.2 -	IT20	-	IT20	VT20	8
TRUCK S-10	4300	E-CTS4G	-	-94	T16PR-U11	-	ITF16	-	6
CHRYSLER									
300	3600	ABA-LX36	G	12.12-	-	-	-	-	6
300C	3500	GH-LE35T	-	-	-	-	-	VKA16	6
	5700	GH-LX57	7	05.2 -	ITL16	-	ITL16	-	16
300M	3500	GF-LR35	-	00.6 -	VK16	-	IK16	VK16	6
		GH-LR35	-	-	VK16	-	IK16	VK16	6
YPSILON	880	ABA-84609	312A2(T/C)	12.12-	-	-	-	-	2
CROSSFIRE	3200	GH-ZH32/32C	112	03.12-	VK16	-	IK16	VK16	12
GRAND VOYAGER	3300	E-GS33L	-	97.1 -99.10	IW16	-	IW16	VW16	6
		GF-GS33L	-	99.10-00	IW16	-	IW16	VW16	6
		GF-RG33L/S	-	01 -01	ITL16	-	ITL16	-	6
		GH-RG33L/LA	-	02 -	ITL16	-	ITL16	-	6
	3800	GF-GS38L	-	99.10-00	IW16	-	IW16	VW16	6
JEEP CHEROKEE	2000	ABA-KL20L	N(T/C)	19.3 -	-	-	-	-	4
	2400	ABA-KL24	B	19.3 -	-	-	-	-	4
	3700	GF/GH/ABA-KJ37	K	01.10-08.6	KJ20CR-L11	-	-	VKA20	6
		ABA-KK37	K	08.6 -	KJ20CR-L11	-	-	VKA20	6
	4000	GF-7MX	MX	99.6 -01	KJ16CR-L11	-	-	VKA16	6
JEEP COMMANDER	4700	GH/ABA-XH47	661	06.5 -	KJ20CR-L11	K20TT	IK20	VK20	8
	5700	GH/ABA-XH57	7	06.5 -07	ITL16	-	ITL16	-	16
JEEP GRAND CHEROKEE	3600	ABA-WK36	G	11.12-	-	-	-	-	6
		ABA-WK36A	G	11.12-	-	-	-	-	6
		ABA-WK36T	G	13.11-	-	-	-	-	6
		ABA-WK36TA	G	13.11-	-	-	-	-	6
		ABA-WK36T	G	17.3 -	-	-	IK20	VK20	6
		ABA-WK36TA	G	17.3 -	-	-	IK20	VK20	6
		DBA-WK36T	G	18.6 -	-	-	-	-	6
		DBA-WK36TA	G	18.6 -	-	-	-	-	6
	4000	E-ZMX	-	92.12-95	KJ16CR-L11	-	-	VKA16	6
		E-ZG40	-	96.3 -98	KJ16CR-L11	-	-	VKA16	6
		GF-WJ40	MX	99.3 -03.2	KJ16CR-L11	-	-	VKA16	6
		GH-WJ40	MX	03.2 -	KJ16CR-L11	-	-	VKA16	6
	4700	GF/GH-WJ47	661	99.3 -05.7	KJ20CR-L11	-	-	VKA20	8
		GH/ABA-WH47	661	05.7 -	KJ20CR-L11	-	-	VKA20	8
	5200	E-ZY	-	92.12-95	K16R-U	K16TT	IK16	VK16	8
		E-ZG52	-	95.12-98	KJ16CR-L11	K16TT	-	VKA16	8
	5700	GH/ABA-WH57	7	05.7 -08.12	ITL16	-	ITL16	-	16
ABA-WK57A		7	11.12-	IKH16	-	IKH16	VKH16	16	
ABA-WK57A		7	13.11-	-	-	-	-	16	
6100	-	-	06.9 -	ITL20	-	ITL20	-	16	
6400	ABA-WK64	4L	17.6 -	-	-	-	-	16	
JEEP COMPASS	2000	ABA-MK49	A	12.3 -	KJ16CR-L11	K16TT	-	VKA16	4
	2400	ABA-MK4924	B	13.7 -	KJ16CR-L11	K16TT	-	VKA16	4
		ABA-M624	B	17.12-	-	-	-	-	4
JEEP PATRIOT	2000	ABA-MK7420	A	12.2 -	KJ16CR-L11	K16TT	-	VKA16	4
	2400	ABA-MK74	B	07.8 -	KJ16CR-L11	K16TT	-	VKA16	4
		ABA-MK74	B	12.2 -	KJ16CR-L11	K16TT	-	VKA16	4
JEEP WRANGLER	2000	ABA-JL20L	N(T/C)	18.11-	-	-	-	-	4
	3600	ABA-JK36S	G	12.1 -	-	-	-	-	6
		ABA-JK36L	G	12.1 -	-	-	-	-	6

DENSO
 AUSTRALIA CHINA
 INDIA
 INDONESIA
 KOREA
 MALAYSIA
 PHILIPPINES
 SAUDI ARABIA
 SINGAPORE
 TAIWAN
 THAILAND
 VIETNAM
 JAPAN
 EUROPE
 MOTOR
 CYCLE
 SMALL
 ENGINE
 REFERENCE
 NUMBER
 PART



EUROPE & U.S.A. | CAR

▶ Spark plug color codes: ■ for Iridium Tough and Iridium Plugs and Iridium TT, ■ for Iridium Power, ■ for Iridium Racing and Two Tops Plugs, ■ for Platinum Plugs and Platinum TT, and black for general spark plugs.

DENSO

AUSTRALIA

CHINA

INDIA

INDONESIA

KOREA

MALAYSIA

PHILIPPINES

SINGAPORE

TAIWAN

THAILAND

VIETNAM

JAPAN

EUROPE & USA

MOTOR CYCLE

SMALL ENGINE

CROSS REFERENCE

PART NUMBER

MODEL	CC	VEHICLE CODE	ENGINE	FROM-TILL	DENSO				QTY	
CHRYSLER										
JEEP WRANGLER										
3600	ABA-JK36L		G	18.1 -	-	-	-	-	6	
	ABA-JK36LR		G	18.1 -	-	-	-	-	6	
	ABA-JL36S		G	18.11 -	-	-	-	-	6	
	ABA-JL36L		G	18.11 -	-	-	-	-	6	
	3800	ABA-JK38S/L		8	07.3 -	ITL16	-	ITL16	6	
	4000	E-SYMX		-	92.12-95	KJ16CR-L11	-	-	VKA16	6
		E-HYMX		-	92.12-95	KJ16CR-L11	-	-	VKA16	6
		E-TJ40S		-	96.9 -99	KJ16CR-L11	-	-	VKA16	6
		E-TJ40H		-	96.9 -99	KJ16CR-L11	-	-	VKA16	6
		GF/GH-TJ40S		MX	99.6 -07.3	KJ16CR-L11	-	-	VKA16	6
GF-TJ40H			-	99.10-01	KJ16CR-L11	-	-	VKA16	6	
JEEP RENEGADE										
1300	3BA-BU13		55282328(T/C)	19.2 -	-	-	-	4		
1400	ABA-BU14		55263624(T/C)	18.6 -	-	-	IXU24	4		
2400	ABA-BU24		6	18.6 -	-	-	-	4		
NEON										
1800	E-PL18		-	98.1 -	K16PR-U	K16TT	IK16	VK16	4	
2000	E-PL20		-	96.3 -99.8	K20PR-U	K20TT	IK20	VK20	4	
	GF-PL2K20		466	99.9 -00	K20PR-U	K20TT	IK20	VK20	4	
PT CRUISER										
2000	GF/GH-PT2K20		T, G	00.7 -	ITL16	-	ITL16	-	4	
	GH/ABA-PT2K24		S	04 -	ITL16	-	ITL16	-	4	
2400	GH-PT24		S	04.10 -	ITL16	-	ITL16	-	4	
	GH/ABA-PT24T		(T/C)	05.2 -	ITL16	-	ITL16	-	4	
2500	E-JA25		-	95.11 -	VK16	-	IK16	VK16	6	
8000			-	99.10-01	KJ20CR-L11	K20TT	IK20	VK20	10	
3500	E-LHF		-	93.12-95	KJ16CR-L11	K16TT	IK16	VK16	6	
VOYAGER										
3300	E-GS33L/S		-	97.2 -99.9	VW16	-	IW16	VW16	6	
	GF-GS33E/S/L		-	99.10 -01.10	VW16	-	IW16	VW16	6	
	GF-RG33S/L		R	01.1 -	ITL16	-	ITL16	-	6	
	GH-RG33S/L		-	02 -	ITL16	-	ITL16	-	6	
	ABA-RG33S		-	-	-	ITL16	-	ITL16	6	
3800	GF-GS38L/S		-	99.10-00	VW16	-	IW16	VW16	6	
CITROEN										
C2										
1400	GH/ABA-A6KFV		KFV	04.4 -	K20PR-U	K20TT	IK20	VK20	4	
1600	GH/ABA-A6NFU		NFU	04.3 -	K20HR-U11	-	IKH20	VKH20	4	
	GH/ABA-A6NFS		NFS	06.3 -	K20HR-U11	-	IKH20	VKH20	4	
C3										
1200	ABA-A5HM01		HM01	14.2 -	-	-	IXUH20I	VXUH20I	3	
	ABA-B6HN01		HN01(T/C)	17.7 -	-	-	-	-	3	
1400	GH-A8KFV		KFV	02.10-06.3	K20PR-U	K20TT	IK20	VK20	4	
	GH/ABA-A31KFU		KFU	06.3 -	XE20HR-U9	-	-	-	4	
1600	GH-A8NFU		NFU	02.12-06.3	K20HR-U11	-	IKH20	VKH20	4	
	GH/ABA-A31NFU		NFU	06.3 -	K20HR-U11	-	IKH20	VKH20	4	
	GH/ABA-A42NFU		NFU	05.4 -	K20HR-U11	-	IKH20	VKH20	4	
	ABA-A55F01		5F01	10.5 -	-	-	-	-	4	
C4										
1200	ABA-B7HN02		HN02(T/C)	15.9 -	-	-	-	-	3	
	GH/ABA-B5NFU		NFU	05.6 -	K20HR-U11	-	IKH20	VKH20	4	
1600	ABA-B75F01		5F01	11.7 -	-	-	-	-	4	
	ABA-B75F01S		5F01	11.7 -	-	-	-	-	4	
	ABA-B75F02S		5F02(T/C)	11.7 -	-	-	-	-	4	
	ABA-B75F02		5F02(T/C)	13.5 -	-	-	-	-	4	
	ABA-B785G01		5G01(T/C)	14.10 -	-	-	-	-	4	
	ABA-B7875G01		5G01(T/C)	14.10 -	-	-	-	-	4	
	2000	GH/ABA-B5RFJ		RFJ	05.6 -	K16HPR-U11	-	IKH16	VKH16	4
		GH/ABA-B5RFK		RFK	05.6 -	K16HPR-U11	-	IKH16	VKH16	4
ABA-B55FW			5FW	09.2 -	-	-	-	-	4	
ABA-B55FT			5FT(T/C)	09.2 -	-	-	-	-	4	
C4 PICASSO										
1600	ABA-B585FXP		5FX(T/C)	09.2 -	-	-	-	-	4	
	ABA-B585FTP		5FT(T/C)	09.2 -	-	-	-	-	4	
	ABA-B585F04P		5FX(T/C)	10.4 -	-	-	-	-	4	
	ABA-B585F02P		5F02(T/C)	11.2 -	-	-	-	-	4	
2000	ABA-B58RFJP		RFJ	07.6 -	IKH16	-	IKH16	VKH16	4	
	ABA-B58RFJ		RFJ	08.2 -	IKH16	-	IKH16	VKH16	4	
C5										
1600	ABA-X75F02		5F02(T/C)	12.10 -	-	-	-	-	4	
	GF/GH-X4RFN		RFN	01.7 -04.12	K16HPR-U11	-	IKH16	VKH16	4	
2000	GF/GH-X4RFNW		RFN	01.7 -04.12	K16HPR-U11	-	IKH16	VKH16	4	
	GH/ABA-X3RFJ		RFJ	04 -08.10	K20HR-U11	-	IKH20	VKH20	4	
	ABA-X7RFJ		-	08.10 -	K20HR-U11	-	IKH20	VKH20	4	
3000	GF/GH-X4XFXW		ES9J4S	01.7 -	IKH16	-	IKH16	VKH16	6	
	GF/GH-X4XFX		-	01.7 -	IKH16	-	IKH16	VKH16	6	

DENSO	9	14	16	20	22	24	27	29	31	32	34	35	DENSO	9	14	16	20	22	24	27	29	31	32	DENSO	9	14	16	20	22	24	27	31
NGK	2	4	5	6	7	8	9	9.5	10	10.5	11	11.5	CHAMPION	18	16,14	12,11	10,9	8,7	6,63,61	4,59	57	55	53	BOSCH	10	9	8	7,6	5	4	3	2



MODEL	CC	VEHICLE CODE	ENGINE	FROM-TILL	DENSO		IRIDIUM POWER	IRIDIUM TOUGH	QTY
CITROEN									
C5	3000	GH/ABA-X3XFU	XFU	04 -08.10	IKH16	-	IKH16	VKH16	6
		ABA-X7XJV	-	08.10-	IKH16	-	IKH16	VKH16	6
C6	3000	ABA-X6XJV	XFV	06.10-	IKH16	-	IKH16	VKH16	6
CHANSON	1600	E-S8NF	NFZ	96.12-99	K20TNR	K20TT	IK20	VK20	4
DS3	1200	ABA-A5CHM01	HM01	14.2 -	-	-	IXUH20I	VXUH20I	3
		ABA-A5CHN01	HN01(T/C)	15.11-	-	-	IXUH20I	VXUH20I	3
		ABA-A5CHN01	HN01(T/C)	16.6 -	-	-	-	-	3
	1600	ABA-A5CHN05	HN05(T/C)	18.10-	-	-	-	-	3
		ABA-A5C5F01	5F01	10.3 -	-	-	-	-	4
		ABA-A5C5F04	5F04	10.5 -	-	-	-	-	4
		ABA-A5C5F02	5F02(T/C)	12.4 -	-	-	-	-	4
		ABA-A5C5F02	5F02(T/C)	13.7 -	-	-	-	-	4
		ABA-A5C5G01	5G01(T/C)	15.2 -	-	-	-	-	4
DS4	1600	ABA-B7C5F02S	5F02(T/C)	11.9 -	-	-	-	-	4
		ABA-B7C5F03S	5F03(T/C)	11.9 -	-	-	-	-	4
		ABA-B7C5F06S	5F06(T/C)	12.9 -	-	-	-	-	4
		ABA-B7C5G01	5G01(T/C)	15.6 -	-	-	-	-	4
DS5	1600	ABA-B85F02	5F02(T/C)	12.8 -	-	-	-	-	4
		ABA-B85G01	5G01(T/C)	16.4 -	-	-	-	-	4
DS7	1600	ABA-X745G06	5G06(T/C)	18.7 -	-	-	-	4	
SAXO	1600	GF/GH-S8NFS	NF	99.3 -	K20TNR	K20TT	IK20	VK20	4
XANTIA	2000	E-X1RF	XU10J	93.7 -99.5	K20TXR	K20TT(*5)	IK20	VK20	4
		E-X1RFW	XU10J	95.12-99.5	K20TXR	K20TT(*5)	IK20	VK20	4
		GF-X2RF	RF	98.8 -01	K20TXR	K20TT(*5)	IK20	VK20	4
		GF-X2RFW	RF	98.8 -01	K20TXR	K20TT(*5)	IK20	VK20	4
	3000	GF-X2XF	XF	98.5 -01	K20TXR	K20TT(*5)	IK20	VK20	6
XM	3000	E-Y3SFW	SF	92.12-95	K20PBR	-	IK20	VK20	6
		E-Y3UFW	UF	93.8 -	K20PBR	-	IK20	VK20	6
		E-Y3UF	UF	93.9 -	K20PBR	-	IK20	VK20	6
		E-Y4UF	UF	94.9 -97	K20PBR	-	IK20	VK20	6
		E-Y4UFW	ZP	94.11-97	K20PBR	-	IK20	VK20	6
		E-Y4XF	-	97.10-01	K20PBR	-	IK20	VK20	6
		E-Y4XFW	XF	97.10-98	K20PBR	-	IK20	VK20	6
		GF-Y4XF	ES9J4	-00.12	K16TR11	K16TT	IK16	VK16	6
XSARA	1600	GF-N6LFW	LF	98.11-99	K20TXR	K20TT(*5)	IK20	VK20	4
		GF-N6NF/N6NFR	NF	99.12 -01.12	K20TXR	K20TT(*5)	IK20	VK20	4
		GF-N6NFW	-	00.2 -01.12	K20PR-U	K20TT	IK20	VK20	4
		GF/GH-N7NFU	TU5JP4	01.12-	K20HR-U11	-	IKH20	VKH20	4
		GF/GH-N7NFUW	TU5JP4	01.12-	K20HR-U11	-	IKH20	VKH20	4
	1800	E-N6LF	LF	98.3 -99	K20TXR	K20TT(*5)	IK20	VK20	4
		GF-N6LFW	LF	98.11-99	K20TXR	K20TT(*5)	IK20	VK20	4
	2000	GF-N6RFS	RF	98.9 -	K20TXR	K20TT(*5)	IK20	VK20	4
		GF-N6RF	RF	98.11-01.5	K20TXR	K20TT(*5)	IK20	VK20	4
		GF-N6RFW	RF	98.11-01.9	K20TXR	K20TT(*5)	IK20	VK20	4
		GF-N7RFN	RFN	01.6 -	K16HPR-U11	-	IKH16	VKH16	4
		GF/GH-N7RFN	RFN	01.6 -	K16HPR-U11	-	IKH16	VKH16	4
		GF/GH-N7RFNW	RFN	01.9 -	K16HPR-U11	-	IKH16	VKH16	4
		GH-N7RFN	RFN(EW10J4)	03.4 -	K16HPR-U11	-	IKH16	VKH16	4
		GH-N68RFN	RFN	04.6 -	K16HPR-U11	-	IKH16	VKH16	4
ZX	1600	E-N2BD	XU5M4Z	92.2 -	K20PR-U	K20TT	IK20	VK20	4
		E-N2LF	XU7JP	93.12-97	K20TXR	K20TT(*5)	IK20	VK20	4
	1800	E-N2LFW	XU7JP	95.2 -97	K20TXR	K20TT(*5)	IK20	VK20	4
		E-N22LFW	XU7JP	-97	K20TXR	K20TT(*5)	IK20	VK20	4
	1900	E-N2DK	XU9JAZ	92.2 -94	K20PR-U	K20TT	IK20	VK20	4
	2000	E-N2RF	XU10J	94.9 -95	K20TXR	K20TT(*5)	IK20	VK20	4
DAEWOO(大宇)GM									
MATIZ	800	GF-KLA4	F8CV	99.11-	W16EXR-U11	W16TT	IW16	VW16	3
		GF-KLA4M	-	00.9 -	W16EXR-U11	W16TT	IW16	VW16	3
DODGE CHRYSLER									
AVENGER	2700	ABA-JSD27	-	07 -	ITL20	-	ITL20	-	6
CALIBER	2000	ABA-PM20	-	07 -	KJ16CR-L11	K16TT	IK16	VK16	4
CHARGER	5700	-	-	07.12-	ITL16	-	ITL16	-	16
	6100	-	-	07 -	ITL20	-	ITL20	-	16
NITRO	3700	ABA-KA37	-	07 -	KJ20CR-L11	K20TT	IK20	VK20	6
MICHIGAN	2200	E-KD22	-	-	W16EPR-U	W16TT	IW16	VW16	4
RAM1500	5700	-	-	04.1 -08.9	ITL16	-	ITL16	-	16

(*5) : It can be used only for a plug with a terminal.

DENSO

AUSTRALIA CHINA INDIA INDONESIA KOREA MALAYSIA PHILIPPINES SAUDIARABIA SINGAPORE TAIWAN THAILAND VIETNAM JAPAN
 EUROPE MOTOR SMALL PART
 CYCLE ENGINE REFERENCE NUMBER



EUROPE & U.S.A. CAR

▶ Spark plug color codes: ■ for Iridium Tough and Iridium Plugs and Iridium TT, ■ for Iridium Power, ■ for Iridium Racing and Two Tops Plugs, ■ for Platinum Plugs and Platinum TT, and black for general spark plugs.

DENSO

CHINA AUSTRALIA

INDIA

INDONESIA

KOREA

PHILIPPINES MALAYSIA

SAUDI ARABIA

SINGAPORE

TAIWAN

THAILAND

VIETNAM

JAPAN

EUROPE & USA

MOTOR CYCLE

SMALL ENGINE

CROSS REFERENCE

PART NUMBER

MODEL	CC	VEHICLE CODE	ENGINE	FROM-TILL	DENSO		IRIDIUM POWER	IRIDIUM TOUGH	QTY
DONKervoort									
D8 SPORT	1800	-	-	98.4 -04.1	-	-	-	-	4
		E150/180/210	AUDI(T/C)	04.1 -	VK20Y	-	-	VK20Y	4
FERRARI									
348	3400	E-F348S	-	94.1 -	IX24	-	IX24	-	8
360	3600	GF/GH-F360	F131	99.6 -	IU24	-	IU24	-	8
		GF/GH-F360S	F131	00 -	IU24	-	IU24	-	8
430 SCUDERIA	4300	ABA-F430SC	-	08.5 -09	IU24	-	IU24	-	8
456GT	5500	E-F456	F116	94.1 -98	IXU27	-	IXU27	-	12
456M GT	5500	GF/GH-F456	F113	98 -	IXU27	-	IXU27	-	12
512TR	5000	E-F512TR	F113	92.3 -	IXU27	-	IXU27	-	12
550	5500	E-F550	F133A	96.11-	IXU27	-	IXU27	-	12
		GF-F550B	F113	01 -	IXU27	-	IXU27	-	12
599F1	6000	ABA-F599	F140C	06.10-	IU24	-	IU24	-	12
612SCAGLIETTI	5700	GH-F612	-	03 -	IXU27	-	IXU27	-	12
CHALLENGE STRADALE	3600	GH-F360SC	-	03 -	IU24	-	IU24	-	8
F355	3500	E-F355B	F129	94.6 -99	IU22	-	IU22	-	8
F355 SPIDER	3500	E-F355S	F129	-99	IU22	-	IU22	-	8
F430	4300	GH-F430/F430S	-	04.9 -	IU24	-	IU24	-	8
F50	4700	E-F50	F130B	96.1 -	IU22	-	IU22	-	12
F512M	4900	E-F512M	F113	95.3 -96	IXU27	-	IXU27	-	12
MARANELLO	5500	GF-F550	F116	97 -	IXU27	-	IXU27	-	12
		GF/GH-F575M	F113E	02.5 -	IXU27	-	IXU27	-	12
FIAT									
BARCHETTA	1800	E-183A1	183A1	96.2 -99.10	K20TNR	K20TT	IK20	VK20	4
		GF-183A1	183A1	99.11-01	K20TNR	K20TT	IK20	VK20	4
		GF-183A6	183A1	02 -	K20TNR	K20TT	IK20	VK20	4
		GH-18318	-	04.9 -	K20PR-U	K20TT	IK20	VK20	4
FIAT500/500C	880	ABA-31209	312A2(T/C)	11.3 -	-	-	-	-	2
		ABA-31209	312A2(T/C)	16.1 -	-	-	-	-	2
	1200	ABA-31212	169A4	08.3 -	XU22EPR-U	XU22TT	IXU22	VXU22	4
		1400	ABA-31214	169A3	08.5 -	XU22EPR-U	XU22TT	IXU22	VXU22
500X	1400	ABA-33414	55263624(T/C)	15.10-	-	-	IXU24	-	4
		ABA-33414	55263623(T/C)	15.10-	-	-	IXU24	-	4
BRAVISSIMO	1600	E-182AB1	-	98.1 -	K20TNR	K20TT	IK20	VK20	4
COUPE FIAT	2000	E-175A1	175A1.000	94.12-97.3	W20EPBR-S	-	IW20	VW20	4
		E-175A3	175A3.000(T/C)	97.4 -98.12	K20PBR-S10	-	IK20	VK20	5
		GF-175A3	175A3(T/C)	99.11-01	K20PBR-S10	-	IK20	VK20	5
GRAND PUNTO	1400	ABA-199142	350A1	06.10-	XU22EPR-U	XU22TT	IXU22	VXU22	4
		ABA-199141	199A6	06.6 -	XU22EPR-U	XU22TT	IXU22	VXU22	4
PANDA	880	ABA-13909	312A2(T/C)	14.11-	-	-	-	-	2
		E-F153A2	-	92.12-	K20PR-U	K20TT	IK20	VK20	4
	1100	E-F141B3	-	93.7 -	K20PR-U	K20TT	IK20	VK20	4
		E-141AKB	176B2	95.4 -99	K20PR-U	K20TT	IK20	VK20	4
		E-141AKA	176B2	95.4 -99	K20PR-U	K20TT	IK20	VK20	4
		GH-16912	188A4(~No2533527)	04.7 -	K16PR-U	K16TT	IK16	VK16	4
	1200	GH-16912	188A4(No2533528~)	04.7 -	XU22EPR-U	XU22TT	IXU22	VXU22	4
		GH-16912Q	188A4(No2533528~)	05.4 -07.4	XU22EPR-U	XU22TT	IXU22	VXU22	4
		ABA-16912	188A4	07.2 -	XU22EPR-U	XU22TT	IXU22	VXU22	4
		ABA-16912Q	188A4	07.4 -	XU22EPR-U	XU22TT	IXU22	VXU22	4
1400		ABA-16914(limited edition vehicle)	169A6	07.10-	-	-	-	-	4
PUNTO	1200	E-176AR2	176A7	96.12-	K20PR-U	K20TT	IK20	VK20	4
		E-176AR5	-	97.1 -98	K20PR-U	K20TT	IK20	VK20	4
	1240	GF-176AR2	-	99.11-99	K20PR-U	K20TT	IK20	VK20	4
		GF-176BV3	176B9	99.11-01	XU24EPR-U	-	IXU24	VXU24	4
		GF/GH-188A5	188A5	00.5 -	XU24EPR-U	-	IXU24	VXU24	4
	1700	GF-188A6	183A1	00.5 -02	K20TNR	K20TT	IK20	VK20	4
		GH-188A6	183A1	03 -	K16PR-U	K16TT	IK16	VK16	4
1800	GF-188A1	183A1.000	00.5 -01	K20TNR	K20TT	IK20	VK20	4	
MULTIPLA	1600	GH-186B6	-	03.4 -04.11	K16PR-U	K16TT	IK16	VK16	4
TEMPRA	2000	E-F60A6	159A6.046	92.5 -	W22EPR-U	-	IW22	VW22	4
TIPO	2000	E-F60A6	-	92.1 -95.10	W22EPR-U	-	IW22	VW22	4
		E-F60A8	-	92.12 -95.10	W22EPR-U	-	IW22	VW22	4
FORD EUROPE									
FIESTA	1600	GH-WFOFYJ	-	04.4 -	PT16VR13	-	ITV16	-	4
		GH-WF0N4J	-	05.5 -	VT20	-	IT20	VT20	4
	1000	ABA-WF0SFJ	SFJ(T/C)	14.2 -	-	-	-	-	3
FOCUS	1500	ABA-MPBM9D	M9D(T/C)	15.10-	-	-	-	-	4

DENSO	9	14	16	20	22	24	27	29	31	32	34	35	DENSO	9	14	16	20	22	24	27	31	32	DENSO	9	14	16	20	22	24	27	31	
NGK	2	4	5	6	7	8	9	9.5	10	10.5	11	11.5	CHAMPION	18	16,14	12,11	10,9	8,7	6,63,61	4,59	57	55	53	BOSCH	10	9	8	7,6	5	4	3	2

MODEL	CC	VEHICLE CODE	ENGINE	FROM-TILL	DENSO		IRIDIUM POWER	IRIDIUM TOUGH	QTY	
FORD EUROPE										
FOCUS	1600	GF/GH-WFOFYD	ZETEC SE	00.3 -	PT16VR13	-	ITV16	-	4	
		GH-WFOHWD	-	05.12-	ITV16	-	ITV16	-	4	
	2000	GF/GH-WFOEDD	ZETEC SE	00.10-	PT16VR13	-	ITV16	-	4	
		GH-WFOALD	-	03.1 -	ITV24	-	ITV24	-	4	
		GH/ABA-WFOAOD	-	06.2 -	VT20	-	IT20	VT20	4	
		ABA-MPBMGD	MGD	13.4 -	-	-	-	-	4	
	2500	GH-WFOHYD	-	06.6 -	-	-	-	-	5	
GALAXY GHIA	2800	GF-WFOGAA	-	99.3 -	K20TXR	K20TT(*5)	-	VK20	6	
GALAXY GLX	2300	GF-WFOGY5	-	99.3 -	VK20	-	IK20	VK20	4	
KA	1300	GF-WFOBJ4	-	99.1 -	T20EPR-U	-	IT20	VT20	4	
KUGA	1500	ABA-WF0M9M	M9M(T/C)	15.9 -	-	-	-	-	4	
	1600	ABA-WF0JTM	JTM(T/C)	13.9 -	-	-	-	-	4	
	2000	ABA-WF0TPM	TPM(T/C)	15.9 -	-	-	-	-	4	
	2500	ABA-WFOHYDP	HYD (T/C)	12.9 -	-	-	IKH20	VKH20	5	
MONDEO	1800	E-WFONRK	-	94.4 -98	PT16VR13	-	ITV16	-	4	
		E-WFOFRK	-	94.4 -98	PT16VR13	-	ITV16	-	4	
	2000	E-WFONNG	-	94.4 -99.2	PT16VR13	-	ITV16	-	4	
		E-WFOFNG	-	94.4 -99.2	PT16VR13	-	ITV16	-	4	
		GF-WFOFNG	-	99.3 -01.4	PT16VR13	-	ITV16	-	4	
		GF-WFONNG	-	99.3 -01.4	PT16VR13	-	ITV16	-	4	
		GH-WFOCJB	CJB	01.5 -	IT20	-	IT20	VT20	4	
		E-WFOFSE	-	94.12-98	PT16EPR-L13	-	IT16	VT16	6	
	2500	E-WFONRF	-	00.10-	IT20	-	IT20	VT20	6	
		GH-WFOLCB	-	02.4 -	PT16EPR-L13	-	IT16	VT16	6	
	3000	GH-WF0MEB	-	06.6 -	IT20	-	IT20	VT20	6	
	FORD U.S.A.									
	ECOSPORT	1500	ABA-MAJUEJ	UEJ	14.5 -	-	-	ITV20	-	4
ESCAPE	2000	TA-EPEWF	YF	01.6 -03.11	PT16VR13	-	ITV16	-	4	
		ABA-LFAL3	L3	06.6 -08.2	VT16	-	IT16	VT16	4	
	2300	ABA-LFAL3	L3	08.2 -	ITV20	-	ITV20	-	4	
		ABA-LFAL3F/LFAL3P	L3	08.2 -	ITV20	-	ITV20	-	4	
	3000	LA-EPFWF	AJ	00.5 -03.11	T16EPR-U15	-	IT16	VT16	6	
		LA-EPFWF	AJ	03.11-06.6	IT20	-	IT20	VT20	6	
		ABA-LFAAJ	AJ	06.6 -09.11	VT16	-	IT16	VT16	6	
EXPEDITION	5400	GF-1FMLU18	-	98.12-	PT16EPR-L13	-	IT16	VT16	8	
EXPLORER	2000	ABA-1FMHK9	9(T/C)	13.11-	-	-	-	-	4	
	2300	ABA-1FM5KH	H(T/C)	15.10-	-	-	-	-	4	
	3500	ABA-1FMHK8	8	11.5 -	ITV20	-	ITV20	-	6	
		ABA-1FM5K8	8	15.10-	-	-	ITV20	-	6	
	4000	E-FMUX4	-	93.4 -	T16EPR-U15	-	IT16	VT16	6	
		E-1FMXU34	-	94.11-97	T16EPR-U15	-	IT16	VT16	6	
		E-1FMXU24	-	94.11-	T16EPR-U15	-	IT16	VT16	6	
		E-1FMXU34	-	96.8 -97	PT16EPR-L13	-	IT16	VT16	6	
		E-1FMXSU34	-	96.8 -98	PT16EPR-L13	-	IT16	VT16	6	
		E-1FMXSU24	-	96.8 -97	PT16EPR-L13	-	IT16	VT16	6	
		GF-1FMXSU34	-	99 -01	PT16EPR-L13	-	IT16	VT16	6	
		GF/GH/ABA-1FMEU74	-	02 -	PT16EPR-L13	-	IT16	VT16	6	
		ABF-1FMKU51	-	07.6 -	IT20	-	IT20	VT20	6	
	4600	GF-1FMWU74	-	02 -	-	-	-	-	8	
		GH-1FMWU74	-	02 -05.11	-	-	-	-	8	
		ABA-1FMWU74	-	07.10-	-	-	-	-	8	
	F150	4600	-	-	99 -00	PT16EPR-L13	-	IT16	VT16	8
5400		-	-	99 -00	PT16EPR-L13	-	IT16	VT16	8	
MUSTANG	3800	E-1FA4P44	-	94.1 -94.6	T20EPR-U	-	IT20	VT20	6	
		E-1FA4P40	-	94.1 -94.6	T20EPR-U	-	IT20	VT20	6	
		E/GH-1FA4P44	RW	95 -	PT16EPR-L13	-	IT16	VT16	6	
		E-1FARW40	-	95.8 -98	IT20	-	IT20	VT20	6	
		E-1FARW44	-	96.8 -98	IT20	-	IT20	VT20	6	
		GF-1FARWP4	-	99.5 -	PT16EPR-L13	-	IT16	VT16	6	
		GF-1FARWP4	-	99.2 -	IT20	-	IT20	VT20	6	
	3900	GH-1FARWP4	-	01 -	PT16EPR-L13	-	IT16	VT16	6	
		GH-1FARW4	-	04.2 -	PT16EPR-L13	-	IT16	VT16	6	
		E-1FAV2P47	-	95.12-98	PT16EPR-L13	-	IT16	VT16	8	
	4600	GF-1FAV2P4	-	99 -99	PT16EPR-L13	-	IT16	VT16	8	
		E-1FAF145	-	95.8 -98	PT16EPR-L13	-	IT16	VT16	8	
		E-1FAF142	-	95.8 -98	PT16EPR-L13	-	IT16	VT16	8	
		GF-1FAV2P4	-	99.5 -99	PT16EPR-L13	-	IT16	VT16	8	

DENSO
 AUSTRALIA CHINA INDIA INDONESIA KOREA MALAYSIA PHILIPPINES SAUDIARABIA SINGAPORE TAIWAN THAILAND VIETNAM JAPAN
 EUROPE MOTOR SMALL CROSS PART
 CYCLE ENGINE REFERENCE NUMBER

(*5) : It can be used only for a plug with a terminal.



EUROPE & U.S.A. | CAR

▶ Spark plug color codes: ■ for Iridium Tough and Iridium Plugs and Iridium TT, ■ for Iridium Power, ■ for Iridium Racing and Two Tops Plugs, ■ for Platinum Plugs and Platinum TT, and black for general spark plugs.

DENSO

AUSTRALIA

CHINA

INDIA

INDONESIA

KOREA

MALAYSIA

PHILIPPINES

SAUDARABIA

SINGAPORE

TAIWAN

THAILAND

VIETNAM

JAPAN

EUROPE & U.S.A.

MOTOR CYCLE

SMALL ENGINE

CROSS REFERENCE

PART NUMBER

MODEL	CC	VEHICLE CODE	ENGINE	FROM-TILL	DENSO		IRIDIUM POWER	IRIDIUM TOUGH	QTY
FORD U.S.A.									
MUSTANG	4600	GF-1FAF1P4	-	99.6 -	PT16EPR-L13	-	IT16	VT16	8
		GF/GH-1FAF1P4	F1	99.7 -	PT16EPR-L13	-	IT16	VT16	8
	4900	E-1FATP45	-	94.1 -	T16PR-U15	-	ITF16	-	8
		E-1FATP42	-	94.1 -	T16PR-U15	-	ITF16	-	8
TAURUS	2900	E-FA5U2	-	92.11-94.9	T16EPR-U	-	IT16	VT16	6
		E-FA5U1	-	92.11-94.9	T16EPR-U	-	IT16	VT16	6
	3000	E-1FASP57	-	95.12-96.7	PT16EPR-L13	-	IT16	VT16	6
		E-1FASP52	-	95.12-97.8	PT16EPR-L13	-	IT16	VT16	6
		E-1FANP52	-	96.2 -	PT16EPR-L13	-	IT16	VT16	6
		E-1FASP57	-	96.8 -97	PT16EPR-L13	-	IT16	VT16	6
	3300	E-1FANP54	-	96 -99	PT16EPR-L13	-	IT16	VT16	6
		E-1FASP54	-	96.8 -	PT16EPR-L13	-	IT16	VT16	6
	3800	E-FA542	-	92.11-94.9	T20EPR-U	-	IT20	VT20	6
		E-FA541	-	92.11-94.9	T20EPR-U	-	IT20	VT20	6
THUNDERBIRD	4900	E-FA6T1	-	92.11-	T16PR-U	-	ITF16	-	8
HOME PARK									
ROADTREK 170	5200	-	-	-	KJ16CR-L11	K16TT	IK16	VK16	8
ROADTREK 190	5900	-	-	-	KJ16CR-L11	K16TT	IK16	VK16	8
HUMMER GM									
HUMMER H2	6000	-	LQ4	03.2 -08	VT16	-	IT16	VT16	8
HUMMER H3	3500	ABA-T345F	-	05.6 -06	ITV16	-	ITV16	-	5
	3700	ABA-T345F	-	07 -09	ITV16	-	ITV16	-	5
HYUNDAI(現代)									
COUPE	2700	GH/ABA-GK27	G6BA	02 -	VK16	-	IK16	VK16	6
ELANTRA	1800	GF/GH-XD18	G4GB	01.1 -	K16PR-U11	K16TT	IK16	VK16	4
		GH-ZD18	G4GB	03 -	K16PR-U11	K16TT	IK16	VK16	4
	2000	GF/GH-XD20	G4GC	01.1 -	K16PR-U11	K16TT	IK16	VK16	4
GRANDEUR	2700	ABA-TG27L	L6EA	06.11-	VK16	-	IK16	VK16	6
	3400	ABA-TG33	G6DB	06.1 -	VK16	-	IK16	VK16	6
SANTA FE	2400	GF/GH-SM24	G4JS	01.1 -	VW16	-	IW16	VW16	4
	2700	GF/GH-SM27	G6BA	01.1 -	VK16	-	IK16	VK16	6
SONATA	2400	GH-NF24	G4KC	05.9 -	VK16	-	IK16	VK16	4
i30	1600	ABA-FD16	-	08.7 -	IXUH22	-	IXUH22	VXUH22	4
	2000	ABA-FD20	-	08.7 -	K16PR-U11	K16TT	IK16	VK16	4
i30cw	1600	ABA-FDW16	-	09.5 -	IXUH22	-	IXUH22	VXUH22	4
	2000	ABA-FDW20	-	09.5 -	K16PR-U11	K16TT	IK16	VK16	4
JM	2000	GH/ABA-JM20	G4GC	04.9 -	K16PR-U11	K16TT	IK16	VK16	4
	2700	GH/ABA-JM27	G6BA	04.9 -	PK16PR-L11	-	IK16	VK16	6
TB	1300	LA-TB13	G4EA	02.10-	K16PR-U11	K16TT	IK16	VK16	4
	1400	DBA-TB14	G4EE	05.11-	K16PR-U11	K16TT	IK16	VK16	4
TRAJET	2000	GF/GH-F20	G4JP	01.1 -	W20EXR-U	-	IW20	VW20	4
	2700	GF/GH-F27	G6BA	01.1 -	VK16	-	IK16	VK16	6
XG	3000	GF/GH-XG30	G6CT	01.5 -	VK16	-	IK16	VK16	6
XG250	2500	GH-TXG25	G6CT	04.3 -	VK16	-	IK16	VK16	6
XG300	3000	GH-XB30	G6CT	03.3 -	VK16	-	IK16	VK16	6
		GH-TXG30	G6CT	04.3 -	VK16	-	IK16	VK16	6
JAGUAR									
DAIMLER	4200	CBA-D82TB	TB(S/C)	05.7 -	VK16	-	IK16	VK16	8
	6000	E-DMSA	8E	95 -96	T22EP-U	-	IT22	-	12
DAIMLER SUPER	4000	E-DMFB	DC	97 -00	VK20	-	IK20	VK20	8
		GF/GH-D25MB	MB	00.10-	VK16	-	IK16	VK16	8
DOUBLE SIX	6000	E-DLSA	-	94.10-95	T22EP-U	-	IT22	-	12
MAJESTIC	6000	E-DMS	-	94.2 -	T22EP-U	-	IT22	-	12
E PACE	2000	DBA-DF2XA	PT204(T/C)	18.2 -	-	-	-	VXEHC24G	4
F PACE	2000	DBA-DC2XB	PT204(T/C)	17.12-	-	-	-	-	4
	3000	CBA-DC3VA	306PS(S/C)	16.1 -	-	-	-	-	6
	2000	DBA-J60XB	PT204(T/C)	17.9 -	-	-	-	VXEHC24G	4
F TYPE	3000	CBA-J608A	306PS(S/C)	13.5 -	-	-	-	-	6
		CBA-J608A	306PS(S/C)	14.6 -	-	-	-	-	6
	5000	CBA-J60MA	508PS(S/C)	13.5 -	-	-	-	-	8
		CBA-J60MA	508PS(S/C)	18.6 -	-	-	-	-	8
S TYPE 3.0 Executive	3000	CBA-J01FD	FB	06.1 -	VT20	-	IT20	VT20	6
S TYPE R	4200	GH-J011C	1B(S/C)	02.7 -	IK16	-	IK16	VK16	8
S TYPE SOVEREIGN	4200	GH-J01HC	-	04.5 -	IK16	-	IK16	VK16	8
S TYPE V6	2500	GH-J01JC	JB	02.7 -	IT20	-	IT20	VT20	6
	3000	GF-J01FA	FC	99.5 -01	IT20	-	IT20	VT20	6
		GF-J01FB	FB	00.10-	IT20	-	IT20	VT20	6

DENSO	9	14	16	20	22	24	27	29	31	32	34	35	DENSO	9	14	16	20	22	24	27	29	31	32	DENSO	9	14	16	20	22	24	27	31
NGK	2	4	5	6	7	8	9	9.5	10	10.5	11	11.5	CHAMPION	18	16,14	12,11	10,9	8,7	6,63,61	4,59	57	55	53	BOSCH	10	9	8	7,6	5	4	3	2



MODEL	CC	VEHICLE CODE	ENGINE	FROM-TILL	DENSO	IRIIDIUM POWER	IRIDIUM TOUGH	QTY
JAGUAR								
S TYPE V6	3000	GH-J01FC	FB	02.7 -	IT20	-	IT20	6
S TYPE V8	4000	GF-J01GA	GC	99.5 -01	VK16	-	IK16	8
		GF-J01GB	-	00.10-	VK16	-	IK16	8
	4200	CBA-J01HD/J011D	HB	06 -	VK16	-	IK16	8
		GH-J01HC	HB	02.7 -06	VK16	-	IK16	8
SOVEREIGN	4000	E-JMDA	9J	97 -97	K20PR-U	K20TT	IK20	6
		E-JMDB	-	97.9 -	K20PR-U	K20TT	IK20	6
		GF-JMDC	LC	99.6 -	VK20	-	IK20	8
		GF/GH-J23LB	LB	00.10-	IK16	-	IK16	8
SOVEREIGN/XJ6/XJ12	6000	E-JLS	-	93.5 -	T22EP-U	-	IT22	12
SUPERV8	4200	GH-J73TA	TB	03.5 -	VK16	-	IK16	8
X TYPE	2000	ABA-J51YB	YB	05.6 -	VT20	-	IT20	6
	2100	GH-J51YA	YB	02.5 -	IT20	-	IT20	6
		GH-J51XA	XB	01.9 -	IT20	-	IT20	6
	2500	ABA-J51XB	XB	05.6 -	VT20	-	IT20	6
		GH-J51WA	WB	01.9 -	IT20	-	IT20	6
	3000	ABA-J51WB	WB	05.6 -	VT20	-	IT20	6
XE	2000	CBA-JA2GA	204PT(T/C)	16.7 -	-	-	-	4
		DBA-JA2XC	PT204(T/C)	18.10-	-	-	VXEHC24G	4
	3000	CBA-JA3VA	306PS(S/C)	16.7 -	-	-	-	6
XF	2000	CBA-JB2GA	204PT(T/C)	15.9 -	-	-	-	4
		DBA-JB2XC	PT204(T/C)	17.11-	-	-	-	4
		DBA-JBS2XC	PT204(T/C)	17.11-	-	-	-	4
		DBA-JB2XC	PT204(T/C)	18.10-	-	-	VXEHC24G	4
		DBA-JBS2XC	PT204(T/C)	18.10-	-	-	-	4
	3000	CBA-J05A	FB	07.11-	VT20	-	IT20	6
		CBA-J05FA	FB	07.11-	VT20	-	IT20	6
		CBA-JB3VA	306PS (S/C, Vehicle identification number: up to U04717)	15.9 -	-	-	-	-
	CBA-JB3VA	306PS (S/C, Vehicle identification number: starting from U04718)	15.9 -	-	-	-	-	6
4200	CBA-J05HA	HB	07.11-	VK16	-	IK16	8	
	CBA-J051A	1B(S/C)	07.11-	VK16	-	IK16	8	
5000	CBA-J05LB/J05MB	508PN(S/C)	09.4 -	VFXEH20	-	-	8	
XJ	2000	CBA-J12PB	204PT(T/C)	12.5 -	-	-	-	4
		CBA-J71VB	VB	06.1 -	VT20	-	IT20	6
	3000	CBA-J128B	306PN(S/C)	12.5 -	-	-	-	6
		CBA-J128B	306PS(S/C)	16.9 -	-	-	-	6
	3200	E-JLGB	AC	97 -99	IK20	-	IK20	8
		GF-JLGC	KC	99.6 -00	VK20	-	IK20	8
		GF-J13KB	KB, G	00 -	VK16	-	IK16	8
		GH-J13KB	KB	-	IK16	-	IK16	8
		E-JLDB	BC	98 -98	IK20	-	IK20	8
	4000	GF-JLDC	LC	99.6 -00	VK20	-	IK20	8
		GF-J13LB	LB, G	00 -	VK16	-	IK16	8
		GH-J13LB	LB	-	IK16	-	IK16	8
	4200	CBA-J72SB	SB	06.1 -	IK16	-	IK16	8
		GH-J80SA	-	04.7 -	VK16	-	IK16	8
	3200	GF-J13KB	-	01.7 -	IK16	-	IK16	8
	4000	GF-J23LB	-	00.10-	VK16	-	IK16	8
	4200	CBA-J73TB/J82TB	TB(S/C)	06.6 -	VK16	-	IK16	8
3200	GF-J13KB	-	01.7 -	IK16	-	IK16	8	
4200	GH-J80TA	-	04.7 -	VK16	-	IK16	8	
	CBA-J12LA	-	10.6 -	VFXEH20	-	-	8	
	CBA-J12MA	(S/C)	10.6 -	VFXEH20	-	-	8	
5000	CBA-J24MA	(S/C)	10.6 -	VFXEH20	-	-	8	
	CBA-J12MA	508PS(S/C)	12.5 -	-	-	-	8	
	CBA-J24MA	508PS(S/C)	12.5 -	-	-	-	8	
XJ6	3000	GH-J71VA	-	04.4 -	VT16	-	IT16	6
	3200	E-JLGA	-	94.10-97	K20PR-U	K20TT	IK20	6
	4000	E-JLDA	-	94.10-97	K20PR-U	K20TT	IK20	6
XJ8	3600	GH-J72RA	-	03.5 -	VK16	-	IK16	8
	4200	GH-J72SA	SB	03.5 -	VK16	-	IK16	8
XJ12	6000	E-JLSA	-	94.10-95	T22EP-U	-	IT22	12
XJR		E-JLFA	-	94.10-98	K22PR-U	-	IK22	6
	4000	E-JLFB	DC(S/C)	98 -99	VK20	-	IK20	8
		GF-J15MB	MB, G, SC(S/C)	00 -	VK20	-	IK20	8

DENSO

AUSTRALIA CHINA INDIA INDONESIA KOREA MALAYSIA PHILIPPINES SAUDI ARABIA SINGAPORE TAIWAN THAILAND VIETNAM JAPAN
 EUROPE MOTOR SMALL CROSS PART
 CYCLE ENGINE REFERENCE NUMBER



EUROPE & U.S.A. CAR

▶ Spark plug color codes: ■ for Iridium Tough and Iridium Plugs and Iridium TT, ■ for Iridium Power, ■ for Iridium Racing and Two Tops Plugs, ■ for Platinum Plugs and Platinum TT, and black for general spark plugs.

DENSO

CHINA AUSTRALIA

INDIA

INDONESIA

KOREA

MALAYSIA

PHILIPPINES

SAUDI ARABIA

SINGAPORE

TAIWAN

THAILAND

VIETNAM

JAPAN

EUROPE & U.S.A.

SMALL MOTOR ENGINE

CROSS REFERENCE

PART NUMBER

MODEL	CC	VEHICLE CODE	ENGINE	FROM-TILL	DENSO		IRIDIUM POWER	IRIDIUM TOUGH	QTY
JAGUAR									
XJR	4000	GH-J15MB	MB(S/C)	-	VK20	-	IK20	VK20	8
	4200	GH-J73TA	TB	03.5 -	VK16	-	IK16	VK16	8
		CBA-J73TB	TB(S/C)	06.6 -	VK16	-	IK16	VK16	8
XJR-S	6000	E-JES	-	92.5 -	T20EPR-U	-	IT20	VT20	12
XJS	4000	E-JDD	-	92.7 -	K20PR-U	K20TT	IK20	VK20	6
		E-JED2	-	94.5 -96	K20PR-U	K20TT	IK20	VK20	6
	6000	E-JES2	-	93.5 -95	T22EP-U	-	IT22	-	12
		E-JDS	-	93.5 -	T22EP-U	-	IT22	-	12
XK	4200	CBA-J435A	5B	06.7 -	IK16	-	IK16	VK16	8
	5000	CBA-J438B	508PN(S/C)	10.6 -	VFXEH20	-	-	VFXEH20	8
		CBA-J438B	508PN	14.1 -	-	-	-	-	8
XK8	4000	GF-JFDA	-	96.8 -99.1	VK20	-	IK20	VK20	8
		GF-JEDA	-	96.8 -99.1	VK20	-	IK20	VK20	8
		GF-JEDC	-	99.2 -00	VK20	-	IK20	VK20	8
		GF-J41NB	NB	00.10 -02.11	VK16	-	IK16	VK16	8
	4200	GH-J412A	2B	02.12 -	VK16	-	IK16	VK16	8
XKR	4000	GF-JEFB	EC	99.2 -99.10	VK20	-	IK20	VK20	8
		GF-J41PA	-	99.10 -00.10	VK16	-	IK16	VK16	8
		GF-J41PB	PB	00.10 -02.11	VK16	-	IK16	VK16	8
	4200	GH-J413A	3B	02.12 -	VK16	-	IK16	VK16	8
		CBA-J 439A	9B	07.4 -	VK16	-	IK16	VK16	8
	5000	CBA-J 43YB	508PS(S/C)	09.4 -	VK16	-	IK16	VK16	8
		CBA-J43YB	508PS(S/C)	14.1 -	-	-	-	-	8
LAMBORGHINI									
DIABLO	5700	E-DE21	-	99 -	IXU27	-	IXU27	-	12
		E-LD4	-	99 -00	IXU27	-	IXU27	-	12
		E-DE01	L522-12	00.10 -	IXU27	-	IXU27	-	12
	6000		L522-61T	99.10 -00.9	IXU27	-	IXU27	-	12
		GF-DE01A	L522-6	00.3 -	IXU27	-	IXU27	-	12
GALLARDO	5000		-	04 -	IK27	-	IK27	-	10
MURCIELAGO	6200	GH-BC10E	L535	01.10 -	IXU27	-	IXU27	-	12
LANCIA									
DEDRA	2000	E-A835A8	-	92.3 -96	W20EPBR-S	-	IW20	VW20	4
DELTA	2000	E-L31E5	-	92.3 -96	W20EPBR-S	-	IW20	VW20	4
LYBRA	2000		-	00 -	K20TNR	K20TT	IK20	VK20	5
THEMA	2000	E-A834F2	-	93.9 -96	W20EPBR-S	-	IW20	VW20	4
	3000	E-L34F	-	94.6 -97	W20EPR-U	-	IW20	VW20	6
LAND ROVER									
DISCOVERY	2000	CBA-LC2A	204PT(T/C)	16.8 -	-	-	-	-	4
		DBA-LC2XB	PT204(T/C)	17.11 -	-	-	-	VXEHC24G	4
		3000	ABA-LR3VA	306PS(S/C)	17.5 -	-	-	-	-
	ABA-LR3VA		306PS(S/C)	18.11 -	-	-	-	-	6
	3900	GF-LT56	56D	00.11 -03.1	VK16	-	IK16	VK16	8
		GF-LT56A	-	00.11 -03.1	VK16	-	IK16	VK16	8
	4000	ABA-LA40A	406PN	05.5 -	-	-	-	-	6
		GH-LT94A	94D	03 -05.5	VK16	-	IK16	VK16	8
	4400	ABA-LA44	408PN	05.5 -	VK16	-	IK16	VK16	8
	5000	ABA-LA5N	508PN	09.6 -	VFXEH20	-	-	VFXEH20	8
		ABA-LA5N	508PN	11.12 -	-	-	-	-	8
	FREELANDER	2500	GF/GH-LN25	25K	01.2 -07.6	VK20	-	IK20	VK20
	3200	CBA-LF32	B6324S	07.6 -	VKH20Y	-	-	-	6
RANGE ROVER									
	2000	CBA-LV2A	204PT(T/C)	12.3 -	-	-	-	-	4
		DBA-LY2XCB	PT204(T/C)	17.7 -	-	-	-	VXEHC24G	4
		DBA-LY2XAB	PT204(T/C)	17.7 -	-	-	-	VXEHC24G	4
		DBA-LV2XB	PT204(T/C)	17.11 -	-	-	-	VXEHC24G	4
	3000	ABA-LW3SA	306PS(S/C)	15.10 -	-	-	-	-	6
		ABA-LG3SB	306PS(S/C)	16.12 -	-	-	-	-	6
		ABA-LGL3SC	306PS(S/C)	16.12 -	-	-	-	-	6
		CBA-LY3VA	306PS(S/C)	17.7 -	-	-	-	-	6
		4000	GF-LP58D	58D	99.5 -02.4	VK16	-	IK16	VK16
	4200	ABA-LM42S	428PS(S/C)	05.7 -	VK16	-	IK16	VK16	8
		ABA-LS42S	428PS(S/C)	06.1 -	VK16	-	IK16	VK16	8
		ABA-LM44	448PN	05.7 -08.3	VK16	-	IK16	VK16	8
		4400	ABA-LS44	448PN	06.1 -	VK16	-	IK16	VK16
	GH-LM44	-	02.4 -	VK20	-	IK20	VK20	8	
4600	GF-LP60D	60D	99.5 -02.4	VK16	-	IK16	VK16	8	
5000	ABA-LS5N · LM5N	508PN	09.6 -	VFXEH20	-	-	VFXEH20	8	

DENSO	9	14	16	20	22	24	27	29	31	32	34	35
NGK	2	4	5	6	7	8	9	9.5	10	10.5	11	11.5

DENSO	9	14	16	20	22	24	27	29	31	32
CHAMPION	18	16,14	12,11	10,9	8,7	6,63,61	4,59	57	55	53

DENSO	9	14	16	20	22	24	27	31
BOSCH	10	9	8	7,6	5	4	3	2



MODEL	CC	VEHICLE CODE	ENGINE	FROM-TILL	DENSO		IRIDIUM POWER	IRIDIUM TOUGH	QTY	
LAND ROVER										
RANGE ROVER		ABA-LS5N	508PN	11.12-	-	-	-	-	8	
		ABA-LM5N	508PN	11.12-	-	-	-	-	8	
	5000	ABA-LS5S · LM5S	508PS(S/C)	09.6 -	VFXEH20	-	-	VFXEH20	8	
		ABA-LM5S	508PS(S/C)	11.12-	-	-	-	-	8	
		ABA-LS5S	508PS(S/C)	11.12-	-	-	-	-	8	
		ABA-LW5SA	508PS(S/C)	15.10-	-	-	-	-	8	
		ABA-LGL5SC	508PS(S/C)	16.12-	-	-	-	-	8	
LINCOLN U.S.A.										
CONTINENTAL	3800	E-LN941	-	92.11-	T20EPR-U	-	IT20	VT20	6	
		E-1LNV97	-	95.8 -97	PT16EPR-L13	-	IT16	VT16	8	
	4600	E-1LNVH97	-	97.9 -99.1	PT16EPR-L13	-	IT16	VT16	8	
		GF-1LNVH97	-	99.2 -01	PT16EPR-L13	-	IT16	VT16	8	
LS V6	3000	GF-1LNAM86	-	99.10-	IT16	-	IT16	VT16	6	
LS V8	3900	GF-1LNAM87	-	99.10-	IK16	-	IK16	VK16	8	
MARK 8	4600	E-L90V	-	93.2 -98	T20EPR-U15	-	IT20	VT20	8	
TOWN CAR	4600	E-1LNWM82	-	98 -01	PT16EPR-L13	-	IT16	VT16	8	
		GF-1LNWM82	-	01 -	PT16EPR-L13	-	IT16	VT16	8	
		GF/GH-M85W	-	02.3 -	PT16EPR-L13	-	IT16	VT16	8	
		GH-M82W	-	-	PT16EPR-L13	-	IT16	VT16	8	
NAVIGATOR	5400		-	08.5 -	PT16EPR-L13	-	IT16	VT16	8	
LOTUS										
ELISE	1800	GF-111	18K	-01	VK20	-	IK20	VK20	4	
ELISE 111R	1800	GH-1117	2ZZ-GE	04.2 -	SK20R11	-	IK20	VK20	4	
ESPRIT	2200	E-82L	-	93.10-	W20ETR-L	-	IW20	VW20	4	
ESPRIT V8-SE	3500	GF-82	-	99 -	K20TNR	K20TT	IK20	VK20	8	
EXIGE	1800	GF-111	18K	00 -	K22PR-U	-	IK22	VK22	4	
		GH-1117	2ZZ-GE	04.6 -	SK20R11	-	IK20	VK20	4	
NEW ELISE	1800		18K	01 -	VK20	-	IK20	VK20	4	
SPORT ELISE	1800		18K	99 -	Q22PR-U	-	IQ22	VQ22	4	
TYPE 99T	1800		18K	03 -	VK20	-	IK20	VK20	4	
MASERATI										
3200GT/GTA	3200	GF-338	AM585	99 -	IU24	-	IU24	-	8	
COUPE	4200	GF-MCP	M138	02.3 -	IU24	-	IU24	-	8	
GHIBLI	2800	E-MG	AM574	92 -95	XU24EPR-U	-	IXU24	VXU24	6	
QUATTROPORTE	2800	E-MQ	AM574	95 -98	XU24EPR-U	-	IXU24	VXU24	6	
		E/GF-QP6	AM574	95.3 -	XU27EPR-U	-	IXU27	-	6	
		GF-QP6	AM574	98 -	XU24EPR-U	-	IXU24	VXU24	6	
	3200	E-MQ8	AM578	95 -98	XU24EPR-U	-	IXU24	VXU24	8	
	4200		-	95.3 -	-	-	-	-	8	
SHAMAL	3200	E-SM	-	93.3 -96	XU27EPR-U	-	IXU27	-	8	
SPIDER	4200	GF-SPY	M138	01 -	IU24	-	IU24	-	8	
SPIDER ZAGATO	2800	E-MS	-	01.5 -	W24EP-U	-	IW24	-	6	
MERCEDES BENZ										
220E	2200	E-124022	M111.960	92.11-93.6	Q16P-U11	-	IQ16	VQ16	4	
220TE	2200	E-124082	M111.960	92.11-93.6	Q16P-U11	-	IQ16	VQ16	4	
280E	2800	E-124028	M104.942	92.11-93.6	Q16P-U11	-	IQ16	VQ16	6	
320CE	3200	E-124052	M104.992	92.11-93.6	K16PR-U	K16TT	IK16	VK16	6	
		E-124066	M104.992	92.11-93.6	K16PR-U	K16TT	IK16	VK16	6	
320E	3200	E-124032	M104.992	92.11-93.6	K16PR-U	K16TT	IK16	VK16	6	
320TE	3200	E-124092	M104.992	92.11-	K16PR-U	K16TT	IK16	VK16	6	
400E	4200	E-124034	M119.975	92.1 -93.6	K16PR-U	K16TT	IK16	VK16	8	
400SEL	4200	E-140043	M119.971	92.9 -93.7	K16PR-U	K16TT	IK16	VK16	8	
500GE	5000	E-4632281	M117.965	93.8 -	W20EPR-U	-	IW20	VW20	8	
500SL	5000	E-129067	M119.972	93.6 -	K16PR-U	K16TT	IK16	VK16	8	
600SE	6000	E-140056	M120.080	93.2 -93.5	K16PR-U	K16TT	IK16	VK16	12	
600SEC	6000	E-140076	M120.980	93.2 -93.5	K16PR-U	K16TT	IK16	VK16	12	
600SL	6000	E-129076	M120.981	92.11-93.6	K16PR-U	K16TT	IK16	VK16	12	
A160	1600	GF/GH-168033	166	98.9 -	K20PBR-S10	-	IK20	VK20	4	
		GF/GH-168133	166	01.9 -	K20PBR-S10	-	IK20	VK20	4	
		DBA-169032	266	05.2 -09.8	K20PR-U	K20TT	IK20	VK20	4	
A170	1300	5BA-177084	282(T/C)	18.10-	-	-	-	-	4	
		1600	DBA-176042	270(T/C)	15.11-	-	-	-	-	4
		DBA-176042	270(T/C)	17.7 -	-	-	-	-	-	4
A180	1700	DBA-169032	266	09.8 -	K20PR-U	K20TT	IK20	VK20	4	
		1900	GF/GH-168032	1669	99.10-	K20PBR-S10	-	IK20	VK20	4
A190	1900	GF/GH-168032	1669	99.10-	K20PBR-S10	-	IK20	VK20	4	
A200	2000	DBA-169033	266M20	05.2 -	K20PR-U	K20TT	IK20	VK20	4	

DENSO
 AUSTRALIA CHINA INDIA INDONESIA KOREA MALAYSIA PHILIPPINES SAUDIARABIA SINGAPORE TAIWAN THAILAND VIETNAM JAPAN
 EUROPE MOTOR SMALL CROSS PART
 CYCLE ENGINE REFERENCE NUMBER



EUROPE & U.S.A. CAR

▶ Spark plug color codes: ■ for Iridium Tough and Iridium Plugs and Iridium TT, ■ for Iridium Power, ■ for Iridium Racing and Two Tops Plugs, ■ for Platinum Plugs and Platinum TT, and black for general spark plugs.

DENSO	MODEL	CC	VEHICLE CODE	ENGINE	FROM-TILL	DENSO	TJ	IRIDIUM POWER	IRIDIUM TOUGH	QTY	REGION		
											CHINA	AUSTRALIA	
MERCEDES BENZ													
	A200	2000	CBA-169034	266M20(T/C)	05.11-	VK20	-	IK20	VK20	4			
	A210EVOLUTION	2100	GH-168135	-	02.5 -	VK20	-	IK20	VK20	4			
	A210L	2100	GH-203742	-	03.5 -	VK20	-	IK20	VK20	4			
	A250	2000	DBA-176046	270M20(T/C)	14.4 -	-	-	-	-	4			
			DBA-176051	270M20(T/C)	15.11-	-	-	-	-	-	4		
	B170	1700	CBA-245232	266	06.1 -09.8	K20PR-U	K20TT	IK20	VK20	4			
	B180	1600	DBA-246242	270(T/C)	15.2 -	-	-	-	-	4			
			DBA-246242	270(T/C)	17.7 -	-	-	-	-	-	4		
		1700	CBA-245232	266	09.8 -	K20PR-U	K20TT	IK20	VK20	4			
	B200	2000	CBA-245233	266M20	06.1 -	K20PR-U	K20TT	IK20	VK20	4			
			CBA-245234	266M20(T/C)	06.1 -	VK20	-	IK20	VK20	4			
	B250	2000	DBA-246246	270M20(T/C)	15.2 -	-	-	-	-	4			
	C180	1600	DBA-205040C	274M16(T/C)	14.7 -	-	-	-	-	4			
			DBA-205240C	274M16(T/C)	14.10-	-	-	-	-	-	4		
			DBA-205340C	274M16(T/C)	16.3 -	-	-	-	-	-	4		
			DBA-205440C	274M16(T/C)	16.9 -	-	-	-	-	-	4		
			DBA-205040C	274M16(T/C)	17.2 -	-	-	-	-	-	4		
			DBA-205040C	274M16(T/C)	17.7 -	-	-	-	-	-	4		
			DBA-205240C	274M16(T/C)	17.7 -	-	-	-	-	-	4		
			DBA-205340C	274M16(T/C)	17.7 -	-	-	-	-	-	4		
			DBA-205440C	274M16(T/C)	17.7 -	-	-	-	-	-	4		
			DBA-205440	274M16(T/C)	18.7 -	-	-	-	-	-	4		
			DBA-205340	274M16(T/C)	18.7 -	-	-	-	-	-	4		
			DBA-204349	271	11.10-	VXUH22	-	IXUH22	VXUH22	4			
			DBA-204049	271	11.10-	VXUH22	-	IXUH22	VXUH22	4			
			DBA-204249	271	11.10-	VXUH22	-	IXUH22	VXUH22	4			
	DBA-204349	271(T/C)	14.6 -	VXUH22	-	IXUH22	VXUH22	4					
	C180 KOMPRESSOR	1800	GH-203046/203246	M271.940(S/C)(*3)	02.9 -	VKH20	-	IKH20	VKH20	4			
			GH-203746	271(S/C)(*3)	03.9 -	VKH20	-	IKH20	VKH20	4			
			DBA-203046/203246/203746	271(S/C)(*3)	05.8 -	VKH20	-	IKH20	VKH20	4			
			DBA-203746	271(S/C)(*3)	05.8 -	VKH20	-	IKH20	VKH20	4			
	C200	1500	5AA-205077C	264(T/C)	18.7 -	-	-	-	-	4			
			5AA-205077	264(T/C)	18.7 -	-	-	-	-	-	4		
			5AA-205277C	264(T/C)	18.7 -	-	-	-	-	-	4		
			5AA-205277	264(T/C)	18.7 -	-	-	-	-	-	4		
			5AA-205078C	264(T/C)	18.7 -	-	-	-	-	-	4		
			5AA-205078	264(T/C)	18.7 -	-	-	-	-	-	4		
			5AA-205278C	264(T/C)	18.7 -	-	-	-	-	-	4		
			5AA-205278	264(T/C)	18.7 -	-	-	-	-	-	4		
			DBA-204048/204248	271(T/C)	10.2 -	VXUH22	-	IXUH22	VXUH22	4			
			E-202020	M111.941.945	94.3 -98	K16PR-U	K16TT	IK16	VK16	4			
			GF-202080	-	98 -00	K20PBR-S10	-	IK20	VK20	4			
			GF-202020	-	99 -00	K20PBR-S10	-	IK20	VK20	4			
			RBA-205042C	274(T/C)	14.7 -	-	-	-	-	-	4		
			RBA-205042	274(T/C)	14.7 -	-	-	-	-	-	4		
	RBA-205242C	274(T/C)	14.10-	-	-	-	-	-	4				
	RBA-205242	274(T/C)	14.10-	-	-	-	-	-	4				
	C200 KOMPRESSOR	1800	RBA-205042C	274(T/C)	17.2 -	-	-	-	-	4			
			RBA-205042	274(T/C)	17.2 -	-	-	-	-	-	4		
			DBA-205043C	274(T/C)	17.2 -	-	-	-	-	-	4		
			DBA-205043	274(T/C)	17.2 -	-	-	-	-	-	4		
			RBA-205242C	274(T/C)	17.2 -	-	-	-	-	-	4		
			RBA-205242	274(T/C)	17.2 -	-	-	-	-	-	4		
			DBA-205243C	274(T/C)	17.2 -	-	-	-	-	-	4		
			DBA-205243	274(T/C)	17.2 -	-	-	-	-	-	4		
	C200 KOMPRESSOR	2000	GH-203242	M271.940(S/C)(*3)	02.9 -	VKH20	-	IKH20	VKH20	4			
			GH-203042	M271.940(S/C)(*3)	02.9 -05.8	VKH20	-	IKH20	VKH20	4			
			GH-203742	271(S/C)(*3)	03.9 -	VKH20	-	IKH20	VKH20	4			
			DBA-203042/203242/203742	271(S/C)(*3)	05.8 -	VKH20	-	IKH20	VKH20	4			
			DBA-204041/204241	271(S/C)(*4)	07.5 -	VXUH22	-	IXUH22	VXUH22	4			
			GF-203045	M111(S/C)	00 -	VK20	-	IK20	VK20	4			
	C220	2200	GF/GH-203745	11195(S/C)	00 -	VK20	-	IK20	VK20	4			
			GF-202087	111M20, G, SC(S/C)	00.9 -01	VK20	-	IK20	VK20	4			
			GF-203245	(S/C)	01 -	VK20	-	IK20	VK20	4			
	C220	2200	E-202022	M111.961	93.9 -96	K16PR-U	K16TT	IK16	VK16	4			

(*3) : Up to ENG No. 30853899

(*4) : ENG No. 30853900 and up

MODEL	CC	VEHICLE CODE	ENGINE	FROM-TILL	DENSO		IRIDIUM POWER	IRIDIUM TOUGH	QTY	
MERCEDES BENZ										
C230	2300	E-202083	M117.974	96.8 -97	K16PR-U	K16TT	IK16	VK16	4	
		E-202023	M117.974	96.9 -97	K16PR-U	K16TT	IK16	VK16	4	
C230 KOMPRESSOR	1800	GH-203040/203240	271(S/C)(*3)	04.6 -	VKH20	-	IKH20	VKH20	4	
C230	2500	DBA-203052/203252	272M25	05.8 -	VXUH22	-	IXUH22	VXUH22	6	
C240	2400	E/GF-202026	112	97.7 -00	VK16	-	IK16	VK16	12	
		E/GF-202086	112	97.7 -99	VK16	-	IK16	VK16	12	
		GF-202088	M112	00.7 -01.6	VK16	-	IK16	VK16	12	
	2600	GF-203061	112M26	00.7 -02.10	VK16	-	IK16	VK16	12	
		GF-203261	-	01 -	VK16	-	IK16	VK16	12	
		GH-203061/203261	112M26	02.9 -	VK16	-	IK16	VK16	12	
		GH-203081/203281	112M26	02.9 -	VK16	-	IK16	VK16	12	
C250	1800	DBA-204047/204247	271(T/C)	10.2 -	VXUH22	-	IXUH22	VXUH22	4	
		DBA-204347	271	11.10-	VXUH22	-	IXUH22	VXUH22	4	
	2000	RBA-205045	274(T/C)	14.7 -	-	-	-	-	4	
		RBA-205245	274(T/C)	14.10-	-	-	-	-	4	
		RBA-205245	274(T/C)	17.2 -	-	-	-	-	4	
		RBA-205045	274(T/C)	17.2 -	-	-	-	-	4	
	2500	DBA-204052/204252	272M25	06.11-	VXUH22	-	IXUH22	VXUH22	12	
	C280	2800	E-202028	M104.941	93.9 -98	K16PR-U	K16TT	IK16	VK16	6
E/GF-202029			-	97.7 -00	VK16	-	IK16	VK16	12	
3000		DBA-203054/203254	272M30	05.8 -	VXUH22	-	IXUH22	VXUH22	6	
C300	2000	DBA-205348	274(T/C)	16.8 -	-	-	-	-	4	
		DBA-204054/204254	272M30	07.6 -	VXUH22	-	IXUH22	VXUH22	6	
C320	3200	DBA-205448	274(T/C)	16.9 -	-	-	-	-	4	
		GF-203064	M112	00.7 -	VK16	-	IK16	VK16	12	
		GF-203264	M112	01 -	VK16	-	IK16	VK16	12	
		GH-203264	112	02.9 -	VK16	-	IK16	VK16	12	
C350	2000	GH-203064	112	02.9 -	VK16	-	IK16	VK16	12	
		DLA-205047	274(T/C)	16.1 -	-	-	-	-	4	
	3500	DLA-205247	274(T/C)	16.1 -	-	-	-	-	4	
		RBA-204057	276	11.10-	-	-	-	-	6	
CL500	5000	RBA-204257	276	11.10-	-	-	-	-	6	
		GF-215375	-	99 -	VK16	-	-	VK16	16	
CL550	4700	GH-215375	113	02.11-	VK16	-	IK16	VK16	16	
		CBA-216373	278(T/C)	12.2 -	-	-	-	-	8	
CL600	5500	DBA-216371	273	06.11-	VXUH22	-	IXUH22	VXUH22	16	
		5800	GF/GH-215378	113	99.10 -02.10	VK20	-	IK20	VK20	24
		6000	E-140076	120	95.10-99.9	K20PR-U	K20TT	IK20	VK20	12
CLA180	1600	GH-215376	275(T/C)	02.11-	VK20Y	-	-	VK20Y	24	
		ABA-216376	275(T/C)	06.11-	VK20Y	-	-	VK20Y	24	
		DBA-117342	270(T/C)	13.7 -	-	-	-	-	4	
		DBA-117942	270(T/C)	15.6 -	-	-	-	-	4	
CLA220	2000	DBA-117342	270(T/C)	17.7 -	-	-	-	-	4	
		DBA-117942	270(T/C)	17.7 -	-	-	-	-	4	
		DBA-117347	270M20(T/C)	17.7 -	-	-	-	-	4	
		DBA-117947	270M20(T/C)	17.7 -	-	-	-	-	4	
CLA250	2000	DBA-117344	270M20(T/C)	13.7 -	-	-	-	-	4	
		DBA-117944	270M20(T/C)	15.6 -	-	-	-	-	4	
		DBA-117946	270M20(T/C)	15.6 -	-	-	-	-	4	
		DBA-117951	270M20(T/C)	15.11-	-	-	-	-	4	
		DBA-117351	270M20(T/C)	16.8 -	-	-	-	-	4	
CLK200	2000	E/GF-208335	-	97.9 -00	K20TXR	K20TT(*5)	IK20	VK20	4	
		GF-208344	M111	00 -02	VK20	-	IK20	VK20	4	
CLK200 KOMPRESSOR	1800	GH/DBA-209342	271(S/C)(*3)	03.5 -06.5	VKH20	-	IKH20	VKH20	4	
		DBA-209341	271(S/C)(*4)	06.5 -	VXUH22	-	IXUH22	VXUH22	4	
CLK240	2600	GH-209361	112	02.4 -	VK16	-	IK16	VK16	12	
CLK320	3200	E/GF-208365	112	97.9 -	VK16	-	IK16	VK16	12	
		GF/GH-208465	112	00.8 -02	VK16	-	IK16	VK16	12	
		GH-209365	112	02.4 -	VK16	-	IK16	VK16	12	
		GH-209465	112	03.5 -	VK16	-	IK16	VK16	12	
		GH-170415	112 947	-	VK16	-	IK16	VK16	12	
CLK430	4300	-	M113	98.6 -	VK16	-	IK16	VK16	16	
CLS350	3500	DBA-219356/C	272	05.2 -	VXUH22	-	IXUH22	VXUH22	6	
		RBA-218359C	276	12.8 -	-	-	-	-	6	
		RBA-218359	276	12.8 -	-	-	-	-	6	
		RBA-218959C	276	14.1 -	-	-	-	-	6	

(*3) : Up to ENG No. 30853899

(*4) : ENG No. 30853900 and up

(*5) : It can be used only for a plug with a terminal.

DENSO

AUSTRALIA CHINA INDIA INDONESIA KOREA MALAYSIA PHILIPPINES SAUDI ARABIA SINGAPORE TAIWAN THAILAND VIETNAM JAPAN EUROPE MOTOR SMALL CROSS PART & USA CYCLE ENGINE REFERENCE NUMBER



EUROPE & U.S.A. CAR

▶ Spark plug color codes: ■ for Iridium Tough and Iridium Plugs and Iridium TT, ■ for Iridium Power, ■ for Iridium Racing and Two Tops Plugs, ■ for Platinum Plugs and Platinum TT, and black for general spark plugs.

DENSO

AUSTRALIA

CHINA

INDIA

INDONESIA

KOREA

MALAYSIA

PHILIPPINES

SAUDI ARABIA

SINGAPORE

TAIWAN

THAILAND

VIETNAM

JAPAN

EUROPE & USA

SMALL MOTOR ENGINE CYCLE

CROSS REFERENCE PART NUMBER

MODEL	CC	VEHICLE CODE	ENGINE	FROM-TILL	DENSO				QTY		
MERCEDES BENZ											
CLS350	3500	RBA-218959	276	14.1 -	-	-	-	-	6		
CLK350	3500	DBA-209356/209456	272	05.9 -	VXUH22	-	IXUH22	VXUH22	6		
CLS400	3500	MBA-218361	276(T/C)	15.2 -	-	-	-	-	6		
		MBA-218961	276(T/C)	15.2 -	-	-	-	-	6		
CLS450	3000	DAA-257359	256(T/C)	18.6 -	-	-	-	-	6		
CLS500	5000	CBA-219375	-	05.2 -	VK16	-	IK16	VK16	16		
CLS550	4700	CBA-218373	278(T/C)	11.10-	-	-	-	-	8		
		DBA-218373	278(T/C)	14.10-	-	-	-	-	8		
		DBA-218991	278(T/C)	14.10-	-	-	-	-	-	8	
		CBA-219372	273	06.9 -	VXUH22	-	IXUH22	VXUH22	16		
E200	2000	RBA-213042C	274(T/C)	16.7 -	-	-	-	-	4		
		RBA-213242C	274(T/C)	16.11-	-	-	-	-	4		
		DBA-213043C	274(T/C)	16.10-	-	-	-	-	4		
		DBA-213243C	274(T/C)	16.11-	-	-	-	-	4		
		RBA-238342C	274(T/C)	17.5 -	-	-	-	-	4		
		RBA-238442C	M274(T/C)	18.1 -	-	-	-	-	4		
		RBA-213042C	274(T/C)	18.8 -	-	-	-	-	4		
		RBA-238442C	274(T/C)	18.8 -	-	-	-	-	4		
		RBA-238342C	274(T/C)	18.8 -	-	-	-	-	4		
		RBA-213242C	274(T/C)	18.8 -	-	-	-	-	4		
		DBA-213043C	274(T/C)	18.8 -	-	-	-	-	4		
		DBA-213243C	274(T/C)	18.8 -	-	-	-	-	4		
		E220	2200	E-124022	112	93.6 -95.6	Q20PR-U	-	IQ20	VQ20	4
		E230	2300	E-210037	M111.970	95.9 -97	K16PR-U	K16TT	IK16	VK16	4
E240	2400	E/GF-210061	112	97.9 -00	VK16	-	IK16	VK16	12		
		E/GF-210261	112	97.9 -00	VK16	-	IK16	VK16	12		
		GF/GH-210262	112941	00.7 -	VK16	-	IK16	VK16	12		
	2600	GF-210262	112M26	00.7 -03.8	VK16	-	IK16	VK16	12		
		GH-211061	112	02.6 -	VK16	-	IK16	VK16	12		
		GH-211261	112M26	03.8 -	VK16	-	IK16	VK16	12		
E250	1800	DBA-207347/212047C/212247C	271(T/C)	09.10-	VXUH22	-	IXUH22	VXUH22	4		
		RBA-207336	274(T/C)	13.8 -	-	-	-	-	4		
		RBA-207436	274(T/C)	13.8 -	-	-	-	-	4		
		RBA-212036C	274(T/C)	14.10-	-	-	-	-	4		
		RBA-212236C	274(T/C)	14.10-	-	-	-	-	4		
		2000	RBA-207336	274(T/C)	15.5 -	-	-	-	-	4	
			RBA-207436	274(T/C)	15.5 -	-	-	-	-	4	
			RBA-213245C	274(T/C)	16.11-	-	-	-	-	4	
			RBA-213045C	274(T/C)	16.10-	-	-	-	-	4	
			RBA-213045C	274(T/C)	18.8 -	-	-	-	-	4	
		RBA-213245C	274(T/C)	18.8 -	-	-	-	-	4		
E280	3000	DBA-211052C/211252C	272M25	07.8 -	VXUH22	-	IXUH22	VXUH22	6		
		DBA-211054C/211254C	272M30	05.8 -	VXUH22	-	IXUH22	VXUH22	6		
		E-124088/124028	M104.942	93.10-96	K16PR-U	K16TT	IK16	VK16	6		
		DBA-211054C/211254C	272M30	05.8 -	VXUH22	-	IXUH22	VXUH22	6		
E300	2000	DBA-238348C	274(T/C)	17.5 -	-	-	-	-	4		
		DBA-238348C	274(T/C)	18.8 -	-	-	-	-	4		
	3000	DBA-212054C/212254C	272M30	09.5 -	VXUH22	-	IXUH22	VXUH22	6		
		RBA-212055C	276	11.11-	-	-	-	-	6		
		RBA-212080C	276	11.11-	-	-	-	-	6		
	3500	RBA-212255C	276	11.11-	VXUH22	-	IXUH22	VXUH22	6		
		RBA-212280C	276	11.11-	-	-	-	-	6		
		RBA-212255C	276	14.4 -	-	-	-	-	6		
E320		3200	E-210055	M104.995	95.9 -98	K16PR-U	K16TT	IK16	VK16	6	
			E/GF-210082	112	97.7 -	VK16	-	IK16	VK16	12	
	E/GF-210065		112	97.7 -	VK16	-	IK16	VK16	12		
	E/GF-210282		112	97.7 -	VK16	-	IK16	VK16	12		
	E/GF/GH-210265		112941	97.7 -	VK16	-	IK16	VK16	12		
	GH-211065		112	02.6 -	VK16	-	IK16	VK16	12		
	GH-211282		112	03.11-	VK16	-	IK16	VK16	12		
	GH-211265C		112	03.8 -	VK16	-	IK16	VK16	12		
E350	2000	DLA-213050C	274(T/C)	17.8 -	-	-	-	-	4		
		DLA-213050C	274(T/C)	18.8 -	-	-	-	-	4		
	3500	DBA-211056C/211256C	272	05.2 -	VXUH22	-	IXUH22	VXUH22	6		
		DBA-211087/211287	272	05.2 -	VXUH22	-	IXUH22	VXUH22	6		
		DBA-207356	272	09.7 -	VXUH22	-	IXUH22	VXUH22	6		
DBA-212256C/212287C	272	10.2 -	VXUH22	-	IXUH22	VXUH22	6				

DENSO	9	14	16	20	22	24	27	29	31	32	34	35	DENSO	9	14	16	20	22	24	27	29	31	32	DENSO	9	14	16	20	22	24	27	31
NGK	2	4	5	6	7	8	9	9.5	10	10.5	11	11.5	CHAMPION	18	16,14	12,11	10,9	8,7	6,63,61	4,59	57	55	53	BOSCH	10	9	8	7,6	5	4	3	2

MODEL	CC	VEHICLE CODE	ENGINE	FROM-TILL	DENSO		IRIDIUM POWER	IRIDIUM TOUGH	QTY
MERCEDES BENZ									
E350	3500	DBA-212056C/212087C	272	09.5 -	VXUH22	-	IXUH22	VXUH22	6
		DBA-207456	272	10.4 -	VXUH22	-	IXUH22	VXUH22	6
		RBA-207359	276	11.7 -	-	-	-	-	6
		RBA-207459	276	11.7 -	-	-	-	-	6
		RBA-212059C	276	11.11-	-	-	-	-	6
		RBA-212059	276	11.11-	-	-	-	-	6
		RBA-212259C	276	11.11-	-	-	-	-	6
		RBA-212259	276	11.11-	-	-	-	-	6
E400	3000	DBA-238366	276M30(T/C)	17.5 -	-	-	-	-	6
		DBA-238466	M276(T/C)	18.1 -	-	-	-	-	6
	3500	DAA-212095C	276	14.10-	-	-	-	-	6
		MBA-207361	276(T/C)	15.1 -	-	-	-	-	6
		MBA-207461	276(T/C)	15.1 -	-	-	-	-	6
		MBA-212061C	276(T/C)	15.2 -	-	-	-	-	6
		MBA-212261C	276(T/C)	15.2 -	-	-	-	-	6
		RBA-213071	276(T/C)	16.10-	-	-	-	-	6
	4000	RBA-213271	276(T/C)	16.11-	-	-	-	-	6
	4200	E-210072	M119.985	96.3 -97	K16PR-U	K16TT	IK16	VK16	8
E430	4300	E/GF/GH-210070	-	97.9 -	VK16	-	IK16	VK16	16
		E/GF-210270	-	98.7 -	VK16	-	IK16	VK16	16
E450	3000	DBA-213068	276M30(T/C)	18.8 -	-	-	-	-	6
		DBA-238468	276M30(T/C)	18.8 -	-	-	-	-	6
		DBA-238368	276M30(T/C)	18.8 -	-	-	-	-	6
		DBA-213268	276M30(T/C)	18.8 -	-	-	-	-	6
E500	5000	GH-211070	113	02.6 -	VK16	-	IK16	VK16	16
		GH-211270	113	03.11-	VK16	-	IK16	VK16	12
		E-124036	-	-94	K16PR-U	K16TT	IK16	VK16	8
		CBA-211070/211270	113	05.8 -	VK16	-	IK16	VK16	16
E550	4700	CBA-207373	278(T/C)	11.11-	-	-	-	-	8
		CBA-212073	278(T/C)	11.11-	-	-	-	-	8
		CBA-212273	278(T/C)	11.11-	-	-	-	-	8
		DBA-212073	278(T/C)	14.10-	-	-	-	-	8
		DBA-212273	278(T/C)	14.10-	-	-	-	-	8
	5500	CBA-211072/211272	273	07.1 -	VXUH22	-	IXUH22	VXUH22	16
CBA-212072/207372/212272	273	09.5 -	VXUH22	-	IXUH22	VXUH22	16		
G320	3200	E-463230	M104.996	94.12-98	K16PR-U	K16TT	IK16	VK16	6
		E-463231	M104.996	94.12-98	K16PR-U	K16TT	IK16	VK16	6
		E-463208	M104.996	95.8 -98	K16PR-U	K16TT	IK16	VK16	6
		GF-G320S/L	112	97.10-01	VK16	-	IK16	VK16	12
		GF/GH-463244	112	01 -	VK16	-	IK16	VK16	12
G320L	3200	GF/GH-463245	112	01 -	VK16	-	IK16	VK16	12
G500	5000	GF-G500L	113	99.10-01	VK16	-	IK16	VK16	16
		GF-G500S	113	99.10-01	VK16	-	IK16	VK16	16
G500L	5000	GF/GH/ABA-463248	113	01.6 -	VK16	-	IK16	VK16	16
G550	4000	ABA-463234	176(T/C)	15.12-	-	-	-	-	8
		ABA-463234	176(T/C)	16.11-	-	-	-	-	8
		ABA-463260	176(T/C)	18.6 -	-	-	-	-	8
G550L	5500	ABA-463236	273	09.3 -	VXUH22	-	IXUH22	VXUH22	8
GL550	4700	CBA-166873	278(T/C)	13.4 -	-	-	-	-	8
	5500	CBA-164886	273	06.10-	VXUH22	-	IXUH22	VXUH22	8
GLA180	1600	DBA-156942	270(T/C)	17.4 -	-	-	-	-	4
GLA220	2000	DBA-156947	270M20(T/C)	17.9 -	-	-	-	-	4
GLA250	2000	DBA-156946	270M20(T/C)	14.5 -	-	-	-	-	4
		DBA-156946	270M20(T/C)	17.4 -	-	-	-	-	4
GLC200	2000	DBA-253942C	274(T/C)	17.2 -	-	-	-	-	4
		DBA-253342C	274(T/C)	17.2 -	-	-	-	-	4
GLC250	2000	DBA-253946C	274(T/C)	16.2 -	-	-	-	-	4
		DBA-253946	274(T/C)	17.2 -	-	-	-	-	4
		DBA-253346	274(T/C)	17.2 -	-	-	-	-	4
GLC350	2000	DLA-253954	274(T/C)	16.9 -	-	-	-	-	4
		DLA-253354	274(T/C)	17.2 -	-	-	-	-	4
GLK300	3000	CBA-204981	272M30	08.10-	VXUH22	-	IXUH22	VXUH22	6
GLK350	3500	RBA-204988	276	12.7 -	-	-	-	-	6
GLS550	4700	CBA-166873	278(T/C)	16.4 -	-	-	-	-	8
M200	2000	CBA-245233	266M20	06.1 -	VK20	-	IK20	VK20	4
M200 TURBO	2000	CBA-245234	266M20(T/C)	06.1 -	VK20	-	IK20	VK20	4
ML320	3200	GF/GH-163154	112	98.9 -	VK16	-	IK16	VK16	12

DENSO
 AUSTRALIA CHINA INDIA INDONESIA KOREA MALAYSIA PHILIPPINES SAUDI ARABIA SINGAPORE TAIWAN THAILAND VIETNAM JAPAN
 EUROPE MOTOR SMALL CROSS PART
 CYCLE ENGINE REFERENCE NUMBER



EUROPE & U.S.A. CAR

▶ Spark plug color codes: ■ for Iridium Tough and Iridium Plugs and Iridium TT, ■ for Iridium Power, ■ for Iridium Racing and Two Tops Plugs, ■ for Platinum Plugs and Platinum TT, and black for general spark plugs.

DENSO

CHINA AUSTRALIA

INDIA

INDONESIA

KOREA

MALAYSIA

PHILIPPINES

SAUDI ARABIA

SINGAPORE

TAIWAN

THAILAND

VIETNAM

JAPAN

EUROPE & USA

MOTOR CYCLE

SMALL ENGINE

CROSS REFERENCE

PART NUMBER

MODEL	CC	VEHICLE CODE	ENGINE	FROM-TILL	DENSO		IRIDIUM POWER	IRIDIUM TOUGH	QTY
MERCEDES BENZ									
ML350	3700	GH-163157	112M37	03.3 -05.10	VK16	-	IK16	VK16	12
	3500	DBA-164186	272	05.10-	VXUH22	-	IXUH22	VXUH22	6
		RBA-166057	276	12.6 -	-	-	-	-	6
ML430	4300	GF-163172	113(4)	98.8 -01	VK16	-	IK16	VK16	16
ML500	5000	CBA-164175C	113	05.10-	VK16	-	IK16	VK16	16
ML550	5500	CBA-164172C	273	07.1 -	VXUH22	-	IXUH22	VXUH22	8
R350	3500	DBA-251065	272	06.3 -	VXUH22	-	IXUH22	VXUH22	6
		RBA-251057	276	12.1 -	-	-	-	-	6
R500	5000	CBA-251075	113	06.3 -	VK16	-	IK16	VK16	6
R550	5500	CBA-251072	273	07.10-	VXUH22	-	IXUH22	VXUH22	8
S280	2800	E-140028	M104.944	93.10-95	K16PR-U	K16TT	IK16	VK16	6
S320	3200	E-140032M	M104.944	93.9 -98	K16PR-U	K16TT	IK16	VK16	6
		GF/GH-220065	112	98.11-	VK16	-	IK16	VK16	12
S350	3500	DBA-221056	272	05.10-	VXUH22	-	IXUH22	VXUH22	6
		RBA-221057	276	11.7 -	-	-	-	-	6
	3700	GH-220067	112972	02.11-	VK16	-	IK16	VK16	12
S400	3000	DBA-217364	276M30(T/C)	16.3 -	-	-	-	-	6
		DBA-222066	276M30(T/C)	17.8 -	-	-	-	-	6
S400 HYBRID	3500	DAA-222057	276	14.6 -	-	-	-	6	
S430	4300	GF-220070	113(4)	98.11 -02.11	VK16	-	IK16	VK16	16
		GH-220083	1134	02.11-	VK16	-	IK16	VK16	16
S450	3000	DAA-222058	256(T/C)	18.3 -	-	-	-	-	6
		DAA-222158	256(T/C)	18.3 -	-	-	-	-	6
		DBA-217364	276M30(T/C)	18.6 -	-	-	-	-	6
S500	5000	E-140070/140050	M119.970.980	93.10-	K16PR-U	K16TT	IK16	VK16	8
		GF/GH-220075	113	98.11 -05.10	VK16	-	IK16	VK16	16
	5500	DBA-221071	273	05.10 -06.11	VXUH22	-	IXUH22	VXUH22	8
S500L	5000	GF/GH-220175	113	98.11 -05.10	VK16	-	IK16	VK16	16
		DBA-221171/221186	273	05.10-	VXUH22	-	IXUH22	VXUH22	8
S550 HYBRID	3000	DLA-222163	276M30(T/C)	14.11-	-	-	-	6	
S550	4700	CBA-221073	278(T/C)	11.7 -	-	-	-	-	8
		DBA-222182	278(T/C)	13.10-	-	-	-	-	8
		DBA-222182C	278(T/C)	13.10-	-	-	-	-	8
		DBA-217482	278(T/C)	16.6 -	-	-	-	-	8
		DBA-217482	278(T/C)	16.6 -	-	-	-	-	8
S550L	4700	CBA-221173	278(T/C)	11.7 -	-	-	-	-	8
		CBA-221194	278(T/C)	11.7 -	-	-	-	-	8
S550	5500	DBA-221071/221086	273	06.11-	VXUH22	-	IXUH22	VXUH22	8
S550L	5500	DBA-221171	273	06.11-	VXUH22	-	IXUH22	VXUH22	8
S560	3000	DLA-222173	276M30(T/C)	18.12-	-	-	-	-	6
		DBA-222183	176(T/C)	17.8 -	-	-	-	-	8
		DBA-222186	176(T/C)	17.8 -	-	-	-	-	8
	4000	DBA-217483	176(T/C)	18.6 -	-	-	-	-	8
		DBA-217383C	176(T/C)	18.6 -	-	-	-	-	8
		DBA-217386	176(T/C)	18.6 -	-	-	-	-	8
S600 HYBRID	3500	DAA-221095	272(HYBRID)	10.11-	VXUH22	-	IXUH22	VXUH22	6
S600L HYBRID	3500	DAA-221195	272(HYBRID)	11.7 -	VXUH22	-	IXUH22	VXUH22	6
S600	6000	E-140056	120	93.10-94	K16PR-U	K16TT	IK16	VK16	12
		E-140076	120	93.10-98	K16PR-U	K16TT	IK16	VK16	12
	CBA-222176C	277(T/C)	14.6 -	-	-	-	-	12	
	ABA-222176C	277(T/C)	17.8 -	-	-	-	-	VK20Y	12
	S600L	5500	GH-220176	275(T/C)	03 -	VK20Y	-	-	VK20Y
GF-220178			137(T/C)	00.5 -	VK20	-	IK20	VK20	24
5500		GH-220178	137970(T/C)	-03	VK20	-	IK20	VK20	24
		ABA/DBA-221176	275(T/C)	06.11-	VK20Y	-	-	VK20Y	24
6000	E-140057	120	93.10-98	K16PR-U	K16TT	IK16	VK16	12	
SL320	3200	GF-129064	112	98.8 -01	VK16	-	IK16	VK16	12
SL350	3500	CBA-230456	272	06.11-08.5	VXUH22	-	IXUH22	VXUH22	6
		DBA-230458	272	08.5 -	VXUH22	-	IXUH22	VXUH22	6
		RBA-231457	276	12.3 -	-	-	-	-	6
	3700	RBA-231457	276	15.9 -	-	-	-	-	6
		GH-230467	112M37	03.6 -05.10	VK16	-	IK16	VK16	12
SL400	3000	DBA-231466	276M30(T/C)	16.6 -	-	-	-	6	
SL500	5000	GF-129068	-	98.8 -01	VK16	-	IK16	VK16	16
		GH-230475	113	01.10-03.5	VK16	-	IK16	VK16	16
		CBA-230475	113	05.10 -06.10	VK16	-	IK16	VK16	16
SL550	4700	CBA-231473	278(T/C)	12.3 -	-	-	-	8	

DENSO	9	14	16	20	22	24	27	29	31	32	35	DENSO	9	14	16	20	22	24	27	29	31	32	DENSO	9	14	16	20	22	24	27	31	
NGK	2	4	5	6	7	8	9	9.5	10	10.5	11	11.5	CHAMPION	18	16,14	12,11	10,9	8,7	6,63,61	4,59	57	55	53	BOSCH	10	9	8	7,6	5	4	3	2



MODEL	CC	VEHICLE CODE	ENGINE	FROM-TILL	DENSO		IRIDIUM POWER	IRIDIUM TOUGH	QTY
MERCEDES BENZ									
SL550	4700	CBA-231473	278(T/C)	16.6 -	-	-	-	-	8
	5000	CBA-230471	273	06.11-	VXUH22	-	IXUH22	VXUH22	16
SL600	6000	E-129076	120	93.10-00	VK16	-	IK16	VK16	12
	5500	GH-230476	275(T/C)	03.6 -	VK20Y	-	-	VK20Y	12
		CBA/ABA-230477	275(T/C)	-	VK20Y	-	-	VK20Y	12
SLC180	1600	DBA-172431	274M16(T/C)	16.6 -	-	-	-	4	
SLC200	2000	DBA-172434	274(T/C)	16.6 -	-	-	-	4	
SLK200	1800	DBA-172448	271(T/C)	13.2 -	-	-	IXUH22	VXUH22	4
		CBA-172448	271(T/C)	13.8 -	VXUH22	-	IXUH22	VXUH22	4
		DBA-172448	271(T/C)	13.8 -	VXUH22	-	IXUH22	VXUH22	4
	2000	CBA-172448	271(T/C)	14.8 -	-	-	-	-	4
		DBA-172448	271(T/C)	14.8 -	-	-	-	-	4
		DBA-172434	274(T/C)	15.8 -	-	-	-	-	4
SLK200 KOMPRESSOR	1800	CBA-171442	271(S/C)(*3)	06.2 -08.5	VKH20	-	IKH20	VKH20	4
		DBA-171445	271(S/C)(*4)	08.5 -	VXUH22	-	IXUH22	VXUH22	4
SLK230 KOMPRESSOR	2300	E-170447	-	96.12-	IK16	-	IK16	VK16	4
		GF-170447	(S/C)	99 -00	K20PBR-S10	-	IK20	VK20	4
		GF/GH-170449	1118(S/C)	01 -	VK20	-	IK20	VK20	4
SLK280	3000	DBA-171454	272M30	05.8 -	VXUH22	-	IXUH22	VXUH22	6
SLK320	3200	GF/GH-170465	112947	00 -	VK16	-	IK16	VK16	12
SLK350	3500	CBA-171456	272	04.9 -08.5	VXUH22	-	IXUH22	VXUH22	6
		DBA-171458	272	08.5 -	VXUH22	-	IXUH22	VXUH22	6
		MBA-172457	276	13.8 -	-	-	-	-	6
SLR	5400	GH-199376	155(S/C)	04.10-07.8	VKH20	-	IKH22	VKH20	16
		ABA-199476	M155(S/C)	07.8 -	VXUH22	-	IXUH22	VXUH22	8
V230	2300	GF/GH-638230	-	98.6 -	K20PBR-S10	-	IK20	VK20	4
		GF/GH-638234	-	98.6 -99	K20PBR-S10	-	IK20	VK20	4
V260	2000	ABA-447813	274(T/C)	18.11-	-	-	-	4	
V280	2800	GF-638280	-	99.5 -06.11	K20TXR	K20TT(*5)	IK20	VK20	6
V350	3500	ABA-639811/639811C	112M37	06.11 -07.11	VXUH22	-	IXUH22	VXUH22	6
		ABA-639350/639350C	M272E35	07.11-	VXUH22	-	IXUH22	VXUH22	6
VANEO	1900	GH-414700	1669	03.10-	VK20	-	IK20	VK20	4
VIANO	3200	GH-639811/C	112	03.10-	VK16	-	IK16	VK16	12
MERCEDES MAYBACH S550	4700	DBA-222982C	278(T/C)	15.2 -	-	-	-	-	8
		DBA-222985	278(T/C)	15.9 -	-	-	-	-	8
MERCEDES MAYBACH S560	4000	DBA-222983C	176(T/C)	17.9 -	-	-	-	-	8
		DBA-222986	176(T/C)	17.9 -	-	-	-	-	8
MERCEDES MAYBACH S600	6000	ABA-222976C	277(T/C)	15.2 -	VK20Y	-	-	VK20Y	24
MERCEDES MAYBACH S650	6000	ABA-222980C	279(T/C)	17.9 -	VK20Y	-	-	VK20Y	12
MERCURY FORD									
222	2800	E-24V	-	92.4 -	W24EP-U	-	IW24	-	6
COUGAR	2500	GF-12WCLC	-	99.6 -00	T16EPR-U15	-	IT16	VT16	6
GRAND MARQUIS	4600	E-M71W	-	93.12 -98.11	T16EPR-U15	-	IT16	VT16	8
		GF-1MEWM75	-	98.12-	T16EPR-U15	-	IT16	VT16	8
		GF-M71W	W	01 -	PT16EPR-L13	-	IT16	VT16	8
TOWN CAR	4600	GF-1LNWM82	W	01 -	PT16EPR-L13	-	IT16	VT16	8
MG-ROVER									
MG F	1800	E-RD18K	-	95.8 -	VK20	-	IK20	VK20	4
MG TF135	1800	GH-RD18K	18K	03.7 -	VK16	-	IK16	VK16	4
MG TF160	1800	GH-RD18K	18K	03.7 -	VK16	-	IK16	VK16	4
MG RV8	3900	E-RA48A	-	93.10-97	W20EPR-U	-	IW20	VW20	8
MORGAN									
+8	4000	-	-	01 -	VK20	-	IK20	VK20	8
	4600	-	-	97 -99	VK20	-	IK20	VK20	8
4/4	1800	-	-	93.2 -	ITV22	-	ITV22	-	4
AERO 8	4400	-	BMW M62B44	00 -	VK20	-	IK20	VK20	8
ROADSTER	3000	-	-	05 -	-	-	-	-	6
MAYBACH									
MAYBACH57	5500	GH-240078	M285	02.9 -	VK20	-	IK20	VK20	12
MAYBACH62	5500	GH-240178	M285	02.9 -	VK20	-	IK20	VK20	12
OPEL									
ASTRA	1600	E-XD160	X16	96.9 -98.10	K20TXR	K20TT(*5)	IK20	VK20	4
		E-XD160W	X16	96.9 -98.10	K20TXR	K20TT(*5)	IK20	VK20	4
		GF-XK160	X16	98.11 -00.11	K20TXR	K20TT(*5)	IK20	VK20	4
		GF-XK161	Z16(XE)	00.11-04.5	K20TXR	K20TT(*5)	IK20	VK20	4
		TA-XK161	Z16	04.5 -	K20TXR	K20TT(*5)	IK20	VK20	4
		E-XD180W	X18	96.9 -	K20TXR	K20TT(*5)	IK20	VK20	4

(*3) : Up to ENG No. 30853899

(*4) : ENG No. 30853900 and up

(*5) : It can be used only for a plug with a terminal.

DENSO

AUSTRALIA CHINA

INDIA

INDONESIA

KOREA

MALAYSIA

PHILIPPINES

SAUDI ARABIA

SINGAPORE

TAIWAN

THAILAND

VIETNAM

JAPAN

EUROPE & USA

MOTOR

SMALL

ENGINE

REFERENCE

NUMBER

PART

CROSS

CYCLE

PART

NUMBER

PART

NUMBER



EUROPE & U.S.A. CAR

▶ Spark plug color codes: ■ for Iridium Tough and Iridium Plugs and Iridium TT, ■ for Iridium Power, ■ for Iridium Racing and Two Tops Plugs, ■ for Platinum Plugs and Platinum TT, and black for general spark plugs.

DENSO

CHINA AUSTRALIA

INDIA

INDONESIA

KOREA

MALAYSIA

PHILIPPINES

SAUDI ARABIA

SINGAPORE

TAIWAN

THAILAND

VIETNAM

JAPAN

EUROPE & USA

MOTOR CYCLE

SMALL ENGINE

CROSS REFERENCE

PART NUMBER

MODEL	CC	VEHICLE CODE	ENGINE	FROM-TILL	DENSO				QTY	
OPEL										
ASTRA										
1800	E-XD180K		X18	96.9 -	K20TXR	K20TT(*5)	IK20	VK20	4	
	E-XD180		X18	96.9 -98.6	K20TXR	K20TT(*5)	IK20	VK20	4	
	GF-XK180		-	98.6 -00.11	K20TXR	K20TT(*5)	IK20	VK20	4	
	GF-XK181		Z18(XE)	00.11-	K20TXR	K20TT(*5)	IK20	VK20	4	
	TA-XK181		Z18	04.5 -04.11	K20TXR	K20TT(*5)	IK20	VK20	4	
	GH-AH04Z18/W		Z18	04.11-	KJ16CR-L11	-	-	VKA16	4	
	E-XD201		C20XE	92.11-98.6	K20PR-U	K20TT	IK20	VK20	4	
	E-XD200W		C20NE	92.11-98.6	K20PR-U	K20TT	IK20	VK20	4	
	E-XD200		C20NE	92.12-98.6	K20PR-U	K20TT	IK20	VK20	4	
	E-XD200K		C20NE	94.2 -98.6	K20PR-U	K20TT	IK20	VK20	4	
2000	E-XD202W		X20	95.9 -98.6	K20TXR	K20TT(*5)	IK20	VK20	4	
	E-XD202		X20	95.9 -98.6	K20TXR	K20TT(*5)	IK20	VK20	4	
	GF-XK200		-	00.6 -01	K20TXR	K20TT(*5)	IK20	VK20	4	
	GH-AH04Z20/W		Z20(T/C)	04.11-	KJ16CR-L11	-	-	VKA16	4	
	GF-XK220		Z22(SE)	00.11-02	ITV20	-	ITV20	-	4	
	TA-XK220		Z22	03 -	ITV20	-	ITV20	-	4	
	E-XE20TF		C20LET	94.3 -95	K20TXR	K20TT(*5)	IK20	VK20	4	
	E-XE200		X20XE	94.1 -95	K20TXR	K20TT(*5)	IK20	VK20	4	
	CALIBRA									
	2000	E-XE20TF		C20LET	94.3 -95	K20TXR	K20TT(*5)	IK20	VK20	4
E-XE200			X20XE	94.1 -95	K20TXR	K20TT(*5)	IK20	VK20	4	
MERIVA										
1600	TA-X01Z16		Z16	04.3 -	K20TXR	K20TT(*5)	IK20	VK20	4	
OMEGA										
2000	E-XF200W		X20	95.9 -99.9	K20TXR	K20TT(*5)	IK20	VK20	4	
	E-XF200		X20	95.9 -99.9	K20TXR	K20TT(*5)	IK20	VK20	4	
2500	E-XF250W		X25XE	94.9 -99.9	K20TXR	K20TT(*5)	IK20	VK20	6	
	E-XF250		X25XE	94.9 -99.9	K20TXR	K20TT(*5)	IK20	VK20	6	
	GF-XF250W		X25	00.6 -02	K20TXR	K20TT(*5)	IK20	VK20	6	
2600	GF-XF250		X25	00.6 -02	K20TXR	K20TT(*5)	IK20	VK20	6	
	E-XB260		C26NE	92.9 -94	W20FPR-U	-	IWF20	-	6	
	TA-XF260		Y26(SE)	02 -	K20PBR-S10	-	IK20	VK20	6	
3000	E-XB301W		C30SE	92.3 -94	K20TXR	K20TT(*5)	IK20	VK20	6	
	E-XB301		C30SE	92.3 -94	K20TXR	K20TT(*5)	IK20	VK20	6	
	E-XF300		X30XE	94.9 -99.9	K20TXR	K20TT(*5)	IK20	VK20	6	
	E-XF300W		X30XE	94.9 -99.9	K20TXR	K20TT(*5)	IK20	VK20	6	
	GF-XF300W		X30	00.6 -02	K20TXR	K20TT(*5)	IK20	VK20	6	
	GF-XF300		X30	00.6 -02	K20TXR	K20TT(*5)	IK20	VK20	6	
	GF-XF300		X30	00.6 -02	K20TXR	K20TT(*5)	IK20	VK20	6	
SIGNUM										
2200	TA-Z02Z22L		Z22	03.12-	K20PBR	-	IK20	VK20	4	
3200	TA-Z02Z32L		Z32	03.12-	K20PBR-S10	-	IK20	VK20	6	
SPEEDSTER										
2200	GH-E00Z22		Z22	03.1 -	ITV20	-	ITV20	-	4	
TIGRA										
1400	E-XJ140		X14XE	95.10 -98.10	K20TXR	K20TT(*5)	IK20	VK20	4	
1600	GF-XJ160		-	98.11 -99.12	K20TXR	K20TT(*5)	IK20	VK20	4	
VECTRA										
1800	E-XH180/W		X18	96.2 -99.2	K20TXR	K20TT(*5)	IK20	VK20	4	
	GF-XH181		X18(XE)	98.12-00	K20TXR	K20TT(*5)	IK20	VK20	4	
	GF-XH182		Z18(XE)	01.3 -	K20TXR	K20TT(*5)	IK20	VK20	4	
2000	E-XC200P		C20	95.3 -	K20TXR	K20TT(*5)	IK20	VK20	4	
	E-XH200/W		X20	96.2 -99.2	K20TXR	K20TT(*5)	IK20	VK20	4	
	GF-XH201		C20(SEL)	98.12-	K20TXR	K20TT(*5)	IK20	VK20	4	
2200	GF-XH220		Z22(SE)	00.10-	ITV20	-	ITV20	-	4	
	TA-Z02Z22		Z22(SE)	02.7 -	ITV20	-	ITV20	-	4	
	E-XC250		C25	94.3 -95	K20TXR	K20TT(*5)	IK20	VK20	6	
2500	E/GF-XH250		X25	96.2 -	K20TXR	K20TT(*5)	IK20	VK20	6	
	E/GF-XH250W		X25XE	97.2 -	K20TXR	K20TT(*5)	IK20	VK20	6	
	GF-XH260		Y26(SE)	01 -01	K20PBR-S10	-	IK20	VK20	6	
3200	TA-Z02Z32		Z32	03.3 -	K20PBR-S10	-	IK20	VK20	6	
VITA										
1200	GF-XG120		X12	00.6 -01.12	K20TXR	K20TT(*5)	IK20	VK20	4	
	GF/TA-XN120		Z12(XE)	01.12 -02.12	K20TXR	K20TT(*5)	IK20	VK20	4	
	E-XG140		X14	95.2 -98.10	K20TXR	K20TT(*5)	IK20	VK20	4	
1400	E-XG141		X14	96.9 -98.10	K20TXR	K20TT(*5)	IK20	VK20	4	
	GF-XG142		-	00.6 -	K20TXR	K20TT(*5)	IK20	VK20	4	
	GF-XN140		Z14(XE)	01 -	K20TXR	K20TT(*5)	IK20	VK20	4	
1600	GF/TA-XN140		Z14(XE)	01.3 -	K20TXR	K20TT(*5)	IK20	VK20	4	
	E-XG160		X16	95.3 -98.10	K20TXR	K20TT(*5)	IK20	VK20	4	
	GF-XG161		-	00.6 -	K20TXR	K20TT(*5)	IK20	VK20	4	
1800	GF/TA-XN180		Z18(XE)	01.12-	K20TXR	K20TT(*5)	IK20	VK20	4	
ZAFIRA										
1800	GF-XM180		X181	00.2 -00.11	K20TXR	K20TT(*5)	IK20	VK20	4	
	GF-XM181		Z18(XE)	00.11-	K20TXR	K20TT(*5)	IK20	VK20	4	
2200	GH-AH05Z22		Z22	06.1 -	IK16	-	IK16	VK16	4	
PEUGEOT										
RCZ										
1600	ABA-T7R5F02		-	10.7 -	-	-	-	-	4	
	ABA-T7R5F03		-	10.7 -	-	-	-	-	4	

(*5) : It can be used only for a plug with a terminal.



MODEL	CC	VEHICLE CODE	ENGINE	FROM-TILL	DENSO		IRIDIUM POWER	IRIDIUM TOUGH	QTY
PEUGEOT									
1007	1400	ABA/'GH-A8KFV	-	06.3 -	K20PR-U	K20TT	IK20	VK20	4
	1600	ABA/GH-A8NFU	-	06.3 -	K20HR-U11	-	IKH20	VKH20	4
106	1600	E-S2S	NFX	96.9 -00.3	K20TXR	K20TT(*5)	IK20	VK20	4
		GF-S2S	TU5J4 L4	01 -02	K20PR-U	K20TT	IK20	VK20	4
		GH-S2NFX	NFX	03 -	K20PR-U	K20TT	IK20	VK20	4
		E-S10	NFY	95.3 -96.9	K20TXR	K20TT(*5)	IK20	VK20	4
2008	1200	ABA-A94HM01	HM01	14.2 -	-	-	IXUH20I	VXUH20I	3
		ABA-A94HN01	HN01(T/C)	16.9 -	-	-	-	-	3
		ABA-A94HN01	HN01(T/C)	18.7 -	-	-	IXUH20I	VXUH20I	3
205	1600	E-205	XU5MZ	94.6 -	K20PR-U	K20TT	IK20	VK20	4
206	1400	GF-T14LA	KFW	99 -	K20PR-U	K20TT	IK20	VK20	4
		GF-T14	-	99.5 -01.5	K20R-U	K20TT	IK20	VK20	4
		GF-T14	TU3JP	00.5 -	K20PR-U	K20TT	IK20	VK20	4
		GF-T14M	-	00.10-01.9	K20PR-U	K20TT	IK20	VK20	4
		GF-T14L4	TU3JP4	01.9 -03.1	K20PR-U	K20TT	IK20	VK20	4
		GH-T1KFW	KFW	03.1 -	K20PR-U	K20TT	IK20	VK20	4
		GF-T16	-	99.5 -01.3	K20R-U	K20TT	IK20	VK20	4
	1600	GF/GH-A206CC	NFU	00.1 -	K20HR-U11	-	IKH20	VKH20	4
		GF-T16L4	TU5JP4/L4	01.9 -02.9	K20HR-U11	-	IKH20	VKH20	4
		GF-T16XT	NFU	01.3 -01.9	K20HR-U11	-	IKH20	VKH20	4
		GF-T16LA	NFU	01 -	K20HR-U11	-	IKH20	VKH20	4
		GH-2EKNFU	NFU	02.10-	K20HR-U11	-	IKH20	VKH20	4
		GH-T1NFU	NFU/TU5JP4	03 -	K20HR-U11	-	IKH20	VKH20	4
		GH-T16RG	TU5JP4	03.7 -	K20HR-U11	-	IKH20	VKH20	4
		GH-206RC	RFK	03.10-	IKH20	-	IKH20	VKH20	4
		GF-T1S16	RFR	99.7 -01.5	K16HPR-U11	-	IKH16	VKH16	4
		GF-T1S16L4	-	00.12-	K16HPR-U11	-	IKH16	VKH16	4
	2000	GH-2EKRFN	RFN	02.10-	K20HR-U11	-	IKH20	VKH20	4
		GF/GH-M206CC	RFR	02.6 -	K16HPR-U11	-	IKH16	VKH16	4
		GH-T1RFN	RFN	02.9 -	IKH16	-	IKH16	VKH16	4
207	1400	ABA-A7KFUP	-	08.8 -	XE20HR-U9	-	-	-	4
		ABA-A75FW	-	07.5 -	-	-	-	-	4
		ABA-A7C5FW	-	07.5 -	-	-	-	-	4
		ABA-A7W5FW	-	08.4 -	-	-	-	-	4
	1600	ABA-A75FX/A7C5FX (T/C)		07.3 -	-	-	-	-	4
		ABA-A75FY/A7W5FY (T/C)		07.6 -	-	-	-	-	4
		ABA-A75F01 (120PS)		09.10-	-	-	-	-	4
		ABA-A7W5F01	5F01	11.7 -	-	-	-	-	4
		ABA-A75F04 (156PS)(T/C)		10.7 -	-	-	-	-	4
		ABA-A7C5F01	5F01	12.2 -	-	-	-	-	4
208	1200	ABA-A9CHM01	HM01	14.1 -	-	-	IXUH20I	VXUH20I	3
		ABA-A9HM01	HM01	14.1 -	-	-	IXUH20I	VXUH20I	3
		ABA-A9HN01	HN01(T/C)	15.10-	-	-	-	-	3
	1600	ABA-A95F01	EP6C	12.11-	-	-	-	-	4
		ABA-A9C5F02	EP6CDT(T/C)	12.11-	-	-	-	-	4
		ABA-A9C5F03	EP6CDT(T/C)	13.7 -	-	-	-	-	4
		ABA-A9C5G04	5G04(T/C)	15.10-	-	-	-	-	4
		ABA-A9X5G04	5G04(T/C)	15.10-	-	-	-	-	4
3008	1600	ABA-T85F02	5F02(T/C)	10.6 -	-	-	-	-	4
		ABA-T85F02	5G01(T/C)	16.3 -	-	-	-	-	4
		ABA-P845G01	5G01(T/C)	17.3 -	-	-	-	-	4
306	1800	E-N3	XU7JPZ	94.2 -95.11	K20PR-U	K20TT	IK20	VK20	4
		E-N3	XU7JPZ	95.11-99.7	K20TXR	K20TT(*5)	IK20	VK20	4
		E/GF-N5M	LFY	97 -	K20TXR	K20TT(*5)	IK20	VK20	4
		E-N5A	LFZ	97 -00.8	K20TXR	K20TT(*5)	IK20	VK20	4
	2000	E-N3XT	XU10J2Z	94.11-99.7	K20PR-U	K20TT	IK20	VK20	4
		E-N3SI	XU10J2Z	94.2 -95.6	K20PR-U	K20TT	IK20	VK20	4
		E-N3S16/A	XU10J4	94.5 -99.7	K20PR-U	K20TT	IK20	VK20	4
		E-N3C	XU10J2Z	94.6 -99.7	K20PR-U	K20TT	IK20	VK20	4
		E-N5SI	XU10J2	97.8 -99.7	K20PR-U	K20TT	IK20	VK20	4
		E-N5S16	XU10J2	97.8 -99.7	K20PR-U	K20TT	IK20	VK20	4
		E-N5C	XU10J2	97.8 -99.7	K20TXR	K20TT(*5)	IK20	VK20	4
		GF-N5XT	XU10J4R	99.8 -	K20TXR	K20TT(*5)	IK20	VK20	4
		GF-N5SI	XU10J4R	99.8 -	K20TXR	K20TT(*5)	IK20	VK20	4
		GF-N5C	XU10J4	99.8 -	K16R-U	K16TT	IK16	VK16	4
		GF-N5M	-	99.8 -01	K20TXR	K20TT(*5)	IK20	VK20	4
		GF-N5BR	-	99.8 -	K16R-U	K16TT	IK16	VK16	4

DENSO

AUSTRALIA CHINA INDIA INDONESIA KOREA MALAYSIA PHILIPPINES SAUDIARABIA SINGAPORE TAIWAN THAILAND VIETNAM JAPAN
 EUROPE MOTOR SMALL CROSS PART
 CYCLE ENGINE REFERENCE NUMBER

(*5) : It can be used only for a plug with a terminal.



EUROPE & U.S.A. CAR

▶ Spark plug color codes: ■ for Iridium Tough and Iridium Plugs and Iridium TT, ■ for Iridium Power, ■ for Iridium Racing and Two Tops Plugs, ■ for Platinum Plugs and Platinum TT, and black for general spark plugs.

DENSO

AUSTRALIA

CHINA

INDIA

INDONESIA

KOREA

MALAYSIA

PHILIPPINES

SAUDI ARABIA

SINGAPORE

TAIWAN

THAILAND

VIETNAM

JAPAN

EUROPE & USA

MOTOR CYCLE

SMALL ENGINE

CROSS REFERENCE

PART NUMBER

MODEL	CC	VEHICLE CODE	ENGINE	FROM-TILL	DENSO		IRIDIUM POWER	IRIDIUM TOUGH	QTY
PEUGEOT									
306	2000	E-N5BR	-	00 -	K20TXR	K20TT(*5)	IK20	VK20	4
		E-N5XT	RFV	97 -99	K20TXR	K20TT(*5)	IK20	VK20	4
306 S16(FBA#Since8028)	2000	GF-N5S16	XU10J4RS	00 -	K16PR-U	K16TT	IK16	VK16	4
306 S16(FBA#Up to 8028)	2000	GF-N5S16	XU10J4RS	00 -	K20PBR	-	IK20	VK20	4
307	1600	GF/GH/ABA-T5NFU	NFU	02.6 -08.6	K20HR-U11	-	IKH20	VKH20	4
		GH-3EHNFU	NFU	02.9 -08.6	K20HR-U11	-	IKH20	VKH20	4
		GH-3EHNFJ	-	02.8 -	K16HPR-U11	-	IKH16	VKH16	4
	2000	GF-T5	RFN	01.10-02.8	K16HPR-U11	-	IKH16	VKH16	4
		GH-3EHRFN	RFN	02.9 -03.10	K16HPR-U11	-	IKH16	VKH16	4
		GH-T5RFN	EW10J4	02.8 -03.10	K16HPR-U11	-	IKH16	VKH16	4
		GH/ABA-T5RFJ	-	05.11-08.6	VKH16	-	IKH16	VKH16	4
		GH-T5RFK	-	05.11-08.6	VKH16	-	IKH16	VKH16	4
		GH/ABA-3EHRFJ	-	05.11-08.6	VKH16	-	IKH16	VKH16	6
		GH-3CCRfJ	-	05.11-08.6	VKH16	-	IKH16	VKH16	4
307CC	2000	GH-A307CC	EW10J4	04.4 -05.11	K20HR-U11	-	IKH20	VKH20	4
		GH-M307CC	EW10J4S	04.5 -08.6	K20HR-U11	-	IKH20	VKH20	4
308	1200	ABA-T9HN02	HN02(T/C)	15.7 -	-	-	-	-	3
		ABA-T9WHN02	HN02(T/C)	15.7 -	-	-	-	-	3
	1600	ABA-T75FT	(145PS)(T/C)	08.6 -	-	-	-	-	4
		ABA-T75FY	(175PS)(T/C)	08.6 -	-	-	-	-	4
		ABA-T7W5FT	(140PS)(T/C)	08.9 -	-	-	-	-	4
		ABA-T75FX	(150PS)(T/C)	09.2 -	-	-	-	-	4
		ABA-T7C5FT	(140PS)(T/C)	09.6 -	-	-	-	-	4
		ABA-T75FW	(120PS)	09.11-	-	-	-	-	4
		ABA-T7C5F02	(156PS)(T/C)	10.3 -	-	-	-	-	4
		ABA-T75F01	(156PS)(T/C)	11.4 -	-	-	-	-	4
ABA-T75F02/T75F02S	(156PS)(T/C)	10.7 -	-	-	-	-	4		
ABA-T7W5F02	(156PS)(T/C)	10.7 -	-	-	-	-	4		
405	1900	E-15DW	XU9J4	92.1 -	K20PBR	-	IK20	VK20	4
		E-D70MI	XU10J4Z	93.2 -95	K20PR-U	K20TT	IK20	VK20	4
	2000	E-D70BR	XU10J2Z	93.2 -96	K20PR-U	K20TT	IK20	VK20	4
		E-D70	XU10J4Z	93.2 -96	K20PR-U	K20TT	IK20	VK20	4
		406	E-D8	XU10J4R	96.11-99	K20TXR	K20TT(*5)	IK20	VK20
E-D8BR	RFR		97 -99	K20TXR	K20TT(*5)	IK20	VK20	4	
2000	GF-D9		RFR/RFN	00.3 -01.5	K16HPR-U11	-	IKH16	VKH16	4
	E/GF-D9BR		RFR	00.3 -01.5	K16HPR-U11	-	IKH16	VKH16	4
GF/GH-D9L4	EW10J4		01 -	K16HPR-U11	-	IKH16	VKH16	4	
GF/GH-D9BRL4	EW10J4		01 -	K16HPR-U11	-	IKH16	VKH16	4	
2200	GF/GH-D93FZ		EW12J4	02.6 -	K16HPR-U11	-	IKH16	VKH16	4
	E-D8V		ES9J4	96.11-99	K20TNR	K20TT	IK20	VK20	6
	E-D8CPV	ES9J4	96.11-99	K20TNR	K20TT	IK20	VK20	6	
	E-D8BRV	ES9J4	96.11-99	K20TNR	K20TT	IK20	VK20	6	
	3000	GF-D9CPV	ES9J4S	00 -	IKH20	-	IKH20	VKH20	6
		GF/GH-D9V	ES9J4S	00 -	IKH20	-	IKH20	VKH20	6
		GF-D9BRV	ES9J4S-XFX	00.6 -	VKH16	-	IKH16	VKH16	6
		GH-D9CPV	ES9J4S-XFX	03 -	VKH16	-	IKH16	VKH16	6
		GH-D9BRV	ES9J4S-XFX	03 -	VKH16	-	IKH16	VKH16	6
		407	2200	GH-D2	-	05.6 -07.5	VKH16	-	IKH16
GH-D2BR	-			05.6 -07.5	VKH16	-	IKH16	VKH16	4
GH/ABA-D2CPV	-			06.6 -	VKH16	-	IKH16	VKH16	4
3000	ABA-D2Y/D2BRY		-	08.5 -	VKH16	-	IKH16	VKH16	4
	GH/ABA-D2V		-	05.6 -	VKH16	-	IKH16	VKH16	6
GH/ABA-D2BRV	-	05.6 -	VKH16	-	IKH16	VKH16	6		
5008	1600	ABA-T875F02	5F02(T/C)	14.3 -	-	-	-	4	
		ABA-P875G01	5G01(T/C)	17.9 -	-	-	-	4	
508	1600	ABA-W25F02	5F02(T/C)	11.7 -	-	-	-	4	
		ABA-W2W5F02	5F02(T/C)	11.7 -	-	-	-	4	
		ABA-W25G01	5G01(T/C)	15.1 -	-	-	-	4	
		ABA-W2W5G01	5G01(T/C)	15.1 -	-	-	-	4	
605	3000	E-6SK	-	93.11-	K20PBR	-	IK20	VK20	6
		E-Z6	-	93.11-97	K20PBR	-	IK20	VK20	6
		E-Z6NV	XFZ	98 -99	K20TXR	K20TT(*5)	IK20	VK20	6
607	3000	GF-Z8	XFX	01 -	VKH16	-	IKH16	VKH16	6
		GH-Z8XFX	ES9J4S	03 -	VKH16	-	IKH16	VKH16	6
PONTIAC GM									
BONNEVILLE	3800	E-PH23D	-	92.3 -	T16EPR-U15	-	IT16	VT16	6
GRAND AM	2400	E-VB22E	-	95.10-	PT16EPR-L13	-	IT16	VT16	4

(*5) : It can be used only for a plug with a terminal.

MODEL	CC	VEHICLE CODE	ENGINE	FROM-TILL	DENSO		IRIDIUM POWER	IRIDIUM TOUGH	QTY	
PONTIAC GM										
GRAND AM	3100	E-VB23C	-	94.11-96	T16EPR-U	-	IT16	VT16	6	
GRAND PRIX	3400	E-PPW13E	-	92.6 -	T16EPR-U	-	IT16	VT16	6	
PORSCHE										
911 CARRERA	3400	GF-99666K	-	97.10-01	K20PBR-S10	-	IK20	VK20	6	
		GF-99666	-	97.10-01	K20PBR-S10	-	IK20	VK20	6	
	3600	E-993	-	93.11-	K22PBR-S	-	IK22	VK22	12	
		E-993K	-	94.6 -	K22PBR-S	-	IK22	VK22	12	
		GH-99705 · 99705K	-	04.8 -07.8	IK22	-	IK22	VK22	6	
		ABA-99705	-	07.8 -08.7	IK22	-	IK22	VK22	6	
	3800	ABA-997MA101/S	-	08.7 -	IKH20	-	IKH20	VKH20	6	
911 CARRERA 4	3400	GF-99668K	-	97.10-01	K20PBR-S10	-	IK20	VK20	6	
		GF-99668	-	97.10-01	K20PBR-S10	-	IK20	VK20	6	
	3600	ABA-99705 · 99705K · 99705KF	-	-	IK22	-	IK22	VK22	6	
911 CARRERA 4 GTS	3800	ABA-997MA101S	MA101S	11.7 -	-	-	-	-	6	
911 CARRERA 4S	3600	E-993C4S	-	95.11-97.9	K22PBR-S	-	IK22	VK22	12	
		GF/GH-99603	-	02 -	K20PBR-S10	-	IK20	VK20	6	
	3800	ABA-997M9701KF	-	-	IK22	-	IK22	VK22	6	
911 CARRERA RS	3600	E-993RS	-	95.8 -97.9	K22PBR-S	-	IK22	VK22	12	
911 CARRERA S	3800	GH-997M9701/K	-	-	IK22	-	IK22	VK22	6	
		ABA-997M9701	-	-	IK22	-	IK22	VK22	6	
911 TARGE	3600	GF-99603	-	02 -	K20PBR-S10	-	IK20	VK20	6	
		ABA-997MA102	-	08.7 -	IKH20	-	IKH20	VKH20	6	
	3800	ABA-997MA101	-	08.7 -	IKH20	-	IKH20	VKH20	6	
911 TURBO	3600	E-993T	(T/C)	95.6 -	K22TNR	-	IK22	VK22	6	
911 TURBO S	3800	ABA-997MA170	M97.70(T/C)	09.8 -	VK20	-	IK20	VK20	6	
		ABA-997MA170	M41.70(T/C)	09.8 -	VKH20	-	IKH20	VKH20	6	
911GT2	3600	GF/GH-996S64	S64	01.6 -	K22TNR	-	IK22	VK22	6	
		ABA-99770S	-	-	VK22	-	IK22	VK22	6	
911GT3	3600	GF-99663	-	99.8 -	K22PBR-S	-	IK22	VK22	6	
		GH-99667	-	00 -	IK22	-	IK22	VK22	6	
			ABA-99776	-	-	-	-	-	6	
	3800	ABA-997M9777	-	10.2 -	IKH20	-	IKH20	VKH20	6	
911GT3RS	3600	ABA-99776RS	-	-	IXU01-31	-	-	-	6	
928 GTS	5400	E-928M28	-	92.4 -	W20EPB	-	IW20	VW20	8	
968	3000	E-968	-	92.2 -	W20EPB	-	IW20	VW20	4	
BOXSTER	2500	E-986K	-	96.11-98.9	K20TXR	K20TT(*5)	IK20	VK20	6	
		GF-986K	-	98.10-99.9	K20TXR	K20TT(*5)	IK20	VK20	6	
		GF-98665	-	99.10-	K20TXR	K20TT(*5)	IK20	VK20	6	
	2700	GH-98623	-	00 -	K20PBR-S10	-	IK20	VK20	6	
		GH-98725	-	-	IK22	-	IK22	VK22	6	
		ABA-98720	-	05.8 -	IK22	-	IK22	VK22	6	
		ABA-981MA122	MA122	12.6 -	-	-	-	-	6	
	2900	ABA-987MA120	-	09.7 -	IKH20	-	IKH20	VKH20	6	
	3200	GF-98667	-	99.10-	K20PBR-S10	-	IK20	VK20	6	
		GH-98624	-	00 -	K20PBR-S10	-	IK20	VK20	6	
	2700	GH-98726	-	-	IK22	-	IK22	VK22	6	
				ABA-98721	-	05.8 -	IK22	-	IK22	VK22
	3400			ABA-987MA121/C	-	09.7 -	IKH20	-	IKH20	VKH20
			GH-9PABFD	ABF	04.2 -	-	-	-	6	
CAYENNE	3600	ABA-9PAM5501	-	-	-	-	-	-	6	
		GH-9PA00/A	-	03 -	K20PBR-S10	-	IK20	VK20	8	
			GH-9PA50A	(T/C)	03 -	VK22	-	IK22	VK22	8
	4800	ABA-9PAM4801/G	-	-	IKH22	-	IKH22	VKH22	8	
		ABA-9PAM4851A/TA	(T/C)	-	VKH22	-	IKH22	VKH22	8	
				DAA-92ACGE	CGE-EACA(S/C)	10.11-	IK24	-	IK24	-
	CAYENNE S HYBRID	2700	ABA-98720	-	05.8 -08	IK22	-	IK22	VK22	6
ABA-987MA120			-	09.7 -	IKH22	-	IKH22	VKH22	8	
3400		ABA-98721	-	05.8 -	IK22	-	IK22	VK22	6	
		ABA-987MA121	-	09.7 -	IKH20	-	IKH20	VKH20	6	
PANAMERA S HYBRID	3000	DAA-970CGEA	CGE-EACA(S/C)	11.6 -	IK24	-	IK24	-	6	
PANAMERA	3600	ABA-970M46	-	10.3 -	-	-	-	-	6	
	4800	ABA-970M48A	-	09.3 -	-	-	-	-	8	
PANAMERA TURBO	4800	ABA-970M48A	(T/C)	09.3 -	-	-	-	-	8	
PORSCHE TURBO	3600	E-964T2	(T/C)	93.5 -	Q22P-U	-	IQ22	VQ22	6	
RENAULT										
19	1700	E-B532	F3N	92.1 -	W20EPR-U	-	IW20	VW20	4	
AVANTIME	3000	GH-EL7X	L7X	02.11-	VKH16	-	IKH16	VKH16	6	

(*5) : It can be used only for a plug with a terminal.

DENSO

AUSTRALIA CHINA INDIA INDONESIA KOREA MALAYSIA PHILIPPINES SAUDI ARABIA SINGAPORE TAIWAN THAILAND VIETNAM JAPAN EUROPE MOTOR & USA CYCLE SMALL ENGINE CROSS PART REFERENCE NUMBER



EUROPE & U.S.A. CAR

▶ Spark plug color codes: ■ for Iridium Tough and Iridium Plugs and Iridium TT, ■ for Iridium Power, ■ for Iridium Racing and Two Tops Plugs, ■ for Platinum Plugs and Platinum TT, and black for general spark plugs.

PART NUMBER	CROSS REFERENCE	SMALL ENGINE	MOTOR & USA	EUROPE	JAPAN	VIETNAM	THAILAND	TAIWAN	SINGAPORE	SAUDI ARABIA	PHILIPPINES	MALAYSIA	KOREA	INDONESIA	INDIA	CHINA	AUSTRALIA	MODEL	CC	VEHICLE CODE	ENGINE	FROM-TILL	DENSO	TJ	IRIDIUM POWER	IRIDIUM TOUGH	QTY		
																		RENAULT											
																			WIND	1600	ABA-ENK4M	K4M	11.7 -	VK22	-	IK22	VK22	4	
																			KADJAR	1200	ABA-HEH5F	H5F(T/C)	18.4 -	-	-	-	-	4	
																			KANGOO		ABA-KWH5F	H5F(T/C)	14.5 -	-	-	-	-	4	
																				1200	ABA-KWH5F	H5F(T/C)	16.2 -	-	-	-	-	4	
																				1200	ABA-KWH5F1	H5F(T/C)	16.7 -	-	-	-	-	4	
																				1400	GF-KCK7J	K7J	01 -03.8	K20PR-U	K20TT	IK20	VK20	4	
																						GH/ABA-KCK4M	K4M	03.8 -	K20PR-U	K20TT	IK20	VK20	4
																					1600	ABA-KWK4M	K4M	09.9 -	K20PR-U	K20TT	IK20	VK20	4
																					1600	ABA-KWK4M	K4M	11.9 -	K20PR-U	K20TT	IK20	VK20	4
																					1600	ABA-KWK4M	K4M	14.2 -	K20PR-U	-	IK20	VK20	4
																			CAPTUR		ABA-2RH5F	H5F(T/C)	14.2 -	-	-	-	-	4	
																				1200	ABA-2RH5F1	H5F(T/C)	16.3 -	-	-	-	-	4	
																			KOLEOS		ABA-Y2TR	QR25DE,2TR	09.5 -	VFXEH20	-	-	-	VFXEH20	4
																				2500	ABA-Y2TR	2TR	13.11-	-	-	-	-	4	
																			GRAND SCENIC		ABA-JMF4	F4	07.5 -	K20PR-U	K20TT	IK20	VK20	4	
																				LAGUNA		E-56F3R	F3R	94.10-97	W20EPR-U	-	IW20	VW20	4
																			2000		GF-56F3R	-	99 -01	W20EPR-U	-	IW20	VW20	4	
																			2000		GH-GF4	F4R	03.1 -	K20PR-U	K20TT	IK20	VK20	4	
																			3000		E-56Z7X	-	94.10-96	K20TXR	-	-	VK20Y	6	
																			3000		GH-GL7X	L7X	03.1 -	VKH16	-	IKH16	VKH16	6	
																			LUTECIA			ABA-RH4B	H4B(T/C)	15.1 -	-	-	-	-	3
																					900	ABA-RH4B	H4B(T/C)	17.10-	-	-	-	-	3
																						GH-BD4F	D4F	03.2 -	XE20HR-U9	-	-	-	4
																			1200		ABA-RH5F	H5F(T/C)	13.9 -	-	-	-	-	4	
																					ABA-RH5F	H5F(T/C)	14.7 -	-	-	-	-	4	
																				ABA-RH5F1	H5F(T/C)	16.2 -	-	-	-	-	4		
																			1400		E-57E7J	-	94.7 -97	K20PR-U	K20TT	IK20	VK20	4	
																					GF-57E7J	E7J	97 -98	Q16PR-U	-	IQ16	VQ16	4	
																				GF/GH-BK4J	K4J	01 -	K20PR-U	K20TT	IK20	VK20	4		
																				GF-BK7M	-	98.10-	K20TXR	K20TT(*5)	IK20	VK20	4		
																				GF-BK4M	K4M	98.10-01	K20TXR	K20TT(*5)	IK20	VK20	4		
																			1600		ABA-RK4M	K4M	06.3 -	K20PR-U	K20TT	IK20	VK20	4	
																					ABA-RM5M	M5M(T/C)	13.11-	FXE20HR11	-	-	VFXEH20	4	
																					ABA-RM5M1	M5M(T/C)	15.11-	-	-	-	-	4	
																					ABA-RM5M	M5M(T/C)	17.7 -	-	-	-	-	4	
																			1800		E-57F3P	F3P	95.1 -	W20EPR-U	-	IW20	VW20	4	
																					E-57F7P	F7P	95.1 -	K20PR-U	K20TT	IK20	VK20	4	
																				E-57F3PQ	F3PQ	95.8 -	W20EPR-U	-	IW20	VW20	4		
																			2000		GF-BF4	F4	00.12-01	IK20	-	IK20	VK20	4	
																					ABA-RF4C	F4	09.10-	VK22	-	IK22	VK22	4	
																			3000	GF/GH-BL7X	L7X	02 -	VKH20	-	IKH20	VKH20	6		
																			MEGANE		ABA-ZH5F	H5F(T/C)	15.5 -	-	-	-	-	4	
																				1200	ABA-BBH5F	H5F(T/C)	17.11-	-	-	-	-	4	
																				GF-AK4M/ME	-	99 -	K20TXR	K20TT(*5)	IK20	VK20	4		
																				GH/ABA-MK4M/MK4MM	K4M	03 -	K20PR-U	K20TT	IK20	VK20	4		
																			1600		GH/ABA-KMK4M	K4M	04.6 -	K20PR-U	K20TT	IK20	VK20	4	
																					ABA-BBM5M	M5M(T/C)	17.11-	-	-	-	-	4	
																				ABA-KBM5M	M5M(T/C)	17.11-	-	-	-	-	4		
																			1800	ABA-BBM5P	M5P(T/C)	18.8 -	-	-	-	-	4		
																				E-AF3RD2	F3R	96.10-98	W20EP-U	-	IW20	VW20	4		
																				E-AF3R2	F3R	96.10-98	W20EP-U	-	IW20	VW20	4		
																				E-AF7RD2	F7R	96.10-99	K20TXR	K20TT(*5)	IK20	VK20	4		
																				E-AF3RD	F3R	96.6 -98	W20EP-U	-	IW20	VW20	4		
																				E-AF7RD	F7R	96.6 -98	K20TXR	K20TT(*5)	IK20	VK20	4		
																				E-AF3R	F3R	96.7 -98	W20EP-U	-	IW20	VW20	4		
																				E-AF3RJ	F3R	97.4 -99	W16EPR-U	W16TT	IW16	VW16	4		
																				GF-AF3R2	-	99 -	W20EPR-U	-	IW20	VW20	4		
																			2000		GH/ABA-MF4/MF4M	F4R	03 -	K20PR-U	K20TT	IK20	VK20	4	
																					ABA-DZF4R	F4R(T/C)	12.7 -	-	-	-	-	4	
																					GH-KMF4	F4R2	04.6 -	K20PR-U	K20TT	IK20	VK20	4	
																					GH-MF4R2	F4R2(T/C)	04.10 -06.10	VK22	-	IK22	VK22	4	
																					ABA-MF4R2	F4R2(T/C)	06.10-	VK22	-	IK22	VK22	4	
																					ABA-MF4/MF4M	F4	06.11-	K20PR-U	K20TT	IK20	VK20	4	
																					ABA-KMF4	F4	07.4 -	K20PR-U	K20TT	IK20	VK20	4	
																					GH/ABA-EMF4	F4	05.1 -	K20PR-U	K20TT	IK20	VK20	4	
																				ABA-ZM4R	M4R	11.5 -	FXE20HR11	-	-	VFXEH20	4		
																				ABA-KZM4R	M4R	12.12-	FXE20HR11	-	-	VFXEH20	4		

(*5) : It can be used only for a plug with a terminal.



MODEL	CC	VEHICLE CODE	ENGINE	FROM-TILL	DENSO		IRIDIUM POWER	IRIDIUM TOUGH	QTY
RENAULT									
MEGANE	2000	ABA-KZF4R	F4R(T/C)	13.5 -	-	-	-	-	4
SAFRANE	3000	E-54Z7X	Z7X	94.9 -97	K22PBR-S	-	IK22	VK22	6
SCENIC	2000	GF-AF4J	F4, G	00.8 -	K20PR-U	K20TT	IK20	VK20	4
		GF-AF4J2	F4R	01 -	K20PR-U	K20TT	IK20	VK20	4
SPORT SPIDER	2000	E-FF7R	F7R	97 -97	K20PBR	-	IK20	VK20	4
SPORT V6	3000	GH-BL7X	L7X	03 -	VKH20	-	IKH20	VKH20	6
TWINGO	900	DBA-AHH4B	H4B(T/C)	16.9 -	-	-	-	-	3
		ABA-AHH4B1	H4B(T/C)	18.2 -	-	-	-	-	3
	1000	ABA-AHH4D	H4D	17.1 -	-	-	-	-	3
	1100	E-06D7F	D7F	97.7 -98.12	K20TXR	K20TT(*5)	IK20	VK20	4
		GF-06D7F	-	99 -	K20TXR	K20TT(*5)	IK20	VK20	4
	1200	E-06C3G	C3G	95.7 -97.7	W16EP-U	W16TT	IW16	VW16	4
		ABA-ND4F	D4F	08.11-	XE20HR-U9	-	-	VFXEH20	4
		ABA-ND4FT	D4FT(T/C)	08.11-	XE20HR-U9	-	-	-	4
	1600	ABA-NK4M	K4M	09.10-	K20PR-U	K20TT	IK20	VK20	4
		ABA-NK4M	K4M	11.6 -	VK22	-	IK22	VK22	4
ROLLS ROYCE									
CORNICHE	6700	E-RMD	-	94.1 -96	IW16	-	IW16	VW16	8
		GF-AK	L410MT	99 -	IK20	-	IK20	VK20	8
FLYING SPUR	6700	E-RMG	-	94.11-	IW16	-	IW16	VW16	8
PARKWARD	5400	GF-AD	54 12	00 -	KJ14CR11	-	IK16	VK16	12
	6700	E-AWT	-	97.1 -	IK16	-	IK16	VK16	8
PHANTOM	6700	GH-1S68	-	04 -	VK20	-	IK20	VK20	8
SILVER SPIRIT	6700	E-RRS	-	93.2 -	IW16	-	IW16	VW16	8
		E-RMS	-	94.1 -	IW16	-	IW16	VW16	8
		E-AS	-	95.9 -	K16PR-U	K16TT	IK16	VK16	8
SILVER SPUR	6700	E-RRN	-	92.4 -	IW16	-	IW16	VW16	8
		E-SCAZN	-	92.4 -	W16EXR-U	W16TT	IW16	VW16	8
		E-RMN	-	93.10-	IW16	-	IW16	VW16	8
		E-SCAZL	-	95.11-	W16EXR-U	W16TT	IW16	VW16	8
		E-AW	-	95.11-	IK16	-	IK16	VK16	8
		E-AN	-	95.8 -	IK16	-	IK16	VK16	8
		E-ANY	L410MT	96 -00	IK16	-	IK16	VK16	8
		E-ANT	-	96.8 -98	IK16	-	IK16	VK16	8
		E-AYT	L410MT	97 -00	IK16	-	IK16	VK16	8
		E-SCAZN2	-	97.4 -	W16EXR-U	W16TT	IW16	VW16	8
TOURING LIMOUSINE	6700	E-RRW	-	92.9 -	IW16	-	IW16	VW16	8
		E-RMW	-	94.4 -	IW16	-	IW16	VW16	8
ROVER									
75	2500	GF-RJ25	25K	99.7 -	VK16	-	IK16	VK16	6
75 SALOON	2500	GH-RJ25	25K	03.7 -	VK16	-	IK16	VK16	6
75 TOURER	2500	GH-RJ25T	25K	03.7 -	VK16	-	IK16	VK16	6
200	1800	E-RF18	-	96.12-99	K20PR-U	K20TT	IK20	VK20	4
		E-RF18	-	96.7 -99	K20PR-U	K20TT	IK20	VK20	4
216	1600	E-XWD16K	D16A8	92.12-96	K20PR-U11	K20TT	IK20	VK20	4
		E-XWD16	D16A8	92.12-96	K20PR-U11	K20TT	IK20	VK20	4
		E-XWD16S	D16A8	94.12-	K20PR-U11	K20TT	IK20	VK20	4
		E-XWD16KS	D16A8	94.12-	K20PR-U11	K20TT	IK20	VK20	4
		E-RF16	16K	96.7 -00	K20PR-U	K20TT	IK20	VK20	4
220	2000	E-XW20T	20T4G(T/C)	92.12-96	K20PR-U	K20TT	IK20	VK20	4
		E-XW20TS	20T4G(T/C)	94.12-	K20PR-U	K20TT	IK20	VK20	4
		E-XWD20TG	(T/C)	-	K20PR-U	K20TT	IK20	VK20	4
416	1600	E-XWD16W	D16A8	94.12-96	K20PR-U11	K20TT	IK20	VK20	4
		E-RTD16	-	96.7 -	K20PR-U11	K20TT	IK20	VK20	4
420	2000	E-XWG	-	94.5 -	K20R-U	K20TT	IK20	VK20	4
618	1800	E-RHF18	-	96.1 -	KJ20CR-L11	-	-	VKA20	4
620	2000	E-XSU	-	94.10-	KJ20CR-L11	-	-	VKA20	4
		E-RHF20	F20Z1	94.10-	KJ20CR-L11	-	-	VKA20	4
623	2300	E-XSS	-	94.10-	KJ20CR-L11	-	-	VKA20	4
		E-RHH23	H23A3	94.10-	KJ20CR-L11	-	-	VKA20	4
		E-RHF23	-	-98	KJ20CR-L11	-	-	VKA20	4
820	2000	E-RSC27A	-	93.1 -97	K20PR-U	K20TT	IK20	VK20	4
825	2500	E-RS25	-	96.3 -	K20PR-U	K20TT	IK20	VK20	6
827	2700	E-RSC27A	-	93.1 -	KJ20CR-L11	-	-	VKA20	6
CABRIOLET COUPE	1600	E-XW16K	-	96.3 -	K20PR-U11	K20TT	IK20	VK20	4
	1600	E-XW16	-	96.3 -	K20PR-U11	K20TT	IK20	VK20	4
	1800	E-XW18	-	96.3 -	VK20	-	IK20	VK20	4

(*5) : It can be used only for a plug with a terminal.

DENSO

AUSTRALIA CHINA INDIA INDONESIA KOREA MALAYSIA PHILIPPINES SAUDI ARABIA SINGAPORE TAIWAN THAILAND VIETNAM JAPAN EUROPE MOTOR SMALL CROSS PART & USA CYCLE ENGINE REFERENCE NUMBER



EUROPE & U.S.A. | CAR

▶ Spark plug color codes: ■ for Iridium Tough and Iridium Plugs and Iridium TT, ■ for Iridium Power, ■ for Iridium Racing and Two Tops Plugs, ■ for Platinum Plugs and Platinum TT, and black for general spark plugs.

DENSO

CHINA AUSTRALIA

INDIA

INDONESIA

KOREA

MALAYSIA

PHILIPPINES

SAUDI ARABIA

SINGAPORE

TAIWAN

THAILAND

VIETNAM

JAPAN

EUROPE & USA

MOTOR CYCLE

SMALL ENGINE

CROSS REFERENCE

PART NUMBER

MODEL	CC	VEHICLE CODE	ENGINE	FROM-TILL	DENSO		IRIDIUM POWER	IRIDIUM TOUGH	QTY	
ROVER										
LAND ROVER										
2500	Q-LJ13L	-	-	93.9 -	W20EPR-U	-	IW20	VW20	4	
		Y-LJL	-	94.5 -95	W20EPR-U	-	IW20	VW20	4	
	3500	E-LJ23D	-	-	92.12-	W20EPR-U	-	IW20	VW20	8
		E-LJ36D	-	-	93.9 -	W20EPR-U	-	IW20	VW20	8
		E-LJR	36D	-	94.10-	W20EPR-U	-	IW20	VW20	8
3900	E-LD30/31	-	-	97.6 -98	W16EXR-U	W16TT	IW16	VW16	8	
	MINI									
1300	E-XN12A	-	-	92.1 -00	W20EPR-U	-	IW20	VW20	4	
	E-XN12A	-	-	96.11-00	W20EPR-U	-	IW20	VW20	4	
RANGE ROVER										
3900	E-LH36D	-	-	92.11-	J16CR-U	-	IW16	VW16	8	
	E-LP42D	42D	-	95.1 -99	W16EPR-U	W16TT	IW16	VW16	8	
4200	ABA-LM42S	(S/C)	-	05.7 -	VK16	-	IK16	VK16	8	
4300	E-LH40D	-	-	92.11-	J16CR-U	-	IW16	VW16	8	
4600	E-LP46D	46D	-	95.1 -99	W20EPR-U	-	IW20	VW20	8	
	ABA-LG5NA	508PN	-	13.3 -	-	-	-	-	8	
	ABA-LG5SA	508PS(S/C)	-	13.3 -	-	-	-	-	8	
TOURER										
1600	E-XW16W	-	-	96.3 -	K20PR-U11	K20TT	IK20	VK20	4	
1800	E-XW18W	-	-	96.3 -	VK20	-	IK20	VK20	4	
SAAB										
900 16V										
2000	E-AB202SK	B202S	-	92.3 -	IQ22	-	IQ22	VQ22	4	
	E-AB202S	B202S	-	92.3 -	IQ22	-	IQ22	VQ22	4	
	E-DB206I	B206I	-	94.1 -	Q20PR-U11	-	IQ20	VQ20	4	
	E-DB204I	B204I	-	94.10-98	Q20PR-U11	-	IQ20	VQ20	4	
2300	E-DB234I	B234I	-	93.11-98	IQ20	-	IQ20	VQ20	4	
	E-DB234IK	B234I	-	94.7 -98	IQ20	-	IQ20	VQ20	4	
2500	E-DB258I	B258I	-	93.11-97	K20TXR	K20TT(*5)	IK20	VK20	6	
900TURBO16V										
2000	E-AB20S	B20S(T/C)	-	93.1 -	IQ22	-	IQ22	VQ22	4	
	E-DB204L/LK	B204L(T/C)	-	96.11-98	Q22PR-U	-	IQ22	VQ22	4	
9000										
2300	E-CB234R	B234R	-	93.6 -96.12	Q22PR-U11	-	IQ22	VQ22	4	
	E-CB234E	B234E	-	95.11-97	Q22PR-U11	-	IQ22	VQ22	4	
	E-CB234E	B234E	-	96.12-97	Q22PR-U11	-	IQ22	VQ22	4	
	E-CB234R	B234R	-	96.12-	Q22PR-U	-	IQ22	VQ22	4	
3000	E-CB308I	B308I	-	94.11-	K20TXR	K20TT(*5)	IK20	VK20	6	
9-3										
1800	GH-FB207	(T/C)	-	03.1 -	VK20	-	IK20	VK20	4	
	GF-DB204	B204(T/C)	-	98.6 -00	Q22PR-U11	-	IQ22	VQ22	4	
	GF-DB205	B205(150PS)	-	00.11-	Q20PR-U11	-	IQ20	VQ20	4	
	GF-DB205	B205(205PS)(T/C)	-	99.11-	VK20	-	IK20	VK20	4	
	GH/ABA-FB207	(T/C)	-	03.1 -	VK20	-	IK20	VK20	4	
	GH/ABA-FB207	-	-	-	VK20	-	IK20	VK20	4	
	2300	GF-DB234	B234	-	98.5 -	Q20PR-U11	-	IQ20	VQ20	4
2800	GH/ABA-FB284	-	-	05.11-	VKH20	-	IKH20	VKH20	6	
9-5										
2000	GF/GH-EB205	-	-	99.11-	VQ22	-	IQ22	VQ22	4	
2300	GF/GH-EB235	B235E(170PS)(185PS)(T/C)	-	97.10-	VQ22	-	IQ22	VQ22	4	
3000	GF/GH-EB308	B308E(T/C)	-	99.1 -03.11	K22PR-U11	-	IK22	VK22	6	
2000	GH-EB205	B205(T/C)	-	03.5 -	Q22PR-U11	-	IQ22	VQ22	4	
SATURN										
SATURN										
1900	E/GF-S8Z	1C	-	96.11-02	K16PR-U11	K16TT	IK16	VK16	4	
	E-S8ZC	1C	-	96.11-02	K16PR-U11	K16TT	IK16	VK16	4	
	GF-S8ZC	1C, G	-	00.5 -02	K16PR-U11	K16TT	IK16	VK16	4	
SMART										
SMART										
600	GF/GH-MC01M	13(T/C)	-	00.10-	K20TXR	K20TT(*5)	IK20	VK20	6	
	GF/GH-MC01K	13(T/C)	-	00.12-	K20TXR	K20TT(*5)	IK20	VK20	6	
	GF-MC01L	13(T/C)	-	01.4 -	K20TXR	K20TT(*5)	IK20	VK20	6	
	GF/GH-MC01C	13(T/C)	-	01.10-	K20TXR	K20TT(*5)	IK20	VK20	6	
	GH-450335	13(T/C)	-	03 -	K20TXR	K20TT(*5)	IK20	VK20	6	
	GH-MC01X	(T/C)	-	03 -	K20TXR	K20TT(*5)	IK20	VK20	6	
900	DBA-453444	281M09(T/C)	-	17.8 -	-	-	-	-	3	
700	GH-450332/333/432/433	(T/C)	-	03 -	-	-	-	-	6	
700	GH-452334/452434	(T/C)	-	03 -	-	-	-	-	6	
900	ABA-453062	281M09(T/C)	-	17.5 -	-	-	-	-	3	
900	DBA-453344	281M09(T/C)	-	17.8 -	-	-	-	-	3	
1000	CBA-451331/451380	3B21	-	07.10-	XU22HDR9	XUH22TT	IXUH22	VXUH22	3	
	CBA-451431/451480	3B21	-	07.10-	XU22HDR9	XUH22TT	IXUH22	VXUH22	3	
	ABA-451333	(T/C)	-	08.7 -	XU22HDR9	XUH22TT	IXUH22	VXUH22	3	
SMART FORFOUR										
900	DBA-453044	281M09(T/C)	-	17.8 -	-	-	-	-	3	
1300	GH-454031	135	-	04.9 -06.12	K20HR-U11	-	IKH20	VKH20	4	
1500	GH-454032	1355	-	04.9 -06.12	K20HR-U11	-	IKH20	VKH20	4	

(*5) : It can be used only for a plug with a terminal.

MODEL	CC	VEHICLE CODE	ENGINE	FROM-TILL	DENSO		IRIDIUM POWER	IRIDIUM TOUGH	QTY
TVR									
CERBERA	4000		-	99.11-	XU24EPR-U	-	IXU24	VXU24	6
	4200		-	02.2 -	K20TXR	K20TT(*5)	IK20	VK20	8
	4500		-	99.11-	K20TXR	K20TT(*5)	IK20	VK20	8
CHIMAERA	4000	-	-	95.3 -02.1	-	-	-	-	8
	4500		-	95.3 -02.1	IW24	-	IW24	-	8
	5000		-	95.3 -99.11	-	-	-	-	8
GRIFFITH	4000		-	93.3 -99.11	-	-	-	-	8
	5000		-	93.3 -02.1	-	-	-	-	8
TAMORA	3600		-	02.2 -	XU24EPR-U	-	IXU24	VXU24	6
TUSCAN	3600		SP6	00.11-	XU24EPR-U	-	IXU24	VXU24	6
	4000		SP6	00.11-	XU24EPR-U	-	IXU24	VXU24	6
VOLKSWAGEN									
up !	1000	DBA-AACHY	CHY	12.10-	-	-	-	-	3
		DBA-AACHYW	CHY	15.8 -	-	-	-	-	3
		ABA-AADKR	DKR(T/C)	18.7 -	-	-	-	-	3
ARTEON	2000	ABA-3HDJHF	DJH(T/C)	17.10-	-	-	-	-	4
		ABA/GH-1FBWA	BWA(T/C)	06.10-09.1	VK20Y	-	-	VK20Y	4
EOS	2000	ABA-1FCAW	CAW(T/C)	09.1 -	VK22	-	IK22	VK22	4
		ABA/GH-FBUB	BUB	06.10-	-	-	-	-	6
BORA	2000	GF-1JAPK	APK	99.9 -02.9	K20PBR-S10	-	IK20	VK20	4
		GH-1JAZJ	AZJ	02.9 -	VKA16	-	-	VKA16	4
	2300	GF-1JAGZ	AGZ	99.9 -01.7	K20TXR	K20TT(*5)	IK20	VK20	5
		GF/GH-1JAQN	AQN	01.9 -	VKA16	-	-	VKA16	5
	2800	GF-1JAUFEF	AUE	00.10-01.7	VKA16	-	-	VKA16	6
		GF/GH-3BAMXF	AMX	01 -	K20TXR	K20TT(*5)	IK20	VK20	6
		GF/GH-1JBDEF	BDE	01.9 -05.2	VKA16	-	-	VKA16	6
CORRADO	2000	E-509A	9A	92.10-	K22PBR-S	-	IK22	VK22	4
	2900	E-50ABV	ABV	92.4 -	K20TXR	K20TT(*5)	IK20	VK20	6
CROSSPOLO	1200	DBA-6RCBZW	CBZ(T/C)	10.6 -	-	-	-	-	4
		DBA-6RCJZW	CJZ(T/C)	14.11-	-	-	-	-	4
		DBA-6RCJZW	CJZ(T/C)	16.5 -	-	-	-	-	4
GOLF3	1800	GH/ABA-9NBTS	BTS	07.9 -	VKA20	-	-	VKA20	4
		E-1HABS	ABS	92.3 -94.9	W20EPBR-S	-	IW20	VW20	4
		E-1HADZ	ADZ	94.10-	W20EPBR-S	-	IW20	VW20	4
	2000	E-1H2E	2E	92.3 -94.9	W20EPBR-S	-	IW20	VW20	4
		E-1HABF	ABF	92.10-98.7	IK20	-	IK20	VK20	4
		E-1E2EK	2E	94.2 -94.9	W20EPBR-S	-	IW20	VW20	4
		E-1EADYK	ADY	94.10-	W20EPBR-S	-	IW20	VW20	4
		E-1HADY	ADY	94.10-96	W20EPBR-S	-	IW20	VW20	4
		E-1EAGGK	AGG	96.1 -98.7	W20EPBR-S	-	IW20	VW20	4
		E-1HAGG	AGG	96.1 -98.7	W20EPBR-S	-	IW20	VW20	4
2800	E-1HAAA	AAA	92.10-98.7	K20TXR	K20TT(*5)	IK20	VK20	6	
GOLF4	1600	GF-1JAEH	AEH	98.8 -01.7	K20PBR-S10	-	IK20	VK20	4
		GF-1JAVU	AVU	01.7 -02.8	K20PBR-S10	-	IK20	VK20	4
		GF/GH-1JBFQ	BFQ	02.8 -	K20PBR-S10	-	IK20	VK20	4
	1800	GF-1JAGN	AGN	98.8 -99	K20PBR-S10	-	IK20	VK20	4
		GF-1JAUM	AUM	01.9 -02.8	VK20	-	IK20	VK20	4
		GH-1JAUM	AUM	03 -	VK20	-	IK20	VK20	4
		GF-1JAGU	AGU(T/C)	98.8 -01	VK20Y	-	-	VK20Y	4
	2000	GF-1JAPK	APK	98.8 -02.8	K20PBR-S10	-	IK20	VK20	4
		GF-1EAGG	AGG	99.2 -	W20EPBR-S	-	IW20	VW20	4
		GH-1JAZJ	AZJ	03.10-	VKA16	-	-	VKA16	4
3200	GH-1JBFHF	BFH	03 -06.2	-	-	-	-	6	
GOLF5	1400	ABA-1KBLG	BLG(T/C)	07.2 -	-	-	-	-	4
		ABA-1KBMV	BMV(T/C)	08.1 -	VK20Y	-	-	VK20Y	4
		ABA-1KCAX	CAX(T/C)	08.6 -10.2	-	-	-	-	4
	1600	GH-1KBAG	BAG	04.4 -	K20PBR-S10	-	IK20	VK20	4
		GH-1KBLP	BLF	04.9 -	K20PBR-S10	-	IK20	VK20	4
	2000	GH1-KAXW	AXW	04.6 -04.9	VKA16	-	-	VKA16	4
		GH-1KBLX	BLR	05.10-06.2	VKA16	-	-	VKA16	4
		GH-1KBLX	BVY	06.2 -07.10	VKA16	-	-	VKA16	4
		GH-1KAXX	BWA(T/C)	05.5 -06.2	VK20Y	-	-	VK20Y	4
		ABA-1KAXX	BWA(T/C)	07.8 -	VK20Y	-	-	VK20Y	4
ABA-1KBYD		BYD(T/C)	08.10-	-	-	IK22	VK22	4	
3200	ABA/GH-1KBUBF	BUB	06.2 -	-	-	-	-	6	
GOLF6	1200	DBA-1KCBZ	CBZ(T/C)	10.6 -	-	-	-	-	4
	1400	ABA-1KCAX	CAX(T/C)	09.4 -	-	-	-	-	4

(*5) : It can be used only for a plug with a terminal.

DENSO

AUSTRALIA CHINA

INDIA

INDONESIA

KOREA

MALAYSIA

PHILIPPINES

SAUDIARABIA

SINGAPORE

TAIWAN

THAILAND

VIETNAM

JAPAN

EUROPE

MOTOR

SMALL

ENGINE

CROSS

PART

287



EUROPE & U.S.A. CAR

▶ Spark plug color codes: ■ for Iridium Tough and Iridium Plugs and Iridium TT, ■ for Iridium Power, ■ for Iridium Racing and Two Tops Plugs, ■ for Platinum Plugs and Platinum TT, and black for general spark plugs.

DENSO

AUSTRALIA

CHINA

INDIA

INDONESIA

KOREA

MALAYSIA

PHILIPPINES

SAUDI ARABIA

SINGAPORE

TAIWAN

THAILAND

VIETNAM

JAPAN

EUROPE & USA

SMALL MOTOR

ENGINE

CYCLE

CROSS REFERENCE

PART NUMBER

MODEL	CC	VEHICLE CODE	ENGINE	FROM-TILL	DENSO		IRIDIUM POWER	IRIDIUM TOUGH	QTY
VOLKSWAGEN									
GOLF6									
		DBA-1KCAV	CAV(S/C+T/C)	11.8 -	-	-	-	-	4
		DBA-1KCAX	CAX(T/C)	10.2 -	-	-	-	-	4
	1400	ABA-1KCAV	CAV(S/C+T/C)	09.4 -	-	-	-	-	4
		DBA-1KCAVK	CAV(S/C+T/C)	11.10-	-	-	-	-	4
		DBA-1TCTHW	CTH(S/C+T/C)	12.11-	-	-	-	-	4
	2000	ABA-1KCDLF	CDL(T/C)	10.3 -	VK22	-	IK22	VK22	4
		ABA-1KCCZ	CCZ(T/C)	09.9 -	VK22	-	IK22	VK22	4
GOLF									
	1200	DBA-AUCJZ	CJZ(T/C)	13.6 -	-	-	-	-	4
		DBA-AUCJZ	CJZ(T/C)	15.7 -	-	-	-	-	4
		DBA-1KCTHK	CTH(S/C+T/C)	13.3 -	-	-	-	-	4
		DBA-AUCPT	CPT(T/C)	13.6 -	-	-	-	-	4
		DBA-AUCHP	CHP(T/C)	14.1 -	-	-	-	-	4
	1400	DBA-1TCTHW	CTH(S/C+T/C)	14.1 -	-	-	-	-	4
		DBA-AUCPT	CPT(T/C)	15.7 -	-	-	-	-	4
		DBA-AUCHP	CHP(T/C)	15.7 -	-	-	-	-	4
		DLA-AUCUK	CUK(T/C)	15.9 -	-	-	-	-	4
		DBA-1TCZD	CZD(T/C)	16.1 -	-	-	-	-	4
	1800	ABA-AUCJSF	CJS(T/C)	15.7 -	-	-	-	-	4
		ABA-AUCJSF	CJS(T/C)	17.5 -	VKH22	-	IKH22	VKH22	4
		ABA-AUCHH	CHH(T/C)	13.9 -	VKH22	-	IKH22	VKH22	4
	2000	ABA-AUCJXF	CJX(T/C)	14.2 -	VKH22	-	IKH22	VKH22	4
		ABA-AUDJHF	DJH(T/C)	17.5 -	-	-	-	-	4
		ABA-AUDLB	DLB(T/C)	19.2 -	VKH22	-	IKH22	VKH22	4
GOLF PLUS									
	1600	GH-1KBLP	BLF	04.9 -	K20PBR-S10	-	IK20	VK20	4
	2000	GH-1KBLX	BLX	05.10-	VKA16	-	-	VKA16	4
THE BEETLE									
	1200	DBA-16CBZK	CBZ(T/C)	13.3 -	-	-	-	-	4
		DBA-16CBZ	CBZ(T/C)	15.7 -	-	-	-	-	4
	1400	ABA-16CZD	CZD(T/C)	16.11-	-	-	-	-	4
	2000	ABA-16CPL	CPL(T/C)	13.10-	VKH22	-	IKH22	VKH22	4
JETTA									
	1400	ABA-1KBLG	BLG	07.10-	-	-	-	-	4
		ABA-1KCAV	CAV(S/C+T/C)	08.9 -	-	-	-	-	4
	2000	GH-1KBLX	BLX	05.10 - 07.10	VKA16	-	-	VKA16	4
		GH/ABA-1KAXX	BWA(T/C)	06.2 -	VK20Y	-	-	VK20Y	4
LUPO									
	1400	GF-6XAU	AUA	01.7 - 02.9	K20PBR-S10	-	IK20	VK20	4
		GH-6XBBY	BBY	02.9 -	VKA16	-	-	VKA16	4
	1600	GH-6EAVY	AVY	03.4 -	K20PBR-S10	-	IK20	VK20	4
NEW BEETLE									
	1600	ABA/GH-9CBFS	BFS	04.10-	K20PBR-S10	-	IK20	VK20	4
		GF-9CAVC	AVC	00.4 - 02.2	VK20	-	IK20	VK20	4
	1800	GF/GH-9CAWU	AWU(T/C)	02.6 -	VK20Y	-	-	VK20Y	4
		GF-9CAQY	AQY	99.9 - 02.8	K20PBR-S10	-	IK20	VK20	4
	2000	ABA/GH-9CAZJ	AZJ	02.8 -	VKA16	-	-	VKA16	4
		ABA/GH-1YAZJ	AZJ	03.5 -	VKA16	-	-	VKA16	4
PASSAT									
	1400	DBA-3CCAX	CAX(T/C)	11.5 -	-	-	-	-	4
		DBA-3CCAX	CAX(T/C)	13.4 -	-	-	-	-	4
		DBA-3CCZE	CZE(T/C)	15.7 -	-	-	-	-	4
		DLA-3CCUK	CUK(T/C)	16.6 -	-	-	-	-	4
	1800	E-3BADR	ADR	97.8 - 99	K20PBR-S10	-	IK20	VK20	4
		E-3BAEB	AEB(T/C)	97.8 - 99	K20PBR-S10	-	-	VK20Y	4
		GF-3BAPU	APU(T/C)	98 - 01.10	VK20Y	-	-	VK20Y	4
		GF-3BAPT	APT	99.1 -	K20PBR-S10	-	IK20	VK20	4
		ABA-3CBZB	BZB(T/C)	08.2 -	VK20Y	-	-	VK20Y	4
	2000	E-3A2E	2E	94.2 - 94.12	W20EPBR-S	-	IW20	VW20	4
		E-3AADY	ADY	94.10 - 97.7	W20EPBR-S	-	IW20	VW20	4
		GF./GH-3BAZM	AZM	02.4 - 06.4	K20PBR-S10	-	IK20	VK20	4
		ABA/GH-3CBVY	BVY	06.4 - 08.1	VKA16	-	-	VKA16	4
		ABA/GH-3CAXX	BWA(T/C)	06.4 - 08.1	VK20Y	-	-	VK20Y	4
		ABA-3CCAW	CAW(T/C)	08.5 -	-	-	-	-	4
		ABA-3CCHH	CHH(T/C)	16.9 -	VKH22	-	IKH22	VKH22	4
	2300	GF/GH-3BAZX	AZX	01.10 - 06.4	VKA16	-	-	VKA16	5
		E-31AAA	AAA	92.10 - 94.1	K20TXR	K20TT(*5)	IK20	VK20	6
		E-3AAAA	AAA	94.2 - 97.7	K20TXR	K20TT(*5)	IK20	VK20	6
	2800	E-3BACKF	ACK	98.4 - 99	K20PBR-S10	-	-	VK20Y	6
		GF-3BAPRF	APR	99.3 - 01	K20TXR	K20TT(*5)	IK20	VK20	6
		GF/GH-3BAMX	AMX	01.10 - 06.4	K20TXR	K20TT(*5)	IK20	VK20	6
		GF/GH-3BAMXF	AMX	01.9 - 06.4	K20TXR	K20TT(*5)	IK20	VK20	6
	3200	ABA/GH-3CAXZF	AXZ	06.7 -	-	-	-	-	6
	3600	ABA-3CBWSF	BWS	08.9 -	-	-	-	-	6

(*5) : It can be used only for a plug with a terminal.



MODEL	CC	VEHICLE CODE	ENGINE	FROM-TILL	DENSO	IRIIDIUM POWER	IRIDIUM TOUGH	QTY	
VOLKSWAGEN									
PASSAT	4000	GH-3BBDNF	BDN	02.5 -06.4	K20TXR	K20TT(*5)	IK20	VK20	8
PASSAT CC	2000	ABA-3CCAWC	CAW(T/C)	08.11-10.3	-	-	-	-	4
		ABA-3CCCZC	CCZ(T/C)	10.3 -	VK22	-	IK22	VK22	4
	3600	ABA-3CBWSC	BWS	08.11-	-	-	-	-	6
VOLKSWAGEN CC	1800	ABA-3CCDAC	CDA(T/C)	12.7 -	VK22	-	IK22	VK22	4
POLO	1000	ABA-AWCHZ	CHZ(T/C)	18.3 -	-	-	-	-	3
		DBA-6RCBZ	CBZ(T/C)	10.6 -	-	-	-	-	4
	1200	DBA-6RCJZ	CJZ(T/C)	14.8 -	-	-	-	-	4
		DBA-6RCJZ	CJZ(T/C)	15.7 -	-	-	-	-	4
		E-6NAFH	AFH	96.9 -	K20PBR-S10	-	IK20	VK20	4
		GF-6NAHW	AHW	00.5 -02.3	K20PBR-S10	-	IK20	VK20	4
		GH-9NBBY	BBY	02.6 -04.10	VKA16	-	-	VKA16	4
		GH-9NBKY	BKY	04.10 -07.10	KJ16CR-L11	-	-	VKA16	4
		ABA-9NBUD	BUD	07.10 -09.10	VKA20	-	-	VKA20	4
	1400	ABA-6RCGG	CGG	09.10-	VKA20	-	-	VKA20	4
		ABA-6RCAV	CAV(S/C+T/C)	12.11-	-	-	-	-	4
		DBA-6RCPT	CPT(T/C)	13.9 -	-	-	-	-	4
		ABA-6RCTH	CTH(S/C+T/C)	13.9 -	-	-	-	-	4
		DBA-6RCZE	CZE(T/C)	14.10-	-	-	-	-	4
		DBA-6RCZE	CZE(T/C)	15.7 -	-	-	-	-	4
			DBA-6RCZE	CZE(T/C)	15.7 -	-	-	-	-
	1500	ABA-AWDAD	DAD(T/C)	19.1 -	-	-	-	-	4
		E-6NAEE	AEE	95.9 -99	-	-	-	-	4
	1600	E-6NAHS	AHS	96.5 -99	W16ETR-S(*2)	-	IW16	VW16	4
		GF-6NARC	ARC	00.5 -04.10	K20PBR-S10	-	IK20	VK20	4
		ABA/GH-9NBTS	BTS	06.4 -	VKA20	-	-	VKA20	4
	1800	ABA-9NBXJ	BJX(T/C)	05.9 -	VK20Y	-	-	VK20Y	4
		ABA-6RDAJ	DAJ(T/C)	15.2 -	VKH22	-	IKH22	VKH22	4
2000	ABA-AWCZP	CZP(T/C)	18.7 -	VKH22	-	IKH22	VKH22	4	
SCIROCCO	1400	ABA-13CAV	CAV(T/C-S/C)	09.5 -	-	-	-	-	4
		DBA-13CTH	CTH(S/C+T/C)	13.4 -	-	-	-	-	4
		ABA-13CAW	CAW(T/C)	09.5 -	VK22	-	IK22	VK22	4
	2000	ABA-13CCZ	CCZ(T/C)	10.1 -	VK22	-	IK22	VK22	4
		ABA-13CDL	CDL(T/C)	10.2 -	VK22	-	IK22	VK22	4
SHARAN	1400	DBA-7NCAV	CAV(S/C+T/C)	12.10-	-	-	-	-	4
		DBA-7NCZD	CZD(T/C)	15.9 -	-	-	-	-	4
	2800	E-7MAAA	AAA	96.8 -03.9	K20TXR	K20TT(*5)	IK20	VK20	6
TIGUAN	1400	DBA-5NCTH	CTH(S/C+T/C)	12.11-	-	-	-	-	4
		DBA-5NCTH	CTH(S/C+T/C)	13.9 -	-	-	-	-	4
		ABA-5NCZE	CZE(T/C)	17.1 -	-	-	-	-	4
		ABA-5NCZD	CZD(T/C)	19.1 -	-	-	-	-	4
	2000	ABA-5NCAW	CAW(T/C)	08.9 -	VK22	-	IK22	VK22	4
		ABA-5NCCZ	CCZ(T/C)	10.9 -	VK20Y	-	-	VK20Y	4
		ABA-5NCCZ	CCZ(T/C)	10.9 -	VK22	-	IK22	VK22	4
		ABA-5NCCZ	CCZ(T/C)	14.11-	VK22	-	IK22	VK22	4
TOUAREG	3000	DAA-7PCGEA	CGE(S/C)	12.12-	IK24	-	IK24	-	6
	3200	GH-7LAZZS	AZZ	03.9 -04.8	-	-	-	-	6
		GH-7LBMVS	BMV	04.8 -07.5	-	-	-	-	6
	3600	ABA-7LBHKS	BHK	07.5 -	-	-	-	-	6
		DBA-7PCGRA/7PCGRS	CGR	12.12-	-	-	-	-	6
	4200	GH-7LAXQS/7LAXQA	AXQ	03.9 -07.5	K20PBR-S10	-	IK20	VK20	8
		ABA-7LBARA	BAR	07.5 -	VKB20	-	-	VKB20	8
	6000	GH-7LBJNA	BJN	05.7 -	VKA20	-	-	VKA20	12
	TOURAN	1400	ABA-1TBMV	BMV(T/C)	07.4 -	-	-	-	-
ABA-1TBLG			BLG(T/C)	07.4 -	-	-	-	-	4
ABA-1TCAV			CAV(S/C+T/C)	09.9 -	-	-	-	-	4
DBA-1TCAV			CAV(S/C+T/C)	12.7 -	-	-	-	-	4
1600		GH-1TBLP	BLP	04.7 -	K20PBR-S10	-	IK20	VK20	4
		GH-1TBAG	BAG	04.4 -04.7	K20PBR-S10	-	IK20	VK20	4
2000		GH-1TAXW	AXW	04.4 -04.7	VKA16	-	-	VKA16	4
		GH-1TBLX	BLX	04.7 -06.5	VKA16	-	-	VKA16	4
		GH-1TBLX	BLX	06.5 -07.4	VKA16	-	-	VKA16	4
			GH-1TBLX	BLX	06.5 -07.4	VKA16	-	-	VKA16
VANAGON	2500	E-70AAF	AAF	93.5 -	W16EPB10	W16TT	IW16	VW16	5
		E-70ACU	ACU	94.2 -96.4	W20EPBR-S	-	IW20	VW20	5
		GF-70ACUC	ACU	96.5 -	W20EPBR-S	-	IW20	VW20	5
		E-7DAET	AET	96.11-	W20EPBR-S	-	IW20	VW20	5
VENTO	1800	E-1HABS	ABS	92.3 -	W20EPBR-S	-	IW20	VW20	4
		E-1HADZ	ADZ	94.10-98	W20EPBR-S	-	IW20	VW20	4

DENSO

AUSTRALIA CHINA INDIA INDONESIA KOREA MALAYSIA PHILIPPINES SAUDIARABIA SINGAPORE TAIWAN THAILAND VIETNAM JAPAN EUROPE MOTOR CYCLE SMALL ENGINE CROSS PART REFERENCE NUMBER

(*2) : USE REMOVABLE TYPE (*5) : It can be used only for a plug with a terminal.



EUROPE & U.S.A. CAR

▶ Spark plug color codes: ■ for Iridium Tough and Iridium Plugs and Iridium TT, ■ for Iridium Power, ■ for Iridium Racing and Two Tops Plugs, ■ for Platinum Plugs and Platinum TT, and black for general spark plugs.

DENSO

AUSTRALIA

CHINA

INDIA

INDONESIA

KOREA

MALAYSIA

PHILIPPINES

SAUDI ARABIA

SINGAPORE

TAIWAN

THAILAND

VIETNAM

JAPAN

EUROPE & USA

SMALL MOTOR ENGINE

CROSS REFERENCE

NUMBER

MODEL	CC	VEHICLE CODE	ENGINE	FROM-TILL	DENSO		IRIDIUM POWER	IRIDIUM TOUGH	QTY
VOLKSWAGEN									
VENTO	2000	E-1H2E	2E	92.3 -94.9	W20EPBR-S	-	IW20	VW20	4
		E-1HADY	ADY	94.10-98	W20EPBR-S	-	IW20	VW20	4
		E-1HAGG	AGG	96.1 -	W20EPBR-S	-	IW20	VW20	4
	2800	E-1HAAA	AAA	92.10-97	K20TXR	K20TT(*5)	IK20	VK20	6
VOLVO									
850	2400	E-8B5254	B2554	92.3 -96	K20PR-U	K20TT	IK20	VK20	5
		E-8B5252	B5252	92.9 -96	K20PR-U	K20TT	IK20	VK20	5
		E-8B5254W	B5254	93.8 -96	K20PR-U	K20TT	IK20	VK20	5
		E-8B5252W	B5252	93.8 -96	K20PR-U	K20TT	IK20	VK20	5
	2300	E-8B5234/W	B5234(T/C)	93.8 -95.7	IK22	-	IK22	VK22	5
940	2300	E-9B230/W	B230(T/C)	-95	W20EPR-U	-	IW20	VW20	4
960	2500	E-9B6254W	B6254	94.9 -96	K20PR-U	K20TT	IK20	VK20	6
		E-9B6254	B6254	94.9 -96	K20PR-U	K20TT	IK20	VK20	6
C30	2000	CBA-MB4204S	B4204S	09.3 -	VT20	-	IT20	VT20	4
	2400	CBA-MB5244	B5254	07.7 -	K20HR-U11	-	IKH20	VKH20	5
	2500	DBA-MB5254	B5254(T/C)	07.7 -	-	-	-	VKH20Y	5
C70	2300	E-8B5234K	B5234T3(T/C)	97.5 -99.11	-	-	IK22	VK22	5
		GF-8B5234K	B5234(T/C)	99.7 -00	-	-	-	VK20Y	5
		TA-8B5234K	B5234(T/C)	04.7 -06.12	-	-	-	VK20Y	5
	2400	CBA-MB5244	B5254	10.4 -	IKH20	-	IKH20	VKH20	5
		E-8B5254K	B5254T(T/C)	98.9 -99.7	-	-	IK22	VK22	5
		GF-8B5244K	B5244(T/C)	99.7 -01.10	-	-	-	VK20Y	5
		GF-8B5244K	B5244(T/C)	01.1 -01	-	-	-	VK20Y	5
		GH-8B5244K	B5244(T/C)	01.10-04.7	-	-	-	VK20Y	5
	2500	CBA-MB5244	B5244	06.12-	K20HR-U11	-	IKH20	VKH20	5
		2500	DBA-MB5254	B5254(T/C)	06.12-	-	-	-	VKH20Y
S40	1800	E-4B4184W	-	98 -99	K20PBR-S10	-	IK20	VK20	4
		GF-4B4184	-	99.7 -00	K20PBR	-	IK20	VK20	4
	1900	E-4B4194	B4194(T/C)	98 -99	VK20Y	-	-	VK20Y	4
		E-4B4204	-	98 -99	K20PBR-S10	-	IK20	VK20	4
	2000	GF-4B4204	(T/C)	99.7 -02	K20PBR	-	IK20	VK20	4
		GH-4B4204	B4204S2	02.7 -04.5	K20PBR	-	IK20	VK20	4
		CBA-MB4204S	B4204S	09.3 -	VT20	-	IT20	VT20	4
	2400	UA-MB5244	B5244	04.5 -	K20HR-U11	-	IKH20	VKH20	5
		CBA-MB5244	B5244	04 -	K20HR-U11	-	IKH20	VKH20	5
	2500	UA-MB5254	B5254(T/C)	04.5 -	-	-	-	VKH20Y	5
	2400	CBA-MB5244	B5254(T/C)	04.10-	-	-	-	VKH20Y	5
	2500	CBA-MB5244	B5244	04.10-	K20HR-U11	-	IKH20	VKH20	5
		DBA-MB5254A	B5254(T/C)	04.10-	-	-	-	VKH20Y	5
	S60	1500	DBA-FB4154T	B4154T(T/C)	16.2 -	ZXE24HR7	-	-	-
DBA-FB4154T			B4154T(T/C)	17.8 -	ZXE24HLR7	-	-	-	4
DBA-FB4164T			B4164T(T/C)	11.7 -	-	-	-	-	4
2000		DBA-FB420	B420(T/C)	14.2 -	ZXE24HR7	-	-	-	4
		DBA-FB420	B420(S/C+T/C)	16.2 -	ZXE24HR7	-	-	-	4
		DBA-FB420	B420(T/C)	17.8 -	ZXE24HLR7	-	-	-	4
		DBA-FB420	B420(S/C+T/C)	17.8 -	ZXE24HLR7	-	-	-	4
		TA-RB5234	B5234(T/C)	01.10-	PK20PR-P8	-	-	VK20Y	5
2400		GH-RB5244	B5244	01.1 -05.1	K20PR-U	K20TT	IK20	VK20	5
		GH-RB5244	B5244(T/C)	01.1 -01.10	-	-	-	VK20Y	5
		TA-RB5244	B5244	01.10-	-	-	IK20	VK20	5
		TA-RB5244	B5244(T/C)	01.10-	-	-	-	VK20Y	5
		TA-RB5244A	B5244(T/C)	01.10-	-	-	-	VK20Y	5
		LA-RB5244	B5244	02.1 -05.1	K20PBR	-	IK20	VK20	5
	CBA-RB5244T	B5244T(T/C)	04.10-	-	-	-	VK20Y	5	
	CBA-RB5244	B5244	05.1 -	K20PBR	-	IK20	VK20	5	
	LA-RB5254A	B5254(T/C)	02.11-	-	-	-	VK20Y	5	
	2500	LA-RB5254	B5254(T/C)	03.5 -04.10	-	-	-	VK20Y	5
	CBA-RB5254A	B5254(T/C)	05.8 -	-	-	-	VK20Y	5	
	CBA-RB5254	B5254(T/C)	05.11-	-	-	-	VK20Y	5	
3000	CBA-FB6304T	B6304T(T/C)	11.7 -	FK20HQR10(Volvo)	-	-	VFKH20	6	
S60R	2500	CBA-RB5254A	B5254(T/C)	05.8 -	-	-	VKH20Y	5	
S70	2400	GF-8B5244	B5244	99.7 -	K20PR-U	K20TT	IK20	VK20	5
		GF-8B5244	B5244(T/C)	99.7 -	-	-	-	VK20Y	5
	2500	E-8B5252	B5252	97.2 -99	K20PR-U	K20TT	IK20	VK20	5
		E-8B5254	B5254	97.2 -	K20PR-U	K20TT	IK20	VK20	5
2400	E-8B5254	B5254(T/C)	97.2 -	-	-	-	VK20Y	5	
S80	2400	GF-TB5244	B5244	98.12-00.8	K20PR-U	K20TT	IK20	VK20	5

(*5) : It can be used only for a plug with a terminal.



MODEL	CC	VEHICLE CODE	ENGINE	FROM-TILL	DENSO		IRIDIUM POWER	IRIDIUM TOUGH	QTY
VOLVO									
S80	2400	GH-TB5244	B5244	00.8 -01.10	K20PR-U	K20TT	IK20	VK20	5
	2500	DBA-AB5254	B5254(T/C)	09.4 -	-	-	-	VKH20Y	5
	2800	GF-TB6284	B6284(T/C)	98.8 -01.10	-	-	-	VK20Y	6
		LA-TB6284	B6284T(T/C)	02 -	IK22	-	IK22	VK22	6
	2900	GF-TB6304	B6304	99.7 -00	K20PR-U	K20TT	IK20	VK20	6
		GF-TB6294	B6294	99.7 -01.10	K20PRR	-	IK20	VK20	6
		LA-TB6294	B6294	01.10-	K20PRR	-	IK20	VK20	6
		LA-TB6294	B6294(T/C)	01.10-	-	-	-	VK20Y	6
	3000	DBA-AB6304T <small>(Last 6 digits of vehicle identification number: up to 134000)</small>	B6304T(T/C)	09.7 -	-	-	-	VKH20Y	6
		DBA-AB6304T <small>(Last 6 digits of vehicle identification number: starting from 134001)</small>	B6304T(T/C)	09.7 -	FK20HQR10 (Volvo)	-	-	VFKH20	6
		CBA-AB6304T	B6304T(T/C)	10.7 -	FK20HQR10(Volvo)	-	-	VFKH20	6
	3200	CBA-AB6324	B6324	06.11-	IKH20	-	IKH20	VKH20	6
	4400	CBA-AB8444	B8444	06.11-	VK20	-	IK20	VK20	8
	S90	2500	E-986254	-	97.1 -98.12	K20PR-U	K20TT	IK20	VK20
3000		E-986304	-	97.1 -98.12	K20PR-U	K20TT	IK20	VK20	6
V40	1500	DBA-MB4154T	B4154T(T/C)	15.8 -	ZXE24HR7	-	-	-	4
	1600	DBA-MB4164T	B4164T(T/C)	13.12-	-	-	-	-	4
	1800	E-4B4184W	B4184S	97.10-	K20PBR	-	IK20	VK20	4
		GF-4B4184W	-	99.7 -00	K20PBR	-	IK20	VK20	4
	1900	E-4B4194W	B4194(T/C)	97.10-	-	-	-	VK20Y	4
		E-4B4204W	B4204	97.10-	K20PBR	-	IK20	VK20	4
		GF-4B4204W	B4204(T/C)	99.7 -	-	-	-	VK20Y	4
		GF-4B4204W	B4204	99.7 -	K20PBR	-	IK20	VK20	4
		GH-4B4204W	B4204(T/C)	02.7 -	-	-	-	VK20Y	4
		GH-4B4204W	B4204	02.7 -	K20PBR	-	IK20	VK20	4
		DBA-MB5204T	B5204T(T/C)	13.4 -	VKH22	-	IKH22	VKH22	5
		DBA-MB420	B420(T/C)	14.11-	ZXE24HR7	-	-	-	4
	CBA-MB420XC	B420(T/C)	15.7 -	ZXE24HR7	-	-	-	4	
	V50	2000	CBA-MB4204S	B4204S	09.3 -	VT20	-	IT20	VT20
CBA-MBA4204S			B4204S	11.7 -	IT20	-	IT20	VT20	4
2400		UA-MB5244	B5244	04.5 -	IKH22	-	IKH22	VKH22	5
		CBA-MB5244	B5244	04.6 -	IKH20	-	IKH20	VKH20	5
2500		UA-MB5254	B5254(T/C)	04.5 -	-	-	-	VKH20Y	5
		CBA-MB5254A	B5254(T/C)	04.10-	-	-	-	VKH20Y	5
		DBA-MB5254A	B5254(T/C)	05.8 -	-	-	-	VKH20Y	5
DBA-MB5254	B5254(T/C)	05.8 -	-	-	-	VKH20Y	5		
V60	1500	DBA-FB4154T	B4154T(T/C)	16.2 -	ZXE24HR7	-	-	-	4
		DBA-FB4154T	B4154T(T/C)	17.8 -	ZXE24HLR7	-	-	-	4
	1600	DBA-FB4164T	B4164T(T/C)	11.6 -	-	-	-	-	4
		DBA-FB420	B420(T/C)	14.2 -	ZXE24HR7	-	-	-	4
		DBA-FB420	B4204T(T/C)	14.2 -	-	-	-	-	4
		DBA-FB420	B420(S/C+T/C)	16.2 -	ZXE24HR7	-	-	-	4
		DBA-FB420	B420(T/C)	17.8 -	ZXE24HLR7	-	-	-	4
		DBA-FB420	B420(S/C+T/C)	17.8 -	ZXE24HLR7	-	-	-	4
		DBA-ZB420	B420(T/C)	18.9 -	ZXE24HLR7	-	-	-	4
		3000	CBA-FB6304T	B6304T(T/C)	11.6 -	FK20HQR10	-	-	VFKH20
V70	1600	DBA-BB4164TW	B4164T	11.10-	-	-	-	-	4
	2000	CBA-BB4204TW	B4204T	11.10-	-	-	-	-	4
		DBA-BB420W	B420(T/C)	14.12-	ZXE24HR7	-	-	-	4
	2300	E-8B5234W	B5234(T/C)	97.7 -99	VK22	-	IK22	VK22	5
		E-8B5234AW	B5234(T/C)	97.7 -	VK22	-	IK22	VK22	5
		GH-SB5234W	B5234(T/C)	00.4 -	VK22	-	IK22	VK22	5
		TA-SB5234W	B5234(T/C)	02.1 -	-	-	-	VK20Y	5
		E-8B5252W	B5255	97.2 -99	K20PR-U	K20TT	IK20	VK20	5
	2400	E-8B5254W	B5254(T/C)	97.1 -99	K20PR-U	K20TT	IK20	VK20	5
		E-8B5254AW	B5254(T/C)	97.3 -99	K20PR-U	-	-	VK20Y	5
		E-8B5254AWL	B5254(T/C)	98.9 -	-	-	-	VK20Y	5
		GF-8B5244W	B5244	99.7 -	K20PR-U	K20TT	IK20	VK20	5
		NA-8B5252W	B5252(Bi-Fuel)	99.7 -	-	-	-	-	5
		GF-8B5244AW	B5244(T/C)	99.7 -	-	-	-	VK20Y	5
		GF-8B5244AWL	B5244T(T/C)	99.7 -	-	-	-	VK20Y	5
		NA-8B5244W	B5244(Bi-Fuel)	99.7 -	-	-	-	-	5
		GH-SB5244W	B5244(T/C)	00.4 -	-	-	-	VK20Y	5
GH-SB5244W		B5244	00.7 -	K20PBR	-	IK20	VK20	5	
TA-SB5244W	B5244(T/C)	01.10-	-	-	-	VK20Y	5		

DENSO
 AUSTRALIA
 CHINA
 INDIA
 INDONESIA
 KOREA
 MALAYSIA
 PHILIPPINES
 SAUDI ARABIA
 SINGAPORE
 TAIWAN
 THAILAND
 VIETNAM
 JAPAN
 EUROPE & USA
 MOTOR CYCLE
 SMALL ENGINE
 CROSS REFERENCE
 PART NUMBER



EUROPE & U.S.A. CAR

▶ Spark plug color codes: ■ for Iridium Tough and Iridium Plugs and Iridium TT, ■ for Iridium Power, ■ for Iridium Racing and Two Tops Plugs, ■ for Platinum Plugs and Platinum TT, and black for general spark plugs.

DENSO

AUSTRALIA

CHINA

INDIA

INDONESIA

KOREA

MALAYSIA

PHILIPPINES

SAUDI ARABIA

SINGAPORE

TAIWAN

THAILAND

VIETNAM

JAPAN

EUROPE & USA

SMALL MOTOR ENGINE

CROSS REFERENCE

PART NUMBER

MODEL	CC	VEHICLE CODE	ENGINE	FROM-TILL	DENSO		IRIDIUM POWER	IRIDIUM TOUGH	QTY
VOLVO V70	2400	TA-SB5244W	B5244	01.10-	K20PBR	-	IK20	VK20	5
		TA-SB5244AW	B5244(T/C)	01.10-	-	-	-	VK20Y	5
		LA-SB5244W	B5244	02.1 -	K20PBR	-	IK20	VK20	5
		LA-SB5254W	B5254(T/C)	03.5 -	-	-	-	VK20Y	5
		CBA-SB5244TW	B5244(T/C)	04.10-	-	-	-	VK20Y	5
		CBA-SB5244W	B5244	05.1 -	K20PBR	-	IK20	VK20	5
		LA-SB5254AW	B5254(T/C)	02.11-	-	-	-	VKH20Y	5
	2500	CBA-SB5254W	B5254(T/C)	04.10-	-	-	-	VK20Y	5
		CBA-SB5254AW	B5254(T/C)	04.10-	-	-	-	VK20Y	5
		DBA-BB5254W	B5254(T/C)	08.1 -	-	-	-	VKH20Y	5
		DBA-BB6304TW	B6304T(T/C)	07.11-	-	-	-	VKH20Y	6
	3000	CBA-BB6304TW	B6304T(T/C)	07.11-	-	-	-	-	6
		CBA-BB6304TW	B6304T(T/C)	11.10-	FK20HQR10	-	-	VFKH20	6
	3200	CBA-BB6324W	B6324	07.11-	IKH20	-	IKH20	VKH20	6
V90	2000	DBA-PB420	B420(T/C)	17.2 -	ZXE24HLR7	-	-	-	4
		DBA-PB420A	B420(T/C)	17.2 -	ZXE24HLR7	-	-	-	4
		DBA-PB420	B420(S/C+T/C)	17.2 -	ZXE24HLR7	-	-	-	4
		DBA-PB420A	B420(S/C+T/C)	17.2 -	ZXE24HLR7	-	-	-	4
		DLA-PB420PA	B420(S/C+T/C)	17.7 -	ZXE24HLR7	-	-	-	4
	2500	E-9B6254W	-	97.1 -98.12	-	K20TT	IK20	VK20	6
3000	E-9B6304W	-	97.1 -98.12	K20PR-U	K20TT	IK20	VK20	6	
XC40	2000	DBA-XB420XC	B420(T/C)	18.3 -	-	-	-	4	
XC60	2000	CBA-DB420TXC	B4204T(T/C)	10.8 -	-	-	ITV22	-	4
		DBA-DB420XC	B420(T/C)	14.2 -	ZXE24HR7	-	-	-	4
		DBA-DB420XC	B420(S/C+T/C)	16.2 -	ZXE24HR7	-	-	-	4
		DBA-UB420XC	B420(T/C)	17.10-	ZXE24HLR7	-	-	-	4
		DBA-UB420XCA	B420(T/C)	17.10-	ZXE24HLR7	-	-	-	4
		DLA-UB420XCPA	B420(S/C+T/C)	17.10-	ZXE24HLR7	-	-	-	4
		DBA-UB420XC	B420(S/C+T/C)	18.8 -	ZXE24HLR7	-	-	-	4
	2500	CBA-DB525XC	B525(T/C)	15.7 -	FK20HQR8	-	-	VFKH20	5
3000	CBA-DB6304TXC <small>(Last 6 digits of vehicle identification number: up to 134999)</small>	B6304T(T/C)	09.6 -	-	-	-	VKH20Y	6	
	CBA-DB6304TXC <small>(Last 6 digits of vehicle identification number: starting from 135000)</small>	B6304T(T/C)	09.6 -	FK20HQR10 (Volvo)	-	-	VFKH20	6	
XC70	2000	DBA-BB420XC	B420(T/C)	15.7 -	ZXE24HR7	-	-	-	4
		LA-SB5254AWL	B5254T2	02.11-	-	-	-	VK20Y	5
	2500	CBA-SB5254AWL	B5254(T/C)	04.10-	-	-	-	VK20Y	5
		CBA-BB525XC	B525(T/C)	15.7 -	VKH20Y	-	-	VKH20Y	5
	3000	CBA-BB6304TXC <small>(Last 5 digits of vehicle identification number: up to 94000)</small>	B6304T(T/C)	09.7 -	VKH22	-	IKH22	VKH22	6
		CBA-BB6304TXC <small>(Last 5 digits of vehicle identification number: starting from 94001)</small>	B6304T(T/C)	09.7 -	FK20HQR10 (Volvo)	-	-	VFKH20	6
3200	CBA-BB6324XC	B6324	07.11-	IKH20	-	IKH20	VKH20	6	
XC90	2000	DBA-LB420XC	B420(T/C)	16.1 -	ZXE24HR7	-	-	-	4
		DBA-LB420XCA	B420(T/C)	16.1 -	ZXE24HR7	-	-	-	4
		DBA-LB420XC	B420(S/C+T/C)	16.1 -	ZXE24HR7	-	-	-	4
		DBA-LB420XCA	B420(S/C+T/C)	16.1 -	ZXE24HR7	-	-	-	4
		DLA-LB420XCP	B420(S/C+T/C)	16.1 -	ZXE24HR7	-	-	-	4
		DLA-LB420XCPA	B420(S/C+T/C)	16.1 -	ZXE24HR7	-	-	-	4
		DBA-LB420XC	B420(T/C)	17.7 -	ZXE24HLR7	-	-	-	4
		DBA-LB420XCA	B420(T/C)	17.7 -	ZXE24HLR7	-	-	-	4
	2500	DBA-LB420XC	B420(S/C+T/C)	17.7 -	ZXE24HLR7	-	-	-	4
		DBA-LB420XCA	B420(S/C+T/C)	17.7 -	ZXE24HLR7	-	-	-	4
		DLA-LB420XCPA	B420(S/C+T/C)	17.7 -	ZXE24HLR7	-	-	-	4
		LA-CB5254AW	B5254(T/C)	03.5 -	-	-	-	VK20Y	5
	2900	CBA-CB5254AW	B5254(T/C)	04.10-	-	-	-	VK20Y	5
		LA-CB6294AW	B6294T(T/C)	03.5 -	-	-	-	VK20Y	6
3200	CBA-CB6324AW <small>(Last 6 digits of vehicle identification number: up to 568000)</small>	B6324	06.10-	IKH20	-	IKH20	VKH20	6	
	CBA-CB6324AW <small>(Last 6 digits of vehicle identification number: starting from 568001)</small>	B6324	06.10-	FK20HQR10 (Volvo)	-	-	VFKH20	6	
4400	CBA-CB8444AW	B8444	05.8 -	-	-	-	VK20Y	5	

DENSO	9	14	16	20	22	24	27	29	31	32	34	35
NGK	2	4	5	6	7	8	9	9.5	10	10.5	11	11.5

DENSO	9	14	16	20	22	24	27	29	31	32
CHAMPION	18	16,14	12,11	10,9	8,7	6,63,61	4,59	57	55	53

DENSO	9	14	16	20	22	24	27	31
BOSCH	10	9	8	7,6	5	4	3	2



CC	MODEL	FROM-TILL	IRIDIUM POWER	IRIDIUM RACING	DENSO	QTY
HONDA						
25	PEOPLE	84.3 -	IWF16	-	W14FP-UL	1
50	APE(SUPER SE HEAD KIT) (*3)	-	IY24	-	-	1
50	APE/DX(FI)	07.12-	IUF22	-	U20FSR-U	1
50	APE/SPECIAL/DX	01.2 -07	IUF22	-	U20FSR-U	1
50	BENLY /BENLY PRO	12.1 -	IU24D	IU01-□	U24EPR9	1
50	BENLY (CD50)	87.9 -	IUF22	-	U20FSR-U	1
50	BENLY (CD50S/SP)	96.4 -	IUF22	-	U20FSR-U	1
50	BENLY (CL50)	97.4 -	IUF22	-	U20FS-U	1
50	BITE	02.2 -	IUH24	IU01-□	U24FER9	1
50	BROAD	95.1 -	IWF20	-	W20FR-L	1
50	CABINA50/STAND UP	94.9 -	IWF20	-	W20FR-L	1
50	CHALY(CF50)	83.5 -88.3	IUF22	-	U20FS-U	1
50	CHALY50	88.3 -01	IUF22	-	U20FSR-U	1
50	CREA SCOOPY	07.10-	IUH24	IU01-□	U24FER9	1
50	CREA SCOOPY/SPECIAL/i	01 -07	IUH24	IU01-□	U24FER9	1
50	CRF50F	03.9 -	IUF22	-	U20FSR-U	1
50	CRM50	88.2 -	IW24	IW01-□	W24ESR-U	1
50	DAX	-	IUF22	-	U20FSR-U	1
50	DIO(No.3128592~)	03.10-	IUF22	-	U22FSR-U	1
50	DIO(~No.3128591)	03.10-	IUF22	-	U22FSR-U	1
50	DIO CESTA	04.7 -07	IUF22	-	U22FSR-U	1
50	DIO ST	96.7 -	IWF20	-	W20FR-L	1
50	DIO XR BAJA/CESTA	-	IWF20	-	W20FR-L	1
50	DIO ZX/FIT	94.1 -01	IWF20	-	W20FR-L	1
50	DIO/CESTA	07.10-	IUF22	-	U22FSR-U	1
50	DIO50/SE/SP	88.1 -89.12	IWF22	-	W22FPR-U	1
50	DIO50/SR	90.1 -90.12	IWF24	-	W24FSR	1
50	DIO50/SR/ZX	90.12-93.12	IWF20	-	W20FR-L	1
50	DJ1/R/L	85.4 -89	IWF20	-	W20FP-L	1
50	DJ1RR	88.4 -89	IWF22	-	W22FPR-U	1
50	DREAM 50/SPECIAL	97.2 -01	IUH24	IU01-□	U24FER9	1
50	DREAM 50R	03 -	IUH27	IU01-□	IUH27D	1
50	DUNK	14.2 -	IU24D	IU01-□	U24EPR9	1
50	G DASH	89.1 -90	IWF24	-	W24FSR	1
50	GIORCUB(SNC50)	99.8 -	IUF22	-	U20FSR-U	1
50	GIORNO	11.1 -	IUF22	-	U22FSR-U	1
50	GIORNO/SPORT	12.1 -	IUF22	-	U22FSR-U	1
50	GIORNO CREA/DELUXE	99.6 -	IUH24	IU01-□	U24FER9	1
50	GIORNO SPECIAL/DELUXE	92.3 -99.5	IWF20	-	W20FR-L	1
50	GORILLA	99.9 -07	IUF22	-	U20FSR-U	1
50	GORILLA(ULTRA SE BOREUP KIT) (*4)	-	IY24	-	-	1
50	GORILLA(Z50J)	78 -	IUF22	-	U20FS-U	1
50	GYRO CANOPY50	90.12-99.10	IWF24	-	W24FSR	1
50	GYRO CANOPY50	99.10-08.3	IWF24	-	W24FR-L	1
50	GYRO CANOPY50	08.3 -	IY24	-	Y24EPR-C	1
50	GYRO UP50	85.9 -00.4	IWF20	-	W20FP-L	1
50	GYRO UP50	00.4 -07	IWF24	-	W24FR-L	1
50	GYRO X50	82.10-99.12	IWF20	-	W20FR-L	1
50	GYRO X50	99.12-	IWF24	-	W24FR-L	1
50	GYRO X50	08.3 -	IY24	-	Y24EPR-C	1
50	HUMMING/G	80 -81	IWF16	-	W14FP-UL	1
50	JAZZ	86.4 -	IUF22	-	U20FSR-U	1
50	JOKER50	96.8 -	IWF20	-	W20FR-L	1
50	JULIO	98.7 -03	IWF20	-	W20FR-L	1
50	LEAD SS/SDX/R	83 -87	IWF20	-	W20FP-L	1
50	LEAD50	83.2 -92.2	IWF20	-	W20FP-L	1
50	LEAD50	92.3 -96.12	IWF22	-	W22FPR-U	1
50	LEAD50	97.1 -	IWF20	-	W20FR-L	1
50	LITTLE CUB	07.9 -	IUF22	-	U20FSR-U	1
50	LITTLE CUB	96.12-07	IUF22	-	U20FSR-U	1
50	LIVE DIO/J/S/S SPECIAL	99.9 -03	IWF20	-	W20FR-L	1
50	LIVE DIO/ZX/SR/SP/ST/ZX-SP	94.1 -03	IWF20	-	W20FR-L	1
50	MAGNA50	95.4 -07	IUF22	-	U20FSR-U	1
50	MBX50	82 -	IW24	IW01-□	W24ES-U	1
50	MONKEY	99.9 -07	IUF22	-	U20FSR-U	1
50	MONKEY BAJA	91 -	IUF22	-	U20FSR-U	1
50	MONKEY FI	09.2 -	IUF22	-	U20FSR-U	1

CC	MODEL	FROM-TILL	IRIDIUM POWER	IRIDIUM RACING	DENSO	QTY
HONDA						
50	MONKEY R	87.3 -	IUF22	-	U20FS-U	1
50	MONKEY(GOLD)	81 -	IUF22	-	U20FS-U	1
50	MONKEY(ULTRA SE BOREUP KIT) (*4)	-	IY24	-	-	1
50	MONKEY(Z50J)	74 -	IUF22	-	U20FS-U	1
50	MONKEY/RT/SP	85 -	IUF22	-	U20FSR-U	1
50	MOTOCOMPO	81 -	IWF16	-	W14FP-UL	1
50	MOTRA	82 -	IUF22	-	U20FS-U	1
50	MTX50R	83 -	IW24	IW01-□	W24ES-U	1
50	NS-1	91.2 -95.2	IW22	IW01-□	W22ESR-U	1
50	NS-1	95.3 -01	IW24	IW01-□	W24ESR-U	1
50	NS50F AERO	87.2 -91.2	IW24	IW01-□	W24ESR-U	1
50	NS50R	96.8 -	IW24	IW01-□	W24ESR-U	1
50	NSR50	87.6 -89.5	IW24	IW01-□	W24ES-U	1
50	NSR50	89.6 -95.1	IW22	IW01-□	W22ESR-U	1
50	NSR50	95.2 -01	IW24	IW01-□	W24ESR-U	1
50	PAL 50	90.1 -	IWF20	-	W20FR-L	1
50	PAL 50	87.4 -89.12	IWF20	-	W20FR-L	1
50	PRESS CUB	88.2 -07	IUF22	-	U20FSR-U	1
50	PRESS CUB50ST/DX	07.9 -	IUF22	-	U20FSR-U	1
50	QR50(MOTOCROSSER)	83 -	IWF22	-	W14FP-UL	1
50	ROADFOX	84.7 -85	IWF20	-	W20FP-L	1
50	SGX50 VIA	97.6 -01	IWF20	-	W20FR-L	1
50	SMART DIO Z4	04.2 -07	IY24	-	-	1
50	SMART DIO/DELUXE/Z4	01.3 -07	IUH24	IU01-□	U24FER9	1
50	SOLO	03.3 -	IUF22	-	U20FSR-U	1
50	SPACY	84 -86	IUF22	-	U20FS-U	1
50	STAND UP TACT	89.3 -92	IWF24	-	W24FSR	1
50	SUPER CUB 50 PRO	12.7 -	IU22D	IU01-□	U20EPR9S	1
50	SUPER CUB50/STREET	89.1 -07	IUF22	-	U20FSR-U	1
50	SUPER CUB50SDX	82.4 -07	IUF22	-	U22FS-U	1
50	SUPER CUB50ST/DX	82.3 -88.12	IUF22	-	U20FS-U	1
50	SUPER CUB50ST/DX/CUSTOM	07.9 -	IUF22	-	U20FSR-U	1
50	SUPER CUB50SUPERCUSTOM	-88.12	IUF22	-	U20FS-U	1
50	SUPER DIO/SE/SP/SR/ZXSP	-	IWF20	-	W20FR-L	1
50	TACT BASIC	89.9 -92	IWF22	-	W22FPR-U	1
50	TACT FULLMARK/S	82.9 -92.7	IWF20	-	W20FP-L	1
50	TACT IVY	86.4 -87	IUF22	-	U20FS-U	1
50	TACT/BASIC	92.7 -93.4	IWF24	-	W24FSR	1
50	TACT/S/STAND UP	93.4 -	IWF20	-	W20FR-L	1
50	TODAY	07.8 -	IUF22	-	U22FSR-U	1
50	TODAY	02.8 -07	IUF22	-	U22FSR-U	1
50	TOPIC(PRO/FLEX)	95.4 -01	IWF20	-	W20FR-L	1
50	VIA(SGX50)	97.6 -01	IWF20	-	W20FR-L	1
50	VOCAL	83.7 -	IUF22	-	U20FS-U	1
50	XR50MOTARD	05.2 -07	IUF22	-	U20FSR-U	1
50	XR50MOTARD (ULTRA SE BOREUP KIT) (*4)	-	IY24	-	-	1
50	XR50R	00.12-	IUF22	-	U20FSR-U	1
50	Z50R	95.7 -	IUF22	-	U20FSR-U	1
50	ZOOK	90.2 -91	IWF24	-	W24FSR	1
50	ZOOMER	07.10-	IUH24	IU01-□	U24FER9	1
50	ZOOMER	01.4 -13.4	IUH24	IU01-□	U24FER9	1
50	ZOOMER X	13.5 -	IU24D	IU01-□	U24EPR9	1
70	BENLY(CD70K)	-	IUF22	-	U20FS-U	1
70	CHALY(CF70)	83.5 -01	IUF22	-	U20FS-U	1
70	CRF70F	03.9 -	IUF22	-	U20FSR-U	1
70	SUPER CUB 70	95.2 -	IUF22	-	U20FSR-U	1
70	SUPER CUB C70SDX	82.3 -	IUF22	-	U20FS-U	1
70	XR70R	96.8 -	IUF22	-	U20FSR-U	1
80	CR80	-	IW31	IW01-□	IW31	1
80	CR80R	87.9 -02	IW31	IW01-□	IW31	1
80	CR80R II	96 -02	IW31	IW01-□	IW31	1
80	CRF80F	07.6 -	IUF22	-	U22FSR-U	1
80	CRM80	88.3 -	IW24	IW01-□	W24ESR-U	1
80	LEAD80	82 -88	IWF20	-	W20FP-U	1
80	MBX80 INTEGRA	83.6 -	IW24	IW01-□	W24ES-U	1
80	MTX80R	83.6 -	IW24	IW01-□	W24ES-U	1

(*3)KITACO TUNING HEAD (*4)KITACO TUNING HEAD 85cc,88cc,104cc,108cc,117cc,124cc

DENSO

AUSTRALIA CHINA

INDIA

INDONESIA

KOREA

MALAYSIA

PHILIPPINES

SAUDIARABIA

SINGAPORE

TAIWAN

THAILAND

VIETNAM

JAPAN

& USA

EUROPE

MOTOR

SMALL ENGINE REFERENCE NUMBER



JAPAN MOTORCYCLE

▶ Spark plug color codes: ■ for Iridium Tough and Iridium Plugs and Iridium TT, ■ for Iridium Power, ■ for Iridium Racing and Two Tops Plugs, ■ for Platinum Plugs and Platinum TT, and black for general spark plugs.

DENSO
AUSTRALIA
CHINA
INDIA
INDONESIA
KOREA
MALAYSIA
PHILIPPINES
SAUDI ARABIA
SINGAPORE
TAIWAN
THAILAND
VIETNAM
JAPAN
EUROPE & USA
MOTOR CYCLE
SMALL ENGINE
CROSS REFERENCE
PART NUMBER

CC MODEL	FROM-TILL	IRIDIUM POWER	IRIDIUM RACING	DENSO	QTY
HONDA					
80 NSR80	87.11-89.5	IW24	IW01-□	W24ESR-U	1
80 NSR80	89.6-01	IW22	IW01-□	W22ESR-U	1
80 NSR80R	-	IW24	IW01-□	W24ESR-U	1
80 XLR80R	87.8-	IUF22	-	U22FS-U	1
80 XR80R	86.6-	IUF22	-	U22FSR-U	1
85 CR85R/R II	03-	IW31	IW01-□	IW31	1
90 BENLY CD90	81-87.8	IUF22	-	U20FS-U	1
90 BENLY CD90	87.9-01	IUF22	-	U20FS-U	1
90 BENLY CD90S	96.4-	IUF22	-	U20FSR-U	1
90 BROAD90	95.1-	IWF20	-	W20FR-L	1
90 CABINA90	94.9-	IWF20	-	W20FR-L	1
90 EZ-9	90.9-	IWF22	-	W22FSR	1
90 FOURTRAX90EX(QUAD)	94-	IUF22	-	U22FSR-U	1
90 JOKER90	96.8-	IWF20	-	W20FR-L	1
90 LEAD90	88-94.6	IWF20	-	W20FPR-L	1
90 LEAD90	94.7-98	IWF20	-	W20FR-L	1
90 NEW SUPER CUB C90	80-94	IUF22	-	U20FS-U	1
90 SUPER CUB90	95.2-	IUF22	-	U20FSR-U	1
100 APE100(ULTRA SE BOREUP KIT) (*5)	-	IY24	-	-	1
100 APE100/DX	02.2-	IUF22	-	U22FSR-U	1
100 CRF100F	03.9-	IUF22	-	U22FSR-U	1
100 LEAD100	98.1-03	IWF20	-	W20FR-L	1
100 LEAD100(Import)	-	IUF22	-	U22FSR-U	1
100 SPACY100	03.9-	IUF22	-	U20FSR-U	1
100 SUPER CUB100/EX	94-99	IUF22	-	U22FSR-U	1
100 XR100(ULTRA SE BOREUP KIT) (*5)	-	IY24	-	-	1
100 XR100MOTARD	05.2-	IUF22	-	U22FSR-U	1
100 XR100/R	90-	IUF22	-	U22FSR-U	1
100 WAVE100(Import)	04-	IUF22	-	U20FS-U	1
110 BENLY 110/BENLY 110PRO	12.1-	IU24D	IU01-□	U24EPR9	1
110 CT110	81-	IX24	IXU01-□	X24ES-U	1
110 CZ-i110(Import)	08-	IU20	IU01-□	-	1
110 DIO 110	11.6-15.3	IU24D	IU01-□	U24EPR9	1
110 DIO 110	15.3-	IU24D	IU01-□	-	1
110 LEAD/EX	08.1-	IUH24	IU01-□	U22FER9	1
110 NICE110S(Import)	-	IUF22	-	U20FS-U	1
110 SUPER CUB110	09.6-12.3	IU22D	IU01-□	U20EPR9S	1
110 SUPER CUB110	09.6-	IU22D	IU01-□	U20EPR9S	1
110 SUPER CUB110PRO	09.10-	IU22D	IU01-□	U20EPR9S	1
110 CROSSCUB	13.6-	IU22D	IU01-□	U20EPR9	1
110 WAVE110-i (Import)	-	IU22D	IU01-□	U20EPR9S	1
110 ZOOMER X	13.6-	IU24D	IU01-□	U24EPR9	1
125 125T MASTER CUSTOM	82-	IUF22	-	U22FS-U	2
125 @125(Import)	-	IUH24	IU01-□	U24FER9	1
125 ANF125i Innova(Import)	-	IU20	IU01-□	U20EPR9	1
125 BENLY CD125T	79.5-93.6	IUF22	-	U20FS-U	2
125 BENLY CD125T	93.7-01.2	IUF22	-	U20FSR-U	2
125 BENLY CD125T	01.3-	IUH24	IU01-□	U24FER9	2
125 BIALS TL125/S	73-	IX24	IXU01-□	X24ES-U	1
125 CB125JX	81-	IX24	IXU01-□	X24ES-U	1
125 CB125T	81-	IUF22	-	U22FSR-U	2
125 CBF125	08-	IU22D	IU01-□	U22EPR9	1
125 CBX125/F	84.3-93.2	IX27B	IXU01-□	X27EPR-U9	1
125 CBR125R	13.6-	IU24	IU01-□	U24ESR-N	1
125 CBR125R(Import)	04-	IU24	IU01-□	U24ESR-N	1
125 CBX125CUSTOM	84.3-	IX24B	IXU01-□	X24EPR-U9	1
125 CBX125F	93.3-	IX27B	IXU01-□	X27EPR-U9	1
125 CR125	83-	IW27	IW01-□	-	1
125 CR125R	82-96.7	IW27	IW01-□	-	1
125 CR125R	96.7-98.7	IW27	IW01-□	-	1
125 CR125R	98.8-	IW27	IW01-□	-	1
125 CR125R	01.9-	IW27	IW01-□	W27ESR-V	1
125 DASH RS(Import)	-	IW20	IW01-□	W20EP-U	1
125 DREAM125(Import)	-	IU20	IU01-□	U20EPR9	1
125 DYLAN125(Import)	-	IUH24	IU01-□	U24FER9	1
125 GROM	13-	IU20	IU01-□	U20EPR9	1
125 LEAD125	13-	IU22D	IU01-□	U22EPR9	1

CC MODEL	FROM-TILL	IRIDIUM POWER	IRIDIUM RACING	DENSO	QTY
HONDA					
125 LEAD/LEAD EX	08-	IUH24	IU01-□	U22FER9	1
125 LS125R(Import)	-	IW24	IW01-□	W24ES-U	1
125 MBX125F	83.3-85	IW27	IW01-□	W27ES-U	1
125 MTX125R	82-	IW27	IW01-□	W27ES-U	1
125 NSR125	-	IW27	IW01-□	W27ESR-U	1
125 NSR125F	89.6-01	IW27	IW01-□	W27ESR-U	1
125 NX125	88-	IX24	IXU01-□	X24ESR-U	1
125 PANTHEON125(Import)	03-	IUH24	IU01-□	U24FER9	1
125 PCX	10.3-	IU22D	IU01-□	U22EPR9	1
125 RS125R with Detonation Counter	-	-	IA01-□	IA01-32	1
125 RS125R without Detonation Counter	-	-	IAE01-□	IAE01-32	1
125 Sh mode	13.9-	IU22D	IU01-□	U22EPR9	1
125 SH125(Import)	-	IUH24	IU01-□	U24FER9	1
125 SHADOW125	-	IUH24	IU01-□	U24FER9	2
125 SONIC125RS(Import)	-	IU24	IU01-□	U24ESR-N	1
125 SPACY125	94.2-95.8	IX22B	IXU01-□	X22EPR-U9	1
125 SPACY125	95.8-	IUF22	-	U22FSR-U	1
125 SPACY125STRIKER	83.3-87.2	IX22B	IXU01-□	X22EP-U9	1
125 VARADERO125(Import)	-	IUH24	IU01-□	U24FER9	1
125 WAVE125/i(Import)	-	IU22D	IU01-□	U20EPR9	1
125 XLR125R	93.6-	IX24B	IXU01-□	X24EPR-U9	1
125 XR125L(Import)	03-	IX24B	IXU01-□	X24EPR-U9	1
150 @150(Import)	-	IUH24	IU01-□	U24FER9	1
150 CBR150R(Import)	-	IU24	IU01-□	U24ESR-N	1
150 CRF150F(Import)	04-	IX22B	IXU01-□	X22EPR-U9	1
150 CRF150R/R II	06-	IUH24	IU01-□	U24FER9	1
150 DYLAN150(Import)	-	IUH24	IU01-□	U24FER9	1
150 NSR150	-	IW24	IW01-□	W24ES-U	1
150 NSR150SP/RR	-	IW27	IW01-□	W27ES-U	1
150 PANTHEON150(Import)	03-	IUH24	IU01-□	U24FER9	1
150 PCX150	12.6-	IU22D	IU01-□	U22EPR9	1
150 SH150(Import)	-	IUH24	IU01-□	U24FER9	1
200 MTX200R	83.2-	IW27	IW01-□	W27ES-U	1
200 PHANTOM(Import)	-	IX24B	IXU01-□	X24EPR-U9	1
200 TLM200R	85-	IW24	IW01-□	W24ES-U	1
200 TLR200	83-	IX24	IXU01-□	X24ES-U	1
200 XLR200	82-	IX24	IXU01-□	X24ES-U	1
200 XLR200R	93.6-	IX24B	IXU01-□	X24EPR-U9	1
200 XR200R	81-	IX24	IXU01-□	X24ESR-U	1
220 TLM220R	88.3-	IW24	IW01-□	W24ESR-U	1
223 CB223S	08.3-	IX24B	IXU01-□	X24EPR-U9	1
223 FTR223/D	00.9-	IX24B	IXU01-□	X24EPR-U9	1
230 CRF230F(Import)	04-	IX24B	IXU01-□	X24EPR-U9	1
230 CRF230L(Import)	08-	IX24B	IXU01-□	X24EPR-U9	1
230 SL230	97.4-	IX24B	IXU01-□	X24EPR-U9	1
230 XL230	02.4-04	IX24B	IXU01-□	X24EPR-U9	1
230 XR230	05.3-	IX24B	IXU01-□	X24EPR-U9	1
250 250T MASTER/LA CUSTOM	81-	IUF22	-	U22FS-U	2
250 AX-1(250)1000001-1003044	87.12-89.6	IUH24	IU01-□	U24FER9	1
250 AX-1(250)1003045-	89.7-	IUH27	IU01-□	U27FER9	1
250 BROS PRODUCT1/2	-	IX24B	IXU01-□	X24EPR-U9	2
250 CB250F	14.7-	IU24	IU01-□	-	1
250 CB250RS/RS-Z	80.3-	IX24	IXU01-□	X24ES-U	1
250 CBF250(Import)	04-	IUH24	IU01-□	U24FER9	1
250 CBR250Four	86.4-	IUH27	IU01-□	U27FER9	4
250 CBR250R	87.9-90.3	IUH27	IU01-□	U27FER9	4
250 CBR250R	11.3-	IU24	IU01-□	-	1
250 CBR250RR	90.3-	IUH27	IU01-□	U27FER9	4
250 CBX250RS	83.5-	IX24B	IXU01-□	X24EP-U9	1
250 CBX250S	85-	IXG24	IXU01-□	X24GP-U	1
250 CD250u	88.4-93	IUF22	-	U20FSR-U	2
250 CR250	-	IW24	IW01-□	-	1
250 CR250R	87.9-90.8	IW27	IW01-□	-	1
250 CR250R	90.9-96.9	IW24	IW01-□	-	1
250 CR250R	96.9-98.6	IW24	IW01-□	-	1
250 CR250R	98.7-05.1	IW24	IW01-□	-	1
250 CR250R	05.1-	IW27	IW01-□	-	1

(*5) KITACO TUNING HEAD 115cc,125cc,145cc



CC	MODEL	FROM-TILL	IRIDIUM POWER	IRIDIUM RACING	DENSO	QTY
HONDA						
250	CRF250L	12.5 -	IU24	IU01-□	-	1
250	CRF250M	13.4 -	IU24	IU01-□	-	1
250	CRF250R	03.9 -04.8	IUH24D	IU01-□	VUH24D	1
250	CRF250R	04.8 -09	-	IU01-□	IU01-24	1
250	CRF250R/X	09.9 -	-	-	-	1
250	CRF250R	12.4 -	IU24	IU01-□	-	1
250	CRF250X(Import)	04 -09	IUH24D	IU01-□	VUH24D	1
250	CRM250/R	89.4 -	IW24	IW01-□	W24ESR-U	1
250	CRM250AR	97.1 -	IW24	IW01-□	W24ESR-U	1
250	FAZE/ABS/TYPE-S	09.7 -	-	-	-	1
250	FORESIGHT/SE/EX	97.6 -07	IX22B	IXU01-□	X22EPR-U9	1
250	FORZA 250/S/T/ST/X	00.3 -04.3	IX22B	IXU01-□	X22EPR-U9	1
250	FORZA Si	13.7 -	-	-	-	1
250	FORZA X/Z	04.4 -	IX22B	IXU01-□	X22EPR-U9	1
250	FORZA Z/ABS	07.12-	-	-	-	1
250	FREEWAY250	94.2 -99	IX22B	IXU01-□	X20EP-U9	1
250	FTR250	86 -	IXG24	IXU01-□	X24GP-U	1
250	FUSION250/SE	86.4 -99	IX22B	IXU01-□	X20EP-U9	1
250	FUSION250/X/XX	03.3 -07	IX22B	IXU01-□	X20EPR-U9	1
250	GB250CLUBMAN	83.12-	IX24B	IXU01-□	X24EPR-U9	1
250	HELIX	-	IX22B	IXU01-□	X20EPR-U9	1
250	HORNET	96.2 -00.1	IUH24	IU01-□	U24FER9	4
250	HORNET	00.1 -07	IUH27	IU01-□	U27FER9	4
250	JADE250/S	91.2 -	IUH24	IU01-□	U24FER9	4
250	MVX250F	83.2 -84.4	IW24(IW27)	IW01-□	W24ES-U(W27ES-U)	3
250	NIGHTHAWK250	92 -	IUF22	-	U20FSR-U	2
250	NS250F/R/R Rothmans	84.5 -86.9	IW24	IW01-□	W24ES-U	2
250	NSR250R	86.10-87.12	IWM27	IWM01-□	-	2
250	NSR250R/SP	88.1 -89.12	IWM27	IWM01-□	-	2
250	NSR250R/SP/SE	90.1 -93.10	IWM27	IWM01-□	-	2
250	NSR250R/SP/SE	93.11-01	IWM27	IWM01-□	-	2
250	PS250	04.6 -07	IX22B	IXU01-□	X22EPR-U9	1
250	REBEL(CA250T)/SPECIAL	85.4 -	IUF22	-	U20FS-U	2
250	REBEL250	94.2 -	IUF22	-	U20FSR-U	2
250	RS250R withDetonationCounter	-	-	IA01-□	IA01-32	2
250	RS250R withoutDetonationCounter	-	-	IAE01-□	IAE01-32	2
250	RTL250F	05 -	IU20	IU01-□	-	1
250	RTL250R	-	IW20	IW01-□	W20ESR-U	1
250	SPACY250FREEWAY	84 -	IX22B	IXU01-□	X20EP-U9	1
250	TLR250R	86.4 -	IX24	IXU01-□	X24ES-U	1
250	VT250F/INTEGRA	82.6 -87	IX24B	IXU01-□	X24EP-U9	2
250	VT250SPADA	88.12-91	IUH24	IU01-□	U24FER9	2
250	VT250Z	84 -84	IX24B	IXU01-□	X24EP-U9	2
250	VTR	09.3 -	IUH24	IU01-□	U24FER9	2
250	VTR250	98.1 -07	IUH24	IU01-□	U24FER9	2
250	V-TWIN MAGNA250/S	94.6 -07	IUH24	IU01-□	U24FER9	2
250	VTZ250H/H-2 1021001~1033408	87 -88	IX24B	IXU01-□	X24EP-U9	2
250	VTZ250J/K 1055001~1104798	88.6 -89	IUH24	IU01-□	U24FER9	2
250	XELVIS250	91.1 -	IUH24	IU01-□	U24FER9	2
250	XL DEGREE250	91.4 -	IUH24	IU01-□	U24FER9	1
250	XL250/S/R	74 -	IX24	IXU01-□	X24ES-U	1
250	XLR250BAJA	90 -95	IXG24	IXU01-□	X24GPR-U	1
250	XLR250R	85 -90.1	IXG24	IXU01-□	X24GP-U	1
250	XLR250R	90.2 -93.12	IXG24	IXU01-□	X24GPR-U	1
250	XLR250R	94.1 -95.2	IXG27	IXU01-□	X27GPR-U	1
250	XLX250R	83 -	IX24B	IXU01-□	X24EP-U9	1
250	XR BAJA	95 -	IUH24	IU01-□	U24FER9	1
250	XR250	95.2 -03.1	IUH24	IU01-□	U24FER9	1
250	XR250	03.2 -	IUH24	IU01-□	U24FER9	1
250	XR250 MOTARD	03.4 -07	IUH24	IU01-□	U24FER9	1
250	XR250R	-95	IXG27	IXU01-□	X27GPR-U	1
250	XR250R	95 -	IUH27	IU01-□	U27FER9	1
260	RTL260F	08 -	IU20	-	-	1
260	TLM260R	89 -	IW20	IW01-□	W20ES-U	1
260	TLR260	94.12-	IW20	IW01-□	W20ESR-U	1
300	FOURTRAX300EX(QUAD)	94 -	IX24	IXU01-□	X24ESR-U	1

CC	MODEL	FROM-TILL	IRIDIUM POWER	IRIDIUM RACING	DENSO	QTY
HONDA						
300	SH300i(Import)	-	-	-	-	1
350	CB350	68 -	IW22	IW01-□	W22ES-U	2
350	CB350Four	72.6 -	IX22	IXU01-□	X22ES-U	4
400	400X	13.6 -	IU24D	IU01-□	U24EPR9	2
400	BROS400 PRODUCT2	88.1 -94	IX24B	IXU01-□	X24EPR-U9	4
400	CB1(400)	89.3 -	IUH24	IU01-□	U24FER9	4
400	CB400F	13.5 -	IU24D	IU01-□	U24EPR9	2
400	CB400F VERSION	-	IUH24	IU01-□	U24FER9	4
400	CB400F(I · II)	74.12-	IX24	IXU01-□	X24ES-U	4
400	CB400FOUR	97.4 -	IUH24	IU01-□	U24FER9	4
400	CB400LC	82 -	IX24	IXU01-□	X24ES-U	4
400	CB400SS/CAFE RACER STYLE	01.10-	IXG24	IXU01-□	X24GPR-U	1
400	CB400SUPER BOLD'OR	05.3 -07	IUH24	IU01-□	U24FER9	4
400	CB400SuperFour	00.2 -02.1	IUH24	IU01-□	U24FER9	4
400	CB400SuperFour SPECII	02.1 -03.12	IUH24	IU01-□	U24FER9	4
400	CB400SuperFour SPECIII	03.12-07	IUH24	IU01-□	U24FER9	4
400	CB400SuperFour/S/R	92.4 -00.2	IUH24	IU01-□	U24FER9	4
400	CB400SUPER FOUR/SUPER BOLD'OR	07.12-	IUH24	IU01-□	U24FER9	4
400	CBR400F/ENDURANCE	83.12-	IX24	IXU01-□	X24ES-U	4
400	CBR400R	86.7 -	IUH27	IU01-□	U27FER9	4
400	CBR400R	13.4 -	IU24D	IU01-□	U24EPR9	2
400	CBR400RR	88.1 -	IUH24	IU01-□	U24FER9	4
400	CBX400CUSTOM	83 -	IX24B	IXU01-□	X24EP-U9	4
400	CBX400F/INTEGRA	81.11-	IXG24	IXU01-□	X24GP-U	4
400	CL400/RS	98.9 -	IXG24	IXU01-□	X24GP-U	1
400	CM400T	79.8 -	IX24	IXU01-□	X24ES-U	2
400	CX CUSTOM	83.3 -	IX24	IXU01-□	X24ES-U	2
400	CX EURO	82 -	IX24	IXU01-□	X24ES-U	2
400	FT400	82.6 -	IX24	IXU01-□	X24ES-U	1
400	GB400TT·MK II	85.7 -	IX24B	IXU01-□	X24EP-U9	1
400	HAWK CB400N/T-T-AT	77 -	IX24	IXU01-□	X24ES-U	2
400	NS400R	85.5 -86	IW24	IW01-□	W24ES-U	3
400	NV400CUSTOM/SP	83.3 -	IX24B	IXU01-□	X24EPR-U9	4
400	NV400STEED	-	IX22B	IXU01-□	X22EPR-U9	4
400	RVF400	94.1 -01	IY27	-	-	4
400	SHADOW CLASSIC/CUSTOM	08.11-	IX22B	IXU01-□	X22EPR-U9	4
400	SHADOW SLASHER	00.4 -	IX22B	IXU01-□	X22EPR-U9	4
400	SHADOW400	97 -	IX22B	IXU01-□	X22EPR-U9	4
400	SILVERWING400/ABS	01.11-09.2	IUH24	IU01-□	U24FER9	2
400	SILVERWING GT400/ABS	09.3 -	IUH24	IU01-□	U24FER9	2
400	STEED VLS	98.3 -	IX22B	IXU01-□	X22EPR-U9	4
400	STEED VSE/VLX/VCL	96.1 -	IX22B	IXU01-□	X22EPR-U9	4
400	TRANSALP400V	92.3 -	IX24B	IXU01-□	X24EPR-U9	4
400	VF400F/INTEGRA	82.12-	IX24B	IXU01-□	X24EP-U9	4
400	VFR400R	87.4 -89.1	IUH24	IU01-□	U24FER9	4
400	VFR400R	89.1 -93	IY27	-	-	4
400	VFR400Z	87.4 -90.1	IUH24	IU01-□	U24FER9	4
400	VRX ROADSTAR	95.7 -	IX22B	IXU01-□	X22EPR-U9	4
400	VT400S	10.11-	IX22B	IXU01-□	X22EPR-U9	4
400	XL400R	82 -	IX24	IXU01-□	X24ES-U	1
400	XL400V	-	IX24B	IXU01-□	X24EPR-U9	4
400	XR400 MOTARD	05.3 -	IXG24	IXU01-□	X24GPR-U	1
400	XR400R	97.7 -	IXG24	IXU01-□	X24GP-U	1
450	CRF450R	01.11-08	IK24	IK01-□	VK24PRZ11	1
450	CRF450R	08.10-	-	-	-	1
500	CB500/S	96 -03	IUH24	IU01-□	U24FER9	2
500	CBF500(Import)	04 -	IUH24	IU01-□	U24FER9S	2
500	CR500/R	-	IW24	IW01-□	-	1
500	FT500	82.5 -	IX24	IXU01-□	X24ES-U	1
500	GB500TT	85 -	IX24B	IXU01-□	X24EP-U9	1
500	NSR500V withDetonationCounter	-	-	IU01-□	IA01-32	2
500	TRX500(QUAD)	01 -	IX22B	IXU01-□	VX22BC	1
500	WING GL500/CUSTOM	78 -	IX24	IXU01-□	X24ES-U	2
500	XL500S	79 -	IX24	IXU01-□	X24ES-U	1
550	CBX550INTEGRA	82 -	IX24	IXU01-□	X24ES-U	4
600	CB600F	98.3 -	IUH24	IU01-□	U24FER9	4
600	CB600F/ABS(Import)	11 -	IUH27	IU01-□	U27FER9	4

DENSO

AUSTRALIA CHINA

INDIA

INDONESIA

KOREA

MALAYSIA

PHILIPPINES

SAUDIARABIA

SINGAPORE

TAIWAN

THAILAND

VIETNAM

JAPAN

& USA

EUROPE

MOTOR

SMALL

ENGINE

REFERENCE

NUMBER



JAPAN MOTORCYCLE

▶ Spark plug color codes: ■ for Iridium Tough and Iridium Plugs and Iridium TT, ■ for Iridium Power, ■ for Iridium Racing and Two Tops Plugs, ■ for Platinum Plugs and Platinum TT, and black for general spark plugs.

DENSO	CC MODEL		FROM-TILL	IRIDIUM POWER	IRIDIUM RACING	DENSO	QTY
	HONDA						
	600	CB600F HORNET/ABS(Import)	07 -	IUH27	IU01-□	U27FER9	4
	600	CBF600/S ABS(Import)	04 -	IUH24	IU01-□	U24FER9	4
	600	CBR600F	92.6 -	IUH24	IU01-□/ RU01-□	U24FER9	4
	600	CBR600F(Import)	88 -00.9	IUH27	IU01-□	U27FER9	4
	600	CBR600F(Import)	00.10-	IUH27	IU01-□/ RU01-□	IUH27D	4
	600	CBR600F4i	01.3 -	IUH27	IU01-□/ RU01-□	IUH27D	4
	600	CBR600FS(Import)	00.10-	IUH27	IU01-□/ RU01-□	IUH27D	4
	600	CBR600RR	03 -04	IUH24D	IU01-□	VUH24D	4
	600	CBR600RR	05 -08	IUH24D	IU01-□	-	4
	600	CBR600RR/ABS	09.2 -	IUH24D	IU01-□	-	4
	600	CBR600RR(Import)	03 -04	IUH27D	IU01-□	VUH27D	4
	600	CBR600RR(Import)	05 -08	IUH27D	IU01-□	-	4
	600	CBR600RR/ABS(Import)	09 -	IUH24D	IU01-□	-	4
	600	CBR600RR RACE BASE	03 -	IUH24	IU01-□	-	4
	600	FJS600SILVERWING	01 -	IUH24	IU01-□	U24FER9	2
	600	HORNET S(Import)	-	IUH27	IU01-□	U27FER9	4
	600	HORNET600/S	98.3 -	IUH24	IU01-□	U24FER9	4
	600	NV600STEED	88.1 -	IX22B	IXU01-□	X22EPR-U9	4
	600	SILVERWING600/ABS	01.3 -	IUH24	IU01-□	U24FER9	2
	600	SILVER WING GT600/ABS	09.6 -	IUH24	IU01-□	U24FER9	2
	600	STEED VLX	96 -	IX22B	IXU01-□	X22EPR-U9	4
	600	TRANSALP600V	87.4 -	IX24B	IXU01-□	X24EPR-U9	4
	600	VT600C/CD SHADOW VLX/DX	86 -	IX24B	IXU01-□	X24EPR-U9	4
	600	XL600V TRANSALP	87 -	IX24B	IXU01-□	X24EPR-U9	4
	600	XR600R	86 -	IX24B	IXU01-□	X24EPR-U9	1
	650	AFRICATWIN650	88 -90	IX24B	IXU01-□	X24EPR-U9	4
	650	BROS650PRODUCT1/2	88.1 -	IX24B	IXU01-□	X24EPR-U9	4
	650	CBX650CUSTOM	82.12-	IX24B	IXU01-□	X24EP-U9	4
	650	DEAUVILLE(NT650V)	-	IX24B	IXU01-□	X24EPR-U9	4
	650	FMX650(Import)	-	IX24B	IXU01-□	X24EPR-U9	1
	650	FX650 VIGOR	-	IX24B	IXU01-□	X24EPR-U9	1
	650	NTV650	88 -	IX24B	IXU01-□	X24EPR-U9	4
	650	NX650DOMINATOR	88 -	IX24B	IXU01-□	X24EPR-U9	1
	650	SLR650	-	IX22B	IXU01-□	X22EPR-U9	1
	650	TRX650FA	02.5 -	IK16	IK01-□	VK16PRZ11	1
	650	XL650V TRANSALP	-	IX24B	IXU01-□	X24EPR-U9	4
	650	XR650L	92 -	IX22B	IXU01-□	X22EPR-U9	1
	650	XR650R	00.1 -	IK22	IK01-□	K22PR-U11	1
	670	CTX700/700N	13 -	IK20	IK01-□	-	2
	670	INTEGRA(NC700D)	12 -	IK20	IK01-□	-	2
	670	NC700S	12 -	IK20	IK01-□	-	2
	670	NC700X	12 -	IK20	IK01-□	-	2
	680	DN-01	08.3 -	IU24	IU01-□	-	2
	680	DEAUVILLE(Import)	06 -	IU24D	IU01-□	U24EPR9	2
	680	XL700V TRANSALP(Import)	08 -	IU24D	IU01-□	U24EPR9	2
	700	WING INTERSTATE	83 -	IX24B	IXU01-□	X24EPR-U9	2
	750	AFRICATWIN750	90.2 -	IX24B	IXU01-□	X24EPR-U9	4
	750	CB750 Four	69 -77	IX24	IXU01-□	X24ES-U	4
	750	CB750/F2	92.2 -09	IX24B	IXU01-□	X24EPR-U9	4
	750	CB750AERO	77.4 -	IX22	IXU01-□	X22ES-U	4
	750	CB750CUSTOM EXCLUSIVE	80 -	IX24	IXU01-□	X24ES-U	4
	750	CB750K·F	78.12-	IX24	IXU01-□	X24ES-U	4
	750	CBR750F	-	IX24	IXU01-□	X24ES-U	4
	750	CBR750SUPER AERO	87.2 -	IX24B	IXU01-□	X24EP-U9	4
	750	CBX750F	83.12-	IX24B	IXU01-□	X24EP-U9	4
	750	CBX750HORIZON	84.3 -	IX24B	IXU01-□	X24EP-U9	4
	750	INTEGRA(NC750D)	14.2 -	IK20	IK01-□	-	2
	750	NC750S	14 -	IK20	IK01-□	-	2
	750	NC750X	14 -	IK20	IK01-□	-	2
	750	NIGHTHAWK750	91.6 -	IX24B	IXU01-□	X24EPR-U9	4
	750	NR(750)	92.5 -93	IY27	-	-	8
	750	NV750CUSTOM	82 -83	IX24B	IXU01-□	X24EPR-U9	4
	750	RS750MAGNA	93.7 -96	IUH24	IU01-□	U24FER9	4

CC MODEL		FROM-TILL	IRIDIUM POWER	IRIDIUM RACING	DENSO	QTY
HONDA						
750	RVF750(RC45)	94 -95	IUH27	RU01-□	IUH27	4
750	SHADOW SLASHER750	00.11-	IX22B	IXU01-□	X22EPR-U9	4
750	SHADOW750	97.3 -03	IX22B	IXU01-□	X22EPR-U9	4
750	SHADOW750/ABS	04 -	IX22B	IXU01-□	X22EPR-U9	4
750	SHADOW PHANTOM	09.11-	IX22B	IXU01-□	X22EPR-U9	4
750	V45MAGNA	87 -93	IX24B	IXU01-□	X24EP-U9	4
750	VF750C	93.7 -01	IUH24	IU01-□	U24FER9	4
750	VF750F	82.12-	IX24B	IXU01-□	X24EP-U9	4
750	VF750SAVER·MAGNA	82 -96	IX24B	IXU01-□	X24EP-U9	4
750	VFR750F	86 -89	IX24B	IXU01-□	X24EPR-U9	4
750	VFR750F	90.2 -93	IUH24	IU01-□	U24FER9	4
750	VFR750R	87.8 -	IUH27	IU01-□	U27FE9	4
750	VT750S	10.3 -	IX22B	IXU01-□	X22EPR-U9	4
750	XLV750E/R	83 -	IX24B	IXU01-□	X24EPR-U9	4
800	CROSSRUNNER(Import)	11 -	-	IU01-□	VNH27ZB	4
800	VFR800(Import)	02 -09	-	IU01-□	VNH27Z	4
800	VFR800(Import)	98 -01	IU27	IU01-□	U27FER9	4
800	VFR800	02 -	-	IU01-□	VNH24Z	4
800	VFR800	98.4 -02	IU24	IU01-□	U24FER9	4
800	VFR800F	14.4 -	-	IU01-□	VNH27ZB	4
800	VFR800F	14.12-	-	IU01-□	VNH27ZB	4
800	PACIFIC COAST(PC800)	90.11-01	IX22B	IXU01-□	X22EPR-U9	4
900	CB900HORNET	01.10-	IUH24	IU01-□	U24FER9	4
900	CBR900RR FIREBLADE	92 -99	IUH27	IU01-□/ RU01-□	U27FER9	4
900	CBR900RR FIREBLADE(Import)	00.1 -01.12	IUH27	IU01-□/ RU01-□	IUH27D	4
929	CBR929RR FIREBLADE(Import)	00.1 -01.12	IUH27	IU01-□/ RU01-□	IUH27D	4
954	CBR954RR	02.3 -03	IUH24D	IU01-□	VUH24D	4
954	CBR954RR(Import)	02 -03	IUH27D	IU01-□	VUH27D	4
1000	CB1000R(Import)	08 -	IUH27	IU01-□	VUH27ES	4
1000	CB1000SF(Import)	-	IX27B	IXU01-□	X27EPR-U9	4
1000	CB1000SuperFour	92.11-	IX24B	IXU01-□	X24EPR-U9	4
1000	CB1000R(Import)	08 -	IUH24	IU01-□	U24FER9	4
1000	CBF1000/ABS(Import)	-	IUH24	IU01-□	U24FER9	4
1000	CBF1000/ABS(Import)	10 -	IUH24	IU01-□	VUH24ES	4
1000	CBR1000F	93.4 -	IX24B	IXU01-□	X24EPR-U9	4
1000	CBR1000F(Import)	87 -	IX27B	IXU01-□	X27EPR-U9	4
1000	CBR1000RR	04.4 -07	IUH27D	IU01-□	-	4
1000	CBR1000RR	08.7 -	IUH27	IU01-□	VUH27ES	4
1000	CBR1000RR RACE BASE	04.3 -04.12	-	RU01-□	-	4
1000	CBR1000RR RACE BASE	05.1 -07	-	IU01-□	-	4
1000	CBR1000RR RACE BASE	08 -	-	RU01-□	-	4
1000	CBR1000RR(Import)	04 -07	IUH27D	IU01-□	-	4
1000	CBR1000RR(Import)	08 -	IUH27	IU01-□	VUH27ES	4
1000	CBX1000	-	IX24	IXU01-□	X24ESR-U	6
1000	FIRESTORM	97.4 -03	IX24B	IXU01-□	IX24B	2
1000	RC51(RVT1000R)(Import)	00.1 -	IK27	IK01-□	IK27C11	2
1000	VTR1000F(Import)	97 -	IX27B	IXU01-□	IX27B	2
1000	VTR1000SP-1(Import)	00.1 -01.12	IK27	IK01-□	IK27C11	2
1000	VTR1000SP-2(Import)	02 -	IK27	IK01-□	VK27PRZ11	2
1000	XL1000V VARADERO/ABS	99 -	IX24B	IXU01-□	IX24B	2
1000	XL1000V VARADERO/ABS	03 -	-	-	-	2
1100	C2T	-	IX22B	IXU01-□	X22EPR-U9	2
1100	CB1100Type I /ABS	10.3 -	-	-	-	4
1100	CB1100Type II /ABS	10.6 -	-	-	-	4
1100	CB1100EX	14.2 -	-	-	-	4
1100	CBR1100XX SUPERBLACKBIRD	97 -01	IUH27	IU01-□	IUH27	4
1100	CBR1100XX SUPERBLACKBIRD	01.3 -	IUH27D	IU01-□	VUH27D	4
1100	SHADOW	95.1 -	IX22B	IXU01-□	X22EPR-U9	4
1100	SHADOW AERO	98.3 -	IX22B	IXU01-□	X22EPR-U9	4
1100	ST1100/A PAN EUROPEAN	90 -	IUH24	IU01-□	U24FER9	4
1100	VT1100/C/C2/CM	94.2 -	IX22B	IXU01-□	X22EPR-U9	2
1100	X11	99.11-01	IUH24	IU01-□	IUH24	4
1200	VFR1200F	12.11-	IUH27	IU01-□	VUH27ES	4
1200	VFR1200F(EURO)	10.3 -	IUH27	IU01-□	VUH27ES	4

DENSO	9	14	16	20	22	24	27	29	31	32	34	35	DENSO	9	14	16	20	22	24	27	31	DENSO	9	14	16	20	22	24	27	31		
NGK	2	4	5	6	7	8	9	9.5	10	10.5	11	11.5	CHAMPION	18	16,14	12,11	10,9	8,7	6,6,61	4,59	57	55	53	BOSCH	10	9	8	7,6	5	4	3	2



CC	MODEL	FROM-TILL	IRIDIUM POWER	IRIDIUM RACING	DENSO	QTY
HONDA						
1200	VFR1200X	14.3 -	IUH24	IU01-□	VUH24ES	4
1300	CB1300SUPER BOLD'OR	05.2 -	IX24B	IXU01-□	X24EPR-U9	4
1300	CB1300SUPERFOUR	98.3 -03.1	IX24B	IXU01-□	X24EPR-U9	4
1300	CB1300SUPERFOUR	03.2 -	IX24B	IXU01-□	X24EPR-U9	4
1300	CB1300SUPERTOURING	09.12-	IX24B	IXU01-□	X24EPR-U9	4
1200	CTX1300	14.2 -	IU22(Street use) / IU24(Hi-speed use)	IU01-□	U22FER9 / U24FER9	4
1300	PAN-EUROPEAN/ABS	-	IUH24	IU01-□	U22FER9	4
1300	VT1300CR/ABS	10.4 -	IXU22	IXU01-□	XU20EPR-U	4
1300	VT1300CS/ABS	10.5 -	IXU22	IXU01-□	XU20EPR-U	4
1300	VT1300CX/ABS	09.11-	IXU22	IXU01-□	XU20EPR-U	4
1300	VTX1300C/S	02.6 -	IXU22	IXU01-□	XU20EPR-U	4
1300	X4	97 -	IX24B	IXU01-□	X24EPR-U9	4
1300	X4LD	00.3 -	IX24B	IXU01-□	X24EPR-U9	4
1500	F6C	-	IX24B	IXU01-□	X24EPR-U9	6
1500	GOLDWING ASPENCADE GL1500/SE	-	IX24B	IXU01-□	X24EPR-U9	6
1500	GOLDWING GL1500/SE	-	IX22B	IXU01-□	X22EPR-U9	6
1500	VALKYRIE GL1500C	98.10-	IX22B	IXU01-□	X22EPR-U9	6
1500	VALKYRIE INTERSTATE	-	IX24B	IXU01-□	X24EPR-U9	6
1500	VALKYRIE TOURER GL1500CT	-	IX24B	IXU01-□	X24EPR-U9	6
1500	VALKYRIE (Import)	-	IX22B	IXU01-□	X22EPR-U9	6
1500	VALKYRIE/TOURER	-	IX24B	IXU01-□	X24EPR-U9	6
1800	GOLDWING GL1800	01.9 -	IK20	IK01-□	K20PR-U11	6
1800	GOLDWING F6B	13.2 -	IK20	IK01-□	K20PR-U11	6
1800	VALKYRIE RUNE(Import)	03 -	IK16	IK01-□	K16PR-U11	6
1800	VTX	01 -02	IK20	IK01-□	VK20PRZ11	4
1800	VTX Cruiser	01 -	IK20	IK01-□	VK20PRZ11	4
KAWASAKI						
50	KDX50	04 -	IWF16	-	W14FPR-UL	1
50	KS- I	88.1 -90.3	IW24	IW01-□	W24ESR-U	1
50	KSR- I	90.3 -	IW24	IW01-□	W24ESR-U	1
60	KX60	93.1 -93.12	IW27	IW01-□	-	1
60	KX60	-92	IW27	IW01-□	-	1
60	KX60	94.8 -99	IW27	IW01-□	-	1
65	KX65	00.8 -	IW31	IW01-□	IW31	1
65	KX65	06 -	IW31	IW01-□	-	1
80	KS-II	88.1 -90.3	IW24	IW01-□	W24EPR-U	1
80	KSR-II	90.3 -	IW24	IW01-□	W24ESR-U	1
80	KX80/II	82.10-91.7	IW27	IW01-□	-	1
80	KX80/II	91.8 -94.6	-	IW01-□	IW01-32	1
80	KX80/II	94.7 -96.7	-	IW01-□	IW01-32	1
80	KX80/II	96.7 -00.8	-	IW01-□	IW01-32	1
85	KX85/II	00.8 -	-	IW01-□	IW01-32	1
110	KLX110(ULTRA SE BOREUP KIT) (*3)	-	IY24	-	-	1
110	KLX110	01.12-	IUF22	-	U20F5R-U	1
110	KLX110L	09.11-	IUF22	-	U20F5R-U	1
110	KSR110(ULTRA SE BOREUP KIT) (*3)	-	IY24	-	-	1
110	KSR110	02.11-08	IUF22	-	U20F5R-U	1
120	LEOSTAR(Import)	-	IW24	IW01-□	W24ESR-U	1
125	D-TRACKER125	09.12-	IUF22	-	U22F5R-U	1
125	ELIMINATOR125	97.7 -08	IU22	IU01-□	U22ESR-N	1
125	KDX125SR	90 -	IW24	IW01-□	W24ESR-U	1
125	KLX125	09.12-	IUF22	-	U22F5R-U	1
125	KLX125/L(Import)	04 -09	IX24	IXU01-□	X24ESR-U	1
125	KMX125	86 -	IW24	IW01-□	W24ES-U	1
125	KX125	90.8 -91.8	-	IW01-□	IW01-32	1
125	KX125	91.9 -93.7	-	IW01-□	IW01-32	1
125	KX125	93.7 -94.7	IW24	IW01-□	IW24	1
125	KX125	94.7 -03.7	IW27	IW01-□	IW27	1
125	KX125	03.8 -	-	IW01-□	IW01-27	1
150	CERPICO SE	98.7 -	IW27	IW01-□	W27ES-U	1
150	EPSILON150	02.3 -	IU22	IU01-□	U22ESR-N	1
150	KR150SE	-	IW24	IW01-□	W24ES-U	1
150	KRR150SE	98.6 -	IW27	IW01-□	W27ES-U	1
150	VICTOR M150	-	IW24	IW01-□	W24ES-U	1
200	KDX200R	88 -91.11	IW27	IW01-□	W27ESR-U	1
200	KDX200R	91.12-94	IW27	IW01-□	W27ESR-U	1

(*3) KITACO TUNING HEAD

CC	MODEL	FROM-TILL	IRIDIUM POWER	IRIDIUM RACING	DENSO	QTY
KAWASAKI						
200	KDX200/S/SR	89.1 -94	IW27	IW01-□	W27ESR-U	1
200	KMX200	87.2 -	IW24	IW01-□	W24ESR-U	1
220	BAYOU220	-	IX27	IXU01-□	X27ESR-U	1
220	KDX220SR/R	94.4 -	IW24	IW01-□	W24ESR-U	1
220	KLF220	-	IX27	IXU01-□	X27ESR-U	1
250	250TR	02.2 -07	IX27	IXU01-□	X27ESR-U	1
250	250TR	07.2 -	IX24	IXU01-□	X24ESR-U	1
250	BALIOUS/II	91.4 -07	IU27	IU01-□	U27ESR-N	4
250	CASUAL SPORT250	85 -	IX27B	IXU01-□	X27EP-U9	2
250	D TRACKER	98.2 -08.3	IU24	IU01-□	U24ESR-N	1
250	D TRACKER X	08.4 -	IU24	IU01-□	U24ESR-N	1
250	D TRACKER X	11.~ -	IU24	IU01-□	U24ESR-N	1
250	ELIMINATOR250/SE/LX	87 -98	IUF24	-	U24F5R-U	2
250	ELIMINATOR250V	98.1 -07	IU27	IU01-□	U27ESR-N	2
250	EPSILON250	02.3 -03	IU24A	IU01-□	U24ETR	1
250	EPSILON250	04 -06	IU24A	IU01-□	U22ETR	1
250	ESTRELLA	07.2 -	IX24	IXU01-□	X24ESR-U	1
250	ESTRELLA CUSTOM/RS	96.3 -06	IX27	IXU01-□	X27ESR-U	1
250	ESTRELLA/RS	92.5 -06	IX27	IXU01-□	X27ESR-U	1
250	GPZ250	83 -	IX27B	IU01-□	X27EP-U9	2
250	GPZ250R	85 -	IUF24	-	U24F5-U	2
250	KDX250S/R	90 -	IW27	IW01-□	W27ESR-U	1
250	KDX250SR	91 -92	IW27	IW01-□	W27ESR-U	1
250	KDX250SR	92 -	IW24	IW01-□	W24ESR-U	1
250	KL250	82.11-	IW24	IW01-□	W24ES-U	1
250	KL250R	84 -	IX27B	IXU01-□	X27EP-U9	1
250	KLE250ANHELO	93 -95	IUF24	-	U24F5R-U	2
250	KLR250(Import)	-	IX27B	IXU01-□	X27EP-U9	1
250	KLX250	98.2 -	IU24	IU01-□	U24ESR-N	1
250	KLX250	08.04-	IU24	IU01-□	U24ESR-N	1
250	KLX250ES/SR/R	94.3 -	IU24	IU01-□	U24ESR-N	1
250	KLX250R/SR	-94.3	IU27	IU01-□	U27ESR-N	1
250	KR-1	88 -	IW27	IW01-□	W27ESR-U	2
250	KR-1R	89 -	IW31	IW01-□	W31ESR-U	2
250	KR-1S	89 -	IW31	IW01-□	W31ESR-U	2
250	KR250/S	84.4 -	IW27	IW01-□	W27ES-U	2
250	KX250	90.9 -91.8	IW27	IW01-□	-	1
250	KX250	91.9 -92	-	IW01-□	IW01-27	1
250	KX250	94 -94	IW27	IW01-□	IW27	1
250	KX250	94.7 -96.7	IW24	IW01-□	IW24	1
250	KX250	96.7 -98.6	IW22	IW01-□	IW22	1
250	KX250	98.7 -00.7	IW24	IW01-□	IW24	1
250	KX250	00.8 -04.7	IW24	IW01-□	IW24	1
250	KX250	04.8 -	IWM24	IWM01-□	IWM24	1
250	KX250	10 -	IU24	IU01-□	U24ESR-N	1
250	KX250F	04 -05	IU24	IU01-□	U24ESR-NB	1
250	KX250F	06 -10	IU24	IU01-□	U24ESR-N	1
250	KX250F	10.8 -	IU24D	IU01-□	-	1
250	KX250F	11.~ -	IU24D	IU01-□	-	1
250	NINJA 250 / 250R	08.4 -	IU24	IU01-□	U24ESR-N	2
250	SUPERSHERPA	97.2 -07	IU24	IU01-□	U24ESR-N	1
250	Z250FS/LTD	82.12-	IW24	IW01-□	W24ES-U	1
250	Z250FT	79 -	IX24	IXU01-□	X24ES-U	2
250	Z250LTD BELT DRIVE	84 -	IX24	IXU01-□	X24ES-U	2
250	Z250LTD TWIN	81 -	IX24	IXU01-□	X24ES-U	2
250	ZXR250/R	89.2 -	IU27	IU01-□	U27ESR-N	4
250	ZZ-R250	90 -	IUF24	-	U24F5R-U	2
300	BAYOU(QUAD)	-	IX24	IXU01-□	X24ESR-U	1
300	KLF(QUAD)	-	IX24	IXU01-□	X24ES-U	1
300	KLX300R	96.3 -	IU24	IU01-□	U24ESR-N	1
300	MULE500(QUAD)	-	IW16	IW01-□	W16EP-U	1
360	KVF360(QUAD)	02.6 -	IX24B	IXU01-□	X24EPR-U9	1
400	BAYOU400(QUAD)	-	IX24B	IXU01-□	X24EPR-U9	1
400	ELIMINATOR400	86.2 -88.3	IX27	IXU01-□	X27ES-U	4
400	ELIMINATOR400/SE/LX	88.3 -	IX27	IXU01-□	X27ESR-U	4
400	EN400TWIN	85 -88.11	IX24	IXU01-□	X24ES-U	2
400	EN400TWIN	88.12-	IX24	IXU01-□	X24ESR-U	2

DENSO

AUSTRALIA CHINA

INDIA

INDONESIA

KOREA

MALAYSIA

PHILIPPINES

SAUDI ARABIA

SINGAPORE

TAIWAN

THAILAND

VIETNAM

JAPAN

& USA

EUROPE

MOTOR

SMALL

ENGINE

CROSS

PART



JAPAN MOTORCYCLE

▶ Spark plug color codes: ■ for Iridium Tough and Iridium Plugs and Iridium TT, ■ for Iridium Power, ■ for Iridium Racing and Two Tops Plugs, ■ for Platinum Plugs and Platinum TT, and black for general spark plugs.

DENSO

CHINA AUSTRALIA

INDIA

INDONESIA

KOREA

MALAYSIA

PHILIPPINES

SAUDI ARABIA

SINGAPORE

TAIWAN

THAILAND

VIETNAM

JAPAN

EUROPE & USA

MOTOR CYCLE

SMALL ENGINE

CROSS REFERENCE

PART NUMBER

CC MODEL	FROM-TILL	IRIDIUM POWER	IRIDIUM RACING	DENSO	QTY
KAWASAKI					
400 ER-4n/ABS	10.8 -	IU27D	IU01-□	IU27D	2
400 EX-4	94 -95	IX27	IXU01-□	X27ESR-U	2
400 FX400R	85 -89.5	IX27	IXU01-□	X27ES-U	4
400 GPZ400R	89.6 -	IX27	IXU01-□	X27ESR-U	4
400 GPZ400/F	83 -	IX27B	IXU01-□	X27EP-U9	4
400 GPZ400R	85.2 -	IX27	IXU01-□	X27ESR-U	4
400 GPZ400S	86 -	IX27	IXU01-□	X27ES-U	2
400 KH400	76 -	IWF24	-	W24FS-U	3
400 KLE400	-	IX24	IXU01-□	X24ESR-U	2
400 KLF400(QUAD)	-	IX27B	IXU01-□	X27EPR-U9	4
400 KLX400R	03 -	IU24	IU01-□	U24ESR-N	1
400 NINJA 400R/ABS	10.8 -	IU27D	IU01-□	IU27D	2
400 VULCAN II	95 -	IU22	IU01-□	U22ESR-N	2
400 VULCAN400	91 -94.3	IX24	IXU01-□	X24ESR-U	2
400 VULCAN400	94 -94	IX27	IXU01-□	X27ESR-U	2
400 VULCAN400CLASSIC	95.12-03	IU22	IU01-□	U22ESR-N	2
400 VULCAN400DRIFTER	99.2 -03	IU22	IU01-□	U22ESR-N	2
400 W400	06.3 -08	IU24D	IU01-□	U24EPR9	2
400 XANTHUS400	92.4 -95	IU27A	IU01-□	U27ETR	4
400 Z400FX	79.4 -	IX24	IXU01-□	X24ES-U	4
400 Z400GP	82.3 -	IX24	IXU01-□	X24ES-U	4
400 Z400LTD/BELT DRIVE	79 -	IW22	IW01-□	W22ES-U	2
400 Z400LTD-II	81 -	IX24	IXU01-□	X24ES-U	4
400 ZEPHYR x	96.3 -08	IU27	IU01-□	U27ESR-N	4
400 ZEPHYR400	89.4 -95	IX27B	IXU01-□	X27EPR-U9	4
400 ZRX400/II	94.2 -08	IU27	IU01-□	U27ESR-N	4
400 ZX-4	88 -	IU27A	IU01-□	U27ETR	4
400 ZXR400/R	89.3 -	IU27A	IU01-□	U27ETR	4
400 ZZ-R400	90 -	IU27	IU01-□	U27ESR-N	4
450 KLX450R	08.1 -	IU24D	IU01-□	-	1
450 KX450F	06 -08	IU24D	IU01-□	-	1
450 KX450F	09 -	IU24D	IU01-□	-	1
450 KX450F	10.8 -	IU24D	IU01-□	-	1
450 MULE1000 (QUAD)	-	IX22	IXU01-□	X20ES-U	2
500 EN500	90 -	IX27	IXU01-□	X27ESR-U	2
500 ER-5	-	IX27	IXU01-□	X27ESR-U	2
500 GPX500S(Import)	90 -	IX27	IXU01-□	X27ESR-U	2
500 KLE500(Import)	-	IX27	IXU01-□	X27ESR-U	2
500 KX500(Import)	83 -	IW24	IW01-□	-	1
500 VULCAN500(Import)	-	IX27	IXU01-□	X27ES-U	2
600 ELIMINATOR600	-	IX27	IXU01-□	X27ESR-U	4
600 GPX600R	-	IX27	IXU01-□	X27ESR-U	4
600 GPZ600R	85 -	IX27	IXU01-□	X27ES-U	4
600 KL600R	84 -	IX24	IXU01-□	X24ES-U	1
600 NINJA ZX-6R(Import)	95 -02	IU27	IU01-□	U27ESR-N	4
600 NINJA ZX-6RR RACE BASE	04 -06	IU31	IU01-□	-	4
600 NINJA ZX-6R RACE BASE	07 -	IU31	IU01-□	IU31	4
600 NINJA ZX-6RR(Import)	03 -06	IU27	IU01-□	U27ESR-N	4
600 NINJA ZX-6R(Import)	07 -	IU27	IU01-□	U27ESR-N	4
600 ZZ-R600	90 -	IU27	IU01-□	U27ESR-N	4
636 NINJA ZX-6R(Import)	03 -06	IU27	IU01-□	U27ESR-N	4
650 650RS	-	IW24	IW01-□	W24ES-U	4
650 ER-6n(Import)	06 -	IU27D	IU01-□	IU27D	2
650 ER-6f(Import)	06 -	IU27D	IU01-□	IU27D	2
650 KLR650	87 -	IX24B	IXU01-□	X24EP-U9	1
650 KLX650/R	93 -	IX24B	IXU01-□	X24EPR-U9	1
650 NINJA 650R(Import)	-	IU27D	IU01-□	IU27D	2
650 VERSYS(Import)	07 -	IU27D	IU01-□	IU27D	2
650 W650	99.2 -08	IU24	IU01-□	U24ESR-N	2
750 ELIMINATOR750	85.12-	IX24	IXU01-□	X24ES-U	4
750 GPX750R	87 -	IX24	IXU01-□	X24ES-U	4
750 GPZ750/F	83 -	IW27	IW01-□	W27ES-U	4
750 GPZ750R	84.6 -	IX24	IXU01-□	X24ES-U	4
750 GPZ750 TURBO	83 -85	IW27	IW01-□	W27ESR-U	4
750 NINJA ZX-7R/RR(Import)	96 -	IU27	IU01-□	U27ESR-N	4
750 VULCAN750(Import)	-	IX22B	IXU01-□	X22EP-U9	2
750 VZ750TWIN	85 -	IX24B	IXU01-□	X24EP-U9	4

CC MODEL	FROM-TILL	IRIDIUM POWER	IRIDIUM RACING	DENSO	QTY
KAWASAKI					
750 Z750(Import)	04 -10	IU27A	IU01-□	U27ETR	4
750 Z750Four(A4/5)	76 -77	IW24	IW01-□	W24ES-U	4
750 Z750Four(D1)	77 -78	IW24	IW01-□	W24ES-U	4
750 Z750FX(D2/3)	79 -80	IW24	IW01-□	W24ES-U	4
750 Z750RS(Z2/A)	73 -75	IW24	IW01-□	W24ES-U	4
750 Z750GP/SPECTER	82.8 -	IW24	IW01-□	W24ES-U	4
750 ZEPHYR750	90.8 -	IX27	IXU01-□	X27ESR-U	4
750 ZEPHYR750RS	96.2 -	IX27	IXU01-□	X27ESR-U	4
750 ZR-7/S	99.3 -	IX27	IXU01-□	X27ESR-U	4
750 ZR750C	90.1 -	IX27	IXU01-□	X27ESR-U	4
750 ZXR750	89.1 -95	IU27	IU01-□	U27ESR-N	4
750 ZX-7R/RR	96 -	IU27	IU01-□	U27ESR-N	4
800 VN800/CLASSIC(Import)	-	IU22	IU01-□	U22ESR-N	2
800 VULCAN800/CLASSIC	95 -	IU22	IU01-□	U22ESR-N	2
800 VULCAN800DRIFTER	99.2 -	IU22	IU01-□	U22ESR-N	2
800 W800	11.2 -	IU24	IU01-□	U24ESR-N	2
900 900Super4(Z1)	73 -73	IW24	IW01-□	W24ES-U	4
900 ELIMINATOR	84 -	IX24	IXU01-□	X24ESR-U	4
900 GPZ900R	84 -03	IX27	IXU01-□	X27ESR-U	4
900 NINJA ZX-9R(Import)	94 -	IU27A	IU01-□	U27ETR	4
900 VULCAN900CUSTOM/CLASSIC	07.2 -09	IU22D	IU01-□	U22EPR9	2
900 VN900CLASSIC(Import)	06 -	IU22D	IU01-□	U22EPR9	2
900 Z1(Z1A/B)	74 -75	IW24	IW01-□	W24ES-U	4
900 Z900	76 -76	IW24	IW01-□	W24ES-U	4
1000 1000GTR(Import)	86 -	IX27	IXU01-□	X27ESR-U	4
1000 GPZ1000RX(Import)	86 -	IX27	IXU01-□	X27ESR-U	4
1000 KLV1000(Import)	04 -	IU24	IU01-□	U24ESR-N	2
1000 KZ1000POLICE(Import)	82 -	IW24	IW01-□	W24ESR-U	4
1000 NINJA 1000/ABS(Import)	11 -	IU27D	IU01-□	IU27D	4
1000 NINJA ZX-10R(Import)	04 -10	IU27D	IU01-□	IU27D	4
1000 NINJA ZX-10R/ABS(Import)	11 -	IU27D	IU01-□	IU27D	4
1000 VERSYS1000	11 -	IU27D	IU01-□	-	4
1000 Z1000(Import)	03 -06	IU27A	IU01-□	U27ETR	4
1000 Z1000(Import)	07 -	IU27D	IU01-□	IU27D	4
1000 Z1000/Mk II	77 -80	IW24	IW01-□	W24ES-U	4
1000 Z1000FI	77 -80	IW24	IW01-□	W24ES-U	4
1000 Z1000(J)	81 -83	IW24	IW01-□	W24ESR-U	4
1000 Z1000R	82 -83	IW24	IW01-□	W24ESR-U	4
1000 Z1R	78 -78	IW24	IW01-□	W24ES-U	4
1000 Z1R-II	79 -80	IW24	IW01-□	W24ES-U	4
1000 ZL1000	86 -	IX27	IXU01-□	X27ESR-U	4
1000 ZX-10(Import)	87 -90	IU27	IU01-□	U27ESR-N	4
1100 GPz1100	83 -85	IW24	IW01-□	W24ESR-U	4
1100 GPZ1100(Import)	95.3 -	IU27A	IU01-□	U27ETR	4
1100 GPZ1100ABS(Import)	96.3 -	IU27A	IU01-□	U27ETR	4
1100 Z1100R	84 -85	IW24	IW01-□	W24ESR-U	4
1100 Z1100GP	81 -82	IW24	IW01-□	W24ESR-U	4
1100 Z1100LTD	84 -	IW24	IW01-□	W24ESR-U	4
1100 Z1100SPECTRE	82 -	IW24	IW01-□	W24ESR-U	4
1100 ZEPHYR1100	92.3 -	IU27	IU01-□	U27ESR-N	8
1100 ZEPHYR1100RS	96.2 -	IU27	IU01-□	U27ESR-N	8
1100 ZRX1100/II	96.12-	IU27A	IU01-□	U27ETR	4
1100 ZR-1100(ZX-11)(Import)	90 -01	IU27	IU01-□	U27ESR-N	4
1200 NINJA ZX-12R(Import)	00.3 -06	IU27A	IU01-□	IU27A	4
1200 VOYAGERXII(Import)	86 -	IX24B	IXU01-□	X24EPR-U9	4
1200 ZRX1200 DAEG	09.2 -	IU27A	IU01-□	U27ETR	4
1200 ZRX1200R/S	01.3 -08	IU27A	IU01-□	U27ETR	4
1200 ZZ-R1200(Import)	02 -05	IU27	IU01-□	U27ESR-N	4
1300 VOYAGER(Import)	83 -	IW20	IW01-□	W20EPR-U	6
1400 1400GTR(Import)	08 -	IU27D	IU01-□	IU27D	4
1400 ZZR1400(Import)	06 -	IU27D	IU01-□	IU27D	4
1400 Ninja ZX-14R	11 -	IU27D	IU01-□	IU27D	-
1500 VN1500CLASSIC	-	-	IXU01-□	X16EPR-U9	4
1500 VULCAN1500CLASSIC	96.4 -98.2	IX22B	IXU01-□	X22EPR-U9	4
1500 VULCAN1500CLASSIC	98.2 -99	-	IXU01-□	X16EPR-U9	4
1500 VULCAN1500CLASSIC/TOURER FI	00.3 -03	IX22B	IXU01-□	X20EPR-U9	4
1500 VULCAN1500DRIFTER	99.3 -99	IX22B	IXU01-□	X20EPR-U9	4

DENSO	9	14	16	20	22	24	27	29	31	32	35	DENSO	9	14	16	20	22	24	27	29	31	32	DENSO	9	14	16	20	22	24	27	31	
NGK	2	4	5	6	7	8	9	9.5	10	10.5	11	11.5	CHAMPION	18	16,14	12,11	10,9	8,7	6,6,61	4,59	57	55	53	BOSCH	10	9	8	7,6	5	4	3	2



CC	MODEL	FROM-TILL	IRIDIUM POWER	IRIDIUM RACING	DENSO	QTY
KAWASAKI						
1500	VULCAN1500MEAN STREAK	02 -03	IX22B	IXU01-□	X20EPR-U9	4
1500	VULCAN88	87 -	IX22B	IXU01-□	X22EPR-U9	4
1600	VULCAN1600CLASSIC	03 -	IX22B	IXU01-□	X22EPR-U9	4
1600	VULCAN1600MEAN STREAK	03 -	-	-	X20EPR-U9	4
2000	VN2000-VULCAN2000(Import)	04 -05	IK20	IK01-□	VK20	2
SUZUKI						
50	2CYCLE BIRDIE50(RC50)	96.11-	IWF20	-	W20FPR-U	1
50	4CYCLE BIRDIE50(FB50)	96.1 -	IUF22	-	U20FSR-U	1
50	ADDRESS EX	89 -	IWF20	-	W20FPR-U	1
50	ADDRESS TUNE(AD50T)	88 -	IWF20	-	W20FPR-U	1
50	ADDRESS V50/G	06.3 -	IUF22	-	U20FSR-U	1
50	ADDRESS V/TUNE	90 -	IWF20	-	W20FPR-U	1
50	ADDRESS WAY(AD50W)	88 -	IWF20	-	W20FPR-U	1
50	ADDRESS(AD50)	87 -	IWF20	-	W20FPR-U	1
50	BIRDIE(FB50)	83.10-91.2	IUF22	-	U20FS-U	1
50	BIRDIE(FB50)	91.3 -95.4	IUF22	-	U20FSR-U	1
50	BIRDIE(FR50L/G)	91.7 -95.5	IWF16	-	W14FPR-UL	1
50	BIRDIE50	95.5 -04.10	IWF20	-	W20FPR-U	1
50	BIRDIE50	04.11-	IUF22	-	U20FSR-U	1
50	CHOINORI/SEL/SS	03.2 -07	IUF22	-	U20FSR-U	1
50	COLLEDA SCRAMBLER50	96.9 -	IWF20	-	W20FPR-U	1
50	COLLEDA SPORT50	96.3 -	IWF20	-	W20FPR-U	1
50	DR-Z50	08.4 -	IUF22	-	U20FSR-U	1
50	EPO	95.3 -	IWF20	-	W20FPR-U	1
50	GAG50	86.2 -	IUF22	-	U20FS-U	1
50	GEMMA QUEST(FE50)	86.2 -	IWF20	-	W20FP-U	1
50	GS50	05.2 -	IUF22	-	U20FSR-U	1
50	HIUP50/R50	88 -	IWF20	-	W20FPR-U	1
50	HUSTLER(TS50)	80 -95.1	IW22	IW01-□	W22EP-U	1
50	HUSTLER50	95.2 -	IW24	IW01-□	W24EPR-U	1
50	K50	91.3 -	IWF20	-	W20FPR-U	1
50	LET'S/II/II G	96.2 -07	IWF20	-	W20FPR-U	1
50	LET'S IICOMBINATION BRAKE	98.2 -07	IWF20	-	W20FPR-U	1
50	LET'S IIS/II/L/II STANDARD/II G	97.2 -07	IWF20	-	W20FPR-U	1
50	LET'S4/4G/PALLET	04.10-	IUF22	-	U20FSR-U	1
50	LET'S5/5G	08.3 -	IUF22	-	U20FSR-U	1
50	MODE50	87.2 -	IWF20	-	W20FP-U	1
50	MOLLET	86 -94.5	IWF20	-	W20FPR-U	1
50	MOLLET	94.5 -	IWF22	-	W22FPR-U	1
50	MOLLET(FE50)	86 -94	IWF20	-	W20FP-U	1
50	MOLLET(FE50PR)	94.5 -	IWF22	-	W22FPR-U	1
50	RAN	83.1 -88.6	IWF16	-	W16FP-U	1
50	RAN(CF50)	88.6 -	IWF16	-	W16FPR-U	1
50	RG50r	82 -88.5	IW24	IW01-□	W24EP-U	1
50	RG50r	88.5 -	IW24	IW01-□	W24EPR-U	1
50	SEPIA/RS/ZZ	95.2 -	IWF22	-	W22FPR-U	1
50	SEPIA/RS/ZZ(AF50)	89 -95.2	IWF20	-	W20FPR-U	1
50	STREETMAGIC (TR50)/S/II/SD	97.2 -	IWF20	-	W20FPR-U	1
50	SUPER MOLLET	94 -99	IWF22	-	W22FPR-U	1
50	SUPER MOLLET	00.1 -07	IWF20	-	W20FPR-U	1
50	TR50/S/V[STREETMAGIC]	97.2 -	IWF20	-	W20FPR-U	1
50	VERDE	98.3 -00.2	IWF22	-	W22FPR-U	1
50	VERDE	00.4 -	IWF20	-	W20FPR-U	1
50	WOLF50(TV50)	90.1 -	IW24	IW01-□	W24EPR-U	1
50	ZZ	00.5 -07	IWF20	-	W20FPR-U	1
70	DR-Z70	09.4 -	IUF22	-	U22FSR-U	1
70	DR-Z70(Import)	-	IUF22	-	U22FSR-U	1
80	4CYCLE BIRDIE80(FB80)	96.10-	IUF22	-	U20FSR-U	1
80	BIRDIE(FB80)	84 -91.2	IUF22	-	U20FS-U	1
80	BIRDIE(FB80)	91.3 -96.9	IUF22	-	U20FSR-U	1
80	JR80	-	-	-	W22ESR-U	1
80	LT80(QUAD)	-	IWF22	-	W22FP-U	1
80	RM80	89.8 -90.6	IW27	IW01-□	W27ESR-U	1
80	RM80	90.7 -93	IW31	IW01-□	W31ES-U	1
80	RM80	93 -96.7	IW31	IW01-□	IW31	1
80	RM80/LW	96.7 -	IW31	IW01-□	IW31	1
85	RM85/85L	03 -	IW31	IW01-□	W31WSR-U	1

CC	MODEL	FROM-TILL	IRIDIUM POWER	IRIDIUM RACING	DENSO	QTY
SUZUKI						
90	BIRDIE90	01.10-09	IUF22	-	U20FSR-U	1
90	FB90	-	IUF22	-	U20FSR-U	1
90	GEMMA QUEST(CS90)	86 -	IWF20	-	W20FPR-U	1
90	K90	91.3 -	IWF16	-	W14FPR-UL	1
100	ADDRESS V100/TYPE S	91 -05	IWF22	-	W22FPR-U	1
110	ADDRESS110	98.4 -00.3	IWF22	-	W22FPR-U	1
110	ADDRESS110	00.3 -05	IWF20	-	W20FPR-U	1
110	STREETMAGIC/II	98.6 -	IWF22	-	W22FPR-U	1
110	ADDRESS110	15.3 -	IU22D	IU01-□	U22EPR9	1
125	ADDRESS V125/G/G LIMITED	05.2 -	IUF22	-	U20FSR-U	1
125	ADDRESS V125	11 -	IUF22	-	U20FSR-U	1
125	ADDRESS V125S/SS/S LIMITED	10 -	IUF22	-	U20FSR-U	1
125	AVENIS125	98.12-	IU22	IU01-□	U22ESR-N	1
125	DF125E	97.9 -	IX24	IXU01-□	X24ESR-U	1
125	DJEBEL125/SE	93 -	IX24	IXU01-□	X24ESR-U	1
125	DR-Z125/L	04 -	IX24	IXU01-□	X24ESR-U	1
125	GZ125H(Import)	-	IU24	IU01-□	U24ESR-N	1
125	GZ125HS(Import)	-	IU22	IU01-□	U22ESR-N	1
125	INTRUDER LC125	-	IU24	IU01-□	U24ESR-N	2
125	K125	95.1 -	IWF16	-	W14FPR-UL	1
125	MARAUDER125	98.3 -	IX24	IXU01-□	X24ESR-U	1
125	RG125r	85.2 -91.11	IW27	IW01-□	W27ES-U	1
125	RG125r	91.11-	IWM27	IWM01-□	-	1
125	RGV125Pr	-	IWM27	IWM01-□	-	1
125	RM125	83 -91.6	IW27	IW01-□	IW27	1
125	RM125	91.7 -96.7	IW27	IW01-□	IW27	1
125	RM125	96.8 -	-	IW01-□	IW01-24	1
125	TS125R	89 -	IW24	IW01-□	W24ESR-U	1
125	VANVAN125(RV125)	74 -	IWF22	-	W22FPR-U	1
125	VANVAN125(Import)	02 -	IX24	IXU01-□	X24ESR-U	1
125	VECSTAR125	94.7 -95.12	IU24	IU01-□	U24ESR-N	1
125	VECSTAR125(ANT125T)	95.12-05	IU22	IU01-□	U22ESR-N	1
125	WOLF125	92 -	IWM27	IWM01-□	-	1
150	AVENIS150	98.12-	IU22	IU01-□	U22ESR-N	1
150	VECSTAR150(AN150S)	94.10-95.12	IU24	IU01-□	U24ESR-N	1
150	VECSTAR150(AN150T)	95.12-	IU22	IU01-□	U22ESR-N	1
200	BURGMAN200	14.2 -	IU24A	IU01-□	U24ETR	1
200	DF200E	97.3 -	IX24	IXU01-□	X24ESR-U	1
200	DJEBEL200	93.3 -	IX24	IXU01-□	X24ESR-U	1
200	RG200r	92.5 -	IW24	IW01-□	W24ESR-U	1
200	SX200R	85 -88.1	IX24	IXU01-□	X24ES-U	1
200	SX200R	88.1 -	IX24	IXU01-□	X24ESR-U	1
200	TS200R	89 -	IW27	IW01-□	W27ESR-U	1
200	VANVAN200/Z	02.3 -	IX24	IXU01-□	X24ESR-U	1
200	WOLF200	92.5 -	IW24	IW01-□	W24ESR-U	1
250	250SB	02.2 -	IU24	IU01-□	U24ESR-N	1
250	ACROSS250	90.4 -	IUF22	-	U22FSR-U	1
250	BANDIT250/V(GSF250)/VZ	89.12-	IU24	IU01-□	U24ESR-N	4
250	DJEBEL250	92.11-	IX27B	IXU01-□	X27EPR-U9	1
250	DJEBEL250GPS	98.2 -	IU27	IU01-□	U27ESR-N	1
250	DJEVEL250XC	96.2 -	IU27	IU01-□	U27ESR-N	1
250	DR-Z250	01 -	IU27	IU01-□	U27ESR-N	1
250	DR250R	95 -	IU27	IU01-□	U27ESR-N	1
250	DR250S	-89.12	IX24	IXU01-□	X24ES-U	1
250	DR250S/SH/SHE	90.1 -	IX27B	IXU01-□	X27EPR-U9	1
250	GEMMA	08.7 -	IU24A	IU01-□	U22ETR	1
250	GF250/S	85 -	IUF24	-	U24FS-U	4
250	GOOSE250	92 -	IU24A	IU01-□	U24ETR	1
250	GRASSTRACKER/BIGBOY	00.6 -04.3	IX24	IXU01-□	X24ESR-U	1
250	GRASSTRACKER/BIGBOY	04.4 -	IX24	IXU01-□	X24ESR-U	1
250	GS250FW	80.3 -	IX27	IXU01-□	X27ES-U	4
250	GSR250/S	12 -	IU22	-	U22ESR-N	4
250	GSX250/L/T/E	82.2 -	IX24	IXU01-□	X24ES-U	2
250	GSX250FX	02.1 -	IU27	IU01-□	U27ESR-N	4
250	GSX250R(GSX-R250)	87 -88.3	IUF24	-	-	4
250	GSX250R(GSX-R250)	88.3 -	IUF24	-	-	4
250	GSX250S[COBRA]	89.9 -	IU24	IU01-□	U24ESR-N	4

DENSO

AUSTRALIA CHINA

INDIA

INDONESIA

KOREA

MALAYSIA

PHILIPPINES

SAUDI ARABIA

SINGAPORE

TAIWAN

THAILAND

VIETNAM

JAPAN

EUROPE

MOTOR CYCLE

SMALL ENGINE

CROSS REFERENCE

PART NUMBER



JAPAN MOTORCYCLE

▶ Spark plug color codes: ■ for Iridium Tough and Iridium Plugs and Iridium TT, ■ for Iridium Power, ■ for Iridium Racing and Two Tops Plugs, ■ for Platinum Plugs and Platinum TT, and black for general spark plugs.

DENSO

CHINA AUSTRALIA

INDIA

INDONESIA

KOREA

MALAYSIA

PHILIPPINES

SINGAPORE

TAIWAN

THAILAND VIETNAM JAPAN EUROPE & USA

CC MODEL	FROM-TILL	IRIDIUM POWER	IRIDIUM RACING	DENSO	QTY
SUZUKI					
250 GSX250S[KATANA]/VS	91.5 -	IU24	IU01-□	U24ESR-N	4
250 GSX-R250R	-	IU27	IU01-□	U27ESR-N	4
250 INTRUDER(LC250)	99.11-	IU22	IU01-□	U22ESR-N	2
250 MARAUDER250	98.3 -	IX24	IXU01-□	X24ESR-U	1
250 NZ250/S	-	IX24B	IXU01-□	X24EP-U9	1
250 RG250/E	78 -	IW27	IW01-□	W27ES-U	2
250 RG250r/HB	83.2-88.2	IW27	IW01-□	W27ES-U	2
250 RGV250Pr/SP	88.3-90.1	IWM27	IWM01-□	-	2
250 RGV250r/SP	88.3-90.1	IW27	IW01-□	W27ESR-U	2
250 RGV250r/SP	90.2 -	IWM27	IWM01-□	-	2
250 RH250	88.6 -	IW24	IW01-□	W24ESR-U	1
250 RM250	83 -91.7	IW24	IW01-□	IW24	1
250 RM250	91.8-96.8	IW24	IW01-□	IW24	1
250 RM250	96.9-01.5	-	IW01-□	IW01-24	1
250 RMX250	88 -92	IW24	IW01-□	IW24	1
250 RMX250	94.12-96.3	IW27	IW01-□	IW27	1
250 RMX250	96.4 -	IW27	IW01-□	IW27	1
250 RMX250S	92.5-93	IW24	IW01-□	W24ESR-U	1
250 RMX250S	93 -	IW27	IW01-□	W27ESR-U	1
250 RM-Z250	03.8-06	IU24	IU01-□	U24ESR-NB	1
250 RM-Z250	07 -09	IU24D	IU01-□	IU24D	1
250 RM-Z250	10 -	IU24D	IU01-□	IU24D	1
250 SKYWAVE TYPE I /II	98.2-00.8	IU24	IU01-□	U24ESR-N	1
250 SKYWAVE TYPE I /II/S	00.8-02.7	IU24A	IU01-□	U24ETR	1
250 SKYWAVE250/Types/SS	02.8-06.3	IU24A	IU01-□	U24ETR	1
250 SKYWAVE250/M/S/SS/LIMITED	06.4 -	IU24A	IU01-□	U22ETR	1
250 ST250/Etype	03.12-	IX24	IXU01-□	X24ESR-U	1
250 SW-1	92.2 -	IX24	IXU01-□	X24ESR-U	1
250 VL250	99.1 -	IU22	IU01-□	U22ESR-N	2
250 VOLTY TYPE I /II/C/T	95.11-	IX24	IXU01-□	X24ESR-U	1
250 VOLTYGRASSTRACKER	00.4 -	IX24	IXU01-□	X24ESR-U	1
250 WOLF250	88.6 -	IW24	IW01-□	W24ES-U	2
350 DR350	93.9 -	IU27A	IU01-□	U27ETR	1
350 GOOSE350	91.12-	IU24A	IU01-□	U24ETR	1
400 BANDIT400/V	89.6-94.2	IU24A	IU01-□	U24ETR	4
400 BANDIT400/V	94.3 -	IU24	IU01-□	U24ESR-N	4
400 BANDIT400VZ	97.2 -	IU24	IU01-□	U24ESR-N	4
400 BOULEVARD400/LIMITED	05.3-09	IX22B	IXU01-□	X22EPR-U9	2
400 BOULEVARD400	10.3 -	IX22B	IXU01-□	-	2
400 DESPERADO WINDER	99.5 -	IX24B	IXU01-□	X24EPR-U9	2
400 DESPERADO/X	96.5 -	IX24B	IXU01-□	X24EPR-U9	2
400 DR-Z400/S	00.5-10	IU24	IU01-□	U24ESR-N	1
400 DR-Z400SM	04.12-10	IU24	IU01-□	U24ESR-N	1
400 GLADIUS400 ABS	09.12-	IU24D	IU01-□	IU24D	2
400 GN400E	80 -	IX24	IXU01-□	X24ES-U	1
400 GS400/E/L	77.12-	-	-	W20ES-U	2
400 GS400E	91.10-	IX24B	IXU01-□	X24EPR-U9	2
400 GS400E	-91.9	IX24B	IXU01-□	X24EPR-U9	2
400 GSR400/ABS	06.5-09.2	IU24A	IU01-□	U24ETR	4
400 GSR400/ABS	09.3 -	IU24D	IU01-□	IU24D	4
400 GSX400/ZR[IMPULSE]	94.2 -	IU24	IU01-□	U24ESR-N	4
400 GSX400[IMPULSE]/TYPE S	96.2 -	IU24	IU01-□	U24ESR-N	4
400 GSX400[IMPULSE]/TYPE S	04.10-10	IU24	IU01-□	U24ESR-N	4
400 GSX400E/L/T	80 -	IX24	IXU01-□	X24ES-U	4
400 GSX400F	81.4-88.5	IX24	IXU01-□	X24ES-U	4
400 GSX400F	88.6 -	IU24A	IU01-□	U24ETR	4
400 GSX400FS[IMPULSE]	82 -	IX27	IXU01-□	X27ES-U	4
400 GSX400FSV[INAZUMA]	97.3-00.12	IU27A	IU01-□	U27ETR	4
400 GSX400FW/R	83 -86.3	IUF24	-	U24FS-U	4
400 GSX400R	86.4-88.2	IUF24	-	-	4
400 GSX400S[KATANA]	92.4 -	IU24	IU01-□	U24ESR-N	4
400 GSX-R400/R/R-SP	88.3 -	IU24A	IU01-□	U24ETR	4
400 INAZUMA	01.1 -	IU24A	IU01-□	U24ETR	4
400 INTRUDER	94.4 -	IX24B	IXU01-□	X24EPR-U9	2
400 INTRUDER CLASSIC	01.3 -	IX22B	IXU01-□	X22EPR-U9	2
400 RF400R/RV	93.3 -	IU24A	IU01-□	U24ETR	4

CC MODEL	FROM-TILL	IRIDIUM POWER	IRIDIUM RACING	DENSO	QTY
SUZUKI					
400 RG400r	85.7 -	IW27	IW01-□	W27ES-U	4
400 SAVAGE(LS400)	87.1-92.11	IX24B	IXU01-□	X24EP-U9	1
400 SAVAGE(LS400)	92.11-	IX24B	IXU01-□	X24EPR-U9	1
400 SKYWAVE400	98.9-02.8	IU22	IU01-□	U22ESR-N	1
400 SKYWAVE400/LTD/S	02.9-06.5	IU22	IU01-□	U22ESR-N	1
400 SKYWAVE400S/LIMITED	06.6 -	IU22	IU01-□	U22ESR-N	1
400 SV400/S	98.9 -	IU24	IU01-□	U24ESR-N	2
400 TEMPTER(ST400V)	97.4 -	IX24B	IXU01-□	X24EPR-U9	1
450 RM-Z450	04.9-07.9	IU24	IU01-□	IU24	1
450 RM-Z450	07.10-	IU24	IU01-□	-	1
500 GS500/F	04 -	IX24B	IXU01-□	X24EPR-U9	2
500 RG500r	85.4 -	IW27	IW01-□	W27ES-U	4
550 GSX550L	84 -	IX27	IXU01-□	X27ES-U	4
600 BANDIT600/S(Import)	-	IU27A	IU01-□	U27ETR	4
600 GSF600/S(Import)	-	IU27A	IU01-□	U27ETR	4
600 GSR600/ABS(Import)	06 -	IU27	IU01-□	U27ESR-N	4
600 GSX600F(Import)	-	IU27A	IU01-□	U27ETR	4
600 GSX-R600(Import)	98 -03	IU27	IU01-□	U27ESR-N	4
600 GSX-R600(Import)	04 -07	IU27	IU01-□	U27ESR-N	4
600 GSX-R600(Import)	08 -	IU27D	IU01-□	IU27D	4
600 RF600RR/R(Import)	93 -	IU27	IU01-□	U27ESR-N	4
650 DR650RSE	91 -	IX27B	IXU01-□	X27EPR-U9	1
650 DR650SE	-	IU31	IU01-□	U31ESR-N	2
650 GS650G	81.4 -	IX24	IXU01-□	X24ES-U	4
650 GSF650(Import)	05 -	IU24A	IU01-□	U24ETR	4
650 LS650	86 -	IX24B	IXU01-□	X24EP-U9	1
650 LS650P	-	IX24B	IXU01-□	X24EPR-U9	1
650 SFV650 GLADIUS(Import)	09 -	IU24D	IU01-□	IU24D	4
650 SKYWAVE650/LX	02.6-08.10	IU24	IU01-□	U24ESR-N	2
650 SKYWAVE650LX	08.11-	IU22	IU01-□	U22ESR-N	2
650 SV650/S	99 -	IU24	IU01-□	U24ESR-N	2
650 V-STROM650/ABS(Import)	-	IU24	IU01-□	U24ESR-N	2
650 XF650FREEWIND	-	IU31	IU01-□	U31ESR-N	2
750 GSF750	96.1 -	IU27A	IU01-□	U27ETR	4
750 GSR750	13.2 -	IU27D	IU01-□	IU27D	4
750 GSR750/A(Import)	11 -	IU27D	IU01-□	IU27D	4
750 GSX750E	83.2 -	IX24	IXU01-□	X24ES-U	4
750 GSX750F	89.3 -	IX27	IXU01-□	X27ETR	4
750 GSX750R	-	IX27	IXU01-□	X27ES-U	4
750 GSX750S	84.3 -	IX24	IXU01-□	X24ES-U	4
750 GSX750W/SP	94.3 -	IU27	IU01-□	U27ESR-N	4
750 GSX-R750	88.3-89.12	IX27	IXU01-□	X27ETR	4
750 GSX-R750	90.1-92.1	IU31A	IU01-□	U31ETR	4
750 GSX-R750	92.1-95.12	IU27A	IU01-□	U27ETR	4
750 GSX-R750/SP	95.12-03	IU27	IU01-□	U27ESR-N	4
750 GSX-R750 (Import)	04 -07	IU27	IU01-□	U27ESR-N	4
750 GSX-R750 (Import)	08 -	IU27D	IU01-□	IU27D	4
750 GSX-R750R/RK	89.4 -	IU31A	IU01-□	U31ETR	4
750 VS750	85 -	IX24B	IXU01-□	X24EP-U9	2
800 BOULEVARD800	05.3 -	IX24B	IXU01-□	X24EPR-U9	2
800 DESPERADO800/X	96.11-	IX24B	IXU01-□	X24EPR-U9	2
800 DR800S	90 -	IX27B	IXU01-□	X27EPR-U9	1
800 INTRUDER 800	93.5 -	IX24B	IXU01-□	X24EPR-U9	2
800 INTRUDER CLASSIC	01.3 -	IX22B	IXU01-□	X22EPR-U9	2
800 MARAUDER800	-	IX24B	IXU01-□	X24EPR-U9	2
800 VS800	-	IX24B	IXU01-□	X24EPR-U9	2
800 VS800GL	-	IX24B	IXU01-□	X24EPR-U9	2
800 VX800	90.9 -	IX24B	IXU01-□	X24EPR-U9	4
900 RF900R(Import)	94.3 -	IU27	IU01-□	U27ESR-N	4
1000 GSX-R1000(Import)	01 -06	IU27	IU01-□	U27ESR-N	4
1000 GSX-R1000 RACE BASE	01 -06	-	IU01-□	-	4
1000 GSX-R1000(Import)	07 -	IU27D	IU01-□	IU27D	4
1000 GSX-R1000 RACE BASE	07 -	-	IU01-□	-	4
1000 SV1000/S	03.8 -	IU24A	IU01-□	U24ETR	2
1000 TL1000R(Import)	98.4 -	IU24A	IU01-□	U24ETR	2
1000 TL1000S	97.2-98.11	IU27	IU01-□	U27ESR-N	2
1000 TL1000S	98.11-	IU24	IU01-□	U24ESR-N	2

300

DENSO	9	14	16	20	22	24	27	29	31	32	34	35	DENSO	9	14	16	20	22	24	27	29	31	32	DENSO	9	14	16	20	22	24	27	31
NGK	2	4	5	6	7	8	9	9.5	10	10.5	11	11.5	CHAMPION	18	16,14	12,11	10,9	8,7	6,6,61	4,5,9	5,7	5,5	5,3	BOSCH	10	9	8	7,6	5	4	3	2



CC	MODEL	FROM-TILL	IRIDIUM POWER	IRIDIUM RACING	DENSO	QTY
SUZUKI						
1000	V-STROM1000(Import)	02 -	IU24A	IU01-□	U24ETR	2
1100	GSX1100F(Import)	88 -	IX27	IXU01-□	X27ETR	4
1100	GSX1100S[KATANA]	81 -	IX24	IXU01-□	X24ESR-U	4
1100	GSX-R1100(Import)	86 -92	IX27	IXU01-□	X27ETR	4
1100	GSX-R1100W(Import)	93 -	IU27	IU01-□	U27ESR-N	4
1200	BANDIT1200/S	00.5 -07	IX24	IXU01-□	IX24	4
1200	GS1200SS	01 -	IX24	IXU01-□	IX24	4
1200	GSF1200/S/SAV	95.1 -00.4	IX24	IXU01-□	IX24	4
1200	INAZUMA1200	98.4 -	IX24	IXU01-□	IX24	4
1250	BANDIT1250/S ABS	07 -	IU20	IU01-□	U20ESR-N	4
1250	BANDIT1250F ABS	10 -	IU20	IU01-□	U20ESR-N	4
1300	B-KING	08 -	IU27D	IU01-□	IU27D	4
1300	GSX1300R HAYABUSA(Import)	99 -07	IU27	IU01-□	U27ESR-N	4
1300	GSX1300R HAYABUSA(Import)	08 -	IU27D	IU01-□	IU27D	4
1300	GSX1300R HAYABUSA	14 -	IU24D	IU01-□	IU24D	4
1400	GSX1400	01.3 -10	IU24A	IU01-□	U24ETR	4
1400	VS1400GL/GLP	86 -	IX24B	IXU01-□	X24EPR-U9	2
1500	INTRUDER LC	97.12-98.11	IX24B	IXU01-□	X24EPR-U9	2
1500	INTRUDER LC	98.11-	IX22B	IXU01-□	X22EPR-U9	2
1600	MARAUDER1600	04 -	-	-	X20EPR-U9	2
1800	BOULEVARD M109R/R2(Import)	06 -	IU24A	IU01-□	U24ETR	4
1800	BOULEVARD C109R(Import)	08 -	IU24A	IU01-□	U22ETR	4
YAMAHA						
50	ACTIVE SPORT(CH50ET)	84.4 -	IWF22	-	W22FP-U	1
50	ACTIVE(CH50E)	85.6 -	IWF22	-	W22FP-U	1
50	APRIO NATURAL	98.6 -	IWF22	-	W22FPR-U	1
50	AXIS50(YA50/D/H/HS)	91.7 -	IWF22	-	W22FPR-U	1
50	BJ	03.10-	IWF22	-	W22FPR-U	1
50	BOXN(CQ50E)	85.4 -	IWF20	-	W20FP-U10	1
50	BUSINESS V50/B/D/N	-	IWF22	-	W22FSR	1
50	BW'S	12.10-	IU22	IU01-□	U22ESR-N	1
50	BW'S SPORTS	89.1 -	IWF22	-	W22FPR-U	1
50	BW'S(YW50)	98.4 -	IWF22	-	W22FPR-U	1
50	BW'S50(BW50)	88.4 -	IWF22	-	W22FPR-U	1
50	CHAMP CX	88.3 -	IWF22	-	W22FPR-U	1
50	CHAMP(CJ50E/ES)	86.7 -	IWF20	-	W20FP-U10	1
50	CHAMP50RS	87.4 -	IWF22	-	W22FP-U	1
50	CUTE(CN50EC/ED)	84.6 -	IWF20	-	W20FP-U10	1
50	DT50	82 -87.2	IW24	IW01-□	W24ES-U	1
50	DT50	87.3 -93.7	IW24	IW01-□	W24ES-U	1
50	DT50	93.8 -	IW24	IW01-□	W24ES-U	1
50	EXCEL50	86.5 -	IWF20	-	W20FP-U10	1
50	GEAR	07.10-	IU24	IU01-□	U24ESR-N	1
50	GEAR/C	94.9 -07	IWF22	-	W22FSR	1
50	GEAR ALLROUND	00.1 -	IWF22	-	W22FSR	1
50	JOG/Deluxe	07.10-	IU22	IU01-□	U22ESR-N	1
50	JOG ZR	09.1 -	IU22	IU01-□	U22ESR-N	1
50	JOG ZII	98.3 -	IWF22	-	W22FPR-U	1
50	JOG(YG50/Z)	-	IWF22	-	W22FPR-U	1
50	JOG/REMOTECONTROL JOG/ZR/ZII	-	IWF22	-	W22FPR-U	1
50	JOG50	87.2 -	IWF22	-	W22FP-U	1
50	JOG50/EX/Z/ZR	-	IWF22	-	W22FPR-U	1
50	JOGAPRIO	93.11-	IWF22	-	W22FPR-U	1
50	JOGAPRIO TYPE II	95.4 -	IWF22	-	W22FPR-U	1
50	JOGC	98.2 -	IWF22	-	W22FPR-U	1
50	JOGPOCHE	92.6 -	IWF22	-	W22FPR-U	1
50	JOGSPORT(CY50Z)	90.9 -	IWF22	-	W22FPR-U	1
50	JOGSPORT50	88.2 -90.8	IWF20	-	W20FPR-U	1
50	JOGTRUNK(YG50D)	91.3 -	IWF22	-	W22FPR-U	1
50	MATE V50/S/D/N	-	IWF22	-	W22FSR	1
50	MINT50	87.1 -	IWF20	-	W20FP-U10	1
50	MINT50SPECIAL	89.1 -	IWF20	-	W20FP-U	1
50	NEWJOG	89.2 -	IWF20	-	W20FPR-U	1
50	NEWS GEAR	96.6 -07	IWF22	-	W22FSR	1
50	NEWS GEAR	07.10-	IU24	IU01-□	U24ESR-N	1
50	NEWSMATE V50N	00.5 -	IWF22	-	W22FSR	1
50	NEWSMATEV50BUSINESSII	-	IW20	IW01-□	W20ES-U	1

CC	MODEL	FROM-TILL	IRIDIUM POWER	IRIDIUM RACING	DENSO	QTY
YAMAHA						
50	POCKE(QA50)	80 -	IWF22	-	W20FS-U	1
50	PW50(MOTOCROSS)	82 -00.7	IWF22(*1)	-	W14FP-UL	1
50	PW50(MOTOCROSS)	00.8 -	IWF22(*1)	-	W14FPR-UL	1
50	RZ50	81.6 -98.4	IW24	IW01-□	W24ES-U	1
50	RZ50	98.4 -	IW24	IW01-□	W24ESR-U	1
50	SLIDER 50(Import)	-	IWF24	-	W24FSR	1
50	SUPERJOG ZR	94.12-	IWF22	-	W22FPR-U	1
50	TDR50	88.7 -	IW24	IW01-□	W24ESR-U	1
50	TOWNMATE T50S/D/ED	82 -	IUF22	-	U20FS-U	1
50	TRY(CP50E)	85.3 -	IWF20	-	W20FP-U10	1
50	TT-R50E	06 -	IUF22	-	U22FSR-U	1
50	TY50	75.2 -	IWF22	-	W22FS-U	1
50	TZ50	90.2 -	IW27	IW01-□	IW27	1
50	TZM50R	94.3 -	IW27	IW01-□	W27ESR-U	1
50	TZR50	90.2 -93.3	IW27	IW01-□	W27ESR-U	1
50	TZR50	93.3 -	IW24	IW01-□	W24ESR-U	1
50	TZR50R	93.3 -94.2	IW22	IW01-□	W22ESR-U	1
50	TZR50R	94.2 -	IW27	IW01-□	W27ESR-U	1
50	VINO(YJ50R)/CLASSIC	97.3 -04	IWF20	-	W20FPR-U	1
50	VINO/Delux	07.11-	IU22	IU01-□	U22ESR-N	1
50	VINO/Delux	04.3 -07	IU22	IU01-□	U22ESR-N	1
50	VINO Molfe	09.4 -	IU22	IU01-□	U22ESR-N	1
50	VOX	06.5 -	IU22	IU01-□	U22ESR-N	1
50	YB-1	96.1 -	IWF20	-	W20FPR-U	1
50	YB-1 FOUR	00.4 -	IUF22	-	U22FSR-U	1
50	YB50	-	IWF22	-	W22FSR	1
50	YB50	00.5 -	IUF22	-	U22FSR-U	1
50	YG50/Z	-	IWF22	-	W22FPR-U	1
50	YSR50	86.5 -	IWF24	-	W24FS-U	1
50	YV50/C	-	IWF22	-	W22FPR-U	1
70	MATE V70	71 -	IWF22	-	W20FS-U	1
80	BELUGA D(CV80ED)	-	IWF20	-	W20FP-U	1
80	BELUGA(CV80E)	81 -	IWF20	-	W20FP-U	1
80	BUSINESS V80D/N	-	IWF22	-	W22FPR-U	1
80	BW80	85 -	IWF22	-	W22FP-U	1
80	CHAMP(CJ80E)	86.8 -	IWF22	-	W22FP-U	1
80	JOGSPORTS80	88.2 -90.4	IWF22	-	W22FPR-U	1
80	MATE V80/N	82 -92.2	IWF20	-	W20FP-U	1
80	MATE V80/N	92.2 -	IWF20	-	W20FPR-U	1
80	MR80	-	IWF22	-	W22FS-U	1
80	NEWSMATE80	88.7 -	IWF22	-	W22FPR-U	1
80	PW80	83 -	IWF20	-	W20FP-U	1
80	RX80SP	81 -	IWF22	-	W22FS-U	1
80	TDR80	88.8 -	IW24	IW01-□	W24EPR-U	1
80	TOWNMATE T80	-	IUF22	-	U22FS-U	1
80	TOWNMATE T80D/ED	93.6 -	IUF22	-	U20FS-U	1
80	TOWNMATE T80D/ED	-93.6	IWF20	-	W20FPR-U	1
80	TY80	75 -	IWF22	-	W20FS-U	1
80	YF80M(QUAD)	-	IUF22	-	U22FSR-U	1
80	YFM80W(QUAD)	02 -	IUF22	-	U22FSR-U	1
80	YM80M	-	IUF22	-	U22FSR-U	1
80	YSR80	86 -	IWF24	-	W24FS-U	1
80	YZ80	82.9 -92	IW27	IW01-□	-	1
80	YZ80	93 -00	IW31	IW01-□	-	1
80	YZ80LW	94.8 -00	IW31	IW01-□	-	1
80	YZ80LW	01 -	IW31	IW01-□	-	1
85	YZ85/LW	-03	IW31	IW01-□	-	1
85	YZ85/LW	04 -	IW31	IW01-□	IW31	1
90	AXIS90(YA90)	90.7 -	IWF20	-	W20FPR-U	1
90	JOGSPORTS90(CY90Z)	90.3 -	IWF22	-	W22FPR-U	1
90	NEWSMATE T90N/D	94.6 -	IUF22	-	U20FSR-U	1
90	TOWNMATE T90D	97.1 -	IUF22	-	U20FSR-U	1
90	YFM90R(QUAD)	08.10-	IUF22	-	U22FSR-U	1
90	TT-R90	-	IUF22	-	U20FSR-U	1
100	BW'S100	99 -	IWF22	-	W22FPR-U	1
100	GRANDAXIS100(YA100)	98.9 -	IWF22	-	W22FPR-U	1
100	YA100W	-	IWF20	-	W20FPR-U	1

DENSO

AUSTRALIA CHINA

INDIA

INDONESIA

KOREA

MALAYSIA

PHILIPPINES

SAUDIARABIA

SINGAPORE

TAIWAN

THAILAND

VIETNAM

JAPAN

EUROPE

MOTOR CYCLE

SMALL ENGINE

CROSS REFERENCE

PART NUMBER

(*1) Plugs for motocross are three heat ranges higher. They cannot be used for normal operation, due to carbon fouling.



▶ Spark plug color codes: ■ for Iridium Tough and Iridium Plugs and Iridium TT, ■ for Iridium Power, ■ for Iridium Racing and Two Tops Plugs, ■ for Platinum Plugs and Platinum TT, and black for general spark plugs.

DENSO**CHINA AUSTRALIA****INDIA****INDONESIA****KOREA****PHILIPPINES MALAYSIA****SINGAPORE SAUDI ARABIA****TAIWAN****THAILAND****VIETNAM****JAPAN****EUROPE & USA****MOTOR CYCLE****SMALL ENGINE****CROSS REFERENCE****PART NUMBER**

CC MODEL	FROM-TILL	IRIDIUM POWER	IRIDIUM RACING	DENSO	QTY
YAMAHA					
100 YF100M(QUAD)	-	IUF22	-	U22FSR-U	1
110 MIO	03 -	IUF22	-	U22FSR-U	1
110 NUOVO	-	IUF22	-	U22FSR-U	1
110 TT-R110E(Import)	08 -	IUF22	-	U20FSR-U	1
125 AXIS TREET	09.8 -	IU22	IU01-□	U22ESR-N	1
125 BW's125FI(Import)	08 -	IU22	IU01-□	U22ESR-N	1
125 BREEZE YFA125(QUAD)	-	IUF22	-	U22FSR-U	1
125 CYGNUS (XC125)	88 -94	IUF22	-	U20FS-U	1
125 CYGNUS125(XC125/D)	94 -	IU22	IU01-□	U22ESR-N	1
125 CYGNUS SI(XC125)	98 -	IU22	IU01-□	U22ESR-N	1
125 CYGNUS SV(XC125SV)	01 -	IU22	IU01-□	U22ESR-N	1
125 CYGNUS-X/SR(XC125/SR)	03.7 -07	IU22	IU01-□	U22ESR-N	1
125 CYGNUS-X/SR(XC125/SR)FI	07.10-	IU22	IU01-□	U22ESR-N	1
125 CZ125TRACY	83.6 -	IW24	IW01-□	W24EP-U	1
125 DT125	74 -	IW24	IW01-□	W24ES-U	1
125 DT125R	85.7 -88.5	IW24	IW01-□	W24ESR-U	1
125 DT125R/RE	88.6 -	IW27	IW01-□	W27ESR-U	1
125 GRIZZLY125(QUAD)	-	IUF22	-	U22FSR-U	1
125 MAJESTY125(Import)	-06	IU22	IU01-□	U22ESR-N	1
125 MAJESTY125(Import)	07 -	IU24	IU01-□	U24ESR-N	1
125 MAJESTI FI	07 -	IU27A	IU01-□	-	1
125 RZ125	85.4 -	IW24	IW01-□	W24ESR-U	1
125 SR125	81.5 -	IX24	IXU01-□	X24ES-U	1
125 SR125B	97.2 -	IX24	IXU01-□	X24ESR-U	1
125 TDR125/R	-	IW24	IW01-□	W24ESR-U	1
125 TRICITY125	14.7 -	IU22	IU01-□	U22ESR-N	1
125 TT-R125LW	00.4 -	IUF22	-	U22FSR-U	1
125 TW125(Import)	-	IX24	IXU01-□	X24ESR-U	1
125 TZ125 withDetonationCounter	95.11-	-	IA01-□	IA01-32	1
125 TZ125 withoutDetonationCounter	95.11-	-	IAE01-□	IAE01-32	1
125 TZ125 withoutDetonationCounter	95.11-	-	IW01-□	IW01-32	1
125 TZR125	87.4 -89.11	IW27	IW01-□	W27ESR-U	1
125 TZR125	94.2 -	IW27	IW01-□	W27ESR-U	1
125 TZR125R	89.12-	IW24	IW01-□	W24ESR-U	1
125 XT125	82.3 -	IX24	IXU01-□	X24ES-U	1
125 XTZ(Import)	-	IUF22	-	U22FSR-U	1
125 XV125VIRAGO	-	IUF22	-	U20FSR-U	2
125 XVS125DRAGSTAR	-	IUF22	-	U22FSR-U	2
125 YB125	72 -	IWF22	-	W20FS-U	1
125 YB125E(Import)	08 -	IUF22	-	U20FSR-U	1
125 YD125/S	89.4 -	IX22	IXU01-□	X22ESR-U	1
125 YFA-1(TRIKE)	-	IUF22	-	U22FSR-U	1
125 YZ125	74 -91.7	IW27	IW01-□	-	1
125 YZ125	91.8 -96.7	IW27	IW01-□	-	1
125 YZ125	96.7 -98.8	IW27	IW01-□	-	1
125 YZ125	98.8 -	IW27	IW01-□	-	1
125 YZ125	05.7 -	IW27	IW01-□	-	1
125 YZF-R125	08 -	IU24	IU01-□	U24ESR-N	1
150 FZ-16(Import)	08 -	IU24D	IU01-□	U24EPR9	1
150 CYGNUS GT(XC150LC)	92 -	IU22	-	U22ESR-N	1
155 MAJYSTY	13.8 -	IU24D	-	U24EPR9	1
175 DT175(Import)	-	IW24	IW01-□	W24ES-U	1
180 CYGNUS(XC180)	82 -	IX22	IXU01-□	X22ES-U	1
200 AG200	85.2 -	IX24	IXU01-□	X24ES-U	1
200 BLASTER YF200S(QUAD)	90.3 -	IW24	IW01-□	W24ESR-U	1
200 BW200	85.2 -	IX24	IXU01-□	X24ES-U	1
200 DT200R	84 -88.5	IW24	IW01-□	W24ESR-U	1
200 DT200R	88.6 -	IW27	IW01-□	W27ESR-U	1
200 DT200WR	91.1 -93.2	IW27	IW01-□	W27ESR-U	1
200 DT200WR	93.3 -	IW24	IW01-□	W24ESR-U	1
200 SDR200	87.7 -	IW27	IW01-□	W27ESR-U	1
200 TW200	91.2 -02.5	IX24	IXU01-□	X24ESR-U	1
200 TW200E	96.5 -02.5	IX24	IXU01-□	X24ES-U	1
200 XT200	82 -	IX24	IXU01-□	X24ES-U	1
225 BRONCO(ST225)	97.5 -	IX24	IXU01-□	X24ESR-U	1
225 SEROW225	85.8 -89.7	IX24	IXU01-□	X24ESR-U	1
225 SEROW225/S	89.8 -93.5	IX24	IXU01-□	X24ESR-U	1

CC MODEL	FROM-TILL	IRIDIUM POWER	IRIDIUM RACING	DENSO	QTY
YAMAHA					
225 SEROW225W/WE(XT225WE)	93.6 -	IX24	IXU01-□	X24ESR-U	1
225 TW225/E	02.6 -	IX24	IXU01-□	X24ESR-U	1
230 LANZA(DT230)	97.1 -	IW27	IW01-□	W27ESR-U	1
230 TT-R230	07 -	IX24	IXU01-□	X24ESR-U	1
250 DRAGSTAR 250	00.7 -	IUF22	-	U20FSR-U	2
250 DRAGSTAR 250	08.5 -	IUF22	-	U20FSR-U	2
250 FZ250FAZER	86 -	IU27	IU01-□	U27ES-N	4
250 FZR250	88.4 -	IU27	IU01-□	U27ESR-N	4
250 FZR250R	94.3 -	IU24	IU01-□	U24ESR-N	4
250 GRAND MAJESTY	04.3 -	IU22D	IU01-□	U22EPR9	1
250 MAJESTY250/C	99 -	IX24	IXU01-□	X24ESR-U	1
250 MAJESTY250/SV/ABS	95.8 -99	IX24	IXU01-□	X24ESR-U	1
250 MAJESTY	07.5 -	IU22D	IU01-□	U22EPR9	1
250 MAXAM	05.4 -	IU22D	IU01-□	U22EPR9	1
250 MAXAM	-	IU22D	IU01-□	U22EPR9	1
250 R1-Z	90.6 -	IW27	IW01-□	W27ESR-U	2
250 RENAISSA	96.4 -	IUF22	-	U22FSR-U	2
250 RZ250	80.8 -83.1	IW24	IW01-□	W24ES-U	2
250 RZ250R	83.2 -86.6	IW24	IW01-□	W24ESR-U	2
250 RZ250R	86.7 -	IW27	IW01-□	W27ESR-U	2
250 RZ250RR	84.3 -86.6	IW24	IW01-□	W24ESR-U	2
250 SEROW250	05.4 -07	IX22	IXU01-□	X22ESR-U	1
250 SEROW250/S	08.1 -	IX22	IXU01-□	X22ESR-U	1
250 SR250	80.4 -	IW22	IW01-□	W22EP-U	2
250 SRV250/S/T	92.4 -	IUF22	-	U22FSR-U	2
250 SRX250/F	90.3 -	IX24	IXU01-□	X24ES-U	1
250 TDR250	88.1 -	IW27	IW01-□	W27ESR-U	2
250 TRICKER(XG250)/S	04.3 -07	IX22	IXU01-□	X22ESR-U	1
250 TRICKER/S	08.1 -	IX22	IXU01-□	X22ESR-U	1
250 TT-R250	-	IU27	IU01-□	U27ESR-N	1
250 TT250R	93.4 -	IU27	IU01-□	U27ESR-N	1
250 TT250R RAID	94.3 -	IU27	IU01-□	U27ESR-N	1
250 TY250R	85 -	IW20	IW01-□	IW20	1
250 TY250R SCOTTISH	-	IW24	IW01-□	W24ES-U	1
250 TY250Z	94.12-	IW20	IW01-□	IW20	1
250 TY250Z SCOTTISH	94.12-	IW20	IW01-□	IW20	1
250 TZ250	73 -94	-	IWM01-□	IWM01-32	2
250 TZ250	95 -	-	IWM01-□	IWM01-32	2
250 TZ250 withDetonationCounter	95 -	-	IA01-□	IA01-32	2
250 TZ250 withoutDetonationCounter	95 -	-	IAE01-□	IAE01-32	2
250 TZR250	89.3 -90.2	IW24	IW01-□	W24ESR-U	2
250 TZR250/SP	85.11-89.2	IW27	IW01-□	W27ESR-U	2
250 TZR250/SP	90.2 -91.3	IW27	IW01-□	W27ESR-U	2
250 TZR250R/RS	94.2 -	IWM24	IWM01-□	-	2
250 TZR250R/RS/RSP	91.3 -94.1	IWM27	IWM01-□	-	2
250 TZR250SPR	94.12-	IWM27	IWM01-□	-	2
250 WR250F(4ST)	03 -	IU24	IU01-□	U24ESR-N	1
250 WR250R	01 -	IU24	IU01-□	U24ESR-N	1
250 WR250R/X	07.11-	IU27A	IU01-□	U27ETR	1
250 WR250Z	92.1 -96.6	IW24	IW01-□	-	1
250 WR250Z	96.7 -00	IW24	IW01-□	-	1
250 XS250/S	82 -	IX24	IXU01-□	X24ES-U	2
250 XS250SP	82.5 -	IX24	IXU01-□	X24ES-U	2
250 XT250T	83.4 -	IX24	IXU01-□	X24ES-U	1
250 XT250X	06.3 -	IX22	IXU01-□	X22ESR-U	1
250 XT250X	08.5 -	IX22	IXU01-□	X22ESR-U	1
250 XV250/S VIRAGO	94.3 -	IUF22	-	U20FS-U	2
250 YD250	86.9 -89.8	IW22	IW01-□	W22EP-U	1
250 YD250/S	89.9 -	IW22	IW01-□	W22EPR-U	1
250 YFB250FW(QUAD)	-	IX22	IXU01-□	X22ESR-U	1
250 YFM250R(QUAD)	08 -	IX22	IXU01-□	X22ESR-U	1
250 YP250/S/A	-	IX24	IXU01-□	X24ESR-U	1
250 YZ250	74 -96.7	IW24	IW01-□	-	1
250 YZ250	96.7 -	IW24	IW01-□	-	1
250 YZ250F	00.10-	IU24	IU01-□	U24ESR-N	1
250 ZEAL250(FZX250)	92.2 -	IU24	IU01-□	U24ESR-N	4
350 BANSHEE YF350Z(QUAD)	90.3 -	IW24	IW01-□	W24ESR-U	2

DENSO	9	14	16	20	22	24	27	29	31	32	35	DENSO	9	14	16	20	22	24	27	29	31	32	DENSO	9	14	16	20	22	24	27	31	
NGK	2	4	5	6	7	8	9	9.5	10	10.5	11	11.5	CHAMPION	18	16,14	12,11	10,9	8,7	6,6,61	4,5,9	5,7	5,5	5,3	BOSCH	10	9	8	7,6	5	4	3	2



CC	MODEL	FROM-TILL	IRIDIUM POWER	IRIDIUM RACING	DENSO	QTY
YAMAHA						
350	RZ350	81.3 -83.4	IW24	IW01-□	W24ES-U	2
350	RZ350R/RR	83.5 -	IW24	IW01-□	W24ESR-U	2
350	TY350R	86 -	IW20	IW01-□	IW20	1
350	WARRIOR YFM350X(QUAD)	-	IX24	IXU01-□	X24ES-U	1
350	YF350E(QUAD)	-	IX24	IXU01-□	X24ESR-U	1
350	YFM350R(QUAD)	04 -	IX24	IXU01-□	X24ESR-U	1
400	ARTESIA(XT400)	91.8 -	IX24B	IXU01-□	X24EPR-U9	1
400	DIVERSION400	91.7 -	IU24	IU01-□	U24ESR-N	4
400	DRAGSTAR CLASSIC	98.3 -09	IX22B	IXU01-□	X22EPR-U9	2
400	DRAGSTAR FOUR	01.3 -09	IX22B	IXU01-□	X22EPR-U9	2
400	DRAGSTAR(XVS400)	96.2 -01	IX22B	IXU01-□	X22EPR-U9	2
400	DRAGSTAR400	09.11-	IX22B	IXU01-□	-	2
400	DRAGSTAR CLASSIC400	09.11-	IX22B	IXU01-□	-	2
400	FZ400	97.3 -	IU24	IU01-□	U24ESR-N	4
400	FZ400(SCHOOL MODEL)	97.3 -	IU20	IU01-□	U20ESR-N	4
400	FZ400R/N	84.5 -	IX24	IXU01-□	X24ES-U	4
400	FZR400	86.5 -88.3	IU27	IU00-□	U27ES-N	4
400	FZR400	88.5 -89.3	IU24	IU01-□	U24ESR-N	4
400	FZR400R	87.4 -	IU27	IU01-□	U27ESR-N	4
400	FZR400R	89.3 -89.12	IU24	IU01-□	U24ESR-N	4
400	FZR400RR/SP	89.12-94	IU24	IU01-□	U24ESR-N	4
400	GRAND MAJESTY400	05.3 -08.3	IU22D	IU01-□	U22EPR9	1
400	GRAND MAJESTY400	08.3 -	IU22	IU01-□	U22ESR-N	1
400	KODIAK YFM400FWA(QUAD)	-	IX24	IXU01-□	X24ESR-U	1
400	SR400	88.8 -09	IW20	IW01-□	W20EPR-U	1
400	SR400	09.12-	IW20	IW01-□	W20EPR-U	1
400	SR400S LIMITED EDITION	95.8 -	IW20	IW01-□	W20EPR-U	1
400	SRX400	85.4 -91.6	IX22B	IXU01-□	X22EP-U9	1
400	SRX400	91.7 -96	IX24B	IXU01-□	X24EPR-U9	1
400	WR400F	98 -00	IU24	IU01-□	U24ESR-N	1
400	XJ400/D/SP/Z/S/Z-E	80.6 -	IX24	IXU01-□	X24ES-U	4
400	XJR400	93.3 -95.3	IU24	IU01-□	U24ESR-N	4
400	XJR400/R	95.3 -95.12	IU27	IU01-□	U27ESR-N	4
400	XJR400/R II	96.1 -	IU27	IU01-□	U27ESR-N	4
400	XS400SP	80 -82.5	IW20	IW01-□	W20EP-U	2
400	XS400SP	82.5 -	IX24	IXU01-□	X24ES-U	2
400	XT400	82 -	IX22	IXU01-□	X22ES-U	1
400	XV400SP	83.3 -	IW22	IW01-□	W22EP-U	4
400	XV400VIRAGO	87.3 -91.2	IW22	IW01-□	W22EP-U	4
400	XV400VIRAGO	91.3 -	IW22	IW01-□	W22EPR-U	2
400	XVS400DRAGSTAR	00.4 -	IX22B	IXU01-□	X22EPR-U9	2
400	XZ400/D	82 -	IX24	IXU01-□	X24ES-U	2
400	YF400M-FW(QUAD)	94 -98	IX24	IXU01-□	X24ESR-U	2
400	YZ400F	98 -99	IU24	IU01-□	U24ESR-N	1
426	YZ426F	00.10-02.8	IU24	IU01-□	U24ESR-N	1
450	WR450F	03 -	IU24	IU01-□	U24ESR-N	1
450	YFZ450(QUAD)	04 -09	IU24	IU01-□	U24ESR-N	1
450	YFZ450R(QUAD)	10 -	IU24	IU01-□	U24ESR-N	1
450	YZ450F	02.9 -09	IU24	IU01-□	U24ESR-N	1
450	YZ450F	09.10-	IU24	IU01-□	U24ESR-N	1
500	RZV500R	84.5 -	IWF24	-	W24FSR	4
500	SR500	88.7 -	IW20	IW01-□	W20EPR-U	1
500	TMAX	01.8 -04.8	IU22	IU01-□	U22ESR-N	2
500	TMAX	04.9 -08.6	IU22	IU01-□	U22ESR-N	2
500	TMAX	08.7 -	IU22	IU01-□	U22ESR-N	2
530	TMAX530	-	IU22	IU01-□	U22ESR-N	2
530	TMAX530	14.1 -	IU22	-	U22ESR-N	2
535	XV535/S	-	IW20	IW01-□	W20EPR-U	2
535	XV535DX VIRAGO(Import)	-	IW20	IW01-□	W20EPR-U	2
550	GRIZZLY 550FI(QUAD)	08.9 -	-	-	-	1
550	XZ550D	81 -	IX24	IXU01-□	X24ES-U	2
600	FZ6-S FAZER/N(Import)	04 -	IU27A	IU01-□	U27ETR	4
600	FZ6R(Import)	09 -	IU27	IU01-□	U27ESR-N	4
600	FZR600	89 -	IU27	IU01-□	U27ESR-N	4
600	FZS600FAZER	-	IU24	IU01-□	U24ESR-N	4
600	SRX600	85.4 -91.6	IX22B	IXU01-□	X22EP-U9	1
600	SRX600	91.7 -92.5	IX24B	IXU01-□	X24EPR-U9	1

CC	MODEL	FROM-TILL	IRIDIUM POWER	IRIDIUM RACING	DENSO	QTY
YAMAHA						
600	TT600R/RE(Import)	-	IX24B	IXU01-□	X24EPR-U9	1
600	XJ600S/N	92.8 -	IU24	IU01-□	U24ESR-N	4
600	XJ6 DIVERSION/F(Import)	09 -	IU27	IU01-□	U27ESR-N	4
600	XJ6N/S(Import)	09 -	IU27	IU01-□	U27ESR-N	4
600	XT600E	-	IX24B	IXU01-□	X24EPR-U9	1
600	XT600Z TENERE	83 -	IX22B	IXU01-□	X22EP-U9	1
600	YZF600R THUNDERCAT	96 -98	IU27	IU01-□	U27ESR-N	4
600	YZF-R6(Import)	98 -03	IU31A	RU01-□ /IU01-□	U31ETR	4
600	YZF-R6(Import)	04 -	IU31A	RU01-□ /IU01-□	U31ETR	4
650	DRAGSTAR650	-	IX22B	IXU01-□	X22EPR-U9	2
650	XJ650SP	80.7 -	IW22	IW01-□	W22EP-U	4
650	XS650SP	78 -	IW22	IW01-□	W22EP-U	2
650	XVS650DRAGSTAR(Import)	98 -	IX22B	IXU01-□	X22EPR-U9	2
660	GRIZZLY660(QUAD)	04 -	IX24B	IXU01-□	X24EPR-U9	1
660	SZR660(Import)	-	IX24B	IXU01-□	X24EPR-U9	1
660	XT660R/X(Import)	04 -	IU22	IU01-□	U22ESR-N	1
660	XTZ660TENERE	92 -	IX24B	IXU01-□	X24EPR-U9	1
660	YFM660R(QUAD)	03.1 -	IX24B	IXU01-□	X24EPR-U9	1
660	MT-03(Import)	06 -	IU22	-	U22ESR-N	1
700	GRIZZLY 700FI(QUAD)	08.9 -	-	-	-	1
700	YFM700 GRIZZLY(QUAD)	07 -08	IU22D	IU01-□	U22EPR9	1
700	MT-07/07A	14 -	-	-	-	4
750	FZ750	85.4 -	IX24B	IXU01-□	X24EPR-U9	4
750	FZR750	87.2 -	IX24B	IXU01-□	X24EP-U9	4
750	FZR750R	89.2 -	IX27	IXU01-□	X27ESR-U	4
750	FZX750	86.3 -	IX24B	IXU01-□	X24EPR-U9	4
750	XJ750E/E II/D/A	81 -	IW22	IW01-□	W22EP-U	4
750	XS750SP	78 -	IW22	IW01-□	W22EP-U	2
750	XTZ750SUPERTENERE	89 -	IX24B	IXU01-□	X24EPR-U9	2
750	XV750	-	IW22	IW01-□	W22EPR-U	2
750	XV750E	82.1 -	IW22	IW01-□	W22EP-U	2
750	XV750SP	81.3 -	IW22	IW01-□	W22EP-U	2
750	XV750VIRAGO	81 -	IW22	IW01-□	W22EP-U	2
750	YZF750SP	93.2 -	IU27	RU01-□	U27ESR-N	4
750	YZF-R7	-	-	RU01-□ /IU01-□	RU01-31	4
800	FAZER8/ABS	10 -	IU27	IU01-□	U27ESR-N	4
800	FZ8-N/S	10 -	IU27	IU01-□	U27ESR-N	4
850	MT-09	14.4 -	IU27D	IU01-□	U27EPR9	3
850	TDM850	91 -93.4	IX24B	IXU01-□	X24EPR-U9	2
850	TDM850	93.5 -94.1	IX27B	IXU01-□	X27EPR-U9	2
850	TDM850	94.2 -01	IX24B	IXU01-□	X24EPR-U9	2
850	TRX850	95.3 -99	IX24B	IXU01-□	X24EPR-U9	2
900	TDM900	02 -	IX24B	IXU01-□	X24EPR-U9	2
900	XJ900S DIVERSION	95 -03	IX24B	IXU01-□	X24EPR-U9	4
950	BOLT/BOLT-R	13.12-	IU22D	IU01-□	U22EPR-U	2
950	XVS950A(Import)	09 -	IU22D	IU01-□	U22EPR9	2
1000	FZR1000	87 -	IX24	IXU01-□	X24ESR-U	4
1000	FZ1/Fazer	08.2 -	IU27A	IU01-□	U27ETR	4
1000	FZ1 FAZER(Import)	06 -	IU27A	RU01-□ /IU01-□	U27ETR	4
1000	FZS1000FAZER	01 -	IU27	IU01-□	U27ESR-N	4
1000	GTS1000/A	93 -	IX24B	IXU01-□	X24EPR-U9	4
1000	YZF1000R/THUNDERACE	96 -	IX24	IXU01-□	X24ESR-U	4
1000	YZF-R1(Import)	98 -01	IU27	RU01-□ /IU01-□	U27ESR-N	4
1000	YZF-R1(Import)	02 -03	IU27D	RU01-□ /IU01-□	IU27D	4
1000	YZF-R1(Import)	04 -08	IU27A	RU01-□ /IU01-□	U27ETR	4
1000	YZF-R1(Import)	09 -	-	-	-	4
1000	YZF-R1	09.6 -	-	-	-	4
1100	BT1100BULLDOG(Import)	02 -	IW22	IW01-□	W22EPR-U	2
1100	XV1100VIRAGO	95.2 -	IW22	IW01-□	W22EPR-U	2
1100	XVS1100 DRAGSTAR 11	99.3 -	IW22	IW01-□	W22EPR-U	2

DENSO

AUSTRALIA CHINA

INDIA

INDONESIA

KOREA

MALAYSIA

PHILIPPINES

SAUDIARABIA

SINGAPORE

TAIWAN

THAILAND

VIETNAM

JAPAN

& USA

EUROPE

MOTOR

SMALL

ENGINE

REFERENCE NUMBER



JAPAN MOTORCYCLE

▶ Spark plug color codes: ■ for Iridium Tough and Iridium Plugs and Iridium TT, ■ for Iridium Power, ■ for Iridium Racing and Two Tops Plugs, ■ for Platinum Plugs and Platinum TT, and black for general spark plugs.

DENSO

CC MODEL	FROM-TILL	IRIDIUM POWER	IRIDIUM RACING	DENSO	QTY
YAMAHA					
1100 XVS1100A DRAGSTAR 11 CLASSIC	00.3 -	IW22	IW01-□	W22EPR-U	2
1200 FJ1200	91.3 -	IX24B	IXU01-□	X24EPR-U9	4
1200 V-MAX	85 -07	IX24B	IXU01-□	X24EPR-U9	4
1200 XJR1200/R	94.3 -98.3	IX24B	IXU01-□	X24EPR-U9	4
1200 XT1200Z SuperTenera(Import)	10 -	IU24D	IU01-□	-	4
1300 FJR1300/A	01 -13.12	IU24	IU01-□	U24ESR-N	4
1300 FJR1300/A	13.12-	IU24D	IU01-□	U24EPR9	4
1300 FJR1300A/AS	06 -13.12	IU24	IU01-□	U24ESR-N	4
1300 FJR1300A/AS	13.12-	IU24D	IU01-□	U24EPR9	4
1300 ROYALSTAR VENTURE	97 -	IX24B	IXU01-□	X24EPR-U9	4
1300 ROYALSTAR/TOURCLASSIC	96.4 -98	IX22B	IXU01-□	X22EPR-U9	4

CC MODEL	FROM-TILL	IRIDIUM POWER	IRIDIUM RACING	DENSO	QTY
YAMAHA					
1300 XJR1300/SP	98.3 -06.9	IX24B	IXU01-□	X24EPR-U9	4
1300 XJR1300	06.10-	IX24B	IXU01-□	X24EPR-U9	4
1300 XVS1300(Import)	07 -	-	-	-	2
1300 XVZ1300A ROYALSTAR	96 -98	IX22B	IXU01-□	X22EPR-U9	4
1600 XV1600ROADSTAR	99 -	IX22B	IXU01-□	X22EPR-U9	4
1600 XV1600ROADSTAR(Import)	99 -00	IX22B	IXU01-□	X22EPR-U9	4
1680 VMAX(Import)	09 -	IU27D	IU01-□	IU27D	4
1680 VMAX	09.4 -	IU27D	IU01-□	IU27D	4
1700 MT-01(Import)	05 -	IX22B	IXU01-□	X22EPR-U9	4
1700 ROADSTAR WARRIOR XV1700	02 -	IX22B	IXU01-□	X22EPR-U9	4
1900 XU1900A/CU(Import)	06 -	IX24B	IXU01-□	X24EPR-U9	4

CHINA AUSTRALIA

INDIA

INDONESIA

KOREA

MALAYSIA

PHILIPPINES

SAUDI ARABIA

SINGAPORE

TAIWAN

THAILAND

VIETNAM

JAPAN

EUROPE & USA

MOTOR CYCLE

SMALL ENGINE

CROSS REFERENCE

PART NUMBER

DENSO	9	14	16	20	22	24	27	29	31	32	34	35
NGK	2	4	5	6	7	8	9	9.5	10	10.5	11	11.5

DENSO	9	14	16	20	22	24	27	29	31	32
CHAMPION	18	16,14	12,11	10,9	8,7	6,63,61	4,59	57	55	53

DENSO	9	14	16	20	22	24	27	31
BOSCH	10	9	8	7,6	5	4	3	2



CC	MODEL	FROM-TILL	IRIDIUM POWER	IRIDIUM RACING	DENSO	QTY
ADIVA						
125	N125	-	IU24	IU01-□	U24ESR-N	1
125	R125	-	IU24	IU01-□	U24ESR-N	1
250	AD250/IE	-	IU27	IU01-□	U27ESR-N	1
APRILIA						
50	AREA51	-	IWF24	-	W24FSR	1
50	CLASSIC	-	IWF24	IW01-□	W24ES-U	1
50	GULLIVER50	-	IWF22	-	W22FSR	1
50	H2O	-	IWF24	-	W24FSR	1
50	HABANA50/CUSTOM50	-	IWF24	-	W24FPR	1
50	MOJITO50/C	-	IWF24	-	W24FPR	1
50	MX50	-	IWF27	IW01-□	W27ESR	1
50	RALLY(AIRCOOL)	-	IWF22	-	W22FSR	1
50	RALLY(LIQUIDCOOL)	-	IWF24	-	W24FSR	1
50	RS50	-	IWF24	IW01-□	W24ES-U	1
50	RX50	-	IWF24	IW01-□	W24ES-U	1
50	SCARABEO50	93 -01	IWF22	-	W22FSR	1
50	SCARABEO50ST	02 -	IU24	IU01-□	U24ESR-N	1
50	SONIC50	-	IWF24	-	W24FSR	1
50	SR50(Fi)	03 -	IU24A	IU01-□	-	1
50	SR50(CARB)	-04	IWF24	-	W24FSR	1
50	SR50(CARB)	05 -	IWF27	IW01-□	W27ESR-U	1
50	SR50 Purejet	-	-	-	N24EXRB	1
50	TUONO50	-	IWF24	IW01-□	W24ES-U	1
125	ATLANTIC125	03 -	IU24	IU01-□	U24ESR-NB	1
125	LEONARDO	-	IU24	IU01-□	U24ESR-N	1
125	RS125	-	IWF31	IW01-□	-	1
125	SCARABEO125	99 -	IU24	IU01-□	IU24	1
125	SR125	-	IWF24	IW01-□	W24ESR-U	1
150	LEONARDO	-	IU24	IU01-□	U24ESR-N	1
150	SR150	-	IWF24	IW01-□	W24ESR-U	1
200	ATLANTIC200	03 -	IU24	IU01-□	U24ESR-NB	1
200	SCARABEO200	99 -	IU24	IU01-□	U24ESR-N	1
200	SPORTCITY200	05 -	IU22	IU01-□	-	1
250	ATLANTIC250	05 -	IU24	IU01-□	U24ESR-NB	1
250	LEONARDO250	99 -01	IX24	IXU01-□	X24ESR-U	1
250	RS250/SP	-	IWM27	IWM01-□	-	2
250	SCARABEO250/GT	05 -	IU24	IU01-□	U24ESR-NB	1
250	SPORTCITY250	06 -	IU27	IU01-□	-	1
250	SPORTCITY CUBE 250IE	-	IU27	IU01-□	-	1
400	ATLANTIC400	06 -	IU22	IU01-□	-	1
400	SCARABEO400 IE	06 -	IU22	IU01-□	-	1
450	RXV450	06 -	IU24	IU01-□	U24ESR-NB	2
450	SXV450	06 -	IU24	IU01-□	U24ESR-NB	2
500	ATLANTIC500	01 -	IU22	IU01-□	-	1
500	SCARABEO500	03 -	IU22	IU01-□	-	1
550	RXV550	06 -	IU24	IU01-□	U24ESR-NB	2
550	SXV550	06 -	IU24	IU01-□	U24ESR-NB	2
650	MOTO6.5	-	IX24	IXU01-□	X24ES-U	1
650	PEGASO650 ie/STRADA	01 -04	IX24	IXU01-□	-	1
650	PEGASO650STRADA	05 -	IU22	IU01-□	U22ESR-N	1
750	DORSODURO	09 -	IU22	IU01-□	-	2
750	SL750 SHIVER/GT	08 -	IU22	IU01-□	-	2
850	NA850 MANA/GT	08 -	IU22	IU01-□	-	2
1000	ETV1000 CAPONORD	05 -	IXU27	IXU01-□	XU27EPR-U	4
1000	RST1000 FUTURA	01 -	IXU27	IXU01-□	XU27EPR-U	4
1000	RSV1000/MILLE/R	99.1 -04	IXU27	IXU01-□	XU27EPR-U	4
1000	RSV1000R/R FACTORY	04 -	IXU27	IXU01-□	XU27EPR-U	2
1000	RSV1000SP	01 -	IU27	IU01-□	U27ESR-N	2
1000	RSV4 FACTORY/R	09 -10	IU27	IU01-□	-	4
1000	RSV4 FACTORY/R	11 -	IU27A	IU01-□	-	4
1000	SL1000 FALCO	-	IXU27	IXU01-□	XU27EPR-U	4
1000	TUONO1000/R/R FACTORY	03 -	IXU27	IXU01-□	XU27EPR-U	4
BENELLI						
50	491RR/REPLICA	99 -	IWF24	-	W24FSR	1
50	491ST	99 -02	IWF24	-	W24FSR	1
50	NAKED	02 -	IWF24	-	W24FSR	1
125	ADIVA125	01 -	IU22	IU01-□	-	1

CC	MODEL	FROM-TILL	IRIDIUM POWER	IRIDIUM RACING	DENSO	QTY
BENELLI						
125	VELVET125	98 -	IX24	IXU01-□	X24ESR-U	1
150	ADIVA150	01 -	IU22	IU01-□	-	1
150	VELVET150	01 -	IU24	IU01-□	U24ESR-N	1
250	VELVET250	01 -	IU24	IU01-□	U24ESR-N	1
900	TORNADO900/TRE	03 -	IU27	IU01-□	U27ESR-N	3
1130	TnT1130	04 -	IU27	IU01-□	U27ESR-N	3
BETA						
125	REV'125	-	IWF22	IW01-□	W22EP-U	1
200	ALP200	01 -	IX24	IXU01-□	X24ESR-U	1
200	REV'200	-	IWF22	IW01-□	W22EP-U	1
250	REV-3	-	IWF22	IW01-□	W22EP-U	1
250	REV'250	-	IWF22	IW01-□	W22EP-U	1
250	TECHNO	94 -99	IWF22	IW01-□	W22EP-U	1
250	ZERO	90 -93	IWF22	IW01-□	W22EP-U	1
BIMOTA						
400	db-2Jr	-	IWF22	-	W22FP-U	2
400	FW96	97 -	IWF22	-	W22FP-U	2
400	TESI 1D400J	-95	IWF22	-	W22FP-U	2
400	TESI 1D400J	96 -	IWF20	-	W20FP-U	2
400	YB-7	-	IU27	IU01-□	IU27	4
400	YB-7FORGORE	-	IU24	IU01-□	U24ESR-N	4
600	BELLARIA600	-	IU24	IU01-□	U24ESR-N	4
600	YB-9/SR/SRI	-	IU27	IU01-□	IU27	4
600	YB-9SR	94 -95	IU27	IU01-□	U27ESR-N	4
600	YB-9SRi	96 -98	IU27	IU01-□	U27ESR-N	4
652	BB1BIPOST(SUPERMONO BIPOST)	96 -98	IX24	IXU01-□	X24ES-U	2
750	db-1/S/SR	-	IX24	IXU01-□	X24ESR-U	2
750	SB-7	-	IU27A	IU01-□	U27ETR	4
750	YB-4	-	IX27	IXU01-□	X27ESR-U	4
900	db-2/SR	-	IX24B	IXU01-□	X24EPR-U9	2
900	db-2FE	-	IX22B	IXU01-□	X22EPR-U9	2
904	DB3 MANTRA	95 -00	IX22B	IXU01-□	X22EPR-U9	2
904	db-4/IE	-	IXU24	IXU01-□	XU24EPR-U	2
906	TESI 1D906SR	-	IX24	IXU01-□	X24ES-U	2
906	TESI 1D906SR-S	-	IX24	IXU01-□	X24ESR-U	2
992	db-5	05 -	IXU24	IXU01-□	XU24EPR-U	4
992	TESI 2D	-	IU24	IXU01-□	-	4
996	SB8R/SP/K	-	IU27A	IU01-□	U27ETR	2
1000	DIECI-YB-6-YB-8	-	IX27	IXU01-□	X27ESR-U	4
1000	FRANO	-	IX27	IXU01-□	X27ESR-U	4
1000	TUATARA	-	IX24	IXU01-□	X24ESR-U	2
1000	YB11	-	IX24	IXU01-□	X24ESR-U	4
1078	DB5C 1080/1100	-	IXU24	IXU01-□	-	4
1078	DB6C 1080/1100	-	IXU24	IXU01-□	-	4
1078	TESI 3D CONCEPT	-	IXU24	IXU01-□	-	4
1100	SB6-SB6-R	-	IU27	IU01-□	IU27	4
BMW						
450	G450X	08 -	IU27A	IU01-□	-	1
450	R45	78 -85	IWF20	IW01-□	W20EP-U	2
650	C600/C650GT	-	-	-	-	2
650	F650/ST/GS DAKAR/FUNDURO	94 -99	IX24	IXU01-□	X24ES-U	2
650	F650GS/DAKAR/CS	00 -01	IX24	IXU01-□	X24ES-U	1
650	F650GS/DAKAR/CS	02 -	IX24	IXU01-□	-	2
650	G650Xcountry/ Xmoto/Xchallenge	07 -	IX24	IXU01-□	-	2
650	R65	85 -94	IWF22	IW01-□	W22EP-U	2
650	R65/LS	78 -85	IWF22	IW01-□	W22EP-U	2
650	R65G/S	81 -87	IWF20	IW01-□	W20EP-U	2
750	K75/C/RT/S	85 -96	IX22	IXU01-□	X22ES-U	3
800	F650GS	08 -08	IXU24	IXU01-□	XU24EPR-U	2
800	F800S/ST	06 -	IXU24	IXU01-□	XU24EPR-U	2
800	F800GS	09 -	IXU24	IXU01-□	XU24EPR-U	2
800	F800R	09 -	IXU24	IXU01-□	XU24EPR-U	2
800	R80/7/G/S/GS/RT/ST	78 -94	IWF20	IW01-□	W20EP-U	2
850	R850R	94 -99	IK20	IK(Q)01-□	K20TNR	2
850	R850R	00 -06	IK22	IK01-□	K22TNR-S	2
1000	K1	89 -92	IX22B	IXU01-□	X22EP-U9	4

DENSO
 AUSTRALIA CHINA INDIA INDONESIA KOREA MALAYSIA PHILIPPINES SAUDIARABIA SINGAPORE TAIWAN THAILAND VIETNAM JAPAN & USA
 EUROPE MOTOR SMALL CROSS PART
 CYCLE ENGINE REFERENCE NUMBER



EUROPE & U.S.A. MOTORCYCLE

Spark plug color codes: ■ for Iridium Tough and Iridium Plugs and Iridium TT, ■ for Iridium Power, ■ for Iridium Racing and Two Tops Plugs, ■ for Platinum Plugs and Platinum TT, and black for general spark plugs.

DENSO

CC MODEL	FROM-TILL	IRIDIUM POWER	IRIDIUM RACING	DENSO	QTY
BMW					
1000 K100/LT/RS/RT	82 -92	IX22B	IXU01-□	X22EP-U9	4
1000 R100/7	77 -84	IW20	IW01-□	W20EP-U	2
1000 R100CS/RS/RT/S/T	77 -84	IW22	IW01-□	W22EP-U	2
1000 R100R/RS/RT/GS	87 -96	IW20	IW01-□	W20EP-U	2
1000 S1000RR	10 -	-	-	-	4
1100 K1100LT/RS	92 -96	IX22	IXU01-□	X22ESR-U	4
1100 R1100GS/R/RS/RT/S	92 -02	IK22	IK01-□	K22TNR-S	2
1100 R1100S	03 -06	IK22+ IXU22	IK01-□+ IXU01-□	K22TNR-S+ XU22EPR-U	EACH 2
1150 R1150GS/R/RT/RS	99 -02.12	IK22	IK01-□	K22TNR-S	2
1150 R1150GS/R/RT/RS	03.1 -06	IK22+ IXU22	IK01-□+ IXU01-□	K22TNR-S+ XU22EPR-U	EACH 2
1150 R1150R ROCKSTER	03.3 -	IK22+ IXU22	IK01-□+ IXU01-□	K22TNR-S+ XU22EPR-U	EACH 2
1200 HP2 ENDURO	06 -	IXU24	IXU01-□	XU24EPR-U	4
1200 HP2 MEGAMOTO	07 -	IXU24	IXU01-□	XU24EPR-U	4
1200 HP2 SPORTS	08 -	-	-	-	2
1200 K1200GT	03.3 -	IX22B	IXU01-□	X22EPR-U9	4
1200 K1200LT(115PS)	04.6 -	IX22B	IXU01-□	X22EPR-U9	4
1200 K1200LT	97 -04.5	IX22B	IXU01-□	X22EPR-U9	4
1200 K1200RS	97 -	IX22B	IXU01-□	X22EPR-U9	4
1200 K1200S/R	04 -08	IXU27	IXU01-□	XU27EPR-U	4
1200 R1200C	97 -03	IK22	IK01-□	K22PBR-S	2
1200 R1200C	04 -06	IK22+ IXU22	IK01-□+ IXU01-□	K22TNR-S+ XU22EPR-U	EACH 2
1200 R1200C AVANTGARDE	-03	IK22	IK01-□	K22PBR-S	2
1200 R1200C AVANTGARDE	04 -04	IK22+ IXU22	IK01-□+ IXU01-□	K22TNR-S+ XU22EPR-U	EACH 2
1200 R1200C INDEPENDENT	00 -03	IK22	IK01-□	K22PBR-S	2
1200 R1200C INDEPENDENT	04 -04	IK22+ IXU22	IK01-□+ IXU01-□	K22TNR-S+ XU22EPR-U	EACH 2
1200 R1200C MONTAUK	04 -06	IK22+ IXU22	IK01-□+ IXU01-□	K22TNR-S+ XU22EPR-U	EACH 2
1200 R1200CL	03 -03	IK22	IK01-□	K22TNR-S	2
1200 R1200CL	04 -	IK22+ IXU22	IK01-□+ IXU01-□	K22TNR-S+ XU22EPR-U	EACH 2
1200 R1200GS	04 -09	IXU24	IXU01-□	-	4
1200 R1200GS	10 -	-	-	-	2
1200 R1200GS	13 -	-	-	-	2
1200 R1200R	07 -10	IXU24	IXU01-□	XU24EPR-U	4
1200 R1200R/Classic	11 -	-	-	-	2
1200 R1200RT	05 -09	IXU24	IXU01-□	-	4
1200 R1200RT	10 -	-	-	-	2
1200 R1200ST	05 -	IXU24	IXU01-□	XU24EPR-U	4
1200 R1200S	06.5 -	IXU24	IXU01-□	XU24EPR-U	4
1300 K1300S/R/GT	09 -	IXU27	IXU01-□	XU27EPR-U	4
1600 K1600GT/GTL	-	-	-	-	6
BOSSHOSS					
4300 V6 AT2SPEED	-	ITF16	-	-	6
4300 V6TRIKE	-	ITF16	-	-	6
5730 V8 AT2SPEED	-	IK16	IK01-□	IK16	8
5730 V8TRIKE	-	IK16	IK01-□	IK16	8
8200 502BIGBLOCK AT2SPEED	-	IW16	IW01-□	W16EP-U	8
8200 502BIGBLOCK TRIKE	-	IW16	IW01-□	W16EP-U	8
BUELL					
1000 XB9R FIREBOLT	01.9 -	IXU24	IXU01-□	XU24EPR-U	2
1000 XB9S LIGHTNING	02.9 -	IXU24	IXU01-□	XU24EPR-U	2
1000 XB9SX LIGHTNING CITY	05 -10	IXU24	IXU01-□	XU24EPR-U	2
1200 CYCLONE M2	-99	IXU22	IXU01-□	XU22EPR-U	2
1200 CYCLONE M2	00 -01	IXU24	IXU01-□	XU24EPR-U	2
1200 LIGHTNING S-1	-99	IXU22	IXU01-□	XU22EPR-U	2
1200 LIGHTNING S-1	00 -01	IXU24	IXU01-□	XU24EPR-U	2
1200 LIGHTNING X-1	-99	IXU22	IXU01-□	XU22EPR-U	2
1200 LIGHTNING X-1/MILLENNIUM	00 -01	IXU24	IXU01-□	XU24EPR-U	2
1200 THUNDERBOLT S-3	-99	IXU22	IXU01-□	XU22EPR-U	2
1200 THUNDERBOLT S-3	00 -01	IXU24	IXU01-□	XU24EPR-U	2
1200 XB12R FIREBOLT	03.8 -10	IXU24	IXU01-□	XU24EPR-U	2

*USE REMOVABLE TYPE

CC MODEL	FROM-TILL	IRIDIUM POWER	IRIDIUM RACING	DENSO	QTY
BUELL					
1200 XB12S/cg LIGHTNING	03.8 -10	IXU24	IXU01-□	XU24EPR-U	2
1200 XB12Ss LIGHTNING	05 -10	IXU24	IXU01-□	XU24EPR-U	2
1200 XB12STT LIGHTNING SUPER	07 -07	IXU24	IXU01-□	XU24EPR-U	2
1200 XB12X/XT ULYSSES	05 -10	IXU24	IXU01-□	XU24EPR-U	2
BULTACO					
50 LOBITO	01.1 -	IW27	IW01-□	W27ES-U	1
CAGIVA					
50 CUCCILO	-	IWF24	-	W24FS-U	1
50 MITO50	-	IW31	IW01-□	W31ES-U	1
50 PRIMA50	-	IW24	IW01-□	W24ES-U	1
115 STELLA115	-	-	-	-	1
125 125MITO Ev	-	IW27	IW01-□	-	1
125 CUCCILO125	-	IU22	IU01-□	U22ESR-N	1
125 MITO125	-	IW27	IW01-□	-	1
125 PLANET125	-	IW29	IW01-□	IW29	1
125 RAPTOR125	-	IW27	IW01-□	W27ESR-V	1
600 CANYON	-	IQ22	IQ01-□	Q22P-U	1
600 RIVER	-	IQ22	IQ01-□	Q22P-U	1
650 RAPTOR650-V RAPTOR650	-	IU24	IU01-□	U24ESR-N	2
900 ie CANYON	-	IXU24	IXU01-□	XU24EPR-U*	2
1000 XTRA RAPTOR	-	IU24A	IU01-□	U24ETR	2
1000 NAVIGATOR	00 -	IU24A	IU01-□	U24ETR	2
1000 RAPTOR-V RAPTOR	00 -	IU24A	IU01-□	U24ETR	2
DERBI					
50 Antorcha·Coppa·Diablo	-91	IWF22	-	W22FS-U	1
50 Aventura	95 -	IWF24	-	W24FS-U	1
50 FDS·GTS·RD-2	-91	IWF22	-	W22FS-U	1
50 Fenix·FDSuper·StartDS	92 -	IWF24	-	W24FS-U	1
50 Furax	95 -	IWF24	-	W24FS-U	1
50 GPR	01.1 -	IW31	IW01-□	W31ES-U	1
50 Hunter(D+A)	95 -	IWF22	-	W22FP-U	1
50 Hunter(Spain)	95 -	IWF24	-	W24FS-U	1
50 Olimpia·Savanah·Start	-91	IWF22	-	W22FS-U	1
50 PREDATOR	-01.8	IW24	IW01-□	W24ES-U	1
50 RD-2 Country	92 -	IWF24	-	W24FS-U	1
50 Senda	-	IW27	IW01-□	W27ES-U	1
50 Sendra-R	95 -	IW24	IW01-□	W24ES-U	1
50 Sport·Variant·Yumbo	-91	IWF22	-	W22FS-U	1
50 SUPERMOTORD	01.1 -	IW27	IW01-□	W27ES-U	1
50 Urban	95 -	IWF24	-	W24FS-U	1
50 Vamos	-	IWF24	-	W24FSR	1
50 VariantBox·SportR/Top	92 -	IWF24	-	W24FS-U	1
75 1001·ExtraSportCoppa	-	IW24	IW01-□	W24ES-U	1
75 CR74	-	IW31	IW01-□	IW31	1
75 EuropaRD15·Scoot74	-	IW24	IW01-□	W24ES-U	1
75 GPR-75·Sport-75	-	IW31	IW01-□	IW31	1
75 GranPrix74	-	IWF22	-	W20FS-U	1
75 VIVO-75	-	IWF16	-	W16FP-U	1
80 BI 3	95 -	IW24	IW01-□	W24ES-U	1
125 CRS·RC	-	IW31	IW01-□	IW31	1
125 Enduro·RS125TT·Karmathan	-	IW27	IW01-□	IW27	1
125 SportCoppa·TTS9	-	IW27	IW01-□	W27ES-U	1
200 2002·GranPrix·6V	-	IW27	IW01-□	W27ES-U	1
250 CRX·RC·Enduro	-	IW31	IW01-□	IW31	1
250 Turismo250	-	IW27	IW01-□	W27ES-U	1
659 MULHACEN659	-	IU22	-	U22ESR-N	1
DUCATI					
349 350XL PANTAH	82 -83	IWF22	-	W22FPR-U	2
398 F3	86 -88	IWF22	-	W22FPR-U	2
398 MONSTER 400	95 -97	IWF22	-	W22FPR-U	2
398 MONSTER 400/DARK	00 -08	IXU24	IXU01-□	XU24EPR-U*	2
398 SS/SSJ	89 -94	IWF22	-	W22FPR-U	2
499 500SL PANTAH	79 -81	IWF22	-	W22FPR-U	2
583 600SL PANTAH	81 -82	IWF22	-	W22FPR-U	2
583 600SS	91 -97	IXU24	IXU01-□	XU24EPR-U	2
583 600TL	82 -83	IWF22	-	W22FPR-U	2
583 MONSTER 600	93 -06	IXU24	IXU01-□	XU24EPR-U	2



CC	MODEL	FROM-TILL	IRIDIUM POWER	IRIDIUM RACING	DENSO	QTY
DUCATI						
583	MONSTER 600DARK	98 -06	IXU24	IXU01-□	XU24EPR-U	2
620	620SPORT	02 -	IXU27	IXU01-□	-	2
620	MONSTER 620/ie/DARK	03 -	IXU27	IXU01-□	-	2
620	MONSTER 620/ie/DARK	05 -	IXU24	IXU01-□	XU24EPR-U	2
620	MULTISTRADA620	05 -06	IXU24	IXU01-□	XU24EPR-U	2
648	650SL PANTAH	82 -83	IWF22	-	W22FPR-U	2
695	MONSTER 695	07 -	IXU24	IXU01-□	XU24EPR-U	2
696	MONSTER 696/+	08 -	IXU24	IXU01-□	XU24EPR-U*	2
748	748MONOPOSTO/BIPOSTO/S	95 -03	IXU27	IXU01-□	IXU27	2
748	748R	00 -03	IXU27	IXU01-□	IXU27	2
748	748SP	95 -97	IXU27	IXU01-□	IXU27	2
748	748SPS	98 -99	IXU27	IXU01-□	IXU27	2
748	750F1	85 -88	IXU24	IXU01-□	XU24EPR-U*	2
748	750PASO	87 -88	IXU24	IXU01-□	XU24EPR-U*	2
748	750SPORT	88 -89	IXU24	IXU01-□	XU24EPR-U*	2
748	750SPORT	02 -03	IXU24	IXU01-□	XU24EPR-U*	2
748	750SS	91 -97	IXU24	IXU01-□	XU24EPR-U*	2
748	MONSTER 750DARK	99 -03	IXU24	IXU01-□	XU24EPR-U*	2
748	MONSTER750	96 -03	IXU24	IXU01-□	XU24EPR-U*	2
748	SS750FF/HF	99 -03	IXU24	IXU01-□	XU24EPR-U*	2
749	749/S/DARK	03 -07	IU27(♦)	IU01-□(♦)	IU27(♦)	2
749	749R	04 -07	-	IU01-□(♦)	-	2
749	750SS	73 -75	IWF22	-	W22FS-U	2
749	750SS	76 -77	IWF22	-	W22FPR-U	2
749	750SS IMOLA	73 -74	IWF22	-	W22FS-U	2
796	HYPERMOTARD796	10 -	IXU24	IXU01-□	XU24EPR-U	2
796	MONSTER796	10 -	IXU24	IXU01-□	XU24EPR-U	2
802	800SPORT FF/HF	03 -05	IXU24	IXU01-□	XU24EPR-U	2
802	MONSTER800S/DARK ie	03 -04	IXU24	IXU01-□	XU24EPR-U	2
802	MONSTER S2R	05 -07	IXU24	IXU01-□	XU24EPR-U	2
802	SS800FF/HF	03 -07	IXU24	IXU01-□	XU24EPR-U	2
848	848	09 -	-	-	-	2
851	851RACING	88 -88	IXU27	IXU01-□	IXU27	2
851	851STRADA	88 -92	IXU27	IXU01-□	IXU27	2
864	900MHR	79 -84	IWF22	-	W22FPR-U	2
864	900S2	83 -84	IWF22	-	W22FPR-U	2
864	900SD Darmah	77 -80	IWF22	-	W22FPR-U	2
864	900SS	75 -82	IWF22	-	W22FPR-U	2
888	851SP2	90 -90	IXU27	IXU01-□	IXU27	2
888	851SP3	91 -91	IXU27	IXU01-□	IXU27	2
888	888SP4	92 -92	IXU27	IXU01-□	IXU27	2
888	888SP5	93 -93	IXU27	IXU01-□	IXU27	2
888	888SP5(RacingUse)	93 -93	-	IXU01-□	-	2
888	888SPS	92 -92	IXU27	IXU01-□	IXU27	2
888	888SPS(RacingUse)	92 -92	-	IXU01-□	-	2
888	888STRADA	93 -94	IXU27	IXU01-□	IXU27	2
904	900 SPORT	02 -03	IXU24	IXU01-□	XU24EPR-U*	2
904	900SS	91 -98	IXU24	IXU01-□	XU24EPR-U*	2
904	900SS FE	98 -98	IXU24	IXU01-□	XU24EPR-U*	2
904	900SS SUPERLIGHT	92 -97	IXU24	IXU01-□	XU24EPR-U*	2
904	900SUPER SPORT	89 -90	IXU24	IXU01-□	XU24EPR-U*	2
904	906PASO	89 -90	IXU24	IXU01-□	XU24EPR-U*	2
904	907ie	91 -91	IXU24	IXU01-□	XU24EPR-U*	2
904	MH900e	01 -02	IXU24	IXU01-□	XU24EPR-U*	2
904	MONSTER 900	93 -99	IXU24	IXU01-□	XU24EPR-U*	2
904	MONSTER 900CITY	99 -99	IXU24	IXU01-□	XU24EPR-U*	2
904	MONSTER 900CROMO	98 -99	IXU24	IXU01-□	XU24EPR-U*	2
904	MONSTER 900DARK	98 -99	IXU24	IXU01-□	XU24EPR-U*	2
904	MONSTER 900DARK ie	00 -03	IXU24	IXU01-□	XU24EPR-U*	2
904	MONSTER 900ie	00 -03	IXU24	IXU01-□	XU24EPR-U*	2
904	MONSTER 900SPECIAL	98 -99	IXU24	IXU01-□	XU24EPR-U*	2
904	MONSTER 900SPECIAL ie	00 -03	IXU24	IXU01-□	XU24EPR-U*	2
904	SS900FF/HF	00 -02	IXU24	IXU01-□	XU24EPR-U*	2
904	SS900ie	98 -99	IXU24	IXU01-□	XU24EPR-U*	2
916	916MONOPOSTO/BIPOSTO/S	95 -98	IXU27	IXU01-□	IXU27	2
916	916SP	94 -96	IXU27	IXU01-□	IXU27	2
916	916SP(RacingUse)	94 -96	-	IXU01-□	-	2

CC	MODEL	FROM-TILL	IRIDIUM POWER	IRIDIUM RACING	DENSO	QTY
DUCATI						
916	916STRADA	94 -94	IXU27	IXU01-□	IXU27	2
916	MONSTER S4	01 -03	IXU27	IXU01-□	IXU27	2
916	ST4	99 -03	IXU27	IXU01-□	IXU27	2
944	ST2	97 -03	IXU24	IXU01-□	XU24EPR-U	2
973	1000MHRmille/S2mille	85 -85	IWF22	-	W22FPR-U	2
989	DESMOSEDICI RR	07 -08	-	-	-	4
992	GT1000	06 -	IXU24	IXU01-□	XU24EPR-U	4
992	MONSTER 1000S/DARK ie	03 -05	IXU24	IXU01-□	XU24EPR-U	4
992	MONSTER S2R 1000	06 -07	IXU24	IXU01-□	XU24EPR-U	4
992	MULTISTRADA1000DS/SDS	03 -06	IXU24	IXU01-□	XU24EPR-U	4
992	PAUL SMART1000	06 -06	IXU24	IXU01-□	XU24EPR-U	4
992	SPORT1000/S	06 -09	IXU24	IXU01-□	XU24EPR-U	4
992	SS1000DS FF/HF	03 -06	IXU24	IXU01-□	XU24EPR-U	4
992	ST3	04 -07	IU27	IU01-□	IU27	4
996	916SPS	97 -98	IXU27	IXU01-□	IXU27	2
996	916SPS(RacingUse)	97 -98	-	IXU01-□	-	2
996	996MONOPOSTO/BIPOSTO/S	99 -99	IXU27	IXU01-□	IXU27	2
996	996SPS	99 -00	IXU27	IXU01-□	IXU27	2
996	996SPS(RacingUse)	99 -00	-	IXU01-□	-	2
996	MONSTER S4R	03 -06	IXU27	IXU01-□	IXU27	2
996	ST4S/ABS	00 -05	IXU27	IXU01-□	IXU27	2
998	996R	01 -01	IU27(♦)	IU01-□(♦)	IU27(♦)	2
998	998/S	02 -02	IU27(♦)	IU01-□(♦)	IU27(♦)	2
998	998R	02 -02	IU27(♦)	IU01-□(♦)	IU27(♦)	2
998	MONSTER S4R/ S4RS Testastretta	06 -07	IU27(♦)	IU01-□(♦)	IU27(♦)	2
998	MONSTER S4R/ S4RS Testastretta	08 -	-	-	-	2
999	999/S/R	03 -07	IU27(♦)	IU01-□(♦)	IU27(♦)	2
999	999BIPOST	05 -07	IU27(♦)	IU01-□(♦)	IU27(♦)	2
1098	1098/R/S/S Tricolore	07 -08	-	-	-	2
1098	STREETFIGHTER/S	09 -	-	-	-	2
1100	HYPERMOTARD1100/S	08 -	IXU24	IXU01-□	XU24EPR-U	4
1100	MONSTER 1100/S	09 -	IXU24	IXU01-□	XU24EPR-U	4
1100	MULTISTRADA1100/S	07 -09	IXU24	IXU01-□	XU24EPR-U	4
1198	1198/S/R	09 -	-	-	-	2
1200	MULTISTRADA1200/S	10 -	-	-	-	2
ENFIELD						
250	BULLET350STD	-	-	IW01-□	W22ES-U	1
350	BULLET350DX	-	-	IW01-□	W22ES-U	1
ETHOS DESIGN						
100	KONDY100	-	-	-	U16FSR-U	1
G G						
1100	DUET	-	IX22	IXU01-□	X22ESR-U	4
1100	SPARTACO	-	IW20	IW01-□	W20EPR-U	2
1200	CRUSO	-	IK22	IK01-□	K22PBR-S	2
GASGAS						
50	EC50BOY	-	IK16	IK01-□	IK16	1
50	EC50ROOKIE/SM	-	IW27	IW01-□	IW27	1
50	SM50ROOKIE	-	IW27	IW01-□	IW27	1
50	TXT50BOY	-	IK16	IK01-□	IK16	1
50	TXT50ROOKIE	-	IW27	IW01-□	IW27	1
80	TXT80ROOKIE	-	IW27	IW01-□	IW27	1
125	EC125/SM/OHLINS	-	IW24	IW01-□	-	1
125	SM125	-	IW24	IW01-□	-	1
125	TX RANDONNE	11 -	IUF22	-	U20FSR-U	1
125	TXT125/PRO	-	IW16	IW01-□	W16EPR-U	1
200	EC200/OHLINS	-	IW24	IW01-□	-	1
200	TXT200/PRO	-	IW16	IW01-□	W16EPR-U	1
250	EC250/SM/OHLINS	-	IW24	IW01-□	-	1
250	PAMPERA250	-	IW22	IW01-□	W22EPR-U	1
250	SM250	-	IW24	IW01-□	-	1
250	TXT250/PRO	-	IW16	IW01-□	W16EPR-U	1
280	TXT280/PRO	-	IW16	IW01-□	W16EPR-U	1
300	EC300/OHLINS	-	IW24	IW01-□	-	1
300	TXT300/PRO	04 -	IW16	IW01-□	W16EPR-U	1
321	TXT321	-	IW16	IW01-□	W16EPR-U	1

*USE REMOVABLE TYPE ♦ For installation NB3-16SP(nepros) or B3A-16SP by KTC is recommended

DENSO

AUSTRALIA CHINA

INDIA

INDONESIA

KOREA

MALAYSIA

PHILIPPINES

SAUDIARABIA

SINGAPORE

TAIWAN

THAILAND

VIETNAM

JAPAN

& USA

EUROPE

MOTOR

SMALL

ENGINE

CROSS

PART



EUROPE & U.S.A. MOTORCYCLE

Spark plug color codes: ■ for Iridium Tough and Iridium Plugs and Iridium TT, ■ for Iridium Power, ■ for Iridium Racing and Two Tops Plugs, ■ for Platinum Plugs and Platinum TT, and black for general spark plugs.

DENSO

CC MODEL	FROM-TILL	IRIDIUM POWER	IRIDIUM RACING	DENSO	QTY
GASGAS					
450 EC450FSE/OHLINS	-	IU24	IU01-□	U24ESR-N	1
450 EC450FSE SM/OHLINS	-	IU24	IU01-□	U24ESR-N	1
GHEZZI&BRIAN					
1100 FURIA	02 -	IW20	IW01-□	W20EPR-U	2
1100 SUPERTWIN1100	01 -	IW20	IW01-□	W20EPR-U	2
GILERA					
50 RCR50	-	IW27	IW01-□	W27ES-U	1
50 RUNNER SP50	-	IW27	IW01-□	W27ESR-U	1
50 SMT50	-	IW27	IW01-□	W27ES-U	1
125 CRONO125	-	IW31	IW01-□	IW31	1
125 CX125	-	IW31	IW01-□	IW31	1
125 DNA125	01 -	IU27	IU01-□	U27ESR-NB	1
125 RUNNER FX125SP	-	IW27	IW01-□	W27ESR-U	1
125 RUNNER VX125 4T	-	IU27	IU01-□	U27ESR-N	1
175 RUNNER FXR/FXR-DD/SP	-	IW27	IW01-□	W27ESR-U	1
180 DNA180	01 -	IU24	IU01-□	U24ESR-NB	1
180 RUNNER VXR	01 -	IU24	IU01-□	U24ESR-NB	1
200 RUNNER VXR200 4T	-	IU24	IU01-□	U24ESR-N	1
350 SATURNO ISLE OF MAN350	-	IX27B	IXU01-□	X27EPR-U9	1
350 SATURNO350	94 -	IX27B	IXU01-□	X27EPR-U9	1
350 SATURNO350	-93	IX24B	IXU01-□	X24EP-U9	1
500 NEXUS500 SS	-	IU24	IU01-□	U24ESR-N	1
500 SATURNO ISLE OF MAN500	-	IX27B	IXU01-□	X27EPR-U9	1
500 SATURNO500	94 -	IX27B	IXU01-□	X27EPR-U9	1
500 SATURNO500	-93	IX24B	IXU01-□	X24EP-U9	1
HARLEY-DAVIDSON					
883 SPORTSTER(XL)	85 -03	IXU22	IXU01-□	XU22EPR-U	2
883 SPORTSTER(XL883)	04 -09	IXU22	IXU01-□	XU22EPR-U	2
883 SPORTSTER(XL883C)	04 -09	IXU22	IXU01-□	XU22EPR-U	2
883 SPORTSTER(XL883L)	04 -	IXU22	IXU01-□	XU22EPR-U	2
883 SPORTSTER(XL883N)	09 -	IXU22	IXU01-□	XU22EPR-U	2
883 SPORTSTER(XL883R)	05 -	IXU22	IXU01-□	XU22EPR-U	2
1000 XL	79 -85	IWF22	-	W22EPR-U	2
1000 XR	83 -85	IW20	IW01-□	W20EPR-U	2
1100 EVOLUTION1100SERIES	86 -87	IXU22	IXU01-□	XU22EPR-U	2
1130 NIGHT ROD(VRSCD)	06 -07	IXU24	IXU01-□	XU24EPR-U	2
1130 NIGHT ROD SPECIAL(VRSCDX)	07 -07	IXU24	IXU01-□	XU24EPR-U	2
1130 STREET ROD(VRSCR)	05 -07	IXU24	IXU01-□	XU24EPR-U	2
1130 V-ROD(VRSCA-VRSCB)	02.1 -07	IXU24	IXU01-□	XU24EPR-U	2
1200 EVOLUTION1200SERIES	86 -98	IXU22	IXU01-□	-	2
1200 FL PANHEAD	48 -65	-	-	W16PR-U	2
1200 FL SHOVELHEAD	66 -74	-	-	W16PR-U	2
1200 FL SHOVELHEAD	75 -81	IW16	IW01-□	-	2
1200 FX PANHEAD	48 -65	-	-	W16PR-U	2
1200 FX SHOVELHEAD	75 -81	IW16	IW01-□	-	2
1200 SPORTSTER(XL)	98 -03	IXU22	IXU01-□	XU22EPR-U	2
1200 SPORTSTER(XL1200C)	04 -	IXU22	IXU01-□	XU22EPR-U	2
1200 SPORTSTER(XL1200R)	04 -09	IXU22	IXU01-□	XU22EPR-U	2
1200 SPORTSTER(XL1200L)	06 -11	IXU22	IXU01-□	XU22EPR-U	2
1200 SPORTSTER(XL1200N)NIGHTSTER	08 -	IXU22	IXU01-□	XU22EPR-U	2
1200 SPORTSTER(XL150)	07 -07	IXU22	IXU01-□	XU22EPR-U	2
1200 XL1200S(TWINPLUG)	98 -03	IXU22	IXU01-□	XU22EPR-U	4
1200 XL1200X	11 -	IXU24	IXU01-□	XU24EPR-U	2
1200 XR1200	09 -10	IXU24	IXU01-□	XU24EPR-U	2
1200 XR1200X	10 -11	IXU24	IXU01-□	XU24EPR-U	2
1250 V-ROD(VRSCAW)	08 -10	IXU24	IXU01-□	XU24EPR-U	2
1250 V-ROD MUSCLE(VRSCF)	08 -	IXU24	IXU01-□	XU24EPR-U	2
1250 NIGHT ROD(VRSCD)	08 -08	IXU24	IXU01-□	XU24EPR-U	2
1250 NIGHT ROD SPECIAL(VRSCDX)	08 -	IXU24	IXU01-□	XU24EPR-U	2
1250 V-ROD 10th Anniversary(VRSCDN ANV)	12 -	IXU24	IXU01-□	XU24EPR-U	2
1340 DYNAGLIDE(FXD)	84 -98	IW16	IW01-□	-	2
1340 ELECTRAGLIDE(FXH)	84 -98	IW16	IW01-□	-	2
1340 FL SHOVELHEAD	78 -81	IW16	IW01-□	-	2
1340 FL SHOVELHEAD	82 -84	IW16	IW01-□	-	2
1340 FX SHOVELHEAD	82 -84	IW16	IW01-□	-	2
1340 HERITAGE-FATBOY(FLS)	84 -00	IW16	IW01-□	-	2
1340 ROADKING-ROADGLIDE(FH)	84 -98	IW16	IW01-□	-	2

AUSTRALIA

CHINA

INDIA

INDONESIA

KOREA

MALAYSIA

PHILIPPINES

SAUDI ARABIA

SINGAPORE

TAIWAN

THAILAND

VIETNAM

JAPAN

EUROPE & USA

MOTOR CYCLE

SMALL ENGINE

CROSS REFERENCE

CC MODEL	FROM-TILL	IRIDIUM POWER	IRIDIUM RACING	DENSO	QTY
HARLEY-DAVIDSON					
1340 SOFTAIL-BADBOY(FXS)	84 -00	IW16	IW01-□	-	2
1450 DYNA LOWLIDER(FXDL/FXDLI)	99 -06	IXU22	IXU01-□	XU22EPR-U	2
1450 DYNA STREET BOB(FXDBI)	06 -06	IXU22	IXU01-□	XU22EPR-U	2
1450 DYNA SUPERGLIDE(FXDI)	06 -06	IXU22	IXU01-□	XU22EPR-U	2
1450 DYNA SUPERGLIDE CUSTOM(FXDCI)	05 -06	IXU22	IXU01-□	XU22EPR-U	2
1450 DYNA SUPERGLIDE SPORT(FXDX)	99 -05	IXU22	IXU01-□	XU22EPR-U	2
1450 DYNA SUPERGLIDE(FXD)	99 -05	IXU22	IXU01-□	XU22EPR-U	2
1450 DYNA WIDEGLIDE(FXDWG)	99 -06	IXU22	IXU01-□	XU22EPR-U	2
1450 ELECTRAGLIDE CLASSIC(FLHTC)	99 -06	IXU22	IXU01-□	XU22EPR-U	2
1450 ELECTRAGLIDE STANDARD(FLHT)	99 -06	IXU22	IXU01-□	XU22EPR-U	2
1450 FAT BOY(FLSTF)	00 -06	IXU22	IXU01-□	XU22EPR-U	2
1450 HERITAGE SOFTAIL(FLST)	06 -06	IXU22	IXU01-□	XU22EPR-U	2
1450 HERITAGE SOFTAIL CLASSIC(FLSTC/FLSTCI)	00 -06	IXU22	IXU01-□	XU22EPR-U	2
1450 NIGHTTRAIN(FXSTB)	00 -06	IXU22	IXU01-□	XU22EPR-U	2
1450 ROADGLIDE INJECTION(FLTRI)	05 -06	IXU22	IXU01-□	XU22EPR-U	2
1450 ROADKING CLASSIC(FLHRC)	99 -06	IXU22	IXU01-□	XU22EPR-U	2
1450 ROADKING CUSTOM(FLHRS)	04 -06	IXU22	IXU01-□	XU22EPR-U	2
1450 ROADKING(FLHR)	99 -06	IXU22	IXU01-□	XU22EPR-U	2
1450 SOFTAIL DEUCE(FXSTD/FXSTDI)	00 -06	IXU22	IXU01-□	XU22EPR-U	2
1450 SOFTAIL DELUX(FLSTN)	05 -06	IXU22	IXU01-□	XU22EPR-U	2
1450 SOFTAIL STANDARD(FXST)	00 -06	IXU22	IXU01-□	XU22EPR-U	2
1450 SPRINGER SOFTAIL CLASSIC(FLSTSC)	05 -06	IXU22	IXU01-□	XU22EPR-U	2
1450 SPRINGER SOFTAIL(FXSTS)	00 -06	IXU22	IXU01-□	XU22EPR-U	2
1450 STREET GLIDE(FLHX)	06 -06	IXU22	IXU01-□	XU22EPR-U	2
1450 ULTRACLASSIC ELECTRAGLIDE SIDECAR(FLHTCU S/C)	99 -06	IXU22	IXU01-□	XU22EPR-U	2
1450 ULTRACLASSIC ELECTRAGLIDE(FLHTCUI)	99 -06	IXU22	IXU01-□	XU22EPR-U	2
1580 DYNA STREET BOB(FXDB)	07 -	IXU22	IXU01-□	XU22EPR-U	2
1580 DYNA SUPERGLIDE(FXD)	07 -10	IXU22	IXU01-□	XU22EPR-U	2
1580 DYNA SUPERGLIDE CUSTOM(FXDC)	07 -	IXU22	IXU01-□	XU22EPR-U	2
1580 DYNA SWITCH BACK(FLD)	11 -	IXU22	IXU01-□	XU22EPR-U	2
1580 DYNA LOWLIDER(FXDL)	07 -	IXU22	IXU01-□	XU22EPR-U	2
1580 DYNA WIDEGLIDE(FXDWG)	07 -07	IXU22	IXU01-□	XU22EPR-U	2
1580 DYNA WIDEGLIDE(FXDWG)	10 -	IXU22	IXU01-□	XU22EPR-U	2
1580 FAT BOB(FXDF)	08 -	IXU22	IXU01-□	XU22EPR-U	2
1580 FAT BOY(FLSTF)	07 -	IXU22	IXU01-□	XU22EPR-U	2
1580 FAT BOY LO(FLSTFB)	10 -	IXU22	IXU01-□	XU22EPR-U	2
1580 SOFTAIL BLACK LINE(FXS)	11 -	IXU22	IXU01-□	XU22EPR-U	2
1580 SOFTAIL CUSTOM(FXSTC)	07 -10	IXU22	IXU01-□	XU22EPR-U	2
1580 SOFTAIL DELUXE(FLSTN)	07 -	IXU22	IXU01-□	XU22EPR-U	2
1580 HERITAGE SOFTAIL CLASSIC(FLSTC)	07 -	IXU22	IXU01-□	XU22EPR-U	2
1580 SOFTAIL SPRINGER CLASSIC(FLSTSC)	07 -07	IXU22	IXU01-□	XU22EPR-U	2
1580 SOFTAIL STANDARD(FXST)	07 -11	IXU22	IXU01-□	XU22EPR-U	2
1580 NIGHT TRAIN(FXSTB)	07 -09	IXU22	IXU01-□	XU22EPR-U	2
1580 SOFTAIL DEUCE(FXSTD)	07 -07	IXU22	IXU01-□	XU22EPR-U	2
1580 SOFTAIL ROCKER(FXCW)	08 -09	IXU22	IXU01-□	XU22EPR-U	2
1580 SOFTAIL ROCKER C(FXCWC)	08 -11	IXU22	IXU01-□	XU22EPR-U	2
1580 SOFTAIL X-BONES(FLSTSB)	08 -11	IXU22	IXU01-□	XU22EPR-U	2
1580 ULTRACLASSIC ELECTRAGLIDE(FLHTCU)	07 -10	IXU22	IXU01-□	XU22EPR-U	2
1580 ELECTRAGLIDE STANDARD(FLHT)	07 -10	IXU22	IXU01-□	XU22EPR-U	2
1580 ELECTRAGLIDE CLASSIC(FLHTC)	07 -11	IXU22	IXU01-□	XU22EPR-U	2
1580 STREET GLIDE(FLHX)	07 -11	IXU22	IXU01-□	XU22EPR-U	2
1580 ROADKING CLASSIC(FLHRC)	07 -11	IXU22	IXU01-□	XU22EPR-U	2
1580 ROADKING CUSTOM(FLHRS)	07 -07	IXU22	IXU01-□	XU22EPR-U	2
1580 ROADKING(FLHR)	07 -11	IXU22	IXU01-□	XU22EPR-U	2
1580 ROADGLIDE(FLTR)	07 -09	IXU22	IXU01-□	XU22EPR-U	2
1580 ROADGLIDE CUSTOM(FLTRX)	10 -11	IXU22	IXU01-□	XU22EPR-U	2
1580 ULTRACLASSIC ELECTRAGLIDE WITH SIDECAR(FLHTCU S/C)	07 -10	IXU22	IXU01-□	XU22EPR-U	2
1580 CVO ROADGLIDE(FLTR3-CVO)	09 -09	IXU22	IXU01-□	XU22EPR-U	2

DENSO	9	14	16	20	22	24	27	29	31	32	34	35
NGK	2	4	5	6	7	8	9	9.5	10	10.5	11	11.5

DENSO	9	14	16	20	22	24	27	29	31	32
CHAMPION	18	16,14	12,11	10,9	8,7	6,6,6,1	4,5,9	5,7	5,5	5,3

DENSO	9	14	16	20	22	24	27	31
BOSCH	10	9	8	7,6	5	4	3	2



CC	MODEL	FROM-TILL	IRIDIUM POWER	IRIDIUM RACING	DENSO	QTY
HARLEY-DAVIDSON						
1580	CVO ROADKING (FLHR4-CVO)	08 - 08	IXU22	IXU01-□	XU22EPR-U	2
1580	CVO ULTRAClassic ELECTRAGLIDE (FLHTCU3-CVO)	08 - 08	IXU22	IXU01-□	XU22EPR-U	2
1580	CVO ULTRAClassic ELECTRAGLIDE (FLHTCU4-CVO)	09 - 09	IXU22	IXU01-□	XU22EPR-U	2
1580	CVO DYNA FAT BOB (FXDF2-CVO)	10 - 10	IXU22	IXU01-□	XU22EPR-U	2
1690	ELECTRAGLIDE ULTRA LIMITED (FLHTK103)	10 -	IXU22	IXU01-□	XU22EPR-U	2
1690	ELECTRAGLIDE ULTRA LIMITED (FLHTK103 W/SC)	11 - 11	IXU22	IXU01-□	XU22EPR-U	2
1690	ROADGLIDE CUSTOM (FLTRX103)	12 -	IXU22	IXU01-□	XU22EPR-U	2
1690	ROADGLIDE ULTRA (FLTRU103)	11 -	IXU22	IXU01-□	XU22EPR-U	2
1690	ROADKING (FLHR103)	12 -	IXU22	IXU01-□	XU22EPR-U	2
1690	STREET GLIDE (FLHX103)	12 -	IXU22	IXU01-□	XU22EPR-U	2
1690	ULTRAClassic ELECTRAGLIDE (FLHTCU103)	11 -	IXU22	IXU01-□	XU22EPR-U	2
1690	CVO ULTRAClassic ELECTRAGLIDE (FLHTCUSE5)	10 - 10	IXU22	IXU01-□	XU22EPR-U	2
1690	CVO STREET GLIDE (FLHXSE)	10 - 10	IXU22	IXU01-□	XU22EPR-U	2
1800	CVO ROADGLIDE CUSTOM (FLTRXSE)	12 -	IXU22	IXU01-□	XU22EPR-U	2
1800	CVO ROADGLIDE ULTRA (FLTRUSE)	11 - 11	IXU22	IXU01-□	XU22EPR-U	2
1800	CVO SOFTAIL CONVERTIBLE (FLSTSE2)	11 - 11	IXU22	IXU01-□	XU22EPR-U	2
1800	CVO SOFTAIL CONVERTIBLE (FLSTSE3)	12 -	IXU22	IXU01-□	XU22EPR-U	2
1800	CVO STREET GLIDE (FLHXSE2)	11 - 11	IXU22	IXU01-□	XU22EPR-U	2
1800	CVO STREET GLIDE (FLHXSE3)	12 -	IXU22	IXU01-□	XU22EPR-U	2
1800	CVO ULTRAClassic ELECTRAGLIDE (FLHTCUSE6)	11 - 11	IXU22	IXU01-□	XU22EPR-U	2
1800	CVO ULTRAClassic ELECTRAGLIDE (FLHTCUSE7)	12 -	IXU22	IXU01-□	XU22EPR-U	2
HUSABERG						
250	FE250e	-	IXU24	IXU01-□	XU24EPR-U	1
400	DESERT FX400E	00 -	IXU24	IXU01-□	XU24EPR-U	1
400	DESERT FX400E	-99	IU24	IU01-□	U24ES-N	1
400	ENDURO FE400/E	00 -	IXU24	IXU01-□	XU24EPR-U	1
400	ENDURO FE400/E	-99	IU24	IU01-□	U24ES-N	1
400	ENDURO2 FE400S	98 -99	IU24	IU01-□	U24ES-N	1
400	FE400e	01 -	IXU24	IXU01-□	XU24EPR-U	1
400	FS400c	01 -	IXU24	IXU01-□	XU24EPR-U	1
400	FS400e	01 -	IXU24	IXU01-□	XU24EPR-U	1
400	MOTOCROSS FC400	-99	IU24	IU01-□	U24ES-N	1
400	MOTOCROSS FC400	00 -	IXU24	IXU01-□	XU24EPR-U	1
400	SUPERMOTORD FE400ESM	-99	IU24	IU01-□	U24ES-N	1
400	SUPERMOTORD FE400ESM	00 -	IXU24	IXU01-□	XU24EPR-U	1
450	FC450	-	IXU24	IXU01-□	XU24EPR-U	1
450	FE450e	-	IXU24	IXU01-□	XU24EPR-U	1
450	FS450c	-	IXU24	IXU01-□	XU24EPR-U	1
450	FS450e	-	IXU24	IXU01-□	XU24EPR-U	1
470	FC470/6	01 -	IXU24	IXU01-□	XU24EPR-U	1
470	FC470e	01 -	IXU24	IXU01-□	XU24EPR-U	1
470	FX470e	01 -	IXU24	IXU01-□	XU24EPR-U	1
500	DESERT FX501E	-99	IU24	IU01-□	U24ES-N	1
500	DESERT FX501E	00 -	IXU24	IXU01-□	XU24EPR-U	1
500	ENDURO FE501/E	-99	IU24	IU01-□	U24ES-N	1
500	ENDURO FE501/E	00 -	IXU24	IXU01-□	XU24EPR-U	1
500	ENDURO II FE501S	98 -99	IU24	IU01-□	U24ES-N	1
500	MOTOCROSS FC501	-99	IU24	IU01-□	U24ES-N	1
500	MOTOCROSS FC501	00 -	IXU24	IXU01-□	XU24EPR-U	1
500	SUPERMOTORD FE501ESM	-99	IU24	IU01-□	U24ES-N	1
500	SUPERMOTORD FE501ESM	00 -	IXU24	IXU01-□	XU24EPR-U	1
501	FE501e	01 -	IXU24	IXU01-□	XU24EPR-U	1
550	FC550	-	IXU24	IXU01-□	XU24EPR-U	1
550	FC550/4	01 -	IXU24	IXU01-□	XU24EPR-U	1
550	FC550/6	01 -	IXU24	IXU01-□	XU24EPR-U	1
550	FE550e	-	IXU24	IXU01-□	XU24EPR-U	1
600	DESERT FX600E	-99	IU24	IU01-□	U24ES-N	1
600	DESERT FX600E	00 -	IXU24	IXU01-□	XU24EPR-U	1
600	ENDURO FE600/E	-99	IU24	IU01-□	U24ES-N	1

◆ For installation NB3-16SP (nepros) or B3A-16SP by KTC is recommended

CC	MODEL	FROM-TILL	IRIDIUM POWER	IRIDIUM RACING	DENSO	QTY
HUSABERG						
600	ENDURO FE600/E	00 -	IXU24	IXU01-□	XU24EPR-U	1
600	ENDURO II FE600S	98 -99	IU24	IU01-□	U24ES-N	1
600	FC600SM	00 -00	IXU24	IXU01-□	XU24EPR-U	1
600	MOTOCROSS FC600	-99	IU24	IU01-□	U24ES-N	1
600	MOTOCROSS FC600	00 -	IXU24	IXU01-□	XU24EPR-U	1
600	SUPERMOTORD FE600ESM	-99	IU24	IU01-□	U24ES-N	1
600	SUPERMOTORD FE600ESM	00 -	IXU24	IXU01-□	XU24EPR-U	1
650	FE650e	01 -	IXU24	IXU01-□	XU24EPR-U	1
650	FS650c	01 -	IXU24	IXU01-□	XU24EPR-U	1
650	FS650e	01 -	IXU24	IXU01-□	XU24EPR-U	1
650	FX650e	01 -	IXU24	IXU01-□	XU24EPR-U	1
HUSQVARNA						
50	HUSKYBOY S/J	-	IWF22	-	W20FS-U	1
125	CR125	-	IWF31	IW01-□	IWF31	1
125	SM125	99 -	IWF27	IW01-□	-	1
125	SM125	-	IWF27	IW01-□	-	1
125	WR125	-	IWF27	IW01-□	-	1
125	WRE125	-	IWF27	IW01-□	-	1
250	CR250	-	IWF24	IW01-□	-	1
250	TC250	01 -	IU24	IU01-□	U24ESR-NB	1
250	TE250	01 -	IU24	IU01-□	U24ESR-NB	1
250	WR250	-	IWF24	IW01-□	-	1
360	WR360	91 -96	IWF24	IW01-□	IWF24	1
400	SM400R	-	IU24	IU01-□	U24ESR-NB	1
400	TE400	01 -	IU22	IU01-□	U22ES-N	1
400	TE410	-	IU22	IU01-□	U22ES-N	1
450	SM450R	03 -	IU24	IU01-□	U24ESR-NB	1
450	TE450	-	IU24	IU01-□	U24ESR-NB	1
510	SM510R	-	IU24	IU01-□	U24ESR-NB	1
510	TE510/CENTENNIAL	04 -	IU24	IU01-□	U24ESR-NB	1
570	SM570R	01 -	IU22	IU01-□	U22ES-N	1
570	TE570E	01 -	IU22	IU01-□	U22ES-N	1
610	SM610	08 -	IU24A	IU01-□	U24EPR	1
610	SM610/S	00 -07	IU22	IU01-□	U22ES-N	1
610	SM610R	00 -07	IU24	IU01-□	U24ES-N	1
610	TC610	-	IU22	IU01-□	U22ES-N	1
610	TE610/E	-	IU22	IU01-□	U22ES-N	1
630	SM630R	-	-	RU01-□ (◆)	-	1
HYOSUNG						
50	SD50 Sense	02 -	IWF20	-	W20FP-U	1
50	SF50 Prima	02 -	IWF24	-	W24FR-L	1
100	EZ100M	02 -	IWF22	-	W22FP-U	1
110	FX110M MidasGold	02 -	IUF22	-	U20FS-U	1
125	GT125 COMET	03 -	IU24	IU01-□	U24ESR-N	2
125	MS-1-125 Exceed	02 -	IX24	IXU01-□	X24ESR-U	1
125	RT125D	09 -	IU24	IU01-□	U24ESR-N	1
125	RT125 KARION	03 -	IUH24	IU01-□	U24FE9	1
125	RX125	03 -	IUH24	IU01-□	U24FE9	1
250	GT250 COMET	03 -	IU24	IU01-□	U24ESR-N	2
250	GV250 Aquila	02 -	IU24	IU01-□	U24ESR-N	2
ITALJET						
30	TIFFANY	-	IWF16	-	W16FS-U	1
35	VELOCIFERO	-97	IWF20	-	W20FP-L	1
50	DRAGSTAR50	96 -97	IWF24	-	W24FPR	1
50	FORMULA50/50LC	98 -	IWF24	-	W24FSR	1
50	TORPEDO50	98 -	IWF24	-	W24FSR	1
50	VELOCIFERO	98 -	IWF24	-	W24FSR	1
125	DRAGSTAR125	98 -	IWF27	IW01-□	W27ESR-U	1
125	FORMULA125	98 -	IWF24	-	W24FSR	2
125	FORMULA125	-97	IWF22	-	W22FP-U	1
125	TORPEDO125 4T	98 -	IU22	IU01-□	U22ESR-N	1
150	JET-SET150	02 -	IU27	IU01-□	U27ESR-N	1
180	DRAGSTAR180	98 -	IWF24	IW01-□	W24ESR-U	1
KANNON						
5000	FORD KANNON	-	ITF16	-	-	8
5700	CHEVY KANNON	-	IQ16	IQ01-□	IQ16	8
8200	BIG KANNON	-	ITF16	-	-	8

DENSO

AUSTRALIA CHINA

INDIA

INDONESIA

KOREA

MALAYSIA

PHILIPPINES

SAUDI ARABIA

SINGAPORE

TAIWAN

THAILAND

VIETNAM

JAPAN

& USA

EUROPE

MOTOR

SMALL

ENGINE

CROSS

PART



EUROPE & U.S.A. MOTORCYCLE

Spark plug color codes: ■ for Iridium Tough and Iridium Plugs and Iridium TT, ■ for Iridium Power, ■ for Iridium Racing and Two Tops Plugs, ■ for Platinum Plugs and Platinum TT, and black for general spark plugs.

DENSO

CC MODEL	FROM-TILL	IRIDIUM POWER	IRIDIUM RACING	DENSO	QTY
KTM					
50 50ADVENTURE	99 -	IWF24	-	W24FS-U	1
50 50MINI ADVENTURE	03 -	IWM24	IWM01-□	-	1
50 50PROJUNIOR	99 -	IWF24	-	W24FS-U	1
50 50PROSENIOR	99 -	IWF24	-	W24FS-U	1
50 50 SENIOR ADVENTURE	04 -	IWM24	IWM01-□	-	1
50 50SX	10 -	IUF24	-	-	1
50 50SX MINI	09 -	IUF24	-	-	1
50 50SX PROJUNIOR LC	03 -	IWM24	IWM01-□	-	1
50 50SX PROSENIOR LC	03 -	IWM24	IWM01-□	-	1
60 60SX	99 -99	IQ31	IQ02-□	IQ31	1
60 60SX	00 -	IW31	IW01-□	IW31	1
65 65SX	99 -99	IQ31	IQ02-□	IQ31	1
65 65SX	00 -	IW31	IW01-□	IW31	1
65 65SX	03 -	IWM24	IWM01-□	-	1
65 65SX	09 -	IUF24	-	-	1
85 85SX	04 -	IWM31	IWM01-□	IWM31	1
85 85SX	07 -	IWM27	-	-	1
105 105SX	11 -	IWM27	-	-	1
125 125ENDURO	-98	IW27	IW01-□	IW27	1
125 125ENDURO	99 -99	-	IW01-□	IW01-24	1
125 125ENDURO	00 -	IW27	IW01-□	-	1
125 125EXC	00 -	IW27	IW01-□	IW27	1
125 125EXC	09 -	IWM27	-	W27EMR-C	1
125 125STREET ENDURO	-	IW31	IW01-□	IW31	1
125 125SX	-	IW27	IW01-□	IW27	1
125 125SX	08 -	IWM27	-	W27EMR-C	1
125 125DUKE	11 -	-	-	-	1
150 150SX	09 -	IWM27	-	-	1
150 150XC	10 -	IWM27	-	-	1
200 200DUKE	-	-	-	-	1
200 200ENDURO/AL	99 -	IW24	IW01-□	-	1
200 200EXC	00 -	IW24	IW01-□	-	1
200 200EXC	00 -	IW24	IW01-□	-	1
200 200SX	-	IW27	IW01-□	IW27	1
200 200XC-W	06 -	IW24	IW01-□	W24ESR-V	1
250 250ENDURO	-98	IW24	IW01-□	IW24	1
250 250ENDURO	99 -	IWM24	IWM01-□	-	1
250 250EXC	03 -	-	IW01-□	W22ESR-U	1
250 250EXC-F	06 -	IU27A	IU01-□	-	1
250 250EXC-R	03 -	IXU24	IXU01-□	XU24EPR-U	1
250 250EXC RACING	-	IXU24	IXU01-□	XU24EPR-U	1
250 250STREET ENDURO	-	IW24	IW01-□	-	1
250 250SX	03 -	IWM24	IWM01-□	-	1
250 250SX-F	06 -	IU27A	IU01-□	-	1
250 250SX-F	13 -	-	-	-	1
250 250XC-F/XCF-W	07 -	IU27A	IU01-□	-	1
250 250XC-F	13 -	-	-	-	1
300 300ENDURO	-98	IW24	IW01-□	IW24	1
300 300ENDURO	99 -	IWM24	IWM01-□	-	1
300 300EXC	04 -	-	IW01-□	W22ESR-U	1
300 300XC-/W	06 -	-	IW01-□	W22ESR-U	1
350 350SX-F	11 -	-	-	-	1
350 350XC-F	11 -	-	-	-	1
350 350XCF-W	12 -	-	-	-	1
360 360ENDURO	-	IW24	IW01-□	-	1
380 380ENDURO	-98	IW24	IW01-□	IW24	1
380 380ENDURO	99 -	IWM24	IWM01-□	-	1
380 380SX	-	IWM24	IWM01-□	-	1
400 400EXC	06 -	IXU24	IXU01-□	XU24EPR-U	1
400 400EXC	09 -	-	-	-	1
400 400EXC-R	04 -	IXU24	IXU01-□	XU24EPR-U	1
400 400EXC RACING	-	IXU24	IXU01-□	XU24EPR-U	1
400 400ENDURO RACING(EXC-R)	00 -	IU24A	IU01-□	U24ETR	1
400 400SERIES	93 -99	IX24	IXU01-□	X24ES-U	1
400 400SUPER ENDURO E	99 -99	IX24	IXU01-□	X24ESR-U	1
400 400SUPER ENDURO E	00 -	IX24B	IXU01-□	X24EPR-U9	1
400 400XC-W	-	IXU24	IXU01-□	XU24EPR-U	1

AUSTRALIA

CHINA

INDIA

INDONESIA

KOREA

MALAYSIA

PHILIPPINES

SAUDI ARABIA

SINGAPORE

DENSO	9	14	16	20	22	24	27	29	31	32	34	35
NGK	2	4	5	6	7	8	9	9.5	10	10.5	11	11.5

CC MODEL	FROM-TILL	IRIDIUM POWER	IRIDIUM RACING	DENSO	QTY
KTM					
400 400XC-W	09 -	-	-	-	1
450 450EXC	09 -	-	-	-	1
450 450EXC-R	08 -	-	-	-	1
450 450EXC RACING	03 -07	IXU24	IXU01-□	XU24EPR-U	1
450 450SMR	04 -	IXU24	IXU01-□	XU24EPR-U	1
450 450SMR	08 -	IU27A	IU01-□	-	1
450 450SMR	13 -	-	-	-	1
450 450SX/R	03 -	IXU24	IXU01-□	XU24EPR-U	1
450 450SX-F	06 -	IU27A	IU01-□	-	1
450 450SX-F FACTORY	12 -	-	-	-	1
450 450XC-/W	-	IXU24	IXU01-□	XU24EPR-U	1
450 450XC-F	12 -	-	-	-	1
450 450XC-W	12 -	-	-	-	1
450 450XC-W SixDays	10 -	-	-	-	1
450 450XCR-W	08 -	-	-	-	1
500 500EXC	12 -	-	-	-	1
500 500XC-W	12 -	-	-	-	1
520 520ENDURO RACING(EXC/R)	00 -	IU24A	IU01-□	U24ETR	1
525 525EXC RACING	03 -07	IXU24	IXU01-□	XU24EPR-U	1
525 525MXC DESERT RACING	03 -	IXU24	IXU01-□	XU24EPR-U	1
525 525SMR	04 -	IXU24	IXU01-□	XU24EPR-U	1
525 525SX	03 -06	IXU24	IXU01-□	XU24EPR-U	1
525 525XC-/W	07 -	IXU24	IXU01-□	XU24EPR-U	1
530 530EXC-R/XCR-W	08 -	-	-	-	1
530 530XC-W SixDays	10 -	-	-	-	1
540 540SUPERCROSS COUNTRY	99 -99	IX24	IXU01-□	X24ESR-U	1
540 540SUPERCROSS COUNTRY	00 -	IX24B	IXU01-□	X24EPR-U9	1
560 560SMR	07 -	IXU24	IXU01-□	XU24EPR-U	1
620 620SERIES	93 -96	IX24	IXU01-□	X24ES-U	1
620 620SERIES	97 -98	IX24	IXU01-□	IX24	1
620 620SUPERCOMPE	99 -99	IX24	IXU01-□	X24ES-U	1
620 620SUPERCOMPE	00 -	IX24B	IXU01-□	X24EPR-U9	1
620 620SUPERMOTOCOMPE	00 -	IX24B	IXU01-□	X24EPR-U9	1
625 625SMC/SXC	03 -	IXU24	IXU01-□	XU24EPR-U	1
640 640ADVENTURE R	99 -99	IX24	IXU01-□	X24ES-U	1
640 640ADVENTURE R	00 -	IX24B	IXU01-□	X24EPR-U9	1
640 640DUKE	03 -	IXU24	IXU01-□	XU24EPR-U	1
640 640DUKE TYPE II	99 -99	IX24	IXU01-□	X24ESR-U	1
640 640DUKE TYPE II	00 -	IX24B	IXU01-□	X24EPR-U9	1
640 640ENDURO	00 -	IX24B	IXU01-□	X24EPR-U9	1
640 640LC4 ADVENTURE	03 -	IXU24	IXU01-□	XU24EPR-U	1
640 640LC4 ENDURO	03 -	IXU24	IXU01-□	XU24EPR-U	1
640 640LC4 SUPERMOTO	03 -	IXU24	IXU01-□	XU24EPR-U	1
640 640RALLY	98 -98	IX24	IXU01-□	IX24	1
640 640RALLY E	99 -	IX24	IXU01-□	X24ESR-U	1
640 640SUPERENDURO E	99 -99	IX24	IXU01-□	X24ESR-U	1
640 640SUPERMOTO	99 -99	IX24	IXU01-□	X24ESR-U	1
640 640SUPERMOTO	00 -	IX24B	IXU01-□	X24EPR-U9	1
660 660FACTORY REPLICA	03 -	IX27	IXU01-□	X27ESR-U	1
660 660RALLY E	99 -99	IX24	IXU01-□	X24ESR-U	1
660 660RALLY E	00 -	IX24B	IXU01-□	X24EPR-U9	1
660 660SMC	03 -	IXU24	IXU01-□	XU24EPR-U	1
660 660SMS	04 -	IXU24	IXU01-□	XU24EPR-U	1
690 690DUKE	08 -	-	-	-	1
690 690ENDURO/SMC	08 -	-	-	-	1
690 690SUPERMOTO/PRESTIGE/R	07 -	-	-	-	1
950 950 LC8 ADVENTURE/S	03 -	IU24A	IU01-□	U24ETR	2
950 950DUKE	03 -	IU24A	IU01-□	U24ETR	2
950 950SUPER ENDURO R	06 -	IU24A	IU01-□	U24ETR	2
950 950SUPERMOTO/R	06 -	IU24A	IU01-□	U24ETR	2
990 990ADVENTURE/S	06 -	IXU24	IXU01-□	XU24EPR-U	2
990 990SMR	11 -	-	IXU01-□	-	2
990 990SMT	11 -	-	IXU01-□	-	2
990 990 SUPER DUKE	05 -	IXU24	IXU01-□	XU24EPR-U	2
990 990SUPERDUKE	06.9 -	-	IXU01-□	-	2
990 990SUPERDUKE R	-	-	IXU01-□	-	2

DENSO	9	14	16	20	22	24	27	29	31	32
CHAMPION	18	16,14	12,11	10,9	8,7	6,6,6,1	4,5,9	57	55	53

DENSO	9	14	16	20	22	24	27	31
BOSCH	10	9	8	7,6	5	4	3	2



CC	MODEL	FROM-TILL	IRIDIUM POWER	IRIDIUM RACING	DENSO	QTY
KTM						
990	990SUPERMOTO/R	08 - -	-	IXU01-□	-	2
990	990SUPERMOTO T	09 - -	-	IXU01-□	-	2
1190	RC8	08 - -	-	-	-	2
1190	RC8R	09 - -	-	-	-	2
KYMCO						
50	AGILITY50	-	IUF22	-	U20FSR-U	1
50	CARO50/II	-	IUF22	-	U22FSR-U	1
50	LOOKER50	-	IWF24	-	W24FR-L	1
50	SOONER50S/RS	02.5 -	IWF24	-	W24FR-L	1
50	SUPER9/S	03 -	IWF24	-	W24FR-L	1
50	TOPBOY50/OFF	-	IWF24	-	W24FR-L	1
50	VITALITY50 4T	-	IUF22	-	U22FSR-U	1
50	YUP50	-	IWF24	-	W24FR-L	1
100	CARO II 100	-	IUF22	-	U22FS-U	1
100	SOONER100/S	-	IWF24	-	W24FR-L	1
100	TOPBOY100/OFF	-	IWF24	-	W24FR-L	1
125	AGILITY125	-	IUF22	-	U22FSR-U	1
125	CAPTURE125	-	IUF22	-	U22FSR-U	1
125	DINK125	-	IX22B	IXU01-□	X22EPR-U9	1
125	GD125Z	-	IX22B	IXU01-□	X22EPR-U9	1
125	GRAND DINK125X	-	IX22B	IXU01-□	X22EPR-U9	1
125	KCR125	06 -	IU24	IU01-□	U24ESR-N	1
125	LOOKAR125	07 -	IUF22	-	U22FSR-U	1
125	MOVIE AFI 125	-	IU24	IU01-□	U24ESR-N	1
125	RACING125	-	IU24	IU01-□	U24ESR-N	1
125	SUPER8 125	-	IUF22	-	U22FSR-U	1
125	V-LINK 125/SR	-	IUF22	-	U22FSR-U	1
150	GRAND DINK150	-	IX22B	IXU01-□	X22EPR-U9	1
150	MOVIE XL150	-	IUF22	-	U22FSR-U	1
150	RACING150	-	IU24	IU01-□	U24ESR-N	1
200	DINK200i	08 -	IX22B	IXU01-□	X22EPR-U9	1
250	B&W250	-	IX22B	IXU01-□	X22EPR-U9	1
250	GD250Z	-	IX22B	IXU01-□	X22EPR-U9	1
250	GRAND DINK250/X	-	IX22B	IXU01-□	X22EPR-U9	1
250	XCITING250	-	IX22B	IXU01-□	X22EPR-U9	1
250	VENOX250	-	IUF24	-	U24FER9	1
LAVERDA						
668	668CAFE RACER	-	IX27B	IXU01-□	X27EPR-U9	2
750	750S	-	IXU24	IXU01-□	XU24EPR-U*	2
750	750S FORMULA	-	IXU24	IXU01-□	XU24EPR-U*	2
750	DIAMANTE	-	IXU24	IXU01-□	XU24EPR-U*	2
750	GHOST/STRIKE	-	IXU24	IXU01-□	XU24EPR-U*	2
LEM						
50	LX1	02 -	IWF22	-	W22FSR	1
50	LX2SPORT/RACER	97 -	IWF22	-	W22FSR	1
50	LX3SPORT	03 -	IWF22	-	W22FSR	1
MAGNI						
400	SFIDA	-	IW22	IW01-□	W22EP-U	2
1000	ARTURO/SFIDA	-	IW22	IW01-□	W22EP-U	2
1000	AUSTRALIA/2	-	IX27	IXU01-□	X27ESR-U	2
1100	GIAPPONE52	-	IW20	IW01-□	W20EPR-U	2
1100	SFIDA1100 IE	-	IW20	IW01-□	W20EPR-U	2
1200	SPORT1200S	-	IX24	IXU01-□	IX24	4
MALAGUTI						
50	F12PHANTOM50	-	IWF22	-	W22FSR	1
50	F15FIREFOX	-	IWF24	-	W24FPR	1
50	GRIZZLY10	-	IWF22	-	W20FSR-U	1
50	GRIZZLY12	-	IWF22	-	W20FSR-U	1
50	YESTERDAY	-	IWF24	-	W24FPR	1
100	F12PHANTOM100	-	IWF24	-	W24FSR	1
125	MADISON R125	-	IU24	IU01-□	U24ESR-N	1
125	MADISON125	-	IU24	IU01-□	U24ESR-N	1
150	MADISON150	-	IU24	IU01-□	U24ESR-N	1
200	MADISON S200	-	IU24	IU01-□	U24ESR-N	1
250	PHANTOM MAX	-	IU22	IU01-□	-	1
250	MADISON RS250	-	IU27	IU01-□	U27ESR-N	1
250	MADISON250	-	IX24	IXU01-□	X24ESR-U	1

*USE REMOVABLE TYPE

CC	MODEL	FROM-TILL	IRIDIUM POWER	IRIDIUM RACING	DENSO	QTY
MALAGUTI						
400	MADISON400	04 -	IU27	IU01-□	U27ESR-N	1
500	SPIDERMAX500	04 -	IU24A	IU01-□	-	1
MONDIAL						
1000	PIEGA	02 -	IK27	IK02-□	IK27C11	2
MONTESA						
260	COTA4RT	05 -	-	IU01-□	-	1
315	COTA315R	-	IW20	IW01-□	W20ESR-U	1
MOTO GUZZI						
380	V40CAPRICE	-	IUF24	-	U24FS-U	2
380	V40IMOLA	-	IX24	IXU01-□	X24ES-U	2
380	V40TARGA	-96	IW22	IW01-□	W22EP-U	2
750	BREVA V750	03 -	IW24	IW01-□	W24ESR-U	2
750	NEVADA BASE/CLUB	01 -	IW24	IW01-□	W24ES-U	2
750	NEVADA CLASSIC 750	03 -	IW24	IW01-□	W24ESR-U	2
750	NTX	-93	IW24	IW01-□	W24ES-U	2
750	V7 CLASSIC	08 -	IW24	IW01-□	W24ESR-U	2
850	LE MANS	-	IW20	IW01-□	W20EP-U	2
850	GRISO850	06 -	IW20 IU24	-	W20PR-U	2 2
1000	1000S	-	IW22	IW01-□	W22EP-U	2
1000	DAYTONA	97 -	IX27	IXU01-□	X27ESR-U	2
1000	DAYTONA	-96	IX27	IXU01-□	X27ES-U	2
1000	DAYTONA RS	-	IX27	IXU01-□	X27ESR-U	2
1000	LE MANS	-	IW20	IW01-□	W20EP-U	2
1000	SP II	-	IW20	IW01-□	W20EP-U	2
1000	V10 CENTAURO	97 -	IX27	IXU01-□	X27ESR-U	2
1100	BREVA 1100	06 -	IW20+ IU24	IW01-□ +IU01-□	-	EACH 2
1100	CALIFORNIA	96 -	IW20	IW01-□	W20EPR-U	2
1100	CALIFORNIA	-95	IW22	IW01-□	W22EP-U	2
1100	CALIFORNIA ALMINUM/TITANIUM	03 -05	IW20	IW01-□	W20EPR-U	2
1100	CALIFORNIA EV/ JACKAL/TOURING	-	IW20	IW01-□	W20EPR-U	2
1100	CALIFORNIA INJECTION	97 -	IW20	IW01-□	W20EPR-U	2
1100	CALIFORNIA STONE/ SPECIAL SPORT	01 -	IW20	IW01-□	W20EPR-U	2
1100	CALIFORNIA VINTAGE	-	IW20	IW01-□	W20EPR-U	2
1100	GRISO 1100	05 -	IW20+ IU24	IW01-□ +IU01-□	-	EACH 2
1100	QUOTA1100ES	-	IW20	IW01-□	W20EPR-U	2
1100	SPORT	-	IW20	IW01-□	W20EPR-U	2
1100	SPORT CARBURETOR	97 -	IW20	IW01-□	W20EPR-U	2
1100	SPORT CORSA	99 -	IW20	IW01-□	W20EPR-U	2
1100	SPORT INJECTION	97 -	IW20	IW01-□	W20EPR-U	2
1100	V11 BALLABIO	06 -	IW20	IW01-□	W20EPR-U	2
1100	V11COPPA ITALIA/ SPORT BALLABIO	03 -	IW20	IW01-□	W20EPR-U	2
1100	V11LE MANS/ROSSO CORSA/NERO CORSA	01 -06	IW20	IW01-□	W20EPR-U	2
1100	V11ROSSO MANDELLO	03 -06	IW20	IW01-□	W20EPR-U	2
1100	V11SPORT NAKED/ SCURA	03 -06	IW20	IW01-□	W20EPR-U	2
1100	V11SPORT/CAFE SPORT	-	IW20	IW01-□	W20EPR-U	2
1200	1200 SPORT	-	IW20 +IU24	IW01-□ +IU01-□	-	EACH 2
1200	GRISO 8V	08 -	IU24	IU01-□	-	2
1200	NORGE 1200GT	-	IW20 +IU24	IW01-□ +IU01-□	-	EACH 2
MOTO MORINI						
1200	9 1/2	07 -	IU27	IU01-□	U27ESR-N	2
1200	CORSARO1200	06 -	IU27	IU01-□	U27ESR-N	2
MuZ						
660	SKORPION SPORT	-	IX24B	IXU01-□	X24EPR-U9	1
660	SKORPION TOUR	-	IX24B	IXU01-□	X24EPR-U9	1
MV AGUSTA						
750	BRUTALE S/SERIE ORO	01 -	IU27	IU01-□	U27ESR-NB	4

DENSO

AUSTRALIA

CHINA

INDIA

INDONESIA

KOREA

MALAYSIA

PHILIPPINES

SAUDIARABIA

SINGAPORE

TAIWAN

THAILAND

VIETNAM

JAPAN

EUROPE

MOTOR

SMALL

ENGINE

CROSS

PART

311



Spark plug color codes: ■ for Iridium Tough and Iridium Plugs and Iridium TT, ■ for Iridium Power, ■ for Iridium Racing and Two Tops Plugs, ■ for Platinum Plugs and Platinum TT, and black for general spark plugs.

DENSO

CC	MODEL	FROM-TILL	IRIDIUM POWER	IRIDIUM RACING	DENSO	QTY
MV AGUSTA						
750	F4S/SR/SPR/SENNA/SERIE ORO/AGO	00 -	IU27	IU01-□	U27ESR-NB	4
910	BRUTALE910S/R	05 -	IU27	IU01-□	U27ESR-NB	4
1000	F4 1000S/TAMBURINI/AGO	04 -	IU27A	RU01-□ /IU01-□	-	4

CHINA AUSTRALIA

CC	MODEL	FROM-TILL	IRIDIUM POWER	IRIDIUM RACING	DENSO	QTY
MZ						
125	125SM	02.7 -	IU24	IU01-□	U24ESR-N	1
125	RT125/CLASSIC	02.7 -	IU24	IU01-□	U24ESR-N	1
OVER						
850	OV-15A EURO TWIN	-	IX24B	IXU01-□	X24EPR-U9	2
900	OV-10A COMPLETE	-	IXU24	IXU01-□	XU24EPR-U	2

INDIA

CC	MODEL	FROM-TILL	IRIDIUM POWER	IRIDIUM RACING	DENSO	QTY
PEUGEOT						
50	FOX	-	IWF22	-	W22FS-U	1
50	METAL-X/X2/X3	02 -	IWF22	-	W22FSR	1
50	SPEEDFIGHT2 206WRC 50	-	IWF22	-	W22FSR	1
50	SPEEDFIGHT2(AIRC00L)	-	IWF22	-	W22FSR	1
50	SPEEDFIGHT2(LIQUIDCOOL)	-	IWF22	-	W22FSR	1
50	VIVACITY 50	-	IWF22	-	W22FSR	1
50	VOGUE DX/SE	-	IWF22	-	W22FSR	1
50	VOGUE SP/LA POSTE	-	IWF16	-	W16FP-U	1
100	ELYSEO	-	IW24	IW01-□	W24ESR-U	1
100	SPEEDFIGHT2	-	IW24	IW01-□	W24ESR-U	1
100	SPEEDFIGHT2 WRC	-	IW27	IW01-□	W27ESR-U	1
100	VIVACITY 100	-	IW24	IW01-□	W24ESR-U	1
125	JETFORCE125	03.6 -	IU22	IU01-□	-	1

KOREA

CC	MODEL	FROM-TILL	IRIDIUM POWER	IRIDIUM RACING	DENSO	QTY
PGO						
50	PMX50	-	IUF22	-	U22FSR-U	1
50	PMX50 SPORTS	-	IWF22	-	W22FP-U	1
50	RODOSHOW50	-	IWF22	-	W22FPR-U	1
110	PMX110/110NAKID	-	IUF22	-	U22FSR-U	1
110	PMX110 SPORTS	01.1 -	IWF22	-	W22FP-U	1
125	ALLORO125	-	IUF22	-	U22FSR-U	1
125	G-MAX125	-	IUF22	-	U22FSR-U	1
125	i-CHARGE125	-	IUF22	-	U22FS-U	1
125	iBUBU125	-	IUF22	-	U20FSR-U	1
125	i'ME125	-	IUF22	-	U22FSR-U	1
125	MY BUBU125/α	-	IUF22	-	U22FS-U	1
125	T-REX125	01.1 -	IUF22	-	U22FS-U	1
125	TIGRA125	-	IU22	-	U22ESR-N	1
125	X-HOT125	-	IU22	-	U22ESR-N	1
150	G-MAX4V150	-	IU22	-	U22ES-N	1
150	T-REX150	01.1 -	IUF22	-	U22FS-U	1
150	X-HOT150	-	IU22	-	U22ESR-N	1
200	G-MAX200	-	IU22	-	U22ESR-N	1
220	G-MAX220	-	IU22	-	U22ESR-N	1

PHILIPPINES MALAYSIA

CC	MODEL	FROM-TILL	IRIDIUM POWER	IRIDIUM RACING	DENSO	QTY
PIAGGIO						
50	BRAVO PV	-	IWF24	-	W24FSR	1
50	CIAO-P	-	IWF24	-	W24FSR	1
50	DNA50	-	IW27	IW01-□	W27ESR-U	1
50	ICE50	-	IW27	IW01-□	W27ESR-U	1
50	LIBERTY50	-	IU27	IU01-□	U27ESR-N	1
50	NRG POWER MC3	-	IW27	IW01-□	W27ESR-U	1
50	TYPHOON50	-	IW27	IW01-□	W27ES-U	1
50	VESPA 50ET4	-	IU27	IU01-□	U27ESR-N	1
50	ZIP50	-	IW27	IW01-□	W27ES-U	1
50	ZIP&ZIP(HYBRID)	-	IW27	IW01-□	W27ES-U	1
80	TYPHOON80	-	IW27	IW01-□	W27ES-U	1
125	BEVERLY125	-	IU24	IU01-□	U24ESR-NB	1
125	LIBERTY125	-	IU22	IU01-□	U22ESR-N	1
125	RUNNER125VX	02 -	IU24	IU01-□	U24ESR-NB	1
125	SKIPPER125	-	IW27	IW01-□	W27ES-U	1
125	TYPHOON125	-	IW27	IW01-□	W27ESR-U	1
125	VESPA 125ET4	-	IU22	IU01-□	-	1
125	X8-125	-	IU27	IU01-□	U27ESR-N	1
125	ZIP125 4t	-	IU27	IU01-□	U27ESR-N	1
150	HEXAGON150	-	IW27	IW01-□	W27ES-U	1
150	LIBERTY150/LE	-	IU27	IU01-□	U27ESR-N	1

VIETNAM THAILAND TAIWAN SINGAPORE SAUDARABIA

CC	MODEL	FROM-TILL	IRIDIUM POWER	IRIDIUM RACING	DENSO	QTY
SCORPA						
125	SY125F	-	IUF22	-	U22FSR-U	1
125	TY-S125F	-	IUF22	-	U22FSR-U	1
200	SY200FR	08 -	IUF22	-	U22FSR-U	1
250	SY250F/FR	07 -	IU24	IU01-□	U24ESR-N	1
250	SY250R LONGRIDE	-	IW22	IW01-□	W22EP-U	1
250	SY250R	-	IW22	IW01-□	W22EP-U	1
250	T-RIDE 250F	08 -	IU24A	IU01-□	U24ESR-N	1
SHERCO						
50	SHERCO 0.5	-	IW27	IW01-□	W27ES-U	1
80	SHERCO 0.8	-	IW16	IW01-□	W16EP-U	1
125	SHERCO 1.25	-	IW16	IW01-□	W16EP-U	1
200	SHERCO 2.0	-	IW16	IW01-□	W16EP-U	1
250	SHERCO 2.5	-	IW16	IW01-□	W16EP-U	1
290	SHERCO 2.9	-	IW16	IW01-□	W16EP-U	1
320	SHERCO 4T 3.2	-	IQ20	IQ01-□	Q20PR-U*	1
SOLEX						
50	S3800	-	IWF16	-	W16FS-U	1
TITAN						
1573	GECKO SX/RM	-	IW16	IW01-□	W16EPR-U	2
1573	PHENIX T-RM	-	IW16	IW01-□	W16EPR-U	2
1573	PHENIX Z-RM	-	IW16	IW01-□	W16EPR-U	2
1573	ROADRUNNER RM	-	IW16	IW01-□	W16EPR-U	2
1573	SIDEWINDER RM	-	IW16	IW01-□	W16EPR-U	2
TM RACING						
125	TM125ED	96 -	IW27	IW01-□	-	1
250	TM250 4T	01 -	IU24	IU01-□	U24ESR-N	1
250	TM250ED	96 -	IW24	IW01-□	-	1
400	TM400 4T	01 -	IU24	IU01-□	U24ESR-N	1
TOMOS						
50	ALPINO	-	IWF22	-	W22FS-U	1
50	CLASSIC I / II	-	IWF22	-	W22FS-U	1
50	FLEXER SPORT	-	IWF22	-	W22FS-U	1
50	REVIVAL	-	IWF22	-	W22FS-U	1
TRIUMPH						
600	DAYTONA 600	03 -	IU27A	IU01-□	U27ETR	4
600	SPEED FOUR	02 -	IU27A	IU01-□	U27ETR	4

*USE REMOVABLE TYPE



CC	MODEL	FROM-TILL	IRIDIUM POWER	IRIDIUM RACING	DENSO	QTY
TRIUMPH						
600	TT600	-	IU27A	IU01-□	U27ETR	4
620	620SERIES	-	IX27B	IXU01-□	X27EPR-U9	3
675	DAYTONA 675	-	IU27A	IU01-□	U27ETR	3
675	SPEED TRIPLE	-	IU27A	IU01-□	U27ETR	3
675	STREET TRIPLE	-	IU27A	IU01-□	U27ETR	3
800	BONNEVILLE AMERICA	02 -	IX24B	IXU01-□	X24EPR-U9	2
800	BONNEVILLE/T100	01 -03	IX24B	IXU01-□	X24EPR-U9	2
800	SPEEDMASTER	03 -05	IX24B	IXU01-□	X24EPR-U9	2
865	BONNEVILLE/T100	04 -07	IX24B	IXU01-□	X24EPR-U9	2
865	BONNEVILLE/T100	08 -	IX24B	IXU01-□	X24EPR-U9	2
865	SCRAMBLER	06 -	IX24B	IXU01-□	X24EPR-U9	2
865	SPEEDMASTER	06 -	IX24B	IXU01-□	X24EPR-U9	2
865	THRUXTON900	04 -07	IX24B	IXU01-□	X24EPR-U9	2
865	THRUXTON900	08 -	IX24B	IXU01-□	X24EPR-U9	2
885	ADVENTURER	96 -	IX27B	IXU01-□	X27EPR-U9	3
885	LEGEND TT	99 -	IX24B	IXU01-□	X24EPR-U9	3
885	T509SPEED TRIPLE	97 -98	IX24B	IXU01-□	X24EPR-U9	3
885	THUNDERBIRD/SPORT	-	IX27B	IXU01-□	X27EPR-U9	3
885	TIGER	99 -00	IX24B	IXU01-□	X24EPR-U9	3
900	SPEED TRIPLE900	-	IX27B	IXU01-□	X27EPR-U9	3
900	SPRINT900	-	IX27B	IXU01-□	X27EPR-U9	3
900	TROPHY900	96 -	IX27B	IXU01-□	X27EPR-U9	3
955	DAYTONA T595	97 -98	IX24B	IXU01-□	X24EPR-U9	3
955	DAYTONA955i	99 -01	IX24B	IXU01-□	X24EPR-U9	3
955	DAYTONA955i	02 -	IU27A	IU01-□	U27ETR	3
955	SPEED TRIPLE	99 -01	IX24B	IXU01-□	X24EPR-U9	3
955	SPEED TRIPLE	02 -	IU27A	IU01-□	U27ETR	3
955	SPRINT RS	00 -01	IX24B	IXU01-□	X24EPR-U9	3
955	SPRINT RS	02 -	IU27A	IU01-□	U27ETR	3
955	SPRINT ST	99 -01	IX24B	IXU01-□	X24EPR-U9	3
955	SPRINT ST	02 -04	IU27A	IU01-□	U27ETR	3
955	TIGER	01 -04	IX24B	IXU01-□	X24EPR-U9	3
1050	TIGER	05 -	IU27A	IU01-□	U27ETR	3
1050	SPEED TRIPLE	05 -	IU27A	IU01-□	U27ETR	3
1050	SPRINT ST	05 -	IU27A	IU01-□	U27ETR	3
1200	DAYTONA1200	-	IX27B	IXU01-□	X27EPR-U9	4
1200	TROPHY1200	96 -	IX27B	IXU01-□	X27EPR-U9	4
2300	ROCKET III/CLASSIC/TOURING	04 -09	IX24B	IXU01-□	X24EPR-U9	6
URAL						
650	BAVARIAN CLASSIC	-	IWF22	-	W22FP-U	2
650	DECO CLASSIC	-	IWF22	-	W22FP-U	2
650	SOLO	-	IWF24	-	W24FP-U	2
650	SPORTSMAN	-	IWF24	-	W24FP-U	2
VEE TWO						
900	SQUALO/SP	-	IWF22	-	W20FS-U	1
VERTEMATI						
570	C570	-	IU24A	IU01-□	U24ETR	1
570	E570J/EJ	-	IU24A	IU01-□	U24ETR	1
570	S570J/EJ STRADA	03 -	IU24A	IU01-□	U24ETR	1

CC	MODEL	FROM-TILL	IRIDIUM POWER	IRIDIUM RACING	DENSO	QTY
VERTEMATI						
600	SR600 CORSA	03 -	IU24A	IU01-□	U24ETR	1
VESPA						
50	50A AUTOMATICA	-	IW24	IW01-□	W24ES-U	1
50	50ET2CARBURETOR	-	IW27	IW01-□	W27ES-U	1
50	50ET2INJECTION	98 -	IXU27	IXU01-□	IXU27	1
50	50ET4	-	IU27	IU01-□	U27ESR-N	1
50	50HP	-	IWF22	-	W20FS-U	1
50	50S VINTAGE	-	IWF22	-	W22FS-U	1
50	LX50 2T	05 -	IW27	IW01-□	W27ESR	1
50	PK50/S	-	IWF22	-	W20FS-U	1
50	PK50SS	-	IWF22	-	W22FS-U	1
50	VESPACAR APE50VAN	-	IWF22	-	W22FS-U	1
80	PK80E/S	-	IW20	IW01-□	W20ES-U	1
100	100VINTAGE	-00	IWF22	-	W22FS-U	1
125	125A AUTOMATICA	-	IWF24	-	W24FS-U	1
125	125ET3/VINTAGE	-	IWF22	-	W22FS-U	1
125	125ET4	98 -	IU27	IU01-□	U27ESR-N	1
125	GT125L	-	IU24	IU01-□	U24ESR-N	1
125	LX125	05 -	IU22	IU01-□	-	1
125	LXV125	06 -	IU22	IU01-□	-	1
125	P125X/SUPER	-	IWF22	-	W22FS-U	1
125	PK125S	-	IWF22	-	W22FS-U	1
125	PX125 FL2	02.7 -	IWF22	-	W20FS-U	1
125	PX125E	-	IWF22	-	W22FS-U	1
150	150ET4	-	IU27	IU01-□	U27ESR-N	1
150	150ORIGINALE	99 -	IWF22	-	W20FS-U	1
150	PX150	02 -	IWF22	-	W20FS-U	1
150	PX150E	81 -	IWF22	-	W20FS-U	1
150	PX150 FL2	02.7 -	IW20	IW01-□	W20ES-U	1
200	COSA LX200	97 -	IWF24	-	W24FS-U	1
200	COSA2(No.3000001~3028249)	-	IW24	IW01-□	W24ES-U	1
200	COSA2(No.3028250~)	-	IWF24	-	W24FS-U	1
200	GT200L	-	IU24	IU01-□	U24ESR-N	1
200	P200E	-	IW20	IW01-□	W20ES-U	1
200	PX200E/FL2	-	IW20	IW01-□	W20ES-U	1
250	GTS250IE	07 -	IU24	IU01-□	U24ESR-NB	1
250	GTV250IE	-	IU24	IU01-□	U24ESR-NB	1
VOR						
400	400ENDURO	00 -01	IU24A	IU01-□	U22ETR	1
400	400SUPERMOTORD	00 -01	IU24A	IU01-□	U22ETR	1
450	450ED	02 -	IU24A	IU01-□	U22ETR	1
450	450SM	02 -	IU24A	IU01-□	U22ETR	1
500	500ENDURO	00 -01	IU24A	IU01-□	U22ETR	1
500	500SUPERMOTORD	00 -01	IU24A	IU01-□	U22ETR	1
503	503SM	02 -	IU24A	IU01-□	U22ETR	1
530	530ED	02 -	IU24A	IU01-□	U22ETR	1
530	530SM	00 -01	IU24A	IU01-□	U22ETR	1
VYRUS						
992	984C3.2V	-	IXU24	IXU01-□	XU24EPR-U	4

DENSO
 AUSTRALIA CHINA INDIA INDONESIA KOREA MALAYSIA PHILIPPINES SAUDIARABIA SINGAPORE TAIWAN THAILAND VIETNAM JAPAN & USA
 EUROPE MOTOR CYCLE SMALL ENGINE REFERENCE NUMBER



RACING KART

DENSO
AUSTRALIA
CHINA
INDIA
INDONESIA
KOREA
MALAYSIA
PHILIPPINES
SAUDI ARABIA
SINGAPORE
TAIWAN
THAILAND
VIETNAM
JAPAN
EUROPE & USA
MOTOR CYCLE
SMALL ENGINE
CROSS REFERENCE
PART NUMBER

MAKER	CC	ENGINE	COOLING	IRIDIUM POWER	IRIDIUM RACING	
BILAND	250	SA250	WATER	IU24A	IU01-□	
COMER	60	S60·W60	AIR	IWF22	-	
	80	K80·W80	AIR	IWF22	-	
	100	351L/VT/VTI	AIR	IWF31	IWF01-□	
CRG		S-10T1·S-20T1	-	IWF31	IWF01-□	
		- SS97/98/99·SW97/98/99	-	IWF31	IWF01-□	
		WTP60	-	IWF27	IWF01-□	
FOX	100	RTW	WATER	IWF31	IWF01-□	
FUJI ROBIN		- EC03/04/05	-	IWF22	-	
HETSCHEL	100	KZH 100D/100M	AIR/WATER	IWF31	IWF01-□	
HONDA	120	GX120	AIR	IWF20	IWF01-□	
	160	GX160	AIR	IWF20	IWF01-□	
	200	GX200	AIR	IWF20	IWF01-□	
	270	GX270	AIR	IWF20	IWF01-□	
HRT	100	REED·ROTARY	WATER	IWF31	IWF01-□	
IAME	60	Parilla 60GAZELLE/SWIFT	AIR	IWF31	IWF01-□	
	80	Parilla 80LEVRIER	AIR	IWF31	IWF01-□	
	98.3	Komet K55/Super	AIR	IWF31	IWF01-□	
		Parilla 100·Sirio 100	AIR	IWF31	IWF01-□	
		Parilla REEDJET RL/MAXI-RL	WATER	IWF31	IWF01-□	
	99.31		Parilla REEDJET JP.S	AIR	IWF31	IWF01-□
			Parilla TT37/38/39	AIR	IWF31	IWF01-□
			Parilla TT38/39/40	WATER	IWF31	IWF01-□
			Sirio RAP95/TT53/TT56	AIR	IWF31	IWF01-□
		120 Komet Panther TaG	AIR	IWF31	IWF01-□	
		125 Parilla LEOPARD125 TaG	WATER	IWF31	IWF01-□	
		- Parilla MAG95	-	IWF31	IWF01-□	
		125 X30 125 RL	WATER	IWF31	IWF01-□	
ITAL SYSTEM		ML21·ML31·MV21·MV31	AIR	IWF31	IWF01-□	
	99	SL11·SL21·SV11·SV21	AIR	IWF31	IWF01-□	
		SV31·ML41·MV41	WATER	IWF31	IWF01-□	
MAXTER	100	MX-L·MX-V	WATER	IWF31	IWF01-□	
MUGEN	100	MKR100AI	AIR	IWF31	IWF01-□	
PCR	98.1	TSV98·TSL98·PV50	AIR	IWF31	IWF01-□	
	100	PV50W	WATER	IWF31	IWF01-□	
PRD	100	RK100/C/EH	AIR	IWF27	IWF01-□	
		AVANTI	AIR	IWF27	IWF01-□	
	125	FIREBALL	WATER	IWF27	IWF01-□	
ROTAX	99.27	DS-FR	WATER	IWF31	IWF01-□	
	100	DS-DL/DR·DS-EL/ER	AIR	IWF31	IWF01-□	
		VM95·VME	WATER	IWF31	IWF01-□	
	125	125MAX DD2	WATER	IWF27☆	IWF01-□	
		FR125MAX/JUNIOR MAX(From 02~)	WATER	IWF27☆	IWF01-□	
		FR125MAX/JUNIOR MAX(Up to 01)	WATER	IWF31☆	IWF01-□	
	FR125Mini MAX	WATER	IWF27☆	IWF01-□		
SUBARU	130	EX13	AIR	IWF22	-	
	170	EX17	AIR	IWF22	-	
	210	EX21	AIR	IWF22	-	
	270	EX27	AIR	IWF22	-	
	210	KX21	AIR	IWF22	-	
TITAN	100	LL-1/2/3·RV-1·RV-2	AIR	IWF31	IWF01-□	
TKM	200	-	WATER	IU31	IU01-□	
TM RACING	99.15	K11·K12	WATER	IWF31	IWF01-□	
TOHATSU		- K-470 II	-	IWF27	IWF01-□	
VORTEX		VL/B/C/95/95C	AIR	IWF31	IWF01-□	
	100	VL/CW·VL/BW	WATER	IWF31	IWF01-□	
		VR/C/CW/95/95C	AIR	IWF31	IWF01-□	
	125	ROK125	WATER	IWF31	IWF01-□	
		SUPER ROK125	WATER	IWF31	IWF01-□	
YAMAHA	80	YZ80SK	WATER	IWF31	IWF01-□	
	85	YZ85	WATER	IWF31	IWF01-□	
		KT100FP/AZ/SC/SD/SEC	AIR	IWF27	IWF01-□	
	97.6	KT100J	AIR	IWF24	IWF01-□	
		KT100SP·KT100FA	AIR	IWF31	IWF01-□	
	125	YZ125	WATER	IWF27	IWF01-□	
		FK250	AIR	IU27A	IU01-□	
	250	M250WR-F	WATER	IU24	IU01-□	
WR250FK		WATER	IU24	IU01-□		

☆ Denso's Genuine Parts share: 100%

(Note) When driving vehicles with water-cooled engines using IW01-□, there are cases where the plug comes in contact with the driver's arm; if this is the case, please use the following plug types, which have short heads: IWM01-□, IAE01-□.

MARINE, JETSKI & SNOWMOBILE



MODEL	ENGINE	IRIDIUM POWER	IRIDIUM RACING	DENSO
ARCTIC CAT				
SNOWMOBILE				
	F7 Firecat EFI	IW27	IW01-□	W27ESR
	F5 Firecat	IW27	IW01-□	W27ESR
	Mountain Cat 570	IW27	IW01-□	W27ESR
	Mountain Cat 600 EFI	IW27	IW01-□	W27ESR
	Mountain Cat 800 EFI	IW27	IW01-□	W27ESR
	Mountain Cat 900	IW27	IW01-□	W27ESR
BOMBARDIER				
SEA-DOO				
	150 SPEEDSTER	IXU24	IXU01-□	-
	180 CHALLENGER SE	IXU24	IXU01-□	-
	200 SPEEDSTER	IXU24	IXU01-□	-
	205 UTOPIA SE	IXU24	IXU01-□	-
	230 CHALLENGER SE/SP	IXU24	IXU01-□	-
	230 WAKE	IXU24	IXU01-□	-
	CHALLENGER1800/2000/X-20	IWF24	-	W24FPR-U10
	GSX · GSX-L · GTI · GTI-rx · GTX · GTX-L · LRV	IW24	IW01-□	W24ESR
	GTI 130/SE 130/SE 155	IXU24	IXU01-□	-
	GTI-RFI/LE RFI	IW24	IW01-□	W24ESR
	GTX 155/iS 215 · GTX LTD iS 255	IXU24	IXU01-□	-
	GTX 4-TEC LTD SC	IXU24	IXU01-□	-
	GTX 4-TEC Supercharged/LTD	IXU24	IXU01-□	-
	GTX 4-TEC/WAKEBOARD/WE	IXU24	IXU01-□	-
	GTX-RFI · HX · SPX · XP · XP-L	IW24	IW01-□	W24ESR
	ISLAND SPEEDSTAR	IWF24	-	W24FPR-U10
	ISLANDIA SE	IXU24	IXU01-□	-
	RX-DI · GTX-DI(00.4 ~)	IK16	IK01-□	KJ14CR-L11
	RXP	IXU24	IXU01-□	-
	RXP 215 · RXP-X 255 RS	IXU24	IXU01-□	-
	RXT 215/iS 255 · RXT-X 255RS	IXU24	IXU01-□	-
	SPEEDSTER 200	IXU24	IXU01-□	-
	SPEEDSTER WAKE	IXU24	IXU01-□	-
	SPORTSTER 4-TEC	IXU24	IXU01-□	-
	SPORTSTER/1800	IW24	IW01-□	W24ESR
	WAKE 155/PRO 215	IXU24	IXU01-□	XU24EPR-U
	XP DI · LRV-DI	IK16	IK01-□	KJ14CR-L11
	YUTOPIA185/205	IWF24	-	W24FPR-U10
SKI-DOO				
	EXPEDITION SPORT	IW27	IW01-□	W27ESR
	EXPEDITION TUV(12mmHead)	IXU24	IXU01-□	-
	EXPEDITION TUV(14mmHead)	IW27	IW01-□	W27ESR
	FORMULA III 700 · Z583/500/500S/500E	IW27	IW01-□	W27ESR
	GRAND TOURING SE583/500	IW27	IW01-□	W27ESR
	GSX FAN(380F) · GSX FAN(550F)	IW27	IW01-□	W27ESR
	GTX FAN · GTX SPORT	IW27	IW01-□	W27ESR
	MACH 1	IW27	IW01-□	W27ESR
	MACH Z(98)	IW31	IW01-□	W31ESR-U
	MACH Z(99)	IW27	IW01-□	W27ESR
	MINI Z	IW20	IW01-□	W20EPR-U
	MXZ 670 H.O/670/600/500/440	IW27	IW01-□	W27ESR
	MXZ FAN/RenegadeX	IW27	IW01-□	W27ESR
	MXZ X(600H0 · 600H0 SDI · 800H0)	IW27	IW01-□	W27ESR
	SKANDIC LT	IW27	IW01-□	W27ESR
	SKANDIC SUV(550F)	IW27	IW01-□	W27ESR
	SKANDIC SUV(600)	IW27	IW01-□	W27ESR
	SKANDIC SWT/WT/WT(LC)500/380	IW27	IW01-□	W27ESR
	SKANDIC TUNDRA	IW27	IW01-□	W27ESR
	SUMMIT 670/600/583/500	IW27	IW01-□	W27ESR
	SUMMIT ADRENALINE 144(600H0)	IW27	IW01-□	W27ESR
	SUMMIT ADRENALINE 144(800H0)	IW27	IW01-□	W27ESR
	SUMMIT FAN	IW27	IW01-□	W27ESR
	SUMMIT X 144	IW27	IW01-□	W27ESR
	SUMMIT X 151	IW27	IW01-□	W27ESR
	SUMMIT X 159	IW27	IW01-□	W27ESR
	TOURING SLE/LE/E	IW27	IW01-□	W27ESR
	TUNDRA R	IW27	IW01-□	W27ESR
HONDA				
OUTBOARD				
	BF2A	-	-	W14MR-U
	BF2D(2000 ~)	IUF14-UB	-	U14FSR-UB
	BF2D(~ 99)	IUF14-UB	-	U16FSR-UB

DENSO

AUSTRALIA

CHINA

INDIA

INDONESIA

KOREA

MALAYSIA

PHILIPPINES

SAUDIARABIA

SINGAPORE

TAIWAN

THAILAND

VIETNAM

JAPAN

EUROPE

MOTOR

SMALL

CROSS

PART

ENGINE

REFERENCE

NUMBER

315



MARINE, JETSKI & SNOWMOBILE

DENSO

AUSTRALIA

INDIA

INDONESIA

KOREA

MALAYSIA

PHILIPPINES

SAUDI ARABIA

SINGAPORE

TAIWAN

THAILAND

VIETNAM

JAPAN

EUROPE & USA

MOTOR CYCLE

SMALL ENGINE

CROSS REFERENCE

PART NUMBER

MODEL	ENGINE	IRIDIUM POWER	IRIDIUM RACING	DENSO
HONDA				
OUTBOARD				
	BF50	IW16	IW01-□	W16EPR-U
	BF5A · BF5AK	IW16	IW01-□	W16EPR-U
	BF8A/M/9.9A/35A/45A/75/100	-	-	X16FSR-U
	BF8D/9.9D/15D/20D	-	IU01-□	U16FER9
	BF9.9A/15A	-	-	X20FSR-U
	BF25/25A/25D/30/30A/30D/35A/35AM/40/40A	IX22	IXU01-□	X22ESR-U
	BF40D/50D	IX22	IXU01-□	X22ESR-UB
	BF45A/45AM/50/50A	IX22	IXU01-□	X22ESR-U
	BF60A/BFP60A	-	-	-
	BF75AT/90AT	IX22	IXU01-□	X22ESR-U
	BF75D/90D	-	-	-
	BF115A/130A	IK22	IK01-□	KJ22CR-L8
	BF115(10.6 ~)	IK20	IK01-□	KJ20DR-M11
	BF135A(03 ~ 10)/BF150A(03 ~ 10)	IK20	IK01-□	SKJ20DR-M11
	BF135/150(10.6 ~)	IK20	IK01-□	KJ20DR-M11
	BF220/225(01.10 ~) · BF175A/200A/225A	-	IK01-□	VKJ20RZM11
HSR-BENELLI				
PWC				
	S4 STANDUP	IK22	IK01-□	IK22
	S4 PRO EDITION	IK22	IK01-□	IK22
KAWASAKI				
JET SKI				
	JET MATE(650)	IW22	IW01-□	W22ESR-U
	JET SKI 300·440·650SX/X-2/TS/SC	IW22	IW01-□	W22ESR-U
	JET SKI 550(61 ~)	IW24	IW01-□	W24ESR
	JET SKI 550SX	IW24	IW01-□	W24ESR
	JET SKI 750SX/Sxi/SXi PRO/ST/STX/STS	IW24	IW01-□	W24ESR
	JET SKI 750Xi/Zxi/Xi Sport/X-4	IW24	IW01-□	W24ESR
	JET SKI 800SX-R	IW24	IW01-□	W24ESR
	JET SKI 900STX/STA/Zxi/STS · 1100STX/ZXi	IW27	IW01-□	W27ESR
	JET SKI 1100STX D.I.(00.4 ~)	-	-	-
	JET SKI 1200STX-R	IW27	IW01-□	W27ESR
	JET SKI Ultra130D.I.	-	-	-
	JET SKI Ultra150(JH1200-A2 ~)	IW27	IW01-□	W27ESR
	JET SKI Ultra150(JH1200-A1)	-	IW01-□	IW01-27
	JET SKI Ultra150(1200cc)(99.1 ~ 99.12)	-	IW01-□	IW01-27
	JET SKI Ultra150(1200cc)(00.1 ~)	IW27	IW01-□	W27ESR
	JET SKI Ultra250X(07 ~)	IU27	IU01-□	-
	JET SKI Ultra260X/LX	IU27	IU01-□	-
	JET SKI Ultra LX(07 ~)	IU27A	IU01-□	U27ETR
	JET SKI Ultra300X(1500cc)(11.4 ~)	IU27	IU01-□	-
	JET SKI Ultra300LX(1500cc)(11.5 ~)	IU27	IU01-□	-
	JET SKI ST/STX/STS(750cc)	IW24	IW01-□	W24ESR
	JET SKI STX-12F/15F/15S	IU27A	IU01-□	U27ETR
	JET SKI X-2(800cc)	IW24	IW01-□	W24ESR
	JET SKI X-4/ZXi	IW24	IW01-□	W24ESR
	JET SKI Xi/Xi Sport(750cc)	IW24	IW01-□	W24ESR
MERCURY				
OUTBOARD				
	FourStroke 30/40/50/60	IXU22	IXU01-□	XU22EPR-U
	FourStroke 5	IXU22	IXU01-□	XU20EPR-U
	FourStroke 75/90/115	IKH16	IKH01-□	K16HPR-U11
	Optimax 115L/135/150/175/200/225	IK16	IK01-□	PKJ16CR-L11
	Optimax 90L/250XS	-	-	-
	ProMax 200XS	-	-	-
	ProMax 225X	IW24	IW01-□	IW24
	ProMax 250XB	IWF27	-	W27FSR
	ProMax 300X	IWF27	-	IWF27
	SeaPro 8/9.8	IWF22	-	W22FP-U
	SeaPro 10/15/18/25/40	IWF24	-	W24FPR-U10
	Standard 3.3	IWF20	-	W20FPR-U10
	Standard 4/5	IWF22	-	W22FPR-U
	Standard 30/40/50/60	IWF24	-	W24FPR-U10
	Standard 75/90	-	-	SF51
	Standard 115/125	IWF24	-	W24FPR-U10
	Standard 140/150XRi/200XRi/200L XRi	IWF24	-	W24FPR-U10
	Standard 225XRi/250XRi/250L XRi	IWF24	-	W24FSR
	Supercharged 225/250(2006 ~)4stroke,6cyl.	IKH22	IKH01-□	VKH22
	Verado 225/250(2004 ~)4stroke,6cyl.	IKH22	IKH01-□	VKH22

MARINE, JETSKI & SNOWMOBILE



MODEL	ENGINE	IRIDIUM POWER	IRIDIUM RACING	DENSO
NISSAN				
INBOARD				
	HA100S/120S	-	IW01-□	W16ESR-U
	VGA30E/30ET	IQ20	IQ01-□	Q20PR-U11
	YA190S	IW16	IW01-□	W14EPR-U
OUTBOARD				
	NS5B/8B	IWF22	-	W22FP-U10
	NS3.5A	IWF20	-	W20FPR-U10
	NS9.9B/9.9B2/12C/12C2/15B/15B2	IWF22	-	W22FS-U10
	NS18C/18C2/25C/25C2/30A2/30A3	IWF22	-	W22FS-U10
	NS35C/40C/40D	IWF22	-	W22FS-U10
	NS45A/50C/50D/55B/60A/70A/70A2/90A	IWF24	-	W24FSR-U10
	NV120A/140A	IWF24	-	W24FSR-U10
	BF2D	IUF14-UB	-	U16FSR-UB
	BF5A	IW16	IW01-□	W16EPR-U
	BF8A/9.9A	-	-	X16FSR-U
	BF15A	-	-	X20FSR-U
	BF25A/30A/40A/50A	IX22	IXU01-□	X22ESR-U
	BF75A/90A	IX22	IXU01-□	X22ESR-U
	BF115A/130A	IK22	IK01-□	KJ22CR-L8
WATERJET				
	HA145J/170J	IW22	IW01-□	W22ESR-U
	VG30ETJ	IQ20	IQ01-□	Q20PR-U11
	YA190J	IW16	IW01-□	W14EPR-U
POLARIS				
PWC				
	GENESIS	IW27	IW01-□	W27ESR
	GENESIS i · TSX140 · VIRAGE Txi	-	-	-
	OCTANE · PRO1200 · VIRAGE TX	IW27	IW01-□	W27ESR
	SL750 · SLT750	IW22	IW01-□	W22EPR-U
	SL780	IW24	IW01-□	W24EPR-U
SNOWMOBILE				
	120 PRO X(04 ~)	-	IW01-□	W20ESR-U
	600 RMK(03 ~)	IW27	IW01-□	IW27
	Frontier Classic(03 ~)	IK16	IK01-□	K16PR-U
	Frontier Touring(03 ~)	IK16	IK01-□	K16PR-U
	INDY 120 XC SP	-	IW01-□	W20ESR-U
	INDY 500 XC SP	IW29	IW01-□	-
	INDY 700 RMK Vertical EDGE	IW29	IW01-□	-
	INDY 800 PRO X/X2/XR(03 ~)	IW29	IW01-□	-
	INDY 800 RMK Vertical Escape	IW29	IW01-□	-
	INDY LITE 340(91 ~ 98)	IW24	IW01-□	W24ESR
	INDY LITE/TRAIL/TRAIL TOURING	IW24	IW01-□	-
	INDY STORM 800(94 ~ 98)	IW27	IW01-□	W27ESR
	INDY STORM RMK	IW24	IW01-□	-
	INDY STORM RMK 800(97)	IW27	IW01-□	W27ESR
	INDY TRAIL 500(95 ~ 97)	IW27	IW01-□	W27ESR
	INDY TRAIL 500(98 ~ 99)	IW24	IW01-□	W24ESR
	INDY TRAIL RMK	IW27	IW01-□	W27ESR
	INDY TRAIL RMK 550(99 ~)	IW27	IW01-□	W27ESR
	INDY TRAIL TOURING 550(00)	IW24	IW01-□	W24ESR
	INDY TRAIL TOURING 550(02 ~)	IW27	IW01-□	W27ESR
	INDY WIDETRAK LX	IW24	IW01-□	W24ESR
	INDY XCR 440(95 ~ 98)	IW27	IW01-□	W27ESR
	INDY XCR 600(95 ~ 98)	IW27	IW01-□	W27ESR
	INDY XLT PMK/440XCR/600XCR	IW24	IW01-□	-
	INDY XLT SP 600(97 ~ 99)	IW27	IW01-□	W27ESR
	INDY XLT/600XCRSP	IW27	IW01-□	-
	WIDE TRAK LX/500/500EFI	IW24	IW01-□	-
SUZUKI				
JETBOAT				
	PJ650(05501J)(STINGER JET I)	IW24	IW01-□	W24ESR
	PJ650(05501J)(STINGER JET II)	IW24	IW01-□	W24ESR
	TIGER SHARK(BARRACUDA · DAYTONA)	IW27	IW01-□	W27ESR
	TIGER SHARK(MONDEGO · MONTECARO)	IW27	IW01-□	W27ESR
OUTBOARD				
	DF2	IUF22	-	U20FSR-U
	DF5	IU20	IU01-□	U20EPR9
	DF8/8E/9.9/9.9E(09.7 ~)	IU20	IU01-□	U20ESR-N
	DF9.9/15/25/30/40/50	IXU22	IXU01-□	XU20EPR-U
	DF9.9/9.9E(~ 09.6)	IK20	IK01-□	K20PR-U
	DF15E	IK20	IK01-□	K20PR-U
	DF25R/25E	IK20	IK01-□	K20PR-U
	DF30T/30QE	IXU22	IXU01-□	XU20EPR-U
	DF40T/40QH	IXU22	IXU01-□	XU20EPR-U

DENSO

AUSTRALIA CHINA

INDIA

INDONESIA

KOREA

MALAYSIA

PHILIPPINES

SAUDI ARABIA

SINGAPORE

TAIWAN

THAILAND

VIETNAM

JAPAN

EUROPE

MOTOR CYCLE

SMALL ENGINE

CROSS REFERENCE PART NUMBER



MARINE, JETSKI & SNOWMOBILE

DENSO

AUSTRALIA CHINA INDIA INDONESIA KOREA MALAYSIA PHILIPPINES SAUDI ARABIA SINGAPORE SINGAPORE TAIWAN THAILAND VIETNAM JAPAN EUROPE & USA SMALL ENGINE CROSS REFERENCE PART NUMBER

MODEL	ENGINE	IRIDIUM POWER	IRIDIUM RACING	DENSO
SUZUKI				
OUTBOARD				
DF50T/50TH/50QH		IXU22	IXU01-□	XU20EPR-U
DF60/70		IW16	IW01-□	W16EPR-U
DF60T		IW20	IW01-□	W20EPR-U
DF60T/TH(09.12 ~)		IXU22	IXU01-□	XU20EPR-U
DF70T/70TH(~ 08.7)		IW20	IW01-□	W20EPR-U
DF70T/70TH(08.8 ~)		IXU22	IXU01-□	XU20EPR-U
DF90/115/140		IK20	IK01-□	K20PR-U
DF80T/80TH		IXU22	IXU01-□	XU20EPR-U
DF90T(~ 08.7)		IK20	IK01-□	K20PR-U
DF90T/90TH(08.8 ~)		IXU22	IXU01-□	XU20EPR-U
DF100T		IK20	IK01-□	K20PR-U
DF115T/115Z		IK20	IK01-□	K20PR-U
DF140T		IK20	IK01-□	K20PR-U
DF150T/150Z		IK20	IK01-□	K20PR-U
DF175T/175Z		IK20	IK01-□	K20PR-U
DF200T/200Z		IK20	IK01-□	K20PR-U
DF225T/225Z		IK20	IK01-□	K20PR-U
DF250T/250Z		IK20	IK01-□	K20PR-U
DF300T/300Z		IK20	IK01-□	K20PR-U
DT2(~ 90)		-	-	W14FR-U
DT2(91 ~) · DT2.2(97 ~)		-	-	W16FSR
DT3.5/5(~ 94)/5W/8		IWF20	-	W20FR-U
DT4(85 ~) · J2 · J4		IWF16	-	W16FPR-U
DT5Y		IWF22	-	W22FSR
DT5(95 ~) · DT6 · DT9(87 ~)		IWF22	-	W20FSR-U
DT9.9K/16P/20P/25P		IWF22	-	W22FSR
DT9.9(83 ~) · DT15(83 ~)		IWF22	-	W22FS-U10
DT20/25/25K/30/30C		IWF22	-	W22FS-U10
DT35AC/36K/40WK/50K		IWF22	-	W22FS-U10
DT40/40C/50/50C/55C/55TC		IWF24	-	W24FSR-U10
DT65C/65TC/75TC/85TC		IWF24	-	W24FSR-U10
DT90TC/100TC/115TC/140TC/150TC		IWF24	-	W24FSR-U10
DT150YC		IWF24	-	W24FSR-U10
DT175TC/200TC		IWF24	-	W24FSR-U10
TOHATSU				
OUTBOARD				
M2.5A/A2 · M3.5A/A2 · M3.5B/B2		IWF20	-	W20FPR-U10
M4C/5B/5BS/6B/8B/9.8B		IWF22	-	W22FP-U10
M9.9C/9.9D/9.9D2/15C/15D/15D2		IWF22	-	W22FS-U10
M18D/18E/18E2/25C2/25C3		IWF22	-	W22FS-U10
M30A3/30A4/35C/40C/40D/40D2		IWF22	-	W22FS-U10
M50D/50D2/60B/60C/70B/70C/80A		IWF24	-	W24FSR-U10
M90A/120A/120A2/140A/140A2		IWF24	-	W24FSR-U10
MFS9.9B/15B/18B		IXU22	IXU01-□	XU20EPR-U
MFS4A/5A/6A		IXU22	IXU01-□	XU20EPR-U
MFS8A/9.8A/25A/30A		IXU22	IXU01-□	XU20EPR-U
TLDI 40B/50B/70B/90B		-	-	-
YAMAHA				
MARINEJET				
EXCITER 1430TR/SPORT		IWF24	-	W24FSR
EXCITER LS2000		IWF24	-	W24FSR
MJ-650M		IWF24	-	W24FS-U
MJ-700FX/SJ/TZT/XL		IWF22	-	W22FS-U
MJ-700FX/SJ/TZT/XL · MJ-SJ700		IWF22	-	W22FSR
MJ-700RA/ST/TL/TZ/VN/VNR/VN LTD		IWF24	-	W24FSR
MJ-700XL LTD · MJ-XL700/LTD		IWF24	-	W24FSR
MJ-760GP/RA/RZ/VN/VN LTD/XL		IWF24	-	W24FSR
MJ-800GP(~ 98) · MJ-1100RA · MJ-1200GP/XL/SUV		IWF24	-	W24FSR
MJ-800GP(99 ~) · MJ-800TZ/XL · MJ-1200XLL		IW24	IW01-□	W24ESR
MJ-800R/GP · EXCITER1430TR/SPORT		IW24	IW01-□	W24ESR
MJ-1100VN(97 ~)		IWF24	-	W24FSR
MJ-1200R/GP/XLT		IW24	IW01-□	W24ESR
MJ-FX Cruiser High Output(FX1100)(06 ~)		IU27	IU01-□	U27ESR-NB
MJ-FX SHO/Cruiser SHO		IKH20	IKH01-□	-
MJ-FX140/CRUISER · MJ-FX160/CRUISER		IU27	IU01-□	U27ESR-NB
MJ-FZR		IKH20	IKH01-□	-
MJ-FZS		IKH20	IKH01-□	-
MJ-GP1200R/RC(00.5 ~) · MJ-XL1200LTD		IW24	IW01-□	-
MJ-GP1300R		IW24	IW01-□	W24ESR

DENSO	9	14	16	20	22	24	27	29	31	32	34	35	DENSO	9	14	16	20	22	24	27	31	32	DENSO	9	14	16	20	22	24	27	31	
NGK	2	4	5	6	7	8	9	9.5	10	10.5	11	11.5	CHAMPION	18	16,14	12,11	10,9	8,7	6,63,61	4,59	57	55	53	BOSCH	10	9	8	7,6	5	4	3	2

MARINE, JETSKI & SNOWMOBILE



MODEL	ENGINE	IRIDIUM POWER	IRIDIUM RACING	DENSO
YAMAHA				
MARINEJET				
	MJ-GP800R/XLT800	IW24	IW01-□	W24ESR
	MJ-SJ700(02 ~)	IWF22	-	W22FS-U
	MJ-Super Jet	IWF22	-	W22FS-U
	MJ-SUV1200	IWF24	-	W24FSR
	MJ-VX/DX/Cruiser	IU27	IU01-□	U27ESR-NB
	MJ-VX110DX/SP(VX1100)(06 ~)	IU27	IU01-□	U27ESR-NB
	MJ-XL800(00.3 ~)	IW24	IW01-□	W24ESR
	MJ-XL1200LTD(03 ~)	IW24	IW01-□	W24ESR
	MJ-XLT1200/GP1200R	IW24	IW01-□	W24ESR
OUTBOARD				
	2B · 5D	-	-	W16FSR
	2C · 4A/AC/AS · 4B · 4BC · 5C/CS · 20C/CM/CEM	IWF22	-	W22FSR
	3A · 6D · F4A · EK8D	IWF22	-	W20FSR-U
	6CEM/CM · 8CEM/CM · 9.9D/DE · 15D/DE	IWF22	-	W22FS-U10
	9.9D/DE · 15D/DE · 20DEN/DM	IWF22	-	W22FS-U10
	9.9F · 13.5F · 15F · 20D · 25J/N/V · 30D · 40V	IWF22	-	W22FS-U10
	13.5A · 25B · 25J · 25N · 25V · 30D	IWF22	-	W22FS-U10
	20DEM/DM · 25NE/NEH/NM/GE/GEM/GM	IWF22	-	W22FS-U10
	25D · 30A/AEM/AM · 40J/JEK/JEMK/X	IWF22	-	W22FSR
	25HEK/HEMK/HMK/V · 4CV · 150AETO(84,85)	IWF22	-	W22FS-U10
	25NEM · 30G · 50H/DEO/DEMO/DEPO/DEMPO	IWF24	-	W24FSR-U10
	25X · 30H · 40Y · 50G · 50H · 55B · 55D · 60F	IWF24	-	W24FS-U10
	40G(~ 02) · 40V · 40X(01 ~ 02)	IWF22	-	W22FS-U10
	40G(03 ~)	IWF22	-	W22FS-U
	40HM/HEMO/HEO/HEPO/HEMPO · 4C · 6C · 8C	IWF22	-	W22FS-U10
	40Y · 115C(03 ~)	IWF24	-	W24FSR
	50ETK/EMTK · 55B/D	IWF24	-	W24FSR-U10
	60F/FEMO/FEO/FETO · 70B/BEO/BETO/BEMO	IWF24	-	W24FSR-U10
	70C · 75A/B/C · 80A/AEO/AETO · 85A · 90A	IWF24	-	W24FSR-U10
	90A/AEO/AETO · 100A · 115B/C/CETO/F	IWF24	-	W24FSR-U10
	130B · L130B · 140B/C	IWF27	-	W27FSR-U10
	140C · 225C/F/G/BETO · 250B/C	IWF27	-	W27FSR-U10
	140CETO(~ 92) · 150AETO(86,87)	IWF24	-	W24FSR-U10
	140CETO(93 ~)	IWF27	-	W27FSR-U10
	150AET(98 ~ 01) · 150CETO(92 ~ 94)	IWF24	-	W24FSR-U10
	150F/G/J/L · D150N · L150F/J	IWF22	-	W22FS-U10
	175AET(98 ~ 01) · 175AETO(84 ~ 87)	IWF24	-	W24FSR-U10
	175BETO(92 ~ 94) · 200BETO(92 ~ 94)	IWF24	-	W24FSR-U10
	175D/F · 200F/G/H/J · 225D	IWF24	-	W24FSR-U10
	200AET(98 ~ 03) · 200AET(84 ~ 87)	IWF24	-	W24FSR-U10
	250A/AETO · 115BETO · D150H/N · S175D	IWF24	-	W24FSR-U10
	E8D · E9.9C · E15C · E25A · EK9.9H · EK15N · EK25A	IWF22	-	W22FS-U10
	E9.9D · E15D · E30H	IWF24	-	W24FS-U10
	E40G/J/X · E48C · EK40G · K40J	IWF22	-	W22FSR
	E55C	IWF24	-	W24FSR
	E60H/J · E65A · E75B · E115A	IWF24	-	W24FSR-U10
	EK9.9H · EK15N · EK25A · EK25B	IWF22	-	W22FS-U10
	F4A	IWF20	-	W20FS-U
	F2A · F6A/B · F8C · F9.9F · FT8D · FT9.9G	IWF20	-	W20FSR-U
	F6C · F5A	IUF22	-	-
	F8B	-	-	U16FSR-U
	F9.9B · FT9.9A	IUF22	-	U20FSR-U
	F9.9C/D · FT9.9D · F13.5A · F15A · F20A · F25A · F30A	IX22B	IXU01-□	X20EPR-U9
	F15C · F20B · F25D · F30B · F40F · F50F · F60C · FT60D	-	-	-
	F40A/B · F45A · F50A/D · FT25B · FT50B/C	IX22B	IXU01-□	X20EPR-U9
	F40C · F60A · FT60A/B	-	-	X16EPR-U9
	F70A	-	-	-
	F75A · F80A/B · F90A/B · F95A · F100A/B/C	IKH16	IKH01-□	K16HPR-U11
	F115A · F250A · FL115A · FL250A	IKH20	IKH01-□	K20HR-U11
	F150A · F200A · F225A · FL150A · FL200A · FL225A	IKH16	IKH01-□	K16HPR-U11
	F300A · F350A · FL300A · FL350A	IKH20	IKH01-□	K20HR-U11
	K50E · L200A	IWF24	-	W24FSR-U10
	L150A	IWF24	-	W24FS-U10
	L200F/J · S200F · SL200F · L250A	IWF24	-	W24FSR-U10
	L225C/F · L250B · S250A · SL250A	IWF27	-	W27FSR-U10
	S150F · SL150F · E25B · EK25B	IWF22	-	W22FS-U10
	V-MAX 200G · 175F	IWF24	-	W24FSR-U10
	V-MAX 200H · 150G	IWF22	-	W22FSR

DENSO

AUSTRALIA

CHINA

INDIA

INDONESIA

KOREA

MALAYSIA

PHILIPPINES

SAUDI ARABIA

SINGAPORE

TAIWAN

THAILAND

VIETNAM

JAPAN

EUROPE & USA

MOTOR CYCLE

SMALL ENGINE

CROSS REFERENCE PART NUMBER



MARINE, JETSKI & SNOWMOBILE

DENSO

MODEL	ENGINE	IRIDIUM POWER	IRIDIUM RACING	DENSO
YAMAHA				
OUTBOARD				
	V-MAX 250C · 225G	IWF27	-	W27FSR-U10
	V-MAX F225G · F250F · F275A	IKH20	IKH01-□	K20HR-U11
	V-MAX Z150P(~ 01) · LZ150P(~ 01)	IK20	IK01-□	K20PR-U11
	V-MAX Z150P/Q(02 ~) · LZ150P(02 ~)	IK20	IK01-□	K20TXR
	V-MAX Z150Q(00 ~ 01)	IK20	IK01-□	K20PR-U11
	V-MAX Z150Q(02 ~ 05)/QETO · Z240B/BETO	IK20	IK01-□	K20TXR
	V-MAX Z175G(02 ~)	IK22	IK01-□	K22TNR-S
	V-MAX Z175G/H(~ 01)	IK22	IK01-□	K22PR-U11
	V-MAX Z175H(02 ~ 05)/HETO · Z200P/PETO	IK22	IK01-□	K22TNR-S
	V-MAX Z200N(99 ~ 01) · Z200P(01) · LZ200N(01)	IK22	IK01-□	K22PR-U11
	V-MAX Z200N/P(02 ~) · LZ200N(02 ~)	IK22	IK01-□	K22TNR-S
	V-MAX Z225H(03 ~)	IK22	IK01-□	K22TNR-S
	V-MAX Z250D(03 ~)/F(03 ~) · LZ250D(03 ~)	IK22	IK01-□	K22TNR-S
SNOWMOBILE				
	CS340E · ET410TR/PT · EX570E/LT/SX	IW27	IW01-□	W27ESR
	FX Nytro M-TX/R-TX/X-TX	IU27	IU01-□	U27ESR-N
	MM600 · MM700	IW27	IW01-□	W27ESR
	PHAZER/Mountain Lite	IU27A	IU01-□	-
	PHAZER R-TX/M-TX	IU27A	IU01-□	-
	PZ480E/ED/LT/ST · PZ500/ST/ML	IW27	IW01-□	W27ESR
	RS Vector ER/MTN/SE · RS Venture TF · RS Rage	IU24	IU01-□	U24ESR-N
	RS Vector(RS10R/S/ST/SUV/M/MS)(05 ~)	IU24	IU01-□	U24ESR-N
	RS Viking Professional	IU24	IU01-□	U24ESR-N
	RX Warrior(04 ~)	IU27	IU01-□	U27ESR-N
	RX-1(03 ~)	IU27	IU01-□	U27ESR-N
	RX-1/ER/Mountain	IU27	IU01-□	U27ESR-N
	RX-1 Mountain(RX10M)(06 ~)	IU27	IU01-□	U27ESR-NB
	RX-1 M-TX	IU27	IU01-□	U27ESR-NB
	S340 · ET400TR	IW24	IW01-□	W24ESR
	SE80/80E · SV125E · BR250/250L/250T	IWF24	-	W24FSR
	SRX600/600S(~ 98) · SRX700S(~ 98)	IW31	IW01-□	W31ESR-U
	SX Viper700/Mountain · SX Venom	IW27	IW01-□	W27ESR
	SX500 · SX600 · SX700	IW27	IW01-□	W27ESR
	SXV600(SXVenom)(04 ~)	IW27	IW01-□	W27ESR
	SXV700(SXViper)(02 ~)	IW27	IW01-□	W27ESR
	VENTURE Multi Purpose	IU27A	IU01-□	-
	VENTURE Multi Purpose(07-)	IU27A	IU01-□	-
	VK Professional	IU24	IU01-□	U24ESR-N
	VK540E/ED/E II /E III · VT480E · VX500DE/LT	IW27	IW01-□	W27ESR
	VT500XL(04 ~)	IW27	IW01-□	W27ESR
	VT700	IW27	IW01-□	W27ESR
	VX500SXB/XT/XZ	IW27	IW01-□	W27ESR
	VX50DE/LT · VX500SXB/XT/XZ	IW27	IW01-□	W27ESR
	VX600E/ER/LT/ST/SXB/SXS/XT/XZ	IW27	IW01-□	W27ESR
	VX600ST · SRX600S(99 ~) · VX700S(99 ~)	IW27	IW01-□	W27ESR
	VX700ST/SXB · VX750/ST/SXS	IW27	IW01-□	W27ESR

AUSTRALIA

CHINA

INDIA

INDONESIA

KOREA

MALAYSIA

PHILIPPINES

SAUDI ARABIA

SINGAPORE

TAIWAN

THAILAND

VIETNAM

JAPAN

EUROPE

CYCLE

SMALL ENGINE

CROSS REFERENCE

PART NUMBER

DENSO	9	14	16	20	22	24	27	29	31	32	34	35
NGK	2	4	5	6	7	8	9	9.5	10	10.5	11	11.5

DENSO	9	14	16	20	22	24	27	29	31	32
CHAMPION	18	16,14	12,11	10,9	8,7	6,63,61	4,59	57	55	53

DENSO	9	14	16	20	22	24	27	31
BOSCH	10	9	8	7,6	5	4	3	2

⚠ CAUTION:

In Asia Market(Except Japan), use extended type Iridium Power IK16L and IK20L instead of IK16 and IK20.

No extended type Iridium Tough is available.

Concerned cross reference and Denso Normal to Iridium Power chart are shown below.

AC (U.S.A.)	DENSO	IRIDIUM POWER	IRIDIUM TOUGH	CHAMPION (U.S.A.)	DENSO	IRIDIUM POWER	IRIDIUM TOUGH	NGK (Japan)	DENSO	IRIDIUM POWER	IRIDIUM TOUGH	MOTORCRAFT (U.S.A.)	DENSO	IRIDIUM POWER	IRIDIUM TOUGH
41-806	KJ16CR-L11	IK16L	-	RC12MCC4/MC4	KJ16CR-L11	IK16L	-	ZFR5P-G	KJ16CR-L11	IK16L	-	AGSP34C	KJ20CR11	IK20L	-
R44XLSE	KJ16CR-L11	IK16L	-	RC12PEC5	PKJ16CR-L13	IK16L	-	NHSP (China)	DENSO	IRIDIUM POWER	IRIDIUM TOUGH	NGK (Japan)	DENSO	IRIDIUM POWER	IRIDIUM TOUGH
AUTOLITE (U.S.A.)	DENSO	IRIDIUM POWER	IRIDIUM TOUGH	MOTORCRAFT (U.S.A.)	DENSO	IRIDIUM POWER	IRIDIUM TOUGH	K5RHCW	KJ16CR-L11	IK16L	-	FR5-1	KJ20CR-L11	IK20L	-
2585	KJ16CR-L11	IK16L	-	1Y0G-18-110	KJ16CR-L11	IK16L	-	TORCH (China)	DENSO	IRIDIUM POWER	IRIDIUM TOUGH	IZFR6K11	SKJ20DR-M11	IK20L	-
BERU (Germany)	DENSO	IRIDIUM POWER	IRIDIUM TOUGH	AG44	KJ16CR-L11	IK16L	-	K4RTC3	KJ16CR	IK16L	-	IZFR6K13	SKJ20DR-M13	IK20L	-
14F-7HUR2	KJ16CR-L11	IK16L	-	AG54	KJ16CR-L11	IK16L	-	UNIPARTS (U.K.)	DENSO	IRIDIUM POWER	IRIDIUM TOUGH	PZFR6E11	PKJ20CR-L11	IK20L	-
14F-8LUR	KJ16CR11	IK16L	-	NGK (Japan)	DENSO	IRIDIUM POWER	IRIDIUM TOUGH	GSP7666	KJ16CR-L11	IK16L	-	PZFR6F11	PKJ20CR-L11	IK20L	-
BOSCH (Germany)	DENSO	IRIDIUM POWER	IRIDIUM TOUGH	IZFR5F11	SKJ16CR-L11	IK16L	-	AUTOLITE (U.S.A.)	DENSO	IRIDIUM POWER	IRIDIUM TOUGH	PZFR6J11	PKJ20CR-L11	IK20L	-
4428	PKJ16CR-L11	IK16L	-	IZFR5K11	SKJ16DR-M11	IK16L	-	5224	KJ20CR11	IK20L	-	PZFR6R	PKJ20CR8	IK20L	-
F7HER02	KJ16CR-L11	IK16L	-	IZFR5L11	SKJ16CR-L11	IK16L	-	BOSCH (Germany)	DENSO	IRIDIUM POWER	IRIDIUM TOUGH	ZFR6F11 (HONDA)	KJ20CR-L11 (HONDA)	IK20L	-
F7HPP222	PKJ16CR-L11	IK16L	-	PZFR5D11	PKJ16CR-L11	IK16L	-	F7LRCR	KJ20CR11	IK20L	-	ZFR6F11 (MAZDA)	KJ20CR11 (MAZDA)	IK20L	-
F7HPP222U	PKJ16CR-L11	IK16L	-	PZFR5E11	PKJ16CR-L11	IK16L	-	FR7LC2	KJ20CR11	IK20L	-	ZFR6F11 (MITSUBISHI)	KJ20CR-L11 (MITSUBISHI)	IK20L	-
F8LCR	KJ16CR11	IK16L	-	PZFR5F	PKJ16CR8	IK16L	-	FR7LCX	KJ20CR11	IK20L	-	ZFR6FIX11	IK20	IK20L	-
F8LCR2	KJ16CR11	IK16L	-	PZFR5F11	PKJ16CR-L11	IK16L	-	CHAMPION (U.S.A.)	DENSO	IRIDIUM POWER	IRIDIUM TOUGH	ZFR6FIX11P	VK20	IK20L	-
F9LCR	KJ14CR11	IK16L	-	PZFR5F13	PKJ16CR-L13	IK16L	-	QC12PEP	SKJ20CR-A8	IK20L	-	ZFR6J11	KJ20CR-L11	IK20L	-
F9LCR2	KJ14CR-L11	IK16L	-	PZFR5J11	PKJ16CR-L11	IK16L	-	QC12PEPB	SKJ20CR-A8	IK20L	-	ZFR6K11	KJ20DR-M11	IK20L	-
FQR8LE2	KJ16CR-L11	IK16L	-	ZFR4F11 (HONDA)	KJ14CR-L11 (HONDA)	IK16L	-	QC9MC4	KJ20CR-L11	IK20L	-	ZFR6T11G	KJ20DR-M11/PK20GR8	IK20L	-
FQR8LEU2	KJ16CR-L11	IK16L	-	ZFR4F11 (MAZDA)	KJ14CR11 (MAZDA)	IK16L	-	RC8PMPA	PKJ20CR8	IK20L	-	ZFR6U11	KJ20CR-L11	IK20L	-
FR8LCX	KJ16CR11	IK16L	-	ZFR5C11G	KJ16CR-L11	IK16L	-	RC9MCC4	KJ20CR-L11	IK20L	-	SPLITFIRE (U.S.A.)	DENSO	IRIDIUM POWER	IRIDIUM TOUGH
CHAMPION (U.S.A.)	DENSO	IRIDIUM POWER	IRIDIUM TOUGH	ZFR5F	KJ16CR	IK16L	-	MOTORCRAFT (U.S.A.)	DENSO	IRIDIUM POWER	IRIDIUM TOUGH	SF522D	KJ20CR11	IK20L	-
FN14LY	KJ16CR-L11	IK16L	-	ZFR5F11 (HONDA)	KJ16CR-L11 (HONDA)	IK16L	-	1Y0H-18-110	KJ20CR-L11	IK20L	-	SF98E	KJ20CR-L11	IK20L	-
RC10PMPA	PKJ16CR8	IK16L	-	ZFR5F11 (MAZDA)	KJ16CR11 (MAZDA)	IK16L	-	AGSP33C	KJ20CR11	IK20L	-	UNIPARTS (U.K.)	DENSO	IRIDIUM POWER	IRIDIUM TOUGH
RC11LCC4	KJ16CR-L11	IK16L	-	ZFR5F11 (MITSUBISHI)	KJ16CR-L11 (MITSUBISHI)	IK16L	-					GSP6962	KJ20CR-L11	IK20L	-
RC12ECC	KJ16CR-L11	IK16L	-	ZFR5FIX11	IK16	IK16L	-					GSP7664	KJ20CR-L11	IK20L	-
RC12LC4	KJ16CR-L11	IK16L	-	ZFR5FIX11P	VK16	IK16L	-								
RC12LYC	KJ16CR-L11	IK16L	-	ZFR5J11	KJ16CR-L11	IK16L	-								
				ZFR5LP13G	-	IK16L	-								
				ZFR5N11	KJ16CR-L11	IK16L	-								

DENSO NORMAL to IRIDIUM POWER in Asia

DENSO	IRIDIUM POWER	IRIDIUM TOUGH	DENSO	IRIDIUM POWER	IRIDIUM TOUGH	DENSO	IRIDIUM POWER	IRIDIUM TOUGH
KJ14CR11	IK16L	-	KJ20CR-L11	IK20L	-	PKJ20CR-L11	IK20L	-
KJ14CR-L11	IK16L	-	KJ20DR-M11	IK20L	-	SKJ16CR-L11	IK16L	-
KJ16CR	IK16L	-	PKJ16CR8	IK16L	-	SKJ16DR-M11	IK16L	-
KJ16CR11	IK16L	-	PKJ16CR-L11	IK16L	-	SKJ20CR-A8	IK20L	-
KJ16CR-L11	IK16L	-	PKJ16CR-L13	IK16L	-	SKJ20DR-M11	IK20L	-
KJ16CR-U11	IK16L	-	PKJ20CR8	IK20L	-	SKJ20DR-M13	IK20L	-
KJ20CR11	IK20L	-	PKJ20CR-L11	IK20L	-			

DENSO

AUSTRALIA CHINA

INDIA

INDONESIA

KOREA

MALAYSIA

PHILIPPINES

SAUDI ARABIA

SINGAPORE

TAIWAN

THAILAND

VIETNAM

JAPAN

EUROPE & USA

MOTOR CYCLE

SMALL ENGINE

CROSS REFERENCE

PART NUMBER

CROSS REFERENCE ()

DENSO

AUSTRALIA

CHINA

INDIA

INDONESIA

KOREA

MALAYSIA

PHILIPPINES

SINGAPORE

TAIWAN

THAILAND

VIETNAM

JAPAN

EUROPE

USA

SMALL ENGINE

CROSS REFERENCE

PART NUMBER

NGK (Japan)	DENSO	IRIDIUM POWER	IRIDIUM TOUGH/PLUS	NGK (Japan)	DENSO	IRIDIUM POWER	IRIDIUM TOUGH/PLUS	NGK (Japan)	DENSO	IRIDIUM POWER	IRIDIUM TOUGH/PLUS	NGK (Japan)	DENSO	IRIDIUM POWER	IRIDIUM TOUGH/PLUS
A6	M17	-	-	B8ET	IRE01-27	-	-	BCPR6EP8	PQ20R8	IQ20	VQ20	BKR6E9S	K20PR-U9S	IK20G	VK20G
A6FS	MA20PR-U	-	-	B8EV	-	IW24	-	BCPR6EP-N11	PQ20R-P11	IQ20	VQ20	BKR6E-E	K20PR-UR	IK20	VK20
A7	M22	-	-	B8EVX	-	IW24	-	BCPR6EP-N8	PQ20R-P8	IQ20	VQ20	BKR6EGP	IK20	IK20	VK20
AB2	-	-	-	B8HCS	W24FS-U	IWF24	-	BCPR6ES	Q20PR-U	IQ20	VQ20	BKR6E-H	-	-	-
AB6	MW17	-	-	B8HS	W24FS-U	IWF24	-	BCPR6ES11	Q20PR-U11	IQ20	VQ20	BKR6EIX	IK20	IK20	VK20
AB7	-	-	-	B8HS10	W24FS-U10	IWF24	-	BCPR6ET	K20PBR	IK20	VK20	BKR6EIX(LPG)	VK20T	-	VK20T
AP4FS	MA9P-U	-	-	B8HV	IWF24	IWF24	-	BCPR6EV	-	IQ20	VQ20	BKR6EIX11	IK20	IK20	VK20
AP5FS	MA16PR-U	-	-	B8HVX	IWF24	IWF24	-	BCPR6EV11	-	IQ20	VQ20	BKR6EIX11P	VK20	IK20	VK20
AP6FS	MA20P-U	-	-	B8S	W24S-U	-	-	BCPR6EVX	-	IQ20	VQ20	BKR6EIX5(LPG)	SK20R5	-	-
AP9FS	-	-	-	B95EGP	IW01-29	-	-	BCPR6EVX11	-	IQ20	VQ20	BKR6EIXP	VK20Y	-	VK20Y
APR5FS	MA16PR-U	-	-	B95EGV	IW29	-	-	BCPR6EY	Q20R-U	IQ20	VQ20	BKR6EK	K20TXR	IK20	VK20
APR6FS	MA20PR-U	-	-	B9ECS	-	IW27	-	BCPR6EY11	Q20R-U11	IQ20	VQ20	BKR6EK11	K20TR11	IK20	VK20
AR6FS	MA20PR-U	-	-	B9EFS	-	IT27	-	BCPR6EY-N11	Q20PR-U11	IQ20	VQ20	BKR6EKC	K20TNR	IK20	VK20
AR6FS11	MA20PR-U	-	-	B9EG	W27ES-V	IW27	-	BCPR6EY-N11	Q20R-U11	IQ20	VQ20	BKR6EKC-N11	K20TNR	IK20	VK20
B105EGP	IW01-32	-	-	B9EGV	IW27	IW27	-	BCPR7E	Q22PR-U	IQ22	VQ22	BKR6EKE	K20TXR	IK20	VK20
B10ECS	W31ES-U	IW31	-	B9EM	IRE01-27	-	-	BCPR7E11	Q22PR-U11	IQ22	VQ22	BKR6EKPA	PK20TR11	IK20	VK20
B10EG	IW31	IW31	-	B9ES	W27ES-U	IW27	-	BCPR7EDIX	-	-	-	BKR6EKPA	SK20PR-A8	-	VK20Y
B10EGP	IW01-31	-	-	B9EV	-	IW27	-	BCPR7EKD	QL22TR-S	-	-	BKR6EKP11	PK20TR11	IK20	VK20
B10EGP	IW06-31	-	-	B9EVX	-	IW27	-	BCPR7ES	Q22PR-U	IQ22	VQ22	BKR6EKU	K20TXR	IK20	VK20
B10EGV	IW31	IW31	-	B9HCS	IWF27	IWF27	-	BCPR7ES11	Q22PR-U11	IQ22	VQ22	BKR6EKUB	K20TXR	IK20	VK20
B10ES	W31ES-U	IW31	-	B9HS	W27FS-U	IWF27	-	BCPR7ET	K22PBR-S	IK22	VK22	BKR6EKUC	-	-	VKA20
B10EV	-	IW31	-	B9HS10	W27FS-U10	IWF27	-	BCPR7EV	-	IQ22	VQ22	BKR6EKUD	-	-	VKA20
B10EVX	-	IW31	-	B9HV	-	IWF27	-	BCPR7EV11	-	IQ22	VQ22	BKR6EKUE	K20TXR	IK20	VK20
B10HS	W31FS	-	-	B9HVX	-	IWF27	-	BCPR7EVX	-	IQ22	VQ22	BKR6EN	K20PR-U	IK20	VK20
B10HVX	W31FS	-	-	B9S	W27S-U	-	-	BCPR7EVX11	-	IQ22	VQ22	BKR6EN11	K20PR-L11	IK20	VK20
B11EG	IW34	-	-	BCP4ES	Q14R-U11	IQ16	VQ16	BCPR7EY	Q22PR-U	IQ22	VQ22	BKR6EP11	PK20R11	IK20	VK20
B11EGP	IW01-34	-	-	BCP4ES11	Q14R-U11	IQ16	VQ16	BCPR7EY-11	Q22PR-U11	IQ22	VQ22	BKR6EP13	PK20R13	IK20	VK20
B11EGP	IW06-34	-	-	BCP5E	Q16P-U11	IQ16	VQ16	BCPR7EY-N11	Q22PR-U11	IQ22	VQ22	BKR6EP8	PK20R8	IK20	VK20
B11EGV	IW34	IW34	-	BCP5E11	Q16P-U11	IQ16	VQ16	BCPR8EVX11	-	IQ24	-	BKR6EP8(For LPG)	VK20T	-	VK20T
B2	W9-U	-	-	BCP5E5	Q16-U	IQ16	VQ16	BCR8ES	-	IQ24	-	BKR6EPA8	PK20GR8	-	VKA20
B2LM	W9LM-US	-	-	BCP5ES11	Q16-U11	IQ16	VQ16	BCRE527Y	QJ16AR-U	-	-	BKR6EP-N8	PK20R-P8	IK20	VK20
B2LMY	W9LM-US	-	-	BCP5ET	K20PBR	IK20	VK20	BCRE527Y11	QJ16AR-U11	-	-	BKR6EQU	K20TXR	IK20	VK20
B4	W14-U	-	-	BCP5EV	-	IQ16	VQ16	BE527Y11	J16A-U11	-	-	BKR6EQUA	K20TXR	IK20	VK20
B4-10	W14-U	-	-	BCP5EV11	-	IQ16	VQ16	BE529Y11	J16B-U11	-	-	BKR6EQUB	K20TXR	IK20	VK20
B4ES	W14E	-	-	BCP5EVX	-	IQ16	VQ16	BK5E	K16P-U	IK16	VK16	BKR6EQUP	K20TXR	IK20	VK20
B4H	W14F-U	-	-	BCP5EVX11	-	IQ16	VQ16	BK5E11	K16P-U11	IK16	VK16	BKR6EQUA	K20TXR	IK20	VK20
B4H-10	W14F-U	-	-	BCP5EY11	Q16-U11	IQ16	VQ16	BK6E	K20P-U	IK20	VK20	BKR6ERX-11P	VFK20F	IK20	VK20
B4HS	W14F-U	-	-	BCP6E	Q20P-U	IQ20	VQ20	BK6E11	K20PR-U11	IK20	VK20	BKR6ERX-P	VFK20F	IK20	VK20Y
B4L	W14L	-	-	BCP6E11	Q20P-U11	IQ20	VQ20	BK7E11	K22PR-U11	IK22	VK22	BKR6ERX-PS	VFK20F	IK20G	VK20G
B4LM	W14LM-U	-	-	BCP6ES	Q20-U	IQ20	VQ20	BK7EK-N11	K22TM11	IK22	VK22	BKR6ES	K20PR-U	IK20	VK20
B4LMY	W14LM-U	-	-	BCP6ES11	Q20-U11	IQ20	VQ20	BKR4EIX	IK16	IK16	VK16	BKR6ES11	K20PR-U11	IK20	VK20
B5EB	W16ES-U	-	-	BCP6ET	K20PBR	IK20	VK20	BKR4ESA11	-	IK16	VK16	BKR6ES2-10	K20PR-U11	IK20	VK20
B5EB11	W16EKR-S11	IW16	VW16	BCP6EV	-	IQ20	VQ20	BKR5E	K16PR-U	IK16	VK16	BKR6ETA10	K20PBR	IK20	VK20
B5ES	W16ES-U	-	-	BCP6EV11	-	IQ20	VQ20	BKR5E11	K16PR-U11	IK16	VK16	BKR6ETP	-	-	-
B5HS	W16FS-U	-	-	BCP6EVX	-	IQ20	VQ20	BKR5E11(For LPG)	K16PR-U11	-	VK20T	BKR6ETUB	K20PBR-S10	-	VKB20
B5S	W16S-U	-	-	BCP6EVX11	-	IQ20	VQ20	BKR5E-E	K16PR-UR	IK16	VK16	BKR6ETUC	K20PBR-S10	-	VKB20
B6EB	W20EKR-S11	IW20	VW20	BCP6EY11	Q20-U11	IQ20	VQ20	BKR5EGP	IK16	IK16	VK16	BKR6EVX11	-	IK20	VK20
B6EB11	W20EKR-S11	IW20	VW20	BCP7E	Q22P-U	IQ22	VQ22	BKR5EIX	IK16	IK16	VK16	BKR6EVA11	-	IK20	VK20
B6EB-L11	W20EKR-S11	IW20	VW20	BCP7E11	Q22PR-U11	IQ22	VQ22	BKR5EIX11	IK16	IK16	VK16	BKR6EY	K20R-U	IK20	VK20
B6EFS	T20EP-U	IT20	VT20	BCP7ES	Q22P-U	IQ22	VQ22	BKR5EIX11P	VK16	IK16	VK16	BKR6EY11	K20R-U11	IK20	VK20
B6EM	W20EAR	-	-	BCP7ES11	Q22PR-U11	IQ22	VQ22	BKR5EIXP	VK16	IK16	VK16	BKR6EYA	K20R-U	IK20	VK20
B6ES	W20ES-U	-	-	BCP7ET	K22PB	IK22	VK22	BKR5EK	K20TXR	IK20	VK20	BKR6EYA11	K20R-U11	IK20	VK20
B6ES-11	W20ES-U	-	-	BCP7EV	-	IQ22	VQ22	BKR5EKB11	K16TR11	IK16	VK16	BKR6EZ	K20PR-U	IK20	VK20
B6HS	W20FS-U	-	-	BCP7EV11	-	IQ22	VQ22	BKR5EKC	K16TNR-S9	IK16	VK16	BKR6EZB	K20PR-U	IK20	VK20
B6HS10	W20FS-U	-	-	BCP7EVX	-	IQ22	VQ22	BKR5EKP11	PK16TR11	IK16	VK16	BKR7E	K22PR-U	IK22	VK22
B6HSA	W20FS-U	-	-	BCP7EVX11	-	IQ22	VQ22	BKR5EKP13	PK16TR13	IK16	VK16	BKR7E11	K22PR-U11	IK22	VK22
B6L	W16LS	-	-	BCP8EVX11	-	IQ24	-	BKR5EKU	K20TXR	IK20	VK20	BKR7E-E	K22PR-UR	IK22	VK22
B6LY	W16LS	-	-	BCPR4ES11	Q14R-U11	IQ16	VQ16	BKR5EKUC	-	-	VKA16	BKR7EIX	IK22	IK22	VK22
B6S	W20S-U	-	-	BCPR4EY11	Q14R-U11	IQ16	VQ16	BKR5EKUD	-	-	VKA16	BKR7EIX11	IK22	IK22	VK22
B6Y	W20S-U	-	-	BCPR5E	Q16PR-U	IQ16	VQ16	BKR5EKUP	K20TXR	IK20	VK20	BKR7EIX11PS	VK22G	IK22G	VK22G
B77HC	W24FS-U	IWF24	-	BCPR5E11	Q16PR-U11	IQ16	VQ16	BKR5EN	K16PR-U	IK16	VK16	BKR7EIXP	VK22	IK22	VK22
B7EB	W22EKR-S11	IW22	VW22	BCPR5EIX11	IQ16	IQ16	VQ16	BKR5EN11	K16PR-L11	IK16	VK16	BKR7EKC	K22TNR-S	IK22	VK22
B7EB11	W22EKR-S11	IW22	VW22	BCPR5EIX11P	VQ16	IQ16	VQ16	BKR5EP11	PK16R11	IK16	VK16	BKR7EKC-N	K22TMR11	IK22	VK22
B7ECS	W22ES-U	-	-	BCPR5EP11	PQ16R	IQ16	VQ16	BKR5EP8	PK16R8	IK16	VK16	BKR7EK-N11	K22TMR11	IK22	VK22
B7EM	W22EBR	-	-	BCPR5EP13	PQ16R13	IQ16	VQ16	BKR5EQUA	-	IK16	VK16	BKR7EQU	K22TNR-S	IK22	VK22
B7ES	W22ES-U	-	-	BCPR5EP8	PQ16R8	IQ16	VQ16	BKR5ERX-11P	VFK16	IK16	VK16	BKR7EQU	K22PR-L11	IK22	VK22
B7ES11	W22ES-U	-	-	BCPR5EP11	PQ16R-P11	IQ16	VQ16	BKR5ERX-P	VFK16	IK16	VK16	BKR7EQU	-	-	-
B7ET	W22EBR	-	-	BCPR5ES	Q16PR-U	IQ16	VQ16	BKR5ES	K16PR-U	IK16	VK16	BKR7ES11	K22PR-U11	IK22	VK22
B7EV	W22ES-U	-	-	BCPR5ES11	Q16PR-U11	IQ16	VQ16	BKR5ES-11	K16PR-U11	IK16	VK16	BKR7EVX	-	IK22	VK22
B7EVX	W22ES-U	-	-	BCPR5ET	K20PBR	IK20	VK20	BKR5ESA-11	K16PR-U11	IK16	VK16	BKR7EVX11	-	IK22	VK22
B7HCS	W22FS-U	IWF22	-	BCPR5EV	-	IQ16	VQ16	BKR5ETUA	-	-	VKA16	BKR7EY	K22PR-U	IK22	VK22
B7HS	W22FS-U	IWF22	-	BCPR5EV11	-	IQ16	VQ16	BKR5EVX	-	IK16	VK16	BKR8E11	K24PR-U11	IK24	-
B7HS10	W22FS-U10	IWF22	-	BCPR5EVX	-	IQ16	VQ16	BKR5EVX11	-	IK16	VK16	BKR8EIX	IK24	IK24	-
B7HV	-	IWF22	-	BCPR5EVX11	-	IQ16	VQ16	BKR5EVXA	-	IK16	VK16	BKR9EIX	IK27	IK27	-
B7HVX	-	IWF22	-	BCPR5EY	Q16R-U	IQ16	VQ16	BKR5EVA11	-	IK16	VK16	BKR9EIX	IK27	IK27	-
B7S	W22S-U	-	-	BCPR5EY11	Q16R-U11	IQ16	VQ16	BKR5EVA13	-	IK16	VK16	BKR9EIX	IK27	IK27	-
B85EGP	IW01-24	-	-	BCPR5EY-N11	Q16PR-U11	IQ16	VQ16	BKR5EY	K16R-U	IK16	VK16	BKR9EIX	IK27	IK27	-
B85EGV	IW27	IW27	-	BCPR5EY-N11	Q16R-U11	IQ16	VQ16	BKR5EY11	K16R-U11	IK16	VK16	BKR9EIX	IK27	IK27	-
B8ECS	W24ES-U	IW24	-	BCPR6E	Q20PR-U	IQ20	VQ20	BKR5EYA	K16R-U	IK16	VK16	BKR9EIX	IK27	IK27	-
B8EFS	-	IT24	-	BCPR6E11	Q20PR-U11	IQ20	VQ20	BKR5EYA(For LPG)	VK20T	-	VK20T	BKR9EIX	IK27	IK27	-
B8EG	W24ES-V	IW24	-	BCPR6ED	QL20PR-U	-	-	BKR5EYA11	K16R-U11	IK16	VK16	BKR9EIX	IK27	IK27	-
B8EGP	IW01-24	IW24	-	BCPR6EIX11	IQ20	IQ20	VQ20	BKR5EZ	K16PR-U	IK16	VK16				

CROSS REFERENCE (→)

NGK (Japan)	DENSO	IRIDIUM POWER	IRIDIUM TOUGH/PLUS	NGK (Japan)	DENSO	IRIDIUM POWER	IRIDIUM TOUGH/PLUS	NGK (Japan)	DENSO	IRIDIUM POWER	IRIDIUM TOUGH/PLUS	NGK (Japan)	DENSO	IRIDIUM POWER	IRIDIUM TOUGH/PLUS
GR5	W16EXR-U	IW16	VW16	ILKAR7C10	-	-	-	ITR6F13	VT20	IT20	VT20	LMAR8A9	-	-	-
GR5A10	IW16	IW16	VW16	ILKAR7D6G	-	-	-	I2FR5B	-	-	VKB16	LMAR9E-J	-	-	-
GR5IX	IW16	IW16	VW16	ILKAR7F8	FC20HPR8	-	VFXEH22	I2FR5C	-	-	VKA16	LPG1	-	-	VK20
HAMP-FR5C11G	HAMP-IK16F	IK16	VK16	ILKAR7D8	SXU22HPR8	IXUH22I	VXUH22I	I2FR5F11	SKJ16CR-L11	IK16	VK16	LPG1	-	-	VK20T
HAMP-FR6C11G	HAMP-IK20F	IK20	VK20	ILKAR7F7G	-	-	-	I2FR5G	-	-	-	LPG2	-	-	VW20
HAMP-FR6D11G	HAMP-IQ20F	IQ20	VQ20	ILKAR7G9	-	-	-	I2FR5J	-	-	-	LPG2	-	-	VW20T
HAMP-ZFR5F11G	HAMP-IK16FJ	IK16	VK16	ILKAR7G7	-	-	-	I2FR5K11	SKJ16DR-M11	IK16	VK16	LPG3	-	-	VQ20
HAMP-ZFR6F11G	HAMP-IK20FJ	IK20	VK20	ILKAR7K8	-	IXUH22	VXUH22	I2FR5L11	SKJ16CR-L11	IK16	VK16	LPG4	-	-	ITV16
HAMP-ZFR6K11G	HAMP-IK20F	IK20	VK20	ILKAR7K11S	-	-	SXE22HQR11S	I2FR6B	-	-	VKB20	LPG5	-	-	VT20
HB6AIX11P	VKA20	-	VKA20	ILKAR7L11	ZC20HPR11	-	VCH20	I2FR6D11	-	-	-	LPG6	-	-	VK20
HB6BIX11P	VKB20	-	VKB20	ILKAR8H6	-	-	-	I2FR6F11	VKJ20RZ-M11	IK20	VK20	LPG7	-	-	VKH20
IFR5A11	SK16R11	IK16	VK16	ILKR6F11	SXU20HPR11	IXUH20I	VXUH20I	I2FR6H11	VK20	IK20	VK20	LR4CE	U14FSR-UB	IUF14-UB	-
IFR5A-8M(For LPG)	SK16R-P8	-	VK20T	ILKR7A11T	ZXU22HBR11 ^(60/16)	-	-	I2FR6J	-	-	-	LR8A	U24FSR-U	IUF24	-
IFR5D10	VK16	IK16	VK16	ILKR7B8	SXU22HDR8	IXUH22	VXUH22	I2FR6K11	SKJ20DR-M11	IK20	VK20	LR8B	-	-	IUF24
IFR5E11	SK16PR-A11	IK16	VK16	ILKR7C9	SXU22HR9	IXUH22I	VXUH22I	I2FR6K11NS	SKJ20DR-M11S	IK20G	VK20G	LTR5ARX-13P	-	-	ITV16
IFR5G11	SK16PR-L11	IK16	VK16	ILKR7D9	SXU22HPR9	IXUH22I	VXUH22I	I2FR6K11S	SKJ20DR-M11S	IK20G	VK20G	LTR5BI-13	-	-	ITV16
IFR5G11K	SK16PR-L11	IK16	VK16	ILKR7D8	SXU22HPR8	IXUH22I	VXUH22I	I2FR6K13	SKJ20DR-M13	IK20	VK20	LTR5IX11	ITV16	-	ITV16
IFR5J11	VK16	IK16	VK16	ILKR7D11	SXU22HPR11	IXUH22I	VXUH22I	I2FR6P7	-	-	-	LTR6A-10	-	-	ITV20
IFR5L11	VK16PRZ11	IK16	VK16	ILKR7F11	SXU22HPR11	IXUH22I	VXUH22I	I2FR7E-D	-	-	-	LTR6AI-9	-	-	ITV20
IFR5N	VK16	IK16	VK16	ILKR7E6	-	IXUH22	VXUH22	I2FR7M	-	-	-	LTR6AP11	-	-	ITV20
IFR5N10	VK16	IK16	VK16	ILKR7E6	-	IXUH22	VXUH22	I2KR6B10E	-	-	-	LTR6ARX-13P	-	-	ITV20
IFR6A11	SK20R11	IK20	VK20	ILKR7J8	ZXU22HPR8	IXUH22	VXUH22	I2KR7A	-	-	-	LTR6B-10T	-	-	ITV20
IFR6B	SVK20RZ8	-	VK20Y	ILKR7K8	SXU22HDR8	IXUH22	VXUH22	I2KR7B	-	-	-	LTR6BI-9	-	-	ITV20
IFR6B-K	SVK20RZ8	-	VK20Y	ILKR8E6	-	-	-	J10A	X31ETR	-	-	LTR6BI-13	-	-	ITV20
IFR6C	SK20PR-L9	IK20	VK20	ILKR9G8	-	-	-	J10B	X31ETR	-	-	LTR6BP13	-	-	ITV20
IFR6CS	SK20PR-L9S	IK20G	VK20G	ILMAR7A8	-	-	VSUEH22	J9A	X27ETR	IX27	-	LTR6DI-8	-	-	ITV20
IFR6D10	VK20	IK20	VK20	ILTR5A13G	-	-	-	J9B	X27ETR	IX27	-	LTR6IX11	-	-	ITV20
IFR6E11	VK20	IK20	VK20	ILTR5B11	-	-	-	JR10B	X31ETR	-	-	LTR7IX11	-	-	ITV22
IFR6G11K	SK20PR-L11	IK20	VK20	ILTR5C11	-	-	-	JR8B	-	IX24	-	LZFR5AQP	-	-	-
IFR6J	SVK20RZ8	-	VK20Y	ILTR5D	-	-	-	JR8C	-	IX24	-	LZFR5C11	K16HPR-U11	IKH16	VKH16
IFR6J11	SVK20RZ11	IK20	VK20	ILTR5E11	-	-	-	JR9A	X27ETR	IX27	-	LZFR5C11G	K16HPR-U11	IKH16	VKH16
IFR6L11	VK20PRZ11	IK20	VK20	ILTR6A13G	-	-	-	JR9B	X27ETR	IX27	-	LZFR6AI	IKH20	IKH20	VKH20
IFR6Q-G	VK20Y	-	VK20Y	ILTR6A8G	-	-	-	JR9C	X27ETR	IX27	-	LZFR6AP11G	-	-	-
IFR6Q-S	VK20G	IK20G	VK20G	ILTR6B11	-	-	-	KR6A10	XU20EPR-U	IXU22	VXU22	LZFR6AQP	-	-	-
IFR6S	SK20PR-A8	-	VK20Y	ILTR6E11	-	-	-	KR7AI	I XU22	IXU22	VXU22	LZFR6AT-S	-	-	-
IFR6T11	SK20R11	IK20	VK20	ILTR6G8G	-	-	-	KR8AI	I XU24	IXU24	VXU24	LZFR6B10E	-	-	IKH20
IFR6W-7G	VK20Y	-	VK20Y	ILTR6H8G	-	-	-	KR8BI	I XU24	IXU24	VXU24	LZKAR6A11	FXE20HR11	-	VFXEH20
IFR6Z-7G	VK20Y	-	VK20Y	ILZFR5B	VKH16	IKH16	VKH16	KR8DI	-	-	-	LZKAR7A	XE20HR-U9	-	VFXEH22
IFR7F-6D	-	IK22	VK22	ILZFR6A11	VKH20	IKH20	VKH20	KR9CI	I XU27	IXU27	-	LZKR6AI-10G	-	IXUH20I	VXUH20I
IFR7F-8D	VK22	IK22	VK22	ILZFR6B	VKH20Y	-	VKH20Y	L4265S(Use I2FR7E-D)	-	-	-	LZKR6B10E	-	IXUH20I	VXUH20I
IFR7F-8J	VK22	IK22	VK22	ILZFR6C11K	VKH20	IKH20	VKH20	L4265T(Use I2FR7E-D)	-	-	-	LZKR6B-E	-	IXUH20I	VXUH20I
IFR7F-D	VK22	IK22	VK22	ILZFR6CK	VKH20Y	-	VKH20Y	LFR5A11	K16HPR-U11	IKH16	VKH16	LZTR4A11	-	ITL16	-
IFR7F-4D	-	-	-	ILZFR6D11	-	-	-	LFR5AIX11	IKH16	IKH16	VKH16	LZTR4AGP	-	ITL16	-
IFR7G11K	SK22PR-M11	IK22	VK22	ILZKR6F11	-	-	-	LFR5AIX11P	VKH16	IKH16	VKH16	LZTR4AIX13	ITL16	ITL16	-
IFR7G11KS	SK22PR-M11S	IK22G	VK22G	ILZKR6F11	-	-	-	LFR5AP11	IKH16	IKH16	VKH16	LZTR5A13	-	ITL20	-
IFR7L11	VK22PRZ11	IK22	VK22	ILZKR6A11P	-	-	-	LFR5AQP	IKH16	IKH16	VKH16	LZTR5AAGP	-	ITL20	-
IFR7N10	VK22	IK22	VK22	ILZKAR7A	-	-	-	LFR5ARX-11P	VFKH16	IKH16	VKH16	LZTR5AIX13	ITL20	ITL20	-
IFR7U	VK22	IK22	VK22	ILZKAR7A10	FXE22HR11	-	VFXEH22	LFR5B	K16HPR-U11	IKH16	VKH16	LZTR6AIX13	ITL20	ITL20	-
IFR7X-7G	VK22	IK22	VK22	ILZKAR7AP11	-	-	-	LFR5BP11	IKH16	IKH16	VKH16	LZTR6AP11EG	-	-	-
IFR8H11	VK24PRZ11	IK24	-	ILZKAR7B11	-	-	-	LFR5P11	IKH16	IKH16	VKH16	LZTR7AIX13	-	-	-
IFR8L11	VK24PRZ11	IK24	-	ILZKAR7B11GS	-	-	-	LFR6A11	K20HR-U11	IKH20	VKH20	MAR8B-JDS	-	-	-
IFR9H11	VK27PRZ11	IK27	-	ILZKAR7E11S	-	-	-	LFR6AIX11	IKH20	IKH20	VKH20	MAR9A-J	-	-	-
IFR9L11	VK27PRZ11	IK27	-	ILZKAR8F8S	SXE24HCR8S	-	VXEHC24G	LFR6AIX11P	VKH20	IKH20	VKH20	MAR9B-JDS	-	-	-
IGR5B10-D	VW16	IW16	VW16	ILZKAR8J8Y	-	-	VXEHC24G	LFR6AIX-LPG	VKH20T	-	VKH20T	MAR10A-J	-	-	-
IGR6A11	VW20	IW20	VW20	ILZKAR8H8S	-	-	VXEHC24G	LFR6AIXP	VKH20Y	IKH20	VKH20Y	ME8	-	-	-
IGR6B10-D(For LPG)	VW20T	-	VW20T	ILZKBR7A8G(BI HEXO)	-	-	-	LFR6AP11	IKH20	IKH20	VKH20	MR8C-9N	-	IU24D	-
IGR7A	VW22	IW22	VW22	ILZKBR8C7G(BI HEXO)	-	-	-	LFR6AP9	IKH20	IKH20	VKH20	N6245E-10S	-	-	-
IGR7A-G	VW22	IW22	VW22	ILZKR6F11	-	-	-	LFR6AQP	IKH20	IKH20	VKH20	PFR4G11	-	-	-
IGR7B10-D	VW22	IW22	VW22	ILZKR7A	-	-	-	LFR6ARX-11P	VFKH20	IKH20	VKH20	PFR5A11	PQ16R	IQ16	VQ16
IJR7A9	VX22BC	IX22B	-	ILZKR7B8S	SXU22HCR8S	-	VXUHC22G	LFR6B	-	-	VKH20Y	PFR5B	PK16R8	IK16	VK16
IJR8B9	-	IX24B	-	ILZKR7B11	SXU22HCR11	-	VXUHC22G	LFR6BP11	IKH20	IKH20	VKH20	PFR5B11	PK16PR(-L)11	IK16	VK16
IKER7A8EGS	-	-	-	ILZKR7B11S	SXU22HCR11S	-	VXUHC22G	LFR6C11	K20HR-U11	IKH20	VKH20	PFR5B11B	PK16R11	IK16	VK16
IKR6G11	ZXU20PR11	-	VXU20	ILZKR7B11GS	-	-	VXUHC22G	LFR6D	-	-	VKH20Y	PFR5B11C	PK16R11	IK16	VK16
IKR7A	VXU22	IXU22	VXU22	ILZKR8A	-	-	-	LFR7AIXP	VKH22	IKH22	VKH22	PFR5B9	PK16R8	IK16	VK16
IKR7B	VXU22	IXU22	VXU22	ILZNR8A7G	-	-	-	LKA6AIX13P	ZXE20HR13	-	VFXEH20	PFR5B-D(For LPG)	PK16R8	-	VK20T
IKR7C	SXU22PR9	IXU22	VXU22	ILZTR6A8G	-	-	-	LKAR7ARX-11P	VFXEH22	-	-	PFR5C11	PK16R11	IK16	VK16
IKR7D	SXU22PR9	IXU22I	VXU22I	IMR8B9H	VNH24Z	-	-	LKAR8A9	-	-	-	PFR5F11	PK16R	IQ16	VQ16
IKR7E9	VXU22	IXU22	VXU22	IMR8C9H	VUH24D	IUH24	-	LKAR8AI9	-	-	-	PFR5G11	PK16PR(-L)11	IK16	VK16
IKR9F8	-	IXU27	-	IMR8C-9HES	-	-	-	LKAR8BI9	-	-	-	PFR5G11-E	PK16PR(-L)11	IK16	VK16
IKR9J8	-	IXU27	-	IMR9A9H	IUH27D	IUH27	-	LKR6ARX-P	-	IXUH20I	VXUH20I	PFR5G13-E	PK16PR-L11	IK16	VK16
ILFR5B11	SK16HR11	IKH16	VKH16	IMR9B9H	VNH27Z	-	-	LKR6C	XU20HR9	IXUH20I	VXUH20I	PFR5J11	PK16PR-P11	IK16	VK16
ILFR5C11	SK16HR11	IKH16	VKH16	IMR9C9H	VUH27D	IUH27	-	LKR6D10E	XU20HR9	IXUH20I	VXUH20I	PFR5K11	PQ16R	IQ16	VQ16
ILFR6A	VKH20	IKH20	VKH20	IMR9C9HE	VUH27D	IUH27	-	LKR7AI	-	IXUH22	VXUH22	PFR5L11	PK16PR(-L)11	IK16	VK16
ILFR6B	VKH20	IKH20	VKH20	IMR9C9HES	VUH27ES	-	-	LKR7AIX	IXUH22I	IXUH22I	VXUH22I	PFR5L13	VK16	IK16	VK16
ILFR6B	VKH20Y	-	VKH20Y	IMR9D9H	-	-	-	LKR7AIXP	VXUH22I	IXUH22I	VXUH22I	PFR5N11	PK16PR(-L)11	IK16	VK16
ILFR6C	VKH20	IKH20	VKH20	IRIMAC8	IXU24	IXU24	VXU24	LKR7ARX-P	-	IXUH22I	VXUH22I	PFR5P	PK16R8	IK16	VK16
ILFR6C11	SK20HR11	IKH20	VKH20	IRIMAC9	IXU27	IXU27	-	LKR7B	XU22HDR9	IXUH22	VXUH22	PFR5P11	PK16PR(-L)11	IK16	VK16
ILFR6D11	FK20HR11	-	VFKH20	IRITOP 7	IQ22	IQ22	VQ22	LKR7B9	XU22HDR9	IXUH22	VXUH22	PFR5R11	PK16PR(-L)11	IK16	VK16
ILFR6G	VKH20	IKH20	VKH20	IRITOP 8	IQ24	IQ24	-	LKR7B18	IXU22HPR	IXUH22	VXUH22	PFR6A11	PQ20R	IQ20	VQ20
ILFR6J11K	SK20HPR-L11	IKH20	VKH20	IRITOP 9	IQ27	IQ27	-	LKR7B1XP	VXUH22	IXUH22	VXUH22	PFR6B	PK20PR-P8	IK20	VK20
ILFR6T11	SK20HR11	IKH20	VKH20	IRIWAY 7	IK22	IK22	VK22	LKR7C	XU22HR9	IXUH22I	VXUH22I	PFR6B11	PK20PR11	IK20	VK20
ILFR7F-D	VKH22	IKH22	VKH22	IRIWAY 8	IK24	IK24	-	LKR8A	-	-	-	PFR6B11B	PK20R11	IK20	VK20
ILFR7H	VKH22	IKH22	VKH22	IRIWAY 9	IK27	IK27	-	LKR8AP	-	-	-	PFR6B9	PK20PR-P8	IK20	VK20
ILKAR6C10	VFXEH20	-	VFXEH20	ITR4A15	VT16	IT16	VT16	LMAR6A9	-	-	-	PFR6B-D(For LPG)	PK20R8	-	VK20T
ILKAR6F11	SXU20HPR11	IXUH20I	VXUH20I	ITR5F13	VT16	IT16	VT16	LMAR7A9	-	-	-	PFR6C11	PK20R11	IK20	VK20
ILKAR7B11	SC20HR11	-	VCH20	ITR5H13	VT16	IT16	VT16	LMAR7C18	-	-	VSUEH22	PFR6E	PK20PR-P8	IK20	VK20

DENSO
 AUSTRALIA CHINA INDIA INDONESIA KOREA MALAYSIA PHILIPPINES SAUDIARABIA SINGAPORE TAIWAN THAILAND VIETNAM JAPAN & USA EUROPE MOTOR CYCLE SMALL ENGINE PART CROSS REFERENCE NUMBER

CROSS REFERENCE (⇒)

DENSO

AUSTRALIA

CHINA

INDIA

INDONESIA

KOREA

MALAYSIA

PHILIPPINES

SAUDI ARABIA

SINGAPORE

PART NUMBER	CROSS REFERENCE ENGINE		SMALL MOTOR CYCLE		EUROPE & USA		JAPAN		VIETNAM		THAILAND		TAIWAN		SINGAPORE		SAUDI ARABIA		PHILIPPINES		MALAYSIA		KOREA		INDONESIA		INDIA		CHINA		AUSTRALIA		
	NGK (Japan)	DENSO	IRIDIUM POWER	IRIDIUM TOUGH/PLUS	NGK (Japan)	DENSO	IRIDIUM POWER	IRIDIUM TOUGH/PLUS	NGK (Japan)	DENSO	IRIDIUM POWER	IRIDIUM TOUGH/PLUS	NGK (Japan)	DENSO	IRIDIUM POWER	IRIDIUM TOUGH/PLUS	NGK (Japan)	DENSO	IRIDIUM POWER	IRIDIUM TOUGH/PLUS	NGK (Japan)	DENSO	IRIDIUM POWER	IRIDIUM TOUGH/PLUS	NGK (Japan)	DENSO	IRIDIUM POWER	IRIDIUM TOUGH/PLUS	NGK (Japan)	DENSO	IRIDIUM POWER	IRIDIUM TOUGH/PLUS	
PFR6E10	PK20PR-L11	IK20	VK20	PTR4B15	PT16EPR-L13	IT16	VT16	R2558A-10	-	-	-	R5724-8	IT24	IT24	-	-	-	-	-	R5724-9	IT27	IT27	-	-	-	-	-	-	-	-	-		
PFR6G	PK20PR-P8	-	VK20Y	PTR4G15	PT16EPR-L13	IT16	VT16	(M12x26.5x14)	-	-	-	R5830-10	IQ01-31	-	-	-	-	-	-	R5830-10	-	-	-	-	-	-	-	-	-	-	-		
PFR6G11	PK20PR-L11	IK20	VK20	PTR5A10	PT16VR10	ITV16	-	R2558A-8	-	-	-	R5883-10	-	-	-	-	-	-	-	R5883-10	-	-	-	-	-	-	-	-	-	-	-		
PFR6G11-E	PK20PR-L11	IK20	VK20	PTR5A13	PT16VR13	ITV16	-	(M12x26.5x14)	-	-	-	R5883-11	-	-	-	-	-	-	-	R5883-11	-	-	-	-	-	-	-	-	-	-	-		
PFR6G11-E	PK20PR-L11	IK20	VK20	PTR5C13	PT16EPR-L13	IT16	VT16	R2558A-9	-	-	-	R5883-9	-	-	-	-	-	-	-	R5883-9	-	-	-	-	-	-	-	-	-	-	-		
PFR6G11-E	PK20PR-L11	IK20	VK20	PTR6D13G	VT20	IT20	VT20	(M12x26.5x14)	-	-	-	R6021E-10	IW31	IW31	-	-	-	-	-	R6021E-10	IW31	IW31	-	-	-	-	-	-	-	-	-		
PFR6G13	PK20PR-L13	IK20	VK20	PTR6E13	VT20	IT20	VT20	R4118S-10	IW31	IW31	-	R6021E-105	IW01-32	-	-	-	-	-	-	R6021E-105	IW01-32	-	-	-	-	-	-	-	-	-	-	-	
PFR6G13E	PK20PR-L13	IK20	VK20	PTR6F13	VT20	IT20	VT20	R4118S-105	IW01-32	-	-	R6021E-11	IW34	IW34	-	-	-	-	-	R6021E-11	IW34	IW34	-	-	-	-	-	-	-	-	-		
PFR6G-9	PK20PR-P8	-	VK20Y	PZFR5B	-	-	VKB16	R4118S-11	IW34	IW34	-	R6021E-11	IW34	IW34	-	-	-	-	-	R6021E-11	IW34	IW34	-	-	-	-	-	-	-	-	-	-	
PFR6H10	PQ20R	IQ20	VQ20	PZFR5C	-	-	VKA16	R4118S-11	IW34	IW34	-	R6021E-11	IW34	IW34	-	-	-	-	-	R6021E-11	IW34	IW34	-	-	-	-	-	-	-	-	-	-	
PFR6J	PK20PR-P8	IK20	VK20	PZFR5D11	SKJ16CR-L11	-	VKA16	R4118S-75	-	-	-	R6021E-75	-	-	-	-	-	-	-	R6021E-75	-	-	-	-	-	-	-	-	-	-	-	-	
PFR6J11	PK20PR-P11	IK20	VK20	PZFR5E11	SKJ16CR-L11	IK16	VK16	R4118S-8	IW24	IW24	-	R6021E-8	IW24	IW24	-	-	-	-	-	R6021E-8	IW24	IW24	-	-	-	-	-	-	-	-	-	-	
PFR6J13	PK20PR-L13	IK20	VK20	PZFR5F	PKJ16CR8	IK16	VK16	R4118S-85	-	-	-	R6021E-85	-	-	-	-	-	-	-	R6021E-85	-	-	-	-	-	-	-	-	-	-	-	-	
PFR6K11	PQ20R	IQ20	VQ20	PZFR5F11	SKJ16CR-L11	IK16	VK16	R4118S-9	IW27	IW27	-	R6021E-9	IW27	IW27	-	-	-	-	-	R6021E-9	IW27	IW27	-	-	-	-	-	-	-	-	-	-	
PFR6L13	PK20PR-L13	IK20	VK20	PZFR5F13	PKJ16CR-L13	IK16	VK16	R4118S-95	IW29	IW29	-	R6021E-95	IW29	IW29	-	-	-	-	-	R6021E-95	IW29	IW29	-	-	-	-	-	-	-	-	-	-	
PFR6M	PK20PR-P8	-	VK20Y	PZFR5J11	SKJ16CR-L11	IK16	VK16	R4304-A10	IW31	IW31	-	R6051-11	-	-	-	-	-	-	-	R6051-11	-	-	-	-	-	-	-	-	-	-	-	-	-
PFR6N11	PK20PR-L11	IK20	VK20	PZFR5N11T	-	-	VKA16	R4304-A7	IW22	IW22	VW22	R6061-10	IW01-31	-	-	-	-	-	-	R6061-10	IW01-31	-	-	-	-	-	-	-	-	-	-	-	-
PFR6P	PK20R8	-	VK20Y	PZFR5N11TG	-	-	VKA16	R4304-A8	IW24	IW24	-	R6061-10	IW06-31	-	-	-	-	-	-	R6061-10	IW06-31	-	-	-	-	-	-	-	-	-	-	-	-
PFR6P11	PK20PR-(L)11	IK20	VK20	PZFR6B	-	-	VKB20	R4304-A9	IW27	IW27	-	R6061-11	IW01-34	-	-	-	-	-	-	R6061-11	IW01-34	-	-	-	-	-	-	-	-	-	-	-	-
PFR6Q	PK20PR-P8	-	VK20Y	PZFR6E11	PKJ20CR-L11	IK20	VK20	R4630A-10	IW01-31	-	-	R6061-11	IW06-34	-	-	-	-	-	-	R6061-11	IW06-34	-	-	-	-	-	-	-	-	-	-	-	-
PFR6R11	PK20PR-L11	IK20	VK20	PZFR6F	SKJ20CR-A8/PKJ20CR8	IK20	VK20Y	R4630A-10	IW06-31	-	-	R6061-7	-	-	-	-	-	-	-	R6061-7	-	-	-	-	-	-	-	-	-	-	-	-	-
PFR6T10	PK20PR-L11	IK20	VK20	PZFR6F11	PKJ20CR-L11	IK20	VK20	R4630A-105	IW01-32	-	-	R6061-8	-	-	-	-	-	-	-	R6061-8	-	-	-	-	-	-	-	-	-	-	-	-	-
PFR6T10G	PK20PR-L11	IK20	VK20	PZFR6H	-	-	-	R4630A-105	IW01-32	-	-	R6061-9	IW01-27	-	-	-	-	-	-	R6061-9	IW01-27	-	-	-	-	-	-	-	-	-	-	-	-
PFR6T-G	PK20PR-P8	IK20	VK20	PZFR6J11	PKJ20CR-L11	IK20	VK20	R4630A-11	IW06-34	-	-	R6061-9	IW06-27	-	-	-	-	-	-	R6061-9	IW06-27	-	-	-	-	-	-	-	-	-	-	-	-
PFR6U11G	PK20PR-L11	IK20	VK20	PZFR6Q	-	-	-	R4630A-11	IW06-34	-	-	R6120-□	IAE01-□	-	-	-	-	-	-	R6120-□	IAE01-□	-	-	-	-	-	-	-	-	-	-	-	-
PFR6V10D(For LPG)	VK20T	-	VK20T	PZFR6R	-	-	-	R4630A-8	IW01-24	-	-	R6120A-10	IA01-31	-	-	-	-	-	-	R6120A-10	IA01-31	-	-	-	-	-	-	-	-	-	-	-	-
PFR6W-T	-	-	VKB20	PZFR6R	-	-	-	R4630A-85	-	-	-	R6120A-10.5	IA01-32	-	-	-	-	-	-	R6120A-10.5	IA01-32	-	-	-	-	-	-	-	-	-	-	-	-
PFR6X11	PK20PR-L11	IK20	VK20	PZKER7A8EGS	-	-	-	R4630A-9	IW01-27	-	-	R6120A-11	IA01-34	-	-	-	-	-	-	R6120A-11	IA01-34	-	-	-	-	-	-	-	-	-	-	-	-
PFR7A11	VQ22	IQ22	VQ22	PZNA6A11H	-	-	-	R4630A-95	IW01-29	-	-	R6120C-□	-	-	-	-	-	-	-	R6120C-□	-	-	-	-	-	-	-	-	-	-	-	-	-
PFR7AB	-	IK22	VK22	PZTR5A15	PT16EPR-L13	IT16	VT16	R5184-10	IWM01-31	-	-	R6120M-□	-	-	-	-	-	-	-	R6120M-□	-	-	-	-	-	-	-	-	-	-	-	-	-
PFR7B	PK22PR8	IK22	VK22	R0045G-□	-	-	-	R5184-105	IWM01-32	-	-	R6179A-105P	IWM01-32	-	-	-	-	-	-	R6179A-105P	IWM01-32	-	-	-	-	-	-	-	-	-	-	-	-
PFR7B11	VK22	IK22	VK22	R0045J-10	RU01-31	-	-	R5184-11	IWM01-34	-	-	R6179A-10P	IWM01-31	-	-	-	-	-	-	R6179A-10P	IWM01-31	-	-	-	-	-	-	-	-	-	-	-	-
PFR7B-4D	VK22	IK22	VK22	R0045J-11	RU01-34	-	-	R5184-9	-	-	-	R6179A-11P	IWM01-34	-	-	-	-	-	-	R6179A-11P	IWM01-34	-	-	-	-	-	-	-	-	-	-	-	-
PFR7B9	VK22	IK22	VK22	R0045J-12	-	-	-	R5184-95	IWM01-29	-	-	R6179C-105PA	-	-	-	-	-	-	-	R6179C-105PA	-	-	-	-	-	-	-	-	-	-	-	-	-
PFR7B-D	VK22	IK22	VK22	R0045J-9	RU01-27	-	-	R5300A-10	-	-	-	R6198C-9	IW01-27	-	-	-	-	-	-	R6198C-9	IW01-27	-	-	-	-	-	-	-	-	-	-	-	-
PFR7G	PK22PR8	IK22	VK22	R0045Q-10	RU01-31	-	-	R5300A-105	-	-	-	R6198C-9	IW06-27	-	-	-	-	-	-	R6198C-9	IW06-27	-	-	-	-	-	-	-	-	-	-	-	-
PFR7G11	PK22PR-L11	IK22	VK22	R0045Q-11	RU01-34	-	-	R5300A-11	-	-	-	R6252E-8	-	-	-	-	-	-	-	R6252E-8	-	-	-	-	-	-	-	-	-	-	-	-	-
PFR7G11	VK22	IK22	VK22	R016-10	IU01-31	-	-	R5300-N□	-	-	-	R6252K-105	IW01-32	-	-	-	-	-	-	R6252K-105	IW01-32	-	-	-	-	-	-	-	-	-	-	-	-
PFR7G11S	PK22PR-L11S	IK22G	VK22G	R016-11	IU01-34	-	-	R5400(F)-10	IQ31	IQ31	-	R6254E-105	IW01-32	-	-	-	-	-	-	R6254E-105	IW01-32	-	-	-	-	-	-	-	-	-	-	-	-
PFR7G9	PK22PR8	IK22	VK22	R0161-10	IUF31A	IUF31A	-	R5400(F)-7	IQ22	IQ22	VQ22	R6254E-8	IW01-24	-	-	-	-	-	-	R6254E-8	IW01-24	-	-	-	-	-	-	-	-	-	-	-	-
PFR7H10	VK22	IK22	VK22	R0161-11	-	-	-	R5400(F)-8	IQ24	IQ24	-	R6254E-9	IW01-27	-	-	-	-	-	-	R6254E-9	IW01-27	-</											

(*3)MITSUBISHI lean burn excluded.

CROSS REFERENCE (other DENSO)

NGK (Japan)	DENSO	IRIDIUM POWER	IRIDIUM TOUGH/PLUS	NGK (Japan)	DENSO	IRIDIUM POWER	IRIDIUM TOUGH/PLUS	NGK (Japan)	DENSO	IRIDIUM POWER	IRIDIUM TOUGH/PLUS	NGK (Japan)	DENSO	IRIDIUM POWER	IRIDIUM TOUGH/PLUS
R6918 B-7	-	-	-	R7440A-9L (lr)	IRL01-27	-	-	UR4IX	ITF16	ITF16	-	ZKER6A-10EG	-	-	-
R6918 B-8	IW01-24	-	-	R7440B-10T (lr)	IRT01-31	-	-	UR4VX	ITF16	ITF16	-	ZKR7A	XU22EPR-U	IXU22	VXU22
R6918 B-9	IW01-27	-	-	R7440B-11T (lr)	IRT01-34	-	-	UR5	T20PR-U	ITF20	-	ZKR7A10	XU22EPR-U	IXU22	VXU22
R6918 B-9	IW06-27	-	-	R8102A-10	-	-	-	UR5	T20PR-U11	ITF20	-	ZMR7AP	IU22	IU22	-
R6918C-□	IW01-□	-	-	R847-10	-	-	-	UR55	T20PR-U15	ITF20	-	AC (U.S.A.) DENSO IRI IRI POWER POWER TOUGH/PLUS			
R7112-10	IK31	IK31	-	R847-11	-	-	-	UR55IX	ITF20	ITF20	-				
R7112-7	IK22	IK22	VK22	RE7AL	-	-	-	UR55VX	-	ITF20	-	121XLS	X24EP-U9	IX24B	-
R7112-8	IK24	IK24	-	RE7CL	-	-	-	UR5IX	ITF20	ITF20	-	41	W27S-U	-	-
R7112-9	IK27	IK27	-	RE9BT	-	-	-	UR5VX	-	ITF20	-	41-101 (ITR4A15)	VT16	IT16	VT16
R7113-10	IK31	IK31	-	SD10	-	-	-	UR6IX	ITF20	ITF20	-	41-103 (ILTR5811)	-	ITL16	-
R7113-7	IK22	IK22	VK22	SD10	S29	-	-	UR6VX	-	ITF20	-	41-104 (ZTJ20R10 DENSO)	ZTJ20R10	IT20	VT20
R7113-8	IK24	IK24	-	SD10A	S29A	-	-	WR4-1	MA9P-U	-	-	41-105 (ILTR5C11)	-	ITL16	-
R7113-9	IK27	IK27	-	SD10A	S29A	-	-	WR5	MA20PR-U	-	-	41-108 (ILTR5D)	-	ITV16	-
R7114-10	IK31	IK31	-	SD11A	IRE01-27	-	-	WR5IX	-	-	-	41-109 (GM12622561)	-	ITV16	-
R7114-8	IK24	IK24	-	SD11A	IRE01-31	-	-	XR4	W16PR-U	-	-	41-110	ZTJ16R10	IT16	VT16
R7114-9	IK27	IK27	-	SD11A	S31A	-	-	XR45	W16PR-U	-	-	41-116 (GM12626906)	-	ITV16	-
R7115-10	IK31	IK31	-	SIFR6A11	VK20	IK20	VK20	XR45IX	-	-	-	41-125 (GM12647827)	-	ITV16	-
R7115-8	IK24	IK24	-	SILFR6A	VKH20Y	-	VKH20Y	XR4IX	-	-	-	41-600	T16EPR-U15	IT16	VT16
R7115-9	IK27	IK27	-	SILFR6A11	VKH20	IKH20	VKH20	XR5	W20PR-U	-	-	41-601	T16EPR-U15	IT16	VT16
R7116-10	IK01-31	-	-	SILFR6A6	VKH20Y	-	VKH20Y	XR5IX	-	-	-	41-602	K20PR-U	IK20	VK20
R7116-8	IK01-24	-	-	SILFR6B8	VKH20Y	-	VKH20Y	YR5	T20R-U	-	-	41-603	K16PR-U	IK16	VK16
R7116-9	IK01-27	-	-	SILFR6C11	VKH20	IKH20	VKH20	YR55IX	ITF20	ITF20	-	41-606	T16EPR-U15	IT16	VT16
R7117-10	IK01-31	-	-	SILKAR6G11G	-	-	-	YR55VX	-	ITF20	-	41-608	K16PR-U11	IK16	VK16
R7117-8	IK01-24	-	-	SILKAR8C6DS	-	-	-	YR5IX	ITF20	ITF20	-	41-610	K16PR-U	IK16	VK16
R7117-9	IK01-27	-	-	SILKGR9A7ES	-	-	-	YR5VX	-	ITF20	-	41-611	K16PR-U11	IK16	VK16
R7118-10	IK02-31	-	-	SILKR6D10G	-	-	-	ZF6A11	QJ20CR11	IQ20	VQ20	41-627	K16PR-U11	IK16	VK16
R7118-8	IK02-24	-	-	SILKR7H8	-	-	-	ZFR4F11 (HONDA)	KJ14CR-L11	IK16	VK16	41-628	K16PR-U	IK16	VK16
R7118-9	IK02-27	-	-	SILKR8AS	-	-	-	ZFR4F11 (MAZDA)	KJ14CR11	IK16	VK16	41-629	K16PR-U	IK16	VK16
R7119-10	IK02-31	-	-	SILMAR9A9S	-	-	-	ZFR5A11	QJ16CR11	IQ16	VQ16	41-801	K20PR-U11	IK20	VK20
R7119-8	IK02-24	-	-	SILTR6A7G	-	-	-	ZFR5AP	IK16	IK16	VK16	41-806	KJ16CR-L11	IK16	VK16
R7119-9	IK02-27	-	-	SILZBR8D8S	-	-	-	ZFR5C11G	KJ16CR-L11	IK16	VK16	41-900	PT16EPR-L13	IT16	VT16
R7232-10	IQ31	IQ31	-	SILZKAR7AS	-	-	-	ZFR5D11	K16GPR-U11	-	-	41-902	PT16EPR-L13	IT16	VT16
R7232-11	IQ34	IQ34	-	SILZKAR7B11	-	-	VFXEH22	ZFR5E11	K16GPR-U11	-	-	41-904	PT16EPR-L13	IT16	VT16
R7232-7	IQ22	IQ22	VQ22	SILZKAR7E8S	-	-	-	ZFR5F	KJ16CR	IK16	VK16	41-905	ITF16	ITF16	-
R7232-8	IQ24	IQ24	-	SILZKBR8C8S	-	-	-	ZFR5F11 (HONDA)	KJ16CR-L11	IK16	VK16	41-906	PT16EPR-L13	IT16	VT16
R7232-9	IQ27	IQ27	-	SILZKFR8B7S	-	-	-	ZFR5F11 (MAZDA)	KJ16CR11	-	VK20T	41-907	PT16EPR-L13	IT16	VT16
R7232-10	IQ31	IQ31	-	SILZKFR8C7S	-	-	-	ZFR5F11 (LPG, MAZDA)	KJ16CR11	IK16	VK16	41-908	PT16EPR-L13	IT16	VT16
R7233-7	IQ22	IQ22	VQ22	SILZKFR8D7G	-	-	-	ZFR5F11 (MITSUBISHI)	KJ16CR-U11 ^(*)	IK16	VK16	41-910	PT16EPR-L13	IT16	VT16
R7233-8	IQ24	IQ24	-	SILZKFR8D7S	-	-	-	ZFR5FGP	IK16	IK16	VK16	41-911	PT16EPR-L13	IT16	VT16
R7233-9	IQ27	IQ27	-	SILZKFR8E7S	-	-	-	ZFR5FIX11	IK16	IK16	VK16	41-912	PT16EPR-L13	IT16	VT16
R7234-10	IQ31	IQ31	-	SILZKGBR8B8S	-	-	-	ZFR5FIX11P	VK16	IK16	VK16	41-913	PT16EPR-L13	IT16	VT16
R7234-8	IQ24	IQ24	-	SILZKR6B10E	-	-	-	ZFR5G	K16DTR-S11	-	-	41-914	PT16EPR-L13	IT16	VT16
R7234-9	IQ27	IQ27	-	SILZKR6B-11	-	-	-	ZFR5J11	KJ16CR-L11	IK16	VK16	41-915	PT16EPR-L13	IT16	VT16
R7235-10	IQ31	IQ31	-	SILZKR6D8E	ZXE20HCR8	IXUH20I	VXUHC20I	ZFR5LP13G	-	-	-	41-916	PT16EPR-L13	IT16	VT16
R7235-8	IQ24	IQ24	-	SILZKR7C-11S	SXU22HCR11S	-	VXUH20G	ZFR5N11	KJ16CR-L11	IK16	VK16	41-917	PT16EPR-L13	IT16	VT16
R7235-9	IQ27	IQ27	-	SILZMFR8A7S	-	-	-	ZFR5P-G	KJ16CR-L11	-	VKA16	41-918	PT16EPR-L13	IT16	VT16
R7236-10	IQ01-31	-	-	SILZNR8C7H	-	-	-	ZFR6A11	QJ20CR11	IQ20	VQ20	41-919	PT16EPR-L13	IT16	VT16
R7236-8	IQ01-24	-	-	SIMR8A9	-	-	-	ZFR6F11 (HONDA)	KJ20CR-L11	IK20	VK20	41-920	PT16EPR-L13	IT16	VT16
R7236-9	IQ01-27	-	-	SIZFR6A6D	-	-	-	ZFR6F11 (MAZDA)	KJ20CR11	IK20	VK20	41-921	PT16EPR-L13	IT16	VT16
R7237-10	IQ01-31	-	-	SIZFR6B8EG	-	-	-	ZFR6F11 (MITSUBISHI)	KJ20CR-U11 ^(*)	IK20	VK20	41-922	PT16EPR-L13	IT16	VT16
R7237-8	IQ01-24	-	-	SR5	T20NR-U11	IT20	VT20	ZFR6F11G	-	-	-	41-923	PT16EPR-L13	IT16	VT16
R7237-9	IQ01-27	-	-	T813J-N13	-	-	-	ZFR6FIX11	IK20	IK20	VK20	41-924	PT16EPR-L13	IT16	VT16
R7238-10	IQ02-31	-	-	TR4	T16EPR-U	IT16	VT16	ZFR6FIX11P	VK20	IK20	VK20	41-925	PT16EPR-L13	IT16	VT16
R7238-8	IQ02-24	-	-	TR4-2	T16EPR-U	IT16	VT16	ZFR6G	K20DTR-S11	-	-	41-926	PT16EPR-L13	IT16	VT16
R7238-9	IQ02-27	-	-	TR4IX	IT16	IT16	VT16	ZFR6J11	KJ20CR-L11	IK20	VK20	41-927	PT16EPR-L13	IT16	VT16
R7239-10	IQ02-31	-	-	TR4VX	IT16	IT16	VT16	ZFR6K11	KJ20DR-M11	IK20	VK20	41-928	PT16EPR-L13	IT16	VT16
R7239-8	IQ02-24	-	-	TR5	T20EPR-U	IT20	VT20	ZFR6K11S	KJ20DR-M11S	IK20G	VK20G	41-929	PT16EPR-L13	IT16	VT16
R7239-9	IQ02-27	-	-	TR5-1	T20EPR-U	IT20	VT20	ZFR6KIX11PS	VK20G	IK20G	VK20G	41-930	PT16EPR-L13	IT16	VT16
R7279-□ (lr)	IK02-□	-	-	TR5-11X	IT20	IT20	VT20	ZFR6MP	SKJ20CR-A8	IK20	VK20	41-931	PT16EPR-L13	IT16	VT16
R7282-□ (lr)	IAE01-□	-	-	TR5-1VX	IT20	IT20	VT20	ZFR6S-Q	K20PBR-S10	IK20	VK20	41-932	PT16EPR-L13	IT16	VT16
R7282A-□ (lr)	IA01-□	-	-	TR55	T20EPR-U15	IT20	VT20	ZFR6T11G	KJ20DR-M11	-	VKA20	41-933	PT16EPR-L13	IT16	VT16
R7282C-□ (lr) No Gasket	-	-	-	TR55-1VX	IT20	IT20	VT20	ZFR6T11G	KJ20DR-M11	-	VKA20	41-934	PT16EPR-L13	IT16	VT16
R7282M-□ (lr)	-	-	-	TR55-11X	IT20	IT20	VT20	ZFR6U9	KJ20CR-L11	IK20	VK20Y	41-935	PT16EPR-L13	IT16	VT16
R7345-9	IKH27	IKH27	-	TR55IX	IT20	IT20	VT20	ZFR6U11	KJ20CR-L11	IK20	VK20	41-936	PT16EPR-L13	IT16	VT16
R7376-□ (lr)	IW01-□	-	-	TR55VX	IT20	IT20	VT20	ZFR7F	KJ22CR-L8	IK22	VK22	41-937	PT16EPR-L13	IT16	VT16
R7376-7	-	-	-	TR5A10	T16VR-U10	ITV16	-	ZFR7F11	KJ22CR-L11	IK22	VK22	41-938	PT16EPR-L13	IT16	VT16
R7376B-□ (lr)	-	-	-	TR5A13	T16VR-U10	ITV16	-	ZFR7J11	KJ22CR-L11	IK22	VK22	41-939	PT16EPR-L13	IT16	VT16
R7420-□ (lr)	IRE01-□	-	-	TR5A13	T16VR-U10	ITV16	-	ZG5A	J16CR-U	IW16	VW16	41-940	PT16EPR-L13	IT16	VT16
R7429A-10	-	-	-	TR5A1-13	VT16	IT16	VT16	ZGR5A	J16CR-U	IW16	VW16	41-941	PT16EPR-L13	IT16	VT16
R7433-10 (lr)	IK31	IK31	-	TR5B13	T16VR-U10	ITV16	-	ZGR5B	W16DTR-S	-	-	41-942	PT16EPR-L13	IT16	VT16
R7433-8 (lr)	IK24	IK24	-	TR5B13	T16VR-U10	ITV16	-	ZGR5B11	W16DTR-S	-	-	41-943	PT16EPR-L13	IT16	VT16
R7433-9 (lr)	IK27	IK27	-	TR5BP12	ITV16	ITV16	-	ZGR5C	J16CR-U	IW16	VW16	41-944	PT16EPR-L13	IT16	VT16
R7434-10 (lr)	IK01-31	-	-	TR5IX	IT20	IT20	VT20	ZGR5E	J16CR-U	IW16	VW16	41-945	PT16EPR-L13	IT16	VT16
R7434-8 (lr)	IK01-24	-	-	TR5VX	IT20	IT20	VT20	ZGR6B11	W20DTR-S	-	-	41-946	PT16EPR-L13	IT16	VT16
R7434-9 (lr)	IK01-27	-	-	TR6	T20EPR-U	IT20	VT20	ZKR7A-HTU	-	-	-	41-947	PT16EPR-L13	IT16	VT16
R7435-8 (lr)	IQ24	IQ24	-	TR6AP13	IT20	IT20	VT20					41-948	PT16EPR-L13	IT16	VT16
R															

CROSS REFERENCE (⇒)

DENSO

AUSTRALIA

CHINA

INDIA

INDONESIA

KOREA

MALAYSIA

PHILIPPINES

SINGAPORE

TAIWAN

THAILAND

VIETNAM

JAPAN

EUROPE & USA

SMALL ENGINE

CROSS REFERENCE

PART NUMBER

AC (U.S.A.)	DENSO	IRIDIUM POWER	IRIDIUM TOUGH/PLUS	AC (U.S.A.)	DENSO	IRIDIUM POWER	IRIDIUM TOUGH/PLUS	AC (U.S.A.)	DENSO	IRIDIUM POWER	IRIDIUM TOUGH/PLUS	AC (U.S.A.)	DENSO	IRIDIUM POWER	IRIDIUM TOUGH/PLUS
43FS	W20FP-U	IWF20	-	CR42CLTS	T20EPR-U	IT20	VT20	R43CS	W20PR-U	-	-	S104F	U20FS-U	IUF22	-
43LS	W16LS	-	-	CR42CTS	T20PR-U	ITF20	-	R43CT6	T20R-U	-	-	S121XL	X24ES-U	IX24	-
43N	W20ES-U	-	-	CR42N	W22ESR-U	-	-	R43CTS	T20PR-U	ITF20	-	S122F	X24FS-U	-	-
43S	W20PR-U	-	-	CR42TS	T20PR-U	ITF20	-	R43CTS6	T20PR-U15	ITF20	-	S123XL	X22ES-U	IX22	-
43TS	T20P-U	ITF20	-	CR42XLS	W20EPR-U	IW20	VW20	R43CXL	W20ESR-U	-	-	S124FS	X20FS-U	-	-
43XL	W20ES-U	-	-	CR42XLSX	W20EPR-U11	IW20	VW20	R43CXLS	W20EXR-U	IW20	VW20	S404XLG	IW01-27	IW27	-
43XLS	W20EP-U	IW20	VW20	CR43	W20SR-U	-	-	R43FS	W20FPR-U	IWF20	-	S40F	W27FS-U	IWF27	-
43XLS	W20EX-U	IW20	VW20	CR43CXLS	W16EPR-U	IW16	VW16	R43LTS	T20EPR-U	IT20	VT20	S40FG	-	-	-
44	W16S-U	-	-	CR43N	W20ESR-U	-	-	R43LTSE	T20EPR-U	IT20	VT20	S40FR	W27FSR	IWF27	-
44F	W16FS-U	-	-	CR43S	W20PR-U	-	-	R43LTSX	T20EPR-U15	IT20	VT20	S40XL	W27ES-U	IW27	-
44FFS	W16FP-U	IWF16	-	CR43TS	T20PR-U	ITF20	-	R43N	W20ESR-U	-	-	S40XLG	-	IW31	-
44N	W20ES-U	-	-	CR43TSM	T20PR-U	ITF20	-	R43NS	W20EPR-U	IW20	VW20	S40XLR	W27ESR	IW27	-
44NS	W16EP-U	IW16	VW16	CR44N	W20ESR-U	-	-	R43NS	W20EXR-U	IW20	VW20	S40XLR	W27ESR-U	IW27	-
44NS	W16EX-U	IW16	VW16	CR44NS	W16EPR-U	IW16	VW16	R43NTS6	T20EPR-U15	IT20	VT20	S412FR	W24FSR	IWF24	-
44S	W16PR-U	-	-	CR45L	W14L	-	-	R43NTSE	T20NR-U11	IT20	VT20	S41F	W24FS-U	IWF24	-
44TS	T16P-U	ITF16	-	CR45TS	T16PR-U	ITF16	-	R43S	W20PR-U	-	-	S41FG	-	IWF27	-
44XL	W20ES-U	-	-	CS41	W22M-U	-	-	R43T	T20R-U	-	-	S41FR	W24FSR	IWF24	-
44XLS	W16EP-U	IW16	VW16	CS42	W22M-U	-	-	R43TS	T20PR-U	ITF20	-	S41SLG	IW01-27	IW27	-
44XLS	W16EX-U	IW16	VW16	CS42S	W22MP-U	-	-	R43TS6	T20PR-U15	ITF20	-	S41XL	W27ES-U	IW27	-
45	W14-U	-	-	CS42T	T22M-U	-	-	R43TSK	T20PR-U	ITF20	-	S41XLR	W27ESR	IW27	-
45F	W16FS-U	-	-	CS45	W20M-U	-	-	R43TSX	T20PR-U15	ITF20	-	S41XLR	W27ESR-U	IW27	-
45FFS	W14FP-U	IWF16	-	CS45T	T20M-U	-	-	R43TX	T20R-U	-	-	S42	W24S-U	-	-
45L	W14L	-	-	CS49	W14M-U	-	-	R43XL	W20ESR-U	-	-	S42F	W22FS-U	IWF22	-
45LS	W14L	-	-	FR1LS	K20PR-U11	IK20	VK20	R43XLS	W20EPR-U	IW20	VW20	S42FR	W22FSR	IWF22	-
45NS	W14EP-U	IW16	VW16	FR2LS	K20PR-U11	IK20	VK20	R43XLS	W20EXR-U	IW20	VW20	S42XL	W22ES-U	-	-
45NS	W14EX-U	IW16	VW16	FR3CLS	K16PR-U11	IK16	VK16	R44CF	W16FSR	-	-	S42XLR	W22ESR-U	-	-
45S	W14PR-U	-	-	FR3CLS	K16R-U11	IK16	VK16	R44CXL	W20ESR-U	-	-	S43XL	W20ES-U	-	-
45TS	T16P-U	ITF16	-	FR3LM	QJ16HR-U9	-	-	R44CXLS	W16EPR-U	IW16	VW16	S43XLR	W20ESR-U	-	-
45XL	W16ES-U	-	-	FR3LS	K16PR-U11	IK16	VK16	R44CXLS	W16EXR-U	IW16	VW16	S44	W16S-U	-	-
45XLS	W14EP-U	IW16	VW16	FR3LS	K16R-U11	IK16	VK16	R44F	W16FSR	-	-	S44F	W16FS-U	-	-
45XLS	W14EX-U	IW16	VW16	FR3LS6	K16PR-U11	IK16	VK16	R44LT	W16EPR-U	IW16	VW16	S44XL	W20ES-U	-	-
46	W9-U	-	-	FR3LSK	K16PR-U11	IK16	VK16	R44LTS	T16EPR-U	IT16	VT16	S45F	W16FS-U	-	-
46F	W14F-U	-	-	FR4LE	QJ16HR-U9	-	-	R44LTS6	T16EPR-U15	IT16	VT16	S46	W9-U	-	-
46FFS	W9FP	-	-	FR5LS	K16PR-U11	IK16	VK16	R44LTS6K	T16EPR-U15	IT16	VT16	S81F	M22	-	-
46N	W16ES-U	-	-	HE2	ITV20	-	-	R44LTSM	T16EPR-U	IT16	VT16	S82F	M22	-	-
46S	W9PR-U	-	-	LM46	W14LM-U	-	-	R44N	W16ESR-U	-	-	S83F	M17	-	-
46TS	T14PR-U	ITF16	-	LM49	W14LM-U	-	-	R44NS	W16EPR-U	IW16	VW16	S85F	L14-U/M14	-	-
46XL	W16ES-U	-	-	M40FFG	-	-	-	R44NS	W16EXR-U	IW16	VW16	SV4XL	SF50	-	-
46XLS	W9EP	-	-	M40FFX	W27FS-U10	IWF27	-	R44NSX	W16EPR-U11	IW16	VW16	V40FFK	SF51	-	-
47XL	W14E	-	-	M41FF	W24FS-U	IWF24	-	R44NTSE	T16NR-U11	IT16	VT16	V40FFM	SF50	-	-
83CTS	MA20P-U	-	-	M41FFG	-	IWF27	-	R44S	W16PR-U	-	-	V40FFS	SF50	-	-
83TS	MA20P-U	-	-	M41K	W22S-U	-	-	R44SX	W16PR-U	-	-	VB40FFK	SF50	-	-
84T	MA16PR-U	-	-	M42FF	W22FS-U	IWF22	-	R44T	T16R-U	-	-	VR40FFM	SF50	-	-
84TS	MA16PR-U	-	-	M43FF	W20FS-U	IWF22	-	R44TS	T16PR-U	ITF16	-	APEX (Japan)			
85T	MA16PR-U	-	-	M43S	W20PR-U	-	-	R44TS8	T16PR-U15	ITF16	-				
85TS	MA16PR-U	-	-	M44C	W16S-U	-	-	R44TSX	T16PR-U15	ITF16	-	06	IQ20	IQ20	VQ20
86TS	MA9P-U	-	-	M44L	W14L	-	-	R44TX	T16R-U15	-	-	06STD	IK20	IK20	VK20
B43	W20S-U	-	-	M45	W14-U	-	-	R44XL	W20ESR-U	-	-	07	IQ22	IQ22	VQ22
C41CLTS	T22EP-U	IT22	-	M45FF	W16FS-U	-	-	R44XLS	W16EPR-U	IW16	VW16	07STD	IK22	IK22	VK22
C41CXLS	W22EP-U	IW22	VW22	M47	W9-U	-	-	R44XLS	W16EXR-U	IW16	VW16	08	IQ24	IQ24	-
C42-1	W24S-U	-	-	MR43LTS	T20EPR-U	IT20	VT20	R44XLS6	W16EXR-U11	IW16	VW16	08STD	IK24	IK24	-
C42CFS	W22FP-U	IWF22	-	MR441	T16R-U	-	-	R44XLSE	KJ16CR-L11	IK16	VK16	09	IQ27	IQ27	-
C42CLTS	T20EP-U	IT20	VT20	R121CXLS	X24EPR-U9	IX24B	-	R44XLSM	J16BR-U	-	-	09STD	IK27	IK27	-
C42CXLS	W20EP-U	IW20	VW20	R121XLS	X24EPR-U9	IX24B	-	R45NS	W14EP-U	IW16	VW16	AUTOLITE (U.S.A.)			
C42N	W22ES-U	-	-	R41CF	W24FSR	IWF24	-	R45NS	W14EXR-U	IW16	VW16				
C42XLS	W20EP-U	IW20	VW20	R41CXL	W27ESR	IW27	-	R45NSX	W14EXR-U11	IW16	VW16	2684	IRE01-27	-	-
C43	W20S-U	-	-	R41CXL	W27ESR-U	IW27	-	R45NTSE	T16NR-U11	IT16	VT16	2686	IRE01-27	-	-
C43CXLS	W16EP-U	IW16	VW16	R41F	W24FSR	IWF24	-	R45S	W14PR-U	-	-	103	T20EPR-U	IT20	VT20
C43L	W16LS	-	-	R41XL	W27ESR	IW27	-	R45SX	W14PR-U	-	-	104	T20EPR-U	IT20	VT20
C43N	W20ES-U	-	-	R41XL	W27ESR-U	IW27	-	R45T	T16R-U	-	-	105	T16EPR-U	IT16	VT16
C44	W16S-U	-	-	R42CF	W22FSR	IWF22	-	R45TS	T16PR-U	ITF16	-	106	T16EPR-U	IT16	VT16
C44N	W20ES-U	-	-	R42CFS	W22FPR-U	IWF22	-	R45TS8	T16PR-U15	ITF16	-	115	MA20P-U	-	-
C44NS	W16EX-U	IW16	VW16	R42CLTS	T20EPR-U	IT20	VT20	R45TSX	T16PR-U15	ITF16	-	117	MA16PR-U	-	-
C44S	W16PR-U	-	-	R42CLTS6	T20EPR-U15	IT20	VT20	R45XL	W16ESR-U	-	-	124	MA20PR-U	-	-
C45	W14-U	-	-	R42CT	T20R-U	-	-	R45XLS	W14EP-U	IW16	VW16	127	MA16PR-U	-	-
C45L	W14L	-	-	R42CTS	T20PR-U	ITF20	-	R45XLS	W14EXR-U	IW16	VW16	13	T20P-U	ITF20	-
C47W	W9-U	-	-	R42CXL	W22ESR-U	-	-	R45XLS6	W14EXR-U11	IW16	VW16	14	T20P-U	ITF20	-
C49	W9-U	-	-	R42CXLS	W22EPR-U	IW22	VW22	R46LTS	T16EPR-U	IT16	VT16	144	T20R-U	-	-
C81	M22	-	-	R42F	W22FSR	IWF22	-	R46S	W9PR-U	-	-	145	T20R-U	-	-
C82	M22	-	-	R42FS	W22FPR-U	IWF22	-	R46SX	W9PR-U	-	-	146	T16R-U	-	-
C82T	MA20P-U	-	-	R42LTS	T20EPR-U	IT20	VT20	R46SZ	W9PR-U	-	-	147	T16R-U	-	-
C83	M17	-	-	R42LTS6	T20EPR-U15	IT20	VT20	R46T	T16R-U	-	-	15	T16P-U	ITF16	-
C85	L14-U	-	-	R42LTSM	T20EPR-U	IT20	VT20	R46TS	T14PR-U	ITF16	-	156	MA16PR-U	-	-
C85S	L14-U	-	-	R42NS	W22EPR-U	IW22	VW22	R46TSX	T14PR-U15	ITF16	-	16	T16P-U	ITF16	-
C85TS	MA16PR-U	-	-	R42S	W20PR-U	-	-	R46TX	T16R-U15	-	-	166	MA16PR-U	-	-
C86	L14-U	-	-	R42T	T20R-U	-	-	R47S	W9PR-U	-	-	175	W16PR-U	-	-
C86S	L14-U	-	-	R42TS	T20PR-U	ITF20	-	R47SX	W9PR-U	-	-	203	T20PR-U	ITF20	-
C87	L14-U	-	-	R42TSM	T20PR-U	ITF20	-	R83CTS	MA20PR-U	-	-	215	W16LS	-	-
C88	L14-U	-	-	R42TX	T20R-U	-	-	R83TS	MA20PR-U	-	-	216	W14L	-	-
C88L	L14-U	-	-	R42XL	W22ESR-U	-	-	R84TS	MA16PR-U	-	-	217	W14L	-	-
CFR1CLS	K22PR-U	IK22	VK22	R42XLS	W22EPR-U	IW22	VW22	R84TSX	MA16PR-U11	-	-	218	W14L	-	-
CFR2CLS	K20PR-U	IK20	VK20	R42XLS6	W22EPR-U11	IW22	VW22	R85T	MA16PR-U	-	-	2243	W20SR-U	-	-
CFR3CLS	K16PR-U	IK16	VK16	R42XLSM	W22EPR-U	IW22	VW22	R85TS	MA16PR-U	-	-	225	W14L	-	-
CR41CXLS	W22EPR-U	IW22	VW22	R43	W20SR-U	-	-	R86T	MA16PR-U	-	-	23	T20PR-U	ITF20	-
CR425FS	W20FPR-U	IWF20	-	R43C	W20SR-U	-	-	R86TS5	MA16PR-U11	-	-	24	T20PR-U	ITF20	-
CR425XLS	W16EPR-U	IW16	VW16	R43CFS	W20FPR-U	IWF20	-	S102F	U22FS-U	IUF22	-	2413	-	IW34	-

(1) This comparison chart does not guarantee capability with any vehicle. Please use it for reference only. (2) Plug specifications (design, materials, etc.) varies according to manufacturer. (3) Choose your plug model by referring to the vehicle model compatibility table. (4) When choosing a plug model for tuning vehicles and vehicles not listed in the vehicle model compatibility chart, the customer is responsible for determining the correct plug.

CROSS REFERENCE (other DENSO)

AUTOLITE (U.S.A.)	DENSO	IRIDIUM POWER	IRIDIUM TOUGH/PLUS	AUTOLITE (U.S.A.)	DENSO	IRIDIUM POWER	IRIDIUM TOUGH/PLUS	AUTOLITE (U.S.A.)	DENSO	IRIDIUM POWER	IRIDIUM TOUGH/PLUS	AUTOLITE (U.S.A.)	DENSO	IRIDIUM POWER	IRIDIUM TOUGH/PLUS
2414	-	IW31	-	3116	L14-U	-	-	494	W16LS	-	-	9921	K20PBR	IK20	VK20
2415	IW01-27	IW27	-	312	W27S-U	-	-	495	W16LS	-	-	996	W14L	-	-
2416	IW24	IW24	-	313	W24S-U	-	-	497	W14L	-	-	AG12	W24EP-U	IW24	-
2417	IW24	IW24	-	314	W20S-U	-	-	51	W24EP-U	IW24	-	AG22	W22EP-U	IW22	VW22
2453	-	-	-	315	W16S-U	-	-	5125	MA20PR-U	-	-	AP5143	IT20	IT20	VT20
2454	-	-	-	316	W14-U	-	-	5143	T20EPR-U	IT20	VT20	APP5144	PT16EPR-L13	IT20	VT20
2455	-	IWF27	-	317	W14-U	-	-	5144	T20EPR-U	IT20	VT20	APP5144	PTJ16R15	IT20	VT20
2456	-	IWF24	-	318	W9-U	-	-	5164	T20EPR-U	IT20	VT20	AP64	PK20PR11	IK20	VK20
2457	-	IWF24	-	33	MA20P-U	-	-	5184	K16PR-U11	IK16	VK16	APP3923	PK20PR11	IK20	VK20
25	T16PR-U	ITF16	-	34	MA20P-U	-	-	52	W24EP-U	IW24	-	APP3924	PK16PR-(L)11	IK16	VK16
2526	IRE01-27	-	-	35	MA16PR-U	-	-	5224	KJ20CR11	IK20	VK20	AR5383	IW06-31	-	-
2526	W25EDR14	-	-	353	W24S-U	-	-	53	W22EP-U	IW22	VW22	MP4316	-	IWF22	-
253	W22M-U	-	-	354	W20S-U	-	-	535	W16FS-U	-	-	XP63 (Pt,Ir)	VW20	IW20	VW20
254	W22M-U	-	-	355	W16S-U	-	-	536	W14F-U	-	-	(BERU (Germany) DENSO IRIDIUM POWER)			
2543	T20NR-U11	IT20	VT20	356	W14-U	-	-	54	W20EP-U	IW20	VW20	12-5DU	X22EP-U9	IX22B	-
2544	T20NR-U11	IT20	VT20	357	W9-U	-	-	54	W20EX-U	IW20	VW20	12R-5DU	X22EPR-U9	IX22B	-
2545	T16NR-U11	IT16	VT16	358	W9-U	-	-	55	W16EP-U	IW16	VW16	12VR-8SE	XE20HR-U9	-	VFXEH20
2546	T16NR-U11	IT16	VT16	36	MA16PR-U	-	-	55	W16EX-U	IW16	VW16	12ZR-65PP2 (BIHEX)	-	-	-
255	W20M-U	-	-	3606	T16PR-U15	ITF16	-	56	W14EP-U	IW16	VW16	12ZR-65PP2-1 (BIHEX)	-	-	-
2553	T22M-U	-	-	37	MA9P-U	-	-	56	W14EX-U	IW16	VW16	12ZR-65P02 (BIHEX)	-	-	-
2554	T22M-U	-	-	373	M22	-	-	565	W16PR-U	-	-	12ZR-65P03 (BIHEX)	-	-	-
258	W14M-U	-	-	374	M22	-	-	566	W14PR-U	-	-	14-10A	W14F-U	-	-
2585	KJ16CR-L11	IK16	VK16	375	M17	-	-	567	W9PR-U	-	-	14-10B	W14FP-UL	IWF16	-
2592	W31ES-U	IW31	-	376	L14-U	-	-	57	W9EP	-	-	14-10C	W14E	-	-
2593	W27ES-U	IW27	-	377	L14-U	-	-	584	MA20PR-U	-	-	14-10D	W14EP-U	IW16	VW16
2594	W24ES-U	IW24	-	378	L14-U	-	-	601	T16EPR-U15	IT16	VT16	14-10E	W14P-U	-	-
26	T16PR-U	ITF16	-	379	L14-U	-	-	602	K20PR-U	IK20	VK20	14-2AS1	W27FS-U	IWF27	-
2611	W31ES-U	IW31	-	386	L14-U	-	-	603	K16R-U	IK16	VK16	14-3A1	W24FS-U	IWF24	-
2612	W27ES-U	IW27	-	3922	K22PR-U	IK22	VK22	604	T20EPR-U15	IT20	VT20	14-3AS1	IWF24	IWF24	-
2613	W24ES-U	IW24	-	3923	K20PR-U	IK20	VK20	605	T16EPR-U15	IT16	VT16	14-3AU	W24FS-U	IWF24	-
2614	W22ESR-U	-	-	3924	PQ16R	IQ16	VQ16	63	W22EPR-U	IW22	VW22	14-3CS	IW24	IW24	-
2614	W22ES-U	-	-	3926	K16PR-U11	IK16	VK16	64	W20EPR-U	IW20	VW20	14-4A	W22FS-U	IWF22	-
2615	W22ESR-U	-	-	3926	K16R-U11	IK16	VK16	64	W20EXR-U	IW20	VW20	14-4AS1	IWF24	IWF24	-
2615	W22ES-U	-	-	393	W22ES-U	-	-	646	W14EXR-U13	IW16	VW16	14-4AU	W22FS-U	IWF22	-
2616	W20ESR-U	-	-	394	W20ES-U	-	-	65	W16EPR-U	IW16	VW16	14-4CS1	IW24	IW24	-
2616	W20ES-U	-	-	395	W16ES-U	-	-	65	W16EXR-U	IW16	VW16	14-4DPO	IW24	IW24	-
2634	W27FS-U10	IWF27	-	396	W16ES-U	-	-	66	W14EP-U	IW16	VW16	14-5A	W22FS-U	IWF22	-
2635	W22FS-U	IWF22	-	397	W14E	-	-	66	W14EXR-U	IW16	VW16	14-5AU	W22FS-U	IWF22	-
2636	W20FS-U	IWF22	-	398	W14E	-	-	664	T20PR-U15	ITF20	-	14-5BU	W22FP-U	IWF22	-
2652	W24FS-U	IWF24	-	402	W22ESR-U	-	-	665	T16PR-U15	ITF16	-	14-5C	W22ES-U	-	-
2653	W22FS-U	IWF22	-	403	W22ESR-U	-	-	666	T16PR-U15	ITF16	-	14-5D	W22EP-U	IW22	VW22
2654	W22FS-U	IWF22	-	404	W20ESR-U	-	-	667	T14PR-U15	ITF16	-	14-5DTU	W22EPB	IW22	VW22
2655	W20FS-U	IWF22	-	405	W16ESR-U	-	-	67	W14EXR-U	IW16	VW16	14-5DU	W22EP-U	IW22	VW22
2656	W16FS-U	-	-	4051	W31ES-U	IW31	-	684	T20R-U	-	-	14-5DUO	W22EP-U	IW22	VW22
2675	W16LS	-	-	4052	W31ES-U	IW31	-	685	T20R-U	-	-	14-5E	W22S-U	-	-
2676	W14L	-	-	4053	W27ES-U	IW27	-	687	T16R-U15	-	-	14-5F	W20PR-U	-	-
2677	W14L	-	-	4054	W24ES-U	IW24	-	724	T20PR-U	ITF20	-	14-6B	W20FP-U	IWF20	-
2696	M22	-	-	4055	W22ES-U	-	-	725	T16PR-U	ITF16	-	14-6BU	W20FP-U	IWF20	-
2697	M17	-	-	4056	W20ES-U	-	-	726	T16PR-U	ITF16	-	14-6C	W20ES-U	-	-
27	T14PR-U	ITF16	-	406	W16ESR-U	-	-	727	T14PR-U	ITF16	-	14-6D	W20EP-U	IW20	VW20
2715	X24FS-U	-	-	4062	W31ES-U	IW31	-	73	W20PR-U	-	-	14-6DTU	W20EPB	IW20	VW20
2716	X20FS-U	-	-	4063	W27ESR	IW27	-	74	W20PR-U	-	-	14-6DU	W20EP-U	IW20	VW20
273	W22FP-U	IWF22	-	4063	W27ESR-U	IW27	-	745	MA16PR-U	-	-	14-6DUO	W20EP-U	IW20	VW20
2735	X20FS-U	-	-	4092	W24FSR	IWF24	-	746	MA16PR-U	-	-	14-7AU	W20FS-U	IWF22	-
274	W20FP-U	IWF20	-	4093	W22FSR	IWF22	-	747	MA9P-U	-	-	14-7BU	W20FP-U	IWF20	-
275	W16FP-U	IWF16	-	411	W24FS-U	IWF24	-	75	W16PR-U	-	-	14-7C	W20ES-U	-	-
2755	X22ES-U	IX22	-	4113	W20FP-U	IWF20	-	76	W14PR-U	-	-	14-7CU	W20ES-U	-	-
276	W9FP	-	-	4114	W20FP-U	IWF20	-	763	T16NR-U11	IT16	VT16	14-7D	W20EP-U	IW20	VW20
2772	M22	-	-	4123	W20FPR-U	IWF20	-	764	T20EPR-U	IT20	VT20	14-7DTU	W20EPB	IW20	VW20
2773	M22	-	-	413	W22FS-U	IWF22	-	765	T16EPR-U	IT16	VT16	14-7DU	W20EP-U	IW20	VW20
2775	L14-U/M14	-	-	4132	X27ES-U	IX27	-	766	T16EPR-U	IT16	VT16	14-7DUO	W20EP-U	IW20	VW20
2794	U24FS-U	IUF24	-	4133	X24ES-U	IX24	-	767	T16EPR-U	IT16	VT16	14-7E	W20S-U	-	-
2795	U22FS-U	IUF22	-	414	W20FS-U	IWF22	-	77	W9PR-U	-	-	14-7F	W20PR-U	-	-
2796	U20FS-U	IUF22	-	4143	X24ESR-U	IX24	-	784	MA20PR-U	-	-	14-8A	W16FS-U	-	-
284	W20FPR-U	IWF20	-	415	W16FS-U	-	-	804	MA20PR-U	-	-	14-8B	W16FP-U	IWF16	-
2852	SF50	-	-	4152	X27EP-U9	IX27B	-	84	W20PR-U	-	-	14-8C	W16ES-U	-	-
2872	SF51	-	-	4153	X24EP-U9	IX24B	-	847	W9PR-U	-	-	14-8D	W16EP-U	IW16	VW16
2892	SF50	-	-	416	W14F-U	-	-	85	W16PR-U	-	-	14-8DC	W16EP-U	IW16	VW16
292	W27S-U	-	-	4162	X27EPR-U9	IX27B	-	86	W14PR-U	-	-	14-8DTU	W16EPB10	IW16	VW16
294	W16S-U	-	-	4163	X24EPR-U9	IX24B	-	864	T20EPR-U	IT20	VT20	14-8DU	W16EP-U	IW16	VW16
295	W14-U	-	-	4164	X22EPR-U9	IX22B	-	865	T16EPR-U	IT16	VT16	14-8DUO	W16EP-U	IW16	VW16
2954	T22M-U	-	-	4173	X24FS-U	-	-	87	W9PR-U	-	-	14-8E	W16S-U	-	-
2956	T20M-U	-	-	425	W16FSR	-	-	884	T20EPR-U15	IT20	VT20	14-8F	W16PR-U	-	-
297	W9-U	-	-	4251	W24ES-U	IW24	-	9061	K22PBR-S	IK22	VK22	14-8LUR	J16CR-U	IW16	VW16
2974	W22MP-U	-	-	4253	W16EX-U	IW16	VW16	9062	K20PBR	IK20	VK20	14-9C	W16ES-U	-	-
2976	W16S-U	-	-	426	W14FR-U	-	-	9063	K20PBR	IK20	VK20	14-9DU	W14EP-U	IW16	VW16
298	W9-U	-	-	4263	W20EXR-U	IW20	VW20	9064	K20TXR	IK20	VK20	14-9DUO	W14EP-U	IW16	VW16
2985	W22MP-U	-	-	4265	W16EXR-U	IW16	VW16	907	K20PR-U11	IK20	VK20	14-9EUO	W14LM-U	-	-
3013	W24S-U	-	-	4275	W16PR-U	-	-	908	T16EPR-U15	IT16	VT16	14F-03DAR	K22PBR-S	IK22	VK22
3014	W20S-U	-	-	437	W14L	-	-	915	J16BR-U	-	-	14F-5DUO	K22PR-U	IK22	VK22
3017	W9-U	-	-	44	MA20PR-U	-	-	925	J16BR-U	-	-	14F-5MPURO3	VKH22	IKH22	VKH22
302	W20SR-U	-	-	45	MA16PR-U	-	-	94	T22EP-U	IT22	-	14F-6DPUR021	VK22	IK22	VK22
303	W20S-U	-	-	456	W14LM-U	-	-	945	T20EPR-U	IT20	VT20	14F-6DSR	IK20	IK20	VK20
3035	L14-U/M14	-	-	458	W14LM-U	-	-	965	T16PR-U15	ITF16	-	14F-6DTU	K20PBR	IK20	VK20
3055	MA20PR-U	-	-	46	MA16PR-U	-	-	966	T16PR-U15	ITF16	-				
306	W9-U	-	-	483	T20EPR-U	IT20	VT20	985	T20EPR-U	IT20	VT20				

DENSO
 AUSTRALIA
 CHINA
 INDIA
 INDONESIA
 KOREA
 MALAYSIA
 PHILIPPINES
 SAUDI ARABIA
 SINGAPORE
 TAIWAN
 THAILAND
 VIETNAM
 JAPAN
 EUROPE
 MOTOR CYCLE
 SMALL ENGINE
 CROSS REFERENCE
 PART NUMBER

CROSS REFERENCE ()

DENSO

AUSTRALIA

INDIA

INDONESIA

MALAYSIA

PHILIPPINES

SINGAPORE

TAIWAN

THAILAND

VIETNAM

PART NUMBER	SMALL ENGINE		MOTOR CYCLE		EUROPE & USA		JAPAN		VIETNAM		THAILAND		SINGAPORE		MALAYSIA		INDONESIA		INDIA		CHINA		AUSTRALIA	
	BERU (Germany)	DENSO	IRIDIUM POWER	IRIDIUM TOUGH/PLUS	BERU (Germany)	DENSO	IRIDIUM POWER	IRIDIUM TOUGH/PLUS	BOSCH (Germany)	DENSO	IRIDIUM POWER	IRIDIUM TOUGH/PLUS	BOSCH (Germany)	DENSO	IRIDIUM POWER	IRIDIUM TOUGH/PLUS	BOSCH (Germany)	DENSO	IRIDIUM POWER	IRIDIUM TOUGH/PLUS	BOSCH (Germany)	DENSO	IRIDIUM POWER	IRIDIUM TOUGH/PLUS
14F-6DUO	K20P-U	IK20	VK20	S5	IW20	IW20	VW20	F6DP	IK20	IK20	VK20	FQ8DE	-	-	-	-	FQ8DE	-	-	-	-	-	-	-
14F-6DUOR	K20P-U	IK20	VK20	S6	-	IWF22	-	F6DP0R	IK20	IK20	VK20	FQR8LE2	KJ16CR-L11	IK16	VK16	FQR8LE2	KJ16CR-L11	IK16	VK16	-	-	-	-	-
14F-7LDUR	K20TXR	IK20	VK20	S9	IW22	IW22	VW22	F6DPP332	VK20	IK20	VK20	FR10DC	K16PR-U	IK16	VK16	FR10DC	K16PR-U	IK16	VK16	-	-	-	-	-
14F-7DU	K20P-U	IK20	VK20	UXF79P	K20TXR	IK20	VK20	F6DPX	IK20	IK20	VK20	FR10DCX	K16PR-U11	IK16	VK16	FR10DCX	K16PR-U11	IK16	VK16	-	-	-	-	-
14F-7DUOR	K20P-U	IK20	VK20	BLITZ (Japan)		DENSO		F6DSR	IK20	IK20	VK20	FR10DX	K16PR-U11	IK16	VK16	FR10DX	K16PR-U11	IK16	VK16	-	-	-	-	-
14F-7DUR	K20P-U	IK20	VK20	R6105-10	IQ31	IQ31	-	F6DTC	K20PBR	IK20	VK20	FR56	IK22	IK22	VK22	FR56	IK22	IK22	VK22	-	-	-	-	-
14F-7HUR2	KJ16CR-L11	IK16	VK16	R6105-7	IQ22	IQ22	VQ22	F6HER2	-	-	-	FR5DC	K22PR-U	IK22	VK22	FR5DC	K22PR-U	IK22	VK22	-	-	-	-	-
14F-8DU	K16P-U11	IK16	VK16	R6105-8	IQ24	IQ24	-	F6KPP332S	VK20Y	-	VK20Y	FR5DCX	K22PR-U11	IK22	VK22	FR5DCX	K22PR-U11	IK22	VK22	-	-	-	-	-
14F-8DU4	K16P-U11	IK16	VK16	R6105-9	IQ27	IQ27	-	F6LTCR	K20PBR	IK20	VK20	FR5DP	-	-	-	FR5DP	-	-	-	-	-	-	-	-
14F-8DUO	K16P-U11	IK16	VK16	R6105-10	IQ27	IQ27	-	F6MPP332	VKH20	IKH20	VKH20	FR5DP1	IK22	IK22	VK22	FR5DP1	IK22	IK22	VK22	-	-	-	-	-
14F-8LDUSR	K20TXR	IK20	VK20	R6187-105	IRE01-32	-	-	F7DC	K20P-U	IK20	VK20	FR5DP1X	IK22	IK22	VK22	FR5DP1X	IK22	IK22	VK22	-	-	-	-	-
14F-8LUR	KJ16CR11	IK16	VK16	R6187-11	IRE01-34	-	-	F7DC0	K20P-U	IK20	VK20	FR5DP222U	VK22	IK22	VK22	FR5DP222U	VK22	IK22	VK22	-	-	-	-	-
14F-9DUO	K16P-U11	IK16	VK16	R6187-115	IRE01-35	-	-	F7DCR4	K20P-U	IK20	VK20	FR5DP222U	VK22	IK22	VK22	FR5DP222U	VK22	IK22	VK22	-	-	-	-	-
14FGH-8DUPURX2	PK16PR-(L)11	IK16	VK16	R6427-10	IK31	IK31	-	F7DCR4	K20P-U	IK20	VK20	FR5DTC	K22PBR-S	IK22	VK22	FR5DTC	K22PBR-S	IK22	VK22	-	-	-	-	-
14FGH-8DTUR	K20PBR-S10	IK20	VK20	R6427-7	IK22	IK22	VK22	F7DCX	K20PR-U11	IK20	VK20	FR6D+	K20PR-U	IK20	VK20	FR6D+	K20PR-U	IK20	VK20	-	-	-	-	-
14FGH-7DTURX	K20PBR-S10	IK20	VK20	R6427-8	IK24	IK24	-	F7DER	K20PR-U	IK20	VK20	FR6DC	K20PR-U	IK20	VK20	FR6DC	K20PR-U	IK20	VK20	-	-	-	-	-
14FGH-7DTURXO	K20PBR-S10	IK20	VK20	R6427-8	IK24	IK24	-	F7DP	IK20	IK20	VK20	FR6DC2	K20PR-U	IK20	VK20	FR6DC2	K20PR-U	IK20	VK20	-	-	-	-	-
14FGH-8DUPURX2	PK16PR-(L)11	IK16	VK16	R6427-9	IK27	IK27	-	F7DPER	PK20PR-P8	IK20	VK20	FR6DC4	K20PR-U	IK20	VK20	FR6DC4	K20PR-U	IK20	VK20	-	-	-	-	-
14FGH-8DUPURX2	PK16PR-(L)11	IK16	VK16	T7340B-6	IK20	IK20	VK20	F7DPP22T	PK20PR-P8	IK20	VK20	FR6DCX	K20PR-U11	IK20	VK20	FR6DCX	K20PR-U11	IK20	VK20	-	-	-	-	-
14FGH-8DUPURX2	PK16PR-(L)11	IK16	VK16	T7340B-7	IK22	IK22	VK22	F7DPP22U	PK20PR11	IK20	VK20	FR6DDC	K22TMR11	IK22	VK22	FR6DDC	K22TMR11	IK22	VK22	-	-	-	-	-
14FGH-8DUPURX2	PK16PR-(L)11	IK16	VK16	T7340B-8	IK24	IK24	-	F7DPP332	PK20PR11	IK20	VK20	FR6DP	IK20	IK20	VK20	FR6DP	IK20	IK20	VK20	-	-	-	-	-
14FGH-8DUPURX2	PK16PR-(L)11	IK16	VK16	T7341B-6	IQ20	IQ20	VQ20	F7DTC	K20PBR	IK20	VK20	FR6DP1X	IK20	IK20	VK20	FR6DP1X	IK20	IK20	VK20	-	-	-	-	-
14FGH-8DUPURX2	PK16PR-(L)11	IK16	VK16	T7341B-7	IQ22	IQ22	VQ22	F7HER2	KJ16CR-L11	IK16	VK16	FR6DP222U	VK20	IK20	VK20	FR6DP222U	VK20	IK20	VK20	-	-	-	-	-
14FGH-8DUPURX2	PK16PR-(L)11	IK16	VK16	T7341B-8	IQ24	IQ24	-	F7HER2	KJ16CR-L11	IK16	VK16	FR6DP332S	VK20	IK20	VK20	FR6DP332S	VK20	IK20	VK20	-	-	-	-	-
14FR-5DPUX	IK22	IK22	VK22	BOSCH (Germany)		DENSO		F7HPP222	SKJ16CR-L11	IK16	VK16	FR6DP332S	VK20	IK20	VK20	FR6DP332S	VK20	IK20	VK20	-	-	-	-	-
14FR-5DTU	K22PBR-S	IK22	VK22	4417	PK20PR11	IK20	VK20	F7KPP332S	-	-	-	FR6DP332S	VK20	IK20	VK20	FR6DP332S	VK20	IK20	VK20	-	-	-	-	-
14FR-5DU	K22PR-U	IK22	VK22	4418	PK16PR-(L)11	IK16	VK16	F7KPP332U	VK20	IK20	VK20	FR6DPX	IK20	IK20	VK20	FR6DPX	IK20	IK20	VK20	-	-	-	-	-
14FR-5LDU	K20TXR	IK20	VK20	4419	-	-	-	F7KPP332U	VK20	IK20	VK20	FR6DS	IK20	IK20	VK20	FR6DS	IK20	IK20	VK20	-	-	-	-	-
14FR-6DPUX	IK20	IK20	VK20	4428	SKJ16CR-L11	IK16	VK16	F7LTCR	K20PBR-S10	IK20	VK20	FR6DTC	K20PBR	IK20	VK20	FR6DTC	K20PBR	IK20	VK20	-	-	-	-	-
14FR-6DU	K20PR-U	IK20	VK20	4448	ITF16	ITF16	-	F7LTCR2	K20R-U	IK20	VK20	FR6DTCW	K20PBR-S10	IK20	VK20	FR6DTCW	K20PBR-S10	IK20	VK20	-	-	-	-	-
14FR-6LDU	K20TXR	IK20	VK20	4449	ITF16	ITF16	-	F7LTCR	KJ20CR11	IK20	VK20	FR6KDC	K20TNR-S	IK20	VK20	FR6KDC	K20TNR-S	IK20	VK20	-	-	-	-	-
14FR-7DUPUX	IK20	IK20	VK20	4457	VT20	IT20	VT20	F7LDCR	K20TXR	IK20	VK20	FR6KDE0	K20TXR	IK20	VK20	FR6KDE0	K20TXR	IK20	VK20	-	-	-	-	-
14FR-7DU	K20PR-U	IK20	VK20	4458	PT16EPR-L13	IT16	VT16	F7LDCR	K20TXR	IK20	VK20	FR6KPP332S	VK20	IK20	VK20	FR6KPP332S	VK20	IK20	VK20	-	-	-	-	-
14FR-7DUX	K20PR-U11	IK20	VK20	4459	PT16EPR-L13	IT16	VT16	F7LTCR	K20PBR-S10	IK20	VK20	FR6KTC	K20PBR	IK20	VK20	FR6KTC	K20PBR	IK20	VK20	-	-	-	-	-
14FR-8LDU	K20TXR	IK20	VK20	4469	PT16EPR-L13	IT16	VT16	F8DC	K16P-U11	IK16	VK16	FR6LDC	K20TR11	IK20	VK20	FR6LDC	K20TR11	IK20	VK20	-	-	-	-	-
14FR-8DPUX	IK16	IK16	VK16	4477	VW20	IW20	VW20	F8DC0	K16P-U11	IK16	VK16	FR6MPP332	VKH20	IKH20	VKH20	FR6MPP332	VKH20	IKH20	VKH20	-	-	-	-	-
14FR-8DU	K16PR-U	IK16	VK16	4478	P16PR11	IW16	VW16	F8DC0	K16P-U11	IK16	VK16	FR6NPP332	VKH22	IKH22	VKH22	FR6NPP332	VKH22	IKH22	VKH22	-	-	-	-	-
14FR-8DUX	K16PR-U11	IK16	VK16	4479	-	-	-	F8DCX	K16P-U11	IK16	VK16	FR78	VK20	IK20	VK20	FR78	VK20	IK20	VK20	-	-	-	-	-
14FR-8NQU213	K20HR-U11	IKH20	VKH20	0 241 145 513	-	-	-	F8DER	K16PR-U	IK16	VK16	FR78X	VK20	IK20	VK20	FR78X	VK20	IK20	VK20	-	-	-	-	-
14G-8DTU	W20EPR-S	IW20	VW20	0 241 245 670	VK22	IK22	VK22	F8DPER	PK16PR-(L)11	IK16	VK16	FR7D+	K20PR-U	IK20	VK20	FR7D+	K20PR-U	IK20	VK20	-	-	-	-	-
14GH-7DTUR	W20EPR-S	IW20	VW20	06E905611	VK20	IK20	VK20	F8DPP22U	PK16PR-(L)11	IK16	VK16	FR7D+X	K20PR-U11	IK20	VK20	FR7D+X	K20PR-U11	IK20	VK20	-	-	-	-	-
14GH-8DTUR	W20EPR-S	IW20	VW20	087712-07	IXU01-31	-	-	F8DPP332	PK16PR-(L)11	IK16	VK16	FR7DC	K20PR-U	IK20	VK20	FR7DC	K20PR-U	IK20	VK20	-	-	-	-	-
14K-5DU	T22EP-U	IT22	-	4501 (Pe-Ir FUSION)	VK16	IK16	VK16	F8KTCR	K20PBR-S10	IK20	VK20	FR7DC+	K20PR-U	IK20	VK20	FR7DC+	K20PR-U	IK20	VK20	-	-	-	-	-
14K-5DUO	T22EP-U	IT22	-	4503 (Pe-Ir FUSION)	VK20	IK20	VK20	F8LTCR	K16R-U	IK16	VK16	FR7DC2	K20PR-U	IK20	VK20	FR7DC2	K20PR-U	IK20	VK20	-	-	-	-	-
14K-6DU	T20EP-U	IT20	VT20	D10B	MA16PR-U	-	-	F8LDCR	K20TXR	IK20	VK20	FR7DCX	K20PR-U11	IK20	VK20	FR7DCX	K20PR-U11	IK20	VK20	-	-	-	-	-
14K-6DUO	T20EP-U	IT20	VT20	D10BC	MA16PR-U	-	-	F8LTCR	KJ16CR11	IK16	VK16	FR7DE	K20PR-U	IK20	VK20	FR7DE	K20PR-U	IK20	VK20	-	-	-	-	-
14K-7DU	T20EP-U	IT20	VT20	D6B	MA20P-U	-	-	F8LDCR	K20TXR	IK20	VK20	FR7DP	IK20	IK20	VK20	FR7DP	IK20	IK20	VK20	-	-	-	-	-
14K-8DU	T16EPR-U	IT16	VT16	D6BC	MA20P-U	-	-	F9LTCR	KJ14CR11	IK16	VK16	FR7DP1X	IK20	IK20	VK20	FR7DP1X	IK20	IK20	VK20	-	-	-	-	-
14K-8DUO	T16EPR-U	IT16	VT16	D6BP	MA20P-U	-	-	F9LDCR	KJ14CR-L11	IK16	VK16	FR7DPP+	PK20PR-P8											

CROSS REFERENCE (other DENSO)

BOSCH (Germany)				DENSO				IRIDIUM POWER				IRIDIUM TOUGH/PLUS				BOSCH (Germany)				DENSO				IRIDIUM POWER				IRIDIUM TOUGH/PLUS				BOSCH (Germany)				DENSO				IRIDIUM POWER				IRIDIUM TOUGH/PLUS			
FR8DP	IK16	IK16	VK16	HR5DC	T22EP-U	IT22	-	M10A0	L14-U	-	-	W4DP0	IW24	IW24	-	W4DP0	IW24	IW24	-																												
FR8DP1X	IK16	IK16	VK16	HR6BC	T20PR-U	ITF20	-	M10AC	L14-U/M14	-	-	W5AC	W22FS-U	IWF22	-	W5AC	W22FS-U	IWF22	-																												
FR8DPX	IK16	IK16	VK16	HR6D+	T20EPR-U	IT20	VT20	M10ACO	L14-U	-	-	W5AP	IWF22	IWF22	-	W5AP	IWF22	IWF22	-																												
FR8DS	IK16	IK16	VK16	HR6DC	T20EPR-U	IT20	VT20	M12B	L14-U/M14	-	-	W5AP	IWF22	IWF22	-	W5AP	IWF22	IWF22	-																												
FR8HC	QJ16HR-U9	-	-	HR6DP	T20EPR-U	IT20	VT20	M5A	M22	-	-	W5AS	IWF22	IWF22	-	W5AS	IWF22	IWF22	-																												
FR8HCOX	QJ16HR-U9	-	-	HR6DPP33V	VT20	IT20	VT20	M5AC	M22	-	-	W5B	W22FP-U	IWF22	-	W5B	W22FP-U	IWF22	-																												
FR8HP	QJ16HR-U9	-	-	HR6DS	T20EPR-U	IT20	VT20	M7A	M17	-	-	W5BC	W22FP-U	IWF22	-	W5BC	W22FP-U	IWF22	-																												
FR8HPO	QJ16HR-U9	-	-	HR78	VT20	IT20	VT20	M7AC	M17	-	-	W5BP	IWF22	IWF22	-	W5BP	IWF22	IWF22	-																												
FR8HPX	-	-	-	HR78X	VT20	IT20	VT20	M8A	L14-U/M14	-	-	W5C	W22ES-U	-	-	W5C	W22ES-U	-	-																												
FR8KDC	K16TR11	IK16	VK16	HR7BC	T20PR-U	ITF20	-	M8A0	L14-U	-	-	W5CC	W22ES-U	-	-	W5CC	W22ES-U	-	-																												
FR8LCX	KJ16CR11	IK16	VK16	HR7CCY	-	-	-	M8AC	L14-U/M14	-	-	W5CCX	W22ES-U	-	-	W5CCX	W22ES-U	-	-																												
FR8LDC	K20TXR	IK20	VK20	HR7D+	T20EPR-U	IT20	VT20	M8AC0	L14-U	-	-	W5CP	W22ES-U	-	-	W5CP	W22ES-U	-	-																												
FR8LDC4	K20TXR	IK20	VK20	HR7DC	T20EPR-U	IT20	VT20	M95T1	L14-U/M14	-	-	W5CS	W22ES-U	-	-	W5CS	W22ES-U	-	-																												
FR8LP	IK16	IK16	VK16	HR7DC0	T20EPR-U	IT20	VT20	U260T1	U22FS-U	IUF22	-	W5D	W22EP-U	IW22	VW22	W5D	W22EP-U	IW22	VW22																												
FR8LPX	IK16	IK16	VK16	HR7DCX	T20EPR-U	IT20	VT20	U2A	U24FS-U	IUF24	-	W5D1	W22EP-U	IW22	VW22	W5D1	W22EP-U	IW22	VW22																												
FR8MC9	K16HPR-U11	IKH16	VKH16	HR7DCY	T20EPR-U15	IT20	VT20	U3CC	U22ES-N	IU22	-	W5DC	W22EP-U	IW22	VW22	W5DC	W22EP-U	IW22	VW22																												
FR8ME	K16HPR-U11	IKH16	VKH16	HR7DP	IT20	IT20	VT20	U4A	U22FS-U	IUF22	-	W5DCO	W22EP-U	IW22	VW22	W5DCO	W22EP-U	IW22	VW22																												
FR8NP	IKH16	IKH16	VKH16	HR7DPP22	ZT20EPR11	IT20	VT20	U4AC	U22FS-U	IUF22	-	W5DP	IW22	IW22	VW22	W5DP	IW22	IW22	VW22																												
FR8SE0	K16HPR-U11	IKH16	VKH16	HR7DPX	IT20	IT20	VT20	U5AC	U20FS-U	IUF22	-	W5DPO	W22ES-U	-	-	W5DPO	W22ES-U	-	-																												
FR8SPP332	VKH16	IKH16	VKH16	HR7MCU	T16VR-U10	ITV16	-	U6AC	U20FS-U	IUF22	-	W5DTC	W22EPB	IW22	VW22	W5DTC	W22EPB	IW22	VW22																												
FR8TE2	-	-	-	HR7MPP	PT16VR13	ITV16	-	UH4CC	U24FER9	IUH24	-	W5EC	W22S-U	-	-	W5EC	W22S-U	-	-																												
FR8TI332	-	-	-	HR7MPP+	PT16VR13	ITV16	-	UH5CC	U24FER9	IUH24	-	W6AC	W20FS-U	IWF22	-	W6AC	W20FS-U	IWF22	-																												
FR91X	-	-	-	HR7MPP+V	PT16VR13	ITV16	-	UR2AS	IUF24	IUF24	-	W6BC	W20FP-U	IWF20	-	W6BC	W20FP-U	IWF20	-																												
FR9DCX	Q14R-U11	IQ16	VQ16	HR7MPP22U	PT16VR13	ITV16	-	UR2CC	U24ESR-N	IU24	-	W6CC	W22ES-U	-	-	W6CC	W22ES-U	-	-																												
FR9HC	QJ16HR-U9	-	-	HR7MPP22V	PT16VR13	ITV16	-	UR3AC	U22FSR-U	IUF22	-	W6D	W20EP-U	IW20	VW20	W6D	W20EP-U	IW20	VW20																												
FR9HCX	QJ16HR-U9	-	-	HR7MPP302X	PT16VR13	ITV16	-	UR3AS	U22FSR-U	IUF22	-	W6D1	W20EP-U	IW20	VW20	W6D1	W20EP-U	IW20	VW20																												
FR9HX	QJ16HR-U9	-	-	HR7MEV	-	-	ITV20	UR3CC	U22ESR-N	IU22	-	W6DC	W20EP-U	IW20	VW20	W6DC	W20EP-U	IW20	VW20																												
H09DC	IT27	IT27	-	HR7N1332(Fomoco)	-	-	ITV20	UR4AC	U22FSR-U	IUF22	-	W6DC0	W20EP-U	IW20	VW20	W6DC0	W20EP-U	IW20	VW20																												
H10B	T14PR-U	ITF16	-	HR8AC	T20R-U	-	-	UR4AS	U20FSR-U	IUF22	-	W6DP	IW20	IW20	VW20	W6DP	IW20	IW20	VW20																												
H10BC	T16P-U	ITF16	-	HR8ACV	T20R-U	-	-	UR5AC	U20FSR-U	IUF22	-	W6DP0	W22ES-U	-	-	W6DP0	W22ES-U	-	-																												
H2CS	IT27	IT27	-	HR8AP	T20R-U	-	-	UR5DC	U20EPR9	IU20	-	W6DTC	W20EPB	IW20	VW20	W6DTC	W20EPB	IW20	VW20																												
H3CS	IT24	IT24	-	HR8APY	T20R-U	-	-	UR6AC	U20FSR-U	IUF22	-	W7AC	W20FS-U	IWF22	-	W7AC	W20FS-U	IWF22	-																												
H4CS	IT24	IT24	-	HR8BC	T16PR-U	ITF16	-	USR7AC	-	-	-	W7ACV	W20FS-U	IWF22	-	W7ACV	W20FS-U	IWF22	-																												
H56	T22EP-U	IT22	-	HR8BCY	T16PR-U15	ITF16	-	V6S113828	-	-	-	W7AP	-	IWF22	-	W7AP	-	IWF22	-																												
H5DC	T22EP-U	IT22	-	HR8BP	T16PR-U	ITF16	-	VR8SE	XE20HR-U9	-	VFXEH20	W7B	W20FP-U	IWF20	-	VR8SE	XE20HR-U9	-	VFXEH20																												
H5DC0	T22EP-U	IT22	-	HR8BPX	T16PR-U11	ITF16	-	VR8SEV	XE20HR-U9	-	VFXEH20	W7BC	W20FP-U	IWF20	-	VR8SEV	XE20HR-U9	-	VFXEH20																												
H5DP	T22EP-U	IT22	-	HR8BPY	T16PR-U15	ITF16	-	VR8SEVU	XE20HR-U9	-	VFXEH20	W7BP	-	IWF22	-	VR8SEVU	XE20HR-U9	-	VFXEH20																												
H6B	T20P-U	ITF20	-	HR8BPZ	T16PR-U15	ITF16	-	W06AS	W31FS	-	-	W7C0	W20ES-U	-	-	W06AS	W31FS	-	-																												
H6BC	T20P-U	ITF20	-	HR8D+	T20EPR-U	IT20	VT20	W06CS	IW34	IW34	-	W7CC	W20ES-U	-	-	W06CS	IW34	IW34	-																												
H6DC	T20EP-U	IT20	VT20	HR8DC	T20EPR-U	IT20	VT20	W07AS	W31FS	-	-	W7CC0	W20ES-U	-	-	W07AS	W31FS	-	-																												
H6DC0	T20EP-U	IT20	VT20	HR8DCX	T16EPR-U	IT16	VT16	W07CS	IW34	IW34	-	W7D	W20EP-U	IW20	VW20	W07CS	IW34	IW34	-																												
H6DP	T20EP-U	IT20	VT20	HR8DCY	T16EPR-U15	IT16	VT16	W08AS	IWF27	IWF27	-	W7DC	W20EP-U	IW20	VW20	W08AS	IWF27	IWF27	-																												
H7BC	T20P-U	ITF20	-	HR8DP	IT16	IT16	VT16	W08CS	IW31	IW31	-	W7DC0	W20EP-U	IW20	VW20	W08CS	IW31	IW31	-																												
H7CC	-	-	-	HR8DPP15V	PT16EPR-L13	IT16	VT16	W10A	W14F-U	-	-	W7DCR	W20EP-U	IW20	VW20	W10A	W14F-U	-	-																												
H7DC	T20EP-U	IT20	VT20	HR8DPP22U	PT16EPR-L13	IT16	VT16	W10AC	W14F-U	-	-	W7DCX	W20EPR-U11	IW20	VW20	W10AC	W14F-U	-	-																												
H7DC0	T20EP-U	IT20	VT20	HR8DPP22U	PT16EPR-L13	IT16	VT16	W10C	W14E	-	-	W7DP	IW20	IW20	VW20	W10C	W14E	-	-																												
H7DCY	T20EP-U15	IT20	VT20	HR8DPV	IT16	IT16	VT16	W10CC	W14E	-	-	W7DPX	IW20	IW20	VW20	W10CC	W14E	-	-																												
H7DP	T20EP-U	IT20	VT20	HR8DPX	IT16	IT16	VT16	W10D	W9EP	-	-	W7DSR	IW20	IW20	VW20	W10D	W9EP	-	-																												
H7DPY	IT20	IT20	VT20	HR8DPY	IT16	IT16	VT16	W10DC	W9EP	-	-	W7DTC	W20EPB	IW20	VW20	W10DC	W9EP	-	-																												
H7LDCR	T20EPR-U	IT20	VT20	HR8LCO	T20NR-U11	IT20	VT20	W10DCX	W9EP	-	-	W7DX	W20EPR-U11	IW20	VW20	W10DCX	W9EP	-	-																												
H8BC	T16P-U	ITF16	-	HR8LPX	T16NR-U11	IT16	VT16	W10EC	W14-U	-	-	W7EC	W20S-U	-	-	W10EC	W14-U	-	-																												
H8D	T16EPR-U	IT16	VT16	HR8MEV	T16VR-U10	ITV16	-	W10F	W14PR-U	-	-	W7FC	W20PR-U	-	-	W10F	W14PR-U	-	-																												
H8DC	T16EPR-U	IT16	VT16	HR8MPV	ITV16	ITV16	-	W10FC	W14PR-U	-	-	W7LTCR	W20EPR-S	IW20	VW20	W10FC	W14PR-U	-	-																												
H8DC0	T16EPR-U	IT16	VT16	HR8NPP302	PT16VR13	ITV16	-	W10LCX	-	-	-	W8A	W16FS-U	-	-	W10LCX	-	-	-																												
H8DP	IT16	IT16	VT16	HR91GX	T16PR-U	ITF16	-	W11E0	-	-	-	W8A0	W16FS-U	-	-	W11E0	-	-	-																												
H9B	T14PR-U	ITF16	-	HR91YO	-	-	-	W12A	-	-	-	W8AC	W16FS-U	-	-	W12A	-	-	-																												
H9BC	T14PR-U	ITF16	-	HR9AC	T16R-U	-	-	W2A	W27FS-U	IWF27	-	W8AO	W16FS-U	-	-	W2A	W27FS-U	IWF27	-																												
H9BCV	T14PR-U15	ITF16	-	HR9ACV	T16R-U15	-	-	W2AC	W27FS-U	IWF27	-	W8AP	IWF16	IWF16	-	W2AC	W27FS-U	IWF27	-																												
H9DC	T16EPR-U	IT16	VT16	HR9AP	T16R-U	-	-	W2AS	IWF27	IWF27	-	W8B	W16FP-U	IWF16	-	W2AS	IWF27	IWF27	-																												
H9DC0	T16EPR-U	IT16	VT16	HR9APX	T16R-U15	-	-	W2CC	W27ES-U	IW27	-	W8BC	W16FP-U	IWF16	-	W2CC	W27ES-U	IW27	-																												
H9DCY	T16EPR-U15	IT16	VT16	HR9APY	T16R-U15	-	-	W2CS	IW31	IW31	-	W8BP	W16FP-U	IWF16	-	W2CS	IW31	IW31	-																												
HGR6DQ1 (Pt-IR FUSION)	VT20	IT20	VT20	HR9BC	T16PR-U	ITF16	-	W3A	W24FS-U	IWF24	-	W8CC	W16ES-U	-	-	W3A	W24FS-U	IWF24	-																												
HGR6KQC	T20EPR-U	IT20	VT20	HR9BCY	T16PR-U15	ITF16	-	W3AC	W24FS-U	IWF24	-	W8DC	W16EP-U	IW16	VW16	W3AC	W24FS-U	IWF24	-																												
HGR7DQ1 (Pt-IR FUSION)	VT20	IT20	VT20	HR9BCZ	T16PR-U15	ITF16	-	W3AP	IWF24	IWF24	-	W8DC0	W16EP-U	IW16	VW16	W3AP	IWF24	IWF24	-																												
HGR7HQPE0	-	-	-	HR9BP	T16PR-U	ITF16	-	W3AS	IWF24	IWF24	-	W8DC04	W20EP-U	IW20	VW20	W3AS	IWF24	IWF24	-																												
HGR7KQC	T20EPR-U	IT20	VT20	HR9BPX	T16PR-U11	ITF16	-	W3C	W24ES-U	IW24	-	W8DCX	W16EPR-U11	IW16	VW16	W3C	W24ES-U	IW24	-																												
HGR8DQ1 (Pt-IR FUSION)	VT16	IT16	VT16	HR9BPY	T16PR-U15	ITF16	-	W3CC	W24ES-U	IW24	-	W8DP	IW16	IW16	VW16	W3CC	W24ES-U	IW24	-																												
HGR8MQ1 (Pt-IR FUSION)	-	ITV16	-	HR9BPZ	T16PR-U15	ITF16	-	W3CP	IW24	IW24	-	W8DPV	W16EP-U11	IW16	VW16	W3CP	IW24	IW24	-																												
HGR9BQ1 (Pt-IR FUSION)	-	ITF16	-	HR9DC	T16EPR-U	IT16	VT16	W3CS	IW24	IW24	-	W8DPX	W16EP-U11	IW16	VW16	W3CS	IW24	IW24	-																												
HGR9DQ1 (Pt-IR FUSION)	-	-	-	HR9DCX	T16EPR-U15	IT16	VT16	W3DP	W24EP-U	IW24	-	W8DTC	W20EPB	IW20	VW20	W3DP	W24EP-U	IW24	-																												
HLR8STEX	ITV20	ITV20	-	HR9DCY	T16EPR-U15	IT16	VT16	W3DP0	IW01-24	-	-	W8DX	W16EP-U11	IW16	VW16	W3DP0	IW01-24	-	-																												
HR10AC	T14PR-U	ITF16	-	HR9DPX	IT16	IT16	VT16	W4A	W24FS-U	IWF24	-	W8E	W16S-U	-	-	W4A	W24FS-U	IWF24	-																												
HR10ACV	T14PR-U15	ITF16	-	HR9DPY	IT16	IT16	VT16	W4A1	W24FS-U	IWF24	-	W8FC	W16PR-U	-	-	W4A1	W24FS-U	IWF24	-																												
HR10BC	T14PR-U	ITF16	-	HR9HCO	T20NR-U11	IT20	VT20	W4A2	W24FS-U	IWF24	-	W8LCR	J16CR-U	IW16	VW16	W4A2	W24FS-U	IWF24	-																												
HR10BCX	T14PR-U15	ITF16	-	HR9HCO	T16EPR-U	IT16	VT16	W4AC	W24FS-U	IWF24																																					

CROSS REFERENCE (⇒)

DENSO

AUSTRALIA

CHINA

INDIA

INDONESIA

KOREA

MALAYSIA

PHILIPPINES

SAUDI ARABIA

SINGAPORE

TAIWAN

THAILAND

VIETNAM

JAPAN

MOTOR CYCLE

EUROPE & USA

CROSS REFERENCE ENGINE

PART NUMBER

	BOSCH (Germany)	DENSO	IRIDIUM POWER	IRIDIUM TOUGH/PLUS	BOSCH (Germany)	DENSO	IRIDIUM POWER	IRIDIUM TOUGH/PLUS	BOSCH (Germany)	DENSO	IRIDIUM POWER	IRIDIUM TOUGH/PLUS	CHAMPION (U.S.A.)	DENSO	IRIDIUM POWER	IRIDIUM TOUGH/PLUS
	W9DTC	W16EPB10	IW16	VW16	WR7DC+	W20EPR-U	IW20	VW20	X4CC	X24ES-U	IX24	-	9801(Iridium)	VK20Y	-	VK20Y
	W9E	W14-U	-	-	WR7DC2	W20EPR-U	IW20	VW20	X4CS	IX24	IX24	-	9802(Iridium)	VK20	IK20	VK20
	W9E0	W14LM-U	-	-	WR7DCX	W20EPR-U11	IW20	VW20	X4DC	X27EP-U9	IX27B	-	9803(Iridium)	VK20	IK20	VK20
	W9EC	W14-U	-	-	WR7DP	IW20	IW20	VW20	X5CC	X24ES-U	IX24	-	9804(Iridium)	VW20	IW20	VW20
	W9ECO	W14LM-U	-	-	WR7DP1	IW20	IW20	VW20	X5DC	X22EP-U9	IX22B	-	A10	X20ES-U	-	-
	W9LC	J14CR-U	IW16	VW16	WR7DP1X	IW20	IW20	VW20	X5DTC	X22ES-U	IX22	-	A57C	X31ESR-U	-	-
	W9LCX	J14CR-U	IW16	VW16	WR7DPX	IW20	IW20	VW20	XR2AS	X24FS-U	-	-	A57G	IXU01-31	-	-
	W9LDCR	W16ETR-S	IW16	VW16	WR7DS	IW20	IW20	VW20	XR2CS	IX24	IX24	-	A59C	X27ES-U	IX27/IXU27	-
	W9LVX	-	-	-	WR7DS+	IW20	IW20	VW20	XR4AS	X24FS-U	-	-	A59G	IX27/IXU27	IX27/IXU27	-
	WEA	SF50	-	-	WR7DTC	W20EPBR-S	IW20	VW20	XR4CS	X24ESR-U	IX24	-	A59GC	IX27/IXU27	IX27/IXU27	-
	WGR6DQI (Pt-Ir Fusion)	VW20	IW20	VW20	WR7EC	W20SR-U	-	-	XR4DC	X27EP-U9	IX27B	-	A59C	X27EP-U9	IX27B	-
	WGR7DQI (Pt-Ir Fusion)	VW20	IW20	VW20	WR7LC	J16CR-U	IW16	VW16	XR5CC	X24ESR-U	IX24	-	A6	X24ES-U	IX24	-
	WGR8DQI (Pt-Ir Fusion)	VW16	IW16	VW16	WR7LDC	W20ET-S	IW20	VW20	XR5DC	X22EP-U9	IX22B	-	A61	X27ES-U	IX27/IXU27	-
	WGR9DQI (Pt-Ir Fusion)	-	-	-	WR7LT+	W20EPBR-S	IW20	VW20	XR6CC	X24ESR-U	IX24	-	A61G	IX27	IX27	-
	WK175T1	W20M-U	-	-	WR8AC	W16FSR	-	-	XR7CC	X22ESR-U	IX22	-	A6G	IX24	IX24	-
	WR10AC	W14FR-L	IWF16	-	WR8AP	W16FSR	-	-	XR7DC	X22EPR-U9	IX22B	-	A6HC	X24EP-U9	IX24B	-
	WR10AC	W14FR-U	-	-	WR8B+	W16FPR-U	IW16	VW16	XR7LDC	-	-	-	A6YC	X24ES-U	IX24	-
	WR10BC	W14FPR-U	IWF16	-	WR8BC	W16FPR-U	IWF16	-	XR8DC	X20EPR-U9	-	-	A8HC	X22EP-U9	IX22B	-
	WR10DC	W14EPR-U	IW16	VW16	WR8BP	W16FPR-U	IWF16	-	Y5DDC	XU22EPR-U	-	-	A8Y	X24ES-U	IX24	-
	WR10DCX	W14EXR-U11	IW16	VW16	WR8CC	W16ESR-U	-	-	Y6DC	XU20EPR-U	IXU22	VXU22	A8YC	X22EP-U9	IX22B	-
	WR10F	W14PR-U	-	-	WR8CCX	W16ESR-U	-	-	Y6NPP332	VXUH22	IXUH22	VXUH22	BL11Y	T20P-U	ITF20	-
	WR10FC	W14PR-U	-	-	WR8CP	W16ESR-U	-	-	Y7LPP332W	VXU22	IXU22	VXU22	BL55	-	-	-
	WR10FCY	W14PR-U	-	-	WR8D+	W16EPR-U	IW16	VW16	Y7MPP33	VXUH22	IXUH22	VXUH22	BL57	-	-	-
	WR10FCZ	W14PR-U	-	-	WR8D+X	W16EPR-U11	IW16	VW16	Y7MPP332	VXUH22	IXUH22	VXUH22	BL57Y	-	-	-
	WR10FY	W14PR-U	-	-	WR8DC	W16EPR-U	IW16	VW16	YR5DDE	XU24EPR-U	IXU24	VXU24	BN14Y	T16EPR-U	IT16	VT16
	WR10LC	J14CR-U	IW16	VW16	WR8DC04	W20EPR-U	IW20	VW20	YR5LDE	XU24EPR-U	IXU24	VXU24	C10YCC	K20P-U	IK20	VK20
	WR10LCV	J14CR-U	IW16	VW16	WR8DC4	W16EPR-U	IW16	VW16	Y6NPP3320	VXUH22	IXUH22	VXUH22	C10YCX	K20P-U	IK20	VK20
	WR11E0	W9LMR-US	-	-	WR8DCX	W16EPR-U11	IW16	VW16	YR6LDE	XU22EPR-U	IXU22	VXU22	C11YCC	K16P-U11	IK16	VK16
	WR11F	W9PR-U	-	-	WR8DP	IW16	IW16	VW16	YR6LDEM14	XU22EPR-U	IXU22	VXU22	C12YCC	K16P-U11	IK16	VK16
	WR12EC	W9LMR-US	-	-	WR8DP1	IW16	IW16	VW16	YR6NPP332	VXUH22	IXUH22	VXUH22	C279YC	K22PR-U	IK22	VK22
	WR2CC	W31ESR-U	IW31	-	WR8DP1X	IW16	IW16	VW16	YR7DC	XU22EPR-U	IXU22	VXU22	C281YC	K20P-U	IK20	VK20
	WR3AP	IWF27	IWF27	-	WR8DPX	IW16	IW16	VW16	YR7DE	XU22EPR-U	IXU22	VXU22	C53C	IK31	IK31	-
	WR3CC	W27ESR	IW27	-	WR8DS	W16EPR-U	IW16	VW16	YR7LPP332W	VXU22	IXU22	VXU22	C55C	IK31	IK31	-
	WR3CC	W27ESR-U	IW27	-	WR8EC	W16S-U	-	-	YR7MPP33	VXUH22	IXUH22	VXUH22	C57	IK01-31	-	-
	WR3CP	IW27	IW27	-	WR8FC	W16PR-U	-	-	Z65113320(BiHex)	-	-	-	C57A	IK01-31	-	-
	WR3CS	IW27	IW27	-	WR8HP	-	-	-	ZGRSTPP332(BiHex)	-	-	-	C57C/CX	IK31	IK31	-
	WR3CTC	IRE01-27	-	-	WR8HP	J16AR-U11	-	-	ZGR6STE2(BiHex)	-	-	-	C57J4C	IK01-31	-	-
	WR3DC	IW27	IW27	-	WR8LP	IW16	IW16	VW16	ZQR8S(BiHex)	-	-	-	C57YC	IK31	IK31	-
	WR4AC	W24FSR	IWF24	-	WR8LT+	W20EPBR-S	IW20	VW20	ZMRSTPP339(BiHex)	-	-	-	C59C	IK27	IK27	-
	WR4AP	IWF24	IWF24	-	WR91	VW16	IW16	VW16	ZRS51332(BiHex)	-	-	-	C59YC	IK27	IK27	-
	WR4CC	W24ESR-U	IW24	-	WR91V	P16PR11	IW16	VW16	ZRSTPP33(BiHex)	-	-	-	C61C	IK27	IK27	-
	WR4CP	IW24	IW24	-	WR91V0	-	-	-	ZRSTPP330A(BiHex)	-	-	-	C61YC	IK27	IK27	-
	WR4DPO	IW01-24	-	-	WR91X	VW16	IW16	VW16	ZRSTPP33-S(BiHex)	-	-	-	C63C	IK24	IK24	-
	WR4DPO	IW24	IW24	-	WR9CC	W14E	-	-	Z65113320R(BiHex)	-	-	-	C63YC	IK24	IK24	-
	WR56	VW22	IW22	VW22	WR9D+	W16EPR-U	IW16	VW16	ZR8TPP15(BiHex)	-	-	-	C6BMC	K22PBR-S	IK22	VK22
	WR5AC	W22FSR	IWF22	-	WR9DC	W14EPR-U	IW16	VW16	CHAMPION (U.S.A.)	DENSO	IRIDIUM POWER	IRIDIUM TOUGH/PLUS	C6BYC	K22PB	IK22	VK22
	WR5AP	IWF22	IWF22	-	WR9DCX	W14EXR-U11	IW16	VW16	206	IK20	IK20	VK20	C6BYC4	K22PB	IK22	VK22
	WR5CC	W22ESR-U	-	-	WR9DCY	W14EXR-U11	IW16	VW16	207	IK22	IK22	VK22	C6VPYC	IK22	IK22	VK22
	WR5CP	W22ES-U	-	-	WR9DP	W14EPR-U	IW16	VW16	208	IK24	IK24	-	C6YCC	K22PR-U	IK22	VK22
	WR5D+	W22EPR-U	IW22	VW22	WR9DPX	W14EXR-U11	IW16	VW16	209	IK27	IK27	-	C7GY	IK22	IK22	VK22
	WR5DC	W22EPR-U	IW22	VW22	WR9DS	W14EPR-U	IW16	VW16	307	IW22	IW22	VW22	C7YC	K22PR-U	IK22	VK22
	WR5DP	IW22	IW22	VW22	WR9E0	W14LM-U	-	-	308	IW24	IW24	-	C7YCC	K22PR-U	IK22	VK22
	WR5DS	IW22	IW22	VW22	WR9EC	W14-U	-	-	470	-	ITL20	-	C7YCX	K22PR-U	IK22	VK22
	WR6AC	W22FSR	IWF22	-	WR9ECO	W14-U	-	-	860	MA20PR-U	-	-	C9BMC	K20TXR	IK20	VK20
	WR6BC	W20FPR-U	IWF20	-	WR9EC3	W14L	-	-	870	MA16PR-U	-	-	C9BYC	K20PBR	IK20	VK20
	WR6CC	W22ESR-U	-	-	WR9FC	W14PR-U	-	-	3013	T16EPR-U15	IT16	VT16	C9GY	IK20	IK20	VK20
	WR6D+	W20EPR-U	IW20	VW20	WR9FCY	W14PR-U	-	-	3015	T16EPR-U	IT16	VT16	C9MCC	K20-U	IK20	VK20
	WR6DC	W20EPR-U	IW20	VW20	WR9FCZ	W14PR-U	-	-	3018	T16PR-U11	ITF16	-	C9YC	K20P-U	IK20	VK20
	WR6DCX	W20EPR-U11	IW20	VW20	WR9FP	W14PR-U	-	-	3025	T16PR-U15	ITF16	-	C9YC4	K20PR-U11	IK20	VK20
	WR6DP	IW20	IW20	VW20	WR9FPZ	W14PR-U	-	-	3031	W16EXR-U13	IW16	VW16	C9YCC	K20P-U	IK20	VK20
	WR6DP0	IW20	IW20	VW20	WR9FPY	W14PR-U	-	-	3034	-	IK16	VK16	C9YCX	K20P-U	IK20	VK20
	WR6DP1X	IW20	IW20	VW20	WR9HC	J16AR-U11	-	-	3071	Q16PR-U	IQ16	VQ16	CJ11	W14M-U	-	-
	WR6DPX	IW20	IW20	VW20	WR9LCX	J14CR-U	IW16	VW16	3322	W16EPR-U	IW16	VW16	CJ14	W14M-U	-	-
	WR6DS	IW20	IW20	VW20	WR9LE	J14CR-U	IW16	VW16	3344	K20PR-U	IK20	VK20	CJ4	W22M-U	-	-
	WR6DTC	W20EPBR-S	IW20	VW20	WR9LEV	J14CR-U	IW16	VW16	3401	T16EPR-U	IT16	VT16	CJ6	W22M-U	-	-
	WR78	W20EPBR-S	IW20	VW20	WR9LP	J14CR-U	IW16	VW16	3405	W16EXR-U	IW16	VW16	CJ6Y	W22MP-U	-	-
	WR78G	IWF20	IWF20	-	WR9LS	J14CR-U	IW16	VW16	3407	T16EPR-U15	IT16	VT16	CJ7Y	W22MP-U	-	-
	WR78X	W20EPBR-S	IW20	VW20	WS12E	W14M-U	-	-	3415	W20EPR-U	IW20	VW20	CJ8	W20M-U	-	-
	WR7AC	W20FSR-U	IWF22	-	WS5E	W22M-U	-	-	7015(Double-Pt)	VT16	IT16	VT16	CJ8Y	W20MP-U	-	-
	WR7AP	-	IWF22	-	WS5F	W22MP-U	-	-	7018(Double-Pt)	ITF16	ITF16	-	D10	M17	-	-
	WR7B	W20FPR-U	IWF20	-	WS6E	W20M-U	-	-	7032(Double-Pt)							

CROSS REFERENCE (→)

CHAMPION (U.S.A.)	DENSO	IRIDIUM POWER	IRIDIUM TOUGH/PLUS	CHAMPION (U.S.A.)	DENSO	IRIDIUM POWER	IRIDIUM TOUGH/PLUS	CHAMPION (U.S.A.)	DENSO	IRIDIUM POWER	IRIDIUM TOUGH/PLUS	CHAMPION (U.S.A.)	DENSO	IRIDIUM POWER	IRIDIUM TOUGH/PLUS
DJ6J	T22M-U	-	-	L60R	-	-	IWF24	N62R	IW06-27	-	-	QL81Y	W22FPR-U	IWF22	-
DJ6Y	T22MP-U	-	-	L61Y	W24FP-U	IWF24	-	N64Y	W24EP-U	IW24	-	QL82C	W22FSR	IWF22	-
DJ7J	T20M-U	-	-	L62R	-	-	IWF24	N65Y	W22EP-U	IW22	VW22	QL82YC	W22FPR-U	IWF22	-
DJ7Y	T20MP-U	-	-	L64Y	W22FP-U	IWF22	-	N66Y	W20EP-U	IW20	VW20	QL86C	W20FSR-U	IWF22	-
DJ8J	T20M-U	-	-	L66Y	W20FP-U	IWF20	-	N6BYC	W22EPB	IW22	VW22	QL87C	W20FSR-U	IWF22	-
F10	MA20PR-U	-	-	L66Y	IWF22	IWF22	-	N6GY	IW24	IW24	-	QL87YC	W20FPR-U	IWF20	-
F10C	MA20PR-U	-	-	L76V	SF50	-	-	N6YC	W24EP-U	IW24	-	QN2C	W27ESR	IW27	-
F11Y	MA16PR-U	-	-	L77J	W27FS-U	IWF27	-	N6YCC	W24EP-U	IW24	-	QN2C	W27ESR-U	IW27	-
F11YC	MA16PR-U	-	-	L77J4	W27FS-U10	IWF27	-	N6YCX	W24EP-U	IW24	-	QN2G	IW27	IW27	-
F14Y	MA9P-U	-	-	L77JC	W27FS-U	IWF27	-	N7	W16ES-U	-	-	QN3C	W24ESR-U	IW24	-
F14YC	MA9P-U	-	-	L77JC4	W27FS-U10	IWF27	-	N74C	W22ES-U	-	-	QN53VS	IW01-32	-	-
F7Y	MA20P-U	-	-	L78C	W24FS-U	IWF24	-	N79Y	W22EP-U	IW22	VW22	QN84	W27ESR-V	IW27	-
F7YC	MA20P-U	-	-	L78V	SF51	-	-	N7BMC	W20ETR-L	IW20	VW20	QN86	W24ESR-V	IW24	-
F7YCC	MA20P-U	-	-	L78Y	W24FP-U	IWF24	-	N7BYC	W22EPB	IW22	VW22	R10	X20ES-U	-	-
F9Y	MA20P-U	-	-	L7J	W22FS-U	IWF22	-	N7GY	IW22	IW22	VW22	R6	X24ES-U	IX24	-
F9YC	MA20P-U	-	-	L81Y	W22FP-U	IWF22	-	N7YC	W22EP-U	IW22	VW22	R6G	IX24	IX24	-
FN14LY	KJ16CR-L11	IK16	VK16	L82C	W22FS-U	IWF22	-	N7YC4	W22EP-U11	IW22	VW22	R8	X22ES-U	IX22	-
FR5LP1	-	-	-	L82R	-	-	-	N7YCC	W22EP-U	IW22	VW22	RA4GHC	XU27EPR-U	IXU27	-
G2	U24ESR-N	IU24	-	L82YC	W22FP-U	IWF22	-	N7YCX	W22EP-U	IW22	VW22	RA4HC	XU24EPR-U	IXU24	VXU24
G53C	IU01-34	-	-	L82YCC	W22FP-U	IWF22	-	N8	W14E	-	-	RA4YC	XU27EPR-U	IXU27	-
G53R	IU01-34	-	-	L84R	-	-	-	N80G	IW34	IW34	-	RA59GC	IXU27	IXU27	-
G54V	RU01-31	-	-	L85C	W20FS-U	IWF22	-	N82	-	IW29	-	RA59PP	IXU27	IXU27	-
G55	U31ESR-N	IU31	-	L86C	W16FS-U	-	-	N82G	IW31	IW31	-	RA6HC	XU24EPR-U	IXU24	VXU24
G55C	U31ESR-N	IU31	-	L86CC	W16FS-U	-	-	N82S	IW31	IW31	-	RA6YC	XU24EPR-U	IXU24	VXU24
G55R	IU01-31	-	-	L87R	-	-	IWF27	N84	W27ES-V	IW27	-	RA8HC	XU22EPR-U	IXU22	VXU22
G57C	U31ESR-N	IU31	-	L87YC	W20FP-U	IWF20	-	N84G	IW29	IW29	-	RA8YC	XU22EPR-U	IXU22	VXU22
G57R	IU01-31	-	-	L87YCC	W20FP-U	IWF20	-	N86	W24ES-V	IW24	-	RAX92C	X27ESR-U	IX27	-
G58	U27ES-N	IU27	-	L88A	W16FS-U	-	-	N86G	IW27	IW27	-	RAX92DC	X27ETR	IX27	-
G59C	U27ES-N	IU27	-	L89CM	W16FS-U	-	-	N87	W24ES-U	IW24	-	RAX92YC	X27EPR-U9	IX27B	-
G59R	IU01-27	-	-	L90C	W16FS-U	-	-	N87G	IW24	IW24	-	RAX94C	X24ESR-U	IX24	-
G61	U27ES-N	IU27	-	L92Y	W16FP-U	IWF16	-	N8GY	IW20	IW20	VW20	RAX94YC	X24EPR-U9	IX24B	-
G63	U24ES-N	IU24	-	L92YC	W16FP-U	IWF16	-	N8L	J16BR-U	-	-	RAX96C	X22ESR-U	IX22	-
G63	U24ESR-N	IU24	-	L95Y	W9FP	-	-	N8Y	W20EP-U	IW20	VW20	RAX96YC	X22EPR-U9	IX22B	-
GI	U27ES-N	IU27	-	L95YC	W9FP	-	-	N9BMC	W20ETR-L	IW20	VW20	RC10MC4	K16R-U11	IK16	VK16
H10C	W14L	-	-	L9G	-	-	IWF22	N9BYC	W20EPB	IW20	VW20	RC10MCC	KJ16CR-L11	IK16	VK16
H10C	W16LS	-	-	L9J	W20FS-U	IWF22	-	N9BYC4	W20EPB	IW20	VW20	RC10PMPA	PKJ16CR8	IK16	VK16
H10J	W14L	-	-	N1	W31ES-U	IW31	-	N9Y	W20EP-U	IW20	VW20	RC10PYC	IK16	IK16	VK16
H11	W14L	-	-	N10PY	IW20	IW20	VW20	N9YC	W20EP-U	IW20	VW20	RC10PYP4	PK16PR(-L)11	IK16	VK16
H12	W14L	-	-	N10Y	W20EP-U	IW20	VW20	N9YC	W20EX-U	IW20	VW20	RC10PYPB4	PK16PR(-L)11	IK16	VK16
H18Y	W16LS	-	-	N10Y	W20EX-U	IW20	VW20	N9YC4	W20EPR-U11	IW20	VW20	RC10WYPB4	-	-	-
H8C	W16LS	-	-	N10Y4	W20EPR-U11	IW20	VW20	N9YC4	W20EX-U11	IW20	VW20	RC10YC	K16PR-U	IK16	VK16
H8J	W16LS	-	-	N10Y4	W20EX-U11	IW20	VW20	N9YCC	W20EP-U	IW20	VW20	RC10YC4	K16PR-U11	IK16	VK16
H10	W20S-U	-	-	N11YC	W16EP-U	IW16	VW16	N9YCX	W20EP-U	IW20	VW20	RC10YCC	K16PR-U	IK16	VK16
J10Y	W20PR-U	-	-	N11YC	W16EX-U	IW16	VW16	OBL9Y	T20PR-U	ITF20	-	RC10YCC4	K16PR-U11	IK16	VK16
J11C	W9-U	-	-	N11YC4	W16EP-U11	IW16	VW16	OJ12Y	W16PR-U	-	-	RC11LCC4	KJ16CR-L11	IK16	VK16
J11J	W9-U	-	-	N11YC4	W16EX-U11	IW16	VW16	ON11Y	W16EPR-U	IW16	VW16	RC11PYPB4	PK16PR(-L)11	IK16	VK16
J11Y	W16PR-U	-	-	N11YCC	W16EP-U	IW16	VW16	ON12Y	W16EPR-U	IW16	VW16	RC11ZYC4	K16GPR-U11	-	-
J12C	W9-U	-	-	N12YC	W16EP-U	IW16	VW16	P7	X24FS-U	-	-	RC12ECC	KJ16CR-L11	IK16	VK16
J12J	W9-U	-	-	N12YC	W16EX-U	IW16	VW16	P7G	-	-	-	RC12LC4	KJ16CR-L11	-	VKA16
J12YC	W16PR-U	-	-	N12YCC	W16EP-U	IW16	VW16	P82M	W22FS-U	IWF22	-	RC12LYC	KJ16CR-L11	IK16	VK16
J13Y	W14PR-U	-	-	N13L	J16BR-U	-	-	P86M	W16FS-U	-	-	RC12MC4	KJ16CR-L11	IK16	VK16
J14J	W9-U	-	-	N13Y	W16EP-U	IW16	VW16	P8G	-	-	-	RC12MCC4	KJ16CR-L11	IK16	VK16
J14YC	W14PR-U	-	-	N14LY	J16AR-U11	-	-	P8Y	X20FS-U	-	-	RC12PEC5	PKJ16CR-L13	IK16	VK16
J17LM	W14LM-U	-	-	N14Y	W16EP-U	IW16	VW16	P-A5HC	X22ES-U	IX22	-	RC12PYP	PK16PR8	IK16	VK16
J18YC	W9PR-U	-	-	N16YC	W14EP-U	IW16	VW16	P-A7HC	X22ES-U	IX22	-	RC12YC	K16PR-U	IK16	VK16
J19LM	W9LM-US	-	-	N178B	IRE01-27	-	-	P-G7C	U22ES-N	IU22	-	RC12YC	K16R-U	IK16	VK16
J2J	W27S-U	-	-	N179BC	IRE01-27	-	-	P-L7YC4	W20FP-U10	IWF20	-	RC12YC4	K16PR-U11	IK16	VK16
J4C	W24S-U	-	-	N180B	IRE01-27	-	-	P-L9YC	W20FP-U	IWF20	-	RC12YC5	K16R-U11	IK16	VK16
J4J	W24S-U	-	-	N19V	-	-	-	P-N5C	W24ES-U	IW24	-	RC279YC	K22PR-U	IK22	VK22
J5	W22S-U	-	-	N1C	W27ES-U	IW27	-	P-RA7HC	X22EPR-U9	IX22B	-	RC281YC	K20PR-U	IK20	VK20
J6C	W20S-U	-	-	N21	W14E	-	-	P-RL55C	W20FR-L	IWF20	-	RC57C	IK31	IK31	-
J6J	W20S-U	-	-	N279Y	W22EP-U	IW22	VW22	P-RL95C	W14FR-L	IWF16	-	RC59C	IK27	IK27	-
J7	W16S-U	-	-	N279YC	W22EP-U	IW22	VW22	P-RZ9HC	U20FSR-U	IUF22	-	RC59YC	IK27	IK27	-
J7J	W16S-U	-	-	N281YC	W20EP-U	IW20	VW20	P-Z7HC	U22FS-U	IUF22	-	RC61YC	IK27	IK27	-
J8C	W14-U	-	-	N288	W20ES-U	-	-	P-Z9HC	U20FS-U	IUF22	-	RC6BMC	K22PBR-S	IK22	VK22
J8J	W14-U	-	-	N2C	W27ES-U	IW27	-	QC12PEP	SKJ20CR-A8	IK20L/IK20	-	RC6PYP	PK22PR8	IK22	VK22
K13	L14-U/M14	-	-	N2G	IW27	IW27	-	QC12PEPB	SKJ20CR-A8	IK20L/IK20	-	RC6VPYC	IK22	IK22	VK22
K15J	L14-U/M14	-	-	N3C	W24ES-U	IW24	-	QC57	IK31	IK31	-	RC6YC	K22PR-U	IK22	VK22
K8	M22	-	-	N3CX	W24ES-U	IW24	-	QC57C	IK31	IK31	-	RC6YCC	K22PR-U	IK22	VK22
K9	M22	-	-	N3G	IW24	IW24	-	QC59	IK31	IK31	-	RC7BMC	K22PBR-S	IK22	VK22
KC10PYPB4	PK16PR(-L)11	IK16	VK16	N4C	W22ES-U	-	-	QC59C	IK27	IK27	-	RC7BYC	K22PBR-S	IK22	VK22
L10	W16FS-U	-	-	N4G	W22ES-U	-	-	QC59YC	IK27	IK27	-	RC7BYC4	K22PBR-S	IK22	VK22
L10S	W22FS-U	IWF22	-	N4YC	W22EP-U	IW22	VW22	QC9MC4	KJ20CR-L11	IK20	VK20	RC7GYC	IK22	IK22	VK22
L12Y	W16FP-U	IWF16	-	N52R	-	-	-	QL16V	SF24	IWF24	-	RC7PYCB	IK22	IK22	VK22
L15Y	W9FP	-	-	N54R	IW01-34	-	-	QL16V	W24FS-U	IWF24	-	RC7PYCB4	IK22	IK22	VK22
L20V	SF50	-	-	N54R	IW06-34	-	-	QL55	W31FS	-	-	RC7YC	K22PR-U	IK22	VK22
L2G	IWF27	IWF27	-	N55G	IW34	IW34	-	QL76V	SF50	-	-	RC7YC4	K22PR-U11	IK22	VK22
L3G	IWF24	IWF24	-	N57	W31ES-U	IW31	-	QL77CC	W27FSR	IWF27	-	RC7YCC	K22PR-U	IK22	VK22
L4G	IWF22	IWF22	-	N57G	IW31	IW31	-	QL77J	W27FSR	IWF27	-	RC7YCC4	K22PR-U11	IK22	VK22
L4J	W27FS-U	IWF27	-	N57R	IW01-31	-	-	QL77J4	W27FSR-U10	IWF27	-	RC7YCX	K22PR-U	IK22	VK22
L5	W22FS-U	IWF22	-	N59G	IW29	IW29	-	QL77JC	W27FSR	IWF27	-	RC87YCL	K20PR-U	IK20	VK20
L54R	-	-	-	N5C	W20ES-U	-	-	QL77JC4	W27FSR-U10	IWF27	-	RC89PYC	IK16	IK16	VK16
L55C	W31FS	-	-	N6	W16ES-U	-	-	QL78C	W24FSR	IWF24	-	RC89TMC	K20PBR-S10	IK20	VK20
L55G	W31FS	-	-	N60	W27ES-U	IW27	-	QL78V	SF51	-	-	RC8BYC	K20PBR	IK20	VK20
L57R	-	IWF27	-	N60R	IW01-29	-	-	QL78YC	W24FPR	IWF24	-	RC8PMPA	SKJ20CR-A8	IK20	VK20
L58R	-	IWF27	-	N62R	IW01-27	-	-	QL7J	W22FSR	IWF22	-	RC8PYP	PK20PR-P8	IK20	VK20

DENSO
 AUSTRALIA | CHINA | INDIA | INDONESIA | KOREA | MALAYSIA | PHILIPPINES | SAUDI ARABIA | SINGAPORE | TAIWAN | THAILAND | VIETNAM | JAPAN & USA | EUROPE MOTOR CYCLE | SMALL ENGINE REFERENCE NUMBER

CROSS REFERENCE ()

DENSO

AUSTRALIA

CHINA

INDIA

INDONESIA

KOREA

MALAYSIA

PHILIPPINES

SINGAPORE

SAUDI ARABIA

TAIWAN

THAILAND

VIETNAM

JAPAN

EUROPE

USA

SMALL ENGINE

MOTOR CYCLE

CROSS REFERENCE

PART NUMBER

CHAMPION (U.S.A.)	DENSO	IRIDIUM POWER	IRIDIUM TOUGH/PLUS	CHAMPION (U.S.A.)	DENSO	IRIDIUM POWER	IRIDIUM TOUGH/PLUS	CHAMPION (U.S.A.)	DENSO	IRIDIUM POWER	IRIDIUM TOUGH/PLUS	CHAMPION (U.S.A.)	DENSO	IRIDIUM POWER	IRIDIUM TOUGH/PLUS
RC8PYP4	PK20PR11	IK20	VK20	RJ13Y	W14PR-U	-	-	RN9GY	IW20	IW20	VW20	UN79Y	W22EP-U	IW22	VW22
RC8VTYC	K20PBR-S10	IK20	VK20	RJ14YC	W14PR-U	-	-	RN9YC	W20EPR-U	IW20	VW20	V12YC	T16P-U	ITF16	-
RC8YC	K20PR-U	IK20	VK20	RJ17LM	W14LM-U	-	-	RN9YC	W20EXR-U	IW20	VW20	V15YC	T16P-U	ITF16	-
RC8YC4	K20PR-U11	IK20	VK20	RJ18YC	W9PR-U	-	-	RN9YC4	W20EPR-U11	IW20	VW20	V55C	-	-	-
RC8YCC	K20PR-U	IK20	VK20	RJ18YC6	W9PR-U	-	-	RN9YC4	W20EXR-U11	IW20	VW20	V57C	-	-	-
RC8YCC4	K20PR-U11	IK20	VK20	RJ18YC8	W9PR-U	-	-	RN9YCC	W20EPR-U	IW20	VW20	V57YC	-	-	-
RC8YCL	K20PR-U	IK20	VK20	RJ19LM	W9LMR-US	-	-	RN9YCC4	W20EXR-U11	IW20	VW20	V59C	-	ITF27	-
RC8YLC	K20PR-U	IK20	VK20	RJ6C	W20SR-U	-	-	RN9YCX	W20EPR-U	IW20	VW20	V61	-	ITF24	-
RC92LYC	-	-	-	RJ6J	W20SR-U	-	-	RP7	X24FS-U	-	-	V9YC	T20P-U	ITF20	-
RC9BMC	K20TXR	IK20	VK20	RJ7	W20SR-U	-	-	RS10LC	T20EPR-U	IT20	VT20	XC92YC	K16PR-U	IK16	VK16
RC9BYC	K20PBR	IK20	VK20	RJ8C	W20SR-U	-	-	RS10LC	T20NR-U11	IT20	VT20	XJ10Y	W20PR-U	-	-
RC9MC4	KJ20CR-L11	IK20	VK20	RL12Y	W16FPR-U	IWF16	-	RS12PYP	PT16EPR-L13	IT16	VT16	Y82	-	-	-
RC9MCC	K20R-U	IK20	VK20	RL19	W16FSR	-	-	RS12YC	T16EPR-U	IT16	VT16	Z10	U20FS-U	IUF22	-
RC9MCC4	KJ20CR-L11	IK20	VK20	RL4J	W24FSR	IWF24	-	RS12YC6	T16EPR-U15	IT16	VT16	Z10G	IUF22	IUF22	-
RC9YCC	K20PR-U	IK20	VK20	RL77J	W27FSR	IWF27	-	RS13LYC	T16NR-U11	IT16	VT16	Z12	U20FS-U	IUF22	-
RC9YCC4	K20PR-U11	IK20	VK20	RL77JC4	W27FSR-U10	IWF27	-	RS13LYC	T20EPR-U	IT20	VT20	Z6	U24FS-U	IUF24	-
RC9YCC	K20PR-U	IK20	VK20	RL78C	W24FSR	IWF24	-	RS14LC	T16NR-U11	IT16	VT16	Z7G	IUF22	IUF22	-
RC9YCC4	K20PR-U11	IK20	VK20	RL7J	W22FSR	IWF22	-	RS14YC	T16EPR-U	IT16	VT16	Z8	U22FS-U	IUF22	-
RC9YCN4	K20PR-U11	IK20	VK20	RL82C	W22FSR	IWF22	-	RS14YC6	T16EPR-U15	IT16	VT16	Z9Y	U22FS-U	IUF22	-
RCJ4	W22M-U	-	-	RL82YC	W22FPR-U	IWF22	-	RS15LYC	T16NR-U11	IT16	VT16	DAYTONA MAXFIRE (Japan)			
RCJ6	W22M-U	-	-	RL82YCC	W22FPR-U	IWF22	-	RS16YC	T16EPR-U	IT16	VT16	DENSO	IRIDIUM POWER	IRIDIUM TOUGH/PLUS	
RCJ6Y	W22MPR-U	-	-	RL86C	W20FSR-U	IWF22	-	RS17YX	T16EPR-U	IT16	VT16	61479	IW24	IW24	-
RCJ6Y	W22MP-U	-	-	RL87YC	W20FPR-U	IWF20	-	RS279YC	T22EPR-U	IT22	-	61480	IW27	IW27	-
RCJ7Y	W22MPR-U	-	-	RL87YCC	W20FPR-U	IWF20	-	RS281YC	T20EPR-U	IT20	VT20	61481	IU24	IU24	-
RCJ8	W20MR-U	-	-	RL90	W16FSR	-	-	RS5C	T22EP-U	IT22	-	61482	IU27	IU27	-
RCJ8Y	W20MPR-U10	-	-	RL92YC	W16FPR-U	IWF16	-	RS6YC	T22EP-U	IT22	-	61483	IUH24	IUH24	-
RD14	L14-U	-	-	RN10GY	IW20	IW20	VW20	RS6YCC	T22EP-U	IT22	-	61484	IUH27	IUH27	-
RD15Y	L14-U	-	-	RN10PYP4	VW20	IW20	VW20	RS7YC	T22EP-U	IT22	-	61485	IUF22	IUF22	-
RD16	L14-U	-	-	RN10VTYC4	W20EPBR-S	IW20	VW20	RS9YC	T20EPR-U	IT20	VT20	61486	IUF22	IUF22	-
RD16J	L14-U	-	-	RN10Y4	W20EPR-U11	IW20	VW20	RS9YCC	T20EPR-U	IT20	VT20	61487	IUF24	IUF24	-
RD18Y	L14-U	-	-	RN10Y4	W20EXR-U11	IW20	VW20	RS9YCC	T20EPR-U	IT20	VT20	61488	IX24	IX24	-
RDJ6J	T22M-U	-	-	RN10YC	W20EPR-U	IW20	VW20	RV12C	T16R-U	-	-	61489	IX27	IX27	-
RDJ7J	T20M-U	-	-	RN11YC	W16EPR-U	IW16	VW16	RV12C6	T16R-U15	-	-	61490	IWF20	IWF20	-
RDJ7Y	T20MP-U	-	-	RN11YC	W16EXR-U	IW16	VW16	RV12YC	T20PR-U	ITF20	-	61491	IWF22	IWF22	-
RDJ8J	T20M-U	-	-	RN11YC4	W16EPR-U11	IW16	VW16	RV12YC6	T20PR-U11	ITF20	-	61492	IWF24	IWF24	-
RE10LC	T20NR-U11	IT20	VT20	RN11YC4	W16EXR-U11	IW16	VW16	RV12YC6	T20PR-U15	ITF20	-	61493	IX22B	IX22B	-
RE10PM5	-	ITL20	-	RN11YCC	W16EPR-U	IW16	VW16	RV15YC	T16PR-U	ITF16	-	61494	IX24B	IX24B	-
RE10PMC5	-	ITL20	-	RN11YCC4	W16EPR-U11	IW16	VW16	RV15YC4	T16PR-U11	ITF16	-	EYQUEM (France)			
RE12PEC5	-	ITL16	-	RN12MC4	W16EXR-U11	IW16	VW16	RV15YC6	T16PR-U15	ITF16	-	DENSO	IRIDIUM POWER	IRIDIUM TOUGH/PLUS	
RE14MCC5	-	ITL16	-	RN12YC	W16EPR-U	IW16	VW16	RV15YC8	T16PR-U15	ITF16	-	200	W14F-U	-	-
RE14PLP5	-	ITL16	-	RN12YC	W16EXR-U	IW16	VW16	RV17YC	T14PR-U	ITF16	-	406	W16FS-U	-	-
RE16MC	-	ITL16	-	RN12YC4	W16EXR-U11	IW16	VW16	RV17YC6	T14PR-U15	ITF16	-	500	W16FS-U	-	-
RE7PYC5	-	ITV16	-	RN12YC6	W16EPR-U11	IW16	VW16	RV19YC	T14PR-U	ITF16	-	1000	W24FS-U	IWF24	-
RE7PYP6	PT16VR13	ITV16	-	RN12YCC	W16EPR-U	IW16	VW16	RV19YC6	T14PR-U15	ITF16	-	1100	W27FS-U	IWF27	-
RE7YCC	T16VR-U10	ITV16	-	RN13L	J16BR-U	-	-	RV8C	T20R-U	-	-	1150	W27FS-U	IWF27	-
REA8MCL	XE20HR-U9	-	VFXEH20	RN13LYC	J16BR-U	-	-	RV8C6	T20R-U	-	-	5002	W16FS-U	-	-
REA8WYPB4	ZC20HPR11	-	VCH20	RN14LY	J16BR-U	-	-	RV9YC	T20PR-U	ITF20	-	1000C	W24S-U	-	-
REC14PYC	K16HPR-U11	IKH16	VKH16	RN14MC5	W16EXR-U13	IW16	VW16	RZ8	U22FSR-U	IUF22	-	1000CM	W22S-U	-	-
REC9MCLX	K20HR-U11	IKH20	VKH20	RN14PMP5	P16R13	IW16	VW16	RZ94C	U24FSR-U	IUF24	-	1000L	W24ES-U	IW24	-
REC9YCL	K20HR-U11	IKH20	VKH20	RN14Y	W14EPR-U	IW16	VW16	RZ96C	U22FSR-U	IUF22	-	100M	W24FS-U	IWF24	-
RE8MCL	-	IXUH22	VXUH22	RN14Y	W14EXR-U	IW16	VW16	RZ98C	U20FSR-U	IUF22	-	1100L	W24ES-U	IW24	-
RER8YC	-	IXUH22	VXUH22	RN14Y6	W14EXR-U11	IW16	VW16	S10YCC	T20EP-U	IT20	VT20	1150L	W27ES-U	IW27	-
RER8ZYCB4	-	-	-	RN14YC	W14EXR-U	IW16	VW16	S12YC	T16EPR-U	IT16	VT16	300A	W14L	-	-
RF10C	MA20PR-U	-	-	RN14YC	W16EPR-U	IW16	VW16	S12YCC	T16EPR-U	IT16	VT16	30AM	W14L	-	-
RF11LC	MA20PR-U	-	-	RN16YC	W14EPR-U	IW16	VW16	S14YC	T16EPR-U	IT16	VT16	450L	W14E	-	-
RF11YC	MA16PR-U	-	-	RN16YC5	W14EXR-U11	IW16	VW16	S279YC	T20EP-U	IT20	VT20	480CS	W14PR-U	-	-
RF12	MA16PR-U	-	-	RN179BC	IRE01-27	-	-	S281YC	T20EP-U	IT20	VT20	500A	W16LS	-	-
RF12-5	MA16PR-U11	-	-	RN180B	W22EBR	-	-	S379YC	T22EP-U	IT22	-	500C	W20S-U	-	-
RF14LC	MA16PR-U	-	-	RN1C	W27ESR	IW27	-	S57YC	IT27	-	-	500CT	T20M-U	-	-
RF14Y	MA9P-U	-	-	RN1C	W27ESR-U	IW27	-	S59YC	IT27	-	-	500CM	W20S-U	-	-
RF14Y4	MA16PR-U11	-	-	RN2	W27ESR	IW27	-	S6YC	T22EP-U	IT22	-	500CS	W16PR-U	-	-
RF14YC	MA16PR-U	-	-	RN2	W27ESR-U	IW27	-	S6YCC	T22EP-U	IT22	-	500CT	W20M-U	-	-
RF18YC	MA9P-U	-	-	RN279YC	W22EPR-U	IW22	VW22	S7YC	T22EP-U	IT22	-	500JS	T16P-U	ITF16	-
RF7YCC	MA20PR-U	-	-	RN281YC	W20EPR-U	IW20	VW20	S7YCC	T22EP-U	IT22	-	500M	W16FS-U	-	-
RF9YC	MA20PR-U	-	-	RN2C	W27ESR	IW27	-	S9YC	T20EP-U	IT20	VT20	505JS	T16P-U	ITF16	-
RFN14LY	QJ16AR-U	-	-	RN2C	W27ESR-U	IW27	-	S9YCC	T20EP-U	IT20	VT20	50AM	W16LS	-	-
RFN14LY	QJ16HR-U9	-	-	RN2G	IW27	IW27	-	S9YCC	T20EP-U	IT20	VT20	50M	W16FS-U	-	-
RG4HC	U27ESR-N	IU27	-	RN3C	W24ESR-U	IW24	-	UD16	L14-U	-	-	520CS	W16PR-U	-	-
RG4PHP	IU27	IU27	-	RN3G	IW24	IW24	-	UJ12	W9-U	-	-	550CS	W16PR-U	-	-
RG59V	RU01-31	-	-	RN4C	W22ESR-U	-	-	UJ12C	W14-U	-	-	550JS	T16P-U	ITF16	-
RG6YC	U24ESR-N	IU24	-	RN57YC	IW29	IW29	-	UJ12Y	W16PR-U	-	-	550LS	W14EX-U	IW16	VW16
RG6YCA	U24ESR-N	IU24	-	RN5C	W20ESR-U	-	-	UJ2J	W24S-U	-	-	550S	W14FP-U	IWF16	-
RG92C	U27ESR-N	IU27	-	RN6YC	W24EPR-U	IW24	-	UJ4J	W24S-U	-	-	580LS	W14EX-U	IW16	VW16
RG92DC	U27ETR	IU27A	-	RN6YCC	W24EPR-U	IW24	-	UJ6	W20S-U	-	-	580S	W16FP-U	IWF16	-
RG94C	U24ESR-N	IU24	-	RN74C	W22ESR-U	-	-	UJ8	W20S-U	-	-	600CS	W20PR-U	-	-
RG96C	U22ESR-N	IU22	-	RN7BYC	W22EPB	IW22	VW22	UJ81C	W22S-U	-	-	600JS	T20P-U	ITF20	-
RGU92C	U27FER9	IUH27	-	RN7GY	IW22	IW22	VW22	UJ81J	W22S-U	-	-	600L	W20ES-U	-	-
RGU94C	U24FER9	IUH24	-	RN7Y	W22EPR-U	IW22	VW22	UK10	M17	-	-	600LS	W16EP-U	IW16	VW16
RH10C	W16LS	-	-	RN7YC	W22EPR-U	IW22	VW22	UL17V	SF50	-	-	600S	W16FP-U	IWF16	-
RH12	W16LS	-	-	RN7YC4	W22EPR-U11	IW22	VW22	UL18V	SF50	-	-	700	W20FS-U	IWF22	-
RH8C	W16LS	-	-	RN7YCC	W22EPR-U	IW22	VW22	UL19V	SF50	-	-	700C	W20S-U	-	-
RJ10Y	W20PR-U	-	-	RN7YCC4	W22EPR-U11	IW22	VW22	UL4J	W22FS-U	IWF22	-	700CM	W20S-U	-	-
RJ11Y	W16PR-U	-	-	RN7YCC	W22EPR-U	IW22	VW22	UL77V	SF						

CROSS REFERENCE (→)

EYQUEM (France)	DENSO	IRIDIUM POWER	IRIDIUM TOUGH/ PLUS	EYQUEM (France)	DENSO	IRIDIUM POWER	IRIDIUM TOUGH/ PLUS	HKS (Japan)		IRIDIUM POWER	IRIDIUM TOUGH/ PLUS	MOTORCRAFT (U.S.A.)		DENSO	IRIDIUM POWER	IRIDIUM TOUGH/ PLUS
								DENSO	IRIDIUM POWER			DENSO	IRIDIUM POWER			
70M	W20FS-U	IWF22	-	RC52LJS	T20EPR-U	IT20	VT20	M40i	IK24	IK24	-	AER32	W20FPR-U	IWF20	-	-
750	W20FS-U	IWF22	-	RC52LJS5	T20EPR-U	IT20	VT20	M40iL	IKH24	IKH24	-	AER4	W16FSR	-	-	-
750L	W20ES-U	-	-	RC52LS	W20EPR-U	IW20	VW20	M40LF	ITV24	ITV24	-	AER4X	W16FSR	-	-	-
750LS	W20EP-U	IW20	VW20	RC52LS5	W20EPR-U11	IW20	VW20	M40X	IXU24	IXU24	VXU24	AER6	W14FR-U	-	-	-
753LJS	T20EP-U	IT20	VT20	RC62HJSDP	PT16VR13	ITV16	-	M45	IQ27	IQ27	-	AES4C	W16FS-U	-	-	-
755	W22FS-U	IWF22	-	RC62LJS	T20EPR-U	IT20	VT20	M45G	IW27	IW27	-	AF22	T20P-U	ITF20	-	-
755C	W22S-U	-	-	RC62LJS5	T20EPR-U	IT20	VT20	M45i	IK27	IK27	-	AF32	T20P-U	ITF20	-	-
755CJT	T22M-U	-	-	RC62LS	W20EPR-U	IW20	VW20	M45iL	IKH27	IKH27	-	AF3NX	T22M-U	-	-	-
755CM	W20S-U	-	-	RC62LS5	K20PR-U11	IK20	VK20	M45RE	IRE01-27	-	-	AF42C	T16P-U	ITF16	-	-
755CT	W22M-U	-	-	RC62LS5	W20EPR-U11	IW20	VW20	M45REL	IRL01-27	-	-	AF52C	T16P-U	ITF16	-	-
755L	W20ES-U	-	-	RC62S	W22FPR-U	IWF22	-	M45X	IXU27	IXU27	-	AF5NX	T20M-U	-	-	-
755LJS	T20EP-U	IT20	VT20	RC72LJS5	T22EP-U	IT22	-	M50RE	IRE01-31	-	-	AG040	-	IW31	-	-
755LS	W20EP-U	IW20	VW20	RC72LS	W22EPR-U	IW22	VW22	M50RET	IRT01-31	-	-	AG051	W31ES-U	IW31	-	-
755M	W20FS-U	IWF22	-	RC72LS5	W22EPR-U11	IW22	VW22	M525RE	IRE01-32	-	-	AG071	W27ES-U	IW27	-	-
755S	W22FP-U	IWF22	-	RC82LS	W22EPR-U	IW22	VW22	M55RE	IRE01-34	-	-	AG091	W24ES-U	IW24	-	-
755SX	W22FP-U	IWF22	-	RC82LS5	W22EPR-U11	IW22	VW22	S30i	IK20	IK20	VK20	AG092C	W24ES-U	IW24	-	-
755X	W22FS-U	IWF22	-	RFC42LS	K16PR-U	IK16	VK16	S35	IQ22	IQ22	VQ22	AG12C	W24EP-U	IW24	-	-
75LM	W20ES-U	-	-	RFC42LS2E	K20TXR	IK20	VK20	S35i	IK22	IK22	VK22	AG1C	W24ES-U	IW24	-	-
75M	W20FS-U	IWF22	-	RFC42LS5	K16PR-U11	IK16	VK16	S40	IQ24	IQ24	-	AG1CX	W24ES-U	IW24	-	-
775SX	W20FP-U	IWF20	-	RFC42LZ2E	K20TXR	IK20	VK20	S40i	IK24	IK24	-	AG1X	W22ES-U	-	-	-
775X	W20FS-U	IWF22	-	RFC50LZ2E	K20TXR	IK20	VK20	MOTORCRAFT (U.S.A.)	DENSO	IRIDIUM POWER	IRIDIUM TOUGH/ PLUS	AG2	W22ES-U	-	-	-
800LJS	T20EP-U	IT20	VT20	RFC52LS	K20PR-U	IK20	VK20	1Y00-18-110	W16EPR-U	IW16	VW16	AG200	-	IW34	-	-
800LS	W22EP-U	IW22	VW22	RFC52LS2E	K20TXR	IK20	VK20	1Y01-18-110	W20EPR-U	IW20	VW20	AG203	-	IW34	-	-
803LJS	T22EP-U	IT22	-	RFC52LS3	K20PBR	IK20	VK20	1Y03-18-110	W16EPR-U11	IW16	VW16	AG22C	W22EP-U	IW22	VW22	-
805L	W22ES-U	-	-	RFC52LS5	K20PR-U11	IK20	VK20	1Y03-18-110	W16EPR-U11	IW16	VW16	AG22CT	W20EPB	IW20	VW20	-
805LJS	T22EP-U	IT22	-	RFC52LSP	PK20PR11	IK20	VK20	1Y06-18-110	K16PR-U	IK16	VK16	AG23	IW24	IW24	-	-
805LP	IW24	IW24	-	RFC57LS3	K20PBR	IK20	VK20	1Y07-18-110	K20PR-U	IK20	VK20	AG2C	W22ES-U	-	-	-
850	W22FS-U	IWF22	-	RFC58LS	K20PR-U	IK20	VK20	1Y09-18-110	K16PR-U11	IK16	VK16	AG2CX	W22ES-U	-	-	-
850LS	W22EP-U	IW22	VW22	RFC58LS2E	K20TXR	IK20	VK20	1Y0A-18-110	K20PR-U11	IK20	VK20	AG2X	W22ES-U	-	-	-
C30LS	W14EP-U	IW16	VW16	RFC58LS3	K20PBR	IK20	VK20	1Y0B-18-110	K22PR-U11	IK22	VK22	AG3	W20ES-U	-	-	-
C32LS	W16EP-U	IW16	VW16	RFC58LS5	K20PR-U11	IK20	VK20	1Y0F-18-110	XU22EPR-U	IXU22	VXU22	AG32	W20EP-U	IW20	VW20	-
C32S	W16FP-U	IWF16	-	RFC58LSP	PK20PR11	IK20	VK20	1Y0G-18-110	KJ16CR-L11	IK16	VK16	AG32A	W20EP-U	IW20	VW20	-
C42LJS3	T16EPR-U	IT16	VT16	RFC58LZ2E	K20TXR	IK20	VK20	1Y0H-18-110	KJ20CR-L11	IK20	VK20	AG32A	W20EX-U	IW20	VW20	-
C42S	W20FP-U	IWF20	-	RFC58LZK	K20PR-U11	IK20	VK20	1Y0K-18-110	W16EXR-U13	IW16	VW16	AG32C	W20EP-U	IW20	VW20	-
C52LJS	T20EPR-U	IT20	VT20	RFC62LS	K22PR-U	IK22	VK22	1Y0L-18-110	J16AR-U11	-	-	AG32C	W20EX-U	IW20	VW20	-
C52LS	W16EP-U	IW16	VW16	RFC62LS3	K22PBR-S	IK22	VK22	1YR1-18-110	VW20	IW20	VW20	AG32CT	W20EPB	IW20	VW20	-
C52LS3X	W16EPB10	IW16	VW16	RFC62LS3X	K22PBR-S	IK22	VK22	1YR7-18-110	VK20	IK20	VK20	AG3C	W20ES-U	-	-	-
C62	W22FS-U	IWF22	-	RFC62LS5	K22PR-U11	IK22	VK22	1YR9-18-110	VK16	IK16	VK16	AG3CX	W20ES-U	-	-	-
C62LJS	T20EP-U	IT20	VT20	RFC82LS	K22PR-U	IK22	VK22	1YRA-18-110	VK20	IK20	VK20	AG3X	W20ES-U	-	-	-
C62LS	W20EP-U	IW20	VW20	RFC82LS3	K22PBR-S	IK22	VK22	1YRF-18-110	VXU22	IXU22	VXU22	AG4	W16ES-U	-	-	-
C62LS3X	W20EPB	IW20	VW20	RFC82LS5	K22PR-U11	IK22	VK22	1YRH-18-110	VK16	IK16	VK16	AG400	-	IW31	-	-
C62S	W22FP-U	IWF22	-	RFN52HZ	K16HPR-U11	IKH16	VKH16	1YR-18-110	VK20	IK20	VK20	AG403	-	IW31	-	-
C72LJS	T22EP-U	IT22	-	RFN52HZ3A	K16HPR-U11	IKH16	VKH16	A11	W9-U	-	-	AG42C	W16EP-U	IW16	VW16	-
C72LS	W22EP-U	IW22	VW22	RFN52LZ	K16PR-U	IK16	VK16	A11LM	W14LM-U	-	-	AG44	KJ16CR-L11	IK16	VK16	-
C72LS3X	W22EPB	IW22	VW22	RFN58HZ	K20HR-U11	IKH20	VKH20	A11NX	W14M-U	-	-	AG5	W16ES-U	-	-	-
C82LJS	T22EP-U	IT22	-	RFN58LZ	K20PR-U	IK20	VK20	A11X	W9-U	-	-	AG501	W31ES-U	IW31	-	-
C82LS	W22EP-U	IW22	VW22	RKC52JS	MA20PR-U	-	-	A21X	W24S-U	-	-	AG501X	W31ES-U	IW31	-	-
C82LS3X	W22EPB	IW22	VW22	T850	U22FS-U	IUF22	-	A22	W20PR-U	-	-	AG52	W14EP-U	IW16	VW16	-
C83LJS	T22EP-U	IT22	-	XC30LS	W14EPR-U	IW16	VW16	A22NX	W22MP-U	-	-	AG52C	W14EX-U	IW16	VW16	-
C92LS	W24EP-U	IW24	-	XC32LS	W16EPR-U	IW16	VW16	A2C	W24S-U	-	-	AG54	KJ16CR-L11	IK16	VK16	-
D1000	X24FS-U	-	-	XC42S	W20FPR-U	IWF20	-	A2NX	W22M-U	-	-	AG600	IW01-27	IW27	-	-
D1000L	X27ES-U	IX27	-	XC52LS	W16EPR-U	IW16	VW16	A32	W20PR-U	-	-	AG603	W27ES-U	IW27	-	-
D1050L	X27ES-U	IX27	-	XC62LJS	T20EPR-U	IT20	VT20	A3NX	W22M-U	-	-	AG7	W14E	-	-	-
D755	X20FS-U	-	-	XC62LS	W20EPR-U	IW20	VW20	A3X	W20S-U	-	-	AG701C	W27ES-U	IW27	-	-
D775	X16FSR-U	-	-	XC62S	W22FPR-U	IWF22	-	A42C	W16PR-U	-	-	AG701X	W27ES-U	IW27	-	-
D800L	X22ES-U	IX22	-	XC72LS	W22EPR-U	IW22	VW22	A42N	W16S-U	-	-	AG82	W9EP	-	-	-
D900L	X24ES-U	IX24	-	XFC62LS	K22PR-U	IK22	VK22	A5	W16S-U	-	-	AG9	W14E	-	-	-
FC42LS	K16P-U11	IK16	VK16	XFC82LS	K22PR-U	IK22	VK22	A52	W14PR-U	-	-	AG901	W24ES-U	IW24	-	-
FC42LS2E	K20TXR	IK20	VK20	XKC52JS	MA20PR-U	-	-	A5X	W16S-U	-	-	AG901X	W24ES-U	IW24	-	-
FC52LS	K20P-U	IK20	VK20	XKC62JS	MA20PR-U	-	-	A7C	W14-U	-	-	AG902	W24EP-U	IW24	-	-
FC58LS	K20P-U	IK20	VK20	HARLEY-DAVIDSON (U.S.A.)	DENSO	IRIDIUM POWER	IRIDIUM TOUGH/ PLUS	A7CLM	W14LM-U	-	-	AG903	IW24	IW24	-	-
FC58LS2E	K20TXR	IK20	VK20	10R12A	XU24EPR-U	IXU24	VXU24	A7CX	W14-U	-	-	AGF12C	T22EP-U	IT22	-	-
FC58LS3	K20PBR	IK20	VK20	10R12X	XU24EPR-U	IXU24	VXU24	A7LM	W14LM-U	-	-	AGF22C	T20EP-U	IT20	VT20	-
FC62LS	K20P-U	IK20	VK20	3	W16LS	-	-	A7NX	W20M-U	-	-	AGFS22FE13J	T20EPR-U	IT20	VT20	-
FC62LS3	K20PBR	IK20	VK20	3-4	W16PR-U	-	-	A7X	W14-U	-	-	AGFS22IPJ	VT20	IT20	VT20	-
FC62LS3X	K20PBR	IK20	VK20	4	W16LS	-	-	A82	W9PR-U	-	-	AGP12C	K22PR-U	IK22	VK22	-
FC72LS	K22PR-U	IK22	VK22	4-5	W22FP-U	IWF22	-	A9	W9-U	-	-	AGP22C	K20P-U	IK20	VK20	-
FC82LS	K22PR-U	IK22	VK22	4R	W16LS	-	-	A901	W27S-U	-	-	AGPR12C	K22PR-U	IK22	VK22	-
FC82LS2	K22TMR11	IK22	VK22	4R5	W22FP-U10	IWF22	-	A9X	W9-U	-	-	AGPR12PP	PK20PR-P11	IK20	VK20	-
FC82LS3	K22PB	IK22	VK22	5	W20S-U	-	-	AE1C	W22FS-U	IWF22	-	AGPR12PP8	PK20PR-P8	IK20	VK20	-
K200M	L14-U/M14	-	-	5A6	W16EX-U	IW16	VW16	AE1X	W22FS-U	IWF22	-	AGPR22C	K20PR-U	IK20	VK20	-
K300JS	MA16PR-U	-	-	5R6	W16EXR-U	IW16	VW16	AE22C	W22FP-U	IWF22	-	AGPR22C1	K20PR-U11	IK20	VK20	-
K300M	M17	-	-	5R6A	W16EXR-U11	IW16	VW16	AE2C	W22FS-U	IWF22	-	AGPR22P	IK20	IK20	VK20	-
K450JS	MA16PR-U	-	-	5RL	J16CR-U	IW16	VW16	AE2X	W22FS-U	IWF22	-	AGPR22PP	PK20PR11	IK20	VK20	-
K500M	M17	-	-	6R12	XU22EPR-U	IXU22	VXU22	AE32C	W20FP-U	IWF20	-	AGPR22PP8	PK20PR-P8	IK20	VK20	-
K550JS	MA20P-U	-	-	8	IW31	IW31	-	AE3C	W20FS-U	IWF22	-	AGPR22PPJ	PK20PR11	IK20	VK20	-
K600M	M22	-	-	HKS (Japan)	DENSO	IRIDIUM POWER	IRIDIUM TOUGH/ PLUS	AE3X	W20FS-U	IWF22	-	AGPR32C	K20PR-U	IK20	VK20	-
K750M	M17	-	-	M35	IQ22	IQ22	VQ22	AE4	W16FS-U	-	-	AGPR32C1	K20PR-U11	IK20	VK20	-
KC52JS	MA20P-U	-	-	M35G	IW22	IW22	VW22	AE42	W16FP-U	IWF16	-	AGPR901C	-	IQ24	-	-
KC62JS	MA20P-U	-	-	M35i	IK22	IK22	VK22	AE4X	W16FS-U	-	-	AGPR902C	-	IQ27	-	-
R1000	W24FSR	IWF24	-	M35iL	IKH22	IKH22	VKH22	AE6	W14F-U	-	-	AGPR902P	IQ27	IQ27	-	-
R850	W22FSR	IWF22	-	M35LF	ITV22	ITV22	-	AE62	W9FP	-	-	AGR12C	W24EPR-U	IW24	-	-
RC30LS	W14EPR-U	IW16	VW16	M40	IQ24	IQ24	-	AE901	W24FS-U	IWF24	-	AGR1C	W22ESR-U	-	-	-
RC32LS	W16EPR-U	IW16	VW16	M40G	IW24	IW24	-	AE901X	W24FS-U	IWF24	-	AGR1X	W22ESR-U	-	-	-
RC32LS5	W16EPR-U11	IW16	VW16	M40G	IW24	IW24	-	AER22C	W22FPR-U	I						

CROSS REFERENCE (⇒)

DENSO

AUSTRALIA

CHINA

INDONESIA

INDIA

MALAYSIA

PHILIPPINES

SINGAPORE

TAIWAN

THAILAND

VIETNAM

JAPAN

EUROPE

SMALL ENGINE

MOTOR CYCLE

PART NUMBER REFERENCE

MOTORCRAFT (U.S.A.)	DENSO	IRIDIUM POWER	IRIDIUM TOUGH/PLUS	MOTORCRAFT (U.S.A.)	DENSO	IRIDIUM POWER	IRIDIUM TOUGH/PLUS	MOTORCRAFT (U.S.A.)	DENSO	IRIDIUM POWER	IRIDIUM TOUGH/PLUS	MOTORCRAFT (U.S.A.)	DENSO	IRIDIUM POWER	IRIDIUM TOUGH/PLUS																																																																																																																																																																												
AGR2C	W22ESR-U	-	-	AGSP32FSM	VK16	IK16	VK16	AV1X	W22FS-U	IWF22	-	BRF3M	MA20PR-U	-	-																																																																																																																																																																												
AGR2X	W22ESR-U	-	-	AGSP32P	PQ16R	IQ16	VQ16	AV203	-	-	-	BRF42	MA16PR-U	-	-																																																																																																																																																																												
AGR31	W20ESR-U	-	-	AGSP32PP	PQ16R	IQ16	VQ16	AV23	-	IWF24	-	BRF6	MA16PR-U	-	-																																																																																																																																																																												
AGR32C	W20EPR-U	IW20	VW20	AGSP32Z	IK16	IK16	VK16	AV2X	W20FS-U	IWF22	-	BRF82	MA16PR-U	-	-																																																																																																																																																																												
AGR32C	W20EXR-U	IW20	VW20	AGSP33C	KJ20CR11	IK20	VK20	AV4	W16FS-U	-	-	BSF3	MA20PR-U	-	-																																																																																																																																																																												
AGR34CU	W20EXR-U	IW20	VW20	AGSP34C	KJ20CR11	IK20	VK20	AV403	-	-	-	BSF31	MA20PR-U	-	-																																																																																																																																																																												
AGR3X	W20ESR-U	-	-	AGSP52C	K16PR-U11	IK16	VK16	AV6	W14F-U	-	-	BSF31-4	MA20PR-U	-	-																																																																																																																																																																												
AGR41	W16ESR-U	-	-	AGSP54	KJ16CR-L11	IK16	VK16	AV603	-	IWF27	-	BSF42C	MA16PR-U	-	-																																																																																																																																																																												
AGR42C	W16EPR-U	IW16	VW16	AL11	W14L	-	-	AV901X	W27FS-U	IWF27	-	BSF44C	MA20PR-U	-	-																																																																																																																																																																												
AGR42C	W16EXR-U	IW16	VW16	AL5	W16LS	-	-	AV901X-4	W27FS-U10	IWF27	-	BSF6	MA16PR-U	-	-																																																																																																																																																																												
AGR44	J16BR-U	-	-	AL7	W14L	-	-	AV903	-	IWF24	-	BSF82C	MA16PR-U	-	-																																																																																																																																																																												
AGR44CU	W16EXR-U	IW16	VW16	AL7C	W14L	-	-	AVKO	SF50	-	-	BSF92	MA9P-U	-	-																																																																																																																																																																												
AGR51	W16ESR-U	-	-	AL7X	W14L	-	-	AVKOD	SF51	-	-	BT10	L14-U/M14	-	-																																																																																																																																																																												
AGR52	W14EXR-U	IW16	VW16	AL82	W14L	-	-	AVZKO	SF50	-	-	BT15	L14-U	-	-																																																																																																																																																																												
AGR52A	W14EPR-U	IW16	VW16	AL9	W14L	-	-	AWR32	T20EPR-U	IT20	VT20	BT3	M22	-	-																																																																																																																																																																												
AGR52C-6	W14EXR-U11	IW16	VW16	AL9X	W14L	-	-	AWR32-5	T20EPR-U15	IT20	VT20	BT4	M22	-	-																																																																																																																																																																												
AGR54	J16BR-U	-	-	AR31	W20SR-U	-	-	AWR42	T16EPR-U	IT16	VT16	BT6	M17	-	-																																																																																																																																																																												
AGR701X	W27ESR	IW27	-	AR32	W20PR-U	-	-	AWS42EE	PT16EPR-L13	IT16	VT16	BT8	L14-U/M14	-	-																																																																																																																																																																												
AGR701X	W27ESR-U	IW27	-	AR41	W20SR-U	-	-	AWS44EE	PT16EPR-L13	IT16	VT16	BT9	L14-U/M14	-	-																																																																																																																																																																												
AGR803C	W27ES-U	IW27	-	AR42	W16PR-U	-	-	AWSF22C	T20EPR-U	IT20	VT20	BTF3	MA20PR-U	-	-																																																																																																																																																																												
AGR82	W14EXR-U	IW16	VW16	AR42-6	W16PR-U	-	-	AWSF22E	T20EPR-U	IT20	VT20	BTF31	MA20PR-U	-	-																																																																																																																																																																												
AGR901X	W24ESR-U	IW24	-	AR52	W14PR-U	-	-	AWSF22FM	PT16EPR-L13	IT16	VT16	BTF42	MA16PR-U	-	-																																																																																																																																																																												
AGRF2	T20EPR-U	IT20	VT20	AR52-6	W14PR-U	-	-	AWSF22FS/F	PT16EPR-L13	IT16	VT16	BTF6	MA16PR-U	-	-																																																																																																																																																																												
AGRF22-6	T20EPR-U15	IT20	VT20	AR55	W20SR-U	-	-	AWSF24C	T20NR-U11	IT20	VT20	BTRF42	MA16PR-U	-	-																																																																																																																																																																												
AGRF22C	T20EPR-U	IT20	VT20	AR82	W9PR-U	-	-	AWSF32C	T20EPR-U	IT20	VT20	BZ8	L14-U	-	-																																																																																																																																																																												
AGRF22C1	T20EPR-U	IT20	VT20	AR82-6	W9PR-U	-	-	AWSF32E	PT16EPR-L13	IT16	VT16	CYFS12F-3(SPS12A)	-	ITV22	-																																																																																																																																																																												
AGRF22PP	T20EPR-U	IT20	VT20	AR82-S	W9PR-U	-	-	AWSF32EE	PT16EPR-L13	IT16	VT16	CYFS12YYP	-	ITV22	-																																																																																																																																																																												
AGRF32	T20EPR-U	IT20	VT20	AR8-6	T16R-U15	-	-	AWSF32EM	-	-	-	CYFS12YPC	-	ITV22	-																																																																																																																																																																												
AGRF32-6	T20EPR-U15	IT20	VT20	ARF2	T20R-U	-	-	AWSF32F	PT16EPR-L13	IT16	VT16	CYFS12YPC5	-	ITV22	-																																																																																																																																																																												
AGRF32C1	T20EPR-U	IT20	VT20	ARF22C	T20PR-U	ITF20	-	AWSF32FM	PT16EPR-L13	IT16	VT16	CYFS12YECB	-	ITV22	-																																																																																																																																																																												
AGRF42	T16EPR-U	IT16	VT16	ARF2-6	T20R-U	-	-	AWSF32FP	PT16EPR-L13	IT16	VT16	HG22C	X24EP-U9	IX24B	-																																																																																																																																																																												
AGRF42C1	T16EPR-U	IT16	VT16	ARF3	T20R-U	-	-	AWSF32PF	PT16EPR-L13	IT16	VT16	HG2C	X24ES-U	IX24	-																																																																																																																																																																												
AGRF42C-6	T16EPR-U15	IT16	VT16	ARF32	T20PR-U	ITF20	-	AWSF32PM	PT16EPR-L13	IT16	VT16	HGS22C	X24EPR-U9	IX24B	-																																																																																																																																																																												
AGRF52	T16EPR-U	IT16	VT16	ARF32C-6	T20PR-U15	ITF20	-	AWSF32PMF4	-	-	-	HV22	X20FS-U	-	-																																																																																																																																																																												
AGRP44	T20EPR-U	IT20	VT20	ARF32M	T20PR-U	ITF20	-	AWSF32PP	PT16EPR-L13	IT16	VT16	HV2C	X24FS-U	-	-																																																																																																																																																																												
AGS081C	W27ES-U	IW27	-	ARF3-6	T20R-U	-	-	AWSF32Z11	VT16	IT16	VT16	HV3	X20FS-U	-	-																																																																																																																																																																												
AGS12C	W22EPR-U	IW22	VW22	ARF4	T20R-U	-	-	AWSF34C	T20NR-U11	IT20	VT20	PV1	U24FS-U	IUF24	-																																																																																																																																																																												
AGS1C	W22ESR-U	-	-	ARF42	T16PR-U	ITF16	-	AWSF34P	T20NR-U11	IT20	VT20	PV2	U22FS-U	IUF22	-																																																																																																																																																																												
AGS22C	W22EPR-U	IW22	VW22	ARF42-8	T16PR-U15	ITF16	-	AWSF34PP	T20NR-U11	IT20	VT20	PV3	U20FS-U	IUF22	-																																																																																																																																																																												
AGS2C	W22ESR-U	-	-	ARF42C-6	T16PR-U15	ITF16	-	AWSF3PP	PT16EPR-L13	IT16	VT16	PZT1F	-	-	-																																																																																																																																																																												
AGS32C	W16EXR-U11	IW16	VW16	ARF4-6	T20R-U	-	-	AWSF42C	T16EPR-U	IT16	VT16	PZT2F	-	-	-																																																																																																																																																																												
AGS3C	W20ESR-U	-	-	ARF52	T16PR-U	ITF16	-	AWSF42C-6	T16EPR-U15	IT16	VT16	SP412	T20EPR-U15	IT20	VT20																																																																																																																																																																												
AGS42C	W16EXR-U	IW16	VW16	ARF52-6	T16PR-U15	ITF16	-	AWSF42EE	PT16EPR-L13	IT16	VT16	<table border="1"> <thead> <tr> <th>NHSP (China)</th> <th>DENSO</th> <th>IRIDIUM POWER</th> <th>IRIDIUM TOUGH/PLUS</th> </tr> </thead> <tbody> <tr> <td>A7RTC</td><td>U20FSR-U</td><td>IUF22</td><td>-</td> </tr> <tr> <td>A7T</td><td>U22FS-U</td><td>IUF22</td><td>-</td> </tr> <tr> <td>A7TC</td><td>U22FS-U</td><td>IUF22</td><td>-</td> </tr> <tr> <td>B8RC</td><td>U24ESR-N</td><td>IU24</td><td>-</td> </tr> <tr> <td>D6TC</td><td>X20FS-U</td><td>-</td><td>-</td> </tr> <tr> <td>D7</td><td>X22ES-U</td><td>IX22</td><td>-</td> </tr> <tr> <td>D8RTC</td><td>X24ESR-U</td><td>IX24</td><td>-</td> </tr> <tr> <td>D8T</td><td>X24ES-U</td><td>IX24</td><td>-</td> </tr> <tr> <td>D8TC</td><td>X24ES-U</td><td>IX24</td><td>-</td> </tr> <tr> <td>DF7RECZ</td><td>XU22EPR-U</td><td>IXU22</td><td>VXU22</td> </tr> <tr> <td>E5C</td><td>W14F-U</td><td>-</td><td>-</td> </tr> <tr> <td>E5T</td><td>W14FP-U</td><td>IWF16</td><td>-</td> </tr> <tr> <td>E6C</td><td>W16FS-U</td><td>-</td><td>-</td> </tr> <tr> <td>E6T</td><td>W14FP-UL</td><td>IWF16</td><td>-</td> </tr> <tr> <td>E6TC</td><td>W14FP-UL</td><td>IWF16</td><td>-</td> </tr> <tr> <td>E7C</td><td>W20FS-U</td><td>IWF22</td><td>-</td> </tr> <tr> <td>E7RTC</td><td>W20FPR-U</td><td>IWF20</td><td>-</td> </tr> <tr> <td>E7TC</td><td>W20FP-U</td><td>IWF20</td><td>-</td> </tr> <tr> <td>E7TJC</td><td>-</td><td>-</td><td>-</td> </tr> <tr> <td>E8C</td><td>W22FS-U</td><td>IWF22</td><td>-</td> </tr> <tr> <td>E8TC</td><td>W22FP-U</td><td>IWF22</td><td>-</td> </tr> <tr> <td>F5C</td><td>W14E</td><td>-</td><td>-</td> </tr> <tr> <td>F5T</td><td>W14EX-U</td><td>IW16</td><td>VW16</td> </tr> <tr> <td>F5TC</td><td>W14EX-U</td><td>IW16</td><td>VW16</td> </tr> <tr> <td>F6RTC</td><td>W16EXR-U11</td><td>IW16</td><td>VW16</td> </tr> <tr> <td>F6RTC</td><td>-</td><td>-</td><td>-</td> </tr> <tr> <td>F6TC</td><td>W16EX-U</td><td>IW16</td><td>VW16</td> </tr> <tr> <td>F6TC</td><td>W16EP-U</td><td>IW16</td><td>VW16</td> </tr> <tr> <td>F7RTC</td><td>W20EXR-U</td><td>IW20</td><td>VW20</td> </tr> <tr> <td>F7TC</td><td>W20EX-U</td><td>IW20</td><td>VW20</td> </tr> <tr> <td>F7TJC</td><td>W16EPB10</td><td>IW16</td><td>VW16</td> </tr> <tr> <td>F8C</td><td>W22ES-U</td><td>-</td><td>-</td> </tr> <tr> <td>F8TC</td><td>W22EP-U</td><td>IW22</td><td>VW22</td> </tr> <tr> <td>G3F</td><td>W14-U</td><td>-</td><td>-</td> </tr> <tr> <td>G3TC</td><td>W14PR-U</td><td>-</td><td>-</td> </tr> <tr> <td>G5RC</td><td>W20SR-U</td><td>-</td><td>-</td> </tr> <tr> <td>G6</td><td>W20S-U</td><td>-</td><td>-</td> </tr> <tr> <td>H5</td><td>W20S-U</td><td>-</td><td>-</td> </tr> <tr> <td>K5RHCW</td><td>KJ16CR-L11</td><td>IK16L</td><td>-</td> </tr> <tr> <td>K6EPPOR</td><td>-</td><td>-</td><td>-</td> </tr> <tr> <td>K6RTC</td><td>K16PR-U11</td><td>IK16</td><td>VK16</td> </tr> <tr> <td>K6RTC</td><td>Q16R-U</td><td>IQ16</td><td>VQ16</td> </tr> </tbody> </table>				NHSP (China)	DENSO	IRIDIUM POWER	IRIDIUM TOUGH/PLUS	A7RTC	U20FSR-U	IUF22	-	A7T	U22FS-U	IUF22	-	A7TC	U22FS-U	IUF22	-	B8RC	U24ESR-N	IU24	-	D6TC	X20FS-U	-	-	D7	X22ES-U	IX22	-	D8RTC	X24ESR-U	IX24	-	D8T	X24ES-U	IX24	-	D8TC	X24ES-U	IX24	-	DF7RECZ	XU22EPR-U	IXU22	VXU22	E5C	W14F-U	-	-	E5T	W14FP-U	IWF16	-	E6C	W16FS-U	-	-	E6T	W14FP-UL	IWF16	-	E6TC	W14FP-UL	IWF16	-	E7C	W20FS-U	IWF22	-	E7RTC	W20FPR-U	IWF20	-	E7TC	W20FP-U	IWF20	-	E7TJC	-	-	-	E8C	W22FS-U	IWF22	-	E8TC	W22FP-U	IWF22	-	F5C	W14E	-	-	F5T	W14EX-U	IW16	VW16	F5TC	W14EX-U	IW16	VW16	F6RTC	W16EXR-U11	IW16	VW16	F6RTC	-	-	-	F6TC	W16EX-U	IW16	VW16	F6TC	W16EP-U	IW16	VW16	F7RTC	W20EXR-U	IW20	VW20	F7TC	W20EX-U	IW20	VW20	F7TJC	W16EPB10	IW16	VW16	F8C	W22ES-U	-	-	F8TC	W22EP-U	IW22	VW22	G3F	W14-U	-	-	G3TC	W14PR-U	-	-	G5RC	W20SR-U	-	-	G6	W20S-U	-	-	H5	W20S-U	-	-	K5RHCW	KJ16CR-L11	IK16L	-	K6EPPOR	-	-	-	K6RTC	K16PR-U11	IK16	VK16	K6RTC	Q16R-U	IQ16	VQ16
NHSP (China)	DENSO	IRIDIUM POWER	IRIDIUM TOUGH/PLUS																																																																																																																																																																																								
A7RTC	U20FSR-U	IUF22	-																																																																																																																																																																																								
A7T	U22FS-U	IUF22	-																																																																																																																																																																																								
A7TC	U22FS-U	IUF22	-																																																																																																																																																																																								
B8RC	U24ESR-N	IU24	-																																																																																																																																																																																								
D6TC	X20FS-U	-	-																																																																																																																																																																																								
D7	X22ES-U	IX22	-																																																																																																																																																																																								
D8RTC	X24ESR-U	IX24	-																																																																																																																																																																																								
D8T	X24ES-U	IX24	-																																																																																																																																																																																								
D8TC	X24ES-U	IX24	-																																																																																																																																																																																								
DF7RECZ	XU22EPR-U	IXU22	VXU22																																																																																																																																																																																								
E5C	W14F-U	-	-																																																																																																																																																																																								
E5T	W14FP-U	IWF16	-																																																																																																																																																																																								
E6C	W16FS-U	-	-																																																																																																																																																																																								
E6T	W14FP-UL	IWF16	-																																																																																																																																																																																								
E6TC	W14FP-UL	IWF16	-																																																																																																																																																																																								
E7C	W20FS-U	IWF22	-																																																																																																																																																																																								
E7RTC	W20FPR-U	IWF20	-																																																																																																																																																																																								
E7TC	W20FP-U	IWF20	-																																																																																																																																																																																								
E7TJC	-	-	-																																																																																																																																																																																								
E8C	W22FS-U	IWF22	-																																																																																																																																																																																								
E8TC	W22FP-U	IWF22	-																																																																																																																																																																																								
F5C	W14E	-	-																																																																																																																																																																																								
F5T	W14EX-U	IW16	VW16																																																																																																																																																																																								
F5TC	W14EX-U	IW16	VW16																																																																																																																																																																																								
F6RTC	W16EXR-U11	IW16	VW16																																																																																																																																																																																								
F6RTC	-	-	-																																																																																																																																																																																								
F6TC	W16EX-U	IW16	VW16																																																																																																																																																																																								
F6TC	W16EP-U	IW16	VW16																																																																																																																																																																																								
F7RTC	W20EXR-U	IW20	VW20																																																																																																																																																																																								
F7TC	W20EX-U	IW20	VW20																																																																																																																																																																																								
F7TJC	W16EPB10	IW16	VW16																																																																																																																																																																																								
F8C	W22ES-U	-	-																																																																																																																																																																																								
F8TC	W22EP-U	IW22	VW22																																																																																																																																																																																								
G3F	W14-U	-	-																																																																																																																																																																																								
G3TC	W14PR-U	-	-																																																																																																																																																																																								
G5RC	W20SR-U	-	-																																																																																																																																																																																								
G6	W20S-U	-	-																																																																																																																																																																																								
H5	W20S-U	-	-																																																																																																																																																																																								
K5RHCW	KJ16CR-L11	IK16L	-																																																																																																																																																																																								
K6EPPOR	-	-	-																																																																																																																																																																																								
K6RTC	K16PR-U11	IK16	VK16																																																																																																																																																																																								
K6RTC	Q16R-U	IQ16	VQ16																																																																																																																																																																																								
AGS42C	W16EXR-U	IW16	VW16	ARF52-8	T16PR-U15	ITF16	-	AWSF42P	T16EPR-U	IT16	VT16	A7RTC	U20FSR-U	IUF22	-																																																																																																																																																																												
AGS44	J16BR-U	-	-	ARF6	T16R-U	-	-	AWSF42PP	PT16EPR-L13	IT16	VT16	A7T	U22FS-U	IUF22	-																																																																																																																																																																												
AGS4C	W16ESR-U	-	-	ARF62	T14PR-U	ITF16	-	AWSF44C	T16NR-U11	IT16	VT16	B8RC	U24ESR-N	IU24	-																																																																																																																																																																												
AGS52C	W14EXR-U	IW16	VW16	ARF62-6	T14PR-U15	ITF16	-	AWSF44EE	PT16EPR-L13	IT16	VT16	D6TC	X20FS-U	-	-																																																																																																																																																																												
AGS52C-6	W14EXR-U11	IW16	VW16	ARF8	T16R-U	-	-	AWSF44PP	PT16EPR-L13	IT16	VT16	D7	X22ES-U	IX22	-																																																																																																																																																																												
AGSF2	T22EP-U	IT22	-	ARF8-6	T16R-U15	-	-	AWSF52C	T16EPR-U	IT16	VT16	D8RTC	X24ESR-U	IX24	-																																																																																																																																																																												
AGSF22C	T20EPR-U	IT20	VT20	ARL5	W16LS	-	-	AWSF54C	T16NR-U11	IT16	VT16	D8T	X24ES-U	IX24	-																																																																																																																																																																												
AGSF22FCM	PT16EPR-L13	IT16	VT16	ARL8	W14L	-	-	AWSF62	T16EPR-U	IT16	VT16	D8TC	X24ES-U	IX24	-																																																																																																																																																																												
AGSF22FM1	PT16EPR-L13	IT16	VT16	ARL82	W14L	-	-	AWSFA32C	T20EPR-U	IT20	VT20	DF7RECZ	XU22EPR-U	IXU22	VXU22																																																																																																																																																																												
AGSF22FSM	VT20	IT20	VT20	AS42C	W20PR-U	-	-	AYFS092FEC	ITV24	ITV24	-	E5C	W14F-U	-	-																																																																																																																																																																												
AGSF22PP	PT16EPR-L13	IT16	VT16	AS4C	W20SR-U	-	-	AYFS22C	ITV22	ITV22	-	E5T	W14FP-U	IWF16	-																																																																																																																																																																												
AGSF22PPJ	VT20	IT20	VT20	AS52C	W16PR-U	-	-	AYFS22CB	ITV22	ITV22	-	E6C	W16FS-U	-	-																																																																																																																																																																												
AGSF22PPM	VT20	IT20	VT20	AS82-7	W14PR-U	-	-	AYFS22FE1J	ITV22	ITV22	-	E6T	W14FP-UL	IWF16	-																																																																																																																																																																												
AGSF22WM	VT20	IT20	VT20	ASF32C	T20PR-U	ITF20	-	AYFS22FM	ITV22	ITV22	-	E6TC	W14FP-UL	IWF16	-																																																																																																																																																																												
AGSF24C	T20EPR-U	IT20	VT20	ASF32C-6	T20PR-U15	ITF20	-	AYFS22PP	ITV22	ITV22	-	E7C	W20FS-U	IWF22	-																																																																																																																																																																												
AGSF24FM	IT20	IT20	VT20	ASF32CM	T20PR-U	ITF20	-	AYRF22PG1	PT16VR13	ITV16	-	E7RTC	W20FPR-U	IWF20	-																																																																																																																																																																												
AGSF24N	-	-	VT20	ASF32M	T20PR-U	ITF20	-	AYRF22PP	PT16VR13	ITV16	-	E7TC	W20FP-U	IWF20	-																																																																																																																																																																												
AGSF24N	-	-	VT20	ASF32P	T20PR-U11	ITF20	-	AZ2	W24S-U	-	-	E7TJC	-	-	-																																																																																																																																																																												
AGSF24PGM	VT20	IT20	VT20	ASF32P	T20PR-U11	ITF20	-	AZ3	W20S-U	-	-	E8C	W22FS-U	IWF22	-																																																																																																																																																																												
AGSF24PN	IT20	IT20	VT20	ASF3C	T20PR-U	ITF20	-	AZ7	W9-U	-	-	E8TC	W22FP-U	IWF22	-																																																																																																																																																																												
AGSF32C	T20EPR-U	IT20	VT20	ASF3C-6	T20PR-U15	ITF20	-	AZ9	W9-U	-	-	F5C	W14E	-	-																																																																																																																																																																												
AGSF32FEC	-	IT16	VT16	ASF42C	T16PR-U	ITF16	-	AZF522FE	PT16VR13	ITV16	-	F5T	W14EX-U	IW16	VW16																																																																																																																																																																												
AGSF32FFM	IT20	IT20	VT20	ASF42C-6	T16PR-U15	ITF16	-	AZF522PP	PT16VR13	ITV16	-	F5TC	W14EX-U	IW16	VW16																																																																																																																																																																												
AGSF32FSM	-	-	-	ASF42C-7	T16PR-U	ITF16	-	AZF532FE	PT16VR13	ITV16	-	F6RTC	W16EXR-U11	IW16	VW16																																																																																																																																																																												
AGSF32M	IT20	IT20	VT20	ASF42P	T16PR-U	ITF16	-	B3W	M22	-	-	F6RTC	-	-	-																																																																																																																																																																												
AGSF32M	IT20	IT20	VT20	ASF44P	T16																																																																																																																																																																																						

CROSS REFERENCE (→)

NHSP (China)				DENSO				SPLITFIRE (U.S.A.)				DENSO				TORCH (China)				DENSO				TORCH (China)				DENSO											
		IRIDIUM POWER	IRIDIUM TOUGH/PLUS			IRIDIUM POWER	IRIDIUM TOUGH/PLUS			IRIDIUM POWER	IRIDIUM TOUGH/PLUS			IRIDIUM POWER	IRIDIUM TOUGH/PLUS			IRIDIUM POWER	IRIDIUM TOUGH/PLUS			IRIDIUM POWER	IRIDIUM TOUGH/PLUS			IRIDIUM POWER	IRIDIUM TOUGH/PLUS			IRIDIUM POWER	IRIDIUM TOUGH/PLUS								
K6RTCX	-	-	-	SF2D6	T20PR-U	ITF20	-	D7TC	X22EP-U9	IX22B	-	T1137C	U22FS-U	IUF22	-	D7TC	X22EP-U9	IX22B	-	T1137C	U22FS-U	IUF22	-	D7TC	X22EP-U9	IX22B	-	T1137C	U22FS-U	IUF22	-	D7TC	X22EP-U9	IX22B	-				
K6RTDC	K20TXR	IK20	VK20	SF2E	T16PR-U	ITF16	-	D8C	X24ES-U	IX24	-	T5RTC	MA16PR-U	-	-	D8C	X24ES-U	IX24	-	T5RTC	MA16PR-U	-	-	D8C	X24ES-U	IX24	-	T5RTC	MA16PR-U	-	-	D8C	X24ES-U	IX24	-	T5RTC	MA16PR-U	-	-
K6RTJC	K20PBR	IK20	VK20	SF30C	W20S-U	-	-	D8RC	X24ESR-U	IX24	-	T6RTC	MA20PR-U	-	-	D8RC	X24ESR-U	IX24	-	T6RTC	MA20PR-U	-	-	D8RC	X24ESR-U	IX24	-	T6RTC	MA20PR-U	-	-	D8RC	X24ESR-U	IX24	-	T6RTC	MA20PR-U	-	-
K6TC	Q16-U	IQ16	VQ16	SF392A	K24PR-U11	IK24	-	D8RTC	X24EPR-U9	IX24B	-	T6TC	MA20P-U	-	-	D8RTC	X24EPR-U9	IX24B	-	T6TC	MA20P-U	-	-	D8RTC	X24EPR-U9	IX24B	-	T6TC	MA20P-U	-	-	D8RTC	X24EPR-U9	IX24B	-	T6TC	MA20P-U	-	-
K6TCOR	-	-	-	SF392B	K22PR-U	IK22	VK22	D8TC	X24EP-U9	IX24B	-					D8TC	X24EP-U9	IX24B	-					D8TC	X24EP-U9	IX24B	-					D8TC	X24EP-U9	IX24B	-				
K6TJC	K20PBR	IK20	VK20	SF392C	K20PR-U	IK20	VK20	D8TC	X24EP-U9	IX24B	-					D8TC	X24EP-U9	IX24B	-					D8TC	X24EP-U9	IX24B	-					D8TC	X24EP-U9	IX24B	-				
K7RTC	K20PR-U11	IK20	VK20	SF392D	K16PR-U	IK16	VK16	D87RTC	XU22EPR-U	IXU22	VXU22					D87RTC	XU22EPR-U	IXU22	VXU22					D87RTC	XU22EPR-U	IXU22	VXU22					D87RTC	XU22EPR-U	IXU22	VXU22				
K7RTC	Q20R-U	IQ20	VQ20	SF392D6	K16PR-U	IK16	VK16	DK7RTC9	XU22PR9	IXU22	VXU22					DK7RTC9	XU22PR9	IXU22	VXU22					DK7RTC9	XU22PR9	IXU22	VXU22					DK7RTC9	XU22PR9	IXU22	VXU22				
K7RTCO	-	-	-	SF393C	-	-	-	DK7RTPP	-	IXU22	VXU22					DK7RTPP	-	IXU22	VXU22					DK7RTPP	-	IXU22	VXU22					DK7RTPP	-	IXU22	VXU22				
K7RTC	-	-	-	SF405A	W31ES-U	IW31	-	E4RTC	W14FPR-UL	IWF16	-					E4RTC	W14FPR-UL	IWF16	-					E4RTC	W14FPR-UL	IWF16	-					E4RTC	W14FPR-UL	IWF16	-				
K7RTCX	-	-	-	SF405D	W24ES-U	IW24	-	E4TC	W14FP-UL	IWF16	-					E4TC	W14FP-UL	IWF16	-					E4TC	W14FP-UL	IWF16	-					E4TC	W14FP-UL	IWF16	-				
K7RTJC	K20PBR	IK20	VK20	SF405F	W22ES-U	-	-	E5RTC	W16FPR-U	IWF16	-					E5RTC	W16FPR-U	IWF16	-					E5RTC	W16FPR-U	IWF16	-					E5RTC	W16FPR-U	IWF16	-				
K7TC	Q20-U	IQ20	VQ20	SF406B	W27ES-U	IW27	-	E5TC	W16FP-U	IWF16	-					E5TC	W16FP-U	IWF16	-					E5TC	W16FP-U	IWF16	-					E5TC	W16FP-U	IWF16	-				
K7TJC	K20PBR	IK20	VK20	SF406C	W24ES-U	IW24	-	E6C	W20FS-U	IWF22	-					E6C	W20FS-U	IWF22	-					E6C	W20FS-U	IWF22	-					E6C	W20FS-U	IWF22	-				
L5C	W14M-U	-	-	SF409B	W24FS-U	IWF24	-	E6RC	W20FSR-U	IWF22	-					E6RC	W20FSR-U	IWF22	-					E6RC	W20FSR-U	IWF22	-					E6RC	W20FSR-U	IWF22	-				
L5T	W14MP-U10	-	-	SF409C	W22FS-U	IWF22	-	E6RTC	W20FPR-U	IWF20	-					E6RTC	W20FPR-U	IWF20	-					E6RTC	W20FPR-U	IWF20	-					E6RTC	W20FPR-U	IWF20	-				
L6T	W20MP-U	-	-	SF40D	W20ESR-U	-	-	E6TC	W20FP-U	IWF20	-					E6TC	W20FP-U	IWF20	-					E6TC	W20FP-U	IWF20	-					E6TC	W20FP-U	IWF20	-				
L6T	W20M-U	-	-	SF412C	W20FPR-U	IWF20	-	E7RTC	W22FPR-U	IWF22	-					E7RTC	W22FPR-U	IWF22	-					E7RTC	W22FPR-U	IWF22	-					E7RTC	W22FPR-U	IWF22	-				
L7	W22M-U	-	-	SF413B	X27ES-U	IX27	-	E7TC	W22FP-U	IWF22	-					E7TC	W22FP-U	IWF22	-					E7TC	W22FP-U	IWF22	-					E7TC	W22FP-U	IWF22	-				
L7T	W22MP-U	-	-	SF415B	X27EP-U9	IX27B	-	E8C	W24FS-U	IWF24	-					E8C	W24FS-U	IWF24	-					E8C	W24FS-U	IWF24	-					E8C	W24FS-U	IWF24	-				
L7Y	W22M-U	-	-	SF416B	X27EPR-U9	IX27B	-	E8RC	W24FSR	IWF24	-					E8RC	W24FSR	IWF24	-					E8RC	W24FSR	IWF24	-					E8RC	W24FSR	IWF24	-				
L8RT	W22MPR-U	-	-	SF416C	X24EPR-U9	IX24B	-	E8RTC	W24FPR	IWF24	-					E8RTC	W24FPR	IWF24	-					E8RTC	W24FPR	IWF24	-					E8RTC	W24FPR	IWF24	-				
L9	W22M-U	-	-	SF416D	X22EPR-U9	IX22B	-	E8TC	W24FP-U	IWF24	-					E8TC	W24FP-U	IWF24	-					E8TC	W24FP-U	IWF24	-					E8TC	W24FP-U	IWF24	-				
L9T	W22MP-U	-	-	SF419D	U20FS-U	IUF22	-	F5RF	W16EXR-U	IW16	VW16					F5RF	W16EXR-U	IW16	VW16					F5RF	W16EXR-U	IW16	VW16					F5RF	W16EXR-U	IW16	VW16				
N6	T20M-U	-	-	SF426C	W20EXR-U	IW20	VW20	F5RTC	W16EXR-U	IW16	VW16					F5RTC	W16EXR-U	IW16	VW16					F5RTC	W16EXR-U	IW16	VW16					F5RTC	W16EXR-U	IW16	VW16				
N9	T22M-U	-	-	SF426E	W16EXR-U	IW16	VW16	F5TC	W16EX-U	IW16	VW16					F5TC	W16EX-U	IW16	VW16					F5TC	W16EX-U	IW16	VW16					F5TC	W16EX-U	IW16	VW16				
Q7TC	T16EPR-U	IT16	VT16	SF430B	U27ESR-U	IU27	-	F5TC	W16EP-U11	IW16	VW16					F5TC	W16EP-U11	IW16	VW16					F5TC	W16EP-U11	IW16	VW16					F5TC	W16EP-U11	IW16	VW16				
R4C	MW17	-	-	SF430C	U24ESR-N	IU24	-	F5TC11	W16EX-U11	IW16	VW16					F5TC11	W16EX-U11	IW16	VW16					F5TC11	W16EX-U11	IW16	VW16					F5TC11	W16EX-U11	IW16	VW16				
T5RTC	MA20PR-U	-	-	SF45F	W14LM-U	-	-	F6RF	W20EXR-U	IW20	VW20					F6RF	W20EXR-U	IW20	VW20					F6RF	W20EXR-U	IW20	VW20					F6RF	W20EXR-U	IW20	VW20				
				SF4E	MA16PR-U	-	-	F6RTC	W20EXR-U	IW20	VW20					F6RTC	W20EXR-U	IW20	VW20					F6RTC	W20EXR-U	IW20	VW20					F6RTC	W20EXR-U	IW20	VW20				
				SF512E	MA20PR-U	-	-	F6T	W20EX-U	IW20	VW20					F6T	W20EX-U	IW20	VW20					F6T	W20EX-U	IW20	VW20					F6T	W20EX-U	IW20	VW20				
				SF514D	T20EPR-U	IT20	VT20	F6TC	W20EX-U	IW20	VW20					F6TC	W20EX-U	IW20	VW20					F6TC	W20EX-U	IW20	VW20					F6TC	W20EX-U	IW20	VW20				
				SF516D	T20EPR-U	IT20	VT20	F7C	W22ES-U	-	-					F7C	W22ES-U	-	-					F7C	W22ES-U	-	-					F7C	W22ES-U	-	-				
				SF522D	KJ20CR11	IK20	VK20	F7RC	W22EPR-U	IW22	VW22					F7RC	W22EPR-U	IW22	VW22					F7RC	W22EPR-U	IW22	VW22					F7RC	W22EPR-U	IW22	VW22				
				SF524E	T16EPR-U	IT16	VT16	F7RTC	W22EPR-U	IW22	VW22					F7RTC	W22EPR-U	IW22	VW22					F7RTC	W22EPR-U	IW22	VW22					F7RTC	W22EPR-U	IW22	VW22				
				SF550C	K20PR-U11	IK20	VK20	F7RTJC	W20EPB	IW20	VW20					F7RTJC	W20EPB	IW20	VW20					F7RTJC	W20EPB	IW20	VW20					F7RTJC	W20EPB	IW20	VW20				
				SF552B	-	-	-	F7TC	W22EP-U	IW22	VW22					F7TC	W22EP-U	IW22	VW22					F7TC	W22EP-U	IW22	VW22					F7TC	W22EP-U	IW22	VW22				
				SF552C	-	-	-	F7TJC	W20EPB	IW20	VW20					F7TJC	W20EPB	IW20	VW20					F7TJC	W20EPB	IW20	VW20					F7TJC	W20EPB	IW20	VW20				
				SF6A	W24EPR-U	IW24	-	F8C	W24ES-U	IW24	-					F8C	W24ES-U	IW24	-					F8C	W24ES-U	IW24	-					F8C	W24ES-U	IW24	-				
				SF6C	W20EPR-U	IW20	VW20	F8RC	W24ESR-U	IW24	-					F8RC	W24ESR-U	IW24	-					F8RC	W24ESR-U	IW24	-					F8RC	W24ESR-U	IW24	-				
				SF6D	W20EPR-U	IW20	VW20	F8RTC	W24EPR-U	IW24	-					F8RTC	W24EPR-U	IW24	-					F8RTC	W24EPR-U	IW24	-					F8RTC	W24EPR-U	IW24	-				
				SF6E	W16EPR-U	IW16	VW16	F8TC	W24EPR-U	IW24	-					F8TC	W24EPR-U	IW24	-					F8TC	W24EPR-U	IW24	-					F8TC	W24EPR-U	IW24	-				
				SF6F6	W14EXR-U11	IW16	VW16	G4C	W14-U	-	-					G4C	W14-U	-	-					G4C	W14-U	-	-					G4C	W14-U	-	-				
				SF8E	W16PR-U	-	-	G4RC	W14-U	-	-					G4RC	W14-U	-	-					G4RC	W14-U	-	-					G4RC	W14-U	-	-				
				SF98E	KJ20CR-L11	IK20	VK20	G6C																															

CAR MAKER GENUINE P/N CROSS REFERENCE (

98079-56841

other



DENSO

AUSTRALIA

CHINA

INDIA

INDONESIA

KOREA

MALAYSIA

PHILIPPINES

SINGAPORE

SAUDI ARABIA

TAIWAN

THAILAND

VIETNAM

JAPAN

EUROPE

USA

SMALL ENGINE

CROSS REFERENCE

PART NUMBER

ABARTH	DENSO	IRIDIUM POWER	IRIDIUM TOUGH/PLUS	AUDI/VW	DENSO	IRIDIUM POWER	IRIDIUM TOUGH/PLUS	BMW	DENSO	IRIDIUM POWER	IRIDIUM TOUGH/PLUS
55210685 (IKR9F8)	-	IXU27	-	101-000-033AG	-	IK16	VK16	12-12-0032-136 (BKR6EQU)	K20TXR	IK20	VK20
ALFA ROMEO	DENSO	IRIDIUM POWER	IRIDIUM TOUGH/PLUS	101-000-034AA	W20EP-U	IW20	VW20	12-12-0032-137 (ILZFR6D11)	-	-	-
0007686643 (WR6DTC)	W20EPBR-S	IW20	VW20	101-000-035AB (BKR5EQU)	K20TXR	IK20	VK20	12-12-0032-273 (LKR8AP)	-	-	-
0055182623 (FR5CP)	IK16	IK16	VK16	101-000-035AE (BK7EQU)	K22TM11	IK22	VK22	12-12-0034-091 (ZKBR7AP-HTU)	-	-	-
07-85723 (PTR6E13)	VT20	IT20	VT20	101-000-035AH (BKR5EQU)	K20TXR	IK20	VK20	12-12-0034-098 (PLZKBR7AG, Bi Hex)	-	-	-
4644-9690 (BKR6EKPA)	IK20	IK20	VK20	101-000-035HU (BKR6EKUB)	K20TXR	IK20	VK20	12-12-0034-677 (12RZ-6SP03, Beru, Bi Hex)	-	-	-
4652-1529 (BKR6EKPA)	IK20	IK20	VK20	101-000-036AA (BUR6ET)	W20EPBR-S	IW20	VW20	12-12-0035-531 (ILZKBR7A-8G)	-	-	-
4655-0992 (CR7EKC)	-	IU22	-	101-000-036AB (BUR5ET)	W20EPBR-S	IW20	VW20	12-12-0035-747 (PFR7B)	PK22PR8	IK22	VK22
50051491 (ILZKR7G7G)	-	-	-	101-000-036AC (BURSET-10)	W20EPBR-S	IW20	VW20	12-12-0037-051 (ZRS5TTP332)	-	-	-
55210685 (IKR9F8)	-	IXU27	-	101-000-038AA	W16ETR-S	IW16	VW16	12-12-0037-244 (ZGR6STE2)	-	-	-
55217232 (ILKAR7D6G)	-	-	-	101-000-038AB	W16ETR-S	IW16	VW16	12-12-0037-580 (ZRS5TTP333)	-	-	-
55249868 (IKR9J8)	-	IXU24	VXU24	101-000-039AA	W16ETR-S	IW16	VW16	12-12-0037-581 (ZMR5TTP33)	-	-	-
6056-9086 (PGR6A)	P20PR8	IW20	VW20	101-000-039AB (BPR5EQU)	W16ETR-S	IW16	VW16	12-12-0037-582 (ZRS5TTP33-S)	-	-	-
6056-9957 (PFR6B W/O Nut)	VK20	IK20	VK20	101-000-040AC	W20EPBR-S	IW20	VW20	12-12-0037-663 (LZFR6AP11GS)	-	-	-
6057-9903 (PFR6B Solid)	PK20PR-P8	IK20	VK20	101-000-040AD	W20EPBR-S	IW20	VW20	12-12-0038-349 (ZKBR7A-HTU)	-	-	-
6059-9495 (PMR7A)	IU22	IU22	-	101-000-040AE	W20EPBR-S	IW20	VW20	12-12-0038-704 (SILZKBR8CBS, Bi-Hex)	-	-	-
670050892 (LKR8AP7JDS)	-	-	-	101-000-041AC (147GH7)	K20PBR-S10	IK20	VK20	12-12-0038-832 (ZMR5TTP339, Bi Hex)	-	-	-
ASTONMARTIN	DENSO	IRIDIUM POWER	IRIDIUM TOUGH/PLUS	101-000-041AD	K20PBR-S10	IK22	VK22	12-12-0038-894 (ZRS5TTP339, Bi Hex)	-	-	-
07-100528 (PTR7E13)	-	IT22	-	101-000-041AE	K22PBR-S	IK22	VK22	12-12-0038-896 (SILZKBR8CBS, Bi Hex)	-	-	-
07-10056 (IFR7N10)	VK22	IK22	VK22	101-000-044AA (FR8DS)	IK16	IK16	VK16	12-12-0039-634 (ZMR5TTP330)	-	-	-
07-123116 (BCPR6E)	Q20PR-U	IQ20	VQ20	101-000-044AA (FR8DS)	IK16	IK16	VK16	12-12-0039-664 (SILZBR8D8S)	-	-	-
07-70920 (BCR8ES)	IQ24	IQ24	-	101-000-047AA	W16EP-U	IW16	VW16	12-12-0040-551 (RERK4ZVYVB, Bi Hex)	-	-	-
07-85126 (PTR6E13)	VT20	IT20	VT20	101-000-047AB	P20PR8	IW20	VW20	12-12-0040-552 (SILZKGR8BBS, Bi Hex) spec set	-	-	-
07-85890 (PTR5E13)	VT16	IT16	VT16	101-000-049AD	-	IK20	VK20	12-12-0040-573 (SILZKBR8ES)	-	-	-
AUDI/VW	DENSO	IRIDIUM POWER	IRIDIUM TOUGH/PLUS	101-000-050AA	W20EPBR-S	IW20	VW20	12-12-0040-581 (ZRS5TTP330A)	-	-	-
04C-905-606A (ZKER6A-10EG)	-	-	-	101-000-050AC	W20EPBR-S	IW20	VW20	12-12-0041-666 (SILZKGR8BBS, Bi Hex)	-	-	-
04C-905-616A (O 241 135 516)	-	-	-	101-000-051AA (F7LTCR)	K20PBR-S10	IK20	VK20	12-12-0041-946 (ZRS5TTP3320, Bi Hex)	-	-	-
03C-905-601A (PZFR6B8EG)	-	-	-	101-000-051AB	K22PBR-S	IK22	VK22	12-12-0046-646 (SILZKGR8CBS, Bi Hex)	-	-	-
03C-905-601B (SIZFR6B8EG)	-	-	-	101-000-052AA (HGR7KQC)	T20EPR-U	IT20	VT20	12-12-0054-451 (ZRS5TTP3320, Bi Hex)	-	-	-
03F-905-600 (PZFR6Q)	-	-	-	101-000-054AC (FGR7KQE)	K20TXR	IK20	VK20	12-12-0054-551 (ZRS5TTP3320, Bi Hex)	-	-	-
03F-905-600A (IZFR6P7)	-	-	-	101-000-055AA	K20TXR	IK20	VK20	12-12-0054-552 (SILZKGR8BBS, Bi Hex) spec set	-	-	-
04E-905-601 (PKZER7A8EGS)	-	-	-	101-000-060AA	-	IK16	VK16	12-12-0040-573 (SILZKBR8ES)	-	-	-
04E-905-601B (PKZER7B8EGS)	-	-	-	101-000-062AA (PZFR6D-11)	-	-	VKA20	12-12-0040-581 (ZRS5TTP330A)	-	-	-
04E-905-602 (PKER7A8EGS)	-	-	-	101-000-062AB (PZFR5D-11)	-	-	VKA16	12-12-0041-666 (SILZKGR8BBS, Bi Hex)	-	-	-
04E-905-602D (IKER7A8EGS)	-	-	-	101-000-063AA (PFR6Q)	PK20PR-P8	-	VK20Y	12-12-0041-946 (ZRS5TTP3320, Bi Hex)	-	-	-
04E-905-612 (O 241 145 513)	-	-	-	101-000-063AC (PFR7Q)	PK22PR8	IK22	VK22	12-12-0046-646 (SILZKGR8CBS, Bi Hex)	-	-	-
04E-905-612C (O 241 145 519)	-	-	-	101-000-065AA (BKR6ETA-10)	K20TXR	IK20	VK20	12-12-0054-451 (ZRS5TTP3320, Bi Hex)	-	-	-
06E-905-611 (O6E905611)	IK20	VK20	-	101-000-067AA (BKR6EQUA)	K20TXR	IK20	VK20	12-12-2-158-165 (12ZR-6SP2)	-	-	-
06H-905-601A (PFR7S8EG)	IK22	VK22	-	101-000-067AA (BKR6EQUA)	K20TXR	IK20	VK20	12-12-2-158-252 (IZFR6H11)	-	-	-
06H-905-601C (PFR7S8EG)	IK22	VK22	-	101-000-068AA (ZFR6S-Q)	K20PBR-S10	IK20	VK20	12-12-2-158-253 (FR7NPP332)	-	-	-
06H-905-611 (BOSCH O 241 245 670)	IK22	VK22	-	101-000-068AA (FGR6HQE)	K20PBR-S10	IK20	VK20	12-12-2-455-258 (SILZKGR8BBS)	-	-	-
06H-905-621 (BERU)	IK22	VK22	-	101-000-068AA (FGR6HQE)	K20PBR-S10	IK20	VK20	12-12-2-293-697 (12ZR-6SP2-1)	-	-	-
06K-905-601B (PLFER7A8EG)	IKH22	VKH22	-	101-905-600 (PZFR5Q11)	SKJ16CR-L11	IK16	VK16	12-12-2-343-144 (D8EA)	X24ES-U	IX24	-
06K-905-601D (PLFER7A8EG)	IKH22	VKH22	-	101-905-601 (PZFR5D-11)	SKJ16CR-L11	-	VKA16	12-12-2-357-197 (LMAR8A1-8E)	-	-	-
06K-905-601L (ILFER7A8EG)	-	-	-	101-905-601F (VW-AG, BOSCH)	KJ20DR-M11	IK20L	VKA20	12-12-7-653-439 (CR8EB)	U24ESR-NB	IU24	-
06K-905-601M (SILFER8C7ES)	-	-	-	101-905-601F (VW-AG, BOSCH)	PK20GR8	IK20L	VKA20	12-12-7-664-404 (DR8EB)	IX24	IX24	-
06K-905-611C (BOSCH 06K 905 611C)	IKH22	VKH22	-	101-905-602 (PZFR6M-11G)	-	-	-	12-12-7-671-301 (DCPR8EKC)	XU24EPR-U	IXU24	VXU24
06M-905-606F (SILKGR9A7ES)	-	-	-	101-905-602 (PZFR6M-11G)	-	-	-	12-12-7-671-302 (YR6LDE)	XU22EPR-U	IXU22	VXU22
079-905-626E (BERU)	IKH24	-	-	101-905-603B (14F-7HUR2)	KJ20CR-L11	IK20	VK20	12-12-7-677-560 (YR5LDE)	XU24EPR-U	IXU24	VXU24
079-905-626G (BERU)	IKH24	-	-	101-905-606A (IKZR7B)	-	-	-	12-12-7-698-956 (MAR9B-JDS)	-	-	-
079-905-626J (BERU)	IKH24	-	-	101-905-607 (BKR6EKUE)	K20TXR	IK20	VK20	12-12-7-699-116 (KR9CI)	IXU27	IXU27	-
079-905-626LBERU)	IKH24	-	-	101-905-608AA (FGR6HQE)	K20PBR-S10	IK20	VK20	12-12-7-710-636 (CR9EKB)	IU27A	-	-
101-000-000AB	W20EP-U	IW20	VW20	101-905-611 (PFR6U-11G)	PK20PR-L11	IK20	VK20	12-12-7-726-112 (MAR8B-JDS)	-	-	-
101-000-001AB	W20EPB	IW20	VW20	101-905-611A (PFR6X11)	PK20PR-L11	IK20	VK20	12-12-9-064-619 (BKR6EK)	K20TXR	IK20	VK20
101-000-001AC	W20EPB	IW20	VW20	101-905-611D (PFR6S11E)	-	-	-	12-12-9-069-048 (PKR7A)	VXU22	IXU22	VXU22
101-000-001AD	W16EPB10	IW16	VW16	101-905-611G (PFR8S8EG)	IK24	IK24	-	12-12-9-071-003 (BKR6EQU)	K20TXR	IK20	VK20
101-000-001AE	W16EPB10	IW16	VW16	101-905-615A (FGR7KQEO)	K20PBR-S10	IK20	VK20	7-699-166 (KR9CI)	IXU27	IXU27	-
101-000-002AB	W20EP-U	IW20	VW20	101-905-616 (BKR6EQUA)	K20TXR	IK20	VK20	12-12-9-071-003 (BKR6EQU)	K20TXR	IK20	VK20
101-000-003AA	K22PB	IK22	VK22	101-905-617 (ZFR5P-G)	-	-	-	12-12-9-071-003 (BKR6EQU)	K20TXR	IK20	VK20
101-000-004AA	K22PB	IK22	VK22	101-905-617C (ZFR6T-11G)	KJ20DR-M11	-	VKA20	12-12-9-071-003 (BKR6EQU)	K20TXR	IK20	VK20
101-000-005AA	W20EPB	IW20	VW20	101-905-617C (ZFR6T-11G)	PK20GR8	-	VKA20	12-12-9-071-003 (BKR6EQU)	K20TXR	IK20	VK20
101-000-005AB (W7DTC)	W20EPB	IW20	VW20	101-905-620 (PZFR5N-11TG)	-	-	VKA16	12-12-9-071-003 (BKR6EQU)	K20TXR	IK20	VK20
101-000-005AC	W22EPB	IW22	VW22	101-905-621 (PFR7W-T)	-	-	IK22	12-12-9-071-003 (BKR6EQU)	K20TXR	IK20	VK20
101-000-005AD	W16EPB10	IW16	VW16	101-905-621A (PFR6W-T)	-	-	VKB20	12-12-9-071-003 (BKR6EQU)	K20TXR	IK20	VK20
101-000-005AE	W16EPB10	IW16	VW16	101-905-621B (PFR6W-TG)	-	-	VKB20	12-12-9-071-003 (BKR6EQU)	K20TXR	IK20	VK20
101-000-005AF	W16EPB10	IW16	VW16	101-905-621C (PFR7W-TG)	-	-	IK22	12-12-9-071-003 (BKR6EQU)	K20TXR	IK20	VK20
101-000-006AB	W20EP-U	IW20	VW20	101-905-622 (ILZKR7A)	-	-	-	12-12-9-071-003 (BKR6EQU)	K20TXR	IK20	VK20
101-000-006AC	W20EP-U	IW20	VW20	101-905-622A (ILZKR8A)	-	-	-	12-12-9-071-003 (BKR6EQU)	K20TXR	IK20	VK20
101-000-007AA	W20EPB	IW20	VW20	101-905-624 (ZKR7APQ)	-	-	-	12-12-9-071-003 (BKR6EQU)	K20TXR	IK20	VK20
101-000-007AB	W20EPB	IW20	VW20	101-905-626 (PZFR6R)	SKJ20CR-AB/PKJ20CR8	-	-	12-12-9-071-003 (BKR6EQU)	K20TXR	IK20	VK20
101-000-007AC	W16EPB10	IW16	VW16	101-905-626A (SIZFR6A6D)	-	-	-	12-12-9-071-003 (BKR6EQU)	K20TXR	IK20	VK20
101-000-007AD	W20EPB	IW20	VW20	101-905-626E (EYQUEUM)	-	-	-	12-12-9-071-003 (BKR6EQU)	K20TXR	IK20	VK20
101-000-016AA	PK22PR8	IK22	VK22	101-905-626G (EYQUEUM)	-	-	-	12-12-9-071-003 (BKR6EQU)	K20TXR	IK20	VK20
101-000-016AB	PK20PR-P8	IK20	VK20	101-905-631A (F7KPP332U)	VK20						

CITROEN	DENSO	IRIDIUM POWER	IRIDIUM TOUGH/PLUS	DAIHATSU	DENSO	IRIDIUM POWER	IRIDIUM TOUGH/PLUS	DAIHATSU	DENSO	IRIDIUM POWER	IRIDIUM TOUGH/PLUS
5960.G4 (PLZKBR7AG)	-	-	-	90048-51169-000	K20BR-S10	IK20	VK20	999-06910-X9-016 (DPR8EIX9)	-	IX24B	-
5960.J3 (RFC58LZK)	K20PR-U11	IK20	VK20	90048-51170	K20PTR-S	IK20	VK20	999-06910-X9-017 (DPR9EIX9)	-	IX27B	-
5960.L0 (ZQR8S)302, Bi Hex	-	-	-	90048-51172	SVK20RZ11	IK20	VK20	999-06910-X9-018 (DCPR7EIX)	-	IXU22	VXU22
5960.L5 (ILZKBR7A8G, Bi Hex)	-	-	-	90048-51173-000 (IFR6J11)	SVK20RZ11	IK20	VK20	999-06910-X9-019 (ZFR5FIX11)	-	IK16	VK16
5962.7W (FR7ME)	K20HR-U11	IKH20	VKH20	90048-51175-000	PK20PTR-S9	IK20	VK20	999-06910-X9-020 (ZFR6FIX11)	-	IK20	VK20
9807776680 (ZR55PP3320)	-	-	-	90048-51178-000 (IFR6J)	SVK20RZ8	-	VK20Y	999-06910-X9-021 (CR8EIX9)	-	IUH24	-
9808465980 (ZR551332, Bi Hex)	-	-	-	90048-51179	ZXU22HBR11	-	-	999-06910-X9-022 (CR9EIX9)	-	IUH27	-
9813769880 (ILZKBR8C7G, Bi Hex)	-	-	-	90048-51180-000 (ILKR7A11T)	ZXU22HBR11 (*6)	-	-	999-06910-X9-023 (CR8EIX)	-	IU24	-
								999-06910-X9-024 (CR8EIX)	-	IU27	-
								999-06910-X9-026 (BPR5EIX)	-	IW16	VW16
								999-06910-X9-027 (BPR6EIX)	-	IW20	VW20
								999-06910-X9-028 (BKR5EIX)	-	IK16	VK16
								999-06910-X9-030 (BKR7EIX11)	-	IK22	VK22
								999-06910-X9-031 (BCPR7EDIX)	-	-	-
								999-06910-X9-032 (BKR5EIXP)	-	-	VK16
								999-06910-X9-033 (BKR5EIX11P)	-	-	VK16
								999-06910-X9-034 (BKR6EIXP)	-	-	VK20/VK20Y
								999-06910-X9-035 (BKR6EIX11P)	-	-	VK20
								99906-850P9-006	W20FPR-U	IWF20	-
								99906-850P9-009	W22ESR-U	-	-
								99906-850P9-011	W16EPR11	IW16	VW16
								99906-850P9-012	W20EPR11	IW20	VW20
								99906-850P9-013	W16EXR-U13	IW16	VW16
								99906-850P9-015	W16ETR-S	IW16	VW16
								99906-850P9-017	J16A-U11	-	-
								99906-850P9-018	J16BR-U11	-	-
								99934-07685-100	W16EX-U11	IW16	VW16
								99934-08685-100	W20EX-U11	IW20	VW20
								99934-09685-100	W20FP-U	IWF20	-
								99934-10685-100	W9EP	-	-
								99934-12685-100	W16FP-U	IWF16	-
								99934-13685-100	W20EP11	IW20	VW20
								99934-14685-100	W16EX-U13	IW16	VW16
								NDIK16	IK16	IK16	VK16
								NDIK16A	IK16	IK16	VK16
								NDIK20	IK20	IK20	VK20
								NDIK20A	IK20	IK20	VK20
								NDIK22	IK22	IK22	VK22
								NDIK22A	IK22	IK22	VK22
								NDIK24A	IK24	IK24	-
								NDIK27A	IK27	IK27	-
								NDIQ16	IQ16	IQ16	VQ16
								NDIQ16A	IQ16	IQ16	VQ16
								NDIQ20	IQ20	IQ20	VQ20
								NDIQ20A	IQ20	IQ20	VQ20
								NDIQ22	IQ22	IQ22	VQ22
								NDIQ22A	IQ22	IQ22	VQ22
								NDIQ24A	IQ24	IQ24	-
								NDIQ27A	IQ27	IQ27	-
								NDIW16	IW16	IW16	VW16
								NDIW16A	IW16	IW16	VW16
								NDIW20	IW20	IW20	VW20
								NDIW20A	IW20	IW20	VW20
								NDIW22	IW22	IW22	VW22
								NDIW22A	IW22	IW22	VW22
								NDIXU22	IXU22	IXU22	VXU22
								NDIXU22A	IXU22	IXU22	VXU22
								NDIXU24	IXU24	IXU24	VXU24
								NDIXU24A	IXU24	IXU24	VXU24
								NDIXUH20IA	IXUH20I	IXUH20I	VXUH20I
								NDIXUH22IA	IXUH22I	IXUH22I	VXUH22I
								NDVK20Y	VK20Y	-	VK20Y
								NDVK20YA	VK20Y	-	VK20Y
								NDVXUH20IA	VXUH20I	VXUH20I	VXUH20I
								NDVXUH22IA	VXUH22I	IXUH22I	VXUH22I
								NDVK16	VK16	IK16	VK16
								NDVK16A	VK16	IK16	VK16
								NDVK20	VK20	IK20	VK20
								NDVK20A	VK20	IK20	VK20
								NDVK22	VK22	IK22	VK22
								NDVK22A	VK22	IK22	VK22
								NDVQ16	VQ16	IQ16	VQ16
								NDVQ16A	VQ16	IQ16	VQ16
								NDVQ20	VQ20	IQ20	VQ20
								NDVQ20A	VQ20	IQ20	VQ20
								NDVQ22	VQ22	IQ22	VQ22
								NDVQ22A	VQ22	IQ22	VQ22

CAR MAKER GENUINE P/N CROSS REFERENCE (

98079-56841

other

DENSO

HONDA	DENSO	IRIDIUM POWER	IRIDIUM TOUGH/PLUS	HONDA	DENSO	IRIDIUM POWER	IRIDIUM TOUGH/PLUS	HONDA	DENSO	IRIDIUM POWER	IRIDIUM TOUGH/PLUS
98059-57916(CR7EH9)	U22FER9	IUH24	-	98079-5514G(ZFR5F-11)	KJ16CR-L11	IK16	VK16	98079-571CV	SK22PR-M11S	IK22G	VK22G
98059-57926	U22FER9	IUH24	-	98079-5514H(PFR5G-11)	PK16PR-L11	IK16	VK16	98079-57816(BR7ES)	W22ESR-U	-	-
98059-58910(C8EH-9)	U24FE9	IUH24	-	98079-5514N(PZFR5F-11)	SKJ16CR-L11	IK16	VK16	98079-57840(B7ES)	W22ES-U	-	-
98059-58916(CR8EH-9)	U24FER9	IUH24	-	98079-5514P(ZFR5J-11)	KJ16CR-L11	IK16	VK16	98079-57855	W22EPR-U	IW22	VW22
98059-58920	U24FE9	IUH24	-	98079-55155	W16EPR-U11	IW16	VW16	98079-5785C	K22PR-UR	IK22	VK22
98059-58926	U24FER9	IUH24	-	98079-55158	Q16PR-U11	IQ16	VQ16	98079-57877(BR7ES)	W22ESR-U	-	-
98059-5892D	IUH24D	IUH24	-	98079-5515E	K16PR-U11	IK16	VK16	98079-5787G(ZFR7F)	KJ22CR-L8	IK22	VK22
98059-5896(CR8EH9S)	U24FER9S	IUH24	-	98079-5515G	KJ16CR-L11	IK16	VK16	98079-5787T(PFR7N-D)	PK22PR8	IK22	VK22
98059-589K6	U24FER9S	IUH24	-	98079-5515H	PK16PR-L11	IK16	VK16	98079-5815E	K24PR-U11	IK24	-
98059-59910(C9EH-9)	U27FER9	IUH27	-	98079-5515J	K16PR-L11	IK16	VK16	98079-5815U	IK24C11	IK24	-
98059-59916(CR9EH-9)	U27FER9	IUH27	-	98079-5515N	PKJ16CR-L11	IK16	VK16	98079-5817U(FR8BI-11)	IK24C11	IK24	-
98059-5991U(IMR9A-9H)	IUH27D	IUH27	-	98079-5515U	VK16PR-Z11	IK16	VK16	98079-58644(B8EG)	-	IW24	-
98059-5992U	IUH27D	IUH27	-	98079-5515W	SKJ16CR-L11	IK16	VK16	98079-58678(B9EV)	W24ES-V	IW24	-
98059-599J6(CR9EH-9S)	-	IUH27	-	98079-55173(BUR5EB-11)	W16EKR-S11	IW16	VW16	98079-58816(BR8ES)	W24ESR	IW24	-
98061-58611(DP8Z)	X24GP-U	IXG24	-	98079-5517U(IFR5L11)	VK16PRZ11	IK16	VK16	98079-58816(BR8ES)	W24ESR-U	IW24	-
98061-58616(DPR8Z)	X24GPR-U	IXG24	-	98079-5517V(IFR5G11K)	SK16PR-L11	IK16	VK16	98079-58840(B8ES)	W24ES-U	IW24	-
98061-59616(DPR9Z)	X27GPR-U	IXG27	-	98079-5517W(IZFR5F11)	SKJ16CR-L11	IK16	VK16	98079-58857	W24ESR-U	IW24	-
98066-55716(DR5HS)	X16FSR-U	-	-	98079-55183	W16EKR-S11	IW16	VW16	98079-5915U	IK27C11	IK27	-
98066-55740(D5HS)	X16FSR-U	-	-	98079-55827	W16EPR-U(THREAD)	IW16	VW16	98079-5917U(FR9B11)	IK27C11	IK27	-
98066-56717(D6HA)	X20FS-U	-	-	98079-55840(B5ES)	W16ES-U	-	-	98079-59644(B9EV)	-	IW27	-
98066-56726	X20FSR-U	-	-	98079-55841(BP5ES)	W16EX-U	IW16	VW16	98079-59659	W27ESR-V	IW27	-
98066-58717(D8HA)	X24FS-U	-	-	98079-55841(BP5ES)	W16EP-U	IW16	VW16	98079-59678(B9EG)	W27ES-U	IW27	-
98069-38716(DR8ES-L)	X24ESR-U	IX24	-	98079-55846(BPR5E)	W16EXR-U	IW16	VW16	98079-59811(B9ES)	W27ES-U	IW27	-
98069-38719(DR8ES-L)	X24ESR-U	IX24	-	98079-55846(BPR5ES)	W16EPR-U	IW16	VW16	98079-59819(BR9ECS)	W27ESR	IW27	-
98069-56911(DP6EA-9)	X20EPR-U9	-	-	98079-55855	W16EPR-U(SOLID)	IW16	VW16	98079-59819(BR9ECS)	W27ESR-U	IW27	-
98069-5692U	VX20BC	-	-	98079-55855	W16EPR-U	IW16	VW16	98079-59840(B9ES)	W27ES-U	IW27	-
98069-57717(D7EA)	X22ES-U	IX22	-	98079-5585C	K16PR-UR	IK16	VK16	98079-59847(BR9ES)	W27ESR-U	IW27	-
98069-57726	X22ESR-U	IX22	-	98079-5585V	J16CR-U	IW16	VW16	98079-59847(BR9ES)	W27ESR-U	IW27	-
98069-57756	X22ESR-UB	IX22	-	98079-5587V(ZGR5A)	J16CR-U	IW16	VW16	98079-59855	W27EMR-C	IWM27	-
98069-57911(DP7EA-9)	X22EP-U9	IX22B	-	98079-55A4N(PFR5F-13)	PQ16R	IQ16	VQ16	98079-59872(B9ECS)	-	IW27	-
98069-57916(DPR7EA-9)	X22EPR-U9	IX22B	-	98079-55A5N	PKJ16CR-L13	IK16	VK16	98079-59875(BR9ECM)	W27EMR-C	IWM27	-
98069-5792U	VX22BC	IX22B	-	98079-56132	W20EXR-U11	IW20	VW20	98079-60875(BR10ECM)	-	IWM31	-
98069-57956	X22EPR-UB9	IX22B	-	98079-56144(BP6ES-11)	W20EX-U11	IW20	VW20	9807B-5515W	SKJ16DR-M11	IK16	VK16
98069-58717(D8EA)	X24ES-U	IX24	-	98079-56144(BP6ES-11)	W20EXR-U11	IW20	VW20	9807B-5615P	KJ20DR-M11	IK20	VK20
98069-58726	X24ESR-U	IX24	-	98079-56146(BPR6EY-11)	W20EXR-U11	IW20	VW20	9807B-5615W	SKJ20DR-M11	IK20	VK20
98069-58911(DP8EA-9)	X24EP-U9	IX24B	-	98079-56148(BCPR6E-11)	Q20PR-U11	IQ20	VQ20	9807B-5617P(ZFR6K11)	KJ20DR-M11	IK20	VK20
98069-58916(DPR8EA-9)	X24EPR-U9	IX24B	-	98079-5614A(BCPR6EY-N11)	Q20R-U11	IQ20	VQ20	9807B-5617P(ZFR6K11S)	KJ20DR-M11S	IK20G	VK20G
98069-58926	X24EPR-U9	IX24B	-	98079-5614E(BKR6E-11)	K20PR-U11	IK20	VK20	9807B-561CP	KJ20DR-M11S	IK20G	VK20G
98069-5991F(DPR9EVX-9)	IX27B	IX27B	-	98079-5614F(BCPR6EVX-11)	-	IQ20	VQ20	9807B-561CW	SKJ20DR-M11S	IK20G	VK20G
98069-59926	X27EPR-U9	IX27B	-	98079-5614G(ZFR6F-11)	KJ20CR-L11	IK20	VK20	9807B-56A5W	SKJ20DR-M13	IK20	VK20
98073-54740(BM4A)	W14M-U	-	-	98079-5614H(PFR6G-11)	PK20PR-L11	IK20	VK20	9807B-56A7W(ZFR6K13)	SKJ20DR-M13	IK20	VK20
98073-54744(BMR4A)	W14MR-U	-	-	98079-5614J(BKR6E-N11)	K20PR-L11	IK20	VK20				
98073-54750	W14M-U	-	-	98079-5614N(PZFR6F-11)	PKJ20CR-L11	IK20	VK20				
98073-54754	W14MR-U	-	-	98079-5614P(ZFR6J-11)	KJ20CR-L11	IK20	VK20				
98073-54941(BPM4A-10)	W14MP-U10	-	-	98079-56155	W20EPR-U11	IW20	VW20				
98073-54944(BPMR4A)	W14MPR-U10	-	-	98079-56158	Q20PR-U11	IQ20	VQ20				
98073-54951	W14MP-U10	-	-	98079-5615E	K20PR-U11	IK20	VK20				
98073-56740(BM6A)	W20M-U	-	-	98079-5615G	KJ20CR-L11	IK20	VK20				
98073-56744(BMR6A)	W20MR-U	-	-	98079-5615H	PK20PR-L11	IK20	VK20				
98073-56750	W20M-U	-	-	98079-5615J	K20PR-L11	IK20	VK20				
98073-56941(BPM6A-10)	W20MP-U10	-	-	98079-5615N	PKJ20CR-L11	IK20	VK20				
98073-56944(BPMR6A)	W20MPR-U10	-	-	98079-5615U	VK20PRZ11	IK20	VK20				
98076-54710(B-4H)	W14F-U	-	-	98079-5615V	SK20PR-L11	IK20	VK20				
98076-54711(BP4HS)	W14FP-UL	IWF16	-	98079-56173(BUR6EB-11)	W20EKR-S11	IW20	VW20				
98076-54719(BP4HS)	W14FP-UL	IWF16	-	98079-56183	W20EKR-S11	IW20	VW20				
98076-54747(BPR4HS)	W14FPR-UL	IWF16	-	98079-561CJ	K20PR-L11S	IK20G	VK20G				
98076-54911(BP4HS-10)	W14FP-UL10	IWF16	-	98079-56832	W20EXR-U	IW20	VW20				
98076-54914(BPR4HS-10)	W14FPR-UL10	IWF16	-	98079-56840(B6ES)	W20ES-U	-	-				
98076-5491G(BR4HS-9)	W14FR-L	IWF16	-	98079-56841(BP6ES)	W20EX-U	IW20	VW20				
98076-54921	W14FP-UL10	IWF16	-	98079-56841(BP6ES)	W20EP-U	IW20	VW20				
98076-55711(BP5HS)	W16FP-U	IWF16	-	98079-56846(BPR6ES)	W20EXR-U	IW20	VW20				
98076-55719(BP5HS)	W16FP-U	IWF16	-	98079-56846(BPR6ES)	W20EPR-U	IW20	VW20				
98076-56713(BP6HSA)	W20FR-L	IWF20	-	98079-56847(BR6ES)	W20ESR-U	-	-				
98076-56715(BPR6HSA)	W20FR-L	IWF20	-	98079-56854	W20EP-U	IW20	VW20				
98076-56717(BPR6HS)	W20FPR-U	IWF20	-	98079-56855	W20EPR-U	IW20	VW20				
98076-56719(BP6HS)	W20FP-U	IWF20	-	98079-56855-03	W20EPR-U	IW20	VW20				
98076-5671G(BR6HSA)	W20FR-L	IWF20	-	98079-5685C	K20PR-UR	IK20	VK20				
98076-56721	W20FP	IWF20	-	98079-568CE	K20PR-U8S	IK20G	VK20G				
98076-56725	W20FPR-L	IWF20	-	98079-5695U	SK20PR-L9	IK20	VK20				
98076-56729	W20FPR-U	IWF20	-	98079-5697U(IFR6C)	SK20PR-L9	IK20	VK20				
98076-5672G	W20FR-L	IWF20	-	98079-5699E(BKR6E-9S)	K20PR-U9S	IK20G	VK20G				
98076-56756	W20FPR	IWF20	-	98079-5699U(IFR6CS)	SK20PR-L9S	IK20G	VK20G				
98076-56917(BPR6HS-10)	W20FPR-U10	IWF20	-	98079-569CE	K20PR-U9S	IK20G	VK20G				
98076-5691G(BR6HSA-9)	W20FR-L	IWF20	-	98079-569CU	SK20PR-L9S	IK20G	VK20G				
98076-56927	W20FPR-U10	IWF20	-	98079-56A7W(IZFR6K13)	SKJ20DR-M13	IK20	VK20				
98076-5692G	W20FR-L9	IWF20	-	98079-5714H(PFR7G-11)	SK20PR-L11	IK22	VK22				
98076-57717(BPR7HS)	W22FPR-U	IWF22	-	98079-57155-01	W22EPR-U11	IW22	VW22				
98076-58710(B8HS)	W24FS-U	IWF24	-	98079-5715E	Q22PR-U11	IQ22	VQ22				
98076-58716(BR8HS)	W24FSR	IWF24	-	98079-5715E	K22PR-U11	IK22	VK22				
98076-5871G(BR8HSA)	W24FR-L	IWF24	-	98079-5715G	KJ22CR-L11	IK22	VK22				
98076-5872G	W24FR-L	IWF24	-	98079-5715H(Use 571CH)	PK22PR-L11(Use PK22PR-L11S)	IK22	VK22				
98076-5891G(BR8HSA-9)	W24FR-L	IWF24	-	98079-5715J	K22PR-L11	IK22	VK22				
98079-54855	W14EPR-U	IW16	VW16	98079-5715U	VK22PR-Z11	IK22	VK22				
98079-5485V	J14CR-U	IW16	VW16	98079-5715V	SK22PR-M11	IK22	VK22				
98079-55132	W16EXR-U11	IW16	VW16	98079-57173(BUR7EB-11)	W22EP-S11	IW22	VW22				
98079-55145(BPR5ES-11)	W16EXR-U11	IW16	VW16	98079-57175(BR6EB-L11)	W20EKR-S11	IW20	VW20				
98079-55146(BCPR5EY-11)	W16EXR-U11	IW16	VW16	98079-57183	W22EKR-S11	IW22	VW22				
98079-55148(BCPR5EY-11)	Q16PR-U11	IQ16	VQ16	98079-571BH(PFR7G11S)	PK22PR-L11S	IK22G	VK22G				

CAR MAKER GENUINE P/N CROSS REFERENCE (

98079-56841

other



DENSO

AUSTRALIA

CHINA

INDIA

INDONESIA

KOREA

MALAYSIA

PHILIPPINES

SINGAPORE

SAUDI ARABIA

TAIWAN

THAILAND

VIETNAM

JAPAN

EUROPE

SMALL ENGINE

CROSS REFERENCE

PART NUMBER

ISUZU	DENSO	IRIDIUM POWER	IRIDIUM TOUGH/PLUS	KAWASAKI	DENSO	IRIDIUM POWER	IRIDIUM TOUGH/PLUS	MAZDA	DENSO	IRIDIUM POWER	IRIDIUM TOUGH/PLUS
5-86003124-0 (ZFR6F-11)	KJ20CR-L11	IK20	VK20	J4520-IX27	IX27	IX27	-	1002-77-550 (BP5EY)	W16EX-U	IW16	VW16
5-86007635-0 (BKR5E-11)	K16PR-U11	IK16	VK16	J4520-IX27B	IX27B	IX27B	-	1003-77-550 (BP6EY)	W20EX-U	IW20	VW20
5-86007636-0 (ZFR5J-11)	KJ16CR-L11	IK16	VK16	J4520-IXU01-27	IXU01-27	-	-	1409 18 110	W16EX-U13	IW16	VW16
5-86007639-0 (ZFR6J-11)	KJ20CR-L11	IK20	VK20	J4520-IXU01-31	IXU01-31	-	-	1410-18-110 (BP5ES-13)	W16EX-U13	IW16	VW16
5-86013957-0 (PZFR5F-13)	PKJ16CR-L13	IK16	VK16	J4520-IXU01-34	IXU01-34	-	-	1482-18-600A (BR8EQ)	IRE01-27	-	-
5-86103386-0 (PFR6B-11)	PK20PR11	IK20	VK20	J4520-IXU22	IXU22	IXU22	VXU22	1482-18-600A (BR8EQ)	W25EDR14	-	-
5-86103389-0 (PGR5A-11)	P16PR11	IW16	VW16	J4520-IXU24	IXU24	IXU24	VXU24	1483 18 600	W25EDR	-	-
5-86121749-0 (BKR5E-11)	K16PR-U11	IK16	VK16	J4520-U20FSR-U	U20FSR-U	IUF22	-	1534 18 110	W16EX-U	IW16	VW16
5-861413160 (DILKAR6A11)	FXE20HR11	-	VFXEH20	J4520-U22ESR-N	U22ESR-N	IUF22	-	1A01-18-110 (PGR5A)	P16PR8	IW16	VW16
8-94120560-0 (BPR5E-11)	W16EXR-U11	IW16	VW16	J4520-U22FSR-U	U22FSR-U	IUF22	-	1A02-18-110 (KR7A)	IXU22	IXU22	VXU22
8-94120561-0	W16EXR-U11	IW16	VW16	J4520-U24ESR-N	U24ESR-N	IUF22	-	1A03-18-110 (KR7A)	VXU22	IXU22	VXU22
8-94120562-0	W20EXR-U11	IW20	VW20	J4520-U27ESR-N	U27ESR-N	IUF22	-	1A10-18-110 (GR5A)	IW16	IW16	VW16
8-94160627-0	W20EXR-U11	IW20	VW20	J4520-U27ETR	U27ETR	IUF22	-	1A11 18 110	IXU22C	IXU22	VXU22
8-94217232-0 (BPR6E-11)	W20EXR-U11	IW20	VW20	J4520-W20EP-U	W20EP-U	IUF22	-	1A12 18 110 (LKR7B)	IXU22HPR	IXU22	VXU22
8-94217232-0 (BPR6E-11)	W20EXR-U11	IW20	VW20	J4520-W20EPR-U	W20EPR-U	IUF22	-	1A13 18 110	IXU22HPR	IXU22	VXU22
8-94219943-0 (BPR6E)	W20EXR-U11	IW20	VW20	J4520-W20FPR-U	W20FPR-U	IUF22	-	1A14 18 110 (LMAR7A)	-	-	VXU22
8-94219943-0 (BPR6E)	W20EXR-U11	IW20	VW20	J4520-W22FPR-U	W22FPR-U	IUF22	-	1A15 18 110	ZXU22HPR8	IXU22	VXU22
8-94235966-0 (BP5E-11)	W16EX-U11	IW16	VW16	J4520-W24ESR-U	W24ESR-U	IUF22	-	1A16 18 110 (LKR7B)	ZXU22HPR8	IXU22	VXU22
8-94235966-0 (BP5E-11)	W16EX-U11	IW16	VW16	J4520-W24FS-U10	W24FS-U10	IUF22	-	1A17 18 110 (LMAR7C)	-	-	VXU22
8-94237203-0	W16EX-U11	IW16	VW16	J4520-W27ES-U	W27ES-U	IUF22	-	1A18 18 110 (LKR7F1)	-	-	VXU22
8-94241059-0 (BP6E-11)	W20EX-U11	IW20	VW20	J4520-W27ESR-U	W27ESR-U	IUF22	-	1A61 18 110 (DCPR7EVX)	-	-	VXU22
8-94241059-0 (BP6E-11)	W20EX-U11	IW20	VW20	J4520-W31ESR-U	W31ESR-U	IUF22	-	IM00 18 110	FK16HR11	-	VFKH16
8-94252270-0	W20EX-U11	IW20	VW20	J4520-X20EPR-U9	X20EPR-U9	IUF22	-	1N04 18 110 (BKR5EY-11)	K16R-U11	IK16	VK16
8-94328372-0 (BKR6E-11)	K20PR-U11	IK20	VK20	J4520-X20FS-U	X20FS-U	IUF22	-	1N08 18 110 (PFR5G-11)	PK16PR(L)11	IK16	VK16
8-94328374-0	K20PR-U11	IK20	VK20	J4520-X22EPR-U9	X22EPR-U9	IX22B	-	1N14 18 110	FXE16HE11	-	-
8-94328375-0	K22PR-U11	IK22	VK22	J4520-X24EP-U9	X24EP-U9	IX24B	-	1N19 18 110 (LZKAR6AP11)	FXE20HR11	-	VFXEH20
8-97012928-0 (BKR6E)	K20PR-U	IK20	VK20	J4520-X24EPR-U9	X24EPR-U9	IX24B	-	1N24 18 110	IXU20HE11	-	VFXEH20E
8-97012930-0	K20PR-U	IK20	VK20	J4520-X24ES-U	X24ES-U	IX24	-	1N25 18 110 (DILZKAR6A11)	FXE20HE11	-	VFXEH20E
8-97012931-0	K22PR-U	IK22	VK22	J4520-X24ESR-U	X24ESR-U	IX24	-	1UD0 18 110	IW16	IW16	VW16
8-97111376-0	PK16PR11	IK16	VK16	J4520-X24GP-U	X24GP-U	IXG24	-	1UD1 18 110	IW20	IW20	VW20
8-97170268-0	K16PR-P11	IK16	VK16	J4520-X27EPR-U9	X27EPR-U9	IX27B	-	1UD2 18 110	IW22	IW22	VW22
8-97311393-0	SXU16HPR9	-	-	KTM DENSO				1UD3 18 110	IK16	IK16	VK16
8-97350555-0 (ZFR7E-D)	-	-	-	78039093000 (LKR8A9)				1UD4 18 110	IK20	IK20	VK20
8-97380046-0	GX8-1	-	-	90139093000				1UD6 18 110	IQ16	IQ16	VQ16
9-9811929-0	GX8-1	-	-	KUBOTA DENSO				1UD7 18 110	IQ20	IQ20	VQ20
9-82513103-0 (BP6E)	W20EX-U	IW20	VW20	0790923150				1UD9 18 110	IXU22	IXU22	VXU22
9-82513103-0 (BP6E)	W20EX-U	IW20	VW20	0790923160				1UN0 18 110 (BPR5EIX)	-	-	IW16
9-82513106-0 (BP5E)	W16EX-U	IW16	VW16	1264767740				1UN1 18 110 (BPR6EIX)	-	-	IW20
9-82513106-0 (BP5E)	W16EX-U	IW16	VW16	1268167740				1UN2 18 110 (BPR7EIX)	-	-	IW22
9-82513106-0 (BP5E)	W16EX-U	IW16	VW16	1307867710				1UN3 18 110 (BPR5EIX11)	-	-	IW16
9-82513106-0 (BP5E)	W16EX-U	IW16	VW16	1310167711				1UN4 18 110 (BPR6EIX11)	-	-	IW20
9-82513106-0 (BP5E)	W16EX-U	IW16	VW16	1315767710				1UN6 18 110 (BKR5EIX)	-	-	IK16
9-82513106-0 (BP5E)	W16EX-U	IW16	VW16	1317367711-1328167711				1UN7 18 110 (BKR6EIX)	-	-	IK20
9-82513106-0 (BP5E)	W16EX-U	IW16	VW16	1321167711				1UN9 18 110 (BKR5EIX11)	-	-	IK16
9-82513106-0 (BP5E)	W16EX-U	IW16	VW16	1328167711				1UNA 18 110 (BKR6EIX11)	-	-	IK20
9-82513106-0 (BP5E)	W16EX-U	IW16	VW16	1330267710				1UNC 18 110 (BCPR5EIX11)	-	-	IQ16
9-82513106-0 (BP5E)	W16EX-U	IW16	VW16	1337567740				1UND 18 110 (BCPR6EIX11)	-	-	IQ20
9-82513106-0 (BP5E)	W16EX-U	IW16	VW16	1340367711				1UNF 18 110 (DCPR7EIX)	-	-	IXU22
9-82513106-0 (BP5E)	W16EX-U	IW16	VW16	1341267710				1UNG 18 110 (ZFR5F11)	-	-	IK16
9-82513106-0 (BP5E)	W16EX-U	IW16	VW16	1345167712				1UNH 18 110 (ZFR6F11)	-	-	IK20
9-82513106-0 (BP5E)	W16EX-U	IW16	VW16	1358167710				1UTO 18 110	VW16	IW16	VW16
9-82513106-0 (BP5E)	W16EX-U	IW16	VW16	1366167711				1UT1 18 110	VW20	IW20	VW20
9-82513106-0 (BP5E)	W16EX-U	IW16	VW16	1371167711				1UT2 18 110	VW22	IW22	VW22
9-82513106-0 (BP5E)	W16EX-U	IW16	VW16	1374267711				1UT3 18 110	VK16	IK16	VK16
9-82513106-0 (BP5E)	W16EX-U	IW16	VW16	1390267711				1UT4 18 110	VK20	IK20	VK20
9-82513106-0 (BP5E)	W16EX-U	IW16	VW16	LAND ROVER DENSO				1UT6 18 110	VQ16	IQ16	VQ16
9-82513106-0 (BP5E)	W16EX-U	IW16	VW16	ERR3799 (RN11YC)				1UT7 18 110	VQ20	IQ20	VQ20
9-82513106-0 (BP5E)	W16EX-U	IW16	VW16	LR005483 (FoMoCo: ILFR6B)				1UT9 18 110	VXU22	IXU22	VXU22
9-82513106-0 (BP5E)	W16EX-U	IW16	VW16	LR019484 (ILKAR6C10)				1UX0 18 110 (BPR5EIXP)	-	-	VW16
9-82513106-0 (BP5E)	W16EX-U	IW16	VW16	LR025605 (ILTR6G8G)				1UX1 18 110 (BPR6EIXP)	-	-	VW20
9-82513106-0 (BP5E)	W16EX-U	IW16	VW16	LR032080 (ILKAR7C10)				1UX3 18 110 (BPR5EIX-11P)	-	-	VW16
9-82513106-0 (BP5E)	W16EX-U	IW16	VW16	LR050998 (SILZKAR7E8S)				1UX4 18 110 (BPR6EIX-11P)	-	-	VW20
9-82513106-0 (BP5E)	W16EX-U	IW16	VW16	LOTUS DENSO				1UX6 18 110 (BKR5EIXP)	-	-	VK16
9-82513106-0 (BP5E)	W16EX-U	IW16	VW16	A100E6277S (BKR6E)				1UX7 18 110 (BKR6EIXP)	-	-	VK20/VK20Y
9-82513106-0 (BP5E)	W16EX-U	IW16	VW16	A910E7009F (BPR6EK-N)				1UX9 18 110 (BKR5EIX11P)	-	-	VK16
9-82513106-0 (BP5E)	W16EX-U	IW16	VW16	A918E6039F (BKR6EK)				1UXA 18 110 (BKR6EIX11P)	-	-	VK20
9-82513106-0 (BP5E)	W16EX-U	IW16	VW16	PS30-4017621AF (BK6E)				1UXC 18 110 (BCPR5EIX11P)	-	-	VQ16
9-82513106-0 (BP5E)	W16EX-U	IW16	VW16	MASERATI DENSO				1UXD 18 110 (BCPR6EIX11P)	-	-	VQ20
9-82513106-0 (BP5E)	W16EX-U	IW16	VW16	CND-96596 (BP8E5)				1UXF 18 110 (DCPR7EIXP)	-	-	VXU22
9-82513106-0 (BP5E)	W16EX-U	IW16	VW16	CND-96875 (DCPR8E)				1UXG 18 110 (ZFR5F11P)	-	-	VK16
9-82513106-0 (BP5E)	W16EX-U	IW16	VW16	CND-97219 (DCPR9E)				1UXH 18 110 (ZFR6F11P)	-	-	VK20
9-82513106-0 (BP5E)	W16EX-U	IW16	VW16	000310235 (SILKAR8C6DS)				1UXJ 18 110 (BPR5EIX13P)	-	-	VT16
9-82513106-0 (BP5E)	W16EX-U	IW16	VW16	MAZDA DENSO				1WT1 18 110	W16TT	-	-
9-82513106-0 (BP5E)	W16EX-U	IW16	VW16	0222 18 110				1WT2 18 110	K16TT	-	-
9-82513106-0 (BP5E)	W16EX-U	IW16	VW16	0259-18-110 (BP6ES)				1WT3 18 110	K20TT	-	-
9-82513106-0 (BP5E)	W16EX-U	IW16	VW16	0259-18-110 (BP6ES)				1WT4 18 110	XU22TT	-	-
9-82513106-0 (BP5E)	W16EX-U	IW16	VW16	0418 18 110 A				1WT5 18 110	XUH22TT	-	-
9-82513106-0 (BP5E)	W16EX-U	IW16	VW16	0419-18-110 (B7ES)				3710-18-110 (BP6ES-13)	W20EX-U13	IW20	VW20
9-82513106-0 (BP5E)	W16EX-U	IW16	VW16	0420-18-110 (B8ES)				3953 18 110	W16EXR-U	IW16	VW16
9-82513106-0 (BP5E)	W16EX-U	IW16	VW16	0660-18-110 (BP5ES)				3954 18 110	W20EXR-U	IW20	VW20
9-82513106-0 (BP5E)	W16EX-U	IW16	VW16	0660-18-110 (BP5ES)				4095 18 110	W14EX-U	IW16	VW16
9-82513106-0 (BP5E)	W16EX-U	IW16	VW16	0801 18 600				4096 18 110 A	W14EX-U13	-	-
9-82513106-0 (BP5E)	W16EX-U	IW16	VW16	0865-18-600 (B6EM)				4882 18 110	W9EP	-	-

(*3)MITSUBISHI lean burn excluded.

CAR MAKER GENUINE P/N CROSS REFERENCE

98079-56841

other

DENSO

MAZDA	DENSO	IRIDIUM POWER	IRIDIUM TOUGH/PLUS	MAZDA	DENSO	IRIDIUM POWER	IRIDIUM TOUGH/PLUS	MITSUBISHI	DENSO	IRIDIUM POWER	IRIDIUM TOUGH/PLUS
AJ03-18-110(AGSF32W)	T16EPR-U15	IT16	VT16	N331 18 110	S29A	-	-	1822A085 (DILFR5A)	-	-	VFKH16
AJ09-18-110(AGSF32M)	T16EPR-U15	IT16	VT16	N338-18-110(SD11A)	IRE01-31	-	-	1822A088(DILKR6D11G)	-	-	-
AY02-18-110(DCP7E)	XU22EP-U	IXU22	VXU22	N338-18-110(SD11A)	S31A	-	-	1822A104(SILKR7H8)	-	-	-
AY01 18 110	XU22EP-U	IXU22	VXU22	N339-18-110(SD10A)	IRE01-27	-	-	1822A125(ILKR7K8)	SXU22HDR8	IXUH22	VXUH22
AZ08-18-110(BPR5E)	W16EPR-U	IW16	VW16	N339-18-110(SD10A)	S29A	-	-	1822A130(ILKR6K8)	-	IXUH20I	VXUH20I
AZ09 18 110	W16EPR-U	IW16	VW16	N342-18-110(BUR9EQ)	IRE01-27	-	-	1822A150(DILFR5L11)	-	-	VFKH16
AZ28-18-110(DCP7EVX)	-	IXU22	VXU22	N343-18-110(BUR7EQ)	-	-	-	1822A154(DIFR5E11)	-	-	-
B602 18 110	W16EXR-U11	IW16	VW16	N3A1-18-110(BUR9EQP)	IRE01-27	-	-	801001	-	-	-
B64N-18-110(BRES27Y-11)	J16AR-U11	-	-	N3A2-18-110(BUR7EQP)	-	-	-	MD313443(PFR6G-11)	PK20PR11	IK20	VK20
B64P 18 110	J16AR-U11	-	-	P51R-18-110(REA8WYPB4)	ZC20HPR11	-	VCH20	MD314766(BKR7EKC-N)	K22TMR11	IK22	VK22
B660-18-110(BCP6E-11)	Q20P-U11	IQ20	VQ20	PE01-18-110(DILKAR7F8))	FC20HPR8	-	VFXEH22	MD320543(BKR7EKC-N-11)	K22TMR11	IK22	VK22
B667 18 110	Q20P-U11	IQ20	VQ20	PE02 18 110	FC20HPR8(MAZDA)	-	VFXEH22	MD321150(BKR6EKC-N-11)	K20TNR	IK20	VK20
B673 18 110	AGN2(MOTORCRAFT)W16EPR-U	IW16	VW16	PE5R 18 110(ILKAR7L11)	ZC20HPR11	-	VCH20	MD322771	PK20PR11	IK20	VK20
B696 18 110	Q20PR-U	IQ20	VQ20	PE5S 18 110	ZC20HPR11	-	VCH20	MD336367(PZFR6B)	-	-	VKB20
B6B3-18-110(BCPR5E-11)	Q16PR-U11	IQ16	VQ16	PY8V-18-110(DILKAR7M8)	-	-	-	MD338991(PGR7A)	P22PR8	IW22	VW22
B6B4 18 110	Q16PR-U11	IQ16	VQ16	YF10-18-110(AZFS32FE)	-	-	-	MD343244	P22PR8	IW22	VW22
BP01-18-110(BKR5E-11)	K16PR-U11	IK16	VK16	Z601 18 110	PT16VR13	ITV16	-	MD343277(PGR6A)	VW20	IW20	VW20
BP02 18 110	K16PR-U11(DENSO)	IK16	VK16	Z6B7 18 110	SK16PR-E11	IK16	VK16	MD348296(PZFR5B)	-	-	VKB16
BP03-18-110(BKR6E-11)	K20PR-U11	IK20	VK20	ZJ46 18 110	K16PZR13	IK16	VK16	MD350291(RC8YC4)	K20PR-U11	IK20	VK20
BP04 18 110	K20PR-U11(DENSO)	IK20	VK20	ZJY6 18 110	SK16PR-E13(FoMoCo)	IK16	VK16	MD351467(PZFR5C)	-	-	VKB16
BP05-18-110(BKR7E-11)	K22PR-U11	IK22	VK22	ZM01 18 110	SKJ16CR-A8	IK16	VK16	MD355067(BKR6EKUC)	-	-	VKA20
BP06 18 110	K22PR-U11	IK22	VK22	ZM02 18 110	SKJ20CR-A8	IK20	VK20	MD357531	P20PR-P8	IK20	VK20Y
BP48 18 110	K16PR-U	IK16	VK16	ZY51 18 110	FK16PR11(FoMoCo)	-	-	MD358200(ZFR6F11)	KJ20CR-U11(*3)	IK20	VK20
BP49-18-110(BKR6E)	K20PR-U	IK20	VK20	ZYY1 18 110	FK16PR11(MAZDA)	-	-	MD358202	KJ20CR-U11(*3)	IK20	VK20
BP50 18 110	K20PR-U	IK20	VK20	ZZJ1 18 110	-	ITV22	-	MD360019(IZFR6B)	-	-	VKB20
BP8J 18 110	SK20PR-F8	IK20	VK20	ZZS1-18-110(DCPR7E)	XU22EPR-U	IXU22	VXU22	MD360383(IZFR5B)	-	-	VKB16
BP8K 18 110	SK16PR-F8	IK16	VK16	ZZS2 18 110	XU22EPR-U	IXU22	VXU22	MD361067	SK16PR-A11	IK16	VK16
BPY2 18 110	K16PR-U11(MAZDA)	IK16	VK16	ZZS4 18 110	J16CR-U	IW16	VW16	MD362097(ZFR5F-11)	KJ16CR-U11(*3)	IK16	VK16
BPY4 18 110	K20PR-U11(MAZDA)	IK20	VK20					MD362098	KJ16CR-U11(*3)	IK16	VK16
E356-18-110(BE527Y-11)	J16A-U11	-	-	MERCEDES BENZ		DENSO		IRIDIUM POWER		IRIDIUM TOUGH/PLUS	
E357 18 110	J16A-U11	-	-	0 012468 V001(LKR8A)	-	-	-	MD362902(BKR5EKUC)	-	-	VKA16
E552 18 110	AGN2(MOTORCRAFT)W16EPR-U	IW16	VW16	0 012468 V002(LKR8A)	-	-	-	MD366819(IZFR5C)	-	-	VKA16
F201-18-110(ZFR6A-11)	QJ20CR11	IQ20	VQ20	003 085 V005 0000 00(BKR6EKE)	K20TXR	IK20	VK20	MD366819(IZFR5C)	-	-	-
F202 18 110 A	QJ20CR11	IQ20	VQ20	003 159 67 03 26(F8DC4)	K16P-U11	IK16	VK16	MD370906(DCPR6EKU)	-	-	-
F204 18 110	QJ16CR11	IQ16	VQ16	003 159 75 03 26(F8KTCR)	K20PBR-S10	IK20	VK20	MD371434(IGR7A)	VW22	IW22	VW22
F211 18 110	Q16PR-U	IQ16	VQ16	003 159 81 03 26(F8G8BDPURX2)	K20PBR-L(11)	IK16	VK16	MD371435	S22PR-A7	IW22	VW22
F220-18-110(BCPR6E-11)	Q20PR-U11	IQ20	VQ20	003 159 81 03 26(F8G8BDPURX2)	PK16PR(L-11)	IK16	VK16	MD372421(BKR5EKUD)	-	-	VKA16
F221 18 110	Q20PR-U11	IQ20	VQ20	003 159 91 03(BKR5EKUP)	K20TXR	IK20	VK20	MD372422(BKR6EKUD)	-	-	VKA20
F285-18-110(ZFR6F-11)	KJ20CR11	IK20	VK20	003 159 92 03(BKR6EKE)	K20TXR	IK20	VK20	MD372553(IFR5E11)	SK16PR-A11	IK16	VK16
F286 18 110	KJ20CR11	IK20	VK20	003 159 92 03(BKR6EKE)	K20TXR	IK20	VK20	MD372588(IFR6E11)	SK20PR-A11	IK20	VK20
F287-18-110(ZFR5F-11)	KJ16CR11	IK16	VK16	003 159 94 03(PFR5R11)	PK16PR(L-11)	IK16	VK16	MD373645	SK20PR-A11	IK20	VK20
F288 18 110	KJ16CR11(DENSO)	IK16	VK16	003 159 94 0326(IFR5D10)	VK16	IK16	VK16	MD374841(IGR7A-G)	VW22	IW22	VW22
F25K 18 110	W6EPR-U/Copper Gasket	-	-	003 159 96 03(IFR5D10)	VK16	IK16	VK16	MD375642(BKR5ETUA)	-	-	VKA16
F2Y2 18 110	KJ16CR11(MAZDA)	IK16	VK16	003 159 97 03 26(IFR6D10)	VK20	IK20	VK20	MD378582(IFR6B)	SVK20RZ8	-	VK20Y
F8L6-18-110(ZFR4F-11)	KJ14CR11	IK16	VK16	003 159 97 03 26(IFR6D10)	VK20	IK20	VK20	ME220826(IFR7F-D)	VK22	IK22	VK22
F8L7 18 110	KJ14CR11	IK16	VK16	004 159 13 03(ILFR6A)	VKH20	IKH20	VKH20	ME222165(IFR7F8)	VK22	IK22	VK22
F8L8-18-110(BPR4E5-13)	W14EXR-U13	IW16	VW16	004 159 14 03 26(IFR6Q-G)	VK20Y	-	VK20Y	MN119256(ILZFR5B)	VKH16	IKH16	VKH16
F8L9 18 110	W14EXR-U13	IW16	VW16	004 159 14 03 26(IFR6Q-G)	VK20Y	-	VK20Y	MN119487(IFR6S)	SK20PR-A8	-	VK20Y
FE6F 18 110	Q22PR-U11	IQ22	VQ22	004 159 18 0326(Y7MPP33)	VXUH22	IXUH22	VXUH22	MN119500(IGR6A11)	VW20	IW20	VW20
FE79-18-110(BPR6E5-11)	W20EXR-U11	IW20	VW20	004 159 19 03	PK20PR11	IK20	VK20	MN119942(BKR6ETUB)	K20PBR-S10	-	VKB20
FE79-18-110(BPR6E5-11)	W20EPR-U11	IW20	VW20	004 159 20 03 26(F7DPP332)	PK20PR11	IK20	VK20	MN122257	SVK20RZ8	-	VK20Y
FE82 18 110	W20EXR-U11	IW20	VW20	004 159 25 03(SILZKR7A-S)	-	-	-	MN122493	SXU22PR-A9	IXU22	VXU22
FEDK-18-110(BPR5E5-13)	W16EXR-U13	IW16	VW16	004 159 34 03(PLKR7A)	-	IXUH22	VXUH22	MN122494(IGR7B)	VXU22	IXU22	VXU22
FEDM 18 110	W16EXR-U13	IW16	VW16	004 159 36 03(BKR6E2B)	K20PR-U11	IK20	VK20	MN128362(FR75E)	IKH20	IKH20	VKH20
FEEG-18-110(BPR6E5-13)	W20EXR-U13	IW20	VW20	004 159 39 03(ILZKAR7A10)	FXE22HR11	-	VFXEH22	MN137919(FR7NPP33)	VKH20	IKH20	VKH20
FEEH 18 110	W20EXR-U13	IW20	VW20	004 159 44 0326(F6DPP332)	VK20	IK20	VK20	MN158596(ILZFR6A1)	IKH20	IKH20	VKH20
GY01 18 110	-	IT16	VT16	004 159 44 0326(Y6NPP3320)	VXUH22	IXUH22	VXUH22	MN163235(FR5E1)	IK16	IK16	VK16
GY02 18 110	-	IT16	VT16	004 159 44 0326(Y6NPP3320)	VXUH22	IXUH22	VXUH22	MN163807	K20PSR-B8	IK20	VK20
IA50-18-110(BKR6E)	K20PR-U	IK20	VK20	004 159 49 03(PLKR7A)	VXUH22	IXUH22	VXUH22	MN176628(FR7S130)	IKH20	IKH20	VKH20
JE26-18-110(BCPR5EVX-11)	-	IK20	VK20	004 159 58 03(PLKR7B8E)	VXUH22	IXUH22	VXUH22	MQ500368	ZXU20PR11	-	VXU20
JE28 18 110	Q16PR-TP11	IQ16	VQ16	004 159 64 03(Z6S113320)	-	-	-	MQ503107	ZXU20HPR11	IXUH20I	VXUH22I
JE41-18-110(BKR5EVX-11)	-	IK16	VK16	004 159 69 03(V6S113328)	-	-	-	MQ507909(LMAR7CI-8)	-	-	VSUEH22
JE42 18 110	K16PR-TP11	IK16	VK16	004 159 70 03(SILZKFR8C7S)	-	-	-	MQ504108(LKR7B18)	IXU22HPR	IXUH22	VXUH22
JE43-18-110(BKR6EVX-11)	IK20	IK20	VK20	004 159 75 03(SILZKFR8D7S)	-	-	-	MQ504109	IXU22HPR	IXUH22	VXUH22
JE44 18 110	K20PR-TP11	IK20	VK20	A000 159 05 00(SILZKFR8F7S)	-	-	-	MQ504110(ILMARA8)	-	-	VSUEH22
JF03-18-110(BCP5E-11)	Q16P-U11	IQ16	VQ16	A004 159 58 03(PLKR7B8E)	VXUH22	IXUH22	VXUH22	MQ510099(ILZKR6F11)	IXUH20I	IXUH20I	VXUH20I
JF04 18 110	Q16P-U11	IQ16	VQ16	A004 159 60 03(SILZKFR8B7S)	-	-	-	MQ701126(ILZKAR5AP11)	-	-	-
KJ11-18-110(PZFR6F)	SKJ20CR-A8/PKJ20CR8	IK20	VK20	A004 159 64 03(Z6S113320)	-	-	-	MQ701127(ILZKAR6AP11)	-	-	VFXEH20
KJ12 18 110	PKJ20CR8	IK20	VK20	A004 159 68 03(SILZKFR8B7S)	-	-	-	MQ701128(ILZKAR7AP11)	-	-	VFXEH22
KJ13-18-110(PZFR5F)	PKJ16CR8	IK16	VK16	A004 159 69 03(V6S113328)	-	-	-	MQ703981(DILZKAR6A11)	FXE20HE11	-	VFXEH20
KJ14 18 110	PKJ16CR8	IK16	VK16	A004 159 75 03(SILZKFR8D7S)	-	-	-	MR984943	SK20PR-A8	IK20	VK20
L303-18-110(ITR5F13)	VT16	IT16	VT16	A004 159 76 03(SILZKFR8D7G)	-	-	-	MS851022	W16EP	IW16	VW16
L341-18-110(ITR6F13)	VT20	IT20	VT20	A004 159 79 03(SILZKFR8E7S)	-	-	-	MS851023	W20EP	IW20	VW20
L3Y1-18-110(ILTR6A13G)	-	ITV20	-	A004 159 81 03(Z6S113320R)	-	-	-	MS851024	W22EP	IW22	VW22
L3Y2-18-110(ILTR5A13G)	-	ITV16	-					MS851027	W16EP11	IW16	VW16
L3Y3-18-110(ILTR6A8G)	-	ITV20	-					MS851028	W20EP11	IW20	VW20
L813-18-110(ITR6F13)	VT20	IT20	VT20					MS851029	W22EP11	IW22	VW22
L845-18-110(TR5A1 13)	VT16	IT16	VT16					MS851097	W16EX-U	IW16	VW16
LFJD-18-110(LTR5B1 13)	-	ITV16	-					MS851101	W14EX-U	IW16	VW16
LFJF-18-110(LTR5B1 13)	-	ITV16	-					MS851102	W16EX-U	IW16	VW16
LFJR-18-110(LTR6B1 13)	-	ITV20	-					MS851104	W20EX-U	IW20	VW20
N201-18-600(BR8EQ-14)	IRE01-27	-	-					MS851106	W14EX-U11	IW16	VW16
N201-18-600(BR8EQ-14)	W25EDR14	-	-					MS851107	W16EX-U11		

CAR MAKER GENUINE P/N CROSS REFERENCE

98079-56841

other



(*1) Remove the gasket before use.

DENSO

AUSTRALIA

INDIA

INDONESIA

KOREA

MALAYSIA

PHILIPPINES

SAUDI ARABIA

SINGAPORE

TAIWAN

THAILAND

VIETNAM

JAPAN

EUROPE

USA

SMALL MOTOR

ENGINE

CYCLE

REFERENCE

PART NUMBER

MITSUBISHI	DENSO	IRIDIUM POWER	IRIDIUM TOUGH/PLUS	MITSUBISHI	DENSO	IRIDIUM POWER	IRIDIUM TOUGH/PLUS	NISSAN	DENSO	IRIDIUM POWER	IRIDIUM TOUGH/PLUS
MS851187(BP5E-11)	W16EP-U11	IW16	VW16	MZ602037	IXU22	IXU22	VXU22	22401-58S15(PFR5A-11)	VQ16	IQ16	VQ16
MS851188(BP6E-11)	W20EX-U11	IW20	VW20	MZ602038	IXU24	IXU24	VXU24	22401-58S16(PFR6A-11)	VQ20	IQ20	VQ20
MS851188(BP6E-11)	W20EPR-U11	IW20	VW20	MZ602039	IXU27	IXU27	-	22401-5M014(PLFR4A-11)	-	-	-
MS851189(BP7E-11)	W22EP-U11	IW22	VW22	MZ602040	VK16	IK16	VK16	22401-5M015(PLFR5A-11)	VKH16	IKH16	VKH16
MS851232(BPR5E)	W16EXR-U	IW16	VW16	MZ602041	VK20	IK20	VK20	22401-5M016(PLFR6A-11)	VKH20	IKH20	VKH20
MS851232(BPR5E)	W16EPR-U	IW16	VW16	MZ602042	VK22	IK22	VK22	22401-5TA1C	DXE22H11CT	-	-
MS851233(BPR6E)	W20EXR-U	IW20	VW20	MZ602043	VQ16	IQ16	VQ16	22401-6A00G(ILKR7K8)	SXU22HDR8	IXUH22	VXUH22
MS851233(BPR6E)	W20EPR-U	IW20	VW20	MZ602044	VQ20	IQ20	VQ20	22401-6N215(LZFR5AQP)	-	-	-
MS851237(BPR5E-11)	W16EPR11	IW16	VW16	MZ602045	VQ22	IQ22	VQ22	22401-85E15(LFR5A-11)	K16PR-U11	IK16	VK16
MS851238(BPR6E-11)	W20EPR11	IW20	VW20	MZ602046	VW16	IW16	VW16	22401-85E16(BKR6E-11)	K20PR-U11	IK20	VK20
MS851239(BPR7E-11)	W22EPR-U11	IW22	VW22	MZ602047	VW20	IW20	VW20	22401-8H 616(PLFR6A-9)	VKH20	IKH20	VKH20
MS851243(BP5EA-L)	W16EX-U	IW16	VW16	MZ602048	VW22	IW22	VW22	22401-8H514(LFR4A-11)	-	-	-
MS851302(BU6EA-11)	W20EP-S11	IW20	VW20	MZ602049	VXU22	IXU22	VXU22	22401-8H515(LFR5A-11)	K16HPR-U11	IKH16	VKH16
MS851254(BU7EA-11)	W22EP-S11	IW22	VW22	MZ602050	VXU24	IXU24	VXU24	22401-8H516(LFR6A-11)	K20PR-U11	-	-
MS851273(BU6EA-11)	W20EPR-S11	IW20	VW20	MZ602060(BPR5EIX11)	-	IW16	VW16	22401-8P315(PFR5P)	VK16	IK16	VK16
MS851274(BUR7EA-11)	W22EP-S11	IW22	VW22	MZ602061(BPR6EIX11)	-	IW20	VW20	22401-97E65(PFR5C-11)	VK16	IK16	VK16
MS851283(BP6E)	W20EP-U	IW20	VW20	MZ602062(BPR7EIX)	-	IW22	VW22	22401-AA800	ZXE27HBR8	-	VXEBH27
MS851292(PGR6B)	P20PR-S11	IW20	VW20	MZ602063(BCPR5EIX11)	-	IQ16	VQ16	22401-A780(SILZKAR7B11)	-	-	VFXEH22
MS851302(PGR6A-11)	VW20	IW20	VW20	MZ602064(BCPR6EIX11)	-	IQ20	VQ20	22401-A781(SILZKAR7B11)	-	-	VFXEH22
MS851302(PGR6A-11) LPG	VW20T	-	VW20T	MZ602065(BKR5EIX11)	-	IK16	VK16	22401-AG215(LFR5A-11)	VK16	IK16	VK16
MS851316(DCPR6E)	XU20EPR-U	IXU22	VXU22	MZ602066(BKR6EIX11)	-	IK20	VK20	22401-AG315(BKR5EQUA)	VK16	IK16	VK16
MS851317(DCPR7E)	XU22EPR-U	IXU22	VXU22	MZ602067(DCPR7EIX)	-	IXU22	VXU22	22401-AH415(FR5BP-11)	IK16	IK16	VK16
MS851332(PFR6B-11)	PK20PR11	IK20	VK20	MZ602068(ZFR5F1X11)	-	IK16	VK16	22401-ALS15(LFR5BP-11)	IKH16	IKH16	VKH16
MS851335(PFR5J-11)	PK16PR-P11	IK16	VK16	MZ602069(ZFR6F1X11)	-	IK20	VK20	22401-AR015(LFR5AQP)	IKH16	IKH16	VKH16
MS851336(PFR6J-11)	PK20PR-P11	IK20	VK20	MZ602070(BPR5EIX)	-	IW16	VW16	22401-CK81B(PLZKAR6A11)	FXE20HR11	-	VFXEH20
MS851346(PFR6M)	PK20PR-P8	IK20	VK20	MZ602071(BPR6EIX)	-	IW20	VW20	22401-ED715(Use ED71B)	FXE20HE11	-	VFXEH20E
MS851347(PFR7M)	VK22	IK22	VK22	MZ602072(BKR5EIX)	-	IK16	VK16	22401-ED71A	FXE16HE11	-	-
MS851352(BK6E)	K20P-U	IK20	VK20	MZ602073(BKR6EIX)	-	IK20	VK20	22401-ED71B	FXE20HE11	-	VFXEH20E
MS851357(BKR5E-11)	K16PR-U11	IK16	VK16	MZ602074(BPR6EIX-LPG)	-	-	VW20T	22401-ED814(LZKAR5AP11)	-	-	-
MS851358(BKR6E-11)	K20PR-U11	IK20	VK20	MZ602075(BKR6EIX-LPG)	-	-	VK20T	22401-ED815(LZKAR6AP11)	FXE20HR11	-	VFXEH20
MS851359(BKR7E-11)	K22PR-U11	IK22	VK22	MZ602077(BKR6EIX11P)	-	-	VK20	22401-ED816(LZKAR7AP11)	FXE22HR11	-	VFXEH22
MS851361(BK5E-11)	K16P-U11	IK16	VK16	MZ602078(BCPR5EIX11P)	-	-	VQ16	22401-EN215	ZXE20HR13	-	VFXEH20
MS851362(BK6E-11)	K20PR-U11	IK20	VK20	MZ602079(BCPR6EIX11P)	-	-	VQ20	22401-EW61C	FXE22HR11	-	VFXEH22
MS851363(BK7E-11)	K22PR-U11	IK22	VK22	MZ602080(DCPR7EIXP)	-	-	VXU22	22401-F6515(PFR5A-11A)	VQ16(*1)	IQ16(*1)	VQ16(*1)
MS851368(BKR6E)	K20PR-U	IK20	VK20	MZ602081(BKR7EIX11)	-	IK22	VK22	22401-F6516(PFR6A-11A)	VQ20(*1)	IQ20(*1)	VQ20(*1)
MS851402	W16EPR-U	IW16	VW16	MZ602082(BKR5EIXP)	-	-	VK16	22401-HA009(ITR5F13)	-	IT16	VT16
MS851403	W20EPR-U	IW20	VW20	MZ602083(BKR6EIXP)	-	-	VK20Y	22401-HA00C(LTR5B1-13)	-	ITV16	-
MS851412	W16EPR	IW16	VW16	MZ602084(ZFR5F1X11P)	-	-	VK16	22401-HA00F(ILKAR7L11)	ZC20HPR11	-	VCH20
MS851413	W20EPR	IW20	VW20	MZ602085(ZFR6F1X11P)	-	-	VK20	22401-HC000(BPR5E-13)	W16EXR-U13	IW16	VW16
MS851417	W16EPR11	IW16	VW16	MZ60210	K16TT	IK16	VK16	22401-JA01B(DILKAR6A11)	FXE20HR11	-	VFXEH20
MS851418	W20EPR11	IW20	VW20	MZ602111	K20TT	IK20	VK20	22401-JD01A	FXE20HR11	-	VFXEH20
MS851419	W22EPR11	IW22	VW22	MZ602114	XU22TT	IXU22	VXU22	22401-JF01D(DILKAR8A8)	-	-	-
MS851428	W20EP-S11	IW20	VW20	MZ602112	XUH22TT	IXUH22	VXUH22	22401-JK01D	FXE24HR11	-	-
MS851429	W22EP-S11	IW22	VW22	MZ602113	W16TT	IW16	VW16	22401-M7715(B5E5)	W16ES-U	-	-
MS851437	W16EP-U	IW16	VW16	MZ602676(BKR5EIX11P)	-	-	VK16	22401-M7716(B6E5)	W20ES-U	-	-
MS851438	W20EP-U	IW20	VW20	NISSAN		DENSO		22401-N8714(BP4E5-11)	W14EX-U11	IW16	VW16
MS851438	W22EP-U	IW22	VW22	22401-01B14(BPR4E5-L11)	W14EXR-U11	IW16	VW16	22401-N8715(BP5E-11)	W16EX-U11	IW16	VW16
MS851447	W20EPR-S11	IW20	VW20	22401-01M14(BP4E5-L11)	W14EX-U11	IW16	VW16	22401-N8716(BP6E-11)	W16EP-U11	IW16	VW16
MS851448	W16EPR-S11	IW16	VW16	22401-01P15(BCPR5E5-11)	Q16PR-U11	IQ16	VQ16	22401-N8716(BP6E-11)	W20EPR-U11	IW20	VW20
MS851463	P20PR-S11	IW20	VW20	22401-01P15(BCPR6E5-11)	Q20PR-U11	IQ20	VQ20	22401-0A622(BKR6E-H)	-	-	-
MS851473	P20PR11	IW20	VW20	22401-08U15(PFR5K-11)	VQ16	IQ16	VQ16	22401-OP616(PFR6F-11A)	VQ16(*1)	IQ16(*1)	VQ16(*1)
MS851486	XU20EPR-U	IXU22	VXU22	22401-01P16(BCPR6E5-11)	Q16P-U11	IQ16	VQ16	22401-OP616(PFR6F-11A)	VQ20(*1)	IQ20(*1)	VQ20(*1)
MS851487	XU22EPR-U	IXU22	VXU22	22401-10P15(BCP5E-11)	Q16P-U11	IQ16	VQ16	22401-P8314(BPR4E5-11)	W14EXR-U11	IW16	VW16
MS851501	PK16PR-P11	IK16	VK16	22401-12E15(BCPR5E5)	Q16PR-U	IQ16	VQ16	22401-P8315(BPR5E-11)	W16EXR-U11	IW16	VW16
MS851502	PK20PR-P11	IK20	VK20	22401-18V16(PGR6A(0.7))LPG	VW20T	-	VW20T	22401-P8316(BPR6E-11)	W20EXR-U11	IW20	VW20
MS851506	PK20PR-P8	-	VK20Y	22401-19V16(BCP6E5(0.7))	Q20-U	IQ20	VQ20	22401-P8316(BPR6E-11)	W20EPR-U11	IW20	VW20
MS851722	K20P-U	IK20	VK20	22401-1HA1C(DILKAR7E11HS)	-	-	-	22401-S6015(BP5E-13)	W16EX-U13	IW16	VW16
MS851727	K16PR-U11	IK16	VK16	22401-1K1C(DILKAR7C9H)	-	-	-	22401-V0516(BP6E5(0.7))	W20EX-U	IW20	VW20
MS851728	K20PR-U11	IK20	VK20	22401-1KT1B(DILZKAR6A11)	FXE20HE11	-	VFXEH20E	22401-V0516(BP6E5(0.7))	W20EP-U	IW20	VW20
MS851728(BKR6E-11)	K20PR-U11	IK20	VK20	22401-1LA1C(DILKAR7B11)	-	-	-	22401-V1414(BPR4E5)	W14EXR-U	IW16	VW16
MS851729	K22PR-U11	IK22	VK22	22401-1N516(BKR6E-N)	K20PR-U	IK20	VK20	22401-V1415(BPR5E5)	W16EXR-U	IW16	VW16
MS851732(Use MS851728)	K20P-U11(Use K20PR-U11)	IK20	VK20	22401-1P115(PFR5G-11)	VK16	IK16	VK16	22401-V1415(BPR5E5)	W16EPR-U	IW16	VW16
MS851738	K20PR-U	IK20	VK20	22401-1P116(PFR6G-11)	VK20	IK20	VK20	22401-V5015(BCP5E-11)	Q16-U11	IQ16	VQ16
MS851783	K22TM11	IK22	VK22	22401-1P117(PFR7G-11)	VK22	IK22	VK22	22401-V5016(BCP6E-11)	Q20P-U11	IQ20	VQ20
MS851861(PFR6J)	PK20PR-P8	IK20	VK20	22401-1TT1C(DILKAR7E9HS)	-	-	-	22401-VB000(PFR5E-11)	W16EPR-U11	IW16	VW16
MS851872(BK7E-K-11)	K22TM11	IK22	VK22	22401-1VA1C(DILKAR7D11H)	-	-	-	22401-VR306(IGR6B-10D)LPG	VW20T	-	VW20T
MS851881(BPR6EKN)	W20ETR-L	-	-	22401-20J05(BKR5E)	K16PR-U	IK16	VK16	22401-VS116(PFR6V10D)LPG	VK20T	-	VK20T
MS851882(BPR7EKN)	W22ETR-L8	IW22	VW22	22401-21B16(BPR6E)	W20EPR-U	IW20	VW20	22401-W8915(BP5E5)	W16EX-U	IW16	VW16
MZ602110	K16TT	IK16	VK16	22401-27N65(PFR5B-11)	VK16	IK16	VK16	22401-W8916(BP6E5)	W16EP-U	IW16	VW16
MZ602111	K20TT	IK20	VK20	22401-27N66(PFR6B-11)	VK20	IK20	VK20	22401-W8916(BP6E5)	W20EX-U	IW20	VW20
MZ602114	XU22TT	IXU22	VXU22	22401-27N66(PFR6B-11)	VW16	IW16	VW16	22401-W8916(BP6E5)	W20EP-U	IW20	VW20
MZ602112	XUH22TT	IXUH22	VXUH22	22401-27T65(PGR5A-11)	K16R-U11	IK16	VK16	22401-WA006(PFR6G-9)	VK20	IK20	VK20
MZ602113	W16TT	IW16	VW16	22401-2J204(BKR4EY-11)	-	IK16	VK16	22401-WD517(FR7A1-D)	IK22	IK22	VK22
MZ602020	IK1										

CAR MAKER GENUINE P/N CROSS REFERENCE (

98079-56841

other

DENSO

NISSAN	DENSO	IRIDIUM POWER	IRIDIUM TOUGH/PLUS	RENAULT	DENSO	IRIDIUM POWER	IRIDIUM TOUGH/PLUS	SUBARU	DENSO	IRIDIUM POWER	IRIDIUM TOUGH/PLUS
B2401-HA00E (TR5A1-13)	-	IT16	VT16	77-01-041-215 (BP6EFS)	T20EP-U	IT20	VT20	22401AA830 (ILKAR8H6)	-	-	-
B2401-HA00F (ILKAR7L11)	ZC20HPR11	-	VCH20	82-00-492-426 (PFR7Z-TG)	VK22	IK22	VK22	22401AA870 (SILKAR8D6)	-	-	-
B2401-HG00A (SILZKFR8C7S)	-	-	-	96-32-182-880 (PFR6E-10)	PK20PR11	IK20	VK20	22401AA880 (DILZKAR7B8)	-	-	-
B2401-HG00B (SILZKFR8E7S)	-	-	-					22401AA940 (DILKAR7Q8)	-	-	-
BY480-BKR5E (BKR5EIX)	IK16	VK16						22401KA000 (BU6EA-11)	W20EP-S11	IW20	VW20
BY480-BKR6E (BKR6EIX)	IK20	VK20						22401KA010 (BCP6E-11)	Q20P-U11	IQ20	VQ20
BY480-BPR5E (BPR5EIX)	IW16	VW16						22401KA030	Q20P-U11	IQ20	VQ20
BY480-BPR6E (BPR6EIX)	IW20	VW20						22401KA060	W20EPR-S11	IW20	VW20
BY480-BPR7E (BPR7EIX)	IW22	VW22						22401KA080 (BKR6E)	K20PR-U	IK20	VK20Y
BY480-BPR8E (BPR8EIX)	IW24	-	-					22401KA090	Q20PR-U	IQ20	VQ20
BY480-BPR9E (BPR9EIX)	IW27	-	-					22401KA100 (BCPR6E)	Q20PR-U	IQ20	VQ20
BY480-DCPR7E (DCPR7EIX)	IXU22	VXU22						22401KA130	W20EPR-U	IW20	VW20
BY481-BCPR5 (BCPR5EIX11)	IQ16	VQ16						22401KA140 (ZFR6G)	K20DTR-S11	-	-
BY481-BCPR6 (BCPR6EIX11)	IQ20	VQ20						22401KA150	K20PR-U	IK20	VK20
BY481-BKR5E (BKR5EIX11)	IK16	VK16						22401KA160	K20DTR-S11	-	-
BY481-BKR6E (BKR6EIX11)	IK20	VK20						22401KA170 (ZFR5G)	K16DTR-S11	-	-
BY481-BKR7E (BKR7EIX11)	IK22	VK22						22401KA180	K16DTR-S11	-	-
BY481-BPR5E (BPR5EIX11)	IW16	VW16						22401KA190	W16EPR-U11	IW16	VW16
BY481-BPR6E (BPR6EIX11)	IW20	VW20						22401KA200	K16PR-U11	IK16	VK16
BY481-LFR5A (LFR5AIX11)	IKH16	VKH16						22401KA210 (BKR5E-11)	K16PR-U11	IK16	VK16
BY481-LFR6A (LFR6AIX11)	IKH20	VKH20						22401KA240 (DCPR7E)	XU22EPR-U	IXU22	VXU22
BY481-ZFR5F (ZFR5F1X11)	IK16	VK16						22401KA260	XU22EPR-U	IXU22	VXU22
BY481-ZFR6F (ZFR6F1X11)	IK20	VK20						22401KA290 (BKR4E-11)	-	IK16	VK16
BY482-BKR6E (BKR6EIX-LPG)	-	VK20T						22401KA310 (DCPR8E)	XU24EPR-U	IXU24	VXU24
BY482-BPR6E (BPR6EIX-LPG)	-	VW20T						22401KA320 (DCPR8EIX)	-	IXU24	VXU24
BY483-BCPR5 (BCPR5EIX11P)	-	VQ16						22401KA330 (ZFR6MP)	SKJ20CR-A8	IK20	VK20
BY483-BCPR6 (BCPR6EIX11P)	-	VQ20						22401KA340 (KRB8B1)	IXU24	IXU24	VXU24
BY483-BKR5E (BKR5EIX11P)	-	VK16						22401KA430 (BKR6EPA)	PK20TR11	-	-
BY483-BKR6E (BKR6EIX11P)	-	VK20						22401KA430 (BKR6EPA)	SK20PR-A8	-	-
BY483-LFR5A (LFR5AIX11P)	-	VKH16						22401KA450 (BKR6EIX)	K16PR-U	IK16	VK16
BY483-LFR6A (LFR6AIX11P)	-	VKH20						22401KA450 (LKR7A1)	IXUH22	IXUH22	VXUH22
BY483-ZFR5F (ZFR5F1X11P)	-	VK16						22401KA460 (BKR6ETP)	SK20PR-A8	-	-
BY483-ZFR6F (ZFR6F1X11P)	-	VK20						380280102	W20EX-U	IW20	VW20
BY484-BKR5E (BKR5EIXP)	-	VK16						420543200 (BP5E5)	W16EX-U	IW16	VW16
BY484-BKR6E (BKR6EIXP)	-	VK20Y						420543200 (BP5E5)	W16EP-U	IW16	VW16
BY484-BKR7E (BKR7EIXP)	-	VK22						420545502	W20EP	IW20	VW20
BY484-DCPR7 (DCPR7EIXP)	-	VXU22						420545602	W16EP-U11	IW16	VW16
BY484-LFR6A (LFR6AIXP)	-	VKH20Y						420545702	W20EP-U11	IW20	VW20
BY484-LFR7A (LFR7AIXP)	-	VKH22						420545800 (BE529Y-11)	J16B-U11	-	-
								420545802	J16B-U11	-	-
								420547102	W16EX-U	IW16	VW16
								420547302	W16EX-U11	IW16	VW16
								480287100	W14EX-U11	IW16	VW16
								490010033 (BPR5E5)	W16EXR-U	IW16	VW16
								490010033 (BPR5E5)	W16EPR-U	IW16	VW16
								490010043 (BP5EY)	W16EX-U	IW16	VW16
								490010053 (BP6EY)	W20EX-U	IW20	VW20
								490010082	W16EXR-U	IW16	VW16
								490010092	W20EXR-U	IW20	VW20
								820541812	W20FS	IWF22	-
								820548600 (B6E5)	W20ES-U	-	-
								90048-51198	SXU22HPR9	IXUH22I	VXUH22I
								90048-51199 (ILKR7D9)	SXU22HPR9	IXUH22I	VXUH22I
								90048-51209 (ILKR7D9)	SXU22HPR9	IXUH22I	VXUH22I
								90048-51210	SXU22HPR9	IXUH22I	VXUH22I
								90048-51213 (ILKR7D8)	SXU22HPR8	IXUH22I	VXUH22I
								90048-51214	SXU22HPR8	IXUH22I	VXUH22I
								90048-51215 (SILKRD10G)	-	IXUH20I	VXUH20I
								90048-51216 (SILKAR6G11G)	-	-	VFXEH20
								90048-51220	-	-	-
								9199038	PT16VR13	ITV16	-
								SAB330DE0710	VK16	IK16	VK16
								SAB330DE0720	VK20	IK20	VK20
								SAB330DE0730	VK22	IK22	VK22
								SAB330DE0800	VXU22	IXU22	VXU22
								SAB330DE0810	VXU24	IXU24	VXU24
								SAB330DE2340	SK20PR-A8	IK20	VK20
								SAB330DE2640	IKH20	IKH20	VKH20
								SAB330DE2650	IKH22	IKH22	VKH22
								SAB330DE2670	VKH20	IKH20	VKH20
								SAB330DE2680	VKH22	IKH22	VKH22
								SAB330DE2800	VK20Y	-	VK20Y
								SAB330DE3360	IK16	IK16	VK16
								SAB330DE3370	IK20	IK20	VK20
								SAB330DE3430	IXU22	IXU22	VXU22
								SAB330DE3440	IXU24	IXU24	VXU24
								SAB330DE3450	IK22	IK22	VK22
								SAB330DE3710	VK16	IK16	VK16
								SAB330DE3715	ITV20	ITV20	-
								SAB330DE3720	VK20	IK20	VK20
								SAB330DE3730	VK22	IK22	VK22
								SAB330DE3800	VXU22	IXU22	VXU22
								SAB330DE3810	VXU24	IXU24	VXU24
								SAB330DE3950	VK20Y	-	VK20Y
								SAB330DE4540	VKH20Y	-	VKH20Y
								SAB330DE5140	IKH20	IKH20	VKH20
								SAB330DE5150	VKH20	IKH20	VKH20
								SAB330DE5170	IKH22	IKH22	VKH22
								SAB330DE5210	ITV20	ITV20	-
								SAB330DE5260	VKH20Y	-	VKH20Y

DENSO

AUSTRALIA CHINA

INDIA

INDONESIA KOREA

MALAYSIA PHILIPPINES

SAUDIARABIA SINGAPORE

TAIWAN THAILAND

VIETNAM JAPAN

& USA

CYCLE

SMALL ENGINE REFERENCE NUMBER

CAR MAKER GENUINE P/N CROSS REFERENCE (

98079-56841

other



DENSO

AUSTRALIA

CHINA

INDIA

INDONESIA

KOREA

INDONESIA

INDONESIA

INDONESIA

INDONESIA

INDONESIA

INDONESIA

INDONESIA

INDONESIA

INDONESIA

INDONESIA

INDONESIA

INDONESIA

INDONESIA

SUBARU		DENSO		IRIDIUM POWER		IRIDIUM TOUGH/PLUS		SUZUKI		DENSO		IRIDIUM POWER		IRIDIUM TOUGH/PLUS		SUZUKI		DENSO		IRIDIUM POWER		IRIDIUM TOUGH/PLUS	
SAB330DE5270	VKH22	IKH22	VKH22	09482-00224	X27ESR-U	IX27	-	09482-00463	U31ETR	IU31A	-	-	-	-	-	09482-00468	W16EPR-U	IU16	VW16	-	-	-	-
SAB330DE8430	IK22	IK22	VK22	09482-00233-111	W27ESR	IW27	-	09482-00472(BR9ECM)	W27EMR-C	IWM27	-	-	-	-	-	09482-00473	W27EMR-C	IWM27	-	-	-	-	-
SAB330DE8640	SK16PR-A11	IK16	VK16	09482-00239(BPR8ES)	W24EPR-U	IW24	-	09482-00476	W27EMR-C	IWM27	-	-	-	-	-	09482-00477(BKR5E)	K16PR-U	IK16	VK16	-	-	-	-
SAB330DE8680	IK16	IK16	VK16	09482-00240-111	W24EPR	IW24	-	09482-00478(B10ES)	K16PR-U	IK16	VK16	-	-	-	-	09482-00479(DCPR7EVX)	K16PR-U	IK16	VK16	-	-	-	-
SAB330DE8690	IK20	IK20	VK20	09482-00244-111	W22FPR	IWF22	-	09482-00481(DCPR8EVX)	W31ES-U	IW31	-	-	-	-	-	09482-00493(BPR5E-11)	W16EPR-U11	IW16	VW16	-	-	-	-
SAB330DE8720	IXU22	IXU22	VXU22	09482-00247-111	W24ESR	IW24	-	09482-00494(BKR6E-11)	K20PR-U11	IK20	VK20	-	-	-	-	09482-00495(BPR7EY)	W22EPR-U	IW22	VW22	-	-	-	-
SAB330DE8730	IXU24	IXU24	VXU24	09482-00255(BPR7HS)	W22FPR-U	IWF22	-	09482-00496	W16EPR-U11	IW16	VW16	-	-	-	-	09482-00497	K16PR-U11	IK16	VK16	-	-	-	-
SAB330DE8740	IXUH22	IXUH22	VXUH22	09482-00258(BPMR6A)	W20MPR-U10	-	-	09482-00498	W22EPR-U	IW22	VW22	-	-	-	-	09482-00499(R4118S-8)	W22EPR-U	IW22	VW22	-	-	-	-
SAB330DE8750	VXUH22	VXUH22	VXUH22	09482-00261(BPMR4A)	W14MPR-U10	-	-	09482-00500(R4118S-9)	IW27	IW27	-	-	-	-	-	09482-00501(PGR5A)	P16PR8	IW16	VW16	-	-	-	-
SAB330DE8760	IXUH22I	IXUH22I	VXUH22I	09482-00262(BP5HS-10)	W16FP-U	IWF16	-	09482-00502(BPR7HS-10)	W22FPR-U	IWF22	-	-	-	-	-	09482-00503	K20PR-U11	IK20	VK20	-	-	-	-
SAB330DE8770	VXUH22I	IXUH22I	VXUH22I	09482-00263	W16FP-U10	IWF16	-	09482-00504(GR5AI-10)	IW16	IW16	VW16	-	-	-	-	09482-00505(R6918 B-8)	IW01-24	-	-	-	-	-	-
SAB330NG0508(BKR5EIX)	IK16	IK16	VK16	09482-00264(BP6HS-10)	W20FP-U10	IWF20	-	09482-00506	W20EPR-U	IW20	VW20	-	-	-	-	09482-00507	W16EPR-U11	IW16	VW16	-	-	-	-
SAB330NG0511(BKR5EIX-11)	IK16	IK16	VK16	09482-00265	W20FP-U10	IWF20	-	09482-00508	W20EPR-U	IW20	VW20	-	-	-	-	09482-00509	W16EPR-U11	IW16	VW16	-	-	-	-
SAB330NG0608(BKR6EIX)	-	-	VK20Y	09482-00266	W22FS-U10	IWF22	-	09482-00510	K16PR-U11	IK16	VK16	-	-	-	-	09482-00511	K16PR-U11	IK16	VK16	-	-	-	-
SAB330NG0611(BKR6EIX-11)	IK20	IK20	VK20	09482-00269(B7HS-10)	W22FS-U10	IWF22	-	09482-00512(CR7E)	U22ESR-N	IU22	-	-	-	-	-	09482-00513	W22EPR-U	IW22	VW22	-	-	-	-
SAB330NG1708(DCPR7EIX)	IXU22	IXU22	VXU22	09482-00278(B8HS-10)	W24FS-U10	IWF24	-	09482-00514	P16PR8	IW16	VW16	-	-	-	-	09482-00515	W22EPR-U	IW22	VW22	-	-	-	-
SAB330NG4611(LFR6AIX11)	IKH20	IKH20	VKH20	09482-00280(BR8HS-10)	W24FSR-U10	IWF24	-	09482-00516	W22EPR-U	IW22	VW22	-	-	-	-	09482-00517	W22EPR-U	IW22	VW22	-	-	-	-
SAB330NG7611(LFR6AIX11P)	VKH20	IKH20	VKH20	09482-00284	W20EX-U11	IW20	VW20	09482-00518	W22FPR-U	IWF22	-	-	-	-	-	09482-00519	W22FPR-U	IWF22	-	-	-	-	-
SAB330NG8508(BKR5EIXP)	VK16	IK16	VK16	09482-00286	W20EXR-U11	IW20	VW20	09482-00520	W22FPR-U	IWF22	-	-	-	-	-	09482-00521	W22FPR-U	IWF22	-	-	-	-	-
SAB330NG8511(BKR5EIX-11P)	VK16	IK16	VK16	09482-00287(BP5ES-11)	W16EX-U11	IW16	VW16	09482-00522	VXU22	IXU22	VXU22	-	-	-	-	09482-00523	W22EPR-U	IW22	VW22	-	-	-	-
SAB330NG8608(BKR6EIXP)	VK20Y	-	VK20Y	09482-00288(BP5E5-11)	W16EPR-U11	IW16	VW16	09482-00524	VXU22	IXU22	VXU22	-	-	-	-	09482-00525	W22EPR-U	IW22	VW22	-	-	-	-
SAB330NG8611(BKR6EIX-11P)	VK20	IK20	VK20	09482-00294(C6HA)	U20FS-U	IUF22	-	09482-00526	VXU22	IXU22	VXU22	-	-	-	-	09482-00527	W22EPR-U	IW22	VW22	-	-	-	-
SAB330NG8708(BKR7EIXP)	VK22	IK22	VK22	09482-00298-111	W16FP-UL	IWF16	-	09482-00528	VXU22	IXU22	VXU22	-	-	-	-	09482-00529	W22EPR-U	IW22	VW22	-	-	-	-
SAB330NG9708(DCPR7EIXP)	VXU22	IXU22	VXU22	09482-00299(BPR6ES)	W20EXR-U	IW20	VW20	09482-00530	VXU22	IXU22	VXU22	-	-	-	-	09482-00531	W22EPR-U	IW22	VW22	-	-	-	-
SAB33NG5708(IRIWAY7)	IK27	IK27	-	09482-00302-111	W20FPR-U	IWF20	-	09482-00532	VXU22	IXU22	VXU22	-	-	-	-	09482-00533	W22EPR-U	IW22	VW22	-	-	-	-
SAB33NG6808(IRIMAC8)	IXU24	IXU24	VXU24	09482-00303	W20EX-U	IW20	VW20	09482-00534	VXU22	IXU22	VXU22	-	-	-	-	09482-00535	W22EPR-U	IW22	VW22	-	-	-	-
				09482-00312	W16EXR-U11	IW16	VW16	09482-00536	VXU22	IXU22	VXU22	-	-	-	-	09482-00537	W22EPR-U	IW22	VW22	-	-	-	-
				09482-00314	U22FSR-U	IUF22	-	09482-00538	VXU22	IXU22	VXU22	-	-	-	-	09482-00539	W22EPR-U	IW22	VW22	-	-	-	-
				09482-00316(BPR5HS)	W16FPR-U	IWF16	-	09482-00540	VXU22	IXU22	VXU22	-	-	-	-	09482-00541	W22EPR-U	IW22	VW22	-	-	-	-
				09482-00317(C8HA)	U24FS-U	IUF24	-	09482-00542	VXU22	IXU22	VXU22	-	-	-	-	09482-00543	W22EPR-U	IW22	VW22	-	-	-	-
				09482-00320-111	U24FSR-U	IUF24	-	09482-00544	VXU22	IXU22	VXU22	-	-	-	-	09482-00545	W22EPR-U	IW22	VW22	-	-	-	-
				09482-00322(BP5EV)	-	IW16	VW16	09482-00546	VXU22	IXU22	VXU22	-	-	-	-	09482-00547	W22EPR-U	IW22	VW22	-	-	-	-
				09482-00330(DPR9EA-9)	X27EPR-U9	IX27B	-	09482-00548	VXU22	IXU22	VXU22	-	-	-	-	09482-00549	W22EPR-U	IW22	VW22	-	-	-	-
				09482-00331-111	X27EPR-U9	IX27B	-	09482-00550	VXU22	IXU22	VXU22	-	-	-	-	09482-00551	W22EPR-U	IW22	VW22	-	-	-	-
				09482-00332(DP8EA-9)	X24EP-U9	IX24B	-	09482-00552	VXU22	IXU22	VXU22	-	-	-	-	09482-00553	W22EPR-U	IW22	VW22	-	-	-	-
				09482-00333-111	X24EP-U9	IX24B	-	09482-00554	VXU22	IXU22	VXU22	-	-	-	-	09482-00555	W22EPR-U	IW22	VW22	-	-	-	-
				09482-00334(DPR8EA-9)	X24EPR-U9	IX24B	-	09482-00556	VXU22	IXU22	VXU22	-	-	-	-	09482-00557	W22EPR-U	IW22	VW22	-	-	-	-
				09482-00335-111	X24EPR-U9	IX24B	-	09482-00558	VXU22	IXU22	VXU22	-	-	-	-	09482-00559	W22EPR-U	IW22	VW22	-	-	-	-
				09482-00338(B6HS-10)	W20FS-U	IWF22	-	09482-00560	VXU22	IXU22	VXU22	-	-	-	-	09482-00561	W22EPR-U	IW22	VW22	-	-	-	-
				09482-00340(CR6HS)	U20FSR-U	IUF22	-	09482-00562	VXU22	IXU22	VXU22	-	-	-	-	09482-00563	W22EPR-U	IW22	VW22	-	-	-	-
				09482-00349(BR9ES)	W27ESR	IW27	-	09482-00564	VXU22	IXU22	VXU22	-	-	-	-	09482-00565	W22EPR-U	IW22	VW22	-	-	-	-
				09482-00354(DPR7EA-9)	X22EPR-U9	IX22B	-	09482-00566	VXU22	IXU22	VXU22	-	-	-	-	09482-00567	W22EPR-U	IW22	VW22	-	-	-	-
				09482-00355-111	X22EPR-U9	IX22B	-	09482-00568	VXU22	IXU22	VXU22	-	-	-	-	09482-00569	W22EPR-U	IW22	VW22	-	-	-	-
				09482-00359(BPR5HS)	W16FPR-U	IWF16	-	09482-00570	VXU22	IXU22	VXU22	-	-	-	-	09482-00571	W22EPR-U	IW22	VW22	-	-	-	-
				09482-00362(ZG5A)	J16CR-U	IW16	VW16	09482-00572	VXU22	IXU22	VXU22	-	-	-	-	09482-00573	W22EPR-U	IW22	VW22	-	-	-	-
				09482-00368	XU22EP-U	IXU22	VXU22	09482-00574	VXU22	IXU22	VXU22	-	-	-	-	09482-00575	W22EPR-U	IW22	VW22	-	-	-	-
				09482-00369(DCP7E)	XU22EP-U	IXU22	VXU22	09482-00576	VXU22	IXU22	VXU22	-	-	-	-	09482-00577	W22EPR-U	IW22	VW22	-	-	-	-
				09482-00373(L8A)	U24FS-U	IUF24	-	09482-00578	VXU22	IXU22	VXU22	-	-	-	-	09482-00579	W22EPR-U	IW22	VW22	-	-	-	-
				09482-00375(BR8HS-10)	W24FS-U10	IWF24	-	09482-00580	VXU22	IXU22	VXU22	-</											

(*3)MITSUBISHI lean burn excluded.

CAR MAKER GENUINE P/N CROSS REFERENCE

98079-56841

other

DENSO

SUZUKI	DENSO	IRIDIUM POWER	IRIDIUM TOUGH/PLUS	TACTI	DENSO	IRIDIUM POWER	IRIDIUM TOUGH/PLUS	TACTI	DENSO	IRIDIUM POWER	IRIDIUM TOUGH/PLUS
99000-79K24-24B	IX24B	IX24B	-	267700-1420	IQ01-27	-	-	V9110-3121	K20PR-U11	IK20	VK20
99000-79K24-27A	IU27A	IU27A	-	267700-1430	IQ01-31	-	-	V9110-3122	K20R-U	IK20	VK20
99000-79K24-27B	IX27B	IX27B	-	267700-1440	IQ01-34	-	-	V9110-3129	Q16R-U	IQ16	VQ16
99000-79K24-31A	IU31A	IU31A	-	267700-1460	IQ02-24	-	-	V9110-3130	K16PR-U11	IK16	VK16
99000-79K24-F22	IUF22	IUF22	-	267700-1470	IQ02-27	-	-	V9110-3131	KJ16CR11	IK16	VK16
99000-79K24-F24	IUF24	IUF24	-	267700-1480	IQ02-31	-	-	V9110-3132	KJ16CR-L11	IK16	VK16
99000-79K24-H24	IUH24	IUH24	-	267700-1570	RU01-27	-	-	V9110-3133	KJ20CR11	IK20	VK20
99000-79K24-H27	IUH27	IUH27	-	267700-1580	RU01-31	-	-	V9110-3135	K16GPR-U11	-	-
99000-79K24-IW4	IW24	IW24	-	267700-1590	RU01-34	-	-	V9110-3137	Q16PR-U	IQ16	VQ16
99000-79K24-IW7	IW27	IW27	-	267700-2940	IAE01-32	-	-	V9110-3139	K20R-U11	IK20	VK20
99000-79K24-U22	IU22	IU22	-	267700-2950	IAE01-34	-	-	V9110-3140	Q20R-U	IQ20	VQ20
99000-79K24-U24	IU24	IU24	-	267700-4450	IKH01-24	-	-	V9110-3141	PK20PR-P11	IK20	VK20
99000-79K24-U27	IU27	IU27	-	267700-4460	IKH01-27	-	-	V9110-3142	PK20PR-L11	IK20	VK20
99000-79K24-U31	IU31	IU31	-	267700-4470	IKH01-31	-	-	V9110-3143	K16PR-L11	IK16	VK16
99000-79K24-W22	IWF22	IWF22	-	V9110-2001	W16EXR-U11	IW16	VW16	V9110-3144	K20PR-L11	IK20	VK20
99000-79K24-W24	IWF24	IWF24	-	V9110-2002	W16EXR-U	IW16	VW16	V9110-3145	K20PR-U	IK20	VK20
99000-79K24-W27	IWF27	IWF27	-	V9110-2003	K16R-U11	IK16	VK16	V9110-3167	KJ14CR-L11	IK16	VK16
99000-79K24-W31	IW31	IW31	-	V9110-2005	J16BR-U	-	-	V9110-3168	PK20PR11	IK20	VK20
99000-79K24-X22	IX22	IX22	-	V9110-2010	K20R-U11	IK20	VK20	V9110-3169	KJ20CR-L11	IK20	VK20
99000-79K24-X24	IX24	IX24	-	V9110-2011	XU22EPR-U	IXU22	VXU22	V9110-3170	W22EKR-S11	IW22	VW22
99000-79K24-X27	IX27	IX27	-	V9110-2012	Q20R-U11	IQ20	VQ20	V9110-3175	PKJ16CR8	IK16	VK16
99000-79K60-BP6(BPR6EIX11)	-	IW20	VW20	V9110-2022	J16AYR	-	-	V9110-3176	XU22EP-U	IXU22	VXU22
99000-79K60-DC7(DCPR7EIX)	-	IXU22	VXU22	V9110-2023	KJ20CR-L11	IK20	VK20	V9110-3178	XU20EPR-U	IXU22	VXU22
99000-79K60-K5R(BKR5EIX)	-	IK16	VK16	V9110-2028	KJ16CR-L11	IK16	VK16	V9110-3179	XU22EPR-U	IXU22	VXU22
99000-79K60-K6R(BKR6EIX)	-	IK20	VK20	V9110-2039	K22TNR-S	IK22	VK22	V9110-3180	XU24EPR-U	IXU24	VXU24
99000-79K60-KR6(BKR6EIX11)	-	IK20	VK20	V9110-2041	K20TR11	IK20	VK20	V9110-3181	Q16-U11	IQ16	VQ16
99000-79K60-P5R(BPR5EIX)	-	IW16	VW16	V9110-2043	K20PR-U11	IK20	VK20	V9110-3182	Q20-U11	IQ20	VQ20
99000-79K60-P6R(BPR6EIX)	-	IW20	VW20	V9110-2044	W16EPR-U	IW16	VW16	V9110-3183	Q14R-U11	IQ16	VQ16
99000-79K60-P7R(BPR7EIX)	-	IW22	VW22	V9110-2047	K20PR-U	IK20	VK20	V9110-3186	Q16PR-U11	IQ16	VQ16
99000-79K60-PR5(BPR5EIX11)	-	IW16	VW16	V9110-2048	KJ16CR-U11(*3)	IK16	VK16	V9110-3187	Q20PR-U11	IQ20	VQ20
99000-79K73-K16	VK16	IK16	VK16	V9110-2049	K20TNR-S9	IK20	VK20	V9110-3188	QL20PR-U	-	-
99000-79K73-K20	VK20	IK20	VK20	V9110-2301	IQ16	IQ16	VQ16	V9110-3189	QL20TR-S	-	-
99000-79K73-KH2	VKH20	IKH20	VKH20	V9110-2302	IQ20	IQ20	VQ20	V9110-3190	QL22TR-S	-	-
99000-79K73-U20	VXU20	-	VXU20	V9110-2303	IK16	IK16	VK16	V9110-3191	K16PR-U	IK16	VK16
99000-79K73-U22	VXU22	IXU22	VXU22	V9110-2304	IK20	IK20	VK20	V9110-3192	K22PR-U11	IK22	VK22
99000-79K73-U24	VXU24	IXU24	VXU24	V9110-2305	IW16	IW16	VW16	V9110-3194	K16TR11	IK16	VK16
99000-79K73-UH2	VXUH22	IXUH22	VXUH22	V9110-2306	IW20	IW20	VW20	V9110-3195	K20TR11	IK20	VK20
99000-79K73-VW16	VW16	IW16	VW16	V9110-2307	IW22	IW22	VW22	V9110-3196	K20TNR-S	IK20	VK20
99000-79K73-W20	VW20	IW20	VW20	V9110-2308	IXU22	IXU22	VXU22	V9110-3197	K22TNR-S	IK22	VK22
99000-79K73-W22	VW22	IW22	VW22	V9110-2309	IXU24	IXU24	VXU24	V9110-3198	K20DTR-S11	-	-
99000-79L65-001(BKR6EIX11P)	-	-	VK20	V9110-2601	VQ16	IQ16	VQ16	V9110-3199	W16EP-U11	IW16	VW16
99000-79L65-002(BKR5EIXP)	-	-	VK16	V9110-2602	VQ20	IQ20	VQ20	V9110-3201	W16EPR-U11	IW16	VW16
99000-79L65-003(BKR6EIXP)	-	-	VK20Y	V9110-2603	VK16	IK16	VK16	V9110-3202	W14EX-U	IW16	VW16
99000-79L65-004(DCPR7EIXP)	-	-	VXU22	V9110-2604	VK20	IK20	VK20	V9110-3203	W16EX-U	IW16	VW16
99000-79L65-005(BKR5EIX11P)	-	-	VK16	V9110-2605	VW16	IW16	VW16	V9110-3204	W20EX-U	IW20	VW20
99000-79L65-006(BKR7EIXP)	-	-	VK22	V9110-2606	VW20	IW20	VW20	V9110-3205	W16EX-U11	IW16	VW16
99000-79L65-008(BPR5EIX11P)	-	-	VW16	V9110-2607	VW22	IW22	VW22	V9110-3206	W20EX-U11	IW20	VW20
99000-79L65-009(BPR6EIXP)	-	-	VW20	V9110-2608	VXU22	IXU22	VXU22	V9110-3208	LP20-U(LPG)	-	VW20T
99000-79L65-010(BPR6EIX11P)	-	-	VW20	V9110-2609	VXU24	IXU24	VXU24	V9110-3210	W16EXR-U	IW16	VW16
99000-79X12-K16	K16TT	-	-	V9110-3000	J16AR-U11	-	-	V9110-3211	W20EXR-U	IW20	VW20
99000-79X12-K20	K20TT	-	-	V9110-3001	J16BR-U	-	-	V9110-3212	W20EXR-U11	IW20	VW20
99000-79X12-W16	W16TT	-	-	V9110-3002	J16BR-U11	-	-	V9110-3213	W16EXR-U13	IW16	VW16
99000-79X12-XU2	XU22TT	-	-	V9110-3006	Q16R-U11	IQ16	VQ16	V9110-3214	LP20R-U(LPG)	-	VW20T
99000-79X12-XUH	XUH22TT	-	-	V9110-3007	Q20PR-U	IQ20	VQ20	V9110-3215	W16ET-S	IW16	VW16
11182-51201(DILKAR7D11H)	-	-	-	V9110-3009	Q20R-U11	IQ20	VQ20	V9110-3216	W16ETR-S	IW16	VW16
11182-52200(DXE22H11CT)	-	-	-	V9110-3012	W14EX-U11	IW16	VW16	V9110-3217	W16DTR-S	-	-
				V9110-3013	W14EXR-U	IW16	VW16	V9110-3218	W20DTR-S	-	-
				V9110-3014	W14EXR-U11	IW16	VW16	V9110-3219	W20DTR-SA	-	-
067600-1810	IW06-27	-	-	V9110-3016	W16EKR-S11	IW16	VW16	V9110-3220	J16A-U11	-	-
067600-1820	IW06-31	-	-	V9110-3018	W16EP-U	IW16	VW16	V9110-3221	J16B-U11	-	-
067600-1830	IW06-34	-	-	V9110-3021	W16EPR-U	IW16	VW16	V9110-3232	W16FP-U10	IWF16	-
267700-1010	IU01-24	-	-	V9110-3025	W16ES-U	-	-	V9110-3235	QJ16AR-U	-	-
267700-1020	IU01-27	-	-	V9110-3029	W16EX-U13	IW16	VW16	V9110-3245	PK20PR-P8	-	VK20Y
267700-1030	IU01-31	-	-	V9110-3032	W16EXR-U11	IW16	VW16	V9110-3247	PKJ20CR-L11	IK20	VK20
267700-1040	IU01-34	-	-	V9110-3033	W16FSR	-	-	V9110-3248	K16DTR-S11	-	-
267700-1060	IXU01-24	-	-	V9110-3034	W16FS-U	-	-	V9110-3249	K22TMR11	IK22	VK22
267700-1070	IXU01-27	-	-	V9110-3035	W16LS	-	-	V9110-3252	S29	-	-
267700-1080	IXU01-31	-	-	V9110-3037	W16PR-U	-	-	V9110-3261	J16AYR	-	-
267700-1090	IXU01-34	-	-	V9110-3041	W20EKR-S11	IW20	VW20	V9110-3264	PK16PR11	IK16	VK16
267700-1110	IW01-24	-	-	V9110-3043	W20EP-U	IW20	VW20	V9110-3266	Q16PR-TP11	IQ16	VQ16
267700-1120	IW01-27	-	-	V9110-3047	W20EPR-U	IW20	VW20	V9110-3293	K16PR-P11	IK16	VK16
267700-1130	IW01-29	-	-	V9110-3049	W20EPR-U11	IW20	VW20	V9110-3304	K20TNR	IK20	VK20
267700-1140	IW01-31	-	-	V9110-3051	W20ES-U	-	-	V9110-3305	K20TNR-S9	IK20	VK20
267700-1150	IW01-32	-	-	V9110-3057	W20ESR-U	-	-	V9110-3311	KJ16CR-U11(*3)	IK16	VK16
267700-1160	IW01-34	-	-	V9110-3059	W20ET-S	IW20	VW20	V9110-3329	K16TNR-S9	IK16	VK16
267700-1210	IWM01-29	-	-	V9110-3060	W20ETR-S	IW20	VW20	V9110-3374	KJ20DR-M11	IK20	VK20
267700-1220	IWM01-31	-	-	V9110-3068	W20FP-U	IWF20	-	V9110-3381	K20HR-U11	IKH20	VKH20
267700-1230	IWM01-32	-	-	V9110-3072	W20FSR	IWF22	-	V9110-3445	XU22HDR9	IXUH22	VXUH22
267700-1240	IWM01-34	-	-	V9110-3073	W20FS-U	IWF22	-	V9110-3451	KJ20CR-U11(*3)	IK20	VK20
267700-1260	IA01-31	-	-	V9110-3075	W20S-U	-	-	V9110-3455	KJ20DR-M11S	IK20G	VK20G
267700-1270	IA01-32	-	-	V9110-3076	W20SR-U	-	-	V9110-3456	K20PR-SU9	IK20	VK20
267700-1280	IA01-34	-	-	V9110-3085	W22EP-U	IW22	VW22	V9110-3463	K20PR-U8S	IK20G	VK20G
267700-1310	IK01-24	-	-	V9110-3088	W22EPR-U	IW22	VW22	V9110-3470	K20PR-U9S	IK20G	VK20G
267700-1320	IK01-27	-	-	V9110-3093	W22ES-U	-	-	V9110-3486	XU20HR9	IXUH20I	VXUH20I
267700-1330	IK01-31	-	-	V9110-3098	W22ESR-U	-	-	V9110-4000	U16FS-U	-	-
267700-1340	IK01-34	-	-	V9110-3105	W27EDR14	-	-	V9110-4002	U20FS-U	IUF22	-
267700-1360	IK02-24	-	-	V9110-3110	W16ESR-U	-	-	V9110-4004	U20FSR-U	IUF22	-
267700-1370	IK02-27	-	-	V9110-3114	P16PR11	IW16	VW16	V9110-4006	U22FS-U	IUF22	-
267700-1380	IK02-31	-	-	V9110-3119	K16R-U	IK16	VK16	V9110-4008	U22FSR-U	IUF22	-
267700-1410	IQ01-24	-	-	V9110-3120	K16R-U11	IK16	VK16	V9110-4011	W9FP	-	-

DENSO
 AUSTRALIA
 CHINA
 INDIA
 INDONESIA
 KOREA
 MALAYSIA
 PHILIPPINES
 SAUDI ARABIA
 SINGAPORE
 TAIWAN
 THAILAND
 VIETNAM
 JAPAN
 EUROPE
 MOTOR CYCLE
 & USA
 SMALL ENGINE
 CROSS REFERENCE
 PART NUMBER

CAR MAKER GENUINE P/N CROSS REFERENCE (

98079-56841

other

DENSO

DENSO

AUSTRALIA

INDIA

INDONESIA

KOREA

MALAYSIA

PHILIPPINES

SAUDI ARABIA

SINGAPORE

TAIWAN

THAILAND

VIETNAM

JAPAN

EUROPE

SMALL MOTOR ENGINE

CROSS REFERENCE

PART NUMBER

348

TACTI	DENSO	IRIDIUM POWER	IRIDIUM TOUGH/PLUS	TACTI	DENSO	IRIDIUM POWER	IRIDIUM TOUGH/PLUS	TACTI	DENSO	IRIDIUM POWER	IRIDIUM TOUGH/PLUS
V9110-4012	W14F-U	-	-	V9110-5337	IXU27	IXU27	-	V9110-5686	VXEBH27	-	VXEBH27
V9110-4013	W14FP-U	IWF16	-	V9110-5338	ITV16	ITV16	-	V9110-5719	IRE01-27	-	-
V9110-4014	W14FP-UL	IWF16	-	V9110-5339	ITV20	ITV20	-	V9110-5720	IRE01-31	-	-
V9110-4019	W16FP-U	IWF16	-	V9110-5340	ITV22	ITV22	-	V9110-5721	IRE01-32	-	-
V9110-4021	W22FP-U	IWF22	-	V9110-5341	ITV24	ITV24	-	V9110-5722	IRE01-34	-	-
V9110-4024	W22FSR	IWF22	-	V9110-5342	ITV27	ITV27	-	V9110-5741	IRE01-35	-	-
V9110-4025	W22FS-U	IWF22	-	V9110-5343	IKH16	IKH16	VKH16	V9110-5752	IRT01-31	-	-
V9110-4027	W22S-U	-	-	V9110-5344	IKH20	IKH20	VKH20	V9110-5753	IRT01-34	-	-
V9110-4028	W24EP-U	IW24	-	V9110-5345	IKH22	IKH22	VKH22	V9110-5754	IRL01-27	-	-
V9110-4030	W24ES-U	IW24	-	V9110-5346	IKH24	IKH24	-	V9110-5755	IRL01-31	-	-
V9110-4033	W24ESR-U	IW24	-	V9110-5347	IKH27	IKH27	-	V9110-6004	W9-U	-	-
V9110-4034	W24ES-V	IW24	-	V9110-5348	IK22G	IK22G	VK22G	V9110-6008	W14-U	-	-
V9110-4037	W24FSR	IWF24	-	V9110-5349	ITL16	ITL16	-	V9110-6009	W14E	-	-
V9110-4038	W24FS-U	IWF24	-	V9110-5350	ITL20	ITL20	-	V9110-6010	W14EP-U	IW16	VW16
V9110-4045	W27ESR-U	IW27	-	V9110-5351	IK16G	IK16G	VK16G	V9110-6011	W14EPR-U	IW16	VW16
V9110-4046	W27ES-U	IW27	-	V9110-5352	IK20G	IK20G	VK20G	V9110-6021	W14PR-U	-	-
V9110-4047	W27ES-V	IW27	-	V9110-5353	IXUH22	IXUH22	VXUH22	V9110-6022	W20M-U	-	-
V9110-4052	W27FS-U	IWF27	-	V9110-5354	IXUH20I	IXUH20I	VXUH20I	V9110-6023	W20MP-U	-	-
V9110-4054	W27FSR	IWF27	-	V9110-5355	IXU22I	IXU22I	VXU22I	V9110-6026	W22M-U	-	-
V9110-4075	X16FSR-U	-	-	V9110-5356	IXUH22I	IXUH22I	VXUH22I	V9110-6027	W22MP-U	-	-
V9110-4076	X20ES-U	-	-	V9110-5359	IWF16	IWF16	-	V9110-6028	W27FS-U10	IWF27	-
V9110-4078	X20FS-U	-	-	V9110-5360	IU20	IU20	-	V9110-6037	W20FP-U10	IWF20	-
V9110-4080	X20FSR-U	-	-	V9110-5361	IU22	IU22	-	V9110-6039	T20M-U	-	-
V9110-4086	X22EPR-U9	IX22B	-	V9110-5362	IU24	IU24	-	V9110-6041	T22M-U	-	-
V9110-4090	X22ES-U	IX22	-	V9110-5363	IU27	IU27	-	V9110-6044	W9EXR-U	-	-
V9110-4091	X22ESR-U	IX22	-	V9110-5364	IU31	IU31	-	V9110-6045	W9EP	-	-
V9110-4096	X24EPR-U9	IX24B	-	V9110-5365	IU24A	IU24A	-	V9110-6046	W9EX-U	-	-
V9110-4099	X24ES-U	IX24	-	V9110-5366	IU27A	IU27A	-	V9110-6047	W24FS-U10	IWF24	-
V9110-4101	X24ESR-U	IX24	-	V9110-5367	IU31A	IU31A	-	V9110-6076	K16HPR-U11	IKH16	VKH16
V9110-4103	X24FS-U	-	-	V9110-5368	IUH24	IUH24	-	V9110-7001	K16TT	-	-
V9110-4111	X27EPR-U9	IX27B	-	V9110-5369	IUH27	IUH27	-	V9110-7002	K20TT	-	-
V9110-4114	X27ES-U	IX27	-	V9110-5371	IX22	IX22	-	V9110-7003	W16TT	-	-
V9110-4116	X27ESR-U	IX27	-	V9110-5372	IX24	IX24	-	V9110-7004	XU22TT	-	-
V9110-4148	W16FP-UL	IWF16	-	V9110-5373	IX27	IX27	-	V9110-7005	XUH22TT	-	-
V9110-4149	W20FP-L	IWF20	-	V9110-5375	IX22B	IX22B	-	V9110-7006	XUH20TTI	IXUH20I	VXUH20I
V9110-4150	X24GP-U	IXG24	-	V9110-5376	IX24B	IX24B	-				
V9110-4152	W9FP-UL	-	-	V9110-5377	IX27B	IX27B	-				
V9110-4157	X20ESR-U	-	-	V9110-5378	IWF20	IWF20	-				
V9110-5000	L14-U	-	-	V9110-5379	IWF22	IWF22	-				
V9110-5008	MA16PR-U	-	-	V9110-5380	IWF24	IWF24	-				
V9110-5013	MA20PR-U	-	-	V9110-5381	IWF27	IWF27	-				
V9110-5020	T14PR-U	ITF16	-	V9110-5383	IUF22	IUF22	-				
V9110-5022	T16EPR-U	IT16	VT16	V9110-5384	IUF24	IUF24	-				
V9110-5023	T16EPR-U15	IT16	VT16	V9110-5391	IWM24	IWM24	-				
V9110-5026	T16PR-U11	ITF16	-	V9110-5392	IWM27	IWM27	-				
V9110-5032	T20EPR-U	IT20	VT20	V9110-5393	IWM31	IWM31	-				
V9110-5036	T20PR-U11	ITF20	-	V9110-5394	IXG24	IXG24	-				
V9110-5040	T22EP-U	IT22	-	V9110-5395	IXG27	IXG27	-				
V9110-5044	W16S-U	-	-	V9110-5501	VK20T	-	VK20T				
V9110-5046	W20PR-U	-	-	V9110-5502	VW20T	-	VW20T				
V9110-5060	K20PBR	IK20	VK20	V9110-5503	VKH20T	-	VKH20T				
V9110-5061	K20PBR-S10	IK20	VK20	V9110-5601	VQ16	IQ16	VQ16				
V9110-5063	K20TXR	IK20	VK20	V9110-5602	VQ20	IQ20	VQ20				
V9110-5064	W16EPB10	IW16	VW16	V9110-5603	VK16	IK16	VK16				
V9110-5065	W20EPB	IW20	VW20	V9110-5604	VK20	IK20	VK20				
V9110-5070	PT16EPR-L13	IT16	VT16	V9110-5605	VW16	IW16	VW16				
V9110-5301	IQ16	IQ16	VQ16	V9110-5606	VW20	IW20	VW20				
V9110-5302	IQ20	IQ20	VQ20	V9110-5607	VW22	IW22	VW22				
V9110-5303	IK16	IK16	VK16	V9110-5608	VXU22	IXU22	VXU22				
V9110-5304	IK20	IK20	VK20	V9110-5609	VXU24	IXU24	VXU24				
V9110-5305	IW16	IW16	VW16	V9110-5610	VK22	IK22	VK22				
V9110-5306	IW20	IW20	VW20	V9110-5611	VXUH22	IXUH22	VXUH22				
V9110-5307	IW22	IW22	VW22	V9110-5613	VQ22	IQ22	VQ22				
V9110-5308	IXU22	IXU22	VXU22	V9110-5617	VKH16	IKH16	VKH16				
V9110-5309	IXU24	IXU24	VXU24	V9110-5618	VKH20	IKH20	VKH20				
V9110-5310	IK22	IK22	VK22	V9110-5619	VKH22	IKH22	VKH22				
V9110-5311	IK24	IK24	-	V9110-5620	VK20Y	-	VK20Y				
V9110-5312	IK27	IK27	-	V9110-5621	VT16	IT16	VT16				
V9110-5313	IQ22	IQ22	VQ22	V9110-5622	VKA16	-	VKA16				
V9110-5314	IQ24	IQ24	-	V9110-5623	VKA20	-	VKA20				
V9110-5315	IQ27	IQ27	-	V9110-5624	VKB16	-	VKB16				
V9110-5316	IW24	IW24	-	V9110-5625	VKB20	-	VKB20				
V9110-5317	IW27	IW27	-	V9110-5636	VK22G	IK22G	VK22G				
V9110-5318	IW29	IW29	-	V9110-5637	VCH20	-	VCH20				
V9110-5319	IW31	IW31	-	V9110-5638	VT20	IT20	VT20				
V9110-5320	IW34	IW34	-	V9110-5639	VKH20Y	-	VKH20Y				
V9110-5321	IK31	IK31	-	V9110-5640	VK16G	IK16G	VK16G				
V9110-5322	IK34	IK34	-	V9110-5641	VK20G	IK20G	VK20G				
V9110-5323	IQ31	IQ31	-	V9110-5643	VFKBH20	-	VFKBH20				
V9110-5324	IQ34	IQ34	-	V9110-5644	VFXEH20E	-	VFXEH20E				
V9110-5325	IT16	IT16	VT16	V9110-5645	VFXEH20	-	VFXEH20				
V9110-5326	IT20	IT20	VT20	V9110-5646	VFXEH22	-	VFXEH22				
V9110-5327	IT22	IT22	-	V9110-5647	VFK16	-	VFK16				
V9110-5328	IT24	IT24	-	V9110-5648	VFK20F	-	VFK20F				
V9110-5329	IT27	IT27	-	V9110-5649	VXU20	-	VXU20				
V9110-5330	ITF16	ITF16	-	V9110-5650	VXUH20I	IXUH20I	VXUH20I				
V9110-5331	ITF20	ITF20	-	V9110-5651	VXU22I	IXU22I	VXU22I				
V9110-5332	ITF22	ITF22	-	V9110-5654	VFKH16	-	VFKH16				
V9110-5333	ITF24	ITF24	-	V9110-5655	VFKH20	-	VFKH20				
V9110-5334	ITF27	ITF27	-	V9110-5656	VXUH22I	IXUH22I	VXUH22I				
								TOYOTA	DENSO	IRIDIUM POWER	IRIDIUM TOUGH/PLUS
								90048-51185(ILFR6C11)	SK20HR-A11	IKH20	VKH20
								90048-51207(ILKR6F11)	SXU20HPR11	IXUH20I	VXUH20I
								90048-51208	SXU20HPR11	IXUH20I	VXUH20I
								90048-51213(ILKR7D8)	SXU22HPR8	IXUH22I	VXUH22I
								90048-51214	SXU22HPR8	IXUH22I	VXUH22I
								90048-51215(SILKR6D10G)	-	IXUH20I	VXUH20I
								90048-51216(SILKAR6G11G)	-	-	VFXEH20

CAR MAKER GENUINE P/N CROSS REFERENCE (

98079-56841

other

DENSO

TOYOTA	DENSO	IRIDIUM POWER	IRIDIUM TOUGH/PLUS	TOYOTA	DENSO	IRIDIUM POWER	IRIDIUM TOUGH/PLUS	TOYOTA	DENSO	IRIDIUM POWER	IRIDIUM TOUGH/PLUS
90919-01095	W16ETR-S	IW16	VW16	90919-01192	K16TR11	IK16	VK16	90919-01284	FK16BR-AL8	-	VFKB16
90919-01096 (BPR5EK-A)	W16ETR-S	IW16	VW16	90919-01193 (BKRE5EK-B1)	K16TR11	IK16	VK16	90919-01285 (DILKAR8J9G)	-	-	VDCH22F
90919-01097	W20ETR-S	IW20	VW20	90919-01194	PK20TR11	IK20	VK20	90919-01286	FK16HBR-J8	-	-
90919-01098 (BPR6EY)	W20EXR-U	IW20	VW20	90919-01195 (BKRE6EKP-B1)	PK20TR11	IK20	VK20	90919-01287	FK20HR-A8	-	VFKH20
90919-01100	T16EX-U	IT16	VT16	90919-01196	PK16TR11	IK16	VK16	90919-01288	FK20HBR-TJ8	-	VFKBH20
90919-01102 (BPR5EY)	W16EXR-U	IW16	VW16	90919-01197 (BKRE5EKP-B1)	PK16TR11	IK16	VK16	90919-01289	FK16HR-Q8	-	VFCH16
90919-01103 (BPR4EY)	W14EXR-U	IW16	VW16	90919-01198	K20TR11	IK20	VK20	90919-01290	SC16HR-G11	-	-
90919-01104 (BPR5EY-11)	W16EXR-U11	IW16	VW16	90919-01200	PK16TR13	IK16	VK16	90919-01291	FC20HR-G8	-	-
90919-01108	W14EXR-U11	IW16	VW16	90919-01201 (BKRE5EKP-B3)	PK16TR13	IK16	VK16	90919-01292	FC16HR-GQ8	-	VFCH16
90919-01109 (BPR4EY-11)	W14EXR-U11	IW16	VW16	90919-01202 (BKRE6EKB-1)	K20TR11	IK20	VK20	90919-01294 (DILFR5M8D)	-	-	VDKH16T
90919-01113	J16AR-U11	-	-	90919-01203	PK16R-P8	IK16	VK16	90919-01295	EC22HPR-D7	-	-
90919-01114 (BRE527Y-11)	J16AR-U11	-	-	90919-01205	PK16R8	IK16	VK16	90919-01296	FK16HBR-GJ8	-	-
90919-01115	P16R	IW16	VW16	90919-01206 (BKRE5EP-8)	PK16R8	IK16	VK16	90919-01297	FK20HR-Q8	-	-
90919-01116 (BPR5EP-11)	P16R	IW16	VW16	90919-01207	SK20R-P11	IK20	VK20	90919-01298	FC16HR-CY9	-	VFCH16
90919-01116 (BPR5EP-11) LPG	*P16R	-	VW20T	90919-01208	PK20GR8	-	VKA20	90919-A1002	SK20HR11 (Overseas Product)	IKH20	VKH20
90919-01117	J16B-U11	-	-	90919-01209	SK16R-P11	IK16	VK16	90919-A1003	SK16HR11 (Overseas Product)	IKH16	VKH16
90919-01118 (BE529Y-11)	J16B-U11	-	-	90919-01210	SK20R11	IK20	VK20	90919-T1002-A	K16R-UJ (Overseas Product)	IK16	VK16
90919-01119	J16BR-U	-	-	90919-01211 (IFR6A11)	SK20R11	IK20	VK20	90919-T1003	K16R-UJ11 (Overseas Product)	IK16	VK16
90919-01120 (BRE529Y)	J16AR-U11	-	-	90919-01212	SK20R-P13	IK20	VK20	90919-T1004-A	K20HR-UJ11 (Overseas Product)	IKH20	VKH20
90919-01121	PQ16R	IQ16	VQ16	90919-01213 (BKRE6EPA-8)	PK20GR8	-	VKA20	90919-T1005	K20HR-UJ11 (Overseas Product)	IKH20	VKH20
90919-01121-83	PQ16R (Overseas Product)	IQ16	VQ16	90919-01214	SK16R-P8	IK16	VK16	90919-T1006	SK20HR11 (Overseas Product)	IKH20	VKH20
90919-01122 (BCPR5EP-11)	PQ16R	IQ16	VQ16	90919-01215 (IFR5A-8N) LPG	SK16R-P8	-	VK20T	90919-T1007-A	SK20R11 (Overseas Product)	IK20	VK20
90919-01123	J16BR-U11	-	-	90919-01216	PK20TR-G11	-	VK20T	90919-T1009	SK20HR11 (Overseas Product)	-	VCH20
90919-01125	W20EXR-U11	IW20	VW20	90919-01217	SK16R11	IK16	VK16	90919-W1001-A	K20HR-UJ11 (Overseas Product)	IKH20	VKH20
90919-01126 (BPR6EY-11)	W20EXR-U11	IW20	VW20	90919-01218 (IFR5A11)	SK16R11	IK16	VK16	90919-W1002	SK20HR11 (Overseas Product)	IKH20	VKH20
90919-01127	PQ20R	IQ20	VQ20	90919-01219	*SK16R-P11	IK16	VK16	90919-WX002 (ILKAR7G9)	-	-	VKH20Y
90919-01127-83	PQ20R (Overseas Product)	IQ20	VQ20	90919-01220	*PK20R11	IK20	VK20	90919-YZZAA	Q16-U	IQ16	VQ16
90919-01128 (BCPR6EP-11)	PQ20R	IQ20	VQ20	90919-01221	SK20BGR11	-	VKA20	90919-YZZAB	Q20-U	IQ20	VQ20
90919-01129	Q16R-U11	IQ16	VQ16	90919-01222	SK20R5	-	-	90919-YZZAC	Q20-U11	IQ20	VQ20
90919-01129-8N	Q16R-U11 (Overseas Product)	IQ16	VQ16	90919-01223	P16R8	IW16	VW16	90919-YZZAD	K16-U	IK16	VK16
90919-01131	Q20R-U11	IQ20	VQ20	90919-01224 (BPR5EP8)	P16R8	IW16	VW16	90919-YZZAE	K16-U11	IK16	VK16
90919-01131-8N	Q20R-U11 (Overseas Product)	IQ20	VQ20	90919-01225	*SK20R-P11	IK20	VK20	90919-YZZAF	K20-U	IK20	VK20
90919-01133	P16R13	IW16	VW16	90919-01226	SK20BR11 (For Japan)	-	VKB20	90919-YZZAG	K20-U11	IK20	VK20
90919-01134 (BPR5EP-13)	P16R13	IW16	VW16	90919-01228	PK20TR8-G	IK20	VK20	90999-09006	W16EX-U (Removable)	IW16	VW16
90919-01135	*PQ20R-P11	IQ20	VQ20	90919-01229	SK20R5-G	-	-	90999-09007	W20EX-U (Removable)	IW20	VW20
90919-01136 (BCPR6EP-N-11)	PQ20R-P11	IQ20	VQ20	90919-01230	SK20BR11 (For EU)	-	VKB20	SU003-00416	ZXE27HBR8	-	VXEBH27
90919-01139	W20EX-U11	IW20	VW20	90919-01231	SK20R8	-	VK20Y	SU003-04931	ZXE27HBR8	-	VXEBH27
90919-01141	PQ16R-P11	IQ16	VQ16	90919-01233	SK16HR11	IKH16	VKH16				
90919-01143	*P16R	IW16	VW16	90919-01235	K20HR-U11	IKH20	VKH20				
90919-01144 (BPR5EP-11)	P16R	IW16	VW16	90919-01236 (LFR6A11)	K20HR-U11	IKH20	VKH20				
90919-01144 (BPR5EP-11) LPG	*P16R	-	VW20T	90919-01237 (USE 01210)	SK20R11 (OEM ONLY)	IK20	VK20				
90919-01145	PQ20R-P8	IQ20	VQ20	90919-01238 (IFR6A11)	SK20R11	IK20	VK20				
90919-01146 (BCPR6EP-N-8)	PQ20R-P8	IQ20	VQ20	90919-01239	SK16R8-PG	-	VK20T				
90919-01147	P20R8	-	VW20T	90919-01240 (USE 01217)	SK16R11 (OEM ONLY)	IK16	VK16				
90919-01148 (BPR6EP-8)	P20R8	IW20	VW20	90919-01240-79	SK16R11	IK16	VK16				
90919-01148 (BPR6EP-8) LPG	P20R8	-	VW20T	90919-01241 (IFR5A11)	SK16R11	IK16	VK16				
90919-01149	Q20R-U	IQ20	VQ20	90919-01242 (USE 01164)	K16R-U11 (OEM ONLY)	IK16	VK16				
90919-01149-8N	Q20R-U (Overseas Product)	IQ20	VQ20	90919-01243	K16HR11	-	VFKH16				
90919-01151	PQ16R8	IQ16	VQ16	90919-01244 (USE 01176)	K16R-U (OEM ONLY)	IK16	VK16				
90919-01151-83	PQ16R8 (Overseas Product)	IQ16	VQ16	90919-01245 (BKRE5EYA)	K16R-U	IK16	VK16				
90919-01152 (BCPR5EP-8)	PQ16R8	IQ16	VQ16	90919-01247	FK20HR11	-	VFKH20				
90919-01153	Q16R-U	IQ16	VQ16	90919-01248 (ILFR6D11)	FK20HR11	-	VFKH20				
90919-01153-8N	Q16R-U (Overseas Product)	IQ16	VQ16	90919-01249	FK20HBR11	-	VFKBH20				
90919-01155	QJ16AR-U	-	-	90919-01249-79	FK20HBR11	-	VFKBH20				
90919-01155-8N	QJ16AR-U (Overseas Product)	-	-	90919-01250	S20R8-G	-	VW20T				
90919-01157	PQ16R13	IQ16	VQ16	90919-01252	FK16R11	-	-				
90919-01158 (BCPR5EP-13)	PQ16R13	IQ16	VQ16	90919-01253	SC20HR11	-	VCH20				
90919-01159	Q16-U11	IQ16	VQ16	90919-01254	SK20HR8-T	-	VKH20T				
90919-01161	PQ20R8	IQ20	VQ20	90919-01255	FK20HBR11-T	-	VFKBH20				
90919-01162 (BCPR6EP-8)	PQ20R8	IQ20	VQ20	90919-01256	FC22HR9	-	-				
90919-01164	K16R-U11	IK16	VK16	90919-01256A	FC22HR9-G	-	-				
90919-01165 (BKRE5EYA-11)	K16R-U11	IK16	VK16	90919-01258	K16HR-U11	IKH16	VKH16				
90919-01166	K20R-U	IK20	VK20	90919-01259	FK16HR-A8	-	VFKH16				
90919-01166-8N	K20R-U (Overseas Product)	IK20	VK20	90919-01259-79	FK16HR-A8	-	-				
90919-01168	PK16R11	IK16	VK16	90919-01260	PK16TR-L11	-	-				
90919-01168-83	PK16R11 (Overseas Product)	IK16	VK16	90919-01261	FK20HR11-G	-	-				
90919-01169 (BKRE5EP-11)	PK16R11	IK16	VK16	90919-01262	FK20HR8-G	-	VKH20T				
90919-01170	Q14R-U11	IQ16	VQ16	90919-01263	FK20HBR8	-	VFKBH20				
90919-01172	PK20R-P8	IK20	VK20	90919-01263-79	FK20HBR8	-	VFKBH20				
90919-01173 (BKRE6EP-N-8)	PK20R-P8	IK20	VK20	90919-01264	SK20R-B5	-	-				
90919-01174	QJ16AR-U11	-	-	90919-01265	FK16R-A8	-	VFK16				
90919-01176	K16R-U	IK16	VK16	90919-01266	SK20HR-A11	IKH20	VKH20				
90919-01177 (BKRE5EYA)	K16R-U	IK16	VK16	90919-01267	K20HR-UAG8	-	-				
90919-01178	PK20R11	IK20	VK20	90919-01268	K16R-UAG8	-	-				
90919-01178-83	PK20R11 (Overseas Product)	IK20	VK20	90919-01269	SK16HR-G11	-	-				
90919-01179 (BKRE6EP-11)	PK20R11	IK20	VK20	90919-01270	SC20HR-G11	-	-				
90919-01180	PK20R8	-	VK20Y	90919-01271 (TRD:90919-A0002)	VXUH22	IXUH22	VXUH22				
90919-01180 *LPG	PK20R8	-	VK20T	90919-01272	FK16R-AL8	-	VFK16				
90919-01180-83	PK20R8 (Overseas Product)	-	VK20T	90919-01274	FC20HR-BG9	-	-				
90919-01181 (BKRE6EP-8)	PK20R8	IK20	VK20	90919-01275	SC16HR11	-	-				
90919-01181 (BKRE6EP-8) LPG	PK20R8	-	VK20T	90919-01276 (DILFR7K9G)	-	-	VDKH22F				
90919-01182	PQ20R13	IQ20	VQ20	90919-01276-79 (DILFR7K9G)	-	-	VDKH22F				
90919-01184	K20R-U11	IK20	VK20	90919-01277	SK20HR-GT8	-	VKH20T				
90919-01184-8N	K20R-U11 (Overseas Product)	IK20	VK20	90919-01278	VKH20Y (GRMN)	-	VKH20Y				
90919-01185 (BKRE6EYA-11)	K20R-U11	IK20	VK20	90919-01279	FK20HBR-J8	-	VFKBH20				
90919-01187	PK20R13	IK20	VK20	90919-01279-79	FK20HBR-J8	-	VFKBH20				
90919-01188 (BKRE6EP-13)	PK20R13	IK20	VK20	90919-01280	FC16HR8	-	-				
90919-01190	SK20R8-G	-	VK20T	90919-01281	FC16HR-C9	-	VFCH16				
90919-01191	SK20HR11	IKH20	VKH20	90919-01281-1	FC16HR-C9	-	VFCH16				

CAR MAKER GENUINE P/N CROSS REFERENCE (

98079-56841

other



DENSO

USA & EUROPE MOTOR SMALL PART CROSS REFERENCE ENGINE CYCLE JAPAN VIETNAM THAILAND TAIWAN SINGAPORE SAUDI ARABIA PHILIPPINES MALAYSIA INDONESIA KOREA INDIA CHINA AUSTRALIA

YAMAHA	DENSO	IRIDIUM POWER	IRIDIUM TOUGH/PLUS	YAMAHA	DENSO	IRIDIUM POWER	IRIDIUM TOUGH/PLUS	YAMAHA (Overseas)	DENSO	IRIDIUM POWER	IRIDIUM TOUGH/PLUS
90793-20155 (DPR9EIX9)	-	IX27B	-	94703-00117 (BP7ES)	W22EP-U	IW22	VW22	9079E-ND022	W20EP-U	IW20	VW20
90793-20156 (BPR6HIX)	-	IWF20	-	94703-00133 (BP5ES)	W16EX-U	IW16	VW16	9079E-ND023	W20FP-U	IWF20	-
90793-20157 (BPR7HIX)	-	IWF22	-	94703-00133 (BP5ES)	W16EP-U	IW16	VW16	9079E-ND024	W20FPR-U	IWF20	-
90793-20158 (BR6HIX)	-	-	-	94703-00157 (D8EA)	X24ES-U	IX24	-	9079E-ND026	W22EP-U	IW22	VW22
90793-20159 (BR7HIX)	-	IWF22	-	94703-00159 (BP4HS)	W14FP-UL	IWF16	-	9079E-ND027	W22EPR-U	IW22	VW22
90793-20160 (BR8EIX)	-	IW24	-	94703-00160 (B8HS-10)	W24FS-U10	IWF24	-	9079E-ND028	W22FPR-U	IWF22	-
90793-20161 (BR9EIX)	-	IW27	-	94703-00168 (BP5HS)	W16FP-U	IWF16	-	9079E-ND030	W24ES-U	IW24	-
90793-20162 (CR8EIX9)	-	IUH24	-	94703-00181	X24ES-U	IX24	-	9079E-ND031	W24ESR-U	IW24	-
90793-20163 (CR9EIX9)	-	IUH27	-	94703-00188 (BR9ES)	W27ESR	IW27	-	9079E-ND032	W24EP-U	IW24	-
90793-20164 (BR8HIX)	-	IWF24	-	94703-00188 (BR9ES)	W27ESR-U	IW27	-	9079E-ND033	W24FP-U	IWF24	-
90793-20165 (BR10EIX)	-	IW31	-	94703-00189 (D7EA)	X22ES-U	IX22	-	9079E-ND035	W27ES-U	IW27	-
90793-20166 (BPR8HIX)	-	IWF24	-	94703-00194 (BPR5HS)	W16FPR-U	IWF16	-	9079E-ND036	W27ESR-U	IW27	-
90793-20167 (BPR5EIX)	-	IW16	VW16	94703-00198 (BPR6HS)	W20FPR-U	IWF20	-	9079E-ND037	X22EP-U9	IX22B	-
90793-20168 (BPR6EIX)	-	IW20	VW20	94703-00203 (DR8ES-L)	X24ESR-U	IX24	-	9079E-ND038	X24EPR-U9	IX24B	-
90793-20169 (CR5HIX)	-	-	-	94703-00204 (BR8ES)	W24ESR	IW24	-	9079E-ND039	X24ES-U	IX24	-
90793-20170 (CR6HIX)	-	IUF22	-	94703-00204 (BR8ES)	W24ESR-U	IW24	-	9079E-ND040	W22FP-U	IWF22	-
90793-20171 (CR7HIX)	-	IUF22	-	94703-00207 (B4ES)	W14E	-	-	9079E-ND041	U20FS-U	IUF22	-
90793-20172 (CR7EIX)	-	IU22	-	94703-00213 (C6HA)	U20FS-U	IUF22	-	9079E-ND042	W22ES-U	-	-
90793-20173 (DPR7EIX9)	-	IX22B	-	94703-00215 (C7HA)	U22FS-U	IUF22	-	9079E-ND043	X22ES-U	IX22	-
90793-20174 (CR8HIX)	-	IUF24	-	94703-00217 (B7HS-10)	W22FS-U10	IWF22	-	9079E-ND044	X24ESR-U	IX24	-
90793-20175 (BPR7EIX)	-	IW22	VW22	94703-00218 (BPR7ES)	W22EPR-U	IW22	VW22	9079E-ND045	U27ES-N	IU27	-
90793-22008	W16ES-U	-	-	94703-00220	W22EPR-U	IW22	VW22	9079E-ND046	W20FP-U10	IWF20	-
90793-22010	W27ES-U	IW27	-	94703-00222	X24ESR-U	IX24	-	9079E-ND049	X20FS-U	-	-
90793-22035	W20ESR-U	-	-	94703-00223	W20FP-U	IWF20	-	9079E-ND050	X24FS-U	-	-
90793-22036	W22ESR-U	-	-	94703-00227 (BPR7HS)	W22FPR-U	IWF22	-	9079E-ND051	U16FS-U	-	-
90793-22037	W27ESR-U	IW27	-	94703-00232 (BP6HS-10)	W20FP-U10	IWF20	-	9079E-ND052	W22FP-U10	IWF22	-
90793-22039	W24FSR	IWF24	-	94703-00234 (BPR6ES)	W20EXR-U	IW20	VW20	9079E-ND053	W22EP-U11	IW22	VW22
90793-22045	W20EXR-U11	IW20	VW20	94703-00234 (BPR6ES)	W20EPR-U	IW20	VW20	9079E-ND055	W16FP-U	IWF16	-
90793-22047	X22EPR-U9	IX22B	-	94703-00235	W20FPR-U	IWF20	-	9079E-ND056	X27GPR-U	IXG27	-
90793-22093	IU22	IU22	-	94703-00241 (DPR8EA-9)	X24EPR-U9	IX24B	-	9079E-ND057	U22FSR-U	IUF22	-
90793-22094	IU24	IU24	-	94703-00254 (C7HSA)	U22FS-U	IUF22	-	9079E-ND058	U24ESR-N	IU24	-
90793-22095	IU27	IU27	-	94703-00256 (C6HSA)	U20FS-U	IUF22	-	9079E-ND059	U27ESR-N	IU27	-
90793-22096	IUH24	IUH24	-	94703-00258 (BPR4HS)	W14FPR-UL	IWF16	-	9079E-ND060	X20EPR-U9	-	-
90793-22097	IUH27	IUH27	-	94703-00262 (DPR7EA-9)	X22EPR-U9	IX22B	-	9079E-ND067	W20FS-U10	IWF20	-
90793-22098	IX22B	IX22B	-	94703-00263 (DP7EA-9)	X22EP-U9	IX22B	-	9079E-ND069	X27EPR-U9	IX27B	-
90793-22099	IX24B	IX24B	-	94703-00264 (BP7HS-10)	W22FP-U10	IWF22	-	9079E-ND070	X22EPR-U9	IX22B	-
90793-22100	IX27B	IX27B	-	94703-00267 (BP8ES-11)	W24EP-U	IW24	-	9079E-ND071	W20EPR-U	IW20	VW20
90793-22101	IW22	IW22	VW22	94703-00275 (DP8EA-9)	X24EP-U9	IX24B	-	9079E-ND072	W16EPR-U	IW16	VW16
90793-22102	IU31	IU31	-	94703-00307	U27ES-N	IU27	-	9079E-ND073	X24EP-U9	IX24B	-
90793-22103	IU24A	IU24A	-	94703-00310 (C-2H)	-	-	-	9079E-ND075	W16EP-U	IW16	VW16
90793-22104	IU27A	IU27A	-	94703-00314 (C8E)	U24ES-N	IU24	-	9079E-ND077	W9EXR-U	-	-
90793-22105	IU31A	IU31A	-	94703-00315 (C9E)	U27ES-N	IU27	-	9079E-ND078	X22ESR-U	IX22	-
90793-22106	IX22	IX22	-	94703-00318 (CR9E)	U27ESR-N	IU27	-	9079E-ND079	X27ES-U	IX27	-
90793-22107	IX24	IX24	-	94703-00319	U27ESR-N	IU27	-	9079E-ND081	K16HPR-U11	IKH16	VKH16
90793-22108	IX27	IX27	-	94703-00320 (BP7ES-11)	W22EP-U11	IW22	VW22	9079E-ND084	IWF20	IWF20	-
90793-22109	IWF22	IWF22	-	94703-00323 (B8EG)	W24ES-V	IW24	-	9079E-ND085	W20M-U	-	-
90793-22110	IWF24	IWF24	-	94703-00325 (B9EG)	W27ES-V	IW27	-	IQG-10862-20	XU22EPR-U	IXU22	VXU22
90793-22111	IWF27	IWF27	-	94703-00327	W22FPR-U	IWF22	-				
90793-22112	IW16	IW16	VW16	94703-00329	U24ESR-N	IU24	-				
90793-22114	IUF22	IUF22	-	94703-00330 (CR8E)	U24ESR-N	IU24	-				
90793-22115	IUF24	IUF24	-	94703-00332 (R5184-10S)	IWM01-32	-	-	5105 0K16	IK16	IK16	VK16
90793-22088	IW24	IW24	-	94703-00333 (DR8EA)	X24ESR-U	IX24	-	5105 0K20	IK20	IK20	VK20
90793-22089	IW27	IW27	-	94703-00345 (DR7EA)	X22ESR-U	IX22	-	5105 0K22	IK22	IK22	VK22
90793-22090	IW29	IW29	-	94703-00352	U22ESR-N	IU22	-	5105 0Q16	IQ16	IQ16	VQ16
90793-22091	IW31	IW31	-	94703-00353 (CR7E)	U22ESR-N	IU22	-	5105 0Q20	IQ20	IQ20	VQ20
90793-22092	IW34	IW34	-	94703-00355	W22FSR	IWF22	-	5105 0Q22	IQ22	IQ22	VQ22
90890-78079 (BP6EV)	-	IW20	VW20	94703-00366 (CR7HSA)	U22FSR-U	IUF22	-	5105 0T16	IT16	IT16	VT16
90890-78082 (B10EGV)	IW31	IW31	-	94703-00367 (B10EG)	-	IW31	-	5105 0T20	IT20	IT20	VT20
90890-78086	W24ESR-U	IW24	-	94709-00195 (BR8HS)	W24FSR	IWF24	-	5105 0T22	IT22	IT22	-
90890-78094	W20FS-U	IWF22	-	94709-00247 (BR8HS-10)	W24FSR-U10	IWF24	-	5105 0W16	IW16	IW16	VW16
90890-78097	W14FP-UL	IWF16	-	94709-00324 (BR9EG)	W27ESR-V	IW27	-	5105 0W20	IW20	IW20	VW20
90890-78102	W20M-U	-	-	94709-00357 (BR9ECM)	W27EMR-C	IWM27	-	5105 0W22	IW22	IW22	VW22
90893-22113	IW20	IW20	VW20	94709-00383 (BR9ECS)	W27ESR-V	IW27	-	5105 TF16	ITF16	ITF16	-
94700-00886 (Indonesia)	U22FS-U	IUF22	-	94709-00384 (BR10ECS)	-	IW31	-	5105 TF20	ITF20	ITF20	-
94701-00254 (C7HSA)	U22FS-U	IUF22	-	94709-00391 (LFR5A-11)	K16HPR-U11	IKH16	VKH16	5105 TV16	ITV16	ITV16	-
94701-00256 (C6HSA)	U20FS-U	IUF22	-	94709-00400 (LFR6A-11)	K20HR-U11	IKH20	VKH20	5105 TV20	ITV20	ITV20	-
94701-00265	U22FSR-U	IUF22	-	94709-00N01 (BP5HM)	W16FP-U	IWF16	-	5105 VK16	VK16	IK16	VK16
94701-00353 (CR7E)	U22ESR-N	IU22	-	Q1Q-DNS-021-000	IXU22	IXU22	VXU22	5105 VK20	VK20	IK20	VK20
94701-00366 (CR7HSA)	U22FSR-U	IUF22	-	Q1Q-DNS-022-000	I XU24	I XU24	V XU24	5105 VK22	VK22	IK22	VK22
94701-00372 (CR6HSA)	U20FSR-U	IUF22	-	Q1Q-DNS-026-000	IQ22	IQ22	VQ22	5105 VKH2 00	VKH20	IKH20	VKH20
94701-00407	IU27D	IU27	-					5105 VQ16	VQ16	IQ16	VQ16
94701-00408 (CR9EIA9)	IU27D	IU27	-					5105 VQ20	VQ20	IQ20	VQ20
94702-00374 (R6179A-10SP)	IWM01-32	-	-					5105 VQ22	VQ22	IQ22	VQ22
94703-00001 (B-4H)	W14F-U	-	-	9079E-ND001	W16FS-U	-	-	5105 VT16	VT16	IT16	VT16
94703-00039 (B6HS)	W20FS-U	IWF22	-	9079E-ND002	W20FS-U	IWF22	-	5105 VW16	VW16	IW16	VW16
94703-00040 (B7HS)	W22FS-U	IWF22	-	9079E-ND004	W22FS-U	IWF22	-	5105 VW20	VW20	IW20	VW20
94703-00041 (B8HS)	W24FS-U	IWF24	-	9079E-ND006	W24FS-U	IWF24	-	5105 VW22	VW22	IW22	VW22
94703-00043 (B6ES)	W20ES-U	-	-	9079E-ND007	W24FS-U10	IWF24	-	5105 VXU2 20	VXU22	IXU22	VXU22
94703-00044 (B7ES)	W22ES-U	-	-	9079E-ND008	W27FS-U	IWF27	-	5105 WF22	IWF22	IWF22	-
94703-00045 (B8ES)	W24ES-U	IW24	-	9079E-ND009	W27FS-U10	IWF27	-	5105 XU22	IXU22	IXU22	VXU22
94703-00046 (B9ES)	W27ES-U	IW27	-	9079E-ND010	W16FSR	-	-				
94703-00050 (BP7HS)	W22FP-U	IWF22	-	9079E-ND011	W20FSR-U	IWF22	-				
94703-00069 (B5HS)	W16FS-U	-	-	9079E-ND012	W22FSR	IWF22	-				
94703-00078 (B5ES)	W16ES-U	-	-	9079E-ND013	W24FSR	IWF24	-				
94703-00108 (BP6HS)	W20FP-U	IWF20	-	9079E-ND014	W24FSR-U10	IWF24	-				
94703-00110 (BR7HS)	W22FSR	IWF22	-	9079E-ND015	W27FSR	IWF27	-				
94703-00112 (BR7ES)	W22ESR-U	-	-	9079E-ND016	W27FSR-U10	IWF27	-				
94703-00114 (BR9EV)	-	IW27	-								

DENSO → IRIIDIUM POWER, TOUGH, PLUS,

No.	DENSO	NUT	IRIDIUM POWER	NUT	IRIDIUM TOUGH/PLUS	NUT		NUT	No.	DENSO	NUT	IRIDIUM POWER	NUT	IRIDIUM TOUGH/PLUS	NUT		NUT
1	•K16TNR-S9	S	IK16	S	VK16	S	K16TT	S	111	ITF16	S	ITF16	S	-	-	-	-
2	•K20PTR-S	S	IK20	S	VK20	S	K20TT	S	112	ITF20	S	ITF20	S	-	-	-	-
3	•K20TNR-S	S	IK20	S	VK20	S	K20TT	S	113	ITF22	S	ITF22	S	-	-	-	-
4	•K20TNR-S9	S	IK20	S	VK20	S	K20TT	S	114	ITF24	S	ITF24	S	-	-	-	-
5	•P16R	S	-	S	VW20T	S	-	S	115	ITF27	S	ITF27	S	-	-	-	-
6	•P16R	S	IW16	RC	VW16	S	W16TT	RC	116	ITL16	S	ITL16	S	-	-	-	-
7	•PK20R11	S	IK20	S	VK20	S	-	S	117	ITL20	S	ITL20	S	-	-	-	-
8	•PQ20R-P11	S	IQ20	S	VQ20	S	-	S	118	ITV16	S	ITV16	S	-	-	-	-
9	•SK16PR-A11	S	IK16	S	VK16	S	-	S	119	ITV20	S	ITV20	S	-	-	-	-
10	•SK16R-P11	S	IK16	S	VK16	S	-	S	120	ITV22	S	ITV22	S	-	-	-	-
11	•W16EPR-U	T	IW16	RC	VW16	S	W16TT	RC	121	ITV24	S	ITV24	S	-	-	-	-
12	•XU22EPR-U	T	IXU22	RC	VXU22	RC	XU22TT	S	122	ITV27	S	ITV27	S	-	-	-	-
13	DK16R-B5	S	-	-	-	-	-	-	123	IU01-24	R	-	-	-	-	-	-
14	DK20PR-D13	S	-	-	-	-	-	-	124	IU01-27	R	-	-	-	-	-	-
15	DXE22HQR-D11S	S	-	-	-	-	-	-	125	IU01-31	R	-	-	-	-	-	-
16	DXU22HCR-D11S	S	-	-	-	-	-	-	126	IU01-34	R	-	-	-	-	-	-
17	FC20HPR8	S	-	-	-	-	-	-	127	IU20	R	IU20	R	-	-	-	-
18	FC22HR9	S	-	-	-	-	-	-	128	IU22	R	IU22	R	-	-	-	-
19	FC22HR9-G	S	-	-	-	-	-	-	129	IU22D	R	IU22D	R	-	-	-	-
20	FK16HQR11	S	-	-	VFKH16	S	-	S	130	IU24	R	IU24	R	-	-	-	-
21	FK16HR11	S	-	-	VFKH16	S	-	S	131	IU24A	R	IU24A	R	-	-	-	-
22	FK16HR-A8	S	-	-	-	S	-	S	132	IU24D	T	IU24	R	-	-	-	-
23	FK16R-A8	S	-	-	-	S	-	S	133	IU27	R	IU27	R	-	-	-	-
24	FK16R11	S	-	-	VFK16	S	-	S	134	IU27A	R	IU27A	R	-	-	-	-
25	FK20HBR8	S	-	-	VFKBH20	S	-	S	135	IU27D	T	IU27	R	-	-	-	-
26	FK20HBR11	S	-	-	VFKBH20	S	-	S	136	IU31	R	IU31	R	-	-	-	-
27	FK20HBR11-T	S	-	-	VFKBH20	S	-	S	137	IU31A	R	IU31A	R	-	-	-	-
28	FK20HQR8 (HYUNDAI)	S	-	-	VFKH20	S	-	S	138	IUF14-UB	R	IUF14-UB	R	-	-	-	-
29	FK20HQR8 (VOLVO)	S	-	-	VFKH20	S	-	S	139	IUF22	R	IUF22	R	-	-	-	-
30	FK20HQR10 (VOLVO)	S	-	-	VFKH20	S	-	S	140	IUF24	R	IUF24	R	-	-	-	-
31	FK20HQR10 (FOMOCO)	S	-	-	VFKH20	S	-	S	141	IUF27A	R	IUF27A	R	-	-	-	-
32	FK20HR11	S	-	-	VFKH20	S	-	S	142	IUF31A	R	IUF31A	R	-	-	-	-
33	FK20HR8-G	S	-	-	-	S	-	S	143	IUH24	R	IUH24	R	-	-	-	-
34	FK20HR11-G	S	-	-	-	S	-	S	144	IUH24D	T	IUH24	R	-	-	-	-
35	FXE16HE11	S	-	-	-	S	-	S	145	IUH27	R	IUH27	R	-	-	-	-
36	FXE20HE11C(OE)	S	-	-	-	S	-	S	146	IUH27D	T	IUH27	R	-	-	-	-
37	FXE20HE11C(AM)	S	-	-	-	S	-	S	147	IW01-24	RC	-	-	-	-	-	-
38	FXE20HE11 (AM)	S	-	-	VFXEH20E	S	-	S	148	IW01-27	RC	-	-	-	-	-	-
39	FXE20HE11 (OE)	S	-	-	VFXEH20E	S	-	S	149	IW01-29	RC	-	-	-	-	-	-
40	FXE20HR11 (AM)	S	-	-	VFXEH20	S	-	S	150	IW01-31	RC	-	-	-	-	-	-
41	FXE20HR11 (OE)	S	-	-	VFXEH20	S	-	S	151	IW01-32	RC	-	-	-	-	-	-
42	FXE20HR11 (OE)	S	-	-	VFXEH20	S	-	S	152	IW01-34	RC	-	-	-	-	-	-
43	FXE22HR11 (AM)	S	-	-	VFXEH22	S	-	S	153	IW06-27	S	-	-	-	-	-	-
44	FXE22HR11 (OE)	S	-	-	VFXEH22	S	-	S	154	IW06-31	S	-	-	-	-	-	-
45	FXE24HR11 (AM)	S	-	-	-	S	-	S	155	IW06-34	S	-	-	-	-	-	-
46	FXE24HR11 (OE)	S	-	-	-	S	-	S	156	IW16	RC	IW16	RC	VW16	S	-	-
47	FXU16HR11	S	-	-	-	S	-	S	157	IW20	RC	IW20	RC	VW20	S	-	-
48	FXU22HR11	S	-	-	-	S	-	S	158	IW22	RC	IW22	RC	VW22	S	-	-
49	FXU22HR8	S	-	-	-	S	-	S	159	IW24	RC	IW24	RC	-	-	-	-
50	GE3-F (For CNG)	S	-	-	-	S	-	S	160	IW27	RC	IW27	RC	-	-	-	-
51	GX8-1 (For CNG)	S	-	-	-	S	-	S	161	IW29	RC	IW29	RC	-	-	-	-
52	IA01-31	S	-	-	-	S	-	S	162	IW31	RC	IW31	RC	-	-	-	-
53	IA01-32	S	-	-	-	S	-	S	163	IW34	RC	IW34	RC	-	-	-	-
54	IA01-34	S	-	-	-	S	-	S	164	IWF16	R	IWF16	R	-	-	-	-
55	IAE01-32	S	-	-	-	S	-	S	165	IWF20	R	IWF20	R	-	-	-	-
56	IAE01-34	S	-	-	-	S	-	S	166	IWF22	R	IWF22	R	-	-	-	-
57	IK01-24	S	-	-	-	S	-	S	167	IWF24	R	IWF24	R	-	-	-	-
58	IK01-27	S	-	-	-	S	-	S	168	IWF27	R	IWF27	R	-	-	-	-
59	IK01-31	S	-	-	-	S	-	S	169	IWM01-29	S	-	-	-	-	-	-
60	IK01-34	S	-	-	-	S	-	S	170	IWM01-31	S	-	-	-	-	-	-
61	IK02-24	S	-	-	-	S	-	S	171	IWM01-32	S	-	-	-	-	-	-
62	IK02-31	S	-	-	-	S	-	S	172	IWM01-34	S	-	-	-	-	-	-
63	IK16	S	IK16	S	VK16	S	-	S	173	IWM24	S	IWM24	S	-	-	-	-
64	IK16G	S	IK16G	S	VK16G	S	-	S	174	IWM27	S	IWM27	S	-	-	-	-
65	IK20	S	IK20	S	VK20	S	-	S	175	IWM31	S	IWM31	S	-	-	-	-
66	IK20G	S	IK20G	S	VK20G	S	-	S	176	IX22	S	IX22	S	-	-	-	-
67	IK22	S	IK22	S	VK22	S	-	S	177	IX22B	R	IX22B	R	-	-	-	-
68	IK22G	S	IK22G	S	VK22G	S	-	S	178	IX24	R	IX24	R	-	-	-	-
69	IK24	S	IK24	S	-	S	-	S	179	IX24B	R	IX24B	R	-	-	-	-
70	IK24C11	S	IK24	S	-	S	-	S	180	IX27	R	IX27	R	-	-	-	-
71	IK27	S	IK27	S	-	S	-	S	181	IX27B	R	IX27B	R	-	-	-	-
72	IK27C11	S	IK27	S	-	S	-	S	182	IXG24	R	IXG24	R	-	-	-	-
73	IK31	S	IK31	S	-	S	-	S	183	IXG27	R	IXG27	R	-	-	-	-
74	IK34	S	IK34	S	-	S	-	S	184	IXU01-24	R	-	-	-	-	-	-
75	IKH01-24	S	-	-	-	S	-	S	185	IXU01-27	R	-	-	-	-	-	-
76	IKH01-27	S	-	-	-	S	-	S	186	IXU01-31	R	-	-	-	-	-	-
77	IKH01-31	S	-	-	-	S	-	S	187	IXU01-34	R	-	-	-	-	-	-
78	IKH16	S	IKH16	S	VKH16	S	-	S	188	IXU22	RC	IXU22	RC	VXU22	RC	-	-
79	IKH20	S	IKH20	S	VKH20	S	-	S	189	IXU22C	S	IXU22	RC	VXU22	RC	-	-
80	IKH22	S	IKH22	S	VKH22	S	-	S	190	IXU22HPR	S	IXUH22	S	VXUH22	S	-	-
81	IKH24	S	IKH24	S	-	S	-	S	191	IXU22I	S	IXU22I	S	VXU22I	S	-	-
82	IKH27	S	IKH27	S	-	S	-	S	192	IXU24	RC	IXU24	RC	VXU24	RC	-	-
83	IQ01-24	S	-	-	-	S	-	S	193	IXU27	RC	IXU27	RC	-	-	-	-
84	IQ01-27	S	-	-	-	S	-	S	194	IXUH20I	S	IXUH20I	S	VXUH20I	S	-	-
85	IQ01-31	S	-	-	-	S	-	S	195	IXUH22	S	IXUH22	S	VXUH22	S	-	-
86	IQ01-34	S	-	-	-	S	-	S	196	IXUH22I	S	IXUH22I	RC	VXUH22I	S	-	-
87	IQ02-24	S	-	-	-	S	-	S	197	IY24	S	IY24	S	-	-	-	-
88	IQ02-27	S	-	-	-	S	-	S	198	IY27	R	IY27	R	-	-	-	-
89	IQ02-31	S	-	-	-	S	-	S	199	IY31	R	IY31	R	-	-	-	-
90	IQ16	S	IQ16	S	VQ16	S	-	S	200	J14CR-U	S	IW16	RC	VW16	S	-	-
91	IQ20	S	IQ20	S	VQ20	S	-	S	201	J16AR-U11	S	-	-	-	-	-	-
92	IQ22	S	IQ22	S	VQ22	S	-	S	202	J16A-U11	S	-	-	-	-	-	-
93	IQ24	S	IQ24	S	-	S	-	S	203	J16AY	S	-	-	-	-	-	-
94	IQ27	S	IQ27	S	-	S	-	S	204	J16AYR	S	-	-	-	-	-	-
95	IQ31	S	IQ31	S	-	S	-	S	205	J16BR-U	S	-	-	-	-	-	-
96	IQ34	S	IQ34	S	-	S	-	S	206	J16BR-U11	S	-	-	-	-	-	-
97	IRE01-27	RC	-	-	-	S	-	S	207	J16B-U11	S	-	-	-	-	-	-
98	IRE01-31	RC	-	-	-	S	-	S	208	J16CR-U	S	IW16	RC	VW16	S	-	-
99	IRE01-32	RC	-	-	-	S	-	S	209	J16CR-U	S	IW16	RC	VW16	S	-	-
100	IRE01-34	RC	-	-	-	S	-	S	210	K16DTR-S11	S	-	-	-	-	-	-
101	IRE01-35	RC	-	-	-	S	-	S	211	K16GPR-U11	S	-	-	-	-	-	-
102	IRL01-27	S	-	-	-	S	-	S	212	K16HPR-U11	S	IKH16	S	VKH16	S	-	-
103	IRL01-31	S	-	-	-	S	-	S	213	K16HR-U11	S	IKH16	S	VKH16	S	-	-
104	IRT01-31	S	-	-													

DENSO → IRIIDIUM POWER, TOUGH, PLUS, T₂

PART NUMBER	CROSS REFERENCE	SMALL ENGINE	MOTOR CYCLE	EUROPE & USA	JAPAN	VIETNAM	THAILAND	TAIWAN	SINGAPORE	SAUDIARABIA	PHILIPPINES	MALAYSIA	KOREA	INDONESIA	INDIA	CHINA	AUSTRALIA	No.	DENSO	NUT	IRIDIUM POWER		IRIDIUM TOUGH/PLUS		T ₂		No.	DENSO	NUT	IRIDIUM POWER		IRIDIUM TOUGH/PLUS		T ₂		NUT		
																					NUT	IRIDIUM POWER	NUT	IRIDIUM TOUGH/PLUS	NUT	T ₂				NUT	T ₂	NUT	IRIDIUM POWER	NUT	IRIDIUM TOUGH/PLUS		NUT	T ₂
221																		221	K16PR-UR	S	IK16		VK16		K16TT	S	331	PK20R8	S	IK20		VK20T						
222																		222	K16PSR-B8	S	IK16		VK16		K16TT	S	332	PK20R8	S	IK20		VK20						
223																		223	K16P-U	S	IK16		VK16		K16TT	S	333	PK20R-P8	S	IK20		VK20						
224																		224	K16P-U11	S	IK16		VK16		K16TT	S	334	PK20TR11	S	IK20		VK20						
225																		225	K16R-U	S	-		VK20T		-	S	335	PK20TR11-G	S	IK20		VK20						
226																		226	K16R-U	S	-		VK20T		-	S	336	PK20TR8-G	S	IK20		VK20						
227																		227	K16R-U	S	IK16		VK16		K16TT	S	337	PK22PR11	S	IK22		VK22						
228																		228	K16R-U	S	IK16		VK16		K16TT	S	338	PK22PR8	S	IK22		VK22						
229																		229	K16R-U11	S	IK16		VK16		K16TT	S	339	PK22PR-L11S	S	IK22G		VK22G						
230																		230	K16TR11	S	IK16		VK16		K16TT	S	340	PKJ16CR8	S	IK16		VK16						
231																		231	K16TT	S	-		-		K16TT	S	341	PKJ16CR-L11	S	IK16		VK16						
232																		232	K16-U	S	IK16		VK16		K16TT	S	342	PKJ16CR-L13	S	IK16		VK16						
233																		233	K16-U11	S	IK16		VK16		K16TT	S	343	PKJ20CR8	S	IK20		VK20						
234																		234	K20BR-S10	S	IK20		VK20		K20TT	S	344	PKJ20CR-L11	S	IK20G		VK20G						
235																		235	K20DTR-S11	S	-		-		-	S	345	PKJ20CR-L11	S	IK20		VK20						
236																		236	K20HR-U11	S	IKH20		VKH20		K20TT	S	346	PKJ20CR-M11	S	IK20		VK20						
237																		237	K20PBR	R	IK20		VK20		K20TT	S	347	PQ16R	S	IQ16		VQ16						
238																		238	K20PBR-S 10	R	IK20		VK20		K20TT	S	348	PQ16R13	S	IQ16		VQ16						
239																		239	K20PR-L11	S	IK20		VK20		K20TT	S	349	PQ16R8	S	IQ16		VQ16						
240																		240	K20PR-SU9	S	IK20		VK20		K20TT	S	350	PQ16R-P11	S	IQ16		VQ16						
241																		241	K20PR-TP11	S	IK20		VK20		K20TT	S	351	PQ20R	S	IQ20		VQ20						
242																		242	K20PR-U	R	-		VK20T		-	S	352	PQ20R13	S	IQ20		VQ20						
243																		243	K20PR-U	R	-		VK20Y		-	S	353	PQ20R8	S	IQ20		VQ20						
244																		244	K20PR-U	S	-		VK20T		-	S	354	PQ20R-P11	S	IQ20		VQ20						
245																		245	K20PR-U	S	-		VK20Y		-	S	355	PQ20R-P8	S	IQ20		VQ20						
246																		246	K20PR-U	R	IK20		VK20		K20TT	S	356	PT16EPR10	S	IT16		VT16						
247																		247	K20PR-U	S	IK20		VK20		K20TT	S	357	PT16EPR13	S	IT16		VT16						
248																		248	K20PR-U11	S	IK20		VK20		K20TT	S	358	PT16EPR-L13	S	IT16		VT16						
249																		249	K20PR-U11	S	IK20		VK20		K20TT	S	359	PT16VR10	S	ITV16		-						
250																		250	K20PR-U8S	S	IK20G		VK20G		-	S	360	PT16VR13	S	ITV16		-						
251																		251	K20PR-U9S	S	IK20G		VK20G		-	S	361	PTJ14R15	S	IT16		VT16						
252																		252	K20PR-UR	S	IK20		VK20		K20TT	S	362	PTJ16R15	S	IT16		VT16						
253																		253	K20PSR-B8	S	IK20		VK20		K20TT	S	363	Q14R-U11	S	IQ16		VQ16						Q16TT
254																		254	K20P-U	S	IK20		VK20		K20TT	S	364	Q16PR-TP11	S	IQ16		VQ16						Q16TT
255																		255	K20R-U	S	IK20		VK20		K20TT	S	365	Q16PR-U	S	IQ16		VQ16						Q16TT
256																		256	K20R-U11	S	IK20		VK20		K20TT	S	366	Q16PR-U	R	IQ16		VQ16						Q16TT
257																		257	K20TNR	S	IK20		VK20		K20TT	S	367	Q16PR-U11	S	IQ16		VQ16						Q16TT
258																		258	K20TR11	S	IK20		VK20		K20TT	S	368	Q16PR-U11	R	IQ16		VQ16						Q16TT
259																		259	K20TT	S	-		-		K20TT	S	369	Q16PR-U15	S	IQ16		VQ16						Q16TT
260																		260	K20TXR	R	IK20		VK20		K20TT	S	370	Q16P-U11	S	IQ16		VQ16						Q16TT
261																		261	K20-U	S	IK20		VK20		K20TT	S	371	Q16-U11	R	IQ16		VQ16						Q16TT
262																		262	K20-U11	S	IK20		VK20		K20TT	S	372	Q16R-U	S	IQ16		VQ16						Q16TT
263																		263	K22PB	S	IK22		VK22		K20TT	S	373	Q16R-U11	S	IQ16		VQ16						Q16TT
264																		264	K22PBR-S	R	IK22		VK22		-	S	374	Q16-U	S	IQ16		VQ16						Q16TT
265																		265	K22PR-L11	S	IK22		VK22		-	S	375	Q16-U11	S	IQ16		VQ16						Q16TT
266																		266	K22PR-U	R	IK22		VK22		-	S	376	Q20PR-U	S	IQ20		VQ20						Q20TT
267																		267	K22PR-U11	S	IK22		VK22		-	S	377	Q20PR-U	S	IQ20		VQ20						Q20TT
268																		268	K22PR-UR	S	IK22		VK22		-	S	378	Q20PR-U11	S	IQ20		VQ20						Q20TT
269																		269	K22TM11	S	IK22		VK22		-	S	379	Q20PR-U11	S	IQ20		VQ20						Q20TT
270																		270	K22TMR11	S	IK22		VK22		-	S	380	Q20P-U	R	IQ20		VQ20						Q20TT
271																		271	K22TNR-S	S	IK22		VK22		-	S	381	Q20P-U11	S	IQ20		VQ20						Q20TT
272																		272	K24PR-U11	S	IK24		-		-	S	382	Q20P-U11	R	IQ20		VQ20						Q20TT
273																		273	KJ14CR11	S	IK16		VK16		K16TT	S	383	Q20R-U	S	IQ20		VQ20						Q20TT
274																		274	KJ14CR-L11	S	IK16		VK16		K16TT	S	384	Q20R-U11	S	IQ20		VQ20						Q20TT
275																		275	KJ16CR	S	IK16		VK16		K16TT	S	385	Q20-U	S	IQ20		VQ20						Q20TT
276																		276	KJ16CR11	S	-		VK20T		-	S	386	Q20-U11										

DENSO → IRIIDIUM POWER, TOUGH, PLUS, T_T

No.	DENSO	NUT	IRIDIUM POWER	NUT	IRIDIUM TOUGH/PLUS	NUT	T _T	NUT	No.	DENSO	NUT	IRIDIUM POWER	NUT	IRIDIUM TOUGH/PLUS	NUT	T _T	NUT
441	SK20R-B5	S	-	-	-	-	-	-	551	VFKB16	S	-	-	VFKB16	S	-	-
442	SK20R-P11	S	IK20	S	VK20	S	-	-	552	VFKBH20	S	-	-	VFKBH20	S	-	-
443	SK20R-P13	S	IK20	S	VK20	S	-	-	553	VFKH16	S	-	-	VFKH16	S	-	-
444	SK22PR-M11	S	IK22	S	VK22	S	-	-	554	VFKH20	S	-	-	VFKH20	S	-	-
445	SK22PR-M11S	S	IK22G	S	VK22G	S	-	-	555	VFXEH20	S	-	-	VFXEH20	S	-	-
446	SKJ16CR-A8	S	IK16	S	VK16	S	-	-	556	VFXEH20E	S	-	-	VFXEH20E	S	-	-
447	SKJ16CR-L11	S	IK16	S	VK16	S	-	-	557	VFXEH22	S	-	-	VFXEH22	S	-	-
448	SKJ16DR-M11	S	IK16	S	VK16	S	-	-	558	VFXEHC22G	S	-	-	VFXEHC22G	S	-	-
449	SKJ20CR-A8	S	IK20	S	VK20	S	-	-	559	VFXUHC22FG	S	-	-	VFXUHC22FG	S	-	-
450	SKJ20DR-M11	S	IK20	S	VK20	S	-	-	560	VK16	IK16	S	-	VK16	S	-	-
451	SKJ20DR-M11S	S	IK20G	S	VK20G	S	-	-	561	VK16G	IK16G	S	-	VK16G	S	-	-
452	SKJ20DR-M11S	S	IK20G	S	VK20G	S	-	-	562	VK16PRZ11	IK16	S	-	-	S	-	-
453	SKJ20DR-M13	S	IK20	S	VK20	S	-	-	563	VK20	IK20	S	-	VK20	S	-	-
454	SKJ20DR-M13	S	IK20	S	VK20	S	-	-	564	VK20G	IK20G	S	-	VK20G	S	-	-
455	SVK20RZ11	S	IK20	S	VK20	S	-	-	565	VK20PRZ11	IK20	S	-	-	S	-	-
456	SVK20RZ8	S	-	-	VK20Y	S	-	-	566	VK20T	-	S	-	VK20T	S	-	-
457	SXE22HQR11S	-	-	-	-	-	-	-	567	VK22	IK22	S	-	VK22	S	-	-
458	SXU16HPR9	-	-	-	-	-	-	-	568	VK22G	IK22G	S	-	VK22G	S	-	-
459	SXU22HCR8S	-	-	-	-	-	-	-	569	VK22PRZ11	IK22	S	-	-	S	-	-
460	SXU22HCR11	-	IXUH22I	S	VXUH22I	S	-	-	570	VK24PRZ11	IK24	S	-	-	S	-	-
461	SXU22HCR11S	-	-	-	-	-	-	-	571	VK27PRZ11	IK27	S	-	-	S	-	-
462	SXU22HDR8	-	IXUH22	S	VXUH22	S	-	-	572	VKA16	-	S	-	VKA16	S	-	-
463	SXU22HPR11	-	IXUH22I	S	VXUH22I	S	-	-	573	VKA20	-	S	-	VKA20	S	-	-
464	SXU22HPR9	-	IXUH22I	S	VXUH22I	S	-	-	574	VKB16	-	S	-	VKB16	S	-	-
465	SXU22PR9	-	IXU22	RC	VXU22	RC	-	-	575	VKB20	-	S	-	VKB20	S	-	-
466	SXU22PR-A9	-	IXU22	RC	VXU22	RC	-	-	576	VKH16	IKH16	S	-	VKH16	S	-	-
467	T14PR-U	-	ITF16	S	-	-	-	-	577	VKH20	IKH20	S	-	VKH20	S	-	-
468	T14PR-U15	-	ITF16	S	-	-	-	-	578	VKH20T	-	S	-	VKH20T	S	-	-
469	T16EPR-U	R	IT16	S	VT16	S	T16TT	S	579	VKH20Y	-	S	-	VKH20Y	S	-	-
470	T16EPR-U15	R	IT16	S	VT16	S	T16TT	S	580	VKH22	IKH22	RC	-	VKH22	S	-	-
471	T16NR-U11	-	IT16	S	VT16	S	T16TT	S	581	VKJ20RZ-M11	-	-	-	-	-	-	-
472	T16PR-U	-	ITF16	S	-	-	-	-	582	VNH24Z	-	-	-	-	-	-	-
473	T16PR-U11	-	ITF16	S	-	-	-	-	583	VNH27Z	-	-	-	-	-	-	-
474	T16PR-U15	-	ITF16	S	-	-	-	-	584	VQ16	IQ16	S	-	VQ16	S	-	-
475	T16P-U	-	ITF16	S	-	-	-	-	585	VQ20	IQ20	S	-	VQ20	S	-	-
476	T16R-U	-	-	-	-	-	-	-	586	VQ22	IQ22	S	-	VQ22	S	-	-
477	T16R-U15	-	-	-	-	-	-	-	587	VSUEH22	-	S	-	VSUEH22	S	-	-
478	T16-U15	-	-	-	-	-	-	-	588	VT16	IT16	S	-	VT16	S	-	-
479	T16VR-U10	-	ITV16	S	-	-	TV16TT	S	589	VT20	IT20	S	-	VT20	S	-	-
480	T20EPR-U	R	IT20	S	VT20	S	T20TT	S	590	VUH24D	IUH24	R	-	-	-	-	-
481	T20EPR-U15	R	IT20	S	VT20	S	T20TT	S	591	VUH27D	IUH27	R	-	-	-	-	-
482	T20EP-U	R	IT20	S	VT20	S	T20TT	S	592	VUH24ES	IUH24	R	-	-	-	-	-
483	T20EP-U15	R	IT20	S	VT20	S	T20TT	S	593	VUH27ES	IUH27	R	-	-	-	-	-
484	T20MP-U	R	-	-	-	-	-	-	594	VW16	RC	IW16	S	VW16	S	-	-
485	T20M-U	R	-	-	-	-	-	-	595	VW16R-A13	RC	IW16	S	VW16	S	-	-
486	T20NR-U11	-	IT20	S	VT20	S	T20TT	S	596	VW20	RC	IW20	S	VW20	S	-	-
487	T20PR-U	-	ITF20	S	-	-	-	-	597	VW20T	-	S	-	VW20T	S	-	-
488	T20PR-U11	-	ITF20	S	-	-	-	-	598	VW22	RC	IW22	S	VW22	S	-	-
489	T20PR-U15	-	ITF20	S	-	-	-	-	599	VX22BC	R	IX22B	-	-	-	-	-
490	T20P-U	-	ITF20	S	-	-	-	-	600	VXEBH27	-	-	-	VXEBH27	-	-	-
491	T20R-U	-	-	-	-	-	-	-	601	VXEHC24G	-	-	-	VXEHC24G	-	-	-
492	T22EP-U	R	IT22	S	-	-	-	-	602	VXU20	-	-	-	VXU20	-	-	-
493	T22MP-U	R	-	-	-	-	-	-	603	VXU22	RC	IXU22	RC	VXU22	RC	-	-
494	T22M-U	R	-	-	-	-	-	-	604	VXU24	RC	IXU24	RC	VXU24	RC	-	-
495	TJ14R-P15	R	IT16	S	VT16	S	T16TT	S	605	VXU22I	S	IXU22I	S	VXU22I	S	-	-
496	TR22-10	R	IWF22	S	-	-	-	-	606	VXUH22	S	IXUH22	S	VXUH22	S	-	-
497	U14FSR-UB	S	IUF14-UB	S	-	-	-	-	607	VXUH20I	S	IXUH20I	S	VXUH20I	S	-	-
498	U14FS-UB	S	IUF14-UB	S	-	-	-	-	608	VXUH22I	S	IXUH22I	S	VXUH22I	S	-	-
499	U16FER9	T	-	-	-	-	-	-	609	VXUHC22G	-	-	-	VXUHC22G	-	-	-
500	U16FSR-U	T	-	-	-	-	-	-	610	W14E	-	-	-	-	-	-	-
501	U16FSR-UB	S	-	-	-	-	-	-	611	W14EKR-511	-	-	-	-	-	-	-
502	U16FS-U	S	-	-	-	-	-	-	612	W14EPR-U	IW16	RC	VW16	RC	VW16	S	W16TT
503	U16FS-UB	S	-	-	-	-	-	-	613	W14EP-U	IW16	RC	VW16	RC	VW16	S	W16TT
504	U20EPR9	T	IU20	R	-	-	-	-	614	W14EXR-U	IW16	RC	VW16	RC	VW16	S	W16TT
505	U20ESR-N	T	IU20	R	-	-	-	-	615	W14EXR-U11	IW16	RC	VW16	RC	VW16	S	W16TT
506	U20ESR-N	T	IU20	R	-	-	-	-	616	W14EXR-U13	IW16	RC	VW16	RC	VW16	S	W16TT
507	U20FSR-U	T	IUF22	R	-	-	-	-	617	W14EX-U	IW16	RC	VW16	RC	VW16	S	W16TT
508	U20FS-U	T	IUF22	R	-	-	-	-	618	W14EX-U	IW16	RC	VW16	RC	VW16	S	W16TT
509	U22EPR9	T	IU22	R	-	-	-	-	619	W14EX-U11	IW16	RC	VW16	RC	VW16	S	W16TT
510	U22EPR9	T	IU24A(High Speed)	R	-	-	-	-	620	W14FP-L	IWF16	R	-	-	-	-	-
511	U22EPR9	T	IU24D(High Speed)	R	-	-	-	-	621	W14FPR-U	IWF16	R	-	-	-	-	-
512	U22ES-N	T	IU22	R	-	-	-	-	622	W14FPR-UL	IWF16	R	-	-	-	-	-
513	U22ESR-N	T	IU22	R	-	-	-	-	623	W14FPR-UL10	IWF16	R	-	-	-	-	-
514	U22ESR-N	T	IU22	R	-	-	-	-	624	W14FP-U	IWF16	R	-	-	-	-	-
515	U22ETR	T	-	-	-	-	-	-	625	W14FP-UL	IWF16	R	-	-	-	-	-
516	U22ETR	T	-	-	-	-	-	-	626	W14FP-UL10	IWF16	R	-	-	-	-	-
517	U22FER9	T	-	-	-	-	-	-	627	W14FR-L	IWF16	R	-	-	-	-	-
518	U22FSR-U	T	IUF22	R	-	-	-	-	628	W14FR-U	-	-	-	-	-	-	-
519	U22FS-U	T	IUF22	R	-	-	-	-	629	W14F-U	-	-	-	-	-	-	-
520	U24EPR9	T	IU24A	R	-	-	-	-	630	W14F-U	-	-	-	-	-	-	-
521	U24ES-N	T	IU24	R	-	-	-	-	631	W14L	-	-	-	-	-	-	-
522	U24ESR-N	T	IU24	R	-	-	-	-	632	W14LM-U	-	-	-	-	-	-	-
523	U24ESR-N	T	IU24	R	-	-	-	-	633	W14LM-US	-	-	-	-	-	-	-
524	U24ESR-NB	T	IU24	R	-	-	-	-	634	W14MPR-U10	-	-	-	-	-	-	-
525	U24ETR	T	IU24A	R	-	-	-	-	635	W14MP-U10	-	-	-	-	-	-	-
526	U24ETR	T	IU24A	R	-	-	-	-	636	W14MR-U	-	-	-	-	-	-	-
527	U24FE9	T	IUH24	R	-	-	-	-	637	W14M-U	-	-	-	-	-	-	-
528	U24FER9	T	IUH24	R	-	-	-	-	638	W14PR-U	-	-	-	-	-	-	-
529	U24FER9S	T	IUH24	R	-	-	-	-	639	W14-U	-	-	-	-	-	-	-
530	U24FSR-U	T	IUF24	R	-	-	-	-	640	W16DTR-S	-	-	-	-	-	-	-
531	U24FS-U	T	IUF24	R	-	-	-	-	641	W16EKR-511	IW16	RC	VW16	RC	VW16	S	W16TT
532	U27ES-N	T	IU27	R	-	-	-	-	642	W16EP	IW16	RC	VW16	RC	VW16	S	W16TT
533	U27ESR-N	T	IU27	R	-	-	-	-	643	W16EP11	IW16	RC	VW16	RC	VW16	S	W16TT
534	U27ESR-N	T	IU27	R	-	-	-	-	644	W16EPB 10	IW16	RC	VW16	RC	VW16	S	W16TT
535	U27ESR-NB	S	IU27	R	-	-	-	-	645	W16EPR	IW16	RC	VW16	RC	VW16	S	W16TT
536	U27ETR	T	IU27A	R	-	-	-	-	646	W16EPR	IW16	RC	VW16	RC	VW16	S	W16TT
537	U27ETR	T	IU27A	R	-	-	-	-	647	W16EPR11	IW16	RC	VW16	RC	VW16	S	W16TT
538	U27FER9	T	IUH27	R	-	-	-	-	648	W16EPR-U	IW16	RC	VW16	RC	VW16	S	W16TT
539	U31ESR-N	T	IU31	R	-	-	-	-	649	W16EPR-U	IW16	RC	VW16	RC	VW16	S	W16TT
540	U31ESR-N	T	IU31	R													

DENSO → IRIIDIUM POWER, TOUGH, PLUS, T

PART NUMBER	CROSS REFERENCE	SMALL ENGINE	MOTOR CYCLE	EUROPE & USA	JAPAN	VIETNAM	THAILAND	TAIWAN	SINGAPORE	SAUDIARABIA	PHILIPPINES	MALAYSIA	KOREA	INDONESIA	INDIA	CHINA	AUSTRALIA	DENSO			
																		No.	DENSO	NUT	IRIDIUM POWER
661	W16EXR-U11	S	IW16	RC	VW16	S	W16TT	RC	771	W24EP	R	IW24	RC	-	-	-	-	-			
662	W16EXR-U11	S	IW16	RC	VW16	S	W16TT	RC	772	W24EPR	R	IW24	RC	-	-	-	-	-			
663	W16EXR-U13	S	IW16	RC	VW16	S	W16TT	RC	773	W24EPR-U	R	IW24	RC	-	-	-	-	-			
664	W16EX-U	S	IW16	RC	VW16	S	W16TT	RC	774	W24EP-U	R	IW24	RC	-	-	-	-	-			
665	W16EX-U	S	IW16	RC	VW16	S	W16TT	RC	775	W24ESR	S	IW24	RC	-	-	-	-	-			
666	W16EX-U11	S	IW16	RC	VW16	S	W16TT	RC	776	W24ESR-U	S	IW24	RC	-	-	-	-	-			
667	W16EX-U11	S	IW16	RC	VW16	S	W16TT	RC	777	W24ESR-V	S	IW24	RC	-	-	-	-	-			
668	W16EX-U13	S	IW16	RC	VW16	S	W16TT	RC	778	W24ES-U	R	IW24	RC	-	-	-	-	-			
669	W16FPR-U	R	IWF16	R	-	-	-	-	779	W24ES-V	R	IW24	RC	-	-	-	-	-			
670	W16FP-U	R	IWF16	R	-	-	-	-	780	W24FPR	R	IWF24	R	-	-	-	-	-			
671	W16FP-U10	S	IWF16	R	-	-	-	-	781	W24FPR-U10	R	IWF24	R	-	-	-	-	-			
672	W16FSR	R	-	-	-	-	-	-	782	W24FP-U	R	IWF24	R	-	-	-	-	-			
673	W16FS-U	R	-	-	-	-	-	-	783	W24FR-L	T	IWF24	R	-	-	-	-	-			
674	W16LS	R	-	-	-	-	-	-	784	W24FSR	R	IWF24	R	-	-	-	-	-			
675	W16PR-U	R	-	-	-	-	-	-	785	W24FSR-U10	R	IWF24	R	-	-	-	-	-			
676	W16S-U	R	-	-	-	-	-	-	786	W24FS-U	R	IWF24	R	-	-	-	-	-			
677	W16TT	RC	-	-	-	-	W16TT	RC	787	W24FS-U10	R	IWF24	R	-	-	-	-	-			
678	W20DTR-S	S	-	-	-	-	-	-	788	W24S-U	R	-	-	-	-	-	-	-			
679	W20DTR-SA	S	-	-	-	-	-	-	789	W25EDR14	S	-	-	-	-	-	-	-			
680	W20EAR	S	-	-	-	-	-	-	790	W27EBR	S	-	-	-	-	-	-	-			
681	W20EKR-S11	S	IW20	RC	VW20	S	W20TT	RC	791	W27EDR14	S	-	-	-	-	-	-	-			
682	W20EP	S	IW20	RC	VW20	S	W20TT	RC	792	W27EDR14	R	-	-	-	-	-	-	-			
683	W20EP11	S	-	-	VW20T	S	-	-	793	W27EMR-C	S	IWM27	S	-	-	-	-	-			
684	W20EP11	S	IW20	RC	VW20	S	W20TT	RC	794	W27ESR	S	IW27	RC	-	-	-	-	-			
685	W20EPB	R	IW20	RC	VW20	S	W20TT	RC	795	W27ESR-U	S	IW27	RC	-	-	-	-	-			
686	W20EPBR-S	R	IW20	RC	VW20	S	W20TT	RC	796	W27ESR-V	S	IW27	RC	-	-	-	-	-			
687	W20EPR	R	IW20	RC	VW20	S	W20TT	RC	797	W27ES-U	R	IW27	RC	-	-	-	-	-			
688	W20EPR11	S	IW20	RC	VW20	S	W20TT	RC	798	W27ES-V	R	IW27	RC	-	-	-	-	-			
689	W20EPR-S11	S	IW20	RC	VW20	S	W20TT	RC	799	W27FSR	R	IWF27	R	-	-	-	-	-			
690	W20EPR-U	S	IW20	RC	VW20	S	W20TT	RC	800	W27FSR-U10	R	IWF27	R	-	-	-	-	-			
691	W20EPR-U	S	IW20	RC	VW20	S	W20TT	RC	801	W27FS-U	R	IWF27	R	-	-	-	-	-			
692	W20EPR-U10	S	IW20	RC	VW20	S	W20TT	RC	802	W27FS-U10	R	IWF27	R	-	-	-	-	-			
693	W20EPR-U11	S	IW20	RC	VW20	S	W20TT	RC	803	W27S-U	R	-	-	-	-	-	-				
694	W20EP-S11	S	IW20	RC	VW20	S	W20TT	RC	804	W29EBR	S	-	-	-	-	-	-				
695	W20EP-U	S	IW20	RC	VW20	S	W20TT	RC	805	W31ESR-U	R	IW31	RC	-	-	-	-	-			
696	W20EP-U	S	IW20	RC	VW20	S	W20TT	RC	806	W31ES-U	R	IW31	RC	-	-	-	-	-			
697	W20EP-U11	S	IW20	RC	VW20	S	W20TT	RC	807	W31FS	R	-	-	-	-	-	-	-			
698	W20ESR-U	R	-	-	-	-	-	-	808	W31S-U	R	-	-	-	-	-	-	-			
699	W20ES-U	R	-	-	-	-	-	-	809	W9EP	S	-	-	-	-	-	-	-			
700	W20ETR-L	S	IW20	RC	VW20	S	W20TT	RC	810	W9EP	R	-	-	-	-	-	-	-			
701	W20ET-S	S	IW20	RC	VW20	S	W20TT	RC	811	W9EXR-U	S	-	-	-	-	-	-	-			
702	W20EXR-U	S	-	-	VW20T	S	-	-	812	W9EXR-U	S	-	-	-	-	-	-	-			
703	W20EXR-U	S	-	-	VW20T	S	-	-	813	W9EX-U	S	-	-	-	-	-	-	-			
704	W20EXR-U	S	IW20	RC	VW20	S	W20TT	RC	814	W9FP	T	-	-	-	-	-	-	-			
705	W20EXR-U	R	IW20	RC	VW20	S	W20TT	RC	815	W9FP	R	-	-	-	-	-	-	-			
706	W20EXR-U11	S	-	-	VW20T	S	-	-	816	W9FP-UL	R	-	-	-	-	-	-	-			
707	W20EXR-U11	S	-	-	VW20T	S	-	-	817	W9LMR-US	R	-	-	-	-	-	-	-			
708	W20EXR-U11	S	IW20	RC	VW20	S	W20TT	RC	818	W9LM-US	R	-	-	-	-	-	-	-			
709	W20EXR-U11	S	IW20	RC	VW20	S	W20TT	RC	819	W9PR-U	R	-	-	-	-	-	-	-			
710	W20EXR-U13	S	IW20	RC	VW20	S	W20TT	RC	820	W9P-U	R	-	-	-	-	-	-	-			
711	W20EX-U	S	-	-	VW20T	S	-	-	821	W9-U	R	-	-	-	-	-	-	-			
712	W20EX-U	S	-	-	VW20T	S	-	-	822	X16EPR-U9	T	-	-	-	-	-	-	-			
713	W20EX-U	S	IW20	RC	VW20	S	W20TT	RC	823	X16FSR-U	T	-	-	-	-	-	-	-			
714	W20EX-U	S	IW20	RC	VW20	S	W20TT	RC	824	X20EPR-U9	T	-	-	-	-	-	-	-			
715	W20EX-U11	S	IW20	RC	VW20	S	W20TT	RC	825	X20ESR-U	T	-	-	-	-	-	-	-			
716	W20EX-U11	S	IW20	RC	VW20	S	W20TT	RC	826	X20ES-U	T	-	-	-	-	-	-	-			
717	W20EX-U13	S	IW20	RC	VW20	S	W20TT	RC	827	X20FSR-U	T	-	-	-	-	-	-	-			
718	W20FP	R	IWF20	R	-	-	WF20TT	RC	828	X20FS-U	T	-	-	-	-	-	-	-			
719	W20FP-L	R	IWF20	R	-	-	WF20TT	RC	829	X22EPR-U9	T	IX22B	R	-	-	-	-	-			
720	W20FPR	R	IWF20	R	-	-	WF20TT	RC	830	X22EP-U9	T	IX22B	R	-	-	-	-	-			
721	W20FPR-U	R	IWF20	R	-	-	WF20TT	RC	831	X22ESR-U	T	IX22	R	-	-	-	-	-			
722	W20FPR-U10	R	IWF20	R	-	-	WF20TT	RC	832	X22ESR-UB	S	IX22	R	-	-	-	-	-			
723	W20FP-U	R	IWF20	R	-	-	WF20TT	RC	833	X22ES-U	T	IX22	R	-	-	-	-	-			
724	W20FP-U10	R	IWF20	R	-	-	WF20TT	RC	834	X24EPR-U9	T	IX24B	R	-	-	-	-	-			
725	W20FR-L	T	IWF20	R	-	-	WF20TT	RC	835	X24EP-U9	T	IX24B	R	-	-	-	-	-			
726	W20FR-L9	T	IWF20	R	-	-	WF20TT	RC	836	X24ESR-U	T	IX24	R	-	-	-	-	-			
727	W20FS	R	IWF22	R	-	-	-	-	837	X24ES-U	T	IX24	R	-	-	-	-	-			
728	W20FSR	R	IWF22	R	-	-	-	-	838	X24FS-U	T	-	-	-	-	-	-	-			
729	W20FSR-U	R	IWF22	R	-	-	-	-	839	X24GPR-U	T	IXG24	R	-	-	-	-	-			
730	W20FS-U	R	IWF22	R	-	-	-	-	840	X24GP-U	T	IXG24	R	-	-	-	-	-			
731	W20MPR-U10	R	-	-	-	-	-	-	841	X27EPR-U9	T	IX27B	R	-	-	-	-	-			
732	W20MP-U	R	-	-	-	-	-	-	842	X27EP-U9	T	IX27B	R	-	-	-	-	-			
733	W20MP-U10	R	-	-	-	-	-	-	843	X27ESR-U	T	IX27	R	-	-	-	-	-			
734	W20MR-U	R	-	-	-	-	-	-	844	X27ES-U	T	IX27	R	-	-	-	-	-			
735	W20M-U	R	-	-	-	-	-	-	845	X27ETR	T	IX27	R	-	-	-	-	-			
736	W20M-US	R	-	-	-	-	-	-	846	X27GPR-U	T	IXG27	R	-	-	-	-	-			
737	W20PR-U	R	-	-	-	-	-	-	847	X31ESR-U	T	-	-	-	-	-	-	-			
738	W20P-U	R	-	-	-	-	-	-	848	X31ES-U	T	-	-	-	-	-	-	-			
739	W20SR-U	R	-	-	-	-	-	-	849	X31ETR	T	-	-	-	-	-	-	-			
740	W20S-U	R	-	-	-	-	-	-	850	XE20HR-U9	S	-	-	-	-	-	-	-			
741	W22EBR	S	-	-	-	-	-	-	851	XU20EPR-U	S	IXU22	RC	VFXEH20	S	-	-	-			
742	W22EKR-S11	S	IW22	RC	VW22	S	W22TT	RC	852	XU20HR9	S	IXUH20I	RC	VXU22	RC	XUH20TTI	S	-			
743	W22EP	S	IW22	RC	VW22	S	W22TT	RC	853	XU22EP-P	S	IXU22	RC	VXU22	RC	-	-	-			
744	W22EP	S	IW22	RC	VW22	S	W22TT	RC	854	XU22EPR-U	S	IXU22	RC	VXU22	RC	-	-	-			
745	W22EPB	R	IW22	RC	VW22	S	W22TT	RC	855	XU22EP-U	S	IXU22	RC	VXU22	RC	-	-	-			
746	W22EPR	R	IW22	RC	VW22	S	W22TT	RC	856	XU22HDR9	S	IXUH22	S	VXUH22	S	-	-	-			
747	W22EPR11	S	IW22	RC	VW22	S	W22TT	RC	857	XU22HR9	S	IXUH22I	S	VXUH22I	S	-	-	-			
748	W22EPR-U	S	IW22	RC	VW22	S	W22TT	RC	858	XU22PR9	S	IXU22	RC	VXU22	RC	-	-	-			
749	W22EPR-U	S	IW22	RC	VW22	S	W22TT	RC	859	XU22TT	S	-	-	-	-	-	-	-			
750	W22EPR-U11	S	IW22	RC	VW22	S	W22TT	RC	860	XU24EPR-U	S	-	-	-	-	-	-	-			
751	W22EP-S11	S	IW22	RC	VW22	S	W22TT	RC	861	XU24EPR-U	R	IXU24	RC	VXU24	RC	-	-	-			
752	W22EP-U	S	IW22	RC	VW22	S	W22TT	RC	862	XU24EP-U	S	IXU24	RC	VXU24	RC	-	-	-			
753	W22EP-U11	S	IW22	RC	VW22	S	W22TT	RC	863	XU27EPR-U	S	IXU27	RC	-	-	-	-	-			
754	W22ESR	R	-	-	-	-	-														

IRIDIUM POWER, TOUGH, RACING CHART

DIA. xREACH Hex	IRIDIUM POWER (φ0.4mm)			IRIDIUM TOUGH (φ0.4mm)			IRIDIUM RACING (φ0.4mm)		
	PLUG	PART NUMBER	NUT	PLUG	PART NUMBER	NUT	PLUG	PART NUMBER	NUT
M14x19 16HEX	IK16	067700-8681	S	VK16	267700-0711	S	IK01-24 IK02-24 IK01-27 IK02-27 IK01-31 IK02-31 IK01-34	267700-1311 267700-1361 267700-1321 267700-1371 267700-1331 267700-1381 267700-1341	S S S S S S S
	IK20	067700-8691	S	VK20	267700-0721	S			
	IK22	067700-8431	S	VK22	267700-0731	S			
	IK24	067700-8461	S						
	IK27	067700-8471	S						
	IK31	067700-9221	S						
	IK34	067700-9591	S						
M14x19 16HEX STAINLESS GASKET	IK16G	267700-5611	S	VK16G	267700-5631	S			
	IK20G	267700-5621	S	VK20G	267700-5641	S			
	IK22G	267700-5661	S	VK22G	267700-5671	S			
M14x19 16HEX DOUBLE NEEDLEIRIDIUM				VFK16	267700-9151	S			
				VFK20F	267700-9161	S			
M14x19 16HEX NEW3ELECTRODE DOUBLE NEEDLE IRIIDIUM				VFKB16	267700-9271	S			
M14x22,16HEX NEW3ELECTRODE,SHROUD				VKA16	267700-5031	S			
				VKA20	267700-5041	S			
M14x19,16HEX NEW3ELECTRODE				VKB16	267700-5051	S			
				VKB20	267700-5061	S			
M14x26.5 16HEX DOUBLE NEEDLEIRIDIUM				VFKH16	267700-7411	S			
				VFKH20	267700-7421	S			
				VDKH16T	267700-8920	S			
				VDKH22F	267700-8751	S			
M14x26.5, 16HEX NEW3ELECTRODE DOUBLE NEEDLE IRIIDIUM			S	VFKBH20	267700-7661	S			
M14x26.5 16HEX	IKH16 IKH20	267700-3661	S	VKH16	267700-3681	S	IKH01-24 IKH01-27 IKH01-31	267700-4451 267700-4461 267700-4471	S S S S S
		267700-3671	S	VKH20	267700-3691	S			
	IKH22 IKH24 IKH27	267700-2651	S	VKH20Y	267700-4541	S			
		267700-4281	S	VKH22	267700-2681	S			
		267700-4291	S						
M14x19 16HEX	IQ16 IQ20 IQ22 IQ24	067700-8701	S	VQ16	267700-0741	S	IQ01-24 IQ02-24 IQ01-27 IQ02-27 IQ01-31 IQ02-31 IQ01-34	267700-1411 267700-1461 267700-1421 267700-1471 267700-1431 267700-1481 267700-1441	S S S S S S S
		067700-8711	S	VQ20	267700-0751	S			
		067700-8481	S	VQ22	267700-0761	S			
	067700-8491	S							
	IQ27	067700-8502	S						
	IQ31	067700-9231	S						
M14x19 20.6HEX	IW16 IW20 IW22 IW24 IW27 IW29 IW31 IW34	067700-8651	RC	VW16	267700-0771	S	IW01-24 IW01-27 IW01-29 IW01-31 IW01-32 IW01-34	267700-1111 267700-1121 267700-1131 267700-1141 267700-1151 267700-1161	RC RC RC RC RC RC RC
		067700-8661	RC	VW20	267700-0781	S			
		067700-8671	RC	VW22	267700-0791	S			
		067700-8891	RC						
		067700-8901	RC						
		067700-8911	RC						
		067700-8921	RC						
067700-8931	RC								
M14x19 20.6HEX NON-RESISTOR							IW06-27 IW06-31 IW06-34	067600-1811 067600-1821 067600-1831	S S S
M14x21.5 20.6HEX ROTARY							IRE01-27 IRE01-31 IRE01-32 IRE01-34 IRE01-35	267700-1521 267700-1531 267700-1541 267700-1551 267700-1561	S S S S S
							IRT01-31 IRT01-34	267700-4841 267700-4851	S S
							IRL01-27 IRL01-31	267700-4821 267700-4831	S S
M14x25 16HEX TAPER SEAT LONG INSULATOR50mm	ITV16	267700-3701	S						
	ITV20	267700-3711	S						
	ITV22	267700-2501	S						
	ITV24	267700-2511	S						
	ITV27	267700-2521	S						
M14x25x16HEX TAPER SEAT LONG INSULATOR56mm	ITL16	267700-4981	S						
	ITL20	267700-4991	S						
M14x17.5 16HEX TAPER SEAT	IT16	267700-0611	S	VT16	267700-2811	S			
	IT20	267700-0621	S	VT20	267700-4481	S			
	IT22	267700-0631	S						
	IT24	267700-0641	S						
	IT27	267700-0651	S						
M14x11.2 16HEX TAPER SEAT	ITF16	267700-0661	S						
	ITF20	267700-0671	S						
	ITF22	267700-0681	S						
	ITF24	267700-0691	S						
	ITF27	267700-0701	S						

S: SOLID; R: REMOVABLE; RC: CRIMPED; T: THREAD

DENSO
 AUSTRALIA | CHINA | INDIA | INDONESIA | KOREA | MALAYSIA | PHILIPPINES | SAUDIARABIA | SINGAPORE | TAIWAN | THAILAND | VIETNAM | JAPAN | EUROPE MOTOR & USA | SMALL ENGINE REFERENCE | PART NUMBER

IRIDIUM POWER, TOUGH, RACING CHART

DIA. xREACH Hex	IRIDIUM POWER (φ0.4mm)			IRIDIUM TOUGH (φ0.4mm)			IRIDIUM RACING (φ0.4mm)		
	PLUG	PART NUMBER	NUT	PLUG	PART NUMBER	NUT	PLUG	PART NUMBER	NUT
M14x19 20.6HEX COMPACT TYPE	IWM24	267700-2891	S						
	IWM27	267700-2901	S				IWM01-29	267700-1211	S
	IWM31	267700-2911	S				IWM01-31	267700-1221	S
M14x12.7 20.6HEX	IWF16	267700-5001	R						
	IWF20	267700-5011	R						
	IWF22	067700-9411	R						
	IWF24	067700-9421	R						
M14x22 16HEX							IA01-31	267700-1261	S
							IA01-32	267700-1271	S
M14x19 16HEX							IA01-34	267700-1281	S
							IAE01-32	267700-2941	S
M12x26.5, 14HEX				VCH16	267700-9211	S			
				VCH20	267700-7671	S			
M12x26.5, 14HEX DOUBLE NEEDLEIRIDIUM				VFCH16	267700-9281	S			
				VFXEH20	267700-7641	S			
				VFXEH22	267700-7651	S			
				VDCH22F	267700-9291	S			
M12x26.5, 14HEX NEW3ELECTRODE DOUBLE NEEDLE IRIIDIUM				VXEBH27	267700-9171	S			
M12x28, 14HEX SHROUD 1.5mm				VXEHC24G	267700-9231	S			
M12x28, 14HEX DOUBLE NEEDLEIRIDIUM SHROUD 1.5mm				VFXEHC22G	267700-9221	S			
M12x28.5, 14HEX DOUBLE NEEDLEIRIDIUM SHROUD 2mm				VFXEH20E	267700-7631	S			
M12x19 16HEX	IXU22	067700-8721	RC	VXU20	267700-9141	S	IXU01-24	267700-1061	R
	IXU24	067700-8731	RC	VXU22	267700-0801	S			
	IXU27	067700-8601	RC	VXU24	267700-0811	S			
	IXU22I	267700-8431	S	VXU22I	267700-8441	S			
M12x26.5, 16HEX	IXUH20I	267700-8171	S	VXUH20I	267700-8161	S			
	IXUH22	267700-6451	S	VXUH22	267700-6461	S			
	IXUH22I	267700-7371	S	VXUH22I	267700-7381	S			
M12x28, 16HEX SHROUD 1.5mm			VXUHC22G	267700-8671	S				
M12x28, 16HEX DOUBLE NEEDLEIRIDIUM SHROUD 1.5mm				VFXUHC22FG	267700-8681	S			
M12x19 18HEX	IX22	067700-9351	R				IXU01-24	267700-1061	R
	IX24	067700-9361	R						
	IX27	067700-9371	R				IXU01-27	267700-1071	R
	IX22B	067700-9381	R						
	IX24B	067700-9391	R						
	IX27B	067700-9401	R						
M12x22, 18HEX SHROUD 3mm	IXG24	267700-2921	R				IXU01-24	267700-1061	R
	IXG27	267700-2931	R				IXU01-27	267700-1071	R
M10x26.5 14HEX				VSUEH22	267700-9240	S			
M10x19 16HEX	IU20	267700-5021	R				IU01-24	267700-1011	R
	IU22	067700-9262	R						
	IU24	067700-9272	R						
	IU24A	067700-9302	R						
	IU27	067700-9282	R						
	IU27A	067700-9312	R						
	IU31	067700-9292	R						
	IU31A	067700-9321	R						
	IU22D	267700-0830	T						
	IU24D	267700-0840	T						
IU27D	267700-0850	T							
M10x19, HALF THREAD 16HEX	IUH24	067700-9330	R				IU01-24	267700-1011	R
	IUH27	067700-9340	R				IU01-27	267700-1021	R
M10x12.7 16HEX	IUF14-UB	267700-0540	S						
	IUF22	067700-9481	R						
	IUF24	067700-9491	R						
	IUF27A	067700-9701	R						
	IUF31A	067700-9711	R						
M8x19 13HEX HALF THREAD	IY24	267700-4491	R						
	IY27	267700-4501	R						
	IY31	267700-4511	R						

S: SOLID; R: REMOVABLE; RC: CRIMPED; T: THREAD

DIA. xREACH Hex	IRIDIUM PLUS (φ0.4mm)								
	PLUG	PART NUMBER	NUT						
M14x26.5,16HEX	VKH20T	267700-7760	S						
M14x19,16HEX	VK20T	067700-9540	S						
M14x19,20.6HEX	VW20T	067700-9240	S						
M14x26.5,16HEX	VDKH16T	267700-8620	S						

φ0.4mm IRIDIUM PLUG CHART

DIA. xREACH Hex	IRIDIUM PLUG (φ0.4mm)			IRIDIUM POWER (φ0.4mm)			IRIDIUM TOUGH (φ0.4mm)			IRIDIUM RACING (φ0.4mm)		
	PLUG	PART NUMBER	NUT	PLUG	PART NUMBER	NUT	PLUG	PART NUMBER	NUT	PLUG	PART NUMBER	NUT
M14x19 16HEX	IK24C11	067700-9550	S	IK24	067700-8461	S				IK01-24	267700-1311	S
	IK27C11	067700-9520	S	IK27	067700-8471	S				IK02-24	267700-1361	S
M12x19,16HEX	IXU22C	267700-5170	S	IXU22	067700-8721	RC	VXU22	267700-0801	RC	IK01-27	267700-1321	S
M12x26.5,16HEX	IXU22HPR	267700-7170	S	IXUH22	267700-6451	S	VXUH22	267700-6461	S	IK02-27	267700-1371	S
M10x19 16HEX	IU22D	267700-0830	T	IU22D	267700-0831	T				IU01-24	267700-1011	R
	IU24D	267700-0840	T	IU24D	267700-0841	T				IU01-27	267700-1021	R
	IU27D	267700-0850	T	IU27D	267700-0851	T				RU01-27	267700-1571	R
	IU31D	267700-0860	T	IU31	067700-9292	R				IU01-31	267700-1031	R
M10x19 16HEX,HALFTHREAD	IUH24D	067700-9560	T	IUH24	067700-9331	R				IU01-31	267700-1031	R
	IUH27D	067700-9570	T	IUH27	067700-9341	R				RU01-31	267700-1581	R
M14x19 16HEX	VK16PRZ11	267700-1840	S	IK16	067700-8681	S	VK16	267700-0711	S	IK01-24	267700-1311	S
	VK20PRZ11	267700-1850	S	IK20	067700-8691	S	VK20	267700-0721	S			
	VK22PRZ11	267700-1860	S	IK22	067700-8431	S	VK22	267700-0731	S			
	VK24PRZ11	267700-1870	S	IK24	067700-8461	S						
	VK27PRZ11	267700-2050	S	IK27	067700-8471	S						
	VKJ20RZ-M11	267700-1970	S									
M14x19,20.6HEX	SVK20RZ8	067700-9740	S				VK20Y	267700-3721	S	IK02-24	267700-1361	S
	SVK20RZ11	067700-8620	S	IK20	067700-8691	S	VK20	267700-0721	S	IK01-27	267700-1321	S
	VW16R-A13	267700-1640	S	IW16	067700-8651	S	VW16	267700-0771	S	IK02-27	267700-1371	S
M12x19,18HEX	VX22BC	067700-9720	R	IX22B	067700-9381	R						
M10x19HalfThread 16Hex φ10.5	VNH24Z	267700-2060	T							IU01-24	267700-1011	R
	VNH27Z	267700-2070	T							IU01-27	267700-1021	R
M10x19 HalfThread 16HEX	VUH24D	267700-2011	T	IUH24	067700-9331	R				RU01-27	267700-1571	R
	VUH27D	267700-1931	T	IUH27	067700-9341	R				IU01-24	267700-1011	R
	VUH24ES	267700-6130	T							IU01-27	267700-1021	R
	VUH27ES	267700-4770	T							RU01-27	267700-1571	R
										RU01-27	267700-1570	R

φ0.55(F,Z),0.7mm(D,S) IRIDIUM PLUG CHART

DIA. xREACH Hex	IRIDIUM PLUG (φ0.7,0.55mm)			IRIDIUM POWER (φ0.4mm)			IRIDIUM TOUGH/PLUS (φ0.4mm)			
	PLUG	PART NUMBER	NUT	PLUG	PART NUMBER	NUT	PLUG	PART NUMBER	NUT	
M14x19, 16HEX DOUBLE NEEDLE IRIDIUM, COPPER G.E.	DK20PR-D13	267700-7390	S				VFK20F	267700-9161	S	
M14x19 16HEX DOUBLE NEEDLE IRIDIUM	FK16R11	267700-5290	S				VFK16	267700-9151	S	
	FK16PR11(FOMOCO)	267700-5760	S				VFK16	267700-9151	S	
	FK16PR11(mazda)	267700-5820	S				VFK16	267700-9151	S	
	FK16R-A8	267700-7780	S				VFK16	267700-9151	S	
	FK16R-AL8	267700-8340	S				VFK16	267700-9151	S	
M14x26.5 16HEX DOUBLE NEEDLE IRIDIUM	FK16HQR11	267700-5920	S				VFKH16	267700-7411	S	
	FK16HR11	267700-7140	S				VFKH16	267700-7411	S	
	FK16HR-A8	267700-7700	S				VFKH16	267700-7411	S	
	FK20HQR8	267700-7190	S				VFKH20	267700-7421	S	
	FK20HQR8(VOLVO)	067800-7920	S				VFKH20	267700-7421	S	
	FK20HQR10(VOLVO)	067800-7860	S				VFKH20	267700-7421	S	
	FK20HQR10(FOMOCO)	267700-7340	S				VFKH20	267700-7421	S	
	FK20HR11	267700-4230	S				VFKH20	267700-7421	S	
	FK20HR8-G	267700-7570	S				VFKH20	267700-7421	S	
	FK20HR11-G	267700-7600	S				VFKH20	267700-7421	S	
	M14x26.5,16HEX NEWSELECTRODE,DOUBLE NEEDLE IRIDIUM	FK20HBR11	267700-4200	S				VFKBH20	267700-7661	S
		FK20HBR11-T	267700-7180	S				VFKBH20	267700-7661	S
FK20HBR8		267700-7770	S							
M12x26.5 14HEX DOUBLE NEEDLE IRIDIUM	DXE22HQR-D11S	267700-7800	S							
	FC20HPR8	267700-7710	S							
	FC22HR9	267700-7400	S							
	FC22HR9-G	267700-7620	S							
	FXE20HE11C(AM)	267700-7720	S							
	FXE20HE11C(OE)	267700-7730	S							
	FXE20HR11·(AM)	267700-4880	S				VFXEH20	267700-7641	S	
	FXE20HR11·(OE)	267700-7300	S				VFXEH20	267700-7641	S	
	FXE20HR11·(OE)	267700-7320	S				VFXEH20	267700-7641	S	
	FXE22HR11·(AM)	267700-5830	S				VFXEH22	267700-7651	S	
	FXE22HR11·(OE)	267700-7290	S				VFXEH22	267700-7651	S	
	FXE24HR11·(AM)	267700-6970	S							
FXE24HR11·(OE)	267700-7280	S								

S: SOLID; R: REMOVABLE; RC: CRIMPED; T: THREAD

AUSTRALIA CHINA INDIA INDONESIA KOREA MALAYSIA PHILIPPINES SAUDIARABIA SINGAPORE TAIWAN THAILAND VIETNAM JAPAN & USA EUROPE MOTOR CYCLE SMALL ENGINE REFERENCE PART NUMBER

φ0.55(F,Z),0.7mm(D,S) IRIIDIUM PLUG CHART

DIA. xREACH Hex	IRIDIUM PLUG (φ0.7,0.55mm)			IRIDIUM POWER (φ0.4mm)			IRIDIUM TOUGH/PLUS (φ0.4mm)		
	PLUG	PART NUMBER	NUT	PLUG	PART NUMBER	NUT	PLUG	PART NUMBER	NUT
M12x28.5x14HEX SHROUD	FXE16HE11·	267700-4950	S						
DOUBLE NEEDLE IRIIDIUM	FXE20HE11·(AM)	267700-5480	S				VFXEH20E	267700-7631	S
M12x28.5x16HEX SHROUD, DOUBLE NEEDLE IRIIDIUM SUS GASKET,COPPER G.E.	FXE20HE11·(OE)	267700-7310	S				VFXEH20E	267700-7631	S
M12x26.5x16HEX DOUBLE NEEDLE IRIIDIUM	DXU22HCR-D11S	267700-7580	S						
M12x26.5x16HEX DOUBLE NEEDLE IRIIDIUM	FXU16HR11	267700-7260	S						
	FXU22HR11	267700-7520	S						
	FXU22HR8	267700-7560	S						
M14x19 16HEX	·SK16PR-A11	267700-0870	S	IK16	067700-8681	S	VK16	267700-0711	S
	·SK16R-P11	067700-8860	S	IK16	067700-8681	S	VK16	267700-0711	S
	K16PSR-B8	267700-5860	S	IK16	067700-8681	S	VK16	267700-0711	S
	K20PSR-B8	267700-4380	S	IK20	067700-8681	S	VK20	267700-0721	S
	KJ20SR11	267700-0950	S	IK20	067700-8681	S	VK20	267700-0721	S
	SK16PR-A11	067700-8640	S	IK16	067700-8681	S	VK16	267700-0711	S
	SK16PR-E11	267700-2740	S	IK16	067700-8681	S	VK16	267700-0711	S
M14x19 16HEX	SK16PR-F8	267700-4340	S	IK16	067700-8681	S	VK16	267700-0711	S
	SK16PR-L11	267700-2200	S	IK16	067700-8681	S	VK16	267700-0711	S
	SK16R11	067700-8840	S	IK16	067700-8681	S	VK16	267700-0711	S
	SK16R8-PG(For LPG)	267700-3130	S				VK20T	067700-9540	S
	SK16R-P11	067700-8280	S	IK16	067700-8681	S	VK16	267700-0711	S
	SK16R-P8	067700-8350	S	IK16	067700-8681	S	VK16	267700-0711	S
	SK20BR11(For EU)	067700-3560	S				VKB20	267700-5061	S
	SK20BR11(For Japan)	067700-9530	S				VKB20	267700-5061	S
	SK20PR-A11	267700-0570	S	IK20	067700-8691	S	VK20	267700-0721	S
	SK20PR-A8	267700-2340	S	IK20	067700-8691	S	VK20	267700-0721	S
	SK20PR-B8	267700-2310	S	IK20	067700-8691	S	VK20	267700-0721	S
	SK20PR-F8	267700-4360	S	IK20	067700-8691	S	VK20	267700-0721	S
	SK20PR-L11·	267700-5600	S	IK20	067700-8691	S	VK20	267700-0721	S
	SK20PR-L9	067700-8630	S	IK20	067700-8691	S	VK20	267700-0721	S
	SK20PR-L9	067700-8760	S	IK20	067700-8691	S	VK20	267700-0721	S
	SK20PR-N9	267700-6690	S	IK20	067700-8691	S	VK20	267700-0721	S
	SK20PR-N9S	267700-6150	S	IK20G	267700-5621	S	VK20G	267700-5641	S
	SK20R11	067700-8340	S	IK20	067700-8691	S	VK20	267700-0721	S
	SK20R5	067700-3510	S						
	SK20R5G	067700-3520	S						
	SK20R8	267700-2570	S				VK20Y	267700-3721	S
	SK20R8G(For LPG)	267700-4140	S				VK20T	067700-9540	S
	SK20R-P11	067700-8200	S	IK20	067700-8691	S	VK20	267700-0721	S
	SK20R-P13	067700-8360	S	IK20	067700-8691	S	VK20	267700-0721	S
	SK22PR-M11	267700-0930	S	IK22	067700-8431	S	VK22	267700-0731	S
	SK22PR-M11S·	267700-6160	S	IK22G	267700-5661	S	VK22G	267700-5671	S
M14x19 16HEX	SKJ16CR-A8	267700-0890	S	IK16	067700-8681	S	VK16	267700-0711	S
EXTENDED	SKJ16CR-L11	067700-9680	S	IK16	067700-8681	S	VK16	267700-0711	S
M14x20.5 16HEX	SKJ20CR-A8	267700-1760	S	IK20	067700-8691	S	VK20	267700-0721	S
EXTENDED,SHROUD	SKJ16DR-M11	267700-2610	S	IK16	067700-8681	S	VK16	267700-0711	S
	SKJ20DR-M11	267700-0910	S	IK20	067700-8691	S	VK20	267700-0721	S
	SKJ20DR-M13·	267700-6110	S	IK20	067700-8691	S	VK20	267700-0721	S
	SKJ20DR-M13	267700-0560	S	IK20	067700-8691	S	VK20	267700-0721	S
	SKJ20DR-M11S·	267700-6100	S	IK20G	267700-5621	S	VK20G	267700-5641	S
	SKJ20DR-M11S	267700-4930	S	IK20G	267700-5621	S	VK20G	267700-5641	S
M14x22,16HEX NEW3ELECTRODE,SHROUD	SK20BGR11	067700-9730	S				VKA20	267700-5041	S
M14x26.5 16HEX	SK16HR11	267700-3000	S	IKH16	267700-3661	S	VKH16	267700-3681	S
	SK20HR8-T(For LPG)	267700-6070	S				VKH20T	267700-7760	S
	SK20HR11	267700-4120	S	IKH20	267700-3671	S	VKH20	267700-3691	S
	SK20HPR-L11·	267700-5500	S	IKH20	267700-3671	S	VKH20	267700-3691	S
	ZK20HQR8	267700-7750	S	IKH20	267700-3671	S	VKH20	267700-3691	S
M14x19 20.6HEX	S20R8-G(For LPG)	267700-4690	S				VW20T	067700-9240	S
	S22PR-A7	067700-9670	S	IW22	067700-8671	RC	VW22	267700-0791	S
	GE3-F(For CNG)	067800-9250	S						
M14x17.5 16HEX,TAPER SEAT	ZTJ16R10	AN067800-8180	S	IT20	267700-0621	S	VT20	267700-4481	S
M14x25,16HEX TAPER SEAT	ZT20EPR11	067800-7340	S	IT20	267700-0621	S	VT20	267700-4481	S
	ZTJ16VR10	AN067800-7870	S	ITV16	267700-3701	S			
M12x19 16HEX	ZXU20PR11	267700-7020	S				VXU20	267700-9141	S
	SXU22PR9	267700-5900	S	IXU22	067700-8721	RC	VXU22	267700-0801	RC
	SXU22PR-A9	267700-3020	S	IXU22	067700-8721	RC	VXU22	267700-0801	RC
M12x26.5 14HEX	SC20HR11	267700-5580	S				VCH20	267700-7671	S
	ZC20HPR11(mazda)	267700-7940	S				VCH20	267700-7671	S
	SXE22HQR11S	267700-7810	S						
	ZXE20HR13(OE)	267700-4640	S				VFXEH20	267700-7641	S
	ZXE20HR13(AM)	267700-4320	S				VFXEH20	267700-7641	S
M12x26.5 16HEX	SXU16HPR9	267700-2190	S						
	SXU20HPR11	267700-8130	S	IXUH20I	267700-8171	S	VXUH20I	267700-8161	S
	SXU22HDR8	267700-4530	S	IXUH22	267700-6451	S	VXUH22	267700-6461	S
	SXU22HPR9	267700-5970	S	IXUH22I	267700-7371	S	VXUH22I	267700-7381	S
	ZXU22HBR11	267700-2970	S						
	GX8-1·(For CNG)	267700-5590	S						
M12x26.5 HEX16,EXTENDED	ZXU20HCR8	267700-7550	S	IXUH22I	267700-7371	S	VXUH22I	267700-7381	S
M12x28 16HEX	SXU22HCR11S	267700-5530	S						
EXTENDED SHROUD	SXU22HCR11	267700-6050	S	IXUH22I	267700-7371	S	VXUH22I	267700-7381	S
	SXU22HCR8S	267700-7740	S						

S: SOLID; R: REMOVABLE; RC: CRIMPED; T: THREAD

PLATINUM PLUG CHART

DIA. xREACH Hex	PLATINUM PLUG			IRIDIUM PLUG	IRIDIUM POWER (φ0.4mm)			IRIDIUM TOUGH PLUS (φ0.4mm)			
	PLUG	PART NUMBER	NUT		PLUG	PART NUMBER	NUT	PLUG	PART NUMBER	NUT	
M14x19 16HEX	·PK20R11	067700-8880	S	-	IK20	067700-8691	S	VK20	267700-0721	S	
	K16PR-P11	067700-8250	S	SK16PR-L11	IK16	067700-8681	S	VK16	267700-0711	S	
	K16PR-TP11	067700-7060	S	SK16PR-L11	IK16	067700-8681	S	VK16	267700-0711	S	
	K20PR-TP11	067700-7070	S	SK20PR-L11	IK20	067700-8691	S	VK20	267700-0721	S	
	PK16PR11	067700-7370	S	SK16PR-L11	IK16	067700-8681	S	VK16	267700-0711	S	
	PK16PR-L11	067700-6740	S	SK16PR-L11	IK16	067700-8681	S	VK16	267700-0711	S	
	PK16PR-L11	067700-6740	S	SK16PR-L11	IK16G	267700-5611	S	VK16G	267700-5631	S	
	PK16PR-P11	067700-6870	S	SK16PR-A11	IK16	067700-8681	S	VK16	267700-0711	S	
	PK16R11	067700-6680	S	SK16R11	IK16	067700-8681	S	VK16	267700-0711	S	
	PK16R8	067700-6661	S	SK16R-P8	IK16	067700-8681	S	VK16	267700-0711	S	
	PK20PR11	067700-7380	S	SK20PR-L11	IK20	067700-8691	S	VK20	267700-0721	S	
	PK20PR11	067700-0300	S	SK20PR-L11	IK20	067700-8691	S	VK20	267700-0721	S	
	M14x19 16HEX	PK20PR-L11	067700-6750	S	SK20PR-L11	IK20	067700-8691	S	VK20	267700-0721	S
		PK20PR-L13	067700-7480	S	-	IK20	067700-8691	S	VK20	267700-0721	S
		PK20PR-P11	067700-6460	S	SK20PR-A11	IK20	067700-8691	S	VK20	267700-0721	S
PK20PR-P8		067700-0020	S	SK20PR-A8	-	-	-	VK20Y	267700-3721	S	
PK20PR-P8		067700-7610	S	SK20PR-A8	-	-	-	VK20Y	267700-3721	S	
PK20R11		067700-6690	S	SK20R11	IK20	067700-8691	S	VK20	267700-0721	S	
PK20R13		067700-6710	S	SK20R-P13	IK20	067700-8691	S	VK20	267700-0721	S	
PK20R8		067700-6670	S	SK20R8	IK20	067700-8691	S	VK20	267700-0721	S	
PK20R8(For LPG)		067700-6670	S	SK20R8	-	-	-	VK20T	067700-9541	S	
PK20R-P8		067700-6440	S	-	IK20	067700-8691	S	VK20	267700-0721	S	
PK22PR11		067700-7390	S	SK22PR-M11	IK22	067700-8431	S	VK22	267700-0731	S	
PK22PR8		067700-7690	S	-	IK22	067700-8431	S	VK22	267700-0731	S	
PK22PR-L11S		267700-0980	S	SK22PR-M11S	IK22G	267700-5661	S	VK22G	267700-5671	S	
M14x19 16HEX EXTENDED	PKJ16CR8	067700-7800	S	SKJ16CR-A8	IK16	067700-8681	S	VK16	267700-0711	S	
	PKJ16CR-L11	067700-7130	S	SKJ16CR-L11	IK16	067700-8681	S	VK16	267700-0711	S	
	PKJ16CR-L13	067700-8300	S	-	IK16	067700-8681	S	VK16	267700-0711	S	
	PKJ20CR8	067700-7810	S	SKJ20CR-A8	IK20	067700-8691	S	VK20	267700-0721	S	
	PKJ20CR-L11	067700-7140	S	SKJ20DR-M11	IK20	067700-8691	S	VK20	267700-0721	S	
	PKJ20CR-L11	067700-7140	S	SKJ20DR-M11	IK20G	267700-5621	S	VK20G	267700-5641	S	
M14x19 16HEX 2ELECTRODE	PKJ20CR-M11	067700-9460	S	SKJ20DR-M11	IK20	067700-8691	S	VK20	267700-0721	S	
	PK16TR11	067700-7990	S	-	IK16	067700-8681	S	VK16	267700-0711	S	
	PK16TR13	067700-8120	S	-	IK16	067700-8681	S	VK16	267700-0711	S	
	PK20PTR-S9	267700-2320	S	-	IK20	067700-8691	S	VK20	267700-0721	S	
	PK20TR11	067700-7930	S	-	IK20	067700-8691	S	VK20	267700-0721	S	
	PK20TR11-G	067700-8830	S	-	IK20	067700-8691	S	VK20	267700-0721	S	
M14x22 16HEX,SHROUD	PK20TR8-G	067700-9920	S	-	IK20	067700-8691	S	VK20	267700-0721	S	
	PK20GR8	067700-8211	S	-	-	-	-	VKA20	267700-5041	S	
M14x19 16HEX	·PQ20R-P11	067700-3992	S	-	IQ20	067700-8711	S	VQ20	267700-0751	S	
	PQ16R	067700-4171	S	-	IQ16	067700-8701	S	VQ16	267700-0741	S	
	PQ16R13	067700-4210	S	-	IQ16	067700-8701	S	VQ16	267700-0741	S	
	PQ16R8	067700-4851	S	-	IQ16	067700-8701	S	VQ16	267700-0741	S	
	PQ16R-P11	067700-4072	S	-	IQ16	067700-8701	S	VQ16	267700-0741	S	
	PQ20R	067700-4191	S	-	IQ20	067700-8711	S	VQ20	267700-0751	S	
	PQ20R13	067700-4220	S	-	IQ20	067700-8711	S	VQ20	267700-0751	S	
	PQ20R8	067700-4861	S	-	IQ20	067700-8711	S	VQ20	267700-0751	S	
	PQ20R-P11	067700-4082	S	-	IQ20	067700-8711	S	VQ20	267700-0751	S	
	PQ20R-P8	067700-4102	S	-	IQ20	067700-8711	S	VQ20	267700-0751	S	
	Q16PR-TP11	067700-6640	S	-	IQ16	067700-8701	S	VQ16	267700-0741	S	
	M14x19 20.6HEX	·P16R	067700-4120	S	-	IW16	067700-8651	RC	VW16	267700-0771	S
		·P16R(For LPG)	067700-4120	S	-	-	-	-	VW20T	067700-9241	S
P16PR11		067700-3390	S	-	IW16	067700-8651	RC	VW16	267700-0771	S	
P16PR8		067700-8260	S	-	IW16	067700-8651	RC	VW16	267700-0771	S	
P16R		067700-4130	S	-	IW16	067700-8651	RC	VW16	267700-0771	S	
P16R(For LPG)		067700-4130	S	-	-	-	-	VW20T	067700-9240	S	
P16R13		067700-4110	S	-	IW16	067700-8651	RC	VW16	267700-0771	S	
P16R8		067700-8960	S	-	IW16	067700-8651	RC	VW16	267700-0771	S	
P20PR11		067700-3400	S	-	IW20	067700-8661	RC	VW20	267700-0781	S	
P20PR8		067700-8270	S	-	IW20	067700-8661	RC	VW20	267700-0781	S	
P20PR-S11		067700-3380	S	-	IW20	067700-8661	RC	VW20	267700-0781	S	
P20R11		067700-4200	S	-	IW20	067700-8661	RC	VW20	267700-0781	S	
P20R8		067700-4140	S	-	IW20	067700-8661	RC	VW20	267700-0781	S	
P20R8(For LPG)		067700-4140	S	-	-	-	-	VW20T	067700-9241	S	
P22PR8	067700-7250	S	S22PR-A7	IW22	067700-8671	RC	VW22	267700-0791	S		
M14x17.5 16HEX TAPER SEAT	PT16EPR10	067800-9390	S	-	IT16	267700-0611	S	VT16	267700-2811	S	
	PT16EPR13	067800-9400	S	-	IT16	267700-0611	S	VT16	267700-2811	S	
	PT16EPR-L13	067700-8140	S	-	IT16	267700-0611	S	VT16	267700-2811	S	
	PTJ14R15	067800-7270	S	-	IT16	267700-0611	S	VT16	267700-2811	S	
	PTJ16R15	067800-7280	S	-	IT16	267700-0611	S	VT16	267700-2811	S	
	TJ14R-P15	067800-7260	S	-	IT16	267700-0611	S	VT16	267700-2811	S	
M14x25, 16HEX TAPER SEAT	PT16VR10	267700-6120	S	-	ITV16	267700-3701	S	-	-	-	
	PT16VR13	067700-7940	S	-	ITV16	267700-3701	S	-	-	-	
M12x19, 16HEX	XU22EP-P	067800-4530	S	SXU22PR9	IXU22	067700-8722	RC	VXU22	267700-0801	RC	

S: SOLID; R: REMOVABLE; RC: CRIMPED; T: THREAD

DENSO
 AUSTRALIA | CHINA | INDIA | INDONESIA | KOREA | MALAYSIA | PHILIPPINES | SAUDI ARABIA | SINGAPORE | TAIWAN | THAILAND | VIETNAM | JAPAN & USA
 EUROPE MOTOR
 SMALL ENGINE REFERENCE NUMBER

DIA. xREACH Hex	PLUG	PART NUMBER	NUT
M14x19, 16Hex	K16TT	267700-7431	S
M14x19, 16Hex	K20TT	267700-7441	S
M12x26.5, 16Hex	KH16TT	267700-7451	S
M12x26.5, 16Hex	KH20TT	267700-7460	S
M14x19, 16Hex	Q16TT	267700-7471	S
M14x19, 16Hex	Q20TT	267700-7481	S
M14x19, 20.6Hex	W16TT	267700-6301	RC
M14x19, 20.6Hex	W20TT	267700-6311	RC
M14x19, 20.6Hex	W22TT	267700-7510	RC
M14x12.7, 20.6Hex	WF20TT	267700-7500	RC
M12x19, 16Hex	XU22TT	267700-7080	S
M12x26.5, 16Hex	XUH22TT	267700-7090	S
M12x26.5, 16Hex	XUH20TTI	267700-8290	S
M14x17.5, 16Hex, Taper seat	T16TT	267700-7820	S
M14x17.5, 16Hex, Taper seat	T20TT	267700-7830	S
M14x25, 16Hex, Taper seat	TV16TT	267700-7490	S

STANDARD, RESISTOR PLUG CHART

DIA. xREACH Hex	STANDARD PLUG			RESISTOR PLUG			IRIDIUM POWER (φ0.4mm)			IRIDIUM TOUGH/PLUS (φ0.4mm)			IRIDIUM RACING (φ0.4mm)			
	PLUG	PART NUMBER	NUT	PLUG	PART NUMBER	NUT	PLUG	PART NUMBER	NUT	PLUG	PART NUMBER	NUT	PLUG	PART NUMBER	NUT	
M14x19 16HEX 1.5mm PROJECTION	K16P-U	067600-0380	S	K16PR-U	067700-6300	S	IK16	067700-8681	S	VK16	267700-0711	S				
				K16PR-U	067700-7500	R	IK16	067700-8681	S	VK16	267700-0711	S				
				K20PR-U	067700-6310	S	IK20	067700-8691	S	VK20	267700-0721	S				
				K20PR-U(For LPG)	067700-6310	S				VK20T	067700-9540	S				
				K20PR-U	067700-7510	R	IK20	067700-8691	S	VK20	267700-0721	S				
				K20PR-U8S	267700-6290	S	IK20G	267700-5621	S	VK20G	267700-5641	S				
	K16P-U11	067600-0350	S	K20PR-U8S	267700-4390	S	IK20G	267700-5621	S	VK20G	267700-5641	S				
				K20PR-SU9(Semi Surface)	267700-0960	S	IK20	067700-8691	S	VK20	267700-0721	S				
				K22PR-U	067700-7520	R	IK22	067700-8431	S	VK22	267700-0731	S				
							IK24	067700-8461	S				IK01-24	267700-1311	S	
													IK02-24	267700-1361	S	
													IK01-27	267700-1321	S	
M14x19 16HEX 2.5mm PROJECTION	K16-U	067600-0740	S	K16PR-UR	267700-5230	S	IK16	067700-8681	S	VK16	267700-0711	S				
				K20PR-UR	267700-5240	S	IK20	067700-8691	S	VK20	267700-0721	S				
				K22PR-UR	267700-5250	S	IK22	067700-8431	S	VK22	267700-0731	S				
				K16PR-U11	067700-6270	S	IK16	067700-8681	S	VK16	267700-0711	S				
				K16PR-U11(For LPG)	067600-6270	S				VK20T	067700-9540	S				
				K20PR-U11	067700-6280	S	IK20	067700-8691	S	VK20	267700-0721	S				
	K16-U11	067600-0750	S	K20PR-U11	067700-0420	S	IK20	067700-8691	S	VK20	267700-0721	S				
				K20-U	067600-0760	S	IK20	067700-8691	S	VK20	267700-0721	S				
				K20-U11	067600-0770	S	IK22	067700-8431	S	VK22	267700-0731	S				
							IK24	067700-8461	S				IK01-24	267700-1311	S	
													IK02-24	267700-1361	S	
M14x19 16HEX 2.5mm PROJECTION EXTENDED	K16-U	067600-0740	S	K16PR-L11	067700-6550	S	IK16	067700-8681	S	VK16	267700-0711	S				
				K20PR-L11	067700-6560	S	IK20	067700-8691	S	VK20	267700-0721	S				
				K22PR-L11	067700-6570	S	IK22	067700-8431	S	VK22	267700-0731	S				
				K16R-U	067700-6400	S	IK16	067700-8681	S	VK16	267700-0711	S				
				K16R-U(For LPG)	067700-6400	S				VK20T	067700-9540	S				
				K16R-U	067700-7660	S	IK16	067700-8681	S	VK16	267700-0711	S				
	K16-U11	067600-0750	S	K16R-U11	067700-6420	S	IK16	067700-8681	S	VK16	267700-0711	S				
				K20R-U	067700-6410	S	IK20	067700-8691	S	VK20	267700-0721	S				
				K20R-U11	067700-6430	S	IK20	067700-8691	S	VK20	267700-0721	S				
M14x20.5 16HEX, SHROUD	K16-U	067600-0740	S	KJ14CR11	067700-6730	S	IK16	067700-8681	S	VK16	267700-0711	S				
				KJ14CR-L11	067700-7450	S	IK16	067700-8681	S	VK16	267700-0711	S				
				KJ16CR	067700-7410	S	IK16	067700-8681	S	VK16	267700-0711	S				
				KJ16CR11	067700-6770	S	IK16	067700-8681	S	VK16	267700-0711	S				
				KJ16CR11(For LPG)	067700-6770	S				VK20T	067700-9540	S				
				KJ16CR-L11	067700-6940	S	IK16	067700-8681	S	VK16	267700-0711	S				
	K16-U11	067600-0750	S	KJ16CR-U11(*)	067700-8810	S	IK16	067700-8681	S	VK16	267700-0711	S				
				KJ20CR11	067700-6780	S	IK20	067700-8691	S	VK20	267700-0721	S				
				KJ20CR-L11	067700-6950	S	IK20	067700-8691	S	VK20	267700-0721	S				
				KJ20CR-U11	067700-7780	S	IK20	067700-8691	S	VK20	267700-0721	S				
				KJ20CR-U11(*)	067700-0570	S	IK20	067700-8691	S	VK20	267700-0721	S				
				KJ22CR-L11	067700-6960	S	IK22	067700-8431	S	VK22	267700-0731	S				
M14x22.5 16HEX, SHROUD	K16-U	067600-0740	S	KJ22CR-L8	067700-8240	S	IK22	067700-8431	S	VK22	267700-0731	S				
				KJ20DR-M11	267700-0550	S	IK20	067700-8691	S	VK20	267700-0721	S				
	M14x19 16HEX 2ELECTRODE ZELECTRODE, SHROUD, Semi-Surface (S)	K22TM11	067600-1130	S	-K16TNR-S9	067700-9770	S	IK16	067700-8681	S	VK16	267700-0711	S			
					K16TR11	067700-7900	S	IK16	067700-8681	S	VK16	267700-0711	S			
					-K20PTR-S	067700-9760	S	IK20	067700-8691	S	VK20	267700-0721	S			
					K20TNR	067700-8770	S	IK20	067700-8691	S	VK20	267700-0721	S			
					-K20TNR-S	067700-8000	S	IK20	067700-8691	S	VK20	267700-0721	S			
					-K20TNR-S9	067700-8800	S	IK20	067700-8691	S	VK20	267700-0721	S			
K22TM11	067600-1130	S	K20TR11	067700-8110	S	IK20	067700-8691	S	VK20	267700-0721	S					
			K20TXR	067700-8080	R	IK20	067700-8691	S	VK20	267700-0721	S					
			K22TMR11	067700-0510	S	IK22	067700-8431	S	VK22	267700-0731	S					
			K22TNR-S	067700-7910	S	IK22	067700-8431	S	VK22	267700-0731	S					
			K16DTR-S11	067700-7330	S											
			K20DTR-S11	067700-7230	S											

STANDARD, RESISTOR PLUG CHART

DIA. xREACH Hex	STANDARD PLUG			RESISTOR PLUG			IRIDIUM POWER (φ0.4mm)			IRIDIUM TOUGH/PLUS (φ0.4mm)			IRIDIUM RACING (φ0.4mm)					
	PLUG	PART NUMBER	NUT	PLUG	PART NUMBER	NUT	PLUG	PART NUMBER	NUT	PLUG	PART NUMBER	NUT	PLUG	PART NUMBER	NUT			
M14x19 16HEX 3ELECTRODE 3ELECTRODE SEMI-SURFACE(S)	K22PB	067600-2770	R	K20BR-S10	067700-9750	S	IK20	067700-8691	S	VK20	267700-0721	S						
				K20PBR	067700-8050	R	IK20	067700-8691	S	VK20	267700-0721	S						
				K20PBR-S 10	067700-8060	R	IK20	067700-8691	S	VK20	267700-0721	S						
				K22PBR-S	067700-8070	R	IK22	067700-8431	S	VK22	267700-0731	S						
M14x19 16HEX 1.5mmPROJECTION	Q20P-U Q22P-U	067600-7680 067600-7690	R	Q16PR-U	067700-6000	S	IQ16	067700-8701	S	VQ16	267700-0741	S	IQ01-24 IQ02-24 IQ01-27 IQ02-27 IQ01-31 IQ02-31 IQ01-34	267700-1411 267700-1461 267700-1421 267700-1471 267700-1431 267700-1481 267700-1441	S S S S S S S			
				Q16PR-U	067700-4450	R	IQ16	067700-8701	S	VQ16	267700-0741	S						
				Q20PR-U	067700-6060	S	IQ20	067700-8711	S	VQ20	267700-0751	S						
				Q20PR-U	067700-4460	R	IQ20	067700-8711	S	VQ20	267700-0751	S						
				Q22PR-U	067700-4470	R	IQ22	067700-8481	S	VQ22	267700-0761	S						
							IQ24	067700-8491	S									
										IQ27	067700-8502	S						
				M14x19 16HEX 1.5mmPROJECTION	Q20P-U11 Q20P-U11	067600-7810 067600-7300	S R	Q16PR-U15	067700-4660	R	IQ16	067700-8701				S	VQ16	267700-0741
Q20PR-U11	067700-6070	S	IQ20					067700-8711	S	VQ20	267700-0751	S						
Q20PR-U11	067700-4520	R	IQ20					067700-8711	S	VQ20	267700-0751	S						
Q22PR-U11	067700-6090	S	IQ22					067700-8481	S	VQ22	267700-0761	S						
M14x19 16HEX 2.5mmPROJECTION	Q16-U Q16-U11 Q20-U Q20-U11	067600-0700 067600-7071 067600-0720 067600-7081	S S S S	Q14R-U11	067700-4670	S	IQ16	067700-8701	S	VQ16	267700-0741	S						
				Q16R-U	067700-4410	S	IQ16	067700-8701	S	VQ16	267700-0741	S						
				Q16R-U11	067700-4431	S	IQ16	067700-8701	S	VQ16	267700-0741	S						
				Q20R-U	067700-4421	S	IQ20	067700-8711	S	VQ20	267700-0751	S						
M14x19 16HEX 2.5mmPROJECTION EXTENDED	QJ14C11	067600-7100	S	QJ16AR-U	067700-5920	S												
				QJ16AR-U11	067700-5930	S												
				QJ16CR11	067700-6230	S	IQ16	067700-8701	S	VQ16	267700-0741	S						
				QJ20CR11	067700-6100	S	IQ20	067700-8711	S	VQ20	267700-0751	S						
M14x19 16HEX QL LONG				QL20PR-U	067700-7290	S												
				QL20TR-S	067700-7260	S												
				QL22TR-S	067700-7270	S												
M14x26.5 16HEX				K16HR-U11	067700-3020	S	IKH16	267700-3661	S	VKH16	267700-3681	S	IKH01-24 IKH01-27 IKH01-31	267700-4451 267700-4461 267700-4471	S S S S			
				K16HR-U11	267700-6280	S	IKH16	267700-3661	S	VKH16	267700-3681	S						
				K20HR-U11	267700-2880	S	IKH20	267700-3671	S	VKH20	267700-3691	S						
							IKH22	267700-2651	S	VKH22	267700-2681	S						
M14x12.7 20.6HEX NON-PROJECTION	W14F-U W14F-U W16FS-U W20FS W20FS-U W22FS-U W22FS-U10 TR22-10 W24FS-U W24FS-U10 W27FS-U W27FS-U10 W31FS	067600-6681 067600-6821 067600-6831 067600-3231 067600-6841 067600-6851 267700-4710 067600-9270 067600-6861 067600-6671 067600-6871 067600-6191 067600-2571	S R R R R R R R R R R R R	W14FR-U	067700-3330	R												
				W16FSR	067700-0831	R												
				W20FSR	067700-0841	R	IWF22	067700-9411	R									
				W20FSR-U	067700-3341	R	IWF22	067700-9411	R									
				W22FSR	067700-0851	R	IWF22	067700-9411	R									
							IWF22	067700-9411	R									
							IWF22	067700-9411	R									
							IWF22	067700-9411	R									
							W24FSR	067700-0861	R	IWF24	067700-9421	R						
							W24FSR-U10	067700-8170	R	IWF24	067700-9421	R						
							W27FSR	067700-0871	R	IWF27	067700-9431	R						
							W27FSR-U10	067700-0891	R	IWF27	067700-9431	R						
M14x12.7 20.6HEX 1.5mmPROJECTION	W9FP W20FP W14FP-U W16FP-U W20FP-U W22FP-U W24FP-U W16FP-U10 W20FP-U10	067600-1612 067600-1651 067600-6121 067600-6131 067600-6141 067600-6151 067600-6281 067600-6161 067600-6201	R R R R R R R R	W20FPR	067700-3941	R	IWF20	267700-5011	R									
				W22FPR	067700-1851	R	IWF22	067700-9411	R									
				W24FPR	067700-4000	R	IWF24	067700-9421	R									
				W14FPR-U	067700-4760	R	IWF16	267700-5001	R									
				W16FPR-U	067700-4700	R	IWF16	267700-5001	R									
				W20FPR-U	067700-3831	R	IWF20	267700-5011	R									
				W22FPR-U	067700-3841	R	IWF22	067700-9411	R									
							IWF24	067700-9421	R									
							IWF16	267700-5001	R									
							W20FPR-U10	067700-3081	T	IWF20	267700-5011	R						
							W24FPR-U10	067700-8820	R	IWF24	067700-9421	R						
M14x12.7 20.6HEX 3.5mmPROJECTION	W9FP-UL W14FP-L W14FP-UL W14FP-UL10 W20FP-L	067600-6601 067600-6522 067600-6591 067600-6611 067600-8960	R R R R T	W14FPR-UL	067700-1881	R	IWF16	267700-5001	R									
				W14FPR-UL10	067700-1871	R	IWF16	267700-5001	R									
							IWF16	267700-5001	R									
							IWF20	267700-5011	R									
M14x12.7 20.6HEX	W20FP-U W20FP-U10 W22FP-U W22FP-U10	067600-8870 067600-8890 067600-8880 067600-8900	R R R R				IWF20	267700-5011	R									
							IWF20	267700-5011	R									
							IWF22	067700-9411	R									
							IWF22	067700-9411	R									
M14x12.7 20.6HEX RETRACTED PROJECTION	W14FR-L W20FR-L W20FR-L9 W24FR-L	067700-6800 067700-6810 267700-2080 067700-6820	T T T T				IWF16	267700-5001	R									
							IWF20	267700-5011	R									
							IWF20	267700-5011	R									
							IWF24	067700-9421	R									
M14x19 20.6HEX COMPACT				W24EMR-C	067700-7190	S	IWM24	267700-2891	S				IWM01-29	267700-1211	S			
				W27EMR-C	067700-5500	S	IWM27	267700-2901	S				IWM01-31	267700-1221	S			
							IWM31	267700-2911	S				IWM01-32	267700-1231	S			
													IWM01-34	267700-1241	S			

S: SOLID; R: REMOVABLE; RC: CRIMPED; T: THREAD

DENSO

AUSTRALIA CHINA

INDIA

INDONESIA

KOREA

MALAYSIA

PHILIPPINES

SAUDI ARABIA

SINGAPORE

TAIWAN

THAILAND

VIETNAM

JAPAN

EUROPE

MOTOR

SMALL

ENGINE

PART

STANDARD, RESISTOR PLUG CHART

DIA. xREACH Hex	STANDARD PLUG			RESISTOR PLUG			IRIDIUM POWER (φ0.4mm)			IRIDIUM TOUGH/PLUS (φ0.4mm)			IRIDIUM RACING (φ0.4mm)		
	PLUG	PART NUMBER	NUT	PLUG	PART NUMBER	NUT	PLUG	PART NUMBER	NUT	PLUG	PART NUMBER	NUT	PLUG	PART NUMBER	NUT
M14x19 20.6HEX EXTENDED	J16A-U11 J16AY J16B-U11	067600-7931	S	J14CR-U	067700-6980	S	IW16	067700-8651	RC	VW16	267700-0771	S			
		067600-8820	S	J16AR-U11	067700-3531	S									
		067600-7971	S	J16AYR	067700-7310	S									
				J16BR-U	067700-3472	S									
				J16BR-U11	067700-3571	S									
			J16CR-U	067700-6990	S	IW16	067700-8651	RC	VW16	267700-0771	S				
			J16CR-U	067700-8190	R	IW16	067700-8651	RC	VW16	267700-0771	S				
M14x19.5x20.6HEX 2ELECTRODE, ROTARY				W20EAR	067700-0642	S									
M14x19.5x20.6HEX 3ELECTRODE, ROTARY				W22EBR	067700-0750	S							IRE01-27	267700-1521	RC
				W27EBR	067700-0770	S							IRE01-31	267700-1531	RC
				W29EBR	067700-0780	S							IRE01-27	267700-1521	RC
M14x19.5 20.6HEX 4ELECTRODE, ROTARY				W25EDR14	067700-2890	S							IRE01-27	267700-1521	RC
				W27EDR14	067700-2900	S							IRE01-27	267700-1521	RC
				W27EDR14	067700-0690	R							IRE01-27	267700-1521	RC
M14x19 20.6HEX, ROTARY RX8, TRAILING													IRT01-31	267700-4841	S
													IRT01-34	267700-4851	S
M14x21 20.6HEX, ROTARY RX8, LEADING													IRL01-27	267700-4821	S
													IRL01-31	267700-4831	S
M14x21.5 20.6HEX ROTARY, SURFACE				S29	067700-2830	S							IRE01-27	267700-1521	RC
				S29A	067700-4820	S							IRE01-27	267700-1521	RC
				S31A	067700-4830	S							IRE01-31	267700-1531	RC
													IRE01-32	267700-1541	RC
													IRE01-34	267700-1551	RC
													IRE01-35	267700-1551	RC
M14x12.7 20.6HEX SURFACE	SF-24 SF-50 SF-51	067800-0280 067800-0031 067800-0041	R R R												
M14x11.2 20.6HEX	W14L W16LS	067600-3341 067600-3351	R R												
M14x9.5 20.6HEX 1.5mm PROJECTION	W9P-U W20P-U	067600-7712 067600-7751	R R	W9PR-U W14PR-U W16PR-U W20PR-U	067700-2912 067700-2931 067700-2921 067700-2951	R R R R									
M14x9.5 20.6HEX NON-PROJECTION	W9-U W14-U W16S-U W20S-U W22S-U W24S-U W27S-U W31S-U	067600-6900 067600-6781 067600-6791 067600-6801 067600-6891 067600-6881 067600-5781 067600-5791	R R R R R R R R	W20SR-U	067700-3041	R									
M14x9.5 20.6HEX, COMPACT	W9LM-US W14LM-U W14LM-US	067600-8790 067600-6711 067600-8600	R R R	W9LMR-US	067700-7850	R									
M14x9.5 19HEX, COMPACT	W14M-U W20M-U W20M-US W22M-U W14MP-U10 W20MP-U10 W20MP-U W22MP-U	067600-7421 067600-7441 067600-8590 067600-7451 067600-7461 067600-7581 067600-7481 067600-7491	R R R R R R R R	W14MR-U W20MR-U	067700-3201 067700-3221	R R									
				W14MPR-U10	067700-3281	R									
				W20MPR-U10	067700-3301	R									
				W22MPR-U	067700-3350	R									
M14x11.2 16HEX, TAPER SEAT NON-PROJECTION	T16-U15	067600-0450	S	T16R-U T16R-U15 T20R-U	067700-5650 067700-5670 067700-5950	S S S									
M14x11.2 16HEX, TAPER SEAT 1.5mm PROJECTION	T16P-U T20P-U	067600-9700 067600-9711	S S	T14PR-U T14PR-U15 T16PR-U T16PR-U11 T16PR-U15 T20PR-U T20PR-U11 T20PR-U15	067700-5700 067700-5720 067700-5750 067700-5760 067700-5770 067700-5851 067700-5861 067700-5871	S S S S S S S S	ITF16 ITF16 ITF16 ITF16 ITF16 ITF20 ITF20 ITF20	267700-0661 267700-0661 267700-0661 267700-0661 267700-0661 267700-0671 267700-0671 267700-0671	S S S S S S S S						
M14x17.5 16HEX TAPER SEAT	T20EP-U T22EP-U T20EP-U15	067600-7380 067600-7390 067600-7370	R R R	T16EPR-U T20EPR-U T16EPR-U15 T20EPR-U15	067700-3130 067700-3140 067700-3190 067700-3210	R R R R	IT16 IT20 IT22 IT16 IT20 IT16	267700-0611 267700-0621 267700-0631 267700-0611 267700-0621 267700-0611	S S S S S S	VT16 VT20 VT16 VT20 VT16	267700-2811 267700-4481 267700-2811 267700-4481 267700-2811	S S S S S			
M14x20.5 16HEX, HALF THREAD TAPER SEAT, SHROUD				T16NR-U11 T20NR-U11	067700-6130 067700-6140	S S	IT16 IT20	267700-0611 267700-0621	S S	VT16 VT20	267700-2811 267700-4481	S S			
M14x25 16HEX TAPER SEAT				T16VR-U10	267700-4810	S	ITV16 ITV20 ITV22 ITV24 ITV27	267700-3701 267700-3711 267700-2501 267700-2511 267700-2521	S S S S S						
M14x7.8 16HEX, COMPACT TAPER SEAT	T20M-U T22M-U T20MP-U T22MP-U	067600-8450 067600-8460 067600-8470 067600-8480	R R R R												
M18x12.7 22.2HEX	L14-U	067600-7570	R												

S: SOLID; R: REMOVABLE; RC: CRIMPED; T: THREAD

DENSO

AUSTRALIA CHINA

INDIA

INDONESIA KOREA

MALAYSIA

PHILIPPINES SAUDI ARABIA SINGAPORE

TAIWAN

THAILAND VIETNAM

JAPAN

EUROPE MOTOR & USA

CYCLE

SMALL ENGINE

CROSS REFERENCE NUMBER

STANDARD, RESISTOR PLUG CHART

DENSO

DIA. xREACH Hex	STANDARD PLUG			RESISTOR PLUG			IRIDIUM POWER (φ0.4mm)			IRIDIUM TOUGH/PLUS (φ0.4mm)			IRIDIUM RACING (φ0.4mm)		
	PLUG	PART NUMBER	NUT	PLUG	PART NUMBER	NUT	PLUG	PART NUMBER	NUT	PLUG	PART NUMBER	NUT	PLUG	PART NUMBER	NUT
M18x12 20.6HEX	MW17	067600-0420	R												
M18x12 25.4HEX	M14 M17 M22 M24S	067600-0310 067600-0320 067600-0330 067600-0340	R R R R												
M18x11.7 20.6HEX TAPER SEAT	MA9P-U MA20P-U	067600-7511 067600-7550	R R	MA16PR-U MA16PR-U11 MA20PR-U	067700-3630 067700-3640 067700-3660	R R R									
M12x26.5 14HEX				XE20HR-U9	267700-5810	S				VFXEH20	267700-7642	S			
M12x19 16HEX	XU22EP-U XU24EP-U	067800-4180 067800-4260	S S	XU20EPR-U XU22EPR-U XU22EPR-U XU22PR9 XU24EPR-U XU24EPR-U XU27EPR-U	067700-5800 067700-8870 067700-5240 267700-5490 067700-5250 067700-8150 067700-8090	S S S S R R R	IXU22 IXU22 IXU22 IXU24 IXU24 IXU27	067700-8721 067700-8721 067700-8721 067700-8731 067700-8731 067700-8601	RC RC RC RC RC RC	VXU20 VXU22 VXU22 VXU22 VXU24 VXU24	267700-9141 267700-0801 267700-0801 267700-0801 267700-0811 267700-0811	S RC RC RC RC RC	IXU01-24 IXU01-24	267700-1061 267700-1061	R R
M12x26.5 16HEX				XU20HR9 XU22HDR9 XU22HR9	267700-8140 267700-4520 267700-5180	S S S	IXUH201 IXUH22 IXUH221	267700-8171 267700-6451 267700-7371	S S S	VXUH201 VXUH22 VXUH221	267700-8161 267700-6461 267700-7381	S S S			
M12x19 18HEX	X20ES-U X22ES-U X24ES-U X27ES-U X31ES-U	067800-4110 067800-4120 067800-4130 067800-4140 067800-4160	T T T T T	X20ESR-U X22ESR-U X22ESR-UB X24ESR-U X27ESR-U X31ESR-U	067700-5060 067700-5070 267700-6430 067700-5080 067700-5090 067700-5110	T T S T T T	IX22 IX22 IX24 IX27	067700-9351 067700-9351 067700-9361 067700-9371	R R R R				IXU01-24 IXU01-27 IXU01-31 IXU01-34	267700-1061 267700-1071 267700-1081 267700-1091	R R R R
M12x19 18HEX 1.5mmPROJECTION	X22EP-U9 X24EP-U9 X27EP-U9	067800-4350 067800-4360 067800-4370	T T T	X16EPR-U9 X20EPR-U9 X22EPR-U9 X24EPR-U9 X27EPR-U9	067700-5270 067700-5280 067700-5290 067700-5300 067700-5310	T T T T T	IX22B IX24B IX27B	067700-9381 067700-9391 067700-9401	R R R				IXU01-24 IXU01-27	267700-1061 267700-1071	R R
M12x19x18HEX 2ELECTRODE	X27EPR-U9	067800-4370	T	X27ETR X31ETR	067700-5030 067700-5140	T T	IX27	067700-9371	R				IXU01-27 IXU01-31	267700-1071 267700-1081	R R
M12x22x18HEX 3mmSHROUD	X24GP-U	067800-4550	T	X24GPR-U X27GPR-U	067700-5540 067700-5550	T T	IXG24 IXG27	267700-2921 267700-2931	R R				IXU01-24 IXU01-27	267700-1061 267700-1071	R R
M12x12.7 18HEX	X20FS-U X24FS-U	067800-4020 067800-4040	T T	X16FSR-U X20FSR-U	067700-5010 067700-5020	T T									
M10x12.7 16HEX	U16FS-U U20FS-U U22FS-U U24FS-U U14FS-UB U16FS-UB	067800-4590 067800-4600 067800-4610 067800-4620 067800-6400 067800-4690	T T T T S S	U16FSR-U U20FSR-U U22FSR-U U24FSR-U U14FSR-UB U16FSR-UB	067700-5580 067700-5590 067700-5600 067700-5610 067700-8290 067700-5990	T T T T S S	IUF22 IUF22 IUF24 IUF27A IUF31A IUF14-UB	067700-9481 067700-9481 067700-9491 067700-9701 067700-9711 267700-0540	R R R R R S						
M10x19 16HEX 0.6mmPROJECTION	U22ES-N U24ES-N U27ES-N	067800-4850 067800-4860 067800-4870	T T T	U20ESR-N U22ESR-N U24ESR-N U27ESR-N U31ESR-N U22ESR-NB U24ESR-NB U27ESR-NB	067700-8850 067700-5320 067700-5380 067700-5390 067700-5640 267700-2730 267700-2300 267700-2280	T T T T T S S S	IU20 IU22 IU24 IU27 IU31 IU22 IU24 IU27	267700-5021 067700-9262 067700-9272 067700-9282 067700-9292 067700-9262 067700-9272 067700-9282	R R R R R R R R				IU01-24 IU01-27 RU01-27 IU01-31 RU01-31 IU01-24 IU01-27 RU01-27	267700-1011 267700-1021 267700-1571 267700-1031 267700-1581 267700-1011 267700-1021 267700-1571	R R R R R R R R
M10x19 16HEX 1.5mmPROJECTION				U20EPR9 U22EPR9 U24EPR9	267700-4580 267700-6480 267700-6490	T T T	IU20 IU22D IU22 IU24D IU24	267700-5022 267700-0831 267700-0831 067700-9262 267700-0841 067700-9272	R R R R R				IU01-24	267700-1011	R
M10x19 16HEX 2ELECTRODE				U22ETR U24ETR U27ETR U31ETR	067700-5560 067700-5450 067700-5460 067700-5630	T T T T	IU24A IU27A IU31A	067700-9302 067700-9312 067700-9321	R R R				IU01-24 IU01-27 RU01-27 IU01-31 RU01-31	267700-1011 267700-1021 267700-1571 267700-1031 267700-1581	R R R R R
M10x19 16HEX, φ 10.5				N24EXRB	267700-2290	S	IU24	067700-9272	R				IU01-24	267700-1011	R
M10x19 HALF THREAD 16HEX For Honda	U24FE9	067800-4820	T	U16FER9 U22FER9 U24FER9 U24FER9S U27FER9	267700-0520 067700-5810 067700-5820 267700-4790 067700-5830	T T T T T	IUH24 IUH24 IUH27	067700-9331 067700-9331 067700-9341	R R R				IU01-24 IU01-24 IU01-27 RU01-27	267700-1011 267700-1011 267700-1021 267700-1571	R R R R
M8x19 HALF THREAD 13HEX				Y24FER-C Y27FER-C Y31FER-C	067700-7550 067700-7560 067700-7570	T T T	IY24 IY27 IY31	267700-4491 267700-4501 267700-4511	R R R						

S: SOLID; R: REMOVABLE; RC: CRIMPED; T: THREAD

No	DENSO	PART NUMBER	SPEC.	CENTER/E.	GROUND/E.	R/STD	NUT	Gap	MAIN USE	MAIN APPLICATION	STOCK NUMBER
1	•K16TNR-S9	067700-9770	2Elec.Surface	Ni	Nix2	R	S	0.9	AUTOMOBILE	DAIHATSU	3329
2	•K20PTR-S	067700-9760	2Elec.Surface	Ni	Nix2	R	S	1.0	AUTOMOBILE	DAIHATSU	3368
3	•K20TNR-S	067700-8000	2Elec.Surface	Ni	Nix2	R	S	1.0	AUTOMOBILE	DAIHATSU	3196
4	•K20TNR-S9	067700-8800	2Elec.Surface	Ni	Nix2	R	S	0.9	AUTOMOBILE	DAIHATSU	3305
5	•P16R	067700-4120	Platinum	1.1Pt	Pt	R	S	1.0	AUTOMOBILE	TOYOTA	3228
6	•PK20R11	067700-8880	Platinum	1.1Pt	Pt	R	S	1.1	AUTOMOBILE	TOYOTA	#N/A
7	•PQ20R-P11	067700-3992	DoublePt Platinum	1.1Pt	DoublePt	R	S	1.1	AUTOMOBILE	TOYOTA	3224
8	•SK16PR-A11	067700-0870	Iridium	0.71r	Pt	R	S	1.1	AUTOMOBILE	DAIHATSU	3356
9	•SK16R-P11	067700-8860	DoublePt Iridium	0.71r	DoublePt	R	S	1.1	AUTOMOBILE	TOYOTA	#N/A
10	•SK20R-P11	067700-3150	DoublePt Iridium	0.71r	DoublePt	R	S	1.1	AUTOMOBILE	TOYOTA	3335
11	•W16EPR-U	067700-4570	Resistor	Ni	Ni	R	T	0.8	AUTOMOBILE	SUZUKI	#N/A
12	•XU22EPR-U	067700-8870	φ12x16Hex	Ni	Ni	R	S	0.9	AUTOMOBILE	DAIHATSU	3480
13	DK16R-B5	267700-8580	Double Needle φ14×19	0.71r	Pt NEEDLE	R	S	0.5	AUTOMOBILE	TOYOTA	3476
14	DK20PR-D13	267700-7390	Double Needle Iridium	0.71r	Pt NEEDLE,Cu EE	R	S	1.3	AUTOMOBILE	HONDA	#N/A
15	DXE22HCR11S	267700-8320	Double Needle φ12×26.5 Shroud 1.5 SUS Gasket	0.71r	Pt Needle	R	S	1.1	AUTOMOBILE	HONDA	#N/A
16	DXE22HQR-D11S	267700-7800	Double Needle φ12Iridium.Long Reach SUS Gasket	0.71r	Pt NEEDLE	R	S	1.1	AUTOMOBILE	HONDA	#N/A
17	DXU22HCR-D11S	267700-7580	Double Needle Extended Shroud φ12 Long Reach Iridium SUS Gasket	0.71r	Pt NEEDLE,Cu EE	R	S	1.1	AUTOMOBILE	HONDA	3483
18	FC16HR8	267700-8180	Double Needle φ12Iridium.Long Reach	0.551r	Pt NEEDLE	R	S	0.8	AUTOMOBILE	TOYOTA	#N/A
19	FC16HR-Q8	267700-8780	Double Needle φ12Iridium.Long Reach	0.71r	Pt NEEDLE,Cu EE	R	S	0.8	AUTOMOBILE	TOYOTA	#N/A
20	FC20HPR8	267700-7710	Double Needle φ12Iridium.Long Reach	0.551r	Pt NEEDLE	R	S	0.8	AUTOMOBILE	MAZDA	#N/A
21	FC20HR-BG9	267700-8360	Double Needle φ12×26.5 w/t Grease	0.551r	Pt Needle	R	S	0.9	AUTOMOBILE	TOYOTA	#N/A
22	FC22HR9	267700-7400	Double Needle φ12Iridium.Long Reach	0.551r	Pt NEEDLE	R	S	0.9	AUTOMOBILE	TOYOTA	#N/A
23	FC22HR9-G	267700-7620	Double Needleφ12 Long Reach Iridium w/t Grease	0.551r	Pt NEEDLE	R	S	0.9	AUTOMOBILE	TOYOTA	#N/A
24	FK16BR-AL8	267700-8560	Double Needle 3Elec M12 Iridium Long Reach	0.551r	Pt NEEDLE	R	S	0.8	AUTOMOBILE	TOYOTA	3458
25	FK16HQR11	267700-5920	Double Needle Long Reach Iridium	0.551r	Pt NEEDLE	R	S	1.1	AUTOMOBILE	HYUNDAI,KIA	3450
26	FK16HR11	267700-7140	Double Needle Long Reach Iridium	0.551r	Pt NEEDLE	R	S	1.1	AUTOMOBILE	TOYOTA	3484
27	FK16HR-A8	267700-7700	Double Needle Long Reach Iridium	0.551r	Pt NEEDLE	R	S	0.8	AUTOMOBILE	TOYOTA	3440
28	FK16R11	267700-5290	Double Needle Iridium	0.551r	Pt NEEDLE	R	S	1.1	AUTOMOBILE	TOYOTA	3485
29	FK16R-A8	267700-7780	Double Needle Iridium	0.551r	Pt NEEDLE	R	S	0.8	AUTOMOBILE	TOYOTA	#N/A
30	FK16R-AL8	267700-8340	Double Needle φ14×26.5	0.551r	Pt Needle	R	S	0.8	AUTOMOBILE	TOYOTA	#N/A
31	FK16HBR-J8	267700-8590	Double Needle 3Elec φ14×26.5	0.71r	Pt NEEDLE	R	S	0.8	AUTOMOBILE	TOYOTA	3473
32	FK20HBR11	267700-4200	Double Needle 3Elec Long Reach Iridium Shroud	0.551r	Pt NEEDLE	R	S	1.1	AUTOMOBILE	TOYOTA	#N/A
33	FK20HBR11-T	267700-7180	Double Needle 3Elec Long Reach Iridium Shroud	0.551r	Pt NEEDLE	R	S	1.1	AUTOMOBILE	TOYOTA	#N/A
34	FK20HBR8	267700-7770	Double Needle 3Elec Long Reach Iridium Shroud	0.551r	Pt NEEDLE	R	S	0.8	AUTOMOBILE	TOYOTA	#N/A
35	FK20HQR10	067800-7860	Double Needle Long Reach Iridium	0.551r	Pt NEEDLE	R	S	1.0	AUTOMOBILE	VOLVO	#N/A
36	FK20HQR10	267700-7340	Double Needle Long Reach Iridium	0.551r	Pt NEEDLE	R	S	1.0	AUTOMOBILE	FOMOCO	#N/A
37	FK20HQR8	067800-7920	Double Needle Long Reach Iridium	0.551r	Pt NEEDLE	R	S	0.8	AUTOMOBILE	VOLVO	#N/A
38	FK20HQR8	267700-7190	Double Needle Long Reach Iridium	0.551r	Pt NEEDLE	R	S	0.8	AUTOMOBILE	HYUNDAI,KIA	3459
39	FK20HR11	267700-4230	Double Needle Long Reach Iridium	0.551r	Pt NEEDLE	R	S	1.1	AUTOMOBILE	TOYOTA,SUBARU	3426
40	FK20HR11-G	267700-7600	Double Needle Long Reach Iridium w/t Grease	0.551r	Pt NEEDLE	R	S	1.1	AUTOMOBILE	TOYOTA	#N/A
41	FK20HR8-G	267700-7570	Double Needle Long Reach Iridium w/t Grease	0.551r	Pt NEEDLE	R	S	0.8	AUTOMOBILE	TOYOTA	#N/A
42	FXE16HE11	267700-4950	Double Needle φ12Iridium.Long Reach,Shroud	0.551r	Pt NEEDLE	R	S	1.1	AUTOMOBILE	NISSAN	3438
43	FXE20HE11·(AM)	267700-5480	Double Needle φ12Iridium.Long Reach,Shroud	0.551r	Pt NEEDLE	R	S	1.1	AUTOMOBILE	NISSAN	3436
44	FXE20HE11·(OE)	267700-7310	Double Needle φ12Iridium.Long Reach,Shroud	0.551r	Pt NEEDLE	R	S	1.1	AUTOMOBILE	NISSAN	#N/A
45	FXE20HE11C	267700-7720	Double Needleφ12 Long Reach Iridium	0.551r	Pt NEEDLE	R	S	1.1	AUTOMOBILE	AUTOMOBILE	#N/A
46	FXE20HE11C	267700-7730	Double Needleφ12 Long Reach Iridium	0.551r	Pt NEEDLE	R	S	1.1	AUTOMOBILE	AUTOMOBILE	#N/A
47	FXE20HR11·(AM)	267700-4880	Double Needle φ12Iridium.Long Reach	0.551r	Pt NEEDLE	R	S	1.1	AUTOMOBILE	NISSAN	3439
48	FXE20HR11·(OE)	267700-7300	Double Needle φ12Iridium.Long Reach	0.551r	Pt NEEDLE	R	S	1.1	AUTOMOBILE	NISSAN	#N/A
49	FXE20HR11·(OE)	267700-7320	Double Needle φ12Iridium.Long Reach	0.551r	Pt NEEDLE	R	S	1.1	AUTOMOBILE	NISSAN	#N/A
50	FXE22HR11·(AM)	267700-5830	Double Needle φ12Iridium.Long Reach	0.551r	Pt NEEDLE	R	S	1.1	AUTOMOBILE	NISSAN	3442
51	FXE22HR11·(OE)	267700-7290	Double Needle φ12Iridium.Long Reach	0.551r	Pt NEEDLE	R	S	1.1	AUTOMOBILE	NISSAN	#N/A
52	FXE24HR11·(AM)	267700-6970	Double Needle φ12Iridium.Long Reach	0.551r	Pt NEEDLE	R	S	1.1	AUTOMOBILE	NISSAN	3457
53	FXE24HR11·(OE)	267700-7280	Double Needle φ12Iridium.Long Reach	0.551r	Pt NEEDLE	R	S	1.1	AUTOMOBILE	NISSAN	#N/A
54	FXU16HR11	267700-7260	Double Needle φ12Iridium.Long Reach	0.551r	Pt NEEDLE	R	S	1.1	AUTOMOBILE	HYUNDAI,KIA	3478
55	FXU22HR11	267700-7520	Double Needle φ12Iridium.Long Reach	0.551r	Pt NEEDLE	R	S	1.1	AUTOMOBILE	DAIHATSU	#N/A
56	FXU22HR8	267700-7560	Double Needleφ12 Long Reach Iridium	0.551r	Pt NEEDLE	R	S	0.8	AUTOMOBILE	DAIHATSU	#N/A
57	GE3-F	067800-9250	Iridium,GAP0.32mm,CNG	0.71r	Pt	R	S	0.3	CNG	VOLVO	6123
58	GX8-1	267700-5590	CNG, φ12x26.5,Iridium	0.71r	Pt	R	S	0.8	CNG	ISUZU	3462
59	IA01-31	267700-1261	Iridium Racing	0.41r	□Pt	R	S	0.6	MOTORCYCLE	MOTORCYCLE	5723
60	IA01-32	267700-1271	Iridium Racing	0.41r	□Pt	R	S	0.6	MOTORCYCLE	MOTORCYCLE	5724
61	IA01-34	267700-1281	Iridium Racing	0.41r	□Pt	R	S	0.6	MOTORCYCLE	MOTORCYCLE	5725
62	IAE01-32	267700-2941	Iridium Racing	0.41r	□Pt	R	S	0.6	MOTORCYCLE	MOTORCYCLE	5747
63	IAE01-34	267700-2951	Iridium Racing	0.41r	□Pt	R	S	0.6	MOTORCYCLE	MOTORCYCLE	5748
64	IK01-24	267700-1311	Iridium Racing	0.41r	□Pt	R	S	0.6	AUTOMOBILE	AUTOMOBILE	5701
65	IK01-27	267700-1321	Iridium Racing	0.41r	□Pt	R	S	0.7	AUTOMOBILE	AUTOMOBILE	5702
66	IK01-31	267700-1331	Iridium Racing	0.41r	□Pt	R	S	0.7	AUTOMOBILE	AUTOMOBILE	5703
67	IK01-34	267700-1341	Iridium Racing	0.41r	□Pt	R	S	0.7	AUTOMOBILE	AUTOMOBILE	5742
68	IK02-24	267700-1361	Iridium Racing	0.41r	□Pt	R	S	0.7	AUTOMOBILE	AUTOMOBILE	5704
69	IK02-27	267700-1371	Iridium Racing	0.41r	□Pt	R	S	0.7	AUTOMOBILE	AUTOMOBILE	5705
70	IK02-31	267700-1381	Iridium Racing	0.41r	□Pt	R	S	0.7	AUTOMOBILE	AUTOMOBILE	5706
71	IK16	067700-8681	Iridium Power	0.41r	TAPERCUT	R	S	1.1	AUTOMOBILE	AUTOMOBILE	5303
72	IK16G	267700-5611	Iridium Power/SUS GASKET	0.41r	TAPERCUT	R	S	1.1	AUTOMOBILE	AUTOMOBILE	5351
73	IK16TT	267700-8450	Iridium TT φ14x19	0.41r	Pt Needle	R	S	1.0	AUTOMOBILE	AUTOMOBILE	5304
74	IK20	067700-8691	Iridium Power	0.41r	TAPERCUT	R	S	1.1	AUTOMOBILE	AUTOMOBILE	5304
75	IK20TT	267700-8530	Iridium TT φ14x19	0.41r	Pt Needle	R	S	1.0	AUTOMOBILE	AUTOMOBILE	5352
76	IK20G	267700-5621	Iridium Power/SUS GASKET	0.41r	TAPERCUT	R	S	1.1	AUTOMOBILE	AUTOMOBILE	5310
77	IK22	067700-8431	Iridium Power	0.41r	TAPERCUT	R	S	0.8	AUTOMOBILE	AUTOMOBILE	5348
78	IK22G	267700-5661	Iridium Power/SUS GASKET	0.41r	TAPERCUT	R	S	0.8	AUTOMOBILE	AUTOMOBILE	5311
79	IK24	067700-8461	Iridium Power	0.41r	TAPERCUT	R	S	0.8	AUTOMOBILE	AUTOMOBILE	5335
80	IK24C11	067700-9550	Iridium	0.41r	TAPERCUT	R	S	1.1	MOTORCYCLE	HONDA	5312
81	IK27	067700-8472	Iridium Power	0.41r	TAPERCUT	R	S	0.8	AUTOMOBILE	AUTOMOBILE	5336
82	IK27C11	067700-9520	Iridium	0.41r	TAPERCUT	R	S	1.1	MOTORCYCLE	HONDA	5321
83	IK31	067700-9221	Iridium Power	0.41r	TAPERCUT	R	S	0.8	AUTOMOBILE	AUTOMOBILE	5322
84	IK34	067700-9591	Iridium Power	0.41r	TAPERCUT	R	S	0.8	AUTOMOBILE	AUTOMOBILE	5749
85	IKH01-24	267700-4451	Iridium Racing	0.41r	□Pt	R	S	0.7	AUTOMOBILE	AUTOMOBILE	5750
86	IKH01-27	267700-4461	Iridium Racing	0.41r	□Pt	R	S	0.7	AUTOMOBILE	AUTOMOBILE	5751
87	IKH01-31	267700-4471	Iridium Racing	0.41r	□Pt	R	S	0.7	AUTOMOBILE	AUTOMOBILE	5751

S: SOLID; R: REMOVABLE; RC: CRIMPED; T: THREAD
 HON:HONDA SUB:SUBARU SUZ:SUZUKI MAZ:MAZDA MIT:MITSUBISHI KAW:KAWASAKI YAM:YAMAHA

DENSO
 AUSTRALIA CHINA INDIA INDONESIA KOREA MALAYSIA PHILIPPINES SAUDIARABIA SINGAPORE TAIWAN THAILAND VIETNAM JAPAN & USA EUROPE MOTOR CYCLE SMALL ENGINE REFERENCE PART NUMBER

DENSO
AUSTRALIA
CHINA
INDIA
INDONESIA
KOREA
MALAYSIA
PHILIPPINES
SAUDI ARABIA
SINGAPORE
TAIWAN
THAILAND
VIETNAM
JAPAN
EUROPE & USA
SMALL MOTOR ENGINE
CROSS REFERENCE
PART NUMBER

No	DENSO	PART NUMBER	SPEC.	CENTER/E	GROUND/E	R/STD	NUT	Gap	MAIN USE	MAIN APPLICATION	STOCK NUMBER
88	IKH16	267700-3661	Iridium Power	0.4lr	TAPERCUT	R	S	1.1	AUTOMOBILE	AUTOMOBILE	5343
89	IKH16TT	267700-8460	Iridium TT Φ14x26.5	0.4lr	Pt Needle	R	S	1.0	AUTOMOBILE	AUTOMOBILE	
90	IKBH20TT	267700-8480	Iridium TT, 3Elec. Surface, Φ14x26.5	0.4lr	Pt Needle	R	S	1.0	AUTOMOBILE	AUTOMOBILE	
91	IKH20	267700-3671	Iridium Power	0.4lr	TAPERCUT	R	S	1.1	AUTOMOBILE	AUTOMOBILE	5344
92	IKH20TT	267700-8470	Iridium TT Φ14x26.5	0.4lr	Pt Needle	R	S	1.0	AUTOMOBILE	AUTOMOBILE	
93	IKH22	267700-2651	Iridium Power	0.4lr	TAPERCUT	R	S	0.8	AUTOMOBILE	AUTOMOBILE	5345
94	IKH24	267700-4281	Iridium Power	0.4lr	TAPERCUT	R	S	0.8	AUTOMOBILE	AUTOMOBILE	5346
95	IKH27	267700-4291	Iridium Power	0.4lr	TAPERCUT	R	S	0.8	AUTOMOBILE	AUTOMOBILE	5347
96	IQ01-24	267700-1411	Iridium Racing	0.4lr	□Pt	R	S	0.7	AUTOMOBILE	AUTOMOBILE	5707
97	IQ01-27	267700-1421	Iridium Racing	0.4lr	□Pt	R	S	0.7	AUTOMOBILE	AUTOMOBILE	5708
98	IQ01-31	267700-1431	Iridium Racing	0.4lr	□Pt	R	S	0.7	AUTOMOBILE	AUTOMOBILE	5709
99	IQ01-34	267700-1441	Iridium Racing	0.4lr	□Pt	R	S	0.7	AUTOMOBILE	AUTOMOBILE	5743
100	IQ02-24	267700-1461	Iridium Racing	0.4lr	□Pt	R	S	0.7	AUTOMOBILE	AUTOMOBILE	5710
101	IQ02-27	267700-1471	Iridium Racing	0.4lr	□Pt	R	S	0.7	AUTOMOBILE	AUTOMOBILE	5711
102	IQ02-31	267700-1481	Iridium Racing	0.4lr	□Pt	R	S	0.7	AUTOMOBILE	AUTOMOBILE	5712
103	IQ16	067700-8701	Iridium Power	0.4lr	TAPERCUT	R	S	1.1	AUTOMOBILE	AUTOMOBILE	5301
104	IQ16TT	267700-8190	Iridium TT Φ14x19	0.4lr	Pt Needle	R	S	1.0	AUTOMOBILE	AUTOMOBILE	
105	IQ20	067700-8711	Iridium Power	0.4lr	TAPERCUT	R	S	1.1	AUTOMOBILE	AUTOMOBILE	5302
106	IQ20TT	267700-8200	Iridium TT Φ14x19	0.4lr	Pt Needle	R	S	1.0	AUTOMOBILE	AUTOMOBILE	
107	IQ22	067700-8481	Iridium Power	0.4lr	TAPERCUT	R	S	0.8	AUTOMOBILE	AUTOMOBILE	5313
108	IQ24	067700-8491	Iridium Power	0.4lr	TAPERCUT	R	S	0.8	AUTOMOBILE	AUTOMOBILE	5314
109	IQ27	067700-8502	Iridium Power	0.4lr	TAPERCUT	R	S	0.8	AUTOMOBILE	AUTOMOBILE	5315
110	IQ31	067700-9231	Iridium Power	0.4lr	TAPERCUT	R	S	0.8	AUTOMOBILE	AUTOMOBILE	5323
111	IQ34	067700-9601	Iridium Power	0.4lr	TAPERCUT	R	S	0.8	AUTOMOBILE	AUTOMOBILE	5324
112	IRE01-27	267700-1521	Iridium Racing	0.4lr	□Pt	R	S	0.7	AUTOMOBILE	MAZDA ROTARY	5719
113	IRE01-31	267700-1531	Iridium Racing	0.4lr	□Pt	R	S	0.7	AUTOMOBILE	MAZDA ROTARY	5720
114	IRE01-32	267700-1541	Iridium Racing	0.4lr	□Pt	R	S	0.7	AUTOMOBILE	MAZDA ROTARY	5721
115	IRE01-34	267700-1551	Iridium Racing	0.4lr	□Pt	R	S	0.7	AUTOMOBILE	MAZDA ROTARY	5722
116	IRE01-35	267700-1561	Iridium Racing	0.4lr	□Pt	R	S	0.7	AUTOMOBILE	MAZDA ROTARY	5741
117	IRL01-27	267700-4821	Iridium Racing	0.4lr	□Pt	R	S	1.1	AUTOMOBILE	MAZDA ROTARY,RX8	5754
118	IRL01-31	267700-4831	Iridium Racing	0.4lr	□Pt	R	S	1.1	AUTOMOBILE	MAZDA ROTARY,RX8	5755
119	IRT01-31	267700-4841	Iridium Racing	0.4lr	□Pt	R	S	1.1	AUTOMOBILE	MAZDA ROTARY,RX8	5752
120	IRT01-34	267700-4851	Iridium Racing	0.4lr	□Pt	R	S	1.1	AUTOMOBILE	MAZDA ROTARY,RX8	5753
121	IT16	267700-0611	Iridium Power	0.4lr	TAPERCUT	R	S	1.1	AUTOMOBILE	AUTOMOBILE	5325
122	IT16TT	267700-8230	Iridium TT Φ14x17.5, Taper seat	0.4lr	Pt Needle	R	S	1.0	AUTOMOBILE	AUTOMOBILE	
123	IT20	267700-0621	Iridium Power	0.4lr	TAPERCUT	R	S	1.1	AUTOMOBILE	AUTOMOBILE	5326
124	IT20TT	267700-8520	Iridium TT Φ14x17.5, Taper seat	0.4lr	Pt Needle	R	S	1.0	AUTOMOBILE	AUTOMOBILE	
125	IT22	267700-0631	Iridium Power	0.4lr	TAPERCUT	R	S	0.8	AUTOMOBILE	AUTOMOBILE	5327
126	IT24	267700-0641	Iridium Power	0.4lr	TAPERCUT	R	S	0.8	AUTOMOBILE	AUTOMOBILE	5328
127	IT27	267700-0651	Iridium Power	0.4lr	TAPERCUT	R	S	0.8	AUTOMOBILE	AUTOMOBILE	5329
128	ITF16	267700-0661	Iridium Power	0.4lr	TAPERCUT	R	S	1.1	AUTOMOBILE	AUTOMOBILE	5330
129	ITF16TT	267700-8260	Iridium TT Φ14x11.2, Taper seat	0.4lr	Pt Needle	R	S	1.0	AUTOMOBILE	AUTOMOBILE	
130	ITF20	267700-0671	Iridium Power	0.4lr	TAPERCUT	R	S	1.1	AUTOMOBILE	AUTOMOBILE	5331
131	ITF16TT	267700-8270	Iridium TT Φ14x11.2, Taper seat	0.4lr	Pt Needle	R	S	1.0	AUTOMOBILE	AUTOMOBILE	
132	ITF22	267700-0681	Iridium Power	0.4lr	TAPERCUT	R	S	0.8	AUTOMOBILE	AUTOMOBILE	5332
133	ITF24	267700-0691	Iridium Power	0.4lr	TAPERCUT	R	S	0.8	AUTOMOBILE	AUTOMOBILE	5333
134	ITF27	267700-0701	Iridium Power	0.4lr	TAPERCUT	R	S	0.8	AUTOMOBILE	AUTOMOBILE	5334
135	ITL16	267700-4981	Iridium Power	0.4lr	TAPERCUT	R	S	1.1	AUTOMOBILE	AUTOMOBILE	5349
136	ITL16TT	267700-8280	Iridium TT Φ14x25, Taper seat	0.4lr	Pt Needle	R	S	1.0	AUTOMOBILE	AUTOMOBILE	
137	ITL20	267700-4991	Iridium Power	0.4lr	TAPERCUT	R	S	1.1	AUTOMOBILE	AUTOMOBILE	5350
138	ITV16	267700-3701	Iridium Power	0.4lr	TAPERCUT	R	S	1.1	AUTOMOBILE	AUTOMOBILE	5338
139	ITV16TT	267700-8240	Iridium TT Φ14x25, Taper seat	0.4lr	Pt Needle	R	S	1.0	AUTOMOBILE	AUTOMOBILE	
140	ITV20	267700-3711	Iridium Power	0.4lr	TAPERCUT	R	S	1.1	AUTOMOBILE	AUTOMOBILE	5339
141	ITV20TT	267700-8250	Iridium TT Φ14x25, Taper seat	0.4lr	Pt Needle	R	S	1.0	AUTOMOBILE	AUTOMOBILE	
142	ITV22	267700-2501	Iridium Power	0.4lr	TAPERCUT	R	S	0.8	AUTOMOBILE	AUTOMOBILE	5340
143	ITV24	267700-2511	Iridium Power	0.4lr	TAPERCUT	R	S	0.8	AUTOMOBILE	AUTOMOBILE	5341
144	ITV27	267700-2521	Iridium Power	0.4lr	TAPERCUT	R	S	0.8	AUTOMOBILE	AUTOMOBILE	5342
145	IU01-24	267700-1011	Iridium Racing	0.4lr	□Pt	R	R	0.6	MOTORCYCLE	MOTORCYCLE	5734
146	IU01-27	267700-1021	Iridium Racing	0.4lr	□Pt	R	R	0.6	MOTORCYCLE	MOTORCYCLE	5735
147	IU01-31	267700-1031	Iridium Racing	0.4lr	□Pt	R	R	0.6	MOTORCYCLE	MOTORCYCLE	5736
148	IU01-34	267700-1041	Iridium Racing	0.4lr	□Pt	R	R	0.6	MOTORCYCLE	MOTORCYCLE	5737
149	IU20	267700-5021	Iridium Power	0.4lr	TAPERCUT	R	R	0.9	MOTORCYCLE	MOTORCYCLE	5360
150	IU22	067700-9262	Iridium Power	0.4lr	TAPERCUT	R	R	0.9	MOTORCYCLE	MOTORCYCLE	5361
151	IU22D	267700-0830	Iridium Power	0.4lr	TAPERCUT	R	T	0.9	MOTORCYCLE	SUZUKI	#N/A
152	IU24	067700-9272	Iridium Power	0.4lr	TAPERCUT	R	R	0.9	MOTORCYCLE	MOTORCYCLE	5362
153	IU24A	067700-9302	Iridium Power	0.4lr	SLANT	R	R	0.9	MOTORCYCLE	MOTORCYCLE	5365
154	IU24D	267700-0840	Iridium	0.4lr	TAPERCUT	R	T	0.9	MOTORCYCLE	SUZUKI	5403
155	IU27	067700-9282	Iridium Power	0.4lr	TAPERCUT	R	R	0.9	MOTORCYCLE	MOTORCYCLE	5363
156	IU27A	067700-9312	Iridium Power	0.4lr	SLANT	R	R	0.9	MOTORCYCLE	MOTORCYCLE	5366
157	IU27D	267700-0850	Iridium	0.4lr	TAPERCUT	R	T	0.9	MOTORCYCLE	YAMAHA	5390
158	IU31	067700-9292	Iridium Power	0.4lr	TAPERCUT	R	R	0.9	MOTORCYCLE	MOTORCYCLE	5364
159	IU31A	067700-9321	Iridium Power	0.4lr	SLANT	R	R	0.9	MOTORCYCLE	MOTORCYCLE	5367
160	IU31D	267700-0860	Iridium Power	0.4lr	TAPERCUT	R	T	0.9	MOTORCYCLE	MOTORCYCLE	
161	IUF14-UB	267700-0540	Iridium	0.4lr	Ni	R	S	0.7	MOTORCYCLE	HONDA	5389
162	IUF22	067700-9481	Iridium Power	0.4lr	TAPERCUT	R	R	0.8	MOTORCYCLE	MOTORCYCLE	5383
163	IUF24	067700-9491	Iridium Power	0.4lr	TAPERCUT	R	R	0.8	MOTORCYCLE	MOTORCYCLE	5384
164	IUF27A	067700-9701	Iridium Power	0.4lr	Ni SLANT	R	R	0.9	MOTORCYCLE	MOTORCYCLE	5385
165	IUF31A	067700-9711	Iridium Power	0.4lr	Ni SLANT	R	R	0.9	MOTORCYCLE	MOTORCYCLE	5386
166	IUH24	067700-9331	Iridium Power	0.4lr	TAPERCUT	R	R	0.9	MOTORCYCLE	MOTORCYCLE	5368
167	IUH24D	067700-9560	Iridium	0.4lr	TAPERCUT	R	T	0.9	MOTORCYCLE	HONDA	5387
168	IUH27	067700-9341	Iridium Power	0.4lr	TAPERCUT	R	R	0.9	MOTORCYCLE	MOTORCYCLE	5369
169	IUH27D	067700-9570	Iridium	0.4lr	TAPERCUT	R	T	0.9	MOTORCYCLE	HONDA	5388
170	IW01-24	267700-1111	Iridium Racing	0.4lr	□Pt	R	RC	0.6	MOTORCYCLE	MOTORCYCLE	5713
171	IW01-27	267700-1121	Iridium Racing	0.4lr	□Pt	R	RC	0.6	MOTORCYCLE	MOTORCYCLE	5714
172	IW01-29	267700-1131	Iridium Racing	0.4lr	□Pt	R	RC	0.6	MOTORCYCLE	MOTORCYCLE	5715
173	IW01-31	267700-1141	Iridium Racing	0.4lr	□Pt	R	RC	0.6	MOTORCYCLE	MOTORCYCLE	5716
174	IW01-32	267700-1151	Iridium Racing	0.4lr	□Pt	R	RC	0.6	MOTORCYCLE	MOTORCYCLE	5717

No	DENSO	PART NUMBER	SPEC.	CENTER/E.	GROUND/E.	R/STD	NUT	Gap	MAIN USE	MAIN APPLICATION	STOCK NUMBER
175	IW01-34	267700-1161	Iridium Racing	0.4lr	□Pt	R	RC	0.6	MOTORCYCLE	MOTORCYCLE	5718
176	IW06-27	067600-1811	Iridium Racing	0.4lr	□Pt	STD	S	0.6	AUTOMOBILE	AUTOMOBILE	5744
177	IW06-31	067600-1821	Iridium Racing	0.4lr	□Pt	STD	S	0.6	AUTOMOBILE	AUTOMOBILE	5745
178	IW06-34	067600-1831	Iridium Racing	0.4lr	□Pt	STD	S	0.6	AUTOMOBILE	AUTOMOBILE	5746
179	IW16	067700-8651	Iridium Power	0.4lr	TAPERCUT	R	RC	1.1	AUTOMOBILE	AUTOMOBILE	5305
180	IW16TT	267700-8210	Iridium TT Φ14x19	0.4lr	Pt Needle	R	S	1.0	AUTOMOBILE	AUTOMOBILE	
181	IW20	067700-8661	Iridium Power	0.4lr	TAPERCUT	R	RC	1.1	AUTOMOBILE	AUTOMOBILE	5306
182	IW20TT	267700-8220	Iridium TT Φ14x19	0.4lr	Pt Needle	R	S	1.0	AUTOMOBILE	AUTOMOBILE	
183	IW22	067700-8671	Iridium Power	0.4lr	TAPERCUT	R	RC	0.8	AUTOMOBILE	AUTOMOBILE	5307
184	IW24	067700-8891	Iridium Power	0.4lr	TAPERCUT	R	RC	0.7	MOTORCYCLE	MOTORCYCLE	5316
185	IW27	067700-8901	Iridium Power	0.4lr	TAPERCUT	R	RC	0.7	MOTORCYCLE	MOTORCYCLE	5317
186	IW29	067700-8911	Iridium Power	0.4lr	TAPERCUT	R	RC	0.7	MOTORCYCLE	MOTORCYCLE	5318
187	IW31	067700-8921	Iridium Power	0.4lr	TAPERCUT	R	RC	0.7	MOTORCYCLE	MOTORCYCLE	5319
188	IW34	067700-8931	Iridium Power	0.4lr	TAPERCUT	R	RC	0.7	MOTORCYCLE	MOTORCYCLE	5320
189	IWF16	267700-5001	Iridium Power	0.4lr	TAPERCUT	R	R	0.8	MOTORCYCLE	MOTORCYCLE	5359
190	IWF20	267700-5011	Iridium Power	0.4lr	TAPERCUT	R	R	0.8	MOTORCYCLE	MOTORCYCLE	5378
191	IWF22	067700-9411	Iridium Power	0.4lr	TAPERCUT	R	R	0.8	MOTORCYCLE	MOTORCYCLE	5379
192	IWF24	067700-9421	Iridium Power	0.4lr	TAPERCUT	R	R	0.8	MOTORCYCLE	MOTORCYCLE	5380
193	IWF27	067700-9431	Iridium Power	0.4lr	TAPERCUT	R	R	0.8	MOTORCYCLE	MOTORCYCLE	5381
194	IWM01-29	267700-1211	Iridium Racing	0.4lr	□Pt	R	S	0.6	MOTORCYCLE	MOTORCYCLE	5726
195	IWM01-31	267700-1221	Iridium Racing	0.4lr	□Pt	R	S	0.6	MOTORCYCLE	MOTORCYCLE	5727
196	IWM01-32	267700-1231	Iridium Racing	0.4lr	□Pt	R	S	0.6	MOTORCYCLE	MOTORCYCLE	5728
197	IWM01-34	267700-1241	Iridium Racing	0.4lr	□Pt	R	S	0.6	MOTORCYCLE	MOTORCYCLE	5729
198	IWM24	267700-2891	Iridium Power	0.4lr	TAPERCUT	R	S	0.8	MOTORCYCLE	MOTORCYCLE	5391
199	IWM27	267700-2901	Iridium Power	0.4lr	TAPERCUT	R	S	0.8	MOTORCYCLE	MOTORCYCLE	5392
200	IWM31	267700-2911	Iridium Power	0.4lr	TAPERCUT	R	S	0.8	MOTORCYCLE	MOTORCYCLE	5393
201	IX22	067700-9351	Iridium Power	0.4lr	TAPERCUT	R	R	0.8	MOTORCYCLE	MOTORCYCLE	5371
202	IX22B	067700-9381	Iridium Power	0.4lr	TAPERCUT	R	R	0.9	MOTORCYCLE	MOTORCYCLE	5375
203	IX24	067700-9361	Iridium Power	0.4lr	TAPERCUT	R	R	0.8	MOTORCYCLE	MOTORCYCLE	5372
204	IX24B	067700-9391	Iridium Power	0.4lr	TAPERCUT	R	R	0.9	MOTORCYCLE	MOTORCYCLE	5376
205	IX27	067700-9371	Iridium Power	0.4lr	TAPERCUT	R	R	0.8	MOTORCYCLE	MOTORCYCLE	5373
206	IX27B	067700-9401	Iridium Power	0.4lr	TAPERCUT	R	R	0.9	MOTORCYCLE	MOTORCYCLE	5377
207	IXEH20ETT	267700-8490	Iridium TT Φ12x26.5+Shroud 2mm,	0.4lr	Pt Needle	R	S	1.0	AUTOMOBILE	AUTOMOBILE	
208	IXEH20TT	267700-8500	Iridium TT Φ12x26.5, Hex14	0.4lr	Pt Needle	R	S	1.0	AUTOMOBILE	AUTOMOBILE	
209	IXEH22TT	267700-8510	Iridium TT Φ12x26.5, Hex14	0.4lr	Pt Needle	R	S	1.0	AUTOMOBILE	AUTOMOBILE	
210	IXG24	267700-2921	Iridium Power	0.4lr	TAPERCUT	R	R	0.7	MOTORCYCLE	MOTORCYCLE	5394
211	IXG27	267700-2931	Iridium Power	0.4lr	TAPERCUT	R	R	0.7	MOTORCYCLE	MOTORCYCLE	5395
212	IXU01-24	267700-1061	Iridium Racing	0.4lr	□Pt	R	R	0.6	MOTORCYCLE	MOTORCYCLE	5730
213	IXU01-27	267700-1071	Iridium Racing	0.4lr	□Pt	R	R	0.6	MOTORCYCLE	MOTORCYCLE	5731
214	IXU01-31	267700-1081	Iridium Racing	0.4lr	□Pt	R	R	0.6	MOTORCYCLE	MOTORCYCLE	5732
215	IXU01-34	267700-1091	Iridium Racing	0.4lr	□Pt	R	R	0.6	MOTORCYCLE	MOTORCYCLE	5733
216	IXU22	067700-8721	Iridium Power	0.4lr	TAPERCUT	R	RC	0.9	AUTOMOBILE	AUTOMOBILE	5308
217	IXU22C	267700-5170	Single Iridium	0.4lr	TAPERCUT	R	S	0.8	AUTOMOBILE	SUZUKI	#N/A
218	IXU22HPR	267700-7170	Iridium,Long Reach	0.4lr	Ni	R	S	0.8	AUTOMOBILE	SUZUKI,MAZDA660cc	3474
219	IXU22I	267700-8431	Iridium Power	0.4lr	TAPERCUT	R	S	0.9	AUTOMOBILE	AUTOMOBILE	5355
220	IXU24	067700-8731	Iridium Power	0.4lr	TAPERCUT	R	RC	0.9	AUTOMOBILE	AUTOMOBILE	5309
221	IXU27	067700-8601	Iridium Power	0.4lr	TAPERCUT	R	RC	0.9	MOTORCYCLE	MOTORCYCLE	5337
222	IXUH20I	267700-8171	Iridium Power	0.4lr	TAPERCUT	R	S	0.9	AUTOMOBILE	AUTOMOBILE	5354
223	IXUH22	267700-6451	Iridium Power	0.4lr	TAPERCUT	R	S	0.9	AUTOMOBILE	AUTOMOBILE	5353
224	IXUH22I	267700-7371	Iridium Power	0.4lr	TAPERCUT	R	S	0.9	AUTOMOBILE	AUTOMOBILE	5356
225	IY24	267700-4491	Iridium Power	0.4lr	Ni	R	R	0.7	MOTORCYCLE	MOTORCYCLE	5400
226	IY27	267700-4501	Iridium Power	0.4lr	Ni	R	R	0.7	MOTORCYCLE	MOTORCYCLE	5401
227	IY31	267700-4511	Iridium Power	0.4lr	Ni	R	R	0.7	MOTORCYCLE	MOTORCYCLE	5402
228	J14CR-U	067700-6980	Extended	Ni	Ni	R	S	0.8	AUTOMOBILE	HONDA	3381
229	J16AR-U11	067700-3531	Extended	Ni	Ni	R	S	1.1	AUTOMOBILE	TOYOTA	3000
230	J16A-U11	067600-7931	Extended	Ni	Ni	STD	S	1.1	AUTOMOBILE	TOYOTA	3220
231	J16AY	067600-8820	2Elec.Extended	Ni	Nix2	STD	S	1.1	AUTOMOBILE	DAIHATSU	3222
232	J16AYR	067700-7310	2Elec.Extended	Ni	Nix2	R	S	1.1	AUTOMOBILE	DAIHATSU	3261
233	J16BR-U	067700-3472	Extended	Ni	Ni	R	S	0.8	AUTOMOBILE	TOYOTA	3001
234	J16BR-U11	067700-3571	Extended	Ni	Ni	R	S	1.1	AUTOMOBILE	TOYOTA	3002
235	J16B-U11	067600-7971	Extended	Ni	Ni	STD	S	1.1	AUTOMOBILE	TOYOTA	3221
236	J16CR-U	067700-6990	Extended	Ni	Ni	R	S	0.8	AUTOMOBILE	MAZDA,HONDA	3407
237	J16CR-U	067700-8190	Extended	Ni	Ni	R	R	0.8	AUTOMOBILE	MAZDA,HONDA	3256
238	K16DTR-S11	067700-7330	2Elec.Shroud,Surface	Ni	Nix2	R	S	1.1	AUTOMOBILE	SUBARU	3248
239	K16GPR-U11	067700-0540	Shroud	Ni	Ni	R	S	1.1	AUTOMOBILE	NISSAN	3135
240	K16HPR-U11	067700-3020	26.5mmReach	Ni	Ni	R	S	1.1	AUTOMOBILE	SUZUKI,YAMAHA	6076
241	K16HR-U11	267700-6280	26.5mmReach	Ni	Ni	R	S	1.1	AUTOMOBILE	TOYOTA,DAIHATSU	3482
242	K16HR-UA8	267700-8370	Φ14X26.5	Ni	Ni	R	S	0.8	SMALL ENGINE	SMALL ENGINE	#N/A
243	K16PR-L11	067700-6550	ISO Small HexResistor	Ni	Ni	R	S	1.1	AUTOMOBILE	HONDA	3143
244	K16PR-P11	067700-8250	Single Platinum	1.1Pt	Ni	R	S	1.1	AUTOMOBILE	ISUZU	3293
245	K16PR-TP11	067700-7060	Single Platinum	1.1Pt	TAPERCUT	R	S	1.1	AUTOMOBILE	MAZDA	3166
246	K16PR-U	067700-6300	ISO Small HexResistor	Ni	Ni	R	S	0.8	AUTOMOBILE	MAZ,MIT,SUB	3191
247	K16PR-U	067700-7500	ISO Small HexResistor	Ni	Ni	R	R	0.8	AUTOMOBILE	MAZ,MIT,SUB	3349
248	K16PR-U11	067700-6270	ISO Small HexResistor	Ni	Ni	R	S	1.1	AUTOMOBILE	MAZ,MIT,SUB	3130
249	K16PR-UR	267700-5230	ISO,10KOHM Resistor	Ni	Ni	R	S	0.8	AUTOMOBILE	HONDA	#N/A
250	K16PSR-B8	267700-5860	Single Iridium	0.7lr	Ni	R	S	0.8	AUTOMOBILE	NISSAN	3437
251	K16P-U	067600-0380	Standard	Ni	Ni	STD	S	0.8	AUTOMOBILE	MAZ,MIT,SUB	3280
252	K16P-U11	067600-0350	Standard	Ni	Ni	STD	S	1.1	AUTOMOBILE	MAZ,MIT,SUB	3397
253	K16PZR13	267700-7900	Φ14X19 <FoMoCo Logo>	0.55lr	Ni	R	S	1.3	AUTOMOBILE	MAZDA	#N/A
254	K16R-U	067700-6400	ISO Small HexResistor	Ni	Ni	R	S	0.8	AUTOMOBILE	TOYOTA	3119
255	K16R-U	067700-7660	ISO Small HexResistor	Ni	Ni	R	S	0.8	AUTOMOBILE	TOYOTA	#N/A
256	K16R-U11	067700-6420	ISO Small HexResistor	Ni	Ni	R	S	1.1	AUTOMOBILE	TOYOTA	3120
257	K16R-UAG8	267700-7920	Φ14X19 w/t Grease	Ni	Ni	R	S	0.8	AUTOMOBILE	TOYOTA	#N/A
258	K16TR11	067700-7900	2Elec.	Ni	Nix2	R	S	1.1	AUTOMOBILE	TOYOTA	3194
259	K16TT	267700-7431	Ni NEEDLE	1.5Ni	1.5Ni	R	S	1.0	AUTOMOBILE	AUTOMOBILE	4603
260	K16-U	067600-0740	Standard	Ni	Ni	STD	S	0.8	AUTOMOBILE	TOYOTA	3338
261	K16-U11	067600-0750	Standard	Ni	Ni	STD	S	1.1	AUTOMOBILE	TOYOTA	#N/A

S: SOLID; R: REMOVABLE; RC: CRIMPED; T: THREAD
 HON:HONDA SUB:SUBARU SUZ:SUZUKI MAZ:MAZDA MIT:MITSUBISHI KAW:KAWASAKI YAM:YAMAHA

DENSO
 AUSTRALIA CHINA INDIA INDONESIA KOREA MALAYSIA PHILIPPINES SAUDIARABIA SINGAPORE TAIWAN THAILAND VIETNAM JAPAN & USA EUROPE MOTOR SMALL ENGINE REFERENCE PART NUMBER

No	DENSO	PART NUMBER	SPEC.	CENTER/E.	GROUND/E.	R/STD	NUT	Gap	MAIN USE	MAIN APPLICATION	STOCK NUMBER
349	PK20GR8	067700-8211	Shroud Platinum	1.1Pt	Pt	R	S	0.8	AUTOMOBILE	TOYOTA	3326
350	PK20PR11	067700-0300	Platinum	1.1Pt	Pt	R	S	1.1	AUTOMOBILE	MITSUBISHI	#N/A
351	PK20PR11	067700-7380	Platinum	1.1Pt	Pt	R	S	1.1	AUTOMOBILE	MITSUBISHI	3168
352	PK20PR-L11	067700-6750	Platinum	1.1Pt	Pt	R	S	1.1	AUTOMOBILE	HONDA	3142
353	PK20PR-L13	067700-7480	Platinum	1.1Pt	Pt	R	S	1.3	AUTOMOBILE	HONDA	3172
354	PK20PR-P11	067700-6460	DoublePt Platinum	1.1Pt	DoublePt	R	S	1.1	AUTOMOBILE	MITSUBISHI	3141
355	PK20PR-P8	067700-0020	DoublePt Platinum	1.1Pt	DoublePt	R	S	0.8	AUTOMOBILE	MITSUBISHI	3245
356	PK20PR-P8	067700-7610	DoublePt Platinum	1.1Pt	DoublePt	R	S	0.8	AUTOMOBILE	MITSUBISHI	#N/A
357	PK20PTR-S9	267700-2320	2Elec.Surface Platinum	1.1Pt	Nix2Elec.	R	S	0.9	AUTOMOBILE	DAIHATSU	3380
358	PK20R11	067700-6690	Platinum	1.1Pt	Pt	R	S	1.1	AUTOMOBILE	TOYOTA	3128
359	PK20R13	067700-6710	Platinum	1.1Pt	Pt	R	S	1.3	AUTOMOBILE	TOYOTA	3226
360	PK20R8	067700-6670	Platinum	1.1Pt	Pt	R	S	0.8	AUTOMOBILE	TOYOTA	3127
361	PK20R-P8	067700-6440	DoublePt Platinum	1.1Pt	DoublePt	R	S	0.8	AUTOMOBILE	TOYOTA	3227
362	PK20TR11	067700-7930	2Elect. Platinum	1.1Pt	Nix2Elec.	R	S	1.1	AUTOMOBILE	TOYOTA	3253
363	PK20TR8-G	067700-9920	2Elect. Platinum,CNG	1.1Pt	Nix2Elec.	R	S	0.8	AUTOMOBILE	TOYOTA	#N/A
364	PK20TT	267700-6330	Prutinum TT, Φ14x19	1.1Pt	1.5Ni	R	S	1.0	AUTOMOBILE	AUTOMOBILE	
365	PKH20TT	267700-6350	Prutinum TT, Φ14x26.5	1.1Pt	1.5Ni	R	S	1.0	AUTOMOBILE	AUTOMOBILE	
366	PK22PR11	067700-7390	Platinum	1.1Pt	Pt	R	S	1.1	AUTOMOBILE	ISUZU	3265
367	PK22PR8	067700-7690	Platinum	1.1Pt	Pt	R	S	0.8	AUTOMOBILE	MITSUBISHI	3273
368	PK22PR-L11S	267700-4160	Platinum,SUS GASKET	1.1Pt	Pt	R	S	1.1	AUTOMOBILE	HONDA	3284
369	PK22TT	267700-7790	Prutinum TT, Φ14x19	1.1Pt	1.5Ni	R	S	1.0	AUTOMOBILE	AUTOMOBILE	
370	PKJ16CR8	067700-7800	Extended Platinum	1.1Pt	Pt	R	S	0.8	AUTOMOBILE	MAZDA	3175
371	PKJ16CR-L11	067700-7130	Extended Platinum	1.1Pt	Pt	R	S	1.1	AUTOMOBILE	HONDA	3246
372	PKJ16CR-L13	067700-8300	Extended Platinum	1.1Pt	Pt	R	S	1.3	AUTOMOBILE	HONDA	3357
373	PKJ20CR8	067700-7810	Extended Platinum	1.1Pt	Pt	R	S	0.8	AUTOMOBILE	MAZDA	3173
374	PKJ20CR-L11	067700-7140	Extended Platinum	1.1Pt	Pt	R	S	1.1	AUTOMOBILE	HONDA	3247
375	PKJ20CR-M11	067700-9460	Extended Platinum	1.1Pt	Pt	R	S	1.1	AUTOMOBILE	HONDA	3392
376	PQ16R	067700-4171	Platinum	1.1Pt	Pt	R	S	1.1	AUTOMOBILE	TOYOTA	3005
377	PQ16R13	067700-4210	Platinum	1.1Pt	Pt	R	S	1.3	AUTOMOBILE	TOYOTA	3404
378	PQ16R8	067700-4851	Platinum	1.1Pt	Pt	R	S	0.8	AUTOMOBILE	TOYOTA	3123
379	PQ16R-P11	067700-4072	DoublePt Platinum	1.1Pt	DoublePt	R	S	1.1	AUTOMOBILE	TOYOTA	#N/A
380	PQ16TT	267700-6360	Prutinum TT, Φ14x19	1.1Pt	1.5Ni	R	S	1.0	AUTOMOBILE	AUTOMOBILE	
381	PQ20R	067700-4191	Platinum	1.1Pt	Pt	R	S	1.1	AUTOMOBILE	TOYOTA	3117
382	PQ20R13	067700-4220	Platinum	1.1Pt	Pt	R	S	1.3	AUTOMOBILE	TOYOTA	3244
383	PQ20R8	067700-4861	Platinum	1.1Pt	Pt	R	S	0.8	AUTOMOBILE	TOYOTA	3223
384	PQ20R-P11	067700-4082	DoublePt Platinum	1.1Pt	DoublePt	R	S	1.1	AUTOMOBILE	TOYOTA	3322
385	PQ20R-P8	067700-4102	DoublePt Platinum	1.1Pt	DoublePt	R	S	0.8	AUTOMOBILE	TOYOTA	3113
386	PQ20TT	267700-6370	Prutinum TT, Φ14x19	1.1Pt	1.5Ni	R	S	1.0	AUTOMOBILE	AUTOMOBILE	
387	PT16EPR10	067800-9390	Platinum	1.1Pt	Pt	R	S	1.0	AUTOMOBILE	GM	5091
388	PT16EPR13	067800-9400	Platinum	1.1Pt	Pt	R	S	1.3	AUTOMOBILE	GM	5092
389	PT16EPR-L13	067700-8140	Platinum	1.1Pt	Pt	R	S	1.3	AUTOMOBILE	GM,FORD	5070
390	PT16TT	267700-7200	Prutinum TT, Φ14x17.5, Taper seat	1.1Pt	1.5Ni	R	S	1.0	AUTOMOBILE	AUTOMOBILE	
391	PT20TT	267700-7210	Prutinum TT, Φ14x17.5, Taper seat	1.1Pt	1.5Ni	R	S	1.0	AUTOMOBILE	AUTOMOBILE	
392	PT16VR10	267700-6120	PlatinumxLongreach	1.1Pt	Pt	R	S	1.0	AUTOMOBILE	FORD	5093
393	PT16VR13	067700-7940	PlatinumxLongreach	1.1Pt	Pt	R	S	1.3	AUTOMOBILE	FORD	5068
394	PT16TT	267700-7240	Prutinum TT, Φ14x11.2, Taper seat	1.1Pt	1.5Ni	R	S	1.0	AUTOMOBILE	AUTOMOBILE	
395	PT20TT	267700-7250	Prutinum TT, Φ14x11.2, Taper seat	1.1Pt	1.5Ni	R	S	1.0	AUTOMOBILE	AUTOMOBILE	
396	PTJ14R15	067800-7270	Extended Platinum	1.1Pt	Pt	R	S	1.5	AUTOMOBILE	GM	5078
397	PTJ16R15	067800-7280	Extended Platinum	1.1Pt	Pt	R	S	1.5	AUTOMOBILE	GM	5077
398	PTV16TT	267700-7220	Prutinum TT, Φ14x25, Taper seat	1.1Pt	1.5Ni	R	S	1.0	AUTOMOBILE	AUTOMOBILE	
399	PW16TT	267700-6380	Prutinum TT, Φ14x19	1.1Pt	1.5Ni	R	S	1.0	AUTOMOBILE	AUTOMOBILE	
400	PW20TT	267700-6390	Prutinum TT, Φ14x19	1.1Pt	1.5Ni	R	S	1.0	AUTOMOBILE	AUTOMOBILE	
401	Q14R-U11	067700-4670	Small HexResistor	Ni	Ni	R	S	1.1	AUTOMOBILE	TOYOTA	3183
402	Q16PR-TP11	067700-6640	Single Platinum	1.1Pt	TAPERCUT	R	S	1.1	AUTOMOBILE	MAZDA	3266
403	Q16PR-U	067700-4450	Small HexResistor	Ni	Ni	R	R	0.8	AUTOMOBILE	MAZDA	3137
404	Q16PR-U	067700-6000	Small HexResistor	Ni	Ni	R	S	0.8	AUTOMOBILE	MAZDA	3346
405	Q16PR-U11	067700-4510	Small HexResistor	Ni	Ni	R	R	1.1	AUTOMOBILE	MAZDA	5016
406	Q16PR-U11	067700-6050	Small HexResistor	Ni	Ni	R	S	1.1	AUTOMOBILE	MAZDA	3186
407	Q16PR-U15	067700-4660	Small HexResistor	Ni	Ni	R	R	1.5	AUTOMOBILE	CHRYSLER	5017
408	Q16P-U11	067600-7200	Standard	Ni	Ni	STD	R	1.1	AUTOMOBILE	MAZDA	3254
409	Q16P-U11	067600-7800	Standard	Ni	Ni	STD	S	1.1	AUTOMOBILE	MAZDA	3184
410	Q16R-U	067700-4410	Small HexResistor	Ni	Ni	R	S	0.8	AUTOMOBILE	TOYOTA	3129
411	Q16R-U11	067700-4431	Small HexResistor	Ni	Ni	R	S	1.1	AUTOMOBILE	TOYOTA	3006
412	Q16TT	267700-7471	Ni NEEDLE	1.5Ni	1.5Ni	R	S	1.0	AUTOMOBILE	AUTOMOBILE	4607
413	Q16-U	067600-0700	Standard	Ni	Ni	STD	S	0.8	AUTOMOBILE	TOYOTA	3340
414	Q16-U11	067600-7071	Standard	Ni	Ni	STD	S	1.1	AUTOMOBILE	TOYOTA	3181
415	Q20PR-U	067700-4460	Small HexResistor	Ni	Ni	R	R	0.8	AUTOMOBILE	MAZDA,SUBARU	3007
416	Q20PR-U	067700-6060	Small HexResistor	Ni	Ni	R	S	0.8	AUTOMOBILE	MAZDA,SUBARU	3424
417	Q20PR-U11	067700-4520	Small HexResistor	Ni	Ni	R	R	1.1	AUTOMOBILE	MAZDA	3008
418	Q20PR-U11	067700-6070	Small HexResistor	Ni	Ni	R	S	1.1	AUTOMOBILE	MAZDA	3187
419	Q20P-U	067600-7680	Standard	Ni	Ni	STD	R	0.8	AUTOMOBILE	MAZDA,SUBARU	3125
420	Q20P-U11	067600-7300	Standard	Ni	Ni	STD	R	1.1	AUTOMOBILE	MAZDA,SUBARU	3136
421	Q20P-U11	067600-7810	Standard	Ni	Ni	STD	S	1.1	AUTOMOBILE	MAZDA,SUBARU	3185
422	Q20R-U	067700-4421	Small HexResistor	Ni	Ni	R	S	0.8	AUTOMOBILE	TOYOTA	3140
423	Q20R-U11	067700-4441	Small HexResistor	Ni	Ni	R	S	1.1	AUTOMOBILE	TOYOTA	3009
424	Q20TT	267700-7481	Ni NEEDLE	1.5Ni	1.5Ni	R	S	1.0	AUTOMOBILE	AUTOMOBILE	4608
425	Q20-U	067600-0720	Standard	Ni	Ni	STD	S	0.8	AUTOMOBILE	TOYOTA	3351
426	Q20-U11	067600-7081	Standard	Ni	Ni	STD	S	1.1	AUTOMOBILE	TOYOTA	3182
427	Q22PR-U	067700-4470	Small HexResistor	Ni	Ni	R	R	0.8	AUTOMOBILE	MAZDA,SUBARU	3010
428	Q22PR-U11	067700-4530	Small HexResistor	Ni	Ni	R	R	1.1	AUTOMOBILE	MAZDA	3257
429	Q22PR-U11	067700-6090	Small HexResistor	Ni	Ni	R	S	1.1	AUTOMOBILE	MAZDA	3379
430	Q22P-U	067600-7690	Standard	Ni	Ni	STD	R	0.8	AUTOMOBILE	MAZDA,SUBARU	3255
431	QJ14C11	067600-7100	Extended	Ni	Ni	STD	S	1.1	AUTOMOBILE	MAZDA	3236
432	QJ16AR-U	067700-5920	Extended	Ni	Ni	R	S	0.8	AUTOMOBILE	TOYOTA	3235
433	QJ16AR-U11	067700-5930	Extended	Ni	Ni	R	S	1.1	AUTOMOBILE	TOYOTA	3332
434	QJ16CR11	067700-6230	Extended	Ni	Ni	R	S	1.1	AUTOMOBILE	MAZDA	3295
435	QJ16HR-U9	067700-5910	Extended	Ni	Ni	R	R	0.9	AUTOMOBILE	CHRYSLER	5018

S: SOLID; R: REMOVABLE; RC: CRIMPED; T: THREAD
 HON:HONDA SUB:SUBARU SUZ:SUZUKI MAZ:MAZDA MIT:MITSUBISHI KAW:KAWASAKI YAM:YAMAHA

DENSO
 AUSTRALIA CHINA INDIA INDONESIA KOREA MALAYSIA PHILIPPINES SAUDIARABIA SINGAPORE TAIWAN THAILAND VIETNAM JAPAN & USA EUROPE MOTOR CYCLE SMALL ENGINE REFERENCE PART NUMBER

PART NUMBER	CROSS REFERENCE	SMALL ENGINE	MOTOR CYCLE	EUROPE & USA	JAPAN	VIETNAM	THAILAND	TAIWAN	SINGAPORE	SAUDIARABIA	PHILIPPINES	MALAYSIA	KOREA	INDONESIA	INDIA	CHINA	AUSTRALIA	DENSO	No	PART NUMBER	SPEC.	CENTER/E.	GROUND/E.	R/STD	NUT	Gap	MAIN USE	MAIN APPLICATION	STOCK NUMBER	
																			436	QJ20CR11	067700-6100	Extended	Ni	Ni	R	S	1.1	AUTOMOBILE	MAZDA	3112
																			437	QL20PR-U	067700-7290	Small Hex,Long Housing	Ni	Ni	R	S	0.8	AUTOMOBILE	DAIHATSU	3188
																			438	QL20TR-S	067700-7260	2Elec.Surface	Ni	Nix2,Surface	R	S	1.0	AUTOMOBILE	DAIHATSU	3189
																			439	QL22TR-S	067700-7270	2Elec.Surface	Ni	Nix2,Surface	R	S	1.0	AUTOMOBILE	DAIHATSU	3190
																			440	RU01-27	267700-1570	Surface Racing	Ni	Surface	R	R	1.1	MOTORCYCLE	MOTORCYCLE	5738
																			441	RU01-31	267700-1580	Surface Racing	Ni	Surface	R	R	1.1	MOTORCYCLE	MOTORCYCLE	5739
																			442	RU01-34	267700-1590	Surface Racing	Ni	Surface	R	R	1.1	MOTORCYCLE	MOTORCYCLE	5740
																			443	S20R8-G	267700-4690	Iridium,CNG	0.71r	Pt	R	S	0.8	AUTOMOBILE	TOYOTA	3447
																			444	S22PR-A7	067700-9670	Iridium	0.71r	Pt	R	S	0.7	AUTOMOBILE	MITSUBISHI	3354
																			445	S-29	067700-2830	ROTARY	Ni	Surface	R	S	1.95	AUTOMOBILE	MAZDA RE	3252
																			446	S-29A	067700-4820	ROTARY	Ni	Surface	R	S	1.95	AUTOMOBILE	MAZDA RE	3106
																			447	S-31A	067700-4830	ROTARY	Ni	Surface	R	S	1.95	AUTOMOBILE	MAZDA RE	3111
																			448	SC16HR11	267700-8300	φ12×26.5	0.71r	Pt	R	S	1.1	AUTOMOBILE	TOYOTA	#N/A
																			449	SC20HR11	267700-5580	φ12Iridium.Long Reach	0.71r	Pt	R	S	1.1	AUTOMOBILE	TOYOTA	3444
																			450	SC20HR-G11	267700-7930	φ12×26.5 w/t Grease	0.71r	Pt	R	S	1.1	AUTOMOBILE	TOYOTA	#N/A
																			451	SF-24	067800-0280	Surface	Ni	Surface	STD	R	1.6	MARINE	Johnson	6038
																			452	SF-50	067800-0031	Surface	Ni	Surface	STD	R	1.3	MARINE	Johnson	6001
																			453	SF-51	067800-0041	Surface	Ni	Surface	STD	R	1.6	MARINE	Johnson	6002
																			454	SK16HR11	267700-3000	Long Reach Iridium	0.71r	Pt	R	S	1.1	AUTOMOBILE	TOYOTA	3417
																			455	SK16HR-G11	267700-7870	φ14×26.5 w/t Grease	0.71r	Pt	R	S	1.1	AUTOMOBILE	TOYOTA	#N/A
																			456	SK16PR-A11	067700-8640	Iridium	0.71r	Pt	R	S	1.1	AUTOMOBILE	MITSUBISHI	3400
																			457	SK16PR-E11	267700-2740	Iridium	0.71r	Pt	R	S	1.1	AUTOMOBILE	MAZDA	3412
																			458	SK16PR-F8	267700-4340	Iridium	0.71r	Pt	R	S	0.8	AUTOMOBILE	MAZDA	3435
																			459	SK16PR-L11	267700-2200	Iridium	0.71r	Pt	R	S	1.1	AUTOMOBILE	HONDA	3395
																			460	SK16R11	067700-8840	Iridium	0.71r	Pt	R	S	1.1	AUTOMOBILE	TOYOTA	3324
																			461	SK16R8-PG	267700-3130	Iridium,CNG	0.71r	Pt	R	S	0.8	AUTOMOBILE	TOYOTA	#N/A
																			462	SK16R-P11	067700-8280	DoublePt Iridium	0.71r	DoublePt	R	S	1.1	AUTOMOBILE	TOYOTA	3353
																			463	SK16R-P8	067700-8350	DoublePt Iridium	0.71r	DoublePt	R	S	0.8	AUTOMOBILE	TOYOTA	3303
																			464	SK20BGR11	067700-9730	3Elec. Iridium ,Shroud	0.71r	Pt	R	S	1.1	AUTOMOBILE	TOYOTA	3472
																			465	SK20BR11	067700-3560	3Elec. Iridium ,EU	0.71r	Ptx3	R	S	1.1	AUTOMOBILE	TOYOTA	3471
																			466	SK20BR11	067700-9530	3Elec. Iridium ,JAPAN	0.71r	Ptx3	R	S	1.1	AUTOMOBILE	TOYOTA	#N/A
																			467	SK20HBR-J8	267700-8570	3Elec. Iridium ,JAPAN	0.71r	Ptx3	R	S	0.8	AUTOMOBILE	TOYOTA	#N/A
																			468	SK20HPR-L11	267700-5500	Long Reach Iridium	0.71r	Pt	R	S	1.1	AUTOMOBILE	HONDA	3433
																			469	SK20HR11	267700-4120	Long Reach Iridium	0.71r	Pt	R	S	1.1	AUTOMOBILE	TOYOTA	3421
																			470	SK20HR8-T	267700-6070	Long Reach Iridium LPG	0.71r	Pt	R	S	0.8	AUTOMOBILE	TOYOTA	3460
																			471	SK20HR-A11	267700-7850	φ14×26.5	0.71r	Pt	R	S	1.1	AUTOMOBILE	TOYOTA	#N/A
																			472	SK20HR-GT8	267700-8540	φ14×26.5 w/t Grease	0.71r	Pt	R	RC	0.8	AUTOMOBILE	AUTOMOBILE	#N/A
																			473	SK20PR-A11	267700-0570	Iridium	0.71r	Pt	R	S	1.1	AUTOMOBILE	MITSUBISHI	3418
																			474	SK20PR-A8	267700-2340	Iridium	0.71r	Pt	R	S	0.8	AUTOMOBILE	MITSUBISHI	3403
																			475	SK20PR-B8	267700-2310	Iridium	0.71r	Pt	R	S	0.8	AUTOMOBILE	MITSUBISHI	3408
																			476	SK20PR-F8	267700-4360	Iridium	0.71r	Pt	R	S	0.8	AUTOMOBILE	MAZDA	3430
																			477	SK20PR-L11	267700-5600	Iridium	0.71r	Pt	R	S	1.1	AUTOMOBILE	HONDA	3443
																			478	SK20PR-L9	067700-8630	Iridium	0.71r	Pt	R	S	0.9	AUTOMOBILE	HONDA	3307
																			479	SK20PR-L9	067700-8760	Iridium	0.71r	Pt	R	S	0.9	AUTOMOBILE	HONDA	#N/A
																			480	SK20PR-N9	267700-6690	Iridium	0.71r	Pt	R	S	0.9	AUTOMOBILE	HONDA	#N/A
																			481	SK20PR-N9S	267700-6150	Iridium,SUS GASKET	0.71r	Pt	R	S	0.9	AUTOMOBILE	HONDA	#N/A
																			482	SK20R11	067700-8340	Iridium	0.71r	Pt	R	S	1.1	AUTOMOBILE	TOYOTA	3297
																			483	SK20R11	267700-2980	Iridium	0.71r	Pt	R	S	1.1	AUTOMOBILE	TOYOTA	#N/A
																			484	SK20R5-G	067700-3520	Iridium,CNG,w/t Grease	0.71r	Pt	R	S	0.5	AUTOMOBILE	TOYOTA	3415
																			485	SK20R8	267700-2570	Iridium	0.71r	Pt	R	S	0.8	AUTOMOBILE	TOYOTA	3416
																			486	SK20R8-G	267700-4140	Iridium,CNG,w/t Grease	0.71r	Pt	R	S	0.8	AUTOMOBILE	TOYOTA	#N/A
																			487	SK20R-B5	267700-6700	Iridium	0.71r	Pt	R	S	0.5	AUTOMOBILE	TOYOTA	
																			488	SK20R-P11	067700-8200	DoublePt Iridium	0.71r	DoublePt	R	S	1.1	AUTOMOBILE	TOYOTA	3398
																			489	SK20R-P13	067700-8360	DoublePt Iridium	0.71r	DoublePt	R	S	1.3	AUTOMOBILE	TOYOTA	3298
																			490	SK22PR-M11	267700-0930	Iridium	0.71r	Pt	R	S	1.1	AUTOMOBILE	HONDA	3372
																			491	SK22PR-M11S	267700-6160	Iridium,SUS GASKET	0.71r	Pt	R	S	1.1	AUTOMOBILE	HONDA	3419
																			492	SKJ16CR-A8	267700-0890	Extended Iridium	0.71r	Pt	R	S	0.8	AUTOMOBILE	MAZDA	3370
																			493	SKJ16CR-L11	067700-9680	Extended Iridium	0.71r	Pt	R	S	1.1	AUTOMOBILE	HONDA	3396
																			494	SKJ16DR-M11	267700-2610	Extended Iridium,Shroud	0.71r	Pt	R	S	1.1	AUTOMOBILE	HONDA	3422
																			495	SKJ20CR-A8	267700-1760	Extended Iridium	0.71r	Pt	R	S	0.8	AUTOMOBILE	HONDA	3371
																			496	SKJ20DR-M11	267700-0910	Extended Iridium,Shroud	0.71r	Pt	R	S	1.1	AUTOMOBILE	HONDA	3377
																			497	SKJ20DR-M11S	267700-4930	Extended Iridium,Shroud ,SUS	0.71r	Pt	R	S	1.1	AUTOMOBILE	HONDA	3432
																			498	SKJ20DR-M11S	267700-6100	Extended Iridium,Shroud ,SUS	0.71r	Pt	R	S	1.1	AUTOMOBILE	HONDA	#N/A
																			499	SKJ20DR-M13	267700-0560	Extended Iridium,Shroud	0.71r	Pt	R	S	1.3	AUTOMOBILE	HONDA	3401

No	DENSO	PART NUMBER	SPEC.	CENTER/E.	GROUND/E.	R/STD	NUT	Gap	MAIN USE	MAIN APPLICATION	STOCK NUMBER
523	T16PR-U11	067700-5760	Resistor	Ni	Ni	R	S	1.1	AUTOMOBILE	GM,FORD	5026
524	T16PR-U15	067700-5770	Resistor	Ni	Ni	R	S	1.5	AUTOMOBILE	GM,FORD	5027
525	T16P-U	067600-9700	Standard	Ni	Ni	STD	S	0.9	AUTOMOBILE	GM,FORD	5024
526	T16R-U	067700-5650	Resistor	Ni	Ni	R	S	0.9	AUTOMOBILE	GM,FORD	5029
527	T16R-U15	067700-5670	Resistor	Ni	Ni	R	S	1.5	AUTOMOBILE	GM,FORD	5030
528	T16TT	267700-7820	Ni NEEDLE	1.5Ni	1.5Ni	R	S	1.0	AUTOMOBILE	AUTOMOBILE	4616
529	T16-U15	067600-0450	Standard	Ni	Ni	STD	S	1.5	AUTOMOBILE	GM,FORD	5072
530	T16VR-U10	267700-4810	Taperseat,Longreach	Ni	Ni	R	S	1.0	AUTOMOBILE	Ford	5086
531	T20EPR-U	067700-3140	Resistor	Ni	Ni	R	R	0.8	AUTOMOBILE	GM,FORD	5032
532	T20EPR-U15	067700-3210	Resistor	Ni	Ni	R	R	1.5	AUTOMOBILE	GM,FORD	5033
533	T20EP-U	067600-7380	Standard	Ni	Ni	STD	R	0.8	AUTOMOBILE	GM,FORD	5031
534	T20EP-U15	067600-7370	Standard	Ni	Ni	STD	R	1.5	AUTOMOBILE	GM,FORD	5050
535	T20MP-U	067600-8470	Standard	Ni	Ni	STD	R	0.6	SMALL ENGINE	SMALL ENGINE	6040
536	T20M-U	067600-8450	Standard	Ni	Ni	STD	R	0.6	SMALL ENGINE	SMALL ENGINE	6039
537	T20NR-U11	067700-6140	Resistor	Ni	Ni	R	S	1.1	AUTOMOBILE	Ford	5048
538	T20PR-U	067700-5851	Resistor	Ni	Ni	R	S	0.9	AUTOMOBILE	GM,FORD	5035
539	T20PR-U11	067700-5861	Resistor	Ni	Ni	R	S	1.1	AUTOMOBILE	GM,FORD	5036
540	T20PR-U15	067700-5871	Resistor	Ni	Ni	R	S	1.5	AUTOMOBILE	GM,FORD	5037
541	T20P-U	067600-9711	Standard	Ni	Ni	STD	S	0.9	AUTOMOBILE	GM,FORD	5034
542	T20R-U	067700-5950	Resistor	Ni	Ni	R	S	0.9	AUTOMOBILE	GM,FORD	5038
543	T20TT	267700-7830	Ni NEEDLE	1.5Ni	1.5Ni	R	S	1.0	AUTOMOBILE	AUTOMOBILE	4617
544	T22EP-U	067600-7390	Standard	Ni	Ni	STD	R	0.8	AUTOMOBILE	GM,FORD	5040
545	T22MP-U	067600-8480	Standard	Ni	Ni	STD	R	0.6	SMALL ENGINE	SMALL ENGINE	6042
546	T22M-U	067600-8460	Standard	Ni	Ni	STD	R	0.6	SMALL ENGINE	SMALL ENGINE	6041
547	TJ14R-P15	067800-7260	Extended Single Platinum	1.1Pt	Ni	R	S	1.5	AUTOMOBILE	GM	5071
548	TJ16R15	067800-6840	Extended,Taperseat	Ni	Ni	R	S	1.5	AUTOMOBILE	GM	#N/A
549	TR22-10	067600-9270	Standard	Ni	Ni	STD	R	1.0	MARINE	SUZUKI,YAMAHA	6052
550	TV16TT	267700-7490	Ni NEEDLE	1.5Ni	1.5Ni	R	S	1.0	AUTOMOBILE	AUTOMOBILE	4619
551	U14FSR-UB	067700-8290	Resistor	Ni	Ni	R	S	0.7	MOTORCYCLE	HONDA	6070
552	U14FS-UB	067800-6400	Standard	Ni	Ni	STD	S	0.7	MOTORCYCLE	HONDA	#N/A
553	U16FER9	267700-0520	φ10Half Thread	Ni	Ni	R	T	0.9	MOTORCYCLE	HONDA	4222
554	U16FSR-U	067700-5580	Resistor	Ni	Ni	R	T	0.7	MOTORCYCLE	HONDA	4171
555	U16FSR-U	267700-6610	Resistor	Ni	Ni	R	T	0.7	MOTORCYCLE	HONDA	#N/A
556	U16FSR-UB	067700-5990	Resistor	Ni	Ni	R	S	0.7	MOTORCYCLE	HONDA	6050
557	U16FS-U	067800-4590	Standard	Ni	Ni	STD	T	0.7	MOTORCYCLE	HONDA	4000
558	U16FS-U	067800-7760	Standard	Ni	Ni	STD	T	0.7	MOTORCYCLE	HONDA	#N/A
559	U16FS-UB	067800-4690	Standard	Ni	Ni	STD	S	0.7	MOTORCYCLE	HONDA	6077
560	U20EPR9	267700-4580	φ10x19	Ni	Ni	R	T	0.9	MOTORCYCLE	HONDA	4228
561	U20EPR9	267700-6470	φ10x19	Ni	Ni	R	T	0.9	MOTORCYCLE	HONDA	4228
562	U20ESR-N	067700-8850	φ10x19	Ni	Ni	R	T	0.8	MOTORCYCLE	KAW,SUZ,YAM	4221
563	U20ESR-N	267700-6510	φ10x19	Ni	Ni	R	T	0.8	MOTORCYCLE	SUZUKI	#N/A
564	U20FSR-U	067700-5590	Resistor	Ni	Ni	R	T	0.7	MOTORCYCLE	HONDA	4004
565	U20FSR-U	267700-6620	Resistor	Ni	Ni	R	T	0.7	MOTORCYCLE	HONDA	#N/A
566	U20FS-U	067800-4600	Standard	Ni	Ni	STD	T	0.7	MOTORCYCLE	HONDA	4002
567	U20FS-U	067800-7770	Standard	Ni	Ni	STD	T	0.7	MOTORCYCLE	HONDA	#N/A
568	U22EPR9	267700-6480	φ10x19	Ni	Ni	R	T	0.9	MOTORCYCLE	HONDA	4234
569	U22ES-N	067800-4850	φ10x19	Ni	Ni	STD	T	0.8	MOTORCYCLE	KAW,SUZ,YAM	4137
570	U22ES-N	067800-7540	φ10x19	Ni	Ni	STD	T	0.8	MOTORCYCLE	KAW,SUZ,YAM	#N/A
571	U22ESR-N	067700-5320	φ10x19	Ni	Ni	R	T	0.8	MOTORCYCLE	KAW,SUZ,YAM	4174
572	U22ESR-N	267700-6520	φ10x19	Ni	Ni	R	T	0.8	MOTORCYCLE	SUZUKI	#N/A
573	U22ESR-NB	267700-2730	φ10x19	Ni	Ni	R	S	0.8	MOTORCYCLE	ZONSHIN	4231
574	U22ETR	067700-5560	φ10 x2Elec.	Ni	Nix2	R	T	0.7	MOTORCYCLE	KAWASAKI	4201
575	U22ETR	267700-6560	φ10 x2Elec.	Ni	Nix2	R	T	0.7	MOTORCYCLE	SUZUKI	#N/A
576	U22FER9	067700-5810	φ10Half Thread	Ni	Ni	R	T	0.9	MOTORCYCLE	HONDA	4212
577	U22FSR-U	067700-5600	Resistor	Ni	Ni	R	T	0.7	MOTORCYCLE	HON,SUZ,YAM,KAW	4008
578	U22FSR-U	267700-6630	Resistor	Ni	Ni	R	T	0.7	MOTORCYCLE	HONDA	#N/A
579	U22FS-U	067800-4610	Standard	Ni	Ni	STD	T	0.7	MOTORCYCLE	HON,SUZ,YAM,KAW	4006
580	U22FS-U	067800-7780	Standard	Ni	Ni	STD	T	0.7	MOTORCYCLE	HONDA	#N/A
581	U24EPR9	267700-6490	φ10x19	Ni	Ni	R	T	0.9	MOTORCYCLE	HONDA	4233
582	U24ES-N	067800-4860	φ10x19	Ni	Ni	STD	T	0.8	MOTORCYCLE	KAW,SUZ,YAM	4196
583	U24ES-N	067800-7550	φ10x19	Ni	Ni	STD	T	0.8	MOTORCYCLE	KAW,SUZ,YAM	#N/A
584	U24ESR-N	067700-5380	φ10x19	Ni	Ni	R	T	0.8	MOTORCYCLE	KAW,SUZ,YAM	4126
585	U24ESR-N	267700-6530	φ10x19	Ni	Ni	R	T	0.8	MOTORCYCLE	SUZUKI	#N/A
586	U24ESR-NB	267700-2300	φ10x19,Solid Terminal	Ni	Ni	R	S	0.8	MOTORCYCLE	HONDA	4223
587	U24ETR	067700-5450	φ10 x2Elec.	Ni	Nix2	R	T	0.7	MOTORCYCLE	KAWASAKI	4158
588	U24ETR	267700-6570	φ10 x2Elec.	Ni	Nix2	R	T	0.7	MOTORCYCLE	SUZUKI	#N/A
589	U24FE9	067800-4820	φ10Half Thread	Ni	Ni	STD	T	0.9	MOTORCYCLE	HONDA	4202
590	U24FER9	067700-5820	φ10Half Thread	Ni	Ni	R	T	0.9	MOTORCYCLE	HONDA	4127
591	U24FER9S	267700-4790	φ10Half Thread,SUS	Ni	Ni	R	T	0.9	MOTORCYCLE	HONDA	#N/A
592	U24FSR-U	067700-5610	Resistor	Ni	Ni	R	T	0.7	MOTORCYCLE	HON,SUZ,YAM,KAW	4010
593	U24FSR-U	267700-6640	Resistor	Ni	Ni	R	T	0.7	MOTORCYCLE	HONDA	#N/A
594	U24FS-U	067800-4620	Standard	Ni	Ni	STD	T	0.7	MOTORCYCLE	HONDA	4009
595	U24FS-U	067800-7790	Standard	Ni	Ni	STD	T	0.7	MOTORCYCLE	HONDA	#N/A
596	U27ES-N	067800-4870	φ10x19	Ni	Ni	STD	T	0.8	MOTORCYCLE	KAW,SUZ,YAM	4128
597	U27ES-N	067800-7560	φ10x19	Ni	Ni	STD	T	0.8	MOTORCYCLE	KAW,SUZ,YAM	#N/A
598	U27ESR-N	067700-5390	φ10x19	Ni	Ni	R	T	0.8	MOTORCYCLE	KAW,SUZ,YAM	4131
599	U27ESR-N	267700-6540	φ10x19	Ni	Ni	R	T	0.8	MOTORCYCLE	SUZUKI	#N/A
600	U27ESR-NB	267700-2280	φ10x19,Solid Terminal	Ni	Ni	R	S	0.8	MOTORCYCLE	KAW,SUZ,YAM	4224
601	U27ETR	067700-5460	φ10 x2Elec.	Ni	Nix2	R	T	0.7	MOTORCYCLE	KAWASAKI,SUZUKI	4155
602	U27ETR	267700-6580	φ10 x2Elec.	Ni	Nix2	R	T	0.7	MOTORCYCLE	SUZUKI	#N/A
603	U27FER9	067700-5830	φ10Half Thread	Ni	Ni	R	T	0.9	MOTORCYCLE	HONDA	4129
604	U31ESR-N	067700-5640	φ10x19	Ni	Ni	R	T	0.8	MOTORCYCLE	KAW,SUZ,YAM	4187
605	U31ESR-N	267700-6550	φ10x19	Ni	Ni	R	T	0.8	MOTORCYCLE	SUZUKI	#N/A
606	U31ETR	067700-5630	φ10 x2Elec.	Ni	Nix2	R	T	0.7	MOTORCYCLE	KAWASAKI,YAMAHA	4135
607	U31ETR	267700-6590	φ10 x2Elec.	Ni	Nix2	R	T	0.7	MOTORCYCLE	SUZUKI	#N/A
608	VCH20	267700-7671	Iridium Tough	0.4lr	Pt	R	S	1.1	AUTOMOBILE	AUTOMOBILE	5637
609	VCH16	267700-9211	Iridium Tough	0.4lr	Pt	R	S	1.1	AUTOMOBILE	AUTOMOBILE	5658

S: SOLID; R: REMOVABLE; RC: CRIMPED; T: THREAD
 HON:HONDA SUB:SUBARU SUZ:SUZUKI MAZ:MAZDA MIT:MITSUBISHI KAW:KAWASAKI YAM:YAMAHA

DENSO
 AUSTRALIA CHINA INDIA INDONESIA KOREA MALAYSIA PHILIPPINES SAUDIARABIA SINGAPORE TAIWAN THAILAND VIETNAM JAPAN & USA EUROPE MOTOR CYCLE SMALL ENGINE REFERENCE PART NUMBER

PART NUMBER	CROSS REFERENCE	SMALL ENGINE	EUROPE & USA	JAPAN	VIETNAM	THAILAND	TAIWAN	SINGAPORE	SAUDIARABIA	PHILIPPINES	MALAYSIA	KOREA	INDONESIA	INDIA	CHINA	AUSTRALIA	DENSO	No	PART NUMBER	SPEC.	CENTER/E	GROUND/E	R/STD	NUT	GAP	MAIN USE	MAIN APPLICATION	STOCK NUMBER	
																		610	VDCH22F	267700-9291	Iridium Tough (Needle type)	0.71r	Pt NEEDLE	R	S	0.9	AUTOMOBILE	AUTOMOBILE	#N/A
																		611	VDKH16T	267700-8920	Iridium Plus (Needle type)	0.71r	Pt NEEDLE	R	S	0.8	AUTOMOBILE	AUTOMOBILE	5504
																		612	VDKH22F	267700-8751	Iridium Tough (Needle type)	0.71r	Pt NEEDLE	R	S	0.9	AUTOMOBILE	AUTOMOBILE	#N/A
																		613	VFCH16	267700-9281	Iridium Tough (Needle type)	0.41r	Pt NEEDLE	R	S	0.8	AUTOMOBILE	AUTOMOBILE	#N/A
																		614	VFK16	267700-9151	Iridium Tough (Needle type)	0.41r	Pt NEEDLE	R	S	1.1	AUTOMOBILE	AUTOMOBILE	5647
																		615	VFK20F	267700-9161	Iridium Tough (Needle type)	0.41r	Pt NEEDLE	R	S	1.1	AUTOMOBILE	AUTOMOBILE	5648
																		616	VFKB16	267700-9271	3Elec.Iridium Tough,Shroud	0.41r	Pt NEEDLE	R	S	0.8	AUTOMOBILE	AUTOMOBILE	#N/A
																		617	VFKBH20	267700-7661	3Elec.Iridium Tough,Shroud	0.41r	Pt NEEDLE	R	S	1.1	AUTOMOBILE	AUTOMOBILE	5643
																		618	VFKH16	267700-7411	Iridium Tough (Needle type)	0.41r	Pt NEEDLE	R	S	1.1	AUTOMOBILE	AUTOMOBILE	5654
																		619	VFKH20	267700-7421	Iridium Tough (Needle type)	0.41r	Pt NEEDLE	R	S	1.1	AUTOMOBILE	AUTOMOBILE	5655
																		620	VFXEH20	267700-7641	Iridium Tough (Needle type)	0.41r	Pt NEEDLE	R	S	1.1	AUTOMOBILE	AUTOMOBILE	5645
																		621	VFXEH20E	267700-7631	Iridium Tough (Needle type)	0.41r	Pt NEEDLE	R	S	1.1	AUTOMOBILE	AUTOMOBILE	5644
																		622	VFXEH22	267700-7651	Iridium Tough (Needle type)	0.41r	Pt NEEDLE	R	S	1.1	AUTOMOBILE	AUTOMOBILE	5646
																		623	VFXEHC22G	267700-9221	Double Needle φ12X26.5 Shroud 1.5 SUS Gasket	0.41r	Pt NEEDLE	R	S	0.8	AUTOMOBILE	AUTOMOBILE	5659
																		624	VFXUHC22FG	267700-8681	Iridium Tough (Needle type),SUS GASKET. SHROUD	0.41r	Pt NEEDLE	R	S	1.1	AUTOMOBILE	AUTOMOBILE	5653
																		625	VK16	267700-0711	Iridium Tough	0.41r	Pt	R	S	1.1	AUTOMOBILE	AUTOMOBILE	5603
																		626	VK16G	267700-5631	Iridium Tough/SUS GASKET	0.41r	Pt	R	S	1.1	AUTOMOBILE	AUTOMOBILE	5640
																		627	VK16PRZ11	267700-1840	Iridium	0.41r	Pt TAPERCUT	R	S	1.1	MOTORCYCLE	HONDA	5628
																		628	VK20	267700-0721	Iridium Tough	0.41r	Pt	R	S	1.1	AUTOMOBILE	AUTOMOBILE	5604
																		629	VK20G	267700-5641	Iridium Tough/SUS GASKET	0.41r	Pt	R	S	1.1	AUTOMOBILE	AUTOMOBILE	5641
																		630	VK20PRZ11	267700-1850	Iridium	0.41r	Pt TAPERCUT	R	S	1.1	MOTORCYCLE	HONDA	5615
																		631	VK20T	067700-9540	Iridium Plus	0.41r	Pt	R	S	0.8	AUTOMOBILE	AUTOMOBILE	5501
																		632	VK20Y	267700-3721	Iridium Tough	0.41r	Pt	R	S	0.8	AUTOMOBILE	AUTOMOBILE	5620
																		633	VK22	267700-0731	Iridium Tough	0.41r	Pt	R	S	0.8	AUTOMOBILE	AUTOMOBILE	5610
																		634	VK22G	267700-5671	Iridium Tough/SUS GASKET	0.41r	Pt	R	S	0.8	AUTOMOBILE	AUTOMOBILE	5636
																		635	VK22PRZ11	267700-1860	Iridium	0.41r	Pt TAPERCUT	R	S	1.1	MOTORCYCLE	HONDA	5629
																		636	VK24PRZ11	267700-1870	Iridium	0.41r	Pt TAPERCUT	R	S	1.1	MOTORCYCLE	HONDA	5616
																		637	VK27PRZ11	267700-2050	Iridium	0.41r	Pt TAPERCUT	R	S	1.1	MOTORCYCLE	HONDA	5630
																		638	VKA16	267700-5031	3Elec.Iridium Tough,Shroud	0.41r	Pt 3Elec.	R	S	1.1	AUTOMOBILE	AUTOMOBILE	5622
																		639	VKA20	267700-5041	3Elec.Iridium Tough,Shroud	0.41r	Pt 3Elec.	R	S	1.1	AUTOMOBILE	AUTOMOBILE	5623
																		640	VKB16	267700-5051	3Elec.Iridium Tough	0.41r	Pt 3Elec.	R	S	1.1	AUTOMOBILE	AUTOMOBILE	5624
																		641	VKB20	267700-5061	3Elec.Iridium Tough	0.41r	Pt 3Elec.	R	S	1.1	AUTOMOBILE	AUTOMOBILE	5625
																		642	VKH16	267700-3681	Iridium Tough	0.41r	Pt	R	S	1.1	AUTOMOBILE	AUTOMOBILE	5617
																		643	VKH20	267700-3691	Iridium Tough	0.41r	Pt	R	S	1.1	AUTOMOBILE	AUTOMOBILE	5618
																		644	VKH20T	267700-7760	Iridium Plus,LPG	0.41r	Pt	R	S	0.8	AUTOMOBILE	AUTOMOBILE	5503
																		645	VKH20Y	267700-4541	Iridium Tough	0.41r	Pt	R	S	0.8	AUTOMOBILE	AUTOMOBILE	5639
																		646	VKH22	267700-2681	Iridium Tough	0.41r	Pt	R	S	0.8	AUTOMOBILE	AUTOMOBILE	5619
																		647	VKJ20RZ-M11	267700-1970	Iridium	0.41r	Pt TAPERCUT	R	S	1.1	MOTORCYCLE	HONDA	5633
																		648	VNH24Z	267700-2060	Iridium	0.41r	Pt TAPERCUT	R	S	0.9	MOTORCYCLE	HONDA	5632
																		649	VNH27Z	267700-2070	Iridium	0.41r	Pt TAPERCUT	R	S	0.9	MOTORCYCLE	HONDA	5631
																		650	VNH27ZB	267700-1920	Iridium	0.41r	Pt TAPERCUT	R	S	0.9	MOTORCYCLE	HONDA	#N/A
																		651	VQ16	267700-0741	Iridium Tough	0.41r	Pt	R	S	1.1	AUTOMOBILE	AUTOMOBILE	5601
																		652	VQ20	267700-0751	Iridium Tough	0.41r	Pt	R	S	1.1	AUTOMOBILE	AUTOMOBILE	5602
																		653	VQ22	267700-0761	Iridium Tough	0.41r	Pt	R	S	0.8	AUTOMOBILE	AUTOMOBILE	5613
																		654	VSUEH22	267700-9241	Iridium Tough φ10X26.5	0.71r	Pt	R	S	0.9	AUTOMOBILE	AUTOMOBILE	#N/A
																		655	VT16	267700-2811	Iridium Tough	0.41r	Pt	R	S	1.1	AUTOMOBILE	AUTOMOBILE	5621
																		656	VT20	267700-4481	Iridium Tough	0.41r	Pt	R	S	1.1	AUTOMOBILE	AUTOMOBILE	5638
																		657	VUH24D	267700-2011	Iridium	0.41r	Pt TAPERCUT	R	T	0.9	MOTORCYCLE	HONDA	5626
																		658	VUH24ES	267700-6130	Iridium,SUS GASKET	0.41r	Pt	R	T	0.9	MOTORCYCLE	HONDA	-
																		659	VUH27D	267700-1931	Iridium	0.41r	Pt TAPERCUT	R	T	0.9	MOTORCYCLE	HONDA	5627
																		660	VUH27ES	267700-4770	Iridium,SUS GASKET	0.41r	Pt	R	T	0.9	MOTORCYCLE	HONDA	5642
																		661	VW16	267700-0771	Iridium Tough	0.41r	Pt	R	S	1.1	AUTOMOBILE	AUTOMOBILE	5605
																		662	VW16R-A13	267700-1640	Iridium	0.41r	Pt	R	S	1.3	AUTOMOBILE	AUTOMOBILE	5635
																		663	VW20	267700-0781	Iridium Tough	0.41r	Pt	R	S	1.1	AUTOMOBILE	AUTOMOBILE	5606
																		664	VW20T	067700-9240	Iridium Plus	0.41r	Pt	R	S	0.8	AUTOMOBILE	AUTOMOBILE	5502
																		665	VW22	267700-0791	Iridium Tough	0.41r	Pt	R	S	0.8	AUTOMOBILE	AUTOMOBILE	5607
																		666	VX20BC	067700-9830	Iridium	0.41r	Pt	R	T	0.9	MOTORCYCLE	HONDA	5634
																		667	VX22BC	067700-9720	Iridium	0.41r	Pt	R	T	0.9	MOTORCYCLE	HONDA	5614
																		668	VXEBH27	267700-9171	3Elec.Iridium Tough	0.41r	Pt	R	S	0.8	AUTOMOBILE	AUTOMOBILE	5686
																		669	VXEHC24G	267700-9231	Iridium Tough,SUS GASKET. SHROUD	0.41r	Pt	R	S	1.1	AUTOMOBILE	AUTOMOBILE	5660
																		670	VXU20	267700-9141	Iridium Tough	0.41r	Pt	R	S	1.1	AUTOMOBILE	AUTOMOBILE	5649
																		671	VXU22	267700-0801	Iridium Tough	0.41r	Pt	R	RC	0.9	AUTOMOBILE	AUTOMOBILE	5608
																		672	VXU22I	267700-8441	Iridium Tough	0.41r	Pt	R	S	0.9	AUTOMOBILE	AUTOMOBILE	5651
																		673	VXU24	267700-0811	Iridium Tough	0.41r	Pt	R	RC	0.9	AUTOMOBILE	AUTOMOBILE	5609
																		674	VXUH20I	267700-8161	Iridium Tough	0.41r							

No	DENSO	PART NUMBER	SPEC.	CENTER/E.	GROUND/E.	R/STD	NUT	Gap	MAIN USE	MAIN APPLICATION	STOCK NUMBER
697	W14FR-U	067700-3330	Resistor	Ni	Ni	R	R	0.7	SMALL ENGINE	KUBOTA	4017
698	W14F-U	067600-6681	Standard	Ni	Ni	STD	S	0.7	SMALL ENGINE	KUBOTA	#N/A
699	W14F-U	067600-6821	Standard	Ni	Ni	STD	R	0.7	SMALL ENGINE	KUBOTA	4012
700	W14L	067600-3341	Standard	Ni	Ni	STD	R	0.7	SMALL ENGINE	SMALL ENGINE	6013
701	W14LM-U	067600-6711	Standard	Ni	Ni	STD	R	0.7	SMALL ENGINE	SMALL ENGINE	6014
702	W14LM-US	067600-8600	Standard	Ni	Ni	STD	R	0.7	SMALL ENGINE	SMALL ENGINE	6035
703	W14MPR-U10	067700-3281	Compact Type	Ni	Ni	R	R	1.0	SMALL ENGINE	SMALL ENGINE	6018
704	W14MP-U10	067600-7461	Standard	Ni	Ni	STD	R	1.0	SMALL ENGINE	SMALL ENGINE	6017
705	W14MR-U	067700-3201	Compact Type	Ni	Ni	R	R	0.7	SMALL ENGINE	SMALL ENGINE	6019
706	W14M-U	067600-7421	Standard	Ni	Ni	STD	R	0.7	SMALL ENGINE	SMALL ENGINE	6015
707	W14PR-U	067700-2931	Resistor	Ni	Ni	R	R	0.7	AUTOMOBILE	GM,FORD	6021
708	W14-U	067600-6781	Standard	Ni	Ni	STD	R	0.7	AUTOMOBILE	GM,FORD	6008
709	W16DTR-S	067700-7440	2Elec,Shroud,Surface	Ni	Nix2	R	S	1.0	AUTOMOBILE	DAIHATSU	3217
710	W16EKR-S11	067700-2110	Surface	Ni	NixSurface	R	S	1.1	AUTOMOBILE	HONDA	3016
711	W16EKR-S11	067700-7750	Surface	Ni	NixSurface	R	S	1.1	AUTOMOBILE	HONDA	3016
712	W16EP	067600-1761	Standard	Ni	Ni	STD	S	0.8	AUTOMOBILE	MITSUBISHI	3414
713	W16EP11	067600-6431	Standard	Ni	Ni	STD	S	1.1	AUTOMOBILE	MITSUBISHI	3410
714	W16EPB10	067600-7850	3Elect.	Ni	Nix3Elec.	STD	R	1.0	AUTOMOBILE	Volkswagen	5064
715	W16EPR	067700-0131	Resistor	Ni	Ni	R	S	0.8	AUTOMOBILE	MITSUBISHI	#N/A
716	W16EPR	067700-0161	Resistor	Ni	Ni	R	R	0.8	AUTOMOBILE	MITSUBISHI	#N/A
717	W16EPR11	067700-2620	Resistor	Ni	Ni	R	S	1.1	AUTOMOBILE	MITSUBISHI	3425
718	W16EPR-U	067700-2661	Resistor	Ni	Ni	R	R	0.8	AUTOMOBILE	HON,MAZ,MIT,SUZ	3021
719	W16EPR-U	067700-5960	Resistor	Ni	Ni	R	S	0.8	AUTOMOBILE	HON,MAZ,MIT,SUZ	3345
720	W16EPR-U10	067700-2631	Resistor	Ni	Ni	R	S	1.0	AUTOMOBILE	MITSUBISHI	3022
721	W16EPR-U11	067700-2710	Resistor	Ni	Ni	R	S	1.1	AUTOMOBILE	HONDA,SUBARU,SUZUKI	3201
722	W16EP-U	067600-7231	Standard	Ni	Ni	STD	R	0.8	AUTOMOBILE	MITSUBISHI	3018
723	W16EP-U11	067600-7621	Standard	Ni	Ni	STD	S	1.1	AUTOMOBILE	SUBARU	3199
724	W16ESR-U	067700-2330	Resistor	Ni	Ni	R	R	0.8	SMALL ENGINE	KUBOTA	3110
725	W16ES-U	067600-6031	Standard	Ni	Ni	STD	R	0.8	MOTORCYCLE	YAMAHA	3025
726	W16ETR-S	067700-2171	2Elec,Surface	Ni	Nix2	R	S	1.0	AUTOMOBILE	TOYOTA	3216
727	W16ETR-S	067700-8180	2Elec,Surface	Ni	Nix2	R	R	1.0	AUTOMOBILE	TOYOTA	3285
728	W16ET-S	067600-6632	2Elec,Surface	Ni	Nix2	STD	S	1.0	AUTOMOBILE	TOYOTA	3215
729	W16EXR-U	067700-1531	Resistor	Ni	Ni	R	S	0.8	AUTOMOBILE	TOYOTA	3210
730	W16EXR-U	067700-1571	Resistor	Ni	Ni	R	R	0.8	AUTOMOBILE	TOYOTA	3031
731	W16EXR-U	067700-2291	Resistor	Ni	Ni	R	S	0.8	AUTOMOBILE	TOYOTA	#N/A
732	W16EXR-U11	067700-2431	Resistor	Ni	Ni	R	S	1.1	AUTOMOBILE	TOYOTA	3032
733	W16EXR-U11	067700-2470	Resistor	Ni	Ni	R	R	1.1	AUTOMOBILE	TOYOTA	3032
734	W16EXR-U13	067700-6450	Resistor	Ni	Ni	R	S	1.3	AUTOMOBILE	MAZDA	3213
735	W16EX-U	067600-2210	Standard	Ni	Ni	STD	S	0.8	AUTOMOBILE	TOYOTA	#N/A
736	W16EX-U	067600-4671	Standard	Ni	Ni	STD	S	0.8	AUTOMOBILE	TOYOTA	3203
737	W16EX-U	067600-6381	Standard	Ni	Ni	STD	R	0.8	AUTOMOBILE	TOYOTA	3027
738	W16EX-U11	067600-6331	Standard	Ni	Ni	STD	S	1.1	AUTOMOBILE	TOYOTA	3205
739	W16EX-U11	067600-6481	Standard	Ni	Ni	STD	R	1.1	AUTOMOBILE	TOYOTA	3028
740	W16EX-U13	067600-2051	Standard	Ni	Ni	STD	S	1.3	AUTOMOBILE	MAZDA	3029
741	W16FPR	067700-3931	Resistor	Ni	Ni	R	R	0.7	MOTORCYCLE	SUZUKI,YAMAHA	4020
742	W16FPR-U	067700-4700	Resistor	Ni	Ni	R	R	0.7	MOTORCYCLE	SUZUKI	4192
743	W16FP-U	067600-6131	Standard	Ni	Ni	STD	R	0.7	MOTORCYCLE	MOTORCYCLE	4019
744	W16FP-U10	067600-6161	Standard	Ni	Ni	STD	S	1.0	MOTORCYCLE	YAMAHA	3232
745	W16FSR	067700-0831	Resistor	Ni	Ni	R	R	0.7	MOTORCYCLE	MOTORCYCLE	3033
746	W16FS-U	067600-6831	Standard	Ni	Ni	STD	R	0.7	MOTORCYCLE	MOTORCYCLE	3034
747	W16LS	067600-3351	Standard	Ni	Ni	STD	R	0.7	AUTOMOBILE	AUTOMOBILE	3035
748	W16PR-U	067700-2921	Resistor	Ni	Ni	R	R	0.7	AUTOMOBILE	GM,FORD	3037
749	W16S-U	067600-6791	Standard	Ni	Ni	STD	R	0.7	AUTOMOBILE	GM,FORD	5044
750	W16TT	267700-6301	Ni NEEDLE	1.5Ni	1.5Ni	R	RC	0.8	AUTOMOBILE	AUTOMOBILE	4601
751	W20DTR-S	067700-7320	2Elec,Shroud,Surface	Ni	Nix2	R	S	1.0	AUTOMOBILE	SUBARU	3218
752	W20DTR-SA	067700-2050	2Elec,Shroud,Surface	Ni	Nix2	R	S	1.0	AUTOMOBILE	SUBARU	3219
753	W20EAR	067700-0642	2Elec.for Rotary	Ni	Nix2	R	S	0.95	AUTOMOBILE	MAZDA	3040
754	W20EKR-S11	067700-2200	Surface	Ni	NixSurface	R	S	1.1	AUTOMOBILE	HONDA	3041
755	W20EKR-S11	067700-7760	Surface	Ni	NixSurface	R	S	1.1	AUTOMOBILE	HONDA	3041
756	W20EP	067600-1773	Standard	Ni	Ni	STD	S	0.8	AUTOMOBILE	MITSUBISHI	#N/A
757	W20EP11	067600-6441	Standard	Ni	Ni	STD	S	1.1	AUTOMOBILE	MITSUBISHI	3405
758	W20EPB	067600-2740	3Elect.	Ni	Nix3Elec.	STD	R	0.85	AUTOMOBILE	Volkswagen	5065
759	W20EPBR-S	067700-8040	3Elec. Surface	Ni	Nix3Elec.	R	R	0.85	AUTOMOBILE	Volkswagen	5067
760	W20EPR	067700-0261	Resistor	Ni	Ni	R	R	0.8	AUTOMOBILE	MITSUBISHI	#N/A
761	W20EPR11	067700-6150	Resistor	Ni	Ni	R	S	1.1	AUTOMOBILE	MITSUBISHI	3394
762	W20EPR-S11	067700-2591	Surface	Ni	NixSurface	R	S	1.1	AUTOMOBILE	MITSUBISHI	3046
763	W20EPR-U	067700-2671	Resistor	Ni	Ni	R	R	0.8	AUTOMOBILE	HON,MAZ,MIT,SUZ	3047
764	W20EPR-U	067700-3440	Resistor	Ni	Ni	R	S	0.8	AUTOMOBILE	HON,MAZ,MIT,SUZ	3344
765	W20EPR-U10	067700-2641	Resistor	Ni	Ni	R	S	1.0	AUTOMOBILE	MITSUBISHI	3048
766	W20EPR-U11	067700-2701	Resistor	Ni	Ni	R	S	1.1	AUTOMOBILE	HON,MAZ,MIT,SUZ	3049
767	W20EP-S11	067600-6701	Surface	Ni	NixSurface	STD	S	1.1	AUTOMOBILE	MITSUBISHI	3250
768	W20EP-U	067600-7241	Standard	Ni	Ni	STD	R	0.8	AUTOMOBILE	HON,MAZ,MIT,SUZ	3043
769	W20EP-U	067600-7311	Standard	Ni	Ni	STD	S	0.8	AUTOMOBILE	HON,MAZ,MIT,SUZ	3391
770	W20EP-U11	067600-7660	Standard	Ni	Ni	STD	S	1.1	AUTOMOBILE	HON,MAZ,MIT,SUZ	3109
771	W20ESR-U	067700-2341	Resistor	Ni	Ni	R	R	0.8	MOTORCYCLE	YAMAHA	3057
772	W20ES-U	067600-6041	Standard	Ni	Ni	STD	R	0.8	MOTORCYCLE	SUZUKI	3051
773	W20ETR-L	067700-2160	2Elec. Gap1.0mm	Ni	Nix2	R	S	1.0	AUTOMOBILE	DAIHATSU	3277
774	W20ETR-S	067700-2181	2Elec,Surface	Ni	Nix2	R	S	1.0	AUTOMOBILE	TOYOTA	3060
775	W20ET-S	067600-6652	2Elec.	Ni	Nix2	STD	S	1.0	AUTOMOBILE	TOYOTA	3059
776	W20EXR-U	067700-1541	Resistor	Ni	Ni	R	S	0.8	AUTOMOBILE	TOYOTA	3211
777	W20EXR-U	067700-1581	Resistor	Ni	Ni	R	R	0.8	AUTOMOBILE	TOYOTA	3066
778	W20EXR-U11	067700-2441	Resistor	Ni	Ni	R	S	1.1	AUTOMOBILE	TOYOTA	3212
779	W20EXR-U11	067700-2481	Resistor	Ni	Ni	R	R	1.1	AUTOMOBILE	TOYOTA	3067
780	W20EXR-U13	067700-6590	Resistor	Ni	Ni	R	S	1.3	AUTOMOBILE	MAZDA	3321
781	W20EX-U	067600-4681	Standard	Ni	Ni	STD	S	0.8	AUTOMOBILE	TOYOTA	3204
782	W20EX-U	067600-6391	Standard	Ni	Ni	STD	R	0.8	AUTOMOBILE	TOYOTA	3062
783	W20EX-U11	067600-6341	Standard	Ni	Ni	STD	S	1.1	AUTOMOBILE	TOYOTA	3206

S: SOLID; R: REMOVABLE; RC: CRIMPED; T: THREAD
 HON:HONDA SUB:SUBARU SUZ:SUZUKI MAZ:MAZDA MIT:MITSUBISHI KAW:KAWASAKI YAM:YAMAHA

DENSO
 AUSTRALIA CHINA INDIA INDONESIA KOREA MALAYSIA PHILIPPINES SAUDI ARABIA SINGAPORE TAIWAN THAILAND VIETNAM JAPAN & USA EUROPE MOTOR CYCLE SMALL ENGINE CROSS REFERENCE PART NUMBER

PART NUMBER	CROSS REFERENCE	SMALL ENGINE	MOTOR CYCLE	EUROPE & USA	JAPAN	VIETNAM	THAILAND	TAIWAN	SINGAPORE	SAUDIARABIA	PHILIPPINES	MALAYSIA	KOREA	INDONESIA	INDIA	CHINA	AUSTRALIA	DENSO	No	DENSO	PART NUMBER	SPEC.	CENTER/E.	GROUND/E.	R/STD	NUT	Gap	MAIN USE	MAIN APPLICATION	STOCK NUMBER																																																																																																																																																																																																																																																																																																																																																																																																																																																																																																																																																																																																																																																																																																																																																																																																																																																																																																																																																																																																																																																					
																			784	W20EX-U11	067600-6491	Standard	Ni	Ni	STD	R	1.1	AUTOMOBILE	TOYOTA	3063	785	W20EX-U13	067600-2061	Standard	Ni	Ni	STD	S	1.3	AUTOMOBILE	TOYOTA	3064	786	W20FP	067600-1651	Standard	Ni	Ni	STD	R	0.7	AUTOMOBILE	MAZDA	4216	787	W20FP-L	067600-8960	Standard	Ni	Ni	STD	T	0.7	MOTORCYCLE	HONDA	4149	788	W20FPR	067700-3941	Resistor	Ni	Ni	R	R	0.7	MOTORCYCLE	SUZUKI,YAMAHA	#N/A	789	W20FPR-U	067700-3831	Resistor	Ni	Ni	R	R	0.7	MOTORCYCLE	SUZUKI,YAMAHA	3070	790	W20FPR-U10	067700-3081	Resistor	Ni	Ni	R	T	1.0	AUTOMOBILE	SUZUKI	3268	791	W20FP-U	067600-6141	Standard,EXCEPT ASIA	Ni	Ni	STD	R	0.7	MOTORCYCLE	SUZUKI,YAMAHA,KUBOTA	3068	792	W20FP-U	067600-8870	Standard,ASIA ONLY	Ni	Ni	STD	R	0.65	MOTORCYCLE	SUZUKI,YAMAHA	3068	793	W20FP-U10	067600-8890	Standard,ASIA ONLY	Ni	Ni	STD	R	1.0	MOTORCYCLE	SUZUKI,YAMAHA	6037	794	W20FR-L	067700-6810	Resistor	Ni	Ni	R	T	0.7	MOTORCYCLE	HONDA	4161	795	W20FR-L9	267700-2080	Resistor	Ni	Ni	R	T	0.9	MOTORCYCLE	HONDA	#N/A	796	W20FS	067600-3231	Standard	Ni	Ni	STD	R	0.7	AUTOMOBILE	SUBARU	#N/A	797	W20FSR	067700-0841	Resistor	Ni	Ni	R	R	0.7	MOTORCYCLE	MOTORCYCLE	3072	798	W20FSR-U	067700-3341	Resistor	Ni	Ni	R	R	0.7	MOTORCYCLE	MOTORCYCLE	6053	799	W20FS-U	067600-6841	Standard	Ni	Ni	STD	R	0.7	MOTORCYCLE	SUZUKI,YAMAHA	3073	800	W20MPR-U10	067700-3301	Compact Type	Ni	Ni	R	R	1.0	SMALL ENGINE	SMALL ENGINE	6032	801	W20MP-U	067600-7481	Standard	Ni	Ni	STD	R	0.6	SMALL ENGINE	SMALL ENGINE	6023	802	W20MP-U10	067600-7581	Standard	Ni	Ni	STD	R	1.0	SMALL ENGINE	SMALL ENGINE	6024	803	W20MR-U	067700-3221	Compact Type	Ni	Ni	R	R	0.7	SMALL ENGINE	SMALL ENGINE	6025	804	W20M-U	067600-7441	Standard	Ni	Ni	STD	R	0.7	SMALL ENGINE	SMALL ENGINE	6022	805	W20M-US	067600-8590	Standard	Ni	Ni	STD	R	0.7	SMALL ENGINE	SMALL ENGINE	6036	806	W20PR-U	067700-2951	Resistor	Ni	Ni	R	R	0.7	AUTOMOBILE	GM,FORD	5046	807	W20SR-U	067700-3041	Resistor	Ni	Ni	R	R	0.7	AUTOMOBILE	GM,FORD	3076	808	W20S-U	067600-6801	Standard	Ni	Ni	STD	R	0.7	AUTOMOBILE	GM,FORD	3075	809	W20TT	267700-6311	Ni NEEDLE	1.5Ni	1.5Ni	R	RC	0.8	AUTOMOBILE	AUTOMOBILE	4602	810	W22EBR	067700-0750	3Elec.for Rotary	Ni	Nix3Elec.	R	S	1.1	AUTOMOBILE	MAZDA RE	3082	811	W22EKR-S11	067700-2120	Surface	Ni	NixSurface	R	S	1.1	MOTORCYCLE	HONDA	3170	812	W22EP	067600-1281	Standard	Ni	Ni	STD	R	0.8	AUTOMOBILE	MITSUBISHI	#N/A	813	W22EP	067600-1792	Standard	Ni	Ni	STD	S	0.8	AUTOMOBILE	MITSUBISHI	#N/A	814	W22EPB	067600-2750	3Elect.	Ni	Nix3Elec.	STD	R	0.85	AUTOMOBILE	Volkswagen	5066	815	W22EPR	067700-0271	Resistor	Ni	Ni	R	R	0.8	AUTOMOBILE	MITSUBISHI	#N/A	816	W22EPR11	067700-6160	Resistor	Ni	Ni	R	S	1.1	AUTOMOBILE	MITSUBISHI	#N/A	817	W22EPR-U	067700-2681	Resistor	Ni	Ni	R	R	0.8	AUTOMOBILE	HON,MAZ,MIT,SUZ	3088	818	W22EPR-U	067700-3450	Resistor	Ni	Ni	R	S	0.8	AUTOMOBILE	HON,MAZ,MIT,SUZ	3454	819	W22EPR-U11	067700-2720	Resistor	Ni	Ni	R	S	1.1	AUTOMOBILE	HON,MAZ,MIT,SUZ	3089	820	W22EP-S11	067600-6691	Surface	Ni	NixSurface	STD	S	1.1	AUTOMOBILE	MITSUBISHI	3251	821	W22EP-U	067600-7251	Standard	Ni	Ni	STD	R	0.8	AUTOMOBILE	HON,MAZ,MIT,SUZ	3085	822	W22EP-U11	067600-7670	Standard	Ni	Ni	STD	S	1.1	AUTOMOBILE	HON,MAZ,MIT,SUZ	3200	823	W22ESR	067700-0352	Resistor	Ni	Ni	R	R	0.8	MOTORCYCLE	MOTORCYCLE	3342	824	W22ESR-U	067700-2351	Resistor	Ni	Ni	R	R	0.8	MOTORCYCLE	YAMAHA	3098	825	W22ES-U	067600-6051	Standard	Ni	Ni	STD	R	0.8	AUTOMOBILE	MAZDA,SUZUKI	3093	826	W22ETR-L	067700-2150	2Elec.	Ni	Nix2	R	S	1.0	AUTOMOBILE	DAIHATSU	3315	827	W22ETR-L8	067700-7880	2Elec.	Ni	Nix2	R	S	0.8	AUTOMOBILE	DAIHATSU	3272	828	W22FPR	067700-1851	Resistor	Ni	Ni	R	R	0.7	MOTORCYCLE	SUZUKI	#N/A	829	W22FPR-U	067700-3841	Resistor	Ni	Ni	R	R	0.7	MOTORCYCLE	SUZUKI,YAMAHA	4022	830	W22FP-U	067600-6151	Standard,EXCEPT ASIA	Ni	Ni	STD	R	0.7	MOTORCYCLE	SUZUKI	4021	831	W22FP-U	067600-8880	Standard,ASIA ONLY	Ni	Ni	STD	R	0.65	MOTORCYCLE	SUZUKI,YAMAHA	4021	832	W22FP-U10	067600-6210	Standard,EXCEPT ASIA	Ni	Ni	STD	R	1.0	MOTORCYCLE	SUZUKI,YAMAHA	#N/A	833	W22FP-U10	067600-8900	Standard,ASIA ONLY	Ni	Ni	STD	R	1.0	MOTORCYCLE	SUZUKI,YAMAHA	4168	834	W22FSR	067700-0851	Resistor	Ni	Ni	R	R	0.7	MOTORCYCLE	YAMAHA	4024	835	W22FS-U	067600-6851	Standard	Ni	Ni	STD	R	0.7	MOTORCYCLE	SUZUKI,YAMAHA	4025	836	W22FS-U10	267700-4710	Standard	Ni	Ni	STD	R	1.0	MOTORCYCLE	YAMAHA	4230	837	W22MPR-U	067700-3350	Compact Type	Ni	Ni	R	R	0.6	SMALL ENGINE	SMALL ENGINE	6043	838	W22MP-U	067600-7491	Standard	Ni	Ni	STD	R	0.6	SMALL ENGINE	SMALL ENGINE	6027	839	W22M-U	067600-7451	Standard	Ni	Ni	STD	R	0.7	SMALL ENGINE	SMALL ENGINE	6026	840	W22S-U	067600-6891	Standard	Ni	Ni	STD	R	0.7	SMALL ENGINE	SMALL ENGINE	4027	841	W22TT	267700-7510	Ni NEEDLE	1.5Ni	1.5Ni	R	RC	0.8	AUTOMOBILE	AUTOMOBILE	4621	842	W24EMR-C	067700-7190	Compact for Motocross	Ni	NixCutback	R	S	0.8	MOTORCYCLE	HONDA	4198	843	W24EP	067600-1752	Standard	Ni	Ni	STD	R	0.8	MOTORCYCLE	MOTORCYCLE	#N/A	844	W24EPR	067700-0211	Resistor	Ni	Ni	R	R	0.8	MOTORCYCLE	SUZUKI	#N/A	845	W24EPR-U	067700-2691	Resistor	Ni	Ni	R	R	0.8	MOTORCYCLE	MOTORCYCLE	4136	846	W24EP-U	067600-7261	Standard	Ni	Ni	STD	S	0.8	MOTORCYCLE	MOTORCYCLE	4028	847	W24ESR	067700-5180	Resistor	Ni	Ni	R	S	0.7	SNOWMOBILE	KAW,SUZ,YAM	6068	848	W24ESR-U	067700-2361	Resistor	Ni	Ni	R	R	0.8	MOTORCYCLE	HONDA,YAMAHA	4033	849	W24ESR-V	067700-1921	φ1.3Ni Center Elec.	φ1.3Ni	Ni	R	S	0.6	MOTORCYCLE	HONDA	4035	850	W24ES-U	067600-6061	Standard	Ni	Ni	STD	R	0.8	MOTORCYCLE	SUZUKI	4030	851	W24ES-V	067600-7131	φ1.3Ni Center Elec.	1.3Ni	Ni	STD	R	0.6	MOTORCYCLE	HONDA	4034	852	W24FPR	067700-4000	Resistor	Ni	Ni	R	R	0.7	MOTORCYCLE	SUZUKI,YAMAHA	4188	853	W24FPR-U10	067700-8820	Resistor	Ni	Ni	R	R	1.0	MOTORCYCLE	MOTORCYCLE	6058	854	W24FP-U	067600-6281	Standard	Ni	Ni	STD	R	0.7	MOTORCYCLE	MOTORCYCLE	4178	855	W24FR-L	067700-6820	Resistor	Ni	Ni	R	T	0.7	MOTORCYCLE	HONDA	4154	856	W24FSR	067700-0861	Resistor	Ni	Ni	R	R	0.7	MOTORCYCLE	YAMAHA	4037	857	W24FSR-U10	067700-8170	Resistor	Ni	Ni	R	R	1.0	MOTORCYCLE	YAMAHA	6075	858	W24FS-U	067600-6861	Standard	Ni	Ni	STD	R	0.7	MOTORCYCLE	SUZUKI,YAMAHA	4038	859	W24FS-U10	067600-6671	Standard	Ni	Ni	STD	R	1.0	MOTORCYCLE	YAMAHA	6047	860	W24S-U	067600-6881	Standard	Ni	Ni	STD	R	0.7	SMALL ENGINE	SMALL ENGINE	4040	861	W25EDR14	067700-2890	4Elec.for Rotary	Ni	Nix4Elec.	R	S	1.4	AUTOMOBILE	MAZDA RE	3104	862	W27EBR	067700-0770	3Elec.for Rotary	Ni	Nix3Elec.	R	S	1.1	AUTOMOBILE	MAZDA RE	3107	863	W27EDR14	067700-2900	4Elec.for Rotary	Ni	Nix4Elec.	R	S	1.4	AUTOMOBILE	MAZDA RE	3105	864	W27EMR-C	067700-5500	Compact for Motocross	Ni	NixCutback	R	S	0.8	MOTORCYCLE	HONDA	4159	865	W27ESR	067700-5190	Resistor	Ni	Ni	R	S	0.7	SNOWMOBILE	KAW,SUZ,YAM	6069	866	W27ESR-U	067700-2371	Resistor	Ni	Ni	R	R	0.8	MOTORCYCLE	YAMAHA	4045	867	W27ESR-V	067700-1931	φ1.3Ni Center Elec.	φ1.3Ni	Ni	R	S	0.6	MOTORCYCLE	HONDA	4049	868	W27ES-U	067600-6071	Standard	Ni	Ni	STD	R	0.7	MOTORCYCLE	YAMAHA	4046	869	W27ES-V	067600-7141	φ1.3Ni Center Elec.	1.3Ni

No	DENSO	PART NUMBER	SPEC.	CENTER/E.	GROUND/E.	R/STD	NUT	Gap	MAIN USE	MAIN APPLICATION	STOCK NUMBER
871	W27FSR-U10	067700-0891	Resistor	Ni	Ni	R	R	1.0	MOTORCYCLE	YAMAHA	6055
872	W27FS-U	067600-6871	Standard	Ni	Ni	STD	R	0.7	MOTORCYCLE	SUZUKI,YAMAHA	4052
873	W27FS-U10	067600-6191	Standard	Ni	Ni	STD	R	1.0	MOTORCYCLE	YAMAHA	6028
874	W27S-U	067600-5781	Standard	Ni	Ni	STD	R	0.7	SMALL ENGINE	SMALL ENGINE	4055
875	W29EBR	067700-0780	3Elec.for Rotary	Ni	Nix3Elec.	R	S	1.1	AUTOMOBILE	MAZDA RE	3310
876	W31ESR-U	067700-6500	Resistor	Ni	Ni	R	R	0.8	MOTORCYCLE	MOTORCYCLE	4176
877	W31ES-U	067600-6081	Standard	Ni	Ni	STD	R	0.7	MOTORCYCLE	MOTORCYCLE	4062
878	W31FS	067600-2571	Standard	Ni	Ni	STD	R	0.7	MOTORCYCLE	MOTORCYCLE	4065
879	W31S-U	067600-5791	Standard	Ni	Ni	STD	R	0.7	SMALL ENGINE	SMALL ENGINE	6031
880	W9EP	067600-0871	Standard	Ni	Ni	STD	R	0.8	SMALL ENGINE	SMALL ENGINE	6005
881	W9EP	067600-1713	Standard	Ni	Ni	STD	S	0.8	SMALL ENGINE	SMALL ENGINE	6045
882	W9EXR-U	067700-1511	Resistor	Ni	Ni	R	S	0.8	SMALL ENGINE	SMALL ENGINE	6044
883	W9EXR-U/Copper Gasket	067700-7240	Resistor,Copper Gasket Attached	Ni	Ni,Cu Gasket	R	S	0.8	FORK LIFT	MAZDA	6056
884	W9EXR-UA	267700-8420	φ14×19	Ni	Ni	R	S	0.8	SMALL ENGINE	SMALL ENGINE	#N/A
885	W9EX-U	067600-4641	Standard	Ni	Ni	STD	S	0.8	SMALL ENGINE	SMALL ENGINE	6046
886	W9FP	067600-1612	Standard	Ni	Ni	STD	R	0.7	SMALL ENGINE	SMALL ENGINE	4011
887	W9FP-UL	067600-6601	Standard	Ni	Ni	STD	R	0.7	MOTORCYCLE	HONDA	4152
888	W9LMR-US	067700-7850	Compact Type	Ni	Ni	R	R	0.7	SMALL ENGINE	SMALL ENGINE	6071
889	W9LM-US	067600-8790	Standard	Ni	Ni	STD	R	0.7	SMALL ENGINE	SMALL ENGINE	6057
890	W9PR-U	067700-2912	Resistor	Ni	Ni	R	R	0.7	AUTOMOBILE	GM,FORD	6007
891	W9P-U	067600-7712	Standard	Ni	Ni	STD	R	0.8	AUTOMOBILE	GM,FORD	6006
892	W9-U	067600-6900	Standard	Ni	Ni	STD	R	0.7	AUTOMOBILE	GM,FORD	6004
893	WF20TT	267700-7500	Ni NEEDLE	1.5Ni	1.5Ni	R	RC	0.8	AUTOMOBILE	AUTOMOBILE	4620
894	X16EPR-U9	067700-5270	Resistor	Ni	Ni	R	T	0.9	MOTORCYCLE	HONDA	4190
895	X16FSR-U	067700-5010	Resistor	Ni	Ni	R	T	0.7	MOTORCYCLE	HONDA	4075
896	X20EPR-U9	067700-5280	Resistor	Ni	Ni	R	T	0.9	MOTORCYCLE	HONDA	4125
897	X20ESR-U	067700-5060	Resistor	Ni	Ni	R	T	0.7	MOTORCYCLE	HONDA	4157
898	X20ES-U	067800-4110	Standard	Ni	Ni	STD	T	0.7	MOTORCYCLE	HONDA	4076
899	X20FSR-U	067700-5020	Resistor	Ni	Ni	R	T	0.7	MOTORCYCLE	HONDA	4080
900	X20FS-U	067800-4020	Standard	Ni	Ni	STD	T	0.7	MOTORCYCLE	HONDA	4078
901	X22EPR-U9	067700-5290	Resistor	Ni	Ni	R	T	0.9	MOTORCYCLE	HONDA	4086
902	X22EP-U9	067800-4350	Standard	Ni	Ni	STD	T	0.9	MOTORCYCLE	HONDA	4085
903	X22ESR-U	067700-5070	Resistor	Ni	Ni	R	T	0.7	MOTORCYCLE	HONDA	4091
904	X22ESR-UB	267700-6430	Resistor	Ni	Ni	R	S	0.7	MARINE	HONDA MARINE	4232
905	X22ES-U	067800-4120	Standard	Ni	Ni	STD	T	0.7	MOTORCYCLE	HONDA	4090
906	X24EPR-U9	067700-5300	Resistor	Ni	Ni	R	T	0.9	MOTORCYCLE	HONDA	4096
907	X24EP-U9	067800-4360	Standard	Ni	Ni	STD	T	0.9	MOTORCYCLE	HONDA	4093
908	X24ESR-U	067700-5080	Resistor	Ni	Ni	R	T	0.7	MOTORCYCLE	HONDA	4101
909	X24ES-U	067800-4130	Standard	Ni	Ni	STD	T	0.7	MOTORCYCLE	HONDA	4099
910	X24FS-U	067800-4040	Standard	Ni	Ni	STD	T	0.7	MOTORCYCLE	HONDA	4103
911	X24GPR-U	067700-5540	Shroud	Ni	NixShroud	R	T	0.7	MOTORCYCLE	HONDA	4106
912	X24GP-U	067800-4550	Shroud	Ni	NixShroud	STD	T	0.7	MOTORCYCLE	HONDA	4150
913	X27EPR-U9	067700-5310	Resistor	Ni	Ni	R	T	0.9	MOTORCYCLE	HONDA	4111
914	X27EP-U9	067800-4370	Standard	Ni	Ni	STD	T	0.9	MOTORCYCLE	HONDA	4108
915	X27ESR-U	067700-5090	Resistor	Ni	Ni	R	T	0.7	MOTORCYCLE	HONDA	4116
916	X27ES-U	067800-4140	Standard	Ni	Ni	STD	T	0.7	MOTORCYCLE	HONDA	4114
917	X27ETR	067700-5030	φ12x2Elect.	Ni	Nix2	R	T	0.7	MOTORCYCLE	SUZUKI	4130
918	X27GPR-U	067700-5550	Shroud Resistor	Ni	NixShroud	R	T	0.7	MOTORCYCLE	HONDA	4117
919	X31ESR-U	067700-5110	Resistor	Ni	Ni	R	T	0.7	MOTORCYCLE	HONDA	4194
920	X31ES-U	067800-4160	Standard	Ni	Ni	STD	T	0.7	MOTORCYCLE	HONDA	4119
921	X31ETR	067700-5140	φ12x2Elect.	Ni	Nix2	R	T	0.7	MOTORCYCLE	SUZUKI	4170
922	XE20HR-U9	267700-5810	φ12x14 .Long Reach	Ni	Ni	R	S	0.9	AUTOMOBILE	RENAULT	3427
923	XU20EPR-U	067700-5800	φ12x16Hex	Ni	Ni	R	S	0.9	AUTOMOBILE	SUZ.SUB.MIT	3178
924	XU20HR9	267700-8140	φ12×26.5	Ni	Ni	R	S	0.9	AUTOMOBILE	DAIHATSU	3486
925	XU22EP-P	067800-4530	Single Platinum	1.1Pt	Ni	STD	S	0.8	AUTOMOBILE	SUZUKI	3271
926	XU22EPR-U	067700-5240	φ12x16Hex	Ni	Ni	R	S	0.9	AUTOMOBILE	SUZ.SUB.MIT	3179
927	XU22EP-U	067800-4180	φ12x16Hex	Ni	Ni	STD	S	0.9	AUTOMOBILE	SUZ.SUB.MIT	3176
928	XU22HDR9	267700-4520	φ12Long Reach	Ni	Ni	R	S	0.9	AUTOMOBILE	DAIHATSU	3445
929	XU22HR9	267700-5180	φ12Long Reach	Ni	Ni	R	S	0.9	AUTOMOBILE	DAIHATSU	3464
930	XU22PR9	267700-5490	φ12x16Hexx19mmReach	Ni	Ni	R	S	0.9	AUTOMOBILE	DAIHATSU	3448
931	XU22TT	267700-7080	Ni NEEDLE	1.5Ni	1.5Ni	R	S	0.8	AUTOMOBILE	AUTOMOBILE	4614
932	XU24EPR-U	067700-5250	φ12x16Hex	Ni	Ni	R	S	0.9	AUTOMOBILE	SUZ.SUB.MIT	3180
933	XU24EPR-U	067700-8150	φ12x16Hex	Ni	Ni	R	R	0.9	AUTOMOBILE	SUZ.SUB.MIT	3312
934	XU24EP-U	067800-4260	φ12x16Hex	Ni	Ni	STD	S	0.9	AUTOMOBILE	SUZ.SUB.MIT	3177
935	XU27EPR-U	067700-8090	φ12x16Hex	Ni	Ni	R	R	0.9	MOTORCYCLE	APRILIA	3313
936	XUH20TTI	267700-8291	Ni NEEDLE	1.5Ni	1.5Ni	R	S	0.8	AUTOMOBILE	AUTOMOBILE	7006
937	XUH22TT	267700-7090	Ni NEEDLE	1.5Ni	1.5Ni	R	S	0.8	AUTOMOBILE	AUTOMOBILE	4615
938	Y24FER-C	067700-7550	8mm Thread	Ni	Ni	R	T	0.7	MOTORCYCLE	HONDA	4185
939	Y27FER-C	067700-7560	8mm Thread	Ni	Ni	R	T	0.7	MOTORCYCLE	HONDA	4162
940	Y31FER-C	067700-7570	8mm Thread	Ni	Ni	R	T	0.7	MOTORCYCLE	HONDA	4186
941	ZC20HPR11	267700-7940	φ12×26.5 <Mazda Logo>	0.55Ir	Pt	R	S	1.1	AUTOMOBILE	MAZDA	#N/A
942	ZK20HQR8	267700-7750	Long Reach Iridium	0.55Ir	Pt	R	S	0.8	AUTOMOBILE	HYUNDAI	#N/A
943	ZT20EPR11	067800-7340	Iridium	0.55Ir	Pt	R	S	1.1	AUTOMOBILE	FORD	5087
944	ZTJ16R10	AN067800-8180	Extended Iridium,USA ONLY	0.55Ir	Pt	R	S	1.0	AUTOMOBILE	GM	5090
945	ZTJ16VR10	AN067800-7870	Extended Long Reach Iridium,USA ONLY	0.55Ir	Pt	R	S	1.0	AUTOMOBILE	GM	#N/A
946	ZXE20HR13(AM)	267700-4320	φ12Iridium.Long Reach	0.55Ir	Pt	R	S	1.3	AUTOMOBILE	NISSAN	3446
947	ZXE20HR13(OE)	267700-4640	φ12Iridium.Long Reach	0.55Ir	Pt	R	S	1.3	AUTOMOBILE	NISSAN	#N/A
948	ZXE27HBR8	267700-6210	φ12Iridium.Long Reach	0.55Ir	Pt	R	S	0.8	AUTOMOBILE	TOYOTA ,SUBARU	#N/A
949	ZXU20HCR8	267700-7550	Extended φ12 Long Reach Iridium	0.55Ir	Pt	R	S	0.8	AUTOMOBILE	HYUNDAI,KIA	3479
950	ZXU20HPR11	267700-7950	φ12×26.5	0.55Ir	Pt	R	S	1.1	AUTOMOBILE	SUZUKI	#N/A
951	ZXU20PR11	267700-7020	Iridium	0.55Ir	Pt	R	S	1.1	AUTOMOBILE	SUZUKI	3452
952	ZXU22HBR11	267700-2970	Long Reach Iridium,3Elec.	0.55Ir	Pt 3Elec.	R	S	1.1	AUTOMOBILE	DAIHATSU	3481
953	ZXU22HCR8	267700-7970	φ12×26.5	0.55Ir	Pt	R	S	0.8	AUTOMOBILE	HYUNDAI, KIA	#N/A

DENSO
 AUSTRALIA CHINA INDIA INDONESIA KOREA MALAYSIA PHILIPPINES SAUDI ARABIA SINGAPORE TAIWAN THAILAND VIETNAM JAPAN & USA EUROPE MOTOR CYCLE SMALL ENGINE REFERENCE PART NUMBER

S: SOLID; R: REMOVABLE; RC: CRIMPED; T: THREAD
 HON:HONDA SUB:SUBARU SUZ:SUZUKI MAZ:MAZDA MIT:MITSUBISHI KAW:KAWASAKI YAM:YAMAHA

DENSO
 AUSTRALIA
 CHINA
 INDIA
 INDONESIA
 KOREA
 MALAYSIA
 PHILIPPINES
 SAUDI ARABIA
 SINGAPORE
 TAIWAN
 THAILAND
 VIETNAM
 JAPAN
 EUROPE
 SMALL MOTOR
 CROSS REFERENCE
 ENGINE CYCLE
 & USA

No	DENSO	PART NUMBER	SPEC.	CENTER/E.	GROUND/E.	R/STD	NUT	Gap	MAIN USE	MAIN APPLICATION	STOCK NUMBER
1	K16HPR-U11	JK067700-3020	26.5mmReach	Ni	Ni	R	S	1.1	AUTOMOBILE	SUZUKI,YAMAHA	6076
2	K16HR-U11	JK267700-6280	26.5mmReach	Ni	Ni	R	S	1.1	AUTOMOBILE	TOYOTA,DAIHATSU	3482
3	K16PR-U	JK067700-6300	ISO Small HexResistor	Ni	Ni	R	S	0.8	AUTOMOBILE	MAZ,MIT,SUB	3191
4	K16PR-U	JK067800-1960	ISO Small HexResistor	Ni	Ni	R	S	0.8	AUTOMOBILE	MAZ,MIT,SUB	3191
5	K16PR-U	JK067700-7500	ISO Small HexResistor	Ni	Ni	R	R	0.8	AUTOMOBILE	MAZ,MIT,SUB	#N/A
6	K16PR-U11	JK067800-5450	ISO Small HexResistor	Ni	Ni	R	S	1.1	AUTOMOBILE	MAZ,MIT,SUB	3130
7	K16PR-U11	JK067700-6270	ISO Small HexResistor	Ni	Ni	R	S	1.1	AUTOMOBILE	MAZ,MIT,SUB	#N/A
8	K16P-U	JK067600-0380	Standard	Ni	Ni	STD	S	0.8	AUTOMOBILE	MAZ,MIT,SUB	3280
9	K16P-U	JK067800-1170	Standard	Ni	Ni	STD	S	0.8	AUTOMOBILE	MAZ,MIT,SUB	3280
10	K16R-U	JK067700-6400	ISO Small HexResistor	Ni	Ni	R	S	0.8	AUTOMOBILE	TOYOTA	3119
11	K16R-U	JK067800-6180	ISO Small HexResistor	Ni	Ni	R	S	0.8	AUTOMOBILE	MAZ,MIT,SUB	3119
12	K16R-U11	JK067700-6420	ISO Small HexResistor	Ni	Ni	R	S	1.1	AUTOMOBILE	TOYOTA	3120
13	K16R-U11	JK067800-1890	ISO Small HexResistor	Ni	Ni	R	S	1.1	AUTOMOBILE	TOYOTA	3120
14	K16TR11	JK067700-7900	2Elec.	Ni	Nix2	R	S	1.1	AUTOMOBILE	TOYOTA	3194
15	K16TT	JK267700-7430	Ni NEEDLE	1.5Ni	1.5Ni	R	S	1.0	AUTOMOBILE	AUTOMOBILE	4603
16	K16-U	JK067600-0740	Standard	Ni	Ni	STD	S	0.8	AUTOMOBILE	TOYOTA	3338
17	K16-U11	JK067600-0750	Standard	Ni	Ni	STD	S	1.1	AUTOMOBILE	TOYOTA	#N/A
18	K20HR-U11	JK267700-2880	ISO,Small Hex Resistor,Long Reach	Ni	Ni	R	S	1.1	AUTOMOBILE	TOYOTA	3381
19	K20HR-U11	JK067800-9190	ISO,Small Hex Resistor,Long Reach	Ni	Ni	R	S	1.1	AUTOMOBILE	TOYOTA	3381
20	K20PR-U	JK067700-6310	ISO Small HexResistor	Ni	Ni	R	S	0.8	AUTOMOBILE	MAZ,MIT,SUB	3145
21	K20PR-U	JK067800-3990	ISO Small HexResistor	Ni	Ni	R	S	0.8	AUTOMOBILE	MAZ,MIT,SUB	3145
22	K20PR-U	JK067700-7510	2Elec.	Ni	Nix2	R	R	1.1	AUTOMOBILE	TOYOTA	#N/A
23	K20PR-U11	JK067700-6280	ISO Small HexResistor	Ni	Ni	R	S	1.1	AUTOMOBILE	MAZ,MIT,SUB	3121
24	K20PR-U11	JK067800-5460	ISO Small HexResistor	Ni	Ni	R	S	1.1	AUTOMOBILE	MAZ,MIT,SUB	3121
25	K20P-U	JK067600-0390	Standard	Ni	Ni	STD	S	0.8	AUTOMOBILE	MAZ,MIT,SUB	3276
26	K20P-U	JK067800-1590	Standard	Ni	Ni	STD	S	0.8	AUTOMOBILE	MAZ,MIT,SUB	3276
27	K20P-U	JK067800-2390	Standard	Ni	Ni	STD	R	0.8	AUTOMOBILE	MAZ,MIT,SUB	3276
28	K20R-U	JK067700-6410	ISO Small HexResistor	Ni	Ni	R	S	0.8	AUTOMOBILE	TOYOTA	3122
29	K20R-U	JK067800-5040	ISO Small HexResistor	Ni	Ni	R	S	0.8	AUTOMOBILE	TOYOTA	3122
30	K20R-U11	JK067700-6430	ISO Small HexResistor	Ni	Ni	R	S	1.1	AUTOMOBILE	TOYOTA	3139
31	K20R-U11	JK067800-5560	ISO Small HexResistor	Ni	Ni	R	S	1.1	AUTOMOBILE	TOYOTA	3139
32	K20TNR	JK067700-8770	2Elec.	Ni	Nix2	R	S	1.0	AUTOMOBILE	DAIHATSU	3304
33	K20TR-11	JK067700-8110	2Elec.	Ni	Nix2	R	S	1.1	AUTOMOBILE	TOYOTA	#N/A
34	K20TT	JK267700-7440	Ni NEEDLE	1.5Ni	1.5Ni	R	S	1.0	AUTOMOBILE	AUTOMOBILE	4604
35	K20TXR	JK067700-8080	2Elec.Semi Surface Discharge	Ni	Nix2	R	R	1.0	AUTOMOBILE	Volkswagen	5063
36	K20-U	JK067600-0760	Standard	Ni	Ni	STD	S	0.8	AUTOMOBILE	TOYOTA	3339
37	K20-U11	JK067600-0770	Standard	Ni	Ni	STD	S	1.1	AUTOMOBILE	TOYOTA	#N/A
38	K22PR-U	JK067700-7520	ISO Small HexResistor	Ni	Ni	R	R	0.8	AUTOMOBILE	MAZ,MIT,SUB	#N/A
39	K22PR-U11	JK067700-6290	ISO Small HexResistor	Ni	Ni	R	S	1.1	AUTOMOBILE	MAZ,MIT,SUB	3192
40	KH16TT	JK267700-7450	Ni NEEDLE	1.5Ni	1.5Ni	R	S	1.0	AUTOMOBILE	AUTOMOBILE	4605
41	KH20TT	JK267700-7460	Ni NEEDLE	1.5Ni	1.5Ni	R	S	1.0	AUTOMOBILE	AUTOMOBILE	4618
42	KJ16CR-L11	JK067800-1730	Extended	Ni	Ni	R	S	1.1	AUTOMOBILE	HONDA	3132
43	KJ20CR-L11	JK067800-1740	Extended	Ni	Ni	R	S	1.1	AUTOMOBILE	HONDA	3169
44	Q14R-U11	JK067700-4670	Small HexResistor	Ni	Ni	R	S	1.1	AUTOMOBILE	TOYOTA	3183
45	Q16PR-U	JK067700-6000	Small HexResistor	Ni	Ni	R	R	0.8	AUTOMOBILE	MAZDA	3137
46	Q16PR-U11	JK067700-6050	Small HexResistor	Ni	Ni	R	R	1.1	AUTOMOBILE	MAZDA	5016
47	Q16PR-U11	JK067800-5690	Small HexResistor	Ni	Ni	R	S	1.1	AUTOMOBILE	MAZDA	5016
48	Q16PR-U11	JK067700-4510	Small HexResistor	Ni	Ni	R	R	1.1	AUTOMOBILE	MAZDA	#N/A
49	Q16P-U11	JK067600-7800	Standard	Ni	Ni	STD	S	1.1	AUTOMOBILE	MAZDA	3254
50	Q16R-U	JK067700-4410	Small HexResistor	Ni	Ni	R	S	0.8	AUTOMOBILE	TOYOTA	3129
51	Q16R-U	JK067800-1560	Small HexResistor	Ni	Ni	R	S	0.8	AUTOMOBILE	TOYOTA	#N/A
52	Q16R-U11	JK067700-4430	Small HexResistor	Ni	Ni	R	S	1.1	AUTOMOBILE	TOYOTA	3006
53	Q16R-U11	JK067800-1770	Small HexResistor	Ni	Ni	R	S	1.1	AUTOMOBILE	TOYOTA	#N/A
54	Q16TT	JK267700-7470	Ni NEEDLE	1.5Ni	1.5Ni	R	S	1.0	AUTOMOBILE	AUTOMOBILE	4607
55	Q16-U	JK067600-0700	Standard	Ni	Ni	STD	S	0.8	AUTOMOBILE	TOYOTA	3340
56	Q16-U11	JK067600-7070	Standard	Ni	Ni	STD	S	1.1	AUTOMOBILE	TOYOTA	3181
57	Q20PR-U	JK067700-6060	Small HexResistor	Ni	Ni	R	S	0.8	AUTOMOBILE	MAZDA,SUBARU	3007
58	Q20PR-U	JK067800-6650	Small HexResistor	Ni	Ni	R	S	0.8	AUTOMOBILE	MAZDA,SUBARU	3007
59	Q20PR-U	JK067700-4460	Small HexResistor	Ni	Ni	R	R	0.8	AUTOMOBILE	MAZDA	#N/A
60	Q20PR-U11	JK067700-4520	Small HexResistor	Ni	Ni	R	R	1.1	AUTOMOBILE	MAZDA	3008
61	Q20PR-U11	JK067700-6070	Small HexResistor	Ni	Ni	R	R	1.1	AUTOMOBILE	MAZDA	3008
62	Q20PR-U11	JK067800-6660	Small HexResistor	Ni	Ni	R	S	1.1	AUTOMOBILE	MAZDA	3008
63	Q20P-U	JK067600-7680	Standard	Ni	Ni	STD	R	0.8	AUTOMOBILE	MAZDA,SUBARU	3125
64	Q20R-U	JK067700-4420	Small HexResistor	Ni	Ni	R	S	0.8	AUTOMOBILE	TOYOTA	3140
65	Q20R-U	JK067800-5700	Small HexResistor	Ni	Ni	R	S	0.8	AUTOMOBILE	TOYOTA	3140
66	Q20R-U11	JK067700-4440	Small HexResistor	Ni	Ni	R	S	1.1	AUTOMOBILE	TOYOTA	3009
67	Q20R-U11	JK067800-5710	Small HexResistor	Ni	Ni	R	S	1.1	AUTOMOBILE	TOYOTA	3009
68	Q20TT	JK267700-7480	Ni NEEDLE	1.5Ni	1.5Ni	R	S	1.0	AUTOMOBILE	AUTOMOBILE	4608
69	Q20-U	JK067600-0720	Standard	Ni	Ni	STD	S	0.8	AUTOMOBILE	TOYOTA	3351
70	Q20-U11	JK067600-7080	Standard	Ni	Ni	STD	S	1.1	AUTOMOBILE	TOYOTA	3182
71	Q22P-U	JK067600-7690	Standard	Ni	Ni	STD	R	0.8	AUTOMOBILE	MAZDA,SUBARU	3255
72	QJ16AR-U	JK067800-1900	Extended	Ni	Ni	R	S	0.8	AUTOMOBILE	TOYOTA	3235
73	U16FS-U	JK067800-1640	Standard	Ni	Ni	STD	R	0.7	MOTORCYCLE	HONDA	4000
74	U16FS-U	JK067800-7510	Standard	Ni	Ni	STD	R	0.7	MOTORCYCLE	HONDA	4000
75	U20EPR9	JK067800-6870	φ10x19	Ni	Ni	R	T	0.9	MOTORCYCLE	HONDA	4228
76	U20EPR9S	JK067800-7750	φ10x19	Ni	Ni	R	T	0.9	MOTORCYCLE	MOTORCYCLE	#N/A
77	U20ESR-N	JK067800-7660	φ10x19	Ni	Ni	R	T	0.8	MOTORCYCLE	KAW,SUZ,YAM	4221
78	U20FSR-U	JK067800-7360	Resistor	Ni	Ni	R	T	0.7	MOTORCYCLE	HONDA	4004
79	U20FS-U	JK067800-1650	Standard	Ni	Ni	STD	R	0.7	MOTORCYCLE	HONDA	4002
80	U20FS-U	JK067800-7520	Standard	Ni	Ni	STD	R	0.7	MOTORCYCLE	HONDA	4002
81	U22EPR9	JK067800-7060	φ10x19	Ni	Ni	R	T	0.9	MOTORCYCLE	HONDA	4234
82	U22ES-N	JK067800-7680	φ10x19	Ni	Ni	STD	T	0.8	MOTORCYCLE	KAW,SUZ,YAM	4137
83	U22ESR-N	JK067800-7670	φ10x19	Ni	Ni	R	T	0.8	MOTORCYCLE	KAW,SUZ,YAM	4174
84	U22FER9	JK067800-7480	φ10Half Thread	Ni	Ni	R	T	0.9	MOTORCYCLE	HONDA	4212
85	U22FSR-U	JK067800-7310	Resistor	Ni	Ni	R	T	0.7	MOTORCYCLE	HON,SUZ,YAM,KAW	4008
86	U22FS-U	JK067800-1660	Standard	Ni	Ni	STD	R	0.7	MOTORCYCLE	HON,SUZ,YAM,KAW	4006

No	DENSO	PART NUMBER	SPEC.	CENTER/E.	GROUND/E.	R/STD	NUT	Gap	MAIN USE	MAIN APPLICATION	STOCK NUMBER
87	U22FS-U	JK067800-7530	Standard	Ni	Ni	STD	R	0.7	MOTORCYCLE	HON,SUZ,YAM,KAW	4006
88	U24EPR9	JK067800-7420	φ10x19	Ni	Ni	R	T	0.9	MOTORCYCLE	HONDA	4233
89	U24EPR-N9	JK067800-7950	φ10x19	Ni	Ni	R	T	0.9	MOTORCYCLE	MOTORCYCLE	#N/A
90	U24ES-N	JK067800-6810	φ10x19	Ni	Ni	STD	T	0.8	MOTORCYCLE	KAW,SUZ,YAM	4196
91	U24ESR-N	JK067800-6820	φ10x19	Ni	Ni	R	T	0.8	MOTORCYCLE	KAW,SUZ,YAM	4126
92	U24FER9	JK067800-7500	φ10Half Thread	Ni	Ni	R	T	0.9	MOTORCYCLE	HONDA	4127
93	U27EPR9	JK067800-7840	φ10x19	Ni	Ni	R	T	0.9	MOTORCYCLE	MOTORCYCLE	#N/A
94	U27EPR-N9	JK067800-7980	φ10x19	Ni	Ni	R	T	0.9	MOTORCYCLE	MOTORCYCLE	#N/A
95	U27ESR-N	JK067800-6690	φ10x19	Ni	Ni	R	T	0.8	MOTORCYCLE	KAW,SUZ,YAM	4131
96	U27FER9	JK067800-7650	φ10Half Thread	Ni	Ni	R	T	0.9	MOTORCYCLE	HONDA	4129
97	W14EX-U	JK067800-1110	Standard	Ni	Ni	STD	R	0.8	AUTOMOBILE	TOYOTA	3202
98	W14FP-UL	JK067800-1420	Standard	Ni	Ni	STD	R	0.7	MOTORCYCLE	HONDA	4014
99	W14FP-US	JK067800-6780	Standard	Ni	Ni	STD	R	0.65	MOTORCYCLE	MOTORCYCLE	#N/A
100	W16EP-U	JK067800-1940	Standard	Ni	Ni	STD	R	0.8	AUTOMOBILE	MITSUBISHI	3018
101	W16EP-U	JK067800-6060	Standard	Ni	Ni	STD	S	0.8	AUTOMOBILE	MITSUBISHI	3018
102	W16EP-U11	JK067800-6770	Standard	Ni	Ni	STD	R	1.1	AUTOMOBILE	SUBARU	3199
103	W16EXR-U	JK067800-5660	Resistor	Ni	Ni	R	S	0.8	AUTOMOBILE	TOYOTA	3210
104	W16EXR-U11	JK067800-5240	Resistor	Ni	Ni	R	S	1.1	AUTOMOBILE	TOYOTA	3032
105	W16EX-U	JK067800-1120	Standard	Ni	Ni	STD	R	0.8	AUTOMOBILE	TOYOTA	#N/A
106	W16EX-U	JK067800-5590	Standard	Ni	Ni	STD	S	0.8	AUTOMOBILE	TOYOTA	#N/A
107	W16EX-U11	JK067800-5230	Standard	Ni	Ni	STD	S	1.1	AUTOMOBILE	TOYOTA	3205
108	W16FP-US	JK067800-5980	Standard	Ni	Ni	STD	R	0.65	MOTORCYCLE	MOTORCYCLE	#N/A
109	W20EP-U	JK067800-1080	Standard	Ni	Ni	STD	R	0.8	AUTOMOBILE	HON,MAZ,MIT,SUZ	3043
110	W20EP-US	JK067800-7130	Standard	Ni	Ni	STD	R	0.65	MOTORCYCLE	MOTORCYCLE	#N/A
111	W20ES-US	JK067800-7100	Standard	Ni	Ni	STD	R	0.65	MOTORCYCLE	MOTORCYCLE	#N/A
112	W20EXR-U	JK067800-5670	Resistor	Ni	Ni	R	S	0.8	AUTOMOBILE	TOYOTA	3211
113	W20EXR-U11	JK067800-5680	Resistor	Ni	Ni	R	S	1.1	AUTOMOBILE	TOYOTA	3212
114	W20EX-U	JK067800-1130	Standard	Ni	Ni	STD	R	0.8	AUTOMOBILE	TOYOTA	3204
115	W20EX-U	JK067800-5600	Standard	Ni	Ni	STD	S	0.8	AUTOMOBILE	TOYOTA	3204
116	W20FP-US	JK067800-5990	Standard	Ni	Ni	STD	R	0.65	MOTORCYCLE	MOTORCYCLE	#N/A
117	W20FS-US	JK067800-7070	Standard	Ni	Ni	STD	R	0.65	MOTORCYCLE	MOTORCYCLE	#N/A
118	W22EP-US	JK067800-7140	Standard	Ni	Ni	STD	R	0.65	MOTORCYCLE	MOTORCYCLE	#N/A
119	W22ES-US	JK067800-7110	Standard	Ni	Ni	STD	R	0.65	MOTORCYCLE	MOTORCYCLE	#N/A
120	W22FP-US	JK067800-6000	Standard	Ni	Ni	STD	R	0.65	MOTORCYCLE	MOTORCYCLE	#N/A
121	W22FP-US10	JK067800-6430	Standard	Ni	Ni	STD	R	1	MOTORCYCLE	MOTORCYCLE	#N/A
122	W22FS-US	JK067800-7080	Standard	Ni	Ni	STD	R	0.65	MOTORCYCLE	MOTORCYCLE	#N/A
123	W24EP-US	JK067800-7150	Standard	Ni	Ni	STD	R	0.65	MOTORCYCLE	MOTORCYCLE	#N/A
124	W24ES-US	JK067800-7120	Standard	Ni	Ni	STD	R	0.65	MOTORCYCLE	MOTORCYCLE	#N/A
125	W24FPR-U10	JK067800-5940	Resistor	Ni	Ni	R	R	1.0	MOTORCYCLE	MOTORCYCLE	6058
126	W24FP-US	JK067800-6010	Standard	Ni	Ni	STD	R	0.65	MOTORCYCLE	MOTORCYCLE	#N/A
127	W24FP-US10	JK067800-6440	Standard	Ni	Ni	STD	R	1	MOTORCYCLE	MOTORCYCLE	#N/A
128	W24FS-U	JK067800-1460	Standard	Ni	Ni	STD	R	0.7	MOTORCYCLE	SUZUKI,YAMAHA	4038
129	W24FS-US	JK067800-7090	Standard	Ni	Ni	STD	R	0.65	MOTORCYCLE	MOTORCYCLE	#N/A
130	W9FP-UL	JK067800-1410	Standard	Ni	Ni	STD	R	0.7	MOTORCYCLE	HONDA	4152
131	X20FS-U	JK067800-1780	Standard	Ni	Ni	STD	R	0.7	MOTORCYCLE	HONDA	4078
132	X22EP-U	JK067800-1820	Standard	Ni	Ni	STD	R	0.7	MOTORCYCLE	MOTORCYCLE	#N/A
133	X22ES-U	JK067800-1690	Standard	Ni	Ni	STD	R	0.7	MOTORCYCLE	HONDA	4090
134	X24EPR-U9	JK067800-7300	Resistor	Ni	Ni	R	T	0.9	MOTORCYCLE	HONDA	4096
135	X24EP-U	JK067800-1830	Standard	Ni	Ni	STD	R	0.7	MOTORCYCLE	MOTORCYCLE	#N/A
136	X24EP-U9	JK067800-5080	Standard	Ni	Ni	STD	R	0.9	MOTORCYCLE	HONDA	4093
137	X24ESR-U	JK067800-7610	Resistor	Ni	Ni	R	T	0.7	MOTORCYCLE	HONDA	4101
138	X24ES-U	JK067800-1700	Standard	Ni	Ni	STD	R	0.7	MOTORCYCLE	HONDA	4099
139	XU22EPR-U	JK067800-7700	φ12x16Hex	Ni	Ni	R	S	0.9	AUTOMOBILE	SUZ,SUB.MIT	3179
140	XU22EP-U	JK067800-7690	φ12x16Hex	Ni	Ni	STD	S	0.9	AUTOMOBILE	SUZ,SUB.MIT	3176
141	XU22PR9	JK067800-8290	φ12x16Hexx19mmReach	Ni	Ni	R	S	0.9	AUTOMOBILE	DAIHATSU	3448

DENSO
 AUSTRALIA CHINA INDIA INDONESIA KOREA MALAYSIA PHILIPPINES SAUDIARABIA SINGAPORE TAIWAN THAILAND VIETNAM JAPAN EUROPE MOTOR CYCLE SMALL ENGINE CROSS REFERENCE PART NUMBER

S: SOLID; R: REMOVABLE; RC: CRIMPED; T: THREAD
 HON:HONDA SUB:SUBARU SUZ:SUZUKI MAZ:MAZDA MIT:MITSUBISHI KAW:KAWASAKI YAM:YAMAHA

DENSO
 AUSTRALIA
 CHINA
 INDIA
 INDONESIA
 KOREA
 MALAYSIA
 PHILIPPINES
 SAUDI ARABIA
 SINGAPORE
 TAIWAN
 THAILAND
 VIETNAM
 JAPAN
 EUROPE
 & USA
 SMALL MOTOR ENGINE
 CROSS REFERENCE
 PART NUMBER

No	PART NUMBER	DENSO	SPEC.	CENTER/E.	GROUND/E.	R/STD	NUT	Gap	MAIN USE	MAIN APPLICATION	STOCK NUMBER
1	067600-0310	M14	φ18x12(Hex25.4)	Ni	Ni	STD	R	0.7	SMALL ENGINE	SMALL ENGINE	5001
2	067600-0320	M17	φ18x12(Hex25.4)	Ni	Ni	STD	R	0.7	SMALL ENGINE	SMALL ENGINE	5002
3	067600-0330	M22	φ18x12(Hex25.4)	Ni	Ni	STD	R	0.7	SMALL ENGINE	SMALL ENGINE	5003
4	067600-0340	M24S	φ18x12(Hex25.4)	Ni	Ni	STD	R	0.7	SMALL ENGINE	SMALL ENGINE	5004
5	067600-0350	K16P-U11	Standard	Ni	Ni	STD	S	1.1	AUTOMOBILE	MAZ,MIT,SUB	3397
6	067600-0380	K16P-U	Standard	Ni	Ni	STD	S	0.8	AUTOMOBILE	MAZ,MIT,SUB	3280
7	067600-0390	K20P-U	Standard	Ni	Ni	STD	S	0.8	AUTOMOBILE	MAZ,MIT,SUB	3276
8	067600-0420	MW17	φ18x12(Hex20.6)	Ni	Ni	STD	R	0.7	SMALL ENGINE	SMALL ENGINE	5088
9	067600-0450	T16-U15	Standard	Ni	Ni	STD	S	1.5	AUTOMOBILE	GM,FORD	5072
10	067600-0700	Q16-U	Standard	Ni	Ni	STD	S	0.8	AUTOMOBILE	TOYOTA	3340
11	067600-0720	Q20-U	Standard	Ni	Ni	STD	S	0.8	AUTOMOBILE	TOYOTA	3351
12	067600-0740	K16-U	Standard	Ni	Ni	STD	S	0.8	AUTOMOBILE	TOYOTA	3338
13	067600-0750	K16-U11	Standard	Ni	Ni	STD	S	1.1	AUTOMOBILE	TOYOTA	#N/A
14	067600-0760	K20-U	Standard	Ni	Ni	STD	S	0.8	AUTOMOBILE	TOYOTA	3339
15	067600-0770	K20-U11	Standard	Ni	Ni	STD	S	1.1	AUTOMOBILE	TOYOTA	#N/A
16	067600-0871	W9EP	Standard	Ni	Ni	STD	R	0.8	SMALL ENGINE	SMALL ENGINE	6005
17	067600-0881	W14E	Standard	Ni	Ni	STD	R	0.8	SMALL ENGINE	SMALL ENGINE	6009
18	067600-1130	K22TM11	2Elec.	Ni	Nix2	STD	S	1.1	AUTOMOBILE	MITSUBISHI	3263
19	067600-1281	W22EP	Standard	Ni	Ni	STD	R	0.8	AUTOMOBILE	MITSUBISHI	#N/A
20	067600-1612	W9FP	Standard	Ni	Ni	STD	R	0.7	SMALL ENGINE	SMALL ENGINE	4011
21	067600-1651	W20FP	Standard	Ni	Ni	STD	R	0.7	AUTOMOBILE	MAZDA	4216
22	067600-1713	W9EP	Standard	Ni	Ni	STD	S	0.8	SMALL ENGINE	SMALL ENGINE	6045
23	067600-1752	W24EP	Standard	Ni	Ni	STD	R	0.8	MOTORCYCLE	MOTORCYCLE	#N/A
24	067600-1761	W16EP	Standard	Ni	Ni	STD	S	0.8	AUTOMOBILE	MITSUBISHI	3414
25	067600-1773	W20EP	Standard	Ni	Ni	STD	S	0.8	AUTOMOBILE	MITSUBISHI	#N/A
26	067600-1792	W22EP	Standard	Ni	Ni	STD	S	0.8	AUTOMOBILE	MITSUBISHI	#N/A
27	067600-1811	IW06-27	Iridium Racing	0.4lr	□Pt	STD	S	0.6	AUTOMOBILE	AUTOMOBILE	5744
28	067600-1821	IW06-31	Iridium Racing	0.4lr	□Pt	STD	S	0.6	AUTOMOBILE	AUTOMOBILE	5745
29	067600-1831	IW06-34	Iridium Racing	0.4lr	□Pt	STD	S	0.6	AUTOMOBILE	AUTOMOBILE	5746
30	067600-2051	W16EX-U13	Standard	Ni	Ni	STD	S	1.3	AUTOMOBILE	MAZDA	3029
31	067600-2061	W20EX-U13	Standard	Ni	Ni	STD	S	1.3	AUTOMOBILE	TOYOTA	3064
32	067600-2210	W16EX-U	Standard	Ni	Ni	STD	S	0.8	AUTOMOBILE	TOYOTA	#N/A
33	067600-2571	W31FS	Standard	Ni	Ni	STD	R	0.7	MOTORCYCLE	MOTORCYCLE	4065
34	067600-2740	W20EPB	3Elect.	Ni	Nix3Elec.	STD	R	0.85	AUTOMOBILE	Volkswagen	5065
35	067600-2750	W22EPB	3Elect.	Ni	Nix3Elec.	STD	R	0.85	AUTOMOBILE	Volkswagen	5066
36	067600-2770	K22PB	3Elect.	Ni	Nix3Elec.	STD	R	0.85	AUTOMOBILE	Volkswagen	5069
37	067600-3231	W20FS	Standard	Ni	Ni	STD	R	0.7	AUTOMOBILE	SUBARU	#N/A
38	067600-3341	W14L	Standard	Ni	Ni	STD	R	0.7	SMALL ENGINE	SMALL ENGINE	6013
39	067600-3351	W16LS	Standard	Ni	Ni	STD	R	0.7	AUTOMOBILE	AUTOMOBILE	3035
40	067600-4182	LP20-U	Standard,LPG	Ni	Ni	STD	S	0.7	AUTOMOBILE	LPG	3208
41	067600-4641	W9EX-U	Standard	Ni	Ni	STD	S	0.8	SMALL ENGINE	SMALL ENGINE	6046
42	067600-4663	W14EX-U	Standard	Ni	Ni	STD	S	0.8	AUTOMOBILE	TOYOTA	3202
43	067600-4671	W16EX-U	Standard	Ni	Ni	STD	S	0.8	AUTOMOBILE	TOYOTA	3203
44	067600-4681	W20EX-U	Standard	Ni	Ni	STD	S	0.8	AUTOMOBILE	TOYOTA	3204
45	067600-5781	W27S-U	Standard	Ni	Ni	STD	R	0.7	SMALL ENGINE	SMALL ENGINE	4055
46	067600-5791	W31S-U	Standard	Ni	Ni	STD	R	0.7	SMALL ENGINE	SMALL ENGINE	6031
47	067600-6031	W16ES-U	Standard	Ni	Ni	STD	R	0.8	MOTORCYCLE	YAMAHA	3025
48	067600-6041	W20ES-U	Standard	Ni	Ni	STD	R	0.8	MOTORCYCLE	SUZUKI	3051
49	067600-6051	W22ES-U	Standard	Ni	Ni	STD	R	0.8	AUTOMOBILE	MAZDA,SUZUKI	3093
50	067600-6061	W24ES-U	Standard	Ni	Ni	STD	R	0.8	MOTORCYCLE	SUZUKI	4030
51	067600-6071	W27ES-U	Standard	Ni	Ni	STD	R	0.7	MOTORCYCLE	YAMAHA	4046
52	067600-6081	W31ES-U	Standard	Ni	Ni	STD	R	0.7	MOTORCYCLE	MOTORCYCLE	4062
53	067600-6121	W14FP-U	Standard	Ni	Ni	STD	R	0.7	MOTORCYCLE	SUZUKI	4013
54	067600-6131	W16FP-U	Standard	Ni	Ni	STD	R	0.7	MOTORCYCLE	MOTORCYCLE	4019
55	067600-6141	W20FP-U	Standard,EXCEPT ASIA	Ni	Ni	STD	R	0.7	MOTORCYCLE	SUZUKI,YAMAHA,KUBOTA	3068
56	067600-6151	W22FP-U	Standard,EXCEPT ASIA	Ni	Ni	STD	R	0.7	MOTORCYCLE	SUZUKI	4021
57	067600-6161	W16FP-U10	Standard	Ni	Ni	STD	S	1.0	MOTORCYCLE	YAMAHA	3232
58	067600-6191	W27FS-U10	Standard	Ni	Ni	STD	R	1.0	MOTORCYCLE	YAMAHA	6028
59	067600-6210	W22FP-U10	Standard,EXCEPT ASIA	Ni	Ni	STD	R	1.0	MOTORCYCLE	SUZUKI,YAMAHA	#N/A
60	067600-6281	W24FP-U	Standard	Ni	Ni	STD	R	0.7	MOTORCYCLE	MOTORCYCLE	4178
61	067600-6322	W14EX-U11	Standard	Ni	Ni	STD	S	1.1	AUTOMOBILE	TOYOTA	3012
62	067600-6331	W16EX-U11	Standard	Ni	Ni	STD	S	1.1	AUTOMOBILE	TOYOTA	3205
63	067600-6341	W20EX-U11	Standard	Ni	Ni	STD	S	1.1	AUTOMOBILE	TOYOTA	3206
64	067600-6372	W14EX-U	Standard	Ni	Ni	STD	R	0.8	AUTOMOBILE	TOYOTA	3011
65	067600-6381	W16EX-U	Standard	Ni	Ni	STD	R	0.8	AUTOMOBILE	TOYOTA	3027
66	067600-6391	W20EX-U	Standard	Ni	Ni	STD	R	0.8	AUTOMOBILE	TOYOTA	3062
67	067600-6431	W16EP11	Standard	Ni	Ni	STD	S	1.1	AUTOMOBILE	MITSUBISHI	3410
68	067600-6441	W20EP11	Standard	Ni	Ni	STD	S	1.1	AUTOMOBILE	MITSUBISHI	3405
69	067600-6481	W16EX-U11	Standard	Ni	Ni	STD	R	1.1	AUTOMOBILE	TOYOTA	3028
70	067600-6491	W20EX-U11	Standard	Ni	Ni	STD	R	1.1	AUTOMOBILE	TOYOTA	3063
71	067600-6522	W14FP-L	Standard	Ni	Ni	STD	T	0.7	AUTOMOBILE	HONDA	#N/A
72	067600-6591	W14FP-UL	Standard	Ni	Ni	STD	R	0.7	MOTORCYCLE	HONDA	4014
73	067600-6601	W9FP-UL	Standard	Ni	Ni	STD	R	0.7	MOTORCYCLE	HONDA	4152
74	067600-6611	W14FP-UL10	Standard	Ni	Ni	STD	R	1.0	MOTORCYCLE	HONDA	6012
75	067600-6632	W16ET-S	2Elec,Surface	Ni	Nix2	STD	S	1.0	AUTOMOBILE	TOYOTA	3215
76	067600-6652	W20ET-S	2Elec.	Ni	Nix2	STD	S	1.0	AUTOMOBILE	TOYOTA	3059
77	067600-6671	W24FS-U10	Standard	Ni	Ni	STD	R	1.0	MOTORCYCLE	YAMAHA	6047
78	067600-6681	W14F-U	Standard	Ni	Ni	STD	S	0.7	SMALL ENGINE	KUBOTA	#N/A
79	067600-6691	W22EP-S11	Surface	Ni	NixSurface	STD	S	1.1	AUTOMOBILE	MITSUBISHI	3251
80	067600-6701	W20EP-S11	Surface	Ni	NixSurface	STD	S	1.1	AUTOMOBILE	MITSUBISHI	3250
81	067600-6711	W14LM-U	Standard	Ni	Ni	STD	R	0.7	SMALL ENGINE	SMALL ENGINE	6014
82	067600-6781	W14-U	Standard	Ni	Ni	STD	R	0.7	AUTOMOBILE	GM,FORD	6008
83	067600-6791	W16S-U	Standard	Ni	Ni	STD	R	0.7	AUTOMOBILE	GM,FORD	5044
84	067600-6801	W20S-U	Standard	Ni	Ni	STD	R	0.7	AUTOMOBILE	GM,FORD	3075
85	067600-6821	W14F-U	Standard	Ni	Ni	STD	R	0.7	SMALL ENGINE	KUBOTA	4012
86	067600-6831	W16FS-U	Standard	Ni	Ni	STD	R	0.7	MOTORCYCLE	MOTORCYCLE	3034
87	067600-6841	W20FS-U	Standard	Ni	Ni	STD	R	0.7	MOTORCYCLE	SUZUKI,YAMAHA	3073

No	PART NUMBER	DENSO	SPEC.	CENTER/E.	GROUND/E.	R/STD	NUT	Gap	MAIN USE	MAIN APPLICATION	STOCK NUMBER
88	067600-6851	W22FS-U	Standard	Ni	Ni	STD	R	0.7	MOTORCYCLE	SUZUKI,YAMAHA	4025
89	067600-6861	W24FS-U	Standard	Ni	Ni	STD	R	0.7	MOTORCYCLE	SUZUKI,YAMAHA	4038
90	067600-6871	W27FS-U	Standard	Ni	Ni	STD	R	0.7	MOTORCYCLE	SUZUKI,YAMAHA	4052
91	067600-6881	W24S-U	Standard	Ni	Ni	STD	R	0.7	SMALL ENGINE	SMALL ENGINE	4040
92	067600-6891	W22S-U	Standard	Ni	Ni	STD	R	0.7	SMALL ENGINE	SMALL ENGINE	4027
93	067600-6900	W9-U	Standard	Ni	Ni	STD	R	0.7	AUTOMOBILE	GM,FORD	6004
94	067600-7071	Q16-U11	Standard	Ni	Ni	STD	S	1.1	AUTOMOBILE	TOYOTA	3181
95	067600-7081	Q20-U11	Standard	Ni	Ni	STD	S	1.1	AUTOMOBILE	TOYOTA	3182
96	067600-7100	QJ14C11	Extended	Ni	Ni	STD	S	1.1	AUTOMOBILE	MAZDA	3236
97	067600-7131	W24ES-V	φ1.3Ni Center Elec.	1.3Ni	Ni	STD	R	0.6	MOTORCYCLE	HONDA	4034
98	067600-7141	W27ES-V	φ1.3Ni Center Elec.	1.3Ni	Ni	STD	R	0.6	MOTORCYCLE	HONDA	4047
99	067600-7200	Q16P-U11	Standard	Ni	Ni	STD	R	1.1	AUTOMOBILE	MAZDA	3254
100	067600-7221	W14EP-U	Standard	Ni	Ni	STD	R	0.8	AUTOMOBILE	HONDA	6010
101	067600-7231	W16EP-U	Standard	Ni	Ni	STD	R	0.8	AUTOMOBILE	MITSUBISHI	3018
102	067600-7241	W20EP-U	Standard	Ni	Ni	STD	R	0.8	AUTOMOBILE	HON,MAZ,MIT,SUZ	3043
103	067600-7251	W22EP-U	Standard	Ni	Ni	STD	R	0.8	AUTOMOBILE	HON,MAZ,MIT,SUZ	3085
104	067600-7261	W24EP-U	Standard	Ni	Ni	STD	S	0.8	MOTORCYCLE	MOTORCYCLE	4028
105	067600-7300	Q20P-U11	Standard	Ni	Ni	STD	R	1.1	AUTOMOBILE	MAZDA,SUBARU	3136
106	067600-7311	W20EP-U	Standard	Ni	Ni	STD	S	0.8	AUTOMOBILE	HON,MAZ,MIT,SUZ	3391
107	067600-7370	T20EP-U15	Standard	Ni	Ni	STD	R	1.5	AUTOMOBILE	GM,FORD	5050
108	067600-7380	T20EP-U	Standard	Ni	Ni	STD	R	0.8	AUTOMOBILE	GM,FORD	5031
109	067600-7390	T22EP-U	Standard	Ni	Ni	STD	R	0.8	AUTOMOBILE	GM,FORD	5040
110	067600-7421	W14M-U	Standard	Ni	Ni	STD	R	0.7	SMALL ENGINE	SMALL ENGINE	6015
111	067600-7441	W20M-U	Standard	Ni	Ni	STD	R	0.7	SMALL ENGINE	SMALL ENGINE	6022
112	067600-7451	W22M-U	Standard	Ni	Ni	STD	R	0.7	SMALL ENGINE	SMALL ENGINE	6026
113	067600-7461	W14MP-U10	Standard	Ni	Ni	STD	R	1.0	SMALL ENGINE	SMALL ENGINE	6017
114	067600-7481	W20MP-U	Standard	Ni	Ni	STD	R	0.6	SMALL ENGINE	SMALL ENGINE	6023
115	067600-7491	W22MP-U	Standard	Ni	Ni	STD	R	0.6	SMALL ENGINE	SMALL ENGINE	6027
116	067600-7511	MA9P-U	φ18x12Taper Seat	Ni	Ni	STD	R	0.9	AUTOMOBILE	FORD	5005
117	067600-7550	MA20P-U	φ18x12Taper Seat	Ni	Ni	STD	R	0.9	AUTOMOBILE	FORD	5012
118	067600-7570	L14-U	φ18x12 (Hex22.2)	Ni	Ni	STD	R	0.7	SMALL ENGINE	SMALL ENGINE	5000
119	067600-7581	W20MP-U10	Standard	Ni	Ni	STD	R	1.0	SMALL ENGINE	SMALL ENGINE	6024
120	067600-7621	W16EP-U11	Standard	Ni	Ni	STD	S	1.1	AUTOMOBILE	SUBARU	3199
121	067600-7660	W20EP-U11	Standard	Ni	Ni	STD	S	1.1	AUTOMOBILE	HON,MAZ,MIT,SUZ	3109
122	067600-7670	W22EP-U11	Standard	Ni	Ni	STD	S	1.1	AUTOMOBILE	HON,MAZ,MIT,SUZ	3200
123	067600-7680	Q20P-U	Standard	Ni	Ni	STD	R	0.8	AUTOMOBILE	MAZDA,SUBARU	3125
124	067600-7690	Q22P-U	Standard	Ni	Ni	STD	R	0.8	AUTOMOBILE	MAZDA,SUBARU	3255
125	067600-7712	W9P-U	Standard	Ni	Ni	STD	R	0.8	AUTOMOBILE	GM,FORD	6006
126	067600-7800	Q16P-U11	Standard	Ni	Ni	STD	S	1.1	AUTOMOBILE	MAZDA	3184
127	067600-7810	Q20P-U11	Standard	Ni	Ni	STD	S	1.1	AUTOMOBILE	MAZDA,SUBARU	3185
128	067600-7850	W16EPB10	3Elec.	Ni	Nix3Elec.	STD	R	1.0	AUTOMOBILE	Volkswagen	5064
129	067600-7931	J16A-U11	Extended	Ni	Ni	STD	S	1.1	AUTOMOBILE	TOYOTA	3220
130	067600-7971	J16B-U11	Extended	Ni	Ni	STD	S	1.1	AUTOMOBILE	TOYOTA	3221
131	067600-8450	T20M-U	Standard	Ni	Ni	STD	R	0.6	SMALL ENGINE	SMALL ENGINE	6039
132	067600-8460	T22M-U	Standard	Ni	Ni	STD	R	0.6	SMALL ENGINE	SMALL ENGINE	6041
133	067600-8470	T20MP-U	Standard	Ni	Ni	STD	R	0.6	SMALL ENGINE	SMALL ENGINE	6040
134	067600-8480	T22MP-U	Standard	Ni	Ni	STD	R	0.6	SMALL ENGINE	SMALL ENGINE	6042
135	067600-8590	W20M-US	Standard	Ni	Ni	STD	R	0.7	SMALL ENGINE	SMALL ENGINE	6036
136	067600-8600	W14LM-US	Standard	Ni	Ni	STD	R	0.7	SMALL ENGINE	SMALL ENGINE	6035
137	067600-8790	W9LM-US	Standard	Ni	Ni	STD	R	0.7	SMALL ENGINE	SMALL ENGINE	6057
138	067600-8820	J16AY	2Elec.Extended	Ni	Nix2	STD	S	1.1	AUTOMOBILE	DAIHATSU	3222
139	067600-8870	W20FP-U	Standard,ASIA ONLY	Ni	Ni	STD	R	0.65	MOTORCYCLE	SUZUKI,YAMAHA	3068
140	067600-8880	W22FP-U	Standard,ASIA ONLY	Ni	Ni	STD	R	0.65	MOTORCYCLE	SUZUKI,YAMAHA	4021
141	067600-8890	W20FP-U10	Standard,ASIA ONLY	Ni	Ni	STD	R	1.0	MOTORCYCLE	SUZUKI,YAMAHA	6037
142	067600-8900	W22FP-U10	Standard,ASIA ONLY	Ni	Ni	STD	R	1.0	MOTORCYCLE	SUZUKI,YAMAHA	4168
143	067600-8960	W20FP-L	Standard	Ni	Ni	STD	T	0.7	MOTORCYCLE	HONDA	4149
144	067600-9270	TR22-10	Standard	Ni	Ni	STD	R	1.0	MARINE	SUZUKI,YAMAHA	6052
145	067600-9700	T16P-U	Standard	Ni	Ni	STD	S	0.9	AUTOMOBILE	GM,FORD	5024
146	067600-9711	T20P-U	Standard	Ni	Ni	STD	S	0.9	AUTOMOBILE	GM,FORD	5034
147	067700-0020	PK20PR-P8	DoublePt Platinum	1.1Pt	DoublePt	R	S	0.8	AUTOMOBILE	MITSUBISHI	3245
148	067700-0131	W16EPR	Resistor	Ni	Ni	R	S	0.8	AUTOMOBILE	MITSUBISHI	#N/A
149	067700-0161	W16EPR	Resistor	Ni	Ni	R	R	0.8	AUTOMOBILE	MITSUBISHI	#N/A
150	067700-0211	W24EPR	Resistor	Ni	Ni	R	R	0.8	MOTORCYCLE	SUZUKI	#N/A
151	067700-0261	W20EPR	Resistor	Ni	Ni	R	R	0.8	AUTOMOBILE	MITSUBISHI	#N/A
152	067700-0271	W22EPR	Resistor	Ni	Ni	R	R	0.8	AUTOMOBILE	MITSUBISHI	#N/A
153	067700-0300	PK20PR11	Platinum	1.1Pt	Pt	R	S	1.1	AUTOMOBILE	MITSUBISHI	#N/A
154	067700-0352	W22ESR	Resistor	Ni	Ni	R	R	0.8	MOTORCYCLE	MOTORCYCLE	3342
155	067700-0442	LP20R-U	Resistor,LPG	Ni	Ni	R	S	0.7	AUTOMOBILE	LPG	3214
156	067700-0510	K22TMR11	2Elec.	Ni	Nix2	R	S	1.1	AUTOMOBILE	MITSUBISHI	3249
157	067700-0540	K16GPR-U11	Shroud	Ni	Ni	R	S	1.1	AUTOMOBILE	NISSAN	3135
158	067700-0570	KJ20CR-U11(*)	Extended	Ni	Ni	R	S	1.1	AUTOMOBILE	MITSUBISHI	#N/A
159	067700-0642	W20EAR	2Elec.for Rotary	Ni	Nix2	R	S	0.95	AUTOMOBILE	MAZDA	3040
160	067700-0750	W22EBR	3Elec.for Rotary	Ni	Nix3Elec.	R	S	1.1	AUTOMOBILE	MAZDA RE	3082
161	067700-0770	W27EBR	3Elec.for Rotary	Ni	Nix3Elec.	R	S	1.1	AUTOMOBILE	MAZDA RE	3107
162	067700-0780	W29EBR	3Elec.for Rotary	Ni	Nix3Elec.	R	S	1.1	AUTOMOBILE	MAZDA RE	3310
163	067700-0831	W16FSR	Resistor	Ni	Ni	R	R	0.7	MOTORCYCLE	MOTORCYCLE	3033
164	067700-0841	W20FSR	Resistor	Ni	Ni	R	R	0.7	MOTORCYCLE	MOTORCYCLE	3072
165	067700-0851	W22FSR	Resistor	Ni	Ni	R	R	0.7	MOTORCYCLE	YAMAHA	4024
166	067700-0861	W24FSR	Resistor	Ni	Ni	R	R	0.7	MOTORCYCLE	YAMAHA	4037
167	067700-0871	W27FSR	Resistor	Ni	Ni	R	R	0.7	MOTORCYCLE	MOTORCYCLE	4054
168	067700-0891	W27FSR-U10	Resistor	Ni	Ni	R	R	1.0	MOTORCYCLE	YAMAHA	6055
169	067700-1511	W9EXR-U	Resistor	Ni	Ni	R	S	0.8	SMALL ENGINE	SMALL ENGINE	6044
170	067700-1522	W14EXR-U	Resistor	Ni	Ni	R	S	0.8	AUTOMOBILE	TOYOTA	3013
171	067700-1531	W16EXR-U	Resistor	Ni	Ni	R	S	0.8	AUTOMOBILE	TOYOTA	3210
172	067700-1541	W20EXR-U	Resistor	Ni	Ni	R	S	0.8	AUTOMOBILE	TOYOTA	3211
173	067700-1571	W16EXR-U	Resistor	Ni	Ni	R	R	0.8	AUTOMOBILE	TOYOTA	3031
174	067700-1581	W20EXR-U	Resistor	Ni	Ni	R	R	0.8	AUTOMOBILE	TOYOTA	3066

S: SOLID; R: REMOVABLE; RC: CRIMPED; T: THREAD
 HON:HONDA SUB:SUBARU SUZ:SUZUKI MAZ:MAZDA MIT:MITSUBISHI KAW:KAWASAKI YAM:YAMAHA
 (*)MITSUBISHI lean burn excluded.

DENSO
 AUSTRALIA CHINA INDIA INDONESIA KOREA MALAYSIA PHILIPPINES SAUDIARABIA SINGAPORE TAIWAN THAILAND VIETNAM JAPAN & USA EUROPE MOTOR SMALL ENGINE REFERENCE PART NUMBER
 379

PART NUMBER	No	PART NUMBER	DENSO	SPEC.	CENTER/E.	GROUND/E.	R/STD	NUT	Gap	MAIN USE	MAIN APPLICATION	STOCK NUMBER	DENSO	
													INDIA	AUSTRALIA
175	067700-1851	W22FPR	Resistor	Ni	Ni	R	R	0.7	MOTORCYCLE	SUZUKI	#N/A			
176	067700-1871	W14FPR-UL10	Resistor	Ni	Ni	R	R	1.0	MOTORCYCLE	HONDA	4204			
177	067700-1881	W14FPR-UL	Resistor	Ni	Ni	R	R	0.7	MOTORCYCLE	HONDA	4016			
178	067700-1921	W24ESR-V	φ1.3Ni Center Elec.	φ1.3Ni	Ni	R	S	0.6	MOTORCYCLE	HONDA	4035			
179	067700-1931	W27ESR-V	φ1.3Ni Center Elec.	φ1.3Ni	Ni	R	S	0.6	MOTORCYCLE	HONDA	4049			
180	067700-2050	W20DTR-SA	2Elec,Shroud,Surface	Ni	Nix2	R	S	1.0	AUTOMOBILE	SUBARU	3219			
181	067700-2100	W14EKR-S11	Surface	Ni	NixSurface	R	S	1.1	AUTOMOBILE	HONDA	3108			
182	067700-2110	W16EKR-S11	Surface	Ni	NixSurface	R	S	1.1	AUTOMOBILE	HONDA	3016			
183	067700-2120	W22EKR-S11	Surface	Ni	NixSurface	R	S	1.1	MOTORCYCLE	HONDA	3170			
184	067700-2150	W22ETR-L	2Elec.	Ni	Nix2	R	S	1.0	AUTOMOBILE	DAIHATSU	3315			
185	067700-2160	W20ETR-L	2Elec. Gap1.0mm	Ni	Nix2	R	S	1.0	AUTOMOBILE	DAIHATSU	3277			
186	067700-2171	W16ETR-S	2Elec,Surface	Ni	Nix2	R	S	1.0	AUTOMOBILE	TOYOTA	3216			
187	067700-2181	W20ETR-S	2Elec,Surface	Ni	Nix2	R	S	1.0	AUTOMOBILE	TOYOTA	3060			
188	067700-2200	W20EKR-S11	Surface	Ni	NixSurface	R	S	1.1	AUTOMOBILE	HONDA	3041			
189	067700-2281	W14EXR-U	Resistor	Ni	Ni	R	S	0.8	AUTOMOBILE	TOYOTA	#N/A			
190	067700-2291	W16EXR-U	Resistor	Ni	Ni	R	S	0.8	AUTOMOBILE	TOYOTA	#N/A			
191	067700-2330	W16ESR-U	Resistor	Ni	Ni	R	R	0.8	SMALL ENGINE	KUBOTA	3110			
192	067700-2341	W20ESR-U	Resistor	Ni	Ni	R	R	0.8	MOTORCYCLE	YAMAHA	3057			
193	067700-2351	W22ESR-U	Resistor	Ni	Ni	R	R	0.8	MOTORCYCLE	YAMAHA	3098			
194	067700-2361	W24ESR-U	Resistor	Ni	Ni	R	R	0.8	MOTORCYCLE	HONDA,YAMAHA	4033			
195	067700-2371	W27ESR-U	Resistor	Ni	Ni	R	R	0.8	MOTORCYCLE	YAMAHA	4045			
196	067700-2421	W14EXR-U11	Resistor	Ni	Ni	R	S	1.1	AUTOMOBILE	TOYOTA	3014			
197	067700-2431	W16EXR-U11	Resistor	Ni	Ni	R	S	1.1	AUTOMOBILE	TOYOTA	3032			
198	067700-2441	W20EXR-U11	Resistor	Ni	Ni	R	S	1.1	AUTOMOBILE	TOYOTA	3212			
199	067700-2470	W16EXR-U11	Resistor	Ni	Ni	R	R	1.1	AUTOMOBILE	TOYOTA	3032			
200	067700-2481	W20EXR-U11	Resistor	Ni	Ni	R	R	1.1	AUTOMOBILE	TOYOTA	3067			
201	067700-2591	W20EPR-S11	Surface	Ni	NixSurface	R	S	1.1	AUTOMOBILE	MINI	3046			
202	067700-2620	W16EPR11	Resistor	Ni	Ni	R	S	1.1	AUTOMOBILE	MINI	3425			
203	067700-2631	W16EPR-U10	Resistor	Ni	Ni	R	S	1.0	AUTOMOBILE	MINI	3022			
204	067700-2641	W20EPR-U10	Resistor	Ni	Ni	R	S	1.0	AUTOMOBILE	MINI	3048			
205	067700-2651	W14EPR-U	Resistor	Ni	Ni	R	R	0.8	AUTOMOBILE	HONDA	6011			
206	067700-2661	W16EPR-U	Resistor	Ni	Ni	R	R	0.8	AUTOMOBILE	HON,MAZ,MITS,SUZ	3021			
207	067700-2671	W20EPR-U	Resistor	Ni	Ni	R	R	0.8	AUTOMOBILE	HON,MAZ,MITS,SUZ	3047			
208	067700-2681	W22EPR-U	Resistor	Ni	Ni	R	R	0.8	AUTOMOBILE	HON,MAZ,MITS,SUZ	3088			
209	067700-2691	W24EPR-U	Resistor	Ni	Ni	R	R	0.8	MOTORCYCLE	MOTORCYCLE	4136			
210	067700-2701	W20EPR-U11	Resistor	Ni	Ni	R	S	1.1	AUTOMOBILE	HON,MAZ,MITS,SUZ	3049			
211	067700-2710	W16EPR-U11	Resistor	Ni	Ni	R	S	1.1	AUTOMOBILE	HONDA,SUBARU,SUZUKI	3201			
212	067700-2720	W22EPR-U11	Resistor	Ni	Ni	R	S	1.1	AUTOMOBILE	HON,MAZ,MITS,SUZ	3089			
213	067700-2830	S-29	ROTARY	Ni	Surface	R	S	1.95	AUTOMOBILE	MAZDA RE	3252			
214	067700-2890	W25EDR14	4Elec.for Rotary	Ni	Nix4Elec.	R	S	1.4	AUTOMOBILE	MAZDA RE	3104			
215	067700-2900	W27EDR14	4Elec.for Rotary	Ni	Nix4Elec.	R	S	1.4	AUTOMOBILE	MAZDA RE	3105			
216	067700-2912	W9PR-U	Resistor	Ni	Ni	R	R	0.7	AUTOMOBILE	GM,FORD	6007			
217	067700-2921	W16PR-U	Resistor	Ni	Ni	R	R	0.7	AUTOMOBILE	GM,FORD	3037			
218	067700-2931	W14PR-U	Resistor	Ni	Ni	R	R	0.7	AUTOMOBILE	GM,FORD	6021			
219	067700-2951	W20PR-U	Resistor	Ni	Ni	R	R	0.7	AUTOMOBILE	GM,FORD	5046			
220	067700-3020	K16HPR-U11	26.5mmReach	Ni	Ni	R	S	1.1	AUTOMOBILE	SUZUKI,YAMAHA	6076			
221	067700-3041	W20SR-U	Resistor	Ni	Ni	R	R	0.7	AUTOMOBILE	GM,FORD	3076			
222	067700-3081	W20FPR-U10	Resistor	Ni	Ni	R	T	1.0	AUTOMOBILE	SUZUKI	3268			
223	067700-3130	T16EPR-U	Resistor	Ni	Ni	R	R	0.8	AUTOMOBILE	GM,FORD	5022			
224	067700-3140	T20EPR-U	Resistor	Ni	Ni	R	R	0.8	AUTOMOBILE	GM,FORD	5032			
225	067700-3150	·SK20R-P11	DoublePt Iridium	0.7Ir	DoublePt	R	S	1.1	AUTOMOBILE	TOYOTA	3335			
226	067700-3190	T16EPR-U15	Resistor	Ni	Ni	R	R	1.5	AUTOMOBILE	GM,FORD	5023			
227	067700-3201	W14MR-U	Compact Type	Ni	Ni	R	R	0.7	SMALL ENGINE	SMALL ENGINE	6019			
228	067700-3210	T20EPR-U15	Resistor	Ni	Ni	R	R	1.5	AUTOMOBILE	GM,FORD	5033			
229	067700-3221	W20MR-U	Compact Type	Ni	Ni	R	R	0.7	SMALL ENGINE	SMALL ENGINE	6025			
230	067700-3281	W14MPR-U10	Compact Type	Ni	Ni	R	R	1.0	SMALL ENGINE	SMALL ENGINE	6018			
231	067700-3301	W20MPR-U10	Compact Type	Ni	Ni	R	R	1.0	SMALL ENGINE	SMALL ENGINE	6032			
232	067700-3330	W14FR-U	Resistor	Ni	Ni	R	R	0.7	SMALL ENGINE	KUBOTA	4017			
233	067700-3341	W20FSR-U	Resistor	Ni	Ni	R	R	0.7	MOTORCYCLE	MOTORCYCLE	6053			
234	067700-3350	W22MPR-U	Compact Type	Ni	Ni	R	R	0.6	SMALL ENGINE	SMALL ENGINE	6043			
235	067700-3380	P20PR-S11	Surface Platinum Plug	1.1Pt	PtxSurface	R	S	1.1	AUTOMOBILE	MINI	3116			
236	067700-3390	P16PR11	Platinum	1.1Pt	Pt	R	S	1.1	AUTOMOBILE	MINI	3114			
237	067700-3400	P20PR11	Platinum	1.1Pt	Pt	R	S	1.1	AUTOMOBILE	MINI	3115			
238	067700-3440	W20EPR-U	Resistor	Ni	Ni	R	S	0.8	AUTOMOBILE	HON,MAZ,MITS,SUZ	3344			
239	067700-3450	W22EPR-U	Resistor	Ni	Ni	R	S	0.8	AUTOMOBILE	HON,MAZ,MITS,SUZ	3454			
240	067700-3472	J16BR-U	Extended	Ni	Ni	R	S	0.8	AUTOMOBILE	TOYOTA	3001			
241	067700-3520	SK20R5-G	Iridium,CNG,w/t Grease	0.7Ir	Pt	R	S	0.5	AUTOMOBILE	TOYOTA	3415			
242	067700-3531	J16AR-U11	Extended	Ni	Ni	R	S	1.1	AUTOMOBILE	TOYOTA	3000			
243	067700-3560	SK20BR11	3Elec. Iridium ,EU	0.7Ir	Ptx3	R	S	1.1	AUTOMOBILE	TOYOTA	3471			
244	067700-3571	J16BR-U11	Extended	Ni	Ni	R	S	1.1	AUTOMOBILE	TOYOTA	3002			
245	067700-3630	MA16PR-U	φ18x12Taper Seat	Ni	Ni	R	R	0.9	AUTOMOBILE	FORD	5008			
246	067700-3640	MA16PR-U11	φ18x12Taper Seat	Ni	Ni	R	R	1.1	AUTOMOBILE	FORD	5009			
247	067700-3660	MA20PR-U	φ18x12Taper Seat	Ni	Ni	R	R	0.9	AUTOMOBILE	FORD	5013			
248	067700-3831	W20FPR-U	Resistor	Ni	Ni	R	R	0.7	MOTORCYCLE	SUZUKI,YAMAHA	3070			
249	067700-3841	W22FPR-U	Resistor	Ni	Ni	R	R	0.7	MOTORCYCLE	SUZUKI,YAMAHA	4022			
250	067700-3931	W16FPR	Resistor	Ni	Ni	R	R	0.7	MOTORCYCLE	SUZUKI,YAMAHA	4020			
251	067700-3941	W20FPR	Resistor	Ni	Ni	R	R	0.7	MOTORCYCLE	SUZUKI,YAMAHA	#N/A			
252	067700-3992	·PQ20R-P11	DoublePt Platinum	1.1Pt	DoublePt	R	S	1.1	AUTOMOBILE	TOYOTA	3224			
253	067700-4000	W24FPR	Resistor	Ni	Ni	R	R	0.7	MOTORCYCLE	SUZUKI,YAMAHA	4188			
254	067700-4072	PQ16R-P11	DoublePt Platinum	1.1Pt	DoublePt	R	S	1.1	AUTOMOBILE	TOYOTA	#N/A			
255	067700-4082	PQ20R-P11	DoublePt Platinum	1.1Pt	DoublePt	R	S	1.1	AUTOMOBILE	TOYOTA	3322			
256	067700-4102	PQ20R-P8	DoublePt Platinum	1.1Pt	DoublePt	R	S	0.8	AUTOMOBILE	TOYOTA	3113			
257	067700-4110	P16R13	Platinum	1.1Pt	Pt	R	S	1.3	AUTOMOBILE	TOYOTA	3239			
258	067700-4120	·P16R	Platinum	1.1Pt	Pt	R	S	1.0	AUTOMOBILE	TOYOTA	3228			
259	067700-4130	P16R	Platinum	1.1Pt	Pt	R	S	1.1	AUTOMOBILE	TOYOTA	3004			
260	067700-4140	P20R8	Platinum	1.1Pt	Pt	R	S	0.8	AUTOMOBILE	TOYOTA	3229			
261	067700-4171	PQ16R	Platinum	1.1Pt	Pt	R	S	1.1	AUTOMOBILE	TOYOTA	3005			

No	PART NUMBER	DENSO	SPEC.	CENTER/E.	GROUND/E.	R/STD	NUT	Gap	MAIN USE	MAIN APPLICATION	STOCK NUMBER
262	067700-4191	PQ20R	Platinum	1.1Pt	Pt	R	S	1.1	AUTOMOBILE	TOYOTA	3117
263	067700-4200	P20R11	Platinum	1.1Pt	Pt	R	S	1.1	AUTOMOBILE	TOYOTA	3238
264	067700-4210	PQ16R13	Platinum	1.1Pt	Pt	R	S	1.3	AUTOMOBILE	TOYOTA	3404
265	067700-4220	PQ20R13	Platinum	1.1Pt	Pt	R	S	1.3	AUTOMOBILE	TOYOTA	3244
266	067700-4410	Q16R-U	Small HexResistor	Ni	Ni	R	S	0.8	AUTOMOBILE	TOYOTA	3129
267	067700-4421	Q20R-U	Small HexResistor	Ni	Ni	R	S	0.8	AUTOMOBILE	TOYOTA	3140
268	067700-4431	Q16R-U11	Small HexResistor	Ni	Ni	R	S	1.1	AUTOMOBILE	TOYOTA	3006
269	067700-4441	Q20R-U11	Small HexResistor	Ni	Ni	R	S	1.1	AUTOMOBILE	TOYOTA	3009
270	067700-4450	Q16PR-U	Small HexResistor	Ni	Ni	R	R	0.8	AUTOMOBILE	MAZDA	3137
271	067700-4460	Q20PR-U	Small HexResistor	Ni	Ni	R	R	0.8	AUTOMOBILE	MAZDA,SUBARU	3007
272	067700-4470	Q22PR-U	Small HexResistor	Ni	Ni	R	R	0.8	AUTOMOBILE	MAZDA,SUBARU	3010
273	067700-4510	Q16PR-U11	Small HexResistor	Ni	Ni	R	R	1.1	AUTOMOBILE	MAZDA	5016
274	067700-4520	Q20PR-U11	Small HexResistor	Ni	Ni	R	R	1.1	AUTOMOBILE	MAZDA	3008
275	067700-4530	Q22PR-U11	Small HexResistor	Ni	Ni	R	R	1.1	AUTOMOBILE	MAZDA	3257
276	067700-4660	Q16PR-U15	Small HexResistor	Ni	Ni	R	R	1.5	AUTOMOBILE	CHRYSLER	5017
277	067700-4670	Q14R-U11	Small HexResistor	Ni	Ni	R	S	1.1	AUTOMOBILE	TOYOTA	3183
278	067700-4700	W16FPR-U	Resistor	Ni	Ni	R	R	0.7	MOTORCYCLE	SUZUKI	4192
279	067700-4760	W14FPR-U	Resistor	Ni	Ni	R	R	0.7	MOTORCYCLE	SUZUKI	4184
280	067700-4820	S-29A	ROTARY	Ni	Surface	R	S	1.95	AUTOMOBILE	MAZDA RE	3106
281	067700-4830	S-31A	ROTARY	Ni	Surface	R	S	1.95	AUTOMOBILE	MAZDA RE	3111
282	067700-4851	PQ16R8	Platinum	1.1Pt	Pt	R	S	0.8	AUTOMOBILE	TOYOTA	3123
283	067700-4861	PQ20R8	Platinum	1.1Pt	Pt	R	S	0.8	AUTOMOBILE	TOYOTA	3223
284	067700-5010	X16FSR-U	Resistor	Ni	Ni	R	T	0.7	MOTORCYCLE	HONDA	4075
285	067700-5020	X20FSR-U	Resistor	Ni	Ni	R	T	0.7	MOTORCYCLE	HONDA	4080
286	067700-5030	X27ETR	φ12x2Elect.	Ni	Nix2	R	T	0.7	MOTORCYCLE	SUZUKI	4130
287	067700-5060	X20ESR-U	Resistor	Ni	Ni	R	T	0.7	MOTORCYCLE	HONDA	4157
288	067700-5070	X22ESR-U	Resistor	Ni	Ni	R	T	0.7	MOTORCYCLE	HONDA	4091
289	067700-5080	X24ESR-U	Resistor	Ni	Ni	R	T	0.7	MOTORCYCLE	HONDA	4101
290	067700-5090	X27ESR-U	Resistor	Ni	Ni	R	T	0.7	MOTORCYCLE	HONDA	4116
291	067700-5110	X31ESR-U	Resistor	Ni	Ni	R	T	0.7	MOTORCYCLE	HONDA	4194
292	067700-5140	X31ETR	φ12x2Elect.	Ni	Nix2	R	T	0.7	MOTORCYCLE	SUZUKI	4170
293	067700-5180	W24ESR	Resistor	Ni	Ni	R	S	0.7	SNOWMOBILE	KAW,SUZ,YAM	6068
294	067700-5190	W27ESR	Resistor	Ni	Ni	R	S	0.7	SNOWMOBILE	KAW,SUZ,YAM	6069
295	067700-5240	XU22EPR-U	φ12x16Hex	Ni	Ni	R	S	0.9	AUTOMOBILE	SUZ,SUB.MIT	3179
296	067700-5250	XU24EPR-U	φ12x16Hex	Ni	Ni	R	S	0.9	AUTOMOBILE	SUZ,SUB.MIT	3180
297	067700-5270	X16EPR-U9	Resistor	Ni	Ni	R	T	0.9	MOTORCYCLE	HONDA	4190
298	067700-5280	X20EPR-U9	Resistor	Ni	Ni	R	T	0.9	MOTORCYCLE	HONDA	4125
299	067700-5290	X22EPR-U9	Resistor	Ni	Ni	R	T	0.9	MOTORCYCLE	HONDA	4086
300	067700-5300	X24EPR-U9	Resistor	Ni	Ni	R	T	0.9	MOTORCYCLE	HONDA	4096
301	067700-5310	X27EPR-U9	Resistor	Ni	Ni	R	T	0.9	MOTORCYCLE	HONDA	4111
302	067700-5320	U22ESR-N	φ10x19	Ni	Ni	R	T	0.8	MOTORCYCLE	KAW,SUZ,YAM	4174
303	067700-5380	U24ESR-N	φ10x19	Ni	Ni	R	T	0.8	MOTORCYCLE	KAW,SUZ,YAM	4126
304	067700-5390	U27ESR-N	φ10x19	Ni	Ni	R	T	0.8	MOTORCYCLE	KAW,SUZ,YAM	4131
305	067700-5450	U24ETR	φ10 x2Elec.	Ni	Nix2	R	T	0.7	MOTORCYCLE	KAWASAKI	4158
306	067700-5460	U27ETR	φ10 x2Elec.	Ni	Nix2	R	T	0.7	MOTORCYCLE	KAWASAKI,SUZUKI	4155
307	067700-5500	W27EMR-C	Compact for Motocross	Ni	NixCutback	R	S	0.8	MOTORCYCLE	HONDA	4159
308	067700-5540	X24GPR-U	Shroud	Ni	NixShroud	R	T	0.7	MOTORCYCLE	HONDA	4106
309	067700-5550	X27GPR-U	Shroud Resistor	Ni	NixShroud	R	T	0.7	MOTORCYCLE	HONDA	4117
310	067700-5560	U22ETR	φ10 x2Elec.	Ni	Nix2	R	T	0.7	MOTORCYCLE	KAWASAKI	4201
311	067700-5580	U16FSR-U	Resistor	Ni	Ni	R	T	0.7	MOTORCYCLE	HONDA	4171
312	067700-5590	U20FSR-U	Resistor	Ni	Ni	R	T	0.7	MOTORCYCLE	HONDA	4004
313	067700-5600	U22FSR-U	Resistor	Ni	Ni	R	T	0.7	MOTORCYCLE	HON,SUZ,YAM,KAW	4008
314	067700-5610	U24FSR-U	Resistor	Ni	Ni	R	T	0.7	MOTORCYCLE	HON,SUZ,YAM,KAW	4010
315	067700-5630	U31ETR	φ10 x2Elec.	Ni	Nix2	R	T	0.7	MOTORCYCLE	KAWASAKI,YAMAHA	4135
316	067700-5640	U31ESR-N	φ10x19	Ni	Ni	R	T	0.8	MOTORCYCLE	KAW,SUZ,YAM	4187
317	067700-5650	T16R-U	Resistor	Ni	Ni	R	S	0.9	AUTOMOBILE	GM,FORD	5029
318	067700-5670	T16R-U15	Resistor	Ni	Ni	R	S	1.5	AUTOMOBILE	GM,FORD	5030
319	067700-5700	T14PR-U	Resistor	Ni	Ni	R	S	0.9	AUTOMOBILE	GM,FORD	5020
320	067700-5720	T14PR-U15	Resistor	Ni	Ni	R	S	1.5	AUTOMOBILE	GM,FORD	5021
321	067700-5750	T16PR-U	Resistor	Ni	Ni	R	S	0.9	AUTOMOBILE	GM,FORD	5025
322	067700-5760	T16PR-U11	Resistor	Ni	Ni	R	S	1.1	AUTOMOBILE	GM,FORD	5026
323	067700-5770	T16PR-U15	Resistor	Ni	Ni	R	S	1.5	AUTOMOBILE	GM,FORD	5027
324	067700-5800	XU20EPR-U	φ12x16Hex	Ni	Ni	R	S	0.9	AUTOMOBILE	SUZ,SUB.MIT	3178
325	067700-5810	U22FER9	φ10Half Thread	Ni	Ni	R	T	0.9	MOTORCYCLE	HONDA	4212
326	067700-5820	U24FER9	φ10Half Thread	Ni	Ni	R	T	0.9	MOTORCYCLE	HONDA	4127
327	067700-5830	U27FER9	φ10Half Thread	Ni	Ni	R	T	0.9	MOTORCYCLE	HONDA	4129
328	067700-5851	T20PR-U	Resistor	Ni	Ni	R	S	0.9	AUTOMOBILE	GM,FORD	5035
329	067700-5861	T20PR-U11	Resistor	Ni	Ni	R	S	1.1	AUTOMOBILE	GM,FORD	5036
330	067700-5871	T20PR-U15	Resistor	Ni	Ni	R	S	1.5	AUTOMOBILE	GM,FORD	5037
331	067700-5910	QJ16HR-U9	Extended	Ni	Ni	R	R	0.9	AUTOMOBILE	CHRYSLER	5018
332	067700-5920	QJ16AR-U	Extended	Ni	Ni	R	S	0.8	AUTOMOBILE	TOYOTA	3235
333	067700-5930	QJ16AR-U11	Extended	Ni	Ni	R	S	1.1	AUTOMOBILE	TOYOTA	3332
334	067700-5950	T20R-U	Resistor	Ni	Ni	R	S	0.9	AUTOMOBILE	GM,FORD	5038
335	067700-5960	W16EPR-U	Resistor	Ni	Ni	R	S	0.8	AUTOMOBILE	HON,MAZ,MITS,SUZ	3345
336	067700-5990	U16FSR-UB	Resistor	Ni	Ni	R	S	0.7	MOTORCYCLE	HONDA	6050
337	067700-6000	Q16PR-U	Small HexResistor	Ni	Ni	R	S	0.8	AUTOMOBILE	MAZDA	3346
338	067700-6050	Q16PR-U11	Small HexResistor	Ni	Ni	R	S	1.1	AUTOMOBILE	MAZDA	3186
339	067700-6060	Q20PR-U	Small HexResistor	Ni	Ni	R	S	0.8	AUTOMOBILE	MAZDA,SUBARU	3424
340	067700-6070	Q20PR-U11	Small HexResistor	Ni	Ni	R	S	1.1	AUTOMOBILE	MAZDA	3187
341	067700-6090	Q22PR-U11	Small HexResistor	Ni	Ni	R	S	1.1	AUTOMOBILE	MAZDA	3379
342	067700-6100	QJ20CR11	Extended	Ni	Ni	R	S	1.1	AUTOMOBILE	MAZDA	3112
343	067700-6130	T16NR-U11	Resistor	Ni	Ni	R	S	1.1	AUTOMOBILE	FORD	5047
344	067700-6140	T20NR-U11	Resistor	Ni	Ni	R	S	1.1	AUTOMOBILE	Ford	5048
345	067700-6150	W20EPR11	Resistor	Ni	Ni	R	S	1.1	AUTOMOBILE	MINISUBISHI	3394
346	067700-6160	W22EPR11	Resistor	Ni	Ni	R	S	1.1	AUTOMOBILE	MINISUBISHI	#N/A
347	067700-6230	QJ16CR11	Extended	Ni	Ni	R	S	1.1	AUTOMOBILE	MAZDA	3295
348	067700-6270	K16PR-U11	ISO Small HexResistor	Ni	Ni	R	S	1.1	AUTOMOBILE	MAZ,MIT,SUB	3130

S: SOLID; R: REMOVABLE; RC: CRIMPED; T: THREAD
 HON:HONDA SUB:SUBARU SUZ:SUZUKI MAZ:MAZDA MIT:MINISUBISHI KAW:KAWASAKI YAM:YAMAHA

DENSO
 AUSTRALIA CHINA INDIA INDONESIA KOREA MALAYSIA PHILIPPINES SAUDIARABIA SINGAPORE TAIWAN THAILAND VIETNAM JAPAN & USA EUROPE MOTOR CYCLE SMALL ENGINE REFERENCE PART CROSS NUMBER

No	PART NUMBER	DENSO	SPEC.	CENTER/E.	GROUND/E.	R/STD	NUT	Gap	MAIN USE	MAIN APPLICATION	STOCK NUMBER
436	067700-8120	PK16TR13	2Elec. Platinum	1.1Pt	Nix2Elec.	R	S	1.3	AUTOMOBILE	TOYOTA	3350
437	067700-8140	PT16EPR-L13	Platinum	1.1Pt	Pt	R	S	1.3	AUTOMOBILE	GM,FORD	5070
438	067700-8150	XU24EPR-U	φ12x16Hex	Ni	Ni	R	R	0.9	AUTOMOBILE	SUZ,SUB.MIT	3312
439	067700-8170	W24FSR-U10	Resistor	Ni	Ni	R	R	1.0	MOTORCYCLE	YAMAHA	6075
440	067700-8180	W16ETR-S	2Elec, Surface	Ni	Nix2	R	R	1.0	AUTOMOBILE	TOYOTA	3285
441	067700-8190	J16CR-U	Extended	Ni	Ni	R	R	0.8	AUTOMOBILE	MAZDA,HONDA	3256
442	067700-8200	SK20R-P11	DoublePt Iridium	0.7lr	DoublePt	R	S	1.1	AUTOMOBILE	TOYOTA	3398
443	067700-8211	PK20GR8	Shroud Platinum	1.1Pt	Pt	R	S	0.8	AUTOMOBILE	TOYOTA	3326
444	067700-8240	KJ22CR-L8	Extended	Ni	Ni	R	S	0.8	AUTOMOBILE	HONDA	3296
445	067700-8250	K16PR-P11	Single Platinum	1.1Pt	Ni	R	S	1.1	AUTOMOBILE	ISUZU	3293
446	067700-8260	P16PR8	Platinum	1.1Pt	Pt	R	S	0.8	AUTOMOBILE	SUZUKI	3270
447	067700-8270	P20PR8	Platinum	1.1Pt	Pt	R	S	0.8	AUTOMOBILE	SUZUKI	3306
448	067700-8280	SK16R-P11	DoublePt Iridium	0.7lr	DoublePt	R	S	1.1	AUTOMOBILE	TOYOTA	3353
449	067700-8290	U14FSR-UB	Resistor	Ni	Ni	R	S	0.7	MOTORCYCLE	HONDA	6070
450	067700-8300	PKJ16CR-L13	Extended Platinum	1.1Pt	Pt	R	S	1.3	AUTOMOBILE	HONDA	3357
451	067700-8340	SK20R11	Iridium	0.7lr	Pt	R	S	1.1	AUTOMOBILE	TOYOTA	3297
452	067700-8350	SK16R-P8	DoublePt Iridium	0.7lr	DoublePt	R	S	0.8	AUTOMOBILE	TOYOTA	3303
453	067700-8360	SK20R-P13	DoublePt Iridium	0.7lr	DoublePt	R	S	1.3	AUTOMOBILE	TOYOTA	3298
454	067700-8420	P20PR-P8	Platinum	1.1Pt	Pt	R	S	0.8	AUTOMOBILE	MITSUBISHI	#N/A
455	067700-8431	IK22	Iridium Power	0.4lr	TAPERCUT	R	S	0.8	AUTOMOBILE	AUTOMOBILE	5310
456	067700-8461	IK24	Iridium Power	0.4lr	TAPERCUT	R	S	0.8	AUTOMOBILE	AUTOMOBILE	5311
457	067700-8472	IK27	Iridium Power	0.4lr	TAPERCUT	R	S	0.8	AUTOMOBILE	AUTOMOBILE	5312
458	067700-8481	IQ22	Iridium Power	0.4lr	TAPERCUT	R	S	0.8	AUTOMOBILE	AUTOMOBILE	5313
459	067700-8491	IQ24	Iridium Power	0.4lr	TAPERCUT	R	S	0.8	AUTOMOBILE	AUTOMOBILE	5314
460	067700-8502	IQ27	Iridium Power	0.4lr	TAPERCUT	R	S	0.8	AUTOMOBILE	AUTOMOBILE	5315
461	067700-8602	IXU27	Iridium Power	0.4lr	TAPERCUT	R	RC	0.9	MOTORCYCLE	MOTORCYCLE	5337
462	067700-8620	SVK20RZ11	Iridium	0.4lr	Pt	R	S	1.1	AUTOMOBILE	DAIHATSU	3449
463	067700-8630	SK20PR-L9	Iridium	0.7lr	Pt	R	S	0.9	AUTOMOBILE	HONDA	3307
464	067700-8640	SK16PR-A11	Iridium	0.7lr	Pt	R	S	1.1	AUTOMOBILE	MITSUBISHI	3400
465	067700-8651	IW16	Iridium Power	0.4lr	TAPERCUT	R	RC	1.1	AUTOMOBILE	AUTOMOBILE	5305
466	067700-8661	IW20	Iridium Power	0.4lr	TAPERCUT	R	RC	1.1	AUTOMOBILE	AUTOMOBILE	5306
467	067700-8671	IW22	Iridium Power	0.4lr	TAPERCUT	R	RC	0.8	AUTOMOBILE	AUTOMOBILE	5307
468	067700-8681	IK16	Iridium Power	0.4lr	TAPERCUT	R	S	1.1	AUTOMOBILE	AUTOMOBILE	5303
469	067700-8691	IK20	Iridium Power	0.4lr	TAPERCUT	R	S	1.1	AUTOMOBILE	AUTOMOBILE	5304
470	067700-8701	IQ16	Iridium Power	0.4lr	TAPERCUT	R	S	1.1	AUTOMOBILE	AUTOMOBILE	5301
471	067700-8711	IQ20	Iridium Power	0.4lr	TAPERCUT	R	S	1.1	AUTOMOBILE	AUTOMOBILE	5302
472	067700-8722	IXU22	Iridium Power	0.4lr	TAPERCUT	R	RC	0.9	AUTOMOBILE	AUTOMOBILE	5308
473	067700-8732	IXU24	Iridium Power	0.4lr	TAPERCUT	R	RC	0.9	AUTOMOBILE	AUTOMOBILE	5309
474	067700-8740	K24PR-U11	ISO Small HexResistor	Ni	Ni	R	S	1.1	AUTOMOBILE	MAZ,MIT,SUB	3308
475	067700-8760	SK20PR-L9	Iridium	0.7lr	Pt	R	S	0.9	AUTOMOBILE	HONDA	#N/A
476	067700-8770	K20TNR	2Elec.	Ni	Nix2	R	S	1.0	AUTOMOBILE	DAIHATSU	3304
477	067700-8800	·K20TNR-S9	2Elec.Surface	Ni	Nix2	R	S	0.9	AUTOMOBILE	DAIHATSU	3305
478	067700-8810	KJ16CR-U11(*)	Extended	Ni	Ni	R	S	1.1	AUTOMOBILE	MITSUBISHI	3311
479	067700-8820	W24FPR-U10	Resistor	Ni	Ni	R	R	1.0	MOTORCYCLE	MOTORCYCLE	6058
480	067700-8840	SK16R11	Iridium	0.7lr	Pt	R	S	1.1	AUTOMOBILE	TOYOTA	3324
481	067700-8850	U20ESR-N	φ10x19	Ni	Ni	R	T	0.8	MOTORCYCLE	KAW,SUZ,YAM	4221
482	067700-8860	·SK16R-P11	DoublePt Iridium	0.7lr	DoublePt	R	S	1.1	AUTOMOBILE	TOYOTA	#N/A
483	067700-8870	·XU22EPR-U	φ12x16Hex	Ni	Ni	R	S	0.9	AUTOMOBILE	SUZUKI	3480
484	067700-8880	·PK20R11	Platinum	1.1Pt	Pt	R	S	1.1	AUTOMOBILE	TOYOTA	#N/A
485	067700-8891	IW24	Iridium Power	0.4lr	TAPERCUT	R	RC	0.7	MOTORCYCLE	MOTORCYCLE	5316
486	067700-8901	IW27	Iridium Power	0.4lr	TAPERCUT	R	RC	0.7	MOTORCYCLE	MOTORCYCLE	5317
487	067700-8911	IW29	Iridium Power	0.4lr	TAPERCUT	R	RC	0.7	MOTORCYCLE	MOTORCYCLE	5318
488	067700-8921	IW31	Iridium Power	0.4lr	TAPERCUT	R	RC	0.7	MOTORCYCLE	MOTORCYCLE	5319
489	067700-8931	IW34	Iridium Power	0.4lr	TAPERCUT	R	RC	0.7	MOTORCYCLE	MOTORCYCLE	5320
490	067700-8960	P16R8	Platinum	1.1Pt	Pt	R	S	0.8	AUTOMOBILE	TOYOTA	3393
491	067700-9221	IK31	Iridium Power	0.4lr	TAPERCUT	R	S	0.8	AUTOMOBILE	AUTOMOBILE	5321
492	067700-9231	IQ31	Iridium Power	0.4lr	TAPERCUT	R	S	0.8	AUTOMOBILE	AUTOMOBILE	5323
493	067700-9240	VW20T	Iridium Plus	0.4lr	Pt	R	S	0.8	AUTOMOBILE	AUTOMOBILE	5502
494	067700-9262	IU22	Iridium Power	0.4lr	TAPERCUT	R	R	0.9	MOTORCYCLE	MOTORCYCLE	5361
495	067700-9272	IU24	Iridium Power	0.4lr	TAPERCUT	R	R	0.9	MOTORCYCLE	MOTORCYCLE	5362
496	067700-9282	IU27	Iridium Power	0.4lr	TAPERCUT	R	R	0.9	MOTORCYCLE	MOTORCYCLE	5363
497	067700-9292	IU31	Iridium Power	0.4lr	TAPERCUT	R	R	0.9	MOTORCYCLE	MOTORCYCLE	5364
498	067700-9302	IU24A	Iridium Power	0.4lr	SLANT	R	R	0.9	MOTORCYCLE	MOTORCYCLE	5365
499	067700-9312	IU27A	Iridium Power	0.4lr	SLANT	R	R	0.9	MOTORCYCLE	MOTORCYCLE	5366
500	067700-9321	IU31A	Iridium Power	0.4lr	SLANT	R	R	0.9	MOTORCYCLE	MOTORCYCLE	5367
501	067700-9331	IUH24	Iridium Power	0.4lr	TAPERCUT	R	R	0.9	MOTORCYCLE	MOTORCYCLE	5368
502	067700-9341	IUH27	Iridium Power	0.4lr	TAPERCUT	R	R	0.9	MOTORCYCLE	MOTORCYCLE	5369
503	067700-9351	IX22	Iridium Power	0.4lr	TAPERCUT	R	R	0.8	MOTORCYCLE	MOTORCYCLE	5371
504	067700-9361	IX24	Iridium Power	0.4lr	TAPERCUT	R	R	0.8	MOTORCYCLE	MOTORCYCLE	5372
505	067700-9371	IX27	Iridium Power	0.4lr	TAPERCUT	R	R	0.8	MOTORCYCLE	MOTORCYCLE	5373
506	067700-9381	IX22B	Iridium Power	0.4lr	TAPERCUT	R	R	0.9	MOTORCYCLE	MOTORCYCLE	5375
507	067700-9391	IX24B	Iridium Power	0.4lr	TAPERCUT	R	R	0.9	MOTORCYCLE	MOTORCYCLE	5376
508	067700-9401	IX27B	Iridium Power	0.4lr	TAPERCUT	R	R	0.9	MOTORCYCLE	MOTORCYCLE	5377
509	067700-9411	IWF22	Iridium Power	0.4lr	TAPERCUT	R	R	0.8	MOTORCYCLE	MOTORCYCLE	5379
510	067700-9421	IWF24	Iridium Power	0.4lr	TAPERCUT	R	R	0.8	MOTORCYCLE	MOTORCYCLE	5380
511	067700-9431	IWF27	Iridium Power	0.4lr	TAPERCUT	R	R	0.8	MOTORCYCLE	MOTORCYCLE	5381
512	067700-9460	PKJ20CR-M11	Extended Platinum	1.1Pt	Pt	R	S	1.1	AUTOMOBILE	HONDA	3392
513	067700-9481	IUF22	Iridium Power	0.4lr	TAPERCUT	R	R	0.8	MOTORCYCLE	MOTORCYCLE	5383
514	067700-9491	IUF24	Iridium Power	0.4lr	TAPERCUT	R	R	0.8	MOTORCYCLE	MOTORCYCLE	5384
515	067700-9520	IK27C11	Iridium	0.4lr	TAPERCUT	R	S	1.1	MOTORCYCLE	HONDA	5336
516	067700-9530	SK20BR11	3Elec. Iridium ,JAPAN	0.7lr	Ptx3	R	S	1.1	AUTOMOBILE	TOYOTA	#N/A
517	067700-9540	VK20T	Iridium Plus	0.4lr	Pt	R	S	0.8	AUTOMOBILE	AUTOMOBILE	5501
518	067700-9550	IK24C11	Iridium	0.4lr	TAPERCUT	R	S	1.1	MOTORCYCLE	HONDA	5335
519	067700-9560	IUH24D	Iridium	0.4lr	TAPERCUT	R	T	0.9	MOTORCYCLE	HONDA	5387
520	067700-9570	IUH27D	Iridium	0.4lr	TAPERCUT	R	T	0.9	MOTORCYCLE	HONDA	5388
521	067700-9591	IK34	Iridium Power	0.4lr	TAPERCUT	R	S	0.8	AUTOMOBILE	AUTOMOBILE	5322
522	067700-9601	IQ34	Iridium Power	0.4lr	TAPERCUT	R	S	0.8	AUTOMOBILE	AUTOMOBILE	5324

S: SOLID; R: REMOVABLE; RC: CRIMPED; T: THREAD
 HON:HONDA SUB:SUBARU SUZ:SUZUKI MAZ:MAZDA MIT:MITSUBISHI KAW:KAWASAKI YAM:YAMAHA
 (*)MITSUBISHI lean burn excluded.

DENSO
 AUSTRALIA CHINA INDIA INDONESIA KOREA MALAYSIA PHILIPPINES SAUDIARABIA SINGAPORE TAIWAN THAILAND VIETNAM JAPAN & USA EUROPE MOTOR SMALL ENGINE REFERENCE PART CROSS NUMBER

No	PART NUMBER	DENSO	SPEC.	CENTER/E.	GROUND/E.	R/STD	NUT	Gap	MAIN USE	MAIN APPLICATION	STOCK NUMBER
610	267700-0890	SKJ16CR-A8	Extended Iridium	0.7lr	Pt	R	S	0.8	AUTOMOBILE	MAZDA	3370
611	267700-0910	SKJ20DR-M11	Extended Iridium,Shroud	0.7lr	Pt	R	S	1.1	AUTOMOBILE	HONDA	3377
612	267700-0930	SK22PR-M11	Iridium	0.7lr	Pt	R	S	1.1	AUTOMOBILE	HONDA	3372
613	267700-0950	KJ20SR11	Extended Single Iridium	0.7lr	Ni	R	S	1.1	AUTOMOBILE	SUBARU	3378
614	267700-0960	K20PR-SU9	Surface,Iso,Small Hex Resistor	Ni	Ni	R	S	0.9	AUTOMOBILE	DAIHATSU	3456
615	267700-1011	IU01-24	Iridium Racing	0.4lr	□Pt	R	R	0.6	MOTORCYCLE	MOTORCYCLE	5734
616	267700-1021	IU01-27	Iridium Racing	0.4lr	□Pt	R	R	0.6	MOTORCYCLE	MOTORCYCLE	5735
617	267700-1031	IU01-31	Iridium Racing	0.4lr	□Pt	R	R	0.6	MOTORCYCLE	MOTORCYCLE	5736
618	267700-1041	IU01-34	Iridium Racing	0.4lr	□Pt	R	R	0.6	MOTORCYCLE	MOTORCYCLE	5737
619	267700-1061	IXU01-24	Iridium Racing	0.4lr	□Pt	R	R	0.6	MOTORCYCLE	MOTORCYCLE	5730
620	267700-1071	IXU01-27	Iridium Racing	0.4lr	□Pt	R	R	0.6	MOTORCYCLE	MOTORCYCLE	5731
621	267700-1081	IXU01-31	Iridium Racing	0.4lr	□Pt	R	R	0.6	MOTORCYCLE	MOTORCYCLE	5732
622	267700-1091	IXU01-34	Iridium Racing	0.4lr	□Pt	R	R	0.6	MOTORCYCLE	MOTORCYCLE	5733
623	267700-1111	IW01-24	Iridium Racing	0.4lr	□Pt	R	RC	0.6	MOTORCYCLE	MOTORCYCLE	5713
624	267700-1121	IW01-27	Iridium Racing	0.4lr	□Pt	R	RC	0.6	MOTORCYCLE	MOTORCYCLE	5714
625	267700-1131	IW01-29	Iridium Racing	0.4lr	□Pt	R	RC	0.6	MOTORCYCLE	MOTORCYCLE	5715
626	267700-1141	IW01-31	Iridium Racing	0.4lr	□Pt	R	RC	0.6	MOTORCYCLE	MOTORCYCLE	5716
627	267700-1151	IW01-32	Iridium Racing	0.4lr	□Pt	R	RC	0.6	MOTORCYCLE	MOTORCYCLE	5717
628	267700-1161	IW01-34	Iridium Racing	0.4lr	□Pt	R	RC	0.6	MOTORCYCLE	MOTORCYCLE	5718
629	267700-1211	IWM01-29	Iridium Racing	0.4lr	□Pt	R	S	0.6	MOTORCYCLE	MOTORCYCLE	5726
630	267700-1221	IWM01-31	Iridium Racing	0.4lr	□Pt	R	S	0.6	MOTORCYCLE	MOTORCYCLE	5727
631	267700-1231	IWM01-32	Iridium Racing	0.4lr	□Pt	R	S	0.6	MOTORCYCLE	MOTORCYCLE	5728
632	267700-1241	IWM01-34	Iridium Racing	0.4lr	□Pt	R	S	0.6	MOTORCYCLE	MOTORCYCLE	5729
633	267700-1261	IA01-31	Iridium Racing	0.4lr	□Pt	R	S	0.6	MOTORCYCLE	MOTORCYCLE	5723
634	267700-1271	IA01-32	Iridium Racing	0.4lr	□Pt	R	S	0.6	MOTORCYCLE	MOTORCYCLE	5724
635	267700-1281	IA01-34	Iridium Racing	0.4lr	□Pt	R	S	0.6	MOTORCYCLE	MOTORCYCLE	5725
636	267700-1311	IK01-24	Iridium Racing	0.4lr	□Pt	R	S	0.6	AUTOMOBILE	AUTOMOBILE	5701
637	267700-1321	IK01-27	Iridium Racing	0.4lr	□Pt	R	S	0.7	AUTOMOBILE	AUTOMOBILE	5702
638	267700-1331	IK01-31	Iridium Racing	0.4lr	□Pt	R	S	0.7	AUTOMOBILE	AUTOMOBILE	5703
639	267700-1341	IK01-34	Iridium Racing	0.4lr	□Pt	R	S	0.7	AUTOMOBILE	AUTOMOBILE	5742
640	267700-1361	IK02-24	Iridium Racing	0.4lr	□Pt	R	S	0.7	AUTOMOBILE	AUTOMOBILE	5704
641	267700-1371	IK02-27	Iridium Racing	0.4lr	□Pt	R	S	0.7	AUTOMOBILE	AUTOMOBILE	5705
642	267700-1381	IK02-31	Iridium Racing	0.4lr	□Pt	R	S	0.7	AUTOMOBILE	AUTOMOBILE	5706
643	267700-1411	IQ01-24	Iridium Racing	0.4lr	□Pt	R	S	0.7	AUTOMOBILE	AUTOMOBILE	5707
644	267700-1421	IQ01-27	Iridium Racing	0.4lr	□Pt	R	S	0.7	AUTOMOBILE	AUTOMOBILE	5708
645	267700-1431	IQ01-31	Iridium Racing	0.4lr	□Pt	R	S	0.7	AUTOMOBILE	AUTOMOBILE	5709
646	267700-1441	IQ01-34	Iridium Racing	0.4lr	□Pt	R	S	0.7	AUTOMOBILE	AUTOMOBILE	5743
647	267700-1461	IQ02-24	Iridium Racing	0.4lr	□Pt	R	S	0.7	AUTOMOBILE	AUTOMOBILE	5710
648	267700-1471	IQ02-27	Iridium Racing	0.4lr	□Pt	R	S	0.7	AUTOMOBILE	AUTOMOBILE	5711
649	267700-1481	IQ02-31	Iridium Racing	0.4lr	□Pt	R	S	0.7	AUTOMOBILE	AUTOMOBILE	5712
650	267700-1521	IRE01-27	Iridium Racing	0.4lr	□Pt	R	S	0.7	AUTOMOBILE	MAZDA ROTARY	5719
651	267700-1531	IRE01-31	Iridium Racing	0.4lr	□Pt	R	S	0.7	AUTOMOBILE	MAZDA ROTARY	5720
652	267700-1541	IRE01-32	Iridium Racing	0.4lr	□Pt	R	S	0.7	AUTOMOBILE	MAZDA ROTARY	5721
653	267700-1551	IRE01-34	Iridium Racing	0.4lr	□Pt	R	S	0.7	AUTOMOBILE	MAZDA ROTARY	5722
654	267700-1561	IRE01-35	Iridium Racing	0.4lr	□Pt	R	S	0.7	AUTOMOBILE	MAZDA ROTARY	5741
655	267700-1570	RU01-27	Surface Racing	Ni	Surface	R	R	1.1	MOTORCYCLE	MOTORCYCLE	5738
656	267700-1580	RU01-31	Surface Racing	Ni	Surface	R	R	1.1	MOTORCYCLE	MOTORCYCLE	5739
657	267700-1590	RU01-34	Surface Racing	Ni	Surface	R	R	1.1	MOTORCYCLE	MOTORCYCLE	5740
658	267700-1640	VW16R-A13	Iridium	0.4lr	Pt	R	S	1.3	AUTOMOBILE	AUTOMOBILE	5635
659	267700-1760	SKJ20CR-A8	Extended Iridium	0.7lr	Pt	R	S	0.8	AUTOMOBILE	HONDA	3371
660	267700-1840	VK16PRZ11	Iridium	0.4lr	Pt TAPERCUT	R	S	1.1	MOTORCYCLE	HONDA	5628
661	267700-1850	VK20PRZ11	Iridium	0.4lr	Pt TAPERCUT	R	S	1.1	MOTORCYCLE	HONDA	5615
662	267700-1860	VK22PRZ11	Iridium	0.4lr	Pt TAPERCUT	R	S	1.1	MOTORCYCLE	HONDA	5629
663	267700-1870	VK24PRZ11	Iridium	0.4lr	Pt TAPERCUT	R	S	1.1	MOTORCYCLE	HONDA	5616
664	267700-1920	VNH27ZB	Iridium	0.4lr	Pt TAPERCUT	R	S	0.9	MOTORCYCLE	HONDA	#N/A
665	267700-1931	VUH27D	Iridium	0.4lr	Pt TAPERCUT	R	T	0.9	MOTORCYCLE	HONDA	5627
666	267700-1970	VKJ20RZ-M11	Iridium	0.4lr	Pt TAPERCUT	R	S	1.1	MOTORCYCLE	HONDA	5633
667	267700-2011	VUH24D	Iridium	0.4lr	Pt TAPERCUT	R	T	0.9	MOTORCYCLE	HONDA	5626
668	267700-2050	VK27PRZ11	Iridium	0.4lr	Pt TAPERCUT	R	S	1.1	MOTORCYCLE	HONDA	5630
669	267700-2060	VNH24Z	Iridium	0.4lr	Pt TAPERCUT	R	S	0.9	MOTORCYCLE	HONDA	5632
670	267700-2070	VNH27Z	Iridium	0.4lr	Pt TAPERCUT	R	S	0.9	MOTORCYCLE	HONDA	5631
671	267700-2080	W20FR-L9	Resistor	Ni	Ni	R	T	0.9	MOTORCYCLE	HONDA	#N/A
672	267700-2190	SXU16HPR9	Iridium,Long Reach(Isuzu)	0.7lr	Pt	R	S	0.9	AUTOMOBILE	ISUZU	3423
673	267700-2200	SK16PR-L11	Iridium	0.7lr	Pt	R	S	1.1	AUTOMOBILE	HONDA	3395
674	267700-2280	U27ESR-NB	φ10x19,Solid Terminal	Ni	Ni	R	S	0.8	MOTORCYCLE	KAW,SUZ,YAM	4224
675	267700-2290	N24EXRB	φ10x19(Insulator Dia 10.5)Solid	Ni	Ni	R	S	0.9	MOTORCYCLE	HONDA	4225
676	267700-2300	U24ESR-NB	φ10x19,Solid Terminal	Ni	Ni	R	S	0.8	MOTORCYCLE	HONDA	4223
677	267700-2310	SK20PR-B8	Iridium	0.7lr	Pt	R	S	0.8	AUTOMOBILE	DAIHATSU	3408
678	267700-2320	PK20PTR-S9	2Elec.Surface Platinum	1.1Pt	Nix2Elec.	R	S	0.9	AUTOMOBILE	DAIHATSU	3380
679	267700-2340	SK20PR-A8	Iridium	0.7lr	Pt	R	S	0.8	AUTOMOBILE	DAIHATSU	3403
680	267700-2501	ITV22	Iridium Power	0.4lr	TAPERCUT	R	S	0.8	AUTOMOBILE	DAIHATSU	5340
681	267700-2511	ITV24	Iridium Power	0.4lr	TAPERCUT	R	S	0.8	AUTOMOBILE	DAIHATSU	5341
682	267700-2521	ITV27	Iridium Power	0.4lr	TAPERCUT	R	S	0.8	AUTOMOBILE	DAIHATSU	5342
683	267700-2570	SK20R8	Iridium	0.7lr	Pt	R	S	0.8	AUTOMOBILE	TOYOTA	3416
684	267700-2610	SKJ16DR-M11	Extended Iridium,Shroud	0.7lr	Pt	R	S	1.1	AUTOMOBILE	HONDA	3422
685	267700-2651	IKH22	Iridium Power	0.4lr	TAPERCUT	R	S	0.8	AUTOMOBILE	DAIHATSU	5345
686	267700-2681	VKH22	Iridium Tough	0.4lr	Pt	R	S	0.8	AUTOMOBILE	DAIHATSU	5619
687	267700-2730	U22ESR-NB	φ10x19	Ni	Ni	R	S	0.8	MOTORCYCLE	ZONSHIN	4231
688	267700-2740	SK16PR-E11	Iridium	0.7lr	Pt	R	S	1.1	AUTOMOBILE	MAZDA	3412
689	267700-2811	VT16	Iridium Tough	0.4lr	Pt	R	S	1.1	AUTOMOBILE	DAIHATSU	5621
690	267700-2880	K20HR-U11	ISO,Small Hex Resistor,Long Reach	Ni	Ni	R	S	1.1	AUTOMOBILE	TOYOTA	3381
691	267700-2891	IWM24	Iridium Power	0.4lr	TAPERCUT	R	S	0.8	MOTORCYCLE	MOTORCYCLE	5391
692	267700-2901	IWM27	Iridium Power	0.4lr	TAPERCUT	R	S	0.8	MOTORCYCLE	MOTORCYCLE	5392
693	267700-2911	IWM31	Iridium Power	0.4lr	TAPERCUT	R	S	0.8	MOTORCYCLE	MOTORCYCLE	5393
694	267700-2921	IXG24	Iridium Power	0.4lr	TAPERCUT	R	R	0.7	MOTORCYCLE	MOTORCYCLE	5394
695	267700-2931	IXG27	Iridium Power	0.4lr	TAPERCUT	R	R	0.7	MOTORCYCLE	MOTORCYCLE	5395
696	267700-2941	IAE01-32	Iridium Racing	0.4lr	□Pt	R	S	0.6	MOTORCYCLE	MOTORCYCLE	5747

S: SOLID; R: REMOVABLE; RC: CRIMPED; T: THREAD
 HON:HONDA SUB:SUBARU SUZ:SUZUKI MAZ:MAZDA MIT:MITSUBISHI KAW:KAWASAKI YAM:YAMAHA

DENSO
 AUSTRALIA CHINA INDIA INDONESIA KOREA MALAYSIA PHILIPPINES SAUDI ARABIA SINGAPORE TAIWAN THAILAND VIETNAM JAPAN & USA EUROPE MOTOR CYCLE SMALL ENGINE REFERENCE PART CROSS NUMBER

PART NUMBER	CROSS REFERENCE	MOTOR ENGINE	SMALL ENGINE	EUROPE CYCLE	USA	JAPAN	VIETNAM	THAILAND	TAIWAN	SINGAPORE	SAUDIARABIA	PHILIPPINES	MALAYSIA	KOREA	INDONESIA	INDIA	CHINA	AUSTRALIA	DENSO	SPEC.	CENTER/E.	GROUND/E.	R/STD	NUT	Gap	MAIN USE	MAIN APPLICATION	STOCK
																												NUMBER
697	267700-2951	IAE01-34	Iridium Racing	0.4lr	□Pt	R	S	0.6	MOTORCYCLE	MOTORCYCLE	5748																	
698	267700-2970	ZXU22HBR11	Long Reach Iridium,3Elec.	0.55lr	Pt 3Elec.	R	S	1.1	AUTOMOBILE	DAIHATSU	3481																	
699	267700-2980	SK20R11	Iridium	0.7lr	Pt	R	S	1.1	AUTOMOBILE	TOYOTA	#N/A																	
700	267700-3000	SK16HR11	Long Reach Iridium	0.7lr	Pt	R	S	1.1	AUTOMOBILE	TOYOTA	3417																	
701	267700-3020	SXU22PR-A9	Iridium	0.7lr	Pt	R	S	0.9	AUTOMOBILE	MITSUBISHI	3420																	
702	267700-3130	SK16R8-PG	Iridium,CNG	0.7lr	Pt	R	S	0.8	AUTOMOBILE	TOYOTA	#N/A																	
703	267700-3661	IKH16	Iridium Power	0.4lr	TAPERCUT	R	S	1.1	AUTOMOBILE	AUTOMOBILE	5343																	
704	267700-3671	IKH20	Iridium Power	0.4lr	TAPERCUT	R	S	1.1	AUTOMOBILE	AUTOMOBILE	5344																	
705	267700-3681	VKH16	Iridium Tough	0.4lr	Pt	R	S	1.1	AUTOMOBILE	AUTOMOBILE	5617																	
706	267700-3691	VKH20	Iridium Tough	0.4lr	Pt	R	S	1.1	AUTOMOBILE	AUTOMOBILE	5618																	
707	267700-3701	ITV16	Iridium Power	0.4lr	TAPERCUT	R	S	1.1	AUTOMOBILE	AUTOMOBILE	5338																	
708	267700-3711	ITV20	Iridium Power	0.4lr	TAPERCUT	R	S	1.1	AUTOMOBILE	AUTOMOBILE	5339																	
709	267700-3721	VK20Y	Iridium Tough	0.4lr	Pt	R	S	0.8	AUTOMOBILE	AUTOMOBILE	5620																	
710	267700-4120	SK20HR11	Long Reach Iridium	0.7lr	Pt	R	S	1.1	AUTOMOBILE	TOYOTA	3421																	
711	267700-4140	SK20R8-G	Iridium,CNG,w/t Grease	0.7lr	Pt	R	S	0.8	AUTOMOBILE	TOYOTA	#N/A																	
712	267700-4160	PK22PR-L11S	Platinum,SUS GASKET	1.1Pt	Pt	R	S	1.1	AUTOMOBILE	HONDA	3284																	
713	267700-4200	FK20HBR11	Double Needle 3Elec Long Reach Iridium Shroud	0.55lr	Pt NEEDLE	R	S	1.1	AUTOMOBILE	TOYOTA	3473																	
714	267700-4230	FK20HR11	Double Needle Long Reach Iridium	0.55lr	Pt NEEDLE	R	S	1.1	AUTOMOBILE	TOYOTA,SUBARU	3426																	
715	267700-4281	IKH24	Iridium Power	0.4lr	TAPERCUT	R	S	0.8	AUTOMOBILE	AUTOMOBILE	5346																	
716	267700-4291	IKH27	Iridium Power	0.4lr	TAPERCUT	R	S	0.8	AUTOMOBILE	AUTOMOBILE	5347																	
717	267700-4320	ZXE20HR13(AM)	φ12Iridium.Long Reach	0.55lr	Pt	R	S	1.3	AUTOMOBILE	NISSAN	3446																	
718	267700-4340	SK16PR-F8	Iridium	0.7lr	Pt	R	S	0.8	AUTOMOBILE	MAZDA	3435																	
719	267700-4360	SK20PR-F8	Iridium	0.7lr	Pt	R	S	0.8	AUTOMOBILE	MAZDA	3430																	
720	267700-4380	K20PSR-B8	Iridium	0.7lr	Ni	R	S	0.8	AUTOMOBILE	MITSUBISHI	3431																	
721	267700-4390	K20PR-U9S	SUS GASKET	Ni	Ni	R	S	0.9	AUTOMOBILE	HONDA	3470																	
722	267700-4451	IKH01-24	Iridium Racing	0.4lr	□Pt	R	S	0.7	AUTOMOBILE	AUTOMOBILE	5749																	
723	267700-4461	IKH01-27	Iridium Racing	0.4lr	□Pt	R	S	0.7	AUTOMOBILE	AUTOMOBILE	5750																	
724	267700-4471	IKH01-31	Iridium Racing	0.4lr	□Pt	R	S	0.7	AUTOMOBILE	AUTOMOBILE	5751																	
725	267700-4481	VT20	Iridium Tough	0.4lr	Pt	R	S	1.1	AUTOMOBILE	AUTOMOBILE	5638																	
726	267700-4491	IY24	Iridium Power	0.4lr	Ni	R	R	0.7	MOTORCYCLE	MOTORCYCLE	5400																	
727	267700-4501	IY27	Iridium Power	0.4lr	Ni	R	R	0.7	MOTORCYCLE	MOTORCYCLE	5401																	
728	267700-4511	IY31	Iridium Power	0.4lr	Ni	R	R	0.7	MOTORCYCLE	MOTORCYCLE	5402																	
729	267700-4520	XU22HDR9	φ12Long Reach	Ni	Ni	R	S	0.9	AUTOMOBILE	MITSUBISHI	3445																	
730	267700-4530	SXU22HDR8	Iridium,Long Reach (Mitsubishi)	0.7lr	Pt	R	S	0.8	AUTOMOBILE	MITSUBISHI	3441																	
731	267700-4541	VKH20Y	Iridium Tough	0.4lr	Pt	R	S	0.8	AUTOMOBILE	AUTOMOBILE	5639																	
732	267700-4570	W16EPR-U	Resistor	Ni	Ni	R	T	0.8	AUTOMOBILE	SUZUKI	#N/A																	
733	267700-4580	U20EPR9	φ10x19	Ni	Ni	R	T	0.9	MOTORCYCLE	HONDA	4228																	
734	267700-4640	ZXE20HR13(OE)	φ12Iridium.Long Reach	0.55lr	Pt	R	S	1.3	AUTOMOBILE	NISSAN	#N/A																	
735	267700-4690	S20R8-G	Iridium,CNG	0.7lr	Pt	R	S	0.8	AUTOMOBILE	TOYOTA	3447																	
736	267700-4710	W22FS-U10	Standard	Ni	Ni	STD	R	1.0	MOTORCYCLE	YAMAHA	4230																	
737	267700-4770	VUH27ES	Iridium,SUS GASKET	0.4lr	Pt	R	T	0.9	MOTORCYCLE	HONDA	5642																	
738	267700-4790	U24FER9S	φ10Half Thread,SUS	Ni	Ni	R	T	0.9	MOTORCYCLE	HONDA	#N/A																	
739	267700-4810	T16VR-U10	Taparseat,Longreach	Ni	Ni	R	S	1.0	AUTOMOBILE	Ford	5086																	
740	267700-4821	IRL01-27	Iridium Racing	0.4lr	□Pt	R	S	1.1	AUTOMOBILE	MAZDA ROTARY,RX8	5754																	
741	267700-4831	IRL01-31	Iridium Racing	0.4lr	□Pt	R	S	1.1	AUTOMOBILE	MAZDA ROTARY,RX8	5755																	
742	267700-4841	IRT01-31	Iridium Racing	0.4lr	□Pt	R	S	1.1	AUTOMOBILE	MAZDA ROTARY,RX8	5752																	
743	267700-4851	IRT01-34	Iridium Racing	0.4lr	□Pt	R	S	1.1	AUTOMOBILE	MAZDA ROTARY,RX8	5753																	
744	267700-4880	FXE20HR11·(AM)	Double Needle φ12Iridium.Long Reach	0.55lr	Pt NEEDLE	R	S	1.1	AUTOMOBILE	NISSAN	3439																	
745	267700-4930	SKJ20DR-M11S	Extended Iridium,Shroud ,SUS	0.7lr	Pt	R	S	1.1	AUTOMOBILE	HONDA	3432																	
746	267700-4950	FXE16HE11·	Double Needle φ12Iridium.Long Reach,Shroud	0.55lr	Pt NEEDLE	R	S	1.1	AUTOMOBILE	NISSAN	3438																	
747	267700-4981	ITL16	Iridium Power	0.4lr	TAPERCUT	R	S	1.1	AUTOMOBILE	AUTOMOBILE	5349																	
748	267700-4991	ITL20	Iridium Power	0.4lr	TAPERCUT	R	S	1.1	AUTOMOBILE	AUTOMOBILE	5350																	
749	267700-5001	IWF16	Iridium Power	0.4lr	TAPERCUT	R	R	0.8	MOTORCYCLE	MOTORCYCLE	5359																	
750	267700-5011	IWF20	Iridium Power	0.4lr	TAPERCUT	R	R	0.8	MOTORCYCLE	MOTORCYCLE	5378																	
751	267700-5021	IU20	Iridium Power	0.4lr	TAPERCUT	R	R	0.9	MOTORCYCLE	MOTORCYCLE	5360																	
752	267700-5031	VKA16	3Elec.Iridium Tough,Shroud	0.4lr	Pt 3Elec.	R	S	1.1	AUTOMOBILE	AUTOMOBILE	5622																	
753	267700-5041	VKA20	3Elec.Iridium Tough,Shroud	0.4lr	Pt 3Elec.	R	S	1.1	AUTOMOBILE	AUTOMOBILE	5623																	
754	267700-5051	VKB16	3Elec.Iridium Tough	0.4lr	Pt 3Elec.	R	S	1.1	AUTOMOBILE	AUTOMOBILE	5624																	
755	267700-5061	VKB20	3Elec.Iridium Tough	0.4lr	Pt 3Elec.	R	S	1.1	AUTOMOBILE	AUTOMOBILE	5625																	
756	267700-5170	IXU22C·	Single Iridium	0.4lr	TAPERCUT	R	S	0.8	AUTOMOBILE	SUZUKI	#N/A																	
757	267700-5180	XU22HR9	φ12Long Reach	Ni	Ni	R	S	0.9	AUTOMOBILE	DAIHATSU	3464																	
758	267700-5230	K16PR-UR	ISO,10KOHM Resistor	Ni	Ni	R	S	0.8	AUTOMOBILE	HONDA	#N/A																	
759	267700-5240	K20PR-UR	ISO,10KOHM Resistor	Ni	Ni	R	S	0.8	AUTOMOBILE	HONDA	#N/A																	
760	267700-5250	K22PR-UR	ISO,10KOHM Resistor	Ni	Ni	R	S	0.8	AUTOMOBILE	HONDA	#N/A																	
761	267700-5260	KJ20DR-M11S	Extended Shroud,SUS	Ni	Ni	R	S	1.1	AUTOMOBILE	HONDA	3455																	
762	267700-5290	FK16R11	Double Needle Iridium	0.55lr	Pt NEEDLE	R	S	1.1	AUTOMOBILE	TOYOTA	3440																	
763	267700-5480	FXE20HE11·(AM)	Double Needle φ12Iridium.Long Reach,Shroud	0.55lr	Pt NEEDLE	R	S	1.1	AUTOMOBILE	NISSAN	3436																	
764	267700-5490	XU22PR9	φ12x16Hexx19mmReach	Ni	Ni	R	S	0.9	AUTOMOBILE	DAIHATSU	3448																	
765	267700-5500	SK20HPR-L11·	Long Reach Iridium	0.7lr	Pt	R	S	1.1	AUTOMOBILE	HONDA	3433																	
766	267700-5530	SXU22HCR11S	Extended Shroud Iridium,Long Reach,Shroud,SUS	0.7lr	Pt	R	S	1.1	AUTOMOBILE	HONDA	3461																	
767	267700-5580	SC20HR11	φ12Iridium.Long Reach	0.7lr	Pt	R	S	1.1	AUTOMOBILE	TOYOTA	3444																	
768	267700-5590	GX8-1·	CNG, φ12x26.5,Iridium	0.7lr	Pt	R	S	0.8	CNG	ISUZU	3462																	
769	267700-5600	SK20PR-L11·	Iridium	0.7lr	Pt	R	S	1.1	AUTOMOBILE	HONDA	3443																	
770	267700-5611	IK16G	Iridium Power/SUS GASKET	0.4lr	TAPERCUT	R	S	1.1	AUTOMOBILE	AUTOMOBILE	5351																	
771	267700-5621	IK20G	Iridium Power/SUS GASKET	0.4lr	TAPERCUT	R	S	1.1	AUTOMOBILE	AUTOMOBILE	5352																	
772	267700-5631	VK16G	Iridium Tough/SUS GASKET	0.4lr	Pt	R	S	1.1	AUTOMOBILE	AUTOMOBILE	5640																	
773	267700-5640	VK20G	Iridium Tough/SUS GASKET	0.4lr	Pt	R	S	1.1	AUTOMOBILE	AUTOMOBILE	5641																	
774	267700-5661	IK22G	Iridium Power/SUS GASKET	0.4lr	TAPERCUT	R	S	0.8	AUTOMOBILE	AUTOMOBILE	5348																	
775	267700-5671	VK22G	Iridium Tough/SUS GASKET	0.4lr	Pt	R	S	0.8	AUTOMOBILE	AUTOMOBILE	5636																	
776	267700-5810	XE20HR-U9	φ12x14 .Long Reach	Ni	Ni	R	S	0.9	AUTOMOBILE	RENAULT	3427																	
777	267700-5830	FXE22HR11·(AM)	Double Needle φ12Iridium.Long Reach	0.55lr	Pt NEEDLE	R	S	1.1	AUTOMOBILE	NISSAN	3442																	
778	267700-5860	K16PSR-B8	Single Iridium	0.7lr	Ni	R	S	0.8	AUTOMOBILE	MITSUBISHI	3437																	
779	267700-5900	SKU22PR9	Iridium	0.7lr	Pt	R	S	0.9	AUTOMOBILE	DAIHATSU	3434																	
780	267700-5920	FX16HQR11	Double Needle Long Reach Iridium	0.55lr	Pt NEEDLE	R	S	1.1	AUTOMOBILE	HYUNDAI,KIA	3458																	
781	267700-5970	SXU22HPR9	Iridium,Long Reach (Daihatsu)	0.7lr	Pt	R	S	0.9	AUTOMOBILE	DAIHATSU	3475																	
782	267700-6050	SXU22HCR11	Extended Shroud Iridium,Long Reach,Shroud	0.7lr	Pt	R	S	1.1	AUTOMOBILE	HONDA	3477																	
783	267700-6070	SK20HR8-T	Long Reach Iridium LPG	0.7lr	Pt	R	S	0.8	AUTOMOBILE	TOYOTA	3460																	

No	PART NUMBER	DENSO	SPEC.	CENTER/E.	GROUND/E.	R/STD	NUT	Gap	MAIN USE	MAIN APPLICATION	STOCK NUMBER
784	267700-6100	SKJ20DR-M11S	Extended Iridium,Shroud,SUS	0.7lr	Pt	R	S	1.1	AUTOMOBILE	HONDA	#N/A
785	267700-6110	SKJ20DR-M13	Extended Iridium,Shroud	0.7lr	Pt	R	S	1.3	AUTOMOBILE	HONDA	#N/A
786	267700-6120	PT16VR10	PlatinumxLongreach	1.1Pt	Pt	R	S	1.0	AUTOMOBILE	FORD	5093
787	267700-6130	VUH24ES	Iridium,SUS GASKET	0.4lr	Pt	R	T	0.9	MOTORCYCLE	HONDA	#N/A
788	267700-6150	SK20PR-N9S	Iridium,SUS GASKET	0.7lr	Pt	R	S	0.9	AUTOMOBILE	HONDA	#N/A
789	267700-6160	SK22PR-M11S	Iridium,SUS GASKET	0.7lr	Pt	R	S	1.1	AUTOMOBILE	HONDA	3419
790	267700-6210	ZXE27HBR8	φ12Iridium.Long Reach	0.55lr	Pt	R	S	0.8	AUTOMOBILE	TOYOTA,SUBARU	#N/A
791	267700-6280	K16HR-U11	26.5mmReach	Ni	Ni-U11	R	S	1.1	AUTOMOBILE	TOYOTA,DAIHATSU	3482
792	267700-6290	K20PR-U8S	SUS GASKET	Ni	Ni	R	S	0.8	AUTOMOBILE	HONDA	3463
793	267700-6301	W16TT	Ni NEEDLE	1.5Ni	1.5Ni	R	RC	0.8	AUTOMOBILE	AUTOMOBILE	4601
794	267700-6311	W20TT	Ni NEEDLE	1.5Ni	1.5Ni	R	RC	0.8	AUTOMOBILE	AUTOMOBILE	4602
795	267700-6320	PK16TT	Prutinium TT, φ14x19	1.1Pt	1.5Ni	R	S	1.0	AUTOMOBILE	AUTOMOBILE	
796	267700-6330	PK20TT	Prutinium TT, φ14x19	1.1Pt	1.5Ni	R	S	1.0	AUTOMOBILE	AUTOMOBILE	
797	267700-6340	PKH16TT	Prutinium TT, φ14x26.5	1.1Pt	1.5Ni	R	S	1.0	AUTOMOBILE	AUTOMOBILE	
798	267700-6350	PKH20TT	Prutinium TT, φ14x26.5	1.1Pt	1.5Ni	R	S	1.0	AUTOMOBILE	AUTOMOBILE	
799	267700-6360	PQ16TT	Prutinium TT, φ14x19	1.1Pt	1.5Ni	R	S	1.0	AUTOMOBILE	AUTOMOBILE	
800	267700-6370	PQ20TT	Prutinium TT, φ14x19	1.1Pt	1.5Ni	R	S	1.0	AUTOMOBILE	AUTOMOBILE	
801	267700-6380	PW16TT	Prutinium TT, φ14x19	1.1Pt	1.5Ni	R	S	1.0	AUTOMOBILE	AUTOMOBILE	
802	267700-6390	PW20TT	Prutinium TT, φ14x19	1.1Pt	1.5Ni	R	S	1.0	AUTOMOBILE	AUTOMOBILE	
803	267700-6430	X22ESR-UB	Resistor	Ni	Ni	R	S	0.7	MARINE	HONDA MARINE	4232
804	267700-6451	IXUH22	Iridium Power	0.4lr	TAPERCUT	R	S	0.9	AUTOMOBILE	AUTOMOBILE	5353
805	267700-6461	VXUH22	Iridium Tough	0.4lr	Pt	R	S	0.9	AUTOMOBILE	AUTOMOBILE	5611
806	267700-6470	U20EPR9	φ10x19	Ni	Ni	R	T	0.9	MOTORCYCLE	HONDA	4228
807	267700-6480	U22EPR9	φ10x19	Ni	Ni	R	T	0.9	MOTORCYCLE	HONDA	4234
808	267700-6490	U24EPR9	φ10x19	Ni	Ni	R	T	0.9	MOTORCYCLE	HONDA	4233
809	267700-6510	U20ESR-N	φ10x19	Ni	Ni	R	T	0.8	MOTORCYCLE	SUZUKI	#N/A
810	267700-6520	U22ESR-N	φ10x19	Ni	Ni	R	T	0.8	MOTORCYCLE	SUZUKI	#N/A
811	267700-6530	U24ESR-N	φ10x19	Ni	Ni	R	T	0.8	MOTORCYCLE	SUZUKI	#N/A
812	267700-6540	U27ESR-N	φ10x19	Ni	Ni	R	T	0.8	MOTORCYCLE	SUZUKI	#N/A
813	267700-6550	U31ESR-N	φ10x19	Ni	Ni	R	T	0.8	MOTORCYCLE	SUZUKI	#N/A
814	267700-6560	U22ETR	φ10 x2Elec.	Ni	Nix2	R	T	0.7	MOTORCYCLE	SUZUKI	#N/A
815	267700-6570	U24ETR	φ10 x2Elec.	Ni	Nix2	R	T	0.7	MOTORCYCLE	SUZUKI	#N/A
816	267700-6580	U27ETR	φ10 x2Elec.	Ni	Nix2	R	T	0.7	MOTORCYCLE	SUZUKI	#N/A
817	267700-6590	U31ETR	φ10 x2Elec.	Ni	Nix2	R	T	0.7	MOTORCYCLE	SUZUKI	#N/A
818	267700-6610	U16FSR-U	Resistor	Ni	Ni	R	T	0.7	MOTORCYCLE	HONDA	#N/A
819	267700-6620	U20FSR-U	Resistor	Ni	Ni	R	T	0.7	MOTORCYCLE	HONDA	#N/A
820	267700-6630	U22FSR-U	Resistor	Ni	Ni	R	T	0.7	MOTORCYCLE	HONDA	#N/A
821	267700-6640	U24FSR-U	Resistor	Ni	Ni	R	T	0.7	MOTORCYCLE	HONDA	#N/A
822	267700-6690	SK20PR-N9	Iridium	0.7lr	Pt	R	S	0.9	AUTOMOBILE	HONDA	#N/A
823	267700-6970	FXE24HR11-(AM)	Double Needle φ12Iridium.Long Reach	0.55lr	Pt NEEDLE	R	S	1.1	AUTOMOBILE	NISSAN	3457
824	267700-6700	SK20R-B5	Iridium	0.7lr	Pt	R	S	0.5	AUTOMOBILE	TOYOTA	
825	267700-7020	ZXU20PR11	Iridium	0.55lr	Pt	R	S	1.1	AUTOMOBILE	SUZUKI	3452
826	267700-7080	XU22TT	Ni NEEDLE	1.5Ni	1.5Ni	R	S	0.8	AUTOMOBILE	AUTOMOBILE	4614
827	267700-7090	XUH22TT	Ni NEEDLE	1.5Ni	1.5Ni	R	S	0.8	AUTOMOBILE	AUTOMOBILE	4615
828	267700-7140	FK16HR11	Double Needle Long Reach Iridium	0.55lr	Pt NEEDLE	R	S	1.1	AUTOMOBILE	TOYOTA	3450
829	267700-7171	IXU22HPR	Iridium,Long Reach	0.4lr	Ni	R	S	0.8	AUTOMOBILE	SUZUKI,MAZDA660cc	3474
830	267700-7180	FK20HBR11-T	Double Needle 3Elec Long Reach Iridium Shroud	0.55lr	Pt NEEDLE	R	S	1.1	AUTOMOBILE	TOYOTA	#N/A
831	267700-7190	FK20HQR8	Double Needle Long Reach Iridium	0.55lr	Pt NEEDLE	R	S	0.8	AUTOMOBILE	HYUNDAI,KIA	3459
832	267700-7200	PT16TT	Prutinium TT, φ14x17.5, Taper seat	1.1Pt	1.5Ni	R	S	1.0	AUTOMOBILE	AUTOMOBILE	
833	267700-7210	PT20TT	Prutinium TT, φ14x17.5, Taper seat	1.1Pt	1.5Ni	R	S	1.0	AUTOMOBILE	AUTOMOBILE	
834	267700-7220	PTV16TT	Prutinium TT, φ14x25, Taper seat	1.1Pt	1.5Ni	R	S	1.0	AUTOMOBILE	AUTOMOBILE	
835	267700-7240	PTF16TT	Prutinium TT, φ14x11.2, Taper seat	1.1Pt	1.5Ni	R	S	1.0	AUTOMOBILE	AUTOMOBILE	
836	267700-7250	PTF20TT	Prutinium TT, φ14x11.2, Taper seat	1.1Pt	1.5Ni	R	S	1.0	AUTOMOBILE	AUTOMOBILE	
837	267700-7260	FXU16HR11	Double Needle φ12Iridium.Long Reach	0.55lr	Pt NEEDLE	R	S	1.1	AUTOMOBILE	HYUNDAI,KIA	3478
838	267700-7280	FXE24HR11-(OE)	Double Needle φ12Iridium.Long Reach	0.55lr	Pt NEEDLE	R	S	1.1	AUTOMOBILE	NISSAN	#N/A
839	267700-7290	FXE22HR11-(OE)	Double Needle φ12Iridium.Long Reach	0.55lr	Pt NEEDLE	R	S	1.1	AUTOMOBILE	NISSAN	#N/A
840	267700-7300	FXE20HR11-(OE)	Double Needle φ12Iridium.Long Reach	0.55lr	Pt NEEDLE	R	S	1.1	AUTOMOBILE	NISSAN	#N/A
841	267700-7310	FXE20HE11-(OE)	Double Needle φ12Iridium.Long Reach,Shroud	0.55lr	Pt NEEDLE	R	S	1.1	AUTOMOBILE	NISSAN	#N/A
842	267700-7320	FXE20HR11-(OE)	Double Needle φ12Iridium.Long Reach	0.55lr	Pt NEEDLE	R	S	1.1	AUTOMOBILE	NISSAN	#N/A
843	267700-7330	SXU22HPR8	Iridium,Long Reach (Daihatsu)	0.7lr	Pt	R	S	0.8	AUTOMOBILE	DAIHATSU	#N/A
844	267700-7340	FK20HQR10	Double Needle Long Reach Iridium	0.55lr	Pt NEEDLE	R	S	1.0	AUTOMOBILE	FOMOCO	#N/A
845	267700-7371	IXUH22I	Iridium Power	0.4lr	TAPERCUT	R	S	0.9	AUTOMOBILE	AUTOMOBILE	5356
846	267700-7381	VXUH22I	Iridium Tough	0.4lr	Pt	R	S	0.9	AUTOMOBILE	AUTOMOBILE	5656
847	267700-7390	DK20PR-D13	Double Needle Iridium	0.7lr	Pt NEEDLE,Cu EE	R	S	1.3	AUTOMOBILE	HONDA	3476
848	267700-7400	FC22HR9	Double Needle φ12Iridium.Long Reach	0.55lr	Pt NEEDLE	R	S	0.9	AUTOMOBILE	TOYOTA	#N/A
849	267700-7411	VFKH16	Iridium Tough (Needle type)	0.4lr	Pt NEEDLE	R	S	0.8	AUTOMOBILE	AUTOMOBILE	5654
850	267700-7421	VFKH20	Iridium Tough (Needle type)	0.4lr	Pt NEEDLE	R	S	0.8	AUTOMOBILE	AUTOMOBILE	5655
851	267700-7431	K16TT	Ni NEEDLE	1.5Ni	1.5Ni	R	S	1.0	AUTOMOBILE	AUTOMOBILE	4603
852	267700-7441	K20TT	Ni NEEDLE	1.5Ni	1.5Ni	R	S	1.0	AUTOMOBILE	AUTOMOBILE	4604
853	267700-7451	KH16TT	Ni NEEDLE	1.5Ni	1.5Ni	R	S	1.0	AUTOMOBILE	AUTOMOBILE	4605
854	267700-7460	KH20TT	Ni NEEDLE	1.5Ni	1.5Ni	R	S	1.0	AUTOMOBILE	AUTOMOBILE	4618
855	267700-7471	Q16TT	Ni NEEDLE	1.5Ni	1.5Ni	R	S	1.0	AUTOMOBILE	AUTOMOBILE	4607
856	267700-7481	Q20TT	Ni NEEDLE	1.5Ni	1.5Ni	R	S	1.0	AUTOMOBILE	AUTOMOBILE	4608
857	267700-7490	TV16TT	Ni NEEDLE	1.5Ni	1.5Ni	R	S	1.0	AUTOMOBILE	AUTOMOBILE	4619
858	267700-7500	WF20TT	Ni NEEDLE	1.5Ni	1.5Ni	R	RC	0.8	AUTOMOBILE	AUTOMOBILE	4620
859	267700-7510	W22TT	Ni NEEDLE	1.5Ni	1.5Ni	R	RC	0.8	AUTOMOBILE	AUTOMOBILE	4621
860	267700-7520	FXU22HR11	Double Needle φ12Iridium.Long Reach	0.55lr	Pt NEEDLE	R	S	1.1	AUTOMOBILE	MITSUBISHI	#N/A
861	267700-7550	ZXU20HCR8	Extended φ12 Long Reach Iridium	0.55lr	Pt	R	S	0.8	AUTOMOBILE	HYUNDAI,KIA	3479
862	267700-7560	FXU22HR8	Double Needleφ12 Long Reach Iridium	0.55lr	Pt NEEDLE	R	S	0.8	AUTOMOBILE	MITSUBISHI	#N/A
863	267700-7570	FK20HR8-G	Double Needle Long Reach Iridium w/t Grease	0.55lr	Pt NEEDLE	R	S	0.8	AUTOMOBILE	TOYOTA	#N/A
864	267700-7580	DXU22HCR-D11S	Double Needle Extended Shroud φ12 Long Reach Iridium SUS Gasket	0.7lr	Pt NEEDLE,Cu EE	R	S	1.1	AUTOMOBILE	HONDA	3483
865	267700-7590	SXU22HPR11	Iridium,Long Reach (Daihatsu)	0.7lr	Pt	R	S	1.1	AUTOMOBILE	DAIHATSU	#N/A
866	267700-7600	FK20HR11-G	Double Needle Long Reach Iridium w/t Grease	0.55lr	Pt NEEDLE	R	S	1.1	AUTOMOBILE	TOYOTA	#N/A
867	267700-7620	FC22HR9-G	Double Needleφ12 Long Reach Iridium w/t Grease	0.55lr	Pt NEEDLE	R	S	0.9	AUTOMOBILE	TOYOTA	#N/A
868	267700-7631	VFXEH20E	Iridium Tough (Needle type)	0.4lr	Pt NEEDLE	R	S	1.1	AUTOMOBILE	AUTOMOBILE	5644
869	267700-7641	VFXEH20	Iridium Tough (Needle type)	0.4lr	Pt NEEDLE	R	S	1.1	AUTOMOBILE	AUTOMOBILE	5645
870	267700-7651	VFXEH22	Iridium Tough (Needle type)	0.4lr	Pt NEEDLE	R	S	1.1	AUTOMOBILE	AUTOMOBILE	5646

S: SOLID; R: REMOVABLE; RC: CRIMPED; T: THREAD
HON:HONDA SUB:SUBARU SUZ:SUZUKI MAZ:MAZDA MIT:MITSUBISHI KAW:KAWASAKI YAM:YAMAHA

DENSO
 AUSTRALIA | CHINA | INDIA | INDONESIA | KOREA | MALAYSIA | PHILIPPINES | SAUDI ARABIA | SINGAPORE | TAIWAN | THAILAND | VIETNAM | JAPAN & USA | EUROPE MOTOR CYCLE | SMALL ENGINE REFERENCE | PART NUMBER

No	PART NUMBER	DENSO	SPEC.	CENTER/E.	GROUND/E.	R/STD	NUT	Gap	MAIN USE	MAIN APPLICATION	STOCK NUMBER
1	JK067600-0380	K16P-U	Standard	Ni	Ni	STD	S	0.8	AUTOMOBILE	MAZ,MIT,SUB	3280
2	JK067600-0390	K20P-U	Standard	Ni	Ni	STD	S	0.8	AUTOMOBILE	MAZ,MIT,SUB	3276
3	JK067600-0700	Q16-U	Standard	Ni	Ni	STD	S	0.8	AUTOMOBILE	TOYOTA	3340
4	JK067600-0720	Q20-U	Standard	Ni	Ni	STD	S	0.8	AUTOMOBILE	TOYOTA	3351
5	JK067600-0740	K16-U	Standard	Ni	Ni	STD	S	0.8	AUTOMOBILE	TOYOTA	3338
6	JK067600-0750	K16-U11	Standard	Ni	Ni	STD	S	1.1	AUTOMOBILE	TOYOTA	#N/A
7	JK067600-0760	K20-U	Standard	Ni	Ni	STD	S	0.8	AUTOMOBILE	TOYOTA	3339
8	JK067600-0770	K20-U11	Standard	Ni	Ni	STD	S	1.1	AUTOMOBILE	TOYOTA	#N/A
9	JK067600-7070	Q16-U11	Standard	Ni	Ni	STD	S	1.1	AUTOMOBILE	TOYOTA	3181
10	JK067600-7080	Q20-U11	Standard	Ni	Ni	STD	S	1.1	AUTOMOBILE	TOYOTA	3182
11	JK067600-7680	Q20P-U	Standard	Ni	Ni	STD	R	0.8	AUTOMOBILE	MAZDA,SUBARU	3125
12	JK067600-7690	Q22P-U	Standard	Ni	Ni	STD	R	0.8	AUTOMOBILE	MAZDA,SUBARU	3255
13	JK067600-7800	Q16P-U11	Standard	Ni	Ni	STD	S	1.1	AUTOMOBILE	MAZDA	3254
14	JK067700-3020	K16HPR-U11	26.5mmReach	Ni	Ni	R	S	1.1	AUTOMOBILE	SUZUKI,YAMAHA	6076
15	JK067700-4410	Q16R-U	Small HexResistor	Ni	Ni	R	S	0.8	AUTOMOBILE	TOYOTA	3129
16	JK067700-4420	Q20R-U	Small HexResistor	Ni	Ni	R	S	0.8	AUTOMOBILE	TOYOTA	3140
17	JK067700-4430	Q16R-U11	Small HexResistor	Ni	Ni	R	S	1.1	AUTOMOBILE	TOYOTA	3006
18	JK067700-4440	Q20R-U11	Small HexResistor	Ni	Ni	R	S	1.1	AUTOMOBILE	TOYOTA	3009
19	JK067700-4460	Q20PR-U	Small HexResistor	Ni	Ni	R	R	0.8	AUTOMOBILE	MAZDA	#N/A
20	JK067700-4510	Q16PR-U11	Small HexResistor	Ni	Ni	R	R	1.1	AUTOMOBILE	MAZDA	#N/A
21	JK067700-4520	Q20PR-U11	Small HexResistor	Ni	Ni	R	R	1.1	AUTOMOBILE	MAZDA	3008
22	JK067700-4670	Q14R-U11	Small HexResistor	Ni	Ni	R	S	1.1	AUTOMOBILE	TOYOTA	3183
23	JK067700-6000	Q16PR-U	Small HexResistor	Ni	Ni	R	R	0.8	AUTOMOBILE	MAZDA	3137
24	JK067700-6050	Q16PR-U11	Small HexResistor	Ni	Ni	R	R	1.1	AUTOMOBILE	MAZDA	5016
25	JK067700-6060	Q20PR-U	Small HexResistor	Ni	Ni	R	S	0.8	AUTOMOBILE	MAZDA,SUBARU	3007
26	JK067700-6070	Q20PR-U11	Small HexResistor	Ni	Ni	R	R	1.1	AUTOMOBILE	MAZDA	3008
27	JK067700-6270	K16PR-U11	ISO Small HexResistor	Ni	Ni	R	S	1.1	AUTOMOBILE	MAZ,MIT,SUB	#N/A
28	JK067700-6280	K20PR-U11	ISO Small HexResistor	Ni	Ni	R	S	1.1	AUTOMOBILE	MAZ,MIT,SUB	3121
29	JK067700-6290	K22PR-U11	ISO Small HexResistor	Ni	Ni	R	S	1.1	AUTOMOBILE	MAZ,MIT,SUB	3192
30	JK067700-6300	K16PR-U	ISO Small HexResistor	Ni	Ni	R	S	0.8	AUTOMOBILE	MAZ,MIT,SUB	3191
31	JK067700-6310	K20PR-U	ISO Small HexResistor	Ni	Ni	R	S	0.8	AUTOMOBILE	MAZ,MIT,SUB	3145
32	JK067700-6400	K16R-U	ISO Small HexResistor	Ni	Ni	R	S	0.8	AUTOMOBILE	TOYOTA	3119
33	JK067700-6410	K20R-U	ISO Small HexResistor	Ni	Ni	R	S	0.8	AUTOMOBILE	TOYOTA	3122
34	JK067700-6420	K16R-U11	ISO Small HexResistor	Ni	Ni	R	S	1.1	AUTOMOBILE	TOYOTA	3120
35	JK067700-6430	K20R-U11	ISO Small HexResistor	Ni	Ni	R	S	1.1	AUTOMOBILE	TOYOTA	3139
36	JK067700-7500	K16PR-U	ISO Small HexResistor	Ni	Ni	R	R	0.8	AUTOMOBILE	MAZ,MIT,SUB	#N/A
37	JK067700-7510	K20PR-U	2Elec.	Ni	Nix2	R	R	1.1	AUTOMOBILE	TOYOTA	#N/A
38	JK067700-7520	K22PR-U	ISO Small HexResistor	Ni	Ni	R	R	0.8	AUTOMOBILE	MAZ,MIT,SUB	#N/A
39	JK067700-7900	K16TR11	2Elec.	Ni	Nix2	R	S	1.1	AUTOMOBILE	TOYOTA	3194
40	JK067700-8080	K20TXR	2Elec.Semi Surface Discharge	Ni	Nix2	R	R	1.0	AUTOMOBILE	Volkswagen	5063
41	JK067700-8110	K20TR-11	2Elec.	Ni	Nix2	R	S	1.1	AUTOMOBILE	TOYOTA	#N/A
42	JK067700-8770	K20TNR	2Elec.	Ni	Nix2	R	S	1.0	AUTOMOBILE	DAIHATSU	3304
43	JK267700-2880	K20HR-U11	ISO,Small Hex Resistor,Long Reach	Ni	Ni	R	S	1.1	AUTOMOBILE	TOYOTA	3381
44	JK267700-6280	K16HR-U11	26.5mmReach	Ni	Ni	R	S	1.1	AUTOMOBILE	TOYOTA,DAIHATSU	3482
45	JK267700-7430	K16TT	Ni NEEDLE	1.5Ni	1.5Ni	R	S	1.0	AUTOMOBILE	AUTOMOBILE	4603
46	JK267700-7440	K20TT	Ni NEEDLE	1.5Ni	1.5Ni	R	S	1.0	AUTOMOBILE	AUTOMOBILE	4604
47	JK267700-7450	KH16TT	Ni NEEDLE	1.5Ni	1.5Ni	R	S	1.0	AUTOMOBILE	AUTOMOBILE	4605
48	JK267700-7460	KH20TT	Ni NEEDLE	1.5Ni	1.5Ni	R	S	1.0	AUTOMOBILE	AUTOMOBILE	4618
49	JK267700-7470	Q16TT	Ni NEEDLE	1.5Ni	1.5Ni	R	S	1.0	AUTOMOBILE	AUTOMOBILE	4607
50	JK267700-7480	Q20TT	Ni NEEDLE	1.5Ni	1.5Ni	R	S	1.0	AUTOMOBILE	AUTOMOBILE	4608
51	JK067800-1080	W20EP-U	Standard	Ni	Ni	STD	R	0.8	AUTOMOBILE	HON,MAZ,MIT,SUZ	3043
52	JK067800-1110	W14EX-U	Standard	Ni	Ni	STD	R	0.8	AUTOMOBILE	TOYOTA	3202
53	JK067800-1120	W16EX-U	Standard	Ni	Ni	STD	R	0.8	AUTOMOBILE	TOYOTA	#N/A
54	JK067800-1130	W20EX-U	Standard	Ni	Ni	STD	R	0.8	AUTOMOBILE	TOYOTA	3204
55	JK067800-1170	K16P-U	Standard	Ni	Ni	STD	S	0.8	AUTOMOBILE	MAZ,MIT,SUB	3280
56	JK067800-1410	W9FP-UL	Standard	Ni	Ni	STD	R	0.7	MOTORCYCLE	HONDA	4152
57	JK067800-1420	W14FP-UL	Standard	Ni	Ni	STD	R	0.7	MOTORCYCLE	HONDA	4014
58	JK067800-1460	W24FS-U	Standard	Ni	Ni	STD	R	0.7	MOTORCYCLE	SUZUKI,YAMAHA	4038
59	JK067800-1560	Q16R-U	Small HexResistor	Ni	Ni	R	S	0.8	AUTOMOBILE	TOYOTA	#N/A
60	JK067800-1590	K20P-U	Standard	Ni	Ni	STD	S	0.8	AUTOMOBILE	MAZ,MIT,SUB	3276
61	JK067800-1640	U16FS-U	Standard	Ni	Ni	STD	R	0.7	MOTORCYCLE	HONDA	4000
62	JK067800-1650	U20FS-U	Standard	Ni	Ni	STD	R	0.7	MOTORCYCLE	HONDA	4002
63	JK067800-1660	U22FS-U	Standard	Ni	Ni	STD	R	0.7	MOTORCYCLE	HON,SUZ,YAM,KAW	4006
64	JK067800-1690	X22ES-U	Standard	Ni	Ni	STD	R	0.7	MOTORCYCLE	HONDA	4090
65	JK067800-1700	X24ES-U	Standard	Ni	Ni	STD	R	0.7	MOTORCYCLE	HONDA	4099
66	JK067800-1730	KJ16CR-L11	Extended	Ni	Ni	R	S	1.1	AUTOMOBILE	HONDA	3132
67	JK067800-1740	KJ20CR-L11	Extended	Ni	Ni	R	S	1.1	AUTOMOBILE	HONDA	3169
68	JK067800-1770	Q16R-U11	Small HexResistor	Ni	Ni	R	S	1.1	AUTOMOBILE	TOYOTA	#N/A
69	JK067800-1780	X20FS-U	Standard	Ni	Ni	STD	R	0.7	MOTORCYCLE	HONDA	4078
70	JK067800-1820	X22EP-U	Standard	Ni	Ni	STD	R	0.7	MOTORCYCLE	MOTORCYCLE	#N/A
71	JK067800-1830	X24EP-U	Standard	Ni	Ni	STD	R	0.7	MOTORCYCLE	MOTORCYCLE	#N/A
72	JK067800-1890	K16R-U11	ISO Small HexResistor	Ni	Ni	R	S	1.1	AUTOMOBILE	TOYOTA	3120
73	JK067800-1900	QJ16AR-U	Extended	Ni	Ni	R	S	0.8	AUTOMOBILE	TOYOTA	3235
74	JK067800-1940	W16EP-U	Standard	Ni	Ni	STD	R	0.8	AUTOMOBILE	MITSUBISHI	3018
75	JK067800-1960	K16PR-U	ISO Small HexResistor	Ni	Ni	R	S	0.8	AUTOMOBILE	MAZ,MIT,SUB	3191
76	JK067800-2390	K20P-U	Standard	Ni	Ni	STD	R	0.8	AUTOMOBILE	MAZ,MIT,SUB	3276
77	JK067800-3990	K20PR-U	ISO Small HexResistor	Ni	Ni	R	S	0.8	AUTOMOBILE	MAZ,MIT,SUB	3145
78	JK067800-5040	K20R-U	ISO Small HexResistor	Ni	Ni	R	S	0.8	AUTOMOBILE	TOYOTA	3122
79	JK067800-5080	X24EP-U9	Standard	Ni	Ni	STD	R	0.9	MOTORCYCLE	HONDA	4093
80	JK067800-5230	W16EX-U11	Standard	Ni	Ni	STD	S	1.1	AUTOMOBILE	TOYOTA	3205
81	JK067800-5240	W16EXR-U11	Resistor	Ni	Ni	R	S	1.1	AUTOMOBILE	TOYOTA	3032
82	JK067800-5450	K16PR-U11	ISO Small HexResistor	Ni	Ni	R	S	1.1	AUTOMOBILE	MAZ,MIT,SUB	3130
83	JK067800-5460	K20PR-U11	ISO Small HexResistor	Ni	Ni	R	S	1.1	AUTOMOBILE	MAZ,MIT,SUB	3121
84	JK067800-5560	K20R-U11	ISO Small HexResistor	Ni	Ni	R	S	1.1	AUTOMOBILE	TOYOTA	3139
85	JK067800-5590	W16EX-U	Standard	Ni	Ni	STD	S	0.8	AUTOMOBILE	TOYOTA	#N/A
86	JK067800-5600	W20EX-U	Standard	Ni	Ni	STD	S	0.8	AUTOMOBILE	TOYOTA	3204

S: SOLID; R: REMOVABLE; RC: CRIMPED; T: THREAD
 HON:HONDA SUB:SUBARU SUZ:SUZUKI MAZ:MAZDA MIT:MITSUBISHI KAW:KAWASAKI YAM:YAMAHA

DENSO
 AUSTRALIA CHINA INDIA INDONESIA KOREA MALAYSIA PHILIPPINES SAUDIARABIA SINGAPORE TAIWAN THAILAND VIETNAM JAPAN & USA EUROPE MOTOR SMALL ENGINE REFERENCE PART NUMBER
389

PART No, DENSO., SPECIFICATIONS, TERMINAL, GAP, STOCK No., LIST (0677009770 ⇒ DENSO)

PART NUMBER	CROSS REFERENCE	SMALL ENGINE	MOTOR CYCLE	EUROPE & USA	JAPAN	VIETNAM	THAILAND	TAIWAN	SINGAPORE	SAUDIARABIA	PHILIPPINES	MALAYSIA	KOREA	INDONESIA	INDIA	CHINA	AUSTRALIA	DENSO	SPEC.	CENTER/E.	GROUND/E.	R/STD	NUT	Gap	MAIN USE	MAIN APPLICATION	STOCK NUMBER
																											NO
87	JK067800-5660	W16EXR-U	Resistor	Ni	Ni	R	S	0.8	AUTOMOBILE	TOYOTA	3210																
88	JK067800-5670	W20EXR-U	Resistor	Ni	Ni	R	S	0.8	AUTOMOBILE	TOYOTA	3211																
89	JK067800-5680	W20EXR-U11	Resistor	Ni	Ni	R	S	1.1	AUTOMOBILE	TOYOTA	3212																
90	JK067800-5690	Q16PR-U11	Small HexResistor	Ni	Ni	R	S	1.1	AUTOMOBILE	MAZDA	5016																
91	JK067800-5700	Q20R-U	Small HexResistor	Ni	Ni	R	S	0.8	AUTOMOBILE	TOYOTA	3140																
92	JK067800-5710	Q20R-U11	Small HexResistor	Ni	Ni	R	S	1.1	AUTOMOBILE	TOYOTA	3009																
93	JK067800-5940	W24FPR-U10	Resistor	Ni	Ni	R	R	1.0	MOTORCYCLE	MOTORCYCLE	6058																
94	JK067800-5980	W16FP-US	Standard	Ni	Ni	STD	R	0.65	MOTORCYCLE	MOTORCYCLE	#N/A																
95	JK067800-5990	W20FP-US	Standard	Ni	Ni	STD	R	0.65	MOTORCYCLE	MOTORCYCLE	#N/A																
96	JK067800-6000	W22FP-US	Standard	Ni	Ni	STD	R	0.65	MOTORCYCLE	MOTORCYCLE	#N/A																
97	JK067800-6010	W24FP-US	Standard	Ni	Ni	STD	R	0.65	MOTORCYCLE	MOTORCYCLE	#N/A																
98	JK067800-6060	W16EP-U	Standard	Ni	Ni	STD	S	0.8	AUTOMOBILE	MITSUBISHI	3018																
99	JK067800-6180	K16R-U	ISO Small HexResistor	Ni	Ni	R	S	0.8	AUTOMOBILE	MAZ,MIT,SUB	3119																
100	JK067800-6430	W22FP-US10	Standard	Ni	Ni	STD	R	1	MOTORCYCLE	MOTORCYCLE	#N/A																
101	JK067800-6440	W24FP-US10	Standard	Ni	Ni	STD	R	1	MOTORCYCLE	MOTORCYCLE	#N/A																
102	JK067800-6650	Q20PR-U	Small HexResistor	Ni	Ni	R	S	0.8	AUTOMOBILE	MAZDA,SUBARU	3007																
103	JK067800-6660	Q20PR-U11	Small HexResistor	Ni	Ni	R	S	1.1	AUTOMOBILE	MAZDA	3008																
104	JK067800-6690	U27ESR-N	φ10x19	Ni	Ni	R	T	0.8	MOTORCYCLE	KAW,SUZ,YAM	4131																
105	JK067800-6770	W16EP-U11	Standard	Ni	Ni	STD	R	1.1	AUTOMOBILE	SUBARU	3199																
106	JK067800-6780	W14FP-U	Standard	Ni	Ni	STD	R	0.65	MOTORCYCLE	MOTORCYCLE	#N/A																
107	JK067800-6810	U24ES-N	φ10x19	Ni	Ni	STD	T	0.8	MOTORCYCLE	KAW,SUZ,YAM	4196																
108	JK067800-6820	U24ESR-N	φ10x19	Ni	Ni	R	T	0.8	MOTORCYCLE	KAW,SUZ,YAM	4126																
109	JK067800-6870	U20EPR9	φ10x19	Ni	Ni	R	T	0.9	MOTORCYCLE	HONDA	4228																
110	JK067800-7060	U22EPR9	φ10x19	Ni	Ni	R	T	0.9	MOTORCYCLE	HONDA	4234																
111	JK067800-7070	W20FS-US	Standard	Ni	Ni	STD	R	0.65	MOTORCYCLE	MOTORCYCLE	#N/A																
112	JK067800-7080	W22FS-US	Standard	Ni	Ni	STD	R	0.65	MOTORCYCLE	MOTORCYCLE	#N/A																
113	JK067800-7090	W24FS-US	Standard	Ni	Ni	STD	R	0.65	MOTORCYCLE	MOTORCYCLE	#N/A																
114	JK067800-7100	W20ES-US	Standard	Ni	Ni	STD	R	0.65	MOTORCYCLE	MOTORCYCLE	#N/A																
115	JK067800-7110	W22ES-US	Standard	Ni	Ni	STD	R	0.65	MOTORCYCLE	MOTORCYCLE	#N/A																
116	JK067800-7120	W24ES-US	Standard	Ni	Ni	STD	R	0.65	MOTORCYCLE	MOTORCYCLE	#N/A																
117	JK067800-7130	W20EP-US	Standard	Ni	Ni	STD	R	0.65	MOTORCYCLE	MOTORCYCLE	#N/A																
118	JK067800-7140	W22EP-US	Standard	Ni	Ni	STD	R	0.65	MOTORCYCLE	MOTORCYCLE	#N/A																
119	JK067800-7150	W24EP-US	Standard	Ni	Ni	STD	R	0.65	MOTORCYCLE	MOTORCYCLE	#N/A																
120	JK067800-7300	X24EPR-U9	Resistor	Ni	Ni	R	T	0.9	MOTORCYCLE	HONDA	4096																
121	JK067800-7310	U22FSR-U	Resistor	Ni	Ni	R	T	0.7	MOTORCYCLE	HON,SUZ,YAM,KAW	4008																
122	JK067800-7360	U20FSR-U	Resistor	Ni	Ni	R	T	0.7	MOTORCYCLE	HONDA	4004																
123	JK067800-7420	U24EPR9	φ10x19	Ni	Ni	R	T	0.9	MOTORCYCLE	HONDA	4233																
124	JK067800-7480	U22FER9	φ10Half Thread	Ni	Ni	R	T	0.9	MOTORCYCLE	HONDA	4212																
125	JK067800-7500	U24FER9	φ10Half Thread	Ni	Ni	R	T	0.9	MOTORCYCLE	HONDA	4127																
126	JK067800-7510	U16FS-U	Standard	Ni	Ni	STD	R	0.7	MOTORCYCLE	HONDA	4000																
127	JK067800-7520	U20FS-U	Standard	Ni	Ni	STD	R	0.7	MOTORCYCLE	HONDA	4002																
128	JK067800-7530	U22FS-U	Standard	Ni	Ni	STD	R	0.7	MOTORCYCLE	HON,SUZ,YAM,KAW	4006																
129	JK067800-7610	X24ESR-U	Resistor	Ni	Ni	R	T	0.7	MOTORCYCLE	HONDA	4101																
130	JK067800-7650	U27FER9	φ10Half Thread	Ni	Ni	R	T	0.9	MOTORCYCLE	HONDA	4129																
131	JK067800-7660	U20ESR-N	φ10x19	Ni	Ni	R	T	0.8	MOTORCYCLE	KAW,SUZ,YAM	4221																
132	JK067800-7670	U22ESR-N	φ10x19	Ni	Ni	R	T	0.8	MOTORCYCLE	KAW,SUZ,YAM	4174																
133	JK067800-7680	U22ES-N	φ10x19	Ni	Ni	STD	T	0.8	MOTORCYCLE	KAW,SUZ,YAM	4137																
134	JK067800-7690	XU22EP-U	φ12x16Hex	Ni	Ni	STD	S	0.9	AUTOMOBILE	SUZ,SUB.MIT	3176																
135	JK067800-7700	XU22EPR-U	φ12x16Hex	Ni	Ni	R	S	0.9	AUTOMOBILE	SUZ,SUB.MIT	3179																
136	JK067800-7750	U20EPR9S	φ10x19	Ni	Ni	R	T	0.9	MOTORCYCLE	MOTORCYCLE	#N/A																
137	JK067800-7840	U27EPR9	φ10x19	Ni	Ni	R	T	0.9	MOTORCYCLE	MOTORCYCLE	#N/A																
138	JK067800-7950	U24EPR-N9	φ10x19	Ni	Ni	R	T	0.9	MOTORCYCLE	MOTORCYCLE	#N/A																
139	JK067800-7980	U27EPR-N9	φ10x19	Ni	Ni	R	T	0.9	MOTORCYCLE	MOTORCYCLE	#N/A																
140	JK067800-8290	XU22PR9	φ12x16Hexx19mmReach	Ni	Ni	R	S	0.9	AUTOMOBILE	DAIHATSU	3448																
141	JK067800-9190	K20HR-U11	ISO,Small Hex Resistor,Long Reach	Ni	Ni	R	S	1.1	AUTOMOBILE	TOYOTA	3381																

DISCONTINUED TYPE & REPLACEMENT TYPE

DISCONTINUED TYPE	DISCONTINUED Part No.	NUT	REPLACEMENT TYPE	REPLACEMENT Part No.	NUT	DISCONTINUED TYPE	DISCONTINUED Part No.	NUT	REPLACEMENT TYPE	REPLACEMENT Part No.	NUT
·W20DTR-SA	0677009000	S	W20DTR-SA	0677002050	S	T20PR-U11	0677001242	R	T20PR-U11	0677005861	S
GX8-1	2677004900	S	GX8-1	2677005590	S	T20P-U	0676007042	R	T20P-U	0676009711	S
IK20C11	2677001810	S	IK20	0677008690	RC	T20R-U	0677001180	R	T20R-U	0677005950	S
IU22D	2677000830	T	IU22	0677009261	R	TR20	0676004010	R	W20FS-U	0676006841	R
IXU22C	2677001780	S	IXU22C	2677005170	S	TR22	0676004020	R	W22FS-U	0676006851	R
J14C-U	0676009600	S	J14CR-U	0677006980	S	TR24	0676009280	R	W24FS-U	0676006861	R
J16C-U	0676009610	S	J16CR-U	0677008190	R	TR24-10	0676009290	R	W24FS-U10	0676006671	R
J16HR-U10	0677006010	R	J16BR-U11	0677003571	S	U16FS-L	0678004650	T	U16FS-U	0678004590	T
J20AY	0676008830	S	-	-	-	U20FS-L	0678004660	T	U20FS-U	0678004600	T
K16PR-ZU11	0677007080	R	IK16	0677008680	RC	U20FS-ZU	0678004780	T	IUF22	0677009480	R
K16R-ZU11	0677007110	R	IK16	0677008680	RC	U22FS-L	0678004670	T	U22FS-U	0678004610	T
K16SR14	0678007220	S	IK16	0677008680	RC	U22FS-ZU	0678004790	T	IUF22	0677009480	R
K20PR-L11S	2677005270	S	-	-	-	U24ESR-NZU	0677004790	T	IU24	0677009271	R
K20PR-ZU11	0677007090	R	IK20	0677008690	RC	U24FER-ZU9	0677006360	T	IUH24	0677009330	R
K20P-U11	0676000360	S	K20PR-U11	0677006280	R	U24FE-ZU9	0678004700	T	IUH24	0677009330	R
K20R-ZU11	0677007120	R	IK20	0677008690	S	U24FS-C	0678004770	T	U24FS-U	0678004620	T
K20SR11	0678007240	S	IK20	0677008690	RC	U24FS-L	0678004680	T	U24FS-U	0678004620	T
K20SR14	0678007230	S	IK20	0677008690	RC	U24FSR-C	0677005050	T	U24FSR-U	0677005610	T
K22P11	0676001040	S	K22TMR11	0677000510	S	U24FSR-ZU	0677005620	T	IUF24	0677009490	R
K22P11	0676001050	S	K22TMR11	0677000510	S	U24FS-ZU	0678004800	T	IUF24	0677009490	R
K22PR-TP11	0677007460	S	IK22	0677008430	RC	U27ES-NZU	0678004910	T	IU27	0677009281	R
K22PR-U	0677006320	S	K22PR-U	0677007520	R	U27ESR-NZU	0677004800	T	IU27	0677009281	R
K22PR-ZU	0677005880	R	IK22	0677008430	RC	U27FE9	0678004830	T	U27FER9	0677005830	T
K22PR-ZU11	0677007100	R	IK22	0677008430	RC	U27FER-ZU9	0677006370	T	IUH27	0677009340	R
K22TNR	0677008410	S	K22TNR-S	0677007910	S	U27FE-ZU9	0678004710	T	IUH27	0677009340	R
K24PR-ZU	0677006080	R	IK24	0677008460	RC	U27FS-ZU	0678004880	T	IUF27A	0677009700	R
K27A-Z	0676002280	R	IK27	0677008471	RC	U31ES-NZU	0678004920	T	IU31	0677009291	R
K27PR-ZU	0677008380	R	IK27	0677008471	RC	U31ESR-NZU	0677004840	T	IU31	0677009291	R
K29A-Z	0676002290	R	IK31	0677009220	RC	U31FER9	0677005840	T	U31ESR-N	0677005640	T
K31A-Z	0676002300	R	IK31	0677009220	RC	U31FER-ZU9	0677006380	T	IU31	0677009291	R
KJ22CR11	0677006790	S	KJ22CR-L11	0677006960	S	U31FE-ZU9	0678004720	T	IU31	0677009291	R
MA16PR-U15	0677003650	R	MA16PR-U11	0677003640	R	U31FS-ZU9	0678004890	T	-	-	-
MA16P-U	0676007540	R	MA16PR-U	0677003630	R	U34ES-NZU	0678004930	T	IU01-34	2677001040	R
MA16R-U	0677003680	R	MA16PR-U	0677003630	R	U34FER-ZU9	0677006390	T	IU01-34	2677001040	R
MA20R-U	0677003690	R	MA20PR-U	0677003660	R	U34FE-ZU9	0678004730	T	IU01-34	2677001040	R
MA20R-U11	0677003700	R	MA20PR-U	0677003660	R	U34FS-ZU9	0678004900	T	-	-	-
MA9PR-U	0677003611	R	MA9P-U	0676007511	R	W14EP	0676001725	S	W14EP-U	0676007221	R
MW22	0676000430	R	-	-	-	W14EPR	0677000121	S	W14EPR-U	0677002651	R
MW9	0676000440	S	MW17	0676000420	R	W14EPR11	0677000280	R	W14EXR-U11	0677002421	S
PK22PR-L11	0677006760	S	PK22PR-L11S	2677004160	S	W14EXR-U15	0677004910	R	W14EXR-U11	0677002421	S
PKJ20CR-L13	0677008310	S	PKJ20CR-L11	0677007140	S	W14EXR-ZU	0677003100	R	IW16	0677008650	RC
Q16PR-UL11	0677006180	S	Q16PR-U11	0677006050	S	W14EX-U13	0676001262	S	W14EXR-U13	0677006930	R
Q16PR-ZU11	0677007030	R	IQ16	0677008700	RC	W14EX-ZU	0676009080	R	IW16	0677008650	RC
Q16R-ZU11	0677004380	R	IQ16	0677008700	RC	W14FP	0676001581	R	W14FP-U	0676006121	R
Q16-ZU11	0676007880	R	IQ16	0677008700	RC	W14FPR	0677001901	R	W14FPR-U	0677004760	R
Q20PR-P11	0677006530	S	IQ20	0677008710	RC	W14FPR-L	0677001821	T	W14FPR-UL	0677001881	R
Q20PR-UL11	0677006190	S	K20PR-U11	0677004520	R	W14FPR-L	0677003921	R	W14FPR-UL	0677001881	R
Q20PR-ZU11	0677007040	R	IQ20	0677008710	RC	W14F-U10	0676006811	R	W14F-U	0676006821	R
Q20R-ZU11	0677004390	R	IQ20	0677008710	RC	W14LMR-US	0677007860	R	W14LM-U	0676006711	R
Q20-ZU11	0676007890	R	IQ20	0677008710	RC	W14M-U10	0676007591	R	W14M-U	0676007421	R
Q22PR-P11	0677006540	S	IQ22	0677008480	RC	W14M-US	0676008580	R	W14M-U	0676007421	R
Q22PR-U	0677006210	S	Q22PR-U	0677004470	R	W14PR-U15	0677002961	R	W14PR-U	0677002931	R
Q22PR-UL11	0677006200	S	Q22PR-U11	0677004530	R	W14P-U	0676007721	R	W14PR-U	0677002931	R
Q22PR-ZU	0677004970	R	IQ22	0677008480	RC	W14-U10	0676006771	R	W14-U	0676006781	R
Q22PR-ZU11	0677007050	R	IQ22	0677008480	RC	W14-US	0676008570	R	W14-U	0676006781	R
Q22P-U11	0676007400	R	Q22PR-U11	0677004530	R	W16EK-S11	0676006310	S	W16EKR-S11	0677002110	S
Q22P-U11	0676007820	S	Q22PR-U11	0677004530	R	W16EP	0676001271	R	W16EPR-U	0677002661	R
Q24PR-ZU	0677004980	R	IQ24	0677008490	RC	W16EPR-S11	0677002581	S	W16EPR-U11	0677002710	S
Q27A-Z	0676002480	R	IQ27	0677008501	RC	W16EP-U10	0676007281	S	W16EPR-U10	0677002631	S
Q27PR-ZU	0677008390	R	IQ27	0677008501	RC	W16EP-ZU	0676009110	R	IW16	0677008650	RC
Q29A-Z	0676002490	R	IQ31	0677009230	RC	W16ES-L	0676003323	S	W16ES-U	0676006031	R
Q31A-Z	0676002500	R	IQ31	0677009230	RC	W16ESR-L	0677001431	R	W16ESR-U	0677002330	R
QJ16C11	0676007050	S	QJ16CR11	0677006230	S	W16ET-L	0676002930	S	W16ET-S	0676006632	S
QJ20C11	0676007110	S	QJ20CR11	0677006100	S	W16EX	0676004621	S	W16EX-U	0676006381	R
QL22VR-ZU	0677007340	R	-	-	-	W16EX-GU	0676006231	R	IW16	0677008650	RC
S-25	0677002810	S	IRE01-27	2677001520	RC	W16EXR-ZU	0677003110	R	IW16	0677008650	RC
S-27	0677002820	S	IRE01-27	2677001520	RC	W16EX-ZU	0676009090	R	IW16	0677008650	RC
SF-10	0678000012	R	SF50/SF51	067800-0031/0041	R	W16FP	0676001671	R	W16FP-U	0676006131	R
SK20HPR-L11	2677005460	S	SK20HPR-L11	2677005500	S	W16FP-L	0676006531	T	W16FP-U	0676006131	R
SK20PR-L11	2677005470	S	SK20PR-L11	2677005600	S	W16FP-UL	0676006561	R	W16FP-U	0676006131	R
SK20PR-L9S	2677004430	S	SK20PR-N9S	2677006150	S	W16FS	0676003221	R	W16FS-U	0676006831	R
SK22PR-M11S	2677004170	S	SK22PR-M11S	2677006160	S	W16FSR	0677009150	S	W16FSR	0677000831	R
SXU22HR9	2677005140	S	SXU22HPR9	2677005970	S	W16FS-ZU	0676007830	R	-	-	-
T14PR-U	0677001121	R	T14PR-U	0677005700	S	W16P-U	0676007731	R	W16PR-U	0677002921	R
T14PR-U15	0677001321	R	T14PR-U15	0677005720	S	W16PR-U15	0677002990	R	W16PR-U	0677002921	R
T16EX-U	0676007330	R	T16EPR-U	0677003130	R	W20EA	0676004432	S	W20EAR	0677000642	S
T16PR-U	0677003010	R	T16PR-U	0677005750	S	W20EBR	0677000741	S	W22EBR	0677000750	S
T16PR-U11	0677003000	R	T16PR-U11	0677005760	S	W20EK-S11	0676006660	S	W20EKR-S11	0677002200	S
T16PR-U15	0677002380	R	T16PR-U15	0677005770	S	W20EP	0676001291	R	W20EP-U	0676007241	R
T16PR-U20	0677005780	S	T16PR-U15	0677005770	S	W20EPR	0677000170	R	W20EPR-U	0677002671	R
T16P-U	0676008910	R	T16P-U	0676009700	S	W20EPR	0677000141	R	W20EPR-U	0677002671	R
T16R-U	0677001171	R	T16R-U	0677005650	S	W20EPR-ZU	0677007000	S	IW20	0677008660	RC
T16R-U15	0677001371	R	T16R-U15	0677005670	S	W20EPR-ZU11	0677007010	R	IW20	0677008660	RC
T20EX-U	0676007340	R	T20EP-U	0676007380	R	W20EP-U10	0676007291	S	W20EPR-U10	0677002641	S
T20EX-U	0676009770	S	T20EP-U	0676007380	R	W20EP-ZU	0676009120	R	IW20	0677008660	RC
T20PR-U	0677001142	R	T20PR-U	0677005851	S	W20ES-L	0676003361	S	W20EKR-S11	0677002200	S

S: SOLID R: REMOVABLE RC: CRIMPED T: THREAD

DENSO
 AUSTRALIA CHINA INDIA INDONESIA KOREA MALAYSIA PHILIPPINES SAUDIARABIA SINGAPORE TAIWAN THAILAND VIETNAM JAPAN & USA EUROPE MOTOR

DISCONTINUED TYPE & REPLACEMENT TYPE

DENSO

AUSTRALIA

CHINA

INDIA

INDONESIA

KOREA

MALAYSIA

PHILIPPINES

SINGAPORE

TAIWAN

THAILAND

VIETNAM

JAPAN

EUROPE & USA

SMALL MOTOR

ENGINE

CYCLE

CROSS REFERENCE

NUMBER

DISCONTINUED TYPE	DISCONTINUED Part No.	NUT	REPLACEMENT TYPE	REPLACEMENT Part No.	NUT	DISCONTINUED TYPE	DISCONTINUED Part No.	NUT	REPLACEMENT TYPE	REPLACEMENT Part No.	NUT
W20ES-L11	0676005681	S	W20EKR-S11	0677002200	S	W27EPT	0676003422	R	IW01-27	2677001120	RC
W20ES-L11	0676008690	S	W20EKR-S11	0677002200	S	W27ES	0676003161	R	W27ES-U	0676006071	R
W20ESR-L	0677001441	R	W20EKR-S11	0677002200	S	W27ES	0676004091	R	W27ES-U	0676006071	R
W20ESR-L11	0677002741	R	W20EKR-S11	0677002200	S	W27ES-C	0676009870	R	W27ES-U	0676006071	R
W20ESR-L11	0677007720	R	W20EKR-S11	0677002200	S	W27ESR	0677000321	R	W27ESR-U	0677002371	R
W20ES-U11	0676006091	R	W20ES-U	0676006041	R	W27ESR	0677000371	R	W27ESR-U	0677002371	R
W20ES-ZU	0676009020	R	-	-	-	W27ESR-ZU	0677006110	R	IW27	0677008900	RC
W20ET-L	0676002950	S	W20ETR-L	0677002160	S	W27ES-ZU	0676009050	R	IW27	0677008900	RC
W20ETR	0677002141	S	W20ETR-L	0677002160	S	W27FN	0676004921	R	IWF27	0677009430	R
W20ETR-L8	0677007870	S	W20ETR-L	0677002160	S	W27FPT	0676003521	R	IWF27	0677009430	R
W20EVR-ZU	0677007180	R	IW20	0677008660	RC	W27FSR-U10	0677009210	S	W27FSR-U10	0677000891	R
W20FSR-ZU	0677003120	R	IW20	0677008660	RC	W27FS-ZU	0676009250	R	IWF27	0677009430	R
W20EX-ZU	0676009100	R	IW20	0677008660	RC	W29A-Z	0676002390	R	IW29	0677008910	RC
W20FPR-L	0677004050	T	W20FR-L	0677006810	T	W29EPT	0676003461	R	IW01-29	2677001130	RC
W20FPR-ZU	0677008010	R	IWF20	2677005010	R	W29ESR-V	0677001941	R	IW29	0677008910	RC
W20FSR-U	0677009160	RC	W20FSR-U	0677003341	R	W29ES-V	0676007151	R	IW29	0677008910	RC
W20FS-U10	0676000780	R	W20FS-U	0676006841	R	W29ES-ZU	0676009060	R	IW29	0677008910	RC
W20FS-ZU	0676009220	R	IWF22	0677009410	R	W31A-Z	0676002400	R	IW31	0677008920	RC
W20FT-U	0676008930	T	W20FP-U	0676006141	R	W31EMR-C	0677005510	S	IWM31	2677002910	S
W20P-U	0676007751	R	W20PR-U	0677002951	R	W31EMR-ZU	0677005160	S	IWM31	2677002910	S
W21ES-L11	0676005701	S	W20EKR-S11	0677002200	S	W31EN	0676003641	R	IW01-31	2677001140	RC
W21ES-L11	0676008700	S	W20EKR-S11	0677002200	S	W31EPT	0676003432	R	IW01-31	2677001140	RC
W21ESR-L11	0677002761	S	W20EKR-S11	0677002200	S	W31ESR-ZU	0677006120	R	IW31	0677008920	RC
W21ESR-L11	0677007730	S	W20EKR-S11	0677002200	S	W31ES-ZU	0676009070	R	IW31	0677008920	RC
W22EA	0676004440	S	W22EBR	0677000750	S	W31FN	0676004941	R	-	-	-
W22EAR	0677000650	S	W22EBR	0677000750	S	W31FPT	0676003531	R	-	-	-
W22EAR	0677000050	S	W22EBR	0677000750	S	W31FS-ZU	0676009260	R	-	-	-
W22EB	0676003990	S	W22EBR	0677000750	S	W32EPT	0676003471	R	IW01-32	2677001150	RC
W22EDR	0677002850	S	W25EDR14	0677002890	S	W34EMR-ZU	0677005170	S	IWM01-34	2677001240	S
W22EDR14	0677002880	S	W25EDR14	0677002890	S	W34EN	0676003661	R	IW01-34	2677001160	RC
W22EK-S11	0676006410	S	W22EKR-S11	0677002120	S	W34EPT	0676003442	R	IW01-34	2677001160	RC
W22EP11	0676006451	S	W22EP-U11	0676007670	S	W34ES-ZU	0676009140	R	IW01-34	2677001160	RC
W22EPR	0677000151	S	W22EPR-U11	0677002720	S	W34FN	0676004961	R	-	-	-
W22EPR-S11	0677002600	S	W22EP-S11	0676006691	S	W34FPT	0676003541	R	-	-	-
W22EPR-ZU	0677000710	R	IW22	0677008670	RC	W35EPT	0676003480	R	IW01-34	2677001160	RC
W22EPR-ZU11	0677007020	R	IW22	0677008670	RC	W37EPT	0676003452	R	-	-	-
W22EP-ZU	0676009130	R	IW22	0677008670	RC	W37FN	0676004981	R	-	-	-
W22ES	0676003111	S	W22ES-U	0676006051	R	W37FPT	0676003551	R	-	-	-
W22ES	0676003811	S	W22ES-U	0676006051	R	W9EPR	0677000111	S	W9EXR-U	0677001511	S
W22ES-L	0676003401	S	W22EKR-S11	0677002120	S	W9FP-L	0676006511	T	W9FP-UL	0676006601	R
W22ES-L	0676008670	S	W22EKR-S11	0677002120	S	W9PR-U15	0677002972	R	W9PR-U	0677002912	R
W22ES-L11	0676005691	R	W22EKR-S11	0677002120	S	W9PR-U20	0677002980	R	W9PR-U	0677002912	R
W22ESR	0677007650	R	W22ESR-U	0677002351	R	X16EP-U9	0678004330	T	X16EPR-U9	0677005270	T
W22ESR-L	0677001451	S	W22EKR-S11	0677002120	S	X16FS-U	0678004010	T	X16FSR-U	0677005010	T
W22ESR-L11	0677002751	S	W22EKR-S11	0677002120	S	X20EP-U9	0678004340	T	X20EPR-U9	0677005280	T
W22ES-U11	0676006020	R	W22ES-U	0676006051	R	X20FS-U	0678004070	T	X20FS-U	0678004020	T
W22ES-ZU	0676009030	R	IW24	0677008890	R	X22EPR-GL	0677005480	T	IX22B	0677009380	R
W22ET-L	0676002940	S	W22ETR-L	0677002150	S	X22EPR-ZU9	0677005410	T	IX22B	0677009380	R
W22EXR-U	0677001601	R	W22EPR-U	0677002681	R	X22EP-U	0678004290	T	X22EP-U9	0678004350	T
W22EXR-U11	0677002450	S	W22EPR-U11	0677002720	S	X22EP-ZU9	0678004490	T	IX22	0677009380	R
W22EX-U	0676006401	R	W22EP-U	0676007251	R	X22ES-ZU	0678004200	T	IX22	0677009350	R
W22FP	0676001661	R	W22FP-U	0676006151	R	X22GPR-U	0677005530	T	IXG24	2677002920	R
W22FP-U10	0676006210	R	W22FP-U10	0676008900	R	X22GP-U	0678004540	T	IXG24	2677002920	R
W22FS	0676003241	R	W22FS-U	0676006851	R	X24EPR-GL	0677005490	T	IX24B	0677009390	R
W22FS-ZU	0676009230	R	IWF22	0677009410	R	X24EPR-ZU9	0677005420	T	IX24B	0677009390	R
W22MP-US	0676000810	R	W22MP-U	0676007491	R	X24EP-U	0678004300	T	X24EP-U9	0678004360	T
W22M-US	0676000800	R	W22M-U	0676007451	R	X24EP-ZU9	0678004500	T	IX24B	0677009390	R
W24EP11	0676006470	R	W24EP-U	0676007261	S	X24ESR-ZU	0677008030	T	IX24	0677009360	R
W24EPR-ZU	0677000720	R	IW24	0677008890	RC	X24ES-U	0678004210	T	IX24	0677009360	R
W24ES	0676003121	R	W24ES-U	0676006061	R	X24FSR-U	0677005040	T	X24FS-U	0678004040	T
W24ES	0676009630	S	W24ES-U	0676006061	R	X24FS-U	0678004090	T	-	-	-
W24ESR	0677000362	R	W24ESR-U	0677002361	R	X27EPR-ZU9	0677005430	T	IX27B	0677009400	R
W24ESR	0677000401	RC	W24ESR	0677005180	S	X27EP-ZU9	0678004510	T	IX27B	0677009400	R
W24ESR-U	0677002520	R	W24ESR-U	0677002361	R	X27ESR-ZU	0677008370	T	IX27	0677009370	R
W24ESR-ZU	0677005330	R	IW24	0677008890	RC	X27ES-ZU	0678004220	T	IX27	0677009370	R
W24ES-ZU	0676009040	R	IW24	0677008890	RC	X27ET	0678004050	T	X27ETR	0677005030	T
W24FP	0676001551	R	W24FP-U	0676006281	R	X27GP-U	0678004560	T	X27GPR-U	0677005550	T
W24FPR-L	0677004060	T	W24FPR	0677004000	R	X29ES-ZU	0678004230	T	IXU01-31	2677001080	R
W24FS	0676003251	R	W24FS-U	0676006861	R	X31ES-ZU	0678004240	T	IXU01-31	2677001080	R
W24FSR	0677009190	S	W24FSR	0677000861	R	X34ES-ZU	0678004250	T	IXU01-34	2677001090	R
W24FSR-U10	0677009170	S	W24FSR-U10	0677008170	R	XU20EPR-ZU	0677007200	S	IXU22	0677008720	RC
W24FS-ZU	0676009240	R	IWF24	0677009420	R	XU20EP-U	0678004100	S	XU20EPR-U	0677005800	S
W25EA	0676004450	S	W27EBR	0677000770	S	XU22EPR-ZU	0677007210	S	IXU22	0677008720	RC
W25EA	0676004490	S	W27EBR	0677000770	S	XU22EP-U	0678004320	S	IXU22	0677008720	RC
W25EAR	0677000060	S	W27EBR	0677000770	S	XU24EPR-ZU	0677007220	S	IXU24	0677008730	RC
W25EB	0676004000	S	W27EBR	0677000770	S	XU24EPR-ZU	0677008160	R	IXU24	0677008730	RC
W25EBR	0677000760	S	W27EBR	0677000770	S	XU24EP-U	0678004380	S	IXU24	0677008730	RC
W25EDR	0677002860	S	W25EDR14	0677002890	S	XU27EPR-ZU	0677008100	R	IXU27	0677008600	RC
W25EDR14	0677000680	R	W25EDR14	0677002890	S	Y27FER	0677006340	T	Y27FER-C	0677007560	T
W25EN	0676003611	R	IW01-24	2677001110	RC	Z4	0676002960	R	-	-	-
W25EPT	0676003412	R	IW01-24	2677001110	RC	Z4K	0676002980	R	-	-	-
W25FN	0676004911	R	IWF24	0677009420	R	Z9	0676002970	R	-	-	-
W27A-Z	0676002380	R	IW27	0677008900	RC	ZT16EPR11	0678007320	S	VT16	2677002810	RC
W27EDR14	0677000690	R	W27EDR14	0677002900	S						
W27EMR-ZU	0677005150	S	IWM27	2677002900	S						
W27EN	0676003621	R	IW01-27	2677001120	RC						

Note: Please be aware that substitute models may have different characteristics and prices than the discontinued types they replace.

MEMO

A series of horizontal dashed lines for writing.

MEMO

A series of horizontal dashed lines for writing.

MEMO

A series of horizontal dashed lines for writing.

MEMO

A series of horizontal dashed lines for writing.

MEMO

A series of horizontal dashed lines for writing.

MEMO

A series of horizontal dashed lines for writing.

MEMO

A series of horizontal dashed lines for writing.

Country/ Area	SPARK PLUG SALES COMPANIES	
Australia	DENSO AUTOMOTIVE SYSTEMS AUSTRALIA PTY.LTD. DNAU	
	2-46 Merrindale Drive, Croydon, Victoria 3136, Australia TEL+61-3-8761-1100 FAX+61-3-8761-1505 Plug home page http://www.densoautoparts.com.au/ Find your plugs http://www.denso.com.au/sparkplug/finder	
Brazil	DENSO DO BRASIL LTDA. DNBR	
	Rua Joao Chede, No.891, CIC, CEP:81170-220, Curitiba, Parana, Brazil TEL+55-41-2141-4300 FAX+86-10-5758-2781 Plug home page http://www.denso.com.br/velas Find your plugs http://www.denso.com.br/velas	
China	DENSO (CHINA) INVESTMENT CO., LTD. DICH	
	Room No. 518, The Beijing Fortune Building, No.5 Dong San Huan Bei Lu, Chaoyang District, Beijing, 100004, China TEL+86-10-6590-8337 FAX+86-10-5758-2781	
	J-WORKS PARTS SALES (TIANJIN) CO., LTD. JWCH Unit 603, Tower A, Pacific Century Place, 2A Gong Ti Bei Lu, Chaoyang District, Beijing, China TEL+86-10-65909636~9 FAX+86-10-65393539 Find your plugs https://www.denso.com/global/en/products-and-services/automotive-service-parts-and-accessories/plug/search/china.html	
Germany	DENSO AUTOMOTIVE Deutschland GmbH DNDE	
	Freisinger Strasse 21, 85386 Eching, Germany TEL+49-8165-944-0 FAX+49-8165-944800 Plug home page http://www.denso-am.eu/sparkPlugs.asp Find your plugs http://www.globaldenso.com/PLUG/search/index_euro.html	
India	DENSO INTERNATIONAL INDIA PVT.LTD. DIIN	
	Plot No. 3, Sector-3, IMT Manesar, Gurgaon, Haryana-122050, India TEL+91-124-4803200 FAX+91-124-4803201 Find your plugs https://www.denso.com/global/en/products-and-services/automotive-service-parts-and-accessories/plug/search/india.html	
Indonesia	P.T.DENSO SALES INDONESIA DSIA	
	JL. Gaya Motor I, Sunter II, Kel Sungai Bambu, Tanjung Priok, Jakarta Utara, Jakarta, Indonesia TEL+62-21-6512279 FAX+62-21-6512284 Find your plugs https://www.denso.com/global/en/products-and-services/automotive-service-parts-and-accessories/plug/search/indonesia.html	
Japan	DENSO SALES JAPAN CORPORATION DSJP	
	2-15-13, Shoutou, Shibuya-ku, Tokyo 150-0046, Japan TEL+81-3-6367-9666 FAX+81-3-6367-9619 Plug home page https://www.denso.com/jp/ja/products-and-services/automotive-service-parts-and-accessories/plug/ Find your plugs https://www.denso.com/jp/ja/products-and-services/automotive-service-parts-and-accessories/plug/search/	
Korea	DENSO INTERNATIONAL KOREA CORPORATION DIKR	
	131, Seonggogae-ro, Uiwang-si, Gyeonggi-do, Korea TEL+82-31-340-1700 FAX+82-31-8033-7210 Plug home page http://www.dikr.densokorea.kr/eng/_sub02/sub02_02a.html Find your plugs http://www.dikr.densokorea.kr/eng/_sub02/sub02_02a1.html	
Malaysia	DENSO (MALAYSIA) SDN.BHD. DNMY	
	Lot 2, Jalan P/1, Section 13, 43650 Bandar Baru Bangi, Selangor Darul Ehsan, Malaysia TEL+60-3-87328888 FAX+60-3-87328822 Find your plugs https://www.denso.com/global/en/products-and-services/automotive-service-parts-and-accessories/plug/search/malaysia.html	
Netherlands	DENSO EUROPE B.V. DNEU	
	Hogeweyselaan 165, 1382 JL Weesp, The Netherlands TEL+31-294-493493 FAX+31-294-417122	
Philippines	DENSO PHILIPPINES CORPORATION DNPH	
	109 Unity Avenue, Special Economic Zone, Carmelray Industrial Park 1, 4037 Canlubang, Calamba City, Laguna, Philippines TEL+63-49-549-3030 FAX+63-49-549-3088 Find your plugs https://www.denso.com/global/en/products-and-services/automotive-service-parts-and-accessories/plug/search/philippines.html	
Singapore	DENSO INTERNATIONAL ASIA PTE.LTD. DIAS	
	51 Science Park Road, #01-19 The Aries, Science Park II, 117586, Singapore TEL+65-67768268 FAX+65-67768698 Find your plugs https://www.denso.com/global/en/products-and-services/automotive-service-parts-and-accessories/plug/search/singapore.html	
Taiwan	DENSO TAIWAN CORP. DNTW	
	525, Sec. 2, Mei Su Road Yang Mei Town Taoyuan Hsien, Taiwan TEL+886-3-482-8001 FAX+886-3-482-8003 Plug home page http://www.denso.com.tw/plug/ Find your plugs http://www.denso.com.tw/plug/search_1.asp	
Thailand	DENSO SALES (THAILAND) CO., LTD. DSTH	
	888 Moo 1, Bangna-Trad Km. 27.5, Tambol Bangbo, Amphur Bangbo, Samutprakarn 10560 Thailand TEL+66-2-315-9500 FAX+66-2-315-9555 Find your plugs https://www.denso.com/global/en/products-and-services/automotive-service-parts-and-accessories/plug/search/thailand.html	
Russia	DENSO SALES RUS L.L.C. DSRU	
	Vodny Business Center, 8th floor Golovinskoye shosse 5 building 1, Moscow 125212 Russia TEL+7-495-970-57-57 FAX+7-495-645-68-22 Plug home page http://www.denso-am.co.uk/products/automotive-aftermarket/spark-plug-glow-plug/ Find your plugs http://www.denso.ru/Каталог-601330000000	
Saudi Arabia	DENSO ABDUL LATIF JAMEEL CO., LTD. DNJM	
	P.O.Box 248, Jeddah 21411 -Kingdom of Saudi Arabia TEL+966-2-608-3352 FAX+966-2-608-3350 Plug home page http://www.globaldenso.com/en/products/aftermarket/plug/index.html Find your plugs http://www.globaldenso.com/en/products/aftermarket/plug/search/index_euro.html	
UAE	DENSO SALES MIDDLE EAST & NORTH AFRICA FZE. DSMN	
	Jebel Ali Free Zone, Dubai, United Arab Emirates (UAE) TEL+971-4-880-7789 FAX+971-4-880-7790	
U.K.	DENSO SALES UK LTD. DSUK	
	1 Bishop Square, Hatfield, Herts., AL10 9NE, The United Kingdom TEL+44-1707-282400 FAX+44-1707-282450 Plug home page http://denso-europe.com/products/powertrain/spark-plugs/ Find your plugs http://www.globaldenso.com/en/products/aftermarket/plug/search/index_euro.html	
U.S.A.	DENSO PRODUCTS AND SERVICES AMERICAS, INC. DPAM	
	Head Quarter 3900 Via Oro Avenue, Long Beach, California 90810, U.S.A. TEL+1-310-834-6352 FAX+1-310-513-7319 Plug home page http://densott.com/ Find your plugs http://densott.com/index.aspx	

IDENTIFYING DENSO PLUGS

Iridium Plugs / Platinum Plugs / Normal Plugs

F	K	20	H	R	11																																																									
S	XU	22		PR	9																																																									
	KJ	20		CR	11																																																									
Type of precious metal	Thread Diameter and Hex Size	Heat Range	Reach	Shape (Type)	Shape (Type)	Gap																																																								
D 0.7 mm diameter iridium with needle type platinum F 0.55 mm diameter iridium with needle type platinum P 1.1 mm diameter platinum with platinum tip S 0.7 mm diameter iridium with platinum tip SV,V 0.4 mm diameter iridium with platinum tip Z 0.55 mm diameter iridium with platinum tip	C 12×14.0 L 18×22.2 (Reach: 12.7 mm) M 18×25.4 (Reach: 12 mm) MA 18×20.6 (Taper seat, Reach: 12 mm) MW 18×20.6 (Reach: 12 mm) J 14×20.6 (Projected plug) K 14×16.0 (Miniature plug) KJ 14×16.0 (Projected Miniature plug) LP 14×20.6 (Plug for LPG applications) Q 14×16.0 (Miniature plug) QJ 14×16.0 (Projected Miniature plug) QL 14×20.6 (Miniature long cylinder housing plug) S 14×20.6 (Surface gap plug for RE engines) T 14×16.0 (Taper seat) W 14×20.6 / 14×19.0 (Compact type) X 12×18.0 XE 12×14.0 XU 12×16.0 N 10×16.0 U 10×16.0 Y 8×13.0	<table border="1"> <thead> <tr> <th>Heat Range</th> <th>NGK</th> <th>CHAMPION</th> <th>BOSCH</th> </tr> </thead> <tbody> <tr> <td>4</td> <td></td> <td></td> <td></td> </tr> <tr> <td>9</td> <td>2</td> <td>18</td> <td>10</td> </tr> <tr> <td>14</td> <td>4</td> <td>16,14</td> <td>9</td> </tr> <tr> <td>16</td> <td>5</td> <td>12,11</td> <td>8</td> </tr> <tr> <td>20</td> <td>6</td> <td>10,9</td> <td>7,6</td> </tr> <tr> <td>22</td> <td>7</td> <td>8,7</td> <td>5</td> </tr> <tr> <td>24</td> <td>8</td> <td>6,63,61</td> <td>4</td> </tr> <tr> <td>27</td> <td>9</td> <td>4,59</td> <td>3</td> </tr> <tr> <td>29</td> <td>9.5</td> <td>57</td> <td></td> </tr> <tr> <td>31</td> <td>10</td> <td>55</td> <td>2</td> </tr> <tr> <td>32</td> <td>10.5</td> <td>53</td> <td></td> </tr> <tr> <td>34</td> <td>11</td> <td></td> <td></td> </tr> <tr> <td>35</td> <td>11.5</td> <td></td> <td></td> </tr> </tbody> </table>	Heat Range	NGK	CHAMPION	BOSCH	4				9	2	18	10	14	4	16,14	9	16	5	12,11	8	20	6	10,9	7,6	22	7	8,7	5	24	8	6,63,61	4	27	9	4,59	3	29	9.5	57		31	10	55	2	32	10.5	53		34	11			35	11.5			A 19.0 mm (Spark position: 7.0 mm) J16AR-U11 A 21.5 mm S29A B 19.0 mm (Spark position: 9.5 mm) J16BR-U C 19.0 mm (Spark position: 5.0 mm) KJ20CR-L11 D 20.5 mm (Shroud 2) K20DTR-S11 E (With gasket) 19.0 mm W16EX-U E (With gasket) 20.0 mm W25EBR E Shroud 2.0mm FXE20HE11 F 12.7 mm W20FP-U FE 19.0 mm (Half thread) U24FER9 G 22.0 mm (Shroud 3.0) PK20GR8 G 21.8 mm (Shroud 2.8) X27GPR-U H 26.5 mm K16HPR-U11 H 19.0 mm (Spark position: 8.5 mm) QJ16HR-U L 11.2 mm W14L (Taper seat, Half thread) 17.5 mm T20NR-U11 V (Taper seat) 25.0 mm PT16VR13 None 9.5 mm W14M-U 11.2 mm L14-U, M24S 19.0 mm SK20R11 21.5 mm S29A None (Taper seat) 8.3 mm T20M-U 11.2 mm W14L	A Double ground electrodes W22EA AY Double ground electrodes with bent shape J16AY B Triple ground electrodes W22EB BG Triple ground electrodes (shroud) SK20BGR11 C Shroud 1.5mm SXU22HCR11 D 4 ground electrodes W27EDR D Projected (1.5 mm projection, spark position 3.5 mm) XU22HDR9 K Projected (1 mm projection) W16EKR-S11 LM Compact type (Hex 20.6 mm) W14LM-U M Shortened insulator head length W27EMR-C M Compact type (Hex 19.0 mm) W20M-U P Projected (1.5 mm projection) W16EP-U Q Projected 2mm, Spark position 3.5mm R 5Kohm resistor K16R-U S Non-projected (0 mm Projection) W22ES-U S Iridium on a single side KJ20SR11 T Double ground electrodes K16TR11 TM Double ground electrodes K22TMR11 TN Double ground electrodes K22TNR-S X Fully projected (2.5 mm Projection) W16EX-U	-A Special specification SK16PR-A11 -B Special specification K16PSR-B8 -C Cut-back ground electrode W27EMR-C -D Copper-core Ground DK20PR-D13 -E Special specification SK16PR-E11 -F Special specification SK16PR-F11 -G Grease applied on to threads, for CNG SK20R8-G -GL Platinum center electrode X22EPR-L -L Heat resistant ground electrode K20PR-L11 -L 3.5 mm projected insulator for motorcycles W20FP-UL -L Retracted insulator for motorcycles W20FR-L -M Larger ground electrode SK20PR-M11S -N For Yamaha and Kawasaki U27ESR-N -P Double Platinum Ground Electrode SK20R-P11 -P Single-sided platinum plug K16PR-P11 -R 10K ohm resistor K22PR-UR -S Semi-surface gap discharge type W20EP-S11 -S Stainless gasket U27FER9S -T For LPG SK20HR8-T -T Special specification FK20HBR11-T -TP Taper-cut, single-side platinum plug K20PR-TP11 -U U groove ground electrode K16PR-U -US Star-shaped center electrode W20M-US -V 1.3 mm diameter, nickel center electrode W27ES-V	5 0.5 mm (.020") 8 0.8 mm (.032") 9 0.9 mm (.035") 10 1.0 mm (.040") 11 1.1 mm (.044") 13 1.3 mm (.050") 14 1.4 mm (.055") 15 1.5 mm (.060") <None> Cars: 0.8 mm M/C: 0.7 mm <Exceptions> P16R, PQ16R, PQ20R are 1.1 mm
Heat Range	NGK	CHAMPION	BOSCH																																																											
4																																																														
9	2	18	10																																																											
14	4	16,14	9																																																											
16	5	12,11	8																																																											
20	6	10,9	7,6																																																											
22	7	8,7	5																																																											
24	8	6,63,61	4																																																											
27	9	4,59	3																																																											
29	9.5	57																																																												
31	10	55	2																																																											
32	10.5	53																																																												
34	11																																																													
35	11.5																																																													

IRIDIUMPOWER® Series (Power, Tough, Plus) & T.T.

I	U	27	A																																												
VF	KH	20																																													
High Performance Plug	Thread Diameter, Reach, and Hex Size	Heat Range	Shape (Type)																																												
I 0.4 mm diameter iridium <POWER> V 0.4 mm diameter iridium with platinum tip <TOUGH> VF 0.4 mm diameter iridium with 0.7 mm needle type platinum tip <TOUGH> VD 0.7 mm diameter iridium with 0.7 mm needle type platinum tip <TOUGH> P 1.1 mm platinum center electrode	<Thread Diameter × Reach × Hex Size> (mm) K 14×19.0×16.0 KB 14×19.0×16.0 (New Triple Electrodes) KA 14×22.0 (Shroud 3.0)×16.0 (New Triple Electrodes) KD 14×20.5 (Shroud 1.5)×16.0 KH 14×26.5×16.0 KBH 14×26.5×16.0 (New Triple Electrodes) Q 14×19.0×16.0 W 14×19.0×20.6 WF 14×12.7×20.6 WM 14×19.0×20.6 (Compact Insulator) T 14×17.5 (Taper Seat)×16.0 TF 14×11.2 (Taper Seat)×16.0 TL 14×25.0 (Taper Seat)×16.0 (Long Insulator) TV 14×25.0 (Taper Seat)×16.0 XU 12×19.0×16.0 XUH 12×26.5×16.0 CH 12×26.5×14.0 XEH 12×26.5×14.0 XEBH 12×26.5×14.0 (New Triple Electrodes) X 12×19.0×18.0 XG 12×21.8 (Shroud 2.8)×18.0 U 10×19.0×16.0 UF 10×12.7×16.0 UH 10×19.0 (Half Thread)×16.0 NH 10×19.0 (Half Thread)×16.0 Y 8×19.0 (Half Thread)×13.0	<table border="1"> <thead> <tr> <th>DENSO</th> <th>NGK</th> <th>CHAMPION</th> <th>BOSCH</th> </tr> </thead> <tbody> <tr> <td>16</td> <td>5</td> <td>12,11</td> <td>8</td> </tr> <tr> <td>20</td> <td>6</td> <td>10,9</td> <td>7,6</td> </tr> <tr> <td>22</td> <td>7</td> <td>8,7</td> <td>5</td> </tr> <tr> <td>24</td> <td>8</td> <td>6,63,61</td> <td>4</td> </tr> <tr> <td>27</td> <td>9</td> <td>4,59</td> <td>3</td> </tr> <tr> <td>29</td> <td>9.5</td> <td>57</td> <td></td> </tr> <tr> <td>31</td> <td>10</td> <td>55</td> <td>2</td> </tr> <tr> <td>32</td> <td>10.5</td> <td>53</td> <td></td> </tr> <tr> <td>34</td> <td>11</td> <td></td> <td></td> </tr> <tr> <td>35</td> <td>11.5</td> <td></td> <td></td> </tr> </tbody> </table>	DENSO	NGK	CHAMPION	BOSCH	16	5	12,11	8	20	6	10,9	7,6	22	7	8,7	5	24	8	6,63,61	4	27	9	4,59	3	29	9.5	57		31	10	55	2	32	10.5	53		34	11			35	11.5			A Slant electrode, No U-Groove, No taper cut B Projected insulator (1.5 mm) C No U-Groove D No U-Groove E Shroud: 2 mm ES Stainless steel gasket F Special G Stainless steel gasket, Terminal one type I Spark position: 4 mm Projected insulator (1.5 mm) J Spark position: 5 mm K Spark position: 4 mm Projected insulator (2.5mm) L Spark position: 5 mm T For LPG applications<PLUS> TT TT series Y 0.8 mm gap Z Taper cut
DENSO	NGK	CHAMPION	BOSCH																																												
16	5	12,11	8																																												
20	6	10,9	7,6																																												
22	7	8,7	5																																												
24	8	6,63,61	4																																												
27	9	4,59	3																																												
29	9.5	57																																													
31	10	55	2																																												
32	10.5	53																																													
34	11																																														
35	11.5																																														

SENSATIONAL POWER

Trust Denso's world-class technology to give you the best performance.



ANNIVERSARY
since 1959

Copyright © STI



Next-generation spark plug that exudes latent engine power with its high-performance spark.

IRIDIUM POWER



Superlative performance, long life, and high response.

IRIDIUM TOUGH



Unbeatable spark technology, fine-tuned for racing.

IRIDIUM RACING



● For purchase or for inquiries, please contact...

DENSO CORPORATION

1-1, Showa-cho, Kariya, Aichi 448-8661, Japan

- Photos given in this catalog are all conceptual images. The color and design of products may differ from those of actual ones.
- The appearances and specifications of products are subject to change without notice.
- Data given in this catalog are those as of December 2019. Adaptation information may change after updating or publishing. Please note that this document does not include models that will be released after that.

Printed in Japan.
100189-017 03-16B