



**Legislative
Coordinating Commission**

PROJECT DOCUMENTATION

**Consulting Services to Recommend
Upgrades to Broadcast Television Systems**

PREPARED FOR:

Minnesota Legislative Coordinating Commission

PREPARED BY:

TJ RYAN

Design Engineer

MIKE POUH

Account Executive

7690 Golden Triangle Dr.

Eden Prairie, MN 55344

Phone: 800.388.0008

E-mail: info@alphavideo.com

Web: www.alphavideo.com

Proposal issued:

December 14, 2022



CONTENTS

ALPHA VIDEO DOCUMENTS

CONSULTING SERVICES DOCUMENTS

- Minnesota House of Representative Narrative (SOW)
- Minnesota House of Representatives Equipment List & Labor Estimate
- Minnesota State Senate Narrative (SOW)
- Minnesota State Senate Equipment List & Labor Estimate
- Minnesota Capitol Building Narrative (SOW)
- Minnesota Capitol Building Equipment List & Labor Estimate
- Key Systems Drawings
- System Integration Timeline Estimate / Example

SCOPE OF WORK

HOUSE BROADCAST TELEVISION SYSTEMS UPGRADE

INTRODUCTION

Alpha Video and Audio, Inc. is pleased to present this proposal for Broadcast Television Upgrade. This statement of work describes equipment and services that Alpha Video will deliver, as well as the responsibilities of Minnesota Legislative Coordinating Commission for successful implementation. A detailed equipment list and pricing is attached.

OVERVIEW

We believe that the items in our proposal meet the system requirements, standards of quality, and brand preferences outlined through multiple “needs analysis” meetings, phone calls, and emails. The equipment and systems defined in this proposal are representative of typical installations successfully completed by Alpha Video.

The Minnesota Legislative Coordinating Commission video production facilities are intended to be operated in HD 1080p in accordance with SMPTE 2110 IP standards. The principal cameras are specified to be 4K 59.94 capable and are expected to be configured at 1080p. It is anticipated that the production switchers are specified to be 4K 59.94 capable and are expected to be configured at 1080p. The routing switcher is specified as a full SMPTE 2110 based IP solution with IP Gateways (IPG) used where required (equipment that does not offer a native SMPTE 2110 IP interface) with support for redundant core via SMPTE 2022-7. The routing switcher (with video, audio, and ancillary data) is used to route sources throughout the video production facilities and related systems. Multiple Character Generators, Multi-channel file servers for record and playback and Multiview will be provided. Audio Devices shall be connected to the main routing network via MADI or directly to the main routing fabric. Unlike baseband patching and routing, much of this facility is based on fiber optic patching. 100GB tie lines will be provided between the House State Office building and the Capitol building.

The video production facilities will include the following major locations.

1. Capitol Building House Floor Room 242
2. Capitol Building House Floor A/V Room 214
3. Capitol Building House Hearing Room 120
4. Capitol Building House Hearing A/V Room 120
5. Capitol Building Media Hub B881
6. House State Office Building Rack Room 286
7. House State Office Building Production Control Room 1 287
8. House State Office Building Production Control Room 2 286
9. House State Office Building Edit 1-4 Future
10. House State Office Building Studio
11. House State Office Building Hearing Room B2
12. House State Office Building Hearing Room B2 A/V Room
13. House State Office Building Hearing Room 5
14. House State Office Building Hearing Room 5 A/V Room
15. House State Office Building Hearing Room 10
16. House State Office Building Hearing Room 10 A/V Room
17. House State Office Building Hearing Room 200

18. House State Office Building Hearing Room 200 A/V Room
19. House State Office Building Hearing Room Future Large A & B Rooms
20. House State Office Building Hearing Room Future Large A & B A/V Room
21. House State Office Building Hearing Room Future Medium A, B, C & D Rooms
22. House State Office Building Hearing Room Future Medium A, B, C & D A/V Room
23. House State Office Building Hearing Room Future Small A, B, C & D Rooms
24. House State Office Building Hearing Room Future Small A, B, C & D A/V Room
25. House State Office Building Hearing Room Future Press Conference Room
26. House State Office Building Hearing Room Future Press Conference A/V Room
27. House State Office Building Media Services
28. House State Office Building Office

A number of remote operated 4K POV box cameras are provided in this scope of work. Joystick controller and robotic pan/tilt heads allow for live control of each camera and/or rapid selection of presets controller. Each camera may be connected at a number of locations via newly provided SDI over fiber devices terminating in the rack room and A/V room. Mounting of cameras to be coordinated with owner representatives.

1. Capitol Building House Floor Room 242 via A/V Room 214 – Qty 4
2. House State Office Building Hearing Room Future Large A & B via A/V Room – Qty 8
3. House State Office Building Hearing Room Future Medium A, B, C & D via A/V Room – Qty 16

A number of remote 4K/HD live broadcast studio cameras are provided in this scope of work. Joystick controller and robotic pan/tilt heads allow for live control of each camera and/or rapid selection of presets controller. Each camera may be connected via newly provided SMPTE connections terminating in the rack room and A/V room.

1. House State Office Building Studio– Qty 4

A number of remote operated 4K/UHD 60p PTZ cameras are provided in this scope of work. Joystick controller and digital servo pan/tilt heads allow for live control of each camera and/or rapid selection of presets controller. Each camera may be connected at a number of locations via newly provided SDI over fiber devices terminating in the rack room and A/V room. Mounting of cameras to be coordinated with owner representatives.

1. Capitol Building House Hearing Room 120 via A/V Room 120 – Qty 4
2. House State Office Building Hearing Room Future Small A, B, C & D via A/V Room – Qty 16
3. House State Office Building Hearing Room Future Press Conference via A/V Room – Qty 4

Wireless antenna systems are provided for use with Microphones, IFB's and Intercom systems. Connectivity is provided for antenna locations. Antenna mounting locations shall be a coordinated effort between Alpha Video and Minnesota Legislative engineering staff in association with the wireless manufacturer. Coverage shall be provided throughout the House State Office Building and the Capitol building.

Demolition of existing video production systems.

1. Mark and label all cabling entering impacted area for extension/re-termination.
2. All unused/replaced cable/fiber, etc. to be pulled out at the time of the work.
3. Mark and label all Owner furnished equipment that will be re-used.
4. After owner has marked equipment for reuse or storage, remove all unused cabling and equipment from rack room, control room or interconnecting spaces. Dispose of millwork, equipment racks and equipment that is not being reused or salvaged by owner.

SYSTEM OVERVIEW – SCOPE OF WORK

01.01 CAMERAS CAPITOL

Capitol building cameras used by the House are to be 4K 59.94 HDR capable and expected to be configured for 1080p. Type 1 Cameras are to be 4K/HD compact box cameras. Type 2 Cameras are to be 4K/HD live broadcast studio cameras. Type 1 POV Cameras are to be 4K/UHD 60p PTZ cameras. Cameras based on an IP workflow connecting to the Routing Switcher directly or via IP Gate Ways as required.

A. Type 1 Camera

1. Camera – Qty 4
 - **PROVIDE** and **INSTALL** New Sony HDCP50 Camera Body
 - **PROVIDE** and **INSTALL** New Sony HZCPRV50 60p License
 - **PROVIDE** and **INSTALL** New IDX IA-200A 100W AC Adapter Power Supply
2. Camera Transport
 - **PROVIDE** and **INSTALL** New Multidyne V4-3811-6X2-A-ST Fiber Transceiver with 6 in and 2 out – Qty 1
 - **PROVIDE** and **INSTALL** New Multidyne V4-3811-2X6-A-ST Fiber Transceiver with 2 in and 6 out – Qty 1
 - **PROVIDE** and **INSTALL** New Multidyne RM-1RU-V4 Rack Mount Kit – Qty 3
3. Camera Control – Qty 4
 - **PROVIDE** and **INSTALL** New Sony RCP3500 Camera Remote Control Panel
4. Camera Lens – Qty 4
 - **PROVIDE** and **INSTALL** New Canon CJ20EX5B IASE S 20x Zoom 2/3" UHDXS 4K Lens
5. Camera Package – Qty 4
 - **PROVIDE** and **INSTALL** New Ross Video RRB-X300-PT Robotics PT Head
 - **PROVIDE** and **INSTALL** New Ross Video RRB-UNI-WMB Wall Mount Bracket

B. Type 2 Camera

1. Camera
 - **NOT REQUIRED IN THE CAPITOL BUILDING**
2. Camera Transport
 - **NOT REQUIRED IN THE CAPITOL BUILDING**
3. Camera Control
 - **NOT REQUIRED IN THE CAPITOL BUILDING**
4. Camera Lens
 - **NOT REQUIRED IN THE CAPITOL BUILDING**
5. Camera Package
 - **NOT REQUIRED IN THE CAPITOL BUILDING**

C. Type 1 POV Camera

1. POV Camera – Qty 4
 - **PROVIDE** and **INSTALL** New Sony ILMEFR7K 4K PTZ Camera
 - **PROVIDE** and **INSTALL** New IDX IA-200A 100W AC Adapter Power Supply
2. POV Transport
 - **PROVIDE** and **INSTALL** New Multidyne V4-3811-6X2-A-ST Fiber Transceiver with 6 in and 2 out – Qty 1
 - **PROVIDE** and **INSTALL** New Multidyne V4-3811-2X6-A-ST Fiber Transceiver with 2 in and 6 out – Qty 1

- **PROVIDE** and **INSTALL** New Multidyne RM-1RU-V4 Rack Mount Kit – Qty 2
3. POV Control – Qty 1
 - **PROVIDE** and **INSTALL** New Sony RMIP500/1 Advanced Joystick Controller

D. Camera Accessories

1. Camera Control
 - **NOT REQUIRED IN THE CAPITOL BUILDING**
2. Camera Batteries
 - **NOT REQUIRED IN THE CAPITOL BUILDING**

E. Robotics

1. Robotics Control Server
 - **INCLUDED IN 01.03 CAMERAS HOUSE**

F. Teleprompter

1. Teleprompter
 - **NOT INCLUDED IN THIS SOW**

01.03 CAMERAS HOUSE

House cameras are to be 4K 59.94 HDR capable and expected to be configured for 1080p. Type 1 Cameras are to be 4K/HD compact box cameras. Type 2 Cameras are to be 4K/HD live broadcast studio cameras. Type 1 POV Cameras are to be 4K/UHD 60p PTZ cameras. Cameras based on an IP workflow connecting to the Routing Switcher directly or via IP Gate Ways as required.

A. Type 1 Camera

1. Camera – Qty 24 + 1 Spare
 - **PROVIDE** and **INSTALL** New Sony HDCP50 Camera Body
 - **PROVIDE** and **INSTALL** New Sony HZCPRV50 60p License
 - **PROVIDE** and **INSTALL** New IDX IA-200A 100W AC Adapter Power Supply
2. Camera Transport
 - **PROVIDE** and **INSTALL** New Multidyne V4-3811-6X2-A-ST Fiber Transceiver with 6 in and 2 out – Qty 6
 - **PROVIDE** and **INSTALL** New Multidyne V4-3811-2X6-A-ST Fiber Transceiver with 2 in and 6 out – Qty 6
 - **PROVIDE** and **INSTALL** New Multidyne RM-1RU-V4 Rack Mount Kit – Qty 10
3. Camera Control
 - **PROVIDE** and **INSTALL** New Sony RCP3500 Camera Remote Control Panel – Qty 8
 - **PROVIDE** and **INSTALL** New Ross Video RRB-CTL-3 3 Axis Unified Control System – Qty 3
 - **PROVIDE** and **INSTALL** New Ross Video RRB-CTL-PTZ PTZ Camera Plug-In License – Qty 3
4. Camera Lens – Qty 25
 - **PROVIDE** and **INSTALL** New Canon CJ20EX5B IASE S 20x Zoom 2/3" UHDXS 4K Lens
5. Camera Package – Qty 24
 - **PROVIDE** and **INSTALL** New Ross Video RRB-X300-PT Robotics PT Head
 - **PROVIDE** and **INSTALL** New Ross Video RRB-UNI-WMB Wall Mount Bracket

B. Type 2 Camera

1. Camera – Qty 4
 - **PROVIDE** and **INSTALL** New Sony HDC3200L Camera Body
 - **PROVIDE** and **INSTALL** New Sony HZCPRV50 60p License
 - **PROVIDE** and **INSTALL** New Sony VCT14 Tripod Attachment

- **PROVIDE** and **INSTALL** New Sony HDVFL750 LCD Color Viewfinder
 - **PROVIDE** and **INSTALL** New Sony HDVEL20 7" OLED Viewfinder
2. Camera Transport – Qty 4
 - **PROVIDE** and **INSTALL** New Sony HDCU3100L Camera Control Unit
 - **PROVIDE** and **INSTALL** New Sony HKCUSFP50 ST2110 Interface Kit
 - **PROVIDE** and **INSTALL** New Sony OTM25GLR 25G Long Range SFP+
 3. Camera Control
 - **INCLUDED WITH TYPE 1 CAMERA HOUSE**
 4. Camera Lens – Qty 4
 - **PROVIDE** and **INSTALL** New Canon CJ20EX5B IASE S 20x Zoom 2/3" UHDXS 4K Lens
 - **PROVIDE** and **INSTALL** New Canon MS-210D Full Servo Digital Zoom / Focus Rear Control Kit
 5. Camera Package – Qty 4
 - **PROVIDE** and **INSTALL** New Sony ECM680S Shotgun Mic
 - **PROVIDE** and **INSTALL** New Sony ECO5X5F3M 5-Pin XLR to Dual 3-Pin XLR
 - **PROVIDE** and **INSTALL** New Ross Video CAM-600PT-PKG Robotics PT Head
 - **PROVIDE** and **INSTALL** New Vinten Osprey Plus Pedestal
 - **PROVIDE** and **INSTALL** New Vinten Head Vector 75 Flat Base
 - **PROVIDE** and **INSTALL** New Vinten Pan Bar Telescopic, Vector
 - **PROVIDE** and **INSTALL** New RTS PH-2 Dual Sided Medium Weight Headset
 - **PROVIDE** and **INSTALL** New Custom Camera Case

C. Type 1 POV Camera

1. POV Camera – Qty 20
 - **PROVIDE** and **INSTALL** New Sony ILMEFR7K 4K PTZ Camera
 - **PROVIDE** and **INSTALL** New IDX IA-200A 100W AC Adapter Power Supply
2. POV Transport
 - **PROVIDE** and **INSTALL** New Multidyne V4-3811-6X2-A-ST Fiber Transceiver with 6 in and 2 out – Qty 5
 - **PROVIDE** and **INSTALL** New Multidyne V4-3811-2X6-A-ST Fiber Transceiver with 2 in and 6 out – Qty 5
 - **PROVIDE** and **INSTALL** New Multidyne RM-1RU-V4 Rack Mount Kit – Qty 8
3. POV Control – Qty 3
 - **PROVIDE** and **INSTALL** New Sony RMIP500/1 Advanced Joystick Controller

D. Camera Accessories

1. Camera Control – Qty 3
 - **PROVIDE** and **INSTALL** New Sony MSU3500 Master Setup Unit
2. Camera Batteries
 - **PROVIDE** and **INSTALL** New Anton Bauer Dionic XT Gold Mount Battery – Qty 8
 - **PROVIDE** and **INSTALL** New Anton Bauer Quad Gold Mount Charger – Qty 2

E. Robotics

1. Robotics Control Server
 - **PROVIDE** and **INSTALL** New Ross Video RRB-SRV Robotics Server – Qty 1
 - **PROVIDE** and **INSTALL** New Ross Video RRB-SRV-BKUP Robotics Server Backup – Qty 1
 - **PROVIDE** and **INSTALL** New Ross Video RRB-UNI-CPB Universal Paint Box – Qty 3
 - **PROVIDE** and **INSTALL** New Sony CNA1 Camera Control Network Adapter – Qty 3

F. Teleprompter

1. Teleprompter

- **PROVIDE** and **INSTALL** New Autoscript EPIC-IP19XL Epic IP on camera package with 19" prompt monitor and 24" talent monitor – Qty 4
- **PROVIDE** and **INSTALL** New Autoscript WP-IPSPKG Win Plus software, XBOX-IP video generator and HC-IP controller – Qty 3

02.03 PRODUCTION SWITCHER HOUSE

Production Switchers are to be 4K 59.94 capable and expected to be configured at 1080p. Production Switcher requirements to be a Frame sized to accommodate a minimum of 16 SDI inputs and 16 3G HD SDI outputs and 32 ST2110 25GB Inputs and 32 ST2110 25GB outputs. Production Switcher to include 2 ME's and 4 Multiview outputs with redundant power supply. Frame to include 8 x's 25G SFP's as necessary to facilitate ST2022-7 connection to the ST2110 Routing Switcher. Production Switcher to be licensed for Frame Sync, Format Conversion, Proc Amp and Color Correction. Frame to support Madi and Embedded audio total of 768 x 768. Production Switcher paired with control surface and aux panel. Xpression live CG software included with Carbonite card purchase.

Aux Production Switchers are to be 4K 59.94 capable and expected to be configured at 1080p. The Aux Switcher frame shall be an all-in-one production switcher with built-in graphics, clip server, Multiview, and audio. The Aux switcher will be a single frame sized to accommodate 9 inputs and 6 outputs and to include 2 ME's. The Aux Production Switcher shall be paired with control surface and aux panel. Aux Production Switcher shall connect to Router via Production Switcher Ultrix frame.

A. Production Switcher PCR 1

1. Production Switcher

- **PROVIDE** and **INSTALL** New Ross Video ULTRIX-NS-FR2 2RU Frame with 16x16 plus 2 AUX – Qty 1
- **PROVIDE** and **INSTALL** New Ross Video ULTRISCAPE Multiviewer License – Qty 4
- **PROVIDE** and **INSTALL** New Ross Video ULTRISYNC FrameSync License – Qty 1
- **PROVIDE** and **INSTALL** New Ross Video SWR-SDPE Carbonite Processing Engine Blade – Qty 1
- **PROVIDE** and **INSTALL** New Ross Video ULTRIPower-PS Modular Power Supply – Qty 1
- **PROVIDE** and **INSTALL** New Ross Video ULTRIPower Rackmount 1ru Power Supply Frame With 1 Power Supply – Qty 1
- **PROVIDE** and **INSTALL** New Ross Video CUFR-ADD-ME1 Carbonite ME 1 License – Qty 1
- **PROVIDE** and **INSTALL** New Ross Video CUFR-ADD-ME2 Carbonite ME 2 License – Qty 1
- **PROVIDE** and **INSTALL** New Ross Video CUFR-ADD-FSFC Carbonite FSFC License – Qty 1
- **PROVIDE** and **INSTALL** New Ross Video CUFR-ADD-PACC Carbonite PACC License – Qty 1
- **PROVIDE** and **INSTALL** New Ross Video XDS0-0001-CPS Xpression Livecg Software Only License – Qty 1
- **PROVIDE** and **INSTALL** New Ross Video SFP-HDB-IO-3G 3G SDI HD-BNC Transceiver SFP – Qty 4
- **PROVIDE** and **INSTALL** New Ross Video ULTRIX-IP-IO IP I/O 4 25GB Connect Board – Qty 2
- **PROVIDE** and **INSTALL** New Allowance for 25GB SFP Module – Qty 8
- **PROVIDE** and **INSTALL** New Ross Video TD2S-PANEL Touchdrive 2 ME Control surface – Qty 1
- **PROVIDE** and **INSTALL** New Ross Video TD-TOUCHSCREEN Touchdrive touchscreen display – Qty 1

B. Production Switcher PCR 2

1. Production Switcher

- **PROVIDE** and **INSTALL** New Ross Video ULTRIX-NS-FR2 2RU Frame with 16x16 plus 2 AUX – Qty 1
- **PROVIDE** and **INSTALL** New Ross Video ULTRISCAPE Multiviewer License – Qty 4
- **PROVIDE** and **INSTALL** New Ross Video ULTRISYNC FrameSync License – Qty 1
- **PROVIDE** and **INSTALL** New Ross Video SWR-SDPE Carbonite Processing Engine Blade – Qty 1
- **PROVIDE** and **INSTALL** New Ross Video ULTRIPower-PS Modular Power Supply – Qty 1
- **PROVIDE** and **INSTALL** New Ross Video ULTRIPower Rackmount 1ru Power Supply Frame With 1 Power Supply – Qty 1
- **PROVIDE** and **INSTALL** New Ross Video CUFR-ADD-ME1 Carbonite ME 1 License – Qty 1
- **PROVIDE** and **INSTALL** New Ross Video CUFR-ADD-ME2 Carbonite ME 2 License – Qty 1
- **PROVIDE** and **INSTALL** New Ross Video CUFR-ADD-FSFC Carbonite FSFC License – Qty 1
- **PROVIDE** and **INSTALL** New Ross Video CUFR-ADD-PACC Carbonite PACC License – Qty 1
- **PROVIDE** and **INSTALL** New Ross Video XDS0-0001-CPS Xpression Livecg Software Only License – Qty 1
- **PROVIDE** and **INSTALL** New Ross Video SFP-HDB-IO-3G 3G SDI HD-BNC Transceiver SFP – Qty 4
- **PROVIDE** and **INSTALL** New Ross Video ULTRIX-IP-IO IP I/O 4 25GB Connect Board – Qty 2
- **PROVIDE** and **INSTALL** New Allowance for 25GB SFP Module – Qty 8
- **PROVIDE** and **INSTALL** New Ross Video TD2S-PANEL Touchdrive 2 ME Control surface – Qty 1
- **PROVIDE** and **INSTALL** New Ross Video TD-TOUCHSCREEN Touchdrive touchscreen display – Qty 1

C. Production Switcher AUX 1

1. Production Switcher – Qty 3
 - **PROVIDE** and **INSTALL** New Ross Video GRAPHITE-4RU-2ME-9IN Frame
 - **PROVIDE** and **INSTALL** New Ross Video TD1C-PANEL Touchdrive 1 ME Control surface
 - **PROVIDE** and **INSTALL** New Ross Video TD-TOUCHSCREEN Touchdrive touchscreen display

03.03 ROUTING SWITCHER HOUSE

Routing Switcher shall provide routing of multiple IP signals with general line interface infrastructure of 25/100G (twenty-five or one hundred Gigabit) ports via SFP and/or expansion. Each IP interface shall be comprised of one or more SMPTE 2110 essences including video, ancillary data, and up to 32 audio streams. Router management shall be in band and not require additional networking appliances to manage. All interconnections shall be via single mode fiber optic connection. Network design shall support full actual saturation of all ports without introducing latency or packet loss. For the basis of this calculation the system shall be planned around to support a 4K 59.94 and 1080p 3Gb/s infrastructure, with IPG or highest density native IP device determining number of essences per 25G and 100G line interface. Support for NMOS AMWA IS-05 connection management discovery and registration. Switching shall provide full mono audio level control. Breakaway of Audio, Ancillary Data, and video assignments is expected. Support for PTP/IEEE-1588 timestamping and clock reference. Switching shall be controlled by a broadcast standard routing switcher control system.

Ability to request routes from any source to any destination. All router destination devices shall be able to switch between sources and produce stable error free video from a new source within 400ms of operator command. Provide VAFS path for any Router Destination flows not capable of successfully displaying a new source within specified time. Support for traditional physical router control panel interfaces and support for web-based router control interfaces for operational use only (excludes use of main router programming GUI).

A. Routing Switcher Core

1. Routing Switcher Core Primary
 - **PROVIDE** and **INSTALL** New Evertz NATX-32-100G-1+DF1RP IP Switching Fabric with integrated network address translation. Up to 32x100G or 128x25G – Qty 1
 - **PROVIDE** and **INSTALL** New Evertz DF1-FR Dragon Fire 1RU, single slot, complete with all power and controller redundancy - Qty 1
 - **PROVIDE** and **INSTALL** New Evertz QSFP optical modulars. Quantity per design – Qty 12
 - **PROVIDE** and **INSTALL** New Evertz CBL-PSM8-2xPSM4-SM-5M Breakout Cable to Connect The 8 Ports of a QSFP-DD – Qty 10
 - **PROVIDE** and **INSTALL** New Evertz CBL-MTP-LC16-SM-5M 5 Meter MTP to LC Single Mode Breakout Cable for QSFP DD PSM8 to 8x SFP Optical Transceivers – Qty 2
 - **PROVIDE** and **INSTALL** New Evertz SFPTR-RJ45-SER-AV 1000Mbps RJ45 SFP Module – Qty 2
2. Routing Switcher Core Backup
 - **PROVIDE** and **INSTALL** New Evertz NATX-32-100G-1+DF1RP IP Switching Fabric with integrated network address translation. Up to 32x100G or 128x25G – Qty 1
 - **PROVIDE** and **INSTALL** New Evertz DF1-FR Dragon Fire 1RU, single slot, complete with all power and controller redundancy - Qty 1
 - **PROVIDE** and **INSTALL** New Evertz QSFP optical modulars. Quantity per design – Qty 12
 - **PROVIDE** and **INSTALL** New Evertz CBL-PSM8-2xPSM4-SM-5M Breakout Cable to Connect The 8 Ports of a QSFP-DD – Qty 10
 - **PROVIDE** and **INSTALL** New Evertz CBL-MTP-LC16-SM-5M 5 Meter MTP to LC Single Mode Breakout Cable for QSFP DD PSM8 to 8x SFP Optical Transceivers – Qty 2
 - **PROVIDE** and **INSTALL** New Evertz SFPTR-RJ45-SER-AV 1000Mbps RJ45 SFP Module – Qty 2

IP Gateways shall provide appropriate IP based connectivity back to the Routing Switcher. Encapsulation and De encapsulation of baseband SDI signals supporting 3G single essence SDI to and from SMPTE 2110. Type 1 IP Gateway shall provide up to 32x32 HD SDI to SMPTE 2110 without frame synchronization. Type 2 IP Gateway shall provide up to 16x16 HD SDI to SMPTE 2110 with frame synchronization.

B. IP Gateway

1. Type 1 IPG Frame
 - **PROVIDE** and **INSTALL** New Evertz EV6-FR+PS 6RU Modular Frame – Qty 1
 - **PROVIDE** and **INSTALL** New Evertz EV6-FC Frame Controller – Qty 2
2. Type 1 IPG
 - **PROVIDE** and **INSTALL** New Evertz EV670-X30-HW-V2 Virtualized Media Processor – Qty 1
 - **PROVIDE** and **INSTALL** New Evertz 670IPG-X30-APP-32X Allows 32 x 32 3G HD SDI to ST 2110 – Qty 1
 - **PROVIDE** and **INSTALL** New Evertz evIPG-3G IPG app support for 32 x 32 – Qty 1
 - **PROVIDE** and **INSTALL** New Evertz ev670-32X32-HDBNC-RP Rear Plate – Qty 1
 - **PROVIDE** and **INSTALL** New Evertz QSFP25G-SM-PSM4-LR-G-NFEC 100G QSFP, 4-CH, MPO/APC QSFP – Qty 2
3. Type 2 IPG
 - **PROVIDE** and **INSTALL** New Evertz EV670-X30-HW-V2 Virtualized Media Processor - Qty 2
 - **PROVIDE** and **INSTALL** New Evertz EV670-16x16-HDBNC-RP HDBNC Rear Plate – Qty 2

- **PROVIDE** and **INSTALL** New Evertz evIPG-3G-16FS IPG app support for 16 x 16 with Frame Sync – Qty 2
- **PROVIDE** and **INSTALL** New Evertz QSFP25G-SM-PSM4-LR-G-NFEC 100G QSFP, 4-CH, MPO/APC QSFP – Qty 4

Audio Groomers shall provide TDM Audio to IP Audio, supporting existing TDM modules and AES67 to 302M. Physically the module supports 10x10 TDM and 10GE for IP Audio. Audio Shuffling shall provide for 2560x Mono Channels. To be housed in the same frame where the audio groomer exists. Audio gateway with redundant power, shall provide support for 10x10 TDM/MADI ports by default with 25/10GE AES67 and 302M IP Audio ports. Dante is available with the optional +DANTE64 sub modules.

C. Audio

1. Audio Grooming
 - **PROVIDE** and **INSTALL** New Evertz 570EMR-AG-HUB TDM to IP Audio Gateway – Qty 1
 - **PROVIDE** and **INSTALL** New Evertz 570FR-HF 3RU Multiframe – Qty 1
 - **PROVIDE** and **INSTALL** New Evertz 570FC Vistalink Frame Controller – Qty 1
 - **PROVIDE** and **INSTALL** New Evertz 570PS-HF Power Supply – Qty 1
 - **PROVIDE** and **INSTALL** New Evertz SFP10G-TR13-A SFP+ Optical Transceiver – Qty 4
2. Audio Shuffler
 - **PROVIDE** and **INSTALL** New Evertz 570EMR-ADMX IP Audio engine for mono sub-systems – Qty 2
 - **PROVIDE** and **INSTALL** New Evertz SFP10G-TR13-A SFP+ Optical Transceiver – Qty 2
3. Audio Gateway
 - **PROVIDE** and **INSTALL** New Evertz 9821EMR-AG-HUB 1RU Audio Gateway – Qty 1
 - **PROVIDE** and **INSTALL** New Evertz 9821EMR-IO-DANTE-64 Dante to IP audio module – Qty 8
 - **PROVIDE** and **INSTALL** New Evertz QSFP-10G-TR13-G 40G QSFP+ Optical Transceiver – Qty 2

Router control system shall be provided for standard router control and network orchestration system capable of controlling the routing switcher and other network appliances similar to a baseband broadcast matrix type router. The Routing Control system shall include software web-based and traditional physical router control panel interfaces. Web based system shall allow users to browse to a specific web address to route sources and destinations. Button per source control panels shall support a minimum of 40 buttons and support joystick integration at shading positions for input switching. Programmable XP control panels shall support source to destination, macros, salvos, audio breakaway, metadata breakaway. Routing control system shall be programmed from a web management interface and be capable of salvos/memory/preprogrammed routes.

D. Routing Control

1. Web Service Router Control – Qty 1
 - **PROVIDE** and **INSTALL** New Evertz MAGNUM-ROUTER-VCP-WEB Virtual Control Panel License
 - **PROVIDE** and **INSTALL** New Evertz VUE-WEB Web based interface routing
 - **PROVIDE** and **INSTALL** New Evertz MAGNUM-ANYWHERE-CLIENT 1year License for one seat of VUE anywhere client
2. Type 1 Touch Screen Router Control Panel – Qty 1
 - **PROVIDE** and **INSTALL** New Evertz VUE-TOUCH2 2RU full touch screen rack mountable panel
 - **PROVIDE** and **INSTALL** New Evertz VUEAPP-STUDIO-MANAGER VUE visualization and control
3. Type 1 XY Router Control Panel – Qty 1

- **PROVIDE** and **INSTALL** New Evertz CP-2232E Full rack width router control panel
4. Type 2 XY Router Control Panel – Qty 12
 - **PROVIDE** and **INSTALL** New Evertz CP-1024E 1RU 3 LCD screens, 5 rotary encoders and 24 backlit buttons
 5. Type 1 BPS Router Control Panel – Qty 3
 - **PROVIDE** and **INSTALL** New Evertz CP-1040E 1RU 40 button LCD panel
 6. Type 1 Router Control Server
 - **PROVIDE** and **INSTALL** New Evertz VUE-VCS1 VUE visualization and control application running on a 1RU hardware platform. Provides a single workstation environment – Qty 1
 - **PROVIDE** and **INSTALL** New Evertz SFP25G-TR13 25G Optical Transceiver – Qty 2
 7. Routing Switcher HW & SW
 - **NOT INCLUDED IN THIS SOW**

Universal Protocol Translator (PTX) module shall provide the ability for Evertz and software to interface directly to third party UMD devices and routers. The PTX communicates with the router and UMD protocols either via one of four serial ports or using a built in Ethernet port. All ports - both serial and Ethernet - are bi-directional allowing the device complete flexibility for communication.

E. PTX (Universal Protocol Translator)

1. PTX
 - **PROVIDE** and **INSTALL** New Evertz 7800FR 3RU Multiframe – Qty 1
 - **PROVIDE** and **INSTALL** New Evertz 7800FC+3RU Vistalink Frame Controller – Qty 1
 - **PROVIDE** and **INSTALL** New Evertz 7700PTX-TSL+3RU Interface to switchers supporting TSL protocol (eg. Ross Carbonite Black) – Qty 8
 - **PROVIDE** and **INSTALL** New Evertz 7700R-SC-BRC+3RU Bidirectional 3rd party router/controller module – Qty 6
 - **PROVIDE** and **INSTALL** New Evertz 7700PTX-NV+3RU PTX which controls NVISION based router – Qty 2

Multiview shall provide SMPTE 2110 input and support for SMPTE 2022-7. Multiview shall be configured for 128 inputs and 16 outputs. Dynamic name sets and support for multiple source names based on router present and system name sets. Support for Up/Down clock and audio monitoring. Multiview outputs shall connect to monitors via fiber to HDMI output module. Up/Down timer shall be provided in each control room.

F. MULTIVIEW

1. Multiview
 - **PROVIDE** and **INSTALL** New Evertz EV6-FR+PS 6RU Multiframe – Qty 1
 - **PROVIDE** and **INSTALL** New Evertz EV6-FC Vistalink Frame Controller – Qty 2
 - **PROVIDE** and **INSTALL** New Evertz EV670-X30-HW-V2 Virtualized Media Processor – Qty 2
 - **PROVIDE** and **INSTALL** New Evertz EVVIP-APP-100G-ST2110 ST2110 input monitoring software license – Qty 2
 - **PROVIDE** and **INSTALL** New Evertz evVIP-FK-64-IP-3G License key to enable 64 SD, HD, 3G or 16 UHD inputs on evVIP-100G – Qty 2
 - **PROVIDE** and **INSTALL** New Evertz evVIP-FK-8OUT License key to enable eight outputs at 1080P. If using UHD outputs two UHD output is max per card. – Qty 2

- **PROVIDE** and **INSTALL** New Evertz evMV-FK-VIP-64MON-ADV Feature Key to enable 64 inputs advance audio, video, ancillary data monitoring – Qty 2
 - **PROVIDE** and **INSTALL** New Evertz QSFP25G-SM-PSM4-LR-G-NFEC 100GB QSFP Optical Transceiver – Qty 8
2. Multiview HDMI Converter
 - **PROVIDE** and **INSTALL** New Evertz SCORPION-6 Standalone Frame – Qty 3
 - **PROVIDE** and **INSTALL** New Evertz SCORPION-6-PSX Power Supply – Qty 3
 - **PROVIDE** and **INSTALL** New Evertz MIO-HDMI-OUT-3G-SA HD 3G HDMI Output – Qty 18
 - **PROVIDE** and **INSTALL** New Evertz SFP25G-TR13 25GB Optical Transceiver – Qty 6
 3. Multiview Up/Down Timer – Qty 3
 - **PROVIDE** and **INSTALL** New ESE ES 362UE 100 Minute Master Up/Down Timer

A GPI Tally interface shall be provided to support transfer of GIP information to the Multiview. Tally connections shall be provided to indicate when a particular source is “next-to-air”. Connections shall be provided between the Production Switcher, Monitors, Camera Control Units, and any other devices that accept contact closure or serial tally.

G. TALLY INTERFACE

1. Tally Interface - Qty 1
 - **PROVIDE** and **INSTALL** New Evertz TR-4800E 1RU Physical GPI and GPO Tally Router
 - **PROVIDE** and **INSTALL** New Evertz TR-4800E-BHP 2RU Breakout panel for 32 GPI and 48 GPO

04.03 TEST & MEASUREMENT HOUSE

An IP Network Grand Master Clock and Master Sync Generator are to be 4K 59.94 HDR capable and expected to be configured for 1080p. System shall provide timing for the IP-based video production facility while providing reference to baseband analog and SDI system. The timing clocks shall be synced between the Capitol, Senate, and House. Test signal generators shall provide signals for test generator and digital black and two independently adjustable black burst outputs. Waveform/Vectorscope and Rasterizer are to be 4K 59.94 HDR capable and expected to be configured for 1080p and provide support for SMPTE 2110 and network packet analysis.

A. PTP Grandmaster

1. Type 1 PTP Grandmaster
 - **PROVIDE** and **INSTALL** New Evertz 5700MSC-IP+2PS Master Sync Generator for an IP Or hybrid facility with GPS included – Qty 1
 - **PROVIDE** and **INSTALL** New Evertz SFP10G-TR13-A 10GB SFP+ Optical Transceiver – Qty 2

B. Sync Generator

1. Type 1 Sync Generator
 - **PROVIDE** and **INSTALL** New Evertz 5700MSC-IP-BC+2PS+AUX+10GTG Master Sync Generator for an IP facility acting as a Boundary Clock via PTP from a 5700MSC-IP Grandmaster – Qty 2
 - **PROVIDE** and **INSTALL** New Evertz SFP10G-TR13-A 10GB SFP+ Optical Transceiver – Qty 4
2. Type 2 Sync Changeover – Qty 1
 - **PROVIDE** and **INSTALL** New Evertz 5700ACO Automatic Changeover for the 5700 series

C. Waveform/Vectorscope

1. Type 1 Waveform/Vectorscope
 - **PROVIDE** and **INSTALL** New Leader LV5600 Waveform Monitor mainframe – Qty 4

- **PROVIDE** and **INSTALL** New Leader LV5600-SER01 SDI inputs 4 with CC and CIE display – Qty 4
- **PROVIDE** and **INSTALL** New Leader LV5600-SER03 Digital/Analog Audio 16CH Digital AES EBU Audio 8 CH Analog Audio – Qty 4
- **PROVIDE** and **INSTALL** New Leader LV5600-SER06 25GB IP Input and IP analysis – Qty 4
- **PROVIDE** and **INSTALL** New Leader LV5600-SER26 Customizable user layout display – Qty 4
- **PROVIDE** and **INSTALL** New Leader LR2561 Rackmount adapter – Qty 4
- **PROVIDE** and **INSTALL** New Leader LC2152 25GB SFP Optical Transceiver – Qty 8

D. Test Rasterizer

1. Test Rasterizer
 - **PROVIDE** and **INSTALL** New Leader LV7600 Rasterizer mainframe – Qty 1
 - **PROVIDE** and **INSTALL** New Leader LV5600-SER01 SDI inputs 4 with CC and CIE display – Qty 1
 - **PROVIDE** and **INSTALL** New Leader LV7600-SER03 Digital/Analog Audio 16CH Digital AES EBU Audio 8 CH Analog Audio – Qty 1
 - **PROVIDE** and **INSTALL** New Leader LV7600-SER06 25GB IP Input and IP analysis – Qty 1
 - **PROVIDE** and **INSTALL** New Leader LV7600-SER26 Customizable user layout display – Qty 1
 - **PROVIDE** and **INSTALL** New Leader LC2152 25GB SFP Optical Transceiver – Qty 2

05.03 VIDEO MONITORS & USER INTERFACE HOUSE

Video Monitoring shall be provided throughout the video production facility. Type 1 Monitors to be 24" 4K HDR SDI monitors with an independent feed from the router. These monitors shall provide color accurate images for quality control and shading. Type 2 Monitors to be 24" LED monitors for use with computers and KVM user stations. Type 3 Monitors to be 55" 4K HDR LED monitors for wall mounted Multiview monitoring in the control rooms and a rolling cart monitor on the stage. The Type 3 Monitors will utilize the Multiview functionality provided from the ST2110 router, along with real-time clock and other video as needed. Type 4 Monitors to be 43" 4K HDR LED monitors for monitoring in various office locations.

A. Color Picture Monitor

1. Type 1 Color Picture Monitor
 - **PROVIDE** and **INSTALL** New Sony PVMX2400 24" SDI 4K HDR Monitor – Qty 9
 - **PROVIDE** and **INSTALL** New Sony PVMKRX24 Rackmount Kit – Qty 1
2. Type 2 Color Picture Monitor
 - **PROVIDE** and **INSTALL** New ASUS PA24AC 24" HDR LED Monitor – Qty 26
3. Type 3 Color Picture Monitor
 - **PROVIDE** and **INSTALL** New Sony FW55BZ40H 55" 4K HDR LED Monitor – Qty 9
 - **PROVIDE** and **INSTALL** New LYNX TECHNIK CDH-1813 3G SDI to HDMI Converter – Qty 9
 - **PROVIDE** and **INSTALL** New LYNX TECHNIK R FR 1001 Mounting Bracket – Qty 9
 - **PROVIDE** and **INSTALL** New CHIEF LTM1U Adjust Tilt Wall Mount – Qty 8
 - **PROVIDE** and **INSTALL** New CHIEF MPAUB Cart Mount – Qty 1
4. Type 4 Color Picture Monitor – Qty 5
 - **PROVIDE** and **INSTALL** New SONY FW43BZ35J 43" 4K HDR LED Monitor
 - **PROVIDE** and **INSTALL** New LYNX TECHNIK CDH-1813 3G SDI to HDMI Converter
 - **PROVIDE** and **INSTALL** New LYNX TECHNIK R FR 1001 Mounting Bracket
 - **PROVIDE** and **INSTALL** New CHIEF LTM1U Adjust Tilt Wall Mount

User Interfaces shall be provided throughout the video production facility. Type 1 Mouse to be Optical USB wired mouse for use at various KVM user stations. Type 2 Mouse to be a wireless mouse for use at the CG user stations. Type 3 Mouse to be a wireless gaming mouse for use in the edit bays. Type 1 Keyboard to be wired mouse for use at various KVM user stations. Type 2 Keyboard to be a rackmount keyboard drawer for use in the rack room. Type 3 Mouse to be a Premier Pro Keyboard for use in the edit bays.

B. Mouse

1. Type 1 Mouse – Qty 6
 - **PROVIDE** and **INSTALL** New Dell MS116-BK Optical USB wired Mouse
2. Type 2 Mouse – Qty 4
 - **PROVIDE** and **INSTALL** New Logitech MX ANYWHERE 2S Mouse
3. Type 3 Mouse – Qty 2
 - **PROVIDE** and **INSTALL** New Corsair CH-9315411-NA Wireless Pro gaming Mouse

C. Keyboard

1. Type 1 Keyboard – Qty 4
 - **PROVIDE** and **INSTALL** New Dell KB212-B Keyboard wired
2. Type 2 Keyboard – Qty 1
 - **PROVIDE** and **INSTALL** New Middle Atlantic RM-KB-LCD17KVMHD LCD KVM Drawer
3. Type 3 Keyboard – Qty 2
 - **PROVIDE** and **INSTALL** New Logitech LKB-PPROCC-BJPU Premier Pro keyboard

06.03 CHARACTER GENERATOR HOUSE

Character Generators are to be 4K 59.94 HDR capable and expected to be configured for 1080p and shall provide for HD 3G real-time motion graphics. Character Generator to include 25G SFP's as necessary to facilitate connection to the ST2110 Routing Switcher. Configured systems to be controlled via KVM by a single operator in PCR 1 and PCR 2. An Inception Social Management system shall be provided to bring texts and graphics from social media content for use in productions. A Character Generator server shall be provided to allow collaborative Xpression project workflow and media moving.

A. Character Generator PCR 1

1. Character Generator – Qty 1
 - **PROVIDE** and **INSTALL** New Ross Video XST3-0001 Xpression Studio Software
 - **PROVIDE** and **INSTALL** New Ross Video XST-DLQ Datalinq Server Option
 - **PROVIDE** and **INSTALL** New Ross Video XPN-1RU-IP-M8 Xpression 1RU IP with 2x 25GB SFP
 - **PROVIDE** and **INSTALL** New ALPHA-ALLOWANCE-ENG for SFPs
2. Type 4 Keyboard – Qty 1
 - **PROVIDE** and **INSTALL** New Ross Video XPN-KBD Xpression Custom Keyboard

B. Character Generator PCR 2

1. Character Generator – Qty 1
 - **PROVIDE** and **INSTALL** New Ross Video XST3-0001 Xpression Studio Software
 - **PROVIDE** and **INSTALL** New Ross Video XST-DLQ Datalinq Server Option
 - **PROVIDE** and **INSTALL** New Ross Video XPN-1RU-IP-M8 Xpression 1RU IP with 2x 25GB SFP
 - **PROVIDE** and **INSTALL** New ALPHA-ALLOWANCE-ENG for SFPs
2. Type 4 Keyboard – Qty 1
 - **PROVIDE** and **INSTALL** New Ross Video XPN-KBD Xpression Custom Keyboard

C. Social Media Integration

1. Social Media
 - **PROVIDE** and **INSTALL** New Ross Video INC-SW-SOCIAL Inception Social Software – Qty 1
 - **PROVIDE** and **INSTALL** New Ross Video INC-EXP-USER-INCL Inception User – Qty 5
 - **PROVIDE** and **INSTALL** New Ross Video INC-EXP-SOCIAL-INCL Inception Social Media License – Qty 10
 - **PROVIDE** and **INSTALL** New Ross Video INC-HW-SERVER-G4-W-SE Inception Server – Qty 1

D. Character Generator Server

1. Type 1 Character Generator Server – Qty 1
 - **PROVIDE** and **INSTALL** New Ross Video XPN-GW-HW-SW-M8 Xpression Gateway
 - **PROVIDE** and **INSTALL** New Ross Video XPN-PS Xpression Project Server
 - **PROVIDE** and **INSTALL** New Ross Video XPN-INC Xpression Incoder
 - **PROVIDE** and **INSTALL** New Ross Video XPN-HW-CORE-PLUS-V2 Xpression Core Workflow Tools

07.03 INGEST & PLAYOUT HOUSE

Ingest and Playout to be 4K 59.94 HDR capable and expected to be configured for 1080p. 16 channels from 4 new GV I/O ingest, and playout systems tailored for production workflows on a 1 RU server, with SMPTE ST 2110 support and up to four HD channels. Designed with redundant power supplies, hot-swappable drives, flash-based storage, and RAID-5. The video production and content management system will have improved functionality that can be easily upgraded to support more channels and new technologies.

A. Ingest & Playout

1. Type 1 Ingest & Playout – Qty 4
 - **PROVIDE** and **INSTALL** New Grass Valley GVIO-HW-SV-01-HD I/O Turnkey Server for HD Workflows, Supports Up To 4 Channels
 - **PROVIDE** and **INSTALL** New Grass Valley GVIO-SW-HD I/O Software, Required for Server
 - **PROVIDE** and **INSTALL** New Grass Valley GVIO-SW-SN-LAN Stornext DLC Licence
 - **PROVIDE** and **INSTALL** New Grass Valley GVIO-HW-CX6 ConnectX-6 NIC - Dual 25G/10G Mellanox IP interface Card
 - **PROVIDE** and **INSTALL** New Grass Valley GVIO-HW-SFP-10G x2 10GbE SFP Modules
 - **PROVIDE** and **INSTALL** New Grass Valley GVIO-SW-IP-CH GVIO per channel IP License - for HD

Network Attached Storage to be a new 288TB Raw / 192TB useable network attached storage solution from Grass Valley. The AMS Express appears as a Network Attached Storage (NAS) to clients for direct connectivity via SMB over Ethernet. Graphical interface for setup and monitoring.

B. Network Attached Storage

1. Network Attached Storage
 - **PROVIDE** and **INSTALL** New Grass Valley AMS-EXPR-8T-PRI AMS Express Primary Chassis, (96TB RAW) – Qty 1
 - **PROVIDE** and **INSTALL** New Grass Valley AMS-EXPR-8T-EX AMS Express Expansion Chassis, (96TB RAW) – Qty 2
 - **PROVIDE** and **INSTALL** New Grass Valley AMS-EXPR-RVM-SW Redundant File System Manager for AMS Express – Qty 1
 - **PROVIDE** and **INSTALL** New Grass Valley K2-SWE-24-D-5 Managed Gige Switch,-24 Port, (Dell N1524) – Qty 2

- **PROVIDE** and **INSTALL** New Grass Valley K2-SWE-RD-D-5 External Redundant Power Supply - Qty 2
- **PROVIDE** and **INSTALL** New Allowance for SFP and Fiber Cables – Qty 1

Ingest and Playout Core Management Servers to be new GV servers that have the role of core services on a system with multiple GV stratus servers. The servers provide media management functionality, including the GV Stratus database and associated software components. All existing STRATUS client and site licenses to be transferred from existing STRATUS system. All servers will include the latest STRATUS software and Windows operating systems qualified.

C. Stratus Core

1. Stratus Core

- **PROVIDE** and **INSTALL** New Grass Valley STRATUS-CSA1-SW STRATUS Core A1 Software License - Supports up to 50 clients – Qty 1
- **PROVIDE** and **INSTALL** New Grass Valley STRATUS-CS-FT-HW Hardware Platform Supporting GV Stratus Fault Tolerant Core Services Package – Qty 1
- **PROVIDE** and **INSTALL** New Grass Valley STRATUS-CSGVRE-HW Hardware Platform Supporting a GV Stratus Fault Tolerant Core Services Package – Qty 3
- **PROVIDE** and **INSTALL** New Grass Valley STRATUS-CSGVRE-SW GV Stratus Render Engine Software License – Qty 3
- **PROVIDE** and **INSTALL** New Grass Valley STRATUS-ARCHIVE-A1 Stratus Archive Restore Site License for Stratus Core Services – Qty 1

Edius Software shall be provided for upgrades of the existing Edius workstations to Edius 9.

D. Edius Software

1. Edius Software – Qty 4

- **PROVIDE** and **INSTALL** New Grass Valley EWG9-JUP-DL Grass Valley Edius Workgroup 9 Jump Upgrade from Edius 2-7 And Edius Pro 8
- **PROVIDE** and **INSTALL** New Grass Valley Stratus Connect for Edius Workgroup 9 (Serial Key)
- **PROVIDE** and **INSTALL** New Grass Valley STRA-PREM-CONNECT Adobe Plug In To Access GV Stratus

08.03 KVM MATRIX & INTERFACES HOUSE

An IP KVM system shall be installed for all major systems and operator positions in the video production facility. A KVM Manager shall be installed to transform KVM Transmitters and Receivers into a digital matrix solution. Using standard IP infrastructure to route any user station to any computer on the attached network without any compromises to video quality or control. It allows co-operative sharing of computers to any user station. HDMI to SDI converter shall be provided for connection to the ST2110 Routing Switcher IP Gateway. A KVM Switch shall be provided to support the KVM system.

A. Matrix Based KVM

1. KVM Matrix

- **PROVIDE** and **INSTALL** New Adder ASP-001-US Infinity Manager Device – Qty 2
- **PROVIDE** and **INSTALL** New Adder AIMLIC-192-BCK Infinity AIM software – Qty 1
- **PROVIDE** and **INSTALL** New Adder SFP-SM-LC SFP Single Mode Fiber Module – Qty 4

2. KVM Transmitter
 - **PROVIDE** and **INSTALL** New Adder ALIF4021T-US Dual Head 10GB KVM Transmitter – Qty 20
 - **PROVIDE** and **INSTALL** New Adder SFP-SM-LC-10G SFP Single Mode Fiber Module – Qty 20
 - **PROVIDE** and **INSTALL** New Adder RMK12 Rackmount Kit – Qty 10
 - **PROVIDE** and **INSTALL** New Adder RMK12-BP Blanking Plates – Qty 10
 - **PROVIDE** and **INSTALL** New Lynx Technik CHD-1812 3G HDMI to SDI Converter – Qty 1
3. KVM Receiver
 - **PROVIDE** and **INSTALL** New Adder ALIF4021R-US Dual Head 10GB KVM Receiver – Qty 10
 - **PROVIDE** and **INSTALL** New Adder SFP-SM-LC-10G SFP Single Mode Fiber Module – Qty 10
 - **PROVIDE** and **INSTALL** New Adder RMK12 Rackmount Kit – Qty 10
 - **PROVIDE** and **INSTALL** New Adder RMK12-BP Blanking Plates – Qty 20
4. KVM Switch
 - **PROVIDE** and **INSTALL** New Netgear XSM4348FS-100NES Ethernet Switch - 48SFP+, 2 10GBASE-T Shared - Manageable 3 Layer Supported – Qty 1
 - **PROVIDE** and **INSTALL** New Netgear APS250W-100NES Power Supply – Qty 1
 - **PROVIDE** and **INSTALL** New Addon AXM761-AO SFP+ Optical Transceiver – Qty 48

09.03 VIDEO RECORDING EQUIPMENT HOUSE

A multi-channel recorder and player shall be provided for backup recording of live production, post-production, on-set and any necessary high quality reliable recording and playback as needed.

A. Video Disk Recorder

1. Type 1 Video Disk Recorder
 - **NOT REQUIRED IN THE HOUSE BUILDING**

10.03 DISTRIBUTION & SIGNAL PROCESSING HOUSE

A Modular Signal Processing infrastructure shall be provided for distribution and conversion as necessary throughout the video production facility. Control of modular systems shall be provided by Dashboard software, available free of charge from Ross Video. This allows for easy setup, monitoring, alarms, and management.

A. Distribution Frame

1. Type 1 Distribution Frame – Qty 6
 - **PROVIDE** and **INSTALL** New Ross Video OGX-FR-CN Open Gear OGX Frame
 - **PROVIDE** and **INSTALL** New Ross Video PS-OGX Power Supply

B. Serial Distribution Amplifier

1. Type 1 SDA
 - **PROVIDE** and **INSTALL** New Ross Video SRA-8901-4-R3S Digital Video Distribution Amplifier – Qty 10
 - **PROVIDE** and **INSTALL** New Ross Video SRA-8901-4 Rear Plate 1 x 4 – Qty 20

C. Analog Video Distribution Amplifier

1. Type 1 VDA – Qty 10
 - **PROVIDE** and **INSTALL** New Ross Video UDA-8705A-R2L Video Distribution Amplifier

D. Audio Embedder/De-Embedder

1. Type 1 Embedder/De-Embedder – Qty 16
 - **PROVIDE** and **INSTALL** New Ross Video AMX-8952-C Analog Audio Embedder/De-Embedder
 - **PROVIDE** and **INSTALL** New Ross Video R3C-8952 Rear Module

- **PROVIDE** and **INSTALL** New Ross Video AMX-8952-FS-LICENSE Frame Sync License for AMX
- E. Up Down Cross Converter**
1. Type 1 UDX – Qty 4
 - **PROVIDE** and **INSTALL** New Ross Video GATOR-TOOLBOX Single Channel HD Toolbox
 - **PROVIDE** and **INSTALL** New Ross Video GATOR-TOOLBOX-12G-LICENSE UHD Format Support
 - **PROVIDE** and **INSTALL** New Ross Video GATOR-FRC-LICENSE Frame Rate Conversion License
 - **PROVIDE** and **INSTALL** New Ross Video GATOR-2 12G-SDI 2-Slot Card 6 in and 6 out
 - **PROVIDE** and **INSTALL** New Ross Video R4-GATOR Rear Plate
- F. Scan Converter**
1. Type 1 Scan Converter – Qty 2
 - **PROVIDE** and **INSTALL** New Barco R9004677 Imagepro II Scan Converter & Processor
 2. Scan Converter IO PLATE – Qty 2
 - **PROVIDE** and **INSTALL** New Scan Converter I/O Plate
- G. Fiber Optic Transmitter/Receiver**
1. Type 1 Fiber Optic Transmitter – Qty 5
 - **PROVIDE** and **INSTALL** New LYNX TECHNIK OTT-1842 Dual 3G SDI to Fiber Optic Transmitter
 2. Type 2 Fiber Optic Transmitter – Qty 5
 - **PROVIDE** and **INSTALL** New LYNX TECHNIK OTX-1712 Analog Sync / Video Fiber Optic Transmitter
 3. Type 1 Fiber Optic Receiver – Qty 5
 - **PROVIDE** and **INSTALL** New LYNX TECHNIK ORX-1802 3G Fiber Optic to SDI Receiver
 4. Type 2 Fiber Optic Receiver – Qty 5
 - **PROVIDE** and **INSTALL** New LYNX TECHNIK ORX-1702 Analog Sync / Video Fiber Optic Receiver
- H. HDMI Converter**
1. Type 1 HDMI Converter – Qty 5
 - **PROVIDE** and **INSTALL** New LYNX TECHNIK CDH-1813 3G SDI to HDMI Converter
 2. Type 2 HDMI Converter – Qty 5
 - **PROVIDE** and **INSTALL** New LYNX TECHNIK CHD-1812 3G HDMI to SDI Converter
- I. Media Converter**
1. Type 1 Media Converter – Qty 5
 - **PROVIDE** and **INSTALL** New LYNX TECHNIK OET 1510 Fiber to Ethernet Transceiver

11.03 AUDIO, TIME CODE, CONTROL HOUSE

A Dante enabled; 16 fader audio mixing board shall be provided in each Production Control Room. This mixer will be capable of saving and recalling mixer configurations, and will provide adequate input, output, and sub-mix counts to handle the production needs. The control rooms shall be provided with wall mounted speakers for audio monitoring and Dante enabled volume controllers. The Studio shall be provided with a truss mounted stage announce speaker. Dante enabled Audio interfaces shall be provided for distribution and conversion of necessary audio throughout the video production facility including interfacing with the wireless microphone and IFB systems as well as a number of input and output audio sources and destinations from the new video systems. Rackmount audio monitoring units shall be provided as necessary at various user locations in the equipment rack room and control rooms.

A. Audio Mixing Console

1. Type 1 Mixing Console – Qty 2
 - **PROVIDE** and **INSTALL** New Allen & Heath AH-SQ-5 48 Input Channels 17 Fader w/Dante
 - **PROVIDE** and **INSTALL** New Allen & Heath AH-M-SQ-SDANTE64-A 64x64 Dante Card
2. Type 1 Stage Box – Qty 1
 - **PROVIDE** and **INSTALL** New Allen & Heath AH-DT168 16 Input X 8 Output Dante Audio Expander
 - **PROVIDE** and **INSTALL** New Allen & Heath AH-AB-168-RK19 Rackmount Kit
 - **PROVIDE** and **INSTALL** New SKB 1SKB-R6UW 6RU Rack Stacks W/Roto Racks, Wheels, & Handle
 - **PROVIDE** and **INSTALL** New Middle Atlantic PD-815R-PL Rackmount Power Strip

B. Speaker

1. Type 1 Speaker – Qty 12
 - **PROVIDE** and **INSTALL** New Genelec 8030CP Active 2-Way 5in 60w Studio Monitor
 - **PROVIDE** and **INSTALL** New Genelec 8000-402B Speaker Wall Mount Bracket
2. Type 2 Speaker – Qty 1
 - **PROVIDE** and **INSTALL** New Genelec 8040BPM Active 2-Way 6.5" 180W Studio Monitor
 - **PROVIDE** and **INSTALL** New Genelec 8000-446B Truss mount kit with an adjustable length
 - **PROVIDE** and **INSTALL** New Genelec 8000-444B Long adjustable ceiling mount

C. Audio Interface

1. Type 1 Audio IO Interface – Qty 2
 - **PROVIDE** and **INSTALL** New Focusrite AMS-REDNET-A16R-MKII 16 Channel Analogue Dante I/O Interface
2. Type 1 MADI to Dante Converter – Qty 2
 - **PROVIDE** and **INSTALL** New Focusrite AMS-REDNET-D64R 64 Channel Madi Dante I/O Interface with Redundant Network & Power

D. Microphone

1. Type 1 Mic Receiver – Qty 1
 - **PROVIDE** and **INSTALL** New Shure AD4QUS--A Shure Axient Digital Wireless Receiver, 4-Ch
 - **PROVIDE** and **INSTALL** New Shure UA8100 100' UHF Remote Antenna Extension Cable
 - **PROVIDE** and **INSTALL** New Shure UA874US Active Directional Antenna 470-698 Mhz
 - **PROVIDE** and **INSTALL** New Shure A13HDB Mounting Flange, Heavy Duty, Black
 - **PROVIDE** and **INSTALL** New Atlas Sound MAC-1 Microphone Adapter Clamp
 - **PROVIDE** and **INSTALL** New Atlas Sound AD19BE Extension Tube 45° Angle Tube
2. Type 1 Mic Transmitter – Qty 4
 - **PROVIDE** and **INSTALL** New Shure AD1--G57 Shure Axient Digital Belt Pack Transmitter
 - **PROVIDE** and **INSTALL** New DPA 4060-OC-C-B00 4060 Core Omni Mic
 - **PROVIDE** and **INSTALL** New DPA SCM0013-B 4-Way Clip
 - **PROVIDE** and **INSTALL** New DPA DUA0560 Foam Windscreen
 - **PROVIDE** and **INSTALL** New DPA DAD6010 Mic Adapter
3. Type 1 MIC Battery Charger
 - **PROVIDE** and **INSTALL** New Shure SB900B Rechargeable Battery – Qty 8
 - **PROVIDE** and **INSTALL** New Shure SBC800-US 8 Bay Battery Charger – Qty 1

E. IFB

1. Type 1 IFB Transmitter – Qty 1
 - **PROVIDE** and **INSTALL** New Shure P10T--X55 Dual Transmitter
 - **PROVIDE** and **INSTALL** New Shure UA8100 100' UHF Remote Antenna Extension Cable
 - **PROVIDE** and **INSTALL** New Shure PA805X Passive Directional Antenna (944-952 MHZ)

- **PROVIDE** and **INSTALL** New Shure A13HDB Mounting Flange, Heavy Duty, Black
 - **PROVIDE** and **INSTALL** New Atlas Sound MAC-1 Microphone Adapter Clamp
 - **PROVIDE** and **INSTALL** New Atlas Sound AD19BE Extension Tube 45° Angle Tube
2. Type 1 IFB Receiver – Qty 4
 - **PROVIDE** and **INSTALL** New Shure P10R+/-X55 Bodypack Receiver
 - **PROVIDE** and **INSTALL** New Otto Engineering V1-10437 IFB Earpiece Set, Beige
 3. Type 1 IFB Battery Charger
 - **PROVIDE** and **INSTALL** New Shure SB900B Rechargeable Battery – Qty 8
 - **PROVIDE** and **INSTALL** New Shure SBC800-US 8 Bay Battery Charger – Qty 1

F. Audio Distribution

1. Time Code Distribution Amplifier – Qty 5
 - **PROVIDE** and **INSTALL** New Ross Video ADA-8405-C-R2C Ross Dual 1x4 Audio DA
2. Word Clock Synthesizer – Qty 1
 - **PROVIDE** and **INSTALL** New Ross Video WDA-8409-R2L Word Clock Distribution Amplifier W/Looping Rear Module

G. Audio Monitor

1. Type 1 Audio Monitor – Qty 9
 - **PROVIDE** and **INSTALL** New Wohler iAM1-8 1RU Triple Screen, 8 Channel Dual Input, 3G/HD/SD-SDI, Audio Monitor with Touch Screen Control
 - **PROVIDE** and **INSTALL** New Wohler SFP-2110 w/NMOS SMPTE 2110 Receiver: Multi-Mode 850 Nm, LC (Fiber) Connectors.
 - **PROVIDE** and **INSTALL** New Wohler OPT-DANTE Enable Monitoring from Up to A 64ch Dante Input
2. Type 1 Volume Controller – Qty 3
 - **PROVIDE** and **INSTALL** New Focusrite AMS-REDNET-AM2 Stereo Headphone/Line Out Dante Interface with PoE

12.03 INTERCOM HOUSE

An IP based digital Matrix Intercom system shall be provided and licensed for 48 ports and scalable to 128 ports. The intercom system shall work directly with Dante network audio to receive signals for IFB functions. Rackmount Intercom panels with 16 keys and listen and talk levers shall be provided at various user stations throughout the video production facility. Desktop Intercom panels with 16 keys and listen and talk levers shall be provided at various office and desk locations throughout the video production facility. The Intercom Matrix shall provide wireless intercom to handle multiple lightweight intercom belt packs. Fully integrated solution shall allow for seamless roaming across wide area. The Intercom Access Points convert the DECT signals into Dante compatible OMNEO IP technology signals. Intercom interfaces shall be provided for telephone hybrid using POTs lines or VoIP over public internet. Headsets shall be provided for each control panel. Intercom system can be trunked together with systems from other buildings and programmed using AZedit.

A. Intercom Matrix

1. Type 1 Intercom Matrix – Qty 1
 - **PROVIDE** and **INSTALL** New RTS ODIN32NOCORD Odin 32 Port Matrix No Cord
 - **PROVIDE** and **INSTALL** New RTS ODIN 16 PORT UPGRADE

B. Intercom Panel

1. Type 1 Intercom Panel – Qty 10

- **PROVIDE** and **INSTALL** New RTS KP4016 14 Position Key Panel with Menus and Programming Keypad
2. Type 2 Intercom Panel – Qty 2
 - **PROVIDE** and **INSTALL** New RTS DKP4016 16 Lever Desk Top Key Panel
- C. Wireless Intercom Matrix**
1. Wireless Intercom Matrix – Qty 4
 - **PROVIDE** and **INSTALL** New RTS AP-1800 Access Point 1.92-1.93 GHZ
 - **PROVIDE** and **INSTALL** New Allowance for Poe 12v Power Adapter For Ap-1800
 - **PROVIDE** and **INSTALL** New RTS TR-1800 Wireless Intercom Beltpack
- D. Intercom Interface**
1. Type 1 Intercom Interface – Qty 2
 - **PROVIDE** and **INSTALL** New RTS TIF-PRO2 Interfaces SIP Interface 2 Channels
 - **PROVIDE** and **INSTALL** New RTS TIF-PRO2 PSTN Interfaces TIF-PRO 2 PSTN 2-Channels Upgrade
- E. Intercom Headset**
1. Type 1 Intercom Headset – Qty 12
 - **PROVIDE** and **INSTALL** New RTS PH-88R5 PH-88, Single-Sided Lightweight Headset

13.03 UTILITY COMPUTERS HOUSE

Utility computers shall be provided in various locations throughout the video production facility. Type 1 Small form factor desktop workstations shall be provided for users for basic task and functions. Type 2 Rackmount utility computers shall be provided for various engineering and production functions. The rackmount computers shall be remotely operated from the control rooms via a keyboard, mouse and monitor using the KVM system. Type 3 Rackmount servers shall be provided for advanced engineering functions that require high processing power. The rackmount computers shall be remotely operated from the control rooms via a keyboard, mouse and monitor using the KVM system. Type 4 Workstations shall provide Edit computers with high end graphics cards, Audio Video IO cards and breakout box, network interface cards and touch tablets.

A. Utility Computer

1. Type 1 Utility Computer – Qty 5
 - **PROVIDE** and **INSTALL** New Dell Precision 3460 Small Form Factor Fixed Workstation
2. Type 2 Utility Computer – Qty 2
 - **PROVIDE** and **INSTALL** New Dell Precision 3930 Rackmount Workstation
3. Type 3 Utility Computer – Qty 4
 - **PROVIDE** and **INSTALL** New Dell PowerEdge R7525 Rackmount Server
4. Type 4 Utility Computer – Qty 4
 - **PROVIDE** and **INSTALL** New HP Z3Z16AV_1 HP Z8 G4 Workstation

B. Graphics Card

1. Type 1 Graphics Card – Qty 4
 - **PROVIDE** and **INSTALL** New Nvidia VCNT1000-SB RTX T1000 Graphics Card 4GB ECC GDDR6, 4X Display Port
2. Type 2 Graphics Card – Qty 4
 - **PROVIDE** and **INSTALL** New Nvidia VCNRTXA6000-PB RTX A6000 Graphics Card 48GB ECC GDD46, 4X Display Port

C. Network Interface Card

1. Type 1 Network Interface Card – Qty 4

- **PROVIDE** and **INSTALL** New Atto Tech FFRM-N311-000 Single Channel PCIE 3.0, Low Profile, Integrated QSFP28

D. AV I/O Card

1. Type 1 AV I/O Card – Qty 4
 - **PROVIDE** and **INSTALL** New AJA KONA-4-R0 4K/2K/3G/DUAL LINK/HD/SD I/O, 10-BIT PCIE Card
 - **PROVIDE** and **INSTALL** New AJA K3G-BOX-R0 1RU External Breakout Box for Kona 4
 - **PROVIDE** and **INSTALL** New AJA K3G-BOX-CBL Kona 4 Cable for The K3G-Box

E. Touch Tablet

1. Type 1 Touch Tablet – Qty 4
 - **PROVIDE** and **INSTALL** New WACOM PTH660 Intuos Pro Medium Pen & Graphic Touch Art Tablet

14.03 ARCHIVE HOUSE

An Archive solution shall be provided combining multiple technologies including an LTO Archiving Tape Library; a Content Storage Management Solution; a Transcoding Media Processing Server and a Network Attached Storage Array.

A. LTO

1. Type 1 LTO Library
 - **PROVIDE** and **INSTALL** New Qualstar Q40 Library W/1 LTO-8 SAS Drive – Qty 1
 - **PROVIDE** and **INSTALL** New Qualstar Tape Drive Assembly IBM LTO8 SAS – Qty 1
 - **PROVIDE** and **INSTALL** New Qualstar Q40 And Expansion Cabinet Power Supply – Qty 1
 - **PROVIDE** and **INSTALL** New Qualstar MINISAS 2X Dual Cable 5 Meter – Qty 1
 - **PROVIDE** and **INSTALL** New Qualstar Tape Cartridge LTO-8 Single – Qty 40

B. Content Management

1. Type 1 Content Management
 - **PROVIDE** and **INSTALL** New Telestream DIVA-LIC0048 Diva Core System Includes 1 Diva Core, 1 Data Hub, 1 Diva Link, 500TB Of Storage – Qty 1
 - **PROVIDE** and **INSTALL** New Telestream DIVA-LIC0050 Managed Storage Capacity, 500TB Blocks – Qty 1
 - **PROVIDE** and **INSTALL** New Dell PowerEdge R7525 Rackmount Server
 - **PROVIDE** and **INSTALL** New Western Digital WD161KRYZ 16TB Internal Hard Drive -7200 RPM Class,SATA 6 GB/S, 512 – Qty 12
 - **PROVIDE** and **INSTALL** New Allowance for Hard Drive Trays – Qty 12
 - **PROVIDE** and **INSTALL** New Atto Tech ESAH-1280-GT0 8-PORT External 12GB SAS/SATA TO X8 PCIE 4.0 Host Bus Adapter, Low Profile – Qty 1

C. Transcoding

1. Type 1 Transcoding – Qty 1
 - **PROVIDE** and **INSTALL** New Telestream V-LS-G7-WW-SVR Lightspeed G7 Server System
 - **PROVIDE** and **INSTALL** New Telestream V-XCPCONN-SW Vantage Transcode Pro Connect: Software Only, Single Server License
 - **PROVIDE** and **INSTALL** New Telestream V-ANLZ-SW Vantage Analysis: Software Only, Single Server License

D. NAS

1. Network Attached Storage – Qty 1

PROVIDE and **INSTALL** New Allowance for Network Attached Storage Array

15.03 MASTER CONTROL HOUSE

Master Control Switcher to be 4K 59.94 capable and expected to be configured at 1080p. Master Control Switcher is a keying and branding playout channel with mixing and logo insertion capabilities plus DVE and audio processing tools to deliver on-air channel from the video production facility. A Dashboard turnkey touchscreen client computer shall be provided for manual switching functionality similar to a typical control surface panel.

A. Master Control Switcher

1. Master Control Switcher
 - **NOT INCLUDED IN THIS SOW**

16.03 NDI PROCESSING SYSTEM HOUSE

An NDI (Network Device Interface) shall be provided for transport and management of NDI and other network-based video content. To this end a robust set of hardware and software tools shall be installed. A server running NDI Processing Engine software shall form the core of this system; it can process and transcode multiple streams of NDI simultaneously, as well as handle Multiview tasks and control and ingest of external video streams. The NDI Processing Engine server shall work in concert with another server providing multiple streams of HD-SDI to SDI conversion. This NDI I/O server shall house the necessary hardware and software to transcode these streams. To manage routing and discovery of NDI sources and destinations, both in-facility and externally, a redundant pair of servers will be provided to run the NDI Router and NDI Discovery software. These servers shall be set up in such a way that both processes are available redundantly on both servers. NDI servers will be provided with multiple high-bandwidth connections to the main network switch stack.

A. NDI Processing System

1. NDI Software – Qty 1
 - **PROVIDE** and **INSTALL** New Gallery NDIPEBASE Sienna Processing Engine Base License
 - **PROVIDE** and **INSTALL** New Gallery NDIPEPLUS Sienna Processing Engine Plus License
 - **PROVIDE** and **INSTALL** New Gallery NDIRTR Sienna Virtual Router License
 - **PROVIDE** and **INSTALL** New Gallery NDISRCXMAXI Sienna 32-Ch Source Multi License
 - **PROVIDE** and **INSTALL** New Gallery NDIOUTMUL Sienna 8-Ch Output Multi License
2. NDI Hardware
 - **PROVIDE** and **INSTALL** New Dell Custom Poweredge R6525 Server (Sienna Processing Engine) – Qty 1
 - **PROVIDE** and **INSTALL** New Dell Custom Precision 3930 Server (NDI Router, NDI Discovery Server) – Qty 2
 - **PROVIDE** and **INSTALL** New Custom Poweredge R7515 Server (NDI-SDI I/O Server) – Qty 1

17.03 PRODUCTION NETWORK HOUSE

To manage the large amount of network traffic involved in the video production facility a Primary and Backup Network Core shall be installed in the rack room of each building. The Core stack of each building shall be linked together with 100G fiber cables and network modules. A number of 48 port PoE+ switches shall be provided in the rack room for all necessary production equipment connections. A number of 48 port PoE+ switches shall be installed in all hearing rooms and linked back to the core with 25G fiber cables and network modules. It is intended that these switches be as completely segregated as possible from the corporate office network; the only connection point being public internet access for streaming content to remote locations.

A. Production Network Core

1. Production Network Core Primary
 - **PROVIDE** and **INSTALL** New Cisco C9300X-24Y-A= Catalyst 9300X 24-port 25/10G SFP+ NW-A – Qty 2
 - **PROVIDE** and **INSTALL** New Cisco PWR-C1-1100WAC/2 1100W AC Config 1 Secondary P/S – Qty 1
 - **PROVIDE** and **INSTALL** New Cisco STACK-T1-1M Stackwise 480 Stacking Cable 3.3FT – Qty 1
 - **PROVIDE** and **INSTALL** New Cisco C9300X-NM-2C Catalyst 9300 2 x 40G/100G Network Module – Qty 1
 - **PROVIDE** and **INSTALL** New Cisco QSFP-100G-LR-S 100G QSFP28 100G-LR SMF duplex LC – Qty 2
2. Production Network Core Backup
 - **PROVIDE** and **INSTALL** New Cisco C9300X-24Y-A= Catalyst 9300X 24-port 25/10G SFP+ NW-A – Qty 2
 - **PROVIDE** and **INSTALL** New Cisco PWR-C1-1100WAC/2 1100W AC Config 1 Secondary P/S – Qty 1
 - **PROVIDE** and **INSTALL** New Cisco STACK-T1-1M Stackwise 480 Stacking Cable 3.3FT – Qty 1
 - **PROVIDE** and **INSTALL** New Cisco C9300X-NM-2C Catalyst 9300 2 x 40G/100G Network Module – Qty 1
 - **PROVIDE** and **INSTALL** New Cisco QSFP-100G-LR-S 100G QSFP28 100G-LR SMF duplex LC – Qty 2

B. Production Network Rack Room

1. Production Network Rack Room – Qty 8
 - **PROVIDE** and **INSTALL** New Cisco C9300X-48HX-A Catalyst 9300 48-port mGig UPoE+ Network
 - **PROVIDE** and **INSTALL** New Cisco PWR-C1-1100WAC/2 1100W AC Config 1 Secondary P/S
 - **PROVIDE** and **INSTALL** New Cisco STACK-T1-1M Stackwise 480 Stacking Cable 3.3FT
 - **PROVIDE** and **INSTALL** New Cisco C9300X-NM-8Y Catalyst 9300 8 x 25G Network Module
 - **PROVIDE** and **INSTALL** New Cisco SFP-10/25G-BXD-I Cisco 10/25GBASE-LR Bidirectional -D
 - **PROVIDE** and **INSTALL** New Cisco SFP-10/25G-BXU-I Cisco 10/25GBASE-LR Bidirectional -U

C. Production Network Hearing Room

1. Production Network Hearing Room – Qty 12
 - **PROVIDE** and **INSTALL** New Cisco C9300X-48HX-A Catalyst 9300 48-port mGig UPoE+ Network
 - **PROVIDE** and **INSTALL** New Cisco PWR-C1-1100WAC/2 1100W AC Config 1 Secondary P/S
 - **PROVIDE** and **INSTALL** New Cisco STACK-T1-1M Stackwise 480 Stacking Cable 3.3FT
 - **PROVIDE** and **INSTALL** New Cisco C9300X-NM-8Y Catalyst 9300 8 x 25G Network Module
 - **PROVIDE** and **INSTALL** New Cisco SFP-10/25G-BXD-I Cisco 10/25GBASE-LR Bidirectional -D
 - **PROVIDE** and **INSTALL** New Cisco SFP-10/25G-BXU-I Cisco 10/25GBASE-LR Bidirectional -U

18.03 FURNITURE, MILLWORK & RACKS HOUSE

Consoles shall be constructed to house audio, video, control, and other equipment throughout the video production facility control rooms. Consoles will be outfitted with AC power, turrets to mount production equipment and adjustable monitor arms as needed for each individual operator position. Consoles typically include the ability to house certain equipment in racks and on the console desk such as router and intercom key panels, camera control and shading, video and audio monitors, switcher control surfaces, KVM user stations and interface devices, and audio mixers.

A. Furniture Consoles

1. Furniture Consoles PCR 1
 - **PROVIDE** and **INSTALL** New Forecast Control Room 11 Series GCX – Qty 1
 - **PROVIDE** and **INSTALL** New Forecast LABOR-FORECAST – Qty 1
 - **PROVIDE** and **INSTALL** New Forecast SHIPPING-FORECAST– Qty 1
 - **PROVIDE** and **INSTALL** New Engineering Allowance for Chair – Qty 6
2. Furniture Consoles PCR 2
 - **PROVIDE** and **INSTALL** New Forecast Control Room 11 Series GCX – Qty 1
 - **PROVIDE** and **INSTALL** New Forecast LABOR-FORECAST – Qty 1
 - **PROVIDE** and **INSTALL** New Forecast SHIPPING-FORECAST– Qty 1
 - **PROVIDE** and **INSTALL** New Engineering Allowance for Chair – Qty 6
3. Furniture Consoles Edit
 - **PROVIDE** and **INSTALL** New Forecast GSX-S3 Sit-2-Stand Workstation W/ 4RU Turret & 1-Bay Countertop Insert – Qty 4
 - **PROVIDE** and **INSTALL** New Forecast FC-PDM-1 1RU Filler Panel With 1-Power Module (2x Powered USB And 1x 120v With Circuit Breaker) – Qty 4
 - **PROVIDE** and **INSTALL** New Forecast **PROVIDE** and **INSTALL** New Forecast PDU Standard PDU, 36" W/ 14 X 5-15R 120V Outlets – Qty 4
 - **PROVIDE** and **INSTALL** New Forecast Power Grommet – Qty 4
 - **PROVIDE** and **INSTALL** New Forecast LCD ARM Rail Mounted Fully Articulating Monitor Arm – Qty 12
 - **PROVIDE** and **INSTALL** New Engineering Allowance for Chair – Qty 4
 - **PROVIDE** and **INSTALL** New Engineering Allowance for Acoustics Materials – Qty 4

Racks shall be provided for the new House State Office Building Rack Room. Racks to be 44RU height and 42" Deep gangable racks. These racks will be equipped with fan tops, lights, rear doors, power strips, bus bars and lacing strips. Rack bases shall be provided for mounting racks to computer raised floors.

B. Racks

1. 42"D Gangable Racks
 - **PROVIDE** and **INSTALL** New Middle Atlantic MRK-4442LRD 44SP/42DP Rack – Qty 10
 - **PROVIDE** and **INSTALL** New Middle Atlantic MW-4QFT-FC Fan Top – Qty 10
 - **PROVIDE** and **INSTALL** New Middle Atlantic SPN-44-423 Side Panels – Qty 2
 - **PROVIDE** and **INSTALL** New Middle Atlantic LT-GN-WL Magnetic Work Light – Qty 10
 - **PROVIDE** and **INSTALL** New Middle Atlantic MW-CLVRD-44 Split Rear Doors – Qty 10
 - **PROVIDE** and **INSTALL** New Middle Atlantic GANG-10 Ganging Hardware for 10 Racks – Qty 1
 - **PROVIDE** and **INSTALL** New Middle Atlantic SRB-1-MRK-4224 1 Bay Seismic Base – Qty 10
 - **PROVIDE** and **INSTALL** New Middle Atlantic ANGLE-1-42 FL Angle Brackets – Qty 10
 - **PROVIDE** and **INSTALL** New Middle Atlantic MV-ISO-42 Isolation Kit – Qty 10
 - **PROVIDE** and **INSTALL** New Middle Atlantic MRK-Z4 Seismic Brackets – Qty 10
 - **PROVIDE** and **INSTALL** New Middle Atlantic PDT-2020TL-NS 20 Outlet Power Strips – Qty 20
 - **PROVIDE** and **INSTALL** New Middle Atlantic BB-44-1 Copper Bus Bar – Qty 10
 - **PROVIDE** and **INSTALL** New Middle Atlantic LACE-44-OP Lace Strips– Qty 4
 - **PROVIDE** and **INSTALL** New Engineering Allowance for Miscellaneous Rack Accessories – Qty 1

19.03 PATCHING & CABLES HOUSE

CONFIDENTIAL & PROPRIETARY – NOT FOR DISTRIBUTION

Patch Panels and Patch Cables shall be provided as necessary for the video production facility. Patch Panels shall support 12G normalized patching for video and Cat 6 for network and control. New SMPTE camera cables shall be provided for cameras going to the Stage and on the stage. New Single Mode Fiber camera cables shall be provided for cameras SDI over fiber devices in hearing rooms and session floors. New 100G Single Mode Fiber tie lines shall be provided between the three buildings for the Production Network Switches and the ST2110 Router. New Fiber Enclosures shall be provided in each rack room for the new fiber cables. General purpose audio, video, control, fiber and RF cable and connectors shall be provided as necessary and as called out in the Bill of Materials.

20.03 COMMISSIONING AND TRAINING HOUSE

Manufacturers Commissioning and Training shall be provided for necessary systems. Commissioning of Existing Owner Furnished equipment (except for computers which the Owner may provide to the project for installation of configuration and operating software) is not included. It is expected that some Commissioning and Training shall be done remotely in advance to actual on-site time and work. Commissioning and Training schedule shall be a coordinated effort between Alpha Video, Vendors and Owner. General systems operation and maintenance training shall be provided to designated personnel on the use and operation of the system.

Commissioning and training shall include the following systems:

- **Robotics and Cameras**
- **Production Switcher**
- **Aux Switcher**
- **Routing Switcher**
- **Multiviewer**
- **Tally**
- **Character Generator**
- **Ingest and Playout**
- **Intercom**
- **Asset Management**
- **Transcoding**
- **NDI**
- **Production Network**

ADDITIONAL PROJECT SPECIFICATIONS

ASSUMPTIONS & CONDITIONS

ASSUMPTIONS

Alpha Video is making the following assumptions regarding the site conditions, end user needs, and other design or scope details.

- Relating to the current COVID-19 pandemic:
 - We have assumed that our work on this project and the operations of Minnesota Legislative Coordinating Commission are deemed to be unrestricted OR “essential” business functions, as defined by any pertinent federal, state, and local orders. We have assumed that they will continue to be deemed “essential” through the duration of our engagement and the term of the orders.
 - Alpha Video will fully comply with these orders, including work restrictions. We have assumed all personnel may be permitted to work in isolation or with a minimum of 6’ distance from any other person. Any costs incurred by Alpha Video to comply with any work restrictions not in place as of the date on the cover of this proposal are the responsibility of Minnesota Legislative Coordinating Commission. This shall include, but is not limited to, additional labor, split shifts, overtime, weekend work, holiday work, after-hours work, travel expenses, change fees, additional resources, de- and re-mobilization, etc.
 - Alpha Video may, at our sole discretion, request and be granted additional considerations to ensure the health and safety of our team members.

CONDITIONS

The following are equipment and process conditions that specifically apply to this project.

- Equipment listed within this quote may be subject to procurement delays, which may impact installation dates and/or may result in change orders and revisions to this scope of work.
- This scope of work and the pricing in our proposal is based upon the included timeline. Any deviations will require revising both.
- When equipment or material is shipped directly to your facility, Minnesota Legislative Coordinating Commission will be solely responsible for:
 - Providing written delivery confirmation to Alpha Video & Audio for each item upon arrival.
 - Visually inspecting the outside of each package for carrier damage (and providing photo evidence when required); and,
 - Consolidating, organizing, and securely storing each item. Minnesota Legislative Coordinating Commission acknowledges ownership of received items.

PROJECT TIMELINE

As a leader in the audio-visual and broadcast integration markets, Alpha Video understands that this system is considered mission-critical and impacts the success of your organization. We know that your event schedule does not change and that the show must go on.

However, to meet your required completion dates, we have established the following milestones. Timely achievement of each objective will ensure on-time completion. ***This scope of work and the pricing in our proposal is based upon the following timeline. Any deviations will require revising both.***

APPROXIMATE MILESTONES

Date	Primary Party	Requirement
NTP	Minnesota Legislative Coordinating Commission	Notice to Proceed
NTP +6 Weeks	Alpha Video	Drawing submittals complete
NTP +8 Weeks	Minnesota Legislative Coordinating Commission, Alpha Video	Drawing submittals approved; In-House Build begins
NTP +12 Weeks	Minnesota Legislative Coordinating Commission, Alpha Video	On-Site Build Begins
NTP +16 Weeks	Alpha Video	On-Site Build Complete
NTP +19 Weeks	Alpha Video	Commissioning Complete
NTP +21 Weeks	Minnesota Legislative Coordinating Commission, Alpha Video	Punchlist & Training Complete
NTP +23 Weeks	Alpha Video	Project Closeout

On-site installation can only begin once construction has progressed to the point that electronic equipment can be installed in a secure and clean job site. Please provide the project manager with a schedule outlining when this will occur. A change order will be assessed for any delays beyond the date listed in this proposal.

STANDARDS OF QUALITY

SYSTEM INTEGRATION SERVICES

Alpha will manage all aspects of this project from start to finish to ensure this project is on-time and on-budget. If integration services are provided in this proposal, Alpha will provide the following:

INTEGRATION LABOR AND MATERIALS

Project Team:

- Project Engineering
- Project Management
- Lead Technician and Project Technical Specialists
- Subcontracted services management, oversight, and coordination

Documentation:

- Preliminary Shop Drawings & Approval Submittals
- Detailed Installation Notes
- As-Built Drawings & Documentation

Professional Services:

- System Configuration & Commissioning
- Operational Training and/or On-Site Event Support
- Full System Warranty

Additional Items:

- Freight
- Insurance
- Travel Expenses

STANDARDS OF INTEGRATION

We guarantee the quality of our integration services, providing a multi-point inspection upon the completion of every installation. In summary:

GENERAL

- All system components will be installed in a neat and professional manner.
- Equipment will be new and blemish-free unless otherwise noted in this document.
- Above-ceiling components shall be installed with trim rings and/or grommets when necessary.
- Rack equipment will be installed using proper manufacturer-supplied mounting hardware.
- Blank rack spaces will be filled with either blank or vent panels.
- Racks will have proper ventilation to prevent heat buildup and prolong equipment life.

WIRING AND CABLES

- Rack cabling will be bundled neatly with cable ties or hook & loop as required.
- Low- and high-voltage cabling will be separated according to NFPA 70 (National Electric Code) 2017 specifications.
- All cabling in conduit will comply with the conduit fill specifications in NFPA 70 (National Electric Code) 2017.

- Proper strain relief will be provided at all connections and bends.
- Sufficient service loops will be provided above-ceiling, above/within/under equipment racks, or in cable trays so that components may be unmounted for service without cable strain.
- All connectors will be properly sized to fit the wire type and will be installed according to the manufacturer's specifications.
- All permanently installed cabling will be labeled with computer-generated labels.

INSTALLER TESTING AND ADJUSTMENTS

- Alpha will verify proper grounding on all equipment.
- Video displays will be properly aligned and free from distortion.
- Cabling and loudspeakers will be tested for proper polarity.
- Audio will be free of distortion, hums, buzzes, or pops.
- Loudspeaker systems will be tested and equalized to provide uniform frequency response.
- Control system programs will be tested for proper system operation.

PROJECT TERMS & CONDITIONS

RESPONSIBILITIES OF THE OWNER

This statement of work indicates the responsibilities of Alpha Video & Audio. As in any system installation, this project contains several customer responsibilities. They include, but are not limited to:

- Providing a secure, clean, and dust-free work site by the “On-Site Build Begins” date specified in this proposal;
- Providing secured storage locations and/or laydown areas for housing equipment and installation materials.
- Providing central waste and/or recycling containers for proper disposal of any installation debris;
- Providing, without request for reimbursement, all high voltage AC electrical equipment and labor necessary for proper installation – including mains, transformers, panel boards, surge suppression, receptacles, engineering, stamps, and permits – unless specified as “Alpha-provided” within this proposal;
- Providing and installing adequate HVAC, lighting, fire suppression, and life safety systems;
- Providing, installing, and certifying all necessary low voltage infrastructure – including conduits, pathways, cable trays, penetrations, core drilling, floor boxes, wall boxes, and back boxes – unless specified as “Alpha-provided” within this proposal;
- Providing and installing adequate primary & secondary steel, structures, supports, poles, and/or backing for all mounted equipment;
- Providing a professionally installed, fully functional IP network as required with the capacity to support all system components, bandwidth, routing, and enterprise-level configuration;
- Facilitating IT/network coordination with appropriate representatives and providing any requirements during the design engineering process;
- Facilitating custom control system design by coordinating with appropriate representatives and providing any requirements during the design engineering process;
- Providing access to any owner-furnished equipment, devices, virtual machines, and programming code in a timely manner upon request;
- Providing uninhibited access to the job site during normal business hours (7am to 7pm M-F) unless non-standard work hours are included in our proposal; and,
- Coordination of training times with all required staff.

This proposal assumes that work can be carried out continuously throughout the day with limited to no interruptions. If daily interruptions or delays occur before or during the work described in this scope, change orders may be required due to inefficiencies related to these interruptions.

GENERAL TERMS & CONDITIONS

OWNER-FURNISHED EQUIPMENT

This proposal assumes that all existing “owner-furnished” equipment and programming code required for system functionality is in proper operating condition and without defect. If any of the required existing equipment is not in proper operating condition, a change order may be required for the functionality outlined in this proposal.

Any owner-furnished code that is to be reused is subject to review. Please provide Alpha with all uncompiled code within 14 days of Notice to Proceed. Should owner-furnished code be deemed inadequate, by our sole discretion, Alpha will present a change order to modify or rewrite all or part of the code.

DOCUMENTATION

Alpha Video will provide shop drawings for review and formal approval that reflect the final system design. Upon completion of the project, a full set of as-built drawings will be provided digitally, which will include components of the video, audio and control systems, and any architectural documentation used during the installation. Those drawings will become property of the owner upon final payment.

PROJECT MANAGEMENT

Alpha Video will appoint a project manager as your main point of contact regarding this project. The project manager will manage the installation timeline, oversee the project team, and coordinate work with any additional trades involved in this installation.

CHANGE REQUESTS

After the project begins, any changes to this scope must be requested as a change order. Change requests shall be submitted in written form so that both parties fully understand the request. Any additional costs resulting from change orders shall be the responsibility of the owner.

PROMOTION

Alpha Video may decide to leverage this project for sales and marketing purposes. Content used to promote the project may include, but are not limited to: press releases, blogs, pictures, videos, and case studies. Your company name and logo may be used as part of the content when referencing the project. Alpha Video will provide a list of content assets and the timeline for creating, approving, and distributing the content, as required. We will share and gain your approval of any content published in the trade, submitted for awards, etc. You may use any content assets created by Alpha Video for your purposes.

SYSTEM WARRANTY AND SUPPORT

Alpha Video & Audio, Inc. guarantees the following:

1. Equipment will be new, unless noted otherwise.
2. All workmanship provided by Alpha Video will be free of defects and will be repaired, free of charge, for a period of one (1) year from the date of substantial completion or the first date of beneficial use of the system, whichever date occurs first. Substantial completion shall be defined as the point where the work, or designated portion thereof, is sufficiently complete so that the system can be used for its intended purpose.
3. All equipment and materials provided by Alpha Video that was manufactured by other companies will be warranted under the standard warranty terms of the original manufacturer.
4. If any questions arise during the warranty period about the installation or operation of the system, an Alpha Video engineer will be available to assist and answer any questions by phone.
5. The warranty does not include nor cover expendable materials used with the system installation (e.g., light bulbs, lamps, light fixture lamps, fuses, batteries, portable connection cables, etc.).
6. Alpha Video is not responsible for the reliability of systems that communicate using wireless technology. The performance of equipment utilizing wireless communications is inherently unreliable and will experience "dropouts", distortion, and loss of connectivity from time to time. Interference from other forms of radio frequency transmissions, such as radio and television broadcasts, cell phones, and wireless computer networks, is probable and should be expected.
7. Alpha Video is not responsible for the performance, testing, or configuration of owner-furnished data networks that are used to transmit audio, video, and lighting program data and control signal data. IP-based videoconferencing systems rely upon data networks that can provide consistent bandwidth for the transmission. Videoconferencing that is transmitted over the Internet is subject to the intermittent and unreliable nature of the public network. In the event that the Customer's network is found to be the cause of defects in the quality of the audio/video signals, is unreliable, or has insufficient bandwidth to support the A/V/L system and Alpha Video's network engineers are required to troubleshoot or configure the Customer's network, the cost of this service will be invoiced to the Customer.
8. Any adjustments made by the Customer or the Customer's agent(s), other than routine operational adjustments, shall not be covered under this warranty statement. Re-calibration of settings shall be considered by Alpha Video to be billable time to the Customer at Alpha's standard engineering rates.
9. Procedures such as routine preventative maintenance functions (e.g., keeping filters clean, keeping system environment free from foreign materials, etc.) are the responsibility of the Customer and is not included within this warranty agreement. Failure on the part of the Customer to perform these routine maintenance functions shall void this warranty. Preventative maintenance agreements are available at an additional cost.
10. If warranty work is necessary within the warranty period, Alpha Video will, at its option, repair the defective equipment or return it to the manufacturer for repair.
11. Repairs, modifications, or other work performed by personnel not authorized by Alpha Video during the period of warranty on any equipment of the system may invalidate the warranty.
12. Alpha Video will not be responsible for damages or cost of repairs due to modifications, adjustments, or additions to the system performed by personnel not authorized by Alpha Video prior to acceptance of the system by the Customer.
13. Alpha Video may withhold warranty service if the Customer has an unpaid balance due to be paid to Alpha Video.
14. Regarding Owner-furnished Equipment (OFE):

- a. Alpha Video's intent is to provide a complete system including all equipment. In some cases, the Customer may own equipment which they desire to be included with the installation. Alpha identifies this as OFE.
- b. The use of OFE is solely for the convenience of the Customer and is not included in the warranty or guarantee provided.
- c. Alpha Video shall take reasonable care in handling OFE and install it according to standard industry practices; however, Alpha Video takes no responsibility for the operation, performance, appearance, or effects of OFE before, during, or after its integration into the system. Alpha Video reserves the right to accept or reject OFE based on the equipment's service record, or lack thereof, condition, age, impact to other system components, and operator life safety. Alpha Video will not accept OFE that is purchased by the Customer to replace equipment that is specified in this proposal.
- d. In the event that OFE does not function properly, Alpha Video shall notify the Customer to determine if the OFE is to be a) repaired, b) an alternate unit provided by the Customer, c) the unit is not to be used, or d) Alpha Video is to provide a new unit. Alpha Video shall provide a cost to the Customer for the work to be done. The Customer will authorize any additional costs to the job.
- e. The existing equipment, removed as a courtesy by Alpha Video, that is not being reused, shall be handed over to the Customer. Alpha Video is not responsible for disposal of the existing equipment or its condition when received by the Customer.



Alpha Video & Audio, Inc.
 7690 Golden Triangle Drive
 Eden Prairie, MN 55344
 Phone: 952-896-9898 | Fax: 952-896-9899
 Visit us at www.alphavideo.com

QUOTE

19027

PART NUMBER	MANUFACTURER	DESCRIPTION	QTY	UNIT PRICE	TOTAL PRICE
C-3: Type 1 POV Control Subtotal:					\$3,095.00
01.01 - CAMERAS CAPITOL Subtotal:					\$433,536.98
01.03 - CAMERAS HOUSE					
A-1: TYPE 1 CAMERA					
HDCP50	SONY	3G/4K UHD/HFR Upgradable CMOS POV camera	25.00	\$36,957.60	\$923,940.00
HZCPRV50	SONY	HDC3000 SERIES 50/60P PERMANENT LICENCE	25.00	\$6,720.00	\$168,000.00
IA-200A	IDX	IDX 100 W AC ADAPTER POWER SUPPLY	25.00	\$488.00	\$12,200.00
A-1: Type 1 Camera Subtotal:					\$1,104,140.00
A-2: TYPE 1 CAMERA TRANSPORT					
V4-3811-6X2-A-ST	MULTIDYNE	6 x 2 3G-SDI Video Portable/Throw Down Fiber Optic Transceiver. With (6) 3G-SDI Video Inputs and (2	6.00	\$4,508.00	\$27,048.00
V4-3811-2X6-B-ST	MULTIDYNE	2 x 6 3G-SDI Video Portable/Throw Down Fiber Optic Transceiver. With (2) 3G-SDI Video Inputs and (6	6.00	\$4,097.33	\$24,583.98
RM-1RU-V4	MULTIDYNE	Universal Rack Kit for mounting up to (4) VB Series V4 products in a 1 RU rack space	10.00	\$182.00	\$1,820.00
A-2: Type 1 Camera Transport Subtotal:					\$53,451.98
A-3: TYPE 1 CAMERA CONTROL					
RCP3500	SONY	STANDARD REMOTE CONTROL PANEL	8.00	\$5,251.87	\$42,014.96
RRB-CTL-3	ROSS VIDEO	UNIFIED CONTROL SYSTEM - 3 AXIS	3.00	\$13,691.44	\$41,074.32
RRB-CTL-PTZ	ROSS VIDEO	PTZ CAMERA PLUG-IN LICENSE	3.00	\$3,035.08	\$9,105.24
A-3: Type 1 Camera Control Subtotal:					\$92,194.52
A-4: TYPE 1 LENS					
CJ20EX5B IASE S	CANON	CANON 2/3" UHDXS LENS , FULL SERVO	25.00	\$30,800.00	\$770,000.00
A-4: Type 1 Lens Subtotal:					\$770,000.00
A-5: TYPE 1 CAMERA PACKAGE					
RRB-X300-PT	ROSS VIDEO	X300 ROBOTIC PT HEAD	24.00	\$8,095.08	\$194,281.92
RRB-UNI-WMB	ROSS VIDEO	UNIVERSAL WALL MOUNT BRACKET	24.00	\$660.56	\$15,853.44
A-5: Type 1 Camera Package Subtotal:					\$210,135.36
B-1: TYPE 2 CAMERA					
HDC3200L	SONY	NATIVE FORMAT GLOBAL SHUTTER 4K CAMERA	4.00	\$30,860.67	\$123,442.68
HZCPRV50	SONY	HDC3000 SERIES 50/60P PERMANENT LICENCE	4.00	\$6,720.00	\$26,880.00
VCT14	SONY	SHORT TRIPOD ATTACHMENT	4.00	\$350.27	\$1,401.08
HDVFL750	SONY	LCD COLOR VIEWFINDER	4.00	\$4,998.00	\$19,992.00
HDVFEL20	SONY	.7" OLED VF LCD FOR HDC/PXW CC	4.00	\$4,092.75	\$16,371.00
B-1: Type 2 Camera Subtotal:					\$188,086.76
B-2: TYPE 2 CAMERA TRANSPORT					
HDCU3100L	SONY	SONY 4K/HD CAMERA CONTROL UNIT	4.00	\$11,078.91	\$44,315.64
HKCUSFP50	SONY	ST2110 INTERFACE KIT	4.00	\$19,318.00	\$77,272.00
OTM25GLR	SONY	25G LONG-RANGE SFP+ TRANSCEIVER	8.00	\$1,080.00	\$8,640.00
B-2: Type 2 Camera Transport Subtotal:					\$130,227.64
B-4: TYPE 2 LENS					
CJ20EX5B IASE S	CANON	CANON 2/3" UHDXS LENS , FULL SERVO	4.00	\$30,800.00	\$123,200.00
MS-210D	CANON	CANON ZOOM SERVO + FOCUS MANUAL	4.00	\$2,952.00	\$11,808.00
B-4: Type 2 Lens Subtotal:					\$135,008.00
B-5: TYPE 2 CAMERA PACKAGE					

PART NUMBER	MANUFACTURER	DESCRIPTION	QTY	UNIT PRICE	TOTAL PRICE
ECM680S	SONY	MONO/STEREO SWITCHABLE SHOTGUN MIC/5-PIN	4.00	\$902.72	\$3,610.88
EC05X5F3M	SONY	5-PIN XLR TO DUAL 3-PIN XLR FOR ECM680S	4.00	\$74.24	\$296.96
CAM-600PT-PKG	ROSS VIDEO	CAMBOT 600 SERIES P/T HEAD	4.00	\$25,310.12	\$101,240.48
V4170-0001	VINTEN	Pedestal Osprey Plus	4.00	\$11,141.00	\$44,564.00
		<i>2-stage Studio pedestal; on shot stroke 16.1 in / 41cm; with accessory holder and Quickfix</i>			
V4095-0001	VINTEN	Head Vector 75 Flat base	4.00	\$19,630.00	\$78,520.00
		<i>Flat base head with 1 telescopic pan bar.</i>			
3219-82	VINTEN	Pan bar telescopic, Vector	4.00	\$695.00	\$2,780.00
		<i>Telescopic pan bar for Vector 950, 950i, 75, 750, 750i.</i>			
PH-2 A4M	RTS	PH-2, DUAL-SIDED FULL CUSHION MEDIUM WEIGHT HEADSET, A4M CONNECTOR	4.00	\$304.08	\$1,216.32
CAMERA CASE	CUSTOM	CUSTOM CAMERA CASE	1.00	\$1,193.33	\$1,193.33
B-5: Type 2 Camera Package Subtotal:					\$233,421.97
C-1: TYPE 1 POV CAMERA					
ILMEFR7K	SONY	FR7 CINEMA LINE PTZ CAMERA KIT WITH 28-135mm ZOOM LENS	20.00	\$13,871.39	\$277,427.80
IA-70A	IDX	IDX 70W AC ADAPTER POWER SUPPLY	20.00	\$281.33	\$5,626.60
C-1: Type 1 POV Camera Subtotal:					\$283,054.40
C-2: TYPE 1 POV TRANSPORT					
V4-3811-6X2-A-ST	MULTIDYNE	6 x 2 3G-SDI Video Portable/Throw Down Fiber Optic Transceiver. With (6) 3G-SDI Video Inputs and (2	5.00	\$4,508.00	\$22,540.00
V4-3811-2X6-B-ST	MULTIDYNE	2 x 6 3G-SDI Video Portable/Throw Down Fiber Optic Transceiver. With (2) 3G-SDI Video Inputs and (6	5.00	\$4,097.33	\$20,486.65
RM-1RU-V4	MULTIDYNE	Universal Rack Kit for mounting up to (4) VB Series V4 products in a 1 RU rack space	8.00	\$182.00	\$1,456.00
C-2: Type 1 POV Transport Subtotal:					\$44,482.65
C-3: TYPE 1 POV CONTROL					
RMIP500/1	SONY	PROFESSIONAL REMOTE CONTROLLER W PS	3.00	\$3,095.00	\$9,285.00
C-3: Type 1 POV Control Subtotal:					\$9,285.00
D-1: CAMERA ACCESSORIES CONTROL					
MSU3500	SONY	HALF RACK MASTER SETUP UNIT	3.00	\$11,114.00	\$33,342.00
D-1: Camera Accessories Control Subtotal:					\$33,342.00
D-2: CAMERA ACCESSORIES BATTERIES					
8675-0127	ANTON BAUER	DIONIC XT 150 GOLD MOUNT BATTERY	8.00	\$740.00	\$5,920.00
8475-0119	ANTON BAUER	PERFORMANCE QUAD GOLD MOUNT CHARGER	2.00	\$1,299.00	\$2,598.00
D-2: Camera Accessories Batteries Subtotal:					\$8,518.00
E-1: ROBOTICS CONTROL SERVER					
RRB-SRV	ROSS VIDEO	ROBOTICS SERVER	1.00	\$9,481.52	\$9,481.52
RRB-SRV-BKUP	ROSS VIDEO	ROBOTICS SERVER BACKUP HARDWARE	1.00	\$4,856.68	\$4,856.68
RRB-UNI-CPB	ROSS VIDEO	UNIVERSAL CAMERA PAINT BOX	3.00	\$6,799.72	\$20,399.16
CNA1	SONY	SONY CAMERA CONTROL NETWORK ADAPTOR	3.00	\$1,402.51	\$4,207.53
E-1: Robotics Control Server Subtotal:					\$38,944.89
F-1: TELEPROMPTER					
EPIC-IP19XL	AUTOSCRIPT	EPIC-IP on-camera package with 19" prompt monitor and integrated 24" talent monitor	4.00	\$18,420.00	\$73,680.00
		<i>19" prompt & 24" talent monitor; integrated HD talent monitor; carbon fibre hood; Prompt screen: 19</i>			



Alpha Video & Audio, Inc.
 7690 Golden Triangle Drive
 Eden Prairie, MN 55344
 Phone: 952-896-9898 | Fax: 952-896-9899
 Visit us at www.alphavideo.com

QUOTE
19027

PART NUMBER	MANUFACTURER	DESCRIPTION	QTY	UNIT PRICE	TOTAL PRICE
WP-IPSPKG	AUTOSCRIPT	WinPlus-IPS software application, XBOX-IP prompt video generator, and HC-IP desktop controller packa <i>Inc WP-IPS, A9009-0002: HC-IP desktop scroll control; A9009-0001: XBox-IP HD-SDI prompt video general</i>	3.00	\$4,875.00	\$14,625.00
F-1: Teleprompter Subtotal:					\$88,305.00
01.03 - CAMERAS HOUSE Subtotal:					\$3,422,598.17

02.03 - PRODUCTION SWITCHER HOUSE

A-1: PRODUCTION SWITCHER PCR 1

ULTRIX-NS-FR2	ROSS VIDEO	ULTRIX NEW STYLE 2RU FRAME W/ 16X16 PLUS 2 AUX (ULTRIMIX AND ULTRICLEAN INCLUDED)	1.00	\$16,364.04	\$16,364.04
ULTRISCAPE	ROSS VIDEO	ULTRISCAPE MULTIVIEWER LICENSE	4.00	\$5,060.00	\$20,240.00
ULTRISYNC	ROSS VIDEO	ULTRISYNC FRAMESYNC LICENSE	1.00	\$506.00	\$506.00
SWR-SDPE	ROSS VIDEO	ROSS SOFTWARE DEFINED PROCESSING ENGINE BLADE	1.00	\$10,626.00	\$10,626.00
ULTRIPower-PS	ROSS VIDEO	MODULAR POWER SUPPLY FOR ULTRIPower RACK MOUNT PS FRAME	1.00	\$1,163.80	\$1,163.80
ULTRIPower	ROSS VIDEO	ULTRIX RACKMOUNT 1RU POWER SUPPLY FRAME WITH 1 POWER SUPPLY	1.00	\$2,120.60	\$2,120.60
CUFR-ADD-ME1	ROSS VIDEO	ROSS ULTRIX CARBONITE ME 1 LICENCE	1.00	\$6,375.60	\$6,375.60
CUFR-ADD-ME2	ROSS VIDEO	ROSS ULTRIX CARBONITE ME 2 LICENCE	1.00	\$6,375.60	\$6,375.60
CUFR-ADD-FSFC	ROSS VIDEO	ULTRIX CARBONITE FSFC LICENSE	1.00	\$2,125.20	\$2,125.20
CUFR-ADD-PACC	ROSS VIDEO	ULTRIX CARBONITE PA/CC LICENSE	1.00	\$2,125.20	\$2,125.20
XDS0-0001-CPS	ROSS VIDEO	XPRESSION LIVECG SOFTWARE ONLY LICENSE	1.00	\$0.00	\$0.00
SFP-HDB-IO-3G	ROSS VIDEO	3G SDI HD-BNC TRANCEIVER SFP	4.00	\$258.52	\$1,034.08
ULTRIX-IP-IO	ROSS VIDEO	IP I/O BOARD - (4)25GE, ADVANCED CONNECTIVITY, 2 AUX IO FOR MV	2.00	\$23,276.00	\$46,552.00
ALPHA-ALLOWANCE-ENG	ALPHA	ALPHA ENGINEERING ALLOWANCE FOR 25GB SFP'S	8.00	\$1,333.33	\$10,666.64
TD2S-PANEL	ROSS VIDEO	TOUCHDRIVE 2 ME S SERIES PANEL	1.00	\$18,595.96	\$18,595.96
TD-TouchScreen	ROSS VIDEO	TOUCHDRIVE TOUCHSCREEN DISPLAY	1.00	\$906.20	\$906.20
CUF-PSU	ROSS VIDEO	CARBONITE ULTRA STANDARD POWER SUPPLY	2.00	\$526.24	\$1,052.48
A-1: Production Switcher PCR 1 Subtotal:					\$146,829.40

B-1: PRODUCTION SWITCHER PCR 2

ULTRIX-NS-FR2	ROSS VIDEO	ULTRIX NEW STYLE 2RU FRAME W/ 16X16 PLUS 2 AUX (ULTRIMIX AND ULTRICLEAN INCLUDED)	1.00	\$16,364.04	\$16,364.04
ULTRISCAPE	ROSS VIDEO	ULTRISCAPE MULTIVIEWER LICENSE	4.00	\$5,060.00	\$20,240.00
ULTRISYNC	ROSS VIDEO	ULTRISYNC FRAMESYNC LICENSE	1.00	\$506.00	\$506.00
SWR-SDPE	ROSS VIDEO	ROSS SOFTWARE DEFINED PROCESSING ENGINE BLADE	1.00	\$10,626.00	\$10,626.00
ULTRIPower-PS	ROSS VIDEO	MODULAR POWER SUPPLY FOR ULTRIPower RACK MOUNT PS FRAME	1.00	\$1,163.80	\$1,163.80
ULTRIPower	ROSS VIDEO	ULTRIX RACKMOUNT 1RU POWER SUPPLY FRAME WITH 1 POWER SUPPLY	1.00	\$2,120.60	\$2,120.60
CUFR-ADD-ME1	ROSS VIDEO	ROSS ULTRIX CARBONITE ME 1 LICENCE	1.00	\$6,375.60	\$6,375.60
CUFR-ADD-ME2	ROSS VIDEO	ROSS ULTRIX CARBONITE ME 2 LICENCE	1.00	\$6,375.60	\$6,375.60
CUFR-ADD-FSFC	ROSS VIDEO	ULTRIX CARBONITE FSFC LICENSE	1.00	\$2,125.20	\$2,125.20
CUFR-ADD-PACC	ROSS VIDEO	ULTRIX CARBONITE PA/CC LICENSE	1.00	\$2,125.20	\$2,125.20
XDS0-0001-CPS	ROSS VIDEO	XPRESSION LIVECG SOFTWARE ONLY LICENSE	1.00	\$0.00	\$0.00
SFP-HDB-IO-3G	ROSS VIDEO	3G SDI HD-BNC TRANCEIVER SFP	4.00	\$258.52	\$1,034.08
ULTRIX-IP-IO	ROSS VIDEO	IP I/O BOARD - (4)25GE, ADVANCED CONNECTIVITY, 2 AUX IO FOR MV	2.00	\$23,276.00	\$46,552.00
ALPHA-ALLOWANCE-ENG	ALPHA	ALPHA ENGINEERING ALLOWANCE FOR 25GB SFP'S	8.00	\$1,333.33	\$10,666.64
TD2S-PANEL	ROSS VIDEO	TOUCHDRIVE 2 ME S SERIES PANEL	1.00	\$18,595.96	\$18,595.96

PART NUMBER	MANUFACTURER	DESCRIPTION	QTY	UNIT PRICE	TOTAL PRICE
TD-TouchScreen	ROSS VIDEO	TOUCHDRIVE TOUCHSCREEN DISPLAY	1.00	\$906.20	\$906.20
CUF-PSU	ROSS VIDEO	CARBONITE ULTRA STANDARD POWER SUPPLY	2.00	\$526.24	\$1,052.48
B-1: Production Switcher PCR 2 Subtotal:					\$146,829.40
C-1: PRODUCTION SWITCHER AUX 1					
GRAPHITE-4RU-2ME-9IN	ROSS VIDEO	GRAPHITE 4RU INTEGRATED PRODUCTION SYSTEM	3.00	\$0.00	\$0.00
GRAPHITE-HDBNC-BNC	ROSS VIDEO	HDBNC TO BNC KIT WITH 20 CABLES	3.00	\$440.00	\$1,320.00
GRAPHITE-4RU-ENGINE-M8	ROSS VIDEO	GRAPHITE BASE ENGINE M8	3.00	\$26,828.12	\$80,484.36
GRAPHITE-5IN-9IN-UPG	ROSS VIDEO	5 INPUT TO 9 INPUT SYSTEM UPGRADE	3.00	\$5,369.12	\$16,107.36
GRAPHITE-1ME-2ME-UPG	ROSS VIDEO	2 ME UPGRADE FOR 1 ME SYSTEMS	3.00	\$5,369.12	\$16,107.36
XPR-DLQ	ROSS VIDEO	DATALINQ SERVER OPTION	3.00	\$5,345.20	\$16,035.60
TD1C-PANEL	ROSS VIDEO	TOUCHDRIVE 1 ME COMPACT PANEL	3.00	\$9,705.08	\$29,115.24
TD-TOUCHSCREEN	ROSS VIDEO	TOUCHDRIVE TOUCHSCREEN DISPLAY	3.00	\$906.20	\$2,718.60
CUF-PSU	ROSS VIDEO	CARBONITE ULTRA STANDARD POWER SUPPLY	6.00	\$526.24	\$3,157.44
C-1: Production Switcher AUX 1 Subtotal:					\$165,045.96
02.03 - PRODUCTION SWITCHER HOUSE Subtotal:					\$458,704.76
03.03 - ROUTING SWITCHER HOUSE					
A-1: ROUTING SWITCHER CORE PRIMARY					
NATX-32-100G-1+DF1RP	EVERTZ	IP Switching Fabric with Integrated Network Address Translation. Up to 32x100G or 128x25G. DF1 Rear	1.00	\$66,550.00	\$66,550.00
DF1-FR	EVERTZ	Dragon Fire 1RU, single slot, complete with all power and controller redundancy	1.00	\$11,000.00	\$11,000.00
QSFP200G-SM-LR8-10K-G	EVERTZ	Double density, 1310nm QSFP optical module that supports 8x25G/10G ports. Can be used in application	12.00	\$2,860.00	\$34,320.00
CBL-PSM8-2xPSM4-SM-5M	EVERTZ	MTP PSM8 to 2xMTP PSM4 breakout cable to connect the 8 ports of a QSFP-DD	10.00	\$495.00	\$4,950.00
CBL-MTP-LC16-SM-5M	EVERTZ	5 meter MTP to LC single mode breakout cable for QSFP DD PSM8 to 8x SFP optical transceivers	2.00	\$440.00	\$880.00
SFPTR-RJ45-SER-AV	EVERTZ	1000Mbps RJ45 SFP module with SerDes interface	2.00	\$196.00	\$392.00
A-1: Routing Switcher Core Primary Subtotal:					\$118,092.00
A-2: ROUTING SWITCHER CORE BACKUP					
NATX-32-100G-1+DF1RP	EVERTZ	IP Switching Fabric with Integrated Network Address Translation. Up to 32x100G or 128x25G. DF1 Rear	1.00	\$66,550.00	\$66,550.00
DF1-FR	EVERTZ	Dragon Fire 1RU, single slot, complete with all power and controller redundancy	1.00	\$11,000.00	\$11,000.00
QSFP200G-SM-LR8-10K-G	EVERTZ	Double density, 1310nm QSFP optical module that supports 8x25G/10G ports. Can be used in application	12.00	\$2,860.00	\$34,320.00
CBL-PSM8-2xPSM4-SM-5M	EVERTZ	MTP PSM8 to 2xMTP PSM4 breakout cable to connect the 8 ports of a QSFP-DD	10.00	\$495.00	\$4,950.00
CBL-MTP-LC16-SM-5M	EVERTZ	5 meter MTP to LC single mode breakout cable for QSFP DD PSM8 to 8x SFP optical transceivers	2.00	\$440.00	\$880.00
SFPTR-RJ45-SER-AV	EVERTZ	1000Mbps RJ45 SFP module with SerDes interface	2.00	\$196.00	\$392.00
A-2: Routing Switcher Core Backup Subtotal:					\$118,092.00
B-1: TYPE 1 IPG FRAME					
EV6-FR+PS	EVERTZ	6RU MODULAR FRAME	1.00	\$5,030.67	\$5,030.67
EV6-FC	EVERTZ	FRAME CONTROLLER	2.00	\$1,540.00	\$3,080.00
B-1: Type 1 IPG Frame Subtotal:					\$8,110.67
B-2: TYPE 1 IPG					
EV670-X30-HW-V2	EVERTZ	NEXT GENERATION HIGH DENSITY MEDIA PROCESSING FPGA ACCELERATED HARDWARE	1.00	\$9,900.00	\$9,900.00
670IPG-X30-APP-32X	EVERTZ	Provides the ability to Encapsulate and Decapsulate 32x32 SD, HD, 3G SDI Signals to ST-2110.	1.00	\$102.67	\$102.67

PART NUMBER	MANUFACTURER	DESCRIPTION	QTY	UNIT PRICE	TOTAL PRICE
evIPG-3G	EVERTZ	IPG app support 32x 3G encap and decap	1.00	\$34,496.00	\$34,496.00
ev670-32X32-HDBNC-RP	EVERTZ	Rear plate for ev670-x30-HW. Must use with IPG apps and evVIP-SDI app. Optional for ST-2110 multiview	1.00	\$2,200.00	\$2,200.00
QSFP25G-SM-PSM4-LR-G-NFEC	EVERTZ	100G QSFP, 4-CH, MPO/APC QSFP	2.00	\$1,330.00	\$2,660.00
B-2: Type 1 IPG Subtotal:					\$49,358.67
B-3: TYPE 2 IPG					
EV670-X30-HW-V2	EVERTZ	NEXT GENERATION HIGH DENSITY MEDIA PROCESSING FPGA ACCELERATED HARDWARE	2.00	\$9,900.00	\$19,800.00
EV670-16x16-HDBNC-RP	EVERTZ	HDBNC rearplate option for ev670-X30-HW hardware	2.00	\$1,760.00	\$3,520.00
evIPG-3G-16FS	EVERTZ	IPG app support 16x Encap with Frame Sync and 16x Decap	2.00	\$39,629.33	\$79,258.66
QSFP25G-SM-PSM4-LR-G-NFEC	EVERTZ	100G QSFP, 4-CH, MPO/APC QSFP	4.00	\$1,330.00	\$5,320.00
B-3: Type 2 IPG Subtotal:					\$107,898.66
C-1: AUDIO GROOMING					
570EMR-AG-HUB	EVERTZ	TDM TO IP AUDIO GATEWAY	1.00	\$15,400.00	\$15,400.00
570FR-HF	EVERTZ	EVERTZ 3U MULTIFRAME	1.00	\$1,796.67	\$1,796.67
570FC	EVERTZ	EVERTZ VISTALINK FRAME CONTROLLER	1.00	\$952.00	\$952.00
570PS-HF	EVERTZ	EVERTZ HIGH FLOW POWER SUPPLY	1.00	\$616.00	\$616.00
SFP10G-TR13-A	EVERTZ	EVERTZ SFP+ OPTICAL TRANSCEIVER 10GBS 1310NM DFB SMF 10KM	4.00	\$435.00	\$1,740.00
C-1: Audio Grooming Subtotal:					\$20,504.67
C-2: AUDIO SHUFFLER					
570EMR-ADMX	EVERTZ	IP AUDIO ENGINE FOR MONO SUB-SYSTEMS	2.00	\$11,293.33	\$22,586.66
SFP10G-TR13-A	EVERTZ	EVERTZ SFP+ OPTICAL TRANSCEIVER 10GBS 1310NM DFB SMF 10KM	2.00	\$880.00	\$1,760.00
C-2: Audio Shuffler Subtotal:					\$24,346.66
C-3: AUDIO GATEWAY					
9821EMR-AG-HUB	EVERTZ	1RU AUDIO GATEWAY	1.00	\$22,000.00	\$22,000.00
9821EMR-IO-DANTE-64	EVERTZ	DANTE TO IP AUDIO MODULE	8.00	\$2,750.00	\$22,000.00
QSFP-10G-TR13-G	EVERTZ	EVERTZ 40G PSM LR4 10KM QSFP+ OPTICAL TRANSCEIVER	2.00	\$1,130.00	\$2,260.00
C-3: Audio Gateway Subtotal:					\$46,260.00
D-1: WEB SERVICE ROUTING CONTROL					
MAGNUM-ROUTER-VCP-WEB	EVERTZ	EVERTZ VIRTUAL CONTROL PANEL LICENCE	1.00	\$821.33	\$821.33
VUE-WEB	EVERTZ	Web based interface that provides control interfacing for routing.	1.00	\$1,129.33	\$1,129.33
MAGNUM-ANYWHERE-CLIENT	EVERTZ	Includes a one year license for one seat of VUE Anywhere client (active MAGNUM Annual Software Licen	1.00	\$1.47	\$1.47
D-1: Web Service Routing Control Subtotal:					\$1,952.13
D-2: TYPE 1 TOUCH SCREEN ROUTER CONTROL PANEL					
VUE-TOUCH2	EVERTZ	2RU full touch screen, rackmountable control panel, tailored with base VUE widgets for router, multi	1.00	\$6,038.67	\$6,038.67
VUEAPP-STUDIO-MANAGER	EVERTZ	VUE Visualization and Control for Control Room setup and Feed Management workflow functionality, inclu	1.00	\$513.33	\$513.33
D-2: Type 1 Touch Screen Router Control Panel Subtotal:					\$6,552.00
D-3: TYPE 1 XY ROUTER CONTROL PANEL					
CP-2232E	EVERTZ	EVERTZ FULL RACK WIDTH ROUTER CONTROL PANEL	1.00	\$6,570.67	\$6,570.67
D-3: Type 1 XY Router Control Panel Subtotal:					\$6,570.67
D-4: TYPE 2 XY ROUTER CONTROL PANEL					



Alpha Video & Audio, Inc.
 7690 Golden Triangle Drive
 Eden Prairie, MN 55344
 Phone: 952-896-9898 | Fax: 952-896-9899
 Visit us at www.alphavideo.com

QUOTE
19027

PART NUMBER	MANUFACTURER	DESCRIPTION	QTY	UNIT PRICE	TOTAL PRICE
CP-1024E	EVERTZ	Router control panel, shallow depth 1RU with 3 TFT LCD screens, 5 clickable rotary encoders, 24 back	12.00	\$2,002.00	\$24,024.00
D-4: Type 2 XY Router Control Panel Subtotal:					\$24,024.00
D-5: TYPE 1 BPS ROUTER CONTROL PANEL					
CP-1040E	EVERTZ	EVERTZ 1RU RACK WIDTH ROUTER CONTROL WITH 40 LCD BUTTONS	3.00	\$4,517.33	\$13,551.99
D-5: Type 1 BPS Router Control Panel Subtotal:					\$13,551.99
D-6: TYPE 1 ROUTER CONTROL SERVER					
VUE-VCS1	EVERTZ	VUE visualization and control application running on a 1RU hardware platform. - Provides a single w	1.00	\$11,806.67	\$11,806.67
SFP25G-TR13	EVERTZ	25G Optical Transceiver, 1310nm, SM, 10km, LC Connectors	2.00	\$660.00	\$1,320.00
D-6: Type 1 Router Control Server Subtotal:					\$13,126.67
E-1. PTX					
7800FR	EVERTZ	3RU Multiframe Which Holds up to 15 Single Slot Modules with AC Power Supply	1.00	\$1,694.00	\$1,694.00
7800FC+3RU	EVERTZ	EVERTZ 7700FR AND 7800FR VISTALINK FRAME CONTROLLER	1.00	\$952.00	\$952.00
7700PTX-TSL+3RU	EVERTZ	Interface to switchers supporting TSL protocol (eg. Ross Carbonite Black)	8.00	\$5,133.33	\$41,066.64
7700R-SC-BRC+3RU	EVERTZ	EVERTZ BI DIRECTION 3RD PARTY ROUTER/CONTROLLER MODULE	6.00	\$5,287.33	\$31,723.98
7700PTX-NV+3RU	EVERTZ	PTX Which Controls NVISION Based Router	2.00	\$5,133.33	\$10,266.66
E-1. PTX Subtotal:					\$85,703.28
F-1. MULTIVIEW					
EV6-FR+PS	EVERTZ	6RU MODULAR FRAME	1.00	\$5,030.67	\$5,030.67
EV6-FC	EVERTZ	FRAME CONTROLLER	2.00	\$1,540.00	\$3,080.00
EV670-X30-HW-V2	EVERTZ	NEXT GENERATION HIGH DENSITY MEDIA PROCESSING FPGA ACCELERATED HARDWARE	2.00	\$9,240.00	\$18,480.00
EVVIP-APP-100G-ST2110	EVERTZ	ST2110 INPUT MONITORING SOFTWARE LICENSE	2.00	\$102.67	\$205.34
evVIP-FK-64-IP-3G	EVERTZ	License key to enable 64 SD,HD, 3G or 16 UHD inputs on evVIP-100G	2.00	\$41,066.67	\$82,133.34
evVIP-FK-8OUT	EVERTZ	License key to enable eight outputs at 1080P. If using UHD outputs two UHD output is max per card.	2.00	\$6,981.33	\$13,962.66
evMV-FK-VIP-64MON-ADV	EVERTZ	Feature Key to enable 64 inputs advance audio, video, ancillary data monitoring	2.00	\$5,917.33	\$11,834.66
QSFP25G-SM-PSM4-LR-G-NFEC	EVERTZ	100G QSFP, 4-CH, MPO/APC QSFP	8.00	\$1,330.00	\$10,640.00
F-1. Multiview Subtotal:					\$145,366.67
F-2. MULTIVIEW HDMI CONVERTER					
SCORPION-6	EVERTZ	EVERTZ STANDALONG FRAME	3.00	\$3,901.33	\$11,703.99
SCORPION-6-PSX	EVERTZ	EVERTZ EXTERNAL POWER SUPPLY FOR SCORPION-6	3.00	\$256.67	\$770.01
MIO-HDMI-OUT-3G-SA	EVERTZ	HDMI Output Module - Supports HD/3G for use in SCORPION-2 OR SCORPION-4	18.00	\$718.67	\$12,936.06
SFP25G-TR13	EVERTZ	25G OPTICAL TRANSCEIVER, 1310NM, SM, 10KM, LC CONNECTORS	6.00	\$660.00	\$3,960.00
F-2. Multiview HDMI Converter Subtotal:					\$29,370.06
F-3. MULTIVIEW UP/DOWN TIMER					
ES 362UE	ESE	ES 302UE/Serial Output to drive Timer Slave w/ Rackmount Option	3.00	\$435.00	\$1,305.00
F-3. Multiview Up/Down Timer Subtotal:					\$1,305.00
G-1: TALLY INTERFACE					
TR-4800E	EVERTZ	1RU PHYSICAL GPI AND GPO TALLY ROUTER	1.00	\$2,823.33	\$2,823.33
TR-4800E-BHP	EVERTZ	EVERTZ 2RU BREAKOUT PANEL DB-37 TO PHOENIX CONNECTOR FOR 32 GPI AND 48 GPO	1.00	\$1,796.67	\$1,796.67
G-1: Tally Interface Subtotal:					\$4,620.00

PART NUMBER	MANUFACTURER	DESCRIPTION	QTY	UNIT PRICE	TOTAL PRICE
03.03 - ROUTING SWITCHER HOUSE Subtotal:					\$824,805.80
04.03 - TEST & MEASUREMENT HOUSE					
A-1: TYPE 1 PTP GRAND MASTER					
5700MSC-IP+2PS	EVERTZ	MASTER SYNC GENERATOR FOR AN IP OR HYBRID FACILITY WITH GPS INCLUDED.	1.00	\$10,445.00	\$10,445.00
SFP10G-TR13-A	EVERTZ	EVERTZ SFP+ OPTICAL TRANSCEIVER 10GBS 1310NM DFB SMF 10KM	2.00	\$435.00	\$870.00
A-1: Type 1 PTP Grand Master Subtotal:					\$11,315.00
B-1: TYPE 1 SYNC GENERATOR					
5700MSC-IP-BC+2PS +AUX+10GTG	EVERTZ	Master Sync Generator for an IP facility acting as a Boundary Clock via PTP from a 5700MSC-IP Grandm	2.00	\$16,880.00	\$33,760.00
SFP10G-TR13-A	EVERTZ	EVERTZ SFP+ OPTICAL TRANSCEIVER 10GBS 1310NM DFB SMF 10KM	4.00	\$435.00	\$1,740.00
B-1: Type 1 Sync Generator Subtotal:					\$35,500.00
B-2: TYPE 2 SYNC CHANGEOVER					
5700ACO	EVERTZ	EVERTZ AUTOMATIC CHANGEOVER FOR THE 5700 SERIES MASTER SYNC AND CLOCK GENERATOR	1.00	\$7,315.00	\$7,315.00
B-2: Type 2 Sync Changeover Subtotal:					\$7,315.00
C-1: TYPE 1 WAVEFORM/VECTORSCOPE					
LV5600	LEADER	LEADER WAVEFORM MONITOR MAINFRAME ONLY	4.00	\$10,100.00	\$40,400.00
LV5600-SER01	LEADER	LEADER SDI INPUTS 4 INCLUDES CLOSED CAPTIONS AND CIE DISPLAY	4.00	\$1,460.00	\$5,840.00
LV5600-SER03	LEADER	LEADER DIGITAL ANALOG AUDIO 16CH DIGITAL AEX EBU AUDIO 8 CH ANALOG AUDIO	4.00	\$2,916.00	\$11,664.00
LV5600-SER06	LEADER	IP INPUT - 25G IP Input and IP analysis (requires SFP + Transceiver x 2) **Special Promotion Pricing	4.00	\$13,830.67	\$55,322.68
LV5600-SER26	LEADER	LEADER LAYOUT CUSTOMIZABLE USER LAYOUT DISPLAY	4.00	\$1,150.67	\$4,602.68
LR2561	LEADER	LEADER RACKMOUNT ADAPTER FOR WAVEFORM MONITOR LV5600	4.00	\$580.00	\$2,320.00
LC2152	LEADER	25GbE Single type 10,000km SFP module for LV5600/LV7600/LT4610/LT4611	8.00	\$480.00	\$3,840.00
C-1: Type 1 Waveform/Vectorscope Subtotal:					\$123,989.36
D-1: TEST RASTERIZER					
LV7600	LEADER	LEADER RASTERIZER MAINFRAME ONLY	1.00	\$9,580.00	\$9,580.00
LV5600-SER01	LEADER	LEADER SDI INPUTS 4 INCLUDES CLOSED CAPTIONS AND CIE DISPLAY	1.00	\$1,460.00	\$1,460.00
LV7600-SER03	LEADER	LEADER DIGITAL ANALOG AUDIO 16 CH DIGITAL AES EBU AUDIO	1.00	\$2,916.00	\$2,916.00
LV7600-SER06	LEADER	IP INPUT - 25G IP Input and IP analysis (requires SFP + Transceiver x 2) **Special Promotion Pricing	1.00	\$13,830.67	\$13,830.67
LV7600-SER26	LEADER	LEADER LAYOUT CUSTOMIZABLE USER LAYOUT DISPLAY	1.00	\$1,150.67	\$1,150.67
LC2152	LEADER	25GbE Single type 10,000km SFP module for LV5600/LV7600/LT4610/LT4611	2.00	\$480.00	\$960.00
D-1: Test Rasterizer Subtotal:					\$29,897.34
04.03 - TEST & MEASUREMENT HOUSE Subtotal:					\$208,016.70
05.03 - VIDEO MONITORS & USER INTERFACE HOUSE					
A-1: TYPE 1 COLOR PICTURE MONITOR					
PVMX2400	SONY	24" PROFESSIONAL 4K HDR MONITOR	9.00	\$10,704.91	\$96,344.19
PVMKRX24	SONY	RACK MOUNT KIT FOR PVM-X2400	1.00	\$275.40	\$275.40
A-1: Type 1 Color Picture Monitor Subtotal:					\$96,619.59
A-2: TYPE 2 COLOR PICTURE MONITOR					
PA24AC	ASUS	ASUS 24.1IN 1920X1200 HDR LED MONITOR	26.00	\$479.99	\$12,479.74
A-2: Type 2 Color Picture Monitor Subtotal:					\$12,479.74



Alpha Video & Audio, Inc.
 7690 Golden Triangle Drive
 Eden Prairie, MN 55344
 Phone: 952-896-9898 | Fax: 952-896-9899
 Visit us at www.alphavideo.com

QUOTE

19027

PART NUMBER	MANUFACTURER	DESCRIPTION	QTY	UNIT PRICE	TOTAL PRICE
A-3: TYPE 3 COLOR PICTURE MONITOR					
FW55BZ40H	SONY	55" LED, 4K HDR, PROFESSIONAL DISPLAY	9.00	\$1,301.88	\$11,716.92
CDH-1813	LYNX TECHNIK	YELLOBRIK 3G-SDI TO HDMI CONVERTER	9.00	\$872.00	\$7,848.00
R FR 1001	LYNX TECHNIK	RFR 1001 MOUNTING BRACKET FOR SINGLE YELLOBRIK MODULE	9.00	\$37.27	\$335.43
LTM1U	CHIEF	MICRO-ADJUST TILT WALL MOUNT LARGE	8.00	\$291.84	\$2,334.72
MPAUB	CHIEF	MEDIUM FUSION CART MANUAL ADJUST BLK	1.00	\$1,067.80	\$1,067.80
A-3: Type 3 Color Picture Monitor Subtotal:					\$23,302.87
A-4: TYPE 4 COLOR PICTURE MONITOR					
FW43BZ35J	SONY	43" LED, 4K HDR, PROFESSIONAL DISPLAY	5.00	\$1,050.85	\$5,254.25
CDH-1813	LYNX TECHNIK	YELLOBRIK 3G-SDI TO HDMI CONVERTER	5.00	\$872.00	\$4,360.00
R FR 1001	LYNX TECHNIK	RFR 1001 MOUNTING BRACKET FOR SINGLE YELLOBRIK MODULE	5.00	\$37.27	\$186.35
LTM1U	CHIEF	MICRO-ADJUST TILT WALL MOUNT LARGE	5.00	\$291.84	\$1,459.20
A-4: Type 4 Color Picture Monitor Subtotal:					\$11,259.80
B-1: TYPE 1 MOUSE					
MS116-BK	DELL	OPTICAL MOUSE USB WIRED - BLK	6.00	\$23.99	\$143.94
B-1: Type 1 Mouse Subtotal:					\$143.94
B-2: TYPE 2 MOUSE					
MX ANYWHERE 2S	LOGITECH	Logitech MX ANYWHERE 2S	4.00	\$63.96	\$255.84
B-2: Type 2 Mouse Subtotal:					\$255.84
B-3: TYPE 3 MOUSE					
CH-9315411-NA	CORSAIR	Corsair Dark Core RGB Pro Wireless Gaming Mouse	2.00	\$93.32	\$186.64
B-3: Type 3 Mouse Subtotal:					\$186.64
C-1: TYPE 1 KEYBOARD					
KB212-B	DELL	KEYBOARD - BLACK - 6 FT CABLE LENGTH	4.00	\$31.32	\$125.28
C-1: Type 1 Keyboard Subtotal:					\$125.28
C-2: TYPE 2 KEYBOARD					
RM-KB-LCD17KVMHD	MIDDLE ATLANTIC	KB W/LCD DIG DSPLY & KVM	1.00	\$3,184.20	\$3,184.20
C-2: Type 2 Keyboard Subtotal:					\$3,184.20
C-3: TYPE 3 KEYBOARD					
LKB-PPROCC-BJPU	LOGITECH	Premiere Pro CC - PC Nero Slimline Keyboard	2.00	\$202.67	\$405.34
C-3: Type 3 Keyboard Subtotal:					\$405.34
05.03 - VIDEO MONITORS & USER INTERFACE HOUSE Subtotal:					\$147,963.24
06.03 - CHARACTER GENERATOR HOUSE					
A-1: TYPE 1 CG PCR 1					
XST3-0001	ROSS VIDEO	XPRESSION STUDIO STANDARD EDITION (SW ONLY)	1.00	\$36,482.60	\$36,482.60
XST-DLQ	ROSS VIDEO	DATALINQ SERVER OPTION	1.00	\$5,345.20	\$5,345.20
XPN-1RU-IP-M8	ROSS VIDEO	XPRESSION 1RU IP W 2X 25G SFP CAGES CHASSIS (HW ONLY)	1.00	\$18,570.20	\$18,570.20
ALPHA-ALLOWANCE-ENG	ALPHA	ALPHA ENGINEERING ALLOWANCE FOR 25GB SFP'S	1.00	\$2,666.67	\$2,666.67
A-1: Type 1 CG PCR 1 Subtotal:					\$63,064.67
A-2: TYPE 1 CG PCR 2					
XST3-0001	ROSS VIDEO	XPRESSION STUDIO STANDARD EDITION (SW ONLY)	1.00	\$36,482.60	\$36,482.60
XST-DLQ	ROSS VIDEO	DATALINQ SERVER OPTION	1.00	\$5,345.20	\$5,345.20



Alpha Video & Audio, Inc.
 7690 Golden Triangle Drive
 Eden Prairie, MN 55344
 Phone: 952-896-9898 | Fax: 952-896-9899
 Visit us at www.alphavideo.com

QUOTE
19027

PART NUMBER	MANUFACTURER	DESCRIPTION	QTY	UNIT PRICE	TOTAL PRICE
XPN-1RU-IP-M8	ROSS VIDEO	XPRESSION 1RU IP W 2X 25G SFP CAGES CHASSIS (HW ONLY)	1.00	\$18,570.20	\$18,570.20
ALPHA-ALLOWANCE-ENG	ALPHA	ALPHA ENGINEERING ALLOWANCE FOR 25GB SFP'S	1.00	\$2,666.67	\$2,666.67
A-2: Type 1 CG PCR 2 Subtotal:					\$63,064.67
A-2: TYPE 4 KEYBOARD					
XPN-KBD	ROSS VIDEO	XPRESSION CUSTOM KEYBOARD	1.00	\$1,439.80	\$1,439.80
A-2: Type 4 Keyboard Subtotal:					\$1,439.80
B-1: SOCIAL MEDIA INTEGRATION					
INC-SW-SOCIAL	ROSS VIDEO	INCEPTION SOCIAL - SOFTWARE	1.00	\$10,580.00	\$10,580.00
INC-EXP-USER-INCL	ROSS VIDEO	INCEPTION CONCURRENT USER	5.00	\$0.00	\$0.00
INC-EXP-SOCIAL-INCL	ROSS VIDEO	INCEPTION SOCIAL MEDIA ACCOUNT LICENSE	10.00	\$0.00	\$0.00
INC-HW-SERVER-G4-W-SE	ROSS VIDEO	INCEPTION - SERVER HARDWARE (4TH GENERATION / WINDOWS)	1.00	\$8,725.00	\$8,725.00
B-1: Social Media Integration Subtotal:					\$19,305.00
B-2: TYPE 4 KEYBOARD					
XPN-KBD	ROSS VIDEO	XPRESSION CUSTOM KEYBOARD	1.00	\$1,439.80	\$1,439.80
B-2: Type 4 Keyboard Subtotal:					\$1,439.80
C-1: TYPE 1 CG SERVER					
XPN-GW-HW-SW-M8	ROSS VIDEO	XPRESSION GATEWAY WITH OFFLINE RENDER ENGINE (SW+HW)	1.00	\$21,288.80	\$21,288.80
XPN-PS	ROSS VIDEO	XPRESSION PROJECT SERVER (SW ONLY)	1.00	\$10,690.40	\$10,690.40
XPN-INC	ROSS VIDEO	XPRESSION INCODER (SW ONLY)	1.00	\$5,345.20	\$5,345.20
XPN-HW-CORE-PLUS-V2	ROSS VIDEO	XPRESSION CORE WORKFLOW TOOLS HARDWARE CHASSIS WITH ENHANCED RENDERING (HW ONLY)	1.00	\$9,581.80	\$9,581.80
C-1: Type 1 CG Server Subtotal:					\$46,906.20
06.03 - CHARACTER GENERATOR HOUSE Subtotal:					\$195,220.14
07.03 - INGEST & PLAYOUT HOUSE					
A-1: TYPE 1 INGEST & PLAYOUT					
GVIO-HW-SV-01-HD	GRASS VALLEY	I/O TURNKEY SERVER FOR HD WORKFLOWS, SUPPORTS UP TO 4 CHANNELS	4.00	\$13,702.33	\$54,809.32
GVIO-SW-HD	GRASS VALLEY	I/O SOFTWARE, REQUIRED FOR THE GVIO-HW-SV-01-HD	4.00	\$16,294.67	\$65,178.68
GVIO-SW-SN-LAN	GRASS VALLEY	STORNEXT DLC LICENCE REQUIRED TO ADD GV I/O TO A NEW K2 SAN	4.00	\$2,222.00	\$8,888.00
GVIO-HW-CX6	Grass Valley	ConnectX-6 NIC - Dual 25G/10G Mellanox IP interface Card	4.00	\$1,322.20	\$5,288.80
		<i>Required for all GV I/O 2110 IP Servers. Requires GV I/O-SW and 10G or 25G SFP Modules. Must use 25G SFP for UHD. Includes Rivermax license and silver 1 year support</i>			
GVIO-HW-SFP-10G	Grass Valley	x2 10GbE SFP Modules required for Mellanox card	4.00	\$124.67	\$498.68
GVIO-SW-IP-CH	Grass Valley	GVIO per channel IP License - for HD only	16.00	\$1,414.00	\$22,624.00
A-1: Type 1 Ingest & Playout Subtotal:					\$157,287.48
B-1: NETWORK ATTACHED STORAGE					
AMS-EXPR-8T-PRI	GRASS VALLEY	AMS EXPRESS PRIMARY CHASSIS, (96TB RAW)	1.00	\$36,666.67	\$36,666.67
AMS-EXPR-8T-EX	GRASS VALLEY	AMS EXPRESS EXPANSION CHASSIS, (96TB RAW)	2.00	\$16,133.33	\$32,266.66
AMS-EXPR-RVM-SW	GRASS VALLEY	REDUNDANT FILE SYSTEM MANAGER FOR AMS EXPRESS	1.00	\$0.00	\$0.00
K2-SWE-24-D-5	GRASS VALLEY	MANAGED GIGE SWITCH,-24 PORT, (DELL N1524)	2.00	\$2,895.20	\$5,790.40
K2-SWE-RD-D-5	GRASS VALLEY	EXTERNAL REDUNDANT POWER SUPPLY FOR K2-SWE-XX-D5 GIGE SWITHES	2.00	\$1,229.80	\$2,459.60



Alpha Video & Audio, Inc.
 7690 Golden Triangle Drive
 Eden Prairie, MN 55344
 Phone: 952-896-9898 | Fax: 952-896-9899
 Visit us at www.alphavideo.com

QUOTE
19027

PART NUMBER	MANUFACTURER	DESCRIPTION	QTY	UNIT PRICE	TOTAL PRICE
MISC	ALPHA	SFP'S AND FIBER CABLES (4SFP CABLES, TWO FOR EACH NODE)	1.00	\$4,000.00	\$4,000.00
B-1: Network Attached Storage Subtotal:					\$81,183.33
C-1: STRATUS CORE					
STRATUS-CSA1-SW	GRASS VALLEY	STRATUS Core A1 Software License - Supports up to 50 clients	1.00	\$19,072.53	\$19,072.53
STRATUS-CS-FT-HW	GRASS VALLEY	HARDWARE PLATFORM SUPPORTING GV STRATUS FAULT TOLERANT CORE SERVICES PACKAGE	1.00	\$51,329.67	\$51,329.67
STRATUS-CSGVRE-HW	GRASS VALLEY	HARDWARE PLATFORM SUPPORTING A GV STRATUS FAULT TOLERANT CORE SERVICES PACKAGE	3.00	\$7,247.53	\$21,742.59
STRATUS-CSGVRE-SW	GRASS VALLEY	GV STRATUS RENDER ENGINE SOFTWARE LICENSE	3.00	\$7,628.87	\$22,886.61
STRATUS-ARCHIVE-A1	GRASS VALLEY	STRATUS ARCHIVE RESTORE SITE LICENSE FOR STRATUS CORE SERVICES	1.00	\$10,277.67	\$10,277.67
C-1: Stratus Core Subtotal:					\$125,309.07
D-1: EDIUS SOFTWARE					
647259	GRASS VALLEY	GRASS VALLEY EDIUS WORKGROUP 9 JUMP UPGRADE FROM EDIUS 2-7 AND EDIUS PRO 8	2.00	\$365.93	\$731.86
647273	GRASS VALLEY	STRATUS CONNECT FOR EDIUS WORKGROUP 9 (SERIAL KEY) ALSO INCLUDES ONE STRATUS EXPRESS LICENCE	2.00	\$0.00	\$0.00
STRA-PREM-CONNECT	GRASS VALLEY	ADOBE PLUG IN TO ACCESS GV STRATUS	2.00	\$2,829.87	\$5,659.74
		- Requires the V drive mounted to access material - Plug-in uses a GV STRATUS License - This nomenclature includes the SNFS license and a GV STRATUS Express license			
D-1: Edius Software Subtotal:					\$6,391.60
07.03 - INGEST & PLAYOUT HOUSE Subtotal:					\$370,171.48
08.03 - KVM MATRIX & INTERFACES HOUSE					
A-1: KVM MATRX					
ASP-001-US	ADDER	ADDERLINK INFINITY MANAGER DEVICE - SUPPORTS 24 END POINTS	2.00	\$3,736.00	\$7,472.00
AIMLIC-192-BCK	ADDER	ADDERLINK INFINITY AIM SOFTWARE LICENCES FOR PRIMARY AND FAILOVER UNITS 192 ENDPOINTS	1.00	\$10,100.00	\$10,100.00
SFP-SM-LC	ADDER	SFP SINGLE MODE FIBRE MODULE LC CONNECTION	4.00	\$80.00	\$320.00
A-1: KVM Matrx Subtotal:					\$17,892.00
A-2: KVM TRANSMITTER					
ALIF4021T-US	ADDER	ADDERLINK INFINITY DUAL HEAD 4K 10GBE TRANSMITTER	20.00	\$2,196.00	\$43,920.00
SFP-SM-LC-10G	ADDER	10GBE SFP SINGLE MODE FIBRE MODULE LC CONNECTION	20.00	\$104.00	\$2,080.00
RMK12	ADDER	RACKMOUNT KIT FOR ALIF4000 SERIES, ASP-001 AIM AND ALIF3000	10.00	\$154.40	\$1,544.00
RMK12-BP	ADDER	RMK12 BLANKING PLATE	10.00	\$20.00	\$200.00
CHD-1812	LYNX TECHNIK	3G HDMI TO SDI CONVERTER WITH FRAME SYNCHRONIZER	1.00	\$977.33	\$977.33
A-2: KVM Transmitter Subtotal:					\$48,721.33
A-3: KVM RECEIVER					
ALIF4021R-US	ADDER	ADDERLINK INFINITY DUAL HEAD 4K 10GBE RECEIVER	10.00	\$2,196.00	\$21,960.00
SFP-SM-LC-10G	ADDER	10GBE SFP SINGLE MODE FIBRE MODULE LC CONNECTION	10.00	\$104.00	\$1,040.00
RMK12	ADDER	RACKMOUNT KIT FOR ALIF4000 SERIES, ASP-001 AIM AND ALIF3000	10.00	\$154.40	\$1,544.00
RMK12-BP	ADDER	RMK12 BLANKING PLATE	20.00	\$20.00	\$400.00
A-3: KVM Receiver Subtotal:					\$24,944.00



Alpha Video & Audio, Inc.
 7690 Golden Triangle Drive
 Eden Prairie, MN 55344
 Phone: 952-896-9898 | Fax: 952-896-9899
 Visit us at www.alphavideo.com

QUOTE

19027

PART NUMBER	MANUFACTURER	DESCRIPTION	QTY	UNIT PRICE	TOTAL PRICE
A-4: KVM SWITCH					
XSM4348FS-100NES	NETGEAR	NETGEAR XSM4348FS ETHERNET SWITCH - 48SFP+, 2 10GBASE-T SHARED - MANAGEABLE 3 LAYER SUPPORTED - MO	1.00	\$5,234.67	\$5,234.67
APS250W-100NES	NETGEAR	NETGEAR APS250W POWER SUPPLY UNIT - 120 V AC, 230 V AC UNIT, 250W AC	1.00	\$258.29	\$258.29
AXM761-AO	ADDON (NETGEAR)	ADDON NETGEAR AMX761 COMPATIBLE SFP+ TRANSCEIVER-SFP+	48.00	\$232.69	\$11,169.12
A-4: KVM Switch Subtotal:					\$16,662.08
08.03 - KVM MATRIX & INTERFACES HOUSE Subtotal:					\$108,219.41
10.03 - DISTRIBUTION & SIGNAL PROCESSING HOUSE					
A-1: SPARE POWER SUPPLY					
PS-OGX	ROSS VIDEO	600 WATT UNIVERSAL POWER SUPPLY FOR OGX FRAME	6.00	\$687.24	\$4,123.44
A-1: Spare Power Supply Subtotal:					\$4,123.44
A-1: TYPE 1 DISTRIBUTION FRAME					
OGX-FR-CN	ROSS VIDEO	OPENGEAR OGX FRAME WITH COOLING AND ADVANCED NETWORKING	6.00	\$2,078.28	\$12,469.68
A-1: Type 1 Distribution Frame Subtotal:					\$12,469.68
B-1: TYPE 1 SDA					
SRA-8901-4-R3S	ROSS VIDEO	12G/6G/3G/HD/SD/MADI DISTRIBUTION AMPLIFIER 1 IN / 4 OUT WITH SPLIT REAR MODULE	10.00	\$562.12	\$5,621.20
SRA-8901-4	ROSS VIDEO	12G/6G/3G/HD/SD/MAD DISTRIBUTION AMPLIFIER 1 IN / 4 OUT	20.00	\$482.08	\$9,641.60
B-1: Type 1 SDA Subtotal:					\$15,262.80
C-1: TYPE 1 VDA					
UDA-8705A-R2L	ROSS VIDEO	Ross Utility DA, 1x8, Looping Input	10.00	\$404.80	\$4,048.00
C-1: Type 1 VDA Subtotal:					\$4,048.00
D-1: TYPE 1 EMBEDDER/DE-EMBEDDER					
AMX-8952-C	ROSS VIDEO	HD/3G/12G-SDI EMBEDDER/DE-EMBEDDER, ANALOG AUDIO	16.00	\$1,517.08	\$24,273.28
R3C-8952	ROSS VIDEO	REAR MODULE FOR AMX-8952-C	16.00	\$138.00	\$2,208.00
AMX-8952-FS-LICENSE	ROSS VIDEO	ROSS FRAME SYNC LICENCE FOR AMX-8952	16.00	\$460.00	\$7,360.00
D-1: Type 1 Embedder/De-Embedder Subtotal:					\$33,841.28
E-1: TYPE 1 UDX					
GATOR-TOOLBOX	ROSS VIDEO	GATOR SINGLE CHANNEL UHD TOOLBOX	4.00	\$920.00	\$3,680.00
GATOR-TOOLBOX-12G-LICENSE	ROSS VIDEO	UHD FORMAT SUPPORT TO GATOR-TOOLBOX	4.00	\$920.00	\$3,680.00
GATOR-FRC-LICENSE	ROSS VIDEO	GATOR FRAME RATE CONVERSION SW LICENSE FOR GATOR-TOOLBOX	4.00	\$2,300.00	\$9,200.00
GATOR-2	ROSS VIDEO	GATOR 12G-SDI 2-SLOT CARD (6-SDI-IN / 6-SDI-OUT)	4.00	\$2,760.00	\$11,040.00
R4-GATOR	ROSS VIDEO	12G-SDI 2-SLOT OGX REAR MODULE FOR GATOR	4.00	\$459.08	\$1,836.32
E-1: Type 1 UDX Subtotal:					\$29,436.32
F-1: TYPE 1 SCAN CONVERTER					
R9004677	BARCO	IMAGEPRO II SCAN CONVERTER & PROCESSOR	2.00	\$6,753.33	\$13,506.66
F-1: Type 1 Scan Converter Subtotal:					\$13,506.66
F-2: TYPE 1 SCAN CONVERTER IO PLATE					
ALPHA-ALLOWANCE-ENG	ALPHA	ALPHA ENGINEERING ALLOWANCE FOR SCAN CONVERTER IO PLATE	2.00	\$333.33	\$666.66
F-2: Type 1 Scan Converter IO PLATE Subtotal:					\$666.66
G-1: TYPE 1 FIBER OPTIC TRANSMITTER					
OTT-1842	LYNX TECHNIK	Dual 3G SDI to Fiber Optic Transmitter - (CWDM)	5.00	\$614.33	\$3,071.65

PART NUMBER	MANUFACTURER	DESCRIPTION	QTY	UNIT PRICE	TOTAL PRICE
G-1: Type 1 Fiber Optic Transmitter Subtotal:					\$3,071.65
G-2: TYPE 2 FIBER OPTIC TRANSMITTER					
OTX-1712	LYNX TECHNIK	Analog Sync / Video Fiber Optic Transmitter	5.00	\$982.67	\$4,913.35
G-2: Type 2 Fiber Optic Transmitter Subtotal:					\$4,913.35
G-3: TYPE 1 FIBER OPTIC RECEIVER					
ORX-1802	LYNX TECHNIK	3G Fiber Optic to SDI Receiver	5.00	\$633.33	\$3,166.65
G-3: Type 1 Fiber Optic Receiver Subtotal:					\$3,166.65
G-4: TYPE 2 FIBER OPTIC RECEIVER					
ORX-1702	LYNX TECHNIK	Analog Sync / Video Fiber Optic Receiver	5.00	\$982.67	\$4,913.35
G-4: Type 2 Fiber Optic Receiver Subtotal:					\$4,913.35
H-1: TYPE 1 HDMI CONVERTER					
CDH-1813	LYNX TECHNIK	YELLOBRIK 3G-SDI TO HDMI CONVERTER	5.00	\$872.00	\$4,360.00
H-1: Type 1 HDMI Converter Subtotal:					\$4,360.00
H-2: TYPE 2 HDMI CONVERTER					
CHD-1812	LYNX TECHNIK	3G HDMI TO SDI CONVERTER WITH FRAME SYNCHRONIZER	5.00	\$977.33	\$4,886.65
H-2: Type 2 HDMI Converter Subtotal:					\$4,886.65
I-1: TYPE 1 MEDIA CONVERTER					
OET 1510	LYNX TECHNIK	LYNX TECHNIK YELLOBRIK OET 1510 FIBER TO ETHERNET TRANSCEIVER SWITCH	5.00	\$596.57	\$2,982.85
I-1: Type 1 Media Converter Subtotal:					\$2,982.85
10.03 - DISTRIBUTION & SIGNAL PROCESSING HOUSE Subtotal:					\$141,649.34
11.03 - AUDIO, TIME CODE, CONTROL HOUSE					
A-1: TYPE 1 MIXING CONSOLE					
AH-SQ-5	ALLEN & HEATH	96KHZ XCVI FPGA PROCESSING, 48 INPUT CHANNELS, DEEP PROCESSING, 17 FADERS / 6 LAYERS, 16 ONBOARD PRE	2.00	\$3,957.77	\$7,915.54
AH-M-SQ-SDANTE64-A	ALLEN & HEATH	64 X 64 DANTE CARD FOR SQ / AHM SERIES, 96KHZ / 48KHZ	2.00	\$1,016.67	\$2,033.34
A-1: Type 1 Mixing Console Subtotal:					\$9,948.88
A-2: TYPE 1 STAGE BOX					
AH-DT168	ALLEN & HEATH	16IN X 8OUT DANTE AUDIO EXPANDER WITH DLIVE 96KHZ MIC PREAMPS, 48KHZ / 96KHZ	1.00	\$2,500.76	\$2,500.76
AH-AB-168-RK19	ALLEN & HEATH	OPTIONAL RACK MOUNT KIT FOR AB168, DX168, DT168	1.00	\$98.27	\$98.27
1SKB-R6UW	SKB	6U SPACE RACK STACKS W/ROTO RACKS, WHEELS, AND HANDLE	1.00	\$293.41	\$293.41
PD-815R-PL	MIDDLE ATLANTIC	POWER CENTER W/PILOT LT	1.00	\$126.00	\$126.00
A-2: Type 1 Stage Box Subtotal:					\$3,018.44
B-1: TYPE 1 SPEAKER					
8030CP	GENELEC	GENELEC 8030C ACTIVE TWO WAY 5IN 60W STUDIO MONITOR SINGLE	12.00	\$820.24	\$9,842.88
8000-402B	GENELEC	GENELEC 8000-402B ADJ WALL BRACKET FOR 8000 SERIES BLACK	12.00	\$129.77	\$1,557.24
B-1: Type 1 Speaker Subtotal:					\$11,400.12
B-2: TYPE 2 SPEAKER					
8040BPM	GENELEC	Genelec 8040B 6.5" 2-Way 180W Active Studio Monitor	1.00	\$1,336.12	\$1,336.12
8000-446B	GENELEC	Truss mount kit with an adjustable length feature.	1.00	\$470.24	\$470.24
8000-444B	GENELEC	Long adjustable ceiling mount	1.00	\$470.24	\$470.24
B-2: Type 2 Speaker Subtotal:					\$2,276.60



Alpha Video & Audio, Inc.
 7690 Golden Triangle Drive
 Eden Prairie, MN 55344
 Phone: 952-896-9898 | Fax: 952-896-9899
 Visit us at www.alphavideo.com

QUOTE
19027

PART NUMBER	MANUFACTURER	DESCRIPTION	QTY	UNIT PRICE	TOTAL PRICE
C-1: TYPE 1 AUDIO IO INTERFACE					
AMS-REDNET-A16R-MKII	FOCUSRITE	FOCUSRITE REDNET 16 CHANNEL 24/192 ANALOGUE DANTE I/O INTERFACE WITH LEVEL CONTROL	2.00	\$4,399.99	\$8,799.98
C-1: Type 1 Audio IO Interface Subtotal:					\$8,799.98
C-2: TYPE 1 MADI TO DANTE CONVERTER					
AMS-REDNET-D64R	FOCUSRITE	64 CHANNEL MADI DANTE I/O INTERFACE WITH REDUNDANT NETWORK & POWER	2.00	\$3,999.99	\$7,999.98
C-2: Type 1 MADI to Dante Converter Subtotal:					\$7,999.98
D-1: TYPE 1 MIC RECEIVER					
AD4QUS=-A	SHURE	Shure Axient Digital Wireless Receiver, Four-Channel	1.00	\$6,344.73	\$6,344.73
UA8100	SHURE	100' UHF REMOTE ANTENNA EXTENSION CABLE, BNC-BNC, RG213/U TYPE	1.00	\$244.47	\$244.47
UA874US	SHURE	ACTIVE DIRECTIONAL ANTENNA WITH GAIN SWITCH 470-698 MHZ	1.00	\$358.47	\$358.47
A13HDB	SHURE	MOUNTING FLANGE, HEAVY DUTY, BLACK	1.00	\$12.67	\$12.67
MAC-1	ATLAS SOUND	Microphone Adapter Clamp	1.00	\$29.79	\$29.79
AD19BE	ATLAS SOUND	Extension Tube 45° Angle Tube; 5/8 inch #27 Thread Ebony	1.00	\$18.73	\$18.73
D-1: Type 1 MIC Receiver Subtotal:					\$7,008.86
D-2: TYPE 1 MIC TRANSMITTER					
AD1=-G57	SHURE	Shure Axient Digital Belt Pack Transmitter	4.00	\$8,843.60	\$35,374.40
4060-OC-C-B00	DPA	4060 CORE OMNI MIC, NORMAL SPL, BLACK, MICRODOT	4.00	\$512.00	\$2,048.00
SCM0013-B	DPA	4-WAY CLIP FOR D:SCREET, BLACK	4.00	\$24.53	\$98.12
DUA0560	DPA	FOAM WINDSCREEN FOR D:SCREET	4.00	\$33.07	\$132.28
DAD6010	DPA	MICROPHONE ADAPTER FOR SHURE AXIENT	4.00	\$106.67	\$426.68
D-2: Type 1 MIC Transmitter Subtotal:					\$38,079.48
D-3: TYPE 1 MIC BATTERY CHARGER					
SB900B	SHURE	RECHARGEABLE BATTERY	8.00	\$101.33	\$810.64
SBC800-US	SHURE	8-BAY SHURE BATTERY CHARGER	1.00	\$466.13	\$466.13
D-3: Type 1 MIC Battery Charger Subtotal:					\$1,276.77
E-1: TYPE 1 IFB TRANSMITTER					
P10T=-X55	SHURE	DUAL TRANSMITTER FOR SHURE PSM 1000 PERSONAL MONITOR SYSTEM	1.00	\$3,059.00	\$3,059.00
UA8100	SHURE	100' UHF REMOTE ANTENNA EXTENSION CABLE, BNC-BNC, RG213/U TYPE	1.00	\$244.47	\$244.47
PA805X	SHURE	PASSIVE DIRECTIONAL ANTENNA (944-952 MHZ)	1.00	\$264.73	\$264.73
A13HDB	SHURE	MOUNTING FLANGE, HEAVY DUTY, BLACK	1.00	\$12.67	\$12.67
MAC-1	ATLAS SOUND	Microphone Adapter Clamp	1.00	\$29.79	\$29.79
AD19BE	ATLAS SOUND	Extension Tube 45° Angle Tube; 5/8 inch #27 Thread Ebony	1.00	\$18.73	\$18.73
E-1: Type 1 IFB Transmitter Subtotal:					\$3,629.39
E-2: TYPE 1 IFB RECEIVER					
P10R+=-X55	SHURE	DIVERSITY BODYPACK RECEIVER FOR SHURE PSM 1000 PERSONAL MONITOR SYSTEM	4.00	\$865.13	\$3,460.52
V1-10437	OTTO ENGINEERING	IFB EARPIECE SET, BEIGE	4.00	\$71.93	\$287.72
E-2: Type 1 IFB Receiver Subtotal:					\$3,748.24
E-3: TYPE 1 IFB BATTERY CHARGER					
SB900B	SHURE	RECHARGEABLE BATTERY	8.00	\$101.33	\$810.64
SBC800-US	SHURE	8-BAY SHURE BATTERY CHARGER	1.00	\$466.13	\$466.13



Alpha Video & Audio, Inc.
 7690 Golden Triangle Drive
 Eden Prairie, MN 55344
 Phone: 952-896-9898 | Fax: 952-896-9899
 Visit us at www.alphavideo.com

QUOTE

19027

PART NUMBER	MANUFACTURER	DESCRIPTION	QTY	UNIT PRICE	TOTAL PRICE
E-3: Type 1 IFB Battery Charger Subtotal:					\$1,276.77
F-1: TIME CODE DISTRIBUTION AMPLIFIER					
ADA-8405-C-R2C	ROSS VIDEO	Ross Dual 1x4 Audio DA	5.00	\$421.36	\$2,106.80
F-1: Time Code Distribution Amplifier Subtotal:					\$2,106.80
F-2: WORD CLOCK SYNTHESIZER					
WDA-8409-R2L	ROSS VIDEO	WORD CLOCK DISTRIBUTION AMPLIFIER W/LOOPING REAR MODULE	1.00	\$546.48	\$546.48
F-2: Word Clock Synthesizer Subtotal:					\$546.48
G-1: TYPE 1 AUDIO MONITOR					
iAM1-8	WOHLER	1RU TRIPLE SCREEN, 8 CHANNEL DUAL INPUT, 3G/HD/SD-SDI, AUDIO MONITOR WITH TOUCH SCREEN CONTROL. INCL	9.00	\$3,995.00	\$35,955.00
SFP-2110 w/NMOS	WOHLER	SMPTE 2110 RECEIVER; MULTI-MODE 850 NM, LC (FIBER) CONNECTORS. SFP MODULE WITH SOFTWARE ACTIVATION K	9.00	\$1,995.00	\$17,955.00
OPT-DANTE	WOHLER	ENABLE MONITORING FROM UP TO A 64CH DANTE INPUT. HARDWARE CARD WITH SOFTWARE ACTIVATION KEY.	9.00	\$895.00	\$8,055.00
G-1: Type 1 Audio Monitor Subtotal:					\$61,965.00
G-2: TYPE 1 VOLUME CONTROLLER					
AMS-REDNET-AM2	FOCUSRITE	STEREO HEADPHONE/LINE OUT DANTE INTERFACE WITH POE	3.00	\$699.99	\$2,099.97
G-2: Type 1 Volume Controller Subtotal:					\$2,099.97
11.03 - AUDIO, TIME CODE, CONTROL HOUSE Subtotal:					\$165,181.76
12.03 - INTERCOM HOUSE					
A-1: TYPE 1 INTERCOM MATRIX					
ODIN32NOCORD	RTS	ODIN 32 PORT MATRIX NO CORD	1.00	\$18,652.80	\$18,652.80
ODIN16PORTUPG	RTS	ODIN 16 PORT UPGRADE - PRODUCT MAC ID AND EMAIL ADDRESS MUST BE ISSUED FOR DELIVERY OF SOFTWARE PROD	1.00	\$6,973.87	\$6,973.87
A-1: Type 1 Intercom Matrix Subtotal:					\$25,626.67
B-1: TYPE 1 INTERCOM PANEL					
F.01U.298.698	RTS	14 POSITION KEY PANEL WITH MENUS AND PROGRAMMING KEYPAD, EXTENDED DSP FUNCTIONS, 2 FULL HD COLOUR DI	10.00	\$4,059.73	\$40,597.30
B-1: Type 1 Intercom Panel Subtotal:					\$40,597.30
B-2: TYPE 2 INTERCOM PANEL					
DKP4016	RTS	16 LEVER DESK TOP KEY PANEL	2.00	\$4,892.80	\$9,785.60
B-2: Type 2 Intercom Panel Subtotal:					\$9,785.60
C-1: WIRELESS INTERCOM MATRIX					
AP-1800	RTS	ACCESS POINT 1.92-1.93 GHZ	4.00	\$2,578.13	\$10,312.52
ALPHA-ALLOWANCE-ENG	ALPHA	ALPHA ENGINEERING ALLOWANCE FOR POE 12V Power Adapter for AP-1800	4.00	\$133.33	\$533.32
TR-1800	RTS	BELTPACK 1.92-1.93 GHZ. CONNECTOR TYPE A5F.	4.00	\$2,073.60	\$8,294.40
C-1: Wireless Intercom Matrix Subtotal:					\$19,140.24
D-1: TYPE 1 INTERCOM INTERFACE					
TIF-PRO2	RTS	Interfaces SIP Interface 2 Channels	2.00	\$4,545.07	\$9,090.14
TIF-PRO2 PSTN	RTS	Interfaces TIF-PRO 2 PSTN 2-Channels Upgrade	2.00	\$533.33	\$1,066.66
D-1: Type 1 Intercom Interface Subtotal:					\$10,156.80
E-1: TYPE 1 HEADSET					
PH-88R5	RTS	PH-88, SINGLE-SIDED LIGHTWEIGHT HEADSET, 6' (18M) CORD, A5M CONNECTOR	12.00	\$213.36	\$2,560.32



Alpha Video & Audio, Inc.
 7690 Golden Triangle Drive
 Eden Prairie, MN 55344
 Phone: 952-896-9898 | Fax: 952-896-9899
 Visit us at www.alphavideo.com

QUOTE

19027

PART NUMBER	MANUFACTURER	DESCRIPTION	QTY	UNIT PRICE	TOTAL PRICE
E-1: Type 1 Headset Subtotal:					\$2,560.32
12.03 - INTERCOM HOUSE Subtotal:					\$107,866.93
13.03 - UTILITY COMPUTERS HOUSE					
A-1: TYPE 1 UTILITY COMPUTER					
Precision 3460	DELL	DELL CUSTOM (QUOTE # 1003176769803)	5.00	\$1,887.93	\$9,439.65
A-1: Type 1 Utility Computer Subtotal:					\$9,439.65
A-2: TYPE 2 UTILITY COMPUTER					
Precision 3930	DELL	DELL CUSTOM (QUOTE # 1003176769803)	2.00	\$2,317.37	\$4,634.74
		Guardian VM - Control Point PC			
A-2: Type 2 Utility Computer Subtotal:					\$4,634.74
A-3: TYPE 3 UTILITY COMPUTER					
PowerEdge R7525	DELL	Dell Custom PowerEdge R7525 Rack Server	4.00	\$10,000.00	\$40,000.00
A-3: Type 3 Utility Computer Subtotal:					\$40,000.00
A-4: TYPE 4 UTILITY COMPUTER					
Z3Z16AV_1	HP	HP Z8 G4 WORKSTATION- SINGLE UNIT (TOWER) PACKAGING	4.00	\$18,279.47	\$73,117.88
		Windows 10 Pro for Workstations 2x Intel Xeon Gold 6242R Processor - 20 Cores, 3.10GHz, 35.75MB Cache 6x 16GB (96GB) 2666MHz DDR4 ECC Registered DIMM Module 1x TB HP Z Turbo Drive TLC M.2 SSD 9.5mm DVD-Writer 1st Optical Disc Drive USB Business Slim Wired Keyboard Wired Optical USB Mouse			
A-4: Type 4 Utility Computer Subtotal:					\$73,117.88
B-1: TYPE 1 GRAPHICS CARD					
VCNT1000-SB	NVIDIA	RTX T1000 GRAPHICS CARD 4GB ECC GDDR6, 4X DISPLAY PORT	4.00	\$450.25	\$1,801.00
B-1: Type 1 Graphics Card Subtotal:					\$1,801.00
B-2: TYPE 2 GRAPHICS CARD					
VCNRTXA6000-PB	NVIDIA	RTX A6000 GRAPHICS CARD 48GB ECC GDD46, 4X DISPLAY PORT	4.00	\$6,369.05	\$25,476.20
B-2: Type 2 Graphics Card Subtotal:					\$25,476.20
C-1: TYPE 1 NETWORK INTERFACE CARD					
FFRM-N311-000	ATTO TECH	SINGLE CHANNEL 10/25/40/50/100GBE X16 PCIE 3.0, LOW PROFILE, INTEGRATED QSFP28	4.00	\$2,564.52	\$10,258.08
C-1: Type 1 Network Interface Card Subtotal:					\$10,258.08
D-1: TYPE 1 AV I/O CARD					
KONA-4-R0	AJA	4K/2K/3G/DUAL LINK/HD/SD I/O, 10-BIT PCIE CARD, HDMI OUTPUT WITH HFR SUPPORT	4.00	\$2,042.11	\$8,168.44
K3G-BOX-R0	AJA	1RU EXTERNAL BREAKOUT BOX FOR KONA 4	4.00	\$584.11	\$2,336.44
K3G-BOX-CBL	AJA	KONA 4 CABLE FOR THE K3G-BOX	4.00	\$89.11	\$356.44
D-1: Type 1 AV I/O Card Subtotal:					\$10,861.32
E-1: TYPE 1 TOUCH TABLET					
PTH660	WACOM	INTUOS PRO MEDIUM PEN& GRAPHIC TOUCH ART TABLET	4.00	\$399.93	\$1,599.72
E-1: Type 1 Touch Tablet Subtotal:					\$1,599.72
13.03 - UTILITY COMPUTERS HOUSE Subtotal:					\$177,188.59
14.03 - ARCHIVE HOUSE					
A-1: TYPE 1 LTO LIBRARY					
900362-16-1	QUALSTAR	Q40 LIBRARY W/1 LTO-8 SAS DRIVE	1.00	\$9,640.00	\$9,640.00



Alpha Video & Audio, Inc.
 7690 Golden Triangle Drive
 Eden Prairie, MN 55344
 Phone: 952-896-9898 | Fax: 952-896-9899
 Visit us at www.alphavideo.com

QUOTE

19027

PART NUMBER	MANUFACTURER	DESCRIPTION	QTY	UNIT PRICE	TOTAL PRICE
800-0030-0	QUALSTAR	TAPE DRIVE ASSEMBLY IBM LTO8 SAS	1.00	\$5,920.00	\$5,920.00
802-0061-1	QUALSTAR	Q40 AND EXPANSION CABINET POWER SUPPLY	1.00	\$573.33	\$573.33
738-0166-4	QUALSTAR	MINISAS 2X DUAL CABLE 5 METER	1.00	\$353.33	\$353.33
646-0080-2	QUALSTAR	TAPE CARTRIDGE LTO-8 SINGLE	40.00	\$102.67	\$4,106.80
A-1: Type 1 LTO Library Subtotal:					\$20,593.46
B-1: TYPE 1 CONTENT MANAGEMENT					
DIVA-LIC0048	TELESTREAM	DIVA CORE SYSTEM INCLUDES 1 DIVA CORE, 1 DATA HUB, 1 DIVA LINK, 500TB OF STORAGE	1.00	\$30,000.00	\$30,000.00
DIVA-LIC0050	TELESTREAM	MANAGED STORAGE CAPACITY, 500TB BLOCKS	1.00	\$5,000.00	\$5,000.00
PowerEdge R7525	DELL	DELL CUSTOM (QUOTE # 3000128915518.1)	1.00	\$17,135.03	\$17,135.03
WD161KRYZ	WESTERN DIGITAL	16TB WD GOLD ENTERPRISE CLASS INTERNAL HARD DRIVE -7200 RPM CLASS,SATA 6 GB/S, 512	12.00	\$550.60	\$6,607.20
ALPHA-ALLOWANCE-ENG	ALPHA	ALPHA ENGINEERING ALLOWANCE FOR HARD DRIVE TRAY CADDY	12.00	\$20.00	\$240.00
ESAH-1280-GT0	ATTO TECH	8-PORT EXTERNAL 12GB SAS/SATA TO X8 PCIE 4.0 HOST BUS ADAPTER, LOW PROFILE	1.00	\$596.40	\$596.40
B-1: Type 1 Content Management Subtotal:					\$59,578.63
C-1: TYPE 1 TRANSCODING					
V-LS-G7-WW-SVR	TELESTREAM	LIGHTSPEED G7 SERVER SYSTEM	1.00	\$30,995.00	\$30,995.00
V-XCPCONN-SW	TELESTREAM	Vantage Transcode Pro Connect: Software Only, Single Server License	1.00	\$24,995.00	\$24,995.00
V-ANLZ-SW	TELESTREAM	Vantage Analysis: Software Only, Single Server License	1.00	\$10,995.00	\$10,995.00
C-1: Type 1 Transcoding Subtotal:					\$66,985.00
D-1: NETWORK ATTACHED STORAGE					
ALPHA-ALLOWANCE-ENG	ALPHA	ALPHA ENGINEERING ALLOWANCE FOR NETWORK ATTACHED STORAGE	1.00	\$100,000.00	\$100,000.00
D-1: Network Attached Storage Subtotal:					\$100,000.00
14.03 - ARCHIVE HOUSE Subtotal:					\$247,157.09
16.03 - NDI PROCESSING SYSTEMS HOUSE					
A-1: NDI SOFTWARE					
NDIPEBASE	GALLERY SIENNA	SIENNA PROCESSING ENGINE BASE LICENSE	1.00	\$6,943.05	\$6,943.05
NDIPEPLUS	GALLERY SIENNA	SIENNA PROCESSING ENGINE PLUS LICENSE	1.00	\$6,943.05	\$6,943.05
NDIRTR	GALLERY SIENNA	SIENNA VIRTUAL ROUTER LICENSE	1.00	\$6,943.05	\$6,943.05
NDISRCXMAXI	GALLERY SIENNA	SIENNA 32-CH SOURCE MULTI LICENSE	1.00	\$1,388.61	\$1,388.61
NDIOUTMUL	GALLERY SIENNA	SIENNA 8-CH OUTPUT MULTI LICENSE	1.00	\$1,388.61	\$1,388.61
A-1: NDI Software Subtotal:					\$23,606.37
B-1: NDI HARDWARE					
CUSTOM	DELL	POWEREDGE R6525 SERVER (SIENNA PROCESSING ENGINE)	1.00	\$30,744.81	\$30,744.81
CUSTOM	DELL	PRECISION 3930 SERVER (NDI ROUTER, NDI DSICOVERY SERVER)	2.00	\$2,292.53	\$4,585.06
CUSTOM	DELL	POWEREDGE R7515 SERVER (NDI-SDI I/O SERVER)	1.00	\$7,441.25	\$7,441.25
B-1: NDI Hardware Subtotal:					\$42,771.12
16.03 - NDI Processing Systems HOUSE Subtotal:					\$66,377.49
17.03 - PRODUCTION NETWORK HOUSE					
A-1: PRODUCTION NETWORK CORE PRIMARY					
C9300X-24Y-A=	CISCO	Catalyst 9300X 24-port 25/10G SFP+ NW-A	2.00	\$24,268.87	\$48,537.74
PWR-C1-1100WAC/2	CISCO	1100W AC CONFIG 1 SECONDARY P/S	1.00	\$1,844.43	\$1,844.43
STACK-T1-1M	CISCO	CISCO STACKWISE 480 STACKING CABLE 3.3FT	1.00	\$194.15	\$194.15

PART NUMBER	MANUFACTURER	DESCRIPTION	QTY	UNIT PRICE	TOTAL PRICE
C9300X-NM-2C	CISCO	Catalyst 9300 2 x 40G/100G Network Modul	1.00	\$2,475.43	\$2,475.43
QSFP-100G-LR-S	CISCO	100G QSFP28 100G-LR 10km SMF duplex L	2.00	\$8,731.95	\$17,463.90
A-1: Production Network Core Primary Subtotal:					\$70,515.65
A-2: PRODUCTION NETWORK CORE BACKUP					
C9300X-24Y-A=	CISCO	Catalyst 9300X 24-port 25/10G SFP+ NW-A	2.00	\$24,268.87	\$48,537.74
PWR-C1-1100WAC/2	CISCO	1100W AC CONFIG 1 SECONDARY P/S	1.00	\$1,844.43	\$1,844.43
STACK-T1-1M	CISCO	CISCO STACKWISE 480 STACKING CABLE 3.3FT	1.00	\$194.15	\$194.15
C9300X-NM-2C	CISCO	Catalyst 9300 2 x 40G/100G Network Modul	1.00	\$2,475.43	\$2,475.43
QSFP-100G-LR-S	CISCO	100G QSFP28 100G-LR 10km SMF duplex L	2.00	\$8,731.95	\$17,463.90
A-2: Production Network Core Backup Subtotal:					\$70,515.65
B-1: PRODUCTION NETWORK RACK ROOM					
C9300X-48HX-A	CISCO	Catalyst 9300 48-port mGig UPoE+ Network	8.00	\$14,493.27	\$115,946.16
PWR-C1-1100WAC/2	CISCO	1100W AC CONFIG 1 SECONDARY P/S	8.00	\$1,844.43	\$14,755.44
STACK-T1-1M	CISCO	CISCO STACKWISE 480 STACKING CABLE 3.3FT	8.00	\$194.15	\$1,553.20
C9300X-NM-8Y	CISCO	CATALYST 9300 8 X 25GE NTWK MOD	8.00	\$2,475.43	\$19,803.44
SFP-10/25G-BXD-I	CISCO	Cisco 10/25GBASE-LR BIDIRECTIONAL -D	8.00	\$3,154.96	\$25,239.68
SFP-10/25G-BXU-I	CISCO	Cisco 10/25GBASE-LR BIDIRECTIONAL -U	8.00	\$3,154.96	\$25,239.68
B-1: Production Network Rack Room Subtotal:					\$202,537.60
C-1: PRODUCTION NETWORK HEARING ROOM					
C9300X-48HX-A	CISCO	Catalyst 9300 48-port mGig UPoE+ Network	12.00	\$14,493.27	\$173,919.24
PWR-C1-1100WAC/2	CISCO	1100W AC CONFIG 1 SECONDARY P/S	12.00	\$1,844.43	\$22,133.16
C9300X-NM-8Y	CISCO	CATALYST 9300 8 X 25GE NTWK MOD	12.00	\$2,475.43	\$29,705.16
SFP-10/25G-BXD-I	CISCO	Cisco 10/25GBASE-LR BIDIRECTIONAL -D	12.00	\$3,154.96	\$37,859.52
SFP-10/25G-BXU-I	CISCO	Cisco 10/25GBASE-LR BIDIRECTIONAL -U	12.00	\$3,154.96	\$37,859.52
C-1: Production Network Hearing Room Subtotal:					\$301,476.60
17.03 - PRODUCTION NETWORK HOUSE Subtotal:					\$645,045.50
18.03 - FURNITURE, MILLWORK & RACKS HOUSE					
A-1: FURNITURE CONSOLES PCR 1					
CONTROL ROOM 11 SERIES GCX	FORECAST	FORECAST GCX CONTINUUM CONSOLE	1.00	\$24,576.00	\$24,576.00
LABOR-FORECAST	FORECAST	FORECAST CONSOLES INSTALL LABOR	1.00	\$4,666.67	\$4,666.67
SHIPPING-FORECAST	FORECAST	FORECAST SHIPPING	1.00	\$4,666.67	\$4,666.67
ALPHA-ALLOWANCE-ENG	ALPHA	ALPHA ENGINEERING ALLOWANCE FOR CHAIR	6.00	\$333.33	\$1,999.98
A-1: Furniture Consoles PCR 1 Subtotal:					\$35,909.32
A-2: FURNITURE CONSOLES PCR 2					
CONTROL ROOM 11 SERIES GCX	FORECAST	FORECAST GCX CONTINUUM CONSOLE	1.00	\$24,576.00	\$24,576.00
LABOR-FORECAST	FORECAST	FORECAST CONSOLES INSTALL LABOR	1.00	\$4,666.67	\$4,666.67
SHIPPING-FORECAST	FORECAST	FORECAST SHIPPING	1.00	\$4,666.67	\$4,666.67
ALPHA-ALLOWANCE-ENG	ALPHA	ALPHA ENGINEERING ALLOWANCE FOR CHAIR	6.00	\$333.33	\$1,999.98
A-2: Furniture Consoles PCR 2 Subtotal:					\$35,909.32
A-3: FURNITURE CONSOLES EDIT					
GSX-S3	FORECAST CONSOLES	SIT2STAND WORKSTATION W/ 4RU TURRET & 1-BAY COUNTERTOP INSERT	4.00	\$5,125.33	\$20,501.32



Alpha Video & Audio, Inc.
 7690 Golden Triangle Drive
 Eden Prairie, MN 55344
 Phone: 952-896-9898 | Fax: 952-896-9899
 Visit us at www.alphavideo.com

QUOTE

19027

PART NUMBER	MANUFACTURER	DESCRIPTION	QTY	UNIT PRICE	TOTAL PRICE
FC-PDM-1	FORECAST CONSOLES	PDM-1 1RU FILLER PANEL WITH 1-POWER MODULE (2X POWERED USB AND 1X 120V WITH CIRCUIT BREAKER)	4.00	\$700.00	\$2,800.00
PDU	FORECAST CONSOLES	STANDARD PDU, 36" W/ 14 X 5-15R 120V OUTLETS	4.00	\$202.67	\$810.68
POWER GROMMET	FORECAST CONSOLES	POWER GROMMET W/ 1 X 15A, 125V OUTLET & 2 X USB CHARGING PORTS	4.00	\$160.00	\$640.00
LCD ARM	FORECAST CONSOLES	RAIL MOUNTED FULLY ARTICULATING MONITOR ARM	12.00	\$330.67	\$3,968.04
ALPHA-ALLOWANCE-ENG	ALPHA	ALPHA ENGINEERING ALLOWANCE FOR CHAIR	4.00	\$333.33	\$1,333.32
ALPHA-ALLOWANCE-ENG	ALPHA	ALPHA ENGINEERING ALLOWANCE FOR ACOUSTICS MATERIALS	4.00	\$3,333.33	\$13,333.32
A-3: Furniture Consoles EDIT Subtotal:					\$43,386.68
B-1: 42"D GANGABLE RACKS					
MRK-4442LRD	MIDDLE ATLANTIC	44SP/42DP MULTIBAY RK LRD	10.00	\$1,716.00	\$17,160.00
MW-4QFT-FC	MIDDLE ATLANTIC	4.5"(4)FAN/TOP W/FC M/W	10.00	\$696.00	\$6,960.00
SPN-44-423	MIDDLE ATLANTIC	PR BLK 44SP SDS,42-43"DP	2.00	\$898.80	\$1,797.60
LT-GN-WL	MIDDLE ATLANTIC	MAGNETIC WORKLIGHT,LED	10.00	\$102.00	\$1,020.00
MW-CLVRD-44	MIDDLE ATLANTIC	LG PERF SPLIT REARDR,44SP	10.00	\$516.00	\$5,160.00
GANG-10	MIDDLE ATLANTIC	GANGING HARDWARE FOR 10 R	1.00	\$26.69	\$26.69
SRB-1-MRK-4224	MIDDLE ATLANTIC	1 BAY SEISMIC RIB,MRK,42D,24H	10.00	\$763.20	\$7,632.00
ANGLE-1-42	MIDDLE ATLANTIC	1BAY MRK FL ANGLE(PR)42"	10.00	\$147.60	\$1,476.00
MV-ISO-42	MIDDLE ATLANTIC	ISO KIT MRK/VRK 42"DP	10.00	\$132.60	\$1,326.00
MRK-Z4	MIDDLE ATLANTIC	SEISMIC BRKTS. MRK SE	10.00	\$50.09	\$500.90
PDT-2020TL-NS	MIDDLE ATLANTIC	PD-THIN,1-20A CIR,20 OUT	20.00	\$246.00	\$4,920.00
BB-44-1	MIDDLE ATLANTIC	COPPER BUS BAR,44SPX1	10.00	\$184.80	\$1,848.00
LACE-44-OP	MIDDLE ATLANTIC	77"H,3-1/4"W SLOT LACER	4.00	\$217.80	\$871.20
ALPHA-ALLOWANCE-ENG	ALPHA	ALPHA ENGINEERING ALLOWANCE FOR MISC RACK ACCESSORIES (LOT)	1.00	\$23,333.33	\$23,333.33
B-1: 42"D Gangable Racks Subtotal:					\$74,031.72
18.03 - FURNITURE, MILLWORK & RACKS HOUSE Subtotal:					\$189,237.04
19.03 - PATCHING & CABLES HOUSE					
A-1: VIDEO & AES PATCH PANEL					
B64H-2MWTHD	BITTREE	2 ROWS OF 32 PATCH POINTS, 1.5 RU, FULLY NORMALLED WITH 75 OHM TERMINATION, 3G SDI	6.00	\$1,526.00	\$9,156.00
A-1: Video & AES Patch Panel Subtotal:					\$9,156.00
A-2: AUDIO & INTERCOM PATCH PANEL					
969A625	BITTREE	B96DC-FNAIH/E3 M2OU7B	1.00	\$1,427.00	\$1,427.00
A-2: Audio & Intercom Patch Panel Subtotal:					\$1,427.00
A-3: CAT6 PATCH PANEL					
DSKP124B	BITTREE	KEYSTONE PANEL, 24 POSITION, 1RU, UNLOADED (FOR BELDEN REVCONNECT) - BLACK	12.00	\$157.00	\$1,884.00
NP-2	NEAT-PATCH	NEAT PATCH NP2 CABLE MANAGEMENT BAY	12.00	\$102.00	\$1,224.00
A-3: Cat6 Patch Panel Subtotal:					\$3,108.00
A-4: FIBER PATCH PANEL					
DSKP124B-LC	BITTREE	FLUSH MOUNT, 1 ROW OF 24 COUPLERS, 1 RU, DUPLEX LC TO LC, UPC, BLUE, 1 DESIGNATION STRIP	8.00	\$374.00	\$2,992.00
A-4: Fiber Patch Panel Subtotal:					\$2,992.00
A-5: FIBER ENCLOSURE					



Alpha Video & Audio, Inc.
 7690 Golden Triangle Drive
 Eden Prairie, MN 55344
 Phone: 952-896-9898 | Fax: 952-896-9899
 Visit us at www.alphavideo.com

QUOTE

19027

PART NUMBER	MANUFACTURER	DESCRIPTION	QTY	UNIT PRICE	TOTAL PRICE
CCH-01U	CORNING	Corning Rack Mount 1RU 2 panel Fiber Optic Enclosure	8.00	\$401.64	\$3,213.12
CCH-02U	CORNING	Corning Rack Mount 2RU 4 panel Fiber Optic Enclosure	4.00	\$401.64	\$1,606.56
CCH-CP12-A9	CORNING	Corning Snap in Fiber Optic Patch Panel OS1 Single Mode 6 x LC Duplex	32.00	\$401.64	\$12,852.48
A-5: Fiber Enclosure Subtotal:					\$17,672.16
B-1: PATCH CORD HOLDER					
CLAW	MIDDLE ATLANTIC	WALLMNT CABLE HANGER W/TR	1.00	\$21.29	\$21.29
B-1: Patch Cord Holder Subtotal:					\$21.29
B-2: VIDEO PATCH CABLES					
VPCMK1200-75	BITTREE	MINI-WECO PATCHCORD, 12G+ SDI, 24GHZ, 75 OHM, 12" (30 CM), BLACK	10.00	\$30.80	\$308.00
VPCMK2400-75	BITTREE	MINI-WECO PATCHCORD, 12G+ SDI, 24GHZ, 75 OHM, 24" (60 CM), BLACK	10.00	\$30.80	\$308.00
VPCMK4800-75	BITTREE	MINI-WECO PATCHCORD, 12G+ SDI, 24GHZ, 75 OHM, 48" (120 CM), BLACK	10.00	\$31.73	\$317.30
RTR1L	BITTREE	BNC INSERTION AND REMOVAL TOOL FOR MINI-WECO FORMAT, 12" (30 CM)	2.00	\$101.00	\$202.00
B-2: Video Patch Cables Subtotal:					\$1,135.30
B-3: MID-SIZE PATCH TO BNC					
ADMW12	BITTREE	BNC TO MINI-WECO ADAPTER PLUG, 3G SDI, SHORT (SUPPORTS SIDE-BY-SIDE INSERTION WITH ADMW12L)	4.00	\$27.00	\$108.00
B-3: Mid-Size Patch to BNC Subtotal:					\$108.00
C-1: SMPTE CAMERA CABLES					
JSCBLDN (BLK)PUWFUW-25	JOSEPH ELECTRONICS	SMPTE LEMO CABLE, PUW-FUW, 25'	4.00	\$841.33	\$3,365.32
JSCBLDN (BLK)PUWFUW-100	JOSEPH	SMPTE LEMO CABLE, PUW-FUW, 100'	4.00	\$957.33	\$3,829.32
JSCBLDN (BLK)PUWFUW-250	JOSPEH	SMPTE LEMO CABLE, PUW-FUW, 250'	1.00	\$1,188.00	\$1,188.00
C-1: SMPTE Camera Cables Subtotal:					\$8,382.64
C-2: SMPTE CAMERA IO PANEL					
ALPHA-ALLOWANCE-ENG	ALPHA	ALPHA ENGINEERING ALLOWANCE FOR SMPTE Camera IO Panel	1.00	\$3,333.33	\$3,333.33
C-2: SMPTE Camera IO Panel Subtotal:					\$3,333.33
D-1: AUDIO CABLES					
JAC1192A (BLK)XMBXFB-10	JOSPEH	AUDIO CABLE, M-F, XLR, 10'	4.00	\$32.33	\$129.32
D-1: Audio Cables Subtotal:					\$129.32
D-1: VIDEO CABLES					
JVC1694A(BLK)KBB-25	JOSPEH	RG6 VIDEO CABLE, M-M, BNC, 25'	4.00	\$24.47	\$97.88
JVC1694A(BLK)KBB-100	JOSEPH	RG6 VIDEO CABLE, M-M, BNC, 100'	4.00	\$57.47	\$229.88
D-1: Video Cables Subtotal:					\$327.76
D-2: AUDIO CABLES					
JAC1192A (BLK)XMBXFB-25	JOSEPH	AUDIO CABLE, M-F, XLR, 25'	4.00	\$54.56	\$218.24
MT-8-F-M-25	WHIRLWIND	SNAKE - FAN TO FAN, 8 XLR TO 8 XLRM, 25', W09PR	2.00	\$198.04	\$396.08
RKSS18T	SONY	1/8 TO 1/8 JACK CABLE (T)	10.00	\$10.65	\$106.50
601045	MONOPRICE	Monoprice 1/8in TRS Male to Two 1/4in TS Male Cable_ 5ft	2.00	\$5.32	\$10.64
D-2: Audio Cables Subtotal:					\$731.46
D-3: CAT6 CABLES					



Alpha Video & Audio, Inc.
 7690 Golden Triangle Drive
 Eden Prairie, MN 55344
 Phone: 952-896-9898 | Fax: 952-896-9899
 Visit us at www.alphavideo.com

QUOTE

19027

PART NUMBER	MANUFACTURER	DESCRIPTION	QTY	UNIT PRICE	TOTAL PRICE
CG01072	C2G	1FT/0.3M CAT6 UTP 28AWG BLUE	60.00	\$3.91	\$234.60
CG01165	C2G	1FT/0.3M CAT6 CABLE UTP SLIM 28AWG RED	60.00	\$3.91	\$234.60
CG01160	C2G	1FT/0.3M CAT6 CABLE UTP SLIM 28AWG GREEN	20.00	\$3.91	\$78.20
CG01170	C2G	1FT/0.3M CAT6 CABLE UTP SLIM 28AWG YLW	20.00	\$3.91	\$78.20
CG01185	C2G	1FT/0.3M CAT6 CABLE UTP SLIM 28AWG WHITE	20.00	\$3.91	\$78.20
CG00677	C2G	CAT6A PATCH CABLE, SNAGLESS, SHIELDED, 6' - BLUE	24.00	\$12.07	\$289.68
CG00681	C2G	10FT/3M CAT6A SNAGLESS STP CABLE-BLU	12.00	\$17.97	\$215.64
CG00684	C2G	15FT/4.6M CAT6A SNAGLESS STP CABLE-BLU	12.00	\$22.40	\$268.80
CG00686	C2G	25FT/7.6M CAT6A SNAGLESS STP CABLE-BLU	1.00	\$28.87	\$28.87
D-3: Cat6 Cables Subtotal:					\$1,506.79
D-4: FIBER CABLES					
CG11026	C2G	2M ST-ST 10G OM3 DPX MM T	24.00	\$38.56	\$925.44
CG11011	C2G	2M LC-ST 10G OM3 DPX MM T	24.00	\$46.21	\$1,109.04
CG00998	C2G	2M LC-LC 50/125 OM4 DUPL	24.00	\$24.43	\$586.32
CG34627	C2G	2M LC-ST 9/125 DPX OS1/2	24.00	\$54.08	\$1,297.92
CG08353	C2G	2M ST-ST 9/125 OS1/2 DPX	24.00	\$22.75	\$546.00
HF-TS12ST-0200	CAMPLEX	12-CHANNEL ST-SINGLE MODE TACTICAL FIBER OPTICAL SNAKE-200 FOOT	1.00	\$914.75	\$914.75
D-4: Fiber Cables Subtotal:					\$5,379.47
D-5: HDMI CABLES					
ALPHA-MATERIALS	ALPHA	ALPHA MATERIALS	1.00	\$371.00	\$371.00
D-5: HDMI Cables Subtotal:					\$371.00
D-7: USB CABLES					
CG54171	C2G	2M USB 3.0 AM-AM CBL BLK	4.00	\$7.89	\$31.56
CG54172	C2G	3M USB 3.0 AM-AM CBL BLK	4.00	\$10.40	\$41.60
D-7: USB Cables Subtotal:					\$73.16
D-8: MISCELLANEOUS PRE-MADE CABLES					
ALPHA-ALLOWANCE-ENG	ALPHA	ALPHA ENGINEERING ALLOWANCE FOR PARTS AND CABLES	1.00	\$1,750.00	\$1,750.00
D-8: Miscellaneous Pre-made Cables Subtotal:					\$1,750.00
19.03 - PATCHING & CABLES HOUSE Subtotal:					\$57,604.68
20.03 - COMMISSIONING & TRAINING HOUSE					
A-1: ROSS VIDEO CAMBOT					
CAM-OTR-1DAY	ROSS VIDEO	CAMBOT ONSITE OPERATIONAL TRAINING - 1DAY	1.00	\$2,145.00	\$2,145.00
TRAVEL-PRE-001	ROSS VIDEO	PRE PAID SERVICE EXPENSE TRIP 1	1.00	\$3,176.47	\$3,176.47
CAM-COM-1DAY	ROSS VIDEO	CAMBOT ONSITE COMMISSIONING - 1DAY	1.00	\$2,145.00	\$2,145.00
		<i>600PT Heads Commissioning</i>			
TRAVEL-PRE-002	ROSS VIDEO	PRE PAID SERVICE EXPENSE TRIP 2	1.00	\$3,176.47	\$3,176.47
CAM-COM-1DAY	ROSS VIDEO	CAMBOT ONSITE COMMISSIONING - 1DAY	1.00	\$2,145.00	\$2,145.00
		<i>X300 Heads Commissioning</i>			
TRAVEL-PRE-003	ROSS VIDEO	PRE PAID SERVICE EXPENSE TRIP 3	1.00	\$3,176.47	\$3,176.47
CAM-COM-1DAY	ROSS VIDEO	CAMBOT ONSITE COMMISSIONING - 1DAY	1.00	\$2,145.00	\$2,145.00
		<i>Smartshell Stations Commissioning</i>			
TRAVEL-PRE-004	ROSS VIDEO	PRE PAID SERVICE EXPENSE TRIP 4	1.00	\$3,176.47	\$3,176.47



Alpha Video & Audio, Inc.
 7690 Golden Triangle Drive
 Eden Prairie, MN 55344
 Phone: 952-896-9898 | Fax: 952-896-9899
 Visit us at www.alphavideo.com

QUOTE

19027

PART NUMBER	MANUFACTURER	DESCRIPTION	QTY	UNIT PRICE	TOTAL PRICE
A-1: Ross Video Cambot Subtotal:					\$21,285.88
A-2: ROSS VIDEO CG					
XPRESSION-COM-1DAY	ROSS VIDEO	XPRESSION COMMISSIONING - 1 DAY	1.00	\$2,145.00	\$2,145.00
XPRESSION-OTR-1DAY	ROSS VIDEO	XPRESSION OPERATIONAL TRAINING - 1 DAY	1.00	\$2,145.00	\$2,145.00
TRAVEL-PRE-005	ROSS VIDEO	PRE PAID SERVICE EXPENSE TRIP 5	1.00	\$3,176.47	\$3,176.47
INC-COM-ONSITE-1DAY	ROSS VIDEO	INCEPTION - ON-SITE COMMISSIONING - 1 DAY	1.00	\$2,145.00	\$2,145.00
TRAVEL-PRE-006	ROSS VIDEO	PRE PAID SERVICE EXPENSE TRIP 6	1.00	\$3,176.47	\$3,176.47
INC-TRN-ONSITE-OP-1DAY	ROSS VIDEO	INCEPTION - ON-SITE OPERATIONAL TRAINING - 1 DAY	1.00	\$2,145.00	\$2,145.00
TRAVEL-PRE-007	ROSS VIDEO	PRE PAID SERVICE EXPENSE TRIP 7	1.00	\$3,176.47	\$3,176.47
A-2: Ross Video CG Subtotal:					\$18,109.41
A-3: ROSS VIDEO TALLY					
TLY-ONL-COM-1DAY	ROSS VIDEO	TALLY SYSTEMS ONLINE COMMISSIONING, 1 DAY	1.00	\$1,612.00	\$1,612.00
A-3: Ross Video Tally Subtotal:					\$1,612.00
A-4: ROSS VIDEO MASTER CONTROL					
MC1-ONL-COM-1DAY	ROSS VIDEO	MC1 MASTER CONTROL ONLINE COMMISSIONING, 1 DAY	1.00	\$1,612.00	\$1,612.00
MC1-ONL-1DAY	ROSS VIDEO	MC1 MASTER CONTROL ONLINE TRAINING, 1 DAY	1.00	\$1,612.00	\$1,612.00
A-4: Ross Video Master Control Subtotal:					\$3,224.00
A-5: ROSS VIDEO SWITCHER					
CARBONITE-OTR-1DAY	ROSS VIDEO	CARBONITE OPERATIONS TRAINING - 1 DAY	1.00	\$2,145.00	\$2,145.00
TRAVEL-PRE-008	ROSS VIDEO	PRE PAID SERVICE EXPENSE TRIP 8	1.00	\$3,882.35	\$3,882.35
ULTRIX-COM-1DAY	ROSS VIDEO	ULTRIX ONSITE COMMISSIONING - 1 DAY	1.00	\$2,145.00	\$2,145.00
TRAVEL-PRE-009	ROSS VIDEO	PRE PAID SERVICE EXPENSE TRIP 9	1.00	\$3,176.47	\$3,176.47
ULTRIX-OTR-1DAY	ROSS VIDEO	ULTRIX OPERATIONAL TRAINING - 1 DAY	1.00	\$2,145.00	\$2,145.00
TRAVEL-PRE-010	ROSS VIDEO	PRE PAID SERVICE EXPENSE TRIP 10	1.00	\$3,176.47	\$3,176.47
SOL-PROJMGMT-1DAY	ROSS	PROJECT MANAGEMENT-1 DAY	1.00	\$2,145.00	\$2,145.00
TRAVEL-PRE-011	ROSS VIDEO	ROSS VIDEO ON-SITE EXPENSES	1.00	\$3,176.47	\$3,176.47
A-5: Ross Video Switcher Subtotal:					\$21,991.76
A-6: ROSS VIDEO GRAPHITE					
CARBONITE-COM-1DAY	ROSS VIDEO	CARBONITE COMMISSIONING - 1 DAY	2.00	\$2,145.00	\$4,290.00
CARBONITE-OTR-1DAY	ROSS VIDEO	CARBONITE OPERATIONS TRAINING - 1 DAY	2.00	\$2,145.00	\$4,290.00
TRAVEL-PRE-012	ROSS VIDEO	ROSS VIDEO ON-SITE EXPENSES	2.00	\$2,823.53	\$5,647.06
A-6: Ross Video Graphite Subtotal:					\$14,227.06
B-1: EVERTZ ROUTER					
EVERTZ TRAINING	EVERTZ	EVERTZ TRAINING	5.00	\$2,000.00	\$10,000.00
EVERTZ COMMISSIONING	EVERTZ	EVERTZ COMMISSIONING	10.00	\$1,950.00	\$19,500.00
EVERTZ EXPENSES	EVERTZ	EVERTZ ON-SITE TRAVEL EXPENSES	1.00	\$8,000.00	\$8,000.00
B-1: Evertz Router Subtotal:					\$37,500.00
C-1: GRASS VALLEY INGEST & PLAYOUT					
STRATUS-PRO-MAN	GRASS VALLEY	PROJECT MANAGER-EXPERT LEVEL-DAILY RATE	3.00	\$2,436.67	\$7,310.01
STRATUS-SYS-ENG	GRASS VALLEY	GRASS VALLEY SYSTEM ENGINEER, EXPERT LEVEL DAILY RATE	16.00	\$2,312.00	\$36,992.00
STRATUS-OST	GRASS VALLEY	GRASS VALLEY STRATUS OPERATIONS TRAINING	4.00	\$2,436.67	\$9,746.68



Alpha Video & Audio, Inc.
 7690 Golden Triangle Drive
 Eden Prairie, MN 55344
 Phone: 952-896-9898 | Fax: 952-896-9899
 Visit us at www.alphavideo.com

QUOTE
19027

PART NUMBER	MANUFACTURER	DESCRIPTION	QTY	UNIT PRICE	TOTAL PRICE
C-1: Grass Valley Ingest & Payout Subtotal:					\$54,048.69
D-1: BOSCH INTERCOM					
F.01U.024.616	BOSCH	BOSCH TRAINING COMMUNICATION	1.00	\$2,133.33	\$2,133.33
D-1: Bosch Intercom Subtotal:					\$2,133.33
E-1: TELESTREAM					
CM-WKFLOW-OFFSITE-FP	TELESTREAM	CM OFFSITE WORKFLOW FIXED PRICE	1.00	\$5,100.00	\$5,100.00
TS-COMMISSION-FPNOEX	TELESTREAM	TS-COMMISSIONING-REMOTE WORK-FIXED PRICE-EXPENSES NOT INCLUDED	1.00	\$3,966.67	\$3,966.67
TS-COMMISSION-FPNOEX	TELESTREAM	TS-COMMISSIONING-REMOTE WORK-FIXED PRICE-EXPENSES NOT INCLUDED	1.00	\$3,966.67	\$3,966.67
E-1: Telestream Subtotal:					\$13,033.34
F-1: NDI SOFTWARE					
SIENNASU	IEC	SIENNA ANNUAL SOFTWARE MAINTENANCE - 1 YR	1.00	\$166.57	\$166.57
ALPHA-SMA-GALLERY-8HR	ALPHA	ALPHA ASSURANCE GALLERY SUPPORT AGREEMENT, 1-YR, 8-HR RESPONSE	1.00	\$1,888.51	\$1,888.51
SIENNASU	IEC	SIENNA ANNUAL SOFTWARE MAINTENANCE - 1 YR	1.00	\$166.57	\$166.57
ALPHA-SMA-GALLERY-8HR	ALPHA	ALPHA ASSURANCE GALLERY SUPPORT AGREEMENT, 1-YR, 8-HR RESPONSE	1.00	\$1,888.51	\$1,888.51
F-1: NDI Software Subtotal:					\$4,110.16
G-1: PRODUCTION NETWORK					
ALPHA-ALLOWANCE-ENG	ALPHA	ALPHA ENGINEERING ALLOWANCE FOR NETWORK COMMISSIONING	1.00	\$13,333.33	\$13,333.33
G-1: Production Network Subtotal:					\$13,333.33
20.03 - COMMISSIONING & TRAINING HOUSE Subtotal:					\$204,608.96
21.03 - INTEGRATION HOUSE					
A: GENERAL PURPOSE CABLING					
ALPHA-MATERIALS	ALPHA	ALPHA MATERIALS	1.00	\$100,000.00	\$100,000.00
A: General Purpose Cabling Subtotal:					\$100,000.00
B: LABOR ESTIMATE					
ALPHA-LABOR	ALPHA	ALPHA INTEGRATION LABOR	1.00	\$467,610.00	\$467,610.00
ALPHA-MATERIALS	ALPHA	ALPHA MATERIALS	1.00	\$8,723.00	\$8,723.00
B: Labor Estimate Subtotal:					\$476,333.00
21.03 - INTEGRATION HOUSE Subtotal:					\$576,333.00
22.03 - WARRANTY HOUSE					
A-1: ROSS SUPPORT					
INC-999-OPT-MESSAGING	ROSS VIDEO	INCEPTION - INSTANT MESSAGING PLUGIN - MAINTENANCE	1.00	\$1,055.00	\$1,055.00
INC-999-SW-LIVE	ROSS VIDEO	INCEPTION LIVE - SOFTWARE - MAINTENANCE	1.00	\$4,000.00	\$4,000.00
INC-999-HW-SERVER	ROSS VIDEO	INCEPTION - SERVER HARDWARE - EXTENDED WARRANTY	1.00	\$1,245.00	\$1,245.00
A-1: Ross Support Subtotal:					\$6,300.00
B-1: EVERTZ SUPPORT					
MAGNUM-ANNUAL-LICENSE	EVERTZ	Annual Renewal license for MAGNUM	1.00	\$16,005.00	\$16,005.00
VUE-ANNUAL-LICENSE	EVERTZ	Annual Renewal license for VUE	1.00	\$5,956.11	\$5,956.11
VLPRO-Ser/Sup/Lic.1yr	EVERTZ	Additional 1 year VistaLINK	1.00	\$825.00	\$825.00
B-1: Evertz Support Subtotal:					\$22,786.11
C-1: GVS SUPPORT					



Alpha Video & Audio, Inc.
 7690 Golden Triangle Drive
 Eden Prairie, MN 55344
 Phone: 952-896-9898 | Fax: 952-896-9899
 Visit us at www.alphavideo.com

QUOTE
19027

PART NUMBER	MANUFACTURER	DESCRIPTION	QTY	UNIT PRICE	TOTAL PRICE
AMS-PRIME	GRASS VALLEY	GRASS VALLEY PRIME SA FOR ADVANCED MEDIA STORAGE	1.00	\$7,582.67	\$7,582.67
ASSET MAN-PRIME	GRASS VALLEY	GV CARE-PRIME SA FOR ASSET MANAGEMENT	1.00	\$22,133.73	\$22,133.73
EDITING SYS-PRIME	GRASS VALLEY	GRASS VALLEY GV CARE-PRIME SA FOR EDITING SYSTEMS	1.00	\$123.68	\$123.68
K2-PRIME	GRASS VALLEY	GV CARE-PRIME SA FOR K2, 24X7 TECHNICAL PHONE SUPPORT, 2 HOUR RESPONSE	1.00	\$666.92	\$666.92
PROD SERVER-PRIME	GRASS VALLEY	GRASS VALLEY CARE PRIME SA FOR PRODUCTION SERVERS	1.00	\$25,585.29	\$25,585.29
C-1: GVS Support Subtotal:					\$56,092.29
C-1: QUALSTAR SUPPORT					
EW2-BUND-A	QUALSTAR	SERVICE, EXTENDED/PREFERRED/DOMESTIC/YR. 305 BUNDLE WITH PURCHASE	1.00	\$4,028.00	\$4,028.00
C-1: Qualstar Support Subtotal:					\$4,028.00
D-1: TELESTREAM SUPPORT					
DIVA-SUPP-MS00	TELESTREAM	DIVA FIRST YEAR SUPPORT	1.00	\$6,930.00	\$6,930.00
V-LS-SILVER-MS00	TELESTREAM	ANNUAL SUPPORTFOR SUPPORT DETAILS, PLEASE SEE THE MAINTENANCE AND SUPPORT GUIDE AT:HTTP://WWW.TELE	1.00	\$2,112.00	\$2,112.00
V-LS-ADV-EXP00	TELESTREAM	ANNUAL EXPRESS REPLACEMENTFOR SUPPORT DETAILS, PLEASE SEE THE MAINTENANCE AND SUPPORT GUIDE AT:HTT	1.00	\$1,978.67	\$1,978.67
V-SILVER-MS00	TELESTREAM	SILVER SUPPORT IS CALCULATED AT 15% OF THE LIST PRICE OF PURCHASED SOFTWARE OPTIONS.FOR SUPPORT DET	1.00	\$1,839.20	\$1,839.20
D-1: Telestream Support Subtotal:					\$12,859.87
E-1: CISCO WARRANTY					
C9300-DNA-A-48-5Y	CISCO	C9300 DNA ADVANTAGE 48PT 5YR TERM LIC	1.00	\$6,096.33	\$6,096.33
C9300-DNA-A-24-5Y	CISCO	C9300 DNA ADVANTAGE 24PT 5YR TERM LIC	1.00	\$3,252.03	\$3,252.03
C9300-DNA-A-48-5Y	CISCO	C9300 DNA ADVANTAGE 48PT 5YR TERM LIC	1.00	\$6,096.33	\$6,096.33
C9300-DNA-A-24-5Y	CISCO	C9300 DNA ADVANTAGE 24PT 5YR TERM LIC	1.00	\$3,252.03	\$3,252.03
C9300-DNA-A-48-5Y	CISCO	C9300 DNA ADVANTAGE 48PT 5YR TERM LIC	1.00	\$6,096.33	\$6,096.33
C9300-DNA-A-24-5Y	CISCO	C9300 DNA ADVANTAGE 24PT 5YR TERM LIC	1.00	\$3,252.03	\$3,252.03
E-1: Cisco Warranty Subtotal:					\$28,045.08
F-1: ALPHA WARRANTY					
ALPHA-SMA-SILVER-1YR	ALPHA	ALPHA ASSURANCE SILVER SERVICE AND MAINTENANCE AGREEMENT, 1 YR. TERM	1.00	\$109,454.97	\$109,454.97
ALPHA-SMA-GOLD-1YR	ALPHA	ALPHA ASSURANCE GOLD SERVICE AND MAINTENANCE AGREEMENT, 1 YR. TERM	0.00	\$166,219.90	\$0.00
ALPHA-SMA-PLATINUM-1YR	ALPHA	ALPHA ASSURANCE PLATINUM SERVICE AND MAINTENANCE AGREEMENT, 1 YR. TERM	0.00	\$270,761.29	\$0.00
F-1: Alpha Warranty Subtotal:					\$109,454.97
22.03 - WARRANTY HOUSE Subtotal:					\$239,566.32
PROJECT COSTS					
SECTION COSTS					
ALPHA-WORKMANSHIP	ALPHA	ALPHA WORKMANSHIP WARRANTY	1.00	\$0.00	\$0.00
Section Costs Subtotal:					\$0.00
Project Costs Subtotal:					\$0.00
Subtotal:					\$8,987,053.38
Shipping:					\$0.00
Tax:					\$0.00
Total:					\$8,987,053.38



Alpha Video & Audio, Inc.
7690 Golden Triangle Drive
Eden Prairie, MN 55344
Phone: 952-896-9898 | Fax: 952-896-9899
Visit us at www.alphavideo.com

QUOTE

19027

A 3% convenience fee will be added for all credit card payments.

All information contained within this quote is valid for the next 30 days. Thereafter, all prices and applicable charges are subject to change.

Returns are subject to a minimum 15% restocking fee when accompanied by original packaging.

Shipping costs are not included and will be billed at actual cost.

Sales tax is not included and will be billed at actual cost.

SCOPE OF WORK

SENATE BROADCAST TELEVISION SYSTEMS UPGRADE

INTRODUCTION

Alpha Video and Audio, Inc. is pleased to present this proposal for Broadcast Television Upgrade. This statement of work describes equipment and services that Alpha Video will deliver, as well as the responsibilities of Minnesota Legislative Coordinating Commission for successful implementation. A detailed equipment list and pricing is attached.

OVERVIEW

We believe that the items in our proposal meet the system requirements, standards of quality, and brand preferences outlined through multiple “needs analysis” meetings, phone calls, and emails. The equipment and systems defined in this proposal are representative of typical installations successfully completed by Alpha Video.

The Minnesota Legislative Coordinating Commission video production facilities are intended to be operated in HD 1080p in accordance with SMPTE 2110 IP standards. The principal cameras are specified to be 4K 59.94 capable and are expected to be configured at 1080p. It is anticipated that the production switchers are specified to be 4K 59.94 capable and are expected to be configured at 1080p. The routing switcher is specified as a full SMPTE 2110 based IP solution with IP Gateways (IPG) used where required (equipment that does not offer a native SMPTE 2110 IP interface) with support for redundant core via SMPTE 2022-7. The routing switcher (with video, audio, and ancillary data) is used to route sources throughout the video production facilities and related systems. Multiple Character Generators, Multi-channel file servers for record and playback and Multiview will be provided. Audio Devices shall be connected to the main routing network via MADI or directly to the main routing fabric. Unlike baseband patching and routing, much of this facility is based on fiber optic patching. 100GB tie lines will be provided between the Senate Office building and the Capitol building.

The video production facilities will include the following major locations.

1. Capitol Building Senate Floor Room 240
2. Capitol Building Senate Floor A/V Room 337B
3. Capitol Building Senate Hearing Room 123
4. Capitol Building Senate Hearing A/V Room 123B
5. Capitol Building Senate Committee Meeting Room G15
6. Capitol Building Senate Committee Meeting A/V Room G9C
7. Capitol Building Senate Committee Meeting Room G3
8. Capitol Building Senate Committee Meeting A/V Room G3
9. Capitol Building Senate Committee Meeting Room G23
10. Capitol Building Senate Committee Meeting A/V Room G23C
11. Capitol Building Media Hub B881
12. Senate Building Rack Room G218
13. Senate Building Production Control Room 1 G213
14. Senate Building Production Control Room 2 G215
15. Senate Building Master Control Room 1 / Edit 2 G214
16. Senate Building Edit 1 G210
17. Senate Building Studio G216

18. Senate Building Server Room G247
19. Senate Building Hearing Room 1100
20. Senate Building Hearing Room 1100 A/V Room 1102
21. Senate Building Hearing Room 1150
22. Senate Building Hearing Room 1150 A/V Room 1152
23. Senate Building Hearing Room 1200
24. Senate Building Hearing Room 1200 A/V Room 1203
25. Senate Building Media Services G230
26. Senate Building Office G233
27. Senate Building Office G234

A number of remote operated 4K POV box cameras are provided in this scope of work. Joystick controller and robotic pan/tilt heads allow for live control of each camera and/or rapid selection of presets controller. Each camera may be connected at a number of locations via newly provided SDI over fiber devices terminating in the rack room and A/V room. Mounting of cameras to be coordinated with owner representatives.

1. Capitol Building Senate Floor Room 240 via A/V Room 337B – Qty 4
2. Capitol Building Senate Hearing Room 123 via A/V Room 123B – Qty 4
3. Senate Building Hearing Room 1100 via A/V Room 1102 – Qty 4
4. Senate Building Hearing Room 1150 via A/V Room 1152 – Qty 4
5. Senate Building Hearing Room 1200 via A/V Room 1203 – Qty 4

A number of remote 4K/HD live broadcast studio cameras are provided in this scope of work. Joystick controller and robotic pan/tilt heads allow for live control of each camera and/or rapid selection of presets controller. Each camera may be connected via newly provided SMPTE connections terminating in the rack room and A/V room.

1. Senate Building Studio G216 – Qty 4

A number of remote operated 4K/UHD 60p PTZ cameras are provided in this scope of work. Joystick controller and digital servo pan/tilt heads allow for live control of each camera and/or rapid selection of presets controller. Each camera may be connected at a number of locations via newly provided SDI over fiber devices terminating in the rack room and A/V room. Mounting of cameras to be coordinated with owner representatives.

1. Capitol Building Senate Committee Meeting Room G15 via A/V Room G9C – Qty 4
2. Capitol Building Senate Committee Meeting Room G3 via A/V Room G3 – Qty 4
3. Capitol Building Senate Committee Meeting Room G23 via A/V Room G23C – Qty 4

Wireless antenna systems are provided for use with Microphones, IFB's and Intercom systems. Connectivity is provided for antenna locations. Antenna mounting locations shall be a coordinated effort between Alpha Video and Minnesota Legislative engineering staff in association with the wireless manufacturer. Coverage shall be provided throughout the Senate Office building and the Capitol building.

Demolition of existing video production systems.

1. Mark and label all cabling entering impacted area for extension/re-termination.
2. All unused/replaced cable/fiber, etc. to be pulled out at the time of the work.
3. Mark and label all Owner furnished equipment that will be re-used.
4. After owner has marked equipment for reuse or storage, remove all unused cabling and equipment from rack room, control room or interconnecting spaces. Dispose of millwork, equipment racks and equipment that is not being reused or salvaged by owner.

SYSTEM OVERVIEW – SCOPE OF WORK

01.01 CAMERAS CAPITOL

Capitol building cameras used by the Senate are to be 4K 59.94 HDR capable and expected to be configured for 1080p. Type 1 Cameras are to be 4K/HD compact box cameras. Type 2 Cameras are to be 4K/HD live broadcast studio cameras. Type 1 POV Cameras are to be 4K/UHD 60p PTZ cameras. Cameras based on an IP workflow connecting to the Routing Switcher directly or via IP Gate Ways as required.

A. Type 1 Camera

1. Camera – Qty 8
 - **PROVIDE** and **INSTALL** New Sony HDCP50 Camera Body
 - **PROVIDE** and **INSTALL** New Sony HZCPRV50 60p License
 - **PROVIDE** and **INSTALL** New IDX IA-200A 100W AC Adapter Power Supply
2. Camera Transport
 - **PROVIDE** and **INSTALL** New Multidyne V4-3811-6X2-A-ST Fiber Transceiver with 6 in and 2 out – Qty 2
 - **PROVIDE** and **INSTALL** New Multidyne V4-3811-2X6-A-ST Fiber Transceiver with 2 in and 6 out – Qty 2
 - **PROVIDE** and **INSTALL** New Multidyne RM-1RU-V4 Rack Mount Kit – Qty 3
3. Camera Control – Qty 8
 - **PROVIDE** and **INSTALL** New Sony RCP3500 Camera Remote Control Panel
4. Camera Lens – Qty 8
 - **PROVIDE** and **INSTALL** New Canon CJ20EX5B IASE S 20x Zoom 2/3" UHDXS 4K Lens
5. Camera Package – Qty 8
 - **PROVIDE** and **INSTALL** New Ross Video RRB-X300-PT Robotics PT Head
 - **PROVIDE** and **INSTALL** New Ross Video RRB-UNI-WMB Wall Mount Bracket

B. Type 2 Camera

1. Camera
 - **NOT REQUIRED IN THE CAPITOL BUILDING**
2. Camera Transport
 - **NOT REQUIRED IN THE CAPITOL BUILDING**
3. Camera Control
 - **NOT REQUIRED IN THE CAPITOL BUILDING**
4. Camera Lens
 - **NOT REQUIRED IN THE CAPITOL BUILDING**
5. Camera Package
 - **NOT REQUIRED IN THE CAPITOL BUILDING**

C. Type 1 POV Camera

1. POV Camera – Qty 12
 - **PROVIDE** and **INSTALL** New Sony ILMEFR7K 4K PTZ Camera
 - **PROVIDE** and **INSTALL** New IDX IA-200A 100W AC Adapter Power Supply
2. POV Transport
 - **PROVIDE** and **INSTALL** New Multidyne V4-3811-6X2-A-ST Fiber Transceiver with 6 in and 2 out – Qty 3
 - **PROVIDE** and **INSTALL** New Multidyne V4-3811-2X6-A-ST Fiber Transceiver with 2 in and 6 out – Qty 3

- **PROVIDE** and **INSTALL** New Multidyne RM-1RU-V4 Rack Mount Kit – Qty 4
3. POV Control – Qty 1
 - **PROVIDE** and **INSTALL** New Sony RMIP500/1 Advanced Joystick Controller

D. Camera Accessories

1. Camera Control
 - **NOT REQUIRED IN THE CAPITOL BUILDING**
2. Camera Batteries
 - **NOT REQUIRED IN THE CAPITOL BUILDING**

E. Robotics

1. Robotics Control Server
 - **INCLUDED IN 01.02 CAMERAS SENATE**

F. Teleprompter

1. Teleprompter
 - **NOT INCLUDED IN THIS SOW**

01.02 CAMERAS SENATE

Senate cameras are to be 4K 59.94 HDR capable and expected to be configured for 1080p. Type 1 Cameras are to be 4K/HD compact box cameras. Type 2 Cameras are to be 4K/HD live broadcast studio cameras. Type 1 POV Cameras are to be 4K/UHD 60p PTZ cameras. Cameras based on an IP workflow connecting to the Routing Switcher directly or via IP Gate Ways as required.

A. Type 1 Camera

1. Camera – Qty 12 + 1 Spare
 - **PROVIDE** and **INSTALL** New Sony HDCP50 Camera Body
 - **PROVIDE** and **INSTALL** New Sony HZCPRV50 60p License
 - **PROVIDE** and **INSTALL** New IDX IA-200A 100W AC Adapter Power Supply
2. Camera Transport
 - **PROVIDE** and **INSTALL** New Multidyne V4-3811-6X2-A-ST Fiber Transceiver with 6 in and 2 out – Qty 3
 - **PROVIDE** and **INSTALL** New Multidyne V4-3811-2X6-A-ST Fiber Transceiver with 2 in and 6 out – Qty 3
 - **PROVIDE** and **INSTALL** New Multidyne RM-1RU-V4 Rack Mount Kit – Qty 4
3. Camera Control
 - **PROVIDE** and **INSTALL** New Sony RCP3500 Camera Remote Control Panel – Qty 8
 - **PROVIDE** and **INSTALL** New Ross Video RRB-CTL-3 3 Axis Unified Control System – Qty 3
 - **PROVIDE** and **INSTALL** New Ross Video RRB-CTL-PTZ PTZ Camera Plug-In License – Qty 3
4. Camera Lens – Qty 12
 - **PROVIDE** and **INSTALL** New Canon CJ20EX5B IASE S 20x Zoom 2/3" UHDXS 4K Lens
5. Camera Package – Qty 12
 - **PROVIDE** and **INSTALL** New Ross Video RRB-X300-PT Robotics PT Head
 - **PROVIDE** and **INSTALL** New Ross Video RRB-UNI-WMB Wall Mount Bracket

B. Type 2 Camera

1. Camera – Qty 4
 - **PROVIDE** and **INSTALL** New Sony HDC3200L Camera Body
 - **PROVIDE** and **INSTALL** New Sony HZCPRV50 60p License
 - **PROVIDE** and **INSTALL** New Sony VCT14 Tripod Attachment

- **PROVIDE** and **INSTALL** New Sony HDVFL750 LCD Color Viewfinder
 - **PROVIDE** and **INSTALL** New Sony HDVEL20 7" OLED Viewfinder
2. Camera Transport – Qty 4
 - **PROVIDE** and **INSTALL** New Sony HDCU3100L Camera Control Unit
 - **PROVIDE** and **INSTALL** New Sony HKCUSFP50 ST2110 Interface Kit
 - **PROVIDE** and **INSTALL** New Sony OTM25GLR 25G Long Range SFP+
 3. Camera Control
 - **INCLUDED WITH TYPE 1 CAMERA SENATE**
 4. Camera Lens – Qty 4
 - **PROVIDE** and **INSTALL** New Canon CJ20EX5B IASE S 20x Zoom 2/3" UHDXS 4K Lens
 - **PROVIDE** and **INSTALL** New Canon MS-210D Full Servo Digital Zoom / Focus Rear Control Kit
 5. Camera Package – Qty 4
 - **PROVIDE** and **INSTALL** New Sony ECM680S Shotgun Mic
 - **PROVIDE** and **INSTALL** New Sony ECO5X5F3M 5-Pin XLR to Dual 3-Pin XLR
 - **PROVIDE** and **INSTALL** New Ross Video CAM-600PT-PKG Robotics PT Head
 - **PROVIDE** and **INSTALL** New Vinten Osprey Plus Pedestal
 - **PROVIDE** and **INSTALL** New Vinten Head Vector 75 Flat Base
 - **PROVIDE** and **INSTALL** New Vinten Pan Bar Telescopic, Vector
 - **PROVIDE** and **INSTALL** New RTS PH-2 Dual Sided Medium Weight Headset
 - **PROVIDE** and **INSTALL** New Custom Camera Case

C. Type 1 POV Camera

1. Camera
 - **INCLUDED IN 01.01 CAMERAS CAPITOL**
2. Transport
 - **INCLUDED IN 01.01 CAMERAS CAPITOL**
3. Control – Qty 3
 - **PROVIDE** and **INSTALL** New Panasonic AW-RP150GJ5 Advanced Joystick Controller

D. Camera Accessories

1. Camera Control – Qty 3
 - **PROVIDE** and **INSTALL** New Sony MSU3500 Master Setup Unit
2. Camera Batteries
 - **PROVIDE** and **INSTALL** New Anton Bauer Dionic XT Gold Mount Battery – Qty 8
 - **PROVIDE** and **INSTALL** New Anton Bauer Quad Gold Mount Charger – Qty 2

E. Robotics

1. Robotics Control Server
 - **PROVIDE** and **INSTALL** New Ross Video RRB-SRV Robotics Server – Qty 1
 - **PROVIDE** and **INSTALL** New Ross Video RRB-SRV-BKUP Robotics Server Backup – Qty 1
 - **PROVIDE** and **INSTALL** New Ross Video RRB-UNI-CPB Universal Paint Box – Qty 3
 - **PROVIDE** and **INSTALL** New Sony CNA1 Camera Control Network Adapter – Qty 3

F. Teleprompter

1. Teleprompter
 - **PROVIDE** and **INSTALL** New Autoscript EPIC-IP19XL Epic IP on camera package with 19" prompt monitor and 24" talent monitor – Qty 4
 - **PROVIDE** and **INSTALL** New Autoscript WP-IPSPKG Win Plus software, XBOX-IP video generator and HC-IP controller – Qty 3

02.02 PRODUCTION SWITCHER SENATE

Production Switchers are to be 4K 59.94 capable and expected to be configured at 1080p. Production Switcher requirements to be a Frame sized to accommodate a minimum of 16 SDI inputs and 16 3G HD SDI outputs and 32 ST2110 25GB Inputs and 32 ST2110 25GB outputs. Production Switcher to include 2 ME's and 4 Multiview outputs with redundant power supply. Frame to include 8 x's 25G SFP's as necessary to facilitate ST2022-7 connection to the ST2110 Routing Switcher. Production Switcher to be licensed for Frame Sync, Format Conversion, Proc Amp and Color Correction. Frame to support Madi and Embedded audio total of 768 x 768. Production Switcher paired with control surface and aux panel. Xpression live CG software included with Carbonite card purchase.

Aux Production Switchers are to be 4K 59.94 capable and expected to be configured at 1080p. The Aux Switcher frame shall be an all-in-one production switcher with built-in graphics, clip server, Multiview, and audio. The Aux switcher will be a single frame sized to accommodate 9 inputs and 6 outputs and to include 2 ME's. The Aux Production Switcher shall be paired with control surface and aux panel. Aux Production Switcher shall connect to Router via Production Switcher Ultrix frame.

A. Production Switcher PCR 1

1. Production Switcher

- **PROVIDE** and **INSTALL** New Ross Video ULTRIX-NS-FR2 2RU Frame with 16x16 plus 2 AUX – Qty 1
- **PROVIDE** and **INSTALL** New Ross Video ULTRISCAPE Multiviewer License – Qty 4
- **PROVIDE** and **INSTALL** New Ross Video ULTRISYNC FrameSync License – Qty 1
- **PROVIDE** and **INSTALL** New Ross Video SWR-SDPE Carbonite Processing Engine Blade – Qty 1
- **PROVIDE** and **INSTALL** New Ross Video ULTRIPower-PS Modular Power Supply – Qty 1
- **PROVIDE** and **INSTALL** New Ross Video ULTRIPower Rackmount 1ru Power Supply Frame With 1 Power Supply – Qty 1
- **PROVIDE** and **INSTALL** New Ross Video CUFR-ADD-ME1 Carbonite ME 1 License – Qty 1
- **PROVIDE** and **INSTALL** New Ross Video CUFR-ADD-ME2 Carbonite ME 2 License – Qty 1
- **PROVIDE** and **INSTALL** New Ross Video CUFR-ADD-FSFC Carbonite FSFC License – Qty 1
- **PROVIDE** and **INSTALL** New Ross Video CUFR-ADD-PACC Carbonite PACC License – Qty 1
- **PROVIDE** and **INSTALL** New Ross Video XDS0-0001-CPS Xpression Livecg Software Only License – Qty 1
- **PROVIDE** and **INSTALL** New Ross Video SFP-HDB-IO-3G 3G SDI HD-BNC Transceiver SFP – Qty 4
- **PROVIDE** and **INSTALL** New Ross Video ULTRIX-IP-IO IP I/O 4 25GB Connect Board – Qty 2
- **PROVIDE** and **INSTALL** New Allowance for 25GB SFP Module – Qty 8
- **PROVIDE** and **INSTALL** New Ross Video TD2S-PANEL Touchdrive 2 ME Control surface – Qty 1
- **PROVIDE** and **INSTALL** New Ross Video TD-TOUCHSCREEN Touchdrive touchscreen display – Qty 1

B. Production Switcher PCR 2

1. Production Switcher

- **PROVIDE** and **INSTALL** New Ross Video ULTRIX-NS-FR2 2RU Frame with 16x16 plus 2 AUX – Qty 1
- **PROVIDE** and **INSTALL** New Ross Video ULTRISCAPE Multiviewer License – Qty 4
- **PROVIDE** and **INSTALL** New Ross Video ULTRISYNC FrameSync License – Qty 1
- **PROVIDE** and **INSTALL** New Ross Video SWR-SDPE Carbonite Processing Engine Blade – Qty 1
- **PROVIDE** and **INSTALL** New Ross Video ULTRIPower-PS Modular Power Supply – Qty 1

- **PROVIDE** and **INSTALL** New Ross Video ULTRIPower Rackmount 1ru Power Supply Frame With 1 Power Supply – Qty 1
- **PROVIDE** and **INSTALL** New Ross Video CUFR-ADD-ME1 Carbonite ME 1 License – Qty 1
- **PROVIDE** and **INSTALL** New Ross Video CUFR-ADD-ME2 Carbonite ME 2 License – Qty 1
- **PROVIDE** and **INSTALL** New Ross Video CUFR-ADD-FSFC Carbonite FSFC License – Qty 1
- **PROVIDE** and **INSTALL** New Ross Video CUFR-ADD-PACC Carbonite PACC License – Qty 1
- **PROVIDE** and **INSTALL** New Ross Video XDS0-0001-CPS Xpression Livecg Software Only License – Qty 1
- **PROVIDE** and **INSTALL** New Ross Video SFP-HDB-IO-3G 3G SDI HD-BNC Transceiver SFP – Qty 4
- **PROVIDE** and **INSTALL** New Ross Video ULTRIX-IP-IO IP I/O 4 25GB Connect Board – Qty 2
- **PROVIDE** and **INSTALL** New Allowance for 25GB SFP Module – Qty 8
- **PROVIDE** and **INSTALL** New Ross Video TD2S-PANEL Touchdrive 2 ME Control surface – Qty 1
- **PROVIDE** and **INSTALL** New Ross Video TD-TOUCHSCREEN Touchdrive touchscreen display – Qty 1

C. Production Switcher AUX 1

1. Production Switcher – Qty 3
 - **PROVIDE** and **INSTALL** New Ross Video GRAPHITE-4RU-2ME-9IN Frame
 - **PROVIDE** and **INSTALL** New Ross Video TD1C-PANEL Touchdrive 1 ME Control surface
 - **PROVIDE** and **INSTALL** New Ross Video TD-TOUCHSCREEN Touchdrive touchscreen display

03.02 ROUTING SWITCHER SENATE

Routing Switcher shall provide routing of multiple IP signals with general line interface infrastructure of 25/100G (twenty-five or one hundred Gigabit) ports via SFP and/or expansion. Each IP interface shall be comprised of one or more SMPTE 2110 essences including video, ancillary data, and up to 32 audio streams. Router management shall be in band and not require additional networking appliances to manage. All interconnections shall be via single mode fiber optic connection. Network design shall support full actual saturation of all ports without introducing latency or packet loss. For the basis of this calculation the system shall be planned around to support a 4K 59.94 and 1080p 3Gb/s infrastructure, with IPG or highest density native IP device determining number of essences per 25G and 100G line interface. Support for NMOS AMWA IS-05 connection management discovery and registration. Switching shall provide full mono audio level control. Breakaway of Audio, Ancillary Data, and video assignments is expected. Support for PTP/IEEE-1588 timestamping and clock reference. Switching shall be controlled by a broadcast standard routing switcher control system.

Ability to request routes from any source to any destination. All router destination devices shall be able to switch between sources and produce stable error free video from a new source within 400ms of operator command. Provide VAFS path for any Router Destination flows not capable of successfully displaying a new source within specified time. Support for traditional physical router control panel interfaces and support for web-based router control interfaces for operational use only (excludes use of main router programming GUI).

A. Routing Switcher Core

1. Routing Switcher Core Primary
 - **PROVIDE** and **INSTALL** New Evertz NATX-32-100G-1+DF1RP IP Switching Fabric with integrated network address translation. Up to 32x100G or 128x25G – Qty 1
 - **PROVIDE** and **INSTALL** New Evertz DF1-FR Dragon Fire 1RU, single slot, complete with all power and controller redundancy - Qty 1

- **PROVIDE** and **INSTALL** New Evertz QSFP optical modulars. Quantity per design – Qty 12
 - **PROVIDE** and **INSTALL** New Evertz CBL-PSM8-2xPSM4-SM-5M Breakout Cable to Connect The 8 Ports of a QSFP-DD – Qty 10
 - **PROVIDE** and **INSTALL** New Evertz CBL-MTP-LC16-SM-5M 5 Meter MTP to LC Single Mode Breakout Cable for QSFP DD PSM8 to 8x SFP Optical Transceivers – Qty 2
 - **PROVIDE** and **INSTALL** New Evertz SFPTR-RJ45-SER-AV 1000Mbps RJ45 SFP Module – Qty 2
2. Routing Switcher Core Backup
- **PROVIDE** and **INSTALL** New Evertz NATX-32-100G-1+DF1RP IP Switching Fabric with integrated network address translation. Up to 32x100G or 128x25G – Qty 1
 - **PROVIDE** and **INSTALL** New Evertz DF1-FR Dragon Fire 1RU, single slot, complete with all power and controller redundancy - Qty 1
 - **PROVIDE** and **INSTALL** New Evertz QSFP optical modulars. Quantity per design – Qty 12
 - **PROVIDE** and **INSTALL** New Evertz CBL-PSM8-2xPSM4-SM-5M Breakout Cable to Connect The 8 Ports of a QSFP-DD – Qty 10
 - **PROVIDE** and **INSTALL** New Evertz CBL-MTP-LC16-SM-5M 5 Meter MTP to LC Single Mode Breakout Cable for QSFP DD PSM8 to 8x SFP Optical Transceivers – Qty 2
 - **PROVIDE** and **INSTALL** New Evertz SFPTR-RJ45-SER-AV 1000Mbps RJ45 SFP Module – Qty 2

IP Gateways shall provide appropriate IP based connectivity back to the Routing Switcher. Encapsulation and De encapsulation of baseband SDI signals supporting 3G single essence SDI to and from SMPTE 2110. Type 1 IP Gateway shall provide up to 32x32 HD SDI to SMPTE 2110 without frame synchronization. Type 2 IP Gateway shall provide up to 16x16 HD SDI to SMPTE 2110 with frame synchronization.

B. IP Gateway

1. Type 1 IPG Frame
 - **PROVIDE** and **INSTALL** New Evertz EV6-FR+PS 6RU Modular Frame – Qty 1
 - **PROVIDE** and **INSTALL** New Evertz EV6-FC Frame Controller – Qty 2
2. Type 1 IPG
 - **PROVIDE** and **INSTALL** New Evertz EV670-X30-HW-V2 Virtualized Media Processor – Qty 1
 - **PROVIDE** and **INSTALL** New Evertz 670IPG-X30-APP-32X Allows 32 x 32 3G HD SDI to ST 2110 – Qty 1
 - **PROVIDE** and **INSTALL** New Evertz evIPG-3G IPG app support for 32 x 32 – Qty 1
 - **PROVIDE** and **INSTALL** New Evertz ev670-32X32-HDBNC-RP Rear Plate – Qty 1
 - **PROVIDE** and **INSTALL** New Evertz QSFP25G-SM-PSM4-LR-G-NFEC 100G QSFP, 4-CH, MPO/APC QSFP – Qty 2
3. Type 2 IPG
 - **PROVIDE** and **INSTALL** New Evertz EV670-X30-HW-V2 Virtualized Media Processor - Qty 2
 - **PROVIDE** and **INSTALL** New Evertz EV670-16x16-HDBNC-RP HDBNC Rear Plate – Qty 2
 - **PROVIDE** and **INSTALL** New Evertz evIPG-3G-16FS IPG app support for 16 x 16 with Frame Sync – Qty 2
 - **PROVIDE** and **INSTALL** New Evertz QSFP25G-SM-PSM4-LR-G-NFEC 100G QSFP, 4-CH, MPO/APC QSFP – Qty 4

Audio Groomers shall provide TDM Audio to IP Audio, supporting existing TDM modules and AES67 to 302M. Physically the module supports 10x10 TDM and 10GE for IP Audio. Audio Shuffling shall provide for 2560x Mono Channels. To be housed in the same frame where the audio groomer exists. Audio gateway with redundant power, shall provide support for 10x10 TDM/MADI ports by default with 25/10GE AES67 and 302M IP Audio ports. Dante is available with the optional +DANTE64 sub modules.

C. Audio

1. Audio Grooming
 - **PROVIDE** and **INSTALL** New Evertz 570EMR-AG-HUB TDM to IP Audio Gateway – Qty 1
 - **PROVIDE** and **INSTALL** New Evertz 570FR-HF 3RU Multiframe – Qty 1
 - **PROVIDE** and **INSTALL** New Evertz 570FC Vistalink Frame Controller – Qty 1
 - **PROVIDE** and **INSTALL** New Evertz 570PS-HF Power Supply – Qty 1
 - **PROVIDE** and **INSTALL** New Evertz SFP10G-TR13-A SFP+ Optical Transceiver – Qty 4
2. Audio Shuffler
 - **PROVIDE** and **INSTALL** New Evertz 570EMR-ADMX IP Audio engine for mono sub-systems – Qty 2
 - **PROVIDE** and **INSTALL** New Evertz SFP10G-TR13-A SFP+ Optical Transceiver – Qty 2
3. Audio Gateway
 - **PROVIDE** and **INSTALL** New Evertz 9821EMR-AG-HUB 1RU Audio Gateway – Qty 1
 - **PROVIDE** and **INSTALL** New Evertz 9821EMR-IO-DANTE-64 Dante to IP audio module – Qty 8
 - **PROVIDE** and **INSTALL** New Evertz QSFP-10G-TR13-G 40G QSFP+ Optical Transceiver – Qty 2

Router control system shall be provided for standard router control and network orchestration system capable of controlling the routing switcher and other network appliances similar to a baseband broadcast matrix type router. The Routing Control system shall include software web-based and traditional physical router control panel interfaces. Web based system shall allow users to browse to a specific web address to route sources and destinations. Button per source control panels shall support a minimum of 40 buttons and support joystick integration at shading positions for input switching. Programmable XP control panels shall support source to destination, macros, salvos, audio breakaway, metadata breakaway. Routing control system shall be programmed from a web management interface and be capable of salvos/memory/preprogrammed routes.

D. Routing Control

1. Web Service Router Control – Qty 1
 - **PROVIDE** and **INSTALL** New Evertz MAGNUM-ROUTER-VCP-WEB Virtual Control Panel License
 - **PROVIDE** and **INSTALL** New Evertz VUE-WEB Web based interface routing
 - **PROVIDE** and **INSTALL** New Evertz MAGNUM-ANYWHERE-CLIENT 1year License for one seat of VUE anywhere client
2. Type 1 Touch Screen Router Control Panel – Qty 1
 - **PROVIDE** and **INSTALL** New Evertz VUE-TOUCH2 2RU full touch screen rack mountable panel
 - **PROVIDE** and **INSTALL** New Evertz VUEAPP-STUDIO-MANAGER VUE visualization and control
3. Type 1 XY Router Control Panel – Qty 1
 - **PROVIDE** and **INSTALL** New Evertz CP-2232E Full rack width router control panel
4. Type 2 XY Router Control Panel – Qty 12
 - **PROVIDE** and **INSTALL** New Evertz CP-1024E 1RU 3 LCD screens, 5 rotary encoders and 24 backlit buttons
5. Type 1 BPS Router Control Panel – Qty 3

- **PROVIDE** and **INSTALL** New Evertz CP-1040E 1RU 40 button LCD panel
6. Type 1 Router Control Server
 - **PROVIDE** and **INSTALL** New Evertz VUE-VCS1 VUE visualization and control application running on a 1RU hardware platform. Provides a single workstation environment – Qty 1
 - **PROVIDE** and **INSTALL** New Evertz SFP25G-TR13 25G Optical Transceiver – Qty 2
 7. Routing Switcher HW & SW
 - **NOT INCLUDED IN THIS SOW**

Universal Protocol Translator (PTX) module shall provide the ability for Evertz and software to interface directly to third party UMD devices and routers. The PTX communicates with the router and UMD protocols either via one of four serial ports or using a built in Ethernet port. All ports - both serial and Ethernet - are bi-directional allowing the device complete flexibility for communication.

E. PTX (Universal Protocol Translator)

1. PTX
 - **PROVIDE** and **INSTALL** New Evertz 7800FR 3RU Multiframe – Qty 1
 - **PROVIDE** and **INSTALL** New Evertz 7800FC+3RU Vistalink Frame Controller – Qty 1
 - **PROVIDE** and **INSTALL** New Evertz 7700PTX-TSL+3RU Interface to switchers supporting TSL protocol (eg. Ross Carbonite Black) – Qty 8
 - **PROVIDE** and **INSTALL** New Evertz 7700R-SC-BRC+3RU Bidirectional 3rd party router/controller module – Qty 6
 - **PROVIDE** and **INSTALL** New Evertz 7700PTX-NV+3RU PTX which controls NVISION based router – Qty 2

Multiview shall provide SMPTE 2110 input and support for SMPTE 2022-7. Multiview shall be configured for 128 inputs and 16 outputs. Dynamic name sets and support for multiple source names based on router present and system name sets. Support for Up/Down clock and audio monitoring. Multiview outputs shall connect to monitors via fiber to HDMI output module. Up/Down timer shall be provided in each control room.

F. MULTIVIEW

1. Multiview
 - **PROVIDE** and **INSTALL** New Evertz EV6-FR+PS 6RU Multiframe – Qty 1
 - **PROVIDE** and **INSTALL** New Evertz EV6-FC Vistalink Frame Controller – Qty 2
 - **PROVIDE** and **INSTALL** New Evertz EV670-X30-HW-V2 Virtualized Media Processor – Qty 2
 - **PROVIDE** and **INSTALL** New Evertz EVVIP-APP-100G-ST2110 ST2110 input monitoring software license – Qty 2
 - **PROVIDE** and **INSTALL** New Evertz evVIP-FK-64-IP-3G License key to enable 64 SD, HD, 3G or 16 UHD inputs on evVIP-100G – Qty 2
 - **PROVIDE** and **INSTALL** New Evertz evVIP-FK-8OUT License key to enable eight outputs at 1080P. If using UHD outputs two UHD output is max per card. – Qty 2
 - **PROVIDE** and **INSTALL** New Evertz evMV-FK-VIP-64MON-ADV Feature Key to enable 64 inputs advance audio, video, ancillary data monitoring – Qty 2
 - **PROVIDE** and **INSTALL** New Evertz QSFP25G-SM-PSM4-LR-G-NFEC 100GB QSFP Optical Transceiver – Qty 8
2. Multiview HDMI Converter
 - **PROVIDE** and **INSTALL** New Evertz SCORPION-6 Standalone Frame – Qty 4

- **PROVIDE** and **INSTALL** New Evertz SCORPION-6-PSX Power Supply – Qty 4
 - **PROVIDE** and **INSTALL** New Evertz MIO-HDMI-OUT-3G-SA HD 3G HDMI Output – Qty 24
 - **PROVIDE** and **INSTALL** New Evertz SFP25G-TR13 25GB Optical Transceiver – Qty 8
3. Multiview Up/Down Timer – Qty 4
- **PROVIDE** and **INSTALL** New ESE ES 362UE 100 Minute Master Up/Down Timer

A GPI Tally interface shall be provided to support transfer of GIP information to the Multiview. Tally connections shall be provided to indicate when a particular source is “next-to-air”. Connections shall be provided between the Production Switcher, Monitors, Camera Control Units, and any other devices that accept contact closure or serial tally.

G. TALLY INTERFACE

1. Tally Interface - Qty 1
- **PROVIDE** and **INSTALL** New Evertz TR-4800E 1RU Physical GPI and GPO Tally Router
 - **PROVIDE** and **INSTALL** New Evertz TR-4800E-BHP 2RU Breakout panel for 32 GPI and 48 GPO

04.02 TEST & MEASUREMENT SENATE

An IP Network Grand Master Clock and Master Sync Generator are to be 4K 59.94 HDR capable and expected to be configured for 1080p. System shall provide timing for the IP-based video production facility while providing reference to baseband analog and SDI system. The timing clocks shall be synced between the Capitol, Senate, and House. Test signal generators shall provide signals for test generator and digital black and two independently adjustable black burst outputs. Waveform/Vectorscope and Rasterizer are to be 4K 59.94 HDR capable and expected to be configured for 1080p and provide support for SMPTE 2110 and network packet analysis.

A. PTP Grandmaster

1. Type 1 PTP Grandmaster
- **PROVIDE** and **INSTALL** New Evertz 5700MSC-IP+2PS Master Sync Generator for an IP Or hybrid facility with GPS included – Qty 1
 - **PROVIDE** and **INSTALL** New Evertz SFP10G-TR13-A 10GB SFP+ Optical Transceiver – Qty 2

B. Sync Generator

1. Type 1 Sync Generator
- **PROVIDE** and **INSTALL** New Evertz 5700MSC-IP-BC+2PS+AUX+10GTG Master Sync Generator for an IP facility acting as a Boundary Clock via PTP from a 5700MSC-IP Grandmaster – Qty 2
 - **PROVIDE** and **INSTALL** New Evertz SFP10G-TR13-A 10GB SFP+ Optical Transceiver – Qty 4
2. Type 2 Sync Changeover – Qty 1
- **PROVIDE** and **INSTALL** New Evertz 5700ACO Automatic Changeover for the 5700 series

C. Waveform/Vectorscope

1. Type 1 Waveform/Vectorscope
- **PROVIDE** and **INSTALL** New Leader LV5600 Waveform Monitor mainframe – Qty 4
 - **PROVIDE** and **INSTALL** New Leader LV5600-SER01 SDI inputs 4 with CC and CIE display – Qty 4
 - **PROVIDE** and **INSTALL** New Leader LV5600-SER03 Digital/Analog Audio 16CH Digital AES EBU Audio 8 CH Analog Audio – Qty 4
 - **PROVIDE** and **INSTALL** New Leader LV5600-SER06 25GB IP Input and IP analysis – Qty 4
 - **PROVIDE** and **INSTALL** New Leader LV5600-SER26 Customizable user layout display – Qty 4
 - **PROVIDE** and **INSTALL** New Leader LR2561 Rackmount adapter – Qty 4

- **PROVIDE** and **INSTALL** New Leader LC2152 25GB SFP Optical Transceiver – Qty 8

D. Test Rasterizer

1. Test Rasterizer
 - **PROVIDE** and **INSTALL** New Leader LV7600 Rasterizer mainframe – Qty 1
 - **PROVIDE** and **INSTALL** New Leader LV5600-SER01 SDI inputs 4 with CC and CIE display – Qty 1
 - **PROVIDE** and **INSTALL** New Leader LV7600-SER03 Digital/Analog Audio 16CH Digital AES EBU Audio 8 CH Analog Audio – Qty 1
 - **PROVIDE** and **INSTALL** New Leader LV7600-SER06 25GB IP Input and IP analysis – Qty 1
 - **PROVIDE** and **INSTALL** New Leader LV7600-SER26 Customizable user layout display – Qty 1
 - **PROVIDE** and **INSTALL** New Leader LC2152 25GB SFP Optical Transceiver – Qty 2

05.02 VIDEO MONITORS & USER INTERFACE SENATE

Video Monitoring shall be provided throughout the video production facility. Type 1 Monitors to be 24" 4K HDR SDI monitors with an independent feed from the router. These monitors shall provide color accurate images for quality control and shading. Type 2 Monitors to be 24" LED monitors for use with computers and KVM user stations. Type 3 Monitors to be 55" 4K HDR LED monitors for wall mounted Multiview monitoring in the control rooms and a rolling cart monitor on the stage. The Type 3 Monitors will utilize the Multiview functionality provided from the ST2110 router, along with real-time clock and other video as needed. Type 4 Monitors to be 43" 4K HDR LED monitors for monitoring in various office locations.

A. Color Picture Monitor

1. Type 1 Color Picture Monitor
 - **PROVIDE** and **INSTALL** New Sony PVMX2400 24" SDI 4K HDR Monitor – Qty 6
 - **PROVIDE** and **INSTALL** New Sony PVMKRX24 Rackmount Kit – Qty 1
2. Type 2 Color Picture Monitor
 - **PROVIDE** and **INSTALL** New ASUS PA24AC 24" HDR LED Monitor – Qty 20
3. Type 3 Color Picture Monitor
 - **PROVIDE** and **INSTALL** New Sony FW55BZ40H 55" 4K HDR LED Monitor – Qty 13
 - **PROVIDE** and **INSTALL** New LYNX TECHNIK CDH-1813 3G SDI to HDMI Converter – Qty 13
 - **PROVIDE** and **INSTALL** New LYNX TECHNIK R FR 1001 Mounting Bracket – Qty 13
 - **PROVIDE** and **INSTALL** New CHIEF LTM1U Adjust Tilt Wall Mount – Qty 12
 - **PROVIDE** and **INSTALL** New CHIEF MPAUB Cart Mount – Qty 1
4. Type 4 Color Picture Monitor – Qty 3
 - **PROVIDE** and **INSTALL** New SONY FW43BZ35J 43" 4K HDR LED Monitor
 - **PROVIDE** and **INSTALL** New LYNX TECHNIK CDH-1813 3G SDI to HDMI Converter
 - **PROVIDE** and **INSTALL** New LYNX TECHNIK R FR 1001 Mounting Bracket
 - **PROVIDE** and **INSTALL** New CHIEF LTM1U Adjust Tilt Wall Mount

User Interfaces shall be provided throughout the video production facility. Type 1 Mouse to be Optical USB wired mouse for use at various KVM user stations. Type 2 Mouse to be a wireless mouse for use at the CG user stations. Type 3 Mouse to be a wireless gaming mouse for use in the edit bays. Type 1 Keyboard to be wired mouse for use at various KVM user stations. Type 2 Keyboard to be a rackmount keyboard drawer for use in the rack room. Type 3 Moue to be a Premier Pro Keyboard for use in the edit bays.

B. Mouse

1. Type 1 Mouse – Qty 10
 - **PROVIDE** and **INSTALL** New Dell MS116-BK Optical USB wired Mouse
2. Type 2 Mouse – Qty 2
 - **PROVIDE** and **INSTALL** New Logitech MX ANYWHERE 2S Mouse
3. Type 3 Mouse – Qty 2
 - **PROVIDE** and **INSTALL** New Corsair CH-9315411-NA Wireless Pro gaming Mouse

C. Keyboard

1. Type 1 Keyboard – Qty 8
 - **PROVIDE** and **INSTALL** New Dell KB212-B Keyboard wired
2. Type 2 Keyboard – Qty 1
 - **PROVIDE** and **INSTALL** New Middle Atlantic RM-KB-LCD17KVMHD LCD KVM Drawer
3. Type 3 Keyboard – Qty 2
 - **PROVIDE** and **INSTALL** New Logitech LKB-PPROCC-BJPU Premier Pro keyboard

06.02 CHARACTER GENERATOR SENATE

Character Generators are to be 4K 59.94 HDR capable and expected to be configured for 1080p and shall provide for HD 3G real-time motion graphics. Character Generator to include 25G SFP's as necessary to facilitate connection to the ST2110 Routing Switcher. Configured systems to be controlled via KVM by a single operator in PCR 1 and PCR 2. An Inception Social Management system shall be provided to bring texts and graphics from social media content for use in productions. A Character Generator server shall be provided to allow collaborative Xpression project workflow and media moving.

A. Character Generator PCR 1

1. Character Generator – Qty 1
 - **PROVIDE** and **INSTALL** New Ross Video XST3-0001 Xpression Studio Software
 - **PROVIDE** and **INSTALL** New Ross Video XST-DLQ Datalinq Server Option
 - **PROVIDE** and **INSTALL** New Ross Video XPN-1RU-IP-M8 Xpression 1RU IP with 2x 25GB SFP
 - **PROVIDE** and **INSTALL** New ALPHA-ALLOWANCE-ENG for SFPs
2. Type 4 Keyboard – Qty 1
 - **PROVIDE** and **INSTALL** New Ross Video XPN-KBD Xpression Custom Keyboard

B. Character Generator PCR 2

1. Character Generator – Qty 1
 - **PROVIDE** and **INSTALL** New Ross Video XST3-0001 Xpression Studio Software
 - **PROVIDE** and **INSTALL** New Ross Video XST-DLQ Datalinq Server Option
 - **PROVIDE** and **INSTALL** New Ross Video XPN-1RU-IP-M8 Xpression 1RU IP with 2x 25GB SFP
 - **PROVIDE** and **INSTALL** New ALPHA-ALLOWANCE-ENG for SFPs
2. Type 4 Keyboard – Qty 1
 - **PROVIDE** and **INSTALL** New Ross Video XPN-KBD Xpression Custom Keyboard

C. Social Media Integration

1. Social Media
 - **PROVIDE** and **INSTALL** New Ross Video INC-SW-SOCIAL Inception Social Software – Qty 1
 - **PROVIDE** and **INSTALL** New Ross Video INC-EXP-USER-INCL Inception User – Qty 5
 - **PROVIDE** and **INSTALL** New Ross Video INC-EXP-SOCIAL-INCL Inception Social Media License – Qty 10
 - **PROVIDE** and **INSTALL** New Ross Video INC-HW-SERVER-G4-W-SE Inception Server – Qty 1

D. Character Generator Server

1. Type 1 Character Generator Server – Qty 1
 - **PROVIDE** and **INSTALL** New Ross Video XPN-GW-HW-SW-M8 Xpression Gateway
 - **PROVIDE** and **INSTALL** New Ross Video XPN-PS Xpression Project Server
 - **PROVIDE** and **INSTALL** New Ross Video XPN-INC Xpression Incoder
 - **PROVIDE** and **INSTALL** New Ross Video XPN-HW-CORE-PLUS-V2 Xpression Core Workflow Tools

07.02 INGEST & PLAYOUT SENATE

Ingest and Playout to be 4K 59.94 HDR capable and expected to be configured for 1080p. 16 channels from 4 new GV I/O ingest, and playout systems tailored for production workflows on a 1 RU server, with SMPTE ST 2110 support and up to four HD channels. Ingest and Playout shall be upgraded from existing 16 channel 1080p 59.94 baseband system as necessary to facilitate connection to the ST2110 Routing Switcher.

A. Ingest & Playout

1. Type 1 Ingest & Playout
 - **PROVIDE** and **INSTALL** New Grass Valley GVIO-HW-CX6 GVIO-HW-CX6 ConnectX-6 NIC - Dual 25G/10G Mellanox IP interface Card– Qty 4
 - **PROVIDE** and **INSTALL** New Grass Valley GVIO-HW-SFP-10G x2 10GbE SFP Modules required for Mellanox card – Qty 4
 - **PROVIDE** and **INSTALL** New Grass Valley GVIO-SW-IP-CH GVIO per channel IP License - for HD only – Qty 16

B. Network Attached Storage

1. Network Attached Storage
 - **NOT INCLUDED IN THIS SOW**

C. Stratus Core

1. **Stratus Core**
 - **NOT INCLUDED IN THIS SOW**

D. Edius Software

1. Edius Software
 - **NOT INCLUDED IN THIS SOW**

08.02 KVM MATRIX & INTERFACES SENATE

An IP KVM system shall be installed for all major systems and operator positions in the video production facility. A KVM Manager shall be installed to transform KVM Transmitters and Receivers into a digital matrix solution. Using standard IP infrastructure to route any user station to any computer on the attached network without any compromises to video quality or control. It allows co-operative sharing of computers to any user station. HDMI to SDI converter shall be provided for connection to the ST2110 Routing Switcher IP Gateway. A KVM Switch shall be provided to support the KVM system.

A. Matrix Based KVM

1. KVM Matrix
 - **PROVIDE** and **INSTALL** New Adder ASP-001-US Infinity Manager Device – Qty 2
 - **PROVIDE** and **INSTALL** New Adder AIMLIC-192-BCK Infinity AIM software – Qty 1
 - **PROVIDE** and **INSTALL** New Adder SFP-SM-LC SFP Single Mode Fiber Module – Qty 4
2. KVM Transmitter

- **PROVIDE** and **INSTALL** New Adder ALIF4021T-US Dual Head 10GB KVM Transmitter – Qty 32
 - **PROVIDE** and **INSTALL** New Adder SFP-SM-LC-10G SFP Single Mode Fiber Module – Qty 32
 - **PROVIDE** and **INSTALL** New Adder RMK12 Rackmount Kit – Qty 16
 - **PROVIDE** and **INSTALL** New Adder RMK12-BP Blanking Plates – Qty 16
 - **PROVIDE** and **INSTALL** New Lynx Technik CHD-1812 3G HDMI to SDI Converter – Qty 1
3. KVM Receiver
- **PROVIDE** and **INSTALL** New Adder ALIF4021R-US Dual Head 10GB KVM Receiver – Qty 12
 - **PROVIDE** and **INSTALL** New Adder SFP-SM-LC-10G SFP Single Mode Fiber Module – Qty 12
 - **PROVIDE** and **INSTALL** New Adder RMK12 Rackmount Kit – Qty 12
 - **PROVIDE** and **INSTALL** New Adder RMK12-BP Blanking Plates – Qty 24
4. KVM Switch
- **PROVIDE** and **INSTALL** New Netgear XSM4348FS-100NES Ethernet Switch - 48SFP+, 2 10GBASE-T Shared - Manageable 3 Layer Supported – Qty 1
 - **PROVIDE** and **INSTALL** New Netgear APS250W-100NES Power Supply – Qty 1
 - **PROVIDE** and **INSTALL** New Addon AXM761-AO SFP+ Optical Transceiver – Qty 48

09.02 VIDEO RECORDING EQUIPMENT SENATE

A multi-channel recorder and player shall be provided for backup recording of live production, post-production, on-set and any necessary high quality reliable recording and playback as needed.

A. Video Disk Recorder

1. Type 1 Video Disk Recorder
 - **NOT REQUIRED IN THE SENATE BUILDING**

10.02 DISTRIBUTION & SIGNAL PROCESSING SENATE

A Modular Signal Processing infrastructure shall be provided for distribution and conversion as necessary throughout the video production facility. Control of modular systems shall be provided by DashBoard software, available free of charge from Ross Video. This allows for easy setup, monitoring, alarms, and management.

A. Distribution Frame

1. Type 1 Distribution Frame – Qty 6
 - **PROVIDE** and **INSTALL** New Ross Video OGX-FR-CN Open Gear OGX Frame
 - **PROVIDE** and **INSTALL** New Ross Video PS-OGX Power Supply

B. Serial Distribution Amplifier

1. Type 1 SDA
 - **PROVIDE** and **INSTALL** New Ross Video SRA-8901-4-R3S Digital Video Distribution Amplifier – Qty 10
 - **PROVIDE** and **INSTALL** New Ross Video SRA-8901-4 Rear Plate 1 x 4 – Qty 20

C. Analog Video Distribution Amplifier

1. Type 1 VDA – Qty 10
 - **PROVIDE** and **INSTALL** New Ross Video UDA-8705A-R2L Video Distribution Amplifier

D. Audio Embedder/De-Embedder

1. Type 1 Embedder/De-Embedder – Qty 16
 - **PROVIDE** and **INSTALL** New Ross Video AMX-8952-C Analog Audio Embedder/De-Embedder
 - **PROVIDE** and **INSTALL** New Ross Video R3C-8952 Rear Module
 - **PROVIDE** and **INSTALL** New Ross Video AMX-8952-FS-LICENSE Frame Sync License for AMX

E. Up Down Cross Converter

1. Type 1 UDX – Qty 4
 - **PROVIDE** and **INSTALL** New Ross Video GATOR-TOOLBOX Single Channel HD Toolbox
 - **PROVIDE** and **INSTALL** New Ross Video GATOR-TOOLBOX-12G-LICENSE UHD Format Support
 - **PROVIDE** and **INSTALL** New Ross Video GATOR-FRC-LICENSE Frame Rate Conversion License
 - **PROVIDE** and **INSTALL** New Ross Video GATOR-2 12G-SDI 2-Slot Card 6 in and 6 out
 - **PROVIDE** and **INSTALL** New Ross Video R4-GATOR Rear Plate

F. Scan Converter

1. Type 1 Scan Converter – Qty 2
 - **PROVIDE** and **INSTALL** New Barco R9004677 Imagepro II Scan Converter & Processor
2. Scan Converter IO PLATE – Qty 2
 - **PROVIDE** and **INSTALL** New Scan Converter I/O Plate

G. Fiber Optic Transmitter/Receiver

1. Type 1 Fiber Optic Transmitter – Qty 5
 - **PROVIDE** and **INSTALL** New LYNX TECHNIK OTT-1842 Dual 3G SDI to Fiber Optic Transmitter
2. Type 2 Fiber Optic Transmitter – Qty 5
 - **PROVIDE** and **INSTALL** New LYNX TECHNIK OTX-1712 Analog Sync / Video Fiber Optic Transmitter
3. Type 1 Fiber Optic Receiver – Qty 5
 - **PROVIDE** and **INSTALL** New LYNX TECHNIK ORX-1802 3G Fiber Optic to SDI Receiver
4. Type 2 Fiber Optic Receiver – Qty 5
 - **PROVIDE** and **INSTALL** New LYNX TECHNIK ORX-1702 Analog Sync / Video Fiber Optic Receiver

H. HDMI Converter

1. Type 1 HDMI Converter – Qty 5
 - **PROVIDE** and **INSTALL** New LYNX TECHNIK CDH-1813 3G SDI to HDMI Converter
2. Type 2 HDMI Converter – Qty 5
 - **PROVIDE** and **INSTALL** New LYNX TECHNIK CHD-1812 3G HDMI to SDI Converter

I. Media Converter

1. Type 1 Media Converter – Qty 5
 - **PROVIDE** and **INSTALL** New LYNX TECHNIK OET 1510 Fiber to Ethernet Transceiver

11.02 AUDIO, TIME CODE, CONTROL SENATE

A Dante enabled; 16 fader audio mixing board shall be provided in each Production Control Room. This mixer will be capable of saving and recalling mixer configurations, and will provide adequate input, output, and sub-mix counts to handle the production needs. The control rooms shall be provided with wall mounted speakers for audio monitoring and Dante enabled volume controllers. The Studio shall be provided with a truss mounted stage announce speaker. Dante enabled Audio interfaces shall be provided for distribution and conversion of necessary audio throughout the video production facility including interfacing with the wireless microphone and IFB systems as well as a number of input and output audio sources and destinations from the new video systems. Rackmount audio monitoring units shall be provided as necessary at various user locations in the equipment rack room and control rooms.

A. Audio Mixing Console

1. Type 1 Mixing Console – Qty 2

- **PROVIDE** and **INSTALL** New Allen & Heath AH-SQ-5 48 Input Channels 17 Fader w/Dante
 - **PROVIDE** and **INSTALL** New Allen & Heath AH-M-SQ-SDANTE64-A 64x64 Dante Card
2. Type 1 Stage Box – Qty 1
 - **PROVIDE** and **INSTALL** New Allen & Heath AH-DT168 16 Input X 8 Output Dante Audio Expander
 - **PROVIDE** and **INSTALL** New Allen & Heath AH-AB-168-RK19 Rackmount Kit
 - **PROVIDE** and **INSTALL** New SKB 1SKB-R6UW 6RU Rack Stacks W/Roto Racks, Wheels, & Handle
 - **PROVIDE** and **INSTALL** New Middle Atlantic PD-815R-PL Rackmount Power Strip

B. Speaker

1. Type 1 Speaker – Qty 8
 - **PROVIDE** and **INSTALL** New Genelec 8030CP Active 2-Way 5in 60w Studio Monitor
 - **PROVIDE** and **INSTALL** New Genelec 8000-402B Speaker Wall Mount Bracket
2. Type 2 Speaker – Qty 1
 - **PROVIDE** and **INSTALL** New Genelec 8040BPM Active 2-Way 6.5" 180W Studio Monitor
 - **PROVIDE** and **INSTALL** New Genelec 8000-446B Truss mount kit with an adjustable length
 - **PROVIDE** and **INSTALL** New Genelec 8000-444B Long adjustable ceiling mount

C. Audio Interface

1. Type 1 Audio IO Interface – Qty 2
 - **PROVIDE** and **INSTALL** New Focusrite AMS-REDNET-A16R-MKII 16 Channel Analogue Dante I/O Interface
2. Type 1 MADI to Dante Converter – Qty 2
 - **PROVIDE** and **INSTALL** New Focusrite AMS-REDNET-D64R 64 Channel Madi Dante I/O Interface with Redundant Network & Power

D. Microphone

1. Type 1 Mic Receiver – Qty 1
 - **PROVIDE** and **INSTALL** New Shure AD4QUS--A Shure Axient Digital Wireless Receiver, 4-Ch
 - **PROVIDE** and **INSTALL** New Shure UA8100 100' UHF Remote Antenna Extension Cable
 - **PROVIDE** and **INSTALL** New Shure UA874US Active Directional Antenna 470-698 Mhz
 - **PROVIDE** and **INSTALL** New Shure A13HDB Mounting Flange, Heavy Duty, Black
 - **PROVIDE** and **INSTALL** New Atlas Sound MAC-1 Microphone Adapter Clamp
 - **PROVIDE** and **INSTALL** New Atlas Sound AD19BE Extension Tube 45° Angle Tube
2. Type 1 Mic Transmitter – Qty 4
 - **PROVIDE** and **INSTALL** New Shure AD1--G57 Shure Axient Digital Belt Pack Transmitter
 - **PROVIDE** and **INSTALL** New DPA 4060-OC-C-B00 4060 Core Omni Mic
 - **PROVIDE** and **INSTALL** New DPA SCM0013-B 4-Way Clip
 - **PROVIDE** and **INSTALL** New DPA DUA0560 Foam Windscreen
 - **PROVIDE** and **INSTALL** New DPA DAD6010 Mic Adapter
3. Type 1 MIC Battery Charger
 - **PROVIDE** and **INSTALL** New Shure SB900B Rechargeable Battery – Qty 8
 - **PROVIDE** and **INSTALL** New Shure SBC800-US 8 Bay Battery Charger – Qty 1

E. IFB

1. Type 1 IFB Transmitter – Qty 1
 - **PROVIDE** and **INSTALL** New Shure P10T--X55 Dual Transmitter
 - **PROVIDE** and **INSTALL** New Shure UA8100 100' UHF Remote Antenna Extension Cable
 - **PROVIDE** and **INSTALL** New Shure PA805X Passive Directional Antenna (944-952 MHZ)
 - **PROVIDE** and **INSTALL** New Shure A13HDB Mounting Flange, Heavy Duty, Black

- **PROVIDE** and **INSTALL** New Atlas Sound MAC-1 Microphone Adapter Clamp
 - **PROVIDE** and **INSTALL** New Atlas Sound AD19BE Extension Tube 45° Angle Tube
2. Type 1 IFB Receiver – Qty 4
 - **PROVIDE** and **INSTALL** New Shure P10R+/-X55 Bodypack Receiver
 - **PROVIDE** and **INSTALL** New Otto Engineering V1-10437 IFB Earpiece Set, Beige
 3. Type 1 IFB Battery Charger
 - **PROVIDE** and **INSTALL** New Shure SB900B Rechargeable Battery – Qty 8
 - **PROVIDE** and **INSTALL** New Shure SBC800-US 8 Bay Battery Charger – Qty 1

F. Audio Distribution

1. Time Code Distribution Amplifier – Qty 5
 - **PROVIDE** and **INSTALL** New Ross Video ADA-8405-C-R2C Ross Dual 1x4 Audio DA
2. Word Clock Synthesizer – Qty 1
 - **PROVIDE** and **INSTALL** New Ross Video WDA-8409-R2L Word Clock Distribution Amplifier W/Looping Rear Module

G. Audio Monitor

1. Type 1 Audio Monitor – Qty 9
 - **PROVIDE** and **INSTALL** New Wohler iAM1-8 1RU Triple Screen, 8 Channel Dual Input, 3G/HD/SD-SDI, Audio Monitor with Touch Screen Control
 - **PROVIDE** and **INSTALL** New Wohler SFP-2110 w/NMOS SMPTE 2110 Receiver: Multi-Mode 850 Nm, LC (Fiber) Connectors.
 - **PROVIDE** and **INSTALL** New Wohler OPT-DANTE Enable Monitoring from Up to A 64ch Dante Input
2. Type 1 Volume Controller – Qty 4
 - **PROVIDE** and **INSTALL** New Focusrite AMS-REDNET-AM2 Stereo Headphone/Line Out Dante Interface with PoE

12.02 INTERCOM SENATE

An IP based digital Matrix Intercom system shall be provided and licensed for 48 ports and scalable to 128 ports. The intercom system shall work directly with Dante network audio to receive signals for IFB functions. Rackmount Intercom panels with 16 keys and listen and talk levers shall be provided at various user stations throughout the video production facility. Desktop Intercom panels with 16 keys and listen and talk levers shall be provided at various office and desk locations throughout the video production facility. The Intercom Matrix shall provide wireless intercom to handle multiple lightweight intercom belt packs. Fully integrated solution shall allow for seamless roaming across wide area. The Intercom Access Points convert the DECT signals into Dante compatible OMNEO IP technology signals. Intercom interfaces shall be provided for telephone hybrid using POTs lines or VoIP over public internet. Headsets shall be provided for each control panel. Intercom system can be trunked together with systems from other buildings and programmed using AZedit.

A. Intercom Matrix

1. Type 1 Intercom Matrix – Qty 1
 - **PROVIDE** and **INSTALL** New RTS ODIN32NOCORD Odin 32 Port Matrix No Cord
 - **PROVIDE** and **INSTALL** New RTS ODIN 16 PORT UPGRADE

B. Intercom Panel

1. Type 1 Intercom Panel – Qty 14
 - **PROVIDE** and **INSTALL** New RTS KP4016 14 Position Key Panel with Menus and Programming Keypad

2. Type 2 Intercom Panel – Qty 3
 - **PROVIDE** and **INSTALL** New RTS DKP4016 16 Lever Desk Top Key Panel

C. Wireless Intercom Matrix

1. Wireless Intercom Matrix – Qty 4
 - **PROVIDE** and **INSTALL** New RTS AP-1800 Access Point 1.92-1.93 GHZ
 - **PROVIDE** and **INSTALL** New Allowance for Poe 12v Power Adapter For Ap-1800
 - **PROVIDE** and **INSTALL** New RTS TR-1800 Wireless Intercom Beltpack

D. Intercom Interface

1. Type 1 Intercom Interface – Qty 2
 - **PROVIDE** and **INSTALL** New RTS TIF-PRO2 Interfaces SIP Interface 2 Channels
 - **PROVIDE** and **INSTALL** New RTS TIF-PRO2 PSTN Interfaces TIF-PRO 2 PSTN 2-Channels Upgrade

E. Intercom Headset

1. Type 1 Intercom Headset – Qty 17
 - **PROVIDE** and **INSTALL** New RTS PH-88R5 PH-88, Single-Sided Lightweight Headset

13.02 UTILITY COMPUTERS SENATE

Utility computers shall be provided in various locations throughout the video production facility. Type 1 Small form factor desktop workstations shall be provided for users for basic task and functions. Type 2 Rackmount utility computers shall be provided for various engineering and production functions. The rackmount computers shall be remotely operated from the control rooms via a keyboard, mouse and monitor using the KVM system. Type 3 Rackmount servers shall be provided for advanced engineering functions that require high processing power. The rackmount computers shall be remotely operated from the control rooms via a keyboard, mouse and monitor using the KVM system.

A. Utility Computer

1. Type 1 Utility Computer – Qty 5
 - **PROVIDE** and **INSTALL** New Dell Precision 3460 Small Form Factor Fixed Workstation
2. Type 2 Utility Computer – Qty 2
 - **PROVIDE** and **INSTALL** New Dell Precision 3930 Rackmount Workstation
3. Type 3 Utility Computer – Qty 4
 - **PROVIDE** and **INSTALL** New Dell PowerEdge R7525 Rackmount Server
4. Type 4 Utility Computer
 - **NOT INCLUDED IN THIS SOW**

B. Graphics Card

1. Type 1 Graphics Card
 - **NOT INCLUDED IN THIS SOW**
2. Type 2 Graphics Card
 - **NOT INCLUDED IN THIS SOW**

C. Network Interface Card

1. Type 1 Network Interface Card
 - **NOT INCLUDED IN THIS SOW**

D. AV I/O Card

1. Type 1 AV I/O Card
 - **NOT INCLUDED IN THIS SOW**

E. Touch Tablet

1. Type 1 Touch Tablet
 - **NOT INCLUDED IN THIS SOW**

14.02 ARCHIVE SENATE

An Archive solution shall be provided combining multiple technologies including an LTO Archiving Tape Library; a Content Storage Management Solution; a Transcoding Media Processing Server and a Network Attached Storage Array.

A. LTO

1. Type 1 LTO Library
 - **NOT INCLUDED IN THIS SOW**

B. Content Management

1. Type 1 Content Management
 - **NOT INCLUDED IN THIS SOW**

C. Transcoding

1. Type 1 Transcoding
 - **NOT INCLUDED IN THIS SOW**

D. NAS

1. Network Attached Storage – Qty 1
 - **PROVIDE** and **INSTALL** New Allowance for Network Attached Storage Array

15.02 MASTER CONTROL SENATE

Master Control Switcher to be 4K 59.94 capable and expected to be configured at 1080p. Master Control Switcher is a keying and branding playout channel with mixing and logo insertion capabilities plus DVE and audio processing tools to deliver on-air channel from the video production facility. A Dashboard turnkey touchscreen client computer shall be provided for manual switching functionality similar to a typical control surface panel.

A. Master Control Switcher

1. Master Control Switcher
 - **NOT INCLUDED IN THIS SOW**

16.02 NDI PROCESSING SYSTEM SENATE

An NDI (Network Device Interface) shall be provided for transport and management of NDI and other network-based video content. To this end a robust set of hardware and software tools shall be installed. A server running NDI Processing Engine software shall form the core of this system; it can process and transcode multiple streams of NDI simultaneously, as well as handle Multiview tasks and control and ingest of external video streams. The NDI Processing Engine server shall work in concert with another server providing multiple streams of HD-SDI to SDI conversion. This NDI I/O server shall house the necessary hardware and software to transcode these streams. To manage routing and discovery of NDI sources and destinations, both in-facility and externally, a redundant pair of servers will be provided to run the NDI Router and NDI Discovery software. These servers shall be set up in such a way that both processes are available redundantly on both servers. NDI servers will be provided with multiple high-bandwidth connections to the main network switch stack.

A. NDI Processing System

1. NDI Software – Qty 1
 - **PROVIDE** and **INSTALL** New Gallery NDIPEBASE Sienna Processing Engine Base License

- **PROVIDE** and **INSTALL** New Gallery NDIPEPLUS Sienna Processing Engine Plus License
 - **PROVIDE** and **INSTALL** New Gallery NDIRTR Sienna Virtual Router License
 - **PROVIDE** and **INSTALL** New Gallery NDISRCXMAXI Sienna 32-Ch Source Multi License
 - **PROVIDE** and **INSTALL** New Gallery NDIOUTMUL Sienna 8-Ch Output Multi License
2. NDI Hardware
- **PROVIDE** and **INSTALL** New Dell Custom Poweredge R6525 Server (Sienna Processing Engine) – Qty 1
 - **PROVIDE** and **INSTALL** New Dell Custom Precision 3930 Server (NDI Router, NDI Discovery Server) – Qty 2
 - **PROVIDE** and **INSTALL** New Custom Poweredge R7515 Server (NDI-SDI I/O Server) – Qty 1

17.02 PRODUCTION NETWORK SENATE

To manage the large amount of network traffic involved in the video production facility a Primary and Backup Network Core shall be installed in the rack room of each building. The Core stack of each building shall be linked together with 100G fiber cables and network modules. A number of 48 port PoE+ switches shall be provided in the rack room for all necessary production equipment connections. A number of 48 port PoE+ switches shall be installed in all hearing rooms and linked back to the core with 25G fiber cables and network modules. It is intended that these switches be as completely segregated as possible from the corporate office network; the only connection point being public internet access for streaming content to remote locations.

A. Production Network Core

1. Production Network Core Primary
 - **PROVIDE** and **INSTALL** New Cisco C9300X-24Y-A= Catalyst 9300X 24-port 25/10G SFP+ NW-A – Qty 2
 - **PROVIDE** and **INSTALL** New Cisco PWR-C1-1100WAC/2 1100W AC Config 1 Secondary P/S – Qty 1
 - **PROVIDE** and **INSTALL** New Cisco STACK-T1-1M Stackwise 480 Stacking Cable 3.3FT – Qty 1
 - **PROVIDE** and **INSTALL** New Cisco C9300X-NM-2C Catalyst 9300 2 x 40G/100G Network Module – Qty 1
 - **PROVIDE** and **INSTALL** New Cisco QSFP-100G-LR-S 100G QSFP28 100G-LR SMF duplex LC – Qty 2
2. Production Network Core Backup
 - **PROVIDE** and **INSTALL** New Cisco C9300X-24Y-A= Catalyst 9300X 24-port 25/10G SFP+ NW-A – Qty 2
 - **PROVIDE** and **INSTALL** New Cisco PWR-C1-1100WAC/2 1100W AC Config 1 Secondary P/S – Qty 1
 - **PROVIDE** and **INSTALL** New Cisco STACK-T1-1M Stackwise 480 Stacking Cable 3.3FT – Qty 1
 - **PROVIDE** and **INSTALL** New Cisco C9300X-NM-2C Catalyst 9300 2 x 40G/100G Network Module – Qty 1
 - **PROVIDE** and **INSTALL** New Cisco QSFP-100G-LR-S 100G QSFP28 100G-LR SMF duplex LC – Qty 2

B. Production Network Rack Room

1. Production Network Rack Room – Qty 8
 - **PROVIDE** and **INSTALL** New Cisco C9300X-48HX-A Catalyst 9300 48-port mGig UPoE+ Network
 - **PROVIDE** and **INSTALL** New Cisco PWR-C1-1100WAC/2 1100W AC Config 1 Secondary P/S
 - **PROVIDE** and **INSTALL** New Cisco STACK-T1-1M Stackwise 480 Stacking Cable 3.3FT

- **PROVIDE** and **INSTALL** New Cisco C9300X-NM-8Y Catalyst 9300 8 x 25G Network Module
- **PROVIDE** and **INSTALL** New Cisco SFP-10/25G-BXD-I Cisco 10/25GBASE-LR Bidirectional -D
- **PROVIDE** and **INSTALL** New Cisco SFP-10/25G-BXU-I Cisco 10/25GBASE-LR Bidirectional -U

C. Production Network Hearing Room

1. Production Network Hearing Room – Qty 8
 - **PROVIDE** and **INSTALL** New Cisco C9300X-48HX-A Catalyst 9300 48-port mGig UPoE+ Network
 - **PROVIDE** and **INSTALL** New Cisco PWR-C1-1100WAC/2 1100W AC Config 1 Secondary P/S
 - **PROVIDE** and **INSTALL** New Cisco STACK-T1-1M Stackwise 480 Stacking Cable 3.3FT
 - **PROVIDE** and **INSTALL** New Cisco C9300X-NM-8Y Catalyst 9300 8 x 25G Network Module
 - **PROVIDE** and **INSTALL** New Cisco SFP-10/25G-BXD-I Cisco 10/25GBASE-LR Bidirectional -D
 - **PROVIDE** and **INSTALL** New Cisco SFP-10/25G-BXU-I Cisco 10/25GBASE-LR Bidirectional -U

18.02 FURNITURE, MILLWORK & RACKS SENATE

Consoles shall be constructed to house audio, video, control, and other equipment throughout the video production facility control rooms. Consoles will be outfitted with AC power, turrets to mount production equipment and adjustable monitor arms as needed for each individual operator position. Consoles typically include the ability to house certain equipment in racks and on the console desk such as router and intercom key panels, camera control and shading, video and audio monitors, switcher control surfaces, KVM user stations and interface devices, and audio mixers.

A. Furniture Consoles

1. Furniture Consoles Master Control
 - **PROVIDE** and **INSTALL** New Forecast FC-GCX-C3 3-Bay X-Chassis with Countertop, Rear Rail, and Support Leg – Qty 1
 - **PROVIDE** and **INSTALL** New Forecast FC-GCX-C3- CLIENT 3-Bay Client Section with Countertop, Rear Rail, Integrated Cable Basket, and Modes – Qty 1
 - **PROVIDE** and **INSTALL** New Forecast FC-GCX-CF-1 Bay Counter Insert – Qty 1
 - **PROVIDE** and **INSTALL** New Forecast FC-GCX-T-4 Removable, Vented 4 Ru Turret – Qty 3
 - **PROVIDE** and **INSTALL** New Forecast FC-PDM-1 1RU Filler Panel With 1-Power Module (2x Powered USB And 1x 120v With Circuit Breaker) – Qty 1
 - **PROVIDE** and **INSTALL** New Forecast PDU Standard PDU, 36" W/ 14 X 5-15R 120V Outlets – Qty 1
 - **PROVIDE** and **INSTALL** New Forecast Power Grommet – Qty 3
 - **PROVIDE** and **INSTALL** New Forecast LCD ARM Rail Mounted Fully Articulating Monitor Arm – Qty 4
 - **PROVIDE** and **INSTALL** New Engineering Allowance for Chair – Qty 2
 - **PROVIDE** and **INSTALL** New Engineering Allowance for Acoustics Materials – Qty 1
2. Furniture Consoles Aux
 - **PROVIDE** and **INSTALL** New Forecast GSX-S3 Sit-2-Stand Workstation W/ 4RU Turret & 1-Bay Countertop Insert – Qty 3
 - **PROVIDE** and **INSTALL** New Forecast FC-PDM-1 1RU Filler Panel With 1-Power Module (2x Powered USB And 1x 120v With Circuit Breaker) – Qty 3
 - **PROVIDE** and **INSTALL** New Forecast **PROVIDE** and **INSTALL** New Forecast PDU Standard PDU, 36" W/ 14 X 5-15R 120V Outlets – Qty 3
 - **PROVIDE** and **INSTALL** New Forecast Power Grommet – Qty 3
 - **PROVIDE** and **INSTALL** New Forecast LCD ARM Rail Mounted Fully Articulating Monitor Arm – Qty 9

- **PROVIDE** and **INSTALL** New Engineering Allowance for Chair – Qty 3
- **PROVIDE** and **INSTALL** New Engineering Allowance for Acoustics Materials – Qty 3

Racks are not required in the Senate Building Rack Room. Racks to be 44RU height and 42” Deep gangable racks. These racks will be equipped with fan tops, lights, rear doors, power strips, bus bars and lacing strips. Rack bases shall be provided for mounting racks to computer raised floors.

B. Racks

1. 42”D Gangable Racks
 - **NOT REQUIRED IN THE SENATE BUILDING**

19.02 PATCHING & CABLES SENATE

Patch Panels and Patch Cables shall be provided as necessary for the video production facility. Patch Panels shall support 12G normalized patching for video and Cat 6 for network and control. New SMPTE camera cables shall be provided for cameras going to the Stage and on the stage. New Single Mode Fiber camera cables shall be provided for cameras SDI over fiber devices in hearing rooms and session floors. New 100G Single Mode Fiber tie lines shall be provided between the three buildings for the Production Network Switches and the ST2110 Router. New Fiber Enclosures shall be provided in each rack room for the new fiber cables. General purpose audio, video, control, fiber and RF cable and connectors shall be provided as necessary and as called out in the Bill of Materials.

20.02 COMMISSIONING AND TRAINING SENATE

Manufacturers Commissioning and Training shall be provided for necessary systems. Commissioning of Existing Owner Furnished equipment (except for computers which the Owner may provide to the project for installation of configuration and operating software) is not included. It is expected that some Commissioning and Training shall be done remotely in advance to actual on-site time and work. Commissioning and Training schedule shall be a coordinated effort between Alpha Video, Vendors and Owner. General systems operation and maintenance training shall be provided to designated personnel on the use and operation of the system.

Commissioning and training shall include the following systems:

- **Robotics and Cameras**
- **Production Switcher**
- **Aux Switcher**
- **Routing Switcher**
- **Multiviewer**
- **Tally**
- **Character Generator**
- **Ingest and Playout**
- **Intercom**
- **NDI**
- **Production Network**

ADDITIONAL PROJECT SPECIFICATIONS

ASSUMPTIONS & CONDITIONS

ASSUMPTIONS

Alpha Video is making the following assumptions regarding the site conditions, end user needs, and other design or scope details.

- Relating to the current COVID-19 pandemic:
 - We have assumed that our work on this project and the operations of Minnesota Legislative Coordinating Commission are deemed to be unrestricted OR “essential” business functions, as defined by any pertinent federal, state, and local orders. We have assumed that they will continue to be deemed “essential” through the duration of our engagement and the term of the orders.
 - Alpha Video will fully comply with these orders, including work restrictions. We have assumed all personnel may be permitted to work in isolation or with a minimum of 6’ distance from any other person. Any costs incurred by Alpha Video to comply with any work restrictions not in place as of the date on the cover of this proposal are the responsibility of Minnesota Legislative Coordinating Commission. This shall include, but is not limited to, additional labor, split shifts, overtime, weekend work, holiday work, after-hours work, travel expenses, change fees, additional resources, de- and re-mobilization, etc.
 - Alpha Video may, at our sole discretion, request and be granted additional considerations to ensure the health and safety of our team members.

CONDITIONS

The following are equipment and process conditions that specifically apply to this project.

- Equipment listed within this quote may be subject to procurement delays, which may impact installation dates and/or may result in change orders and revisions to this scope of work.
- This scope of work and the pricing in our proposal is based upon the included timeline. Any deviations will require revising both.
- When equipment or material is shipped directly to your facility, Minnesota Legislative Coordinating Commission will be solely responsible for:
 - Providing written delivery confirmation to Alpha Video & Audio for each item upon arrival.
 - Visually inspecting the outside of each package for carrier damage (and providing photo evidence when required); and,
 - Consolidating, organizing, and securely storing each item. Minnesota Legislative Coordinating Commission acknowledges ownership of received items.

PROJECT TIMELINE

As a leader in the audio-visual and broadcast integration markets, Alpha Video understands that this system is considered mission-critical and impacts the success of your organization. We know that your event schedule does not change and that the show must go on.

However, to meet your required completion dates, we have established the following milestones. Timely achievement of each objective will ensure on-time completion. ***This scope of work and the pricing in our proposal is based upon the following timeline. Any deviations will require revising both.***

APPROXIMATE MILESTONES

Date	Primary Party	Requirement
NTP	Minnesota Legislative Coordinating Commission	Notice to Proceed
NTP +6 Weeks	Alpha Video	Drawing submittals complete
NTP +8 Weeks	Minnesota Legislative Coordinating Commission, Alpha Video	Drawing submittals approved; In-House Build begins
NTP +12 Weeks	Minnesota Legislative Coordinating Commission, Alpha Video	On-Site Build Begins
NTP +16 Weeks	Alpha Video	On-Site Build Complete
NTP +19 Weeks	Alpha Video	Commissioning Complete
NTP +21 Weeks	Minnesota Legislative Coordinating Commission, Alpha Video	Punchlist & Training Complete
NTP +23 Weeks	Alpha Video	Project Closeout

On-site installation can only begin once construction has progressed to the point that electronic equipment can be installed in a secure and clean job site. Please provide the project manager with a schedule outlining when this will occur. A change order will be assessed for any delays beyond the date listed in this proposal.

STANDARDS OF QUALITY

SYSTEM INTEGRATION SERVICES

Alpha will manage all aspects of this project from start to finish to ensure this project is on-time and on-budget. If integration services are provided in this proposal, Alpha will provide the following:

INTEGRATION LABOR AND MATERIALS

Project Team:

- Project Engineering
- Project Management
- Lead Technician and Project Technical Specialists
- Subcontracted services management, oversight, and coordination

Documentation:

- Preliminary Shop Drawings & Approval Submittals
- Detailed Installation Notes
- As-Built Drawings & Documentation

Professional Services:

- System Configuration & Commissioning
- Operational Training and/or On-Site Event Support
- Full System Warranty

Additional Items:

- Freight
- Insurance
- Travel Expenses

STANDARDS OF INTEGRATION

We guarantee the quality of our integration services, providing a multi-point inspection upon the completion of every installation. In summary:

GENERAL

- All system components will be installed in a neat and professional manner.
- Equipment will be new and blemish-free unless otherwise noted in this document.
- Above-ceiling components shall be installed with trim rings and/or grommets when necessary.
- Rack equipment will be installed using proper manufacturer-supplied mounting hardware.
- Blank rack spaces will be filled with either blank or vent panels.
- Racks will have proper ventilation to prevent heat buildup and prolong equipment life.

WIRING AND CABLES

- Rack cabling will be bundled neatly with cable ties or hook & loop as required.
- Low- and high-voltage cabling will be separated according to NFPA 70 (National Electric Code) 2017 specifications.
- All cabling in conduit will comply with the conduit fill specifications in NFPA 70 (National Electric Code) 2017.

- Proper strain relief will be provided at all connections and bends.
- Sufficient service loops will be provided above-ceiling, above/within/under equipment racks, or in cable trays so that components may be unmounted for service without cable strain.
- All connectors will be properly sized to fit the wire type and will be installed according to the manufacturer's specifications.
- All permanently installed cabling will be labeled with computer-generated labels.

INSTALLER TESTING AND ADJUSTMENTS

- Alpha will verify proper grounding on all equipment.
- Video displays will be properly aligned and free from distortion.
- Cabling and loudspeakers will be tested for proper polarity.
- Audio will be free of distortion, hums, buzzes, or pops.
- Loudspeaker systems will be tested and equalized to provide uniform frequency response.
- Control system programs will be tested for proper system operation.

PROJECT TERMS & CONDITIONS

RESPONSIBILITIES OF THE OWNER

This statement of work indicates the responsibilities of Alpha Video & Audio. As in any system installation, this project contains several customer responsibilities. They include, but are not limited to:

- Providing a secure, clean, and dust-free work site by the “On-Site Build Begins” date specified in this proposal;
- Providing secured storage locations and/or laydown areas for housing equipment and installation materials.
- Providing central waste and/or recycling containers for proper disposal of any installation debris;
- Providing, without request for reimbursement, all high voltage AC electrical equipment and labor necessary for proper installation – including mains, transformers, panel boards, surge suppression, receptacles, engineering, stamps, and permits – unless specified as “Alpha-provided” within this proposal;
- Providing and installing adequate HVAC, lighting, fire suppression, and life safety systems;
- Providing, installing, and certifying all necessary low voltage infrastructure – including conduits, pathways, cable trays, penetrations, core drilling, floor boxes, wall boxes, and back boxes – unless specified as “Alpha-provided” within this proposal;
- Providing and installing adequate primary & secondary steel, structures, supports, poles, and/or backing for all mounted equipment;
- Providing a professionally installed, fully functional IP network as required with the capacity to support all system components, bandwidth, routing, and enterprise-level configuration;
- Facilitating IT/network coordination with appropriate representatives and providing any requirements during the design engineering process;
- Facilitating custom control system design by coordinating with appropriate representatives and providing any requirements during the design engineering process;
- Providing access to any owner-furnished equipment, devices, virtual machines, and programming code in a timely manner upon request;
- Providing uninhibited access to the job site during normal business hours (7am to 7pm M-F) unless non-standard work hours are included in our proposal; and,
- Coordination of training times with all required staff.

This proposal assumes that work can be carried out continuously throughout the day with limited to no interruptions. If daily interruptions or delays occur before or during the work described in this scope, change orders may be required due to inefficiencies related to these interruptions.

GENERAL TERMS & CONDITIONS

OWNER-FURNISHED EQUIPMENT

This proposal assumes that all existing “owner-furnished” equipment and programming code required for system functionality is in proper operating condition and without defect. If any of the required existing equipment is not in proper operating condition, a change order may be required for the functionality outlined in this proposal.

Any owner-furnished code that is to be reused is subject to review. Please provide Alpha with all uncompiled code within 14 days of Notice to Proceed. Should owner-furnished code be deemed inadequate, by our sole discretion, Alpha will present a change order to modify or rewrite all or part of the code.

DOCUMENTATION

Alpha Video will provide shop drawings for review and formal approval that reflect the final system design. Upon completion of the project, a full set of as-built drawings will be provided digitally, which will include components of the video, audio and control systems, and any architectural documentation used during the installation. Those drawings will become property of the owner upon final payment.

PROJECT MANAGEMENT

Alpha Video will appoint a project manager as your main point of contact regarding this project. The project manager will manage the installation timeline, oversee the project team, and coordinate work with any additional trades involved in this installation.

CHANGE REQUESTS

After the project begins, any changes to this scope must be requested as a change order. Change requests shall be submitted in written form so that both parties fully understand the request. Any additional costs resulting from change orders shall be the responsibility of the owner.

PROMOTION

Alpha Video may decide to leverage this project for sales and marketing purposes. Content used to promote the project may include, but are not limited to: press releases, blogs, pictures, videos, and case studies. Your company name and logo may be used as part of the content when referencing the project. Alpha Video will provide a list of content assets and the timeline for creating, approving, and distributing the content, as required. We will share and gain your approval of any content published in the trade, submitted for awards, etc. You may use any content assets created by Alpha Video for your purposes.

SYSTEM WARRANTY AND SUPPORT

Alpha Video & Audio, Inc. guarantees the following:

1. Equipment will be new, unless noted otherwise.
2. All workmanship provided by Alpha Video will be free of defects and will be repaired, free of charge, for a period of one (1) year from the date of substantial completion or the first date of beneficial use of the system, whichever date occurs first. Substantial completion shall be defined as the point where the work, or designated portion thereof, is sufficiently complete so that the system can be used for its intended purpose.
3. All equipment and materials provided by Alpha Video that was manufactured by other companies will be warranted under the standard warranty terms of the original manufacturer.
4. If any questions arise during the warranty period about the installation or operation of the system, an Alpha Video engineer will be available to assist and answer any questions by phone.
5. The warranty does not include nor cover expendable materials used with the system installation (e.g., light bulbs, lamps, light fixture lamps, fuses, batteries, portable connection cables, etc.).
6. Alpha Video is not responsible for the reliability of systems that communicate using wireless technology. The performance of equipment utilizing wireless communications is inherently unreliable and will experience "dropouts", distortion, and loss of connectivity from time to time. Interference from other forms of radio frequency transmissions, such as radio and television broadcasts, cell phones, and wireless computer networks, is probable and should be expected.
7. Alpha Video is not responsible for the performance, testing, or configuration of owner-furnished data networks that are used to transmit audio, video, and lighting program data and control signal data. IP-based videoconferencing systems rely upon data networks that can provide consistent bandwidth for the transmission. Videoconferencing that is transmitted over the Internet is subject to the intermittent and unreliable nature of the public network. In the event that the Customer's network is found to be the cause of defects in the quality of the audio/video signals, is unreliable, or has insufficient bandwidth to support the A/V/L system and Alpha Video's network engineers are required to troubleshoot or configure the Customer's network, the cost of this service will be invoiced to the Customer.
8. Any adjustments made by the Customer or the Customer's agent(s), other than routine operational adjustments, shall not be covered under this warranty statement. Re-calibration of settings shall be considered by Alpha Video to be billable time to the Customer at Alpha's standard engineering rates.
9. Procedures such as routine preventative maintenance functions (e.g., keeping filters clean, keeping system environment free from foreign materials, etc.) are the responsibility of the Customer and is not included within this warranty agreement. Failure on the part of the Customer to perform these routine maintenance functions shall void this warranty. Preventative maintenance agreements are available at an additional cost.
10. If warranty work is necessary within the warranty period, Alpha Video will, at its option, repair the defective equipment or return it to the manufacturer for repair.
11. Repairs, modifications, or other work performed by personnel not authorized by Alpha Video during the period of warranty on any equipment of the system may invalidate the warranty.
12. Alpha Video will not be responsible for damages or cost of repairs due to modifications, adjustments, or additions to the system performed by personnel not authorized by Alpha Video prior to acceptance of the system by the Customer.
13. Alpha Video may withhold warranty service if the Customer has an unpaid balance due to be paid to Alpha Video.
14. Regarding Owner-furnished Equipment (OFE):

- a. Alpha Video's intent is to provide a complete system including all equipment. In some cases, the Customer may own equipment which they desire to be included with the installation. Alpha identifies this as OFE.
- b. The use of OFE is solely for the convenience of the Customer and is not included in the warranty or guarantee provided.
- c. Alpha Video shall take reasonable care in handling OFE and install it according to standard industry practices; however, Alpha Video takes no responsibility for the operation, performance, appearance, or effects of OFE before, during, or after its integration into the system. Alpha Video reserves the right to accept or reject OFE based on the equipment's service record, or lack thereof, condition, age, impact to other system components, and operator life safety. Alpha Video will not accept OFE that is purchased by the Customer to replace equipment that is specified in this proposal.
- d. In the event that OFE does not function properly, Alpha Video shall notify the Customer to determine if the OFE is to be a) repaired, b) an alternate unit provided by the Customer, c) the unit is not to be used, or d) Alpha Video is to provide a new unit. Alpha Video shall provide a cost to the Customer for the work to be done. The Customer will authorize any additional costs to the job.
- e. The existing equipment, removed as a courtesy by Alpha Video, that is not being reused, shall be handed over to the Customer. Alpha Video is not responsible for disposal of the existing equipment or its condition when received by the Customer.



Alpha Video & Audio, Inc.
 7690 Golden Triangle Drive
 Eden Prairie, MN 55344
 Phone: 952-896-9898 | Fax: 952-896-9899
 Visit us at www.alphavideo.com

QUOTE
19026

PREPARED FOR **SITE LOCATION**

Company: Minnesota Legislative Coordinating Commission
Address: 95 University Ave W Ste G430
 St. Paul, MN 55155

Company: Minnesota State Senate
Address: 95 University Ave W Ste G430
 St. Paul, MN 55155

Date: 2022-10-19

SALES REPRESENTATIVE

Mike Pouh
 System Sales Executive
 (952)841-3365
 mike.pouh@alphavideo.com

TITLE

Television Systems Upgrade Senate

PART NUMBER	MANUFACTURER	DESCRIPTION	QTY	UNIT PRICE	TOTAL PRICE
-------------	--------------	-------------	-----	------------	-------------

01.01 - CAMERAS CAPITOL

A-1: TYPE 1 CAMERA

HDCP50	SONY	3G/4K UHD/HFR Upgradable CMOS POV camera	8.00	\$36,957.60	\$295,660.80
HZCPRV50	SONY	HDC3000 SERIES 50/60P PERMANENT LICENCE	8.00	\$6,720.00	\$53,760.00
IA-200A	IDX	IDX 100 W AC ADAPTER POWER SUPPLY	2.00	\$488.00	\$976.00
A-1: Type 1 Camera Subtotal:					\$350,396.80

A-2: TYPE 1 CAMERA TRANSPORT

V4-3811-6X2-A-ST	MULTIDYNE	6 x 2 3G-SDI Video Portable/Throw Down Fiber Optic Transceiver. With (6) 3G-SDI Video Inputs and (2	2.00	\$4,508.00	\$9,016.00
V4-3811-2X6-B-ST	MULTIDYNE	2 x 6 3G-SDI Video Portable/Throw Down Fiber Optic Transceiver. With (2) 3G-SDI Video Inputs and (6	2.00	\$4,097.33	\$8,194.66
RM-1RU-V4	MULTIDYNE	Universal Rack Kit for mounting up to (4) VB Series V4 products in a 1 RU rack space	3.00	\$182.00	\$546.00
A-2: Type 1 Camera Transport Subtotal:					\$17,756.66

A-3: TYPE 1 CAMERA CONTROL

RCP3500	SONY	STANDARD REMOTE CONTROL PANEL	8.00	\$5,251.87	\$42,014.96
A-3: Type 1 Camera Control Subtotal:					\$42,014.96

A-4: TYPE 1 LENS

CJ20EX5B IASE S	CANON	CANON 2/3" UHDXS LENS , FULL SERVO	8.00	\$29,333.33	\$234,666.64
A-4: Type 1 Lens Subtotal:					\$234,666.64

A-5: TYPE 1 CAMERA PACKAGE

RRB-X300-PT	ROSS VIDEO	X300 ROBOTIC PT HEAD	8.00	\$8,095.08	\$64,760.64
RRB-UNI-WMB	ROSS VIDEO	UNIVERSAL WALL MOUNT BRACKET	8.00	\$660.56	\$5,284.48
A-5: Type 1 Camera Package Subtotal:					\$70,045.12

C-1: TYPE 1 POV CAMERA

ILMEFR7K	SONY	FR7 CINEMA LINE PTZ CAMERA KIT WITH 28-135mm ZOOM LENS	12.00	\$13,871.39	\$166,456.68
IA-70A	IDX	IDX 70W AC ADAPTER POWER SUPPLY	12.00	\$281.33	\$3,375.96
C-1: Type 1 POV Camera Subtotal:					\$169,832.64

C-2: TYPE 1 POV TRANSPORT

V4-3811-6X2-A-ST	MULTIDYNE	6 x 2 3G-SDI Video Portable/Throw Down Fiber Optic Transceiver. With (6) 3G-SDI Video Inputs and (2	3.00	\$4,508.00	\$13,524.00
V4-3811-2X6-B-ST	MULTIDYNE	2 x 6 3G-SDI Video Portable/Throw Down Fiber Optic Transceiver. With (2) 3G-SDI Video Inputs and (6	3.00	\$4,097.33	\$12,291.99
RM-1RU-V4	MULTIDYNE	Universal Rack Kit for mounting up to (4) VB Series V4 products in a 1 RU rack space	4.00	\$182.00	\$728.00
C-2: Type 1 POV Transport Subtotal:					\$26,543.99

C-3: TYPE 1 POV CONTROL

RMIP500/1	SONY	PROFESSIONAL REMOTE CONTROLLER W PS	1.00	\$3,095.00	\$3,095.00
-----------	------	-------------------------------------	------	------------	------------



Alpha Video & Audio, Inc.
 7690 Golden Triangle Drive
 Eden Prairie, MN 55344
 Phone: 952-896-9898 | Fax: 952-896-9899
 Visit us at www.alphavideo.com

QUOTE

19026

PART NUMBER	MANUFACTURER	DESCRIPTION	QTY	UNIT PRICE	TOTAL PRICE
C-3: Type 1 POV Control Subtotal:					\$3,095.00
01.01 - CAMERAS CAPITOL Subtotal:					\$914,351.81
01.02 - CAMERAS SENATE					
A-1: TYPE 1 CAMERA					
HDCP50	SONY	3G/4K UHD/HFR Upgradable CMOS POV camera	13.00	\$36,957.60	\$480,448.80
HZCPRV50	SONY	HDC3000 SERIES 50/60P PERMANENT LICENCE	13.00	\$6,720.00	\$87,360.00
IA-200A	IDX	IDX 100 W AC ADAPTER POWER SUPPLY	13.00	\$488.00	\$6,344.00
A-1: Type 1 Camera Subtotal:					\$574,152.80
A-2: TYPE 1 CAMERA TRANSPORT					
V4-3811-6X2-A-ST	MULTIDYNE	6 x 2 3G-SDI Video Portable/Throw Down Fiber Optic Transceiver. With (6) 3G-SDI Video Inputs and (2	3.00	\$4,508.00	\$13,524.00
V4-3811-2X6-B-ST	MULTIDYNE	2 x 6 3G-SDI Video Portable/Throw Down Fiber Optic Transceiver. With (2) 3G-SDI Video Inputs and (6	3.00	\$4,097.33	\$12,291.99
RM-1RU-V4	MULTIDYNE	Universal Rack Kit for mounting up to (4) VB Series V4 products in a 1 RU rack space	4.00	\$182.00	\$728.00
A-2: Type 1 Camera Transport Subtotal:					\$26,543.99
A-3: TYPE 1 CAMERA CONTROL					
RCP3500	SONY	STANDARD REMOTE CONTROL PANEL	8.00	\$5,251.87	\$42,014.96
RRB-CTL-3	ROSS VIDEO	UNIFIED CONTROL SYSTEM - 3 AXIS	3.00	\$13,691.44	\$41,074.32
RRB-CTL-PTZ	ROSS VIDEO	PTZ CAMERA PLUG-IN LICENSE	3.00	\$3,035.08	\$9,105.24
A-3: Type 1 Camera Control Subtotal:					\$92,194.52
A-4: TYPE 1 LENS					
CJ20EX5B IASE S	CANON	CANON 2/3" UHDXS LENS , FULL SERVO	12.00	\$29,333.33	\$351,999.96
A-4: Type 1 Lens Subtotal:					\$351,999.96
A-5: TYPE 1 CAMERA PACKAGE					
RRB-X300-PT	ROSS VIDEO	X300 ROBOTIC PT HEAD	12.00	\$8,095.08	\$97,140.96
RRB-UNI-WMB	ROSS VIDEO	UNIVERSAL WALL MOUNT BRACKET	12.00	\$660.56	\$7,926.72
A-5: Type 1 Camera Package Subtotal:					\$105,067.68
B-1: TYPE 2 CAMERA					
HDC3200L	SONY	NATIVE FORMAT GLOBAL SHUTTER 4K CAMERA	4.00	\$30,860.67	\$123,442.68
HZCPRV50	SONY	HDC3000 SERIES 50/60P PERMANENT LICENCE	4.00	\$6,720.00	\$26,880.00
VCT14	SONY	SHORT TRIPOD ATTACHMENT	4.00	\$350.27	\$1,401.08
HDVFL750	SONY	LCD COLOR VIEWFINDER	4.00	\$4,998.00	\$19,992.00
HDVFEL20	SONY	.7" OLED VF LCD FOR HDC/PXW CC	4.00	\$4,092.75	\$16,371.00
B-1: Type 2 Camera Subtotal:					\$188,086.76
B-2: TYPE 2 CAMERA TRANSPORT					
HDCU3100L	SONY	SONY 4K/HD CAMERA CONTROL UNIT	4.00	\$11,078.91	\$44,315.64
HKCUSFP50	SONY	ST2110 INTERFACE KIT	4.00	\$19,318.00	\$77,272.00
B-2: Type 2 Camera Transport Subtotal:					\$121,587.64
B-2: TYPE 2 CAMERA TRANSPORT					
OTM25GLR	SONY	25G LONG-RANGE SFP+ TRANSCEIVER	8.00	\$1,080.00	\$8,640.00
B-2: Type 2 Camera Transport Subtotal:					\$8,640.00
B-4: TYPE 2 LENS					
CJ20EX5B IASE S	CANON	CANON 2/3" UHDXS LENS , FULL SERVO	4.00	\$29,333.33	\$117,333.32
MS-210D	CANON	CANON ZOOM SERVO + FOCUS MANUAL	4.00	\$2,952.00	\$11,808.00
B-4: Type 2 Lens Subtotal:					\$129,141.32



Alpha Video & Audio, Inc.
 7690 Golden Triangle Drive
 Eden Prairie, MN 55344
 Phone: 952-896-9898 | Fax: 952-896-9899
 Visit us at www.alphavideo.com

QUOTE

19026

PART NUMBER	MANUFACTURER	DESCRIPTION	QTY	UNIT PRICE	TOTAL PRICE
B-5: TYPE 2 CAMERA PACKAGE					
ECM680S	SONY	MONO/STEREO SWITCHABLE SHOTGUN MIC/5-PIN	4.00	\$902.72	\$3,610.88
EC05X5F3M	SONY	5-PIN XLR TO DUAL 3-PIN XLR FOR ECM680S	4.00	\$74.24	\$296.96
CAM-600PT-PKG	ROSS VIDEO	CAMBOT 600 SERIES P/T HEAD	4.00	\$25,310.12	\$101,240.48
V4170-0001	VINTEN	Pedestal Osprey Plus	4.00	\$11,141.00	\$44,564.00
		<i>2-stage Studio pedestal; on shot stroke 16.1 in / 41cm; with accessory holder and Quickfix</i>			
V4095-0001	VINTEN	Head Vector 75 Flat base	4.00	\$19,630.00	\$78,520.00
		<i>Flat base head with 1 telescopic pan bar.</i>			
3219-82	VINTEN	Pan bar telescopic, Vector	4.00	\$695.00	\$2,780.00
		<i>Telescopic pan bar for Vector 950, 950i, 75, 750, 750i.</i>			
PH-2 A4M	RTS	PH-2, DUAL-SIDED FULL CUSHION MEDIUM WEIGHT HEADSET, A4M CONNECTOR	4.00	\$304.08	\$1,216.32
CAMERA CASE	CUSTOM	CUSTOM CAMERA CASE	1.00	\$1,193.33	\$1,193.33
B-5: Type 2 Camera Package Subtotal:					\$233,421.97
C-3: TYPE 1 POV CONTROL					
RMIP500/1	SONY	PROFESSIONAL REMOTE CONTROLLER W PS	3.00	\$3,095.00	\$9,285.00
C-3: Type 1 POV Control Subtotal:					\$9,285.00
D-1: CAMERA ACCESSORIES CONTROL					
MSU3500	SONY	HALF RACK MASTER SETUP UNIT	3.00	\$11,114.00	\$33,342.00
D-1: Camera Accessories Control Subtotal:					\$33,342.00
D-2: CAMERA ACCESSORIES BATTERIES					
8675-0127	ANTON BAUER	DIONIC XT 150 GOLD MOUNT BATTERY	8.00	\$740.00	\$5,920.00
8475-0119	ANTON BAUER	PERFORMANCE QUAD GOLD MOUNT CHARGER	2.00	\$1,299.00	\$2,598.00
D-2: Camera Accessories Batteries Subtotal:					\$8,518.00
E-1: ROBOTICS CONTROL SERVER					
RRB-SRV	ROSS VIDEO	ROBOTICS SERVER	1.00	\$9,481.52	\$9,481.52
RRB-SRV-BKUP	ROSS VIDEO	ROBOTICS SERVER BACKUP HARDWARE	1.00	\$4,856.68	\$4,856.68
RRB-UNI-CPB	ROSS VIDEO	UNIVERSAL CAMERA PAINT BOX	3.00	\$6,799.72	\$20,399.16
CNA1	SONY	SONY CAMERA CONTROL NETWORK ADAPTOR	3.00	\$1,402.51	\$4,207.53
E-1: Robotics Control Server Subtotal:					\$38,944.89
F-1: TELEPROMPTER					
EPIC-IP19XL	AUTOSCRIPT	EPIC-IP on-camera package with 19" prompt monitor and integrated 24" talent monitor	4.00	\$18,420.00	\$73,680.00
		<i>19" prompt & 24" talent monitor; integrated HD talent monitor; carbon fibre hood; Prompt screen: 19</i>			
WP-IPSPKG	AUTOSCRIPT	WinPlus-IPS software application, XBOX-IP prompt video generator, and HC-IP desktop controller packa	3.00	\$4,875.00	\$14,625.00
		<i>Inc WP-IPS, A9009-0002: HC-IP desktop scroll control; A9009-0001: XBox-IP HD-SDI prompt video general</i>			
F-1: Teleprompter Subtotal:					\$88,305.00
01.02 - CAMERAS SENATE Subtotal:					\$2,009,231.53
02.02 - PRODUCTION SWITCHER SENATE					
A-1: PRODUCTION SWITCHER PCR 1					
ULTRIX-NS-FR2	ROSS VIDEO	ULTRIX NEW STYLE 2RU FRAME W/ 16X16 PLUS 2 AUX (ULTRIMIX AND ULTRICLEAN INCLUDED)	1.00	\$16,364.04	\$16,364.04
ULTRISCAPE	ROSS VIDEO	ULTRISCAPE MULTIVIEWER LICENSE	4.00	\$5,060.00	\$20,240.00
ULTRISYNC	ROSS VIDEO	ULTRISYNC FRAMESYNC LICENSE	1.00	\$506.00	\$506.00

PART NUMBER	MANUFACTURER	DESCRIPTION	QTY	UNIT PRICE	TOTAL PRICE
SWR-SDPE	ROSS VIDEO	ROSS SOFTWARE DEFINED PROCESSING ENGINE BLADE	1.00	\$10,626.00	\$10,626.00
ULTRIPower-PS	ROSS VIDEO	MODULAR POWER SUPPLY FOR ULTRIPower RACK MOUNT PS FRAME	1.00	\$1,163.80	\$1,163.80
ULTRIPower	ROSS VIDEO	ULTRIX RACKMOUNT 1RU POWER SUPPLY FRAME WITH 1 POWER SUPPLY	1.00	\$2,120.60	\$2,120.60
CUFR-ADD-ME1	ROSS VIDEO	ROSS ULTRIX CARBONITE ME 1 LICENCE	1.00	\$6,375.60	\$6,375.60
CUFR-ADD-ME2	ROSS VIDEO	ROSS ULTRIX CARBONITE ME 2 LICENCE	1.00	\$6,375.60	\$6,375.60
CUFR-ADD-FSFC	ROSS VIDEO	ULTRIX CARBONITE FSFC LICENSE	1.00	\$2,125.20	\$2,125.20
CUFR-ADD-PACC	ROSS VIDEO	ULTRIX CARBONITE PA/CC LICENSE	1.00	\$2,125.20	\$2,125.20
XDS0-0001-CPS	ROSS VIDEO	XPRESSION LIVECG SOFTWARE ONLY LICENSE	1.00	\$0.00	\$0.00
SFP-HDB-IO-3G	ROSS VIDEO	3G SDI HD-BNC TRANCEIVER SFP	4.00	\$258.52	\$1,034.08
ULTRIX-IP-IO	ROSS VIDEO	IP I/O BOARD - (4)25GE, ADVANCED CONNECTIVITY, 2 AUX IO FOR MV	2.00	\$23,276.00	\$46,552.00
ALPHA-ALLOWANCE-ENG	ALPHA	ALPHA ENGINEERING ALLOWANCE FOR 25GB SFP'S	8.00	\$1,333.33	\$10,666.64
TD2S-PANEL	ROSS VIDEO	TOUCHDRIVE 2 ME S SERIES PANEL	1.00	\$18,595.96	\$18,595.96
TD-TouchScreen	ROSS VIDEO	TOUCHDRIVE TOUCHSCREEN DISPLAY	1.00	\$906.20	\$906.20
CUF-PSU	ROSS VIDEO	CARBONITE ULTRA STANDARD POWER SUPPLY	2.00	\$526.24	\$1,052.48
A-1: Production Switcher PCR 1 Subtotal:					\$146,829.40
B-1: PRODUCTION SWITCHER PCR 2					
ULTRIX-NS-FR2	ROSS VIDEO	ULTRIX NEW STYLE 2RU FRAME W/ 16X16 PLUS 2 AUX (ULTRIMIX AND ULTRICLEAN INCLUDED)	1.00	\$16,364.04	\$16,364.04
ULTRISCAPE	ROSS VIDEO	ULTRISCAPE MULTIVIEWER LICENSE	4.00	\$5,060.00	\$20,240.00
ULTRISYNC	ROSS VIDEO	ULTRISYNC FRAMESYNC LICENSE	1.00	\$506.00	\$506.00
SWR-SDPE	ROSS VIDEO	ROSS SOFTWARE DEFINED PROCESSING ENGINE BLADE	1.00	\$10,626.00	\$10,626.00
ULTRIPower-PS	ROSS VIDEO	MODULAR POWER SUPPLY FOR ULTRIPower RACK MOUNT PS FRAME	1.00	\$1,163.80	\$1,163.80
ULTRIPower	ROSS VIDEO	ULTRIX RACKMOUNT 1RU POWER SUPPLY FRAME WITH 1 POWER SUPPLY	1.00	\$2,120.60	\$2,120.60
CUFR-ADD-ME1	ROSS VIDEO	ROSS ULTRIX CARBONITE ME 1 LICENCE	1.00	\$6,375.60	\$6,375.60
CUFR-ADD-ME2	ROSS VIDEO	ROSS ULTRIX CARBONITE ME 2 LICENCE	1.00	\$6,375.60	\$6,375.60
CUFR-ADD-FSFC	ROSS VIDEO	ULTRIX CARBONITE FSFC LICENSE	1.00	\$2,125.20	\$2,125.20
CUFR-ADD-PACC	ROSS VIDEO	ULTRIX CARBONITE PA/CC LICENSE	1.00	\$2,125.20	\$2,125.20
XDS0-0001-CPS	ROSS VIDEO	XPRESSION LIVECG SOFTWARE ONLY LICENSE	1.00	\$0.00	\$0.00
SFP-HDB-IO-3G	ROSS VIDEO	3G SDI HD-BNC TRANCEIVER SFP	4.00	\$258.52	\$1,034.08
ULTRIX-IP-IO	ROSS VIDEO	IP I/O BOARD - (4)25GE, ADVANCED CONNECTIVITY, 2 AUX IO FOR MV	2.00	\$23,276.00	\$46,552.00
ALPHA-ALLOWANCE-ENG	ALPHA	ALPHA ENGINEERING ALLOWANCE FOR 25GB SFP'S	8.00	\$1,333.33	\$10,666.64
TD2S-PANEL	ROSS VIDEO	TOUCHDRIVE 2 ME S SERIES PANEL	1.00	\$18,595.96	\$18,595.96
TD-TouchScreen	ROSS VIDEO	TOUCHDRIVE TOUCHSCREEN DISPLAY	1.00	\$906.20	\$906.20
CUF-PSU	ROSS VIDEO	CARBONITE ULTRA STANDARD POWER SUPPLY	2.00	\$526.24	\$1,052.48
B-1: Production Switcher PCR 2 Subtotal:					\$146,829.40
C-1: PRODUCTION SWITCHER AUX 1					
GRAPHITE-4RU-2ME-9IN	ROSS VIDEO	GRAPHITE 4RU INTEGRATED PRODUCTION SYSTEM	3.00	\$0.00	\$0.00
GRAPHITE-HDBNC-BNC	ROSS VIDEO	HDBNC TO BNC KIT WITH 20 CABLES	3.00	\$440.00	\$1,320.00
GRAPHITE-4RU-ENGINE-M8	ROSS VIDEO	GRAPHITE BASE ENGINE M8	3.00	\$26,828.12	\$80,484.36
GRAPHITE-5IN-9IN-UPG	ROSS VIDEO	5 INPUT TO 9 INPUT SYSTEM UPGRADE	3.00	\$5,369.12	\$16,107.36

PART NUMBER	MANUFACTURER	DESCRIPTION	QTY	UNIT PRICE	TOTAL PRICE
GRAPHITE-1ME-2ME-UPG	ROSS VIDEO	2 ME UPGRADE FOR 1 ME SYSTEMS	3.00	\$5,369.12	\$16,107.36
XPR-DLQ	ROSS VIDEO	DATALINQ SERVER OPTION	3.00	\$5,345.20	\$16,035.60
TD1C-PANEL	ROSS VIDEO	TOUCHDRIVE 1 ME COMPACT PANEL	3.00	\$9,705.08	\$29,115.24
TD-TOUCHSCREEN	ROSS VIDEO	TOUCHDRIVE TOUCHSCREEN DISPLAY	3.00	\$906.20	\$2,718.60
CUF-PSU	ROSS VIDEO	CARBONITE ULTRA STANDARD POWER SUPPLY	6.00	\$526.24	\$3,157.44
C-1: Production Switcher AUX 1 Subtotal:					\$165,045.96
02.02 - PRODUCTION SWITCHER SENATE Subtotal:					\$458,704.76

03.02 - ROUTING SWITCHER SENATE

A-1: ROUTING SWITCHER CORE PRIMARY

NATX-32-100G-1+DF1RP	EVERTZ	IP Switching Fabric with Integrated Network Address Translation. Up to 32x100G or 128x25G. DF1 Rear Dragon Fire 1RU, single slot, complete with all power and controller redundancy	1.00	\$66,550.00	\$66,550.00
DF1-FR	EVERTZ	Dragon Fire 1RU, single slot, complete with all power and controller redundancy	1.00	\$11,000.00	\$11,000.00
QSFP200G-SM-LR8-10K-G	EVERTZ	Double density, 1310nm QSFP optical module that supports 8x25G/10G ports. Can be used in application	12.00	\$2,860.00	\$34,320.00
CBL-PSM8-2xPSM4-SM-5M	EVERTZ	MTP PSM8 to 2xMTP PSM4 breakout cable to connect the 8 ports of a QSFP-DD	10.00	\$495.00	\$4,950.00
CBL-MTP-LC16-SM-5M	EVERTZ	5 meter MTP to LC single mode breakout cable for QSFP DD PSM8 to 8x SFP optical transceivers	2.00	\$440.00	\$880.00
SFPTR-RJ45-SER-AV	EVERTZ	1000Mbps RJ45 SFP module with SerDes interface	2.00	\$196.00	\$392.00
A-1: Routing Switcher Core Primary Subtotal:					\$118,092.00

A-2: ROUTING SWITCHER CORE BACKUP

NATX-32-100G-1+DF1RP	EVERTZ	IP Switching Fabric with Integrated Network Address Translation. Up to 32x100G or 128x25G. DF1 Rear Dragon Fire 1RU, single slot, complete with all power and controller redundancy	1.00	\$66,550.00	\$66,550.00
DF1-FR	EVERTZ	Dragon Fire 1RU, single slot, complete with all power and controller redundancy	1.00	\$11,000.00	\$11,000.00
QSFP200G-SM-LR8-10K-G	EVERTZ	Double density, 1310nm QSFP optical module that supports 8x25G/10G ports. Can be used in application	12.00	\$2,860.00	\$34,320.00
CBL-PSM8-2xPSM4-SM-5M	EVERTZ	MTP PSM8 to 2xMTP PSM4 breakout cable to connect the 8 ports of a QSFP-DD	10.00	\$495.00	\$4,950.00
CBL-MTP-LC16-SM-5M	EVERTZ	5 meter MTP to LC single mode breakout cable for QSFP DD PSM8 to 8x SFP optical transceivers	2.00	\$440.00	\$880.00
SFPTR-RJ45-SER-AV	EVERTZ	1000Mbps RJ45 SFP module with SerDes interface	2.00	\$196.00	\$392.00
A-2: Routing Switcher Core Backup Subtotal:					\$118,092.00

B-1: TYPE 1 IPG FRAME

EV6-FR+PS	EVERTZ	6RU MODULAR FRAME	1.00	\$5,030.67	\$5,030.67
EV6-FC	EVERTZ	FRAME CONTROLLER	2.00	\$1,540.00	\$3,080.00
B-1: Type 1 IPG Frame Subtotal:					\$8,110.67

B-2: TYPE 1 IPG

EV670-X30-HW-V2	EVERTZ	NEXT GENERATION HIGH DENSITY MEDIA PROCESSING FPGA ACCELERATED HARDWARE	1.00	\$9,900.00	\$9,900.00
670IPG-X30-APP-32X	EVERTZ	Provides the ability to Encapsulate and Decapsulate 32x32 SD, HD, 3G SDI Signals to ST-2110.	1.00	\$102.67	\$102.67
evIPG-3G	EVERTZ	IPG app support 32x 3G encap and decap	1.00	\$34,496.00	\$34,496.00
ev670-32X32-HDBNC-RP	EVERTZ	Rear plate for ev670-x30-HW. Must use with IPG apps and evVIP-SDI app. Optional for ST-2110 multivie	1.00	\$2,200.00	\$2,200.00
QSFP25G-SM-PSM4-LR-G-NFEC	EVERTZ	100G QSFP, 4-CH, MPO/APC QSFP	2.00	\$1,330.00	\$2,660.00
B-2: Type 1 IPG Subtotal:					\$49,358.67

B-3: TYPE 2 IPG

EV670-X30-HW-V2	EVERTZ	NEXT GENERATION HIGH DENSITY MEDIA PROCESSING FPGA ACCELERATED HARDWARE	2.00	\$9,900.00	\$19,800.00
EV670-16x16-HDBNC-RP	EVERTZ	HDBNC rearplate option for ev670-X30-HW hardware	2.00	\$1,760.00	\$3,520.00
evIPG-3G-16FS	EVERTZ	IPG app support 16x Encap with Frame Sync and 16x Decap	2.00	\$39,629.33	\$79,258.66

PART NUMBER	MANUFACTURER	DESCRIPTION	QTY	UNIT PRICE	TOTAL PRICE
QSFP25G-SM-PSM4-LR-G-NFEC	EVERTZ	100G QSFP, 4-CH, MPO/APC QSFP	4.00	\$1,330.00	\$5,320.00
B-3: Type 2 IPG Subtotal:					\$107,898.66
C-1: AUDIO GROOMING					
570EMR-AG-HUB	EVERTZ	TDM TO IP AUDIO GATEWAY	1.00	\$15,400.00	\$15,400.00
570FR-HF	EVERTZ	EVERTZ 3U MULTIFRAME	1.00	\$1,796.67	\$1,796.67
570FC	EVERTZ	EVERTZ VISTALINK FRAME CONTROLLER	1.00	\$952.00	\$952.00
570PS-HF	EVERTZ	EVERTZ HIGH FLOW POWER SUPPLY	1.00	\$616.00	\$616.00
SFP10G-TR13-A	EVERTZ	EVERTZ SFP+ OPTICAL TRANSCEIVER 10GBS 1310NM DFB SMF 10KM	4.00	\$435.00	\$1,740.00
C-1: Audio Grooming Subtotal:					\$20,504.67
C-2: AUDIO SHUFFLER					
570EMR-ADMX	EVERTZ	IP AUDIO ENGINE FOR MONO SUB-SYSTEMS	2.00	\$11,293.33	\$22,586.66
SFP10G-TR13-A	EVERTZ	EVERTZ SFP+ OPTICAL TRANSCEIVER 10GBS 1310NM DFB SMF 10KM	2.00	\$435.00	\$870.00
C-2: Audio Shuffler Subtotal:					\$23,456.66
C-3: AUDIO GATEWAY					
9821EMR-AG-HUB	EVERTZ	1RU AUDIO GATEWAY	1.00	\$22,000.00	\$22,000.00
9821EMR-IO-DANTE-64	EVERTZ	DANTE TO IP AUDIO MODULE	8.00	\$2,750.00	\$22,000.00
QSFP-10G-TR13-G	EVERTZ	EVERTZ 40G PSM LR4 10KM QSFP+ OPTICAL TRANSCEIVER	2.00	\$1,130.00	\$2,260.00
C-3: Audio Gateway Subtotal:					\$46,260.00
D-1: WEB SERVICE ROUTER CONTROL					
MAGNUM-ROUTER-VCP-WEB	EVERTZ	EVERTZ VIRTUAL CONTROL PANEL LICENCE	1.00	\$821.33	\$821.33
VUE-WEB	EVERTZ	Web based interface that provides control interfacing for routing.	1.00	\$1,129.33	\$1,129.33
MAGNUM-ANYWHERE-CLIENT	EVERTZ	Includes a one year license for one seat of VUE Anywhere client (active MAGNUM Annual Software Licen	1.00	\$1.47	\$1.47
D-1: Web Service Router Control Subtotal:					\$1,952.13
D-2: TYPE 1 TOUCH SCREEN ROUTER CONTROL PANEL					
VUE-TOUCH2	EVERTZ	2RU full touch screen, rackmountable control panel, tailored with base VUE widgets for router, multi	1.00	\$6,038.67	\$6,038.67
VUEAPP-STUDIO-MANAGER	EVERTZ	VUE Visualization and Control for Control Room setup and Feed Management workflow functionality, incu	1.00	\$513.33	\$513.33
D-2: Type 1 Touch Screen Router Control Panel Subtotal:					\$6,552.00
D-3: TYPE 1 XY ROUTER CONTROL PANEL					
CP-2232E	EVERTZ	EVERTZ FULL RACK WIDTH ROUTER CONTROL PANEL	1.00	\$6,570.67	\$6,570.67
D-3: Type 1 XY Router Control Panel Subtotal:					\$6,570.67
D-4: TYPE 2 XY ROUTER CONTROL PANEL					
CP-1024E	EVERTZ	Router control panel, shallow depth 1RU with 3 TFT LCD screens, 5 clickable rotary encoders, 24 back	12.00	\$2,002.00	\$24,024.00
D-4: Type 2 XY Router Control Panel Subtotal:					\$24,024.00
D-5: TYPE 1 BPS ROUTER CONTROL PANEL					
CP-1040E	EVERTZ	EVERTZ 1RU RACK WIDTH ROUTER CONTROL WITH 40 LCD BUTTONS	3.00	\$4,517.33	\$13,551.99
D-5: Type 1 BPS Router Control Panel Subtotal:					\$13,551.99
D-6: TYPE 1 ROUTER CONTROL SERVER					
VUE-VCS1	EVERTZ	VUE visualization and control application running on a 1RU hardware platform. Provides a single work	1.00	\$11,806.67	\$11,806.67
SFP25G-TR13	EVERTZ	25G Optical Transceiver, 1310nm, SM, 10km, LC Connectors	2.00	\$660.00	\$1,320.00

PART NUMBER	MANUFACTURER	DESCRIPTION	QTY	UNIT PRICE	TOTAL PRICE
D-6: Type 1 Router Control Server Subtotal:					\$13,126.67
E-1. PTX					
7800FR	EVERTZ	3RU Multiframe Which Holds up to 15 Single Slot Modules with AC Power Supply	1.00	\$1,694.00	\$1,694.00
7800FC+3RU	EVERTZ	EVERTZ 7700FR AND 7800FR VISTALINK FRAME CONTROLLER	1.00	\$952.00	\$952.00
7700PTX-TSL+3RU	EVERTZ	Interface to switchers supporting TSL protocol (eg. Ross Carbonite Black)	8.00	\$5,133.33	\$41,066.64
7700R-SC-BRC+3RU	EVERTZ	EVERTZ BI DIRECTION 3RD PARTY ROUTER/CONTROLLER MODULE	6.00	\$5,287.33	\$31,723.98
7700PTX-NV+3RU	EVERTZ	PTX Which Controls NVISION Based Router	2.00	\$5,133.33	\$10,266.66
E-1. PTX Subtotal:					\$85,703.28
F-1. MULTIVIEW					
EV6-FR+PS	EVERTZ	6RU MODULAR FRAME	1.00	\$5,030.67	\$5,030.67
EV6-FC	EVERTZ	FRAME CONTROLLER	2.00	\$1,540.00	\$3,080.00
EV670-X30-HW-V2	EVERTZ	NEXT GENERATION HIGH DENSITY MEDIA PROCESSING FPGA ACCELERATED HARDWARE	2.00	\$9,240.00	\$18,480.00
EVVIP-APP-100G-ST2110	EVERTZ	ST2110 INPUT MONITORING SOFTWARE LICENSE	2.00	\$102.67	\$205.34
evVIP-FK-64-IP-3G	EVERTZ	License key to enable 64 SD,HD, 3G or 16 UHD inputs on evVIP-100G	2.00	\$41,066.67	\$82,133.34
evVIP-FK-8OUT	EVERTZ	License key to enable eight outputs at 1080P. If using UHD outputs two UHD output is max per card.	2.00	\$6,981.33	\$13,962.66
evMV-FK-VIP-64MON-ADV	EVERTZ	Feature Key to enable 64 inputs advance audio, video, ancillary data monitoring	2.00	\$5,917.33	\$11,834.66
QSFP25G-SM-PSM4-LR-G-NFEC	EVERTZ	100G QSFP, 4-CH, MPO/APC QSFP	8.00	\$1,330.00	\$10,640.00
F-1. Multiview Subtotal:					\$145,366.67
F-2. MULTIVIEW HDMI CONVERTER					
SCORPION-6	EVERTZ	EVERTZ STANDALONE FRAME	4.00	\$3,901.33	\$15,605.32
SCORPION-6-PSX	EVERTZ	EVERTZ EXTERNAL POWER SUPPLY FOR SCORPION-6	4.00	\$256.67	\$1,026.68
MIO-HDMI-OUT-3G-SA	EVERTZ	HDMI Output Module - Supports HD/3G for use in SCORPION-2 OR SCORPION-4	24.00	\$718.67	\$17,248.08
SFP25G-TR13	EVERTZ	25G OPTICAL TRANSCEIVER, 1310NM, SM, 10KM, LC CONNECTORS	8.00	\$660.00	\$5,280.00
F-2. Multiview HDMI Converter Subtotal:					\$39,160.08
F-3. MULTIVIEW UP/DOWN TIMER					
ES 362UE	ESE	ES 302UE/Serial Output to drive Timer Slave w/ Rackmount Option	4.00	\$435.00	\$1,740.00
F-3. Multiview Up/Down Timer Subtotal:					\$1,740.00
G-1: TALLY INTERFACE					
TR-4800E	EVERTZ	1RU PHYSICAL GPI AND GPO TALLY ROUTER	1.00	\$2,823.33	\$2,823.33
TR-4800E-BHP	EVERTZ	EVERTZ 2RU BREAKOUT PANEL DB-37 TO PHOENIX CONNECTOR FOR 32 GPI AND 48 GPO	1.00	\$1,796.67	\$1,796.67
G-1: Tally Interface Subtotal:					\$4,620.00
03.02 - ROUTING SWITCHER SENATE Subtotal:					\$834,140.82
04.02 - TEST & MEASUREMENT SENATE					
A-1: TYPE 1 PTP GRAND MASTER					
5700MSC-IP+2PS	EVERTZ	MASTER SYNC GENERATOR FOR AN IP OR HYBRID FACILITY WITH GPS INCLUDED.	1.00	\$10,445.00	\$10,445.00
SFP10G-TR13-A	EVERTZ	EVERTZ SFP+ OPTICAL TRANSCEIVER 10GBS 1310NM DFB SMF 10KM	2.00	\$435.00	\$870.00
A-1: Type 1 PTP Grand Master Subtotal:					\$11,315.00
B-1: TYPE 1 SYNC GENERATOR					
5700MSC-IP-BC+2PS+AUX+10GTG	EVERTZ	Master Sync Generator for an IP facility acting as a Boundary Clock via PTP from a 5700MSC-IP Grandm	2.00	\$16,880.00	\$33,760.00



Alpha Video & Audio, Inc.
 7690 Golden Triangle Drive
 Eden Prairie, MN 55344
 Phone: 952-896-9898 | Fax: 952-896-9899
 Visit us at www.alphavideo.com

QUOTE
19026

PART NUMBER	MANUFACTURER	DESCRIPTION	QTY	UNIT PRICE	TOTAL PRICE
SFP10G-TR13-A	EVERTZ	EVERTZ SFP+ OPTICAL TRANSCEIVER 10GBS 1310NM DFB SMF 10KM	4.00	\$435.00	\$1,740.00
B-1: Type 1 Sync Generator Subtotal:					\$35,500.00
B-2: TYPE 2 SYNC CHANGEOVER					
5700ACO	EVERTZ	EVERTZ AUTOMATIC CHANGEOVER FOR THE 5700 SERIES MASTER SYNC AND CLOCK GENERATOR	1.00	\$7,315.00	\$7,315.00
B-2: Type 2 Sync Changeover Subtotal:					\$7,315.00
C-1: TYPE 1 WAVEFORM/VECTORSCOPE					
LV5600	LEADER	LEADER WAVEFORM MONITOR MAINFRAME ONLY	4.00	\$10,100.00	\$40,400.00
LV5600-SER01	LEADER	LEADER SDI INPUTS 4 INCLUDES CLOSED CAPTIONS AND CIE DISPLAY	4.00	\$1,460.00	\$5,840.00
LV5600-SER03	LEADER	LEADER DIGITAL ANALOG AUDIO 16CH DIGITAL AEX EBU AUDIO 8 CH ANALOG AUDIO	4.00	\$2,916.00	\$11,664.00
LV5600-SER06	LEADER	IP INPUT - 25G IP Input and IP analysis (requires SFP + Transceiver x 2) **Special Promotion Pricing	4.00	\$13,830.67	\$55,322.68
LV5600-SER26	LEADER	LEADER LAYOUT CUSTOMIZABLE USER LAYOUT DISPLAY	4.00	\$1,150.67	\$4,602.68
LR2561	LEADER	LEADER RACKMOUNT ADAPTER FOR WAVEFORM MONITOR LV5600	4.00	\$580.00	\$2,320.00
LC2152	LEADER	25GbE Single type 10,000km SFP module for LV5600/LV7600/LT4610/LT4611	8.00	\$480.00	\$3,840.00
C-1: Type 1 Waveform/Vectorscope Subtotal:					\$123,989.36
D-1: TEST RASTERIZER					
LV7600	LEADER	LEADER RASTERIZER MAINFRAME ONLY	1.00	\$9,580.00	\$9,580.00
LV5600-SER01	LEADER	LEADER SDI INPUTS 4 INCLUDES CLOSED CAPTIONS AND CIE DISPLAY	1.00	\$1,460.00	\$1,460.00
LV7600-SER03	LEADER	LEADER DIGITAL ANALOG AUDIO 16 CH DIGITAL AES EBU AUDIO	1.00	\$2,916.00	\$2,916.00
LV7600-SER06	LEADER	IP INPUT - 25G IP Input and IP analysis (requires SFP + Transceiver x 2) **Special Promotion Pricing	1.00	\$13,830.67	\$13,830.67
LV7600-SER26	LEADER	LEADER LAYOUT CUSTOMIZABLE USER LAYOUT DISPLAY	1.00	\$1,150.67	\$1,150.67
LC2152	LEADER	25GbE Single type 10,000km SFP module for LV5600/LV7600/LT4610/LT4611	2.00	\$480.00	\$960.00
D-1: Test Rasterizer Subtotal:					\$29,897.34
04.02 - TEST & MEASUREMENT SENATE Subtotal:					\$208,016.70
05.02 - VIDEO MONITORS & USER INTERFACE SENATE					
A-1: TYPE 1 COLOR PICTURE MONITOR					
PVMX2400	SONY	24" PROFESSIONAL 4K HDR MONITOR	6.00	\$10,704.91	\$64,229.46
PVMKRX24	SONY	RACK MOUNT KIT FOR PVM-X2400	1.00	\$275.40	\$275.40
A-1: Type 1 Color Picture Monitor Subtotal:					\$64,504.86
A-2: TYPE 2 COLOR PICTURE MONITOR					
PA24AC	ASUS	ASUS 24.1IN 1920X1200 HDR LED MONITOR	20.00	\$479.99	\$9,599.80
A-2: Type 2 Color Picture Monitor Subtotal:					\$9,599.80
A-3: TYPE 3 COLOR PICTURE MONITOR					
FW55BZ40H	SONY	55" LED, 4K HDR, PROFESSIONAL DISPLAY	13.00	\$1,301.88	\$16,924.44
CDH-1813	LYNX TECHNIK	YELLOBRIK 3G-SDI TO HDMI CONVERTER	13.00	\$872.00	\$11,336.00
R FR 1001	LYNX TECHNIK	RFR 1001 MOUNTING BRACKET FOR SINGLE YELLOBRIK MODULE	13.00	\$37.27	\$484.51
LTM1U	CHIEF	MICRO-ADJUST TILT WALL MOUNT LARGE	12.00	\$291.84	\$3,502.08
MPAUB	CHIEF	MEDIUM FUSION CART MANUAL ADJUST BLK	1.00	\$1,067.80	\$1,067.80
A-3: Type 3 Color Picture Monitor Subtotal:					\$33,314.83
A-4: TYPE 4 COLOR PICTURE MONITOR					



Alpha Video & Audio, Inc.
 7690 Golden Triangle Drive
 Eden Prairie, MN 55344
 Phone: 952-896-9898 | Fax: 952-896-9899
 Visit us at www.alphavideo.com

QUOTE
19026

PART NUMBER	MANUFACTURER	DESCRIPTION	QTY	UNIT PRICE	TOTAL PRICE
FW43BZ35J	SONY	43" LED, 4K HDR, PROFESSIONAL DISPLAY	3.00	\$1,050.85	\$3,152.55
CDH-1813	LYNX TECHNIK	YELLOBRIK 3G-SDI TO HDMI CONVERTER	3.00	\$872.00	\$2,616.00
R FR 1001	LYNX TECHNIK	RFR 1001 MOUNTING BRACKET FOR SINGLE YELLOBRIK MODULE	3.00	\$37.27	\$111.81
LTM1U	CHIEF	MICRO-ADJUST TILT WALL MOUNT LARGE	3.00	\$291.84	\$875.52
A-4: Type 4 Color Picture Monitor Subtotal:					\$6,755.88
B-1: TYPE 1 MOUSE					
MS116-BK	DELL	OPTICAL MOUSE USB WIRED - BLK	10.00	\$23.99	\$239.90
B-1: Type 1 Mouse Subtotal:					\$239.90
B-2: TYPE 2 MOUSE					
MX ANYWHERE 2S	LOGITECH	Logitech MX ANYWHERE 2S	2.00	\$63.96	\$127.92
B-2: Type 2 Mouse Subtotal:					\$127.92
B-3: TYPE 3 MOUSE					
CH-9315411-NA	CORSAIR	Corsair Dark Core RGB Pro Wireless Gaming Mouse	2.00	\$93.32	\$186.64
B-3: Type 3 Mouse Subtotal:					\$186.64
C-1: TYPE 1 KEYBOARD					
KB212-B	DELL	KEYBOARD - BLACK - 6 FT CABLE LENGTH	8.00	\$31.32	\$250.56
C-1: Type 1 Keyboard Subtotal:					\$250.56
C-2: TYPE 2 KEYBOARD					
RM-KB-LCD17KVMHD	MIDDLE ATLANTIC	KB W/LCD DIG DSPLY & KVM	1.00	\$3,184.20	\$3,184.20
C-2: Type 2 Keyboard Subtotal:					\$3,184.20
C-3: TYPE 3 KEYBOARD					
LKB-PPROCC-BJPU	LOGITECH	Premiere Pro CC - PC Nero Slimline Keyboard	2.00	\$202.67	\$405.34
C-3: Type 3 Keyboard Subtotal:					\$405.34
05.02 - VIDEO MONITORS & USER INTERFACE SENATE Subtotal:					\$118,569.93
06.02 - CHARACTER GENERATOR SENATE					
A-1: TYPE 1 CG PCR 1					
XST3-0001	ROSS VIDEO	XPRESSION STUDIO STANDARD EDITION (SW ONLY)	1.00	\$36,482.60	\$36,482.60
XST-DLQ	ROSS VIDEO	DATALINQ SERVER OPTION	1.00	\$5,345.20	\$5,345.20
XPN-1RU-IP-M8	ROSS VIDEO	XPRESSION 1RU IP W 2X 25G SFP CAGES CHASSIS (HW ONLY)	1.00	\$18,570.20	\$18,570.20
ALPHA-ALLOWANCE-ENG	ALPHA	ALPHA ENGINEERING ALLOWANCE FOR 25GB SFP'S	1.00	\$2,666.67	\$2,666.67
A-1: Type 1 CG PCR 1 Subtotal:					\$63,064.67
A-2: TYPE 4 KEYBOARD					
XPN-KBD	ROSS VIDEO	XPRESSION CUSTOM KEYBOARD	1.00	\$1,439.80	\$1,439.80
A-2: Type 4 Keyboard Subtotal:					\$1,439.80
B-1: TYPE 1 CG PCR 2					
XST3-0001	ROSS VIDEO	XPRESSION STUDIO STANDARD EDITION (SW ONLY)	1.00	\$36,482.60	\$36,482.60
XST-DLQ	ROSS VIDEO	DATALINQ SERVER OPTION	1.00	\$5,345.20	\$5,345.20
XPN-1RU-IP-M8	ROSS VIDEO	XPRESSION 1RU IP W 2X 25G SFP CAGES CHASSIS (HW ONLY)	1.00	\$18,570.20	\$18,570.20
ALPHA-ALLOWANCE-ENG	ALPHA	ALPHA ENGINEERING ALLOWANCE FOR 25GB SFP'S	1.00	\$2,666.67	\$2,666.67
B-1: Type 1 CG PCR 2 Subtotal:					\$63,064.67
B-2: TYPE 4 KEYBOARD					
XPN-KBD	ROSS VIDEO	XPRESSION CUSTOM KEYBOARD	1.00	\$1,439.80	\$1,439.80

PART NUMBER	MANUFACTURER	DESCRIPTION	QTY	UNIT PRICE	TOTAL PRICE
B-2: Type 4 Keyboard Subtotal:					\$1,439.80
C-1: SOCIAL MEDIA INTEGRATION					
INC-SW-SOCIAL	ROSS VIDEO	INCEPTION SOCIAL - SOFTWARE	1.00	\$10,580.00	\$10,580.00
INC-EXP-USER-INCL	ROSS VIDEO	INCEPTION CONCURRENT USER	5.00	\$0.00	\$0.00
INC-EXP-SOCIAL-INCL	ROSS VIDEO	INCEPTION SOCIAL MEDIA ACCOUNT LICENSE	10.00	\$0.00	\$0.00
INC-HW-SERVER-G4-W-SE	ROSS VIDEO	INCEPTION - SERVER HARDWARE (4TH GENERATION / WINDOWS)	1.00	\$8,725.00	\$8,725.00
C-1: Social Media Integration Subtotal:					\$19,305.00
D-1: TYPE 1 CG SERVER					
XPN-GW-HW-SW-M8	ROSS VIDEO	XPRESSION GATEWAY WITH OFFLINE RENDER ENGINE (SW+HW)	1.00	\$21,288.80	\$21,288.80
XPN-PS	ROSS VIDEO	XPRESSION PROJECT SERVER (SW ONLY)	1.00	\$10,690.40	\$10,690.40
XPN-INC	ROSS VIDEO	XPRESSION INCODER (SW ONLY)	1.00	\$5,345.20	\$5,345.20
XPN-HW-CORE-PLUS-V2	ROSS VIDEO	XPRESSION CORE WORKFLOW TOOLS HARDWARE CHASSIS WITH ENHANCED RENDERING (HW ONLY)	1.00	\$9,581.80	\$9,581.80
D-1: Type 1 CG Server Subtotal:					\$46,906.20
06.02 - CHARACTER GENERATOR SENATE Subtotal:					\$195,220.14
07.02 - INGEST & PLAYOUT SENATE					
A-1: TYPE 1 INGEST & PLAYOUT					
GVIO-HW-CX6	Grass Valley	ConnectX-6 NIC - Dual 25G/10G Mellanox IP interface Card <i>Required for all GV I/O 2110 IP Servers. Requires GV I/O-SW and 10G or 25G SFP Modules. Must use 25G SFP for UHD. Includes Rivermax license and silver 1 year support</i>	4.00	\$1,322.20	\$5,288.80
GVIO-HW-SFP-10G	Grass Valley	x2 10GbE SFP Modules required for Mellanox card	4.00	\$124.67	\$498.68
GVIO-SW-IP-CH	Grass Valley	GVIO per channel IP License - for HD only	16.00	\$1,414.00	\$22,624.00
A-1: Type 1 Ingest & Playout Subtotal:					\$28,411.48
07.02 - INGEST & PLAYOUT SENATE Subtotal:					\$28,411.48
08.02 - KVM MATRIX & INTERFACES SENATE					
A-1: KVM MATRX					
ASP-001-US	ADDER	ADDERLINK INFINITY MANAGER DEVICE - SUPPORTS 24 END POINTS	2.00	\$3,736.00	\$7,472.00
AIMLIC-192-BCK	ADDER	ADDERLINK INFINITY AIM SOFTWARE LICENCES FOR PRIMARY AND FAILOVER UNITS 192 ENDPOINTS	1.00	\$10,100.00	\$10,100.00
SFP-SM-LC	ADDER	SFP SINGLE MODE FIBRE MODULE LC CONNECTION	4.00	\$80.00	\$320.00
A-1: KVM Matrx Subtotal:					\$17,892.00
A-2: KVM TRANSMITTER					
ALIF4021T-US	ADDER	ADDERLINK INFINITY DUAL HEAD 4K 10GBE TRANSMITTER	32.00	\$2,196.00	\$70,272.00
SFP-SM-LC-10G	ADDER	10GBE SFP SINGLE MODE FIBRE MODULE LC CONNECTION	32.00	\$104.00	\$3,328.00
RMK12	ADDER	RACKMOUNT KIT FOR ALIF4000 SERIES, ASP-001 AIM AND ALIF3000	16.00	\$154.40	\$2,470.40
RMK12-BP	ADDER	RMK12 BLANKING PLATE	16.00	\$20.00	\$320.00
CHD-1812	LYNX TECHNIK	3G HDMI TO SDI CONVERTER WITH FRAME SYNCHRONIZER	1.00	\$977.33	\$977.33
A-2: KVM Transmitter Subtotal:					\$77,367.73
A-3: KVM RECEIVER					
ALIF4021R-US	ADDER	ADDERLINK INFINITY DUAL HEAD 4K 10GBE RECEIVER	12.00	\$2,196.00	\$26,352.00



Alpha Video & Audio, Inc.
 7690 Golden Triangle Drive
 Eden Prairie, MN 55344
 Phone: 952-896-9898 | Fax: 952-896-9899
 Visit us at www.alphavideo.com

QUOTE
19026

PART NUMBER	MANUFACTURER	DESCRIPTION	QTY	UNIT PRICE	TOTAL PRICE
SFP-SM-LC-10G	ADDER	10GBE SFP SINGLE MODE FIBRE MODULE LC CONNECTION	12.00	\$104.00	\$1,248.00
RMK12	ADDER	RACKMOUNT KIT FOR ALIF4000 SERIES, ASP-001 AIM AND ALIF3000	12.00	\$154.40	\$1,852.80
RMK12-BP	ADDER	RMK12 BLANKING PLATE	24.00	\$20.00	\$480.00
A-3: KVM Receiver Subtotal:					\$29,932.80
A-4: KVM SWITCH					
XSM4348FS-100NES	NETGEAR	NETGEAR XSM4348FS ETHERNET SWITCH - 48SFP+, 2 10GBASE-T SHARED - MANAGEABLE 3 LAYER SUPPORTED - MO	1.00	\$5,234.67	\$5,234.67
APS250W-100NES	NETGEAR	NETGEAR APS250W POWER SUPPLY UNIT - 120 V AC, 230 V AC UNIT, 250W AC	1.00	\$258.29	\$258.29
AXM761-AO	ADDON (NETGEAR)	ADDON NETGEAR AXM761 COMPATIBLE SFP+ TRANSCEIVER-SFP+	48.00	\$232.69	\$11,169.12
A-4: KVM Switch Subtotal:					\$16,662.08
08.02 - KVM MATRIX & INTERFACES SENATE Subtotal:					\$141,854.61
10.02 - DISTRIBUTION & SIGNAL PROCESSING SENATE					
A-1: SPARE POWER SUPPLY					
PS-OGX	ROSS VIDEO	600 WATT UNIVERSAL POWER SUPPLY FOR OGX FRAME	6.00	\$687.24	\$4,123.44
A-1: Spare Power Supply Subtotal:					\$4,123.44
A-1: TYPE 1 DISTRIBUTION FRAME					
OGX-FR-CN	ROSS VIDEO	OPENGear OGX FRAME WITH COOLING AND ADVANCED NETWORKING	6.00	\$2,078.28	\$12,469.68
A-1: Type 1 Distribution Frame Subtotal:					\$12,469.68
B-1: TYPE 1 SDA					
SRA-8901-4-R3S	ROSS VIDEO	12G/6G/3G/HD/SD/MADI DISTRIBUTION AMPLIFIER 1 IN / 4 OUT WITH SPLIT REAR MODULE	10.00	\$562.12	\$5,621.20
SRA-8901-4	ROSS VIDEO	12G/6G/3G/HD/SD/MAD DISTRIBUTION AMPLIFIER 1 IN / 4 OUT	20.00	\$482.08	\$9,641.60
B-1: Type 1 SDA Subtotal:					\$15,262.80
C-1: TYPE 1 VDA					
UDA-8705A-R2L	ROSS VIDEO	Ross Utility DA, 1x8, Looping Input	10.00	\$404.80	\$4,048.00
C-1: Type 1 VDA Subtotal:					\$4,048.00
D-1: TYPE 1 EMBEDDER/DE-EMBEDDER					
AMX-8952-C	ROSS VIDEO	HD/3G/12G-SDI EMBEDDER/DE-EMBEDDER, ANALOG AUDIO	16.00	\$1,517.08	\$24,273.28
R3C-8952	ROSS VIDEO	REAR MODULE FOR AMX-8952-C	16.00	\$138.00	\$2,208.00
AMX-8952-FS-LICENSE	ROSS VIDEO	ROSS FRAME SYNC LICENCE FOR AMX-8952	16.00	\$460.00	\$7,360.00
D-1: Type 1 Embedder/De-Embedder Subtotal:					\$33,841.28
E-1: TYPE 1 UDX					
GATOR-TOOLBOX	ROSS VIDEO	GATOR SINGLE CHANNEL UHD TOOLBOX	4.00	\$920.00	\$3,680.00
GATOR-TOOLBOX-12G-LICENSE	ROSS VIDEO	UHD FORMAT SUPPORT TO GATOR-TOOLBOX	4.00	\$920.00	\$3,680.00
GATOR-FRC-LICENSE	ROSS VIDEO	GATOR FRAME RATE CONVERSION SW LICENSE FOR GATOR-TOOLBOX	4.00	\$2,300.00	\$9,200.00
GATOR-2	ROSS VIDEO	GATOR 12G-SDI 2-SLOT CARD (6-SDI-IN / 6-SDI-OUT)	4.00	\$2,760.00	\$11,040.00
R4-GATOR	ROSS VIDEO	12G-SDI 2-SLOT OGX REAR MODULE FOR GATOR	4.00	\$459.08	\$1,836.32
E-1: Type 1 UDX Subtotal:					\$29,436.32
F-1: TYPE 1 SCAN CONVERTER					
R9004677	BARCO	IMAGEPRO II SCAN CONVERTER & PROCESSOR	2.00	\$6,753.33	\$13,506.66
F-1: Type 1 Scan Converter Subtotal:					\$13,506.66



Alpha Video & Audio, Inc.
 7690 Golden Triangle Drive
 Eden Prairie, MN 55344
 Phone: 952-896-9898 | Fax: 952-896-9899
 Visit us at www.alphavideo.com

QUOTE

19026

PART NUMBER	MANUFACTURER	DESCRIPTION	QTY	UNIT PRICE	TOTAL PRICE
F-2: TYPE 1 SCAN CONVERTER IO PLATE					
ALPHA-ALLOWANCE-ENG	ALPHA	ALPHA ENGINEERING ALLOWANCE FOR SCAN CONVERTER IO PLATE	2.00	\$333.33	\$666.66
F-2: Type 1 Scan Converter IO PLATE Subtotal:					\$666.66
G-1: TYPE 1 FIBER OPTIC TRANSMITTER					
OTT-1842	LYNX TECHNIK	Dual 3G SDI to Fiber Optic Transmitter - (CWDM)	5.00	\$614.33	\$3,071.65
G-1: Type 1 Fiber Optic Transmitter Subtotal:					\$3,071.65
G-2: TYPE 2 FIBER OPTIC TRANSMITTER					
OTX-1712	LYNX TECHNIK	Analog Sync / Video Fiber Optic Transmitter	5.00	\$982.67	\$4,913.35
G-2: Type 2 Fiber Optic Transmitter Subtotal:					\$4,913.35
G-3: TYPE 1 FIBER OPTIC RECEIVER					
ORX-1802	LYNX TECHNIK	3G Fiber Optic to SDI Receiver	5.00	\$633.33	\$3,166.65
G-3: Type 1 Fiber Optic Receiver Subtotal:					\$3,166.65
G-4: TYPE 2 FIBER OPTIC RECEIVER					
ORX-1702	LYNX TECHNIK	Analog Sync / Video Fiber Optic Receiver	5.00	\$982.67	\$4,913.35
G-4: Type 2 Fiber Optic Receiver Subtotal:					\$4,913.35
H-1: TYPE 1 HDMI CONVERTER					
CDH-1813	LYNX TECHNIK	YELLOBRIK 3G-SDI TO HDMI CONVERTER	5.00	\$872.00	\$4,360.00
H-1: Type 1 HDMI Converter Subtotal:					\$4,360.00
H-2: TYPE 2 HDMI CONVERTER					
CHD-1812	LYNX TECHNIK	3G HDMI TO SDI CONVERTER WITH FRAME SYNCHRONIZER	5.00	\$977.33	\$4,886.65
H-2: Type 2 HDMI Converter Subtotal:					\$4,886.65
I-1: TYPE 1 MEDIA CONVERTER					
OET 1510	LYNX TECHNIK	LYNX TECHNIK YELLOBRIK OET 1510 FIBER TO ETHERNET TRANSCEIVER SWITCH	5.00	\$596.57	\$2,982.85
I-1: Type 1 Media Converter Subtotal:					\$2,982.85
10.02 - DISTRIBUTION & SIGNAL PROCESSING SENATE Subtotal:					\$141,649.34
11.02 - AUDIO, TIME CODE, CONTROL SENATE					
A-1: TYPE 1 MIXING CONSOLE					
AH-SQ-5	ALLEN & HEATH	96KHZ XCVI FPGA PROCESSING, 48 INPUT CHANNELS, DEEP PROCESSING, 17 FADERS / 6 LAYERS, 16 ONBOARD PRE	2.00	\$3,957.77	\$7,915.54
AH-M-SQ-SDANTE64-A	ALLEN & HEATH	64 X 64 DANTE CARD FOR SQ / AHM SERIES, 96KHZ / 48KHZ	2.00	\$1,016.67	\$2,033.34
A-1: Type 1 Mixing Console Subtotal:					\$9,948.88
A-2: TYPE 1 STAGE BOX					
AH-DT168	ALLEN & HEATH	16IN X 8OUT DANTE AUDIO EXPANDER WITH DLIVE 96KHZ MIC PREAMPS, 48KHZ / 96KHZ	1.00	\$2,500.76	\$2,500.76
AH-AB-168-RK19	ALLEN & HEATH	OPTIONAL RACK MOUNT KIT FOR AB168, DX168, DT168	1.00	\$98.27	\$98.27
1SKB-R6UW	SKB	6U SPACE RACK STACKS W/ROTO RACKS, WHEELS, AND HANDLE	1.00	\$293.41	\$293.41
PD-815R-PL	MIDDLE ATLANTIC	POWER CENTER W/PILOT LT	1.00	\$126.00	\$126.00
A-2: Type 1 Stage Box Subtotal:					\$3,018.44
B-1: TYPE 1 SPEAKER					
8030CP	GENELEC	GENELEC 8030C ACTIVE TWO WAY 5IN 60W STUDIO MONITOR SINGLE	8.00	\$820.24	\$6,561.92
8000-402B	GENELEC	GENELEC 8000-402B ADJ WALL BRACKET FOR 8000 SERIES BLACK	8.00	\$129.77	\$1,038.16
B-1: Type 1 Speaker Subtotal:					\$7,600.08



Alpha Video & Audio, Inc.
 7690 Golden Triangle Drive
 Eden Prairie, MN 55344
 Phone: 952-896-9898 | Fax: 952-896-9899
 Visit us at www.alphavideo.com

QUOTE
19026

PART NUMBER	MANUFACTURER	DESCRIPTION	QTY	UNIT PRICE	TOTAL PRICE
B-2: TYPE 2 SPEAKER					
8040BPM	GENELEC	Genelec 8040B 6.5" 2-Way 180W Active Studio Monitor	1.00	\$1,336.12	\$1,336.12
8000-446B	GENELEC	Truss mount kit with an adjustable length feature.	1.00	\$470.24	\$470.24
8000-444B	GENELEC	Long adjustable ceiling mount	1.00	\$470.24	\$470.24
B-2: Type 2 Speaker Subtotal:					\$2,276.60
C-1: TYPE 1 AUDIO IO INTERFACE					
AMS-REDNET-A16R-MKII	FOCUSRITE	FOCUSRITE REDNET 16 CHANNEL 24/192 ANALOGUE DANTE I/O INTERFACE WITH LEVEL CONTROL	2.00	\$4,399.99	\$8,799.98
C-1: Type 1 Audio IO Interface Subtotal:					\$8,799.98
C-2: TYPE 1 MADI TO DANTE CONVERTER					
AMS-REDNET-D64R	FOCUSRITE	64 CHANNEL MADI DANTE I/O INTERFACE WITH REDUNDANT NETWORK & POWER	2.00	\$3,999.99	\$7,999.98
C-2: Type 1 MADI to Dante Converter Subtotal:					\$7,999.98
D-1: TYPE 1 MIC RECEIVER					
AD4QUS=-A	SHURE	Shure Axient Digital Wireless Receiver, Four-Channel	1.00	\$6,344.73	\$6,344.73
UA8100	SHURE	100' UHF REMOTE ANTENNA EXTENSION CABLE, BNC-BNC, RG213/U TYPE	1.00	\$244.47	\$244.47
UA874US	SHURE	ACTIVE DIRECTIONAL ANTENNA WITH GAIN SWITCH 470-698 MHZ	1.00	\$358.47	\$358.47
A13HDB	SHURE	MOUNTING FLANGE, HEAVY DUTY, BLACK	1.00	\$12.67	\$12.67
MAC-1	ATLAS SOUND	Microphone Adapter Clamp	1.00	\$29.79	\$29.79
AD19BE	ATLAS SOUND	Extension Tube 45° Angle Tube; 5/8 inch #27 Thread Ebony	1.00	\$18.73	\$18.73
D-1: Type 1 MIC Receiver Subtotal:					\$7,008.86
D-2: TYPE 1 MIC TRANSMITTER					
AD1=-G57	SHURE	Shure Axient Digital Belt Pack Transmitter	4.00	\$843.60	\$3,374.40
4060-OC-C-B00	DPA	4060 CORE OMNI MIC, NORMAL SPL, BLACK, MICRODOT	4.00	\$512.00	\$2,048.00
SCM0013-B	DPA	4-WAY CLIP FOR D:SCREET, BLACK	4.00	\$24.53	\$98.12
DUA0560	DPA	FOAM WINDSCREEN FOR D:SCREET	4.00	\$33.07	\$132.28
DAD6010	DPA	MICROPHONE ADAPTER FOR SHURE AXIENT	4.00	\$106.67	\$426.68
D-2: Type 1 MIC Transmitter Subtotal:					\$6,079.48
D-3: TYPE 1 MIC BATTERY CHARGER					
SB900B	SHURE	RECHARGEABLE BATTERY	8.00	\$101.33	\$810.64
SBC800-US	SHURE	8-BAY SHURE BATTERY CHARGER	1.00	\$466.13	\$466.13
D-3: Type 1 MIC Battery Charger Subtotal:					\$1,276.77
E-1: TYPE 1 IFB TRANSMITTER					
P10T=-X55	SHURE	DUAL TRANSMITTER FOR SHURE PSM 1000 PERSONAL MONITOR SYSTEM	1.00	\$3,059.00	\$3,059.00
UA8100	SHURE	100' UHF REMOTE ANTENNA EXTENSION CABLE, BNC-BNC, RG213/U TYPE	1.00	\$244.47	\$244.47
PA805X	SHURE	PASSIVE DIRECTIONAL ANTENNA (944-952 MHZ)	1.00	\$264.73	\$264.73
A13HDB	SHURE	MOUNTING FLANGE, HEAVY DUTY, BLACK	1.00	\$12.67	\$12.67
MAC-1	ATLAS SOUND	Microphone Adapter Clamp	1.00	\$29.79	\$29.79
AD19BE	ATLAS SOUND	Extension Tube 45° Angle Tube; 5/8 inch #27 Thread Ebony	1.00	\$18.73	\$18.73
E-1: Type 1 IFB Transmitter Subtotal:					\$3,629.39
E-2: TYPE 1 IFB RECEIVER					
P10R+=-X55	SHURE	DIVERSITY BODYPACK RECEIVER FOR SHURE PSM 1000 PERSONAL MONITOR SYSTEM	4.00	\$865.13	\$3,460.52



Alpha Video & Audio, Inc.
 7690 Golden Triangle Drive
 Eden Prairie, MN 55344
 Phone: 952-896-9898 | Fax: 952-896-9899
 Visit us at www.alphavideo.com

QUOTE
19026

PART NUMBER	MANUFACTURER	DESCRIPTION	QTY	UNIT PRICE	TOTAL PRICE
V1-10437	OTTO ENGINEERING	IFB EARPIECE SET, BEIGE	4.00	\$71.93	\$287.72
E-2: Type 1 IFB Receiver Subtotal:					\$3,748.24
E-3: TYPE 1 IFB BATTERY CHARGER					
SB900B	SHURE	RECHARGEABLE BATTERY	8.00	\$101.33	\$810.64
SBC800-US	SHURE	8-BAY SHURE BATTERY CHARGER	1.00	\$466.13	\$466.13
E-3: Type 1 IFB Battery Charger Subtotal:					\$1,276.77
F-1: TIME CODE DISTRIBUTION AMPLIFIER					
ADA-8405-C-R2C	ROSS VIDEO	Ross Dual 1x4 Audio DA	5.00	\$421.36	\$2,106.80
F-1: Time Code Distribution Amplifier Subtotal:					\$2,106.80
F-2: WORD CLOCK SYNTHESIZER					
WDA-8409-R2L	ROSS VIDEO	WORD CLOCK DISTRIBUTION AMPLIFIER W/LOOPING REAR MODULE	1.00	\$546.48	\$546.48
F-2: Word Clock Synthesizer Subtotal:					\$546.48
G-1: TYPE 1 AUDIO MONITOR					
iAM1-8	WOHLER	1RU TRIPLE SCREEN, 8 CHANNEL DUAL INPUT, 3G/HD/SD-SDI, AUDIO MONITOR WITH TOUCH SCREEN CONTROL. INCL	9.00	\$3,995.00	\$35,955.00
SFP-2110 w/NMOS	WOHLER	SMPTE 2110 RECEIVER; MULTI-MODE 850 NM, LC (FIBER) CONNECTORS. SFP MODULE WITH SOFTWARE ACTIVATION K	9.00	\$1,995.00	\$17,955.00
OPT-DANTE	WOHLER	ENABLE MONITORING FROM UP TO A 64CH DANTE INPUT. HARDWARE CARD WITH SOFTWARE ACTIVATION KEY.	9.00	\$895.00	\$8,055.00
G-1: Type 1 Audio Monitor Subtotal:					\$61,965.00
G-2: TYPE 1 VOLUME CONTROLLER					
AMS-REDNET-AM2	FOCUSRITE	STEREO HEADPHONE/LINE OUT DANTE INTERFACE WITH POE	4.00	\$699.99	\$2,799.96
G-2: Type 1 Volume Controller Subtotal:					\$2,799.96
11.02 - AUDIO, TIME CODE, CONTROL SENATE Subtotal:					\$130,081.71
12.02 - INTERCOM SENATE					
A-1: TYPE 1 INTERCOM MATRIX					
ODIN32NOCORD	RTS	ODIN 32 PORT MATRIX NO CORD	1.00	\$18,652.80	\$18,652.80
ODIN16PORTUPG	RTS	ODIN 16 PORT UPGRADE - PRODUCT MAC ID AND EMAIL ADDRESS MUST BE ISSUED FOR DELIVERY OF SOFTWARE PROD	1.00	\$6,973.87	\$6,973.87
A-1: Type 1 Intercom Matrix Subtotal:					\$25,626.67
B-1: TYPE 1 INTERCOM PANEL					
F.01U.298.698	RTS	14 POSITION KEY PANEL WITH MENUS AND PROGRAMMING KEYPAD, EXTENDED DSP FUNCTIONS, 2 FULL HD COLOUR DI	14.00	\$4,059.73	\$56,836.22
B-1: Type 1 Intercom Panel Subtotal:					\$56,836.22
B-2: TYPE 2 INTERCOM PANEL					
DKP4016	RTS	16 LEVER DESK TOP KEY PANEL	3.00	\$4,892.80	\$14,678.40
B-2: Type 2 Intercom Panel Subtotal:					\$14,678.40
C-1: WIRELESS INTERCOM MATRIX					
AP-1800	RTS	ACCESS POINT 1.92-1.93 GHZ	4.00	\$2,578.13	\$10,312.52
ALPHA-ALLOWANCE-ENG	ALPHA	ALPHA ENGINEERING ALLOWANCE FOR POE 12V Power Adapter for AP-1800	4.00	\$133.33	\$533.32
TR-1800	RTS	BELTPACK 1.92-1.93 GHZ. CONNECTOR TYPE A5F.	4.00	\$2,073.60	\$8,294.40
C-1: Wireless Intercom Matrix Subtotal:					\$19,140.24
D-1: TYPE 1 INTERCOM INTERFACE					



Alpha Video & Audio, Inc.
 7690 Golden Triangle Drive
 Eden Prairie, MN 55344
 Phone: 952-896-9898 | Fax: 952-896-9899
 Visit us at www.alphavideo.com

QUOTE
19026

PART NUMBER	MANUFACTURER	DESCRIPTION	QTY	UNIT PRICE	TOTAL PRICE
TIF-PRO2	RTS	Interfaces SIP Interface 2 Channels	2.00	\$4,545.07	\$9,090.14
TIF-PRO2 PSTN	RTS	Interfaces TIF-PRO 2 PSTN 2-Channels Upgrade	2.00	\$533.33	\$1,066.66
D-1: Type 1 Intercom Interface Subtotal:					\$10,156.80
E-1: TYPE 1 HEADSET					
PH-88R5	RTS	PH-88, SINGLE-SIDED LIGHTWEIGHT HEADSET, 6' (18M) CORD, A5M CONNECTOR	17.00	\$213.36	\$3,627.12
E-1: Type 1 Headset Subtotal:					\$3,627.12
12.02 - INTERCOM SENATE Subtotal:					\$130,065.45
13.02 - UTILITY COMPUTERS SENATE					
A-1: TYPE 1 UTILITY COMPUTER					
Precision 3460	DELL	DELL CUSTOM (QUOTE # 1003176769803)	5.00	\$1,887.93	\$9,439.65
A-1: Type 1 Utility Computer Subtotal:					\$9,439.65
A-2: TYPE 2 UTILITY COMPUTER					
Precision 3930	DELL	DELL CUSTOM (QUOTE # 1003176769803)	2.00	\$2,317.37	\$4,634.74
		<i>Guardian VM - Control Point PC</i>			
A-2: Type 2 Utility Computer Subtotal:					\$4,634.74
A-3: TYPE 3 UTILITY COMPUTER					
PowerEdge R7525	DELL	Dell Custom PowerEdge R7525 Rack Server	4.00	\$10,000.00	\$40,000.00
A-3: Type 3 Utility Computer Subtotal:					\$40,000.00
13.02 - UTILITY COMPUTERS SENATE Subtotal:					\$54,074.39
14.02 - ARCHIVE SENATE					
D-1: NETWORK ATTACHED STORAGE					
ALPHA-ALLOWANCE-ENG	ALPHA	ALPHA ENGINEERING ALLOWANCE FOR NETWORK ATTACHED STORAGE	1.00	\$100,000.00	\$100,000.00
D-1: Network Attached Storage Subtotal:					\$100,000.00
14.02 - ARCHIVE SENATE Subtotal:					\$100,000.00
16.02 - NDI PROCESSING SYSTEM SENATE					
A-1: NDI SOFTWARE					
NDIPEBASE	GALLERY SIENNA	SIENNA PROCESSING ENGINE BASE LICENSE	1.00	\$6,943.05	\$6,943.05
NDIPEPLUS	GALLERY SIENNA	SIENNA PROCESSING ENGINE PLUS LICENSE	1.00	\$6,943.05	\$6,943.05
NDIRTR	GALLERY SIENNA	SIENNA VIRTUAL ROUTER LICENSE	1.00	\$6,943.05	\$6,943.05
NDISRCXMAXI	GALLERY SIENNA	SIENNA 32-CH SOURCE MULTI LICENSE	1.00	\$1,388.61	\$1,388.61
NDIOUTMUL	GALLERY SIENNA	SIENNA 8-CH OUTPUT MULTI LICENSE	1.00	\$1,388.61	\$1,388.61
A-1: NDI Software Subtotal:					\$23,606.37
B-1: NDI HARDWARE					
CUSTOM	DELL	POWEREDGE R6525 SERVER (SIENNA PROCESSING ENGINE)	1.00	\$30,744.81	\$30,744.81
CUSTOM	DELL	PRECISION 3930 SERVER (NDI ROUTER, NDI DISCOVERY SERVER)	2.00	\$2,292.53	\$4,585.06
CUSTOM	DELL	POWEREDGE R7515 SERVER (NDI-SDI I/O SERVER)	1.00	\$7,441.25	\$7,441.25
B-1: NDI Hardware Subtotal:					\$42,771.12
16.02 - NDI PROCESSING SYSTEM SENATE Subtotal:					\$66,377.49
17.02 - PRODUCTION NETWORK SENATE					
A-1: PRODUCTION NETWORK CORE PRIMARY					
C9300X-24Y-A=	CISCO	Catalyst 9300X 24-port 25/10G SFP+ NW-A	2.00	\$24,268.87	\$48,537.74
PWR-C1-1100WAC/2	CISCO	1100W AC CONFIG 1 SECONDARY P/S	1.00	\$1,844.43	\$1,844.43



Alpha Video & Audio, Inc.
 7690 Golden Triangle Drive
 Eden Prairie, MN 55344
 Phone: 952-896-9898 | Fax: 952-896-9899
 Visit us at www.alphavideo.com

QUOTE
19026

PART NUMBER	MANUFACTURER	DESCRIPTION	QTY	UNIT PRICE	TOTAL PRICE
STACK-T1-1M	CISCO	CISCO STACKWISE 480 STACKING CABLE 3.3FT	1.00	\$194.15	\$194.15
C9300X-NM-2C	CISCO	Catalyst 9300 2 x 40G/100G Network Module	1.00	\$2,475.43	\$2,475.43
QSFP-100G-LR-S	CISCO	100G QSFP28 100G-LR 10km SMF duplex LC	2.00	\$8,731.95	\$17,463.90
A-1: Production Network Core Primary Subtotal:					\$70,515.65
A-2: PRODUCTION NETWORK CORE BACKUP					
C9300X-24Y-A=	CISCO	Catalyst 9300X 24-port 25/10G SFP+ NW-A	2.00	\$24,268.87	\$48,537.74
PWR-C1-1100WAC/2	CISCO	1100W AC CONFIG 1 SECONDARY P/S	1.00	\$1,844.43	\$1,844.43
STACK-T1-1M	CISCO	CISCO STACKWISE 480 STACKING CABLE 3.3FT	1.00	\$194.15	\$194.15
C9300X-NM-2C	CISCO	Catalyst 9300 2 x 40G/100G Network Modul	1.00	\$2,475.43	\$2,475.43
QSFP-100G-LR-S	CISCO	100G QSFP28 100G-LR 10km SMF duplex L	2.00	\$8,731.95	\$17,463.90
A-2: Production Network Core Backup Subtotal:					\$70,515.65
B-1: PRODUCTION NETWORK RACK ROOM					
C9300X-48HX-A	CISCO	Catalyst 9300 48-port mGig UPoE+ Network	8.00	\$14,493.27	\$115,946.16
PWR-C1-1100WAC/2	CISCO	1100W AC CONFIG 1 SECONDARY P/S	8.00	\$1,844.43	\$14,755.44
STACK-T1-1M	CISCO	CISCO STACKWISE 480 STACKING CABLE 3.3FT	8.00	\$194.15	\$1,553.20
C9300X-NM-8Y	CISCO	CATALYST 9300 8 X 25GE NTWK MOD	8.00	\$2,475.43	\$19,803.44
SFP-10/25G-BXD-I	CISCO	Cisco 10/25GBASE-LR BIDIRECTIONAL -D	8.00	\$3,154.96	\$25,239.68
SFP-10/25G-BXU-I	CISCO	Cisco 10/25GBASE-LR BIDIRECTIONAL -U	8.00	\$3,154.96	\$25,239.68
B-1: Production Network Rack Room Subtotal:					\$202,537.60
C-1: PRODUCTION NETWORK HEARING ROOM					
C9300X-48HX-A	CISCO	Catalyst 9300 48-port mGig UPoE+ Network	8.00	\$14,493.27	\$115,946.16
PWR-C1-1100WAC/2	CISCO	1100W AC CONFIG 1 SECONDARY P/S	8.00	\$1,844.43	\$14,755.44
C9300X-NM-8Y	CISCO	CATALYST 9300 8 X 25GE NTWK MOD	8.00	\$2,475.43	\$19,803.44
SFP-10/25G-BXD-I	CISCO	Cisco 10/25GBASE-LR BIDIRECTIONAL -D	8.00	\$3,154.96	\$25,239.68
SFP-10/25G-BXU-I	CISCO	Cisco 10/25GBASE-LR BIDIRECTIONAL -U	8.00	\$3,154.96	\$25,239.68
C-1: Production Network Hearing Room Subtotal:					\$200,984.40
17.02 - PRODUCTION NETWORK SENATE Subtotal:					\$544,553.30
18.02 - FURNITURE, MILLWORK & RACKS SENATE					
A-1: FURNITURE CONSOLES MASTER CONTROL					
FC-GCX-C3	FORECAST CONSOLES	3-BAY X-CHASSIS WITH COUNTERTOP, REAR RAIL, AND SUPPORT LEG	1.00	\$3,400.00	\$3,400.00
FC-GCX-C3- CLIENT	FORECAST CONSOLES	3-BAY CLIENT SECTION WITH COUNTERTOP, REAR RAIL, INTEGRATED CABLE BASKET, AND MODES	1.00	\$2,850.00	\$2,850.00
FC-GCX-CF-1	FORECAST CONSOLES	BAY COUNTER INSERT	1.00	\$115.00	\$115.00
FC-GCX-T-4	FORECAST CONSOLES	REMOVABLE, VENTED 4 RU TURRET	3.00	\$375.00	\$1,125.00
FC-PDM-1	FORECAST CONSOLES	PDM-1 1RU FILLER PANEL WITH 1-POWER MODULE (2X POWERED USB AND 1X 120V WITH CIRCUIT BREAKER)	1.00	\$700.00	\$700.00
PDU	FORECAST CONSOLES	STANDARD PDU, 36" W/ 14 X 5-15R 120V OUTLETS	1.00	\$202.67	\$202.67
POWER GROMMET	FORECAST CONSOLES	POWER GROMMET W/ 1 X 15A, 125V OUTLET & 2 X USB CHARGING PORTS	3.00	\$160.00	\$480.00
LCD ARM	FORECAST CONSOLES	RAIL MOUNTED FULLY ARTICULATING MONITOR ARM	4.00	\$330.67	\$1,322.68
ALPHA-ALLOWANCE-ENG	ALPHA	ALPHA ENGINEERING ALLOWANCE FOR CHAIR	2.00	\$333.33	\$666.66
ALPHA-ALLOWANCE-ENG	ALPHA	ALPHA ENGINEERING ALLOWANCE FOR ACOUSTICS MATERIALS	1.00	\$3,333.33	\$3,333.33
A-1: Furniture Consoles Master Control Subtotal:					\$14,195.34

PART NUMBER	MANUFACTURER	DESCRIPTION	QTY	UNIT PRICE	TOTAL PRICE
A-2: FURNITURE CONSOLES AUX					
GSX-S3	FORECAST CONSOLES	SIT2STAND WORKSTATION W/ 4RU TURRET & 1-BAY COUNTERTOP INSERT	3.00	\$5,125.33	\$15,375.99
FC-PDM-1	FORECAST CONSOLES	PDM-1 1RU FILLER PANEL WITH 1-POWER MODULE (2X POWERED USB AND 1X 120V WITH CIRCUIT BREAKER)	3.00	\$700.00	\$2,100.00
PDU	FORECAST CONSOLES	STANDARD PDU, 36" W/ 14 X 5-15R 120V OUTLETS	3.00	\$202.67	\$608.01
POWER GROMMET	FORECAST CONSOLES	POWER GROMMET W/ 1 X 15A, 125V OUTLET & 2 X USB CHARGING PORTS	3.00	\$160.00	\$480.00
LCD ARM	FORECAST CONSOLES	RAIL MOUNTED FULLY ARTICULATING MONITOR ARM	9.00	\$330.67	\$2,976.03
ALPHA-ALLOWANCE-ENG	ALPHA	ALPHA ENGINEERING ALLOWANCE FOR CHAIR	3.00	\$333.33	\$999.99
ALPHA-ALLOWANCE-ENG	ALPHA	ALPHA ENGINEERING ALLOWANCE FOR ACOUSTICS MATERIALS	3.00	\$3,333.33	\$9,999.99
A-2: Furniture Consoles Aux Subtotal:					\$32,540.01
18.02 - FURNITURE, MILLWORK & RACKS SENATE Subtotal:					\$46,735.35
19.02 - PATCHING & CABLES SENATE					
A-1: VIDEO & AES PATCH PANEL					
B64H-2MWTHTD	BITTREE	2 ROWS OF 32 PATCH POINTS, 1.5 RU, FULLY NORMALLED WITH 75 OHM TERMINATION, 3G SDI	6.00	\$1,526.00	\$9,156.00
A-1: Video & AES Patch Panel Subtotal:					\$9,156.00
A-2: AUDIO & INTERCOM PATCH PANEL					
969A625	BITTREE	B96DC-FNAIH/E3 M2OU7B	1.00	\$1,427.00	\$1,427.00
A-2: Audio & Intercom Patch Panel Subtotal:					\$1,427.00
A-3: CAT6 PATCH PANEL					
DSKP124B	BITTREE	KEYSTONE PANEL, 24 POSITION, 1RU, UNLOADED (FOR BELDEN REVCONNECT) - BLACK	12.00	\$157.00	\$1,884.00
NP-2	NEAT-PATCH	NEAT PATCH NP2 CABLE MANAGEMENT BAY	12.00	\$102.00	\$1,224.00
A-3: Cat6 Patch Panel Subtotal:					\$3,108.00
A-4: FIBER PATCH PANEL					
DSKP124B-LC	BITTREE	FLUSH MOUNT, 1 ROW OF 24 COUPLERS, 1 RU, DUPLEX LC TO LC, UPC, BLUE, 1 DESIGNATION STRIP	8.00	\$374.00	\$2,992.00
A-4: Fiber Patch Panel Subtotal:					\$2,992.00
A-5: FIBER ENCLOSURE					
CCH-01U	CORNING	Corning Rack Mount 1RU 2 panel Fiber Optic Enclosure	8.00	\$401.64	\$3,213.12
CCH-02U	CORNING	Corning Rack Mount 2RU 4 panel Fiber Optic Enclosure	4.00	\$401.64	\$1,606.56
CCH-CP12-A9	CORNING	Corning Snap in Fiber Optic Patch Panel OS1 Single Mode 6 x LC Duplex	32.00	\$401.64	\$12,852.48
A-5: Fiber Enclosure Subtotal:					\$17,672.16
B-1: PATCH CORD HOLDER					
CLAW	MIDDLE ATLANTIC	WALLMNT CABLE HANGER W/TR	1.00	\$21.29	\$21.29
B-1: Patch Cord Holder Subtotal:					\$21.29
B-2: VIDEO PATCH CABLES					
VPCMK1200-75	BITTREE	MINI-WECO PATCHCORD, 12G+ SDI, 24GHZ, 75 OHM, 12" (30 CM), BLACK	10.00	\$30.80	\$308.00
VPCMK2400-75	BITTREE	MINI-WECO PATCHCORD, 12G+ SDI, 24GHZ, 75 OHM, 24" (60 CM), BLACK	10.00	\$30.80	\$308.00
VPCMK4800-75	BITTREE	MINI-WECO PATCHCORD, 12G+ SDI, 24GHZ, 75 OHM, 48" (120 CM), BLACK	10.00	\$31.73	\$317.30
RTR1L	BITTREE	BNC INSERTION AND REMOVAL TOOL FOR MINI-WECO FORMAT, 12" (30 CM)	2.00	\$101.00	\$202.00
B-2: Video Patch Cables Subtotal:					\$1,135.30



Alpha Video & Audio, Inc.
 7690 Golden Triangle Drive
 Eden Prairie, MN 55344
 Phone: 952-896-9898 | Fax: 952-896-9899
 Visit us at www.alphavideo.com

QUOTE

19026

PART NUMBER	MANUFACTURER	DESCRIPTION	QTY	UNIT PRICE	TOTAL PRICE
B-3: MID-SIZE PATCH TO BNC					
ADMW12	BITTREE	BNC TO MINI-WECO ADAPTER PLUG, 3G SDI, SHORT (SUPPORTS SIDE-BY-SIDE INSERTION WITH ADMW12L)	4.00	\$27.00	\$108.00
B-3: Mid-Size Patch to BNC Subtotal:					\$108.00
C-1: SMPTE CAMERA CABLES					
JSCBLDN (BLK)PUWFUW-25	JOSEPH ELECTRONICS	SMPTE LEMO CABLE, PUW-FUW, 25'	4.00	\$841.33	\$3,365.32
JSCBLDN (BLK)PUWFUW-100	JOSEPH	SMPTE LEMO CABLE, PUW-FUW, 100'	4.00	\$957.33	\$3,829.32
JSCBLDN (BLK)PUWFUW-250	JOSPEH	SMPTE LEMO CABLE, PUW-FUW, 250'	1.00	\$1,188.00	\$1,188.00
C-1: SMPTE Camera Cables Subtotal:					\$8,382.64
C-2: SMPTE CAMERA IO PANEL					
ALPHA-ALLOWANCE-ENG	ALPHA	ALPHA ENGINEERING ALLOWANCE FOR SMPTE Camera IO Panel	1.00	\$3,333.33	\$3,333.33
C-2: SMPTE Camera IO Panel Subtotal:					\$3,333.33
D-2: AUDIO CABLES					
RKSS18T	SONY	1/8 TO 1/8 JACK CABLE (T)	10.00	\$10.65	\$106.50
601045	MONOPRICE	Monoprice 1/8in TRS Male to Two 1/4in TS Male Cable_5ft	2.00	\$5.32	\$10.64
D-2: Audio Cables Subtotal:					\$117.14
D-3: CAT6 CABLES					
CG01072	C2G	1FT/0.3M CAT6 UTP 28AWG BLUE	60.00	\$3.91	\$234.60
CG01165	C2G	1FT/0.3M CAT6 CABLE UTP SLIM 28AWG RED	60.00	\$3.91	\$234.60
CG01160	C2G	1FT/0.3M CAT6 CABLE UTP SLIM 28AWG GREEN	20.00	\$3.91	\$78.20
CG01170	C2G	1FT/0.3M CAT6 CABLE UTP SLIM 28AWG YLW	20.00	\$3.91	\$78.20
CG01185	C2G	1FT/0.3M CAT6 CABLE UTP SLIM 28AWG WHITE	20.00	\$3.91	\$78.20
CG00677	C2G	CAT6A PATCH CABLE, SNAGLESS, SHIELDED, 6' - BLUE	24.00	\$12.07	\$289.68
CG00681	C2G	10FT/3M CAT6A SNAGLESS STP CABLE-BLU	12.00	\$17.97	\$215.64
CG00684	C2G	15FT/4.6M CAT6A SNAGLESS STP CABLE-BLU	12.00	\$22.40	\$268.80
CG00686	C2G	25FT/7.6M CAT6A SNAGLESS STP CABLE-BLU	1.00	\$28.87	\$28.87
D-3: Cat6 Cables Subtotal:					\$1,506.79
D-4: FIBER CABLES					
CG11026	C2G	2M ST-ST 10G OM3 DPX MM T	24.00	\$38.56	\$925.44
CG11011	C2G	2M LC-ST 10G OM3 DPX MM T	24.00	\$46.21	\$1,109.04
CG00998	C2G	2M LC-LC 50/125 OM4 DUPL	24.00	\$24.43	\$586.32
CG34627	C2G	2M LC-ST 9/125 DPX OS1/2	24.00	\$54.08	\$1,297.92
CG08353	C2G	2M ST-ST 9/125 OS1/2 DPX	24.00	\$22.75	\$546.00
HF-TS12ST-0200	CAMPLEX	12-CHANNEL ST-SINGLE MODE TACTICAL FIBER OPTICAL SNAKE-200 FOOT	10.00	\$914.75	\$9,147.50
D-4: Fiber Cables Subtotal:					\$13,612.22
D-5: HDMI CABLES					
ALPHA-MATERIALS	ALPHA	ALPHA MATERIALS	1.00	\$371.00	\$371.00
D-5: HDMI Cables Subtotal:					\$371.00
D-7: USB CABLES					
CG54171	C2G	2M USB 3.0 AM-AM CBL BLK	4.00	\$7.89	\$31.56
CG54172	C2G	3M USB 3.0 AM-AM CBL BLK	4.00	\$10.40	\$41.60
D-7: USB Cables Subtotal:					\$73.16



Alpha Video & Audio, Inc.
 7690 Golden Triangle Drive
 Eden Prairie, MN 55344
 Phone: 952-896-9898 | Fax: 952-896-9899
 Visit us at www.alphavideo.com

QUOTE
19026

PART NUMBER	MANUFACTURER	DESCRIPTION	QTY	UNIT PRICE	TOTAL PRICE
D-8: MISCELLANEOUS PRE-MADE CABLES					
ALPHA-ALLOWANCE-ENG	ALPHA	ALPHA ENGINEERING ALLOWANCE FOR PARTS AND CABLES	1.00	\$1,750.00	\$1,750.00
D-8: Miscellaneous Pre-made Cables Subtotal:					\$1,750.00
19.02 - PATCHING & CABLES SENATE Subtotal:					\$64,766.03
20.02 - COMMISSIONING & TRAINING SENATE					
A-1: ROSS VIDEO CABBOT					
CAM-OTR-1DAY	ROSS VIDEO	CABBOT ONSITE OPERATIONAL TRAINING - 1DAY	1.00	\$2,145.00	\$2,145.00
TRAVEL-PRE-001	ROSS VIDEO	PRE PAID SERVICE EXPENSE TRIP 1	1.00	\$3,176.47	\$3,176.47
CAM-COM-1DAY	ROSS VIDEO	CABBOT ONSITE COMMISSIONING - 1DAY	1.00	\$2,145.00	\$2,145.00
		<i>600PT Heads Commissioning</i>			
TRAVEL-PRE-002	ROSS VIDEO	PRE PAID SERVICE EXPENSE TRIP 2	1.00	\$3,176.47	\$3,176.47
CAM-COM-1DAY	ROSS VIDEO	CABBOT ONSITE COMMISSIONING - 1DAY	1.00	\$2,145.00	\$2,145.00
		<i>X300 Heads Commissioning</i>			
TRAVEL-PRE-003	ROSS VIDEO	PRE PAID SERVICE EXPENSE TRIP 3	1.00	\$3,176.47	\$3,176.47
CAM-COM-1DAY	ROSS VIDEO	CABBOT ONSITE COMMISSIONING - 1DAY	1.00	\$2,145.00	\$2,145.00
		<i>Smartshell Stations Commissioning</i>			
TRAVEL-PRE-004	ROSS VIDEO	PRE PAID SERVICE EXPENSE TRIP 4	1.00	\$3,176.47	\$3,176.47
A-1: Ross Video Cabbot Subtotal:					\$21,285.88
A-2: ROSS VIDEO CG					
XPRESSION-COM-1DAY	ROSS VIDEO	XPRESSION COMMISSIONING - 1 DAY	1.00	\$2,145.00	\$2,145.00
XPRESSION-OTR-1DAY	ROSS VIDEO	XPRESSION OPERATIONAL TRAINING - 1 DAY	1.00	\$2,145.00	\$2,145.00
TRAVEL-PRE-005	ROSS VIDEO	PRE PAID SERVICE EXPENSE TRIP 5	1.00	\$3,176.47	\$3,176.47
INC-COM-ONSITE-1DAY	ROSS VIDEO	INCEPTION - ON-SITE COMMISSIONING - 1 DAY	1.00	\$2,145.00	\$2,145.00
TRAVEL-PRE-006	ROSS VIDEO	PRE PAID SERVICE EXPENSE TRIP 6	1.00	\$3,176.47	\$3,176.47
INC-TRN-ONSITE-OP-1DAY	ROSS VIDEO	INCEPTION - ON-SITE OPERATIONAL TRAINING - 1 DAY	1.00	\$2,145.00	\$2,145.00
TRAVEL-PRE-007	ROSS VIDEO	PRE PAID SERVICE EXPENSE TRIP 7	1.00	\$3,176.47	\$3,176.47
A-2: Ross Video CG Subtotal:					\$18,109.41
A-3: ROSS VIDEO TALLY					
TLY-ONL-COM-1DAY	ROSS VIDEO	TALLY SYSTEMS ONLINE COMMISSIONING, 1 DAY	1.00	\$1,612.00	\$1,612.00
A-3: Ross Video Tally Subtotal:					\$1,612.00
A-4: ROSS VIDEO MASTER CONTROL					
MC1-ONL-COM-1DAY	ROSS VIDEO	MC1 MASTER CONTROL ONLINE COMMISSIONING, 1 DAY	1.00	\$1,612.00	\$1,612.00
MC1-ONL-1DAY	ROSS VIDEO	MC1 MASTER CONTROL ONLINE TRAINING, 1 DAY	1.00	\$1,612.00	\$1,612.00
A-4: Ross Video Master Control Subtotal:					\$3,224.00
A-5: ROSS VIDEO SWITCHER					
CARBONITE-OTR-1DAY	ROSS VIDEO	CARBONITE OPERATIONS TRAINING - 1 DAY	1.00	\$2,145.00	\$2,145.00
TRAVEL-PRE-008	ROSS VIDEO	PRE PAID SERVICE EXPENSE TRIP 8	1.00	\$3,882.35	\$3,882.35
ULTRIX-COM-1DAY	ROSS VIDEO	ULTRIX ONSITE COMMISSIONING - 1 DAY	1.00	\$2,145.00	\$2,145.00
TRAVEL-PRE-009	ROSS VIDEO	PRE PAID SERVICE EXPENSE TRIP 9	1.00	\$3,176.47	\$3,176.47
ULTRIX-OTR-1DAY	ROSS VIDEO	ULTRIX OPERATIONAL TRAINING - 1 DAY	1.00	\$2,145.00	\$2,145.00
TRAVEL-PRE-010	ROSS VIDEO	PRE PAID SERVICE EXPENSE TRIP 10	1.00	\$3,176.47	\$3,176.47



Alpha Video & Audio, Inc.
 7690 Golden Triangle Drive
 Eden Prairie, MN 55344
 Phone: 952-896-9898 | Fax: 952-896-9899
 Visit us at www.alphavideo.com

QUOTE

19026

PART NUMBER	MANUFACTURER	DESCRIPTION	QTY	UNIT PRICE	TOTAL PRICE
SOL-PROJMGMT-1DAY	ROSS	PROJECT MANAGEMENT-1 DAY	1.00	\$2,145.00	\$2,145.00
TRAVEL-PRE-011	ROSS VIDEO	ROSS VIDEO ON-SITE EXPENSES	1.00	\$3,176.47	\$3,176.47
A-5: Ross Video Switcher Subtotal:					\$21,991.76
A-6: ROSS VIDEO GRAPHITE					
CARBONITE-COM-1DAY	ROSS VIDEO	CARBONITE COMMISSIONING - 1 DAY	2.00	\$2,145.00	\$4,290.00
CARBONITE-OTR-1DAY	ROSS VIDEO	CARBONITE OPERATIONS TRAINING - 1 DAY	2.00	\$2,145.00	\$4,290.00
TRAVEL-PRE-012	ROSS VIDEO	ROSS VIDEO ON-SITE EXPENSES	2.00	\$2,823.53	\$5,647.06
A-6: Ross Video Graphite Subtotal:					\$14,227.06
B-1: EVERTZ ROUTER					
EVERTZ TRAINING	EVERTZ	EVERTZ TRAINING	5.00	\$2,000.00	\$10,000.00
EVERTZ COMMISSIONING	EVERTZ	EVERTZ COMMISSIONING	10.00	\$1,950.00	\$19,500.00
EVERTZ EXPENSES	EVERTZ	EVERTZ ON-SITE TRAVEL EXPENSES	1.00	\$8,000.00	\$8,000.00
B-1: Evertz Router Subtotal:					\$37,500.00
D-1: BOSCH INTERCOM					
F.01U.024.616	BOSCH	BOSCH TRAINING COMMUNICATION	1.00	\$2,133.33	\$2,133.33
D-1: Bosch Intercom Subtotal:					\$2,133.33
F-1: NDI SOFTWARE					
SIENNASU	IEC	SIENNA ANNUAL SOFTWARE MAINTENANCE - 1 YR	1.00	\$166.57	\$166.57
ALPHA-SMA-GALLERY-8HR	ALPHA	ALPHA ASSURANCE GALLERY SUPPORT AGREEMENT, 1-YR, 8-HR RESPONSE	1.00	\$1,888.51	\$1,888.51
SIENNASU	IEC	SIENNA ANNUAL SOFTWARE MAINTENANCE - 1 YR	1.00	\$166.57	\$166.57
ALPHA-SMA-GALLERY-8HR	ALPHA	ALPHA ASSURANCE GALLERY SUPPORT AGREEMENT, 1-YR, 8-HR RESPONSE	1.00	\$1,888.51	\$1,888.51
F-1: NDI Software Subtotal:					\$4,110.16
G-1: PRODUCTION NETWORK					
ALPHA-ALLOWANCE-ENG	ALPHA	ALPHA ENGINEERING ALLOWANCE FOR NETWORK COMMISSIONING	1.00	\$13,333.33	\$13,333.33
G-1: Production Network Subtotal:					\$13,333.33
20.02 - COMMISSIONING & TRAINING SENATE Subtotal:					\$137,526.93
21.02 - INTEGRATION SENATE					
A: GENERAL PURPOSE CABLING					
ALPHA-MATERIALS	ALPHA	ALPHA MATERIALS	1.00	\$100,000.00	\$100,000.00
A: General Purpose Cabling Subtotal:					\$100,000.00
B: LABOR ESTIMATE					
ALPHA-LABOR	ALPHA	ALPHA INTEGRATION LABOR	1.00	\$458,950.00	\$458,950.00
ALPHA-MATERIALS	ALPHA	ALPHA MATERIALS	1.00	\$8,723.00	\$8,723.00
B: Labor Estimate Subtotal:					\$467,673.00
21.02 - INTEGRATION SENATE Subtotal:					\$567,673.00
22.02 - WARRANTY SENATE					
A-1: ROSS SUPPORT					
INC-999-OPT-MESSAGING	ROSS VIDEO	INCEPTION - INSTANT MESSAGING PLUGIN - MAINTENANCE	1.00	\$1,055.00	\$1,055.00
INC-999-SW-LIVE	ROSS VIDEO	INCEPTION LIVE - SOFTWARE - MAINTENANCE	1.00	\$4,000.00	\$4,000.00
INC-999-HW-SERVER	ROSS VIDEO	INCEPTION - SERVER HARDWARE - EXTENDED WARRANTY	1.00	\$1,245.00	\$1,245.00



Alpha Video & Audio, Inc.
 7690 Golden Triangle Drive
 Eden Prairie, MN 55344
 Phone: 952-896-9898 | Fax: 952-896-9899
 Visit us at www.alphavideo.com

QUOTE
19026

PART NUMBER	MANUFACTURER	DESCRIPTION	QTY	UNIT PRICE	TOTAL PRICE
A-1: Ross Support Subtotal:					\$6,300.00
B-1: EVERTZ SUPPORT					
MAGNUM-ANNUAL-LICENSE	EVERTZ	Annual Renewal license for MAGNUM	1.00	\$16,005.00	\$16,005.00
VUE-ANNUAL-LICENSE	EVERTZ	Annual Renewal license for VUE	1.00	\$5,956.11	\$5,956.11
VLPRO-Ser/Sup/Lic.1yr	EVERTZ	Additional 1 year VistaLINK	1.00	\$825.00	\$825.00
B-1: Evertz Support Subtotal:					\$22,786.11
C-1: GVS SUPPORT					
AMS-PRIME	GRASS VALLEY	GRASS VALLEY PRIME SA FOR ADVANCED MEDIA STORAGE	1.00	\$7,582.67	\$7,582.67
ASSET MAN-PRIME	GRASS VALLEY	GV CARE-PRIME SA FOR ASSET MANAGEMENT	1.00	\$22,133.73	\$22,133.73
EDITING SYS-PRIME	GRASS VALLEY	GRASS VALLEY GV CARE-PRIME SA FOR EDITING SYSTEMS	1.00	\$123.68	\$123.68
K2-PRIME	GRASS VALLEY	GV CARE-PRIME SA FOR K2, 24X7 TECHNICAL PHONE SUPPORT, 2 HOUR RESPONSE	1.00	\$666.92	\$666.92
PROD SERVER-PRIME	GRASS VALLEY	GRASS VALLEY CARE PRIME SA FOR PRODUCTION SERVERS	1.00	\$25,585.29	\$25,585.29
C-1: GVS Support Subtotal:					\$56,092.29
C-1: QUALSTAR SUPPORT					
EW2-BUND-A	QUALSTAR	SERVICE, EXTENDED/PREFERRED/DOMESTIC/YR. 305 BUNDLE WITH PURCHASE	1.00	\$4,028.00	\$4,028.00
C-1: Qualstar Support Subtotal:					\$4,028.00
D-1: TELESTREAM SUPPORT					
DIVA-SUPP-MS00	TELESTREAM	DIVA FIRST YEAR SUPPORT	1.00	\$6,930.00	\$6,930.00
V-LS-SILVER-MS00	TELESTREAM	ANNUAL SUPPORTFOR SUPPORT DETAILS, PLEASE SEE THE MAINTENANCE AND SUPPORT GUIDE AT:HTTP://WWW.TELE	1.00	\$2,112.00	\$2,112.00
V-LS-ADV-EXP00	TELESTREAM	ANNUAL EXPRESS REPLACEMENTFOR SUPPORT DETAILS, PLEASE SEE THE MAINTENANCE AND SUPPORT GUIDE AT:HTT	1.00	\$1,978.67	\$1,978.67
V-SILVER-MS00	TELESTREAM	SILVER SUPPORT IS CALCULATED AT 15% OF THE LIST PRICE OF PURCHASED SOFTWARE OPTIONS.FOR SUPPORT DET	1.00	\$1,839.20	\$1,839.20
D-1: Telestream Support Subtotal:					\$12,859.87
E-1: CISCO WARRANTY					
C9300-DNA-A-48-5Y	CISCO	C9300 DNA ADVANTAGE 48PT 5YR TERM LIC	1.00	\$6,096.33	\$6,096.33
C9300-DNA-A-24-5Y	CISCO	C9300 DNA ADVANTAGE 24PT 5YR TERM LIC	1.00	\$3,252.03	\$3,252.03
C9300-DNA-A-48-5Y	CISCO	C9300 DNA ADVANTAGE 48PT 5YR TERM LIC	1.00	\$6,096.33	\$6,096.33
C9300-DNA-A-24-5Y	CISCO	C9300 DNA ADVANTAGE 24PT 5YR TERM LIC	1.00	\$3,252.03	\$3,252.03
C9300-DNA-A-48-5Y	CISCO	C9300 DNA ADVANTAGE 48PT 5YR TERM LIC	1.00	\$6,096.33	\$6,096.33
C9300-DNA-A-24-5Y	CISCO	C9300 DNA ADVANTAGE 24PT 5YR TERM LIC	1.00	\$3,252.03	\$3,252.03
E-1: Cisco Warranty Subtotal:					\$28,045.08
F-1: ALPHA WARRANTY					
ALPHA-SMA-SILVER-1YR	ALPHA	ALPHA ASSURANCE SILVER SERVICE AND MAINTENANCE AGREEMENT, 1 YR. TERM	1.00	\$109,454.97	\$109,454.97
ALPHA-SMA-GOLD-1YR	ALPHA	ALPHA ASSURANCE GOLD SERVICE AND MAINTENANCE AGREEMENT, 1 YR. TERM	0.00	\$166,219.90	\$0.00
ALPHA-SMA-PLATINUM-1YR	ALPHA	ALPHA ASSURANCE PLATINUM SERVICE AND MAINTENANCE AGREEMENT, 1 YR. TERM	0.00	\$270,761.29	\$0.00
F-1: Alpha Warranty Subtotal:					\$109,454.97
22.02 - WARRANTY SENATE Subtotal:					\$239,566.32
PROJECT COSTS					
SECTION COSTS					



Alpha Video & Audio, Inc.
 7690 Golden Triangle Drive
 Eden Prairie, MN 55344
 Phone: 952-896-9898 | Fax: 952-896-9899
 Visit us at www.alphavideo.com

QUOTE
19026

PART NUMBER	MANUFACTURER	DESCRIPTION	QTY	UNIT PRICE	TOTAL PRICE
ALPHA-WORKMANSHIP	ALPHA	ALPHA WORKMANSHIP WARRANTY	1.00	\$0.00	\$0.00
Section Costs Subtotal:					\$0.00
Project Costs Subtotal:					\$0.00
Subtotal:					\$7,131,571.09
Shipping:					\$0.00
Tax:					\$0.00
Total:					\$7,131,571.09

A 3% convenience fee will be added for all credit card payments.

All information contained within this quote is valid for the next 30 days. Thereafter, all prices and applicable charges are subject to change.

Returns are subject to a minimum 15% restocking fee when accompanied by original packaging.

Shipping costs are not included and will be billed at actual cost.

Sales tax is not included and will be billed at actual cost.

SCOPE OF WORK

CAPITOL BROADCAST TELEVISION SYSTEMS UPGRADE

INTRODUCTION

Alpha Video and Audio, Inc. is pleased to present this proposal for Broadcast Television Upgrade. This statement of work describes equipment and services that Alpha Video will deliver, as well as the responsibilities of Minnesota Legislative Coordinating Commission for successful implementation. A detailed equipment list and pricing is attached.

OVERVIEW

We believe that the items in our proposal meet the system requirements, standards of quality, and brand preferences outlined through multiple “needs analysis” meetings, phone calls, and emails. The equipment and systems defined in this proposal are representative of typical installations successfully completed by Alpha Video.

The Minnesota Legislative Coordinating Commission video production facilities are intended to be operated in HD 1080p in accordance with SMPTE 2110 IP standards. The principal cameras are specified to be 4K 59.94 capable and are expected to be configured at 1080p. It is anticipated that the production switchers are specified to be 4K 59.94 capable and are expected to be configured at 1080p. The routing switcher is specified as a full SMPTE 2110 based IP solution with IP Gateways (IPG) used where required (equipment that does not offer a native SMPTE 2110 IP interface) with support for redundant core via SMPTE 2022-7. The routing switcher (with video, audio, and ancillary data) is used to route sources throughout the video production facilities and related systems. Multiple Character Generators, Multi-channel file servers for record and playback and Multiview will be provided. Audio Devices shall be connected to the main routing network via MADI or directly to the main routing fabric. Unlike baseband patching and routing, much of this facility is based on fiber optic patching. 100GB tie lines will be provided between the Senate Office building and the Capitol building and the House State Office building and the Capitol building.

The video production facilities will include the following major locations.

1. Capitol Building Media Hub B881
2. Capitol Building Press Core Room B900
3. Capitol Building Press Core Room B900 A/V Room B941
4. Capitol Building Press Conference Room B971
5. Capitol Building Press Conference Room B971 A/V Room B973
6. Capitol Building East Telco B883
7. Capitol Building West Telco B292
8. Capitol Building Fiber Panel #1 Elevators
9. Capitol Building Fiber Panel #2 Governor's Office
10. Capitol Building Fiber Panel #3 G8 Hallway
11. Capitol Building Fiber Panel #4 B971
12. Senate Building Rack Room G218
13. Senate Building Server Room G247
14. House State Office Building Rack Room 286

A number of remote operated 4K/UHD 60p PTZ cameras are provided in this scope of work. Joystick controller and digital servo pan/tilt heads allow for live control of each camera and/or rapid selection of presets controller. Each camera may be connected at a number of locations via newly provided SDI over fiber devices terminating in the rack room and A/V room. Mounting of cameras to be coordinated with owner representatives.

1. Capitol Building Press Conference Room B971 via A/V Room B973 – Qty 2

Wireless antenna systems are provided for use with Microphones, IFB's and Intercom systems. Connectivity is provided for antenna locations. Antenna mounting locations shall be a coordinated effort between Alpha Video and Minnesota Legislative engineering staff in association with the wireless manufacturer. Coverage shall be provided throughout the Senate Office building, the House State Office building, and the Capitol building.

100G Network tie lines shall be provided between the Senate Office building and the Capitol building, and the House State Office building, and the Capitol building. All interconnections shall be via single mode fiber optic connection. Fiber enclosures shall be used as demarcation points in each rack room. Routing Switcher and Production Network shall utilize 1310 nanometer plug in SFP optical module's

1. Capitol Building Media Hub B881
2. Senate Building Rack Room G218
3. Senate Building Server Room G247
4. House State Office Building Rack Room 286

Demolition of existing video production systems.

1. Mark and label all cabling entering impacted area for extension/re-termination.
2. All unused/replaced cable/fiber, etc. to be pulled out at the time of the work.
3. Mark and label all Owner furnished equipment that will be re-used.
4. After owner has marked equipment for reuse or storage, remove all unused cabling and equipment from rack room, control room or interconnecting spaces. Dispose of millwork, equipment racks and equipment that is not being reused or salvaged by owner.

SYSTEM OVERVIEW – SCOPE OF WORK

01.01 CAMERAS CAPITOL

Capitol building cameras are to be 4K 59.94 HDR capable and expected to be configured for 1080p. Type 1 Cameras are to be 4K/HD compact box cameras. Type 2 Cameras are to be 4K/HD live broadcast studio cameras. Type 1 POV Cameras are to be 4K/UHD 60p PTZ cameras. Cameras based on an IP workflow connecting to the Routing Switcher directly or via IP Gate Ways as required.

A. Type 1 Camera

1. Camera
 - **NOT INCLUDED IN THIS SOW**
2. Camera Transport
 - **NOT INCLUDED IN THIS SOW**
3. Camera Control – Qty 1
 - **PROVIDE** and **INSTALL** New Ross Video RRB-CTL-3 3 Axis Unified Control System
 - **PROVIDE** and **INSTALL** New Ross Video RRB-CTL-PTZ PTZ Camera Plug-In License
4. Camera Lens
 - **NOT INCLUDED IN THIS SOW**
5. Camera Package
 - **NOT INCLUDED IN THIS SOW**

B. Type 2 Camera

1. Camera
 - **NOT REQUIRED IN THE CAPITOL BUILDING**
2. Camera Transport
 - **NOT REQUIRED IN THE CAPITOL BUILDING**
3. Camera Control
 - **NOT REQUIRED IN THE CAPITOL BUILDING**
4. Camera Lens
 - **NOT REQUIRED IN THE CAPITOL BUILDING**
5. Camera Package
 - **NOT REQUIRED IN THE CAPITOL BUILDING**

C. Type 1 POV Camera

1. POV Camera – Qty 2
 - **PROVIDE** and **INSTALL** New Sony ILMEFR7K 4K PTZ Camera
 - **PROVIDE** and **INSTALL** New IDX IA-200A 100W AC Adapter Power Supply
2. POV Transport
 - **PROVIDE** and **INSTALL** New Multidyne V4-3811-6X2-A-ST Fiber Transceiver with 6 in and 2 out – Qty 1
 - **PROVIDE** and **INSTALL** New Multidyne V4-3811-2X6-A-ST Fiber Transceiver with 2 in and 6 out – Qty 1
 - **PROVIDE** and **INSTALL** New Multidyne RM-1RU-V4 Rack Mount Kit – Qty 2
3. POV Control – Qty 1
 - **PROVIDE** and **INSTALL** New Sony RMIP500/1 Advanced Joystick Controller

D. Camera Accessories

1. Camera Control
 - **NOT REQUIRED IN THE CAPITOL BUILDING**

2. Camera Batteries
 - **NOT REQUIRED IN THE CAPITOL BUILDING**

E. Robotics

1. Robotics Control Server
 - **NOT INCLUDED IN THIS SOW**

F. Teleprompter

1. Teleprompter – Qty 1
 - **PROVIDE** and **INSTALL** New Autoscript WP-IPSPKG Win Plus software, XBOX-IP video generator and HC-IP controller

02.01 PRODUCTION SWITCHER CAPITOL

Production Switchers are to be 4K 59.94 capable and expected to be configured at 1080p. Production Switcher requirements to be a Frame sized to accommodate a minimum of 16 SDI inputs and 16 3G HD SDI outputs and 32 ST2110 25GB Inputs and 32 ST2110 25GB outputs. Production Switcher to include 2 ME's and 4 Multiview outputs with redundant power supply. Frame to include 8 x's 25G SFP's as necessary to facilitate ST2022-7 connection to the ST2110 Routing Switcher. Production Switcher to be licensed for Frame Sync, Format Conversion, Proc Amp and Color Correction. Frame to support Madi and Embedded audio total of 768 x 768. Production Switcher paired with control surface and aux panel. Xpression live CG software included with Carbonite card purchase.

Aux Production Switchers are to be 4K 59.94 capable and expected to be configured at 1080p. The Aux Switcher frame shall be an all-in-one production switcher with built-in graphics, clip server, Multiview, and audio. The Aux switcher will be a single frame sized to accommodate 9 inputs and 6 outputs and to include 2 ME's. The Aux Production Switcher shall be paired with control surface and aux panel. Aux Production Switcher shall connect to Router via Production Switcher Ultrix frame.

A. Production Switcher

1. Production Switcher
 - **NOT REQUIRED IN THE CAPITOL BUILDING**

03.01 ROUTING SWITCHER CAPITOL

Routing Switcher shall provide routing of multiple IP signals with general line interface infrastructure of 25/100G (twenty-five or one hundred Gigabit) ports via SFP and/or expansion. Each IP interface shall be comprised of one or more SMPTE 2110 essences including video, ancillary data, and up to 32 audio streams. Router management shall be in band and not require additional networking appliances to manage. All interconnections shall be via single mode fiber optic connection. Network design shall support full actual saturation of all ports without introducing latency or packet loss. For the basis of this calculation the system shall be planned around to support a 4K 59.94 and 1080p 3Gb/s infrastructure, with IPG or highest density native IP device determining number of essences per 25G and 100G line interface. Support for NMOS AMWA IS-05 connection management discovery and registration. Switching shall provide full mono audio level control. Breakaway of Audio, Ancillary Data, and video assignments is expected. Support for PTP/IEEE-1588 timestamping and clock reference. Switching shall be controlled by a broadcast standard routing switcher control system.

Ability to request routes from any source to any destination. All router destination devices shall be able to switch between sources and produce stable error free video from a new source within 400ms of operator command. Provide VAFS path for any Router Destination flows not capable of successfully displaying a new source within specified time. Support for traditional physical router control panel interfaces and support for web-based router control interfaces for operational use only (excludes use of main router programming GUI).

A. Routing Switcher Core

1. Routing Switcher Core Primary
 - **PROVIDE** and **INSTALL** New Evertz NATX-32-100G-1+DF1RP IP Switching Fabric with integrated network address translation. Up to 32x100G or 128x25G – Qty 1
 - **PROVIDE** and **INSTALL** New Evertz DF1-FR Dragon Fire 1RU, single slot, complete with all power and controller redundancy - Qty 1
 - **PROVIDE** and **INSTALL** New Evertz QSFP optical modulars. Quantity per design – Qty 12
 - **PROVIDE** and **INSTALL** New Evertz CBL-PSM8-2xPSM4-SM-5M Breakout Cable to Connect The 8 Ports of a QSFP-DD – Qty 10
 - **PROVIDE** and **INSTALL** New Evertz CBL-MTP-LC16-SM-5M 5 Meter MTP to LC Single Mode Breakout Cable for QSFP DD PSM8 to 8x SFP Optical Transceivers – Qty 2
 - **PROVIDE** and **INSTALL** New Evertz SFPTR-RJ45-SER-AV 1000Mbps RJ45 SFP Module – Qty 2
2. Routing Switcher Core Backup
 - **PROVIDE** and **INSTALL** New Evertz NATX-32-100G-1+DF1RP IP Switching Fabric with integrated network address translation. Up to 32x100G or 128x25G – Qty 1
 - **PROVIDE** and **INSTALL** New Evertz DF1-FR Dragon Fire 1RU, single slot, complete with all power and controller redundancy - Qty 1
 - **PROVIDE** and **INSTALL** New Evertz QSFP optical modulars. Quantity per design – Qty 12
 - **PROVIDE** and **INSTALL** New Evertz CBL-PSM8-2xPSM4-SM-5M Breakout Cable to Connect The 8 Ports of a QSFP-DD – Qty 10
 - **PROVIDE** and **INSTALL** New Evertz CBL-MTP-LC16-SM-5M 5 Meter MTP to LC Single Mode Breakout Cable for QSFP DD PSM8 to 8x SFP Optical Transceivers – Qty 2
 - **PROVIDE** and **INSTALL** New Evertz SFPTR-RJ45-SER-AV 1000Mbps RJ45 SFP Module – Qty 2

IP Gateways shall provide appropriate IP based connectivity back to the Routing Switcher. Encapsulation and De encapsulation of baseband SDI signals supporting 3G single essence SDI to and from SMPTE 2110. Type 1 IP Gateway shall provide up to 32x32 HD SDI to SMPTE 2110 without frame synchronization. Type 2 IP Gateway shall provide up to 16x16 HD SDI to SMPTE 2110 with frame synchronization.

B. IP Gateway

1. Type 1 IPG Frame
 - **PROVIDE** and **INSTALL** New Evertz EV6-FR+PS 6RU Modular Frame – Qty 1
 - **PROVIDE** and **INSTALL** New Evertz EV6-FC Frame Controller – Qty 2
2. Type 1 IPG
 - **PROVIDE** and **INSTALL** New Evertz EV670-X30-HW-V2 Virtualized Media Processor – Qty 1
 - **PROVIDE** and **INSTALL** New Evertz 670IPG-X30-APP-32X Allows 32 x 32 3G HD SDI to ST 2110 – Qty 1
 - **PROVIDE** and **INSTALL** New Evertz evIPG-3G IPG app support for 32 x 32 – Qty 1
 - **PROVIDE** and **INSTALL** New Evertz ev670-32X32-HDBNC-RP Rear Plate – Qty 1

- **PROVIDE** and **INSTALL** New Evertz QSFP25G-SM-PSM4-LR-G-NFEC 100G QSFP, 4-CH, MPO/APC QSFP – Qty 2
3. Type 2 IPG
 - **PROVIDE** and **INSTALL** New Evertz EV670-X30-HW-V2 Virtualized Media Processor - Qty 2
 - **PROVIDE** and **INSTALL** New Evertz EV670-16x16-HDBNC-RP HDBNC Rear Plate – Qty 2
 - **PROVIDE** and **INSTALL** New Evertz evIPG-3G-16FS IPG app support for 16 x 16 with Frame Sync – Qty 2
 - **PROVIDE** and **INSTALL** New Evertz QSFP25G-SM-PSM4-LR-G-NFEC 100G QSFP, 4-CH, MPO/APC QSFP – Qty 4

Audio Groomers shall provide TDM Audio to IP Audio, supporting existing TDM modules and AES67 to 302M. Physically the module supports 10x10 TDM and 10GE for IP Audio. Audio Shuffling shall provide for 2560x Mono Channels. To be housed in the same frame where the audio groomer exists. Audio gateway with redundant power, shall provide support for 10x10 TDM/MADI ports by default with 25/10GE AES67 and 302M IP Audio ports. Dante is available with the optional +DANTE64 sub modules.

C. Audio

1. Audio Grooming
 - **PROVIDE** and **INSTALL** New Evertz 570EMR-AG-HUB TDM to IP Audio Gateway – Qty 1
 - **PROVIDE** and **INSTALL** New Evertz 570FR-HF 3RU Multiframe – Qty 1
 - **PROVIDE** and **INSTALL** New Evertz 570FC Vistalink Frame Controller – Qty 1
 - **PROVIDE** and **INSTALL** New Evertz 570PS-HF Power Supply – Qty 1
 - **PROVIDE** and **INSTALL** New Evertz SFP10G-TR13-A SFP+ Optical Transceiver – Qty 4
2. Audio Shuffler
 - **NOT REQUIRED IN THE CAPITOL BUILDING**
3. Audio Gateway
 - **NOT REQUIRED IN THE CAPITOL BUILDING**

Router control system shall be provided for standard router control and network orchestration system capable of controlling the routing switcher and other network appliances similar to a baseband broadcast matrix type router. The Routing Control system shall include software web-based and traditional physical router control panel interfaces. Web based system shall allow users to browse to a specific web address to route sources and destinations. Button per source control panels shall support a minimum of 40 buttons and support joystick integration at shading positions for input switching. Programmable XP control panels shall support source to destination, macros, salvos, audio breakaway, metadata breakaway. Routing control system shall be programmed from a web management interface and be capable of salvos/memory/preprogrammed routes.

D. Routing Control

1. Web Service Router Control – Qty 1
 - **PROVIDE** and **INSTALL** New Evertz MAGNUM-ROUTER-VCP-WEB Virtual Control Panel License
 - **PROVIDE** and **INSTALL** New Evertz VUE-WEB Web based interface routing
 - **PROVIDE** and **INSTALL** New Evertz MAGNUM-ANYWHERE-CLIENT 1year License for one seat of VUE anywhere client
2. Type 1 Touch Screen Router Control Panel – Qty 1
 - **PROVIDE** and **INSTALL** New Evertz VUE-TOUCH2 2RU full touch screen rack mountable panel
 - **PROVIDE** and **INSTALL** New Evertz VUEAPP-STUDIO-MANAGER VUE visualization and control

3. Type 1 XY Router Control Panel – Qty 1
 - **PROVIDE** and **INSTALL** New Evertz CP-2232E Full rack width router control panel
4. Type 2 XY Router Control Panel – Qty 1
 - **PROVIDE** and **INSTALL** New Evertz CP-1024E 1RU 3 LCD screens, 5 rotary encoders and 24 backlit buttons
5. Type 1 BPS Router Control Panel – Qty 1
 - **PROVIDE** and **INSTALL** New Evertz CP-1040E 1RU 40 button LCD panel
6. Type 1 Router Control Server
 - **PROVIDE** and **INSTALL** New Evertz VUE-VCS1 VUE visualization and control application running on a 1RU hardware platform. Provides a single workstation environment – Qty 1
 - **PROVIDE** and **INSTALL** New Evertz SFP25G-TR13 25G Optical Transceiver – Qty 2
7. Routing Switcher HW & SW
 - **PROVIDE** and **INSTALL** New Evertz MAGNUM-HW 1RU Enterprise Server – Qty 2
 - **PROVIDE** and **INSTALL** New Evertz VLPRO-HW Hardware for Vistalink Pro Server Client License – Qty 2
 - **PROVIDE** and **INSTALL** New Evertz SFP10G-TR13-A SFP+ Optical Transceiver 10GBS 1310NM DFB SMF 10KM – Qty 4
 - **PROVIDE** and **INSTALL** New Evertz MAGNUM SUITE Magnum Software Suite – Qty 1
 - **PROVIDE** and **INSTALL** New Evertz INSITE-HW-SRV Insite HW Node – Qty 1
 - **PROVIDE** and **INSTALL** New Evertz SFP10G-TR13-A SFP+ Optical Transceiver 10GBS 1310NM DFB SMF 10KM – Qty 2

Universal Protocol Translator (PTX) module shall provide the ability for Evertz and software to interface directly to third party UMD devices and routers. The PTX communicates with the router and UMD protocols either via one of four serial ports or using a built in Ethernet port. All ports - both serial and Ethernet - are bi-directional allowing the device complete flexibility for communication.

E. PTX (Universal Protocol Translator)

1. PTX
 - **PROVIDE** and **INSTALL** New Evertz 7800FR 3RU Multiframe – Qty 1
 - **PROVIDE** and **INSTALL** New Evertz 7800FC+3RU Vistalink Frame Controller – Qty 1
 - **PROVIDE** and **INSTALL** New Evertz 7700PTX-TSL+3RU Interface to switchers supporting TSL protocol (eg. Ross Carbonite Black) – Qty 8
 - **PROVIDE** and **INSTALL** New Evertz 7700R-SC-BRC+3RU Bidirectional 3rd party router/controller module – Qty 6
 - **PROVIDE** and **INSTALL** New Evertz 7700PTX-NV+3RU PTX which controls NVISION based router – Qty 2

Multiview shall provide SMPTE 2110 input and support for SMPTE 2022-7. Multiview shall be configured for 128 inputs and 16 outputs. Dynamic name sets and support for multiple source names based on router present and system name sets. Support for Up/Down clock and audio monitoring. Multiview outputs shall connect to monitors via fiber to HDMI output module. Up/Down timer shall be provided in each control room.

F. MULTIVIEW

1. Multiview
 - **NOT REQUIRED IN THE CAPITOL BUILDING**

A GPI Tally interface shall be provided to support transfer of GPI information to the Multiview. Tally connections shall be provided to indicate when a particular source is "next-to-air". Connections shall be provided between the Production Switcher, Monitors, Camera Control Units, and any other devices that accept contact closure or serial tally.

G. TALLY INTERFACE

1. Tally Interface - Qty 1
 - **PROVIDE** and **INSTALL** New Evertz TR-4800E 1RU Physical GPI and GPO Tally Router
 - **PROVIDE** and **INSTALL** New Evertz TR-4800E-BHP 2RU Breakout panel for 32 GPI and 48 GPO

04.01 TEST & MEASUREMENT CAPITOL

An IP Network Grand Master Clock and Master Sync Generator are to be 4K 59.94 HDR capable and expected to be configured for 1080p. System shall provide timing for the IP-based video production facility while providing reference to baseband analog and SDI system. The timing clocks shall be synced between the Capitol, Senate, and House. Test signal generators shall provide signals for test generator and digital black and two independently adjustable black burst outputs. Waveform/Vectorscope and Rasterizer are to be 4K 59.94 HDR capable and expected to be configured for 1080p and provide support for SMPTE 2110 and network packet analysis.

A. PTP Grandmaster

1. Type 1 PTP Grandmaster
 - **PROVIDE** and **INSTALL** New Evertz 5700MSC-IP+2PS Master Sync Generator for an IP Or hybrid facility with GPS included – Qty 1
 - **PROVIDE** and **INSTALL** New Evertz SFP10G-TR13-A 10GB SFP+ Optical Transceiver – Qty 2

B. Sync Generator

1. Type 1 Sync Generator
 - **PROVIDE** and **INSTALL** New Evertz 5700MSC-IP-BC+2PS+AUX+10GTG Master Sync Generator for an IP facility acting as a Boundary Clock via PTP from a 5700MSC-IP Grandmaster – Qty 2
 - **PROVIDE** and **INSTALL** New Evertz SFP10G-TR13-A 10GB SFP+ Optical Transceiver – Qty 4
2. Type 2 Sync Changeover – Qty 1
 - **PROVIDE** and **INSTALL** New Evertz 5700ACO Automatic Changeover for the 5700 series

C. Waveform/Vectorscope

1. Type 1 Waveform/Vectorscope
 - **PROVIDE** and **INSTALL** New Leader LV5600 Waveform Monitor mainframe – Qty 1
 - **PROVIDE** and **INSTALL** New Leader LV5600-SER01 SDI inputs 4 with CC and CIE display – Qty 1
 - **PROVIDE** and **INSTALL** New Leader LV5600-SER03 Digital/Analog Audio 16CH Digital AES EBU Audio 8 CH Analog Audio – Qty 1
 - **PROVIDE** and **INSTALL** New Leader LV5600-SER06 25GB IP Input and IP analysis – Qty 1
 - **PROVIDE** and **INSTALL** New Leader LV5600-SER26 Customizable user layout display – Qty 1
 - **PROVIDE** and **INSTALL** New Leader LR2561 Rackmount adapter – Qty 1
 - **PROVIDE** and **INSTALL** New Leader LC2152 25GB SFP Optical Transceiver – Qty 2

D. Test Rasterizer

1. Test Rasterizer
 - **NOT REQUIRED IN THE CAPITOL BUILDING**

05.01 VIDEO MONITORS & USER INTERFACE CAPITOL

Video Monitoring shall be provided throughout the video production facility. Type 1 Monitors to be 24" 4K HDR SDI monitors with an independent feed from the router. These monitors shall provide color accurate images for quality control and shading. Type 2 Monitors to be 24" LED monitors for use with computers and KVM user stations. Type 3 Monitors to be 55" 4K HDR LED monitors for wall mounted Multiview monitoring in the control rooms and a rolling cart monitor on the stage. The Type 3 Monitors will utilize the Multiview functionality provided from the ST2110 router, along with real-time clock and other video as needed. Type 4 Monitors to be 43" 4K HDR LED monitors for monitoring in various office locations.

A. Color Picture Monitor

1. Type 1 Color Picture Monitor
 - **PROVIDE and INSTALL** New Sony PVMX2400 24" SDI 4K HDR Monitor – Qty 1
 - **PROVIDE and INSTALL** New Sony PVMKRX24 Rackmount Kit – Qty 1
2. Type 2 Color Picture Monitor
 - **NOT REQUIRED IN THE CAPITOL BUILDING**
3. Type 3 Color Picture Monitor
 - **NOT REQUIRED IN THE CAPITOL BUILDING**
4. Type 4 Color Picture Monitor
 - **NOT REQUIRED IN THE CAPITOL BUILDING**

User Interfaces shall be provided throughout the video production facility. Type 1 Mouse to be Optical USB wired mouse for use at various KVM user stations. Type 2 Mouse to be a wireless mouse for use at the CG user stations. Type 3 Mouse to be a wireless gaming mouse for use in the edit bays. Type 1 Keyboard to be wired mouse for use at various KVM user stations. Type 2 Keyboard to be a rackmount keyboard drawer for use in the rack room. Type 3 Mouse to be a Premier Pro Keyboard for use in the edit bays.

B. Mouse

1. Type 1 Mouse
 - **NOT REQUIRED IN THE CAPITOL BUILDING**
2. Type 2 Mouse
 - **NOT REQUIRED IN THE CAPITOL BUILDING**
3. Type 3 Mouse
 - **NOT REQUIRED IN THE CAPITOL BUILDING**

C. Keyboard

1. Type 1 Keyboard
 - **NOT REQUIRED IN THE CAPITOL BUILDING**
2. Type 2 Keyboard – Qty 1
 - **PROVIDE and INSTALL** New Middle Atlantic RM-KB-LCD17KVMHD LCD KVM Drawer
3. Type 3 Keyboard
 - **NOT REQUIRED IN THE CAPITOL BUILDING**

06.01 CHARACTER GENERATOR CAPITOL

Character Generators are to be 4K 59.94 HDR capable and expected to be configured for 1080p and shall provide for HD 3G real-time motion graphics. Character Generator to include 25G SFP's as necessary to facilitate connection to the ST2110 Routing Switcher. Configured systems to be controlled via KVM by a single operator in PCR 1 and PCR 2. An Inception Social Management system shall be provided to bring texts and graphics from social media content for use in productions. A Character Generator server shall be provided to allow collaborative Xpression project workflow and media moving.

A. Character Generator

1. Character Generator
 - **NOT REQUIRED IN THE CAPITOL BUILDING**

07.01 INGEST & PLAYOUT CAPITOL

Ingest and Playout to be 4K 59.94 HDR capable and expected to be configured for 1080p. 16 channels from 4 new GV I/O ingest, and playout systems tailored for production workflows on a 1 RU server, with SMPTE ST 2110 support and up to four HD channels.

A. Ingest & Playout

1. Type 1 Ingest & Playout
 - **NOT REQUIRED IN THE CAPITOL BUILDING**

B. Network Attached Storage

1. Network Attached Storage
 - **NOT REQUIRED IN THE CAPITOL BUILDING**

C. Stratus Core

1. **Stratus Core**
 - **NOT REQUIRED IN THE CAPITOL BUILDING**

D. Edius Software

1. Edius Software
 - **NOT REQUIRED IN THE CAPITOL BUILDING**

08.01 KVM MATRIX & INTERFACES CAPITOL

An IP KVM system shall be installed for all major systems and operator positions in the video production facility. A KVM Manager shall be installed to transform KVM Transmitters and Receivers into a digital matrix solution. Using standard IP infrastructure to route any user station to any computer on the attached network without any compromises to video quality or control. It allows co-operative sharing of computers to any user station. HDMI to SDI converter shall be provided for connection to the ST2110 Routing Switcher IP Gateway. A KVM Switch shall be provided to support the KVM system.

A. Matrix Based KVM

1. KVM Matrix
 - **PROVIDE** and **INSTALL** New Adder ASP-001-US Infinity Manager Device – Qty 2
 - **PROVIDE** and **INSTALL** New Adder AIMLIC-192-BCK Infinity AIM software – Qty 1
 - **PROVIDE** and **INSTALL** New Adder SFP-SM-LC SFP Single Mode Fiber Module – Qty 4
2. KVM Transmitter
 - **PROVIDE** and **INSTALL** New Adder ALIF4021T-US Dual Head 10GB KVM Transmitter – Qty 10
 - **PROVIDE** and **INSTALL** New Adder SFP-SM-LC-10G SFP Single Mode Fiber Module – Qty 10

- **PROVIDE** and **INSTALL** New Adder RMK12 Rackmount Kit – Qty 5
 - **PROVIDE** and **INSTALL** New Adder RMK12-BP Blanking Plates – Qty 10
 - **PROVIDE** and **INSTALL** New Lynx Technik CHD-1812 3G HDMI to SDI Converter – Qty 1
3. KVM Receiver
- **PROVIDE** and **INSTALL** New Adder ALIF4021R-US Dual Head 10GB KVM Receiver – Qty 5
 - **PROVIDE** and **INSTALL** New Adder SFP-SM-LC-10G SFP Single Mode Fiber Module – Qty 5
 - **PROVIDE** and **INSTALL** New Adder RMK12 Rackmount Kit – Qty 5
 - **PROVIDE** and **INSTALL** New Adder RMK12-BP Blanking Plates – Qty 10
4. KVM Switch
- **PROVIDE** and **INSTALL** New Netgear XSM4348FS-100NES Ethernet Switch - 48SFP+, 2 10GBASE-T Shared - Manageable 3 Layer Supported – Qty 1
 - **PROVIDE** and **INSTALL** New Netgear APS250W-100NES Power Supply – Qty 1
 - **PROVIDE** and **INSTALL** New Addon AXM761-AO SFP+ Optical Transceiver – Qty 48

09.01 VIDEO RECORDING EQUIPMENT CAPITOL

A multi-channel recorder and player shall be provided for backup recording of live production, post-production, on-set and any necessary high quality reliable recording and playback as needed.

A. Video Disk Recorder

1. Type 1 Video Disk Recorder
 - **NOT REQUIRED IN THE CAPITOL BUILDING**

10.01 DISTRIBUTION & SIGNAL PROCESSING CAPITOL

A Modular Signal Processing infrastructure shall be provided for distribution and conversion as necessary throughout the video production facility. Control of modular systems shall be provided by DashBoard software, available free of charge from Ross Video. This allows for easy setup, monitoring, alarms, and management.

A. Distribution Frame

1. Type 1 Distribution Frame – Qty 5
 - **PROVIDE** and **INSTALL** New Ross Video OGX-FR-CN Open Gear OGX Frame
 - **PROVIDE** and **INSTALL** New Ross Video PS-OGX Power Supply

B. Serial Distribution Amplifier

1. Type 1 SDA
 - **PROVIDE** and **INSTALL** New Ross Video SRA-8901-4-R3S Digital Video Distribution Amplifier – Qty 10
 - **PROVIDE** and **INSTALL** New Ross Video SRA-8901-4 Rear Plate 1 x 4 – Qty 20

C. Analog Video Distribution Amplifier

1. Type 1 VDA – Qty 10
 - **PROVIDE** and **INSTALL** New Ross Video UDA-8705A-R2L Video Distribution Amplifier

D. Audio Embedder/De-Embedder

1. Type 1 Embedder/De-Embedder – Qty 9
 - **PROVIDE** and **INSTALL** New Ross Video AMX-8952-C Analog Audio Embedder/De-Embedder
 - **PROVIDE** and **INSTALL** New Ross Video R3C-8952 Rear Module
 - **PROVIDE** and **INSTALL** New Ross Video AMX-8952-FS-LICENSE Frame Sync License for AMX

E. Up Down Cross Converter

1. Type 1 UDX – Qty 4

- **PROVIDE** and **INSTALL** New Ross Video GATOR-TOOLBOX Single Channel HD Toolbox
- **PROVIDE** and **INSTALL** New Ross Video GATOR-TOOLBOX-12G-LICENSE UHD Format Support
- **PROVIDE** and **INSTALL** New Ross Video GATOR-FRC-LICENSE Frame Rate Conversion License
- **PROVIDE** and **INSTALL** New Ross Video GATOR-2 12G-SDI 2-Slot Card 6 in and 6 out
- **PROVIDE** and **INSTALL** New Ross Video R4-GATOR Rear Plate

F. Scan Converter

1. Type 1 Scan Converter – Qty 2
 - **PROVIDE** and **INSTALL** New Barco R9004677 Imagepro II Scan Converter & Processor
2. Scan Converter IO PLATE – Qty 2
 - **PROVIDE** and **INSTALL** New Scan Converter I/O Plate

G. Fiber Optic Transmitter/Receiver

1. Type 1 Fiber Optic Transmitter – Qty 5
 - **PROVIDE** and **INSTALL** New LYNX TECHNIK OTT-1842 Dual 3G SDI to Fiber Optic Transmitter
2. Type 2 Fiber Optic Transmitter – Qty 5
 - **PROVIDE** and **INSTALL** New LYNX TECHNIK OTX-1712 Analog Sync / Video Fiber Optic Transmitter
3. Type 1 Fiber Optic Receiver – Qty 5
 - **PROVIDE** and **INSTALL** New LYNX TECHNIK ORX-1802 3G Fiber Optic to SDI Receiver
4. Type 2 Fiber Optic Receiver – Qty 5
 - **PROVIDE** and **INSTALL** New LYNX TECHNIK ORX-1702 Analog Sync / Video Fiber Optic Receiver

H. HDMI Converter

1. Type 1 HDMI Converter – Qty 5
 - **PROVIDE** and **INSTALL** New LYNX TECHNIK CDH-1813 3G SDI to HDMI Converter
2. Type 2 HDMI Converter – Qty 5
 - **PROVIDE** and **INSTALL** New LYNX TECHNIK CHD-1812 3G HDMI to SDI Converter

I. Media Converter

1. Type 1 Media Converter – Qty 5
 - **PROVIDE** and **INSTALL** New LYNX TECHNIK OET 1510 Fiber to Ethernet Transceiver

11.01 AUDIO, TIME CODE, CONTROL CAPITOL

A Dante enabled; 16 fader audio mixing board shall be provided in each Production Control Room. This mixer will be capable of saving and recalling mixer configurations, and will provide adequate input, output, and sub-mix counts to handle the production needs. The control rooms shall be provided with wall mounted speakers for audio monitoring and Dante enabled volume controllers. The Studio shall be provided with a truss mounted stage announce speaker. Dante enabled Audio interfaces shall be provided for distribution and conversion of necessary audio throughout the video production facility including interfacing with the wireless microphone and IFB systems as well as a number of input and output audio sources and destinations from the new video systems. Rackmount audio monitoring units shall be provided as necessary at various user locations in the equipment rack room and control rooms.

A. Audio Mixing Console

1. Type 1 Mixing Console
 - **NOT REQUIRED IN THE CAPITOL BUILDING**
2. Type 1 Stage Box

- **NOT REQUIRED IN THE CAPITOL BUILDING**

B. Speaker

1. Type 1 Speaker
 - **NOT REQUIRED IN THE CAPITOL BUILDING**
2. Type 2 Speaker
 - **NOT REQUIRED IN THE CAPITOL BUILDING**

C. Audio Interface

1. Type 1 Audio IO Interface – Qty 1
 - **PROVIDE** and **INSTALL** New Focusrite AMS-REDNET-A16R-MKII 16 Channel Analogue Dante I/O Interface
2. Type 1 MAD1 to Dante Converter – Qty 1
 - **PROVIDE** and **INSTALL** New Focusrite AMS-REDNET-D64R 64 Channel Madi Dante I/O Interface with Redundant Network & Power

D. Microphone

1. Type 1 Mic Receiver
 - **NOT REQUIRED IN THE CAPITOL BUILDING**
2. Type 1 Mic Transmitter
 - **NOT REQUIRED IN THE CAPITOL BUILDING**
3. Type 1 MIC Battery Charger
 - **NOT REQUIRED IN THE CAPITOL BUILDING**

E. IFB

1. Type 1 IFB Transmitter
 - **NOT REQUIRED IN THE CAPITOL BUILDING**
2. Type 1 IFB Receiver
 - **NOT REQUIRED IN THE CAPITOL BUILDING**
3. Type 1 IFB Battery Charger
 - **NOT REQUIRED IN THE CAPITOL BUILDING**

F. Audio Distribution

1. Time Code Distribution Amplifier – Qty 2
 - **PROVIDE** and **INSTALL** New Ross Video ADA-8405-C-R2C Ross Dual 1x4 Audio DA
2. Word Clock Synthesizer – Qty 1
 - **PROVIDE** and **INSTALL** New Ross Video WDA-8409-R2L Word Clock Distribution Amplifier W/Looping Rear Module

G. Audio Monitor

1. Type 1 Audio Monitor – Qty 1
 - **PROVIDE** and **INSTALL** New Wohler iAM1-8 1RU Triple Screen, 8 Channel Dual Input, 3G/HD/SD-SDI, Audio Monitor with Touch Screen Control
 - **PROVIDE** and **INSTALL** New Wohler SFP-2110 w/NMOS SMPTE 2110 Receiver: Multi-Mode 850 Nm, LC (Fiber) Connectors.
 - **PROVIDE** and **INSTALL** New Wohler OPT-DANTE Enable Monitoring from Up to A 64ch Dante Input
2. Type 1 Volume Controller
 - **NOT REQUIRED IN THE CAPITOL BUILDING**

12.01 INTERCOM CAPITOL

An IP based digital Matrix Intercom system shall be provided and licensed for 48 ports and scalable to 128 ports. The intercom system shall work directly with Dante network audio to receive signals for IFB functions. Rackmount Intercom panels with 16 keys and listen and talk levers shall be provided at various user stations throughout the video production facility. Desktop Intercom panels with 16 keys and listen and talk levers shall be provided at various office and desk locations throughout the video production facility. The Intercom Matrix shall provide wireless intercom to handle multiple lightweight intercom belt packs. Fully integrated solution shall allow for seamless roaming across wide area. The Intercom Access Points convert the DECT signals into Dante compatible OMNEO IP technology signals. Intercom interfaces shall be provided for telephone hybrid using POTs lines or VoIP over public internet. Headsets shall be provided for each control panel. Intercom system can be trunked together with systems from other buildings and programmed using AZedit.

A. Intercom Matrix

1. Type 1 Intercom Matrix – Qty 1
 - **PROVIDE** and **INSTALL** New RTS ODIN32NOCORD Odin 32 Port Matrix No Cord
 - **PROVIDE** and **INSTALL** New RTS ODIN 16 PORT UPGRADE

B. Intercom Panel

1. Type 1 Intercom Panel – Qty 3
 - **PROVIDE** and **INSTALL** New RTS KP4016 14 Position Key Panel with Menus and Programming Keypad
2. Type 2 Intercom Panel – Qty 1
 - **PROVIDE** and **INSTALL** New RTS DKP4016 16 Lever Desk Top Key Panel

C. Wireless Intercom Matrix

1. Wireless Intercom Matrix – Qty 4
 - **PROVIDE** and **INSTALL** New RTS AP-1800 Access Point 1.92-1.93 GHZ
 - **PROVIDE** and **INSTALL** New Allowance for Poe 12v Power Adapter For Ap-1800
 - **PROVIDE** and **INSTALL** New RTS TR-1800 Wireless Intercom Beltpack

D. Intercom Interface

1. Type 1 Intercom Interface – Qty 2
 - **PROVIDE** and **INSTALL** New RTS TIF-PRO2 Interfaces SIP Interface 2 Channels
 - **PROVIDE** and **INSTALL** New RTS TIF-PRO2 PSTN Interfaces TIF-PRO 2 PSTN 2-Channels Upgrade

E. Intercom Headset

1. Type 1 Intercom Headset – Qty 4
 - **PROVIDE** and **INSTALL** New RTS PH-88R5 PH-88, Single-Sided Lightweight Headset

13.01 UTILITY COMPUTERS CAPITOL

Utility computers shall be provided in various locations throughout the video production facility. Type 1 Small form factor desktop workstations shall be provided for users for basic task and functions. Type 2 Rackmount utility computers shall be provided for various engineering and production functions. The rackmount computers shall be remotely operated from the control rooms via a keyboard, mouse and monitor using the KVM system. Type 3 Rackmount servers shall be provided for advanced engineering functions that require high processing power. The rackmount computers shall be remotely operated from the control rooms via a keyboard, mouse and monitor using the KVM system. Type 4 Workstations shall provide Edit computers with high end graphics cards, Audio Video IO cards and breakout box, network interface cards and touch tablets.

A. Utility Computer

1. Type 1 Utility Computer
 - **NOT REQUIRED IN THE CAPITOL BUILDING**
2. Type 2 Utility Computer – Qty 2
 - **PROVIDE and INSTALL** New Dell Precision 3930 Rackmount Workstation
3. Type 3 Utility Computer – Qty 1
 - **PROVIDE and INSTALL** New Dell PowerEdge R7525 Rackmount Server
4. Type 4 Utility Computer
 - **NOT REQUIRED IN THE CAPITOL BUILDING**

B. Graphics Card

1. Type 1 Graphics Card
 - **NOT REQUIRED IN THE CAPITOL BUILDING**
2. Type 2 Graphics Card
 - **NOT REQUIRED IN THE CAPITOL BUILDING**

C. Network Interface Card

1. Type 1 Network Interface Card
 - **NOT REQUIRED IN THE CAPITOL BUILDING**

D. AV I/O Card

1. Type 1 AV I/O Card
 - **NOT REQUIRED IN THE CAPITOL BUILDING**

E. Touch Tablet

1. Type 1 Touch Tablet
 - **NOT REQUIRED IN THE CAPITOL BUILDING**

14.01 ARCHIVE CAPITOL

An Archive solution shall be provided combining multiple technologies including an LTO Archiving Tape Library; a Content Storage Management Solution; a Transcoding Media Processing Server and a Network Attached Storage Array.

A. LTO

1. Type 1 LTO Library
 - **NOT REQUIRED IN THE CAPITOL BUILDING**

B. Content Management

1. Type 1 Content Management
 - **NOT REQUIRED IN THE CAPITOL BUILDING**

C. Transcoding

1. Type 1 Transcoding
 - **NOT REQUIRED IN THE CAPITOL BUILDING**

D. NAS

1. Network Attached Storage
 - **NOT REQUIRED IN THE CAPITOL BUILDING**

15.01 MASTER CONTROL CAPITOL

Master Control Switcher to be 4K 59.94 capable and expected to be configured at 1080p. Master Control Switcher is a keying and branding playout channel with mixing and logo insertion capabilities plus DVE and audio processing tools to deliver on-air channel from the video production facility. A Dashboard turnkey touchscreen client computer shall be provided for manual switching functionality similar to a typical control surface panel.

A. Master Control Switcher

1. Master Control Switcher – Qty 1
 - **PROVIDE** and **INSTALL** New Ross Video GATOR-MC1-2-R4 MC1 Mixer/Keyer - SDI 6IN/6OUT W/Rear Module
 - **PROVIDE** and **INSTALL** New Ross Video MC1-MASTERCTRL-LICENSE Master Control License for MC1-Gator Platform
 - **PROVIDE** and **INSTALL** New Ross Video MC1-DVE-1CH-LICENSE DVE (1 Channel) License for MC1-Gator Platform
 - **PROVIDE** and **INSTALL** New Ross Video DB-TURNKEY-HW Dashboard Turnkey Client

16.01 NDI PROCESSING SYSTEM CAPITOL

An NDI (Network Device Interface) shall be provided for transport and management of NDI and other network-based video content. To this end a robust set of hardware and software tools shall be installed. A server running NDI Processing Engine software shall form the core of this system; it can process and transcode multiple streams of NDI simultaneously, as well as handle Multiview tasks and control and ingest of external video streams. The NDI Processing Engine server shall work in concert with another server providing multiple streams of HD-SDI to SDI conversion. This NDI I/O server shall house the necessary hardware and software to transcode these streams. To manage routing and discovery of NDI sources and destinations, both in-facility and externally, a redundant pair of servers will be provided to run the NDI Router and NDI Discovery software. These servers shall be set up in such a way that both processes are available redundantly on both servers. NDI servers will be provided with multiple high-bandwidth connections to the main network switch stack.

A. NDI Processing System

1. NDI Software
 - **NOT REQUIRED IN THE CAPITOL BUILDING**
2. NDI Hardware
 - **NOT REQUIRED IN THE CAPITOL BUILDING**

17.01 PRODUCTION NETWORK CAPITOL

To manage the large amount of network traffic involved in the video production facility a Primary and Backup Network Core shall be installed in the rack room of each building. The Core stack of each building shall be linked together with 100G fiber cables and network modules. A number of 48 port PoE+ switches shall be provided in the rack room for all necessary production equipment connections. A number of 48 port PoE+ switches shall be installed in all hearing rooms and linked back to the core with 25G fiber cables and network modules. It is intended that these switches be as completely segregated as possible from the corporate office network; the only connection point being public internet access for streaming content to remote locations.

A. Production Network Core

1. Production Network Core Primary

- **PROVIDE** and **INSTALL** New Cisco C9300X-24Y-A= Catalyst 9300X 24-port 25/10G SFP+ NW-A – Qty 2
 - **PROVIDE** and **INSTALL** New Cisco PWR-C1-1100WAC/2 1100W AC Config 1 Secondary P/S – Qty 2
 - **PROVIDE** and **INSTALL** New Cisco STACK-T1-1M Stackwise 480 Stacking Cable 3.3FT – Qty 2
 - **PROVIDE** and **INSTALL** New Cisco C9300X-NM-2C Catalyst 9300 2 x 40G/100G Network Module – Qty 2
 - **PROVIDE** and **INSTALL** New Cisco QSFP-100G-LR-S 100G QSFP28 100G-LR SMF duplex LC – Qty 4
2. Production Network Core Backup
- **PROVIDE** and **INSTALL** New Cisco C9300X-24Y-A= Catalyst 9300X 24-port 25/10G SFP+ NW-A – Qty 2
 - **PROVIDE** and **INSTALL** New Cisco PWR-C1-1100WAC/2 1100W AC Config 1 Secondary P/S – Qty 2
 - **PROVIDE** and **INSTALL** New Cisco STACK-T1-1M Stackwise 480 Stacking Cable 3.3FT – Qty 2
 - **PROVIDE** and **INSTALL** New Cisco C9300X-NM-2C Catalyst 9300 2 x 40G/100G Network Module – Qty 2
 - **PROVIDE** and **INSTALL** New Cisco QSFP-100G-LR-S 100G QSFP28 100G-LR SMF duplex LC – Qty 4

B. Production Network Rack Room

1. Production Network Rack Room – Qty 4
- **PROVIDE** and **INSTALL** New Cisco C9300X-48HX-A Catalyst 9300 48-port mGig UPoE+ Network
 - **PROVIDE** and **INSTALL** New Cisco PWR-C1-1100WAC/2 1100W AC Config 1 Secondary P/S
 - **PROVIDE** and **INSTALL** New Cisco STACK-T1-1M Stackwise 480 Stacking Cable 3.3FT
 - **PROVIDE** and **INSTALL** New Cisco C9300X-NM-8Y Catalyst 9300 8 x 25G Network Module
 - **PROVIDE** and **INSTALL** New Cisco SFP-10/25G-BXD-I Cisco 10/25GBASE-LR Bidirectional -D
 - **PROVIDE** and **INSTALL** New Cisco SFP-10/25G-BXU-I Cisco 10/25GBASE-LR Bidirectional -U

C. Production Network Hearing Room

1. Production Network Hearing Room – Qty 12
- **PROVIDE** and **INSTALL** New Cisco C9300X-48HX-A Catalyst 9300 48-port mGig UPoE+ Network
 - **PROVIDE** and **INSTALL** New Cisco PWR-C1-1100WAC/2 1100W AC Config 1 Secondary P/S
 - **PROVIDE** and **INSTALL** New Cisco STACK-T1-1M Stackwise 480 Stacking Cable 3.3FT
 - **PROVIDE** and **INSTALL** New Cisco C9300X-NM-8Y Catalyst 9300 8 x 25G Network Module
 - **PROVIDE** and **INSTALL** New Cisco SFP-10/25G-BXD-I Cisco 10/25GBASE-LR Bidirectional -D
 - **PROVIDE** and **INSTALL** New Cisco SFP-10/25G-BXU-I Cisco 10/25GBASE-LR Bidirectional -U

18.01 FURNITURE, MILLWORK & RACKS CAPITOL

Consoles shall be constructed to house audio, video, control, and other equipment throughout the video production facility control rooms. Consoles will be outfitted with AC power, turrets to mount production equipment and adjustable monitor arms as needed for each individual operator position. Consoles typically include the ability to house certain equipment in racks and on the console desk such as router and intercom key panels, camera control and shading, video and audio monitors, switcher control surfaces, KVM user stations and interface devices, and audio mixers.

A. Furniture Consoles

1. Furniture Consoles
- **NOT REQUIRED IN THE CAPITOL BUILDING**

Racks are not required in the Senate Building Rack Room. Racks to be 44RU height and 42" Deep gangable racks. These racks will be equipped with fan tops, lights, rear doors, power strips, bus bars and lacing strips. Rack bases shall be provided for mounting racks to computer raised floors.

B. Racks

1. 42"D Gangable Racks
 - **NOT REQUIRED IN THE CAPITOL BUILDING**

19.01 PATCHING & CABLES CAPITOL

Patch Panels and Patch Cables shall be provided as necessary for the video production facility. Patch Panels shall support 12G normalized patching for video and Cat 6 for network and control. New SMPTE camera cables shall be provided for cameras going to the Stage and on the stage. New Single Mode Fiber camera cables shall be provided for cameras SDI over fiber devices in hearing rooms and session floors. New 100G Single Mode Fiber tie lines shall be provided between the three buildings for the Production Network Switches and the ST2110 Router. New Fiber Enclosures shall be provided in each rack room for the new fiber cables. General purpose audio, video, control, fiber and RF cable and connectors shall be provided as necessary and as called out in the Bill of Materials.

20.01 COMMISSIONING AND TRAINING CAPITOL

Manufacturers Commissioning and Training shall be provided for necessary systems. Commissioning of Existing Owner Furnished equipment (except for computers which the Owner may provide to the project for installation of configuration and operating software) is not included. It is expected that some Commissioning and Training shall be done remotely in advance to actual on-site time and work. Commissioning and Training schedule shall be a coordinated effort between Alpha Video, Vendors and Owner. General systems operation and maintenance training shall be provided to designated personnel on the use and operation of the system.

Commissioning and training shall include the following systems:

- **Master Control Switcher**
- **Routing Switcher**
- **Tally**
- **Intercom**
- **Production Network**

ADDITIONAL PROJECT SPECIFICATIONS

ASSUMPTIONS & CONDITIONS

ASSUMPTIONS

Alpha Video is making the following assumptions regarding the site conditions, end user needs, and other design or scope details.

- Relating to the current COVID-19 pandemic:
 - We have assumed that our work on this project and the operations of Minnesota Legislative Coordinating Commission are deemed to be unrestricted OR “essential” business functions, as defined by any pertinent federal, state, and local orders. We have assumed that they will continue to be deemed “essential” through the duration of our engagement and the term of the orders.
 - Alpha Video will fully comply with these orders, including work restrictions. We have assumed all personnel may be permitted to work in isolation or with a minimum of 6’ distance from any other person. Any costs incurred by Alpha Video to comply with any work restrictions not in place as of the date on the cover of this proposal are the responsibility of Minnesota Legislative Coordinating Commission. This shall include, but is not limited to, additional labor, split shifts, overtime, weekend work, holiday work, after-hours work, travel expenses, change fees, additional resources, de- and re-mobilization, etc.
 - Alpha Video may, at our sole discretion, request and be granted additional considerations to ensure the health and safety of our team members.

CONDITIONS

The following are equipment and process conditions that specifically apply to this project.

- Equipment listed within this quote may be subject to procurement delays, which may impact installation dates and/or may result in change orders and revisions to this scope of work.
- This scope of work and the pricing in our proposal is based upon the included timeline. Any deviations will require revising both.
- When equipment or material is shipped directly to your facility, Minnesota Legislative Coordinating Commission will be solely responsible for:
 - Providing written delivery confirmation to Alpha Video & Audio for each item upon arrival.
 - Visually inspecting the outside of each package for carrier damage (and providing photo evidence when required); and,
 - Consolidating, organizing, and securely storing each item. Minnesota Legislative Coordinating Commission acknowledges ownership of received items.

PROJECT TIMELINE

As a leader in the audio-visual and broadcast integration markets, Alpha Video understands that this system is considered mission-critical and impacts the success of your organization. We know that your event schedule does not change and that the show must go on.

However, to meet your required completion dates, we have established the following milestones. Timely achievement of each objective will ensure on-time completion. ***This scope of work and the pricing in our proposal is based upon the following timeline. Any deviations will require revising both.***

APPROXIMATE MILESTONES

Date	Primary Party	Requirement
NTP	Minnesota Legislative Coordinating Commission	Notice to Proceed
NTP +6 Weeks	Alpha Video	Drawing submittals complete
NTP +8 Weeks	Minnesota Legislative Coordinating Commission, Alpha Video	Drawing submittals approved; In-House Build begins
NTP +12 Weeks	Minnesota Legislative Coordinating Commission, Alpha Video	On-Site Build Begins
NTP +16 Weeks	Alpha Video	On-Site Build Complete
NTP +19 Weeks	Alpha Video	Commissioning Complete
NTP +21 Weeks	Minnesota Legislative Coordinating Commission, Alpha Video	Punchlist & Training Complete
NTP +23 Weeks	Alpha Video	Project Closeout

On-site installation can only begin once construction has progressed to the point that electronic equipment can be installed in a secure and clean job site. Please provide the project manager with a schedule outlining when this will occur. A change order will be assessed for any delays beyond the date listed in this proposal.

STANDARDS OF QUALITY

SYSTEM INTEGRATION SERVICES

Alpha will manage all aspects of this project from start to finish to ensure this project is on-time and on-budget. If integration services are provided in this proposal, Alpha will provide the following:

INTEGRATION LABOR AND MATERIALS

Project Team:

- Project Engineering
- Project Management
- Lead Technician and Project Technical Specialists
- Subcontracted services management, oversight, and coordination

Documentation:

- Preliminary Shop Drawings & Approval Submittals
- Detailed Installation Notes
- As-Built Drawings & Documentation

Professional Services:

- System Configuration & Commissioning
- Operational Training and/or On-Site Event Support
- Full System Warranty

Additional Items:

- Freight
- Insurance
- Travel Expenses

STANDARDS OF INTEGRATION

We guarantee the quality of our integration services, providing a multi-point inspection upon the completion of every installation. In summary:

GENERAL

- All system components will be installed in a neat and professional manner.
- Equipment will be new and blemish-free unless otherwise noted in this document.
- Above-ceiling components shall be installed with trim rings and/or grommets when necessary.
- Rack equipment will be installed using proper manufacturer-supplied mounting hardware.
- Blank rack spaces will be filled with either blank or vent panels.
- Racks will have proper ventilation to prevent heat buildup and prolong equipment life.

WIRING AND CABLES

- Rack cabling will be bundled neatly with cable ties or hook & loop as required.
- Low- and high-voltage cabling will be separated according to NFPA 70 (National Electric Code) 2017 specifications.
- All cabling in conduit will comply with the conduit fill specifications in NFPA 70 (National Electric Code) 2017.

- Proper strain relief will be provided at all connections and bends.
- Sufficient service loops will be provided above-ceiling, above/within/under equipment racks, or in cable trays so that components may be unmounted for service without cable strain.
- All connectors will be properly sized to fit the wire type and will be installed according to the manufacturer's specifications.
- All permanently installed cabling will be labeled with computer-generated labels.

INSTALLER TESTING AND ADJUSTMENTS

- Alpha will verify proper grounding on all equipment.
- Video displays will be properly aligned and free from distortion.
- Cabling and loudspeakers will be tested for proper polarity.
- Audio will be free of distortion, hums, buzzes, or pops.
- Loudspeaker systems will be tested and equalized to provide uniform frequency response.
- Control system programs will be tested for proper system operation.

PROJECT TERMS & CONDITIONS

RESPONSIBILITIES OF THE OWNER

This statement of work indicates the responsibilities of Alpha Video & Audio. As in any system installation, this project contains several customer responsibilities. They include, but are not limited to:

- Providing a secure, clean, and dust-free work site by the “On-Site Build Begins” date specified in this proposal;
- Providing secured storage locations and/or laydown areas for housing equipment and installation materials.
- Providing central waste and/or recycling containers for proper disposal of any installation debris;
- Providing, without request for reimbursement, all high voltage AC electrical equipment and labor necessary for proper installation – including mains, transformers, panel boards, surge suppression, receptacles, engineering, stamps, and permits – unless specified as “Alpha-provided” within this proposal;
- Providing and installing adequate HVAC, lighting, fire suppression, and life safety systems;
- Providing, installing, and certifying all necessary low voltage infrastructure – including conduits, pathways, cable trays, penetrations, core drilling, floor boxes, wall boxes, and back boxes – unless specified as “Alpha-provided” within this proposal;
- Providing and installing adequate primary & secondary steel, structures, supports, poles, and/or backing for all mounted equipment;
- Providing a professionally installed, fully functional IP network as required with the capacity to support all system components, bandwidth, routing, and enterprise-level configuration;
- Facilitating IT/network coordination with appropriate representatives and providing any requirements during the design engineering process;
- Facilitating custom control system design by coordinating with appropriate representatives and providing any requirements during the design engineering process;
- Providing access to any owner-furnished equipment, devices, virtual machines, and programming code in a timely manner upon request;
- Providing uninhibited access to the job site during normal business hours (7am to 7pm M-F) unless non-standard work hours are included in our proposal; and,
- Coordination of training times with all required staff.

This proposal assumes that work can be carried out continuously throughout the day with limited to no interruptions. If daily interruptions or delays occur before or during the work described in this scope, change orders may be required due to inefficiencies related to these interruptions.

GENERAL TERMS & CONDITIONS

OWNER-FURNISHED EQUIPMENT

This proposal assumes that all existing “owner-furnished” equipment and programming code required for system functionality is in proper operating condition and without defect. If any of the required existing equipment is not in proper operating condition, a change order may be required for the functionality outlined in this proposal.

Any owner-furnished code that is to be reused is subject to review. Please provide Alpha with all uncompiled code within 14 days of Notice to Proceed. Should owner-furnished code be deemed inadequate, by our sole discretion, Alpha will present a change order to modify or rewrite all or part of the code.

DOCUMENTATION

Alpha Video will provide shop drawings for review and formal approval that reflect the final system design. Upon completion of the project, a full set of as-built drawings will be provided digitally, which will include components of the video, audio and control systems, and any architectural documentation used during the installation. Those drawings will become property of the owner upon final payment.

PROJECT MANAGEMENT

Alpha Video will appoint a project manager as your main point of contact regarding this project. The project manager will manage the installation timeline, oversee the project team, and coordinate work with any additional trades involved in this installation.

CHANGE REQUESTS

After the project begins, any changes to this scope must be requested as a change order. Change requests shall be submitted in written form so that both parties fully understand the request. Any additional costs resulting from change orders shall be the responsibility of the owner.

PROMOTION

Alpha Video may decide to leverage this project for sales and marketing purposes. Content used to promote the project may include, but are not limited to: press releases, blogs, pictures, videos, and case studies. Your company name and logo may be used as part of the content when referencing the project. Alpha Video will provide a list of content assets and the timeline for creating, approving, and distributing the content, as required. We will share and gain your approval of any content published in the trade, submitted for awards, etc. You may use any content assets created by Alpha Video for your purposes.

SYSTEM WARRANTY AND SUPPORT

Alpha Video & Audio, Inc. guarantees the following:

1. Equipment will be new, unless noted otherwise.
2. All workmanship provided by Alpha Video will be free of defects and will be repaired, free of charge, for a period of one (1) year from the date of substantial completion or the first date of beneficial use of the system, whichever date occurs first. Substantial completion shall be defined as the point where the work, or designated portion thereof, is sufficiently complete so that the system can be used for its intended purpose.
3. All equipment and materials provided by Alpha Video that was manufactured by other companies will be warranted under the standard warranty terms of the original manufacturer.
4. If any questions arise during the warranty period about the installation or operation of the system, an Alpha Video engineer will be available to assist and answer any questions by phone.
5. The warranty does not include nor cover expendable materials used with the system installation (e.g., light bulbs, lamps, light fixture lamps, fuses, batteries, portable connection cables, etc.).
6. Alpha Video is not responsible for the reliability of systems that communicate using wireless technology. The performance of equipment utilizing wireless communications is inherently unreliable and will experience "dropouts", distortion, and loss of connectivity from time to time. Interference from other forms of radio frequency transmissions, such as radio and television broadcasts, cell phones, and wireless computer networks, is probable and should be expected.
7. Alpha Video is not responsible for the performance, testing, or configuration of owner-furnished data networks that are used to transmit audio, video, and lighting program data and control signal data. IP-based videoconferencing systems rely upon data networks that can provide consistent bandwidth for the transmission. Videoconferencing that is transmitted over the Internet is subject to the intermittent and unreliable nature of the public network. In the event that the Customer's network is found to be the cause of defects in the quality of the audio/video signals, is unreliable, or has insufficient bandwidth to support the A/V/L system and Alpha Video's network engineers are required to troubleshoot or configure the Customer's network, the cost of this service will be invoiced to the Customer.
8. Any adjustments made by the Customer or the Customer's agent(s), other than routine operational adjustments, shall not be covered under this warranty statement. Re-calibration of settings shall be considered by Alpha Video to be billable time to the Customer at Alpha's standard engineering rates.
9. Procedures such as routine preventative maintenance functions (e.g., keeping filters clean, keeping system environment free from foreign materials, etc.) are the responsibility of the Customer and is not included within this warranty agreement. Failure on the part of the Customer to perform these routine maintenance functions shall void this warranty. Preventative maintenance agreements are available at an additional cost.
10. If warranty work is necessary within the warranty period, Alpha Video will, at its option, repair the defective equipment or return it to the manufacturer for repair.
11. Repairs, modifications, or other work performed by personnel not authorized by Alpha Video during the period of warranty on any equipment of the system may invalidate the warranty.
12. Alpha Video will not be responsible for damages or cost of repairs due to modifications, adjustments, or additions to the system performed by personnel not authorized by Alpha Video prior to acceptance of the system by the Customer.
13. Alpha Video may withhold warranty service if the Customer has an unpaid balance due to be paid to Alpha Video.
14. Regarding Owner-furnished Equipment (OFE):

- a. Alpha Video's intent is to provide a complete system including all equipment. In some cases, the Customer may own equipment which they desire to be included with the installation. Alpha identifies this as OFE.
- b. The use of OFE is solely for the convenience of the Customer and is not included in the warranty or guarantee provided.
- c. Alpha Video shall take reasonable care in handling OFE and install it according to standard industry practices; however, Alpha Video takes no responsibility for the operation, performance, appearance, or effects of OFE before, during, or after its integration into the system. Alpha Video reserves the right to accept or reject OFE based on the equipment's service record, or lack thereof, condition, age, impact to other system components, and operator life safety. Alpha Video will not accept OFE that is purchased by the Customer to replace equipment that is specified in this proposal.
- d. In the event that OFE does not function properly, Alpha Video shall notify the Customer to determine if the OFE is to be a) repaired, b) an alternate unit provided by the Customer, c) the unit is not to be used, or d) Alpha Video is to provide a new unit. Alpha Video shall provide a cost to the Customer for the work to be done. The Customer will authorize any additional costs to the job.
- e. The existing equipment, removed as a courtesy by Alpha Video, that is not being reused, shall be handed over to the Customer. Alpha Video is not responsible for disposal of the existing equipment or its condition when received by the Customer.

PART NUMBER	MANUFACTURER	DESCRIPTION	QTY	UNIT PRICE	TOTAL PRICE
A-2: ROUTING SWITCHER CORE BACKUP					
NATX-32-100G-1+DF1RP	EVERTZ	IP Switching Fabric with Integrated Network Address Translation. Up to 32x100G or 128x25G. DF1 Rear Dragon Fire 1RU, single slot, complete with all power and controller redundancy	1.00	\$66,550.00	\$66,550.00
DF1-FR	EVERTZ	Double density, 1310nm QSFP optical module that supports 8x25G/10G ports. Can be used in application	1.00	\$11,000.00	\$11,000.00
QSFP200G-SM-LR8-10K-G	EVERTZ	MTP PSM8 to 2xMTP PSM4 breakout cable to connect the 8 ports of a QSFP-DD	12.00	\$2,860.00	\$34,320.00
CBL-PSM8-2xPSM4-SM-5M	EVERTZ	5 meter MTP to LC single mode breakout cable for QSFP DD PSM8 to 8x SFP optical transceivers	10.00	\$495.00	\$4,950.00
CBL-MTP-LC16-SM-5M	EVERTZ	1000Mbps RJ45 SFP module with SerDes interface	2.00	\$440.00	\$880.00
SFPTR-RJ45-SER-AV	EVERTZ		2.00	\$196.00	\$392.00
A-2: Routing Switcher Core Backup Subtotal:					\$118,092.00
B-1: TYPE 1 IPG FRAME					
EV6-FR+PS	EVERTZ	6RU MODULAR FRAME	1.00	\$5,030.67	\$5,030.67
EV6-FC	EVERTZ	FRAME CONTROLLER	2.00	\$1,540.00	\$3,080.00
B-1: Type 1 IPG Frame Subtotal:					\$8,110.67
B-2: TYPE 1 IPG					
EV670-X30-HW-V2	EVERTZ	NEXT GENERATION HIGH DENSITY MEDIA PROCESSING FPGA ACCELERATED HARDWARE	1.00	\$9,900.00	\$9,900.00
670IPG-X30-APP-32X	EVERTZ	Provides the ability to Encapsulate and Decapsulate 32x32 SD, HD, 3G SDI Signals to ST-2110.	1.00	\$102.67	\$102.67
evIPG-3G	EVERTZ	IPG app support 32x 3G encap and decap	1.00	\$34,496.00	\$34,496.00
ev670-32X32-HDBNC-RP	EVERTZ	Rear plate for ev670-x30-HW. Must use with IPG apps and evVIP-SDI app. Optional for ST-2110 multivie	1.00	\$2,200.00	\$2,200.00
QSFP25G-SM-PSM4-LR-G-NFEC	EVERTZ	100G QSFP, 4-CH, MPO/APC QSFP	2.00	\$1,330.00	\$2,660.00
B-2: Type 1 IPG Subtotal:					\$49,358.67
B-3: TYPE 2 IPG					
EV670-X30-HW-V2	EVERTZ	NEXT GENERATION HIGH DENSITY MEDIA PROCESSING FPGA ACCELERATED HARDWARE	2.00	\$9,900.00	\$19,800.00
EV670-16x16-HDBNC-RP	EVERTZ	HDBNC rearplate option for ev670-X30-HW hardware	2.00	\$1,760.00	\$3,520.00
evIPG-3G-16FS	EVERTZ	IPG app support 16x Encap with Frame Sync and 16x Decap	2.00	\$39,629.33	\$79,258.66
QSFP25G-SM-PSM4-LR-G-NFEC	EVERTZ	100G QSFP, 4-CH, MPO/APC QSFP	4.00	\$1,330.00	\$5,320.00
B-3: Type 2 IPG Subtotal:					\$107,898.66
C-1: AUDIO GROOMING					
570EMR-AG-HUB	EVERTZ	TDM TO IP AUDIO GATEWAY	1.00	\$15,400.00	\$15,400.00
570FR-HF	EVERTZ	EVERTZ 3U MULTIFRAME	1.00	\$1,796.67	\$1,796.67
570FC	EVERTZ	EVERTZ VISTALINK FRAME CONTROLLER	1.00	\$952.00	\$952.00
570PS-HF	EVERTZ	EVERTZ HIGH FLOW POWER SUPPLY	1.00	\$616.00	\$616.00
SFP10G-TR13-A	EVERTZ	EVERTZ SFP+ OPTICAL TRANSCEIVER 10GBS 1310NM DFB SMF 10KM	4.00	\$435.00	\$1,740.00
C-1: Audio Grooming Subtotal:					\$20,504.67
D-1: WEB SERVICE ROUTING CONTROL					
MAGNUM-ROUTER-VCP-WEB	EVERTZ	EVERTZ VIRTUAL CONTROL PANEL LICENCE	1.00	\$821.33	\$821.33
VUE-WEB	EVERTZ	Web based interface that provides control interfacing for routing.	1.00	\$1,129.33	\$1,129.33
MAGNUM-ANYWHERE-CLIENT	EVERTZ	Includes a one year license for one seat of VUE Anywhere client (active MAGNUM Annual Software Licen	1.00	\$1.47	\$1.47
D-1: Web Service Routing Control Subtotal:					\$1,952.13
D-2: TYPE 1 TOUCH SCREEN ROUTER CONTROL PANEL					



Alpha Video & Audio, Inc.
 7690 Golden Triangle Drive
 Eden Prairie, MN 55344
 Phone: 952-896-9898 | Fax: 952-896-9899
 Visit us at www.alphavideo.com

QUOTE
19025

PART NUMBER	MANUFACTURER	DESCRIPTION	QTY	UNIT PRICE	TOTAL PRICE
VUE-TOUCH2	EVERTZ	2RU full touch screen, rackmountable control panel, tailored with base VUE widgets for router, multi	1.00	\$6,038.67	\$6,038.67
VUEAPP-STUDIO-MANAGER	EVERTZ	VUE Visualization and Control for Control Room setup and Feed Management workflow functionality, incu	1.00	\$513.33	\$513.33
D-2: Type 1 Touch Screen Router Control Panel Subtotal:					\$6,552.00
D-3: TYPE 1 XY ROUTER CONTROL PANEL					
CP-2232E	EVERTZ	EVERTZ FULL RACK WIDTH ROUTER CONTRO PANEL	1.00	\$6,570.67	\$6,570.67
D-3: Type 1 XY Router Control Panel Subtotal:					\$6,570.67
D-4: TYPE 2 XY ROUTER CONTROL PANEL					
CP-1024E	EVERTZ	Router control panel, shallow depth 1RU with 3 TFT LCD screens, 5 clickable rotary encoders, 24 back	1.00	\$2,002.00	\$2,002.00
D-4: Type 2 XY Router Control Panel Subtotal:					\$2,002.00
D-5: TYPE 1 BPS ROUTER CONTROL PANEL					
CP-1040E	EVERTZ	EVERTZ 1RU RACK WIDTH ROUTER CONTROL WITH 40 LCD BUTTONS	1.00	\$4,517.33	\$4,517.33
D-5: Type 1 BPS Router Control Panel Subtotal:					\$4,517.33
D-6: TYPE 1 ROUTER CONTROL SERVER					
VUE-VCS1	EVERTZ	VUE visualization and control application running on a 1RU hardware platform. - Provides a single w	1.00	\$11,806.67	\$11,806.67
SFP25G-TR13	EVERTZ	25G Optical Transceiver, 1310nm, SM, 10km, LC Connectors	2.00	\$660.00	\$1,320.00
D-6: Type 1 Router Control Server Subtotal:					\$13,126.67
D-7. ROUTING SWITCHER CONTROL HW & SW					
MAGNUM-HW	EVERTZ	1RU ENTERPRISE SERVER	2.00	\$8,800.00	\$17,600.00
VLPRO-HW	EVERTZ	EVERTZ HARDWARE FOR VISTALINK PRO SERVER CLIENT LICENSE	2.00	\$13,750.00	\$27,500.00
SFP10G-TR13-A	EVERTZ	EVERTZ SFP+ OPTICAL TRANSCEIVER 10GBS 1310NM DFB SMF 10KM	4.00	\$435.00	\$1,740.00
MAGNUM SUITE	EVERTZ	MAGNUM SOFTWARE SUITE	1.00	\$160,673.33	\$160,673.33
		<i>**INCLUDES; MAGNUM-ENTERPRISE-SDVN, MAGNUM-ENTERPRISE-SDVN-R, MAGNUM-FABROC-API, MAGNUM-FABROC-LIC-10K-1YR, MAGNUM-CLIENTHOST, MAGNUM-CLIENTHOST-R, MAGNUM-MULTIVIEWER, MAGNUM-MULTIVIEWER-R, MAGNUM-NAMES, MAGNUM-NAMES-R, MAGNUM-TALLY, MAGNUM-TALLY-R, MAGNUM-SDK-ADMX, & MAGNUM-SK-NMOS.</i>			
INSITE-HW-SRV	EVERTZ	INSITE HW NODE	1.00	\$29,333.33	\$29,333.33
SFP10G-TR13-A	EVERTZ	EVERTZ SFP+ OPTICAL TRANSCEIVER 10GBS 1310NM DFB SMF 10KM	2.00	\$435.00	\$870.00
D-7. Routing Switcher Control HW & SW Subtotal:					\$237,716.66
E-1. PTX					
7800FR	EVERTZ	3RU Multiframe Which Holds up to 15 Single Slot Modules with AC Power Supply	1.00	\$1,694.00	\$1,694.00
7800FC+3RU	EVERTZ	EVERTZ 7700FR AND 7800FR VISTALINK FRAME CONTROLLER	1.00	\$952.00	\$952.00
7700PTX-TSL+3RU	EVERTZ	Interface to switchers supporting TSL protocol (eg. Ross Carbonite Black)	8.00	\$5,133.33	\$41,066.64
7700R-SC-BRC+3RU	EVERTZ	EVERTZ BI DIRECTION 3RD PARTY ROUTER/CONTROLLER MODULE	6.00	\$5,287.33	\$31,723.98
7700PTX-NV+3RU	EVERTZ	PTX Which Controls NVISION Based Router	2.00	\$5,133.33	\$10,266.66
E-1. PTX Subtotal:					\$85,703.28
G-1: TALLY INTERFACE					
TR-4800E	EVERTZ	1RU PHYSICAL GPI AND GPO TALLY ROUTER	1.00	\$2,823.33	\$2,823.33
TR-4800E-BHP	EVERTZ	EVERTZ 2RU BREAKOUT PANEL DB-37 TO PHOENIX CONNECTOR FOR 32 GPI AND 48 GPO	1.00	\$1,796.67	\$1,796.67
G-1: Tally Interface Subtotal:					\$4,620.00

PART NUMBER	MANUFACTURER	DESCRIPTION	QTY	UNIT PRICE	TOTAL PRICE
03.01 - ROUTING SWITCHER CAPITOL Subtotal:					\$784,817.41
04.01 - TEST & MEASUREMENT CAPITOL					
A-1: TYPE 1 PTP GRAND MASTER					
5700MSC-IP+2PS	EVERTZ	MASTER SYNC GENERATOR FOR AN IP OR HYBRID FACILITY WITH GPS INCLUDED.	1.00	\$10,445.00	\$10,445.00
SFP10G-TR13-A	EVERTZ	EVERTZ SFP+ OPTICAL TRANSCEIVER 10GBS 1310NM DFB SMF 10KM	2.00	\$435.00	\$870.00
A-1: Type 1 PTP Grand Master Subtotal:					\$11,315.00
B-1: TYPE 1 SYNC GENERATOR					
5700MSC-IP-BC+2PS +AUX+10GTG	EVERTZ	Master Sync Generator for an IP facility acting as a Boundary Clock via PTP from a 5700MSC-IP Grandm	2.00	\$16,880.00	\$33,760.00
SFP10G-TR13-A	EVERTZ	EVERTZ SFP+ OPTICAL TRANSCEIVER 10GBS 1310NM DFB SMF 10KM	4.00	\$435.00	\$1,740.00
B-1: Type 1 Sync Generator Subtotal:					\$35,500.00
B-2: TYPE 2 SYNC CHANGEOVER					
5700ACO	EVERTZ	EVERTZ AUTOMATIC CHANGEOVER FOR THE 5700 SERIES MASTER SYNC AND CLOCK GENERATOR	1.00	\$6,827.33	\$6,827.33
B-2: Type 2 Sync Changeover Subtotal:					\$6,827.33
C-1: TYPE 1 WAVEFORM/VECTORSCOPE					
LV5600	LEADER	LEADER WAVEFORM MONITOR MAINFRAME ONLY	1.00	\$10,100.00	\$10,100.00
LV5600-SER01	LEADER	LEADER SDI INPUTS 4 INCLUDES CLOSED CAPTIONS AND CIE DISPLAY	1.00	\$1,460.00	\$1,460.00
LV5600-SER03	LEADER	LEADER DIGITAL ANALOG AUDIO 16CH DIGITAL AEX EBU AUDIO 8 CH ANALOG AUDIO	1.00	\$2,916.00	\$2,916.00
LV5600-SER06	LEADER	IP INPUT - 25G IP Input and IP analysis (requires SFP + Transceiver x 2) **Special Promotion Pricing	1.00	\$13,830.67	\$13,830.67
LV5600-SER26	LEADER	LEADER LAYOUT CUSTOMIZABLE USER LAYOUT DISPLAY	1.00	\$1,150.67	\$1,150.67
LR2561	LEADER	LEADER RACKMOUNT ADAPTER FOR WAVEFORM MONITOR LV5600	1.00	\$580.00	\$580.00
LC2152	LEADER	25GbE Single type 10,000km SFP module for LV5600/LV7600/LT4610/LT4611	2.00	\$480.00	\$960.00
C-1: Type 1 Waveform/Vectorscope Subtotal:					\$30,997.34
04.01 - TEST & MEASUREMENT CAPITOL Subtotal:					\$84,639.67
05.01 - VIDEO MONITORS & USER INTERFACE CAPITOL					
A-1: TYPE 1 COLOR PICTURE MONITOR					
PVMX2400	SONY	24" PROFESSIONAL 4K HDR MONITOR	1.00	\$10,704.91	\$10,704.91
PVMKRX24	SONY	RACK MOUNT KIT FOR PVM-X2400	1.00	\$275.40	\$275.40
A-1: Type 1 Color Picture Monitor Subtotal:					\$10,980.31
C-2: TYPE 2 KEYBOARD					
RM-KB-LCD17KVMHD	MIDDLE ATLANTIC	KB W/LCD DIG DSPLY & KVM	1.00	\$3,184.20	\$3,184.20
C-2: Type 2 Keyboard Subtotal:					\$3,184.20
05.01 - VIDEO MONITORS & USER INTERFACE CAPITOL Subtotal:					\$14,164.51
08.01 - KVM MATRIX & INTERFACES CAPITOL					
A-1: MATRIX BASED KVM					
ASP-001-US	ADDER	ADDERLINK INFINITY MANAGER DEVICE - SUPPORTS 24 END POINTS	2.00	\$3,736.00	\$7,472.00
AIMLIC-192-BCK	ADDER	ADDERLINK INFINITY AIM SOFTWARE LICENCES FOR PRIMARY AND FAILOVER UNITS 192 ENDPOINTS	1.00	\$10,100.00	\$10,100.00
SFP-SM-LC	ADDER	SFP SINGLE MODE FIBRE MODULE LC CONNECTION	4.00	\$80.00	\$320.00
A-1: Matrix Based KVM Subtotal:					\$17,892.00
A-2: KVM TRANSMITTER					

PART NUMBER	MANUFACTURER	DESCRIPTION	QTY	UNIT PRICE	TOTAL PRICE
ALIF4021T-US	ADDER	ADDERLINK INFINITY DUAL HEAD 4K 10GBE TRANSMITTER	10.00	\$2,196.00	\$21,960.00
SFP-SM-LC-10G	ADDER	10GBE SFP SINGLE MODE FIBRE MODULE LC CONNECTION	10.00	\$104.00	\$1,040.00
RMK12	ADDER	RACKMOUNT KIT FOR ALIF4000 SERIES, ASP-001 AIM AND ALIF3000	5.00	\$154.40	\$772.00
RMK12-BP	ADDER	RMK12 BLANKING PLATE	10.00	\$20.00	\$200.00
CHD-1812	LYNX TECHNIK	3G HDMI TO SDI CONVERTER WITH FRAME SYNCHRONIZER	1.00	\$977.33	\$977.33
A-2: KVM Transmitter Subtotal:					\$24,949.33
A-3: KVM RECEIVER					
ALIF4021R-US	ADDER	ADDERLINK INFINITY DUAL HEAD 4K 10GBE RECEIVER	5.00	\$2,196.00	\$10,980.00
SFP-SM-LC-10G	ADDER	10GBE SFP SINGLE MODE FIBRE MODULE LC CONNECTION	5.00	\$104.00	\$520.00
RMK12	ADDER	RACKMOUNT KIT FOR ALIF4000 SERIES, ASP-001 AIM AND ALIF3000	5.00	\$154.40	\$772.00
RMK12-BP	ADDER	RMK12 BLANKING PLATE	10.00	\$20.00	\$200.00
A-3: KVM Receiver Subtotal:					\$12,472.00
A-4: KVM SWITCH					
XSM4348FS-100NES	NETGEAR	NETGEAR XSM4348FS ETHERNET SWITCH - 48SFP+, 2 10GBASE-T SHARED - MANAGEABLE 3 LAYER SUPPORTED - MO	1.00	\$5,234.67	\$5,234.67
APS250W-100NES	NETGEAR	NETGEAR APS250W POWER SUPPLY UNIT - 120 V AC, 230 V AC UNIT, 250W AC	1.00	\$258.29	\$258.29
AXM761-AO	ADDON (NETGEAR)	ADDON NETGEAR AMX761 COMPATIBLE SFP+ TRANSCEIVER-SFP+	48.00	\$232.69	\$11,169.12
A-4: KVM Switch Subtotal:					\$16,662.08
08.01 - KVM MATRIX & INTERFACES CAPITOL Subtotal:					\$71,975.41
10.01 - DISTRIBUTION & SIGNAL PROCESSING CAPITOL					
A-1: SPARE POWER SUPPLY					
PS-OGX	ROSS VIDEO	600 WATT UNIVERSAL POWER SUPPLY FOR OGX FRAME	5.00	\$687.24	\$3,436.20
A-1: Spare Power Supply Subtotal:					\$3,436.20
A-1: TYPE 1 DISTRIBUTION FRAME					
OGX-FR-CN	ROSS VIDEO	OPENGear OGX FRAME WITH COOLING AND ADVANCED NETWORKING	5.00	\$2,078.28	\$10,391.40
A-1: Type 1 Distribution Frame Subtotal:					\$10,391.40
B-1: TYPE 1 SDA					
SRA-8901-4-R3S	ROSS VIDEO	12G/6G/3G/HD/SD/MADI DISTRIBUTION AMPLIFIER 1 IN / 4 OUT WITH SPLIT REAR MODULE	10.00	\$562.12	\$5,621.20
SRA-8901-4	ROSS VIDEO	12G/6G/3G/HD/SD/MAD DISTRIBUTION AMPLIFIER 1 IN / 4 OUT	20.00	\$482.08	\$9,641.60
B-1: Type 1 SDA Subtotal:					\$15,262.80
C-1: TYPE 1 VDA					
UDA-8705A-R2L	ROSS VIDEO	Ross Utility DA, 1x8, Looping Input	10.00	\$404.80	\$4,048.00
C-1: Type 1 VDA Subtotal:					\$4,048.00
D-1: TYPE 1 EMBEDDER/DE-EMBEDDER					
AMX-8952-C	ROSS VIDEO	HD/3G/12G-SDI EMBEDDER/DE-EMBEDDER, ANALOG AUDIO	9.00	\$1,517.08	\$13,653.72
R3C-8952	ROSS VIDEO	REAR MODULE FOR AMX-8952-C	9.00	\$138.00	\$1,242.00
AMX-8952-FS-LICENSE	ROSS VIDEO	ROSS FRAME SYNC LICENCE FOR AMX-8952	9.00	\$460.00	\$4,140.00
D-1: Type 1 Embedder/De-Embedder Subtotal:					\$19,035.72
E-1: TYPE 1 UDX					
GATOR-TOOLBOX	ROSS VIDEO	GATOR SINGLE CHANNEL UHD TOOLBOX	4.00	\$920.00	\$3,680.00



Alpha Video & Audio, Inc.
 7690 Golden Triangle Drive
 Eden Prairie, MN 55344
 Phone: 952-896-9898 | Fax: 952-896-9899
 Visit us at www.alphavideo.com

QUOTE

19025

PART NUMBER	MANUFACTURER	DESCRIPTION	QTY	UNIT PRICE	TOTAL PRICE
GATOR-TOOLBOX-12G-LICENSE	ROSS VIDEO	UHD FORMAT SUPPORT TO GATOR-TOOLBOX	4.00	\$920.00	\$3,680.00
GATOR-FRC-LICENSE	ROSS VIDEO	GATOR FRAME RATE CONVERSION SW LICENSE FOR GATOR-TOOLBOX	4.00	\$2,300.00	\$9,200.00
GATOR-2	ROSS VIDEO	GATOR 12G-SDI 2-SLOT CARD (6-SDI-IN / 6-SDI-OUT)	4.00	\$2,760.00	\$11,040.00
R4-GATOR	ROSS VIDEO	12G-SDI 2-SLOT OGX REAR MODULE FOR GATOR	4.00	\$459.08	\$1,836.32
E-1: Type 1 UDX Subtotal:					\$29,436.32
F-1: TYPE 1 SCAN CONVERTER					
R9004677	BARCO	IMAGEPRO II SCAN CONVERTER & PROCESSOR	2.00	\$6,753.33	\$13,506.66
F-1: Type 1 Scan Converter Subtotal:					\$13,506.66
F-2: TYPE 1 SCAN CONVERTER IO PLATE					
ALPHA-ALLOWANCE-ENG	ALPHA	ALPHA ENGINEERING ALLOWANCE FOR SCAN CONVERTER IO PLATE	2.00	\$333.33	\$666.66
F-2: Type 1 Scan Converter IO PLATE Subtotal:					\$666.66
G-1: TYPE 1 FIBER OPTIC TRANSMITTER					
OTT-1842	LYNX TECHNIK	Dual 3G SDI to Fiber Optic Transmitter - (CWDM)	5.00	\$614.33	\$3,071.65
G-1: Type 1 Fiber Optic Transmitter Subtotal:					\$3,071.65
G-2: TYPE 2 FIBER OPTIC TRANSMITTER					
OTX-1712	LYNX TECHNIK	Analog Sync / Video Fiber Optic Transmitter	5.00	\$982.67	\$4,913.35
G-2: Type 2 Fiber Optic Transmitter Subtotal:					\$4,913.35
G-3: TYPE 1 FIBER OPTIC RECEIVER					
ORX-1802	LYNX TECHNIK	3G Fiber Optic to SDI Receiver	5.00	\$633.33	\$3,166.65
G-3: Type 1 Fiber Optic Receiver Subtotal:					\$3,166.65
G-4: TYPE 2 FIBER OPTIC RECEIVER					
ORX-1702	LYNX TECHNIK	Analog Sync / Video Fiber Optic Receiver	5.00	\$982.67	\$4,913.35
G-4: Type 2 Fiber Optic Receiver Subtotal:					\$4,913.35
H-1: TYPE 1 HDMI CONVERTER					
CDH-1813	LYNX TECHNIK	YELLOBRIK 3G-SDI TO HDMI CONVERTER	5.00	\$872.00	\$4,360.00
H-1: Type 1 HDMI Converter Subtotal:					\$4,360.00
H-2: TYPE 2 HDMI CONVERTER					
CHD-1812	LYNX TECHNIK	3G HDMI TO SDI CONVERTER WITH FRAME SYNCHRONIZER	5.00	\$977.33	\$4,886.65
H-2: Type 2 HDMI Converter Subtotal:					\$4,886.65
I-1: TYPE 1 MEDIA CONVERTER					
OET 1510	LYNX TECHNIK	LYNX TECHNIK YELLOBRIK OET 1510 FIBER TO ETHERNET TRANSCEIVER SWITCH	5.00	\$596.57	\$2,982.85
I-1: Type 1 Media Converter Subtotal:					\$2,982.85
10.01 - DISTRIBUTION & SIGNAL PROCESSING CAPITOL Subtotal:					\$124,078.26
11.01 - AUDIO, TIME CODE, CONTROL CAPITOL					
C-1: TYPE 1 AUDIO IO INTERFACE					
AMS-REDNET-A16R-MKII	FOCUSRITE	FOCUSRITE REDNET 16 CHANNEL 24/192 ANALOGUE DANTE I/O INTERFACE WITH LEVEL CONTROL	1.00	\$4,399.99	\$4,399.99
C-1: Type 1 Audio IO Interface Subtotal:					\$4,399.99
C-2: TYPE 1 MADi TO DANTE CONVERTER					
AMS-REDNET-D64R	FOCUSRITE	64 CHANNEL MADi DANTE I/O INTERFACE WITH REDUNDANT NETWORK & POWER	1.00	\$3,999.99	\$3,999.99
C-2: Type 1 MADi to Dante Converter Subtotal:					\$3,999.99
F-1: TIME CODE DISTRIBUTION AMPLIFIER					



Alpha Video & Audio, Inc.
 7690 Golden Triangle Drive
 Eden Prairie, MN 55344
 Phone: 952-896-9898 | Fax: 952-896-9899
 Visit us at www.alphavideo.com

QUOTE
19025

PART NUMBER	MANUFACTURER	DESCRIPTION	QTY	UNIT PRICE	TOTAL PRICE
ADA-8405-C-R2C	ROSS VIDEO	Ross Dual 1x4 Audio DA	2.00	\$421.36	\$842.72
F-1: Time Code Distribution Amplifier Subtotal:					\$842.72
F-2: WORD CLOCK SYNTHESIZER					
WDA-8409-R2L	ROSS VIDEO	WORD CLOCK DISTRIBUTION AMPLIFIER W/LOOPING REAR MODULE	1.00	\$546.48	\$546.48
F-2: Word Clock Synthesizer Subtotal:					\$546.48
G-1: TYPE 1 AUDIO MONITOR					
iAM1-8	WOHLER	1RU TRIPLE SCREEN, 8 CHANNEL DUAL INPUT, 3G/HD/SD-SDI, AUDIO MONITOR WITH TOUCH SCREEN CONTROL. INCL	1.00	\$3,995.00	\$3,995.00
SFP-2110 w/NMOS	WOHLER	SMPTE 2110 RECEIVER; MULTI-MODE 850 NM, LC (FIBER) CONNECTORS. SFP MODULE WITH SOFTWARE ACTIVATION K	1.00	\$1,995.00	\$1,995.00
OPT-DANTE	WOHLER	ENABLE MONITORING FROM UP TO A 64CH DANTE INPUT. HARDWARE CARD WITH SOFTWARE ACTIVATION KEY.	1.00	\$895.00	\$895.00
G-1: Type 1 Audio Monitor Subtotal:					\$6,885.00
11.01 - AUDIO, TIME CODE, CONTROL CAPITOL Subtotal:					\$16,674.18
12.01 - INTERCOM CAPITOL					
A-1: TYPE 1 INTERCOM MATRIX					
ODIN32NOCORD	RTS	ODIN 32 PORT MATRIX NO CORD	1.00	\$18,652.80	\$18,652.80
A-1: Type 1 Intercom Matrix Subtotal:					\$18,652.80
B-1: TYPE 1 INTERCOM PANEL					
F.01U.298.698	RTS	14 POSITION KEY PANEL WITH MENUS AND PROGRAMMING KEYPAD, EXTENDED DSP FUNCTIONS, 2 FULL HD COLOUR DI	3.00	\$4,059.73	\$12,179.19
B-1: Type 1 Intercom Panel Subtotal:					\$12,179.19
B-2: TYPE 2 INTERCOM PANEL					
DKP4016	RTS	16 LEVER DESK TOP KEY PANEL	1.00	\$4,369.00	\$4,369.00
B-2: Type 2 Intercom Panel Subtotal:					\$4,369.00
C-1: WIRELESS INTERCOM MATRIX					
AP-1800	RTS	ACCESS POINT 1.92-1.93 GHZ	4.00	\$2,578.13	\$10,312.52
ALPHA-ALLOWANCE-ENG	ALPHA	ALPHA ENGINEERING ALLOWANCE FOR POE 12V Power Adapter for AP-1800	4.00	\$133.33	\$533.32
TR-1800	RTS	BELTPACK 1.92-1.93 GHZ. CONNECTOR TYPE A5F.	4.00	\$2,073.60	\$8,294.40
C-1: Wireless Intercom Matrix Subtotal:					\$19,140.24
D-1: TYPE 1 INTERCOM INTERFACE					
TIF-PRO2	RTS	Interfaces SIP Interface 2 Channels	1.00	\$4,545.07	\$4,545.07
TIF-PRO2 PSTN	RTS	Interfaces TIF-PRO 2 PSTN 2-Channels Upgrade	1.00	\$533.33	\$533.33
D-1: Type 1 Intercom Interface Subtotal:					\$5,078.40
E-1: TYPE 1 HEADSET					
PH-88R5	RTS	PH-88, SINGLE-SIDED LIGHTWEIGHT HEADSET, 6' (18M) CORD, A5M CONNECTOR	4.00	\$213.36	\$853.44
E-1: Type 1 Headset Subtotal:					\$853.44
12.01 - INTERCOM CAPITOL Subtotal:					\$60,273.07
13.01 - UTILITY COMPUTERS CAPITOL					
A-2: TYPE 2 UTILITY COMPUTER					
Precision 3930	DELL	DELL CUSTOM (QUOTE # 1003176769803)	2.00	\$2,317.37	\$4,634.74
		Guardian VM - Control Point PC			
A-2: Type 2 Utility Computer Subtotal:					\$4,634.74



Alpha Video & Audio, Inc.
 7690 Golden Triangle Drive
 Eden Prairie, MN 55344
 Phone: 952-896-9898 | Fax: 952-896-9899
 Visit us at www.alphavideo.com

QUOTE

19025

PART NUMBER	MANUFACTURER	DESCRIPTION	QTY	UNIT PRICE	TOTAL PRICE
A-3: TYPE 3 UTILITY COMPUTER					
PowerEdge R7525	DELL	Dell Custom PowerEdge R7525 Rack Server	1.00	\$10,000.00	\$10,000.00
A-3: Type 3 Utility Computer Subtotal:					\$10,000.00
13.01 - UTILITY COMPUTERS CAPITOL Subtotal:					\$14,634.74
15.02 - MASTER CONTROL SENATE					
A-1: MASTER CONTROL SWITCHER					
GATOR-MC1-2-R4	ROSS VIDEO	MC1 MIXER/KEYER - SDI 6IN/6OUT W/REAR MODULE	1.00	\$4,553.08	\$4,553.08
MC1-MASTERCTRL-LICENSE	ROSS VIDEO	MASTER CONTROL LICENSE FOR MC1-GATOR PLATFORM	1.00	\$1,012.00	\$1,012.00
MC1-DVE-1CH-LICENSE	ROSS VIDEO	DVE (1 CHANNEL) LICENSE FOR MC1-GATOR PLATFORM	1.00	\$1,012.00	\$1,012.00
DB-TURNKEY-HW	ROSS VIDEO	DASHBOARD TURNKEY CLIENT	1.00	\$4,830.00	\$4,830.00
A-1: Master Control Switcher Subtotal:					\$11,407.08
15.02 - MASTER CONTROL SENATE Subtotal:					\$11,407.08
17.01 - PRODUCTION NETWORK CAPITOL					
A-1: PRODUCTION NETWORK CORE PRIMARY					
C9300X-24Y-A=	CISCO	Catalyst 9300X 24-port 25/10G SFP+ NW-A	2.00	\$24,268.87	\$48,537.74
PWR-C1-1100WAC/2	CISCO	1100W AC CONFIG 1 SECONDARY P/S	2.00	\$1,844.43	\$3,688.86
STACK-T1-1M	CISCO	CISCO STACKWISE 480 STACKING CABLE 3.3FT	2.00	\$194.15	\$388.30
C9300X-NM-2C	CISCO	Catalyst 9300 2 x 40G/100G Network Modul	2.00	\$2,475.43	\$4,950.86
QSFP-100G-LR-S	CISCO	100G QSFP28 100G-LR 10km SMF duplex L	4.00	\$8,731.95	\$34,927.80
A-1: Production Network Core Primary Subtotal:					\$92,493.56
A-2: PRODUCTION NETWORK CORE BACKUP					
C9300X-24Y-A=	CISCO	Catalyst 9300X 24-port 25/10G SFP+ NW-A	2.00	\$24,268.87	\$48,537.74
PWR-C1-1100WAC/2	CISCO	1100W AC CONFIG 1 SECONDARY P/S	2.00	\$1,844.43	\$3,688.86
STACK-T1-1M	CISCO	CISCO STACKWISE 480 STACKING CABLE 3.3FT	2.00	\$194.15	\$388.30
C9300X-NM-2C	CISCO	Catalyst 9300 2 x 40G/100G Network Modul	2.00	\$2,475.43	\$4,950.86
QSFP-100G-LR-S	CISCO	100G QSFP28 100G-LR 10km SMF duplex L	4.00	\$8,731.95	\$34,927.80
A-2: Production Network Core Backup Subtotal:					\$92,493.56
B-1: PRODUCTION NETWORK RACK ROOM					
C9300X-48HX-A	CISCO	Catalyst 9300 48-port mGig UPoE+ Network	4.00	\$14,493.27	\$57,973.08
PWR-C1-1100WAC/2	CISCO	1100W AC CONFIG 1 SECONDARY P/S	4.00	\$1,844.43	\$7,377.72
STACK-T1-1M	CISCO	CISCO STACKWISE 480 STACKING CABLE 3.3FT	4.00	\$194.15	\$776.60
C9300X-NM-8Y	CISCO	CATALYST 9300 8 X 25GE NTKW MOD	4.00	\$2,475.43	\$9,901.72
SFP-10/25G-BXD-I	CISCO	Cisco 10/25GBASE-LR BIDIRECTIONAL -D	4.00	\$3,154.96	\$12,619.84
SFP-10/25G-BXU-I	CISCO	Cisco 10/25GBASE-LR BIDIRECTIONAL -U	4.00	\$3,154.96	\$12,619.84
B-1: Production Network Rack Room Subtotal:					\$101,268.80
C-1: PRODUCTION NETWORK HEARING ROOM					
C9300X-48HX-A	CISCO	Catalyst 9300 48-port mGig UPoE+ Network	12.00	\$14,493.27	\$173,919.24
PWR-C1-1100WAC/2	CISCO	1100W AC CONFIG 1 SECONDARY P/S	12.00	\$1,844.43	\$22,133.16
C9300X-NM-8Y	CISCO	CATALYST 9300 8 X 25GE NTKW MOD	12.00	\$2,475.43	\$29,705.16
SFP-10/25G-BXD-I	CISCO	Cisco 10/25GBASE-LR BIDIRECTIONAL -D	12.00	\$3,154.96	\$37,859.52
SFP-10/25G-BXU-I	CISCO	Cisco 10/25GBASE-LR BIDIRECTIONAL -U	12.00	\$3,154.96	\$37,859.52
C-1: Production Network Hearing Room Subtotal:					\$301,476.60
17.01 - PRODUCTION NETWORK CAPITOL Subtotal:					\$587,732.52



Alpha Video & Audio, Inc.
 7690 Golden Triangle Drive
 Eden Prairie, MN 55344
 Phone: 952-896-9898 | Fax: 952-896-9899
 Visit us at www.alphavideo.com

QUOTE
19025

PART NUMBER	MANUFACTURER	DESCRIPTION	QTY	UNIT PRICE	TOTAL PRICE
19.01 - PATCHING & CABLES CAPITOL					
A-1: VIDEO & AES PATCH PANEL					
B64H-2MWTHD	BITTREE	2 ROWS OF 32 PATCH POINTS, 1.5 RU, FULLY NORMALLED WITH 75 OHM TERMINATION, 3G SDI	6.00	\$1,526.00	\$9,156.00
A-1: Video & AES Patch Panel Subtotal:					\$9,156.00
A-2: AUDIO & INTERCOM PATCH PANEL					
969A625	BITTREE	B96DC-FNAIH/E3 M2OU7B	1.00	\$1,427.00	\$1,427.00
A-2: Audio & Intercom Patch Panel Subtotal:					\$1,427.00
A-3: CAT6 PATCH PANEL					
DSKP124B	BITTREE	KEYSTONE PANEL, 24 POSITION, 1RU, UNLOADED (FOR BELDEN REVCONNECT) - BLACK	12.00	\$157.00	\$1,884.00
NP-2	NEAT-PATCH	NEAT PATCH NP2 CABLE MANAGEMENT BAY	12.00	\$102.00	\$1,224.00
A-3: Cat6 Patch Panel Subtotal:					\$3,108.00
A-4: FIBER PATCH PANEL					
DSKP124B-LC	BITTREE	FLUSH MOUNT, 1 ROW OF 24 COUPLERS, 1 RU, DUPLEX LC TO LC, UPC, BLUE, 1 DESIGNATION STRIP	6.00	\$374.00	\$2,244.00
A-4: Fiber Patch Panel Subtotal:					\$2,244.00
A-5: FIBER ENCLOSURE					
CCH-02U	CORNING	Corning Rack Mount 2RU 4 panel Fiber Optic Enclosure	4.00	\$401.64	\$1,606.56
CCH-CP12-A9	CORNING	Corning Snap in Fiber Optic Patch Panel OS1 Single Mode 6 x LC Duplex	16.00	\$401.64	\$6,426.24
A-5: Fiber Enclosure Subtotal:					\$8,032.80
B-1: PATCH CORD HOLDER					
CLAW	MIDDLE ATLANTIC	WALLMNT CABLE HANGER W/TR	1.00	\$21.29	\$21.29
B-1: Patch Cord Holder Subtotal:					\$21.29
B-2: VIDEO PATCH CABLES					
VPCMK1200-75	BITTREE	MINI-WECO PATCHCORD, 12G+ SDI, 24GHZ, 75 OHM, 12" (30 CM), BLACK	6.00	\$30.80	\$184.80
VPCMK2400-75	BITTREE	MINI-WECO PATCHCORD, 12G+ SDI, 24GHZ, 75 OHM, 24" (60 CM), BLACK	6.00	\$30.80	\$184.80
VPCMK4800-75	BITTREE	MINI-WECO PATCHCORD, 12G+ SDI, 24GHZ, 75 OHM, 48" (120 CM), BLACK	6.00	\$31.73	\$190.38
RTR1L	BITTREE	BNC INSERTION AND REMOVAL TOOL FOR MINI-WECO FORMAT, 12" (30 CM)	1.00	\$101.00	\$101.00
B-2: Video Patch Cables Subtotal:					\$660.98
B-3: MID-SIZE PATCH TO BNC					
ADMW12	BITTREE	BNC TO MINI-WECO ADAPTER PLUG, 3G SDI, SHORT (SUPPORTS SIDE-BY-SIDE INSERTION WITH ADMW12L)	4.00	\$27.00	\$108.00
B-3: Mid-Size Patch to BNC Subtotal:					\$108.00
D-1: VIDEO CABLES					
JVC1694A(BLK)KBB-25	JOSPEH	RG6 VIDEO CABLE, M-M, BNC, 25'	4.00	\$24.47	\$97.88
JVC1694A(BLK)KBB-100	JOSEPH	RG6 VIDEO CABLE, M-M, BNC, 100'	4.00	\$57.47	\$229.88
D-1: Video Cables Subtotal:					\$327.76
D-3: CAT6 CABLES					
CG01072	C2G	1FT/0.3M CAT6 UTP 28AWG BLUE	60.00	\$3.91	\$234.60
CG01165	C2G	1FT/0.3M CAT6 CABLE UTP SLIM 28AWG RED	60.00	\$3.91	\$234.60
CG01160	C2G	1FT/0.3M CAT6 CABLE UTP SLIM 28AWG GREEN	20.00	\$3.91	\$78.20
CG01170	C2G	1FT/0.3M CAT6 CABLE UTP SLIM 28AWG YLW	20.00	\$3.91	\$78.20



Alpha Video & Audio, Inc.
 7690 Golden Triangle Drive
 Eden Prairie, MN 55344
 Phone: 952-896-9898 | Fax: 952-896-9899
 Visit us at www.alphavideo.com

QUOTE
19025

PART NUMBER	MANUFACTURER	DESCRIPTION	QTY	UNIT PRICE	TOTAL PRICE
CG01185	C2G	1FT/0.3M CAT6 CABLE UTP SLIM 28AWG WHITE	20.00	\$3.91	\$78.20
CG00677	C2G	CAT6A PATCH CABLE, SNAGLESS, SHIELDED, 6' - BLUE	24.00	\$12.07	\$289.68
CG00681	C2G	10FT/3M CAT6A SNAGLESS STP CABLE-BLU	12.00	\$17.97	\$215.64
CG00684	C2G	15FT/4.6M CAT6A SNAGLESS STP CABLE-BLU	12.00	\$22.40	\$268.80
CG00686	C2G	25FT/7.6M CAT6A SNAGLESS STP CABLE-BLU	1.00	\$28.87	\$28.87
D-3: Cat6 Cables Subtotal:					\$1,506.79
D-4: FIBER CABLES					
CG11026	C2G	2M ST-ST 10G OM3 DPX MM T	24.00	\$38.56	\$925.44
CG11011	C2G	2M LC-ST 10G OM3 DPX MM T	24.00	\$46.21	\$1,109.04
CG00998	C2G	2M LC-LC 50/125 OM4 DUPL	24.00	\$24.43	\$586.32
CG34627	C2G	2M LC-ST 9/125 DPX OS1/2	24.00	\$54.08	\$1,297.92
CG08353	C2G	2M ST-ST 9/125 OS1/2 DPX	24.00	\$22.75	\$546.00
HF-TS12ST-0200	CAMPLEX	12-CHANNEL ST-SINGLE MODE TACTICAL FIBER OPTICAL SNAKE-200 FOOT	1.00	\$914.75	\$914.75
D-4: Fiber Cables Subtotal:					\$5,379.47
D-5: HDMI CABLES					
ALPHA-MATERIALS	ALPHA	ALPHA MATERIALS	1.00	\$185.50	\$185.50
D-5: HDMI Cables Subtotal:					\$185.50
D-7: USB CABLES					
CG54171	C2G	2M USB 3.0 AM-AM CBL BLK	4.00	\$7.89	\$31.56
CG54172	C2G	3M USB 3.0 AM-AM CBL BLK	4.00	\$10.40	\$41.60
D-7: USB Cables Subtotal:					\$73.16
D-8: MISCELLANEOUS PRE-MADE CABLES					
ALPHA-ALLOWANCE-ENG	ALPHA	ALPHA ENGINEERING ALLOWANCE FOR PARTS AND CABLES	1.00	\$1,750.00	\$1,750.00
D-8: Miscellaneous Pre-made Cables Subtotal:					\$1,750.00
19.01 - PATCHING & CABLES CAPITOL Subtotal:					\$33,980.75
20.01 - COMMISSIONING & TRAINING CAPITOL					
A-4: ROSS VIDEO MASTER CONTROL					
MC1-ONL-COM-1DAY	ROSS VIDEO	MC1 MASTER CONTROL ONLINE COMMISSIONING, 1 DAY	2.00	\$1,612.00	\$3,224.00
MC1-ONL-1DAY	ROSS VIDEO	MC1 MASTER CONTROL ONLINE TRAINING, 1 DAY	2.00	\$1,612.00	\$3,224.00
A-4: Ross Video Master Control Subtotal:					\$6,448.00
B-1: EVERTZ ROUTER					
EVERTZ TRAINING	EVERTZ	EVERTZ TRAINING	5.00	\$2,000.00	\$10,000.00
EVERTZ COMMISSIONING	EVERTZ	EVERTZ COMMISSIONING	10.00	\$1,950.00	\$19,500.00
EVERTZ EXPENSES	EVERTZ	EVERTZ ON-SITE TRAVEL EXPENSES	1.00	\$8,000.00	\$8,000.00
B-1: Evertz Router Subtotal:					\$37,500.00
D-1: BOSCH INTERCOM					
F.01U.024.616	BOSCH	BOSCH TRAINING COMMUNICATION	1.00	\$2,133.33	\$2,133.33
D-1: Bosch Intercom Subtotal:					\$2,133.33
G-1: PRODUCTION NETWORK					
ALPHA-ALLOWANCE-ENG	ALPHA	ALPHA ENGINEERING ALLOWANCE FOR NETWORK COMMISSIONING	1.00	\$13,333.33	\$13,333.33
G-1: Production Network Subtotal:					\$13,333.33
20.01 - COMMISSIONING & TRAINING CAPITOL Subtotal:					\$59,414.66



Alpha Video & Audio, Inc.
 7690 Golden Triangle Drive
 Eden Prairie, MN 55344
 Phone: 952-896-9898 | Fax: 952-896-9899
 Visit us at www.alphavideo.com

QUOTE
19025

PART NUMBER	MANUFACTURER	DESCRIPTION	QTY	UNIT PRICE	TOTAL PRICE
21.01 - INTEGRATION CAPITOL					
A: GENERAL PURPOSE CABLING					
ALPHA-MATERIALS	ALPHA	ALPHA MATERIALS	1.00	\$140,000.00	\$140,000.00
A: General Purpose Cabling Subtotal:					\$140,000.00
B: LABOR ESTIMATE					
ALPHA-LABOR	ALPHA	ALPHA INTEGRATION LABOR	1.00	\$327,940.00	\$327,940.00
ALPHA-MATERIALS	ALPHA	ALPHA MATERIALS	1.00	\$8,723.00	\$8,723.00
B: Labor Estimate Subtotal:					\$336,663.00
21.01 - INTEGRATION CAPITOL Subtotal:					\$476,663.00
22.01 - WARRANTY CAPITOL					
B-1: EVERTZ SUPPORT					
MAGNUM-ANNUAL-LICENSE	EVERTZ	Annual Renewal license for MAGNUM	1.00	\$16,005.00	\$16,005.00
VUE-ANNUAL-LICENSE	EVERTZ	Annual Renewal license for VUE	1.00	\$5,956.11	\$5,956.11
VLPRO-Ser/Sup/Lic.1yr	EVERTZ	Additional 1 year VistaLINK	1.00	\$825.00	\$825.00
B-1: Evertz Support Subtotal:					\$22,786.11
E-1: CISCO WARRANTY					
C9300-DNA-A-48-5Y	CISCO	C9300 DNA ADVANTAGE 48PT 5YR TERM LIC	1.00	\$6,096.33	\$6,096.33
C9300-DNA-A-24-5Y	CISCO	C9300 DNA ADVANTAGE 24PT 5YR TERM LIC	1.00	\$3,252.03	\$3,252.03
C9300-DNA-A-48-5Y	CISCO	C9300 DNA ADVANTAGE 48PT 5YR TERM LIC	1.00	\$6,096.33	\$6,096.33
C9300-DNA-A-24-5Y	CISCO	C9300 DNA ADVANTAGE 24PT 5YR TERM LIC	1.00	\$3,252.03	\$3,252.03
C9300-DNA-A-48-5Y	CISCO	C9300 DNA ADVANTAGE 48PT 5YR TERM LIC	1.00	\$6,096.33	\$6,096.33
C9300-DNA-A-24-5Y	CISCO	C9300 DNA ADVANTAGE 24PT 5YR TERM LIC	1.00	\$3,252.03	\$3,252.03
E-1: Cisco Warranty Subtotal:					\$28,045.08
F-1: ALPHA WARRANTY					
ALPHA-SMA-SILVER-1YR	ALPHA	ALPHA ASSURANCE SILVER SERVICE AND MAINTENANCE AGREEMENT, 1 YR. TERM	1.00	\$109,454.97	\$109,454.97
ALPHA-SMA-GOLD-1YR	ALPHA	ALPHA ASSURANCE GOLD SERVICE AND MAINTENANCE AGREEMENT, 1 YR. TERM	0.00	\$166,219.90	\$0.00
ALPHA-SMA-PLATINUM-1YR	ALPHA	ALPHA ASSURANCE PLATINUM SERVICE AND MAINTENANCE AGREEMENT, 1 YR. TERM	0.00	\$270,761.29	\$0.00
F-1: Alpha Warranty Subtotal:					\$109,454.97
22.01 - WARRANTY CAPITOL Subtotal:					\$160,286.16
PROJECT COSTS					
SECTION COSTS					
ALPHA-WORKMANSHIP	ALPHA	ALPHA WORKMANSHIP WARRANTY	1.00	\$0.00	\$0.00
Section Costs Subtotal:					\$0.00
Project Costs Subtotal:					\$0.00
Subtotal:					\$2,562,712.71
Shipping:					\$0.00
Tax:					\$0.00
Total:					\$2,562,712.71



Alpha Video & Audio, Inc.
7690 Golden Triangle Drive
Eden Prairie, MN 55344
Phone: 952-896-9898 | Fax: 952-896-9899
Visit us at www.alphavideo.com

QUOTE

19025

A 3% convenience fee will be added for all credit card payments.

All information contained within this quote is valid for the next 30 days. Thereafter, all prices and applicable charges are subject to change.

Returns are subject to a minimum 15% restocking fee when accompanied by original packaging.

Shipping costs are not included and will be billed at actual cost.

Sales tax is not included and will be billed at actual cost.

Senate Office Building
Senate Control Room Home

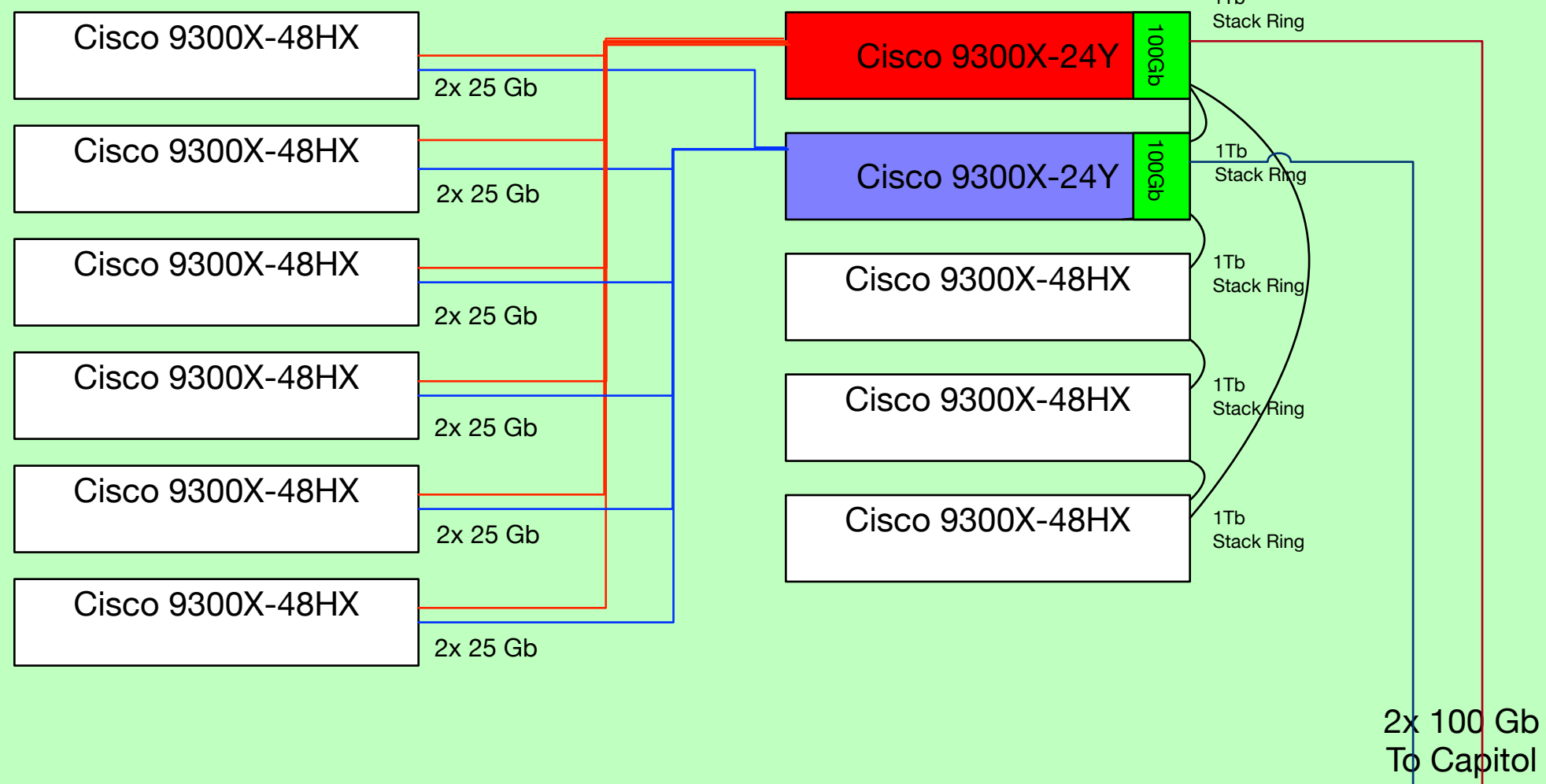

House Office Building
House of Reps Control Room Home

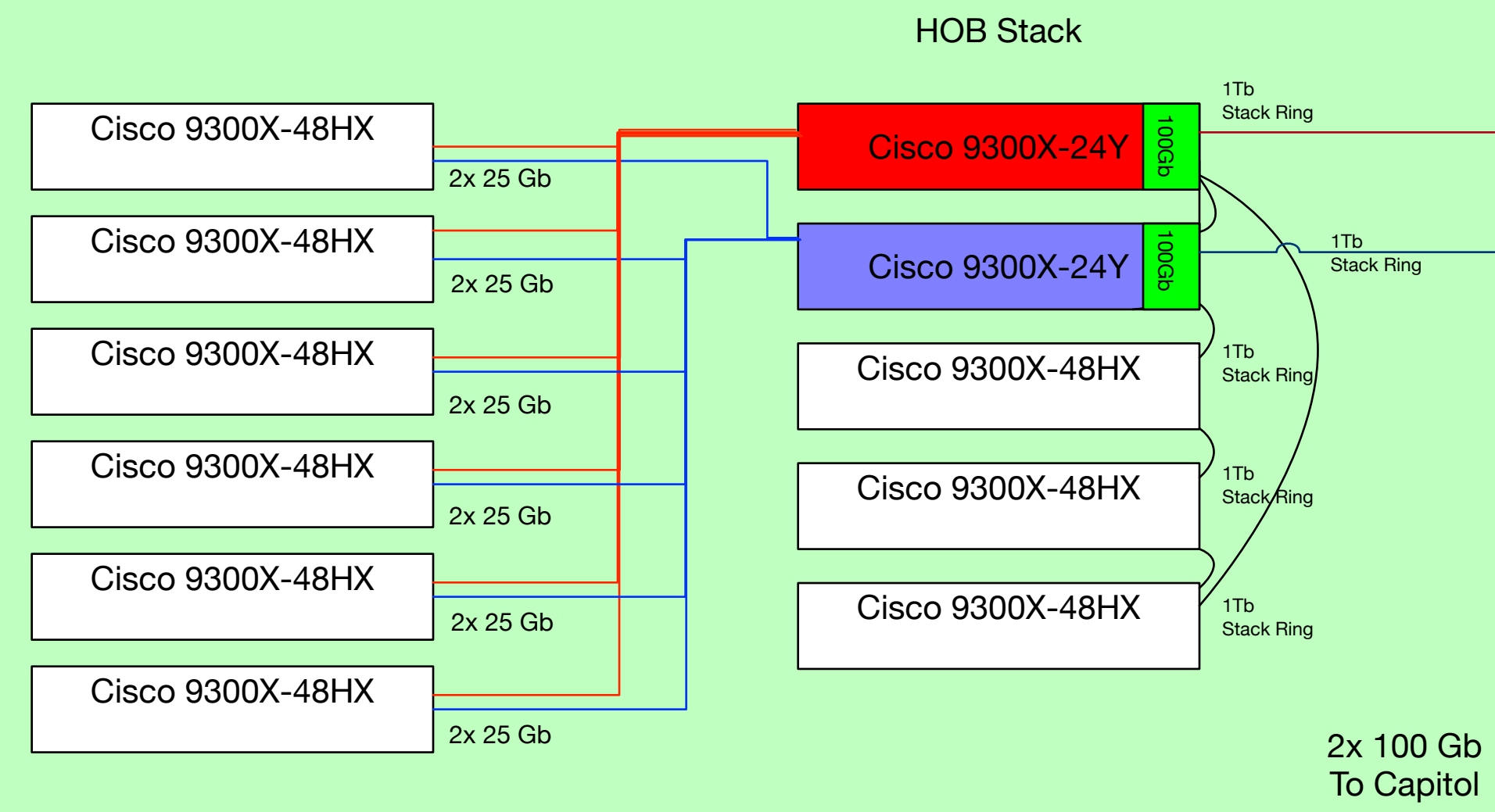

Capital Building
Core, Meeting Rooms, Supreme Court

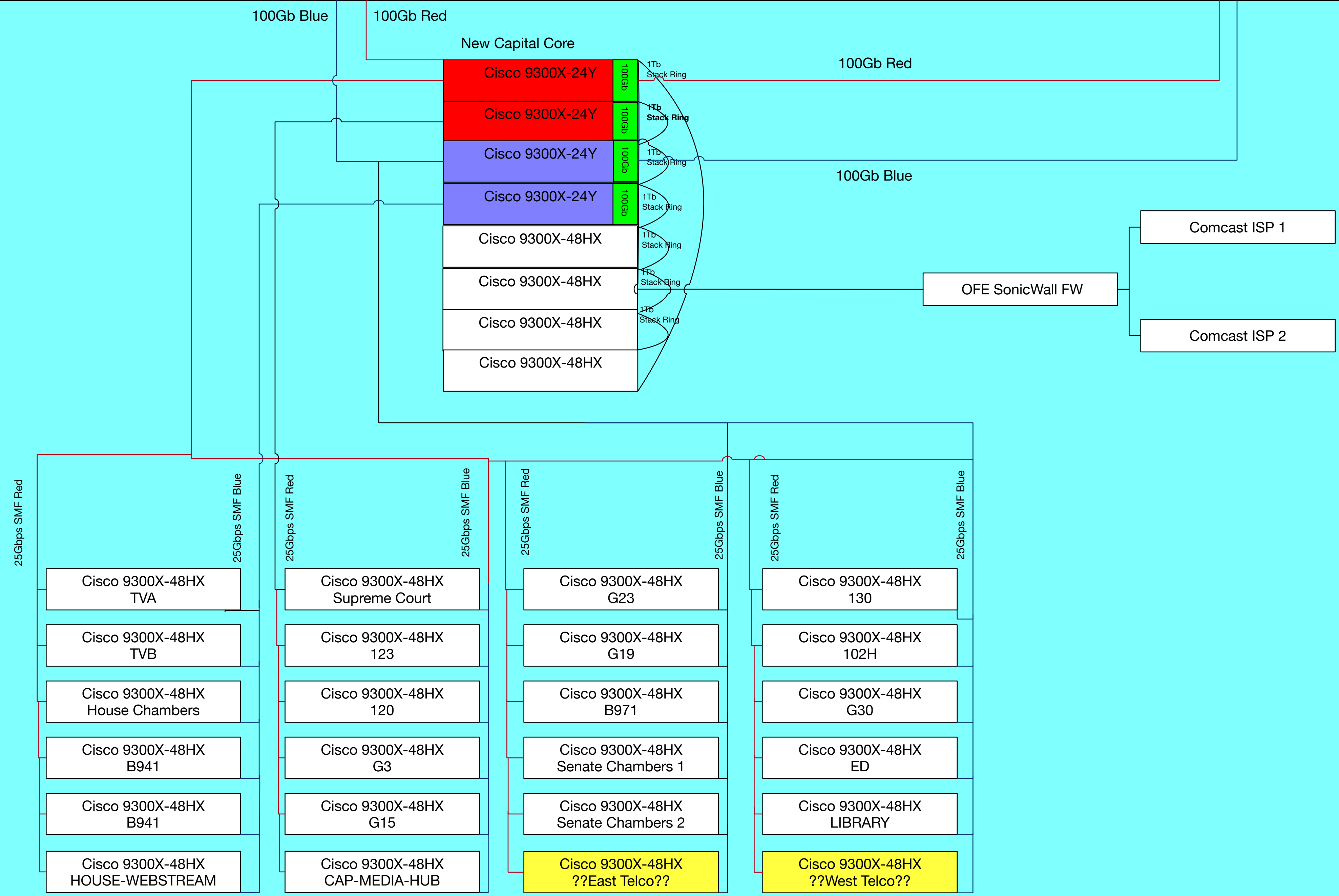

Each Switch connects at 2x 25Gbs to Core

***Preliminary Design**
***Subject to change based on further discussion**

MINNESOTA SENATE IP UPGRADE

System Overview

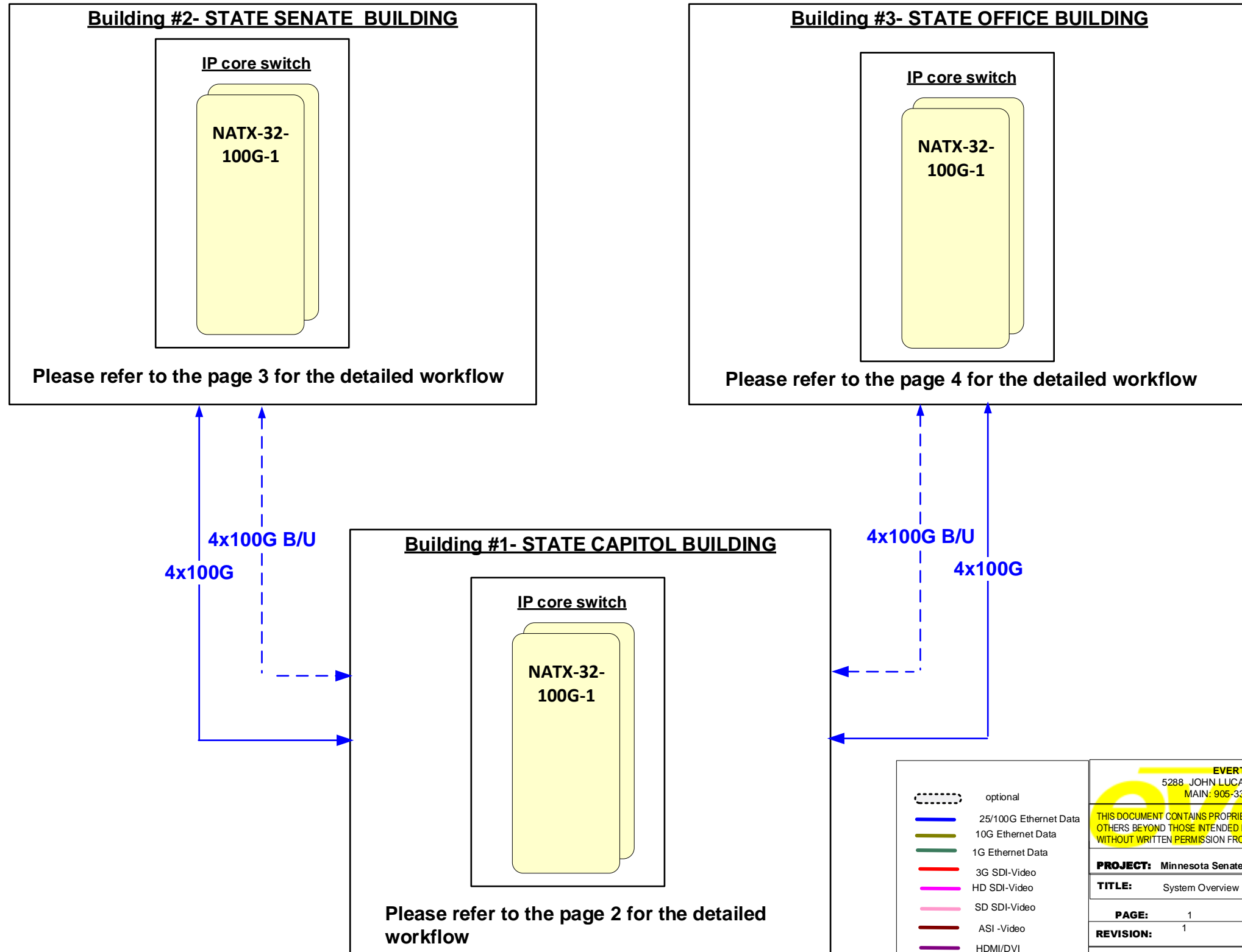

EVERTZ MICROSYSTEMS, LTD. 5288 JOHN LUCAS, BURLINGTON, ONTARIO, L7L 5Z9 MAIN: 905-335-3700 FAX: 905-335-0909	
<small>THIS DOCUMENT CONTAINS PROPRIETARY INFORMATION AND MAY NOT BE DISCLOSED TO OTHERS BEYOND THOSE INTENDED BY EVERTZ MICROSYSTEMS LTD. FOR ANY PURPOSE WITHOUT WRITTEN PERMISSION FROM EVERTZ MICROSYSTEMS LTD.</small>	
PROJECT: Minnesota Senate IP Upgrade	
TITLE: System Overview	
PAGE: 1	DATE CREATED: 12 May 2022
REVISION: 1	LAST UPDATE:
DRAWN: Susha Vincent & Maha <small>lsmail</small>	Quote no.
SCALE: None	

- optional
- 25/100G Ethernet Data
- 10G Ethernet Data
- 1G Ethernet Data
- 3G SDI-Video
- HD SDI-Video
- SD SDI-Video
- ASI -Video
- HDMI/DVI
- AES/MADI/Analog Audio
- Xlink
- TDM Signal

Building #1- State Capitol Building

***Preliminary Design**
***Subject to change based on further discussion**

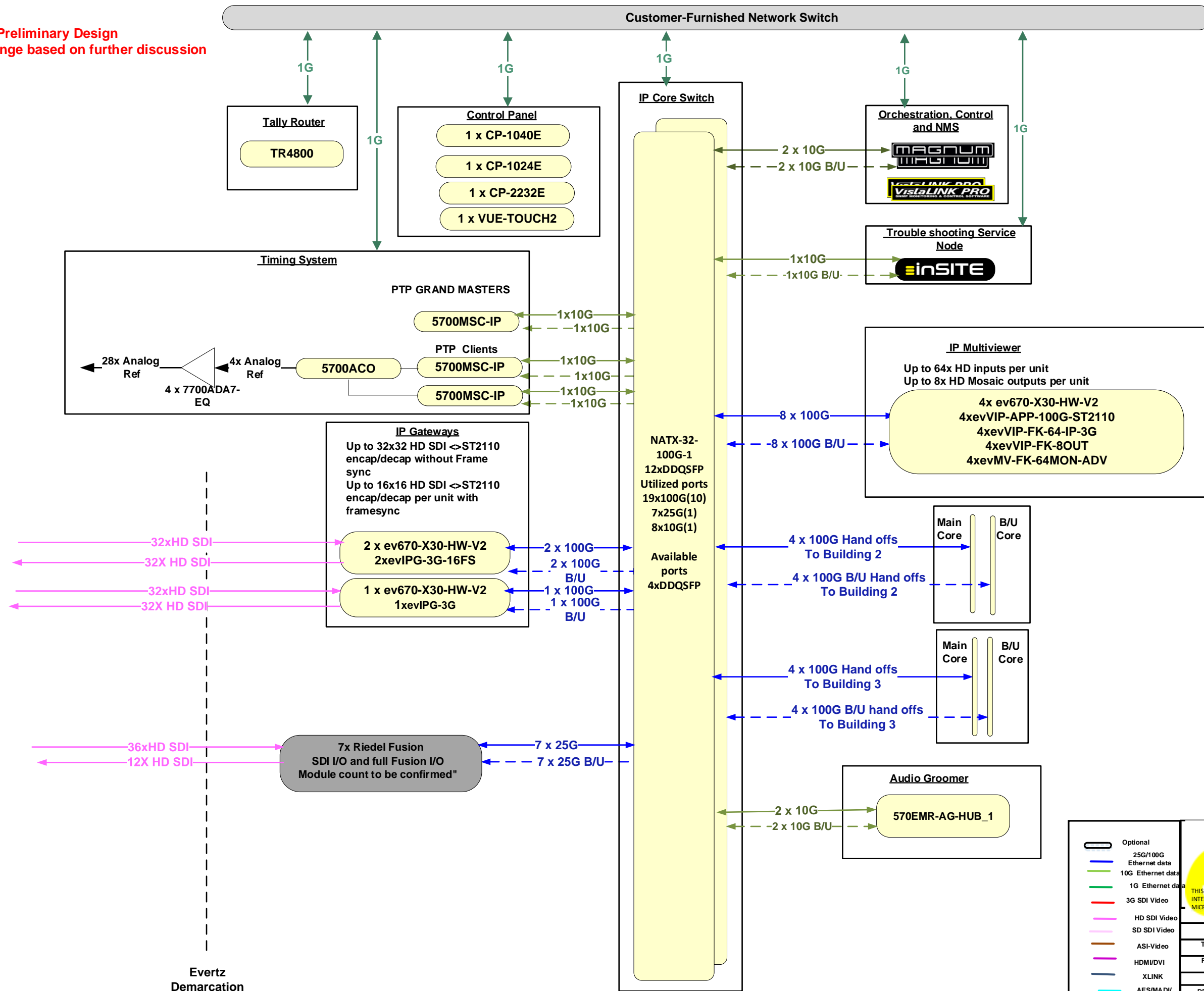

<p>Legend</p> <ul style="list-style-type: none"> — Optional — 25G/100G Ethernet data — 10G Ethernet data — 1G Ethernet data — 3G SDI Video — HD SDI Video — SD SDI Video — ASI-Video — HDM/DVI — XLINK — AES/MADI/Analog Audio — TDM Signal 	<p>evertz</p> <p><small>EVERTZ MICROSYSTEMS, LTD. 5288 JOHN LUCAS, BURLINGTON, ONTARIO, L7L 5Z9 MAIN: 905-335-3700 FAX: 905-335-0909</small></p>	
	<p>THIS DOCUMENT CONTAINS PROPRIETARY INFORMATION AND MAY NOT BE DISCLOSED TO OTHERS BEYOND THOSE INTENDED BY EVERTZ MICROSYSTEMS LTD. FOR ANY PURPOSE WITHOUT WRITTEN PERMISSION FROM EVERTZ MICROSYSTEMS LTD.</p>	
	<p>PROJECT : Minnesota IP Upgrade</p>	
	<p>TITLE : System Overview</p>	
	<p>PAGE : 1</p>	<p>DATE CREATED : 12 May 2022</p>
<p>REVISION : 1</p>	<p>LAST UPDATE :</p>	
<p>DRAWN : Susha Vincent, Maha Ismail, Adam Harrod</p>		<p>Quote No :</p>
<p>SCALE : None</p>		<p>Quote No :</p>

***Preliminary Design**
***Subject to change based on further discussion**

Building #2- STATE SENATE BUILDING

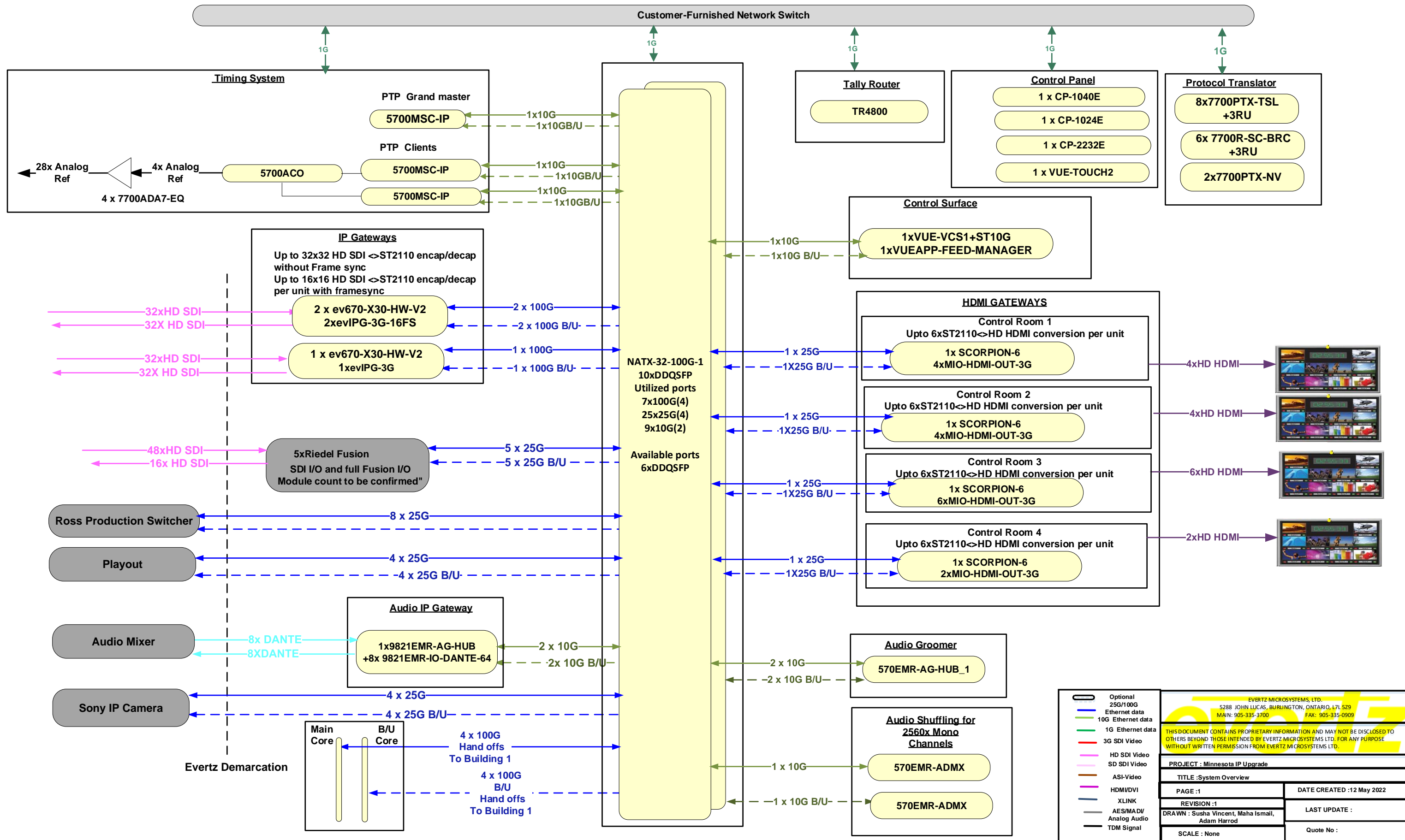

<p>EVERTZ</p> <p>EVERTZ MICROSYSTEMS, LTD. 5288 JOHN LUCAS, BURLINGTON, ONTARIO, L7L 5Z9 MAIN: 905-335-3700 FAX: 905-335-0909</p> <p>THIS DOCUMENT CONTAINS PROPRIETARY INFORMATION AND MAY NOT BE DISCLOSED TO OTHERS BEYOND THOSE INTENDED BY EVERTZ MICROSYSTEMS LTD. FOR ANY PURPOSE WITHOUT WRITTEN PERMISSION FROM EVERTZ MICROSYSTEMS LTD.</p>	
<p>PROJECT : Minnesota IP Upgrade</p>	
<p>TITLE :System Overview</p>	
<p>PAGE :1</p>	<p>DATE CREATED :12 May 2022</p>
<p>REVISION :1</p>	<p>LAST UPDATE :</p>
<p>DRAWN : Susha Vincent, Maha Ismail, Adam Harrod</p>	<p>Quote No :</p>
<p>SCALE : None</p>	

*Preliminary Design
 *Subject to change based on further discussion

Building #3- STATE OFFICE BUILDING

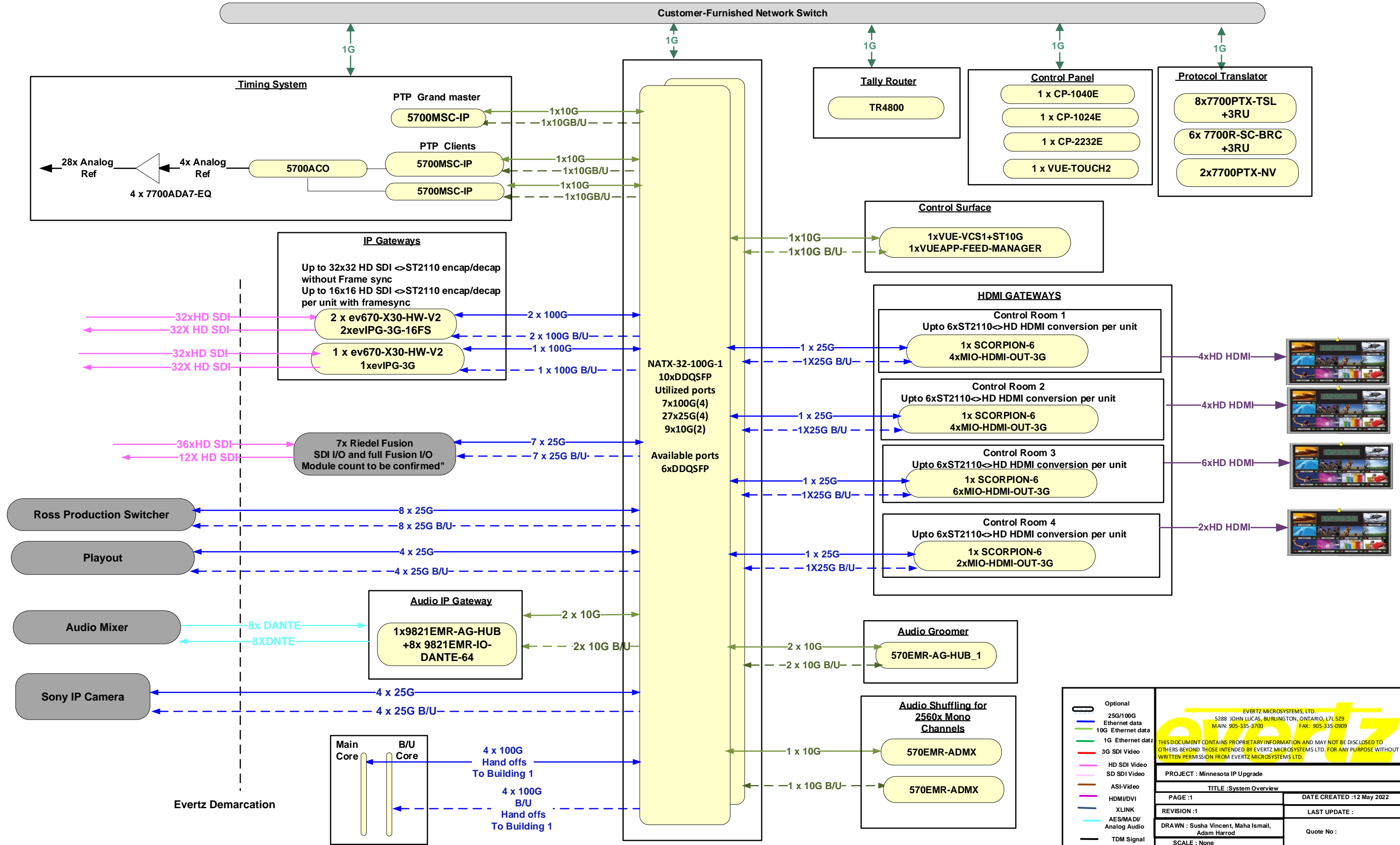

<ul style="list-style-type: none"> Optional 25G/100G Ethernet data 10G Ethernet data 1G Ethernet data 3G SDI Video HD SDI Video SD SDI Video ASI-Video HDMI/DVI XLINK AES/MADI/ Analog Audio TDM Signal 	EVERTZ MICROSYSTEMS, LTD. <small>5288 JOHN LUCAS, BURLINGTON, ONTARIO, L7L 5Z9 MAIN: 905-335-3700 FAX: 905-335-0909</small>	
	<small>THIS DOCUMENT CONTAINS PROPRIETARY INFORMATION AND MAY NOT BE DISCLOSED TO OTHERS BEYOND THOSE INTENDED BY EVERTZ MICROSYSTEMS LTD. FOR ANY PURPOSE WITHOUT WRITTEN PERMISSION FROM EVERTZ MICROSYSTEMS LTD.</small>	
PROJECT : Minnesota IP Upgrade		
TITLE : System Overview		
PAGE : 1	DATE CREATED : 12 May 2022	
REVISION : 1	LAST UPDATE :	
DRAWN : Susha Vincent, Maha Ismail, Adam Harrod		Quote No :
SCALE : None		

Minnesota Senate IP Upgrade
Important Notes and Assumptions -To be discussed and confirmed by customer

GENERAL:

- A preliminary design and a budgetary quote are proposed. Subject to change based on the further discussion and detailed requirements capture.
- System is uncompressed 1080i. Feeds frame rates to be confirmed.
- All of the breakout cables, QSFP MTP <> LC conversion , to be provided by SI. If Evertz is expected to provide them, a respective quote will follow
- It is assumed that the customer has a dedicated VLAN to distribute the control and management feeds between the Capitol building and the other two buildings- Senate building and the State office building.
- Distance between buildings is less than 10km. Buildings will be connected via SM tie-lines.

IP CORE SWITCH:

- Evertz is proposing main/redundant NATX 32 IP switches in each building. Each switch has 16x 200G physical ports. Each port can be broken into 2 x 100G lanes or 8x 10G/25 G lanes, allowing for high bandwidth switching in a 1RU frame.
- Network Address Translation could be enabled on the NATX ports to enable connecting to non NMOS-compliant third party devices without the need of adding an external NAT card.
- Additional 16x 200G additional ports could be enabled on each switch with the purchase of an additional FK.
- For future expansion or to upgrade feeds to 12G, further discussions would be needed on core capacity, optics, number of edge devices & their licenses upgrades, etc...
- The feature key for the expansion of the switch capacity to include additional 16xDDQSFP has been included in the optional quote.

IP GATEWAYS:

- The ev670-X30 gateway has been proposed. Each unit is capable of supporting up to 32x32 1080p encap/decap without Frame sync or 16x16 1080p encap/decap with frame sync.
- An optional quote for the frame sync option for the Scorpion-X18 platform has been proposed.

MULTIVIEWER:

- The ev670-X30 multi-viewer has been proposed to support up to 64 x unique 3G/HD inputs and 8x mosaic outputs
- The multi-viewer server is centralized at the capitol building and the monitoring facilities are available at the senate and the house building. There is no monitoring available in the capitol building as per the requirement.

HDMI GATEWAYS:

- Evertz is proposing Scorpion-6 frames with HDMI MIO modules to provide HDMI interfaces of the multi-viewer mosaic outputs
- Each Scorpion-6 frame can hold up to 6x HDMI modules to support up to 6x feeds per frame with a resolution of up to 1080p

AUDIO:

- 9821-EMR-AG-HUB is proposed at the Senate and the Office buildings as a Dante <> 2110-30 gateway for the 8x8 DANTE I/O
- 570EMR-AG-HUB is proposed as the audio groomer to match audio profiles of incoming 2110 feeds from third-party devices to ST 2110-30 standard (4ch/MC). A groomer will be needed for each type of conversion. A groomer is included per building. Exact number of groomers needed to be discussed and confirmed.
- 2x 570EMR-ADMX has been proposed as the audio shuffler for the Audio Shuffling for 2560x Mono Channels in each of the Senate and the House building.

THIRD PARTY:

- A list of all third party equipment must be detailed and their protocols provided and confirmed. Additional review and discussion of these will be required
- Any specific third party specific requirements MUST be provided and confirmed, as additional equipment might be required . No third party control is expected in the proposed solution
- Any third party IP native devices are assumed to be NMOS IS-04/IS-05 compliant (IS-04 v1.2, IS-05 v1.0), do not require IGMP and can support clean switching. Network address translation and custom drivers (as well as associate development costs), may be required for devices that are not compliant
 - All IP cameras, the production switcher, playout and other customer-furnished third-party 2110 devices are assumed to be NMOS compliant
 - If clean switching is expected on any third party device, further discussion will be needed to account for it in bandwidth calculation
 - Number of audio channels per MC to be confirmed. An additional groomer may need to be added.
- 7700PTX Protocol translators are proposed in building #2 and #3 to support communication with third-party production switcher along with the 7700R-SC-BRC .

Minnesota Senate IP Upgrade
Important Notes and Assumptions -To be discussed and confirmed by customer

TALLY:

- Magnum-Tally has been included along with a TR-4800 Tally router per building.

CONTROL, MONITORING & TIMING:

- Proposed a centralized VLPRO NMS and Magnum orchestration and control system and the centralized inSITE commissioning/service node for setting the system and the trouble shooting for the service team
- CP-1040E control panel is a 1RU X-Y hard panel with 40 full color dynamic LCD buttons, all of which are fully programmable.
- The CP-1024E is an XY Control Panel with 24 illuminated push buttons and three display windows which are used for source, destination and level information. The unit also has 5 scroll knobs used for scrolling through lists and configuration options.
- The CP-2232E remote control panel features two high resolution color touch-screen LCD display's alongside an array of function assignable dynamic 32x LCD buttons which are programmable.
- VUE-TOUCH2 is a rack-mountable 2RU control panel. It is a user-friendly touch panel to provide XY routing and MV control.
- Evertz proposed VUE-VCS control surfaces. VUE-VCS1; visualization and control application running on a 1RU hardware platform and provides a single workstation environment. VUE-VCS2; VUE visualization and control application running on a 3RU hardware platform, Provides two independent workstations in a single platform,
- All of the sources are sync'd and properly timed prior to entering the gateways
- 1x5700MSC Grand master clock with a boundary pair is proposed in each building. A redundant 5700MSC Grand master is recommended in the case of fail over. Analog reference is generated by a couple of MSCs linked to an ACO per building.
- Specific details and requirements in regards to the Monitoring and NMS (SNMP traps) are to be further discussed, reviewed and captured accordingly.
- Any requirements for SNMP traps from third party devices; will require a full list of devices, MIBs to be provided and further reviewed. Additional cost WILL be applicable based on devices.
- IMPORTANT: Exact requirements and specifics of control system must be further reviewed, discussed and finalized. Additional cost might be applicable.

INGEST CONTROL
2) STRATUS INGEST SCHEDULER
 - Ingest control of GV I/O channels
 - Crash and Scheduled recording
 - Includes Channel Panel
(Floating License)



2) STRATUS ELITE

HD EDITING - EDIUS
3) EDIUS WG software
 - STRATUS Connected
 - Shared Storage Connected



3) EDIUS 9 WORKGROUP
 3) STRATUS CONNECT

DESKTOP PROXY EDITING
2) EDIUS XS
 - Full featured proxy editing
 - Includes ALL STRATUS Express features
(Floating Licenses)



2) STRATUS FLEX

DESKTOP PROXY BROWSE
10) STRATUS EXPRESS
 - MOS Plugin; Search, view, log
 - Archive Send and Restore
 - Media Management
(Floating Licenses)



10) STRATUS EXPRESS

PLAYOUT CONTROL
1) STRATUS PLAYOUT
 - Playback control of GV I/O
 - Includes Scheduler, Channel Panel, Media Management
(Floating license)



1) STRATUS ELITE



3) GV I/O - 4 CHANNEL VIDEO SERVERS
 AMS Express Shared Storage Connected
 ALL Channels are bi-directional (PLAY or RECORD)
 XDCAM EX/HD and AVCI 50 mb/s codecs available

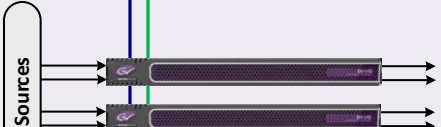

SDI Sources

GV AMS EXPRESS SHARED STORAGE
 Includes: STORAGE MANAGER VM (K2 FSM)
 - Redundant Storage Manager ships Q2/3 2021
 12 x 8TB Drives Per Chassis
 96 TB Raw / 64 TB Useable Per Chassis



PRIMARY RAID CHASSIS INC: STORAGE MANAGER
 EXPANSION RAID CHASSIS

INGEST / PLAYOUT / SHARED STORAGE

2) RENDER ENGINES
 - Conform and Send stories from EDIUS XS proxy editors
 - Create Proxy from file ingested video and finished edited stories



RENDER ENGINES

STRATUS A1 CORE SERVER FAULT TOLERANT
 Database, License, Rules, Workflow and MOS Server
 Includes: HTTP Proxy Server



A-1 FT CORE SERVICES

STRATUS Site Licenses:
 Rules and Workflow Engine
 Archive (Send and Restore)



HTTP PROXY SERVER

STRATUS CORE SERVICES

Control Point PC
 GV Guardian: SNMP Monitoring
 Control Panel: STRATUS Configuration
 Site Config: Software Deployment
Customer Supplied PC



ENGINEERING

Harmonic
 ProMedia Carbon transcode server
(Customer Supplied)

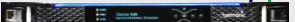

TRANSCODE

SGL (Masstech)
 STRATUS Archive/Restore from SGL Flashnet Archive (LTO7)*
(Customer Supplied)



*Masstech suggesting House upgrade to Kumulate system

ARCHIVE

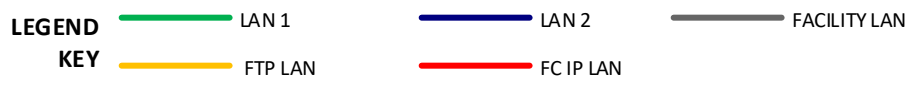

Quote Option **Grass Valley Factory Turnkey** **Software License Only Customer Furnished Equipment (CFE)**



OWNER:
MINNESOTA HOUSE OF REPRESENTATIVES
ST. PAUL, MN

REV	DATE	REV BY:	APP BY:	SHEET TITLE:	DRAWING NUMBER:
1	13APR21	smj		GV STRATUS DRAWING April 13, 2021	001
2					
3					
4					
5					

DATE ISSUED: 1-30-2015 ENG. BY: SMJ DRAWN BY: SMJ SCALE: NTS mnt house preim stratus drawing v2 13apr 2021.vsd

INGEST CONTROL
4) STRATUS INGEST SCHEDULER
 - Ingest control of GV I/O channels
 - Crash and Scheduled recording
 - Includes Channel Panel
(Floating License)



4) STRATUS ELITE

P2 / XDCAM INGEST
4) RMI / CHANNEL PANEL
 - Removable Media Ingest
 - Channel Panel GV I/O Control
 - Shared Storage Connected



4) STRATUS PRO

HD EDITING - EDIUS
2) EDIUS WG software
 - STRATUS Connected
 - Shared Storage Connected



2) EDIUS 9 WORKGROUP
 2) STRATUS CONNECT

DESKTOP PROXY EDITING
2) EDIUS XS
 - Full featured proxy editing
 - Includes ALL STRATUS Express features
(Floating Licenses)



2) STRATUS FLEX

DESKTOP PROXY BROWSE
5) STRATUS EXPRESS
 - MOS Plugin; Search, view, log
 - Archive Send and Restore
 - Media Management
(Floating Licenses)



5) STRATUS EXPRESS

PLAYOUT CONTROL
1) STRATUS PLAYOUT
 - Playback control of GV I/O
 - Includes Scheduler, Channel Panel, Media Management
(Floating license)



1) STRATUS ELITE

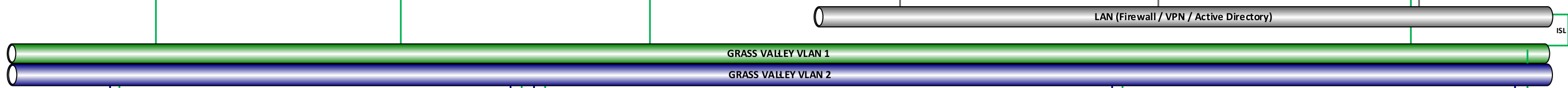

4) GV I/O - 4 CHANNEL VIDEO SERVERS
 AMS Express Shared Storage Connected
 ALL Channels are bi-directional (PLAY or RECORD)
 XDCAM EX/HD and AVC1 50 mb/s codecs available



SDI Sources

10 GbE
10 GbE
10 GbE
10 GbE

GV AMS EXPRESS
 PRIMARY RAID CHASSIS INC: STORAGE MANAGER
 EXPANSION RAID CHASSIS
 OPTIONAL EXPANSION RAID CHASSIS

GV AMS EXPRESS SHARED STORAGE
 Includes: STORAGE MANAGER VM (K2 FSM)
 - Redundant Storage Manager ships Q2/3 2021
 12 x 8TB Drives Per Chassis
 96 TB Raw / 64 TB Useable Per Chassis

INGEST / PLAYOUT / SHARED STORAGE

3) RENDER ENGINES
 - Conform and Send stories from EDIUS XS proxy editors
 - Create Proxy from file ingested video and finished edited stories



RENDER ENGINES

STRATUS A1 CORE SERVER
FAULT TOLERANT
 Database, License, Rules, Workflow and MOS Server
 Includes: HTTP Proxy Server



A-1 FT CORE SERVICES
 HTTP PROXY SERVER

STRATUS Site Licenses:
 - Rules and Workflow Engine

OPTION:
 - Archive (Send and Restore)

Networking in this drawing is conceptual and not an as-wire diagram. Further network discussions will be required.

STRATUS CORE SERVICES

Control Point PC
 GV Guardian: SNMP Monitoring
 Control Panel: STRATUS Configuration
 Site Config: Software Deployment
 Customer Supplied PC



ENGINEERING

Telestream
 Telestream Vantage transcode server
 (Customer Supplied)



TRANSCODE

Manual Archive/Restore from Windows based NAS.
 Hoping to add STRATUS Archive Site License.
(Archive control TBD)



ARCHIVE

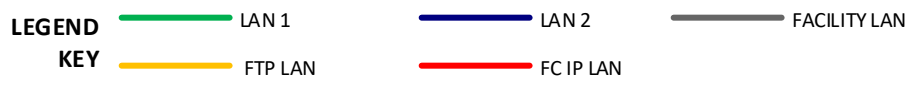

Quote Option

Grass Valley Factory Turnkey

Software License Only
 Customer Furnished Equipment (CFE)



OWNER:
MINNESOTA SENATE
ST. PAUL, MN

REV	DATE	REV BY:	APP BY:	SHEET TITLE:	DRAWING NUMBER:
1	11JUL22	smj		GV STRATUS DRAWING (PRELIMINARY) July 11, 2022	001
2					
3					
4					
5					

DATE ISSUED: 1-30-2015 ENG. BY: SMJ DRAWN BY: SMJ SCALE: NTS mn senate prelm stratus drawing v2r 11jul 2022.vsd

