

Kubota®



KUBOTA TIGHT TAIL SWING COMPACT EXCAVATOR

U

U35-4

The U35-4 has a new cab so spacious, so comfortable and so deluxe, you'll think you're in a 5-ton machine.



With a spacious new 5-ton class deluxe cab, the 3.5-ton U35-4 compact excavator brings more comfort and luxury to almost any challenge.

WORKABILITY

HYDRAULIC ANGLE BLADE (Optional)

Save time and work more efficiently. With a simple movement of the dozer lever, the hydraulic angle blade can be angled to the right or left to push soil to the side as the machine moves forward, eliminating the need for repetitive repositioning at right angles when backfilling trenches.



1. Bolt-on Cutting Edge*

The cutting edge protects the angle blade during heavy-duty dozing operations. The reversible cutting edge is divided into two sections to easily invert the edge for continued use.

**Standard on Angle Blade models.*

2. Durable Fixed Hook

The thick side plate of the dozer blade enhances the strength of the fixed hook. The hole is enlarged to accommodate thicker chains for a more secured tie-down.





AUX1 diverter valve

The diverter valve allows auxiliary oil to be diverted to the operation of auxiliary attachments without removal of the thumb attachment pipeline for increased efficiency on the go.

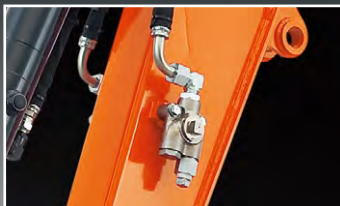

Tight Spots

The angle blade lets you work efficiently in confined spaces, alongside walls, and near busy roads. No wider than the tracks, it's also easy to transport between jobs.

Easy Operation

Angle blade operation has been enhanced for easier control. Up, down and float movements are made with a single lever, while left and right angle positioning is made by the rocker switch on top of the lever.



Float Position

The float function is a standard feature on the U35-4*. Ground finishing work can be completed quickly and simply without the need to adjust the dozer height. After backfilling, simply travel backwards along the covered ditch with the dozer in the float position.

**Standard on both angle blade & standard blade models.*

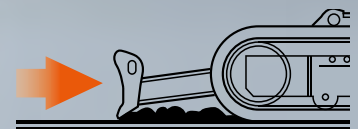

Generous Approach Angle

Navigate ramps and over obstacles with confidence - Kubota's angle blade has a 32 degree approach angle.



DELUXE INTERIOR

Kubota believes that operator comfort is a top priority. That's why the U35-4 is equipped with the same spacious cab as our larger 5-ton excavators. This roomy cab features a larger entrance, more legroom and an interior that is both luxurious and comfortable. Enhanced ergonomics allow you to perform routine operations with ease.



Wider Entrance

The U35-4 features a much wider door and more ample foot space, making it a breeze to get on and off the excavator.

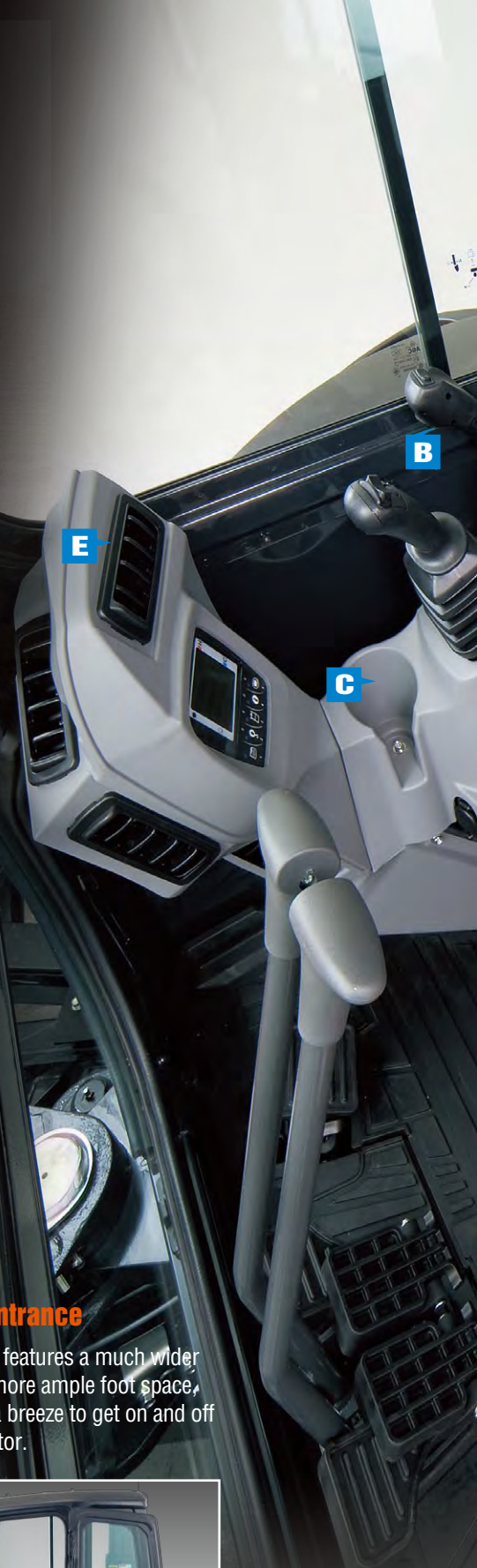



A. Deluxe Suspension Seat

Kubota's high back suspension seat has been designed for maximum operator comfort and to minimize fatigue during extended machine operation. The deluxe reclining seat offers weight compensation, firm adjustable wrist support and retractable seat belts.

B. 2-speed Travel Switch

By placing the 2-speed travel switch on the dozer lever, dozing operations can be done faster and easier.

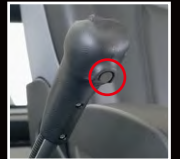

C. Cup Holder

With the convenience of a bigger cup holder, you can quench your thirst and work longer without leaving the cab. Or store your cell phone. The charging port is located conveniently close by.

D. Wrist Rest

A thoughtfully designed wrist rest enhances operation and reduces operator fatigue.

E. Air Conditioning

Enhanced air circulation in the cab results from a more powerful cooling/heating unit and six vents positioned around the operator to offer optimal all weather comfort.



TPSS

Operators can select the ISO pattern or SAE backhoe pattern by turning a switch positioned within easy reach while seated.

Easy-open Front Slide Window

Unlike many excavator windows, the front glass window of the U35-4 opens with ease. Just flip the latches on the window sides and slide it up. A gas-assist mechanism makes this action almost effortless.



SUPERIOR PERFORMANCE

Handle any job with confidence. The Kubota U35-4 combines superior power and outstanding versatility to tackle demanding jobs in a variety of conditions. Operate auxiliary attachments more easily than ever with precise oil flow control to the auxiliary circuit. More powerful arm breakout force combined with an array of enhanced functions results in the smooth, productive operation Kubota machines are known for.

Kubota Original Direct Injection Engine

The U35-4 is powered by Kubota's impressive 24.8 HP direct injection engine. Engineered with the power to maximize digging and lifting performance, it also delivers minimized noise, vibration and fuel consumption.

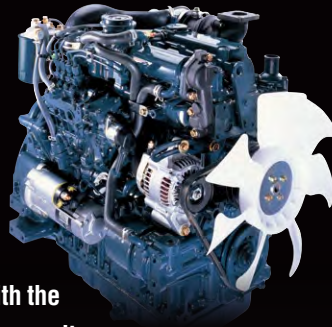

Proportional flow control of auxiliary circuit (AUX1) and maximum oil flow setting

Now you can conveniently program up to five different oil flow rates for specific attachments on the new digital control panel. No tools or manual adjustment is required. And, with a maximum AUX 1 circuit oil flow now up to 15.8 GPM (60 liters) you can operate a larger variety of auxiliary attachments than ever before.



Auto-shift

The U35-4 auto-shift automatically shifts travel speed from high to low, depending on traction and terrain, allowing smoother operation when dozing and turning.

Third-line hydraulic return

A standard third-line hydraulic return system allows oil return directly to the tank without running through the control valves during operation of one-way hydraulic attachments. This decreases the likelihood of oil contamination, and results in less back pressure and greater oil flow efficiency.

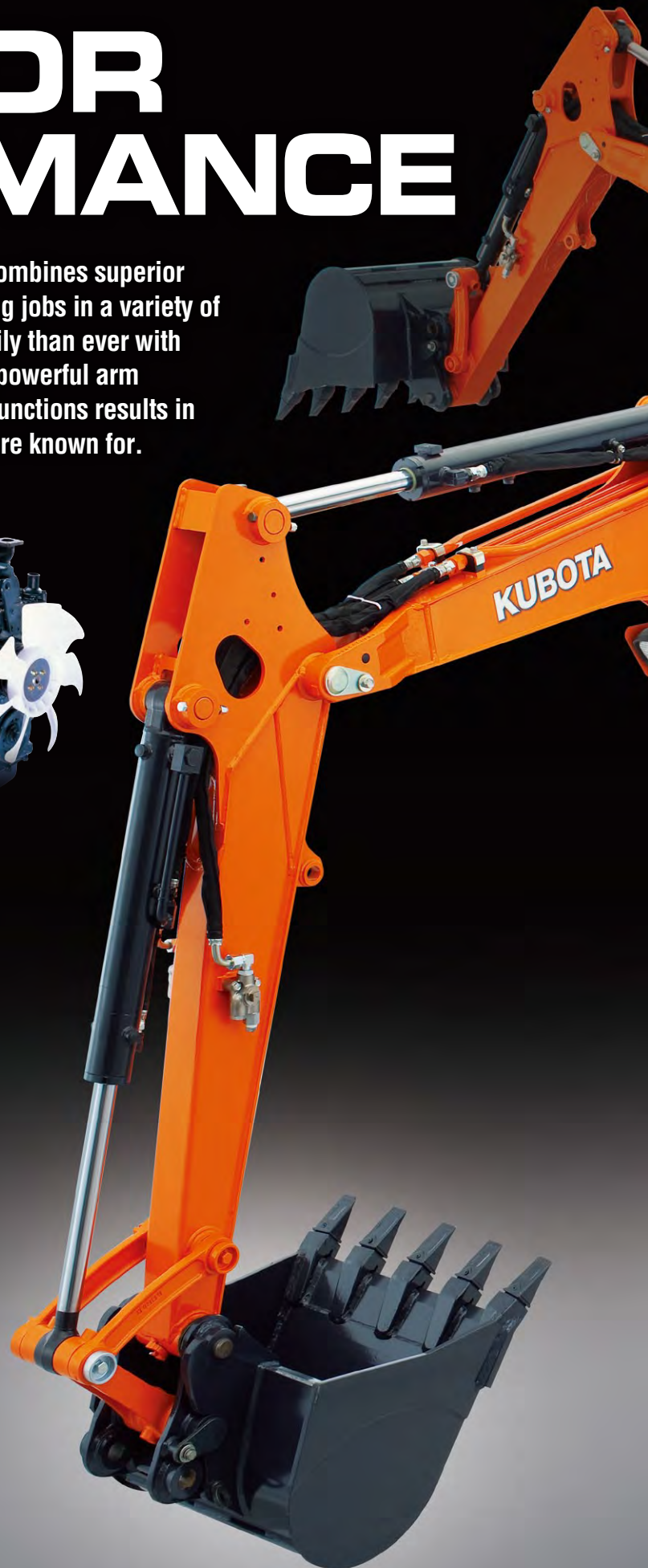



Auto idling system

When U35-4 control levers are in neutral for more than 4 seconds, engine RPM automatically idles. Move any control lever, and engine RPM immediately returns. This innovative feature not only lowers noise and exhaust emissions, but also reduces operating cost and fuel consumption.

Large-capacity variable displacement pump

The U35-4's performance matched boom, arm and bucket movements are the best in the industry. Kubota's unique hydraulic system and large-capacity variable displacement pumps give you the precise control needed to operate smoothly and efficiently in confined quarters. With the hydraulic power harnessed in the U35-4's front working group superior digging force is available when you need it.

Tight Tail Swing

With its counterweight protruding a mere 1.9 inches, the U35-4's tight tail swing proves to be highly versatile when undertaking operations wherever space is confined, eliminating costly damage to the engine hood and side panels. For added safety and improved operator visibility, the engine hood is set 5 inches inside the edge of the counterweight.



Travel negative brake

The travel negative brake locks the tracks to prevent inadvertent movement of the machine. This keeps the excavator secure during transport or while parked on slopes.

Swivel negative brake

The swivel negative brake automatically locks the swivel function in its current position. This prevents unexpected machine movement. It's particularly useful during work on slopes or when towing the excavator between worksites.

Front bush pins

Bushings on all pivot points on the front attachment and connecting points on the swing bracket is one more feature that adds to the enviable durability of this machine.

Easy Maintenance

Kubota's attention to user-friendliness can even be found in U35-4's engine layout. Primary engine components are consolidated onto one side for easier access so inspections and repairs can be made quickly and easily.

- A. Dual Element Air Cleaner**
- B. Water Separator**
- C. Fuel Filter**
- D. Starter Motor**
- E. Alternator**



Steel Panels

Durable steel side panels open easily for quick inspection and routine maintenance. Positioning inside the counterweight's edge gives panels added protection against inadvertent damage.

Accumulator

The accumulator makes replacing attachments safer and more efficient. Turning the key to the "on" position clears residual pressure in the auxiliary hydraulic hose. If the engine is accidentally shut off while the front attachment is raised, turning the key to the "on" position allows you to safely lower it.

MAINTENANCE

Although your Kubota excavator is state-of-the-art, its maintenance doesn't get much easier. Thanks to the full-opening rear and right side hoods, engine, control valves and various components are accessible for easy inspection and repair.

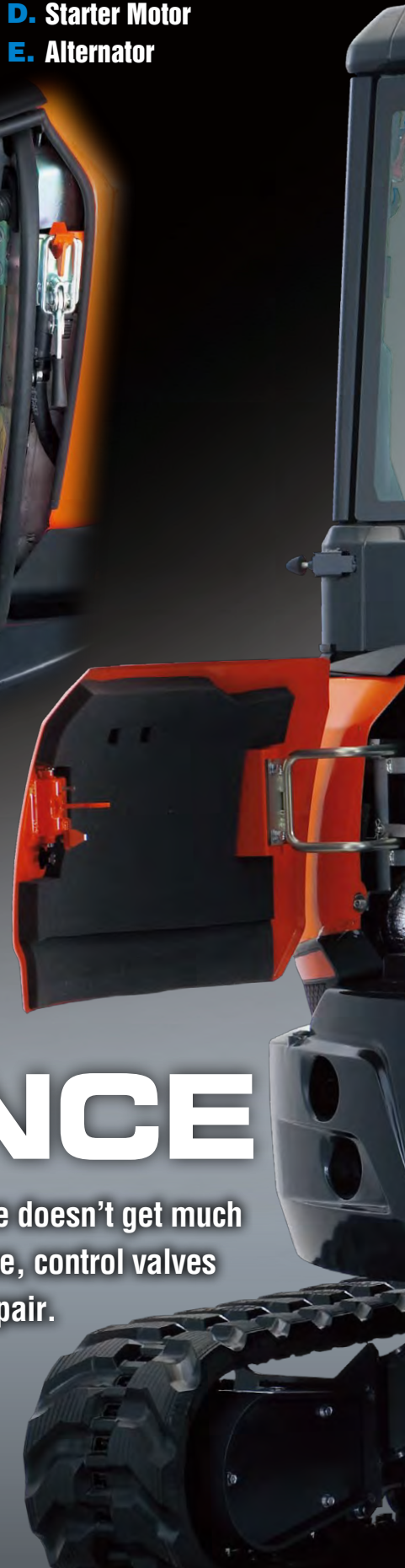



KUBOTA

U35-4
KUBOTA
MADE IN JAPAN



NEW DIGITAL PANEL



- A. Hour Meter**
- B. Coolant Temperature**
- C. Clock**
- D. Fuel Level**
- E. Engine RPM**



With easy access, simple settings, and easy-to-read indicators and alerts, you'll always be aware of the status of your excavator's critical functions. The wider, more visible display screen with easy push button operation puts convenience at the operator's fingertips. In keeping with Kubota's Intelligent Control System functionality, this new digital panel is more informative and user-friendly than ever.

Operation History Record

Operation history is automatically recorded on the U35-4. You can trace back up to 90 days of the machine's usage dates by simply checking the built-in calendar.

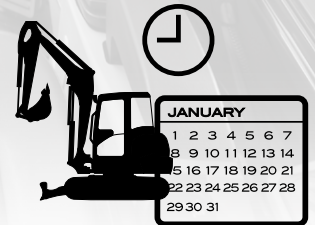

Service Mode



Warning Mode



Operation History Record



Max. Oil Flow Setting

Convenient Pre-installed Attachment Icons



AUX (Standard)



Tilt Bucket



Breaker



Clamshell



Auger



Grapple



Rotary Grapple



Brush Cutter

U35-4 OPTIONS

STANDARD EQUIPMENT

Safety system

- Engine start safety system
- Travel motor with disc brake
- Swivel motor with disc brake
- All hydraulic control

Working equipment

- Auxiliary hydraulic circuit 1 with proportional control on right control lever
- 2 working lights on cab and 1 light on the boom
- Dozer blade with float function
- Thumb bracket and relief valve

Operator's Space

- ROPS/OPG (TOP Guard, Level I) canopy
- Weight-adjustable full suspension seat
- Retractable seat belt
- Hydraulic pilot control levers with wrist rests
- Travel levers with foot pedals
- Two pattern selection system
- Digital panel with diagnosis function
- 12V power source
- Cup holder
- Horn

Engine/Fuel system

- Double element air filter
- Auto idling system
- Water separator with drain cock

Undercarriage

- Dozer blade with float
- 11.8" (300mm) rubber track
- 1 × upper track roller
- 5 double-flange track rollers on each side
- 2-speed travel switch on dozer lever
- 2-speed travel with auto-shift

Hydraulic system

- Pressure accumulator
- Hydraulic pressure checking ports
- Straight travel circuit
- Third line hydraulic return
- 2 variable pumps and 1 gear pump
- Adjustable maximum oil flow on auxiliary hydraulic circuits 1
- Auxiliary switch (AUX1) on right control lever

Others

- Tool box
- Grease gun holder

OPTIONAL EQUIPMENT

- Cab with A/C
- Canopy lights
- Rear working lights
- Beacon lights
- Angle blade with float function and BOE
- Travel alarm
- Spark arrest muffler

WORKING RANGE

Model			U35-4
A	Max. digging height	ft. in. (mm)	15'10.7"(4844)
B	Max. dumping height	ft. in. (mm)	11'0.7"(3370)
C	Max. digging depth	ft. in. (mm)	9'8.9"(2970)
D	Max. vertical digging depth	ft. in. (mm)	6'7.3"(2013)
E	Max. digging radius at ground	ft. in. (mm)	16'11.3"(5165)
F	Max. digging radius	ft. in. (mm)	17'3.6"(5272)
G	Min. turning radius	W/O swing ft. in. (mm)	7'4.6"(2250)
		W swing ft. in. (mm)	5'9.1"(1755)
H	Min. tail turning radius	ft. in. (mm)	2'11.5"(901)

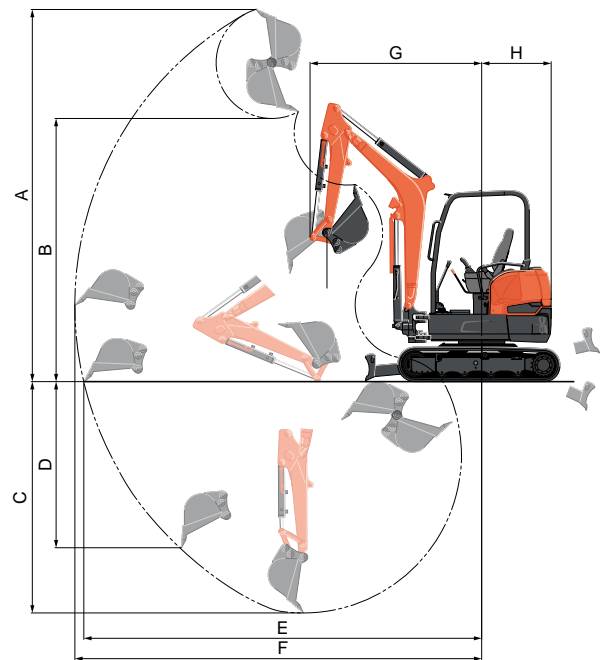

LIFTING CAPACITY

Canopy rubber

LIFT POINT HEIGHT (ft)	LIFTING CAPACITY OVER-FRONT BLADE DOWN unit=1000 lbs			LIFTING CAPACITY OVER-SIDE unit=1000 lbs		
	LIFT POINT RADIUS (ft)			LIFT POINT RADIUS (ft)		
	8	12	14	8	12	MAX
6	1.95	1.36	1.28	1.95	1.11	0.87
4	2.73	1.53	1.35	1.96	1.08	0.85
2	3.23	1.68	1.41	1.88	1.05	0.84
GL	0	3.33	1.77	1.84	1.02	0.82

Machine with ROPS canopy and rubber crawler, without bucket

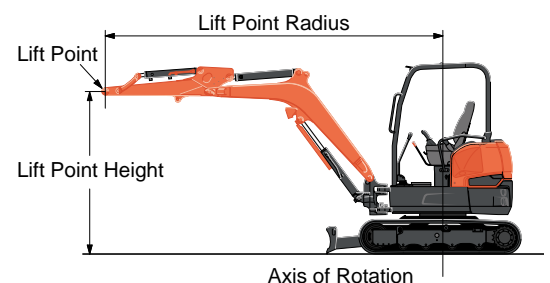

SPECIFICATIONS

Model				U35-4	U35-4 Angle Blade
Type of ROPS / OPG (TOP Guard, Level I)				Canopy / Cab	
Type of tracks				Rubber / Steel	Rubber / Steel
Engine	Model			Kubota D1703M-DI-E4	
	Output (SAE J1995 gross)		HP (kW) / rpm	24.8 (18.5) / 2200	
	Output (SAE J1349 net)		HP (kW) / rpm	23.9 (17.8) / 2200	
	Displacement		cu. in. (cc)	100.5 (1647)	
Dimensions	Overall length		ft. in. (mm)	15'7" (4749)	
	Overall height		ft. in. (mm)	8'1.2 (2470)	
	Overall width		ft. in. (mm)	5'6.9" (1700)	
	Min. ground clearance		in. (mm)	11.34 (288)	
Hydraulic system	Pump capacity		GPM (ℓ/min)	10.5 (39.6.) x 2 / 5.5 (20.9) x 1	
	Auxiliary hydraulic flow	AUX1	GPM (ℓ/min)	15.8 (60)	
	Max. breakout force	Bucket / Arm	lbs. (kgf)	7924 (3594) / 4451 (2019)	
Drive system	Travel speed		Low / High	mph (km/h)	
	Max. traction force		Low speed	lbs. (kgf)	
	Tumbler distance		ft. in. (mm)		5'6.5" (1688)
	Crawler length		ft. in. (mm)		6'10" (2084)
	Shoe width		Rubber	in. (mm)	
	Ground contact pressure		Rubber Canopy / Cab	psi (kgf/cm ²)	4.89 (0.34) / 5.08 (0.36)
		Steel Canopy / Cab	psi (kgf/cm ²)	5.00 (0.35) / 5.19 (0.36)	
Steel Canopy / Cab		psi (kgf/cm ²)		5.21 (0.37) / 5.40 (0.38)	
Swing system	Unit swing speed		rpm	8.9	
	Boom swing angle	Left / Right	degree	71 / 45	
Blade	Dimensions		Width	ft. in. (mm)	
			Height	ft. in. (mm)	
	Max. lift above ground		in. (mm)		1'1.5" (343)
	Max. drop below ground		in. (mm)		15.98 (406)
	Angle		Left / Right	degree	
				14.53 (369)	
				18.74 (476)	
				-	
				25 / 25	
Hydraulic oil (Reservoir / System)			gal (ℓ)	11.8 (44.6) / 16.1 (61)	
Fuel reservoir			gal (ℓ)	12.4 (46.9)	
Operating weight		Rubber Canopy / Cab	lbs. (kgf)	8129 (3687) / 8451 (3833)	
(Including operator's weight @ 175 lbs.)		Steel Canopy / Cab	lbs. (kgf)	8478 (3845) / 8800 (3991)	
				8325 (3776) / 8647 (3922)	
				8674 (3934) / 8996 (4080)	

The company reserves the right to change the above specifications without notice. This brochure is for descriptive purposes only. Please contact your local Kubota dealer for warranty information. For your safety, Kubota strongly recommends the use of a Rollover Protective Structure (ROPS) and seat belt for almost all applications.

DIMENSIONS

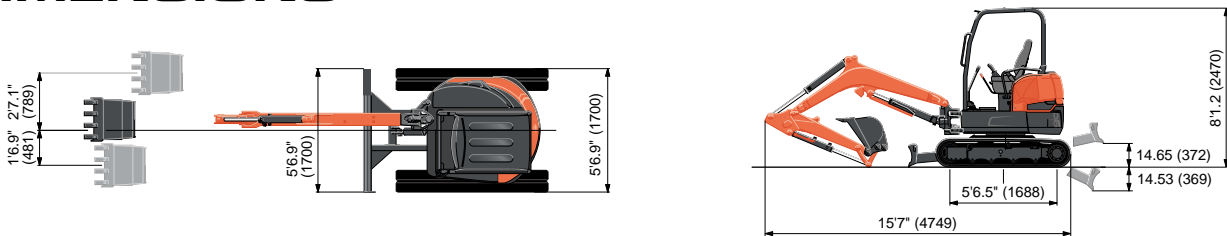

Unit: ft. in. (mm)



KUBOTA TRACTOR CORPORATION

Kubota Tractor Corporation, 3401 Del Amo Boulevard, Torrance CA 90503
 Western Division: 1175 S. Guild Ave., Lodi, CA 95240 Tel (209) 334-9910
 Central Division: 14855 FAA Boulevard, Fort Worth, TX 76155 Tel (817) 571-0900
 Northern Division: 6300 at One Kubota Way, Groveport, OH 43125 Tel (614) 835-1100
 Southeast Division: 1025 Northbrook Parkway, Suwanee, GA 30024 Tel (770) 995-8855

Visit our web site at: www.kubota.com

