

# KOBELCO

SK350DLC-11 / SK400DLC-11

Performance  Design

Ultra High Reach Demolition Excavator  
**SK350D<sub>LC</sub> SK400D<sub>LC</sub>**



**Japan's No.1**  
Demolition Equipment Supplier

*Built for Perfectionists™*



# Performance Design

**PERFORMANCE** — More power and more speed give the efficiency and productivity you demand.

**DESIGN** — Operator-centric design makes no compromises in ease-of-use or comfort.

The new SK350DLC and SK400DLC demolition excavators blend performance and design to provide value unseen until now. And as dedicated demolition machines, they provide the functionality and accessories to get any job done. KOBELCO continue to push the envelope to create an unforgettable and unparalleled experience.

## SK350D<sub>LC</sub> SK400D<sub>LC</sub>

### To the Next Level of Power and Functional Aesthetics

#### High-output engine

High engine output provides excellent performance in all aspects of work.

Model : HINO J08EYD

#### Engine output

**213kW/2,100min<sup>-1</sup>**

ISO 14396 : without fan

#### Exquisitely designed LED backlighting

Switches and dials are equipped with LED backlighting. In addition to increasing recognizability at night, the lighting gives the interior a classy aura.

#### Automatic lighting LED door light

A bright LED door light turns on in conjunction with opening the door and turning off the key.







### Simple operation with the jog dial

Several operations combined in the jog dial. Watch the screen associated with the dial, and then turn, select, push, and go. Simple!



### New console tilt makes getting in and out easy

The design of the left console with safety lever takes getting in and out into consideration with a large-angle recoil.



### Know everything at a glance: Large 10-inch colour monitor

Incorporates the industry's biggest large-format monitor. The information you need is easy to see and operating the menus is simple. The large camera image means you can quickly confirm safety conditions.



## Specification selection

Select attachments to perform demolition from high heights to lower stories, and even basement levels with just one machine.

## Ultra long attachment specification

### Ideal for demolishing buildings over 20m high

The cross-cylinder construction allows for 3-piece ultra-long attachments, and the overall reach can be adjusted through arm selection\* and the use of an insert boom.

These machines are ideal for demolishing buildings 5 to 8 stories tall and jobs that require a reach of over 12m.

\*Arm selection available only for SK400DLC

#### Maximum working height (arm top pin)

##### SK350DLC

6.1m arm, with boom insert : **Approximately 21.0m**

##### SK400DLC

6.1m arm, with boom insert : **Approximately 21.1m**

8.7m arm, with boom insert : **Approximately 24.7m**



#### KOBELCO original nibbler KR1100TPR-2

- Maximum jaw opening width : 1,100mm
- Crushing force : 1,550kN (center) / 950kN (tip)
- Cutter length : 200mm
- Mass : 2,600kg

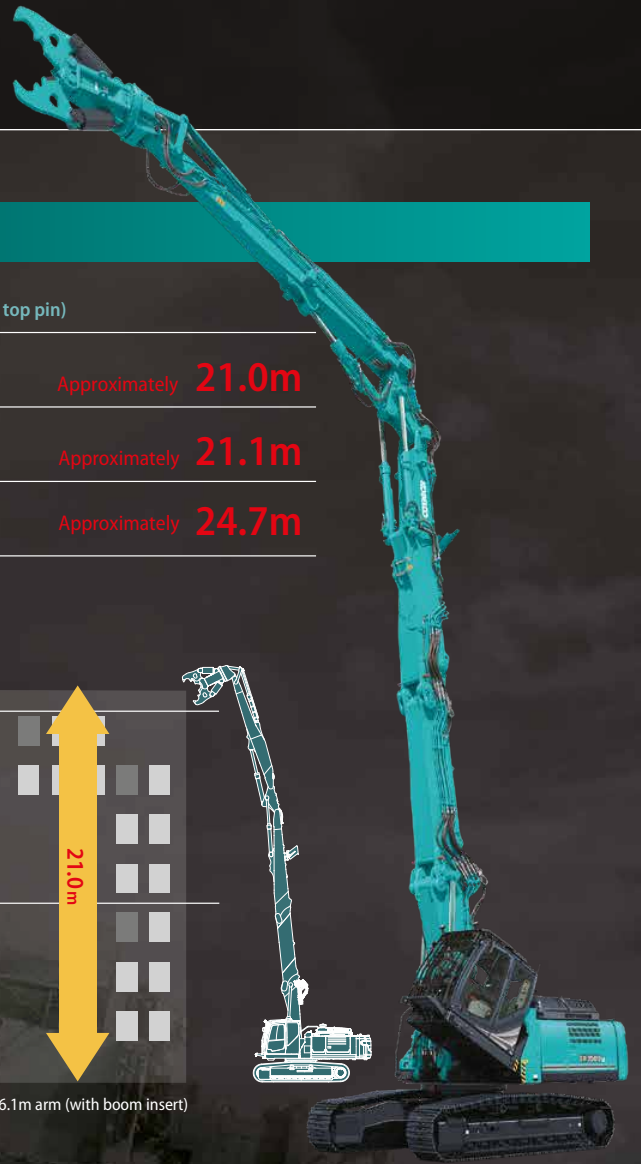
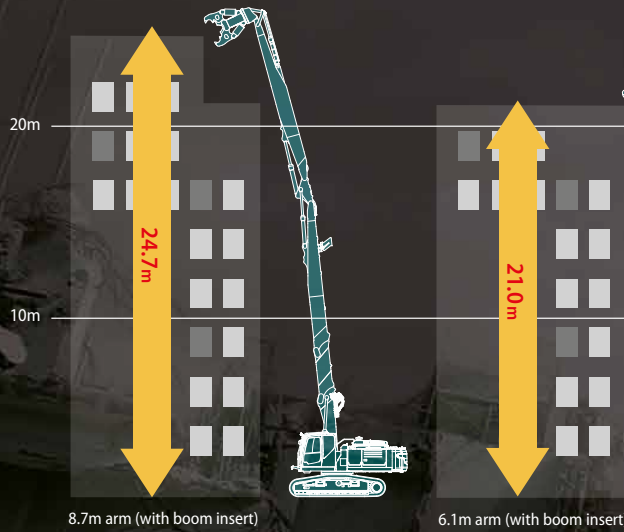

## Separate boom specification

### Demolish lower stories, foundations, basements

A wide working range enables the demolition of lower stories, down to the building's foundation. The large, powerful crusher attachment is perfect for jobs that demand power. And, the strong attachment holding ability enables a high level of work efficiency.



#### KOBELCO original nibbler KR1350TPR-40

- Maximum jaw opening width : 1,350mm
- Crushing force : 1,770kN (center)  
1,210kN (tip)
- Cutter length : 200mm
- Mass : 3,800kg

#### Working range (arm top pin)

SK350DLC :  
Approximately **13.6m**

SK400DLC :  
Approximately **13.7m**

SK350DLC :  
Approximately **6.3m**

SK400DLC :  
Approximately **6.2m**

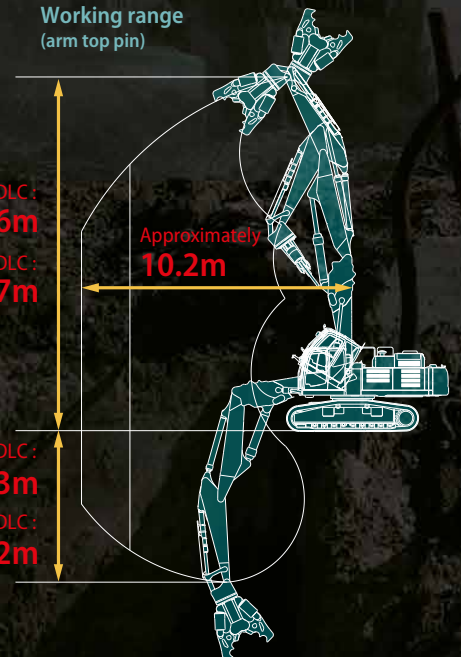



# Transport of disassembled machine

Including NEXT attachments, incorporates KOBELCO's state-of-the-art assembly/disassembly technology.

## Quick assembly NEXT attachments

Attaching a boom attachment to the main boom uses the NEXT joint system, consisting of a hook joint on the back and left-right separated manual pins on the belly. Safely and quickly assemble and disassemble.

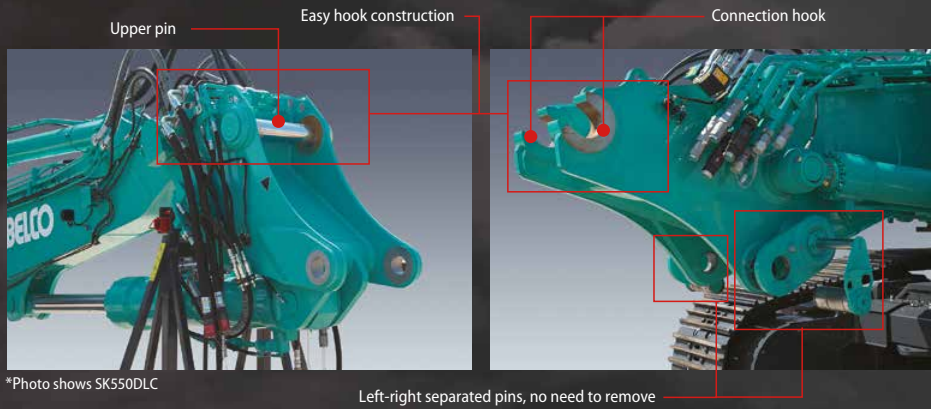

\*Photo shows SK550DLC

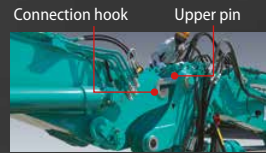

Upper side (dorsal side): Just hook the pin on the hooks. No need to insert/ remove pins.



Lower side (belly side): Includes a guide for easily aligning the pin positions.

\*Photo shows SK550DLC



NEXT pin removal equipment available for handy attachment disassembly.

## Piping connection also simple with multi-coupler and other implements

With the attachment joint part, connect the hydraulic piping to the boom side, and then connect/disconnect with the multi-coupler or quick coupler. Safely and conveniently connect piping on the ground.



Multi-coupler

Quick-coupler

\*Photo shows SK550DLC

## Quick hitch piping is equipped as standard

Dedicated piping is equipped as standard to attach the quick hitch for easy exchange of front attachments.



## Object handling hook (OHK hook) is equipped as standard

Lifting hook equipped on the bucket link part with the separate boom specification. It can lift the ultra long attachment by itself, so no loading crane is necessary when changing attachments or loading/unloading the machine onto a transport truck.



## Crawler width changeable while grounded (only SK400DLC)

Crawlers can be retracted to reduce crawler machine width to below 3m for ease of transport. The hydraulic system makes light work of extending or retracting with crawler shoes remaining on ground.



Crawler width when retracted : **2,980m**



## Attachment pressure drain from the display

Hydraulic oil pressure draining before exchanging the front attachment or disassembling the boom attachment can be done by selecting it on the display from the operator's seat.

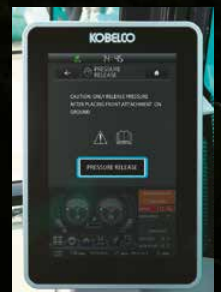

## Separable counterweight (only SK400DLC)

The counterweight is separable for easy attachment/detachment when transporting the base machine.



Because it is constructed with the separable weight inside a case-style weight, removal can be done quickly.

## Attachment height during transport

[NEXT Ultra long attachment specification]

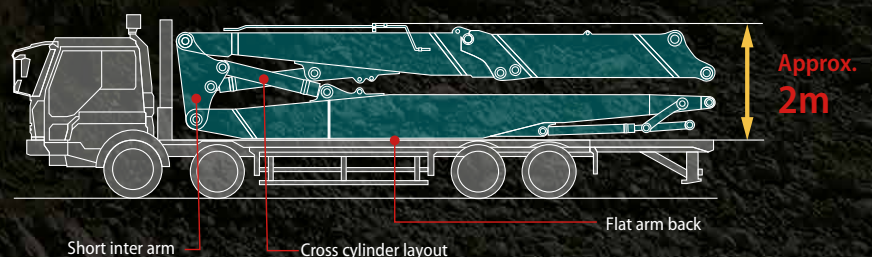



## Reliability and safety

KOBELCO's latest technology for keeping the machine in top shape and protecting the operator.

### Stability warning system with longitudinal/horizontal detection

The device calculates the tipping danger area from the posture and swing angle of the attachment, and if it detects a dangerous situation, it alerts the operator with an alarm and a warning on the screen. By detecting longitudinal / lateral position of the upper structure, work can be done in a larger radius at the more stable, lateral upper structure direction.



Stability warning display

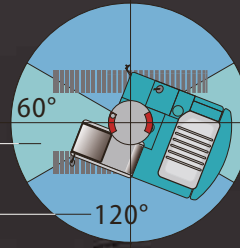

Vertical direction  
Lateral direction

### Cab interference prevention system with soft-stop feature

If the attachment comes within a certain distance of the cab, an alarm and warning on the screen alert the operator, and the attachment stops softly and automatically to protect the operator. Since there is no worry of contact, the operator can confidently perform lever operation even close to the cab.



Cab interference warning display



Boom angle sensor



Jib angle sensor



Arm angle sensor



Bucket angle sensor

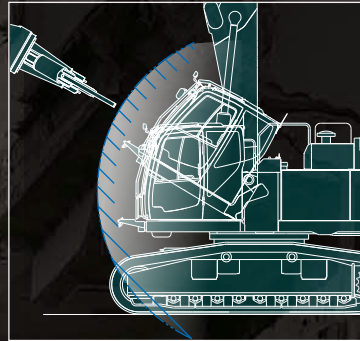

### LED work light to keep visibility in low light or at night

Equipped with six high brightness LED work lights. The lights keep the work area bright even in low light or at night. Work area safety can also be quickly confirmed.



Upper structure (1 light)



Cab top (2 lights)



Cab bottom (1 light)



Attachment (2 lights)

### Right, left and rear view cameras / Eagle-Eye View

Cameras are equipped on the rear, right, and left sides of the base machine. Camera image is easily visible on the large 10-inch monitor. The blind spots behind and to the right can be checked in a glance from the operator's seat to confirm safety. The operator can choose how to display the camera image.



Simultaneous rear/right view



Top-down view



Rear-side camera



Left-side view



Right-side camera



Eagle-eye view

### Note : Loading of lashing point (only SK400DLC)

On the drive motor side, the brackets are attached to the top of the lower car body as lashing points to prevent interference between the piping cover and the binding wire.

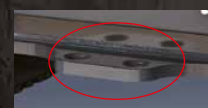

Idler side



Drive Motor side



## Comfort

A unique operating environment of building demolition machine to prevent operator fatigue.

### Demolition spec cab with tilting function



Easy to clean open/close cab guard (upper front window and skylight)

\*Photo shows SK550DLC

A Demolition spec cab with a 30° tilt capability is equipped as standard for comfortably demolishing tall buildings where the operator spends a long time looking up. With no beam between the front window and skylight to block visibility and angled grids on the cab guard, good work visibility is maintained.



Vertical open/close roller shades to block direct sunlight.



High upper visibility



36% larger front wiper wiping area (compared to standard cab)



Emergency manual valve for lowering cab



Cab tilt operation switch

### Air suspension seat

An air suspension seat is equipped as standard, with excellent shock absorption to prevent fatigue even when sitting for a long time. It includes a wide four-inch arm rest that allows you to take a comfortable position and a seat heater for comfortable operation even in winter season.



\*Photo shows SK500 excavator





## Equipment

For ensuring the machine remains safely usable for a long time.



**Reinforced upper frame under cover guards**  
6mm-thick steel plate cover protects devices in the base machine.



**Lower frame guard**  
9mm-thick steel plate cover protects travel-system hydraulic circuits.



**Safety valve for boom & arm & jib cylinder**  
Prevents attachment from falling if piping is ruptured.

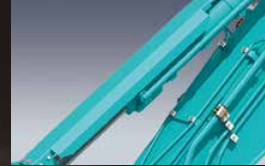

**Bucket cylinder guard**  
Prevents damage to the cylinder from falling debris.



**Falling object deflector (Ultra long attachment)**  
The guard deflects falling debris away from the machine.



**Full truck guide (option)**  
Prevents treads from coming off when mounting on demolition rubble.



**Crawler extension / retraction mechanism guard (only SK400DLC)**  
Hydraulic cylinders protected from flying demolition debris.



**Public address system**  
Alert workers in the area with clear audio quality.



**Travel alarm**  
The alarm cautions workers in the area that the machine is traveling.



**Battery shut-off device**  
Battery cut-off switch prevents battery discharge over long periods.



**Cab lower mirror**  
Check safety at foot areas and under the cab when tilted.



**Cab entry step**  
Positioned for convenient access to the tilt cab.



**Refueling pump**  
Quickly and safely refuel from the ground.



**Auto lubrication system**  
Quickly lubricate the attachments.

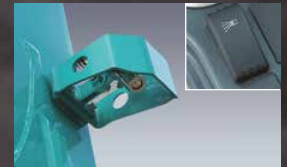

**Water spray**  
Drain circuit is provided for rust prevention.

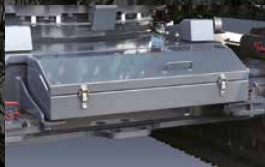

**Additional storage box (option SK350DLC)**  
Equipped with a storage box for storing tools and implements.

\* The accessory settings may differ according to the specification. Refer to the list of key accessories on the back page for details.





## Standard and optional equipment

● = std ○ = opt. — = not available

Category	Description	SK350DLC-11		SK400DLC-11		
		Separate boom Attachment	Ultra long Attachment (21m height)	Separate boom Attachment	Ultra long Attachment (21m height)	Ultra Long Attachment (25m height)
Engine	Hino J08EYD	●	●	●	●	●
	Exhaust DOC DPF SCR system	●	●	●	●	●
	Alternator 24V / 60A	●	●	●	●	●
	Starter motor 24V / 5kW	●	●	●	●	●
	Batteries 2 x 12V (120Ah)	●	●	●	●	●
	Fan suction type cooling system	●	●	●	●	●
	Auto deceleration function	●	●	●	●	●
Hydraulic system	Auto idle stop	●	●	●	●	●
	3 work modes H, S, Eco	●	●	●	●	●
	Power boost (34.3MPa)	●	—	●	—	—
	Heavy lift mode	●	—	●	—	—
	Pressure release function	●	●	●	●	●
	Independent travel function	●	●	●	●	●
	Auto warm up system	●	●	●	●	●
	Proportional Hand Control (for Rotation & N&B piping)	●	●	●	●	●
	Hydraulic oil VG32	●	●	●	●	●
	Hydraulic oil VG46	○	○	○	○	○
	Hydraulic oil VG68	○	○	○	○	○
Piping	Rotation & N&B piping	●	●	●	●	●
	QH piping	●	●	●	●	●
Cabin	Air suspension seat with heating	●	●	●	●	●
	10 inch colour monitor	●	●	●	●	●
	LED door light	●	●	●	●	●
	Air-conditioner	●	●	●	●	●
	DAB+ radio (FM/AM & AUX & USB & Bluetooth* & hands free telephone)	●	●	●	●	●
	Harness for cab four lights and cab yellow flasher	●	●	●	●	●
	Parallel wiper	●	●	●	●	●
Lights	12V power supply	●	●	●	●	●
	LED work lights ; 2 on cab top & 1 on cab bottom & 1 on upper structure	●	●	●	●	●
	LED work lights ; 2 on boom	●	—	●	—	—
Working equipment	LED work lights ; 2 on arm	—	●	—	●	●
	NEXT Separate boom attachment package	●	○	●	○	○
	NEXT Ultra Long attachment package for 21m pin height	○	●	○	●	—
	NEXT Ultra Long attachment package for 25m pin height	—	—	○	—	●
	NEXT water spray (water pump & tank are not included)	●	●	●	●	●
	Kobelco original Nibbler KR1100TPR (for Ultra Long attachment)	—	○	—	○	○
	Kobelco original Nibbler KR1350TPR (for Separate boom attachment)	○	—	○	—	—
C/W	OHK hook	●	—	●	—	—
	Heavier C/W (TTL 9,460kg)	●	●	—	—	—
Undercarriage	Layered C/W (TTL 10,080kg)	—	—	●	●	●
	VLC (Hydraulic variable undercarriage)	—	—	●	●	●
	600mm triple grouser shoe	●	●	●	●	●
	600mm double grouser shoe	○	○	○	○	○
	700mm triple grouser shoe	○	○	—	—	—
	800mm triple grouser shoe	○	○	—	—	—
	Track guides (one per side)	●	●	—	—	—
	Additional track guides (two per side)	○	○	—	—	—
	Track guides (two per side)	—	—	●	●	●
	Additional track guides (one per side)	—	—	○	○	○
	Full track guide	○	○	○	○	○
Safety	Lower frame guard	●	●	●	●	●
	Engine emergency stop switch	●	●	●	●	●
	Pump emergency mode (KPSS release switch)	●	●	●	●	●
	Emergency accel dial	●	●	●	●	●
	Emergency manual valve for lowering attachment	●	●	●	●	●
	Emergency manual valve for lowering cab	●	●	●	●	●
	Over load alarm	●	—	●	—	—
	Safety valve for boom & arm & jib cylinder	●	●	●	●	●
	Demolition spec cab (PSA glass, Tilting function)	●	●	●	●	●
	OPG Level II top guard (ISO 10262;1998)	●	●	●	●	●
	OPG Level II front guard (ISO 10262;1998)	●	●	●	●	●
	Eagle-eye view camera (Rear, Right, Left)	●	●	●	●	●
	Cab lower mirror	●	●	●	●	●
	Falling object deflector	—	●	—	●	●
	Seatbelt indicator on display	●	●	●	●	●
	Travel alarm	●	●	●	●	●
	Cab interference prevention system	●	●	●	●	●
Stability warning system	●	●	●	●	●	
Public address system	●	●	●	●	●	
Others	Extended guard rail	○	○	○	○	○
	Refueling pump	●	●	●	●	●
	Auto lubrication system	●	●	●	●	●
	Harness for engine room light	●	●	●	●	●
	NEXT pin removal equipment	●	●	●	●	●
	NEXT stand for 3.5m insert boom (for 21m Ultra Long attachment)	—	○	—	○	—
	NEXT stand for 2.4m insert boom (for 25m Ultra Long attachment)	—	—	—	—	○
	Additional storage box	○	○	○	●	●
	Bucket cylinder guard	●	●	●	●	●
RAL colour	○	○	○	○	○	
KOMEXS	●	●	●	●	●	



## SK350D<sub>LC</sub> SK350DLC-11



### Engine

Model	HINO J08EYD
Type	Four-stroke 6 cylinder watercooled direct injection turbo charger (with intercooler) diesel engine.
No. of cylinders	6
Bore and stroke	112 mm x 130 mm
Displacement	7,684 ml
Rated power output	213 kW/2,100min <sup>-1</sup> (ISO 14396 : Without fan)
Max. torque	1,017 N-m / 1,600min <sup>-1</sup> (ISO 14396 : Without fan)



### Hydraulic system

Pump	
Type	Two variable displacement piston pumps + extra pump + pilot pump
Max. discharge flow	2 x 294 L/min 1 x 42.6, 1 x 21 L/min
Relief valve setting	
Boom, arm and bucket	31.4 MPa
Power Boost	34.3 MPa (for separate boom)
Travel circuit	34.3 MPa
Swing circuit	29.0 MPa
Control circuit	5.0 MPa
Nibbler (Crusher) circuit	31.4 MPa (Open & Close) 20.6 MPa (Rotation)
Pilot control pump	Gear type
Main control valves	8-spool
Oil cooler	Air cooled type



### Swing system

Swing motor	One fixed displacement piston motor
Brake	Hydraulic; locking automatically when the swing control lever is in the neutral position
Parking brake	Wet multiple plate
Swing speed	5.5 min <sup>-1</sup> (Ultra long attachment) 10.0 min <sup>-1</sup> (Separate boom)
Tail swing radius	3,600 mm
Swing torque	119.6 kN-m



### Travel system

Travel motors	Variable displacement axial piston motor x 2
Travel brakes	Hydraulic brake
Parking brakes	Wet multiple plate
Travel shoes	48 each side
Travel speed (high / low)	5.6 / 3.3km/h
Drawbar pulling force	317 kN (SAE)
Gradeability	70% {35°}



### Cab & control

#### Cab

All-weather, sound-suppressed steel cab mounted on the silicon-sealed viscous mounts and equipped with a heavy, insulated floor mat  
Demolition spec cab with tilting function (30°)

#### Control

Two hand levers and two foot pedals for travel  
Two hand levers and one foot pedal for excavating and swing  
Electric rotary-type engine throttle

#### Noise levels

External	105 d B(A) (2000/14/EC)
Operator	72 db (A) (ISO 6396)

#### Vibration levels

Hand/arm*	≤2.5 m/s <sup>2</sup>
Body*	≤0.5 m/s <sup>2</sup>

\* For the risk assessment according to 2002/44/EC, refer to ISO/TR 25398: 2006.



### Boom, arm & bucket

bore x stroke (mm)

Attachment type	NEXT Ultra long attachment
Boom cylinders	170 x 1,505
Jib cylinders	140 x 1,210
Arm cylinder	170 x 1,210
Bucket cylinder	125 x 1,200
Attachment type	Separate attachment
Boom cylinders	170 x 1,505
Jib cylinder	240 x 1,317
Arm cylinder	170 x 1,788
Bucket cylinder	150 x 1,193



### Refilling capacities & lubrications

Fuel tank	503 L
Cooling system	35.0 L
Engine oil	28.5 L
Travel reduction gear	2 x 8.0 L
Swing reduction gear	7.4 L
Hydraulic oil tank	245 L tank oil level 410 L hydraulic system
DEF/Urea tank	83 L

### Operating weight & ground pressure

Attachment type	NEXT Ultra long attachment/ equipment*	Separate attachment*
	6.1m arm (21m height)	
Operating Weight	45,000 kg	45,400 kg
Ground Pressure	84 kPa	85 kPa

\* Measured with max tool weight



## Engine

Model	HINO J08EYD
Type	Four-stroke 6 cylinder water-cooled direct injection turbo charger (with intercooler) diesel engine.
No. of cylinders	6
Bore and stroke	112 mm x 130 mm
Displacement	7,684 ml
Rated power output	213kW/2,100min <sup>-1</sup> (ISO 14396 : Without fan)
Max. torque	1,017N-m/1,600min <sup>-1</sup> (ISO 14396 : Without fan)

## Hydraulic system

Pump	
Type	Two variable displacement piston pumps + extra pump + pilot pump
Max. discharge flow	2 x 294 L/min 1 x 42.6, 1 x 21L/min
Relief valve setting	
Boom, arm and bucket	31.4 MPa
Power Boost	34.3 MPa (for Separate boom)
Travel circuit	34.3 MPa
Swing circuit	29.0 MPa
Control circuit	5.0 MPa
Nibbler (Crusher) circuit	31.4 MPa (Open & Close) 20.6 MPa (Rotation)
Pilot control pump	Gear type
Main control valves	8-spool
Oil cooler	Air cooled type

## Swing system

Swing motor	One fixed displacement piston motor
Brake	Hydraulic; locking automatically when the swing control lever is in the neutral position
Parking brake	Wet multiple plate
Swing speed	5.5 min <sup>-1</sup> (Ultra long attachment) 10.0 min <sup>-1</sup> (Separate boom)
Tail swing radius	3,600 mm
Swing torque	119.6 kN-n

## Travel system

Travel motors	Variable displacement axial piston motor x 2
Travel brakes	Hydraulic brake
Parking brakes	Wet multiple plate
Travel shoes	48 each side
Travel speed (high / low)	5.6 / 3.3km/h
Drawbar pulling force	315 kN (SAE)
Gradeability	70% {35°}

## Cab & control

Cab	
All-weather, sound-suppressed steel cab mounted on the silicon-sealed viscous mounts and equipped with a heavy, insulated floor mat Demolition spec cab with tilting function (30°)	
Control	
Two hand levers and two foot pedals for travel Two hand levers and one foot pedal for excavating and swing Electric rotary-type engine throttle	
Noise levels	
External	105 d B(A) (2000/14/EC)
Operator	72 db (A) (ISO 6396)
Vibration levels	
Hand/arm*	≤2.5 m/s <sup>2</sup>
Body*	≤0.5 m/s <sup>2</sup>

\* For the risk assessment according to 2002/44/EC, refer to ISO/TR 25398: 2006.

## Boom, arm & bucket

bore x stroke (mm)

Attachment type	NEXT Ultra long attachment
Boom cylinders	170 x 1,505
Jib cylinders	140 x 1,210
Arm cylinder	170 x 1,210
Bucket cylinder	125 x 1,200
Attachment type	Separate attachment
Boom cylinders	170 x 1,505
Jib cylinder	240 x 1,317
Arm cylinder	170 x 1,788
Bucket cylinder	150 x 1,193

## Refilling capacities & lubrications

Fuel tank	503 L
Cooling system	35.0 L
Engine oil	28.5 L
Travel reduction gear	2 x 8.0 L
Swing reduction gear	7.4 L
Hydraulic oil tank	245 L tank oil level
	410 L hydraulic system
DEF/Urea tank	83 L

## Operating weight & ground pressure

Attachment type	NEXT Ultra long attachment/ equipment*		Separate attachment*
	6.1m arm (21m height)	8.7m arm (25m height)	
Operating weight	49,600 kg	50,100 kg	49,700 kg
Ground Pressure	93 kPa	94 kPa	93 kPa

\* Measured with max tool weight



## Attachments

### Nibbler

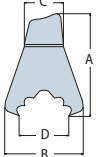
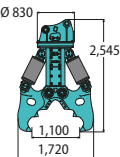
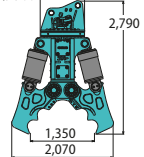
Model		KR1100TPR-2	KR1350TPR-40	
Weight	kg	2,600	3,800	
Dimensions	 <p>A Overall length B Width C Diameter D Jaw opening width</p>			
	Blade length	mm	200	200
Crushing force	Top	kN	950	1,210
	Center	kN	1,550	1,770
Assemble dimensions	Arm top width	mm	325	380
	Pin diameter	mm	80	90
Working hydraulic pressure	MPa	34.3	31.4	

Note: Units follow the International System of Units (SI).

## Dimensions

### SK350D<sub>LC</sub> ※ Excluding height of grouser

#### Dimensions (base machine + base boom)

Unit: mm

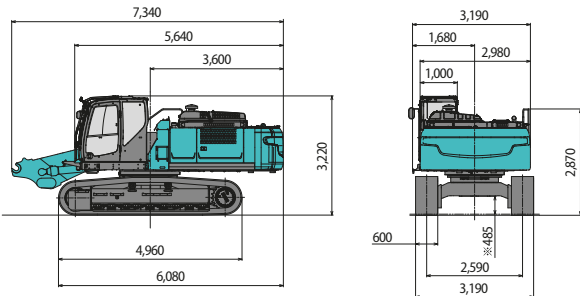

#### Assembled machine dimensions

Unit: mm

- NEXT Ultra long attachment specification : 6.1m arm + 3.5m boom insert

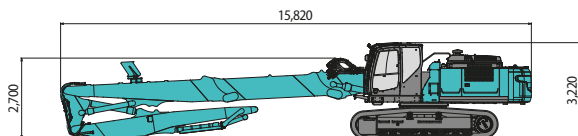

- NEXT Ultra long attachment specification : 6.1m arm

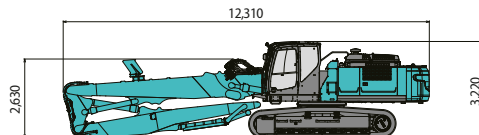

- NEXT Separate boom specification

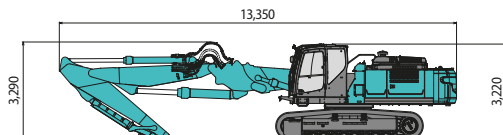

### SK400D<sub>LC</sub> ※ Excluding height of grouser

#### Dimensions (base machine + base boom)

Unit: mm

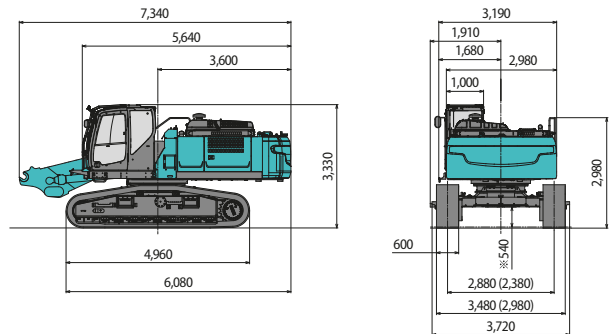

#### Assembled machine dimensions

Unit: mm

- NEXT Ultra long attachment specification : 8.7m arm + 2.4m boom insert

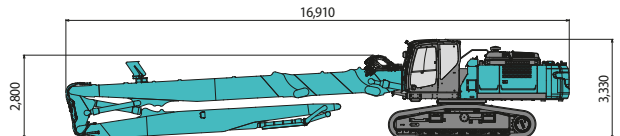

- NEXT Ultra long attachment specification : 8.7m arm

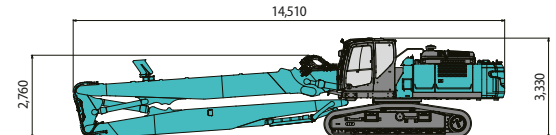

- NEXT Ultra long attachment specification : 6.1m arm + 3.5m boom insert

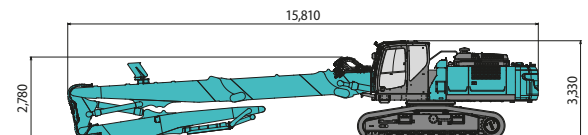

- NEXT Ultra long attachment specification : 6.1m arm

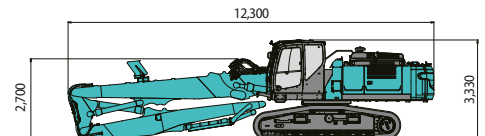

- NEXT Separate boom specification

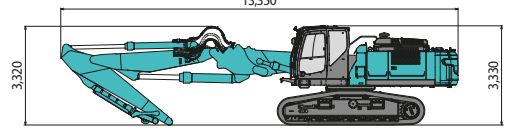



## Disassembled dimensions and weight

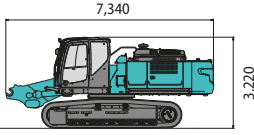
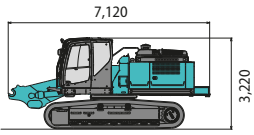
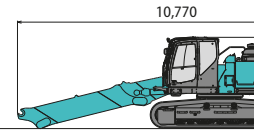
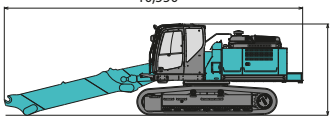
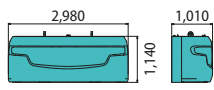
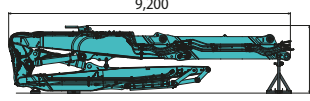
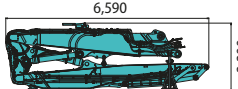
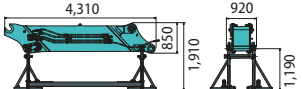
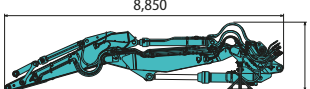

### SK350D<sub>LC</sub>

Unit: mm

<p>Base machine + base boom</p>  <p>Weight: 34,700 kg</p>	<p>Base machine + base boom (without counterweight)</p>  <p>Weight: 25,200 kg</p>	<p>Base machine + base boom + boom insert</p>  <p>Weight: 36,400 kg</p>
<p>Base machine + base boom + boom insert (without counterweight)</p>  <p>Weight: 26,900 kg</p>	<p>Counterweight (including bolt)</p>  <p>Weight: 9,490 kg</p>	<p>NEXT Ultra long attachment : 6.1m arm + 3.5m boom insert (including enclosed stand)</p>  <p>Overall width: 1,770 mm Weight: 7,750 kg</p>
<p>NEXT Ultra long attachment : 6.1m arm (including enclosed stand)</p>  <p>Overall width: 1,770 mm Weight: 6,040 kg</p>	<p>NEXT Ultra long attachment : 3.5m boom insert (including optional stand)</p>  <p>Overall width: 1,770 mm Weight: 1,980 kg</p>	<p>NEXT Separate boom (including enclosed stand)</p>  <p>Overall width: 1,770 mm Weight: 6,740 kg</p>

### SK400D<sub>LC</sub>

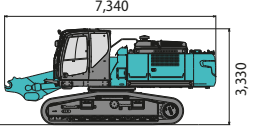
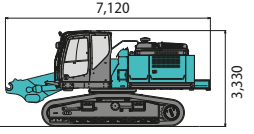
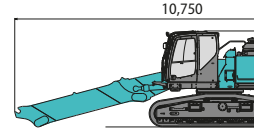
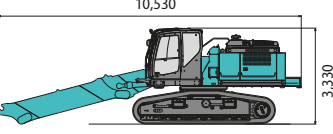
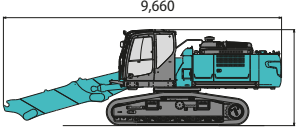
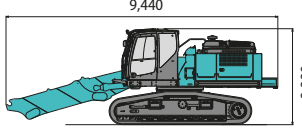
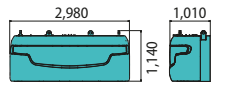
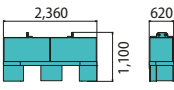
Unit: mm

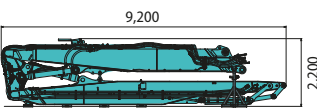
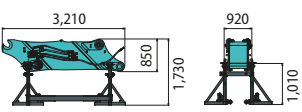
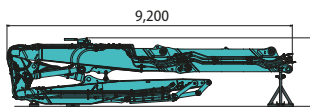
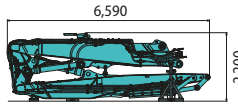
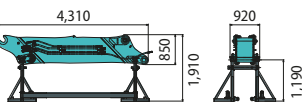
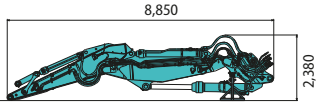
<p>Base machine + base boom</p>  <p>Weight: 39,000 kg</p>	<p>Base machine + base boom (without counterweight)</p>  <p>Weight: 28,800 kg</p>	<p>Base machine + base boom + 3.5m boom insert</p>  <p>Weight: 40,700 kg</p>
<p>Base machine + base boom + 3.5m boom insert (without counterweight)</p>  <p>Weight: 30,500 kg</p>	<p>Base machine + base boom + 2.4m boom insert</p>  <p>Weight: 40,400 kg</p>	<p>Base machine + base boom + 2.4m boom insert (without counterweight)</p>  <p>Weight: 30,200 kg</p>
<p>Counterweight Case (including bolt)</p>  <p>Weight: 3,270 kg</p>	<p>Counterweight (including bolt)</p>  <p>Weight: 6,860 kg</p>	<p>NEXT Ultra long attachment : 8.7m arm + 2.4m boom insert (including enclosed stand)</p>  <p>Overall width: 1,770 mm Weight: 8,590 kg</p>
<p>NEXT Ultra long attachment : 8.7m arm (including enclosed stand)</p>  <p>Overall width: 1,770 mm Weight: 7,150 kg</p>	<p>NEXT Ultra long attachment : 2.4m boom insert (including optional stand)</p>  <p>Overall width: 1,770 mm Weight: 1,680 kg</p>	<p>NEXT Ultra long attachment : 6.1m arm + 3.5m boom insert (including enclosed stand)</p>  <p>Overall width: 1,770 mm Weight: 7,750 kg</p>
<p>NEXT Ultra long attachment : 6.1m arm (including enclosed stand)</p>  <p>Overall width: 1,770 mm Weight: 6,040 kg</p>	<p>NEXT Ultra long attachment : 3.5m boom insert (including optional stand)</p>  <p>Overall width: 1,770 mm Weight: 1,980 kg</p>	<p>NEXT Separate boom (including enclosed stand)</p>  <p>Overall width: 1,770 mm Weight: 6,740 kg</p>





## Working ranges

### NEXT Ultra long attachment specification

**SK350D<sub>LC</sub>** 6.1m arm + 3.5m boom insert Max. tool weight = 2,600kg

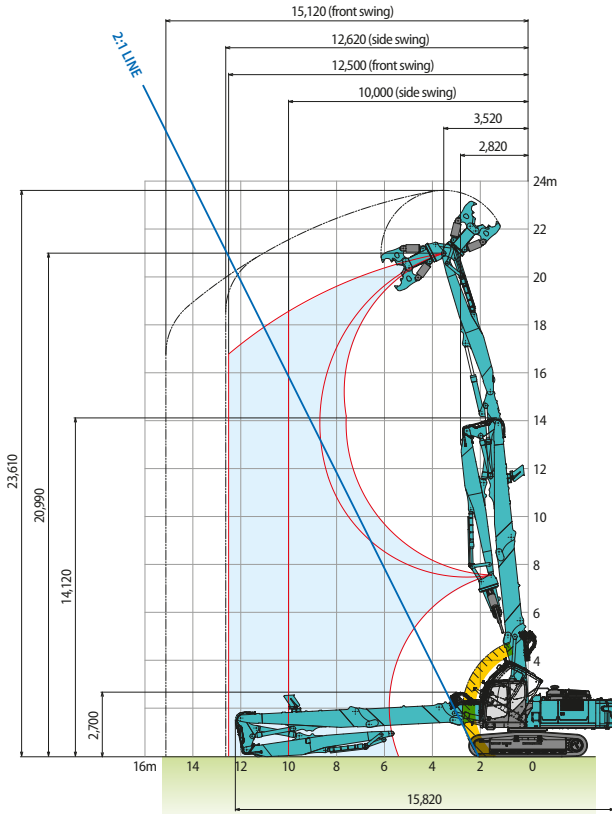

**SK400D<sub>LC</sub>** 8.7m arm + 2.4m boom insert Max. tool weight = 2,600kg

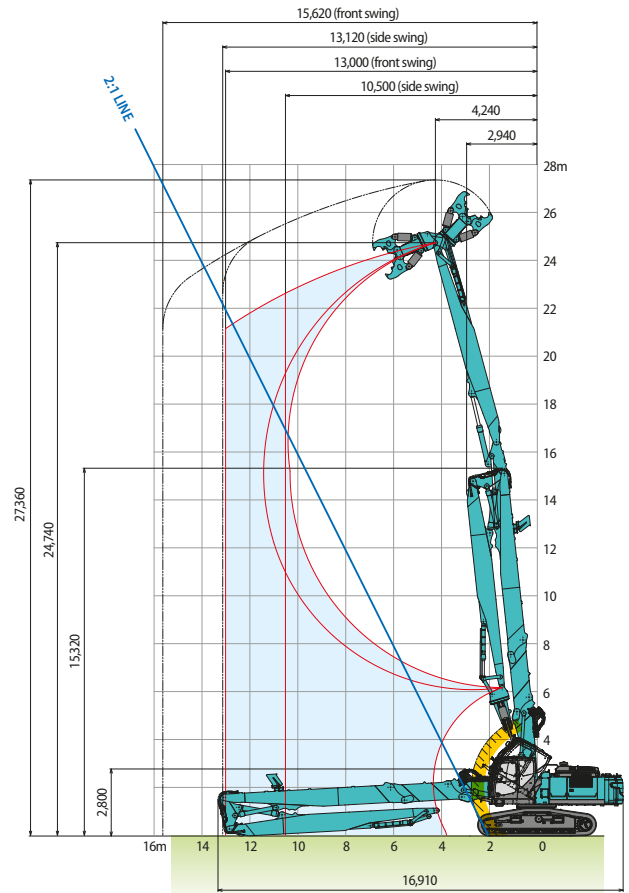

**SK350D<sub>LC</sub>** 6.1m arm Max. tool weight = 2,600kg

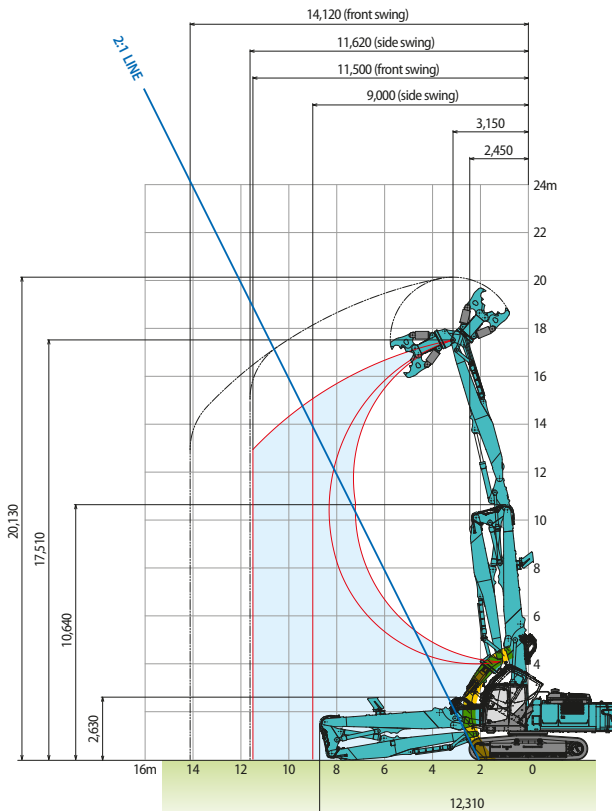

**SK400D<sub>LC</sub>** 8.7m arm Max. tool weight = 2,600kg

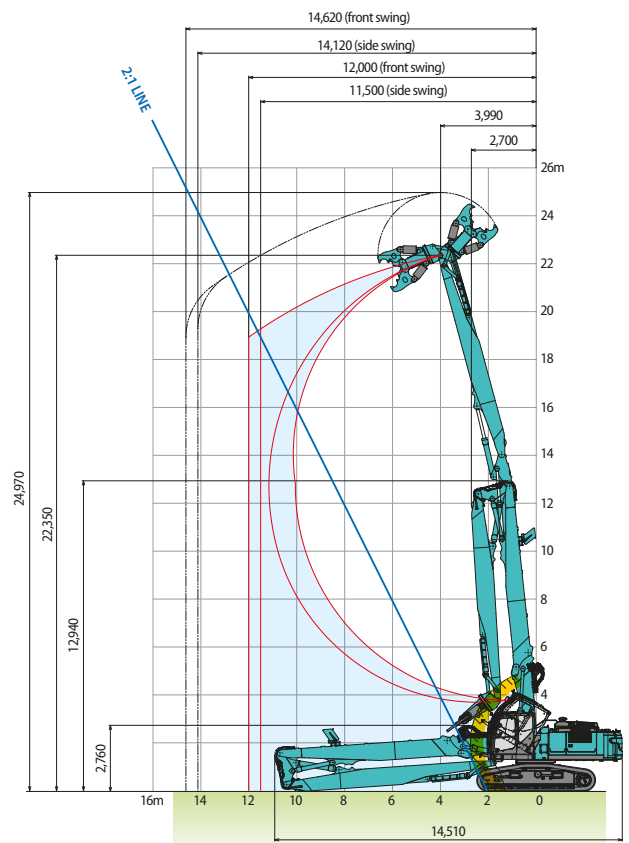

**SK400D.LC 6.1m arm + 3.5m boom insert**

Max. tool weight = 3,000kg

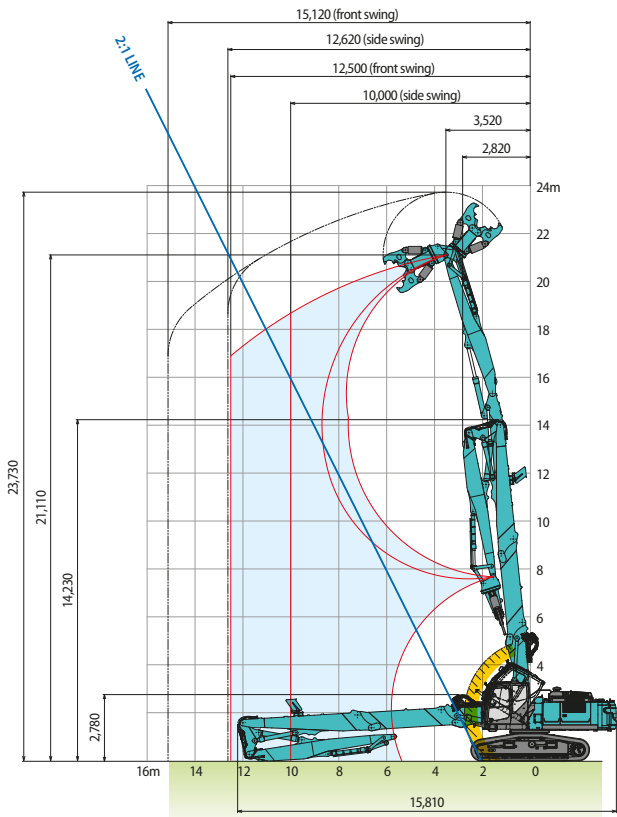

**SK400D.LC 6.1m arm**

Max. tool weight = 3,000kg

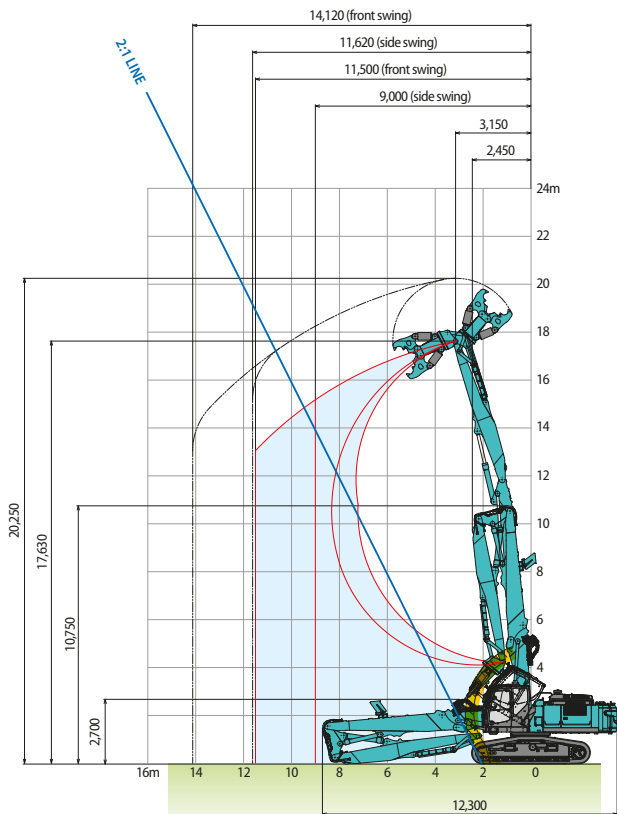

 Cab interference prevention system operating area.

**NEXT Separate boom specification**

**SK350D.LC**

Max. tool weight = 4,000kg

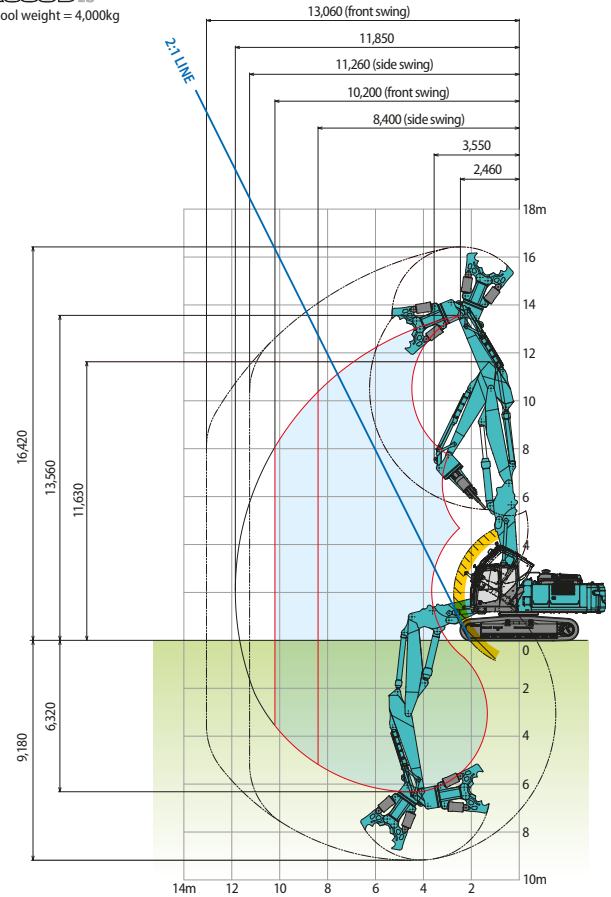

**SK400D.LC**

Max. tool weight = 4,000kg

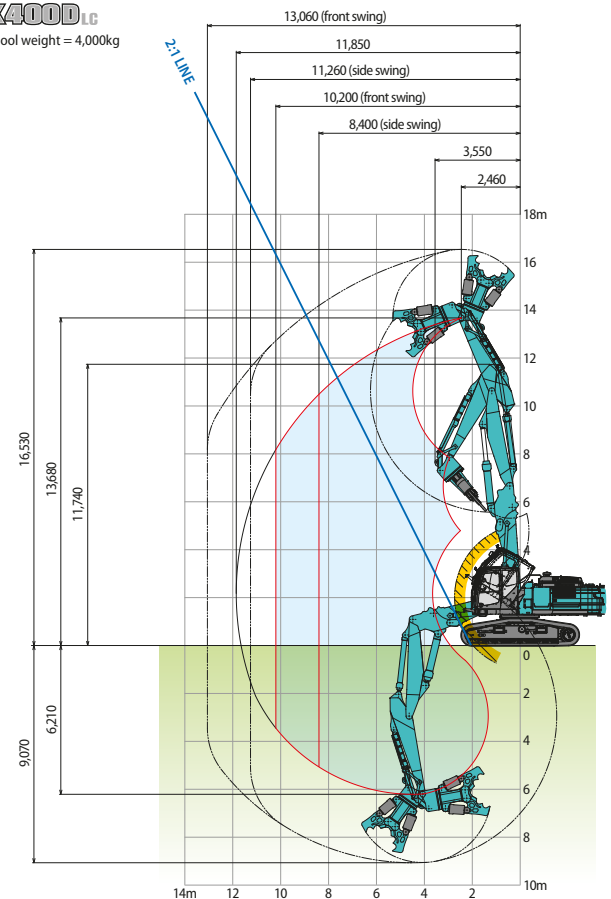



## Lift capacities

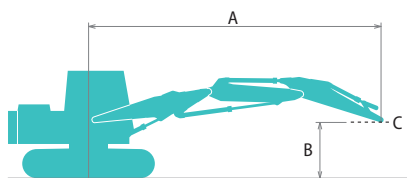

Rating over front



Rating over side or 90 degrees

A – Reach from swing centerline to arm top  
 B – Arm top pin height above/below ground  
 C – Lift point  
 Relief valve setting: 34.3 MPa

### SK350D.LC

Unit : kg

		Separate boom		Arm: 3.3 m		Without front attachment		Counterweight: 9,460kg		Shoe: 600 mm (Heavy Lift)				At Max. Reach					
B Height	Radius A	1.5 m		3.0 m		4.5 m		6.0 m		7.5 m		9.0 m		10.5 m		Radius			
		13.5 m																*13,050	*13,050
12.0 m						*10,940	*10,940	*9,640	*9,640								*7,580	*7,580	6.41 m
10.5 m						*9,320	*9,320	*9,870	*9,870	*9,410	8,000						*6,190	*6,190	8.31 m
9.0 m						*8,470	*8,470	*9,440	*9,440	*8,200	8,030	*8,540	5,610				*5,520	4,780	9.61 m
7.5 m						*9,600	*9,600	*10,390	*10,390	*10,660	7,720	*7,920	5,540	*5,620	3,960		*5,510	3,920	10.53 m
6.0 m						*17,220	16,490	*13,730	10,240	*7,930	7,200	*7,780	5,290	6,610	3,940		*4,930	3,400	11.18 m
4.5 m				*23,360	*23,360	*17,550	15,020	*10,000	9,010	*8,670	6,580	*5,550	4,950	6,450	3,790		*4,870	3,100	11.60 m
3.0 m						*16,310	13,480	*11,730	8,190	*9,610	6,010	7,930	4,620	6,260	3,620		*4,890	2,930	11.82 m
1.5 m						*18,940	12,390	*13,300	7,600	9,920	5,600	7,640	4,360	6,100	3,470		*5,000	2,890	11.84 m
G.L.				*9,520	*9,520	*17,740	11,970	*11,810	7,360	9,700	5,400	7,470	4,210	6,020	3,390		*4,940	2,970	11.67 m
-1.5 m				*15,980	*15,980	*12,000	*12,000	*9,450	7,480	*8,590	5,380	*7,170	4,180	*5,550	3,410		*4,080	3,170	11.29 m
-3.0 m		*17,870	*17,870	*21,770	*21,770	*19,250	12,890	*14,500	8,420	*6,650	5,520	*5,500	4,290	*4,340	3,600		*3,890	3,610	10.58 m
-4.5 m				*24,050	*24,050	*17,450	13,220	*13,260	8,600	*9,610	6,160	*5,640	4,640				*4,730	4,490	9.27 m
-6.0 m						*13,640	*13,640	*9,060	8,880								*7,650	*7,650	6.52 m

### SK400D.LC

Unit : kg

		Separate boom		Arm: 3.3 m		Without front attachment		Counterweight: 10,080kg		Shoe: 600 mm (Heavy Lift)				At Max. Reach					
B Height	Radius A	1.5 m		3.0 m		4.5 m		6.0 m		7.5 m		9.0 m		10.5 m		Radius			
		13.5 m																*12,010	*12,010
12.0 m						*10,810	*10,810	*9,910	*9,910								*7,420	*7,420	6.58 m
10.5 m						*9,230	*9,230	*9,820	*9,820	*9,420	*9,420						*6,120	*6,120	8.42 m
9.0 m						*8,450	*8,450	*9,450	*9,450	*8,130	*8,130	*8,470	7,170				*5,480	*5,480	9.69 m
7.5 m						*9,920	*9,920	*10,580	*10,580	*10,740	9,680	*7,900	7,080	*6,240	5,230		*5,130	*5,120	10.59 m
6.0 m						*17,190	*17,190	*13,790	12,890	*7,970	*7,970	*7,790	6,810	7,520	5,200		*4,940	4,530	11.22 m
4.5 m				*21,440	*21,440	*17,640	*17,640	*10,120	*10,120	*8,730	8,500	*5,780	*5,780	7,350	5,040		*4,870	4,190	11.63 m
3.0 m						*16,560	*16,560	*11,860	10,810	*9,680	7,920	*8,380	6,130	7,170	4,860		*4,890	4,010	11.83 m
1.5 m						*19,070	16,580	*13,400	10,230	*10,600	7,520	8,740	5,870	7,010	4,720		*5,010	3,980	11.83 m
G.L.				*10,250	*10,250	*17,460	16,190	*11,550	10,010	*9,910	7,330	*8,200	5,720	*6,600	4,640		*4,880	4,080	11.65 m
-1.5 m				*16,400	*16,400	*11,380	*11,380	*9,290	*9,290	*8,460	7,320	*7,070	5,710	*5,440	4,670		*4,000	*4,000	11.25 m
-3.0 m		*18,190	*18,190	*22,230	*22,230	*19,160	17,180	*14,450	11,110	*6,480	*6,480	*5,350	*5,350	*3,940	*3,940		*3,930	*3,930	10.51 m
-4.5 m				*23,740	*23,740	*17,260	*17,260	*13,110	11,320	*9,380	8,110	*5,290	*5,290				*4,830	*4,830	9.14 m
-6.0 m						13,130	13,130	*8,550	*8,550								*8,360	*8,360	6.09 m

#### Notes:

- Do not attempt to lift or hold any load that is greater than these lift capacities at their specified lift point radius and height. Weight of all accessories must be deducted from the above lift capacities.
- Lift capacities are based on machine standing on level, firm, and uniform ground. User must make allowance for job conditions such as soft or uneven ground out of level conditions, side loads, sudden stopping of loads, hazardous conditions, experience of personnel, etc.
- Arm top pin is defined as lift point.
- The above lift capacities are in compliance with SAE J/ISO 10567. They do not exceed 87 % of hydraulic lift capacity or 75 % of tipping load. Lifting capacities marked with an asterisk (\*) are limited by hydraulic capacity rather than tipping load.
- Operator should be fully acquainted with the operator's and Maintenance Instructions before operating this machine and rules for safe operation of equipment should be adhered to at all times.
- Lift capacities apply to only machine as originally manufactured and normally equipped by KOBELCO CONSTRUCTION MACHINERY CO., LTD.
- This table cannot be applied for high reach demolition machines.

Note: Bluetooth® is a registered trademark of the Bluetooth SIG Inc.

Note: This catalogue may contain attachments and optional equipment that are not available in your area. And it may contain photographs of machines with specifications that differ from those of machines sold in your areas. Please consult your nearest KOBELCO distributor for those items you require. Due to our policy of continuous product improvements all designs and specifications are subject to change without advance notice.

Copyright by **KOBELCO CONSTRUCTION MACHINERY CO., LTD.** No part of this catalogue may be reproduced in any manner without notice.

## KOBELCO CONSTRUCTION MACHINERY EUROPE B.V.

Veluwezoom 15  
 1327 AE Almere  
 The Netherlands  
 www.kobelco-europe.com

Enquiries To: