

# B1500A Semiconductor Device Analyzer

A single-box solution that covers all your device characterization needs

## Introduction

The B1500A Semiconductor Device Analyzer integrates multiple measurement and analysis capabilities for accurate and quick device characterization into a single instrument. It is the only parameter analyzer with the versatility to provide a wide range of device characterization capabilities, uncompromised measurement reliability, and repeatability.



# Accelerate Fundamental Current-Voltage, Capacitance, and Advanced Ultra-Fast IV Device Characterization

## A single-box solution that covers all of your device characterizations needs

The B1500A Semiconductor Device Analyzer integrates multiple measurement and analysis capabilities for accurate and quick device characterization into a single instrument. It is the only parameter analyzer with the versatility to provide a wide range of device characterization capabilities, uncompromised measurement reliability, and repeatability.

It supports all aspects of measurement, from fundamental current-voltage (IV) and capacitance-voltage (CV) characterization up to state-of-the-art fast pulsed IV testing. In addition, the B1500A's ten-slot modular architecture allows you to add or upgrade measurement modules if your measurement needs to change over time.

Keysight Technologies, Inc. EasyEXPERT group+, resident GUI-based software running on the B1500A's embedded Windows 10 platform, supports efficient and repeatable device characterization. Furnished with hundreds of ready-to-use measurements (application tests), the B1500A provides an intuitive and powerful environment for test execution and analysis. It facilitates the accurate and fast electrical characterization and evaluation of devices, materials, semiconductors, active/passive components, or virtually any other type of electronic device.

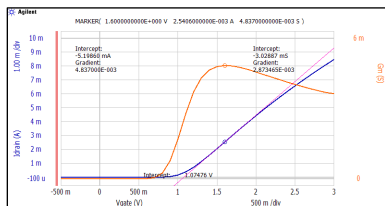

Figure 1. IV measurement

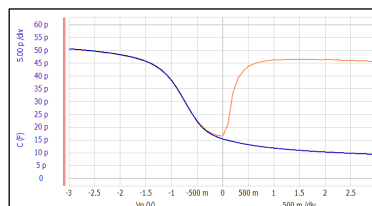

Figure 2. Capacitance measurement

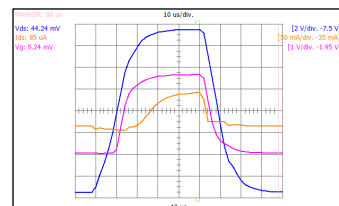

Figure 3. Pulsed IV measurement

Key features	Benefits
Precision voltage and current measurement (0.5 $\mu$ V and 0.1 fA resolution)	<ul style="list-style-type: none"> <li>Accurate characterization of low-level voltages and currents.</li> </ul>
Accurate and low-cost solutions to switch between multi-frequency (1 kHz to 5 MHz) capacitance measurement (CV, C-f, and C-t) and current/voltage (IV) measurement.	<ul style="list-style-type: none"> <li>Switch between CV and IV measurements without the need to re-cable</li> <li>Maintain low-current measurement resolution (down to 1 fA with SCUU and 0.1 fA with ASUs)</li> <li>Full CV compensation out to the DUT</li> </ul>
Ultra-fast IV measurements with 100 ns pulsing and 5 ns sampling rate	<ul style="list-style-type: none"> <li>Capture ultra-fast transient phenomena not accurately measurable with conventional test instruments</li> </ul>
Over 300 ready-to-use application tests	<ul style="list-style-type: none"> <li>Reduce the time needed to learn the instrument, make a measurement, and become productive</li> </ul>
Curve tracer mode with oscilloscope view	<ul style="list-style-type: none"> <li>Develop tests interactively and immediately view the device characteristics</li> <li>Verify current and voltage pulses without any additional equipment (Oscilloscope view with MCSMU)</li> </ul>
Powerful data analysis and robust data management	<ul style="list-style-type: none"> <li>Analyze measured data automatically without an external PC</li> <li>Store measured data and test conditions automatically and quickly recall this information at a later time</li> </ul>

## Making Everyone a Device Characterization Expert

### EasyEXPERT group+ makes device characterization as easy as 1, 2, 3.

The B1500A's EasyEXPERT group+ software includes over 300 ready-to-use application tests, allowing you to measure in three easy steps.

The application test libraries furnished with the B1500A's EasyEXPERT group+ software can help you accelerate the characterization of semiconductor devices and electronic materials, active/passive components, and many other types of electronic devices. Examples of available application tests are shown in the table to the below.

## Category

CMOS transistor
Bipolar Junction Transistor (BJT)
Discrete device
Memory
Power device
Nano device
Reliability test

## Application tests

Id-Vg, Id-Vd, Vth, breakdown, capacitance, QSCV, etc.
Ic-Vc, diode, Gummel plot, breakdown, hfe, capacitance, etc.
Id-Vg, Id-Vd, Ic-Vc, diode, etc.
Vth, capacitance, endurance test, etc.
Pulsed Id-Vg, pulsed Id-Vd, breakdown, etc.
Resistance, Id-Vg, Id-Vd, Ic-Vc, etc.
NBTI/PBTI, charge pumping, electro migration, hot carrier injection, V-Ramp, J-Ramp, TDDb, etc

**Step 1.** Select a measurement from one of the furnished libraries.

**Step 2.** Modify the measurement parameters as needed. (Note: Customized tests can be saved into a "My favorite" setup)

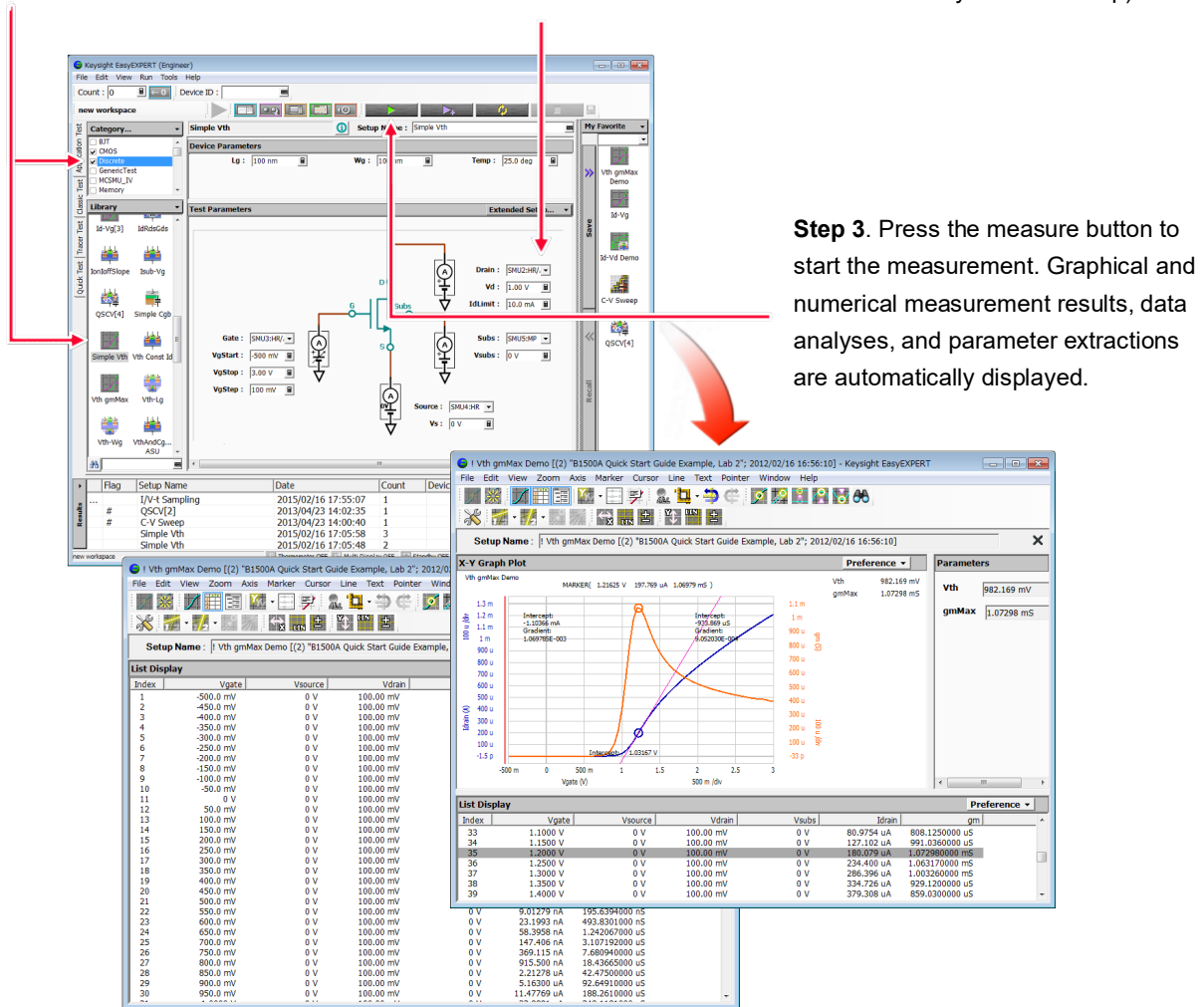
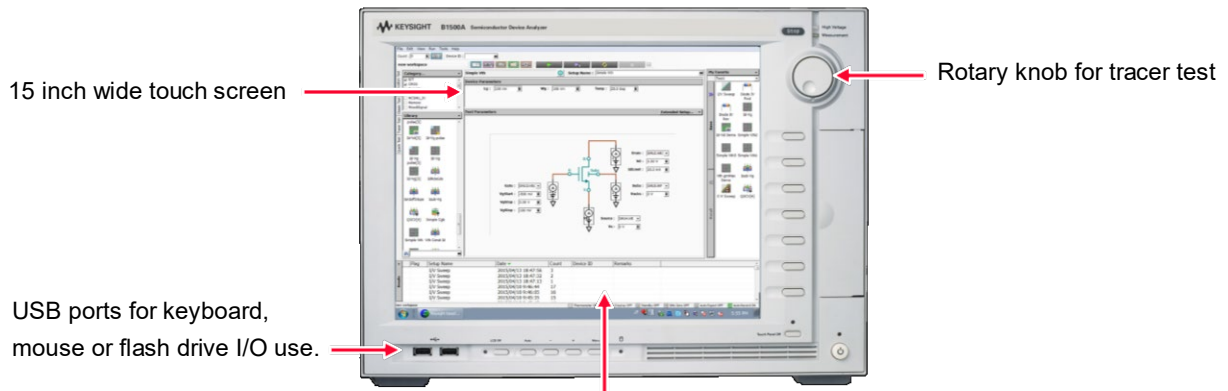

Figure 4. EasyExpert group+ makes device characterization as easy as 1, 2, 3

# EasyEXPERT group+ Software's Intuitive GUI Facilitates Device Characterization

The B1500A platform includes a 15-inch wide touch screen, embedded Windows 10 OS, built-in SSD and DVD drive, and GPIB, USB, and LAN interfaces



## EasyEXPERT group+ supports multiple test modes to improve

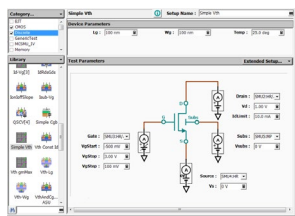

### Application test mode

The application test mode provides application-oriented point-and-click test setup and execution. An application test can be selected from the library by device type and desired measurement.

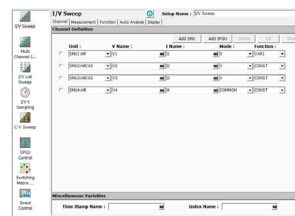

### Classic test mode

The classic test mode provides function-oriented test setup and execution with a similar look and feels to the 4155/4156.

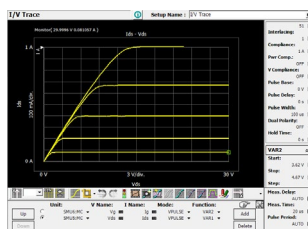

### Tracer test mode

The tracer test mode offers intuitive and interactive sweep control using a rotary knob similar to a curve tracer. Test setups created in tracer test mode can be seamlessly and instantaneously transferred to classic test mode.

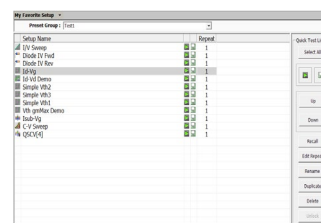

### Quick test mode

The quick test mode enables you to perform test sequencing without programming. To make an automated test sequence, you can select, copy, rearrange, and cut and paste any application tests with a few simple mouse clicks.

# Customizable and Expandable IV, CV, and Ultra-Fast IV Measurement Capabilities Meet Virtually All Testing Needs

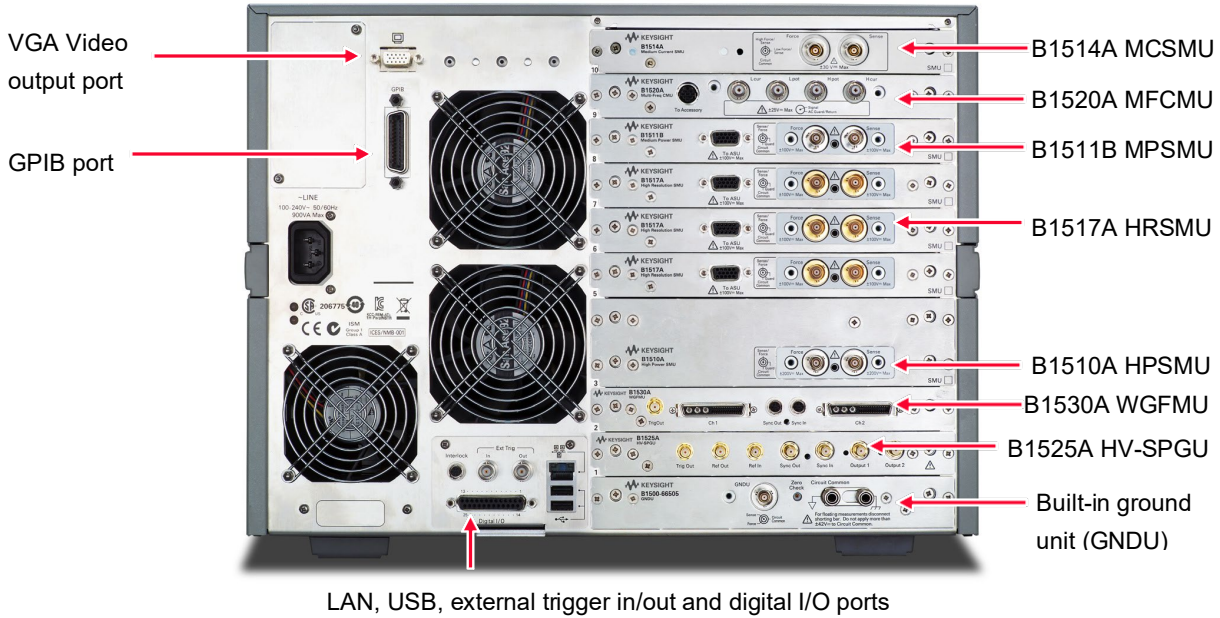

Test coverage	Supported module	Key specifications	Key features
For DC and pulsed IV measurement	B1510A High power Source/Measure Unit (HPSMU)	<ul style="list-style-type: none"> <li>Up to 200 V / 1 A</li> <li>Min 10 fA / 2 <math>\mu</math>V resolution</li> </ul>	<ul style="list-style-type: none"> <li>Min 100 <math>\mu</math>s Sampling (time domain) measurement</li> <li>Min 500 <math>\mu</math>s pulse width with 100 <math>\mu</math>s resolution</li> <li>Quasi-static capacitance-voltage (QSCV) measurement with leakage current compensation</li> <li>4 quadrant operation</li> <li>Kelvin (4-wire) connection</li> <li>Spot, sweep, and other capabilities</li> </ul>
	B1511B Medium Power Source/Measure Unit (MPSMU)	<ul style="list-style-type: none"> <li>Up to 100 V/0.1 A</li> <li>Min 10 fA / 0.5 <math>\mu</math>V resolution</li> <li>Optional ASU for 0.1 fA and IV/CV switching</li> </ul>	
	B1517A High-Resolution Source/Measure Unit (HRSMU)	<ul style="list-style-type: none"> <li>Up to 100 V/0.1 A</li> <li>Min 1 fA / 0.5 <math>\mu</math>V resolution</li> <li>Optional ASU for 0.1 fA and IV/CV switching</li> </ul>	
	B1514A 50 $\mu$ s Pulse Medium Current Source/Measure Unit (MCSMU)	Up to 30 V / 1 A (0.1 A DC)	
For capacitance measurement	B1520A Multi-Frequency Capacitance Measurement Unit (MFCMU)	<ul style="list-style-type: none"> <li>1 kHz to 5 MHz frequency range</li> <li>25 V built-in DC bias and 100 V DC bias with SMU and SCUU</li> </ul>	<ul style="list-style-type: none"> <li>AC impedance measurement (C-V, C-f, C-t)</li> <li>Easy, fast, and accurate IV and CV measurements with automated switching via SCUU</li> </ul>
For ultra-fast pulsed and transient IV measurement	B1530A Waveform Generator/Fast Measurement Unit (WGFMU)	<ul style="list-style-type: none"> <li>10 ns programmable resolution for waveform generation</li> <li>200 MSA/s simultaneous high-speed measurement</li> <li>10 V peak-to-peak output</li> </ul>	<ul style="list-style-type: none"> <li>No load line effects; accurate pulsed IV measurement using SMU-based technology</li> <li>Enabled for advanced applications like NBTI/PBTI, RTN, etc.</li> </ul>
For pulse generation	B1525A High Voltage Semiconductor Pulse Generator Unit (HV-SPGU)	Up to $\pm$ 40 V high voltage output	<ul style="list-style-type: none"> <li>Two-level and three-level pulsing and arbitrary waveform generation capability on each channel</li> <li>Ideal for non-volatile memory testing</li> </ul>

# Absolute Current/Voltage Measurement Confidence

## B1500A SMUs provide easy and accurate IV measurement

A source/monitor unit (SMU) integrates all the resources necessary for IV measurement into a compact module. These include a current source, a voltage source, a current meter, and a voltage meter, along with the ability to switch easily between these resources. The tight integration of these capabilities enables B1500A SMU performance to achieve sub pA current measurement resolution. In addition, SMUs have internal feedback mechanisms that enable them to maintain accurate and stable output and a compliance (limit) feature that protects devices from damage due to excessive voltage or current. All B1500A SMUs also support triaxial connections with active guarding for low current measurement, 4-wire (Kelvin) force and sense connections for low resistance measurement, and full 4-quadrant operation.

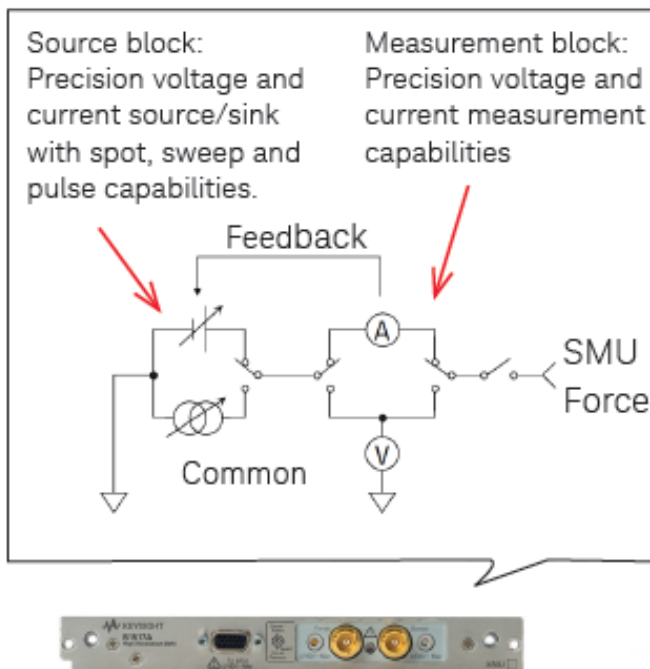

Figure 5. Source/monitor unit

## Multiple functions enhance SMU capabilities

The B1500A SMUs have a variety of versatile measurement capabilities. They can make basic single-point spot measurements and perform sweep measurements of up to 10,001 points. They can also produce voltage and current pulses as narrow as 50  $\mu\text{s}$  and measure quantities over time every 100  $\mu\text{s}$ . In addition, the B1500A SMUs can source and measure voltages and currents of up to 200 V and 1 A, and they can measure voltages and currents with resolutions down to 0.5  $\mu\text{V}$  and 0.1 fA. Other advanced features, such as fast auto-ranging and large capacitive load stabilization, further help to improve performance. The B1500A supports many SMUs, making it easy to mix and match SMU types to meet a wide range of testing needs. The B1500A's SMUs can meet virtually every device and material testing requirement.

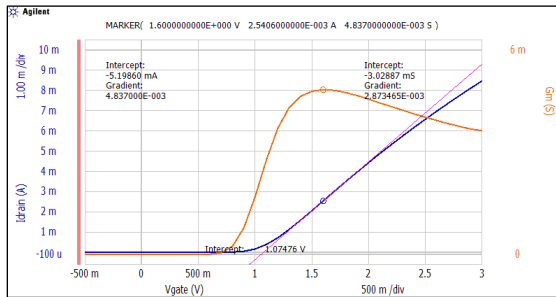

Figure 6. Sweep measurement

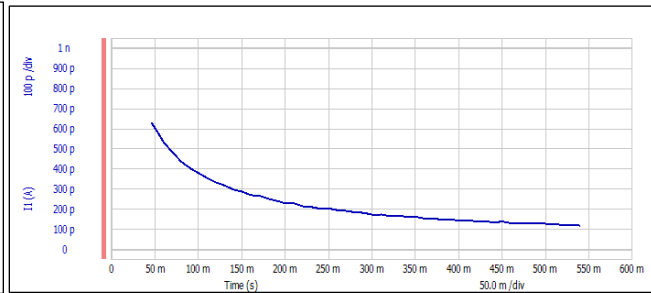

Figure 7. Time sampling measurement

## Impressive 0.1 fA measurement combined with seamless IV-CV switching capability

The B1500A's MPSMU and HRSMU provide an innate measurement resolution of 10 fA and 1 fA (respectively). However, if you need more low current performance, then you can achieve 0.1 fA measurement resolution by combining either of them with the atto-sense and switch unit (ASU). The ASU provides the additional benefit of enabling users to switch between SMU measurements and measurements made through an available BNC input. The ASU's BNC input can be used with the B1500A's MFCMU module for low-cost CV-IV switching (2 SMUs with ASUs required), and it can also be used with other external instruments.

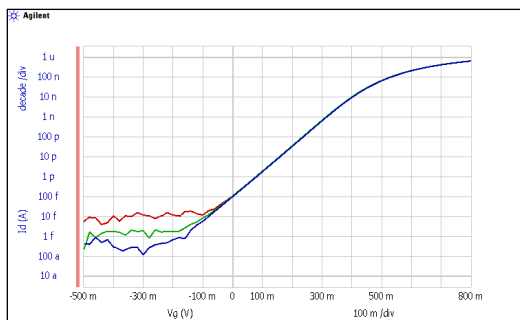

Figure 8. Ultra-low current measurement down to sub-fA



Figure 9. Optional ASU



# Complete Range of Capacitance Measurement Solutions

## Measure C-V, C-f, and C-t from 1 kHz to 5 MHz

The B1500A supports a multi-frequency capacitance measurement unit (MFCMU). The MFCMU can perform all of the capacitance measurements necessary for semiconductor device evaluation, including capacitance vs. voltage (C-V), capacitance vs. frequency (C-f), and capacitance vs. time (C-t). The MFCMU can measure across a wide frequency range (1 kHz to 5 MHz) with a minimum 1 mHz resolution. The MFCMU can also provide up to 25 V of DC measurement bias.

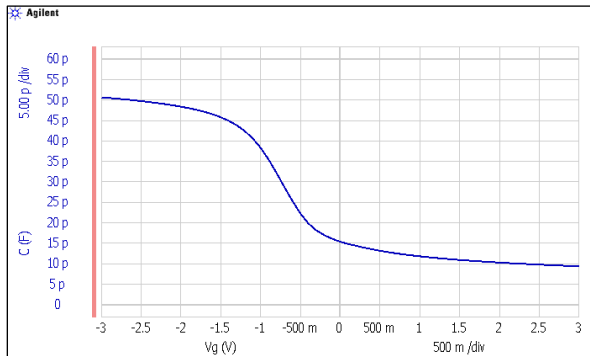

Figure 10. High-frequency CV curve

## Accurate quasi-static CV (QSCV) measurement with leakage compensation

Characterizing the quasi-static CV (QSCV) response of a MOSFET is crucial to understanding its behavior in the important inversion region since high-frequency CV (HFCV) measurements cannot supply this information. The B1500A supports a QSCV measurement function that works with its HPSMUs, MPSMUs, and HRSMUs, and does not require any additional hardware. The QSCV function can compensate for gate leakage currents and perform an offset calibration to remove parasitic capacitances from the measurement.

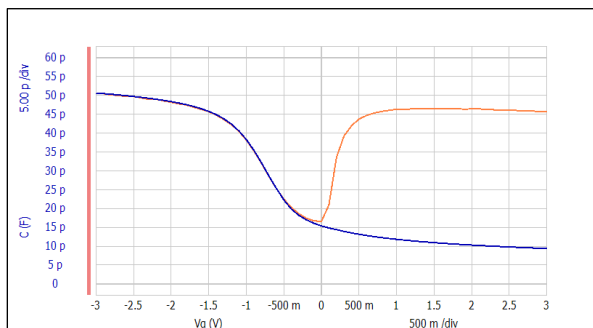

Figure 11. The single instrument performs both high-frequency CV and quasi-static CV measurements

## Switch seamlessly between accurate CV and IV measurements

Since CV and IV measurements use different cabling, manually switching between these measurements can be annoying and time-consuming. To solve this, the B1500A supports an optional SMU CMU unify unit (SCUU) and guard switch unit (GSWU) that supports seamless switching between CV and IV measurements without sacrificing performance. Although optional, by shorting the guards together during capacitance measurements, the GSWU stabilizes the cable inductance and improves capacitance measurement accuracy. The SCUU also has a built-in bias-T that allows the connected SMUs to be used as bias sources for the MFCMU, thereby allowing capacitance measurements with up to 100 V of DC bias. These capabilities allow you to quickly perform both HFCV and QSCV measurements with just one instrument.

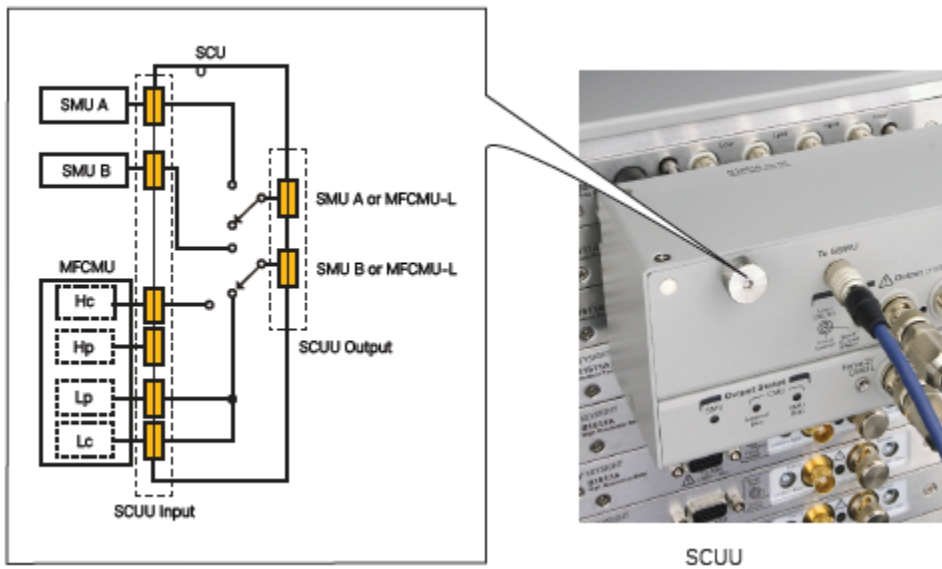
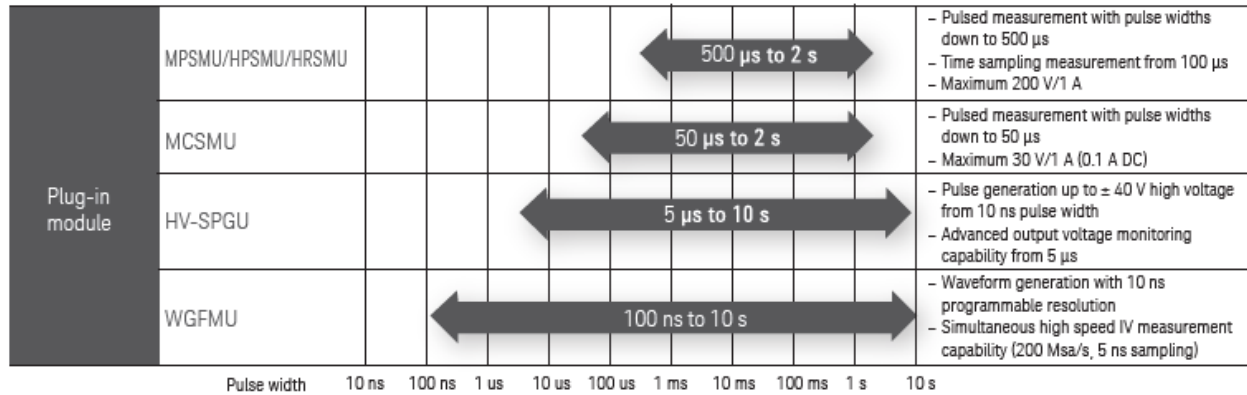

Figure 12. SCUU block diagram

# Multiple Options for Advanced Pulsed Measurement Needs



## A wide range of pulsed measurement solutions

Pulsed measurements play an increasingly important role in device characterization. While the reasons for this are complex, the twin factors of new device physics issues arising from decreasing device sizes and incorporating more exotic materials into device fabrication are the main forces driving this trend. To meet these challenges, the B1500A offers a wide range of pulsed measurement solutions across both its SMU and dedicated pulse generator module options. These choices provide maximum flexibility to select a B1500A configuration with both the capability to meet your pulsed current measurement needs as well as the ability to upgrade in the future if your test needs to change.

## SMU pulsing down to 500 $\mu$ s provides cost-effective time-based measurement

The basic B1500A SMUs (MPSMU, HPSMU, and HRSMU) have both pulsing and time sampling measurement capabilities. An intrinsic timing circuit built into the hardware ensures accurate and repeatable pulse generation down to a width of 500  $\mu$ s. These SMUs can also perform precision time sampling measurements in intervals of 100  $\mu$ s

## MCSMU supports 50 $\mu$ s pulsing and higher instantaneous power

The 50  $\mu$ s pulse medium current SMU (MCSMU) is a specialized SMU designed for faster-pulsed IV measurement. In pulsed mode, it can output higher instantaneous power than the HPSMU (1 A @ 30 V), and it can create current or voltage pulses down to a width of 50  $\mu$ s (10 times narrower than the HPSMU, MPSMU, or HRSMU). In addition, the MCSMU supports the EasyEXPERT group+ oscilloscope view that allows monitoring of multiple voltages and current waveforms (minimum 2  $\mu$ s sampling rate) right on the B1500A front panel. This feature makes it extremely easy to optimize pulsed measurement timings and produce valid Id-Vg and Id-Vd curves.

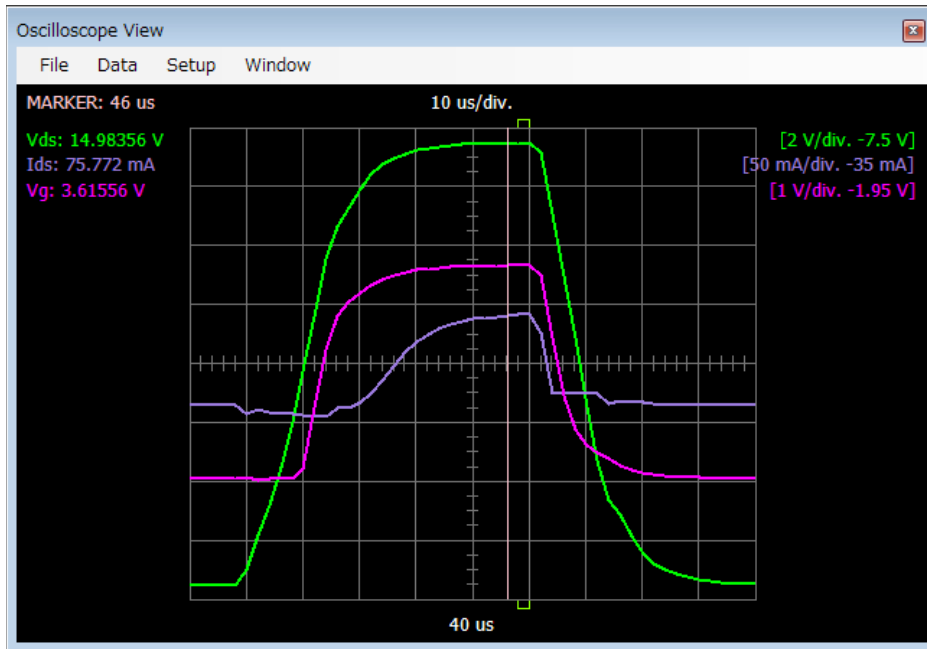

Figure 13. 50  $\mu$ s pulse waveforms generated by MCSMU

# More Efficient Pulsing Improves Advanced Memory and Device Characterization

## HV-SPGU supplies $\pm 40$ V output and supports up to 3-level pulsing for non-volatile memory test

The high-voltage semiconductor pulse generator unit (HV-SPGU) can output pulses of up to  $\pm 40$  V (into an open load), making it ideal for applications such as flash memory evaluation. Moreover, in pulse generator unit (PGU) mode, both HV-SPGU channels can force 2-level or 3-level pulses, which supports the testing of complex flash memory cells. These capabilities make the HV-SPGU the best pulse generator for advanced non-volatile memory (NVM) device characterization.

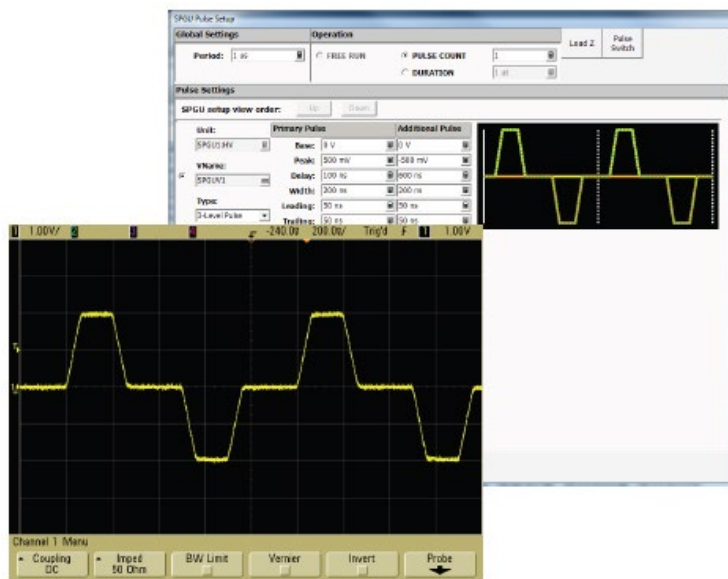

Figure 14. HV-SPGU supports up to 3-level pulsing

## EasyEXPERT group+ HV-SPGU GUI makes it easy to create arbitrary waveforms

In addition to the PGU mode, the HV-SPGU supports an arbitrary linear waveform generator (ALWG) mode for more complex waveform generation. The EasyEXPERT group+ GUI supports a convenient interface for the HV-SPGU ALWG mode, making it easy to create complex waveforms. Waveforms can be created both through an interactive graphical interface as well as by specifying points via a spreadsheet-like table.

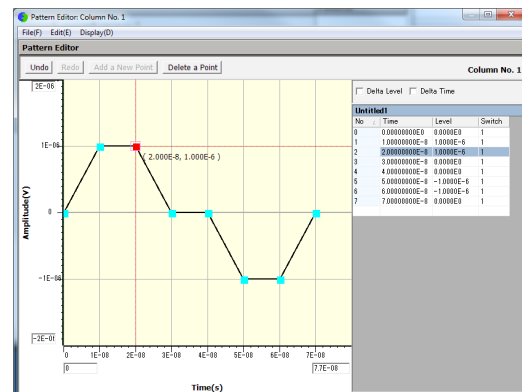
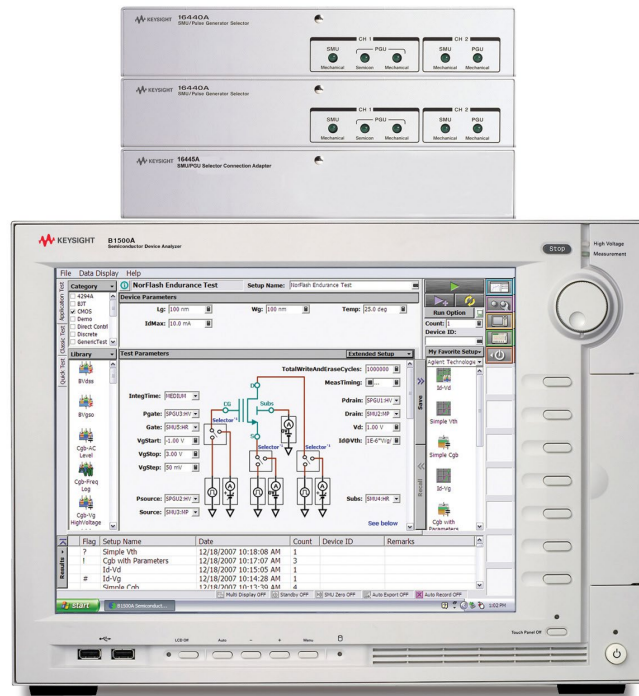

Figure 15. The HV-SPGU supports an arbitrary linear waveform generator (ALWG) mode for more complex waveform generation

## A 15x improvement in write/erase endurance test times

Endurance testing on non-volatile memory is both necessary and time-consuming. However, the B1500A's HV-SPGU module supports numerous features that improve write/erase endurance by up to 15x (relative to the 4155/4156). The HV-SPGU module achieves this impressive performance boost through shorter pulse periods, three-level pulsing, solid-state relays to create an open output state, and faster switching when using the optional 16440A SMU/Pulse Generator Selector. The net result is the fastest and most cost-effective benchtop solution for NVM cell endurance testing on the market.



**Figure 16.** B1500A's HV-SPGU module supports numerous features that enable it to improve write/erase endurance times

# WGFMU Module Enables Ultra-Fast Pulsed Measurements not Previously Possible with Conventional Instruments

## Powerful waveform generator/fast measurement unit (WGFMU) supports advanced ultra-fast pulsed and transient measurement

In many cases, ultra-fast pulsed and transient IV characterizations of advanced next-generation devices is essential to understand their behavior fully. Although it is possible to use a collection of equipment (such as a pulse generator, an oscilloscope, and a shunt resistor) to measure the dynamic behavior of these devices, factors such as instrument accuracy, cabling complexity, and shunt resistance error compensation make it difficult to get valid data. The Keysight B1500A's WGFMU module solves these measurement challenges by combining the capability to generate arbitrary waveforms (with pulse widths down to 100 ns) and simultaneously measure voltage or current with a 5 ns (200 MSa/s) sampling rate. Moreover, in fast IV mode, the WGFMU module can perform ultra-fast voltage or current measurement without inserting a 50  $\Omega$  series resistance into the measurement path (just like an SMU). These features make the WGFMU module ideal for performing ultra-fast NBTI/PBTI, random telegraph signal noise (RTN) measurement, and other ultra-fast pulsed and transient IV measurements.

## WGFMU provides pulsed and transient measurement without load line effects

A classical pulse generator has a 50  $\Omega$  output impedance, which can produce undesirable behavior. When combined with the DUT impedance, the 50  $\Omega$  output impedance creates a voltage divider that impacts the actual voltage applied to the DUT. While it is possible to compensate for this load line effect when the DUT impedance is fixed, if the DUT has dynamic or variable impedance, compensation is impossible. Therefore, pulse generator-based solutions cannot accurately measure the pulsed or transient response of devices whose characteristics change under measurements, such as MOSFET  $I_d$ - $V_g$  sweeps and non-volatile/resistive memory cells. However, the WGFMU module's fast IV mode is SMU-based, so it can perform pulsed and transient IV measurements without introducing any load line effects. In addition, the WGFMU module has a dynamic feedback circuit to ensure that the output voltage matches its programmed value (just like an SMU). The WGFMU module also has a dynamic range selection capability to optimize measurement resolution along the entire waveform output. For these reasons, the WGFMU module's SMU-based design allows it to perform accurate, fast pulse, and transient IV measurements even for devices with dynamically changing characteristics.

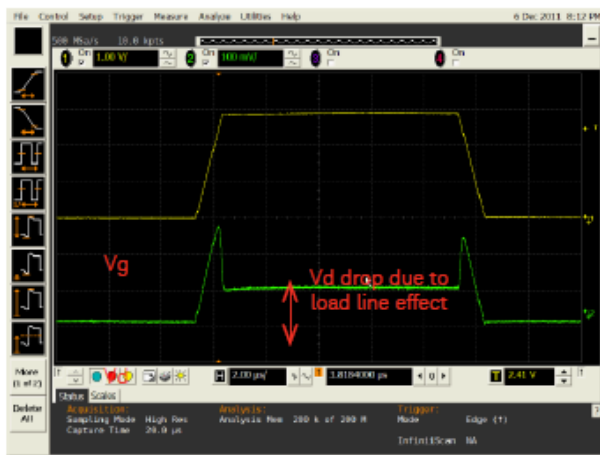
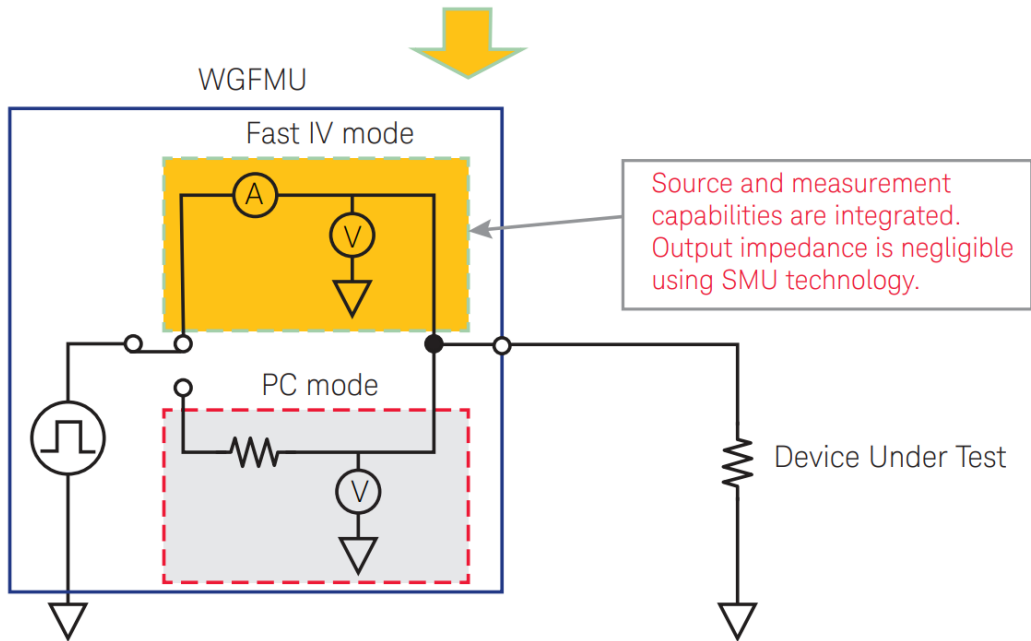
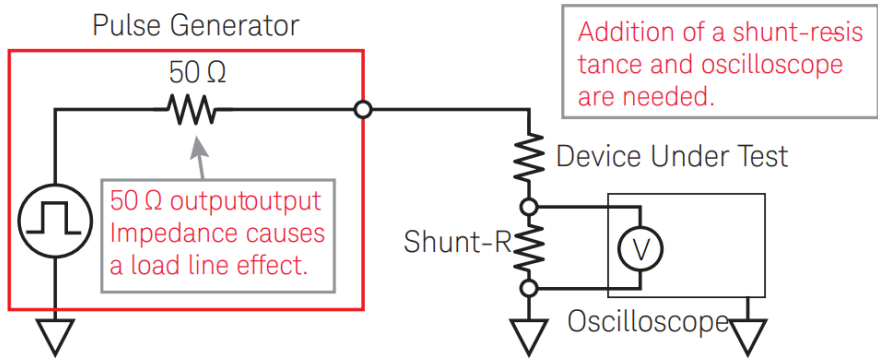

**Figure 17.** Effect of 50 Ω load line on Id-Vg measurement (conventional PG based solution)

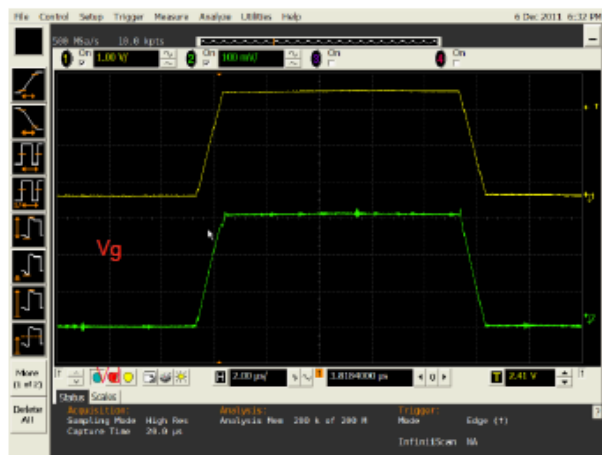

**Figure 18.** WGF MU module's high-speed SMU technology eliminates load line effects



# B1500A Overcomes Advanced Device Characterization Challenges

## Ultra-fast NBTI/PBT

MOSFET threshold voltage ( $V_{th}$ ) degradation under high gate bias and high temperature is critical for advanced semiconductor reliability. The twin phenomena of negative bias temperature instability (NBTI) and positive bias temperature instability (PBTI) require extremely fast measurement equipment since the  $V_{th}$  degradation recovers very quickly once the stress is removed. In fact, measurement needs to begin within a time range of 1  $\mu$ s to 100  $\mu$ s after removing the stress to avoid dynamic recovery effects. The Keysight B1500A offers two solutions for BTI testing: an SMU-based on-the-fly measurement scheme with a sampling rate of 100  $\mu$ s and a WGFMU-based ultra-fast technique that can start measurement in less than 1  $\mu$ s.

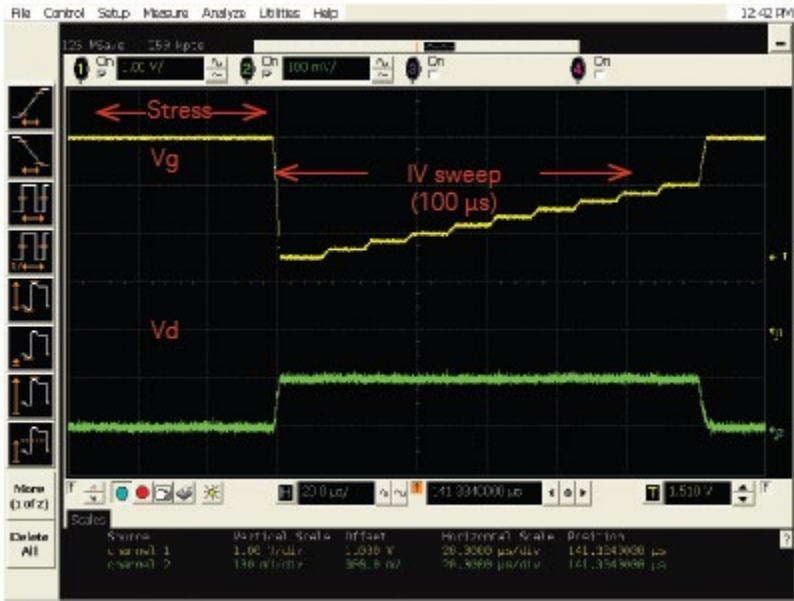

Figure 19. 1  $\mu$ s ultra-fast BTI measurement

## Random telegraph signal noise (RTN)

Random telegraph signal noise (RTN) is a phenomenon that typically causes fluctuations in the drain current of a MOSFET. It is observed as random switching between two or more discrete current levels, and the root cause is generally considered to be due to electron trapping and de-trapping. Although RTN has long been a concern of CMOS image sensor makers, as device sizes have shrunk, it has become of concern to all semiconductor device manufacturers since it has begun to impact SRAM cell stability. The WGFMU module is an ideal tool for measuring RTN since it has a noise floor of less than 0.1 mV (rms), a 5 ns sampling rate, and a four-million-point data buffer. These capabilities enable the WGFMU module to measure RTN over a frequency range that extends from less than 1 Hz up to several MHz.

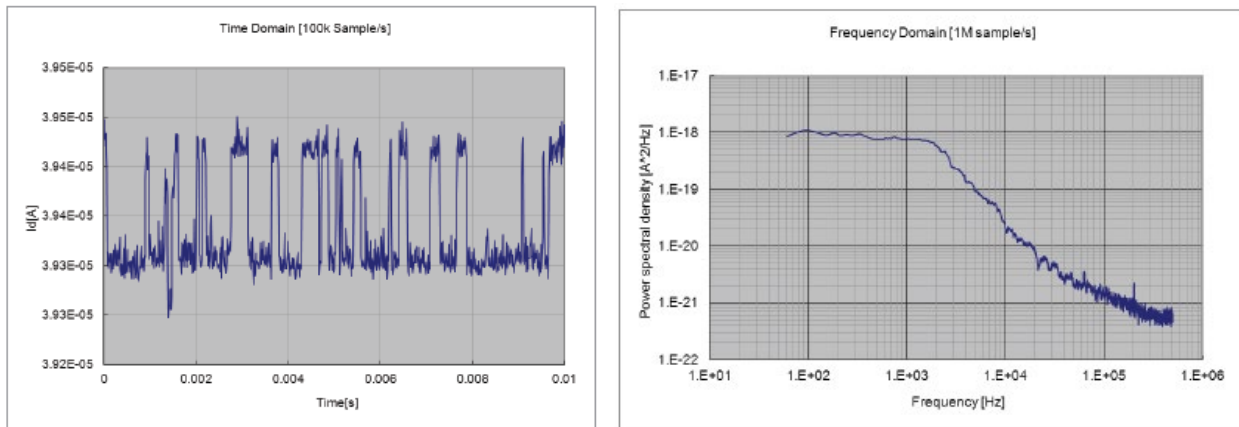

Figure 20. Random telegraph signal noise (RTN) measurement

Also, an on-wafer automated RTN measurement system can be provided at a low cost by using WGFMU with W7801B, the WaferPro Express WGFMU measurement bundle software license.

### Key features of W7801B

- Automated RTN and  $1/f$  noise measurement and data analysis
- Wafer mapping
- Multiple data overlapping display
- System noise floor display and data clipping

To learn more about the W7801B, please see the link below.

- <https://www.keysight.com/en/pd-3068581-pn-E4727B/advanced-low-frequency-noise-analyzer>
- <https://www.keysight.com/us/en/assets/3120-1435/data-sheets/E4727B-Advanced-Low-Frequency-Noise-Analyzer.pdf>

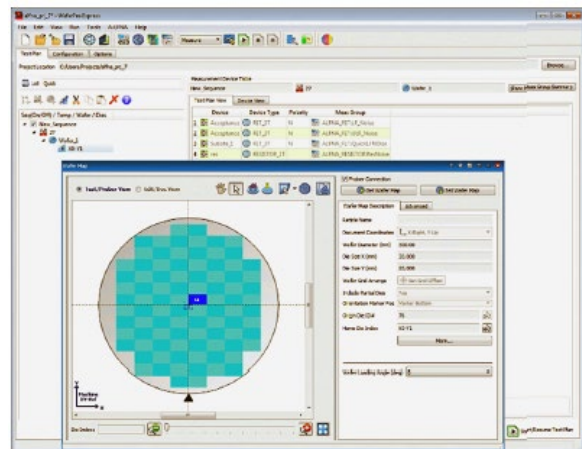

Figure 21. Using WGFMU with W7801B the WaferPro Express WGFMU measurement bundle software license

# EasyEXPERT group+ Makes It Easy to Collect, Process, and Organize Parametric Measurement Data

## Application test mode provides extensive libraries of pre-defined tests

Application test mode provides convenient task-oriented point-and-click test setup and execution. An application test can be selected from the furnished libraries by device type and desired measurement and then executed after modifying the default input parameters as needed. Modified test setups can be stored in a “My Favorite” list for quick future execution. The application tests are also completely user-modifiable using EasyEXPERT group+'s built-in graphical programming environment.

## Classic test mode provides full hardware control along with the 4155/56 look and feel

Classic test mode provides full access to the B1500A's hardware capabilities. It has a similar look and feel and uses the same terminology as the 4155/4156's front-panel interface. In addition, it actually improves the 4155/4156 user interface by taking full advantage of EasyEXPERT group+'s windows-based features.

## Automated graphical display, analysis, and parameter extraction capabilities improve efficiency

EasyEXPERT group+ supports powerful data display, analysis, and arithmetic functions that facilitate automated data analysis and parameter extraction. The pre-defined data analyses and parameter extractions are performed in real-time, allowing you to see measurement results immediately without any post-measurement data processing. Moreover, both graphical and numerical results can be saved automatically to any connected remote storage location.

## Data is protected for both interactive and automated measurements

EasyEXPERT group+ has numerous means to ensure measurement data integrity. It supports multiple workspaces (that can be either public or private) to provide an easy means to manage data and application tests. It also provides the ability to back up workspaces and export them to other computers. Within a workspace, you can select automatic data recording, which saves not only the measurement data but also the measurement setup conditions as well to improve the repeatability of your device characterizations. The measurement setup and data can easily be recalled later to duplicate the measurement. It is also easy to export measurement data manually or automatically into file formats such as TXT, CSV, etc., for further analysis on an external PC.

Application Test mode

Classic Test mode

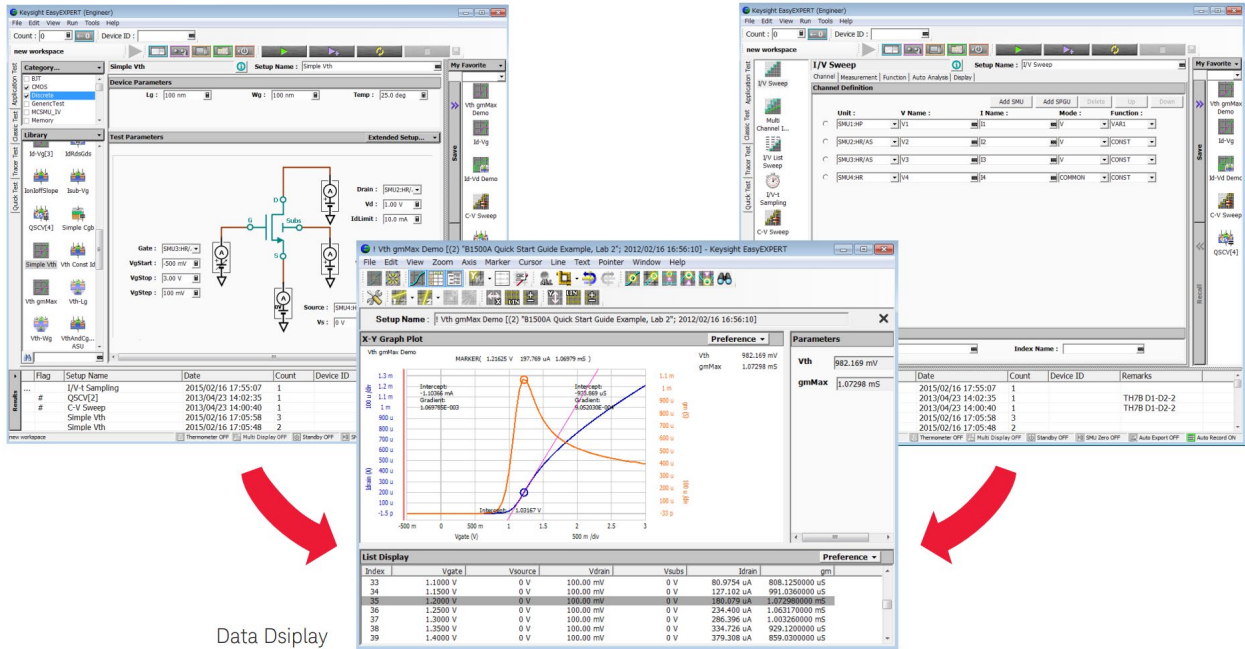

Data Display

Figure 22. Application test mode, data display, automated graphical display, and classic test mode on EasyExpert group+

# Quickly Optimize Test Conditions of Unfamiliar Devices

## Tracer test's knob-based real-time curve tracing capabilities accelerate device characterization

Tracer test mode offers intuitive and interactive sweep control using a rotary knob similar to that of an analog curve tracer. Just like a curve tracer, you can sweep in only one direction (useful for R&D device analysis) or in both directions (useful for failure analysis applications). Furthermore, test setups created in tracer test mode can be quickly transferred into classic test mode and enhanced using classic test mode's auto-analysis tools.

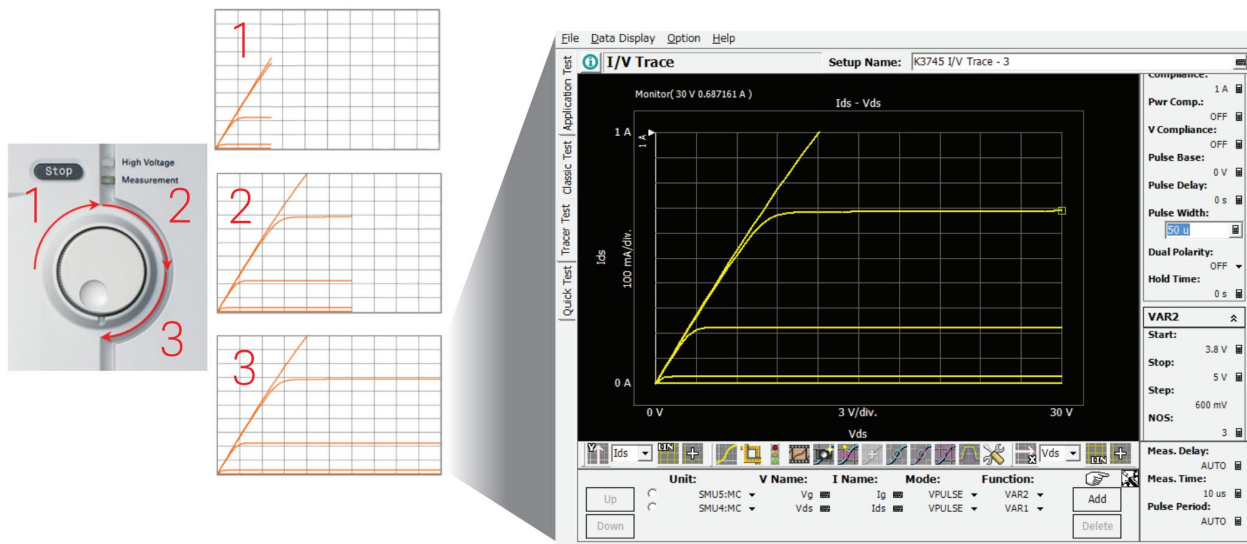
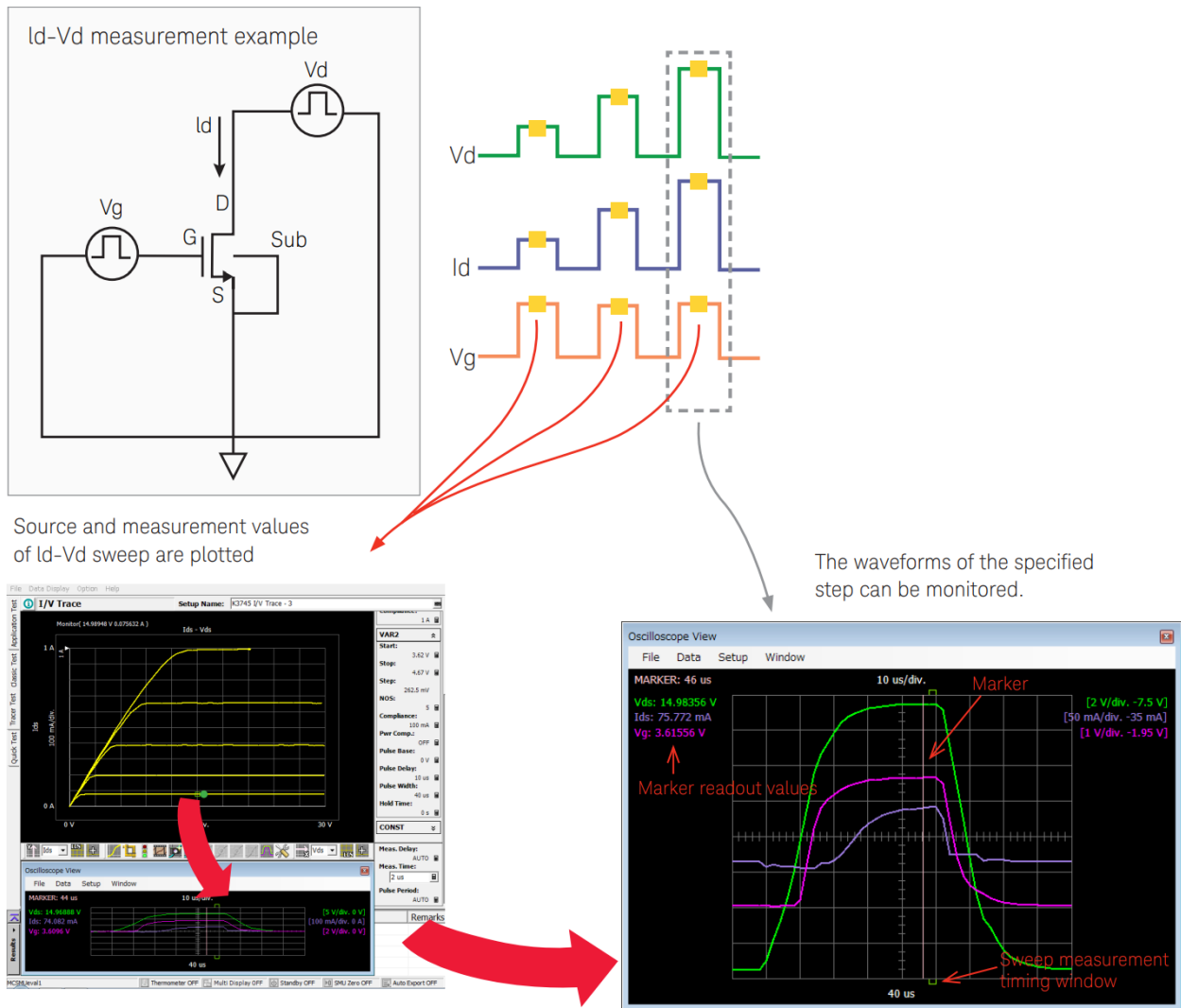

Figure 23. Tracer test mode offers intuitive and interactive sweep control using a rotary knob

# Verify pulsed measurements without an external oscilloscope

The Oscilloscope view (available for use with the MCSMU modules in tracer test mode) displays measured current and voltage data versus time right on the B1500A front panel. The Oscilloscope view can display pulsed waveform timings at any user-specified point along a sweep measurement. The pulsed waveforms appear in a separate window for easy measurement timing verification. This feature is useful for verifying waveforms, optimizing timing parameters, and debugging pulsed measurements.

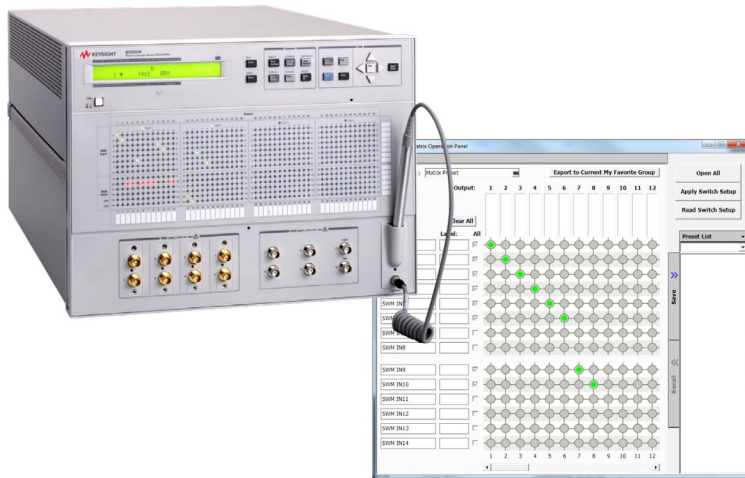

**Figure 24.** Oscilloscope view can display pulsed waveform timings at any userspecified point along a sweep measurement

# Optimize the Use of Switching Matrices, Wafer Probers, and IC-CAP

## EasyEXPERT group+ provides convenient switching matrix control

A switching matrix is often used with a parameter analyzer to provide more flexible connectivity. To help with this, EasyEXPERT group+ supports an intuitive GUI to control the Keysight B2200A, B2201A, and E5250A switching matrices. It both eliminates the need to program and facilitates automated testing.



**Figure 25.** EasyEXPERT group+ supports an intuitive GUI to control the Keysight B2200A, B2201A, and E5250A switching matrices

## Support for Keysight IC-CAP MDM file conversion

Keysight IC-CAP, a popular device modeling software solution, has long supported the B1500A. However, now the B1500A supports an MDM file converter tool to convert EasyEXPERT group+ data into the IC-CAP compatible MDM file format. This allows IC-CAP users to take advantage of EasyEXPERT group+'s powerful capabilities when performing device modeling characterizations.

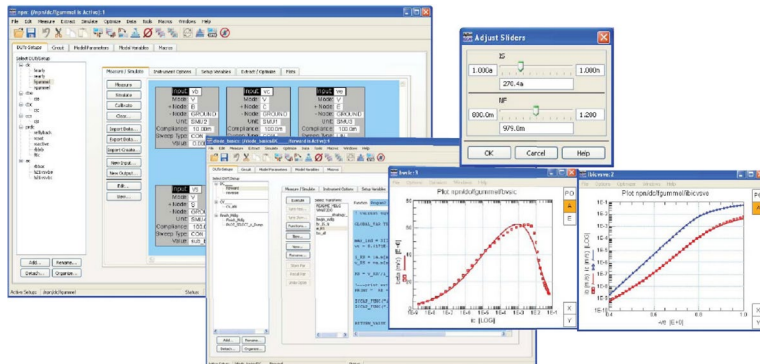

**Figure 26.** the B1500A supports an MDM file converter tool to convert EasyEXPERT group+ data into the IC-CAP compatible MDM file format

# Automate testing with semi-auto wafer probers

A GUI-based quick test mode enables you to perform test sequencing without programming. You can select, copy, rearrange, and cut-and-paste application tests with a few simple mouse clicks. Once you have selected and arranged your tests, simply click the measurement button to run an automated test sequence. You can combine wafer prober control with the quick test mode to perform multiple testing across the wafer. If you are using a switching matrix, you can also call switching patterns automatically. All popular semiautomatic wafer probers are supported, and you can also create your own wafer prober drivers.

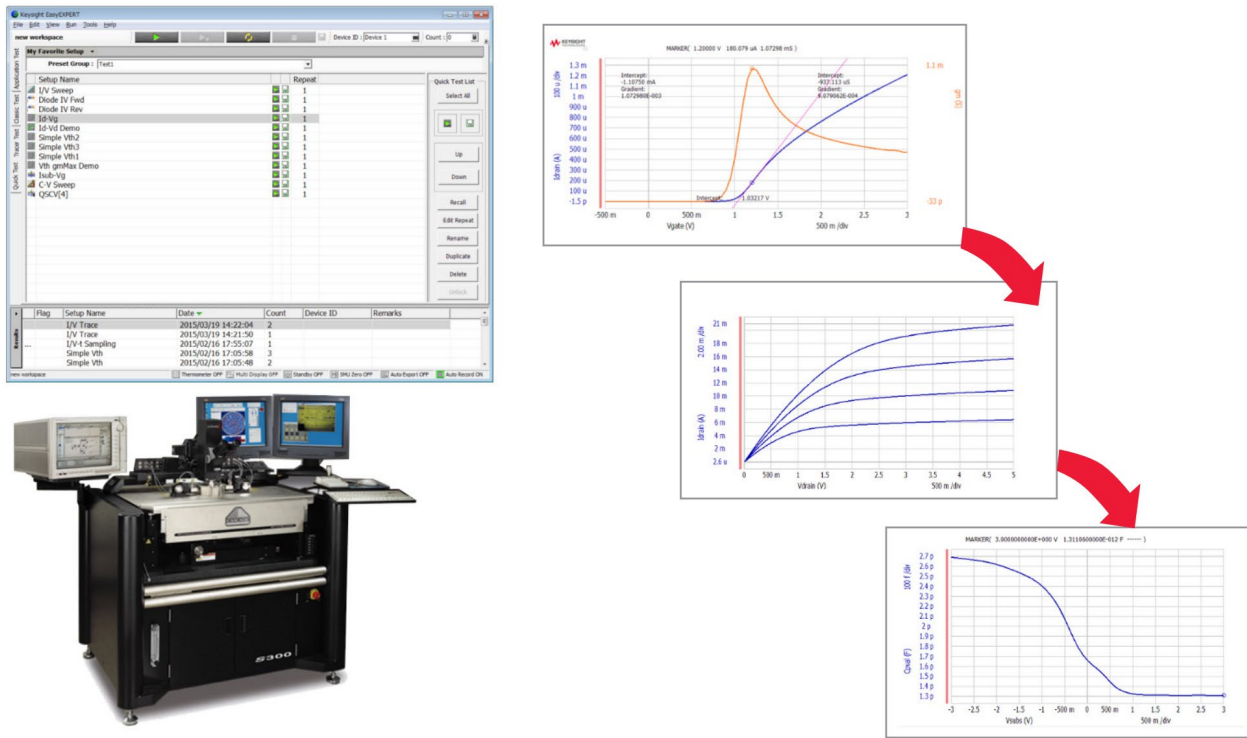

Figure 27. A GUI-based quick test mode enables you to perform test sequencing without programming.



# Flexible B1500A Remote Control and Networking Options

## Utilize your interactively created application tests for remote testing

The LAN-based EasyEXPERT group+ remote control function allows you to use the hundreds of furnished application tests for automated testing in the programming language of your choice. The B1500A is the only parameter analyzer that maximizes your efficiency by allowing you to modify and create application tests interactively and then run them remotely.

## B1500A FLEX command set optimizes speed and efficiency

If you prefer to control the B1500A's hardware resources directly, then you can use the B1500A's FLEX command set. You can use FLEX commands with any programming language via the GPIB interface. Moreover, extremely fast measurement speeds are possible since the B1500A front panel does not update under FLEX control.

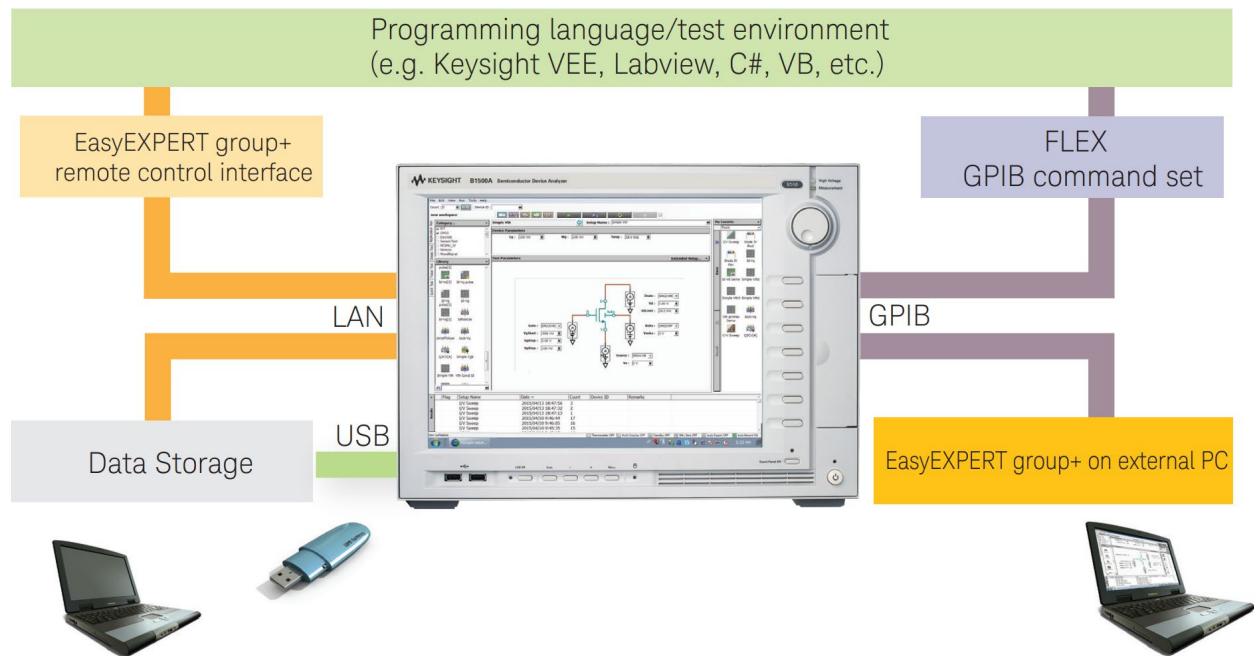

Figure 28. Flexible B1500A Remote Control and Networking Options

## Take full advantage of the analyzer's powerful measurement and analysis capabilities from the lab to the office

EasyEXPERT group+ can be installed on your PC and used as your personal analyzer. Because it can be connected to the instrument via a USB-GPIB interface, it is portable and can be used seamlessly either for offline tasks in the office or online measurement execution in the lab. It does not need to be within range of the instrument to operate correctly, and most of the tasks can be operated in the office with the PC peripherals such as wide display, USB, SSD, and software such as Excel to improve productivity.

## Optimize the use of existing Keysight 4155/4156 hardware and measurement setups

You can use EasyEXPERT group+ to control the 4155/4156 (B or C versions) over GPIB from a PC. This allows you to use 4155/4156 measurement resources while enjoying the flexibility and data transfer capabilities available in a Windows-based environment. In addition, a 4155/4156 setup file converter tool is available that can translate 4155/4156 MES and DAT files into equivalent classic mode tests. Both of these capabilities are especially useful in labs where you have a mixture of newer B1500A units and older 4155/4156 equipment.

# For More Information

Keysight Precision Current-Voltage Analyzer Series and Power Device Analyzer Series

Visit: [www.keysight.com/find/analyzer](http://www.keysight.com/find/analyzer)



Keysight enables innovators to push the boundaries of engineering by quickly solving design, emulation, and test challenges to create the best product experiences. Start your innovation journey at [www.keysight.com](http://www.keysight.com).



This information is subject to change without notice. © Keysight Technologies, 2018 – 2023, Published in USA, March 29, 2023, 5991-2443EN