

NFX250 Network Services Platform Hardware Guide

Published
2023-09-21

Juniper Networks, Inc.
1133 Innovation Way
Sunnyvale, California 94089
USA
408-745-2000
www.juniper.net

Juniper Networks, the Juniper Networks logo, Juniper, and Junos are registered trademarks of Juniper Networks, Inc. in the United States and other countries. All other trademarks, service marks, registered marks, or registered service marks are the property of their respective owners.

Juniper Networks assumes no responsibility for any inaccuracies in this document. Juniper Networks reserves the right to change, modify, transfer, or otherwise revise this publication without notice.

NFX250 Network Services Platform Hardware Guide
Copyright © 2023 Juniper Networks, Inc. All rights reserved.

The information in this document is current as of the date on the title page.

YEAR 2000 NOTICE

Juniper Networks hardware and software products are Year 2000 compliant. Junos OS has no known time-related limitations through the year 2038. However, the NTP application is known to have some difficulty in the year 2036.

END USER LICENSE AGREEMENT

The Juniper Networks product that is the subject of this technical documentation consists of (or is intended for use with) Juniper Networks software. Use of such software is subject to the terms and conditions of the End User License Agreement ("EULA") posted at <https://support.juniper.net/support/eula/>. By downloading, installing or using such software, you agree to the terms and conditions of that EULA.

Table of Contents

About This Guide | viii

1

Overview

NFX250 Network Services Platform Overview | 2

NFX250 Device Hardware Overview | 2

NFX250 Device Models | 3

NFX250 Chassis | 6

Front Panel of an NFX250 Device | 6

Rear Panel of an NFX250 Device | 7

Chassis Status LEDs on NFX250 Devices | 8

Network Port and Uplink Port LEDs on NFX250 Devices | 10

Management Port LEDs on NFX250 Devices | 12

NFX250 Cooling System | 13

NFX250 Power System | 14

Power Supply in NFX250 Devices | 15

AC Power Supply Specifications for an NFX250 Device | 15

AC Power Cord Specifications for an NFX250 Device | 15

2

Site Planning, Preparation, and Specifications

Site Preparation Checklist for NFX250 Devices | 20

NFX250 Site Guidelines and Requirements | 22

General Site Guidelines | 23

Site Electrical Wiring Guidelines | 23

Chassis Physical Specifications for an NFX250 Device | 24

Clearance Requirements for Airflow and Hardware Maintenance for an NFX250 Device | 25

Rack Requirements for NFX250 Devices | 26

- Cabinet Requirements for an NFX250 Device | 28
- Requirements for Mounting an NFX250 Device on a Desktop or Other Level Surface | 29
- Requirements for Mounting an NFX250-LS1 Device on a Wall | 30

NFX250 Network Cable and Transceiver Planning | 30

- Pluggable Transceivers Supported on NFX250 Devices | 30
- SFP+ Direct Attach Cables for NFX250 Devices | 60
- Understanding NFX250 Devices Fiber-Optic Cable Signal Loss, Attenuation, and Dispersion | 65
- Calculating the Fiber-Optic Cable Power Budget for an NFX250 Device | 66
- Calculating the Fiber-Optic Cable Power Margin for an NFX250 Device | 67

NFX250 Cable Specifications and Pinouts | 69

- Cable Specifications for Console and Management Connections for the NFX250 Devices | 69
- Mini-USB Type-B Console Port Specifications for an NFX250 Device | 70
- Console Port Connector Pinouts for NFX250 Devices | 71
- USB Port Specifications for an NFX250 Device | 72
- Management Port Connector Pinout Information for an NFX250 Device | 73
- Network Port Connector Pinout Information for an NFX250 Device | 74
- RJ-45 to DB-9 Serial Port Adapter Pinout Information for an NFX250 Device | 75

3

Initial Installation and Configuration

NFX250 Installation Overview | 78

Unpacking and Mounting the NFX250 | 79

- Unpacking an NFX250 Device | 79
- Parts Inventory (Packing List) for an NFX250 Device | 80
- Register Products—Mandatory to Validate SLAs | 81
- Mounting an NFX250 Device | 81
- Mounting an NFX250 Device on a Desk or Other Level Surface | 82
- Mounting an NFX250-LS1 Device on a Wall | 83

Mounting an NFX250 Device on Two Posts in a Rack | 86

Mounting an NFX250 Device on Four Posts in a Rack or Cabinet | 88

Connecting the NFX250 to Power | 91

Connecting Earth Ground to an NFX250 Device | 91

Connecting AC Power to an NFX250 Device | 93

Connecting the NFX250 to the Network | 95

Connecting an NFX250 Device to a Network for Out-of-Band Management | 95

Connecting an NFX250 Device to a Management Console | 96

Connecting an NFX250 Device to a Management Console Using Mini-USB Type-B Console Port | 98

Initial Configuration on NFX250 Devices | 99

4

Maintaining Components

Maintaining Transceivers on the NFX250 | 104

Installing a Transceiver in an NFX250 Device | 104

Removing a Transceiver from an NFX250 Device | 105

Maintaining Fiber Optic Cables on the NFX250 | 107

Connecting a Fiber-Optic Cable to an NFX250 Device | 108

Disconnecting a Fiber-Optic Cable from an NFX250 Device | 109

Maintaining Fiber-Optic Cables in an NFX250 Device | 110

Removing the NFX250 Device from a Rack or Cabinet | 111

Powering Off an NFX250 Device | 111

Removing an NFX250 Device from a Rack or Cabinet | 113

5

Troubleshooting Hardware

Understanding Alarm Types and Severity Levels on NFX250 Devices | 116

6

Contacting Customer Support and Returning the Chassis or Components

Contacting Customer Support and Returning the Chassis or Components | 119

Returning a NFX250 Device or Component for Repair or Replacement | 119

Locating the Serial Number on an NFX250 Device | 120

Listing the Device and Components Details with the CLI | 120

Locating the Chassis Serial Number ID Label on an NFX250 Device | 121

Contacting Customer Support to Obtain a Return Materials Authorization for an NFX250 Device | 121

Packing a NFX250 Device or Component for Shipping | 122

Packing a NFX250 Device for Shipping | 123

Packing NFX250 Device Components for Shipping | 124

7

Safety and Compliance Information

General Safety Guidelines and Warnings | 127

Definitions of Safety Warning Levels | 128

Qualified Personnel Warning | 130

Warning Statement for Norway and Sweden | 130

Fire Safety Requirements | 131

Installation Instructions Warning | 132

Chassis Lifting Guidelines for NFX250 Devices | 133

Restricted Access Warning | 133

Ramp Warning | 134

Rack-Mounting and Cabinet-Mounting Warnings | 135

Laser and LED Safety Guidelines and Warnings for the NFX250 Devices | 139

Radiation from Open Port Apertures Warning | 145

Maintenance and Operational Safety Guidelines and Warnings | 146

General Electrical Safety Guidelines and Warnings | 151

Action to Take After an Electrical Accident | 153

Prevention of Electrostatic Discharge Damage | 153

AC Power Electrical Safety Guidelines | 155

AC Power Disconnection Warning | 156

TN Power Warning | 157

Agency Approvals for NFX250 Devices | 158

Compliance Statements for EMC Requirements for NFX250 Devices | 159

Statements of Volatility for Juniper Network Devices | 163

About This Guide

Use this guide to install hardware and perform initial software configuration, routine maintenance, and troubleshooting for the NFX250 Series devices. After completing the installation and basic configuration procedures covered in this guide, refer to the Getting Started with NFX250 Network Services Platform guide for information about further software configuration.

RELATED DOCUMENTATION

| [NFX250 Network Services Platform Quick Start](#)

1

CHAPTER

Overview

[NFX250 Network Services Platform Overview | 2](#)

[NFX250 Chassis | 6](#)

[NFX250 Cooling System | 13](#)

[NFX250 Power System | 14](#)

NFX250 Network Services Platform Overview

IN THIS SECTION

- [NFX250 Device Hardware Overview | 2](#)
- [NFX250 Device Models | 3](#)

NFX250 Device Hardware Overview

IN THIS SECTION

- [NFX250 Hardware | 2](#)
- [System Software | 3](#)

The Juniper Networks NFX250 Network Services Platform comprises the Juniper Networks NFX250 devices, which are Juniper Network's secure, automated, software-driven customer premises equipment (CPE) devices that deliver virtualized network and security services on demand. Leveraging Network Functions Virtualization (NFV) and built on the Juniper Cloud CPE solution, NFX250 enables service providers to deploy and service chain multiple, secure, high-performance virtualized network functions (VNFs) as a single device. This automated, software-driven solution dynamically provisions new services on demand.

This topic covers:

NFX250 Hardware

NFX250 devices are available in four compact 1 U models that provide VNF and Packet Forwarding Engine capacity, and a rich set of Layer 2 and Layer 3 features.

NFX250 device has Eight 1-GbE network ports, two 1-GbE RJ-45 ports which can be used as either access ports or as uplinks, two SFP ports, two SFP+ ports, and one management port. NFX250 device has a 1 U form factor and comes with built-in fans and power supply.

Figure 1: NFX250 Port Panel

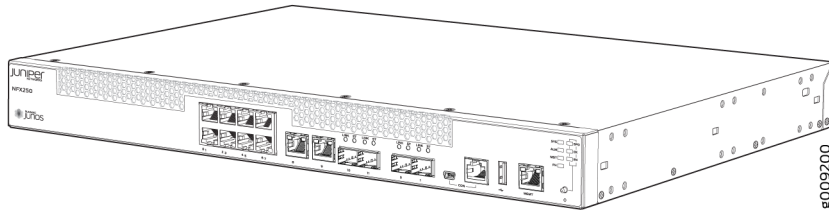

NFX250 device can be used as:

- An integrated branch router and switch, extensible with VNFs.
- A CPE for service providers.
- A secure router for distributed enterprises.

System Software

NFX250 devices use the Junos Device Manager (JDM) for virtual machine (VM) lifecycle and device management, and for a host of other functions. The JDM CLI is displayed when you log in to the NFX250 device. The JDM CLI is similar to the Junos OS CLI in look and provides the same added-value facilities as the Junos OS CLI.

You can manage the device by using the JDM CLI, accessible through the console and the out-of-band management ports on the device.

NFX250 Device Models

The NFX250 device is available in four models. All the models are shipped with built-in AC power supply and have airflow-out (front-to-back) cooling.

[Table 1 on page 4](#) lists the NFX250 device models.

Table 1: NFX250 Device Models

Product Numbers	Control Plane	Memory	Ports	Power Supply	Airflow
NFX250-S1	1.9 GHz 6-core Intel CPU	16 GB of memory and 100 GB of enterprise grade solid-state drive (SSD) storage	Eight 1-GbE network ports, two 1-GbE RJ-45 ports which can be used as either access ports or as uplinks, two SFP ports, two SFP+ ports, one Management port, and two Console ports	AC	Front-to-back (AFO) forced cooling
NFX250-S2	1.9 GHz 6-core Intel CPU	32 GB of memory and 400 GB of enterprise grade SSD storage	Eight 1-GbE network ports, two 1-GbE RJ-45 ports which can be used as either access ports or as uplinks, two SFP ports, two SFP+ ports, one Management port, and two Console ports	AC	Front-to-back (AFO) forced cooling

Table 1: NFX250 Device Models *(Continued)*

Product Numbers	Control Plane	Memory	Ports	Power Supply	Airflow
NFX250-LS1	1.6 GHz 4-core Intel CPU	16 GB of memory and 100 GB of enterprise grade solid-state drive (SSD) storage	Eight 1-GbE network ports, two 1-GbE RJ-45 ports which can be used as either access ports or as uplinks, two SFP ports, two SFP+ ports, one Management port, and two Console ports	AC	Front-to-back (AFO) forced cooling
NFX250-S1E	2.0 GHz 6-core Intel CPU	16 GB of memory and 200 GB of enterprise grade solid-state drive (SSD) storage	Ten 1-GbE network ports, two 1-GbE RJ-45 ports which can be used as either access ports or as uplinks, two SFP ports, two SFP+ ports, one Management port, and two Console ports	AC	Front-to-back (AFO) forced cooling

RELATED DOCUMENTATION

| [NFX250 Installation Overview](#) | 78

NFX250 Chassis

IN THIS SECTION

- [Front Panel of an NFX250 Device | 6](#)
- [Rear Panel of an NFX250 Device | 7](#)
- [Chassis Status LEDs on NFX250 Devices | 8](#)
- [Network Port and Uplink Port LEDs on NFX250 Devices | 10](#)
- [Management Port LEDs on NFX250 Devices | 12](#)

Front Panel of an NFX250 Device

The front panel of an NFX250 device consists of the following components:

- Eight 1-Gigabit Ethernet network ports
- Two 1-Gigabit Ethernet RJ-45 network/uplink ports
- Two 1-Gigabit SFP network/uplink ports
- Two 1/10-Gigabit SFP+ uplink ports
- SFP and SFP+ ports Link and Status LEDs
- 1 Mini-USB Type-B Console Port
- 1 RJ-45 Console port
- 1 USB port
- 1-Gigabit Management port
- 4 System Status LEDs
- 3 Port Parameter LEDs
- 1 Mode Button

Figure 2: NFX250 Front Panel Components

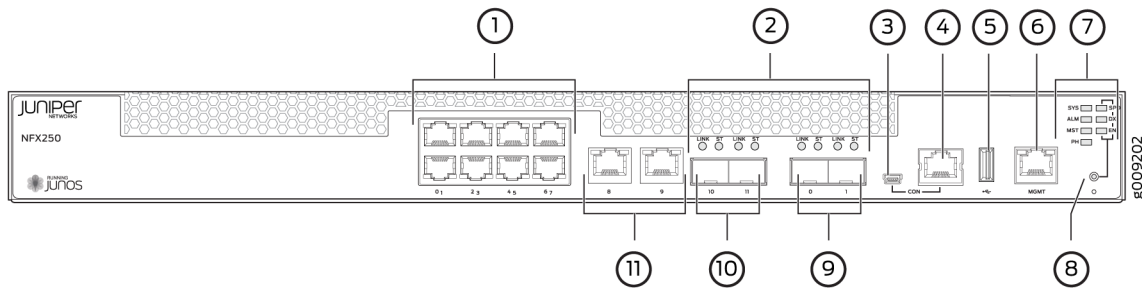

1– 1-Gigabit Ethernet RJ-45 network ports	7– System status LEDs
2– SFP and SFP+ ports Link and Status LEDs	8– Mode button
3– Mini-USB console port	9– 1/10-Gigabit SFP+ uplink ports
4– Console port	10– 1-Gigabit SFP network/uplink ports
5– USB port	11– 1-Gigabit Ethernet RJ-45 network/uplink ports
6– 1-Gigabit Management port	

SEE ALSO

[Prevention of Electrostatic Discharge Damage | 153](#)

[Connecting an NFX250 Device to a Network for Out-of-Band Management | 95](#)

Rear Panel of an NFX250 Device

The rear panel of the NFX250 device consists of the following components (see [Figure 3 on page 8](#)):

- Ground area
- Electrostatic discharge (ESD) point
- Exhaust vents
- Power switch
- AC power cord inlet

Figure 3: NFX250 Device Switch Rear Panel

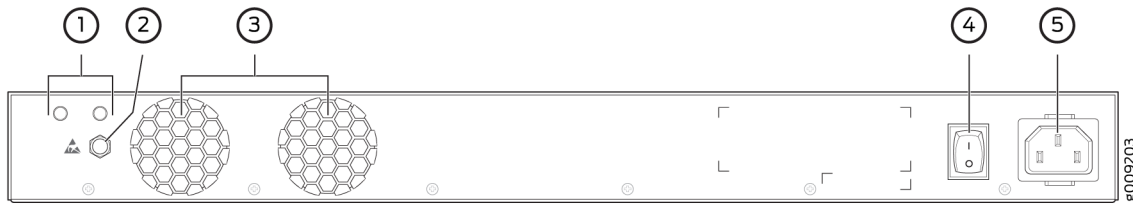

1– Ground area

2– Electrostatic discharge (ESD) point

3– Exhaust vents

4– Power switch

5– AC power cord inlet

Chassis Status LEDs on NFX250 Devices

The front panel of an NFX250 device has chassis status LEDs (labeled **ALM**, **SYS**, **MST** and **PH**) , next to the **MGMT** port (see [Figure 4 on page 8](#)).

Figure 4: Chassis Status LEDs in an NFX250 Device

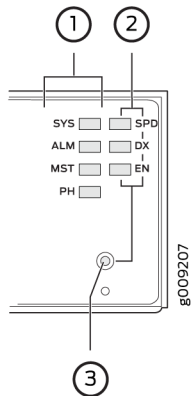
1– Chassis status LEDs (**ALM**, **SYS**, **MST**, and **PH**)2– Port parameter LEDs (**SPD**, **DX**, and **EN**)

3– Mode button

[Table 2 on page 9](#) describes the chassis status LEDs in NFX250 Device, their colors and states, and the status they indicate. You can view the colors of the four LEDs remotely through the CLI by issuing the operational mode command `show chassis led`.

Table 2: Chassis Status LEDs in an NFX250 Device

LED Label	Color	State and Description
ALM (Alarm)	Unlit	There is no alarm or the device is halted.
	Red	There is a major alarm.
	Amber	There is a minor alarm.
SYS (System)	Green	<ul style="list-style-type: none"> On steadily—Junos OS has been loaded on the device. Blinking—The device is booting. Off—The device is powered off or is halted.
MST (Primary)	Green	<ul style="list-style-type: none"> On steadily—The device is functioning normally. Off—The device is powered off or is halted.
PH	Unlit	There is no Network Service Activator transaction.
	Green	<ul style="list-style-type: none"> On steadily—Network Service Activator transaction is successfully completed. That is, the Network Service Orchestrator in NFX250 contacted the Network Service Activator and provisioned the software image successfully. Blinking—Network Service Activator transaction is underway. Off—The device is powered off or is halted.
	Amber	<ul style="list-style-type: none"> On steadily—Network Service Activator transaction is terminated unsuccessfully. Blinking—Network Service Activator transaction is waiting for user input.

A major alarm (red) indicates a critical error condition that requires immediate action.

A minor alarm (amber) indicates a noncritical condition that requires monitoring or maintenance. A minor alarm left unchecked might cause interruption in service or performance degradation.

All four LEDs can be lit simultaneously.

Network Port and Uplink Port LEDs on NFX250 Devices

Each network port and uplink port on the front panel of an NFX250 has two LEDs that indicate link activity and port status (see [Figure 5 on page 10](#)).

Figure 5: LEDs on the Network Port

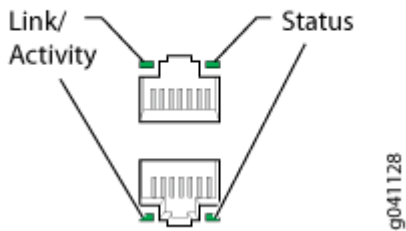

[Table 3 on page 10](#) describes the Link/Activity LED.

Table 3: Link/Activity LED on the Network Ports and Uplink Ports in NFX250 Devices

LED	Color	State and Description
Link/Activity	Green	<ul style="list-style-type: none"> Blinking—The port and the link are active, and there is link activity. On steadily—The port and the link are active, but there is no link activity. Off—The port is not active.

[Figure 6 on page 11](#) shows the LEDs that indicate the status of one of the three port parameters—speed, duplex mode, and administrative status. Use the **Mode** button on the far right side of the front panel to toggle the Status LED to show the different port parameters. You can tell which port parameter

(speed, duplex mode, or administrative status) is indicated by the Status LED by looking at which port status mode LED (**SPD**, **DX**, or **EN**) is lit.

Figure 6: Port Status Mode LEDs of an NFX250 Device

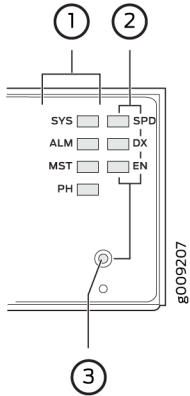

1– Chassis status LEDs (**ALM**, **SYS**, **MST**, and **PH**)

3– Mode button

2– Port parameter LEDs (**SPD**, **DX**, and **EN**)

Table 4 on page 11 describes the Status LED.

Table 4: Status LED on the Network Ports and Uplink Ports in NFX250 Devices

Port Parameters	State and Description
Speed	<p>Indicates the speed. The speed indicators for network ports are:</p> <ul style="list-style-type: none"> • One blink per second—10 Mbps • Two blinks per second—100 Mbps • Three blinks per second—1000 Mbps
Duplex mode	<p>Indicates the duplex mode. The status indicators are:</p> <ul style="list-style-type: none"> • On steadily—Port is set to full-duplex mode. • Off—Port is set to half-duplex mode.

Table 4: Status LED on the Network Ports and Uplink Ports in NFX250 Devices (Continued)

Port Parameters	State and Description
Administrative status	<p>Indicates the administrative status. The status indicators are:</p> <ul style="list-style-type: none"> • On steadily—Port is administratively enabled. • Off—Port is administratively disabled.

You can tell which port parameter is indicated by the Status LED on network ports by issuing the operational mode command `show chassis led`.

Management Port LEDs on NFX250 Devices

The management port on the front panel of an NFX250 device has two LEDs that indicate link activity and port status (see [Figure 7 on page 12](#)).

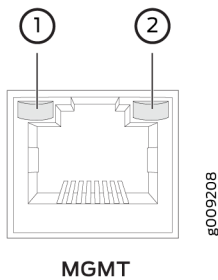
Figure 7: LEDs on the Management Port of an NFX250

1– Link/Activity

2– Status

[Table 5 on page 13](#) describes the Link/Activity LED.

Table 5: Link/Activity LED on the Management Port of an NFX250 Device

LED	Color	State and Description
Link/Activity	Green	<ul style="list-style-type: none"> • Blinking—The port and the link are active, and there is link activity. • On steadily—The port and the link are active, but there is no link activity. • Off—The port is not active.

[Table 6 on page 13](#) describes the Status LED.

Table 6: Status LED on the Management Port of an NFX250 Device

LED	Color	State and Description
Status	Green	Indicates the speed. The speed indicators are: <ul style="list-style-type: none"> • One blink per second—10 Mbps • Two blinks per second—100 Mbps • Three blinks per second—1000 Mbps

RELATED DOCUMENTATION

[NFX250 Installation Overview | 78](#)

[NFX250 Network Cable and Transceiver Planning | 30](#)

NFX250 Cooling System

The NFX250 devices have front-to-back airflow. The air intake to cool the chassis is located on the front of the chassis. Air is pulled into the chassis and pushed toward the fans, which are built-in. Hot air exhausts from the rear of the chassis. See [Figure 8 on page 14](#).

Figure 8: Front-to-Back Airflow Through the NFX250 Chassis

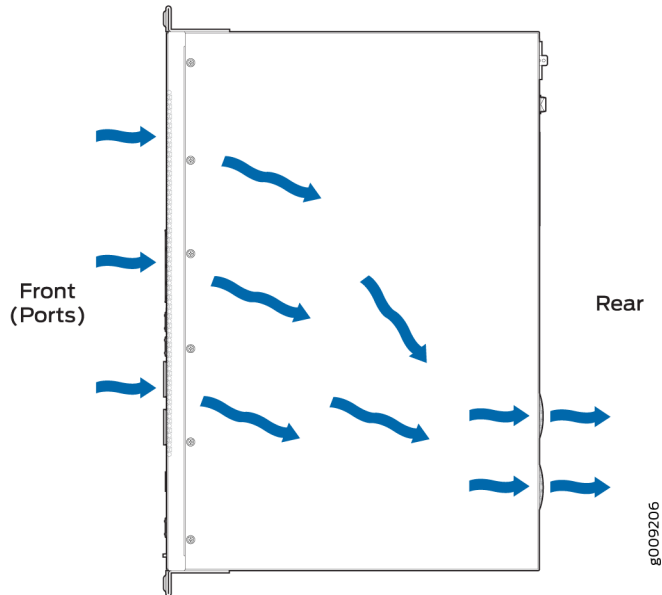

RELATED DOCUMENTATION

[Clearance Requirements for Airflow and Hardware Maintenance for an NFX250 Device | 25](#)

NFX250 Power System

IN THIS SECTION

- [Power Supply in NFX250 Devices | 15](#)
- [AC Power Supply Specifications for an NFX250 Device | 15](#)
- [AC Power Cord Specifications for an NFX250 Device | 15](#)

Power Supply in NFX250 Devices

NFX250 devices use a fixed, internal AC power supply. The power supply distributes different output voltages to the device components according to their voltage requirements. The power supply is fixed in the chassis and is not field-replaceable.

The power supply has a single AC appliance inlet that requires a dedicated AC power feed. The AC power cord inlet is on the rear panel of the device.

AC Power Supply Specifications for an NFX250 Device

Table 7 on page 15 describes the AC power specifications for an NFX250 device.

Table 7: AC Power Specifications for an NFX250 Device

Item	Specification
AC input voltage	Operating range: <ul style="list-style-type: none"> • 100 through 240 VAC
AC input line frequency	50–60 Hz nominal
AC input current rating	3 A at 240 VAC
Maximum power consumption	140 W

AC Power Cord Specifications for an NFX250 Device

A detachable AC power cord is supplied with the AC power supplies. The coupler is type C13 as described by International Electrotechnical Commission (IEC) standard 60320. The plug at the male end of the power cord fits into the power source outlet that is standard for your geographical location.



CAUTION: The AC power cord provided with each power supply is intended for use with that power supply only and not for any other use.

NOTE: In North America, AC power cords must not exceed 4.5 meters in length, to comply with National Electrical Code (NEC) Sections 400-8 (NFPA 75, 5-2.2) and 210-52 and Canadian Electrical Code (CEC) Section 4-010(3). The cords supplied with the switch are in compliance.

Table 8 on page 16 gives the AC power cord specifications for the countries and regions listed in the table.

Table 8: AC Power Cord Specifications

Country/Region	Electrical Specifications	Plug Standards	Juniper Model Number
Argentina	250 VAC, 10 A, 50 Hz	IRAM 2073 Type RA/3	CBL-EX-PWR-C13-AR
Australia	250 VAC, 10 A, 50 Hz	AS/NZZS 3112 Type SAA/3	CBL-EX-PWR-C13-AU
Brazil	250 VAC, 10 A, 50 Hz	NBR 14136 Type BR/3	CBL-EX-PWR-C13-BR
China	250 VAC, 10 A, 50 Hz	GB 1002-1996 Type PRC/3	CBL-EX-PWR-C13-CH
Europe (except Italy, Switzerland, and United Kingdom)	250 VAC, 10 A, 50 Hz	CEE (7) VII Type VIIG	CBL-EX-PWR-C13-EU
India	250 VAC, 10 A, 50 Hz	IS 1293 Type IND/3	CBL-EX-PWR-C13-IN
Israel	250 VAC, 10 A, 50 Hz	SI 32/1971 Type IL/3G	CBL-EX-PWR-C13-IL
Italy	250 VAC, 10 A, 50 Hz	CEI 23-16 Type I/3G	CBL-EX-PWR-C13-IT

Table 8: AC Power Cord Specifications (Continued)

Country/Region	Electrical Specifications	Plug Standards	Juniper Model Number
Japan	125 VAC, 12 A, 50 Hz or 60 Hz	SS-00259 Type VCTF	CBL-EX-PWR-C13-JP
Korea	250 VAC, 10 A, 50 Hz or 60 Hz	CEE (7) VII Type VIIGK	CBL-EX-PWR-C13-KR
North America	125 VAC, 13 A, 60 Hz	NEMA 5-15 Type N5-15	CBL-EX-PWR-C13-US
South Africa	250 VAC, 10 A, 50 Hz	SABS 164/1:1992 Type ZA/13	CBL-EX-PWR-C13-SA
Switzerland	250 VAC, 10 A, 50 Hz	SEV 6534-2 Type 12G	CBL-EX-PWR-C13-SZ
Taiwan	125 VAC, 11 A and 15 A, 50 Hz	NEMA 5-15P Type N5-15P	CBL-EX-PWR-C13-TW
United Kingdom	250 VAC, 10 A, 50 Hz	BS 1363/A Type BS89/13	CBL-EX-PWR-C13-UK

Figure 9 on page 17 illustrates the plug on the power cord for some of the countries or regions listed in Table 8 on page 16.

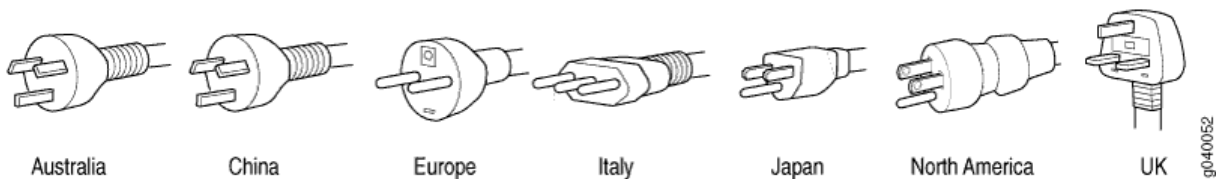
Figure 9: AC Plug Types**SEE ALSO**

[General Safety Guidelines and Warnings | 127](#)

[General Electrical Safety Guidelines and Warnings | 151](#)

| [Prevention of Electrostatic Discharge Damage | 153](#)

RELATED DOCUMENTATION

| [Connecting the NFX250 to Power | 91](#)

2

CHAPTER

Site Planning, Preparation, and Specifications

Site Preparation Checklist for NFX250 Devices | 20

NFX250 Site Guidelines and Requirements | 22

NFX250 Network Cable and Transceiver Planning | 30

NFX250 Cable Specifications and Pinouts | 69

Site Preparation Checklist for NFX250 Devices

The checklist in [Table 9 on page 20](#) summarizes the tasks you need to perform when preparing a site for NFX250 devices installation.

Table 9: Site Preparation Checklist

Item or Task	For More Information	Performed by	Date
Environment			
Verify that environmental factors such as temperature and humidity do not exceed device tolerances.	Environmental Requirements and Specifications for an NFX250 Device		
Power			
Measure distance between external power sources and device installation site.			
Locate sites for connection of system grounding.			
Calculate the power consumption and requirements.	"AC Power Supply Specifications for an NFX250 Device" on page 15		
Hardware Configuration			
Choose the number and types of devices you want to install.	"NFX250 Device Hardware Overview" on page 2 "NFX250 Device Models" on page 3		
Rack or Cabinet			

Table 9: Site Preparation Checklist (Continued)

Item or Task	For More Information	Performed by	Date
Verify that your rack or cabinet meets the minimum requirements for the installation of the device.	"Rack Requirements for NFX250 Devices" on page 26 "Cabinet Requirements for an NFX250 Device" on page 28		
Plan rack or cabinet location, including required space clearances.	"Clearance Requirements for Airflow and Hardware Maintenance for an NFX250 Device" on page 25		
Secure the rack or cabinet to the floor and building structure.			
Desk			
Verify that the desk meets the minimum requirements for the installation of the device.	"Requirements for Mounting an NFX250 Device on a Desktop or Other Level Surface" on page 29		
Verify that there is appropriate clearance in your selected location.	"Clearance Requirements for Airflow and Hardware Maintenance for an NFX250 Device" on page 25		
Wall			
Verify that the wall meets the minimum requirements for the installation of the NFX250-LS1 device.	"Requirements for Mounting an NFX250-LS1 Device on a Wall" on page 30		
Verify that there is appropriate clearance in your selected location.	"Clearance Requirements for Airflow and Hardware Maintenance for an NFX250 Device" on page 25		

Table 9: Site Preparation Checklist (Continued)

Item or Task	For More Information	Performed by	Date
Cables			
Acquire cables and connectors: <ul style="list-style-type: none"> • Determine the number of cables needed based on your planned configuration. • Review the maximum distance allowed for each cable. Choose the length of cable based on the distance between the hardware components being connected. 			
Plan the cable routing and management.			

RELATED DOCUMENTATION

General Safety Guidelines and Warnings

General Site Guidelines

[NFX250 Installation Overview | 78](#)

[Mounting an NFX250 Device | 81](#)

NFX250 Site Guidelines and Requirements

IN THIS SECTION

- [General Site Guidelines | 23](#)
- [Site Electrical Wiring Guidelines | 23](#)
- [Chassis Physical Specifications for an NFX250 Device | 24](#)

- [Clearance Requirements for Airflow and Hardware Maintenance for an NFX250 Device | 25](#)
- [Rack Requirements for NFX250 Devices | 26](#)
- [Cabinet Requirements for an NFX250 Device | 28](#)
- [Requirements for Mounting an NFX250 Device on a Desktop or Other Level Surface | 29](#)
- [Requirements for Mounting an NFX250-LS1 Device on a Wall | 30](#)

General Site Guidelines

Efficient device operation requires proper site planning and maintenance. It also requires proper layout of the equipment, rack or cabinet, and wiring closet.

To plan and create an acceptable operating environment for your device and prevent environmentally caused equipment failures:

- Keep the area around the chassis free from dust and conductive material, such as metal flakes.
- Follow prescribed airflow guidelines to ensure that the cooling system functions properly. Ensure that exhaust from other equipment does not blow into the intake vents of the device.
- Follow the prescribed electrostatic discharge (ESD) prevention procedures to prevent damaging the equipment. Static discharge can cause components to fail completely or intermittently over time.
- Install the device in a secure area, so that only authorized personnel can access the device.

Site Electrical Wiring Guidelines

[Table 10 on page 24](#) describes the factors you must consider while planning the electrical wiring at your site.



WARNING: You must provide a properly grounded and shielded environment and use electrical surge-suppression devices.

Avertissement Vous devez établir un environnement protégé et convenablement mis à la terre et utiliser des dispositifs de parasurtension.

Table 10: Site Electrical Wiring Guidelines

Site Wiring Factor	Guidelines
Signaling limitations	<p>If your site experiences any of the following problems, consult experts in electrical surge suppression and shielding:</p> <ul style="list-style-type: none"> • Improperly installed wires cause radio frequency interference (RFI). • Damage from lightning strikes occurs when wires exceed recommended distances or pass between buildings. • Electromagnetic pulses (EMPs) caused by lightning damage unshielded conductors and electronic devices.
Radio frequency interference	<p>To reduce or eliminate RFI from your site wiring, do the following:</p> <ul style="list-style-type: none"> • Use a twisted-pair cable with a good distribution of grounding conductors. • If you must exceed the recommended distances, use a high-quality twisted-pair cable with one ground conductor for each data signal, when applicable.
Electromagnetic compatibility	<p>If your site is susceptible to problems with electromagnetic compatibility (EMC), particularly from lightning or radio transmitters, seek expert advice.</p> <p>Strong sources of electromagnetic interference (EMI) can cause:</p> <ul style="list-style-type: none"> • Destruction of the signal drivers and receivers in the device, • Electrical hazards as a result of power surges conducted over the lines into the equipment.

Chassis Physical Specifications for an NFX250 Device

NFX250 device chassis is a rigid sheet-metal structure that houses the hardware components. [Table 11 on page 25](#) summarizes the physical specifications of the NFX250 chassis.

Table 11: Physical Specifications for the NFX250 Device Chassis

Product SKU	Height	Width	Depth	Weight
NFX250-S1	1.72 in. (4.3 cm)	17.36 in. (44.1 cm)	12 in. (30.5 cm)	9.4 lb (4.3 kg)
NFX250-S2	1.72 in. (4.3 cm)	17.36 in. (44.1 cm)	12 in. (30.5 cm)	9.4 lb (4.3 kg)
NFX250-LS1	1.72 in. (4.3 cm)	17.36 in. (44.1 cm)	12 in. (30.5 cm)	9 lb (4 kg)

Clearance Requirements for Airflow and Hardware Maintenance for an NFX250 Device

When planning the site for installing an NFX250 device, you must allow sufficient clearance around the installed chassis (see [Figure 10 on page 26](#)).

Figure 10: Clearance Requirements for Airflow and Hardware Maintenance for an NFX250 Device

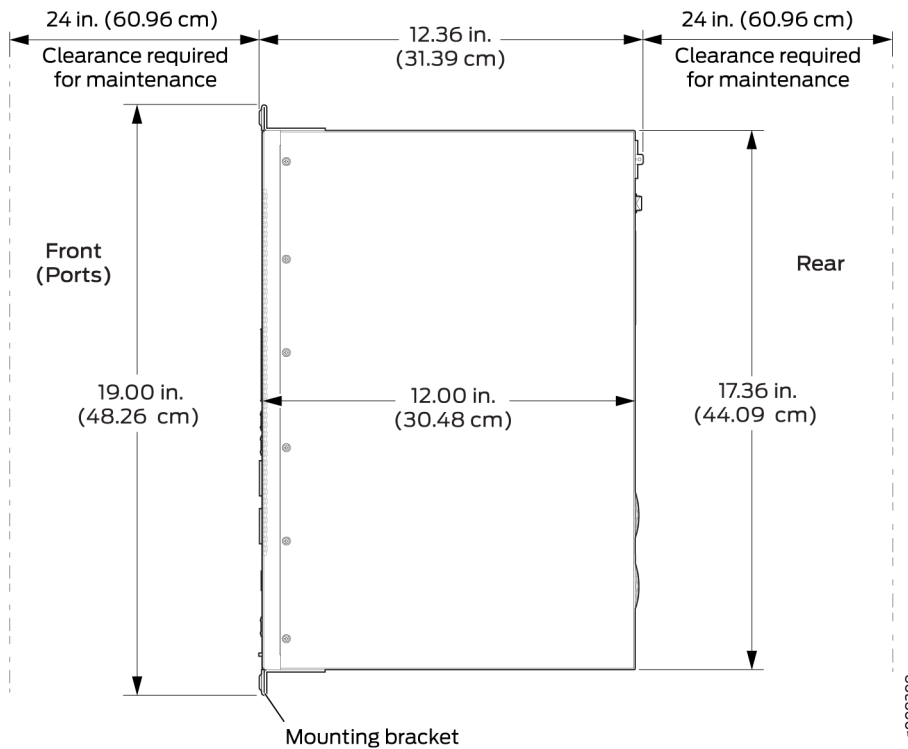

- For the cooling system to function properly, the airflow around the chassis must be unrestricted. See ["NFX250 Cooling System" on page 13](#) for more information about the airflow through the chassis.
- If you are mounting an NFX250 device in a rack or cabinet with other equipment, ensure that the exhaust from other equipment does not blow into the intake vents of the chassis.
- Leave at least 24 in. (61 cm) both in front of and behind the NFX250 device. For service personnel to remove and install hardware components, you must leave adequate space at the front and back of the NFX250. NEBS GR-63 recommends that you allow at least 30 in. (76.2 cm) in front of the rack or cabinet and 24 in. (61 cm) behind the rack or cabinet.

Rack Requirements for NFX250 Devices

You can mount the NFX250 devices on two-post racks or four-post racks.

Rack requirements consist of:

- Rack type
- Mounting bracket hole spacing

- Rack size and strength
- Rack connection to the building structure

Table 12 on page 27 provides the rack requirements and specifications for the device.

Table 12: Rack Requirements and Specifications for the Device

Rack Requirement	Guidelines
Rack type	<p>Use a two-post rack or a four-post rack. You can mount the device on any two-post or four-post rack that provides bracket holes or hole patterns spaced at 1 U (1.75 in. or 4.45 cm) increments and that meets the size and strength requirements to support the weight.</p> <p>A U is the standard rack unit defined in <i>Cabinets, Racks, Panels, and Associated Equipment</i> (document number EIA-310-D) published by the Electronics Industry Association (http://www.ecianow.org/standards-practices/standards/).</p> <p>The rack must meet the strength requirements to support the weight of the chassis.</p>
Mounting bracket hole spacing	<p>The holes in the mounting brackets are spaced at 1 U (1.75 in. or 4.45 cm), so that the device can be mounted in any rack that provides holes spaced at that distance.</p>
Rack size and strength	<ul style="list-style-type: none"> • Ensure that the rack complies with the standard defined for 19-in. rack as defined in <i>Cabinets, Racks, Panels, and Associated Equipment</i> (document number EIA-310-D) published by the Electronics Industry Association (http://www.ecianow.org/standards-practices/standards/). • Ensure that the rack rails are spaced widely enough to accommodate the device chassis' external dimensions of 1.72 in. (4.3 cm) height, 17.36 in. (44.1 cm) width, and 12 in. (30.5 cm) depth. The 19-in. rack brackets dimensions are 0.82 in. (2.1 cm) wide, 1.72 in. (4.3 cm) height, and 2.1 in. (5.4 cm) depth. The 23-in. rack brackets dimensions are 3.3 in. (8.4 cm) wide, 1.72 in. (4.3 cm) height, and 8.5 in. (21.6 cm) depth. • The rack must be strong enough to support the weight of the device. • Ensure that the spacing of rails and adjacent racks allows for the proper clearance around the device and rack.

Table 12: Rack Requirements and Specifications for the Device (Continued)

Rack Requirement	Guidelines
Rack connection to building structure	<ul style="list-style-type: none"> Secure the rack to the building structure. If earthquakes are a possibility in your geographical area, secure the rack to the floor. Secure the rack to the ceiling brackets as well as wall or floor brackets for maximum stability.

One pair of mounting brackets for mounting the device on two posts of a rack is supplied with each device. For mounting the device on four posts of a rack or cabinet, you can order a four-post rack-mount kit separately.

SEE ALSO

[Mounting an NFX250 Device on Two Posts in a Rack | 86](#)

[Mounting an NFX250 Device on Four Posts in a Rack or Cabinet | 88](#)

Cabinet Requirements for an NFX250 Device

You can mount the NFX250 device in an enclosure or cabinet that contains a four-post 19-in. open rack as defined in *Cabinets, Racks, Panels, and Associated Equipment* (document number EIA-310-D) published by the Electronics Industry Association.

Cabinet requirements consist of:

- Cabinet size and clearance
- Cabinet airflow requirements

[Table 13 on page 29](#) provides the cabinet requirements and specifications for the NFX250 device.

Table 13: Cabinet Requirements for the NFX250 Device

Cabinet Requirement	Guidelines
Cabinet size and clearance	The minimum cabinet size for accommodating an NFX250 device is 36 in. (91.4 cm) deep. Large cabinets improve airflow and reduce the chance of overheating.
Cabinet airflow requirements	<p>When you mount the switch in a cabinet, ensure that ventilation through the cabinet is sufficient to prevent overheating.</p> <ul style="list-style-type: none"> • Ensure that the cool air supply you provide through the cabinet adequately dissipates the thermal output of the switch (or switches). • Ensure that the cabinet allows the chassis hot exhaust air to exit the cabinet without recirculating into the switch. An open cabinet (without a top or doors) that employs hot air exhaust extraction from the top allows the best airflow through the chassis. If the cabinet contains a top or doors, perforations in these elements assist with removing the hot air exhaust. • Install the switch in the cabinet in a way that maximizes the open space on the side of the chassis that has the hot air exhaust. • Route and dress all cables to minimize the blockage of airflow to and from the chassis. • Ensure that the spacing of rails and adjacent cabinets allows for the proper clearance around the switch and cabinet. • A cabinet larger than the minimum required provides better airflow and reduces the chance of overheating.

Requirements for Mounting an NFX250 Device on a Desktop or Other Level Surface

You can install NFX250 device on a desktop or other such level surface, by attaching the four rubber feet (provided) to the bottom of the chassis.

When choosing a location, allow at least 6 in. (15.2 cm) of clearance between the front and back of the chassis and adjacent equipment or walls.

Ensure that the desktop or other level surface on which the device is installed is stable and securely supported.

Requirements for Mounting an NFX250-LS1 Device on a Wall

You can install the NFX250-LS1 device on a wall. When choosing a location, allow at least 6 in. (15.2 cm) of clearance between the front and back of the chassis and adjacent equipment or walls.

Ensure that the wall onto which the device is installed is stable and securely supported.

If you are mounting the device in sheetrock (wall board with a gypsum plaster core) or in wall board not backed by wall studs, use hollow wall anchors capable of supporting the combined weight of two fully loaded chassis. Insert the screws into wall studs wherever possible to provide added support for the chassis.

Use the wall-mount kit from Juniper Networks to mount the device on a wall. The wall-mount kit is not part of the standard package and must be ordered separately.

NFX250 Network Cable and Transceiver Planning

IN THIS SECTION

- [Pluggable Transceivers Supported on NFX250 Devices | 30](#)
- [SFP+ Direct Attach Cables for NFX250 Devices | 60](#)
- [Understanding NFX250 Devices Fiber-Optic Cable Signal Loss, Attenuation, and Dispersion | 65](#)
- [Calculating the Fiber-Optic Cable Power Budget for an NFX250 Device | 66](#)
- [Calculating the Fiber-Optic Cable Power Margin for an NFX250 Device | 67](#)

Pluggable Transceivers Supported on NFX250 Devices

Uplink module ports on NFX250 devices support SFP and SFP+ transceivers. This topic describes the optical interfaces supported for those transceivers. It also lists the copper interface supported for the SFP transceivers.

NOTE: We recommend that you use only optical transceivers and optical connectors purchased from Juniper Networks with your Juniper Networks device.



CAUTION: The Juniper Networks Technical Assistance Center (JTAC) provides complete support for Juniper-supplied optical modules and cables. However, JTAC does not provide support for third-party optical modules and cables that are not qualified or supplied by Juniper Networks. If you face a problem running a Juniper device that uses third-party optical modules or cables, JTAC may help you diagnose host-related issues if the observed issue is not, in the opinion of JTAC, related to the use of the third-party optical modules or cables. Your JTAC engineer will likely request that you check the third-party optical module or cable and, if required, replace it with an equivalent Juniper-qualified component.

Use of third-party optical modules with high-power consumption (for example, coherent ZR or ZR+) can potentially cause thermal damage to or reduce the lifespan of the host equipment. Any damage to the host equipment due to the use of third-party optical modules or cables is the users' responsibility. Juniper Networks will accept no liability for any damage caused due to such use.

The tables in this topic describe the optical interface support over single-mode fiber-optic (SMF) and multimode fiber-optic (MMF) cables and over the copper interface for SFP transceivers:

- [Table 14 on page 31](#)—Optical interface support and copper interface support for Gigabit Ethernet SFP transceivers in NFX250 devices.
- [Table 15 on page 54](#)—Optical interface support for Gigabit Ethernet SFP+ transceivers.

Table 14: Optical Interface Support and Copper Interface Support for Gigabit Ethernet SFP Transceivers in NFX250 Devices

Ethernet Standard	Specification	Value
1000BASE-T	Model number	EX-SFP-1GE-T
	Rate	10/100/1000 Mbps
	Connector type	RJ-45

Table 14: Optical Interface Support and Copper Interface Support for Gigabit Ethernet SFP Transceivers in NFX250 Devices (Continued)

Ethernet Standard	Specification	Value
	Transmitter wavelength	-
	Minimum launch power	-
	Maximum launch power	-
	Minimum receiver sensitivity	-
	Maximum input power	-
	Core/Cladding size	-
	Modal bandwidth	-
	Distance	100 m (328 ft)
	Software required	Junos OS for NFX250 Devices, Release 15.1X53-D40 or later
	Support for Virtual Chassis configuration	Yes
1000BASE-SX	Model number	EX-SFP-1GE-SX
	Rate	1000 Mbps
	Connector type	LC
	Fiber count	Dual

Table 14: Optical Interface Support and Copper Interface Support for Gigabit Ethernet SFP Transceivers in NFX250 Devices (Continued)

Ethernet Standard	Specification	Value			
	Transmitter wavelength	850 nm			
	Minimum launch power	-9.5 dBm			
	Maximum launch power	-3 dBm			
	Minimum receiver sensitivity	-21 dBm			
	Maximum input power	0 dBm			
	Fiber type	MMF			
	Core/Cladding size	62.5/125 μ m	62.5/125 μ m	50/125 μ m	50/125 μ m
	Fiber grade	FDDI	OM1	-	OM2
	Modal bandwidth	160 MHz/km	200 MHz/km	400 MHz/km	500 MHz/km
	Distance	220 m (722 ft)	275 m (902 ft)	500 m (1640 ft)	550 m (1804 ft)
	Software required	Junos OS for NFX250 Devices, Release 15.1X53-D40 or later			
	Support for Virtual Chassis configuration	Yes			
1000BASE-SX-ET	Model number	EX-SFP-1GE-SX-ET			

Table 14: Optical Interface Support and Copper Interface Support for Gigabit Ethernet SFP Transceivers in NFX250 Devices (Continued)

Ethernet Standard	Specification	Value			
	Rate	1000 Mbps			
	Connector type	LC			
	Fiber count	Dual			
	Transmitter wavelength	850 nm			
	Minimum launch power	-9.5 dBm			
	Maximum launch power	-3 dBm			
	Minimum receiver sensitivity	-21 dBm			
	Maximum input power	0 dBm			
	Fiber type	MMF			
	Core/Cladding size	62.5/125 μ m	62.5/125 μ m	50/125 μ m	50/125 μ m
	Fiber grade	FDDI	OM1	-	OM2
	Modal bandwidth	160 MHz/km	200 MHz/km	400 MHz/km	500 MHz/km
	Distance	220 m (722 ft)	275 m (902 ft)	500 m (1640 ft)	550 m (1804 ft)
	Software required	Junos OS for NFX250 Devices, Release 15.1X53-D40 or later			

Table 14: Optical Interface Support and Copper Interface Support for Gigabit Ethernet SFP Transceivers in NFX250 Devices (Continued)

Ethernet Standard	Specification	Value
	Support for Virtual Chassis configuration	Yes
1000BASE-LX	Model number	EX-SFP-1GE-LX
	Rate	1000 Mbps
	Connector type	LC
	Fiber count	Dual
	Transmitter wavelength	1310 nm
	Minimum launch power	-9.5 dBm
	Maximum launch power	-3 dBm
	Minimum receiver sensitivity	-25 dBm
	Maximum input power	-3 dBm
	Fiber type	SMF
	Core/Cladding size	9/125 μ m
	Modal bandwidth	-
	Distance	10 km (6.2 miles)

Table 14: Optical Interface Support and Copper Interface Support for Gigabit Ethernet SFP Transceivers in NFX250 Devices (Continued)

Ethernet Standard	Specification	Value
	Software required	Junos OS for NFX250 Devices, Release 15.1X53-D40 or later
	Support for Virtual Chassis configuration	Yes
1000BASE-BX-U	Model number	EX-SFP-GE10KT13R14
	Rate	1000 Mbps
	Connector type	LC
	Fiber count	Single
	Transmitter wavelength	1310 nm
	Receiver wavelength	1490 nm
	Minimum launch power	-9 dBm
	Maximum launch power	-3 dBm
	Minimum receiver sensitivity	-30 dBm
	Maximum input power	-3 dBm
	Fiber type	SMF
	Core/Cladding size	9/125 μm

Table 14: Optical Interface Support and Copper Interface Support for Gigabit Ethernet SFP Transceivers in NFX250 Devices (Continued)

Ethernet Standard	Specification	Value
	Modal bandwidth	-
	Distance	10 km (6.2 miles)
	Software required	Junos OS for NFX250 Devices, Release 15.1X53-D40 or later
	Support for Virtual Chassis configuration	Yes
1000BASE-BX-D	Model number	EX-SFP-GE10KT14R13
	Rate	1000 Mbps
	Connector type	LC
	Fiber count	Single
	Transmitter wavelength	1490 nm
	Receiver wavelength	1310 nm
	Minimum launch power	-9 dBm
	Maximum launch power	-3 dBm
	Minimum receiver sensitivity	-30 dBm
	Maximum input power	-3 dBm

Table 14: Optical Interface Support and Copper Interface Support for Gigabit Ethernet SFP Transceivers in NFX250 Devices (Continued)

Ethernet Standard	Specification	Value
	Fiber type	SMF
	Core/Cladding size	9/125 μm
	Modal bandwidth	-
	Distance	10 km (6.2 miles)
	Software required	Junos OS for NFX250 Devices, Release 15.1X53-D40 or later
	Support for Virtual Chassis configuration	Yes
1000BASE-BX-U	Model number	EX-SFP-GE10KT13R15
	Rate	1000 Mbps
	Connector type	LC
	Fiber count	Single
	Transmitter wavelength	1310 nm
	Receiver wavelength	1550 nm
	Minimum launch power	-9 dBm
	Maximum launch power	-3 dBm

Table 14: Optical Interface Support and Copper Interface Support for Gigabit Ethernet SFP Transceivers in NFX250 Devices (Continued)

Ethernet Standard	Specification	Value
	Minimum receiver sensitivity	-21 dBm
	Maximum input power	-3 dBm
	Fiber type	SMF
	Core/Cladding size	9/125 μ m
	Modal bandwidth	-
	Distance	10 km (6.2 miles)
	Software required	Junos OS for NFX250 Devices, Release 15.1X53-D40 or later
	Support for Virtual Chassis configuration	Yes
1000BASE-BX-D	Model number	EX-SFP-GE10KT15R13
	Rate	1000 Mbps
	Connector type	LC
	Fiber count	Single
	Transmitter wavelength	1550 nm
	Receiver wavelength	1310 nm

Table 14: Optical Interface Support and Copper Interface Support for Gigabit Ethernet SFP Transceivers in NFX250 Devices (Continued)

Ethernet Standard	Specification	Value
	Minimum launch power	-9 dBm
	Maximum launch power	-3 dBm
	Minimum receiver sensitivity	-21 dBm
	Maximum input power	-3 dBm
	Fiber type	SMF
	Core/Cladding size	9/125 μ m
	Modal bandwidth	-
	Distance	10 km (6.2 miles)
	Software required	Junos OS for NFX250 Devices, Release 15.1X53-D40 or later
	Support for Virtual Chassis configuration	Yes
1000BASE-BX-U	Model number	EX-SFP-GE40KT13R15
	Rate	1000 Mbps
	Connector type	LC
	Fiber count	Single

Table 14: Optical Interface Support and Copper Interface Support for Gigabit Ethernet SFP Transceivers in NFX250 Devices (Continued)

Ethernet Standard	Specification	Value
	Transmitter wavelength	1310 nm
	Receiver wavelength	1550 nm
	Minimum launch power	-6.5 dBm
	Maximum launch power	2 dBm
	Minimum receiver sensitivity	-23 dBm
	Maximum input power	-3 dBm
	Fiber type	SMF
	Core/Cladding size	9/125 μ m
	Modal bandwidth	-
	Distance	40 km (24.8 miles)
	Software required	Junos OS for NFX250 Devices, Release 15.1X53-D40 or later
	Support for Virtual Chassis configuration	Yes
1000BASE-BX-D	Model number	EX-SFP-GE40KT15R13
	Rate	1000 Mbps

Table 14: Optical Interface Support and Copper Interface Support for Gigabit Ethernet SFP Transceivers in NFX250 Devices (Continued)

Ethernet Standard	Specification	Value
	Connector type	LC
	Fiber count	Single
	Transmitter wavelength	1550 nm
	Receiver wavelength	1310 nm
	Minimum launch power	-6.5 dBm
	Maximum launch power	2 dBm
	Minimum receiver sensitivity	-23 dBm
	Maximum input power	-3 dBm
	Fiber type	SMF
	Core/Cladding size	9/125 μ m
	Modal bandwidth	-
	Distance	40 km (24.8 miles)
	Software required	Junos OS for NFX250 Devices, Release 15.1X53-D40 or later
	Support for Virtual Chassis configuration	Yes

Table 14: Optical Interface Support and Copper Interface Support for Gigabit Ethernet SFP Transceivers in NFX250 Devices (Continued)

Ethernet Standard	Specification	Value
1000BASE-LX	Model number	EX-SFP-1GE-LX40K
	Rate	1000 Mbps
	Connector type	LC
	Fiber count	Double
	Transmitter wavelength	1310 nm
	Minimum launch power	-14 dBm
	Maximum launch power	-8 dBm
	Minimum receiver sensitivity	-45 dBm
	Maximum input power	-3 dBm
	Fiber type	SMF
	Core/Cladding size	9/125 μ m
	Modal bandwidth	-
	Distance	40 km (24.8 miles)
	Software required	Junos OS for NFX250 Devices, Release 15.1X53-D40 or later

Table 14: Optical Interface Support and Copper Interface Support for Gigabit Ethernet SFP Transceivers in NFX250 Devices (Continued)

Ethernet Standard	Specification	Value
	Support for Virtual Chassis configuration	Yes
1000BASE-LH (or 1000BASE-ZX)	Model number	EX-SFP-1GE-LH
	Rate	1000 Mbps
	Connector type	LC
	Fiber count	Dual
	Transmitter wavelength	1550 nm
	Minimum launch power	-2 dBm
	Maximum launch power	5 dBm
	Minimum receiver sensitivity	-25 dBm
	Maximum input power	-3 dBm
	Fiber type	SMF
	Core/Cladding size	9/125 μ m
	Modal bandwidth	-
	Distance	70 km (43.5 miles)

Table 14: Optical Interface Support and Copper Interface Support for Gigabit Ethernet SFP Transceivers in NFX250 Devices (Continued)

Ethernet Standard	Specification	Value
	Software required	Junos OS for NFX250 Devices, Release 15.1X53-D40 or later
	Support for Virtual Chassis configuration	Yes
1000BASE-LX	Model number	EX-SFP-GE80KCW1470
	Rate	1000 Mbps
	Connector type	LC
	Fiber count	Single
	Transmitter wavelength	1470 nm
	Minimum launch power	0 dBm
	Maximum launch power	5 dBm
	Minimum receiver sensitivity	-32 dBm
	Maximum input power	-8 dBm
	Fiber type	SMF
	Core/Cladding size	9/125 μm
	Modal bandwidth	-

Table 14: Optical Interface Support and Copper Interface Support for Gigabit Ethernet SFP Transceivers in NFX250 Devices (Continued)

Ethernet Standard	Specification	Value
	Distance	80 km (49.7 miles)
	DOM support	Available
	Software required	Junos OS for NFX250 Devices, Release 15.1X53-D40 or later
	Support for Virtual Chassis configuration	Yes
1000BASE-LX	Model number	EX-SFP-GE80KCW1490
	Rate	1000 Mbps
	Connector type	LC
	Fiber count	Single
	Transmitter wavelength	1490 nm
	Minimum launch power	0 dBm
	Maximum launch power	5 dBm
	Minimum receiver sensitivity	-32 dBm
	Maximum input power	-8 dBm
Fiber type	SMF	

Table 14: Optical Interface Support and Copper Interface Support for Gigabit Ethernet SFP Transceivers in NFX250 Devices (Continued)

Ethernet Standard	Specification	Value
	Core/Cladding size	9/125 μm
	Modal bandwidth	-
	Distance	80 km (49.7 miles)
	DOM support	Available
	Software required	Junos OS for NFX250 Devices, Release 15.1X53-D40 or later
	Support for Virtual Chassis configuration	Yes
1000BASE-LX	Model number	EX-SFP-GE80KCW1510
	Rate	1000 Mbps
	Connector type	LC
	Fiber count	Single
	Transmitter wavelength	1510 nm
	Minimum launch power	0 dBm
	Maximum launch power	5 dBm
	Minimum receiver sensitivity	-32 dBm

Table 14: Optical Interface Support and Copper Interface Support for Gigabit Ethernet SFP Transceivers in NFX250 Devices (Continued)

Ethernet Standard	Specification	Value
	Maximum input power	-8 dBm
	Fiber type	SMF
	Core/Cladding size	9/125 μ m
	Modal bandwidth	-
	Distance	80 km (49.7 miles)
	DOM support	Available
	Software required	Junos OS for NFX250 Devices, Release 15.1X53-D40 or later
	Support for Virtual Chassis configuration	Yes
1000BASE-LX	Model number	EX-SFP-GE80KCW1530
	Rate	1000 Mbps
	Connector type	LC
	Fiber count	Single
	Transmitter wavelength	1530 nm
	Minimum launch power	0 dBm

Table 14: Optical Interface Support and Copper Interface Support for Gigabit Ethernet SFP Transceivers in NFX250 Devices (Continued)

Ethernet Standard	Specification	Value
	Maximum launch power	5 dBm
	Minimum receiver sensitivity	-32 dBm
	Maximum input power	-8 dBm
	Fiber type	SMF
	Core/Cladding size	9/125 μ m
	Modal bandwidth	-
	Distance	80 km (49.7 miles)
	DOM support	Available
	Software required	Junos OS for NFX250 Devices, Release 15.1X53-D40 or later
	Support for Virtual Chassis configuration	Yes
1000BASE-LX	Model number	EX-SFP-GE80KCW1550
	Rate	1000 Mbps
	Connector type	LC
	Fiber count	Single

Table 14: Optical Interface Support and Copper Interface Support for Gigabit Ethernet SFP Transceivers in NFX250 Devices (Continued)

Ethernet Standard	Specification	Value
	Transmitter wavelength	1550 nm
	Minimum launch power	0 dBm
	Maximum launch power	5 dBm
	Minimum receiver sensitivity	-32 dBm
	Maximum input power	-8 dBm
	Fiber type	SMF
	Core/Cladding size	9/125 μ m
	Modal bandwidth	-
	Distance	80 km (49.7 miles)
	DOM support	Available
	Software required	Junos OS for NFX250 Devices, Release 15.1X53-D40 or later
	Support for Virtual Chassis configuration	Yes
1000BASE-LX	Model number	EX-SFP-GE80KCW1570
	Rate	1000 Mbps

Table 14: Optical Interface Support and Copper Interface Support for Gigabit Ethernet SFP Transceivers in NFX250 Devices (Continued)

Ethernet Standard	Specification	Value
	Connector type	LC
	Fiber count	Single
	Transmitter wavelength	1570 nm
	Minimum launch power	0 dBm
	Maximum launch power	5 dBm
	Minimum receiver sensitivity	-32 dBm
	Maximum input power	-8 dBm
	Fiber type	SMF
	Core/Cladding size	9/125 μ m
	Modal bandwidth	-
	Distance	80 km (49.7 miles)
	DOM support	Available
	Software required	Junos OS for NFX250 Devices, Release 15.1X53-D40 or later
	Support for Virtual Chassis configuration	Yes

Table 14: Optical Interface Support and Copper Interface Support for Gigabit Ethernet SFP Transceivers in NFX250 Devices (Continued)

Ethernet Standard	Specification	Value
1000BASE-LX	Model number	EX-SFP-GE80KCW1590
	Rate	1000 Mbps
	Connector type	LC
	Fiber count	Single
	Transmitter wavelength	1590 nm
	Minimum launch power	0 dBm
	Maximum launch power	5 dBm
	Minimum receiver sensitivity	-32 dBm
	Maximum input power	-8 dBm
	Fiber type	SMF
	Core/Cladding size	9/125 μ m
	Modal bandwidth	-
	Distance	80 km (49.7 miles)
	DOM support	Available
Software required	Junos OS for NFX250 Devices, Release 15.1X53-D40 or later	

Table 14: Optical Interface Support and Copper Interface Support for Gigabit Ethernet SFP Transceivers in NFX250 Devices (Continued)

Ethernet Standard	Specification	Value
	Support for Virtual Chassis configuration	Yes
1000BASE-LX	Model number	EX-SFP-GE80KCW1610
	Rate	1000 Mbps
	Connector type	LC
	Fiber count	Single
	Transmitter wavelength	1610 nm
	Minimum launch power	0 dBm
	Maximum launch power	5 dBm
	Minimum receiver sensitivity	-32 dBm
	Maximum input power	-8 dBm
	Fiber type	SMF
	Core/Cladding size	9/125 μ m
	Modal bandwidth	-
	Distance	80 km (49.7 miles)
DOM support	Available	

Table 14: Optical Interface Support and Copper Interface Support for Gigabit Ethernet SFP Transceivers in NFX250 Devices (Continued)

Ethernet Standard	Specification	Value
	Software required	Junos OS for NFX250 Devices, Release 15.1X53-D40 or later
	Support for Virtual Chassis configuration	Yes

Table 15: Optical Interface Support for Gigabit Ethernet SFP+ Transceivers in NFX250 Devices

Ethernet Standard	Specification	Value
10GBASE-USR	Model number	EX-SFP-10GE-USR
	Rate	10 Gbps
	Connector type	LC
	Fiber count	Dual
	Transmitter wavelength	850 nm
	Minimum launch power	-7.3 dBm
	Maximum launch power	-1.3 dBm
	Minimum receiver sensitivity	-11.1 dBm
	Maximum input power	-1.0 dBm
	Fiber type	MMF

Table 15: Optical Interface Support for Gigabit Ethernet SFP+ Transceivers in NFX250 Devices
(Continued)

Ethernet Standard	Specification	Value		
	Core/Cladding size	62.5/125 5 μm	50/125 μm	50/125 μm
	Fiber grade	OM1	OM3	OM3
	Modal bandwidth	200 MH z/km	500 MH z/km	1500 MHz/km
	Distance	10 m (32.8 ft)	30 m (98.4 ft)	100 m (328 ft)
	DOM support	Available		
	Software required	Junos OS for NFX250 Devices, Release 15.1X53-D40 or later		
	Support for Virtual Chassis configuration	Yes		
10GBASE-SR	Model number	EX-SFP-10GE-SR		
	Rate	10 Gbps		
	Connector type	LC		
	Fiber count	Dual		
	Transmitter wavelength	850 nm		
	Minimum launch power	-7.3 dBm		

Table 15: Optical Interface Support for Gigabit Ethernet SFP+ Transceivers in NFX250 Devices
(Continued)

Ethernet Standard	Specification	Value				
	Maximum launch power	-1 dBm				
	Minimum receiver sensitivity	-9.9 dBm				
	Maximum input power	-1 dBm				
	Fiber type	MMF				
	Core/Cladding size	62.5/12 5 μ m	62.5/12 5 μ m	50/125 μ m	50/125 μ m	50/125 μ m
	Fiber grade	FDDI	OM1	-	OM2	OM3
	Modal bandwidth	160 MH z/km	200 MH z/km	400 MH z/km	500 MH z/km	1500 M Hz/km
	Distance	26 m (85 ft)	33 m (108 ft)	66 m (216 ft)	82 m (269 ft)	300 m (984 ft)
	DOM support	Available				
	Software required	Junos OS for NFX250 Devices, Release 15.1X53-D40 or later				
	Support for Virtual Chassis configuration	Yes				
10GBASE-LR	Model number	EX-SFP-10GE-LR				
	Rate	10 Gbps				

Table 15: Optical Interface Support for Gigabit Ethernet SFP+ Transceivers in NFX250 Devices
(Continued)

Ethernet Standard	Specification	Value
	Connector type	LC
	Fiber count	Dual
	Transmitter wavelength	1310 nm
	Minimum launch power	-8.2 dBm
	Maximum launch power	0.5 dBm
	Minimum receiver sensitivity	-18 dBm
	Maximum input power	0.5 dBm
	Fiber type	SMF
	Core/Cladding size	9/125 μ m
	Modal bandwidth	-
	Distance	10 km (6.2 miles)
	DOM support	Available
	Software required	Junos OS for NFX250 Devices, Release 15.1X53-D40 or later
	Support for Virtual Chassis configuration	Yes

Table 15: Optical Interface Support for Gigabit Ethernet SFP+ Transceivers in NFX250 Devices
(Continued)

Ethernet Standard	Specification	Value
10GBASE-ER	Model number	EX-SFP-10GE-ER
	Rate	10 Gbps
	Connector type	LC
	Fiber count	Dual
	Transmitter wavelength	1550 nm
	Minimum launch power	-4.7 dBm
	Maximum launch power	4 dBm
	Minimum receiver sensitivity	-11.3 dBm
	Maximum input power	-1 dBm
	Fiber type	SMF
	Core/Cladding size	9/125 μm
	Modal bandwidth	-
	Distance	40 km (24.8 miles)
	DOM support	Available

Table 15: Optical Interface Support for Gigabit Ethernet SFP+ Transceivers in NFX250 Devices
(Continued)

Ethernet Standard	Specification	Value
	Software required	Junos OS for NFX250 Devices, Release 15.1X53-D40 or later
	Support for Virtual Chassis configuration	Yes
10GBASE-ZR	Model number	EX-SFP-10GE-ZR
	Rate	10 Gbps
	Connector type	LC
	Fiber count	Dual
	Transmitter wavelength	1550 nm
	Minimum launch power	0 dBm
	Maximum launch power	5 dBm
	Minimum receiver sensitivity	-20 dBm
	Maximum input power	-8 dBm
	Fiber type	SMF
	Core/Cladding size	9/125 μm
	Modal bandwidth	-

Table 15: Optical Interface Support for Gigabit Ethernet SFP+ Transceivers in NFX250 Devices
(Continued)

Ethernet Standard	Specification	Value
	Distance	80 km (49.7 miles)
	DOM support	Available
	Software required	Junos OS for NFX250 Devices, Release 15.1X53-D40 or later
	Support for Virtual Chassis configuration	Yes

SEE ALSO

[Front Panel of an NFX250 Device | 6](#)

[Installing a Transceiver in an NFX250 Device | 104](#)

[Removing a Transceiver from an NFX250 Device | 105](#)

SFP+ Direct Attach Cables for NFX250 Devices

IN THIS SECTION

[Cable Specifications | 61](#)

[Standards Supported by These Cables | 64](#)

Small form-factor pluggable plus transceiver (SFP+) direct attach copper (DAC) cables, also known as Twinax cables, are suitable for in-rack connections between servers and switches. They are suitable for short distances of up to 23 ft (7 m), making them ideal for highly cost-effective networking connectivity within a rack and between adjacent racks.

This topic describes:

Cable Specifications

NFX250 devices support SFP+ passive DAC cables. The passive Twinax cable is a straight cable with no active electronic components. NFX250 devices support 1 m, 3 m, and 5 m long SFP+ passive DAC cables.

NOTE: We recommend that you use only SFP+ DAC cables purchased from Juniper Networks with your Juniper Networks device.



CAUTION: The Juniper Networks Technical Assistance Center (JTAC) provides complete support for Juniper-supplied optical modules and cables. However, JTAC does not provide support for third-party optical modules and cables that are not qualified or supplied by Juniper Networks. If you face a problem running a Juniper device that uses third-party optical modules or cables, JTAC may help you diagnose host-related issues if the observed issue is not, in the opinion of JTAC, related to the use of the third-party optical modules or cables. Your JTAC engineer will likely request that you check the third-party optical module or cable and, if required, replace it with an equivalent Juniper-qualified component.

Use of third-party optical modules with high-power consumption (for example, coherent ZR or ZR+) can potentially cause thermal damage to or reduce the lifespan of the host equipment. Any damage to the host equipment due to the use of third-party optical modules or cables is the users' responsibility. Juniper Networks will accept no liability for any damage caused due to such use.

The cables are hot-removable and hot-insertable: You can remove and replace them without powering off the switch or disrupting switch functions. A cable comprises a low-voltage cable assembly that connects directly into two SFP+ ports, one at each end of the cable. The cables use high-performance integrated duplex serial data links for bidirectional communication and are designed for data rates of up to 10 Gbps.

[Table 16 on page 62](#) describes the cable specifications.

Table 16: SFP+ Direct Attach Copper Cable Specifications

Model Number	Specification	Value
EX-SFP-10GE-DAC-1M	Rate	10-Gbps full-duplex serial transmission
	Connector type	SFP+ passive Twinax cable assembly
	Supply voltage	3.3 V
	Power consumption (per end)	0.57 W
	Storage temperature	-40° C through 85° C
	Cable type	Twinax
	Wire AWG	30 AWG
	Minimum cable bend radius	1 in. (2.54 cm)
	Cable characteristic impedance	100 ohms
	Crosstalk between pairs	2% maximum
	Time delay	1.31 nsec/ft
	Length	1 m (3.3 ft)
EX-SFP-10GE-DAC-3M	Rate	10-Gbps full-duplex serial transmission
	Connector type	SFP+ passive Twinax cable assembly
	Supply voltage	3.3 V

Table 16: SFP+ Direct Attach Copper Cable Specifications (Continued)

Model Number	Specification	Value
	Power consumption (per end)	0.57 W
	Storage temperature	-40° C through 85° C
	Cable type	Twinax
	Wire AWG	30 AWG
	Minimum cable bend radius	1 in. (2.54 cm)
	Cable characteristic impedance	100 ohms
	Crosstalk between pairs	2% maximum
	Time delay	1.31 nsec/ft
	Length	3 m (9.9 ft)
EX-SFP-10GE-DAC-5M	Rate	10-Gbps full-duplex serial transmission
	Connector type	SFP+ passive Twinax cable assembly
	Supply voltage	3.3 V
	Power consumption (per end)	0.57 W
	Storage temperature	-40° C through 85° C

Table 16: SFP+ Direct Attach Copper Cable Specifications (Continued)

Model Number	Specification	Value
	Cable type	Twinax
	Wire AWG	24 AWG
	Minimum cable bend radius	1 in. (2.54 cm)
	Cable characteristic impedance	100 ohms
	Crosstalk between pairs	2% maximum
	Time delay	1.31 nsec/ft
	Length	5 m (16.4 ft)

Standards Supported by These Cables

The cables comply with the following standards:

- SFP mechanical standard SFF-843—see <ftp://ftp.seagate.com/sff/SFF-8431.PDF> .
- Electrical interface standard SFF-8432—see <ftp://ftp.seagate.com/sff/SFF-8432.PDF> .
- SFP+ Multi-Source Alliance (MSA) standards

SEE ALSO

[Pluggable Transceivers Supported on NFX250 Devices | 30](#)

[Installing a Transceiver in an NFX250 Device | 104](#)

[Removing a Transceiver from an NFX250 Device | 105](#)

Understanding NFX250 Devices Fiber-Optic Cable Signal Loss, Attenuation, and Dispersion

IN THIS SECTION

- [Signal Loss in Multimode and Single-Mode Fiber-Optic Cables | 65](#)
- [Attenuation and Dispersion in Fiber-Optic Cable | 65](#)

To determine the power budget and power margin needed for fiber-optic connections, you need to understand how signal loss, attenuation, and dispersion affect transmission. The NFX250 devices use various types of network cable, including multimode and single-mode fiber-optic cables.

Signal Loss in Multimode and Single-Mode Fiber-Optic Cables

Multimode fiber is large enough in diameter to allow rays of light to reflect internally (bounce off the walls of the fiber). Interfaces with multimode optics typically use LEDs as light sources. However, LEDs are not coherent light sources. They spray varying wavelengths of light into the multimode fiber, which reflects the light at different angles. Light rays travel in jagged lines through a multimode fiber, causing signal dispersion. When light traveling in the fiber core radiates into the fiber cladding (layers of lower refractive index material in close contact with a core material of higher refractive index), higher-order mode loss occurs. Together, these factors reduce the transmission distance of multimode fiber compared to that of single-mode fiber.

Single-mode fiber is so small in diameter that rays of light reflect internally through one layer only. Interfaces with single-mode optics use lasers as light sources. Lasers generate a single wavelength of light, which travels in a straight line through the single-mode fiber. Compared to multimode fiber, single-mode fiber has a higher bandwidth and can carry signals for longer distances. It is consequently more expensive.

For information about the maximum transmission distance and supported wavelength range for the types of single-mode and multimode fiber-optic cables that are connected to the NFX250 devices, see ["Pluggable Transceivers Supported on NFX250 Devices" on page 30](#). Exceeding the maximum transmission distances can result in significant signal loss, which causes unreliable transmission.

Attenuation and Dispersion in Fiber-Optic Cable

An optical data link functions correctly provided that modulated light reaching the receiver has enough power to be demodulated correctly. *Attenuation* is the reduction in strength of the light signal during

transmission. Passive media components such as cables, cable splices, and connectors cause attenuation. Although attenuation is significantly lower for optical fiber than for other media, it still occurs in both multimode and single-mode transmission. An efficient optical data link must transmit enough light to overcome attenuation.

Dispersion is the spreading of the signal over time. The following two types of dispersion can affect signal transmission through an optical data link:

- Chromatic dispersion, which is the spreading of the signal over time caused by the different speeds of light rays.
- Modal dispersion, which is the spreading of the signal over time caused by the different propagation modes in the fiber.

For multimode transmission, modal dispersion, rather than chromatic dispersion or attenuation, usually limits the maximum bit rate and link length. For single-mode transmission, modal dispersion is not a factor. However, at higher bit rates and over longer distances, chromatic dispersion limits the maximum link length.

An efficient optical data link must have enough light to exceed the minimum power that the receiver requires to operate within its specifications. In addition, the total dispersion must be within the limits specified for the type of link in Telcordia Technologies document GR-253-CORE (Section 4.3) and International Telecommunications Union (ITU) document G.957.

When chromatic dispersion is at the maximum allowed, its effect can be considered as a power penalty in the power budget. The optical power budget must allow for the sum of component attenuation, power penalties (including those from dispersion), and a safety margin for unexpected losses.

Calculating the Fiber-Optic Cable Power Budget for an NFX250 Device

Calculate the link's power budget when planning fiber-optic cable layout and distances to ensure that fiber-optic connections have sufficient power for correct operation. The power budget is the maximum amount of power the link can transmit. When you calculate the power budget, you use a worst-case analysis to provide a margin of error, even though all the parts of an actual system do not operate at the worst-case levels.

To calculate the worst-case estimate for fiber-optic cable power budget (P^B) for the link:

1. Determine values for the link's minimum transmitter power (P_T) and minimum receiver sensitivity (P_R). For example, here, (P_T) and (P_R) are measured in decibels, and decibels are referenced to 1 milliwatt (dBm).

$$P_T = -15 \text{ dBm}$$

$$P_R = -28 \text{ dBm}$$

NOTE: See the specifications for your transmitter and receiver to find the minimum transmitter power and minimum receiver sensitivity.

2. Calculate the power budget (PB) by subtracting (P_R) from (PT):

$$-15 \text{ dBm} - (-28 \text{ dBm}) = 13 \text{ dBm}$$

Calculating the Fiber-Optic Cable Power Margin for an NFX250 Device

Before you begin to calculate the power margin:

- Calculate the power budget. See ["Calculating the Fiber-Optic Cable Power Budget for an NFX250 Device" on page 66](#).

Calculate the link's power margin when planning fiber-optic cable layout and distances to ensure that fiber-optic connections have sufficient signal power to overcome system losses and still satisfy the minimum input requirements of the receiver for the required performance level. The power margin (P_M) is the amount of power available after attenuation or link loss (LL) has been subtracted from the power budget (P_B).

When you calculate the power margin, you use a worst-case analysis to provide a margin of error, even though all the parts of an actual system do not operate at worst-case levels. A power margin (P_M) greater than zero indicates that the power budget is sufficient to operate the receiver and that it does not exceed the maximum receiver input power. This means the link will work. A (P_M) that is zero or negative indicates insufficient power to operate the receiver. See the specification for your receiver to find the maximum receiver input power.

To calculate the worst-case estimate for the power margin (P_M) for the link:

1. Determine the maximum value for link loss (LL) by adding estimated values for applicable link-loss factors—for example, use the sample values for various factors as provided in [Table 17 on page 67](#) (here, the link is 2 km long and multimode, and the (P_B) is 13 dBm):

Table 17: Estimated Values for Factors Causing Link Loss

Link-Loss Factor	Estimated Link-Loss Value	Sample Link Loss (LL) Calculation Values
Higher-order mode losses	Multimode—0.5 dBm	0.5 dBm

Table 17: Estimated Values for Factors Causing Link Loss (*Continued*)

Link-Loss Factor	Estimated Link-Loss Value	Sample Link Loss (LL) Calculation Values
	Single-mode—None	0 dBm
Modal and chromatic dispersion	Multimode—None, if product of bandwidth and distance is less than 500 MHz/km	0 dBm
	Single-mode—None	0 dBm
Connector	0.5 dBm	This example assumes five connectors. Loss for five connectors: 5 (0.5 dBm) = 2.5 dBm.
Splice	0.5 dBm	This example assumes two splices. Loss for two splices: 2 (0.5 dBm) = 1 dBm.
Fiber attenuation	Multimode—1 dBm/km	This example assumes the link is 2 km long. Fiber attenuation for 2 km: 2 km (1 dBm/km) = 2 dBm.
	Single-mode—0.5 dBm/km	This example assumes the link is 2 km long. Fiber attenuation for 2 km: 2 km (0.5 dBm/km) = 1 dBm.
Clock Recovery Module (CRM)	1 dBm	1 dBm

NOTE: For information about the actual amount of signal loss caused by equipment and other factors, see your vendor documentation for that equipment.

2. Calculate the (P_M) by subtracting (LL) from (P_B):

$$P_B - LL = P_M$$

$$13 \text{ dBm} - 0.5 \text{ dBm [HOL]} - 5 (0.5 \text{ dBm}) - 2 (0.5 \text{ dBm}) - 2 \text{ km} (1.0 \text{ dBm/km}) - 1 \text{ dB [CRM]} = P_M$$

$$13 \text{ dBm} - 0.5 \text{ dBm} - 2.5 \text{ dBm} - 1 \text{ dBm} - 2 \text{ dBm} - 1 \text{ dBm} = P_M$$

$$P_M = 6 \text{ dBm}$$

The calculated power margin is greater than zero, indicating that the link has sufficient power for transmission. Also, the power margin value does not exceed the maximum receiver input power. Refer to the specifications for your receiver to find the maximum receiver input power.

NFX250 Cable Specifications and Pinouts

IN THIS SECTION

- [Cable Specifications for Console and Management Connections for the NFX250 Devices | 69](#)
- [Mini-USB Type-B Console Port Specifications for an NFX250 Device | 70](#)
- [Console Port Connector Pinouts for NFX250 Devices | 71](#)
- [USB Port Specifications for an NFX250 Device | 72](#)
- [Management Port Connector Pinout Information for an NFX250 Device | 73](#)
- [Network Port Connector Pinout Information for an NFX250 Device | 74](#)
- [RJ-45 to DB-9 Serial Port Adapter Pinout Information for an NFX250 Device | 75](#)

Cable Specifications for Console and Management Connections for the NFX250 Devices

[Table 18 on page 69](#) lists the specifications for the cables that connect the NFX250 devices to a management device.

Table 18: Cable Specifications for Console and Management Connections for the NFX250 Devices

Port on NFX250 Device	Cable Specification	Maximum Length	Device Receptacle
Console port	RS-232 (EIA-232) serial cable	7 feet (2.13 meters)	RJ-45
Management port	Category 5 cable or equivalent suitable for 1000BASE-T operation	328 feet (100 meters)	RJ-45

NOTE: We no longer include a DB-9 to RJ-45 cable or a DB-9 to RJ-45 adapter with a CAT5E copper cable as part of the device package. If you require a console cable, you can order it separately with the part number JNP-CBL-RJ45-DB9 (DB-9 to RJ-45 adapter with a CAT5E copper cable).

SEE ALSO

[Connecting an NFX250 Device to a Management Console | 96](#)

[Connecting an NFX250 Device to a Network for Out-of-Band Management | 95](#)

Mini-USB Type-B Console Port Specifications for an NFX250 Device

NFX250 Device has two: an RJ-45 port, and a Mini-USB port.

By default, the RJ-45 port is set as the active console port. It can display all the early boot and low-level message output and you can access the device through this port in the debugger prompt.

The Mini-USB port is the passive console port. You can change the status of the port to active or passive using the `port-type` configuration statement. See [Configuring the Console Port Type \(CLI Procedure\)](#).

The Mini-USB console port uses a Mini-B plug (5-pin) connector to connect to a console management device. The default baud rate for the console port is 9600 baud.

[Table 19 on page 70](#) provides the pinout information of the Mini-USB Type-B console port.

Table 19: Mini-USB Type-B Console Port Pinout Information for NFX250 Devices

Pin	Signal	Description
1	VCC	+5 VDC
2	D-	Data -
3	D+	Data +

Table 19: Mini-USB Type-B Console Port Pinout Information for NFX250 Devices (Continued)

Pin	Signal	Description
X	N/C	May be N/C, GND or used as an attached device presence indicator
4	GND	Ground

SEE ALSO

| *Configuring the Console Port Type (CLI Procedure)*

Console Port Connector Pinouts for NFX250 Devices

The console port (labeled **CON**) is an RS-232 serial interface that uses an RJ-45 connector to connect to a console management device. The default baud rate for the console port is 9600 baud.

[Table 20 on page 71](#) provides the pinout information for the RJ-45 console connector.

NOTE: If your laptop or PC does not have a DB-9 plug connector pin and you want to connect your laptop or PC directly to an NFX250 device, use a combination of the RJ-45 cable and RJ-45 to DB-9 adapter and a USB to DB-9 plug adapter. You must provide the USB to DB-9 plug adapter.

Table 20: Console Port Connector Pinouts for the NFX250 Device

Pin	Signal	Description
1	RTS Output	Request to send
2	DTR Output	Data terminal ready
3	TxD Output	Transmit data

Table 20: Console Port Connector Pinouts for the NFX250 Device *(Continued)*

Pin	Signal	Description
4	Signal Ground	Signal ground
5	Signal Ground	Signal ground
6	RxD Input	Receive data
7	DCD Input	Data carrier detect
8	CTS Input	Clear to send

SEE ALSO

[Connecting an NFX250 Device to a Management Console | 96](#)

USB Port Specifications for an NFX250 Device

The following Juniper Networks USB flash drives have been tested and are officially supported for the USB port in the NFX250 devices:

- RE-USB-1G-S—1-gigabyte (GB) USB flash drive
- RE-USB-2G-S—2-GB USB flash drive
- RE-USB-4G-S—4-GB USB flash drive



CAUTION: Any USB memory product not listed as supported for the NFX250 device has not been tested by Juniper Networks. The use of any unsupported USB memory product could expose your device to unpredictable behavior. Juniper Networks Technical Assistance Center (JTAC) can provide only limited support for issues related to unsupported hardware. We strongly recommend that you use only supported USB flash drives.



CAUTION: Remove the USB flash drive before upgrading Junos OS or rebooting a NFX250 device. Failure to do so could expose your device to unpredictable behavior.

NOTE: Executing the `request system snapshot` CLI command on a NFX250 device requires an external USB flash drive with at least 4 GB of free space. We recommend using the RE-USB-4G-S flash drive.

NOTE: USB flash drives used with the NFX250 device must support USB 2.0 or later.

Management Port Connector Pinout Information for an NFX250 Device

The 1000BASE-T RJ-45 management port on an NFX250 device uses an RJ-45 connector to connect to a management device for out-of-band management.

[Table 21 on page 73](#) provides the pinout information of the RJ-45 management port connector.

Table 21: RJ-45 Management Port Connector Pinouts for the NFX250 Devices

Pin	Signal	Description
1	TRP1+	Transmit/receive data pair 1
2	TRP1-	Transmit/receive data pair 1
3	TRP2+	Transmit/receive data pair 2
4	TRP3+	Transmit/receive data pair 3
5	TRP3-	Transmit/receive data pair 3
6	TRP2-	Transmit/receive data pair 2

Table 21: RJ-45 Management Port Connector Pinouts for the NFX250 Devices (Continued)

Pin	Signal	Description
7	TRP4+	Transmit/receive data pair 4
8	TRP4-	Transmit/receive data pair 4

Network Port Connector Pinout Information for an NFX250 Device

A network port on an NFX250 device uses an RJ-45 connector to connect to a device.

The port uses an autosensing RJ-45 connector to support a 10/100/1000Base-T connection. Two LEDs on the port indicate link/activity on the port and the port status. See ["Network Port and Uplink Port LEDs on NFX250 Devices" on page 10](#).

[Table 22 on page 74](#) provides the pinout information for the RJ-45 connector.

Table 22: Network Port Connector Pinout Information for NFX250 Devices

Pin	Signal	Description
1	TRP1+	Transmit/receive data pair 1 Negative Vport (in PoE models)
2	TRP1-	Transmit/receive data pair 1 Negative Vport (in PoE models)
3	TRP2+	Transmit/receive data pair 2 Positive Vport (in PoE models)
4	TRP3+	Transmit/receive data pair 3
5	TRP3-	Transmit/receive data pair 3

Table 22: Network Port Connector Pinout Information for NFX250 Devices *(Continued)*

Pin	Signal	Description
6	TRP2-	Transmit/receive data pair 2 Positive Vport (in PoE models)
7	TRP4+	Transmit/receive data pair 4
8	TRP4-	Transmit/receive data pair 4

RJ-45 to DB-9 Serial Port Adapter Pinout Information for an NFX250 Device

The console port is an RS-232 serial interface that uses an RJ-45 connector to connect to a management device such as a PC or a laptop. If your laptop or PC does not have a DB-9 plug connector pin and you want to connect your laptop or PC to an NFX250 device, use a combination of the RJ-45 to DB-9 socket adapter along with a USB to DB-9 plug adapter.

NOTE: We no longer include a DB-9 to RJ-45 cable or a DB-9 to RJ-45 adapter with a CAT5E copper cable as part of the device package. If you require a console cable, you can order it separately with the part number JNP-CBL-RJ45-DB9 (DB-9 to RJ-45 adapter with a CAT5E copper cable).

Table 23 on page 75 provides the pinout information for the RJ-45 to DB-9 serial port adapter.

Table 23: RJ-45 to DB-9 Serial Port Adapter Pinout Information

RJ-45 Pin	Signal	DB-9 Pin	Signal
1	RTS	8	CTS
2	DTR	6	DSR

Table 23: RJ-45 to DB-9 Serial Port Adapter Pinout Information (Continued)

RJ-45 Pin	Signal	DB-9 Pin	Signal
3	TXD	2	RXD
4	GND	5	GND
6	RXD	3	TXD
7	DSR	4	DTR
8	CTS	7	RTS

SEE ALSO

| [Connecting an NFX250 Device to a Management Console](#) | 96

3

CHAPTER

Initial Installation and Configuration

NFX250 Installation Overview | 78

Unpacking and Mounting the NFX250 | 79

Connecting the NFX250 to Power | 91

Connecting the NFX250 to the Network | 95

Initial Configuration on NFX250 Devices | 99

NFX250 Installation Overview

To install and connect an NFX250 device:

1. Follow instructions in ["Unpacking an NFX250 Device" on page 79](#).
2. Mount the device by following instructions appropriate for your site:
 - ["Mounting an NFX250 Device on a Desk or Other Level Surface" on page 82](#) (using the rubber feet provided)
 - ["Mounting an NFX250 Device on Two Posts in a Rack" on page 86](#) (using the mounting brackets provided)
 - ["Mounting an NFX250 Device on Four Posts in a Rack or Cabinet" on page 88](#) (using the separately orderable four-post rack-mount kit)
 - ["Mounting an NFX250-LS1 Device on a Wall" on page 83](#) (using the separately orderable wall-mount kit)
3. Follow instructions in ["Connecting Earth Ground to an NFX250 Device" on page 91](#).
4. Follow instructions in ["Connecting AC Power to an NFX250 Device" on page 93](#).
5. Perform initial configuration of the device by following instructions in ["Configuring an NFX250 Device" on page 99](#).
6. Set the device's management options by following the appropriate instructions:
 - ["Connecting an NFX250 Device to a Management Console" on page 96](#)
 - ["Connecting an NFX250 Device to a Network for Out-of-Band Management" on page 95](#)

RELATED DOCUMENTATION

[Rack Requirements for NFX250 Devices | 26](#)

[Cabinet Requirements for an NFX250 Device | 28](#)

[Clearance Requirements for Airflow and Hardware Maintenance for an NFX250 Device | 25](#)

Unpacking and Mounting the NFX250

IN THIS SECTION

- [Unpacking an NFX250 Device | 79](#)
- [Parts Inventory \(Packing List\) for an NFX250 Device | 80](#)
- [Register Products—Mandatory to Validate SLAs | 81](#)
- [Mounting an NFX250 Device | 81](#)
- [Mounting an NFX250 Device on a Desk or Other Level Surface | 82](#)
- [Mounting an NFX250-LS1 Device on a Wall | 83](#)
- [Mounting an NFX250 Device on Two Posts in a Rack | 86](#)
- [Mounting an NFX250 Device on Four Posts in a Rack or Cabinet | 88](#)

Unpacking an NFX250 Device

The NFX250 devices are shipped in a cardboard carton, secured with foam packing material. The carton has an accessory compartment and contains the quick start instructions.



CAUTION: NFX250 devices are maximally protected inside the shipping carton. Do not unpack the switches until you are ready to begin installation.

To unpack the switch:

1. Open the carton.
2. Pull out the packing material holding the device in place.
3. Verify the parts received against the inventory on the label attached to the carton. See "[Parts Inventory \(Packing List\) for an NFX250 Device](#)" on page 80.
4. Save the shipping carton and packing materials in case you need to move or ship the switch later.

SEE ALSO

| [Initial Configuration on NFX250 Devices | 99](#)

Parts Inventory (Packing List) for an NFX250 Device

The NFX250 devices are shipped in a cardboard carton, secured with foam packing material. The carton contains an accessory box.

The device shipment includes a packing list. Check the parts you receive in the device shipping carton against the items on the packing list. The parts shipped depend on the configuration you order.

If any part on the packing list is missing, contact your customer service representative or contact Juniper customer care from within the U.S. or Canada by telephone at 1-888-314-5822. For international-dial or direct-dial options in countries without toll-free numbers, see <https://www.juniper.net/support/requesting-support.html>.

Table 24 on page 80 lists the parts and their quantities in the packing list.

Table 24: Packing List for an NFX250 Device

Component	Quantity
Device	1
AC power cord appropriate for your geographical location	1
AC power cord retainer clip	1
Mounting brackets	2
Mounting screws to attach the mounting brackets to the device chassis	8
Rubber feet	4
Quick Start installation instructions	1
Juniper Networks Product Warranty	1
End User License Agreement	1

NOTE: We no longer include a DB-9 to RJ-45 cable or a DB-9 to RJ-45 adapter with a CAT5E copper cable as part of the device package. If you require a console cable, you can order it separately with the part number JNP-CBL-RJ45-DB9 (DB-9 to RJ-45 adapter with a CAT5E copper cable).

NOTE: You must provide mounting screws that are appropriate for your rack or cabinet to mount the chassis on a rack or a cabinet.

Register Products—Mandatory to Validate SLAs

Register all new Juniper Networks hardware products and changes to an existing installed product using the Juniper Networks website to activate your hardware replacement service-level agreements (SLAs).



CAUTION: Register product serial numbers on the Juniper Networks website. Update the installation base data if any addition or change to the installation base occurs or if the installation base is moved. Juniper Networks is not responsible for not meeting the hardware replacement service-level agreement for products that do not have registered serial numbers or accurate installation base data.

Register your product(s) at <https://tools.juniper.net/svcreg/SRegSerialNum.jsp>.

Update your installation base at <https://www.juniper.net/customers/csc/management/updateinstallbase.jsp>.

Mounting an NFX250 Device

Table 25 on page 82 lists the methods you can use to mount an NFX250 device.

Table 25: NFX250 Device Mounting Methods

Mounting Method	Device Model	Comments
Desk or other level surface (using rubber feet)	<ul style="list-style-type: none"> • NFX250-S1 • NFX250-S2 • NFX250-LS1 	On a desk or other level surface by using rubber feet provided with the device.
Two-post rack or cabinet	<ul style="list-style-type: none"> • NFX250-S1 • NFX250-S2 • NFX250-LS1 	On two posts in a 19-in. rack or cabinet by using the mounting brackets.
Four-post rack or cabinet	<ul style="list-style-type: none"> • NFX250-S1 • NFX250-S2 • NFX250-LS1 	<ul style="list-style-type: none"> • On four posts in a 19-in. rack or cabinet by using the separately orderable four-post rack-mount kit • On two posts in a 19-in. rack or cabinet by using the two post rack mounting brackets.
Wall Mounting	NFX250-LS1	On a wall by using separately orderable wall-mount kit

The holes in the mounting brackets are placed at 1 U (1.75 in. or 4.45 cm) apart so that the switch can be mounted in any rack or cabinet that provides holes spaced at that distance.

See the Related Documentation for detailed descriptions of the various rack or cabinet mounting options.

Mounting an NFX250 Device on a Desk or Other Level Surface

Before mounting the device on a desk or other level surface:

- Verify that the site meets the requirements described in "[Site Preparation Checklist for NFX250 Devices](#)" on page 20.
- Place the desk in its permanent location, allowing adequate clearance for airflow and maintenance, and secure it to the building structure.

- Read [General Safety Guidelines and Warnings](#), with particular attention to "Chassis Lifting Guidelines for NFX250 Devices" on page 133.
- Ensure that you have the 4 rubber feet to stabilize the chassis on the a desk or other level surface (provided in the accessory box in the switch carton)

You can mount an NFX250 device on a desk or other level surface by using the four rubber feet that are shipped with the switch. The rubber feet stabilize the chassis.

To mount an NFX250 device on a desk or other level surface:

1. Remove the device from the shipping carton (see ["Unpacking an NFX250 Device" on page 79](#)).
2. Turn the chassis upside down on the desk or the level surface where you intend to mount the device.
3. Attach the rubber feet to the bottom of the chassis as shown in [Figure 11 on page 83](#)
4. Turn the chassis right side up on the desk or the level surface.

Figure 11: Attaching Rubber Feet to the NFX250 Device

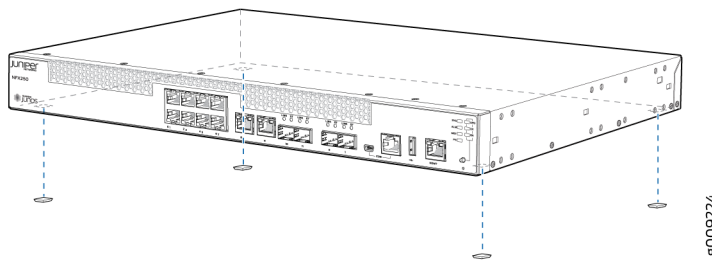

SEE ALSO

[Clearance Requirements for Airflow and Hardware Maintenance for an NFX250 Device](#) | 25

Mounting an NFX250-LS1 Device on a Wall

Before mounting an NFX250-LS1 device on a wall:

- Verify that the site meets the requirements described in ["Site Preparation Checklist for NFX250 Devices" on page 20](#).
- Read [General Safety Guidelines and Warnings](#), with particular attention to "Chassis Lifting Guidelines for NFX250 Devices" on page 133.
- Remove the device from the shipping carton (see ["Unpacking an NFX250 Device" on page 79](#)).

Ensure that you have the following parts and tools available:

- Phillips (+) screwdriver, number 2
- 2 wall-mount brackets (provided with the wall-mount kit)
- 8 wall-mount bracket screws (provided with the wall-mount kit)
- 4 mounting screws (8-32 x 1.25 in. or M4 x 30 mm) (not included)
- Hollow wall anchors capable of supporting the weight of a fully loaded NFX250-LS1 device, up to 9 lb (4 kg) (not included)—if you are mounting the device in sheetrock (wall board with a gypsum plaster core) or in wall board not backed by wall studs

You can mount an NFX250-LS1 device on a wall by using the separately orderable wall-mount kit.

To mount the device on a wall:

1. Attach the wall-mount brackets to the sides of the chassis using four of the wall-mount bracket screws on each side, as shown in [Figure 12 on page 84](#).

Figure 12: Attaching Wall-Mount Brackets to the NFX250 Device Chassis

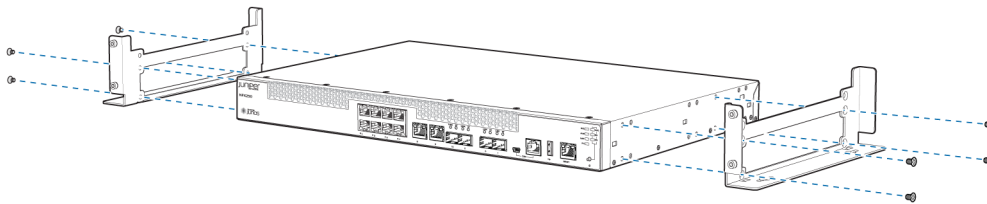

8009079

2. Install four mounting screws on the wall as shown in [Figure 13 on page 85](#).

Figure 13: Measurements for Installing Mounting Screws for NFX250 Device on a Wall

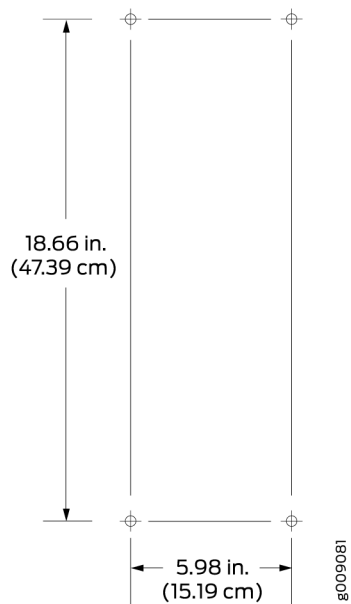

- a. Drill a hole A and install a mounting screw.
 - b. Drill a hole B at a distance of 5.98 in. (15.19 cm.) on a level line to the right from hole A and install a mounting screw.
 - c. Drill two holes at a distance of 18.66 in. (47.39 cm) on a plumb line from hole A and B, install the mounting screws.
 - d. Screw the mounting screws only part way in, leaving about 1/4 in. (6 mm) distance between the head of the screw and the wall.
3. If the mounting screws are inserted in wall board with no stud behind it, you must use dry wall anchors rated to support 20 lb (9 kg). Insert the screws into wall studs wherever possible to provide added support for the chassis.
 4. Grasp each side of the device, lift the device, and hang the brackets from the mounting screws such that the front panel of the device faces to your right or left side as shown in [Figure 14 on page 86](#).

Figure 14: Mounting the NFX250 Device on a Wall

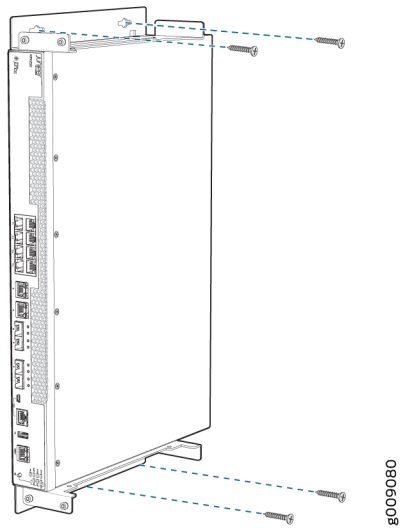

5. Tighten the mounting screws.

Mounting an NFX250 Device on Two Posts in a Rack

Before mounting an NFX250 device on two posts in a rack:

- Place the rack in its permanent location, allowing adequate clearance for airflow and maintenance, and secure it to the building structure.
- Read [General Safety Guidelines and Warnings](#).
- Remove the device from the shipping carton.

Ensure that you have the following parts and tools available:

- Phillips (+) screwdriver, number 2
- 2 mounting brackets and 8 mounting screws (provided in the accessory box shipped with the device)
- Screws to secure the chassis to the rack (not provided)

You can mount an NFX250 device on two posts of a 19-in. rack (either a two-post or a four-post rack).

NOTE: If you need to mount the device in a recessed position on either a two-post rack or a four-post rack, you can use the 2-in.-recess front brackets provided in the separately orderable four-post rack-mount kit.

NOTE: One person must be available to lift the device while another secures the device to the rack.



CAUTION: If you are mounting multiple devices on a rack, mount a device in the bottom of the rack first and proceed to mount the rest of the devices from bottom to top.

To mount the device on two posts in a rack:

1. Place the device on a flat, stable surface.
2. Align the mounting brackets along the front, rear, or center of the side panels of the device chassis depending on how you want to mount the device. For example, if you want to front-mount the device, align the brackets along the front of the side panel. See [Figure 15 on page 87](#).

Figure 15: Attaching the Mounting Bracket to the Side Panel of the Device

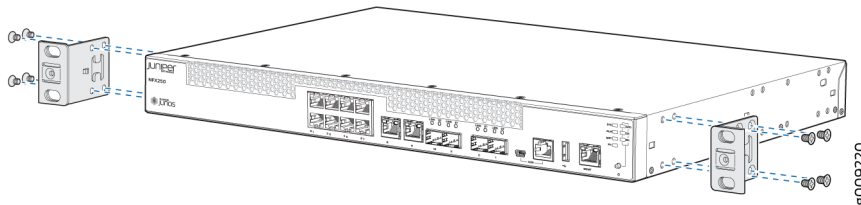

NOTE: If you need to mount the device in a recessed position, use the 2-in.-recess front mount brackets from the separately orderable four-post rack-mount kit.

3. Align the bottom holes in the mounting brackets with holes on the side panels of the device chassis.
4. Insert mounting screws into the aligned holes. Tighten the screws.
5. Ensure that the other holes in the mounting brackets are aligned with the holes in the side panels. Insert a screw in each hole and tighten the screws.

6. Have one person grasp both sides of the device, lift the device, and position it in the rack, aligning the mounting bracket holes with the threaded holes in the rack or cabinet rail. Align the bottom hole in both the mounting brackets with a hole in each rack rail, making sure the chassis is level. See [Figure 16 on page 88](#).

Figure 16: Mounting the Device on Two Posts in a Rack

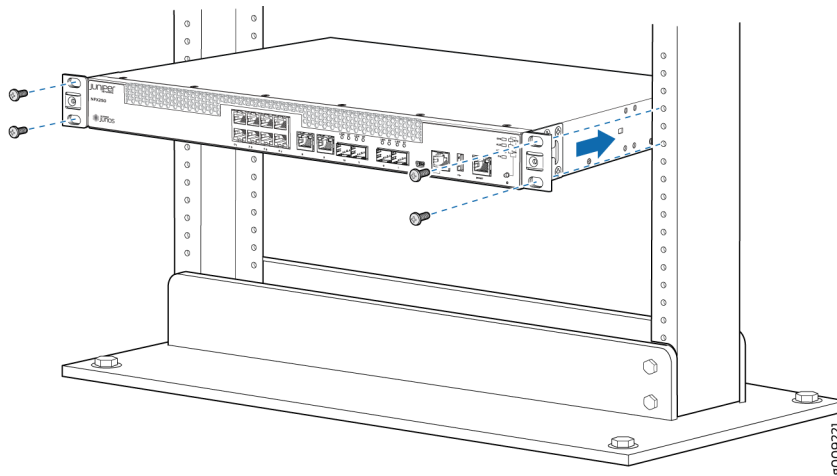

7. Have a second person secure the device to the rack by using the appropriate screws. Tighten the screws.
8. Ensure that the device chassis is level by verifying that all screws on one side of the rack are aligned with the screws on the other side.

Mounting an NFX250 Device on Four Posts in a Rack or Cabinet

Before mounting the device on four posts in a rack:

- Place the rack in its permanent location, allowing adequate clearance for airflow and maintenance, and secure it to the building structure.
- Read [General Safety Guidelines and Warnings](#), with particular attention to "[Chassis Lifting Guidelines for NFX250 Devices](#)" on page 133.
- Remove the device from the shipping carton (see "[Unpacking an NFX250 Device](#)" on page 79).
- Have two persons available to mount the device. One person will support the device in a level position, and the second person will secure the device to the rack.

Ensure that you have the following parts and tools available:

- Phillips (+) screwdriver, number 2
- 12 flat-head M4x6-mm Phillips mounting screws (provided with the four-post rack-mount kit)
- One pair of front-mounting brackets
- One pair of rear mounting-blades
- Screws to secure the front-mounting brackets and the rear mounting-blades to the rack (not provided)

You can mount an NFX250 device on four posts of a 19-in. rack or cabinet by using the separately orderable four-post rack-mount kit. (The remainder of this topic uses *rack* to mean *rack or cabinet*.)

You can mount the device on two posts in either a two-post rack or a four-post rack by using the mounting brackets provided with the device. See ["Mounting an NFX250 Device on Two Posts in a Rack" on page 86](#).

NOTE: If you are mounting the device on four posts, ensure that the rack is 21.5 in. through 31.5 in. deep if you will mount the device flush with the rack front and that the rack is 23.5 in. through 32.5 in. deep if you will mount the device 2 in. recessed from the rack front, thus ensuring that the protective earthing terminal is accessible through the opening in the rear mounting-blade.



CAUTION: If you are mounting multiple units on a rack, mount the heaviest unit at the bottom of the rack and mount the other units from the bottom of the rack to the top in decreasing order of the weight of the units.

To mount the device on four posts in a rack:

1. Place the device on a flat, stable surface.
2. Align a front bracket (either flush with the front of the chassis or 2-in.-recessed from the front of the chassis) along the side panel of the device chassis. Align the two holes in the front of the brackets with the two holes on the front of the side panel.

NOTE: Each side of the chassis has twelve holes for attaching the front-mounting brackets to the device.

Six holes on the chassis side align with six holes in the front bracket when the front bracket is mounted flush with the chassis front or recessed 2 in. from the front of the chassis.

3. Insert M4x6-mm Phillips flat-head mounting screws into the two aligned holes and tighten the screws. Ensure that the remaining two holes in the front bracket are aligned with the two holes in the side panel. See [Figure 17 on page 90](#).

Figure 17: Attaching the Front-Mounting Bracket to the Device Chassis

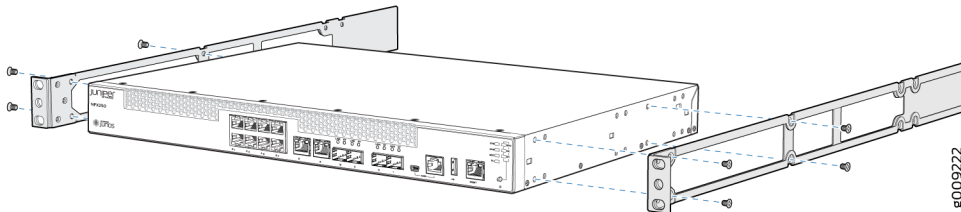

4. Insert M4x6-mm Phillips flat-head mounting screws into the remaining two holes in the front bracket and tighten the screws.
5. Repeat steps 2 through 4 for attaching the front bracket to the other side of the chassis.
6. Have one person grasp both sides of the device, lift the device, and position it in the rack, aligning the front bracket holes with the threaded holes in the front post of the rack. Align the bottom hole in both the front-mounting brackets with a hole in each rack rail, making sure the chassis is level. See [Figure 18 on page 90](#).

Figure 18: Mounting the Device on the Front Posts in a Rack

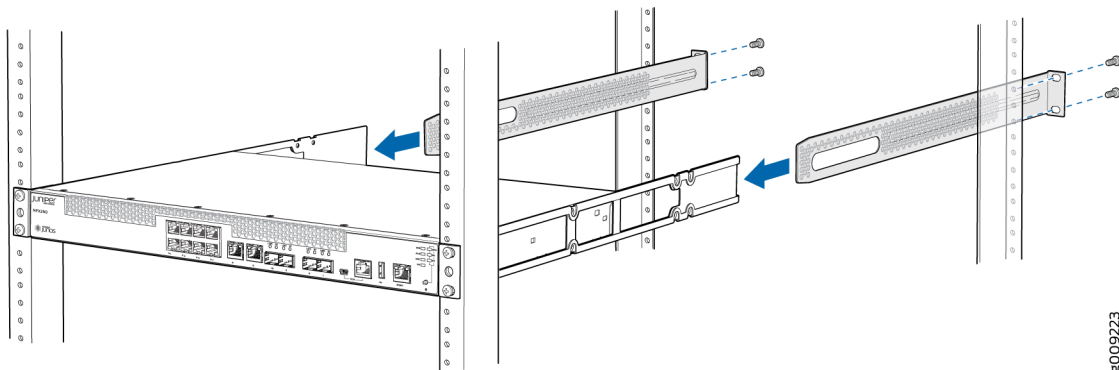

7. Have a second person secure the front of the device to the rack by using the appropriate screws for your rack.
8. Slide the rear mounting-blades into the front-mounting brackets.
9. Attach the rear mounting-blades to the rear post by using the appropriate screws for your rack. Tighten the screws.

10. Ensure that the device chassis is level by verifying that all the screws on the front of the rack are aligned with the screws at the back of the rack.

Connecting the NFX250 to Power

IN THIS SECTION

- [Connecting Earth Ground to an NFX250 Device | 91](#)
- [Connecting AC Power to an NFX250 Device | 93](#)

Connecting Earth Ground to an NFX250 Device

IN THIS SECTION

- [Parts and Tools Required for Connecting an NFX250 Device to Earth Ground | 92](#)
- [Connecting Earth Ground to an NFX250 Device | 92](#)

Electromagnetic Compatibility (EMC) and Electrostatic Discharge (ESD) requirements are met by the device chassis. The AC power cord provides surge protection.

You must install the NFX250 device in a restricted-access location and ensure that the chassis is always properly grounded. The NFX250 device has a two-hole protective grounding terminal provided on the chassis. See [Figure 19 on page 93](#). We recommend that you use this protective grounding terminal as the preferred method for grounding the chassis regardless of the power supply configuration. However, if additional grounding methods are available, you can also use those methods. For example, you can use the grounding wire in the AC power cord or use the grounding terminal or lug on a DC power supply. This tested system meets or exceeds all applicable EMC regulatory requirements with the two-hole protective grounding terminal.

This topic describes:

Parts and Tools Required for Connecting an NFX250 Device to Earth Ground

Table 26 on page 92 lists the earthing terminal location, grounding cable requirements, grounding lug specifications, screws and washers required, and the screwdriver needed for connecting a device to earth ground. Before you begin connecting a switch to earth ground, ensure you have the parts and tools required for your device.

Table 26: Parts and Tools Required for Connecting an NFX250 Device to Earth Ground

Device	Earthing Terminal Location	Grounding Cable Requirements	Grounding Lug Specifications	Screws and Washers	Screwdriver	Additional Information
NFX250	Rear panel of chassis	14 AWG (2 mm ²), minimum 90°C wire, or as permitted by the local code	Panduit LCC10-14BWL or equivalent—not provided	<ul style="list-style-type: none"> Two 10-32 x .25 in. screws with #10 split-lock washer — not provided Two #10 flat washers—not provided 	Phillips (+) number 2	

Connecting Earth Ground to an NFX250 Device

To connect earth ground to a device:

1. Connect one end of the grounding cable to a proper earth ground, such as the rack in which the switch is mounted.
2. Place the grounding lug attached to the grounding cable over the protective earthing terminal. See [Figure 19 on page 93](#).

Figure 19: Connecting a Grounding Cable to an NFX250 Device

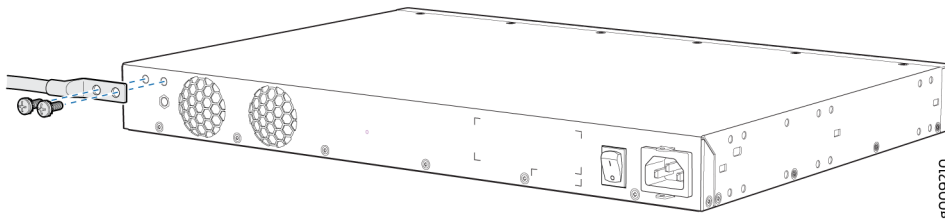

3. Secure the grounding lug to the protective earthing terminal with the washers and screws.
4. Dress the grounding cable and ensure that it does not touch or block access to other device components.



WARNING: Ensure that the cable does not drape where people could trip over it.

Connecting AC Power to an NFX250 Device

Ensure that you have the following parts and tools available:

- A power cord appropriate for your geographical location
- A power cord retainer clip



CAUTION: NFX250 device gets additional grounding when you plug the power supply in the device into a grounded AC power outlet by using the AC power cord appropriate for your geographical location (see "[AC Power Cord Specifications for an NFX250 Device](#)" on page 15).

The power supply in an NFX250 device is located on the rear panel.

To connect AC power to the device:

1. Squeeze the two sides of the power cord retainer clip and insert the L-shaped ends of the wire clip into the holes in the bracket on each side of the AC power cord inlet on the rear panel.
The power cord retainer clip extends out of the chassis by 3 in.
2. Locate the power cord or cords shipped with the device; the cords have plugs appropriate for your geographical location. See "[AC Power Cord Specifications for an NFX250 Device](#)" on page 15.



WARNING: Ensure that the power cord does not drape where people can trip on it or block access to switch components.

3. Insert the coupler end of the power cord into the AC power cord inlet on the rear panel.
4. Push the power cord into the slot in the adjustment nut of the power cord retainer clip. Turn the nut until it is tight against the base of the coupler and the slot in the nut is turned 90° from the top of the device.
5. If the AC power source outlet has a power switch, set it to the OFF (O) position.
6. Insert the power cord plug into an AC power source outlet.
7. If the AC power source outlet has a power switch, set it to the ON (I) position.

NOTE: The retainer brackets on your switch might be above and below the power inlet rather than on either side.

Figure 20: Connecting an AC Power Cord to the AC Power Cord Inlet on NFX250 Device

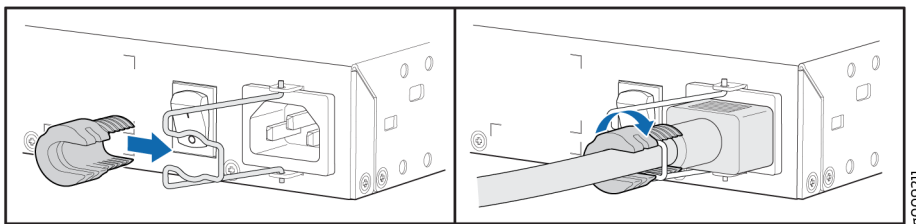

RELATED DOCUMENTATION

[AC Power Supply Specifications for an NFX250 Device | 15](#)

[AC Power Cord Specifications for an NFX250 Device | 15](#)

Connecting the NFX250 to the Network

IN THIS SECTION

- [Connecting an NFX250 Device to a Network for Out-of-Band Management | 95](#)
- [Connecting an NFX250 Device to a Management Console | 96](#)
- [Connecting an NFX250 Device to a Management Console Using Mini-USB Type-B Console Port | 98](#)

Connecting an NFX250 Device to a Network for Out-of-Band Management

Ensure that you have an appropriate cable available.

You can monitor and manage the NFX250 device using a dedicated management channel. NFX250 devices have one management port, Eight 1-Gigabit Ethernet RJ-45 ports, two 1-Gigabit Ethernet RJ-45 network/uplink ports, two 1-Gigabit Ethernet small form-factor pluggable (SFP) ports, and two 1/10-Gigabit Ethernet SFP+ ports. Use the management port to connect the NFX250 device to a network for out-of-band management.

To connect an NFX250 device to a network for out-of-band management (see [Figure 21 on page 96](#)):

1. Connect one end of the cable to the management port (labeled **MGMT**) on the NFX250 device.
2. Connect the other end of the cable to the management switch (see [Figure 21 on page 96](#)).

Figure 21: Connecting an NFX250 Device to a Network for Out-of-Band Management

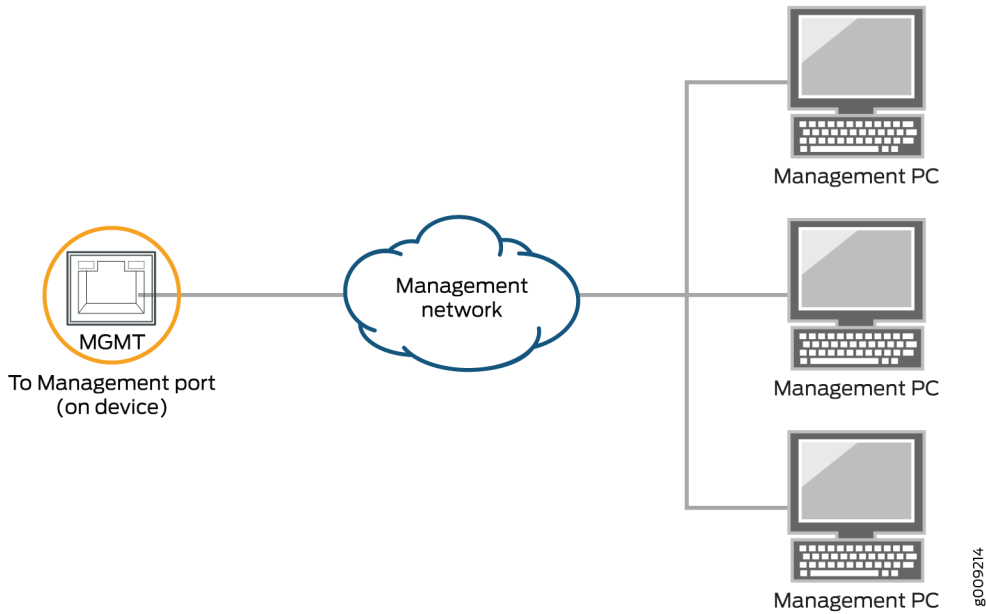

SEE ALSO

[Front Panel of an NFX250 Device](#) | 6

Connecting an NFX250 Device to a Management Console

Ensure that you have an RJ-45 to DB-9 rollover cable available.

NOTE: We no longer include a DB-9 to RJ-45 cable or a DB-9 to RJ-45 adapter with a CAT5E copper cable as part of the device package. If you require a console cable, you can order it separately with the part number JNP-CBL-RJ45-DB9 (DB-9 to RJ-45 adapter with a CAT5E copper cable).

NOTE: If your laptop or PC does not have a DB-9 plug connector pin and you want to connect your laptop or PC directly to the NFX250 device, use a combination of the RJ-45 cable and

RJ-45 to DB-9 adapter and a USB to DB-9 plug adapter. You must provide the USB to DB-9 plug adapter.

NFX250 device has a console port with an RJ-45 connector. Use the console port to connect the device to a management console or to a console server.

To connect the NFX250 device to a management console (see [Figure 22 on page 97](#) and [Figure 23 on page 97](#)):

1. Connect one end of the Ethernet cable to the console port (labeled **CON**).
2. Connect the other end of the Ethernet cable into the console server (see [Figure 22 on page 97](#)) or management console (see [Figure 23 on page 97](#)).

Figure 22: Connecting the NFX250 Device to a Management Console Through a Console Server

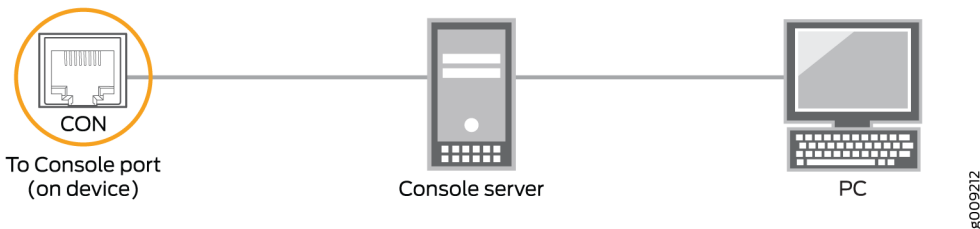

Figure 23: Connecting the NFX250 Device Directly to a Management Console



SEE ALSO

[Console Port Connector Pinouts for NFX250 Devices](#) | 71

Connecting an NFX250 Device to a Management Console Using Mini-USB Type-B Console Port

Before you begin connecting an NFX250 device by using the Mini-USB Type-B console port:

- Ensure that the USB to Serial driver is installed on the host machine. You can download the driver from <https://webdownload.juniper.net/swdl/dl/secure/site/1/record/5029.html>
- Ensure that the hyper terminal properties of the console server or laptop are set as follows:
 - Baud rate—9600
 - Flow control—None
 - Data—8
 - Parity—None
 - Stop bits—1
 - DCD state—Disregard

Ensure that you have the following parts and tools available:

- 1 mini-USB cable with Standard-A and Mini-USB Type- B (5-pin) connectors (not provided).

You can configure and manage NFX250 devices by using the RJ-45 console port or the Mini-USB Type-B console port. However, the console input will be active only on one port at a time—only one port will be set active at a time.

By default, the RJ-45 port is set as an active console port and the Mini-USB Type-B port is the passive console port. For information about configuring the console port type, see [Configuring the Console Port Type \(CLI Procedure\)](#).

If your laptop or PC does not have a DB-9 plug connector pin or RJ-45 connector pin, you can connect your laptop or PC directly to an NFX250 device by using a mini-USB cable that has a Standard-A USB connector on one end and a Mini-USB Type-B (5 pin) connector on the other end.

This section describes the process of connecting an NFX250 device to the management console by using the Mini-USB Type-B console port.

For information about configuring and managing an NFX250 device by using the RJ-45 console port, see ["Connecting an NFX250 Device to a Management Console" on page 96](#).

To connect the NFX250 device to the console using Mini-USB Type-B console port:

1. Connect the Standard-A connector of the mini-USB cable to the host machine (PC or Laptop).

2. Connect the Mini-USB Type-B (5-pin) connector of the mini-USB cable to the Mini-USB Type-B console port (labeled **CON**) on the NFX250 device.
3. Set the Mini-USB Type-B console port as the active console port by using the command `port-type`. For information about configuring the console port type, see [Configuring the Console Port Type \(CLI Procedure\)](#).
4. Reboot the NFX250 device.

After the connection is established, the Mini-USB Type-B becomes the active console port. The host machine connected to the Mini-USB Type-B console port displays log messages and lets you control NFX250 device functionality through it.

SEE ALSO

[Console Port Connector Pinouts for NFX250 Devices | 71](#)

[Connecting an NFX250 Device to a Network for Out-of-Band Management | 95](#)

Initial Configuration on NFX250 Devices

Before you begin connecting and configuring an NFX250 device, set the following parameter values on the console server or PC:

- Baud Rate—9600
- Flow Control—None
- Data—8
- Parity—None
- Stop Bits—1
- DCD State—Disregard

You must perform the initial configuration of the NFX250 device through the console port using the command-line interface (CLI).

To connect and configure the device from the console:

1. Connect the console port to a laptop or PC using an RJ-45 cable and RJ-45 to DB-9 adapter. The console (**CON**) port is located on the management panel of the device.

2. If the Network Service Orchestrator module is configured, this client connects to the Network Activator and provisions the latest software image, if the image on the NFX250 device is not the latest.

NOTE: If authentication is configured, you will receive an authentication code, which must be provided on the Web page specified by the operator.

3. The Juniper Device Manager (JDM) command-line interface (CLI) displays; log in as **root**. There is no password. If the software booted before you connected to the console port, you might need to press the Enter key for the prompt to appear.

```
login: root
```

4. Start the CLI.

```
root@jdm% cli
```

5. Enter configuration mode.

```
root@jdm> configure
```

6. Add a password to the root administration user account.

```
[edit]
root@jdm# set system root-authentication plain-text-password
New password: password
Retype new password: password
```

7. (Optional) Configure the name of the device. If the name includes spaces, enclose the name in quotation marks (" ").

```
[edit]
root@jdm# set system host-name host-name
```

8. Configure the IP address and prefix length for the device management interface.

```
[edit]
root@jdm# set interfaces jmgmt0 unit 0 family inet address address/prefix-length
```

jmgmt0 is the out-of-band management network interface in JDM.

To configure an IPV6 address, run the `root@jdm# set interface jmgmt0 family inet6 address address v6_address`.

NOTE: jmgmt0 is found on the front panel of the NFX250 device.

9. Configure the default gateway.

```
[edit]
root@jdm# set routing-options static route default next-hop address
```

10. Commit the configuration to activate it on the device.

```
[edit]
root@jdm# commit
```

If Network Service Orchestrator module is configured, this client connects to the Network Activator as soon as the device is switched on, and provisions the initial configuration and the latest software image and, if the image on the NFX250 device is not the latest.

The Network Activator is responsible for the bare-minimum bootstrapping of the NFX250. After successful configuration and software upgrade, the device reboots and the Network Service Activator configuration is removed.

To complete the Network Service Orchestrator module process:

1. Connect to any front panel WAN port (see [Figure 24 on page 102](#)).
2. Open web browser and enter the IP address 10.10.10.1.
3. Enter the authentication code in the Web page that is displayed.

Once the process is complete, a confirmation message is displayed. Click Logs to display details of the bootstrapping process.

NOTE: You can also use the CLI to provide the authentication code:

```
root@jdm> test phone-home server-authentication-code code
```

Figure 24: NFX250 Front Panel Components

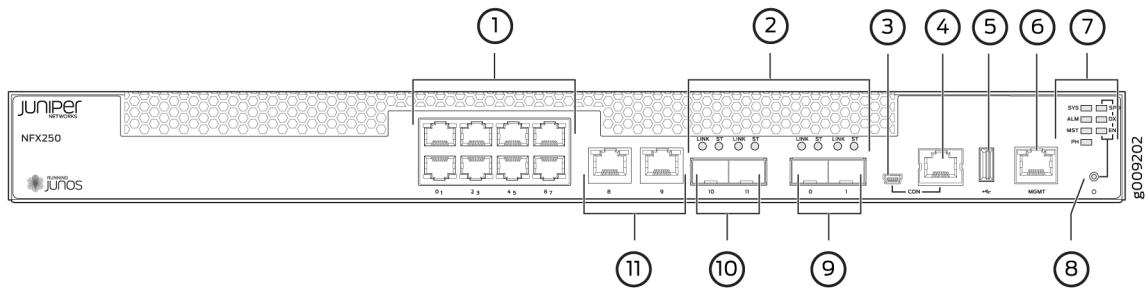

1– 1-Gigabit Ethernet RJ-45 network ports	7– System status LEDs
2– SFP and SFP+ ports Link and Status LEDs	8– Mode button
3– mini-USB console port	9– 1/10-Gigabit SFP+ uplink ports
4– Console port	10– 1-Gigabit SFP network/uplink ports
5– USB port	11– 1-Gigabit Ethernet RJ-45 network/uplink ports
6– 1-Gigabit Management port	

RELATED DOCUMENTATION

[NFX250 Installation Overview](#) | 78

4

CHAPTER

Maintaining Components

Maintaining Transceivers on the NFX250 | 104

Maintaining Fiber Optic Cables on the NFX250 | 107

Removing the NFX250 Device from a Rack or Cabinet | 111

Maintaining Transceivers on the NFX250

IN THIS SECTION

- [Installing a Transceiver in an NFX250 Device | 104](#)
- [Removing a Transceiver from an NFX250 Device | 105](#)

Installing a Transceiver in an NFX250 Device

Before you begin installing a transceiver in an NFX250 device, ensure that you have taken the necessary precautions for safe handling of lasers (see "[Laser and LED Safety Guidelines and Warnings for the NFX250 Devices](#)" on page 139).

Ensure that you have a rubber safety cap available to cover the transceiver.

The transceivers for the NFX250 devices are hot-removable and hot-insertable field-replaceable units (FRUs). You can remove and replace them without powering off the device or disrupting device functions.

To install a transceiver in a NFX250 device:



CAUTION: To avoid electrostatic discharge (ESD) damage to the transceiver, do not touch the connector pins at the end of the transceiver.

1. Remove the transceiver from its bag.
2. Check to see whether the transceiver is covered by a rubber safety cap. If it is not, cover the transceiver with a rubber safety cap.



LASER WARNING: Do not leave a fiber-optic transceiver uncovered except when inserting or removing a cable. The rubber safety cap keeps the port clean and prevents accidental exposure to laser light.

3. If the port in which you want to install the transceiver is covered with a dust cover, remove the dust cover and save it in case you need to cover the port later.

- Using both hands, carefully place the transceiver in the empty port. The connectors must face the device chassis.



CAUTION: Before you slide the transceiver into the port, ensure that the transceiver is aligned correctly. Misalignment might cause the pins to bend, making the transceiver unusable. See [Figure 25 on page 105](#) for the correct orientation for your device.

- Slide the transceiver in gently until it is fully seated. See [Figure 25 on page 105](#) for an example of inserting an SFP or SFP+ transceiver.
- Remove the rubber safety cap when you are ready to connect the cable to the transceiver.



LASER WARNING: Do not look directly into a fiber-optic transceiver or into the ends of fiber-optic cables. Fiber-optic transceivers and fiber-optic cables connected to transceivers emit laser light that can damage your eyes.

Figure 25: Installing a Transceiver in an NFX250 Device

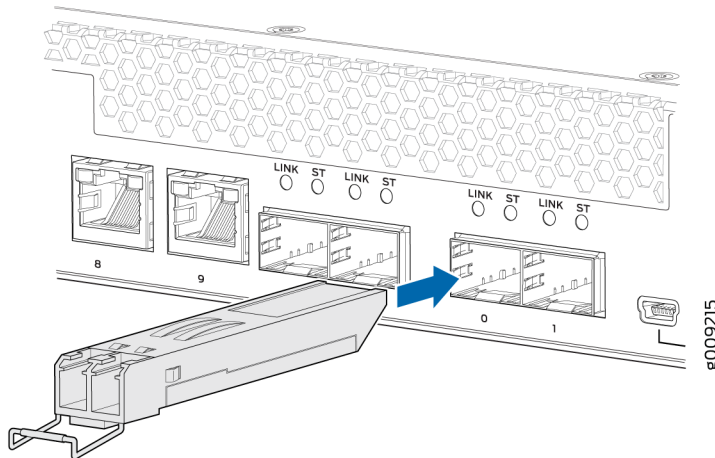

Removing a Transceiver from an NFX250 Device

Before you begin removing a transceiver from the NFX250 device, ensure that you have taken the necessary precautions for safe handling of lasers (see "[Laser and LED Safety Guidelines and Warnings for the NFX250 Devices](#)" on page 139).

Ensure that you have the following parts and tools available:

- Electrostatic bag or an antistatic mat
- Rubber safety caps to cover the transceiver and fiber-optic cable connector
- Dust cover to cover the port

The transceivers for the NFX250 devices are hot-removable and hot-insertable field-replaceable units (FRUs). You can remove and replace them without powering off the device or disrupting device functions.

To remove a transceiver from the NFX250 device:

1. Place the antistatic bag or antistatic mat on a flat, stable surface.
2. Label the cable connected to the transceiver so that you can reconnect it correctly.



LASER WARNING: Do not look directly into a fiber-optic transceiver or into the ends of fiber-optic cables. Fiber-optic transceivers and fiber-optic cables connected to transceivers emit laser light that can damage your eyes.



LASER WARNING: Do not leave a fiber-optic transceiver uncovered except when inserting or removing a cable. The rubber safety cap keeps the port clean and prevents accidental exposure to laser light.



CAUTION: Do not bend fiber-optic cables beyond their minimum bend radius. Bending the cables beyond their minimum bend radius can damage the cables and cause problems that are difficult to diagnose.

3. Remove the cable connected to the transceiver (see "[Disconnecting a Fiber-Optic Cable from an NFX250 Device](#)" on page 109). Cover the transceiver and the end of each fiber-optic cable connector with a rubber safety cap immediately after disconnecting the fiber-optic cables.
4. Using your fingers, pull the ejector lever away from the transceiver to unlock the transceiver.



CAUTION: Before removing the transceiver, make sure you open the ejector lever completely until you hear it click. This prevents damage to the transceiver.

5. Grasp the transceiver ejector lever and gently slide the transceiver approximately 0.5 in. (1.3 cm) straight out of the port (see [Figure 26 on page 107](#)).



CAUTION: To avoid electrostatic discharge (ESD) damage to the transceiver, do not touch the connector pins at the end of the transceiver.

6. Using your fingers, grasp the body of the transceiver and pull it straight out of the port.
7. Place the transceiver in the electrostatic bag or on the antistatic mat placed on a flat, stable surface.
8. Place the dust cover over the empty port.

Figure 26: Removing a Transceiver from an NFX250 Device

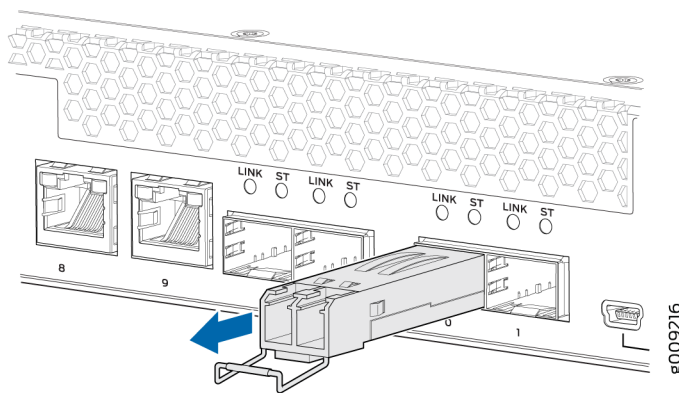

Maintaining Fiber Optic Cables on the NFX250

IN THIS SECTION

- [Connecting a Fiber-Optic Cable to an NFX250 Device | 108](#)
- [Disconnecting a Fiber-Optic Cable from an NFX250 Device | 109](#)
- [Maintaining Fiber-Optic Cables in an NFX250 Device | 110](#)

Connecting a Fiber-Optic Cable to an NFX250 Device

Before you connect a fiber-optic cable to an optical transceiver installed in an NFX250 device, ensure that you have taken the necessary precautions for safe handling of lasers (see "[Laser and LED Safety Guidelines and Warnings for the NFX250 Devices](#)" on page 139).

You can connect fiber-optic cables to the field-replaceable unit (FRU) optical transceivers installed in NFX250 devices.

To connect a fiber-optic cable to an optical transceiver installed in an NFX250 device:



LASER WARNING: Do not look directly into a fiber-optic transceiver or into the ends of fiber-optic cables. Fiber-optic transceivers and fiber-optic cables connected to transceivers emit laser light that can damage your eyes.



LASER WARNING: Do not stare into the laser beam or view it directly with optical instruments even if the interface has been disabled.

1. If the fiber-optic cable connector is covered by a rubber safety cap, remove the cap. Save the cap.
2. If the optical transceiver is covered by a rubber safety cap, remove the cap. Save the cap.
3. Insert the cable connector into the optical transceiver (see [Figure 27 on page 109](#)).
4. Secure the cables so that they are not supporting their own weight. Place excess cable out of the way in a neatly coiled loop. Placing fasteners on a loop helps cables maintain their shape.



CAUTION: Do not bend fiber-optic cables beyond their minimum bend radius. Bending the cables beyond their minimum bend radius can damage the cables and cause problems that are difficult to diagnose.



CAUTION: Do not let fiber-optic cables hang free from the connector. Do not allow fastened loops of cables to dangle, which stresses the cables at the fastening point.

Figure 27: Inserting a Fiber-Optic Cable into a Transceiver

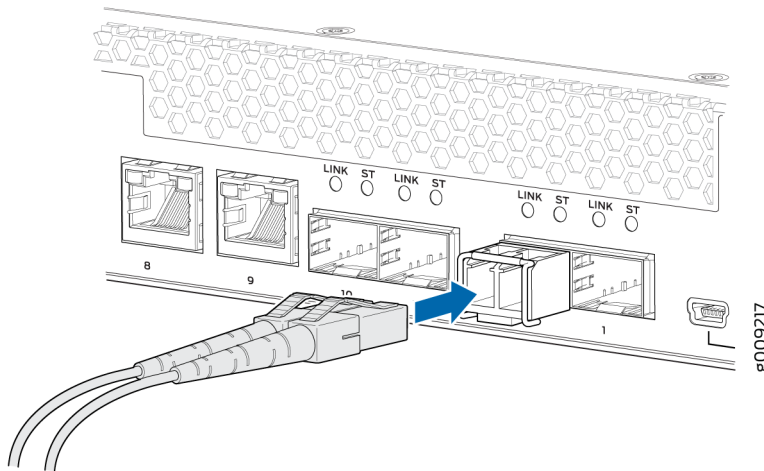

Disconnecting a Fiber-Optic Cable from an NFX250 Device

Before you disconnect a fiber-optic cable from an optical transceiver installed in an NFX250 device, ensure that you have taken the necessary precautions for safe handling of lasers (see "[Laser and LED Safety Guidelines and Warnings for the NFX250 Devices](#)" on page 139).

Ensure that you have the following parts and tools available:

- Rubber safety cap to cover the transceiver
- Rubber safety cap to cover the fiber-optic cable connector

To disconnect a fiber-optic cable from an optical transceiver installed in the NFX250 device:

1. (Recommended) Disable the port in which the transceiver is installed by including the disable statement at the [edit interfaces] hierarchy level for the specific interface.



LASER WARNING: Do not look directly into a fiber-optic transceiver or into the ends of fiber-optic cables. Fiber-optic transceivers and fiber-optic cables connected to transceivers emit laser light that can damage your eyes.



LASER WARNING: Do not stare into the laser beam or view it directly with optical instruments even if the interface has been disabled.

2. Carefully unplug the fiber-optic cable connector from the transceiver.
3. Cover the transceiver with a rubber safety cap.



LASER WARNING: Do not leave a fiber-optic transceiver uncovered except when inserting or removing a cable. The rubber safety cap keeps the port clean and prevents accidental exposure to laser light.

4. Cover the fiber-optic cable connector with the rubber safety cap.

Maintaining Fiber-Optic Cables in an NFX250 Device

To maintain fiber-optic cables in NFX250 devices:

- When you unplug a fiber-optic cable from a transceiver, place rubber safety caps over the transceiver and on the end of the cable.
- Anchor fiber-optic cable to avoid stress on the connectors. When attaching a fiber-optic cable to a transceiver, be sure to secure the fiber-optic cable so that it is not supporting its own weight as it hangs to the floor. Never let a fiber-optic cable hang free from the connector.
- Do not bend fiber-optic cables beyond their minimum bend radius. Bending the cables beyond their minimum bend radius can damage the cables and cause problems that are difficult to diagnose.
- Frequent plugging and unplugging of fiber-optic cables in and out of optical instruments can damage the instruments, which are expensive to repair. Attach a short fiber extension to the optical equipment. Any wear and tear due to frequent plugging and unplugging is then absorbed by the short fiber extension, which is easier and less expensive to replace than the instruments.
- Keep fiber-optic cable connections clean. Microdeposits of oil and dust in the canal of the transceiver or cable connector can cause loss of light, reduction in signal power, and possibly intermittent problems with the optical connection.

To clean the transceiver canal, use an appropriate fiber-cleaning device such as RIFOCS Fiber Optic Adaptor Cleaning Wands (part number 946). Follow the directions in the cleaning kit you use.

After cleaning the transceiver, make sure that the connector tip of the fiber-optic cable is clean. Use only an approved alcohol-free fiber-optic cable cleaning kit such as the Cletop-S® Fiber Cleaner. Follow the directions in the cleaning kit you use.

Removing the NFX250 Device from a Rack or Cabinet

IN THIS SECTION

- [Powering Off an NFX250 Device | 111](#)
- [Removing an NFX250 Device from a Rack or Cabinet | 113](#)

Powering Off an NFX250 Device

If you need to power off the NFX250 device, follow the procedure in this topic.

Before you power off the switch:

- Ensure that you understand how to prevent electrostatic discharge damage. See [Prevention of Electrostatic Discharge Damage](#).
- Ensure that you do not need to forward traffic through the device.

Ensure that you have the following parts and tools available to power off the switch:

- An electrostatic discharge (ESD) grounding strap
- An external management device such as a PC
- A cable to connect the external management device to the console port (CON) or management port (MGMT) on the device

To power off the device:

1. Connect the management device (such as a PC) to the console (CON) port or the management (MGMT) port on the device:
 - For connecting a management device to the console port, see ["Connecting an NFX250 Device to a Management Console" on page 96](#).
 - For connecting a management device to the management port, see ["Connecting an NFX250 Device to a Network for Out-of-Band Management" on page 95](#)
2. From the PC connected to the device, issue the following operational mode CLI command:

```
user@switch> request system halt
```

This command shuts down the switch gracefully and preserves system state information. A message displays on the console confirming that the operating system has halted.

You will see the following output (or something similar, depending on the hardware being shut down):

```
user@switch> request system halt
warning: This command will halt all the members.
If planning to halt only one member use the member option
Halt the system ? [yes,no] (no) yes

*** FINAL System shutdown message from user@switch ***
System going down IMMEDIATELY

Shutdown NOW!
[pid 14102]
message sent

{master:0}
user@switch> Waiting (max 300 seconds) for system process `vnlru' to stop...done
Waiting (max 300 seconds) for system process `vnlru_mem' to stop...done
Waiting (max 300 seconds) for system process `bufdaemon' to stop...done
Waiting (max 300 seconds) for system process `syncer' to stop...
Syncing disks, vnodes remaining...3 3 1 2 2 0 0 0 0 done

syncing disks... All buffers synced.
Uptime: 38d18h0m6s
recorded reboot as normal shutdown

The operating system has halted.
Please press any key to reboot
```



CAUTION: The final output of any version of this command is the “The operating system has halted. Please press any key to reboot” message. Wait at least 60 seconds after first seeing this message before following the instructions in Steps 3 and 4 to power off the device.



CAUTION: Ensure that you have halted your system safely before turning off the power supply.

3. Attach the ESD grounding strap to your bare wrist and connect the strap to the ESD point on the chassis.
4. Set the power switch to OFF (0) position.

SEE ALSO

| [Connecting AC Power to an NFX250 Device](#) | 93

Removing an NFX250 Device from a Rack or Cabinet

Before removing the device from a rack:

Ensure that you have the following parts and tools available to remove the device:

- A Phillips (+) screwdriver, number 2 or number 3, depending on the size of your rack mounting screws.
- A labeled bag to hold the removed screws.

If you need to relocate an installed NFX250 device, use the procedure described in this topic. (The remainder of this topic uses *rack* to mean *rack or cabinet*.)

NOTE: When you remove multiple devices from a rack, remove the device at the top of the rack first and proceed to remove the rest of the devices from top to bottom.



CAUTION: At least two people must be available to lift a device chassis out of a rack—one person to unscrew the mounting screws from the brackets and the second person to hold the chassis.

- Ensure that the rack or cabinet is stable and secured to the building.
- Ensure that there is enough space to place the removed device in its new location and along the path to the new location.

- Read [General Safety Guidelines and Warnings](#), with particular attention to "[Chassis Lifting Guidelines for NFX250 Devices](#)" on page 133.
- Ensure that the device has been safely powered off and that you have unplugged (disconnected) the power cords.
- Ensure that you have disconnected any cables or wires attached to the device.

To remove an NFX250 device from a rack:

1. Use the appropriate Phillips (+) screwdriver to remove the mounting screws that attach the chassis front-mounting brackets to the rack.
2. Place the removed screws in a labeled bag. You will need them when you reinstall the chassis.
3. Lift the chassis from the rack and carefully move the chassis to its new location.

SEE ALSO

[General Safety Guidelines and Warnings | 127](#)

[Chassis Lifting Guidelines for NFX250 Devices | 133](#)

5

CHAPTER

Troubleshooting Hardware

[Understanding Alarm Types and Severity Levels on NFX250 Devices](#) | 116

Understanding Alarm Types and Severity Levels on NFX250 Devices

Alarms alert you to conditions that might prevent normal operation of the NFX250 device. [Table 27 on page 116](#) provides a list of alarm terms and definitions that may help you in monitoring the device.

Table 27: Alarm Terms and Definitions

Term	Definition
Alarm	Signal alerting you to conditions that might prevent normal operation. LEDs are the alarm indicators on the device. Blinking amber LEDs indicate yellow alarm conditions for chassis components.
Alarm condition	Failure event that triggers an alarm.
Alarm severity levels	<p>Seriousness of the alarm. The level of severity can be either major (red) or minor (yellow).</p> <ul style="list-style-type: none"> • Major (red)—Indicates a critical situation on the device that has resulted from one of the following conditions. A red alarm condition requires immediate action. <ul style="list-style-type: none"> • One or more hardware components have failed. • One or more hardware components have exceeded temperature thresholds. • An alarm condition configured on an interface has triggered a critical warning. • Minor (yellow or amber)—Indicates a noncritical condition on the device that, if left unchecked, might cause an interruption in service or degradation in performance. A yellow alarm condition requires monitoring or maintenance. For example, a missing rescue configuration generates a yellow system alarm.

Table 27: Alarm Terms and Definitions (Continued)

Term	Definition
Alarm types	<p>Alarms include the following types:</p> <ul style="list-style-type: none">• Chassis alarm—Predefined alarm triggered by a physical condition on the device such as a power supply failure or excessive component temperature.• Interface alarm—Alarm you configure to alert you when an interface link is down. Applies to ethernet, fibre-channel, and management-ethernet interfaces. You can configure a red (major) or yellow (minor) alarm for the link-down condition, or have the condition ignored.• System alarm—Predefined alarm that might be triggered by a missing rescue configuration, failure to install a license for a licensed software feature, or high disk usage.

RELATED DOCUMENTATION

[NFX250 Device Hardware Overview | 2](#)

6

CHAPTER

Contacting Customer Support and Returning the Chassis or Components

Contacting Customer Support and Returning the Chassis or Components | 119

Contacting Customer Support and Returning the Chassis or Components

IN THIS SECTION

- [Returning a NFX250 Device or Component for Repair or Replacement | 119](#)
- [Locating the Serial Number on an NFX250 Device | 120](#)
- [Contacting Customer Support to Obtain a Return Materials Authorization for an NFX250 Device | 121](#)
- [Packing a NFX250 Device or Component for Shipping | 122](#)

Returning a NFX250 Device or Component for Repair or Replacement

If you need to return a NFX250 device or component to Juniper Networks for repair or replacement, follow this procedure:

1. Determine the serial number of the device or component. For instructions, see "[Locating the Serial Number on an NFX250 Device](#)" on page 120.
2. Obtain a Return Materials Authorization (RMA) number from the Juniper Technical Assistance Center (JTAC) as described in "[Contacting Customer Support to Obtain a Return Materials Authorization for an NFX250 Device](#)" on page 121.

NOTE: Do not return any device or component to Juniper Networks unless you have first obtained an RMA number. Juniper Networks reserves the right to refuse shipments that do not have an RMA. Refused shipments are returned to the customer through collect freight.

3. Pack the NFX250 device or component for shipping as described in "[Packing a NFX250 Device or Component for Shipping](#)" on page 122.

For more information about return and repair policies, see the customer support page at <https://www.juniper.net/support/guidelines.html>.

SEE ALSO

| [NFX250 Device Hardware Overview | 2](#)

Locating the Serial Number on an NFX250 Device

IN THIS SECTION

- [Listing the Device and Components Details with the CLI | 120](#)
- [Locating the Chassis Serial Number ID Label on an NFX250 Device | 121](#)

If you are returning a device to Juniper Networks for repair or replacement, you must locate the serial number of the device. You must provide the serial number to the Juniper Networks Technical Assistance Center (JTAC) when you contact them to obtain Return Materials Authorization (RMA).

If the device is operational and you can access the CLI, you can list serial numbers for the device with a CLI command.

NOTE: The NFX250 device does not have any field-replaceable unit. The power supply and fans are fixed.

Listing the Device and Components Details with the CLI

To list the device and device components and their serial numbers, enter the following CLI command:

The following output lists the device components and serial numbers for a NFX250 device:

NOTE: Log on to Log on to Junos Control Plane (JCP), the Junos Virtual Maching in NFX250, from the JDM command-line interface (CLI): `root@jdm# ssh vjunos`. The JCP CLI displays, which is same as the Junos CLI.

```
user@switch> show chassis hardware
Hardware inventory:
Item          Version  Part number  Serial number  Description
CChassis                      D
Pseudo CB 0
Routing Engine 0          BUILTIN    BUILTIN       RE-NFX250-ATT-S2
FPC 0                REV 02    650-065559   DC4115AN0025
  CPU                  BUILTIN    BUILTIN       FPC CPU
  PIC 0                REV 02    BUILTIN      BUILTIN       10x10/100/1000 Base-T-2x1G SFP-
```



Xcvr 12	REV 01	740-031980	ARN2FUA	SFP+-10G-SR
Xcvr 13	REV 01	740-031980	AN40MW2	SFP+-10G-SR
Power Supply 0				
Fan Tray 0				fan-ctrl-0 0, Front to Back Airflow -
AFO				
Fan Tray 1				fan-ctrl-0 1, Front to Back Airflow -
AFO				

For information about the `show chassis hardware` command, see the *Junos OS System Basics and Services Command Reference* at <https://www.juniper.net/documentation/software/junos/index.html>.

Locating the Chassis Serial Number ID Label on an NFX250 Device

The serial number ID label is located on the back of the chassis on an NFX250 device. See Figure 1.

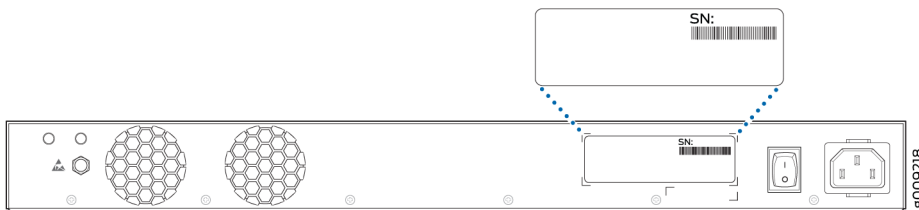
Figure 28: Location of the Serial Number ID Label on an NFX250 Device



Contacting Customer Support to Obtain a Return Materials Authorization for an NFX250 Device

If you are returning a NFX250 device or component to Juniper Networks for repair or replacement, obtain a Return Materials Authorization (RMA) from the Juniper Networks Technical Assistance Center (JTAC).

After locating the serial number of the device or component you want to return, open a service request with Juniper Networks Technical Assistance Center (JTAC) on the Web or by telephone.

For instructions on locating the serial number of the device or component you want to return, see "[Locating the Serial Number on an NFX250 Device](#)" on page 120.

Before you request an RMA from JTAC, be prepared to provide the following information:

- Your existing service request number, if you have one

- Serial number of the component
- Your name, organization name, telephone number, fax number, and shipping address
- Details of the failure or problem
- Type of activity being performed on the device when the problem occurred
- Configuration data displayed by one or more `show` commands

You can contact JTAC 24 hours a day, seven days a week on the Web or by telephone:

- Service Request Manager: <https://support.juniper.net/support/>
- Telephone: +1-888-314-JTAC (+1-888-314-5822), toll-free in the USA, Canada, and Mexico

NOTE: For international or direct-dial options in countries without toll-free numbers, see <https://support.juniper.net/support/> .

If you are contacting JTAC by telephone, enter your 12-digit service request number followed by the pound (#) key for an existing case, or press the star (*) key to be routed to the next available support engineer.

The support representative validates your request and issues an RMA number for return of the component.

Packing a NFX250 Device or Component for Shipping

IN THIS SECTION

- [Packing a NFX250 Device for Shipping | 123](#)
- [Packing NFX250 Device Components for Shipping | 124](#)

If you are returning a NFX250 device or component to Juniper Networks for repair or replacement, pack the item as described in this topic.

Before you pack a NFX250 device or component:

- Ensure that you have taken the necessary precautions to prevent electrostatic discharge (ESD) damage. See [Prevention of Electrostatic Discharge Damage](#).
- Retrieve the original shipping carton and packing materials. Contact your JTAC representative if you do not have these materials, to learn about approved packing materials. See ["Contacting Customer Support to Obtain a Return Materials Authorization for an NFX250 Device" on page 121](#).

Ensure that you have the following parts and tools available:

- ESD grounding strap.
- Antistatic bag, one for each component.
- If you are returning the chassis, an appropriate screwdriver for the mounting screws used on your rack or cabinet.

This topic describes:

Packing a NFX250 Device for Shipping

To pack a NFX250 device for shipping:

1. Power down the NFX250 device and remove the power cables. See ["Powering Off an NFX250 Device" on page 111](#).
2. Remove the cables that connect the device to all external devices.
3. Remove all field-replaceable units (FRUs) from the NFX250 device.
4. Have one person support the weight of the device while another person unscrews and removes the mounting screws.
5. Remove the device from the rack or cabinet (see ["Chassis Lifting Guidelines for NFX250 Devices" on page 133](#)) and place the device in an antistatic bag.
6. Place the device in the shipping carton.
7. Place the packing foam on top and around the device.
8. If you are returning accessories or FRUs with the device, pack them as instructed in ["Packing NFX250 Device Components for Shipping" on page 122](#).
9. Replace the accessory box on top of the packing foam.
10. Close the top of the cardboard shipping box and seal it with packing tape.
11. Write the RMA number on the exterior of the box to ensure proper tracking.

Packing NFX250 Device Components for Shipping



CAUTION: Do not stack the NFX250 device components. Return individual components in separate boxes if they do not fit together on one level in the shipping box.

To pack and ship NFX250 device components:

- Place individual FRUs in antistatic bags.
- Ensure that the components are adequately protected with packing materials and packed so that the pieces are prevented from moving around inside the carton.
- Close the top of the cardboard shipping box and seal it with packing tape.
- Write the RMA number on the exterior of the box to ensure proper tracking.

7

CHAPTER

Safety and Compliance Information

- General Safety Guidelines and Warnings | 127
- Definitions of Safety Warning Levels | 128
- Qualified Personnel Warning | 130
- Warning Statement for Norway and Sweden | 130
- Fire Safety Requirements | 131
- Installation Instructions Warning | 132
- Chassis Lifting Guidelines for NFX250 Devices | 133
- Restricted Access Warning | 133
- Ramp Warning | 134
- Rack-Mounting and Cabinet-Mounting Warnings | 135
- Laser and LED Safety Guidelines and Warnings for the NFX250 Devices | 139
- Radiation from Open Port Apertures Warning | 145
- Maintenance and Operational Safety Guidelines and Warnings | 146
- General Electrical Safety Guidelines and Warnings | 151
- Action to Take After an Electrical Accident | 153
- Prevention of Electrostatic Discharge Damage | 153
- AC Power Electrical Safety Guidelines | 155
- AC Power Disconnection Warning | 156
- TN Power Warning | 157
- Agency Approvals for NFX250 Devices | 158

Compliance Statements for EMC Requirements for NFX250 Devices | 159

Statements of Volatility for Juniper Network Devices | 163

General Safety Guidelines and Warnings

The following guidelines help ensure your safety and protect the device from damage. The list of guidelines might not address all potentially hazardous situations in your working environment, so be alert and exercise good judgment at all times.

- Perform only the procedures explicitly described in the hardware documentation for this device. Make sure that only authorized service personnel perform other system services.
- Keep the area around the device clear and free from dust before, during, and after installation.
- Keep tools away from areas where people could trip over them while walking.
- Do not wear loose clothing or jewelry, such as rings, bracelets, or chains, which could become caught in the device.
- Wear safety glasses if you are working under any conditions that could be hazardous to your eyes.
- Do not perform any actions that create a potential hazard to people or make the equipment unsafe.
- Never attempt to lift an object that is too heavy for one person to handle.
- Never install or manipulate wiring during electrical storms.
- Never install electrical jacks in wet locations unless the jacks are specifically designed for wet environments.
- Operate the device only when it is properly grounded.
- Follow the instructions in this guide to properly ground the device to earth.
- Replace fuses only with fuses of the same type and rating.
- Do not open or remove chassis covers or sheet-metal parts unless instructions are provided in the hardware documentation for this device. Such an action could cause severe electrical shock.
- Do not push or force any objects through any opening in the chassis frame. Such an action could result in electrical shock or fire.
- Avoid spilling liquid onto the chassis or onto any device component. Such an action could cause electrical shock or damage the device.
- Avoid touching uninsulated electrical wires or terminals that have not been disconnected from their power source. Such an action could cause electrical shock.

- Some parts of the chassis, including AC and DC power supply surfaces, power supply unit handles, SFB card handles, and fan tray handles might become hot. The following label provides the warning for hot surfaces on the chassis:



- Always ensure that all modules, power supplies, and cover panels are fully inserted and that the installation screws are fully tightened.

Definitions of Safety Warning Levels

The documentation uses the following levels of safety warnings (there are two *Warning* formats):

NOTE: You might find this information helpful in a particular situation, or you might overlook this important information if it was not highlighted in a Note.



CAUTION: You need to observe the specified guidelines to prevent minor injury or discomfort to you or severe damage to the device.

Attention Veillez à respecter les consignes indiquées pour éviter toute incommodité ou blessure légère, voire des dégâts graves pour l'appareil.



LASER WARNING: This symbol alerts you to the risk of personal injury from a laser.

Avertissement Ce symbole signale un risque de blessure provoquée par rayon laser.



WARNING: This symbol means danger. You are in a situation that could cause bodily injury. Before you work on any equipment, be aware of the hazards involved with electrical circuitry, and familiarize yourself with standard practices for preventing accidents.

Waarschuwing Dit waarschuwingssymbool betekent gevaar. U verkeert in een situatie die lichamelijk letsel kan veroorzaken. Voordat u aan enige apparatuur gaat werken, dient u zich bewust te zijn van de bij elektrische schakelingen betrokken risico's en dient u op de hoogte te zijn van standaard maatregelen om ongelukken te voorkomen.

Varoitus Tämä varoitusmerkki merkitsee vaaraa. Olet tilanteessa, joka voi johtaa ruumiinvammaan. Ennen kuin työskentelet minkään laitteiston parissa, ota selvää sähkökytkentöihin liittyvistä vaaroista ja tavanomaisista onnettomuuksien ehkäisykeinoista.

Avertissement Ce symbole d'avertissement indique un danger. Vous vous trouvez dans une situation pouvant causer des blessures ou des dommages corporels. Avant de travailler sur un équipement, soyez conscient des dangers posés par les circuits électriques et familiarisez-vous avec les procédures couramment utilisées pour éviter les accidents.

Warnung Dieses Warnsymbol bedeutet Gefahr. Sie befinden sich in einer Situation, die zu einer Körperverletzung führen könnte. Bevor Sie mit der Arbeit an irgendeinem Gerät beginnen, seien Sie sich der mit elektrischen Stromkreisen verbundenen Gefahren und der Standardpraktiken zur Vermeidung von Unfällen bewußt.

Avvertenza Questo simbolo di avvertenza indica un pericolo. La situazione potrebbe causare infortuni alle persone. Prima di lavorare su qualsiasi apparecchiatura, occorre conoscere i pericoli relativi ai circuiti elettrici ed essere al corrente delle pratiche standard per la prevenzione di incidenti.

Advarsel Dette varselsymbolet betyr fare. Du befinner deg i en situasjon som kan føre til personskade. Før du utfører arbeid på utstyr, må du være oppmerksom på de faremomentene som elektriske kretser innebærer, samt gjøre deg kjent med vanlig praksis når det gjelder å unngå ulykker.

Aviso Este símbolo de aviso indica perigo. Encontra-se numa situação que lhe poderá causar danos físicos. Antes de começar a trabalhar com qualquer equipamento, familiarize-se com os perigos relacionados com circuitos eléctricos, e com quaisquer práticas comuns que possam prevenir possíveis acidentes.

¡Atención! Este símbolo de aviso significa peligro. Existe riesgo para su integridad física. Antes de manipular cualquier equipo, considerar los riesgos que entraña la corriente eléctrica y familiarizarse con los procedimientos estándar de prevención de accidentes.

Varning! Denna varningssymbol signalerar fara. Du befinner dig i en situation som kan leda till personskada. Innan du utför arbete på någon utrustning måste du vara medveten om farorna med elkretsar och känna till vanligt förfarande för att förebygga skador.

Qualified Personnel Warning



WARNING: Only trained and qualified personnel should install or replace the device.

Waarschuwing Installatie en reparaties mogen uitsluitend door getraind en bevoegd personeel uitgevoerd worden.

Varoitus Ainoastaan koulutettu ja pätevä henkilökunta saa asentaa tai vaihtaa tämän laitteen.

Avertissement Tout installation ou remplacement de l'appareil doit être réalisé par du personnel qualifié et compétent.

Warnung Gerät nur von geschultem, qualifiziertem Personal installieren oder auswechseln lassen.

Avvertenza Solo personale addestrato e qualificato deve essere autorizzato ad installare o sostituire questo apparecchio.

Advarsel Kun kvalifisert personell med riktig opplæring bør montere eller bytte ut dette utstyret.

Aviso Este equipamento deverá ser instalado ou substituído apenas por pessoal devidamente treinado e qualificado.

¡Atención! Estos equipos deben ser instalados y reemplazados exclusivamente por personal técnico adecuadamente preparado y capacitado.

Varning! Denna utrustning ska endast installeras och bytas ut av utbildad och kvalificerad personal.

Warning Statement for Norway and Sweden



WARNING: The equipment must be connected to an earthed mains socket-outlet.

Advarsel Apparatet skal kobles til en jordet stikkontakt.

Varning! Apparaten skall anslutas till jordat nätuttag.

Fire Safety Requirements

IN THIS SECTION

- [Fire Suppression | 131](#)
- [Fire Suppression Equipment | 131](#)

In the event of a fire emergency, the safety of people is the primary concern. You should establish procedures for protecting people in the event of a fire emergency, provide safety training, and properly provision fire-control equipment and fire extinguishers.

In addition, you should establish procedures to protect your equipment in the event of a fire emergency. Juniper Networks products should be installed in an environment suitable for electronic equipment. We recommend that fire suppression equipment be available in the event of a fire in the vicinity of the equipment and that all local fire, safety, and electrical codes and ordinances be observed when you install and operate your equipment.

Fire Suppression

In the event of an electrical hazard or an electrical fire, you should first turn power off to the equipment at the source. Then use a Type C fire extinguisher, which uses noncorrosive fire retardants, to extinguish the fire.

Fire Suppression Equipment

Type C fire extinguishers, which use noncorrosive fire retardants such as carbon dioxide and Halotron™, are most effective for suppressing electrical fires. Type C fire extinguishers displace oxygen from the point of combustion to eliminate the fire. For extinguishing fire on or around equipment that draws air from the environment for cooling, you should use this type of inert oxygen displacement extinguisher instead of an extinguisher that leaves residues on equipment.

Do not use multipurpose Type ABC chemical fire extinguishers (dry chemical fire extinguishers). The primary ingredient in these fire extinguishers is monoammonium phosphate, which is very sticky and

difficult to clean. In addition, in the presence of minute amounts of moisture, monoammonium phosphate can become highly corrosive and corrodes most metals.

Any equipment in a room in which a chemical fire extinguisher has been discharged is subject to premature failure and unreliable operation. The equipment is considered to be irreparably damaged.

NOTE: To keep warranties effective, do not use a dry chemical fire extinguisher to control a fire at or near a Juniper Networks device. If a dry chemical fire extinguisher is used, the unit is no longer eligible for coverage under a service agreement.

We recommend that you dispose of any irreparably damaged equipment in an environmentally responsible manner.

Installation Instructions Warning



WARNING: Read the installation instructions before you connect the device to a power source.

Waarschuwing Raadpleeg de installatie-aanwijzingen voordat u het systeem met de voeding verbindt.

Varoitus Lue asennusohjeet ennen järjestelmän yhdistämistä virtälähteeseen.

Avertissement Avant de brancher le système sur la source d'alimentation, consulter les directives d'installation.

Warnung Lesen Sie die Installationsanweisungen, bevor Sie das System an die Stromquelle anschließen.

Avvertenza Consultare le istruzioni di installazione prima di collegare il sistema all'alimentatore.

Advarsel Les installasjonsinstruksjonene før systemet kobles til strømkilden.

Aviso Leia as instruções de instalação antes de ligar o sistema à sua fonte de energia.

¡Atención! Ver las instrucciones de instalación antes de conectar el sistema a la red de alimentación.

Varning! Läs installationsanvisningarna innan du kopplar systemet till dess strömförsörjningsenhet.

Chassis Lifting Guidelines for NFX250 Devices

The weight of an NFX250 device is approximately 9.4 lb (4.3 kg). Observe the following guidelines for lifting and moving an NFX250 device:

- Before installing the device, verify that the intended site meets the specified power, environmental, and clearance requirements.
- Before lifting or moving the switch, disconnect all external cables.

RELATED DOCUMENTATION

General Safety Guidelines and Warnings

Installation Instructions Warning

Restricted Access Warning



WARNING: This unit is intended for installation in restricted access areas. A restricted access area is an area to which access can be gained only by service personnel through the use of a special tool, lock and key, or other means of security, and which is controlled by the authority responsible for the location.

Waarschuwing Dit toestel is bedoeld voor installatie op plaatsen met beperkte toegang. Een plaats met beperkte toegang is een plaats waar toegang slechts door servicepersoneel verkregen kan worden door middel van een speciaal instrument, een slot en sleutel, of een ander veiligheidsmiddel, en welke beheerd wordt door de overheidsinstantie die verantwoordelijk is voor de locatie.

Varoitus Tämä laite on tarkoitettu asennettavaksi paikkaan, johon pääsy on rajoitettua. Paikka, johon pääsy on rajoitettua, tarkoittaa paikkaa, johon vain huoltohenkilöstö pääsee jonkin erikoistyökalun, lukkoon sopivan avaimen tai jonkin muun turvalaitteen avulla ja joka on paikasta vastuussa olevien toimivaltaisten henkilöiden valvoma.

Avertissement Cet appareil est à installer dans des zones d'accès réservé. Ces dernières sont des zones auxquelles seul le personnel de service peut accéder en utilisant un outil spécial, un mécanisme de verrouillage et une clé, ou tout autre moyen de sécurité.

L'accès aux zones de sécurité est sous le contrôle de l'autorité responsable de l'emplacement.

Warnung Diese Einheit ist zur Installation in Bereichen mit beschränktem Zutritt vorgesehen. Ein Bereich mit beschränktem Zutritt ist ein Bereich, zu dem nur Wartungspersonal mit einem Spezialwerkzeugs, Schloß und Schlüssel oder anderer Sicherheitsvorkehrungen Zugang hat, und der von dem für die Anlage zuständigen Gremium kontrolliert wird.

Avvertenza Questa unità deve essere installata in un'area ad accesso limitato. Un'area ad accesso limitato è un'area accessibile solo a personale di assistenza tramite un'attrezzo speciale, lucchetto, o altri dispositivi di sicurezza, ed è controllata dall'autorità responsabile della zona.

Advarsel Denne enheten er laget for installasjon i områder med begrenset adgang. Et område med begrenset adgang gir kun adgang til servicepersonale som bruker et spesielt verktøy, lås og nøkkel, eller en annen sikkerhetsanordning, og det kontrolleres av den autoriteten som er ansvarlig for området.

Aviso Esta unidade foi concebida para instalação em áreas de acesso restrito. Uma área de acesso restrito é uma área à qual apenas tem acesso o pessoal de serviço autorizado, que possua uma ferramenta, chave e fechadura especial, ou qualquer outra forma de segurança. Esta área é controlada pela autoridade responsável pelo local.

¡Atención! Esta unidad ha sido diseñada para instalarse en áreas de acceso restringido. Área de acceso restringido significa un área a la que solamente tiene acceso el personal de servicio mediante la utilización de una herramienta especial, cerradura con llave, o algún otro medio de seguridad, y que está bajo el control de la autoridad responsable del local.

Warning! Denna enhet är avsedd för installation i områden med begränsat tillträde. Ett område med begränsat tillträde får endast tillträdas av servicepersonal med ett speciellt verktyg, lås och nyckel, eller annan säkerhetsanordning, och kontrolleras av den auktoritet som ansvarar för området.

Ramp Warning



WARNING: When installing the device, do not use a ramp inclined at more than 10 degrees.

Waarschuwing Gebruik een oprijplaat niet onder een hoek van meer dan 10 graden.

Varoitus Älä käytä sellaista kaltevaa pintaa, jonka kaltevuus ylittää 10 astetta.

Avertissement Ne pas utiliser une rampe dont l'inclinaison est supérieure à 10 degrés.

Warnung Keine Rampen mit einer Neigung von mehr als 10 Grad verwenden.

Avvertenza Non usare una rampa con pendenza superiore a 10 gradi.

Advarsel Bruk aldri en rampe som heller mer enn 10 grader.

Aviso Não utilize uma rampa com uma inclinação superior a 10 graus.

¡Atención! No usar una rampa inclinada más de 10 grados.

Varning! Använd inte ramp med en lutning på mer än 10 grader.

Rack-Mounting and Cabinet-Mounting Warnings

Ensure that the rack or cabinet in which the device is installed is evenly and securely supported. Uneven mechanical loading could lead to a hazardous condition.



WARNING: To prevent bodily injury when mounting or servicing the device in a rack, take the following precautions to ensure that the system remains stable. The following directives help maintain your safety:

- Install the device in a rack that is secured to the building structure.
- Mount the device at the bottom of the rack if it is the only unit in the rack.
- When mounting the device on a partially filled rack, load the rack from the bottom to the top, with the heaviest component at the bottom of the rack.
- If the rack is provided with stabilizing equipment, install the stabilizers before mounting or servicing the device in the rack.

Waarschuwing Om lichamelijk letsel te voorkomen wanneer u dit toestel in een rek monteert of het daar een servicebeurt geeft, moet u speciale voorzorgsmaatregelen nemen om ervoor te zorgen dat het toestel stabiel blijft. De onderstaande richtlijnen worden verstrekt om uw veiligheid te verzekeren:

- De Juniper Networks switch moet in een stellage worden geïnstalleerd die aan een bouwsel is verankerd.
- Dit toestel dient onderaan in het rek gemonteerd te worden als het toestel het enige in het rek is.
- Wanneer u dit toestel in een gedeeltelijk gevuld rek monteert, dient u het rek van onderen naar boven te laden met het zwaarste onderdeel onderaan in het rek.
- Als het rek voorzien is van stabiliseringshulpmiddelen, dient u de stabilisatoren te monteren voordat u het toestel in het rek monteert of het daar een servicebeurt geeft.

Varoitus Kun laite asetetaan telineeseen tai huolletaan sen ollessa telineessä, on noudatettava erityisiä varotoimia järjestelmän vakavuuden säilyttämiseksi, jotta vältytään loukkaantumiselta. Noudata seuraavia turvallisuusohjeita:

- Juniper Networks switch on asennettava telineeseen, joka on kiinnitetty rakennukseen.
- Jos telineessä ei ole muita laitteita, aseta laite telineen alaosaan.
- Jos laite asetetaan osaksi täytettyyn telineeseen, aloita kuormittaminen sen alaosasta kaikkein raskaimmalla esineellä ja siirry sitten sen yläosaan.
- Jos telinettä varten on vakaimet, asenna ne ennen laitteen asettamista telineeseen tai sen huoltamista siinä.

Avertissement Pour éviter toute blessure corporelle pendant les opérations de montage ou de réparation de cette unité en casier, il convient de prendre des précautions spéciales afin de maintenir la stabilité du système. Les directives ci-dessous sont destinées à assurer la protection du personnel:

- Le rack sur lequel est monté le Juniper Networks switch doit être fixé à la structure du bâtiment.
- Si cette unité constitue la seule unité montée en casier, elle doit être placée dans le bas.
- Si cette unité est montée dans un casier partiellement rempli, charger le casier de bas en haut en plaçant l'élément le plus lourd dans le bas.
- Si le casier est équipé de dispositifs stabilisateurs, installer les stabilisateurs avant de monter ou de réparer l'unité en casier.

Warnung Zur Vermeidung von Körperverletzung beim Anbringen oder Warten dieser Einheit in einem Gestell müssen Sie besondere Vorkehrungen treffen, um sicherzustellen, daß das System stabil bleibt. Die folgenden Richtlinien sollen zur Gewährleistung Ihrer Sicherheit dienen:

- Der Juniper Networks switch muß in einem Gestell installiert werden, das in der Gebäudestruktur verankert ist.
- Wenn diese Einheit die einzige im Gestell ist, sollte sie unten im Gestell angebracht werden.
- Bei Anbringung dieser Einheit in einem zum Teil gefüllten Gestell ist das Gestell von unten nach oben zu laden, wobei das schwerste Bauteil unten im Gestell anzubringen ist.
- Wird das Gestell mit Stabilisierungszubehör geliefert, sind zuerst die Stabilisatoren zu installieren, bevor Sie die Einheit im Gestell anbringen oder sie warten.

Avvertenza Per evitare infortuni fisici durante il montaggio o la manutenzione di questa unità in un supporto, occorre osservare speciali precauzioni per garantire che il sistema rimanga stabile. Le seguenti direttive vengono fornite per garantire la sicurezza personale:

- Il Juniper Networks switch deve essere installato in un telaio, il quale deve essere fissato alla struttura dell'edificio.
- Questa unità deve venire montata sul fondo del supporto, se si tratta dell'unica unità da montare nel supporto.
- Quando questa unità viene montata in un supporto parzialmente pieno, caricare il supporto dal basso all'alto, con il componente più pesante sistemato sul fondo del supporto.
- Se il supporto è dotato di dispositivi stabilizzanti, installare tali dispositivi prima di montare o di procedere alla manutenzione dell'unità nel supporto.

Advarsel Unngå fysiske skader under montering eller reparasjonsarbeid på denne enheten når den befinner seg i et kabinett. Vær nøye med at systemet er stabilt. Følgende retningslinjer er gitt for å verne om sikkerheten:

- Juniper Networks switch må installeres i et stativ som er forankret til bygningsstrukturen.

- Denne enheten bør monteres nederst i kabinettet hvis dette er den eneste enheten i kabinettet.
- Ved montering av denne enheten i et kabinett som er delvis fylt, skal kabinettet lastes fra bunnen og opp med den tyngste komponenten nederst i kabinettet.
- Hvis kabinettet er utstyrt med stabiliseringsutstyr, skal stabilisatorene installeres før montering eller utføring av reparasjonsarbeid på enheten i kabinettet.

Aviso Para se prevenir contra danos corporais ao montar ou reparar esta unidade numa estante, deverá tomar precauções especiais para se certificar de que o sistema possui um suporte estável. As seguintes directrizes ajudá-lo-ão a efectuar o seu trabalho com segurança:

- O Juniper Networks switch deverá ser instalado numa prateleira fixa à estrutura do edifício.
- Esta unidade deverá ser montada na parte inferior da estante, caso seja esta a única unidade a ser montada.
- Ao montar esta unidade numa estante parcialmente ocupada, coloque os itens mais pesados na parte inferior da estante, arrumando-os de baixo para cima.
- Se a estante possuir um dispositivo de estabilização, instale-o antes de montar ou reparar a unidade.

¡Atención! Para evitar lesiones durante el montaje de este equipo sobre un bastidor, oerriormente durante su mantenimiento, se debe poner mucho cuidado en que el sistema quede bien estable. Para garantizar su seguridad, proceda según las siguientes instrucciones:

- El Juniper Networks switch debe instalarse en un bastidor fijado a la estructura del edificio.
- Colocar el equipo en la parte inferior del bastidor, cuando sea la única unidad en el mismo.
- Cuando este equipo se vaya a instalar en un bastidor parcialmente ocupado, comenzar la instalación desde la parte inferior hacia la superior colocando el equipo más pesado en la parte inferior.
- Si el bastidor dispone de dispositivos estabilizadores, instalar éstos antes de montar o proceder al mantenimiento del equipo instalado en el bastidor.

Warning! För att undvika kroppsskada när du installerar eller utför underhållsarbete på denna enhet på en ställning måste du vidta särskilda försiktighetsåtgärder för att försäkra dig om att systemet står stadigt. Följande riktlinjer ges för att trygga din säkerhet:

- Juniper Networks switch måste installeras i en ställning som är förankrad i byggnadens struktur.
- Om denna enhet är den enda enheten på ställningen skall den installeras längst ned på ställningen.
- Om denna enhet installeras på en delvis fylld ställning skall ställningen fyllas nedifrån och upp, med de tyngsta enheterna längst ned på ställningen.
- Om ställningen är försedd med stabiliseringsdon skall dessa monteras fast innan enheten installeras eller underhålls på ställningen.

Laser and LED Safety Guidelines and Warnings for the NFX250 Devices

IN THIS SECTION

- [General Laser Safety Guidelines | 140](#)
- [Class 1M Laser Product Warning | 140](#)
- [Class 1M Laser Radiation Warning | 141](#)
- [Class 1 Laser Product Warning | 141](#)
- [Class 1 LED Product Warning | 142](#)
- [Laser Beam Warning | 142](#)
- [Unterminated Fiber-Optic Cable Warning | 143](#)

NFX250 devices are equipped with laser transmitters:

- SFP and SFP+ transceivers are classified as Class 1 Laser Products (complies with 21 CFR 1040.10 and 1040.11 except for deviations pursuant to Laser Notice 50, dated July 26, 2001) or Class 1 LED Products.

Observe the following guidelines and warnings:

General Laser Safety Guidelines

When working around ports that support optical transceivers, observe the following safety guidelines to prevent eye injury:

- Do not look into unterminated ports or at fibers that connect to unknown sources.
- Do not examine unterminated optical ports with optical instruments.
- Avoid direct exposure to the beam.



LASER WARNING: Unterminated optical connectors can emit invisible laser radiation. The lens in the human eye focuses all the laser power on the retina, so focusing the eye directly on a laser source—even a low-power laser—could permanently damage the eye.

Class 1M Laser Product Warning



LASER WARNING: Class 1M laser product.

Waarschuwing Laserproducten van Klasse 1M (IEC).

Varoitus Luokan 1M (IEC) lasertuotteita.

Attention Produits laser catégorie 1M (IEC).

Warnung Laserprodukte der Klasse 1M (IEC).

Avvertenza Prodotti laser di Classe 1M (IEC).

Advarel Klasse 1M (IEC) laserprodukter.

Aviso Produtos laser Classe 1M (IEC).

¡Atención! Productos láser de Clase 1M (IEC).

Varning! Laserprodukter av Klass 1M (IEC).

Class 1M Laser Radiation Warning



LASER WARNING: Class 1M laser radiation when open. Do not view directly with optical instruments.

Class 1 Laser Product Warning



LASER WARNING: Class 1 laser product.

Waarschuwing Klasse-1 laser produkt.

Varoitus Luokan 1 lasertuote.

Attention Produit laser de classe I.

Warnung Laserprodukt der Klasse 1.

Avvertenza Prodotto laser di Classe 1.

Advarsel Laserprodukt av klasse 1.

Aviso Produto laser de classe 1.

¡Atención! Producto láser Clase I.

Varning! Laserprodukt av klass 1.

Class 1 LED Product Warning



LASER WARNING: Class 1 LED product.

Waarschuwing Klasse 1 LED-product.

Varoitus Luokan 1 valodiodituote.

Attention Alarme de produit LED Class I.

Warnung Class 1 LED-Produktwarnung.

Avvertenza Avvertenza prodotto LED di Classe 1.

Advarel LED-produkt i klasse 1.

Aviso Produto de classe 1 com LED.

¡Atención! Aviso sobre producto LED de Clase 1.

Varning! Lysdiodprodukt av klass 1.

Laser Beam Warning



LASER WARNING: Do not stare into the laser beam or view it directly with optical instruments.

Waarschuwing Niet in de straal staren of hem rechtstreeks bekijken met optische instrumenten.

Varoitus Älä katso säteeseen äläkä tarkastele sitä suoraan optisen laitteen avulla.

Attention Ne pas fixer le faisceau des yeux, ni l'observer directement à l'aide d'instruments optiques.

Warnung Nicht direkt in den Strahl blicken und ihn nicht direkt mit optischen Geräten prüfen.

Avvertenza Non fissare il raggio con gli occhi né usare strumenti ottici per osservarlo direttamente.

Advarel Stirr eller se ikke direkte p strlen med optiske instrumenter.

Aviso Não olhe fixamente para o raio, nem olhe para ele directamente com instrumentos ópticos.

¡Atención! No mirar fijamente el haz ni observarlo directamente con instrumentos ópticos.

Warning! Rikta inte blicken in mot strålen och titta inte direkt på den genom optiska instrument.

Unterminated Fiber-Optic Cable Warning



WARNING: Invisible laser radiation might be emitted from the unterminated connector of a fiber-optic cable. To avoid injury to your eye, do not view the fiber optics with a magnifying optical device, such as a loupe, within 100 mm.

Waarschuwing Er kunnen onzichtbare laserstralen worden uitgezonden vanuit het uiteinde van de onafgebroken vezelkabel of connector. Niet in de straal kijken of deze rechtstreeks bekijken met optische instrumenten. Als u de laseruitvoer met bepaalde optische instrumenten bekijkt (zoals bijv. een oogloep, vergrootglas of microscoop) binnen een afstand van 100 mm kan dit gevaar voor uw ogen opleveren.

Varoitus Päättämättömän kuitukaapelin tai -liittimen päästä voi tulla näkymätöntä lasersäteilyä. Älä tuijota sädettä tai katso sitä suoraan optisilla välineillä. Lasersäteen katsominen tietyillä optisilla välineillä (esim. suurennuslasilla tai mikroskoopilla) 10 cm:n päästä tai sitä lähempää voi olla vaarallista silmille.

Attention Des émissions de radiations laser invisibles peuvent se produire à l'extrémité d'un câble en fibre ou d'un raccord sans terminaison. Ne pas fixer du regard le rayon ou l'observer directement avec des instruments optiques. L'observation du laser à l'aide certains instruments optiques (loupes et microscopes) à une distance inférieure à 100 mm peut poser des risques pour les yeux.

Warnung Eine unsichtbare Laserstrahlung kann vom Ende des nicht angeschlossenen Glasfaserkabels oder Steckers ausgestrahlt werden. Nicht in den Laserstrahl schauen oder diesen mit einem optischen Instrument direkt ansehen. Ein Betrachten des Laserstrahls mit bestimmten optischen Instrumenten, wie z.B. Augenlupen, Vergrößerungsgläsern und Mikroskopen innerhalb eines Abstands von 100 mm kann für das Auge gefährlich sein.

Avvertenza L'estremità del connettore o del cavo ottico senza terminazione può emettere radiazioni laser invisibili. Non fissare il raggio od osservarlo in modo diretto con strumenti ottici. L'osservazione del fascio laser con determinati strumenti ottici (come lupette, lenti di ingrandimento o microscopi) entro una distanza di 100 mm può provocare danni agli occhi.

Advarsel Usynlig laserstråling kan emitte fra enden av den ikke-terminerte fiberkabelen eller koblingen. Ikke se inn i strålen og se heller ikke direkte på strålen med optiske instrumenter. Observering av laserutgang med visse optiske instrumenter (for eksempel øyelupe, forstørrelsesglass eller mikroskop) innenfor en avstand på 100 mm kan være farlig for øynene.

Aviso Radiação laser invisível pode ser emitida pela ponta de um conector ou cabo de fibra não terminado. Não olhe fixa ou diretamente para o feixe ou com instrumentos ópticos. Visualizar a emissão do laser com certos instrumentos ópticos (por exemplo, lupas, lentes de aumento ou microscópios) a uma distância de 100 mm pode causar riscos à visão.

¡Atención! El extremo de un cable o conector de fibra sin terminación puede emitir radiación láser invisible. No se acerque al radio de acción ni lo mire directamente con instrumentos ópticos. La exposición del ojo a una salida de láser con determinados instrumentos ópticos (por ejemplo, lupas y microscopios) a una distancia de 100 mm puede comportar lesiones oculares.

Varning! Osynlig laserstrålning kan komma från änden på en oavslutad fiberkabel eller -anslutning. Titta inte rakt in i strålen eller direkt på den med optiska instrument. Att titta på laserstrålen med vissa optiska instrument (t.ex. lupper, förstoringsglas och mikroskop) från ett avstånd på 100 mm kan skada ögonen.

RELATED DOCUMENTATION

General Safety Guidelines and Warnings

Radiation from Open Port Apertures Warning

Installation Instructions Warning

Grounded Equipment Warning

Radiation from Open Port Apertures Warning



LASER WARNING: Because invisible radiation might be emitted from the aperture of the port when no fiber cable is connected, avoid exposure to radiation and do not stare into open apertures.

Waarschuwing Aangezien onzichtbare straling vanuit de opening van de poort kan komen als er geen fiberkabel aangesloten is, dient blootstelling aan straling en het kijken in open openingen vermeden te worden.

Varoitus Koska portin aukosta voi emittoitua näkymätöntä säteilyä, kun kuitukaapelia ei ole kytkettyä, vältä säteilylle altistumista äläkä katso avoimiin aukkoihin.

Avertissement Des radiations invisibles à l'il nu pouvant traverser l'ouverture du port lorsqu'aucun câble en fibre optique n'y est connecté, il est recommandé de ne pas regarder fixement l'intérieur de ces ouvertures.

Warnung Aus der Port-Öffnung können unsichtbare Strahlen emittieren, wenn kein Glasfaserkabel angeschlossen ist. Vermeiden Sie es, sich den Strahlungen auszusetzen, und starren Sie nicht in die Öffnungen!

Avvertenza Quando i cavi in fibra non sono inseriti, radiazioni invisibili possono essere emesse attraverso l'apertura della porta. Evitate di esporvi alle radiazioni e non guardate direttamente nelle aperture.

Advarsel Unngå utsettelse for stråling, og stirr ikke inn i åpninger som er åpne, fordi usynlig stråling kan emitteres fra portens åpning når det ikke er tilkoblet en fiberkabel.

Aviso Dada a possibilidade de emissão de radiação invisível através do orifício da via de acesso, quando esta não tiver nenhum cabo de fibra conectado, deverá evitar a exposição à radiação e não deverá olhar fixamente para orifícios que se encontrarem a descoberto.

¡Atención! Debido a que la apertura del puerto puede emitir radiación invisible cuando no existe un cable de fibra conectado, evite mirar directamente a las aperturas para no exponerse a la radiación.

Warning! Osynlig strålning kan avges från en portöppning utan ansluten fiberkabel och du bör därför undvika att bli utsatt för strålning genom att inte stirra in i oskyddade öppningar.

Maintenance and Operational Safety Guidelines and Warnings

IN THIS SECTION

- Battery Handling Warning | 146
- Jewelry Removal Warning | 147
- Lightning Activity Warning | 149
- Operating Temperature Warning | 149
- Product Disposal Warning | 151

While performing the maintenance activities for devices, observe the following guidelines and warnings:

Battery Handling Warning



WARNING: Replacing a battery incorrectly might result in an explosion. Replace a battery only with the same or equivalent type recommended by the manufacturer. Dispose of used batteries according to the manufacturer's instructions.

Waarschuwing Er is ontploffingsgevaar als de batterij verkeerd vervangen wordt. Vervang de batterij slechts met hetzelfde of een equivalent type dat door de fabrikant aanbevolen is. Gebruikte batterijen dienen overeenkomstig fabrieksvoorschriften weggegooid te worden.

Varoitus Räjähdyksen vaara, jos akku on vaihdettu väärään akkuun. Käytä vaihtamiseen ainoastaan saman- tai vastaaventyypistä akkua, joka on valmistajan suosittelema. Hävitä käytetyt akut valmistajan ohjeiden mukaan.

Avertissement Danger d'explosion si la pile n'est pas remplacée correctement. Ne la remplacer que par une pile de type semblable ou équivalent, recommandée par le fabricant. Jeter les piles usagées conformément aux instructions du fabricant.

Warnung Bei Einsetzen einer falschen Batterie besteht Explosionsgefahr. Ersetzen Sie die Batterie nur durch den gleichen oder vom Hersteller empfohlenen Batterietyp. Entsorgen Sie die benutzten Batterien nach den Anweisungen des Herstellers.

Advarsel Det kan være fare for eksplosjon hvis batteriet skiftes på feil måte. Skift kun med samme eller tilsvarende type som er anbefalt av produsenten. Kasser brukte batterier i henhold til produsentens instruksjoner.

Avvertenza Pericolo di esplosione se la batteria non è installata correttamente. Sostituire solo con una di tipo uguale o equivalente, consigliata dal produttore. Eliminare le batterie usate secondo le istruzioni del produttore.

Aviso Existe perigo de explosão se a bateria for substituída incorrectamente. Substitua a bateria por uma bateria igual ou de um tipo equivalente recomendado pelo fabricante. Destrua as baterias usadas conforme as instruções do fabricante.

¡Atención! Existe peligro de explosión si la batería se reemplaza de manera incorrecta. Reemplazar la batería EXclusivamente con el mismo tipo o el equivalente recomendado por el fabricante. Desechar las baterías gastadas según las instrucciones del fabricante.

Varning! Explosionsfara vid felaktigt batteribyte. Ersätt endast batteriet med samma batterityp som rekommenderas av tillverkaren eller motsvarande. Följ tillverkarens anvisningar vid kassering av använda batterier.

Jewelry Removal Warning



WARNING: Before working on equipment that is connected to power lines, remove jewelry, including rings, necklaces, and watches. Metal objects heat up when connected to power and ground and can cause serious burns or can be welded to the terminals.

Waarschuwing Alvorens aan apparatuur te werken die met elektrische leidingen is verbonden, sieraden (inclusief ringen, kettingen en horloges) verwijderen. Metalen voorwerpen worden warm wanneer ze met stroom en aarde zijn verbonden, en kunnen ernstige brandwonden veroorzaken of het metalen voorwerp aan de aansluitklemmen lassen.

Varoitus Ennen kuin työskentelet voimavirtajohtoihin kytkettyjen laitteiden parissa, ota pois kaikki korut (sormukset, kaulakorut ja kellot mukaan lukien). Metalliesineet

kuumenevat, kun ne ovat yhteydessä sähkövirran ja maan kanssa, ja ne voivat aiheuttaa vakavia palovammoja tai hitsata metalliesineet kiinni liitännänapoihin.

Avertissement Avant d'accéder à cet équipement connecté aux lignes électriques, ôter tout bijou (anneaux, colliers et montres compris). Lorsqu'ils sont branchés à l'alimentation et reliés à la terre, les objets métalliques chauffent, ce qui peut provoquer des blessures graves ou souder l'objet métallique aux bornes.

Warnung Vor der Arbeit an Geräten, die an das Netz angeschlossen sind, jeglichen Schmuck (einschließlich Ringe, Ketten und Uhren) abnehmen. Metallgegenstände erhitzen sich, wenn sie an das Netz und die Erde angeschlossen werden, und können schwere Verbrennungen verursachen oder an die Anschlußklemmen angeschweißt werden.

Avvertenza Prima di intervenire su apparecchiature collegate alle linee di alimentazione, togliersi qualsiasi monile (inclusi anelli, collane, braccialetti ed orologi). Gli oggetti metallici si riscaldano quando sono collegati tra punti di alimentazione e massa: possono causare ustioni gravi oppure il metallo può saldarsi ai terminali.

Advarsel Fjern alle smykker (inkludert ringer, halskjeder og klokker) før du skal arbeide på utstyr som er koblet til kraftledninger. Metallgjenstander som er koblet til kraftledninger og jord blir svært varme og kan forårsake alvorlige brannskader eller smelte fast til polene.

Aviso Antes de trabalhar em equipamento que esteja ligado a linhas de corrente, retire todas as jóias que estiver a usar (incluindo anéis, fios e relógios). Os objectos metálicos aquecerão em contacto com a corrente e em contacto com a ligação à terra, podendo causar queimaduras graves ou ficarem soldados aos terminais.

¡Atención! Antes de operar sobre equipos conectados a líneas de alimentación, quitarse las joyas (incluidos anillos, collares y relojes). Los objetos de metal se calientan cuando se conectan a la alimentación y a tierra, lo que puede ocasionar quemaduras graves o que los objetos metálicos queden soldados a los bornes.

Varning! Tag av alla smycken (inklusive ringar, halsband och armbandsur) innan du arbetar på utrustning som är kopplad till kraftledningar. Metallobjekt hettas upp när de kopplas ihop med ström och jord och kan förorsaka allvarliga brännskador; metallobjekt kan också sammansvetsas med kontakterna.

Lightning Activity Warning



WARNING: Do not work on the system or connect or disconnect cables during periods of lightning activity.

Waarschuwing Tijdens onweer dat gepaard gaat met bliksem, dient u niet aan het systeem te werken of kabels aan te sluiten of te ontkoppelen.

Varoitus Älä työskentele järjestelmän parissa äläkä yhdistä tai irrota kaapeleita ukkosilmalla.

Avertissement Ne pas travailler sur le système ni brancher ou débrancher les câbles pendant un orage.

Warnung Arbeiten Sie nicht am System und schließen Sie keine Kabel an bzw. trennen Sie keine ab, wenn es gewittert.

Avvertenza Non lavorare sul sistema o collegare oppure scollegare i cavi durante un temporale con fulmini.

Advarsel Utfør aldri arbeid på systemet, eller koble kabler til eller fra systemet når det tordner eller lyner.

Aviso Não trabalhe no sistema ou ligue e desligue cabos durante períodos de mau tempo (trovoada).

¡Atención! No operar el sistema ni conectar o desconectar cables durante el transcurso de descargas eléctricas en la atmósfera.

Varning! Vid åska skall du aldrig utföra arbete på systemet eller ansluta eller koppla loss kablar.

Operating Temperature Warning



WARNING: To prevent the device from overheating, do not operate it in an area that exceeds the maximum recommended ambient temperature. To prevent airflow restriction, allow at least 6 in. (15.2 cm) of clearance around the ventilation openings.

Waarschuwing Om te voorkomen dat welke switch van de Juniper Networks router dan ook oververhit raakt, dient u deze niet te bedienen op een plaats waar de maximale aanbevolen omgevingstemperatuur van 40° C wordt overschreden. Om te voorkomen

dat de luchtstroom wordt beperkt, dient er minstens 15,2 cm speling rond de ventilatieopeningen te zijn.

Varoitus Ettei Juniper Networks switch-sarjan reititin ylikuumentuisi, sitä ei saa käyttää tilassa, jonka lämpötila ylittää korkeimman suositellun ympäristölämpötilan 40° C. Ettei ilmanvaihto estyisi, tuuletusaukkojen ympärille on jätettävä ainakin 15,2 cm tilaa.

Avertissement Pour éviter toute surchauffe des routeurs de la gamme Juniper Networks switch, ne l'utilisez pas dans une zone où la température ambiante est supérieure à 40° C. Pour permettre un flot d'air constant, dégagez un espace d'au moins 15,2 cm autour des ouvertures de ventilations.

Warnung Um einen Router der switch vor Überhitzung zu schützen, darf dieser nicht in einer Gegend betrieben werden, in der die Umgebungstemperatur das empfohlene Maximum von 40° C überschreitet. Um Lüftungsverschluß zu verhindern, achten Sie darauf, daß mindestens 15,2 cm lichter Raum um die Lüftungsöffnungen herum frei bleibt.

Avvertenza Per evitare il surriscaldamento dei switch, non adoperateli in un locale che ecceda la temperatura ambientale massima di 40° C. Per evitare che la circolazione dell'aria sia impedita, lasciate uno spazio di almeno 15.2 cm di fronte alle aperture delle ventole.

Advarsel Unngå overoppheting av eventuelle rutere i Juniper Networks switch Disse skal ikke brukes på steder der den anbefalte maksimale omgivelsestemperaturen overstiger 40° C (104° F). Sørg for at klaringen rundt lufteåpningene er minst 15,2 cm (6 tommer) for å forhindre nedsatt luftsirkulasjon.

Aviso Para evitar o sobreaquecimento do encaminhador Juniper Networks switch, não utilize este equipamento numa área que exceda a temperatura máxima recomendada de 40° C. Para evitar a restrição à circulação de ar, deixe pelo menos um espaço de 15,2 cm à volta das aberturas de ventilação.

¡Atención! Para impedir que un encaminador de la serie Juniper Networks switch se recaliente, no lo haga funcionar en un área en la que se supere la temperatura ambiente máxima recomendada de 40° C. Para impedir la restricción de la entrada de aire, deje un espacio mínimo de 15,2 cm alrededor de las aperturas para ventilación.

Varning! Förhindra att en Juniper Networks switch överhettas genom att inte använda den i ett område där den maximalt rekommenderade omgivningstemperaturen på 40° C överskrids. Förhindra att luftcirkulationen inskränks genom att se till att det finns fritt utrymme på minst 15,2 cm omkring ventilationsöppningarna.

Product Disposal Warning



WARNING: Disposal of this device must be handled according to all national laws and regulations.

Waarschuwing Dit produkt dient volgens alle landelijke wetten en voorschriften te worden afgedankt.

Varoitus Tämän tuotteen lopullisesta hävittämisestä tulee huolehtia kaikkia valtakunnallisia lakeja ja säännöksiä noudattaen.

Avertissement La mise au rebut définitive de ce produit doit être effectuée conformément à toutes les lois et réglementations en vigueur.

Warnung Dieses Produkt muß den geltenden Gesetzen und Vorschriften entsprechend entsorgt werden.

Avvertenza L'eliminazione finale di questo prodotto deve essere eseguita osservando le normative italiane vigenti in materia

Advarsel Endelig disponering av dette produktet må skje i henhold til nasjonale lover og forskrifter.

Aviso A descartagem final deste produto deverá ser efectuada de acordo com os regulamentos e a legislação nacional.

¡Atención! El desecho final de este producto debe realizarse según todas las leyes y regulaciones nacionales

Warning! Slutlig kassering av denna produkt bör skötas i enlighet med landets alla lagar och föreskrifter.

General Electrical Safety Guidelines and Warnings



WARNING: Certain ports on the device are designed for use as intrabuilding (within-the-building) interfaces only (Type 2 or Type 4 ports as described in *GR-1089-CORE*) and require isolation from the exposed outside plant (OSP) cabling. To comply with NEBS (Network Equipment-Building System) requirements and protect against lightning surges and commercial power disturbances, the intrabuilding ports *must not* be metallically connected to interfaces that connect to the OSP or its wiring. The

intrabuilding ports on the device are suitable for connection to intrabuilding or unexposed wiring or cabling only. The addition of primary protectors is not sufficient protection for connecting these interfaces metalically to OSP wiring.

Avertissement Certains ports de l'appareil sont destinés à un usage en intérieur uniquement (ports Type 2 ou Type 4 tels que décrits dans le document *GR-1089-CORE*) et doivent être isolés du câblage de l'installation extérieure exposée. Pour respecter les exigences NEBS et assurer une protection contre la foudre et les perturbations de tension secteur, les ports pour intérieur *ne doivent pas* être raccordés physiquement aux interfaces prévues pour la connexion à l'installation extérieure ou à son câblage. Les ports pour intérieur de l'appareil sont réservés au raccordement de câbles pour intérieur ou non exposés uniquement. L'ajout de protections ne constitue pas une précaution suffisante pour raccorder physiquement ces interfaces au câblage de l'installation extérieure.



CAUTION: Before removing or installing components of a device, connect an electrostatic discharge (ESD) grounding strap to an ESD point and wrap and fasten the other end of the strap around your bare wrist. Failure to use an ESD grounding strap could result in damage to the device.

Attention Avant de retirer ou d'installer des composants d'un appareil, raccordez un bracelet antistatique à un point de décharge électrostatique et fixez le bracelet à votre poignet nu. L'absence de port d'un bracelet antistatique pourrait provoquer des dégâts sur l'appareil.

- Install the device in compliance with the following local, national, and international electrical codes:
 - United States—National Fire Protection Association (NFPA 70), United States National Electrical Code.
 - Other countries—International Electromechanical Commission (IEC) 60364, Part 1 through Part 7.
 - Evaluated to the TN power system.
 - Canada—Canadian Electrical Code, Part 1, CSA C22.1.
 - Suitable for installation in Information Technology Rooms in accordance with Article 645 of the National Electrical Code and NFPA 75.

Peut être installé dans des salles de matériel de traitement de l'information conformément à l'article 645 du National Electrical Code et à la NFPA 75.
- Locate the emergency power-off switch for the room in which you are working so that if an electrical accident occurs, you can quickly turn off the power.

- Make sure that you clean grounding surface and give them a bright finish before making grounding connections.
- Do not work alone if potentially hazardous conditions exist anywhere in your workspace.
- Never assume that power is disconnected from a circuit. Always check the circuit before starting to work.
- Carefully look for possible hazards in your work area, such as moist floors, ungrounded power extension cords, and missing safety grounds.
- Operate the device within marked electrical ratings and product usage instructions.
- To ensure that the device and peripheral equipment function safely and correctly, use the cables and connectors specified for the attached peripheral equipment, and make certain they are in good condition.

You can remove and replace many device components without powering off or disconnecting power to the device, as detailed elsewhere in the hardware documentation for this device. Never install equipment that appears to be damaged.

Action to Take After an Electrical Accident

If an electrical accident results in an injury, take the following actions in this order:

1. Use caution. Be aware of potentially hazardous conditions that could cause further injury.
2. Disconnect power from the device.
3. If possible, send another person to get medical aid. Otherwise, assess the condition of the victim, and then call for help.

Prevention of Electrostatic Discharge Damage

Device components that are shipped in antistatic bags are sensitive to damage from static electricity. Some components can be impaired by voltages as low as 30 V. You can easily generate potentially damaging static voltages whenever you handle plastic or foam packing material or if you move components across plastic or carpets. Observe the following guidelines to minimize the potential for electrostatic discharge (ESD) damage, which can cause intermittent or complete component failures:

- Always use an ESD wrist strap when you are handling components that are subject to ESD damage, and make sure that it is in direct contact with your skin.

If a grounding strap is not available, hold the component in its antistatic bag (see [Figure 29 on page 155](#)) in one hand and touch the exposed, bare metal of the device with the other hand immediately before inserting the component into the device.



WARNING: For safety, periodically check the resistance value of the ESD grounding strap. The measurement must be in the range 1 through 10 Mohms.

Avertissement Par mesure de sécurité, vérifiez régulièrement la résistance du bracelet antistatique. Cette valeur doit être comprise entre 1 et 10 mégohms (Mohms).

- When handling any component that is subject to ESD damage and that is removed from the device, make sure the equipment end of your ESD wrist strap is attached to the ESD point on the chassis.

If no grounding strap is available, touch the exposed, bare metal of the device to ground yourself before handling the component.

- Avoid contact between the component that is subject to ESD damage and your clothing. ESD voltages emitted from clothing can damage components.
- When removing or installing a component that is subject to ESD damage, always place it component-side up on an antistatic surface, in an antistatic card rack, or in an antistatic bag (see [Figure 29 on page 155](#)). If you are returning a component, place it in an antistatic bag before packing it.

Figure 29: Placing a Component into an Antistatic Bag

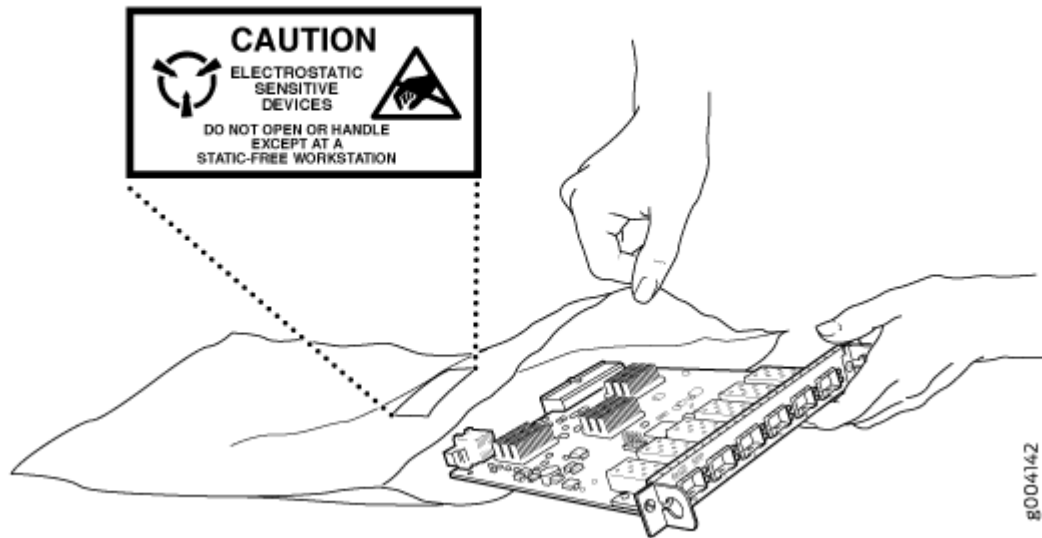

CAUTION: ANSI/TIA/EIA-568 cables such as Category 5e and Category 6 can get electrostatically charged. To dissipate this charge, always ground the cables to a suitable and safe earth ground before connecting them to the system.

Attention Les câbles ANSI/TIA/EIA-568, par exemple Cat 5e et Cat 6, peuvent emmagasiner des charges électrostatiques. Pour évacuer ces charges, reliez toujours les câbles à une prise de terre adaptée avant de les raccorder au système.

AC Power Electrical Safety Guidelines

The following electrical safety guidelines apply to AC-powered devices:

- Note the following warnings printed on the device:

“CAUTION: THIS UNIT HAS MORE THAN ONE POWER SUPPLY CORD. DISCONNECT ALL POWER SUPPLY CORDS BEFORE SERVICING TO AVOID ELECTRIC SHOCK.”

“ATTENTION: CET APPAREIL COMPORTE PLUS D'UN CORDON D'ALIMENTATION. AFIN DE PRÉVENIR LES CHOCS ÉLECTRIQUES, DÉBRANCHER TOUT CORDON D'ALIMENTATION AVANT DE FAIRE LE DÉPANNAGE.”

- AC-powered devices are shipped with a three-wire electrical cord with a grounding-type plug that fits only a grounding-type power outlet. Do not circumvent this safety feature. Equipment grounding must comply with local and national electrical codes.
- You must provide an external certified circuit breaker (2-pole circuit breaker or 4-pole circuit breaker based on your device) rated minimum 20 A in the building installation.
- The power cord serves as the main disconnecting device for the AC-powered device. The socket outlet must be near the AC-powered device and be easily accessible.
- For devices that have more than one power supply connection, you must ensure that all power connections are fully disconnected so that power to the device is completely removed to prevent electric shock. To disconnect power, unplug all power cords (one for each power supply).

Power Cable Warning (Japanese)

WARNING: The attached power cable is only for this product. Do not use the cable for another product.

注意

附属の電源コードセットはこの製品専用です。
他の電気機器には使用しないでください。

0017283

AC Power Disconnection Warning



WARNING: Before working on the device or near power supplies, unplug all the power cords from an AC-powered device.

Waarschuwing Voordat u aan een frame of in de nabijheid van voedingen werkt, dient u bij wisselstroom toestellen de stekker van het netsnoer uit het stopcontact te halen.

Varoitus Kytke irti vaihtovirtalaitteiden virtajohto, ennen kuin teet mitään asennuspohjalle tai työskentelet virtalähteiden läheisyydessä.

Avertissement Avant de travailler sur un châssis ou à proximité d'une alimentation électrique, débrancher le cordon d'alimentation des unités en courant alternatif.

Warnung Bevor Sie an einem Chassis oder in der Nähe von Netzgeräten arbeiten, ziehen Sie bei Wechselstromeinheiten das Netzkabel ab bzw.

Avvertenza Prima di lavorare su un telaio o intorno ad alimentatori, scollegare il cavo di alimentazione sulle unità CA.

Advarsel Før det utføres arbeid på kabinettet eller det arbeides i nærheten av strømforsyningsenheter, skal strømledningen trekkes ut på vekselstrømsenheter.

Aviso Antes de trabalhar num chassis, ou antes de trabalhar perto de unidades de fornecimento de energia, desligue o cabo de alimentação nas unidades de corrente alternada.

¡Atención! Antes de manipular el chasis de un equipo o trabajar cerca de una fuente de alimentación, desenchufar el cable de alimentación en los equipos de corriente alterna (CA).

Varning! Innan du arbetar med ett chassi eller nära strömförsörjningsenheter skall du för växelströmsenheter dra ur nätsladden.

TN Power Warning



WARNING: The device is designed to work with a TN power system.

Waarschuwing Het apparaat is ontworpen om te functioneren met TN energiesystemen.

Varoitus Koje on suunniteltu toimimaan TN-sähkövoimajärjestelmien yhteydessä.

Avertissement Ce dispositif a été conçu pour fonctionner avec des systèmes d'alimentation TN.

Warnung Das Gerät ist für die Verwendung mit TN-Stromsystemen ausgelegt.

Avvertenza Il dispositivo è stato progettato per l'uso con sistemi di alimentazione TN.

Advarsel Utstyret er utfomet til bruk med TN-strømsystemer.

Aviso O dispositivo foi criado para operar com sistemas de corrente TN.

¡Atención! El equipo está diseñado para trabajar con sistemas de alimentación tipo TN.

Varning! Enheten är konstruerad för användning tillsammans med elkraftssystem av TN-typ.

Agency Approvals for NFX250 Devices

IN THIS SECTION

- [Compliance Statement for Argentina | 159](#)

The NFX250 hardware devices comply with the following standards:

- Safety
 - CAN/CSA-C22.2 No. 60950-1 Information Technology Equipment
 - UL 60950-1 Information Technology Equipment
 - EN 60950-1 Information Technology Equipment
 - IEC 60950-1 Information Technology Equipment
 - EN 60825-1 Safety of Laser Products - Part 1: Equipment classification and requirements
- EMC
 - FCC 47CFR Part 15 Class A (USA)
 - EN 55032 Class A Emissions (Europe)
 - ICES-003 Class A (Canada)
 - VCCI Class A (Japan)
 - AS/NZS CISPR 32 Class A (Australia/New Zealand)
 - CISPR 22 Class A
 - CISPR 32 Class A
 - KN 32 (South Korea)

- KN 35 (South Korea)
- EN 55024 (Europe)
- EN 300386 (Europe)
- EN 61000-3-2 Power Line Harmonics
- EN 61000-3-3 Voltage Fluctuations and Flicker
- EN 61000-4-2 ESD
- EN 61000-4-3 Radiated Immunity
- EN 61000-4-4 EFT
- EN 61000-4-5 Surge
- EN 61000-4-6 Low Frequency Common Immunity
- EN 61000-4-11 Voltage Dips and Sags

Compliance Statement for Argentina

EQUIPO DE USO IDÓNEO.

RELATED DOCUMENTATION

[Compliance Statements for EMC Requirements for NFX250 Devices | 159](#)

Compliance Statements for EMC Requirements for NFX250 Devices

IN THIS SECTION

[Canada | 160](#)

- European Community | 161
- Israel | 161
- Japan | 161
- Korea | 162
- United States | 162
- FCC Part 15 Statement | 162

This topic describes the EMC requirements for the NFX250 hardware devices.

NOTE: NFX Series devices are not Network Equipment Building System (NEBS) compliant.

Canada

This Class A digital apparatus complies with Canadian ICES-003.

Cet appareil numérique de la classe A est conforme à la norme NMB-003 du Canada.

The Industry Canada label identifies certified equipment. This certification means that the equipment meets certain telecommunications network protective, operational, and safety requirements. Industry Canada does not guarantee the equipment will operate to the users' satisfaction.

Before installing this equipment, users should ensure that it is permissible to connect the equipment to the facilities of the local telecommunications company. The equipment must also be installed using an acceptable method of connection. In some cases, the inside wiring associated with a single line individual service can be extended by means of a certified connector assembly. The customer should be aware that compliance with the above conditions might not prevent degradation of service in some situations.

Repairs to certified equipment should be made by an authorized Canadian maintenance facility designated by the supplier. Any repairs or alterations made by the user to this equipment, or equipment malfunctions, might give the telecommunications company cause to request the user to disconnect the equipment.



CAUTION: Users should not attempt to make electrical ground connections by themselves, but should contact the appropriate inspection authority or an electrician, as appropriate.

Users should ensure for their own protection that the electrical ground connections of the power utility, telephone lines, and internal metallic water pipe system, if present, are connected together. This precaution might be particularly important in rural areas.

European Community

This is a Class A device. In a domestic environment this device might cause radio interference, in which case the user needs to take adequate measures.

Israel

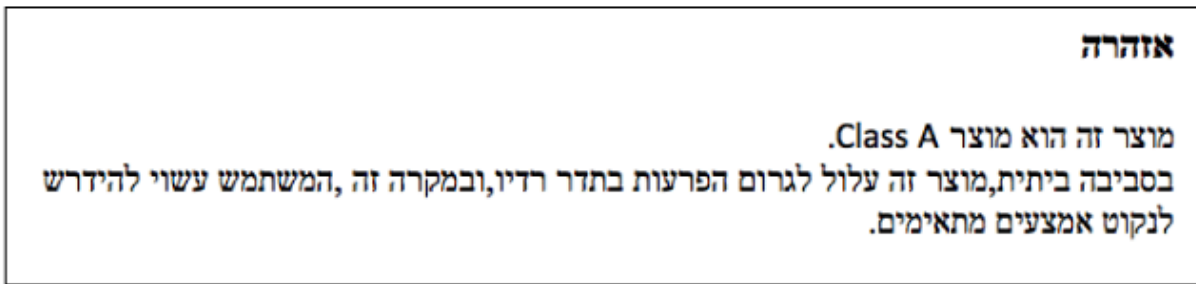

Translation from Hebrew–Warning: This product is Class A. In residential environments, the product may cause radio interference, and in such a situation, the user may be required to take adequate measures.

Japan

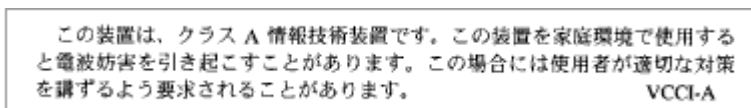

The preceding translates as follows:

This is a Class A device. In a domestic environment this device might cause radio interference, in which case the user needs to take adequate measures.

VCCI-A

Korea

이 기기는 업무용(A급) 전자파적합기기로서 판매자 또는 사용자는 이 점을 주의하시기 바라며, 가정외의 지역에서 사용하는 것을 목적으로 합니다.

Korean Class A Warning

9040913

The preceding translates as follows:

This equipment is Industrial (Class A) electromagnetic wave suitability equipment and seller or user should take notice of it, and this equipment is to be used in the places except for home

United States

The device has been tested and found to comply with the limits for a Class A digital device, pursuant to Part 15 of the FCC Rules. These limits are designed to provide reasonable protection against harmful interference when the equipment is operated in a commercial environment. This equipment generates, uses, and can radiate radio frequency energy and, if not installed and used in accordance with the instruction manual, might cause harmful interference to radio communications. Operation of this equipment in a residential area is likely to cause harmful interference, in which case users need to correct the interference at their own expense.

FCC Part 15 Statement

This equipment has been tested and found to comply with the limits for a Class A digital device pursuant to Part 15 of the FCC Rules. These limits are designed to provide reasonable protection against harmful interference in a residential installation. This equipment generates, uses, and can radiate radio frequency energy and, if not installed and used in accordance with the instructions, might cause harmful interference to radio communications. However, there is no guarantee that interference will not occur in a particular installation.

If this equipment does cause harmful interference to radio or television reception, which can be determined by turning the equipment off and on, the user is encouraged to try and correct the interference by one or more of the following measures:

- Reorient or relocate the receiving antenna.
- Increase the separation between the equipment and the receiver.
- Connect the equipment into an outlet on a circuit different from that to which the receiver is connected.
- Consult the dealer or an experienced radio or TV technician for help.

RELATED DOCUMENTATION

| [Agency Approvals for NFX250 Devices](#) | 158

Statements of Volatility for Juniper Network Devices

A *statement of volatility (SoV)*—sometimes known as *letter of volatility (LoV)*—identifies the volatile and non-volatile storage components in Juniper Networks devices, and describes how to remove non-volatile storage components from the device.

NOTE: Individual FRUs do not have separate SoV or LoV documents. They are covered in the SoV or LoV of the Juniper Networks device in which they are installed.

NOTE: Statements of volatility are not available for all Juniper Networks devices.

CTP Series:

- [CTP150](#)
- [CTP2000](#)

EX Series:

- EX2200 and EX2200-C
- EX2300-24P, EX2300-24T, and EX2300-24T-DC
- EX2300-48P and EX2300-48T
- EX2300-C
- EX3300
- EX3400-24P, EX3400-24T, EX3400-24T-DC
- EX3400-48P, EX3400-48T, EX3400-48T-AFI
- EX4200
- EX4300
- EX4300-48MP
- EX4400
 1. EX4400-24T
 2. EX4400-24P
 3. EX4400-24MP
 4. EX4400-24X
 5. EX4400-48T
 6. EX4400-48P
 7. EX4400-48MP
 8. EX4400-48F
- EX4500
- EX4550
- EX4600
- EX8200
- EX9251
- EX9253
- XRE200 External Routing Engine

LN Series:

- [LN1000-CC](#)

MX Series:

- [M7i](#)
- [M7i Compact Forwarding Engine Board \(CFEB\)](#)
- [M40e and M10i](#)
- [M320](#)
- [MX5, MX10, MX40, and MX80](#)
- [MX104](#)
- [MX204](#)
- [MX304](#)
- [MX240, MX480, and MX960](#)
- [MX10003](#)
- [RE-A-2000 Route Engine](#)
- [RE-S-X6-64G Routing Engine](#)

NFX Series:

- [NFX250](#)

QFX Series:

- [QFX3008-I](#)
- [QFX3100](#)
- [QFX3500](#)
- [QFX3600](#)
- [QFX5100-24Q](#)
- [QFX5100-48S](#)
- [QFX5100-48T](#)
- [QFX5110-32Q](#)

- [QFX5110-48S](#)
- [QFX5120](#)
 1. [QFX5120-32C](#)
 2. [QFX5120-48T](#)
 3. [QFX5120-48Y](#)
 4. [QFX5120-48YM](#)
- [QFX5200](#)
- [QFX5200-32C](#)
- [QFX10008](#) and [QFX10016](#)

SRX Series:

- [SRX100](#)
- [SRX110](#)
- [SRX210B](#)
- [SRX210H-POE](#)
- [SRX210H-P-MGW](#)
- [SRX220](#)
- [SRX240H](#)
- [SRX240H-POE](#)
- [SRX300](#)
- [SRX320](#)
- [SRX340](#) and [SRX345](#)
- [SRX380](#)
- [SRX550](#)
- [SRX650](#)
- [SRX1400](#)
- [SRX1500](#)

- SRX3400 and SRX3600
- SRX4200
- SRX4600
- SRX5400, SRX5600, and SRX5800
- SRX-MP-1SERIAL
- SSG-520M

T Series:

- RE-A-2000 Route Engine