

ACX7024 and ACX7024X Cloud Metro Router Hardware Guide

Published
2024-03-24

Juniper Networks, Inc.
1133 Innovation Way
Sunnyvale, California 94089
USA
408-745-2000
www.juniper.net

Juniper Networks, the Juniper Networks logo, Juniper, and Junos are registered trademarks of Juniper Networks, Inc. in the United States and other countries. All other trademarks, service marks, registered marks, or registered service marks are the property of their respective owners.

Juniper Networks assumes no responsibility for any inaccuracies in this document. Juniper Networks reserves the right to change, modify, transfer, or otherwise revise this publication without notice.

ACX7024 and ACX7024X Cloud Metro Router Hardware Guide
Copyright © 2024 Juniper Networks, Inc. All rights reserved.

The information in this document is current as of the date on the title page.

YEAR 2000 NOTICE

Juniper Networks hardware and software products are Year 2000 compliant. Junos OS has no known time-related limitations through the year 2038. However, the NTP application is known to have some difficulty in the year 2036.

END USER LICENSE AGREEMENT

The Juniper Networks product that is the subject of this technical documentation consists of (or is intended for use with) Juniper Networks software. Use of such software is subject to the terms and conditions of the End User License Agreement ("EULA") posted at <https://support.juniper.net/support/eula/>. By downloading, installing or using such software, you agree to the terms and conditions of that EULA.

Table of Contents

[About This Guide | viii](#)

1

[Fast Track: Initial Installation](#)

[Fast Track to Rack Installation and Power | 2](#)

[Install an ACX7024 or ACX7024X Router in a Rack | 2](#)

[Connect to Power | 3](#)

2

[Overview](#)

[ACX7024 and ACX7024X System Overview | 7](#)

[ACX7024 and ACX7024X Hardware Overview | 7](#)

[ACX7024 Router Models | 12](#)

[ACX7024X Router Models | 12](#)

[Field-Replaceable Units in ACX7024 and ACX7024X Routers | 13](#)

[Hardware Redundancy of ACX7024 and ACX7024X Router Components and Functionality | 13](#)

[ACX7024 and ACX7024X Routers Hardware and CLI Terminology Mapping | 14](#)

[ACX7024 and ACX7024X System Software Overview | 16](#)

[ACX7024 and ACX7024X Chassis | 17](#)

[Management Panel on ACX7024 and ACX7024X Routers | 17](#)

[Management Port LEDs on ACX7024 and ACX7024X Routers | 19](#)

[Port Panel on ACX7024 and ACX7024X Routers | 20](#)

[Network Port LEDs on ACX7024 and ACX7024X Routers | 21](#)

[Chassis Status LEDs on ACX7024 and ACX7024X Routers | 22](#)

[Cooling System and Airflow in ACX7024 and ACX7024X Routers | 24](#)

[ACX7024 and ACX7024X Power System | 26](#)

[AC Power Supply for ACX7024 and ACX7024X Routers | 27](#)

[AC Power Specifications for ACX7024 and ACX7024X Routers | 28](#)

AC Power Cord Specifications for ACX7024 and ACX7024X Routers | 29

AC Power Supply Module LEDs on ACX7024 and ACX7024X Routers | 31

DC Power Supply for ACX7024 and ACX7024X Routers | 33

DC Power Specifications for ACX7024 and ACX7024X Routers | 34

DC Power Supply Module LEDs on ACX7024 and ACX7024X Routers | 35

Site Planning, Preparation, and Specifications

Site Preparation Checklist for ACX7024 and ACX7024X Routers | 38

ACX7024 and ACX7024X Site Guidelines and Requirements | 39

General Site Guidelines | 40

ACX7024 and ACX7024X Site Electrical Wiring Guidelines | 40

Chassis Physical Specifications for ACX7024 and ACX7024X Routers | 42

Environmental Requirements and Specifications for ACX7024 Routers | 42

Environmental Requirements and Specifications for ACX7024X Routers | 43

Grounding Cable and Lug Specifications for ACX7024 and ACX7024X Routers | 44

Clearance Requirements for Hardware Maintenance of ACX7024 and ACX7024X Routers | 45

Rack Requirements for ACX7024 and ACX7024X Routers | 46

Cabinet Requirements for ACX7024 and ACX7024X Routers | 47

ACX7024 and ACX7024X Network Cable and Transceiver Planning | 48

Determining Transceiver Support for ACX7024 and ACX7024X | 48

Cable and Connector Specifications for ACX7024 and ACX7024X | 49

Calculating Power Budget and Power Margin for Fiber-Optic Cables | 57

How to Calculate Power Budget for Fiber-Optic Cables | 57

How to Calculate Power Margin for Fiber-Optic Cables | 58

Fiber-Optic Cable Signal Loss, Attenuation, and Dispersion | 60

ACX7024 and ACX7024X Management and Console Port Specifications and Pinouts | 61

Management Cable Specifications for ACX7024 and ACX7024X Routers | 62

Management Port Connector Pinout Information for ACX7024 and ACX7024X Routers | 62

4

Console Port Connector Pinout on ACX7024 and ACX7024X Routers | 63

USB Port Specifications for ACX7024 and ACX7024X Routers | 64

Initial Installation and Configuration

ACX7024 and ACX7024X Installation Overview | 67

Unpack and Mount an ACX7024 or ACX7024X Router | 67

Unpack an ACX7024 or ACX7024X Router | 67

Register Products—Mandatory to Validate SLAs | 68

Mount an ACX7024 or ACX7024X in a Rack | 69

Install an ACX7024 or ACX7024X Router in a Rack | 69

Connect ACX7024 or ACX7024X to Power | 71

Connect Earth Ground to ACX7024 or ACX7024X Routers | 71

Connect AC Power to an ACX7024 or ACX7024X Router | 73

Connect DC Power to an ACX7024 or ACX7024X Router | 74

Connect ACX7024 or ACX7024X to External Devices | 79

Connect an ACX7024 or ACX7024X Router to a Management Console | 79

Connect an ACX7024 or ACX7024X Router to a Network for Out-of-Band Management | 80

Connect an ACX7024 or ACX7024X Router to External Clocking and Timing Devices | 81

Perform Initial Software Configuration for ACX7024 and ACX7024X Routers | 82

5

Maintaining Components

Maintaining the ACX7024 and ACX7024X Power Supplies | 87

Replace an ACX7024 or ACX7024X Power Supply Module | 87

Remove an ACX7024 or ACX7024X AC Power Supply Module | 87

Install an ACX7024 or ACX7024X AC Power Supply Module | 89

Remove an ACX7024 or ACX7024X DC Power Supply Module | 90

Install an ACX7024 or ACX7024X DC Power Supply Module | 92

Maintain the ACX7024 and ACX7024X Transceivers and Fiber-Optic Cables | 94

Remove a Transceiver | 94

Install a Transceiver | 96

Remove a QSFP28 Transceiver | 99

Install a QSFP28 Transceiver | 100

How to Connect a Fiber-Optic Cable to a Transceiver on an ACX7024 or ACX7024X Router | 101

How to Disconnect a Fiber-Optic Cable from a Transceiver on an ACX7024 or ACX7024X Router | 102

How to Maintain Fiber-Optic Cable for an ACX7024 and ACX7024X Router | 103

Uninstall the ACX7024 or ACX7024X Router | 104

Power Off an ACX7024 or ACX7024X Router | 104

Remove an ACX7024 or ACX7024X Router from a Rack or Cabinet | 106

6

Troubleshooting Hardware

Troubleshooting the ACX7024 or ACX7024X Router | 109

Alarm Types and Severity Classes on ACX7024 and ACX7024X Routers | 109

7

Contacting Customer Support and Returning the Chassis or Components

Returning an ACX7024 or ACX7024X Chassis or Components | 113

How to Return a Hardware Component to Juniper Networks, Inc. | 113

How to Locate the Serial Number on an ACX7024 and ACX7024X Router or Component | 114

List the Chassis and Component Details Using the CLI | 115

Locate the Chassis Serial Number ID Label on an ACX7024 or ACX7024X Router | 115

Locate the Serial Number ID Labels on an ACX7024 Power Supply Module | 115

Guidelines for Packing Hardware Components for Shipment | 116

8

Safety and Compliance Information

General Safety Guidelines and Warnings | 119

Definitions of Safety Warning Levels | 120

Qualified Personnel Warning | 122

Warning Statement for Norway and Sweden | 122

Fire Safety Requirements | 123

Installation Instructions Warning | 124

Chassis and Component Lifting Guidelines | 125

Restricted Access Warning	125
Ramp Warning	127
Rack-Mounting and Cabinet-Mounting Warnings	127
Grounded Equipment Warning	131
Radiation from Open Port Apertures Warning	132
Laser and LED Safety Guidelines and Warnings	133
Maintenance and Operational Safety Guidelines and Warnings	136
General Electrical Safety Guidelines and Warnings	142
Prevention of Electrostatic Discharge Damage	143
Site Electrical Wiring Guidelines	145
AC Power Electrical Safety Guidelines	146
AC Power Disconnection Warning	147
DC Power Disconnection Warning	148
DC Power Grounding Requirements and Warning	149
DC Power Wiring Sequence Warning	150
DC Power Wiring Terminations Warning	152
Multiple Power Supplies Disconnection Warning	153
TN Power Warning	154
Action to Take After an Electrical Accident	154
Compliance Standards for ACX7024 Routers	155
Compliance Standards for ACX7024X Routers	158
Compliance Statements for NEBS	160
Compliance Statements for EMC Requirements	160
Compliance Statements for Environmental Requirements	162

About This Guide

Use this guide to install hardware and perform initial software configuration, routine maintenance, and troubleshooting for the ACX7024 and ACX7024X Cloud Metro Router.

After completing the installation and basic configuration procedures covered in this guide, refer to the [Junos OS Evolved](#) documentation for information about further software configuration.

1

CHAPTER

Fast Track: Initial Installation

[Fast Track to Rack Installation and Power](#) | 2

Fast Track to Rack Installation and Power

SUMMARY

This procedure guides you through the steps to install the ACX7024 or ACX7024X router in a rack and connect it to power.

IN THIS SECTION

- [Install an ACX7024 or ACX7024X Router in a Rack | 2](#)
- [Connect to Power | 3](#)

Install an ACX7024 or ACX7024X Router in a Rack

You can install an ACX7024 or ACX7024X router into a two-post rack or a cabinet. We'll walk you through the steps to install an AC-powered ACX7024 router in a two-post rack.

Before you install, review the following:

- ["ACX7024 and ACX7024X Site Guidelines and Requirements" on page 39](#)
 - [General Safety Guidelines and Warnings](#)
1. Wrap and fasten one end of the ESD grounding strap around your bare wrist, and connect the other end of the strap to a site ESD point.
 2. Position the router in front of the rack.
The mounting brackets are preinstalled on the ACX7024 and ACX7024X routers.
 3. Lift the router and position it in the rack. Line up the bottom hole in each mounting bracket with a hole in each rack rail, making sure the router is level.

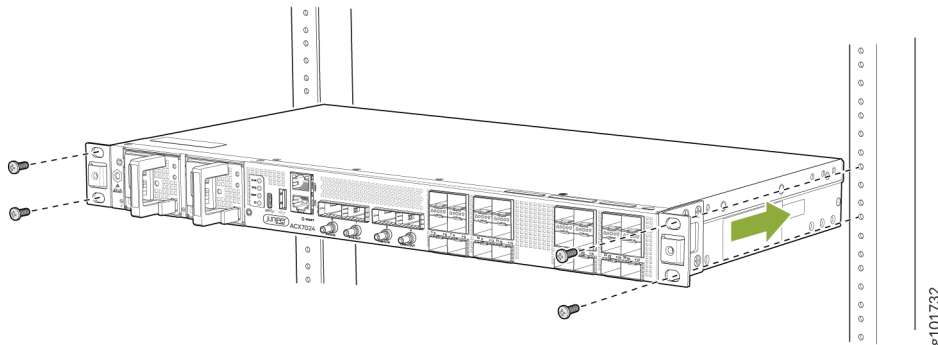

4. Secure the chassis to the rack using the rack mount screws (not provided). Tighten the screws at the bottom first, then tighten the screws at the top.
5. Check to see that the mounting screws on each side of the rack are aligned and the router is level.

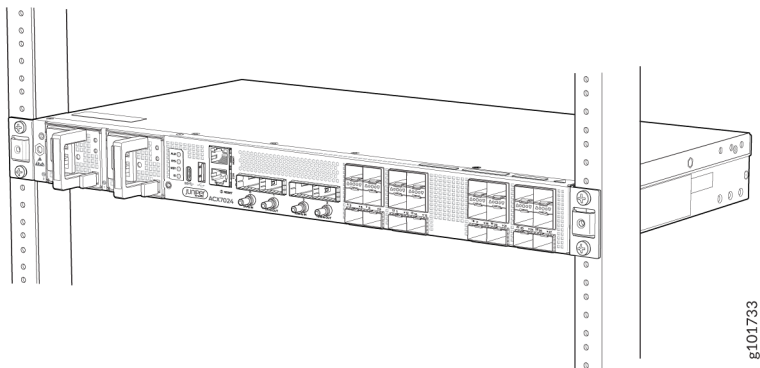

Connect to Power

IN THIS SECTION

- [Ground the ACX7024 or ACX7024X Router | 3](#)
- [Connect the Power Cord and Power On the Router | 4](#)

To connect the ACX7024 or ACX7024X router to AC power, you must do the following:

Ground the ACX7024 or ACX7024X Router

To ground the ACX7024 and ACX7024X routers:

1. Verify that a licensed electrician has attached the cable lug that is provided with the router to the grounding cable.
2. Ensure that all grounding surfaces are clean and brought to a bright finish before you make grounding connections.
3. Connect the grounding cable to a proper earth ground.
4. Place the grounding cable lug over the grounding points on the side of the chassis.

Figure 1: Connect the Grounding Cable to the ACX7024 or ACX7024X Router

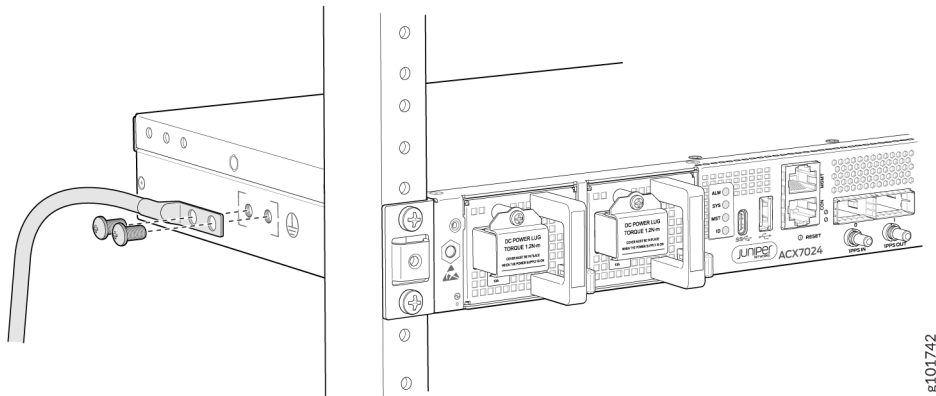

5. Secure the grounding cable lug with the screws. Apply 2.5 N-m of torque to the screws.
6. Dress the grounding cable and verify that it does not touch or block access to router components, and that it does not drape where people could trip over it.

Connect the Power Cord and Power On the Router

For information about the supported AC power cord specifications, see ["AC Power Cord Specifications for ACX7024 and ACX7024X Routers"](#) on page 29 .

To connect an AC power cord to an ACX7024 or ACX7024X router:

1. Wrap and fasten one end of the ESD grounding strap around your bare wrist, and connect the other end of the strap to the ESD point on the chassis.
2. Power off the AC input appliance inlet on the source power supply.
3. Connect the power cord to the power source outlet.

NOTE: Each power supply module (PSM) must be connected to a dedicated AC power feed and a dedicated customer-site 2-pole circuit breaker. We recommend that you use a dedicated customer-site circuit breaker rated for 16A, or as required by local code.

4. Press the small tab on the power cord retainer strip to loosen the loop. Slide the loop until you have enough space to insert the power cord coupler into the inlet.
5. Insert the power cord coupler firmly into the inlet.
6. Slide the loop toward the PSM until it is snug against the base of the coupler.

7. Press the tab on the loop and draw out the loop into a tight circle.
8. Route the power cord appropriately. Verify that the power cord does not block the air exhaust and access to router components, or drape where people could trip over it.
9. Power on the source power supply.
10. Repeat Step "2" on page 4 through Step "9" on page 5 for installing the remaining PSM.

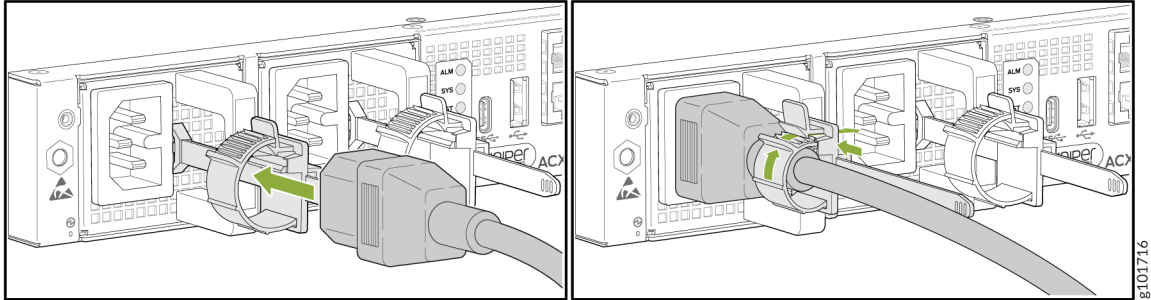

2

CHAPTER

Overview

[ACX7024 and ACX7024X System Overview | 7](#)

[ACX7024 and ACX7024X Chassis | 17](#)

[Cooling System and Airflow in ACX7024 and ACX7024X Routers | 24](#)

[ACX7024 and ACX7024X Power System | 26](#)

ACX7024 and ACX7024X System Overview

IN THIS SECTION

- [ACX7024 and ACX7024X Hardware Overview | 7](#)
- [ACX7024 Router Models | 12](#)
- [ACX7024X Router Models | 12](#)
- [Field-Replaceable Units in ACX7024 and ACX7024X Routers | 13](#)
- [Hardware Redundancy of ACX7024 and ACX7024X Router Components and Functionality | 13](#)
- [ACX7024 and ACX7024X Routers Hardware and CLI Terminology Mapping | 14](#)
- [ACX7024 and ACX7024X System Software Overview | 16](#)

ACX7024 and ACX7024X Hardware Overview

IN THIS SECTION

- [Components on the Front and Rear Panels of an ACX7024 Router | 8](#)
- [Components on the Front and Rear Panels of an ACX7024X Router | 10](#)
- [Benefits of ACX7024 and ACX7024X Routers | 11](#)

The Juniper Networks® ACX7024 and ACX7024X Cloud Metro routers are high-performance access routers that are designed to address the growing demands of metro applications. With a compact 1-U fixed form factor and advanced timing capabilities, these routers are well suited to support Ethernet business services, residential access, and 5G mobile deployments.

The ACX7024 and ACX7024X routers have a system throughput of 360 Gbps. With 1-Gigabit Ethernet (GbE) through 100GbE port flexibility, these routers provide the scalability to accommodate service migration and growth. The routers run Junos OS Evolved and provide several capabilities that include

support for the latest protocol and traffic engineering technologies, enhanced security, and precision timing for mobile backhaul applications.

The ACX7024 and ACX7024X routers have the same form factor, FRUs, and physical specifications. However, the ACX7024 is an industrial-rated (itemp) router with a temperature-hardened design. On the other hand, the ACX7024X is a commercial-grade router with higher RAM and CPU capabilities than ACX7024 to improve scale and performance aspects.

You can manage the ACX7024 and ACX7024X routers by using the CLI.

Figure 2: DC-Powered ACX7024 Router



Figure 3: DC-Powered ACX7024X Router



We ship the ACX7024 and ACX7024X routers with front-to-back airflow (airflow out or AFO) and AC or DC power supply modules (PSMs).

Components on the Front and Rear Panels of an ACX7024 Router

[Figure 4 on page 9](#) shows the front view of an AC-powered ACX7024 Router.

Figure 4: Front View of an AC-Powered ACX7024 Router

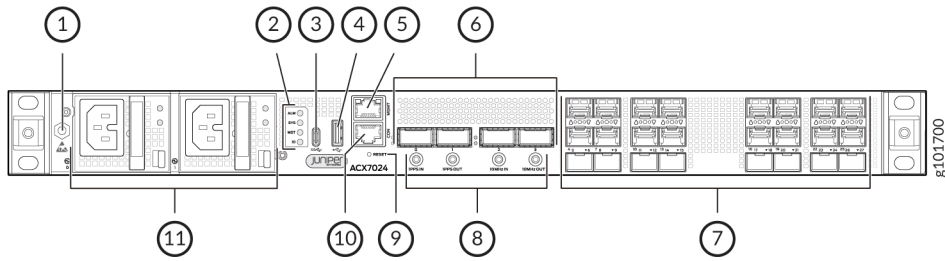

1– ESD point	7– 24 SFP28 ports
2– Status LEDs	8– 1-PPS and 10-MHz GPS input and output ports
3– USB Type-C port	9– Reset (RESET) button
4– USB Type-A port	10– Console (CON) port
5– Management (MGMT) port	11– AC PSMs
6– 4 QSFP28 ports	

Figure 5 on page 9 shows the front view of a DC-powered ACX7024 router.

Figure 5: Front View of a DC-Powered ACX7024 Router

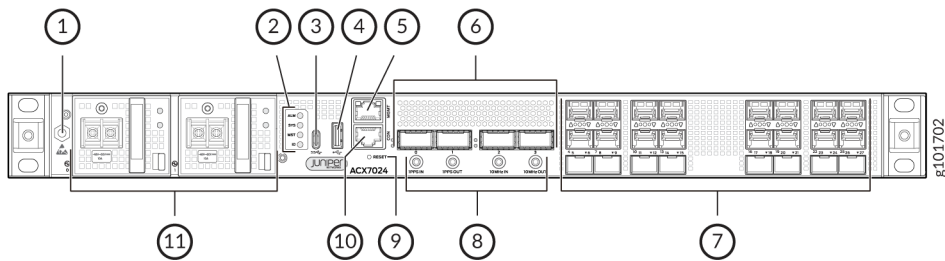

1– ESD point	7– 24 SFP28 ports
2– Status LEDs	8– 1-PPS and 10-MHz GPS input and output ports
3– USB Type-C port	9– Reset (RESET) button
4– USB Type-A port	10– Console (CON) port
5– Management (MGMT) port	11– DC PSMs
6– 4 QSFP28 ports	

Figure 6 on page 10 shows the rear view of an ACX7024 router.

Figure 6: Rear View of an ACX7024 Router

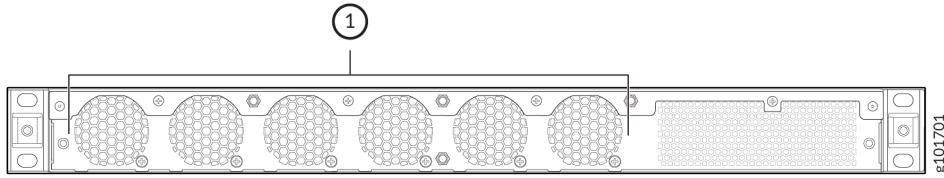

- 1– Six system fans

Components on the Front and Rear Panels of an ACX7024X Router

Figure 7 on page 10 shows the front view of an AC-powered ACX7024X Router.

Figure 7: Front View of an AC-Powered ACX7024X Router

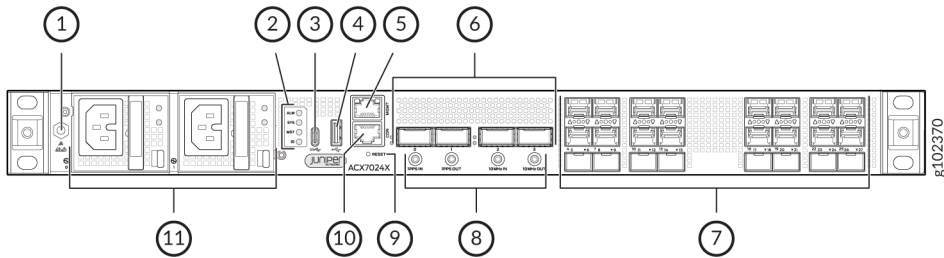

1– ESD point	7– 24 SFP28 ports
2– Status LEDs	8– 1-PPS and 10-MHz GPS input and output ports
3– USB Type-C port	9– Reset (RESET) button
4– USB Type-A port	10– Console (CON) port
5– Management (MGMT) port	11– AC PSMs
6– 4 QSFP28 ports	

Figure 8 on page 11 shows the front view of a DC-powered ACX7024X router.

Figure 8: Front View of a DC-Powered ACX7024X Router

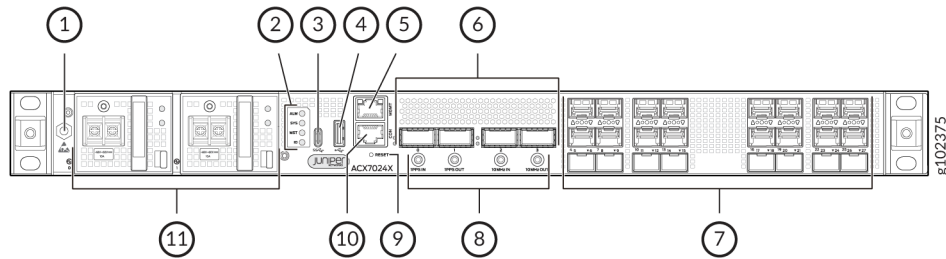

1– ESD point	7– 24 SFP28 ports
2– Status LEDs	8– 1-PPS and 10-MHz GPS input and output ports
3– USB Type-C port	9– Reset (RESET) button
4– USB Type-A port	10– Console (CON) port
5– Management (MGMT) port	11– DC PSMs
6– 4 QSFP28 ports	

Figure 9 on page 11 shows the rear view of an ACX7024X router.

Figure 9: Rear View of an ACX7024X Router

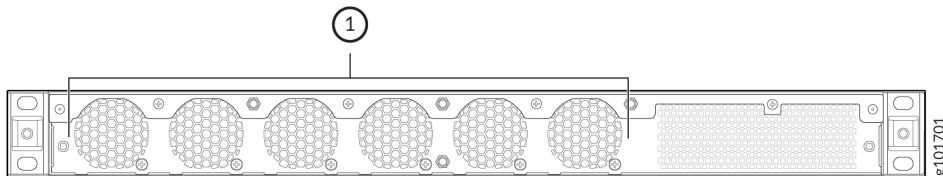

1– Six system fans

Benefits of ACX7024 and ACX7024X Routers

- **Compact form factor**—Has a compact 1-U form factor that enables you to use it in a wide variety of environmental deployments. You can use the ACX7024 and ACX7024X in networks with limited rack space and cooling capacity.
- **Advanced timing features**—Supports precision timing capabilities including Synchronous Ethernet, Precision Time Protocol (PTP), and Class C timing for low-latency 5G services.
- **Next-gen capabilities**—Supports next-generation protocols including segment routing, Segment Routing IPv6 (SRv6), MPLS, and EVPN-VXLAN.

ACX7024 Router Models

The ACX7024 routers are available with either AC or DC power supply modules (PSMs) and with airflow-out (AFO). AFO is also known as *front-to-back* cooling.

[Table 1 on page 12](#) lists the model numbers for ACX7024 routers.

Table 1: ACX7024 Router Model Numbers and Description

Model Number	Power Supply	Airflow
ACX7024-DC-1PSU	DC	Front-to-back (AFO)
ACX7024-DC-2PSU	DC	Front-to-back (AFO)
ACX7024-AC-1PSU	AC	Front-to-back (AFO)
ACX7024-AC-2PSU	AC	Front-to-back (AFO)

ACX7024X Router Models

The ACX7024X routers are available with either AC or DC power supply modules (PSMs) and with airflow-out (AFO). AFO is also known as *front-to-back* cooling.

[Table 2 on page 12](#) lists the model numbers for ACX7024X routers.

Table 2: ACX7024X Router Model Numbers and Description

Model Number	Power Supply	Airflow
ACX7024X-DC-2PSU	DC	Front-to-back (AFO)
ACX7024X-AC-2PSU	AC	Front-to-back (AFO)

Field-Replaceable Units in ACX7024 and ACX7024X Routers

Field-replaceable units (FRUs) are components that you can replace at your site. The following are the FRUs in ACX7024 and ACX7024X routers:

- Power supply modules (PSMs)
- Transceivers

NOTE: If you have a Juniper J-Care service contract, register any addition, change, or upgrade of hardware components at <https://www.juniper.net/customers/csc/management/updateinstallbase.jsp>. Failure to do so can result in significant delays if you need replacement parts. This note does not apply if you replace existing components with the same type of component.

NOTE: Before removing the optical transceivers, we recommend that you disable the interface using the **set interfaces *interface-name* disable** command.

Hardware Redundancy of ACX7024 and ACX7024X Router Components and Functionality

The following hardware components provide redundancy on ACX7024 and ACX7024X routers:

- Power supply modules (PSMs)—You can install two PSMs on ACX7024 and ACX7024X routers to provide full power redundancy to the device. Each PSM provides power to all the components in the router. If one PSM fails, or if you remove one PSM, the second PSM balances the electrical load without interruption. Connect the first power source feed to one PSM, and connect the other power source feed to the second PSM.



CAUTION: Do not connect both the power source feeds to the same power supply input terminal.

- Cooling system—Each ACX7024 and ACX7024X router has six system fans that provide redundancy for cooling. When a system fan (single or multiple) fails, a chassis alarm is raised and the fan(s) need to be replaced. In case of a single fan failure, the router continues to operate with the remaining fans according to GR-3108 specifications. However, if multiple fans fail, it requires immediate

replacement of the fans. The system fans in an ACX7024 and ACX7024X router are fixed and cannot be replaced at your site. You must return the router to Juniper Networks for repair or replacement of the fans (see ["Returning an ACX7024 or ACX7024X Chassis or Components" on page 113](#)).

ACX7024 and ACX7024X Routers Hardware and CLI Terminology Mapping

Table 3 on page 14 describes the hardware terms used in the Junos OS CLI for the ACX7024 router.

Table 3: CLI Equivalents of Terms Used in Documentation for ACX7024 Routers

Hardware Item (as Displayed in the CLI)	Description (as Displayed in the CLI) for ACX7024 Routers	Value (as Displayed in the CLI)	Item in Documentation	Additional Information
Chassis	JNP7024 [ACX7024]	-	Router chassis	"Chassis Physical Specifications for ACX7024 and ACX7024X Routers" on page 42
Routing Engine	RE-ACX-7024	-	Built-in Routing Engine	-
FPC <i>n</i>	ACX7024-FPC	The value of <i>n</i> is always 0.	The router does not have actual Flexible PIC Concentrator (FPC) line cards. In this case, FPC refers to the router.	-
PIC <i>n</i>	MRATE- 24xSFP28 + 4xQSFP	The value of <i>n</i> is always 0.	Abbreviated name of the PIC. The router does not have physical PICs. The built-in network ports on the front panel of the router map to logical PICs.	-

Table 3: CLI Equivalents of Terms Used in Documentation for ACX7024 Routers (Continued)

Hardware Item (as Displayed in the CLI)	Description (as Displayed in the CLI) for ACX7024 Routers	Value (as Displayed in the CLI)	Item in Documentation	Additional Information
PSM (<i>n</i>)	JPSU-400W-DC-AFI or JPSU-400W-AC-AFI	<i>n</i> is a value in the range of 0-1. The value corresponds to the power supply slot number.	AC or DC power supply module	"ACX7024 and ACX7024X Power System" on page 26
Fan tray (<i>n</i>)	ACX7024 Fan, Front to Back Airflow - AFO	The value of <i>n</i> is always 0.	System fan	"Cooling System and Airflow in ACX7024 and ACX7024X Routers" on page 24

Table 4 on page 15 describes the hardware terms used in the Junos OS CLI for the ACX7024X router.

Table 4: CLI Equivalents of Terms Used in Documentation for ACX7024X Routers

Hardware Item (as Displayed in the CLI)	Description (as Displayed in the CLI) for ACX7024X Routers	Value (as Displayed in the CLI)	Item in Documentation	Additional Information
Chassis	JNP7024X [ACX7024X]	-	Router chassis	"Chassis Physical Specifications for ACX7024 and ACX7024X Routers" on page 42
Routing Engine	RE-ACX-7024X	-	Built-in Routing Engine	-

Table 4: CLI Equivalents of Terms Used in Documentation for ACX7024X Routers (Continued)

Hardware Item (as Displayed in the CLI)	Description (as Displayed in the CLI) for ACX7024X Routers	Value (as Displayed in the CLI)	Item in Documentation	Additional Information
FPC <i>n</i>	ACX7024X-FPC	The value of <i>n</i> is always 0.	The router does not have actual Flexible PIC Concentrator (FPC) line cards. In this case, FPC refers to the router.	-
PIC <i>n</i>	MRATE- 24xSFP28 + 4xQSFP	The value of <i>n</i> is always 0.	Abbreviated name of the PIC. The router does not have physical PICs. The built-in network ports on the front panel of the router map to logical PICs.	-
PSM (<i>n</i>)	JPSU-400W-DC-AFI or JPSU-400W-AC-AFI	<i>n</i> is a value in the range of 0-1. The value corresponds to the power supply slot number.	DC power supply module	"ACX7024 and ACX7024X Power System" on page 26
Fan tray (<i>n</i>)	ACX7024X Fan, Front to Back Airflow - AFO	The value of <i>n</i> is always 0.	System fan	"Cooling System and Airflow in ACX7024 and ACX7024X Routers" on page 24

ACX7024 and ACX7024X System Software Overview

The ACX7024 and ACX7024X runs Junos OS Evolved, which provides Layer 2 and Layer 3 switching, routing, and security services. Junos OS Evolved runs natively on Linux and has direct access to all Linux

utilities and operations. It has a modular design that supports upgrades on a component-by-component basis without a system reboot. Only those components that are changed are restarted. Junos OS Evolved is easily portable, and it requires minimal effort to make it work on any platform. Junos OS Evolved has a modernized infrastructure, which ensures high availability, portability, faster innovation, and simplified upgrades.

For information about features supported on ACX Series devices, see [Feature Explorer](#).

RELATED DOCUMENTATION

[Cooling System and Airflow in ACX7024 and ACX7024X Routers | 24](#)

[ACX7024 and ACX7024X Power System | 26](#)

ACX7024 and ACX7024X Chassis

IN THIS SECTION

- [Management Panel on ACX7024 and ACX7024X Routers | 17](#)
- [Management Port LEDs on ACX7024 and ACX7024X Routers | 19](#)
- [Port Panel on ACX7024 and ACX7024X Routers | 20](#)
- [Network Port LEDs on ACX7024 and ACX7024X Routers | 21](#)
- [Chassis Status LEDs on ACX7024 and ACX7024X Routers | 22](#)

Management Panel on ACX7024 and ACX7024X Routers

The management panel on ACX7024 and ACX7024X routers is located on the front of the router along with the interface ports. [Figure 10 on page 18](#) shows the management panel components on an ACX7024 and ACX7024X router.

Figure 10: Management Panel Components on ACX7024 and ACX7024X Routers

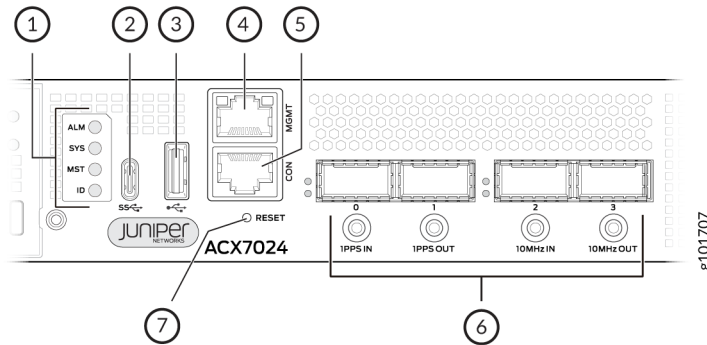

1– Status LEDs	5– Console (CON) port
2– USB Type-C port	6– 1-PPS and 10-MHz GPS SMB connector ports
3– USB Type-A port	7– Reset (RESET) button
4– Management (MGMT) port	

The management panel on an ACX7024 and ACX7024X router displays the router product number, and it consists of the following components:

- Status LEDs—**ALM**, **SYS**, **MST**, and **ID** LEDs.
- USB Type-C port for external GNSS dongle support. The ACX7024 and ACX7024X routers supports the Furuno TB-1 external GNSS receiver. To learn how to connect an ACX7024 or ACX7024X router to a Furuno TB-1 GNSS receiver, see [Grand Master Clock Support Using External GNSS Receiver for ACX7024](#).
- USB Type-A port for image updates.
- Management (**MGMT**) port—10/100/1000BASE-T port that uses an RJ-45 connector to connect to a management device for out-of-band management.
- SMB connector ports that support 1-PPS and 10-MHz timing devices.
- Console (**CON**) port—Uses an RJ-45 connector to connect to a console management device. Additionally, you can use the **CON** port as a GPS time of day (TOD) port. To connect to both console and a TOD device simultaneously, you must use a breakout cable.

NOTE: If you connect to both console and a TOD device simultaneously using a breakout cable, make sure that you have not configured the `log-out-on-disconnect` statement at the `[edit system ports console]` hierarchy level.

- Reset (**RESET**) button to reset the router.

Management Port LEDs on ACX7024 and ACX7024X Routers

The ACX7024 and ACX7024X routers have a management port that has separate LEDs to indicate link status and link activity. The port is located on the management panel and is labeled **MGMT**. [Figure 11 on page 19](#) shows the location of the LEDs.

Figure 11: Management Port LEDs on an ACX7024 and ACX7024X Router

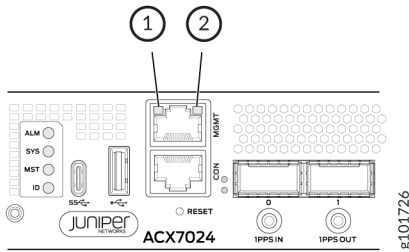

1. Link activity LED
2. Status LED

[Table 5 on page 19](#) describes the RJ-45 management port LEDs on ACX7024 routers.

Table 5: Management Port LEDs on ACX7024 and ACX7024X Routers

LED	Color	State	Description
Link activity LED	Unlit	Off	No link is established.
	Green	Blinking	A link is established, and there is link activity.
Status LED	Unlit	Off	No link is established, or the port speed is 10 Mbps.
	Yellow	On steadily	The port speed is 100 Mbps.

Table 5: Management Port LEDs on ACX7024 and ACX7024X Routers (Continued)

LED	Color	State	Description
	Green	On steadily	The port speed is 1 Gbps.

Port Panel on ACX7024 and ACX7024X Routers

You can configure the ACX7024 and ACX7024X ports into 100GbE or 25GbE interfaces as follows:

- Four 100GbE ports (ports **0** through **3**) that support quad small form-factor pluggable 28 (QSFP28) transceivers. You can channelize these ports into four 25-Gbps interfaces using breakout cables and channelization configuration. These ports also support 40-Gbps speed, when you use QSFP+ optics. You can channelize these 40-Gbps ports into four 10-Gbps interfaces using breakout cables and channelization configuration.
- Twenty-four 25GbE ports (ports **4** through **27**) that operate at 25-Gbps speed with small form-factor pluggable 28 (SFP28) transceivers, 10-Gbps speed with SFP+ transceivers, or 1-Gbps speed with SFP transceivers.

NOTE: If you configure Precision Time Protocol (PTP), no interfaces are created for port **27** and the port is disabled.

For more information about valid port configurations on ACX7024 and ACX7024X routers, see [Port Checker Tool](#).

Figure 12 on page 20 shows the port panel on an ACX7024 and ACX7024X router.

Figure 12: ACX7024 and ACX7024X Port Panel

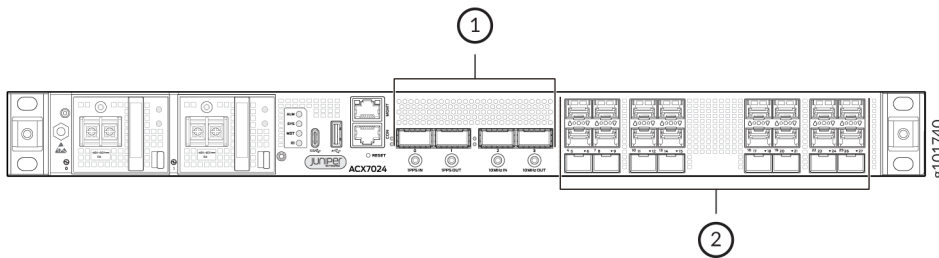

1– Four 100GbE QSFP28 ports

2– Twenty-four 25GbE/10GbE/1GbE SFP28 ports

Network Port LEDs on ACX7024 and ACX7024X Routers

Each ACX7024 and ACX7024X network port has a single LED to indicate link status, activity on the link, or a fault condition. [Figure 13 on page 21](#) and [Figure 14 on page 21](#) show the location of the LEDs on an ACX7024 and ACX7024X router.

Figure 13: QSFP28 Port LEDs

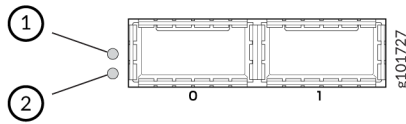

1– Left-port LED

2– Right-port LED

Figure 14: SFP28 Port LEDs

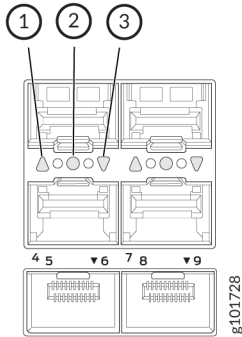

1– Upper-port LED

3– Lower-port LED

2– Middle-port LED

[Table 6 on page 22](#) describes the network port LEDs on the ACX7024 and ACX7024X routers, their colors and states, and the status that they indicate.

Table 6: Network Port LEDs on ACX7024 and ACX7024X Routers

LED Color	LED State	Description
Unlit	Off	There is no power, the link is down, or a transceiver is not present.
Green	On steadily	A link is established, and all channels are up.
	Blinking	The beacon function is enabled on the port.
Amber	On steadily	One or more channels are up. At least one channel has activity, but not all connections are active.
	Blinking	The port is disabled in the CLI.
Red	On steadily	All channels are down.

Chassis Status LEDs on ACX7024 and ACX7024X Routers

Each ACX7024 and ACX7024X router has four status LEDs that indicate the system status. You can find these LEDs to the left of the USB ports (see [Figure 15 on page 22](#)).

Figure 15: Chassis Status LEDs on an ACX7024 and ACX7024X Router

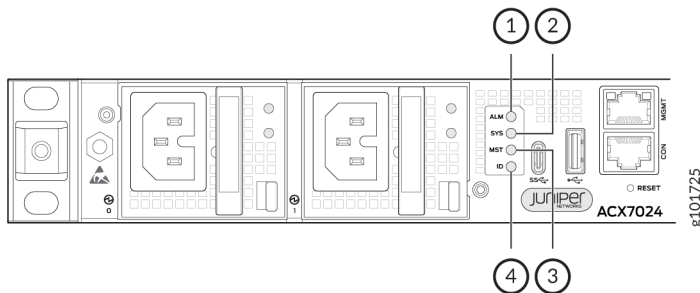

1– ALM (Alarm)

3– MST (Primary)

2– **SYS** (System)4– **ID** (Identification)

Table 7 on page 23 describes the chassis status LEDs on an ACX7024 and ACX7024X router, their colors and states, and the status that the colors indicate. You can view the colors of the LEDs remotely through the CLI by running the operational mode command `show chassis led`.

Table 7: Chassis Status LEDs on an ACX7024 and ACX7024X Router

Name	Color	State	Description
ALM —Alarm LED	Unlit	Off	The router is halted, or there is no alarm.
	Red	On steadily	A major hardware fault has occurred, such as a temperature alarm or power failure, and the router has halted. Switch off power to the router and unplug the power cords. Correct any voltage or site temperature issues, and allow the router to cool down. Power on the router, and monitor the power supply LEDs to determine where the error is occurring.
		Blinking	Indicates a major and a minor alarm
	Amber	On steadily	A minor alarm has occurred, such as a software error. Switch off power to the router and unplug the power cords. Power on the router, and monitor the status LEDs to ensure that Junos OS Evolved boots up properly.
		Blinking	Indicates the presence of a major and a minor alarm.
SYS —System LED	Unlit	Off	The router is powered off or halted.

Table 7: Chassis Status LEDs on an ACX7024 and ACX7024X Router (*Continued*)

Name	Color	State	Description
	Green	On steadily	Junos OS Evolved is loaded on the router.
		Blinking	The device is loading the software or the device is powering off.
		Slow blinking	The device is powering up.
MST —Primary LED	Green	On steadily	The router is a standalone router.
ID —Identification LED	Unlit	Off	The beacon feature is not enabled on the router. You can enable this feature by using the request chassis beacon command.
	Blue	Blinking	The beacon feature is enabled on the router. You can disable this feature by using the request chassis beacon command.

RELATED DOCUMENTATION

[ACX7024 and ACX7024X System Overview | 7](#)

Cooling System and Airflow in ACX7024 and ACX7024X Routers

The cooling system in an ACX7024 and ACX7024X router consists of six system fans. When a system fan (single or multiple) fails, a chassis alarm is raised and the fan(s) need to be replaced. In case of a

single fan failure, the router continues to operate with the remaining fans according to GR-3108 specifications. However, if multiple fans fail, it requires immediate replacement of the fans.

The system fans in an ACX7024 and ACX7024X router are fixed and cannot be replaced at your site. You must return the router to Juniper Networks for repair or replacement of the fans (see ["Returning an ACX7024 or ACX7024X Chassis or Components" on page 113](#)).

Figure 16: System Fans in an ACX7024 and ACX7024X Router

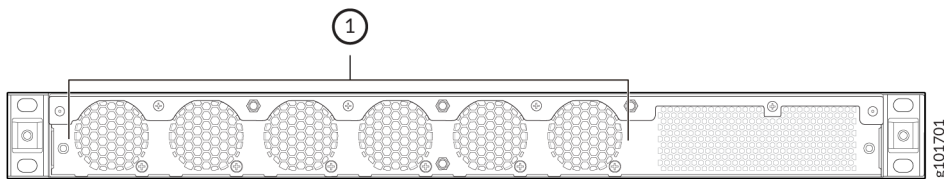

1– System fans

The ACX7024 and ACX7024X routers support only front-to-back airflow (airflow out or AFO). In AFO models, the device pulls in air through the front of the chassis toward the system fans, from where it exhausts the air out of the chassis. [Figure 17 on page 26](#) shows the airflow direction in an ACX7024 and ACX7024X router.

NOTE: Leave at least 6 in. (15.2 cm) clearance each at the front and rear of the chassis for airflow and to accommodate the interface and power cable bend radius.

Figure 17: AFO Airflow Through ACX7024 and ACX7024X Chassis



RELATED DOCUMENTATION

[ACX7024 and ACX7024X System Overview | 7](#)

[ACX7024 and ACX7024X Power System | 26](#)

ACX7024 and ACX7024X Power System

IN THIS SECTION

- [AC Power Supply for ACX7024 and ACX7024X Routers | 27](#)
- [AC Power Specifications for ACX7024 and ACX7024X Routers | 28](#)
- [AC Power Cord Specifications for ACX7024 and ACX7024X Routers | 29](#)
- [AC Power Supply Module LEDs on ACX7024 and ACX7024X Routers | 31](#)

- DC Power Supply for ACX7024 and ACX7024X Routers | 33
- DC Power Specifications for ACX7024 and ACX7024X Routers | 34
- DC Power Supply Module LEDs on ACX7024 and ACX7024X Routers | 35

AC Power Supply for ACX7024 and ACX7024X Routers

IN THIS SECTION

- AC Power Supply Airflow | 28

The power supply modules (PSMs) in ACX7024 and ACX7024X routers are hot-removable and hot-insertable field-replaceable units (FRUs). The PSMs are preinstalled in the router. You can install replacement PSMs without powering off the router or disrupting the router function.

NOTE: This device is designed to support overvoltage category II (OVC II). If the equipment is subjected to transient voltages greater than OVC II, it will need additional external protection. Ensure that the component you use for this external protection complies with IEC 61643/UL 1449 based on the local code.



CAUTION: Do not use AC and DC PSMs together in the same chassis.

Figure 18 on page 28 shows the AC PSM for ACX7024 and ACX7024X routers.

Figure 18: AC PSM Used in an ACX7024 and ACX7024X Router

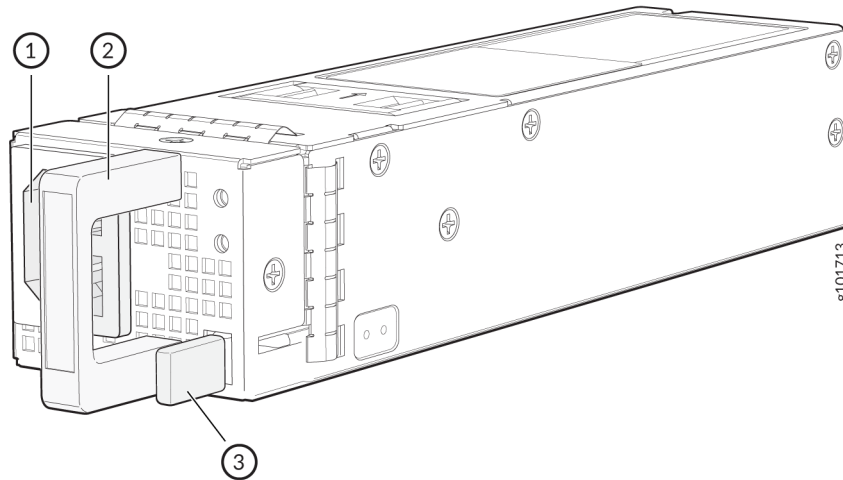

1– AC inlet

3– Latch lever

2– Handle

AC Power Supply Airflow

Each PSM has its own internal cooling system. The PSMs in ACX7024 and ACX7024X routers support back-to-front airflow (airflow in or AFI). This is because the PSMs on ACX7024 and ACX7024X routers are installed on the front panel of the chassis and the ACX7024 and ACX7024X chassis supports front-to-back airflow (airflow out or AFO). The AFI airflow of the PSMs supports the AFO airflow of the ACX7024 and ACX7024X chassis.

The ACX7024 and ACX7024X AC power supply model number is **JPSU-400W-AC-AFI**.

AC Power Specifications for ACX7024 and ACX7024X Routers

Table 8 on page 28 describes the AC power specifications for ACX7024 and ACX7024X routers.

Table 8: AC Power Specifications for ACX7024 and ACX7024X Routers

Item	Specifications for ACX7024 and ACX7024X
AC input voltage	Operating range: 90 VAC to 264 VAC

Table 8: AC Power Specifications for ACX7024 and ACX7024X Routers (Continued)

Item	Specifications for ACX7024 and ACX7024X
AC input line frequency	50 Hz - 60 Hz
AC input current rating	6 A at 100 VAC 3 A at 200 VAC
Typical power consumption (without optics) at 25 °C	97 W
Maximum power consumption (without optics)	150 W

AC Power Cord Specifications for ACX7024 and ACX7024X Routers

Each AC power supply has a single AC appliance inlet that requires a dedicated AC power feed. The coupler for the AC power cord is type C15 as described by International Electrotechnical Commission (IEC) standard 60320. The plug end of the power cord fits into the power source outlet that is standard for your geographical location.





NOTE: In North America, AC power cords must not exceed 4.5 meters in length to comply with National Electrical Code (NEC) Sections 400-8 (NFPA 75, 5-2.2) and 210-52 and Canadian Electrical Code (CEC) Section 4-010(3). The ACX Series power cords comply with the standards.

Table 9 on page 30 lists the AC power cord specifications for each country or region.

Table 9: AC Power Cord Specifications

Country/Region	Electrical Specifications	Plug Standards	Juniper Model Number	Spare Juniper Model Number	Graphic
Argentina	250 VAC, 10 A, 50 Hz	IRAM 2073 Type RA/3	-	CBL-PWR-C15M-HITEMP-AR	
Australia	250 VAC, 10 A, 50 Hz	AS/NZS 3112-2000 Type SAA/3	CG_CBL-C15-02-AU	CBL-PWR-C15M-HITEMP-AU	
Brazil NOTE: For Brazil, the minimum and maximum temperature rating of the cord is -20 °C to +70 °C	250 VAC, 10 A, 50 Hz	NBR 14136 Type BR/3	-	CBL-PWR-C15M-HITEMP-BR	
China NOTE: For China, the minimum and maximum temperature rating of the cord is -20 °C to +65 °C	250 VAC, 10 A, 50 Hz	GB 2099/GB 1002 Type PRC/3	CG_CBL-C15-02-CH	CBL-PWR-C15M-HITEMP-CH	
Europe (except Italy, Switzerland, and United Kingdom)	250 VAC, 10 A, 50 Hz	CEE (7) VII Type VIIG	CG_CBL-C15-02-EU	CBL-PWR-C15M-HITEMP-EU	
Italy	250 VAC, 10 A, 50 Hz	CEI 23-16 Type I/3G	CG_CBL-C15-02-IT-CH	CBL-PWR-C15M-HITEMP-IT	

Table 9: AC Power Cord Specifications (Continued)

Country/Region	Electrical Specifications	Plug Standards	Juniper Model Number	Spare Juniper Model Number	Graphic
Japan NOTE: For Japan, the minimum and maximum temperature rating of the cord is -20 °C to +90 °C	125 VAC, 15 A, 50 Hz	JIS 8303 Type 498GJ	CG_CBL-C15-02-JP	CBL-PWR-C15M-HITEMP-JP	
North America	125 VAC, 15 A, 50 Hz	NEMA 5-15 Type 498G	CG_CBL-C15-02-US	CBL-PWR-C15M-HITEMP-US	
South Africa and India	250 VAC, 10 A, 50 Hz	SABS 164/1:1992 Type ZA/3	-	CBL-PWR-C15M-HITEMP-SA	
South Korea and some parts of Europe	250 VAC, 10 A, 50 Hz	CEE(7) VII Type VIIG	-	CBL-PWR-C15M-HITEMP-KR	
Switzerland	250 VAC, 10 A, 50 Hz	SEV 1011/6534-2 Type 12G	CG_CBL-C15-02-SZ	CBL-PWR-C15M-HITEMP-SZ	
United Kingdom	250 VAC, 10 A, 50 Hz	BS 1363/A Type BS89/13	CG_CBL-C15-02-UK	CBL-PWR-C15M-HITEMP-UK	

AC Power Supply Module LEDs on ACX7024 and ACX7024X Routers

The AC power supply module (PSM) on an ACX7024 and ACX7024X router uses two LEDs to indicate power status. [Figure 19 on page 32](#) shows the location of the LEDs on the AC PSM.

Figure 19: AC PSM LEDs

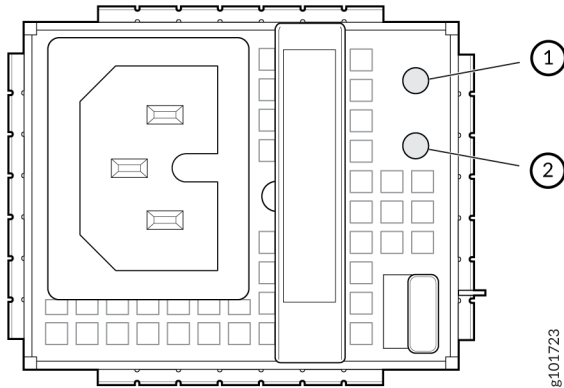

1– PWR LED

2– FAIL LED

Table 10 on page 32 describes the LEDs on the AC PSMs.

Table 10: AC PSM LEDs on ACX7024 and ACX7024X Routers

Name	Color	State	Description
PWR	Unlit	Off	The PSM is receiving no input power.
	Green	On steadily	The PSM is receiving input power.
FAIL	Amber	On steadily	An error is detected in the PSM. Replace the PSM as soon as possible. To maintain proper airflow through the chassis, leave the PSM installed in the chassis until you are ready to replace it.

DC Power Supply for ACX7024 and ACX7024X Routers

IN THIS SECTION

- DC Power Supply Airflow | 34

The power supply modules (PSMs) in ACX7024 and ACX7024X routers are hot-removable and hot-insertable field-replaceable units (FRUs). The PSMs are preinstalled in the router. You can install replacement PSMs without powering off the router or disrupting the router function.

NOTE: This device is designed to support overvoltage category II (OVC II). If the equipment is subjected to transient voltages greater than OVC II, it will need additional external protection. Ensure that the component you use for this external protection complies with IEC 61643/UL 1449 based on the local code.



CAUTION: Do not use AC and DC PSMs together in the same chassis.

Figure 20 on page 33 shows the DC PSM for ACX7024 and ACX7024X routers.

Figure 20: DC PSM for an ACX7024 and ACX7024X Router

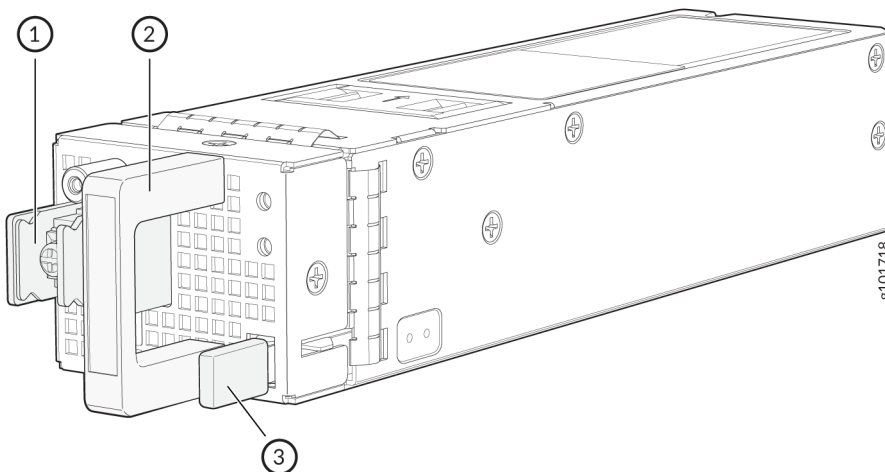

1– Terminal block cover	3– Latch lever
2– Handle	

DC Power Supply Airflow

Each PSM has its own internal cooling system. The PSMs in ACX7024 and ACX7024X routers support back-to-front airflow (airflow in or AFI). This is because the PSMs on ACX7024 and ACX7024X routers are installed on the front panel of the chassis and the ACX7024 and ACX7024X chassis supports front-to-back airflow (airflow out or AFO). The AFI airflow of the PSMs supports the AFO airflow of the ACX7024 and ACX7024X chassis.

The ACX7024 and ACX7024X DC power supply model number is **JPSU-400W-DC-AFI**.

DC Power Specifications for ACX7024 and ACX7024X Routers

[Table 11 on page 34](#) describes the DC power specifications for the ACX7024 and ACX7024X routers.

Table 11: DC Power Specifications for ACX7024 and ACX7024X Routers

Item	Specifications for ACX7024
DC input voltage	<ul style="list-style-type: none"> Rated operating voltage: -48 VDC through -60 VDC Operating voltage range: 40 VDC through 72 VDC
DC input current rating	<ul style="list-style-type: none"> 10 A at 48 VDC 8.3 A at 60 VDC
Typical power consumption (without optics) at 25 °C	97 W
Maximum power consumption (without optics)	150 W

DC Power Supply Module LEDs on ACX7024 and ACX7024X Routers

Figure 21 on page 35 shows the location of the LEDs on the DC power supply module (PSM).

Figure 21: DC PSM LEDs

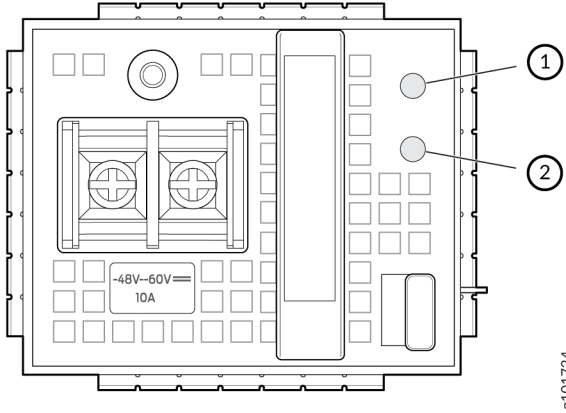

1– PWR LED

2– FAIL LED

Table 12 on page 35 describes the LEDs on the DC PSMs.

Table 12: DC PSM LEDs on ACX7024 and ACX7024X Routers

Name	Color	State	Description
PWR	Unlit	Off	The PSM is receiving no input power.
	Green	On steadily	The PSM is receiving input power.
FAIL	Amber	On steadily	An error is detected in the PSM. Replace the PSM as soon as possible. To maintain proper airflow through the chassis, leave the PSM installed in the chassis until you are ready to replace it.

RELATED DOCUMENTATION

[ACX7024 and ACX7024X System Overview | 7](#)

[Maintaining the ACX7024 and ACX7024X Power Supplies | 87](#)

3

CHAPTER

Site Planning, Preparation, and Specifications

Site Preparation Checklist for ACX7024 and ACX7024X Routers | 38

ACX7024 and ACX7024X Site Guidelines and Requirements | 39

ACX7024 and ACX7024X Network Cable and Transceiver Planning | 48

ACX7024 and ACX7024X Management and Console Port Specifications and Pinouts | 61

Site Preparation Checklist for ACX7024 and ACX7024X Routers

The "Site Preparation Checklist for ACX7024 and ACX7024X Routers" on page 38 summarizes the tasks you need to perform when preparing a site for an installation.

Table 13: Site Preparation Checklist

Item or Task	For More Information	Performed by	Date
Environment			
Verify that environmental factors such as temperature and humidity do not exceed router tolerances.	"Environmental Requirements and Specifications for ACX7024 Routers" on page 42		
Power			
Measure the distance between external power sources and router installation site.			
Calculate the power consumption and requirements.	"DC Power Specifications for ACX7024 and ACX7024X Routers" on page 34		
Rack or Cabinet			
Verify that your rack or cabinet meets the minimum requirements for the installation of the router.	"Rack Requirements for ACX7024 and ACX7024X Routers" on page 46		
Plan rack or cabinet location, including required space clearances.	"Clearance Requirements for Hardware Maintenance of ACX7024 and ACX7024X Routers" on page 45		

Table 13: Site Preparation Checklist (Continued)

Item or Task	For More Information	Performed by	Date
Secure the rack or cabinet to the floor and building structure.			
Cables			
Acquire cables and connectors: <ul style="list-style-type: none"> • Determine the number of cables needed based on your planned configuration. • Review the maximum distance allowed for each cable. Choose the length of cable based on the distance between the hardware components being connected. 	"Determining Transceiver Support for ACX7024 and ACX7024X" on page 48 "Cable and Connector Specifications for ACX7024 and ACX7024X" on page 49		
Plan the cable routing and management.			

ACX7024 and ACX7024X Site Guidelines and Requirements

IN THIS SECTION

- General Site Guidelines | 40
- ACX7024 and ACX7024X Site Electrical Wiring Guidelines | 40
- Chassis Physical Specifications for ACX7024 and ACX7024X Routers | 42
- Environmental Requirements and Specifications for ACX7024 Routers | 42
- Environmental Requirements and Specifications for ACX7024X Routers | 43
- Grounding Cable and Lug Specifications for ACX7024 and ACX7024X Routers | 44

- [Clearance Requirements for Hardware Maintenance of ACX7024 and ACX7024X Routers | 45](#)
- [Rack Requirements for ACX7024 and ACX7024X Routers | 46](#)
- [Cabinet Requirements for ACX7024 and ACX7024X Routers | 47](#)

General Site Guidelines

Efficient device operation requires proper site planning and maintenance. It also requires proper layout of the equipment, rack or cabinet, and wiring closet.

To plan and create an acceptable operating environment for your device and prevent environmentally caused equipment failures:

- Keep the area around the chassis free from dust and conductive material, such as metal flakes.
- Follow prescribed airflow guidelines to ensure that the cooling system functions properly. Ensure that exhaust from other equipment does not blow into the intake vents of the device.
- Follow the prescribed electrostatic discharge (ESD) prevention procedures to prevent damaging the equipment. Static discharge can cause components to fail completely or intermittently over time.
- Install the device in a secure area, so that only authorized personnel can access the device.

ACX7024 and ACX7024X Site Electrical Wiring Guidelines

[Table 14 on page 41](#) describes the factors you must consider while planning the electrical wiring at your site.



WARNING: You must provide a properly grounded and shielded environment and use electrical surge-suppression devices.

Avertissement Vous devez établir un environnement protégé et convenablement mis à la terre et utiliser des dispositifs de parasurtension.

Table 14: Site Electrical Wiring Guidelines

Site Wiring Factor	Guidelines
Signaling limitations	<p>If your site experiences any of the following problems, consult experts in electrical surge suppression and shielding:</p> <ul style="list-style-type: none"> • Improperly installed wires cause radio frequency interference (RFI). • Damage from lightning strikes occurs when wires exceed recommended distances or pass between buildings. • Electromagnetic pulses (EMPs) caused by lightning damage unshielded conductors and electronic devices.
Radio frequency interference	<p>To reduce or eliminate RFI from your site wiring, do the following:</p> <ul style="list-style-type: none"> • Use a twisted-pair cable with a good distribution of grounding conductors. • If you must exceed the recommended distances, use a high-quality twisted-pair cable with one ground conductor for each data signal, when applicable.
Electromagnetic compatibility	<p>If your site is susceptible to problems with electromagnetic compatibility (EMC), particularly from lightning or radio transmitters, seek expert advice.</p> <p>Strong sources of electromagnetic interference (EMI) can cause:</p> <ul style="list-style-type: none"> • Destruction of the signal drivers and receivers in the device, • Electrical hazards as a result of power surges conducted over the lines into the equipment.



WARNING: The intrabuilding port(s) (**MGMT** and **CON** ports) of the equipment or subassembly must use shielded intrabuilding cabling or wiring that is grounded at both ends.

Chassis Physical Specifications for ACX7024 and ACX7024X Routers

The ACX7024 and ACX7024X router chassis is a rigid sheet-metal structure that houses the hardware components. Chassis Physical Specifications for ACX7024 and ACX7024X Routers summarizes the physical specifications of an ACX7024 and ACX7024X router and its components.

Table 15: Physical Specifications for ACX7024 and ACX7024X Router Chassis and FRUs

Item	Height	Width	Depth	Weight
ACX7024 and ACX7024X	1.75 in. (4.4 cm)	19 in. (48.2 cm)	9.6 in. (24.4 cm)	<ul style="list-style-type: none"> • With FRUs installed: 12.5 lb (5.66 kg) • With no FRUs installed: 10 lb (4.55 kg)
PSM	1.57 in. (4.0 cm)	1.97 in. (5.0 cm)	9.0 in. (23.0 cm)	1.3 lb (0.59 kg)

Environmental Requirements and Specifications for ACX7024 Routers

You must install the router in a rack or cabinet. To ensure proper functioning of the router, house it in a dry, clean, well-ventilated, and temperature-controlled environment.

Follow these environmental guidelines:

- Keep the site as dust-free as possible. Dust can clog air intake vents and filters, reducing the efficiency of the router cooling system.
- Maintain ambient airflow for normal router operation. If the airflow is blocked or restricted, or if the intake air is too warm, the router might overheat and the router temperature monitor might shut down the device to protect the hardware components.
- For outside plant installation (OSP) or indoor non-office environment, you must protect the router against dust, fog, salt fog, pests, moisture, and other airborne contaminants. For OSPs, we recommend that you install the device in a sealed cabinet such as an IP65 cabinet with heat exchanger. The cabinet must also comply with Telcordia GR487 specification.

NOTE: The sealed cabinet should always remain closed. However, if the cabinet door is opened for any maintenance service, ensure that the door remains open only for the minimum required service time. If the cabinet door remains open for an extended period, outside contaminants (such as dust and moisture) can enter the cabinet and affect the functioning of the device within the cabinet.

Table 16 on page 43 provides the required environmental conditions for normal router operation.

Table 16: ACX7024 Router Environmental Tolerances

Description	Tolerance
Altitude	No performance degradation up to 6000 feet (1,829 meters)
Relative humidity	Normal operation ensured in relative humidity range of 5% through 90%, noncondensing.
Temperature	<ul style="list-style-type: none"> • Normal operation ensured in temperature range of -40°F through 149°F (-40°C through 65°C). • Nonoperating storage temperature in shipping container: -40°F through 158°F (-40°C through 70°C).

Environmental Requirements and Specifications for ACX7024X Routers

You must install the router in a rack or cabinet. To ensure proper functioning of the router, house it in a dry, clean, well-ventilated, and temperature-controlled environment.

Follow these environmental guidelines:

- Keep the site as dust-free as possible. Dust can clog air intake vents and filters, reducing the efficiency of the router cooling system.
- Maintain ambient airflow for normal router operation. If the airflow is blocked or restricted, or if the intake air is too warm, the router might overheat and the router temperature monitor might shut down the device to protect the hardware components.

Table 17 on page 44 provides the required environmental conditions for normal router operation.

Table 17: ACX7024X Router Environmental Tolerances

Description	Tolerance
Altitude	No performance degradation up to 6000 feet (1,829 meters)
Relative humidity	Normal operation ensured in relative humidity range of 5% through 90%, noncondensing.
Temperature	<ul style="list-style-type: none"> • Normal operation ensured in temperature range: 32°F through 104°F (0°C through 40°C). • Short term operating temperature (GR63-NEBS) environment : 131°F (55°C). • Nonoperating storage temperature in shipping container: -40°F through 158°F (-40°C through 70°C).

Grounding Cable and Lug Specifications for ACX7024 and ACX7024X Routers

For installations that require a separate grounding conductor to the chassis, you must ground the router properly before you connect power. Grounding ensures proper operation and satisfies safety and electromagnetic interference (EMI) requirements. To ground an ACX7024 or ACX7024X router, connect a grounding cable to earth ground, and then attach the grounding cable to the chassis grounding points.

The grounding points are in the form of studs that are sized for #10-32 screws.



CAUTION: Before you install the router, a licensed electrician must attach a cable lug to the grounding cables that you supply. See ["Connect Earth Ground to ACX7024 or ACX7024X Routers" on page 71](#) . A cable with an incorrectly attached lug can damage the router.

The ACX7024 and ACX7024X router uses an LCD6 2-hole grounding lug and the grounding lug accommodates a 6 AWG, 90 °C stranded copper wire (green with yellow insulation), or as required by local electric code.

Clearance Requirements for Hardware Maintenance of ACX7024 and ACX7024X Routers

When planning the site for installing an ACX7024 or ACX7024X router, you must allow sufficient clearance around the installed chassis (see [Figure 22 on page 45](#)).

Figure 22: Clearance Requirements for Hardware Maintenance of ACX7024 and ACX7024X Routers

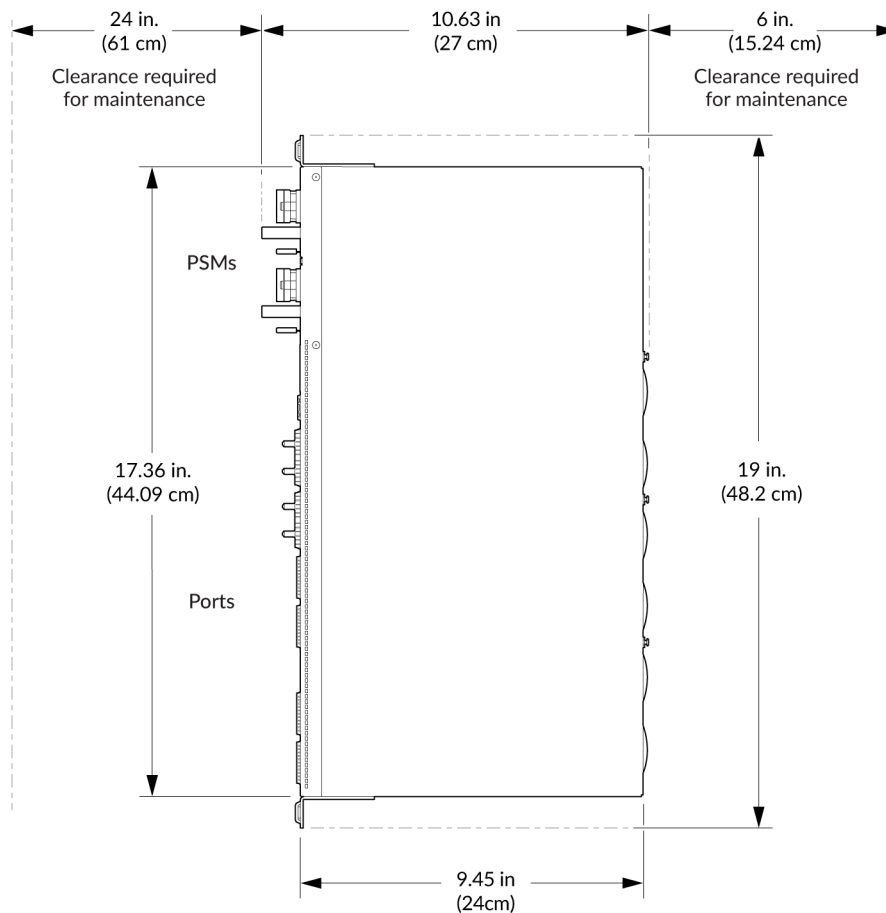

8101710

- For the cooling system to function properly, the airflow around the chassis must be unrestricted. See ["Cooling System and Airflow in ACX7024 and ACX7024X Routers" on page 24](#) for more information about the airflow through the chassis.
- If you are mounting an ACX7024 or ACX7024X router in a rack that has other equipment installed, ensure that the exhaust from other equipment does not blow into the intake vents of the chassis.

- Leave adequate space at the front of the router for service personnel to remove and to install hardware components. Allow at least 24 in. (61 cm) of space at the front and 6 in. (15.2 cm) at the rear of the router.

Rack Requirements for ACX7024 and ACX7024X Routers

We've designed the ACX7024 and ACX7024X routers to be installed on two-post racks. [Table 18 on page 46](#) provides the rack requirements and specifications for ACX7024 and ACX7024X routers.

Table 18: Rack Requirements and Specifications

Rack Requirement	Guidelines
Rack type	<p>Use a two-post rack that provides bracket holes or hole patterns spaced at 1-U (1.75 in. or 4.45 cm) increments and meets the size and strength requirements to support the weight.</p> <p>A U is the standard rack unit defined by the Electronic Components Industry Association (http://www.ecianow.org).</p>
Mounting bracket hole spacing	The holes in the mounting brackets are spaced at 1-U (1.75 in. or 4.45 cm), so that you can mount the device in any rack that provides holes that are spaced at that distance.
Rack size and strength	<ul style="list-style-type: none"> • Ensure that the rack complies with the size and strength standards of a 19-in. rack as defined by the Electronic Components Industry Association (http://www.ecianow.org). • Ensure that the rack rails are spaced widely enough to accommodate the external dimensions of the device chassis. The outer edges of the front mounting brackets extend the width of the chassis to 19 in. (48.2 cm). • The rack must be strong enough to support the weight of the device. The fully configured ACX7024 or ACX7024X router weighs about 12.5 lb (5.66 kg). • Ensure that the spacing of rails and adjacent racks provides for proper clearance around the device and rack.
Securing rack to building structure	<ul style="list-style-type: none"> • If your geographical area is earthquake-prone, secure the rack to the floor. • Secure the rack to the ceiling brackets as well as wall or floor brackets for maximum stability.

Cabinet Requirements for ACX7024 and ACX7024X Routers

Table 19 on page 47 provides the cabinet requirements and specifications.

Table 19: Cabinet Requirements and Specifications

Cabinet Requirement	Guidelines
Cabinet size and clearance	The minimum total clearance inside the cabinet is 6 in. (15.2 cm) between the inside of the front door and the inside of the rear door.
Type and strength	<p>Inside the cabinet, use a two-post rack that provides bracket holes or hole patterns spaced at 1-U (1.75 in. or 4.45 cm) increments and meets the size and strength requirements to support the weight.</p> <p>A U is the standard rack unit defined by the Electronic Components Industry Association (http://www.ecianow.org).</p>
Cabinet airflow requirements	<p>When you mount the device in a cabinet, ensure that ventilation through the cabinet is sufficient to prevent overheating.</p> <ul style="list-style-type: none"> • Ensure adequate cool air supply to dissipate the thermal output of the device or devices. • Ensure that the hot air exhaust of the chassis exits the cabinet without recirculating into the device. An open cabinet (without a top or doors) that employs hot air exhaust extraction from the top ensures the best airflow through the chassis. If the cabinet contains a top or doors, perforations in these elements help remove the hot air exhaust. • Install the device in the cabinet in a way that maximizes the open space on the side of the chassis that has the hot air exhaust. • Route and dress all cables to minimize the blockage of airflow to and from the chassis. • Ensure that the spacing of rails and adjacent cabinets is such that there is proper clearance around the device and cabinet. • A cabinet larger than the minimum required provides better airflow and reduces the chance of overheating.

Table 19: Cabinet Requirements and Specifications *(Continued)*

Cabinet Requirement	Guidelines
Securing cabinet to building structure	<ul style="list-style-type: none"> • If your geographical area is earthquake-prone, secure the cabinet to the floor. • Secure the cabinet to the ceiling brackets as well as wall or floor brackets for maximum stability.

RELATED DOCUMENTATION

| [Site Preparation Checklist for ACX7024 and ACX7024X Routers](#) | 38

ACX7024 and ACX7024X Network Cable and Transceiver Planning

IN THIS SECTION

- [Determining Transceiver Support for ACX7024 and ACX7024X](#) | 48
- [Cable and Connector Specifications for ACX7024 and ACX7024X](#) | 49
- [Calculating Power Budget and Power Margin for Fiber-Optic Cables](#) | 57
- [Fiber-Optic Cable Signal Loss, Attenuation, and Dispersion](#) | 60

Determining Transceiver Support for ACX7024 and ACX7024X

You can use the Hardware Compatibility Tool to find information about the pluggable transceivers and connector types supported by your Juniper Networks device. The tool also documents the optical and cable characteristics, where applicable, for each transceiver. You can search for transceivers by product—

and the tool displays all the transceivers supported on that device—or by category, interface speed, or type. You can find the list of supported transceivers for ACX7024 and ACX7024X routers at <https://apps.juniper.net/hct/product/>.



CAUTION: If you face a problem running a Juniper Networks device that uses a third party optic or cable, the Juniper Networks Technical Assistance Center (JTAC) can help you diagnose the source of the problem. Your JTAC engineer might recommend that you check the third party optic or cable and potentially replace it with an equivalent Juniper Networks optic or cable that is qualified for the device.

The I-temp and C-temp transceivers on ACX7024 support the following ambient temperature values:

- I-temp SFP, SFP+, and SFP28 transceivers up to 2W in full working temperature range (-40°C to 65°C)
- I-temp QSFP28 transceivers up to 5W in full working temperature range (-40°C to 65°C)
- C-temp SFP, SFP+, and SFP28 transceivers up to 1.4W in maximum working temperature range (0°C to 55°C)
- C-temp QSFP28 transceivers up to 5W in maximum working temperature range (0°C to 55°C)

The C-temp transceivers on ACX7024X support the following ambient temperature values:

- C-temp SFP, SFP+, and SFP28 transceivers up to 2W in maximum working temperature range (0°C to 55°C)
- C-temp QSFP28 transceivers up to 5W in maximum working temperature range (0°C to 55°C)

Cable and Connector Specifications for ACX7024 and ACX7024X

IN THIS SECTION

- [12-Fiber MPO Connectors | 50](#)
- [24-Fiber MPO Connectors | 55](#)
- [CS Connector | 56](#)
- [LC Duplex Connectors | 56](#)

The transceivers that an ACX7024 and ACX7024X device supports use fiber-optic cables and connectors. The type of connector and the type of fiber depend on the transceiver type.

You can determine the supported cables and connectors for your specific transceiver by using the [Hardware Compatibility Tool](#).



CAUTION: To maintain agency approvals, you must use only a properly constructed, shielded cable.

NOTE: The terms multifiber push-on (MPO) and multifiber termination push-on (MTP) describe the same connector type. The rest of this topic uses MPO to mean MPO or MTP.

12-Fiber MPO Connectors

The 12-fiber MPO connectors on Juniper Networks devices use two types of cables—patch cables with MPO connectors on both ends, and breakout cables with an MPO connector on one end and four LC duplex connectors on the other end. Depending on the application, the cables might use single-mode fiber (SMF) or multimode fiber (MMF). Juniper Networks sells cables that meet the supported transceiver requirements, but you are not required to purchase cables from Juniper Networks.

Ensure that you order cables with the correct polarity. Vendors refer to these crossover cables as *key up to key up*, *latch up to latch up*, *Type B*, or *Method B*. If you are using patch panels between two transceivers, ensure that the proper polarity is maintained through the cable plant.

Also, ensure that the fiber end in the connector is finished correctly. Physical contact (PC) refers to fiber that has been polished flat. Angled physical contact (APC) refers to fiber that has been polished at an angle. Ultra physical contact (UPC) refers to fiber that has been polished flat to a finer finish. You can determine the required fiber end with the connector type in the [Hardware Compatibility Tool](#).

12-Fiber Ribbon Patch Cables with MPO Connectors

You can use 12-fiber ribbon patch cables with socket MPO connectors to connect two transceivers of the same type—for example, 40GBASE-SR4-to-40GBASESR4 or 100GBASE-SR4-to-100GBASE-SR4. You can also connect 4x10GBASE-LR or 4x10GBASE-SR transceivers by using patch cables—for example, 4x10GBASE-LR-to-4x10GBASE-LR or 4x10GBASE-SR-to-4x10GBASE-SR—instead of breaking the signal out into four separate signals.

[Table 20 on page 51](#) describes the signals on each fiber. [Table 21 on page 51](#) shows the pin-to-pin connections for proper polarity.

Table 20: Cable Signals for 12-Fiber Ribbon Patch Cables

Fiber	Signal
1	Tx0 (Transmit)
2	Tx1 (Transmit)
3	Tx2 (Transmit)
4	Tx3 (Transmit)
5	Unused
6	Unused
7	Unused
8	Unused
9	Rx3 (Receive)
10	Rx2 (Receive)
11	Rx1 (Receive)
12	Rx0 (Receive)

Table 21: Cable Pinouts for 12-Fiber Ribbon Patch Cables

MPO Pin	MPO Pin
1	12

Table 21: Cable Pinouts for 12-Fiber Ribbon Patch Cables (Continued)

MPO Pin	MPO Pin
2	11
3	10
4	9
5	8
6	7
7	6
8	5
9	4
10	3
11	2
12	1

12-Fiber Ribbon Breakout Cables with MPO-to-LC Duplex Connectors

You can use 12-fiber ribbon breakout cables with MPO-to-LC duplex connectors to connect a QSFP+ transceiver to four separate SFP+ transceivers—for example, 4x10GBASE-LR-to-10GBASE-LR or 4x10GBASE-SR-to-10GBASE-SR SFP+ transceivers. The breakout cable is constructed out of a 12-fiber ribbon fiber-optic cable. The ribbon cable splits from a single cable with a socket MPO connector on one end into four cable pairs with four LC duplex connectors on the other end.

[Figure 23 on page 53](#) shows an example of a typical 12-fiber ribbon breakout cable with MPO-to-LC duplex connectors (depending on the manufacturer, your cable might look different).

Figure 23: 12-Fiber Ribbon Breakout Cable

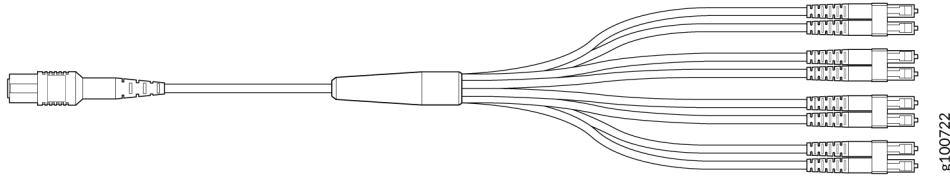

Table 22 on page 53 describes the way the fibers are connected between the MPO and LC duplex connectors. The cable signals are the same as those described in Table 20 on page 51 .

Table 22: Cable Pinouts for 12-Fiber Ribbon Breakout Cables

MPO Connector Pin	LC Duplex Connector Pin
1	Tx on LC Duplex 1
2	Tx on LC Duplex 2
3	Tx on LC Duplex 3
4	Tx on LC Duplex 4
5	Unused
6	Unused
7	Unused
8	Unused
9	Rx on LC Duplex 4
10	Rx on LC Duplex 3
11	Rx on LC Duplex 2

Table 22: Cable Pinouts for 12-Fiber Ribbon Breakout Cables (Continued)

MPO Connector Pin	LC Duplex Connector Pin
12	Rx on LC Duplex 1

12-Ribbon Patch and Breakout Cables Available from Juniper Networks

Juniper Networks sells 12-ribbon patch and breakout cables with MPO connectors that meet the requirements described earlier. You are not required to purchase cables from Juniper Networks. [Table 23 on page 54](#) describes the available cables.

Table 23: 12-Ribbon Patch and Breakout Cables Available from Juniper Networks

Cable Type	Connector Type	Fiber Type	Cable Length	Juniper Model Number
12-ribbon patch	Socket MPO/PC to socket MPO/PC, key up to key up	MMF (OM3)	1 m	MTP12-FF-M1M
			3 m	MTP12-FF-M3M
			5 m	MTP12-FF-M5M
			10 m	MTP12-FF-M10M
	Socket MPO/APC to socket MPO/APC, key up to key up	SMF	1 m	MTP12-FF-S1M
			3 m	MTP12-FF-S3M
			5 m	MTP12-FF-S5M
			10 m	MTP12-FF-S10M
12-ribbon breakout	Socket MPO/PC, key up, to four LC/UPC duplex	MMF (OM3)	1 m	MTP-4LC-M1M

Table 23: 12-Ribbon Patch and Breakout Cables Available from Juniper Networks (Continued)

Cable Type	Connector Type	Fiber Type	Cable Length	Juniper Model Number
			3 m	MTP-4LC-M3M
			5 m	MTP-4LC-M5M
			10 m	MTP-4LC-M10M
	Socket MPO/APC, key up, to four LC/UPC duplex	SMF	1 m	MTP-4LC-S1M
			3 m	MTP-4LC-S3M
			5 m	MTP-4LC-S5M
			10 m	MTP-4LC-S10M

24-Fiber MPO Connectors

You can use patch cables with 24-fiber MPO connectors to connect two supported transceivers of the same type—for example, 2x100GE-SR-to-2x100GE-SR.

Figure 24 on page 55 shows the 24-fiber MPO optical lane assignments.

Figure 24: 24-Fiber MPO Optical Lane Assignments

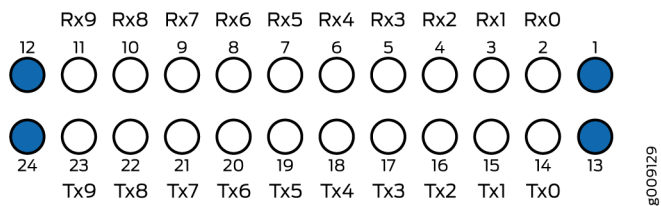

NOTE: You must order cables with the correct polarity. Vendors refer to these crossover cables as *key up to key up*, *latch up to latch up*, *Type B*, or *Method B*. If you are using patch panels between two transceivers, ensure that the proper polarity is maintained through the cable plant.

The MPO optical connector for the CFP2-100G-SR10-D3 is defined in *Section 5.6* of the *CFP2 Hardware Specification* and *Section 88.10.3* of *IEEE STD 802.3-2012*. These specifications include the following requirements:

- Recommended Option A in IEEE STD 802.3-2012.
- The transceiver receptacle is a plug. A patch cable with a socket connector is required to connect to the module.
- Ferrule finish must be a flat-polished interface that is compliant with IEC 61754-7.
- Alignment key is key up.

The optical interface must meet the FT-1435-CORE requirement in *Generic Requirements for Multi-Fiber Optical Connectors*. The module must pass the wiggle test defined by IEC 62150-3.

CS Connector

You can use patch cables with CS connectors to connect two supported transceivers of the same type—for example, 2x100G-LR4 to 2x100G-LR4 or 2x100G-CWDM4 to 2x100G-CWDM4. CS connectors are compact connectors that are designed for next-generation QSFP-DD transceivers. The CS connector provides easy backward compatibility with QSFP28 and QSFP56 transceivers.

LC Duplex Connectors

You can use patch cables with LC duplex connectors to connect two supported transceivers of the same type—for example, 40GBASE-LR4-to-40GBASE-LR4 or 100GBASE-LR4-to-100GBASE-LR4. A patch cable is one fiber pair with two LC duplex connectors at opposite ends. LC duplex connectors are also used with 12-fiber ribbon breakout cables.

[Figure 25 on page 57](#) shows how to install an LC duplex connector in a transceiver.

Figure 25: LC Duplex Connector

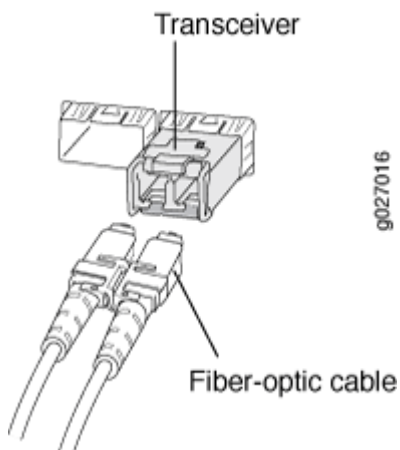

Calculating Power Budget and Power Margin for Fiber-Optic Cables

IN THIS SECTION

- [How to Calculate Power Budget for Fiber-Optic Cables | 57](#)
- [How to Calculate Power Margin for Fiber-Optic Cables | 58](#)

Use the information in this topic and the specifications for your optical interface to calculate the power budget and power margin for fiber-optic cables.

TIP: You can use the [Hardware Compatibility Tool](#) to find information about the pluggable transceivers supported on your Juniper Networks device.

To calculate the power budget and power margin, perform the following tasks:

How to Calculate Power Budget for Fiber-Optic Cables

To ensure that fiber-optic connections have sufficient power for correct operation, you need to calculate the link's power budget, which is the maximum amount of power it can transmit. When you calculate the power budget, you use a worst-case analysis to provide a margin of error, even though all the parts

of an actual system do not operate at the worst-case levels. To calculate the worst-case estimate of power budget (P_B), you assume minimum transmitter power (P_T) and minimum receiver sensitivity (P_R):

$$P_B = P_T - P_R$$

The following hypothetical power budget equation uses values measured in decibels (dB) and decibels referred to one milliwatt (dBm):

$$P_B = P_T - P_R$$

$$P_B = -15 \text{ dBm} - (-28 \text{ dBm})$$

$$P_B = 13 \text{ dB}$$

How to Calculate Power Margin for Fiber-Optic Cables

After calculating a link's power budget, you can calculate the power margin (P_M), which represents the amount of power available after subtracting attenuation or link loss (LL) from the power budget (P_B). A worst-case estimate of P_M assumes maximum LL:

$$P_M = P_B - LL$$

P_M greater than zero indicates that the power budget is sufficient to operate the receiver.

Factors that can cause link loss include higher-order mode losses, modal and chromatic dispersion, connectors, splices, and fiber attenuation. [Table 24 on page 58](#) lists an estimated amount of loss for the factors used in the following sample calculations. For information about the actual amount of signal loss caused by equipment and other factors, refer to vendor documentation.

Table 24: Estimated Values for Factors Causing Link Loss

Link-Loss Factor	Estimated Link-Loss Value
Higher-order mode losses	Single mode—None Multimode—0.5 dB
Modal and chromatic dispersion	Single mode—None Multimode—None, if product of bandwidth and distance is less than 500 MHz-km
Faulty connector	0.5 dB

Table 24: Estimated Values for Factors Causing Link Loss (Continued)

Link-Loss Factor	Estimated Link-Loss Value
Splice	0.5 dB
Fiber attenuation	Single mode—0.5 dB/km Multimode—1 dB/km

The following sample calculation for a 2-km-long multimode link with a power budget (P_B) of 13 dB uses the estimated values from [Table 24 on page 58](#). This example calculates link loss (LL) as the sum of fiber attenuation (2 km @ 1 dB/km, or 2 dB) and loss for five connectors (0.5 dB per connector, or 2.5 dB) and two splices (0.5 dB per splice, or 1 dB) as well as higher-order mode losses (0.5 dB). The power margin (P_M) is calculated as follows:

$$P_M = P_B - LL$$

$$P_M = 13 \text{ dB} - 2 \text{ km (1 dB/km)} - 5 (0.5 \text{ dB}) - 2 (0.5 \text{ dB}) - 0.5 \text{ dB}$$

$$P_M = 13 \text{ dB} - 2 \text{ dB} - 2.5 \text{ dB} - 1 \text{ dB} - 0.5 \text{ dB}$$

$$P_M = 7 \text{ dB}$$

The following sample calculation for an 8-km-long single-mode link with a power budget (P_B) of 13 dB uses the estimated values from [Table 24 on page 58](#). This example calculates link loss (LL) as the sum of fiber attenuation (8 km @ 0.5 dB/km, or 4 dB) and loss for seven connectors (0.5 dB per connector, or 3.5 dB). The power margin (P_M) is calculated as follows:

$$P_M = P_B - LL$$

$$P_M = 13 \text{ dB} - 8 \text{ km (0.5 dB/km)} - 7(0.5 \text{ dB})$$

$$P_M = 13 \text{ dB} - 4 \text{ dB} - 3.5 \text{ dB}$$

$$P_M = 5.5 \text{ dB}$$

In both examples, the calculated power margin is greater than zero, indicating that the link has sufficient power for transmission and does not exceed the maximum receiver input power.

Fiber-Optic Cable Signal Loss, Attenuation, and Dispersion

IN THIS SECTION

- [Signal Loss in Multimode and Single-Mode Fiber-Optic Cable | 60](#)
- [Attenuation and Dispersion in Fiber-Optic Cable | 60](#)

Signal Loss in Multimode and Single-Mode Fiber-Optic Cable

Multimode fiber is large enough in diameter to allow rays of light to reflect internally (bounce off the walls of the fiber). Interfaces with multimode optics typically use LEDs as light sources. However, LEDs are not coherent sources. They spray varying wavelengths of light into the multimode fiber, which reflects the light at different angles. Light rays travel in jagged lines through a multimode fiber, causing signal dispersion. When light traveling in the fiber core radiates into the fiber cladding, higher-order mode loss results. Together these factors limit the transmission distance of multimode fiber compared with single-mode fiber.

Single-mode fiber is so small in diameter that rays of light can reflect internally through one layer only. Interfaces with single-mode optics use lasers as light sources. Lasers generate a single wavelength of light, which travels in a straight line through the single-mode fiber. Compared with multimode fiber, single-mode fiber has higher bandwidth and can carry signals for longer distances.

Exceeding the maximum transmission distances can result in significant signal loss, which causes unreliable transmission.

Attenuation and Dispersion in Fiber-Optic Cable

Correct functioning of an optical data link depends on modulated light reaching the receiver with enough power to be demodulated correctly. *Attenuation* is the reduction in power of the light signal as it is transmitted. Attenuation is caused by passive media components such as cables, cable splices, and connectors. Although attenuation is significantly lower for optical fiber than for other media, it still occurs in both multimode and single-mode transmission. An efficient optical data link must have enough light available to overcome attenuation.

Dispersion is the spreading of the signal over time. The following two types of dispersion can affect an optical data link:

- Chromatic dispersion—Spreading of the signal over time, resulting from the different speeds of light rays.

- Modal dispersion—Spreading of the signal over time, resulting from the different propagation modes in the fiber.

For multimode transmission, modal dispersion—rather than chromatic dispersion or attenuation—usually limits the maximum bit rate and link length. For single-mode transmission, modal dispersion is not a factor. However, at higher bit rates and over longer distances, chromatic dispersion rather than modal dispersion limits maximum link length.

An efficient optical data link must have enough light to exceed the minimum power that the receiver requires to operate within its specifications. In addition, the total dispersion must be less than the limits specified for the type of link in Telcordia Technologies document GR-253-CORE (Section 4.3) and International Telecommunications Union (ITU) document G.957.

When chromatic dispersion is at the maximum allowed, its effect can be considered as a power penalty in the power budget. The optical power budget must allow for the sum of component attenuation, power penalties (including those from dispersion), and a safety margin for unexpected losses.

RELATED DOCUMENTATION

[ACX7024 and ACX7024X System Overview | 7](#)

[Port Panel on ACX7024 and ACX7024X Routers | 20](#)

ACX7024 and ACX7024X Management and Console Port Specifications and Pinouts

IN THIS SECTION

- [Management Cable Specifications for ACX7024 and ACX7024X Routers | 62](#)
- [Management Port Connector Pinout Information for ACX7024 and ACX7024X Routers | 62](#)
- [Console Port Connector Pinout on ACX7024 and ACX7024X Routers | 63](#)
- [USB Port Specifications for ACX7024 and ACX7024X Routers | 64](#)

Management Cable Specifications for ACX7024 and ACX7024X Routers

Table 25 on page 62 lists the specifications for the cables that connect the console and management ports to management devices.

Table 25: Specifications of Cables to Connect to Management Devices

Ports	Cable Specifications	Receptacle	Additional Information
Console (CON) port	RS-232 (EIA-232) serial cable	RJ-45	"Connect an ACX7024 or ACX7024X Router to a Management Console" on page 79
Management (MGMT) port	Ethernet cable with an RJ-45 connector	RJ-45	"Connect an ACX7024 or ACX7024X Router to a Network for Out-of-Band Management" on page 80

Management Port Connector Pinout Information for ACX7024 and ACX7024X Routers

The management port—labeled **MGMT**—on an ACX7024 and ACX7024X uses an RJ-45 connector to connect to a management device for out-of-band management.

The port uses an autosensing RJ-45 connector to support a 10/100BASE-T connection.

Table 26 on page 62 provides the pinout information for the RJ-45 connector for the management port.

Table 26: Management Port Connector Pinout Information

Pin	Description	Direction
1	TRP1+	Transmit/receive data pair 1

Table 26: Management Port Connector Pinout Information (*Continued*)

Pin	Description	Direction
2	TRP1-	Transmit/receive data pair 1
3	TRP2+	Transmit/receive data pair 2
4	TRP3+	Transmit/receive data pair 3
5	TRP3-	Transmit/receive data pair 3
6	TRP2-	Transmit/receive data pair 2
7	TRP4+	Transmit/receive data pair 4
8	TRP4-	Transmit/receive data pair 4

Console Port Connector Pinout on ACX7024 and ACX7024X Routers

The port labeled **CON** on the front panel is an RS-232 serial interface that uses an RJ-45 connector to connect to a console management device. The default baud rate for the console port is 9600 baud.

Use a cable with the pinouts described in [Table 27 on page 64](#) to connect an ACX7024 or ACX7024X to a console management device.

NOTE: If your laptop or PC does not have a DB-9 plug connector pin and you want to connect your laptop or PC directly to an ACX7024 or ACX7024X, use a combination of the RJ-45 cable and RJ-45 to DB-9 adapter and a USB to DB-9 plug adapter.

Table 27: Console Port and TOD Connector Pinout Information

Pin	Signal	Description
1	N/C	Not Connected
2	DSR Output TOD Output	Data set ready (DSR) Time of Day (TOD) for Precision Time Protocol (PTP) applications. You can use DSR pins as a TOD universal asynchronous receiver/transmitter (UART) by using a breakout cable.
3	RxD Input	Receive data
4	Signal Ground	Signal ground
5	Signal Ground	Signal ground
6	TxD Output	Transmit data
7	TOD Output	Time of Day (TOD) for Precision Time Protocol (PTP) applications. You can use data terminal ready (DTR) pins as a TOD universal asynchronous receiver/transmitter (UART) by using breakout cables.
8	N/C	Not Connected

USB Port Specifications for ACX7024 and ACX7024X Routers

The ACX7024 and ACX7024X router uses the following USB ports:

- One USB 2.0 Type A port that is backward compatible with USB 1.0. You can use this port for software installation and upgrade using a USB storage device.

- One USB 3.0 Type C port that is backward compatible with USB 2.0. You can use this port for a Global Navigation Satellite System (GNSS) module.



CAUTION: Remove the USB flash drive before upgrading Junos OS Evolved or rebooting an ACX7024 or ACX7024X. Failure to do so could cause the router to behave unpredictably.

RELATED DOCUMENTATION

| [Management Panel on ACX7024 and ACX7024X Routers](#) | 17

4

CHAPTER

Initial Installation and Configuration

[ACX7024 and ACX7024X Installation Overview | 67](#)

[Unpack and Mount an ACX7024 or ACX7024X Router | 67](#)

[Connect ACX7024 or ACX7024X to Power | 71](#)

[Connect ACX7024 or ACX7024X to External Devices | 79](#)

[Perform Initial Software Configuration for ACX7024 and ACX7024X Routers | 82](#)

ACX7024 and ACX7024X Installation Overview

To install and connect an ACX7024 or ACX7024X router:

1. Follow the instructions in ["Unpack and Mount an ACX7024 or ACX7024X Router" on page 67](#) .
2. Determine how the device is to be mounted.
For instructions on mounting, see ["Mount an ACX7024 or ACX7024X in a Rack" on page 69](#) .
3. Follow the instructions in:
 - a. ["Connect Earth Ground to ACX7024 or ACX7024X Routers" on page 71](#) .
 - b. ["Connect AC Power to an ACX7024 or ACX7024X Router" on page 73](#) ["Connect DC Power to an ACX7024 or ACX7024X Router" on page 74](#) .
4. ["Perform Initial Software Configuration for ACX7024 and ACX7024X Routers" on page 82](#) .

Unpack and Mount an ACX7024 or ACX7024X Router

IN THIS SECTION

- [Unpack an ACX7024 or ACX7024X Router | 67](#)
- [Register Products—Mandatory to Validate SLAs | 68](#)
- [Mount an ACX7024 or ACX7024X in a Rack | 69](#)

Unpack an ACX7024 or ACX7024X Router

The ACX7024 and ACX7024X router chassis is a rigid sheet-metal structure that houses the hardware components. We ship the ACX7024 and ACX7024X router in a cardboard carton, secured with foam packing material. The carton also contains an accessory box and quick start instructions.



CAUTION: The shipping carton maximally protects the ACX7024 and ACX7024X routers. Do not unpack the router until you are ready to begin installation.

To unpack an ACX7024 or ACX7024X router:

1. Move the shipping carton to a staging area as close to the installation site as possible, where you have enough room to remove the system components.
2. Position the carton so that the arrows are pointing up.
3. Open the top flaps on the shipping carton.
4. Remove the accessory box, and verify the contents against the inventory included in the box.
5. Pull out the packing material that holds the router in place.
6. Verify the chassis components that you received.
7. Save the shipping carton and packing materials in case you need to move or ship the router later.

Table 28: ACX7024 and ACX7024X Router Parts List

Component	Quantity
Chassis with six system fans and preinstalled PSMs	1
Two-post rack mounting brackets that are preinstalled on the router	2
Documentation roadmap card	1
#10-32 grounding screws to secure the grounding lug	2
LCD6 2-hole grounding lug	1

Register Products—Mandatory to Validate SLAs

Register all new Juniper Networks hardware products and changes to an existing installed product using the Juniper Networks website. Registering products and changes to products activates your hardware replacement service-level agreements (SLAs).



CAUTION: Register product serial numbers on the Juniper Networks website. Update the installation base data if any installation base data is added or changed or if the installation base is moved. Juniper Networks will not be held accountable for customers not meeting the hardware replacement service-level agreement (SLA) for products that do not have registered serial numbers or accurate installation base data.

Register your product or products at <https://tools.juniper.net/svcreg/SRegSerialNum.jsp>.

Update your installation base at <https://www.juniper.net/customers/csc/management/updateinstallbase.jsp>.

Mount an ACX7024 or ACX7024X in a Rack

IN THIS SECTION

- [Install an ACX7024 or ACX7024X Router in a Rack | 69](#)

Install an ACX7024 or ACX7024X Router in a Rack

To install the router in a two-post rack:

1. Wrap and fasten one end of the ESD grounding strap around your bare wrist, and connect the other end of the strap to a site ESD point.
2. Position the router in front of the rack.

The mounting brackets are preinstalled on the ACX7024 and ACX7024X routers.

3. Lift the router and position it in the rack. Line up the bottom hole in each mounting bracket with a hole in each rack rail, making sure the router is level.

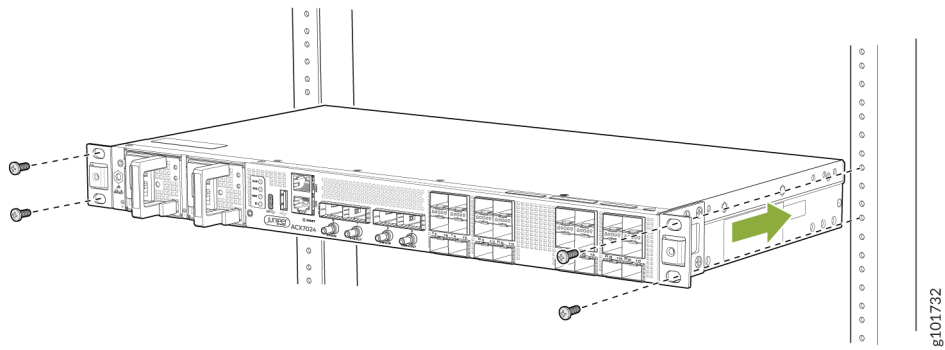

4. Secure the chassis to the rack using the rack mount screws (not provided). Tighten the screws at the bottom first, then tighten the screws at the top.
5. Check to see that the mounting screws on each side of the rack are aligned and the router is level.

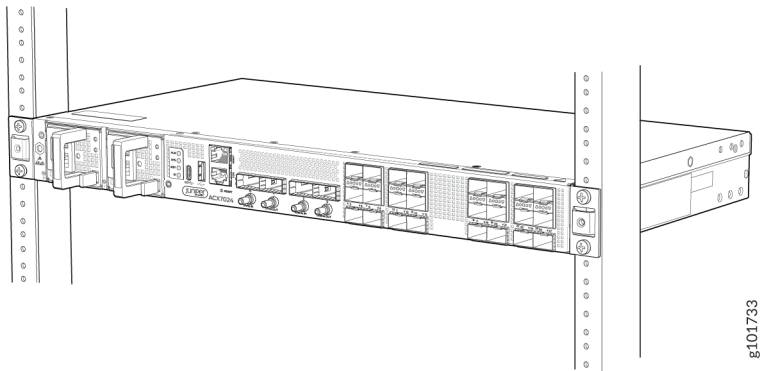

RELATED DOCUMENTATION

[Rack Requirements for ACX7024 and ACX7024X Routers | 46](#)

[ACX7024 and ACX7024X Installation Overview | 67](#)

[Connect Earth Ground to ACX7024 or ACX7024X Routers | 71](#)

Connect ACX7024 or ACX7024X to Power

IN THIS SECTION

- [Connect Earth Ground to ACX7024 or ACX7024X Routers | 71](#)
- [Connect AC Power to an ACX7024 or ACX7024X Router | 73](#)
- [Connect DC Power to an ACX7024 or ACX7024X Router | 74](#)

Connect Earth Ground to ACX7024 or ACX7024X Routers

Before you begin to connect the router to earth ground, ensure that you have the following parts and tools available:

- A grounding cable—6 AWG, 90° C stranded copper wire (green with yellow insulation), or as required by local electric code.
- Two #10-32 grounding screws to secure the grounding lug
- LCD6 2-hole grounding lug
- A Phillips (+) screwdriver, number 2 (not provided)
- An electrostatic discharge (ESD) grounding wrist strap

To meet safety and electromagnetic interference (EMI) requirements and to ensure proper operation, you must ground the router properly before connecting power.

You must install the ACX7024 or ACX7024X in a restricted-access location and ensure that the chassis is always properly grounded. The ACX7024 and ACX7024X routers have a two-hole protective grounding terminal provided on the chassis. See [Figure 27 on page 72](#). Under all circumstances, use this grounding connection to ground the chassis. For AC-powered systems, you must also use the grounding wire in the AC power cord along with the two-hole grounding lug connection. This tested system meets or exceeds all applicable EMC regulatory requirements with the two-hole protective grounding terminal.

Before you connect earth ground to the protective earthing terminal of ACX7024 and ACX7024X routers, ensure that a licensed electrician has attached an appropriate grounding lug to the grounding cable.

Figure 26 on page 72 shows the grounding point on ACX7024 and ACX7024X routers.

Figure 26: Grounding Point on the ACX7024 and ACX7024X Routers

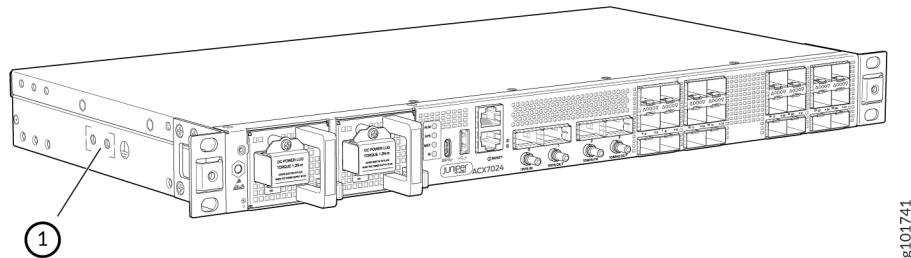

1– Grounding point

To ground the ACX7024 and ACX7024X routers:

1. Verify that a licensed electrician has attached the cable lug that is provided with the router to the grounding cable.
2. Ensure that all grounding surfaces are clean and brought to a bright finish before you make grounding connections.
3. Connect the grounding cable to a proper earth ground.
4. Place the grounding cable lug over the grounding points on the side of the chassis (see [Figure 27 on page 72](#)).

Figure 27: Connect the Grounding Cable to the ACX7024 or ACX7024X Router

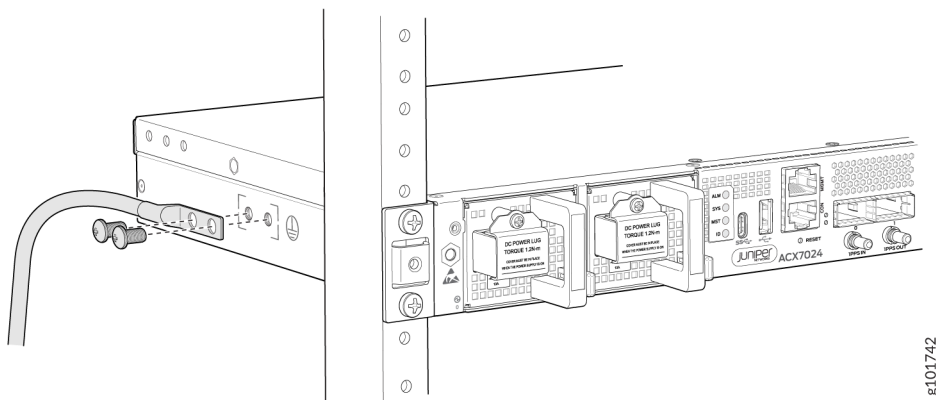

5. Secure the grounding cable lug with the screws. Apply 2.5 N-m of torque to the screws.
6. Dress the grounding cable and verify that it does not touch or block access to router components, and that it does not drape where people could trip over it.

Connect AC Power to an ACX7024 or ACX7024X Router

Ensure that you have a power cord appropriate for your geographical location available to connect AC power to the router.

Before you begin connecting AC power to the router:

- Ensure that you have taken the necessary precautions to prevent electrostatic discharge (ESD) damage (see "[Prevention of Electrostatic Discharge Damage](#)" on page 143).
- Ensure that you have connected the router chassis to earth ground.



CAUTION: Before you connect power to the router, a licensed electrician must attach a cable lug to the grounding and power cables that you supply. A cable with an incorrectly attached lug can damage the router (for example, by causing a short circuit). To meet safety and electromagnetic interference (EMI) requirements and to ensure proper operation, you must connect the chassis to earth ground before you connect it to power. Under all circumstances, use the protective earthing terminal on the router chassis to connect to the earth ground. The router gains additional grounding when you plug the PSM in the router to a grounded AC power outlet by using the AC power cord appropriate for your geographical location.

- Install the PSM in the chassis.

The power supply module (PSM) in an ACX7024 and ACX7024X router is a hot-removable and hot-insertable field-replaceable unit (FRU). You can remove and replace it without powering off the router or disrupting routing functions.

NOTE: You must connect each PSM to a dedicated power source outlet.

To connect AC power to an ACX7024 or ACX7024X router:

1. Wrap and fasten one end of the ESD grounding strap around your bare wrist, and connect the other end of the strap to the ESD point on the chassis.
2. Power off the AC input appliance inlet on the source power supply.
3. Connect the power cord to the power source outlet.

NOTE: Each power supply must be connected to a dedicated AC power feed and a dedicated customer-site 2-pole circuit breaker. We recommend that you use a dedicated customer-site circuit breaker rated for 16A, or as required by local code.

4. Press the small tab on the power cord retainer strip to loosen the loop. Slide the loop until you have enough space to insert the power cord coupler into the inlet.
5. Insert the power cord coupler firmly into the inlet.
6. Slide the loop toward the PSM until it is snug against the base of the coupler.
7. Press the tab on the loop and draw out the loop into a tight circle (see [Figure 28 on page 74](#)).
8. Route the power cord appropriately. Verify that the power cord does not block the air exhaust and access to router components, or drape where people could trip over it.
9. Power on the source power supply.
10. Repeat Step 4 through Step 9 for installing the remaining PSM.

Figure 28: Connect an AC power cord to an ACX7024 or ACX7024X Router

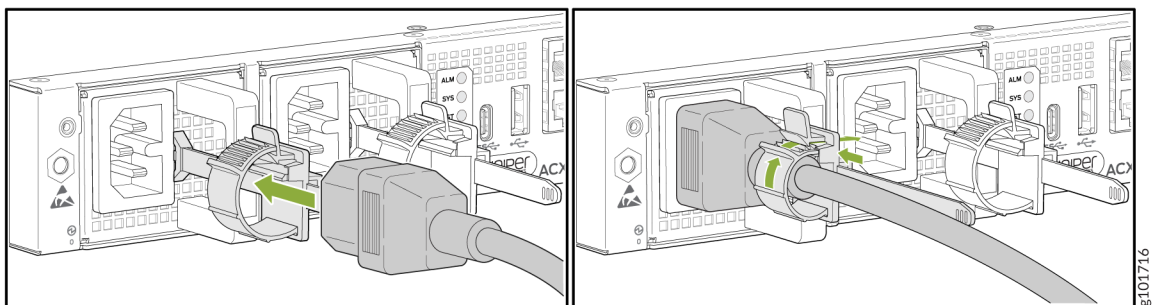

Connect DC Power to an ACX7024 or ACX7024X Router

Before you begin connecting DC power to the router:

- Ensure that you have taken the necessary precautions to prevent electrostatic discharge (ESD) damage (see "[Prevention of Electrostatic Discharge Damage](#)" on page 143).
- Ensure that you have connected the router chassis to earth ground.



CAUTION: Before you connect power to the router, a licensed electrician must attach a cable lug to the grounding and power cables that you supply. A cable with an incorrectly attached lug can damage the router (for example, by causing a short circuit). To meet safety and electromagnetic interference (EMI) requirements and to ensure proper operation, you must connect the chassis to earth ground before you connect it to power. Under all circumstances, use the protective earthing terminal on the router chassis to connect to the earth ground.

- Install the power supply module (PSM) in the chassis.

Ensure that you have the following parts and tools available:

- Two DC power source cables (16 AWG wire or as required by local electric code)
- An electrostatic discharge (ESD) grounding wrist strap
- Phillips (+) screwdriver, number 2 (not provided) for tightening screws on the PSM terminals.
- Phillips (+) screwdriver, number 1 (not provided) for tightening the terminal cover screws.
- Multimeter (not provided)

The PSM in an ACX7024 and ACX7024X router is a hot-removable and hot-insertable field-replaceable unit (FRU). You can remove and replace it without powering off the router or disrupting routing functions.

To connect DC power to an ACX7024 or ACX7024X router:

1. Wrap and fasten one end of the ESD grounding strap around your bare wrist. Connect the other end of the strap to the ESD point on the chassis.
2. Verify that the DC power cables are correctly labeled before making connections to the power supply. In a typical power distribution scheme where the return is connected to chassis ground at the battery plant, you can use a multimeter to verify the resistance of the -48 V and RTN DC cables to chassis ground:
 - The cable with very low resistance (indicating a closed circuit) to chassis ground is positive (+). You install this cable on the V+ (return) DC power input terminal.
 - The cable with very high resistance (indicating an open circuit) to chassis ground is negative (-). You install this cable on the V- (input) DC power input terminal.



CAUTION: You must ensure that power connections maintain the proper polarity. The power source cables might be labeled (+) and (-) to indicate their polarity.

There is no standard color coding for DC power cables. Use the color coding that you see on the external DC power source at your site to determine the color coding for the leads on the power cables that attach to the DC power input terminals on each PSM.

3. Install heat-shrink tubing insulation around the power cables.

To install heat-shrink tubing:

- a. Slide the tubing over the portion of the cable where it is attached to the lug barrel. Ensure that tubing covers the end of the wire and the barrel of the lug attached to it.
- b. Shrink the tubing with a heat gun. Ensure that you heat all sides of the tubing evenly so that it shrinks around the cable tightly.

Figure 29 on page 76 shows the steps to install heat-shrink tubing.

NOTE: Do not overheat the tubing.

Figure 29: How to Install Heat-Shrink Tubing

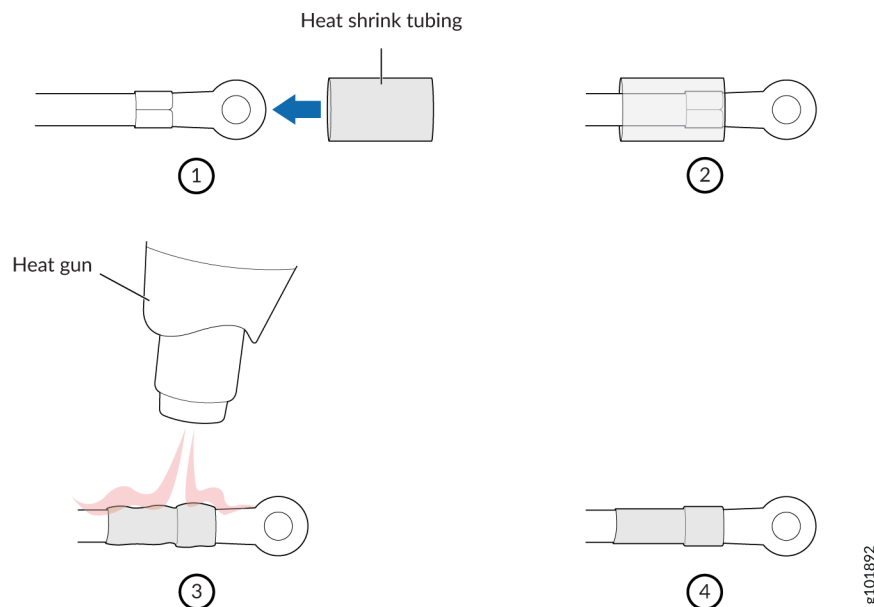

4. Ensure that the input circuit breaker is open so that the voltage across the DC power source cable leads is 0 V and that the cable leads do not become active while you are connecting DC power.

NOTE: The V+ terminals are referred to as +RTN, and V- terminals are referred to as -48 V in "DC Power Wiring Sequence Warning" on page 150 .

5. Ensure that the PSMs are fully inserted in the chassis.
6. Remove the terminal block cover protecting the terminals on the faceplate (see [Figure 30 on page 78](#)).
7. Remove the screws on the terminals by using the Phillips number 2 screwdriver. Save the screws.



WARNING: Ensure that the power cables do not block access to device components or drape where people can trip over them.

8. Connect each PSM to the power sources. Secure power source cables to the PSMs by screwing the ring lugs attached to the cables to the appropriate terminals by using the screw from the terminals (see [Figure 30 on page 78](#)).

The ACX7024 and ACX7024X router is designed to operate with a DC PSM that has a single, nonredundant, feed input. For source redundancy, you must install two DC PSMs in the ACX7024 and ACX7024X; connect source (A) to one PSM and source (B) to the second PSM. This configuration provides the commonly deployed A/B feed redundancy for the system.



CAUTION: The connection between each power source and PSM must include a circuit breaker. We recommend that you use a customer-site 2-pole circuit breaker rated for 10A, or as required by local electrical code.

Do not connect two sources to a single PSM because doing so can potentially cause circulating current in feed wires whenever there is any difference in the voltage of the two sources.

NOTE: To connect the DC source or DC mains to an ACX7024 or ACX7024X router, use a 16 AWG wire or as required by local electric code.

- a. Secure the ring lug of the positive (+) DC power source cable to the **RTN** (return) terminal on the DC PSM.
- b. Secure the ring lug of the negative (-) DC power source cable to the **-48V** (input) terminal on the DC PSM.
- c. Tighten the screws on the PSM terminals until snug using the Phillips number 2 screwdriver. Do not overtighten—apply 1.2 N-m of torque to the screws.

NOTE: After you crimp the input DC wires to its wiring lugs, cover the lugs and crimped area with a suitable heat shrink sleeve. The heat shrink sleeve prevents bare lugs or crimped areas from being exposed.

9. Replace the terminal block cover. Apply 0.5 N-m of torque to the screws.
10. Close the input circuit breaker.

NOTE: The switch powers on as soon as the PSM receives power. There is no power switch on the device.

Figure 30: Connect DC Power Cable to an ACX7024 or ACX7024X Router

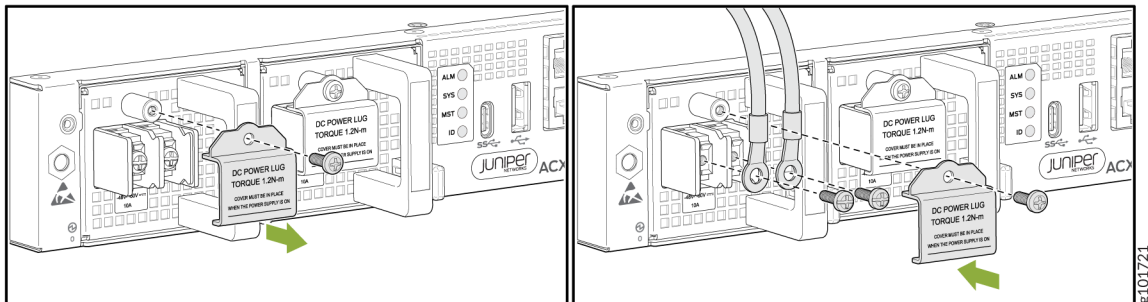

RELATED DOCUMENTATION

[ACX7024 and ACX7024X Power System | 26](#)

[Maintaining the ACX7024 and ACX7024X Power Supplies | 87](#)

Connect ACX7024 or ACX7024X to External Devices

IN THIS SECTION

- [Connect an ACX7024 or ACX7024X Router to a Management Console | 79](#)
- [Connect an ACX7024 or ACX7024X Router to a Network for Out-of-Band Management | 80](#)
- [Connect an ACX7024 or ACX7024X Router to External Clocking and Timing Devices | 81](#)

Connect an ACX7024 or ACX7024X Router to a Management Console

Ensure that you have an RJ-45 to DB-9 rollover cable available.

NOTE: If your laptop or PC does not have a DB-9 pin contact and you want to connect your laptop or PC directly to the ACX7024 or ACX7024X router, use a combination of the RJ-45 cable and RJ-45 to DB-9 adapter and a USB to DB-9 plug adapter.

Each ACX7024 and ACX7024X router has a console port with an RJ-45 connector. Use the console port to connect the device to a management console or to a console server.

To connect the ACX7024 or ACX7024X router to a management console (see [Figure 31 on page 80](#) and [Figure 32 on page 80](#)):

1. Connect one end of the Ethernet cable to the console port (labeled **CON**).
2. Connect the other end of the Ethernet cable into the console server (see [Figure 31 on page 80](#)) or management console (see [Figure 32 on page 80](#)).

Figure 31: Connect the ACX7024 Router to a Management Console through a Console Server

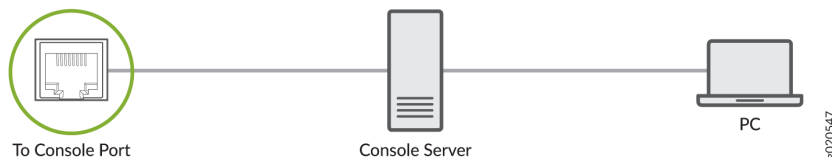
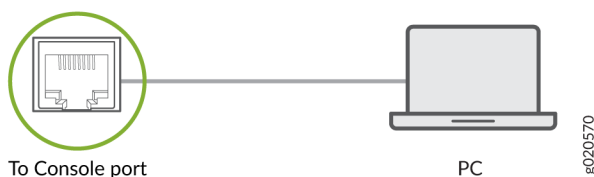

Figure 32: Connect the ACX7024 or ACX7024X Router Directly to a Management Console



Connect an ACX7024 or ACX7024X Router to a Network for Out-of-Band Management

Ensure that you have an appropriate cable available. See ["ACX7024 and ACX7024X Network Cable and Transceiver Planning"](#) on page 48 .

You can monitor and manage the ACX7024 or ACX7024X router by using a dedicated management channel. Use the management ports to connect the ACX7024 or ACX7024X router to a network for out-of-band management.

NOTE: You cannot use the management ports to perform the initial configuration of the ACX7024 or ACX7024X router. You must configure the management ports before you can successfully connect to the ACX7024 or ACX7024X router using these ports. See ["Perform Initial Software Configuration for ACX7024 and ACX7024X Routers"](#) on page 82 .

To connect an ACX7024 or ACX7024X router to a network for out-of-band management (see [Figure 33 on page 81](#)):

1. Connect one end of the cable to the management port labeled **MGMT** on the ACX7024 or ACX7024X router.
2. Connect the other end of the cable to the management PC (see [Figure 33 on page 81](#)).

Figure 33: Connect an ACX7024 or ACX7024X Router to a Network for Out-of-Band Management

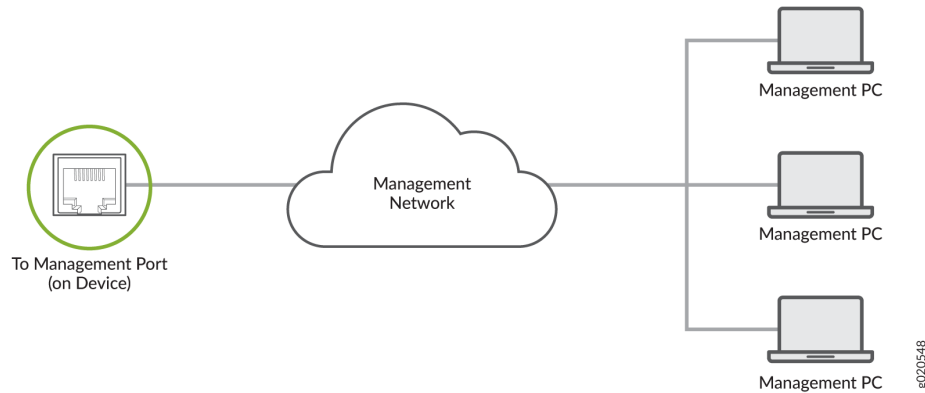

Connect an ACX7024 or ACX7024X Router to External Clocking and Timing Devices

Each ACX7024 and ACX7024X router has four DIN connector ports that support 1 pulse per second (1-PPS) and 10 -megahertz (10-MHz) inputs and outputs for interface to external timing devices.

NOTE: Ensure that you use a cable of 3 m or less in length for the 10-MHz and 1-PPS connectors.

To connect the DIN-to-BNC coaxial cable to the external clocking input port:

1. Connect one end of the DIN-to-BNC coaxial cable to either the 1-PPS connector or the 10-MHz connector on the router.
2. Connect the other end of the DIN-to-BNC coaxial cable to the 1-PPS or 10-MHz measurement equipment.

NOTE: Ensure that the 10-MHz or 1-PPS source network equipment contains a low-voltage complementary metal oxide semiconductor (CMOS) or is compatible with low-voltage (3.3 V) transistor-transistor logic (TTL).

Perform Initial Software Configuration for ACX7024 and ACX7024X Routers

You can easily customize the factory-default configuration with just a few commands. Initially, you'll need to make changes through the console port. After you configure the management port, you can access the ACX7024 or ACX7024X using SSH and make additional configuration changes. You can always revert to the factory-default configuration whenever you want.

Have the following information ready before you begin customizing the router:

- Hostname
 - Root authentication password
 - Management port IP address
 - Default gateway IP address
 - IP address and prefix length of remote prefixes
 - (Optional) SNMP read community, location, and contact information
1. Verify that the following default serial port settings are configured on your laptop or desktop PC:
 - Baud Rate—9600
 - Flow Control—None
 - Data—8
 - Parity—None
 - Stop Bits—1
 - DCD State—Disregard
 2. Connect the console port on the ACX7024 or ACX7024X to a laptop or a desktop PC using the RJ-45 cable and RJ-45 to DB-9 adapter. The console (**CON**) port is the lower RJ-45 port on the left side of the port panel.

NOTE: If your laptop or desktop PC doesn't have a serial port, use a serial-to-USB adapter (not provided).

3. At the Junos OS Evolved login prompt, type **root** to log in.

You don't need to enter a password. If the software boots before you connect your laptop or desktop PC to the console port, you might need to press the Enter key for the prompt to appear.

```
re0 login: root
```

4. Start the CLI.

```
[vrf:none] root@re0:~# cli
```

5. Enter configuration mode.

```
root@re0> configure
```

6. Stop the chassis auto-upgrade process.

```
[edit]  
root@re0# delete chassis auto-image-upgrade
```

7. Stop zero-touch provisioning (ZTP).

```
[edit]  
root@re0# delete system commit factory-settings
```

NOTE: ZTP is enabled on the ACX7024 and ACX7024X in the factory-default configuration. You must stop ZTP before you configure any settings. Until you assign a root password and perform an initial commit, you might see ZTP-related messages on the console. You can safely ignore these messages while you configure the root password.

8. Add a password for the root administration user account.

```
[edit]  
root@re0# set system root-authentication plain-text-password  
New password: password  
Retype new password: password
```

- Commit the configuration, and wait for the ZTP process to stop.

```
[edit]
root@re0# commit
```

A message appears on the console, confirming that the ZTP process has stopped.

```
[edit]
root@# [ 511.430877] ztp.py[13237]: 2021-03-04 05:28:00 INFO: ZTP:(et-0/2/7) DHCP request
timed out
[ 511.432804] ztp.py[13237]: 2021-03-04 05:28:00 INFO: ZTP: checkZTPAbort: Upgrade
detected pending abort
[ 511.433586] ztp.py[13237]: 2021-03-04 05:28:00 INFO: ZTP: notifier loop user requested
ZTP abort
[ 511.485370] ztp.py[13237]: 2021-03-04 05:28:00 INFO: ZTP: exiting
[ 511.580800] ztp.py[31898]: Notice: PID found for app ztp in /var/run/pid/ztp.pid is
13237.Executing command: (/usr/sbin/cleanzk -c /var/run/zkid/13237.id;rm /var/run/zkid/
13237.id)
[ 512.614206] ztp.py[31898]: rm: cannot remove '/var/run/zkid/13237.id': No such file or
directory
```

- (Optional) Give the router a name. If the name includes spaces, enclose the name in quotation marks (" ").

```
[edit]
root@re0# set system host-name host-name
```

- Configure the default gateway.

```
[edit]
root@re0# set routing-options static route 0.0.0.0/0 next-hop destination-ip
```

- Configure the IP address and prefix length for the management port on the router. On the ACX7024 and ACX7024X, the management port (**MGMT**) is the upper RJ-45 port on the left side of the port panel.

```
[edit]
root@re0# set interfaces re0:mgmt-0 unit 0 family inet address address/prefix-length
```

13. (Optional) Configure specific static routes to remote prefixes if you do not want the remote prefixes to use the default route.

```
[edit]
root@re0# set routing-options static route address/prefix-length next-hop destination-ip
```

14. Enable Telnet service, if required.

```
[edit]
root@re0# set system services telnet
```

NOTE: When Telnet is enabled, you cannot log in to the ACX7024 or ACX7024X using root credentials. Root login is allowed only for SSH access.

15. Enable SSH service.

```
[edit]
root@re0# set system services ssh
```

16. To allow users to log in to the router as root users through SSH, include the **root-login** statement.

```
[edit system services ssh]
root@re0# root-login (allow)
```

NOTE: By default, users are not allowed to log in to the router as root users through SSH.

17. Commit the configuration.

Your changed configuration becomes the active configuration for the router.

```
[edit]
root@re0# commit
```

5

CHAPTER

Maintaining Components

Maintaining the ACX7024 and ACX7024X Power Supplies | 87

Maintain the ACX7024 and ACX7024X Transceivers and Fiber-Optic Cables |
94

Uninstall the ACX7024 or ACX7024X Router | 104

Maintaining the ACX7024 and ACX7024X Power Supplies

IN THIS SECTION

- [Replace an ACX7024 or ACX7024X Power Supply Module | 87](#)

Replace an ACX7024 or ACX7024X Power Supply Module

IN THIS SECTION

- [Remove an ACX7024 or ACX7024X AC Power Supply Module | 87](#)
- [Install an ACX7024 or ACX7024X AC Power Supply Module | 89](#)
- [Remove an ACX7024 or ACX7024X DC Power Supply Module | 90](#)
- [Install an ACX7024 or ACX7024X DC Power Supply Module | 92](#)

Remove an ACX7024 or ACX7024X AC Power Supply Module

Before you remove a PSM from a router, ensure that you have taken the necessary precautions to prevent electrostatic discharge (ESD) damage (see *Prevention of Electrostatic Discharge Damage*).

Ensure that you have the following parts and tools available to remove a PSM from a router:

- ESD grounding strap
- Antistatic bag or an antistatic mat

The power supply modules (PSMs) in ACX7024 and ACX7024X routers are hot-removable and hot-insertable field-replaceable units (FRUs). You can remove and replace the PSMs without powering off the router or disrupting routing functions.



CAUTION: Replace the PSM with a new PSM within 1 minute of removal to prevent chassis overheating.

To remove an AC PSM from an ACX7024 or ACX7024X router (see [Figure 34 on page 88](#)):

1. Place the antistatic bag or the antistatic mat on a flat, stable surface.
2. Wrap and fasten one end of the ESD grounding strap around your bare wrist, and connect the other end of the strap to the ESD point on the chassis.

NOTE: If only one PSM is installed in your router, you must power off the router before removing the PSM. See ["Power Off an ACX7024 or ACX7024X Router" on page 104](#).

3. Disconnect power to the router. If the AC power source outlet has a power switch, set it to the off (O) position. If the AC power source outlet does not have a power switch, gently pull out the power cord plug connected to the power source outlet.
4. Remove the power source cable from the power supply faceplate. Remove the power cord from the power supply faceplate by gently pulling out the socket end of the power cord connected to the power supply faceplate.
5. Slide the ejector lever toward the handle until you can no longer slide it.
6. Grasp the PSM handle and pull firmly to slide the PSM halfway out of the chassis.
7. Place one hand under the PSM to support it and slide it completely out of the chassis. Take care not to touch power supply components, pins, leads, or solder connections.
8. Place the PSM in the antistatic bag or on the antistatic mat placed on a flat, stable surface.

Figure 34: Remove PSM from an ACX7024 or ACX7024X Router

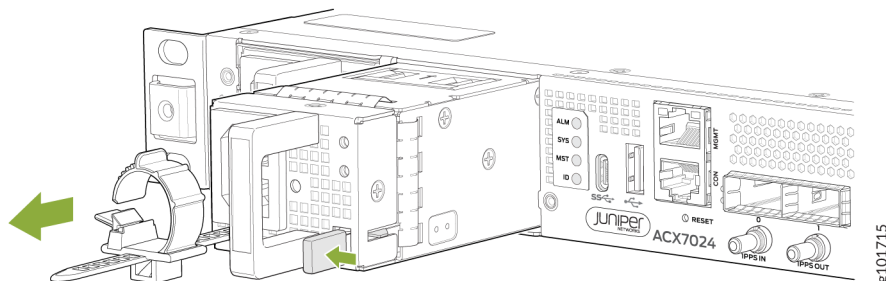

Install an ACX7024 or ACX7024X AC Power Supply Module

Before you install a PSM in a router, ensure that you have taken the necessary precautions to prevent electrostatic discharge (ESD) damage (see *Prevention of Electrostatic Discharge Damage*).

The power supply modules (PSMs) in ACX7024 and ACX7024X routers are hot-removable and hot-insertable field-replaceable units (FRUs). You can remove and replace the PSMs without powering off the router or disrupting routing functions.

To install an AC PSM in an ACX7024 or ACX7024X router (see [Figure 35 on page 89](#)):

1. Wrap and fasten one end of the ESD grounding strap around your bare wrist, and connect the other end of the strap to the ESD point on the chassis.
2. Taking care not to touch power supply components, pins, leads, or solder connections, remove the PSM from its bag.
3. Using both hands, place the PSM in the power supply slot on the front panel of the router and slide it in until it is fully seated and the ejector lever slides into place.
4. Press the latch located on the side of the PSM to slide it into the chassis.
5. Attach the power cord to the PSM.
6. Attach the power cord to the AC power source, and switch on the dedicated customer-site 2-pole circuit breaker. Follow the instructions for your site.
7. Observe the status LED on the power supply faceplate. If the PSM is correctly installed and functioning normally, the status LED lights green steadily.

Figure 35: Install an AC PSM in an ACX7024 or ACX7024X Router

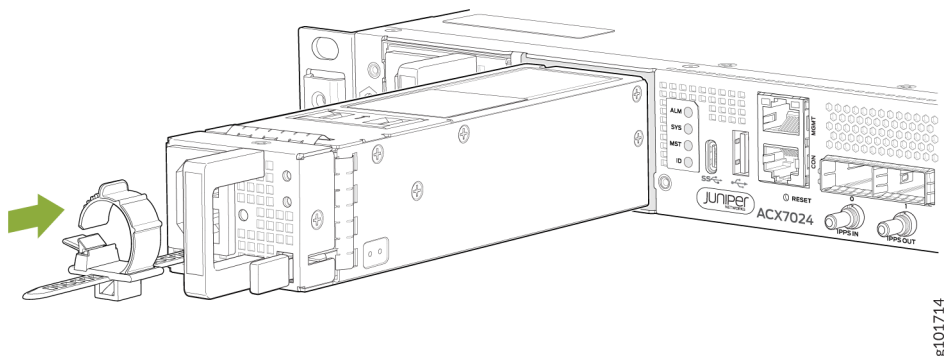

g101714

Figure 36: Install an AC Power Cord in an ACX7024 or ACX7024X Router

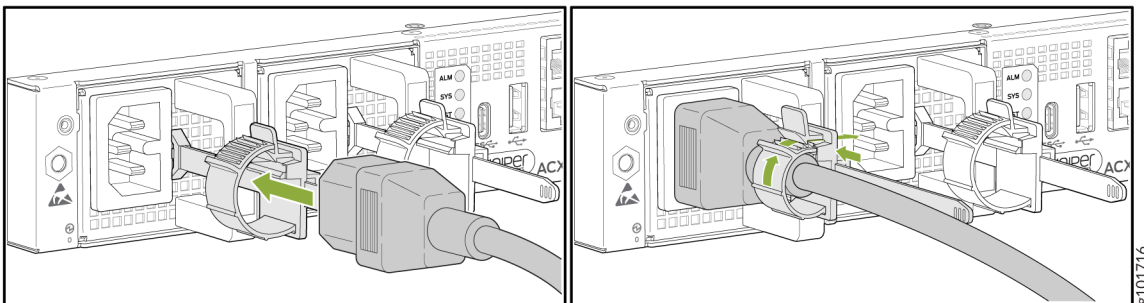

NOTE: Each PSM must be connected to a dedicated power source outlet.

NOTE: If you have a Juniper J-Care service contract, register any addition, change, or upgrade of hardware components at <https://www.juniper.net/customers/csc/management/updateinstallbase.jsp> . Failure to do so can result in significant delays if you need replacement parts. This note does not apply if you replace components with the same type of component.

Remove an ACX7024 or ACX7024X DC Power Supply Module

Before you remove a power supply module (PSM), be aware of the following:

NOTE: The minimum required number of PSMs must always be present in the router.



WARNING: Before performing DC power procedures, ensure that power is removed from the DC circuit. To ensure that all power is off, locate the two-pole circuit breaker on the panel board that services the DC circuit, switch the circuit breaker to the off position, and tape the switch handle of the circuit breaker in the off position.

NOTE: After powering off a PSM, wait at least 60 seconds before turning it back on.

To remove a DC PSM:

1. Switch off the dedicated customer-site two-pole circuit breaker for the PSM being removed. Follow your site's procedures for preventing ESD damage.
2. Make sure that the voltage across the DC power source cable leads is 0 V and that there is no chance that the cables might become active during the removal process.
3. Verify that the **PWR** LED on the PSM is unlit.
4. Wrap and fasten one end of the ESD grounding strap around your bare wrist, and connect the other end of the strap to the ESD point on the chassis.
5. Remove the terminal block cover protecting the terminals on the faceplate.
6. Using a Phillips number 2 screwdriver, remove the screw from each of the DC power terminals (see [Figure 37 on page 91](#)).
7. Remove the cable lugs from the terminals.
8. Carefully move the power cables out of the way.
9. Press the latch located on the DC PSM, to release it from the chassis.
10. Pull the PSM straight out of the chassis (see [Figure 38 on page 91](#)).

Figure 37: Disconnect the DC Power Cables

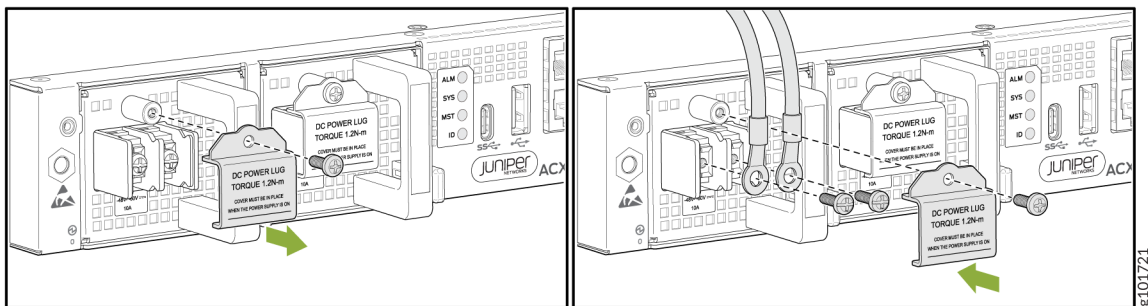
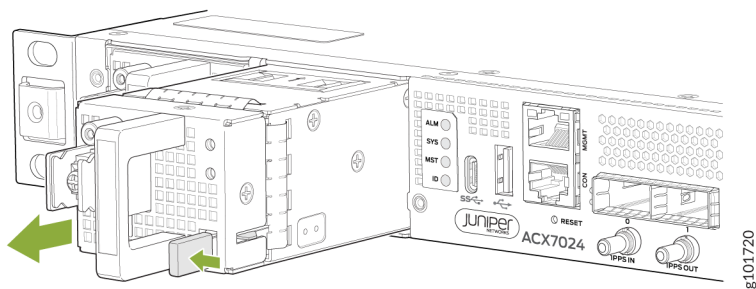

Figure 38: Remove a DC PSM



Install an ACX7024 or ACX7024X DC Power Supply Module



WARNING: Before performing DC power procedures, ensure that power is removed from the DC circuit. To ensure that all power is off, locate the circuit breaker on the panel board that services the DC circuit, switch the circuit breaker to the off position, and tape the switch handle of the circuit breaker in the off position.

To install a DC PSM (see [Figure 39 on page 93](#)):

1. Ensure that the voltage across the DC power source cable leads is 0 V and that there is no chance that the cable leads might become active during installation.
2. Wrap and fasten one end of the ESD grounding strap around your bare wrist, and connect the other end of the strap to the ESD point on the chassis.
3. Using both hands, slide the DC PSM straight into the slot on the front panel of the chassis until the PSM is fully seated in the slot.
4. Remove the terminal block cover protecting the terminals on the faceplate.
5. Remove the screws from the terminals.
6. Secure each power cable lug to the terminal with the screw (see [Figure 40 on page 93](#)). Do not overtighten the screw.
 - a. Secure the positive (+) DC source power cable lug to the **RTN** (return) terminal.
 - b. Secure the negative (-) DC source power cable lug to the **-48V** (input) terminal.



CAUTION:

- You must ensure that power connections maintain the proper polarity. The power source cables might be labeled (+) and (-) to indicate their polarity. There is no standard color coding for DC power cables. Use the color coding that you see on the external DC power source at your site to determine the color coding for the leads on the power cables that attach to the DC power input terminals on each PSM.
 - Ensure that each power cable lug seats flush against the surface of the terminal block as you are tightening the screws. Ensure that each screw is properly threaded into the terminal. Applying installation torque to the screw when the screw is improperly threaded can result in damage to the terminal.
7. Replace the terminal block cover over the terminals on the faceplate.
 8. Verify that the power cabling is correct, that the cables do not touch or block access to router components, and that the cables do not drape where people could trip over them.

- Attach the power cable to the DC power source. Then switch on the dedicated customer-site two-pole circuit breaker.

NOTE: If you are installing more than one PSM, turn on all PSMs at the same time.

- Observe the **PWR** LED on the power supply faceplate. If the PSM is installed correctly and is functioning normally, the **PWR** LED lights green steadily.

Figure 39: Install a DC PSM in an ACX7024 or ACX7024X Router

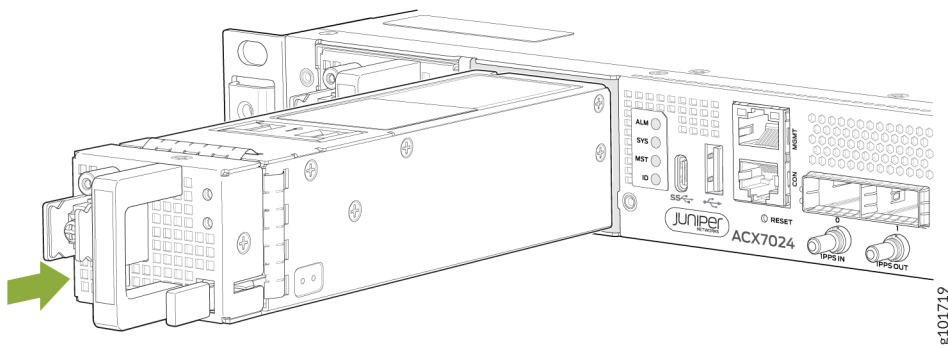
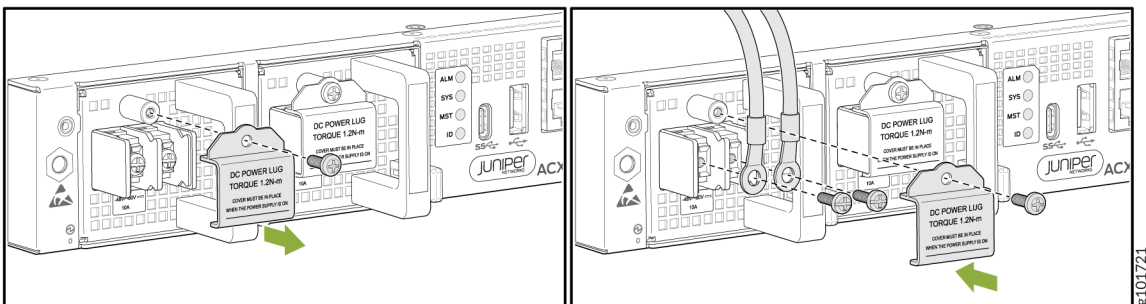

Figure 40: Connect the DC Power Cables



RELATED DOCUMENTATION

[ACX7024 and ACX7024X Power System | 26](#)

Maintain the ACX7024 and ACX7024X Transceivers and Fiber-Optic Cables

IN THIS SECTION

- [Remove a Transceiver | 94](#)
- [Install a Transceiver | 96](#)
- [Remove a QSFP28 Transceiver | 99](#)
- [Install a QSFP28 Transceiver | 100](#)
- [How to Connect a Fiber-Optic Cable to a Transceiver on an ACX7024 or ACX7024X Router | 101](#)
- [How to Disconnect a Fiber-Optic Cable from a Transceiver on an ACX7024 or ACX7024X Router | 102](#)
- [How to Maintain Fiber-Optic Cable for an ACX7024 and ACX7024X Router | 103](#)

The transceivers for the ACX7024 and ACX7024X routers are hot-removable and hot-insertable field-replaceable units (FRUs). You can remove and replace them without powering off the device or disrupting device functions.

To understand how to install a transceiver in or remove one from an ACX7024 or ACX7024X router, read the following sections:

Remove a Transceiver

Before you remove a transceiver from a device, ensure that you have taken the necessary precautions for the safe handling of lasers (see *Laser and LED Safety Guidelines and Warnings*).

Ensure that you have the following parts and tools available:

- An antistatic bag or an antistatic mat
- Rubber safety caps to cover the transceiver and fiber-optic cable connector
- A dust cover to cover the port or a replacement transceiver

NOTE: After you remove a transceiver or when you change the media-type configuration, wait for 6 seconds for the interface to display the operational commands.

Figure 41 on page 96 shows how to remove a quad small form-factor pluggable plus (QSFP+) transceiver. The procedure is the same for all types of transceivers except for the QSFP28 transceivers.

To remove a transceiver from a device:

1. Place the antistatic bag or antistatic mat on a flat, stable surface.
2. Wrap and fasten one end of the ESD wrist strap around your bare wrist, and connect the other end of the strap to a site ESD point.
3. Label the cable connected to the transceiver so that you can reconnect it correctly.



LASER WARNING: Do not look directly into a fiber-optic transceiver or into the ends of fiber-optic cables. Fiber-optic transceivers and fiber-optic cables connected to transceivers emit laser light that can damage your eyes.



LASER WARNING: Do not leave a fiber-optic transceiver uncovered except when inserting or removing a cable. The rubber safety cap keeps the port clean and prevents accidental exposure to laser light.

4. Remove the cable connected to the transceiver (see "[How to Disconnect a Fiber-Optic Cable from a Transceiver on an ACX7024 or ACX7024X Router](#)" on page 102). Cover the transceiver and the end of each fiber-optic cable connector with a rubber safety cap immediately after disconnecting the fiber-optic cables.
5. If there is a cable management system, arrange the cable in the cable management system to prevent it from dislodging or developing stress points. Secure the cable so that it does not support its own weight as it hangs to the floor. Place excess cable out of the way in a neatly coiled loop in the cable management system. Placing fasteners on the loop helps to maintain its shape.



CAUTION: Do not bend the fiber-optic cable beyond its minimum bend radius. An arc smaller than a few inches in diameter can damage the cable and cause problems that are difficult to diagnose.

6. To remove an SFP, an SFP+, or a QSFP+ transceiver:
 - a. By using your fingers, pull open the ejector lever on the transceiver to unlock the transceiver.



CAUTION: Before removing the transceiver, make sure that you open the ejector lever completely until you hear it click. Doing this prevents damage to the transceiver.

- b. Grasp the transceiver ejector lever and gently slide the transceiver approximately 0.5 in. (1.3 cm) straight out of the port.



CAUTION: To prevent ESD damage to the transceiver, do not touch the connector pins at the end of the transceiver.

Figure 41: Remove a QSFP+ transceiver

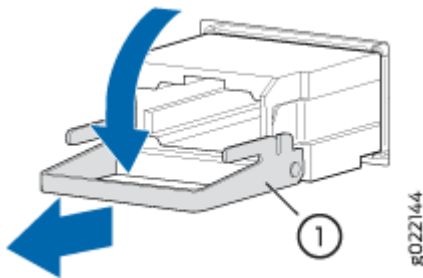

1- Ejector lever

7. By using your fingers, grasp the body of the transceiver and pull it straight out of the port.
8. Place the transceiver in the antistatic bag or on the antistatic mat placed on a flat, stable surface.
9. Place the dust cover over the empty port or install the replacement transceiver.

Install a Transceiver

Before you install a transceiver in a device, ensure that you have taken the necessary precautions for safe handling of lasers (see *Laser and LED Safety Guidelines and Warnings*).

Ensure that you have a rubber safety cap available to cover the transceiver.

NOTE: After you insert a transceiver or after you change the media-type configuration, wait for 6 seconds for the interface to display operational commands.

NOTE: We recommend that you use only optical transceivers and optical connectors purchased from Juniper Networks with your Juniper Networks device.



CAUTION: If you face a problem running a Juniper Networks device that uses a third-party optic or cable, the Juniper Networks Technical Assistance Center (JTAC) can help you diagnose the source of the problem. Your JTAC engineer might recommend that you check the third-party optic or cable and potentially replace it with an equivalent Juniper Networks optic or cable that is qualified for the device.

Figure 42 on page 99 shows how to install a quad small form-factor pluggable plus (QSFP+) transceiver. The procedure is the same for all types of transceivers except the QSFP28 transceivers. To install a QSFP28 transceiver, see "[Install a QSFP28 Transceiver](#)" on page 100 .

To install an SFP, an SFP+, or a QSFP+ transceiver:



CAUTION: To prevent electrostatic discharge (ESD) damage to the transceiver, do not touch the connector pins at the end of the transceiver.

1. Wrap and fasten one end of the ESD wrist strap around your bare wrist, and connect the other end of the strap to a site ESD point.
2. Remove the transceiver from its bag.
3. Check to see whether the transceiver is covered with a rubber safety cap. If it is not, cover the transceiver with a rubber safety cap.



LASER WARNING: Do not leave a fiber-optic transceiver uncovered except when inserting or removing a cable. The rubber safety cap keeps the port clean and prevents accidental exposure to laser light.

4. If the port in which you want to install the transceiver is covered with a dust cover, remove the dust cover and save it in case you need to cover the port later. If you are hot-swapping a transceiver, wait for at least 10 seconds after removing the transceiver from the port before installing a new transceiver.



CAUTION: Before you slide the transceiver into the port, ensure that the transceiver is aligned correctly. Misalignment might cause the pins to bend, making the transceiver unusable.

5. Using both hands, carefully insert the transceiver in the empty port. The connectors must face the chassis. Slide the transceiver in gently until it is fully seated.
6. Remove the rubber safety cap from the transceiver and the end of the cable, and insert the cable into the transceiver.



LASER WARNING: Do not look directly into a fiber-optic transceiver or into the ends of fiber-optic cables. Fiber-optic transceivers and fiber-optic cable connected to a transceiver emit laser light that can damage your eyes.



CAUTION: Do not leave a fiber-optic transceiver uncovered except when inserting or removing cable. The safety cap keeps the port clean and prevents accidental exposure to laser light.

7. If there is a cable management system, arrange the cable in the cable management system to prevent the cable from dislodging or developing stress points. Secure the cable so that it does not support its own weight as it hangs to the floor. Place excess cable out of the way in a neatly coiled loop in the cable management system. Placing fasteners on the loop helps to maintain its shape.



CAUTION: Do not let fiber-optic cable hang free from the connector. Do not allow fastened loops of cable to dangle, which stresses the cable at the fastening point.



CAUTION: Avoid bending fiber-optic cable beyond its minimum bend radius. An arc smaller than a few inches in diameter can damage the cable and cause problems that are difficult to diagnose.

Figure 42: Install a QSFP+ Transceiver

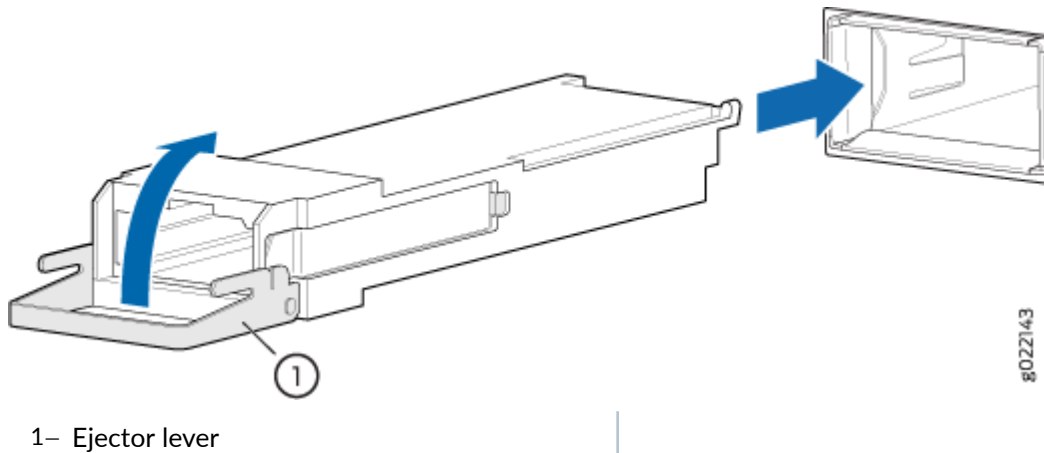

Remove a QSFP28 Transceiver

The 28-Gbps quad small form-factor pluggable (QSFP28) transceivers are hot-insertable and hot-removable. Removing a QSFP28 transceiver does not interrupt the device functioning, but the removed QSFP28 transceiver no longer receives or transmits data.

Figure 43: QSFP28 Transceiver

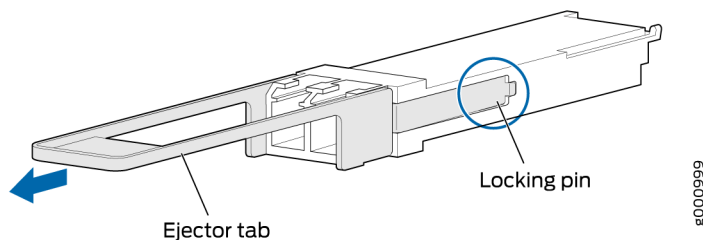

To remove a QSFP28 transceiver (see [Figure 43 on page 99](#)):

1. Place an electrostatic bag or antistatic mat on a flat, stable surface to receive the QSFP28 transceiver. Have ready a rubber safety cap for the QSFP28 transceiver and the cable.
2. Wrap and fasten one end of the ESD wrist strap around your bare wrist, and connect the other end of the strap to a site ESD point.
3. Label the cable connected to the QSFP28 transceiver so that you can later reconnect it to the correct QSFP28 transceiver.

4. Disconnect the cable from the QSFP28 transceiver. Immediately cover the transceiver and the end of the cable with a rubber safety cap.



LASER WARNING: Do not look directly into a fiber-optic transceiver or into the ends of fiber-optic cables. Fiber-optic transceivers and fiber-optic cable connected to a transceiver emit laser light that can damage your eyes.



CAUTION: Do not leave a fiber-optic transceiver uncovered except when inserting or removing cable. The safety cap keeps the port clean and prevents accidental exposure to laser light.

5. Arrange the cable in the cable management system to prevent it from dislodging or developing stress points. Secure the cable so that it is not supporting its own weight as it hangs to the floor. Place excess cable out of the way in a neatly coiled loop in the cable management system. Placing fasteners on the loop helps to maintain its shape.



CAUTION: Avoid bending fiber-optic cable beyond its minimum bend radius. An arc smaller than a few inches in diameter can damage the cable and cause problems that are difficult to diagnose.

6. Pull the transceiver's rubber handle straight back. The locking pins on the transceiver are automatically released. Place the transceiver on the antistatic mat or in the electrostatic bag.

Install a QSFP28 Transceiver

To install a replacement QSFP28:

1. Wrap and fasten one end of the ESD wrist strap around your bare wrist, and connect the other end of the strap to a site ESD point.
2. Verify that a rubber safety cap covers the QSFP28 transceiver. Install a rubber safety cap, if necessary.
3. Orient the QSFP28 over the port so that the QSFP28 connector faces the appropriate direction.
4. Slide the QSFP28 into the slot until the locking pins lock in place. If there is resistance, remove the QSFP28 and flip it so that the connector faces the other direction.
5. Remove the rubber safety cap from the transceiver and the end of the cable, and insert the cable into the transceiver.



LASER WARNING: Do not look directly into a fiber-optic transceiver or into the ends of fiber-optic cables. Fiber-optic transceivers and fiber-optic cable connected to a transceiver emit laser light that can damage your eyes.



CAUTION: Do not leave a fiber-optic transceiver uncovered except when inserting or removing cable. The safety cap keeps the port clean and prevents accidental exposure to laser light.

6. Arrange the cable in the cable management system to prevent the cable from dislodging or developing stress points. Secure the cable so that it is not supporting its own weight as it hangs to the floor. Place excess cable out of the way in a neatly coiled loop in the cable management system. Placing fasteners on the loop helps to maintain its shape.



CAUTION: Do not let fiber-optic cable hang free from the connector. Do not allow fastened loops of cable to dangle, which stresses the cable at the fastening point.



CAUTION: Avoid bending fiber-optic cable beyond its minimum bend radius. An arc smaller than a few inches in diameter can damage the cable and cause problems that are difficult to diagnose.

7. Verify that the status LEDs indicate that the QSFP28 is functioning correctly.

How to Connect a Fiber-Optic Cable to a Transceiver on an ACX7024 or ACX7024X Router

Before you connect a fiber-optic cable to an optical transceiver installed in the ACX7024 or ACX7024X router, ensure that you have taken the necessary precautions for safe handling of lasers (see *Laser and LED Safety Guidelines and Warnings*).

To connect a fiber-optic cable to an optical transceiver installed in the ACX7024 or ACX7024X router:



LASER WARNING: Do not look directly into a fiber-optic transceiver or into the ends of fiber-optic cables. Fiber-optic transceivers and fiber-optic cables connected to transceivers emit laser light that can damage your eyes.



LASER WARNING: Do not stare into the laser beam or view it directly with optical instruments even if the interface has been disabled.

1. If the fiber-optic cable connector is covered by a rubber safety cap, remove the cap. Save the cap.
2. If the optical transceiver is covered by a rubber safety cap, remove the cap. Save the cap.
3. Insert the cable connector into the optical transceiver.
4. Secure the cables so that they are not supporting their own weight. Place excess cable out of the way in a neatly coiled loop. Placing fasteners on a loop helps cables maintain their shape.



CAUTION: Do not bend fiber-optic cables beyond their minimum bend radius. Bending the cables beyond their minimum bend radius can damage the cables and cause problems that are difficult to diagnose.



CAUTION: Do not let fiber-optic cables hang free from the connector. Do not allow fastened loops of cables to dangle, which stresses the cables at the fastening point.

How to Disconnect a Fiber-Optic Cable from a Transceiver on an ACX7024 or ACX7024X Router

Before you disconnect a fiber-optic cable from an optical transceiver installed in a ACX7024 or ACX7024X router, ensure that you have taken the necessary precautions for safe handling of lasers (see *Laser and LED Safety Guidelines and Warnings*).

Ensure that you have the following parts and tools available:

- Rubber safety cap to cover the transceiver
- Rubber safety cap to cover the fiber-optic cable connector

To disconnect a fiber-optic cable from an optical transceiver installed in the ACX7024 or ACX7024X router:

1. (Recommended) Disable the port in which the transceiver is installed by including the `disable` statement at the `[edit interfaces]` hierarchy level for the specific interface.



LASER WARNING: Do not look directly into a fiber-optic transceiver or into the ends of fiber-optic cables. Fiber-optic transceivers and fiber-optic cables connected to transceivers emit laser light that can damage your eyes.



LASER WARNING: Do not stare into the laser beam or view it directly with optical instruments even if the interface has been disabled.

2. Carefully unplug the fiber-optic cable connector from the transceiver.
3. Cover the transceiver with a rubber safety cap.



LASER WARNING: Do not leave a fiber-optic transceiver uncovered except when inserting or removing a cable. The rubber safety cap keeps the port clean and prevents accidental exposure to laser light.

4. Cover the fiber-optic cable connector with the rubber safety cap.

How to Maintain Fiber-Optic Cable for an ACX7024 and ACX7024X Router

To maintain fiber-optic cables in an ACX7024 or ACX7024X router:

- When you unplug a fiber-optic cable from a transceiver, place rubber safety caps over the transceiver and on the end of the cable.
- Anchor fiber-optic cable to avoid stress on the connectors. When attaching a fiber-optic cable to a transceiver, be sure to secure the fiber-optic cable so that it does not support its own weight as it hangs to the floor. Never let a fiber-optic cable hang free from the connector.
- Do not bend fiber-optic cables beyond their minimum bend radius. Bending the cables beyond their minimum bend radius can damage the cables and cause problems that are difficult to diagnose.
- Frequent plugging and unplugging of fiber-optic cables into and out of optical instruments can damage the instruments, which are expensive to repair. Attach a short fiber extension to the optical

equipment. Any wear and tear due to frequent plugging and unplugging is then absorbed by the short fiber extension, which is easier and less expensive to replace than the instruments.

- Keep fiber-optic cable connections clean. Microdeposits of oil and dust in the canal of the transceiver or cable connector can cause loss of light, reduction in signal power, and possibly intermittent problems with the optical connection.

To clean the transceiver canal, use an appropriate fiber-cleaning device such as RIFOCS Fiber Optic Adaptor Cleaning Wands (part number 946). Follow the directions in the cleaning kit you use.

After cleaning the transceiver, make sure that the connector tip of the fiber-optic cable is clean. Use only an approved alcohol-free fiber-optic cable cleaning kit such as the Cletop-S® Fiber Cleaner. Follow the directions in the cleaning kit you use.

Uninstall the ACX7024 or ACX7024X Router

IN THIS SECTION

- [Power Off an ACX7024 or ACX7024X Router | 104](#)
- [Remove an ACX7024 or ACX7024X Router from a Rack or Cabinet | 106](#)

Power Off an ACX7024 or ACX7024X Router

Before you power off an ACX7024 or ACX7024X router:

- Ensure that you have taken the necessary precautions to prevent electrostatic discharge (ESD) damage. See *Prevention of Electrostatic Discharge Damage*.
- Ensure that you do not need to forward traffic through the router.

Ensure that you have the following parts and tools available to power off the router:

- An ESD grounding strap
- An external management device such as a PC

- An RJ-45 to DB-9 rollover cable to connect the external management device to the console port

To power off your ACX7024 or ACX7024X router:

1. Connect to the router using one of the following methods:

- Connect a management device to the console (**CON**) port on the router. For instructions about connecting a management device to the console (**CON**) port, see ["Connect an ACX7024 or ACX7024X Router to a Management Console" on page 79](#) .
- Connect a management device to the (**MGMT**) port on the router. For instructions about connecting a management device to the management (**MGMT**) port, see ["Connect an ACX7024 or ACX7024X Router to a Network for Out-of-Band Management" on page 80](#) .

2. Shut down Junos OS from the external management device by issuing the request system halt operational mode CLI command. This command shuts down the router gracefully and preserves the system state information. A message appears on the console, confirming that the operating system has halted.

```
user@host> request system halt
All nodes will halt, do you wish to continue ? [yes,no] (no) yes
```

You see the following output (or something similar, depending on the hardware being shut down) after entering the command:

```
System going down IMMEDIATELY

*** System shutdown message from user@host ***

halt the system at Tue Feb 16 16:40:55 2021
```

3. Wrap and fasten one end of the ESD grounding strap around your bare wrist, and connect the other end of the strap to the ESD point on the chassis.
4. Disconnect power to the router by performing one of the following tasks:
 - AC power supply—If the AC power source outlet has a power switch, set it to the off (**O**) position. If the AC power source outlet does not have a power switch, gently pull out the power cord plug connected to the power source outlet.
 - DC power supply—Switch the circuit breaker on the panel board that services the DC circuit to the off position.
5. Remove the power source cable from the power supply faceplate:

- AC power supply—Remove the power cord from the power supply faceplate by detaching the power cord retainer and gently pulling out the socket end of the power cord connected to the power supply faceplate.
 - DC power supply—Remove the screws securing the ring lugs attached to the power source cables to the power supply module (PSM) using the screwdriver, and remove the power source cables from the PSM. Replace the screws on the terminals and tighten them.
6. Remove the power source cable from the power supply faceplate.
Remove the screws securing the ring lugs attached to the power source cables to the PSM using the screwdriver, and remove the power source cables from the PSM. Replace the screws on the terminals and tighten them.
 7. Uncable the router before removing it from the rack or cabinet.

Remove an ACX7024 or ACX7024X Router from a Rack or Cabinet

Before you remove the ACX7024 or ACX7024X router from its rack, ensure that you have a Phillips (+) screwdriver, number 2 or number 3, depending on the size of your rack mounting screws.

If you need to relocate an installed ACX7024 or ACX7024X router, use the procedure described in this topic.

NOTE: When you remove multiple devices from a rack, remove the device in the top of the rack first and proceed to remove the rest of the devices from top to bottom.

- Ensure that the rack is stable and secured to the building.
- Ensure that there is enough space to place the removed router in its new location and along the path to the new location.
- Read *General Safety Guidelines and Warnings*.
- Use the appropriate power-off sequence to safely power off the device. See "[Power Off an ACX7024 or ACX7024X Router](#)" on page 104 .
- Disconnect the power cords.
- Ensure that you have disconnected any cables or wires attached to the router ports.

To remove an ACX7024 or ACX7024X router from a rack or cabinet:

1. Have one person support the weight of the router while another person uses the screwdriver to remove the front mounting screws that attach the rack mounting brackets to the rack or cabinet.
2. Slowly slide the router out of the rack, with the mounting brackets attached to its sides.
3. Place the removed screws in a labeled bag. You will need them when you reinstall the chassis.
4. Transport the router to your new location.

RELATED DOCUMENTATION

| [Mount an ACX7024 or ACX7024X in a Rack](#)

6

CHAPTER

Troubleshooting Hardware

[Troubleshooting the ACX7024 or ACX7024X Router](#) | 109

Troubleshooting the ACX7024 or ACX7024X Router

IN THIS SECTION

- [Alarm Types and Severity Classes on ACX7024 and ACX7024X Routers | 109](#)

Alarm Types and Severity Classes on ACX7024 and ACX7024X Routers

IN THIS SECTION

- [Alarm Types | 110](#)
- [Alarm Severity Classes | 110](#)

Before monitoring the alarms on the router, become familiar with the terms defined in [Table 29 on page 109](#).

Table 29: Alarm Terms

Term	Definition
Alarm	Signal that alerts you to conditions that might prevent normal operation. On a router, the alarm signal is the ALM LED that is lit on the front of the chassis.
Alarm condition	Failure event that triggers an alarm.
Alarm severity	Seriousness of the alarm. The level of severity can be either major (steady red) or minor (steady amber).

Table 29: Alarm Terms (Continued)

Term	Definition
Chassis alarm	Predefined alarm that is triggered by a physical condition on the router, such as a power failure, excessive component temperature, or media failure.
System alarm	Predefined alarm that is triggered by a missing rescue configuration or failure to install a license for a licensed software feature.

Alarm Types

The router supports these alarms:

- Chassis alarms indicate a failure on the router or one of its components. Chassis alarms are preset and cannot be modified.
- System alarms indicate a missing rescue configuration. System alarms are preset and cannot be modified, although you can configure them to appear automatically in the J-Web interface display or CLI display.

Alarm Severity Classes

Alarms on ACX7024 and ACX7024X routers have two severity classes:

- Major (steady red)—Indicates a critical situation on the router that has resulted from one of the following conditions. A major alarm condition requires immediate action.
 - One or more hardware components have failed.
 - If any fan has failed.
 - If any power supply module (PSM) is not connected or if a PSM has failed.
 - One or more hardware components have exceeded temperature thresholds.
 - An alarm condition that is configured on an interface has triggered a critical warning.
- Minor (steady amber)—Indicates a noncritical condition on the router that, if left unchecked, might cause an interruption in service or degradation in performance. A minor alarm condition requires monitoring or maintenance.

A missing rescue configuration generates a minor system alarm.

RELATED DOCUMENTATION

| [Returning an ACX7024 or ACX7024X Chassis or Components](#) | **113**

7

CHAPTER

Contacting Customer Support and Returning the Chassis or Components

[Returning an ACX7024 or ACX7024X Chassis or Components](#) | 113

Returning an ACX7024 or ACX7024X Chassis or Components

IN THIS SECTION

- [How to Return a Hardware Component to Juniper Networks, Inc. | 113](#)
- [How to Locate the Serial Number on an ACX7024 and ACX7024X Router or Component | 114](#)

How to Return a Hardware Component to Juniper Networks, Inc.

If a hardware component fails, please contact Juniper Networks, Inc. to obtain a Return Material Authorization (RMA) number. This number is used to track the returned material at the factory and to return repaired or new components to the customer as needed.

NOTE: Do not return any component to Juniper Networks, Inc. unless you have first obtained an RMA number. Juniper Networks, Inc. reserves the right to refuse shipments that do not have an RMA. Refused shipments are returned to the customer by collect freight.

For more information about return and repair policies, see the customer support webpage at <https://support.juniper.net/support/>.

For product problems or technical support issues, contact the Juniper Networks Technical Assistance Center (JTAC) by using the Service Request Manager link at <https://support.juniper.net/support/> or at 1-888-314-JTAC (within the United States) or 1-408-745-9500 (from outside the United States).

To return a defective hardware component:

1. Determine the part number and serial number of the defective component.
2. Obtain an RMA number from the Juniper Networks Technical Assistance Center (JTAC). You can send e-mail or telephone as described above.
3. Provide the following information in your e-mail message or during the telephone call:
 - Part number and serial number of component

- Your name, organization name, telephone number, and fax number
 - Description of the failure
4. The support representative validates your request and issues an RMA number for return of the component.
 5. Pack the component for shipment.

How to Locate the Serial Number on an ACX7024 and ACX7024X Router or Component

SUMMARY

IN THIS SECTION

- [List the Chassis and Component Details Using the CLI | 115](#)
- [Locate the Chassis Serial Number ID Label on an ACX7024 or ACX7024X Router | 115](#)
- [Locate the Serial Number ID Labels on an ACX7024 Power Supply Module | 115](#)
- [Guidelines for Packing Hardware Components for Shipment | 116](#)

If you are returning a router or component to Juniper Networks for repair or replacement, you must locate the serial number of the router or component. You must provide the serial number to the Juniper Networks Technical Assistance Center (JTAC) when you contact them to obtain a Return Materials Authorization (RMA).

If the router is operational and you can access the command-line interface (CLI), you can list serial numbers for the router and for some components with a CLI command. If you do not have access to the CLI or if the serial number for the component does not appear in the command output, you can locate the serial number ID label on the router or component.

NOTE: If you want to find the serial number ID label on a component, you need to remove the component from the router chassis, for which you must have the required parts and tools available.

List the Chassis and Component Details Using the CLI

To list the components and serial numbers of ACX7024 or ACX7024X routers, use the `show chassis hardware` CLI operational mode command.

The `show chassis hardware` output for ACX7024:

```

user@device> show chassis hardware
Hardware inventory:
Item          Version  Part number  Serial number  Description
Chassis              FL1822AN0036  JNP7024 [ACX7024]
PSM 0              REV 02   740-134839  1F34C070224  JPSU-400W-DC-AFI
PSM 1              REV 02   740-134839  1F34C070023  JPSU-400W-DC-AFI
Routing Engine 0  REV 06   650-136135  FL1822AN0036  RE-ACX-7024
CB 0                BUILTIN    BUILTIN      Control Board
FPC 0                BUILTIN    BUILTIN      ACX7024-FPC
  PIC 0              BUILTIN    BUILTIN      MRATE- 24xSFP28 + 4xQSFP
Fan Tray 0          BUILTIN    BUILTIN      ACX7024 Fan, Front to Back Airflow - AF0

```

Locate the Chassis Serial Number ID Label on an ACX7024 or ACX7024X Router

On the ACX7024 and ACX7024X router product models, the serial number ID label is located on the right side of the device. See [Figure 44 on page 115](#) for an example of where to find the serial number ID.

Figure 44: Location of the Serial Number ID Label on an ACX7024 and ACX7024X Router

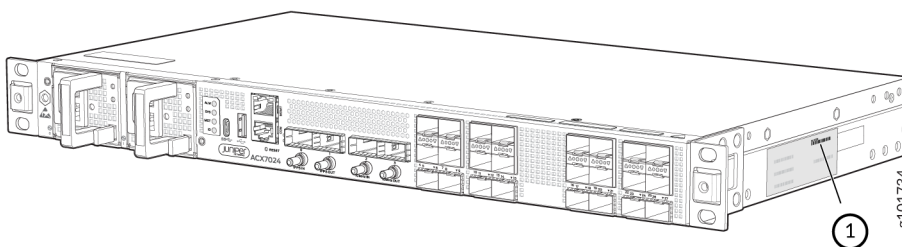

Locate the Serial Number ID Labels on an ACX7024 Power Supply Module

The power supply modules (PSMs) installed in ACX7024 and ACX7024X routers are field-replaceable units (FRUs). For each FRU, you must remove the FRU from the router chassis to see the FRU serial number ID label.

The serial number ID label for a DC PSM is on the top of the DC PSM. See [Figure 45 on page 116](#) .

Figure 45: ACX7024 and ACX7024X DC PSM Serial Number Location

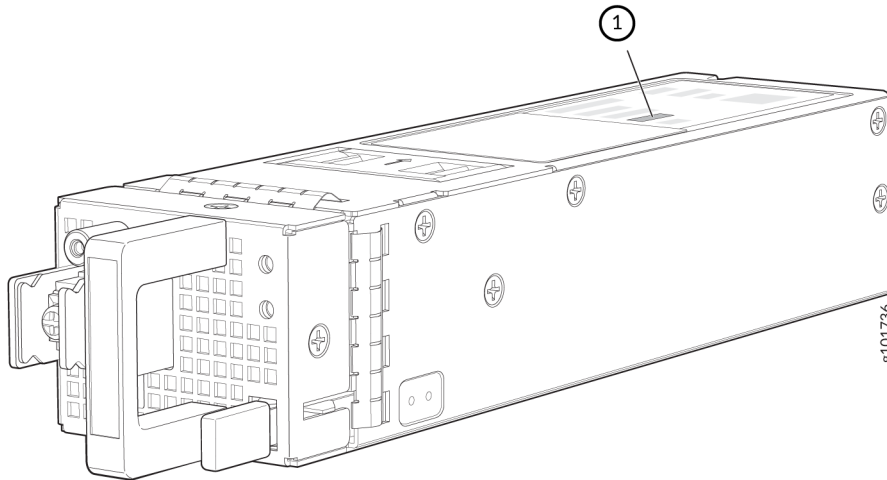

Guidelines for Packing Hardware Components for Shipment

To pack and ship individual components:

- When you return components, make sure that they are adequately protected with packing materials and packed so that the pieces are prevented from moving around inside the carton.
- Use the original shipping materials if they are available.
- Place individual components in antistatic bags.
- Write the RMA number on the exterior of the box to ensure proper tracking.



CAUTION: Do not stack any of the hardware components.



CHAPTER

Safety and Compliance Information

General Safety Guidelines and Warnings | 119

Definitions of Safety Warning Levels | 120

Qualified Personnel Warning | 122

Warning Statement for Norway and Sweden | 122

Fire Safety Requirements | 123

Installation Instructions Warning | 124

Chassis and Component Lifting Guidelines | 125

Restricted Access Warning | 125

Ramp Warning | 127

Rack-Mounting and Cabinet-Mounting Warnings | 127

Grounded Equipment Warning | 131

Radiation from Open Port Apertures Warning | 132

Laser and LED Safety Guidelines and Warnings | 133

Maintenance and Operational Safety Guidelines and Warnings | 136

General Electrical Safety Guidelines and Warnings | 142

Prevention of Electrostatic Discharge Damage | 143

Site Electrical Wiring Guidelines | 145

AC Power Electrical Safety Guidelines | 146

AC Power Disconnection Warning | 147

DC Power Disconnection Warning | 148

DC Power Grounding Requirements and Warning | 149

DC Power Wiring Sequence Warning | 150

DC Power Wiring Terminations Warning | 152

Multiple Power Supplies Disconnection Warning | 153

TN Power Warning | 154

Action to Take After an Electrical Accident | 154

Compliance Standards for ACX7024 Routers | 155

Compliance Standards for ACX7024X Routers | 158

Compliance Statements for NEBS | 160

Compliance Statements for EMC Requirements | 160

Compliance Statements for Environmental Requirements | 162

General Safety Guidelines and Warnings

The following guidelines help ensure your safety and protect the device from damage. The list of guidelines might not address all potentially hazardous situations in your working environment, so be alert and exercise good judgment at all times.

- Perform only the procedures explicitly described in the hardware documentation for this device. Make sure that only authorized service personnel perform other system services.
- Keep the area around the device clear and free from dust before, during, and after installation.
- Keep tools away from areas where people could trip over them while walking.
- Do not wear loose clothing or jewelry, such as rings, bracelets, or chains, which could become caught in the device.
- Wear safety glasses if you are working under any conditions that could be hazardous to your eyes.
- Do not perform any actions that create a potential hazard to people or make the equipment unsafe.
- Never attempt to lift an object that is too heavy for one person to handle.
- Never install or manipulate wiring during electrical storms.
- Never install electrical jacks in wet locations unless the jacks are specifically designed for wet environments.
- Operate the device only when it is properly grounded.
- Follow the instructions in this guide to properly ground the device to earth.
- Replace fuses only with fuses of the same type and rating.
- Do not open or remove chassis covers or sheet-metal parts unless instructions are provided in the hardware documentation for this device. Such an action could cause severe electrical shock.
- Do not push or force any objects through any opening in the chassis frame. Such an action could result in electrical shock or fire.
- Avoid spilling liquid onto the chassis or onto any device component. Such an action could cause electrical shock or damage the device.
- Avoid touching uninsulated electrical wires or terminals that have not been disconnected from their power source. Such an action could cause electrical shock.

- Some parts of the chassis, including AC and DC power supply surfaces, power supply unit handles, SFB card handles, and fan tray handles might become hot. The following label provides the warning for hot surfaces on the chassis:



- Always ensure that all modules, power supplies, and cover panels are fully inserted and that the installation screws are fully tightened.

Definitions of Safety Warning Levels

The documentation uses the following levels of safety warnings (there are two *Warning* formats):

NOTE: You might find this information helpful in a particular situation, or you might overlook this important information if it was not highlighted in a Note.



CAUTION: You need to observe the specified guidelines to prevent minor injury or discomfort to you or severe damage to the device.

Attention Veillez à respecter les consignes indiquées pour éviter toute incommodité ou blessure légère, voire des dégâts graves pour l'appareil.



LASER WARNING: This symbol alerts you to the risk of personal injury from a laser.

Avertissement Ce symbole signale un risque de blessure provoquée par rayon laser.



WARNING: This symbol means danger. You are in a situation that could cause bodily injury. Before you work on any equipment, be aware of the hazards involved with electrical circuitry, and familiarize yourself with standard practices for preventing accidents.

Waarschuwing Dit waarschuwingssymbool betekent gevaar. U verkeert in een situatie die lichamelijk letsel kan veroorzaken. Voordat u aan enige apparatuur gaat werken, dient u zich bewust te zijn van de bij elektrische schakelingen betrokken risico's en dient u op de hoogte te zijn van standaard maatregelen om ongelukken te voorkomen.

Varoitus Tämä varoitusmerkki merkitsee vaaraa. Olet tilanteessa, joka voi johtaa ruumiinvammaan. Ennen kuin työskentelet minkään laitteiston parissa, ota selvää sähkökytkentöihin liittyvistä vaaroista ja tavanomaisista onnettomuuksien ehkäisykeinoista.

Avertissement Ce symbole d'avertissement indique un danger. Vous vous trouvez dans une situation pouvant causer des blessures ou des dommages corporels. Avant de travailler sur un équipement, soyez conscient des dangers posés par les circuits électriques et familiarisez-vous avec les procédures couramment utilisées pour éviter les accidents.

Warnung Dieses Warnsymbol bedeutet Gefahr. Sie befinden sich in einer Situation, die zu einer Körperverletzung führen könnte. Bevor Sie mit der Arbeit an irgendeinem Gerät beginnen, seien Sie sich der mit elektrischen Stromkreisen verbundenen Gefahren und der Standardpraktiken zur Vermeidung von Unfällen bewusst.

Avvertenza Questo simbolo di avvertenza indica un pericolo. La situazione potrebbe causare infortuni alle persone. Prima di lavorare su qualsiasi apparecchiatura, occorre conoscere i pericoli relativi ai circuiti elettrici ed essere al corrente delle pratiche standard per la prevenzione di incidenti.

Advarsel Dette varselsymbolet betyr fare. Du befinner deg i en situasjon som kan føre til personskade. Før du utfører arbeid på utstyr, må du være oppmerksom på de faremomentene som elektriske kretser innebærer, samt gjøre deg kjent med vanlig praksis når det gjelder å unngå ulykker.

Aviso Este símbolo de aviso indica perigo. Encontra-se numa situação que lhe poderá causar danos físicos. Antes de começar a trabalhar com qualquer equipamento, familiarize-se com os perigos relacionados com circuitos eléctricos, e com quaisquer práticas comuns que possam prevenir possíveis acidentes.

¡Atención! Este símbolo de aviso significa peligro. Existe riesgo para su integridad física. Antes de manipular cualquier equipo, considerar los riesgos que entraña la corriente eléctrica y familiarizarse con los procedimientos estándar de prevención de accidentes.

Varning! Denna varningssymbol signalerar fara. Du befinner dig i en situation som kan leda till personskada. Innan du utför arbete på någon utrustning måste du vara medveten om farorna med elkretsar och känna till vanligt förfarande för att förebygga skador.

Qualified Personnel Warning



WARNING: Only trained and qualified personnel should install or replace the device.

Waarschuwing Installatie en reparaties mogen uitsluitend door getraind en bevoegd personeel uitgevoerd worden.

Varoitus Ainoastaan koulutettu ja pätevä henkilökunta saa asentaa tai vaihtaa tämän laitteen.

Avertissement Tout installation ou remplacement de l'appareil doit être réalisé par du personnel qualifié et compétent.

Warnung Gerät nur von geschultem, qualifiziertem Personal installieren oder auswechseln lassen.

Avvertenza Solo personale addestrato e qualificato deve essere autorizzato ad installare o sostituire questo apparecchio.

Advarsel Kun kvalifisert personell med riktig opplæring bør montere eller bytte ut dette utstyret.

Aviso Este equipamento deverá ser instalado ou substituído apenas por pessoal devidamente treinado e qualificado.

¡Atención! Estos equipos deben ser instalados y reemplazados exclusivamente por personal técnico adecuadamente preparado y capacitado.

Varning! Denna utrustning ska endast installeras och bytas ut av utbildad och kvalificerad personal.

Warning Statement for Norway and Sweden



WARNING: The equipment must be connected to an earthed mains socket-outlet.

Advarsel Apparatet skal kobles til en jordet stikkontakt.

Varning! Apparaten skall anslutas till jordat nätuttag.

Fire Safety Requirements

IN THIS SECTION

- [Fire Suppression | 123](#)
- [Fire Suppression Equipment | 123](#)

In the event of a fire emergency, the safety of people is the primary concern. You should establish procedures for protecting people in the event of a fire emergency, provide safety training, and properly provision fire-control equipment and fire extinguishers.

In addition, you should establish procedures to protect your equipment in the event of a fire emergency. Juniper Networks products should be installed in an environment suitable for electronic equipment. We recommend that fire suppression equipment be available in the event of a fire in the vicinity of the equipment and that all local fire, safety, and electrical codes and ordinances be observed when you install and operate your equipment.

Fire Suppression

In the event of an electrical hazard or an electrical fire, you should first turn power off to the equipment at the source. Then use a Type C fire extinguisher, which uses noncorrosive fire retardants, to extinguish the fire.

Fire Suppression Equipment

Type C fire extinguishers, which use noncorrosive fire retardants such as carbon dioxide and Halotron™, are most effective for suppressing electrical fires. Type C fire extinguishers displace oxygen from the point of combustion to eliminate the fire. For extinguishing fire on or around equipment that draws air from the environment for cooling, you should use this type of inert oxygen displacement extinguisher instead of an extinguisher that leaves residues on equipment.

Do not use multipurpose Type ABC chemical fire extinguishers (dry chemical fire extinguishers). The primary ingredient in these fire extinguishers is monoammonium phosphate, which is very sticky and

difficult to clean. In addition, in the presence of minute amounts of moisture, monoammonium phosphate can become highly corrosive and corrodes most metals.

Any equipment in a room in which a chemical fire extinguisher has been discharged is subject to premature failure and unreliable operation. The equipment is considered to be irreparably damaged.

NOTE: To keep warranties effective, do not use a dry chemical fire extinguisher to control a fire at or near a Juniper Networks device. If a dry chemical fire extinguisher is used, the unit is no longer eligible for coverage under a service agreement.

We recommend that you dispose of any irreparably damaged equipment in an environmentally responsible manner.

Installation Instructions Warning



WARNING: Read the installation instructions before you connect the device to a power source.

Waarschuwing Raadpleeg de installatie-aanwijzingen voordat u het systeem met de voeding verbindt.

Varoitus Lue asennusohjeet ennen järjestelmän yhdistämistä virtälähteeseen.

Avertissement Avant de brancher le système sur la source d'alimentation, consulter les directives d'installation.

Warnung Lesen Sie die Installationsanweisungen, bevor Sie das System an die Stromquelle anschließen.

Avvertenza Consultare le istruzioni di installazione prima di collegare il sistema all'alimentatore.

Advarsel Les installasjonsinstruksjonene før systemet kobles til strømkilden.

Aviso Leia as instruções de instalação antes de ligar o sistema à sua fonte de energia.

¡Atención! Ver las instrucciones de instalación antes de conectar el sistema a la red de alimentación.

Varning! Läs installationsanvisningarna innan du kopplar systemet till dess strömförsörjningsenhet.

Chassis and Component Lifting Guidelines

- Before moving the device to a site, ensure that the site meets the power, environmental, and clearance requirements.
- Before lifting or moving the device, disconnect all external cables and wires.
- As when lifting any heavy object, ensure that your legs bear most of the weight rather than your back. Keep your knees bent and your back relatively straight. Do not twist your body as you lift. Balance the load evenly and be sure that your footing is firm.
- Use the following lifting guidelines to lift devices and components:
 - Up to 39.7 lb (18 kg): One person.
 - From 39.7 lb (18 kg) to 70.5 lb (32 kg): Two or more people.
 - From 70.5 lb (32 kg) to 121.2 lb (55 kg): Three or more people.
 - Above 121.2 lb (55 kg): Use material handling systems (such as levers, slings, lifts, and so on). When this is not practical, engage specially trained persons or systems (such as riggers or movers).

Restricted Access Warning



WARNING: This unit is intended for installation in restricted access areas. A restricted access area is an area to which access can be gained only by service personnel through the use of a special tool, lock and key, or other means of security, and which is controlled by the authority responsible for the location.

Waarschuwing Dit toestel is bedoeld voor installatie op plaatsen met beperkte toegang. Een plaats met beperkte toegang is een plaats waar toegang slechts door servicepersoneel verkregen kan worden door middel van een speciaal instrument, een slot en sleutel, of een ander veiligheidsmiddel, en welke beheerd wordt door de overheidsinstantie die verantwoordelijk is voor de locatie.

Varoitus Tämä laite on tarkoitettu asennettavaksi paikkaan, johon pääsy on rajoitettua. Paikka, johon pääsy on rajoitettua, tarkoittaa paikkaa, johon vain huoltohenkilöstö pääsee jonkin erikoistyökalun, lukkoon sopivan avaimen tai jonkin muun turvalaitteen avulla ja joka on paikasta vastuussa olevien toimivaltaisten henkilöiden valvoma.

Avertissement Cet appareil est à installer dans des zones d'accès réservé. Ces dernières sont des zones auxquelles seul le personnel de service peut accéder en utilisant un outil spécial, un mécanisme de verrouillage et une clé, ou tout autre moyen de sécurité. L'accès aux zones de sécurité est sous le contrôle de l'autorité responsable de l'emplacement.

Warnung Diese Einheit ist zur Installation in Bereichen mit beschränktem Zutritt vorgesehen. Ein Bereich mit beschränktem Zutritt ist ein Bereich, zu dem nur Wartungspersonal mit einem Spezialwerkzeug, Schloß und Schlüssel oder anderer Sicherheitsvorkehrungen Zugang hat, und der von dem für die Anlage zuständigen Gremium kontrolliert wird.

Avvertenza Questa unità deve essere installata in un'area ad accesso limitato. Un'area ad accesso limitato è un'area accessibile solo a personale di assistenza tramite un'attrezzo speciale, lucchetto, o altri dispositivi di sicurezza, ed è controllata dall'autorità responsabile della zona.

Advarsel Denne enheten er laget for installasjon i områder med begrenset adgang. Et område med begrenset adgang gir kun adgang til servicepersonale som bruker et spesielt verktøy, lås og nøkkel, eller en annen sikkerhetsanordning, og det kontrolleres av den autoriteten som er ansvarlig for området.

Aviso Esta unidade foi concebida para instalação em áreas de acesso restrito. Uma área de acesso restrito é uma área à qual apenas tem acesso o pessoal de serviço autorizado, que possua uma ferramenta, chave e fechadura especial, ou qualquer outra forma de segurança. Esta área é controlada pela autoridade responsável pelo local.

¡Atención! Esta unidad ha sido diseñada para instalarse en áreas de acceso restringido. Área de acceso restringido significa un área a la que solamente tiene acceso el personal de servicio mediante la utilización de una herramienta especial, cerradura con llave, o algún otro medio de seguridad, y que está bajo el control de la autoridad responsable del local.

Warning! Denna enhet är avsedd för installation i områden med begränsat tillträde. Ett område med begränsat tillträde får endast tillträdas av servicepersonal med ett speciellt verktyg, lås och nyckel, eller annan säkerhetsanordning, och kontrolleras av den auktoritet som ansvarar för området.

Ramp Warning



WARNING: When installing the device, do not use a ramp inclined at more than 10 degrees.

Waarschuwing Gebruik een oprijplaat niet onder een hoek van meer dan 10 graden.

Varoitus Älä käytä sellaista kaltevaa pintaa, jonka kaltevuus ylittää 10 astetta.

Avertissement Ne pas utiliser une rampe dont l'inclinaison est supérieure à 10 degrés.

Warnung Keine Rampen mit einer Neigung von mehr als 10 Grad verwenden.

Avvertenza Non usare una rampa con pendenza superiore a 10 gradi.

Advarsel Bruk aldri en rampe som heller mer enn 10 grader.

Aviso Não utilize uma rampa com uma inclinação superior a 10 graus.

¡Atención! No usar una rampa inclinada más de 10 grados.

Varning! Använd inte ramp med en lutning på mer än 10 grader.

Rack-Mounting and Cabinet-Mounting Warnings

Ensure that the rack or cabinet in which the device is installed is evenly and securely supported. Uneven mechanical loading could lead to a hazardous condition.



WARNING: To prevent bodily injury when mounting or servicing the device in a rack, take the following precautions to ensure that the system remains stable. The following directives help maintain your safety:

- Install the device in a rack that is secured to the building structure.
- Mount the device at the bottom of the rack if it is the only unit in the rack.
- When mounting the device on a partially filled rack, load the rack from the bottom to the top, with the heaviest component at the bottom of the rack.

- If the rack is provided with stabilizing equipment, install the stabilizers before mounting or servicing the device in the rack.

Waarschuwing Om lichamelijk letsel te voorkomen wanneer u dit toestel in een rek monteert of het daar een servicebeurt geeft, moet u speciale voorzorgsmaatregelen nemen om ervoor te zorgen dat het toestel stabiel blijft. De onderstaande richtlijnen worden verstrekt om uw veiligheid te verzekeren:

- De Juniper Networks switch moet in een stellage worden geïnstalleerd die aan een bouwsel is verankerd.
- Dit toestel dient onderaan in het rek gemonteerd te worden als het toestel het enige in het rek is.
- Wanneer u dit toestel in een gedeeltelijk gevuld rek monteert, dient u het rek van onderen naar boven te laden met het zwaarste onderdeel onderaan in het rek.
- Als het rek voorzien is van stabiliseringshulpmiddelen, dient u de stabilisatoren te monteren voordat u het toestel in het rek monteert of het daar een servicebeurt geeft.

Varoitus Kun laite asetetaan telineeseen tai huolletaan sen ollessa telineessä, on noudatettava erityisiä varotoimia järjestelmän vakavuuden säilyttämiseksi, jotta vältetään loukkaantumiselta. Noudata seuraavia turvallisuusohjeita:

- Juniper Networks switch on asennettava telineeseen, joka on kiinnitetty rakennukseen.
- Jos telineessä ei ole muita laitteita, aseta laite telineen alaosaan.
- Jos laite asetetaan osaksi täytettyyn telineeseen, aloita kuormittaminen sen alaosasta kaikkein raskaimmalla esineellä ja siirry sitten sen yläosaan.
- Jos telinettä varten on vakaimet, asenna ne ennen laitteen asettamista telineeseen tai sen huoltamista siinä.

Avertissement Pour éviter toute blessure corporelle pendant les opérations de montage ou de réparation de cette unité en casier, il convient de prendre des précautions spéciales afin de maintenir la stabilité du système. Les directives ci-dessous sont destinées à assurer la protection du personnel:

- Le rack sur lequel est monté le Juniper Networks switch doit être fixé à la structure du bâtiment.

- Si cette unité constitue la seule unité montée en casier, elle doit être placée dans le bas.
- Si cette unité est montée dans un casier partiellement rempli, charger le casier de bas en haut en plaçant l'élément le plus lourd dans le bas.
- Si le casier est équipé de dispositifs stabilisateurs, installer les stabilisateurs avant de monter ou de réparer l'unité en casier.

Warnung Zur Vermeidung von Körperverletzung beim Anbringen oder Warten dieser Einheit in einem Gestell müssen Sie besondere Vorkehrungen treffen, um sicherzustellen, daß das System stabil bleibt. Die folgenden Richtlinien sollen zur Gewährleistung Ihrer Sicherheit dienen:

- Der Juniper Networks switch muß in einem Gestell installiert werden, das in der Gebäudestruktur verankert ist.
- Wenn diese Einheit die einzige im Gestell ist, sollte sie unten im Gestell angebracht werden.
- Bei Anbringung dieser Einheit in einem zum Teil gefüllten Gestell ist das Gestell von unten nach oben zu laden, wobei das schwerste Bauteil unten im Gestell anzubringen ist.
- Wird das Gestell mit Stabilisierungszubehör geliefert, sind zuerst die Stabilisatoren zu installieren, bevor Sie die Einheit im Gestell anbringen oder sie warten.

Avvertenza Per evitare infortuni fisici durante il montaggio o la manutenzione di questa unità in un supporto, occorre osservare speciali precauzioni per garantire che il sistema rimanga stabile. Le seguenti direttive vengono fornite per garantire la sicurezza personale:

- Il Juniper Networks switch deve essere installato in un telaio, il quale deve essere fissato alla struttura dell'edificio.
- Questa unità deve venire montata sul fondo del supporto, se si tratta dell'unica unità da montare nel supporto.
- Quando questa unità viene montata in un supporto parzialmente pieno, caricare il supporto dal basso all'alto, con il componente più pesante sistemato sul fondo del supporto.
- Se il supporto è dotato di dispositivi stabilizzanti, installare tali dispositivi prima di montare o di procedere alla manutenzione dell'unità nel supporto.

Advarsel Unngå fysiske skader under montering eller reparasjonsarbeid på denne enheten når den befinner seg i et kabinett. Vær nøye med at systemet er stabilt. Følgende retningslinjer er gitt for å verne om sikkerheten:

- Juniper Networks switch må installeres i et stativ som er forankret til bygningsstrukturen.
- Denne enheten bør monteres nederst i kabinettet hvis dette er den eneste enheten i kabinettet.
- Ved montering av denne enheten i et kabinett som er delvis fylt, skal kabinettet lastes fra bunnen og opp med den tyngste komponenten nederst i kabinettet.
- Hvis kabinettet er utstyrt med stabiliseringsutstyr, skal stabilisatorene installeres før montering eller utføring av reparasjonsarbeid på enheten i kabinettet.

Aviso Para se prevenir contra danos corporais ao montar ou reparar esta unidade numa estante, deverá tomar precauções especiais para se certificar de que o sistema possui um suporte estável. As seguintes directrizes ajudá-lo-ão a efectuar o seu trabalho com segurança:

- O Juniper Networks switch deverá ser instalado numa prateleira fixa à estrutura do edifício.
- Esta unidade deverá ser montada na parte inferior da estante, caso seja esta a única unidade a ser montada.
- Ao montar esta unidade numa estante parcialmente ocupada, coloque os itens mais pesados na parte inferior da estante, arrumando-os de baixo para cima.
- Se a estante possuir um dispositivo de estabilização, instale-o antes de montar ou reparar a unidade.

¡Atención! Para evitar lesiones durante el montaje de este equipo sobre un bastidor, oerriormente durante su mantenimiento, se debe poner mucho cuidado en que el sistema quede bien estable. Para garantizar su seguridad, proceda según las siguientes instrucciones:

- El Juniper Networks switch debe instalarse en un bastidor fijado a la estructura del edificio.
- Colocar el equipo en la parte inferior del bastidor, cuando sea la única unidad en el mismo.

- Cuando este equipo se vaya a instalar en un bastidor parcialmente ocupado, comenzar la instalación desde la parte inferior hacia la superior colocando el equipo más pesado en la parte inferior.
- Si el bastidor dispone de dispositivos estabilizadores, instalar éstos antes de montar o proceder al mantenimiento del equipo instalado en el bastidor.

Warning! För att undvika kroppsskada när du installerar eller utför underhållsarbete på denna enhet på en ställning måste du vidta särskilda försiktighetsåtgärder för att försäkra dig om att systemet står stadigt. Följande riktlinjer ges för att trygga din säkerhet:

- Juniper Networks switch måste installeras i en ställning som är förankrad i byggnadens struktur.
- Om denna enhet är den enda enheten på ställningen skall den installeras längst ned på ställningen.
- Om denna enhet installeras på en delvis fylld ställning skall ställningen fyllas nedifrån och upp, med de tyngsta enheterna längst ned på ställningen.
- Om ställningen är försedd med stabiliseringsdon skall dessa monteras fast innan enheten installeras eller underhålls på ställningen.

Grounded Equipment Warning



WARNING: This device must be properly grounded at all times. Follow the instructions in this guide to properly ground the device to earth.

Waarschuwing Dit apparaat moet altijd goed geaard zijn. Volg de instructies in deze gids om het apparaat goed te aarden.

Varoitus Laitteen on oltava pysyvästi maadoitettu. Maadoita laite asianmukaisesti noudattamalla tämän oppaan ohjeita.

Avertissement L'appareil doit être correctement mis à la terre à tout moment. Suivez les instructions de ce guide pour correctement mettre l'appareil à la terre.

Warnung Das Gerät muss immer ordnungsgemäß geerdet sein. Befolgen Sie die Anweisungen in dieser Anleitung, um das Gerät ordnungsgemäß zu erden.

Avvertenza Questo dispositivo deve sempre disporre di una connessione a massa. Seguire le istruzioni indicate in questa guida per connettere correttamente il dispositivo a massa.

Advarsel Denne enheten på jordes skikkelig hele tiden. Følg instruksjonene i denne veiledningen for å jorde enheten.

Aviso Este equipamento deverá estar ligado à terra. Siga las instrucciones en esta guía para conectar correctamente este dispositivo a tierra.

¡Atención! Este dispositivo debe estar correctamente conectado a tierra en todo momento. Siga las instrucciones en esta guía para conectar correctamente este dispositivo a tierra.

Varning! Den här enheten måste vara ordentligt jordad. Följ instruktionerna i den här guiden för att jorda enheten ordentligt.

Radiation from Open Port Apertures Warning



LASER WARNING: Because invisible radiation might be emitted from the aperture of the port when no fiber cable is connected, avoid exposure to radiation and do not stare into open apertures.

Waarschuwing Aangezien onzichtbare straling vanuit de opening van de poort kan komen als er geen fiberkabel aangesloten is, dient blootstelling aan straling en het kijken in open openingen vermeden te worden.

Varoitus Koska portin aukosta voi emittoitua näkymätöntä säteilyä, kun kuitukaapelia ei ole kytkettyä, vältä säteilylle altistumista äläkä katso avoimiin aukkoihin.

Avertissement Des radiations invisibles à l'il nu pouvant traverser l'ouverture du port lorsqu'aucun câble en fibre optique n'y est connecté, il est recommandé de ne pas regarder fixement l'intérieur de ces ouvertures.

Warnung Aus der Port-Öffnung können unsichtbare Strahlen emittieren, wenn kein Glasfaserkabel angeschlossen ist. Vermeiden Sie es, sich den Strahlungen auszusetzen, und starren Sie nicht in die Öffnungen!

Avvertenza Quando i cavi in fibra non sono inseriti, radiazioni invisibili possono essere emesse attraverso l'apertura della porta. Evitate di esporvi alle radiazioni e non guardate direttamente nelle aperture.

Advarsel Unngå utsettelse for stråling, og stirr ikke inn i åpninger som er åpne, fordi usynlig stråling kan emitteres fra portens åpning når det ikke er tilkoblet en fiberkabel.

Aviso Dada a possibilidade de emissão de radiação invisível através do orifício da via de acesso, quando esta não tiver nenhum cabo de fibra conectado, deverá evitar a EXposição à radiação e não deverá olhar fixamente para orifícios que se encontrarem a descoberto.

¡Atención! Debido a que la apertura del puerto puede emitir radiación invisible cuando no existe un cable de fibra conectado, evite mirar directamente a las aperturas para no exponerse a la radiación.

Varning! Osynlig strålning kan avges från en portöppning utan ansluten fiberkabel och du bör därför undvika att bli utsatt för strålning genom att inte stirra in i oskyddade öppningar.

Laser and LED Safety Guidelines and Warnings

IN THIS SECTION

- [General Laser Safety Guidelines | 134](#)
- [Class 1 Laser Product Warning | 134](#)
- [Class 1 LED Product Warning | 135](#)
- [Laser Beam Warning | 135](#)

Juniper Networks devices are equipped with laser transmitters, which are considered a Class 1 Laser Product by the U.S. Food and Drug Administration and are evaluated as a Class 1 Laser Product per IEC/EN 60825-1 requirements.

Observe the following guidelines and warnings:

General Laser Safety Guidelines

When working around ports that support optical transceivers, observe the following safety guidelines to prevent eye injury:

- Do not look into unterminated ports or at fibers that connect to unknown sources.
- Do not examine unterminated optical ports with optical instruments.
- Avoid direct exposure to the beam.



LASER WARNING: Unterminated optical connectors can emit invisible laser radiation. The lens in the human eye focuses all the laser power on the retina, so focusing the eye directly on a laser source—even a low-power laser—could permanently damage the eye.

Avertissement Les connecteurs à fibre optique sans terminaison peuvent émettre un rayonnement laser invisible. Le cristallin de l'œil humain faisant converger toute la puissance du laser sur la rétine, toute focalisation directe de l'œil sur une source laser, —même de faible puissance—, peut entraîner des lésions oculaires irréversibles.

Class 1 Laser Product Warning



LASER WARNING: Class 1 laser product.

Waarschuwing Klasse-1 laser produkt.

Varoitus Luokan 1 lasertuote.

Avertissement Produit laser de classe I.

Warnung Laserprodukt der Klasse 1.

Avvertenza Prodotto laser di Classe 1.

Advarsel Laserprodukt av klasse 1.

Aviso Produto laser de classe 1.

¡Atención! Producto láser Clase I.

Varning! Laserprodukt av klass 1.

Class 1 LED Product Warning



LASER WARNING: Class 1 LED product.

Waarschuwing Klasse 1 LED-product.

Varoitus Luokan 1 valodiodituote.

Avertissement Alarme de produit LED Class I.

Warnung Class 1 LED-Produktwarnung.

Avvertenza Avvertenza prodotto LED di Classe 1.

Advarel LED-produkt i klasse 1.

Aviso Produto de classe 1 com LED.

¡Atención! Aviso sobre producto LED de Clase 1.

Varning! Lysdiodprodukt av klass 1.

Laser Beam Warning



LASER WARNING: Do not stare into the laser beam or view it directly with optical instruments.

Waarschuwing Niet in de straal staren of hem rechtstreeks bekijken met optische instrumenten.

Varoitus Älä katso säteeseen äläkä tarkastele sitä suoraan optisen laitteen avulla.

Avertissement Ne pas fixer le faisceau des yeux, ni l'observer directement à l'aide d'instruments optiques.

Warnung Nicht direkt in den Strahl blicken und ihn nicht direkt mit optischen Geräten prüfen.

Avvertenza Non fissare il raggio con gli occhi né usare strumenti ottici per osservarlo direttamente.

Advarel Stirr eller se ikke direkte p strlen med optiske instrumenter.

Aviso Não olhe fixamente para o raio, nem olhe para ele directamente com instrumentos ópticos.

¡Atención! No mirar fijamente el haz ni observarlo directamente con instrumentos ópticos.

Warning! Rikta inte blicken in mot strålen och titta inte direkt på den genom optiska instrument.

Maintenance and Operational Safety Guidelines and Warnings

IN THIS SECTION

- [Battery Handling Warning | 136](#)
- [Jewelry Removal Warning | 137](#)
- [Lightning Activity Warning | 139](#)
- [Operating Temperature Warning | 140](#)
- [Product Disposal Warning | 141](#)

While performing the maintenance activities for devices, observe the following guidelines and warnings:

Battery Handling Warning



WARNING: Replacing a battery incorrectly might result in an explosion. Replace a battery only with the same or equivalent type recommended by the manufacturer. Dispose of used batteries according to the manufacturer's instructions.

Waarschuwing Er is ontploffingsgevaar als de batterij verkeerd vervangen wordt. Vervang de batterij slechts met hetzelfde of een equivalent type dat door de fabrikant

aanbevolen is. Gebruikte batterijen dienen overeenkomstig fabrieksvoorschriften weggeworpen te worden.

Varoitus Räjähdyksen vaara, jos akku on vaihdettu väärään akkuun. Käytä vaihtamiseen ainoastaan saman- tai vastaavantyyppistä akkua, joka on valmistajan suosittama. Hävitä käytetyt akut valmistajan ohjeiden mukaan.

Avertissement Danger d'explosion si la pile n'est pas remplacée correctement. Ne la remplacer que par une pile de type semblable ou équivalent, recommandée par le fabricant. Jeter les piles usagées conformément aux instructions du fabricant.

Warnung Bei Einsetzen einer falschen Batterie besteht Explosionsgefahr. Ersetzen Sie die Batterie nur durch den gleichen oder vom Hersteller empfohlenen Batterietyp. Entsorgen Sie die benutzten Batterien nach den Anweisungen des Herstellers.

Advarsel Det kan være fare for eksplosjon hvis batteriet skiftes på feil måte. Skift kun med samme eller tilsvarende type som er anbefalt av produsenten. Kasser brukte batterier i henhold til produsentens instruksjoner.

Avvertenza Pericolo di esplosione se la batteria non è installata correttamente. Sostituire solo con una di tipo uguale o equivalente, consigliata dal produttore. Eliminare le batterie usate secondo le istruzioni del produttore.

Aviso Existe perigo de explosão se a bateria for substituída incorrectamente. Substitua a bateria por uma bateria igual ou de um tipo equivalente recomendado pelo fabricante. Destrua as baterias usadas conforme as instruções do fabricante.

¡Atención! Existe peligro de explosión si la batería se reemplaza de manera incorrecta. Reemplazar la batería EXclusivamente con el mismo tipo o el equivalente recomendado por el fabricante. Desechar las baterías gastadas según las instrucciones del fabricante.

Varning! Explosionsfara vid felaktigt batteribyte. Ersätt endast batteriet med samma batterityp som rekommenderas av tillverkaren eller motsvarande. Följ tillverkarens anvisningar vid kassering av använda batterier.

Jewelry Removal Warning



WARNING: Before working on equipment that is connected to power lines, remove jewelry, including rings, necklaces, and watches. Metal objects heat up when connected to power and ground and can cause serious burns or can be welded to the terminals.

Waarschuwing Alvorens aan apparatuur te werken die met elektrische leidingen is verbonden, sieraden (inclusief ringen, kettingen en horloges) verwijderen. Metalen voorwerpen worden warm wanneer ze met stroom en aarde zijn verbonden, en kunnen ernstige brandwonden veroorzaken of het metalen voorwerp aan de aansluitklemmen lassen.

Varoitus Ennen kuin työskentelet voimavirtajohtoihin kytkettyjen laitteiden parissa, ota pois kaikki korut (sormukset, kaulakorut ja kellot mukaan lukien). Metalliesineet kuumenevat, kun ne ovat yhteydessä sähkövirran ja maan kanssa, ja ne voivat aiheuttaa vakavia palovammoja tai hitsata metalliesineet kiinni liitännänapoihin.

Avertissement Avant d'accéder à cet équipement connecté aux lignes électriques, ôter tout bijou (anneaux, colliers et montres compris). Lorsqu'ils sont branchés à l'alimentation et reliés à la terre, les objets métalliques chauffent, ce qui peut provoquer des blessures graves ou souder l'objet métallique aux bornes.

Warnung Vor der Arbeit an Geräten, die an das Netz angeschlossen sind, jeglichen Schmuck (einschließlich Ringe, Ketten und Uhren) abnehmen. Metallgegenstände erhitzen sich, wenn sie an das Netz und die Erde angeschlossen werden, und können schwere Verbrennungen verursachen oder an die Anschlußklemmen angeschweißt werden.

Avvertenza Prima di intervenire su apparecchiature collegate alle linee di alimentazione, togliersi qualsiasi monile (inclusi anelli, collane, braccialetti ed orologi). Gli oggetti metallici si riscaldano quando sono collegati tra punti di alimentazione e massa: possono causare ustioni gravi oppure il metallo può saldarsi ai terminali.

Advarsel Fjern alle smykker (inkludert ringer, halskjeder og klokker) før du skal arbeide på utstyr som er koblet til kraftledninger. Metallgjenstander som er koblet til kraftledninger og jord blir svært varme og kan forårsake alvorlige brannskader eller smelte fast til polene.

Aviso Antes de trabalhar em equipamento que esteja ligado a linhas de corrente, retire todas as jóias que estiver a usar (incluindo anéis, fios e relógios). Os objectos metálicos aquecerão em contacto com a corrente e em contacto com a ligação à terra, podendo causar queimaduras graves ou ficarem soldados aos terminais.

¡Atención! Antes de operar sobre equipos conectados a líneas de alimentación, quitarse las joyas (incluidos anillos, collares y relojes). Los objetos de metal se calientan cuando se conectan a la alimentación y a tierra, lo que puede ocasionar quemaduras graves o que los objetos metálicos queden soldados a los bornes.

Warning! Tag av alla smycken (inklusive ringar, halsband och armbandsur) innan du arbetar på utrustning som är kopplad till kraftledning. Metallobjekt hettas upp när de kopplas ihop med ström och jord och kan förorsaka allvarliga brännskador; metallobjekt kan också sammansvetsas med kontakterna.

Lightning Activity Warning



WARNING: Do not work on the system or connect or disconnect cables during periods of lightning activity.

Waarschuwing Tijdens onweer dat gepaard gaat met bliksem, dient u niet aan het systeem te werken of kabels aan te sluiten of te ontkoppelen.

Varoitus Älä työskentele järjestelmän parissa äläkä yhdistä tai irrota kaapeleita ukkosilmalla.

Avertissement Ne pas travailler sur le système ni brancher ou débrancher les câbles pendant un orage.

Warnung Arbeiten Sie nicht am System und schließen Sie keine Kabel an bzw. trennen Sie keine ab, wenn es gewittert.

Avvertenza Non lavorare sul sistema o collegare oppure scollegare i cavi durante un temporale con fulmini.

Advarsel Utfør aldri arbeid på systemet, eller koble kabler til eller fra systemet når det tordner eller lyner.

Aviso Não trabalhe no sistema ou ligue e desligue cabos durante períodos de mau tempo (trovoada).

¡Atención! No operar el sistema ni conectar o desconectar cables durante el transcurso de descargas eléctricas en la atmósfera.

Warning! Vid åska skall du aldrig utföra arbete på systemet eller ansluta eller koppla loss kablar.

Operating Temperature Warning



WARNING: To prevent the device from overheating, do not operate it in an area that exceeds the maximum recommended ambient temperature. To prevent airflow restriction, allow at least 6 in. (15.2 cm) of clearance around the ventilation openings.

Waarschuwing Om te voorkomen dat welke switch van de Juniper Networks router dan ook oververhit raakt, dient u deze niet te bedienen op een plaats waar de maximale aanbevolen omgevingstemperatuur van 40° C wordt overschreden. Om te voorkomen dat de luchtstroom wordt beperkt, dient er minstens 15,2 cm speling rond de ventilatie-openingen te zijn.

Varoitus Ettei Juniper Networks switch-sarjan reititin ylikuumentuisi, sitä ei saa käyttää tilassa, jonka lämpötila ylittää korkeimman suositellun ympäristölämpötilan 40° C. Ettei ilmanvaihto estyisi, tuuletusaukkojen ympärille on jätettävä ainakin 15,2 cm tilaa.

Avertissement Pour éviter toute surchauffe des routeurs de la gamme Juniper Networks switch, ne l'utilisez pas dans une zone où la température ambiante est supérieure à 40° C. Pour permettre un flot d'air constant, dégagez un espace d'au moins 15,2 cm autour des ouvertures de ventilations.

Warnung Um einen Router der switch vor Überhitzung zu schützen, darf dieser nicht in einer Gegend betrieben werden, in der die Umgebungstemperatur das empfohlene Maximum von 40° C überschreitet. Um Lüftungsverschluß zu verhindern, achten Sie darauf, daß mindestens 15,2 cm lichter Raum um die Lüftungsöffnungen herum frei bleibt.

Avvertenza Per evitare il surriscaldamento dei switch, non adoperateli in un locale che ecceda la temperatura ambientale massima di 40° C. Per evitare che la circolazione dell'aria sia impedita, lasciate uno spazio di almeno 15.2 cm di fronte alle aperture delle ventole.

Advarsel Unngå overoppheting av eventuelle rutere i Juniper Networks switch Disse skal ikke brukes på steder der den anbefalte maksimale omgivelsestemperaturen overstiger 40° C (104° F). Sørg for at klaringen rundt lufteåpningene er minst 15,2 cm (6 tommer) for å forhindre nedsatt luftsirkulasjon.

Aviso Para evitar o sobreaquecimento do encaminhador Juniper Networks switch, não utilize este equipamento numa área que exceda a temperatura máxima recomendada de 40° C. Para evitar a restrição à circulação de ar, deixe pelo menos um espaço de 15,2 cm à volta das aberturas de ventilação.

¡Atención! Para impedir que un encaminador de la serie Juniper Networks switch se recaliente, no lo haga funcionar en un área en la que se supere la temperatura ambiente máxima recomendada de 40° C. Para impedir la restricción de la entrada de aire, deje un espacio mínimo de 15,2 cm alrededor de las aperturas para ventilación.

Warning! Förhindra att en Juniper Networks switch överhettas genom att inte använda den i ett område där den maximalt rekommenderade omgivningstemperaturen på 40° C överskrids. Förhindra att luftcirkulationen inskränks genom att se till att det finns fritt utrymme på minst 15,2 cm omkring ventilationsöppningarna.

Product Disposal Warning



WARNING: Disposal of this device must be handled according to all national laws and regulations.

Waarschuwing Dit produkt dient volgens alle landelijke wetten en voorschriften te worden afgedankt.

Varoitus Tämän tuotteen lopullisesta hävittämisestä tulee huolehtia kaikkia valtakunnallisia lakeja ja säännöksiä noudattaen.

Avertissement La mise au rebut définitive de ce produit doit être effectuée conformément à toutes les lois et réglementations en vigueur.

Warnung Dieses Produkt muß den geltenden Gesetzen und Vorschriften entsprechend entsorgt werden.

Avvertenza L'eliminazione finale di questo prodotto deve essere eseguita osservando le normative italiane vigenti in materia

Advarsel Endelig disponering av dette produktet må skje i henhold til nasjonale lover og forskrifter.

Aviso A descartagem final deste produto deverá ser efectuada de acordo com os regulamentos e a legislação nacional.

¡Atención! El desecho final de este producto debe realizarse según todas las leyes y regulaciones nacionales

Warning! Slutlig kassering av denna produkt bör skötas i enlighet med landets alla lagar och föreskrifter.

General Electrical Safety Guidelines and Warnings



WARNING: Certain ports on the device are designed for use as intrabuilding (within-the-building) interfaces only (Type 2 or Type 4 ports as described in *GR-1089-CORE*) and require isolation from the exposed outside plant (OSP) cabling. To comply with NEBS (Network Equipment-Building System) requirements and protect against lightning surges and commercial power disturbances, the intrabuilding ports *must not* be metallicly connected to interfaces that connect to the OSP or its wiring. The intrabuilding ports on the device are suitable for connection to intrabuilding or unexposed wiring or cabling only. The addition of primary protectors is not sufficient protection for connecting these interfaces metallicly to OSP wiring.

Avertissement Certains ports de l'appareil sont destinés à un usage en intérieur uniquement (ports Type 2 ou Type 4 tels que décrits dans le document *GR-1089-CORE*) et doivent être isolés du câblage de l'installation extérieure exposée. Pour respecter les exigences NEBS et assurer une protection contre la foudre et les perturbations de tension secteur, les ports pour intérieur *ne doivent pas* être raccordés physiquement aux interfaces prévues pour la connexion à l'installation extérieure ou à son câblage. Les ports pour intérieur de l'appareil sont réservés au raccordement de câbles pour intérieur ou non exposés uniquement. L'ajout de protections ne constitue pas une précaution suffisante pour raccorder physiquement ces interfaces au câblage de l'installation extérieure.



CAUTION: Before removing or installing components of a device, connect an electrostatic discharge (ESD) grounding strap to an ESD point and wrap and fasten the other end of the strap around your bare wrist. Failure to use an ESD grounding strap could result in damage to the device.

Attention Avant de retirer ou d'installer des composants d'un appareil, raccordez un bracelet antistatique à un point de décharge électrostatique et fixez le bracelet à votre poignet nu. L'absence de port d'un bracelet antistatique pourrait provoquer des dégâts sur l'appareil.

- Install the device in compliance with the following local, national, and international electrical codes:
 - United States—National Fire Protection Association (NFPA 70), United States National Electrical Code.
 - Other countries—International Electromechanical Commission (IEC) 60364, Part 1 through Part 7.
 - Evaluated to the TN power system.

- Canada—Canadian Electrical Code, Part 1, CSA C22.1.
- Suitable for installation in Information Technology Rooms in accordance with Article 645 of the National Electrical Code and NFPA 75.

Peut être installé dans des salles de matériel de traitement de l'information conformément à l'article 645 du National Electrical Code et à la NFPA 75.

- Locate the emergency power-off switch for the room in which you are working so that if an electrical accident occurs, you can quickly turn off the power.
- Make sure that you clean grounding surface and give them a bright finish before making grounding connections.
- Do not work alone if potentially hazardous conditions exist anywhere in your workspace.
- Never assume that power is disconnected from a circuit. Always check the circuit before starting to work.
- Carefully look for possible hazards in your work area, such as moist floors, ungrounded power extension cords, and missing safety grounds.
- Operate the device within marked electrical ratings and product usage instructions.
- To ensure that the device and peripheral equipment function safely and correctly, use the cables and connectors specified for the attached peripheral equipment, and make certain they are in good condition.

You can remove and replace many device components without powering off or disconnecting power to the device, as detailed elsewhere in the hardware documentation for this device. Never install equipment that appears to be damaged.

Prevention of Electrostatic Discharge Damage

Device components that are shipped in antistatic bags are sensitive to damage from static electricity. Some components can be impaired by voltages as low as 30 V. You can easily generate potentially damaging static voltages whenever you handle plastic or foam packing material or if you move components across plastic or carpets. Observe the following guidelines to minimize the potential for electrostatic discharge (ESD) damage, which can cause intermittent or complete component failures:

- Always use an ESD wrist strap when you are handling components that are subject to ESD damage, and make sure that it is in direct contact with your skin.

If a grounding strap is not available, hold the component in its antistatic bag (see [Figure 46 on page 144](#)) in one hand and touch the exposed, bare metal of the device with the other hand immediately before inserting the component into the device.



WARNING: For safety, periodically check the resistance value of the ESD grounding strap. The measurement must be in the range 1 through 10 Mohms.

Avertissement Par mesure de sécurité, vérifiez régulièrement la résistance du bracelet antistatique. Cette valeur doit être comprise entre 1 et 10 mégohms (Mohms).

- When handling any component that is subject to ESD damage and that is removed from the device, make sure the equipment end of your ESD wrist strap is attached to the ESD point on the chassis.

If no grounding strap is available, touch the exposed, bare metal of the device to ground yourself before handling the component.

- Avoid contact between the component that is subject to ESD damage and your clothing. ESD voltages emitted from clothing can damage components.
- When removing or installing a component that is subject to ESD damage, always place it component-side up on an antistatic surface, in an antistatic card rack, or in an antistatic bag (see [Figure 46 on page 144](#)). If you are returning a component, place it in an antistatic bag before packing it.

Figure 46: Placing a Component into an Antistatic Bag

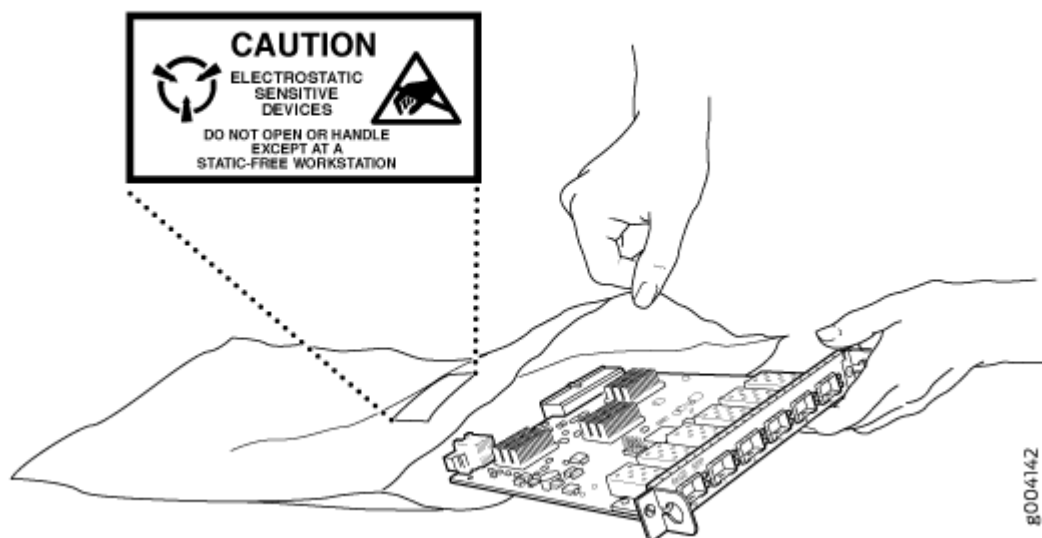

R004142



CAUTION: ANSI/TIA/EIA-568 cables such as Category 5e and Category 6 can get electrostatically charged. To dissipate this charge, always ground the cables to a suitable and safe earth ground before connecting them to the system.

Attention Les câbles ANSI/TIA/EIA-568, par exemple Cat 5e et Cat 6, peuvent emmagasiner des charges électrostatiques. Pour évacuer ces charges, reliez toujours les câbles à une prise de terre adaptée avant de les raccorder au système.

Site Electrical Wiring Guidelines

Table 30 on page 145 describes the factors you must consider while planning the electrical wiring at your site.



WARNING: You must provide a properly grounded and shielded environment and use electrical surge-suppression devices.

Avertissement Vous devez établir un environnement protégé et convenablement mis à la terre et utiliser des dispositifs de parasurtension.

Table 30: Site Electrical Wiring Guidelines

Site Wiring Factor	Guidelines
Signaling limitations	<p>If your site experiences any of the following problems, consult experts in electrical surge suppression and shielding:</p> <ul style="list-style-type: none"> • Improperly installed wires cause radio frequency interference (RFI). • Damage from lightning strikes occurs when wires exceed recommended distances or pass between buildings. • Electromagnetic pulses (EMPs) caused by lightning damage unshielded conductors and electronic devices.

Table 30: Site Electrical Wiring Guidelines (Continued)

Site Wiring Factor	Guidelines
Radio frequency interference	<p>To reduce or eliminate RFI from your site wiring, do the following:</p> <ul style="list-style-type: none"> • Use a twisted-pair cable with a good distribution of grounding conductors. • If you must exceed the recommended distances, use a high-quality twisted-pair cable with one ground conductor for each data signal, when applicable.
Electromagnetic compatibility	<p>If your site is susceptible to problems with electromagnetic compatibility (EMC), particularly from lightning or radio transmitters, seek expert advice.</p> <p>Strong sources of electromagnetic interference (EMI) can cause:</p> <ul style="list-style-type: none"> • Destruction of the signal drivers and receivers in the device, • Electrical hazards as a result of power surges conducted over the lines into the equipment.

AC Power Electrical Safety Guidelines

The following electrical safety guidelines apply to AC-powered devices:



CAUTION: For devices with AC power supplies, an external surge protective device (SPD) must be used at the AC power source.

- Note the following warnings printed on the device:

“CAUTION: THIS UNIT HAS MORE THAN ONE POWER SUPPLY CORD. DISCONNECT ALL POWER SUPPLY CORDS BEFORE SERVICING TO AVOID ELECTRIC SHOCK.”

“ATTENTION: CET APPAREIL COMPORTE PLUS D'UN CORDON D'ALIMENTATION. AFIN DE PRÉVENIR LES CHOCS ÉLECTRIQUES, DÉBRANCHER TOUT CORDON D'ALIMENTATION AVANT DE FAIRE LE DÉPANNAGE.”

- AC-powered devices are shipped with a three-wire electrical cord with a grounding-type plug that fits only a grounding-type power outlet. Do not circumvent this safety feature. Equipment grounding must comply with local and national electrical codes.

- You must provide an external certified circuit breaker (2-pole circuit breaker or 4-pole circuit breaker based on your device) rated minimum 20 A in the building installation.
- The power cord serves as the main disconnecting device for the AC-powered device. The socket outlet must be near the AC-powered device and be easily accessible.
- For devices that have more than one power supply connection, you must ensure that all power connections are fully disconnected so that power to the device is completely removed to prevent electric shock. To disconnect power, unplug all power cords (one for each power supply).

Power Cable Warning (Japanese)

WARNING: The attached power cable is only for this product. Do not use the cable for another product.

注意

附属の電源コードセットはこの製品専用です。
他の電気機器には使用しないでください。

0417283

AC Power Disconnection Warning



WARNING: Before working on the device or near power supplies, unplug all the power cords from an AC-powered device.

Waarschuwing Voordat u aan een frame of in de nabijheid van voedingen werkt, dient u bij wisselstroom toestellen de stekker van het netsnoer uit het stopcontact te halen.

Varoitus Kytke irti vaihtovirtalaitteiden virtajohto, ennen kuin teet mitään asennuspohjalle tai työskentelet virtalähteiden läheisyydessä.

Avertissement Avant de travailler sur un châssis ou à proximité d'une alimentation électrique, débrancher le cordon d'alimentation des unités en courant alternatif.

Warnung Bevor Sie an einem Chassis oder in der Nähe von Netzgeräten arbeiten, ziehen Sie bei Wechselstromeinheiten das Netzkabel ab bzw.

Avvertenza Prima di lavorare su un telaio o intorno ad alimentatori, scollegare il cavo di alimentazione sulle unità CA.

Advarsel Før det utføres arbeid på kabinettet eller det arbeides i nærheten av strømforsyningsenheter, skal strømledningen trekkes ut på vekselstrømsenheter.

Aviso Antes de trabalhar num chassis, ou antes de trabalhar perto de unidades de fornecimento de energia, desligue o cabo de alimentação nas unidades de corrente alternada.

¡Atención! Antes de manipular el chasis de un equipo o trabajar cerca de una fuente de alimentación, desenchufar el cable de alimentación en los equipos de corriente alterna (CA).

Warning! Innan du arbetar med ett chassi eller nära strömförsörjningsenheter skall du för växelströmsenheter dra ur nätsladden.

DC Power Disconnection Warning



WARNING: Before performing any of the DC power procedures, ensure that power is removed from the DC circuit. To ensure that all power is off, locate the circuit breaker on the panel board that services the DC circuit, switch the circuit breaker to the OFF position, and tape the device handle of the circuit breaker in the OFF position.

Waarschuwing Voordat u een van de onderstaande procedures uitvoert, dient u te controleren of de stroom naar het gelijkstroom circuit uitgeschakeld is. Om u ervan te verzekeren dat alle stroom UIT is geschakeld, kiest u op het schakelbord de stroomverbreker die het gelijkstroom circuit bedient, draait de stroomverbreker naar de UIT positie en plakt de schakelaarhendel van de stroomverbreker met plakband in de UIT positie vast.

Varoitus Varmista, että tasavirtapiirissä ei ole virtaa ennen seuraavien toimenpiteiden suorittamista. Varmistaaksesi, että virta on KATKAISTU täysin, paikanna tasavirrasta huolehtivassa kojetaulussa sijaitseva suojakytkin, käännä suojakytkin KATKAISTU-asentoon ja teippaa suojakytkimen varsi niin, että se pysyy KATKAISTU-asennossa.

Avertissement Avant de pratiquer l'une quelconque des procédures ci-dessous, vérifier que le circuit en courant continu n'est plus sous tension. Pour en être sûr, localiser le disjoncteur situé sur le panneau de service du circuit en courant continu, placer le disjoncteur en position fermée (OFF) et, à l'aide d'un ruban adhésif, bloquer la poignée du disjoncteur en position OFF.

Warnung Vor Ausführung der folgenden Vorgänge ist sicherzustellen, daß die Gleichstromschaltung keinen Strom erhält. Um sicherzustellen, daß sämtlicher Strom abgestellt ist, machen Sie auf der Schalttafel den Unterbrecher für die Gleichstromschaltung ausfindig, stellen Sie den Unterbrecher auf AUS, und kleben Sie den Schaltergriff des Unterbrechers mit Klebeband in der AUS-Stellung fest.

Avvertenza Prima di svolgere una qualsiasi delle procedure seguenti, verificare che il circuito CC non sia alimentato. Per verificare che tutta l'alimentazione sia scollegata (OFF), individuare l'interruttore automatico sul quadro strumenti che alimenta il circuito CC, mettere l'interruttore in posizione OFF e fissarlo con nastro adesivo in tale posizione.

Advarsel Før noen av disse prosedyrene utføres, kontroller at strømmen er frakoblet likestrømkretsen. Sørg for at all strøm er slått AV. Dette gjøres ved å lokalisere strømbryteren på brytertavlen som betjener likestrømkretsen, slå strømbryteren AV og teipe bryterhåndtaket på strømbryteren i AV-stilling.

Aviso Antes de executar um dos seguintes procedimentos, certifique-se que desligou a fonte de alimentação de energia do circuito de corrente contínua. Para se assegurar que toda a corrente foi DESLIGADA, localize o disjuntor no painel que serve o circuito de corrente contínua e coloque-o na posição OFF (Desligado), segurando nessa posição a manivela do interruptor do disjuntor com fita isoladora.

¡Atención! Antes de proceder con los siguientes pasos, comprobar que la alimentación del circuito de corriente continua (CC) esté cortada (OFF). Para asegurarse de que toda la alimentación esté cortada (OFF), localizar el interruptor automático en el panel que alimenta al circuito de corriente continua, cambiar el interruptor automático a la posición de Apagado (OFF), y sujetar con cinta la palanca del interruptor automático en posición de Apagado (OFF).

Varning! Innan du utför någon av följande procedurer måste du kontrollera att strömförsörjningen till likströmskretsen är bruten. Kontrollera att all strömförsörjning är BRUTEN genom att slå AV det överspänningsskydd som skyddar likströmskretsen och tejpa fast överspänningsskyddets omkopplare i FRÅN-läget.

DC Power Grounding Requirements and Warning

An insulated grounding conductor that is identical in size to the grounded and ungrounded branch circuit supply conductors but is identifiable by green and yellow stripes is installed as part of the branch circuit that supplies the device. The grounding conductor is a separately derived system at the supply transformer or motor generator set.



WARNING: When you install the device, the ground connection must always be made first and disconnected last.

Waarschuwing Bij de installatie van het toestel moet de aardverbinding altijd het eerste worden gemaakt en het laatste worden losgemaakt.

Varoitus Laitetta asennettaessa on maahan yhdistäminen aina tehtävä ensiksi ja maadoituksen irti kytkeminen viimeiseksi.

Avertissement Lors de l'installation de l'appareil, la mise à la terre doit toujours être connectée en premier et déconnectée en dernier.

Warnung Der Erdanschluß muß bei der Installation der Einheit immer zuerst hergestellt und zuletzt abgetrennt werden.

Avvertenza In fase di installazione dell'unità, eseguire sempre per primo il collegamento a massa e disconnetterlo per ultimo.

Advarsel Når enheten installeres, må jordledningen alltid tilkobles først og frakobles sist.

Aviso Ao instalar a unidade, a ligação à terra deverá ser sempre a primeira a ser ligada, e a última a ser desligada.

¡Atención! Al instalar el equipo, conectar la tierra la primera y desconectarla la última.

Warning! Vid installation av enheten måste jordledningen alltid anslutas först och kopplas bort sist.

DC Power Wiring Sequence Warning



WARNING: Wire the DC power supply using the appropriate lugs. When connecting power, the proper wiring sequence is ground to ground, +RTN to +RTN, then -48 V to -48 V. When disconnecting power, the proper wiring sequence is -48 V to -48 V, +RTN to +RTN, then ground to ground. Note that the ground wire must always be connected first and disconnected last.

Waarschuwing De juiste bedradingsvolgorde verbonden is aarde naar aarde, +RTN naar +RTN, en -48 V naar -48 V. De juiste bedradingsvolgorde losgemaakt is en -48 naar -48 V, +RTN naar +RTN, aarde naar aarde.

Varoitus Oikea yhdistettävä kytkentäjärjestys on maajohto maajohtoon, +RTN varten +RTN, -48 V varten - 48 V. Oikea irrotettava kytkentäjärjestys on -48 V varten - 48 V, +RTN varten +RTN, maajohto maajohtoon.

Avertissement Câblez l'alimentation d'alimentation CC En utilisant les crochets appropriés à l'extrémité de câblage. En reliant la puissance, l'ordre approprié de câblage est rectifié pour rectifier, +RTN à +RTN, puis -48 V à -48 V. En débranchant la puissance, l'ordre approprié de câblage est -48 V à -48 V, +RTN à +RTN, a alors rectifié pour rectifier. Notez que le fil de masse devrait toujours être relié d'abord et débranché pour la dernière fois. Notez que le fil de masse devrait toujours être relié d'abord et débranché pour la dernière fois.

Warnung Die Stromzufuhr ist nur mit geeigneten Ringösen an das DC Netzteil anzuschliessen. Die richtige Anschlusssequenz ist: Erdanschluss zu Erdanschluss, +RTN zu +RTN und dann -48V zu -48V. Die richtige Sequenz zum Abtrennen der Stromversorgung ist -48V zu -48V, +RTN zu +RTN und dann Erdanschluss zu Erdanschluss. Es ist zu beachten dass der Erdanschluss immer zuerst angeschlossen und als letztes abgetrennt wird.

Avvertenza Mostra la morsettiera dell'alimentatore CC. Cablare l'alimentatore CC usando i connettori adatti all'estremità del cablaggio, come illustrato. La corretta sequenza di cablaggio è da massa a massa, da positivo a positivo (da linea ad L) e da negativo a negativo (da neutro a N). Tenere presente che il filo di massa deve sempre venire collegato per primo e scollegato per ultimo.

Advarsel Riktig tilkoples tilkoplingssekvens er jord til jord, +RTN til +RTN, -48 V til -48 V. Riktig frakoples tilkoplingssekvens er -48 V til -48 V, +RTN til +RTN, jord til jord.

Aviso Ate con alambre la fuente de potencia cc Usando los terminales apropiados en el extremo del cableado. Al conectar potencia, la secuencia apropiada del cableado se muele para moler, +RTN a +RTN, entonces -48 V a -48 V. Al desconectar potencia, la secuencia apropiada del cableado es -48 V a -48 V, +RTN a +RTN, entonces molió para moler. Observe que el alambre de tierra se debe conectar siempre primero y desconectar por último. Observe que el alambre de tierra se debe conectar siempre primero y desconectar por último.

¡Atención! Wire a fonte de alimentação de DC Usando os talões apropriados nan Extremidade da fiação. Ao conectar a potência, a seqüência apropriada da fiação é moída para moer, +RTN a +RTN, então -48 V a -48 V. Ao desconectar a potência, a seqüência apropriada da fiação é -48 V a -48 V, +RTN a +RTN, moeu então para moer. Anote que o fio à terra deve sempre ser conectado primeiramente e desconectado por último. Anote que o fio à terra deve sempre ser conectado primeiramente e desconectado por último.

Warning! Korrekt kopplingssekvens ar jord till jord, +RTN till +RTN, -48 V till -48 V.
Korrekt kopplas kopplingssekvens ar -48 V till -48 V, +RTN till +RTN, jord till jord.

DC Power Wiring Terminations Warning



WARNING: When stranded wiring is required, use approved wiring terminations, such as closed-loop or spade-type with upturned lugs. These terminations must be the appropriate size for the wires and must clamp both the insulation and conductor.

Waarschuwing Wanneer geslagen bedrading vereist is, dient u bedrading te gebruiken die voorzien is van goedgekeurde aansluitpunten, zoals het gesloten-lus type of het grijperschop type waarbij de aansluitpunten omhoog wijzen. Deze aansluitpunten dienen de juiste maat voor de draden te hebben en dienen zowel de isolatie als de geleider vast te klemmen.

Varoitus Jos säikeellinen johdin on tarpeen, käytä hyväksyttyä johdinliitääntä, esimerkiksi suljettua silmukkaa tai kourumaista liitääntä, jossa on ylöspäin käännetyt kiinnityskorvat. Tällaisten liitääntöjen tulee olla kooltaan johtimiin sopivia ja niiden tulee puristaa yhteen sekä eristeen että johdinosan.

Avertissement Quand des fils torsadés sont nécessaires, utiliser des douilles terminales homologuées telles que celles à circuit fermé ou du type à plage ouverte avec cosses rebroussées. Ces douilles terminales doivent être de la taille qui convient aux fils et doivent être refermées sur la gaine isolante et sur le conducteur.

Warnung Wenn Litzenverdrahtung erforderlich ist, sind zugelassene Verdrahtungsabschlüsse, z.B. für einen geschlossenen Regelkreis oder gabelförmig, mit nach oben gerichteten Kabelschuhen zu verwenden. Diese Abschlüsse sollten die angemessene Größe für die Drähte haben und sowohl die Isolierung als auch den Leiter festklemmen.

Avvertenza Quando occorre usare trecce, usare connettori omologati, come quelli a occhiello o a forcella con linguette rivolte verso l'alto. I connettori devono avere la misura adatta per il cablaggio e devono serrare sia l'isolante che il conduttore.

Advarsel Hvis det er nødvendig med flertrådede ledninger, brukes godkjente ledningsavslutninger, som for eksempel lukket sløyfe eller spadetype med oppoverbøyde kabelsko. Disse avslutningene skal ha riktig størrelse i forhold til ledningene, og skal klemme sammen både isolasjonen og lederen.

Aviso Quando forem requeridas montagens de instalação eléctrica de cabo torcido, use terminações de cabo aprovadas, tais como, terminações de cabo em circuito fechado e planas com terminais de orelha voltados para cima. Estas terminações de cabo deverão ser do tamanho apropriado para os respectivos cabos, e deverão prender simultaneamente o isolamento e o fio condutor.

¡Atención! Cuando se necesite hilo trenzado, utilizar terminales para cables homologados, tales como las de tipo "bucle cerrado" o "espada", con las lengüetas de conexión vueltas hacia arriba. Estos terminales deberán ser del tamaño apropiado para los cables que se utilicen, y tendrán que sujetar tanto el aislante como el conductor.

Warning! När flertrådiga ledningar krävs måste godkända ledningskontakter användas, t.ex. kabelsko av slutet eller öppen typ med uppåtvänd tapp. Storleken på dessa kontakter måste vara avpassad till ledningarna och måste kunna hålla både isoleringen och ledaren fastklämda.

Multiple Power Supplies Disconnection Warning



WARNING: The network device has more than one power supply connection. All connections must be removed completely to remove power from the unit completely.

Waarschuwing Deze eenheid heeft meer dan één stroomtoevoerverbinding; alle verbindingen moeten volledig worden verwijderd om de stroom van deze eenheid volledig te verwijderen.

Varoitus Tässä laitteessa on useampia virtalähdekytkentöjä. Kaikki kytkennät on irrotettava kokonaan, jotta virta poistettaisiin täysin laitteesta.

Avertissement Cette unité est équipée de plusieurs raccordements d'alimentation. Pour supprimer tout courant électrique de l'unité, tous les cordons d'alimentation doivent être débranchés.

Warnung Diese Einheit verfügt über mehr als einen Stromanschluß; um Strom gänzlich von der Einheit fernzuhalten, müssen alle Stromzufuhren abgetrennt sein.

Avvertenza Questa unità ha più di una connessione per alimentatore elettrico; tutte le connessioni devono essere completamente rimosse per togliere l'elettricità dall'unità.

Advarsel Denne enheten har mer enn én strømtilkobling. Alle tilkoblinger må kobles helt fra for å eliminere strøm fra enheten.

Aviso Este dispositivo possui mais do que uma conexão de fonte de alimentação de energia; para poder remover a fonte de alimentação de energia, deverão ser desconectadas todas as conexões existentes.

¡Atención! Esta unidad tiene más de una conexión de suministros de alimentación; para eliminar la alimentación por completo, deben desconectarse completamente todas las conexiones.

Varning! Denna enhet har mer än en strömförsörjningsanslutning; alla anslutningar måste vara helt avlägsnade innan strömtillförseln till enheten är fullständigt bruten.

TN Power Warning



WARNING: The device is designed to work with a TN power system.

Waarschuwing Het apparaat is ontworpen om te functioneren met TN energiesystemen.

Varoitus Koje on suunniteltu toimimaan TN-sähkövoimajärjestelmien yhteydessä.

Avertissement Ce dispositif a été conçu pour fonctionner avec des systèmes d'alimentation TN.

Warnung Das Gerät ist für die Verwendung mit TN-Stromsystemen ausgelegt.

Avvertenza Il dispositivo è stato progettato per l'uso con sistemi di alimentazione TN.

Advarsel Utstyret er utfomet til bruk med TN-strømssystemer.

Aviso O dispositivo foi criado para operar com sistemas de corrente TN.

¡Atención! El equipo está diseñado para trabajar con sistemas de alimentación tipo TN.

Varning! Enheten är konstruerad för användning tillsammans med elkraftssystem av TN-typ.

Action to Take After an Electrical Accident

If an electrical accident results in an injury, take the following actions in this order:

1. Use caution. Be aware of potentially hazardous conditions that could cause further injury.
2. Disconnect power from the device.
3. If possible, send another person to get medical aid. Otherwise, assess the condition of the victim, and then call for help.

Compliance Standards for ACX7024 Routers

IN THIS SECTION

- [Compliance Statement for Argentina | 157](#)

The ACX7024 routers comply with the following standards:

- Safety
 - CAN/CSA-C22.2 No. 62368-1 and 60950-1
 - UL 62368-1 and 60950-1
 - Taiwan BSMI
 - China CCC
 - BS EN 62368-1
 - IEC 62368-1 (All country deviations): 2nd Edition: CB Scheme
 - CFR, Title 21, Chapter 1, Subchapter J, Part 1040
 - REDR c 1370 OR CAN/CSA-E 60825-1- Part 1
 - IEC 60825-1
 - IEC 60825-2
- Industry Standards
 - IEEE 1613:2013 Network devices in power substations
 - Environmental, Safety- including high dielectric requirements and Impulse test

- Exception- forced air cooling and boot up time
- DC input -48 VDC meets dielectric strength
- IEC 60255-21-1: Vibration
- IEC 60255-21-2: Shock and bump
- IEC 60255-21-3: Seismic
- IEC 61850-3: 2013 Telecom equipment in Power station and substation environments (environmental).
- Railway EN 50125-3 humidity requirements (system in shelter/ building)
- Railway EN 50125-3 Class T1 vibration (system in shelter/ building), 3 meter from Track
- EMC Requirements
 - FCC 47 CFR Part 15
 - ICES-003 / ICES-GEN
 - BS EN 55032
 - BS EN 55035
 - EN 300 386 V1.6.1
 - EN 300 386 V2.2.1
 - BS EN 300 386
 - EN 55032
 - CISPR 32
 - EN 55035
 - CISPR 35
 - IEC/EN 61000 Series
 - IEC/EN 61000-3-2
 - IEC/EN 61000-3-3
 - AS/NZS CISPR 32
 - VCCI-CISPR 32

- BSMI CNS 15936
- KS C 9835 (Old KN 35)
- KS C 9832 (Old KN 32)
- KS C 9610
- BS EN 61000 Series
- NEBS GR1089
- NEBS
 - GR-63-CORE: NEBS, Physical Protection
 - GR-1089-CORE: EMC and Electrical Safety for Network Telecommunications Equipment
 - GR-3108 Class 2
 - SR-3580 NEBS Criteria Levels (Level 3 Compliance)
- Energy Efficiency requirements
 - AT&T TEER (ATIS-06000015.03.2013)
 - ECR 3.0.1
 - ETSI ES 203 136 (2013-05)
 - Verizon TEEER (VZ.TPR.9205 Issue 6)
- ETSI
 - ETSI Storage EN 300 019 2.1 class 1.2
 - ETSI Transportation EN 300 019 class 2.3
 - ETSI Operational EN 300 019 Class 3.2

Compliance Statement for Argentina

EQUIPO DE USO IDÓNEO.

Compliance Standards for ACX7024X Routers

IN THIS SECTION

- [Compliance Statement for Argentina | 160](#)

The ACX7024X routers comply with the following standards:

- Safety
 - CAN/CSA-C22.2 No. 62368-1 and 60950-1
 - UL 62368-1 and 60950-1
 - Taiwan BSMI
 - China CCC
 - BS EN 62368-1
 - IEC 62368-1 (All country deviations): 2nd Edition: CB Scheme
 - CFR, Title 21, Chapter 1, Subchapter J, Part 1040
 - REDR c 1370 OR CAN/CSA-E 60825-1- Part 1
 - IEC 60825-1
 - IEC 60825-2
- EMC Requirements
 - FCC 47 CFR Part 15
 - ICES-003 / ICES-GEN
 - BS EN 55032
 - BS EN 55035
 - EN 300 386 V1.6.1
 - EN 300 386 V2.2.1

- BS EN 300 386
- EN 55032
- CISPR 32
- EN 55035
- CISPR 35
- IEC/EN 61000 Series
- IEC/EN 61000-3-2
- IEC/EN 61000-3-3
- AS/NZS CISPR 32
- VCCI-CISPR 32
- BSMI CNS 15936
- KS C 9835 (Old KN 35)
- KS C 9832 (Old KN 32)
- KS C 9610
- BS EN 61000 Series
- NEBS GR1089
- Energy Efficiency requirements
 - AT&T TEER (ATIS-06000015.03.2013)
 - ECR 3.0.1
 - ETSI ES 203 136 (2013-05)
 - Verizon TEEER (VZ.TPR.9205 Issue 6)
- ETSI
 - ETSI Storage EN 300 019 2.1 class 1.2
 - ETSI Transportation EN 300 019 class 2.3
 - ETSI Operational EN 300 019 Class 3.2

Compliance Statement for Argentina

EQUIPO DE USO IDÓNEO.

Compliance Statements for NEBS

- The equipment is suitable for installation as part of the Common Bonding Network (CBN).
- The equipment is suitable for installation in locations where the National Electrical Code (NEC) applies.
- The battery return connection is to be treated as an isolated DC return (that is, DC-I), as defined in GR-1089-CORE.
- You must provision a readily accessible device outside of the equipment to disconnect power. The device must also be rated based on local electrical code practice.

Compliance Statements for EMC Requirements

IN THIS SECTION

- [Canada | 160](#)
- [European Community | 161](#)
- [Israel | 161](#)
- [Japan | 161](#)
- [United States | 161](#)

Canada

CAN ICES-3 (A)/NMB-3(A)

European Community

This is a Class A product. In a domestic environment, this product might cause radio interference in which case the user might be required to take adequate measures.

Israel

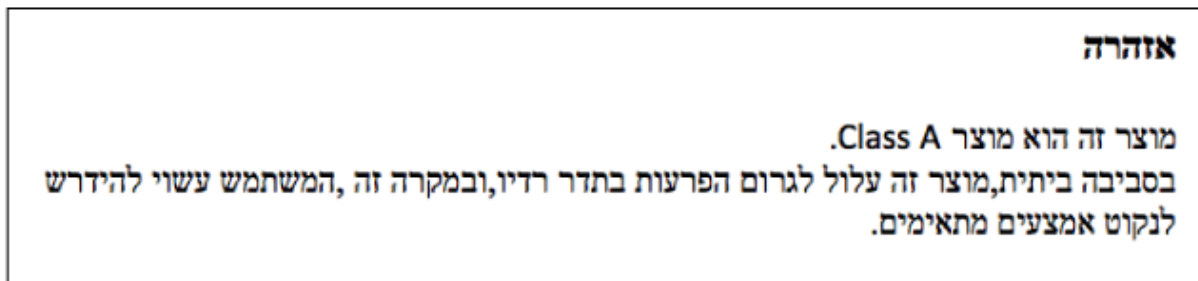

Translation from Hebrew—Warning: This product is Class A. In residential environments, the product might cause radio interference, and in such a situation, the user might be required to take adequate measures.

Japan

この装置は、クラス A 情報技術装置です。この装置を家庭環境で使用すると電波妨害を引き起こすことがあります。この場合には使用者が適切な対策を講ずるよう要求されることがあります。 VCCI-A

The preceding translates as follows:

This is a Class A product based on the standard of the Voluntary Control Council for Interference by Information Technology Equipment (VCCI). If this product is used near a radio or television receiver in a domestic environment, it might cause radio interference. Install and use the equipment according to the instruction manual. VCCI-A.

United States

The hardware equipment has been tested and found to comply with the limits for a Class A digital device, pursuant to Part 15 of the FCC Rules. These limits are designed to provide reasonable protection

against harmful interference when the equipment is operated in a commercial environment. This equipment generates, uses, and can radiate radio frequency energy and, if not installed and used in accordance with the instruction manual, might cause harmful interference to radio communications. Operation of this equipment in a residential area is likely to cause harmful interference in which case the user will be required to correct the interference at his own expense.

Compliance Statements for Environmental Requirements

Batteries in this product are not based on mercury, lead, or cadmium substances. The batteries used in this product are in compliance with EU Directives 91/157/EEC, 93/86/EEC, and 98/101/EEC. The product documentation includes instructional information about the proper method of reclamation and recycling.