

LE1K Series

User Manual

NO. G03-LE1K-F

Revision: 3.0

Release date: November 13, 2023

Trademark:

*** Specifications and Information contained in this documentation are furnished for information use only, and are subject to change at any time without notice, and should not be construed as a commitment by manufacturer.**

Environmental Protection Announcement

Do not dispose this electronic device into the trash while discarding. To minimize pollution and ensure environment protection of mother earth, please recycle.



TABLE OF CONTENT

ENVIRONMENTAL SAFETY INSTRUCTION.....	iii
USER'S NOTICE.....	iv
MANUAL REVISION INFORMATION.....	iv
ITEM CHECKLIST.....	iv
CHAPTER 1 INTRODUCTION OF THE MOTHERBOARD	
1-1 FEATURE OF MOTHERBOARD.....	1
1-2 SPECIFICATION.....	2
1-3 LAYOUT DIAGRAM.....	3
CHAPTER 2 HARDWARE INSTALLATION	
2-1 JUMPER SETTING.....	9
2-2 CONNECTORS AND HEADERS.....	14
2-2-1 CONNECTORS.....	14
2-2-2 HEADERS.....	18
2-2-3 Maximum Voltage & Current Limit.....	25
CHAPTER 3 INTRODUCING BIOS	
3-1 ENTERING SETUP.....	26
3-2 BIOS MENU SCREEN.....	27
3-3 FUNCTION KEYS.....	27
3-4 GETTING HELP.....	28
3-5 MEMU BARS.....	28
3-6 MAIN MENU.....	29
3-7 ADVANCED MENU.....	30
3-8 CHIPSET MENU.....	41
3-9 SECURITY MENU.....	44
3-10 BOOT MENU.....	46
3-11 SAVE & EXIT MENU.....	47



Environmental Safety Instruction

- Avoid the dusty, humidity and temperature extremes. Do not place the product in any area where it may become wet.
- 0 to 60 centigrade is the suitable temperature. (The figure comes from the request of the main chipset)
- Generally speaking, dramatic changes in temperature may lead to contact malfunction and crackles due to constant thermal expansion and contraction from the welding spots' that connect components and PCB. Computer should go through an adaptive phase before it boots when it is moved from a cold environment to a warmer one to avoid condensation phenomenon. These water drops attached on PCB or the surface of the components can bring about phenomena as minor as computer instability resulted from corrosion and oxidation from components and PCB or as major as short circuit that can burn the components. Suggest starting the computer until the temperature goes up.
- The increasing temperature of the capacitor may decrease the life of computer. Using the close case may decrease the life of other device because the higher temperature in the inner of the case.
- Attention to the heat sink when you over-clocking. The higher temperature may decrease the life of the device and burned the capacitor.

USER'S NOTICE

COPYRIGHT OF THIS MANUAL BELONGS TO THE MANUFACTURER. NO PART OF THIS MANUAL, INCLUDING THE PRODUCTS AND SOFTWARE DESCRIBED IN IT MAY BE REPRODUCED, TRANSMITTED OR TRANSLATED INTO ANY LANGUAGE IN ANY FORM OR BY ANY MEANS WITHOUT WRITTEN PERMISSION OF THE MANUFACTURER.

THIS MANUAL CONTAINS ALL INFORMATION REQUIRED TO USE THIS MOTHER-BOARD SERIES AND WE DO ASSURE THIS MANUAL MEETS USER'S REQUIREMENT BUT WILL CHANGE, CORRECT ANY TIME WITHOUT NOTICE. MANUFACTURER PROVIDES THIS MANUAL "AS IS" WITHOUT WARRANTY OF ANY KIND, AND WILL NOT BE LIABLE FOR ANY INDIRECT, SPECIAL, INCIDENTAL OR CONSEQUENTIAL DAMAGES (INCLUDING DAMAGES FOR LOSS OF PROFIT, LOSS OF BUSINESS, LOSS OF USE OF DATA, INTERRUPTION OF BUSINESS AND THE LIKE).

PRODUCTS AND CORPORATE NAMES APPEARING IN THIS MANUAL MAY OR MAY NOT BE REGISTERED TRADEMARKS OR COPYRIGHTS OF THEIR RESPECTIVE COMPANIES, AND THEY ARE USED ONLY FOR IDENTIFICATION OR EXPLANATION AND TO THE OWNER'S BENEFIT, WITHOUT INTENT TO INFRINGE.

Manual Revision Information

Reversion	Revision History	Date
3.0	Third Edition	November 13, 2023

Item Checklist

- Motherboard
- Cable(s)
- I/O Back panel shield

Chapter 1: Introduction of the Motherboard

1-1 Feature of Motherboard

- Intel® Elkhart Lake Quad Core™ (2.0Hz/10W) MCP Processor (Turbo 2.6GHz)
- Support 1* DDR4 3200MHz SO-DIMM up to 32GB
- Integrated with 2* Intel i225V 2.5GbE LAN chip
- Support 1* SATAIII (6Gb/s) Devices
- Support 1* HDMI(Co-lay CRT) port & 1* eDP & 1* LVDS Output
- Support 2* External COM port (RS232/422/485) & 2* Internal COM port (RS232)
- Support 2* External USB 3.2(Gen.1), 2* External USB 2.0, 6* Internal USB2.0
- Onboard 1* M.2 M-key supports SATA or NVMe/ PCIe2 interface
- Onboard 1* M.2 E-key support WIFI/BT Module
- Onboard 1* M.2 B-key support 4G/5G Module
- Support Smart FAN function
- Support ACPI S3 Function
- Support Watchdog Timer Technology
- 5.25" Form Factor (200mm * 120mm)

1-2 Specification

Spec	Description
CPU	<ul style="list-style-type: none"> ● Integrated Intel® Elkhart Lake series CPU <p>* for detailed CPU support information please visit our website</p>
Memory	<ul style="list-style-type: none"> ● 1*DDR4 SO-DIMM slot support 1* DDR4 3200MHz up to 32GB
Expansion Slot	<ul style="list-style-type: none"> ● 1* M.2 E-key 2230 slot supports WIFI/BT Module (M2E1) ● 1* M.2 B-key 3042/3052 slot supports 4G/5G Module (M2B1) ● 1* SIM card slot function with M.2 B-key, 3042/3052 slot (SIMCARD1)
Storage	<ul style="list-style-type: none"> ● 1* SATA III 6G/s connector ● 1* M.2 M-key 2242/2280 slot supports SATA or NVMe/ PCIe2 interface (M2M1)
LAN Chip	<ul style="list-style-type: none"> ● 2* Intel® i225V 2.5GbE ● Support Fast Ethernet LAN function of providing 10/100/1000/2500Mbps Ethernet data transfer rate <p><i>* Note: 2500Mbps high-speed transmission rate is only supported over CAT 5e UTP cable.</i></p>
Audio Chip	<ul style="list-style-type: none"> ● USB Audio Chip Codec integrated ● Audio driver and utility included
BIOS	<ul style="list-style-type: none"> ● AMI Flash ROM
Rear I/O	<ul style="list-style-type: none"> ● 1* Power Button ● 1* HDMI ● 2* RS232/422/485 ports with 5V/12V selectable Jumper ● 2* USB2.0 ports ● 2* 2.5GbE RJ45 LAN Ports ● 2* USB 3.2(Gen.1) ports ● 1* Lockable 12V~28V DC-in power Jack
Internal I/O	<ul style="list-style-type: none"> ● 2* RS232 with 5V/12V selectable Jumper ● 1* F_PH1 header ● 1* PS/2 keyboard & mouse header ● 2* USB 2.0 connector

	<ul style="list-style-type: none"> ● 1* Front Panel Audio header (FP_AUDIO1) ● 1* 3W Amplifier connector (SPEAK_CON1) ● 1* LVDS header, 1* eDP header ● 1* LVDS inverter header (INVERTER1) ● 1* Front Panel header (JW_FP1) ● 1* CPU FAN connector ● 1* SMBUS/I2C ● 1* USB2.0 header
--	---

1-3 Layout Diagram

Rear IO Panel Diagram:

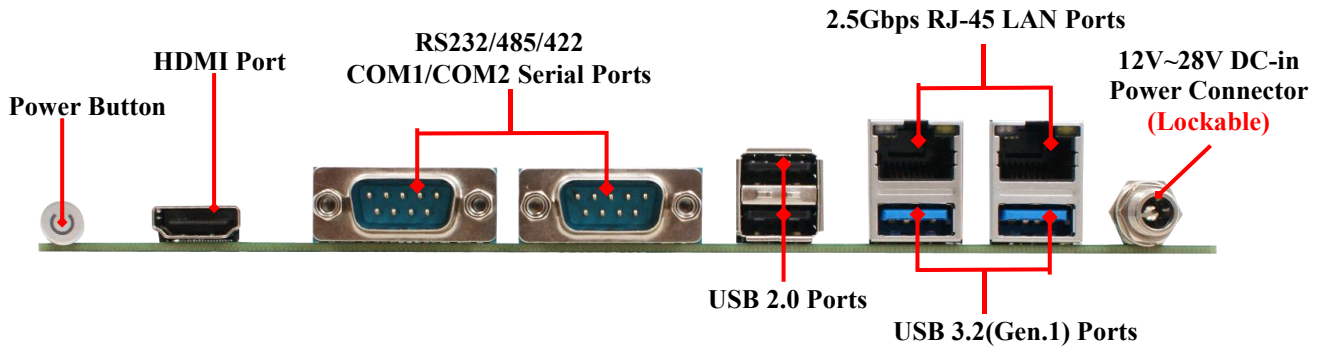

Motherboard Internal Diagram-Front Side

JLE1K-0P

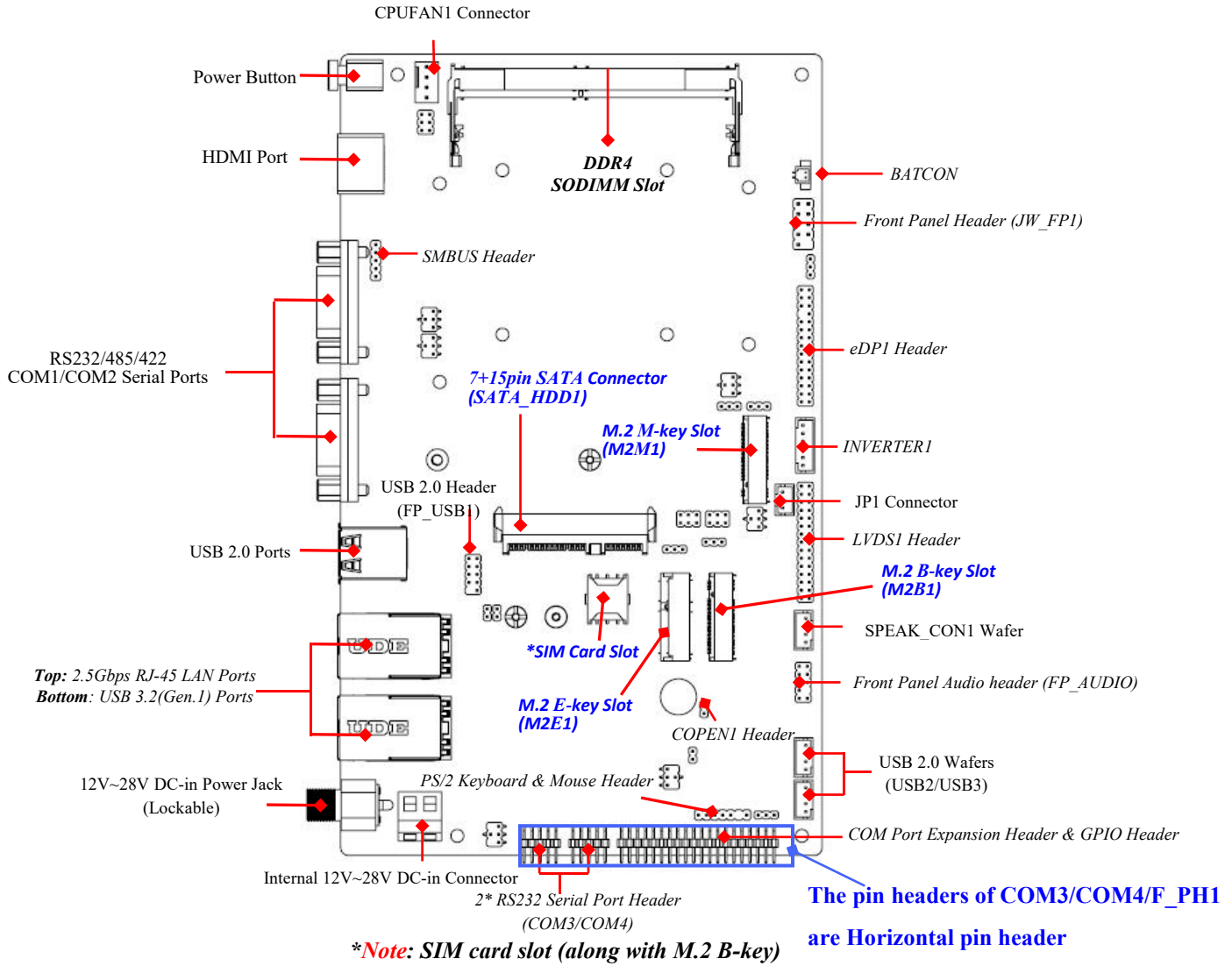

JLE1K-0E

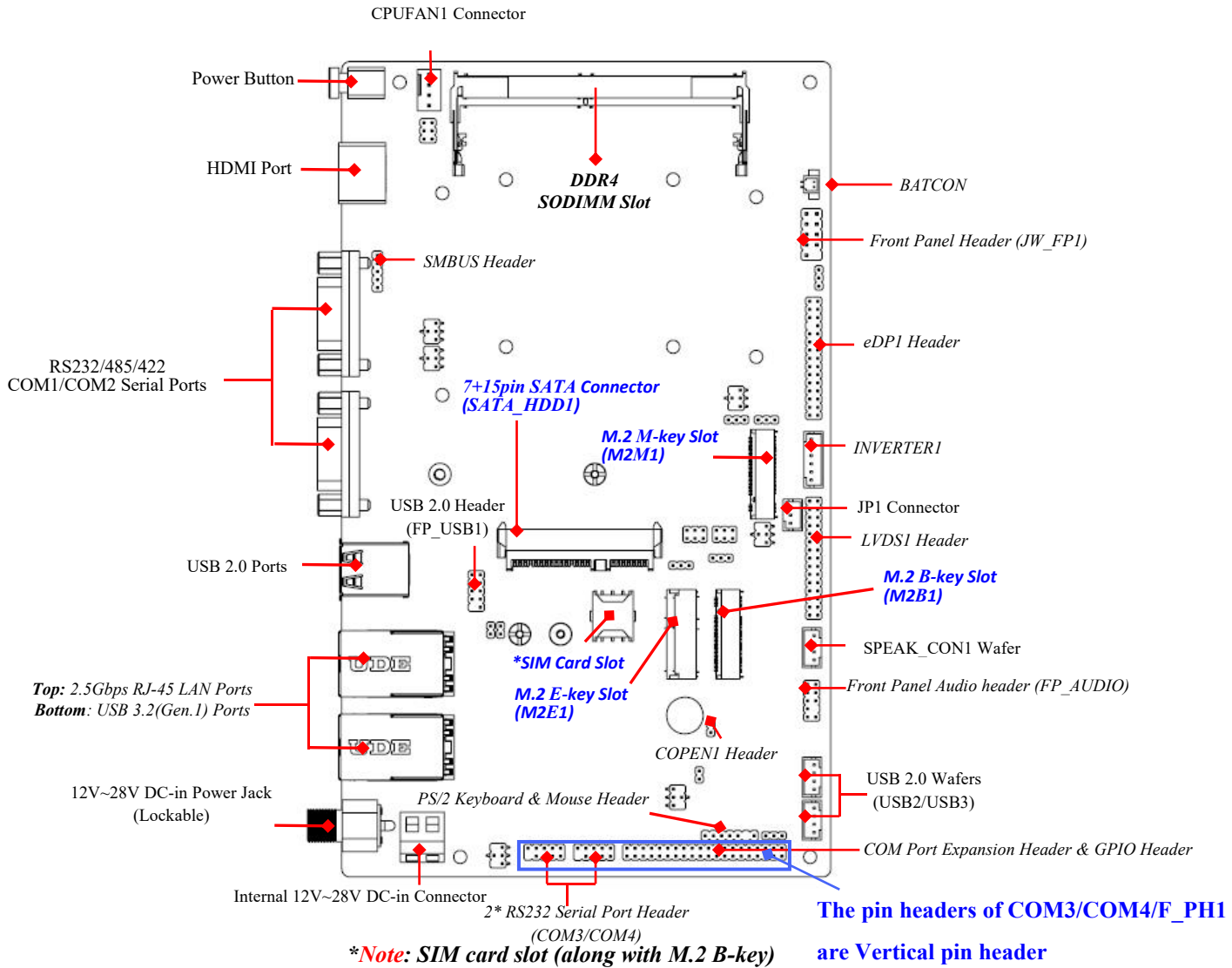

Motherboard Jumper Positions:

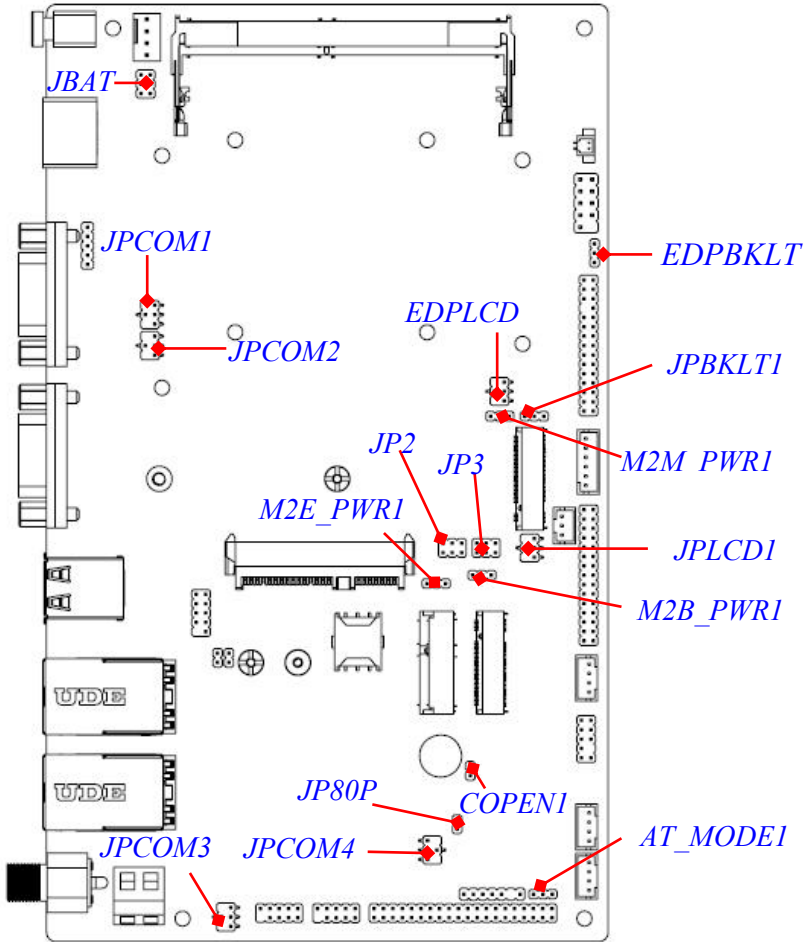

***Note:** The diagrams in the manual are mostly taken from **JLE1K-0E** series unless otherwise stated.

Jumpers

Jumper	Name	Description	Pitch
JPCOM1/JPCOM2	COM1/COM2 Pin9 Function Select	4-Pin Block	2.0mm
JPCOM3	COM3 Pin9 Function Select	4-Pin Block	2.0mm
JPCOM4	COM4 Pin9 Function Select	4-Pin Block	2.0mm
AT_MODE1	ATX Mode/AT Mode Select	3-Pin Block	2.0mm
JP80P	Set GPIO Port	2-Pin Block	2.0mm
M2E_PWR1/ M2M_PWR1/ M2B_PWR1	M2E1 & M2M1 & M2B1 Power Select	3-Pin Block	2.0mm
JP2/JP3	M2M1 Connector Function Select	6-Pin Block	2.0mm
JPLCD1	LVDS LCD VCC 3.3V / 5V /12V Select	4-Pin Block	2.0mm
JPBKLT1	LVDS1 LCD BACKLIGHT VCC Select	3-Pin Block	2.0mm
JBAT	Pin (1&2): Clear RTC Pin(3&4): Clear CMOS Pin(5&6): ME Disable	6-Pin Block	2.0mm
EDPLCD	eDP1 Screen supply voltage	4-Pin Block	2.0mm
EDPBKLT	eDP1 Backlight voltage	3-Pin Block	2.0mm

Headers

Header	Name	Description	Pitch
COM3/COM4	RS232 Header	9-pin Block	2.0mm
F_PH1	COM Port Expansion Header & GPIO Header	40-pin Block	2.0mm
PS2KBMS1	PS/2 Keyboard & Mouse Header	6-pin Block	2.0mm
COPEN1	Case Open Message Display Function	2-pin Block	2.0mm
FP_USB1	USB 2.0 Header	9-pin Block	2.0mm

FP_AUDIO1	Line-Out, MIC-In Header	9-pin Block	2.0mm
LVDS1	24-bit dual channel LVDS Header	30-pin Block	2.0mm
INVERTER1	LVDS1 Inverter Header	6-pin Block	2.0mm
JW_FP1	Front Panel Header (PWR LED/ HD LED/Power Button /Reset)	9-pin Block	2.54mm
SMBUS1	SMBUS Header	5-pin Block	2.0mm
eDP1	eDP Header	30-pin Block	2.0mm

Connectors

Connector	Name
DCIN1	Lockable 12V~28V DC-in power Jack
UL1/UL2	Top: 2.5Gbps RJ-45 LAN Port Connectors Bottom: USB 3.2(Gen.1) Port Connectors
USB1	USB 2.0 Port Connector X2
COM1/COM2	RS232/485/422 Serial Port Connector
HDMI1	HDMI Port Connector
USB2/USB3	USB 2.0 Wafer
SPEAK_CON1	3W Amplifier Wafer
JP1	Light Control Connector
CPUFAN1	CPU FAN Connector
DCIN3	Internal 12V~28V DC-in Connector

***Note:** Maximum current limit for USB ports from **UL1/UL2** is **1.5A** while using **5V** working voltage

Chapter 2

Hardware Installation

2-1 Jumper Setting

JPCOM1/JPCOM2 (4-pin) :COM1/COM2 Pin9 Function Select *Pitch=2.0mm*

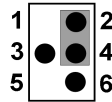
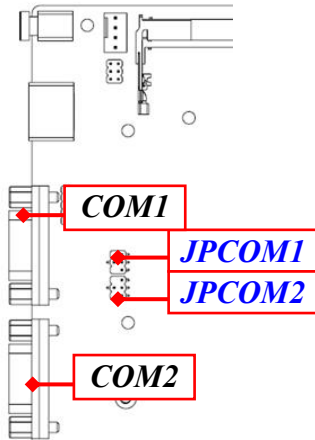

2-4 Closed: RI=
RS232

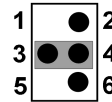

3-4 Closed:
RI= +5V

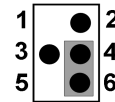

4-6 Closed:
RI= +12V

JPCOM3 (4-pin) :COM3 Pin9 Function Select *Pitch=2.0mm*

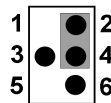
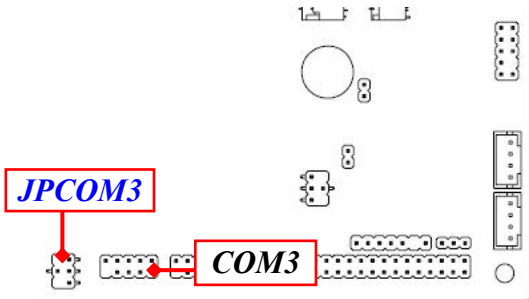

2-4 Closed: RI=
RS232

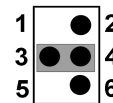

3-4 Closed:
RI= +5V

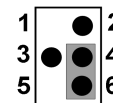

4-6 Closed:
RI= +12V

JPCOM4 (4-pin) : COM4 Pin9 Function Select Pitch=2.0mm

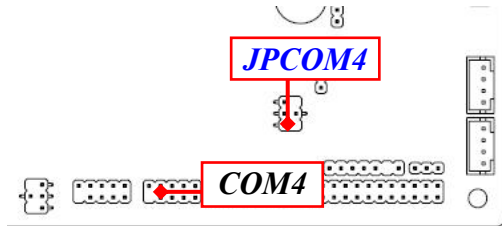

2-4 Closed:
RI=RS232



3-4 Closed:
RI=5V



4-6 Closed:
RI=12V

AT_MODE1 (3-pin): ATX Mode/AT Mode Select Pitch=2.0mm

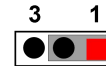
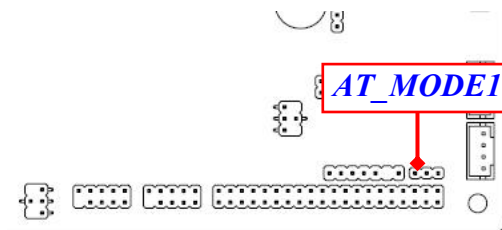

1-2 Closed:ATX Mode Selected

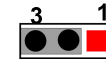

2-3 Closed:AT Mode Selected

**ATX Mode Selected: Press power button to power on after power input ready;
AT Mode Selected: Directly power on as power input ready*

JP80P1 (2-pin): Set GPIO Port Pitch=2.0mm

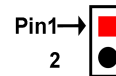
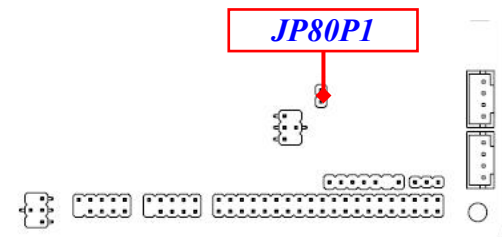

1-2 Open: GPIO=80 Port

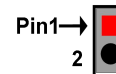

1-2 Closed: GPIO=GPIO Port

M2B_PWR1 & M2E_PWR1 & M2M_PWR1 (3-pin): M2B1 & M2E1 & M2M1 Power Select Pitch=2.0mm

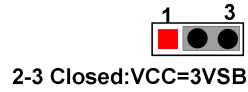
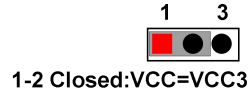
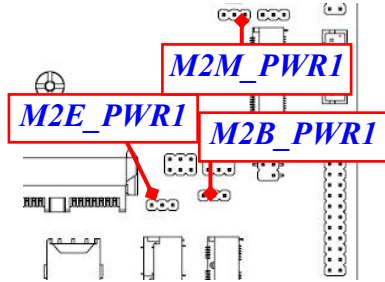

JP2&JP3 (6-pin): M2M1 Connector Function Select Pitch=2.0mm

JP2&JP3 → M2M1 Connector Select

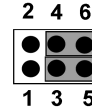
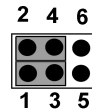
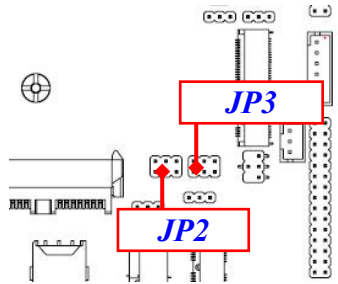

1-3 & 2-4 Closed: MSATA select 3-5 & 4-6 Closed: NVME select

JPLCD1 (4-pin): LVDS LCD VCC 3.3V / 5V / 12V Select Pitch=2.0mm

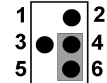
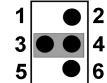
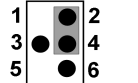
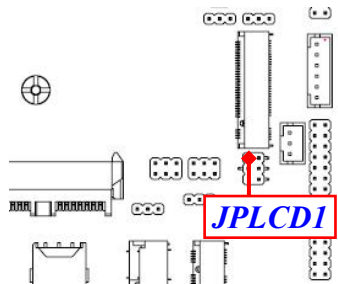

2-4 Closed:
3.3V

3-4 Closed:
5V

4-6 Closed:
12V

JPBKLT1 (3-pin): LVDS1 LCD BACKLIGHT VCC Select *Pitch=2.0mm*

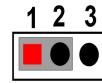
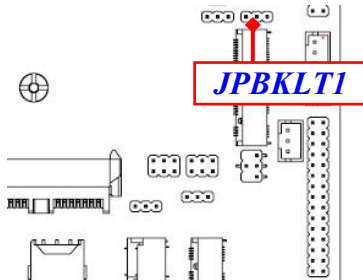

1-2 Closed:
VCC= +5V

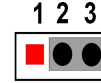

2-3 Closed:
VCC= +12V

Pin (1-2) of JBAT (6-pin): Clear RTC *Pitch=2.0mm*

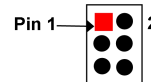
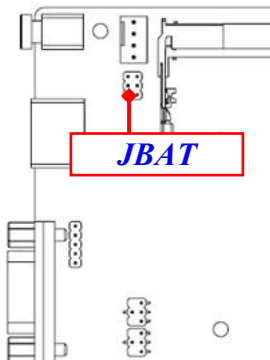

1-2 Open: Normal(Default);

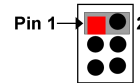

1-2 Closed: Clear RTC.

Pin (3-4) of JBAT (6-pin): Clear CMOS *Pitch=2.0mm*

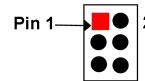
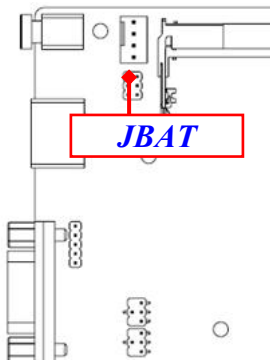

3-4 Open: Normal(Default);

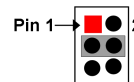

3-4 Closed: Clear CMOS.

Pin (5-6) of JBAT (6-pin): ME Disable Pitch=2.0mm

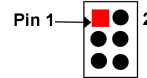
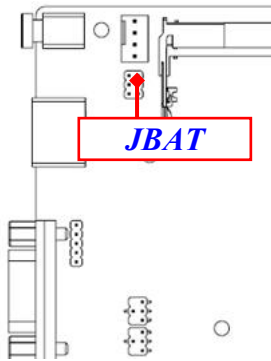

5-6 Open: Normal(Default);

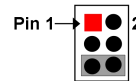

5-6 Closed: ME Disable.

EDPLCD (4-pin): eDP1 Screen supply voltage Pitch=2.0mm

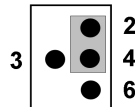
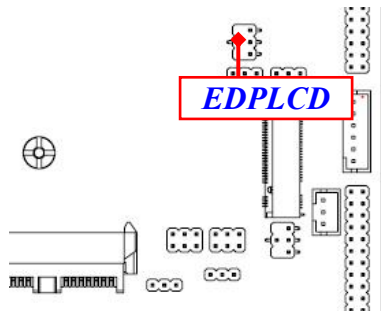

2-4 Closed:
3.3V;

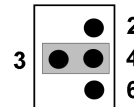

3-4 Closed:
5V;

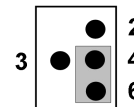

4-6 Closed:
12V.

EDPBKLT (3-pin): eDP1 Backlight voltage Pitch=2.0mm

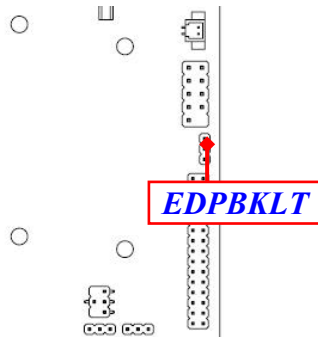

1-2 Closed:VCC=5V









2-3 Closed:VCC=12V

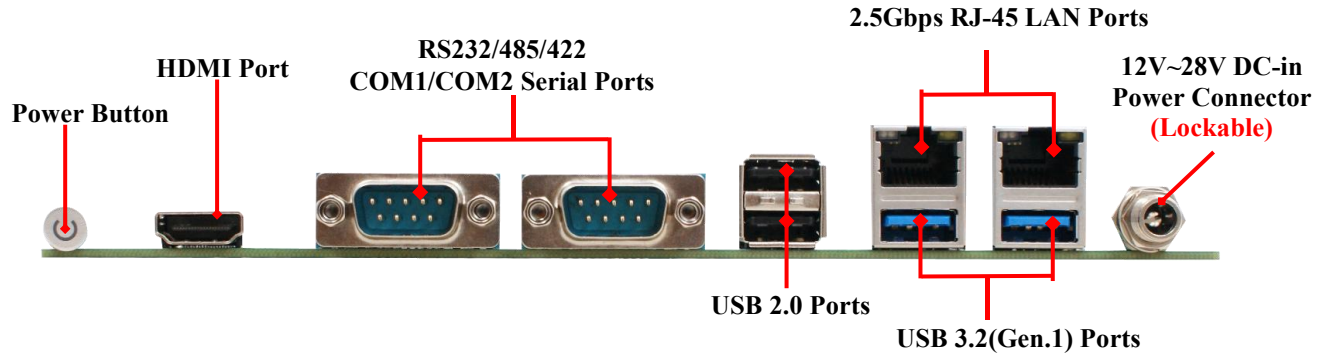

2-2 Connectors and Headers

2-2-1 Connectors

Rear I/O Connectors



<i>Icon</i>	<i>Name</i>	<i>Function</i>
	Power Button/LED	For user to power on/off the system, also function as power status LED.
	HDMI Port	To connect display device that support HDMI specification.
	RS232/485/422 Serial Ports	Mainly for user to connect external MODEM or other devices that supports Serial Communications Interface.
	USB 2.0 Ports	To connect USB keyboard, mouse or other devices compatible with USB specification.
	2.5Gbps RJ-45 LAN Ports	This connector is standard 2.5Gbps RJ-45 LAN jack for Network connection. (*Note: 2.5Gbps is only supported with CAT 5e UTP cable).

	<p>USB 3.2(Gen.1) Ports</p>	<p>To connect USB keyboard, mouse or other devices compatible with USB 3.2(Gen.1) specification. Ports support up to 5Gbps data transfer rate.</p>
	<p>12V~28V DC-in Power Connector (Lockable)</p>	<p>For user to connect compatible power adapter to provide power supply for the system.</p>

(1) COM1/COM2 (9-pin Block): RS232/422/485 Serial Port

The pin assignment for RS-232/ 422/ 485 is listed as follows:

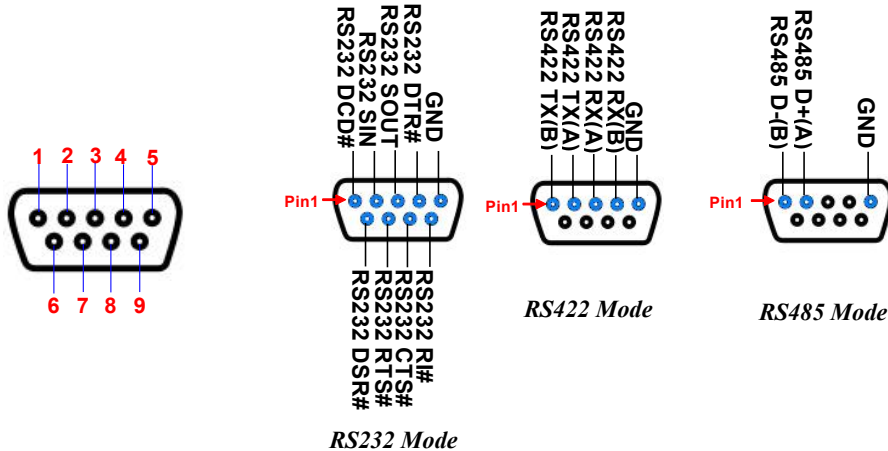

COM1 & COM2 port can function as RS232/422/485 port. In default settings COM1/2 functions as RS232 port. With compatible COM cable COM1 can function as RS422 or RS 485 port. User also needs to go to BIOS to set '**Transmission Mode Select**' for COM1/2 at first, before using specialized cable to connect different pins of this port.

(2) For 2.5Gbps RJ-45 LAN Port LED

** There are two LED next to the LAN port. Please refer to the table below for the LAN port LED indications

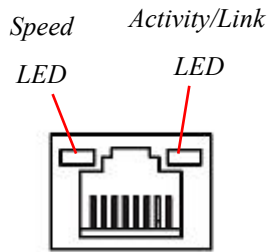

Speed LED	
Off	10/100Mbps Connection
Orange	1Gbps Connection
Green	2.5Gbps Connection

Activity/Link LED	
Status	Description
Off	No Link
Blinking	Data Activity
On	Link

Note: 2500Mbps high-speed transmission rate is **only** supported over **CAT 5e UTP cable**

(3) USB2/USB3 (4-pin): USB 2.0 Wafer

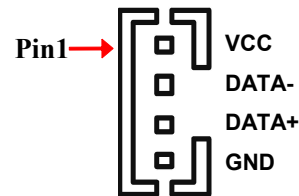
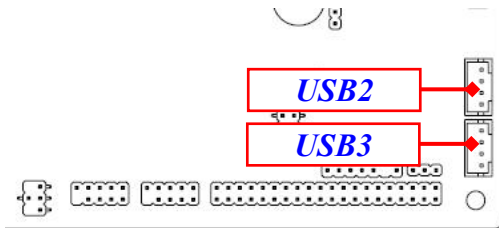

(4) SPEAK_CON1 (4-pin): 3W Amplifier Wafer

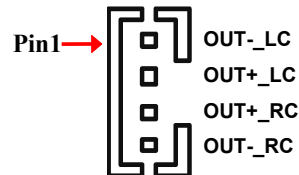
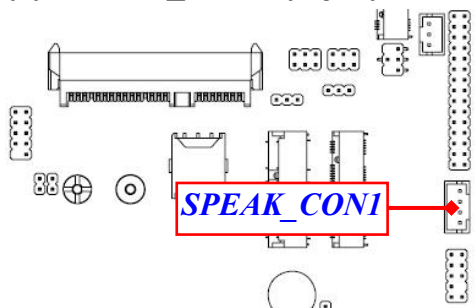

(5) JP1 (3-pin): Light Control Connector

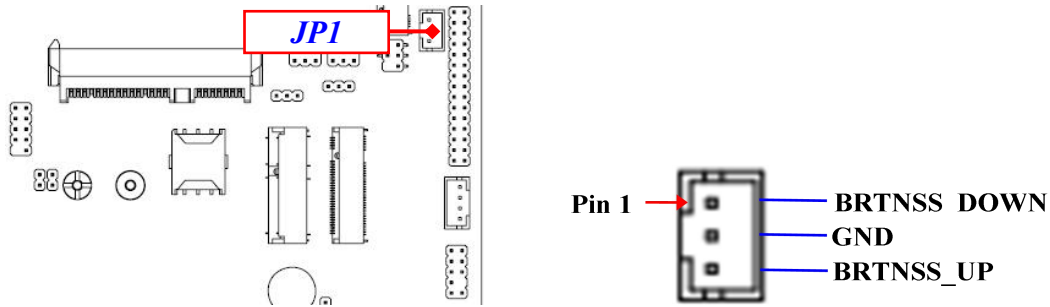

(6) CPUFAN1 (4-pin): CPU FAN Connector

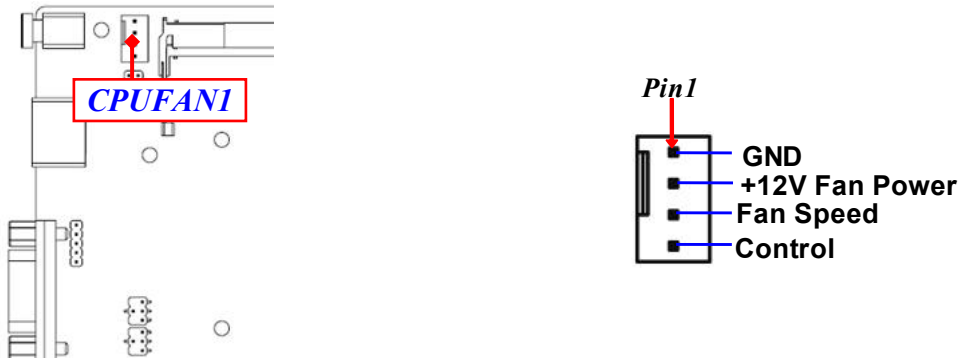

(7) DCIN3 (2-pin block): Internal 12V~28V DC-in Connector

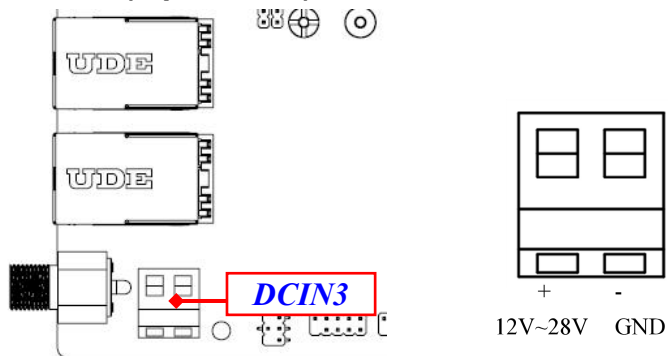

(8) BATCON (2-pin): Battery Connector

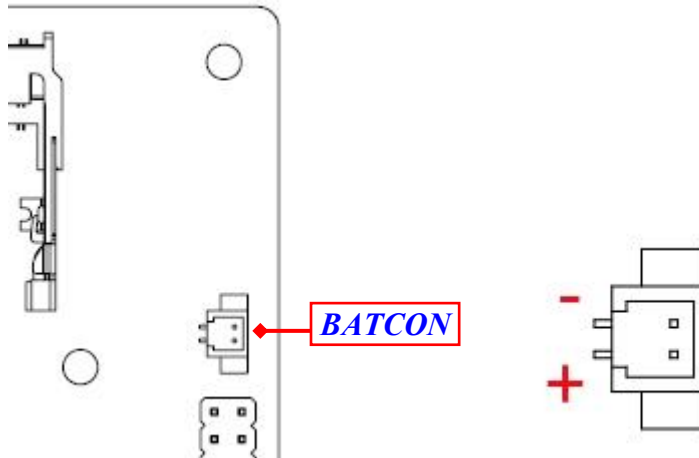

2-2-2 Headers

(1) COM3/4 (9-pin): RS232 Header *Pitch=2.0 mm*

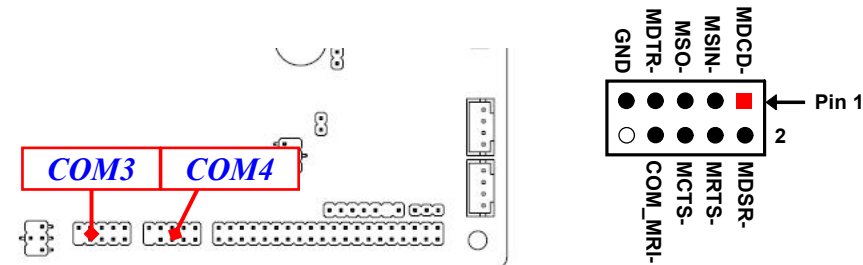

(2) F_PH1 (40-pin): COM Port Expansion Header & GPIO Header *Pitch=2.0mm*

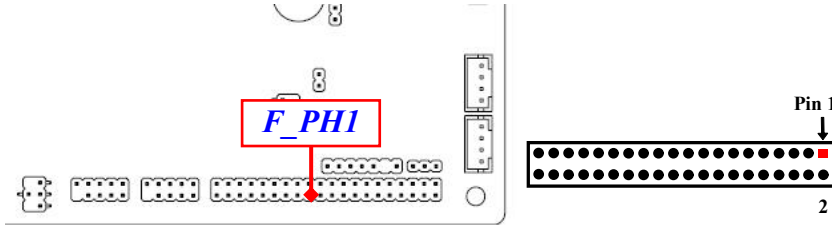

Pin NO.	Pin Define	Pin NO.	Pin Define
Pin 1	VCC	Pin 2	VCC
Pin 3	GL850_USBN3_A	Pin 4	GL850_USBN4_A
Pin 5	GL850_USBP3_A	Pin 6	GL850_USBP4_A
Pin 7	GND	Pin 8	GND
Pin 9	GND	Pin 10	NC
Pin 11	DCD5-	Pin 12	DSR5-
Pin 13	SIN5	Pin 14	RTS5-
Pin 15	SOUT5	Pin 16	CTS5-
Pin 17	DTR5-	Pin 18	RI5-
Pin 19	GND	Pin 20	NC
Pin 21	DCD6-	Pin 22	DSR6-
Pin 23	SIN6	Pin 24	RTS6-
Pin 25	SOUT6	Pin 26	CTS6-
Pin 27	DTR6-	Pin 28	RI6-
Pin 29	GND	Pin 30	NC
Pin 31	SIO_GPIO80	Pin 32	SIO_GPIO81
Pin 33	SIO_GPIO82	Pin 34	SIO_GPIO83
Pin 35	SIO_GPIO84	Pin 36	SIO_GPIO85
Pin 37	SIO_GPIO86	Pin 38	SIO_GPIO87
Pin 39	GND	Pin 40	VCC

(3) PS2KBMS1 (6-pin): PS/2 Keyboard & Mouse Header *Pitch=2.0mm*

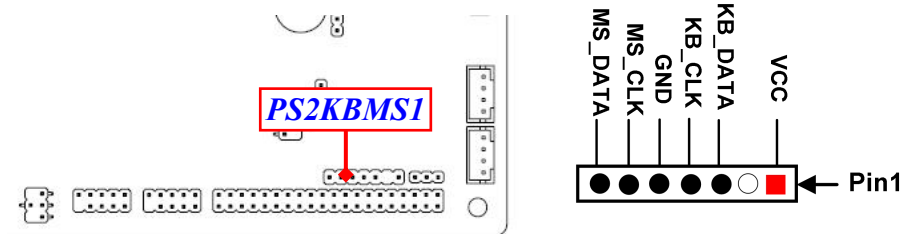

(4) COPEN1 (2-pin): Case Open Message Display Function *Pitch=2.0mm*

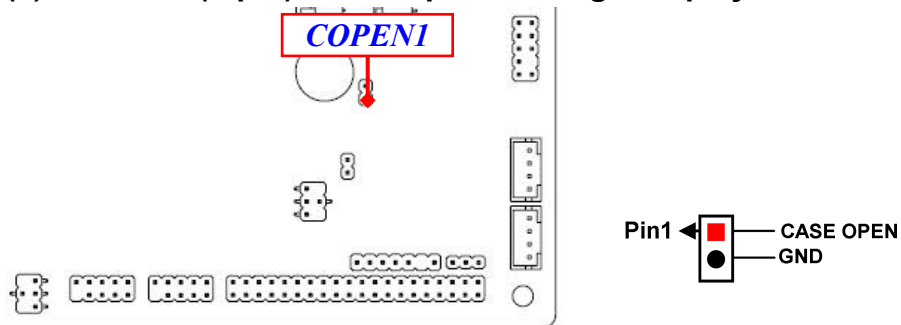

Pin 1-2 Close: When Case open function pin short to GND, the Case open function was detected. When Used, needs to enter BIOS and enable 'Case Open Detect' function. In this case if your case is removed, next time when you restart your computer, a message will be displayed on screen to inform you of this.

(5) **FP_USB1 (9-pin): USB 2.0 Port Header** *Pitch=2.0mm*

FP_USB1 → 2 USB 2.0 Port*

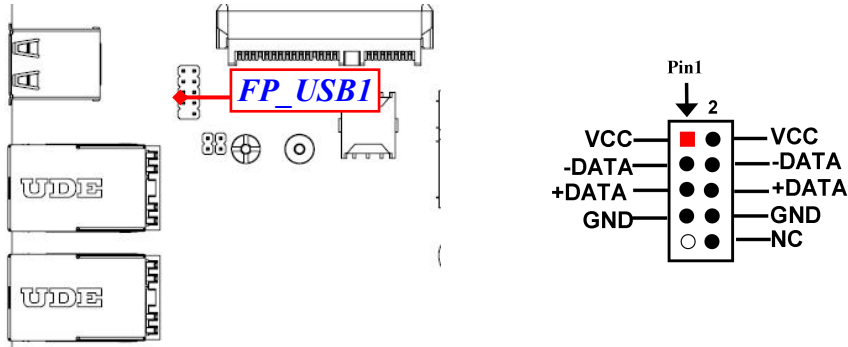

(6) **FP_AUDIO1 (9-pin): Line-Out, MIC-In Header** *Pitch=2.0mm*

This header connects to Front Panel Line-out, MIC-In connector with cable

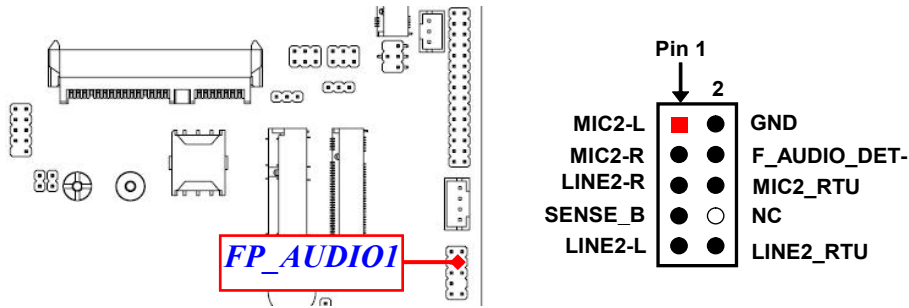

(7) LVDS1 (30-Pin): 24-bit dual channel LVDS Header *Pitch=2.0mm*

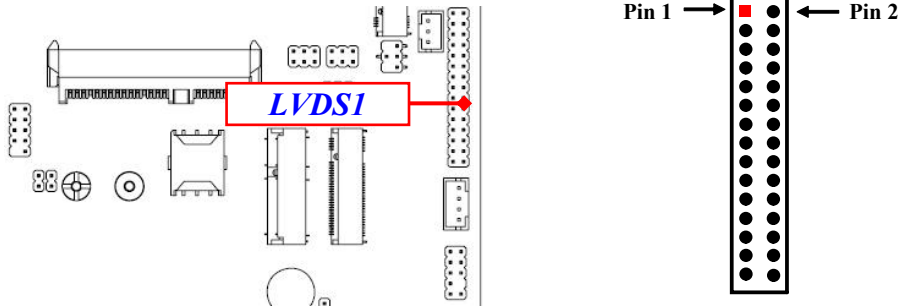

Pin NO.	Pin Define	Pin NO.	Pin Define
Pin 1	LVD_VCC	Pin 2	LVD_VCC
Pin 3	LVD_VCC	Pin 4	GND
Pin 5	GND	Pin 6	GND
Pin 7	LVDSA_DATAN0	Pin 8	LVDSA_DATAP0
Pin 9	LVDSA_DATAN1	Pin 10	LVDSA_DATAP1
Pin 11	LVDSA_DATAN2	Pin 12	LVDSA_DATAP2
Pin 13	GND	Pin 14	GND
Pin 15	LVDSA_CLKN	Pin 16	LVDSA_CLKP
Pin 17	LVDSA_DATAN3	Pin 18	LVDSA_DATAP3
Pin 19	LVDSB_DATAN0	Pin 20	LVDSB_DATAP0
Pin 21	LVDSB_DATAN1	Pin 22	LVDSB_DATAP1
Pin 23	LVDSB_DATAN2	Pin 24	LVDSB_DATAP2
Pin 25	GND	Pin 26	GND
Pin 27	LVDSB_CLKN	Pin 28	LVDSB_CLKP
Pin 29	LVDSB_DATAN3	Pin 30	LVDSB_DATAP3

(8) INVERTER1 (6-Pin): LVDS1 Inverter Header *Pitch=2.0mm*

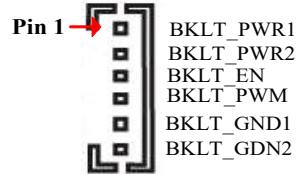
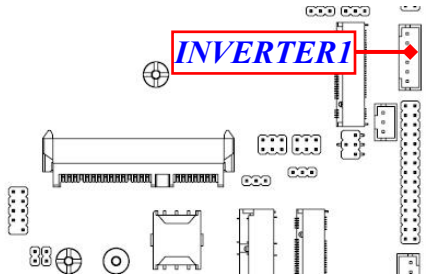

(9) JW_FP1 (9-pin): Front Panel Header *Pitch=2.54mm*

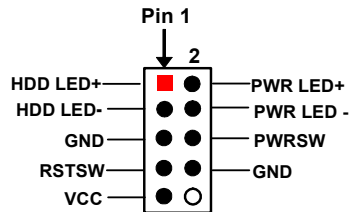
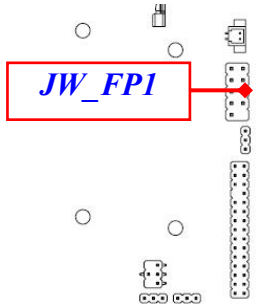

(10) SMBUS1 (5-Pin): SMBUS Header *Pitch=2.0mm*

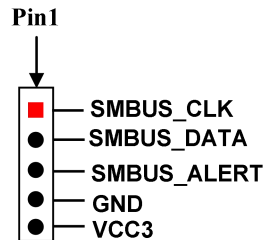
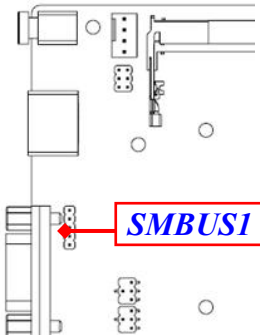

(11) eDP1 (30-pin): eDP Header *Pitch=2.0mm*

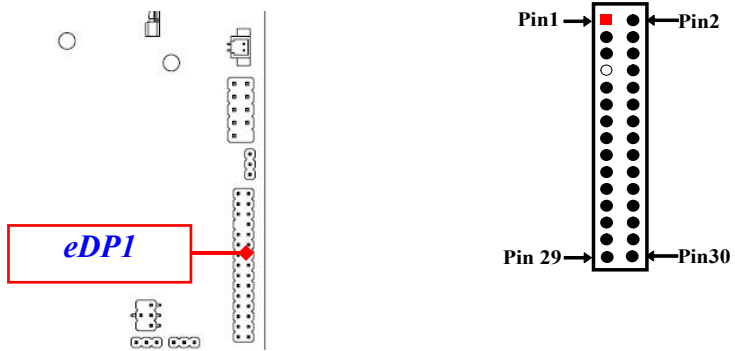

Pin NO.	Pin Define	Pin NO.	Pin Define
Pin 1	BKLT_PW	Pin 2	EDP_INVCC
Pin 3	BKLT_PW	Pin 4	GND
Pin 5	GND	Pin 6	NC
Pin 7	NC	Pin 8	NC
Pin 9	EDP_LCD_VCC	Pin 10	NC
Pin 11	EDP_LCD_VCC	Pin 12	EDP_BKLTCTL
Pin 13	GND	Pin 14	GND
Pin 15	EDP_BKLTEN	Pin 16	EDP_AUXP_C
Pin 17	EDP_HPD	Pin 18	EDP_AUXN_C
Pin 19	GND	Pin 20	GND
Pin 21	EDP_LAN+3	Pin 22	EDP_LANE-3
Pin 23	EDP_LAN+2	Pin 24	EDP_LANE-2
Pin 25	GND	Pin 26	GND
Pin 27	EDP_LAN+1	Pin 28	EDP_LANE-1
Pin 29	EDP_LAN+0	Pin 30	EDP_LANE-0

2-2-3 Maximum Voltage & Current Limit

Below is a list of maximum voltage & Current Limit specification for motherboard interface (including but not limited to slots, connectors, wafers and headers) for setup reference:

Location	Function	Working Voltage	Current Support
JPCOM1	COM1 Function Select	5V or 12V	0.5A
JPCOM2	COM2 Function Select	5V or 12V	0.5A
JPCOM3	COM3 Port Pin9 Function	5V/12V	0.5A
JPCOM4	COM4 Port Pin9 Function	5V/12V	0.5A
SMBUS1	SMBUS	5V	0.3A
CPUFAN1	CPU FAN	12V	1.5A
JW_FP1	Front Panel	5V	1A
USB2/USB3	USB 2.0 Port	5V	1.5A
FP_USB1	USB 2.0 Header	5V	1.5A
PS2KBMS1	PS/2 Keyboard & Mouse	5V	0.5A
M2E_PWR1	M.2 E-key Power	3.3V	2A
M2M_PWR1	M.2 M-key Power	3.3V	2A
M2B_PWR1	M.2 B-key Power	3.3V	2A

Chapter 3

Introducing BIOS

Notice! The BIOS options in this manual are for reference only. Different configurations may lead to difference in BIOS screen and BIOS screens in manuals are usually the first BIOS version when the board is released and may be different from your purchased motherboard. Users are welcome to download the latest BIOS version form our official website.

The BIOS is a program located on a Flash Memory on the motherboard. This program is a bridge between motherboard and operating system. When you start the computer, the BIOS program will gain control. The BIOS first operates an auto-diagnostic test called POST (power on self test) for all the necessary hardware, it detects the entire hardware device and configures the parameters of the hardware synchronization. Only when these tasks are completed done it gives up control of the computer to operating system (OS). Since the BIOS is the only channel for hardware and software to communicate, it is the key factor for system stability, and in ensuring that your system performance as its best.

3-1 Entering Setup

Power on the computer and by pressing immediately allows you to enter Setup. If the message disappears before your respond and you still wish to enter Setup, restart the system to try again by turning it OFF then ON or pressing the “RESET” button on the system case. You may also restart by simultaneously pressing <Ctrl>, <Alt> and <Delete> keys. If you do not press the keys at the correct time and the system does not boot, an error message will be displayed and you will again be asked to

Press **** to enter Setup

3-2 BIOS Menu Screen

The following diagram show a general BIOS menu screen:

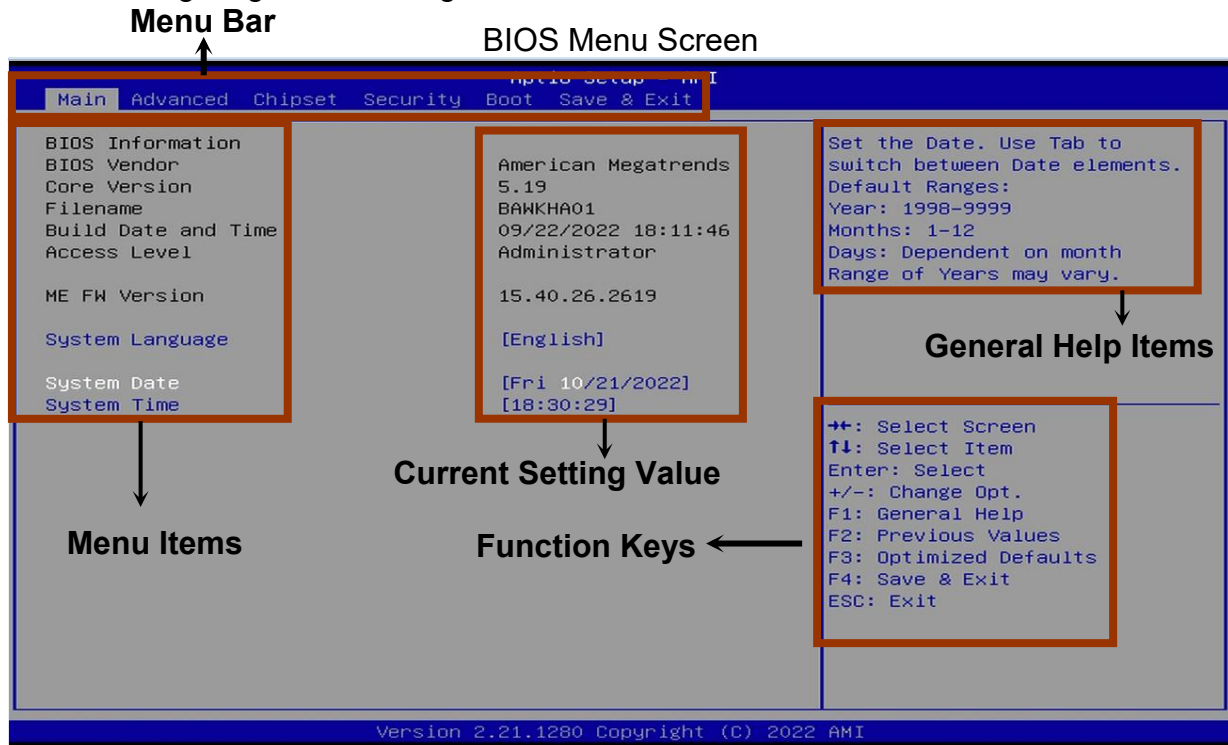

3-3 Function Keys

In the above BIOS Setup main menu of, you can see several options. We will explain these options step by step in the following pages of this chapter, but let us first see a short description of the function keys you may use here:

- Press ←→ (left, right) to select screen;
- Press ↑↓ (up, down) to choose, in the main menu, the option you want to confirm or to modify.
- Press <Enter> to select.

-
- Press <+>/<-> keys when you want to modify the BIOS parameters for the active option.
 - [F1]: General help.
 - [F2]: Previous values.
 - [F3]: Optimized defaults.
 - [F4]: Save & Exit.
 - Press <Esc> to quit the BIOS Setup.

3-4 Getting Help

Main Menu

The on-line description of the highlighted setup function is displayed at the top right corner the screen.

Status Page Setup Menu/Option Page Setup Menu

Press [F1] to pop up a small help window that describes the appropriate keys to use and the possible selections for the highlighted item. To exit the Help Window, press <Esc>.

3-5 Menu Bars

There are six menu bars on top of BIOS screen:

Main	To change system basic configuration
Advanced	To change system advanced configuration
Chipset	To change chipset configuration
Security	Password settings
Boot	To change boot settings
Save & Exit	Save setting, loading and exit options.

User can press the right or left arrow key on the keyboard to switch from menu bar. The selected one is highlighted.

3-6 Main Menu

Main menu screen includes some basic system information. Highlight the item and then use the <+> or <-> and numerical keyboard keys to select the value you want in each item.

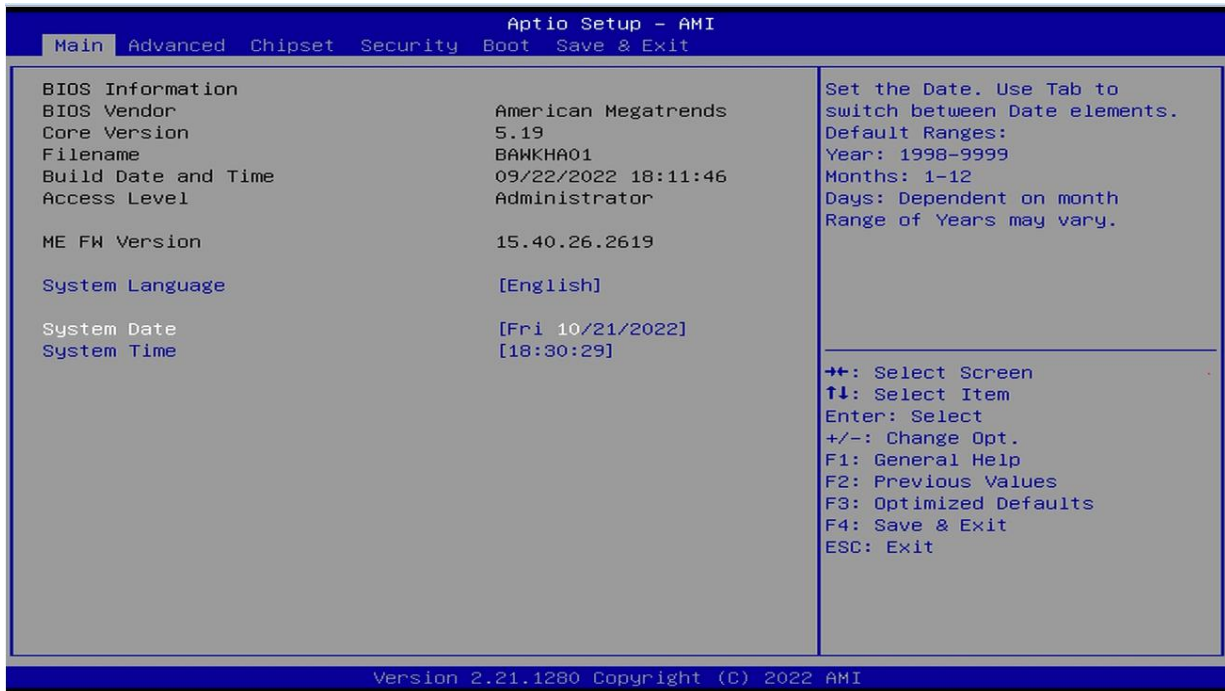

System Date

Set the date. Please use [Tab] to switch between date elements.

System Time

Set the time. Please use [Tab] to switch between time elements.

3-7 Advanced Menu

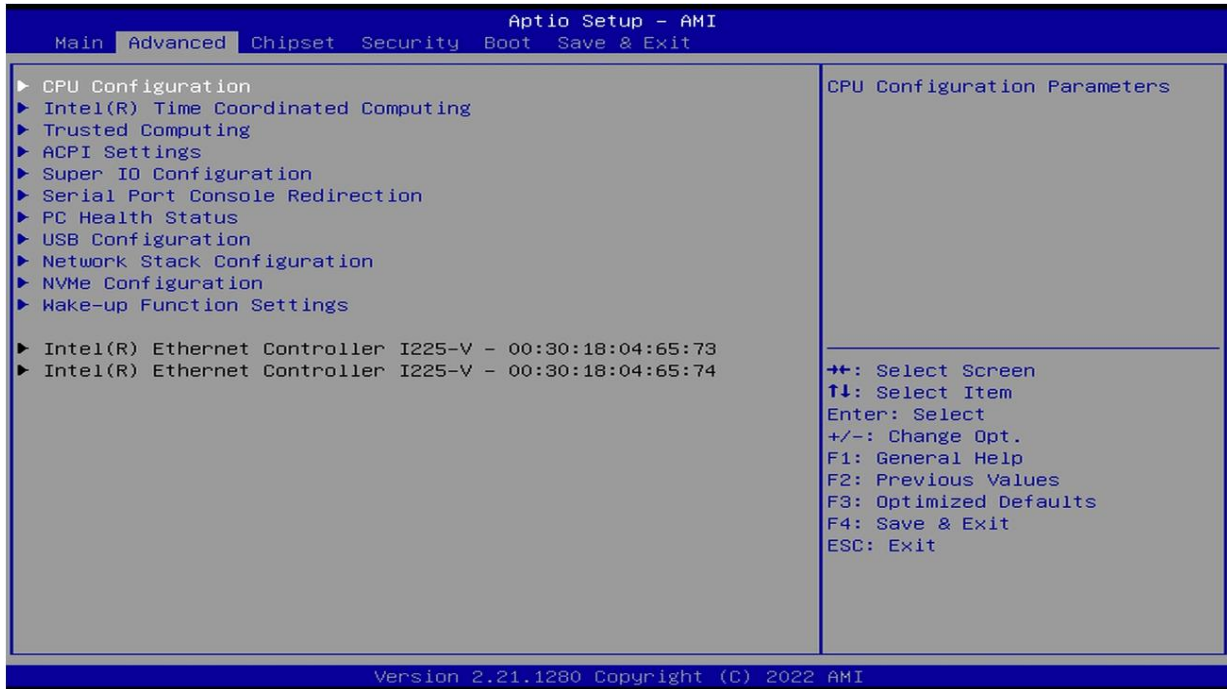

▶ CPU Configuration

Press [Enter] to make settings for the following sub-item:

Boot Performance Mode

Use this item to select the performance state that the BIOS will set starting from reset vector.

The optional settings: [Max Battery]; [Max Non-Turbo Performance]; [Turbo Performance]

Intel(R) SpeedStep(tm)

Use this item to allows more than two frequency ranges to be supported.

The optional settings: [Disabled]; [Enabled]

When set as [Enabled], the following sub-items shall appear:

Turbo Mode

Use this item to enable/disable processor Turbo Mode (requires EMTTM enabled)

too). AUTO means enabled.

The optional settings: [Disabled]; [Enabled]

C states

Use this item to enable/disable CPU Power Management. Allows CPU to go to C states when it's not 100% utilized

The optional settings: [Disabled]; [Enabled]

When set as [Enabled], the following sub-items shall appear:

Enhanced C-states

Use this item to enable/disable C1E. When enabled, CPU will switch to minimum speed when all cores enter C-State.

The optional settings: [Disabled]; [Enabled]

Package C State Limit

Use this item to Maximum Package C State Limit Setting. CPU Default: Leaves to Factory default value. AUTO: available Package C State Limit.

The optional settings: [C0/C1]; [C2]; [C3]; [C6]; [C7]; [C7S]; [C8]; [C9]; [C10]; [CPU Default]; [Auto]

Power Limit 1 Override

Use this item to enable/disable Power Limit1 override. If this option is disabled, BIOS will program the default values for Power Limit1 and Power Limit1 Time Window.

The optional settings: [Disabled]; [Enabled]

When set as [Enabled], the following sub-items shall appear:

Power Limit 1

Use this item Power Limit 1 in Milli Watts. BIOS will round to the nearest 1/8W when programming. 0= no custom override. For 12.50W, enter 12500. Overclocking SKU: Value must be between Max and Min Power Limits (specified by PACKAGE_POWER_SKU_MSR). Other SKUs: This value must be between Min Power Limit and TDP Limit. If value is 0, BIOS will program TDP value.

Power Limit 1 Time Window

Use this item to power Limit 1 Time Window value in seconds. The value may vary from 0 to 128. 0=default value (28 sec for Mobile and 8 sec for desktop). Defines time Window which TDP value should be maintained.

The optional settings: [0]; [1]; [2]; [3]; [4]; [5]; [6]; [7]; [8]; [10]; [12]; [14];

[16] ; [20] ; [24] ; [28] ; [32] ; [40] ; [48] ; [56] ; [64] ; [80] ; [96] ; [112] ; [128]

Power Limit 2 Override

Use this item to enabled/disable power Limit 2 override. If this option is disabled, BIOS will program the default values for Power Limit 2.

The optional settings: [Disabled]; [Enabled].

When set as [Enabled], user can make further settings in the following items:

Power Limit 2

Use this item to power Limit 2 value in Milli watts. BIOS will round to the nearest 1/8W when programming. If the value is 0, BIOS will program this value as 1.25*TDP. For 12.50W, enter 12500. Processor applies control policies such that the package power does not exceed this limit.

▶ **Intel(R) Time Coordinated Computing**

Press [Enter] to make settings for the following sub-item:

Use this item to Intel(R) Time Coordinated Computing (Intel (R) TCC) options

Press [Enter] to make settings for the following sub-items

In tel(R) TCC Mode

Use this item to enable or disable Intel(R) TCC mode. when enabled, this will modify system settings to improve real-time performance. The full list of settings and their current state are displayed below when Intel(R) TCC mode is enabled

The optional settings: [Disabled]; [Enabled].

When set as [Enabled], user can make further settings in the following items:

Intel(R) TCC Authentication

Use this item to enabled/disable authentication of Intel(R) TCC configuration data.

The optional settings: [Disabled]; [Enabled].

When set **Intel(R) TCC Mode** as [Disabled], user can make further settings in the following items:

IO Fabric Low Latency

Use this item to enabled or disable IO Fabric Low Latency. This will turn off some power management in the PCH IO fabrics. This option provides the most aggressive IO Fabric performance setting. S3 state is NOT supported

The optional settings: [Disabled]; [Enabled].

GT CLOS

Use this item to enable or disable Graphics Technology(GT) Class of Service. Enable will reduce Gfx LLC allocation to minimize impact of Gfx workload on LLC. The optional settings: [Disabled]; [Enabled].

▶ **Trusted Computing**

Press [Enter] to make settings for the following sub-item:

Security Device Support

Use this item to enable or disable BIOS support for security device. OS will not show Security Device. TCG EFI protocol and INT1A interface will not be available.

The optional settings: [Disabled]; [Enabled].

When set as [Enabled], the following sub-items shall appear:

Active PCR Banks

Available PCR Banks

SHA-1 PCR Bank

Use this item to enable or disable SHA-1 PCR Bank

The optional settings are: [Disabled]; [Enabled]

SHA256 PCR Bank

Use this item to enable or disable SHA256 PCR Bank

The optional settings are: [Disabled]; [Enabled]

SHA384 PCR Bank

Use this item to enable or disable SHA384 PCR Bank

The optional settings are: [Disabled]; [Enabled]

SM3_256 PCR Bank

Use this item to enable or disable SM3_256 PCR Bank

The optional settings are: [Disabled]; [Enabled]

Pending Operation

Use this item to schedule an operation for the security device.

NOTE: Your computer will reboot during restart in order to change state of security device

The optional settings are: [None]; [TPM Clear]

▶ **ACPI Settings**

Press [Enter] to make settings for the following sub-item:

ACPI Sleep State

Use this item to select ACPI sleep state the system will enter when the suspend button is pressed.

The optional settings are: [Suspend Disabled]; [S3 only (Suspend to RAM)].

▶ **Super I/O Configuration**

Press [Enter] to make settings for the following sub-items:

Serial Port 1/2 Configuration

Press [Enter] to make settings for the following items:

Serial Port

Use this item to enable or disable serial port (COM).

The optional settings are: [Disabled]; [Enabled].

When set as [Enabled], the following sub-items shall appear:

Device Settings

Change Settings

Use this item to select an optimal setting for super IO device.

The optional settings are: [Auto]; [IO=3F8h; IRQ=4;]; [IO=2F8h; IRQ=3;]; [IO=3E8h; IRQ=4;]; [IO=2E8h; IRQ=3;].

Transmission Mode Select

Use this item to select transmission mode.

The optional settings are: [RS422]; [RS232]; [RS485].

▶ **Serial Port 3/4 Configuration**

Press [Enter] to make settings for the following items:

Serial Port

Use this item to enable or disable serial port (COM).

The optional settings are: [Disabled]; [Enabled].

When set as [Enabled], the following sub-items shall appear:

Device Settings

Change Settings

Use this item to select an optimal setting for super IO device.

The optional settings are: [Auto]; [IO=3F8h; IRQ=10;]; [IO=2F8h; IRQ=10;]; [IO=3E8h; IRQ=10;]; [IO=2E8h; IRQ=10;]; [IO=2F0h; IRQ=10;]; [IO=2E0h; IRQ=10;].

ERP Support

Use this item to energy-related products function disable ERP.

The optional settings are: [Disabled]; [Enabled].

Case Open Detect

Use this item to detect Case has already open or not. Show message in POST.

The optional settings: [Disabled]; [Enabled].

When set as **[Enabled]**, system will detect if COPEN has been short or not (*refer to **COPEN1** jumper setting for Case Open Detection*); if Pin 1&2 of **CASE OPEN** are short, system will show Case Open Message during POST

WatchDog Reset Timer

This item support WDT reset function.

The optional settings: [Disabled]; [Enabled].

Use this item to enable or disable WatchDog Timer Control. When set as [Enabled], the following sub-items shall appear:

WatchDog Reset Timer Value

User can set a value in the range of [10] to [255] seconds or in the range of [1] to [255] minutes.

WatchDog Reset Timer Unit

The optional settings are: [Sec.]; [Min.].

WatchDog Wake-up Timer

Support WDT Wake-up.

The optional settings: [Disabled]; [Enabled]. When set as [Enabled], the following sub-items shall appear:

WatchDog Wake-up Timer Value

User can set a value in the range of [10] to [4095] seconds when ‘**WatchDog Wake-up Timer Unit**’ set as [Sec.], or in the range of [1] to [4095] minutes when ‘**WatchDog Wake-up Timer Unit**’ set as [Min.].

WatchDog Wake-up Timer Unit

The optional settings are: [Sec.]; [Min.].

ATX Power Emulate AT Power

This item support Emulate AT power function, MB power On/Off control by power supply. Use needs to select ‘AT or ATX Mode’ on MB jumper at first (refer to AT_MODE1 jumper setting Pin 1&2 of for ATX Mode & Pin 2&3 of AT Mode Select).

▶ **Serial Port Console Redirection**

COM1

Console Redirection

The optional settings: [Disabled]; [Enabled]. When set as [Enabled], the following sub-items shall appear:

▶ **Console Redirection Settings**

The settings specify how the host computer and the remote computer (which the user is using) will exchange data. Both computers should have the same or compatible settings.

Press [Enter] to make settings for the following items:

Terminal Type

The optional settings: [VT100]; [VT100+]; [VT-UTF8]; [ANSI].

Emulation: VT100: ASCII char set; VT100+: Extends VT100 to support color, function keys, etc.; VT-UTF8: Uses UTF8 encoding to map Unicode chars onto 1 or more bytes; ANSI: Extended ASCII char set.

Bits per second

Use this item to select serial port transmission speed. The speed must be matched on the other side. Long or noisy lines may require lower speeds.

The optional settings: [9600]; [19200]; [38400]; [57600]; [115200].

Data Bits

The optional settings: [7]; [8].

Parity

A parity bit can be sent with the data bits to detect some transmission errors.

The optional settings: [None]; [Even]; [Odd]; [Mark]; [Space].

Even: parity bit is 0 if the num of 1's in the data bits is odd; Mark: parity bit is always 1; Space: Parity bit is always 0; Mark and Space Parity do not allow for error detection.

Stop Bits

Stop bits indicate the end of a serial data packet. (A start bit indicates the beginning). The standard settings is 1 stop bit. Communication with slow devices may require more than 1 stop bit.

The optional settings: [1]; [2].

Flow Control

Flow control can prevent data loss from buffer overflow. When sending data, if the receiving buffers are full, a “stop” signal can be sent to stop the data flow. Once the buffers are empty, a “start” signal can be sent to re-start the flow. Hardware flow control uses two wires to send start/stop signals.

The optional settings: [None]; [Hardware RTS/CTS].

VT-UTF8 Combo Key Support

Use this item to enable VT-UTF8 Combination Key Support for ANSI/VT100 terminals.

The optional settings: [Disabled]; [Enabled].

Recorder Mode

With this mode enable only text will be sent. This is to capture Terminal data.

The optional settings: [Disabled]; [Enabled].

Resolution 100x31

Use this item to enable or disable extended terminal resolution.

The optional settings: [Disabled]; [Enabled].

Legacy OS Redirection Resolution

On Legacy OS, the Number of Rows and Columns supported redirection.

The optional settings: [80x24]; [80x25].

Putty KeyPad

Use this item to select FunctionKey and KeyPad on Putty.

Console Redirection EMS

The optional settings: [Disabled]; [Enabled]. When set as [Enabled], the following sub-items shall appear:

▶ **Console Redirection Settings**

The settings specify how the host computer and the remote computer (which the user is using) will exchange data. Both computers should have the same or compatible settings.

Press [Enter] to make settings for the following items:

Terminal Type EMS

The optional settings: [VT100]; [VT100+]; [VT-UTF8]; [ANSI].

Emulation: VT100: ASCII char set; VT100+: Extends VT100 to support color, function keys, etc.; VT-UTF8: Uses UTF8 encoding to map Unicode chars onto 1

or more bytes; ANSI: Extended ASCII char set.

Bits per second EMS

Use this item to select serial port transmission speed. The speed must be matched on the other side. Long or noisy lines may require lower speeds.

The optional settings: [9600]; [19200]; [57600]; [115200].

Flow Control EMS

Flow control can prevent data loss from buffer overflow. When sending data, if the receiving buffers are full, a “stop” signal can be sent to stop the data flow. Once the buffers are empty, a “start” signal can be sent to re-start the flow. Hardware flow control uses two wires to send start/stop signals.

The optional settings: [None]; [Hardware RTS/CTS]; [Software Xon/Xoff].

Data Bits EMS

Parity EMS

Stop Bits EMS

▶ **PC Health Status**

Press [Enter] to view current hardware health status, set shutdown temperature, or make further settings in ‘**SmartFan Configuration**’.

SmartFan Configuration

Press [Enter] to make settings for SmartFAN Configuration:

CPUFAN Smart Mode

The optional settings are: [Disabled]; [Enabled].

When set as [Enabled], the following sub-items shall appear:

CPUFAN Full-Speed Temperature

Use this item to set CPUFAN full speed temperature. Fan will run at full speed when above the pre-set temperature.

CPUFAN Full-Speed Duty

Use this item to set CPUFAN full speed duty. Fan will run at full speed when above the pre-set duty.

CPUFAN Idle-Speed Temperature

Use this item to set CPUFAN idle speed temperature. Fan will run at idle speed when below the pre-set temperature.

CPUFAN Idle-Speed Duty

Use this item to set CPUFAN idle speed duty. Fan will run at idle speed when

below the pre-set duty.

▶ **USB Configuration**

XHCI Hand-off

This is a workaround for OSES without XHCI hand-off support. The XHCI ownership change should be claimed by XHCI driver.

The optional settings are: [Enabled]; [Disabled].

USB Mass Storage Driver Support

The optional settings are: [Disabled]; [Enabled].

USB Hardware Delays and Time-outs

USB Transfer time-out

Use this item to set the time-out value for control, bulk, and interrupt transfers.

The optional settings are: [1 sec]; [5 sec]; [10 sec]; [20 sec].

Device reset time-out

Use this item to set USB mass storage device start unit command time-out.

The optional settings are: [10 sec]; [20 sec]; [30 sec]; [40 sec].

Device power-up delay

Use this item to set maximum time the device will take before it properly reports itself to the host controller. 'Auto' uses default value: for a root port it is 100 ms, for a hub port the delay is taken from hub descriptor.

The optional settings: [Auto]; [Manual].

Select [Manual] you can set value for the following sub-item: '**Device Power-up Delay in Seconds**'.

Device Power-up Delay in Seconds

The delay range is from [1] to [40] seconds, in one second increments.

▶ **Network Stack Configuration**

Press [Enter] to go to '**Network Stack**' screen to enable or disable UEFI Network Stack.

Network Stack

The optional settings are: [Enabled]; [Disabled].

When set as [Enabled], the following sub-items shall appear:

Ipv4 PXE Support

The optional settings are: [Disabled]; [Enabled].

Use this item to enable Ipv4 PXE Boot Support. When set as [Disabled], Ipv4 boot

optional will not be created.

Ipv6 PXE Support

The optional settings are: [Disabled]; [Enabled].

Use this item to enable Ipv6 PXE Boot Support. When set as [Disabled], Ipv6 boot optional will not be created.

PXE Boot Wait Time

Use this item to set wait time to press [ESC] key to abort the PXE boot.

Media Detect Count

Use this item to set number of times presence of media will be checked.

Use either [+] / [-] or numeric keys to set the value.

▶ **NVMe Configuration**

Press [Enter] to view current NVMe Configuration.

**Note: options only when NVMe device is available.*

▶ **Wakeup Function Settings**

Press [Enter] to make settings for the following sub-items:

Wake-up System with Fixed Time

Use this item to enable or disable system wake on alarm event.

The optional settings: [Disabled]; [Enabled].

When set as [Enabled], system will wake on the hour/min/sec specified.

Wake-up Hour

Use this item to 0-23. For example, 3 for 3am and 15 for 3pm

Wake-up Minute

Use this item to 0-59

Wake-up Second

Use this item to 0-59

When set **Wake-up System with Fixed Time** as [Enabled], user can make further settings in the following items:

Wake-up System with Dynamic Time

Use this item to enable or disable system wake on alarm event.

System will wake on the current time + Increase minutes.

The optional settings: [Disabled]; [Enabled].

When set as [Enabled], system will wake on the current time + increased minute(s).

Wake-up Time Increase

Use this item to 1 to 60 minute(s)

PS2 KB/MS Wake-Up from S3-S5

Use this item to PS2 KB/MS Wake-Up is affected by ERP function in S4-S5.

Please disable ERP before activating this function in S4-S5

The optional settings: [Disabled]; [Enabled].

USB Power Gating S4- S5

Use this item to USB Wake-up is affected by ERP function in S4. Please disable ERP before activating this function in S4.

The optional settings: [Disabled]; [Enabled].

****Note:** This function is supported when 'ERP Support' is set as [Disabled].

PCIe Wake-up from S3-S5

The optional settings: [Disabled]; [Enabled].

- ▶ **Intel® Ethernet Controller I225-V- XX:XX:XX:XX:XX:XX**
- ▶ **Intel® Ethernet Controller I225-V- XX:XX:XX:XX:XX:XX**

3-8 Chipset Menu

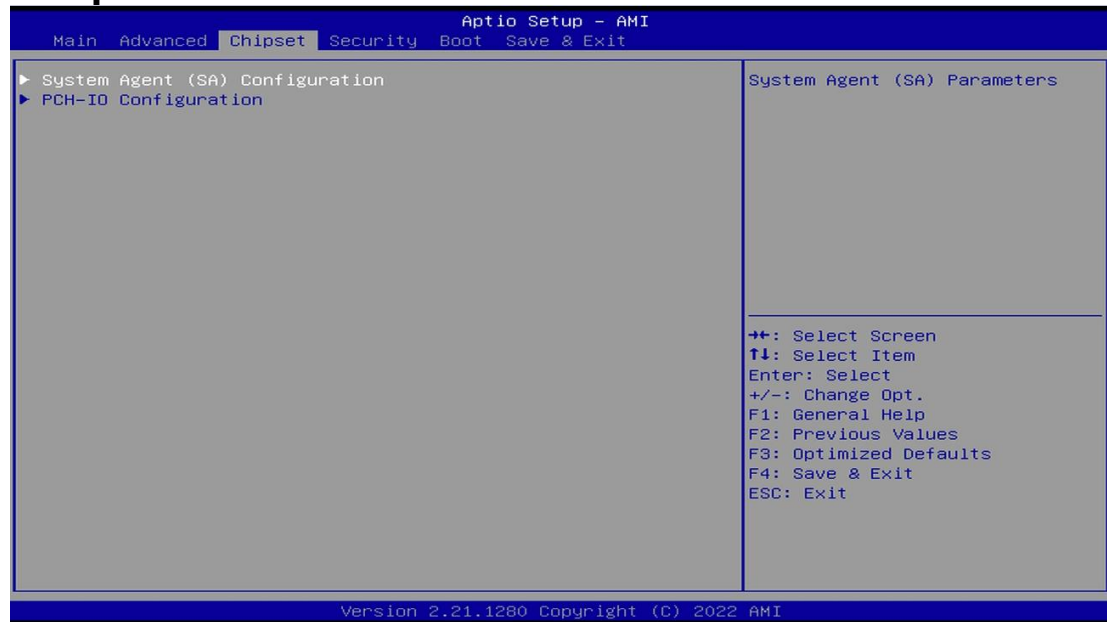

▶ **System Agent(SA) Configuration**

Press [Enter] to make settings for the following sub-items:

GTT Size

Use this item to select the GTT Size.

The optional settings: [2MB]; [4MB]; [8MB].

DVMT Pre-Allocated

Use this item to select DVMT 5.0 pre-allocated (fixed) graphics memory size used by the internal graphics device.

The optional settings: [0M]; [4M]; [8M]; [12M]; [16M]; [20M]; [24M]; [28M]; [32M]; [36M]; [40M]; [44M]; [48M]; [52M]; [56M]; [60M]; [64M]; [96M]; [128M]; [160M]

DVMT Total Gfx Mem

Use this item to select DVMT 5.0 total graphics memory size used by the internal graphics device.

The optional settings: [128M]; [256M]; [MAX].

Active LFP

The optional settings are: [Disable]; [LVDS]

LVDS Panel Type

The optional settings are: [800x480 1ch 18-bit]; [800x600 1ch 18-bit]; [800x600 1ch 24-bit]; [1024x600 1ch 18-bit]; [1024x768 1ch 18-bit]; [1024x768 1ch 24-bit]; [1280x768 1ch 24-bit]; [1280x800 1ch 18-bit]; [1280x800 1ch 24-bit]; [1366x768 1ch 18-bit]; [1366x768 1ch 24-bit]; [1440x900 2ch 18-bit]; [1440x900 2ch 24-bit]; [1280x1024 2ch 24-bit]; [1680x1050 2ch 24-bit]; [1920x1080 2ch 24-bit].

Backlight Control

Use this item to back light control setting

The optional settings are: [PWM Inverted]; [PWM Normal]

Total Memory.

▶ **PCH-IO Configuration**

Press [Enter] to make further settings in south bridge parameters.

▶ **PCI Express Configuration**

Press [Enter] to make further settings in south bridge parameters.

Peer Memory Write Enable

The optional settings: [Enabled]; [Disabled].

▶ **SATA Configuration**

Press [Enter] to make settings for the following sub-items:

SATA Controller

Use this item to enable/disable SATA Device

When set as [Enabled], the following sub-items shall appear:

SATA Mode Selection

Use this item to Determines how SATA controller(s) operate.

The optional settings: [AHCI]

SATA Port

SATA Port

The optional settings: [Enabled]; [Disabled].

Hot Plug

Use this item to Designates this port as hot pluggable

The optional settings: [Enabled]; [Disabled].

M.2

M.2

The optional settings: [Enabled]; [Disabled].

HD-Audio Support

The optional settings: [Enabled]; [Disabled].

System State after Power Failure

Use this item to specify what state to go to when power is re-applied after a power failure

The optional settings: [Always On]; [Always Onff]; [Former State]

PinCntrl Driver GPIO Scheme

Use this item to enable/disable PinCntrl Driver GPIO Scheme

The optional settings: [Enabled]; [Disabled]

3-9 Security Menu

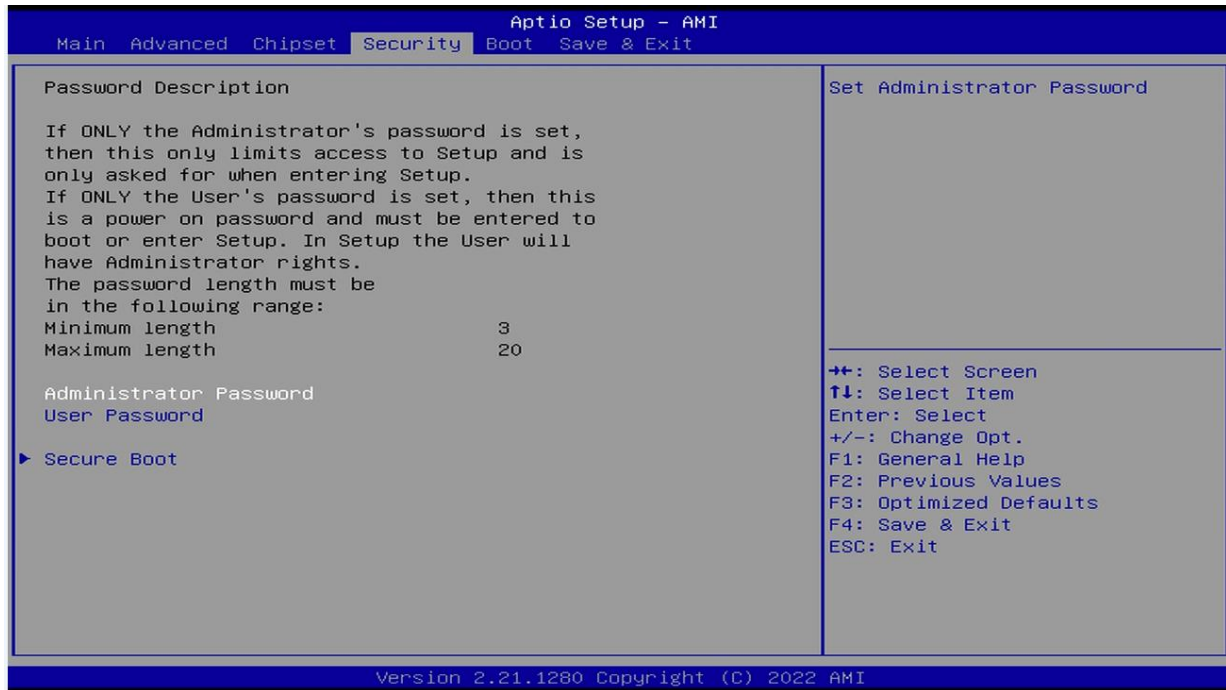

Security menu allow users to change administrator password and user password settings.

Administrator Password

If there is no password present on system, please press [Enter] to create new administrator password. If password is present on system, please press [Enter] to verify old password then to clear/change password. Press again to confirm the new administrator password.

User Password

If there is no password present on system, please press [Enter] to create new administrator password. If password is present on system, please press [Enter] to verify old password then to clear/change password. Press again to confirm the new administrator password.

▶ **Secure Boot**

Press [Enter] to make customized secure settings:

Secure Boot Control

The optional settings are: [Disabled]; [Enabled].

Secure Boot can be enabled if 1. System running in user mode with enrolled Platform Key (PK); 2. CSM function is disabled.

Secure Boot Mode

The optional settings are: [Standard]; [Custom].

Set UEFI Secure Boot Mode to Standard mode or Custom mode. This change is effective after save. After reset, this mode will return to Standard mode.

**When set as [Custom], user can make further settings in 'Key Management'.*

▶ **Restore Factory Keys**

Use this item to force system to User Mode, to install factory default Secure Boot key databases.

▶ **Reset To Setup Mode**

Use this item to delete all Secure Boot key databases from NVRAM.

▶ **Key Management**

This item enables experienced users to modify Secure Boot variables, which includes the following items:

Provision Factory Default Keys

This item is for user to install factory default secure boot keys when system is in Setup Mode.

▶ **Enroll all Factory Default Keys**

This item forces system to User Mode-install all Factory Default keys.

▶ **Save all Secure Boot Variables**

This item will save NVRAM content of all Secure Boot variables to the files (WFI_SIGNATURE_LIST data format) in root folder on a target file system device.

▶ **Platform Key (PK)/Key Exchange Keys/Authorized Signature/Forbidden Signature/ Authorized TimeStamps/OS Recovery Signatures**

Use this item to enroll Factory Defaults or load the keys from a file with:

1. Public Key Certificate in:

a) EFI_SIGNATURE_LIST

- b) EFI_CERT_X509 (DER encoded)
- c) EFI_CERT_RSA2048 (bin)
- d) EFI_CERT_SHA256 (bin)

2. Authenticated UEFI Variable

3-10 Boot Menu

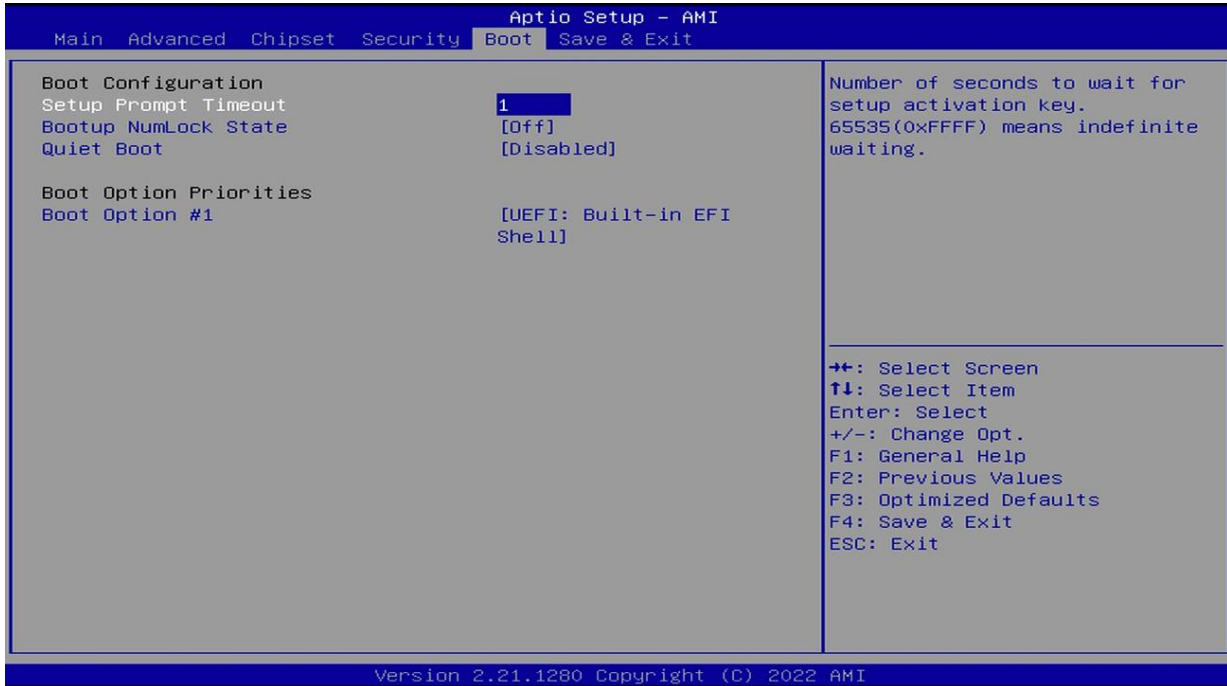

Boot Configuration

Setup Prompt Timeout

Use this item to set number of seconds to wait for setup activation key.

Bootup Numlock State

Use this item to select keyboard NumLock state.

The optional settings are: [On]; [Off].

Quiet Boot

The optional settings are: [Disabled]; [Enabled].

Boot Option Priorities

Boot Option # 1

Use this item to set system boot order.

The optional settings are: [UEFI: Built-in EFI Shell]; [Disabled].

3-11 Save & Exit Menu

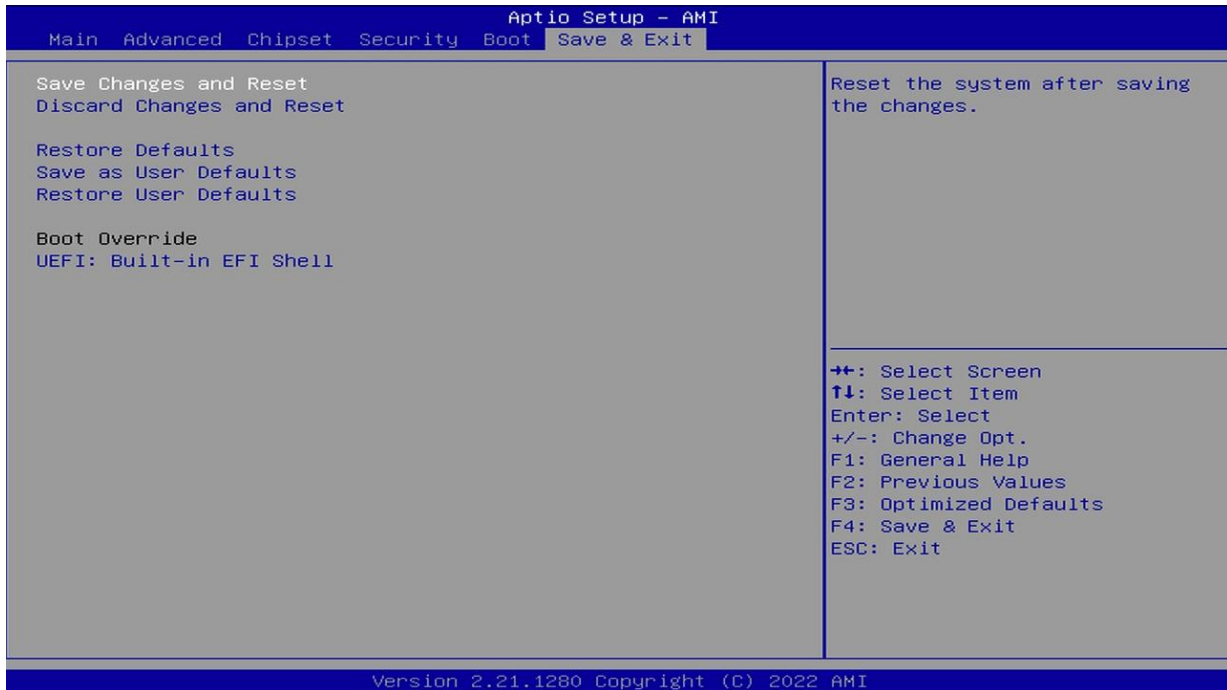

Save Changes and Reset

This item allows user to reset the system after saving the changes.

Discard Changes and Reset

This item allows user to reset the system without saving any changes.

Restore Defaults

Use this item to restore /load default values for all the setup options.

Save as User Defaults

Use this item to save the changes done so far as user defaults.

Restore User Defaults

Use this item to restore defaults to all the setup options.

Boot Override

UEFI: Built-in EFI Shell

Launch Internal EFI shell application (shell.efi).