

AT-GS900MX Series

GIGABIT ETHERNET SWITCHES

- ❑ AT-GS924MX
- ❑ AT-GS924MPX
- ❑ AT-GS948MX
- ❑ AT-GS948MPX

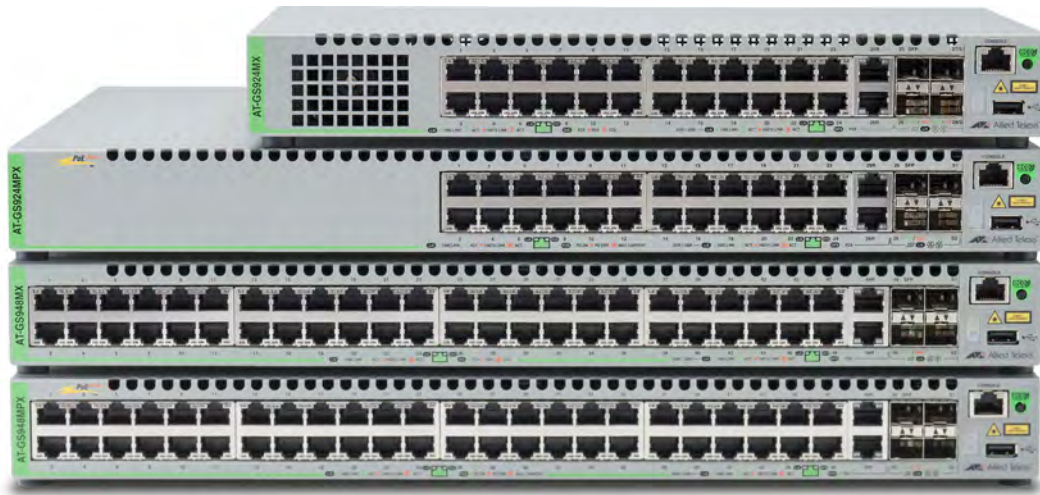

Installation Guide for Stand-alone Switches

Copyright © 2015 Allied Telesis, Inc.

All rights reserved. No part of this publication may be reproduced without prior written permission from Allied Telesis, Inc.

Allied Telesis and the Allied Telesis logo are trademarks of Allied Telesis, Incorporated. All other product names, company names, logos or other designations mentioned herein are trademarks or registered trademarks of their respective owners.

Allied Telesis, Inc. reserves the right to make changes in specifications and other information contained in this document without prior written notice. The information provided herein is subject to change without notice. In no event shall Allied Telesis, Inc. be liable for any incidental, special, indirect, or consequential damages whatsoever, including but not limited to lost profits, arising out of or related to this manual or the information contained herein, even if Allied Telesis, Inc. has been advised of, known, or should have known, the possibility of such damages.

Electrical Safety and Emissions Standards

This product meets the following standards.

U.S. Federal Communications Commission

Radiated Energy

Note: This equipment has been tested and found to comply with the limits for a Class A digital device pursuant to Part 15 of FCC Rules. These limits are designed to provide reasonable protection against harmful interference when the equipment is operated in a commercial environment. This equipment generates, uses, and can radiate radio frequency energy and, if not installed and used in accordance with this instruction manual, may cause harmful interference to radio communications. Operation of this equipment in a residential area is likely to cause harmful interference in which case the user will be required to correct the interference at his own expense.

Note: Modifications or changes not expressly approved of by the manufacturer or the FCC, can void your right to operate this equipment.

Industry Canada

This Class A digital apparatus complies with Canadian ICES-003.

Cet appareil numérique de la classe A est conforme à la norme NMB-003 du Canada.

RFI Emissions: FCC Class A, EN55022 Class A, EN61000-3-2, EN61000-3-3, VCCI Class A, RCM, CE

Warning: In a domestic environment this product may cause radio interference in which case the user may be required to take adequate measures.

EMC (Immunity): EN55024

Electrical Safety: EN60950-1 (TUV), UL 60950-1 (CUL_{US})



Laser Safety

EN60825-1

Translated Safety Statements

Important: Safety statements that have the  symbol are translated into multiple languages in the *Translated Safety Statements* document at www.alliedtelesis.com/support.

Contents

Document Conventions	14
Contacting Allied Telesis	15
Chapter 1: Overview	17
Features	18
AT-GS900MX Models	18
10/100/1000 Mbps Twisted Pair Ports	18
Power over Ethernet.....	19
SFP Slots	19
S1 and S2 Stacking Slots	19
LEDs.....	20
Installation Options.....	20
MAC Address Table	20
Management Software and Interfaces	20
Management Methods.....	20
Front and Back Panels	21
Management Panel	24
10/100/1000Base-T Twisted Pair Ports	25
Speed	25
Duplex Mode	25
Wiring Configuration.....	26
Maximum Distance.....	26
Power over Ethernet.....	26
Cable Requirements.....	26
Port Pinouts.....	27
Power over Ethernet.....	28
PoE Standards	28
Powered Device Classes	29
Cable Requirements.....	29
Power Budget.....	31
Port Prioritization	31
Wiring Implementation.....	32
SFP Slots.....	33
Combo Twisted Pair Ports and SFP Slots.....	34
Stacking Slots.....	35
eco-friendly Button.....	36
LEDs.....	37
LEDs for the Twisted Pair Ports	37
LEDs for the PoE Twisted Pair Ports.....	38
LEDs for the Combo Twisted Pair Ports.....	40
LEDs for the SFP Slots	42
LEDs for the Stacking Slots.....	42
Switch ID LED	43
USB Port.....	45
Console Port	46
Power Supply	47
Chapter 2: Beginning the Installation	49
Reviewing Safety Precautions.....	50
Choosing a Site for the Switch	54

Unpacking the Switch	55
Chapter 3: Installing the Switch on a Table or in an Equipment Rack	59
Selecting a Site for the Switch	60
Installing the Switch on a Table	61
Installing the Switch in an Equipment Rack	62
Chapter 4: Installing the Switch on a Wall	67
Installing the AT-GS924MX Switch on a Wall.....	68
Positions of the Switch on a Wall.....	68
Recommended Minimum Wall Area Dimensions	69
Wall Guidelines.....	70
Tools and Material	71
Installing the AT-GS924MX Switch.....	71
Installing the AT-GS924MPX, AT-GS948MX, and AT-GS948MPX Switches on a Wall	76
Position of the Switch on the Wall	76
Recommended Minimum Wall Area Dimensions	76
Positions of the Brackets	78
Plywood Base for a Wall with Wooden Studs.....	78
Wall Guidelines.....	81
Tools and Material	82
Installing the Plywood Base.....	82
Installing the Switch on the Plywood Base	82
Installing the Switch on a Concrete Wall	85
Chapter 5: Cabling the Networking Ports	89
Cabling the Twisted Pair Ports.....	90
Installing SFP Transceivers	92
Installing SFP Modules	93
Chapter 6: Powering On the Switch	97
Powering On the Switch.....	98
Monitoring the Initialization Processes.....	101
Configuring the Switch for Stand-alone Operations.....	104
Starting a Local Management Session	104
Disabling VCStack	106
Specifying Ports in the Command Line Interface for Stand-alone Switches.....	109
Chapter 7: Troubleshooting	111
Appendix A: Technical Specifications	115
Physical Specifications	115
Environmental Specifications.....	116
Power Specifications.....	116
Certifications	117
RJ-45 Twisted Pair Port Pinouts.....	118
RJ-45 Style Serial Console Port Pinouts	119

Figures

Figure 1: Front Panels of the AT-GS924MX and AT-GS924MPX Switches.....	21
Figure 2: Front Panels of the AT-GS948MX and AT-GS948MPX Switches.....	22
Figure 3: Back Panel of the AT-GS924MX Switch	23
Figure 4: Back Panel of the AT-GS924MPX and AT-GS948MPX Switches	23
Figure 5: Back Panel of the AT-GS948MX Switch	23
Figure 6: AT-GS900MX Series Management Panel.....	24
Figure 7: Stacking Transceiver.....	35
Figure 8: LEDs for the Twisted Pair Ports on the AT-GS924MX and AT-GS948MX Switches	37
Figure 9: LEDs for the PoE Twisted Pair Ports on the AT-GS924MPX and AT-GS948MPX Switches.....	39
Figure 10: LEDs for the Combo Twisted Pair Ports.....	41
Figure 11: SFP Slot LEDs	42
Figure 12: Switch ID LED	43
Figure 13: Switch ID LED Not in Low Power Mode	44
Figure 14: Switch ID LEDs in Low Power Mode	44
Figure 15: Components of the Switches.....	55
Figure 16: Components of the AT-GS924MX Switch	56
Figure 17: Turning the Switch Upside Down	62
Figure 18: Removing the Rubber Feet	62
Figure 19: Installing Brackets on the AT-GS924MX Switch	63
Figure 20: Attaching Brackets to the AT-GS924MX, AT-GS948MX, and AT-GS948MPX Switches.....	64
Figure 21: Attaching Brackets to the AT-GS924MX, AT-GS948MX, and AT-GS948MPX Switches (Continued).....	65
Figure 22: Mounting the Switch in an Equipment Rack.....	66
Figure 23: Positions of the AT-GS924MX Switch on a Wall.....	68
Figure 24: Minimum Wall Area Dimensions for the AT-GS924MX Switch with the Front Panel on the Left	69
Figure 25: Minimum Wall Area Dimensions for the AT-GS924MX Switch with the Front Panel on the Right.....	70
Figure 26: Attaching the Brackets to the AT-GS924MX Switch for Wall Installation	72
Figure 27: Marking the Locations of the Bracket Holes on a Concrete Wall	73
Figure 28: Installing the AT-GS924MX Switch on a Wall	75
Figure 29: Positions of the AT-GS924MPX, AT-GS948MX, and AT-GS948MPX Switches on a Wall.....	76
Figure 30: Minimum Wall Area Dimensions for the Switch When the Front Panel is on the Left	77
Figure 31: Minimum Wall Area Dimensions for the Switch When the Front Panel is on the Right.....	77
Figure 32: Bracket Positions on the Switch	78
Figure 33: Switch on a Plywood Base	79
Figure 34: Distances Between the Brackets on the AT-GS924MPX, AT-GS948MX, and AT-GS948MPX Switches	80
Figure 35: Steps to Installing the Switch with a Plywood Base	81
Figure 36: Attaching the Brackets for Wall Installation for All Switches Except the AT-GS924MX Switch.....	83
Figure 37: Securing the Switch to the Plywood Base.....	84
Figure 38: Marking the Locations of the Bracket Holes on a Concrete Wall	85
Figure 39: Installing the AT-GS924MPX, AT-GS948MX, or AT-GS948MPX Switch on a Wall.....	86
Figure 40: Removing the Dust Plug from an SFP Slot	93
Figure 41: Installing an SFP Transceiver.....	93
Figure 42: Removing the Dust Cover from an SFP Transceiver	94
Figure 43: Positioning the SFP Handle in the Upright Position	94
Figure 44: Connecting a Fiber Optic Cable to an SFP Transceiver.....	95
Figure 45: Installing the Retaining Clip.....	98
Figure 46: Raising the Retaining Clip	99
Figure 47: Plugging in the AC Power Cord.....	99
Figure 48: Lowering the Retaining Clip.....	99
Figure 49: Switch Initialization Messages.....	101
Figure 50: Switch Initialization Messages (Continued).....	102

Figure 51: Switch Initialization Messages (Continued) 103
Figure 52: Connecting the Management Cable to the Console Port 105
Figure 53: User Exec Mode Prompt..... 106
Figure 54: SHOW STACK Command..... 106
Figure 55: Moving to the Global Configuration Mode 107
Figure 56: Confirmation Prompt for the NO STACK ENABLE Command 107
Figure 57: Returning to the Privileged Exec Mode 108
Figure 58: Saving the Changes with the WRITE Command..... 108
Figure 59: PORT Parameter in the Command Line Interface..... 109
Figure 60: RJ-45 Socket Pin Layout (Front View)..... 118

Tables

Table 1: Twisted Pair Cable for the 10/100/1000Base-T Ports	26
Table 2: IEEE Powered Device Classes	29
Table 3: Twisted Pair Cable Requirements for the 10/100Base-TX Ports at 10 or 100Mbps	29
Table 4: Twisted Pair Cable Requirements for the 10/100/1000Base-T Ports at 1000Mbps	30
Table 5: Combo Port Pairs	34
Table 6: LEDs on the Twisted Pair Ports on the AT-GS924MX and AT-GS948MX Switches	38
Table 7: LEDs for the PoE Twisted Pair Ports on the AT-GS924MPX and AT-GS948MPX Switches	39
Table 8: LEDs on the Combo Twisted Pair Ports	41
Table 9: SFP Slot LEDs	42
Table 10: S1 and S2 Slot LEDs	43
Table 11: Product Dimensions	115
Table 12: Product Weights	115
Table 13: Ventilation Requirements	116
Table 14: Environmental Specifications	116
Table 15: Input Voltages	116
Table 16: Maximum Power Consumption	117
Table 17: Heat Dissipation	117
Table 18: Product Certifications	117
Table 19: Pin Signals for 10 and 100 Mbps	118
Table 20: Pin Signals for 1000 Mbps	118
Table 21: RJ-45 Style Serial Console Port Pin Signals	119

Preface

This guide contains the installation instructions for the AT-GS900MX Series of Layer 2+ Gigabit Ethernet switches. This preface contains the following sections:

- “Document Conventions” on page 14
- “Contacting Allied Telesis” on page 15

Note

This guide explains how to install the switches as stand-alone units. For instructions on how to install them in a stack configuration with Virtual Chassis Stacking (VCStack™), refer to the *AT-GS900MX Series Installation Guide for VCStack*.

Document Conventions

This document uses the following conventions:

Note

Notes provide additional information.



Caution

Cautions inform you that performing or omitting a specific action may result in equipment damage or loss of data.



Warning

Warnings inform you that performing or omitting a specific action may result in bodily injury.

Contacting Allied Telesis

If you need assistance with this product, you may contact Allied Telesis technical support by going to the Support & Services section of the Allied Telesis web site at **www.alliedtelesis.com/support**. You can find links for the following services on this page:

- ❑ 24/7 Online Support — Enter our interactive support center to search for answers to your product questions in our knowledge database, to check support tickets, to learn about RMAs, and to contact Allied Telesis technical experts.
- ❑ USA and EMEA phone support — Select the phone number that best fits your location and customer type.
- ❑ Hardware warranty information — Learn about Allied Telesis warranties and register your product online.
- ❑ Replacement Services — Submit a Return Merchandise Authorization (RMA) request via our interactive support center.
- ❑ Documentation — View the most recent installation and user guides, software release notes, white papers, and data sheets for your products.
- ❑ Software Downloads — Download the latest software releases for your managed products.

For sales or corporate information, go to **www.alliedtelesis.com/purchase** and select your region.

Chapter 1

Overview

This chapter contains the following sections:

- “Features” on page 18
- “Front and Back Panels” on page 21
- “Management Panel” on page 24
- “10/100/1000Base-T Twisted Pair Ports” on page 25
- “Power over Ethernet” on page 28
- “SFP Slots” on page 33
- “Combo Twisted Pair Ports and SFP Slots” on page 34
- “Stacking Slots” on page 35
- “eco-friendly Button” on page 36
- “LEDs” on page 37
- “USB Port” on page 45
- “Console Port” on page 46
- “Power Supply” on page 47

Note

This guide explains how to install the switches as stand-alone units. For instructions on how to install them in a stack configuration with Virtual Chassis Stacking (VCStack™), refer to the *AT-GS900MX Series Installation Guide for VCStack*.

Features

The AT-GS900MX Series Switches and their features are listed in this section:

AT-GS900MX Models

Here are model names of the AT-GS900MX Series switches:

- ❑ AT-GS924MX
- ❑ AT-GS924MPX
- ❑ AT-GS948MX
- ❑ AT-GS948MPX

10/100/1000 Mbps Twisted Pair Ports

Here are the basic features of the 10/100/1000 Mbps twisted pair ports:

- ❑ 24 or 48 ports per switch
- ❑ 10Base-T, 100Base-TX, and 1000Base-T compliant
- ❑ IEEE 802.3u Auto-Negotiation compliant
- ❑ Auto-MDI/MDIX
- ❑ 100 meters (328 feet) maximum operating distance
- ❑ IEEE 802.3x flow control in 10/100Base-TX full-duplex mode
- ❑ IEEE 802.3x backpressure in 10/100Base-TX half-duplex mode
- ❑ IEEE 802.3ab 1000Base-T
- ❑ Jumbo frames up to 9KB
- ❑ RJ-45 connectors

Note

Two twisted pair ports are paired with the SFP slots to form combo port pairs. For information, “Combo Twisted Pair Ports and SFP Slots” on page 34.

Power over Ethernet

Here are the basic features of Power over Ethernet (PoE) on the twisted pair ports on the AT-GS924MPX and AT-GS948MPX Switches:

- Supported on ports 1 to 24 on the AT-GS924MPX Switch and ports 1 to 48 on the AT-GS948MPX Switch
- Supports PoE (15.4 watts maximum) and PoE+ (30 watts maximum) powered devices
- Supports powered device classes 0 to 4
- Maximum power budget of 370 watts
- Port prioritization
- Mode A wiring

SFP Slots

Here are the basic features of the two SFP slots on the switches:

- Supports 1000Base-SX/LX SFP transceivers
- Supports single-port BiDi 1000Base-LX SFP transceivers
- Supports 1000Base-ZX SFP transceivers

Note

SFP transceivers must be purchased separately. For a list of supported transceivers, contact your Allied Telesis distributor or reseller.

Note

The SFP slots are paired with two twisted pair 10/100/1000Base-T ports to form combo port pairs. For information, refer to “Combo Twisted Pair Ports and SFP Slots” on page 34.

S1 and S2 Stacking Slots

The S1 and S2 slots are stacking ports for the VCStack feature. You may use the slots to build a stack of up to four switches. The slots support AT-SP10TW Twisted Pair Transceivers. For more information, refer to the “Stacking Slots” on page 35.

LEDs

Here are the port LEDs:

- Link/activity and duplex mode LEDs for the twisted pair ports on non-PoE switches
- Link/activity and PoE status LEDs for the twisted pair ports on PoE switches
- Link/activity LEDs for SFP and SFP+ slots
- Switch ID number LED
- eco-friendly button turns off the LEDs to conserve electricity

Installation Options

Here are the installation options for the switches:

- 19-inch equipment rack
- Desk or tabletop
- Wall

MAC Address Table

Here are the basic features of the MAC address tables of the switches:

- Storage capacity of 16,000 dynamic MAC address entries
- Storage capacity of 256 static MAC address entries
- Automatic learning and aging

Management Software and Interfaces

Here are the management software and interfaces:

- AlliedWare Plus Management Software
- Command line interface

Management Methods

Here are the methods for managing the switches:

- Local management through the Console port
- Remote Telnet and Secure Shell management
- SNMPv1, v2c, and v3

Front and Back Panels

The front panels of the AT-GS900MX Series switches are shown in Figure 1 here and Figure 2 on page 22.

AT-GS924MX

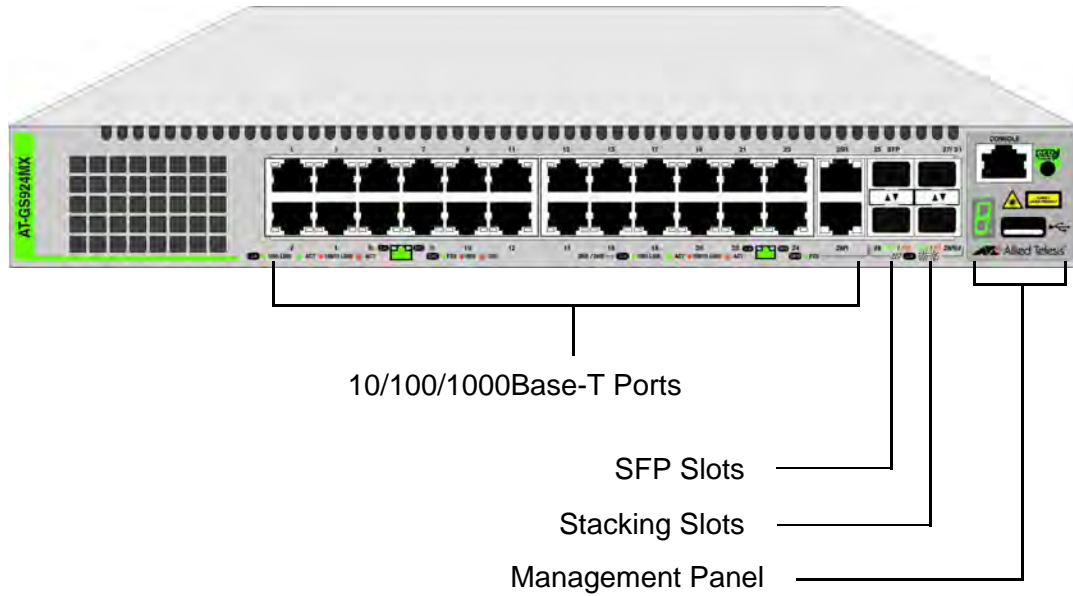

AT-GS924MPX

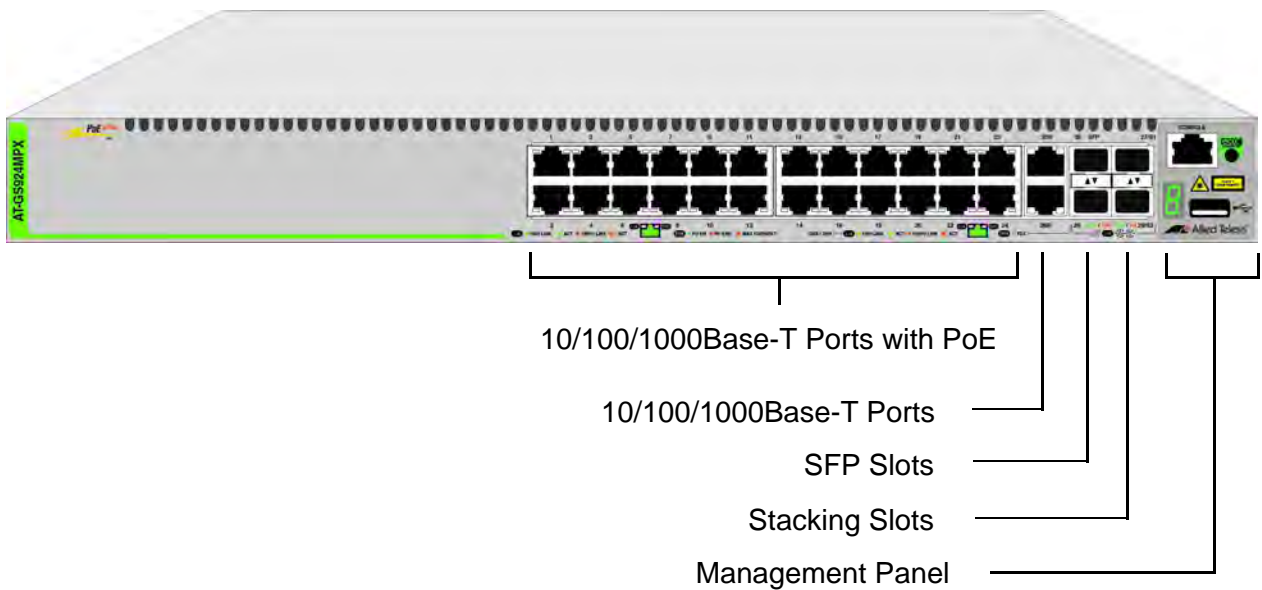
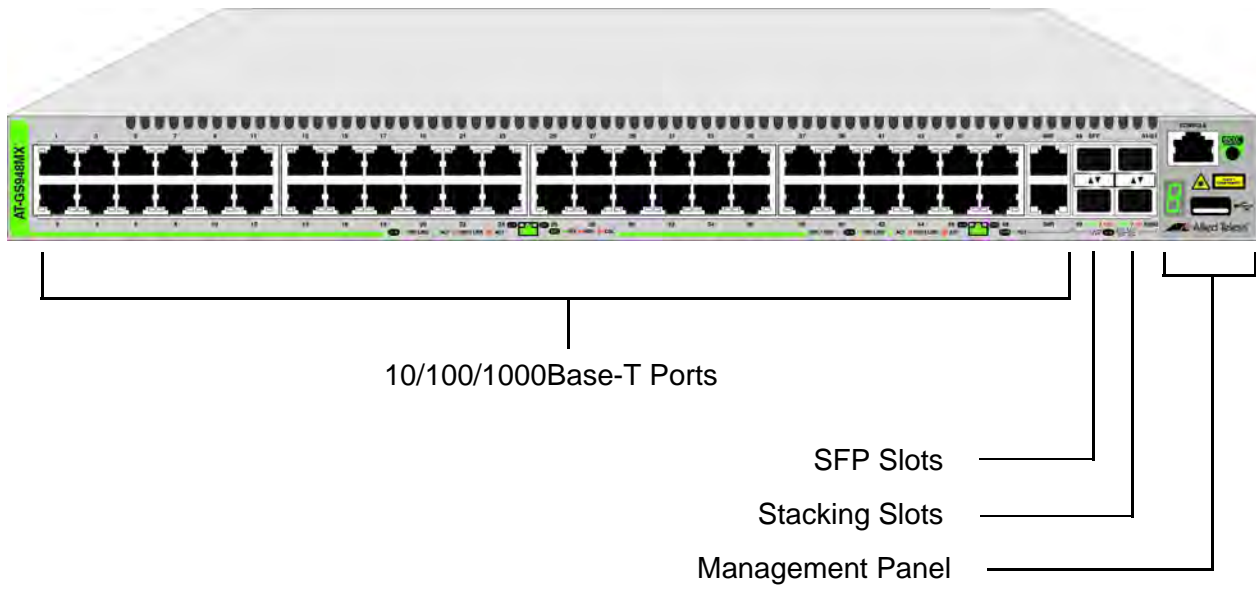

Figure 1. Front Panels of the AT-GS924MX and AT-GS924MPX Switches

AT-GS948MX



AT-GS948MPX

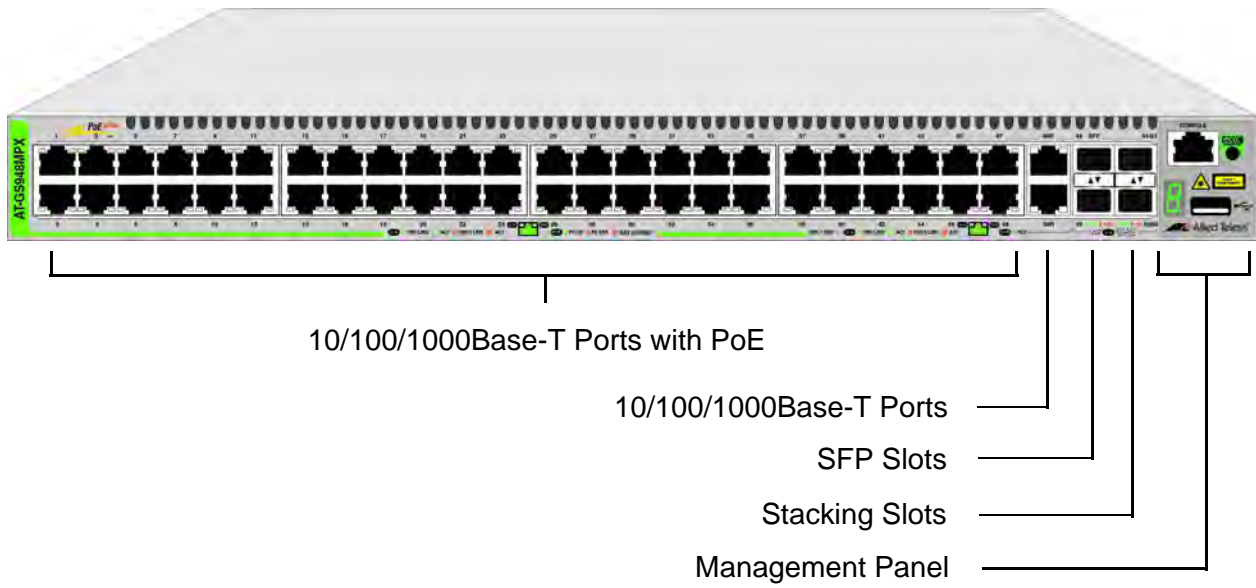

Figure 2. Front Panels of the AT-GS948MX and AT-GS948MPX Switches

The back panel of the AT-GS924MX Switch is shown in Figure 3.



Figure 3. Back Panel of the AT-GS924MX Switch

The back panel of the AT-GS924MPX and AT-GS948MPX Switches is shown in Figure 4.



Figure 4. Back Panel of the AT-GS924MPX and AT-GS948MPX Switches

The back panel of the AT-GS948MX Switch is shown in Figure 5.



Figure 5. Back Panel of the AT-GS948MX Switch

Management Panel

Figure 6 identifies the components in the management panels on the AT-GS900MX Series switches.

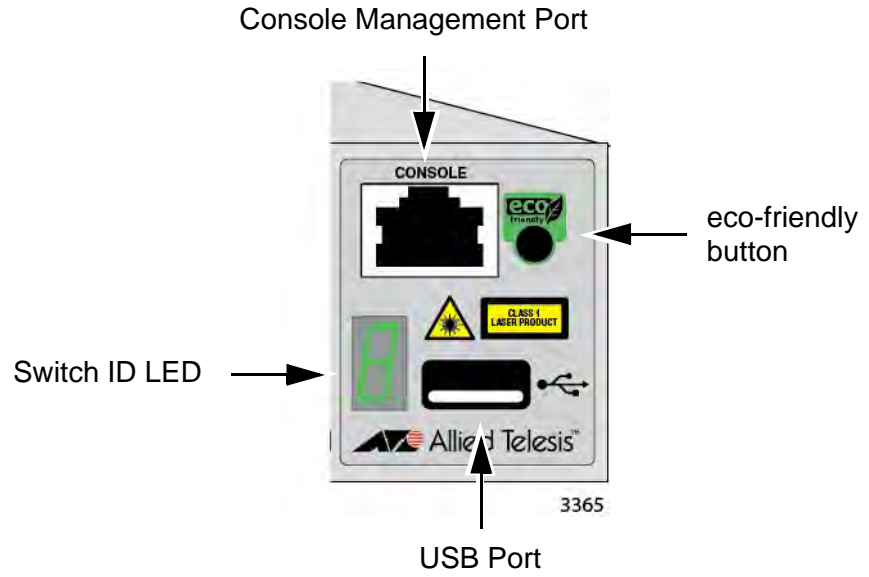

Figure 6. AT-GS900MX Series Management Panel

10/100/1000Base-T Twisted Pair Ports

The AT-GS900MX Series switches have 24 or 48 10/100/1000Base-T ports, depending on the model.

Note

Two twisted pair ports are paired with the SFP slots to form combo ports. For information, refer to “Combo Twisted Pair Ports and SFP Slots” on page 34.

Speed The ports can operate at 10, 100, or 1000 Mbps. The speeds may be set manually using the management software or automatically with Auto-Negotiation (IEEE 802.3u), the default setting.

Note

The ports must be set to Auto-Negotiation to function at 1000 Mbps and are not compatible with devices that are not IEEE 802.3u compliant.

Duplex Mode The twisted pair ports can operate in either half- or full-duplex mode. The duplex mode of a port, like port speed, may be set manually using the management software or automatically with Auto-Negotiation (IEEE 802.3u), the default setting.

The speed and duplex mode settings of a port may be set independently of each other. For example, a port may be configured such that its speed is set manually while its duplex mode is established through Auto-Negotiation.

Note

A switch port should not use Auto-Negotiation to set its duplex mode if it is connected to a network device that does not support Auto-Negotiation for 10 or 100 Mbps operation and has a fixed duplex mode of full-duplex. Otherwise, a duplex-mode mismatch may occur in which a switch port and a network device operate at different duplex modes. The duplex modes of switch ports that are connected to network devices that do not support Auto-Negotiation should be set manually through the management software.

Wiring Configuration

The wiring configuration of a port operating at 10 or 100 Mbps can be MDI or MDI-X. The wiring configurations of a switch port and a network device connected with straight-through twisted pair cabling have to be opposite, such that one device is using MDI and the other MDI-X. For instance, a switch port has to be set to MDI-X if it is connected to a network device set to MDI.

You may set the wiring configurations of the ports manually or let the switch configure them automatically with auto-MDI/MDI-X (IEEE 802.3ab-compliant). This feature enables the switch to automatically negotiate with network devices to establish their proper settings.

The MDI and MDI-X settings do not apply when ports are operating at 1000 Mbps.

Maximum Distance

The ports have a maximum operating distance of 100 meters (328 feet).

Power over Ethernet

The 10/100/1000Base-T ports on the AT-GS924MPX and AT-GS948MPX Switches support Power over Ethernet (PoE). The ports supply DC power to network devices over the network twisted pair cables. The switches support PoE (IEEE 802.3af) and PoE+ (IEEE 802.3at). For background information, refer to “Power over Ethernet” on page 28.

Cable Requirements

The cable requirements of the ports are given in Table 1.

Table 1. Twisted Pair Cable for the 10/100/1000Base-T Ports

Cable Type	10Mbps	100Mbps	1000Mbps
Standard TIA/EIA 568-B-compliant Category 3 shielded or unshielded cabling with 100 ohm impedance and a frequency of 16 MHz.	Yes	Yes	No
Standard TIA/EIA 568-A-compliant Category 5 or TIA/EIA 568-B-compliant Enhanced Category 5 (Cat 5e) shielded or unshielded cabling with 100 ohm impedance and a frequency of 100 MHz.	Yes	Yes	Yes
Standard TIA/EIA 568-B-compliant Category 6 or 6a shielded cabling.	Yes	Yes	Yes

Port Pinouts Refer to Table 19 on page 118 and Table 20 on page 118 for the port pinouts of the 10/100/1000Base-T twisted pair ports.

Power over Ethernet

The AT-GS924MPX and AT-GS948MPX Switches feature Power over Ethernet (PoE) on the 10/100/1000Base-T ports. PoE is used to supply power to network devices over the same twisted pair cables that carry the network traffic.

The main advantage of PoE is that it can make it easier to install a network. The selection of a location for a network device is often limited by whether there is a power source nearby. This often limits equipment placement or requires the added time and cost of having additional electrical sources installed. But with PoE, you can install PoE-compatible devices wherever they are needed without having to worry about whether there are power sources nearby.

A device that provides PoE to other network devices is referred to as *power sourcing equipment* (PSE). The AT-GS924MPX and AT-GS948MPX Switches act as PSE units by adding DC power to the network cable, thus functioning as a central power source for other network devices.

Devices that receive their power from a PSE are called *powered devices* (PD). Examples include wireless access points, IP telephones, webcams, and even other Ethernet switches.

The switch automatically determines whether or not a device connected to a port is a powered device. Ports that are connected to network nodes that are not powered devices (that is, devices that receive their power from another power source) function as regular Ethernet ports, without PoE. The PoE feature remains activated on the ports, but no power is delivered to the devices.

PoE Standards

The AT-GS924MPX and AT-GS948MPX Switches support these PoE standards:

- ❑ PoE (IEEE 802.3af): This standard provides up to 15.4 watts at the switch port to support powered devices that require up to 12.95 watts.
- ❑ PoE+ (IEEE 802.3at): This standard provides up to 30.0 watts at the switch port to support powered devices that require up to 25.5 watts.

Powered Device Classes

Powered devices are grouped into the five classes listed in Table 2. The classes are based on the amount of power the devices require. The switches support all five classes.

Table 2. IEEE Powered Device Classes

Class	Maximum Power Output from a Switch Port	PD Power Range
0	15.4W	0.44W to 12.95W
1	4.0W	0.44W to 3.84W
2	7.0W	3.84W to 6.49W
3	15.4W	6.49W to 12.95W
4	30.0W	12.95W to 25.5W

Cable Requirements

The cable requirements for ports operating at 10 or 100Mbps are given in Table 3.

Table 3. Twisted Pair Cable Requirements for the 10/100Base-TX Ports at 10 or 100Mbps

Cable Type	10Mbps			100Mbps		
	Non-PoE	PoE	PoE+	Non-PoE	PoE	PoE+
Standard TIA/EIA 568-B-compliant Category 3 shielded or unshielded cabling with 100 ohm impedance and a frequency of 16 MHz.	Yes	No	No	Yes	No	No
Standard TIA/EIA 568-A-compliant Category 5 shielded or unshielded cabling with 100 ohm impedance and a frequency of 100 MHz.	Yes	Yes	No	Yes	Yes	No
Standard TIA/EIA 568-B-compliant Enhanced Category 5 (Cat 5e) shielded or unshielded cabling with 100 ohm impedance and a frequency of 100 MHz.	Yes	Yes	Yes	Yes	Yes	Yes

Table 3. Twisted Pair Cable Requirements for the 10/100Base-TX Ports at 10 or 100Mbps

Cable Type	10Mbps			100Mbps		
	Non-PoE	PoE	PoE+	Non-PoE	PoE	PoE+
Standard TIA/EIA 568-B-compliant Category 6 or 6a shielded cabling.	Yes	Yes	Yes	Yes	Yes	Yes

The cable requirements for ports operating at 1000Mbps are given in Table 4.

Table 4. Twisted Pair Cable Requirements for the 10/100/1000Base-T Ports at 1000Mbps

Cable Type	1000Mbps		
	Non-PoE	PoE	PoE+
Standard TIA/EIA 568-B-compliant Category 3 shielded or unshielded cabling with 100 ohm impedance and a frequency of 16 MHz.	No	No	No
Standard TIA/EIA 568-A-compliant Category 5 shielded or unshielded cabling with 100 ohm impedance and a frequency of 100 MHz.	Yes	Yes	No
Standard TIA/EIA 568-B-compliant Enhanced Category 5 (Cat 5e) shielded or unshielded cabling with 100 ohm impedance and a frequency of 100 MHz.	Yes	Yes	Yes
Standard TIA/EIA 568-B-compliant Category 6 or 6a shielded cabling.	Yes	Yes	Yes

Power Budget

The AT-GS924MPX and AT-GS948MPX Switches have a power budget of 370 watts. This is the maximum amount of power the switches can provide at one time to the powered devices.

The power requirements of the PoE devices determine the maximum number of devices the switch can support at one time. So long as the total power requirements of the powered devices is less than the power budget of the switch, the switch can supply power to all the devices. But if the total power requirements exceed the power budget, the switch denies power to one or more ports using a mechanism referred to as port prioritization.

To determine whether the power requirements of the PoE devices you plan to connect to the switch exceed its power budget, refer to their documentation for their power requirements and add the requirements together. The switch should be able to power all the devices simultaneously as long as the total is below its power budget. If the total exceeds the available power budget, you should consider reducing the number of PoE devices so that all of the devices receive power. Otherwise, the switch powers a subset of the devices, based on port prioritization.

The switch can handle different power requirements on different ports. This enables you to connect different classes of PoE equipment to the ports on the switch.

Port Prioritization

If the power requirements of the powered devices exceed the switch's power budget, the switch denies power to some ports based on a system called port prioritization. You may use this mechanism to ensure that powered devices critical to the operations of your network are given preferential treatment by the switch in the distribution of power should the demands of the devices exceed the available capacity.

There are three priority levels:

- Critical
- High
- Low

Ports set to the Critical level, the highest priority level, are guaranteed power before any of the ports assigned to the other two priority levels. Ports assigned to the other priority levels receive power only if all the Critical ports are receiving power. Ports that are connected to your most critical powered devices should be assigned to this level. If there is not enough power to support all the ports set to the Critical priority level, power is provided to the ports based on port number, in ascending order.

The High level is the second highest level. Ports set to this level receive power only if all the ports set to the Critical level are already receiving power. If there is not enough power to support all of the ports set to the

High priority level, power is provided to the ports based on port number, in ascending order.

The lowest priority level is Low. This is the default setting. Ports set to this level only receive power if all of the ports assigned to the other two levels are already receiving power. As with the other levels, if there is not enough power to support all of the ports set to the Low priority level, power is provided to the ports based on port number, in ascending order.

Power allocation is dynamic. Ports supplying power to powered devices may cease power transmission if the switch's power budget is at maximum usage, and new powered devices, connected to ports with higher priorities, become active.

Wiring Implementation

The IEEE 802.3af standard defines two methods for delivering DC power over twisted pair cable by a PSE, such as a switch, to PDs. These methods, known as Alternatives A and B, identify which of the wires within the cables are to carry the DC power from the switches to the PDs.

Twisted pair cabling typically consists of eight wires. With 10Base-T and 100Base-TX devices, the wires connected to pins 1, 2, 3, and 6 on the RJ-45 connectors carry the network traffic while the wires connected to pins 4, 5, 7, and 8 are unused. With 1000Base-T devices, all eight wires are used to carry network data.

It takes four wires to deliver DC power to a PD. With Alternative A, the power is delivered on pins 1, 2, 3, and 6. These are the same pins in 10Base-T and 100Base-TX devices that carry the network data. With Alternative B, the power is provided over 4, 5, 7, and 8, which are spare wires.

The ports on the AT-GS924MPX and AT-GS948MPX Switches deliver the power using pins 4, 5, 7, and 8, which corresponds to Alternative B in the IEEE 802.3af standard. Therefore, the switches can support PDs that use Alternative B to receive power.

PDs that comply with the IEEE 802.3af and 802.3at standards are required to support both Alternative A and B. However, non-standard PDs and PDs that were manufactured before the completion of the IEEE 802.3af and 802.3at standards and that support only Alternative A will not work with the switches.

SFP Slots

The switches have two SFP slots that support the following types of SFP 1000Mbps transceivers:

- ❑ 1000Base-SX/LX SFP transceivers
- ❑ Single-port BiDi 1000Base-LX SFP transceivers
- ❑ 1000Base-ZX SFP transceivers

You may use the transceivers to connect switches to other network devices over large distances, build high-speed backbone networks between network devices, or connect high-speed devices, such as servers, to your network.

The switches support a variety of short and long distance SFP modules. For a list of supported SFP modules, contact your Allied Telesis representative or visit our web site.

Note

The SFP slots and two twisted pair ports are paired together to form combo port pairs. For information, refer to “Combo Twisted Pair Ports and SFP Slots” on page 34.

Combo Twisted Pair Ports and SFP Slots

Two twisted pair ports and SFP slots are paired together to form combo port pairs. Each pair contains one 10/100/1000Base-T port and one SFP slot. The combo port pairs for the switches are listed in Table 5.

Table 5. Combo Port Pairs

Model	10/100/1000 Base-T Port	SFP Slot
AT-GS924MX and AT-GS924MPX	25R	25
	26R	26
AT-GS948MX and AT-GS948MPX	49R	49
	50R	50

The rule to follow when using the combo port pairs is to use only one device in a pair at a time. For example, if you decide to use twisted pair port 25R on the AT-GS924MX or AT-GS924MPX Switch, then you cannot use SFP slot 25. Or, if you choose to use SFP slot 49 on the AT-GS948MX or AT-GS948MPX Switch, then you cannot use the twisted pair port 49R.

The rules for using the combo port pairs are listed here:

- ❑ You may use either the twisted pair port or SFP slot of a combo port pair, but not both at the same time.
- ❑ If you connect both the twisted pair port and SFP slot of a combo port pair to network devices, the SFP slot takes priority, and the twisted pair port is blocked.
- ❑ The SFP slot becomes active when the SFP transceiver establishes a link to a network device.
- ❑ The twisted pair port and SFP slot of a combo port pair share the same settings, such as VLAN assignments, access control lists, and spanning tree.

Stacking Slots

The S1 and S2 slots on the front panel of the switch are used with special stacking transceivers to create a VCStack of up to four switches. The switches of a VCStack act as a single virtual unit. They synchronize their actions so that switching operations, like spanning tree protocols, virtual LANs, and static port trunks, span across all the units and ports. The two main advantages of stacks are:

- ❑ You can manage multiple units simultaneously, which can simplify network management.
- ❑ You have more flexibility with some of the features. For instance, a static port trunk on a stand-alone switch has to consist of ports from the same switch. In contrast, a static trunk on a stack may consist of ports from different switches in the same stack.

The stacking transceiver is shown in Figure 7. It is called the AT-SP10TW, and has two SFP transceiver-style connectors and one meter of twinax cable.



Figure 7. Stacking Transceiver

Note

This guide explains how to install the devices as stand-alone units. For instructions on how to install the switches in a stack with Virtual Chassis Stacking (VCStack), refer to the *AT-GS900MX Series Installation Guide for VCStack*.

Note

For stacking, the stacking slots only support the AT-SP10TW stacking transceiver. However, the stacking slots may also be used as regular networking ports.

eco-friendly Button

The eco-friendly button on the front panel of the switch is used to toggle the port LEDs on or off. You might turn off the LEDs to conserve electricity when you are not monitoring the device. You can also toggle the LEDs with the ECOFRIENDLY LED and NO ECOFRIENDLY LED commands in the Global Configuration mode of the command line interface. The switch is said to be operating in a low power mode when the LEDs are turned off.

Operating the switch in the low power mode with the LEDs turned off does not interfere with the network operations of the device.

The management software on the switch has a command that blinks the LEDs so that you can quickly and easily identify a specific unit among the devices in an equipment rack. It is the FINDME command. The command works on the switch even if you turned off the LEDs with the eco-friendly button or NO ECOFRIENDLY LED command.

The Switch ID LED is always on, but it displays different information depending on whether the LEDs are on or off. When the LEDs are on, the ID LED displays the ID number of the switch. When the switch is operating in the low power mode with the LEDs off, the ID LED indicates whether the switch is a stand-alone unit or the master or member switch of a VCStack, as detailed in Figure 14 on page 44.

Note

Before checking or troubleshooting the network connections to the ports on the switch, you should always check to be sure that the LEDs are on by either pressing the eco-friendly button or issuing the ECOFRIENDLY LED and NO ECOFRIENDLY LED commands in the Global Configuration mode of the command line interface.

LEDs

This section describes the functions of the LEDs.

LEDs for the Twisted Pair Ports

The twisted pair ports on the AT-GS924MX and AT-GS948MX Switches have two LEDs that display link, activity and duplex mode information. The LEDs are shown in Figure 8.

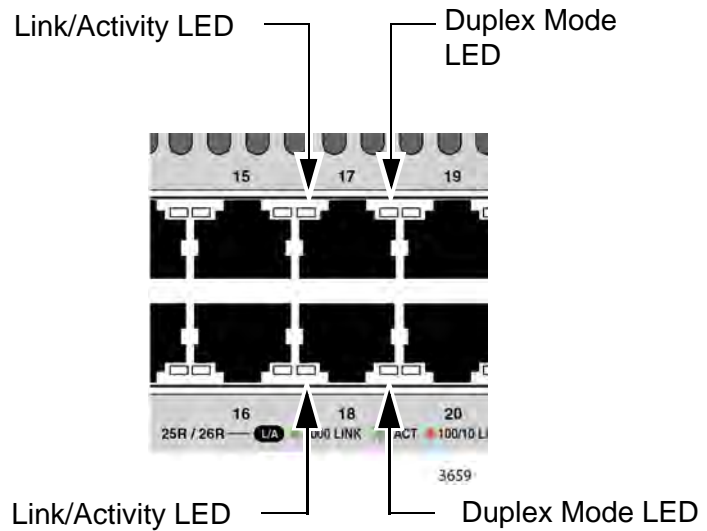

Figure 8. LEDs for the Twisted Pair Ports on the AT-GS924MX and AT-GS948MX Switches

The LEDs are described in Table 6 on page 38.

Table 6. LEDs on the Twisted Pair Ports on the AT-GS924MX and AT-GS948MX Switches

LED	State	Description
Link/ Activity LED	Solid Green	A port has established a 1000 Mbps link to a network device.
	Flashing Green	A port is transmitting or receiving data at 1000 Mbps.
	Solid Amber	A port has established a 10 or 100 Mbps link to a network device.
	Flashing Amber	A port is transmitting or receiving data at 10 or 100 Mbps.
	Off	A port has not established a link with another network device or the LEDs are turned off. To turn on the LEDs, use the eco-friendly button.
Duplex Mode LED	Solid Green	A port is operating in full-duplex mode.
	Solid Amber	A port is operating in half-duplex mode.
	Flashing Amber	Collisions are occurring on a port.

LEDs for the PoE Twisted Pair Ports

The PoE twisted pair ports on the AT-GS924MPX and AT-GS948MPX Switches have two LEDs that display link, activity and PoE information. The LEDs are shown in Figure 9 on page 39.

Note

The duplex mode information for the ports on the AT-GS924MPX and AT-GS948MPX Switches is available from the management software.

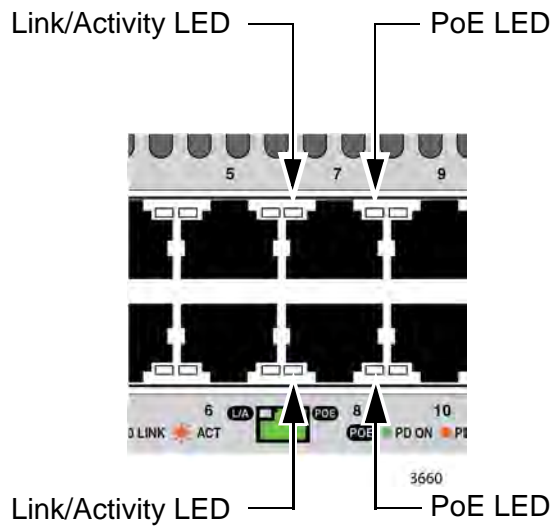

Figure 9. LEDs for the PoE Twisted Pair Ports on the AT-GS924MPX and AT-GS948MPX Switches

The LEDs are described in Table 7.

Table 7. LEDs for the PoE Twisted Pair Ports on the AT-GS924MPX and AT-GS948MPX Switches

LED	State	Description
Link/ Activity LED	Solid Green	A port has established a 1000 Mbps link to a network device.
	Flashing Green	A port is transmitting or receiving data at 1000 Mbps.
	Solid Amber	A port has established a 10 or 100 Mbps link to a network device.
	Flashing Amber	A port is transmitting or receiving data at 10 or 100 Mbps.
	Off	A port has not established a link with another network device or the LEDs are turned off. To turn on the LEDs, use the eco-friendly button.

Table 7. LEDs for the PoE Twisted Pair Ports on the AT-GS924MPX and AT-GS948MPX Switches (Continued)

LED	State	Description
PoE	Green	The switch is detecting a powered device (PD) on the port and is delivering power to it.
	Solid Amber	The switch has shut down PoE+ on the port because of a fault condition.
	Flashing Amber	The switch is detecting a PD on the port but is not delivering power to it because the maximum power budget has been reached.
	Off	This LED state can result from the following conditions: <ul style="list-style-type: none"> ❑ The port is not connected to a PD. ❑ The PD is powered off. ❑ The port is disabled in the management software. ❑ PoE is disabled on the port. ❑ The LEDs on the Ethernet line cards are turned off. To turn on the LEDs, use the eco-friendly button.

LEDs for the Combo Twisted Pair Ports

Ports 25R and 26R on the AT-GS924MX and AT-GS924MPX Switches and ports 49R and 50R on the AT-GS948MX and AT-GS948MPX Switches have two LEDs that display link, activity and duplex mode information. The LEDs are shown in Figure 10 on page 41.

Note

The combo twisted pair ports are paired with the SFP slots to form combo port pairs. For information, refer to “Combo Twisted Pair Ports and SFP Slots” on page 34.

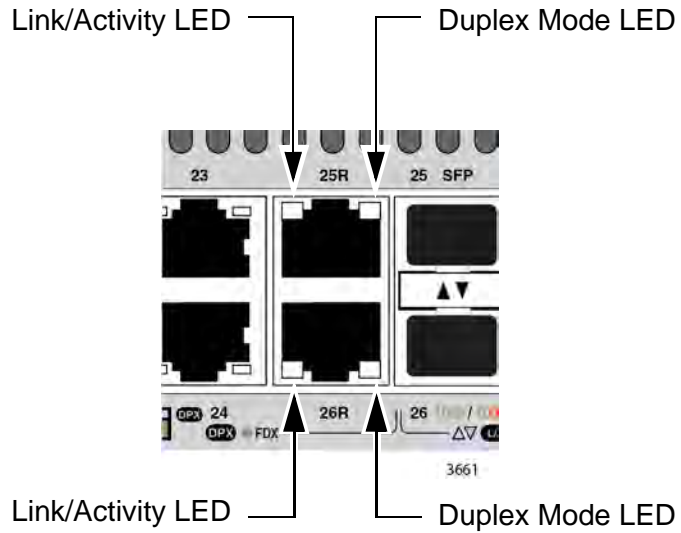

Figure 10. LEDs for the Combo Twisted Pair Ports

The LEDs are described in Table 8.

Table 8. LEDs on the Combo Twisted Pair Ports

LED	State	Description
Link/ Activity LED	Solid Green	A port has established a 1000 Mbps link to a network device.
	Flashing Green	A port is transmitting or receiving data at 1000 Mbps.
	Solid Amber	A port has established a 10 or 100 Mbps link to a network device.
	Flashing Amber	A port is transmitting or receiving data at 10 or 100 Mbps.
	Off	A port has not established a link with another network device or the LEDs are turned off. To turn on the LEDs, use the eco-friendly button.
Duplex Mode LED	Solid Green	A port is operating in full-duplex mode. (The ports do not support half-duplex mode.)
	Solid Amber	A port has not established a link with another network device or the LEDs are turned off. To turn on the LEDs, use the eco-friendly button.

LEDs for the SFP Slots

The LEDs for the SFP slots are located between the slots, as shown in Figure 11. Each SFP slot has one LED. The left-hand LED is for the top slot and the right-hand LED is for the bottom slot.

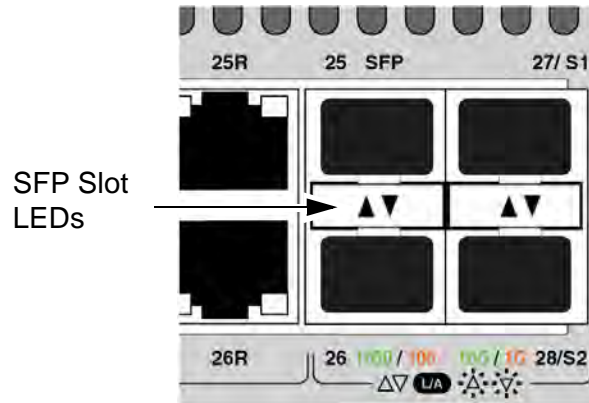

Figure 11. SFP Slot LEDs

The LEDs are described in Table 9.

Table 9. SFP Slot LEDs

LED	State	Description
Link/Activity	Off	The slot is empty, the SFP transceiver has not established a link to a network device, or the LEDs are turned off. To turn on the LEDs, use the eco-friendly button.
	Solid green	The SFP transceiver has established a 100 or 1000 Mbps link to a network device.
	Flashing green	The SFP transceiver is receiving or transmitting packets to a network device.

LEDs for the Stacking Slots

Slots S1 and S2 are stacking slots for the VCStack feature. You can use the slots to build a virtual switch of up to four switches. For background information, refer to the *AT-GS900MX Series Installation Guide for VCStack*. Table 10 on page 43 defines the LED states when the slots contain stacking transceivers.

Table 10. S1 and S2 Slot LEDs

LED	State	Description
Link/Activity	Off	The slot is empty, the stacking transceiver has not established a link to a network device, or the LEDs are turned off. To turn on the LEDs, use the eco-friendly button.
	Solid green	The stacking transceiver has established a link to another switch in the stack.
	Flashing green	The stacking transceiver is receiving or transmitting packets.

Switch ID LED

The Switch ID LED, shown in Figure 12, displays the ID number of the switch. A stand-alone switch has the ID number 0. Switches in a VCStack have the numbers 1 to 4. Chapter 6, “Powering On the Switch” on page 97 has the procedure for verifying and, if necessary, changing the ID number of the switch.

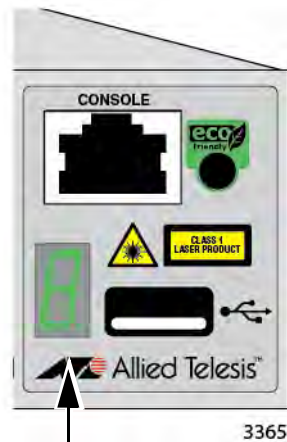

Switch ID LED

Figure 12. Switch ID LED

The states of the LED when the switch is not operating in the low power mode are shown in Figure 13 on page 44.

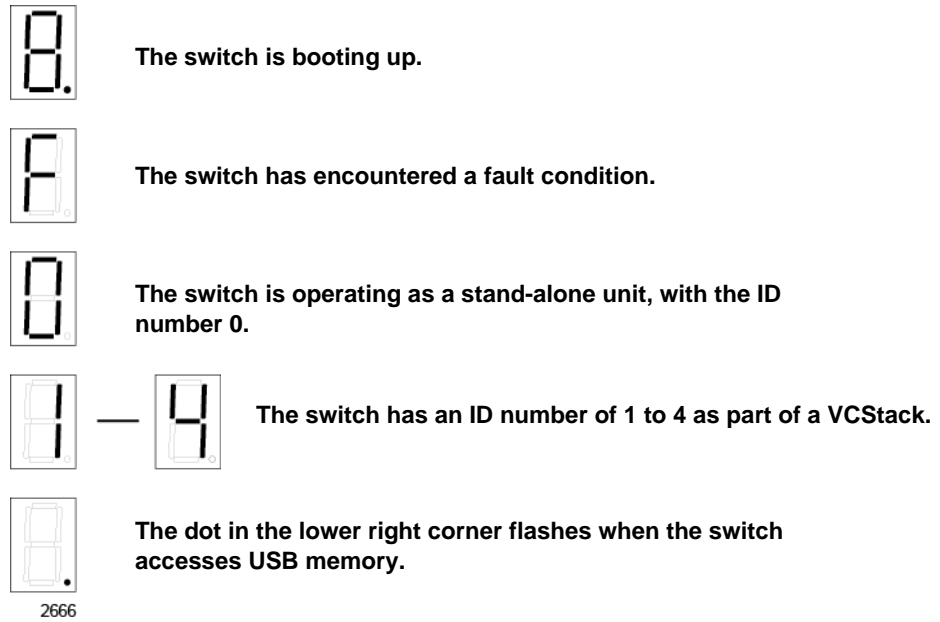

Figure 13. Switch ID LED Not in Low Power Mode

The switch displays the letter “F” for fault on the ID LED if it encounters one of the following problems:

- A cooling fan has failed.
- The internal temperature of the switch has exceeded the normal operating range and the switch may shut down.

Note

You can use the `SHOW SYSTEM ENVIRONMENT` command in the command line interface to identify the source of the problem.

The states of the LED when the switch is operating in the low power mode are shown in Figure 14.

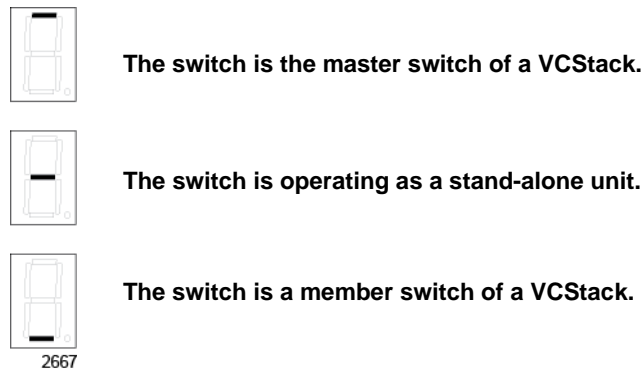

Figure 14. Switch ID LEDs in Low Power Mode

USB Port

The management panel has a USB port. You may use the port to store configuration files on flash drives and to restore configuration files to switches whose settings have been lost or corrupted, or to quickly configure replacement units. You may also use the port and flash drives to update the management firmware on the switches.

The port is USB2.0 compatible.

Console Port

The Console port is used to conduct management sessions with the switch to configure its features and parameter settings. This type of management uses serial RS-232 and is commonly referred to as local or out-of-band management because it is not conducted over your network. To perform local management, you must be at the location of the switch and must use the management cable included with the switch.

To establish a local management session with the switch, connect a terminal or a personal computer with a terminal emulation program to the Console port, which has an RJ-45 style (8P8C) connector, using the provided management cable. The cable has RJ-45 style (8P8C) and DB-9 (D-sub 9-pin) connectors.

The Console port is set to the following specifications:

- Default baud rate: 9600 bps (Range is 9600 to 115200 bps)
- Data bits: 8
- Parity: None
- Stop bits: 1
- Flow control: None

Note

These settings are for a DEC VT100 or ANSI terminal, or an equivalent terminal emulation program.

Power Supply

The AT-GS900MX Series switches come with one AC power supply. The back panels have one AC connector. The power supply is not field-replaceable, refer to “Technical Specifications” on page 115 for the input voltage range.

**Warning**

Power cord is used as a disconnection device. To de-energize equipment, disconnect the power cord. ⚡ E3

Note

The switches are powered on or off by connecting or disconnecting the power cords.

Chapter 2

Beginning the Installation

The chapter contains the following sections:

- “Reviewing Safety Precautions” on page 50
- “Choosing a Site for the Switch” on page 54
- “Unpacking the Switch” on page 55

Reviewing Safety Precautions

Please review the following safety precautions before beginning the installation procedure.

Note

Safety statements that have the  symbol are translated into multiple languages in the *Translated Safety Statements* document at www.alliedtelesis.com/support.



Warning

Class 1 Laser product.  L1



Warning

Do not stare into the laser beam.  L2



Warning

Do not look directly at the fiber optic cable ends or inspect the cable ends with an optical lens.  L6



Warning

To prevent electric shock, do not remove the cover. No user-serviceable parts inside. This unit contains hazardous voltages and should only be opened by a trained and qualified technician. To avoid the possibility of electric shock, disconnect electric power to the product before connecting or disconnecting the LAN cables.  E1



Warning

Do not work on equipment or cables during periods of lightning activity.  E2



Warning

Power cord is used as a disconnection device. To de-energize equipment, disconnect the power cord. ⚡ E3



Warning

Class I Equipment. This equipment must be earthed. The power plug must be connected to a properly wired earth ground socket outlet. An improperly wired socket outlet could place hazardous voltages on accessible metal parts. ⚡ E4

Note

Pluggable Equipment. The socket outlet shall be installed near the equipment and shall be easily accessible. ⚡ E5



Caution

Air vents must not be blocked and must have free access to the room ambient air for cooling. ⚡ E6



Warning

Operating Temperatures. This product is designed for a maximum ambient temperature of 50 degrees C. ⚡ E57

Note

All Countries: Install product in accordance with local and National Electrical Codes. ⚡ E8



Warning

Only trained and qualified personnel are allowed to install or replace this equipment. ⚡ E14



Caution

Circuit Overloading: Consideration should be given to the connection of the equipment to the supply circuit and the effect that overloading of circuits might have on overcurrent protection and supply wiring. Appropriate consideration of equipment nameplate ratings should be used when addressing this concern. ⚡ E21



Caution

Risk of explosion if battery is replaced by an incorrect type. Replace only with the same or equivalent type recommended by the manufacturer. Dispose of used batteries according to the manufacturer's instructions.

Attention: Le remplacement de la batterie par une batterie de type incorrect peut provoquer un danger d'explosion. La remplacer uniquement par une batterie du même type ou de type équivalent recommandée par le constructeur. Les batteries doivent être éliminées conformément aux instructions du constructeur. ⚡ E22



Warning

Mounting of the equipment in the rack should be such that a hazardous condition is not created due to uneven mechanical loading. ⚡ E25

Note

Use dedicated power circuits or power conditioners to supply reliable electrical power to the device. ⚡ E27



Warning

This unit might have more than one power cord. To reduce the risk of electric shock, disconnect all power cords before servicing the unit. ⚡ E30

Note

If installed in a closed or multi-unit rack assembly, the operating ambient temperature of the rack environment may be greater than the room ambient temperature. Therefore, consideration should be given to installing the equipment in an environment compatible with the manufacturer's maximum rated ambient temperature (Tmra). ⌘ E35



Caution

Installation of the equipment in a rack should be such that the amount of air flow required for safe operation of the equipment is not compromised. ⌘ E36



Warning

Reliable earthing of rack-mounted equipment should be maintained. Particular attention should be given to supply connections other than direct connections to the branch circuits (e.g., use of power strips). ⌘ E37



Warning

To reduce the risk of electric shock, the PoE ports on this product must not connect to cabling that is routed outside the building where this device is located. ⌘ E40



Caution

The unit does not contain serviceable components. Please return damaged units for servicing. ⌘ E42



Warning

When you remove an SFP module from this product, the case temperature of the SFP may exceed 40° C (158° F). Exercise caution when handling with unprotected hands. ⌘ E43

Choosing a Site for the Switch

Observe these requirements when planning the installation of the switch.

- ❑ If you plan to install the switch in an equipment rack, check to be sure that the rack is safely secured so that it will not tip over. Devices in a rack should be installed starting at the bottom, with the heavier devices near the bottom of the rack.
- ❑ If you plan to install the switch on a table, check to be sure that the table is level and stable.
- ❑ The power outlet should be located near the switch and be easily accessible.
- ❑ The site should allow for easy access to the ports on the front of the switch, so that you can easily connect and disconnect cables, and view the port LEDs.
- ❑ The site should allow for adequate air flow around the unit and through the cooling vents on the front and rear panels. (The ventilation direction in units that have a cooling fan is from front to back, with the fan on the back panel drawing the air out of the unit.)
- ❑ The site should not expose the switch to moisture or water.
- ❑ The site should be a dust-free environment.
- ❑ The site should include dedicated power circuits or power conditioners to supply reliable electrical power to the network devices.
- ❑ Do not install the switch in a wiring or utility box because it will overheat and fail from inadequate airflow.



Warning

Switches should not be stacked on top of one another on a table or desktop because that could present a personal safety hazard if you need to move or replace switches. ⚡ E76

Unpacking the Switch

All switches, except the AT-GS924MX Switch, come with the components listed in Figure 15. If any item is missing or damaged, contact your Allied Telesis sales representative for assistance.



One 2 m (6.6 ft) local management cable with RJ-45 (8P8C) and DB-9 (D-sub 9-pin) connectors.

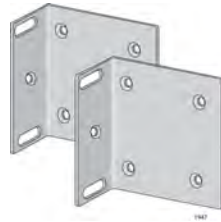

Two rack mounting brackets



One regional AC power cord



Eight bracket screws



Two anchors for concrete walls:
Length: 29.6 mm (1 1/8 in.)
Diameter: 6.0 mm (0.25 in.)



Two screws for wood or concrete walls:
Length: 31 mm (1 1/4 in.)
Width: 4.3 mm (1/8 in.)



Power cord retaining clip

Figure 15. Components of the Switches

The AT-GS924MX Switch comes with the components shown in Figure 16 on page 56.



One 2 m (6.6 ft) local management cable with RJ-45 (8P8C) and DB-9 (D-sub 9-pin) connectors.



One wall or equipment rack mounting bracket



One long wall or equipment rack mounting bracket



One regional AC power cord



Eight bracket screws



Two anchors for concrete walls:
Length: 29.6 mm (1 1/8 in.)
Diameter: 6.0 mm (0.25 in.)



Two screws for wood or concrete walls:
Length: 31 mm (1 1/4 in.)
Width: 4.3 mm (1/8 in.)



Power cord retaining clip

Figure 16. Components of the AT-GS924MX Switch

Note

You should retain the original packaging material in the event you need to return the unit to Allied Telesis.

Chapter 3

Installing the Switch on a Table or in an Equipment Rack

The procedures in this chapter are:

- “Selecting a Site for the Switch” on page 60
- “Installing the Switch on a Table” on page 61
- “Installing the Switch in an Equipment Rack” on page 62

Selecting a Site for the Switch

Here are the site guidelines for the switch:

- ❑ The power outlet should be located near the switch and be easily accessible.
- ❑ The site should allow for easy access to the ports on the front of the switch, so that you can easily connect and disconnect cables, and view the port LEDs.
- ❑ The site should allow for adequate air flow around the unit and through the cooling vents on the front and rear panels. (The ventilation direction in a unit with a cooling fan is from front to back, with the fan on the back panel drawing the air out of the unit.)
- ❑ If you are installing the switch in an equipment rack, you should verify that the rack is safely secured so that it will not tip over. You should install devices starting at the bottom of the rack, with the heavier devices near the bottom.
- ❑ If you are installing the switch on a table or desk, you should verify that the table or desk is level and secure.
- ❑ The site should not expose the switch to moisture or water.
- ❑ The site should be a dust-free environment.
- ❑ The site should include dedicated power circuits or power conditioners to supply reliable electrical power to the network devices.
- ❑ The site should not expose the twisted pair cabling to sources of electrical noise, such as radio transmitters, broadband amplifiers, power lines, electric motors, and fluorescent fixtures.
- ❑ Switch ports are suitable for intra-building connections, or where non-exposed cabling is required.
- ❑ Do not place objects on top of the switch.

Installing the Switch on a Table

This section contains the procedure for installing the switch on a table or desk.

Note

The rubber feet on the bottom of the chassis should be left on for table installation.



Warning

Switches should not be stacked on top of one another on a table or desktop because that could present a personal safety hazard if you need to move or replace switches. *see* E76

To install the chassis on a table, perform the following procedure:

1. Review “Selecting a Site for the Switch” on page 60 to verify the suitability of the site for the switch.
2. Check to be sure that the table is strong enough to support the weight of the switch.
3. Lift the switch onto the table.
4. Go to Chapter 5, “Cabling the Networking Ports” on page 89 to connect the network cables.

Installing the Switch in an Equipment Rack

This procedure requires the following items:

- Eight bracket screws (included with the switch)
- Two equipment rack brackets (included with the switch)
- Flat-head screwdriver (not provided)
- Cross-head screwdriver (not provided)
- Four standard equipment rack screws (not provided)

Installation guidelines may be found in “Choosing a Site for the Switch” on page 54. Here is the procedure for installing the switch in a 19-inch equipment rack.



Caution

The chassis may be heavy and awkward to lift. Allied Telesis recommends that you get assistance when mounting the chassis in an equipment rack. *⚡* E28

1. Place the unit upside down on a level, secure surface. See Figure 17.



Figure 17. Turning the Switch Upside Down

2. Using a flat-head screwdriver, pry the rubber feet from the bottom of the switch. See Figure 18.



Figure 18. Removing the Rubber Feet

3. Turn the switch over.
4. Attach the two rack mount brackets to the sides of the switch with the eight bracket screws that come with the unit.

The AT-GS924MX Switch comes with one short bracket and one long bracket. When installing the device in an equipment rack, Allied Telesis recommends installing the short bracket on the right side and the long bracket on the left side, as you face the front of the unit, so that the stacking ports on the unit align with the same ports on other AT-GS900MX Series switches in the equipment rack. The possible positions of the brackets are shown in Figure 19.



Figure 19. Installing Brackets on the AT-GS924MX Switch

The bracket positions for the AT-GS924MPX, AT-GS948MX, and AT-GS948MPX Switches are shown in Figure 20 on page 64 and Figure 21 on page 65.

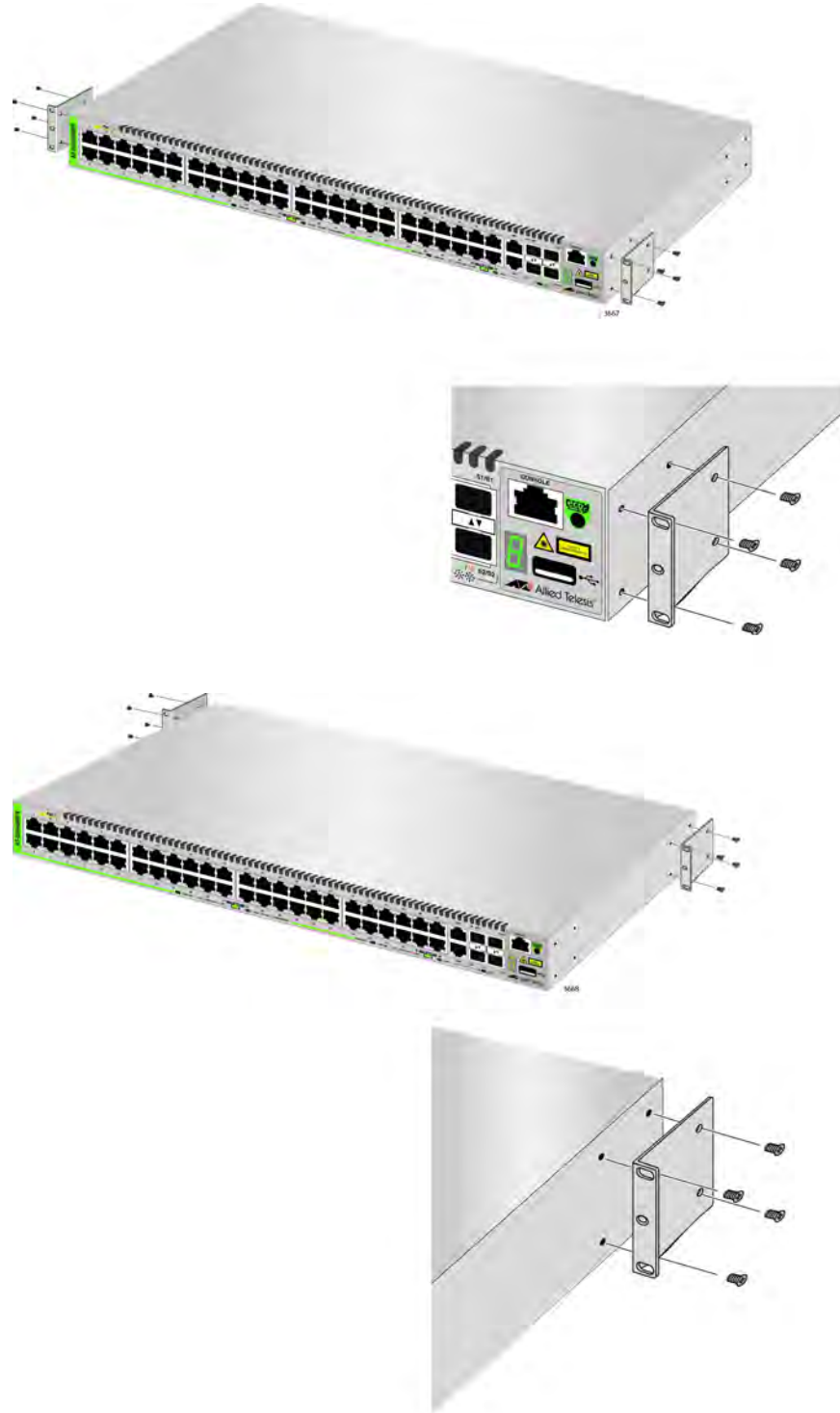

Figure 20. Attaching Brackets to the AT-GS924MX, AT-GS948MX, and AT-GS948MPX Switches



Figure 21. Attaching Brackets to the AT-GS924MX, AT-GS948MX, and AT-GS948MPX Switches (Continued)

5. While another person holds the switch in the equipment rack, secure it with standard equipment rack screws (not provided), as shown in Figure 22.



Figure 22. Mounting the Switch in an Equipment Rack

6. Go to Chapter 5, “Cabling the Networking Ports” on page 89, to connect the network cables to the ports on the switch.

Chapter 4

Installing the Switch on a Wall

The procedures in this chapter are:

- “Installing the AT-GS924MX Switch on a Wall” on page 68
- “Installing the AT-GS924MPX, AT-GS948MX, and AT-GS948MPX Switches on a Wall” on page 76

Installing the AT-GS924MX Switch on a Wall

This section contains the tools, guidelines, and procedures for installing the AT-GS924MX Switch on a wall.

Positions of the Switch on a Wall

You may install the switch on the wall with the front panel on the left or right, as shown in Figure 23. You may not install it with the front panel on the top or bottom.

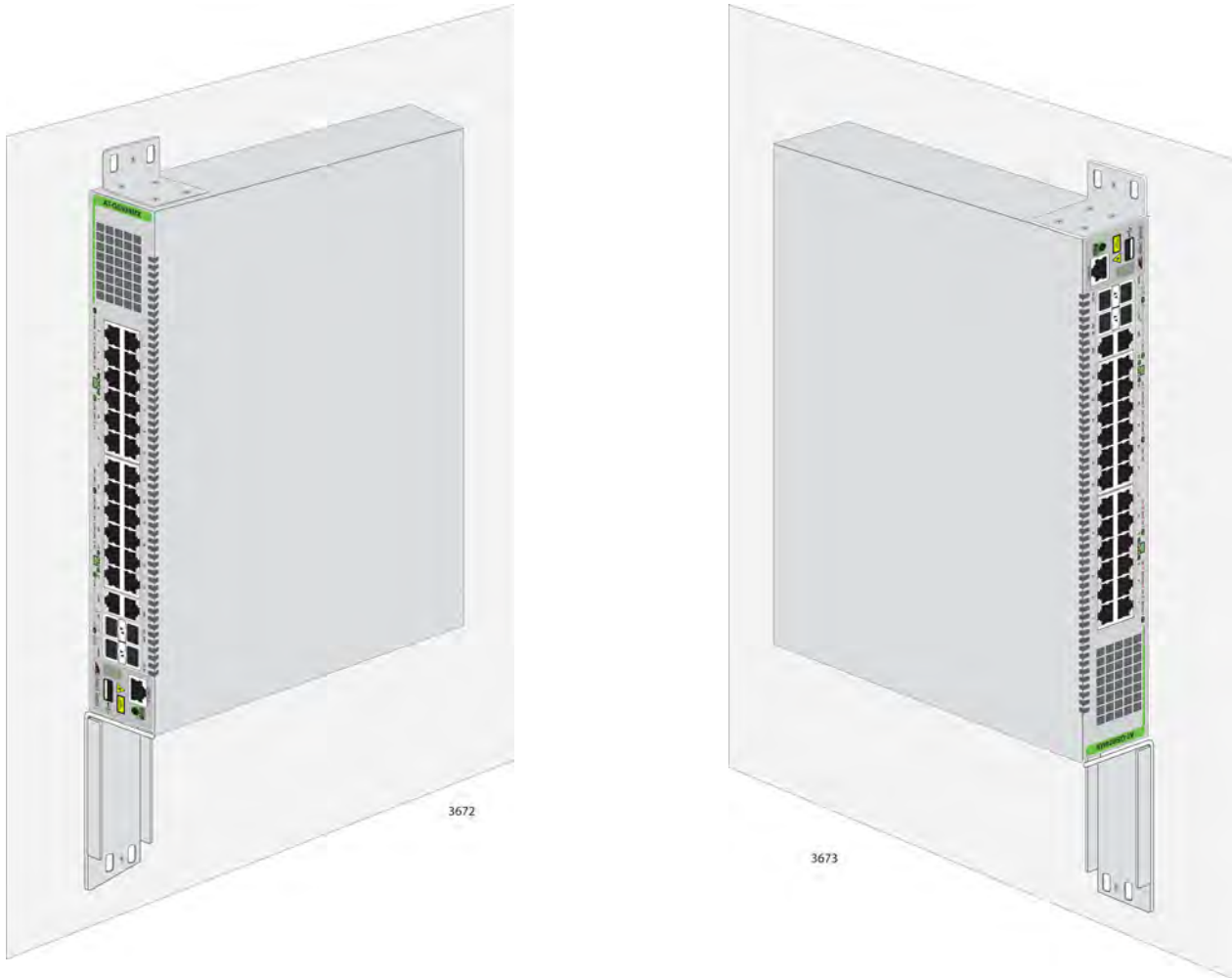

Figure 23. Positions of the AT-GS924MX Switch on a Wall

Recommended Minimum Wall Area Dimensions

The wall location for the AT-GS924MX Switch must provide adequate space to the front and back panels so that you can service the unit, and for ventilation. The recommended minimum dimensions for the reserved wall area are listed here:

- ❑ Width: 54.0 centimeters (21 1/4 inches)
- ❑ Height: 43.2 centimeters (17 inches)

You should position the switch in the reserved wall area such that the front panel has more space than the rear panel. This may make it easier for you to service and maintain the unit. Figure 24 and Figure 25 on page 70 illustrate the recommended positions of the switch in the reserved area when the front panel is on the left and right, respectively.

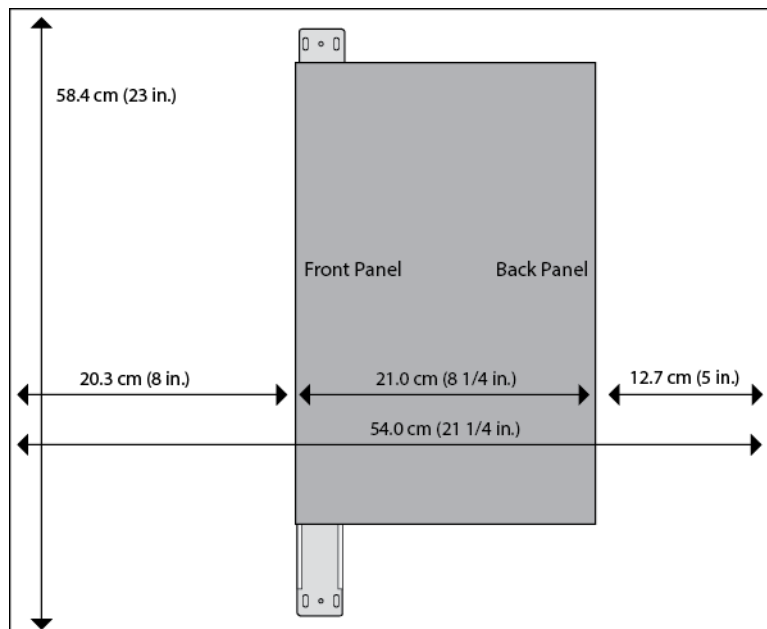

Figure 24. Minimum Wall Area Dimensions for the AT-GS924MX Switch with the Front Panel on the Left

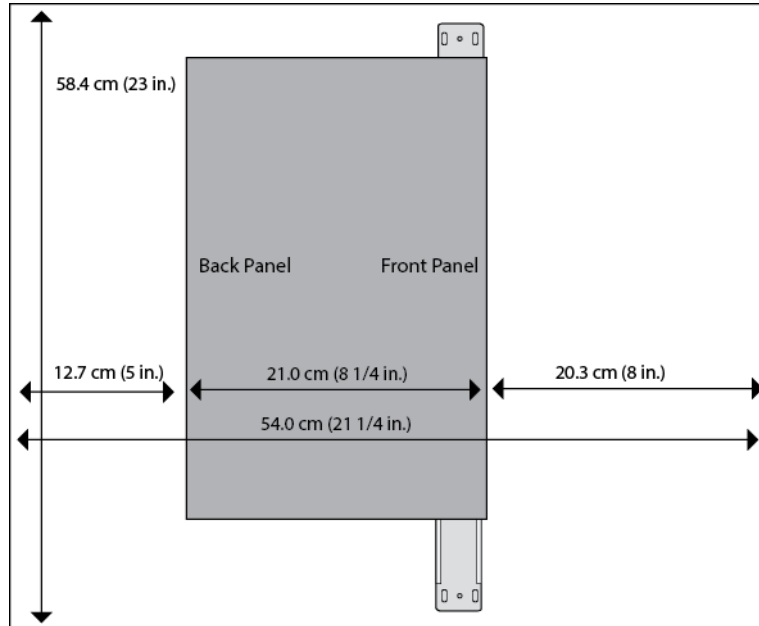

Figure 25. Minimum Wall Area Dimensions for the AT-GS924MX Switch with the Front Panel on the Right

Wall Guidelines

Here are the guidelines to installing the AT-GS924MX Switch on a wall.

- You may install the switch on a wall that has wooden studs.
- You may install the switch on a concrete wall.
- You should not install the switch on a wall that has metal studs. Metal studs may not be strong enough to safely support the device.
- You should not install the switch only on Sheetrock or a similar material. Sheetrock is not strong enough to safely support the device.

Tools and Material

Here are the required tools and material for installing the switch on a wall:

- Eight bracket screws (included with the switch)
- Two wall or equipment rack brackets (included with the switch)
- Two wall screws (included with the switch)
- Two anchors for a concrete wall (included with the switch)
- Flat-head screwdriver (not provided)
- Cross-head screwdriver (not provided)
- Stud finder for a wooden wall, capable of identifying the middle of wall studs and hot electrical wiring (not provided)
- Drill and a 1/4" carbide drill bit for a concrete wall (not provided)



Caution

The supplied screws and anchors may not be appropriate for all walls. A qualified building contractor should determine the hardware requirements for your wall prior to installing the chassis. *~ E74*

Installing the AT-GS924MX Switch

Please review “Reviewing Safety Precautions” on page 50 and “Selecting a Site for the Switch” on page 60 before performing this procedure.

To install the AT-GS924MX Switch on a wall, perform the following procedure:

1. Place the switch on a table or desk.
2. Perform Step 1 to Step 3 in “Installing the Switch in an Equipment Rack” on page 62 to remove the rubber feet from the bottom of the switch.
3. Position the two short brackets that come with the switch against the sides of the unit as shown in Figure 26 on page 72, and secure them with eight screws, also included with the switch.



Positions of the brackets if the switch is to be installed on the wall with the front panel on the left.



Position of the brackets if the switch is to be installed on the wall with the front panel on the right.

Figure 26. Attaching the Brackets to the AT-GS924MX Switch for Wall Installation

4. If you are installing the switch on a wall with wooden studs, use a stud finder to locate and mark with a pencil or pen the middle of a stud in the wall where you plan to install the switch. Be sure that the selected location adheres to the recommendations in “Recommended Minimum Wall Area Dimensions” on page 69.

Note

If you are installing the switch on a concrete wall, perform Step 5 to Step 8. If you are installing the device on a wooden stud, go to Step 9.

5. Have another person hold the switch on the concrete wall at the selected location for the device while you use a pencil or pen to mark the wall with the locations of the two screw holes in the brackets. See Figure 27. Be sure that the selected location adheres to the recommendations in “Recommended Minimum Wall Area Dimensions” on page 69.

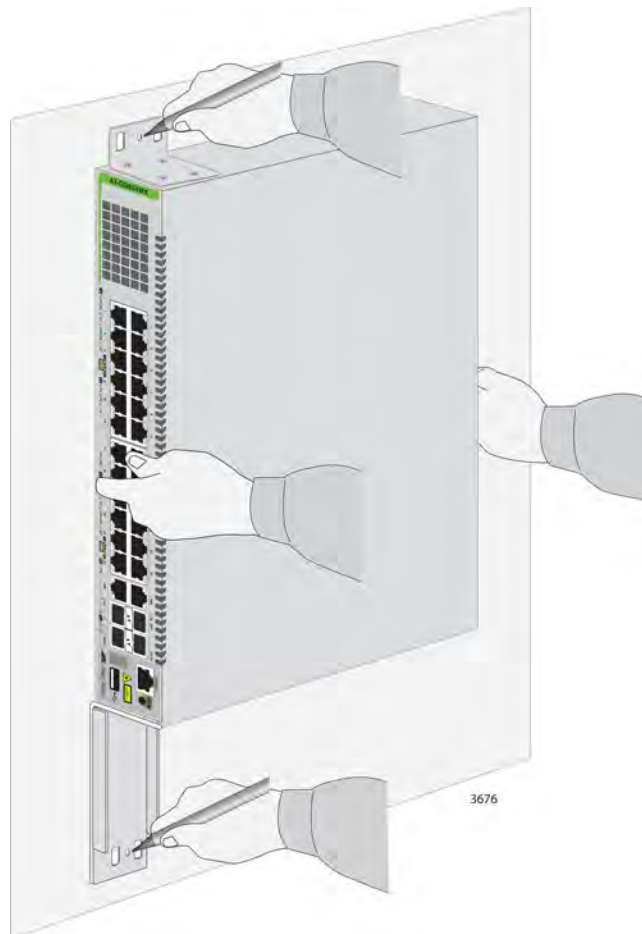

Figure 27. Marking the Locations of the Bracket Holes on a Concrete Wall

6. Place the switch on a table or desk.
7. Use a drill and a 1/4" carbide drill bit to pre-drill the two holes you marked in Step 5. Please review the following guidelines:
 - ❑ Prior to drilling, set the drill to hammer-and-rotation mode. This breaks up the concrete and cleans out the hole.
 - ❑ Allied Telesis recommends cleaning out the holes with a brush or compressed air.
8. Insert the two anchors into the holes.
9. Have another person hold the switch at the selected wall location while you secure it to the wall with the two provided screws. See Figure 28 on page 75. Be sure to observe the following guidelines as you install the switch on the wall:
 - ❑ If you are installing the switch on a wall with wooden studs, you must secure the switch to the middle of the stud you identified in Step 4.
 - ❑ Be sure to leave sufficient space from other devices or walls so that you can access the front and back panels. Refer to "Recommended Minimum Wall Area Dimensions" on page 69.

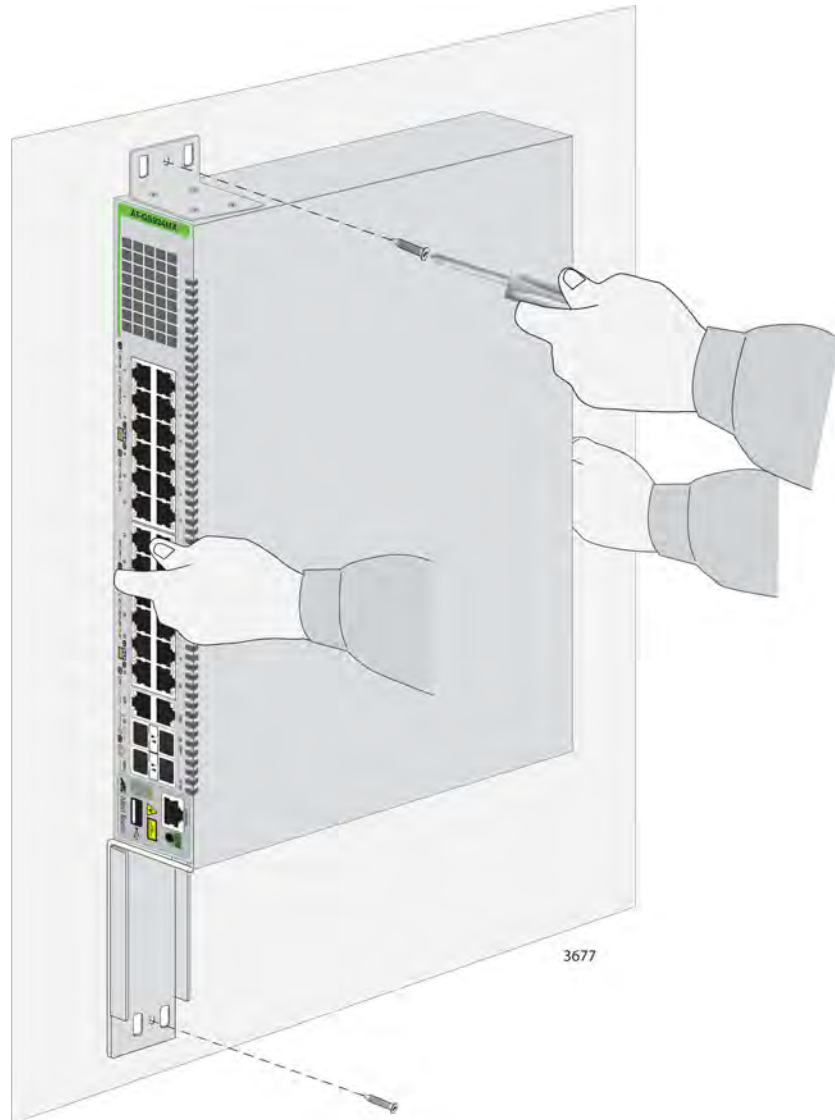

Figure 28. Installing the AT-GS924MX Switch on a Wall

This completes the procedure for mounting the AT-GS924MX Switch on a wall. Go to Chapter 5, “Cabling the Networking Ports” on page 89 for instructions on how to attach the network cables.

Installing the AT-GS924MPX, AT-GS948MX, and AT-GS948MPX Switches on a Wall

This section contains the instructions for installing the AT-GS924MPX, AT-GS948MX, and AT-GS948MPX Switches on a wall.

Position of the Switch on the Wall

The switch may be installed on the wall with the front panel on the left or right, as shown in Figure 29. You may not install the switch with the front panel on the top or bottom.

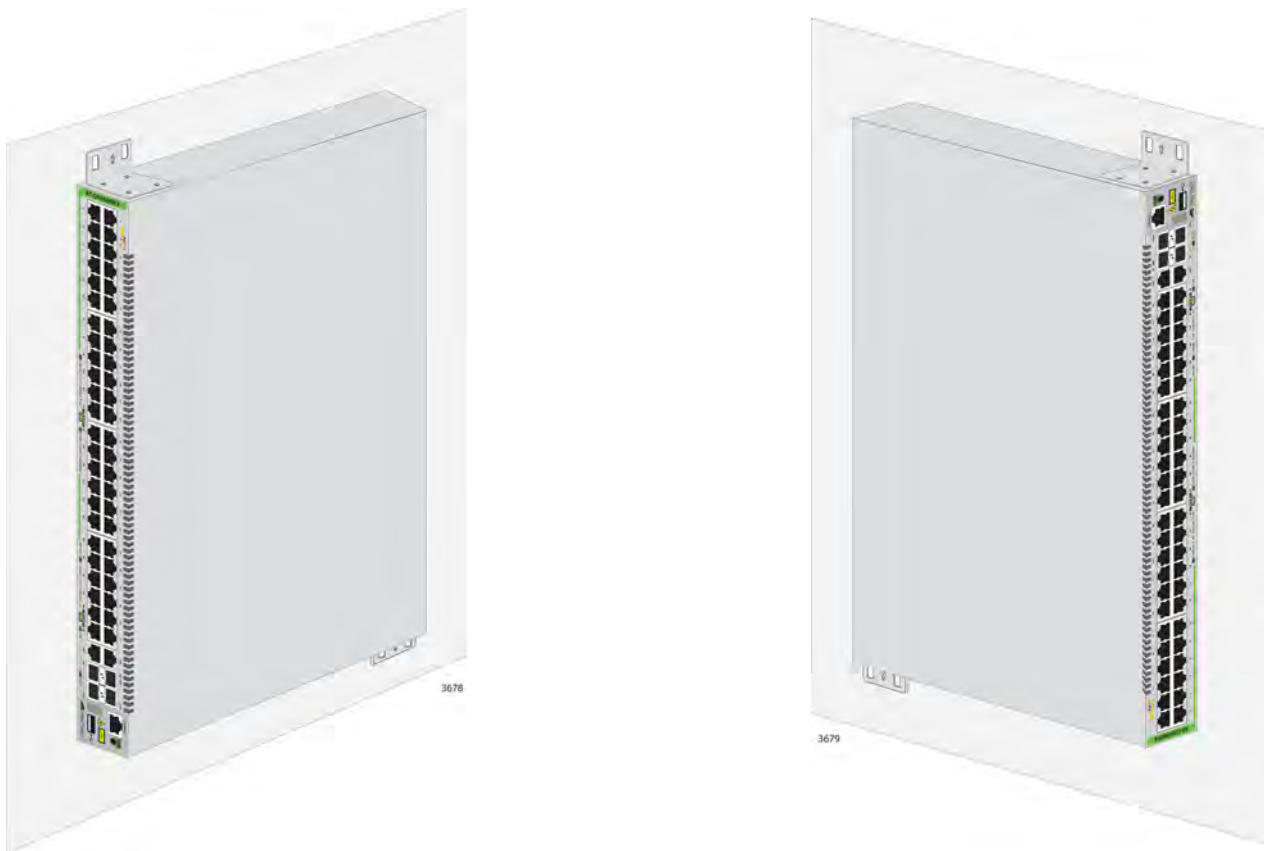

Figure 29. Positions of the AT-GS924MPX, AT-GS948MX, and AT-GS948MPX Switches on a Wall

Recommended Minimum Wall Area Dimensions

The recommended minimum dimensions for the reserved wall area for the AT-GS924MPX, AT-GS948MX, and AT-GS948MPX Switches are listed here:

- ❑ Width: 68.0 centimeters (27 inches)
- ❑ Height: 58.4 centimeters (23 inches)

The placement of the switch in the reserved area should provide the front panel with more area than the back panel so that you can connect network cables, install SFP modules, and view port LEDs. Figure 30 shows the recommended position of the switch in the reserved area when the front panel is on the left. Figure 31 shows the recommended position of the device when the front panel is on the right.

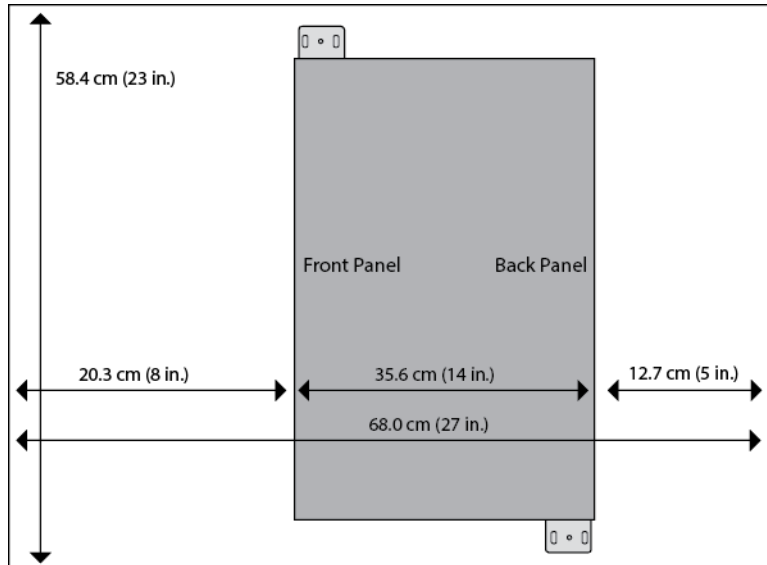

Figure 30. Minimum Wall Area Dimensions for the Switch When the Front Panel is on the Left

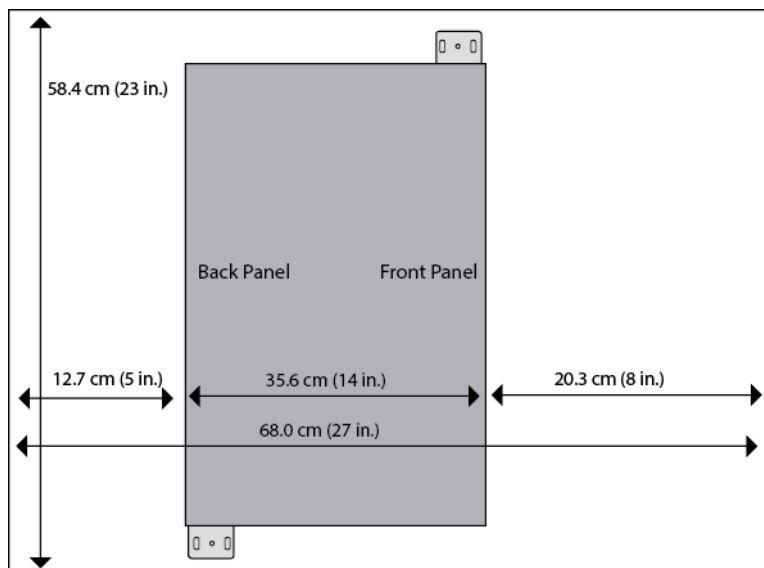

Figure 31. Minimum Wall Area Dimensions for the Switch When the Front Panel is on the Right

Positions of the Brackets

You should install the two brackets diagonally across from each other on the sides of the switch. Allied Telesis recommends installing the bracket for the front panel above the chassis and the bracket for the back panel below the chassis. See Figure 32.

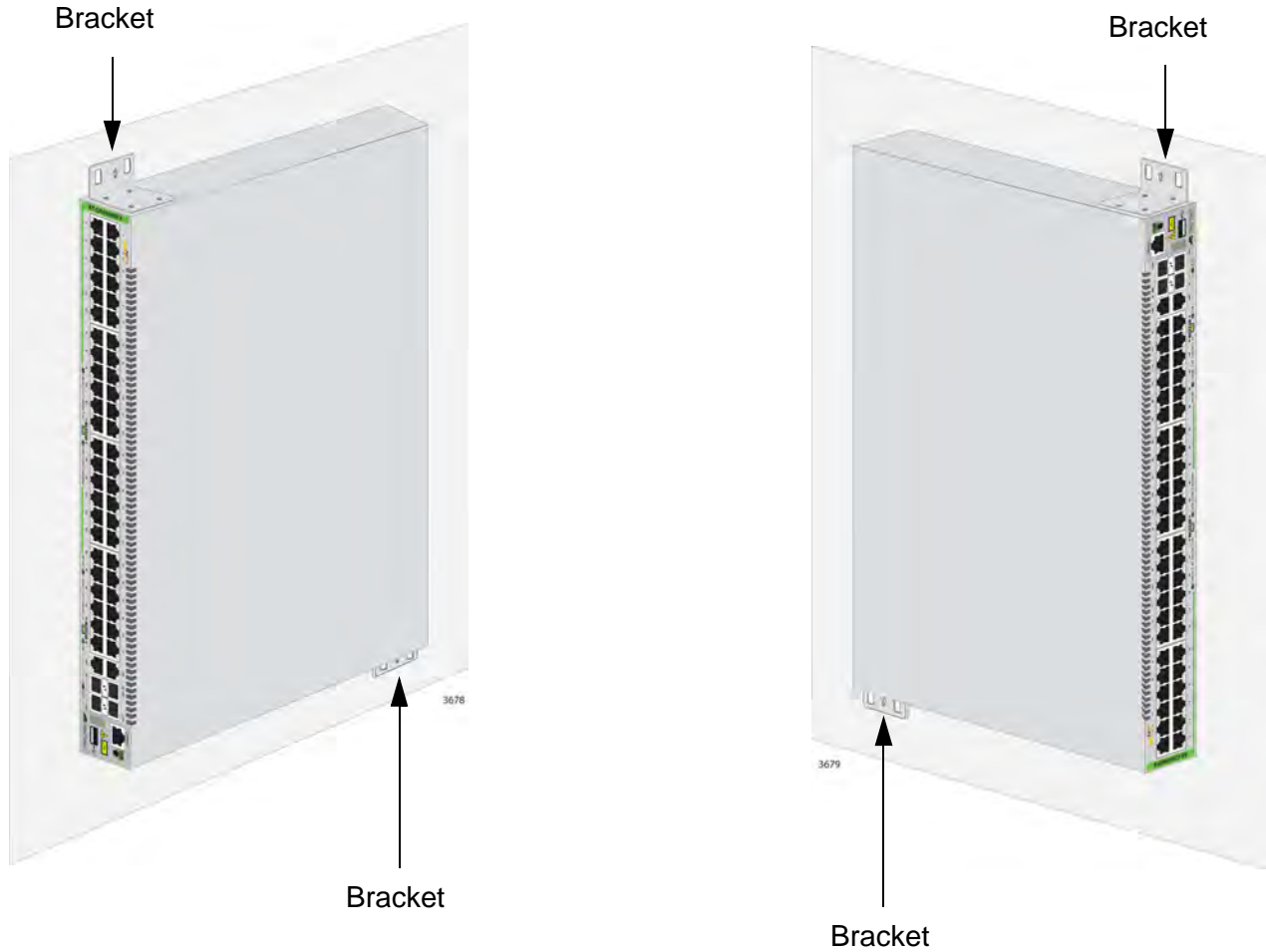

Figure 32. Bracket Positions on the Switch

Plywood Base for a Wall with Wooden Studs

If you are installing the AT-GS924MPX, AT-GS948MX, and AT-GS948MPX Switch on a wall that has wooden studs, Allied Telesis recommends using a plywood base to attach the device to the wall. (A plywood base is not required for a concrete wall.) See Figure 33 on page 79.

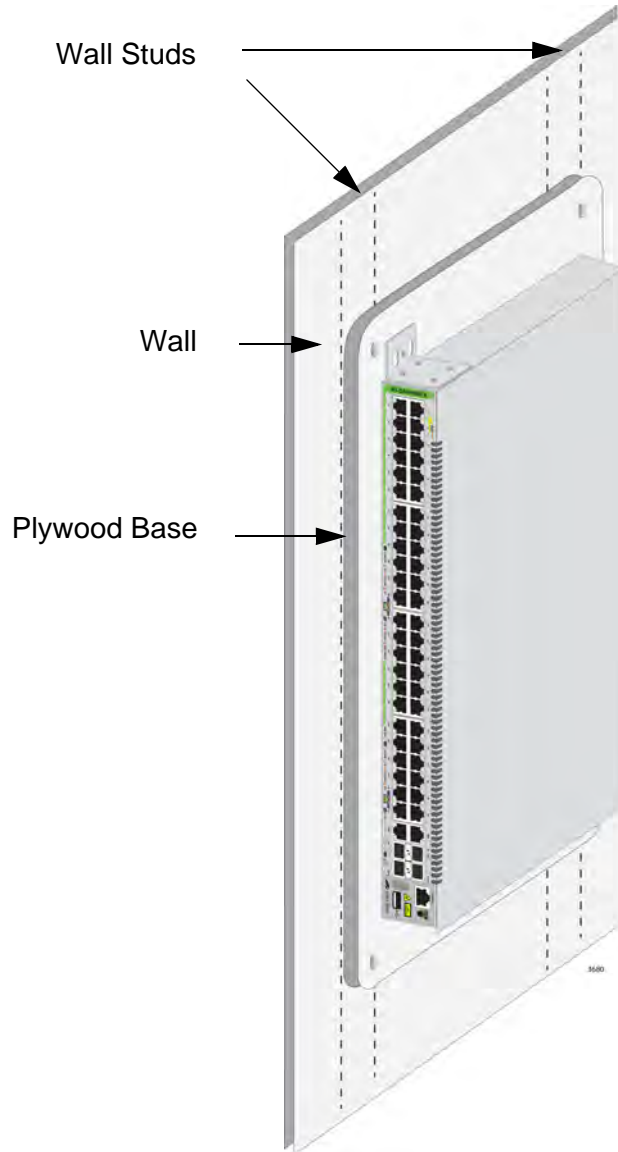

Figure 33. Switch on a Plywood Base

The plywood base allows you to mount the switch on two wall studs. Without the base, only one bracket could be attached to a stud. This is because the standard distance between two studs in a wall is 41 centimeters (16 inches) while the distances between the two brackets on the switches are 26.7 centimeters (10 1/2 inches) for the AT-GS948MX Switch and 31.8 centimeters (12 1/2 inches) for the AT-GS924MPX and AT-GS948MPX Switches. See Figure 34 on page 80.

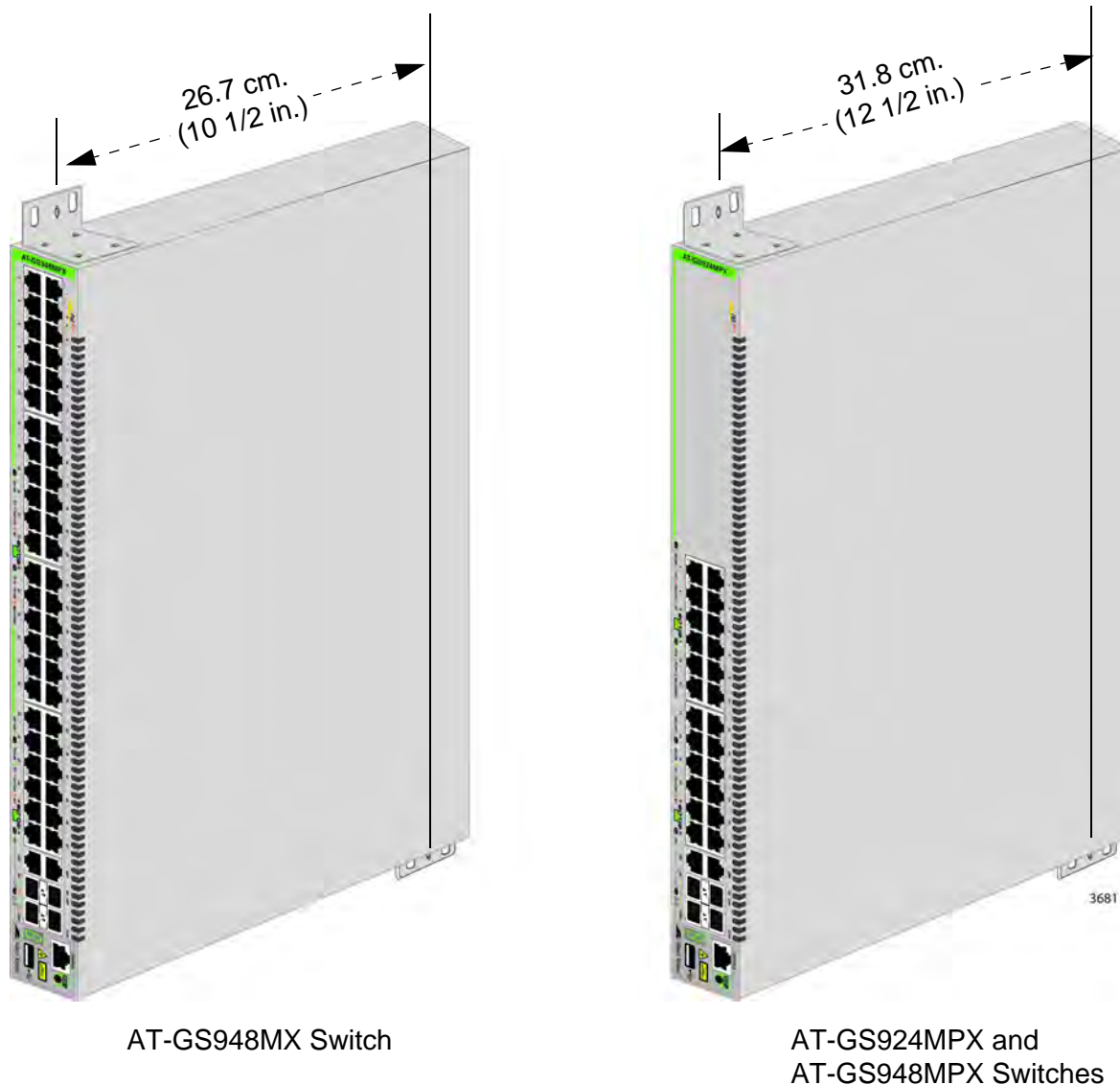

Figure 34. Distances Between the Brackets on the AT-GS924MPX, AT-GS948MX, and AT-GS948MPX Switches

The recommended minimum dimensions of the plywood base are listed here:

- ❑ Width: 50.8 centimeters (20 inches)
- ❑ Height: 55.9 centimeters (22 inches)
- ❑ Thickness: 5.1 centimeters (2 inches)

The dimensions assume the wall studs are 41 centimeters (16 inches) apart. You may need to adjust the width of the base if the distance between the studs in your wall is different from the industry standard.

You should install the plywood base to the wall and then install the switch on the base. See Figure 35.

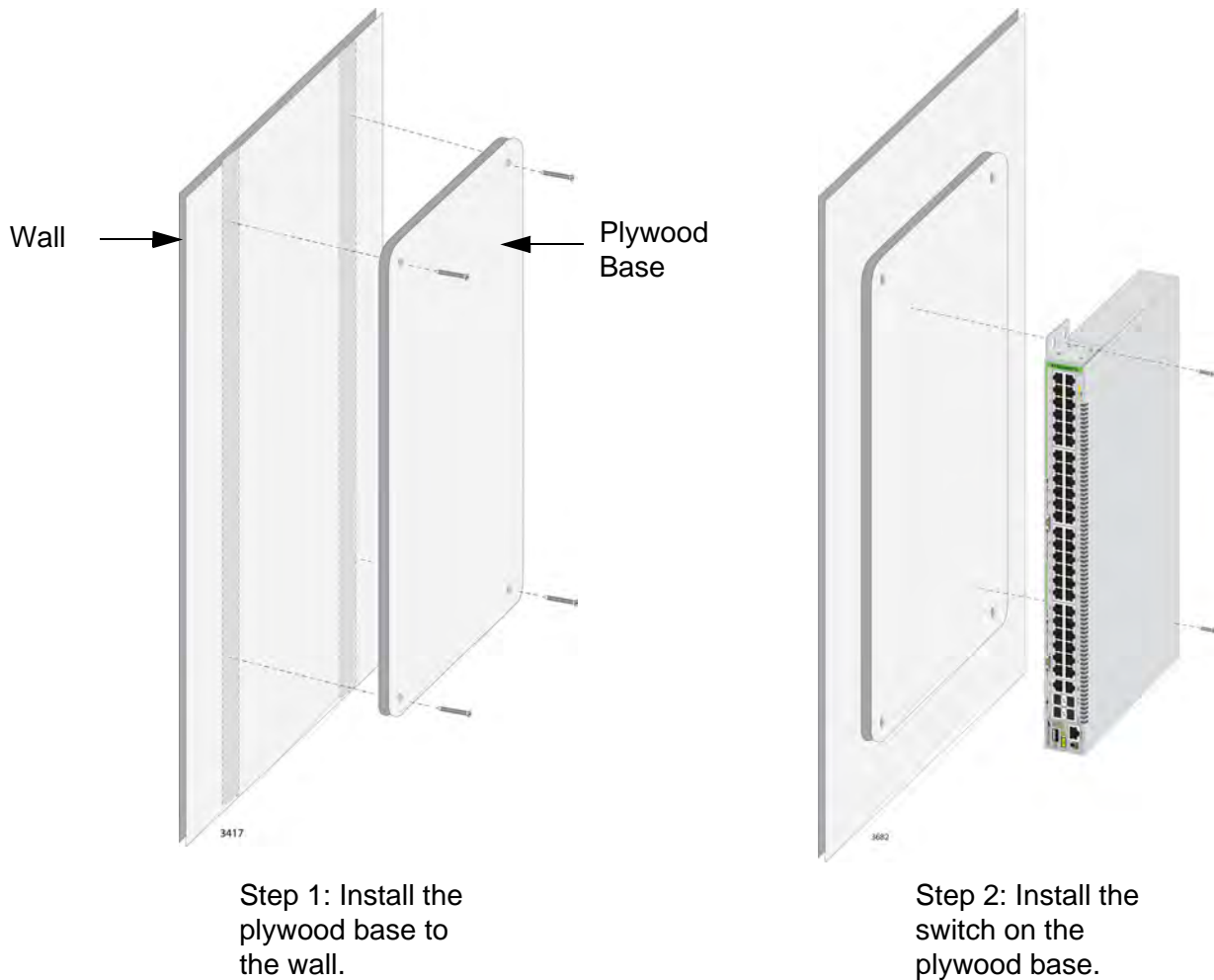

Figure 35. Steps to Installing the Switch with a Plywood Base

Wall Guidelines

Here are the guidelines to installing the AT-GS924MPX, AT-GS948MX, and AT-GS948MPX Switches on a wall.

- You may install the switch on a wall that has wooden studs.
- You may install the switch on a concrete wall.
- If you are installing the switch on a wall with wooden studs, you should use a plywood base to support the switch. For more information, refer to “Plywood Base for a Wall with Wooden Studs” on page 78. A plywood base is not required for a concrete wall.
- You should not install the switch only on Sheetrock or similar material. Sheetrock is not strong enough to safely support the device.

- ❑ You should not install the switch on a metal stud. Metal studs may not be strong enough to safely support the device.

Tools and Material

Here are the required tools and material for installing the switch on a wall:

- ❑ Eight bracket screws (included with the switch)
- ❑ Two wall or equipment rack brackets (included with the switch)
- ❑ Two wall screws (included with the switch)
- ❑ Two anchors for a concrete wall (included with the switch)
- ❑ Flat-head screwdriver (not provided)
- ❑ Cross-head screwdriver (not provided)
- ❑ Stud finder for a wooden wall, capable of identifying the middle of wooden studs and hot electrical wiring (not provided)
- ❑ Drill and a 1/4" carbide drill bit for a concrete wall (not provided)
- ❑ Plywood base if you are installing the switch on a wall with wooden studs (not provided.) Refer to "Plywood Base for a Wall with Wooden Studs" on page 78 for the dimensions.
- ❑ Four screws and anchors for attaching the plywood base to the wall (not provided)



Caution

The supplied screws and anchors may not be appropriate for all walls. A qualified building contractor should determine the hardware requirements for your wall prior to installing the chassis. *or* E74

Installing the Plywood Base

A plywood base is recommended when installing the switch on a wall that has wooden studs. Refer to "Plywood Base for a Wall with Wooden Studs" on page 78. Consult a qualified building contractor for installation instructions for the plywood base. Here are the installation guidelines:

- ❑ You should use a stud finder to identify the middle of studs and hot electrical wiring in the wall.
- ❑ You should attach the base to two wall studs with a minimum of four screws.
- ❑ The selected wall location for the base should adhere to the recommendations in "Choosing a Site for the Switch" on page 54 and "Recommended Minimum Wall Area Dimensions" on page 76.

Installing the Switch on the Plywood Base

Please review "Reviewing Safety Precautions" on page 50 and "Selecting a Site for the Switch" on page 60 before performing this procedure.

To install the AT-GS924MPX, AT-GS948MX, or AT-GS948MPX Switch on the plywood base, perform the following procedure:

1. Perform Step 1 to Step 3 in “Installing the Switch in an Equipment Rack” on page 62 to remove the rubber feet from the bottom of the switch.
2. Install the two brackets diagonally across from each other on the sides of the switch, with the eight bracket screws included with the device. See Figure 36.



Positions of the brackets if the switch is to be installed on the wall with the front panel on the left.



Position of the brackets if the switch is to be installed on the wall with the front panel on the right.

Figure 36. Attaching the Brackets for Wall Installation for All Switches Except the AT-GS924MX Switch

3. Have another person hold the switch on the plywood base on the wall while you secure it with the two provided screws. See Figure 37 on page 84.

As you position the switch on the wall, be sure to leave sufficient space from other devices or walls so that you can access the front and back panels. Refer to “Recommended Minimum Wall Area Dimensions” on page 76.

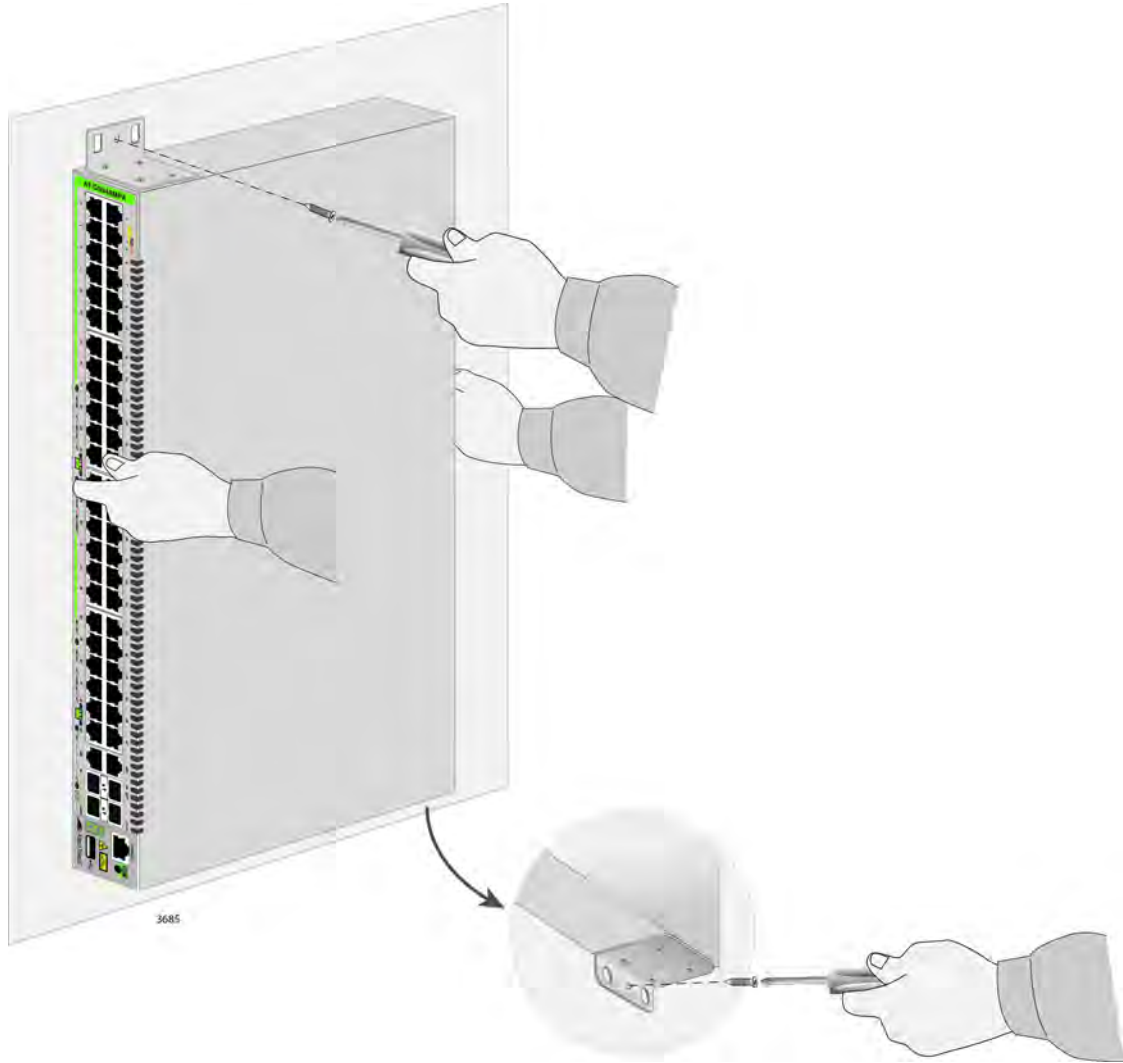

Figure 37. Securing the Switch to the Plywood Base

This completes the procedure for mounting the switch on the wall. Go to Chapter 5, “Cabling the Networking Ports” on page 89, for instructions on how to connect the network cables to the ports on the switch.

Installing the Switch on a Concrete Wall

To install the AT-GS924MPX, AT-GS948MX, or AT-GS948MPX Switch on a concrete wall, perform the following procedure:

1. Perform Step 1 to Step 3 in “Installing the Switch in an Equipment Rack” on page 62 to remove the rubber feet from the bottom of the switch.
2. Install the two brackets diagonally across from each other on the sides of the switch, with the eight bracket screws included with the device. See Figure 36 on page 83.
3. Have another person hold the switch on the concrete wall at the selected location for the device while you use a pencil or pen to mark the wall with the locations of the two screw holes in the brackets. See Figure 38. The selected wall location should adhere to the recommendations in “Choosing a Site for the Switch” on page 54 and “Recommended Minimum Wall Area Dimensions” on page 76.

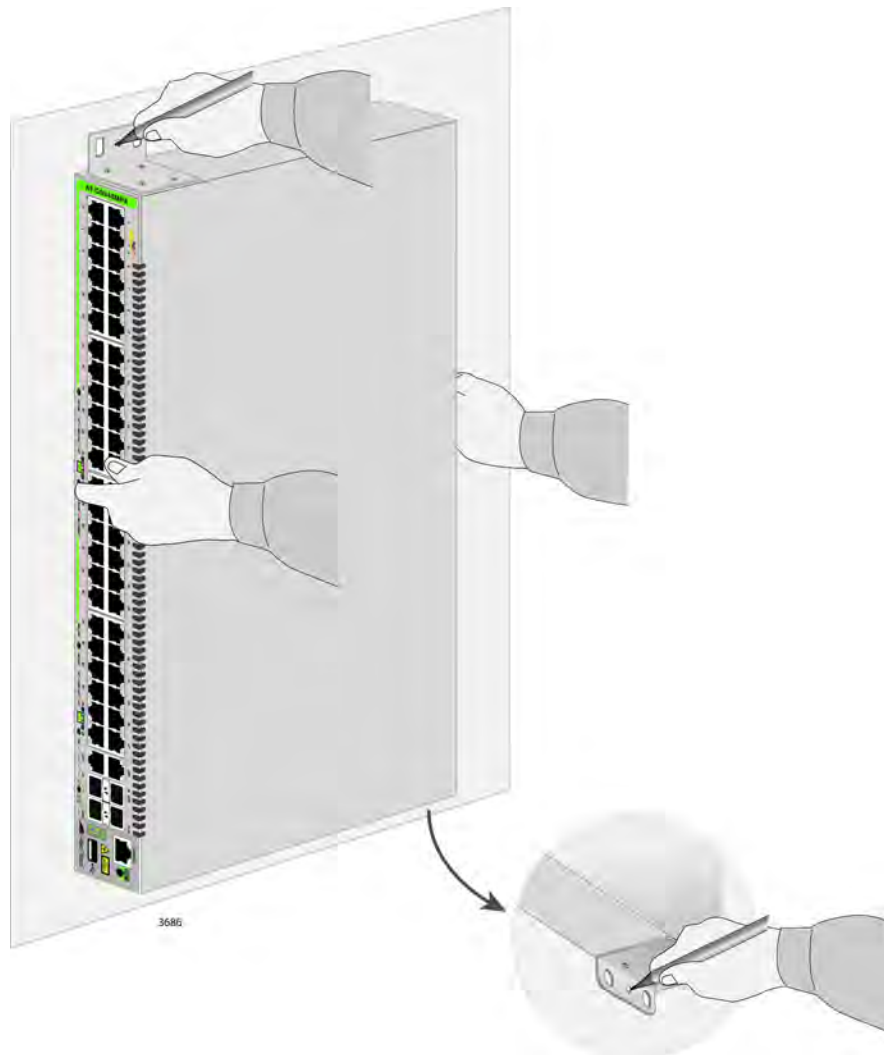

Figure 38. Marking the Locations of the Bracket Holes on a Concrete Wall

4. Place the switch on a table or desk.
5. Use a drill and a 1/4" carbide drill bit to pre-drill the two holes you marked in Step 3. Please review the following guidelines:
 - ❑ Prior to drilling, set the drill to hammer-and-rotation mode. This breaks up the concrete and cleans out the hole.
 - ❑ Allied Telesis recommends cleaning out the holes with a brush or compressed air.
6. Insert the two anchors into the holes.
7. Have another person hold the switch at the selected wall location while you secure it to the wall with the two provided screws. See Figure 39.

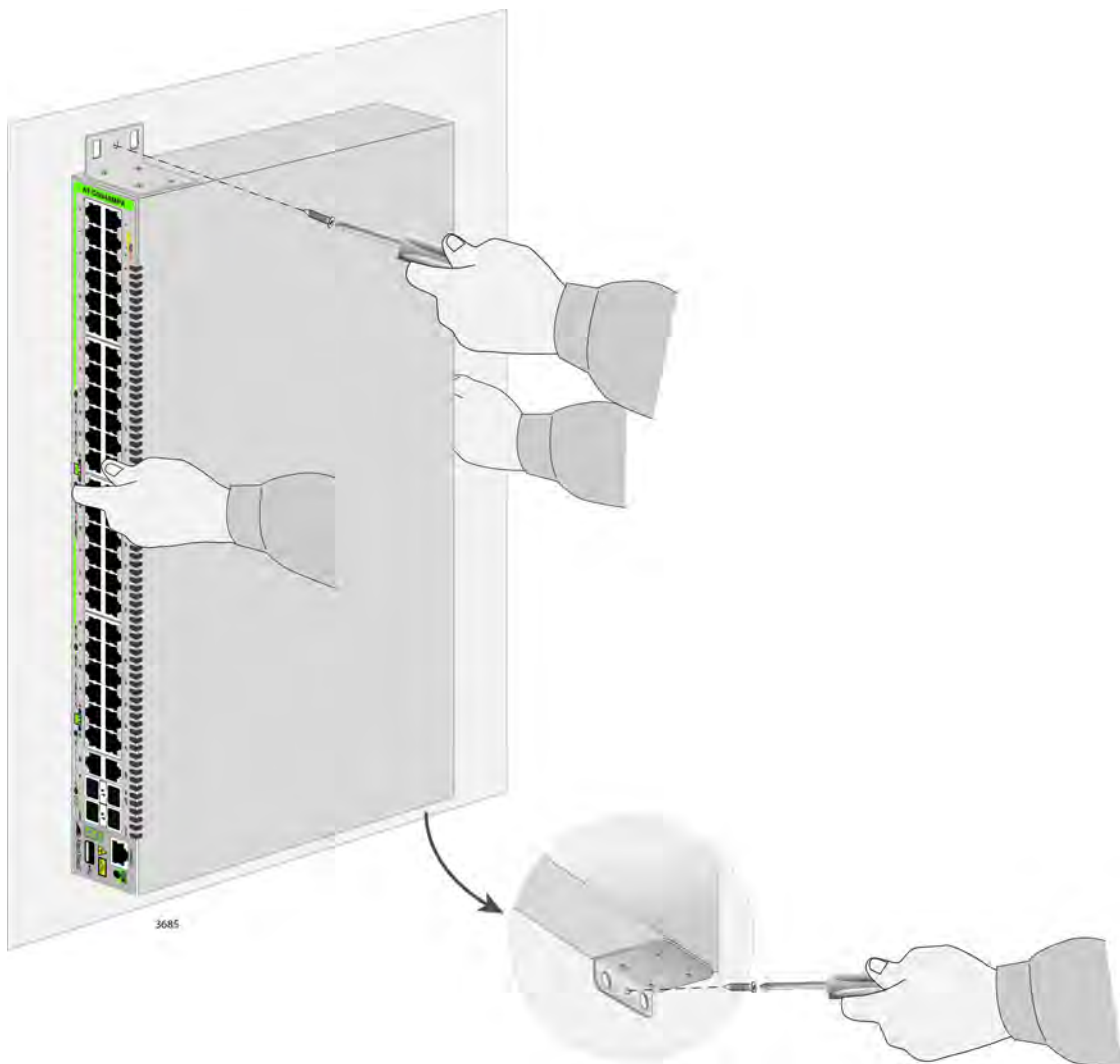

Figure 39. Installing the AT-GS924MPX, AT-GS948MX, or AT-GS948MPX Switch on a Wall

This completes the procedure for mounting the switch on the wall. Go to Chapter 5, “Cabling the Networking Ports” on page 89, for instructions on how to connect the network cables to the ports on the switch.

Chapter 5

Cabling the Networking Ports

This chapter contains the following procedures:

- ❑ “Cabling the Twisted Pair Ports” on page 90
- ❑ “Installing SFP Transceivers” on page 92

Cabling the Twisted Pair Ports

Here are the guidelines to cabling the 10/100/1000Base-T twisted pair ports:

- ❑ The cable specifications for the twisted pair ports are listed in Table 1 on page 26.
- ❑ The connectors on the cables should fit snugly into the ports, and the tabs should lock the connectors into place.
- ❑ The default setting for the wiring configurations of the ports is auto-MDI/MDI-X. The default setting is appropriate for switch ports that are connected to 10/100Base-TX network devices that also support auto-MDI/MDI-X.
- ❑ The default auto-MDI/MDI-X setting is not appropriate for switch ports that are connected to 10/100Base-TX network devices that do not support auto-MDI/MDI-X and have a fixed wiring configuration. For switch ports connected to those types of network devices, you should disable auto-MDI/MDI-X and set the wiring configurations manually.
- ❑ The appropriate MDI/MDI-X setting for a switch port connected to a 10/100Base-TX network device with a fixed wiring configuration depends on the setting of the network device and whether the switch and network device are connected with straight-through or crossover cable. If you are using straight-through twisted pair cable, the wiring configurations of a port on the switch and a port on a network device must be opposite each other, such that one port uses MDI and the other MDI-X. For example, if a network device has a fixed wiring configuration of MDI, you must disable auto-MDI/MDI-X on the corresponding switch port and manually set it to MDI-X. If you are using crossover twisted pair cable, the wiring configurations of a port on the switch and a port on a network device must be the same.
- ❑ The default speed setting for the ports is Auto-Negotiation. This setting is appropriate for ports connected to network devices that also support Auto-Negotiation.
- ❑ The default speed setting of Auto-Negotiation is not appropriate for ports connected to 10/100Base-TX network devices that do not support Auto-Negotiation and have fixed speeds. For those switch ports, you should disable Auto-Negotiation and set the port's speed manually to match the speeds of the network devices.
- ❑ The 10/100/1000Base-T ports must be set to Auto-Negotiation, the default setting, to operate at 1000Mbps.
- ❑ The default duplex mode setting for the ports is Auto-Negotiation. This setting is appropriate for ports connected to network devices that also support Auto-Negotiation for duplex modes.

- ❑ The default duplex mode setting of Auto-Negotiation is not appropriate for ports connected to network devices that do not support Auto-Negotiation and have a fixed duplex mode. You should disable Auto-Negotiation on those ports and set their duplex modes manually to avoid the possibility of duplex mode mismatches. A switch port using Auto-Negotiation defaults to half-duplex if it detects that the end node is not using Auto-Negotiation. This can result in a mismatch if the end node is operating at a fixed duplex mode of full-duplex.
- ❑ Do not attach cables to ports of static or LACP port trunks until after you have configured the trunks on the switch. Otherwise, the ports will form network loops that can adversely affect network performance.

Installing SFP Transceivers

This section contains guidelines and procedures for installing SFP transceivers. The installation procedures are listed here:

Here are general installation guidelines for SFP transceivers:

- ❑ SFP transceivers are hot-swappable. You may install them while the chassis is powered on.
- ❑ The SFP slots are paired with two 10/100/1000Base-T twisted pair ports to form combo pair ports. You may use either the SFP slot or twisted pair port of a combo pair, but not both at the same time. For more information, refer to “Combo Twisted Pair Ports and SFP Slots” on page 34.
- ❑ Your Allied Telesis sales representative can provide you with a list of supported transceivers for the units.
- ❑ The operational specifications and fiber optic cable requirements of the transceivers are provided in the documents included with the devices.
- ❑ You should install a transceiver before connecting the fiber optic cable.
- ❑ Fiber optic transceivers are dust-sensitive. Always keep the plug in the optical bores when a fiber optic cable is not installed, or when you store the transceiver. When you do remove the plug, keep it for future use.
- ❑ Unnecessary removal and insertion of a transceiver can lead to premature failure.
- ❑ Do not install SFP transceivers in the S1 and S2 slots. These slots are for stacking transceivers and are not used when the switch is used as a stand-alone unit.



Warning

A transceiver can be damaged by static electricity. Be sure to observe all standard electrostatic discharge (ESD) precautions, such as wearing an antistatic wrist strap, to avoid damaging the device. ⚡ E77

Installing SFP Modules

To install SFP transceivers in slots 25 and 26 of the 26-port switches or slots 49 and 50 of the 50-port switches, perform the following procedure:

1. Remove the dust plug from a transceiver slot on the switch. See Figure 40.

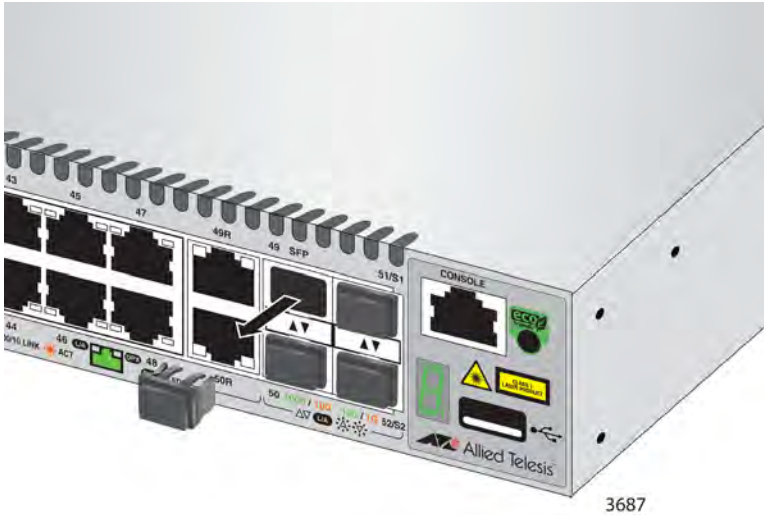

Figure 40. Removing the Dust Plug from an SFP Slot

2. Remove the transceiver from its shipping container and store the packaging material in a safe location.
3. If you are installing the transceiver in a top slot, position the transceiver with the handle on top. If you are installing the transceiver in a bottom slot, position the transceiver with the handle beneath the module.
4. Slide the transceiver into the slot until it clicks into place. See Figure 41.



Figure 41. Installing an SFP Transceiver

Note

If you are ready to attach the fiber optic cable to the transceiver, continue with the next step. Otherwise, repeat Step 1 to Step 4 to install another SFP transceiver in the switch.

5. Remove the dust cover from the transceiver, as shown in Figure 42.

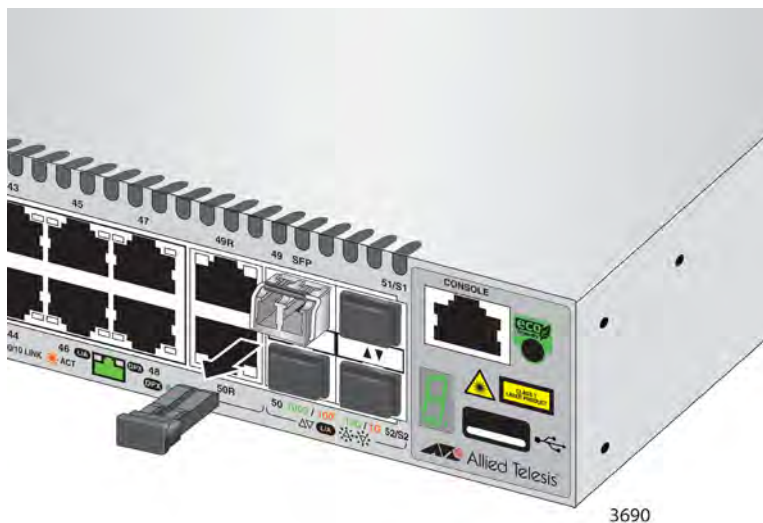

Figure 42. Removing the Dust Cover from an SFP Transceiver

6. Verify the position of the handle on the SFP transceiver. If the transceiver is in a top slot, the handle should be in the upright position, as shown in Figure 43. If the transceiver is in a bottom slot, the handle should be in the down position.



Figure 43. Positioning the SFP Handle in the Upright Position

7. Connect the fiber optic cable to the transceiver, as shown in Figure 44. The connector on the cable should fit snugly into the port, and the tab should lock the connector into place.

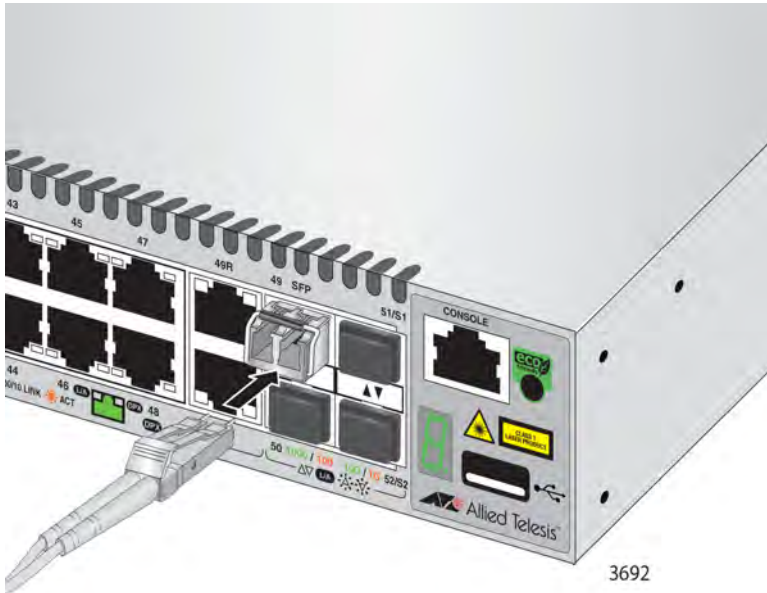

Figure 44. Connecting a Fiber Optic Cable to an SFP Transceiver

8. Repeat this procedure to install a second transceiver.
9. After installing the transceivers, go to Chapter 6, “Powering On the Switch” on page 97.

Chapter 6

Powering On the Switch

This chapter contains the following procedures:

- ❑ “Powering On the Switch” on page 98
- ❑ “Monitoring the Initialization Processes” on page 101
- ❑ “Configuring the Switch for Stand-alone Operations” on page 104
- ❑ “Specifying Ports in the Command Line Interface for Stand-alone Switches” on page 109

Powering On the Switch

Before powering on the switch, refer to “Power Specifications” on page 116 for the power specifications. To install the power cord retaining clip and power on the switch, perform the following procedure:

1. To install the power cord retaining clip, position it with the “u” part facing down, press in the sides, and insert the ends of the clip into the holes in the retaining bracket on the AC connector. See Figure 45.

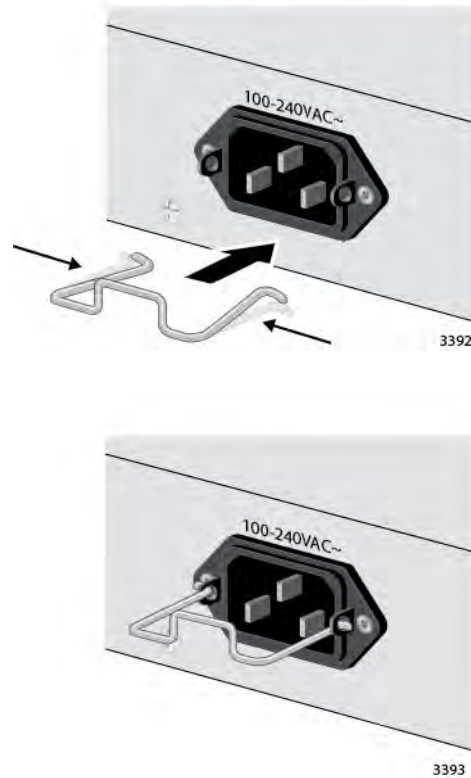

Figure 45. Installing the Retaining Clip

2. Raise the retaining clip. See Figure 46 on page 99.



Figure 46. Raising the Retaining Clip

3. Connect the power cord to the connector. See Figure 47.

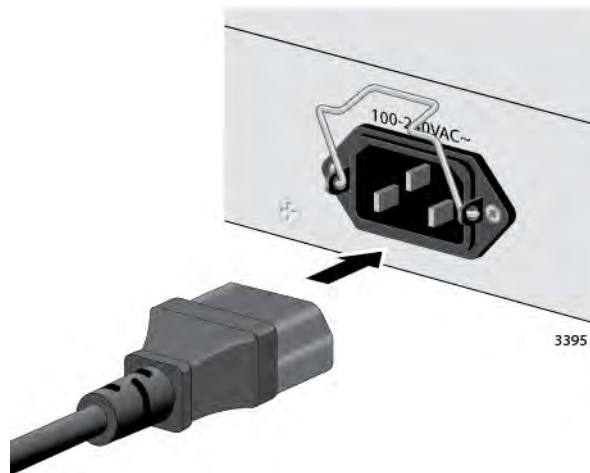

Figure 47. Plugging in the AC Power Cord

4. Lower the retaining clip to secure the power cord to the switch. See Figure 48.

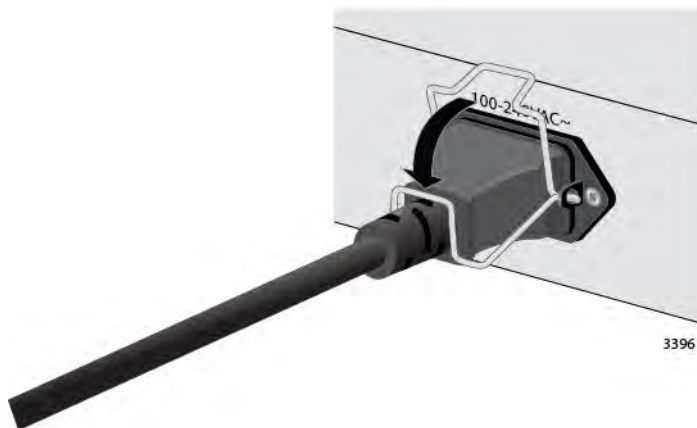

Figure 48. Lowering the Retaining Clip

5. Connect the other end of the power cord to an appropriate power source.



Warning

Power cord is used as a disconnection device. To de-energize equipment, disconnect the power cord. ⚡ E3

Note

Pluggable Equipment. The socket outlet shall be installed near the equipment and shall be easily accessible. ⚡ E5

6. Go to “Monitoring the Initialization Processes” on page 101 or “Configuring the Switch for Stand-alone Operations” on page 104.

Monitoring the Initialization Processes

It takes about one and a half minutes for the switch to initialize its management software programs and features, and load the default configuration. You may monitor the progress of the initialization process by watching the switch ID LED. It displays the number “8” for the first minute and afterwards the number “1.”

You may also monitor the bootup sequence by connecting a terminal or computer that has a terminal emulator program to the Console port on the master switch. The messages are given in Figure 49 here to Figure 51 on page 103. The messages may differ slightly depending on whether your switch is a PoE or non-PoE model.

After the switch has initialized its management software, go to “Configuring the Switch for Stand-alone Operations” on page 104.

```

Bootloader 3.0.10 loaded
Press <Ctrl+B> for the Boot Menu

Reading filesystem...
Loading flash: gs900-5.4.4E-0.1.rel...
Verifying release... OK
Booting...
Starting base/first... [ OK ]
Mounting virtual filesystems... [ OK ]

      _____
     /         \
    /   \       / / \ \
   /     \     / /  \ \
  /       \   / /   \ \
 /         \ / /     \ \
/_____ \ / /       \ \
          / /         \ \

Allied Telesis Inc.
AlliedWare Plus (TM) v5.4.4E
Current release filename: gs900-5.4.4E-0.1.rel
Original release filename: x310-5.4.4E-0.1.rel
Built: Wed Jan 14 13:42:17 NZDT 2015

```

Figure 49. Switch Initialization Messages

```

Mounting static filesystems... [ OK ]
Checking flash filesystem... [ OK ]
Mounting flash filesystem... [ OK ]
Checking for last gasp debug output... [ OK ]
Checking NVS filesystem... [ OK ]
Mounting NVS filesystem... [ OK ]
Starting base/dbus... [ OK ]
Starting base/syslog... [ OK ]
Starting base/loopback... [ OK ]
Starting base/poe_done... [ OK ]
Starting base/sysctl... [ OK ]
Received event poefw.done
Starting base/portmapper... [ OK ]
Received event syslog.done
Starting base/reboot-stability... [ OK ]
Checking system reboot stability... [ OK ]
Starting base/cron... [ OK ]
Starting base/appmond... [ OK ]
Starting hardware/openhpi... [ OK ]
Starting hardware/timeout... [ OK ]
Starting base/inet... [ OK ]
Starting base/modules... [ OK ]
Received event modules.done
Received event board.inserted
Received event hardware.done
Starting network/startup... [ OK ]
Starting base/external-media... [ OK ]
Starting network/stackd... [ OK ]
Starting network/election.timeout... [ OK ]
Received event network.enabled

Initializing HA processes:
hostd, auth, cntrd, epsr, hsl, imiproxyd, mstp
nsm, rmon, sflowd, udlld, atmfd, imi, irdpd
lcp, lldp, loopprot

Received event network.initialized
00:00:58 awplus-1 VCS[897]: No neighboring members found, unit may be in a
stand alone configuration

```

Figure 50. Switch Initialization Messages (Continued)

```
Received event vcs.elected-master
00:00:58 awplus-1 VCS[897]: Startup speed can be improved by adding 'no stack
1' to configuration
00:00:58 awplus-1 VCS[897]: Member 1 (eccd.6dc1.19ff) has become the Active
Master

Assigning Active Workload to HA processes:
hsl, nsm, irdpd, lacpd, loprotd, mstpd, rmond
sflowd, authd, epsrd, lldpd, imi, imiproxyd

Received event network.activated

Loading default configuration
Warning: flash:/default.cfg does not exist, loading factory defaults.
..
done!
Received event network.configured

awplus login:
```

Figure 51. Switch Initialization Messages (Continued)

Configuring the Switch for Stand-alone Operations

After the switch has initialized its management software, examine the switch ID LED on the front panel and do one of the following:

- ❑ If the LED is displaying “0,” the installation procedure is complete. The switch is now ready for network operations as a stand-alone unit. Refer to the *Software Reference for AT-GS900MX Series Switches, AlliedWare Plus Operating System*, for instructions on how to configure the operating parameters.
- ❑ If the LED is not displaying “0” (for example, if is displaying the default number “1”), perform the following procedures to disable the VCStack feature.

You can disable the VCStack feature from a local management session of the switch using the Console port. To start a local management session, go to “Starting a Local Management Session,” next.



Caution

You have to reset the switch to disable the VCStack feature. Some network traffic may be lost if the device is already connected to a live network. ⚡ E75

Note

The initial management session of the switch must be from the Console port.

Starting a Local Management Session

This procedure requires a terminal or a terminal emulator program and the management cable that comes with the switch. To start a local management session on the switch, perform the following procedure:

1. Connect the RJ-45 connector on the management cable to the Console port on the front panel of the switch, as shown in Figure 52 on page 105.



Figure 52. Connecting the Management Cable to the Console Port

2. Connect the other end of the cable to an RS-232 port on a terminal or PC with a terminal emulator program.
3. Configure the terminal or terminal emulator program as follows:
 - Baud rate: 9600 bps (The baud rate of the Console Port is adjustable from 1200 to 115200 bps. The default is 9600 bps.)
 - Data bits: 8
 - Parity: None
 - Stop bits: 1
 - Flow control: None

Note

The port settings are for a DEC VT100 or ANSI terminal, or an equivalent terminal emulator program.

4. Press Enter.
You are prompted for a user name and password.
5. When prompted for a user name, go to “Disabling VCStack” on page 106.

Disabling VCStack

To disable the VCStack feature to use the switch as stand-alone unit, perform the following procedure:



Caution

Disabling the VCStack feature requires resetting the switch. If the switch is already connected to a live network, some network traffic may be lost. ⚡ E75A

1. When prompted, enter a user name and password to log on the switch. If this is the initial management session of the switch, enter “manager” as the user name and “friend” as the password. The user name and password are case sensitive.

The local management session starts when the User Exec mode prompt, shown in Figure 53, is displayed.

```
awpl us>
```

Figure 53. User Exec Mode Prompt

Note

The User Exec mode is the first level in the command mode interface. For complete information on the modes and commands, refer to the *Software Reference for AT-GS900MX Series Switches, AlliedWare Plus Operating System* from www.alliedtelesis.com/support.

2. Enter the SHOW STACK command to display the status of the VCStack feature. Figure 54 is an example of the command.

```
awplus> show stack
Virtual Chassis Stacking summary information
ID      Pending ID  MAC address      Priority  Status  Role
1       -            0015:774f:ed30  128     Ready   Active Master
Operational Status
Stack MAC address 0015:774f:ed30
awpl us(config)#
```

(Stand alone Uni t)

Figure 54. SHOW STACK Command

3. Review the following items:
 - ❑ If the Operational Status is “Stacking Hardware Disabled,” the VCStack feature is already disabled on the switch. The switch is ready for operations as a stand-alone switch in your network. No further installation steps are required.
 - ❑ If the Operational Status is “Standalone Unit,” as shown in Figure 54 on page 106, the VCStack feature is active on the unit. You must disable it by performing the steps in the rest of this procedure before you can use the SFP+ stacking slots with regular SFP or SFP+ transceivers. The reason the status says “standalone” is because the switch considers itself a stack of one switch.
4. Move to the Global Configuration mode by entering the ENABLE and CONFIGURE TERMINAL commands, as shown in Figure 55.

```
awpl us> enable
awpl us# configure terminal
Enter configuration commands, one per line. End with CNTL/Z
awpl us(config)#
```

Figure 55. Moving to the Global Configuration Mode

5. To disable the VCStack feature on the switch, enter the NO STACK ENABLE command, which has this format:

```
no stack id enable
```

The ID parameter is the ID number of the switch, displayed on the ID LED. Replace the parameter with whatever number is on the ID LED. For example, if the ID number of the switch is 1, the default value, enter the command as follows:

```
awpl us(config)# no stack 1 enable
```

This confirmation prompt in Figure 56 is displayed.

```
Warning: This will disable the stacking hardware on member-1.
Are you sure you want to continue? (y/n):
```

Figure 56. Confirmation Prompt for the NO STACK ENABLE Command

6. Type Y to disable VCStack on the switch or N to cancel the procedure.

7. Enter the EXIT command to return to the Privileged Exec mode, as shown in Figure 57.

```
awpl us(config)# exit
awpl us#
```

Figure 57. Returning to the Privileged Exec Mode

8. Enter the WRITE command to save your change in the configuration file. The switch displays the confirmation prompt in Figure 58.

```
awpl us# write
Building configuration ...
[OK]
awpl us#
```

Figure 58. Saving the Changes with the WRITE Command

9. Enter the REBOOT command to reboot the switch.
10. At the confirmation prompt, type “Y” for yes.
11. Wait for the switch to initialize its management software and afterwards examine the Switch ID LED. If the ID number is “0,” the switch is ready for normal network operations as a stand-alone unit. Refer to the *Software Reference for AT-GS900MX Series Switches, AlliedWare Plus Operating System*, for instructions on how to configure the operating parameters. If the number is not “0,” repeat this procedure.

Specifying Ports in the Command Line Interface for Stand-alone Switches

The command line interface in the management software on the switch has a parameter that you use to specify the individual ports. The parameter is the PORT parameter, and Figure 59 shows its format.

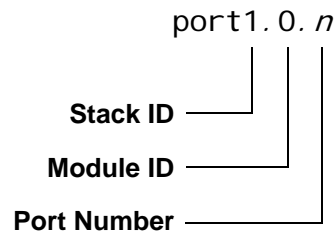

Figure 59. PORT Parameter in the Command Line Interface

The first number is the switch's ID number. The ID number for stand-alone switches is not the value 0 displayed on the Switch ID LEDs. Rather, it is 1. Be sure to enter 1, not 0, as the ID number in the PORT parameter when configuring ports on stand-alone switches.

The module ID value is used with multi-module products. This value does not apply to the AT-GS900MX Series switches and should always be 0.

The third value is a port number on the switch. You may specify only one port number in a PORT parameter, but you may specify more than one PORT parameter in many commands where the parameter is supported.

Here is an example of the PORT parameter on a stand-alone switch. It uses the INTERFACE command to enter the Port Interface mode for ports 15 and 17:

```
awpl us> enable
awpl us# configure terminal
awpl us(config)# interface port1.0.15, port1.0.17
```

For instructions on the command line interface and the PORT parameter, refer to the *Software Reference for AT-GS900MX Series Switches, AlliedWare Plus Operating System*.

Chapter 7

Troubleshooting

This chapter contains suggestions on how to troubleshoot the switch if a problem occurs.

Note

For further assistance, please contact Allied Telesis Technical Support at www.alliedtelesis.com/support.

Problem 1: The Switch ID LED on the front of the switch is off.

Solutions: The unit is not receiving power. Try the following:

- Verify that the power cord is securely connected to the power source and to the AC connector on the back panel of the switch.
- Verify that the power outlet has power by connecting another device to it.
- Try connecting the unit to another power source.
- Try a different power cord.
- Verify that the voltage from the power source is within the required levels for your region.

Problem 2: All of the port LEDs are off even though the ports are connected to active network devices.

Solution: The switch may be operating in the low power mode. To toggle on the LEDs, press the eco-friendly button on the front panel of the switch. You may also toggle the LEDs off and on with the ECOFRIENDLY LED and NO ECOFRIENDLY LED commands in the command line interface.

Problem 3: A twisted pair port on the switch is connected to a network device, but the port's LINK/ACT LED is off.

Solutions: The port is unable to establish a link to a network device. Try the following:

- Verify that the port is connected to the correct twisted pair cable. This is to eliminate the possibility that the port is connected to the wrong network device.
- Verify that the network device connected to the twisted pair port is powered on and is operating properly.

- ❑ Try connecting another network device to the twisted pair port with a different cable. If the twisted pair port is able to establish a link, then the problem is with the cable or the other network device.
- ❑ Verify that the twisted pair cable does not exceed 100 meters (328 feet).
- ❑ Verify that you are using the appropriate category of twisted pair cable. The cable types are listed in Table 1 on page 26 for the 10/100/1000Base-T ports.

Note

A 1000Base connection may require five to ten seconds to establish a link.

Problem 4: The LINK/ACT LED for an SFP transceiver is off.

Solutions: The fiber optic port on the transceiver is unable to establish a link to a network device. Try the following:

- ❑ Verify that the remote network device connected to the fiber optic port is operating properly.
- ❑ Verify that the fiber optic cable is securely connected to the port on the SFP module and to the port on the remote network device.
- ❑ Check that the transceiver is fully inserted in the slot.
- ❑ Check to be sure that the transceiver is not installed in slot S1 or S2 in the switch.
- ❑ Verify that the operating specifications of the fiber optic ports on the transceiver and remote network device are compatible.
- ❑ Verify that the correct type of fiber optic cabling is being used.
- ❑ Verify that the port is connected to the correct fiber optic cable. This is to eliminate the possibility that the port is connected to the wrong remote network device.
- ❑ Try connecting another network device to the fiber optic port using a different cable. If the port is able to establish a link, then the problem is with the cable or with the other network device.
- ❑ Use the switch's management software to verify that the port is enabled.
- ❑ If the remote network device is a managed device, use its management firmware to determine whether its port is enabled.
- ❑ Test the attenuation of both directions on the fiber optic cable with a fiber optic tester to determine whether the optical signal is too weak (sensitivity) or too strong (maximum input power).

Problem 5: Network performance between a twisted pair port on the switch and a network device is slow.

Solution: There might be a duplex mode mismatch between the port and the network device. This can occur when a twisted pair port using Auto-Negotiation is connected to a remote device that has a fixed speed of 10 or 100 Mbps and a fixed duplex mode of full-duplex. If this is the cause of the problem, adjust the duplex mode of the port on the network device or switch so that both ports are using the same duplex mode. You can use either the LEDs or management software on the switch to determine the duplex mode settings of the ports. The LEDs are described in Table 6 on page 38.

Problem 6: The switch functions intermittently.

Solutions: Check the system hardware status through the management software:

- ❑ Use the SHOW SYSTEM ENVIRONMENT command in the Privileged Exec mode to verify that the input voltage from the power source to the switch is stable and within the approved operating range. The unit will shut down if the input voltage fluctuates above or below the approved operating range.
- ❑ Use the SHOW SYSTEM ENVIRONMENT command in the Privileged Exec mode to verify that the fan is operating correctly.
- ❑ Verify that the location of the switch allows for adequate airflow. The unit will shut down if it is in danger of overheating.

Problem 7: The Switch ID LED on the front of the switch is flashing the letter “F.”

Solutions: One or more of the following problems has occurred:

- ❑ A cooling fan has failed.
- ❑ The input voltage on the power supply is outside the normal operating range.
- ❑ The internal temperature of the switch has exceeded the normal operating range, and the switch may shut down.

Contact your Allied Telesis sales representative for assistance.

Problem 8: The AT-GS924MPX or AT-GS948MPX Switch is not providing power to a PoE device.

Solutions: Try the following:

- ❑ Review the PD's documentation to confirm that the device supports Alternative B of the IEEE 802.3at standard. Alternative B is one of two modes that define the connector pins that deliver the power from the port on the line card to the PD. In Alternative B, the power

is carried on pins 4, 5, 7, and 8 on the RJ-45 port, the same pins that carry the network traffic. The other mode, Alternative A, defines pins 1, 2, 3, and 6 as the power carriers. The AT-GS924MPX and AT-GS948MPX Switches do not support Alternative A. Most powered devices are designed to accept power by either mode, but some legacy devices may only support one mode. This can be verified by reviewing the device's documentation or data sheet. Legacy devices that only support Alternative A will not work with the switches.

- ❑ Check that the device's power requirements do not exceed 30 W. This can be verified by reviewing the device's documentation or data sheet.
- ❑ Verify that you are using the appropriate category of twisted-pair cable by referring to Table 1 on page 26.
- ❑ Use the management software on the switch to determine whether PoE is enabled on the port. The default setting for PoE is enabled.
- ❑ Use the management software on the switch to determine whether the PoE power setting for the port has been reduced to a value below the power requirements of the device.
- ❑ Try connecting the device to a different port on the switch.

Appendix A

Technical Specifications

This appendix contains the following sections:

- "Physical Specifications"
- "Environmental Specifications" on page 116
- "Power Specifications" on page 116
- "Certifications" on page 117
- "RJ-45 Twisted Pair Port Pinouts" on page 118
- "RJ-45 Style Serial Console Port Pinouts" on page 119

Physical Specifications

Dimensions (H x W x D)

Table 11. Product Dimensions

AT-GS924MX	4.4 cm x 33.9 cm x 21.1 cm (1.7 in. x 13.4 in. x 8.3 in.)
AT-GS924MPX	4.4 cm x 44.0 cm x 35.6 cm (1.7 in. x 17.3 in. x 14.0 in.)
AT-GS948MX	4.4 cm x 44.0 cm x 30.7 cm (1.7 in. x 17.3 in. x 12.1 in.)
AT-GS948MPX	4.4 cm x 44.0 cm x 35.6 cm (1.7 in. x 17.3 in. x 14.0 in.)

Weights

Table 12. Product Weights

AT-GS924MX	2.5 kg (5.5 lb.)
AT-GS924MPX	5.3 kg (11.7 lb.)
AT-GS948MX	4.5 kg (9.9 lb.)
AT-GS948MPX	5.8 kg (12.8 lb.)

Ventilation

Table 13. Ventilation Requirements

Recommended Minimum Ventilation on All Sides	10 cm (4.0 in)
--	----------------

Environmental Specifications

Table 14. Environmental Specifications

Operating Ambient Temperature	0° C to 50° C (32° F to 122° F)
Storage Temperature	-25° C to 70° C (-13° F to 158° F)
Operating Humidity	5% to 90% noncondensing
Storage Humidity	5% to 95% noncondensing
Maximum Operating Altitude	AT-GS924MX: 2,000 m (6,562 ft)
	AT-GS924MPX: 3,000 m (9,842 ft)
	AT-GS948MX: 2,000 m (6,562 ft)
	AT-GS948MPX: 3,000 m (9,842 ft)
Maximum Nonoperating Altitude	4,000 m (13,100 ft)

Power Specifications

Input Voltages

Table 15. Input Voltages

AT-GS924MX	AC model: 100-240 VAC, 1.0A maximum, 50/60 Hz
AT-GS924MPX	AC model: 100-240 VAC, 5.0A maximum, 50/60 Hz
AT-GS948MX	AC model: 100-240 VAC, 1.0A maximum, 50/60 Hz
AT-GS948MPX	AC model: 100-240 VAC, 5.0A maximum, 50/60 Hz

Maximum Power Consumption

Table 16. Maximum Power Consumption

AT-GS924MX	30.7 watts
AT-GS924MPX	464.3 watts
AT-GS948MX	50.8 watts
AT-GS948MPX	480.6 watts

Heat Dissipation (British Thermal Units/hour)

Table 17. Heat Dissipation

AT-GS924MX	104.6 BTU/h
AT-GS924MPX	321.7 BTU/h
AT-GS948MX	173.1 BTU/h
AT-GS948MPX	377.4 BTU/h

Certifications

Table 18. Product Certifications

EMI (Emissions)	FCC Class A, EN55022 Class A, EN61000-3-2, EN61000-3-3, VCCI Class A, CISPR Class A, RCM, CE
EMC (Immunity)	EN55024
Electrical and Laser Safety	EN60950-1 (TUV), UL 60950-1 (cULUS), EN60825-1
Compliance Marks	CE, cULUS, TUV, RCM

RJ-45 Twisted Pair Port Pinouts

Figure 60 illustrates the pin layout of the RJ-45 connectors and ports.

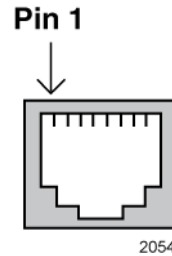

Figure 60. RJ-45 Socket Pin Layout (Front View)

Table 19 lists the pin signals for 10 and 100 Mbps.

Table 19. Pin Signals for 10 and 100 Mbps

Pin	MDI Signal	MDI-X Signal
1	TX+	RX+
2	TX-	RX-
3	RX+	TX+
4	Not used	Not used
5	Not used	Not used
6	RX-	TX-
7	Not used	Not used
8	Not used	Not used

The pin signals for a port operating at 1000 Mbps are shown in Table 20.

Table 20. Pin Signals for 1000 Mbps

Pinout	Pair
1	Pair 1 +
2	Pair 1 -
3	Pair 2 +
4	Pair 3 +

Table 20. Pin Signals for 1000 Mbps (Continued)

Pinout	Pair
5	Pair 3 -
6	Pair 2 -
7	Pair 4 +
8	Pair 4 -

RJ-45 Style Serial Console Port Pinouts

The pin signals of the RJ-45 style serial Console port are listed in Table 21.

Table 21. RJ-45 Style Serial Console Port Pin Signals

Pin	Signal
1	Looped to pin 8
2	Looped to pin 7
3	Transmit Data
4	Ground
5	Ground
6	Receive Data
7	Looped to pin 2
8	Looped to pin 1

