

XDPL8221 50W Reference Board Engineering Report

XDP™ Digital Power

About this document

Scope and purpose

This document contains the specification, schematic, bill of materials and measurement results of the 50 W form factor board as LED driver which using the Infineon XDPL8221 dual-stage multi-mode flyback + PFC combo controller.

Intended audience

This document is intended for anyone wishing to design high-performance dual-stage digital flyback AC-DC converters for LED lighting based on the PFC+Flyback combo controller XDPL8221.

Table of contents

About this document.....	1
Table of contents.....	1
1 Introduction	2
2 Design features	3
3 Design specification	4
4 Schematic and description	6
5 PCB Layout.....	7
6 XDPL8221 50 W Reference board measurement results.....	8
6.1 Operating window.....	8
6.2 Performance.....	9
6.3 0 to 10 V Linear dimming.....	14
6.4 0 to 10 V Eye-adapted dimming.....	15
6.5 Time-to-light.....	16
6.6 Standby power consumption	16
6.7 EMI Performance	17
7 Bill of materials.....	18
7.1 Transformer specification.....	24
Revision history.....	26

Introduction

1 Introduction

XDPL8221 50 W reference design is a digitally configurable LED driver which has an universal input of 90 to 305 V_{AC} or 90 to 430 V_{DC}, and wide output load range of 16 to 48 V_{DC} with isolated dimming interface (with CDM10VD). Please refer next page for the main design features of this board based on XDPL8221 and CDM10VD.

Note: The 50 W reference design is ready for evaluation without the need of any pre-programming by the user as the XDPL8221 chip on PCB has already been burned with the default full set of working parameters configuration. Please connect the AC Input, LED output and dimming input as shown in **Figure 1**, for the test setup.

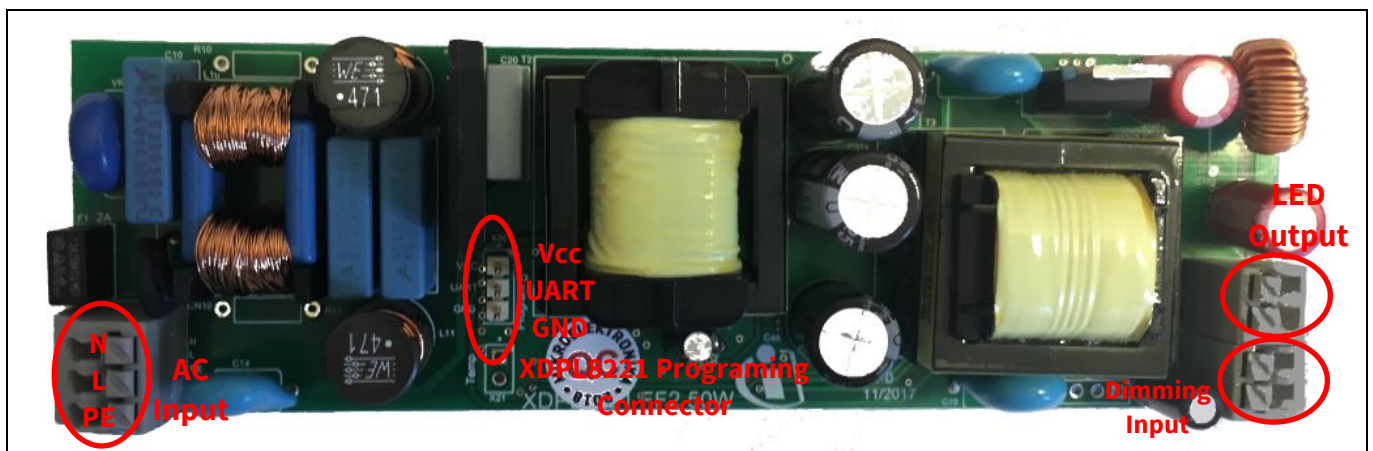

Figure 1 XDPL8221 50 W reference board

Design features

2 Design features

XDPL8221 50 W reference board as LED driver has following design features:

- Dual-stage flyback and separated power factor correction (PFC) with high-precision primary side-controlled constant voltage (CV), constant current (CC) and limited power (LP) output.
- Excellent current accuracy of typical +/-2% across universal input voltage range (90 to 305 V_{AC} or 90 to 430 V_{DC}) and wide output voltage range (from 16 V_{DC} to 48 V_{DC})
- Integrated 600 V HV cell and PFC aux winding charge pump power supply for fast startup start time under 250 ms
- Flyback stage with multi-mode control (QR1 + DCM + ABM) enables high efficiency and low dimming output
- High power factor (PF>0.9) and low input current total harmonic distortion (iTHD < 15%) across universal input voltage range (90 to 305 V_{ac}) and down to 30% load
- Low Bill Of Materials (BOM)
- Configurable dimming curve to either linear or quadratic (eye-adaptive).
- Configurable minimum dimming current down to 1%
- Intelligent thermal management with adaptive temperature protection
- Active bleeder for dim-to-off function
- UART command interface to control the operation of the LED driver as well as to read out the operating status information from the digital controller XDPL8221
- Output independent forward mode auxiliary power supply for an accurate primary side regulation
- Isolated 0 – 10 V dimming interface with CDM10VD

Note: CDM10VD is a fully integrated 0-10 V dimming interface IC from Infineon which transmits secondary auxiliary side analog voltage based signals from 0-10 V dimmer to primary side, by driving an external opto-coupler with a 5 mA current based PWM signal. For more details about CDM10VD, please visit Infineon website: <http://www.infineon.com/CDM10VD>.

3 Design specification

Table 1 and **Table 2** list the electrical specification and system protection of this reference design.

Table 1 Electrical specification

Specification	Symbol	Value	Unit
AC Input voltage range	V_{IN_AC}	90 to 305	V_{AC}
DC Input voltage range	V_{IN_DC}	90 to 430	V_{DC}
Output LED load range (includes dimming) ¹	V_{LED}	16 to 48	V_{DC}
Non-dimmed full output current setting ²	I_{out_set}	1500	mA
Total line and load regulation tolerance	-	± 2	%
Dimming input voltage range	V_{DIM}	0 to 10	V
Limited Maximum Power	P_{lim}	50	W
PWM Dimming frequency	f_{dim}	500 to 1500	Hz
Minimum output current setting ²	$I_{out_dim_min}$	15	mA
Output current dimming curve ²	C_{dim}	Linear or quadratic	-
Efficiency (V_{out} : 48 V_{DC} , I_{out} : 2.08A, non-dimming)	η	< 89	%
Power factor (V_{in} : 120 to 277 V_{AC} +/-10%, V_{out} : 29 to 48 V_{DC} , >30% load)	PF	> 0.9	-
Input current total harmonic distortion (V_{in} : 120 to 277 V_{AC} +/-10%, V_{out} : 29 to 48 V_{DC} , >30% load)	iTHD	< 15	%

¹ Configurable in XDPL8221

² Configurable in XDPL8221

Design specification

Table 2 System protections

Protection	Symbol	Value	Unit
Nominal Input over-voltage protection level ¹	V_{in_OV}	320	V_{AC}
Nominal Input under-voltage protection level ¹	V_{in_UV}	76	V_{AC}
Nominal output over-voltage protection level ²	V_{out_OV}	53	V_{DC}
Nominal output over-current (average) protection level ²	$I_{out_max_avg}$	1500	mA
IC internal over-temperature detection threshold ¹	$T_{critical}$	119	°C
Input over-voltage protection reaction ³	Reaction_OVP_Vin	Auto-restart	-
Input under-voltage protection reaction ³	Reaction_UVP_Vin	Auto-restart	-
Bus over-voltage protection level 2	Reaction_OVP2_Vbus	Auto-restart	-
Primary over-current protection level 2	Reaction_OCP2	Auto-restart	-
Output over-voltage (output open) protection reaction ³	Reaction_OVP_Vout	Auto-restart	-
Output under-voltage (output short) protection reaction ³	Reaction_UVP_Vout	Auto-restart	-
Output over-current (average) protection reaction ³	Reaction_Iout_max_avg	Auto-restart	-
IC over-temperature protection reaction ³	Reaction_TP	Auto-restart	-
Auto-restart idle time ⁴	$t_{auto_restart}$	1	s
Fast auto-restart idle time ⁵	$t_{fast_auto_restart}$	400	ms

¹ Protection can be disabled and its level can be configured.

² Protection cannot be disabled and its level can be configured.

³ Protection reaction can be configured as either auto-restart or latched mode

⁴ Auto-restart time can be configured.

⁵ Fast auto-restart time can be configured.

4 Schematic and description

Figure 2 shows the complete schematic of the 50 W reference design:

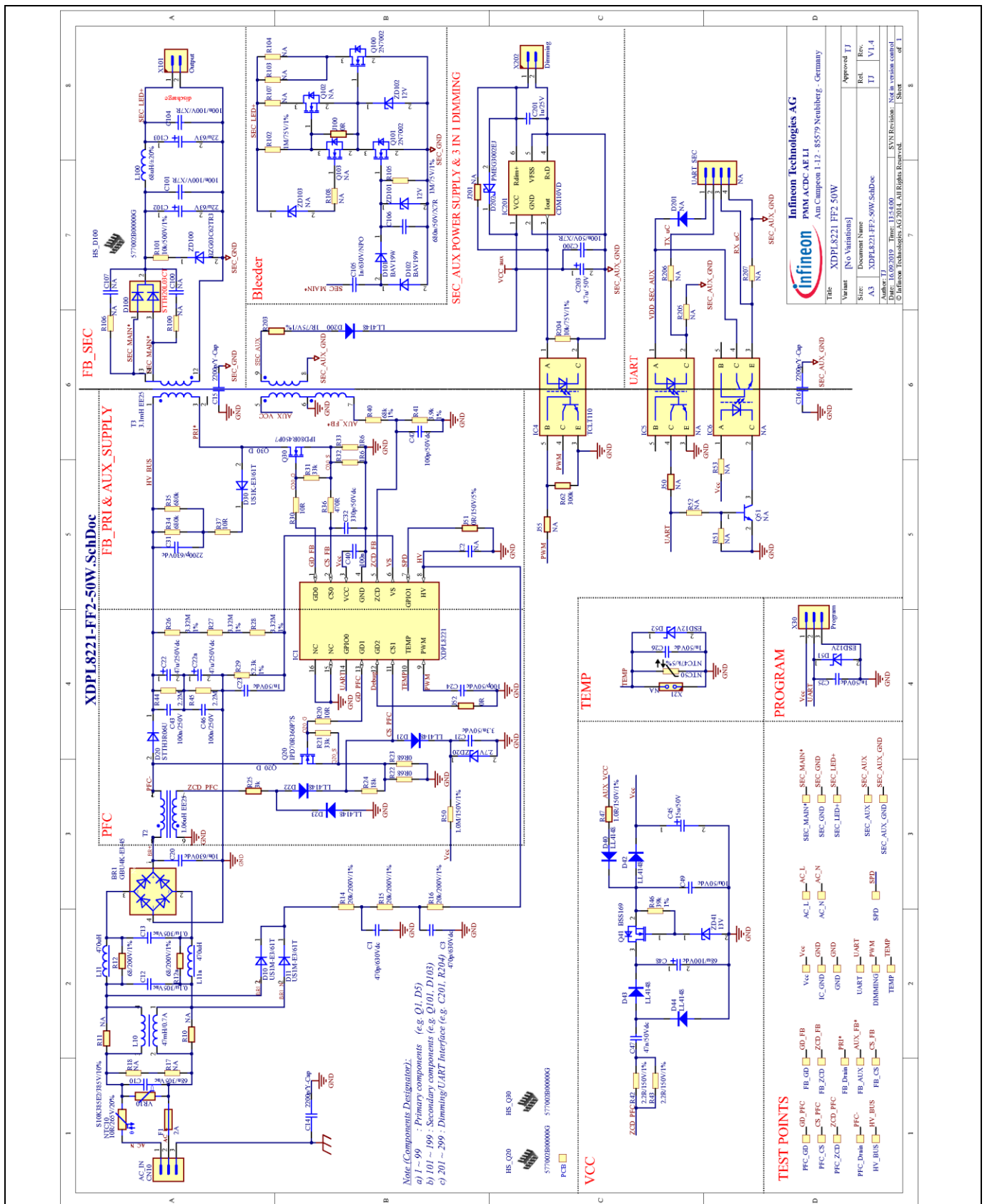

Figure 2 Schematic of the 50 W reference design

5 PCB Layout

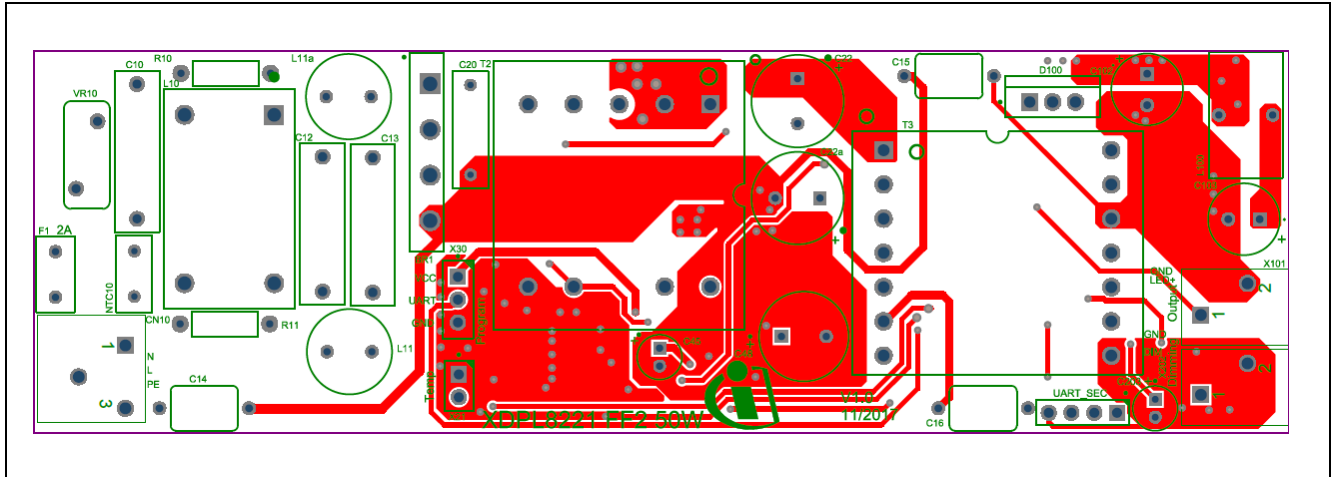

Figure 3 PCB Top side

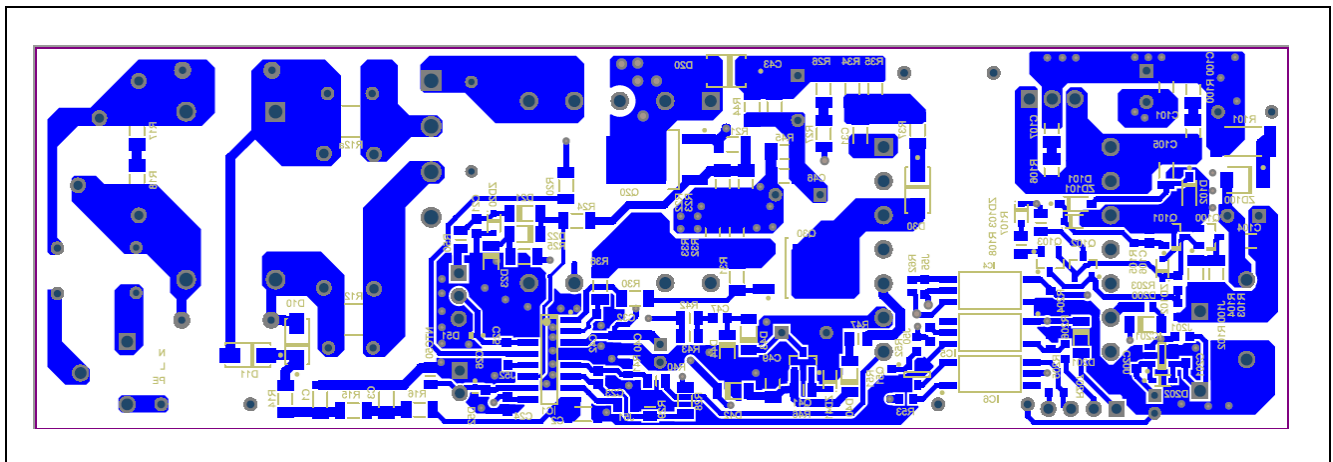

Figure 4 PCB Bottom side

6 XDPL8221 50 W Reference board measurement results

6.1 Operating window

The operating window of the XDPL8221 50 W reference board is measured with an electronic load, $V_{ac} = 230\text{ V} / 50\text{ Hz}$ at room temperature.

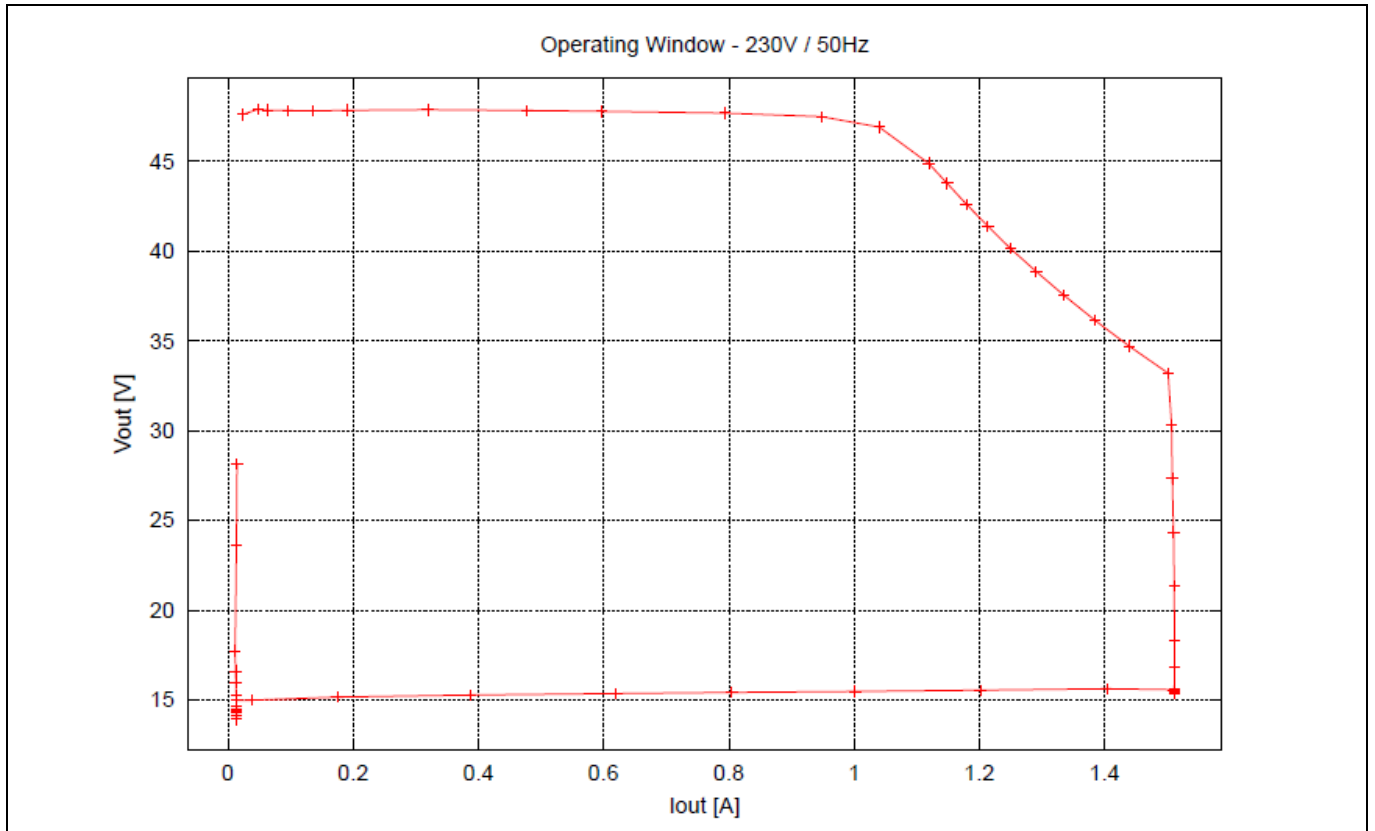

Figure 5 XDPL8221 50 W Reference board operating window

6.2 Performance

Table 3 Measurement result with 6 LEDs

V _{IN} (V _{AC})	P _{IN} (W)	V _{OUT} (V)	I _{OUT} (A)	Power factor	THD (%)	η (%)
120	34.26	18.61	1.51	99.36	9.96	82.56
140	33.85	18.61	1.51	99.16	11.05	83.55
200	33.44	18.61	1.51	98.74	8.76	84.60
220	33.36	18.61	1.51	98.43	8.37	84.78
230	33.35	18.61	1.52	98.25	8.11	84.80
240	33.34	18.60	1.52	98.04	8.00	84.85
264	33.31	18.60	1.52	97.39	7.83	84.94
277	33.26	18.6	1.52	96.99	8.21	86.99

Table 4 Measurement result with 10 LEDs

V _{IN} (V _{AC})	P _{IN} (W)	V _{OUT} (V)	I _{OUT} (A)	Power factor	THD (%)	η (%)
120	54.87	30.76	1.51	99.08	13.31	84.97
140	54.54	30.76	1.51	99.43	9.62	85.48
200	53.33	30.76	1.51	99.18	10.06	87.43
220	53.27	30.76	1.51	99.17	7.39	87.54
230	53.22	30.76	1.51	99.09	7.42	87.62
240	53.14	30.76	1.51	99.00	7.26	87.74
264	52.99	30.76	1.51	98.70	7.28	88.00
277	52.91	30.77	1.51	98.52	7.36	88.14

Table 5 Measurement result with 13 LEDs

V _{IN} (V _{AC})	P _{IN} (W)	V _{OUT} (V)	I _{OUT} (A)	Power factor	THD (%)	η (%)
120	58.44	40.21	1.24	99.43	8.80	85.38
140	57.25	40.20	1.24	99.35	9.54	87.16
200	56.51	40.21	1.24	99.21	7.94	88.30
220	56.41	40.21	1.24	99.10	7.31	88.45
230	56.32	40.21	1.24	99.01	7.67	88.60
240	56.29	40.22	1.24	98.90	7.34	88.65
264	56.23	40.22	1.24	98.56	7.09	88.75
277	56.19	40.22	1.24	98.37	7.36	88.89

Note: Due to the limited power mode, the current is limited so that the output power does not exceed the defined 50 W.

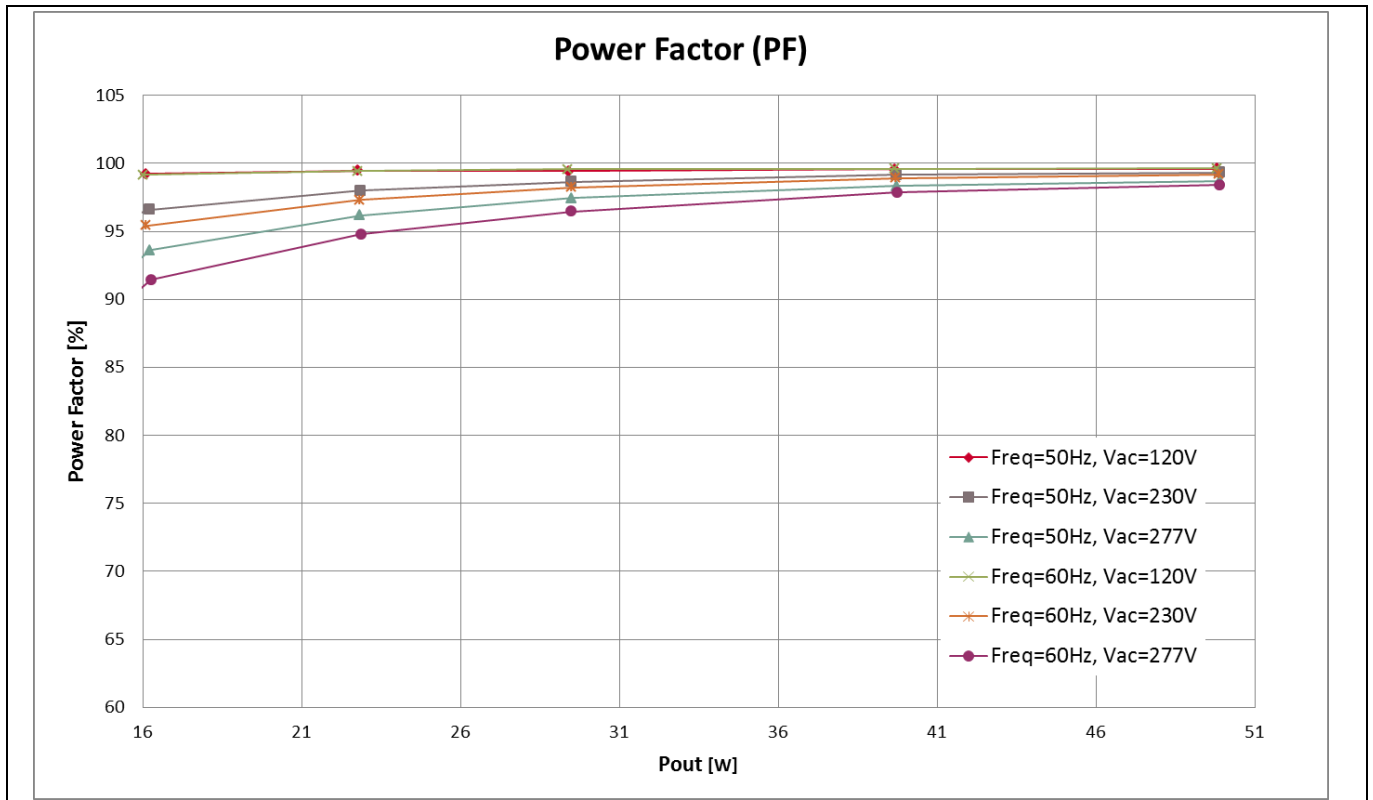

Figure 6 XDPL8221 50 W Reference board power factor with 13 LEDs

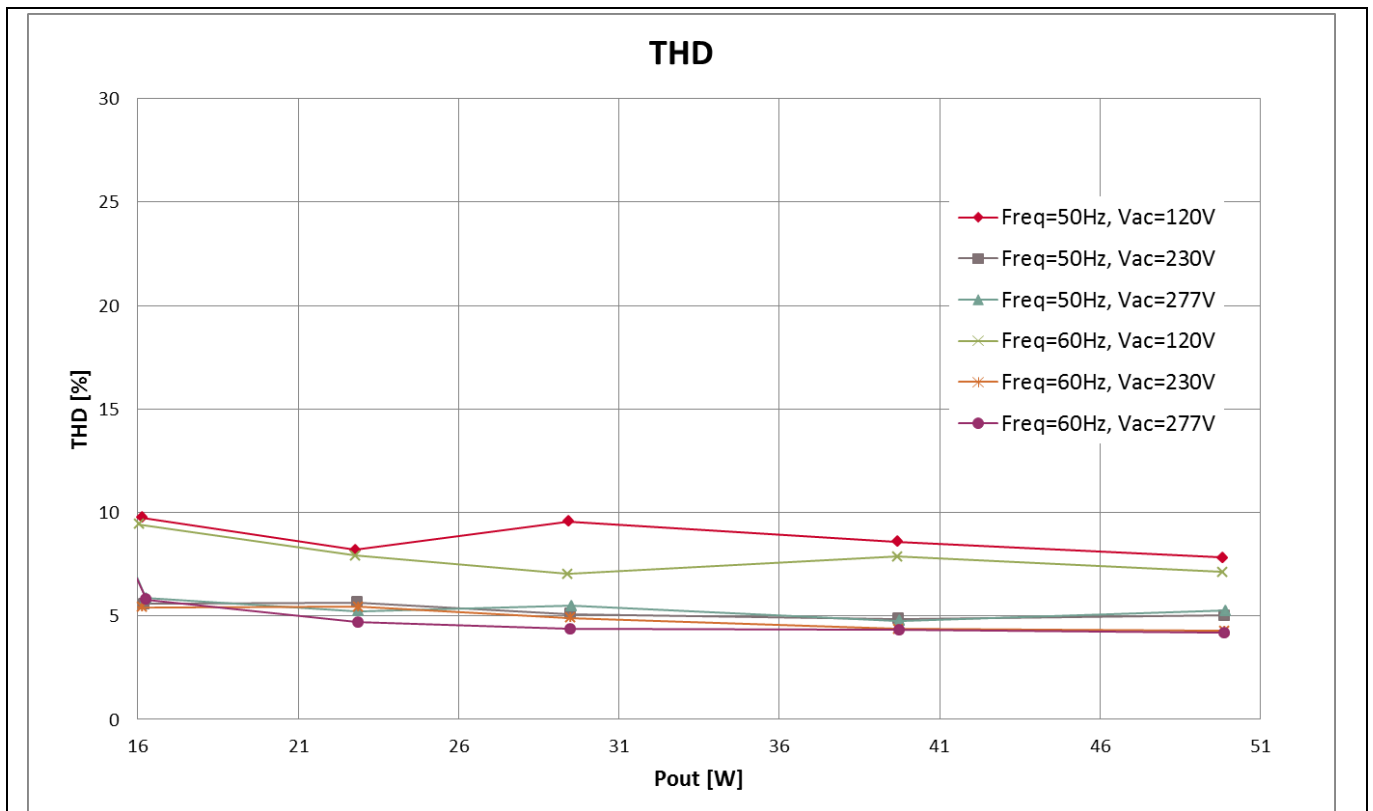

Figure 7 XDPL8221 50 W Reference board THD with 13 LEDs

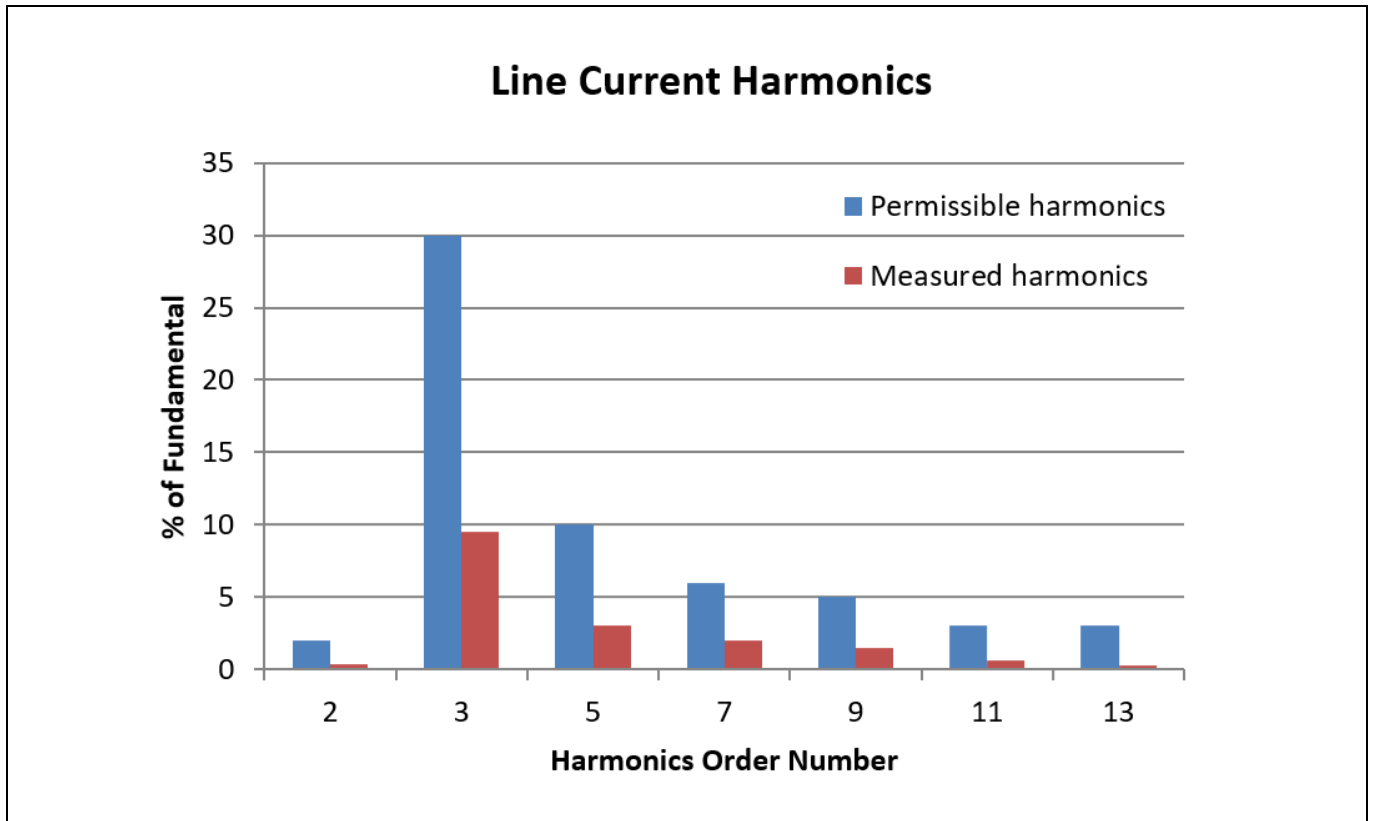

Figure 8 Line current harmonics Vac = 90 V/60 Hz, 100% dimming

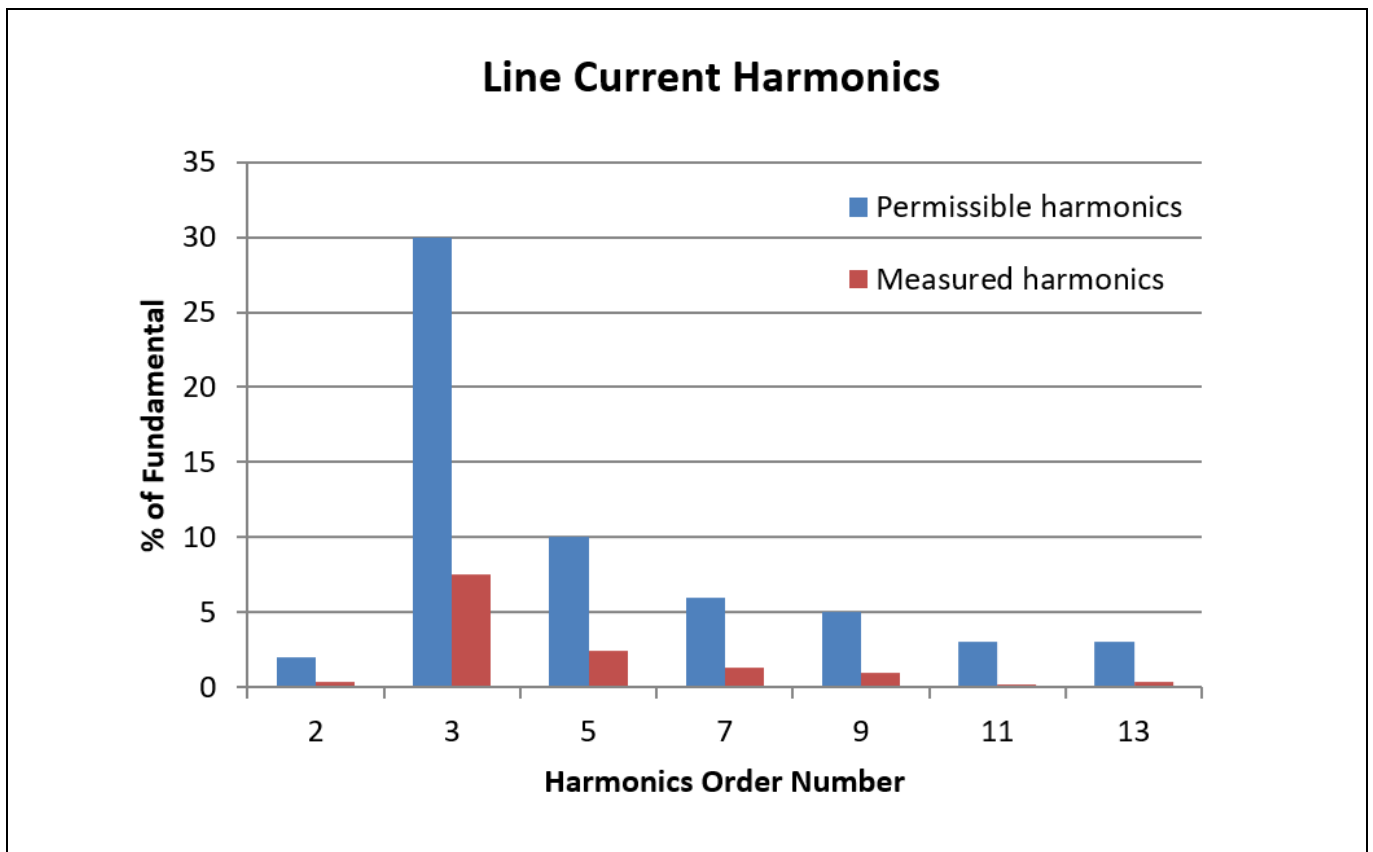

Figure 9 Line current harmonics Vac = 90 V/60 Hz, 30% dimming

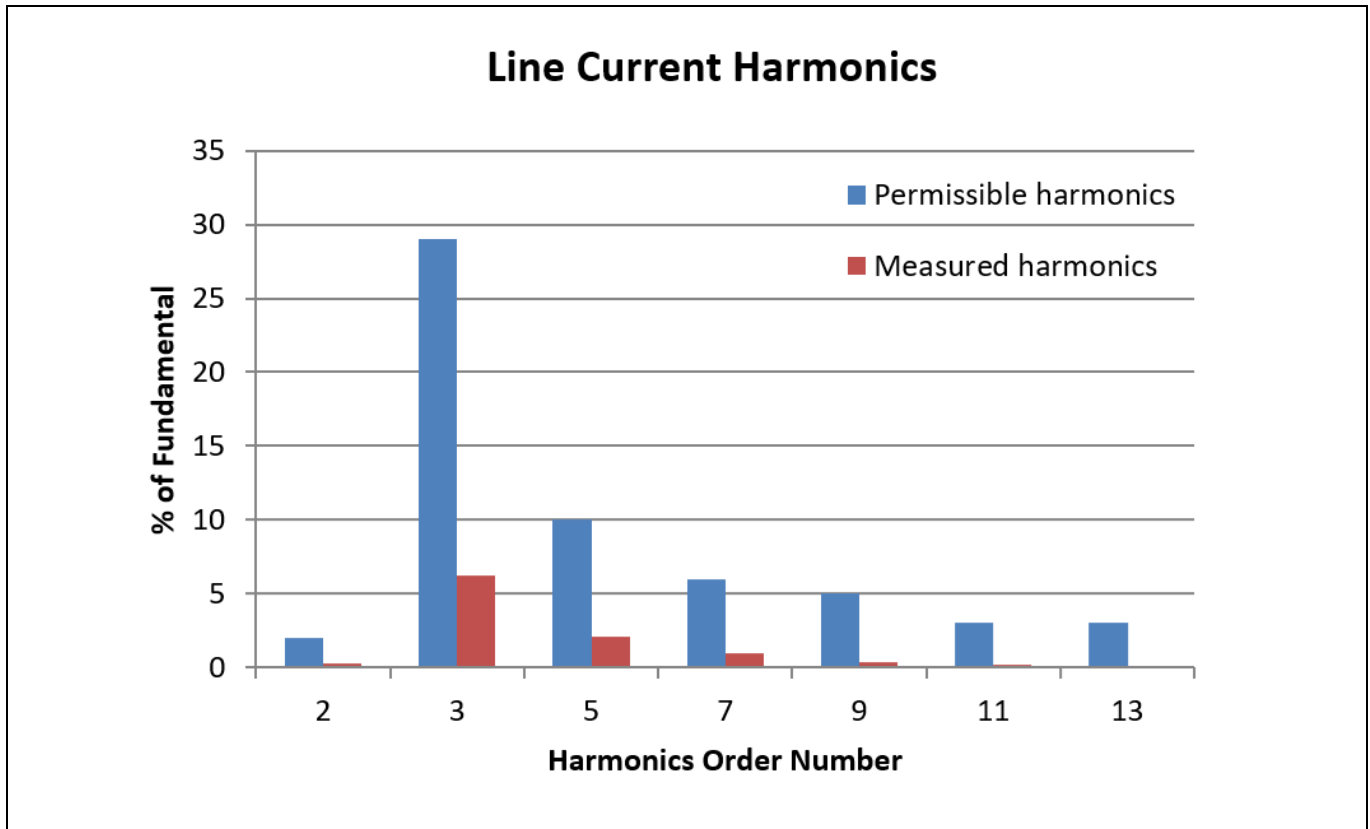

Figure 10 Line current harmonics Vac = 230 V/50 Hz, 100% dimming

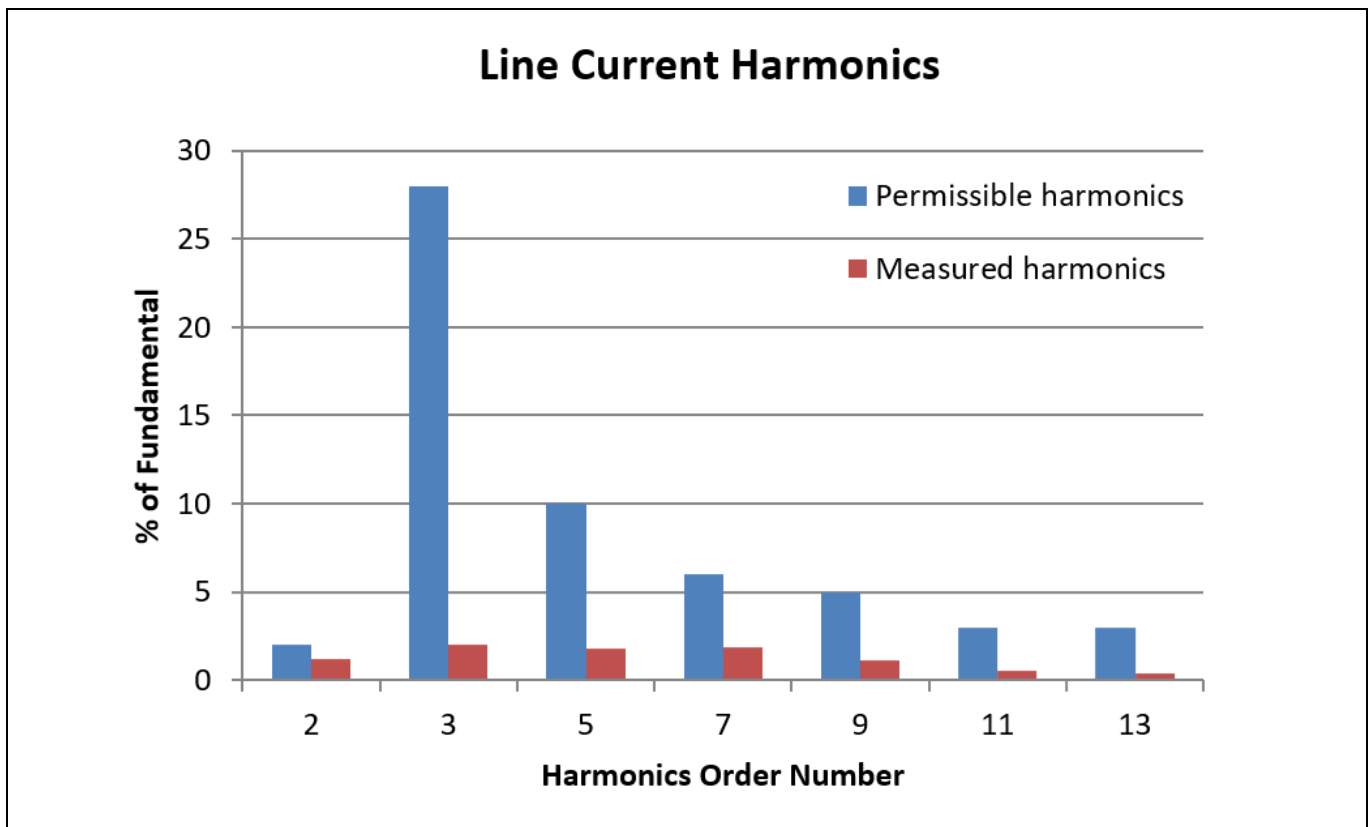

Figure 11 Line current harmonics Vac = 230 V/50 Hz, 30% dimming

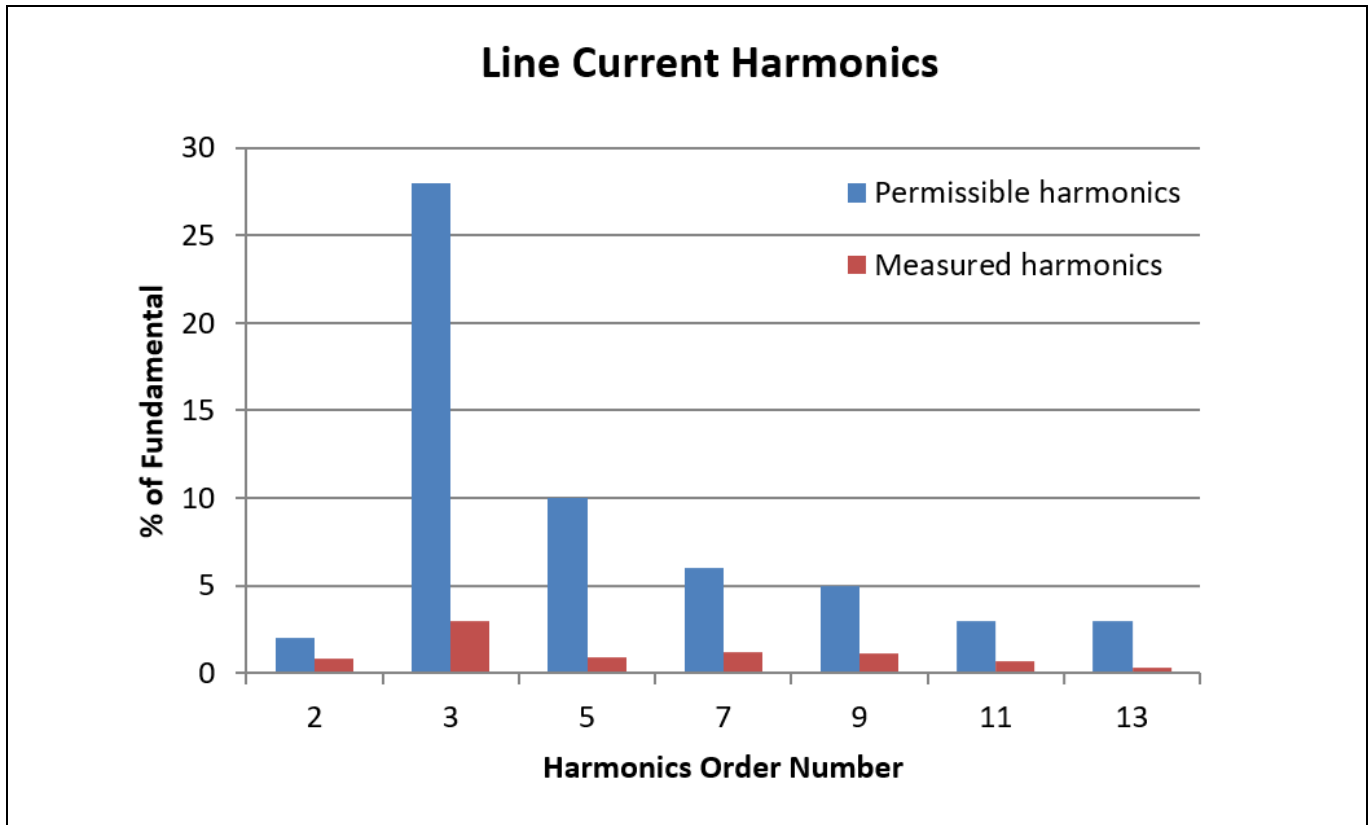

Figure 12 Line current harmonics Vac = 277 V/60 Hz, 100% dimming

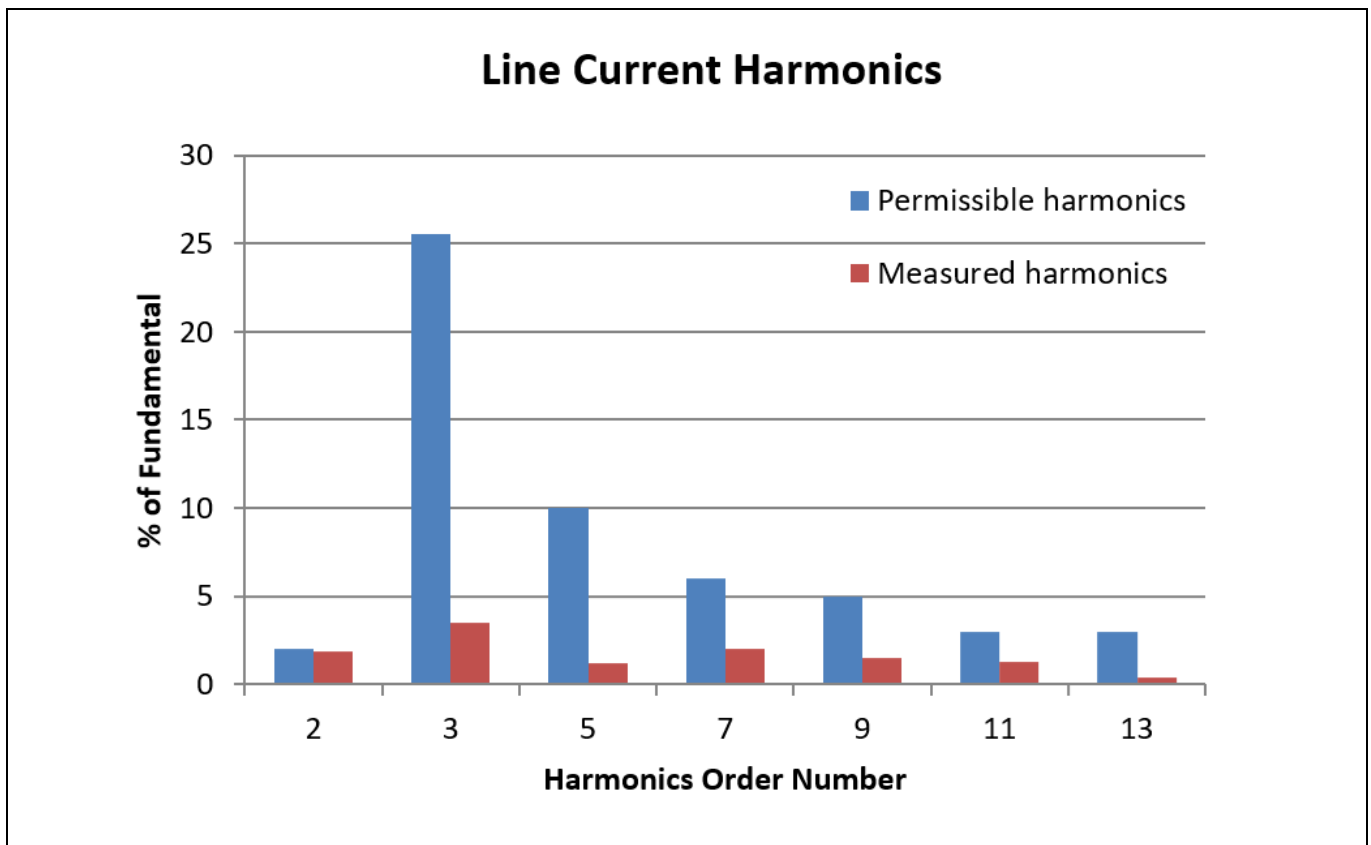

Figure 13 Line current harmonics Vac =277 V/60 Hz, 30% dimming

6.3 0 to 10 V Linear dimming

This section provides measurement results for the 0 to 10 V dimming feature. A linear curve was configured for this measurement using the .dpVision GUI. The measurement was done for an input voltage of 230 VAC, 50 Hz and an output load of 13 LEDs.

Table 6 Output current at different dimming voltages with 13 LEDs

Vdim (V)	0.50	1.00	1.50	2.00	2.50	3.00	3.50	4.00	4.50	5.00
Io (A)	0.015	0.015	0.053	0.134	0.216	0.338	0.467	0.5223	0.589	0.702
Vdim (V)	5.50	6.00	6.50	7.00	7.50	8.00	8.50	9.00	9.50	10.00
Io (A)	0.763	0.867	0.912	1.013	1.105	1.181	1.251	1.252	1.252	1.252

Note: Due to the limited power mode, the current is limited so that the output power does not exceed the defined 50 W.

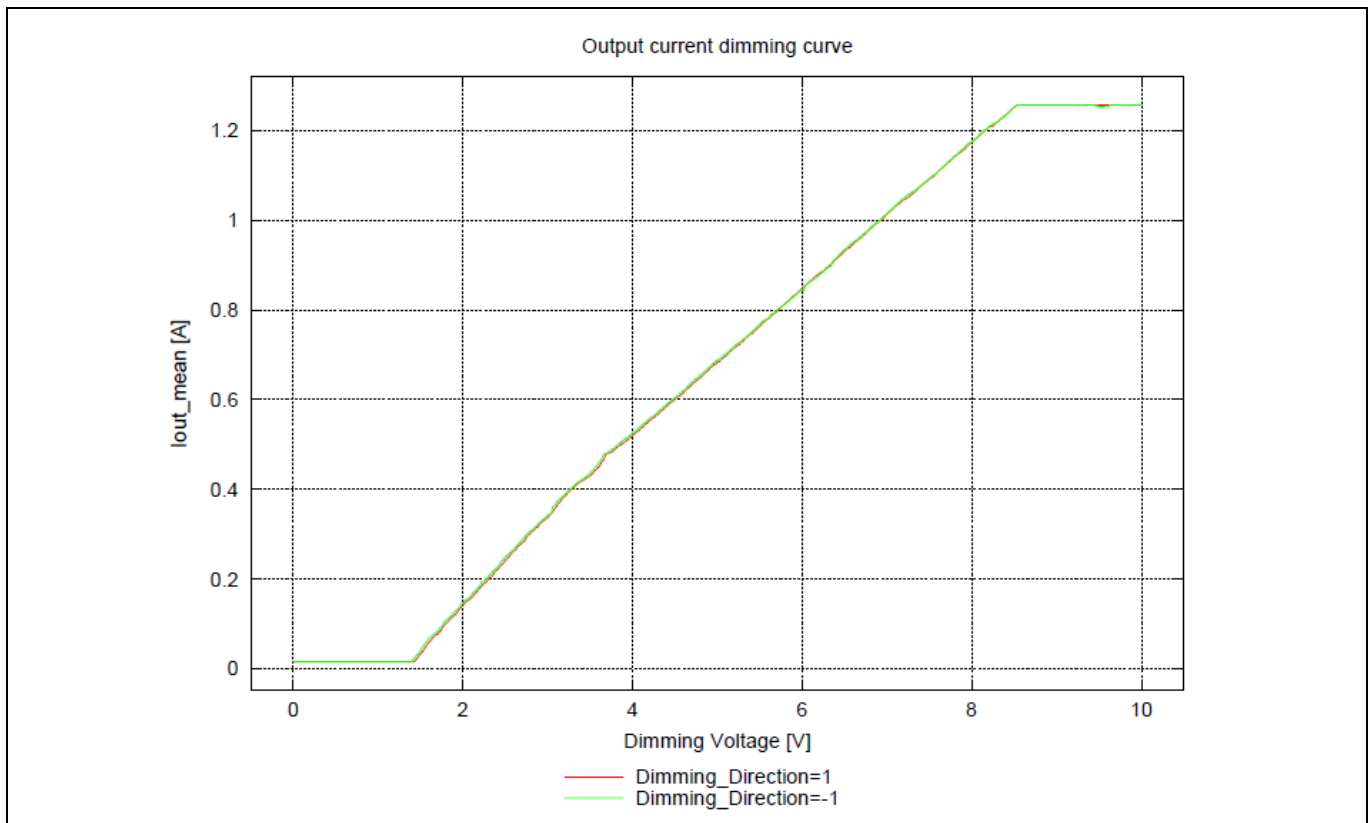

Figure 14 XDPL8221 50 W Reference board linear dimming curve with 230 VAC/50 Hz , 13 LEDs

6.4 0 to 10 V Eye-adapted dimming

This section provides measurement results for the 0 to 10 V dimming feature with an eye-adapted (quadratic) curve. The measurement was done for an input voltage of 230 VAC, 50 Hz and an output load of 13 LEDs.

Table 7 Output current at different dimming voltages with 13 LEDs

Vdim (V)	0.50	1.00	1.50	2.00	2.50	3.00	3.50	4.00	4.50	5.00
Io (A)	0.0165	0.0165	0.0175	0.032	0.064	0.111	0.165	0.225	0.293	0.375
Vdim (V)	5.50	6.00	6.50	7.00	7.50	8.00	8.50	9.00	9.50	10.00
Io (A)	0.471	0.565	0.661	0.762	0.891	1,022	1.153	1.252	1.252	1.252

Note: Due to the limited power mode, the current is limited so that the output power does not exceed the defined 50 W.

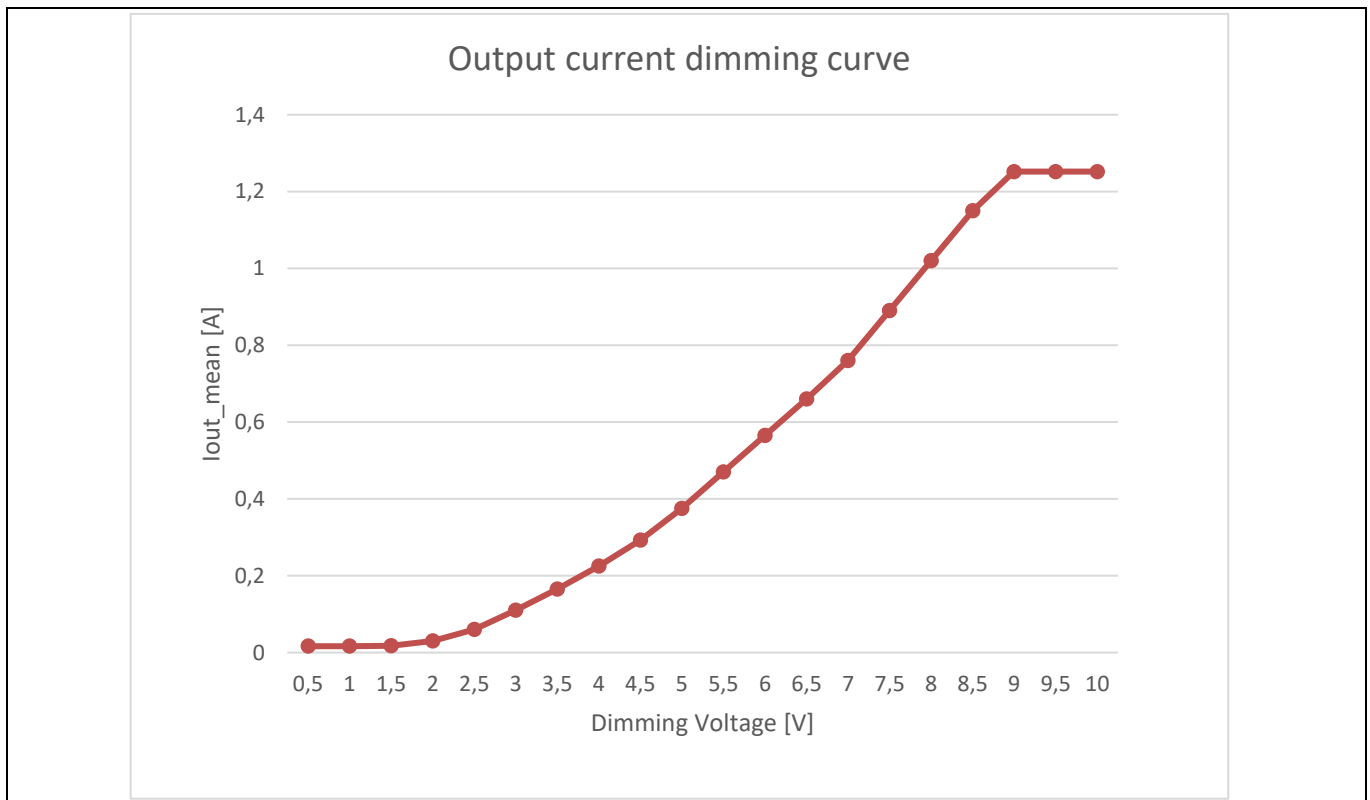

Figure 15 XDPL8221 50 W Reference board eye-adapted dimming curve with 230 VAC/50 Hz , 13 LEDs

6.5 Time-to-light

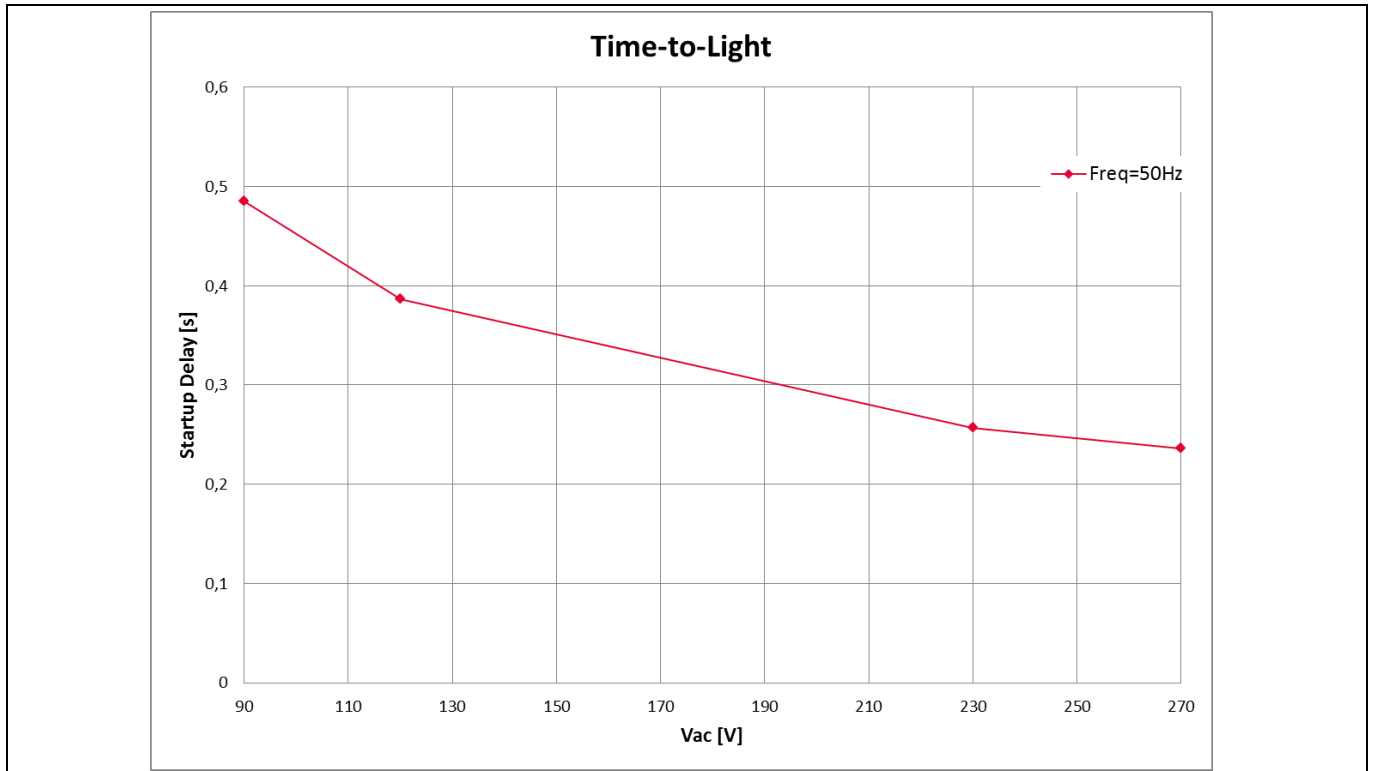

Figure 16 XDPL8221 50 W Reference board time-to-light

6.6 Standby power consumption

The standby power consumption is measured including CDM10VD and bleeder.

Table 8 Standby power

Input	Dim-to-off	Output open
120 VAC	83 mW	182 mW
230 VAC	123 mW	192 mW
277 VAC	142 mW	240 mW

6.7 EMI Performance

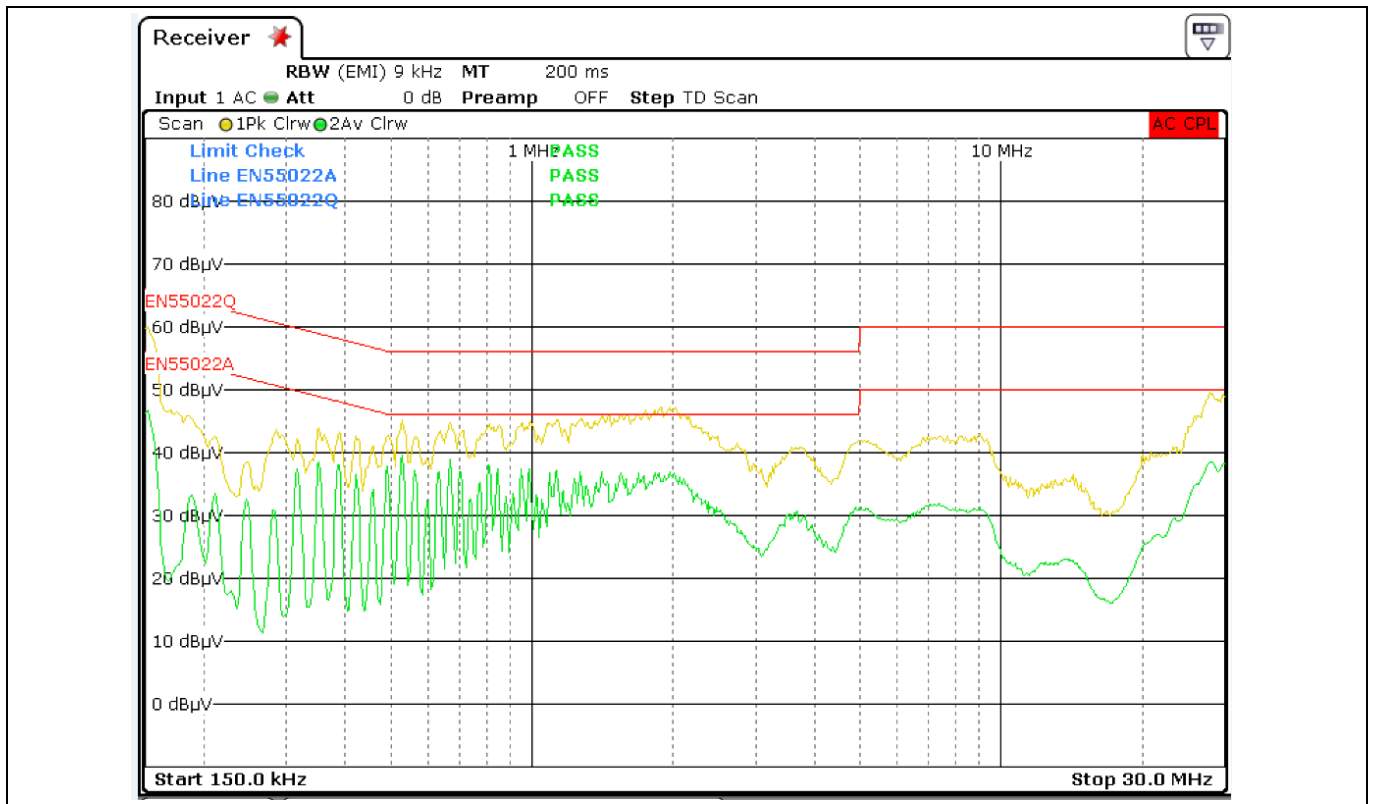

Figure 17 EMI Measurement @ 230 VAC with full load

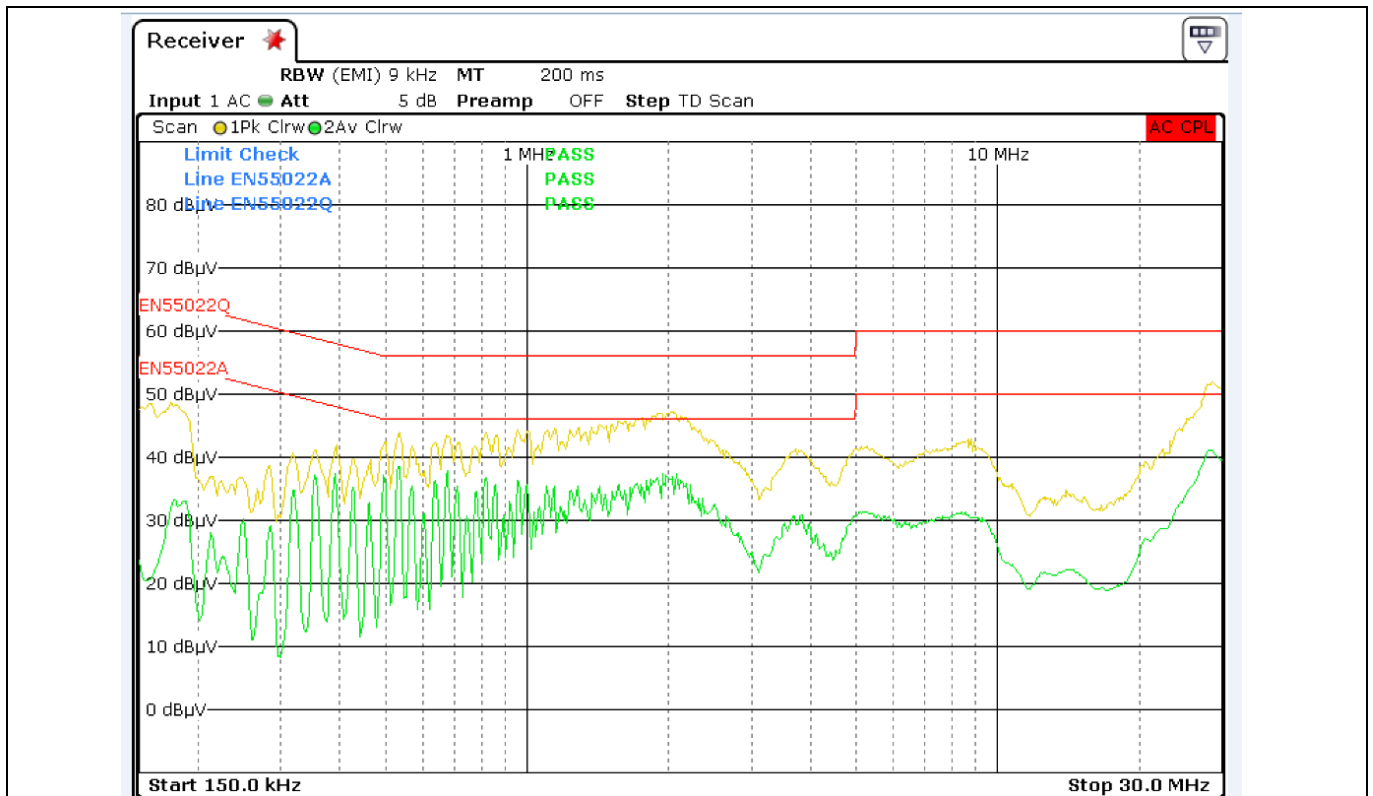

Figure 18 EMI Measurement @ 110 VAC with full load

Bill of Materials

7 Bill of Materials

Table 9 XDPL8221 50 W Reference board bill of materials

Quan-tity	Designator	Value	Description	Manufacturer	Manufacturer PartNumber
1	BR1	GBU4K-E3/45	4 Amp, 800V, SIP4	Diodes	GBU4K-E3/45
2	C1, C3	470p	Cap-1206-470p/630V/5%/COG	muRata	GRM31A5C2J471JW01D
1	C10	68n	EMI Cap 68n/305V/X2/10%	TDK	B32922C3683K
2	C12, C13	0.1u	EMI Cap 100n/305Vac, B32922	TDK	B32922C3104K
3	C14, C15, C16	2200p/Y-Cap	Y-Cap 2200pF/250V/pitch 10	Murata	DE1E3KX222MA5B
1	C20	10n	MKT, 10nF/630V/± 10%, 15mm, 4x12.5mm	Vishay	BFC237261103
1	C21	3.3n	GCM-Series General Purpose Monolithic Ceramic Capacitor for Automotive	muRata	GCM188R71H332KA37#
2	C22, C22a	47u	Al-Cap-47u/250V/20%/pitch 5x10x25	Rubycon	250BXW47MEFR10X25
3	C23, C25, C26	1n	GCM-Series General Purpose Monolithic Ceramic Capacitor for Automotive	muRata	GCM1885C1H102JA16#
2	C24, C42	100p	GRM-Series General Purpose Monolithic Ceramic Capacitor	muRata	GRM1885C1H101JA01#
1	C31	2200p	Cap-1206-2200p/630V/10%/X7R	muRata	GRM31BR72J222KW01L
1	C32	330p	GRM-Series General Purpose Monolithic Ceramic Capacitor	muRata	GRM1885C1H331JA01#
2	C40, C200	100n	Cap-0603-100n/50V/0.1/X7R	AVX	06035C104K4Z2A
2	C43, C46	100n	Cap-1206-100n/250V/10%/X7R	muRata	GRM31CR72E104KW03L
1	C45	15u	Aluminum Electrolytic Capacitor, NHG Series, Type A, 15u, 50V, Pitch 2mm,	Panasonic	EEU-FC1H150
1	C47	47n	GCM-Series General Purpose Monolithic Ceramic Capacitor for Automotive	muRata	GCM188R71H473KA55#

XDPL8221 50W Reference Board Engineering Report

XDPTM Digital Power



Bill of Materials

Quantity	Designator	Value	Description	Manufacturer	Manufacturer PartNumber
1	C48	68u	Aluminum Electrolytic Capacitor, UHE series	Nichicon	UHE2A680MPD1TD
1	C49	10u	Cap-1206-10u/50V/10%/X5R	muRata	GRM31CR61H106KA12#
2	C101, C104	100n	Cap-1206-100n/100V/0.1/X7R	TDK	C3216X7R2A104K160AA
2	C102, C103	22u	Al-Cap 22uF/ 63V/pitch 3.5/DxH8,00x12.00mm	Wuerth Elektronik	870055874002
1	C105	1n	Cap-1206-1n/630V/0.5/NPO	TDK	CGA5F4C0G2J102J085AA
1	C106	680n	Cap-0603-680n/50V/0.1/X5R	TDK	C1608X5R1H684K080AB
1	C201	1u	Multilayer Ceramic Chip Capacitor, C Series, Commercial Grade, General	TDK	C1608X7R1E105K080AB
1	C203	4.7u	Al Cap 4.7uF/50V/pitch 2mm	Panasonic	EEUFC1H4R7
1	CN10	691412120003 MB	7.92 mm Contact Pitch, Right Angle Header	Wuerth Electronics	691412120003MB
2	D10, D11	US1M-E3/61T	Surface mount Ultrafast rectifier 1.0A/1000V	Vishay Semiconductor	
1	D20	STTH3R06U	Ultrafast diode 600V/3A/DO-214AA	STMicroelectronics	STTH3R06U
8	D21, D22, D23, D40, D42, D43, D44, D200	LL4148	Small signal diode / 100V	Fairchild Semiconductor	LL4148
1	D30	US1K-E3/61T	Ultrafast diode 800V/1.0A/DO-214AC	Vishay General Semiconductor	US1K-E3/61T
2	D51, D52	PESD12VS1UB	Unidirectional ESD protection diode / 12V	NXP Semiconductors	PESD12VS1UB
1	D100	STTH20L03CT	Dual diode, TO220AB, 100V, CC	ST	STTH20L03CT
2	D101, D102	BAV19W	Diode 100V, 400mA, SOD123	Diodes Inc.	BAV19W
1	D202	PMEG3002EJ	Schottky diode / 30V, 200mA, SOD323	NXP Semiconductors	PMEG3002EJ
1	F1	2A	Radial lead fuse Rectangular - Slow Blow, 2A, 250V	Multicomp	MST 2A 250V

XDPL8221 50W Reference Board Engineering Report

XDPTM Digital Power



Bill of Materials

Quantity	Designator	Value	Description	Manufacturer	Manufacturer PartNumber
3	HS_D100, HS_Q20, HS_Q30	577002B00000 G	Slim Low Cost Channel Style Heat Sink	Aavid Thermalloy	577002B00000G
1	IC1	XDPL8221	LED Combo control IC for PFC and FB conversion	Infineon Technologies	XDPL8221
1	IC4	TCLT110	Optocoupler, Phototransistor Output, CTR 100% - 200% at 10mA, (Operating Temp -55°C - 100°C)	Vishay	TCLT1103
2	IC5, IC6	NA	Optocoupler, Phototransistor Output, CTR 100% - 200% at 10mA, (Operating Temp -55°C - 100°C)	Vishay	TCLT1103
1	IC201	CDM10VD	Dimming interface IC SOT- 23-6	Infineon Technologies	CDM10VD-3
1	J51	0R	0R/150V/5%	Yageo/Phycom p	RC0805JR-070RL
1	J100	0R	0R/50V	Bourns	CR0603-J/-000ELF
1	L10	47mH/0.7A	Choke 47mH/0.7A/B82732F	Epcos	B82732F2701B001
2	L11, L11a	470uH	470uH, 1.15A, 0R47, pitch 5mm, 13 x 10 x 15mm	Wuerth	7447480471
1	L100	68uH	WE-FI Leaded Toroidal Line Choke	Wurth Elektronik	7447033
1	NTC10	10R	10R/265V/20%	Epcos	B57235S0100M0
1	NTC50	NTC47k	NTC47k/5%/0805	Epcos	B57471V2473J062
1	PCB	PCB	PCB, 140x42,5mm ² , 2 Layer, 35 um, FR4, 1.55 mm Standard, Soldermask green both sides, Silkscreen white both sides		
1	Q20	IPD70R360P7 S	CoolMOS P7, 700V, 12.5A, DPAK	Infineon Technologies	IPD70R360P7S
1	Q30	IPD80R450P7	CoolMOS™ P7, 800V, 11A, DPAK	Infineon Technologies	IPD80R450P7
1	Q41	BSS169	MOSFET N-Ch, 100V, 90mA, 120hm, SOT23	Infineon Technologies	BSS169
2	Q100, Q101	2N7002	OptiMOS transistor 60V, 30hm, 300mA,SOT23	Infineon Technologies	2N7002

XDPL8221 50W Reference Board Engineering Report

XDP™ Digital Power



Bill of Materials

Quantity	Designator	Value	Description	Manufacturer	Manufacturer PartNumber
2	R12, R12a	68	68/200V/1%	TE CONNECTIVITY	352068RJT
5	R14, R15, R16, R103, R104	20k	20k/200V/1%	Vishay	CRCW120620K0FKE A
3	R20, R30, R37	10R	10R/200V/1%	Vishay	CRCW120610R0FKE A
2	R21, R31	33k	33k/200V/1%	Vishay	CRCW120633K0FKE A
2	R22, R23	0R68	0.68/675mV/1%	Vishay	RCWE1206R680FKE A
2	R24, R25	18k	18k/200V/1%	Vishay	CRCW120618K0FKE A
3	R26, R27, R28	3.32M	3.32M/200V/1%	Vishay	CRCW12063M32FKE A
1	R29	52.3k	52.3k/150V/1%	Panasonic	ERJP06F5232V
2	R32, R33	1R6	1.6/200V/1%	Bourns	CRM1206-FW-1R60 E LF
2	R34, R35	680k	680k/200V/1%	Vishay	CRCW1206680KFKE A
1	R36	470R	470R/200V/1%	Vishay	CRCW1206470RFKE A
1	R40	68k	68k/150V/1%	Vishay	CRCW080568K0FKE A
1	R41	3.9k	3.9k/75V/1%	Vishay	CRCW06033K90FKE A
2	R42, R43	2.2R	2.2R/150V/1%	Vishay	CRCW08052R20FKE A
2	R44, R45	2.2M	2.2M/200V/1%	Yageo/Phycomp	RC1206FR-072M2
1	R46	39k	39k/150V/1%	Vishay	CRCW080539K0FKE A
1	R47	1.0R	1.0R/150V/1%	Vishay	CRCW08051R00FKE A
1	R50	1.0M	1.0M/150V/1%	Vishay	CRCW08051M00FKE A
1	R62	300k	300k/75V/1%	Vishay	CRCW0603300KFKE D
1	R101	10k	10k/500V/1%	Vishay	CRCW251210K0FKE G
1	R102	51k	51k/75V/1%	Vishay	CRCW060351K0FK

XDPL8221 50W Reference Board Engineering Report

XDPTM Digital Power



Bill of Materials

Quantity	Designator	Value	Description	Manufacturer	Manufacturer PartNumber
1	R105	1M	1M/75V/1%	Yageo/Phycomp	RC0603FR-071ML
1	R203	1R	1R/75V/1%	Vishay	CRCW06031R00FKE D
1	R204	10k	10k/75V/1%	Yageo/Phycomp	RC0603FR-0710KL
1	T2	1.06uH EE25	EE25 1060uH, 2A, N87, Gab 1.5mm	Wuerth Electronics	750343237, rev01
1	T3	3.1mH EE25	EE25_14Pin, 3.1mH, 0.8A	Wuerth Electronics	750343127, rev01
1	VR10	S10K385E2K1	S10K385E2K1/385V/10%	Epcos	B72210S0381K101
1	X30	HTSW-103-07-G-S	Through hole .025" SQ Post Header, 2.54mm pitch, 3 pin, vertical, single row	Samtec	HTSW-103-07-G-S
2	X101, X202	691412120002 MB	Through-hole Shrouded Header, Top Entry, Vertical, 2.5mm Pitch, 2 Pins, Single Row, White	Wuerth Electronics	691412120002MB
1	ZD20	BZX384-C2V7	Zener Diode / 2.7V/SOD-323	NXP	BZX384-C2V7
1	ZD41	BZX384-C13	Zener Diode / 13V/SOD-323	NXP	BZX384-C13
1	ZD100	BZG03C62TR3	Zener Diode / 62V/ SMA	Vishay	BZG03C62TR3
2	ZD101, ZD102	BZX384-C12	Zener Diode / 12V/SOD-323	NXP	BZX384-C12
0	AC_L, AC_N, DIMMING, FB_AUX, FB_CS, FB_Drain, FB_ZCD, GND, HV_BUS, IC_GND, PFC_CS, PFC_Drain, PFC_GD, PFC_ZCD, SEC_AUX, SEC_AUX_GND, SEC_GND, SEC_LED+, SEC_MAIN*	TP SMD	Testpad Not Assembled		

Bill of Materials

Quantity	Designator	Value	Description	Manufacturer	Manufacturer PartNumber
	SPD, TEMP, UART, Vcc				
0	C2	NA	Cap-1206-470p/630V/5%/COG	TDK	C3216C0G2J471J085AA
0	C100, C107	NA	Cap-1206-1n/100V/0.1/X7R	AVX	12061C102KAT2A
0	D201	NA	Small Signal Diode / 100V	Fairchild Semiconductor	LL4148
0	FB_GD	TP SMD	Testpad Not Assembled		
0	J50, J55, J201	NA	0R/50V	Bourns	CR0603-J/-000ELF
0	J52	0R	0R/50V	Bourns	CR0603-J/-000ELF
0	Q51	NA	NPN Silicon AF Transistor	NEXPERIA	BC847C,215
0	Q102, Q103	NA	OptiMOS Transistor 60V, 30hm, 300mA,SOT23	Infineon Technologies	2N7002
0	R10, R11	NA	510K/350V/5%	Welwyn Components Limited	MFP1-510KJI
0	R17, R18	NA	1M/200V/1%	Yageo/Phycomp	RC1206FR-071M0L
0	R51, R52, R53, R205, R206, R207	NA	10k/75V/1%	Yageo/Phycomp	RC0603FR-0710KL
0	R100, R106	NA	47R/200V/1%	Yageo/Phycomp	RC1206FR-0747RL
0	R107, R108	NA	100k/150V/1%	Vishay	CRCW0805100KFKEA
0	UART_SEC	NA	Through hole .025" SQ Post Header, Hi-Temp Strip, 2.54 mm pitch, 4 pin, vertical, single row	Samtec	HTSW-104-07-G-S
0	X21	NA	Through hole .025" SQ Post Header, 2.54 mm pitch, 2 pin, vertical, single row	Samtec	TSW-102-07-L-S
0	ZD103	NA	Zener Diode / 24V/SOD-323	NXP	BZX384-C12

7.1 Transformer specification

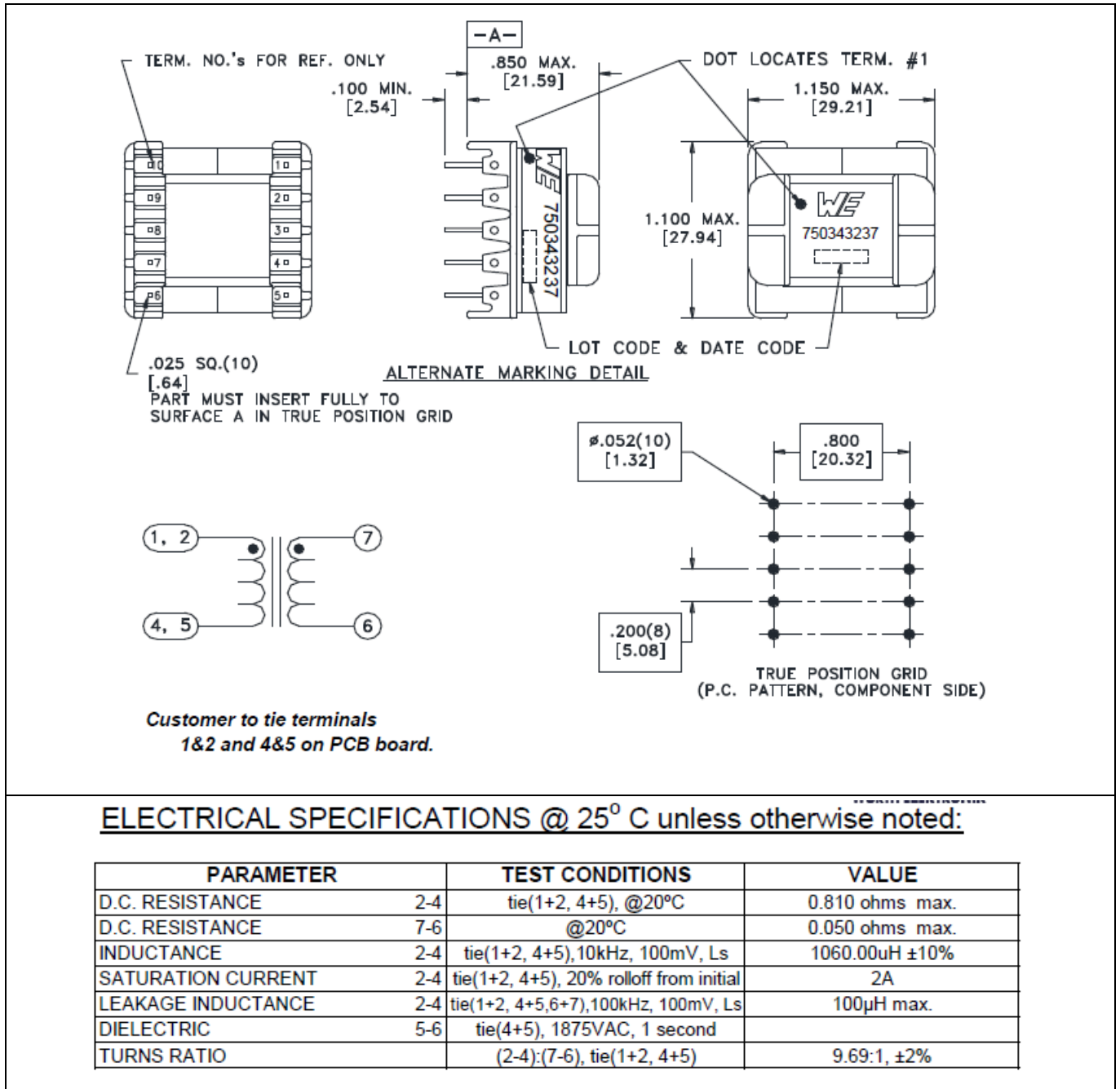

Figure 19 Würth Elektronik PFC choke 750343237 rev00 specification

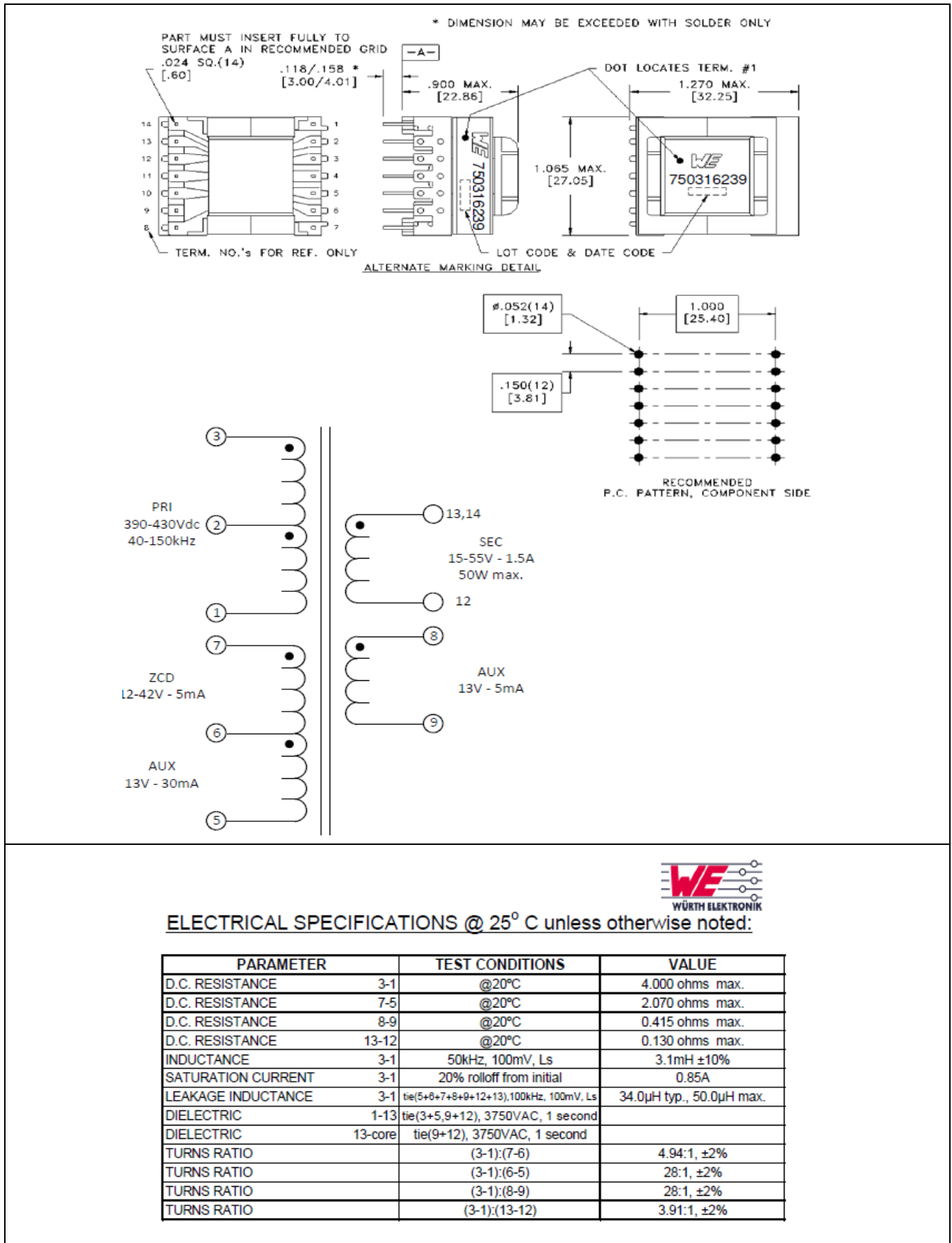

Figure 20 Würth Elektronik flyback transformer 750343127 rev01 specification

Revision history

Revision history

Document version	Date of release	Description of changes
1.0	2018-10-23	First release
1.1	2019-12-03	Correction of some values/formats

Trademarks

All referenced product or service names and trademarks are the property of their respective owners.

Edition 2019-12-03

Published by

Infineon Technologies AG

81726 Munich, Germany

© 2020 Infineon Technologies AG.

All Rights Reserved.

Do you have a question about this document?

Email: erratum@infineon.com

Document reference

QG_201711_PL39_005

IMPORTANT NOTICE

The information contained in this application note is given as a hint for the implementation of the product only and shall in no event be regarded as a description or warranty of a certain functionality, condition or quality of the product. Before implementation of the product, the recipient of this application note must verify any function and other technical information given herein in the real application. Infineon Technologies hereby disclaims any and all warranties and liabilities of any kind (including without limitation warranties of non-infringement of intellectual property rights of any third party) with respect to any and all information given in this application note.

The data contained in this document is exclusively intended for technically trained staff. It is the responsibility of customer's technical departments to evaluate the suitability of the product for the intended application and the completeness of the product information given in this document with respect to such application.

For further information on the product, technology, delivery terms and conditions and prices please contact your nearest Infineon Technologies office (www.infineon.com).

WARNINGS

Due to technical requirements products may contain dangerous substances. For information on the types in question please contact your nearest Infineon Technologies office.

Except as otherwise explicitly approved by Infineon Technologies in a written document signed by authorized representatives of Infineon Technologies, Infineon Technologies' products may not be used in any applications where a failure of the product or any consequences of the use thereof can reasonably be expected to result in personal injury.