

TO-247PLUS

Description of the packages and assembly guidelines

About this document

Scope and purpose

TO-247PLUS is the new package family introduced by Infineon which includes the TO-247PLUS 3pin and the TO-247PLUS 4pin. These packages were developed to accommodate more silicon and to have higher current carrying capability than TO-247-3 package described by the industry JEDEC standard and then the TO-247-4. Furthermore, the new TO-247PLUS show improved thermal performance R_{thJH} with respect to the mentioned TO-247-3 and TO-247-4 packages. Using the same silicon die as in a TO-247-3 and TO-247-4, customers can achieve higher current levels at the same junction temperature or get lower junction temperature at the same collector current.

Intended audience

This application note is intended to designers that use TO-247PLUS package, especially in industrial and automotive applications. A minimum level of knowledge in thermal design is required.

Table of contents

About this document	1
Table of contents	1
1 Product Description	2
1.1 Mechanical details and main differences between TO-247PLUS 3pin, TO-247-3 and TO-264-3	3
1.2 Mechanical details and main differences between TO-247PLUS 4pin and TO-247-4	5
1.3 Electrical and thermal performance	6
1.4 Thermal measurements and comparison	8
2 Assembly of TO-247PLUS Packages	11
2.1 Clip selection	13
2.2 Mounting with metal bars	13
2.3 Lead bending	14
3 References	16
4 Useful material and links	17
5 Revision history	18

Product Description

1 Product Description

TO-247PLUS is a package family intended to be mounted using clips or pressure systems. The PLUS nomenclature after the three digit JEDEC's code number 247, denotes the Infineon's packages with no screwing hole. It includes the three terminals TO-247PLUS 3pin and the four terminals TO-247PLUS 4pin. It allows higher power dissipation than TO-247-3 or TO-247-4 and it dramatically reduces heatsink space with respect to a standard TO-264. Furthermore, this package can reduce the number of devices in parallel and can simplify the mechanical assembly of customer's application, allowing designers to reduce both the size and the cost of their systems.

This package has been selected to accommodate larger IGBTs and fast rectifier diodes, which was not possible using the standard TO-247-3 or TO-247-4, allowing significant footprint reduction with respect to TO-264-3 at the same time.

TO-247PLUS 3pin package will be identified within Infineon's IGBT nomenclature with the Letter "Q" at the third position. This is indicated in Figure 1.

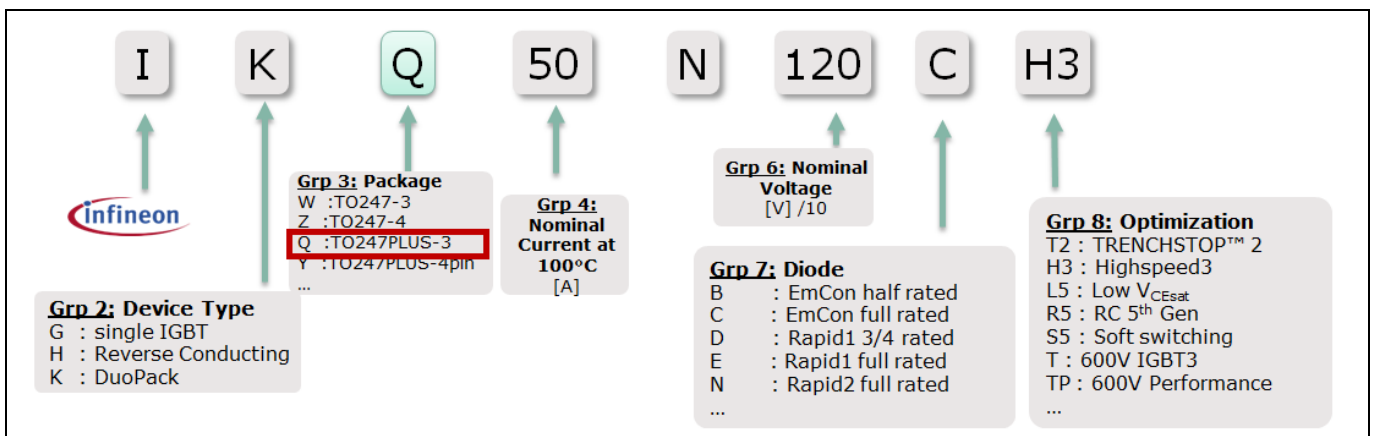

Figure 1 Infineon Discrete IGBTs Nomenclature for the TO-247PLUS 3pin

TO-247PLUS 4pin package will be identified within Infineon's IGBT nomenclature with the Letter "Y" at the third position. This is indicated in Figure 2.

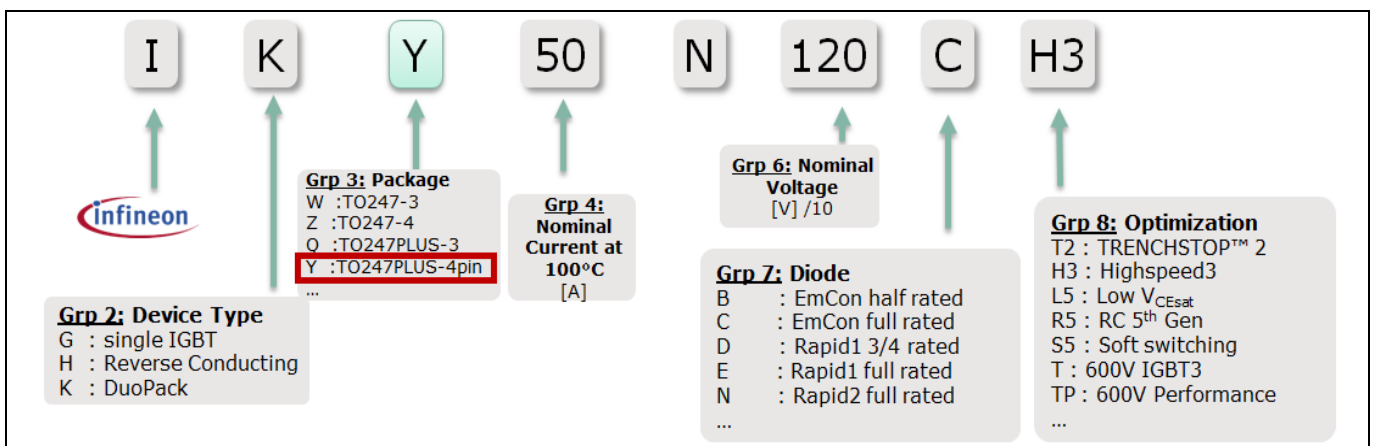

Figure 2 Infineon Discrete IGBTs Nomenclature for the TO-247PLUS 4pin

Figure 3 shows the physical appearance of the packages described in this application note.

Product Description

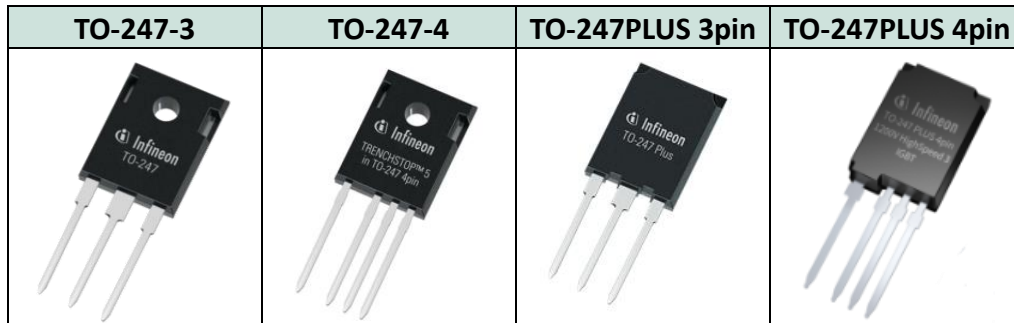

Figure 3 Infineon Discrete IGBTs Nomenclature for the TO-247PLUS 4pin

TO-247PLUS 3pin, TO-247PLUS 4pin and TO-247-4 packages can be found on the following Infineon web pages:

www.infineon.com/to-247plus (which includes both 600V and 1200V TO-247PLUS 3pin portfolios).

www.infineon.com/to-247-4 (which includes both 650V in TO-247-4 and 1200V in TO-247PLUS 4pin product portfolios).

1.1 Mechanical details and main differences between TO-247PLUS 3pin, TO-247-3 and TO-264-3

The newly introduced TO-247PLUS 3pin is similar to the Transistor Outline 247-3 described in the JEDEC standard. General mechanical dimensions and mechanical drawings are displayed in Figure 4. For a more detailed mechanical description please refers to product data sheet.

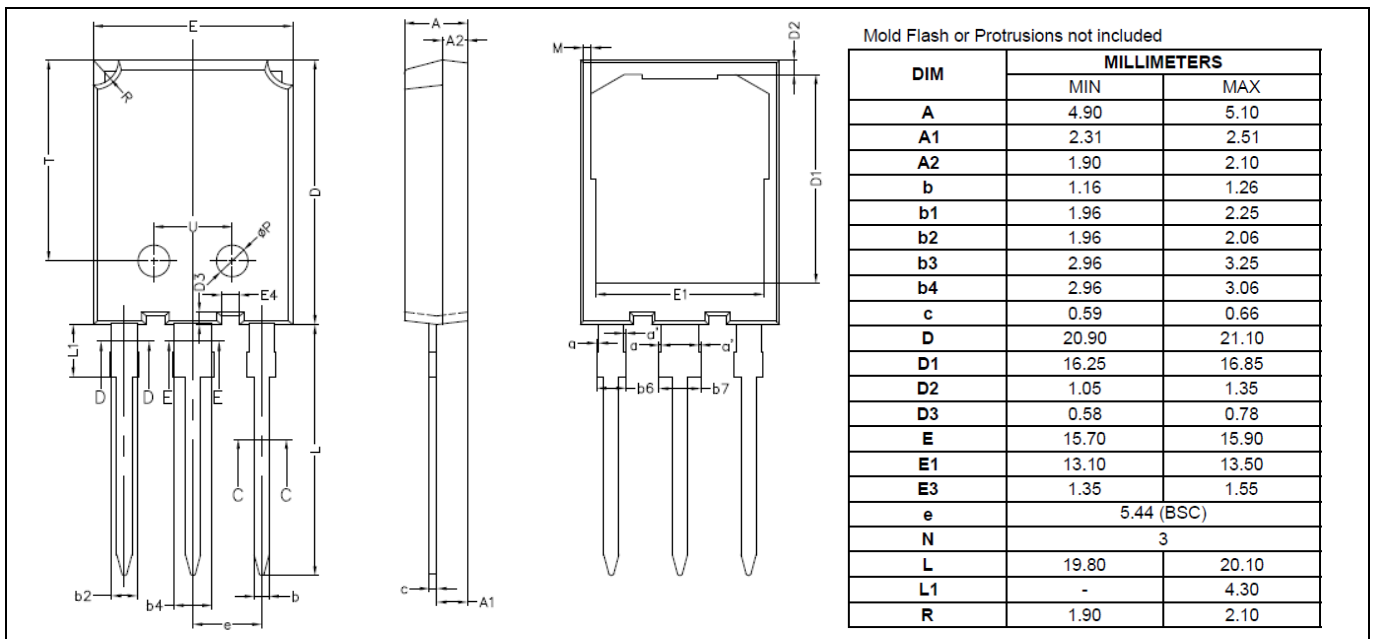

Figure 4 TO-247PLUS 3pin mechanical drawing and dimensions

This package has been designed with the intention to be compatible to the TO-247-3 in form, fit and function with only few minor changes. In respect to the TO-264, it shows significant changes in the plastic body while maintaining the same terminals' pitch and dimensions.

Product Description

Figure 5 specifies the main difference between TO-247-3 and TO-247PLUS 3pin.

The main difference is the missing hole of the TO-247PLUS 3pin, emphasized in the red circle "1" of Figure 5. The typical thermal pad area of a standard TO-247-3 is about 140 mm², while the typical thermal pad area of the PLUS version is about 190 mm²; an increase of about 26 %.

Another important difference is the location of the lateral mould clamping areas, necessary for a correct mould compound deposition. These are emphasized, in the Figure 5, with the red circles "2". TO-247PLUS 3pin still features these clamping areas, but these are placed at the upper corners. This change increases the clearance and creepage distances between said clamping areas, which lie at the collector potential, to the eventual metal clip used for fixing, that is usually at the heatsink potential. Further details can be found in the Infineon Application Note: AN2012-10 "Electrical safety and isolation in high voltage discrete component - applications and design hints" [1].

Furthermore, an important difference still to be mentioned is represented by the newly introduced design of the TO-247PLUS 3pin marked in Figure 5 with the red circle "3". These dents increase the creepage distance between terminals by about 2 mm which is important in applications where a minimum creepage distance of 3 mm is required.

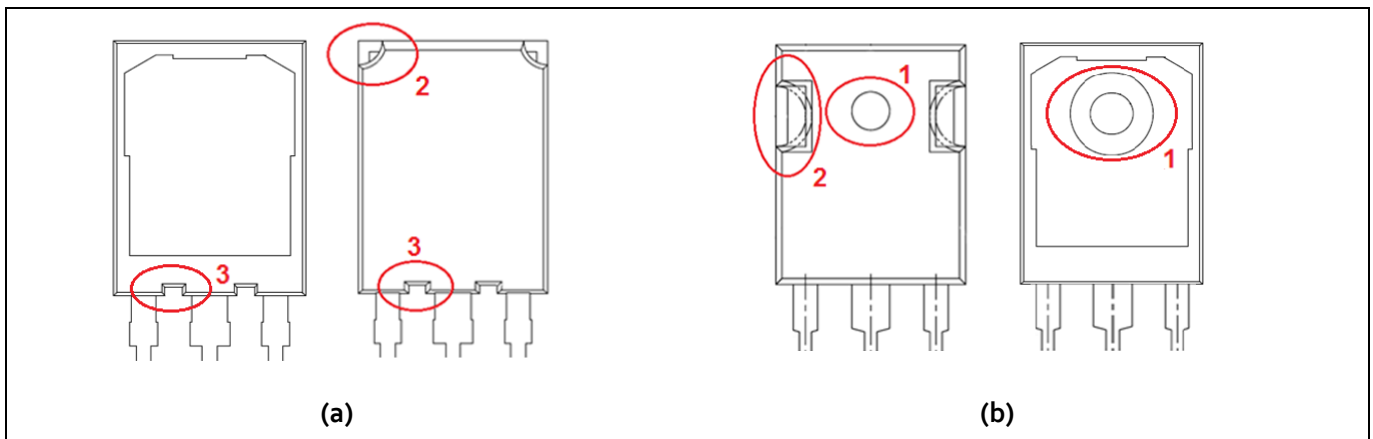

Figure 5 Main differences between (a) TO-247PLUS 3pin and (b) JEDEC TO standard 247-3

Figure 6 compares the TO-247PLUS 3pin and the TO-264. Beside the evident presence of the screw hole in the TO-264, the main difference here is the total package footprint. In a TO-247PLUS 3pin, the plastic body has a typical dimension of 15.80 mm × 21.00 mm, while the TO-264 package has a typical plastic body dimension of 20.20 mm × 26.00 mm. Due to the presence of the screw hole, the useful thermal pad area for die attach is about the same as in the TO-247PLUS 3pin.

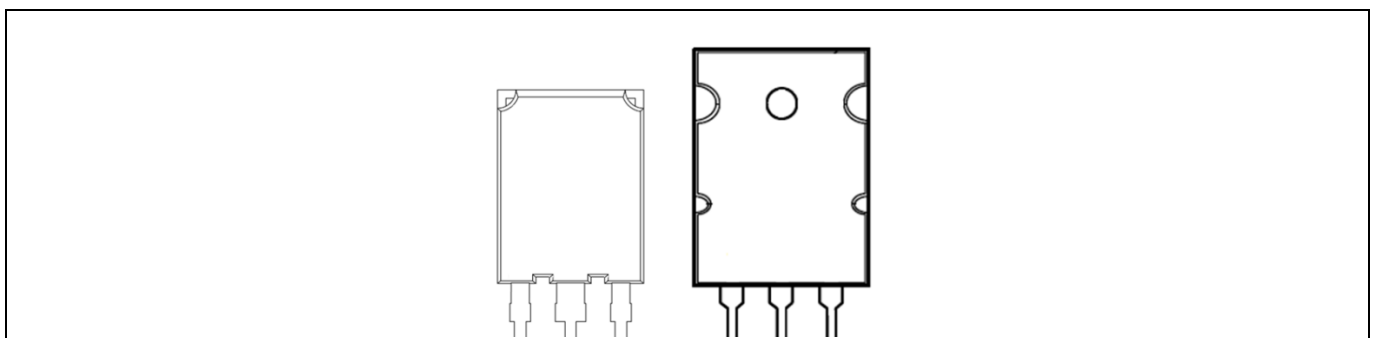

Figure 6 Comparison between TO-247PLUS 3pin to the left and TO-264 (right). The packages are represented in the same scale

Product Description

1.2 Mechanical details and main differences between TO-247PLUS 4pin and TO-247-4

The newly introduced TO-247PLUS 4pin is similar to the TO-247-4. General mechanical dimensions and mechanical drawings are displayed in Figure 7. For a more detailed mechanical description please refers to product data sheet.

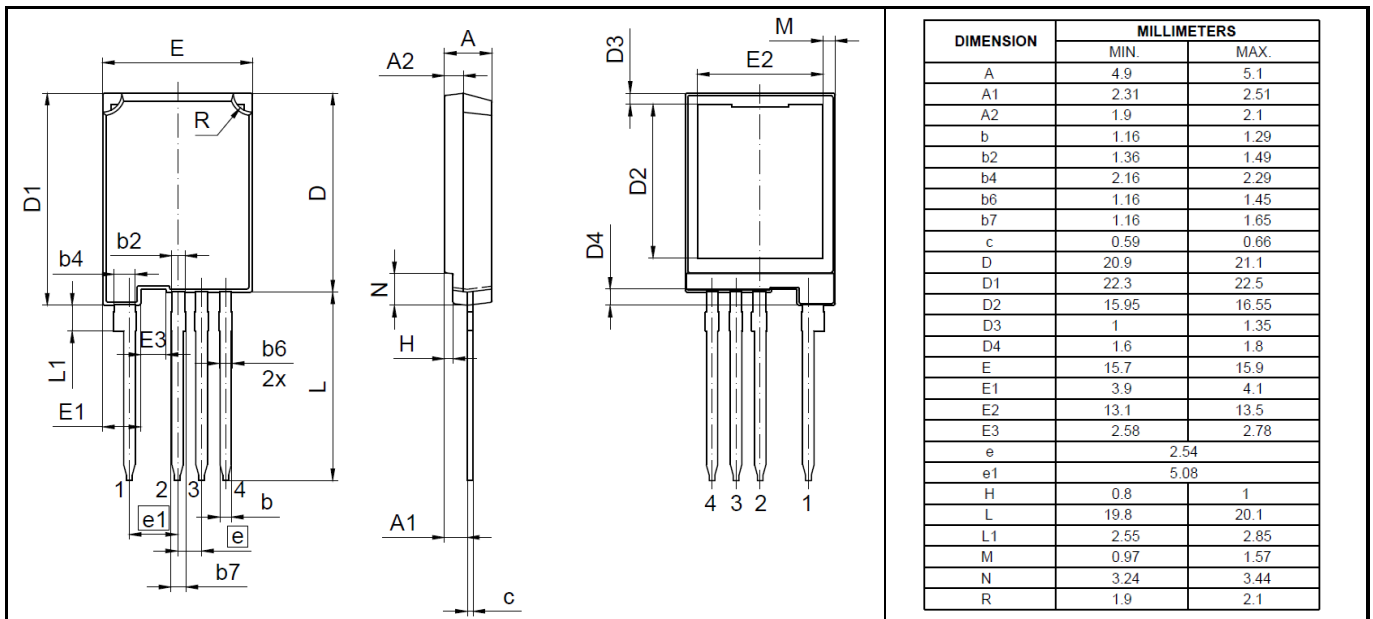

Figure 7 TO-247PLUS 4pin mechanical drawing and dimensions

This package has been designed with the intention to be compatible to the TO-247-4 in form, fit and function with minor changes only.

Figure 7 specifies the main differences between TO-247-4 and TO-247PLUS 4pin.

The most evident is the missing hole of the TO-247PLUS 4pin, emphasized in the red circle "1" of Figure 7. The typical thermal pad area of a standard TO-247-4 is about 140 mm², while the typical thermal pad area of the PLUS version is about 190 mm²; an increase of about 26 %.

Also in the TO-247-4, similarly to the three terminals version, another important difference is the location of the lateral mould clamping areas, necessary for a correct mould compound deposition. These are emphasized, in the Figure 7, with the red circles "2". TO-247PLUS 4pin still features these clamping areas, but these are placed at the upper corners. This change, it increases the clearance and creepage distances between said clamping areas, which lie at the collector potential, to the eventual metal clip used for fixing, that is usually at the heatsink potential. Further details can be found in the Infineon Application Note: AN2012-10 "Electrical safety and isolation in high voltage discrete component - applications and design hints" [1].

Furthermore, an important difference still to be mentioned is represented by the newly introduced design of the TO-247PLUS 4pin marked in Figure 8 with the red circle "3". This indentation increases the creepage distance between collector terminal and power emitter terminal by about 2 mm which is important in applications where a minimum creepage distance over 4 mm is required.

The 4 leads version has been introduced in order to cope with the large demand of large current high switching speed devices. In fact, 4 pin package version of the TO-247PLUS may allow reaching over 20% reduction in switching losses at nominal current compared to the corresponding 3 pin version.

Product Description

Further details can be found in the Infineon Application Note ANo1, 2014-10-16 "TRENCHSTOP™ 5 IGB T in a Kelvin Emitter Configuration" [3].

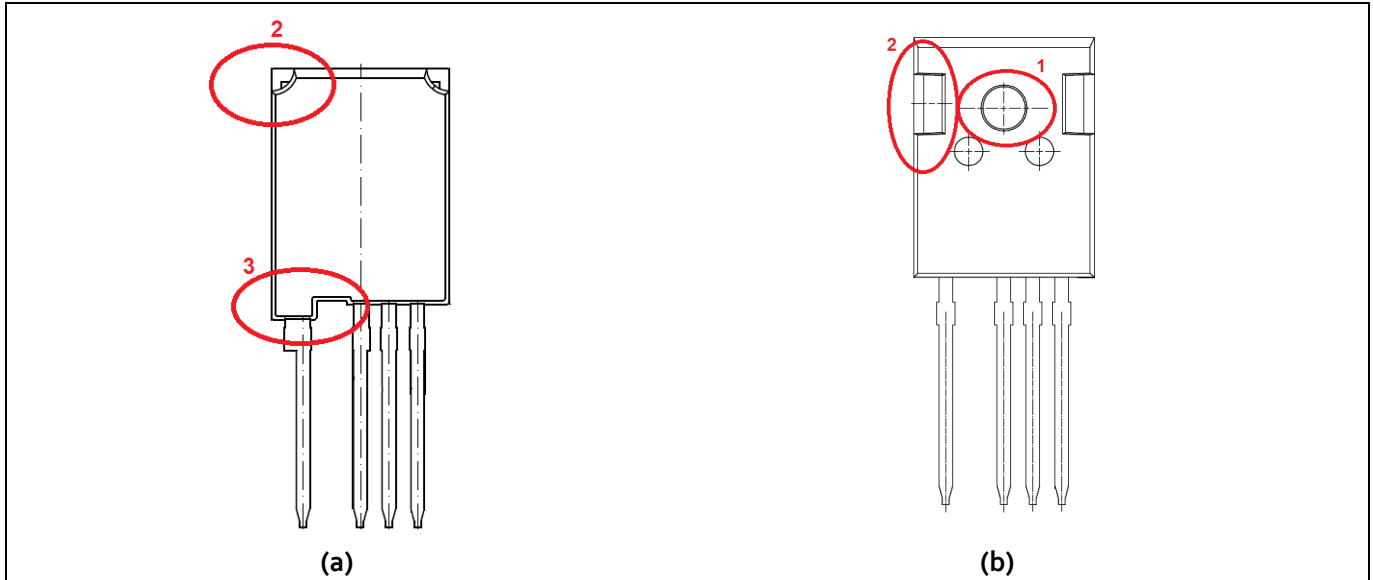

Figure 8 Main differences between (a) TO-247PLUS 4pin and (b) TO-247-4

1.3 Electrical and thermal performance

The main benefits which result from these packages are:

- Accommodation of larger die size
- Improved thermal spreading
- Enhanced pressure distribution

In the first case, simply using more silicon, it is possible to achieve higher current levels or improved thermal resistance at the same current ratings.

Using the largest possible dies, a TO-247PLUS could handle twice the current of a corresponding TO-247.

Unfortunately, due to parasitic electrical resistance in the total power loop, like PCB tracks, solder joint, terminals and bond wires, the maximum current needs to be limited to avoid excessive heat generation.

It is important to distinguish the limitations introduced by external package design factors like PCB tracks, PCB pads and solder joints, from intrinsic package limitations including bond wires and package terminals.

Regarding the external package design factors, a good design recommendation is to follow the JEDEC standards and recommendations for the track dimensioning. It is also strongly recommended, for a high reliability of the system, to keep the solder joint between PCB pads and terminals below 100-105 °C. Observing this simple temperature limitation can significantly increase the system reliability.

Regarding the limitations, the most significant came from the bond wires. For this reason, the new TO-247PLUS has a special bond wire configuration. This has been designed to offer more room and to populate the design with a large number of bond wires. This allows achieving higher current levels than in the corresponding TO-247-3 and TO-247-4.

As a practical example, the DC collector current vs. case temperature of a former IKW75N60T and the new IKQ120N60T are displayed in Figure 9. Besides the obvious difference in terms of die size, in the first case the limit due to the bond wire dissipation at $T_c = 25\text{ °C}$ was 80A, while in the second case, related to the new IKQ120N60T, it is now 160A.

Product Description

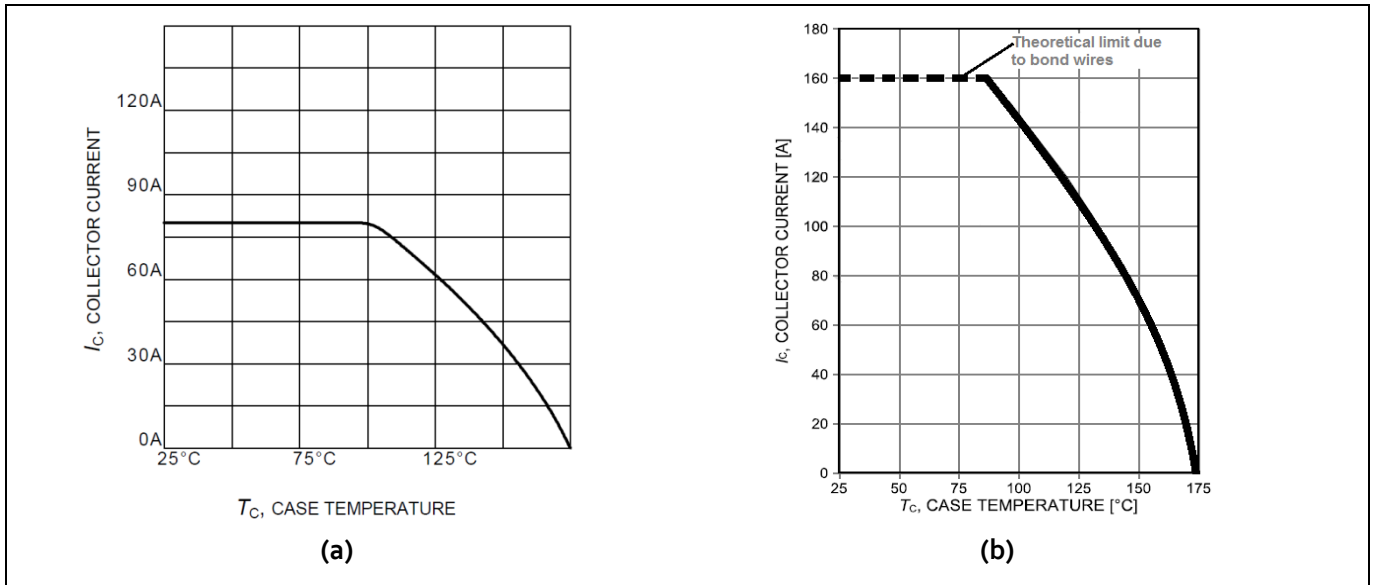

Figure 9 DC collector current vs. case temperature of (a) IKW75N60T and (b) IKQ120N60CT as given in the according datasheets

Customers that want to maintain the same output current in their systems can benefit from the larger die size to dramatically improve efficiency, decrease junction temperature and therefore increase the expected lifetime.

Some current limitation may occur because the device leads are heating up during operation. Figure 10 shows a simplified drawing of a package which is mounted into a PCB.

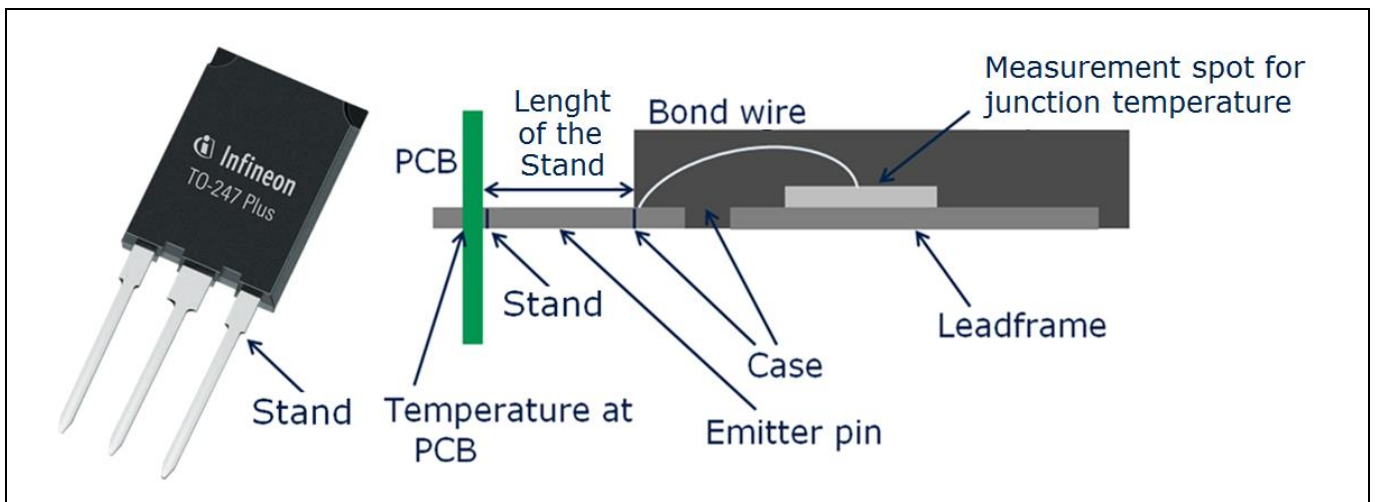

Figure 10 Internal structure of the TO-247PLUS

To ensure the high current carrying capability of the TO-247PLUS, the device should be assembled so that the leads are kept short. The minimum distance of TO-247PLUS is usually the length of the stand-off on the terminals. With increasing length between stand-offs and PCB, the leads' and the bond wires' temperature increase. Critical for the TO-247PLUS is the temperature of the mould compound. Therefore, the bond wire temperature should be kept below 220°C. Table 1 summarizes the results of an estimation of the maximum rms current for different scenarios. For the estimation it was assumed that the pin temperature T_{pin} and the junction temperature T_{vj} are kept constant over time. The total pin length between case and PCB is 18mm.

Product Description

Table 1 Example for rms current carrying capability

T_{pin} [°C]	t [s]	t_{vj} [°C]	Maximum current [A_{RMS}]
125	1	100	90
125	5	120	70
125	10	130	65
110	coninuous	105	75

1.4 Thermal measurements and comparison

As mentioned above, other significant advantages arising from TO-247PLUS, are the enhanced thermal spreading and the improved pressure distribution. This is quantified in the comparative test performed using the same silicon die on standard TO-247 and on TO-247PLUS. In this case, a comparative measurement between TO-247-3 and TO-247PLUS 3pin, measuring case and junction temperature, have been performed.

A 54mm² IGBT die and 26 mm² Diode die have been assembled on TO-247-3 and on the TO-247PLUS 3pin version. The devices under tests (DUT) were subject to the same load conditions and exposed to the same power dissipation. For the 54mm² die, the power dissipation was maintained constant at ~50W during the test. Both DUT were assembled onto a heatsink with a thermal resistance R_{thHA} of 1.2K/W, fixed with a clip which ensured 15 PSI to the thermal pad corresponding to a clip loading force of about 19.6N on the TO-247PLUS 3pin plastic body and using a Kapton isolation foil having 0.76 (K · in²)/W at 15 PSI. Afterwards, as above, the DUT were assembled again on a 1.2K/W heatsink, with CLIP at 15 PSI, but in this case using a ZnO silicone based thermal interface material (TIM) having a thermal conductivity of 0.81 W/mK.

Thermal resistance measurements on the application on the IGBT were performed according to IEC60747-9, method 1. Per unit results [p.u.] using TO-247-3 mounted on isolation foil as per reference, are reported in the Figure 11 for the IGBT.

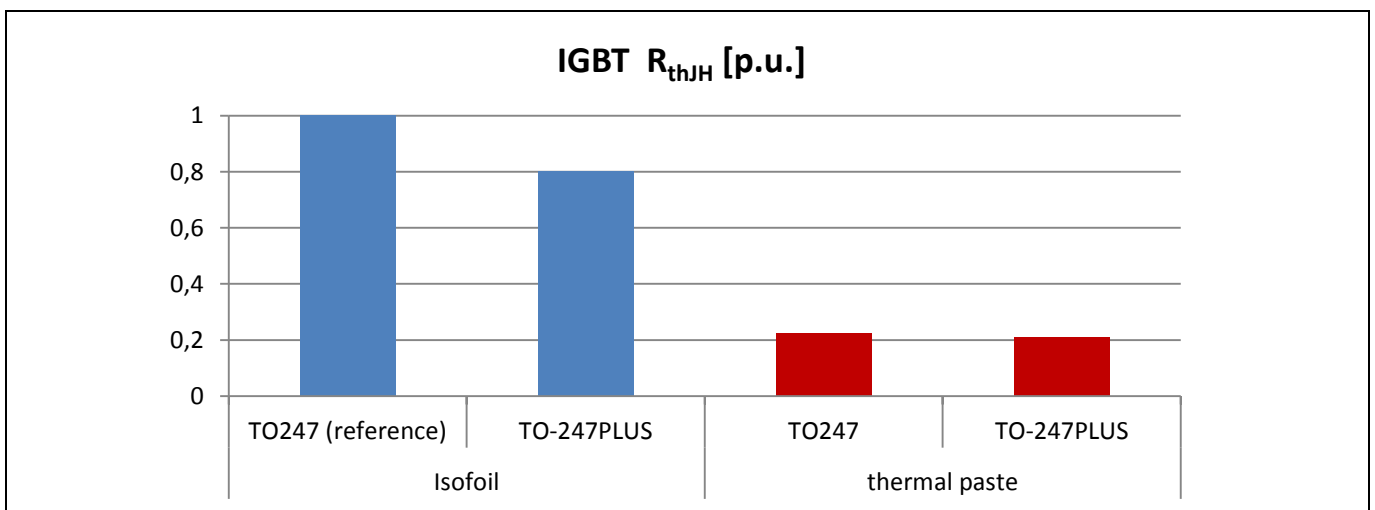

Figure 11 R_{thJH} IGBT comparison. Results are given in per unit and using as reference the standard TO-247-3 mounted on a heatsink using isolation foil

Similar results, as reported in Figure 12, were found when comparing the 26mm² diode. The total power dissipation was reduced to 30W to avoid overheating of the component. The absolute value of the R_{thJH} was obviously higher than in the former case. When using the R_{thJH} of the standard TO-247-3 mounted on isolation foil as a reference, the comparison with the TO-247PLUS version revealed an even higher difference. This phenomenon can easily be explained by the improved thermal spreading of the TO-247PLUS, which is

Product Description

emphasized especially at smaller dies. This phenomenon is particularly useful in order to fully exploit the performance of Infineon’s most recent IGBT technology having larger current density per unit area of silicon.

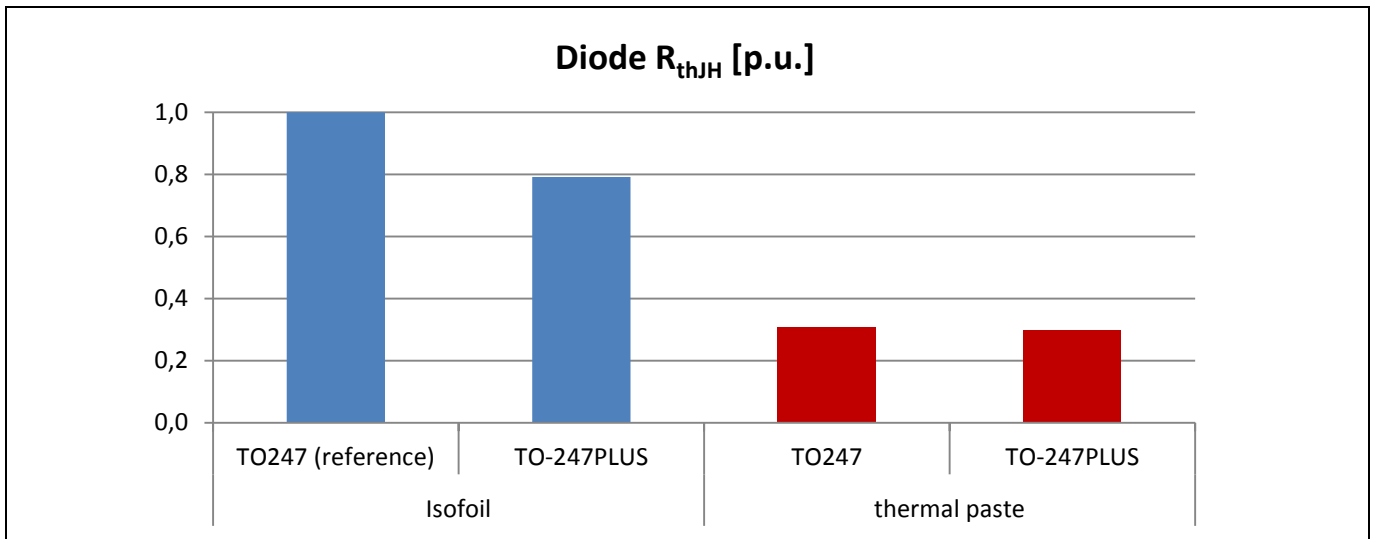

Figure 12 R_{thJH} diode comparison. Results are given in per unit and using as reference the standard TO-247-3 mounted on a heatsink using isolation foil

Furthermore, to crosscheck the validity of the measurements on the application, a special test was performed using two different methods.

Infra-Red camera method, partial opening the package and filling the hole with an Infra-Red (IR) transmissible material. A high resolution IR camera was installed to get the chip’s temperature. A cationic UV-curing epoxy was used, which was developed especially for application of fiber optic techniques and withstand temperatures of up to 180 °C. The DUT can be seen in Figure 13 a.

Thermocouple method, a hole was drilled into the mold compound from the front side of the package above the center of the chip, just to reach a distance of about 300-500 μm from the chip’s surface. Utilizing a thermally conductive glue, a thermocouple to monitor the chip temperature was glued into the package. Power dissipation was 28 W and a clip was used, ensuring a pressure of 25 PSI to the thermal pad. The clip’s loading force was 30.9 newton. The reworked device is pictured in Figure 13 b.

Product Description



Figure 13 Samples prepared for testing: (a) IR camera, (b) thermocouple.

Test results are summarized in Table 2.

Table 2 Test comparison between the two methods of measurement

	Thermocouple	IR camera
Temperature measured	64.7°C	62.6°C
Deviation (calibration)	+1.0°C	+1.7°C
Compensation to 25°C ambient	-0.6°C	+0.5°C
Final junction temperature	65.1°C	64.8°C

A deviation of about 0.3 °C was observed between the two methods. This is in good agreement with the calculation that resulted in a temperature of $T_{vj} = 66.6 \text{ °C}$; very close to the mentioned temperature. These results also show that the mentioned methods are both valid to have a good estimation of the T_{vj} in real applications.

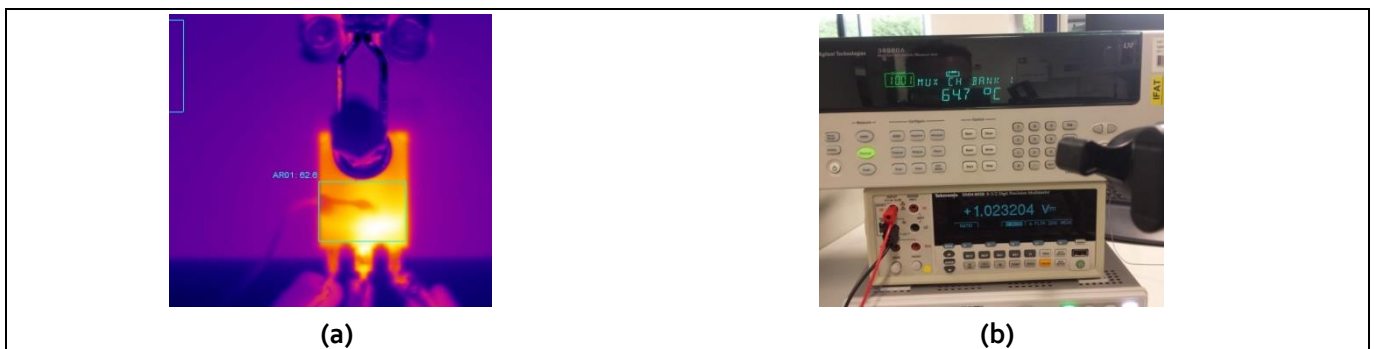

Figure 14 DUT using two methods: (a) IR camera (b) thermocouple

2 Assembly of TO-247PLUS Packages

Due to the missing hole, the TO-247PLUS need to be assembled using clips or pressure systems. One of the biggest advantages in using TO-247PLUS packages with clip assembly technique is the uniform pressure distribution exerted onto the component and the reliable mechanical stability even under vibrations and mechanical shocks. This is especially appreciated in automotive applications and in some specific industrial applications having harsh mechanical environments.

Ensuring a stable and even mechanical pressure will consequently provide a good heat transfer. Indeed, as for any kind of discrete package, heat transfer from TO-247PLUS thermal pad to the heat sink's surface depends on the related surfaces' quality. Both, the heat sink surface and the thermal pad surface of the TO-247PLUS are uneven.

Figure 15 contains a measurement of the planarity of a TO-247-3 along the diagonal of the chip.

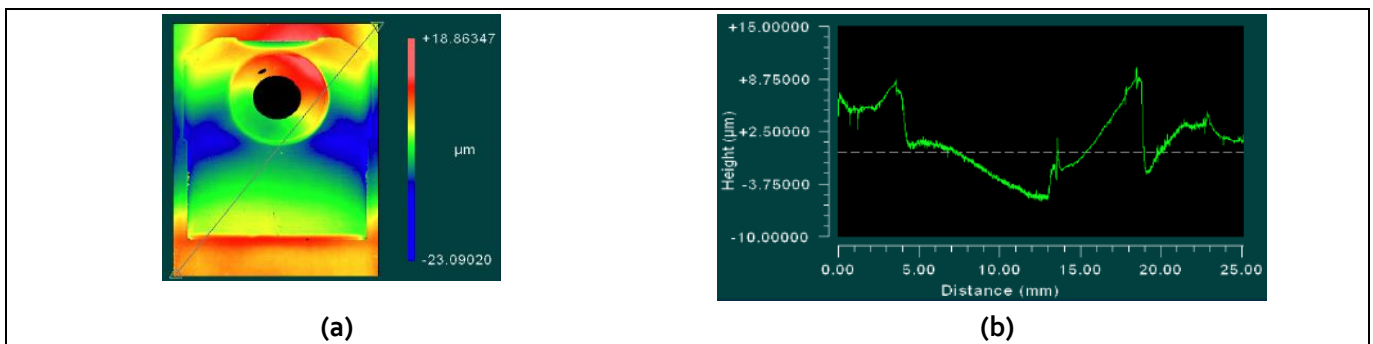

Figure 15 (a) Image and (b) measurement of the planarity of a TO-247-3 along chip's diagonal path

Figure 16 schematically depicts the interface between the surfaces. In both cases, as a result, air is trapped between the two surfaces, preventing direct heat transfer. Air is a poor thermal conductor with a very limited thermal conductivity of about 0.03 W/(mK).

In this condition, only very little heat can be transferred from the thermal pad to the heat sink. This clearly highlights the importance of having a good thermal connection between the thermal pad of the component and the heat sink.

Several variables like surface roughness, surface flatness, surface cleanliness, paint finishes and intermediate materials may affect the heat transfer. The mechanical specifications suggested for the heat sink to reduce the impact of the mentioned variables as much as possible, include:

- Roughness: $R_z < 15\mu\text{m}$
- Flatness: $F_z < 30\mu\text{m}$ per 100mm
- Machining without overlaps
- Mounting area clean and free of dust, particles, grease, oil and other pollutants

Figure 16 shows a close-up view of the interface between the two contacting surfaces of TO-247PLUS thermal pad and the heat sink. In Figure 16 a, is depicted the heat transfer without thermal paste. In Figure 16 b, is displayed the heat transfer using a thermal interface material (TIM).

The red arrows dimensions and thicknesses indicate the quality of the thermal transfer. The finish quality is exaggerated for the sake of the argument.

When applying a pressure to the top of the component, the thermal contact might be significantly improved. The higher the pressure, and therefore the contact force, the lower the thermal resistance.

Assembly of TO-247PLUS Packages

This dependency is not linear; it includes a quick drop at low pressure values, replaced by a more gradual reduction with increased pressure.

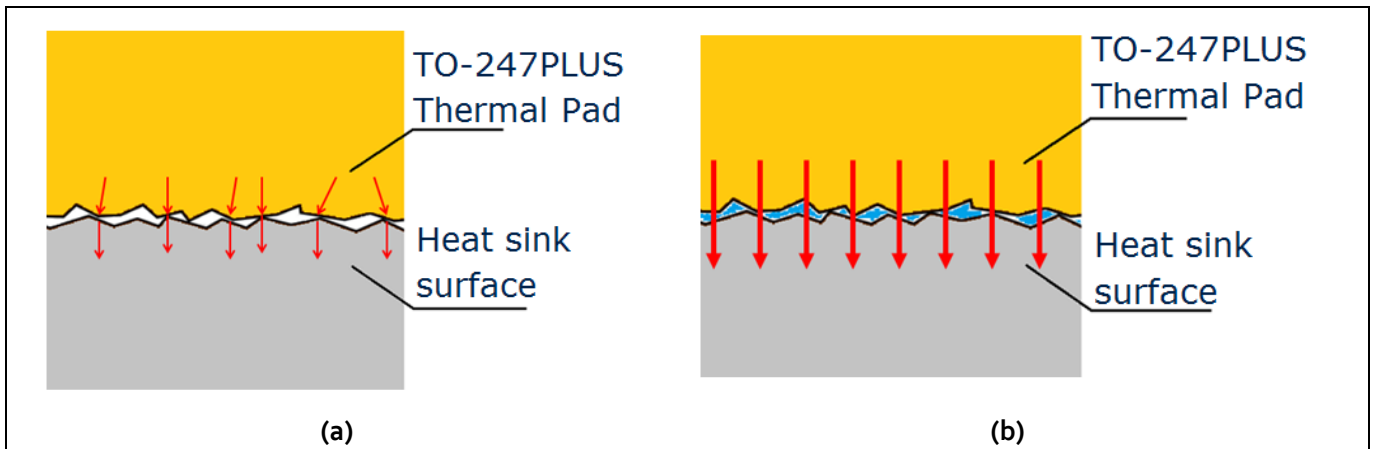

Figure 16 Close-up view of the interfaces between TO-247PLUS thermal pad and heat sink. (a) Heat transfer without thermal paste and (b) heat transfer using a thermal interface material

The thermal pads on the back of the TO-247PLUS 3pin and TO-247PLUS 4pin are electrically connected to the backside of the die included. Therefore, it is not electrically isolated from the terminals. This means that in cases where the devices are connected in half bridge or cascade topologies sharing the same heat sink, it is necessary to insert an electrically isolating material between the thermal pad of the package and the heat sink [2]. Such isolator also performs as thermal interface and in most of the cases it is not necessary to add further TIM layers. Many Companies offer a broad range of isolator pads, please refer to [2] for further details. The introduction of these isolator materials leads to higher thermal resistance as hinted out in Figure 17.

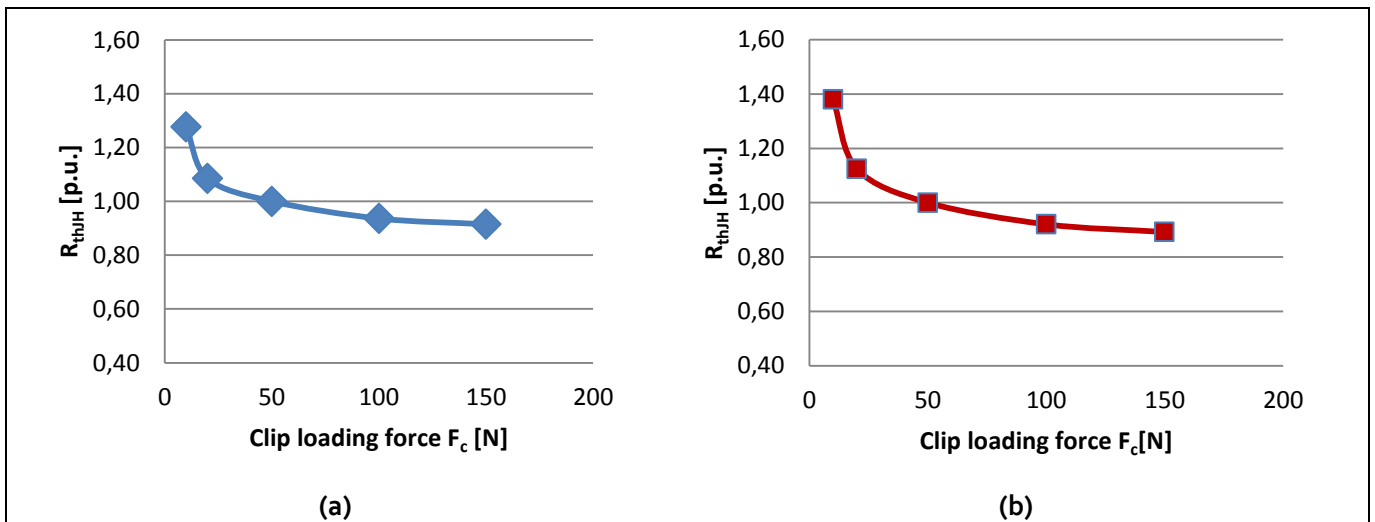

Figure 17 IGBT R_{thJH} vs. clip loading force when mounted in TO-247PLUS 3pin using (a) thermal paste and (b) isolation foil. R_{thJH} values are expressed in per unit [p.u.] respect to the R_{thJH} value at 50N.

Graphs in Figure 17 denote a sharper drop when using isolation pads as interface material compared to thermal paste or grease. This is intrinsic to the material used and, as quite intuitive reason, is due to higher compressibility of the isolator material compared to TIM and due to the better thermal spreading at higher R_{thCH} .

Assembly of TO-247PLUS Packages

The recommended clip loading force to get a sufficiently low thermal resistance R_{thJH} value is about 15-20 N when using TIM, while it is about 25-30 N when using an isolator pad. These values can slightly change according with isolation foil material and thickness selected. Exceeding 60-80 N does not provide any significant improvements. On the contrary, it may lead to isolator or package damage. Indeed, as specified in [1], the contact area between the plastic case and the clip must be treated carefully. The maximum pressure allowed to the plastic body is 150N/mm². Beyond this value, cracks in the moulded body may appear. Therefore, clips have to be round or smooth in the contact area to avoid concentrated loads to the plastic body of the package. Considering that the average contact area of a spring is in the range of 1...3mm², the use of clips having a loading force that exceeds values of 150...250N must be avoided.

Regarding thermal interface materials, the most widely used thermal greases are silicon based with thermally conductive particles in the range of 10...20µm. Also other thermal interface materials, when cured and carefully applied can be recommended.

For a correct and even distribution of thermal paste/grease, Infineon recommends a hard rubber roller or a screen print solution. The optimal thickness of the grease layer applied depends on the type of thermal paste selected, but considering the above mentioned flatness and roughness surface values for both, device and heat sink, a recommended thermal grease thickness value should lie between 20µm to 50µm. Exceeding these values by thickly applying TIM is counterproductive. Indeed, it can happen that the excessively applied TIM can hold the two surfaces apart and even lead to an increase in the thermal resistance instead of reducing it.

2.1 Clip selection

A multitude of clips, which can be used in customer applications, are available on the market. These clips are already clearly specified in [1] in detail. Each of these may present a different advantage, dependant on the application. **Error! Reference source not found.** Table 3 summarizes the most important types.

Table 3 Summary of different clip types and typical usage

Type of Clips	Type of heat sink	min / max clip loading force	
Saddle Clips	Heat sink thickness > 5mm thickness mushroom heat sink or aluminium plates or even chassis	15N	60N
U Clips	Heat sink thickness > 5mm thickness Plates or flat heat sink	15N	40N
Heatsink anchor Clips	Special extruded heat sink with specific profiles usually > 5mm thickness in the position of anchorage	25N	50N
Clips with screw	All standard extruded heat sinks Usually > 5mm thickness	20N	100N

2.2 Mounting with metal bars

Besides the mounting with clips, a mounting method with metal bars can be used to assemble the TO-247PLUS. If the pressure is distributed equally on the total area of the devices, a maximum pressure of 250 N can be applied. Problems with this method may occur if the metal bar stresses the package's edges as depicted in Figure 18. Therefore, during the mounting process, the bow of the metal bar should be kept to a minimum to avoid problems.

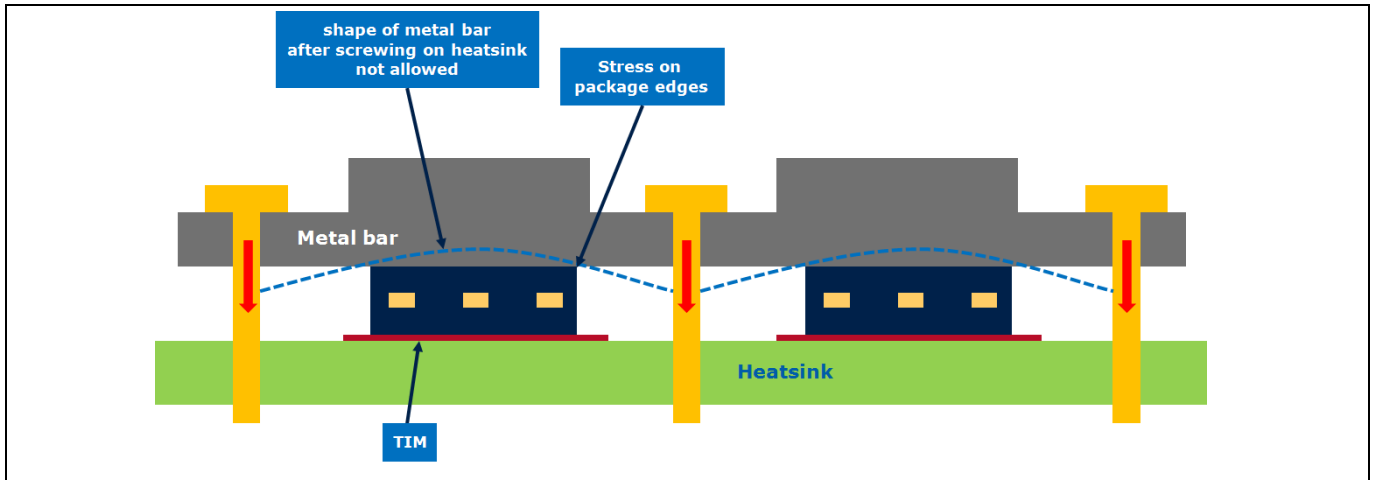

Figure 18 Stress on the edges due to mounting with metal bar

2.3 Lead bending

To fulfil the increasing demand for higher integration, an alternative method for lead bending as described in [1] is presented in this chapter. If the bending is close to the case it might happen that the mechanical stress damages the device so that the connection between lead frame and mould compound is not sufficient anymore to protect the die against humidity for instance. Thus, the alternative solution is based on two tools to bend the device as can be seen in Figure 19. The first tool is a fixing tool which has the purpose to reduce the stress to the device to prevent damage. The second tool bends the leads.

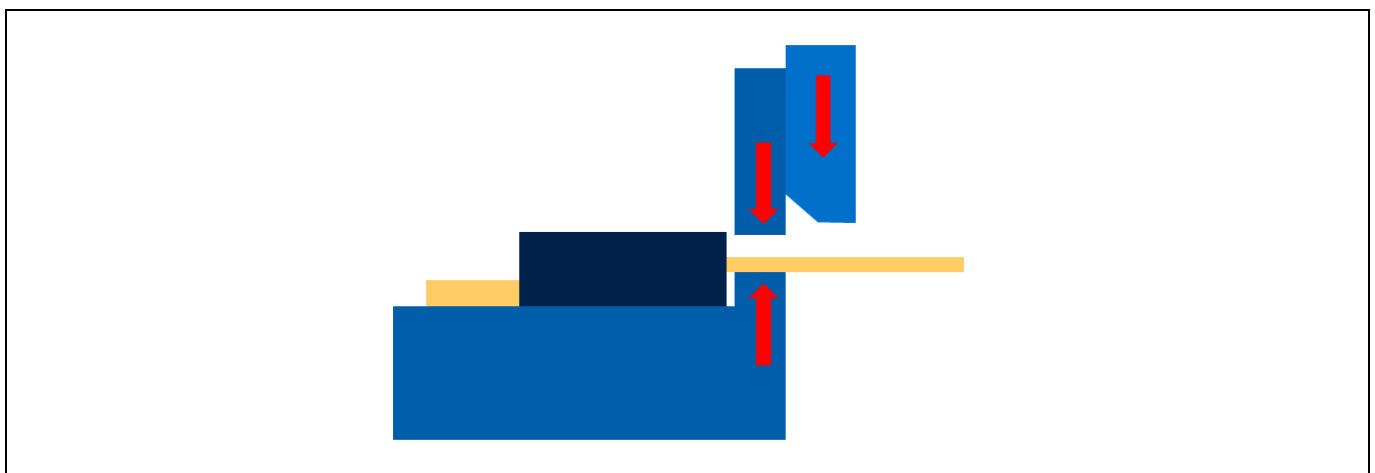

Figure 19 Fixing and bending tool

In the first step, the fixing tool is clamping the leads as depicted in Figure 20.

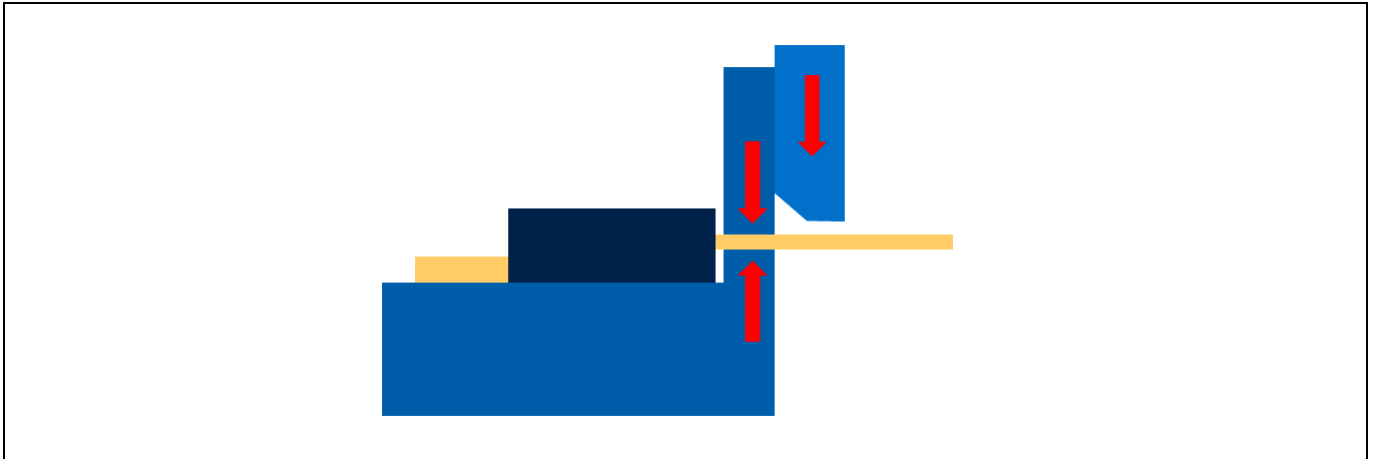

Figure 20 Fixing tool clamps the leads

After the leads are fixed, the final bending of the leads takes place in a second step which can be seen in Figure 21.

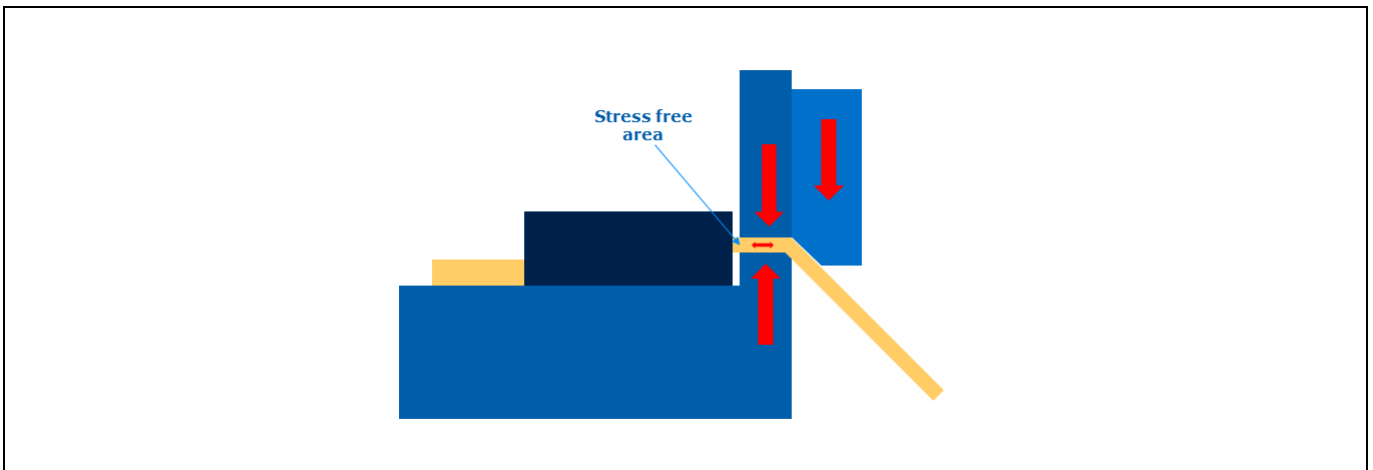

Figure 21 Bending after the leads were fixed

3 References

- [1] Infineon Technologies AG: DS1-2008, Recommendations for Assembly of Infineon TO Packages, Edition 2008-03, March 2008.
- [2] Infineon Technologies AG: AN2012-10, Electrical safety and isolation in high voltage discrete component applications and design hints, V1.0, October 2012.
- [3] Infineon Technologies AG: AN01, 2014-10-16 "TRENCHSTOP™ 5 IGB T in a Kelvin Emitter Configuration"

4 Useful material and links

- **IGBT web page:** <http://www.infineon.com/igbt>
 - Contains application note and spice models for discrete IGBT
- **TO-247-4 web page:** www.infineon.com/to-247-4
 - Includes both 650V in TO-247-4 and 1200V in TO-247PLUS 4pin product portfolios.
- **TO-247PLUS web page:** <http://www.infineon.com/TO-247PLUS>

This page includes:

- Product Technical Description
- Use in Application
- Assembly Details
- TO-247PLUS Product Brief
- Infineon TO-247PLUS datasheets

5 Revision history

Major changes since the last revision

Page or Reference	Description of change
--	Revision 1.0 - First Release - Fabio Brucchi
1, 2, 4, 5, 7, 11, 13	Revision 2.0 - Updates and introduction of TO-247-4PLUS package – Fabio Brucchi

Trademarks of Infineon Technologies AG

μ HVIC™, μ IPM™, μ PFC™, AU-ConvertIR™, AURIX™, C166™, CanPAK™, CIPOS™, CIPURSE™, CoolDP™, CoolGaN™, COOLiR™, CoolMOS™, CoolSET™, CoolSiC™, DAVE™, DI-POL™, DirectFET™, DrBlade™, EasyPIM™, EconoBRIDGE™, EconoDUAL™, EconoPACK™, EconoPIM™, EiceDRIVER™, eupec™, FCOS™, GaNpowIR™, HEXFET™, HITFET™, HybridPACK™, iMOTION™, IRAM™, ISOFACE™, IsoPACK™, LEDriviR™, LITIX™, MIPAQ™, ModSTACK™, my-d™, NovalithiC™, OPTIGA™, OptiMOS™, ORIGA™, PowIRaudio™, PowIRStage™, PrimePACK™, PrimeSTACK™, PROFET™, PRO-SIL™, RASIC™, REAL3™, SmartLEWIS™, SOLID FLASH™, SPOC™, StrongIRFET™, SupIRBuck™, TEMPFET™, TRENCHSTOP™, TriCore™, UHVIC™, XHP™, XMC™

Trademarks updated November 2015

Other Trademarks

All referenced product or service names and trademarks are the property of their respective owners.

Edition 2017-02-10

Published by

Infineon Technologies AG

81726 Munich, Germany

© 2017 Infineon Technologies AG.

All Rights Reserved.

Do you have a question about this document?

Email: erratum@infineon.com

Document reference

AN2017-01

IMPORTANT NOTICE

The information contained in this application note is given as a hint for the implementation of the product only and shall in no event be regarded as a description or warranty of a certain functionality, condition or quality of the product. Before implementation of the product, the recipient of this application note must verify any function and other technical information given herein in the real application. Infineon Technologies hereby disclaims any and all warranties and liabilities of any kind (including without limitation warranties of non-infringement of intellectual property rights of any third party) with respect to any and all information given in this application note.

The data contained in this document is exclusively intended for technically trained staff. It is the responsibility of customer's technical departments to evaluate the suitability of the product for the intended application and the completeness of the product information given in this document with respect to such application.

For further information on the product, technology, delivery terms and conditions and prices please contact your nearest Infineon Technologies office (www.infineon.com).

WARNINGS

Due to technical requirements products may contain dangerous substances. For information on the types in question please contact your nearest Infineon Technologies office.

Except as otherwise explicitly approved by Infineon Technologies in a written document signed by authorized representatives of Infineon Technologies, Infineon Technologies' products may not be used in any applications where a failure of the product or any consequences of the use thereof can reasonably be expected to result in personal injury.