



Catalog78

Table of Contents

Sales and Service

| | |
|------------------|---|
| Facilities | 4 |
| Policies | 8 |

Impedance Measurement 11

| | |
|---|----|
| Manual Impedance Bridges | 17 |
| Automatic Impedance Bridges and Comparators | 22 |
| High-Frequency Instruments | 33 |
| Capacitance Bridges | 43 |
| Resistance Bridges and Megohmmeters | 55 |
| Inductance Bridges | 59 |
| Capacitance Standards and Decades ... | 63 |
| Resistance Standards and Decades ... | 79 |
| Inductance Standards and Decades ... | 86 |

Coaxial Components 90

| | |
|---------------------|-----|
| GR874® series | 91 |
| GR900® series | 107 |

Signal Sources 117

| | |
|----------------------------------|-----|
| Synthesizers | 118 |
| High-Frequency Oscillators | 121 |
| Low-Frequency Oscillators | 124 |

IC Testers 128

Component/Network/Module Tester 143

PC-Board Testers 151

| | |
|------------------------------------|-----|
| Logic Test Systems | 152 |
| Digital/Analog Test Systems | 154 |
| Programming Station | 157 |
| In-Circuit/Functional Tester | 158 |
| Test-System Software | 159 |
| Bug Hound | 162 |

Acoustic/Vibration Instruments and Systems 165

| | |
|---|-----|
| Sound-Level Meters | 166 |
| Noise Dosimeters | 169 |
| Calibrators | 169 |
| Noise Recorders | 171 |
| Signal Analyzers | 172 |
| Graphic Recorders/Analyzers | 173 |
| Community Noise Analyzer | 176 |
| Microphones/Preamplifiers/Accessories . | 177 |
| Audio Test Instruments | 180 |
| Integrating Real-Time Analyzer | 184 |
| Spectrum Analyzer | 186 |
| Digital Signal Analysis Systems | 188 |
| Vibration Control Systems | 190 |

Strobotac® stroboscopes 193

Variac® line-voltage regulators . 205

Variac® adjustable autotransformers 213

General 237

| | |
|--|-----|
| Binding Posts, Jacks, Plugs, Adaptors, and Cords | 237 |
| Counter | 242 |
| Scaler | 244 |

Appendix 245

| | |
|---|-----|
| Abbreviations, Symbols, and Prefixes .. | 245 |
| National Stock Numbers | 246 |
| Alphabetical Index | 248 |
| Numerical Index | 254 |

Printed in U.S.A.
GenRad, Inc., Concord, Massachusetts, U.S.A. 01742
© 1978



GenRad and the Challenge of Change

Electronics and the application of electronics, more than any other technology, demonstrate the concept of acceleration of change in today's society. The time cycle from discovery to obsolescence has been compressed to the point where total product lifetime is frequently briefer than the time formerly required just to develop a new product.

During the past decade GenRad has met the challenge of rapid change by being one of the first to apply the minicomputer, and later the microcomputer, to measurement technology. Early in the development and application of printed-circuit boards, GenRad was the first on the market with a computer-controlled system that could

automatically test digital circuits. It was also quick to recognize the importance of software as an adjunct to test-system hardware. Consequently, GenRad's CAPS VIII Software Package is acclaimed by many to be the most advanced software ever developed for test systems.

Before the first microcomputers were available in production quantities, GenRad's development engineers were busy designing the next generation of automatic testers around them. GenRad's 2230 Component Test System and its new line of Digibridge™ impedance bridges are examples of how successful GenRad has been in quickly applying the microcomputer to product areas in which it excels.

Measurement and analysis of noise and vibration are also areas where GenRad plays a leadership role, as it has for over 40 years. In this catalog you will find two new analyzers, the 2512 and the 1995, that dramatically illustrate how greatly improved performance at considerably lower cost can be achieved through innovative application of new technologies.

On the marketing side, GenRad continues to expand its services worldwide in response to ever-changing national



and international requirements. To support the huge number of GenRad board test systems now installed worldwide, several GenRad System Centers have been established around the world. One of the services offered by the System Centers, programming, typifies the after-sale support GenRad provides its customers. Five subsidiary companies in Europe and a sixth one in Canada continue to play an increasingly important role in customer support as GenRad's worldwide growth continues.

Catalog 78 describes all current GenRad instruments and test systems. Those instruments that are used primarily for testing or measuring electronic/electrical phenomena are described fully. Instruments and systems used for measuring and analyzing sound and vibration are described briefly since separate catalog data are available. The same is true of the PC-board test systems. Several postage-paid cards are inserted at the rear of this catalog for your use in requesting additional information on any product or product line.

We welcome any comments or suggestions you might have regarding our products, service, policies, or any other matters.

GenRad Serves Its Customers through a World-Wide Sales and Service Network

The following listings, organized by geographic area, identify the world-wide sales/service facilities of GenRad. In the United States, GenRad's sales and service support is divided into Eastern, Central, and Western Regions, each of which is comprised of a regional staff and two or more district offices.

Five subsidiary companies in Europe and another one in Canada maintain an effective and efficient sales/service link between headquarters and customers in those areas.

Customers located in geographic areas in which GenRad has no direct representation are served by carefully selected independent organizations whose personnel are thoroughly knowledgeable about the uses and applications of GenRad products.

For prompt attention to your inquiries, please correspond with the facility nearest you as indicated below and on the following pages.

UNITED STATES, PUERTO RICO, and CANADA

GenRad, Inc.

Main Office and Plant
300 Baker Avenue
Concord, MA 01742
(From Metropolitan Boston)
Tel: 646-7409
(From all other locations)
Tel: 617 369-8770
TWX: 710 347-1051
Cable Address: GENRADCO Concord
(Mass.)

WASHINGTON SALES OFFICE

Maryland, Virginia, Washington, D.C.
West Virginia
GenRad, Inc.
15 Firstfield Road
Gaithersburg, MD 20760
TEL: (301) 948-7071
TWX: (710) 828-9741

LOS ANGELES SALES OFFICE

Arizona, Hawaii (Non-Government), Nevada
(Clark County only), Southern California
GenRad, Inc.
P.O. Box 19500
17361 Armstrong Avenue
Irvine, CA 92714
TEL: (714) 540-9830
TWX: (910) 595-1762

CENTRAL REGIONAL HEADQUARTERS

GenRad, Inc.
1067 East State Parkway
Schaumburg, IL 60195
TEL: (312) 884-6900
TWX: (910) 291-1209

SAN FRANCISCO SALES OFFICE

Colorado, Hawaii (Government), Idaho,
Montana, Nevada (except Clark County),
New Mexico, Northern California, Oregon,
Utah, Washington, Wyoming
GenRad, Inc.
2855 Bowers Avenue
Santa Clara, CA 95051
TEL: (408) 985-0662
TWX: (910) 338-0291

EASTERN REGIONAL HEADQUARTERS

GenRad, Inc.
Bolton, MA 01740
TEL: (617) 779-5562
(From Metropolitan Boston)
TEL: 646-0550

CHICAGO SALES OFFICE

Illinois, Iowa, Kansas, Minnesota, Missouri,
Nebraska, North Dakota, South Dakota,
Wisconsin
GenRad, Inc.
1067 East State Parkway
Schaumburg, IL 60195
TEL: (312) 884-6900
TWX: (910) 291-1209

ALASKA

Harry J. Lang & Associates
1406 West 47th Avenue
Anchorage, AK 99503
TEL: (907) 279-5741

ATLANTA SALES OFFICE

Alabama, Florida, Georgia, Mississippi,
North Carolina, South Carolina, Tennessee
GenRad, Inc.
1 Dunwoody Park
Suite 107
Atlanta, GA 30341
TEL: (404) 394-5380

BOSTON SALES OFFICE

Connecticut, Maine, Massachusetts,
New Hampshire, Rhode Island, Vermont
GenRad, Inc.
Bolton, MA 01740
TEL: (617) 779-5562
(from Metropolitan Boston)
TEL: 646-0550

NEW YORK SALES OFFICE

Delaware, New Jersey, New York,
Pennsylvania (Eastern)
GenRad, Inc.
380 Midland Avenue
Saddle Brook, NJ 07662
TEL: (NJ) (201) 791-8990
(NY) (212) 964-2722
TWX: (710) 988-2205

DALLAS SALES OFFICE

Arkansas, Louisiana, Oklahoma, Texas
GenRad, Inc.
777 South Central Expressway
Suite 4A
Richardson, TX 75080
TEL: (214) 234-3357
TWX: (910) 867-4771

DAYTON SALES OFFICE

Indiana, Kentucky, Michigan, Ohio,
Pennsylvania (Western)
GenRad, Inc.
3300 South Dixie Drive
Dayton, OH 45439
TEL: (513) 294-1500
TWX: (810) 459-1785

WESTERN REGIONAL HEADQUARTERS

GenRad, Inc.
2855 Bowers Avenue
Santa Clara, CA 95051
TEL: (408) 985-0662
TWX: (910) 338-0291

PUERTO RICO

Southern International Sales Company
555 Calle Rosales
Santurce, PR 00936
TEL: (809) 722-0863, 742-0600
TELEX: 365-384

CANADA

British Columbia, Central and Western
Ontario, Western Provinces

GenRad Ltd.

307 Evans Avenue
Toronto, Ontario, Canada
M8Z 1K2
TEL: (416) 252-3395
TELEX: 06-967624

Eastern Ontario, Ottawa, Quebec and
Maritime Provinces

GenRad Ltd.

100 Alexis Nihon Boulevard
Suite 875
St. Laurent, Quebec, Canada
H4M 2P4
TEL: (514) 747-1052
TELEX: 05-826652

ASIA and PACIFIC

AUSTRALIA

Warburton Franki Industries (Adelaide)
Pty. Limited
322 Grange Rd.
Kidman Park, South Australia 5025
(Post Box 1567, G.P.O. Adelaide 5001)
Tel: 356-7333
Cable: ZELEMITE-ADELAIDE
Telex: Warfran AAB2579

Warburton Franki Industries (Brisbane)
Pty. Limited
13 Chester Street
Fortitude Valley
P.O. Box 345
Queensland 4006, Australia
Tel: 52-7255
Cable: FRIGDEL-BRISBANE
Telex: Warfran 41052

Warburton Franki Industries (Melbourne)
Pty. Limited
220 Park Street
P.O. Box 35
South Melbourne, Victoria 3205 Australia
Tel: 699-4999
Cable: IGNITION-MELBOURNE
Telex: Warfran AA31370

Warburton Franki Industries (Perth)
Pty. Limited
98 Belgravia Street
Belmont, Western Australia 6104
P.O. Box 313
Cloverdale 6105, Western Australia
Tel: 65-7000
Cable: PENTAGON-PERTH
Telex: Warfran 92908

Warburton Franki Industries (Sydney)
Pty. Limited
199 Parramatta Rd.
P.O. Box 394
Auburn, N.S.W. 2144 Australia
Tel: 648-1711
Cable: BOOSTER-SYDNEY
Telex: Warfran AA22265

HONG KONG and MACAU

Gilman & Company, Ltd.
World Trade Centre, 24F
280, Gloucester Road
P.O. Box 56
Causeway Bay, Hong Kong, B.C.C.
Tel: 5-794266
Cable: GILMAN-HONG KONG
Telex: HX83667

INDIA

Hinditron Services Pvt. Ltd.
69-A L. Jagmohandas Marg
Bombay 400 006, India
Tel: 365 344
Cable: TEKHIND
Telex: 112326

Hinditron Services Pvt. Ltd.
"Hinditron House"
412 Rajmahal Vilas Extension
Bangalore 560 016, India
Tel: 33139
Cable: TEKHIND
Telex: 043741

JAPAN

For GR Systems:

Tokyo Electron Laboratories, Inc.
Meiho Building
21 1-chome Nishi-Shinjuku
Tokyo 160, Japan
Tel: 03-343-4411
Cable: LABTEL
Telex: 0232 2240

Tokyo Electron Laboratories, Inc.
Umeda Taisei Building
45 Manzai-Cho, Kita-ku
Osaka 530, Japan
Tel: 06-313-4831
Cable: LABTEL
Telex: 0523 6030

Tokyo Electron Laboratories, Inc.
1 Higashikata-Machi, Midori-ku
Yokohama, Kanagawa, Japan
Tel: 045-471-8321
Cable: LABTEL
Telex: 0382 3018

For GR Instruments:

Midoriya Electric Co., Ltd.
2-7-19 Kyobashi, Chuo-ku
Tokyo 104, Japan
Tel: 03-561-8851
Cable: MIDRIYAELC
Telex: J24531

KOREA

M-C International
Rooms 1406 & 1407
91-1 Sokongdong, Chung-ku
C.P.O. Box 1355
Seoul, Korea
Tel: 23-4101 thru 23-4105
Cable: EMCEEKOREA-SEOUL
Telex: 787-K24228

M-C International
717 Market Street
San Francisco, CA 94103
Tel: (415) 543-1455
Cable: EMCEE SAN FRANCISCO
Telex: 340851

MALAYSIA

Vanguard Company
87, Jalan Ampang
P.O. Box No. 975
Kuala Lumpur, Malaysia
Tel: 88213
Cable: VANCO-KUALA LUMPUR

NEW ZEALAND

W. & K. McLean Limited
103-105 Felton Mathew Avenue
P.O. Box 3097
Auckland 6, New Zealand
Tel: 587-039
Cable: KOSFY-AUCKLAND
Telex: NZ2763

W. & K. McLean Limited
P.O. Box 2421
Christchurch, New Zealand
Tel: 64-403
Cable: KOSFY-CHRISTCHURCH

W. & K. McLean Limited
181 Upper Willis Street
G.P.O. Box 496
Wellington 1, New Zealand
Tel: 555-869
Cable: KOSFY-WELLINGTON
Telex: NZ3053

PAKISTAN

Pak Land Corporation
Central Commercial Area
P.E.C.H. Society
Karachi 29, Pakistan
Tel: 472 315
Cable: PAKLAND-KARACHI

SINGAPORE

Vanguard Company
308A, Upper Paya Lebar Road
Singapore, 19 Singapore
Tel: 806822
Cable: VANCO-SINGAPORE

TAIWAN

Heighten Trading Company, Limited
16, Nanking East Road, Section 3
P.O. Box 1408
Taipei, Taiwan, Republic of China
Tel: 551-9916
Cable: HEIGHTEN-TAIPEI
Telex: 21472

THAILAND

G. Simon Radio Co., Ltd.
30 Patpong Avenue, Suriwong
Bangkok, Thailand
Tel: 2340991-3
Cable: SIMONCO-BANGKOK

LATIN AMERICA

ARGENTINA and PARAGUAY

Coasin S.A.

Virrey del Pino 4071
Buenos Aires, Argentina
Tel: 52-3185, 52-5248, 51-9363
Cable: COASIN-BUENOS AIRES
Telex: 012-2284

Coasin, Inc.

c/o Intermetra Corporation
11 Park Place, Suite 2003
New York, NY 10007
Tel: (212) 349-7630-1-2
Telex: 141457

BOLIVIA

Coasin Bolivia S.R.L.

Av. 6 de Agosto 2300 3er. Piso
Casilla 7295
La Paz, Bolivia
Tel: 40962
Cable: COALAP

Coasin, Inc.

c/o Intermetra Corporation
11 Park Place, Suite 2003
New York, NY 10007
Tel: (212) 349-7630-1-2
Telex: 141457

BRAZIL

Ambriex S.A.

Rua Ceará No. 104, 2.º e 3.º ands.
20.000 Rio de Janeiro, RJ, Brazil
Tel: 264-7406, 264-7625, 264-0461
Cable: RAIOCARDIO RIO DE JANEIRO
Telex: (021)21128

Ambriex S.A.

Rua Tupi, 535
01233 São Paulo, SP, Brazil
Tel: 66-0912, 67-7806, 67-1870
Cable: RAIOCARDIO SAOPAULO
Telex: (011)21348

Ambriex S.A.

Rua Dr. Flores, 105 - s/713
90.000 Porto Alegre, RS, Brazil
Tel: 24-7411
Cable: PORTOCARDIO

Ambriex S.A.

Rua São Paulo, 893 - Conj. 1307
30.000 Belo Horizonte, MG, Brazil
Tel: 224-0533

Ambriex S.A.

SQN-113 Bloco E - Apt. 402
70.000 Brasília, DF, Brazil
Tel: 73-2921

Intermetra Corporation

11 Park Place, Suite 2003
New York, NY 10007
Tel: (212) 349-7630-1-2
Telex: 141457

CARRIBBEAN ISLANDS

West Indies Sales Company Ltd.

7360 N.W. 66th Street
Miami, FL 33166
Tel: (305) 592-8188

CHILE

Coasin Chile, Ltda.

Ismael Valdés Vergara 336, Of. 41
Casilla 14588 - Correo 21
Santiago, Chile
Tel: 39-6713
Cable: COACHIL-SANTIAGO

Coasin, Inc.

c/o Intermetra Corporation
11 Park Place, Suite 2003
New York, NY 10007
Tel: (212) 349-7630-1-2
Telex: 141457

COLOMBIA

TeC Asociados Ltda.

Carrera 9a. No. 62-44, Of. 101
Apartado Aéreo 18631
Bogotá, D.E., Colombia
Tel: 55 39 27, 59 27 52
Cable: TECA

ECUADOR

Sumitec Ltda.

Rumichaca 825 - 827
P.O. Box 259-4492
Guayaquil, Ecuador
Tel: 30 24 84, 30 14 19
Cable: SUMITEC-GUAYAQUIL
Telex: 3361

MEXICO

Mexitek, S.A.

Eugenia 408, Dept. 1
Apdo. Postal 12-1012
Mexico 12, D.F., Mexico
Tel: (905) 536-09-10, 523-9751

PERU

IRE Ingenieros S.A.

Avda. Franklin D. Roosevelt 105
Lima 1, Perú
Tel: 28 86 50
Cable: IREING-LIMA
Telex: 25663

URUGUAY

Coasin Uruguay S.R.L.

Cerrito 613 - 4.º Piso
Casilla de Correo 1400 - Correo Central
Montevideo, Uruguay
Tel: 91-79-78
Cable: COAUR MONTEVIDEO

Coasin, Inc.

c/o Intermetra Corporation
11 Park Place, Suite 2003
New York, NY 10007
Tel: (212) 349-7630-1-2
Telex: 141457

VENEZUELA

Coasin C.A.

Avda. Habana con Valparaiso
Edif. Eguski - Local 3 - Los Caobos
Apdo. Postal 50939
Sabana Grande No. 1
Caracas 105, Venezuela
Tel: 782-9109, 782-8741, 782-2302
Cable: INSTRUVEN
Telex: 21228

Coasin, Inc.

c/o Intermetra Corporation
11 Park Place, Suite 2003
New York, NY 10007
Tel: (212) 349-7630-1-2
Telex: 141457

EUROPE

For countries not listed, please contact:

GenRad, Inc.

International Department
300 Baker Avenue
Concord, MA 01742, U.S.A.
Tel: 617 369-4400
TWX: 710 347-1051
Telex: 92 33 54
Cable Address: GENRADCO Concord
(Mass.)

AUSTRIA

Gotele Ges. m.b.H.

Sandwirtgasse 9
A-1060 Vienna, Austria
Tel: 56 16 17
Telex: (01) 12 922

BELGIUM

Geveke Electronique et

Automation SA
119-121 Rue Anatole France
B-1030 Brussels, Belgium
Tel: 2-241-4550
Telex: 230-28

BULGARIA

Gotele Elektronik fur Industrie &

Wissenschaft
Bahnhofstrasse 76
8500 Frauenfeld, Switzerland
Tel: 33 551
Telex: 76 811

DENMARK

Sophus Berendsen A/S

1256 Copenhagen K
10 Amaliegade, Denmark
Tel: (01) 14 85 00
Telex: 22 285

EIRE

GenRad Ltd.

Bourne End
Bucks SL8 5 AT, England
Tel: (06285) 2 66 11
Telex: 84 83 21

FINLAND

Into O/Y
P.O. Box 22
SF 00661, Helsinki 66, Finland
Tel: 742 133
Telex: 121 836

FRANCE

GenRad
96, Rue Orfila
75020 Paris, France
Tel: (01) 797 07 39
Telex: 22 09 91

GERMANY

GenRad GmbH
Trausnitzstrasse 8
D-8 Munich 80, West Germany
Tel: (089) 40 18 01
Telex: 52 99 17

GREECE

Marios Dalleggio Representations
2, Alopekis Street
Athens 139, Greece
Tel: (021) 710 669
Telex: 216435

HUNGARY

Gotele Elektronik fur Industrie & Wissenschaft
Bahnhofstrasse 76
8500 Frauenfeld, Switzerland
Tel: 33 551
Telex: 76 811

ITALY

GenRad SpA
Via San Gregorio, 12
20124 Milan, Italy
Tel: (02) 20 92 57
Telex: 34 37 3

NETHERLANDS

Geveke Electronica en Automatie N.V.
Kabelweg 25
P.O. Box 652
Amsterdam-W2, Netherlands
Tel: (020) 802 802
Telex: 12219

NORWAY

Bergman & Plesner Instrumentering A/S
P.O. Box 129 Veitvet
Oslo 5, Norway
Tel: (472) 16 22 10
Telex: 17271

PORTUGAL

Casa Serras E. Dias Serras Lda.
Rua Augusta 228
Lisbon-2, Portugal
Tel: (019) 32 01 33
Cable: SERAS DOURO

RUMANIA

Gotele Elektronik fur Industrie & Wissenschaft
Bahnhofstrasse 76
8500 Frauenfeld, Switzerland
Tel: 33 551
Telex: 76 811

SPAIN

Hispaño Electronica S.A.
Poligono Industrial Urtinsa
Apartado Correos 48
Alcorcon, (Madrid), Spain
Tel: (341) 619 41 08
Telex: (050) 22404

SWEDEN

Johan Lagercrantz K.B.
Kanalvägen 5
P.O. Box 48
S-194 01 Upplands Väsby, Sweden
Tel: 760 861 20
Telex: 11275

SWITZERLAND

GenRad AG
Helenastrasse 3
P.O. Box
8034 Zurich, Switzerland
Tel: (01) 55 24 20
Telex: 53 638

Seyffer & Co., AG

Hohlstrasse 550
8048 Zurich, Switzerland
Tel: (01) 62 82 00
Telex: 52 540

TURKEY

Nükleer Elektronik Limited
Fevzi Çakmak Sok. 33/3
Yenisehir, Ankara, Turkey
Tel: 18 7270
Telex: 42 229

UNITED KINGDOM

GenRad Ltd.
Bourne End
Bucks SL8 5 AT, England
Tel: (06285) 2 66 11
Telex: 84 8321

USSR

Gotele Elektronik fur Industrie & Wissenschaft
Bahnhofstrasse 76
8500 Frauenfeld, Switzerland
Tel: 33 551
Telex: 76 811

YUGOSLAVIA

Gotele Elektronik fur Industrie & Wissenschaft
Bahnhofstrasse 76
8500 Frauenfeld, Switzerland
Tel: 33 551
Telex: 76 811

THE MIDDLE EAST AND AFRICA

For countries not listed, please contact:

GenRad, Inc.
International Department
300 Baker Avenue
Concord, MA 01742, U.S.A.
Tel: 617 369-4400
TWX: 710 347-1051
Telex: 92 33 54
Cable Address: GENRADCO Concord (Mass.)

EGYPT

Lotus Engineering Org.
22 Kasr El Nil
P.O. Box 1252
Cairo, Egypt
Tel: 71 617
Telex: 08791 2483

IRAN

Irantronics Co. Ltd.
20 Salm Road, Roosevelt Ave.
Tehran, Iran
Tel: 82 82 94
Telex: 21 29 56

ISRAEL

Eastronics Ltd.
11 Rozanis Street
P.O. Box 39300
61390 Tel Aviv, Israel
Tel: (03) 47 51 51
Telex: 33638

LEBANON

Projects S.A.L.
P.O. Box 11-5281
Beirut, Lebanon
Tel: 33 16 80
Telex: 21 075

MOZAMBIQUE

Telecomunicações de Mozambique Ltd.
P.O. Box 2512
Maputo, Mozambique
Tel: 25 913
Telex: 62 86

NIGERIA

Mofat Engineering Co. Ltd.
89 Wakeman Street, Yaba
P.O. Box 6369
Lagos, Nigeria
Tel: 21595

SAUDI ARABIA

Electronic Equipment Marketing Est.
P.O. Box 3750
Riyadh, Saudi Arabia
Tel: 32 761
Telex: 20 120

SOUTH AFRICA

Associated Electronics (Pty.) Ltd.
P.O. Box 31094
150 Caroline Street
Brixton, Johannesburg 2017
Republic of South Africa
Tel: 839 1824
Telex: 88 432

Sales and Service

The sales/service facilities identified on the preceding pages have been geographically located so as to shorten as much as possible the communication link between GenRad and its customers. You, the customer, need only to contact the facility nearest you for prompt sales and service assistance. Each facility, whether GenRad owned and operated or that of a carefully selected representative, is staffed by sales and service personnel who have received thorough factory training on the products described in this catalog.

Warranty

Each product manufactured by GenRad and described in this catalog is warranted against defects in material and workmanship. A statement of the specific warranty coverage of each product appears in the instruction manual provided with the product and, when a test system is the product, the warranty statement is also attached to the quotation. GenRad follows a policy of maintaining a repair capability for every product for 10 years after the original shipment of the product.

A copy of the specific warranty applicable to a product will be provided upon request.

Service Policy

Your local GenRad office or representative will assist you in all matters relating to product maintenance, such as calibration, repair, replacement parts and service contracts. Field servicing of GenRad system products can be accomplished by any of the following methods:

- By GenRad on a contract specifying a fixed price per period or per call,
- By GenRad on a per call basis with no contract, or
- By the customer, after service training by GenRad.

Products that have been repaired at a GenRad service facility, with a charge for both parts and labor, are warranted to perform in full accordance with the specifications in effect at the time of original shipment. If, within a period of three months after such repair, it is found and verified by us that the product fails to meet this standard, it will be repaired or, at our option, replaced with no charge for parts or labor, provided the product is returned to a GenRad service facility.

Any GenRad product returned for credit will be subject to a restocking charge. If more than six months have elapsed since original shipment, it will not be accepted for credit. Authorization must be obtained from your local GenRad office or representative before a product is returned for credit.

Ordering Information

The procedures, terms, and conditions outlined on these pages apply to most GenRad products. Where practical, exceptions are noted. However, all exceptions are not covered and we advise that you contact GenRad's nearest sales office to verify specific terms and conditions.

Where to Order

USA and Canada

Please address orders and other communications to the sales facility nearest you.

Other Countries

Customers outside the United States and Canada are served by GenRad, its European subsidiaries, and by various export representatives, listed on pages 5 through 7. Please direct all communications to the appropriate representative. For countries not listed, inquiries should be addressed to GenRad, Inc., Concord, Massachusetts 01742, USA.

How to Order

Standard Catalog Terms

Always order by catalog number (if included), type number, and complete description. Some ac-operated instruments are supplied wired for operation from 115-volt power, unless otherwise specified, although most instruments come equipped with a 115-V/230-V slide switch that permits selectable power operation. Most instruments can also be supplied for operation from other common voltages and frequencies as indicated in the specifications under Power. Be sure to specify operating voltage and frequency if other than nominal 115 volts, 60 Hz.

Special Features

Special features and modifications not listed in the specifications (such as extra calibrations or software) are available at extra cost. Please include in your order information regarding any nonstandard features desired.

Nonstandard Systems

Systems that require hardware and/or software other than that described in the catalog are subject to quotation. Please make reference to the quotation when placing your order for the applicable system.

Conditions of Sale

Determination of prices, terms and conditions of sale and final acceptance of orders are made only at GenRad's facilities in Concord, MA and Santa Clara, CA; at GenRad Ltd., Toronto, Canada; or at any of GenRad's European subsidiaries.

USA and Canada

For instruments: Terms are net 30 days if credit has been arranged; otherwise, unless payment is received before shipment, shipment will be made COD. Extended terms are available for higher-priced instruments.

For systems: Subject to credit approval, partial payments are required with issuance of purchase order, at time of shipment, and 30 days from installation and acceptance. Actual terms are available on request. Assistance in the area of leasing or conditional sale is also available.

Outside USA and Canada

Terms of payment for orders placed on GenRad representatives and on GenRad European subsidiaries are those that are mutually agreed upon. If there is no representative in your area, the terms for orders placed directly on GenRad, Inc. are full payment in advance of shipment or an irrevocable letter of credit, unless other terms have been previously arranged.

Quantity Discount

Quantity discounts apply to some products. Refer to current price list for applicable discounts.

Minimum Billing

The minimum billing per order is \$25. This applies to all purchases except cash-with-order transactions.

Source-Inspection Surcharge

A surcharge of 1 percent (\$5.00 minimum) applies on all orders requiring inspection before shipment. The inspection surcharge applies on each shipment inspected and covers only our costs.

Shipping Instructions

Unless specific instructions accompany the order, we shall use our judgment as to the best method of shipment. Shipments can be made by either air or surface transportation. For fast delivery, at a reasonable premium over other means, air shipment is generally recommended and will be employed on request.

Prices

The prices of all instruments described in this catalog appear in separate price lists, copies of which may be requested from any of the sales offices listed herein. Prices in the domestic price lists apply only on transactions originating in the USA, include the cost of domestic packing, are F.O.B. shipping point, and are exclusive of all taxes now in effect or that may be imposed by Federal, State, or local governments. Exceptions are noted in the price list.

Prices given in the price lists are subject to change without notice. Formal price quotations remain in effect for 30 days, 60 days for quotations to export customers. An export-order-handling charge and special packing charge are applied to export orders. Applicable F.O.B. prices for transactions originating outside the USA may be obtained from the GenRad subsidiary or representative nearest you (see pages 4 through 7).

Power-Supply Considerations

GenRad ac-operated instruments will meet the published specifications when operated from power lines whose voltages and frequencies are within the limits stated in the specifications under the heading Power.

Most instruments have input voltage ranges of 100 to 125 and 200 to 250 volts and will therefore operate on nominal power-line voltages of 115, 220, 230, and 240 volts. The voltage range for which an instrument is wired is marked at the power-input plug or cord. Proper fuses for this voltage range are fitted in the fuse holders.

When the power-line voltage on which the instrument is to be operated is specified on the order, the necessary changes in connections, fuses, and name plate are made at the factory. Instruments equipped with line-voltage-selector slide switches are set for 115 volts when shipped.

Certain instruments are available for use only on power lines of 220, 230, and 240 volts (nominal).

For most instruments, the normal operating frequency range is 48 to 62 hertz.

All ac-operated instruments are supplied with three-wire power cords, designed for USA standard three-wire receptacles.

Battery Operation

Portable, battery-operated instruments are shipped with dry-cell batteries packed separately to prevent drain and leakage during shipment. To render the instrument operative, the user need only install the batteries.

Dimensions

Over-all dimensions are given for instruments except that the depth dimension for rack-mount instruments is actually depth behind panel, i.e., clearance required. However, no allowance is made for additional clearance that may be required for cables and connectors at rear panel.

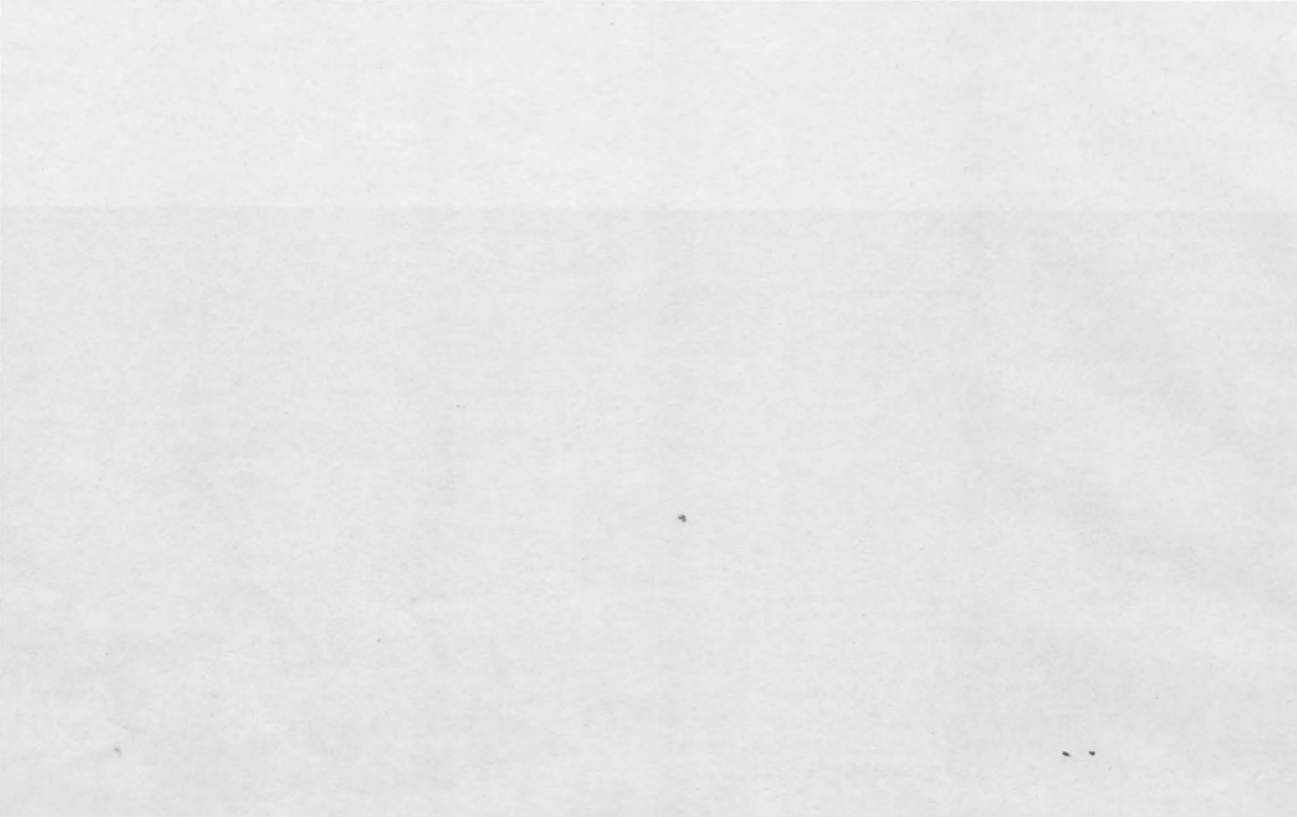

Impedance Measurement

GenRad makes a wide line of impedance-measuring instruments which covers a variety of applications in research and development laboratories, incoming inspection, quality control, production testing, and service repair. The chart lists these GenRad instruments and

some of their main characteristics. It should be of aid in selecting the best instrument for a particular measurement. Refer to the individual catalog pages for full specifications.

| Instrument | Quantities Measured Main (Secondary) | Frequencies Internal (External) | Basic Accuracy | Readout Main (Secondary) | Features |
|--|--------------------------------------|------------------------------------|------------------------------------|--------------------------|---|
| IMPEDANCE | | | | | |
| MANUAL RLC: | | | | | |
| 1650-B Impedance Bridge | C, G, R, L (D, Q) | dc, 1 kHz (10 Hz — 100 kHz) | 1% | dial (dial) | Portable. Orthonull® balance-finder helps low-Q balance. |
| 1656 Impedance Bridge | C, G, R, L (D, Q) | dc, 1 kHz (20 Hz — 20 kHz) | 0.1% | 4 digits (dial) | Lever switches for fast balance. Sensitive dc bridge. <i>portable</i> |
| 1608 Impedance Bridge | C, G, R, L (D, Q) | dc, 1 kHz (20 Hz — 20 kHz) | .05% | 4+ digits (dial-digits) | Accurate. Digital readout with units. |
| AUTOMATIC RLC: | | | | | |
| 1657 RLC Digibridge™ <i>p 22</i> | C, R, L (D, Q) | 120 Hz, ** 1 kHz | 0.2% | 5 digits (4 digits) | Built-in test fixture. μ P-controlled. 3 meas/s. |
| 1658 RLC Digibridge™ <i>p 24</i> | C, R, L (D, Q) | 120 Hz, ** 1 kHz (other available) | 0.1% | 5 digits (4 digits) | Multi-limit sorting. μ P-controlled. 3 meas speeds. Autorange. |
| 1683 Automatic RLC Bridge <i>p 26</i> | C, L (D, R) | 120 Hz, ** 1 kHz | 0.1% | 4½ digits (4½ digits) | Fast. Variable test voltage. Leakage current, ESR options. |
| 1685 Digital Impedance Meter <i>p 28</i> | C, R, L (D, Q) | dc, 120 Hz, ** 1 kHz | 0.1% (dc & 1 kHz) 0.5% (120 Hz) | 4½ digits (dial) | DC resistance. Built-in limit comparator. |
| DEVIATION: | | | | | |
| 1654 Impedance Comparator | $\Delta Z\%$, $\Delta \theta$ | 100 Hz; 1, 10, & 100 kHz | to .003% | meters | No balance. % indication. Rapid sorting. |
| 1654-Z Sorting Systems include 1782 Analog Limit Comparator for multi-limit sorting and/or 1413 Decade Capacitor to indicate $\Delta C\%$ and ΔD . | | | | | |
| HIGH FREQUENCY: | | | | | |
| 1687 MHz LC Digibridge™ <i>p. 33</i> | C, L (R, G, D, Q) | 1 MHz | 0.1% | 5 digits (4 digits) | Multi-limit sorting. μ P-controlled. % deviation. |
| 1606-B Radio-Frequency Bridge | R, X | (400 kHz — 60 MHz) | 2% | dials | Wide frequency range. Direct reading in ohms. |
| 1602-B UHF Admittance Meter | G, B | (20 MHz — 1.5 GHz) | 3% | dials | Direct-reading G and B. Wide frequency range. Versatile. |
| 874-LBB Slotted Line | SWR, Γ , λ , Z | (300 MHz — 9 GHz) | see specifications | scale and ext det | Wide frequency range. Low residual SWR. |
| 900-LB Precision Slotted Line | SWR, Γ , λ , Z | (300 MHz — 8.5 GHz) | see specifications | scale and ext det | Wide frequency range. Extremely low residual SWR. |
| CAPACITANCE | | | | | |
| 1615 Capacitance Bridge | C (D, G) | (10 Hz — 100 kHz) | .01% | 6 digits (4 digits) | 10^{-5} pF to 11 μ F. Lever adjustment. 2- or 3-terminal. |
| 1620 Capacitance-Measuring Assembly includes 1615 Bridge, 1311 Oscillator, 1232 Detector to get part-per-million C and D sensitivity. | | | | | |
| 1616 Precision Capacitance Bridge | C (G) | (10 Hz — 100 kHz) | .001% | 13 digits (5 digits) | 10^{-7} pF to 10 μ F. 10^{-10} μ S to 1000 μ S. 2- or 3-terminal. |
| 1621 Precision Capacitance Measuring System includes 1616 Bridge, 1316 Oscillator, 1238 Detector for .01-ppm sensitivity. | | | | | |
| 1617 Capacitance Bridge | C (D) | 120 Hz ** (40 Hz — 1 kHz) | 1% | dial (dial) | 1 pF to 1 F, high bias provided. 4-terminal. Measures leakage current. |
| 1686 Digital Capacitance Meter | C (D) | 120 Hz, ** 1 kHz | 0.5% (120 Hz) 0.1% (1 kHz) | 4½ digits (dial) | Limit comparator. 4 meas/s. Variable test voltage. |
| RESISTANCE | | | | | |
| 1666 DC Resistance Bridge | R, G | dc | .01% | 6 digits | Wide range. 1 μ Ω to 1 T Ω (1 pS). Guarded. 4-terminal. Lever switches. |
| 1644 Megohm Bridge | R | dc | 1% | dial | ΔR dial to 0.1%. 10 V to 1000 V. 1 k Ω -to-1000 T Ω resistance range. |
| 1863 Megohmmeter | R | dc | 3% to 12% | meter | 50, 100, 200, 250 or 500-V test voltage. 50 k Ω -to-20 T Ω resistance range. |
| 1864 Megohmmeter | R | dc | 3% to 12% | meter | 10 V to 1000 V in 1-V or 10-V steps. 50 k Ω -to-200 T Ω resistance range. |
| INDUCTANCE | | | | | |
| 1633-A Incremental Inductance Bridge | L (R, Q) | ext osc, int det (20 Hz — 20 kHz) | 1% | dial (dial) | For iron-core coils. 9 internal detector frequencies 50 Hz — 15.75 kHz. |
| 1630-AV Inductance-Measuring System includes 1633 Bridge, 1308 Oscillator, 1265 dc bias supply to get up to 5-A dc bias. 400-V rms signal. | | | | | |

*See also 2230 Component Test System. **100-Hz version available.

The following discussion defines some of the terms used in the specifications of impedance-measuring instruments and outlines some of the measurement methods used.

Definitions

Ohm's Law For dc, Ohm's law defines resistance, R , as the ratio of the voltage across a device to the current through it.

$$R = \frac{E}{I} \quad (1)$$

The reciprocal of resistance is conductance, G .

For ac, this ratio is complex because the voltage and current have relative phase as well as magnitude. This complex quantity is impedance, Z .

$$Z = \frac{E}{I} = R + jX \quad (2)$$

where R is (ac) resistance and X is reactance.

The reciprocal of impedance is admittance, Y .

$$Y = \frac{1}{Z} = \frac{1}{E} = G + jB \quad (3)$$

where G is (ac) conductance and B is susceptance.

Other quantities used to express impedances and their units and prefixes are given in the Appendix at the rear of the catalog.

Equivalent Series and Parallel Components, D and Q Any impedance, regardless of its actual physical configuration, can be expressed, at any given frequency, as either a series or a parallel combination of resistance and reactance, as shown in Figure 1. The relationship between these elements is:

$$\begin{aligned} Z = R_s + jX_s &= \frac{1}{Y} = \frac{1}{G_p + jB_p} \\ &= \frac{G_p}{G_p^2 + B_p^2} - j \frac{B_p}{G_p^2 + B_p^2} \end{aligned} \quad (4)$$

or:

$$\begin{aligned} Y = G_p + jB_p &= \frac{1}{Z} = \frac{1}{R_s + jX_s} \\ &= \frac{R_s}{R_s^2 + X_s^2} - j \frac{X_s}{R_s^2 + X_s^2} \end{aligned} \quad (5)$$

where the subscripts s and p denote series and parallel values. We could also use parallel resistance instead of parallel conductance, $R_p = 1/G_p$, and parallel reactance instead of parallel susceptance, $X_p = 1/B_p$; but $R_p \neq R_s$ and $X_p \neq X_s$; see Equation (5).

The dissipation factor, D , is defined as

$$D = \frac{R_s}{X_s} = \frac{X_p}{R_p} = \frac{G_p}{B_p} \quad (6)$$

and the storage (or quality) factor

$$Q = \frac{1}{D} = \frac{X_s}{R_s} = \frac{R_p}{X_p} = \frac{B_p}{G_p} \quad (7)$$

Using these quantities, we get

$$R_p = \frac{1}{G_p} = R_s (1 + Q^2) \quad (8)$$

and

$$X_p = \frac{1}{B_p} = X_s (1 + D^2) \quad (9)$$

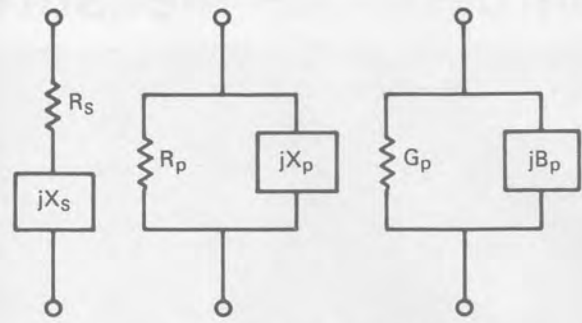

Figure 1. Series and parallel components of impedance.

The reactances of Figure 1 are either capacitive or inductive so that, at any given frequency, an impedance acts like a combination of equivalent resistance and inductance, L , or equivalent resistance and capacitance, C , and these quantities have different values depending upon whether they are in series or in parallel. The relationships between these quantities are:

$$C_p = C_s \left(\frac{1}{1 + D^2} \right) \quad (10)$$

or

$$C_s = C_p (1 + D^2), \quad (11)$$

$$L_p = L_s \left(1 + \frac{1}{Q^2} \right) \quad (12)$$

or

$$L_s = L_p \frac{Q^2}{1 + Q^2}, \quad (13)$$

$$\text{and } D \text{ of a capacitor} = \omega R_s C_s = \frac{1}{\omega C_p R_p} \quad (14)$$

$$\text{and } Q \text{ of an inductor} = \frac{\omega L_s}{R_s} = \frac{R_p}{\omega L_p} \quad (15)$$

Many GenRad bridges allow the measurement of either the series or parallel values of C and L . Generally, components are specified in terms of their series values. Note that if $D < 0.1$ (or $Q > 10$) the difference between series and parallel values is less than 1%. Most ac bridges measure D of capacitance and Q of inductance and sometimes the Q of resistors can also be measured. In some countries, D is referred to as $\tan \delta$, the tangent of the angle δ in the vector (phasor) representation of impedance or admittance of Figure 2. This figure also defines the power factor, PF.

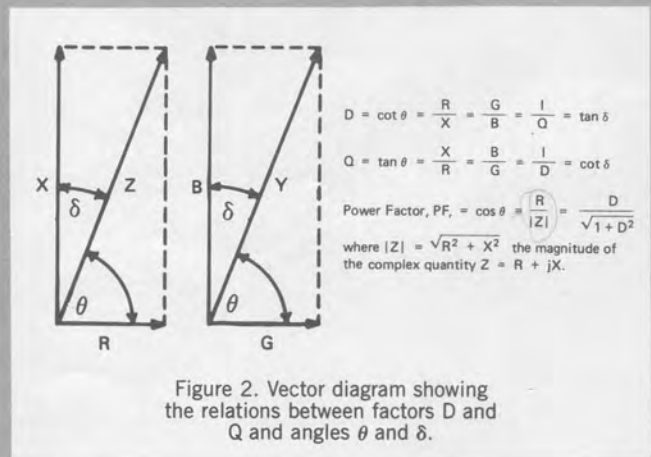

Figure 2. Vector diagram showing the relations between factors D and Q and angles θ and δ .

Three- and Four-Terminal Measurements Many GenRad instruments are capable of making measurements that are quite immune to errors caused by either shunt admittance or series impedance. This means that they make good guarded, three-terminal measurements or four-terminal "Kelvin" measurements, respectively.

In order to measure the direct capacitance C_{HL} in the circuit of Figure 3, the guard terminal, G, must not be left floating because, if it is, C_{HL} is shunted by the series combination of C_{HG} and C_{LG} . A three-terminal connection must be made and the instrument used must not be affected by these two shunting capacitances. This situation is very common, particularly when measuring shielded, three-terminal capacitance or any high impedance connected with shielded cables. The shunting impedances are not always just capacitive; they could be leakage resistances in a dc measurement or even actual circuit components, as would be the case if a component must be measured while it is connected in a circuit. Almost all of GenRad's bridges and meters are capable of making such three-terminal, or guarded, measurements, but the amount of shunt admittance they can tolerate without error depends on the type of circuit used. The best in this respect are the precise transformer-type capacitance bridges (1615 and 1616 — see **Measurement Methods**).

When low impedances are measured, a two-terminal connection has errors caused by the addition of the series impedance of the connecting leads to the impedance to be measured. One way to correct for this error is to

short-circuit the test leads at the far end, measure the lead impedance, and subtract it from later measurements of the unknown. A better way is to make a four-terminal measurement. The four-terminal impedance value of Figure 4 is E_o/I_{in} , and this value is independent of the "lead" impedances, Z_1, Z_2, Z_3 and Z_4 . Any instrument that makes a four-terminal connection and is immune to lead impedances of reasonable value makes a good four-terminal measurement. This four-terminal connection is also called a Kelvin connection, after Lord Kelvin whose famous bridge (used in the GR 1666) makes good four-terminal resistance measurements. Many low-impedance standards have four terminals and require this type of measurement, as does the accurate measurement of any low-valued impedance.

The terminals carrying the current (Figure 4) are called the current terminals and those used to make the voltage measurement are called the potential terminals. In theory, and in many cases, these pairs of terminals can be interchanged and yet give the same result. Most instruments, however, can tolerate more series impedance in some of their connections than in others so that consideration should be given as to how they are connected. Also, when very high currents are used, they should be applied to the current terminals, which are designed to carry them; the potential terminals could be damaged.

In many cases, four-terminal measurements are made on low-valued components that have only two lead wires, in order to avoid errors caused by the connections to the bridge. Two connections are made to each lead, and it is the position of the inner connections that determines how much of the component's lead impedance is included in the measurement. In Figure 4, the effective four-terminal value includes all the impedance between the junctions a and b and, in the two-lead case, these points are where the inner connection is made.

Several GenRad instruments make good four-terminal measurements. Many of these also make good three-terminal measurements at the same time and sometimes this combination is called a "five-terminal" measurement.

Coaxial Two-Terminal Measurements At higher frequencies, in the megahertz range and up, many instruments make only two-terminal measurements and these use coaxial connections. In order to make precise, repeatable measurements, a precision connector is required. The GR900® connector was designed for this purpose. It can reduce capacitance uncertainties to a few femtofarads and resistance uncertainties to a fraction of a milliohm. GenRad makes several instruments that use these precision connectors (see **Coaxial-Line Instruments**).

Measurement Methods

Bridges and Meters Historically, impedance-measuring instruments were usually divided into meter types, which measured voltage or current on meters calibrated in impedance quantities, and bridge or null types, which required an adjustment and indicated impedance on a scale or dial associated with a variable component of some kind. A bridge was generally more accurate while a meter was faster and easier to use.

Many applications require both accuracy and speed. Some years ago, GenRad developed both bridges that made fast balances automatically and impedance meters that used precise circuitry and digital readouts to obtain good accuracy. The distinction between bridge and meter became less meaningful. More recently, the GR Digi-bridge™ method has all but destroyed this distinction because while, strictly speaking, it uses a meter method, it has many properties of a bridge.

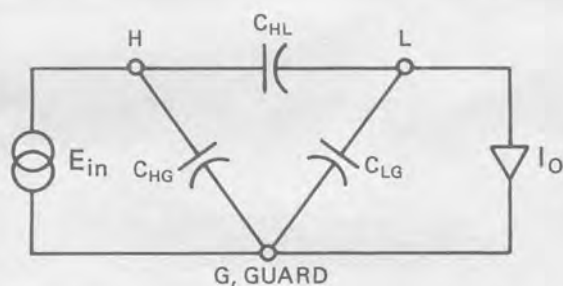

$$\frac{I_o}{E_{in}} = j\omega C_{HL}$$

Figure 3. Three-terminal capacitance and an ideal 3-terminal measurement.

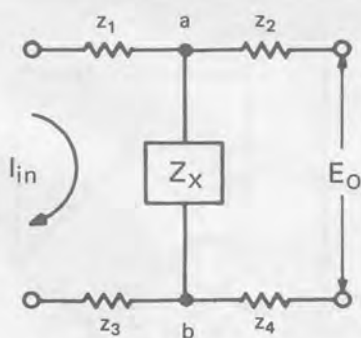

$$\frac{E_o}{I_{in}} = Z_x$$

Figure 4. 4-terminal impedance and an ideal 4-terminal measurement.

GenRad makes many types of impedance-measuring instruments. The various measurement techniques used are discussed below.

DC Bridges The Wheatstone bridge measures an unknown resistance, R_x , in terms of calibrated standards of resistance connected as shown in Figure 5. A dc source (GEN) must be applied and a dc null detector (DET) used to detect output voltage. When this output voltage is zero, the bridge is balanced or nulled and the relationship between the resistors is

$$R_x = \frac{R_N R_B}{R_A} = R_N R_B G_A \quad (16)$$

Generally, one of the standard resistors is adjustable and has a calibrated readout proportional to its value. Another standard (or the other two) is changed to extend the bridge range. The GR 1644 Megohm Bridge is a Wheatstone bridge designed for measuring high-value resistors at high voltages. A guarded Wheatstone circuit is used in the GR 1666 Resistance Bridge, which also uses the Kelvin Double Bridge circuit to make four-terminal measurements.

AC Bridges This Wheatstone bridge circuit is adaptable to ac measurements but, with complex ac impedance, two balances are necessary to balance both the real (resistive) and imaginary (reactive) parts in order to obtain a null. At balance

$$Z_x = R_x + jX_x = Z_N Y_A Z_B \quad (17)$$

or

$$Y_x = G_x + jB_x = Y_N Z_A Y_B \quad (18)$$

The first of these equations expresses the unknown in terms of impedance and the second in terms of admittance. To satisfy these equations, at least one of the three arms, N, A, or B, must be complex.

A reactance, X_x , can be measured in terms of a similar reactance in an adjacent arm (Figure 6) or an unlike reactance in the opposite arm (Figure 7). Bridges rarely use standard inductors.

The complex arm required to satisfy balance conditions of Equations (17) or (18) may be a resistance and reactance either in series or parallel. The bridge will indicate equivalent series components if this complex arm is a series connection in an adjacent arm or a parallel connection in the opposite arm. The converse is also true.

If both components in this complex arm are adjustable, the balances for the real and imaginary parts of the unknown will be independent of each other and orthog-

onal. If only one component of this combination is adjustable, this component will be proportional to D or Q of the unknown. In this case, when D is very high or Q very low, the two bridge adjustments will interact, causing a slow balance convergence. The 1650-B Impedance Bridge and the 1617 Capacitance Bridge use a mechanical ganging of the bridge controls (called the Orthonull® balance finder) to facilitate convergence.

GenRad's three general-purpose impedance bridges (1650-B, 1656, and 1608) use the basic circuits of Figures 5, 6 and 7 to measure R, C and L and have additional D or Q adjustments connected to allow both series and parallel equivalent values. These use adjustable resistors (pots or decades) and resistance ratio arms to extend the range. The GR 1606 RF Bridge uses variable capacitors for better high-frequency performance. One of these is in the same arm with the unknown and makes what is known as a series substitution measurement, in which the equivalent series reactance of the unknown is measured as a change in this series-connected variable capacitor.

Transformer-Ratio-Arm Bridges While inductance standards are rarely used in bridges because they are generally larger, less stable, and less pure than resistors or capacitors, a transformer can form an inductively-coupled voltage divider whose ratio is more precise and stable than one made with resistors or capacitors. Ratio accuracies of a few parts per million are possible even for ratios as high as 1000 to 1 and these ratios are virtually unaffected by age, temperature, humidity or voltage. Such a divider can be used as two adjacent arms of a bridge, giving the bridge extremely precise ratio accuracy.

The GR 1654 Impedance Comparator uses a fixed, unity-ratio transformer and the two precise capacitance bridges, GR 1615 and GR 1616, use multiple-tapped transformers to allow decade adjustment, as shown simplified in Figure 8. The balance equation for this circuit is

$$G_x + j\omega C_x = \frac{N_1}{N_2} [\beta_1 G_1 + \beta_2 G_2 + \dots + j\omega (\alpha_1 C_1 + \alpha_2 C_2 + \dots)] \quad (19)$$

where α and β are the decade ratio values adjusted by the panel lever controls. (Actually, there are many more than two of each.)

Transformer-ratio-arm bridges have a second, equally important, characteristic in that they can make very good three-terminal measurements. Their tolerance to loading capacitances is illustrated in Figure 8. Here, C_B shunts

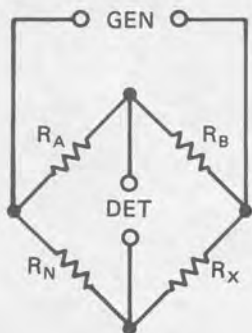
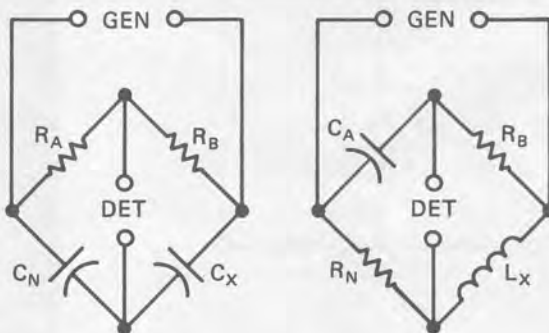

Figure 5. The general Wheatstone bridge circuit.



Figures 6 and 7. Circuits for capacitance bridges in which like reactances (left) or unlike reactances (right) are compared.

the detector, causing no error directly, only a reduction in sensitivity if C_B is very large. The other capacitance, C_A , shunts the transformer winding and thus tends to reduce the voltage across the unknown. However, because of the tight coupling between the two windings (N_1 and N_2), the voltage on the standard capacitors will be reduced in very nearly the same proportion as the unknown voltage, leaving the balance condition (almost) unchanged. A $1\text{-}\mu\text{F}$ load at 1 kHz makes an almost negligible error. This high immunity allows remote measurements with long cables with guarded shields and even many measurements of capacitors connected in networks.

Active and Automatic Bridges In the transformer-type bridge of Figure 8, fixed standards are used and voltages are varied to give a null. A potentiometer could also be used to vary the voltage on a fixed standard, but its output resistance would add to the impedance of the standard. A

multi-stage, unity-gain amplifier can have a very low output impedance so that, when used with a potentiometer, it makes good adjustable voltage to drive fixed standards. This scheme is used on the GR 1633 Incremental Inductance Bridge, allowing it to make direct-reading measurements at many different frequencies.

The GR 1683 Automatic Bridge adjusts voltages on fixed standards automatically so that no manual adjustment is required. This method is outlined in Figure 9. The voltages on the two standards, G_S and C_S , are rapidly adjusted by two precision-resistor voltage dividers controlled by digital signals (i.e., two digital-to-analog converters). At null, the measurement results are proportional to these divider ratios which, in turn, are proportional to the digital control settings. A decimal display of these digital numbers is therefore a measure of the unknown impedance.

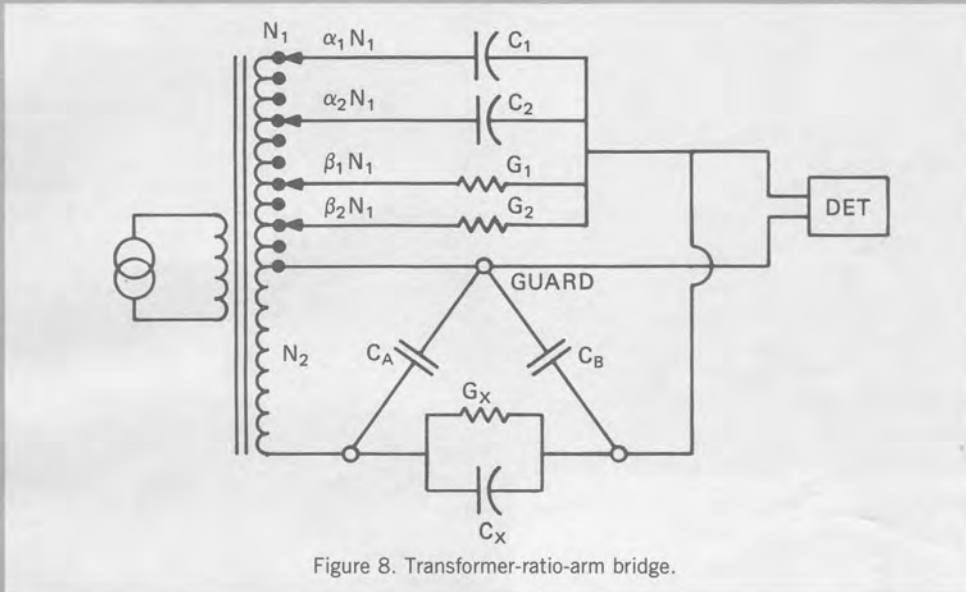

Figure 8. Transformer-ratio-arm bridge.

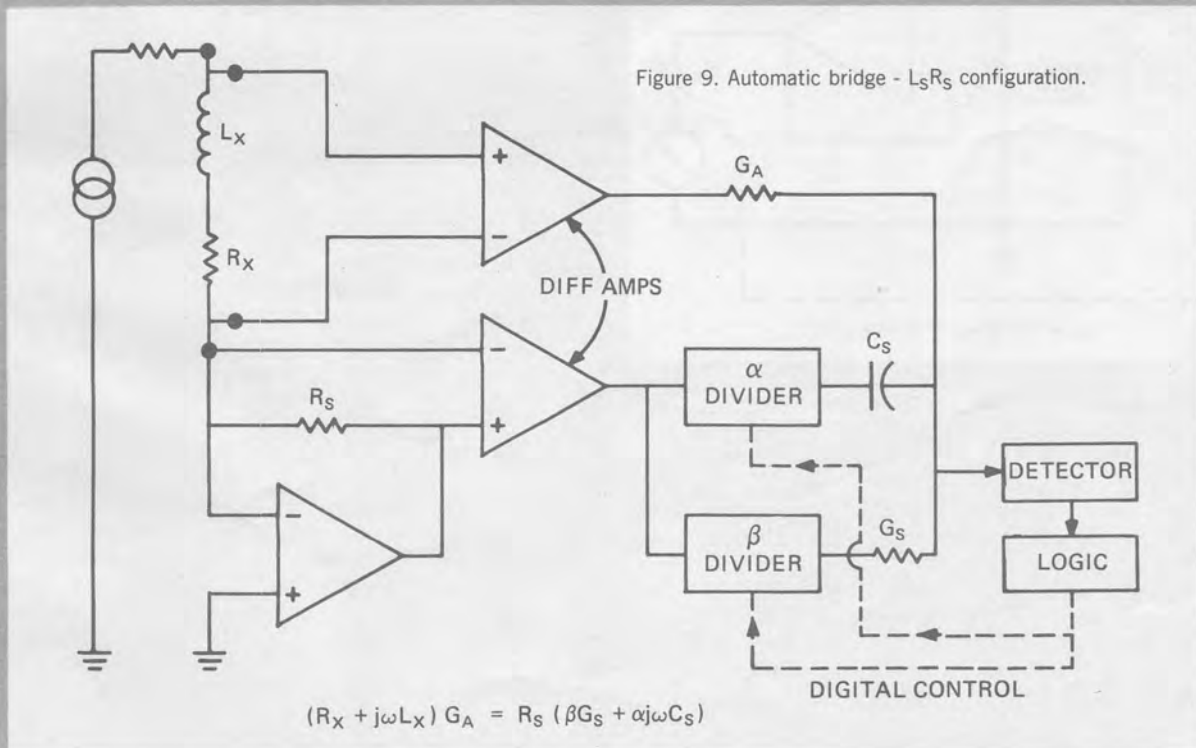

Figure 9. Automatic bridge - $L_S R_S$ configuration.

$$(R_X + j\omega L_X) G_A = R_S (\beta G_S + \alpha j\omega C_S)$$

Impedance Comparator The GR 1654 Impedance Comparator is both bridge and meter. It measures the difference between two, similar, externally-connected impedances which, together with two precision inductively-coupled arms, form a bridge circuit. This bridge is not balanced. Instead, the phase components of the bridge unbalance voltage are displayed on meters as percent-magnitude difference and phase-angle difference. If these impedances are relatively pure resistance, capacitance, or inductance, then the magnitude difference is very nearly the percent difference in R, C or L and the phase-angle difference is ΔQ , ΔD and $\Delta \Delta$, respectively.

This comparator can indicate very small differences, down to .003%, if the two external impedances are close in value. It can also resolve D differences of .00003. Moreover, it makes measurements at 100 Hz, 1 kHz, 10 kHz, and 100 kHz. This combination of sensitivity and wide frequency range is valuable for many difficult measurements. Impedance comparators can be combined with analog limit comparators and decade standards to make inexpensive test systems for rapid sorting (see the 1654-Z systems).

Analog Meters The two GR megohmmeters (1863 and 1864) use the simple analog meter method outlined in Figure 10. Here, a high dc voltage is applied to the unknown, R_x , and the subsequent current is measured as a voltage across a standard resistor, R_s (one of a set selected by a range switch). The value of the applied voltage is selected by panel switches that also change the meter sensitivity so that the meter deflection is a function of R_x , not I_x . These megohmmeters have wide range, going up to over 100 T Ω . They are commonly used for testing insulation resistance of electrical machinery and leakage resistance of capacitors.

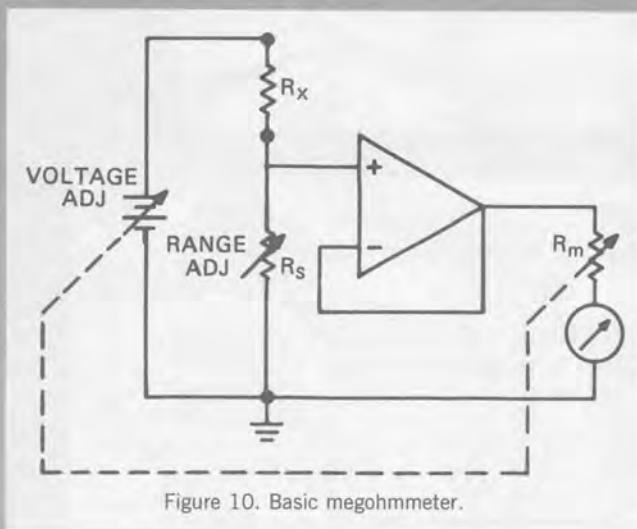

Figure 10. Basic megohmmeter.

Digital Meters Just as digital voltmeters have much better accuracy than analog ones, so too can digital impedance meters be much more accurate than analog types. One obvious reason is the increased resolution or readability of a multidigit readout as compared to an analog scale. To make this resolution useful, however, requires precise measurement circuitry.

In the GR 1685 Digital Impedance Meter and 1686 Digital Capacitance Meter, the secret of getting good accuracy is the precise analog ratiometer used. Rather than try, as do the megohmmeters, to hold a voltage (or current) constant so that a single variable current (or voltage) is a measure of impedance, these digital meters measure both voltage and current and take their ratio on a

modified phase-sensitive, dual-slope integrator circuit capable of high precision. These two instruments have built-in digital limit comparators for rapid go/no-go sorting. A high D (or low Q) limit may also be set.

Like the automatic bridge and the Digibridges, these digital meters use an active measurement circuit that has good immunity to both lead impedance and shunt loading and thus makes good "five-terminal" measurements (see Figure 9).

Digibridge™ Meters Impedance is defined as a ratio or division, and the best way to make an accurate division is with a digital computer. The GenRad Digibridges (1657, 1658, and 1687) use small, inexpensive microprocessors for a precise digital division and for many other functions as well.

Digibridges are not really bridges because there is no null. They successively measure the voltage across the unknown and the voltage across a standard resistor carrying the same current, with the same ac analog-to-digital converter, and divide the digital results. The quotient is independent of the scale factor of the converter because it cancels in the division. These Digibridges measure complex ac quantities so that the measuring circuit must also include a phase-sensitive detector, two measurements must be made on each signal, and the division is that of two complex numbers. To express the results in terms of capacitance or inductance requires a multiplication or division by the angular frequency, which is precisely known because a quartz-crystal oscillator is used.

Because the result is independent of the detector-converter gain, the only precise components, besides the crystal oscillator, are the standard resistors used. In this respect, the Digibridge is more like a bridge than a meter. It has the advantage over a bridge that no adjustable components are necessary, and adjustable components are a main source of the phase shifts that cause D or Q errors, as well as being another source of magnitude error.

The GR 1658 and 1687 have a keyboard with which to enter test limits for fast multiple-limit sorting of components.

Coaxial-Line Instruments

The Admittance Meter The high-frequency behavior of conventional bridge circuits is limited by residual impedances in the lumped bridge elements and their connections. At frequencies higher than about 100 MHz, circuits based on coaxial-line techniques are more satisfactory. The GR 1602-B UHF Admittance Meter is a null device based on these techniques. It uses adjustable coupling loops to sample currents in the unknown and in standards of conductance and susceptance. When a null balance is made, scales associated with these adjustments read admittance directly.

The Slotted Line One of the basic methods of determining impedance of a coaxial device is the measurement of the standing-wave ratio it introduces into a uniform line. The measurement is made by means of a coaxial line in whose outer conductor is a longitudinal slot. An electrostatic probe enters the line through this slot and can be moved along the line to sample the electric field between the inner and outer conductors. From the voltage maximum and minimum, and their location with respect to the unknown, the impedance can be calculated. This instrument is one of few in which the impedance standard is inherently part of the instrument and can be determined in absolute terms, from physical dimensions.

GenRad offers two slotted lines: the 874-LBB for general impedance measurements, and the highly accurate 900-LB for precise impedance measurements.

1650-B Impedance Bridge

- measures L, C, and loss; R and G
- 1% accuracy
- 20 Hz to 20 kHz, internal 1 kHz and dc
- portable, self-contained, battery-operated

The 1650 Impedance Bridge will measure the inductance and storage factor, Q, of inductors*, the capacitance and dissipation factor, D, of capacitors, and the ac and dc resistance or conductance of resistors.

Three-terminal measurements can be made in the presence of considerable stray capacitance to ground.

This bridge is completely self-contained and portable. Battery-powered, low-drain solid-state oscillator and detector are included. The panel meter indicates both dc and ac bridge unbalances.

The measured quantities, R, G, L, C, D, and Q, are indicated directly on dials with logarithmic scales for constant percentage accuracy. Multipliers and the units of measurement are indicated by the range setting.

The bridge circuit elements are high-quality, stable components that ensure long-term accuracy. The Ortho-null® balance finder, a patented mechanical-ganging device, is used to make a low-Q (high-D) balance possible without a sliding null. This mechanism, which may be switched in or out as desired, adds accuracy as well as



convenience to low-Q measurements that are practically impossible on other impedance bridges.

The Flip-Tilt case provides a convenient handle and a captive protective cover and base that allow the bridge panel to be tilted for use at any angle.

* Including such low-Q inductors as rf coils measured at 1 kHz.

SPECIFICATIONS

| Ranges of Measurement | Accuracy | | |
|--|---|---|-----------|
| | 20 Hz to 20 kHz † | DC | Residuals |
| Capacitance 1 pF to 1100 μF, series or parallel, 7 ranges | ±1% ± 1 pF | — | ≈ 0.5 pF |
| Inductance 1 μH to 1100 H, series or parallel, 7 ranges | ±1% ± 1 μH | — | ≈ 0.2 μH |
| Resistance ac or dc, 1 mΩ to 1.1 MΩ, 7 ranges | ±1% ± 1 mΩ | ±1%, 1 Ω to 100 kΩ, ext supply or detector required for > 100 kΩ and < 1 Ω. | ≈ 1 mΩ |
| Conductance ac or dc, 1 nΩ to 1.1 Ω, 7 ranges | ±1% ± 1 nΩ | ±1%, 10 μΩ to 1 Ω, ext supply or detector required for < 10 μΩ. | |
| Dissipation Factor, D, at 1 kHz: 0.001 to 1, of series C, 0.1 to 50, of parallel C. | ±5% ± 0.001 at 1 kHz and lower | — | |
| Storage Factor, Q, at 1 kHz: 0.02 to 10, of series L, 1 to 1000, of parallel L. | 1/Q accurate to ±5 ± 0.001 at f ≤ 1 kHz | — | |

† Bridge operates up to 100 kHz with reduced accuracy.

Generator: Internal; 1 kHz ±2%. Type 1310 or 1311 Oscillator recommended if external generator is required. Internal dc supply, 6 V, 60 mA, max.

Detector: Internal or external; internal detector response flat or selective at 1 kHz; sensitivity control provided. Type 1232-A Tuned Amplifier and Null Detector is recommended if external detector is required. Combination of 1311 oscillator and 1232 detector is available as the 1240 Bridge Oscillator-Detector.

DC Polarization: Capacitors can be biased to 600 V from external dc power supply for series capacitance measurements.

Required: None. Earphones can be used for high precision at extremes of bridge ranges.

Available: Type 1650-P1 TEST JIG.

National stock numbers are listed at the back of the catalog.

Power: 4 size-D cells, supplied.

Mechanical: Flip-Tilt case and rack mount. DIMENSIONS (wxhxd): Portable, 13x6.75x12.25 in. (330x171x311 mm); rack, 19x12.25x4.13 in. (483x311x105 mm). WEIGHT: Portable, 17 lb (8 kg) net, 21 lb (10 kg) shipping; rack, 18 lb (9 kg) net, 30 lb (14 kg) shipping.

| Description | Catalog Number |
|---|----------------|
| 1650-B Impedance Bridge | |
| Portable Model | 1650-9702 |
| Rack Model | 1650-9703 |
| Replacement Battery , size D cell, 4 req'd | 8410-0200 |
| Patent Number 2,966,257. | |



1656 Impedance Bridge

- measures R, L, C, and G
- 0.1% basic accuracy
- fast lever balancing
- digital readout of RLC and G
- portable, self-contained

Today's components demand high-precision measurements; today's schedules demand fast answers. GR's 1656 meets these demands. A precision adaptation of a long-time favorite bridge, the 1656 simplifies 4-place balancing with lever switches and reduces possible reading error with in-line digital readout of impedance.

Though of laboratory accuracy, the 1656 is also the ideal general-purpose instrument for production, inspection, and field use. It's fully portable and self-contained for both ac and dc measurements and demands no special training for proper use.

Measure extremely large or small value of R or G with ease — you will appreciate the extraordinary sensitivity of the detector in this instrument. Indeed, there are few

National stock numbers are listed at the back of the catalog.

impedance measurements that will challenge it, whether dc or audio-frequency. Notice the width of the ranges specified below.

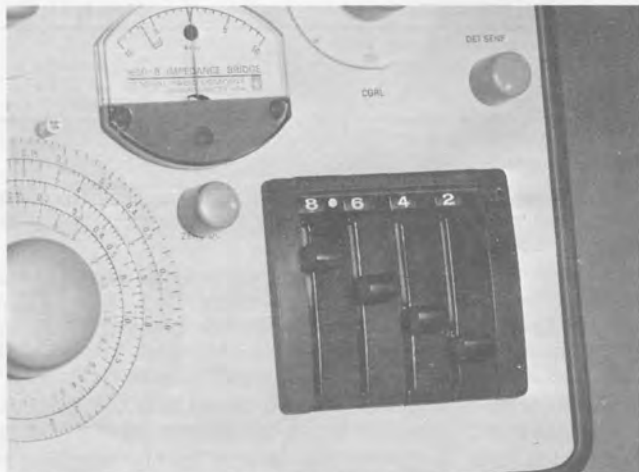

Lever-arm switches on 1656 permit fast balances and easy-to-read answers.

SPECIFICATIONS

| Range | Resolution (one digit on lowest range) | Accuracy* | |
|--|--|--|--|
| | | Frequencies ≤ 1 kHz and small phase angle ($f_s =$ full scale) | Frequencies > 1 kHz or large phase angle Typical additional error terms |
| Capacitance: 0.1 pF to 1100 μ F Series or parallel, 7 ranges | 0.1 pF | $\pm(0.1\%$ of reading $+ 0.01\%$ of $f_s +$ 0.2% of reading on highest range) | $\pm[0.2 Df_{Hz} + 0.5 D^2 + 0.002 (f_{Hz})^2]\%$ |
| Inductance: 0.1 μ H to 1100 H Series or parallel, 7 ranges | 0.1 μ H | $\pm(0.1\%$ of reading $+ 0.01\%$ of $f_s +$ 0.2% of reading on lowest range) | $\pm[0.2 f_{Hz}/Q + 0.5/Q^2 + 0.002 (f_{Hz})^2]\%$ |
| Resistance: 0.1 m Ω to 1.1 M Ω Ac or dc, 7 ranges | 0.1 m Ω | $\pm(0.1\%$ of reading $+ 0.01\%$ of $f_s +$ 0.2% of reading on lowest range)** | $\pm[Qf_{Hz} + 0.003 (f_{Hz})^2]\%^{**}$ |
| Conductance: 0.1 n Ω to 1.1 Ω Ac or dc, 7 ranges | 0.1 n Ω | $\pm(0.1\%$ of reading $+ 0.01\%$ of $f_s +$ 0.2% of reading on highest range)** | $\pm[Qf_{Hz} + 0.003 (f_{Hz})^2]\%^{**}$ |
| Dissipation Factor, D: series capacitance 0 to 1 | — | $\pm(0.001 \pm 5\%$ of reading) | $\pm(0.001 f_{Hz} + 5\%$ of reading) |
| parallel capacitance 0.1 to 50 | — | $\pm 5\%$ of reading (sliding null at high D) | $\pm 5\%$ of reading |
| Storage Factor, Q: series inductance 0.02 to 10 | — | $\pm 5\%$ of reading (sliding null at low Q) | $\pm 5\%$ of reading |
| parallel inductance 1 to ∞ | — | $\pm(5\%$ of reading $+ 0.001)$ for $1/Q$ | $\pm(5\%$ of reading $+ 0.001 f_{Hz})$ for $1/Q$ |

* Full accuracy applies from 15 to 35°C, <85% RH (useful from 0 to 45°C). Residual terminal impedances of ≈ 0.3 pF, 0.15 μ H, and 1 m Ω must be corrected to obtain specified accuracy.

** Terms apply to ac measurements when external phase balance is properly adjusted; otherwise accuracy is 0.5% of reading.

Generator: Internal, 1 kHz $\pm 2\%$ ac, 1.5 V dc. External, 20 Hz to 20 kHz ac; Type 1310 or 1311 Oscillator recommended.

Detector: Internal, 1 kHz ac with >20 -dB rejection at 2nd harmonic or flat, meter indication; 10- μ V/mm dc meter sensitivity. External, Type 1232 Tuned Amplifier and Null Detector recommended.

Bias: 600 V max on capacitors; small currents allowable on inductors and resistors; external only.

Terminals: $3/4$ -in.-spaced binding posts for unknown; pin jacks for external ac generator and capacitor for ac phase balance; phone jacks for external detector, bias, and DQ adjustment.

Supplied: Batteries.

Available: 1650-P1 TEST JIG for rapid and convenient connection of axial-lead components to bridge. Permits 3-terminal connection for negligible zero capacitance, introduces 80-m Ω total lead resistance (which only affects measurements on very low impedances), and adds a D or $1/Q$ error of less than 0.007.

Power: 5 D-cells, supplied; battery checks provided.

Mechanical: Flip-Tilt case and rack mount. DIMENSIONS (wxhxd): Portable, 13.25x12.87x6.69 in. (337x327x170 mm); rack, 19x12.25x5.75 in. (483x311x146 mm). WEIGHT: Portable, 15 lb (7 kg) net, 21 lb (10 kg) shipping; rack, 16 lb (8 kg) net, 28 lb (13 kg) shipping.



Flip-Tilt case provides complete protection.

| Description | Catalog Number |
|--|----------------|
| 1656 Impedance Bridge | |
| Portable Model | 1656-9701 |
| Rack Model | 1656-9702 |
| D Cell , replacement battery for 1656 (5 req'd) | 8410-0200 |



1650-P1 Test Jig

This test-jig adaptor is used to connect components quickly to a pair of terminals and can be placed on the bench directly in front of the operator. Thus, the test jig and 1650-B, 1656, or 1608-A Impedance Bridge make a

rapid and efficient component sorting device when the panel meter of the bridge is used as a limit indicator.

The test jig makes a three-terminal connection to the bridge, so that the residual zero capacitance is negligible. The lead resistance (0.08 ohm total) has effect only when very low impedances are measured, and the lead capacitance affects only the measurement of the Q of inductors, introducing a small error in D (or $1/Q$) of less than 0.007.

Weight: Net, 10 oz (285 grams); shipping, 4 lb (1.9 kg).

| Description | Catalog Number |
|-------------------------|----------------|
| 1650-P1 Test Jig | 1650-9601 |

National stock numbers are listed at the back of the catalog.



1608-A Impedance Bridge

- measures C, R, L, and G with digital readout
- $\pm 0.05\%$ accuracy
- 20 Hz to 20 kHz (external generator)
- internal 1-kHz oscillator and detector
- measures impedance of any phase angle
- accurate D and Q readings

This wide-range bridge will measure precision components to an accuracy of 0.05% — capacitance, inductance, and ac as well as dc resistance and conductance. An almost error-free readout and rapid-balance adjustments allow accurate and fast laboratory or production tests. Six bridge circuits cover all possible phase angles so that any network can be measured, even such "black boxes" as filters, transducers, and equalizers.

In ac resistance and conductance measurements, a Q adjustment for precise balancing gives phase information useful in predicting high-frequency behavior. This capability is also useful for measuring lossy reactances, such as rf chokes, without a sliding null. The high phase precision of ± 0.0005 radian makes D or Q measurements meaningful on low-loss reactances, which must often have tight D or Q tolerances for use in precision networks.

National stock numbers are listed at the back of the catalog.

The 1608-A will measure resistors at EIA-specified dc voltages, three-terminal capacitors and small capacitors remotely located, voltage-biased capacitors or current-biased inductors and resistors. Almost any impedance is measurable over the audio-frequency range.

The ability to measure small capacitances by a three-terminal connection makes possible the measurement of the capacitance between components, wires, or mounting structures. Long, shielded cables can be used without significantly affecting the accuracy of the measurement.

For production testing of components, the 1650-P1 test jig is recommended.

This self-contained bridge system includes six bridges, along with suitable ac and dc sources and detectors. The bridge elements are precision units. The wire-wound resistors are similar to those used in GR decade resistance boxes; the standard capacitor is a combination silver-mica and stabilized-polystyrene unit, with a low temperature coefficient.

The readout system is digital for C, R, L, and G, as well as for the Q of resistors. D and Q for capacitors and inductors are read from a dial with the correct scale illuminated. Decimal points and units are indicated automatically, and there are no multiplying factors for any quantity at 1 kHz or dc.

The C-R-L-G readout has both coarse and fine adjustments controlled by concentric knobs.

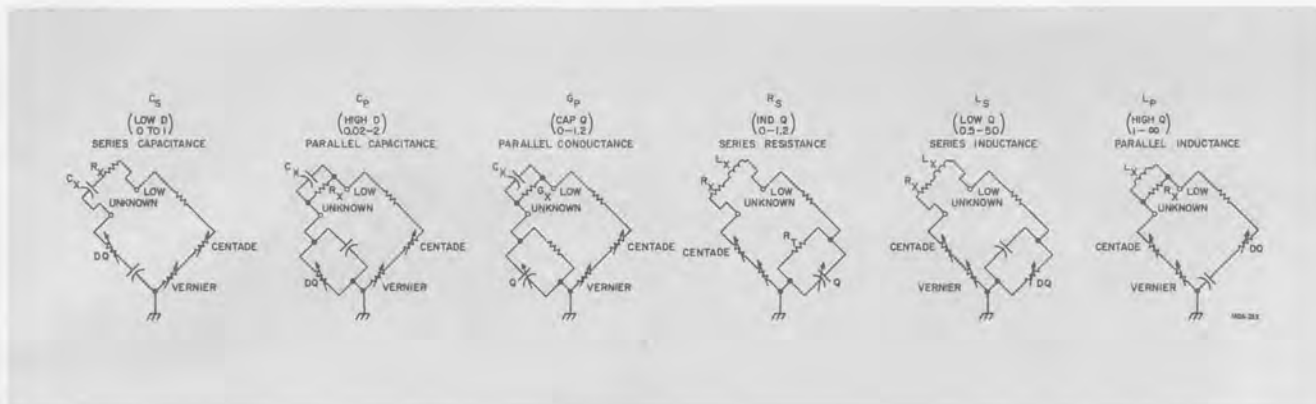

Elementary schematics of the capacitance, conductance, resistance, and reactance bridges.

The 1-kHz frequency-selective networks for the internal oscillator and tuned detector are on a plug-in module, which can be easily replaced with modules available for other internal test frequencies. Provision is made for use with an external oscillator and detector. Three dc supplies are included to obtain maximum sensitivity over a wide range of resistance.

SPECIFICATIONS

Ranges:

Capacitance: 0.05 pF to 1100 μ F in seven ranges, series or parallel.

Inductance: 0.05 μ H to 1100 H in seven ranges, series or parallel.

Resistance: (series) 0.05 milliohm to 1.1 megohms, ac or dc.

Conductance: (parallel) 0.05 nanomho to 1.1 mhos, ac or dc (20,000 megohms to 0.9 ohm).

D: (of series capacitance) — 0.0005 to 1 at 1 kHz.

(of parallel capacitance) — 0.02 to 2 at 1 kHz.

Q: (of series inductance) — 0.5 to 50 at 1 kHz.

(of parallel inductance) — 1 to 2000 at 1 kHz.

(of series resistance) — 0.0005 to 1.2 inductive at 1 kHz.

(of parallel conductance) — 0.0005 to 1.2 capacitive at 1 kHz.

Frequency: 1 kHz with internal oscillator module supplied; 20 Hz to 20 kHz with external oscillator.

Accuracy:

C, G, R, L

At 1 kHz: $\pm 0.05\% \pm 0.005\%$ of full scale except on lowest R and L ranges and highest C and G ranges, where it is $\pm 0.2\% \pm 0.005\%$ of full scale.

Additional error terms for high frequency and large phase angle:

C and L: $[\pm 0.001(f_{kHz})^2 \pm 0.1Df_{kHz} \pm 0.5D^2]\%$ of measured value.

R and G: $[\pm 0.002(f_{kHz})^2 \pm 10^{-6}(f_{kHz})^2 \pm 0.1Q]\%$ of measured value.

Residual Terminal Impedance: R \cong 0.001 Ω , L \cong 0.15 μ H, C \cong 0.25 pF.

National stock numbers are listed at the back of the catalog.

DC Resistance and Conductance: Same as for 1-kHz measurement, except that accuracy is limited by sensitivity at the range extremes. Balances to 0.1% are possible from 1 ohm to 1 megohm with the internal supply and detector.

D (or $\frac{1}{Q}$) of C or L: $\pm 0.0005 \pm 5\%$ at 1 kHz or lower.
 $\pm 0.0005f_{kHz} \pm 5\%$ above 1 kHz.

Q of R or G: $\pm 0.0005f_{kHz} \pm 2\%$.

Generator: Internal, 1 kHz $\pm 1\%$ module normally supplied; plug-in modules for other frequencies available on special order. Level control provided. With external generator, frequency range of bridge is 20 Hz to 20 kHz. Type 1310-B Oscillator recommended if external generator required. Internal dc supply 3.5, 35, and 350 V, adjustable; power limited to $\frac{1}{3}W$ or less.

Detector: Internal or external; ac; can be used either flat or selective at frequency of plug-in module (normally 1 kHz); other frequencies available; second-harmonic rejection of 25 dB. Sensitivity control provided. Type 1232-A Tuned Amplifier and Null Detector recommended when external generator is used.

Dc Bias: Capacitors can be biased to 500 V from external source; bias current up to 40 mA can be applied to inductors.

Supplied: Power cord, spare indicator lamps.

Available: 1650-P1 TEST JIG.

Power: 105 to 125 or 210 to 250 V, 50 to 60 Hz; 10 W.

Mechanical: Rack-bench cabinet. DIMENSIONS (wxhxd): Bench, 19x12.5x11.5 in. (483x318x293 mm); rack, 19x12.25x10 in. (483x312x254 mm). WEIGHT: 37 lb (17 kg) net, 54 lb (25 kg) shipping.

| Description | Catalog Number |
|--------------------------------|----------------|
| 1608-A Impedance Bridge | |
| Bench Model, 115 V | 1608-9801 |
| Bench Model, 230 V | 1608-9802 |
| Rack Model, 115 V | 1608-9811 |
| Rack Model, 230 V | 1608-9812 |



1657 RLC Digibridge™

- automatically measures R, L, C, D and Q
- 0.2% basic accuracy
- five-digit display for R, L and C
- four-digit display for D and Q
- microprocessor-directed ranging
- selectable test frequencies of 1 kHz and 120 Hz (100 Hz)
- series or parallel measurement mode selection
- built-in Kelvin test fixture tests radial and axial lead components
- no calibration is ever required

The GR 1657 Digibridge™ is an automatic microprocessor-based bridge designed to measure R, L, C, D and Q at a test time faster than three measurements per second, unqualified. Basic accuracy for R, L and C is 0.2%.

A *five*, full-digit LED readout is displayed for R, L and C and *four* full digits are displayed for D and Q. This broad visual display capability is augmented with microprocessor-directed ranging and automatic decimal point positioning.

Microprocessor-directed ranging takes the guess-work out of setting the correct range. Lighted arrows on the front panel indicate which range button is to be depressed and thus, automatically, the correct range is identified. Whether measuring impedance or loss/quality factor, the GR 1657's microprocessor directs the instrument and the operator to achieve optimum ranging. No chance for operator mistakes, as no operator decisions are required.

Three range positions provide measurements in multiples of 100, as each range has two full decades of measurement capability, a feature made possible by automatic decimal point positioning. In conjunction with the microprocessor-directed ranging, the automatic decimal point positioning causes the measurement to be made on the lowest possible range, so maximum resolution is always achieved. Residual errors inherent in all measurement instruments, such as ± 1 count error, therefore become negligible for most GR 1657 meas-

National stock numbers are listed at the back of the catalog.

measurements. The automatic decimal-point-positioning feature plus the use of full digits for the most significant digit allows D measurement from 10^{-4} to 10^1 .

Either a 1-kHz or 120-Hz (100-Hz) test frequency can be selected by the operator. Series or parallel measurement modes are operator selectable across the full measurement range of every test parameter.

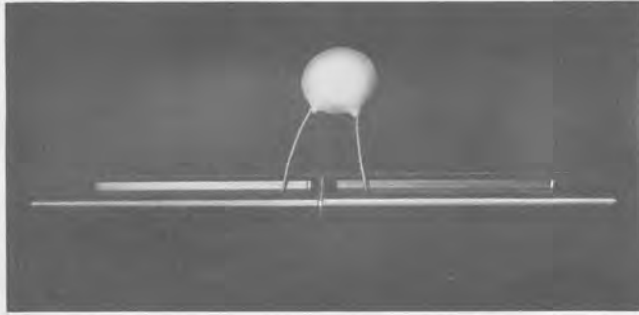

The high reliability Kelvin test fixture accommodates either radial or axial lead components. Test radial lead components by removing the two test clips, or insert the clips and test axial lead components. Each test clip can be moved to the right or left to accommodate various size components. The Kelvin test method assures more accurate measurement.

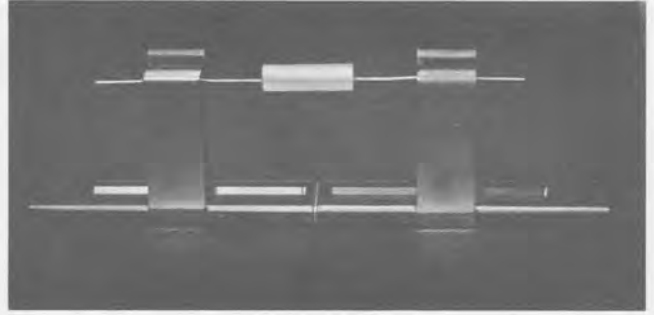

SPECIFICATIONS

Measurement Mode: Measures R series or parallel; L and Q series or parallel; C and D series or parallel. All measurement modes are pushbutton selectable.

Measurement Speed: Greater than three measurements per second, unqualified.

Test Frequencies: 1 kHz and 120 Hz. Also 100 Hz in place of 120 Hz. Pushbutton selectable.

Ranges: Pushbutton selectable.

Three ranges for R, L and C (multiples of 100)

R = 00.001 Ω to 99.999 M Ω

L = 0.0001 mH to 9999.9 H

C = 0.0001 nF to 99999. μ F

One range for D and Q

D = .0001 to 9.999

Q = 00.01 to 999.9

Accuracy: R, L and C = $\pm 0.2\%$ of reading covering the following ranges of value.

| Mode | Frequency | Min | Max |
|------|-----------------|--------------|-------------------|
| R | 120 Hz or 1 kHz | 2.0 Ω | 1.9999 M Ω |
| L | 1 kHz | 200 μ H | 199.99 H |
| L | 120 Hz | 2.0 mH | 1999.9 H |
| C | 1 kHz | 200 pF | 199.99 μ F |
| C | 120 Hz | 2.0 nF | 1999.9 μ F |

For values outside of these ranges, or for values for high-phase components or networks, contact your local GenRad sales office.

D = $\pm[0.001 + 0.002(1 + D)D]$

Q = $\pm[0.01 + 0.002(1 + Q)Q]$

Display: R, L and C — Five full digits (99999), LED display with automatic decimal point positioning.

D and Q — Four full digits (9999), LED display with automatic decimal point positioning.

Applied Voltage: 0.3 V rms maximum.

Supplied: Power cord.

National stock numbers are listed at the back of the catalog.

Power: 90 to 125 or 180 to 250 V, 48 to 62 Hz. Voltage selected by rear-panel switch. 25 W maximum.

Mechanical: Bench model. DIMENSIONS (wxhxd): 14.75x4.37x13.00 in. (356.35x101.97x330.20 mm). WEIGHT: 12.5 lb (5.7 kg) net, 22 lb (10 kg) shipping.

Description

1657 RLC Digibridge™

120-Hz and 1-kHz Test Frequencies

1657-9700

100-Hz and 1-kHz Test Frequencies

1657-9800

Extender Cable (for remote measurements)

1657-9600





1658 RLC Digibridge™

- automatically measures R, L, C, D and Q
- 0.1% basic accuracy
- 10 bins for sorting
- autoranging
- IEEE 488 bus/handler interface option
- three test speeds
- selectable continuous, average or single component measurements
- three types of display — programmed bin limits, measured values or bin number
- five-digit display for R, L and C
- four-digit display for D and Q
- selectable test frequencies of 1 kHz and 120 Hz (100 Hz)
- series or parallel measurement mode selection
- built-in Kelvin test fixture tests radial and axial lead components
- no calibration is ever required — lower cost of ownership

The GR 1658 represents a new era in impedance measuring instruments. Unique features such as measurement averaging and selectable test speeds allow a greater testing flexibility.

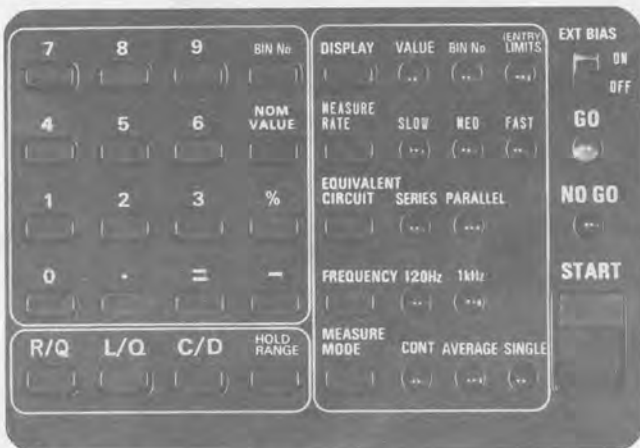

Keyboard Controls

- *Display* — The broad visual display of a five, full-digit LED readout for R, L and C and four full digits for D and Q is augmented with automatic decimal point positioning. All numbers go to 9. Through the use of the DISPLAY key three types of display can be selected: VALUE — the measured value of the component under test; BIN No. — the bin assignment for the measured device (example: If the measured device falls within the programmed limits of bin 8, the display will show the numeral 8); and (ENTRY) LIMITS — which displays the programmed limits for any bin or displays the nominal value.

- *Selectable Test Speeds* — In some testing applications, speed is not important. In others, accuracy may not be too important. The GR 1658 allows the user to trade accuracy for speed and vice versa. Keyboard selections are: SLOW (1.5/s typical, 0.1% accuracy), MEDIUM (3/s typical, 0.2% accuracy) and FAST (7/s typical, 0.5% accuracy) in CONT operation mode.

- *Selectable Equivalent Circuit* — The SERIES or PARALLEL circuit is operator selectable across the full measurement range of every test parameter.

- *Test Frequencies* — Either 120 Hz (100 Hz) or 1 kHz are selectable. Several frequencies are available for substitution.

- *Measurement Control* — Three test conditions are available for selection: CONT — for continuous repetitive measurements; AVERAGE — provides a running average of 10 successive measurements (initiated by START); and SINGLE. This averaging feature is very useful for unstable components or noisy environments and provides smoothing of any possible noise or slight variation from one measurement to another.

- *Autoranging* — This microprocessor-controlled feature takes the guesswork out of setting the proper range. Automatic ranging can be inhibited by the HOLD RANGE pushbutton. The RANGE HELD indicator is not lighted when in the autoranging operational mode.

- *Measurement Parameters* — These keys provide selection of the basic parameter to be measured: R/Q, L/Q or C/D. A series R measurement can be useful in determining the equivalent series resistance of capacitors.

High Reliability Kelvin Test Fixture Test radial lead components by removing the two test clips, or insert the clips and test axial lead components. Each test clip can be moved to the right or left to accommodate various size components. The Kelvin test method assures more accurate measurement.

National stock numbers are listed at the back of the catalog.



Rear View of the GR 1658 with IEEE 488 Bus/Handler Interface

IEEE 488 Bus/Handler Option An IEEE 488 bus interface and an autohandler output allow the 1658 to be connected to an unlimited variety of ancillary equipment, such as handlers, printers or calculator-based systems.

Component Sorting/Binning The limit comparison feature provides 10 bins for sorting. Bin 0 is designated for D/Q, bins 1 through 8 for multi-band sorting and bin 9 is for components that do not meet any of the specified limits of bins 1 through 8. RLC limits for bins 1 through 8 are entered as percentage deviations from the nominal value and can be symmetrical (e.g., 1%, 2%, 5%) or asymmetrical (e.g., -20% 80%, -30% 10%). The DQ limit is entered as a number and represents a single limit comparison. GO/NO-GO is indicated whether the bin number or measured value is selected as the main display. Bin limits are entered in ascending order with the tightest limits in the lowest bin (1% bin 1, 2% bin 2, etc.). Bin limits are held in each bin until changed or cleared by turning off the power switch. For electrical outputs, the IEEE 488 bus/handler option is required.

• **Entry of Symmetrical Limits**

Example: 1.5 μ F capacitor with D < .005
Sort: \pm 1%, 2%, 5%, 10%
Select desired measure rate, equivalent circuit, frequency, measure mode.
With DISPLAY key, select ENTRY LIMITS
Enter D limit: 0 0 5 = BIN No. 0
With C/D key, select μ F
Enter nominal value: 1 . 5 = NOM VALUE
Enter bin limits:

- 1 % = BIN No. 1
- 2 % = BIN No. 2
- 5 % = BIN No. 3
- 10 % = BIN No. 4
- Close remaining bins:*
- 0 % = BIN No. 5
- 0 % = BIN No. 6
- 0 % = BIN No. 7
- 0 % = BIN No. 8

• **Entry of Asymmetrical Limits**

Example: 1.5 μ F capacitor with D < .005
Sort: match components to .25%
Select desired measure rate, equivalent circuit, frequency, measure mode.
With DISPLAY key, select ENTRY LIMITS
Enter D limit: 0 0 5 = BIN No. 0
With C/D key, select μ F
Enter nominal value: 1 . 5 = NOM VALUE
Enter bin limits:

- 1 % - 7 5 % = BIN No. 1
- 7 5 % - 5 % = BIN No. 2
- 5 % - 2 5 % = BIN No. 3
- 2 5 % 0 % = BIN No. 4
- 0 % - 2 5 % = BIN No. 5
- 2 5 % - 5 % = BIN No. 6
- 5 % - 7 5 % = BIN No. 7
- 7 5 % - 1 % = BIN No. 8

*Initially, at power up, bins 0 through 8 are closed so the procedure shown for closing unused bins is not required.

SPECIFICATIONS

Measurement Mode: Measures R and Q series or parallel; L and Q series or parallel; C and D series or parallel. All measurement modes are key selectable.

Measurement Speed (CONT operation mode): Slow (1.5/s typical), medium (3/s typical) or fast (7/s typical), key selectable. See accuracy table for speed/accuracy data.

Test Frequencies: 1 kHz and 120 Hz. Also 100 Hz in place of 120 Hz. Key selectable.

Measurement Ranges: Autoranging automatically finds the optimum range. Three internal ranges used. Microprocessor indicates over/under range conditions. Hold range/automatic feature is key selectable. 5:1 overrange at top of each range. 50:1 overrange on highest range of R and C at 120 Hz (and at 100 Hz on 100 Hz/1 kHz model).

- R = 0.0001 Ω to 9.9999 M Ω at 1 kHz
- R = 0.0001 Ω to 99.999 M Ω at 120 Hz (or 100 Hz)
- L = .00001 mH to 999.99 H at 1 kHz
- L = 0.0001 mH to 9999.9 H at 120 Hz (or 100 Hz)
- C = .00001 nF to 999.99 μ F at 1 kHz
- C = 0.0001 nF to 99999. μ F at 120 Hz (or 100 Hz)
- D = .0001 to 9.999
- Q = 00.01 to 999.9 for L/Q
- Q = .0001 to 9.999 for R/Q

Accuracy:

| Meas Mode | Test Freq | RLC and DQ Values | | | | |
|-----------|-------------|-------------------|-------------------|-------------|------------|-------------|
| | | Min | Max | Accuracy | | |
| | | | | Slow | Med | Fast |
| C | 1 kHz | .200 nF | 199.9 μ F | \pm 0.1% | \pm 0.2% | \pm 0.5% |
| C | 120 Hz* | 2.0 nF | 1999.9 μ F | \pm 0.1% | \pm 0.2% | \pm 0.5% |
| D | Either | .0000 | .1000 | \pm .0005 | \pm .001 | \pm .0025 |
| L | 1 kHz | .200 mH | 199.99 H | \pm 0.1% | \pm 0.2% | \pm 0.5% |
| L | 120 Hz* | 2.0 mH | 1999.9 H | \pm 0.1% | \pm 0.2% | \pm 0.5% |
| Q | Either | 00.00 | 02.00 | \pm .01 | \pm .01 | \pm .01 |
| R | 1kHz/120Hz* | 2.0 Ω | 1.9999 M Ω | \pm 0.1% | \pm 0.2% | \pm 0.5% |
| Q | Either | .0000 | .1000 | \pm .001 | \pm .002 | \pm .005 |

*Values also apply to 100 Hz. For values outside of these ranges, or for values for high-phase components or networks, contact your local GenRad sales office.

Display: Three selectable display modes.

1. Measured values. R, L and C — Five full digits (99999), LED display with automatic decimal point positioning. D and Q — Four full digits (9999), LED display with automatic decimal point positioning.
2. Bin number. Identifies bin for tested component.
3. Programmed limits for any bin.

Measurement Control: Continuous, average (average value of 10 measurements), or single. Key selectable.

External Bias: Up to 60 V can be applied. Applied Voltage: 0.3 V rms maximum.

Supplied: Power cord.

Power: 90 to 125 or 180 to 250 V, 48 to 62 Hz. Voltage selected by rear panel switch. 30 W maximum.

Mechanical: Bench model. DIMENSIONS (wxhxd): 14.78x4.4x13.5 in. (37.54x11.18x34.29 cm). WEIGHT: 13.5 lb (6.14 kg) net, 18 lb (8.2 kg) shipping.

| Description | Catalog Number |
|---|----------------|
| 1658 RLC DigiBridge™ | |
| 120 Hz and 1 kHz Test Frequencies | 1658-9700 |
| 100 Hz and 1 kHz Test Frequencies | 1658-9800 |
| 120 Hz and 1 kHz Test Frequencies with IEEE 488 Bus/Handler Interface | 1658-9701 |
| 100 Hz and 1 kHz Test Frequencies with IEEE 488 Bus/Handler Interface | 1658-9801 |
| Extender Cable (for remote measurements) | 1657-9600 |



1683 Automatic RLC Bridge

- **Resistance:** 1 $\mu\Omega$ to 2 M Ω
- **Inductance:** 0.1 nH to 2000 H
- **Capacitance:** 0.01 pF to 0.2 F
- **0.1% basic accuracy**
- **up to 20 measurements per second**

The 1683 Automatic RLC Bridge is a fully-automatic, low-frequency, five-terminal impedance bridge that measures capacitance, inductance, and resistance with loss expressed as a series element. It is a true bridge whose accuracy depends on stable passive standards. The automatic nature of the bridge allows unskilled personnel to make precision measurements at the push of a button.

The accuracy and rapid speed of balance make the 1683 a natural choice for incoming inspection, quality control, and high-volume production applications where a large number of components must be measured in as short a time as possible. The wide range of the 1683 enables it to measure almost any type of component.

The data-output option enables you to retrieve, record, analyze, and utilize volumes of data in a minimum of time. The bridge is designed to interface with scanners, comparators, card- and tape-punch machines, recorders, and computers.

The programming option allows for external control of the bridge functions. This is desirable for fully-automated testing where a master computer may be controlling one or more bridges and other accessory equipment. The computer would function as controller, data retriever, data analyzer, and decision maker to reduce the possibility of error. Such a controlled system would provide for extremely fast, accurate, and economical component evaluation.

National stock numbers are listed at the back of the catalog.

The five-terminal feature provides you with the ability to measure accurately low-impedance and high-impedance components far removed from the bridge. The Kelvin-type connection lessens the effects of lead impedance and enables milliohms of impedance to be measured at the end of several feet of cable. The fifth terminal, the cable shield, is used to reduce the effect of stray capacitances on measurements of high impedance. This feature is especially useful when a series of small-valued capacitors is measured in sequence with a scanner system.



The bias feature and leakage option provide the ability to characterize large-valued tantalum- and electrolytic-class capacitors at one station. The equivalent-series-resistance (ESR) option provides you with another means to express loss in capacitor measurements as required by some MIL specifications.

The many features incorporated in the 1683 Automatic RLC Bridge allow you to accomplish fast, accurate, and economical testing of resistors, inductors, and capacitors in a number of applications ranging from laboratory use to the most sophisticated of computer-controlled systems.

| Measurement | Range | | Accuracy (% of reading) ± (% of full scale) |
|--|---|--|--|
| | at 120 Hz | at 1 kHz | |
| CAPACITANCE With concurrent loss measurement (that can be displayed as dissipation factor or equivalent series resistance) and optional GO, NO-GO leakage-current test. | 0000.1 pF to 1999.9 μF 02.000 mF to 19.999 mF 020.00 mF to 199.99 mF | 000.01 pF to 199.99 μF 0200.0 μF to 1999.9 μF 02.000 mF to 19.999 mF | ±0.1% ±0.05% ±1% ±0.5% ±5%* (typically 1%) ±0.5% |
| INDUCTANCE With concurrent loss measurement expressed as series resistance. | 00.001 μH to 19.999 μH 020.00 μH to 199.99 μH 0200.0 μH to 1999.9 H | 0000.1 nH to 1999.9 nH 02.000 μH to 19.999 μH 020.00 μH to 199.99 H | ±5%* (typically 1%) ±0.5% ±1.0% ±0.1% ±0.1% ±0.1% |
| RESISTANCE Simple resistance, or series resistance with inductance measurements. | 00.001 mΩ to 19.999 mΩ 020.00 mΩ to 199.99 mΩ 0200.0 mΩ to 1999.9 kΩ | | ±5%* (typically 1%) ±0.5% ±1% ±0.5% ±0.1% ±0.05% |
| DISSIPATION FACTOR (D) Concurrent with capacitance measurements. | 0.0000 to 1.9999 accuracy differs on the following capacitance ranges: 0.2000 mF to 19.999 mF 0200.0 μF to 1999.9 μF 20.000 mF to 199.99 mF 02.000 mF to 19.999 mF | | ±1% ±0.05% ±1% ±0.5% ±5% ±5% |
| EQUIVALENT SERIES RESISTANCE (Option 4) Concurrent with capacitance measurements. | 00.001 mΩ to 19.999 mΩ 020.00 mΩ to 1999.9 kΩ with C reading of: 03000 to 19999 02000 to 02999 01000 to 01999 | | ±5%* (typically 1%) ±0.5% ±1% ±0.1% ±1% ±0.125% ±1% ±0.5% |
| LEAKAGE CURRENT (Option 3) GO, NO-GO indication concurrent with capacitance measurement. | 2.5 μA to 25 mA in 5 ranges | | 2% of reading |

* In single or variable measurement mode; ±1% of reading plus ±0.1% of full scale in tracking mode.

SPECIFICATIONS

Display: Reactive and resistive readouts, each with 4½-digit resolution, high-intensity neon readout tubes, decimal point, and unit of measurement. Display also indicates measurement frequency, unbalanced condition, manual- or remote-ranging condition, and GO or NO-GO result of leakage current measurement.

Speed: Measurement rate at 1 kHz is ≈ 20 measurements per second for ±1% of full-scale change in unknown, 16/s for ±10% change, and 8/s for ±100% change; at 120 Hz, rates 10 times slower. Interval between measurements can be infinite (measurements initiated by front-panel pushbutton or external closure to ground) or from ≈ 20 ms to 1 s as set by front-panel control so that measurements are repetitive. Speed may be decreased slightly when D is measured near the low end of each capacitance range.

Terminals: Five; 4-terminal connection minimizes errors due to lead impedance and ground terminal minimizes error due to stray capacitance. Connections to unknown are made by coaxial cables at the front and the rear of the instrument. A 1683-P1 Test Fixture is available for the rapid connection of axial-lead components and contains a start button to initiate the measurements. Stray capacitance up to 2 pF across the test fixture can be cancelled by an adjustment on the rear of the 1683.

Ranges: Nine for all measurements except five for leakage current. Ranging can be automatic, manual, or remote except leakage current which has no automatic ranging.

Oscillator Level: Voltage applied to unknown can be reduced from the normal 2.2 V rms for special applications.

Sensitivity: Can be manually or remotely reduced from maximum, with consequent loss of resolution, to overcome problems with non-linear or rapidly changing unknown or external noise or hum pickup.

Bias: 0 to 3 V internal, manually or remotely set; 600 V max, external.

Leakage-Current Test (Option 3): NO-GO limit can be manually set with 2% accuracy or remotely measured with 2% accuracy from 1 μA (under vernier control) to 25 mA. External monitoring of leakage current or of a dc voltage proportional to leakage current provided.

Interface:

Low-Level Data Output (Option 5A): 50-pin Amphenol Type 57 connector provides 11 digits of measurement data (5 for reactance, 5 for resistance, 1 for range) plus various control inputs and outputs for systems use. Digits are 1-2-4-8-weighted BCD at standard TTL logic levels (logic "0" ≈ ground with 10-mA sink capability, logic "1" ≥ 3.5 V).

High-Level Data Output (Option 5B): Same as low-level except all outputs are 15-V swing (logic "0" ≈ ground with 10-mA sink capability, logic "1" ≈ +15 V behind 12 kΩ).

Remote Programmability (Option 2): 50-pin Amphenol Type 57 connector provides terminals for external remote programming of all control functions except line-voltage control. Functions are controlled by closures to ground or standard TTL levels.

Environment: TEMPERATURE: +10 to +40°C operating.

Available: 1683-P1 TEST FIXTURE, 2995-9158 BIAS SUPPLY, printers, recorders, card-punch couplers, scanners.

Power: 100 to 125 and 200 to 250 V, 50-60 Hz, 110 W.

Mechanical: Bench or rack models. DIMENSIONS (wxhxd): Bench, 19x7.88x25.38 in. (483x200x645 mm); rack, 19x7x23.75 in. (483x178x604 mm). WEIGHT: Bench, 60 lb (28 kg) net, 74 lb (34 kg) shipping; rack, 50 lb (23 kg) net, 67 lb (31 kg) shipping.

| Description | Catalog Number |
|--|--|
| 1683 Automatic RLC Bridge Bench Model, power freq: 60 Hz Bench Model, power freq: 50 Hz Rack Model, power freq: 60 Hz Rack Model, power freq: 50 Hz | (Describe exactly as shown at the left.) |
| Select following options, if desired OP2 Remote Programmability OP3 Leakage Current OP4 ESR Readout OP5A* Low-Level Data Output OP5B* High-Level Data Output | |
| Accessory available 1683-P1 Test Fixture for axial leads | |

* Not available together in the same instrument.

Patent Numbers 3,562,641 and 3,227,893.

National stock numbers are listed at the back of the catalog.



A complete incoming-inspection station for passive components

1685 Digital Impedance Meter

- automatically measures R, L, and C on each range automatic GO/NO GO limits for D and Q
- measures series C and L at either 120 Hz or 1 kHz
- measures resistance at dc
- 0.1% basic accuracy for dc and 1-kHz measurements and 0.5% for 120-Hz measurements
- C range is 0.01 pF to 20,000 μ F; L range, 0.01 μ H to 2000 H; R range, 0.1 m Ω to 20 M Ω
- built-in limit comparator provides fast GO/NO GO sorting

Up to now, an incoming-inspection station for passive components typically consisted of several interconnected instruments that involved a great deal of manual manipulation on the part of the inspector to achieve proper results. Now, most (if not all) of those instruments can be replaced by GenRad's 1685 Digital Impedance Meter. And, what is more important, many of the operations have been automated, which greatly speeds up the inspection process whether you screen many of the same type of component or measure the value of several different components.

The GR 1685 has many convenient features that make it an operator-oriented instrument, particularly when used with its optional built-in limit comparator and test fixture. After reviewing the following GR 1685 operating features and their benefits you will agree that GenRad has greatly simplified impedance measurements with this new instrument.

- *Range switch with directional arrows* — Arrows at the top of the RANGE switch indicate which way to turn the 9-position switch to set the correct range. When at the correct range, both arrows are extinguished. No thinking is required with this step — just follow the arrows.

- *Clear digital readout of measurement* — The R, L, or C measurement clearly appears on a 4½-digit LED display. There is no doubt that the measurement value is.

- *Selectable measurement modes* — A MEASUREMENT MODE switch allows the operator to make a single measurement or to make repetitive meas-

urements at rates ranging from four per second to one every 10 seconds. This, of course, allows you to measure value changes as the device being measured is subjected to environmental changes.

- *Easy parameter selection* — A clearly marked, five-position PARAMETER switch sets the instrument for the proper measurement with minimum effort. It has separate 1-kHz and 120-Hz positions for capacitance and inductance measurements.

- *D and Q dial with directional arrows* — Lighted directional arrows above the D and Q dial guide you in determining the D or Q of a device under test or when a D or Q limit has been exceeded. To find the value of D or Q, you simply turn the dial until the lit arrow goes off and read the values on the dial. If you wish to set a high-D or low-Q limit, set the value on the dial and the red and green arrows will give a GO/NO GO indication.

- *Limit comparator speeds up inspection process* — Once the upper and lower measurement limits of the devices being checked have been set with the 5-digit limit switches, measuring is just a matter of inserting devices in the test fixture and watching the indicator lights. If the measurement is within the set limits, the GO light goes on and you make your next measurement. If it is outside the limits, the LOW or HIGH light will go on and you reject the device. When checking D or Q against a set limit, the HIGH D light will turn on for either a high D or low Q.

- *A red lamp tells you when the instrument is making a measurement*

- *Test fixture has PASS/FAIL lights* — Normally, these two lights are all an inspector need pay attention to when inspecting a batch of components that are approximately the same value. The lights work in conjunction with the limit comparator.

Provisions have been made for the GR 1685 to operate with external equipment such as additional limit comparators, handlers, data printers, and card punches. Meter output levels are standard TTL, open collector, for total interface flexibility. The GR 1685 comes supplied with an output-data connector set by which you connect to external equipment.

National stock numbers are listed at the back of the catalog.

SPECIFICATIONS

RLC Ranges:

FULL-SCALE READINGS AND ACCURACY MULTIPLIER

| Switch Position | Capacitance | | | | Resistance | | | Inductance | | | Voltage Multiplier A |
|-----------------|-------------|----|-----------|---|------------|----|----------|------------|-----------|----|-------------------------|
| | 1 kHz | M | 120 Hz | M | DC | M | 120 Hz | M | 1 kHz | M | |
| 1 | 1999.9μF* | 10 | 19.99mF** | 4 | 199.99mΩ* | 20 | 199.9μH* | 10 | 19.999μH* | 10 | 0.1 |
| 2 | 199.99μF | 3 | 1.99mF | 2 | 1999.9mΩ | 3 | 1.999mH | 2 | 199.99μH | 3 | 0.1 |
| 3 | 19.999μF | 1 | 199.9μF | 1 | 19.999Ω | 1 | 19.99mH | 1 | 1999.9μH | 1 | 1 |
| 4 | 1999.9nF | 1 | 19.99μF | 1 | 199.99Ω | 1 | 199.9mH | 1 | 19.999mH | 1 | 1 |
| 5 | 199.99nF | 1 | 1.999μF | 1 | 1999.9Ω | 1 | 1.999H | 1 | 199.99mH | 1 | 1 |
| 6 | 19.999nF | 1 | 199.9nF | 1 | 19.999kΩ | 1 | 19.99H | 1 | 1999.9mH | 1 | 1 |
| 7 | 1999.9pF | 2 | 19.99nF | 1 | 199.99kΩ | 1 | 199.9H | 1 | 19.999H | 1 | 1 |
| 8 | 199.99pF | 3 | 1.999nF | 2 | 1999.9kΩ | 3 | 1.999kH | 2 | 199.99H | 3 | 5 |
| 9 | — | — | — | — | 19.999MΩ | 5 | — | — | — | — | 5 |

*Not recommended **Extends to 0.1F at reduced accuracy M = Accuracy Multiplier (see below)

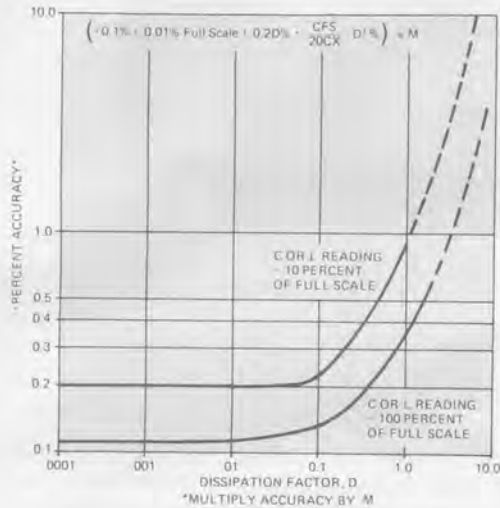

C and L accuracy at 1-kHz Test Frequency

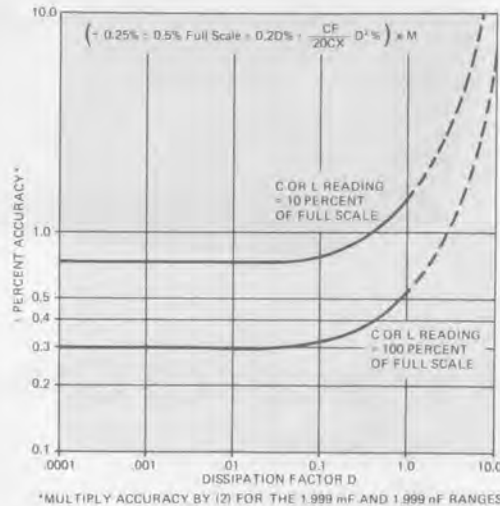

C and L accuracy at 120-Hz Test Frequency

Accuracy: Basically, 0.1% for dc and 1-kHz measurements; 0.5% for 120-Hz measurements. See curves for exact accuracies. ($\pm 0.1\% \pm 0.01\%$ full scale) $\times M$ for dc resistance. See "RLC Ranges" table for values of M.

Dissipation Factor/Q Factor: $D = 0$ to 10; $Q = 0.1$ to ∞ .

$$D \text{ accuracy} = \pm(0.001 + 0.0002 \frac{(L \text{ or } C) \text{ Full Scale}}{(L \text{ or } C) \text{ reading}} + 5.0\% \text{ of } D \text{ reading} + 5 D\%) \times M$$

where M = Accuracy Multiplier

Q accuracy is same as D accuracy since dial indicates both D and Q. Dial reads both D and Q, and may be set to give D or Q limit or adjusted to give D or Q value.

Display: 4½ digits, LED display with decimal point and over-range indication. Display normally reads C, R, or L.

Applied Voltage: AC: $A \times 1$ V rms max. DC: $A \times 2$ V max, where A = voltage multiplier (see "RLC Ranges" table). Maximum power is 1/8 W.

Frequency: 1 kHz $\pm 2\%$ and 120 Hz, synchronized to line (100 Hz test frequency for 50-Hz line).

Bias: For capacitors, 2 V internal and 0-100 V external; for inductors, allowable bias current depends on range.

Measurement Speed/Mode: Measurements made on command or repetitively at times from 0.25 s to 10 s. Previous measurement is held during period of new measurement.

Data Outputs (TTL Logic): Open collector, active low. Each of the following outputs will sink 40 mA (max) from an external source of +30 V (max) with low output = +0.4 V (max): BCD measurement value, decimal points, DQ high, reset, strobe, overrange.

Data Inputs: REMOTE START: A positive transition of $< 1 \mu s$ rise time from $0 V < V_L < 0.4 V$ to $+2 V < V_H < +30 V$ initiates a measurement. LAMP TEST: A ground lights all segments of the right-most four digits of the LED display (8 8 8 8) to check operation of all indicator segments.

Limit Option: DATA OUTPUTS (TTL LOGIC): Open collector, active low. Each of the following outputs will sink 40 mA (max)

from an external source of +30V (max) with low output = +0.4V (max): busy, go, DQ high, high limit, low limit, fail. **SUPPLEMENTARY OUTPUTS:** *Clamp:* This line is to be tied to the external relay coils. Audio output line to drive a miniature speaker (or headphone) tied between this output and ground. Signal gives $\approx 1/4s$ audio burst, when measured value falls outside the selected high and low limits. (Not activated by DQ failures.) *Interface:* Lines for interfacing with a digital printer (i.e., GR 1785), a component sorter, a component handler for a specific application, and/or to interface with a multiple limit comparator. **DATA INPUTS:** *Remote Start:* A positive transition of $< 1 \mu s$ rise time from $0 V < V_L < 0.4 V$ to $+2 V < V_H < +30 V$ initiates a measurement. *Limit Disable:* Performs the same function as the toggle switch on the front panel of the limit option module: High input turns limit option OFF, OPEN is equivalent to V_L . ($0 V < V_L < +0.4 V, +2 V < V_H < +30 V$.)

Environment: TEMPERATURE: 0 to +50°C operating (increase accuracy multipliers by 10% for each °C above 35°C or below 15°C), -40 to +75°C storage. HUMIDITY: 95% at 35°C.

Supplied: Power cord, measurement cable, output-data connector set.

Power: 90 to 125 or 180 to 250 V, 48 to 440 Hz, 40 W max.

Mechanical: Bench or rack models, DIMENSIONS (wxhxd): Bench, 17.00x5.59x16.25 in. (432x142x413 mm); rack, 19.00x5.22x16.63 in. (483x133x422 mm). WEIGHT: Bench, 22.5 lb (10.2 kg) net, 31 lb (14.1 kg) shipping; rack, 23.25 lb (10.54 kg) net, 31.75 lb (14.4 kg) shipping.

| Description | Catalog Numbers | |
|---|-----------------|---------------|
| | 60-Hz Models | 50-Hz Models* |
| 1685 Digital Impedance Meter | | |
| Bench model with Limit Comparator | 1685-9702 | 1685-9802 |
| Rack model with Limit Comparator | 1685-9703 | 1685-9803 |
| 1686-P1 Test Fixture, Kelvin clips | 1686-9600 | |

*50-Hz line frequency, 100-Hz test frequency.

National stock numbers are listed at the back of the catalog.



1654 Impedance Comparator

- **0.003% impedance-difference resolution**
- **100 Hz to 100 kHz—4 fixed frequencies**
- **wide impedance ranges:**
 - 2 Ω to 20 M Ω
 - 0.1 pF to 1000 μ F
 - 20 μ H to 1000 H
- **stable solid-state circuits**
- **fast sorting —**
 - > 10,000/h, with accessory limit comparator

The GR 1654 Impedance Comparator indicates on large panel meters and by analog output voltages the difference in magnitude and phase angle between two external impedances, usually a standard and an unknown. Owing to its speed and percent-deviation readout, the 1654 is of great value in the sorting, selecting, and adjusting of components in production and inspection applications.

Accurate Because the 1654 measures differences to an accuracy of 3% of full scale, the measurement accuracy and resolution as a percent of the total impedance are considerably better, with comparison precisions to $\pm 0.003\%$. In addition, the magnitude channel of the 1654 has been linearized to ensure accurate readings without correction for up to 30% impedance differences. Solid-state circuits are used in the 1654 so that drift of the meter zero is negligible, permitting more certain accuracy and fewer interruptions for readjustment.

Versatile Test voltage, frequency, and measurement ranges of impedance and phase-angle differences are all selected by front-panel controls. Test voltage and measurement ranges are related and their panel switches interlocked to reflect this relationship. Four measurement ranges can be used with each test voltage. The highest test level, 3 volts, gives the greatest sensitivity: 0.1% and 0.001 radian, full scale. The lower levels, 1.0 and

National stock numbers are listed at the back of the catalog.

0.3 volt, permit measurement of more fragile components, allow easy voltage-coefficient tests, and (while limiting maximum sensitivity) extend large-difference capability to 30% and 0.3 radian, full scale.

Wide ranges of impedance, resistance, capacitance, and inductance can be compared with the 1654. Since it is a transformer bridge, its accuracy is little affected by loading or by stray impedances for most measurements. A guard terminal is provided for making three-terminal connections to minimize the effects of stray fixture and cable capacitance.



1680-P1 Test Fixture.

HIGH-SPEED SORTING, SYSTEMS EXPANSION

The 1654 measures the difference between two externally connected components. For comparison measurements you need a standard. For rapid sorting you need either a limit comparator or an alert operator who can mentally juggle up to six numbers simultaneously. You can solve these problems neatly by adding to the basic impedance comparator or, more neatly yet, by letting us do the adding in the form of one of several models of the 1654-Z Sorting System.

One model of the 1654-Z contains, in addition to the 1654 Impedance Comparator, one of our latest and best decade capacitors. A second model contains a versatile limit comparator especially designed for the 1654, and a third model contains both.

The 1413 Precision Decade Capacitor provides a range of from 0 to 1.11111 μF , an accuracy of 0.05%, and a resolution of 1 pF. Any value in its range is set easily by six in-line readout dials, and it may be connected to either the front or the rear of the 1654.

The 1782 Analog Limit Comparator provides four limits that you may use as your needs dictate: a high and low limit for both magnitude and phase, two values of magnitude only or phase only, or four high limits to sort components into five categories (say 5, 10, 20 and 30% and reject). All limits can be set to an accuracy of within $\pm 2\%$ of full scale and bright-light panel indicators provide results of the comparison in terms of GO or NO GO. The 1782 is available also with a relay option to control automatic sorting mechanisms. The components can be applied manually or automatically at rates up to four per second. For special applications, up to 16 limit comparators can be connected to the 1654. Call your local GR sales engineer for further details on incorporating additional limit comparators or other automatic measuring and sorting equipment.

TYPICAL USES

Rapid sorting and matching of precision components, subassemblies, and networks, manually or with automatic equipment.

Measuring the effects of time and environment on components, with high precision and continuous indication.

Rapid testing of the tracking of ganged potentiometers and variable capacitors.

Studying the frequency dependence of components.

Easy comparison of quantities usually requiring laboratory techniques, such as:

Small impedance differences.

D of low-loss dielectric materials.

$D \left(= \frac{1}{Q} \right)$ of inductors.

Q or phase angle of wire-wound resistors or potentiometers.

Balance of transformer windings.

Semiconductor capacitances.

Capacitance drift with temperature.



1654-Z1 Sorting System includes limit comparator for additional limits.



1654-Z2 Sorting System contains precise capacitance decade standard.



1654-Z3 Sorting System includes both a limit comparator and capacitance decade standard.

SPECIFICATIONS

Frequencies: Internal only 100 Hz, 1, 10, and 100 kHz, $\pm 1\%$.

Ranges: 0.1% to 30% full-scale impedance difference; 0.001 to 0.3 radian full-scale phase-angle difference. Available ranges depend on test voltage selected as shown in the following table.

| Test Voltage | Impedance Difference | | | | | Phase-Angle Difference | | | | | |
|--------------|----------------------|-----|---|---|-------|---------------------------|-------|------|------|-----|-----|
| | Full-scale Range — % | | | | | Full-scale Range — Radian | | | | | |
| | 0.1 | 0.3 | 1 | 3 | 10 30 | 0.001 | 0.003 | 0.01 | 0.03 | 0.1 | 0.3 |
| 0.3 V | | | x | x | x | | | x | x | x | x |
| 1 V | | x | x | x | x | | x | x | x | x | x |
| 3 V | x | x | x | x | | x | x | x | x | | |

Impedance Ranges (0.3-V test voltage*)

| Freq | Resistance | Capacitance | Inductance |
|---------|-----------------------------|------------------------------|---------------------------|
| 100 Hz | 2 Ω — 20 M Ω | 1000 pF — 1000 μF | 5 mH — 1000 H |
| 1 kHz | 2 Ω — 2 M Ω | 50 pF** — 100 μF | 500 μH — 100 H |
| 10 kHz | 2 Ω — 200 k Ω | 50 pF** — 10 μF | 50 μH — 1 H |
| 100 kHz | 10 Ω — 10 k Ω | 50 pF** — 0.1 μF | 20 μH — 10 mH |

* Low R and L limits are increased and upper C limit decreased by 10:1 for 1-V test voltage and by 100:1 for 3-V.

** To 0.1 pF by substitution method.

National stock numbers are listed at the back of the catalog.

Resolution: Meter, 0.003% and 0.00003 radian. Analog-voltage output, 0.001% and 0.00001 radian.

Accuracy: 3% of full scale.

Voltage Across Standard and Unknown: 0.3, 1, or 3 V selected by front-panel control. Test voltage of 2 V (with 0.6 and 6 V) can be obtained on special order.

Analog-Voltage Outputs: Voltages proportional to meter deflections at two rear-panel connectors: ± 10 V full scale behind $< 10 \Omega$ for 1782 Analog Limit Comparator; ± 3 V or ± 10 V (depending on range) full scale behind 2 k Ω for DVM, A-D converter or other use.

Test Speed: About 1 component per second with meter, max. With analog output voltage, about 4 components per second, except about 1 component per second at 100 Hz.

Power: 105 to 125 or 210 to 250 V, 50-60 Hz, 15 W except 1654-Z1, 35 W.

Supplied: Multiple-contact connector and power cord.

Available: 1782 ANALOG LIMIT COMPARATOR (supplied with -Z1 and -Z3); 1413 PRECISION DECADE CAPACITOR (supplied with -Z2 and -Z3) and other GR decade boxes and standards of resistance, capacitance, and inductance; 1680-P1 TEST FIXTURE for rapid connection of components (includes con-

necting cables); 1654-9600 ADAPTOR KIT for components with 3/4-in. spaced leads; 874-MB COUPLING PROBES for components with 1 1/4-in. spaced leads; and 874-R33 PATCH CORDS for connection to GR874@-terminated standards or unknowns.

Mechanical: 1654, bench or rack models; 1654-Z, all units mounted in a single cabinet with necessary interconnections made. DIMENSIONS (wxhxd): 1654 bench, 19.5x8.75x15 in. (495x222x381 mm); 1654 rack, 19x7x13.5 in. (483x178x343 mm); 1654-Z1, 12x19.5x15 in. (305x222x381 mm); 1654-Z2, -Z3, 17.5x19.5x15 in. (445x222x381 mm). WEIGHT: 1654 bench, 40 lb (19 kg) net, 60 lb (28 kg) shipping; 1654 rack, 25 lb (12 kg) net, 40 lb (19 kg) shipping; 1654-Z1, 51 lb (24 kg) net, 63 lb (29 kg) shipping; 1654-Z2, 66 lb (30 kg) net, 79 lb (36 kg) shipping; 1654-Z3, 77 lb (35 kg) net, 90 lb (42 kg) shipping.

| Description | Catalog Number |
|--|--------------------------------------|
| 1654 Impedance Comparator | |
| Bench Model | 1654-9700 |
| Rack Model | 1654-9701 |
| 1654-Z Sorting Systems (bench only) | |
| 1654-Z2 includes 1413 Decade Capacitor | (Describe exactly as shown at left.) |
| 1654-Z1 includes 1782 Limit Comparator | |
| 1654-Z3 includes 1413 and 1782 | |
| Select, if desired, with -Z1 and -Z3 only | |
| OP6 Relay Output | |
| Accessories Available | |
| 1680-P1 Test Fixture | 1680-9601 |
| 1654-9600 Adaptor Kit | 1654-9600 |
| 874-MB Coupling Probe (2 req'd for each term pair) | 0874-9666 |
| 874-R33 Patch Cord (2 req'd for each term pair) | 0874-9690 |



1782 Analog Limit Comparator

- accessory to 1654 Impedance Comparator
- 4 independent limits — use for high or low
- 2% of full scale accuracy
- GO/NO GO lights, optional contact closures

The GR 1782 Analog Limit Comparator increases the speed at which the 1654 Impedance Comparator will operate in sorting applications. It compares the analog-voltage output of the 1654 against high and low limits set on the 1782 front panel and displays GO or NO GO lights for manual sorting. Optional relay-equipped models will operate external automatic-sorting devices. Up to 4 com-

ponents per second can be measured with the two instruments together.

Four controls on the front panel permit the limits to be set to 1% resolution; each control can act as either a high limit or a low limit as selected on an adjoining switch and for ΔZ or $\Delta \theta$ as selected by a rear-panel switch.

SPECIFICATIONS

Input: ANALOG VOLTAGE: ± 10 V full scale. RESISTANCE (of each comparator): 66 k Ω , approx.

Output: ANALOG VOLTAGE: Identical to input. DECISION OUTPUTS: Visual or relay contacts. *Visual:* NO-GO lamp for each limit; GO lamp indicates measurement is within all limits. *Relay Contacts (optional):* 5 SPDT contacts, 115 V rms, 0.1 A rms, max.

Accuracy: $\pm 2\%$ of full scale.

Limit Controls: Four independent limits; can be set for + (high) or - (low) with switch adjoining each control. DUAL CONTROLS: Inner scale calibrated 0 to 100 (each division corresponds to 100 mV), outer scale calibrated 0 to 30 (316 mV per division).

Test Speed: Approx 10 tests per second, max, for visual output.

Power: 105 to 125 or 210 to 250 V, 50 to 60 Hz, 20 W.

Supplied: 24-contact connector with relay models only, input-signal cable, power cord.

Mechanical: Convertible bench cabinet. DIMENSIONS (wx hxd): Bench, 17x3.88x9.88 in. (432x99x251 mm); rack, 19x 3.5x8.63 in. (483x89x220 mm). WEIGHT: 9 lb (4 kg) net, 15 lb (7 kg) shipping.



The 1782 is shown here with the 1654 Impedance Comparator to form one version of the 1654-Z Sorting System.

National stock numbers are listed at the back of the catalog.

| Description | Catalog Number |
|-------------------------------------|----------------|
| 1782 Analog Limit Comparator | |
| Bench Model, without relays | 1782-9700 |
| Rack Model, without relays | 1782-9701 |
| Bench Model, with relays | 1782-9702 |
| Rack Model, with relays | 1782-9703 |



1687 Megahertz LC Digibridge™

- automatically measures Ls & Q, Cs & D, Cs & Rs, Cp & Gp
- 0.1% basic accuracy for C
0.2% basic accuracy for L
- automatic limit-comparison (10 bins)
- autoranging
- IEEE 488 bus/handler interface option
- two test speeds
- selectable continuous, average or single component measurements
- four types of display — programmed bin limits, measured values, deviation measurement (ΔL or ΔC), or bin number
- five-digit display for L and C
- four-digit display for Q, D, R and G
- optional Kelvin test fixture tests radial and axial lead components

Keyboard Control

- *Display* — The broad visual display of a five, full-digit LED readout for L and C and four full digits for Q, D, R and G is augmented with complete autoranging. All numbers go to 9. Through the use of the DISPLAY key three types of display can be selected: VALUE — the measured value of the component under test; BIN — the bin assignment for the measured device (example: If the measured device falls within the programmed limits of bin 7, the display will show the numeral 7); and $\Delta C/\Delta L$ — displays the change in value (in percent) of a component from a nominal value entered on the keyboard or from the result of a measurement. The $\Delta C/\Delta L$ feature will be of special interest to users performing environmental testing, precision device testing, production/process control testing, component matching and special lot testing.

An additional display is obtained when the FUNCTION key is set in the ENTER mode. In this mode either the programmed limits for any bin or the nominal value can be displayed. An indicator light located below the LC display denotes whether the measured L or C is a negative value.

- *Selectable Test Speeds* — In some testing applications, speed is not too important. In others, accuracy may not be too important. The GR 1687 allows the user to trade accuracy for speed and vice versa. Keyboard selections are: SLOW (2 measurements/second typical) and FAST (4 measurements/second typical).

- *Measurement Control* — Three test conditions are available for selection: CONT — for continuous repetitive measurements; AVERAGE — provides a running average of 10 successive measurements (initiated by START); and SINGLE (initiated by START). The averaging feature is very useful when greater repeatability is required or when measurements are made in noisy environments.

- *Autoranging* — This microprocessor-controlled feature takes the guesswork out of setting the proper range.

- *Measurement Parameters* — These keys provide selection of the basic parameter to be measured: Ls & Q, Cs & D, Cs & Rs, or Cp & Gp.



National stock numbers are listed at the back of the catalog.

Self-Check/Diagnostics When power is switched on, the GR 1687 automatically performs a thorough internal self-check and other diagnostic functions. Upon completion, the 1687 automatically goes into MEASURE function, CONT-mode,* and Cs/D parameter.

Elimination of Costly, Time-consuming Calibration A unique combination of hardware and software features allows on-line recalibration for special fixturing such as autohandlers. In fact, periodic recertification and recalibration are accomplished by the operator in a two-minute calibration exercise. The required short circuit, open circuit and capacitance standard can be user-supplied or obtained from GenRad as the 1687-9605 calibration kit.

Unique Measurement Cable Design The 1687 eliminates the conventional problems encountered in interfacing MHz bridges to special fixtures such as autohandlers. It does this with a specially designed measurement cable that brings key elements of the test circuit right up to the test head.

IEEE 488 Bus/Handler Option A IEEE 488 bus interface and an autohandler output allow the GR 1687 to be connected to an unlimited variety of ancillary equipment, such as handlers, printers or calculator-based systems.



Rear View of the GR 1687 with IEEE 488 Bus/Handler Interface

Optional High Reliability Kelvin Test Fixture Test radial lead components by removing the test clip plate or insert the test clip plate into the fixture and test axial lead components. Each test clip can be moved to the right or left to accommodate various size components. The Kelvin test method assures more accurate measurement.

Component Sorting/Binning The limit comparison feature provides 10 bins for sorting. Bin 0 is designated

for Q, D, R and G. bins 1 through 8 for multi-band sorting and bin 9 is for components that do not meet any of the specified limits of bins 1 through 8. LC limits for bins 1 through 8 are entered as percentage deviations from the nominal value and can be symmetrical (e.g., 1%, 2%, 5%) or asymmetrical (e.g., -20% 80%, -30% 10%). The Q, D, R or G limit is entered as a number and represents a single limit comparison. GO/NO-GO is indicated regardless of which DISPLAY is selected. Bin limits are entered in ascending order with the tightest limits in the lowest bin (1% bin 1, 2% bin 2, etc). Bin limits are held in each bin until changed or cleared by turning off the power switch. For electrical outputs, the IEEE 488 bus/handler option is required.

• **Entry of Symmetrical Limits**

Example: 150 pF capacitor with $D < .005$

Sort: $\pm 1\%$, 2%, 5%, 10%.

Select desired measure rate, display, measure mode.

With FUNCTION key, select ENTER.

Press Cs/D key.

Enter D limit: . 0 0 5 = BIN 0

Enter nominal value: 1 5 0 = NOM VALUE

Enter bin limits:

1 % = BIN 1

2 % = BIN 2

5 % = BIN 3

1 0 % = BIN 4

Close remaining bins:*

0 % = BIN 5

0 % = BIN 6

0 % = BIN 7

0 % = BIN 8

• **Entry of Asymmetrical Limits**

Example: 150 pF capacitor with $D \leq .005$

Sort: match components to .25%.

Select desired measure rate, display, measure mode.

With FUNCTION key, select ENTER.

Press Cs/D key.

Enter D limit: . 0 0 5 = BIN 0

Enter nominal value: 1 5 0 = NOM VALUE

Enter bin limits:

1 % . 7 5 % = BIN 1

. 7 5 % . 5 % = BIN 2

. 5 % . 2 5 % = BIN 3

. 2 5 % 0 % = BIN 4

0 % - . 2 5 % = BIN 5

- . 2 5 % - . 5 % = BIN 6

- . 5 % - . 7 5 % = BIN 7

- . 7 5 % - 1 % = BIN 8

*Initially, at power up, bins 0 through 8 are closed so the procedure shown for closing unused bins is not required.

*SINGLE mode on power-up if IEEE 488 bus interface is connected.

SPECIFICATIONS

Measurement Modes: Measures series L and Q; series C and D; series C and R; and parallel C and G. All measurement modes are key selectable.

Measurement Speed: Slow (2/s typical), fast (4/s typical). Key selectable. Refer to accuracy statements for speed/accuracy data.

Test Frequency: 1.000 MHz $\pm 0.1\%$

Measurement Ranges:

L = 00.001 to 99999 μH

C = 00.001 to 99999 pF

Q = 00.01 to 999.9

D = .0001 to 9.999

R = 00.01 Ω to 999.9 k Ω

G = 00.01 μS to 999.9 mS

Display: Key selectable.

Value — L/Q, C/D, C/R, C/G. Five full digits (99999) for L or C and four full digits (9999) for Q, D, R or G. Completely autoranging.

Bin number — Identifies bin for tested component.

Programmed limits for any bin.

$\Delta L\%$ or $\Delta C\%$ — Percentage deviation of selected L or C measurement from stored nominal value.

Measurement Control: Continuous, average (running average of 10 measurements), or single. Key selectable.

External Bias: Up to 60 V can be applied. Indicator lights when bias is applied.

Applied Voltage: 0.1 V rms nominal, 0.12 V rms maximum (with 1687-9603 probe). Option: 1 V rms $\pm 20\%$ for C values ≤ 100 pF and rolls-off to 0.12 V rms maximum at 1600 pF (with 1687-9604 probe).

National stock numbers are listed at the back of the catalog.

Accuracy:

These accuracy specifications apply when using the standard 0.1 V probe (1687-9603).

L: ACCURACY = $\pm 0.05\%M \left[\underbrace{3 + \frac{L}{500 \mu H} + \frac{50 \mu H}{L}}_{\text{Basic L Accuracy}} \right] \left[\underbrace{1 + \frac{1}{Q}}_{\text{Cross Term}} \right]$

C: ACCURACY = $\pm 0.05\%M \left[\underbrace{1 + \frac{C}{500 pF} + \frac{50 pF}{C}}_{\text{Basic C Accuracy}} \right] \left[\underbrace{1 + D}_{\text{Cross Term}} \right]$

Q: ACCURACY = $\pm \left[.01 + .001M(1 + Q) \right] \left[\frac{\text{Basic L Accuracy}}{0.2\%} \right]$

D: ACCURACY = $\pm .001M \left[1 + (1 + D) D \right] \left[\frac{\text{Basic C Accuracy}}{0.1\%} \right]$

R: ACCURACY = $\pm 0.1\%M \left[1 + \frac{R}{6 k\Omega} + \frac{150 \Omega}{R} \right] \left[1 + 1/D \right]$

G: ACCURACY = $\pm 0.1\%M \left[1 + \frac{G}{6 mS} + \frac{150 \mu S}{G} \right] \left[1 + 1/D \right]$

These accuracy specifications apply when using the optional 1 V probe (1687-9604).

L: Same as above.

C: ACCURACY = $\pm 0.05\%M \left[\underbrace{3 + \frac{C}{500 pF} + \frac{50 pF}{C}}_{\text{Basic C Accuracy}} \right] \left[\underbrace{1 + D}_{\text{Cross Term}} \right]$

Q: ACCURACY = $\pm \left[.01 + .002M(1 + Q) \right] \left[\frac{\text{Basic L Accuracy}}{0.2\%} \right]$

D: ACCURACY = $\pm .002M \left[1 + (1 + D) D \right] \left[\frac{\text{Basic C Accuracy}}{0.2\%} \right]$

R: ACCURACY = $\pm 0.05\%M \left[3 + \frac{R}{3 k\Omega} + \frac{300 \Omega}{R} \right] \left[1 + 1/D \right]$

G: ACCURACY = $\pm 0.05\%M \left[3 + \frac{G}{3 mS} + \frac{300 \mu S}{G} \right] \left[1 + 1/D \right]$

In above specifications,

M = 1, when using SLOW test rate

M = 5, when using FAST test rate

D = $2\pi fRC$ for series R and C

D = $\frac{G}{2\pi fC}$ for parallel G and C

f = 1 MHz

Accuracy specifications apply over the following temperature ranges (after warmup time of 30 minutes):

$T_a^* = T_{cal} \pm 5^\circ C$ — no recalibration necessary.

$T_a^* = T_{cal} \pm 15^\circ C$. — "open" and "short" recalibration required at $T = T_a \pm 5^\circ C$.

$T_a^* < T_{cal} - 15^\circ C$ — Full ("open," "short," "std")

$T_a^* > T_{cal} + 15^\circ C$ — recalibration required.

*Ambient temperature range $0^\circ C \leq T_a \leq 50^\circ C$.

NOTE: Factory calibration is at $T_{cal} = 25^\circ C$

T_{cal} = temperature of last full recalibration. Calibration applies for 12 months after full recalibration.

Environmental: Operating: +0 to +50°C, 0 to 85% relative humidity. Storage: -40 to +75°C

Supplied: 0.1 V measurement probe with cable (1687-9603) and power cord.

Power: 90 to 125 V or 180 to 250 V, 48 to 62 Hz. Voltage selected by rear-panel switch. 30 W maximum.

Mechanical: Bench model. Dimensions (wxhxd): 14.78x4.4x13.5 in. (37.54x11.18x34.29 cm). WEIGHT: 13.5 lb (6.14 kg) net, 18 lb (8.2 kg) shipping..

| Description | Catalog Number |
|---|----------------|
| 1687 LC Digibridge™ | 1687-9700 |
| 1687 LC Digibridge™ with IEEE 488 Bus/Handler Interface | 1687-9701 |
| 1687-P1 Test Fixture | 1687-9600 |
| 1687 1-V Measurement Probe/Cable | 1687-9604 |
| 1687 Calibration Kit | 1687-9605 |
| Replacement parts: | |
| 1687 Probe Nose Assembly | 1687-9606 |
| 1687 0.1-V Measurement Probe/Cable | 1687-9603 |
| 1687 Reference-Standard Adaptor | 1687-9602 |



1606-B Radio-Frequency Bridge

- 400 kHz to 60 MHz
- direct reading in ohms
- adaptable to coaxial connectors
- accurate, compact, simple operation

The 1606-B accurately and easily measures the resistance and reactance of antennas, transmission lines, networks, and components. It is particularly well suited for measuring low values of impedance of rf devices. Its range can be extended by means of an external parallel capacitor to measure high impedances.

Precision Coaxial Connections In this latest model of the popular 1606 RF Bridge, the Unknown terminals are adaptable to coaxial connectors, in particular the GR900. This is a significant advantage that not only permits the measurement of components having coaxial fittings but also ensures better repeatability and more accurate definition of the measurement plane. This permits the 1606 to be precision calibrated against coaxial standards such as the various GR900® precision components: open- and

short-circuits, 50- and 100-ohm Standard Terminations, and the various lengths of precision air line.

Accessory Adaptor Kit With the 1606-P2 adaptor kit, the 1606-B can be fitted to accept GR900 and GR874® connectors (the adaptors include compensation to match 50-ohm standards and components). The kit will also adapt to a 14-mm flange connector (a GR900 flange is included to convert GR900 connectors), or to other common connectors (N, BNC, TNC, etc) by the use of GR900 adaptors.

Description Measurements are made by a series-substitution method in which the bridge is first balanced with a short circuit across the Unknown terminals. The short is then removed, the unknown impedance connected, and the bridge rebalanced.

The entire mechanical design is such that the instrument can operate under difficult environmental conditions similar to those specified for testing military electronics equipment. The 1606-B bridge is therefore an excellent instrument for field use.

SPECIFICATIONS

| Ranges of Measurement | Accuracy |
|---|--|
| <p>Reactance: $\pm 5000 \Omega$ at 1 MHz. This range varies inversely as the frequency; at other frequencies the dial reading must be divided by the frequency in MHz.</p> <p>Resistance: 0 to 1000 Ω.</p> | <p>Reactance: At frequencies up to 5 MHz, $\pm 2\% \pm (1 + 0.004 Rf) \Omega$; 5 to 50 MHz, $\pm 2\% \pm (1 + 0.0008 Rf) \Omega$; where R is the measured resistance in ohms and f is the frequency in MHz.</p> <p>Resistance: At frequencies up to 50 MHz,</p> $\pm \left[1\% + 0.0024f^2 \left(1 + \frac{R}{1000} \right) \right] \% \pm \frac{10^{-4} X}{f} \Omega + 0.1 \Omega$ <p>(where X is the measured reactance in ohms). Subject to correction for residual parameters.</p> |

Frequency: 400 kHz to 60 MHz.

Satisfactory but somewhat less accurate operation can be obtained at frequencies as low as 100 kHz and somewhat above 60 MHz.

Generator: External only (not supplied), to cover desired frequency range.

Detector: External only (not supplied). A well shielded radio receiver is recommended.

Supplied: 2 leads of different lengths to connect unknown impedance to bridge terminals; 1/2-in. spacer and 3/4-in. screw to mount component to be measured directly on bridge terminals; 874-R22LA Patch Cord.

Available: 1606-P2 PRECISION COAXIAL ADAPTOR KIT.

Mechanical: Bench cabinet. DIMENSIONS (wxhxd): 12.5x9.5x10.25 in. (318x242x261 mm). WEIGHT: 23 lb (11 kg) net, 30 lb (14 kg) shipping.

SPECIFICATIONS FOR 1606-P2

Capacitance Added: By adaptor to GR900, 0.38 pF at reference plane (less fringing capacitance); by flange adaptor, 0.18 pF.

Weight: Net, 10 oz (283 g); shipping, 12 oz (340 g).

| Description | Catalog Number |
|---------------------------------------|----------------|
| 1606-B Radio-Frequency Bridge | 1606-9702 |
| 1606-P2 Precision Coaxial Adaptor Kit | 1606-9602 |

National stock numbers are listed at the back of the catalog.

1602-B UHF Admittance Meter

- 20 MHz to 1.5 GHz
- direct-reading conductance and susceptance
- measures SWR directly



Versatile building block This null-type instrument measures complex impedance and admittance in coaxial systems and, as a reflectometer, will determine SWR, impedance magnitude, and reflection coefficient magnitude. It can be used to adjust a network to a predetermined admittance, to match one network to another, and to match antennas and other networks to 50-ohm circuits.

A broad line of accessories adapts the 1602-B to specific measurements, for example:

Constant-Impedance Adjustable Line The 874-LK20L can be set to one-half wavelength to eliminate corrections for the length of transmission line between the unknown and the measuring point. When the line is set to one-quarter wavelength, the Admittance Meter dials read in impedance parameters, i.e., the series resistance and reactance of the unknown.

874-ML Component Mount for the connection of lumped elements (resistors, capacitors, or inductors).

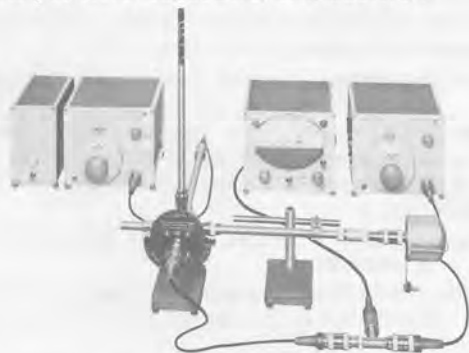

The Admittance Meter assembled for component measurements, with unit oscillator and Detector. A line stretcher (Type 874-LKL) connects the component mount to the unknown terminal of the Admittance Meter.

Description The 1602-B UHF Admittance Meter comprises three identical loops, in parallel, driving a null detector and magnetically coupled to three coaxial lines. All these lines are fed from the same voltage so the current in each line, hence the magnetic field, is proportional to the terminating impedance. One of these lines is terminated with a standard resistance, one with a reactance standard, and one with an unknown admittance. In operation, the coupling of the loops must be adjusted simultaneously until a null is obtained on the detector. Each loop has a calibrated scale and the settings at null condition indicate the value of the unknown device.

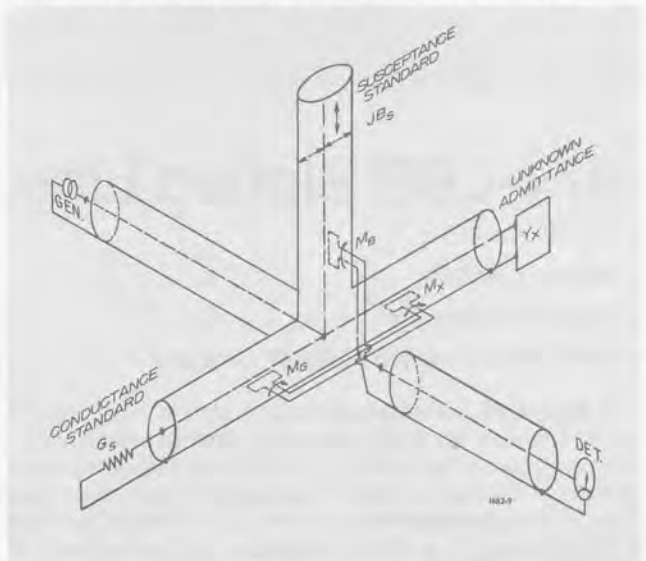

SPECIFICATIONS

Frequency: 40 MHz to 1.5 GHz, direct reading; to 20 MHz with a frequency correction applied to susceptance reading.

Conductance: 0.01 to 4000 m Ω .

Susceptance: -4000 to +4000 m Ω .

Accuracy (both conductance and susceptance): $\pm(3\% + 0.2 \text{ m}\Omega)$ for 0 to 20 m Ω , $\pm(3\sqrt{M}\% + 0.2 \text{ m}\Omega)$ above 20 m Ω (where M is scale multiplying factor), up to 1 GHz; $\pm(5\% + 0.2 \text{ m}\Omega)$ to 1.5 GHz. For matching of impedances to 50 Ω , accuracy is $\pm 3\%$ up to 1.5 GHz.

Supplied: Two 1602-P4 Terminations as conductance standards, one 1602-P1 Adjustable Stub and one 1602-P3 Variable Air Capacitor as susceptance standards, two GR874 patch cords to connect to generator and detector, 1602-P10 and -P11 Multiplier Plates, and a wooden storage case.

Required: GENERATOR: Must supply 1 to 10 V. GR high-frequency oscillators recommended. DETECTOR: Sensitivity of 10 μV needed. 1236 I-F Amplifier recommended.

Available: 874-FBL Bias Insertion Unit, coaxial adaptors, line-stretcher, component mount, oscillators, detector.

Mechanical: TERMINALS: GR874 coaxial connectors which can easily be converted to type N or other common connector types by means of GR874 adaptors. DIMENSIONS (wxhxd): 5.5x7.5x5.5 in. (140x190x140 mm). WEIGHT: 8.5 lb (3.8 kg) net, 18 lb (8.5 kg) shipping.

| Description | Catalog Number |
|--|----------------|
| 1602-B UHF Admittance Meter | 1602-9702 |
| 874-LK20L Constant-Impedance Adjustable Line | 0874-9631 |
| 874-ML Component Mount | 0874-9663 |

National stock numbers are listed at the back of the catalog.

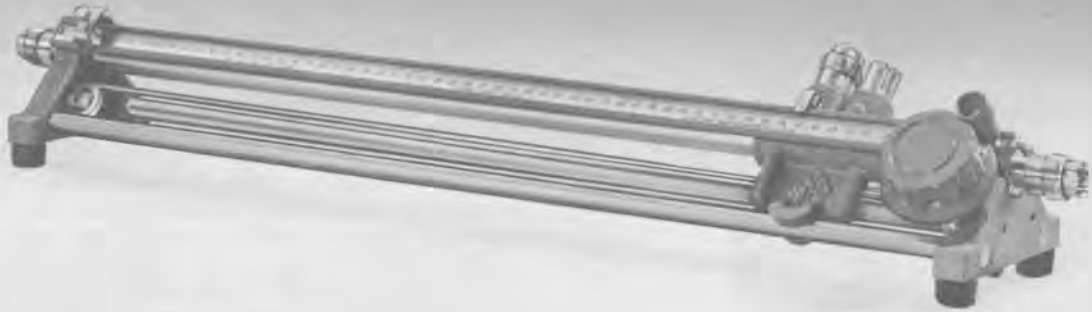

874-LBB Slotted Line

- 300 MHz to 9 GHz
- low residual SWR
- rugged construction
- many lines in one with GR874® adaptors

A basic UHF measurement tool A slotted line is one of the most important basic measuring instruments in high-frequency work. It is used to determine the standing-wave pattern of the electric field in a coaxial transmission line; from this knowledge, several circuit characteristics can be determined of a circuit connected to the load end of the line. For example, the degree of mismatch (usually expressed as SWR) between the load and the transmission line can be calculated from the ratio of the maximum amplitude of the wave to the minimum. The load impedance can be calculated from the SWR and the position of the voltage minimum on the line. Electrical length and time delay can also be measured accurately. These capabilities make the slotted line a valuable instrument for measurements on antennas, components, coaxial elements, networks, transistors, and diodes.

Twenty-two lines in one The 874-LBB can be converted in seconds to interface with any of the popular UG connectors by use of GR874 low-SWR adaptors, available for BNC, C, HN, Microdot, N, SMA, SC, TNC, GR900®, and Amphenol APC-7 connectors. A complete set of adaptors will convert the 874-LBB into the equivalent of 22 low-SWR slotted lines.

The 874-LBB is a 50-ohm, air-dielectric coaxial line whose electric field is sampled by a probe that projects through a longitudinal slot in the outer conductor. The probe rides on a carriage driven by a pulley-and-cord linkage conveniently operated from one end of the line. A source of about one milliwatt rf power is adequate for most measurements. The detector can be a 1-kHz standing-wave indicator such as the GR 1234 or a heterodyne detector. In the former case, rf detection takes place in a diode detector built into the carriage.

SPECIFICATIONS

Frequency: 300 MHz to 8.5 GHz, usable to 9 GHz. Operates below 300 MHz (where probe travel equals ½ wavelength) if extended with lengths of GR874 air line or with another slotted line in series.

Probe: TRAVEL: 50 cm; scale in cm with 1 mm per division. SCALE ACCURACY: $\pm(0.1 \text{ mm} + 0.05\%)$. PICKUP CONSTANT (flatness): $\pm 1.25\%$.

SWR: $<1.01 + 0.0016 (f_{\text{GHz}})^2$ up to 7.5 GHz, <1.10 to 8.5 GHz.

Characteristic Impedance: $50 \Omega \pm 0.5\%$.

Supplied: Storage box, rf probe, 2 microwave diodes, Smith Charts.

Required: 874-D20L Adjustable Stub for tuning diode when audio-frequency detector such as GR 1234 is used, suitable generator and detector, one each 874-R22LA and 874-R22A Patch Cords.

Available: SW meter, detectors, 50- Ω air lines, adaptors, oscillators, and terminations.

Mechanical: DIMENSIONS (wxhxd): 26x4.5x3.5 in. (660x114x89 mm). WEIGHT: 8.5 lb (3.9 kg) net, 23 lb (11 kg) shipping.

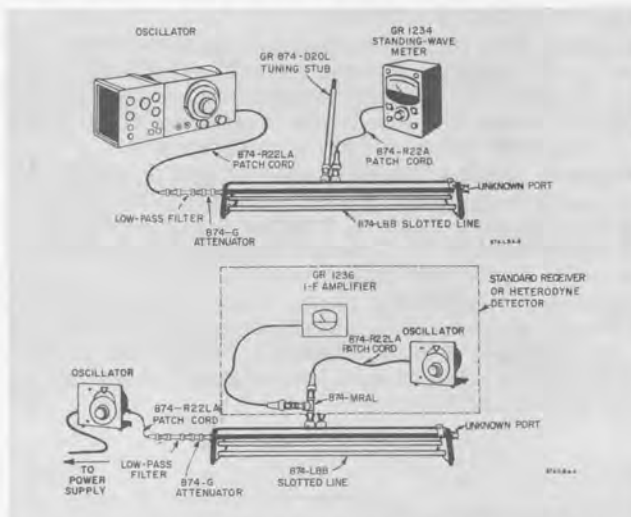

Typical measurement setups showing use of slotted line, SWR indicator (upper) and heterodyne detector (lower).

Description

Catalog Number

874-LBB Slotted Line

0874-9651

National stock numbers are listed at the back of the catalog.



900-LB Precision Slotted Line

- 300 MHz to 8.5 GHz
- extremely low SWR
- impedance is $50 \Omega \pm 0.1\%$
- adaptable with precision to other connectors

Unparalleled precision The most precise coaxial connector, the GR900, and a nearly perfect section of coaxial transmission line combine to give the 900-LB Precision Slotted Line unparalleled performance specifications. The residual SWR of the instrument is that of its GR900® connector: $1.001 + 0.001 f_{\text{GHz}}$. For those whose applications demand the ultimate in accuracy, the 900-LB can be calibrated against a 900-LZ Reference Air Line, an impedance standard with a SWR under 1.0025 at 9 GHz.

In the field of microwave impedance measurement, the slotted line is the fundamental instrument, because of its inherent accuracy, broadband characteristics, and phase-measuring capabilities. Among the many transmission-line parameters that can be determined with the slotted line are SWR, reflection-coefficient magnitude and phase, attenuation or insertion loss, and wavelength. The admittance or impedance of source or termination can be measured; so also can transistor and diode characteristics and dielectric constant. It gives the design engineer all the

SPECIFICATIONS

Frequency: 300 MHz to 8.5 GHz. Operates below 300 MHz (where probe travel equals $\frac{1}{2}$ wavelength) if extended with lengths of GR900 air line or with another slotted line in series.

Probe: TRAVEL: 50 cm; scale in cm. SCALE ACCURACY: $\pm(0.1 \text{ mm} + 0.05\%)$. Attached vernier resolution is 0.1 mm and micrometer carriage-drive resolution is 0.002 mm. PICK-UP CONSTANCY (flatness): $\pm 0.5\%$.

SWR: $<1.001 + 0.001 f_{\text{GHz}}$ (unknown connector side).

Repeatability: Within 0.05% (0.0005 SWR).

Characteristic Impedance: $50 \Omega \pm 0.1\%$. CONTACT RESISTANCE (900-BT connector): $<0.5 \text{ m}\Omega$ inner connector, $<0.07 \text{ m}\Omega$ outer connector.

information he needs to evaluate the over-all performance of devices and networks over a wide band.

The outstandingly low SWR of the 900-LB should save users the many hours required to calibrate less accurate instruments.

Equipped with the appropriate GR900 low-SWR adaptor, the 900-LB becomes a type-N slotted line (or BNC, or TNC, etc) whose specifications still exceed those of slotted lines originally equipped with that connector (see curve below).

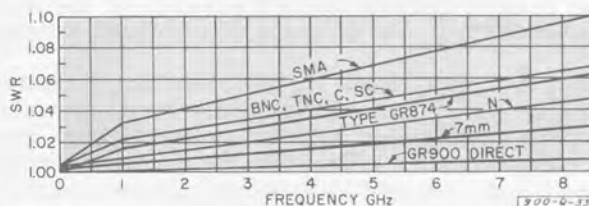

Specified residual SWR of the 900-LB Precision Slotted Line in combination with various GR900® precision adaptors.

Included with the slotted line is a full set of accessories; no additional parts are needed for common measurements, except the generator and detector, which should be selected according to frequency range of interest.

Supplied: Adjustable probe-tuner assembly, rf probe, micrometer carriage drive accurate to 0.01 mm, 900-WN Precision Short-Circuit Termination, 900-WO Precision Open-Circuit Termination, 874-R22A Patch Cord, 874-Q900L adaptor, 1N21C and 1N23C detector diodes, Smith charts, storage case.

Required: Source and detector.

Mechanical: DIMENSIONS (wxhxd): 27.5x10x4.75 in. (699x254x121 mm). WEIGHT: 11 lb (5 kg) net, 34 lb (16 kg) shipping.

Description

Catalog Number

900-LB Precision Slotted Line

0900-9651

National stock numbers are listed at the back of the catalog.

Heterodyne Detectors

40 to 2030 MHz

- high sensitivity
- choice of bandwidth
- agc for null detection
- 70-dB calibrated attenuator
- expanded scale

General-purpose, highly sensitive high-frequency detector systems for relative signal-level measurements or for use as null detectors can be created by combining a 1236 I-F Amplifier and a High-Frequency Oscillator (1362, 1363, or 1218-BV). The excellent shielding provided by such systems makes them ideal for low-level measurements in the presence of high-level external fields.

Gain, loss, signal level These systems can be used to measure insertion loss and attenuation, crosstalk in multiterminal devices such as switches, and antenna gain and radiation patterns. They can also be used as field-strength indicators and as laboratory high-frequency receivers. Signal levels can be measured over an 80-dB range, even more with the use of external attenuators.

RF voltmeter When calibrated at one signal level and frequency with the aid of a standard-signal generator, these systems can be used as selective voltmeters, in a 50-ohm system, at that frequency.

Detector Such systems are recommended as a null detector for the 1602-B UHF Admittance Meter and are an excellent standing-wave indicator for use with the 874-LBB and 900-LB Slotted Lines. These systems are particularly useful for measurements on nonlinear elements, measurements that require a high degree of harmonic rejection and the use of a low-level test signal. The expanded 1-dB full-scale range (equivalent to 1.12 SWR) makes possible very accurate low-SWR measurements at low signal levels.

The system Each system consists of an 874-MRAL Mixer, 1236 I-F Amplifier, 874-G10L 10-dB Pad, and 874-EL-L 90° ELL, plus an oscillator and filter. For maximum shielding, components are equipped with locking GR874® connectors (which can be used interchangeably with the nonlocking type).

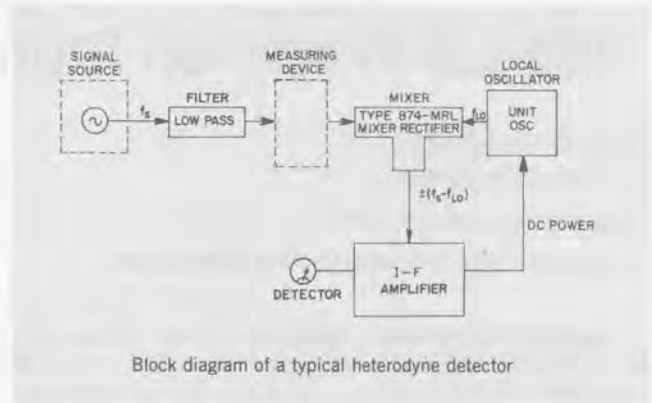

The frequency range can be extended by the use of oscillator harmonics, but with reduced sensitivity and dynamic range. To cover wide frequency ranges economically, it is recommended that you obtain one complete system plus the appropriate oscillators and filters for the additional frequency ranges desired.

For instance, to cover the range from 40 to 950 MHz, selection would consist of a 1363 VHF Oscillator, 1236 I-F Amplifier, 874-MRAL Mixer, 874-G10L 10-dB Pad, 874 EL-L Coaxial Ell and 874-F500L Low Pass Filter to cover the fundamental range of 40 to 350 MHz plus a 1362 UHF Oscillator and 874-F1000L Filter to extend the fundamental range up to 950 MHz.

SPECIFICATIONS

Frequency Range (in MHz):

| | | | |
|----------------------|-------------|-------------|--------------|
| Fundamental | 40* to 530 | 190 to 950 | 870 to 2030 |
| 2nd harmonic** | 82 to 1030 | 410 to 1870 | 1770 to 4030 |
| 3rd harmonic** | 138 to 1530 | 630 to 2790 | 2670 to 6030 |
| 4th harmonic** | 194 to 2030 | 850 to 3710 | 3570 to 8030 |
| Order the following: | | | |
| Local Oscillator | 1363 | 1362 | 1218-BV |
| I-F Amplifier | 1236 | 1236 | 1236 |
| Filter | 874-F500L | 874-F1000L | 874-F2000L |
| Mixer | 874-MRAL | 874-MRAL | 874-MRAL |
| Pad | 874-G10L | 874-G10L | 874-G10L |
| Coaxial 90° ELL | 874-EL-L | 874-EL-L | 874-EL-L |

*40 MHz is the practical low-frequency limit.

**For harmonic operation, the appropriate low-pass filter must be used.

National stock numbers are listed at the back of the catalog.



1236 I-F Amplifier

- 30-MHz precision lab receiver
- bandwidths: 0.5 and 4 MHz
- 2-dB noise figure, 3.5- μ V sensitivity
- preamplifier and 70-dB attenuator
- expanded scale

Precision laboratory receiver The 1236 will meet the many critical demands placed upon a precision laboratory receiver. More than an amplifier, it is a complete 30-MHz measuring receiver with preamplifier, wide-range calibrated attenuator, and a large meter with normal, expanded, and compressed scales. The high sensitivity, or low noise figure, with narrow bandwidth will provide good small-signal performance and noise rejection for excellent measurement accuracy. The availability of a wider bandwidth also greatly simplifies use at higher frequencies where sources are generally less stable.

Gain stability during a measurement is ensured by a fully regulated power supply; 10% line-voltage variations change gain less than 0.05 dB. Frequency stability of your local oscillator can be achieved by use of the 30-MHz i-f output of this amplifier to drive an external afc loop.

Precision attenuation measurements You can measure large values of attenuation easily with the 1236, owing to the wide dynamic range of its preamplifier and attenuator. A 1-dB full-scale, expanded meter scale is provided, which facilitates measurement of small values or changes in attenuation. A continuous gain control permits setting initial readings for easy subtraction in substitution measurements.

Precision SWR measurements The 1236 is recommended for the most precise SWR measurements, of both high and low values. The expanded scale is equivalent to 1.12:1 full scale. The high sensitivity of the 1236 permits the SWR of solid-state devices to be measured at signal levels low enough to avoid the effects of device nonlinearity.

National stock numbers are listed at the back of the catalog.

As a null detector, the 1236 offers the advantages of its compressed (agc) meter scale for convenience in rapid null balancing and its high sensitivity for sharp nulls and precise data. It will also find application in noise-figure measurements.

Precision detector systems The 1236 I-F Amplifier in combination with an appropriate local oscillator (power supply for which is built into the 1236), mixer, low-pass filter, an additional preamplifier, and connecting coaxial components make up a complete precision test receiver. Any one of three different frequency bands within the range of 40 to 2030 MHz are available.

SPECIFICATIONS

Frequency: CENTER FREQUENCY: 30 MHz. BANDWIDTH: \approx 3 MHz wide band, \approx 0.5 MHz narrow band, selected by panel switch.

Sensitivity: 3.5 μ V narrow band, 9 μ V wide band, open-circuit voltage behind 400 Ω for indication 3 dB above noise level. NOISE FIGURE: 2 dB, typical. PREFERRED SOURCE IMPEDANCE: 400 Ω //7 pF (equivalent of 874-MRAL Mixer).

Meter: SCALE: -2 to 10 dB normal, with \pm 0.2-dB linearity over 0 to 10-dB range; 1 dB full scale expanded (1.12:1 SWR) with \pm 0.03-dB linearity; 40-dB min range, compressed scale.

Gain: ATTENUATOR: 70 dB in 10-dB steps with \pm (0.1 dB + 0.1 dB/10 dB) accuracy at 30 MHz; 10-dB min range continuous gain control.

Outputs: VIDEO (modulation): 1.5 V max behind 600 Ω , 1-MHz bandwidth. I-F: 0.5 V max into 50 Ω . POWER SUPPLY: 150 to 300 V dc adjustable, at 30 mA, regulated; 6.3 V ac at 1 A.

Available: GR 1362, 1363, and 1218-BV as local oscillators, 874-MRAL Mixer, low-pass filters, attenuators, adaptors.

Mechanical: Bench cabinet. DIMENSIONS (wxhxd): 8x7.38x8 in. (213x187x213 mm). WEIGHT: 13 lb (6 kg) net, 15 lb (7 kg) shipping.

| Description | Catalog Number |
|--------------------|----------------|
| 1236-I-F Amplifier | 1236-9701 |



1234 Standing-Wave Meter

- SWR ranges 1.05 to 4, full scale
- large meter with light-keyed scales
- precision attenuators
- highly sensitive

Precise SWR measurements The 1234 Standing-Wave Meter incorporates many features to simplify its primary use in measuring SWR with a slotted line, such as the GR 874-LBB or the 900-LB Precision Slotted Line. Accurate measurements of low voltage SWR are possible with the expanded 1.05 scale on the oversize meter face. Reading the wrong meter scale is virtually impossible, as the correct one is identified automatically by a small light.

You have fingertip control over (1) fine tuning of the 1-kHz amplifier, to permit matching exactly the frequency of the modulating oscillator, (2) bandwidth, for optimizing signal-to-noise ratio without affecting amplifier gain, and (3) meter damping, for the right balance between smoothing and speed of response. These controls, plus the other usual ones, give you adequate means to select appropriate measuring characteristics for a wide variety of important tasks.

Precise attenuation measurements In attenuation measurements, the 1234 also offers many particular advantages. Three precision attenuators have a total range of 70 dB in 1-, 5-, and 10-dB steps. Meter scales and attenuators are calibrated for use with a square-law detector. Readings can be interpolated with extremely high resolution on the 1.6- and 0.45-dB full-scale meter ranges. A special "memory" dial behind the wide-range 5-dB/step attenuator knob permits you to make substitution measurements rapidly, without subtraction, and therefore with little possibility of error.

SPECIFICATIONS

Frequency: 1 kHz, adjustable ± 30 Hz. **BANDWIDTH:** 10 to 100 Hz, adjustable with constant gain.

| Input: | Crystal | | | | Bolometer |
|------------------|------------------|---------------------|-------------------|----------------------|----------------------|
| | Optimum source R | 35k Ω | 20k Ω | 2k Ω | 200 Ω |
| Input Z | 1M Ω | 350k Ω //80H | 35k Ω //8H | 3.5k Ω //0.8H | 3.5k Ω //0.8H |
| Sensitivity (fs) | 1.2 μ V | 1 μ V | 0.32 μ V | 0.1 μ V | 0.1 μ V |
| Noise* | 0.12 μ V | 0.12 μ V | 0.036 μ V | 0.012 μ V | 0.012 μ V |

* Equivalent input noise level with optimum source resistance and minimum bandwidth.

Meter: SCALES: SWR, 1 to 4, 3.2 to 10, 1 to 1.2, and 1 to 1.05; dB, 0 to 10, 1.6, and 0.45; bolometer current, 0 to 10 mA. **ACCURACY:** $\pm(0.01$ dB + 2% of reading) for 10-dB scale; ± 0.02 dB for 1.6-dB scale, ± 0.007 dB for 0.45-dB scale. **SPEED:** Slow and Fast, switch selected.

Gain: ATTENUATOR: Three separate attenuators: 20 dB in 10-dB steps with ± 0.1 dB/10 dB accuracy, 45 dB in 5-dB steps with ± 0.05 dB/5 dB accuracy (for source R < 1.5 times optimum listed in table) and < 0.1-dB cumulative error, 5 dB in 1-dB steps with ± 0.01 dB/dB accuracy and < 0.03-dB cumulative error. **GAIN CONTROL:** 6-dB range with coarse and fine controls.

Bolometer Bias Current: 4.3 and 8.7 mA, adjustable $\pm 10\%$. Voltage limited for bolometer protection.

Outputs: DC: 1.5 V max behind 1.5 k Ω . AC: 100 mV rms (SWR range 1 to 4), 300 mV rms (SWR 1 to 1.2), and 1 V rms (SWR 1 to 1.05); 500- Ω source impedance; limitation on load, R > 6 k Ω .

Power: 100 to 125 or 200 to 250 V, 50 to 60 Hz, 4 W max; or 22 to 35 V dc at 90 mA from ext battery (use 1538-P3 Battery and Charger).

Mechanical: Flip-Tilt case. **DIMENSIONS** (wxhxd): 8.38x8.75x11.25 in. (213x222x286 mm). **WEIGHT:** 9 lb (4.1 kg) net, 13 lb (6 kg) shipping.

| Description | Catalog Number |
|-----------------------------|----------------|
| 1234 Standing-Wave Meter | 1234-9701 |
| 1538-P3 Battery and Charger | 1538-9603 |

National stock numbers are listed at the back of the catalog.

Capacitance-Measuring Instruments

This section describes two high-precision capacitance bridges and the test systems built around them, a high-capacitance bridge that measures up to 1.1 F and an automatic digital capacitance meter for rapid production and inspection testing. These instruments, the first four listed in the chart below, are only a small part of our capacitance-measuring capability. Nine other instru-

ments are offered, bridges and meters that measure resistance and inductance as well as capacitance. The 1687 Megahertz LC Digibridge™ may be of particular interest for 1-MHz testing of low-value capacitors; the automatic 1658 Digibridge™ is recommended for inspection and production testing of higher values at low frequencies.

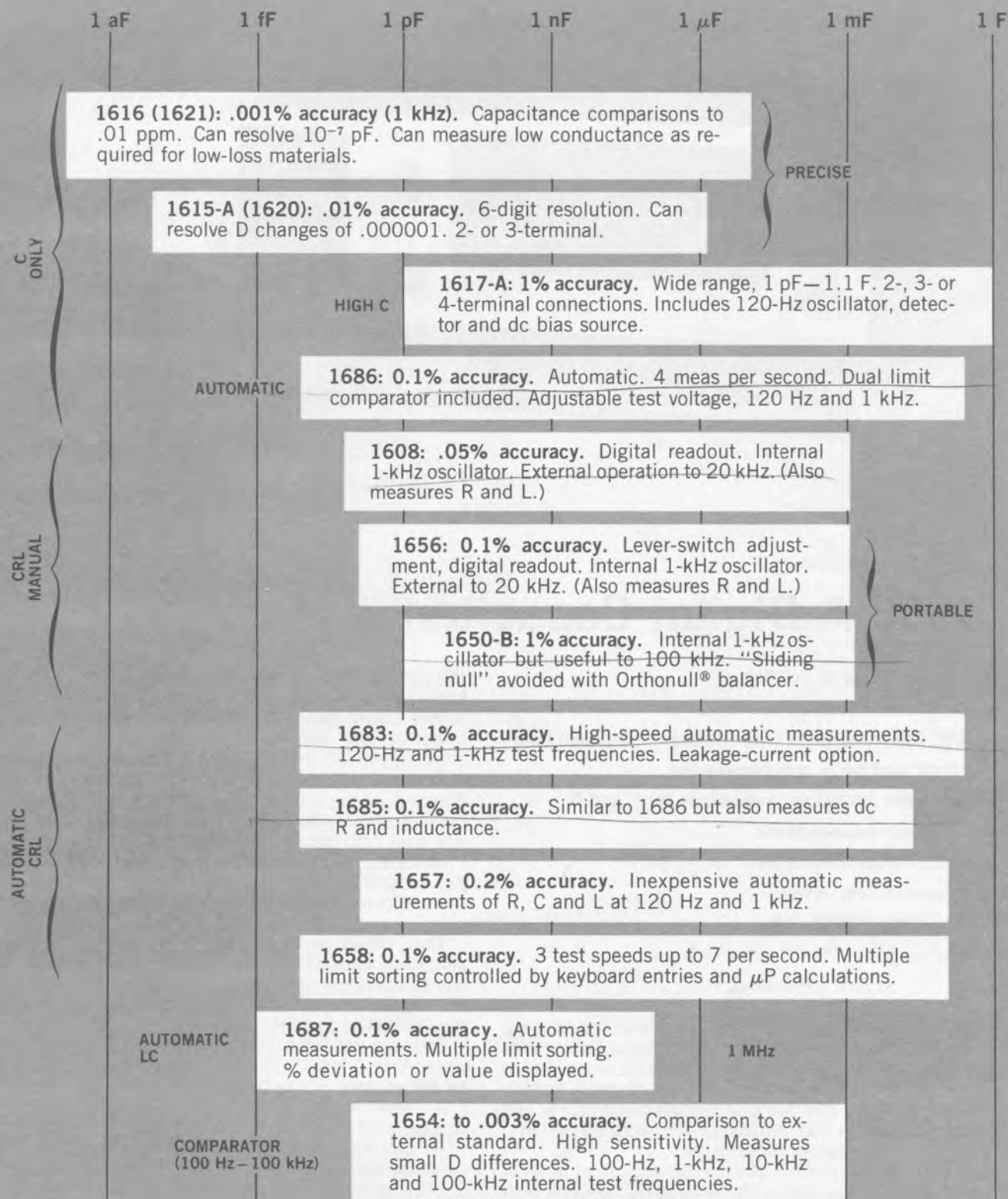



1686-A Digital Capacitance Meter

- C from 0.01 pF to 200,000 μ F
- 0.1% basic accuracy
- fast: 250-millisecond unqualified measurement time
- 120-Hz and 1-kHz test frequencies
- automatic GO/NO GO indications for C and D
- automatic measurement
- internal and external bias
- adjustable test voltage
- data output (BCD)
- over-range to one full farad

GR's 1686-A Digital Capacitance Meter provides the rapid throughput you need for high-volume testing **plus** the high accuracy you need for lab and QC work. Add to these two features wide measurement range, a built-in limit comparator and two test frequencies and you can easily get the idea that GenRad has an excellent performing unit for measuring capacitance.

Anyone can master the 1686's operation in a matter of minutes, partly because of the GO/NO GO lights on both

the instrument and the optional test fixture. Normally, these two lamps are all the operator needs to look at. If either capacitance or dissipation factor is out-of-tolerance, the red NO GO lamp is lit. Otherwise, the bright green GO lamp is lit.

Connect your component and turn the RANGE knob as directed by the arrows. No decisions are required. The measurement units light up automatically. A clear, bright 4½-digit LED display indicates value.

Make a single measurement or repeat at rates from 4 per second to one every 10 seconds. This is a great feature for tracking value changes as you stress a component.

The built-in limit comparator greatly speeds up and simplifies capacitor inspection and sorting. High- and low-capacitance limits are easily set with thumbwheel switches. The dissipation-factor limit is set by rotating the DF dial to the desired value.

On range positions 2 through 6, the test voltage can be varied from 1 V to 0.05 V, and on range position 1 it can be varied from 5 V to 0.25 V.

A 2-volt internal bias may be selected or a 0-to-100 volt external bias may be used.

An optional Kelvin test fixture accommodates either radial or axial lead components. External bias can be applied to the component directly at the fixture.

National stock numbers are listed at the back of the catalog.

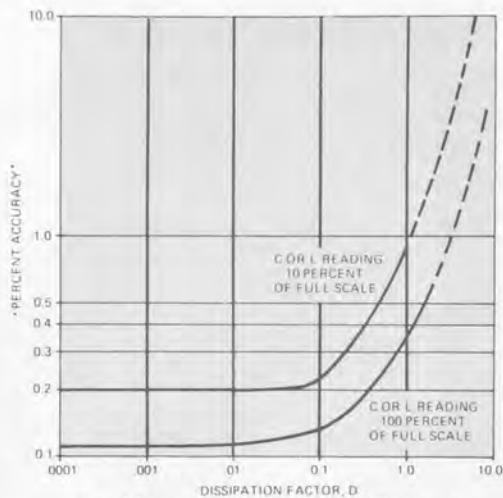

C and L accuracy at 1 kHz Test Frequency

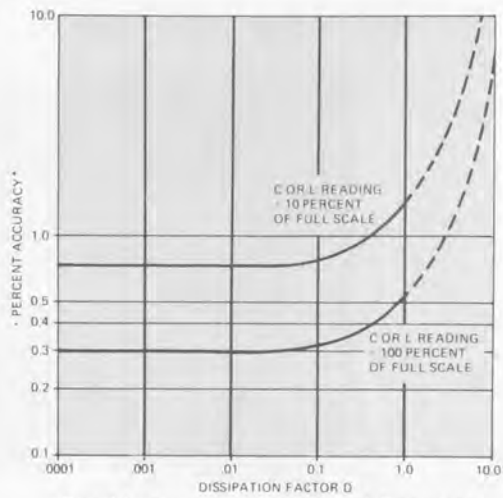

C and L accuracy at 120 Hz Test Frequency

*Multiply Percent Accuracy By M (see Range table).

SPECIFICATIONS

Ranges: Full scale readings, accuracy multipliers, and applied-voltage multipliers.

Capacitance:

| Switch Position | C 1 kHz | M | C 120 Hz | M | Voltage Multiplier A |
|-----------------|-----------|----|------------|----|----------------------|
| 1 | 199.99 pF | 3 | 1.999 nF | 2 | 5 |
| 2 | 1999.9 pF | 1 | 19.99 nF | 1 | 1 |
| 3 | 19.999 nF | 1 | 199.9 nF | 1 | 1 |
| 4 | 199.99 nF | 1 | 1.999 μF | 1 | 1 |
| 5 | 1999.9 nF | 1 | 19.99 μF | 1 | 1 |
| 6 | 19.999 μF | 1 | 199.9 μF | 1 | 1 |
| 7 | 199.99 μF | 3 | 1.999 mF | 2 | 0.1 |
| 8 | 1999.9 μF | 10 | 19.99 mF | 3 | 0.1 |
| 9 | — | — | 199.9 mF** | 6* | 0.1 |

*Typical value. **Extends to 999.9 mF.
 M = Accuracy Multiplier (see below).
 A = Applied-Voltage Multiplier.

Dissipation Factor: D = 0.001 to 10.

Accuracy: CAPACITANCE: Basically 0.1% for 1-kHz measurements; 0.5% for 120-Hz (100-Hz) measurements. See curves for exact accuracies.
 DISSIPATION FACTOR:

$$D_{error} = \pm \left[0.001 + 0.0002 \frac{C_{full\ scale}}{C_{reading}} + 0.05 (1+D)D \right] M$$

where M = Accuracy Multiplier. (See table above.)

Speed: 250 ms for single step or operator-variable from 0.25 s min to 10 s max.

Display: 4½ digits, LED display with decimal point and over-range indication.

Applied Voltage (Variable): Max applied voltage is 1 V × A. (A=Voltage Multiplier. See table above.) Applied voltage is variable from max to 1/20 max on range positions 1 through 6. Maximum power is 1/8 W.

Frequency: 1 kHz ±2% and 120 Hz, synchronized to line (100-Hz test frequency for 50-Hz line).

Bias: 2 V internal and 0-100 V external.

Measurement Mode: Measurements made on command or repetitively at times from 0.25 s to 10 s. Previous measurement is held during period of new measurement.

Data Outputs (TTL Logic): Open collector, active low.

Data Inputs: REMOTE START: A positive transition of <1 μs from 0V <V_L < 0.4 V to +2V <V_H < +30 V initiates a measurement. LAMP TEST: A ground lights all segments of the right-most four digits of the LED display (8 8 8 8) to check operation of all indicator segments.

Limits: DATA OUTPUTS (TTL LOGIC): Open collector, active low. Audio output (≈250 Hz) line drives a miniature speaker (or headphone). Signal gives 1/4-s burst of audio when measured value falls outside the selected high and low limits. (Not activated by D failures.)

Supplied: Power cord, measurement cable, output-data connector set.

Power: 90 to 125 or 180 to 250 V, 48 to 440 Hz, 40 W max.

Mechanical: Bench or rack models. DIMENSIONS (wxhxd): Bench, 17.00×5.59×16.25 in. (432×142×413 mm); rack, 19.00×5.22×16.63 in. (483×133×422 mm). WEIGHT: Bench, 22.5 lb (10.2 kg) net, 31 lb (14.1 kg) shipping; rack, 23.25 lb (10.54 kg) net, 31.75 lb (14.4 kg) shipping.

| Description | Catalog Number |
|---|----------------|
| 1686-A Digital Capacitance Meter | |
| 60-Hz Line Frequency | 1686-9700 |
| 120-Hz Test Frequency | |
| 50-Hz Line Frequency | 1686-9800 |
| 100-Hz Test Frequency | |
| Rack Hardware Kit | 0480-9703 |
| 1686-P1 Test Fixture, Kelvin Clips | 1686-9600 |

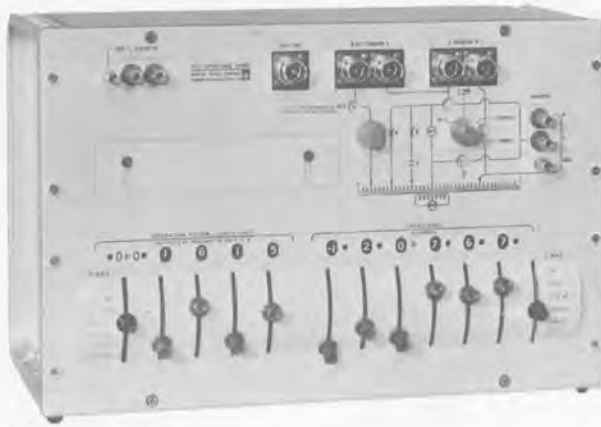

1615-A Capacitance Bridge

The 1615-A is an accurate, high-precision bridge for the measurement and intercomparison of standard capacitors, circuit component capacitors, or dielectric materials. It is available with oscillator and detector in the 1620 assembly. Or, to take full advantage of its wide frequency range, the bridge can be ordered separately for use with oscillator and detector especially selected for your purposes.



1615-P1



1615-P2

SPECIFICATIONS

RANGES

Capacitance, C, 10 aF to 1.11110 μF (10⁻¹⁷ to 10⁻⁶ farad) in 6 ranges, direct-reading, 6-figure resolution; least count 10⁻¹⁷ F (10 aF). With Range-Extension Capacitor, upper limit is 11.11110 μF.

Dissipation Factor, D, At 1 kHz, 0.000001 to 1, 4-figure resolution; least count, 0.000001 (10⁻⁶); range varies directly with frequency.

Conductance, G, 10⁻⁶ μΩ to 100 μΩ, 2 ranges +, 2 ranges -, 4-figure resolution, least count 10⁻⁶ μΩ, independent of frequency; range varies with C range.

ACCURACY

At 1 kHz, ±(0.01% + 0.00003 pF). At higher frequencies and with high capacitance, additional error is
 $[\pm 3 \times 10^{-5}\% + 2 (C_{\mu F}) \times 10^{-3}\% \pm 3 \times 10^{-7} \text{ pF}] \times (f_{\text{kHz}})^2$.

At lower frequencies and with low capacitance, accuracy may be limited by bridge sensitivity.

Comparison accuracy, unknown to external standard, 1 ppm.

±[0.1% of measured value + 10⁻⁵ (1 + f_{kHz} + 5 f_{kHz} C_{μF})]

±[1% of measured value + 10⁻⁵ μΩ + 6 × 10⁻² f_{kHz} C_{μF} × (1 + f_{kHz} + 5 f_{kHz} C_{μF}) μΩ]

Standards: 1000, 100, 10, 1, 0.1, 0.01, 0.001, 0.0001 pF. Temperature coefficient of capacitance is less than 5 ppm/°C for the 1000-, 100-, and 10-pF standards, slightly greater for the smaller units.

Frequency: Approx 50 Hz to 10 kHz. Useful with reduced accuracy to 100 kHz. Below 100 Hz, resolution better than 0.01% or 0.01 pF requires preamplifier or special detector.

Generator: GR 1310 or 1311-A oscillator recommended. Max safe generator voltage (30 × f_{kHz}) volts, 300 V max. If generator

and detector connections are interchanged, 150 to 500 V can be applied, depending on switch settings.

Detector: GR 1232-A Tuned Amplifier and Null Detector recommended. For increased sensitivity needed to measure low-loss small capacitors (on lowest C and D ranges simultaneously) at frequencies below 1 kHz, use 1232-AP or 1238 (with 1311 oscillator).

Supplied: 874-WO Open-Circuit Termination, 874-R22A Patch Cord, 274-NL Patch Cord.

Available: Type 1615-P1 RANGE-EXTENSION CAPACITOR; 1615-P2 COAXIAL ADAPTOR converts 2-terminal binding-post connection on 1615 bridge to GR900® Precision Coaxial Connector for highly repeatable connections and enables measurements with adaptor to be direct-reading by compensating for terminal capacitance.

Mechanical: Rack-bench cabinet. DIMENSIONS (wxhxd): Bench, 19x12.75x10.5 in. (483x324x267 mm); rack, 19x12.25x8.5 in. (483x311x217 mm); 1615-P1 (dia x ln): 3.06x4.87 in. (78x124 mm). WEIGHT: 39 lb (18 kg) net, 58 lb (27 kg) shipping.

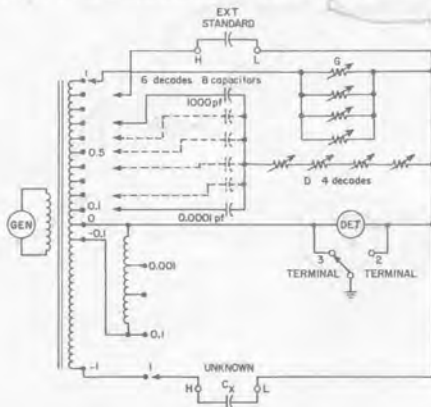

Elementary schematic diagram.

Description

| Description | Catalog Number |
|--|----------------|
| 1615-A Capacitance Bridge | |
| Bench Model | 1615-9801 |
| Rack Model | 1615-9811 |
| 1615-P1 Range-Extension Capacitor | 1615-9601 |
| 1615-P2 Coaxial Adaptor, GR900 to binding posts | 1615-9602 |

National stock numbers are listed at the back of the catalog.



1620-A Capacitance-Measuring Assembly

- 10^{-5} pF to $11.1 \mu\text{F}$, 2- or 3-terminal
- 0.01% accuracy, 1-ppm resolution
- lever balance, in-line readout
- reads dissipation factor or conductance

The 1620-A is a self-contained assembly of the GR 1615-A Capacitance Bridge with appropriate oscillator and null detector for measurements at 11 frequencies between 20 Hz and 20 kHz. For applications requiring other or higher frequencies, to 100 kHz, the 1615-A bridge can be supplied separately and the oscillator and detector selected to meet your needs.

The 1620-A is intended for

- accurate and precise measurements of capacitance and dissipation factor
- measurement of circuit capacitances
- dielectric measurements
- intercomparison of capacitance standards differing in magnitude by as much as 1000:1

The 1615-A Capacitance Bridge brings to the measurement of capacitance, to the intercomparison of standards, and to the measurement of dielectric properties an unusual degree of accuracy, precision, range, and convenience.

High accuracy is achieved through the use of precisely wound transformer ratio arms and highly stable standards fabricated from Invar and hermetically sealed in dry nitrogen. For calibration these standards can be intercompared.

Two- or Three-Terminal Connection Accurate three-terminal measurements can be made even in the presence of capacitances to ground as large as $1 \mu\text{F}$, as might be encountered with the unknown connected by means of long cables. The bridge has the necessary internal shielding to permit one terminal of the unknown capacitor to be directly grounded, so that true two-terminal and

three-terminal measurements can both be made over the whole capacitance range.

Convenient Operation For both capacitance and dissipation factor, the balance controls are smoothly operating, lever-type switches. The readout is digital and the decimal point is automatically positioned. Each capacitance decade has a -1 position to facilitate rapid balancing.

The 1615 elementary diagram is also clearly delineated on the front panel of the bridge. Changes in connections and grounds are automatically indicated, as you switch the bridge terminals for different measurement conditions.

Extend Range to $11.1 \mu\text{F}$ With the 1615-P1 Range-Extension Capacitor, the 1615-A will measure to a maximum of $11.11110 \mu\text{F}$. This capacitor plugs into front-panel bridge terminals and can be adjusted for calibration to the bridge standards.

SPECIFICATIONS

Performance: Refer to the 1615 Bridge.

Frequency: 50, 60, 100, 120, 200, 400, 500, 1000, 2000, 5000, and 10,000 Hz. For use below 100 Hz, 1620-AP (with preamplifier) should be used for resolution beyond 0.01% or 0.01 pF.

Generator: 1311-A Oscillator.

Detector: 1232-A Tuned Amplifier and Null Detector. 1232-P2 Preamplifier added in 1620-AP.

Power: 105 to 125 or 210 to 250 V, 50 to 400 Hz, 22 W for oscillator. Null detector and preamplifier operate from internal battery, 9 Burgess Type E4 cells or equivalent.

Mechanical: Bench cabinet. DIMENSIONS (wxhxd): 19.75x19x11 in. (502x483x280 mm). WEIGHT: 59 lb (27 kg) net, 96 lb (44 kg) shipping.

| Description | Catalog Number |
|---------------------------------------|----------------|
| Capacitance-Measuring Assembly | |
| 1620-A, 115 V | 1620-9701 |
| 1620-A, 230 V | 1620-9702 |
| 1620-AP, with 1232-P2, 115 V | 1620-9829 |
| 1620-AP, with 1232-P2, 230 V | 1620-9830 |
| Replacement Battery (9 used) | 8410-1372 |

National stock numbers are listed at the back of the catalog.



1232-A Tuned Amplifier and Null Detector

- 20 Hz to 20 kHz, 50 and 100 kHz
- 0.1- μV sensitivity
- bandwidth approx 5%
- 120-dB gain

A sensitive null detector like this is the key to many a fussy bridge measurement. Battery operation frees the 1232 from power-line noise and makes it ultra portable. Low-noise solid-state circuitry and high gain make it very sensitive. Its tunability and choice of bandwidth enable you to reject broadband noise as well as the harmonics that might otherwise impair good measurements. Here are its prime uses:

- bridge detector at audio frequencies; with the 1232-P2 Preamplifier it is equally sensitive for extremely high-impedance sources
- audio preamplifier and general-purpose, tunable, or broadband audio amplifier
- a-m detector for 0.5- to 500-MHz carrier frequencies, when used with an 874-VQ Voltmeter Detector
- sensitive audio wave analyzer for approximate measurements

SPECIFICATIONS

Frequency Response: TUNABLE FILTERS: 20 Hz to 20 kHz in 3 ranges; between 2% and 6% bandwidth to 15 kHz; 2nd harmonic at least 34 dB down from peak, 3rd at least 40 dB down; rejection filter on two highest ranges reduces 60-Hz level to at least 60 dB below peak response (50-Hz level is down >50 dB). Dial accuracy is $\pm 3\%$. FIXED-TUNED FILTERS: 50 kHz, 2nd harmonic is 44 dB down; 100 kHz . . . 53 dB down. FLAT RESPONSE: ± 3 dB from 20 Hz to 100 kHz.

Sensitivity: See plot. Typically better than 0.1 μV over most of the frequency range.

National stock numbers are listed at the back of the catalog.

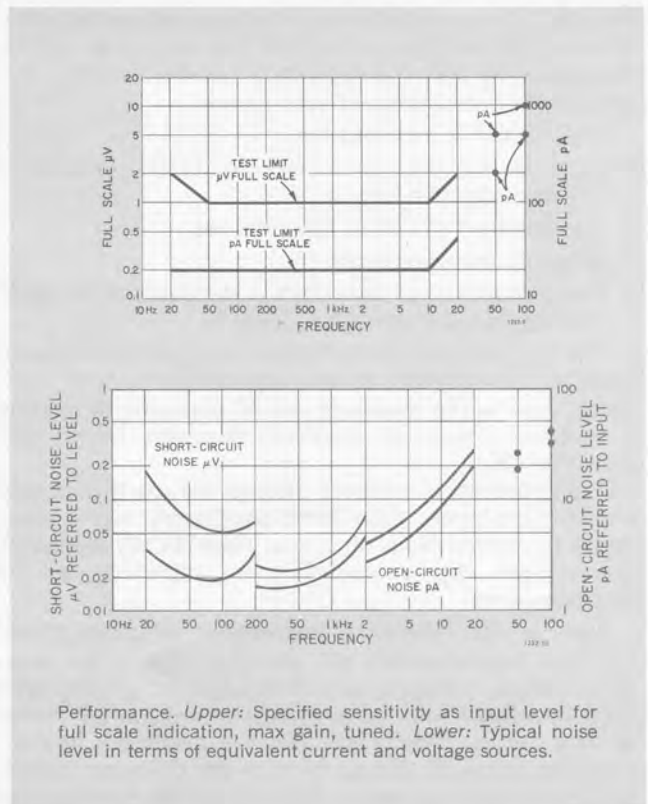

Performance. Upper: Specified sensitivity as input level for full scale indication, max gain, tuned. Lower: Typical noise level in terms of equivalent current and voltage sources.

Noise Level: REFERRED TO INPUT: See plot. Noise figure at 1 kHz is less than 2 dB at an optimum source impedance of 27 k Ω . REFERRED TO OUTPUT: Less than 5 mV on FLAT filter-frequency position, min gain setting, and -20-dB switch position; less than 50 mV in MAX SENS position.

Input: IMPEDANCE: Approx 50 k Ω at max gain; varies inversely with gain to 1 M Ω at min gain. MAX SAFE VOLTAGE: 200 V ac or 400 V dc.

Output: VOLTAGE GAIN: Approx 120 dB on the tunable ranges; 100 dB, flat range; 106 dB at 50 kHz; 100 dB at 100-kHz position. LEVEL: 1 V into 10 k Ω when meter indication is full scale. INTERNAL IMPEDANCE: 3 k Ω . METER LINEARITY: dB differences are accurate to $\pm 5\%$ ± 0.1 division for inputs of less than 0.3 V. COMPRESSION (meter switched to LOG): Reduces fullscale sensitivity by 40 dB. Does not affect bottom 20% of scale. ATTENUATION (meter switched to -20 dB): Linear response with 20-dB less gain than MAX SENS.

Distortion (filter switch in FLAT position): <5% (due to meter rectifiers).

Terminals: Input, GR874 $\text{\textcircled{R}}$ coaxial connector; output, binding posts.

Available: 1232-P2 Preamp to maintain sensitivity of

1232-A at low frequencies when operating from a source impedance above 100 k Ω ; rack-adaptor sets (see below) convert 1232 alone, or with companion instruments, to 19-in. rack-mount width.

Power: 12 V dc, from 9 mercury (M72) cells in series. Est battery life 1500 hours. Optionally, a rechargeable battery (non-mercury) can be supplied on special order.

Mechanical: Convertible bench cabinet. DIMENSIONS (wx hxd): Bench, 8x6x7.5 in. (203x152x190 mm). WEIGHT: 5.75 lb (2.6 kg) net, 8 lb (3.7 kg) shipping.

| Description | Catalog Number |
|--|------------------|
| 1232-A Tuned Amplifier and Null Detector | 1232-9701 |
| 1232-AP Tuned Amplifier and Null Detector, with preamplifier | 1232-9829 |
| Rack-Adaptor Sets | |
| 480-P308, for 1232-A alone | 0480-9838 |
| 480-P316, for 1232-A with 1310 or 1311 oscillator or similar 8-in. wide instrument with convertible-bench cabinet | 0480-9836 |
| 480-P317, for 1232-AP (with preamp) and companion 8-in. instrument | 0480-9837 |
| Replacement Battery, 9 req'd | 8410-1372 |

1232-P2 Preamplifier

The 1232-P2 has particular application to measurements with the 1615-A Capacitance Bridge. It increases sensitivity for measurements made at frequencies well below 1000 Hz if the bridge is set to both its lowest C and D (not G) ranges simultaneously. Low-frequency measurement of small samples of dielectric materials can be made more accurately with the addition of this preamplifier.

SPECIFICATIONS

Voltage Gain: Approx 0.7.

Noise (referred to input): Open-circuit equivalent 0.1 pA; short-circuit equivalent, 0.3 μ V (when used with Type 1232-A tuned to 100 Hz).

Impedances: INPUT: >100 m Ω in parallel with 70 pF. OPTIMUM SOURCE: 3 M Ω . OUTPUT: 10 k Ω .

Connectors: GR874 $\text{\textcircled{R}}$ on cables, input and output.



1232-P2 Preamplifier installed.

Power: 12 V, 200 μ A, supplied by 1232-A.

Mechanical: Special cabinet. DIMENSIONS (wxhxd): 0.75x 6x7.5 in. (19x152x190 mm). WEIGHT: 0.94 lb (0.43 kg) net, 4 lb (1.9 kg) shipping.

| Description | Catalog Number |
|-----------------------------|------------------|
| 1232-P2 Preamplifier | 1232-9602 |

1240 Bridge Oscillator-Detector



The 1232-A Tuned Amplifier and Null Detector and the 1311-A Audio Oscillator have been combined for use with audio-frequency bridges and other null-balance devices. This assembly occupies a minimum of bench space and is supplied with removable panel extensions, which adapt it for rack mounting.

The oscillator supplies 11 fixed frequencies from 50 Hz to 10 kHz. The detector is tunable continuously from National stock numbers are listed at the back of the catalog.

20 Hz to 20 kHz, with additional spot frequencies of 50 kHz to 100 kHz. The assembly is also available with the 1232-P2 Preamplifier included.

SPECIFICATIONS

Power: Null detector, internal battery; oscillator, 105 to 125 or 210 to 250 V, 50 to 400 Hz, 22 W max.

Mechanical: Cabinets bolted together. DIMENSIONS (wxhxd): 19x6x7.75 in. (483x153x197 mm), including panel extensions for rack mounting. WEIGHT: 13.5 lb (7 kg) net, 28 lb (13 kg) shipping.

| Description | Catalog Number |
|---|------------------|
| 1240-A Bridge Oscillator-Detector, 115 V | 1240-9701 |
| 1240-A Bridge Oscillator-Detector, 230 V | 1240-9711 |
| 1240-AP Bridge Oscillator-Detector, with preamplifier, 115 V | 1240-9829 |
| 1240-AP Bridge Oscillator-Detector, with preamplifier, 230 V | 1240-9839 |
| ASA type M72 Replacement battery (for 1232, 9 req'd) | 8410-1372 |

1616 Precision Capacitance Bridge

- 10⁻⁷ pF to 10 μF — 12-digit readout
- 10⁻¹⁰ μV to 1000 μV — 5-digit readout
- 10 Hz to 100 kHz
- up to 150-V input from oscillator
- 3-terminal measurements
- coaxial measurements



The heart of precision The 1616 is the heart of the 1621 Capacitance-Measuring Assembly. The bridge is also available separately for use where oscillator and detector are on hand or in applications in which they must be specialized for a unique need.

The 1616 employs a transformer ratio-arm bridge with which unbalances as small as 0.1 aF (10⁻⁷ pF) and 100 aV (10⁻¹⁰ μV) can be resolved. Detection of such small unbalances is aided by ratio-transformer voltage capabilities up to 160 volts at 1 kHz and by range switching that disconnects the unused internal standards in order to reduce shunt capacitance across the detector input.

SPECIFICATIONS

Capacitance measurement, 3-terminal: DECADES: 12. RANGE: 0.1 aF to 1 μF (10⁻¹⁹ to 10⁻⁴ F). ACCURACY: * ±10 ppm, when most-significant decade is 1, 10, or 100 pF per step; otherwise, and at other frequencies, accuracy is ±[50 ppm + (0.5 + 20 C_{μF}) (f_{kHz})² ppm + (f_{kHz}) aF].

Capacitance, 2-terminal: Same as above, except as follows. RANGE: One additional decade, to 10 μF (10⁻¹⁹ to 10⁻³ F).

Conductance measurement, 3-terminal: DECADES: 5 (virtually extended to 11 by G multiplier). RANGE: 100 aV to 100 μV (10⁻¹⁶ to 10⁻⁴ V). ACCURACY: * ±(0.1% + 1 step in least significant decade). There is a small reduction in conductance accuracy at frequencies other than 1 kHz. RESIDUAL C (across conductance standards): ±(< 0.03 pF).

Conductance, 2-terminal: Same as above, except as follows. RANGE: One additional decade, to 1000 μV (10⁻¹⁶ to 10⁻³ V).

Multipliers: FOR 3-TERM: X1, X10; FOR 2-TERM: X1, X10, X100; affect both C and G. FOR CONDUCTANCE ONLY: X1, X10⁻¹, . . . X10⁻⁶ (7 positions). Effects of these multipliers are included in the specified ranges.

Frequency: 10 Hz to 100 kHz.

Standards: CAPACITANCE: Air dielectric with TC < +20 ppm/°C and D < 10 ppm for 8 lowest decades; Invar†, air dielectric with TC of +3 ±1 ppm/°C and D < 10 ppm for 3 middle decades; mica dielectric with TC of 20 ±10 ppm/°C and D < 200 ppm for 2 highest decades. ADJUSTMENTS for all capacitance standards available through key-locked door on panel. THERMAL LAG: C standards for first 8 decades mounted in an insulated compartment with a thermal time constant of 6 h (time required for compartment interior to reach 63% of ambient change). CONDUCTANCE: Metal-film resistors in T networks with small phase angles.

*Accuracy stated as fraction of measured value, for these conditions: frequency, 1 kHz, except as noted; temperature, 23° ± 1°C; humidity, < 50% RH.

†Registered trademark of the Carpenter Steel Co.

For thermal stability in precision intercomparisons, eight of the twelve internal capacitance standards are mounted in an insulated compartment to reduce the effects of ambient temperature changes. Misreading the values at balance is virtually impossible due to direct-reading lever switches that control the balance for both capacitance and conductance. Panel layout is unusually neat — only the unknown capacitor and, if desired, an external standard for comparison measurements are connected to the front panel; the oscillator and detector are connected to the rear as are the BCD data-output channels.

Comparison: Terminals provided to connect external standard for comparison measurements; 13-position panel switch multiplies standard by -0.1, 0 . . . +1.

Input: The smaller of 160 f_{kHz} or 350 V rms can be applied to the bridge transformer at the GENERATOR terminal without waveform distortion; 500 V rms max, depending on conductance range, when GENERATOR and DETECTOR connections are interchanged.

Interface: GR900® locking coaxial connector on panel to connect 2-terminal unknowns, 2 gold-plated GR874® locking coaxial connectors on panel to connect 3-terminal unknowns and 2 to connect external standard. DATA OUTPUT: 50-pin and 36-pin type 57 connectors on rear provide connection to 8-4-2-1 weighted BCD contacts (rated at 28 V, 1 A) on each switch for capacitance and conductance values respectively. OSCILLATOR and DETECTOR: Connect to rear BNC connectors.

Required: OSCILLATOR: GR 1316 recommended. DETECTOR: GR 1238 recommended. The 1616 Bridge is available with this oscillator and detector as the 1621 Capacitance-Measuring Assembly.

Available: 1316 OSCILLATOR, 1268 DETECTOR, a broad line of capacitance and resistance standards, and coaxial cables for connection of unknowns and standards.

Mechanical: Bench or rack model. DIMENSIONS (wxhxd): Bench, 19.75x13.81x12.88 in. (502x351x327 mm); rack, 19x12.22x10.56 in. (483x310x268 mm). WEIGHT: Bench, 57 lb (26 kg) net, 69 lb (32 kg) shipping; rack, 49 lb (23 kg) net, 61 lb (28 kg) shipping.

| Description | Catalog Number |
|--|----------------|
| 1616 Precision Capacitance Bridge | |
| Bench Model | 1616-9700 |
| Rack Model | 1616-9701 |

National stock numbers are listed at the back of the catalog.

1238 Detector



- 10 Hz to 100 kHz
- 100-nV full-scale sensitivity
- magnitude, in-phase, and quadrature meters for rapid bridge balances
- excellent bridge detector

Designed for the difficult If you've ever had to extract a small signal from noise or to resolve a signal into its in-phase and quadrature components, you can appreciate the advantages of the 1238. With its high gain — 130 dB — and meters not only for magnitude of the input signal but for the in-phase and quadrature components as well, the 1238 lends itself handily to the most exacting applications.

This high-performance detector is attractive in other respects also, including 1-G Ω input impedance for minimum loading, overload protection against signals up to 200 V, and flat or tuned frequency response (with or without line-frequency rejection) to tailor the detector to your signal no matter how "tainted" it might be.

Excellent bridge detector In combination with a special oscillator, GR 1316, that supplies the necessary quadrature reference channels, this detector is superb for sensitive audio-frequency detection. The combination is specifically intended for use with the 1616 Precision Capacitance Bridge, enabling resolutions of one part in 10⁴ of 10 pF. Refer to the 1621 Precision Capacitance Measurement System.

SPECIFICATIONS

Frequency: 10 Hz to 100 kHz, flat or tuned. **FLAT:** ± 5 dB from 10 Hz to 100 kHz. **TUNED:** Set by 4 in-line readout dials with $\pm 5\%$ of reading accuracy, 2 to 4% bandwidth, and second harmonic ≥ 30 dB down from peak. **LINE-REJECTION FILTER:** Reduces line level by ≥ 40 dB while signal is down 6 to 10 dB at 10 Hz from line frequency; filter can be switched out.

Signal Input from bridge or other source: Applied to rear BNC connector. **SENSITIVITY:** Also see curve; 100 nV rms typical for full-scale deflection at most frequencies, compression can be switched in to reduce full-scale sensitivity by 20 dB. **IMPEDANCE:** 1 G Ω //20 pF. **MAXIMUM INPUT:** 200 V rms. **VOLTAGE GAIN:** ≈ 105 dB in flat mode, ≈ 130 dB in tuned mode, set by 12-position switch. **SPOT NOISE VOLTAGE:**

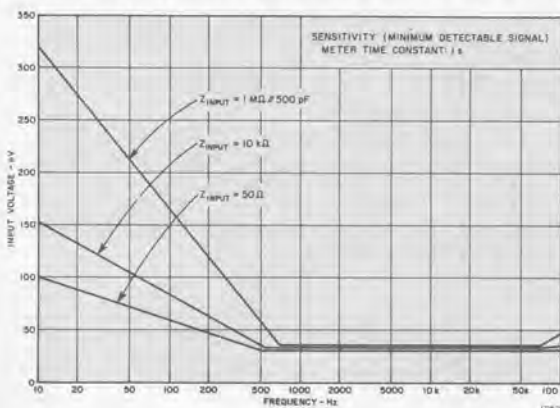

The 1238 Detector consists of a high-impedance low-noise preamplifier, a tuned amplifier, a compression amplifier, and two phase-sensitive detectors. Three panel meters provide the indications: one displays the magnitude of the input signal and two others simultaneously display its in-phase and quadrature components. The reference signals can be rotated continuously from 0 through 360° to ensure that the phase meters respond independently to the components of significance to you, for the most rapid bridge balances or signal analysis.

The effects of noise, hum, or any other input-signal contaminants are normally reduced or eliminated from your measurements by means of a tunable filter, line-rejection filter, and selectable time constants in the phase-sensitive detector circuits — all controlled from the front panel by the simple push of a button or turn of a knob.

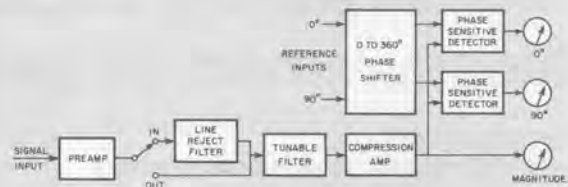

$< 30 \text{ nV} \times \sqrt{\text{bandwidth}_{\text{Hz}}}$ at 1 kHz with input impedance of 70 M Ω //500 pF. **MONITORED** by magnitude, in-phase, and quadrature meters; phase-sensitive detectors contain time-constant variable from 0.1 to 10 s in 5 steps.

Reference Inputs from oscillator: Applied to rear BNC connectors. Two ≥ 1 -V rms reference signals required, with 90° phase difference between them. **PHASE SHIFTER** rotates both references continuously from 0 to 360° and two verniers rotate each reference individually $\approx 10^\circ$.

Outputs: **MAIN AMPLIFIER:** 4 V rms (approx 2.3 V for full scale on Magnitude meter) available at rear BNC connector. **MAGNITUDE:** 6 V dc for full scale deflection; **PHASE DETECTORS:** Up to 1 V dc each for full scale deflection (depending on Sensitivity setting); available at rear 5-pin type 126 jack.

Environment: **TEMPERATURE:** 0 to +55°C operating, -40 to +75°C storage. **BENCH HANDLING:** 4 in. or 45° (MIL-810A-VI). **SHOCK:** 30 G, 11 ms (MIL-T-4807A-4.5-3A).

Required: Oscillator with 0 and 90° outputs; the 1316 Oscillator is recommended.

Power: 100 to 125 and 200 to 250 V, 50 to 60 Hz, 15 W.

Mechanical: Bench or rack models. **DIMENSIONS (wxhxd):** Bench, 19.56x6.66x12.94 in. (497x169x329 mm); rack, 19x5.22x13.06 in. (483x133x332 mm). **WEIGHT:** Bench, 27 lb (13 kg) net, 40 lb (19 kg) shipping; rack, 21 lb (10 kg) net, 34 lb (16 kg) shipping.

| Description | Catalog Number |
|----------------------|----------------|
| 1238 Detector | |
| 60-Hz Bench Model | 1238-9700 |
| 60-Hz Rack Model | 1238-9701 |
| 50-Hz Bench Model | 1238-9703 |
| 50-Hz Rack Model | 1238-9704 |

National stock numbers are listed at the back of the catalog.

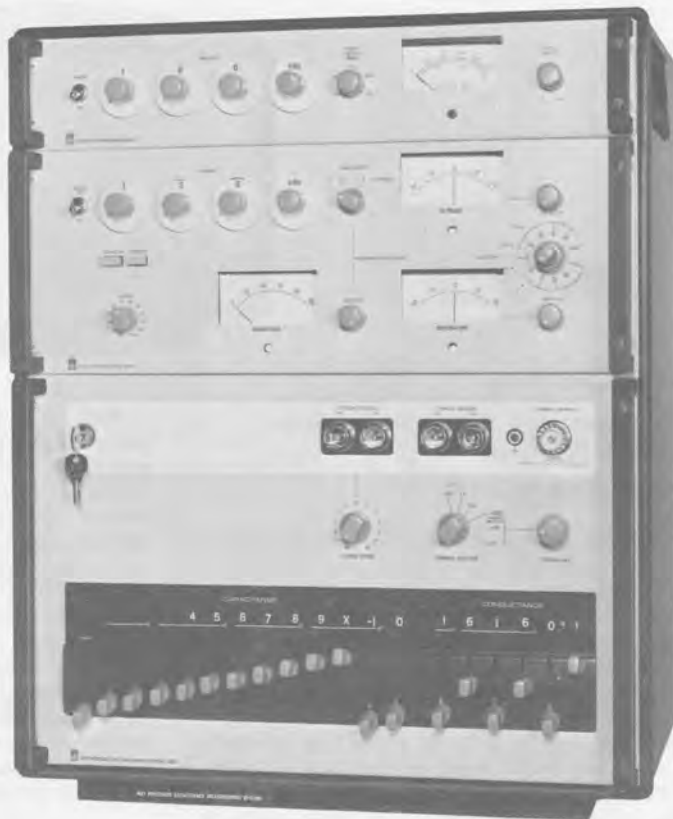

1621 Precision Capacitance - Measurement System

- 10^{-7} pF to $10 \mu\text{F}$
12-digit readout, 10-ppm basic accuracy
- $10^{-10} \mu\text{V}$ to $1000 \mu\text{V}$
5-digit readout, 0.1% basic accuracy
- 10 Hz to 100 kHz
- 3-terminal measurements
with 2- or 3-terminal connection
- comparison measurements
- simple lever balance with in-line readout

The whole of precision The 1621 represents the first major improvement in nearly a decade in ultra-precise laboratory capacitance intercomparisons and dielectric measurements. It is a completely self-contained system capable of capacitance measurements in increments as small as 0.1 aF (10^{-7} pF) and conductance measurements in increments as small as $100 \text{ a}\Omega$ ($10^{-10} \mu\text{V}$; equivalent to a shunt resistance of $10^{10} \text{ M}\Omega$). Measurements are three terminal, with 2- or 3-terminal connection, and provision is also made for the connection of an external standard for comparison measurements.

Such capability and precision are usually accompanied by restricted frequency and complex operation. The 1621, however, avoids these difficulties. Little degradation of performance occurs from 10 Hz to 10 kHz and operation to 100 kHz is possible. Balances are achieved by in-line readout lever switches — easily adjusted and read correctly. All digits of capacitance and conductance, as well as pertinent multipliers, are also provided by BCD-coded contact closures, available at rear-panel connectors for use by printers or data-processing equipment.

National stock numbers are listed at the back of the catalog.

Three integrated units The 1621 is an assembly of three integrated instruments: A precision ratio-arm bridge, a highly stable oscillator, and an extremely sensitive detector. Most of the bridge's internal standards are enclosed in an insulated housing to reduce the effects of ambient temperature changes; unused standards are disconnected to reduce shunt capacitance at the detector input. The oscillator provides up to 125 V or 5 A for sufficient signal to be detected even with unbalances as small as one part in 10^6 of 10 pF . The detector contains three meters to help you speed the balance: One displays the magnitude and the other two simultaneously display the in-phase and quadrature components of any unbalance.

SPECIFICATIONS

(See 1616 for performance specifications)

Frequency: 10 Hz to 100 kHz.

Supplied: 1616 Precision Capacitance Bridge, 1316 Oscillator, 1238 Detector, all necessary interconnection cables, and power cord.

Available: 1408 REFERENCE STANDARD CAPACITORS (10 pF and 100 pF) for calibration.

Power: 100 to 125 and 200 to 250 V, 50 to 60 Hz, 51 W.

Mechanical: Bench or rack models. DIMENSIONS (wxhxd): Bench, 19.75x24.25x15 in. (502x616x381 mm); rack, 19x20.91x11.44 in. (483x531x291 mm). WEIGHT: Bench, 105 lb (48 kg) net, 140 lb (64 kg) shipping; rack, 90 lb (41 kg) net, 125 lb (57 kg) shipping.

| Description | Catalog Number |
|--|----------------|
| 1621 Precision Capacitance-Measurement System | |
| Bench Model, 60-Hz | 1621-9701 |
| Rack Model, 60-Hz | 1621-9702 |
| Bench Model, 50-Hz | 1621-9703 |
| Rack Model, 50-Hz | 1621-9704 |



1617-A Capacitance Bridge

- 1 pF to 1.1 farads
- 20 Hz to 1 kHz
- 1% accuracy
- 2-, 3-, or 4-terminal connections

Self-Contained bridge The 1617-A was specifically designed for measuring capacitance, dissipation factor, and leakage current of electrolytic capacitors, but it will also find considerable use as a general-purpose 1% bridge. It is completely self-contained, including a 120-Hz generator, null detector, dc polarizing-voltage supply, and metering for bias voltage and leakage current. At frequencies other than 120 Hz, use an external oscillator.

Multiterminal connections An unknown capacitor can be connected to the bridge by means of three- or four-terminal connections, as well as the usual two-terminal. The four-terminal connection permits accurate measure-

ment of large capacitance by reducing the effect of the resistance and inductance of leads and connections. Correct measurements of small capacitances are assured by the three-terminal connection, which reduces the effect of stray lead capacitance. A multiterminal configuration is necessary for accurate measurement of capacitors connected by long cables leading, for instance, from the bridge on a nearby bench into an environmental test chamber.

This bridge includes an Orthonull® balance finder, which speeds up measurements of high-dissipation-factor capacitors by eliminating troublesome sliding balance. The operator's safety is enhanced by warning lights indicating the presence of voltage on the bridge terminals.

Electrolytics The 1617 Capacitance Bridge is designed especially for measuring large-valued capacitors like those in table, as well as other electrolytic types, most of which require the special measurement conditions prescribed by MIL or EIA specifications:

National stock numbers are listed at the back of the catalog.

| Specification and Capacitor Type | Frequency | AC Level | C | Accuracy Loss | DC Polarizing Voltage |
|---|------------|--|------|------------------------------------|---|
| MIL C-3965-C MIL C-39006-A Tantalum Foil and Sintered Slug Capacitors | 120 ± 5 Hz | Less than 30% of DCWV or 1 V, pk, whichever is smaller (Less than 1V rms for 39006A) | 2% | R or P.F. 2% (P.F. 2% for -39006A) | C—Sufficient for no reversal of polarity. D—"Polarized Capacitance Bridge" Sum of ac and dc shall not exceed DCWV (Less than 2.2 V for 39006A) |
| MIL C-26655-B MIL C-39003 Solid Tantalum Capacitors MIL C-39018 Aluminum Oxide Capacitors | 120 ± 5 Hz | Limited to 1V, rms | 2% | D, 10% (2% for -39003 and -39018) | C—Max bias 2.2 V. D—"Polarized Bridge", 2.2-V dc max. |
| RS 228 Tantalum Electrolytic Capacitors | 120 Hz | Small enough not to change value | ±2½% | D, 5% | Optional |
| MIL C-62 B Polarized Aluminum Capacitors | 120 ± 5 Hz | Limited to 30% of DCWV or 4 V, whichever is smaller | 2% | D, 2% | No bias required if ac voltage less than 1 V. However, if bias causes differences, measurements with bias shall govern. |
| RS 154 B Dry Aluminum Electrolytic Capacitors | 120 Hz | Small enough not to change value | ±2½% | R or RC | Optional, but if substantial difference occurs, rated dc should be used. |
| RS 205 Electrolytic Capacitors for use in Electronic Instruments | 120 Hz | Small enough not to change value | ±2½% | D | Optional |

SPECIFICATIONS

| Quantity | Frequency | Range | Accuracy * |
|---------------------------|---|------------------------------|--|
| Capacitance | 120 Hz internal | 0 to 0.11 F | ±1% ±1 pF, smallest division 2 pF; residual ("zero") capacitance approx 4 pF |
| | | 0.11 F to 1.1 F | ±2% |
| | 40 Hz to 120 Hz external (useful down to 20 Hz with reduced accuracy) | 0 to 1.1 F | Same as above with suitable generator |
| | | 120 Hz to 1 kHz external | 0 to $\left(\frac{100}{f_{Hz}}\right)^2$ F |
| Dissipation Factor | 120 Hz internal or 40 Hz to 120 Hz | 0 to $10 \frac{f_{Hz}}{120}$ | ±0.001 ±0.01 C ±2% † |
| | 120 Hz to 1 kHz | 0 to 10 | (±0.001 ±0.01 C) $\frac{f_{Hz}}{120}$ ±2% † |

†Additional error (due to lead resistance) for 4-terminal measurements: For C <1%, for D <0.01, if each lead has <1 Ω of resistance, except on the highest measurement range the corresponding lead resistance is 0.1 Ω.

* C is expressed in farads.

Frequency: INTERNAL TEST SIGNAL: 120 Hz (synchronized to power line) for 60-Hz model; 100 Hz for 50-Hz model. Phase reversible. Amplitude selected by switch to be 0.2, 0.5, or 2 V max. EXTERNAL TEST SIGNAL: 20 Hz to 1 kHz. (See table for C range.)

Dc Bias Voltage: Internal power supply and meter: 0 to 600 V in 6 ranges. Meter accuracy: ±3% of full scale. External bias limit: 800 V max.

Bias Current (from internal source): ≈ 15 mA max. **METER:** Range, 0 to 20 mA in 6 ranges; resolution, 0.5 μA (first range); accuracy, ±3% of full scale.

Required, for measurements at frequencies other than twice the line: An oscillator such as the 1311 for spot frequencies or the 1310 for continuous coverage.

Supplied: 4-lead and shielded 2-lead cable assemblies.

National stock numbers are listed at the back of the catalog.

54 CAPACITANCE BRIDGES

Power: 105 to 125 V or 210 to 250 V, 18 W. Both 50 and 60-Hz models.

Mechanical: Flip-Tilt case and rack mount. **DIMENSIONS** (wxhxd): Portable, 16.25x15x9 in. (413x381x229 mm); rack, 19x14x6.13 in. (483x356x155 mm). **WEIGHT:** Portable: 26 lb (12 kg) net, 34 lb (16 kg) shipping; rack, 28 lb (13 kg) net, 43 lb (20 kg) shipping.

| Description | Catalog Number |
|--------------------------------|----------------|
| 1617 Capacitance Bridge | |
| Portable Model (115 V, 60 Hz) | 1617-9701 |
| Portable Model (230 V, 60 Hz) | 1617-9286 |
| Portable Model (115 V, 50 Hz) | 1617-9206 |
| Portable Model (230 V, 50 Hz) | 1617-9266 |
| Rack Model (115 V, 60 Hz) | 1617-9820 |
| Rack Model (230 V, 60 Hz) | 1617-9296 |
| Rack Model (115 V, 50 Hz) | 1617-9216 |
| Rack Model (230 V, 50 Hz) | 1617-9276 |
| Patent Number 2,872,639. | |

Resistance-Measuring Instruments

This section describes a six-digit, wide-range resistance bridge and a megohm bridge and two megohmmeters for measuring high-valued resistors and the leakage resistance of insulating materials. These instruments, the first four listed in the chart below, are but a part of our resistance-measuring capability. Eight other instruments are offered which also measure capacitance and

inductance; four of these make dc measurements. Of particular interest may be the 1656 Impedance Bridge, which has a sensitive dc detector and a four-digit readout, and the automatic 1685 Digital Impedance Meter, which measures dc resistance at 4 measurements per second.

| | 1 $\mu\Omega$ | 1 m Ω | 1 Ω | 1 k Ω | 1 M Ω | 1 G Ω | 1 T Ω | 1000 T Ω | |
|-----------|---|--------------|------------|--------------|--------------|--------------|--------------|----------------------|--|
| DC R | 1666: $\pm 0.01\%$ accuracy. 6-digit resolution. 2-, 3- or 4-terminal resistance and conductance measurement at low applied power. Self-contained sensitive detector. | | | | | | | PRECISION BRIDGE | |
| | 1644: $\pm 1\%$ accuracy. Megohm bridge with seven test voltages, 10 to 1000 V and self-checking internal standards. ΔR to $\pm 0.2\%$. | | | | | | | MEGOHM BRIDGE | |
| | 1863: up to 3% accuracy. 50, 100, 200, 250 & 500 V tests. Up to 20 T Ω . | | | | | | | MEGOHMMETERS | |
| | 1864: up to 3% accuracy. Adjustable voltage, 10 V to 1000 V. Up to 200 T Ω . | | | | | | | | |
| AC AND DC | 1685: $\pm 0.1\%$ accuracy. Automatic, digital readout. Built-in limit comparator. (Also measures L and C.) | | | | | | | DIGITAL METER | |
| | 1608: $\pm 0.05\%$ accuracy. Can apply MIL STD dc test voltages. Also ac resistance and conductance measurements with Q readout. (Also measures L and C.) | | | | | | | PRECISION CRL | |
| | 1656: $\pm 0.1\%$ accuracy. Sensitive dc detector. Low voltage applied. 4-digit readout. Lever adjustments. (Also measures L and C.) | | | | | | | LEVER ADJUSTABLE CRL | |
| | 1650-B: $\pm 1\%$ accuracy. AC or dc measurements. Self-contained, low cost, general-purpose CRL bridge. | | | | | | | CRL BRIDGE | |
| AC ONLY | 1683: $\pm 0.1\%$ accuracy. Automatic bridge. 120-Hz or 1-kHz measurements. Fully automatic, 4½-digit readout. 5-terminal connections. (Also L and C.) | | | | | | | AUTOMATIC BRIDGE | |
| | 1658: $\pm 0.1\%$ accuracy. Automatic Digibridge.™ 120 Hz and 1 kHz. Q readout. 10 bins for sorting. IEEE bus optional. (Also measures L and C.) | | | | | | | DIGIBRIDGES | |
| | 1657: $\pm 0.2\%$ accuracy. Fully automatic Digibridge.™ 120 Hz and 1 kHz. 5-digit display. 5-terminal connection. (Also measures L and C.) | | | | | | | | |
| | 1654: to $\pm 0.003\%$ comparison accuracy. Measures ΔR in % .100 Hz, 1 kHz, 10 kHz and 100 kHz. Phase-angle difference also displayed. | | | | | | | COMPARATOR | |



1666 DC Resistance Bridge

- 0.01% accuracy, direct reading
- six-digit resolution
- 2-, 3-, or 4-terminal resistance or conductance
- 1 $\mu\Omega$ to 1 T Ω range (1 p Ω to 1 M Ω)

The GR 1666 combines the advantages of the Wheatstone and Kelvin bridges in a single instrument that will find application almost anywhere. Whether your requirement is for high accuracy, extremely-low or very-high resistance values, remote measurements, portability, or precise comparison, the 1666 will excel. It can even be set up for rapid sorting of resistors to tight tolerances.

Two-terminal, guarded, or Kelvin connections to the unknown resistor assure that the accuracy inherent in the 1666 can be realized at the point of measurement over the entire range of the bridge from 10^{-6} to 10^{12} ohms. Internal adjustments on all ratio arms and bridge standards allow you to make calibration adjustments conveniently and rapidly, using a set of 1440 Standard Resistors.

The 1666 will make, with ease, such diverse measurements as winding resistance of transformers, switch-contact resistance, diode resistance (forward and reverse), leakage conductance of materials and devices, and the key parameters of resistance thermometers, standard resistors, and decades, by direct and comparison methods. The six lever switches and quick-response detector permit 0.01% balances to be made in less than 10 seconds — part-per-million balances in 20. Resistor sorting can be carried out even faster through use of the null meter as a deviation indicator; overload recovery of the detector is very rapid.

SPECIFICATIONS

Bridge Circuits: Kelvin and guarded Wheatstone in both resistance and conductance configurations.

Ranges: TOTAL MEASUREMENT RANGE, 1 $\mu\Omega$ to 1 T Ω . Resistance ranges, 1 $\mu\Omega$ to 1.1 M Ω in 7 ranges (1 $\mu\Omega$ is one count); conductance ranges, 1 p Ω to 1.1 Ω in 7 ranges (1

National stock numbers are listed at the back of the catalog.

p Ω is one count). RECOMMENDED RANGES: Wheatstone, 100 Ω to 1 T Ω ; Kelvin, 1 $\mu\Omega$ to 10 k Ω .

Resolution: Six digits or 1,111,110 counts.

Accuracy (limit of error): DIRECT READING, $\pm(0.01\% + 10$ ppm of full scale). For low-value readings, when first and second digits are zero, $\pm(0.1\% + 3$ ppm of full scale). These limits apply from 20 to 25°C at <75% RH, within 6 months of calibration. Error remains less than $\pm 0.1\%$ from 0 to 25°C at 95% RH and from 0 to 35°C at 85% RH. TWO-YEAR ACCURACY: Add $\pm 0.01\%$ to above. COMPARISON ACCURACY: $\pm[2 + 0.001 \times (\text{ppm difference})]$ ppm of full scale (decade values to 2 ppm where sensitivity is adequate and difference is small).

Sensitivity (with internal source): RESISTANCE: 2 $\mu\Omega$ at very low values; 10 ppm at 1 Ω ; 5 ppm at 10 Ω ; 1 ppm at 0.1, 1, 10, and 100 k Ω ; 5 ppm at 1 M Ω . CONDUCTANCE: 2 p Ω at very low values, 5 ppm at 1 $\mu\Omega$; 1 ppm at 10 and 100 $\mu\Omega$, 1 and 10 m Ω ; 5 ppm at 100 m Ω ; 10 ppm at 1 Ω . An external source can be used for even better sensitivity.

Sources: INTERNAL: 6 V (set of 4 D cells), 0.01 W max for resistance bridge. EXTERNAL: Up to 30 V dc, 0.5 W max.

Detector: SENSITIVITY: Meter deflection ≈ 5 mm/ μV . INPUT RESISTANCE: approx 20 k Ω . SHORT-CIRCUIT NOISE (slow position): Approx 0.1 μV pk-pk. DRIFT: Typically 0.5 $\mu\text{V}/\text{h}$. RESPONSE (slow/normal/fast, respectively): Low-level time constant, 4/2.5/0.7 s; high-level meter reversal, 1/0.5/0.3 s.

Guard (Wheatstone): No error with ≥ 5 M Ω to ground, either terminal.

Lead Error (Kelvin): Less than 2 $\mu\Omega$ additional with $\leq 0.1\Omega$ in any lead.

Supplied: Set of 4 leads with gold-plated copper alligator clips.

Available: 1440 Standard Resistors, for recalibration.

Power: Battery of 8 D cells (Burgess type 1200 or equivalent), i.e., 4 for internal bridge source and 4 for detector power.

Mechanical: Flip-Tilt case. DIMENSIONS: (wxhxd): 15x12x8 in. (381x305x203 mm). WEIGHT: 21 lb (10 kg) net.

Description

Catalog Number

1666 DC Resistance Bridge, portable
Replacement Battery (8 req'd)

1666-9700
8410-0200



1644-A Megohm Bridge

- 10^3 to 10^{15} ohms
- 1% accuracy to 10^{12} ohms
- ΔR measurements to $\pm 0.2\%$
- seven test voltages
- self-checking internal standards

The 1644-A will measure:

- **Insulation Resistance** of cables, transformers, chokes, components, connectors, wiring, terminals, resistors, capacitors, relays, printed circuits, rotating machines, switches, circuit breakers, meters, strain gages, thermocouples, delay lines, slip rings, commutators, heaters, filters, lightning arresters, and other devices.
- **Resistance** of high-valued resistors, resistance films, diodes, transistors, and piezoelectric elements.
- **Voltage and Temperature Coefficients** of resistance.
- **Volume and Surface Resistivity** of solids, such as printed-board material, resins, plastics, potting and casting compounds, rubber, refractories, and semiconductors; of liquids, such as oils, plasticizers, and solvents; and of sheet materials, including plastics, recording tape, and varnished fabrics.

The circuit is a dc Wheatstone bridge with a high-impedance, high-sensitivity detector. Precision, wire-wound resistors are used for the fixed bridge arm and the lowest-valued decade-step arm. For medium values of the ratio arm, precision metal film resistors are used; for the highest values, carbon film resistors with trimmers. The balancing arm is a wire-wound variable resistor.

The guard terminal eliminates the effects of stray resistances to ground. For capacitor leakage resistance measurement, charging time is a fraction of a second.

National stock numbers are listed at the back of the catalog.

SPECIFICATIONS

Resistance Range: 1 k Ω to 1000 T Ω (10^3 to 10^{15} Ω) in ten ranges.

Accuracy: 10^3 Ω to 10^9 Ω , $\pm 1\%$. After self-calibration: 10^9 to 10^{12} Ω , $\pm 1\%$ *; 10^{13} Ω , $\pm 2\%$; 10^{14} Ω , $\pm 10\%$; 10^{15} Ω , \pm one scale division.

$\Delta R\%$ Dial: $\pm 5\%$ range; accurate to $\pm 0.2\%$ or, for small changes, to $\pm 0.1\%$.

Test Voltage: Voltage accuracy is $\pm 3\% \pm 0.5$ V.

| | | | | | | | | |
|-------------------|----|----|----|-----|-----|-----|------|------------|
| Fixed Voltages** | 10 | 20 | 50 | 100 | 200 | 500 | 1000 | V |
| Minimum Unknown R | 1 | 3 | 7 | 20 | 50 | 150 | 500 | k Ω |

| Minimum Test Voltage for 1% Resolution: for approx 1-mm meter deflection | Multiplier Setting | | Max R _x | Volts |
|---|--------------------|------------------|--------------------|-------|
| | 100 G or less | 100 G | | |
| | 1 T | 10 ¹¹ | 10 | 10 |
| | | 10 ¹² | 100 | 100 |
| | | 10 ¹³ | 200 | 200 |

Short-Circuit Current: <15 mA, 10-50 V; <10 mA, 100-1000 V.

Power: 105 to 125 or 210 to 250 V, 50 to 400 Hz, 13 W.

Mechanical: Flip-Tilt case and rack mount. DIMENSIONS (wx hxd): Portable, 12.75x12.5x7.75 in. (324x318x197 mm); rack, 19x12.25x5 in. (483x312x127 mm). WEIGHT: 19 lb (9 kg) net, 31 lb (15 kg) shipping.

* At high voltages; 1% accuracy is obtainable at 10 V up to 10^{11} Ω .

** Any voltage between 10 and 1000 V may be obtained using an external resistor.

| Description | Catalog Number |
|-----------------------------|------------------|
| 1644-A Megohm Bridge | |
| 115-V Portable Model | 1644-9701 |
| | 1644-9820 |
| 230-V Portable Model | 1644-9711 |
| | 1644-9821 |

Patent Number 2,966,257



GR 1863



GR 1864

1863 and 1864 Megohmmeters

GR 1863

- 5 test voltages: 50 to 500 V
- 50 k Ω to 20 T Ω ($2 \times 10^{13}\Omega$)
- economical, simple operation
- direct reading, safe, stable

GR 1864

- 200 test voltages: 10 to 1090 V
- 50 k Ω to 200 T Ω ($2 \times 10^{14}\Omega$)
- direct reading, safe, stable
- simple operation

If one of these GR megohmmeters doesn't exactly suit your high-resistance measurement needs, the other one should. Although the instruments are similar in appearance and accuracy, their operating ranges differ to match differing needs in the laboratory and production area.

Choice for production and inspection The 1863 Megohmmeter will measure resistance at any of five common test voltages up to 500 V, has fewer controls, and is the lower priced model. It is, therefore, the best selection when several test stations are to be equipped, when the operators are inexperienced, or when specifications call for standard insulation-testing voltages.

Choice for laboratory investigations The 1864 is the more flexible of the two instruments. The test voltage can be set to any value from 10 to 109 volts in 1-volt steps and to 1090 volts in 10-volt steps. Thus, the 1864 can be set to any common, or uncommon, test voltage for ceramic, mica or paper capacitors, or other devices. The reverse resistance of rectifiers can be readily measured; the low test voltages available are especially useful in measuring solid-state diodes. An additional range permits measurements up to 2×10^{14} ohms (200 T Ω).

Both instruments are easy to use with direct-reading meter indication and lighted range switch that shows the multiplier for each range and voltage. The maximum current possible at the terminals is limited to a safe 5 milli-

National stock numbers are listed at the back of the catalog.

amperes and a panel light near the terminals warns when voltage is present. Stable power supplies and feedback voltmeter circuit minimize drift and time-wasting adjustments. Guard and ground terminals permit measurement of grounded or ungrounded two- or three-terminal resistors. The instruments are supplied for rack mounting or in a convenient, portable Flip-Tilt case that is a stand for the meter in use and protects it in transit and storage.

SPECIFICATIONS

Voltage and Resistance Ranges:

| Voltage | R _{min} Full Scale | 10% of Scale Type 1863 | R _{max} † 2½% of Scale | Useful Ranges |
|-----------------|--------------------------------|---------------------------|------------------------------------|------------------|
| 50, 100 V | 50 k Ω | 500 G Ω | 2 T Ω | 7 |
| 200, 250, 500 V | 500 k Ω | 5 T Ω | 20 T Ω | 7 |
| | | Type 1864 | | |
| 10 to 50 V | 50 k Ω | 500 G Ω | 2 T Ω * | 7* |
| 50 to 100 V | 200 k Ω | 5 T Ω | 20 T Ω | 8 |
| 100 to 500 V | 500 k Ω | 5 T Ω | 20 T Ω * | 7* |
| 500 to 1090 V | 5 M Ω | 50 T Ω | 200 T Ω | 8 |

† Note: Meter deflects to the left, so 2½% is near the right; however, the meter scale reads naturally, from left to right.

* Recommended limit.

Resistance Accuracy: ± 2 (meter reading + 1)% on lowest 5 ranges (min reading is 0.5). For 6th, 7th, 8th ranges, respectively, add $\pm 2\%$, $\pm 4\%$, $-$, for the 1863; $\pm 2\%$, $\pm 3\%$, $\pm 5\%$, for the 1864.

Voltage Accuracy (across unknown): $\pm 2\%$.

Short-Circuit Current: 5 mA approx.

Power: 100 to 125 or 200 to 250 V, 50 to 400 Hz, 13 W.

Supplied: Mounting hardware with rack models.

Mechanical: Flip-Tilt case and rack mount. DIMENSIONS (wxhxd): Portable, 6.63x10x6.75 in. (245x254x172 mm); rack, 19x7x4.63 in. (483x178x118 mm). WEIGHT: Portable, 9.5 lb (4.4 kg) net, 14 lb (7 kg) shipping; rack 11 lb (5 kg) net.

| Description | Catalog Number |
|---|-------------------|
| 1863 Megohmmeter Portable Model | 1863-9700 |
| 1864 Megohmmeter Portable Model | 1864-9700 |

Inductance-Measuring Instruments

This section describes a versatile inductance-measuring system designed for testing iron-core chokes and transformers. It is capable of supplying up to 400-V ac signal and 5-A dc bias current. This system, the first listed below, is but a small part of our inductance-measuring capability. Nine other instruments are offered

which measure resistance and capacitance as well as inductance. Of particular interest for rapid testing of low-valued coils is the 1687 Megahertz LC Digibridge™ for testing and sorting at low frequencies, the 1658 Digibridge™ is recommended.

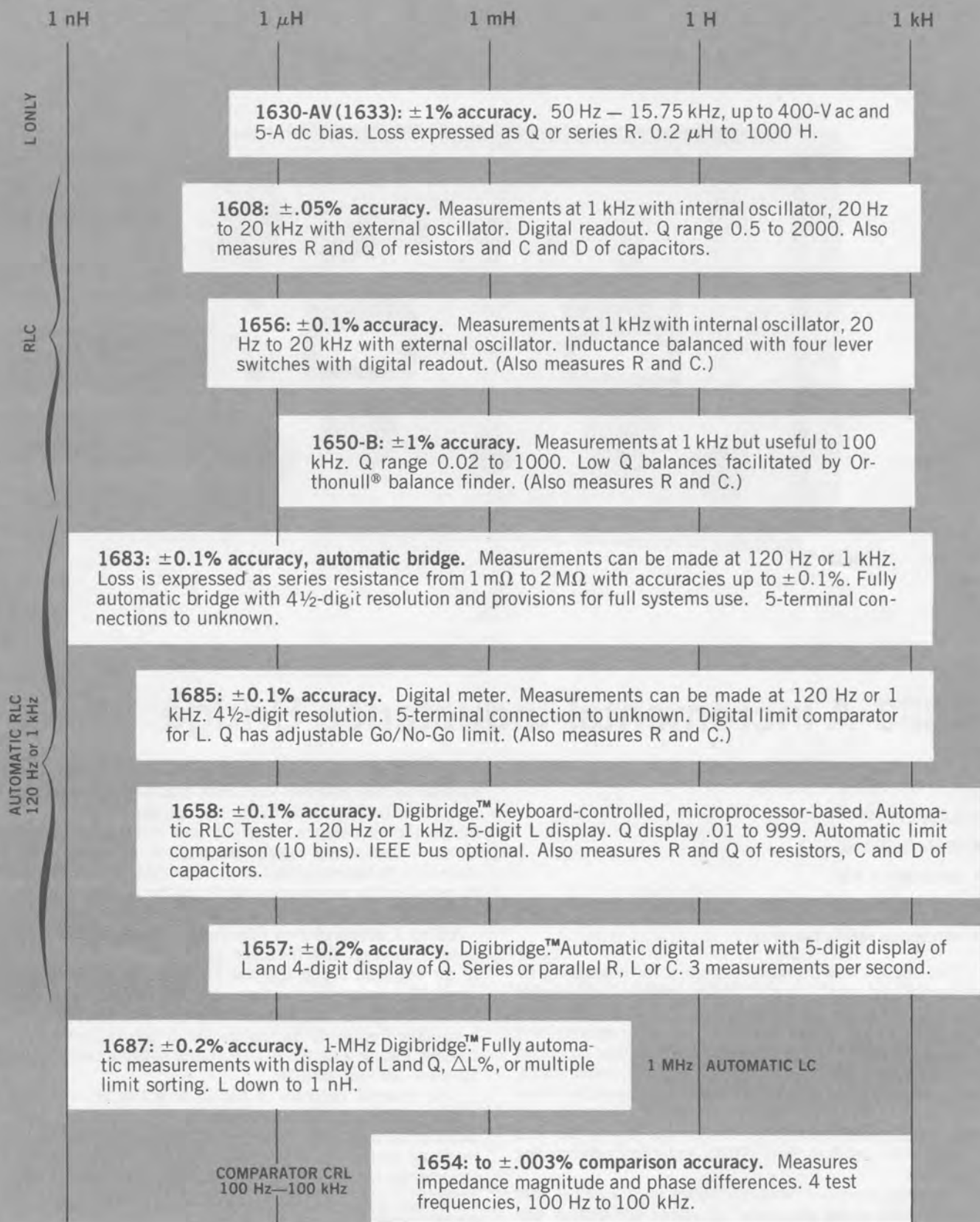

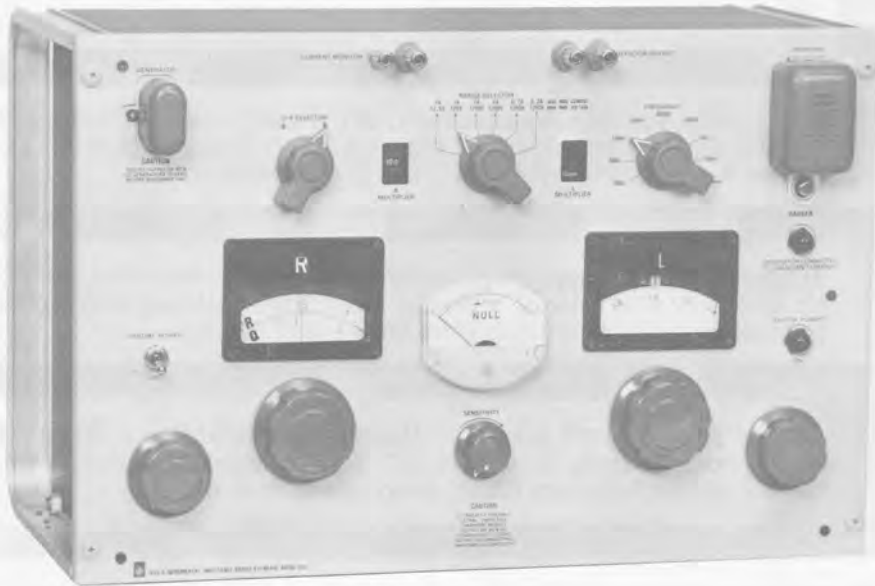

1633-A Incremental-Inductance Bridge

- direct reading at 9 frequencies in series L and R or Q
- 0.2 μ H to 1000 H
- 20 Hz to 20 kHz
- accuracy $\pm 1\%$
- apply up to 1250 V and 50 A, ac and dc
- numerous safety features

The 1633-A was designed primarily for measuring inductance and loss of transformers, chokes, and similar components at very high levels of ac and dc excitation and over a wide frequency range. Easy to operate and flexible in application, it can also measure other nonlinear elements such as Zener diodes, rectifiers, thermistors, and lamps. The bridge contains a highly selective nine-frequency detector for effective harmonic rejection and can be supplied complete with high-power ac and dc supplies as the Type 1630 Inductance-Measuring Assembly.

The incremental-inductance bridge uses a circuit that incorporates active elements* in stable operational am-

National stock numbers are listed at the back of the catalog.

60 INDUCTANCE BRIDGES

plifiers. Although large signal and bias levels may be applied to the unknown inductor, this circuit keeps signals in the bridge small, minimizes corrections, and eliminates sliding balance. Current and voltage in the unknown inductor are nearly identical in magnitude and waveform to those applied at the GENERATOR terminals. In many instances measurements can be made on the inductor while it is actually operating in your circuit.

Up to 7 amperes rms (combined ac and dc) can be passed through the inductor during measurement, up to 50 amperes if you use the 1633-P1 Range-Extension Unit. The impressed voltage can be as high as 1250 volts. Two power supplies are available, a dc supply and a variable-frequency oscillator, which are designed specifically for use with the bridge. Most conventional power supplies are not suitable.

The internal detector is highly selective at nine frequencies between 50 Hz and 15.75 kHz. Owing to high detector sensitivity and low noise, measurements can be made at excitation levels below one volt on the highest inductance ranges and 10 millivolts on the lowest range.

* H. P. Hall, R. G. Fulks, "The Use of Active Devices in Precision Bridges," *Electrical Engineering*, May 1962.

SPECIFICATIONS

Ranges and Accuracy:

| Measurement | Frequency | Full-Scale Ranges | | | | | | Lowest Scale Division | Accuracy |
|---|----------------------|---|--------------|--------------|---------------|----------------|--------------|-----------------------|---|
| | | a | b | c | d | e | f | | |
| Inductance | 50, 60, 100, 120 Hz | 10 mH | 100 mH | 1 H | 10 H | 100 H | 1000 H | 20 μ H | $\pm(1\%$ of reading or 0.1% of full scale) |
| | 400, 800, 1000 Hz | 1 mH | 10 mH | 100 mH | 1 H | 10 H | 100 H | 2 μ H | $\pm(2\pi f_{Hz}/100 Q_x)\%$ *, $\pm 2\%$ above 10 kHz or $\pm 3\%$ above 15.75 kHz |
| | 10, 15.75 kHz | 100 μ H | 1 mH | 10 mH | 100 mH | 1 H | 10 H | 0.2 μ H | |
| Resistance | All | 10 Ω | 100 Ω | 1 k Ω | 10 k Ω | 100 k Ω | 1 M Ω | 10 m Ω | $\pm(2\%$ of reading or 0.1% of full scale) $\pm \frac{4\pi f_{Hz} Q_x}{100}\%$ * |
| Q | | ∞ to 1, direct reading at above frequencies Largest scale reading: 1000 | | | | | | 0.9 | 1/Q accuracy = $\pm 2\% \pm 0.001 \pm 0.0005 f_{Hz}$ * |
| Max rms volts | | 12.5 | 125 | 1250 | 1250 | 1250 | 1250 | | |
| Min rms volts for 1% accuracy (internal detector) | 50, 60 Hz | 0.025 | 0.25 | 2.5 | 2.5 | 2.5 | 2.5 | | |
| | 1 kHz | 0.006 | 0.06 | 0.6 | 0.6 | 0.6 | 0.6 | | |
| Max rms amperes** | | 7 | 7 | 7 | 2 | 0.7 | 0.2 | | |
| | with extension unit† | 50 | 50 | 50 | | | | | |

* The frequency-error term is 5 times larger on highest L range.

** Max rms current = $\sqrt{I_{dc}^2 + I_{ac}^2}$

† 1633-P1 Range-Extension Unit contains a 0.1- Ω resistor, which you connect externally to shunt R_x (on the 3 lowest bridge ranges). Inductance and resistance values are reduced by a factor of 10.

Generator: External only (not supplied). For optimum performance when dc bias is used, ac supply must be able to withstand large dc currents in output circuit, and dc supply large ac currents. For dc bias, use 1265-A Adjustable DC Power Supply, 200 W; over the audio-frequency range, use 1308-A Audio Oscillator and Power Amplifier, 200 VA.

Detectors: INTERNAL: Selectively tuned to 50, 60, 100, 120, 400, 800 Hz, 1, 10, and 15.75 kHz; response varies < 3 dB for frequency components within $\pm 1\%$ of the nominal. Response at 2nd harmonic is typically 50 dB lower. EXTERNAL: Use the 1232-A Tuned Amplifier and Null Detector, which is tunable continuously, 20 Hz to 20 kHz.

Available: 1633-P1 Range-Extension Unit, 1232-A Tuned Amplifier and Null Detector, 1308-A Audio Oscillator and Power Amplifier.

Power: 105 to 125 V or 210 to 250 V, 50 to 60 Hz, ≈ 6 W.

Mechanical: Rack-bench cabinet. DIMENSIONS (wxhxd): Bench, 19x12.75x10.25 in. (483x324x260 mm); rack, 19x12.25x8.75 in. (483x311x222 mm). WEIGHT: 31 lb (14 kg) net, 48 lb (22 kg) shipping.

| Description | Catalog Number |
|---|----------------|
| 1633-A Incremental-Inductance Bridge | |
| 115-V Bench Model | 1633-9801 |
| 115-V Rack Model | 1633-9811 |
| 230-V Bench Model | 1633-9802 |
| 230-V Rack Model | 1633-9812 |

1265-A Adjustable DC Power Supply

The 1265-A supplies dc bias for the 1633-A Incremental-Inductance Bridge. Its characteristics include wide ranges of current and voltage, a passive low-impedance output circuit that will pass high alternating currents, and a choice of voltage or current regulation.

The instrument has four voltage ranges and four current ranges and will deliver its maximum rated power of 200 watts to 8, 80, or 800 ohms. Range switches are interlocked to prevent most likely overload situations. In addition, electronic circuit prevents damage from overload.



SPECIFICATIONS

Full-Scale Output Ranges: 12.5, 40, 125, 400 V dc; 0.16, 0.5, 1.6, 5 A dc; in any combination up to 200 W.

National stock numbers are listed at the back of the catalog.

Meters: Voltage and current; ranges switch with output ranges.

Overload Protection: Overload circuit trips at approx 1½ times full-scale current.

Regulation: VOLTAGE OR CURRENT: 0.2% for 10% line-voltage change; 1% for 100% load change. SPEED OF RESPONSE: Approx 0.1 second.

Hum Level (rms): For 60-Hz operation, approx 70 dB below full-scale dc output (55 dB on 5-A ranges); for 50-Hz operation, 6 dB higher.

Power: 105 to 125 or 210 to 250 V, 50 or 60 Hz, 380 W at rated load. (Specify if for 50 Hz.)

Mechanical: Rack-bench cabinet. DIMENSIONS (wxhxd): Bench, 19x7.5x17.25 in. (483x190x438 mm); rack, 19x7x15 in. (483x178x381 mm). WEIGHT: 70 lb (32 kg) net, 124 lb (57 kg) shipping.

| Description | Catalog Number |
|--|----------------|
| 1265-A Adjustable DC Power Supply | |
| 115-V Models | |
| 60-Hz, Bench | 1265-9801 |
| 60-Hz, Rack | 1265-9811 |
| 50-Hz, Bench | 1265-9803 |
| 50-Hz, Rack | 1265-9813 |
| 230-V Models | |
| 60-Hz, Bench | 1265-9802 |
| 60-Hz, Rack | 1265-9812 |
| 50-Hz, Bench | 1265-9804 |
| 50-Hz, Rack | 1265-9814 |



1630-AV Inductance-Measuring Assembly

- test levels from millivolts to kilovolts
- L accuracy 1% (R and Q, 2%)
- discrete frequencies: 50, 60, 100, 120, . . . 15.75 kHz

This assembly is a complete system for the measurement of inductance and loss of coils with ferromagnetic cores. It consists of a 1633 Incremental-Inductance Bridge with specially suited dc and ac power supplies in a cabinet-type rack with all necessary interconnecting cables.

The supplies can produce 200-voltampere outputs into a wide range of load impedances and are designed to pass the large dc and ac currents required.

The 1308-A oscillator provides continuous coverage from 20 Hz to 20 kHz. When measurements are required at frequencies other than those given for the internal detector, the 1232-A Null Detector is recommended.

SPECIFICATIONS

Supplied: This assembly includes the 1633 Incremental-Inductance Bridge, 1265 Adjustable DC Power Supply and 1308 Audio Oscillator and Power Amplifier.

Mechanical: Pedestal cabinet. DIMENSIONS (wxhxd): 22.5x43x20 in. (572x1092x508 mm). WEIGHT: 310 lb (145 kg) net, 460 lb (215 kg) shipping.

| Description | Catalog Number |
|--|----------------|
| 1630-AV Inductance-Measuring Assembly | |
| 115 V, 60 Hz | 1630-9827 |
| 115 V, 50 Hz | 1630-9847 |
| 230 V, 60 Hz | 1630-9837 |
| 230 V, 50 Hz | 1630-9857 |

1633-P1 Range-Extension Unit

The 1633-P1 can be used with the 1633-A Incremental-Inductance Bridge to extend the current ratings to 50 amperes. It connects a 250-watt, 0.1-ohm resistor in parallel with one of the bridge arms.

SPECIFICATIONS

Inductance Ranges: Only a, b, and c ranges of the 1633-A bridge; its readout must be multiplied by 0.1 (otherwise it



operates normally); upper limits are 100 mH for $f \leq 120$ Hz, 10 mH for $f \leq 1$ kHz.

Accuracy: Additional $\pm 1\%$ error for $f \leq 400$ Hz; correction can be made for errors at higher f . TEMPERATURE COEFFICIENT of resistance: 20 ppm/ $^{\circ}$ C.

Current Rating: 20 A continuous, 50 A intermittent, (total rms); 50 A continuous with forced air cooling.

Terminals: High-current type accommodates wires up to 0.25 in. dia from generator and unknown inductor; binding posts for connection to bridge.

Supplied: Cable, connects to bridge Unknown terminals.

Mechanical: Lab bench cabinet. DIMENSIONS (wxhxd): 10.5x4.25x5 in. (267x108x127 mm). WEIGHT: 5.3 lb (2.4 kg) net, 7 lb (3.2 kg) shipping.

| Description | Catalog Number |
|-------------------------------------|----------------|
| 1633-P1 Range-Extension Unit | 1633-9601 |

National stock numbers are listed at the back of the catalog.

Capacitance Standards and Decades

Choosing a Standard Capacitor GenRad standards and decades cover a wide capacitance range, and over much of this range there is a choice of units using different dielectric materials and, hence, having different electrical properties. The table lists these materials, their major advantages, and the GR standards that use them. In some cases there is also a choice as to the terminal arrangement used. This is also indicated.

Frequency Characteristics Although the characteristics of the high-quality capacitors used as standards closely approach those of an ideal capacitor, to obtain high accuracy the small deviations from the ideal performance must be examined and evaluated. The residual parameters that cause deviations are shown in the two-terminal equivalent circuit of Figure 1. Here, R_m represents the metallic series resistance of the leads and plates or foils, L represents the series inductance of these leads and plates, C_0 represents the high-frequency capacitance of the capacitor (neglecting the inductance), R_l represents the leakage or dc resistance, and $C_1, C_2,$ etc and $R_1, R_2,$ etc represent dielectric polarization effects (the more RC sections used, the more accurate the representation over a wide frequency range).

The most dramatic change in capacitance value occurs at frequencies that approach the resonance of the series inductance and capacitance. The capacitance value C' becomes

$$C' = \frac{C}{1 - \omega^2 LC} \quad (1)$$

or, when well below resonant frequency, $f_r = \frac{1}{2\pi\sqrt{LC}}$

$$C' = C \left[1 + (f/f_r)^2 \right] \quad (2)$$

In the following section, this variation is indicated by either a logarithmic plot of $\Delta C/C$ versus frequency or a tabulation of L or f_r . Above f_r the capacitor becomes inductive.

The effects of molecular and interfacial polarizations cause the capacitance to increase at low frequencies until, at dc, the capacitance is

$$C_{dc} = C_0 + C_1 + C_2 + \dots + C_n \quad (3)$$

Some of the time constants of the RC branches of Figure 1 can be very long, even days, so that the value may change slightly even at extremely low frequencies. This change of capacitance with frequency is approximately proportional to the dissipation factor, D . It is larger in mica capacitors than in polystyrene units because of their relatively high interfacial polarization resulting from their layered structure (see plot of GR 1409 $\Delta C/C$ vs frequency). Mica also exhibits relatively high dielectric absorption and voltage recovery as a result of this interfacial polarization and, generally, should not be used in circuits requiring slow, precise charging and discharging characteristics. Polystyrene is excellent for such applications. It also has extremely high leakage resistance.

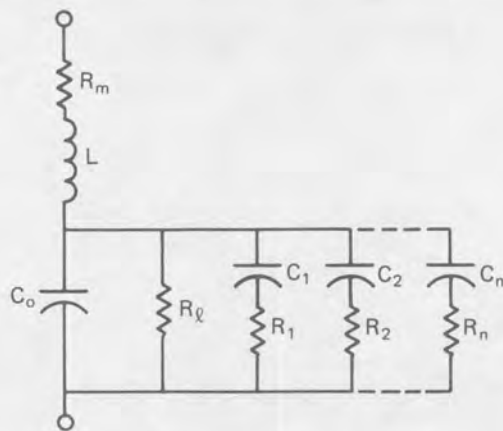

Figure 1. A capacitor equivalent circuit.

Dissipation Factor All capacitors dissipate some energy as heat when current is applied, as indicated by the presence of resistances in Figure 1. The dissipation factor, D , is defined as

$$D = \frac{\text{energy lost}}{\text{energy stored}} = \omega R_s C_s = \frac{1}{\omega R_p C_p} \quad (4)$$

where subscripts s and p refer to the equivalent series and parallel values (see **Impedance Measurement**). This factor D and the equivalent circuit values are frequency dependent. Sometimes ESR (equivalent series resistance) is used to represent loss:

$$\text{ESR} = R_s = \frac{D}{\omega C_s} \quad (\text{Note: } \text{ESR} > R_m) \quad (5)$$

At extremely low frequencies, the major contribution to loss is the leakage resistance, R_l , which gives a component of D of

$$D = \frac{1}{\omega R_l C} \quad (6)$$

where C is the low frequency value. However, even at a frequency of 1 Hz, the dielectric losses become more important in capacitors that have a solid dielectric material.

Interfacial polarization is easy to understand in a composite, layered dielectric in which the two, or more, materials have quite different leakage resistances. When a voltage is applied, the charge will, with time, redistribute itself onto the interface between the materials. While mica is not exactly a composite material, it is a layered natural material that exhibits this effect to some degree. Plastic dielectrics, such as polystyrene, are much more homogeneous, but they still have some variation in resistivity due to impurities and variations in structure which result in small, low-frequency losses.

At somewhat higher frequencies, molecular polarization occurs in materials that have an asymmetrical molecular structure (polar molecules). The molecules of these materials are partially rotated in an electrostatic field, giving rise to frictional losses. The losses are greatest when the electrical field is reversed at the mechanical natural frequency of the molecular structure. In some cases, the resulting impedance change can be accurately represented by a single RC branch, like those in Figure 1. The time constant is dependent on temperature. In air capacitors, the losses in the air dielectric and on the plate surfaces are negligible under conditions of moderate humidity and temperature. The dielectric loss is, therefore, largely in the insulating supports. In guarded, three-terminal "air" capacitors (such as the GR 1403 or GR 1404), the supporting insulators can be placed where the electric field is very weak so that their dielectric loss is extremely small.

At higher frequencies, the major source of loss is the series resistance because this loss increases with frequency: $D = \omega R_m C$. This series resistance becomes important in large electrolytic capacitors at quite low frequencies. In smaller capacitors, however, this effect is not important except at quite high frequencies where skin effect is essentially complete, causing the resistance to increase as the square root of frequency. If we express the resistance as $R_1 \sqrt{f}$, where R_1 is the resistance at 1 MHz and f is the frequency in megahertz, this component of the dissipation becomes

$$D = \omega C R_1 \sqrt{f} \sim (f)^{3/2} \quad (7)$$

at high frequencies. This explains the high-frequency slope of the curves given for the GR 1409 capacitors.

The total D of a capacitor is the sum of all the above effects and a few others that are much less important.

Standard Capacitor Selection Table

| Main Advantages | Dielectric Material | | | | | |
|--------------------------|--|------------------------------------|--|---|--------------------------------------|-------------------------------------|
| | Fused Silica | Dry Nitrogen | Air | Mica | Polystyrene | Polystyrene with transformers |
| super-stable; rugged | high stability; low temperature coefficient (2 ppm/°C) | low-loss; best at high frequencies | stable; low temperature coefficient (≈ 35 ppm/°C) | low-loss; high leakage resistance; good for low freq | allows high values by multiplication | |
| C Ranges | 10, 100 pF | 10, 100, 1,000 pF | 0 — 1,000 pF | up to 1 μ F | up to 1 μ F | 1 μ F — 1 F |
| 3-terminal (low values) | 1408 (S) | 1404 (S) | 1422-CB, -CD, -CL (V) 1403 (S) | 1409 (S) 1413 (D) 1423 (D) | 1412-BC (D) | — |
| 2-terminal | — | — | 1422-D (V) 1405 (S,P) 1406 (S,P) | 1409 (S) 1419-K (D) 1423 (D) | 1419-A, -B (D) 1412-BC (D) | (1417 (M) — limited 2-terminal use) |
| 4-terminal (high values) | — | — | — | (4-terminal connections may be made to 2-terminal capacitors) | | 1417 (M) |

(D) — decade; (M) — multiple-valued standard; (P) — GR900* precision connector; (S) — single-valued standards; (V) — variable



1408 standard, with temperature-controlled air bath.



1408 standard; for use with an oil bath.

1408 Reference Standard Capacitors

- 10 pF, 100 pF
- high stability
- low voltage coefficient
- fused-silica dielectric

Ultra-high stability The continuously improving accuracy of capacitor calibrations by the National Bureau of Standards brings a better knowledge of capacitance to standards laboratories — provided, of course, the laboratories have adequate reference standards. The 1408 Reference Standard Capacitors, with their high stability, are suitable for calibration in parts in 10^7 . The 1616 Precision Capacitance Bridge is highly recommended for accurate calibration of a wide range of working standards from such a reference.

More extensively equipped laboratories are offered the economy of a unit designed for use in a temperature-controlled oil bath. Laboratories that lack a facility can take advantage of the built-in, temperature-controlled air bath of a second version. Two capacitance values are available, 10 pF and 100 pF, and either or both can be ordered in the air-bath version.

Fused-silica dielectric The active elements of the capacitors are gold, deposited on a substrate of fused silica — noted for exceptional stability, low loss, and relative independence of frequency. The plated substrate is mounted in a brass cell which is then sealed in a stainless-steel case containing dry nitrogen.

Air-Bath Version This unit includes one or two standards, as desired, plus a self-contained air bath whose temperature is held constant to within 0.01°C per year to assure the utmost stability of the standards. Since it carries its own environment, it is well adapted for use in laboratories without an oil bath or closely-controlled ambient temperature or in portable laboratories and calibration centers. The air bath operates from 12 volts so that it is an easy matter to transport it under power at all times.

National stock numbers are listed at the back of the catalog.

Oil-Bath Version This unit is for laboratories that want to use the standard in a temperature-controlled oil bath. Two values are available, 10 pF and 100 pF, and each offers the same high precision and stability.

SPECIFICATIONS

Nominal Values: 10 pF and 100 pF.

Calibration: A certificate of calibration is supplied with each capacitor, giving the measured direct capacitance at 1 kHz and at a specified temperature near 25°C for an oil-bath capacitor or near 30°C for an air-bath capacitor. The measured value is obtained by comparison to a precision better than 0.1 ppm with standards whose values are determined and maintained by periodic calibrations made by the National Bureau of Standards. The limit of uncertainty of these calibrations is ± 0.5 ppm.

Adjustment Accuracy: ± 100 ppm.

Stability: Estimated to be better than 0.3 ppm/yr.

Environment: TEMPERATURE COEFFICIENT, $12 \text{ ppm} \pm 2 \text{ ppm}/^\circ\text{C}$. TEMPERATURE CYCLING, from 0 to 60°C , $< 1 \text{ ppm}$ hysteresis at 30°C .

Air-Bath Characteristics: TEMPERATURE, 30°C nominal with stability of $0.01^\circ\text{C}/\text{year}$, $< 0.005^\circ\text{C}/\text{hour}$ if ambient temperature is kept within 1°C . TEMPERATURE COEFFICIENT: $0 \pm 0.05 \text{ ppm}/^\circ\text{C}$ from 17 to 29°C ambient temperature. Thermometer well provided for calibration.

Electrical: DISSIPATION FACTOR, $< 10^{-5}$ at 1 kHz. VOLTAGE, 500 V max. RESIDUAL IMPEDANCES:

| | | LH, LL | CD | CH | CL |
|-----|--------|-------------------|--------|--------|-------|
| air | 10 pF | 0.6 μH | 10 pF | 88 pF | 64 pF |
| | 100 pF | 0.6 μH | 100 pF | 120 pF | 56 pF |
| oil | 10 pF | 0.2 μH | 10 pF | 55 pF | 31 pF |
| | 100 pF | 0.2 μH | 100 pF | 87 pF | 23 pF |

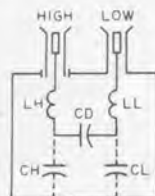

Terminals: Two gold-plated GR874® locking connectors, easily adapted to other common connector types (on air-bath version, connectors can be moved to rear).

Available: GR874 ADAPTORS, 874-R22LA PATCH CORDS.

General: Fused-silica dielectric; plated substrate is hermetically sealed in a dry-nitrogen-filled stainless-steel case. Connections to the air-bath version can be made to the front or the rear as your application dictates. A 12-volt input is provided to maintain a constant air-bath temperature even while the unit is in transit.

Power (Air-bath version only): 100 to 120 or 200 to 240 V, 50 to 60 Hz, 5 W; 12 V at 0.4 A for dc operation, battery connectors provided on rear.

Mechanical: DIMENSIONS (wxhxd): Air-bath version 8.42x8.72x16 in. (214x222x407 mm); oil-bath version, 3.5x11.1x

1.86 in. (89x283x48 mm). **WEIGHT:** Air-bath version (single value), 23 lb (11 kg) net, 32 lb (15 kg) shipping; (two values), 25 lb (12 kg) net, 34 lb (16 kg) shipping; oil-bath version, 3 lb (1.4 kg) net, 7 lb (3.2 kg) shipping.

| Description | Catalog Number |
|---|----------------|
| Reference Standard Capacitor, air bath | |
| 1408, 10 pF | 1408-9700 |
| 1408, 10/10 pF | 1408-9702 |
| 1408, 100 pF | 1408-9703 |
| 1408, 100/100 pF | 1408-9705 |
| 1408, 10/100 pF | 1408-9706 |
| Reference Standard Capacitor, oil bath | |
| 1408-A, 10 pF | 1408-9701 |
| 1408-B, 100 pF | 1408-9704 |



1404 Reference Standard Capacitor

- 10, 100, 1000 pF
- 20 ppm/year stability
- 3-terminal, coaxial connections
- hermetically sealed in dry nitrogen

These capacitors have been designed as primary reference standards of capacitance with which working standards can be compared. The 1615-A Capacitance Bridge is particularly well suited for this purpose and can be

conveniently used to calibrate accurately a wide range of working standards in terms of a 1404 Reference Standard Capacitor. A single 1000- or 100-picofarad standard is also the only standard necessary to calibrate the bridge itself.

In combination with an accurately known external resistor, this capacitor becomes a standard of dissipation factor.

All critical parts of the plate assembly are made of Invar for stability and low temperature coefficient. After heat cycling and adjustment, the assembly is mounted in a heavy brass container, which, after evacuation, is filled with dry nitrogen under pressure slightly above atmospheric and sealed. The container is mounted on an aluminum panel and protected by an outer aluminum case. Each capacitor is subjected to a series of temperature cycles to determine hysteresis and temperature coefficients and to stabilize the capacitance.

Two locking GR874® coaxial connectors are used as terminals. The outer shell of one is connected to the case, but the outer shell of the other is left unconnected to permit the capacitor to be used with an external resistor as a dissipation-factor standard.

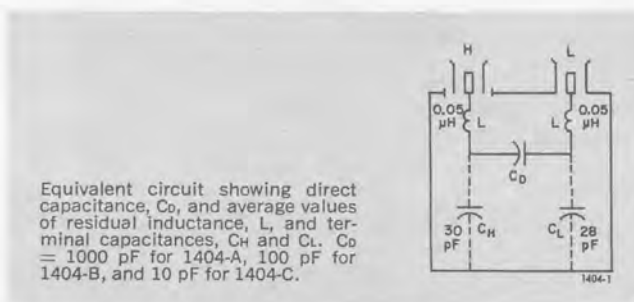

National stock numbers are listed at the back of the catalog.

SPECIFICATIONS

Calibration: A certificate of calibration is supplied with each capacitor, giving the measured direct capacitance at 1 kHz and at 23° ±1°C. The measured value is obtained by a comparison to a precision better than ±1 ppm with working standards whose absolute values are known to an accuracy of ±5 ppm, determined and maintained in terms of reference standards periodically measured by the National Bureau of Standards.

Adjustment Accuracy: The capacitance is adjusted before calibration with an accuracy of ±5 ppm to a capacitance about 5 ppm above the nominal value relative to the capacitance unit maintained by the General Radio reference standards.

Stability: Long-term drift is less than 20 parts per million per year. Maximum change with orientation is 10 ppm and is completely reversible.

Temperature Coefficient of Capacitance: 2 ± 2 ppm/°C for 1404-A and -B, 5 ± 2 ppm/°C for 1404-C, from -20°C to +65°C. A measured value with an accuracy of ±1 ppm/°C is given on the certificate.

Temperature Cycling: For temperature cycling over range from -20°C to +65°C, hysteresis (retraceable) is less than 20 ppm at 23°C.

Dissipation Factor: Less than 10⁻⁵ at 1 kHz.

Residual Impedances: See equivalent circuit for typical values of internal series inductances and terminal capacitances.

Max Voltage: 750 V.

Terminals: Two locking GR874 coaxial connectors; easily convertible to other types of connectors by attachment of locking adaptors. Outer shell of one connector is ungrounded to permit capacitor to be used with external resistor as a dissipation-factor standard.

Required: For connection to 1615-A Capacitance Bridge, 2 Type 874-R20A or 874-R22LA Patch Cords.

Mechanical: Lab-bench cabinet. DIMENSIONS (wxhxd): 6.75x6.63x8 in. (172x169x204 mm). WEIGHT: 8.5 lb (3.9 kg) net, 14 lb (6.4 kg) shipping.

| Description | Catalog Number |
|-------------------------------------|----------------|
| Reference Standard Capacitor | |
| 1404-A, 1000 pF | 1404-9701 |
| 1404-B, 100 pF | 1404-9702 |
| 1404-C, 10 pF | 1404-9703 |

1403 Standard Air Capacitor

- 1000 pF to 1 pF
- calibration accuracy: ±0.02% ±0.01 pF



The 1403 Standard Air Capacitors are stable, three-terminal standards in decimal values from 1 to 1000 pF. Their terminals are arranged to plug directly into the External Standard and Unknown terminals of the 1615 and 1616 capacitance bridges.

SPECIFICATIONS

Calibration: A certificate of calibration is supplied with each unit giving the measured capacitance at 1 kHz and at a specified temperature. The measured value is the direct capacitance between shielded terminals when the capacitor has at least one lead completely shielded and its case connected to a guard point. This value is obtained by comparison, to a precision better than ±(0.01% + 0.00001 pF), with working standards whose absolute values are known to an accuracy typically ±0.01%, determined and maintained in terms of reference standards periodically calibrated by the National Bureau of Standards.

Stability: Capacitance change is less than 0.05% per year.

Residual Impedances: See curve for effect of frequency. Capacitance from either terminal to case is ≈ 30 pF.

National stock numbers are listed at the back of the catalog.

Dissipation Factor: < 20 × 10⁻⁶ max at 1 kHz and 50% or less relative humidity.

Peak Voltage: 1500 V, except 700 V for 1403-A.

Temperature Coefficient of Direct Capacitance: Typically 20 to 40 ppm per degree between 20° and 70°C. The larger coefficients apply to the smaller capacitance values.

Terminals: GR874® coaxial connectors, for complete shielding of the leads. SPACING: 1.13 in (28.6 mm).

Mechanical: Cylindrical case. DIMENSIONS (dia x h): 3.06x5.25 in. (77x133 mm). WEIGHT: 1 lb (0.5 kg) net, 4 lb (1.9 kg) shipping.

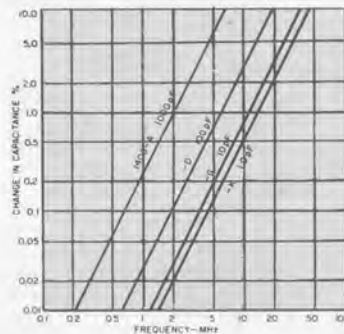

Typical increase (percent) in effective direct capacitance, with frequency produced by residual inductance.

| Description | Nominal Capacitance | Adjustment Accuracy | Catalog Number |
|-------------------------------|---------------------|---------------------|----------------|
| Standard Air Capacitor | | | |
| 1403-A | 1000 pF | 0.1% | 1403-9701 |
| 1403-D | 100 | 0.1 | 1403-9704 |
| 1403-G | 10 | 0.1 | 1403-9707 |
| 1403-K | 1.0 | 0.1 | 1403-9711 |

1406 Coaxial Capacitance Standards

- stable to 0.05% per year
- for rf impedance calibrations
- 100 pF and 1000 pF

The 1406 Coaxial Capacitance Standards are stable, low-loss air capacitors with small, stable and known series inductance. Use them for the accurate, traceable calibration of high-frequency bridges and other impedance-measuring instruments.

Instrument calibration The 1406 standards can be connected directly to instruments, such as the 1616 Precision Capacitance Bridge, equipped with GR900® precision connectors and to others through appropriate adaptors. Series inductance and resistance have been kept to a minimum in the 900-Q9 Adaptor. When other adaptors are used, these quantities should be known to permit correcting for their effects at high frequencies.

These standards can be calibrated at audio frequencies with the 1616 bridge or with the 1615 Capacitance Bridge and the 1615-P2 Coaxial Adaptor. Each has an adjustment for compensating for terminal capacitance, to permit direct-reading measurements.

Repeatable coaxial connection GR900 precision coaxial connectors are used, for stability and repeatable performance that have been proven in use at frequencies as high as 9 GHz. The use of coaxial connectors also meets high-frequency calibration requirements of the National Bureau of Standards.



SPECIFICATIONS

Calibration: A certificate of calibration is supplied with each unit, giving the measured capacitance at 1 kHz and at a specified temperature and relative humidity. The measured capacitance is the capacitance at the reference plane of the GR900 connector. This value is obtained by comparison, to a precision better than $\pm 0.01\%$, with working standards whose absolute values are known to an accuracy typically $\pm 0.01\%$, determined and maintained in terms of reference standards periodically calibrated by the National Bureau of Standards.

Typical Parameters

| Nominal Capacitance | Peak Volts | Dissipation Factor | | Inductance |
|---------------------|------------|---------------------|---------------------|------------|
| | | 1 kHz (40% RH) | 1 MHz | |
| 1000 pF | 700 | 3×10^{-5} | 50×10^{-6} | 8.6 nH |
| 100 pF | 1500 | 30×10^{-5} | 20×10^{-6} | 7.6 nH |

Accuracy: Capacitance adjusted by GR to nominal value $\pm 0.1\%$. **STABILITY:** Capacitance change $< 0.05\%$ per year. **TEMPERATURE COEFFICIENT** of capacitance: Typically 10 to 20 ppm/°C, between 20 and 70°C.

Residual Impedances: See table. Dissipation factor varies as the $3/2$ power of frequency above about 100 kHz. Insulation resistance $> 10^{12} \Omega$, at 23°C and relative humidity $< 50\%$.

Terminal: GR900 precision coaxial connector.

Available: 1615-P2 Adaptor for convenience in calibrating with 1615-A Capacitance Bridge. 900-Q9 Adaptor for connecting the 1406 to 0.25-in. x 28 threaded studs, tapped holes, or GR 938 Binding Posts spaced 0.75 to 1 in. apart.

Mechanical: Cylindrical case. DIMENSIONS (dia x h): 3.06x 5.25 in. (78x134 mm). WEIGHT: 1.5 lb (0.7 kg) net, 4 lb (1.9 kg) shipping.

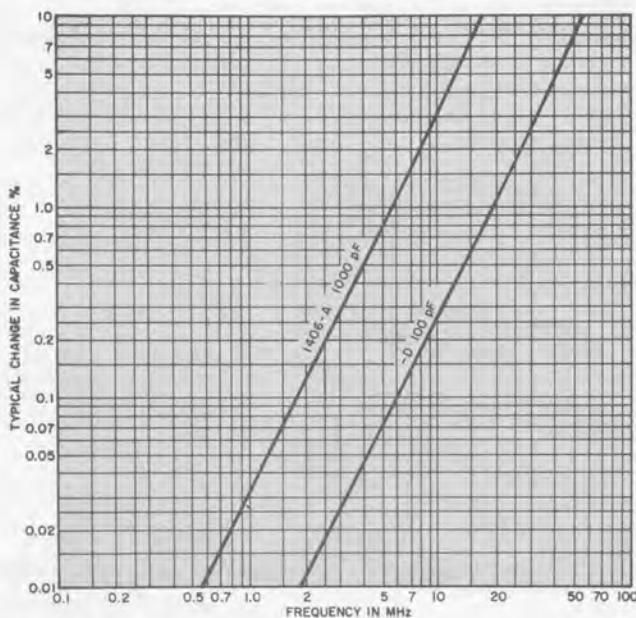

Typical percent increase in capacitance with frequency of 1406 Coaxial Capacitance Standards.

| Description | Catalog Number |
|---|----------------|
| Coaxial Capacitance Standard | |
| 1406-A, 1000 pF | 1406-9701 |
| 1406-D, 100 pF | 1406-9704 |
| 1615-P2 Coaxial Adaptor, GR900 to 1615 Bridge | 1615-9602 |
| 900-Q9 Adaptor, GR900 to binding posts | 0900-9874 |

National stock numbers are listed at the back of the catalog.

1405 Coaxial Capacitance Standards

- 1 and 10 pF
- rf standards
- GR900® connectors



Extending the available values of rf capacitance downward, the 1405 standards permit impedance-measuring instruments to be calibrated at even higher frequencies accurately and with traceability to the National Bureau of Standards.

Accuracy is stated two ways. The first refers to nominal capacitance and includes initial adjustment, aging, and other effects. The second refers to the individual calibration and certificate.

SPECIFICATIONS

Calibration: A certificate of calibration is supplied with each unit, giving the measured capacitance at 1 kHz and at a specified temperature and relative humidity. The measured capacitance is the capacitance at the reference plane of the GR900 connector. This value is obtained by comparison, to a precision better than ± 0.002 pF, with working standards whose

absolute values are known to an accuracy typically $\pm 0.02\%$, determined and maintained in terms of reference standards periodically calibrated by the National Bureau of Standards.

| | 1405-B, 10 pF | 1405-E, 1 pF |
|-----------------------------|-------------------------|--|
| Accuracy at 23°C | $\pm 0.2\%$ (0.02 pF) | $\pm 0.5\%$ (0.005 pF) |
| Calibration Accuracy | $\pm 0.04\%$ | $\pm 0.2\%$ |
| Stability | vs temperature, 10-70°C | -0.004%/°C |
| | vs humidity, <90% RH | — |
| | vs aging | <0.1%/yr |
| Frequency | 0.1% C increase | 40 MHz |
| | 10% C increase | 0.4 GHz |
| Residuals | D at 1 kHz, <50% RH | $<150 \times 10^{-6}$ |
| | insulation R | $>10^{12} \Omega$ at 23°C and <50% RH |
| | equivalent L | 1.6 nH at <250 MHz 1.8 nH at <500 MHz |
| Peak Volts | 1 kV | 3 kV |

Available: ADAPTORS 1615-P2 for calibrating with GR 1615 bridge and 900-Q9 for connecting standard to ¼-inch x 28 threaded stud (GR 938 Binding Post) or tapped hole.

Terminal: GR900 precision coaxial connector.

Mechanical: DIMENSIONS (dia x h): 1.06x2.32 in. (27x59 mm). WEIGHT: 4 oz (103 g) net, 5 oz (142 g) shipping.

| Description | Catalog Number |
|--------------------------------------|----------------|
| Coaxial Capacitance Standards | |
| 1405-B, 10 pF | 1405-9703 |
| 1405-E, 1 pF | 1405-9700 |



GR 1409-T



GR 1409-Y

1409 Standard Capacitors

- 0.001 to 1 μF
- $\pm 0.01\%$ / year stability
- calibration accuracy $\pm 0.02\%$
- two- and three-terminal calibration provided

The 1409 Standard Capacitors are fixed mica capacitors of very high stability for use as two- or three-terminal reference or working standards in the laboratory.

Typical capacitors, observed over more than 15 years, have shown random fluctuations of less than $\pm 0.01\%$ in measured capacitance with no evidence of systematic drift.

These capacitor units consist of a silvered-mica and foil pile, spring-held in a heavy metal clamping structure for mechanical stability. The units are selected for low dissipation factor and are stabilized by heat cycling. They are housed, with silica gel to provide continuous desiccation, in cast aluminum cases, sealed with high-temperature potting wax. A well is provided in the wall of the case for the insertion of a dial-type thermometer. Three jack-

top binding posts are provided on the top of the case and removable plugs on the bottom, for convenient parallel connection without error.

SPECIFICATIONS

Adjustment Accuracy: Within $\pm 0.05\%$ of the nominal capacitance value (two-terminal) marked on the case.

Calibration: A certificate of calibration is supplied with each unit, giving both two- and three-terminal measured capacitances at 1 kHz and at a specified temperature. The measured value is the capacitance added when the standard is plugged directly into General Radio binding posts. This value is obtained by comparison, to a precision better than $\pm 0.01\%$, with working standards whose absolute values are known to an accuracy typically $\pm 0.01\%$, determined and maintained in terms of reference standards periodically calibrated by the National Bureau of Standards.

Stability: Capacitance change is less than 0.01% per year.

Temperature Coefficient of Capacitance: $+35 \pm 10$ ppm per degree C between 10° and 70°C .

Dissipation Factor: Less than 0.0003 at 1 kHz and 23°C (see curves). Measured dissipation factor at 1 kHz is stated in the certificate to an accuracy of ± 0.00005 .

Series Inductance: Typically $0.050 \mu\text{H}$ for 1409-F and -L, $0.055 \mu\text{H}$ for -T and -Y.

Series Resistance at 1 MHz: 0.02 ohm, except for 1409-Y, which is 0.03 ohm.

Frequency Characteristics: See curves. Series resistance varies as the square root of the frequency for frequencies above 100 kHz.

Approx Terminal Capacitance: From H terminal to case (G), 12 to 50 pF. From L terminal (outside foils of capacitor) to case, 300 to 1300 pF.

Leakage Resistance: 5000 ohm-farads or 100 G Ω , whichever is the lesser.

Max Voltage: 500 V pk up to 10 kHz.

Mechanical: Sealed case. DIMENSIONS (wxhxd): 1409-Y, 3.25x5.63x2.69 in. (83x143x69 mm); others, 3.25x4x2 in. (83x102x51 mm). WEIGHT: 1.25 lb (0.6 kg) net, 4 lb (1.9 kg) shipping; the 1409-Y is heavier by approx 1 lb (0.5 kg).

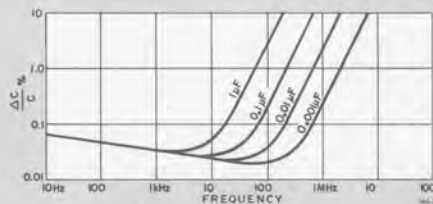

(Above) Change in capacitance as a function of frequency for typical 1409 Capacitors. The 1-kHz value on the plot should be used as a basis of reference in estimating frequency errors. (Below) Dissipation factor as a function of frequency.

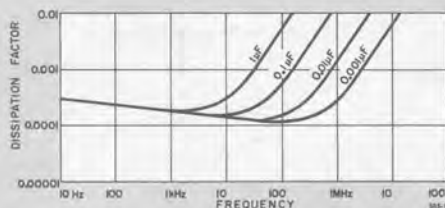

| Description | Nominal Capacitance μF | Catalog Number |
|--------------------------------|-----------------------------------|----------------|
| 1409 Standard Capacitor | | |
| 1409-F | 0.001 | 1409-9706 |
| 1409-L | 0.01 | 1409-9712 |
| 1409-T | 0.1 | 1409-9720 |
| 1409-Y | 1.0 | 1409-9725 |

National stock numbers are listed at the back of the catalog.



1417 Four-Terminal Capacitance Standard

- 1 μF to 1 F in decade steps
- 0.25% basic capacitance accuracy
- 0.02 to 0.25% ratio accuracy
- dissipation-factor standard

The GR 1417 Four-Terminal Capacitance Standard consists of a 1- μF standard capacitor and two precise inductive voltage dividers used to scale the value of the 1- μF capacitor up to 1 F in decade steps. This arrangement provides accuracy and stability unattainable with very high-value true capacitors.

In addition to the seven direct-reading capacitance values, an infinite number of intermediate or higher capacitance values can be obtained by using external capacitors. An external capacitor is simply connected to the 1417's external standard terminals, either directly or in parallel with the 1- μF internal standard, and the resulting capacitance is scaled in value by the 1417's inductive voltage dividers.

The direct-reading accuracy of the 1417 is $\pm 0.25\%$ plus the associated ratio accuracy at test frequencies at 100, 120, or 1000 Hz. Since the 1417 scaling ratios are precise and repeatable, better accuracy can be obtained by measuring the actual value of the internal 1- μF standard or of an external standard before scaling.

The 1417 also serves as a standard of dissipation factor (D). The dissipation factor of the 1417 is inten-

tionally set to 0.01 at test frequencies of 100, 120 and 1000 Hz. Basic D accuracy is ± 0.001 .

The 1417 may also be used as a two-terminal capacitance standard when higher D values can be tolerated. In a two-terminal configuration, D is less than 1 for capacitance values up to 1000 μF at frequencies below 150 Hz. This feature allows the 1417 to be used in calibrating the higher capacitance ranges of popular universal or RLC bridges.

One additional feature of importance is that all the 1417's parameters are measurable (without disassembly) so, in effect, its ultimate accuracy depends on the accuracy of the external measurement equipment.

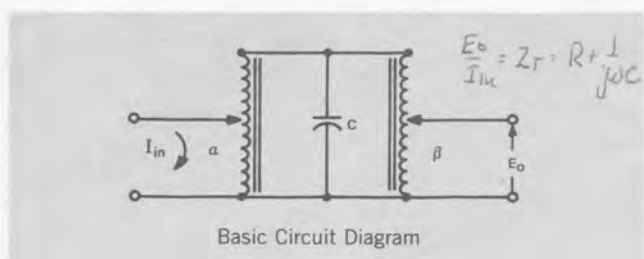

SPECIFICATIONS

| Capacitance Value (Internal Standard) | Ratio Accuracy | | D Accuracy | | Approximate Terminal Impedance | | E Max* AC (V) |
|--|----------------|-------|--------------|-------|--------------------------------|-----------------------|------------------|
| | 100 & 120 Hz | 1 kHz | 100 & 120 Hz | 1 kHz | Z _A (Ω) | Z _B (Ω) | |
| 1 μF | — | — | ±.001 | ±.001 | 0.03 | 0.03 | 20 |
| 10 μF | 0.02% | 0.04% | ±.001 | ±.001 | 7.0 | 15.5 | 6 |
| 100 μF | 0.02% | 0.04% | ±.001 | ±.001 | 3.1 | 6.4 | 2 |
| 1 mF | 0.02% | 0.06% | ±.001 | ±.002 | 1.1 | 2.2 | 0.8 |
| 10 mF | 0.03% | 0.2% | ±.001 | ±.005 | 0.37 | 0.72 | 0.5 |
| 100 mF | 0.1% | ** | ±.003 | ** | 0.13 | 0.23 | 0.25 |
| 1 F | 0.25% | ** | ±.01 | ** | 0.04 | 0.05 | 0.06 |

*DC voltage cannot be applied.

**Not specified

Capacitance: Internal Standard: 1 μF to 1 F in 7 switch-selected decade values. External Standard: Indicated capacitance, multiplied by C ext/1μF.

Capacitance Accuracy, direct-reading: 0.25% plus ratio accuracy at 100 Hz, 120 Hz, and 1 kHz, 20 to 25°C, with low applied voltage (<1/4 E max) using internal standard and a proper four-terminal measurement. (May also be used as a two-terminal standard, with a D < 1 and a capacitance change from the four-terminal value of < 1/2% up to 1mF at 120 Hz or less.)

Capacitance Ratio Accuracy: See table.

Dissipation Factor: 0.01 at 100 Hz, 120 Hz and 1 kHz. For D accuracy, see table.

Terminal Impedances: See figure and table (approx values given).

Temperature Coefficient: Approximately -140 ppm/°C.

Voltage Characteristic: Approximately +0.3% change from O_V to E max (see table) at 100 Hz. Less at higher frequencies.

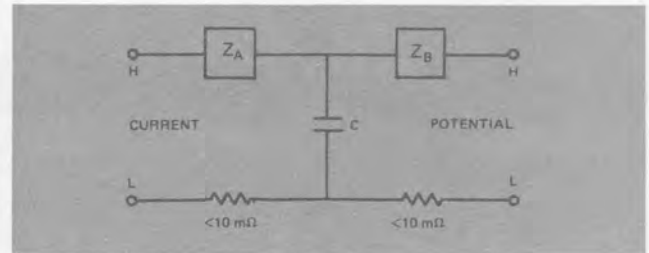

Mechanical: DIMENSIONS: (wxhxd): 8.5×5.9×5.25 in. (21.5×14.7×13.2 cm). WEIGHT: 6 lb (2.7 kg) net, 11 lb (5 kg) shipping.

Description

Catalog Number

1417 Four-Terminal Capacitance Standard

1417-9700

Interior of 1422-D



1422 Precision Capacitors

- variable air capacitors
- stability: better than 0.02% full scale per year
- settable to 40 ppm
- low temperature coefficient, low losses
- wide selection to suit needs

The 1422 is a stable and precise variable air capacitor intended for use as a continuously adjustable standard of capacitance.

One of the most important applications is in ac bridge measurements, either as a built-in standard or as an external standard for substitution measurements. It is available in a variety of ranges, terminal configurations, and scale arrangements to permit selection of precisely the required characteristics.

Two-Terminal The 1422-D is a dual-range, two-terminal capacitor, direct reading in total capacitance at the terminals.

Three-terminal The 1422-CB, -CL, and -CD are three-terminal capacitors with shielded coaxial terminals for use in three-terminal measurements. The calibrated direct capacitance is independent of terminal capacitances to ground, and losses are very low. The 1422-CL has particularly low, constant terminal capacitances, making it suitable for measurement circuits in which high capacitance to guard cannot be tolerated.

Construction The capacitor assembly is mounted in a cast frame for rigidity. This frame and other critical parts are made of aluminum alloys selected to give the strength of brass with the lightness of aluminum. The plates of most models are also aluminum, so that all parts have the same temperature coefficient of linear expansion.

A worm drive is used to obtain high precision of setting. To avoid eccentricity, the shaft and the worm are accurately machined as one piece. The worm and worm wheel are also lapped into each other to improve smoothness. The dial end of the worm shaft runs in a self-aligning ball bearing, while the other end is supported by an adjustable spring mounting, which gives positive longitudinal anchoring to the worm shaft through the use of a pair of sealed, self-lubricating, preloaded ball bearings.

National stock numbers are listed at the back of the catalog.

Similar pairs of preloaded ball bearings provide positive and invariant axial location for the main or rotor shaft. Electrical connection to the rotor is made by means of a silver-alloy brush bearing on a silver-overlay drum to assure a low-noise electrical contact.

Stator insulation in all models is a cross-linked thermo-setting modified polystyrene having low dielectric losses and very high insulation resistance. Rotor insulation, where used (Types 1422-CB and -CL), is grade L-4 stearite, silicone treated.

Accuracy The errors tabulated in the specifications are possible errors, i.e., the sum of error contributions from setting, adjustment, calibration, interpolation, and standards. When the capacitor is in its normal position with the panel horizontal, the actual errors are almost always smaller. The accuracy is improved when the readings are corrected using the 12 calibrated values of capacitance given on the correction chart on the capacitor panel and interpolating linearly between calibrated points. Even better accuracy can be obtained from a precision calibration of approximately 100 points on the capacitor dial, which permits correction for slight residual eccentricities of the worm drive and requires interpolation over only short intervals. This precision calibration is available for all models at an extra charge. Models so calibrated are listed with the additional suffix letter, P, in the type number. A plastic-enclosed certificate of calibration is supplied, giving corrections to one more figure than the tabulated accuracy.

SPECIFICATIONS

Accuracy: See table.

Stability: Capacitance change with time <1 scale division (0.02% of full scale) per year. Long-term accuracy can be estimated from the stability and the initial accuracy.

Calibration: Measured values (supplied) are obtained by comparison at 1 kHz, with working standards whose absolute values are known to an accuracy of $\pm(0.01\% + 0.0001 \text{ pF})$. Each comparison is made to a precision better than $\pm 0.01\%$.



1412-BC Decade Capacitor

- 50 pF to $>1 \mu\text{F}$
- better than 1-pF resolution
- accuracy $\pm(0.5\% + 5 \text{ pF})$
- low loss, leakage, dielectric absorption

The wide capacitance range and high resolution of this decade capacitance box make it exceptionally useful in both laboratory and test shop. Owing to its fine adjustment of capacitance, it is a convenient variable capacitor to use with the 1654 Impedance Comparator. The poly-

styrene dielectric used in the decade steps is necessary for applications requiring low dielectric absorption and constancy of both capacitance and dissipation factor with frequency.

Four decades of polystyrene capacitors and a variable air capacitor are used, mounted in a double-shield box. The double shielding provides 2-terminal and 3-terminal capacitances that are the same except for the capacitance between the terminals. The variable air capacitor with a linear ΔC of 100 pF and a resolution of better than 1 pF provides continuous adjustment between the 100-pF steps of the smallest decade.

SPECIFICATIONS

Capacitance: 50 pF to 1.11115 μF in steps of 100 pF with a 0- to 100-pF variable air capacitor providing continuous adjustment with divisions of 1 pF. Capacitances for 2- and 3-terminal connections differ by about 1 pF (C_{HG} in the drawing). C_{LG} is approx 125 pF.

Min Capacitance: 50 pF with all controls set at zero.

Dielectric: Polystyrene for decade steps.

Accuracy: $\pm(0.5\% + 5 \text{ pF})$ at 1 kHz for total capacitance including 50-pF minimum for the 3-terminal connection.

Temperature Coefficient: $-140 \text{ ppm}/^\circ\text{C}$ (nominal).

Frequency Characteristics: Dc Cap/1-kHz Cap <1.001 . At higher frequencies the increase is approx $\Delta C/C = (f/f_r)^2$. The resonant frequency, f_r , varies from over 400 kHz for a capacitance of 1 μF to about 27 MHz for a capacitance of 150 pF when connections are made to the front terminals. f_r is about 300 kHz and 70 MHz for rear connections and the same capacitances.

Max Operating Temperature: 65°C.

Dielectric Absorption (Voltage Recovery): 0.1% max.

Dissipation Factor: 150 to 1000 pF, 0.001, max, at 1 kHz; over 1000 pF, 0.0002, max, at 1 kHz.

Insulation Resistance: 10^{12} ohms, min.

Max Voltage: 500 V peak, up to 35 kHz.

Terminals: Four 938 Binding Posts with grounding link are provided on the panel. Two of the binding posts are connected to the case and located for convenient use with patch cords in 3-terminal applications. Access is also provided to rear terminals for relay-rack applications.

Mechanical: Lab-bench cabinet; brackets provided for rack mounting. DIMENSIONS (wxhxd): 17.25x3.5x6 in. (439x89x153 mm). WEIGHT: 8.5 lb (3.9 kg) net, 10 lb (4.6 kg) shipping.

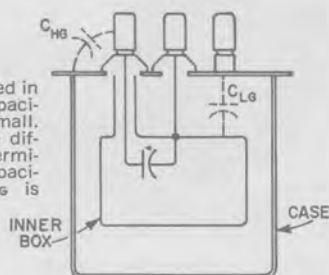

The double shielding used in the 1412-BC Decade Capacitor keeps C_{HG} very small. This capacitance is the difference between the 3-terminal and 2-terminal capacitance of the box; C_{LG} is approx 125 pF.

Description

Catalog Number

1412-BC Decade Capacitor

1412-9410

National stock numbers are listed at the back of the catalog.



1412-BC Decade Capacitor

- 50 pF to $>1 \mu\text{F}$
- better than 1-pF resolution
- accuracy $\pm(0.5\% + 5 \text{ pF})$
- low loss, leakage, dielectric absorption

The wide capacitance range and high resolution of this decade capacitance box make it exceptionally useful in both laboratory and test shop. Owing to its fine adjustment of capacitance, it is a convenient variable capacitor to use with the 1654 Impedance Comparator. The poly-

styrene dielectric used in the decade steps is necessary for applications requiring low dielectric absorption and constancy of both capacitance and dissipation factor with frequency.

Four decades of polystyrene capacitors and a variable air capacitor are used, mounted in a double-shield box. The double shielding provides 2-terminal and 3-terminal capacitances that are the same except for the capacitance between the terminals. The variable air capacitor with a linear ΔC of 100 pF and a resolution of better than 1 pF provides continuous adjustment between the 100-pF steps of the smallest decade.

SPECIFICATIONS

Capacitance: 50 pF to 1.11115 μF in steps of 100 pF with a 0- to 100-pF variable air capacitor providing continuous adjustment with divisions of 1 pF. Capacitances for 2- and 3-terminal connections differ by about 1 pF (C_{HG} in the drawing). C_{LG} is approx 125 pF.

Min Capacitance: 50 pF with all controls set at zero.

Dielectric: Polystyrene for decade steps.

Accuracy: $\pm(0.5\% + 5 \text{ pF})$ at 1 kHz for total capacitance including 50-pF minimum for the 3-terminal connection.

Temperature Coefficient: $-140 \text{ ppm}/^\circ\text{C}$ (nominal).

Frequency Characteristics: Dc Cap/1-kHz Cap <1.001 . At higher frequencies the increase is approx $\Delta C/C = (f/f_r)^2$. The resonant frequency, f_r , varies from over 400 kHz for a capacitance of 1 μF to about 27 MHz for a capacitance of 150 pF when connections are made to the front terminals. f_r is about 300 kHz and 70 MHz for rear connections and the same capacitances.

Max Operating Temperature: 65°C.

Dielectric Absorption (Voltage Recovery): 0.1% max.

Dissipation Factor: 150 to 1000 pF, 0.001, max, at 1 kHz; over 1000 pF, 0.0002, max, at 1 kHz.

Insulation Resistance: 10^{12} ohms, min.

Max Voltage: 500 V peak, up to 35 kHz.

Terminals: Four 938 Binding Posts with grounding link are provided on the panel. Two of the binding posts are connected to the case and located for convenient use with patch cords in 3-terminal applications. Access is also provided to rear terminals for relay-rack applications.

Mechanical: Lab-bench cabinet; brackets provided for rack mounting. DIMENSIONS (wxhxd): 17.25x3.5x6 in. (439x89x153 mm). WEIGHT: 8.5 lb (3.9 kg) net, 10 lb (4.6 kg) shipping.

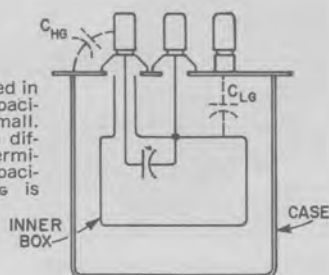

The double shielding used in the 1412-BC Decade Capacitor keeps C_{HG} very small. This capacitance is the difference between the 3-terminal and 2-terminal capacitance of the box; C_{LG} is approx 125 pF.

Description

Catalog Number

1412-BC Decade Capacitor

1412-9410

National stock numbers are listed at the back of the catalog.

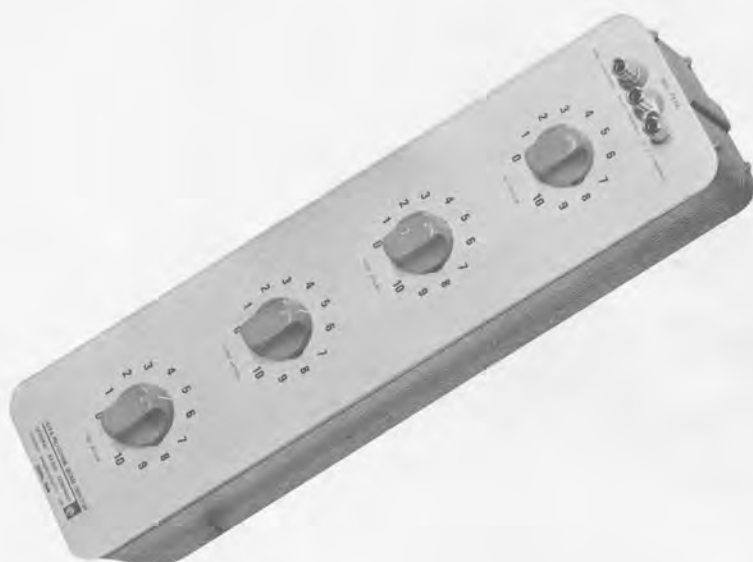

1419 Decade Capacitors

- 100 pF to 1.1 μ F
- choice of models
- two- or three-terminal connection

Type 1419 Decade Capacitors are offered in three models using two different dielectric materials to satisfy a variety of needs.

Types 1419-A and -B (Polystyrene) Capacitance and dissipation factor constant with frequency, essentially noninductive, very low dielectric absorption. The di-

electric is specially prepared of purified high-molecular-weight polystyrene, having very high resistance and freedom from interfacial polarization. Moisture sealing with Teflon* feed-through insulators assures high performance under adverse humidity conditions.

Type 1419-K (Silvered Mica) Higher accuracy, low dissipation factor, and $+35 \pm 10$ ppm/°C temperature coefficient (10-50°C) for use in higher ambient temperatures.

* Registered trademark of E. I. duPont de Nemours and Company.

SPECIFICATIONS

| Type Number | 1419-A | 1419-B | 1419-K |
|--|---|---|---|
| Dielectric | Polystyrene | Polystyrene | Silvered Mica |
| Maximum Capacitance of Box (μ F) | 1.110 | 1.1110 | 1.110 |
| In Steps of (μ F) | 0.001 | 0.0001 | 0.001 |
| Dials | 3 | 4 | 3 |
| Zero Capacitance, typical | | | |
| 2-terminal connection | 37 pF | 50 pF | 41 pF |
| 3-terminal connection | 15 pF | 20 pF | 13 pF |
| Accuracy ¹ | | | |
| 2-terminal connection ² | $\pm 1\%$ | $\pm(1\% + 2 \text{ pF})$ | $\pm 0.5\%$ |
| 3-terminal connection | $\pm 1\%$ except $\pm 1.5\%$ on smallest decade | $\pm 1\%$ except -1% to $-(2\% + 4 \text{ pF})$ on smallest decade | $\pm 0.5\%$ except $\pm 1\%$ on smallest decade |
| Dissipation Factor at 1 kHz | | <0.0002 | <0.0003 |
| Insulation Resistance at 100 V, 25°C 50% RH, typical | | $>10^{12} \Omega$ | $>5 \times 10^9 \Omega$ |
| Max Voltage ³ (dc or peak) | | 500 V up to 35 kHz | 500 V up to 10 kHz |
| Max Operating Temperature (C) | | 65° | 75° |
| Voltage Recovery ⁴ | | <0.1% | <3% |
| Resonant Frequencies (typical) | | 1 μ F—400 kHz; 0.1 μ F—1MHz; 0.01 μ F—2.7 MHz; 0.001 μ F—7.8 MHz; 0.0001 μ F—23 MHz | |
| Dc Cap/1-kHz Cap | | <1.001 | Typically 1.03 |
| Cabinet: Lab-bench | | | |
| Over-all Dimensions — in. (mm) | 13 x 4.31 x 5 (330 x 110 x 127) | 16.3 x 4.31 x 5 (415 x 110 x 127) | 14.13 x 5.5 x 6 (359 x 140 x 153) |
| Net Weight — lb (kg) | 8.38 (3.8) | 10.5 (4.8) | 11.25 (5.5) |
| Shipping Weight — lb (kg) | 10 (4.6) | 11 (5) | 18 (8.5) |
| Catalog Number | 1419-9701 | 1419-9702 | 1419-9711 |

¹ Capacitance increments from zero position are within this percentage of the indicated value for any setting at 1 kHz.

² Units are checked with switch mechanism high, electrically, and the common lead and case grounded.

³ At frequencies above the indicated max, the allowable voltage decreases and is (approx) inversely proportional to frequency. These limits correspond to a temperature of 40°C at max setting of each decade in box.

⁴ Final % of soaking voltage V measured after holding terminal voltage at V for 1 h, then discharging for 10 s through a resistance of V ohms.

National stock numbers are listed at the back of the catalog.



1413 Precision Decade Capacitor

- 0 to $>1 \mu\text{F}$
- 0.05% basic accuracy
- 6-digit resolution
- 3-terminal connections
- provision for BCD output

The 1413 is not only a precision standard, it is a systems component as well — connections are made at the rear and each decade provides contact closures for 1-2-4-8 BCD output. It is an excellent companion to the 1654 Impedance Comparator, with which it is combined in 1654-Z Sorting Systems.

SPECIFICATIONS

Range: 0 to 1.11111 μF , controlled by six in-line-readout dials.

Accuracy: $\pm(0.05\% + 0.5 \text{ pF})$ at 1 kHz.

Stability: $\pm(0.01\% + 0.1 \text{ pF})$ per year. TEMPERATURE COEFFICIENT: $\approx 20 \text{ ppm}/^\circ\text{C}$ from 10 to 50°C .

Zero Capacitance: $\leq 0.1 \text{ pF}$.

Voltage Rating: 500 V pk max up to 10 kHz.

Frequency: See curves.

| | 1 pF to 100 pF | 101 pF to 1000 pF | 1001 pF to 2000 pF | 2001 pF to 0.1 μF | 0.1 μF to 1.11111 μF |
|---|--------------------------------|-------------------------|--------------------------|------------------------------|--|
| Dissipation Factor , max at 1 kHz | 0.002 | 0.001 | 0.0005 | 0.0003 | 0.0004 |
| Insulation Resistance , 3 term., after 2 min at 500 V dc | $\geq 5 \times 10^{10} \Omega$ | | | | $\geq 5 \times 10^9 \Omega$ |
| Terminal Capacitance , max high to case high to guard low to guard | 4 pF 85 pF 45 pF | 8 pF 110 pF 70 pF | 10 pF 125 pF 80 pF | 30 pF 165 pF 110 pF | 60 pF 200 pF 120 pF |

Interface: CONNECTIONS: 2 rear-mounted GR874® locking connectors. DATA OUTPUT: 36-pin Amphenol Type 57 connector provides connections to 1-2-4-8 weighted BCD contacts rated at 28 V, 1 A, on each decade switch.

Available: 0480-9703 RACK-ADAPTOR SET to convert bench models to rack models, 874-Q2 ADAPTOR to convert GR874 connector to binding posts (2 req'd), 938-L SHORTING LINK to connect shields together when 874-Q2 Adaptors are used, 4220-3036 CONNECTOR to mate with Data Output Connector.

National stock numbers are listed at the back of the catalog.

Six precision decades are employed to provide a range of 0 to 1.11111 μF in increments as small as 1 pF and with an accuracy of 0.05% + 0.5 pF. Air capacitors are used for the two lower decades and precision silvered-mica capacitors are used for the remainder. The lower four decades contain adjustments that are factory set but accessible for readjustment later if desired.

The shielding is divided into two parts, arranged to provide low terminal-to-guard capacitances and low detector input capacitance in order to reduce errors with the 1654. When the two shields are connected together, the 1413 becomes a well-shielded three-terminal capacitor with an extremely low zero capacitance, suitable for a variety of applications.

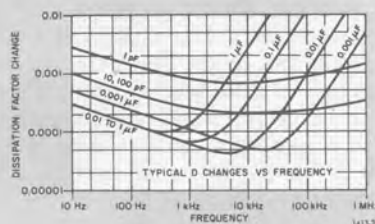
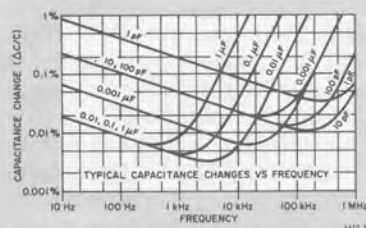

Mechanical: Convertible-bench cabinet. DIMENSIONS (wx hxd): Bench, 17x5.59x11.96 in. (432x142x304 mm); rack, 19x5.22x10.9 in. (483x133x277 mm). WEIGHT: Bench, 23 lb (11 kg) net, 29 lb (14 kg) shipping; rack, 24 lb (11 kg) net, 30 lb (14 kg) shipping.

Description

Catalog Number

1413 Precision Decade Capacitor

Bench Model

1413-9700

Rack Model

1413-9701

Rack-Adaptor Set

0480-9703



1423-A Precision Decade Capacitor

- 100 pF to $> 1 \mu\text{F}$
- $\pm 0.05\%$ accuracy
- two- or three-terminal connection

This capacitor is a versatile tool for calibration laboratories and production-line testing. With it a bridge can be standardized to an accuracy exceeded only by that of the highest quality, individually certified laboratory standards such as the GR 1404 and 1408 Reference Standard Capacitors. Used with a limit bridge, such as the GR 1654 Impedance Comparator, the 1423 facilitates fast and accurate production-line measurements of arbitrary capacitance values with minimum setup time.

Any value of capacitance from 100 pF to $1.111 \mu\text{F}$, in steps of 100 pF, can be set on the four decades and will be known to an accuracy of 0.05%. The terminal capacitance values are set precisely to the nominal value and can be readjusted later at calibration intervals, if necessary, without disturbance of the main capacitors.

The 1423 consists of four decades of high-quality silvered-mica capacitors similar to those used in the GR 1409 Standard Capacitors. The capacitors and associated switches are mounted in an insulated metal compartment, which in turn is mounted in a complete metal cabinet. This double-shielded construction ensures that capacitance at the terminals is the same for either the three-terminal or the two-terminal method of connection (except for a constant difference of about one picofarad). This external capacitance can be included in the two-terminal calibration by the adjustment of a single trimmer.

SPECIFICATIONS

Nominal Values: 100 pF to $1.111 \mu\text{F}$ in steps of 100 pF.

Accuracy: $\pm(0.05\% + 0.05\text{pF})$ at 1 kHz, calibrated in the three-terminal connection. Two-terminal connection (capacitor inserted into Type 777-Q3 Adaptor) adds about 1.3 pF.

Stability: $\pm(0.01\% + 0.05\text{pF})$ per year.

Certificate: A certificate is supplied certifying that each component capacitor was adjusted by comparison, to a precision better than $\pm 0.01\%$, with working standards whose absolute

National stock numbers are listed at the back of the catalog.

78 CAPACITANCE STANDARDS AND DECADES

values are known to an accuracy typically $\pm 0.01\%$, determined and maintained in terms of reference standards periodically calibrated by the National Bureau of Standards.

Frequency: See curves for typical variation of capacitance and dissipation factor with frequency.

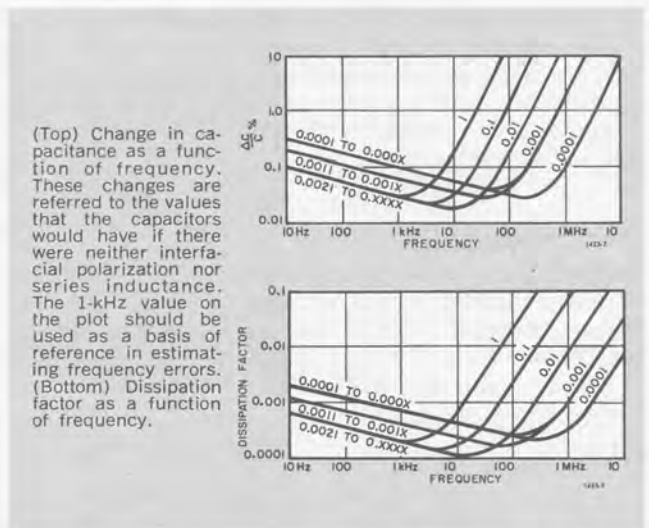

Dissipation Factor: Not greater than 0.001, 0.0005, and 0.0003 for capacitances of 100 to 1000 pF, 1100 to 2000 pF, and 2100 pF to $1.1110 \mu\text{F}$, respectively.

Temperature Coefficient of Capacitance: Approx +20 ppm per degree between 10° and 50°C .

Insulation Resistance: $>5 \times 10^9 \Omega$ to $0.1 \mu\text{F}$ and $>5 \times 10^8 \Omega$ from $0.1 \mu\text{F}$ to $1.111 \mu\text{F}$.

Maximum Voltage: 500 V peak, up to 10 kHz.

Supplied: Two Type 777-Q3 Adaptors.

Mechanical: Rack-bench cabinet. DIMENSIONS (wxhxd): Bench, $19 \times 7.25 \times 10.5$ in. ($483 \times 184 \times 267$ mm); rack, $19 \times 7 \times 8.5$ in. ($483 \times 178 \times 216$ mm). WEIGHT: 26 lb (12 kg) net, 39 lb (18 kg) shipping.

| Description | Catalog Number |
|-----------------------------------|----------------|
| 1423-A Precision Decade Capacitor | |
| Bench Model | 1423-9801 |
| Rack Model | 1423-9811 |

Resistance Standards and Decades

STANDARD RESISTORS

Because of its accuracy of adjustment, long-term stability, low and uniform temperature coefficient, and relative immunity to ambient humidity conditions, the wire-wound resistor is the most suitable type for use as a laboratory standard at audio and low radio frequencies, as well as at dc.

AC CONSIDERATIONS

Resistors designed for ac use differ from those intended for use only at dc in that low series reactance and constancy of resistance as frequency is varied are important design objectives. The residual capacitance and inductance become increasingly important as the frequency is raised, acting to change the terminal resistance from its low-frequency value.

For frequencies where the resistance and its associated residual reactances behave as lumped parameters, the equivalent circuit of a resistor can be represented as shown in Figure 1. L is the equivalent inductance in series with the resistance, and C is the equivalent capacitance across the terminals of the resistor.

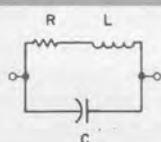

Figure 1.

It is necessary to differentiate clearly between the concepts of equivalent series and equivalent parallel circuits. The two-terminal circuit of Figure 1 can be described as an impedance $R_s + jX_s$, or as an admittance $G + jB = \frac{1}{R_p} + \frac{1}{jX_p}$, wherein the parameters are a function of frequency. This distinction between series and parallel components is more than a mathematical exercise — the use to which the resistor is to be put will frequently determine which component is of principal interest.

The expression for the effective series impedance is:

$$Z_s = R_s + jX_s = \frac{R + j\omega \left[L \left(1 - \frac{\omega^2}{\omega_c^2} \right) - R^2 C \right]}{\left(1 - \frac{\omega^2}{\omega_c^2} \right)^2 + (\omega RC)^2}$$

where $\omega_c = \frac{1}{\sqrt{LC}}$ and $\frac{\omega^2}{\omega_c^2} = \omega^2 LC$.

The effective parallel admittance is given by:

$$Y = G + jB = \frac{1}{R_p} + \frac{1}{jX_p} = \frac{1}{R} + j\omega \left[C - \frac{L}{R^2} \left(1 - \frac{\omega^2}{\omega_c^2} \right) \right] \frac{1}{1 + \left(\frac{\omega L}{R} \right)^2}$$

At low frequencies where terms in ω^2 are negligible, the resistor may be represented by a two-element network consisting of the dc resistance, R , in series with an inductance equal to $L - R^2 C$ or in parallel with a capacitance equal to $C - L/R^2$. Because of the presence of the R^2 term in the equivalent reactive parameters, shunt capacitance is the dominating residual for high values of resistance, while for low values the series inductance invariably predominates. Generally, individual wire-wound resistors above a few kilohms are capacitive, while decades are inductive at somewhat lower values.

In the simplified circuit of Figure 1, the effective parallel resistance of a high-valued resistor in which capaci-

tance dominates would be independent of frequency. Actually, other effects may cause the parallel resistance to decrease with frequency. For example, dielectric losses in the shunt capacitance, C , are equivalent to a resistance

$$R_d = \frac{1}{D\omega C}$$

(where D is the dissipation factor of the distributed capacitance), which decreases with frequency and causes the effective parallel resistance to decrease rapidly beyond a certain frequency. In addition, distributed capacitance along the winding causes a similar rapid decrease in resistance even if its dielectric loss is negligible. The equations above indicate that the effective series resistance of low-valued resistors would be independent of frequency up to quite high frequencies. In practice, if the residual inductance and capacitance are kept small, skin effect becomes the main cause for departure from the low-frequency values of these resistors.

GenRad wire-wound resistance elements are designed to minimize inductance in low-resistance values and to minimize capacitance for high values of resistance. All units up through 200 ohms utilize an Ayrton-Perry winding. For very low-valued units, the residual inductance of such a winding is about 1% of that of a corresponding single winding.

Elements of resistance from 500 ohms to 100 kilohms are unifilar wound on flat cards to provide low inductance and capacitance. Separate resistors of higher values are also wound on flat cards for optimum ac performance but spools are used in decade boxes (see Figure 2). This is because the effect of inductors is negligible at these high frequencies and the effect of capacitance between resistors, which is more important than capacitance across a single resistor, is minimized.

DECADE BOXES

In decade boxes, the residual impedances of the switches, wiring, and cabinet are added to those of the resistors themselves. For multiple-decade boxes, the series inductances are additive, but the capacitance is approximately that across the highest valued decade used (see specifications for each type).

The effect of the residual reactance depends greatly upon the way the resistor is connected in the circuit. For example, parallel capacitance can often be compensated for when the resistor is connected in parallel with a capacitor. For high-valued resistors, the upper frequency limit for a given error is some ten times higher in the effective parallel resistance than it is for the series connection.

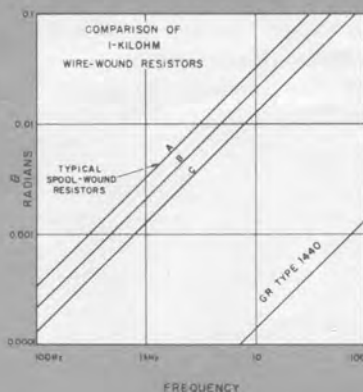

Figure 2.



1440 Standard Resistor

- 0.01Ω to 1 MΩ
- accuracy ±0.01%
- stability ±10 ppm per year
- low thermal emf to copper

These extremely stable resistors are intended for use as laboratory or production standards for calibrating resistance bridges and for substitution measurements.

Units of 0.01 and 0.1 Ω are made of sheet metal with a low temperature coefficient of resistance, punched in a meander pattern to reduce inductance. Units of 1 Ω and above are card-type wire-wound resistors, carefully

wound and adjusted. Low-temperature-coefficient wire is used for units of 1 Ω and 10 Ω; Evanohm* wire is used for units above 10 Ω. All units are heat cycled to reduce strains and are repeatedly checked to eliminate any that show abnormal behavior. They are encased in sealed, oil-filled, diallylphthalate boxes to promote long-term stability and to provide mechanical protection.

The 1440 resistors have low-thermal-emf binding posts and removable banana plugs to provide the four terminals necessary for accurate measurements at low values of resistance. A label on the reverse side lists initial calibration and date, serial number, and space for future calibration data.

* Registered trademark of the Wilbur B. Driver Company.

SPECIFICATIONS

Accuracy: See table. Measurements on the low-value units should be made with a four-terminal connection. All measurements at 23°C.

Calibration Accuracy: Resistors are calibrated by comparison, to a precision of ±20 ppm, with working standards whose absolute values are known typically to ±10 ppm as determined and measured in terms of reference standards periodically measured by the National Bureau of Standards. The measured deviation in % from nominal value, at 23°C and 0.01 watt, is entered on the label on the reverse side of the resistor.

Stability: Typically ±10 ppm per year (1 MΩ to 1 Ω).

Temperature Coefficient (Max): See table.

Power Rating: 1 W. The corresponding current is indicated on the resistor and in the table below. This dissipation will cause

a temperature rise of approx 25°C and a resulting temporary resistance change due to the temperature. If this rating is exceeded, permanent changes may result.

Residual Impedances: Approx shunt capacitance (2-terminal measurement), 2.5 pF; less for 3-terminal measurement. Typical series inductance, see table.

Approx Frequency Characteristics: See table.

Terminals: Gold-plated jack-top copper binding posts (3/4-in. spacing) with banana plugs that are removable and can be replaced by 6-32 screws for installation of soldering lugs.

Dimensions (less terminals): 2.25x2.47x0.34 in. (58x63x9 mm).

Net Weight (approx): 2 oz (57 g).

| Resistance | Accuracy | Max Current | Inductance Typical | Approx Frequency for 0.1% Resistance Change | | Temperature Coefficient | Catalog Number |
|------------|----------|-------------|--------------------|---|------------|-------------------------|----------------|
| | | | | Series R | Parallel R | | |
| 0.01 Ω | ±0.10% | 5 A | 0.1 μH | 3 kHz | 1 kHz | +200 ppm | 1440-9671 |
| 0.1 Ω | ±0.05% | 2 A | 0.1 μH | 20 kHz | 10 kHz | +30 ppm | 1440-9681 |
| 1 Ω | ±0.02% | 1.0 A | 0.12 μH | 300 kHz | 30 kHz | ±20 ppm | 1440-9601 |
| 10 Ω | ±0.01% | 310 mA | 0.13 μH | 1 MHz | 300 kHz | ±20 ppm | 1440-9611 |
| 100 Ω | ±0.01% | 100 mA | 5. μH | 3 MHz | 1 MHz | ±10 ppm | 1440-9621 |
| 1 kΩ | ±0.01% | 30 mA | 2.5 μH | 2 MHz | 1 MHz | ±10 ppm | 1440-9631 |
| 10 kΩ | ±0.01% | 10 mA | | 200 kHz | 1 MHz | ±10 ppm | 1440-9641 |
| 100 kΩ | ±0.01% | 3 mA | | 20 kHz | 100 kHz | ±10 ppm | 1440-9651 |
| 1 MΩ | ±0.02% | 1 mA | | 2 kHz | 10 kHz | ±10 ppm | 1440-9661 |

National stock numbers are listed at the back of the catalog.

1433 Decade Resistor

- $\pm 0.01\%$ accuracy
- good frequency characteristics
- low temperature coefficient
- excellent stability
- low zero resistance



The 1433 Decade Resistors are primarily intended for precision measurement applications where their excellent accuracy, stability, and low zero resistance are important. They are convenient resistance standards for checking the accuracy of resistance-measuring devices and are used as components in dc and audio-frequency impedance bridges. Many of the models can be used up into the radio-frequency range. Although they are quite satisfactory as substitution boxes for optimizing electronic circuitry, the less expensive 1434 Decade Resistors are recommended for such less exacting applications.

Each 1433 Decade Resistor is an assembly of GR 510 Decade-Resistance Units in a single cabinet. Mechanical as well as electrical shielding of the units and switch contacts is provided by the attractive aluminum cabinet and panel. The resistance elements have no electrical connection to the cabinet and panel, for which a separate shield terminal is provided.

The individual decades (510 Decade-Resistance Units) are available for applications requiring only one decade or as components to be built into experimental equipment, production test equipment, or commercial instruments.

SPECIFICATIONS

Accuracy: The specified tolerances apply for low-current measurement at dc or low-frequency ac (see below).

Over-all Accuracy: The difference between the resistances at any setting and at the zero setting is equal to the indicated value $\pm(0.01\% + 2 \text{ m}\Omega)$.

Incremental Accuracy: See table. This is the accuracy of the change in resistance between any two settings on the same dial.

Max Current: The max current for each decade is given in the table below and also appears on the panel of each decade box and on the dial plate of each decade resistance unit.

Frequency Characteristic: The accompanying plot shows the max percentage change in effective series resistance, as a function of frequency for the individual decade units. For low-resistance decades the error is due almost entirely to skin effect and is independent of switch setting. For the high-resistance units the error is due almost entirely to the shunt capacitance and its losses and is approx proportional to the square of the resistance setting.

The high-resistance decades (510-E, -F, -G, and -H) are very commonly used as parallel resistance elements in resonant circuits, in which the shunt capacitance of the decades becomes part of the tuning capacitance. The parallel resistance changes by only a fraction (between a tenth and a hundredth)

National stock numbers are listed at the back of the catalog.

of the series-resistance change, depending on frequency and the insulating material in the switch.

Characteristics of the 1433's are similar to those of the individual 510's modified by the increased series inductance, L_s , and shunt capacitance, C , due to the wiring and the presence of more than one decade in the assembly. At total resistance settings of approx 1000 ohms or less, the frequency characteristics of any of these decade resistors are substantially the same as those shown for the 510's. At higher settings, shunt capacitance becomes the controlling factor, and the effective value of this capacitance depends upon the settings of the individual decades.

Typical Values of R_0 , L_0 , and C for the Decade Resistors:

Zero Resistance (R_0): 0.001 Ω per dial at dc; 0.04 Ω per dial at 1 MHz; proportional to square root of frequency at all frequencies above 100 kHz.

Zero Inductance (L_0): 0.1 μH per dial + 0.2 μH .

Effective Shunt Capacitance (C): This value is determined largely by the highest decade in use. With the low terminal connected to the shield, a value of 15 to 10 pF per decade may be assumed, counting decades down from the highest. Thus, if the third decade from the top is the highest resistance decade in circuit (i.e., not set at zero), the shunting terminal capacitance is 45 to 30 pF. If the highest decade in the assembly is in use, the effective capacitance is 15 to 10 pF, regardless of the settings of the lower-resistance decades.

Temperature Coefficient of Resistance: Less than ± 10 ppm per degree C for values above 100 Ω and ± 20 ppm per degree C for 100 Ω and below, at room temperatures. For the 1433's

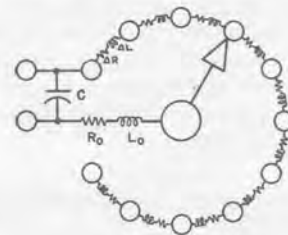

Equivalent circuit of a resistance decade, showing residual impedances.

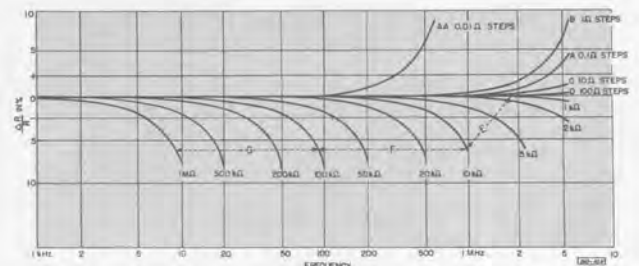

Max percentage change in series resistance as a function of frequency.

the box wiring will increase the over-all temperature coefficient of the 0.1- and 0.01- Ω decades.

Switches: Quadruple-leaf brushes bear on lubricated contact studs of $\frac{3}{8}$ -in. diameter in such a manner as to avoid cutting but yet give a good wiping action. A ball-on-cam detent is provided. There are eleven contact points (0 to 10 inclusive). The switch resistance is less than 0.0005 Ω . The effective capacitance is of the order of 5 pF, with a dissipation factor of 0.06 at 1 kHz for the standard cellulose-filled molded phenolic switch form and 0.01 for the mica-filled phenolic form used in the 510-G and 510-H units.

Max Voltage to Case: 2000 V pk.

Terminals: Low-thermal-emf jack-top binding posts on standard $\frac{3}{4}$ -in. spacing; also provisions for rear-panel connections. Shield terminal is provided.

Mounting: Lab-bench cabinet, rack models include mounting hardware.

Dimensions and Weights: in. (mm), lb (kg):

| | 4-dial U, K, J, L, Q | 5-dial T, N, M, P, Y | 6-dial W, X, B, Z | 7-dial F, G, H |
|------------|---|-------------------------|----------------------|-------------------|
| Width* | 12.3 (312) | 14.8 (375) | 17.3 (439) | |
| Height | 3.5 (89) | | | 5.3 (135) |
| Depth | 5 in. over-all, 4 in. behind panel (127, 102) | | | |
| Net Wt** | 4.8 (2.2) | 5.8 (2.7) | 7 (3.2) | 8.8 (4.0) |
| Ship. Wt** | 5.5 (2.5) | 6.5 (3.0) | 8.5 (3.9) | 10.3 (4.7) |

* Data given for bench models. All rack models same except 19 in. (483 mm) wide.

** Add approx 1 lb (0.5 kg) for rack-mount hardware.

| Type | Total Ohms | Ohms per Step | No. of Dials | Type 510 Decades Used | Catalog Number | |
|--------|------------|---------------|--------------|-----------------------|----------------|-----------|
| | | | | | Bench | Rack |
| 1433-U | 111.1 | 0.01 | 4 | AA, A, B, C | 1433-9700 | 1433-9701 |
| 1433-K | 1111 | 0.1 | 4 | A, B, C, D | 1433-9702 | 1433-9703 |
| 1433-J | 11,110 | 1 | 4 | B, C, D, E | 1433-9704 | 1433-9705 |
| 1433-L | 111,100 | 10 | 4 | C, D, E, F | 1433-9706 | 1433-9707 |
| 1433-Q | 1,111,000 | 100 | 4 | D, E, F, G | 1433-9708 | 1433-9709 |
| 1433-T | 1111.1 | 0.01 | 5 | AA, A, B, C, D | 1433-9710 | 1433-9711 |
| 1433-N | 11,111 | 0.1 | 5 | A, B, C, D, E | 1433-9712 | 1433-9713 |
| 1433-M | 111,110 | 1 | 5 | B, C, D, E, F | 1433-9714 | 1433-9715 |
| 1433-P | 1,111,100 | 10 | 5 | C, D, E, F, G | 1433-9716 | 1433-9717 |
| 1433-Y | 11,111,000 | 100 | 5 | D, E, F, G, H | 1433-9718 | 1433-9719 |
| 1433-W | 11,111.1 | 0.01 | 6 | AA, A, B, C, D, E | 1433-9720 | 1433-9721 |
| 1433-X | 111,111 | 0.1 | 6 | A, B, C, D, E, F | 1433-9722 | 1433-9723 |
| 1433-B | 1,111,110 | 1 | 6 | B, C, D, E, F, G | 1433-9724 | 1433-9725 |
| 1433-Z | 11,111,100 | 10 | 6 | C, D, E, F, G, H | 1433-9726 | 1433-9728 |
| 1433-F | 111,111.1 | 0.01 | 7 | AA, A, B, C, D, E, F | 1433-9729 | 1433-9730 |
| 1433-G | 1,111,111 | 0.1 | 7 | A, B, C, D, E, F, G | 1433-9731 | 1433-9732 |
| 1433-H | 11,111,110 | 1 | 7 | B, C, D, E, F, G, H | 1433-9733 | 1433-9734 |

510 Decade-Resistance Unit

The 510 Decade Units that essentially make up the 1433 are also available separately for applications requiring a single decade or as components for experimental setups, production test equipment, or commercial instruments.

Each Decade-Resistance Unit is enclosed in an aluminum shield; a knob and etched-metal dial plate are supplied. Each decade has ten resistors in series; the contacts in the lower-valued decades have a silver overlay to ensure stability of resistance, and all the decades have a silver contact on the zero setting to give low and constant zero resistance. Winding methods are chosen to reduce the effects of residual reactances.

510-B mounted on a small panel.



SPECIFICATIONS

Electrical: See table.

Terminals: Soldering lugs.

Supplied: Dial plate, knob, template, and mounting screws.

Mechanical: Panel mounting, in shield can. DIMENSIONS: Dia. 3.06 in. (78 mm), depth 3.31 in. (85 mm) behind panel. WEIGHT: 11 oz (312 g) net.

| Type | Total Resistance Ohms | Resistance Per Step (ΔR) Ohms | Accuracy of Resistance Increments | Max Current 40° C Rise | Power Per Step Watts | ΔL μH | C** pF | L_0 μH | Catalog Number |
|---------|-----------------------|---|-----------------------------------|------------------------|----------------------|--------------------|---------|---------------|----------------|
| 510-AA | 0.1 | 0.01 | $\pm 2\%$ | 4 A | 0.16 | 0.01 | 7.7-4.5 | 0.023 | 0510-9806 |
| 510-A | 1 | 0.1 | $\pm 0.4\%$ | 1.6 A | 0.25 | 0.014 | 7.7-4.5 | 0.023 | 0510-9701 |
| 510-B | 10 | 1 | $\pm 0.1\%$ | 800 mA | 0.6 | 0.056 | 7.7-4.5 | 0.023 | 0510-9702 |
| 510-C | 100 | 10 | $\pm 0.04\%$ | 250 mA | 0.6 | 0.11 | 7.7-4.5 | 0.023 | 0510-9703 |
| 510-D | 1000 | 100 | $\pm 0.01\%$ | 80 mA | 0.6 | 5 | 7.7-4.5 | 0.023 | 0510-9704 |
| 510-E | 10,000 | 1000 | $\pm 0.01\%$ | 23 mA | 0.5 | 13 | 7.7-4.5 | 0.023 | 0510-9705 |
| 510-F | 100,000 | 10,000 | $\pm 0.01\%$ | 7 mA | 0.5 | 70 | 7.7-4.5 | 0.023 | 0510-9706 |
| 510-G | 1,000,000 | 100,000 | $\pm 0.01\%$ | 2.3 mA | 0.5 | — | 7.7-4.5 | 0.023 | 0510-9707 |
| 510-H | 10,000,000 | 1,000,000 | $\pm 0.01\%$ | 0.7* mA | 0.5 | — | 7.5-4.5 | 0.023 | 0510-9708 |
| 510-P4 | Switch only | (Black Phenolic Frame) | | | | | | | 0510-9604 |
| 510-P4L | Switch only | (Low-Loss Phenolic Frame) | | | | | | | 0510-9511 |

* Or a max of 4000 V, pk.

** The larger capacitance occurs at the highest setting of the decade. The values given are for units without the shield cans in place. With the shield cans in place, the shunt capacitance is from 0 to 20 pF greater than indicated here, depending on whether the shield is tied to the switch or to the zero end of the decade.

National stock numbers are listed at the back of the catalog.



1434 Decade Resistor

- $\pm 0.02\%$ accuracy
- 5-, 6-, or 7-dial settability
- excellent stability, low cost

These laboratory-quality, budget-priced decade boxes are designed for maximum usefulness and economy in laboratory measurement, testing, and development work. Their accuracy is adequate for all but the most exacting applications. Their small size and clear readout should be particularly useful in experimental setups using small, modern components.

The 1434-M, -N, and -P contain five step decades of resistance in a small cabinet. The 1434-B and -X, 6-dial boxes, permit small as well as large values of resistance to be set with 3- or 4-place resolution and accuracy. The 1434-QC, a "best buy," has four step decades plus a rheostat to provide 1-ohm resolution in a 1-megohm box.

The larger, seven-decade, 1434-G box is easily converted into a 3½-inch relay-rack unit by the addition of angle brackets and dress strips, which are furnished. This box has lug terminals available at the rear, as well as at panel binding posts.

DESCRIPTION

High-quality, wire-wound resistors are used in these decades. The low price is made possible by the use of only six resistors per decade instead of ten. These are combined by switching in such a way that there are no discontinuities; that is, the resistance increases stepwise just as though ten resistors were used. The switches have solid-silver-alloy contacts for low resistance and long life.

Resistors are of low-temperature-coefficient Evanohm* wire, except the 1-ohm/step and 0.1-ohm/step decades which use wire and ribbon (respectively) of another low-temperature coefficient alloy. The resistors of the 100-, 10-, and 1-ohm/step decades are Ayrton-Perry wound to minimize inductance.

* Registered trademark of the Wilbur B. Driver Company.

SPECIFICATIONS

Accuracy: Tolerances apply at low currents and at dc or low-frequency ac.

Over-all: The difference between the resistances at any setting and at the zero setting is equal to the indicated value $\pm (0.02\% + 2 \text{ m}\Omega)$, except for the 1434-QC, which may have an additional error of $\pm 1 \Omega$ when the rheostat is used.

Incremental: See table. This is the accuracy of the change in resistance between any two settings of the same dial.

National stock numbers are listed at the back of the catalog.

Zero Resistance: Approx 3 m Ω per dial at low frequencies; except for the 1434-QC, approx 30 m Ω .

Max Current: See table; these values also appear on the panel of each decade box. When this max current is passed through a decade, the temporary change in value will be less than the accuracy specification. Currents appreciably higher than this will cause permanent damage.

| Total Resistance of Decade | Resistance Per Step | Incremental Accuracy* | Max Current |
|----------------------------|---------------------|-----------------------|-------------|
| 1 Ω | 0.1 Ω | $\pm 3.0\%$ | 1 A |
| 10 Ω | 1.0 Ω | $\pm 0.3\%$ | 0.3 A |
| 100 Ω | 10 Ω | $\pm 0.05\%$ | 160 mA |
| 1 k Ω | 100 Ω | $\pm 0.02\%$ | 50 mA |
| 10 k Ω | 1 k Ω | $\pm 0.02\%$ | 16 mA |
| 100 k Ω | 10 k Ω | $\pm 0.02\%$ | 5 mA |
| 1 M Ω | 100 k Ω | $\pm 0.02\%$ | 1.6 mA |
| 100- Ω Rheostat** | 1 Ω /div | $\pm 1 \Omega$ | 200 mA |

* At low currents and low frequencies.

** Used in 1434-QC.

Temperature Coefficient: $\leq \pm 10 \text{ ppm}/^\circ\text{C}$ at room temperature, except for the low-valued units where the $+0.4\%/^\circ\text{C}$ temperature coefficient of the zero resistance must be added.

Frequency Characteristics: Generally similar to those of the 1433 Decades.

Switches: Multiple wiper, solid-silver-alloy switches are used to obtain low and stable zero resistance.

Terminals: Jack-top binding posts on standard ¾-in. spacing. A shield terminal is also provided. The 1434-G has lug connections accessible from the rear.

Mounting: All types except the 1434-G are in small cabinets for bench use. The 1434-G is also designed for bench use but, with the addition of mounting hardware, becomes 3½-in. high, 19-in. relay-rack unit.

Mechanical Data:

| Models | Width | | Height | | Depth | | Net Weight | | Shipping Weight | |
|-------------|-------|-----|--------|----|-------|-----|------------|-----|-----------------|-----|
| | in. | mm | in. | mm | in. | mm | lb | kg | lb | kg |
| M, N, P, QC | 11¼ | 300 | 2¾ | 70 | 4¼ | 108 | 3 | 1.4 | 4 | 1.9 |
| B, X | 13¾ | 350 | 2¾ | 70 | 4¼ | 108 | 3¼ | 1.5 | 4 | 1.9 |
| G (bench) | 17¾ | 440 | 3½ | 89 | 5 | 127 | 6 | 2.8 | 7 | 3.2 |
| G (rack) | 19 | 483 | 3½ | 89 | 3½ | 89 | 6 | 2.8 | 7 | 3.2 |

| Description | Total Resistance(Ω) | Resistance Per Step | Number of Decades | Catalog Number |
|------------------------|------------------------------|---------------------|-------------------|----------------|
| Decade Resistor | | | | |
| 1434-N | 11,111 | 0.1 Ω | 5 | 1434-9714 |
| 1434-M | 111,110 | 1.0 Ω | 5 | 1434-9713 |
| 1434-P | 1,111,100 | 10 Ω | 5 | 1434-9716 |
| 1434-QC | 1,111,105 | 1 Ω /div | 4 + rheo | 1434-9576 |
| 1434-B | 1,111,110 | 1.0 Ω | 6 | 1434-9702 |
| 1434-X | 111,111 | 0.1 Ω | 6 | 1434-9724 |
| 1434-G | 1,111,111 | 0.1 Ω | 7 | 1434-9707 |



1435 Programmable Decade Resistor

- 1.11 M Ω
- 0.02% basic accuracy
- completely programmable

The 1435 is a completely-programmable five-decade resistor (expandable to six or seven decades on special order) particularly adaptable to automatic test equipment for the control of load-time constant, gain, etc.

Each decade is controlled by a 12-position front-panel switch that displays 0 through X (10) and R (remote). This allows any decade or decades to be manually set while those remaining are remotely controlled. Another switch transfers total control of all the decades to the external control signal, regardless of the setting of the individual decade controls, and this transfer itself is externally programmable.

Four high-quality wire-wound resistors of low-temperature-coefficient Evanohm* wire are used in each decade. All are straight wound except the 10- Ω /step decade which is Ayrton-Perry wound to reduce inductance. Due to discontinuities that may exist when the settings are changed (manually or remotely), two logic lines are provided to short or open the decade-output terminals during the switching interval.

* Registered trademark of the Wilbur B. Driver Co.

SPECIFICATIONS

Range: 1,111,100 Ω total resistance; 10 Ω smallest step. Each decade can be individually controlled: manually by in-line-readout dials or remotely to digital techniques.

Programming: Control by negative true logic, 8-4-2-1 binary-coded decimal, at standard DTL or TTL levels (i.e., logic 0 \approx ground, logic 1 $>$ +3.5 V) or closures to ground applied to rear-panel etched-board (36 pins.) SWITCHING SPEED: $<$ 4 ms per change. Switches are mercury-wetted reed relays for low, stable, and repeatable zero resistance and are used for both manual and remote control.

Resistance Characteristics: ACCURACY: The difference between the resistances at any setting and at the zero setting is equal to the indicated value $\pm(0.02\% + 10 \text{ m}\Omega)$ for all decades except, for 10- Ω /step decade, the tolerance is $\pm(0.05\% + 10 \text{ m}\Omega)$; all at low currents and low or zero frequency. ZERO RESISTANCE: Typically 700 m Ω total (all decades set to zero). TEMPERATURE COEFFICIENT: $\pm(10 \text{ ppm} + 3 \text{ m}\Omega)/^\circ\text{C}$. FREQUENCY DEPENDENCE: At high resistance values, frequency characteristics depend mainly on capacitances and on the type of connections used (2- or 3-terminal,

grounded or guarded). At low resistance values, they depend mainly on the inductance. Calculations based on the values tabulated should give a good approximation to the series-resistance error. (Parameters are defined by diagram.)

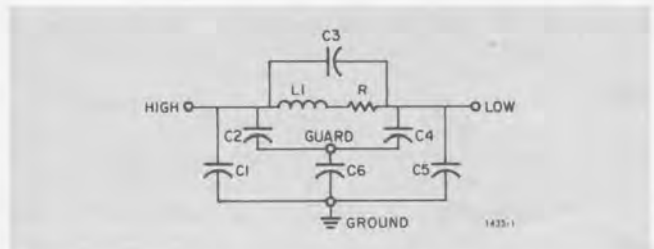

| Parameter | Decade Resistance | |
|-----------|--------------------|------------------|
| | R = 100 k Ω | R = 1 M Ω |
| C1 | 19 pF | 11 pF |
| C2 | 76 pF | 23 pF |
| C3 | 19 pF | 16 pF |
| C4 | 247 pF | 276 pF |
| C5 | 46 pF | 51 pF |
| C6 | 1606 pF | 1606 pF |
| L1 | 23 μH | 23 μH |

Signal Power Ratings: 0.125 W per step of the most-significant non-zero digit (1.25 W max) for specified accuracy; 0.25 W/step (2.5 W max) without damage. Each decade labeled with rated current. GUARD VOLTAGE LIMIT: 100 V max with respect to ground.

Terminals: 5 (High, Low, Ground, Guard, Guard) nickel-plated brass binding posts on rear panel; standard spacing (0.75 in.).

Supplied: Power cord and board-edge connector, for programming input.

Power: 100 to 125 V or 200 to 250 V, 50 to 60 Hz, 7 W.

Mechanical: Bench or rack models. DIMENSIONS (wxhxd): Bench, 19.75x4.22x12.88 in. (502x107x327 mm); rack, 19x3.47x10.8 in. (483x88x275 mm). WEIGHT: Bench, 18 lb (8.5 kg) net, 23 lb (11 kg) shipping; rack, 13 lb (6 kg) net, 18 lb (8.5 kg) shipping.

| Description | Catalog Number |
|-----------------------------------|----------------|
| 1435 Programmable Decade Resistor | |
| Bench Model | 1435-9700 |
| Rack Model | 1435-9701 |

National stock numbers are listed at the back of the catalog.



1455 Decade Voltage Divider

- linearity better than 20 ppm (5-dial model)
- input impedance: 10 or 100 kΩ

The GR 1455 Decade Voltage Dividers provide accurately known voltage ratios from 0.00001 to 1.00000 for use in many common measurements:

- voltage gain or attenuation
- linearity of potentiometers and other controls
- frequency response of audio and rf networks
- transformer turns ratio
- voltmeter calibration

A resistive divider of the Kelvin-Varley type, the 1455 has precision resistors throughout (rather than in selected positions only) for over-all high accuracy. Linearity is as low as 0.02 ppm of input.

Match your needs exactly. Select input impedance, voltage rating, frequency range, 4- or 5-dial resolution, bench or rack mounting.

SPECIFICATIONS

Frequency Characteristic: Acts like simple RC circuit below f_o so that

$$\frac{E_o}{E_{in}} \approx \frac{\text{reading}}{\sqrt{1 + \left(\frac{f}{f_o}\right)^2}}$$

Tabulated value of f_o is at setting that gives max output resistance so that f_o at all other settings is higher. At 0.044 f_o , response is down <0.1%.

Temperature Coefficient: <20 ppm for each resistor. Since voltage ratios are determined by resistors of similar construction, net ambient temperature effects are very small.

Mechanical: Lab-bench cabinet. DIMENSIONS (wxhxd): Bench, 4-dial model, 14.75x3.5x6 in. (375x89x153 mm); 5-dial models, 17.31x3.5x6 in. (440x89x153 mm); rack, 19x3.5x4.63 in. (483x89x117 mm). WEIGHT: Bench, 4-dial model, 6.75 lb (3.1 kg) net, 8 lb (3.7 kg) shipping; 5-dial models, 7.75 lb (3.6 kg) net, 9 lb (4.1 kg) shipping; rack models are each 1 lb (0.5 kg) heavier than corresponding bench models.

National stock numbers are listed at the back of the catalog.

| Type | 1455-A | -BH | -B |
|--|---------|---------|---------|
| Number of Dials: | 4 | 5 | 5 |
| Input Resistance: | 10 kΩ | 100 kΩ | 10 kΩ |
| Accuracy of Input R: (ppm) | +150 | +150 | +150 |
| Input Voltage Rating¹: | 230 V | 700 V | 230 V |
| Frequency Response² f_o: | 850 kHz | 69 kHz | 690 kHz |
| Resolution: (ppm of input) | 100 | 10 | 10 |
| Linearity (sum of A & B) | | | |
| A, Absolute Linearity³ | | | |
| — Ratio — | | | |
| 0.00001 to 0.00010 | — | ±0.02 | ±0.03 |
| 0.00010 to 0.00100 | ±0.3 | ±0.2 | ±0.3 |
| 0.00100 to 0.01000 | ±2 | ±2 | ±3 |
| 0.01000 to 0.10000 | ±15 | ±10 | ±10 |
| 0.10000 to 1.00000 | ±30 | ±20 | ±20 |
| B, Terminal Linearity | | | |
| (in ppm of input). | | | |
| FOUR-TERMINAL (output with respect to low output terminal): | ±0.04 | ±0.004 | ±0.04 |
| THREE-TERMINAL⁴ | ±0.2 | ±0.02 | ±0.2 |
| Max Output Resistance (input shorted): | 2.79 kΩ | 28.8 kΩ | 2.88 kΩ |
| Effective Output Capacitance (typ, unloaded): | 67 pF | 80 pF | 80 pF |

¹ Safe operating limit, will not cause damage.

² Output-level change due to increasing frequency, with no load, with output resistance set to max, up to the tabulated frequency: <3 dB.

³ Measured in ppm of input. Output is taken with respect to reference output measured when the indicated ratio is zero, with frequency in the low audio range, with input <0.5 of Input Voltage Rating. Note: Linearity change due to internal heating, for full rated input voltage, for ratios 0.1 to 1.0: <20 ppm; for ratios <0.1: negligible.

⁴ Output measured with respect to low input terminal. Low output terminal may be floating or connected to the low input terminal.

| Description | Catalog Number |
|------------------------------------|----------------|
| 1455 Decade Voltage Divider | |
| Bench Models | |
| 1455-A, 4-dial, 10-kΩ | 1455-9700 |
| 1455-B, 5-dial, 10-kΩ | 1455-9706 |
| 1455-BH, 5-dial, 100-kΩ | 1455-9708 |
| Rack Models | |
| 1455-A, 4-dial, 10-kΩ | 1455-9701 |
| 1455-B, 5-dial, 10-kΩ | 1455-9707 |
| 1455-BH, 5-dial, 100-kΩ | 1455-9709 |

Inductance Standards and Decades

Construction An inductor with a non-magnetic core (called an "air core") will have higher stability and negligible non-linearity compared to one wound on a core made of a high-permeability alloy (referred to as an "iron core" even if the alloy contains little, or no, iron). However, an air-core coil will have a relatively low Q. Because stability is the prime requirement of a laboratory standard, the GR 1482 Standard Inductors are wound on ceramic forms that magnetically act like air.

For circuit design and other experimental work, a higher Q is preferable, even at the expense of stability and linearity. Therefore, the GR 940 and 1491 Decade Inductors use iron cores. A good balance between these opposing characteristics is possible, however, with cores made from certain powdered alloys so that these decades can maintain good accuracy with time and over a reasonable current range. All GenRad inductors use cores of toroidal shape which generate a very low external field and are relatively immune to pickup from external fields. Coils of this shape can be placed close together with negligible mutual inductance. The symmetry of the toroidal shape also contributes to stability and a constant temperature coefficient.

Inductance Changes The inductance depends not only upon the geometry of the winding and the permeability of the core but also upon the residual impedances that are shown in the equivalent circuit of Figure 1. The largest changes of inductance with frequency are produced by the effective shunt capacitance, C_0 , of the winding and the terminals. Any capacitance increases the effective inductance value as the resonant frequency is approached:

$$L = \frac{L_0}{1 - \omega^2 L_0 C_0} \quad (1)$$

where L_0 is the zero-frequency inductance. The inductor will appear capacitive above resonance. When the frequency is well below the resonant frequency, $f_r = \frac{1}{2\pi\sqrt{L_0 C_0}}$, the fractional increase in inductance is

$$L = L_0 [1 + (f/f_r)^2] \quad (2)$$

The resistances shown in Figure 1 also affect the inductance value and make the effective series and parallel inductance values somewhat different, particularly when

the Q is low: $L_p = L_s (1 + \frac{1}{Q^2})$.

Air-core inductors change very little with current, but the permeability of ferromagnetic materials depends upon the ampere turns of magnetizing force applied. The curves given for the GR 940 show a typical shape. The inductance rises linearly over a small region near zero current, then more rapidly to a maximum, followed by a sudden decrease as saturation is approached. To make these curves independent of inductance value, the current has been normalized to a value $I_{1\%}$ which is the current that produces a specified fractional increase in inductance.

Q vs Frequency The storage (or quality) factor, Q, is the ratio of reactance to resistance and is infinite for a pure inductance. If the resistance is all true series resistance (R_c in Figure 1) and the inductance is constant, then the Q is proportional to frequency: $Q = \omega L/R_c$. But as noted above, L changes with fre-

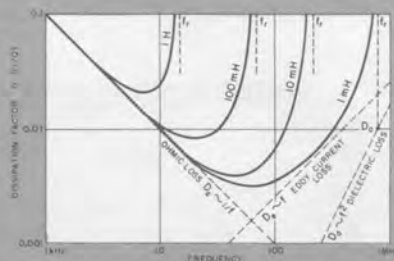

Figure 2. Dissipation-factor variation with frequency in typical air-core 1482 Standard Inductors.

quency and also there are other sources of loss. The components of loss can best be described in terms of the dissipation factor, $D = 1/Q$, because the total D is the sum of the component D's, and these can be plotted as straight lines in logarithmic coordinates, as shown in Figure 2. For an air-core coil, the other sources of loss besides the ohmic or "copper" loss are eddy current loss, in any nearby conductors (such as a case) and in the wire itself, and dielectric loss, in the stray shunting capacitance (shown lumped as C_0).

$$D = \frac{1}{1 - (f/f_r)^2} \left[\frac{R_c}{\omega L_0} + G_e \omega L_0 + (f/f_r)^2 D_0 \right] \quad (3)$$

| | | | |
|---------------------|------------------------|--------------------------------|---------------------------|
| Resonance Factor | Ohmic Loss D_c | Eddy Current Loss, D_e | Dielectric Loss, D_d |
|---------------------|------------------------|--------------------------------|---------------------------|

The higher permeability obtained by using an iron core allows fewer turns for a given inductance, reducing R_c and C_0 and increasing f_r . The core adds two more components to the dissipation factor: one from eddy current loss in the core, which increases D_e , and another from hysteresis loss in the core, which depends on flux density. The effects of these losses are shown in the plots of Q versus frequency for the GR 940 Decade Inductors. The powdered "iron" used in these units has low hysteresis loss so that these curves depend mainly on R_c and G_e .

Calibration The calibrated inductance of a standard inductor is the change in the measured inductance of a circuit when a portion of that circuit is removed and replaced by the inductor. This measured inductance includes small and variable mutual inductances between the inductor and the rest of the circuit, which are negligible when the calibrated inductance is larger than, say, 100 microhenrys, but which can introduce accuracy-limiting uncertainties into the calibration of smaller inductances. These uncertainties can be reduced to less than one nanohenry to permit accurate calibrations down to one microhenry, if the mutual components are made a definite part of the calibrated inductance. One method of achieving this, used in the 1482 Standard Inductors of 200 microhenrys and less, is to provide, on the inductor, a switching link, which connects either the inductor coil or a short circuit through internal leads to the external connection terminals. The calibrated inductance, which is the measured difference of the connection terminals when the switch is moved from coil to short, is to a high degree independent of the external connections or environment.

Since the inductance usually varies with frequency, an accurate calibration requires that the frequency be specified. When, as in inductors with iron cores, the inductance also varies with current, the calibration must also specify a corresponding current or voltage. Since the frequency or current at which the inductor will be used is not usually known, a convenient reference level is zero frequency and zero current (initial permeability). Measurements made at two currents within the linear range and at well below resonant frequency are extrapolated to obtain inductance at zero current and initial permeability of the core material.

Figure 1. Equivalent circuit of an air-core inductor. R_c is the series resistance, G_e is the conductance due to eddy-current loss, and D_0 is the dissipation factor of the distributed capacitance.

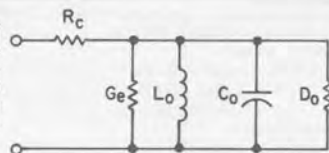



1482-L

1482 Standard Inductor

- stable within $\pm 0.01\%$ per year
- low, known temperature coefficient
- minimized connection errors
- toroidal — free from external fields

The 1482 is an accurate, highly stable standard of self inductance for use as a low-frequency reference or working standard in the laboratory. Records extending over 16 years, including those of inductors that traveled to national laboratories in several countries for calibration, show long-term stabilities well within $\pm 0.01\%$.

Each inductor is a uniformly wound toroid on a ceramic core. It has a negligible external magnetic field and hence essentially no pickup from external fields. The inductor is resiliently supported in a mixture of ground cork and silica gel, after which the whole assembly is cast with a potting compound into a cubical aluminum case.

Sizes of 1 mH and above have three terminals, two for the inductor leads and the third connected to the case, to provide either a two- or three-terminal standard. The 100- μ H size has three additional terminals for the switching used to minimize connection errors.

For comparing other inductors with these standards, the 1632-A Inductance Bridge is recommended.

SPECIFICATIONS

Inductance Range: See table.

Accuracy of Adjustment: See table.

Calibration: A certificate of calibration is provided with each unit, giving measured values of inductance at 100, 200, 400, and 1000 Hz, with temperature and method of measurement specified. These values are obtained by comparison, to a precision, typically, of better than $\pm 0.005\%$, with working standards whose absolute values, determined and maintained in terms of reference standards periodically certified by the National Bureau of Standards, are known to an accuracy typically $\pm (0.02\% + 0.1 \mu\text{H})$ at 100 Hz.

Stability: Inductance change is less than $\pm 0.01\%$ per year.

Dc Resistance: See table for representative values. A measured value of resistance at a specified temperature is given on the certificate of calibration.

Low-Frequency Storage Factor Q: See table for representative values of Q at 100 Hz (essentially from dc resistance). An individual value of Q, calculated from the measured dc resistance, is given on each certificate of calibration.

Temperature Coefficient of Inductance: Approx 30 ppm per $^{\circ}\text{C}$. Minute temperature corrections may be computed from dc resistance changes. A 1% increase in resistance, produced by a temperature increase of 2.54°C , corresponds to 0.0076% increase in inductance.

Resonant Frequency: See table for representative values. A measured value is given on the certificate of calibration.

Max Input Power: For a rise of 20°C , 3 W; for precise work, a rise of 1.5°C , 200 mW. See table for corresponding current limits.

Terminals: Jack-top binding posts on $\frac{3}{4}$ -in. spacing with removable ground strap.

Mechanical: Lab-bench cabinet. DIMENSIONS (wxhxd): 6.5x6.5x8 in. (166x166x204 mm). WEIGHT: 11.5 lb (5.3 kg) net, 13 lb (6 kg) shipping.

| Description | Nominal Inductance | Adjustment Accuracy (Percent) | *Resonant Frequency (kHz) | *Dc Resistance (Ohms) | *Q at 100 Hz | Milliamperes, rms for, | | Catalog Number |
|--------------------------|--------------------|-------------------------------|---------------------------|-----------------------|--------------|------------------------|------|----------------|
| | | | | | | 200 mW | 3 W | |
| Standard Inductor | | | | | | | | |
| 1482-B | 100 μ H | ± 0.25 | 800 | 0.083 | 0.76 | 1550 | 6010 | 1482-9702 |
| 1482-E | 1 mH | ± 0.1 | 800 | 0.83 | 0.75 | 490 | 1890 | 1482-9705 |
| 1482-H | 10 mH | ± 0.1 | 220 | 8.2 | 0.77 | 156 | 600 | 1482-9708 |
| 1482-L | 100 mH | ± 0.1 | 71 | 81 | 0.78 | 50 | 192 | 1482-9712 |
| 1482-P | 1 H | ± 0.1 | 14.6 | 616 | 1.02 | 18 | 70 | 1482-9716 |
| 1482-T | 10 H | ± 0.1 | 4.9 | 6400 | 0.98 | 5.6 | 22 | 1482-9720 |

* Representative values. Actual values given on certificate.

National stock numbers are listed at the back of the catalog.

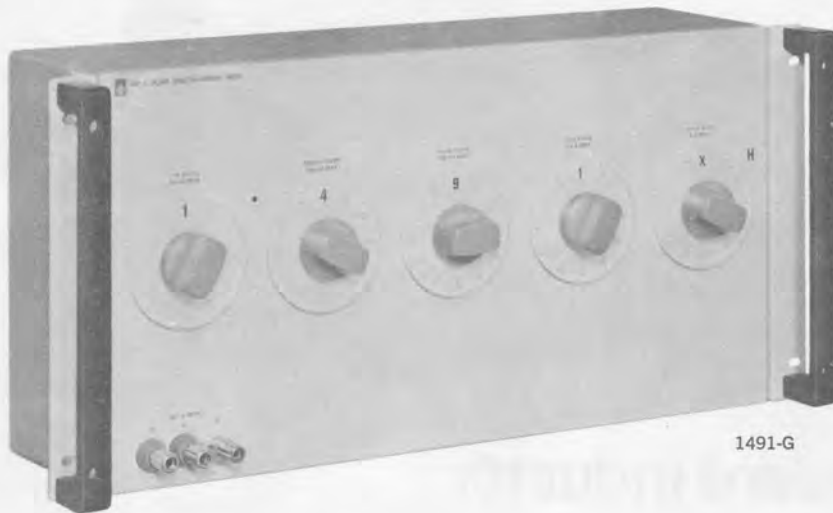

1491-G

1491 Decade Inductor

- high-Q, 200 and above
- shielded toroidal cores for small mutual inductance little effect from external fields
- sealed against moisture

The 1491 Decade Inductor is an assembly of several 940 Decade-Inductor Units in a single metal cabinet. The units have no electrical connection to the panel, but a separate ground terminal is provided, which can be connected to the adjacent low terminal, leading to the smallest decade.

These inductance decades are convenient elements for use in wave filters, equalizers, and tuned circuits throughout the range of audio and low radio frequencies. As components in oscillators, analyzers, and similar equipment, they are especially useful during the preliminary design period, when you need to vary circuit elements over relatively wide ranges to determine optimum operating values. As moderately precise standards of inductance they have values of low-frequency storage factor, Q, that are much larger than those of air-core coils.

SPECIFICATIONS

Note: See also specifications for 940 Decade Inductor Units.

Frequency Characteristics: Percentage increase in effective series inductance (above the zero-frequency value, L_0) may be obtained by interpolation in accompanying graph for any setting of the highest-value decade used, when LOW terminal is grounded to cabinet.

Zero Inductance: Approx $1 \mu\text{H}$.

National stock numbers are listed at the back of the catalog.

Max Voltage: 500 V rms. Switch will break circuit at 500 V if turned rapidly, but voltages above 150 V may cause destructive arcing with switch between detent positions.

Terminals: Binding posts on $\frac{3}{4}$ -in. centers; separate ground terminal provided.

Mechanical: Lab-bench cabinet. DIMENSIONS (wxhxd): Bench, 17x8.75x6.5 in. (432x223x166 mm). WEIGHT: 1491-D, bench model, 23 lb (11 kg) net, 30 lb (14 kg) shipping; 1491-G, bench model, 27 lb (12 kg) net, 34 lb (16 kg) shipping.

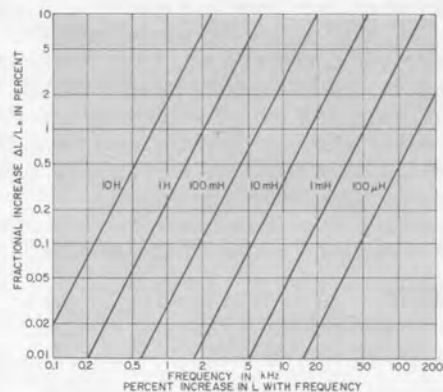

Variation of inductance with frequency for the 1491 Decade Inductors.

| Description | Total | Steps | 940's Included | Catalog Number |
|------------------------|----------|----------|----------------|----------------|
| Decade Inductor | | | | |
| 1491-D Bench | 11.11 H | 0.001 H | E, F, G, H | 1491-9704 |
| 1491-G Bench | 11.111 H | 0.0001 H | DD, E, F, G, H | 1491-9707 |



940-DD

940 Decade-Inductor Unit

Each 940 Decade-Inductor Unit is an assembly of four inductors (relative values, 1, 2, 2, 5) wound on molybdenum-permalloy dust cores, which are combined by switching to give the eleven successive values from 0 to 10. The decade switch has high-quality ceramic stator-and-rotor members and well-defined ball-and-socket detents. All contacts are made of a silver alloy and have a positive wiping action.

SPECIFICATIONS

Accuracy: Each unit is adjusted so that its inductance at zero frequency and initial permeability will be the nominal value within the accuracy tolerance given in the following table:

| Unit | 940-DD | 940-E | 940-F | 940-G | 940-H |
|---------------------|-------------|-----------|-----------|-------------|-------------|
| Inductance per step | 100 μ H | 1 mH | 10 mH | 100 mH | 1 H |
| Accuracy | $\pm 2\%$ | $\pm 2\%$ | $\pm 1\%$ | $\pm 0.6\%$ | $\pm 0.6\%$ |

Frequency Characteristics: For any specific operating frequency, Figure 2 shows the percentage increase in effective series inductance (above the value when $f = 0$), which is encountered with the extreme settings of each of the five decade-inductor units when the chassis is floating. Interpolation may be used for intermediate settings.

Change in Inductance with Current: Fractional change in initial inductance with ac current for each type of toroid is shown in the normal curves, Figure 1, in terms of the ratio of the operating current, I , to I_1 , the current for 0.25% change, solid line (0.1%, broken line). For ratios below unity, inductance change is directly proportional to current. Values of I_1 listed below,

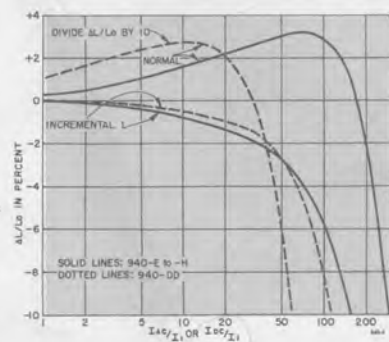

Figure 1. Percentage change in normal and incremental inductance with ac and bias current. Incremental curve is limited to an ac excitation less than I_1 .

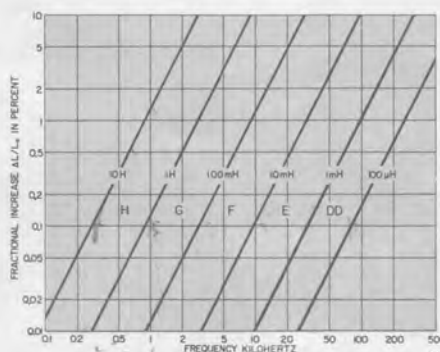

Figure 2. Change in effective inductance with frequency for the 940 Decade-Inductor Units.

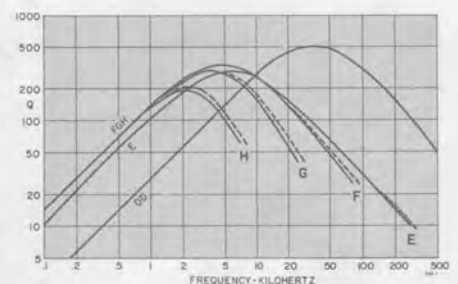

Figure 3. Variation of Q for the maximum inductance of each 940 Decade-Inductor Unit at low excitation levels. Dashed curves correspond to use with chassis floating.

are approximate and are based on the largest inductor in the circuit for each setting.

Incremental Inductance: Dc bias current I_b will reduce the initial inductance as shown in the incremental curves, Figure 1.

| Switch Setting | RMS I_1 (mA) | | | | |
|-------------------|----------------|----------------|-------|-------|-------|
| | 0.1% Increase | 0.25% Increase | | | |
| | 940-DD | 940-E | 940-F | 940-G | 940-H |
| 1 | 141 | 17 | 5.4 | 1.7 | 0.54 |
| 2, 3, 4 | 100 | 12 | 3.8 | 1.2 | 0.38 |
| 5, 6, 7, 8, 9, 10 | 63 | 8 | 2.4 | 0.8 | 0.24 |

Storage Factor Q: See Figure 3:

Dc Resistance: Approx 45 Ω per henry.

Temperature Coefficient: Approx -25 ppm per degree C between 16° and 32° C.

Max Safe Current: Approx 200 times the pertinent I_1 value (30 times for the 940-DD). Max current engraved on dial.

Terminals: Solder lugs. Circuit insulated from chassis.

Mechanical: Panel-mounting (hardware, dial plate, and knob included). DIMENSIONS (wxhxd): 8x3.5x4.25 in. (204x89x108 mm). WEIGHT: 3.5 lb (1.6 kg) net, 6 lb (2.8 kg) shipping.

| Description | Inductance | | Catalog Number |
|------------------------|------------|-------------|------------------|
| | Total | Steps | |
| Decade Inductor | | | |
| 940-DD | 1 mH | 100 μ H | 0940-9810 |
| 940-E | 0.01 H | 0.001 H | 0940-9705 |
| 940-F | 0.1 H | 0.01 H | 0940-9706 |
| 940-G | 1 H | 0.1 H | 0940-9707 |
| 940-H | 10 H | 1 H | 0940-9708 |

National stock numbers are listed at the back of the catalog.

GR874[®] Broad-Band Coaxial Components

50-Ohm Connectors
50-Ohm Adaptors
Terminations and Attenuators
for 50- Ω Systems
50-Ohm Air Lines
50-Ohm Coupling Elements
50-, 72- and 75-Ohm Patch Cords
75-Ohm Components
Miscellaneous



GR900[®] Precision Coaxial Components

50-Ohm Connectors
50-Ohm Adaptors
50-Ohm Terminations
and Attenuators
50-Ohm Air Lines
75-Ohm Components
Miscellaneous

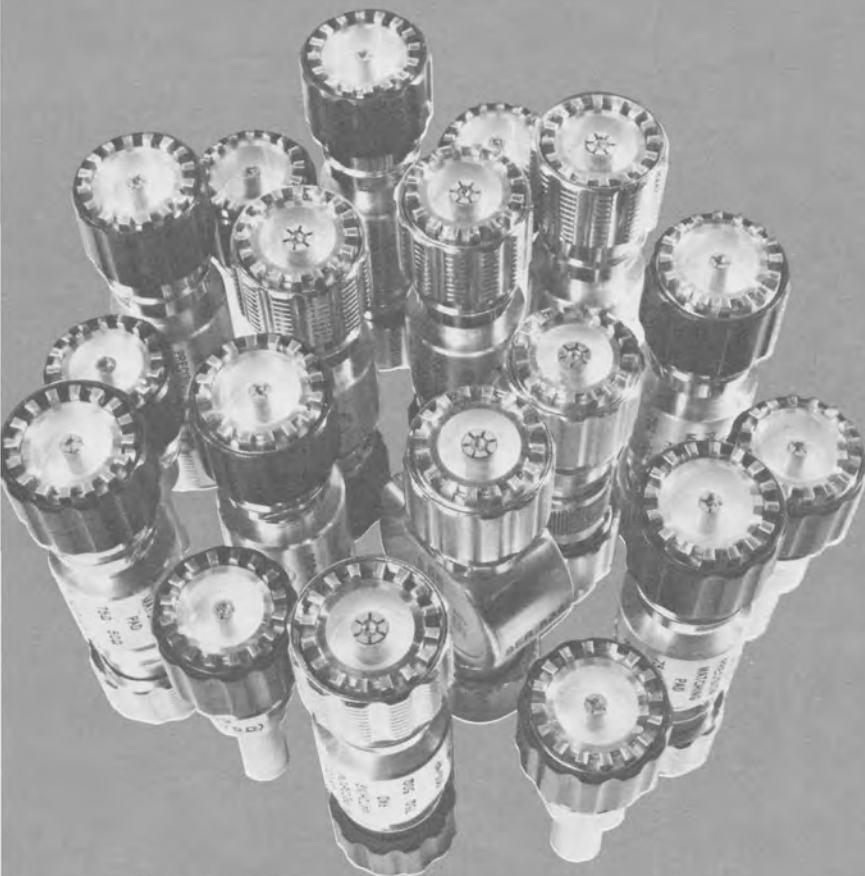

GR874® General-Purpose Coaxial Components

Over 25 years of design refinement GenRad entered the coaxial component field over 25 years ago with the introduction of the GR874® connector. This connector offered not only excellent electrical performance but a major convenience feature — any two, although identical, could be mated. The hermaphrodite, quick-connect GR874 connector was soon joined by a family of circuit elements and adaptors using it. GR874-equipped instruments were added to solve the special measurement problems of vhf and uhf and the availability of these precise measuring instruments in turn made possible a continuous refinement of the basic connector.

A universal choice The GR874 connector has gained wide popularity; highly respected instrument manufacturers have put the electrical and physical advantages of these connectors to good use on their products.

Based on the GR874 connector is a full line of coaxial components and instruments so that a user of the GR874-equipped laboratory need seldom turn to other connector types for a needed element. If he does, there are GR874 adaptors to fit most other common types of connector.

Locking connectors The GR874 connector is available in both the common nonlocking version and a high-performance locking version. The locking version has a threaded coupling nut that permits the two connectors to be mechanically locked together in a stable, semi-permanent union for better electrical repeatability, lower leakage, and less chance of accidental disconnection. The quick-connect/disconnect feature is retained if the coupling nut is not engaged.

Electrical characteristics The GR874 connector has truly outstanding reflection characteristics among standard, general-purpose coaxial connectors in the dc-to-9 GHz frequency range. Its SWR performance is typically superior to that of the type N connector, for example. Its low level of reflections at high frequencies makes the connector of particular value in pulse applications and in time-domain reflectometry. GR874 cable connectors, in fact, offer SWR performance superior to that of any cable with which they can be used and therefore add no significant reflections when used in cabled measurement set-ups. They also provide very low contact resistance, an important requirement to minimize intermodulation in multichannel communications systems.

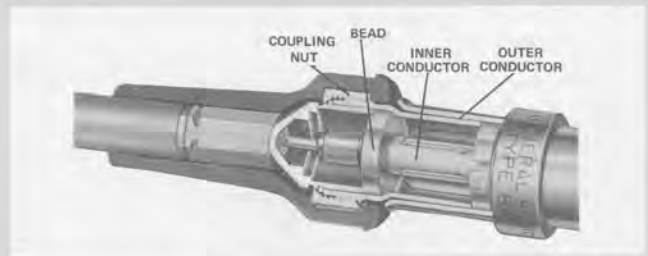

Cutaway view of GR874 basic connector mated with GR874 cable connector.

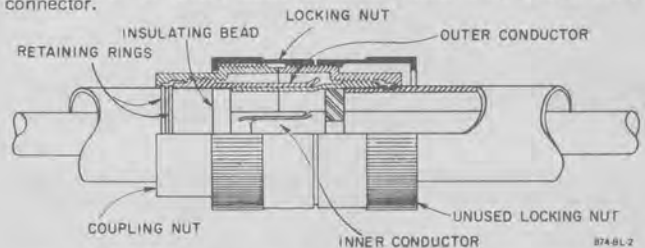

Mechanical characteristics The elements of a GR874 connector include an inner conductor, an outer conductor, a supporting polystyrene bead, a phosphor-bronze retaining ring, and a threaded coupling nut. All metal parts are machined and formed to very close tolerances; all are made of hard-drawn brass, except for the center conductor which is heat-treated beryllium copper to ensure good gripping capability and long wear. A bright-alloy finish on all surfaces produces good conductivity for low loss and gives long-lasting protection against tarnish.

Inner and outer conductors are similar in principle; each is a tube with four longitudinal slots in one end, with two opposite quadrants displaced inward. When two connectors are joined, the undisplaced quadrants of one overlap the displaced quadrants of the other.

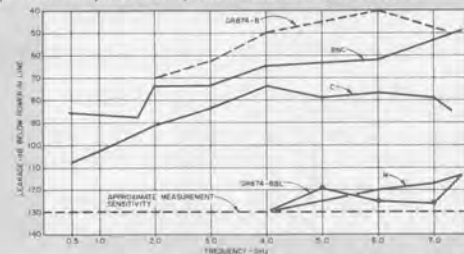

Leakage — note advantage of locking version (874-BBL).

GR874® 50-Ohm Connectors

Basic Connectors

For use on rigid, 14-mm, air-dielectric 50-Ω coaxial lines or with capacitance, inductance, and resistance standards.

Frequency: Dc to 9 GHz.

Electrical: IMPEDANCE: 50 Ω. INPUT VOLTAGE: Up to 1500 V pk. POWER, average into 50-Ω load: Up to 40 kW, dc to 50 kHz, decreasing as $1/\sqrt{f}$ to 0.1 kW at 10 GHz.

Mechanical: DIMENSIONS: Non-locking, 1.19 in. (30 mm) x 0.813 in. (21 mm) dia; locking, same length x 1 in. (25 mm) dia. WEIGHT: 0.2 lb (0.1 kg) net, 1 lb (0.5 kg) shipping.

Description

Catalog Number

Basic 50-Ω Connector
874-B, non-locking
874-BBL, locking

0874-9400
0874-9403

National stock numbers are listed at the back of the catalog.



non-locking



locking

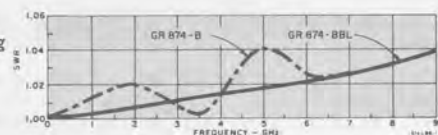

Typical SWR of pairs of connectors.

Cable Connectors

For use with more than 40 different RG types of coaxial cable. Each cable connector consists of a basic connector, plus inner and outer transition pieces, a soft copper ferrule, a heat disk, and a flexible cable guard. The transition pieces maintain the 50-ohm characteristic impedance of the connector throughout the reduction to the cable diameter. The cable inner conductor is soldered to the inner transition piece; the cable braid and jacket are crimped to the outer transition by the specially perforated ferrule. Braid and jacket are thus securely fastened, to minimize reflections and leakage. A neoprene cable guard serves as a protective handle. Sized to grip the cable securely without compressing it, the cable guard adds to the quick-connect/disconnect convenience of the connector.

Frequency: Dc to 7.5 GHz.

Impedance: 50Ω.

Input Voltage, peak: 874-CA, -CLA, -C8A, -CL8A: Up to 1000 V.
874-C58A, -CL58A, -C62A, -CL62A: Up to 500 V.

874-C174A, -CL174A: Up to 300 V.

Power, average into 50-Ω load: 874-CA, -CLA, -C8A, -CL8A: Up to 20 kW, dc to 100 kHz, decreasing as $1/\sqrt{f}$ to 0.1 kW at 5 GHz.

874-C58A, -CL58A, -C62A, -CL62A: Up to 5 kW, dc to 500 kHz, decreasing as $1/\sqrt{f}$ to 0.1 kW at 1 GHz.

874-C174A, -CL174A: Up to 1.8 kW, dc to 300 kHz decreasing as $1/\sqrt{f}$ to 0.1 kW at 80 MHz.

Mechanical: DIMENSIONS: 2.69 in. (68 mm) long x 1 in. (25 mm) dia. WEIGHT: 0.2 lb (0.1 kg) net, 1 lb (0.5 kg) shipping.

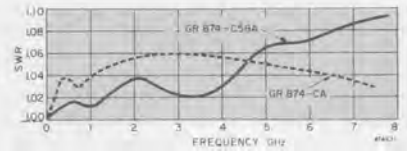

Average SWR of single connector on infinite length of 50-ohm cable.

Description

Catalog Number

50-Ω Cable Connectors:

| | |
|--|-----------|
| For GR 874-A2 Cable: | |
| 874-CA, non-locking | 0874-9410 |
| 874-CLA, locking | 0874-9411 |
| For 50-Ω cable including RG-8A/U, -9B/U, -10A/U, -87A/U, -116/U, -156/U, -165/U, -166/U, 213/U, -214/U, 215/U, -225/U, -227/U, and non-50-Ω cable including RG-11A/U, -12A/U, -13A/U, -638/U, -79B/U, -89/U, -144/U, -146/U, -149/U, -216/U: | |
| 874-C8A, non-locking | 0874-9412 |
| 874-CL8A, locking | 0874-9413 |
| For 50-Ω cable including GR 874-A3, RG-29/U, -55/U series, -58A/U series, -141A/U, -142A/U, -159/U, -23/U: | |
| 874-C58A, non-locking | 0874-9414 |
| 874-CL58A, locking | 0874-9415 |
| For non-50-Ω cable including RG59/U, -62/U series, -71B/U, -140/U, -210/U: | |
| 874-C62A, non-locking | 0874-9416 |
| 874-CL62A, locking | 0874-9417 |
| For 50-Ω cable including RG-174/U, -188/U, -316/U, and non-50-Ω cable including RG-161/U, -187/U, -179/U: | |
| 874-C174A, non-locking | 0874-9418 |
| 874-CL174A, locking | 0874-9419 |

Panel Connectors

For use on equipment panels. Connectors are available to fit popular cable sizes and wire leads. They are mounted to a panel by means of a flange and four screws; the non-locking connector can be mounted either front or back. The recessed connectors protrude forward only 0.13 in. (3.2 mm), for space saving and neatness.

Frequency: Dc to 7.5 GHz.

Impedance: 50Ω.

Input Voltage, peak: 874-PBA, -PLA, -PRLA, -PB8A, -PL8A, -PRL8A: Up to 1000 V.

874-PB58A, -PL58A, -PRL58A, -PB62A, -PL62A, -PRL62A: Up to 500 V.

874-PB174A, -PL174A, -PRL174A: Up to 300 V.

874-PLT, -PRLT: Up to 1500 V.

Power, average into 50-Ω load: 874-PBA, -PLA, -PRLA, -PB8A, -PL8A, -PRL8A: Up to 20 kW, dc to 100 kHz decreasing as $1/\sqrt{f}$ to 0.1 kW at 5 GHz.

874-PB58A, -PL58A, -PRL58A, -PB62A, -PL62A, -PRL62A: Up to 5 kW, dc to 500 kHz, decreasing as $1/\sqrt{f}$ to 0.1 kW at 1 GHz.

874-PB174A, -PL174A, -PRL174A: Up to 1.8 kW, dc to 300 kHz, decreasing as $1/\sqrt{f}$ to 0.1 kW at 80 MHz.

874-PLT, -PRLT: Up to 40 kW, dc to 50 kHz, decreasing as $1/\sqrt{f}$ to 0.1 kW at 10 GHz.

Mechanical: WEIGHT: 0.2 lb (0.1 kg) net, 1 lb (0.5 kg) shipping.



non-locking

locking

recessed

50-Ω Panel Connectors:

| | |
|--|-----------|
| For GR 874-A2 Cable: | |
| 874-PBA, non-locking | 0874-9440 |
| 874-PLA, locking | 0874-9441 |
| 874-PRLA, recessed locking | 0874-9461 |
| For 50-Ω Cable including RG-8A/U, -9B/U, -10A/U, -87A/U, -116/U, -156/U, -165/U, -166/U, -213/U, -214/U, -215/U, -225/U, -227/U, and non-50-Ω cable including RG-11A/U, -12A/U, -13A/U, -63B/U, -79B/U, -89/U, -144/U, -149/U, -216/U: | |
| 874-PB8A, non-locking | 0874-9442 |
| 874-PL8A, locking | 0874-9443 |
| 874-PRL8A, recessed locking | 0874-9463 |
| For 50-Ω cable including GR 874-A3, RG-29/U, -55/U series, -58/U series, -141A/U, -142/U, -159/U, -223/U: | |
| 874-PB58A, non-locking | 0874-9444 |
| 874-PL58A, locking | 0874-9445 |
| 874-PRL58A, recessed locking | 0874-9465 |
| For non-50-Ω cable including RG59/U, -62/U series, -71B/U, -140/U, -210/U: | |
| 874-PB62A, non-locking | 0874-9446 |
| 874-PL62A, locking | 0874-9447 |
| 874-PRL62A, recessed locking | 0874-9467 |
| For 50-Ω cable including RG-174/U, -188/U, -316/U, and non-50-Ω cable including RG-161/U, -187/U, -179/U: | |
| 874-PB174A, non-locking | 0874-9448 |
| 874-PL174A, locking | 0874-9449 |
| 874-PRL174A, recessed locking | 0874-9469 |
| For Wire Leads: | |
| 874-PLT, locking | 0874-9459 |
| 874-PRLT, recessed locking | 0874-9479 |

Panel Feedthrough Connector

Mates any pair of GR874 connectors directly through a panel or wall. Can be mounted as recessed or nonrecessed panel locking connector. Can be mounted through thick bulkheads 0.25 to 2 inches (51 mm), or more, in thickness by counterboring.

Electrical: IMPEDANCE: 50 Ω, nominal. INPUT VOLTAGE: Up to 1500 V pk. POWER, average into 50-Ω load: Up to 40 kW, dc to 50 kHz, decreasing as $1/\sqrt{f}$ to 0.1 kW at 10 GHz.

National stock numbers are listed at the back of the catalog.

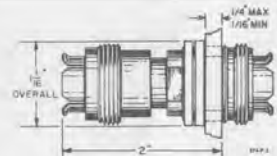

874-PFL Panel Feedthrough Connector

0874-9451

GR874® 50-Ohm Adaptors

Conversion These adaptors provide easy conversion from the GR874® connector to most popular military and industrial coaxial connectors. Many of the adaptors are available with locking GR874 connectors to allow semi-permanent attachment of the adaptor while ensuring stable electrical performance.

Without degradation GR874 adaptors extend the usefulness of GR874 connectors without sacrificing electrical performance. The SWR of the combination of GR874 connector and GR874 adaptor is actually comparable to that of the "other series" connector alone.

Excellent for OEM applications Original-equipment manufacturers recognize the possibilities of these adaptors in combination with the GR874 recessed panel connector. An instrument originally equipped with these connectors can be quickly converted by means of appropriate GR874 adaptors to almost any coaxial connector series; the resulting panel connector protrudes less than an inch in front of the panel.

50-Ohm Adaptor Kit

- fifteen adaptors in one neat package provide the answer to the connector dilemma

Tame the connector menagerie Your device is fitted with type N connectors, your test equipment with UHF, and your patch cords with BNC — is that what plagues you? Or have you just wasted ten minutes trying to force one SMA plug onto another? Frustrating as these experiences may be, they're inevitable because of the multitude of connector types available to manufacturers. There is a bright side, however, and it comes in the form of a small gray box from GenRad. The box contains 15 different adaptor types that allow you to connect to any of 9 popular commercial and military connector types — conveniently and with a minimum of the usual fumbling.

With a double approach All adaptors in the kit have one connector type in common, the GR874. These connectors are hermaphroditic; i.e., any two, although identical, can be plugged together — no more worrying about whether you need a jack or a plug or whatever.

One approach to the problem is simply to connect the appropriate adaptor to each end of a GR874® patch cord and then connect it from one device to the other.

Replace countless adaptors Because any two GR874 adaptors mate, a few of them can perform a cross-connection task that would otherwise involve a costly collection of direct adaptors. For example, interconnection of types BNC, C, Microdot, N, TNC, and UHF plugs and jacks would require 72 direct adaptors, whereas only 12 GR874 adaptors are needed to do the same job. (See Table.)

The mathematics of coaxial adaptors
GIVEN: n types of coaxial connectors
FIND: the number of adaptors required to be able to interconnect any jack or plug to any other one.

| n | With standard coaxial adaptors: 2n(n - 1) | With GenRad coaxial adaptors: 2n |
|---|---|----------------------------------|
| 2 | 4 | 4 |
| 4 | 20 | 8 |
| 6 | 60 | 12 |
| 8 | 112 | 16 |

Equally simple is a second approach. Connect one adaptor to another, with the second adaptor appropriate to whatever type of patch cord you have available.

Supplied: In addition to the adaptors listed below, the kit also includes one 874-T tee connector to connect stubs and other elements in shunt with a coaxial line, one 874-EL 90° ell right-angle line section, and one 874-R33 three-foot 50-Ω cable terminated on one end with a GR874 connector and on the other with banana plugs.

| Qty | Contains GR874 and | GR Type | Qty | Contains GR874 and | GR Type |
|-----|--------------------|----------|-----|--------------------|---------------------------------|
| 2 | BNC jack | 874-QBJA | 1 | SMA jack | 874-QMMJ |
| 2 | BNC plug | 874-QBPA | 1 | SMA plug | 874-QMMP |
| 1 | C jack | 874-QCJA | 1 | TNC jack | 874-QTNJ |
| 1 | C plug | 874-QCP | 1 | TNC plug | 874-QTNP |
| 1 | HN jack | 874-QHJA | 2 | UHF jack | 874-QUJ |
| 1 | HN plug | 874-QHPA | 2 | UHF plug | 874-QUP |
| 3 | N jack | 874-QNJA | 1 | banana jacks | 874-Q2 |
| 3 | N plug | 874-QNP | | | (See also preceding paragraph.) |

Mechanical: All components housed in a rugged steel case with piano hinge, 2 clasps, and carrying handle. DIMENSIONS: (wxhxd): 18.5x4x7 in. (470x102x178 mm). WEIGHT: 4.5 lb (2.1 kg) net, 6 lb (2.8 kg) shipping.

| Description | Catalog Number |
|----------------------|----------------|
| 874-9099 Adaptor Kit | 8074-9099 |



National stock numbers are listed at the back of the catalog.

GR874[®] 50-Ohm Adaptors

Adaptors to BNC

Four adaptors are available; two include a BNC jack with either a non-locking or a locking GR874 connector, and two include a BNC plug with either a non-locking or a locking GR874 connector.

Frequency: Dc to 8.5 GHz.

Electrical: IMPEDANCE: 50 Ω , nominal. INPUT VOLTAGE: Up to 500 V pk. POWER, average into 50- Ω load: Up to 5 kW, dc to 500 kHz, decreasing as $1/\sqrt{f}$ to 0.1 kW at 1 GHz.

Mechanical: WEIGHT: 0.2 lb (0.1 kg) net, 1 lb (0.5 kg) shipping.



874-QBJA



874-QBPA

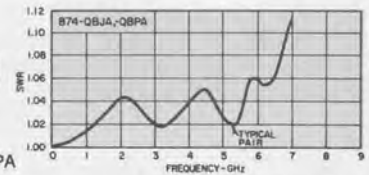

Description

Catalog Number

50- Ω Adaptors to BNC

874-QBJA, BNC jack, non-locking GR874 connector

0874-9700

874-QBJL, BNC jack, locking GR874 connector

0874-9701

874-QBPA, BNC plug, non-locking GR874 connector

0874-9800

874-QBPAL, BNC plug, locking GR874 connector

0874-9801

Adaptors to C

Two adaptors are available; one includes a type C jack, and the other includes a type C plug. Each uses a non-locking GR874 connector on the other end.

Frequency: Dc to 8.5 GHz.

Electrical: IMPEDANCE: 50 Ω nominal. INPUT VOLTAGE: Up to 1000 V pk. POWER, average into 50- Ω load: Up to 20 kW, dc to 100 kHz, decreasing as $1/\sqrt{f}$ to 0.1 kW at 5 GHz.

Mechanical: WEIGHT: 0.2 lb (0.1 kg) net, 1 lb (0.5 kg) shipping.



874-QCJA



874-QCP

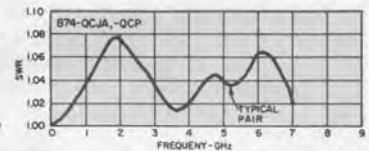

50- Ω Adaptors to C

874-QCJA, C jack, non-locking GR874 connector

0874-9702

874-QCP, C plug, non-locking GR874 connector

0874-9802

Adaptors to HN

Two adaptors are available; one includes a type HN jack and the other includes a type HN plug. Each uses a GR874 non-locking connector on the other end.

Frequency: Dc to 8.5 GHz.

Electrical: IMPEDANCE: 50 Ω , nominal. INPUT VOLTAGE: Up to 1500 V pk. POWER, average into 50- Ω load: Up to 40 kW, dc to 50 kHz, decreasing as $1/\sqrt{f}$ to 0.1 kW at 10 GHz.

Mechanical: WEIGHT: 0.2 lb (0.1 kg) net, 1 lb (0.5 kg) shipping.



QHJA



QHPA

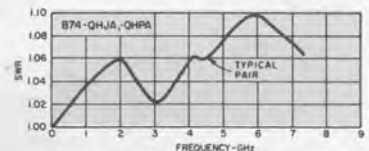

50- Ω Adaptors to HN

874-QHJA, HN jack, non-locking GR874 connector

0874-9704

874-QHPA, HN plug, non-locking GR874 connector

0874-9804

Adaptors to Microdot

Two adaptors are available; one includes a Microdot jack, and the other includes a Microdot plug. Each uses a non-locking GR874 connector on the other end.

Frequency: Dc to 4 GHz.

Electrical: IMPEDANCE: 50 Ω , nominal. INPUT VOLTAGE: Up to 300 V pk. POWER, average into 50- Ω load: Up to 1.8 kW, dc to 300 kHz, decreasing as $1/\sqrt{f}$ to 0.1 kW at 80 MHz.

Mechanical: WEIGHT: 0.2 lb (0.1 kg) net, 1 lb (0.5 kg) shipping.



874-QMDJ



874-QMDP

50- Ω Adaptors to Microdot

874-QMDJ, Microdot jack, non-locking GR874 connector

0874-9720

874-QMDP, Microdot plug, non-locking GR874 connector

0874-9820

National stock numbers are listed at the back of the catalog.

Adaptors to N

Four adaptors are available; two include a type N jack with either a non-locking or a locking GR874 connector, and two include a type N plug with either a non-locking or a locking GR874 connector.

Frequency: Dc to 8.5 GHz.

Electrical: IMPEDANCE: 50 Ω , nominal. INPUT VOLTAGE: Up to 1000 V pk. POWER, average into 50- Ω load: Up to 20 kW, dc to 100 kHz, decreasing as $1/\sqrt{f}$ to 0.1 kW at 5 GHz.

Mechanical: WEIGHT: 0.2 lb (0.1 kg) net, 1 lb (0.5 kg) shipping.

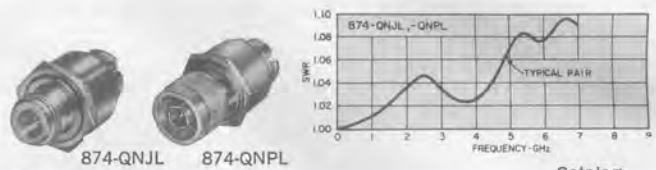

Description

Catalog Number

50- Ω Adaptors to N

874-QNJA, N jack, non-locking GR874 connector

0874-9710

874-QNJL, N jack, locking GR874 connector

0874-9711

874-QNPL, N plug, non-locking GR874 connector

0874-9810

874-QNPL, N plug, locking GR874 connector

0874-9811

Adaptors to SMA

Four adaptors are available; two include an SMA jack with either a non-locking or a locking GR874 connector, and two include an SMA plug with either a non-locking or a locking GR874 connector. These adaptors also mate with NPM, STM, and others.

Frequency: Dc to 8.5 GHz.

Electrical: IMPEDANCE: 50 Ω , nominal. INPUT VOLTAGE: Up to 300 V pk. POWER, average into 50- Ω load: Up to 1.8 kW, dc to 300 kHz, decreasing as $1/\sqrt{f}$ to 0.1 kW at 80 MHz.

Mechanical: WEIGHT: 0.2 lb (0.1 kg) net, 1 lb (0.5 kg) shipping.

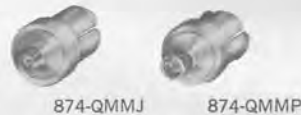

50- Ω Adaptors to SMA

874-QMMJ, SMA jack, non-locking GR874 connector

0874-9722

874-QMMJL, SMA jack, locking GR874 connector

0874-9723

874-QMMP, SMA plug, non-locking GR874 connector

0874-9822

874-QMMP, SMA plug, locking GR874 connector

0874-9823

Adaptors to TNC

Two adaptors are available; one includes a TNC jack, and the other includes a TNC plug. Each uses a non-locking GR874 connector on the other end.

Frequency: Dc to 8.5 GHz.

Electrical: IMPEDANCE: 50 Ω , nominal. INPUT VOLTAGE: Up to 500 V pk. POWER, average into 50- Ω load: Up to 5 kW, dc to 500 kHz, decreasing as $1/\sqrt{f}$ to 0.1 kW at 1 GHz.

Mechanical: WEIGHT: 0.2 lb (0.1 kg) net, 1 lb (0.5 kg) shipping.



Description

Catalog Number

50- Ω Adaptors to TNC

874-QTNJ, TNC jack, non-locking GR874 connector

0874-9716

874-QTNP, TNC plug, non-locking GR874 connector

0874-9816

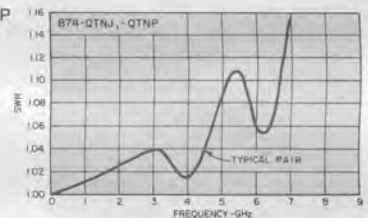

Adaptors to UHF

Three adaptors are available; two include a UHF jack with either a non-locking or a locking GR874 connector, and one includes a UHF plug with a non-locking GR874 connector.

Electrical: IMPEDANCE: 50 Ω , nominal. INPUT VOLTAGE: Up to 500 V pk. POWER, average into 50- Ω load: Up to 5 kW, dc to 500 kHz, decreasing as $1/\sqrt{f}$ to 0.1 kW at 1 GHz.

Mechanical: WEIGHT: 0.2 lb (0.1 kg) net, 1 lb (0.5 kg) shipping.



50- Ω Adaptors to UHF

874-QUJ, UHF jack, non-locking GR874 connector

0874-9718

874-QUJL, UHF jack, locking GR874 connector

0874-9719

874-QUP, UHF plug, non-locking GR874 connector

0874-9818

Adaptor to 7-mm Precision

One adaptor is available and includes an Amphenol APC-7, 7-mm precision, connector on one end and a locking GR874 connector on the other end.

Frequency: Dc to 8.5 GHz.

Electrical: IMPEDANCE: 50 Ω , nominal. INPUT VOLTAGE: Up to 1000 V pk. POWER, average into 50- Ω load: Up to 20 kW, dc to 100 kHz, decreasing as $1/\sqrt{f}$ to 0.1 kW at 5 GHz.

Mechanical: WEIGHT: 0.2 lb (0.1 kg) net, 1 lb (0.5 kg) shipping.



50- Ω Adaptor to 7-mm Precision

874-QAP7L, Amphenol APC-7, locking GR874-connector

0874-9791



National stock numbers are listed at the back of the catalog.

Adaptor to GR900® Connector

One adaptor is available and includes a GR900 precision connector on one end and a locking GR874 connector on the other end.

Frequency: Dc to 8.5 GHz.

Electrical: IMPEDANCE: 50 Ω , nominal. INPUT VOLTAGE: Up to 1500 V pk. POWER, average into 50- Ω load: Up to 40 kW, dc to 50 kHz, decreasing as $1/\sqrt{f}$ to 0.1 kW at 10 GHz.

Mechanical: WEIGHT: 0.2 lb (0.1 kg) net, 1 lb (0.5 kg) shipping.

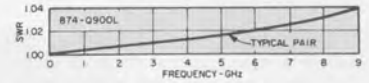

Description

Catalog Number

50- Ω Adaptor to GR900

874-Q900L, GR900 and locking GR874 Connectors

0874-9709

Adaptor to Binding Posts

One adaptor is available and includes a pair of 0.75-in.-spaced binding posts on one end and a non-locking GR874 connector on the other end. Mates with banana plugs. (Note: A single post is also available, on the 874-MB Coupling Probe.)

Mechanical: WEIGHT: 0.2 lb (0.1 kg) net, 1 lb (0.5 kg) shipping.



50- Ω Adaptor to binding post

874-Q2, jacks, non-locking GR874 connector

0874-9870

Adaptors to Banana Plugs

Two adaptors are available; each includes a pair of 0.75-in.-spaced banana plugs and a non-locking GR874 connector on the other end. One adaptor is completely shielded; the other has unshielded banana plugs.

Mechanical: WEIGHT: 0.2 lb (0.1 kg) net, 1 lb (0.5 kg) shipping.



777-Q3



874-Q10

50- Ω Adaptors to banana plugs

777-Q3, shielded plugs
874-Q10, unshielded plugs

0777-9703
0874-9876

BNC Plug with Cable and GR874® Connector

50- Ω shielded cable connects between BNC jack and GR874 coaxial connector. The GR874 end has the space-saving hammerhead shape (axis perpendicular to cable), so convenient when your cable runs parallel to the instrument panel.

Mechanical: LENGTH: 3 ft. (920 mm). NET WEIGHT: 3 oz (85 g).



776-B Patch Cord

0776-9702

GR874[®] Terminations and Attenuators for 50-Ohm Systems

Short-Circuit Terminations

Short-circuit terminations are useful in establishing initial coaxial line-length conditions for impedance measurements. Each termination consists of a fixed short-circuit mounted in a GR874 connector. Each of three versions has a counterpart open-circuit termination.

Frequency: Dc to 7 GHz; to 9 GHz if connector is locked.
Plane Position: Short-circuit plane is effectively 0 to 0.07 cm toward load from the generator face of bead, except in -WN3 where it is 3.2 cm (see drawing). (3.2 cm correspond to the bead-to-reference-plane distance in 874-ML Component Mount).

| Description | Catalog Number |
|--|----------------|
| Short-Circuit Terminations for 50-Ω Lines | |
| 874-WN, non-locking GR874 connector | 0874-9970 |
| 874-WNL, locking GR874 connector | 0874-9971 |
| 874-WN3, non-locking GR874 connector | 0874-9972 |

Mechanical: WEIGHT: 0.2 lb (0.1 kg) net, 1 lb (0.5 kg) shipping.

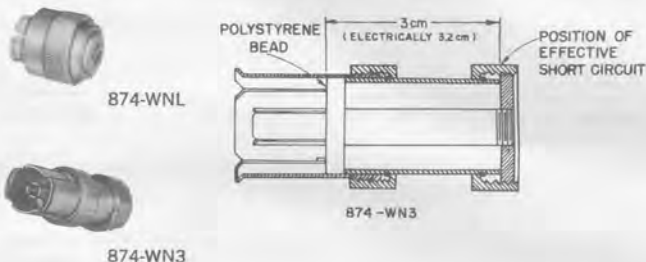

Open-Circuit Terminations

Open-circuit terminations are useful in establishing initial coaxial line-length conditions for impedance measurements and as a shielding cap for open-circuited lines.

Frequency: Dc to 7 GHz; to 9 GHz if locked.
Plane Position (effective position of open-circuit plane, measured from generator face of bead, toward load): 0 to 0.05 cm, for 874-WO; 0 to 0.10 cm, for -WOL, see curve; 3.2 cm, for -WO3, see drawing. The latter position corresponds to that of the short-circuit plane in the 874-WN3 (3.2 cm also correspond to the bead-to-reference-plane distance in 874-ML Component Mount).

Mechanical: WEIGHT: 0.2 lb (0.1 kg) net, 1 lb (0.5 kg) shipping.

| Description | Catalog Number |
|---|----------------|
| Open-Circuit Terminations for 50-Ω Lines | |
| 874-WO, non-locking GR874 connector | 0874-9980 |
| 874-WOL, locking GR874 connector | 0874-9981 |
| 874-WO3, non-locking GR874 connector | 0874-9982 |

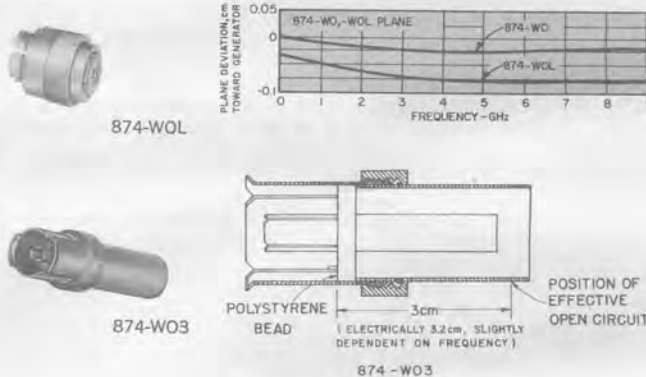

Resistive Terminations

Resistive terminations are useful in slotted-line measurements and for checking accuracy of network analyzers, directional couplers, bridges, and admittance meters. The known location of a purely resistive termination permits the production of many known complex impedances through the addition of sections of 874-L Air Line, fixed or adjustable.

Frequency: Dc to 9 GHz.
Dc Resistance: 50 Ω ± 0.5%.
Electrical: POWER, max continuous: 2 W. SWR: < 1.005 + 0.013 f_{GHz}; also see curves.
Mechanical: WEIGHT: 0.2 lb (0.1 kg) net, 1 lb (0.5 kg) shipping.



| Description | Catalog Number |
|--|----------------|
| Resistive Terminations for 50-Ω Lines | |
| 874-W50B, 50 Ω, non-locking GR874 connector | 0874-9954 |
| 874-W50BL, 50 Ω, locking GR874 connector | 0874-9955 |

Adjustable Stubs

For matching or tuning, for use as adjustable short-circuit terminations, and as reactive elements. With an external indicator, the stub can function as a reaction-type wavemeter. Stub consists of a coaxial line with a sliding short circuit of the multiple-spring-finger type.

Frequency: Dc to 8.5 GHz.
Length: 874-D20L: 20 cm max travel, calibrated in electrical distance from junction in 874-T tee to plane of short circuit. 874-D50L: 50 cm max travel, not calibrated but has an adjustable reference marker.

Electrical: IMPEDANCE: 50 Ω, nominal.
Mechanical: NET WEIGHT: 874-D20L, 0.5 lb (0.2 kg); 874-D50L, 0.9 lb (0.4 kg).

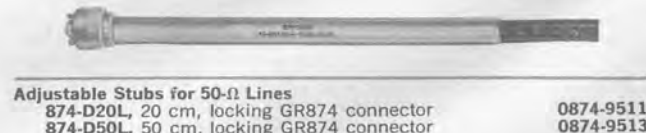

| Description | Catalog Number |
|--|----------------|
| Adjustable Stubs for 50-Ω Lines | |
| 874-D20L, 20 cm, locking GR874 connector | 0874-9511 |
| 874-D50L, 50 cm, locking GR874 connector | 0874-9513 |

National stock numbers are listed at the back of the catalog.

Variable Capacitor

Tuning element for resonant-line circuits, matching transformers, and baluns at low frequencies where line-type elements are awkward to use. Well shielded, Rexolite* insulation, precision ball bearings. Linear capacitance variation.

Frequency: <500 MHz, typical.

Capacitance at low frequencies: 14 to 70 pF at connector, 16.5 to 72.5 pF at junction of 874-T Tee. Refer to graph.

Mechanical: DIMENSIONS: 5.25 in. (133 mm) long x 2.5 in. (64 mm) dia. WEIGHT: 0.8 lb (0.4 kg) net.

* Registered trademark of Brand Rex Division, American Enka Corporation.

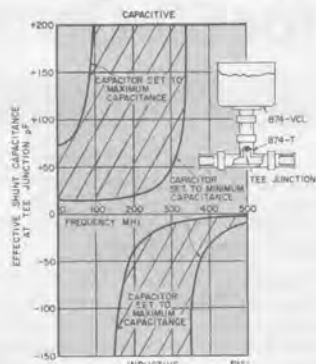

| Description | Catalog Number |
|--|----------------|
| 874-VCL Variable Capacitor, with locking GR874 connector | 0874-9931 |

Fixed Attenuators

Single-section, F type resistance pads, for insertion of fixed attenuation in 50-ohm systems and for isolation and matching to 50 ohms over a broad frequency range. Each attenuator consists of one disk and two cylindrical resistors, as shunt and series elements respectively. The 6-, 14-, and 20-dB attenuators are particularly convenient in pulse applications as voltage dividers.

Frequency: Dc to 4 GHz.

Attenuation Accuracy (relative to correction curves shown): ± 0.2 dB, dc to 1 GHz; ± 0.4 dB, to 2 GHz; ± 0.6 dB, to 4 GHz. TEMPERATURE COEFFICIENT: <0.0003 dB/°C/dB.

Electrical: DC RESISTANCE: 50 $\Omega \pm 1\%$ when terminated in 50 Ω . INPUT POWER, max: 1 W cw or average; 2 kW peak, pulsed.

Mechanical: DIMENSIONS: 3.5 in. (89 mm) long. WEIGHT: 0.2 lb (0.1 kg) net, 1 lb (0.5 kg) shipping.

50- Ω Fixed Attenuators*

| | |
|---|-----------|
| 874-G3, 3 dB ± 0.045 dB, non-locking | 0874-9564 |
| 874-G3L, 3 dB ± 0.045 dB, locking | 0874-9565 |
| 874-G6, 6 dB ± 0.09 dB (X2), non-locking | 0874-9568 |
| 874-G6L, 6 dB ± 0.09 dB (X2), locking | 0874-9569 |
| 874-G10, 10 dB ± 0.15 dB, non-locking | 0874-9570 |
| 874-G10L, 10 dB ± 0.15 dB, locking | 0874-9571 |
| 874-G14, 14 dB ± 0.21 dB (X5), non-locking | 0874-9560 |
| 874-G14L, 14 dB ± 0.21 dB (X5), locking | 0874-9561 |
| 874-G20, 20 dB ± 0.30 dB (X10), non-locking | 0874-9572 |
| 874-G20L, 20 dB ± 0.30 dB (X10), locking | 0874-9573 |

* Connector on each end; locking or non-locking, as noted.



874-G, non-locking

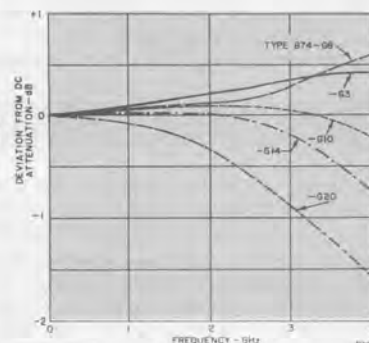

Correction factor

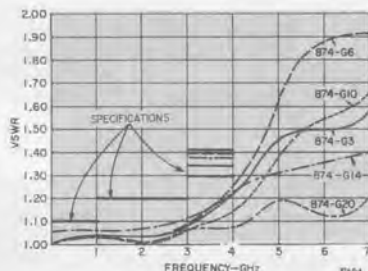

Typical and specified SWR

Adjustable Attenuator

A waveguide-below-cutoff type, useful as a calibrated attenuator or as a sampling device. Calibrated in decibels, on a micrometer-type scale. Absolute attenuation is the sum of insertion loss and scale reading. Phase shift is essentially constant as the attenuation is varied. The main line is a short coaxial section with locking GR874 connectors, one end for source, the other for load. It introduces minimal discontinuity when inserted in a 50-ohm line. The loop output is brought out through 3 feet of 50-ohm cable with a locking GR874 connector. If a source is connected to this output port, signals with relative phases of 0° and 180° are produced at the main line connectors.

Frequency: 100 MHz to 4 GHz.

Relative Attenuation: RANGE: 120 dB, with main line terminated in 50 Ω ; 129 dB, with main line terminated in adjustable stub, set to minimize electric field at the coupling point. MICROMETER SCALE: -9 to 120 dB. ACCURACY: For 50- Ω terminated input, $\pm (0.015 \times \text{difference in scale readings} + 0.2)$ dB, when corrected; correction chart is supplied. For stub-terminated input, $\pm (0.01 \times \text{difference in scale readings} + 0.2)$ dB, direct reading.

Insertion Loss from input connector to end of output cable at 1 GHz, when signal source impedance is 50 Ω : For 50- Ω terminated main line, 30.4 ± 2 dB with scale set at 0 dB; 17 ± 2 dB with scale set at -9 dB (settings below 0 dB not accurate). For stub-terminated unit (that extends range over which calibration is accurate to the -9 dB scale setting), 19 ± 2 dB min. Insertion loss is approx proportional to 1/f, up to 1 GHz. Insertion loss directly through main line is negligible.

National stock numbers are listed at the back of the catalog.

98 GR874® TERMINATIONS AND ATTENUATORS

SWR: MAIN LINE: < 1.03 at 1 GHz, < 1.12 from 1 to 4 GHz. OUTPUT: < 4 at 1 GHz, < 5 from 1 to 4 GHz.

Electrical: INPUT POWER, max: 300 W at 1 GHz; proportional 1/ \sqrt{f} . OUTPUT, max: 0.5 W.

Mechanical: WEIGHT: 1.3 lb (0.6 kg) net.

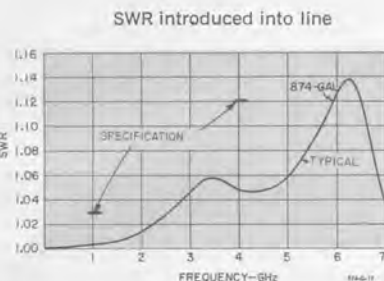

| Description | Catalog Number |
|--|----------------|
| 874-GAL 50- Ω Adjustable Attenuator | 0874-9577 |

GR874[®] 50-Ohm Air Lines

Fixed Air Lines

For use as spacing interconnecting elements of a coaxial system, as time-delay elements, and as absolute impedance references in time-domain reflectometry. Each air line consists of a length of 50- Ω , air-dielectric coaxial line with a GR874 connector at each end.

Frequency: Dc to 7 GHz; to 9 GHz if connectors are locked.

Electrical: IMPEDANCE: 50 Ω ; $\pm 0.4\%$. INPUT VOLTAGE: Up to 1500 V pk. POWER, average into 50- Ω load: Up to 40 kW, dc to 50 kHz, decreasing as $1/\sqrt{f}$ to 0.1 kW at 10 GHz.

| Length: | ELECTRICAL | DELAY TIME |
|----------|----------------------|------------------------|
| 874-L10L | 10.086 \pm 0.06 cm | 0.3366 \pm 0.0018 ns |
| 874-L20L | 20.096 \pm 0.06 cm | 0.6706 \pm 0.0018 ns |
| 874-L30L | 30.111 \pm 0.06 cm | 1.0047 \pm 0.0018 ns |

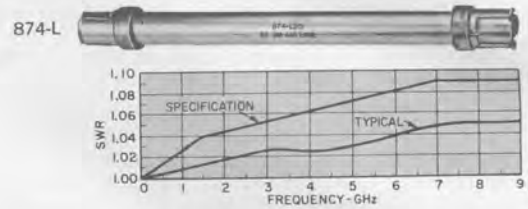

| Description | Catalog Number |
|---|----------------|
| 50-Ω Fixed Rigid Air Lines | |
| 874-L10L, 10 cm, locking GR874 connectors | 0874-9605 |
| 874-L20L, 20 cm, locking GR874 connectors | 0874-9609 |
| 874-L30L, 30 cm, locking GR874 connectors | 0874-9613 |

Constant-Impedance Adjustable Air Lines

Line stretchers with a very low SWR and a uniform characteristic impedance of 50 Ω . Especially useful for eliminating the usual Smith-chart corrections for length of line between unknown and impedance-measuring device. Also useful as impedance-matching transformers and phase-adjustment elements in coaxial systems. Most useful at frequencies above that for which the length of adjustment is a half wavelength.

Frequency: Dc to 7 GHz.

| | 874-LK10L | 874-LK20L |
|-----------------------------|---|---|
| Length of Adjustment | 10 cm | 22 cm |
| HALF WAVELENGTH | at 1.5 GHz | at 680 MHz |
| SWR | < 1.03 at 500 MHz, < 1.06 at 1 GHz, < 1.08 at 1.5 GHz, < 1.10 at 2 GHz | < 1.15 at 3 GHz, < 1.2 at 4 GHz, < 1.25 at 5 GHz |

Electrical: IMPEDANCE: 50 Ω . INPUT VOLTAGE: Up to 1500 V pk. POWER, average into 50- Ω load: Up to 40 kW, dc to 30 kHz, decreasing as $1/\sqrt{f}$ to 0.1 kW at 5 GHz.

Mechanical: LENGTH (min): -LK10L, 14 in. (35 cm); -LK20L, 23 in. (58 cm).



| | |
|---|-----------|
| 50-Ω Constant-Impedance Adjustable Air Lines | |
| 874-LK10L, 10 cm, locking GR874 connectors | 0874-9627 |
| 874-LK20L, 20 cm, locking GR874 connectors | 0874-9631 |

Trombone Constant-Impedance Adjustable Air Line

Used to vary the length of a 50- Ω transmission line between two fixed terminals without moving the terminals or using flexible cables. Consists of two 874-LK20L Adjustable Lines joined at one end by a U-shaped section to form a rigid assembly. Can be plugged into two adjacent GR874 coaxial connectors or inserted in a line by means of two ell's (not included) and installed vertically to save bench space. Low SWR. An excellent phase shifter and variable delay line.

Frequency: Dc to 2 GHz (874-LK10L recommended above 2 GHz).

Length of Adjustment, electrical: 44 cm (half wavelength at 340 MHz).

SWR: < 1.10 to 1 GHz, < 1.25 to 2 GHz.

Electrical: IMPEDANCE: 50 Ω .

Mechanical: LENGTH: 24 to 33 in. (61 to 83 cm). SPACING between centers: 1.1875 in. (30 mm). WEIGHT: 2.5 lb (1.2 kg) net.



| | |
|---|-----------|
| 50-Ω Trombone Constant-Impedance Adjustable Air Line | |
| 874-LTL, 44 cm, locking GR874 connectors | 0874-9645 |

GR874[®] 50-Ohm Coupling Elements

Tee

For connecting stubs and other elements in shunt with a coaxial line.

Electrical: IMPEDANCE: 50 Ω , nominal. INPUT VOLTAGE: Up to 1500 V pk. POWER, average into 50- Ω load: Up to 40 kW, dc to 50 kHz, decreasing as $1/\sqrt{f}$ to 0.1 kW at 10 GHz.

Mechanical: DIMENSIONS: 3.38 in. (86 mm) long x 2.25 in. (57 mm) wide. WEIGHT: 0.4 lb (0.2 kg) net.

National stock numbers are listed at the back of the catalog.



| | |
|-------------------------------------|-----------|
| 50-Ω Tees | |
| 874-T, non-locking GR874 connectors | 0874-9910 |
| 874-TL, locking GR874 connectors | 0874-9911 |

Low-Pass Filters

Recommended for use in impedance- or voltage-measuring systems to reduce harmonics, and especially in systems that contain nonlinear elements or sections that might resonate at a harmonic. Also useful in slotted-line measurements. Uses Chebyshev-type filters that produce a very steep cutoff characteristic at the expense of passband flatness. Spurious responses in the stopband are very small.

Electrical: IMPEDANCE: 50 Ω , nominal. INPUT VOLTAGE: Up to 200 V pk. POWER, average into 50- Ω load; Up to 0.8 kW, dc to 20 MHz, decreasing as $1/\sqrt{f}$ to 0.1 kW at 1 GHz.

Mechanical: LENGTH: -F500L, 10.19 in. (259 mm); -F1000L, 7.13 in. (181 mm); -F2000L, 4.38 in. (111 mm).

| Description | Catalog Number |
|--|----------------|
| 50-Ω Low-Pass Filters | |
| 874-F500L, 500 MHz, locking GR874 connectors | 0874-9537 |
| 874-F1000L, 1 GHz, locking GR874 connectors | 0874-9541 |
| 874-F2000L, 2 GHz, locking GR874 connectors | 0874-9545 |



Typical stop-band response of 874-F500L.

Typical insertion loss and SWR:

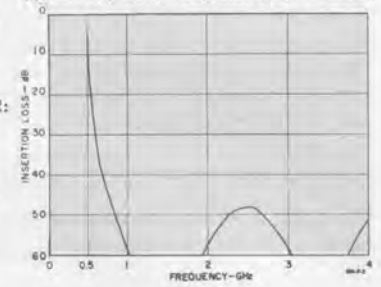
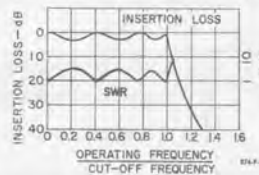

Power Dividers

A coaxial tee with a 16.67- Ω resistor in each leg, connected so the tee is matched at any port when the other two ports are terminated in 50- Ω loads. The match holds throughout the wide frequency range. There is 0° phase difference between the outputs. The use of stable deposited-carbon-film resistors and the linear SWR-frequency relationship make these power dividers particularly valuable for pulse work and in network-analyzer applications.

Frequency: Dc to 7 GHz; to 9 GHz if connectors are locked.
Power Division: Equal within 0.3 dB when symmetrically fed.
Electrical: IMPEDANCE: 50 Ω , nominal. INSERTION LOSS: 6 dB (+2, -0.5 dB), input to each output. INPUT POWER: 2 W max continuous.

Mechanical: DIMENSIONS: 4 in. (102 mm) long x 2.38 in. (50 mm) wide.



| Description | Catalog Number |
|--|----------------|
| 50-Ω Power Dividers | |
| 874-TPD, non-locking GR874 connectors | 0874-9912 |
| 874-TPDL, locking GR874 connectors | 0874-9913 |

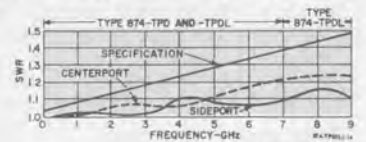

90° Eils

Convenient right-angle line section.
SWR: <1.06 at 2 GHz, <1.15 at 4 GHz.
Electrical: IMPEDANCE: 50 Ω , nominal. ELECTRICAL LENGTH: \approx 7 cm. INPUT VOLTAGE: Up to 1500 V pk. POWER, average into 50- Ω load: Up to 40 kW, dc to 50 kHz, decreasing as $1/\sqrt{f}$ to 0.1 kW at 10 GHz.
Mechanical: DIMENSIONS: 2.25 in. (57 mm) long x 2.25 in. (57 mm) wide.



| | |
|--|-----------|
| 50-Ω 90° Eils | |
| 874-EL, non-locking GR874 connectors | 0874-9526 |
| 874-EL-L, locking GR874 connectors | 0874-9527 |

U-Line Section

A coaxial line section in the shape of a U that is useful in many coaxial setups.
Frequency: Dc to 7 GHz.
Electrical: IMPEDANCE: 50 Ω , nominal.
Mechanical: DIMENSIONS (wxhxd): 2.25x2x0.88 in. (57x51x22 mm). WEIGHT: 0.5 lb (0.3 kg) net.



| | |
|---|-----------|
| 874-U, U-Line Section, non-locking GR874 connectors | 0874-9528 |
|---|-----------|

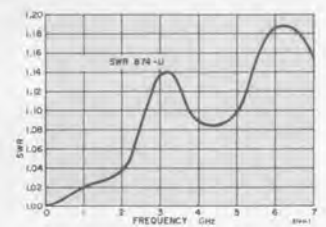

Mixer

A broadband mixer of improved design for use in general applications. It offers wider frequency range, lower SWR, lower-leakage connectors; it requires less local-oscillator power.

Frequency: 10 MHz to 9 GHz. MAX I-F: 60 MHz.
Sensitivity: <6 μ V, typical, input behind 50 Ω will increase output of i-f amplifier (30-MHz i-f, 0.5-MHz bandwidth, 2-dB noise figure) by 3 dB, for mixer current of 0.5 mA.
Input: < 6 mW typically required from local oscillator for 0.2-mA rectified current (signal and L-O source impedances, each 50 Ω).
Electrical: IMPEDANCE: 50 Ω , input; 400 Ω avg//7 pF, output. DIODE: 1N23C.
Mechanical: DIMENSIONS: 4.63 in. (117 mm) long x 2.5 in. (64 mm) wide. WEIGHT: 0.5 lb (0.3 kg) net.

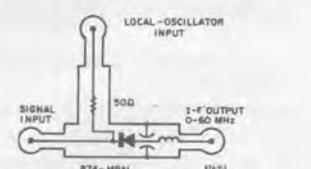
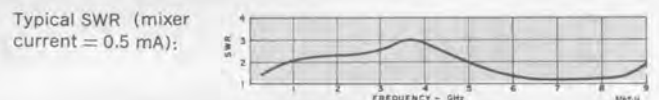

| | |
|--|-----------|
| 874-MRAL Mixer, locking GR874 connectors | 0874-9947 |
|--|-----------|

National stock numbers are listed at the back of the catalog.

Mixer Rectifiers

A broadband rf mixer for use as a heterodyne detector with an i-f amplifier.

Frequency: 40 MHz to 5 GHz, less sensitive at lower and higher frequencies. MAX I-F: 30 MHz.

Sensitivity: < 5 μ V typical (equivalent to \approx 10 μ V behind 50 Ω to increase output of i-f amplifier by 3 dB).

Input: 2 V max required from local oscillator.

Electrical: IMPEDANCE: 50- Ω input, \approx 400- Ω output. DIODE: 1N21B.

Mechanical: DIMENSIONS: 3.75 in. (95 mm) long x 3.5 in. (89 mm) wide.



locking

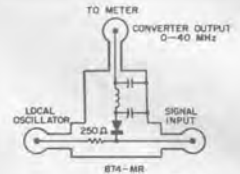

Description

Catalog Number

50- Ω Mixer Rectifiers
874-MRL, locking GR874 connectors

0874-9945

Voltmeter Rectifiers

Used to monitor the voltage in a coaxial system. Similar to 874-VQ but includes a 50- Ω resistor in series with the output-port center conductor. In combination with a signal source and a properly calibrated indicator, it can simulate a 50- Ω generator with known open-circuit voltage and thus be used in an oscillator amplitude-regulating system.

Frequency: 15 MHz to 2.5 GHz when used as a calibrated voltmeter.

Electrical: IMPEDANCE: 50 Ω nominal. INPUT VOLTAGE: 2 V max. BYPASS CAPACITANCE: \approx 300 pF. DIODE: 1N23B.

Mechanical: DIMENSIONS: 3.75 in. (95 mm) long x 2.5 in. (64 mm) wide. WEIGHT: 0.4 lb (0.2 kg) net.



locking

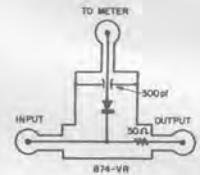

50- Ω Voltmeter Rectifiers
874-VRL, locking GR874 connectors

0874-9943

Voltmeter Detectors

For use as a general-purpose rf-level detector with a dc indicator or as a modulated-signal detector with a sensitive amplifier. It can be inserted into a 50- Ω line without introducing appreciable discontinuity or, with a GR874 50- Ω termination, it can be used as a matched detector to terminate a line.

Frequency: 500 kHz to 2 GHz when used as a matched detector.

SWR: <1.1 at 1 GHz, <1.2 at 2 GHz.

Electrical: IMPEDANCE: 50 Ω , nominal. INPUT VOLTAGE: 2 V max. BYPASS CAPACITANCE: \approx 300 pF. DIODE: 1N23B.

Mechanical: DIMENSIONS: 3.75 in. (95 mm) long x 2.5 in. (64 mm) wide. WEIGHT: 0.4 lb (0.2 kg) net.

Description

Catalog Number

50- Ω Voltmeter Detectors
874-VQL, locking GR874 connectors

0874-9941



locking

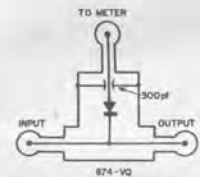

Typical SWR and correction factor.

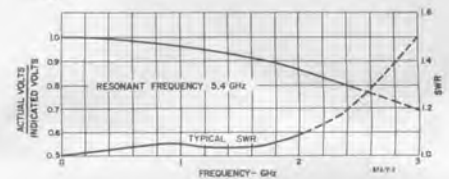

Coupling Capacitors

A short length of coaxial line with a disk capacitor in series with the inner conductor. High frequencies are transmitted with small reflections, but dc and low audio frequencies are blocked.

Frequency: To 4 GHz.

Capacitance: 4700 pF, $-20 + 50\%$, series.

SWR: <1.06 at 1 GHz, <1.15 at 2 GHz, <1.3 from 2 to 4 GHz.

Electrical: IMPEDANCE: 50 Ω , nominal. INPUT VOLTAGE: Up to 500 V pk. POWER, average into 50- Ω load: Up to 5 kW up to 500 kHz, decreasing as $1/\sqrt{f}$ to 0.1 kW at 1 GHz.

Mechanical: LENGTH: 3 in. (76 mm).



non-locking

50- Ω Coupling Capacitors
874-K, non-locking GR874 connectors

0874-9596

Insertion Unit

Small components, pads, vhf transformers, filters, or other networks mounted within the 2-inch long, 9/16-inch diameter space can be conveniently inserted into a 50- Ω coaxial system with minimum leakage and discontinuity.

Electrical: IMPEDANCE: 50 Ω , nominal.

Mechanical: LENGTH: 4.38 in. (111 mm).



874-X Insertion Unit, non-locking GR874 connectors

0874-9990

Coupling Probe

Electrostatic probe consisting of a binding post mounted on a GR874 connector. (Note: A pair of posts is also available, the 874-Q2 Adaptor.)

Electrical: IMPEDANCE: 50 Ω , nominal.

Mechanical: LENGTH: 2.08 in. (53 mm).



874-MB Coupling Probe, non-locking GR874 connector

0874-9666

National stock numbers are listed at the back of the catalog.

Component Mount

A shielded enclosure for convenient mounting of small components to be measured. Use of mount minimizes stray-capacitance variation in impedance measurements of circuit elements. Includes two accessories, an 874-WN3 Short-Circuit Termination and an 874-WO3 Open-Circuit Termination.

Frequency: Dc to 5 GHz.

Electrical: IMPEDANCE: 50 Ω , nominal.

Mechanical: DIAMETER: 3 in. (76 mm). WEIGHT: 0.7 lb (0.4 kg) net.

Description

Catalog Number

874-ML Component Mount, locking GR874 connector

0874-9663



Bias Insertion Unit

Used with slotted lines and the GR 1602-B Admittance Meter for immittance and similar measurements where bias is to be applied to diodes, transistors, and other solid-state devices. It comprises a blocking capacitor in series with the line, an isolating choke, and a low-pass filter.

In slotted-line measurements it is inserted at the source end of the line and therefore introduces no reflections at the measurement terminals.

Dc Current: 2.5 A, max.

Dc Voltage: 400 V, max.

SWR: See curve.

Insertion Loss: Typically, <1.7 dB from 300 MHz to 3 GHz, <0.8 dB from 3 GHz to 5 GHz.

Dimensions: 4 $\frac{3}{8}$ x 3 $\frac{3}{8}$ in. (115 x 99 mm).

Net Weight: 6 $\frac{1}{2}$ oz. (185 g).

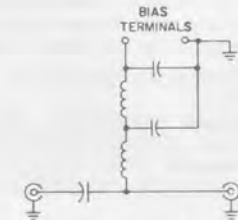
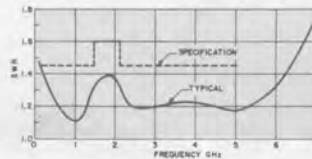

Schematic Diagram of 874-FBL

Description

Catalog Number

Bias Insertion Unit
874-FBL

0874-9759

GR874[®] Patch Cords

50-, 72-, and 75-Ohm Coaxial Patch Cords



874-R20A



874-R22LA



874-R34



874-R33

874-R20 and -R22 These cords (50 Ω or 75 Ω) feature low SWR to 9 GHz and convenient GR874 connectors at each end.

874-R33 This cord (72 Ω) terminates in a pair of banana plugs, one connected to the center conductor and the other to the braid through a 5-in. pigtail. These plugs mate directly with GR 274 and 938 Jacks and 938 Binding Posts. The other end has a GR874 connector.

874-R34 This cord (50 Ω) terminates in a 274-NK Shielded Double Plug. The other end has a GR874 connector.

Electrical Rating: INPUT VOLTAGE: -R20, up to 1000 V pk; -R22, up to 500 V pk. POWER, average into 50- Ω load: -R20, up to 20 kW, dc to 100 kHz, decreasing as $1/\sqrt{f}$ to 0.1 kW at 5 GHz; -R22, up to 5 kW, dc to 500 MHz, decreasing as $1/\sqrt{f}$ to 0.1 kW at 1 GHz.

National stock numbers are listed at the back of the catalog.

102 GR874[®] PATCH CORDS

50- Ω Coaxial Patch Cords, 3 ft long

Low-loss RG-214/U cable, GR874 connectors

874-R20A, non-locking

0874-9680

874-R20LA, locking

0874-9681

General-purpose 874-A3 cable, GR874 connectors

874-R22A, non-locking

0874-9682

874-R22LA, locking

0874-9683

General-purpose RG-58C/U cable

874-R34, with shielded double banana plug

0874-9692

72- Ω Coaxial Patch Cord, 3 ft long

Low-capacitance cable

874-R33, with pair of banana plugs

0874-9690

75- Ω Coaxial Patch Cord, 3 ft long

Low-loss cable, GR874 75- Ω connectors

874-R20 (75 Ω)

0874-9757

General-purpose cable, GR874 75 Ω connectors

874-R22 (75 Ω)

0874-9758

GR874® 75-Ohm Components

New versatility A new series of GR874 general-purpose coaxial components extends the versatility of the line to the field of 75-ohm transmission-line measurements. The series includes matching pads and adaptors to permit direct conversion of existing 50-ohm systems to the 75-ohm capability.

The GR874 75-ohm components use a connector similar to their 50-ohm counterparts except a new inner conductor and insulating bead are used to achieve the 75-ohm characteristic impedance. Although the GR874 50-

ohm and 75-ohm connectors will mate with one another, the combination is not recommended because the inner conductors do not join snugly. A black outer ring is used on the 75- Ω connectors; bright metal, on the 50- Ω ones, ensures distinction.

Frequency response for the new series is specified from dc to 2 GHz although the units are often satisfactory at higher frequencies. Locking connectors are standard in the series; nonlocking 75- Ω connectors are available in OEM quantities.

Basic Connector

For use on rigid 14-mm, air-dielectric, 75- Ω coaxial lines or with capacitance, inductance, and resistance standards.

Frequency: Dc to 2 GHz.

Electrical: IMPEDANCE: 75 Ω , nominal. INPUT: 1.5 kV max, 4 kW max to 1 MHz, 4 kW/ $\sqrt{f_{MHz}}$ max above 1 MHz. LEAKAGE: > 120 dB below signal.

Mechanical: DIMENSIONS: 1.13 in. (29 mm) long x 1.02 in. (26 mm) dia. WEIGHT: 0.2 lb (0.1 kg) net, 1 lb (0.5 kg) shipping.

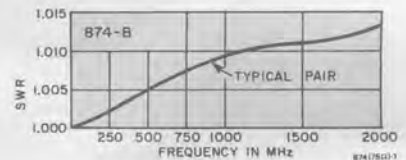

| Description | Catalog Number |
|---------------------------------------|----------------|
| 874-B (75- Ω) Basic Connector | 0874-9730 |

Cable Connectors

For use with flexible cable such as RG-11, RG-59, and RG-187.

Frequency: Dc to 2 GHz.

Electrical: IMPEDANCE: 75 Ω , nominal. INPUT: 1 kV for 0874-9742; 500 V for 0874-9743; 300 V for 0874-9744. LEAKAGE: > 120 dB below signal at GR874 (75 Ω) junction only.

Mechanical: DIMENSIONS: 3.27 in. (83 mm) long x 1.02 in. (26 mm) dia. WEIGHT: 0.2 lb (0.1 kg) net, 1 lb (0.5 kg) shipping.



| Description | Catalog Number |
|---|----------------|
| 75-Ω Cable Connector | |
| 874-C11 (75- Ω), for RG-11 A/U, -12 A/U, -216/U cable | 0874-9742 |
| 874-C59 (75- Ω), for RG-59 B/U, -140/U cable | 0874-9743 |
| 874-C187 (75- Ω), for RG-187 A/U, -179 B/U cable | 0874-9744 |

Panel Connectors

For use on equipment panels.

Frequency: Dc to 2 GHz.

Electrical: IMPEDANCE: 75 Ω , nominal. INPUT: 1 kV for 0874-9745, 500 V for 0874-9746, 300 V for 0874-9747. LEAKAGE: > 120 dB below signal at GR874 (75- Ω) junction only.

Mechanical: DIMENSIONS: 0874-9745 2.08 in. (53 mm) long; 0874-9746 2.23 in. (57 mm) long; 0874-9747 2.53 in. (64 mm) long; ALL 1.06 in. (27 mm) dia. WEIGHT: 0.2 lb (0.1 kg) net, 1 lb (0.5 kg) shipping.



| Description | Catalog Number |
|--|----------------|
| 75-Ω Panel Connector | |
| 874-P11 (75- Ω), for RG-11 A/U, -12A/U, -216/U cable | 0874-9745 |
| 874-P59 (75- Ω), for RG-59 B/U, -140/U cable | 0874-9746 |
| 874-P187 (75- Ω), for RG-187 A/U, -179 B/U cable | 0874-9747 |

Adaptors to BNC

Two adaptors are available; one includes a 75- Ω BNC jack and the other includes a 75- Ω BNC plug. Each uses a locking GR874 (75- Ω) connector on the other end.

Frequency: Dc to 2 GHz.

Electrical: IMPEDANCE: 75 Ω , nominal. INPUT: 500 V max; 3 kW max to 1 MHz, 3 kW/ $\sqrt{f_{MHz}}$ max above 1 MHz.

Mechanical: DIMENSIONS: 0874-9750 1.5 in. (39 mm) long; 0874-9751 1.81 in. (46 mm) long; ALL 1.02 in. (26 mm) dia. WEIGHT: 0.2 lb (0.1 kg) net, 1 lb (0.5 kg) shipping.

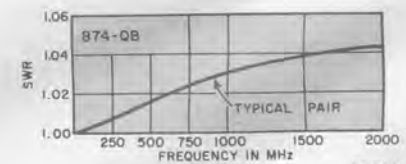

| 75- Ω Adaptors to BNC | Catalog Number |
|--|----------------|
| 874-QBJ (75- Ω), with BNC jack | 0874-9750 |
| 874-QBP (75- Ω), with BNC plug | 0874-9751 |

National stock numbers are listed at the back of the catalog.

Adaptors to Type F

Two adaptors are available; one includes a type F jack and the other includes a type F plug. Each uses a locking GR874 (75- Ω) connector on the other end. Type F jacks are designed for use with 0.023-in. dia. (0.58 mm) wire.

Frequency: Dc to 2 GHz.

Electrical: IMPEDANCE: 75 Ω , nominal.

Mechanical: DIMENSIONS: 0874-9748 2.1 in. (52 mm) long; 0874-9749 1.87 in. (48 mm) long; ALL 1.02 in. (26 mm) dia. WEIGHT: 0.2 lb (0.1 kg) net, 1 lb (0.5 kg) shipping.

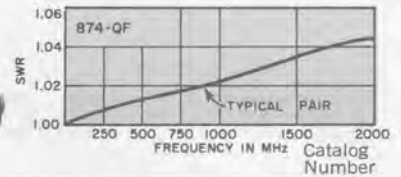

Description

75- Ω Adaptors to F
874-QFJ (75- Ω), with type F jack
874-QFP (75- Ω), with type F plug

0874-9748
0874-9749

Adaptors to Type N

Two adaptors are available; one includes a (75- Ω) type N jack and the other includes a 75- Ω type N plug. Each uses a locking GR874 (75- Ω) connector on the other end.

Frequency: Dc to 2 GHz.

Electrical: IMPEDANCE: 75 Ω , nominal. INPUT: 1 kV max; 4 kW to 1 MHz, 4 kW/ $\sqrt{f_{MHz}}$ max above 1 MHz.

Mechanical: DIMENSIONS: 0874-9754 1.62 in. (41 mm) long; 0874-9755 1.95 in. (50 mm) long; ALL 1.02 in. (26 mm) dia. WEIGHT: 0.2 lb (0.1 kg) net, 1 lb (0.5 kg) shipping.

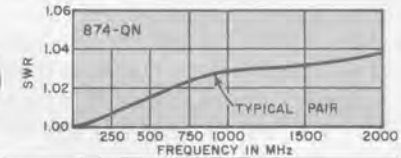

75- Ω Adaptors to N
874-QNJ (75- Ω), with type N jack
874-QNP (75- Ω), with type N plug

0874-9754
0874-9755

Adaptors to Large WE

Two adaptors are available; one includes a large Western Electric jack and the other includes a large Western Electric plug. Each uses a locking GR874 (75- Ω) connector on the other end.

Frequency: Dc to 1 GHz.

Electrical: IMPEDANCE: 75 Ω , nominal.

Mechanical: DIMENSIONS: 0874-9740 3.52 in. (89 mm) long; 0874-9741 3.02 in. (77 mm) long; ALL 1.02 in. (26 mm) dia. WEIGHT: 0.2 lb (0.1 kg) net, 1 lb (0.5 kg) shipping.

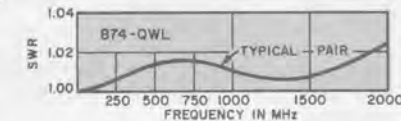

Description

Catalog Number

75- Ω Adaptors to Western Electric, large
874-QWJL (75- Ω), with large WE jack
874-QWPL (75- Ω), with large WE plug

0874-9740
0874-9741

Adaptors to Small WE

Two adaptors are available; one includes a small Western Electric jack and the other includes a small Western Electric plug. Each uses a locking GR874 (75 Ω) connector on the other end.

Frequency: Dc to 1 GHz.

Electrical: IMPEDANCE: 75 Ω , nominal.

Mechanical: DIMENSIONS: 0874-9738 3 in. (76 mm) long; 0874-9739 2.75 in. (70 mm) long; ALL 1.02 in. (26 mm) dia. WEIGHT: 0.2 lb (0.1 kg) net, 1 lb (0.5 kg) shipping.

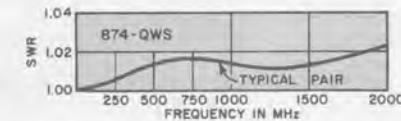

75- Ω Adaptors to Western Electric, small
874-QWJS (75- Ω), with small WE jack
874-QWPS (75- Ω), with small WE plug

0874-9738
0874-9739

Adaptor to GR900 (75 Ω)

Includes a GR900 (75- Ω) connector on one end and a locking GR874 (75- Ω) connector on the other end.

Frequency: Dc to 2 GHz.

Electrical: IMPEDANCE: 75 $\Omega \pm 0.4\%$. INPUT: 1.5 kV max; 4 kW max to 1 MHz, 4 kW/ $\sqrt{f_{MHz}}$ max above 1 MHz. LEAKAGE: > 120 dB below signal.

Mechanical: DIMENSIONS: 2.88 in. (73 mm) long x 1.06 in. (27 mm) dia. WEIGHT: 0.2 lb (0.1 kg) net, 1 lb (0.5 kg) shipping.

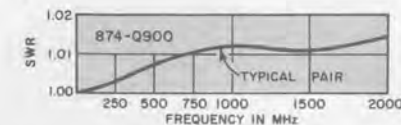

874-Q900 Adaptor, GR874 (75- Ω) to GR900 (75- Ω)

0874-9733

75- to 50-Ohm Matching Pad

A two-port minimum-loss network to match 50-ohm GR874-equipped devices to similarly equipped 75-ohm devices.

Frequency: Dc to 2 GHz.

SWR: 1.05 + 0.12 f_{GHz} for 50- Ω side; 1.05 + 0.08 f_{GHz} for 75- Ω side; also see curve.

Electrical: IMPEDANCE: 50 Ω and 75 Ω . INPUT: 0.5 W max continuous. INSERTION LOSS: 5.72 dB nominal. LEAKAGE: > 120 dB below signal.

Mechanical: DIMENSIONS: 3.5 in. (90 mm) long x 1.02 in. (26 mm) dia. WEIGHT: 0.2 lb (0.1 kg) net, 1 lb (0.5 kg) shipping.



874-MP Matching Pad, 75- Ω to 50- Ω

0874-9736

National stock numbers are listed at the back of the catalog.

Short-Circuit Termination

A fixed short circuit mounted in a locking GR874 (75- Ω) connector for establishing reference conditions in coaxial lines.

Frequency: Dc to 2 GHz.

Plane Position: Short-circuit is effectively 0 to 0.10 cm toward load from face of bead.

Mechanical: DIMENSIONS: 1.19 in. (30 mm) long x 1.02 in. (26 mm) dia. WEIGHT: 0.2 lb (0.1 kg) net, 1 lb (0.5 kg) shipping.

Description

Catalog Number

874-WN (75- Ω) Short-Circuit Termination

0874-9732

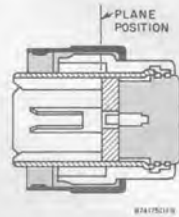

Open-Circuit Termination

A fixed open circuit mounted in a locking GR874 (75- Ω) connector for establishing reference conditions in coaxial lines; also useful as a shielding cap for open-circuited lines.

Frequency: Dc to 2 GHz.

Plane Position: Open-circuit plane is 0 to 0.10 cm toward load from nominal position of face of bead, to match the short-circuit plane in 874-WN Short-Circuit Termination above.

Mechanical: DIMENSIONS: 1.89 in. (30 mm) long x 1.02 in. (26 mm) dia. WEIGHT: 0.2 lb (0.1 kg) net, 1 lb (0.5 kg) shipping.

75-Ohm Termination

A fixed 75- Ω resistor mounted in a locking GR874 (75- Ω) connector for establishing reference conditions in coaxial lines, for impedance matching, and for use as a termination.

Frequency: Dc to 2 GHz.

Dc Resistance: 75 Ω \pm 0.5%. TEMPERATURE COEFFICIENT: < 150 ppm/ $^{\circ}$ C.

SWR: < 1.005 + 0.013 f_{GHz} , to 2 GHz, also see curve.

Electrical: IMPEDANCE: 75 Ω , nominal. INPUT: 1 W with negligible change, 5 W max.

Mechanical: DIMENSIONS: 1.95 in. (50 mm) long x 1.02 in. (26 mm) dia. WEIGHT: 0.2 lb (0.1 kg) net, 1 lb (0.5 kg) shipping.



Description

Catalog Number

874-WO (75- Ω) Open-Circuit Termination

0874-9752

Fixed Attenuators

Single-section, T-type, resistance pads for attenuation, isolation, or matching in 75-ohm coaxial systems.

Frequency: Dc to 2 GHz.

Attenuation: 0874-9731 is 6 \pm 0.5 dB; 0874-9734 is 10 \pm 0.5 dB. TEMPERATURE COEFFICIENT: < 0.0005 dB/ $^{\circ}$ C/dB.

SWR: < 1.05 + 0.05 f_{GHz} , also see curve.

Electrical: IMPEDANCE: 75 Ω , nominal. DC RESISTANCE: 75 Ω \pm 1% when terminated in 75 Ω . DC ATTENUATION: 0874-9731 is 6 \pm 0.1 dB; 0874-9734 is 10 \pm 0.1 dB. INPUT: 0.5 W max continuous cw; 500 W max peak; 0.5 W max average.

Mechanical: DIMENSIONS: 3.5 in. (89 mm) long x 1.02 in. (26 mm) dia. WEIGHT: 0.2 lb (0.1 kg) net, 1 lb (0.5 kg) shipping.

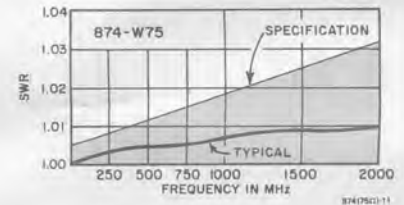

874-W75 (75- Ω) 75- Ω Termination

0874-9737

Air Line

For use as a spacing stub or other element of a coaxial system or as a time-delay element or impedance standard in a time-domain reflectometer.

Frequency: Dc to 2 GHz.

Length: ELECTRICAL: 30.111 \pm 0.06 cm. TIME DELAY: 1.0036 \pm 0.0018 ns.

SWR: < 1.01 + 1.015 f_{GHz} , to 2 GHz, also see curve.

Electrical: IMPEDANCE: 75 Ω \pm 0.4%. INPUT: 1.5 kV max peak; 4 kW max to 1 MHz, 4kW/ $\sqrt{f_{GHz}}$ max above 1 MHz.

Mechanical: DIMENSIONS: 12 in. (305 mm) long x 1.06 in. (27 mm) dia. WEIGHT: 0.4 lb (0.2 kg) net, 2 lb (1 kg) shipping.

874-L30 (75- Ω) Rigid Air line

0874-9735

National stock numbers are listed at the back of the catalog.

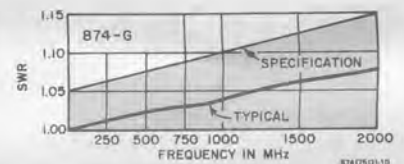

75- Ω Fixed Attenuators

874-G6 (75- Ω), 6-dB attenuation
874-G10 (75- Ω), 10-dB attenuation

0874-9731
0874-9734

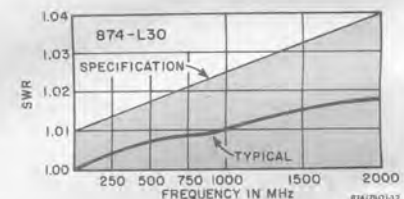

Tools

These tools ensure quick assembly, neat, uniform appearance, and best electrical and mechanical performance of GR874 connectors (50 and 75 Ω).

The 874-TOK Tool Kit consists of an inner-conductor wrench to install the insulating bead and hold the inner conductor, an outer-conductor wrench to install the outer conductor. The other tools are useful for installation of retaining rings.

The 874-T058 or -T08 Crimping Tool assures a neat, fast crimp of the ferrule that clamps the shield braid and outer jacket of the cable to a cable connector.

Crimping Dimensions, across flats of hexagonal crimp: For -T08, 0.389 and 0.411 in. (9.88, 10.45 mm); for -T058, 0.215, 0.250, and 0.375 in. (5.46, 6.35, 9.53 mm).

874-TOK Tool Kit, for all GR874 cable connectors (50, 75 Ω) **0874-9902**

874-T08 Crimping Tool, for GR874(-)8A cable connectors **0874-9900**

874-T058 Crimping Tool, for all other GR874 cable connectors **0874-9901**

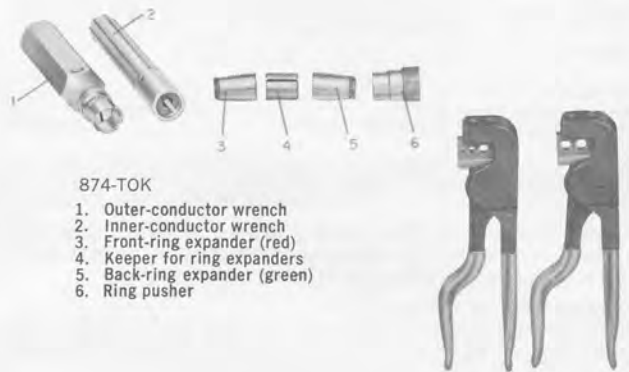

874-TOK

1. Outer-conductor wrench
2. Inner-conductor wrench
3. Front-ring expander (red)
4. Keeper for ring expanders
5. Back-ring expander (green)
6. Ring pusher

874-T058 874-T08

880-DCA Precision Directional Coupler

The 880-DCA is a precision unidirectional 50-ohm coupler with excellent response from 3 GHz to 18 GHz and the highest directivity of any high-frequency, broadband coupler available. Its wide frequency coverage eliminates the need for three, or even four, separate octave couplers with their attendant expense and nuisance in broadband measurements.

Precise tracking of one unit to the next and the lowest SWR of any broadband coupler make the 880-DCA a valuable asset to your reflectometer or network-analysis application. This coupler is also well suited to signal leveling and power or SWR measurements. Altogether, it is a most useful component for your microwave standards lab or new microwave instrumentation.

SPECIFICATIONS

Frequency: 3 to 18 GHz.

Directivity: 34 dB to 8 GHz, 30 dB to 18 GHz; see curve.

SWR (main line): 1.12 to 14 GHz, 1.16 to 18 GHz.

Electrical: IMPEDANCE: 50 Ω . INPUT: Main line 5 kW/ $\sqrt{f_{MHz}}$ max. Auxiliary line, 2 W max. INSERTION LOSS: 0.4 dB max, including coupled power. COUPLING: 18 \pm 2 dB to 18 GHz; see curve. TRACKING (unit to unit): \pm 0.6 dB.

Mechanical: IEEE 7-mm (APC-7) connectors. DIMENSIONS (wxhxd): 5.75x3.3x1.34 in. (146x87x34 mm). WEIGHT: 0.9 lb (0.4 kg) net, 2 lb (1 kg) shipping.

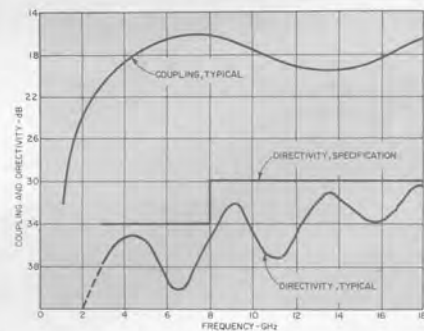

Description

880-DCA Precision Directional Coupler

Catalog Number

0880-9500

National stock numbers are listed at the back of the catalog.

GR900[®] Precision Coaxial Components

The first precision series For many years it was difficult to improve the design of highly accurate high-frequency measuring equipment since any improvements were obscured by connector difficulties. This fact spurred GenRad, with its long experience in coaxial-connector development, to design the first commercial coaxial connector that could honestly be called "precision" — the GR900[®] connector.

A versatile choice The successful development of the GR900[®] connector signaled the initiation of an entire line of precision coaxial components and instruments. These, together with connector kits and precision rod and tubing, can bring GR900 precision to every corner of your laboratory.

Electrical characteristics One of the most important characteristics of a connector is standing-wave ratio and in the GR 900-BT connector $SWR < (1.001 + 0.001 f_{GHz})$. Of ever greater importance in many applications is connector repeatability because this sets the limit of measurement accuracy. The GR 900-BT connector offers repeatability of ± 0.002 dB in insertion loss, $\pm 0.008^\circ$ in insertion phase, and 0.05% in SWR.

Leakage of the GR900 connector is better than 130 dB below signal level — lower than that of any other commonly used coaxial connector. This remarkable characteristic is due to the triple shielding action of the butt contact between outer conductors, the interlocking and overlapping of the centering gear rings, the threaded engagement of the outer locking nut, and the precise machining of the mating surfaces. Insertion loss is extremely small, due to the unique design of the contacts and the use of very low-loss materials — Teflon* for the bead and solid-silver alloys for both inner and outer conductors.

Electrical length of a connector pair is 3.50 cm and is virtually independent of frequency. Dc resistance is typi-

* Registered trademark of the E. I. du Pont de Nemours and Company.

cally $0.4 \text{ m}\Omega$ for the inner conductors and $0.04 \text{ m}\Omega$ for the outer conductors of a mated pair.

The 900-BT connector meets all specifications contained in Part III, Section 1 of the IEEE Standard for Precision Coaxial Connectors, No. 287 and the IEC recommendations contained in IEC publication 457-3.

Mechanical characteristics The spring contact and inner conductor are made of gold-plated solid-silver alloy; the bead support, Teflon; the centering gear ring, stainless steel; the outer conductor, gold-plated coin silver; the retaining ring, phosphor bronze; and the coupling and locking nuts, chrome-plated brass.

When the parts are assembled onto an air line, the coupling nut and retaining ring attach the outer conductor of the connector to the outer conductor of the line. The inner conductor is threaded into the center conductor of the air line and is supported by the Teflon bead.

When two connectors are mated, the centering gear rings interlock and overlap to center the connectors with respect to each other. The interlocking also prevents the connectors from rotating against each other (with possible impairment of repeatability and reliability). The front surfaces of the outer conductors meet at a common reference plane, where they butt firmly together under the pressure of the locking nut.

The front surface of the inner conductor is recessed 0.001 inch with respect to the reference plane of the outer conductor, to ensure outer-conductor contact. Inner-conductor contact is made by a springy center contact assembly that projects slightly beyond the reference plane of the outer conductor until the connector is mated. The spring contact assembly consists of six independently sprung segments that are forced back and together upon mating, thereby making a wiping contact with both the inside of the inner conductor and the mating face of the other center contact. This connector structure is free from the reflections that would be caused by slots in the inner and outer conductors. It will give you exceptionally long life, with excellent repeatability, in part because micro-abrasion of the rubbing surfaces cannot affect the electrically critical conductor diameters.

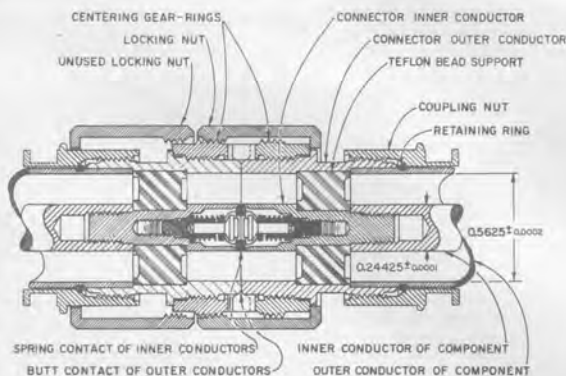

Cross-section view of mated 900-BT Precision Coaxial Connectors.

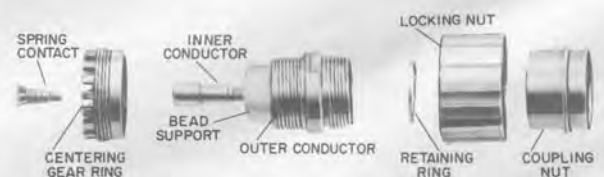

Exploded view of 900-BT Precision Coaxial Connector.

GR900® 50-Ohm Connectors

Basic Precision Connector

For use on rigid, 14-mm, air-dielectric 50-Ω coaxial lines (principal dimensions of 0.5625 in. and 0.24425 in.). 900-BT Connectors are 100% tested at six frequencies. The 900-TOK Tool Kit is recommended for proper assembly.

Frequency: Dc to 8.5 GHz.

SWR: $\leq (1.001 + 0.001 f_{GHz})$ applies to single connectors and pairs.

Repeatability: SWR: Within 0.05%. **INSERTION LOSS:** ± 0.001 dB to 30 MHz, ± 0.002 dB to 1 GHz, ± 0.0025 dB to 8.5 GHz. **PHASE:** Within 0.008° at 1 GHz, 0.015° at 2 GHz, 0.05° at 6 GHz.

Electrical: **IMPEDANCE:** $50 \Omega \pm 0.1\%$ at frequencies where skin depth is negligible. **INPUT VOLTAGE:** Up to 3000 V pk. **POWER** average into 50-Ω load: Up to 20 kW, dc to 1 MHz, decreasing as $1/\sqrt{f}$ at higher f. **INSERTION LOSS:** $< (0.003 \sqrt{f_{GHz}})$ dB per pair. **LEAKAGE:** > 130 dB below signal. **ELECTRICAL LENGTH:** 3.500 ± 0.005 cm per pair; 1.750 ± 0.0025

cm for single connector. **DC CONTACT RESISTANCE:** < 0.07 mΩ for outer conductor, < 0.5 mΩ for inner conductor.

Mechanical: **DIMENSIONS:** 1.19 in. (30 mm) long x 1.06 in. (27 mm) dia. **WEIGHT:** 0.2 lb (0.1 kg) net.

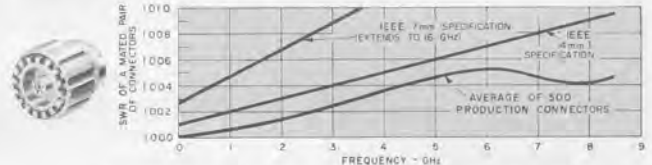

Typical and specified SWR of single and pairs of 900-BT Precision Coaxial Connectors. Specified SWR is identical to that given as IEEE Recommended Practice.

Description

Catalog Number

50-Ω Basic Precision Coaxial Connectors
900-BT, single

0900-9405

Low-Cost Basic Precision Connector

For use on rigid, 14-mm, air-dielectric 50-Ω coaxial lines (principal dimension of 0.5625 in. and 0.24425 in.). The GR890 is a low-cost version of the GR900® precision coaxial connector and is intended for use when the lowest SWR is not required. Below 500 MHz, the difference in SWR, compared with the GR900, is insignificant; above 500 MHz, the SWR specification is somewhat degraded. For example, at 8 GHz the SWR specification is 1.019, compared with 1.009 for the GR900.

The GR 890 connector is generally used at lower frequencies on capacitance, inductance, or resistance standards, and at higher (microwave) frequencies where the SWR of the device is much greater than that of the connector. The other useful properties of the GR900 series, such as repeatability, well-defined reference plane, and low contact resistance, are retained. Grooves in the 890-BT locking nut distinguish the low-cost version from the 900-BT connector, but they mate without restriction.

Frequency: Dc to 8.5 GHz.

SWR: $< (1.003 + 0.002 f_{GHz})$ per connector. For mated connectors, add SWR specs, i.e., double this spec for pair of 890 connectors.

Repeatability: SWR: $\leq \pm 0.0005$ or $\pm 0.05\%$. **INSERTION LOSS:** ± 0.001 dB to 30 MHz, ± 0.002 dB to 1 GHz, ± 0.0025 dB to 8.5 GHz. **PHASE:** $\leq 0.008^\circ$ at 1 GHz, 0.015° at 2 GHz, 0.05° at 6 GHz.

Electrical: **IMPEDANCE:** $50 \Omega \pm 0.3\%$ at frequencies where skin depth is insignificant. **INPUT VOLTAGE:** Up to 3000 V pk. **POWER**, average into 50-Ω load: Up to 20 kW, dc to 1 MHz, decreasing as $1/\sqrt{f}$ at higher f. **INSERTION LOSS:** $< (0.004 \sqrt{f_{GHz}})$ dB per pair. **LEAKAGE:** > 130 dB below signal. **ELECTRICAL LENGTH:** $(3.500 + 0.005 - 0.01)$ cm per pair; $(1.750 + 0.0025 - 0.005)$ cm for single connector. **DC CONTACT RESISTANCE:** < 0.07 mΩ for outer conductor, < 0.5 mΩ for inner conductor.

Mechanical: **DIMENSIONS:** 1.19 in. (30 mm) long x 1.06 in. (27 mm) dia. **WEIGHT:** 0.2 lb (0.1 kg) net.



50-Ω Low-Cost Basic Precision Coaxial Connector
890-BT, single

0890-9405

Cable Precision Connector

For use with more than 12 different RG types of coaxial cable. The SWR of these connectors is much lower than that of even the best-made cables. The braid retention system does not compress the cable, yet it has good pull and torque resistance. The usual distortion and flow of cable dielectric during inner-conductor soldering have been virtually eliminated by means of a Teflon spacer and a special, low-temperature solder supplied with every connector. All inner-conductor parts are captive and supported by a bead.

SWR of connector itself is represented by "ideal section" data (see curves) measured with precision coaxial line in place of cable.

Frequency: Dc to 8.5 GHz.

Electrical: **IMPEDANCE:** 50Ω . **INPUT VOLTAGE:** Up to 1500 V pk. **INSERTION LOSS:** $< (0.006 f_{GHz})$ dB per pair.

National stock numbers are listed at the back of the catalog.

108 GR900® PRECISION CONNECTORS

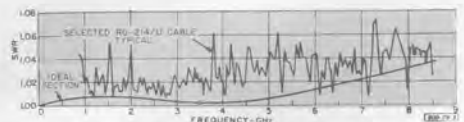

Typical SWR performance of a single Type 900-C9 Connector on an "infinite" length of RG-214/U cable and on an "ideal" section with the same diameters.

50-Ω Coaxial Cable Precision Connector

For RG-9B/U and RG-214/U cable; can be used, with some sacrifice in performance or mechanical reliability, with RG-8/U, -8A/U, -10A/U, -87A/U, -116/U, -156/U, -165/U, -166/U, -213/U, -215/U, -225/U, and -222/U.

900-C9

0900-9421

Panel Mounting Kits

Used to mount standard GR 890 and GR900 connectors on a panel. Kit includes a threaded flange that accepts the outer conductor, mounting hardware, and a gear ring that, for the rotatable version, can be turned to permit any desired angular orientation of the mating connector.

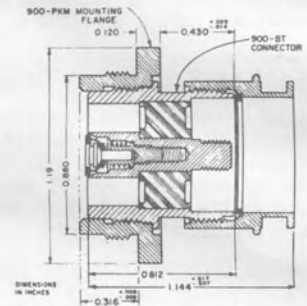

Description

Catalog Number

Panel Mounting Kits
900-PKM, non-rotatable
900-PKMR, rotatable

0900-9498
0900-9500

Rotatable Centering Ring

Permits proper mating with another GR 890 or GR900 connector in any orientation. Threads onto the connector in place of the regular centering gear ring.



Rotatable Centering Ring

0900-9499

Adaptor Flange

To connect GR900 components to instruments (like some bridges) that terminate in a broad plane surface and to a variety of flange-type connectors. This flange threads onto a 900-BT Connector in place of the centering gear ring and locking nut.



Adaptor Flange

0900-9782

GR900® 50-Ohm Adaptors

Conversion plus precision The availability of precision adaptors from the GR900® connectors to other popular coaxial connectors means that the user of GR900 equipped instruments can convert to other series and still retain precision performance. For example, a 900-LB Precision Slotted Line equipped with a 900-QNJ or -QNP adaptor becomes a

type N slotted line with an over-all residual SWR (line plus adaptor) of only 1.02 at 3 GHz. Conversely, users of instruments equipped with SMA, TNC, N, C, and GR874® connectors can, by means of adaptors, take advantage of the precision offered by GR900 tuners, airline standards, terminations, and other elements.

50-Ohm Precision Adaptor Kit

This set consists of the most commonly used GR900 precision adaptors including one each of the jack and plug versions of adaptors to BNC, C, N, SC, SMA, and TNC, as well as adaptors to Amphenol APC-7, and GR874® connectors. All components are supplied in an attractive mahogany storage case with recessed foam inserts.

Mechanical: WEIGHT: 8 lb (3.7 kg) net, 12 lb (5.5 kg) shipping.

| Description | Catalog Number |
|-----------------------------|----------------|
| GR900 Precision Adaptor Set | 0900-9451 |
| GR900 Storage Case | 0900-9450 |



Precision Adaptors to BNC

Two versions: One includes a BNC jack and the other includes a BNC plug. Both use a GR900 precision connector on the other end.

Frequency: Dc to 8.5 GHz.

SWR: $<(1.005 + 0.015 f_{GHz})$ to 1 GHz, $<(1.015 + 0.005 f_{GHz})$ to 8.5 GHz.

Electrical: IMPEDANCE: 50 Ω nominal. INPUT VOLTAGE: Up to 500 V pk. POWER, average into 50- Ω load: Up to 3 kW, dc to 1 MHz, decreasing as $1/\sqrt{f}$ at higher f.

Mechanical: WEIGHT: 0.3 lb (0.2 kg) net; 1.3 lb (0.6 kg) shipping.

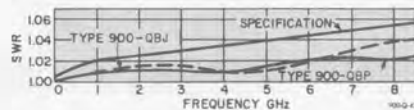

| Description | Catalog Number |
|--|----------------|
| 50- Ω Precision Adaptors to BNC | |
| 900-QBJ, with BNC jack | 0900-9701 |
| 900-QBP, with BNC plug | 0900-9801 |

Precision Adaptors to C

Two versions: One includes a type C jack and the other includes a type C plug. Both use a GR900 precision connector on the other end.

Frequency: Dc to 8.5 GHz.

SWR: $<(1.005 + 0.015 f_{GHz})$ to 1 GHz, $<(0.015 + 0.005 f_{GHz})$ to 8.5 GHz.

Electrical: IMPEDANCE: 50 Ω nominal. INPUT VOLTAGE: Up to 1000 V pk. POWER, average into 50- Ω load: Up to 7 kW, dc to 1 MHz, decreasing as $1/\sqrt{f}$ at higher f.

Mechanical: WEIGHT: 0.3 lb (0.2 kg) net; 1.3 lb (0.6 kg) shipping.

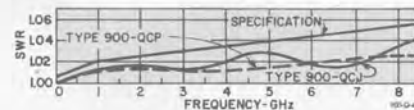

| Description | Catalog Number |
|--------------------------------------|----------------|
| 50- Ω Precision Adaptors to C | |
| 900-QCJ, with C jack | 0900-9703 |
| 900-QCP, with C plug | 0900-9803 |

Precision Adaptors to N

Two versions: One includes a type N jack and the other includes a type N plug. Both use a GR900 precision connector on the other end.

Frequency: Dc to 8.5 GHz.

SWR: $<(1.004 + 0.004 f_{GHz})$ to 8.5 GHz.

Electrical: IMPEDANCE: 50 Ω nominal. INPUT VOLTAGE: Up to 1000 V pk. POWER, average into 50- Ω load: Up to 7 kW, dc to 1 MHz, decreasing as $1/\sqrt{f}$ at higher f.

Mechanical: WEIGHT: 0.3 lb (0.2 kg) net; 1.3 lb (0.6 kg) shipping.

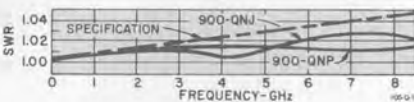

| Description | Catalog Number |
|--------------------------------------|----------------|
| 50- Ω Precision Adaptors to N | |
| 900-QNJ, with N jack | 0900-9711 |
| 900-QNP, with N plug | 0900-9811 |

National stock numbers are listed at the back of the catalog.

Precision Adaptors to TNC

Two versions: One includes a TNC jack and the other includes a TNC plug. Both use a GR900 precision connector on the other end.

Frequency: Dc to 8.5 GHz.

SWR: $<(1.005 + 0.015 f_{GHz})$ to 1 GHz, $<(1.015 + 0.005 f_{GHz})$ to 8.5 GHz.

Electrical: IMPEDANCE: 50 Ω nominal. INPUT VOLTAGE: Up to 500 V pk. POWER, average into 50- Ω load: Up to 3 kW, dc to 1 MHz, decreasing as $1/\sqrt{f}$ at higher f.

Mechanical: WEIGHT: 0.3 lb (0.2 kg) net; 1.3 lb (0.6 kg) shipping.

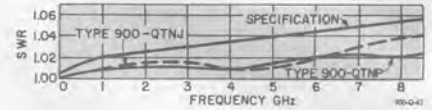

Description

Catalog Number

50- Ω Precision Adaptors to TNC
900-QTNJ, with TNC jack
900-QTNP, with TNC plug

0900-9717
0900-9817

Precision Adaptors to SMA

Two versions: One includes an SMA jack and the other includes an SMA plug. Both use a GR900 precision connector on the other end.

Frequency: Dc to 8.5 GHz.

SWR: $<(1.005 + 0.025 f_{GHz})$ to 1 GHz, $<(1.022 + 0.008 f_{GHz})$ to 8.5 GHz.

Electrical: IMPEDANCE: 50 Ω nominal.

Mechanical: WEIGHT: 0.3 lb (0.2 kg) net; 1.3 lb (0.6 kg) ship.

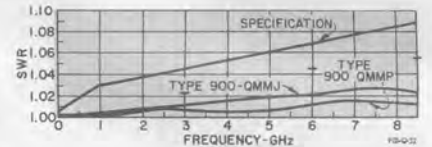

50- Ω Precision Adaptors to SMA
900-QMMJ, with SMA jack
900-QMMP, with SMA plug

0900-9723
0900-9823

Precision Adaptors to SC

Two versions: One includes an SC jack and the other includes an SC plug. Both use a GR900 precision connector on the other end.

Frequency: Dc to 8.5 GHz.

SWR: $<(1.005 + 0.015 f_{GHz})$ to 1 GHz, $<(1.015 + 0.005 f_{GHz})$ to 8.5 GHz.

Electrical: IMPEDANCE: 50 Ω nominal. INPUT VOLTAGE: Up to 1000 V pk. POWER, average into 50- Ω load: Up to 7 kW, dc to 1 MHz, decreasing as $1/\sqrt{f}$ at higher f.

Mechanical: WEIGHT: 0.3 lb (0.2 kg) net; 1.3 lb (0.6 kg) ship.

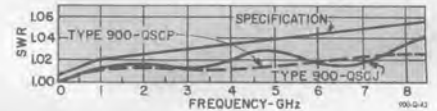

50- Ω Precision Adaptors to SC
900-QSCJ, with SC jack
900-QSCP, with SC plug

0900-9713
0900-9813

Precision Adaptors to 7-mm Precision

Includes an Amphenol APC-7 7-mm connector on one end and a GR900 precision connector on the other.

Frequency: Dc to 8.5 GHz.

SWR: $<(1.003 + 0.003 f_{GHz})$ to 8.5 GHz.

Electrical: IMPEDANCE: 50 Ω nominal. INPUT VOLTAGE: Up to 1000 V pk. POWER, average into 50- Ω load: Up to 6 kW, dc to 1 MHz, decreasing as $1/\sqrt{f}$ at higher f. ELECTRICAL LENGTH: 5.30 ± 0.02 cm.

Mechanical: WEIGHT: 0.3 lb (0.2 kg) net; 1.3 lb (0.6 kg) ship.

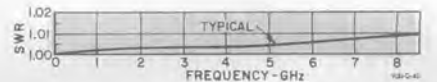

50- Ω Precision Adaptor to 7-mm Precision
900-QAP7, with APC-7 connector

0900-9791

Precision Adaptor to GR874® Connector

Includes a locking GR874 connector on one end and a GR900 precision connector on the other end.

Frequency: Dc to 8.5 GHz.

SWR: $<(1.00 + 0.015 f_{GHz})$ to 1 GHz, $<(1.010 + 0.005 f_{GHz})$ to 8.5 GHz.

Electrical: IMPEDANCE: 50 Ω nominal. INPUT VOLTAGE: Up to 1500 V pk. POWER, average into 50- Ω load: Up to 10 kW, dc to 1 MHz, decreasing as $1/\sqrt{f}$ at higher f.



50- Ω Precision Adaptor to GR874
900-Q874, with locking GR874 connector

0900-9883

Precision Adaptor to Binding Posts

One convertible version: Adapts binding posts (spaced on 0.75- to 1-in. centers) to GR900 connector and (after a simple mechanical modification) adapts GR900 connector to binding posts. Particularly useful for converting "unknown" terminals of bridges.

Electrical: RESIDUAL IMPEDANCE: When binding posts are adapted to GR900, ≈ 3.55 pF and ≈ 4.8 nH are added to terminals. When GR900 is adapted to binding posts, ≈ 5.2 pF

and ≈ 11 nH are added at base and ≈ 20 nH at top of binding posts.

Mechanical: WEIGHT: 0.3 lb (0.2 kg) net; 1.3 lb (0.6 kg) ship.



50- Ω Precision Adaptor to Binding Posts
900-Q9

0900-9874

National stock numbers are listed at the back of the catalog.

GR900[®] 50-Ohm Precision Terminations and Attenuators

Precision Resistive Terminations and Mismatches

Standard terminations are useful for calibration of bridges, slotted lines, admittance bridges, network analyzers, and reflectometers. The 50-ohm 900-W50 termination can also be used as a precision dummy load or as a termination in measurements of networks with more than one port. This termination, together with the 900-WNC Short Circuit and 900-LZ Air Lines, can form a calibration set for computer correction of measuring instruments. With an appropriate GR900 adaptor, it can be used as a low-SWR, precision type-N termination, or BNC, or C, etc.

Standard mismatches introduce reflections of known SWR in a 50-ohm transmission line and are therefore useful in the calibration of reflectometers, network analyzers, and SWR-measuring instruments.



Frequency: Dc to 8.5 GHz.

| | 900 | -W50 | -W100 | -W110 | -W120 | -W150 |
|------------------------------|--------------------------------|----------|---------|---------|---------|-------|
| Dc | | | | | | |
| Resistance: | 50 Ω | 100 Ω | 45.45 Ω | 41.67 Ω | 33.33 Ω | |
| Accuracy: | ±0.3% | ±0.5% | ±0.5% | ±0.5% | ±0.5% | |
| SWR, also see curves: | 1.005 ± 0.005 f _{GHz} | — | 1.1 nom | 1.2 nom | 1.5 nom | |
| Plane Position*: | — | 4 cm nom | — | — | — | |

Electrical: INPUT POWER: <1 W with negligible change, <5 W without damage. TEMPERATURE COEFFICIENT: <150 ppm/°C.

Mechanical: DIMENSIONS: 2 in. (51 mm) long x 1.06 in. (27 mm) dia. WEIGHT: 0.2 lb (0.1 kg) net.

| Description | Catalog Number |
|---|----------------|
| Precision Resistive Terminations | |
| 900-W50 50-Ω Standard Termination | 0900-9953 |
| 900-W100 100-Ω Standard Termination | 0900-9957 |
| Precision Mismatches: | |
| 900-WR110 Standard Mismatch, SWR 1.1 | 0900-9961 |
| 900-WR120 Standard Mismatch, SWR 1.2 | 0900-9963 |
| 900-WR150 Standard Mismatch, SWR 1.5 | 0900-9965 |

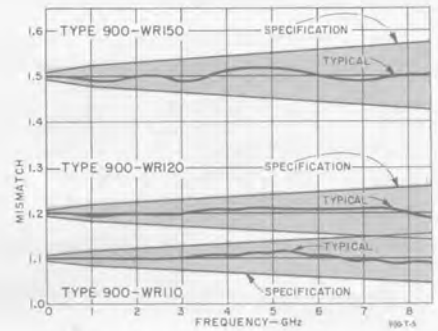
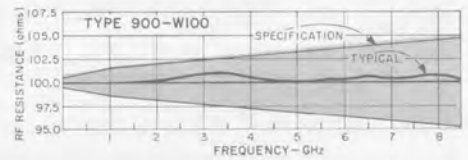
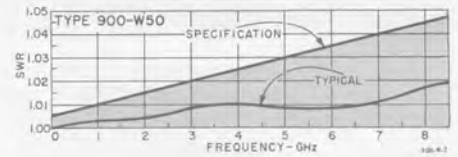

Open-Circuit Terminations

Open-circuit terminations are useful in establishing initial conditions of line length and signal phase, as shielding caps for open-circuited lines, and, at low frequencies, as capacitance standards.

Frequency: Dc to 8.5 GHz.

Plane Position*: For 900-W0, typically 0.26 cm, but varies with frequency within ± 0.012 cm of value shown on graph. For -W04, 4.00 ± 0.01 cm (corresponds to 4-cm offset in 900-W100 and -W200 Standard Terminations).

Electrical: CAPACITANCE: 0.172 ± 0.008 pF for -W0, at low frequencies; 2.670 pF ± 0.25% for -W04, below 70 MHz.



900-W04



900-W0

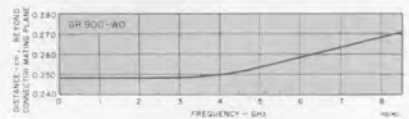
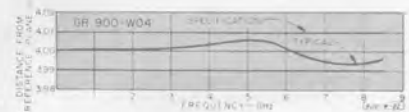

| Precision Open-Circuit Terminations | Catalog Number |
|-------------------------------------|----------------|
| 900-W0, plane at 2.6 mm | 0900-9981 |
| 900-W04, plane at 4 cm | 0900-9985 |

* Location of effective position of termination, measured toward "load", from reference plane of connector (where outer conductors butt together).

National stock numbers are listed at the back of the catalog.

Precision Short-Circuit Terminations

Short-circuit terminations are useful in establishing initial conditions of line length and signal phase in, for example, impedance measurements. An s-c termination consists of a precision-machined, silver-plated disk, mounted in a centering gear ring and locking-nut assembly, to produce a fixed short circuit. The 900-WNC, -WNE, and -WN4 each includes a support for one end of the inner conductor of a 900-LZ Reference Air Line, which is beadless.

Frequency: Dc to 8.5 GHz.

Plane Position:* For 900-WN and -WNC, 0.00 cm; for 900-WNE, 0.26 ± 0.005 cm (corresponding open circuit is 900-WO); for 900-WN4, 4.00 ± 0.01 cm (corresponding resistive terminations are 900-W100 and -W200).

Reflection Coefficients: >0.999 for -WN and -WNC, >0.998 for -WNE, >0.996 for -WN4; all to 8.5 GHz.



900-WN



900-WNE



900-WNC



900-WN4

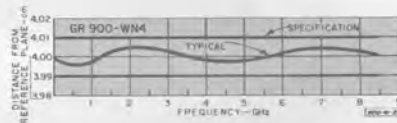

Description

Catalog Number

50-Ω Precision Short-Circuit Terminations

900-WN, without support, plane at 0.00 cm
900-WNC, with support, plane at 0.00 cm
900-WNE, with support, plane at 2.6 mm
900-WN4, with support, plane at 4 cm

0900-9971
0900-9977
0900-9979
0900-9975

Precision Tuner

Used to match out small residual reflections in low-SWR measuring instruments and devices. The tuner has three smoothly adjustable tuning screws that are used in pairs to tune out reflections of any phase throughout the tuner's frequency range. Each screw has a "neutral" setting, independent of frequency, at which it is effectively out of the circuit. Screws can be locked at any setting to enhance the excellent SWR resetability and to protect against accidental disturbance. They can be partially clamped for the desired friction.

Frequency: 1 to 8.5 GHz.

SWR Matching Range: 1.00 to $1.00 + 0.012 f_{GHz}$, worst-case minimum. **RESETABILITY:** $<(1.0005 + 0.0003 f_{GHz})$.

Repeatability: 0.05% (limited by connector).

Electrical: IMPEDANCE: 50 Ω nominal. **INSERTION LOSS:** <0.1 dB to 4 GHz, <0.3 dB to 8.5 GHz. **ELECTRICAL LENGTH:** 12.0 cm.

Mechanical: DIMENSIONS: 4.5x3.5x1 in. (114x89x25mm). **WEIGHT:** 1 lb (0.5 kg) net, 3 lb (1.4 kg) shipping.

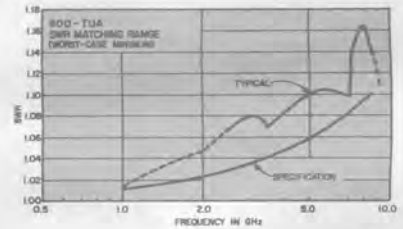
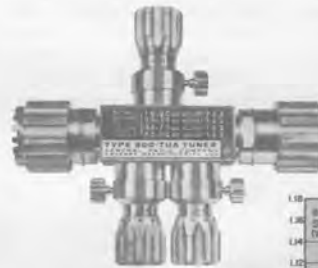

900-TUA Tuner

0900-9635

Precision Fixed Attenuators

GR900 attenuators permit greatly improved accuracy in the measurement of insertion loss, impedance, power, or phase, which requires precise impedance matching of the source and detector. In particular, they are ideal for swept measurements of these quantities. In point-by-point measurements, they reduce or eliminate the need to tune out residual reflections from source or detector.

The SWR characteristic of these attenuators is much lower than was previously available, and they exhibit uniform attenuation over a wide frequency range. They display a high degree of repeatability in SWR, contact resistance, and insertion loss, factors that contribute to their value in substitution measurements. The high repeatability and low SWR also permit them to be accurately calibrated for use as attenuation standards.

Frequency: Dc to 8.5 GHz.

Attenuation Accuracy: ± 0.04 dB at dc, ± 0.2 dB to 5 GHz, ± 0.3 dB to 8.5 GHz. **TEMPERATURE COEFFICIENT:** <0.0001 dB/°C/dB.

SWR: <1.01 to 1 GHz, $<(1.00 + 0.01 f_{GHz})$ above 1 GHz.

Electrical: IMPEDANCE: 50.0 Ω. **INPUT POWER:** <1 W continuous, or <500 W peak with <1 W average. **DC RESISTANCE:** $50.0 \Omega \pm 0.3\%$ when terminated in 50.0 Ω.

Mechanical: DIMENSIONS: 3.75 in. (95 mm) long. **WEIGHT:** 0.7 lb (0.4 kg) net.



Description

Catalog Number

50-Ω Precision Fixed Attenuators:
900-G6, 6 dB
900-G10, 10 dB

0900-9850
0900-9851

* Location of effective position of termination, measured toward "load", from reference plane of connector (where outer conductors butt together).

National stock numbers are listed at the back of the catalog.

GR900® 50-Ohm Precision Air Lines

Reference-Air-Line Set

This set consists of one each of the seven lengths of 900-LZ Reference Air Lines, a 900-WN4 short circuit, and a 900-WO4 open circuit. All components are supplied in an attractive mahogany storage case, with recessed foam insets, which also can be supplied separately.

Mechanical: WEIGHT: 8 lb (3.7 kg) net, 13 lb (6 kg) shipping.

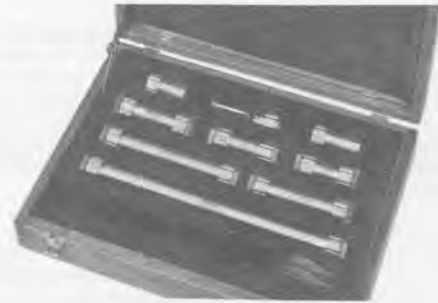

| Description | Catalog Number |
|------------------------------|----------------|
| GR900 Reference-Air-Line Set | 0900-9452 |

Reference Air Lines



For use in calibrations, especially in substitution measurements, as precision capacitance or time-delay standards, as well defined reactance standards, as dielectric sample holders for dielectric-constant and loss measurements with slotted lines and network analyzers, and as absolute impedance references in time-domain reflectometry. The 900-LZ series are beadless, virtually reflectionless coaxial air lines, with spring-loaded supporting tips on the ends of the inner conductor to mate with GR900 connectors; microfinished outer-conductor ends make butt contact with the mating connectors.

Frequency: Dc to 8.5 GHz.

SWR: $<(1.0005 + 0.0002 f_{GHz})$; calibration data supplied.

Repeatability: SWR: Within $(0.010 + 0.003 f_{GHz})\%$.

Electrical: IMPEDANCE: $50 \Omega \pm 0.05\%$ at 23°C and where skin depth is negligible. Additional skin-effect error is calculable. INPUT VOLTAGE: Up to 3000 V pk. POWER, average into 50- Ω load: Up to 20 kW, dc to 1 MHz, decreasing as

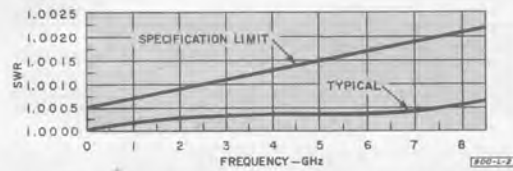

$1/\sqrt{f}$ at higher f. INSERTION LOSS: $<(0.0008 \sqrt{f_{GHz}})$ dB/cm. LEAKAGE: >130 dB below signal. DC CONTACT RESISTANCE each end, when mated with GR900 connector: <0.07 m Ω for outer conductor, <0.5 m Ω for inner conductor.

50- Ω Reference Air Lines

| Type | Electrical Length (± 0.002 cm) cm | Capacitance ($\pm 0.07\%$) pF | Time Delay (± 0.1 ps) ps | Odd $\lambda/4$ Frequencies* GHz | Catalog Number |
|----------|--|---------------------------------------|-------------------------------------|--|----------------|
| 900-LZ3 | 2.998 | 2.0000 | 100.0 | (2n+1) 2.50 | 0900-9603 |
| 900-LZ5 | 4.997 | 3.3333 | 166.7 | (2n+1) 1.50 | 0900-9600 |
| 900-LZ6 | 5.996 | 4.0000 | 200.0 | (2n+1) 1.25 | 0900-9601 |
| 900-LZ7H | 7.495 | 5.0000 | 250.0 | (2n+1) 1.00 | 0900-9602 |
| 900-LZ10 | 9.993 | 6.6667 | 333.3 | (2n+1) 0.75 | 0900-9604 |
| 900-LZ15 | 14.990 | 10.0000 | 500.0 | (2n+1) 0.50 | 0900-9606 |
| 900-LZ30 | 29.979 | 20.0000 | 1000.0 | (2n+1) 0.25 | 0900-9612 |

* Frequencies at which air-line section is an odd multiple of a quarter wavelength, where n is zero or any integer.

Precision Air Lines



Useful as low-SWR line extenders, as 50-ohm impedance standards at frequencies at which the electrical length is an odd multiple of a quarter wavelength, as capacitance and time-delay standards, and as absolute impedance standards in time-domain reflectometry. Each line consists of a short section of precision 50-ohm air line with a GR900 connector at each end.

Frequency: Dc to 8.5 GHz.

SWR: $<(1.0013 + 0.0013 f_{GHz})$.

Electrical: IMPEDANCE: $50 \Omega \pm 0.065\%$. Additional skin-effect error is calculable. INPUT VOLTAGE: Up to 3000 V pk. POWER, average into 50- Ω load: Up to 20 kW, dc to 1 MHz, decreasing as $1/\sqrt{f}$ at higher f. DC CONTACT RE-

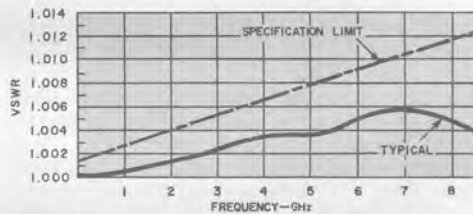

SISTANCE each end, when mated with GR900 connector: <0.07 m Ω for outer conductor, <0.5 m Ω for inner conductor.

50- Ω Precision Air Lines

| Type | Electrical Length (± 0.02 cm) cm | Capacitance pF | Time Delay (± 1 ps) ps | Insertion Loss dB | Catalog Number |
|---------|---|-------------------|-----------------------------------|-------------------------|----------------|
| 900-L10 | 10 | 6.6667 | 333 | $<0.012 \sqrt{f_{GHz}}$ | 0900-9605 |
| 900-L30 | 30 | 20.000 | 1000 | $<0.028 \sqrt{f_{GHz}}$ | 0900-9613 |

¹ J. Zorzy, "Skin-Effect Corrections in Standards," *IEEE Transactions on Instrumentation and Measurement*, Vol. IM-15 No. 4, December 1966, p. 358

National stock numbers are listed at the back of the catalog.

GR900® 75-Ohm Components

New versatility. A new series of GR900® general-purpose coaxial components extends the versatility of the line to the field of 75-ohm transmission-line measurements. The series includes matching pads and adaptors to permit direct conversion of existing 50-ohm systems to the 75-ohm capability.

The GR900 75-ohm components use a connector similar to the 50-ohm counterpart except for an identifying black coupling nut and modified inner conductor and insulating bead. Performance for the new components is specified up to 1 GHz but they are useful to 8.5 GHz or higher.

Basic Precision Connector

For use on rigid, 14-mm, air-dielectric, 75-Ω coaxial lines or with capacitance, inductance, and resistance standards.

Frequency: Dc to 1 GHz, usable to 9 GHz.

SWR: $<(1.0015 + 0.0015 f_{GHz})$.

Repeatability: SWR: ± 0.0006 ($\pm 0.06\%$). INSERTION LOSS: ± 0.001 dB to 30 MHz, ± 0.002 dB to 1 GHz. PHASE: 0.01° at 1 GHz.

Electrical: IMPEDANCE: $75 \Omega \pm 0.3\%$. INPUT VOLTAGE: Up to 3000 V pk. POWER, average into matched load: Up to 18 kW, dc to 1 MHz, decreasing as $1/\sqrt{f}$ at higher f. INSERTION LOSS: $< 0.004 \sqrt{f_{GHz}}$ per pair. LEAKAGE: > 130 dB below signal. ELECTRICAL LENGTH: Nom 1.75 cm (3.5 cm, mated pair); exactly 1.7488 ± 0.0038 cm (3.4976 ± 0.0076 cm). DC CONTACT RESISTANCE: < 0.07 mΩ for outer conductor, < 0.5 mΩ for inner conductor.

Mechanical: DIMENSIONS: 1.19 in. (30 mm) long x 1.06 in. (27 mm) dia. WEIGHT: 0.2 lb (0.1 kg) net, 1 lb (0.5 kg) shipping.



| Description | Catalog Number |
|---|----------------|
| 900-BT (75-Ω) Precision Coaxial Connector | 0900-9730 |

75- to 50-Ohm Precision Matching Pad

A two-port minimum-loss network to match 50-ohm GR900-equipped devices to similarly equipped 75-ohm devices. It features low SWR, low leakage, and the excellent repeatability inherent in GR900 connectors.

Frequency: Dc to 1 GHz, usable to 8.5 GHz.

SWR: Better than $1.003 + 0.003 f_{GHz}$ for 50-Ω side, $1.01 + 0.012 f_{GHz}$ for 75-Ω side.

Electrical: IMPEDANCE: 50 Ω and 75 Ω. INPUT: 1 W max continuous. INSERTION LOSS: 5.72 dB nominal. LEAKAGE: > 130 dB below signal.

Mechanical: DIMENSIONS: 3.75 in. (95 mm) long x 1.06 in. (27 mm) dia. WEIGHT: 0.6 lb (0.3 kg) net, 2 lb (1 kg) shipping.



| | |
|--|-----------|
| 900-MP 50 to 75-Ω Precision Matching Pad | 0900-9732 |
|--|-----------|

Precision 75-Ohm Termination

A fixed 75-Ω resistor mounted in a GR900 (75 Ω) connector for establishing reference conditions in coaxial lines, for impedance matching, for use as a termination, for the calibration of bridges, slotted lines, and reflectometers, and for use as a dummy load in network measurements.

Frequency: Dc to 1 GHz, usable to 9 GHz.

SWR: $<(1.005 + 0.005 f_{GHz})$.

Electrical: IMPEDANCE: $75 \Omega \pm 0.3\%$, temperature coefficient < 150 ppm/°C. INPUT: 1 W with negligible change, 5 W without damage.

Mechanical: DIMENSIONS: 1.83 in. (47 mm) long x 1.06 in. (27 mm) dia. WEIGHT: 0.2 lb (0.1 kg) net, 1 lb (0.5 kg) shipping.



| | |
|---|-----------|
| 900-W75 (75-Ω) Precision Standard Termination | 0900-9733 |
|---|-----------|

National stock numbers are listed at the back of the catalog.

GR900® Miscellany

50-Ohm Precision 90° EII

Permits coaxial devices, such as vertical liquid-dielectric sample holders, to be physically oriented as required, with better electrical performance than could be obtained with flexible cable.

Frequency: Dc to 8.5 GHz.

SWR: $<(1.004 + 0.004 f_{GHz})$.

Electrical: IMPEDANCE: $50 \Omega \pm 0.4\%$ at frequencies where skin depth is small. INPUT VOLTAGE: Up to 1500 V pk. POWER, average into 50- Ω load: Up to 10 kW, dc to 1 MHz, decreasing as $1/\sqrt{f}$ at higher f. INSERTION LOSS: $(0.017 \sqrt{f_{GHz}})$ dB. ELECTRICAL LENGTH: $[10.00 + 0.0014 (f_{GHz})^2 \pm 0.02]$ cm.

Mechanical: Gear rings rotatable, for proper mating in any orientation. MATING DIMENSIONS: 2.066 in. (5.246 mm) from center line of one connector to reference plane of other connector. OVER-ALL DIMENSIONS: 2.69x2.69x0.88 in. (68x68x22 mm). WEIGHT: 0.7 lb (0.3 kg) net.

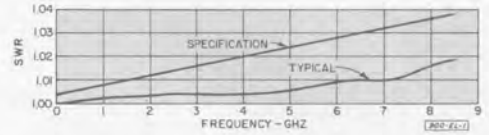

Description

900-EL Precision 90° EII

Catalog Number

0900-9527

Tool Kit

Nine-piece tool kit in fitted case for convenient installation of 890-BT, 900-BT, and 900-C9 50-ohm precision coaxial connectors. With 0900-9904 accessory tools, the kit can also be used for 900-BT (75 Ω) connectors. Complete instructions are included.

Mechanical: WEIGHT: 7 lb (3.2 kg) shipping.

Description

900-TOK Tool Kit

Accessory Tools, for use with 900-TOK on 900-BT (75 Ω) connectors

Catalog Number

0900-9902

0900-9904



Storage Case and Cleaning Kit

Storage Case

An attractive mahogany case with firm, foamed plastic inserts having molded recesses designed to hold various types of GR900® precision coaxial components. An excellent way to keep together a set of adaptors, air lines, terminations, and the like and to carry or store them with minimum exposure to dirt or damage to the precision machined surfaces.

Mechanical: WEIGHT: 8 lb (3.7 kg) shipping.

Cleaning Kit

For cleaning both 50-ohm and 75-ohm GR900 connectors. Solvent supplied in 16-oz aerosol will not affect insulator nor any metal surface in these connectors. Kit also includes two brushes and 24 lint-free wiping pads.

GR900 Storage Case

900-TOC Cleaning Kit

0900-9450

0900-9610



Precision Tube and Rod

Used to fabricate custom-length 14-mm air lines and components in conjunction with GR900 connectors and connector kits. Machining instructions are furnished.

Precision Outer-Conductor Tube

Mechanical: Precision-forged, silver-lined brass; stress relieved to minimize dimensional changes during machining; for use with 890-BT, 900-BT, and -BT (75 Ω) connectors. DIMENSIONS (diameters specified at 23°C): 27 in. (690 mm) long, 0.830 in. nominal OD, 0.5625 in. $\pm 220 \mu\text{in.}$ ID with straightness of 0.005 in./ft and inner-surface finish of 30 $\mu\text{in.}$ max, 0.134 in. nominal wall thickness.

50- Ω Precision Inner-Conductor Rod

Electrical: IMPEDANCE: $50 \pm 0.035 \Omega$ ($\pm 0.07\%$) when centered in 0900-9509 tube.

National stock numbers are listed at the back of the catalog.

116 GR900® PRECISION COAXIAL COMPONENTS

Mechanical: Supplied in pairs; centerless-ground, silver-layered brass rod; for use with 890-BT and 900-BT connectors. DIMENSIONS (diameters specified at 23°C): 13 ± 0.0312 in. (330 mm) long with straightness of 0.0015 in./ft; 0.24425 in. $\pm 65 \mu\text{in.}$ dia with uniformity of $\pm 25 \mu\text{in.}$ and surface finish of 20 $\mu\text{in.}$ max.



Precision Outer-Conductor Tube
50- Ω Precision Inner-Conductor Rod

0900-9509
0900-9507

Signal Sources

Synthesizers
High-Frequency Oscillators
and Power Supplies
Low-Frequency Oscillators

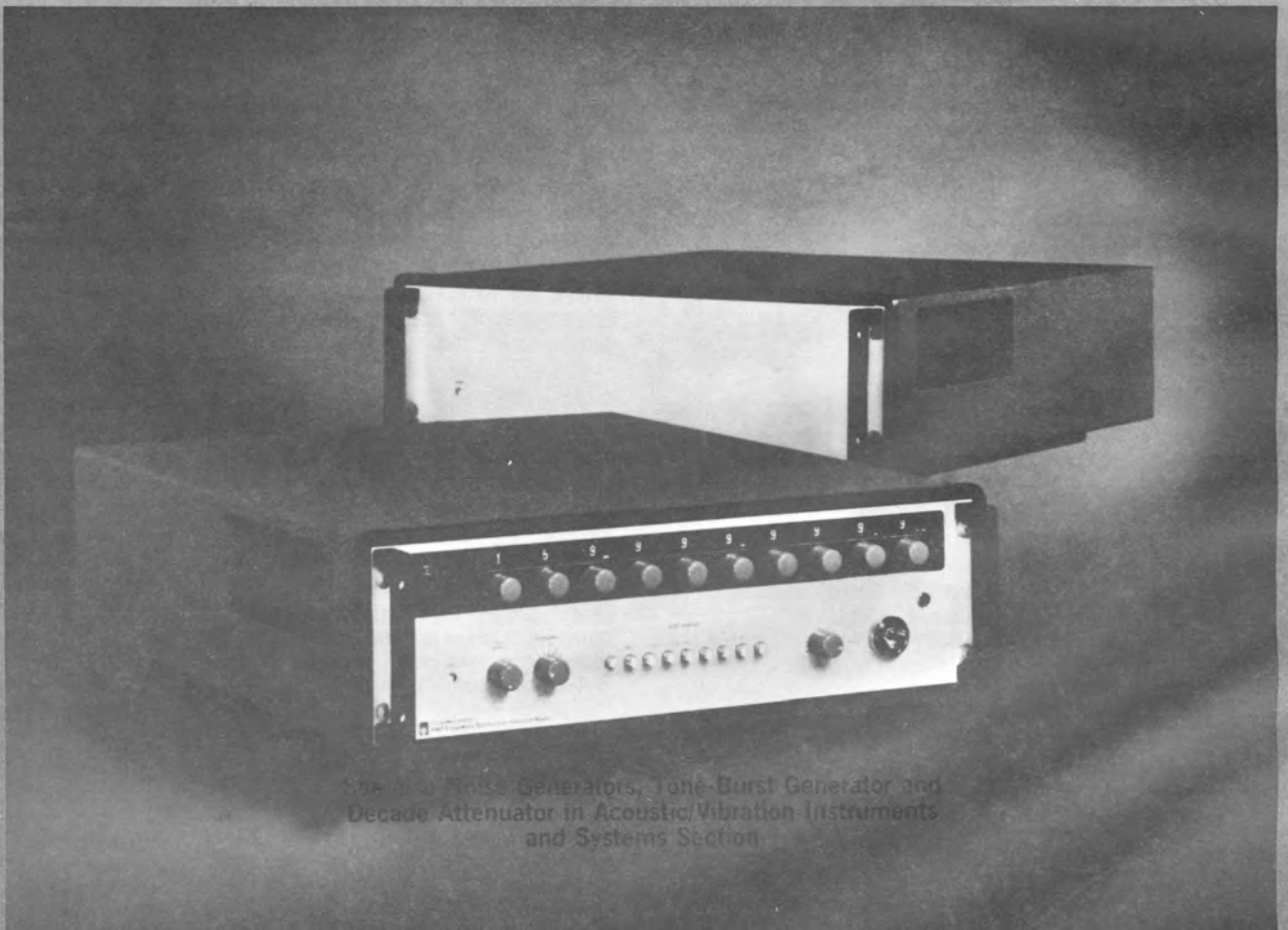

See also Pulse Generators, Tone-Burst Generator and
Decade Attenuator in Acoustic/Vibration Instruments
and Systems Section

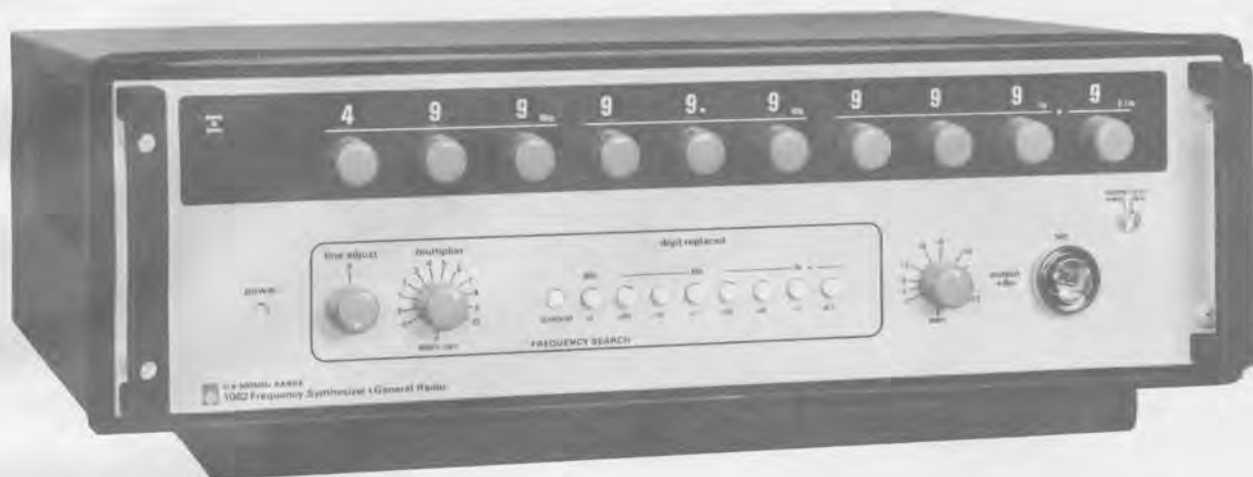

1062 Frequency Synthesizer

- 10 kHz to 500 MHz
- lowest residual phase noise
- < 50- μ s switching speed
- non-harmonic spurious >80-dB down
- amplitude-, frequency- and phase-modulation capabilities
- parallel entry BCD frequency programming
- resolution to 0.1 Hz
- modular plug-in construction

The high spectral purity and stability of the 1062 make it the ideal source to up-convert or multiply into microwave frequency bands. The low residual phase-noise — typically -65 dB — is enhanced by using a novel drift-cancelled loop operating at microwave frequencies, with no high synthesis factors required.

The 50-microsecond switching speed of the GR 1062 permits real-time dynamic displays of *more* measured data in *shorter* time spans. One hundred points in a digitally swept system can be scanned in 45 milliseconds, with 400 microseconds of dwell-time allowed for each measurement.

Exceptional spectral purity The 1062 provides a signal output with exceptional spectral purity for any synthesizer application — non-harmonics are down more than 80 dB (typically 86 dB) below the signal, harmonics are down more than 25 dB and residual phase noise is down close to 100 dB at 10 Hz offset from the carrier. A leveled output ranging from -7 dBm to +13 dBm is set by an externally applied dc signal or, with the local-control option, by a panel control.

Search-sweep standard One of the more useful features of the 1062 is its built-in search-sweep capability. Any decade with 1-MHz steps or less can be electrically converted into a continuously adjustable decade, to extend the resolution two decades beyond its step-digit resolution (a synthesizer with a nominal resolution of 100 Hz actually has 1-Hz resolution via the search-sweep dial).

The decade to be searched is selected by an external control input or, in models with the local-control option, by panel pushbuttons. This capability provides the synthesizer with the convenience of a signal generator for

resonance or bandpass studies and also makes possible sweep-frequency measurements because the search-sweep dial can be remotely controlled by a dc signal or sawtooth waveform. Deviation rates up to 20 kHz can be used in fm applications.

Built-in remote programmability In the 1062, rapid remote programmability is standard — less than 50 μ s per step, set by standard 8-4-2-1 BCD signals. The basic models have front-panel controls omitted for system economy, a neat appearance, and to reduce the possibility of accidental control misadjustments. A local-control panel is available as a standard option.

Highly flexible design A wide choice of options combines the benefits of custom design with the economy of off-the-shelf units. Standard resolution is 10 kHz (5 digits) but is expandable to 0.1 Hz (10 digits) in 1-digit increments.

The synthesizer also offers you a choice of a moderate-precision internal oscillator, a high-precision oscillator, or no internal oscillator at all (for applications where an external frequency standard is available to drive the synthesizer). In applications where two or more synthesizers are to be used, only one need be driven by the external standard (or internal oscillator) because the output from one synthesizer can be used to drive the next. This is both an economy in equipping a large facility and a means of assuring frequency coherence.

SPECIFICATIONS

Fixed Frequency: 10 kHz to 499.99 MHz in 10-kHz steps with 100-Hz search-sweep settability. Finer steps optional, the finest being 0.1-Hz steps with 0.001-Hz search-sweep settability. LOCAL CONTROL (Option 1): Set by in-line-readout panel switches or external remote-control signals; control transferred by single panel control, REMOTE CONTROL: Set by 8-4-2-1 external signals; logic "1" is 0 to 0.5 V at 3 mA, logic "0" is +5 V at 0 mA. PROGRAMMING TIME: Less than 50 μ s to be within 500 Hz (worst case) of any new frequency selected. (Data for frequency offset vs time are shown in the accompanying table.)

| Time After Switching | Largest Digit Switched | | | |
|----------------------|------------------------|---------|---------|------------------|
| | 100 MHz | 10 MHz | 1 MHz | 100 kHz or less |
| 50 μ s | 500 Hz | 50 Hz | 10 Hz | 1 MHz ERROR |
| 100 μ s | 150 Hz | 5 Hz | 1.5 Hz | X DIGIT SWITCHED |
| 1 ms | 3 Hz | <0.1 Hz | <0.1 Hz | (IN MHz) |

National stock numbers are listed at the back of the catalog.

Search-Sweep and Frequency Modulation: SWEEP WIDTH: Up to 11 MHz. Any decade, with steps of 1 MHz or less, can be converted to continuous control with a range of -1 to $+10 \times$ one step of the decade being replaced, with a settability of $1/100$ of one step. LOCAL CONTROL (optional): Digit to be replaced is chosen by panel pushbuttons or external signal; frequency is set by -1 to $+10$ multiplier plus continuous vernier or by external signal. REMOTE CONTROL: Digit to be replaced is chosen by logic signal; frequency is set by $+0.5V$ /step (-0.5 to $+5.0V$) dc signal with nonlinearity of ± 0.3 step max. SWEEP (FM) RATE: DC to 20 kHz, -3 dB. DEVIATION: Pk-pk inside 0- to 9-digit range. DISTORTION: 3% at 5 kHz, 6% max. STABILITY: $\pm 2 \times 10^{-4}$ step/s, $\pm 1 \times 10^{-3}$ step/min, $\pm 1 \times 10^{-2}$ step/h after 2-h warmup.

Amplitude Modulation (at $<5\%$ distortion):

Carrier Frequency

| Carrier Level | 10kHz to 100kHz | 100kHz to 400kHz | 400kHz to 500MHz |
|---------------|------------------------|-------------------------|------------------------|
| +7 dBm | 90%, up to 100-Hz rate | 90%, up to 1-kHz rate | 90%, up to 4-kHz rate |
| +10 dBm | 50%, up to 200-Hz rate | 50%, up to 2.5-kHz rate | 35%, up to 10-kHz rate |

Signal Output Level: 100 mV to 1 V rms (-7 to $+13$ dBm into 50Ω) from $50\text{-}\Omega$ source, available at rear GR874[®] connector (optionally on front panel). LOCAL CONTROL (optional): Set by panel control with $\pm 1.5\text{-dB}$ accuracy or by external remote-control signal. REMOTE CONTROL: Set by external dc signal of $4 \times$ desired rms output voltage, into $100 \text{ k}\Omega$ applied to rear BNC connector. Programming time $< 100 \mu\text{s}$, to within ± 1 dB of desired level. FLATNESS: ± 0.6 dB referred to full output at 100 MHz. HARMONICS: < -25 dB at 10-dBm output into $50\text{-}\Omega$ load (typically < -30 dB). DISCRETE NON-HARMONICS: < -80 dB (typically -86 dB). RESIDUAL PHASE-NOISE MODULATION, rms (also see curve): < -60 dB re 1 radian in 0.5 Hz-to-15 kHz bandwidth. AMPLITUDE-NOISE MODULATION, rms: < -75 dB (typically -80 dB) re 100% carrier in 0.5 Hz-to-15 kHz bandwidth.

Auxiliary Outputs: 10 MHz at $+6$ to $+8$ dBm into 50Ω (will drive another synthesizer) and 1 MHz at $0.8V$ pk-pk into $10 \text{ k}\Omega$, from rear BNC connectors, 42 MHz at -4 to -1 dBm, 1770 to 2170 MHz at -1 to $+3$ dBm, 2270 to 2180 MHz at -3 to $+2$ dBm, 500 to 510 MHz at -15 dBm, all into 50Ω from rear SMA connectors.

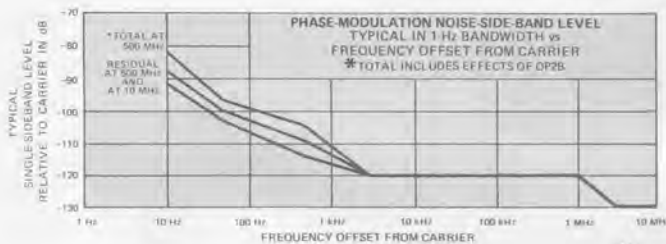

1061 Frequency Synthesizer

- DC to 160 MHz
- spurious $> 80\text{-dB}$ down
- phase noise $> 70\text{-dB}$ down
- $< 50\text{-}\mu\text{s}$ switching speed
- $+20\text{-dBm}$ leveled output
- search sweep
- programmable frequency and amplitude
- frequency- and amplitude-modulation capabilities
- your choice of resolution — 10 kHz to hzm Hz

National stock numbers are listed at the back of the catalog.

Phase Modulation: Output can be phase modulated ± 3 rad at rates from dc to 300 kHz (± 1 rad at 1-MHz rate), by external signal of 1 V/rad at dc, flat within 2 dB to 300 kHz, into $7.5 \text{ k}\Omega$, applied to rear BNC connector. Distortion at ± 3 rad is -25 dB to 300 kHz and at ± 1 rad is -35 dB to 100 kHz, -30 dB to 300 kHz, and -25 dB to 1 MHz.

Accuracy of Fixed Frequency: Equal to that of drive source. Drive source can be internal oscillator or external drive.

Internal Oscillator: (optional): MODERATE STABILITY: 5-MHz crystal oscillator. Adjustment range $> 5 \times 10^{-5}$ by manual trimmer or $> 5 \times 10^{-6}$ by $+6\text{-}$ to $+9\text{-V}$ external dc signal. Stability is $2 \times 10^{-7}/^\circ\text{C}$ from $+20$ to $+50^\circ\text{C}$; $2 \times 10^{-6}/\text{mo}$. HIGH STABILITY: 10-MHz crystal oscillator in proportional-control oven. Adjustment range, $> 4 \times 10^{-6}$ by manual trimmer or $> 5 \times 10^{-7}$ by $+6\text{-}$ to $+9\text{-V}$ external dc signal. Stability, $< 2 \times 10^{-10}/^\circ\text{C}$ from 0 to $+50^\circ\text{C}$. Drift, $\pm 1 \times 10^{-8}/\text{wk}$, $\approx 1 \times 10^{-9}/\text{day}$ after 1 month of continuous operation, $< 2 \times 10^{-10}$ with $\pm 10\%$ line-voltage variation, restabilizes within 2 h after power interruption. Connector provided on rear for battery to maintain oscillator during power interruption.

External Drive (required on models without internal oscillator): 5 or 10 MHz, 130 mV to 2.5 V rms into 50Ω applied to rear BNC connector.

Environment: TEMPERATURE: 0 to $+50^\circ\text{C}$ operating.

Supplied: Power cord, coaxial patch cord with GR874 connectors, 50-pin plug to mate with rear connector.

Available: GR874[®] adaptors.

Power: 90 to 110, 104 to 125, 180 to 220, 194 to 236, or 207 to 250 V; 48 to 66 Hz (45 to 48 Hz with high-line limit decreased 5%. 360 to 440 Hz with low-line limit increased 5%); 85 W max. Connection provided for 15- to 18-V, 200-mA, dc source to maintain high-stability oscillator during power interruption.

Mechanical: Bench or rack models. DIMENSIONS (wxhxd): Bench, $19.75 \times 6.9 \times 24.88$ in. ($502 \times 176 \times 632$ mm); rack, $19 \times 5.22 \times 22.38$ in. ($483 \times 133 \times 569$ mm). WEIGHT: Bench, 62 lb (28 kg) net, 74 lb (33 kg) shipping; rack, 58 lb (26 kg) net, 69 lb (31 kg) shipping.

Description Catalog Number

1062 Frequency Synthesizer, 10 kHz to 500 MHz with 10-kHz resolution and 100-Hz search settability, remote control, and external drive only

Bench Model

Rack Model

(Describe exactly as shown at the left.)

Select following options, if desired

OP1 Local Control Panel

OP2A Moderate-Stability Internal Oscillator*

OP2B High-Stability Internal Oscillator

OP4A 1-kHz digit resolution (10-Hz search)

OP4B 100-Hz digit resolution (1-Hz search)

OP4C 10-Hz digit resolution (0.1-Hz search)

OP4D 1-Hz digit resolution (0.01-Hz search)

OP4E 0.1-Hz digit resolution (0.001-Hz search)

*Not recommended when ordering more than 1-kHz resolution. Available on a special basis only where OP4B, OP4C, OP4D or OP4E is ordered.

High Performance to 160 MHz The 1061 synthesizer is nearly identical to the 1062 except for frequency range and output level — the 1061 provides frequencies to 160 MHz and output levels from 0 to $+20$ dBm into 50Ω . Among the minor differences are slightly different amplitude-modulation characteristics, slightly lower residual phase-modulation noise, and an additional auxiliary output of dc to 10 MHz.

For applications below 160 MHz, the 1061 is an outstanding choice. It features the same low spurious content and low phase-noise levels as the 1062, the same fast switching speeds, built-in search-sweep and external programming, flexible design, and a wide range of

resolutions from 10 kHz to 0.1 Hz — but at a substantially lower cost.

SPECIFICATIONS

Fixed Frequency: 400 kHz to 159.99 MHz (and dc to 10 MHz) in 10-kHz steps with 100-Hz search-sweep settability. Finer steps optional, the finest being 0.1-Hz steps with 0.001-Hz search-sweep settability. **LOCAL CONTROL (Option 1):** Set by in-line-readout panel switches or external remote-control signals; control transferred by single panel control. **REMOTE CONTROL:** Set by 8-4-2-1 external signals; logic "1" is 0 to 0.5 V at 3 mA, logic "0" is +5 V at 0 mA. **PROGRAMMING TIME:** Less than 50 μ s to be within 50 Hz (worst case) of any new frequency selected. (Data for frequency offset vs time are shown in the accompanying table.)

| Time After Switching | Largest Digit Switched | | |
|----------------------|------------------------|---------|---------------------------------------|
| | 10 MHz | 1MHz | 100 kHz or less |
| 50 μ s | 50 Hz | 10 Hz | 1 MHz ERROR X DIGIT SWITCHED (IN MHz) |
| 100 μ s | 5 Hz | 1.5 Hz | |
| 1 ms | <0.1 Hz | <0.1 Hz | |

Search-Sweep and Frequency Modulation: SWEEP WIDTH: Up to 11 MHz. Any decade, with steps of 1 MHz or less, can be converted to continuous control with a range of -1 to $+10 \times$ one step of the decade being replaced, with a settability of 1/100 of one step. **LOCAL CONTROL (optional):** Digit to be replaced is chosen by panel pushbuttons or external signal; frequency is set by -1 to $+10$ multiplier plus continuous vernier or by external signal. **REMOTE CONTROL:** Digit to be replaced is chosen by logic signal; frequency is set by $+0.5V$ /step (-0.5 to $+5.0$ V) dc signal with nonlinearity of ± 0.3 step max. **SWEEP (FM) RATE:** DC to 20 kHz, -3 dB. **DEVIATION:** Pk-pk inside 0- to 9-range. **DISTORTION:** 3% at 5 kHz, 6% max. **STABILITY:** $\pm 2 \times 10^{-4}$ step/s, $\pm 1 \times 10^{-3}$ step/min, $\pm 1 \times 10^{-2}$ step/h after 2-h warmup.

Amplitude Modulation: DC to 1 kHz at 90% modulation, dc to 5 kHz at 30% modulation, dc to 10 kHz at 15% modulation. Control via remote control of Signal Output (see below), achieved by externally summing an a-m rate source with a dc voltage of 2X desired rms output voltage.

Signal Output: 224 mV to 2.24 V rms (0 to $+20$ dBm into 50 Ω) from 50- Ω source, available at rear GR874[®] connector (optionally on front panel). **LOCAL CONTROL (optional):** Set by panel control with ± 1.5 -dB accuracy or by external remote-control signal. **REMOTE CONTROL:** Set by external dc signal of 2X desired rms output voltage, into 100 k Ω applied to rear BNC connector. Programming time $< 100 \mu$ s, to be within ± 1 dB of desired level. **LEVELING (frequency response):** $+1.5 - 0.5$ dB to 1 MHz and ± 0.3 dB above 1 MHz at full output. **HARMONICS:** < -27 dB, output into 50- Ω load (typically 35 dB down). **DISCRETE NON-HARMONICS:** < 80 dB (-86 dB typically). **RESIDUAL PHASE-NOISE MODULATION, rms (also see curve):** < -70 dB re 1 radian in 0.5 Hz-to-15kHz bandwidth. **AMPLITUDE-NOISE MODULATION rms:** < -80 dB re 100% carrier in 0.5 Hz-to-15 kHz bandwidth.

Auxiliary Outputs: Low-level output of dc to 10 MHz at 125 mV $\pm 10\%$ rms, with ± 0.25 -dB flatness, < -38 dB distortion, available at rear BNC connector. 10 MHz at 500 mV $\pm 20\%$ into 50 Ω , which can be used to drive another synthesizer, 1 MHz at 0.8 V pk-pk into 10 k Ω , 42 MHz at 165 mV $\pm 20\%$ into 50 Ω , all available at rear BNC connectors.

Phase Modulation: Output can be phase modulated ± 3 rad at rates from dc to 300 kHz (± 1 rad at 1-MHz rate), by external signal of 1 V/rad at dc, flat within 2 dB to 300 kHz, into 7.5 k Ω ,

National stock numbers are listed at the back of the catalog.

120 SYNTHESIZERS

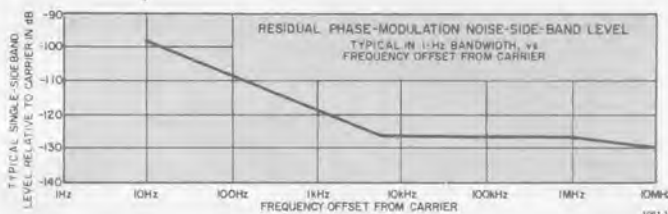

applied to rear BNC connector. Distortion at ± 3 rad is -25 dB to 300 kHz and at ± 1 rad is -35 dB to 100 kHz, -30 dB to 300 kHz, and -25 dB to 1 MHz.

Accuracy of Fixed Frequency: Equal to that of drive source. Drive source can be internal oscillator or external drive.

Internal Oscillator (optional): MODERATE STABILITY: 5-MHz crystal oscillator. Adjustment range $> 5 \times 10^{-5}$ by manual trimmer or $> 5 \times 10^{-6}$ by $+6$ - to $+9$ -V external dc signal. Stability is $2 \times 10^{-7}/^{\circ}\text{C}$ from $+20$ to $+50^{\circ}\text{C}$; $2 \times 10^{-6}/\text{mo}$. HIGH STABILITY: 10-MHz crystal oscillator in proportional-control oven. Adjustment range, $> 4 \times 10^{-6}$ by manual trimmer or $> 5 \times 10^{-7}$ by $+6$ - to $+9$ -V external dc signal. Stability, $< 2 \times 10^{-10}/^{\circ}\text{C}$ from 0 to -50°C . Drift, $\pm 1 \times 10^{-8}/\text{wk}$, $\approx 1 \times 10^{-9}/\text{day}$ after 1 month of continuous operation, $< 2 \times 10^{-10}$ with $\pm 10\%$ line-voltage variation, restabilizes within 2 h after power interruption. Connector provided on rear for battery to maintain oscillator during power interruption.

External Drive (required on models without internal oscillator): 5 or 10 MHz, 130 mV to 2.5 V rms into 50 Ω applied to rear BNC connector.

Environment: TEMPERATURE: 0 to $+50^{\circ}\text{C}$ operating.

Supplied: Power cord, coaxial patch cord with GR874 connectors, 50-pin plug to mate with rear connector.

Available: GR874 adaptors.

Power: 90 to 110, 104 to 125, 180 to 220, 194 to 236, or 207 to 250 V; 48 to 66 Hz (45 to 48 Hz with high-line limit decreased 5%, 360 to 440 Hz with low-line limit increased 5%); 70 W max. Connection provided for 15- to 18-V, 200-mA, dc source to maintain high-stability oscillator during power interruption.

Mechanical: Bench or rack models. DIMENSIONS (wxhxd): Bench, 19.75 \times 6.9 \times 24.88 in. (502 \times 176 \times 632 mm); rack, 19 \times 5.22 \times 22.38 in. (483 \times 133 \times 569 mm). WEIGHT: Bench, 58 lb (27 kg) net, 69 lb (32 kg) shipping; rack, 50 lb (23 kg) net, 61 lb (28 kg) shipping.

| Description | Catalog Number |
|---|--|
| 1061 Frequency Synthesizer , dc to 160 MHz with 10-kHz resolution and 100-Hz search settability, remote control, and external drive only | |
| Bench Model | (Describe exactly as shown at the left.) |
| Rack Model | |
| Select following options, if desired | |
| OP1 Local Control Panel | |
| OP2A Moderate-Stability Internal Oscillator* | |
| OP2B High-Stability Internal Oscillator | |
| OP4A 1-kHz digit resolution (10-Hz search) | |
| OP4B 100-Hz digit resolution (1-Hz search) | |
| OP4C 10-Hz digit resolution (0.1-Hz search) | |
| OP4D 1-Hz digit resolution (0.01-Hz search) | |
| OP4E 0.1-Hz digit resolution (0.001-Hz search) | |

*Not recommended when ordering more than 1-kHz resolution. Available on a special basis only where OP4B, OP4C, OP4D or OP4E is ordered.

High-Frequency Oscillators

500 kHz-to-50 MHz Oscillator

Frequency: 500 kHz to 50 MHz with $\pm 2\%$ calibration accuracy and 0.4% typical warmup frequency drift. Variable L and C in main tuned circuit.

Output: 200 mW into 50 Ω , see curves (1263 or 1267 power supply).

Power: 1267 or 1263 power supply recommended.

Mechanical: Unit cabinet. DIMENSIONS (wxhxddepth behind panel): 8x7.63x9.75 in. (203x193x248 mm). WEIGHT: 12 lb (6 kg) net, 19 lb (9 kg) shipping.

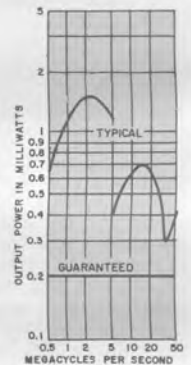

| Description | Catalog Number |
|--|----------------|
| 500 kHz-to-50 MHz Oscillator | |
| 1211-C, without power supply, Bench Model | 1211-9703 |
| Recommended Power Supplies | |
| 1267-B Power Supply for best cw stability and very low residual fm: 115/215/230-V model | 1267-9702 |
| 1263-C Power Supply for monitored and leveled output and square-wave modulation: 115-V model | 1263-9703 |
| 230-V model | 1263-9713 |

56-to-500 MHz Oscillator

Frequency: 56 to 500 MHz with $\pm 2\%$ calibration accuracy and 0.8% typical warmup frequency drift. Variable L and C in main tuned circuit.

Output: To 250 mW into 50 Ω , see curve.

Power: 1267, 1264 or 1263 power supply recommended.

Mechanical: Bench cabinet. DIMENSIONS (wxhxddepth behind panel): 8x7.63x8.25 in. (203x193x210 mm). WEIGHT: 7.5 lb (3.5 kg) net, 10 lb (4.6 kg) shipping.

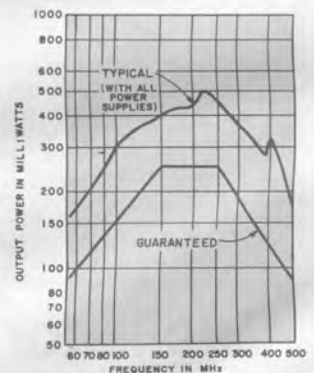

| Description | Catalog Number |
|---|----------------|
| 56-to-500 MHz Oscillator | |
| 1363, without power supply, Bench Model | 1363-9701 |
| Recommended Power Supplies | |
| 1267-B Power Supply for best cw stability and very low residual fm: 115/215/230-V model | 1267-9702 |
| 1264-B Power Supply for square-wave and pulse modulation: 115 V model | 1264-9702 |
| 230-V model | 1264-9703 |
| 1263-C Power Supply for monitored and leveled output and squarewave modulation: 115-V model | 1263-9703 |
| 230-V model | 1263-9713 |

National stock numbers are listed at the back of the catalog.

220-to-920 MHz Oscillator

Frequency: 220 to 920 MHz with $\pm 1\%$ calibration accuracy and 0.2% typical warmup frequency drift. Butterfly tuned circuit.

Output: To 200 mW into 50 Ω , see curve (1264 or 1267 power supply). Calibrated attenuator.

Power: 1267, 1264, or 1263 power supply recommended.

Mechanical: Bench cabinet. DIMENSIONS (wxhxdpeth behind panel): 8x7.63x8.25 in. (203x193x210 mm). WEIGHT: 8 lb (3.4 kg) net, 11 lb (5 kg) shipping.

| Description | Catalog Number |
|--|------------------|
| 220-to-920 MHz Oscillator 1362, without power supply, Bench Model | 1362-9701 |
| Recommended Power Supplies 1267-B Power Supply for best cw stability and very low residual fm: 115/215/230-V model | 1267-9702 |
| 1264-B Power Supply for square-wave and pulse modulation: 115 V model | 1264-9702 |
| 230-V model | 1264-9703 |
| 1263-C Power Supply for monitored and leveled output and squarewave modulation: 115-V model | 1263-9703 |
| 230-V model | 1263-9713 |

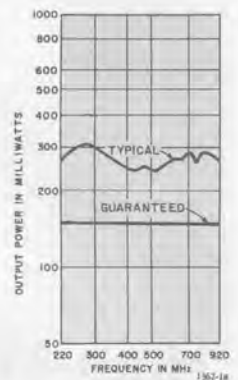

900 MHz-to-2 GHz Oscillator

With its electronic frequency control, the 1218-BV can be phase locked to an external reference signal to provide high power, low noise, and the stability of the reference signal against warmup drift and microphonics. In heterodyne systems, where a difference signal must be stable to remain within the bandwidth of a tuned detector, the 1218-BV can be used as the local oscillator. With a phase detector operating at the difference frequency, the 1218-BV can track small changes in the frequency of the test oscillator and hold the difference frequency steady.

Frequency: 900 to 2000 MHz with $\pm 1\%$ calibration accuracy and 0.1% typical warmup frequency drift. Main tuning by tracked adjustable lines.

Fine Tuning: MANUAL: $> \pm 2$ MHz, by turning of Δf knob. Power-level pulling by Δf control is ± 0.5 dB for ± 2 MHz change. REMOTE: > 4 MHz for 50 V change in dc signal applied to front or rear jacks; ± 25 V typical useful range; Δf control sets center value from +10 to -20 V. Positive-going voltage decreases frequency. Applied voltage ± 50 V max. Input equivalent to 10 k Ω , 150 pF, and -1.3 mA current source in parallel across terminals, one of which is grounded. Ext source should have $< 1000 \Omega$ internal impedance; can be ac coupled. Step-response time $< 1 \mu$ s typical.

Output Level: > 160 mW into 50 Ω to 1.5 GHz, drops linearly to > 110 mW at 2 GHz, see curve. CONTROL: > 20 -dB attenuation by uncalibrated control. EXTERNAL MODULATION: Panel jack provided for external audio-frequency modulation; ≈ 30 V rms into 6 k Ω produces 30% a-m.

Power: 1267, 1264, or 1263 power supply recommended.

Mechanical: Unit cabinet. DIMENSIONS (wxhxdpeth behind panel): 12x7.63x7.5 in. (305x193x191 mm). WEIGHT: 14 lb (7 kg) net, 26 lb (12 kg) shipping.

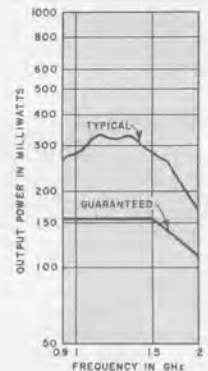

| Description | Catalog Number |
|--|------------------|
| 900-MHz-to-2 GHz Oscillator 1218-BV, without power supply, Bench Model | 1218-9724 |
| Recommended Power Supplies 1267-B Power Supply for best cw stability and very low residual fm: 115/215/230-V model | 1267-9702 |
| 1264-B Power Supply for square-wave and pulse modulation: 115-V model | 1264-9702 |
| 230-V model | 1264-9703 |
| 1263-C Power Supply for monitored and leveled output and square-wave modulation: 115-V model | 1263-9703 |
| 230-V model | 1263-9713 |

Oscillator Power Supplies

1267-B for regulated voltages For such applications as parametric-amplifier pumps, the oscillator must be stable against all power-line variations and free of modulation from power-supply ripple. In these applications, the 1267-B, 1264-B, and 1263-C power supplies are recommended because of their regulated outputs.

1264-B for amplitude modulation Other applications require power supplies in which the plate-supply voltage

is controllable to modulate or to regulate the oscillator output. The 1264-B provides 100% amplitude modulation at a high level by square waves or pulses as well as cw operation. Both plate and heater supplies are electronically regulated and the internal 1-kHz modulation frequency is highly stable.

A switch permits cw, standby, internal square-wave modulated, or externally modulated operation. Independen-

dent panel controls vary the regulated supply voltage for cw operation and the modulation amplitude for square-wave and pulse operation.

1263-C for leveled output and amplitude modulation

The 1263-C is particularly useful in a feedback loop to maintain constant oscillator output as the oscillator frequency is varied. Constant output not only speeds and simplifies measurements where the oscillator is tuned manually but is essential when sweep measurements are being made. Both plate and heater supplies are regulated and an internal 1-kHz is included for square-wave modulation.

The dc potential developed by the oscillator output rectifier is compared with an adjustable dc reference in the feedback system. A rapid correction is applied to the plate current to hold the oscillator output to a preset

level. Rf blanking can be accomplished by external shorting of the reference potential.

SPECIFICATIONS

Supplied: Power cord, output-socket mating plug (entire cable for 1263) plus (for 1263) a GR874-to-GR874 coaxial patch cord, 874-VRL Voltmeter Rectifier, 874-EL-L 90° Ell.

| Description | Catalog Number |
|---|--------------------------------------|
| 1267-B Regulated Power Supply , bench models: 115/215/230-V model | 1267-9702 |
| 1264-B Modulating Power Supply , bench models: 115-V model 230-V model | 1264-9702 1264-9703 |
| 1263-C Amplitude-Regulating Power Supply , bench models: 115-V model 230-V model | 1263-9703 1263-9713 |



1267-B Regulated Power Supply



1264-B Modulating Power Supply



1263-C Amplitude-Regulating Power Supply

| | 1267-B Regulated Power Supply | 1264-B Modulating Power Supply | 1263-C Amplitude-Regulating Power Supply |
|---|---|--|--|
| High Output: | 300 V, 70 mA max; voltage regulation: $\pm 0.25\%$ for line and load changes. $< 1\text{-mV}$ ripple at full load. | 200 to 300 V adjustable, 50 mA max; $< 0.5\text{-V}$ change for 10-V line change. $< 1\text{-mV}$ ripple (B- grounded), $< 5\text{-mV}$ ripple (B+ grounded). | 0 to 300 V adjustable, 30 mA max. $< 1\text{-mV}$ ripple at full load. |
| Low Output: | 6.5 V dc, 1 A max; $\pm 0.25\%$ regulation for line changes. | 6.2 to 6.8 V dc adjustable, 1 A max; $< 5\text{-mV}$ change with 10-V line change. $< 5\text{-mV}$ ripple at full load. | 6.5 V dc, 1 A max; regulated. $< 1\text{-mV}$ ripple. |
| Modulated Output: | None. Standby switch controls 300-V output independently. | 850 to 1150 Hz* internal square wave, adjustable to within 0.3 Hz of desired value (20 Hz to 50 kHz by external 20- to 50-V rms sine-wave input, to 100 kHz by external 20-V positive pulse). $< 0.1\%$ (0.04% typical) frequency change for 10-V line change; 0.5 $\pm 5\%$ adjustable duty ratio. 160 to 210 V adjustable output. $< 1.5 \mu\text{s}$ rise and decay times for 15-k Ω //300-pf load; no rampoff. [†] | 950 to 1050 Hz** internal squarewave, adjustable; $< 5\text{-Hz}$ change with line changes; 0.5 to 0.53 adjustable duty ratio; 50 μs rise and decay, no overshoot, $< 0.5\%$ rampoff. |
| Regulation of Oscillator Output Level: | None | None | Under $\pm 5\%$ rf-output change [†] (including effects of harmonics) below 500 MHz, with 1211, 1215, 1362 oscillators. |
| Output Voltmeter: | None | None | Reads average of rms carrier level with 1-kHz squarewave modulation; accuracy $\pm 10\%$ after standardizing with internal circuit and rectifier correction for extremely high frequencies. |
| Power: | 105 to 125, 195 to 235, or 210 to 250V, 50 to 60 Hz (400 Hz with 5% increase in voltage requirements). 75 W | 105 to 125 or 210 to 250 V, 50 to 60 Hz. 85 W | |
| Mechanical: | Bench cabinet. DIMENSIONS (wxhxd): 4.25x7.63x9.25 in. (108x193x235 mm). WEIGHT: 1267, 8 lb (3.7 kg) net, 10 lb (4.6 kg) shipping. | Bench cabinet. DIMENSIONS (wxhxd): 8x7.63x9.25 in. (203x193x235 mm). WEIGHT: 1264, 12 lb (5.5 kg) net, 15 lb (7 kg) shipping; 1263, 15 lb (7 kg) net, 18 lb (9 kg) shipping. | |

* Internal squarewave generator can be synchronized to external sinewave or squarewave signal; sync range is $> \pm 1\%$ for 5-V-rms, 1-kHz sinewave. In internal squarewave mode, a sync output of > 2 V pk-pk behind 18 k Ω is provided.

** A gate output is coincident with "off" interval of modulation, > 1 V into 30 k Ω // 300 pF; $< 50\text{-}\mu\text{s}$ rise and decay times; < 0.01 V during "on" interval.

[†] Correction time for 2:1 step change in selected oscillator output is < 0.5 ms, cw; < 50 ms 1-kHz squarewave modulated. Recovery time after blanking, < 2 ms, cw; < 200 ms, 1-kHz squarewave modulated. Hum and noise $< \pm 0.3\%$, cw, $< \pm 3\%$, 1-kHz squarewave modulated.

National stock numbers are listed at the back of the catalog.



1310-B Oscillator

- 2 Hz to 2 MHz
- 20-V, constant output, $\pm 2\%$
- 0.25% distortion

The superior characteristics of this oscillator make it an exceptionally useful laboratory signal source.

Constant output over a very wide frequency range facilitates frequency-response measurements.

High-resolution dial and exceptional amplitude and frequency stability are important for measurements of filters and narrow-band devices.

Equally useful in 600-ohm and 50-ohm circuits, since distortion is independent of load, even a short circuit.

When phase-locked to a frequency standard, the oscillator can deliver a high-level standard-frequency output with adjustable amplitude and low distortion.

Description A capacitance-tuned, RC Wien-bridge oscillator drives a low-distortion output amplifier, which isolates the oscillator from the load and delivers a constant voltage behind 600 ohms. All solid-state circuits ensure long, trouble-free life.

A jack is provided for introduction of a synchronizing signal for phase locking or to furnish a signal, independent of the output attenuator setting, to operate a counter, or to synchronize an oscilloscope or another oscillator.

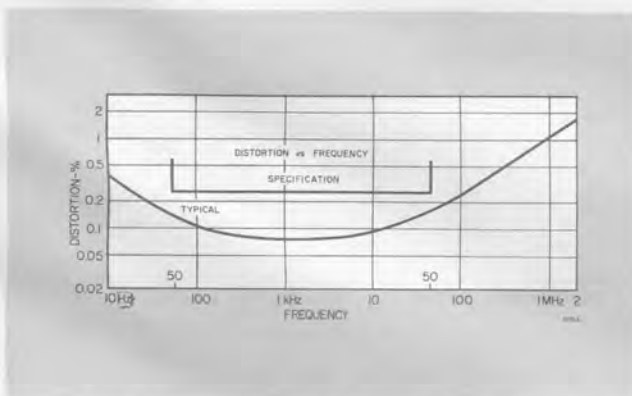

SPECIFICATIONS

Frequency Range: 2 Hz to 2 MHz in 6 decade ranges. Overlap between ranges, 5%.

Accuracy: $\pm 3\%$ of setting.

Stability (typical at 1 kHz): Warmup drift, 0.1%. After warm-up: 0.003% short term (10 min), 0.03% long term (12 h).

Controls: Continuously adjustable main dial covers decade range in 305° , vernier in 4 turns.

Synchronization: Frequency can be locked to external signal. Lock range $\pm 3\%$ per volt rms input up to 10 V. Frequency dial functions as phase adjustment.

Output Voltage: 20 V open circuit, nominal.

Power: ≥ 160 mW into 600 Ω .

Output Impedance: 600 Ω . One terminal grounded.

Attenuation: Continuously adjustable attenuator with >46 -dB range.

Distortion: $<0.25\%$, 50 Hz to 50 kHz with any linear load. Oscillator will drive a short circuit without clipping.

Hum: $<0.02\%$, independent of attenuator setting.

Amplitude vs Frequency: $\pm 2\%$, 20 Hz to 200 kHz, into open circuit or 600- Ω load.

Synchronization: Constant-amplitude (0.8-V), high-impedance (27-k Ω) output to drive counter or oscilloscope.

Terminals: Output, GR 938 Binding Posts; sync, side-panel telephone jack.

Available: ADAPTOR CABLE 1560-P95 (telephone plug to double plug); 0480-9838 SET to rackmount 1310 alone; 0480-9880 SET to rackmount 1310 side-by-side with same-size instrument such as the 1309 Oscillator, 1369 Tone-Burst Generator, or 1232 Amplifier-Detector.

Power: 105 to 125, 195 to 235, or 210 to 250 V, 50 to 400 Hz, 12 W.

Mechanical: Convertible-bench cabinet. DIMENSIONS (w x h x d): 8x6x8.13 in. (204x153x207 mm). WEIGHT: 7.75 lb (3.6 kg) net, 10 lb (4.6 kg) shipping.

Description

1310-B Oscillator

| Description | Catalog Number |
|---------------------------|----------------|
| 115-V Model | 1310-9702 |
| 220-V Model | 1310-9703 |
| 230-V Model | 1310-9704 |
| 1560-P95 Adaptor Cable | 1560-9695 |
| 480-P308 Rack-Adaptor Set | 0480-9838 |
| 480 Rack-Adaptor Set | 0480-9880 |

National stock numbers are listed at the back of the catalog.



1311-A Audio Oscillator

- 50 Hz to 10 kHz, discrete frequencies
- 1 W, 100-V or 4-A output
- transformer output

The 1311 oscillator offers high-power output and load-matching through a multitap output transformer that ensures at least $\frac{1}{2}$ watt into any load from 0.08 to 8000 ohms. Thus, it is ideal for driving impedance bridges where high sensitivity is required at extreme measurement limits and for driving directly such low-impedance devices as acoustic transducers. For bridge measurements, the shielded output-transformer secondary minimizes circulating ground currents. The 1311 is supplied in an assembly with the 1232 Tuned Amplifier and Null Detector as the 1240 Bridge Oscillator-Detector. The 1311 is also included in several GR impedance-measuring systems.

Typical output characteristics

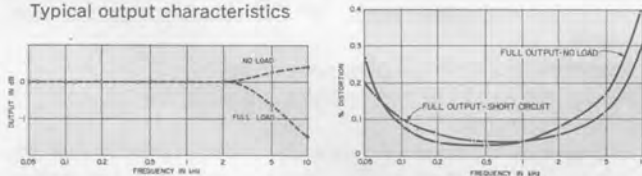

SPECIFICATIONS

Frequency Range: 50 Hz to 10 kHz. Eleven fixed frequencies, 50, 60, 100, 120, 200, 400, and 500 Hz, 1, 2, 5, and 10 kHz. One other frequency can be added at an unused switch position. A Δf control provides $\pm 2\%$ continuous adjustment.

Accuracy: $\pm 1\%$ of setting with Δf control at zero.

National stock numbers are listed at the back of the catalog.

Stability (typical at 1 kHz): Warmup drift, 0.3%. After warm-up: 0.008% short term (10 min), 0.02% long term (12 h).

Synchronization: INPUT: Frequency can be locked to external signal. Lock range, $\pm 3\%$ per volt rms up to 10 V. The Δf control functions as a phase adjustment. **OUTPUT:** Constant amplitude (1 V) to drive counter or oscilloscope. Source impedance 4.7 k Ω .

Output Level: VOLTAGE: Continuously adjustable from 0 to 1, 3, 10, 30, or 100 V open circuit (E_{oc}), dependent on setting of 5-position output switch. **CURRENT:** Continuously adjustable from 0 to 40, 130, 400, 1300, or 4000 mA, into approx short circuit (I_{sc}). **POWER:** >1.0 W into matched load, >0.5 W into any resistive load between 80 m Ω and 8 k Ω .

Output Impedance: One to three times $\frac{E_{oc}}{I_{sc}}$, depending on output amplitude. Output ungrounded.

Distortion: $<0.5\%$ with any linear load. Oscillator will drive a short circuit without clipping.

Hum: $<0.01\%$, independent of output setting.

Terminals: Output, GR 938 Binding Posts and ground terminal with shorting link; sync, telephone jack on side panel.

Available: ADAPTOR CABLE 1560-P95 (telephone plug to double plug), 0480-9838 SET to rackmount 1311-A alone, 0480-9880 SET to rackmount 1311-A side-by-side with same-size instrument such as 1310 Oscillator, 1396 Tone-Burst Generator, or 1232 Amplifier-Detector.

Power: 105 to 125 or 210 to 250 V, 50 to 400 Hz, 22 W.

Mechanical: Convertible-bench cabinet. **DIMENSIONS** (wx hxd): 8x6x7.75 in. (204x153x197 mm). **WEIGHT:** 6 lb (2.8 kg) net, 9 lb (4.1 kg) shipping.

| Description | Catalog Number |
|----------------------------------|----------------|
| 1311-A Audio Oscillator | |
| 115-V Model | 1311-9701 |
| 230-V Model | 1311-9702 |
| 1560-P95 Adaptor Cable | 1560-9695 |
| 480-P308 Rack-Adaptor Set | 0480-9838 |
| 480 Rack-Adaptor Set | 0480-9880 |



1308-A Audio Oscillator and Power Amplifier

- 200-VA output, up to 400 V or 5 A
- 20 Hz to 20 kHz
- output transformer

The 1308-A Audio Oscillator and Power Amplifier is an ac power source covering the audio range. It is an excellent power source for the 1633-A Incremental-Inductance Bridge. Its low dynamic output impedance enhances its usefulness as a power source for general testing over a wide range of supply frequencies. This instrument will provide a low-distortion signal for nonlinear loads, such

as capacitor-input rectifier systems, without clipping. It can also be used to drive small shake tables and to isolate sensitive equipment from power-line transients.

The 1308 also finds many uses as an audio-frequency power amplifier. When it is used with the 1396 Tone-Burst Generator, high-power tone bursts are provided for testing sonar projectors, amplifiers, etc.

This instrument combines a capacitor-tuned, Wien-bridge oscillator, a low-distortion power amplifier, and a tapped output transformer. The output is monitored by an overload circuit, which turns off the output when it starts to exceed safe limits.

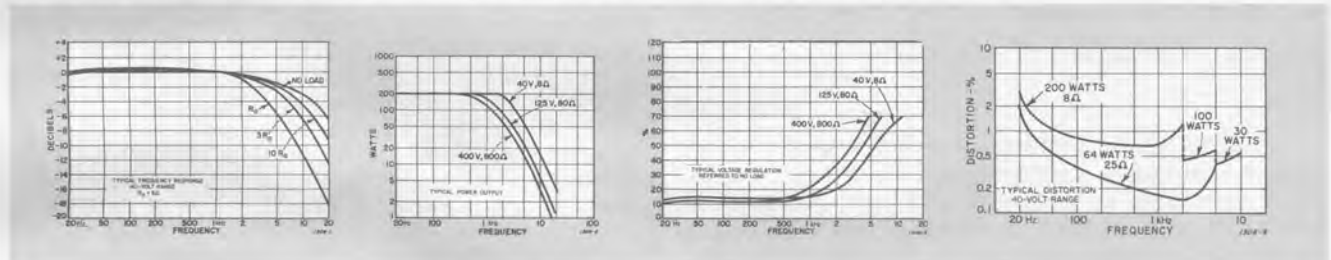

SPECIFICATIONS

Frequency Range: 20 Hz to 20 kHz in 3 ranges. **CONTROLS:** Continuously adjustable main dial covers decade range in 157.5°, vernier in 2 turns.

Accuracy: ±3% of setting or ±1 Hz, whichever is greater.

Frequency Stability (typical at 1 kHz): Warmup drift at full load, 0.3%. After warmup: 0.003% short term (10 min), 0.03% long term (12 h), 0.04% from no load to full load.

Output Voltage Ranges: Max of 4, 12.5, 40, 125, and 400 V open circuit, continuously adjustable from 0 to max.

Output Power: 200 VA max, 50 Hz to 1 kHz. **CURRENT RANGES:** Max of 0.016, 0.05, 0.16, 0.5, 1.6, and 5.0 A.

Regulation: <20%, no load to full load, 20 Hz to 1 kHz. Output impedance is typically 0.3, 0.8, 1.6, 19, and 220 Ω, depending on voltage range, 20 Hz to 1 kHz. Output transformer can pass dc current equal to max of ac current range. Output isolated from ground.

Load Impedances: Short circuit or non-linear loads can be driven. Load impedances of 0.8, 2.5, 8, 80, or 800 Ω, depending on voltage range, are optimum for max available power. **LOAD POWER FACTOR:** Continuous operation at max VA for any power factor 0 to 1 with ambient up to 25°C. Power factor of 0.7 to 1.0 for continuous operation to 40°C ambient. Intermittent operation to 50°C.

Distortion (linear load): <1%, 100 Hz to 10 kHz; <2%, 50 Hz to 100 Hz at max power and 115-V supply.

Hum: <0.3% of max output.

Meters: Indicate output terminal voltage and current.

Voltmeter: 5, 15, 50, 150, and 500 V ±3% full scale.

Ammeter: 0.016, 0.05, 0.16, 0.5, 1.6, and 5 A ±3% f s.

Overload Protection: Electronic overload trips at approx 1.5 × max of current range (manual reset), thermal cut-out on transistor heat sink (automatic reset).

Amplifier Sensitivity: ≤2.0 V for full output.

Input Impedance: 10 kΩ.

Terminals: Output, GR 938 Binding Posts and four-terminal socket on rear panel; input, GR 938 Binding Posts on rear panel.

Supplied: Four-terminal plug, power cord.

Power: 105 to 125 or 210 to 250 V, 50 to 60 Hz, 70 to 500 W, depending on load.

Mechanical: Rack-bench cabinet. **DIMENSIONS** (wxhxd): Bench, 19x7x16.25 in. (483x178x413 mm); rack, 19x7x15 in. (483x178x381 mm). **WEIGHT:** 91 lb (42 kg) net, 145 lb (66 kg) shipping.

| Description | Catalog Number |
|--|----------------|
| 1308-A Audio Oscillator and Power Amplifier | |
| 115-V Bench Model | 1308-9801 |
| 115-V Rack Model | 1308-9811 |
| 230-V Bench Model | 1308-9802 |
| 230-V Rack Model | 1308-9812 |

National stock numbers are listed at the back of the catalog.



1316 Oscillator

- 10 Hz to 100 kHz
- up to 125 V or 5-A output
- output level adjustable and metered
- in-phase and quadrature reference outputs
- in-line readout dials
- current-limited output — short circuits OK

Convenience and performance Set four controls and the 1316 provides any frequency from 10 Hz to 100 kHz with 1% accuracy and with little chance of an improper setting — the dials provide in-line readout, including decimal point and frequency units. Set two more controls, and the 1316 provides up to 1.6 watts of output power (125 V open circuit or 5 A short circuit), low distortion, and accurate metering.

These features alone would qualify the 1316 as an excellent general-purpose oscillator but it offers more: Output constant within $\pm 2\%$, excellent stability (only 0.005% drift over a 12-hour period), and a synchronizing feature that allows the oscillator to be locked to an external standard for even greater accuracy and stability.

Excellent bridge oscillator The 1316 is a high-performance bridge oscillator specifically intended for use with the 1238 Detector and the 1616 Precision Capacitance Bridge. The oscillator supplies 2 references (in quadrature) for the 2-phase phase-sensitive detector, which enables you to make independent and ultra-precise balances of the conductance (real part) and capacitance (imaginary part) of capacitive devices.

The 1316 contains a Wien-bridge oscillator isolated from the load by a low-distortion transformer-coupled power amplifier. The oscillator circuit includes a provision to introduce a synchronizing signal for phase locking or to extract a signal, independent of the output setting, to operate a counter or to synchronize an oscilloscope.

SPECIFICATIONS

Frequency: 10 Hz to 100 kHz in 4 decade ranges. Controlled by one 11-position and one 10-position switch for the most-significant digits and a continuously adjustable dial with detented zero position for the third digit; in-line readout with decimal point and frequency units.

Accuracy: $\pm 1\%$ of setting with continuously adjustable dial at zero detent position. **DRIFT** (typical at 1 kHz): Warmup 0.1%, short-term (10 min) 0.001%, long-term (12 h) 0.005%. **RE-SETTABILITY:** Within 0.005%.

National stock numbers are listed at the back of the catalog.

Power Output: CONTROLLED by 5-position switch and uncalibrated vernier. MONITORED by meter with $\pm 3\%$ accuracy. AVAILABLE at rear BNC connector.

| | Output Range | | | | |
|----------------------------|---|--------------|---------------|--------------|----------------|
| | 1.5 V | 5 V | 15 V | 50 V | 150 V |
| Open circuit E, rms | ≥ 1.25 V | ≥ 4 V | ≥ 12.5 V | ≥ 40 V | ≥ 125 V |
| Distortion | $< 0.2\%$ from 100 Hz to 10 kHz | | | | |
| Hum | 0.003% of max output | | | | |
| Response | output constant within $\pm 2\%$ from 10 Hz to 100 kHz* | | | | |
| Short Circuit I | 5 A | 1.6 A | 0.5 A | 0.16 A | 0.05 A |
| Distortion | $< 0.2\%$ from 100 Hz to 10 kHz | | | | |
| Impedance | 0.25 Ω | 2.5 Ω | 25 Ω | 250 Ω | 2.5 k Ω |
| Power | 1.6 W max into matched load | | | | |

* $\pm 5\%$ for outputs > 30 V rms at frequencies > 50 kHz.

Reference Outputs: Quadrature output lags in-phase output by 90° . Each available at rear BNC connectors.

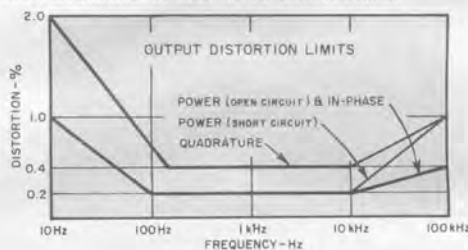

| | In-Phase | Quadrature |
|-------------------------------------|-----------------------|------------|
| Output, open-circuit | 1.25 \pm 0.25 V rms | |
| Distortion, 100 Hz to 10 kHz | $< 0.2\%$ | |
| Response, 10 Hz to 10 kHz | $\pm 2\%$ | |
| | $\pm 4\%$ | |
| Minimum Load | 47 k Ω | |

Synchronization: INPUT: Frequency can be locked to external signal; lock range, $\pm 1\%/V$ rms input up to 10 V; frequency controls function as phase adjustment. OUTPUT: ≥ 0.3 V rms behind 27 k Ω ; useful to sync oscilloscope or to drive a counter or another oscillator. Single rear BNC connector serves as both input and output terminal.

Power: 100 to 125 and 200 to 250 V, 50 to 60 Hz, 36 W.

Mechanical: Bench or rack mount. **DIMENSIONS** (wxhxd): Bench, 19.75x5x13.06 in. (502x127x332 mm); rack, 19x3.47x11.44 in. (483x88x291 mm). **WEIGHT:** Bench, 26 lb (12 kg) net, 32 lb (15 kg) shipping; rack, 21 lb (10 kg) net, 27 lb (12 kg) shipping.

| Description | Catalog Number |
|------------------------|----------------|
| 1316 Oscillator | |
| Bench Model | 1316-9700 |
| Rack Model | 1316-9701 |

IC Testers

Linear
GR 1740

Digital
GR 1742
GR 1744

Increase your testing throughput
and decrease your testing costs.

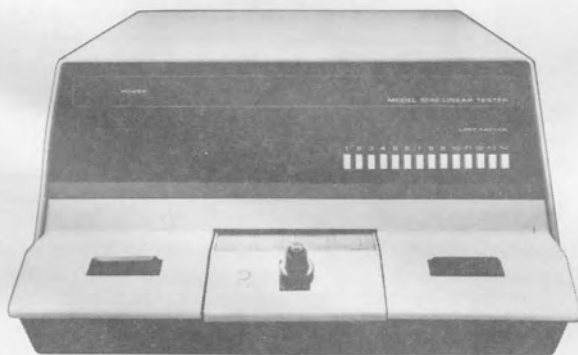

GR 1740

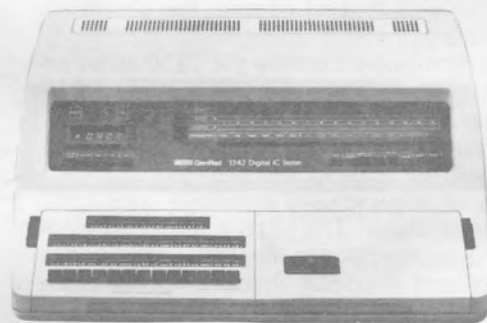

GR 1742

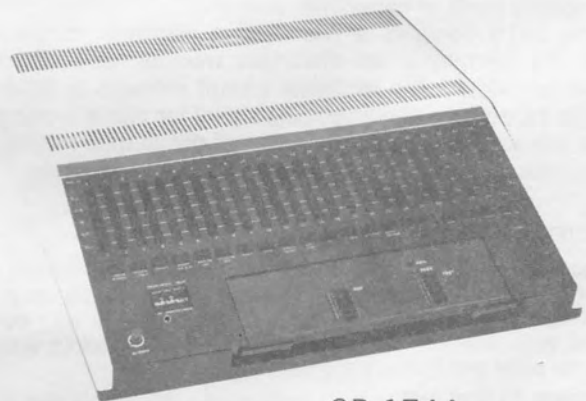

GR 1744



1740 Linear IC Tester

Applications

- **INCOMING INSPECTION**
Automatic Testing with MANUAL Insertion
Automatic Testing with HANDLER indexing
- **IC-MANUFACTURING**
Wafer Probing
Production Testing
Engineering Evaluation
- **"USER'S" PRODUCTION**
Selection for Specific Parameters
- **ENGINEERING**
Evaluation of Manufacturers
Evaluation of Devices
Device Characterization
- **RESEARCH AND DEVELOPMENT**
Device Characterization (Transfer Function)
Evaluation of New Designs

Description

The GR 1740 is an extremely accurate and efficient linear IC test set that provides rapid evaluation of standard, special, and unique analog-type circuits. This compact test set is particularly well suited for volume testing at incoming inspection or preassembly test where operator skills are minimal. When utilized with optional accessories, it becomes an extremely powerful tool for detailed engineering analysis of individual linear ICs.

Proven large signal measurement techniques coupled with total test condition programmability provide the user with testing flexibility found elsewhere only in the most expensive test systems.

When the tester is used as an incoming inspection unit, the operator simply plugs in the program board card, inserts the device into a socket, and presses the start button. If all tests pass, all lights go out and the PASS indicator lights. If any test fails, the light corresponding to that test stays lit, and the FAIL light comes on. When the tester is used in this manner, devices are tested to the correct programmed conditions and test limits.

For versatility in testing, a manual programmer may be used that permits the operator to set a wide range of parameter test limits. The manual programmer can be disconnected or turned off when not in use, thereby returning operation to the hard-wired test limits.

Total device evaluation capability is provided with the transfer-function analyzer, an accessory to the 1740 which is used to generate device transfer characteristics for analysis and evaluation. It provides critical information concerning circuit performance over the entire device operating range. Gain, common mode rejection, and power-supply sensitivity circuits can be generated and visually displayed on an oscilloscope or X-Y Plotter. It is ideal for vendor acceptance, engineering evaluation, circuit design, or establishing initial acceptance test specifications.



Transfer-function analyzer



Manual programmer

The 1740 not only provides the ultimate in bench-top linear IC testers; it has a history of maintenance-free performance interfaced with automatic handlers, digital printers, probers, temperature chambers, and other auxiliary equipment. Because of the instrument's unique patented test circuitry and flexible programming concept, the 1740 provides the capability to test devices that will be used in the future as well as those being used today. In addition, it provides the degree of information required, from a quick go/no-go to detailed information on each parameter tested.

Automatic multipass The automatic multipass sequencer allows each section of a dual, triple or quad device to be tested in sequence. A manual selector switch on the program board allows the operator to select either one particular section to test or full automatic sequencing through all sections.

Operation

The GenRad 1740 Tester is designed to test and evaluate standard, as well as nonstandard, linear circuits and is easily expanded into application areas where requirements exceed those of a typical bench-top tester.

The tester performs fourteen tests in a sequence of thirteen two-phase test steps. The sequencing of these tests is accomplished by controlling relay and transistor switches with signals generated by timing generators. Most parameters are measured in a two-phase test. During the first half of the test phase, initial DUT programmed conditions are established. Then, at the beginning of the second half of the test phase, one of the DUT conditions is changed. Parameter measurement techniques for linear circuits vary depending upon the device and the specific parameter tested.

The heart of the system is the program board where the DUT parameter test limits and test conditions are established and the special circuitry is added where required to accommodate testing specific devices. The program board also contains device compensation networks when required.

Most programmed limits and conditions are established on the program board using 1% resistors. The program boards have as standard documentation an error analysis sheet. The test accuracies are specified for each parameter as a percentage of the basic parameter value.

Each program board contains the necessary circuitry to set up the various special tests required for nonstandard linear circuits. Almost any dc parametric test may be performed on a DUT with a simple modification of the program board. In addition, many ac tests can be incorporated where required.

Program boards can be prepared by the user, simply by following the instructions in the 1740 Instruction Manual, or ordered completely programmed.

Interface with peripheral equipment such as probers, automatic handlers, printers, etc is accomplished with an optional PC board assembly. The circuits located on the PC board include data translation and gating circuits for the data code outputs and the logic required to interface the tester control logic with peripheral equipment. Interface cables are available to connect to the specific pieces of peripheral equipment used. For more detailed information, refer to "IC Tester Handler Interfaces," at the end of this section.

Features

- **Start pushbuttons:** Testing is initiated by pressing either of the two start pushbuttons or a particular test number pushbutton.
- **Test result indicators:** When testing has been initiated by pressing either of the start pushbuttons, all test result indicators will light. These test result indicators will then go out as the corresponding test is completed and passed, or will remain lighted if the test is failed. At the end of the test cycle, either the PASS or FAIL lamp will light.
NOTE: If the power consumption overrange indicator remains lighted, the test cycle has been terminated due to excessive DUT power consumption.
- **Forced-pass test display:** In many instances not all tests are included in the pass or fail decision. To initiate the display of the forced-pass tests, press test #1 button. The tester will cycle as during the normal test mode, and all test result indicators will stay lit, except for those corresponding to the tests that are programmed for "forced pass."



National stock numbers are listed at the back of the catalog.

- **Measured value display:** To initiate the digital meter readout display, press the test pushbutton corresponding to the test for which a readout is desired. The tester will cycle as during the normal test mode. The LIMIT FACTOR of DUT performance relative to the programmed limit point for that test will be displayed on the digital panel meter.
- **Program board:** The program board sets all the test conditions and the parameter limits for the device under test.
- **Program board specifications:** A printed label indicates the programmed test conditions, parameter test limit points, and the device type being tested. For all

- devices, each test is numbered. The test result indicators and pushbuttons are numbered corresponding to the number on the program board label. The program board is usually supplied with a test socket.
 - **Test socket:** Normally, a standard Barnes type RD86-to-DUT adaptor socket is required, depending on the IC package configuration. In special cases, the test socket is mounted directly on the program board.
 - **Device part number:** Printed on the program board label is the identifying part number of the program board for the device being tested.
- Please use one of the cards at the rear of this catalog to request complete information.

TEST SPECIFICATIONS

| DEVICE PARAMETER TEST SEQUENCE | | | | | | | | | | | | | | |
|------------------------------------|----------------------------|------|---------------------------------|------------------------|-----------------------------------|-----------------------------------|--------------|--------------|-------------|-------------------------------|-------------|-------------|-----------------|-----------------|
| See Description of Parameter Tests | | | | | | | | | | | | | | |
| — = force passed, not used | | | | | | | | | | | | | | |
| TEST STEP NO. | 1 | 2 | 3 | 4 | 5 | 6 | 7 | 8 | 9 | 10 | 11 | 12 | 13 | 14 |
| DEVICE TYPES TESTED | PARAMETRIC TESTS PERFORMED | | | | | | | | | | | | | |
| 1. Operational Amplifiers | P.C.O. | P.C. | V_{OS} $R_s \rightarrow 0$ | V_{OS} $R = R_s$ | + | - | I_B | I_{OS} | N&O | CMR | Gain A | Gain B | Slew Rate(+) | Slew Rate(-) |
| 2. Differential Amplifiers | " | " | " | " | " | " | " | " | " | " | " | " | " | " |
| 3. Comparators | " | " | " | " | " | " | " | " | — | " | " | " | — | — |
| 4. Voltage Followers | " | " | " | " | " | " | " | — | " | — | " | — | — | — |
| 5. Video Amplifiers | " | " | " | " | " | " | " | " | — | " | " | — | — | — |
| 6. Sense Amplifiers | " | " | — | STROBE | $V_{O,IL+}$ | $V_{O,IL-}$ | I_B | I_{OS} | $V_{O,IH+}$ | $V_{O,IH-}$ | $V_{O,CM+}$ | $V_{O,CM-}$ | — | — |
| 7. Phase Locked Loops | " | " | — | V_{OO} | $\frac{\Delta V_o}{\Delta V_s}$ + | $\frac{\Delta V_o}{\Delta V_s}$ - | — | — | V_{TRI} | DV_{OO} | V_{DEV1} | V_{DEV2} | — | — |
| 8. Function Generator | " | " | — | f_o | — | $\frac{\Delta f}{\Delta V_s}$ | — | — | V_o | $\frac{\Delta f}{\Delta V_c}$ | — | — | — | — |
| 9. Tone Decoder | " | " | — | V_{O1} | PSS | f_c | V_{O2} | V_{O3} | — | V_{O4} | V_{O5} | V_{O6} | — | — |
| 10. Voltage Regulators | S.C.O. | S.C. | — | $\Delta Ref.$ Volt. | + | - | Line Reg. | Line Reg. | — | — | N&O | — | — | Load Reg. |

National stock numbers are listed at the back of the catalog.

TEST SPECIFICATIONS

DESCRIPTION OF PARAMETER TESTS AND TYPICAL RANGE OF PASS LIMITS

See Test Sequence Chart

| | |
|---------------------------------|--|
| P.C.O. | POWER CONSUMPTION OVERRANGE, 10 mW to 10 W, 50 mA max. If the required power for the Device-Under-Test (DUT) is greater than 199% of programmed limit, all power is removed from the DUT and all testing is stopped. |
| P.C. | POWER CONSUMPTION, 5 mW to 5 W, 50 mA max DC power required to operate the DUT with the output at V_{OO} . |
| S.C.O. | STANDBY CURRENT OVERRANGE, 100 μA to 50 mA If the required standby current for the DUT exceeds 199% of the programmed standby current, all power is removed from the DUT and all testing is stopped. |
| S.C. | STANDBY CURRENT, 50 μA to 25 mA The supply current drawn by the DUT with no output load. |
| V_{OS} $R_S \rightarrow O$ | OFFSET VOLTAGE WITH SOURCE RESISTANCE LESS THAN 50 OHMS, 400 μV to 49.5 mV Voltage required between the input terminals to set automatically the output of the DUT at V_{OO} with less than 50 ohms source resistance. |
| V_{OS} $R_S = R$ | OFFSET VOLTAGE WITH SOURCE RESISTANCE SPECIFIED, 400 μV to 49.5 mV Voltage required between the input terminals to set automatically the output of the DUT at V_{OO} with a specified (programmed) source resistance. |
| PSS(\pm) | POWER SUPPLY SENSITIVITY, 20 μV/V to 1 mV/V The change in input voltage required to keep automatically the output of the DUT at V_{OO} while the (+) supply [(-) supply] is programmed from one value to another, and the (-) supply [(+) supply] is held constant. |
| N&O | NOISE AND OSCILLATION, 20 mV to 1 V rms The noise and oscillation detected at the output of the DUT. The closed loop gain for the DUT can be programmed from unity to 1,000. |
| CMR | COMMON MODE REJECTION RATIO, 400 to 100,000 The ratio of the change in common mode input voltage to the differential input voltage required to keep automatically the output of the DUT at V_{OO} . The (+) common mode voltage and (-) common mode voltage are independently programmed. |
| I_B | BIAS CURRENT, 500 pA to 100 μA; 500 nA to 100 μA for sense amps The average current into the two input terminals of the DUT while the output is automatically set at V_{OO} . |
| I_{OS} | OFFSET CURRENT, 500 pA to 100 μA; 250 nA to 100 μA for sense amps The difference in the two currents into the input terminals of the DUT while the output is automatically set at V_{OO} . |
| GAIN | GAIN A, (B), 400 to 400,000 The large signal voltage gain of the DUT with the programmed gain A(B) load resistance. During this measurement, the DUT output voltage is required to move from one programmed level to another programmed level. The (+) output voltage level and the (-) output voltage level are independently programmed. |
| SLEW RATE | (\pm) SLEW RATE, 0.01 V/μS to 1000 V/μS The rate of change in output voltage in a positive (negative) direction of the DUT in response to an over-driving input signal. |
| Δ REF. VOLT. | REFERENCE TO VOLTAGE TOLERANCE, 1 mV to 12 V The error in the output voltage if the DUT is a three-terminal device, the error in the reference current where applicable, or the error in the reference voltage. |
| LINE REG. | LINE REGULATION, 0.001% to 100% The change in output voltage which results from a programmed change in input voltage. |
| LOAD REG. | LOAD REGULATION, 10 mV/A to 100 V/A The change in output voltage that results from a programmed change in load current. |

| | |
|-------------------------|--|
| STROBE | OUTPUT VOLTAGE INHIBIT The DUT output voltage when the strobe voltage is at a programmed "inhibit" level and the input voltage is at a programmed "high threshold" level. |
| $V_{O, I_{3L}+}$ | OUTPUT VOLTAGE—LOW THRESHOLD POSITIVE, ± 20 mV to ± 5 V The DUT output voltage when the input voltage is at a programmed positive "low threshold" level. |
| $V_{O, I_{L}-}$ | OUTPUT VOLTAGE—LOW THRESHOLD NEGATIVE, ± 20 mV to ± 5 V The DUT output voltage when the input voltage is at a programmed negative "low threshold" level. |
| $V_{O, I_{H}+}$ | OUTPUT VOLTAGE—HIGH THRESHOLD POSITIVE, ± 20 mV to ± 5 V The DUT output voltage when the input voltage is at a programmed positive "high threshold" level. |
| $V_{O, I_{H}-}$ | OUTPUT VOLTAGE—HIGH THRESHOLD NEGATIVE, ± 20 mV to ± 5 V The DUT output voltage when the input voltage is at a programmed negative "high threshold" level. |
| $V_{O, CM+}$ | OUTPUT VOLTAGE—COMMON MODE POSITIVE, ± 20 mV to ± 5 V The DUT output voltage when the input common mode voltage is at a programmed positive level. |
| $V_{O, CM-}$ | OUTPUT VOLTAGE—COMMON MODE NEGATIVE, ± 20 mV to ± 5 V The DUT output voltage when the input common mode voltage is at a programmed negative level. |
| V_{OO} | QUIESCENT OUTPUT VOLTAGE, 100 mV to 10 V The voltage at the demodulated output with DUT locked to a specified frequency. |
| V_{TRI} | TRIANGLE WAVE OUTPUT VOLTAGE, 100 mV to 20 V The amplitude of the triangle wave output compared to a specified output to establish a minimum and maximum amplitude limit. |
| DV_{OO} | DIFFERENTIAL OUTPUT VOLTAGE, QUIESCENT, ± 20 mV to ± 5 V The voltage difference between the demodulated and reference outputs measured with no signal input. |
| V_{DEV1} | OUTPUT DEVIATION 1, 10 mV/% to 1 V/% The change in differential output voltage measured for a specified change in input frequency. |
| V_{DEV2} | OUTPUT DEVIATION 2, 10 mV/% to 1 V/% Same as output deviation 1 except the frequency change and/or limits may be specified differently. |
| f_O | OUTPUT FREQUENCY, 50 KHz to 100 KHz The frequency of the output signal when the control voltage is at its programmed nominal value. |
| V_O | OUTPUT, VOLTAGE, AC, 1 V P-P to 10 V P-P The amplitude of the output waveform. |
| $\Delta f/\Delta V_C$ | MODULATION FACTOR, 1 KHz/V to 50 KHz/V The change in frequency resulting from a programmed change in control voltage. |
| V_{OX} | CONDITIONED OUTPUT VOLTAGE (X = 1, 2, 3, etc.), DC, 0.1 V to 10 V The output voltage amplitude when the input voltage is at a specific condition or frequency. |
| f_C | CENTER FREQUENCY, 50 KHz to 100 KHz The free running frequency when the input voltage is zero, adjustable by potentiometer. |
| $\Delta f/\Delta V_S$ | POWER SUPPLY SENSITIVITY, AC, 0.1 KHz/V to 10 KHz/V The change in output frequency resulting from a programmed change in supply voltage. |
| $\Delta V_O/\Delta V_S$ | POWER SUPPLY SENSITIVITY, DC (+ or -), 0.01 V/V to 1 V/V The change in differential output voltage produced by a specified change in the DUT supply voltage, at f_C . |

National stock numbers are listed at the back of the catalog.

PROGRAMMABLE TEST CONDITIONS

| CONDITIONS | RANGES |
|--|---------------------------------------|
| WHERE APPLICABLE | |
| (+) Power Supply Voltage | +1.5V to +50.0V |
| (-) Power Supply Voltage | -1.5V to -50.0V |
| Source Resistance $R_s \rightarrow 0\Omega$ | Less than 50 Ω |
| Source Resistance Programmed | 50 Ω to 1.2M Ω |
| [1 + Δ] (+) Power Supply Voltage | +1.5V to +50.0V |
| [1 + Δ] (-) Power Supply Voltage | -1.5V to -50.0V |
| (+) Common Mode Input Voltage | 0 to +50.0V |
| (-) Common Mode Input Voltage | 0 to -50.0V |
| Light Load Resistance | 100 Ω to 100K |
| Full Load Resistance | 100 Ω to Light Load Resistance |
| AC Noise (OSC) DUT Gain | 1 V/V to 1000 V/V |
| (+) Output Voltage (Gain A) | 0 to +50.0V |
| (-) Output Voltage (Gain A) | 0 to -50.0V |
| (+) Output Voltage (Gain B) | 0 to +50.0V |
| (-) Output Voltage (Gain B) | 0 to -50.0V |
| COMPARATORS | |
| Output Reference (V_{oo}) | -10V to +10V |
| (+) Output Voltage (Gain A & B) | V_{oo} to 10V |
| (-) Output Voltage (Gain A & B) | -10V to V_{oo} |
| Source Current (Gain B) | 0.1 to 20mA |
| Sink Current (Gain B) | 0.1 to 20mA |
| VOLTAGE REGULATORS | |
| Output Voltage (+), (-) | 1.5V to 50V |
| Input Voltage—Output Voltage | 1.5V to 50V |
| [1 + Δ] (Input Voltage—Output Voltage) | 1.5V to 50V |
| Δ Load Current DC, (Pulsed) | 0 to 50mA, (5A) |

| | |
|---|------------------|
| SENSE AMPS | |
| Reference Voltage | 0 to +1V |
| Differential Mode Input Voltage | -0.5V to +0.5V |
| Strobe Voltage | -18V to +18V |
| Strobe Current | 0 to 10mA |
| Sink Current | 0 to 20mA |
| Source Current | 0 to 20mA |
| PHASE LOCK LOOP | |
| Center Frequency | 5 kHz to 100 kHz |
| (\pm) Deviation from Center Frequency | 0 to $\pm 30\%$ |
| FUNCTION GENERATORS | |
| Input control voltage | 0.01 to 10V |
| [1 + Δ] control voltage | 0.01 to 10V |
| TONE DECODERS | |
| Input signal voltage amplitude | 5mV to 1V p-p |
| [1 + Δ] signal voltage amplitude | 5mV to 1V p-p |
| Input signal frequency | 50kHz to 100 kHz |
| [1 + Δ] signal frequency | 40kHz to 120 kHz |

SPECIFICATIONS

| DIMENSIONS | WEIGHT | POWER REQUIREMENTS |
|------------------|-----------|--------------------|
| 8" HIGH (20 cm) | 30 POUNDS | 115/230 VAC |
| 17" DEEP (44 cm) | (15 kg) | 48 to 62 Hz |
| 17" WIDE (44 cm) | | 150 WATTS MAX |

| Description | Catalog Number |
|--|------------------|
| 1740 Linear IC Tester | 1740-9700 |
| Includes | |
| Automatic Multipass Board | |
| 5144-0296 Program Board for the UA 741 HC in industrial temperature range and 8-pin TO-5 can | |
| UA 741 HC operational amplifier (8-pin can) | |
| 4230-0420 14-pin dual-in-line socket (red base) | |
| 8-pin TO-5 can socket (red base) | |
| 10-pin TO-5 can socket (red base) | |
| 8-pin dual-in-line socket (red base) | |
| Select following options, if desired | |
| Manual Programmer | 1740-9603 |
| Transfer-Function Analyzer | 1740-9602 |

| Description | Catalog Number |
|---|------------------|
| Accessories available | |
| Extender for Chassis Board | 1740-9601 |
| Extender for Program Board | 1740-9600 |
| Partial Set, Field Service Spares Kit | 1740-9606 |
| Includes extenders and those system boards which constitute the majority of the field failures: Extender for Chassis Board, Extender for Program Board, Control Logic Board, Switch Logic Board, Low-Level Analog Board, Amplifier Board, I/O Datalog Board | |
| Standard Handler Interface Kit | 1740-9604 |
| Handler Interface Assembly | 1740-9605 |



1742 Digital IC Tester

Uses

- incoming inspection
- quality control
- failure analysis
- reliability and burn-in
- component engineering

- simple to use—plug in the proper program board, lower the cover and your GR 1742 is ready to test digital ICs.

- accurate—measures dc parameters of the IC to the manufacturer's specifications.

- thorough—performs the most rigorous functional sequence with a 15-bit pseudo-random grey code.

- failure analysis—simple and straightforward with carefully human-engineered front-panel displays and controls.

- fast—designed to allow handlers to operate at their maximum throughput.

- families—able to test TTL, LTTL, STTL, LSTTL, and CMOS up to 20 V, ECL and HTL.

- devices—simple gates, complex arithmetic logic units, multivibrators, shift registers, RAMs, ROMs, timers.

- pins—up to 28, 16 inputs—16 outputs; multiple Vcc's.

Simple to use Setup consists of plugging in a preprogrammed board. Testing is as simple as putting the device under test in a socket and observing the PASS/FAIL lamp.

There is only one board required for each device to be tested. The board specifies all the dc parameters and the function of the device automatically.

To test, the operator inserts the device into the socket, presses the START button and observes the PASS/FAIL lamps. Testing is fast, since the total test time is only 150 milliseconds.



Installing a program board.

TEST PASS OR
FAILURE INDICATORS

PIN FAILURE
INDICATORS
AND CONTROLS



METER SELECT
SWITCHES

TEST MODE
CONTROLS

VOLT/AMMETER

Console control and display panel.

PRECISION
PROGRAM
RESISTORS

ADDITIONAL
WIRING
AREA

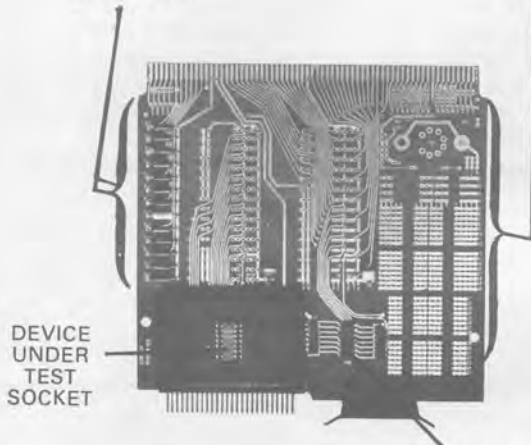

DEVICE
UNDER
TEST
SOCKET

FUNCTIONAL
REFERENCE
DEVICE

Typical dedicated program board.

ASSIGNMENT
SWITCHES FOR
TEST OPTIONS

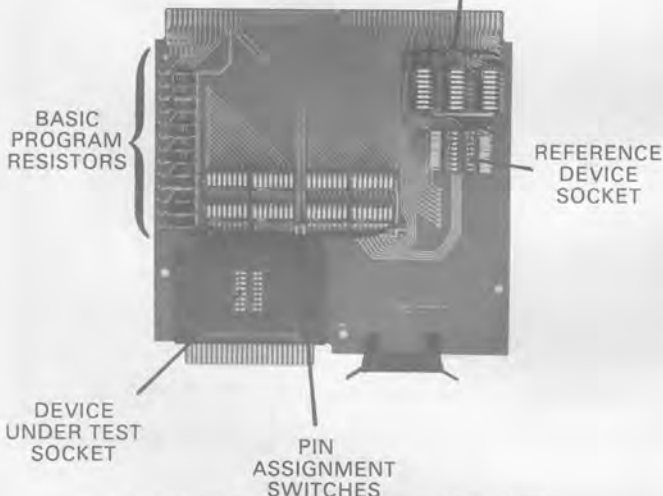

BASIC
PROGRAM
RESISTORS

REFERENCE
DEVICE
SOCKET

DEVICE
UNDER
TEST
SOCKET

PIN
ASSIGNMENT
SWITCHES

Universal program board for 14- or 16-pin DIPs.

Analyze failures Failure analysis is straightforward. Examining rejects can be as simple as identifying how many or as complex as identifying how a test condition causes a failure.

The GR 1742 has several indicators, controls and a meter which helps to identify to the levels needed how a faulty device failed.

The FAIL lamp identifies that a failure has occurred. The next step is to identify the parameter and device pin failures. Additional failure category lamps will pinpoint both exactly.

Failures can occur with inputs, outputs and the supply pins. It is important to know not only which parameter has failed but also the pin related to the failure. Lamps on the front panel indicate both the parameter that failed and the pin that caused the failure.

To identify further the cause of failure, there are buttons and a meter that will identify exactly the parametric value. The meter measures both current and voltage.

The pin of the device tested is selected through simple pushbuttons arranged around the failure lamps. It is easy to read the parameter conditions or limit with the panel meter. In fact, when parameters are measured, the pushbutton selects the proper multiplier and function (volts, milliamps).

Very often, a device has failed because a test condition actually created a limit failure. An example would be that an output (limit) failed because the input threshold (condition) was incorrect. To help in identifying these, the manual programmer allows the analyst to vary conditions and limits during both the parametric and functional sequences.

It can be seen that the GR 1742 is an excellent digital IC failure analysis tool; the failure analysis functions are implemented in a rational and logical manner.

Dedicated program boards These boards require no programming and therefore no setup time is required. The dedicated program board approach eliminates all sources of error, such as incorrect manual input settings and other various specification input methods. The dedicated program board contains the specified test limits and conditions for a single device type to achieve testing correlation with the vendor's specifications. Each board provides test sockets for both the device under test and functional reference device (FRD). Devices with up to 28 pins can be accommodated.

Universal program boards The GR 1742 with universal program boards (UPBs) and the manual programmer provides test flexibility for digital ICs. UPBs allow the

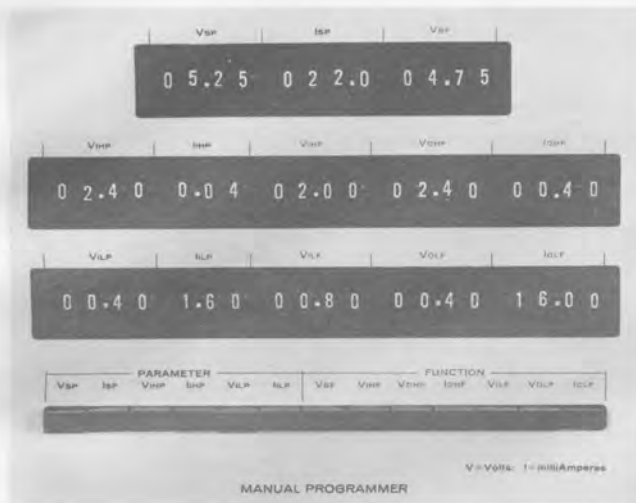

Manual programmer.



GR 1742 interfaces to a variety of automatic handlers.

user to create his own device program. A variety of 14- and 16-pin UPBs are available for testing TTL, CMOS and ECL devices. The UPB switches allow the user to select the inputs and outputs for many different devices within a given family. The manual programmer provides a means to change the UPB programmed limits and test conditions.

Interfacing to automatic handlers High-volume testing at a rate up to 6000 devices per hour can be achieved through the use of an automatic handler. The 1742, with

a test speed of 150 ms per device, has been interfaced to a wide variety of handlers. GenRad's standard handler interface kit consists of analog and digital cables, load boards that compensate for stray impedance between the tester and handler, and an input/output interface logic card which is placed within the 1742 tester. For more detailed information, refer to "IC Tester Handler Interfaces" at the end of this section.

Please use one of the cards at the rear of this catalog to request complete information.

SPECIFICATIONS

| | |
|--------------------------------|---|
| TEST CONDITIONS | |
| Supply Voltage, V_{SP} | Range 0 to +20 V |
| High Input Voltage, V_{IHP} | V_{ILP} to +20 V |
| Low Input Voltage, V_{ILP} | 0 to V_{IHP} |
| TEST LIMITS | |
| Supply Current, I_{SP} | 0 to 200 mA |
| High Input Current, I_{IHP} | 0 to 20 mA |
| Low Input Current, I_{ILP} | 0 to -20 mA |
| TEST CONDITIONS | |
| Supply Voltage, V_{SE} | Range 0 to +20 V |
| High Input Voltage, V_{IHF} | V_{ILF} to +20 V |
| Low Input Voltage, V_{ILF} | 0 to V_{IHF} |
| High Output Current, I_{OHF} | 0 to 20 mA or up to 320 mA by combining outputs |
| Low Output Current, I_{OLF} | 0 to -20 mA, or up to 320 mA by combining outputs |

| | |
|---|--|
| TEST LIMITS | |
| High Output Voltage, V_{OHF} | V_{OLF} to 20 V |
| Low Output Voltage, V_{OLF} | 0 to V_{OHF} |
| Accuracy of Value Selected within Given Range* | |
| V_{SP} | $\pm 15 \text{ mV} \pm 0.5\% - 0.1 \text{ mV/mA of } I_{SP}$ |
| V_{IHP} | $\pm 25 \text{ mV} \pm 0.5\% - 15 \text{ mV/mA of } I_{IHP}$ |
| V_{ILP} | $\pm 25 \text{ mV} \pm 0.5\% + 15 \text{ mV/mA of } I_{ILP}$ |
| I_{SP} | $\pm 200 \mu\text{A} \pm 1.5\%$ |
| I_{IHP} | $\pm 2 \mu\text{A} \pm 0.5\%$ |
| I_{ILP} | $\pm 2 \mu\text{A} \pm 0.5\%$ |
| V_{SF} | $\pm 15 \text{ mV} \pm 0.5\% - 0.1 \text{ mV/mA of } I_{SF}$ |
| V_{IHF} | $\pm 20 \text{ mV} \pm 0.5\% - 15 \text{ mV/mA of } I_{IHF}$ |
| V_{ILF} | $\pm 20 \text{ mV} \pm 0.5\% + 15 \text{ mV/mA of } I_{ILF}$ |
| I_{OHF} | $\pm 20 \mu\text{A} \pm 1\%$ (but never negative) |
| I_{OLF} | $\pm 20 \mu\text{A} \pm 1\%$ (but never positive) |
| V_{OHF} | $\pm 10 \text{ mV} \pm 0.5\%$ |
| V_{OLF} | $\pm 10 \text{ mV} \pm 0.5\%$ |
| MANUAL PROGRAMMER OPTION | |
| Tolerance | $\pm 0.05\%$ of fs $\pm 1\%$ of reading |

*Assumes perfect program board resistors. 1% resistors are used to program these values.

| DIGITAL READOUT | | | |
|--|-----------------------|-----|-----------------|
| | X10 Range | | |
| | Full Scale | %R | %FS |
| Programmed Test Condition & Limit Voltages | +20.00V | 0.5 | 0.05 |
| Programmed Test Condition & Limit Currents, Except I_s | $\pm 20.00\text{mA}$ | 0.5 | 0.05 |
| Programmed Test Condition & Limit I_s Only | +200.0mA | 0.5 | 0.05 |
| DUT Supply Voltage | +20.00V | 0.5 | 0.05 |
| DUT Supply Current | +220.0mA | 2.0 | 0.2 |
| DUT Input Voltage | +20.00V | 0.5 | 0.05 |
| DUT Input Current | $\pm 9.999\text{mA}$ | 1.5 | $0.1 \pm .01/V$ |
| DUT Output Voltage | +20.00V | 0.5 | 0.05 |
| DUT Output Current | $\pm 20.00\text{mA}$ | 1.5 | $0.1 \pm .01/V$ |
| | X1 Range | | |
| | Full Scale | %R | %FS |
| Programmed Test Condition & Limit Voltages | +9.999V | 0.5 | 0.1 |
| Programmed Test Condition & Limit Currents, Except I_s | $\pm 9.999\text{mA}$ | 0.5 | 0.1 |
| Programmed Test Condition & Limit I_s Only | +99.99mA | 0.5 | 0.1 |
| DUT Supply Voltage | +9.999V | 0.5 | 0.1 |
| DUT Supply Current | +99.99mA | 2.0 | 0.2 |
| DUT Input Voltage | +9.999V | 0.5 | 0.1 |
| DUT Input Current | $\pm 0.9999\text{mA}$ | 1.5 | $0.3 \pm .02/V$ |
| DUT Output Voltage | +9.999V | 0.5 | 0.1 |
| DUT Output Current | $\pm 9.999\text{mA}$ | 1.5 | $0.3 \pm .02/V$ |

| PHYSICAL CONFIGURATION | |
|------------------------|---------------------|
| HEIGHT | 8.2 inches, (21 cm) |
| WIDTH | 20 inches, (51 cm) |
| DEPTH | 22 inches, (56 cm) |
| WEIGHT | 50 lbs (22 kg) |

| TESTER INPUT POWER REQUIREMENTS | |
|---------------------------------|--|
| FREQUENCY | 48 to 62 Hz. |
| VOLTAGE, RMS | 115 V \pm 10% or 230 V \pm 10% (switch selectable). |
| CURRENT, RMS | 1.0 A typical at 115 V \pm 10% (protected by 2 A Slo Blo fuse). 0.5 A typical at 230 V \pm 10% (protected by a 1 A Slo Blo fuse). |

| AMBIENT TEMPERATURE | |
|----------------------------|---------------|
| OPERATING | +15 to +35°C. |
| STORAGE | -55 to +85°C. |
| HUMIDITY | |
| Up to 90%, non-condensing. | |

| Description | Catalog Number |
|---|--|
| 1742 Digital IC Tester Basic Digital IC Tester Includes Panel Meter 5150-0626 Dedicated Program Board for SN7400N 5431-8100 SN7400N Quad 2-input gate | 1742-9700 |
| Digital IC Tester with Manual Programmer Includes Basic Digital IC Tester Manual Programmer (when ordered with tester; factory installation only) 1742-9604 14-Pin Universal Program Board for TTL devices 1742-0101 Universal Program Board Library | 1742-9800 |
| Select following options, if desired Universal Program Boards 14-pin dual-in-line for TTL 16-pin dual-in-line for TTL 14-pin flat pack (Barnes Type) for TTL 16-pin flat pack (Barnes Type) for TTL 14-pin dual-in-line for CMOS 16-pin dual-in-line for CMOS 14-pin flat pack (Barnes Type) for CMOS 16-pin flat pack (Barnes Type) for CMOS 16-pin dual-in-line for 10,000 Series ECL | 1742-9604 1742-9605 1742-9606 1742-9607 1742-9608 1742-9609 1742-9610 1742-9611 1742-9612 |
| Program Board Kits 14-pin dual-in-line 16-pin dual-in-line 18-pin dual-in-line 20-pin dual-in-line 22-pin dual-in-line 24-pin dual-in-line 28-pin dual-in-line | 1742-9613 1742-9614 1742-9615 1742-9616 1742-9617 1742-9618 1742-9619 |
| Accessories available Verification board (verifies the metering circuits, 16 drivers, and 16 comparators) Extender for Chassis Boards Partial Set, Field Service Spares Kit Includes extender verification board and those system boards which constitute the majority of the field failures: Control Logic Board; Pattern Generator Board; Condition and Limit Board; Condition and Limit, Amplifier Board; Pin Input Board; Pin Output Board | 1742-9603 1742-9601 1742-9602 |
| Full Set, Field Service Spares Kit Includes the 1742-9602 Partial Set, plus Regulator Board, Display Board, Manual Programmer Amplifier and Reference Board, Remote I/O Interface | 1742-9621 |
| Standard Handler Interface Kit Handler Interface Assembly | 1742-9801 1742-9620 |



1744 Digital IC Tester

- fast functional test rates; up to 1.3 MHz
- interfaces easily with autohandlers or probe stations
- device socket boards eliminate the dedicated board concept
- propagation delay measurements from a minimum of 20 ns
- easily programmed by the user
- program library of over 1,000 different devices provided free
- 24-pin capability

Description The GR 1744 Digital IC Tester provides a low-cost solution to the problem of testing. This small, high performance bench-top unit is easily operator programmed for ICs with up to 24 pins.

The 1744 functionally tests a wide variety of devices including all TTL families, CMOS, ECL, and N-channel MOS. The unit can also test devices with open collector or Tri-State outputs. Another feature of the 1744 is its ability to measure propagation delays from a minimum of 20 ns. This measurement capability is virtually unique for bench-top testers. The 1744 was designed to be particularly useful as an incoming inspection tool for a manufacturer using modest amounts of a wide variety of digital IC types. The instrument displays pass or fail information and identifies each input or output pin that failed during the test sequence. The maximum test rate of the unit is 1.3 MHz.

To test a device, a device socket board is inserted into the tester. Three device socket boards are furnished with the 24-pin version of the unit, for 14-dil, 16-dil and 24-dil packages. The program is selected from the program library and set up on the front-panel switches. A functional reference device (FRD) is also chosen. The device to be tested is then inserted into the test socket and the start test button is depressed. A complete functional test is run on the device under test (DUT) and the pass/fail information is displayed on the front panel. Typical test times on the 1744 are 15 ms. For information on handler interfaces, refer to "IC Tester Handler Interfaces" at the end of this section.

The 1744 is supplied with a program library for testing over 1,000 different devices. Programs for new devices can be easily generated using a manufacturer's data sheet.

Functional test sequence The functional test pattern in the 1744 is a combination of two different techniques. When the combinational mode is selected on the front-panel switches, a binary grey code pattern is utilized. The length of this pattern is 2^n , "n" being the number of inputs selected. This mode of operation assures complete truth table verification of combinatorial devices and provides very fast test times.

When the sequential mode is selected, the 1744 provides a comprehensive pseudo-random grey code pattern. This pattern can vary in length from 6,000 to 80,000 cycles in one test sequence. When any pin between 1 and 16 is selected as an input, 6,000 patterns are generated. When any pin between 17 and 24 is selected as an input, 80,000 patterns are generated. The preset mode of operation is used when devices such as shift registers, counters, or memories are being tested. When this mode is selected, the test result strobe is inhibited for one test cycle so that the functional reference device (FRD) and the device under test (DUT) can be synchronized. The same functional test cycle is then repeated with the test result strobe active.

Programming The GenRad 1744 Tester is completely programmed using the front-panel controls. This eliminates the need for special modules or program boards. It is supplied with three device socket boards. These boards are all that are needed to test most devices. The user is provided with a program library that includes many of the more common families and device types. To create a new program, all that is required is a manufacturer's specification sheet. A family button is then depressed to select the preprogrammed test limits for the device family being programmed. For each pin of the device, a button is then depressed on the row corresponding to the pin's function, i.e., V_{CC} (most positive supply voltage), Input, Output, Clock, or V_{EE} (most negative supply voltage). Any unused pins are grounded. The propagation delay is then set to the proper value, the functional mode is selected, and testing begins.

Please use one of the cards at the rear of this catalog to request complete information.

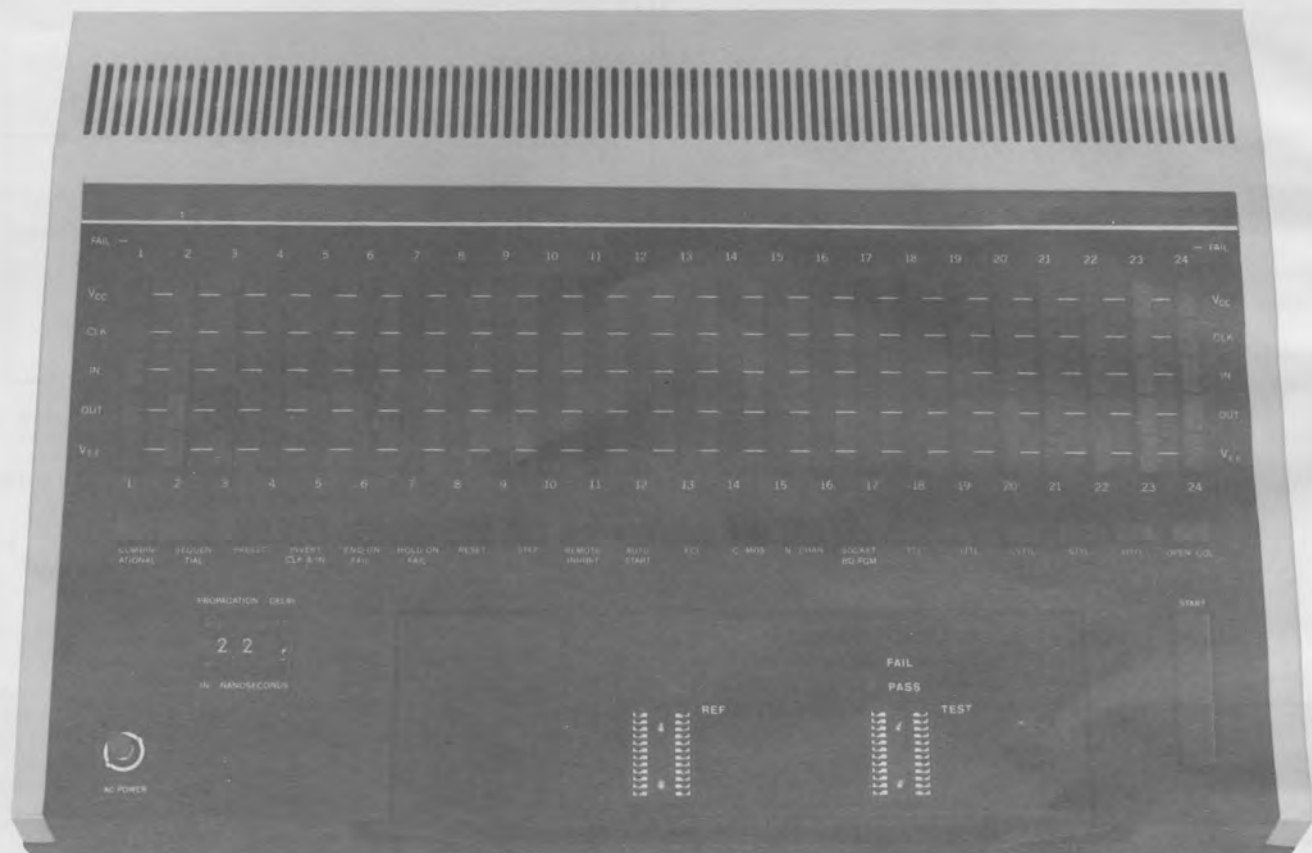

Straightforward front-panel controls simplify programming.

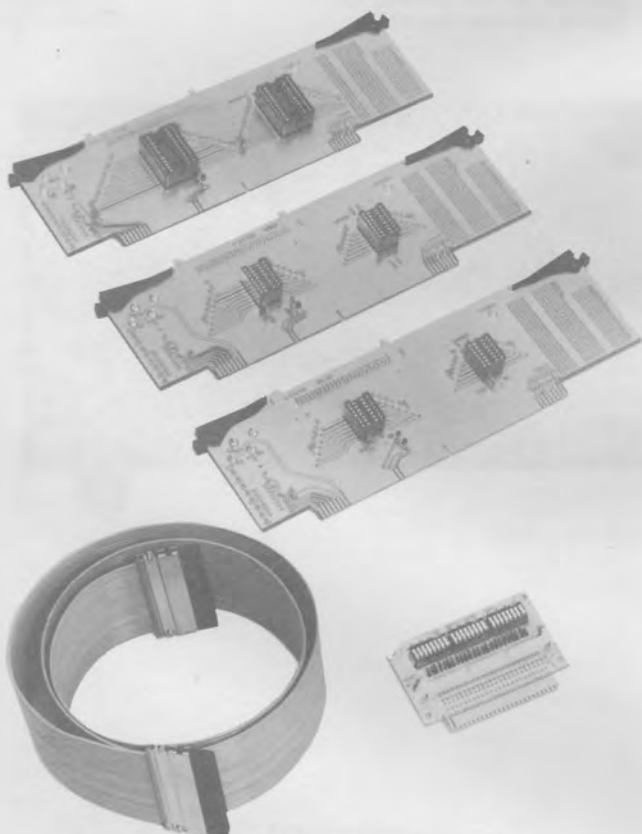

General-purpose device and load boards eliminate high programming costs.

SPECIFICATIONS

| | Range | | Accuracy | |
|---------------------------------|----------|----------|----------|-----|
| | Min | Max | %R | %FS |
| D.C. TEST CONDITIONS: | | | | |
| Supply Voltage V_{CC} | 0V | +5.25 V | 2 | 1 |
| Supply Current I_{CC} | 0 | 300 mA | | |
| High Input Voltage V_{IH} | V_{IL} | V_{CC} | 3 | 2 |
| Low Input Voltage V_{IL} | 0V | V_{IH} | 3 | 1 |
| High Output Current I_{OH} | 0 mA | 20 mA | 3 | 0.5 |
| Low Output Current I_{OL} | -20 mA | 0 mA | 3 | 0.5 |
| High Output Voltage V_{OH} | V_{OL} | 5.25 V | 2 | 1 |
| Low Output Voltage V_{OL} | 0V | V_{OH} | 2 | 1 |

INPUT DRIVERS:

| | |
|-----------------------------|-----------------|
| Number of Drivers Available | Up to 24 |
| Rise Time | 10 ns/volt max. |
| Fall Time | 10 ns/volt max. |
| Skew | < 10 ns |
| Output Capacitance | 100pF typical |
| Driver Impedance | 75 Ω |

| PATTERN GENERATOR: Pattern Modes Three Types a. combinational b. sequential c. preset Combinational Type GREY CODE Frequency 5 kHz to 1.3 MHz Length $t = 2^N$ N = Number of inputs selected Sequential Type PSEUDO-RANDOM GREY CODE Frequency 5 kHz to 1.3 MHz Length 6,000 or 82,000 patterns Clock One per pattern change from V_{IH} or V_{IL} Preset Used in combination with sequential or combinational mode to synchronize the DUT and FRD | | TESTER POWER REQUIREMENTS: Frequency 50 to 60 Hz Voltage RMS 100,120,200,240 VAC $\pm 10\%$ Current 1.5 A (protected by 3 A slow blow fuse) | | | | | | | | | | | | | | | | | | | | | | | | | | | | | | | | | | | | | | | | | | | | | | | |
|--|----------------------------|--|----|-------------|----------------|---------------------------------------|-------------------|----------------|---|----------------------------------|--------------|----------------------------------|---|----------------------------------|--|--------------------------|---|-------------------------------|--|-----------------------------|---|---|--|---------------|--|---------------------|-----------|---------------------|-----------|---------------------|-----------|------------------|-----------|------------------|-----------|------------------|-----------|------------------|-----------|------------------------------|--|---------------------------------------|-----------|---|--|--------------------------------|-----------|----------------------------|-----------|
| | | AMBIENT TEMPERATURE: Operating Range 10 to 50°C Storage Range -40 to 85°C | | | | | | | | | | | | | | | | | | | | | | | | | | | | | | | | | | | | | | | | | | | | | | | |
| | | REAR PANEL CONNECTORS: Autohandler Connector Amphenol 57-40-140 115/230 VAC Connector Switchcraft AC3G | | | | | | | | | | | | | | | | | | | | | | | | | | | | | | | | | | | | | | | | | | | | | | | |
| | | <table border="1"> <thead> <tr> <th>Description</th> <th>Catalog Number</th> </tr> </thead> <tbody> <tr> <td>1744 Digital IC Tester, 24-pin</td> <td>1744-9700</td> </tr> <tr> <td>Includes</td> <td></td> </tr> <tr> <td>14-pin dual-in-line socket board</td> <td></td> </tr> <tr> <td>16-pin dual-in-line socket board</td> <td></td> </tr> <tr> <td>24-pin dual-in-line socket board</td> <td></td> </tr> <tr> <td>Program Library</td> <td></td> </tr> <tr> <td>1 set of blank program sheets</td> <td></td> </tr> <tr> <td>Extender for chassis boards</td> <td></td> </tr> <tr> <td>Select following options, if desired</td> <td></td> </tr> <tr> <td>Socket Boards</td> <td></td> </tr> <tr> <td>14-Pin dual-in-line</td> <td>1744-9600</td> </tr> <tr> <td>16-Pin dual-in-line</td> <td>1744-9601</td> </tr> <tr> <td>24-Pin dual-in-line</td> <td>1744-9602</td> </tr> <tr> <td>14-Pin flat pack</td> <td>1744-9607</td> </tr> <tr> <td>16-Pin flat pack</td> <td>1744-9608</td> </tr> <tr> <td>24-Pin flat pack</td> <td>1744-9609</td> </tr> <tr> <td>Socket Board kit</td> <td>1744-9603</td> </tr> <tr> <td>Accessories available</td> <td></td> </tr> <tr> <td>Partial Set, Field Service Spares Kit</td> <td>1744-9604</td> </tr> <tr> <td>Includes Control and Limit Board, Control Logic Board, Pattern Generator Board, Pin Control Board</td> <td></td> </tr> <tr> <td>Standard Handler Interface Kit</td> <td>1744-9605</td> </tr> <tr> <td>Handler Interface Assembly</td> <td>1744-9606</td> </tr> </tbody> </table> | | Description | Catalog Number | 1744 Digital IC Tester, 24-pin | 1744-9700 | Includes | | 14-pin dual-in-line socket board | | 16-pin dual-in-line socket board | | 24-pin dual-in-line socket board | | Program Library | | 1 set of blank program sheets | | Extender for chassis boards | | Select following options, if desired | | Socket Boards | | 14-Pin dual-in-line | 1744-9600 | 16-Pin dual-in-line | 1744-9601 | 24-Pin dual-in-line | 1744-9602 | 14-Pin flat pack | 1744-9607 | 16-Pin flat pack | 1744-9608 | 24-Pin flat pack | 1744-9609 | Socket Board kit | 1744-9603 | Accessories available | | Partial Set, Field Service Spares Kit | 1744-9604 | Includes Control and Limit Board, Control Logic Board, Pattern Generator Board, Pin Control Board | | Standard Handler Interface Kit | 1744-9605 | Handler Interface Assembly | 1744-9606 |
| Description | Catalog Number | | | | | | | | | | | | | | | | | | | | | | | | | | | | | | | | | | | | | | | | | | | | | | | | |
| 1744 Digital IC Tester, 24-pin | 1744-9700 | | | | | | | | | | | | | | | | | | | | | | | | | | | | | | | | | | | | | | | | | | | | | | | | |
| Includes | | | | | | | | | | | | | | | | | | | | | | | | | | | | | | | | | | | | | | | | | | | | | | | | | |
| 14-pin dual-in-line socket board | | | | | | | | | | | | | | | | | | | | | | | | | | | | | | | | | | | | | | | | | | | | | | | | | |
| 16-pin dual-in-line socket board | | | | | | | | | | | | | | | | | | | | | | | | | | | | | | | | | | | | | | | | | | | | | | | | | |
| 24-pin dual-in-line socket board | | | | | | | | | | | | | | | | | | | | | | | | | | | | | | | | | | | | | | | | | | | | | | | | | |
| Program Library | | | | | | | | | | | | | | | | | | | | | | | | | | | | | | | | | | | | | | | | | | | | | | | | | |
| 1 set of blank program sheets | | | | | | | | | | | | | | | | | | | | | | | | | | | | | | | | | | | | | | | | | | | | | | | | | |
| Extender for chassis boards | | | | | | | | | | | | | | | | | | | | | | | | | | | | | | | | | | | | | | | | | | | | | | | | | |
| Select following options, if desired | | | | | | | | | | | | | | | | | | | | | | | | | | | | | | | | | | | | | | | | | | | | | | | | | |
| Socket Boards | | | | | | | | | | | | | | | | | | | | | | | | | | | | | | | | | | | | | | | | | | | | | | | | | |
| 14-Pin dual-in-line | 1744-9600 | | | | | | | | | | | | | | | | | | | | | | | | | | | | | | | | | | | | | | | | | | | | | | | | |
| 16-Pin dual-in-line | 1744-9601 | | | | | | | | | | | | | | | | | | | | | | | | | | | | | | | | | | | | | | | | | | | | | | | | |
| 24-Pin dual-in-line | 1744-9602 | | | | | | | | | | | | | | | | | | | | | | | | | | | | | | | | | | | | | | | | | | | | | | | | |
| 14-Pin flat pack | 1744-9607 | | | | | | | | | | | | | | | | | | | | | | | | | | | | | | | | | | | | | | | | | | | | | | | | |
| 16-Pin flat pack | 1744-9608 | | | | | | | | | | | | | | | | | | | | | | | | | | | | | | | | | | | | | | | | | | | | | | | | |
| 24-Pin flat pack | 1744-9609 | | | | | | | | | | | | | | | | | | | | | | | | | | | | | | | | | | | | | | | | | | | | | | | | |
| Socket Board kit | 1744-9603 | | | | | | | | | | | | | | | | | | | | | | | | | | | | | | | | | | | | | | | | | | | | | | | | |
| Accessories available | | | | | | | | | | | | | | | | | | | | | | | | | | | | | | | | | | | | | | | | | | | | | | | | | |
| Partial Set, Field Service Spares Kit | 1744-9604 | | | | | | | | | | | | | | | | | | | | | | | | | | | | | | | | | | | | | | | | | | | | | | | | |
| Includes Control and Limit Board, Control Logic Board, Pattern Generator Board, Pin Control Board | | | | | | | | | | | | | | | | | | | | | | | | | | | | | | | | | | | | | | | | | | | | | | | | | |
| Standard Handler Interface Kit | 1744-9605 | | | | | | | | | | | | | | | | | | | | | | | | | | | | | | | | | | | | | | | | | | | | | | | | |
| Handler Interface Assembly | 1744-9606 | | | | | | | | | | | | | | | | | | | | | | | | | | | | | | | | | | | | | | | | | | | | | | | | |
| TECHNOLOGIES TESTED: TTL DTL LTTL RTL LSTTL I ² L STTL HTTL ECL C-MOS (5 volts) N-Chan (5 volts) | | <table border="1"> <thead> <tr> <th>Accuracy</th> <th>%R</th> <th>%FR</th> </tr> </thead> <tbody> <tr> <td>Propagation Delay</td> <td>20 ns to 99 ns</td> <td>5</td> <td>20</td> </tr> <tr> <td>Range: t_d</td> <td>100 ns to 990 ns</td> <td>5</td> <td>3</td> </tr> <tr> <td></td> <td>1 μs to 9.9 μs</td> <td>5</td> <td>3</td> </tr> <tr> <td></td> <td>10 μs to 99.9 μs</td> <td>5</td> <td>3</td> </tr> </tbody> </table> | | Accuracy | %R | %FR | Propagation Delay | 20 ns to 99 ns | 5 | 20 | Range: t_d | 100 ns to 990 ns | 5 | 3 | | 1 μ s to 9.9 μ s | 5 | 3 | | 10 μ s to 99.9 μ s | 5 | 3 | | | | | | | | | | | | | | | | | | | | | | | | | | | |
| Accuracy | %R | %FR | | | | | | | | | | | | | | | | | | | | | | | | | | | | | | | | | | | | | | | | | | | | | | | |
| Propagation Delay | 20 ns to 99 ns | 5 | 20 | | | | | | | | | | | | | | | | | | | | | | | | | | | | | | | | | | | | | | | | | | | | | | |
| Range: t_d | 100 ns to 990 ns | 5 | 3 | | | | | | | | | | | | | | | | | | | | | | | | | | | | | | | | | | | | | | | | | | | | | | |
| | 1 μ s to 9.9 μ s | 5 | 3 | | | | | | | | | | | | | | | | | | | | | | | | | | | | | | | | | | | | | | | | | | | | | | |
| | 10 μ s to 99.9 μ s | 5 | 3 | | | | | | | | | | | | | | | | | | | | | | | | | | | | | | | | | | | | | | | | | | | | | | |

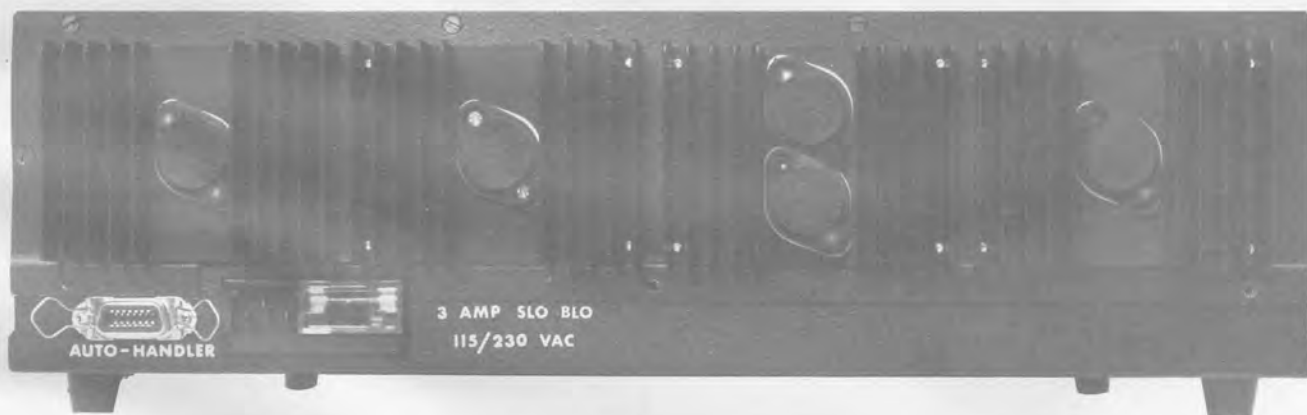

Rear-panel autohandler connection.

IC Tester Handler Interfaces

1740 Handler Interfaces

Standard Handler Interface Kit The standard handler interface kit consists of an analog cable, a digital logic control cable, a cable-to-program-board adaptor, a load board adaptor socket, and an instruction manual. The customer must purchase separately a load board for each device to be tested on the handler. See program card catalog for specific part numbers.

Customer installation consists of installing the handler manufacturer's socket on the digital cable, installing the handler manufacturer's socket to the load board adaptor socket, and connecting the digital and analog cables to the IC Tester.

Since a device manufacturer's process may vary, it is not possible to guarantee analog performance of the handler.

The standard handler interface will operate with the following handlers:

| Manufacturer | Model No. |
|--------------|-----------|
| Daymarc | 952 |
| Daymarc | 1152 |
| MCT | 2608 |
| MCT | 2608E |
| Ramsey | RH202 |

Listing a handler indicates that the interfacing requirements are satisfied by the standard interface. It does not imply an approval or recommendation of the handler.

For other handler interfaces, please contact GenRad. 1740-9604 Standard Handler Interface Kit, includes:

- Analog Cable
- Digital Logic Control Cable
- RD86 Red Base Socket to Cable Adaptor
- Load Board Adaptor Socket
- Instruction Manual

Handler Interface Factory Assembly When a Handler Interface Factory Assembly is purchased, the analog and digital interface cables are terminated by GenRad, selected devices are verified to test properly at the handler, and one day of system verification and customer training is provided. This is done only at the GenRad, Inc., Santa Clara, CA, facility.

The customer is required to supply the following material four weeks before scheduled delivery:

- The Handler
- Handler Analog Connector
- Handler Digital Connector
- One stick (25 devices) of each device to be verified
- The program board for each device to be verified (This last requirement is not necessary if the 1740 Linear IC Tester is purchased at the same time as the Interface.)

1740-9605 Handler Interface Assembly, includes:

- 1740-9604 Handler Interface Kit
- Wiring of connectors
- System verification

1742 Handler Interfaces

Standard Handler Interface Kit The standard handler interface consists of an analog cable, a digital logic control cable, an I/O digital control card, a load board connector, and standard compensation load boards for most devices.

Customer installation consists of placing the I/O digital control card into the tester and installing the handler manufacturer's digital and analog connectors to terminate cables at the handler. Since a device manufacturer's process may vary, it is not possible to guarantee analog performance of the handler.

The standard handler interface will operate with the following handlers:

| Manufacturer | Model No. |
|--------------|-----------|
| CONTREL | H310 |
| DAYMARC | 952 |
| DAYMARC | 1152 |
| DELTA DESIGN | CENTURION |
| IPT | 800 |
| MCT | 2608 |
| MCT | 2608E |
| RAMSEY | RH202 |
| SYM-TEK | 7192 |

Listing a handler indicates that the interfacing requirements are satisfied by the standard interface. It

does not imply an approval or recommendation of the handler. For other handler interfaces, please contact GenRad.

1742-9801 Standard Handler Interface Kit, includes:

- Analog Cable
- Digital Logic Control Cable
- I/O Digital Control Card
- Load Board Connector
- Eight analog load boards for
 - 14-pin TTL, UPB only
 - 14-pin TTL
 - 14-pin Blank
 - 14-pin CMOS, UPB
 - 14-pin CMOS
 - 16-pin TTL
 - 16-pin CMOS
 - 16-pin Blank
- Instruction Manual

Handler Interface Factory Assembly When a Handler Interface Factory Assembly is purchased, the analog and digital interface cables are terminated by GenRad, selected devices are verified to test properly at the handler, and one day of system verification and customer training is provided. This is done only at the GenRad, Inc., Santa Clara, CA, facility.

The customer is required to supply the following material four weeks before scheduled delivery:

- The Handler
- Handler Analog Connector
- Handler Digital Connector
- One stick (25 devices) of each device to be verified
- The program board for each device to be verified (This last requirement is not necessary if the 1742 Digital IC Tester is purchased at the same time as the Interface.)

1742-9620 Handler Interface Assembly, includes:

- 1742-9801 Handler Interface Kit
- Wiring of handler connectors to cables
- System verification

1744 Handler Interfaces

Standard Handler Interface Kit The standard handler interface kit consists of an analog cable, a digital logic control cable, a load board connector, and standard compensation load boards for most devices.

Customer installation consists of installing the handler manufacturer's digital and analog connectors to terminate cables at the handler. Since a device manufacturer's process may vary, it is not possible to guarantee analog performance of the handler.

The standard handler interface will operate with the following handlers:

| Manufacturer | Model No. |
|--------------|-----------|
| CONTREL | H310 |
| DAYMARC | 952 |
| DAYMARC | 1152 |
| DELTA DESIGN | CENTURION |
| IPT | 800 |
| MCT | 2608 |
| MCT | 2608E |
| RAMSEY | RH202 |
| SYM-TEK | 7192 |

Listing a handler indicates that the interfacing requirements are satisfied by the standard interface. It does not imply an approval or recommendation of the handler. For other handler interfaces, please contact GenRad.

1744-9605 Standard Handler Interface Kit, includes:

- Analog Cable
- Digital Logic Control Cable
- Load Board Connector
- Universal Load Board
- Instruction Manual

Handler Interface Factory Assembly When a Handler Interface Factory Assembly is purchased, the analog and digital interface cables are terminated by GenRad, selected devices are verified to test properly at the handler, and one day of system verification and customer training is provided. This is done only at the GenRad, Inc., Santa Clara, CA, facility.

The customer is required to supply the following material four weeks before scheduled delivery:

- The Handler
- Handler Analog Connector
- Handler Digital Connector
- One stick (25 devices) of each device to be verified.

1744-9606 Handler Interface Assembly, includes:

- 1744-9605 Handler Interface Kit
- Wiring of handler connectors to cables
- System verification



2230 Component Test System

A low-cost test system for rapid testing of components, networks and modules — Test them all automatically on one tester . . . 80 tests per second

- For nearly any application
 - thick- and thin-film networks
 - hybrid circuits
 - discrete components on reels
 - sequenced components
 - diodes and transistors
 - small functional modules/circuits
 - switches and relays
 - transformers
 - D/A and A/D converters
- In almost any area
 - production testing
 - incoming inspection
 - quality monitoring
 - environmental testing

The GR 2230 is a true system. It is under complete computer control, operates automatically at the push of a button, and tests in a fraction of a second.

Yet it is half the price of comparable systems and fits handily on a standard-sized desk with absolutely no compromise in utility or versatility.



National stock numbers are listed at the back of the catalog.

The 2230 system can be viewed as a mini-lab wherein several "instruments on boards" are united via both an analog and a digital bus structure through a scanner to quick-disconnect device adaptors. At the heart of this compact, bench-top system is a small but powerful microcomputer to give you computer-controlled speed, accuracy, and flexibility. It can be programmed by just about anyone, thanks to its unique English-language, macro-instruction keyboard. In addition, the 2230 will continuously print out test data and can be easily interfaced to virtually any automated device handler. Options are available for testing various modules and components as well as small circuit boards. Test engineers appreciate the ease of interchanging device adaptors, interfacing to peripheral instrumentation, and data transmission to a central management computer.

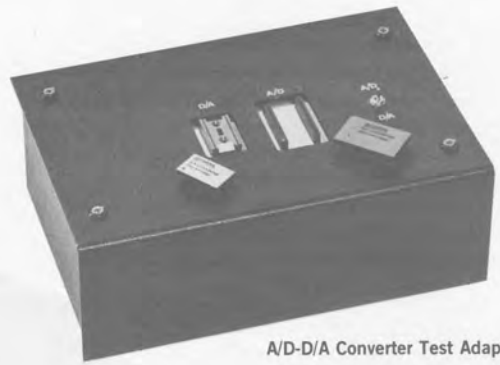

A/D-D/A Converter Test Adaptor



Bed-of-Nails Test Adaptor



Ramsey RH-913 DIP Handler

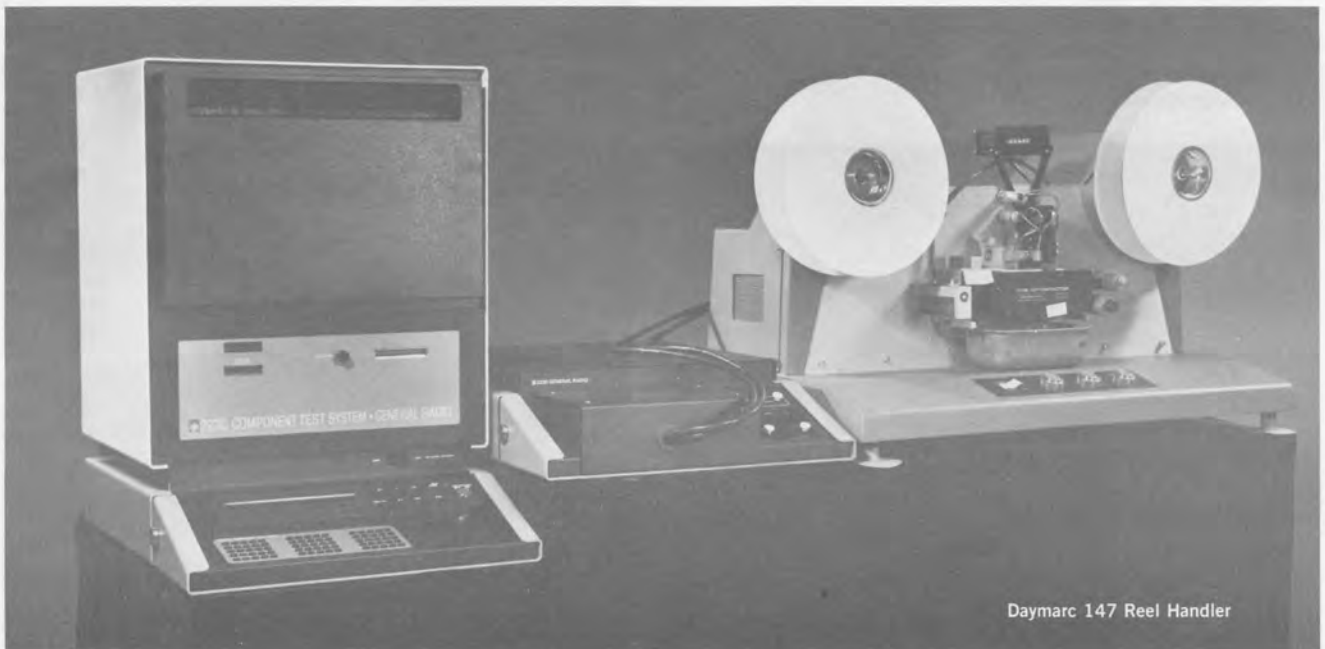

Daymarc 147 Reel Handler

All measurements are performed by plug-in modules — easily adapted to changing requirements and currently suited to testing diverse components with the following features:

- mixed R, L, C and dc measurements with individualized test limits
- point-to-any-other-point scanning with Kelvin connections
- simple programming with macro-instruction keyboard
- both Go/No-Go and parameter readout modes of operation
- quick-disconnect device adaptors for various package styles
- data-logging and data-reduction capabilities with hard-copy output
- ease of interface to automatic device handlers
- computer-controlled speed and accuracy at low cost
- wide range of options for nearly any application

The 2230 is being used in many testing applications such as:

- resistor networks for TV tuners
- thin-film substrates for telephone circuits
- thick-film networks for automotive voltage regulators
- microphone preamps for CB radios
- DIP relay modules for traffic control lights
- small TV circuit boards
- sequenced components on reels
- audio transformers for communication systems
- insulation resistance on capacitors
- ground fault interrupt circuits
- smoke detector modules
- solid-state relays

THE SYSTEM

The GR 2230 is an automatic system for high-volume testing of components, multileaded networks and modules. It operates at the push of a button and provides electrical, hard-copy, and bright-light results of any or all tests.

The entire system is housed in two compact units: a test console and a mainframe. Both units fit handily on a standard-sized desk, require no special power or environmental considerations, and can be on-line in less than an hour. A self-teaching programming manual is provided with each system.

Test Console The test console accepts the device under test and contains all the controls and indicators necessary for preprogrammed testing.

The device to be tested interfaces to the system by means of a device adaptor. Several standard adaptors are available for 16-pin DIP or SIP devices, and blank adaptors are available for complex module interfacing needs. All provide ample space and electrical provisions to accommodate any required special circuitry, and all are interchanged at the flip of a lever. Adaptors are available for interfacing the GR 2230 to several popular automatic handlers.

The built-in scanner provides connections for 16 channels and is expandable to 128 in groups of 16. Each channel consists of three line pairs for Kelvin connections to the device-under-test (DUT) to preserve the accuracy of the measurement at the device. Scanner connections are point-to-any-other-point, completely automatic, and controlled by the computer via simple keyboard commands.

A RUN button initiates preprogrammed tests and the go/no-go results are indicated by PASS or FAIL lamps. A PAUSE lamp indicates a temporary halt in the test procedure to allow for adjustments or any other required operator attention. Testing is resumed by a push of the CONTINUE button. The ESCAPE button stops the testing and reverts the system to a semi-automatic mode.



Daymarc 1152 IC Sorter



The Deval AT 30 Automatic Tester handles components that do not have wire leads, such as chip capacitors and resistors, thermistors, diodes and SOT 23 transistors.



Mainframe The major elements of the system are housed on 10- x 14-inch plug-in modules in the mainframe, including the computer, the DEC LSI-11. The computer is among the fastest of its type available today — a microcomputer with over 400 basic instructions, up to 8K of random-access memory, and 16K of read-only memory, which translates the macro-instruction operating programs.

One measurement module, a DC Ohmmeter, is standard with all systems. Others are available, including a CGRL bridge module and a dc voltage/current-measurement and current-force module. Since all the modules plug in, they can be added or interchanged easily for field expansion or maintenance with minimum down time. Other optional features include a programmable supply controller, ac stimulus and response capabilities, and a data converter testing adaptor.

A card reader/writer allows creation and entry of instruction sets. The instruction sets are stored on convenient magnetic strip cards and can be loaded into the system in seconds for each type of device to be tested. Once the computer is loaded, testing becomes a simple matter of button pushing.

Hard-copy records of the measurement results and instruction sets are provided on command by a built-in thermal printer. The printer produces 20-character lines at rates up to three lines per second on two-inch wide paper — quietly and reliably. An optional data link provides the means of sending measured data to either a teletypewriter or external management computer. Data can also be stored on magnetic cards.

Main Control Panel The main control panel includes a large, easily read, 16-character display for test-program listing and editing, measurement results, error messages, and system self-check results.

Eight special-purpose pushbuttons are included for control convenience and flexibility: SELF CHECK initiates a self-check of the system operation, SINGLE STEP causes the system to pause at the end of each program step, LIST outputs the current test program on the printer, READ reads a magnetic strip card into the system, WRITE writes the current test program onto a magnetic strip card, CLEAR clears the current test program from the system memory, PRINTER activates the thermal printer unit, and ESCAPE places the system in the semi-automatic mode. The remainder of the control panel contains 75 keys, which provide the primary control for all program steps and testing operations.

THE CONTROL

Measurement Functions Nine measurement keys are standard on all systems. Three (HIGH, LOW, and GUARD) route the measurement connections to the DUT and two (CONTACT and SENSE) monitor and control up to 27 connections used primarily for external equipment such as automatic handlers or environmental instrumentation for special applications. Three other keys (RDC, GDC, and RATIO) specify test requirements of the standard DC Ohmmeter measurement module. The INTEGRATE key may be used to minimize hum or noise in critical applications.

Additional functions are provided with the optional CGRL Bridge module. Two keys control the basic measurement parameters of FREQ (120- or 1000-Hz measurement frequency) and BIAS (4 Vdc on or off). A RANGE selection minimizes bridge balance time. A LOW SENS key permits reducing the bridge sensitivity when testing nonlinear capacitors or inductors. The other eight quadruple the measurement capability of the system and include Cs, Cp, ESR, Rp, Gp, Ls and Q. Another option, the DC Voltage/Current Measurement and Current Force module, adds other functions that are particularly useful for diode or transistor measurements. These functions include: CURRENT FORCE to force a specified current, and the two dc measurement functions VDC and IDC.

Logic Functions All 27 logic keys are standard in every system. In addition to such standard functions as AND, OR and NOT, there are logic keys for set definitions including: , to produce a set from two or more values, EXCLUDE to exclude certain values from an operation, @ to determine the numbers in a specified set, MEMBER to determine the condition of specified numbers, and & to



National stock numbers are listed at the back of the catalog.



provide exceptions to a statement. Keys are also provided for branching functions: LABEL to name each statement(s) for later reference by other branching commands, : to terminate a phrase and provide a "go-to" function for "if" statements, IF to transfer control upon specified conditions, GO TO to transfer control unconditionally, CALL to branch to a previously defined routine, RETURN to return to a point following a matching call and ERROR BRANCH to allow the program to continue in a situation where it would normally stop due to an error (non-balance) condition.

Eight keys initiate specific actions: DISPLAY, PRINT, PRINT NAME to print out all statements up to the statement terminator; DELAY to stop program execution for a specified time; PAUSE to stop program execution until the CONTINUE button is pushed; PASS to stop program execution if the device passes all tests; FAIL to stop program execution if the device fails any test; and REG to hold a value in one of 128 specified registers. The editing capabilities are aided by the NEXT STATEMENT key which brings a test statement (between two terminators :) into the display and NEXT KEY which increments keystrokes through the display. The DELETE key deletes keystrokes one at a time (from right to left).

Arithmetic Functions All 23 arithmetic keys are also standard on every GR 2230. Numbers 0 through 9 can be expressed and entered into the system in any manner that an arithmetic number can be legitimately expressed — signed, integers, non-integers/, decimal numbers ., and decimal numbers in engineering notation EE. Numbers up to $\pm 10^{36}$ can be expressed with 6-digit accuracy.

Normal arithmetic operators such as +, -, *, and ÷ are included for addition, subtraction, multiplication, and division. The +, - signs are also useful for engineering notation, measurement polarities, and signal polarities. A % operator is included to simplify limit expressions and () keys are provided to group terms within an expression.

Three comparison operators (<, >, and =) are provided to produce certain specified true or false logical results. Results obtained from such expressions direct program branching and are a powerful tool in preparing instruction sets for complex networks. The → key is used to join command keystrokes which call for something to be placed into a register.

Register "500" concept A group of special registers is set aside to provide access to the data link, the programmable supply controller, the array manipulations feature and other optional capabilities as well. A command such as 5 → REG 523 sets a programmable power supply to 5V, for example.

National stock numbers are listed at the back of the catalog.

THE PERFORMANCE

Scanner Channels: 16 standard, expandable to 128 in groups of 16. Each channel may consist of any of 3 line pairs: HIGH, LOW, or GUARD for Kelvin connections to minimize lead-impedance effects and to preserve the accuracy of the measurement at the device-under-test. Off impedance is greater than $10^{10}\Omega$ and less than 0.5 pF.

Contacts: Form A rated at 1A and 100V max.

Speed: 4ms actuate and release times.

Examples:

- 1 → HIGH: Connects pin 1 of the device adaptor to the HIGH line pair.
- 2 → LOW: Connects pin 2 of the device adaptor to the LOW line pair.
- 3 → GUARD: Connects pin 3 of the device adaptor to the GUARD line pair.

DC Resistance with the standard Ohmmeter Module

RDC, dc resistance: 0.25Ω to 10,000MΩ.

GDC, dc conductance: 0 to 4S.

Ratio, 0 to 1 ratio of two resistors R1 and R2, where

$$R1 < R2 \text{ and the ratio is } \frac{R1}{R1 + R2}$$

Speed: 12ms test time, exclusive of scanner closure time.

Integration: Line-frequency integration programmable for hum rejection of typically 60 dB.

RDC: initiates dc-resistance measurement and displays value.

RDC → PRINT: initiates dc-resistance measurement, displays value, and prints out value on thermal printer. Conductance or ratio measurements are equally simple:

GDC:, RATIO:, GDC → PRINT:, etc.

A few more keystrokes provide a limit test:

```
LABEL 1:
IF 100 - .1% < RDC < 100 + .1%:
PASS:
LABEL 2:
FAIL:
```

That is, if the measured dc resistance is between $100\Omega - 0.1\%$ (99.9Ω) and $100\Omega + 0.1\%$ (100.1Ω), the PASS lamp lights. Otherwise the FAIL lamp will light. Note that the statement is entered in plain language, similar to that used for the familiar electronic pocket calculator.

1 → INTEG: integrates the measurements to obtain greater hum suppression. The 1 is a logic true statement to enable the integration, while 0 would inhibit it.

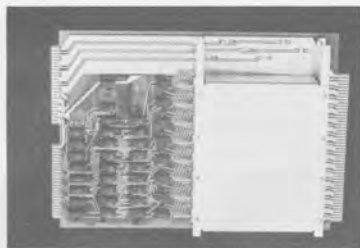

Capacitance with the optional CGRL Bridge Module

Cs series capacitance: 0 to 1mF
 CP parallel capacitance: 0 to 1mF
 ESR equivalent series resistance: 0.8Ω to 1000 MΩ
 RP parallel resistance: 0.8Ω to 1000MΩ
 GP parallel conductance: 0 S to 1.58 S
 Ls series inductance: 120μH to 2500H
 D capacitance dissipation factor: 0 to 2000
 Q quality factor: 0 to 2000
 FREQ measurement frequency: 100 Hz or 120 Hz, and 1 kHz
 Bias: 0 or 4V, internal
 Speed: ≤50 ms per test

CS: initiates series-capacitance measurement and displays value.

D: initiates capacitance dissipation-factor measurement and displays value.

Again, any other measurement is but a matter of a few keystrokes:

CP, RP, ESR: (displayed values), Ls → PRINT: (printed values) etc.

In addition, frequency and bias can be specified:

1000 → FREQ: specifies 1000Hz as the measurement frequency.

1 → BIAS: applies the internal 4V bias (1 is a true statement to apply the bias, a 0 would be a false statement to remove the bias).

2 → LOW SENS: Places the window of CGRL balance at ±10 counts for nonlinear measurements.

In a testing application, limits could also be specified. Also, in these applications, test time is minimized by selecting the appropriate range of the eight available ranges used:

3 → RANGE: locks the bridge on range 3.

0 → RANGE: allows automatic ranging (as the default condition).



For increased scanner capability beyond 32 channels, this test console is used to house additional scanner boards.

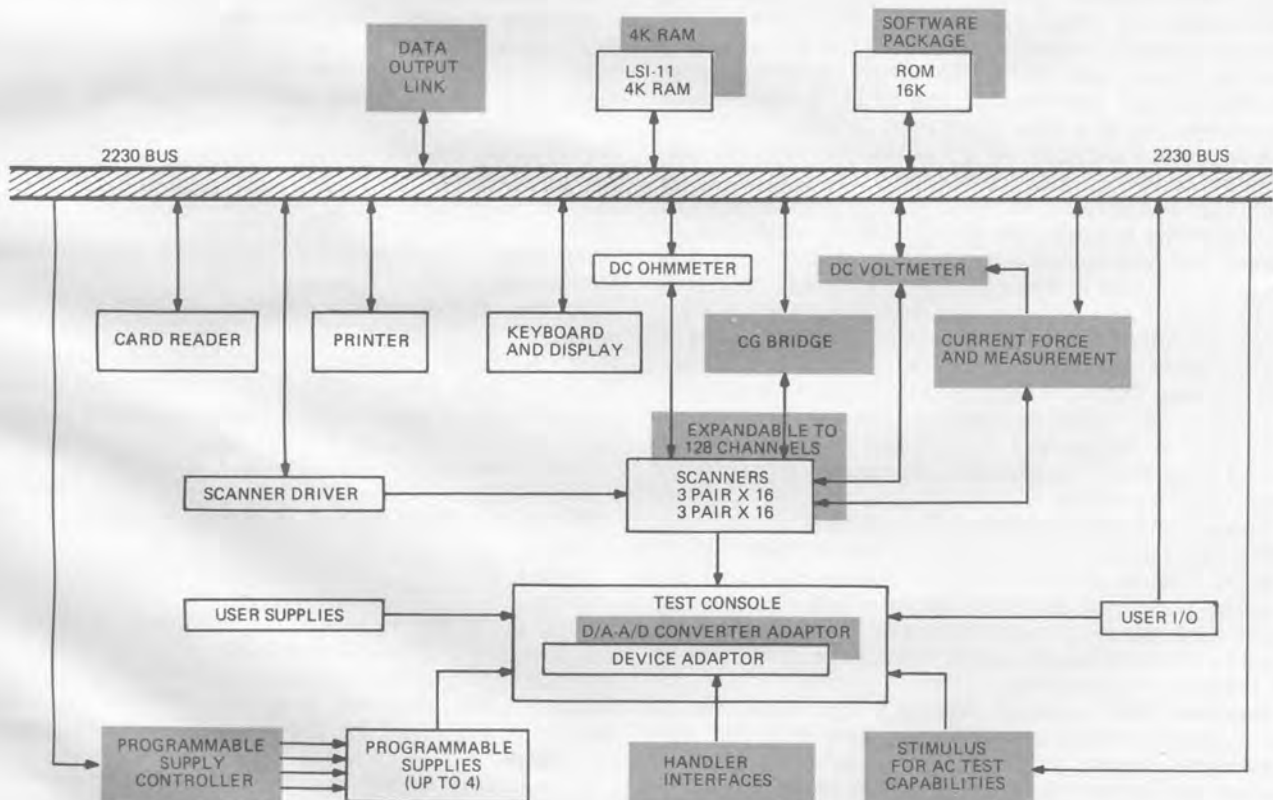

GR 2230 automatic test system. Options are shown in color.

National stock numbers are listed at the back of the catalog.

DC Voltage and Current

with the optional DC Voltage/Current Measurement and Current Force Module

CURRENT FORCE: 100 μ A to 100mA in discrete programmable values of 100 μ A, 200 μ A, 1mA, 2mA, 10mA, 20mA, 100mA. Allows IV tests of semiconductors, in addition to creating circuit test conditions.

VDC, dc voltage: 0V to 64V

IDC, dc current: 0 to 128mA

Speed: 12 ms exclusive of scanner closure times.

Integration: Line-frequency integration programmable for hum rejection of typically 60 dB.

.0001 \rightarrow **CURRENT FORCE:** forces a 100 μ A current through the device.

.02 \rightarrow **CURRENT FORCE:** forces a 20mA current through the device.

VDC: initiates a dc-voltage measurement and displays the value.

IDC: initiates a dc-current measurement and displays the value.

1 \rightarrow **INTEG:** integrates the measurement for greater accuracy in the presence of hum.

Dc voltage measurements in conjunction with current forcing is very useful for testing many types of semiconductors. To evaluate a Zener diode, for example:

.1 \rightarrow **CURRENT:** forces a 100mA current through the diode.

VDC: measures the dc voltage across the diode. A set of voltage values is obtained by simply changing the values used for the forced current.

Input/Output Contact Lines: eight relay drivers switch 100mA at 25V plus 8 TTL compatible lines.

Sense Lines: eight for use with TTL levels plus three pairs for sensing SPDT switch closures.

Contact and sense functions can be used with a variety of component handlers and environmental apparatus:

LABEL 2: label 2 is displayed (a previously defined program statement).

5 \rightarrow **CONTACT:** closes contact 5 (which could actuate the component handler fail bin via a handler interface connection).

Or to actuate a relay which would alter a test condition:

7 \rightarrow **CONTACT:** closes contact 7 (which could activate a relay on the device adaptor to introduce a new signal).

Or to introduce an external power source:

3 \rightarrow **CONTACT:** closes contact 3 (to connect a DUT to a 100V external power supply) via a suitable relay for a leakage test for instance.

0 \rightarrow **CONTACT:** opens all contacts.

In a sense statement,

IF SENSE 1, the 2230 stays in a program loop until the handler is in a ready condition; or if the handler is ready, the program branches to the designated label (5) as shown in this example:

LABEL 1:

IF SENSE 1:

GO TO 5;

LABEL 2:

GO TO 1;

User Power Supplies Power Supplies: +15V at 0.25A, - 15V at 0.25A, and +5V at 1A are supplied. They can be connected to the DUT via relays in conjunction with CONTACT statements. The scanner can also be used to switch power supplies.

Please use one of the cards at the rear of this catalog to request complete information.

SPECIFICATIONS

Display: PANEL. 0.5-inch high x 16-position alphanumeric display with memory and right-to-left sequential character entry for error messages, system self-check results, measure-

ment results, and test programs during preparation. **PRINTER:** 20-character-per-line thermal printer for program listing and test or measurement results. **INDICATORS:** Pass, fail, pause, and run lamps for test results and operational modes.

Program: Written in easy-to-learn test language and entered into random-access memory from macro-instruction tactile keyboard. Programs can be stored on 2 x 10.5-inch magnetic cards. Operating software allows user to prepare and edit programs via keyboard, using panel display as monitor.

Control: By test program written once for type of device under test and stored on magnetic cards or directly by keyboard and panel switches.

Memory: 4K random access for specific program instructions, 16K of ROM for system operating programs.

Supplied: Assurance self-test adaptor, thermal-printer paper, magnetic program-storage cards, and GenRad acceptance test at customer's facility. **Standard System:** Includes DEC LSI-11 microcomputer with 16K ROM, magnetic card reader/writer, thermal printer, panel display, keyboard, dc-resistance-measurement capability, and system test console with I/O controls and 16-channel scanner.

Device Adaptors: Plug-in type 16-pin DIP, 16-pin SIP, and blank device adaptors with access to scanner and I/O connections. Oversize versions are available with ample space for special test circuits.

Environment: Temperature, 0 to 40°C operating. Relative humidity, 80% at 35°C.

Power: 90 to 125 V or 180 to 250 V, 48 to 66 HZ, 500 W max with all options.

Mechanical: DIMENSIONS (wxhxd): Mainframe 19.375x-26.750x24.250 in. (492x679x615mm); test console 19.938x5.656x25.031 in. (506x144x636mm). **WEIGHT:** Mainframe 125.5 lb (57 kg) net; test console 25.5 lb (11.6 kg) net.

| Description | Catalog Number |
|--|--|
| 2230 Component Test System | Order by describing model, line frequency, and options desired. |
| Select the following options, if desired | |
| OP1 CGRL Bridge Measurement Module | |
| OP2 DC Voltage/Current Measurement and Current Force Capability | |
| OP3 Additional 16 Channel Scanner | |
| Options available for customer installation: | |
| OP 1R Retrofit Kit (CGRL Module) | 60Hz 2230-9620 50Hz 2230-9621 |
| OP 2R Retrofit Kit (DCV/I Module) | 60Hz 2230-9622 50Hz 2230-9623 |
| OP 3R Retrofit Kit (16 Channel Scanner) | 2230-9625 |
| Service Kit, for maintenance ease, includes service device adaptor with test boards and cables, standard calibration techniques, troubleshooting procedures using magnetic cards containing diagnostic programs. | 2230-9510 |
| Device Adaptors: | |
| 2230-P1 Device Adaptor (16 Pin DIP) | 2230-9651 |
| 2230-P2 Device Adaptor (16 Pin SIP) | 2230-9652 |
| 2230-P3 Device Adaptor (Blank) | 2230-9653 |
| The following are oversized adaptor boxes allowing more space for adding peripheral circuitry: | |
| 2230-P6 (16 Pin DIP) | 2230-9656 |
| 2230-P8 (Blank) | 2230-9658 |
| Accessories available | |
| 2230-P11 Magnetic Card Pak (50 Cards) | 2230-9609 |
| 2230-P12 Thermal Paper Pak (5 rolls) Sanyo | 2230-9610 |
| 2230-P13 Printer Paper Pak (3 rolls) TI | 2230-9611 |
| GR 2230 Interface for: | |
| Control H300 Handler | 2230-9023 |
| Control H320 Handler | 2230-9009 |
| Daymarc 147 Handler | 2230-9751 |
| Daymarc 149 Handler | 2230-9011 |
| Daymarc 1152 Handler | 2230-9012 |
| Ramsey RH903 Handler | 2230-9750 |
| Ramsey RH913 Handler | 2230-9750 |
| MCT2608 Handler | 2230-9059 |

National stock numbers are listed at the back of the catalog.

RECOMMENDED OPTIONS

Data Output Link: This link provides a means of transferring data to a central computer or TTY. It can be used in conjunction with a management computer to monitor parameter trends in production or incoming inspection. This option consists of a GenRad (LSI-11) Bus Extender and a Termination Card, a DEC Type DLV-11 Serial Line Interface Card and two additional ROM chips which store the firmware for the data port operation.

2 → REG 501: determines data format

REG 8 → REG 500: sends contents of register 8 out the data port.

4 → REG 501: formats data port to transmit ASCII characters.

88 → REG 500: sends the letter X out the data port.

Additional 4K RAM Memory: The added RAM capability expands the GR 2230 standard memory size of 4K to 8 K. The number of keystrokes of program language is increased from 1600 to 3500 with the extra memory. The option contains a GenRad (LSI-11) Bus Extender and a Termination Card and a DEC Type MSV11-B 4K RAM Card.

Expandable Scanner Capability: In order to test small circuit boards and hybrid circuits, additional channels may be required to scan the measurement modules or to provide contact closures for external devices. This option includes a larger test console and sixteen channels of scanning. Up to seven additional scanner cards (OP 3) may be installed in the test console, increasing the scanning capability to 128 pins.

Programmable Supply Control Module: This option provides four programmable outputs of 0 to $\pm 10V$ at 5 mA. The resolution of voltage variation is 12 bits. This affords the user a flexible means of controlling up to 4 voltage-controlled programmable supplies. The required supplies can be integrated by the user or furnished by GenRad with the system. The control module is installed in the test console.

20 → REG 551: Sets the power amplifier (X2) controlled by DAC 1 to 20V.

2 → REG 125: A gain factor is stored to set the DAC 1 to a value within the 10-volt range.

Each of the four DAC outputs is individually controlled by both a gain factor register and a special register used to specify the output voltage.



The programmable supply control module is housed in an oversized test console.

D/A and A/D Converter Testing Capability: This option consists of a special device adaptor with built-in electronics, including a reference D/A converter, and provides the user full testing capability for both D/A and A/D devices with up to 12 bits. Testing is done without any operator adjustments. Tests performed include integral linearity, differential linearity and monotonicity.

Adjustments are eliminated by having an algorithm measure the zero and full-scale values of the converter under test and calculate the value of any code to be tested. Thereafter, the reference is set to the calculated code and simple comparisons are performed. The main advantage of this technique is testing without operator adjustment.

Optional Software Package: This option contains a ROM chip set which affords the user the ability to store data on magnetic cards, to perform array manipulations which are particularly useful for environmental testing where sets of data are stored and manipulated, and to print names or numbers other than those which are keystroke related.

Second (Additional) Test Console: Dual test stations provide the user with two multiplexed test positions. Each station can be interfaced to an automatic handler or used as a manual position. An indicator lamp on each console tells the operator when the respective console is ready to test.

AC Voltage Test Capability: This option contains an ac-to-dc converter module which is installed in the test console. The converter can be scanned and measures frequencies up to 100 kHz. Limits are applied to the dc output which is monitored by the system dc voltmeter. An ac function generator which is interfaced to the system is provided as the stimulus for ac testing. The ac test capability is useful for functional testing of small modules and pc boards.

CGRL Bridge Attenuator: This option provides a means of automatically varying the level of the test signal used. This is useful when testing nonlinear components, such as capacitors and inductors. It is also useful in pc board testing where (parallel) semiconductor junctions could conduct and, therefore, distort measured results on passive components.

Transformer Testing Capability: Audio-frequency transformers have many applications in today's communications equipment. To ensure dependable in-circuit performance, some or all of the following impedance-related parameters must be tested on multiple-winding transformers:

- inductance
- inductance unbalance
- dc resistance
- effective resistance
- transformation ratio
- capacitance

An optional test console has been structured which allows the system to test all of these transformer parameters automatically under 2230 program control. Transformer terminals can be automatically strapped (series connected) and Kelvin connections are made to each terminal during test sequences, all by 2230 program instructions. Test frequencies are 120 Hz or 200 Hz and 1 kHz. A dc bias of up to 200 mA (adjustable) can be applied via program control. The basic option provides a terminal capacity of 16 and is expandable in groups of sixteen.

PC Board Testers

1795-FD and -HD Logic Test Systems

High performance at low cost

1796 Digital/Analog Test System

Large-scale integration of test capability

1799 Digital/Analog Test System

An integrated system *designed* as a hybrid tester

1797 Programming Station

An off-line programming station

2270 In-Circuit/Functional Tester

For automatic electrical inspection of PC boards

Software—The difference in software

is the difference in testers

2220 Bug Hound

For tracing faults on PC boards

Test systems are described only briefly in this section of the catalog. Postage-paid postcards have been inserted at the rear for your convenience in requesting additional information.





1795-HD Logic Test System

High performance at low cost

The GR 1795-HD is a new breed of logic-circuit test system. It contains the same program preparation and diagnostic capabilities as the world-renowned GR 1792-series with CAPS, but at a much lower price. Now, for about the same initial investment required for much simpler systems, you can realize the cost effectiveness that can only be provided by a computer-controlled, simulator-based system. The 1795-HD is ideally suited for use in manufacturing operations, service depots, and in R & D where the simulator-based system is ideal for ensuring that new designs possess a high degree of testability.

Modular Hardware The GR 1795-HD has been designed to test a wide variety of logic modules, cards, and LSI chips. Driver rise times are fast enough to test today's high-speed logic families, yet carefully controlled to avoid crosstalk and ringing. The system can be ordered with as few as 72 driver/sensor pins and yet be field-expanded to include up to 480 pins. The GR 1795-HD offers cartridge-disk mass storage that permits extremely rapid program execution, program storage, housekeeping convenience, and reliability.

Powerful Software The standard software included with each system is LTM (Learn/Test Mode). This

software allows a test program to be created automatically from the response of a known-good board. In addition, it allows the system to record all the internal nodal values. Since all the data from the edge-connector pins and from the internal IC pins are recorded on disk, there is no need for a known-good board during testing and troubleshooting. This is especially important in service depots, where it is often impractical to store racks full of "reference boards." The operator diagnoses faults by simply tracing back from the edge-connector pin until the source of the failure is found. It is important to realize that the GR 1795 finds failures by accurately comparing full nodal data, not by using a transition-count or duty-cycle technique. This results in much more rapid diagnosis and repair, particularly in those difficult situations involving feedback loops.

Available as an option is GR's CAPS software package. This is the most proven, the most accurate and the most widely used program preparation and diagnostic software for logic boards available in the world today. For additional information, refer to "Test-System Software."

Probes A new GR-designed logic probe is available to enable more rapid troubleshooting, even in the presence of pulses. This probe is programmable over a range of -30 volts to +30 volts, and it automatically programs

National stock numbers are listed at the back of the catalog.

itself to sense the correct levels as it is probing from one logic family to the next. The probe can also measure dc voltage on command of either the operator or of the test program. The FINDS package (refer to "Test-System Software") can take over where the regular probe leaves off to improve the resolution of fault location beyond the nodal level, down to the specific bad IC or to the other node involved in a short, etc.

Analog Measurements Analog measurements and stimuli are available on the GR 1795 through the use of our IEC (IEEE, ASCII) bus interface. This option includes a standard GR hardware interface and high-level software routines; so interfacing to any standard ASCII-bus instrument is a routine matter.

Please use one of the cards at the rear of this catalog to request complete information.

1795-FD Logic Test System

an even lower-priced system . . . ideal for the service depot, for additional production capacity, or for the smaller manufacturing operation

The GR 1795-FD is an even lower-priced alternative for those situations where the volume of work is not high enough to justify even the low-priced GR 1795-HD. It shares most of its hardware with the "HD" model and differs mainly in being floppy-disk (FD) based rather than using the hard-disk (HD), cartridge-type disk drives.

The 1795-FD can use the autoprogramming software to create a GO/NO-GO program almost automatically, and the LTM software to create diagnostics. Also, it can use a CAPS/APG generated test program developed on other GR systems, the GR 1797 Programming Station, or a program from a GenRad programming service. Thus, the 1795-FD makes full use of all of the diagnostic tools available, including the diagnostic-resolution module (refer to "Test-System Software").

The GR 1795-FD takes up even less space than the GR 1795-HD, being only two bays wide, and can be field-converted into a 1795-HD as your requirements dictate.

Please use one of the cards at the rear of this catalog to request complete information.





1796 Digital/Analog Test System

An ATE system with large-scale integration of test capability

Large-scale integration of both digital and analog functions is definitely a reality. Squeezing a multitude of functions, both digital and analog, on a single IC and using these ICs on PC boards to provide even more complex functions has resulted in significant manufacturing cost savings. However, the testing costs associated with these PC boards have risen dramatically. What is needed to reduce these costs is large-scale integration of test capability in an ATE system, namely, high-speed digital driver/sensors, sophisticated analog stimulus and measurement modules, and a flexible switching matrix and PCB interface capability.

The 1796 was designed to provide the sophisticated test capability previously found only in special-purpose costly ATE systems. As a GR customer, you obtain the benefits of years of software development and the reliability built-in by GenRad's ten-plus years of experience in supplying ATE systems.

Technical Highlights

The Switching System and PCB Interface It cannot be over emphasized that the switching matrix is the heart of any hybrid ATE system. It provides the paths necessary for all digital/analog signals between the modules of the test system and the board under test. In the 1796, the switching matrices are fully integrated (both hardware

and software) into the system. The result is a digital interface providing high-speed and/or low-speed digital data transfer, an analog interface providing electrically quiet, wide-band (50-MHz bandwidth) connections to the stimulus and measurement modules, and a hybrid interface providing a combination of digital and analog test capability at up to 192 points with a bandwidth in excess of 10 MHz.

The Digital Test Hardware The digital test capability consists of programmable driver/sensors and a high-speed controller with local RAM memory. The driver/sensors are programmable over a ± 30 -volt range and can operate at speeds from dc to over 1.5 MHz. A maximum of 216 to 324 pins can be selected, depending on the ratio of high-speed to low-speed pins.

A high-speed controller with local RAM memory at each driver/sensor pin provides test speeds from 10 kHz to over 1.5 MHz (over 350-million pin transitions per second). In addition to speed, the sophistication and complexity of today's LSI circuit boards require the following important features found in the 1796:

- The controller can switch a driver/sensor back and forth from the drive to the sense mode during high-speed operation to allow for testing of bus-oriented logic.

National stock numbers are listed at the back of the catalog.

- 'DO' loops are available to generate iterative test sequences repetitively or until a specific sensor logic state is reached. This allows initializing logic without using a large part of the local memory.
- Synchronizing inputs are provided to allow the Unit Under Test (UUT) to force the controller to wait for a specific condition before proceeding with the next test step. This allows a UUT on-board-clock to control the timing of the test sequence.
- The 40-MHz controller clock, along with signals corresponding to driver and sensor timing, are provided as outputs to the UUT to generate clock signals for synchronizing the UUT to the tester.
- AC Measurement Unit, capable of measuring ac waveforms from 50 Hz to 7 MHz.
- DC Measurement Unit, capable of making differential voltage and current measurements in five different operating modes: direct, integrate, low-pass filter, peak, and track and hold. These modes permit the user to optimize a test program for speed, accuracy and noise immunity, as needs dictate.
- Resistance Measurement Unit, capable of 4-terminal Kelvin or guarded resistance measurements from 0 to 10 M Ω .
- Frequency Measurement Unit, capable of measuring frequency, period, multiple period, frequency ratio and time interval. Frequency range 0.012 Hz to 40 MHz. Time interval 200 ns to 84 s.

The Analog Stimulus and Measurement Modules Analog stimulus and measurement are accomplished via modules designed for operation in a system environment. The following standard capability is provided:

- AC Sources, providing sine, square or rectangular waveforms from dc to 10 MHz.
- Pulse Generator, programmable in pulse amplitude, pulse duration, pulse separation, rise and fall times, and number of transitions.
- User-Programmable Power Supplies, capable of four quadrant operation with programmable current limits.
- Time-Measurement Unit, capable of time-interval measurement from 2 ns to 1.6 s.

In addition to the above equipment, the 1796 supports the IEEE 488 Interface Bus so that additional equipment required for unique applications can be integrated into the system.

In summary, the 1796 has the capability to meet your testing needs now and into the future, and it is upward compatible to previous GenRad ATE systems in hardware and software.

Please use one of the cards at the rear of this catalog to request complete information.

1799 Digital/Analog Test System

An integrated system designed as a hybrid tester

Until now, if you wanted a combined digital/analog test system you had to choose between a digital tester with some added analog features or a powerful but expensive digital/analog tester which may well have had more capability than you needed. GenRad has now solved this problem by designing a fully integrated digital/analog test system in the medium-price range. By "fully integrated" we mean that the 1799 has been designed as a hybrid test system rather than merely being an enhanced digital test system—as most medium-priced hybrid testers are. This means, for instance, that the software and the hardware "talk" to each other in an efficient manner, and that the measurement "instruments" (in reality, purpose-designed modules) are controlled by high-level language statements rather than a string of meaningless ASCII characters. This, and many other benefits of the integrated "second-generation" approach, makes for a more cost-effective solution to your testing problems.

Cost-Effectiveness is What ATE is All About—and the 1799 Scores in all Major Cost Areas.

Setup Costs Simple UUT interfacing—via plug-in device adaptor with room inside for adding any special interface circuitry, etc. "Universal pins"—under program control each pin can be a logic driver, a logic sensor, an analog source, or an analog measurement pin.

GenRad's world renowned CAPS (Computer Aided Programming Software) package and the newer Automated Program Generation (APG) make for cost-effective program preparation.

Testing Costs High-speed disk-based operation, a simple but flexible operator's control panel, easy change-over of test programs and device adaptors, and reliable operation all combine to produce maximum throughput.

Troubleshooting Costs CAPS-generated diagnostics, a look-ahead-guided-pulse-catching probe, GenRad's unique Diagnostic Resolution Module, and a new Analog Diagnostics package add up to giving the most accurate and detailed error messages available on an ATE system. In addition to providing rapid diagnostics, the unique accuracy of GenRad's systems means that your off-line repair costs will also be lowered considerably.

Technical Highlights

The Switching System and UUT Interface The switching system is the heart of a hybrid test system. Since virtually all stimulus and measurement signals pass through it the performance of the whole system stands or falls on its integrity. The 1799 uses the universal pin scanner from our top-of-the-line 1796 test system, providing a bandwidth in excess of 10 MHz coupled with low cross talk.

The Digital Test Hardware A choice between fixed (internally adjustable) or fully programmable logic driver/sensors is available. The programmable version has a range of ± 15 volts, dual drivers and sensors per pin for mixed logic testing, and strobing of driver output and sensor monitoring for complete control of test timing.

The Analog Stimulus and Measurement Modules Analog stimulus and measurement are accomplished via modules designed for operation in a system environment. The following standard capability is provided:

- AC Sources, providing sine, square or rectangular waveforms from dc to 10 MHz.
- Pulse Generator, programmable in pulse amplitude, pulse duration, pulse separation, rise and fall times, and number of transitions.
- User-Programmable Power Supplies, capable of four quadrant operation with programmable current limits.

- AC Measurement Unit, capable of measuring ac waveforms from 50 Hz to 7 MHz.
- DC Measurement Unit, capable of making differential voltage and current measurements in five different operating modes: direct, integrate, low-pass filter, peak, and track and hold. These modes permit the user to optimize a test program for speed, accuracy and noise immunity, as needs dictate.
- Resistance Measurement Unit, capable of 4-terminal Kelvin or guarded resistance measurements from 0 to 10 M Ω .
- Frequency Measurement Unit, capable of measuring frequency, period, multiple period, frequency ratio and time interval. Frequency range 0.012 Hz to 40 MHz. Time interval 200 ns to 84 s.

In addition to the above equipment, the 1799 supports the IEEE 488 Interface Bus so that additional equipment required for unique applications can be integrated into the system.

In summary, the 1799 has the capability to meet your testing needs now and into the future, and it is upward compatible to previous GenRad ATE systems in hardware and software.

Please use one of the cards at the rear of this catalog to request complete information.



National stock numbers are listed at the back of the catalog.



1797 Programming Station

An off-line station dedicated to program preparation

Most large, automatic PC-board test systems are capable of performing three basic functions: setup, test and diagnosis. However, if the primary use for the system is to test and troubleshoot boards, then it is needless to comment on how difficult it can be to get enough time on the system to generate new test programs.

GenRad's 1797 Programming Station allows programmers to do their thing without interfering with the production operations. Also, since the 1797 contains no test hardware, the production people will have no interest in it whatsoever.

Supports GenRad Systems The 1797 will support GenRad's 1792, 1795, 1796 and 1799 systems, whether they have their own program-generation capability or not. For instance, GenRad's popular low-cost tester, the 1795 with floppy disk drives, is strictly a test and troubleshooting system. To develop programs for a CAPS-equipped 1795 you need a 1797 Programming Station or, if one is available, you can use any of the other

testers listed above. An ideal situation is a single 1797 Programming Station that supports several 1795 units.

On the other hand, if you have one or more GenRad systems, you can free those systems for more test and diagnosis work by shifting the program-generation work to a 1797 Programming Station.

Other convenient features allow you to . . .

- interface with a large variety of peripherals.
- perform program editing.
- perform program duplicating and archiving; an optional second disk drive is useful for this function.
- perform simulation runs.
- enjoy the convenience (and savings) of in-house programming.

Please use one of the cards at the rear of this catalog to request complete information.



2270 In-Circuit/Functional Test System

Focusing on a specific manufacturing problem — PC-board-assembly faults

- cost-effective fault diagnoses
- improved in-circuit testing accuracy
- automatic test generation software
- human-engineered design

Most PC-board faults typically originate during board assembly. GenRad's new 2270 focuses on these faults through fast, accurate, and completely automatic electrical inspection of the finished assembly. Solder shorts, wrong parts, missing parts, backwards parts, or incorrectly seated parts are completely isolated and described in simple English by a printed, board-repair message.

Controlled inspection and elimination of assembly faults before functional test can significantly reduce manufacturing costs by providing some or all of the following benefits:

- A production-line assembly inspection station can typically be reduced to one person, independent of board complexity.
- With simple faults removed, functional-test and fault-troubleshooting bottlenecks can be removed.
- Production capacity can be increased with lower investments in both equipment and program preparation/debug costs.

This PC-board inspection system can initiate future cost savings by providing process feedback data; cumulative faults, yields and throughput time studies can be recorded and analyzed for future process adjustments.

In addition, the 2270 with its LSI-11 based controller and powerful high-level, English-language software was designed with production flexibility in mind. Depending

on production volumes or assembly yields, the 2270 may also have extra capacity for partial or full functional testing of every board either before or after electrical inspection. When 2270 functional modules and IEC bus instrument options are added to the basic system, almost any type of functional testing can be easily performed. The enhanced bar-graph display circuitry designed into the CRT display even makes pot alignments or other circuit adjustments easy and fast. In essence, the 2270 can be looked upon as a powerful controller for custom test requirements.

The 2270 contains other features we think you will like:

- 4 line x 1024 (maximum available on standard system) pin scanner with full crosspoint control for improved in-circuit testing and greater functional test flexibility.
- ATG software to create electrically isolated component tests automatically from circuit topology information.
- Powerful on-line editing and debugging software.
- Human-engineered design. Both the CRT and bed-of-nails work surface can be adjusted by the user to comfortable operating positions.
- A vacuum transducer which generates vacuum from compressed plant air, usually eliminating the need for a noisy and expensive pump.

The 2270 was designed to take advantage of GenRad's expertise and leadership in the fields of RLC component measurement instrumentation and automatic test systems design.

Please use one of the cards at the rear of this catalog to request complete information.

Test-System Software

CAPS Test System Software

Available as an option to GenRad test systems is GR's CAPS software package. This is the most proven, the most accurate and the most widely used program preparation and diagnostic software for logic boards available in the world today. CAPS will save you time in preparing your test programs because it measures your test program's effectiveness in detecting faults and provides analysis documentation that is invaluable to the test engineer in improving the quality of the test program. It can reduce your servicing costs by ensuring that your boards are properly tested before your product is shipped, so that you need not rely on seldom-seen feedback from your final test or service departments to be sure your test program is functionally testing your logic boards.

It can indicate design inconsistencies that may result in manufacturing bottlenecks; in fact, you can analyze your logic designs and accurately write your test programs before the physical prototypes are available. It can give you the information you need to improve your logic-board testability.

APG and FINDS

CAPS can be further enhanced by the addition of the optional Automated Program Generation package (APG) and the Fault Identifying Nodal Diagnostic Software (FINDS). APG and FINDS are available separately so that you can tailor the software you buy to the problems you have. If your major problem is getting programs up and running in the shortest possible time, then you need APG. APG can dramatically reduce the time taken to get your test program from the 60-70% effectiveness level up to the 90% + level. If your major problem is in the fault-location and board-repair area, then you will need the FINDS package. FINDS uses a number of different techniques to pinpoint accurately which is "the bad IC" on a large board, or which node is shorted to which other node, etc rather than merely telling you that "this node is bad." FINDS is particularly useful if your boards are heavily BUS-oriented or if WIRE-AND techniques are used a lot.

Automatic Troubleshooting Using CAPS

GenRad's unique CAPS software package provides not just one but several troubleshooting techniques to reduce complex-board troubleshooting to the point where neither a skilled technician nor a schematic is required. CAPS will isolate faults, not only on digital PC boards but also on those digital networks contained within hybrid boards. If the problem is in the analog portion, CAPS will pinpoint it to the functional analog block for further analysis by the computer-guided analog diagnostic software.

Automatic Fault Location (AFL)*

Automatic Fault Location (AFL) is the mode that provides completely automatic fault identification and location. By "completely automatic," we mean no probing whatsoever. The operator simply presses the START button or footswitch, and within seconds the CRT will display the why, what and where of the failure. The types of failures that can be identified include IC input or output pins stuck high (open) or to ground, shorts between adjacent IC pins, loss of power to an IC, many types of component-insertion failures, many types of multiple

failures, non-plated-through holes, and shorts between adjacent tracks. The starting point for AFL is a data base, or fault dictionary, that contains all typical manufacturing failure mechanisms. Through on-line simulation, recorded I/O data of a unit under test are compared with simulated data for all test steps until the best match is obtained. At that point a message appears on the CRT identifying the nature of the failure. In addition to the CRT presentation, a hard-copy record can also be readily obtained.

This approach does not rely on any operator intervention whatsoever, thereby eliminating the chance of human error in probing, in reading instructions, etc. Simulation is done on-line to allow a complete I/O pin comparison, thus investigating all failure possibilities that could produce the symptom. The fault dictionary contained on the disk is merely the starting point, allowing AFL with on-line simulation to begin where other automatic fault-look-up techniques stop. CAPS picks up where fault dictionaries leave off, resulting in the best possible troubleshooting resolution afforded by the test program and network topology.

CAPS diagnostics: computer-guided tracking probe

A part of the GR CAPS diagnostic option is the computer-guided tracking probe, which allows access to internal nodes on the board. This probe is available in two forms: A single-point GR Logic Probe or a multipoint IC clip. In this troubleshooting mode, the computer directs the operator to probe through the logic, tracking back from a failing output pin. The software guides the operator to probe from node to node (or IC to IC with the clip) until the failure has been located. Because probing is subject to human error, CAPS includes heuristics that adapt the probing routine to correct for operator errors. All probing instructions are determined automatically; there is no need for programmed instructions for the probe.

Smart Probe

A fault dictionary has the advantage of being able to diagnose faults very rapidly because it requires no operator involvement for probing. It has the disadvantage, however, of not always having good resolution be-



*Patent applied for.

cause of poor board visibility. The computer-guided probe, on the other hand, provides excellent resolution, because it has access to internal points on the board. Unfortunately, it can be a slow process always working back from failing outputs pins, probing many levels of logic until the fault is isolated. What is needed is a troubleshooting routine that combines the speed of a fault dictionary with the resolution of the computer-guided tracking probe. Enter GR's new Smart Probe.

The Smart Probe uses inputs from both a fault dictionary and the computer-guided probe to isolate the fault in a fraction of the time of the tracking probe working alone. By first invoking a fault dictionary, the Smart Probe gets enough information to begin probing at the suspected cause of failure instead of at the board output pins. Thus, we optimize troubleshooting speed with low-skilled operating personnel.

Yet, CAPS does not penalize a knowledgeable operator. Provisions can be made to let the operator try out "hunches" about the causes of board failure (under the watchful eye of CAPS, of course). If the hunch proves correct, CAPS will utilize the information and even more rapidly isolate the failure. If the hunch is incorrect, the Smart Probe will take over.

The Smart Probe is available as a single-point Logic Probe or a multipoint IC clip. The Logic Probe is fully programmable over a range of -30 V to +30 V and has dual threshold detection. Use of the probe with CAPS diagnostic software is fully automatic. The software will

automatically program the proper voltage level as the computer automatically guides it from one logic family to another. In addition, the probe can detect transitions and catch pulses down to 25 nanoseconds. It can also measure dc voltage. Its input capacitance is less than 10 pF, which is particularly important when probing MOS logic. The IC clip is available with the Diagnostic Resolution Module (DRM). This speeds up the probing sequence considerably, especially when probing ICs with many inputs or outputs such as multiplexers and decoders. The system will automatically request the operator to use the single-point probe on any IC that cannot be clipped.

Analog Diagnostics

GenRad's computer-guided analog diagnostic software is structured from efficient and flexible programming algorithms to isolate more quickly specific faults on both hybrid and analog boards.

This software maintains a careful balance between automatic and manual programming, thus maximizing both programming and probing efficiency without sacrificing the test flexibility required for analog circuits.

Analog diagnostics represent an enhancement of the standard functional board test program. The vague "circuit area" indictments which are generally common in functional analog test programs can now be improved to the point of indicting specific nodes and components. This is done by mathematically comparing nodal impedance signatures in a suspect area with those impedance signatures previously learned from a known-good board.

```

MESSAGE:

*****
**
**
PROBE: (16 PINS) ** U44.7 **
**
**
*****

STATUS: AFL STARTING POINT

=====
LAST POINT PROBED: U4.5      DIAGNOSIS: BAD /#3
LAST BAD POINT:    U4.5      DIAGNOSIS: BAD /#3
ORIGINAL FAILING TEST #: 1
  
```

```

MESSAGE:

*****
**
**
PROBE: (16 PINS) ** CLIP U3 **
**
**
*****

STATUS: RECLIPPING DUE TO BAD CONTACT

=====
LAST POINT PROBED: U1.5      DIAGNOSIS: BAD /#3
LAST BAD POINT:    U1.5      DIAGNOSIS: BAD /#3
ORIGINAL FAILING TEST #: 1
  
```

```

BOARD: 4351.TP          DATE:
FROM: FINDS            FAIL TEST #84
COMMENT: TWO NODES SHORTED

                                CONNECTIONS
U19.8(7402) SHORTED          U18.3*(74175) U2.9(7437)
                                U4.4(7408) U2.10(7437)
U11.4*(7404) SHORTED        U4.5(7408) U5.1(74H52)
                                U19.9(7402)
  
```

(top left) Message to the operator indicating IC U44 pin 7 is the next point to be probed.

(top right) A second message to the operator indicating that IC U3 must be clipped again owing to a detected bad contact the first time.

(bottom) Final diagnosis stating that the node, described by IC U19 pin 8 and its connections, is shorted to the node described by U11 pin 4 and its connections. The Bug Hound would now be used to find the actual physical location of this short.



Diagnostic-Resolution Module (DRM)

FINDS (software) is used in conjunction with the DRM (hardware) to improve the resolution of the fault identification beyond the usual node level. The DRM is housed in a small box which sits beneath the control panel and incorporates two probes and two clips. Once the guided probe or guided clip has diagnosed a fault to a specific node the software links automatically to FINDS.

Depending on the nature of the fault at the node (permanently stuck, failed but active some of the time), FINDS will direct the operator to use the DRM clips or probes with a suitable strategy. For example, if a short to Vcc or ground is suspected, FINDS will direct the operator to clip an IC on the bad node and check for the shorts. The Smart Clip will automatically check that it has good contact with all the pins on the IC so that errors due to bad clipping, etc are eliminated. If a broken

connection is suspected, FINDS will direct the operator to probe or clip each side of the suspected "open." For a suspected bad IC, FINDS uses a current-tracing technique to identify accurately the cause of the nodal failure. Other strategies are used for other types of fault, and the result is an accurate diagnosis printout which is so much more useful to the repair person than merely identifying the bad node. This results in shorter repair times and fewer boards ruined due to removal of the wrong IC, etc. Throughput on the system is increased even though more probing is required, since incorrectly repaired boards will not be recycled through the tester.

The diagram below, based upon data from a typical manufacturing environment, shows the usefulness of FINDS by comparing the relationship between a nodal diagnosis and the actual fault.

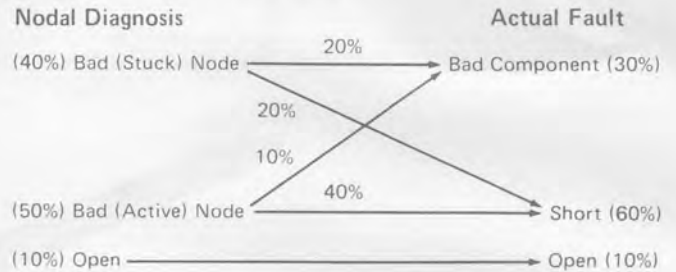

Only 10% of all faults (the "opens") will be accurately diagnosed by nodal diagnosis.

For any other type of fault the cause could be a short or a bad component. The short could be from the node to many other possible nodes and the bad component could be any one of many tied to the node (especially with bus-structured logic). Since 90% of the faults have this possible ambiguity, the benefits of FINDS are quite clear.

Please use one of the cards at the rear of this catalog to request complete information.



2220 Bug Hound

A totally new approach to locating faults on PC boards

- locates "shorts" and "opens"
- locates the bad IC on a node.
- locates shorts between power and ground tracks—including shorted capacitors
- works for all logic families
- requires no power on the board — therefore does not tie up ATE system or other instrumentation such as power supplies or scopes
- easy to use — requires no "sensitivity" or "calibration" adjustments

The GenRad 2220 Bug Hound is a completely self-contained instrument designed to take over where your automatic board-test system leaves off. With information based upon the diagnostic message received from the test system, which gives the electrical location of the fault, the repair person will select one of the Bug Hound's several operating modes and quickly track down the physical location of the fault.

Modes of Operation

Microvoltmeter Mode The two-range microvoltmeter is used to trace dc currents by measuring the voltage drop in the tracks on the board. A 10-mA dc signal can be injected using the two injection clips. This mode is used mainly for tracing shorts between power and ground tracks since the 600-kHz signal used for tracing nodal shorts would normally be shorted by decoupling capacitors between power and ground. Normally one probe is held near one of the injection clips and other probe moved along the track. The meter display will move upscale as the distance between the probes increases. When the probe passes the short, no further increase in meter deflection will occur.

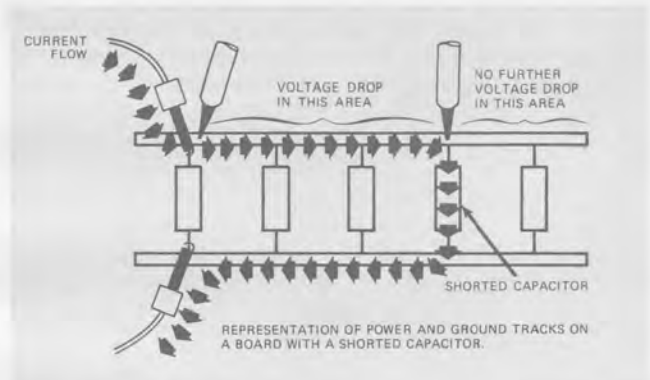

Although normally used in conjunction with the built-in current source, the microvoltmeter can also trace currents generated by ICs on a powered-up board for location of bad ICs or normal nodes, wired-AND nodes, and buses.

Connectivity Mode When the Connectivity Mode is selected, the same two probes used by the microvoltmeter become a threshold resistance tester. The 2220 Bug Hound has a small loudspeaker built-in to sound a tone when the resistance is below 75 ohms. A personal earphone may be used instead of the loudspeaker.

This mode is mainly used for locating open circuits but is also used for locating the second node involved in a short if your ATE does not give you that information. GenRad test systems equipped with the Diagnostic Resolution Module (DRM) will give a diagnostic printout which identifies **both** of the nodes involved in a short; other systems do not have this capability, they only identify **one** of the shorted nodes. In this case, the second of the nodes is located using the Connectivity Mode before using the Signal-Trace Mode to locate the short itself.

Signal-Trace Mode In this mode a 600-kHz signal is injected into the two shorted nodes via the two clips. Where the current flows a magnetic field, which is followed by the unique phase-sensitive* current tracing probe, is set up. When the probe is to one side of the right track, one of the two LEDs mounted in the probe tip will be lit and a tone will sound in the loudspeaker or ear-phone. When the probe is moved to the other side of the track the LED will go out, the other LED will light and the tone will change in pitch. By using a deliberate zig-zagging motion the track can be followed quickly and accurately. There is no ambiguity as to which of the tracks is carrying the current since the LEDs and the tones can only switch immediately over the correct track. Compare this with amplitude-sensitive probes which have to be carefully adjusted to discriminate between tracks, and even then possess some degree of ambiguity when the tracks are closely spaced.

Once the probe passes the short, the LEDs will both go out and so will the tone.

The Phase-Sensitive Probe*

Amplitude-sensitive probes need to have an adjustable sensitivity in order to determine which of several closely spaced tracks is carrying the current, which creates the magnetic field. The diagram on the left shows the response pattern of such a probe for three different field strengths. It is obvious from this that unless the sensitivity can be adjusted, the resolution of such a probe will be

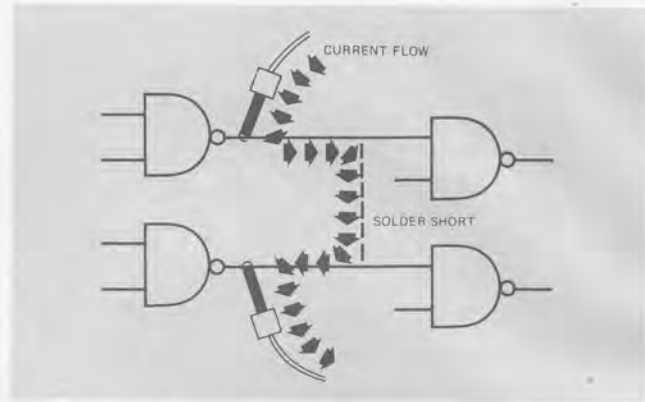

very poor. In addition, since the sensitivity has to be turned down the probe has to be held directly over the track in order to trace. Compare this with the diagram on the right which shows the response of GenRad's unique phase-sensitive probe to the same field strengths. The switchover from one LED to the other occurs directly over the current-carrying track regardless of the field strength. This permits accurate tracing without having to be always directly over the track, and the lack of a sensitivity control means one less operator action to be performed.

*Patent Pending

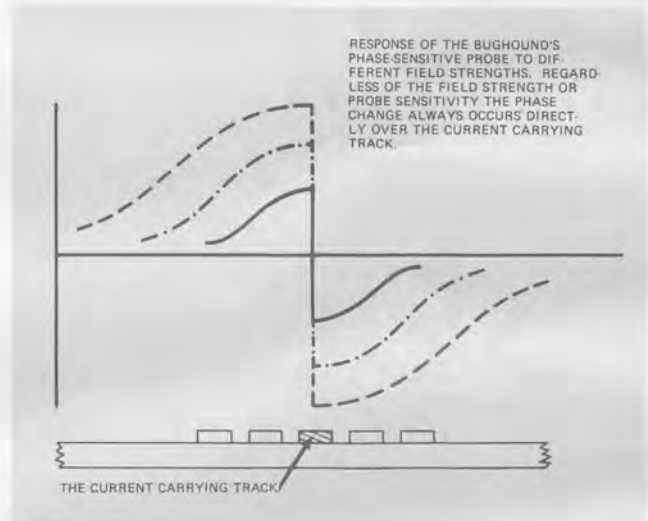
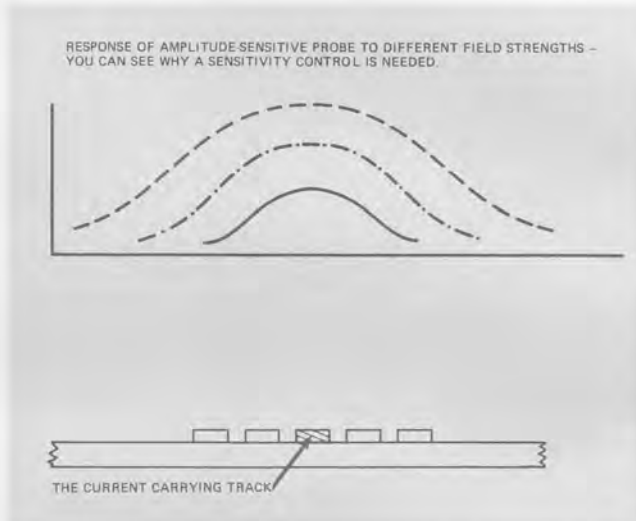

SPECIFICATIONS

Microvoltmeter

Accuracy: $\pm(20\%$ of full scale + $10 \mu\text{V})$.
 Ranges: 50-0-50 μV and 500-0-500 μV .
 Input impedance greater than 100 Ω .
 Differential protection between probes $\pm 15 \text{ V}$.

DC Current Source

Compliance: 1 V dc max open circuit.
 Output current: 10 mA $\pm 20\%$ into short circuit.

Current-Sensing Probe

Source drive signal: 600 kHz $\pm 20\%$, 1 V peak max into open circuit. 20 mA p-p square wave into above circuit. Detector probe: Sensitive to source if probe held within 1/8 inch of copper track.

Connectivity Test: Detects resistance less than 75 $\Omega \pm 10\%$.

Power: 100 to 175 or 200 to 250 V, 50 or 60 Hz.

Mechanical: DIMENSIONS (wxhxd): 8.5x3.12x12.25 in. (21.6x8.4x31.1 cm). WEIGHT: 6 lb (2.7 kg) net, 10 lb (4.5 kg) shipping.

| Description | Catalog Number |
|---------------------|----------------|
| 2220 Bug Hound | 2220-9700 |
| 2220 Trace Probe | 2220-9710 |
| 2220 Test Probe Kit | 2220-9720 |

BLANK
PAGE

Acoustic/Vibration Instruments and Systems

Noise—its impact on our society is increasing rapidly. Contributing factors are increased population density, greater mechanization, and increased public awareness and concern about physiological and psychological effects of noise. With the requirements of new noise standards and legislation coupled with advanced instrumentation, the measurement and control of industrial, community, and product noise have become far more important in recent years.

Vibration control is gaining a similar increase in attention, particularly in the product category. The engineer realizes that, in many instances, control of vibration is necessary before any effective control of noise can be accomplished.

A leader in acoustic measurements since it introduced the first commercial sound-level meter, GenRad has seen major emphasis placed on its acoustic and signal-analysis prod-

uct lines with the passage, in the United States, of The Occupational Safety and Health Act. GenRad can supply all the equipment you need to comply with the noise-measurement standards prescribed by various regulatory agencies for community noise, industrial noise and product noise rating and reduction. In our broad acoustics line are sound-level meters and calibrators, personal noise dosimeters, vibration meters, impact-noise analyzers, preamplifiers, audiometer calibrators, real-time analyzers, recorders, wave analyzers, sound and vibration analyzers, octave-band analyzers, vibration control systems, and many related products.

Acoustic/vibration instruments and systems are described only briefly in this section of the catalog. Postage-paid postcards have been inserted at the rear for your convenience in requesting additional information.



1933 Precision Sound-Level Meter and Analyzer

- from 10 to 140 dB
- ANS1 Type 1
- built-in octave-band analyzer
- impact and impulse capability

The 1933 is an all-purpose instrument for precision sound-level measurements as well as octave-band analysis. Its multifunction capability allows you to use it for numerous OSHA-required measurements. These include: General noise surveys; impact and impulse measurements; audiometric booth-site surveys; post-installation measurements of audiometric booths; measurements to determine proper noise absorbing materials; and analysis measurements for noise-reduction programs.

The 1933 is the logical choice for companies whose noise measurement programs involve more than simple sound-level surveys. It may be purchased alone with standard accessories or in sound-level measurement systems with a variety of accessories and a specially padded luggage-type carrying case. The 1933-9714 system includes a GR 1562-A Sound-Level Calibrator, wind-

screens, and an earphone for aural monitoring. The 1933-9710 system includes all of the above plus a tripod, 60-foot microphone extension cable, and a larger carrying case.



Condensed Specifications

Sound Level: 10 to 130 dB with 1-in. microphone; 20 to 140 dB with 1/2-in. microphone.

Power: Four alkaline energizer C cells provide about 20-h operation.

Supplied: Microphone attenuator, tool kit, 10-ft microphone extension cable, batteries.

Weight: 5.5 lb (2.5 kg).

Description

1933 Precision Sound-Level Meter and Analyzer
 With 1/2-in. and 1-in. microphones
 With 1/2-in. microphone only
1933-9710 Sound Analysis System
1933-9714 Sound Analysis System

Catalog Number

1933-9700
1933-9701
1933-9710
1933-9714

1933-9610 Vibration Integrator System

- extends capabilities of 1933 precision sound-level meter and analyzer
- direct readout in dB re standard references for:
 acceleration
 velocity
 displacement
- handy slide rule gives metric and English vibration units

The 1933-9610 Vibration Integrator System extends the capabilities of the 1933 Precision Sound-Level Meter and Analyzer to include vibration measurements with read-out of acceleration (L_a), velocity (L_v), and displacement (L_d). This added capability increases the versatility of the 1933 for noise-reduction work by permitting the measurement and analysis of structure-borne

vibration as well as airborne noise. It also adds preventive maintenance to the 1933's functions since vibration analysis is often used to detect potential parts' failures in machinery and equipment.

Condensed Specifications

Measurement Range: ACCELERATION: L_a in dB re 10^{-5} m/s²; (octave) 30 to 140 dB (3.16×10^{-4} to 100 m/s²), (flat) 46 to 140 dB (2×10^{-3} to 100 m/s²). VELOCITY: L_v in dB re 10^{-8} m/s; (octave) 60 to 150 dB (1×10^{-5} to 0.316 m/s), (flat) 76 to 150 dB (6.31×10^{-5} to 0.316 m/s). DISPLACEMENT: L_d in dB re 10^{-9} m; (octave) 50 to 150 dB (3.16×10^{-7} to 3.16×10^{-2} m), (flat) 66 to 150 dB (2×10^{-6} to 3.16×10^{-2} m).



1933-9610 Vibration Integrator System

1933-9610

National stock numbers are listed at the back of the catalog.

1982 Precision Sound-Level Meter and Analyzer

- from 30 to 140 dB (150-dB PEAK)
- built-in octave-band analyzer
- ANSI Type 1
- digital and analog display

The 1982 is a truly versatile, all-purpose instrument for precision sound-level measurements, octave-band analysis, and peak and impulse measurements. Its multi-function capability allows you to use it for numerous OSHA-required measurements. These include: General noise surveys; peak and impulse measurements; audiometric booth-site surveys; post-installation measurements of audiometric booths; measurements to determine proper noise absorbing materials; and analysis measurements for noise-reduction programs.

The 1982 combines an easy reading digital display with a clear, linear analog meter. The two displays let the user observe sound-level readings in clear digital form while observing the levels rise and fall on the analog meter. The digital display assures repeatable readings by different users since judgement of the needle position is not required. A special "maximum-hold" feature can be switch selected to "capture" and hold the digital display at the highest sound-level measured while the analog meter continues to indicate every rise and fall in the level. This ensures that the operator will not miss the highest noise level, even when not constantly watching the meter.

The 1982 is the logical choice for companies whose noise measurement programs involve more than simple sound-level surveys. It may be purchased alone with standard accessories or in sound analysis systems with a variety of accessories and a specially padded luggage-type carrying case. The 1982-9720 system includes a GR 1562-A Sound-Level Calibrator, 60-foot microphone extension cable, and tripod.



Condensed Specifications

Sound Level: 30 to 130 dB rms (140-dB PEAK). May be extended to 140-dB rms (150-dB PEAK) using 10-dB microphone attenuator (supplied).

Power: Removable battery pack containing 3 AA-size nickel-cadmium rechargeable cells; 115/220 V ac 50-60 Hz charger supplied.

Supplied: Battery pack assembly, battery charger, 10-ft microphone extension cable, 10-dB microphone attenuator, calibration screwdriver, wrist strap, phone plug, and microphone windscreen.

Weight: 3 lb (1.36 kg).

| Description | Catalog Number |
|---|----------------|
| 1982 Precision Sound-Level Meter and Analyzer | 1982-9700 |
| 1982 Sound Analysis System | 1982-9720 |

1981-B Precision Sound-Level Meter

- 30 to 120 dBA
- digital and analog display
- ANSI Type S1A and IEC 179
- maximum-hold digital display feature

The 1981-B combines an analog meter with a digital display in the same instrument. The two displays let the user observe sound-level readings in clear digital form while observing the levels rise and fall on the analog meter. The digital display assures repeatable readings by different users since judgement of the needle position is not required. A special "maximum-hold" feature can be switch selected to "capture" and hold the digital display at the highest sound level measured while the analog meter continues to indicate every rise and fall in the level. This ensures that the operator will not miss the highest noise level, even when not constantly watching the meter.

The 1981-B is an excellent choice when precision measurements as well as general survey measurements must be made. It is available alone, in a set with a calibrator, and in systems with a tripod, calibrator and other accessories. The 1981-B spans 30 to 120 dBA in two switch-selectable ranges.

Condensed Specifications

Sound-Level: 30 to 120 dBA.

Power: Removable battery pack containing 3 AA-size nickel-cadmium rechargeable cells; 115/220 V ac 50-60 Hz using charger supplied.

Supplied: Carrying pouch, wrist strap, battery pack, battery charger, screwdriver for calibration adjustment, and miniature phone-plug connector.

Weight: 28 oz (0.8 kg).



| | |
|---|-----------|
| 1981-B Precision Sound-Level Meter | 1981-9750 |
| 1981-B Precision Sound Measurement Set (with 1567 single-frequency calibrator) | 1981-9762 |
| 1981-B Precision Noise Measurement System (with 1562-A 5-frequency calibrator, extension cable, tripod, other accessories, and luggage-type carrying case) | 1981-9760 |

National stock numbers are listed at the back of the catalog.

1565-B Sound-Level Meter

- 40 to 140 dB, fast/slow
- ANSI Type 2
- MESA approved
- A, B, C weighting

The 1565-B is a general-purpose sound-level meter, ideal for measurements required by OSHA and for general noise surveys. This popular meter weighs less than 1 pound, features simple pushbutton operation, transistor-radio-type battery power, a rugged ceramic microphone and solid-state circuitry for long-term reliability. The 1565-B may be purchased alone with supplied accessories or in a sound-level measurement set which includes an acoustic calibrator and a carrying/storage case.

Condensed Specifications

Sound Level: 40 to 140 dB.

Power: Two 9-V batteries provide about 50-h operation.

Supplied: Carrying pouch, miniature phone-plug to connect to output which drives recorders, analyzers, etc, screw-driver for calibration adjust, batteries.

Weight: 1 lb (0.45 kg).

| Description | Catalog Number |
|---|----------------|
| 1565-B Sound-Level Meter | 1565-9702 |
| 1565-9902 Sound-Level Measurement Set (with 1562-A Sound-Level Calibrator, 5 frequencies) | 1565-9902 |
| 1565-9903 Sound-Level Measurement Set (with 1567 Sound-Level Calibrator, 1 frequency) | 1565-9903 |
| Carrying Case | 1562-9600 |



Special Meters for Community Noise Applications

The 1565-D is similar to the 1565-B, the major difference being its measurement range of 30 to 130 dB. This lower range capability is often required for noise measurements in the community.

The 1565-D is supplied with the same accessories as the 1565-B, and is available in a set with a 1567 Sound-Level Calibrator, windscreen, and carrying case.

A vehicle noise measurement set is also available with a special 1565-9015 Sound-Level Meter. This meter permits measurements from 50 to 140 dB and has a removable microphone for remote mike placement, specified for vehicle noise measurements. The set includes a tripod for microphone mounting, 100-foot extension cable, windscreen, microphone adaptor, other accessories, and a carrying case.

| | |
|---|-----------|
| 1565-D Sound-Level Meter | 1565-9704 |
| 1565-9907 Sound-Level Measurement Set | 1565-9907 |
| 1565-9906 Vehicle Noise Measurement Set | 1565-9906 |



1983 Sound-Level Meter

- 70 to 120 dBA, fast/slow
- ANSI Type S2A
- MESA approved
- big, easy-to-read scale

The 1983 is a low-cost survey meter that meets current and proposed OSHA requirements for general-purpose sound-level meters. It is designed for utmost simplicity of operation. The large meter scale spans the instrument's full range of 70 to 120 dBA in clearly marked 1-dB increments. Just turn it on and read the level. A-weighting is built-in so that readings are always in dBA. A sound-level measurement set is available which

includes the 1983, a 1567 single-frequency calibrator and a carrying/storage case.

Condensed Specifications

Sound-Level: 70 to 120 dBA.

Power: One 9-V battery provides about 60-h operation.

Supplied: Carrying pouch, miniature phone plug to connect to output which drives recorders, analyzers, etc, screw-driver for calibration adjust, batteries.

Weight: 12 oz (0.34 kg).

| | |
|----------------------------------|-----------|
| 1983 Sound-Level Meter | 1983-9730 |
| 1983 Sound-Level Measurement Set | 1983-9915 |



1983 Vehicle-Noise Measurement Set

- a complete, low-cost system
- for pass-by, start-up, and muffler testing
- meets ANSI S1.4 1971 Type S2A
- 50-dB meter display eliminates range switching

This noise measurement set has been specifically designed to satisfy vehicle-noise-measurement requirements specified by legislation at the Federal, state, and local levels. The set features simplicity of operation and calibration so that reliable measurements can be made by law enforcement officers and others who have not had prior experience in acoustic measurements.

The 1983 is supplied with a remote microphone, and the set includes a 20-foot extension cable and tripod. A 60-

foot extension cable is available as an accessory. This permits the microphone to be located at the measurement point and the observer with the meter to be located away from the sound field to eliminate interference with the measurement.

Condensed Specifications

Sound Level: 70 to 120 dBA.

Power: One 9-V battery (Burgess 2U6 or equal) provides 60-h operation.

Supplied: 1983-9730 Sound-Level Meter, 1567 Sound-Level Calibrator, carrying case, tripod, 20-foot extension cable, windscreen, spare batteries.

Weight: 6.5 lb (2.9 kg).

| | |
|------------------------------------|-----------|
| 1983 Vehicle Noise Measurement Set | 1983-9910 |
|------------------------------------|-----------|



National stock numbers are listed at the back of the catalog.

1954 Noise Dosimeter

- user adjustable to OSHA revisions
- automatic noise-dose measurements
- can be used as an integrating sound meter
- built-in calibrator

The wearable dosimeter is the easy and automatic way to measure a worker's daily noise dose. All measurements are made automatically by the monitor which is worn in a shirt-pocket or clipped on a belt or other convenient location.

GR's 1954 features a tiny remote microphone that can be worn at the ear, on the collar, under ear protectors, or on the monitor where external microphone wires could pose a safety hazard. A built-in acoustic calibrator assures proper system performance before and after measurements and requires less than 10 seconds for a complete calibration check.

Reading the noise dose is quick and easy. At the end of the measurement period, the monitor is plugged into the 1954 indicator and a button is pushed to get a readout of the computed noise dose as an actual percentage of OSHA limits. Only one indicator is required for any number of monitors.

Should OSHA noise limits change, you can re-adjust the 1954 yourself. You need not return it to the factory or a serv-

ice center. In addition to personal noise dose measurements, the 1954 can be used to measure area noise exposure and for making equivalent sound-level measurements.

Condensed Specifications

1954-9710 Noise-Exposure Monitor (5-dB rate)

Noise-Level Exposure: Maximum permissible exposure of 100% in accordance with OSHA is accumulated for the combinations of level and time duration specified in the OSHA regulations.

Power: One 9-V alkaline battery supplied, provides 40 hours of typical operation.

Supplied: Three earloops, one windscreens set (contains 4 windscreens assemblies), one 9-V alkaline battery.

Weight: 9.5 oz (0.27 kg).

1954-9720 Indicator

Readout: When used with the 1954-9710 Noise Exposure Monitor percentages ranging from 0.001 to 999.9 are displayed. These quantities are displayed on a 4-digit LED readout.

Power: Supplied by battery in monitor.

Supplied: An accessory slide rule allows "equivalent continuous sound level" to be computed by entering the measurement period and the percentage or index number displayed.



Jeweler's screwdriver is supplied for calibration, activation of monitor controls, and access to battery compartment.
Weight: 2.75 lb (1.25 kg).

| Description | Catalog Number |
|--|----------------|
| 1954 Noise-Exposure Monitor, 5-dB exchange rate† | 1954-9710 |
| 1954 Noise Exposure Monitor, 3-dB exchange rate† | 1954-9700 |
| 1954 Indicator† | 1954-9720 |
| 1954 Carrying Case | 1954-9600 |

†One monitor and one indicator comprise a complete dosimeter.

1557-A Vibration Calibrator

- calibrates vibration pickups, meters
- generates 1 g at 100 Hz
- portable, battery-operated

This calibrator provides a single-frequency (100 Hz), single-level (1 g) check on the GR Vibration Pickups or any pickup whose total mass is 300 grams or less. It can provide on-the-spot calibration of vibration-measuring systems immediately before and after important

measurements and can also be used to compare transducers or to calibrate working transducers against a standard transducer.

Condensed Specifications

Output: ACCELERATION: 1 g rms $\pm 10\%$. 1 g = 386 in./s² (9.81 m/s²). VELOCITY: 0.614 in./s (15.6 mm/s) rms. DISPLACEMENT: 0.000978 in. (0.0248 mm) rms; 0.00277 in. (0.0704 mm) pk-pk. FREQUENCY: 100 Hz $\pm 1\%$ for 50-gram load; 100 Hz $+0, -2\%$ for 300-gram load.

| | |
|--|-----------|
| 1557-A Vibration Calibrator (with dry battery) | 1557-9702 |
| Replacement Dry Cell, 1 req'd | 8410-1050 |

1562-A Sound-Level Calibrator

- 125 to 2000 Hz
- ± 0.3 -dB accuracy at 500 Hz
- fits many microphones
- MESA approved

The 1562-A is a self-contained unit for making accurate field calibrations on microphones and sound-measuring instruments. This calibrator fits in the palm of your hand, operates on its own battery power, features a single fumble-free control, and provides a precisely known sound-pressure level at five ANSI-preferred frequencies.

Condensed Specifications

Acoustic Output: FREQUENCIES: 125, 250, 500, 1000, and 2000 Hz; $\pm 3\%$. SOUND-PRESSURE LEVEL: 114 dB re 20 μ N/m².

Supplied: Carrying case, adaptors for 1/2- and 1-in. microphones (fits 1-1/8-in. microphones without adaptor), battery.

Power: Battery operated (9V, Burgess PM6 or equal); 120 h use.

Weight: 1 lb (0.5 kg).



| | |
|--|-----------|
| 1562-A Sound-Level Calibrator | 1562-9701 |
| Coupler Adaptor Set, adapts 1562-A to 1/8, 1/4, and 1/2-in. microphone | 1560-9561 |

1567 Sound-Level Calibrator

- low-cost
- ± 0.5 -dB accuracy
- MESA approved

The 1567 Sound-Level Calibrator is specially designed for you who wish to check instrument sensitivity only (not frequency response). The 1567 has a single-level output and is well suited for calibrating acoustic instruments at 1 kHz.

Condensed Specifications

Acoustic Output: FREQUENCY: 1000 Hz, $\pm 3\%$. SOUND-PRESSURE LEVEL: 114 dB re 20 μ N/m².

Supplied: Carrying case, adaptor for 1565-B, battery.

Power: Battery operated, using 9-V Burgess 2U6 or equivalent; 100 h of use.

Weight: 1 lb (0.5 kg).



| | |
|-----------------------------|-----------|
| 1567 Sound-Level Calibrator | 1567-9701 |
|-----------------------------|-----------|

National stock numbers are listed at the back of the catalog.

1562-Z Audiometer Calibration Set

The 1562-Z is a completely self-contained compact kit for field checks of sound-level meters, sound analyzers, and audiometers. It includes a 1565-B Sound-Level Meter, a 1562-A Sound-Level Calibrator, a 1560-P83 Earphone Coupler, spare batteries, a calibration chart, a full set of instructions, and a convenient carrying case to keep everything together. The earphone coupler allows calibration of the earphone without removal of the earphone cushion.

Condensed Specifications

Supplied: 1565-B Sound-Level Meter, 1562 Sound-Level Calibrator, Earphone Coupler, spare batteries, storage case.

Weight: 5 lb (2.3 kg).



| Description | Catalog Number |
|-----------------------------------|----------------|
| 1562-Z Audiometer Calibration Set | 1562-9901 |

1933 Audiometer Calibration System

- versatile calibration
- precision sound-level measurements
- octave-band analysis

This system may be used to calibrate audiometers and check attenuator linearity over the range of 10 dB to 90 dB HL as recommended by the OSHA Standards Advisory Committee. A calibration chart is included in the system to simplify documenting sound-level meter readings for the popular TDH 39, 49, and 50 earphones, and basic microphone-pressure-response data are also provided to facilitate more detailed investigations.

This system includes: 1933-9700 Precision Sound-Level Meter and Analyzer, including 1/2-inch and 1-inch flat random incidence electret-condenser microphones, microphone at-

tenuator, tool kit, microphone extension cable (10 ft) and batteries; dummy microphone; 1/2-inch and 1-inch windscreen (one each); earphone; 1562-A Sound-Level Calibrator with adaptors for 1/2-inch and 1-inch microphones and batteries; 1560-P83 Earphone Coupler; 1933-9603 Carrying Case with custom-padded insert to accommodate all system components plus a compartment for instruction manuals and other paperwork.

Condensed Specifications

(See individual instrument specifications)

Weight: 15 lb (7 kg).



| | |
|------------------------------------|-----------|
| 1933 Audiometer Calibration System | 1933-9716 |
|------------------------------------|-----------|

1560-9619 Audiometer Calibration Accessory Kit

- easy field calibration comparable to factory accuracy
- for use with 1982 or 1933
- includes all necessary calibration data

The 1560-9619 Audiometer Calibration Accessory Kit is designed to be used with either the GenRad 1982 or 1933 Precision Sound-Level Meter and Analyzer for the precise calibration of audiometers. When used with these meters, it permits the periodic calibration of audiometers as required by OSHA and other agencies, to the sound-pressure-level values specified in ANSI S3.6 1969 or other standards which require the NBS Type 9-A coupler to be used in the measurement procedure.

The kit contains all the necessary components needed to measure the acoustic output of audiometers when used with the 1982 or 1933. Included in the kit are a GR 1560-P83 Earphone Coupler which fulfills the requirements of NBS Type 9-A, a 1-inch GenRad Electret-Condenser Microphone, an adaptor (1-inch to 1/2-inch thread), audiometer calibration stand assembly, calibration chart, and instruction sheet.

The calibration chart in the kit documents octave band sound-pressure levels for 125 Hz to 8000 Hz. Data are given for an audiometer setting of 70 dB HL for the

TDH-39, and both 70 dB HL and 90 dB HL for the TDH-49 and TDH-50. Readings are given for the flat and A-weighted scale on the 1982 and 1933 Precision Sound-Level Meters and Analyzers.

The audiometer calibration stand assembly is a cast metal stand which supports the 1-inch microphone, earphone coupler, and 1982 or 1933 preamplifier. It has a polyethylene-foam base for isolation against shock and vibration during the measurement.

The stand eliminates mounting the earphone coupler directly on the sound-level meter and the subsequent risk of the meter falling over.

Condensed Specifications

Frequency Range: 125 Hz to 8 kHz.

Accuracy: The electret microphone response in a P83 NBS Type 9-A coupler is calibrated to be equal to the response of a type L microphone in an NBS 9-A coupler when used to calibrate TDH-39, TDH-49 and TDH-50 earphones mounted in a MX41/AR ear cushion. MICROPHONE/COUPLER CALIBRATION: (Factory), ± 0.2 dB - 125 Hz to 4 kHz; ± 0.3 dB - 6 kHz to 8 kHz. System accuracy when used with 1933-9700



or 1982-9700 and the microphone supplied with the 1560-9619 and calibrated with the 1562 or 1567 Acoustic Calibrator is within 1 dB at audiometric test frequencies 125 Hz to 4 kHz; 1.5 dB at audiometric test frequencies 6 kHz and 8 kHz.

Supplied: (1560-9619), 1560-9683 Earphone Coupler, 1961-9601 Microphone, 1560-9618 Audiometer Calibration Stand Assembly, Calibration Chart, Instruction Sheet.

Weight: Stand assembly, 2.4 lb (1.1 kg).

| | |
|---------------------------------------|-----------|
| Audiometer Calibration Accessory Kit | 1560-9619 |
| Audiometer Calibration Stand Assembly | 1560-9618 |

National stock numbers are listed at the back of the catalog.

1935 Cassette Data Recorder

- excellent companion instrument for the 1933 Precision Sound-Level Meter and Analyzer
- cassette convenience and operating simplicity
- excellent for detailed analysis of field-gathered data

The 1935 is a two-channel, two-track magnetic tape recorder designed to simplify the gathering of acoustic signals for subsequent play back and analysis. It is especially valuable where non-stationary signals must be analyzed because it allows you to record the signal and replay it as often as required for a detailed analysis.

The recorder features a digital readout which indicates the setting of the sound level meter at the time the recording was made. This eliminates the need for you to remember to jot down the range setting during recording.

Although intended primarily for use with the 1933, the recorder can also be used with any instrument that provides an output of 0.5 to 3 volts rms.

Condensed Specifications

Normal Recording Duration: 30 minutes using C60 tape.
TAPE SPEEDS: 1-7/8 in./s ± 2 dB, 20 Hz to 12 kHz using 1935-9603 series cassettes.

Frequency Response: Typical response ± 2 dB, 20 Hz to 12 kHz using 1935-9603 series cassettes.

Power: 5 size-C energizers, supplied, provide about 10-hours operation. 1940 Power Supply and Charger allows line operation of 1935 and recharges suitable batteries (included with power supply).

Supplied: Head demagnetizer, head cleaning kit, interconnecting cables to 1933 Precision Sound-Level Meter and Analyzer, earphone, microphone for voice notes, cassettes, and batteries.

Weight: 7.5 lb (3.4 kg).



| Description | Catalog Number |
|-----------------------------|----------------|
| 1935 Cassette Data Recorder | 1935-9700 |
| Cassette, 30-minute | 1935-9603 |

1985 DC Recorder

- ideal for industrial, laboratory, and community noise recordings
- meets ANSI and IEC Type 1 response when used with GenRad Type 1 meters
- matched to dc outputs of GenRad sound-level meters for guess-free selection of input sensitivities/calibration
- chart speeds from 2 cm/h to 60 cm/min
- 50-dB direct-reading dynamic range
- powered by built-in rechargeable battery for "go anywhere" operation; also operates from ac line or external dc source

Simple, accurate noise recording The GR 1985 is a portable, lightweight, battery-powered strip-chart recorder that is designed to simplify the gathering of noise data in permanent, hard-copy form. Compatible with GenRad sound-level meters (1933, 1981, 1982, 1983), it completes a sound-measurement/recording system that produces permanent plots of noise-level-vs-time without the usual complicated calibration procedures that often cause recording errors. The recorder may also be used with the GenRad 1945 Community Noise Analyzer.

Accuracy of the recorded data is a plus feature of the 1985 since the pen response is fast enough to meet the Type 1 requirements of ANSI and IEC fast and slow meter response when used with a GenRad Type 1 instrument.

Easy setup A front-panel switch on the 1985 allows you to select the proper input sensitivity to match the dc output of each compatible GenRad instrument. There is no need to select an input sen-

sitivity on the 1985 that will handle the voltage range of the output from the instrument. Just set the switch for the proper instrument, adjust the zero and span adjustments, and record. The zero and span adjustments are located on the front panel for quick and easy calibration.

Condensed Specifications

Recorder Type: Portable, battery-powered, single-channel, strip-chart recorder with multiple speeds and with ranges matched to GenRad sound-level meters. Provides a direct reading, 50-dB dynamic range permanent recording of sound-level meter output data.

Standards: When used with the GR 1933, 1981 or 1982 Precision Sound-Level Meters or with the GR 1945 Community Noise Analyzer, the recording system meets the fast and slow meter-response requirements of ANSI S1.4-1971 Type 1, IEC Recommendation Publication 179-1973 Precision Sound-Level Meters, and the Draft Consolidated Revision of IEC Publications R123 and R179 (August 1976) Type 1 (Precision).

When used with the GR 1983, the recording system meets the fast and slow meter response requirements of ANSI S1.4-1971 Type 2, IEC Recommendation Publication 123-1961, Sound-Level Meters and the Draft Consolidated Revision of IEC Publications R123 and R179 (August 1976), Type 2.



Measuring System: SOURCE IMPEDANCE: Up to 100 k Ω maximum.
INPUT IMPEDANCE: Potentiometric on all spans.
INPUT SENSITIVITIES: Seven switch-selectable spans are provided. Front panel switch selects span for specific GenRad instrument as follows:

| GenRad No. | Span (baseline to full scale) |
|-------------------|-------------------------------|
| 1983 | 0 to +250 mV dc |
| 1981 | 0 to +500 mV dc |
| 1945 | |
| (30-80 dB range) | -1.2 to -3.2 V dc |
| 1945 | |
| (50-100 dB range) | -2.0 to -4.0 V dc |
| 1945 | |
| (70-120 dB range) | -2.8 to -4.8 V dc |
| 1982 | 0 to +3.0 V dc |
| 1933 | 0 to +5.0 V dc |

| | |
|-----------------------------|-----------|
| 1985 DC Recorder | 1985-9700 |
| Chart Paper, 20m, pack of 6 | 1985-9600 |
| Pens, pack of 6 | 1985-9601 |
| Carrying Case | 1985-9603 |
| Battery, replacement | 1985-0402 |

National stock numbers are listed at the back of the catalog.

1925 Multifilter

- 3.15 Hz to 80 kHz
- 1/3-octave or octave bands
- calibrated channel attenuators
- display with standard scale factor
- scanned, parallel, and summed outputs

Spectrum shaper or analyzer building block The 1925 Multifilter contains up to 30 parallel octave-band or one-third-octave-band filters from 3.15 Hz to 80 kHz and is supplied with attenuators that permit independent control of the gain in each band. The attenuators let you use the multifilter as an equalizer or spectrum shaper to simulate or to compensate for irregularities in the frequency response of electrical or acoustical transmission systems or transducers. You can also use it as the basis for a serial or parallel frequency analysis system.

Attenuator for each band Each attenuator provides 50 dB of gain control in 1-dB steps, accurate to ± 0.25 dB. Thumbwheel switches control the attenuation and a panel display indicates the "transmission" of the instrument.

SPECIFICATIONS

Frequency: 3.15 Hz to 80 kHz.

Bandwidth: 1/3 octave; octave and 1/10 octave available.

Attenuation: +6 to -12-dB continuous gain adjustment common to all channels plus +25 to -25-dB attenuation in 1-dB steps with ± 0.25 -dB accuracy (re +25-dB setting) by means of a panel thumbwheel switch for each band. Attenuation of each band is indicated by a dot on panel display and represents the transmission between input and summed output. Display has standard 50-dB per decade scale factor; 10-dB per in. vertical, 5 in. per decade horizontal. Lock on panel prevents accidental changes in attenuator settings.

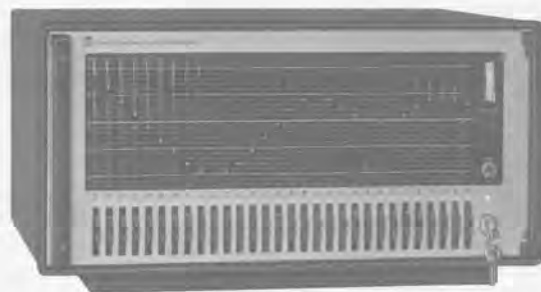

Response: 30 6-pole Butterworth filters with 1/3-octave effective (noise) bandwidths that conform to ANSI S1.11-1966 Class III (high attenuation) and IEC 225-1966 standards or with 1-octave bandwidths that conform to ANSI S1.11-1966 Class II (moderate rate but highest for octave-band filters) and IEC 225-1966 standards. **ACCURACY** of center frequency: $\pm 2\%$. **LEVEL UNIFORMITY:** Within ± 0.50 dB at 25°C, ± 0.75 dB from 0 to 50°C, at center frequency with attenuator at +25 dB. **PASSBAND RIPPLE:** 0.5 dB max pk-pk. **NOISE:** $< 15 \mu\text{V}$ equivalent input noise. **HARMONIC DISTORTION:** $< 0.25\%$ at 1-V output for bands centered below 25 Hz, $< 0.1\%$ at 1-V output for 25 Hz and above. **WEIGHTING:** A, B, C, conforming to ANSI S1.4, IEC 123, and IEC 179.

| Description | Catalog Number | |
|-------------------------------|----------------|-----------|
| | Bench | Rack |
| 1925 Multifilter* | | |
| One-Third-Octave Bands | | |
| 25 Hz to 20 kHz | 1925-9700 | 1925-9701 |
| 12.5 Hz to 10 kHz | 1925-9702 | 1925-9703 |
| 3.15 Hz to 2.5 kHz | 1925-9704 | 1925-9705 |
| 100 Hz to 80 kHz | 1925-9706 | 1925-9707 |

* 45-band models, 1/10-octave-band models, mixed 1/10, 1/3, and 1-octave-band models, or special bandwidths available on special order.

1564-A Sound and Vibration Analyzer

- 2.5 Hz to 25 kHz
- 2 bandwidths: 1/3- and 1/10-octave
- use direct from microphone or vibration pickup
- ac or portable battery operation
- automatic spectrum plots with 1521 recorder

The 1564-A Sound and Vibration Analyzer is designed primarily for measuring the amplitude and frequency of the components of complex sound and vibration spectra. Its 1/3-octave (23%) and 1/10-octave (7%) noise bandwidths provide the flexibility needed for analysis of both the noise and its causes.

Input sources The high input impedance of the analyzer permits direct connection of piezoelectric transducers for measuring sound pressures from 44 to 150 dB re $20 \mu\text{N}/\text{m}^2$ and acceleration from 0.0007 g to 100 g.

The 1560-P42 and 1560-P40 Preamplifiers are available to extend the full scale sensitivity of the analyzer by 20 dB (10:1) and to allow use of the transducer at the end of a long extension cable. Alternatively, for higher sensitivity, the analyzer can be driven from a sound-level meter or vibration meter.

SPECIFICATIONS

Frequency: RANGE: 2.5 Hz to 25 kHz in four decade ranges. **DIAL CALIBRATION:** Logarithmic. **ACCURACY OF CALIBRATION:** $\pm 2\%$ of frequency-dial setting.



Filter Characteristics: Noise bandwidth is either 1/3 octave or 1/10 octave. One-third-octave characteristic has at least 30-dB attenuation at one-half and twice the selected frequency. One-tenth-octave characteristic has at least 40-dB attenuation at one-half and twice the selected frequency. Ultimate attenuation is 70 dB or greater for both characteristics. For both bandwidths, peak response is uniform ± 1 dB from 5 Hz to 10 kHz and ± 1.5 dB from 2.5 Hz to 25 kHz. An *all-pass*, or flat, characteristic is also included.

1564-A Sound and Vibration Analyzer

| | |
|-----------------------|-----------|
| Portable Model, 115 V | 1564-9701 |
| Rack Model, 115 V | 1564-9820 |
| Portable Model, 230 V | 1564-9702 |
| Rack Model, 230 V | 1564-9821 |

Replacement Battery

8410-0410

Patent Number 3,012,197.

National stock numbers are listed at the back of the catalog.

1568-A Wave Analyzer

- 20 Hz to 20 kHz
- 1% constant-percentage bandwidth
- portable, battery-operated
- 85-dB rejection

The 1568-A is an important instrument for high-resolution frequency analyses, whether for measuring vibration and noise components or the spectrum of a complex electrical signal. Good design combines the excellent filter shape of a wave analyzer with the convenient, simple operation of constant-percentage-bandwidth analyzers in a portable, low-cost instrument.

The voltage sensitivity and input impedance, adequate for most uses, can be improved to 10 microvolts full-scale and > 500 megohms, respectively, by the use of a 1560-P42 Preamp and a 1560-P62 Power Supply.

The 1568 excels in such applications as

- harmonic distortion measurements at low frequencies
- harmonic analysis — 1% bw yields 50 components
- detailed analysis of machinery noise and vibration
- separation of close, discrete, low frequencies

SPECIFICATIONS

Frequency: RANGE: 20 Hz to 20 kHz in six half-decade ranges. **DIAL CALIBRATION:** Logarithmic. **ACCURACY OF FREQUENCY CALIBRATION:** 1%.



Filter Characteristics: BANDWIDTH between 3-dB points on selectivity curve: 1% of selected frequency. ATTENUATION, at 20% above and at 20% below selected frequency: > 50 dB referred to the level at the selected frequency. Attenuation at twice and at one-half the selected frequency is ≥ 75 dB referred to the level at the selected frequency. Ultimate attenuation is > 85 dB. UNIFORMITY of filter peak response with tuning: ± 1 dB from 20 Hz to 6.3 kHz and ± 2 dB from 20 Hz to 20 kHz.

| Description | Catalog Number |
|-----------------------------|----------------|
| 1568-A Wave Analyzer | |
| Portable Model, 115 V ac | 1568-9000 |
| Portable Model, 230 V ac | 1568-9010 |
| Replacement Battery | 8410-0410 |

1521-B Graphic Level Recorder

- 7 Hz to 200 kHz
- 1-mV ac sensitivity — 0.8-mA dc
- linear dB plot of rms ac-voltage level
- 20-, 40-, or 80-dB range
- convenient, disposable pens

Stands alone This recorder produces a permanent, reproducible strip-chart record of ac-voltage level as a function of time or of some other quantity. Record, for example, the frequency response of a device or the frequency spectrum of noise or of a complex electrical signal.

The wide range of paper speed facilitates long-period studies (such as traffic-noise) as well as short-duration-transient measurements (such as auditorium-reverberation). Writing speeds and low-frequency cutoff are selected by a single switch. The frequency response can be extended downward to 4.5 Hz with the slower writing speeds, which filter out abrupt level variations. You get a smoothed plot without loss of accuracy.

SPECIFICATIONS

AC Recording: RANGE: 40 dB full-scale with the potentiometer supplied, 20- and 80-dB potentiometers available for ac level recording. **LINEARITY:** $\pm(1\%$ of full-scale dB value plus a frequency error of 0.5 dB at 100 kHz and 1.5 dB at 200 kHz).

Frequency Response and Writing Speed, for AC Level Recording: High-frequency response ± 2 dB, up to 200 kHz. Low-frequency sine-wave response depends on writing speed, as



shown in following table: (With the 80-dB pot, writing speed < 300 dB/s, i.e., 15 in./s.)

| Writing Speed (approx), with 0.1-in. overshoot | | Low-Frequency Cutoff (< 1 dB down) |
|---|----------|---------------------------------------|
| 20 in./s | 508 mm/s | 100 Hz |
| 10 | 254 | 20 Hz |
| 3 | 76 | 7 (3 dB down at 4.5 Hz) |
| 1 | 25 | 7 (3 dB down at 4.5 Hz) |

Dc Recording: RANGE: 0.8 to 1 V (0.8 to 1.0 mA) full-scale, with zero position adjustable over full scale. **RESPONSE:** 3 dB down at 8 Hz (pk-pk amplitude < 25% of full scale). **LINEARITY:** $\pm 1\%$ of full scale.

| | |
|---|-----------|
| Graphic Level Recorder, 40-dB potentiometer,* high-speed motor | |
| 1521-B 60-Hz Bench Model | 1521-9802 |
| 1521-B 60-Hz Rack Model | 1521-9812 |
| Graphic Level Recorder, 40-dB potentiometer, medium-speed motor | |
| 1521-B 60-Hz Bench Model | 1521-9833 |
| 1521-B 60-Hz Rack Model | 1521-9834 |

* Other potentiometers available.

National stock numbers are listed at the back of the catalog.

1523 Graphic Level Recorder

An excellent recorder with plug-in modules for:

- level recordings
 - frequency-response measurements
 - narrow-band wave analysis
- 1-Hz to 500-kHz frequency range
 - 100- μ V sensitivity
 - up to 100-dB dynamic range
 - up to 0.1-dB linearity
 - 3 recorders in one with plug-in versatility
 - remotely programmable — a systems natural

Automatic measurements — simply and graphically The 1523 is *not* just another recorder; it is a measurement center. It incorporates the latest refinements of the recorder field with those of the sweep-oscillator and sound-analyzer fields and does so in one instrument that eliminates the usual bother of trying to keep everything synchronized. Simply connect your signal or device, set up the desired measurement conditions, and push a button — the 1523 does the rest, automatically and without constant attention or control manipulation.

Narrow-band wave analysis for

- product-noise reduction programs
- spectrum-signature work
- vibration studies
- preventive maintenance programs
- distortion measurement
- network analysis

The 1523-P4 Wave Analyzer plug-in gives you the capability to perform high-resolution spectral analysis, swept-frequency analysis with a tuned detector, and amplitude-vs-time measurements at selected frequencies.

The 1523-P4 provides analysis bandwidths of 10 Hz and 100 Hz and an all-pass mode covering the range from 10 Hz to 80 kHz. Most signals can be handled without preamplification, because the analyzer will accommodate inputs over a 140-dB range (3 μ V to 30 V), with capabilities to detect and display any 80-dB portion.

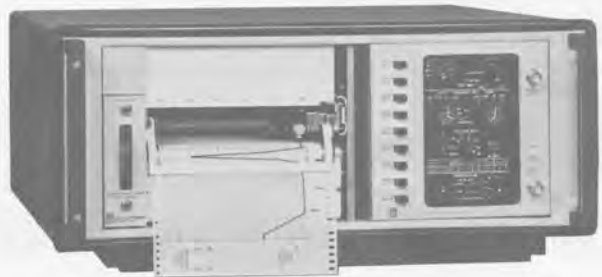

Simple response measurements for

- filter and network response testing
- loudspeaker, amplifier, and tape-recorder evaluation
- performance tests for microphones, hydrophones, and hearing aids
- general medical and educational applications

With the 1523-P2 Sweep Oscillator plug-in, which incorporates a sweep oscillator, your recorder produces frequency-response recordings at the push of a button. You can set the oscillator to sweep the full 1-Hz to 500-kHz range, or various portions of it, at output levels continuously adjustable from 500 μ V to 5 V behind 600 Ω . A unique and versatile constant-Q mode of operation can be selected to speed the recording in many applications by increasing the sweep rate automatically as the frequency increases. Under many conditions, recordings can be made in the constant-Q mode in $\frac{1}{2}$ to $\frac{1}{3}$ the time normally required.

Versatile level recording for

- A-weighted level-vs-time recordings
- reverberation-time measurements
- general level-recording applications

Select the 1523-P1A Preamplifier plug-in for the best in general recorder performance. The 1523-P1A gives you a broad frequency coverage from 1 Hz to 500 kHz, a sensitivity of 100 μ V, and 18 chart speeds from as slow as 20 hours per inch to as fast as half a second per inch. Continuously adjustable attenuation from 0 to 70 dB provides the utmost in recording resolution, and a choice of nine averaging times from 10 ms to 5 s allows supreme flexibility.

National stock numbers are listed at the back of the catalog.

SPECIFICATIONS



with 1523-P1A Preamplifier Plug-in

Input: Chart 0-level can be 0 dB (100 μ V) to 70 dB; set in 10-dB steps plus a continuous vernier. This corresponds to a chart 0-level of 34 dB with the 1560-P42 Preamplifier in the X10 gain position and a -40 dB re 1 V/N/m² microphone. See Maximum Input Sensitivity under 1523 Mainframe Specifications. **MAXIMUM INPUT:** \pm 10 V pk ac to 250 kHz, \pm 5 V pk ac to 500 kHz, re dc component of \pm 350 V max. **IMPEDANCE:** 1 M Ω /30 pF at plug-in; 3.35 k Ω \pm 1% direct to potentiometer via internal switch. **CONNECTORS:** Front and rear BNC and rear 3-pin A3 mike connector that also provides power for 1560-P40 or -P42 Preamplifier.

Input Frequency: FLAT or A-weighted selected by switch on front panel. Response in FLAT, 1 Hz to 500 kHz \pm 0.1 dB to 100 kHz, \pm 2 dB to 500 kHz, except $<$ 3 dB down at 100 kHz on 0-dB range. A-weighted response conforms to ANSI S1.4-1971 Type 1. Response uniformity between FLAT and A-weighted, \pm 0.2 dB at 1 kHz. Low-frequency and crest-factor cutoffs depend on averaging times.



with 1523-P2 Sweep Oscillator Plug-in

Input: Chart 0-level can be 0 dB (100 μ V) to 70 dB; set in 10-dB steps. See also Maximum Input Sensitivity under 1523 Mainframe Specifications. **MAXIMUM INPUT:** \pm 10 V pk ac to 500 kHz, re dc component of \pm 40 V max. **IMPEDANCE:** 1 M Ω /30 pF at plug-in; 3.35 k Ω \pm 1% direct to potentiometer via internal switch. **CONNECTORS:** Front and rear BNC and rear 3-pin A3 mike connector that also provides power for 1560-P40 or -P42 Preamplifier.

Input Frequency: 1 Hz to 500 kHz; flat within \pm 0.1 dB to 100 kHz, within \pm 2 dB to 500 kHz, except on 0-dB range, down $<$ 3 dB at 100 kHz. Averaging times programmed automatically to avoid low-frequency cutoff; program can be inhibited by external input.

Sweep Frequency: 1 Hz to 500 kHz; automatically from lower to upper frequency. Lower frequency can be set to 1, 2, 5, 10, 20, 50, 100, or 200 Hz, 1, 10, or 100 kHz; upper frequency can be set to 10 or 100 Hz, 1, 2, 5, 10, 50, 100, 200, or 500 kHz. **ACCURACY:** \pm 1% of indicated frequency. **STABILITY:** \pm 0.05% over 10 min, \pm 0.25% over 24 h; after 30-min warm-up. **SWEEP TIME:** 5 s to 200 ks/decade in 5, 10, 20 sequence; or manual sweep. Averaging time decreases with frequency as follows: 2 s from 1 to 10 Hz, 200 ms from 10 to 100 Hz, 50 ms from 100 Hz to 100 kHz, and 20 ms from 100 to 500 kHz. **SWEEP RESOLUTION:** 3000 discrete logarithmically scaled steps per decade (0.08% step). **SWEEP VOLTAGE:** Dc output proportional to log of swept frequency available at rear connector.

National stock numbers are listed at the back of the catalog.



with 1523-P4 Wave Analyzer Plug-in

Main Input: Chart 0-level can be -30 dB (3.16 μ V) to +50 dB; set in 10-dB steps supplemented by a 12-dB continuous vernier. **TOTAL MEASUREMENT RANGE:** 140 dB (3.16 μ V to 31.6 V). **DYNAMIC RANGE:** 80 dB, without changing attenuators, may be displayed with the 100-dB potentiometer. **MAXIMUM INPUT:** 30 V rms to 80 kHz, re dc component of \pm 50 V Max. **INPUT OVERLOAD:** Detected by peak monitor and indicated on front panel. **IMPEDANCE:** 1M Ω /30 pF. **CONNECTORS:** Front and rear BNC and rear 3-pin A3 mike connector that also provides power for 1560-P40 or -P42 Preamplifier. **ACCURACY OF RECORDED LEVEL:** \pm 0.5 dB below 10 kHz, \pm 1 dB above (with 50-dB pot).

Analyzer Characteristics: **FREQUENCY:** 10 Hz to 80 kHz. **SWEEP RANGE:** 10 Hz to 10 kHz (10-Hz bandwidth); start and stop frequencies each set by 4-position switch and 10-turn dial. **BANDWIDTH:** 10 Hz, 100 Hz, and "all pass," switch selected. **PASS-BAND SHAPES:** 3-dB bandwidth = 10 ± 1 Hz, 60-dB bandwidth \leq 60 Hz, 80-dB bandwidth \leq 120 Hz; 3-dB bandwidth = 100 ± 10 Hz, 60-dB bandwidth \leq 400 Hz, 80-dB bandwidth \leq 800 Hz. **ACCURACY OF RECORDED FREQUENCY:** \pm 2% or \pm 5 Hz, whichever is greater. **STABILITY:** (After 30-min warmup) \pm 0.05% (10 min), \pm 0.25% (24 h). **DISTORTION:** Internally generated distortion and hum products \geq 75 dB below full scale. **NOISE:** $<$ 1 μ V in a 10-Hz bandwidth. **IMAGE REJECTION:** \geq 80 dB (100 to 180 kHz). **I-F REJECTION:** \geq 80 dB (50 kHz).

MAINFRAME SPECIFICATIONS

Dynamic Range: Up to 100 dB, depending on potentiometer. **POTENTIOMETERS:** 5 available, all easily interchanged and all with 5-in. scales except for 60 dB which has 12-cm scale. 10 dB (with \pm 0.1-dB linearity); 25 dB (\pm 0.15 dB), 50 dB (\pm 0.25 dB), recommended for general use; 60 dB (\pm 0.3 dB), for use with 1523-P3 only; and 100 dB (\pm 0.5 dB). **MAXIMUM INPUT SENSITIVITY:** 100 μ V rms for averaging times 0.1 s or greater, 1 mV rms for averaging times $<$ 0.1 s; except for 10-dB pot, max sensitivity 1 mV; minimum averaging time 50 ms. **DEAD BAND:** \pm 0.15% of full scale; except \pm 0.25% with 0.01, 0.02 and 0.05 s averaging times. **DETECTION:** True rms, error \leq 0.1 dB for 15-dB crest factor, $<$ 0.5 dB for full 20-dB crest factor for frequencies above crest-factor cutoff frequency. **NOISE:** Equivalent input noise $<$ 40 μ V rms. **RE-TRANSMITTING POTENTIOMETER:** Provides dc output voltage, proportional to ac input, of 0 to 10.4 V dc (2 V/in. of pen deflection).

| Description | Catalog Number |
|--|----------------|
| 1523 Graphic Level Recorder Mainframe without plug-in but with potentiometer noted | |
| Potentiometer | Model |
| 50 dB bench | 1523-9700 |
| 50 dB rack | 1523-9701 |
| 25 dB bench | 1523-9704 |
| 25 dB rack | 1523-9705 |
| 60 dB bench | 1523-9706 |
| 60 dB rack | 1523-9707 |
| 100 dB bench | 1523-9708 |
| 100 dB rack | 1523-9709 |
| Select at least 1 of the following plug-Ins | |
| 1523-P1A Preamplifier | 1523-9608 |
| 1523-P2 Sweep Oscillator | 1523-9602 |
| 1523-P4 Wave Analyzer | 1523-9604 |

1945 Community Noise Analyzer

- on-site readout of:
L exceedance levels, L_{dn} and L_{eq}
- does not require tape recorders or calculators
- battery power eliminates ac line requirements
- low-cost, optional weatherproof microphone system
- weatherproof security enclosure available
- analysis durations from 10 minutes to 24 hours available
- data inhibit available



A stand-alone instrument The GR 1945 is designed to satisfy the need for a low-cost, easy-to-use community noise analyzer, without the need for tape recorders, calculators, or computers. It monitors noise levels for up to three sequential time periods having selectable durations from 30 minutes to 24 hours, or 10 minutes to 8 hours (1945-9006), and automatically computes and stores L exceedance levels, L_{dn} , and L_{eq} (optional), for each time period. Answers to the computed levels are instantly available at the push of appropriate pushbuttons. The 1945 displays the levels on an easy-to-read digital display. Sound-level measurements of existing ambient levels can also be made at the push of a button.

The 1945 has a 100-dB dynamic range to ensure that data will not be lost during wide variations in noise levels. This capability, plus the completely automatic electronic operation of the 1945, contributes to the high reliability of its answers.

Security and Environmental Protection For optimum performance and protection of the 1945 at unattended measurement locations, a weatherproof microphone system and weatherproof enclosure are offered as accessories.

SPECIFICATIONS

COMMUNITY NOISE ANALYZER

Sensitivity Range: Microphone input can be directly calibrated with microphone-preamplifier combinations having sensitivity of -35 to -45 dB re 1 V/N/m² (-55 to -65 dB re 1 V/ μ bar). **AUX INPUT:** (For use with 1935 Cassette Recorder) 0.5 V rms corresponds to 120 dB.

Maximum Detected Level: 120 dB rms; provides 14-dB crest factor.

Minimum Detected Level: 5 dB above typical noise floor, using 1972-9600 or 1560-P42 Preamplifier with indicated microphone as follows:

| Microphone input with | A | C | FLAT |
|-----------------------|-------|-------|-------|
| GR 1962 Microphone | 27 dB | 30 dB | 40 dB |
| GR 1961 Microphone | 23 dB | 26 dB | 38 dB |
| GR 1971 Microphone | 25 dB | 25 dB | 29 dB |
| AUX Input | 27 dB | 26 dB | 29 dB |

Statistical Analysis: RESOLUTION: 1 dB. LINEARITY: 0.25 dB. ANALYSIS DURATION: Selected by front panel switch; choices listed below. NUMBER OF SAMPLES: Function of analysis duration as follows:

| Analysis Duration | Number of Samples |
|-------------------------|-------------------|
| 4, 6, 8, 12 or 24 hours | 65528 |
| 2 or 3 hours | 32764 |
| 1 hour | 16382 |
| 1/2 hour | 8191 |

Environmental: TEMPERATURE: -10 to $+60^{\circ}\text{C}$ operating, -40 to $+55^{\circ}\text{C}$ storage (batteries installed), -40 to $+75^{\circ}\text{C}$ storage (batteries removed). HUMIDITY: 0 to 90% RH operating. VIBRATION: 0.030" excursion 10-55 Hz.

Power: 8 "D" cells provide 75 hours' continuous operation or permit 24 hours' running time and 1 week of idling memory contents at 25°C .

Mechanical: DIMENSIONS (wxhxd): Models 1945-9700 and -9710: 8.5x10.75x9.38 in. (216x273x238 mm). WEIGHT: Model 1945-9700: 16.5 lb (7.5 kg) net; model 1945-9710: 15.5 lb (7.1 kg) net.

COMMUNITY NOISE ANALYZER (1945-9006)

Specifications per the above with the following additions:

Statistical Analysis: A front panel switch permits selection of ANALYSIS DURATIONS of 1/2 hour to 24 hours as above or 10 minutes to 8 hours shown below.

| Analysis Duration | Number of Samples |
|-----------------------------|-------------------|
| 1.33, 2, 2.67, 4 or 8 hours | 65528 |
| 40 minutes or 1 hour | 32764 |
| 20 minutes | 16382 |
| 10 minutes | 8191 |

WEATHERPROOF MICROPHONE SYSTEM

Gain: 1:1 or 10:1 (20 dB) ± 0.3 dB at 25°C , slide switch selected; $< \pm 0.3$ dB change from that at 25°C from -30 to $+65^{\circ}\text{C}$.

Frequency: Measured at 1 V rms output into open circuit with 600- Ω source, -30 to $+55^{\circ}\text{C}$.

| | 3 Hz | 5 Hz | 20 Hz | 100 kHz | 300 kHz | 500 kHz |
|-----------|------------|--------------|---------------|------------|------------|------------|
| 1:1 gain | ± 3 dB | ± 1.0 dB | ± 0.25 dB | ± 1 dB | ± 1 dB | ± 1 dB |
| 10:1 gain | ± 3 dB | ± 1.5 dB | ± 0.3 dB | ± 2 dB | ± 2 dB | ± 2 dB |

Input Impedance: Approximately 2 Ω in parallel with less than 6 pF. Driven shield reduces input capacitance loading for condenser microphones.

WEATHERPROOF ENCLOSURE

Environment: SOLAR TEMPERATURE RISE: Less than 10°C in still air. Typically 3°C in light variable wind, 0-5 mph. RAIN: Rainproof for wind-driven fall angle of rain less than 45° from vertical. CONDENSING MOISTURE: Provides protection to instrument for at least 24 hours' exposure to fog or dew conditions. SNOW: Provides protection from snow with wind-driven fall angle less than 45° from vertical.

| Description | Catalog Number |
|---|----------------|
| 1945 Community Noise Analyzer (Requires a microphone and preamplifier) | |
| With L_{eq}/L_{dn} option | 1945-9700 |
| Without L_{eq}/L_{dn} option | 1945-9710 |
| D-weighting option is available on special order Consult factory for ordering information | |
| Community Noise Analyzer (same as 1945-9700/-9710 plus additional analysis durations and Data Inhibit - see specifications) | 1945-9006 |
| Weatherproof Microphone System | 1945-9730 |
| Weatherproof Enclosure | 1945-9640 |

National stock numbers are listed at the back of the catalog.

Electret-Condenser Microphones

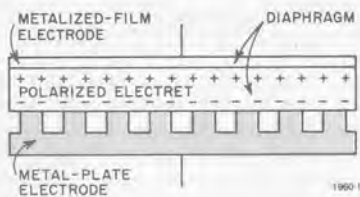

Use of a solid dielectric permits a simplified manufacturing process, and permanent polarization eliminates the need for a polarizing-voltage power supply. The net result is a high-performance laboratory-standard microphone at a moderate cost.

These microphones represent the very latest in microphone technology. They feature very uniform high-frequency performance in both flat random- and flat perpendicular-incidence versions, and are available in a variety of sizes. Since polarization voltage is not required, they can be used with inexpensive preamplifiers such as GR's 1972-9600.

The GR electret microphone is a condenser microphone with a permanently-polarized solid dielectric diaphragm.

1961 1-inch Electret-Condenser Microphones



Frequency: Curves show typical response and guaranteed limits; individual response curve supplied with each microphone. Below 20 Hz, the microphone is typically flat ± 1 dB down to 5 Hz. Microphone is essentially omnidirectional.

Sensitivity Level: NOMINAL: -38 dB re 1 V/N/m² (-58 dB re 1 V/ μ bar). **TEMPERATURE COEFFICIENT:** $< \pm 0.02$ dB/ $^{\circ}$ C typically from 0 to $+55^{\circ}$ C. **MAXIMUM SOUND PRESSURE LEVEL:** 160 dB absolute max.

Impedance: 125 ± 10 pF at 25° C and 1 kHz; temperature coefficient $< +0.2$ pF/ $^{\circ}$ C at 1 kHz.

Environmental: -20 to $+55^{\circ}$ C and 90% RH operating; 1-year exposure in an environment of $+55^{\circ}$ C and 90% RH causes negligible sensitivity change.

Mechanical: TERMINALS: Coaxial, with 0.907-60 thread, adapted to 0.460-60 (thread per in.). DIMENSIONS: 0.936 ± 0.001 in. dia. x 1.045 ± 0.001 in. long (1.435 ± 0.007 in. long with adaptor) (23.77 ± 0.025 x 26.55 ± 0.025 mm). WEIGHT: 1 oz (28 g) net, 1 lb (0.5 kg) shipping.

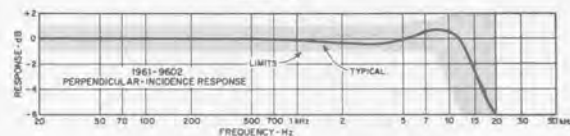
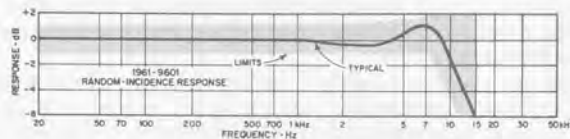

Typical performance
with 1560-P42 and 1972-9600 Preamplifiers (Unity Gain)

| Microphone | Frequency Range | "System" Sensitivity re 1 V/N/m ² | Dynamic Range* re 20 μ N/m ² |
|------------|-----------------|--|---|
| 1961-9601 | 5 Hz to 12 kHz | -38 dB | 20.5 to 140 dB |
| 1961-9602 | 5 Hz to 15 kHz | -38 dB | 20.5 to 140 dB |

*A-weighted noise level to maximum rms sinewave signal without clipping.

| Description | Catalog Number |
|---|----------------|
| 1961 Electret-Condenser Microphones | |
| Flat random-incidence response, 1-inch | 1961-9601 |
| Flat perpendicular-incidence response, 1-inch | 1961-9602 |

1962 1/2-inch Electret-Condenser Microphones



Frequency: Curves show typical response and guaranteed limits; individual response curve supplied with each microphone. Below 20 Hz, the microphone is typically flat ± 1 dB down to 5 Hz. Microphone is essentially omnidirectional.

Sensitivity Level: NOMINAL: -40 dB re 1 V/N/m² (-60 dB re 1 V/ μ bar). **TEMPERATURE COEFFICIENT:** $< \pm 0.02$ dB/ $^{\circ}$ C typically from 0 to $+55^{\circ}$ C. **MAXIMUM SOUND-PRESSURE LEVEL:** 170 dB absolute max.

Impedance: 35 ± 5 pF, at 25° C and 1 kHz; temperature coefficient $< +0.1$ pF/ $^{\circ}$ C, at 1 kHz.

Environmental: -20 to $+55^{\circ}$ C and 90% RH operating; 1-year exposure in an environment of $+55^{\circ}$ C and 90% RH causes negligible sensitivity change.

Mechanical: TERMINALS: Coaxial, with 0.460-60 thread. DIMENSIONS: 0.500 ± 0.005 in. dia. x 0.815 ± 0.001 in. long (12.70 ± 0.127 x 20.70 ± 0.025 mm). WEIGHT: 0.5 oz (14 g) net, 1 lb (0.5 kg) shipping.

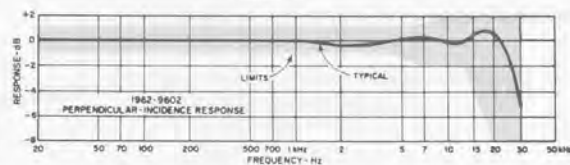
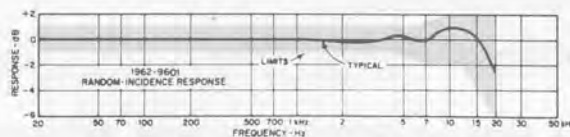

Typical performance
with 1560-P42 and 1972-9600 Preamplifiers (Unity Gain)

| Microphone | Frequency Range | "System" Sensitivity re 1 V/N/m ² | Dynamic Range* re 20 μ N/m ² |
|------------|-----------------|--|---|
| 1962-9601 | 5 Hz to 19 kHz | -41 dB | 26 to 145 dB |
| 1962-9602 | 5 Hz to 24 kHz | -41 dB | 26 to 145 dB |

*A-weighted noise level to maximum rms sinewave signal without clipping.

| 1962 Electret Condenser Microphones | | |
|---|--|-----------|
| Flat random-incidence response, 1/2-inch | | 1962-9601 |
| Flat perpendicular-incidence response, 1/2-inch | | 1962-9602 |

Ceramic Microphones

1-inch Ceramic Microphones



Three versions of the 1-inch ceramic microphone are offered; the differences are described below. All versions use the same microphone cartridge.

Frequency: Curve shows typical random response and guaranteed limits; individual response curve supplied with each microphone. Below 20 Hz, the microphone is typically flat ± 1 dB down to 5 Hz re the 500-Hz level. Time constant of pressure-equalizing leak is typically 0.08 s with a corresponding 3-dB rolloff at 2 Hz.

Sensitivity Level: NOMINAL: -40 dB re 1 V/N/m^2 (-60 dB re $1 \text{ V}/\mu\text{bar}$); MINIMUM: -42 dB re 1 V/N/m^2 (-62 dB re $1 \text{ V}/\mu\text{bar}$). TEMPERATURE COEFFICIENT: ≈ -0.01 dB/ $^{\circ}\text{C}$. KEY SOUND-PRESSURE LEVELS: $<1\%$ distortion at 150 dB; at -184 and $+174$ dB peak, microphone may fail.

Impedance: For 1971-9601 and -9605, $385 \text{ pF} \pm 15\%$ at 23°C ; for 1971-9606, $405 \text{ pF} \pm 15\%$ at 23°C . TEMPERATURE COEFFICIENT of Z, for both: $2.2 \text{ pF}/^{\circ}\text{C}$ from 0 to 50°C .

Environment: TEMPERATURE: -40 to $+60^{\circ}\text{C}$ operating; HUMIDITY: 0 to 100% RH operating.

Mechanical: TERMINALS: 1971-9601, Coaxial with 0.460-60 thread for mounting on 1560-P42 or 1972-9600 preamplifiers. Center terminal is signal, outer terminal (shell) is ground. 0.460-60 threaded adaptor may be removed for mounting on 1560-P40 preamplifier. 1971-9605, Microphone cartridge

1971-9606, Microphone cartridge with flexible conduit and 3-terminal audio connector. DIMENSIONS: Cartridge only, 1.13 in. (29 mm) long, 0.936 ± 0.002 in. ($23.7 \text{ mm} \pm 50 \mu\text{m}$) dia; assembly, 1971-9601, 1.44 in. (36.5 mm) long; 1971-9605, 2.31 in. (59 mm) long; 1971-9606, 11.75 in. (298 mm) long. WEIGHT: 1971-9601, 1.5 oz (41 g) net, 1 lb (0.5 kg) shipping; 1971-9605, 2 oz (56.6 g) net, 1 lb (0.5 kg) shipping; 1971-9606, 10 oz (283 g) net, 2 lb (0.9 kg) shipping.

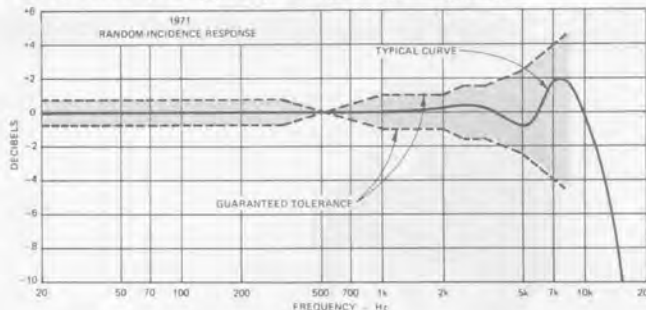

Typical performance of the 1971 Microphones with the 1560-P42 and 1972-9600 Preamplifiers (Unity Gain)

| Frequency Range | "System" Sensitivity re 1 V/N/m^2 | Dynamic Range* re $20 \mu\text{N/m}^2$ |
|------------------|---|--|
| 5 Hz to 12.5 kHz | -40 dB | 22 to 145 dB |

* A-weighted noise level to maximum rms sinewave signal without clipping.

| Description | Catalog Number |
|---------------------------------|----------------|
| 1971 1-inch Ceramic Microphone | 1971-9605 |
| With adaptor to mike connector | 1971-9601 |
| With adaptor to preamplifier | 1971-9606 |
| Assembled with flexible conduit | |

Preamplifiers

1560-P42 Preamplifier

- For electret-condenser, air-condenser, and ceramic microphones and vibration pickups



The 1560-P42 Preamplifier is a high-input impedance, low-noise preamplifier. It is particularly well suited for amplification of the output of capacitive sources, such as electret-condenser, air-condenser, and ceramic microphones and piezoelectric vibration pickups. It is an excellent choice for use with GR sound-level meters and analyzers when a long cable must be used between the microphone and the instrument. It is also a useful probe amplifier for other electrical signals where high input impedance and low noise are necessary. For example, it can increase the sensitivity and input impedance of analyzers, recorders, amplifiers, null detectors, counters, frequency meters, voltmeters, and oscilloscopes. Output from

the preamplifier is through a removable 3-wire shielded cable and the required dc supply voltage is applied from one of the wires to ground.

Gain: 1:1 or 10:1 (20 dB) ± 0.3 dB at 25°C , slide-switch controlled; $< \pm 0.3$ -dB gain change, from that at 25°C , from -30 to $+65^{\circ}\text{C}$.

Frequency Response (at 1-V rms open-circuit output behind 600Ω , -30 to $+55^{\circ}\text{C}$):

| | 3 Hz | 5 Hz | 20 Hz | 100 kHz | 300 kHz | 500 kHz |
|-----------|------------|--------------|---------------|---------|------------|---------|
| 1:1 gain | ± 3 dB | ± 1 dB | ± 0.25 dB | | ± 1 dB | |
| 10:1 gain | ± 3 dB | ± 1.5 dB | ± 0.3 dB | | ± 2 dB | |

Impedance: INPUT: $\approx 2 \text{ G}\Omega$ in parallel with $< 6 \text{ pF}$; driven shield reduces input-capacitance loading for condenser microphones. OUTPUT: $\approx 15 \Omega$ in series with $3.3 \mu\text{F}$.

| | |
|--|-----------|
| 1560-P42 Preamplifier | 1560-9642 |
| Adaptor (to most 1-in. condenser microphones) | 1560-9542 |
| Adaptor (to vibration pickups and 1-in. ceramic microphones) | 1560-9669 |

National stock numbers are listed at the back of the catalog.

1972-9600 Preamp/Adapter



The Preamp/Adapter provides the high input impedance required by electret-condenser and ceramic microphones, unity voltage gain, and the capability to drive cables up to 100 feet in length. The amplifier requires a 9- to 25-volt dc power supply or normal connection to the 1560-P62 Power Supply or most any GR acoustic instrument.

The 1972-9600 has the same input connector as the 1560-P42 Preamp/Adapter; unlike the latter, it does not provide polariza-

tion voltage for air-condenser microphones. It may be driven from the same kind of transducer as the 1560-P42 with the exception of any that require polarization voltage.

Gain: 0 dB, +0 -0.25 dB, at 1 kHz.

Frequency Response: ±1 dB, 5 Hz to 100 kHz; ±3 dB, 3 Hz to 500 kHz (at 0.1 V rms output into an open circuit, driven from 600-Ω source).

Input Impedance: ≈3 pF in parallel with 1 GΩ, at low audio frequencies.

| Description | Catalog Number |
|---------------------|----------------|
| 1972 Preamp/Adapter | 1972-9600 |

1560-P40 Preamp/Adapter

■ For ceramic microphones and vibration pickups

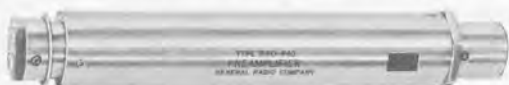

The 1560-P40 Preamp/Adapter is a high input-impedance, low noise preamp/Adapter similar to the 1560-P42 Preamp/Adapter above except it produces no polarizing voltage and therefore cannot be used with condenser microphones.

A 1-inch ceramic microphone (1560-9570 cartridge, adaptor removed) plugs into the input end of the preamp/Adapter case. The output from the preamp/Adapter goes through a 3-terminal shielded connector, 1 terminal of which (with ground) brings in the required dc power.

Frequency Response:

| | 3 Hz | 5 Hz | 20 Hz | 250 kHz | 500 kHz |
|-----------|-------|---------|----------|----------|---------|
| 1:1 gain | | ±1 dB | | ±0.25 dB | |
| 10:1 gain | ±3 dB | ±1.5 dB | ±0.25 dB | ±1.5 dB | |

Gain: 1:1 or 10:1 (20 dB) ±0.3 dB at 25°C, slide-switch controlled; <±0.3-dB gain change (from that at 25°C) from -30° to +55°C.

Impedance: INPUT: 6 pF, >500 MΩ at low audio frequencies. OUTPUT: ≈20 Ω in series with 3.3 μF at 1:1 gain, ≈100 Ω in series with 3.3 μF at 10:1 gain.

| | |
|---|-----------|
| 1560-P40 Preamp/Adapter | 1560-9640 |
| 1560-P96 Adaptor, to microphone connector | 1560-9696 |

Power Supply

1560-P62 POWER SUPPLY Required with 1560-P40, -P42, or 1972-9600 Preamp/Adapters when they are used with instruments that do not include a source of power such as the 1551 and 1565 Sound-Level Meters. Also useful when long cables are to be driven at high levels and as a charger for rechargeable batteries in the 1561 Sound-Level Meter or 1952 Universal Filter.

Input: 100 to 125 or 200 to 250 V, 50 to 60 Hz.

Output: 18 to 21 V dc, 15 mA max; automatic limiting protects

supply and prevents deep battery discharge. **BATTERIES:** Two rechargeable Ni-Cd batteries provide up to 225 mA-hours operation at room temperature between charges. **RIPPLE:** <5 mV rms in CHARGE-OPERATE mode. **CHARGE TIME:** 14 to 16 h for completely discharged battery, constant 22-mA battery-charging current. Rear-panel slide switch selects internal or external battery.

| | |
|------------------------------------|-----------|
| 1560-P62 Power Supply, Bench Model | 1560-9575 |
|------------------------------------|-----------|

Accessories for Acoustic Instruments

Microphone Windscreens

These microphone windscreens reduce the effects of ambient wind noise and protect the microphone diaphragm in oily, misty, or dusty environments. They attach easily to any 1-inch microphone and do not appreciably alter the sensitivity or frequency response of the microphone. The windscreens are made of reticulated polyurethane foam and can be conveniently washed if they become soiled.

Wind-Noise Reduction: 20 dB in winds ≤30 mph.

Microphone Sensitivity Loss: 0 dB to 3 kHz, ≈0.5 dB to 5 kHz, ≈2 dB to 12 kHz; see curve.

Windscreens are also available for ½-inch microphones. Their specifications are similar to those for 1-inch microphones.

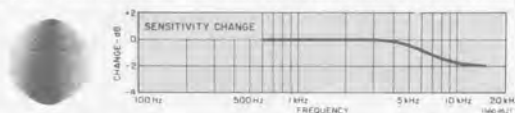

Microphone Windscreens, 4 each per pack

For 1-in. microphones
For ½-in. microphones

1560-9521
1560-9522

Tripod

1560-9590 TRIPOD Versatile — accepts a variety of equipment. A ¼-20 threaded stud fits all GR sound-level meters and electronic stroboscopes, a 1-in. sleeve accepts the 1560-P40 and 1972-9600 Preamp/Adapters, and a ½-in. sleeve accepts the 1560-P42 Preamp/Adapter.

National stock numbers are listed at the back of the catalog.

| | |
|--------|-----------|
| Tripod | 1560-9590 |
|--------|-----------|



1566 Multichannel Amplifier

- 16 channels
- manual or remote channel selection
- 2-Hz to 100-kHz response
- 55-dB gain, manually or remotely adjusted
- calibration noise source built in

Many inputs — one output Many sound and vibration measurements can be simplified by use of a scanner that connects, in sequence or in any arbitrary order, the outputs from a number of transducers to a single analyzer. A scanner system can be set up to measure signals individually or to average all signals.

The 1566 scans up to 16 channels (up to 99 with a special additional unit), amplifies each by up to 55 dB, and provides a built-in pink-noise calibration source that speeds not only the check out of the scanner but also that of any analyzer connected to it.

SPECIFICATIONS

Channels: 16 plus 1 for calibration, expandable to 99 (additional channels housed in a special unit). **CONTROL:** Active channel is selected manually or by external 1-2-4-8 BCD signal, or automatically scanned in sequence with range of channels to be scanned selected by thumbwheel switches; dwell time adjustable from 100 ms to 10 s or infinity (channel advance initiated by external signals); scan set to occur once or repetitively and started, stopped on active channel, or reset to lowest channel by pushbuttons or external closures to ground.

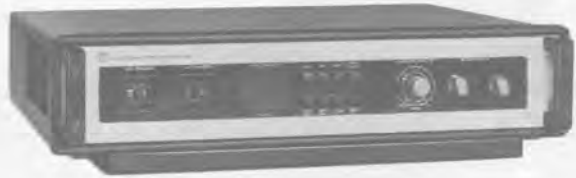

DISPLAY: Two high-intensity neon readout tubes display active channel number.

Frequency: 2 Hz to 100 kHz, flat within ± 0.5 dB.

Sensitivity: 1.8 mV to 1.6 V for 1-V output; gain set in 1-dB increments by panel control or 1-2-4-8 BCD signal at standard DTL levels (logic 0 = ground, logic 1 $\geq +3.5$ V). Rear-panel adjustment provides 10-dB continuous control of gain for all channels for calibration. Each channel includes a 6-dB gain adjustment for transducer sensitivity equalization.

Maximum Input: 5 V rms, 7 V pk.

Impedance: INPUT, 100 k Ω . OUTPUT, 600 Ω .

| Description | Catalog Number |
|------------------------------------|----------------|
| 1566 Multichannel Amplifier | |
| Bench Model | 1566-9700 |
| Rack Model | 1566-9701 |
| Cable Set | 1566-9500 |

1396-B Tone-Burst Generator

- fast, coherent switch for periodic waves
- dc to 2 MHz
- signal attenuated > 60 dB between bursts
- length of burst: 10 μ s to 10 s, or continuous, or 1 to 129 periods of the switched signal
- or burst length controllable by separate input

The 1396-B Tone-Burst Generator fills the gap between steady-state cw testing and step-function, or pulse, testing of amplifiers, meters, etc. It is ideally suited for applications such as the test and calibration of sonar transducers and amplifiers, the measurement of distortion and transient response of amplifiers and loudspeakers, and routine testing of filters and ac meters. Still other uses are found in the measurement of room acoustics and automatic-gain-control circuits, in the synthesis of time ticks on standard-time radio transmissions, and in psychoacoustic instrumentation.

SPECIFICATIONS

Signal Input (signal to be switched): **AMPLITUDE:** ± 1 to ± 10 V pk-pk (7 V rms with 0-V dc component) for proper operation. **FREQUENCY RANGE:** Dc to 2 MHz. **INPUT IMPEDANCE:** 50 k Ω , approx.



Timing Input (signal that controls switch timing): Same specifications as Signal Input except: **INPUT IMPEDANCE:** 20 k Ω , approx.

Signal Output: **OUTPUT ON:** Replica of Signal Input at approx same voltage level; dc coupled; down 3 dB at > 1 MHz. Output current limits at > 25 mA pk, decreasing to > 15 mA at 2 MHz. Output source impedance typically 25 Ω , increasing above 0.2 MHz. Total distortion contribution $< 0.3\%$ at 1 kHz and 10 kHz. **OUTPUT OFF:** Input-to-output transfer (feed-through), < 10 mV (< -60 dB re full output), dc to 1 MHz, increasing above 1 MHz. **SPURIOUS OUTPUTS:** Dc component and change in dc component due to on-off switching (pedestal) can be nulled with front-panel control. Output switching transients are typically 0.2 V pk-pk and 0.2 μ s in duration (120-pF load).

| | |
|------------------------------------|-----------|
| 1396-B Tone-Burst Generator | |
| Bench Model | 1396-9702 |
| Rack Model | 1396-9703 |

National stock numbers are listed at the back of the catalog.

1569 Automatic Level Regulator

- 2 Hz to 100 kHz
- 50-dB control range
- acoustic-system component

Constant level Use this regulator to hold a monitored signal amplitude steady (such as the sound level in a test chamber) while you sweep the frequency or some other parameter. The primary use is to control the excitation level in swept-frequency sound and vibration testing. The 1569 functions as an automatically controlled amplifier/attenuator between the oscillator and the power-amplifier-transducer chain.

The regulator senses a control voltage from a microphone, accelerometer, or other pickup monitoring the quantity to be controlled and adjusts its own attenuation to maintain that control voltage at constant level. Output from the 1569 is indicated on a panel meter with a scale that is linear in dB, showing you where the regulator is operating in its 50-dB control range. You can easily adjust the control rate to suit operating frequency and magnitude-phase relationships in your control loop.



SPECIFICATIONS

Operating Ranges: FREQUENCY: 2 Hz to 100 kHz. CONTROL RANGE: 50 dB. COMPRESSION RATIO: 25, i.e., 0.04 dB per dB.

Main Input: DRIVE VOLTAGE REQUIRED: For normal operation, 1 V; in voltage-leveler mode, 0.2 to 1 V. IMPEDANCE: 100 k Ω .

Output: VOLTAGE: 10 mV to 3 V. IMPEDANCE: 600 Ω . LOAD: Any impedance can be connected without affecting linear operation of output circuit.

| Description | Catalog Number |
|---------------------------------------|------------------|
| 1569 Automatic Level Regulator | 1569-9700 |
| Bench Model | 1569-9701 |
| Rack Model | |

1840-A Output Power Meter

- 20 Hz to 20 kHz
- 0.1 mW to 20 W
- 0.6- Ω to 32-k Ω input impedance
- true rms reading

The 1840-A measures audio-frequency power into any desired magnitude of load impedance. Its important uses include the measurement of:

- Power output of oscillators, amplifiers, preamplifiers, transformers, transducers, and low-frequency lines.
- Output impedance, by adjustment of this load to yield maximum power indication.
- Frequency-response characteristics of amplifiers, transformers, and other audio-frequency devices.

This instrument is basically a multi-tapped audio-frequency transformer with a fixed secondary load. Its two front-panel switches connect eight identical primary windings and six secondary taps in various combinations to provide a total of 48 different primary impedances.



The maximum power rating can be extended for any given impedance with the use of a simple T-network attenuator, design data for which are supplied with the instrument.

SPECIFICATIONS

Power: 0.1 mW to 20 W, 40 Hz to 20 kHz. Below 40 Hz, max rating is reduced by up to 50% (at 25 Hz), depending on impedance selected. Auxiliary dB scale reads from -15 to +43 dB re 1 mW.

Impedance: 0.6 Ω to 32 k Ω in two ranges; yielding 48 individual impedances spaced approximately $\sqrt[3]{2}$ apart.

| | |
|--|------------------|
| 1840-A Output Power Meter | 1840-9701 |
| 480-P212 Relay-Rack Adaptor Set | 0480-9822 |

1381 and 1382 Random-Noise Generators



GR 1381

- 2 Hz to 2, 5, or 50 kHz, Gaussian distribution
- adjustable clipping
- 3-V rms output



GR 1382

- 20 Hz to 50 kHz, Gaussian distribution
- white, pink, or ANSI spectra
- 3-V rms output, balanced, unbalanced, or floating

Predictably random The 1381 and 1382 are companion instruments that generate truly random noise from a semiconductor source. Special precautions are taken

to ensure a symmetrical, Gaussian amplitude distribution. Output level is adjustable from below 3 millivolts to 3 volts rms behind a 600-ohm source impedance. Each model is constructed in a 3½-inch-high, half-rack-width cabinet, convenient for bench use and two can be mounted side-by-side in a relay rack.

Either of these noise generators can be used for simulation of noise in signal paths, as test-signal sources, or for demonstrations of statistical and correlation principles. The different features of the two offer a choice to match your needs.

Lowest frequency The 1381 generates noise that is flat down to 2 Hz and is intended for random-vibration tests and for general-purpose use in the audio and sub-audio range. The upper-frequency limit (at -3 dB) can be switched to 2, 5, or 50 kHz. The output signal can be clipped symmetrically at 2, 3, 4, or 5 times the rms amplitude.

National stock numbers are listed at the back of the catalog.

Pink or white The 1382 generates noise in the 20-Hz to 50-kHz band and is intended for electrical, acoustical, and psycho-acoustical tests. It offers three spectra, white (flat), pink (-3 dB per octave), and ANSI (see specifications). The output can be taken balanced or unbalanced, floating or grounded.

SPECIFICATIONS

Spectrum of 1381: SHAPES: Flat (constant energy per hertz of bandwidth) ± 1 dB from 2 Hz to half of cutoff. CUTOFF FREQUENCY (down 3 dB): 2, 5, or 50 kHz, selected by switch. SPECTRAL DENSITY, at 3-V output level and for 1-Hz bandwidth: 64, 40, and 13 mV, approx, respectively for upper cutoff frequencies of 2, 5, and 50 kHz. SLOPE of amplitude vs frequency above upper cutoff: 12 dB/octave.

Spectrum of 1382: Choice of 3 shapes. WHITE NOISE (flat spectrum, constant energy per hertz bandwidth): ± 1 dB, 20

Hz to 25 kHz, with 3-dB points at approx 10 Hz and 50 kHz; PINK NOISE (constant energy per octave bandwidth): ± 1 dB, 20 Hz to 20 kHz; or ANSI NOISE, as specified in ANSI Standard S1.4-1961.

Output: VOLTAGE: >3 V rms max, open-circuit, for any bandwidth. CONTROL: Continuous adjustment from that level down approx 60 dB. IMPEDANCE: 600 Ω . Can be shorted without causing distortion. 1381 output is unbalanced; 1382 output is floating, can be connected balanced or unbalanced. TERMINALS: 1381 output at front-panel binding posts and rear-panel BNC connector; 1382 output at front-panel binding posts and rear-panel jacks for double plugs.

| Description | Catalog Number |
|-------------------------------|----------------|
| Random-Noise Generator | |
| 1381 (2 Hz to 50 kHz), Bench | 1381-9700 |
| 1381 (2 Hz to 50 kHz), Rack | 1381-9701 |
| 1382 (20 Hz to 50 kHz), Bench | 1382-9700 |
| 1382 (20 Hz to 50 kHz), Rack | 1382-9701 |

1390-B Random Noise Generator

- 5 Hz to 5 MHz
- 30 μ V to 3 V
- ± 1 -dB audio-spectrum-level uniformity

This instrument generates wide-band noise of uniform spectrum level, particularly useful for noise and vibration testing in electrical and mechanical systems. The noise output of a gas-discharge tube is amplified and shaped with low-pass filters to provide wide spectral ranges with upper cutoff frequencies of 20 kHz, 500 kHz, and 5 MHz.

The output level is controlled by a continuous attenuator followed by a 4-step attenuator of 20 dB per step and is metered from over 3 volts to below 30 microvolts. When the attenuator is used, the output impedance remains essentially constant as you change the output level.

Frequency response Drive your device under test with the 1390-B and analyze output with any of several GR analyzers, manually or with a graphic level recorder. In contrast with the usual swept-single-frequency methods, this one makes your DUT handle a wide spectrum simultaneously. The distinction may be significant if the DUT is nonlinear.



Random-Noise Generator with Pink-Noise Filter plugged in.

SPECIFICATIONS

Frequency Range: 5 Hz to 5 MHz.

Output: VOLTAGE: Max open-circuit output is at least 3 V for 20-kHz range, 2 V for 500-kHz range, and 1 V for 5-MHz range. IMPEDANCE: Source impedance for max output is approx 900 Ω . Output is taken from a 2500- Ω potentiometer. Source impedance for attenuated output is 200 Ω . One output terminal is grounded.

| | |
|--------------------------------------|-----------|
| 1390-B Random-Noise Generator | |
| 115-V Model | 1390-9702 |
| 230-V Model | 1390-9703 |
| Rack Adaptor Set (7 in.) | 0480-9842 |

1390-P2 Pink-Noise Filter

When white noise is used for frequency-response measurements in conjunction with a constant-percentage bandwidth analyzer (such as the GR 1564-A Sound and Vibration Analyzer or 1568-A Wave Analyzer), the amplitude-frequency characteristic of a flat system appears to slope upward with increasing frequency at a rate of 3 dB per octave, owing to the constantly increasing bandwidth (in hertz) of the analyzer. The 1390-P2 converts the audio-frequency output of the 1390-B from white noise to pink noise, which has constant energy per octave. Thus it flattens the response curves made with a constant-percentage-bandwidth analyzer.

SPECIFICATIONS

Frequency Response: Sloping -3 dB per octave from 20 Hz to 20 kHz, -6 dB per octave above 20 kHz. Output voltage is approx -5 dB with respect to the input voltage at 20 Hz and -35 dB at 20 kHz. It lies within 1 dB of the straight line connecting these two points on a graph of output in decibels vs log frequency.

Over-all Output Level: When the filter is used with the random-noise generator set for the 20-kHz range, the output voltage of

the filter is approx 30 dB below its input, and the voltage level in each one-third-octave band is approx 17 dB below that. Thus, when the output meter of the generator indicates 3 V, the output of the filter is approx 0.1 V, and the level in each one-third-octave band is approx 15 mV.

Input Impedance: The filter should be driven from a source whose impedance is 1 k Ω or less. Input impedance is variable from 6.5 k Ω + load resistance at zero frequency to 6.7 k Ω at high frequencies.

Output Impedance: The filter should not be operated into a load of less than 20 k Ω . Internal output impedance is variable from 6.5 k Ω + source resistance at low frequencies to approx 200 Ω at high frequencies.

Max Input Voltage: 15 V rms.

Terminals: Input terminals are recessed banana pins on $\frac{3}{4}$ -in. spacing at rear of unit. Output terminals are jack-top binding posts with $\frac{3}{4}$ -in. spacing.

Mechanical: Plug-in unit housing. DIMENSIONS (wxhxd): 1.38x 5x2.87 in. (35x127x73 mm). WEIGHT: 6 oz (0.2 kg) net, 4 lb (1.9 kg) shipping.

| | |
|----------------------------------|-----------|
| 1390-P2 Pink-Noise Filter | 1390-9602 |
|----------------------------------|-----------|

National stock numbers are listed at the back of the catalog.

1383 Random-Noise Generator

- 20 Hz to 20 MHz, ± 1.5 dB
- 30- μ V to 1-V output, open-circuit
- 50-ohm output impedance
- meter and 10-dB-per-step attenuator

This instrument generates wide-band noise of uniform spectrum level, particularly useful for tests in video- and radio-frequency systems.

The maximum output is one volt open circuit from a 50-ohm source. An 8-step attenuator of 10 dB per step permits reduction of the output level to 30 μ V.

SPECIFICATIONS

Spectrum: Flat (constant energy per hertz of bandwidth) ± 1



dB from 20 Hz to 10 MHz, ± 1.5 dB from 10 MHz to 20 MHz.

Output: VOLTAGE ≥ 1 V rms open circuit, at full output. **CONTROL:** Continuous control and 8-step attenuator of 10 dB/step. **METER:** Indicates open-circuit output voltage ahead of 50 Ω . **IMPEDANCE:** 50 Ω . Can be shorted without causing distortion. **TERMINALS:** GR874[®] coaxial connector that can be mounted on either front or rear panel.

| Description | Catalog Number |
|------------------------------------|----------------|
| 1383 Random-Noise Generator | |
| Bench Model | 1383-9700 |
| Rack Model | 1383-9701 |

1952 Universal Filter

- 4-Hz to 60-kHz tuning
- low-pass or high-pass, band-pass or band-reject, ganged for easy tuning
- high attenuation rate — 30 dB/octave
- line or battery operation

The 1952 Universal Filter will perform as a low-pass, high-pass, band-pass, or band-reject filter at the turn of a panel switch. It consists of low-pass and high-pass filters that can be employed singly, in cascade, or in parallel, to provide the assortment of over-all characteristics. The cut-off frequencies of the two filters can be controlled independently or ganged together to provide constant-percentage bandwidth for band-pass or band-reject tuning.

This filter is of value in many signal-conditioning applications. For example, it can be used to control system bandwidth for reduction of extraneous signals or to evaluate the effect of limited bandwidth upon signal intelligibility and data-transmission accuracy. As a high-pass filter it can reduce power-line-related components, as a low-pass filter control high-frequency noise, or as a notch filter eliminate single-frequency components. The 1952 can also act as part of a spectrum analyzer or distortion meter and, with a random-noise generator, produce controlled bands of noise as test signals.

SPECIFICATIONS

Frequency Range: CUT-OFF FREQUENCIES: Adjustable 4 Hz to 60 kHz in four ranges. **PASS-BAND LIMITS:** Low-frequency



response to dc (approx 0.7 Hz with ac input coupling) in Low Pass and Band Reject modes. High-frequency response uniform ± 0.2 dB to 300 kHz in High Pass and Band Reject modes. **CONTROLS:** Log frequency-dial calibration; accuracy $\pm 2\%$ of cut-off frequency (at 3-dB points).

Input: GAIN: 0 or -20 dB, switch selected. **IMPEDANCE:** 100 k Ω . **COUPLING:** Ac or dc, switch selected. Lower cut-off frequency (3 dB down) for ac coupling is about 0.7 Hz. An LC filter at input limits bandwidth to 300 kHz, thus reducing danger of overloading active circuits at frequencies above normal operating range.

Max Input Voltage: SINE WAVE: 3 V rms (8.5 V pk-pk); except with input attenuator at 20 dB, 30 V rms. **DC COUPLED:** ± 4.2 V pk. **AC COUPLED:** Max peak level of ac component must not exceed ± 4.2 V for specified performance; dc level, ± 100 V. Peaks up to ± 100 V are tolerated without damage.

Output: **IMPEDANCE:** 600 Ω . **LOAD:** Any load can be connected without affecting linear operation of output circuit. **TEMPERATURE COEFFICIENT** of output offset voltage: Between 0 and $+4$ mV/ $^{\circ}$ C.

| 1952 Universal Filter | |
|--------------------------------|-----------|
| Bench Model | 1952-9801 |
| Rack Model | 1952-9811 |
| Rechargeable Battery (2 req'd) | 8410-1040 |

1450 Decade Attenuator

- 0 to 111 dB in steps of 0.1 dB
- 600-ohm input and output impedance
- accuracy: ± 0.02 dB $\pm 0.25\%$
- usable to 1 MHz

Use the 1450 Decade Attenuator to provide accurate steps of attenuation for power-level measurements, transmission-efficiency tests, and gain or loss measurements on transistors, filters, amplifiers, and similar equipment. It can also serve as a power-level control in circuits not equipped with other volume controls.



SPECIFICATIONS

Attenuation Range: 111 dB in steps of 0.1 dB.

Terminal Impedance: 600 Ω nominal in either direction. An etched plate indicates the mismatch loss for other than 600- Ω circuits.

| Description | Dials | Attenuation | | Catalog Number |
|--------------------------|-------|-------------|--------|----------------|
| | | Total | Steps | |
| Decade Attenuator | | | | |
| 1450-TB, Bench | 3 | 111 dB | 0.1 dB | 1450-9893 |

National stock numbers are listed at the back of the catalog.

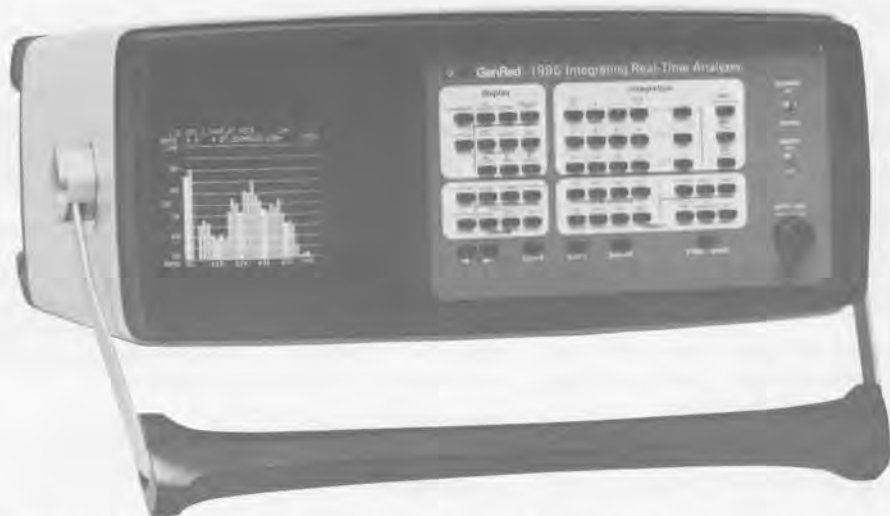

1995 Integrating Real-Time Analyzer

- 25 Hz to 20 kHz or 2.5 Hz to 20 kHz
- 1/3-octave and full-octave real-time analysis
- built-in display scope features bar-graph display or numerical listing
- small and lightweight
- power-line or battery operation for truly portable use
- 50-dB display range
- integration times from 1/8-second to 24 hours
- spectrum comparison capability

The 1995 is designed to satisfy a broad range of noise-measurement requirements in real time, on the spot without the need to make tape recordings for detailed analysis back in the laboratory. A compact, lightweight, microprocessor-based instrument, it can operate from optional rechargeable batteries for truly portable on-site measurements. This is the first instrument in its class that is not dependent on an external power source.

The 1995 is a one-third and full-octave real-time analyzer with long-term integration capabilities. It also operates as an integrating analyzer or integrating sound-level meter to display A-weighted sound level, Flat response, or any selected band level as a function of time.

SPECIFICATIONS

Standards: FILTERS: One-third-octave filters in accordance with: ANSI Standard Specification for Octave, Half-Octave and Third-Octave-Band Filter Sets S1.11 1966, Type E, Class III; IEC Recommendation Publication 225-1966, Octave, Half-Octave and Third-Octave-Band Filters for the Analysis of Sound and Vibration; DIN 45 652, 1964 Third-Octave-Band Filters for Electroacoustical Measurements. A-weighting characteristics and Fast and Slow responses in accordance with: ANSI Standard Specification for Sound-Level Meters S1.4-1971, Type 1; IEC Recommendation Publication 179-1973 Precision Sound-Level Meters; DIN 45 633/1, 1970, Precision Sound-Level Meters General Requirements.

Preamplifier Input: MICROPHONES AND ACCELEROMETERS: Preamplifier has 0.460 x 60 thread for direct connection to one-half inch electret-condenser or air-condenser microphone and various adaptors for use with other microphones and accelerometers. Switchable polarizing voltage for use with air-condenser microphones is provided. ELECTRICAL SIGNALS: BNC to the amplifier thread adaptor supplied.

A built-in display scope features a bar-graph display of one-third-octave or full-octave bands, and a pushbutton allows the user to convert the bar graph to a numerical display with standard deviations listed for each band. Spectrum storage is also built-in, allowing the storage of a spectrum for recall and comparison with new data. The stored spectrum can be retained for a long period of time since the internal memory is powered by a separate battery.

The 1995 is an excellent tool for industrial-noise, community-noise and product-noise applications. Typical applications include:

- Plant and machinery noise reduction
- Sound-power measurements per EPA standards
- Machine-tool measurements per NMTBA
- Aircraft-noise measurements per FAR-36
- Motor-vehicle-passby measurements
- Community-noise measurements (e.g., L_{eq})
- Product-noise rating and reduction

Please use one of the cards at the rear of this catalog to request complete information.

Level Range for Direct Reading in dB re 20 μ Pa

| Nominal Microphone Sensitivity dB re 1 V/Pa | Microphone Sensitivity Range dB re 1 V/Pa | Level Range* For Direct Reading dB re 20 μ Pa | Corresponding Voltage Range |
|--|--|--|-----------------------------|
| -30 | -26 to -36 | 120 to 20 | .63 V to 6.3 μ V |
| -40 | -36 to -46 | 130 to 20 | .63 V to 2 μ V |
| -50 | -46 to -56 | 140 to 20 | .63 V to .63 μ V |
| -60 | -56 to -66 | 140 to 30 | .2 V to .63 μ V |

* Lower level may be limited due to noise depending on the capacitance of the microphone used, its exact sensitivity, and the particular pass band or weighting. Limits apply with preamplifier set to X1 gain. Lower limit may be extended by setting the preamplifier to X10 gain.

Typical sensitivity of GR 1971 Ceramic and 1962 Electret-Condenser Microphones is -40 dB re 1 V/Pa. Equivalent A-weighted noise for 1971 Ceramic Microphone: 21 dB; for 1962 Electret-Condenser Microphone: 27 dB. One-third-octave band levels are typically less than 10 dB for bands from 25 Hz to 20 kHz with 1971 Microphone. One-third-octave band levels decrease with increasing frequency for 1962 Microphone, ranging from typically 30 dB at 25 Hz to 12 dB at 20 kHz.

National stock numbers are listed at the back of the catalog.

IMPEDANCE: Approximately 2 G Ω in parallel with less than 6 pF. **CALIBRATION ADJUSTMENT:** Rear-panel screwdriver adjustment with 10-dB total range. **MAXIMUM INPUT:** For linear operation ± 5 V peak.

Tape Input (rear panel): CONNECTOR: Tape input connector; BNC. **SENSITIVITY:** Nominally 1 V rms full scale. Independent of full-scale range selected and continuously adjustable from 0.316 V to 3.16 V rms full scale. **IMPEDANCE:** 100 k Ω , ac coupled. **MAXIMUM INPUT:** For linear operation, a peak signal 20 dB above full-scale setting; ± 32 V peak without damage. Maximum dc input, ± 30 V without damage.

Overload Indication: Indication of overload on display when peak input voltage exceeds linear range (non-latching).

Filters: **FREQUENCY RANGE:** 1995-9700 and 1995-9720: 25 Hz to 20 kHz one-third-octave center frequencies (standard bands 14 to 43), or 31.5 Hz to 16 kHz, one-octave-band center frequencies (bands 15 to 42); 1995-9710 and 1995-9730: 2.5 Hz to 20 kHz (bands 4 to 43) one-third octave or 4 Hz to 16 kHz octave-band center frequencies (bands 6 to 42). **BANDWIDTH:** Bandwidths of one-third octave or one octave (octaves derived by summing 1/3 octaves). Either result may be displayed at completion of analysis. **CHARACTERISTICS:** One-third-octave filters have nominal 6-pole Butterworth response.

Weighting: A.

Preweighting: Flat or A ahead of filters.

AC Output: Flat output unfiltered provides 0.5 V rms nominal at full scale, output provided from 5 k Ω shortable source.

Video Output: Composite video; negative sync; 1 V p-p into 75 Ω . 8-MHz picture element rate.

Detector and Integrator: **DETECTOR RESPONSE:** True Square Law (rms). **SOUND-PRESSURE LEVEL:** Sound-pressure level with either integration or exponential averaging as selected by operator. **SOUND-EXPOSURE LEVEL:** Sound-exposure level (time reference one second) selected by operator. **INTEGRATION TIMES:** 1/8, 1/4, 1/2, 1, 2, 4, 8, 9, 10, 15, 24 seconds, minutes or hours selectable by operator in linear modes; 1/8, 1/4, 1/2, 1, 2, 4, 8, 9, 10, 15, 24 seconds or minutes selectable by operator in exponential mode. In exponential mode, time constants of 1/8 second and 1 second correspond to FAST and SLOW sound-level meter responses, respectively. **DYNAMIC RANGE:** Dynamic range, including 10-dB allowance for crest factor above full scale, is 63 dB. Linearity error less than ± 0.75 dB for sine wave inputs ranging from +7 dB to -40 dB re full scale and less than ± 1 dB for inputs ranging from -40 to -50 dB re full scale. Resolution is 0.25 dB. **CREST FACTOR:** At least 10 dB at full scale. **OVERLOAD INDICATION:** Indication of overload on display when the integrated level in any band exceeds full scale (non-latching).

Display: **TYPE:** Five-inch raster-scan display with tube face recessed to permit viewing in bright ambient light. **POWER:** Controlled by front-panel switch. Display may be turned off to conserve battery power without affecting performance of instrument. **RANGE:** 50 dB displayed. Full-scale sensitivity selectable from 70 to 140 dB re 20 μ Pa in 10-dB steps. **LEVEL-VS-FREQUENCY:** Bar-graph display of one-third-octave or one-octave band levels plus A-weighted and flat-response levels. A second result, previously stored, may be displayed as a line graph, superposed on the bar graph, for comparison. Status information and one band level (selected by "cursor") displayed alphanumerically. **LEVEL-VS-TIME:** Bar graph of up to 32 sequential integration results plus status information and one integration result (selected by "cursor") displayed alphanumerically. **NUMERICAL RESULT:** All band numbers, levels, and standard deviations (except for octaves) are listed numerically along with status information. In level-vs-time mode, all integration periods and corresponding levels and standard deviations (except for octaves) are displayed. **CURSOR:** A cursor operates in the graphical mode to display the band number, level, and standard deviation of any one selected band. The bar corresponding to the selected band is

intensified for identification. **STORAGE:** A displayed result may be stored and then recalled and displayed alone or superposed on a "real time" result. A composite one-third-octave spectrum developed from one-third-octave band-level maximums in a series of integrations is stored and may be displayed alone or superposed on a "real time" or stored spectrum. **DATA REDUCTION:** In the REDUCED DATA mode, A-weighted and flat-response sound levels and Speech Interference Level are displayed.

Calibration: A built-in noise source permits an overall check on all channels. Overall system calibration, including accessory preamplifier, microphone, or accelerometer, can be performed using any acoustic or vibration calibrator.

Basic Input/Output Interface to Accessories: **VIDEO OUTPUT:** A composite video output signal permits use of large external monitors for display. **START-STOP-PAUSE:** A TTL compatible input allows remote control of panel START, STOP, and PAUSE functions.

Optional Interface to Accessories: **X-Y RECORDER:** An optional output interface in the 1995-9720 and -9730 supplies a 1-V full-scale signal for an X-Y plotter or level recorder. Recorder calibration voltages of 1-V full scale for both axes are available. **LEVEL RECORDER:** Synchronizing and pen lift circuits permit use of GR 1523 recorders. **IEEE 488 INTERFACE:** Optional output interface supplies digital data in IEEE 488 format, permitting use of data printers, computers, calculators, and other accessories compatible with the standard.

Environment: **OPERATING TEMPERATURE RANGE:** 0 to 50°C. **STORAGE TEMPERATURE RANGE:** -40 to +70°C with power supply; -40 to +60°C with batteries. **HUMIDITY:** Operating, up to 90% RH at 40°C.

Power Supply: **LINE POWER SUPPLY:** 1995-3040 plugs into rear-panel recess. Can be removed and replaced with optional rechargeable battery pack plug-in. Power consumption from line is 40 W maximum. Operates from 90 to 125 V or 180 to 250 V, 50 to 60 Hz. Used either to power the instrument or to recharge the batteries. **BATTERY POWER SUPPLY:** Optional rechargeable battery plug-in 1995-3030 provides at least one hour of operation with display on, at least two hours with display off. Battery is charged from power supply to 80% of full capacity in approximately eight hours. **BATTERY VOLTAGE INDICATION:** Low battery voltage is indicated on the display.

Accessories Supplied: Rear-panel mating connector with unterminated 5-foot cable, 2 each; front-panel cable connector lock; preamplifier; 10-foot preamplifier cable; BNC to preamplifier thread adaptor.

Accessories Available: Rechargeable battery pack and accessories; camera adaptor set; carrying case.

Mechanical: **OVERALL DIMENSIONS** (not including handle): (wxhxd): 17 \times 7 \times 17.5 in. (432 \times 178 \times 444 mm). **WEIGHT** (including removable ac power supply): 1995-9700, 41 lb (18.6 kg); 1995-9710, 42.5 lb (19.3 kg); 1995-9720, 42 lb (19.0 kg); 1995-9730, 43.5 lb (19.7 kg).

| Description | Catalog Number |
|---|----------------|
| 1995 Integrating Real-Time Analyzer (25 Hz to 20 kHz) | 1995-9700 |
| 1995 Integrating Real-Time Analyzer (2.5 Hz to 20 kHz) | 1995-9710 |
| 1995 Integrating Real-Time Analyzer (25 Hz to 20 kHz) with output interface | 1995-9720 |
| 1995 Integrating Real-Time Analyzer (2.5 Hz to 20 kHz) with output interface | 1995-9730 |
| Rechargeable Battery Pack and Accessories | 1995-9600 |
| Camera Adaptor Set (includes hood, bracket, and close-up lens) | 1995-9601 |
| Carrying Case: provides space for calibrator, 60-ft cable, battery pack, tripod, microphones, and preamplifiers | 1995-9602 |

National stock numbers are listed at the back of the catalog.



2512 Spectrum Analyzer

for electrical, vibration and acoustic testing

- fast spectrum analysis—up to 100 kHz
- fast real-time analysis—to 20 kHz
- flexible display calibration
- fully annotated and calibrated displays
- uncomplicated control interface
- portable

GenRad's 2512 spectrum analyzer gives you the power, speed and accuracy you need for studying sound and vibration problems—all neatly packaged in a lightweight portable instrument. All the features of earlier generations of spectrum analyzers are included in the GR 2512, plus higher real-time bandwidth, a stable raster-scan display and a simple operator interface.

Easier to use than an oscilloscope The front panel has a minimal number of pushbutton controls. The operator deals with only one function at a time due to the sophisticated interaction between the display and controls. Operation of similar equipment often requires a thorough understanding of a maze of switches, knobs, and buttons.

Ideal for lab or field applications Lightweight, at approximately 38 pounds, the 2512 is compact enough to carry conveniently to the most remote sites.

Please use one of the cards at the rear of this catalog to request complete information.

National stock numbers are listed at the back of the catalog.

SPECIFICATIONS

Frequency Range: DC-10 Hz to dc-100 kHz in a 1-2-5 sequence.

Resolution: 400 lines of frequency resolution.

Frequency Accuracy: Better than $\pm 0.1\%$ from 0 to 45°C, crystal controlled.

Real-Time Frequency: 20 kHz.

Amplitude Linearity: $\pm 0.05\%$ full scale.

Minimum Detectable Signal: 70-dB two-tone dynamic range with averaging.

Frequency Response: ± 1 dB over entire frequency range.

Anti-Aliasing Filter: Included; 96 dB-per-octave rolloff, automatically selected with frequency range.

Input Sensitivity: 1 mV rms full scale to 10 V rms full scale.

Input Impedance: 1 M Ω shunted by 115 pF nominal.

Input Coupling: AC, dc, test-internal square-wave test.

AC Rolloff: -3 dB at 1 Hz.

Maximum Input: 30 V rms, continuous, on all ranges ± 100 V peak, 5 s, transient.

Input Connector: BNC on front panel. Three-terminal microphone connector on rear panel with +18-V bias available for microphone preamplifiers.

Overload Indicator: Front-panel LED is activated for 1/4 s when input exceeds approximately 95% of full-scale range selected.

Low-Level Indicator: Front-panel LED turns on when signal remains at less than 10% of full scale for more than 1/8 second, turns off when signal exceeds 10% of full scale.

Display Functions: Front-panel pushbutton selection of: input versus time, unaveraged spectrum, averaged spectrum, stored spectrum or simultaneous averaged and stored spectra.

Display Calibrations (User Selected): dB re 1 V rms, dB re engineering units, linear volts, volts², volts²/Hz, and volts²-s/Hz and linear re millivolts per engineering unit, also linear and log frequency in Hz or CPM.

Type of Display: Raster scan with full alphanumeric labeling and electronically-generated graticule. Alphanumeric labeling reflects all operational control settings as well as full calibration data for frequency or time and level.

Graphic Resolution: All 400 frequency lines are displayed and visible. Alphanumeric labeling on CRT gives operator complete status of all control settings. These include input coupling, voltage range, type of averaging, number of averages, type of

triggering, windowing invoked, and calibrated annotation of graphic axes.

Cursor: Single, harmonic or sideband with on-screen display of frequency of main cursor and level. Frequency may be read in Hz or CPM dependent upon display mode selected. Level is read in dB re 1 V, dB re E.U., absolute voltage or linear E.U. This function is set by the display scale and E.U. set controls. Sideband also displays Δ frequency between cursors. Cursors operational in input-spectrum, average-spectrum and stored-spectrum modes.

Engineering Units: Display can be calibrated in units relative to engineering units. Vertical scale settable in dB (± 150.0 in 0.1 dB steps) or linear units of 0.1 to 100.0 mV per E. U.

Triggering: Free run, external or internal (rear-panel selected), slope + or -, level \pm full scale in 20% steps. Transient: Capture delay time of -0.5, -0.25, -0.125, 0, +0.125, +0.25, +0.5, +1, +2 of frame time. External input impedance (rear panel) 1 M Ω dc coupled. Indicators: ARM and HOLD indicated by front-panel LED.

Windowing of Data (User Selected): Hanning on or off, or auto (sets Hanning on for free run and off for triggered analysis).

Averaging: Additive, subtractive, exponential, max hold. Number of averages selectable from 1 to 1024 in binary steps.

Spectrum Storage: Memory provided for storage of a reference spectrum. Activated by front-panel button.

Miscellaneous: Front-Panel Connector: BNC signal input. Rear Panel Connectors: Three-Terminal connector. Signal input in parallel with front panel BNC, remote CRT video and synch (BNC), X and Y plotter, pen lift (BNC), external trigger (BNC), external sample input (BNC), digital I/O and optional IEEE 488 bus.

Environment: TEMPERATURE: 0 to 45°C operating.

Supplied: Power cord.

Power: 87 to 125 or 178 to 250 V, 45-66 Hz, 150 W.

Mechanical: Portable, light-weight cabinet. DIMENSIONS (wxhxd): 18.7x7.33x20.88 in.; 24.18-in. depth with handle extended (475x186x530 mm; 613.8-mm depth with handle extended). WEIGHT: 38 lb (17.3 kg) net, approx 55 lb (24.97 kg) shipping.

| Description | Catalog Number |
|--|----------------|
| 2512 Spectrum Analyzer (universal frequency and voltage) | 2512-9700 |

Digital Signal Analysis Systems

... the total digital signal processor

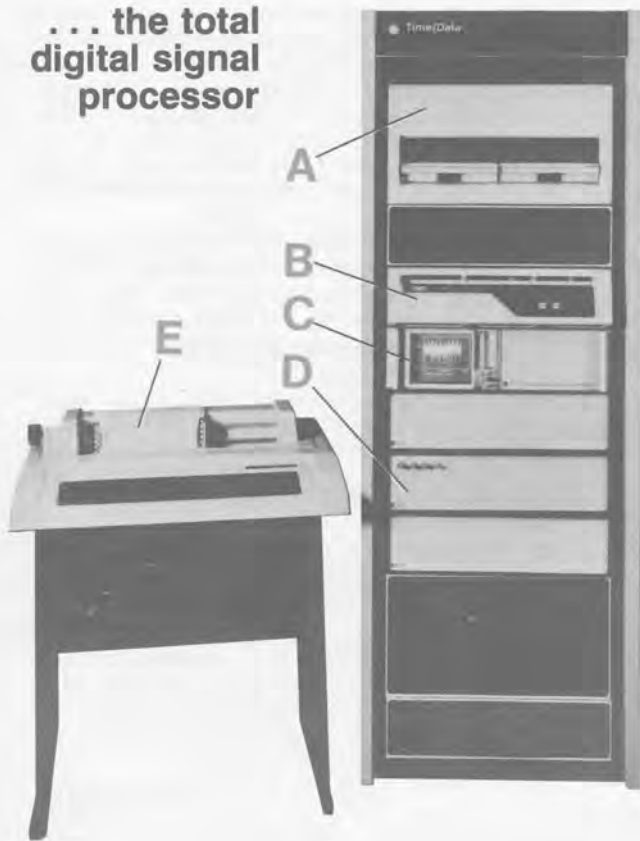

For applications in:

acoustic analysis biomedical research
vibration analysis rotating machine dynamics
structural dynamics geophysical investigations
underwater acoustics machinery condition monitoring

the 20-series analysis systems provide complete, on-line digital signal processing.

These powerful analytical systems use Fast Fourier Transform (FFT) and other time-series analysis techniques to acquire, measure, analyze, and even generate, analog signals in the sub-audio to ultrasonic frequency range.

User-oriented operation, with either the versatile, interactive TSL™ programming language or the optional P2 control panel, makes the 20-series easy to use. A large selection of peripherals and application software options adds to system power and convenience. Standard features include:

- Pre-programmed measurement functions to get you started quickly:

| | |
|---------------------------|--------------------|
| Waveform Averaging | Transfer Function |
| Sampled Waveform | Coherence Function |
| Transient Capture | Auto Correlation |
| Amplitude Histogram | Cross Correlation |
| Direct Fourier Transform | Impulse Response |
| Inverse Fourier Transform | Function |
| Auto Power Spectrum | Spectrum Averaging |
| Cross Power Spectrum | Hanning |
- Report-ready results displayed immediately, fully annotated and calibrated.
- Fully programmable analog data acquisition subsystem.
- Advanced front-end design allows 60% more usable spectrum lines on any of 72 analysis ranges.
- Versatile displays—the display format can be modified from the standard default conditions and descriptive labels can be added for your particular measurement.

A Floppy disk-based operation—avoids fragile, slow, inconvenient paper tape.

B Central processor—a PDP-11 (11/04 in the TDA-20, 11/34 in the TDA-25) with a full 28K memory.

C Storage CRT Display — Fully labelled, calibrated graphics are displayed on this 4" x 5" storage CRT. It can also be used as a fast and silent program listing device.

D Analog Data Acquisition Subsystem (ADS)—The ADS converts analog data into digital information and places it directly into memory for processing. Two input channels are supplied in the basic system, prewired for optional expansion to four inputs. The ADS features complete program control of all functions, selection from 72 possible anti-aliasing filter cutoff frequencies, ultrasharp filter rolloff for more efficient processing, automatic dc offset elimination, floating inputs, and true transient capture capability.

E System Terminal—An LA-36 Printer/Terminal is supplied as the standard system terminal. Other optional terminals, such as the Tektronix 4012 graphic display terminal and keyboard, are available.

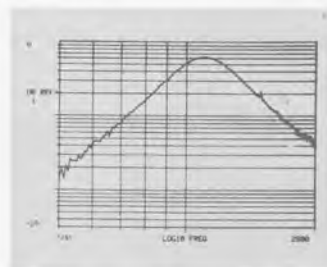

Frequency-Response Function.

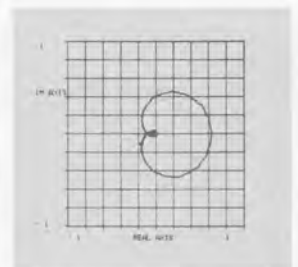

Nyquist Plot.

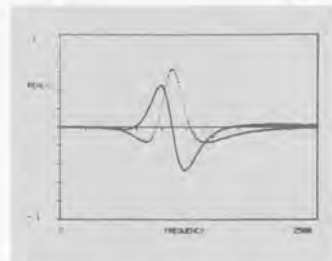

Real = Points; Imaginary = Continuous

TSL (Time-Series Language)

To take advantage of the floppy disks, the RT-11 compatible version of TSL, called TSLRT, is supplied. TSL provides conversation operation—knowledge of computer programming is not required. Results may be displayed in fully, annotated, calibrated formats—easily interpreted, modified, and re-displayed.

RT-11 Operating System

A disk operating system developed by Digital Equipment Corporation, RT-11 maintains complete file management for floppy and moving head disks as well as magnetic tape.

CAPABILITIES

The past several years have seen the development of prepackaged combinations of hardware and software to serve certain application areas ideally suited to the digital signal analysis techniques offered by the 20-series systems.

Modal Analysis This type of analysis characterizes a structure's behavior in terms of its response to its dynamic operating environment.

GenRad offers a variety of software packages to acquire test data, calculate frequency response functions from the data, then extract the key modal parameters (resonant frequencies, damping factors, amplitudes, and phases) which describe this structural behavior.

Animated pictures of the actual physical deformations (mode shapes) of the structure in each mode are graphically displayed. These mode shapes allow quick understanding of the structure's dynamic behavior so that desired structural modifications may be made.

The packages:

MODAMS is a complete investigative tool with NASTRAN bulk data input available;

MESA extracts modal parameters and generates mode shapes with a minimum of operator training;

TSLAMS produces mode shapes in a quick and easy manner;

LAPLACE emphasizes an automated Laplace Transform technique for generalized investigations.

Zoom Analysis Standard spectrum analysis techniques result in a spectrum ranging from dc to some higher frequency with constant resolution throughout this range. Sometimes this resolution is inadequate to resolve two or more closely-spaced resonances or other spectrum detail.

Zoom analysis allows the user to place all available lines of resolution into a narrow, operator-defined band of interest. As the band of analysis is made narrower and narrower, the resolution in the band increases until the desired spectral details are revealed.

Acoustic Analysis For simple, direct calculation of 1/3-octave spectra with either A or flat weighting, the TSLOCA software package is available. TSLOCA is ideal for sound power measurements, product noise measurements, or general acoustic analysis where true real-time processing is not of prime importance.

Engine Order Analysis This option tailors the system to acquire and analyze vibration data and speed signals from rotating machinery. It provides the user with a wide variety of displays of the data, each offering insight into some aspect of the machinery's dynamic vibration characteristics.

Display formats include:

| | |
|-----------------------|--------------------|
| Time Spectrum Display | RPM Spectral Map |
| Time Spectral Map | RPM Order Tracking |
| Time Order Tracking | Campbell's Diagram |
| RPM Spectrum Display | |

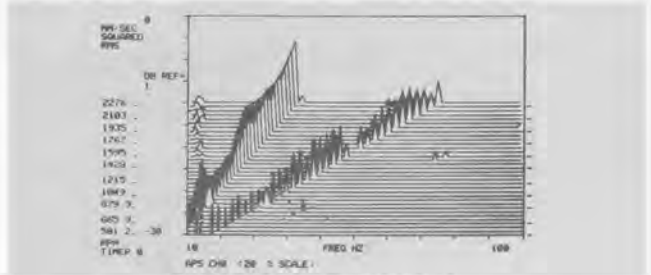

GenRad Engine Order Analysis.

Vibration Control With the addition of the Digital-to-Analog Subsystem (DAS) and the P2 control panel, the system can function as a "turnkey" closed-loop controller of vibration tests. Modular software packages allow the user to add just the capabilities needed.

Modular software packages available include:

Random Control

Narrowband Random on Random Control

Acoustic Random (reverberant chambers) Control

Swept Sine Control

Swept Sine on Random Control

Transient Waveform Control

Shock Spectrum Synthesis, with:

Wavelet Amplitude Equalization and

Transfer Function Equalization

Shock Spectrum Analysis

OPTIONS

FPE-4 Processor This micro-coded system plug-in speeds Fourier Transforms and other spectral computations, offering a 5:1 speed advantage over software processing on the same system.

P2 Control Panel This general-purpose panel permits instrument-like control of data acquisition, processing, and display. Mounted on the front of the system's ADS, the P2 Control Panel simplifies all aspects of signal analysis—there is no language to learn or specialized keyboard to worry about. Overlays, provided with each optional application package, adapt the panel control labels to that particular application, eliminating operator confusion about new control functions.



Centralized Control Panel.

Signal Generation DAS (Digital-to-Analog Subsystem) Fully compatible with ADS—mounts in ADS box, data output can be synchronized with ADS data acquisition. Features 160-kHz maximum output rate, 12-bit digital to analog conversion with direct memory access (DMA) capability, self zeroing offset, less than 10 ohms output impedance, and 100-milliampere drive current at ± 10 volts output. Controlled by TSL or FORTRAN.

PERFORMANCE EXPANSION

Users of time-series analysis techniques often have some special application which requires more than a basic system can offer. For this reason, modular expandability is a GenRad design principle. If the basic system does not meet your specific needs—or if your needs change at some future time—standard modules can be added to adapt your system to a wide range of applications.

Please use one of the cards at the rear of this catalog to request complete information.



Vibration Control Systems

GenRad's TDV Vibration Control Systems provide closed-loop digital control of electrodynamic or hydraulic exciter systems for environmental or structural dynamic testing.

- random control with true Gaussian noise; no periodic (zero-variant) random noise effects
- unified front control panel runs tests, selects displays, allows operator intervention
- built-in safety precautions—automatic alarm and abort lines with smooth shutdown free operators for other tasks, reduce equipment risks, and minimize danger from human error
- fast, repeatable setup—test parameters can be stored for an unlimited number of test programs, assuring identical test conditions for future repeat testing
- fully labelled, calibrated displays gives report-ready documentation on all aspects of system performance and test results, including:

Automatic Calibration showing scales and references in alphanumeric form on the CRT, right along with the data

Better Test Documentation records exact setup parameters, the causes of alarms and aborts, instantaneous grms level throughout the test and total test time

Post-Test Graphic Documentation of drive, monitor, reference, and error spectra, including ability to automatically overlay test tolerance bands

Report-ready hard-copy option available

- mass storage included—with flexible disk storage

A single, centralized control panel with overlay panels controls all test and analysis operations and is readily used by all levels of operators from unskilled to sophisticated.



Safety Features

The system is designed to sense abnormal test conditions and, if any occur, to initiate a controlled, documented abort. Conditions causing automatic abort include:

- Loss of control signal
- ABORT switch pressed by operator
- A signal exceeding spectral level abort limits set for a reference spectrum segment
- A signal exceeding the specified grms limit
- Failure to pass the initial loop continuity check

Random Control

Two spectral estimates of control loop behavior are measured in the Random Control System. The control spectrum reflects short-term changes in the control loop so that the system can take immediate action to maintain

equalization. It is constantly updated with every pass through the loop. The **monitor spectrum** is a long-term statistical average of all control spectrum frames, and provides an accurate indication of how well the test ran throughout its duration. The number of averages may be selected to give the needed post-test documentation accuracy *without slowing the response of the control loop*. In addition, the average grms level of the test duration covered by the monitor spectrum is displayed.

Sine Options

TDV SINE uses a computer-controlled, stable, accurate swept- or discrete-frequency sinusoidal source.

The software for TDV sinusoidal vibration control systems is interactive, conversational. You set up all needed test parameters by typing answers to the questions printed out by the terminal. You define the control strategy in a number of ways: you may decide to filter the drive signals; you can select peak or rms values; you can assign priorities to control signals; your options are numerous.

SINE has multi-channel sine control using digital tracking filters with fixed or proportional bandwidths. GenRad's TDV SINE systems also allow the operator to monitor auxiliary signals not used in the control strategy and to analyze while controlling. Displays include transmissibility plots, co-quad analysis, and mechanical impedance, within a controlled swept-sine or fixed-sine environment. All such displays are fully calibrated and annotated.

Shock Options

GenRad has developed a series of operating options for shock spectrum analysis and the generation of waveforms to produce desired responses on shaker systems. Three separate techniques have been implemented for waveform generation: one of these provides specified time histories while the other two provide a choice of methods to synthesize desired shock response spectra. As with random control and analysis operations, control of the shock system is achieved with a single control panel.

Transient Waveform Control This option is used to produce waveforms with specified time histories on a shaker system. A variety of classical pulses are offered including half-sine, terminal peak sawtooth, square wave, triangular wave, and double pulse. Also, an

operator-supplied sampled analog signal can be used as the time waveform to be reproduced.

Shock Spectrum Analysis Analysis of MAXIMAX shock spectrum is accomplished in all three waveform generation programs with choices of 1/3, 1/6 or 1/12 octave resolution. When more detailed analysis or analysis of recorded transients is required the shock spectrum analysis program permits analysis of primary and residual spectrum as well as MAXIMAX. The program also permits analysis of the spectrum of a single degree of freedom filter.

Shock Spectrum Synthesis Since the shock spectrum does not uniquely define a time waveform, we may select the waveform used to synthesize that shock spectrum. The waveform selected in these systems is a summation of half-sine weighted sinusoidal wavelets. Each of the wavelets is an odd number of half-cycles that are weighted by a half-sine wave.

Functional Description

Features of particular interest in GenRad's Vibration Control Systems are:

Selectable Functions

- Transducer sensitivity
- Test duration
- Start-up time from low to full level
- Low equalization level
- Level change increment
- Shut-down time
- Alarm and abort limits versus frequency
- Alarm and abort limits on overall grms

Displays

- Control Spectrum
- Monitor Spectrum
- Reference Spectrum
- Drive Spectrum
- Error Spectrum
- Auxiliary Spectrum

All displays calibrated in terms of:

Vertical: linear or logarithmic ranges (20, 40, 60, 80, 100 dB); calibrated in g^2/Hz ; adjustable display scaling

Horizontal: linear or logarithmic

All displays may be in points, bars, or continuous format; test tolerance bands may be superimposed on any spectral display.

SPECIFICATIONS

Resolution: 100, 200, 400, 600, or 800 lines (filters).

Bandwidth: variable; dc to 5 kHz (8 kHz optional).

Feedback Control Channels: 1 standard, up to 4 available; 16-channel averager available.

Dynamic Range: >65 dB.

Accuracy: Typically ± 1.0 dB.

BASIC TDV 20/25 CONFIGURATION

Hardware

PDP-11 Digital Controller; PDP-11/04 in TDV-20; PDP-11/34 in TDV-25

28K Memory

Extended Arithmetic Element (EAE)

LA-36 Printer/Terminal with interface; dual floppy disk with ROM bootstrap

Input-channel with programmable attenuator and anti-aliasing filter

Output—single drive channel, with programmable attenuator and anti-aliasing filter

Control panel

Random Control Overlay for panel

CRT with storage capability

Software

Random Control

OPTIONS

- Digital Spectrum Analysis
- Shock Spectrum Analysis
- Shock Spectrum Synthesis and Transient Waveform Control
- Modal Analysis
- Swept Sine Control
- 16-Channel Scanner
- Expansion to 4 Multiplex Channels
- X-Y Plotter with Alphanumeric Capability
- Interactive Graphics Display Terminal 4012
- Hard-Copy Unit, for use with 4012

Please use one of the cards at the rear of this catalog to request complete information.

National stock numbers are listed at the back of the catalog.

BLANK
PAGE

Stroboscopes

Strobe Characteristics

| | Internal Oscillator | | External Triggering | | | | Flash Rate* | | | Super-Bright Light | Battery Operation |
|--|------------------------|----------------------|---------------------|--------|---------------|------------------------------------|--------------------------|--------|---------|--------------------|-------------------|
| | Accurate Time Base | Accurate Calibration | Contact | Signal | Photoelectric | Delayed | (max flashes per minute) | | | | |
| | | | | | | | 3800 | 25,000 | 150,000 | | |
| 1540 with 1540-P1, brightest light | yes | yes | yes | yes | yes | | yes | yes | | yes | |
| 1540 with 1540-P3, brightest light | no internal oscillator | | yes | yes | yes | | yes | yes | | yes | |
| 1540 with 1540-P4, brightest light | | | yes | yes | yes | 100 μ s to 1 s | yes | yes | | yes | |
| 1531-AB, best general-purpose | yes | yes | yes | yes | with 1531-P2 | 100 μ s to 800 ms with 1531-P2 | yes | yes | | | |
| 1538-A, most versatile | yes | yes | yes | yes | with 1531-P2 | 100 μ s to 800 ms with 1531-P2 | yes | yes | yes | with 1538-P4 | with 1538-P3 |
| 1542-B, lowest cost | | | | | | | yes | | | | |
| 1543, low cost | line sync | | yes | | | | yes | | | | |
| 1544, low cost | line sync | | yes | yes | yes | 16 to 330 ms | yes | | | | |
| 1539, excellent for high-speed photography | no internal oscillator | | yes | yes | with 1531-P2 | with 1531-P2 | yes | yes | | | |

* To "stop" motion effectively, the flash rate need not be so high as the rpm of the machinery. For very high speeds, the use of strobe light at a sub-multiple flash rate (and consequently with brighter flashes) often provides the best image. This equipment is augmented by important accessories, including photoelectric pickoffs.



Strobe Characteristics

Internal oscillator Most GR strobes include an internal oscillator that allows the strobe to flash repetitively without need of any external signal. The frequency of the internal oscillator is adjusted by means of a knob (and a range control on some models) and thus the flash rate can be set to any desired value within its range.

Accurate time base Two of the strobes incorporate a line-sync mode, in which the internal oscillator is synchronized to the line frequency or to a submultiple (3600, 1800, 1200, 900, 720 . . . flashes per minute for 60-Hz lines). In the U.S.A., this mode provides 0.1% accuracy at these rates. Thus, the flash rate, which in the normal (free-running) mode can be adjusted continuously without accurate calibration, in the line-sync mode can be set to specific rates with a very high accuracy. The time base (known time interval) thus provided is a great convenience or even a necessity in many applications.

Accurate Calibration In some models, the flash rate is calibrated to an accuracy of $\pm 1\%$ and dial readings can be used to measure speed, rpm, or time.

In many applications, this feature is used to measure rpm so the strobe becomes an accurate and convenient tachometer. Some care must be taken in this application because the action under observation will appear stopped not only at the true rate at which the device is rotating but at whole-number submultiples of it such as $\frac{1}{2}$, $\frac{1}{3}$, $\frac{1}{4}$, etc. The truth can be simply determined as follows: True speed = $A \times B / (A - B)$, where A and B are adjacent apparent measurements (two adjacent settings of the strobe's flash rate at which the object appears stopped).

For example, assume you first obtained a reading of 2400 rpm. You then decreased the flash rate until the object again appeared stopped and this second reading indicated 1800 rpm.

$$\text{True rpm} = \frac{2400 \times 1800}{2400 - 1800} = 7200$$

From the example, it can also be seen that the flash rate of the strobe need not be as high as the speed of the device in order to obtain accurate measurements of rpm.

Strobes that do not contain an internal oscillator require an external signal for operation. Where neither "Accurate Time Base" nor "Accurate Calibration" is indicated (shaded area), the frequency of the internal oscillator (and, hence, the flash rate) is approximate only. With that strobe, the markings on the dial (if any) cannot be used as an accurate measure of speed, rpm, or time unless they have been calibrated by the user.

External Triggering In a strobe with an internal oscillator, the motion of a device under test appears stopped when the flash rate is set to the same rate as the motion (or to some submultiple of it). If the rate of motion changes or the strobe's flash rate changes, the illusion of stopped motion disappears, and the strobe's flash rate must be readjusted for synchronization.

In many cases, the rate of motion changes often so that readjusting the strobe's flash rate to obtain synchronization becomes difficult if not impossible. Also, in many high-speed, non-repetitive events (such as explosions, rifle shots, and the like) it is necessary to flash the strobe at some precise moment determined by the event, not the strobe. In these applications, the strobe must be triggered by an external signal, rather than by its internal oscillator.

Contact The simplest method of triggering is a contact closure (or opening) such as from a switch or relay. The switch can be mounted on the device and operated by a cam, it can be a hand-held pushbutton, a camera flash-synchronization contact, or any of several dozen other switch arrangements.

Signal Another trigger source can be an electrical signal such as from an ultra-precise oscillator in order to obtain greater flash-rate accuracies, a microphone to trigger the flash from a noise such as an explosion, or another piece of electrical or electronic equipment with which synchronization is required.

Photoelectric One of the most common trigger sources is the photoelectric pickoff. These devices use light to create an electrical signal that, in turn, triggers the strobe. They are widely used because they are inexpensive, simple to install, and do not interfere with the normal operation of the device under observation. Several styles are available, including:

- A light source and a photo cell are housed in a single unit (the GR 1536-A and 1536-O). The light is aimed at the path of a piece of reflective tape attached to the device. As the tape moves past the light, the reflection back to the photo cell causes the strobe to flash.
- The light and cell are housed in two different units, mounted so that the light is aimed at the cell. The object under study moves between the light and the cell and alternately blocks the light to the cell and then allows it to pass. This arrangement is particularly useful in many printing applications where the object under study is printed on a web. The 1537-A is such a pickoff; it requires an external light source.

Delayed Without delayed triggering, the strobe flashes immediately following receipt of a trigger and, in many cases, this is exactly what is required. But in some others, this is not desirable and an adjustable time delay is incorporated so the strobe flashes some time after the trigger is applied.

For example, the only convenient place to obtain a trigger on many printing presses is often somewhere remote from the point at which you wish to observe the action — the strobe may then flash at the wrong time unless great care is taken in the placement of the trigger device.

Flash rate The rate at which the strobe flashes is known as its flash rate and is usually measured in flashes per minute (fpm). For GR strobes, the flash rate is adjustable to a maximum of 3800, 25,000 or 150,000, depending on the model.

Super bright The light output from any GR strobe is bright; it has to be for clear viewing. You get the very brightest flashes from the 1540 and almost as bright from the 1538 model equipped with a 1538-P4 High-Intensity Flash Capacitor. The extra light output is very valuable in TV or photographic applications.

Battery operation Most GR strobes are small, light, and very portable. One is capable of battery operation — the 1538-A with a 1538-P3 Battery and Charger.

Strobe Selection and Applications

In principle, all strobes are basically the same — they are very bright, flashing lights normally used to observe action that is too fast to be seen by the unaided eye. When a strobe is aimed at a repetitive action and its flash rate is set to the same speed as the action (or some integer submultiple of it), the action appears stopped. It can be easily viewed, analyzed, and even measured, thanks to the stroboscope.

In practice, strobes differ significantly in their characteristics in order to match more exactly the requirements of a wide variety of applications. They also differ from one manufacturer to another in such important

aspects as flash quality and reliability, attention to engineering and production details, and applications and service assistance. A properly chosen strobe can be an invaluable asset in your application and will undoubtedly reap benefits well in excess of its purchase price.

Since the matter of selection is important, we have tabulated a summary of broad application areas with the appropriate strobes and their features. Later pages give you detailed descriptions of their individual characteristics. We also provide free advice and technical assistance from offices located throughout the world.

| Application | Appropriate GR Strobe | Features Useful in The Application |
|---|--|--|
| Education | | Strobes help demonstrate certain laws of physics, relations between frequency and wavelength, finite velocity of light, effects of combining colors, properties of standing waves, and the laws of gravity. Use a strobe for studies of velocity, acceleration, and energy transfer, or the principles of stroboscopy itself. |
| Physics lab | 1543 1542 | Low cost, accurate time base, external triggering for stable synchronization. Excellent where economy is important; uncalibrated time base. |
| Mechanical engineering | 1539-A with 1531-P2 1544 1531-AB | Wide-range trigger delay for optimum image positioning, detachable lamp. Economical where normal-range trigger delay is adequate; fixed lamp. Accurate calibration enables you to measure rpm. |
| Electrical engineering | 1531-AB or 1538 | Accurate calibration — a must for torque/speed measurements. |
| Chemistry, biology, psychology, etc | 1531-AB 1543 or 1544 | Accurate calibration for precise speed or time measurements. More economical where accurate calibration is not required. |
| Textiles | | The high operating speeds in the textile industry make the strobe almost mandatory. Its versatility permits rapid checks on spindle operation, twist loss, travelers and twisters, pattern pickage, dobbie head, harness cams and motion, shuttle flight and arm tension, boxing and picking, filling transfer and ringing-up bobbin ejection, hopper-stand setting, rapier action, filling transfer, and pickage in shuttleless looms, let-off and takeup, power-arm operation and adjustment, and condition, meshing and running of gears. |
| Shuttle looms | 1540 with 1540-P4 | Super-bright light for maximum clarity, delay triggering for optimum image positioning. |
| Water-jet and shuttleless looms | 1544 | Delay triggering for optimum image positioning, lower cost. |
| Spinning | 1538 or 1531 | Accuracy for speed or rpm measurements; fast, short flash provides clear image. |
| Printing and converting | | High-speed printing presses and converters can be checked easily by means of a strobe. Printing registration, ink or glue uniformity, water catch up, and material stretch can all be checked without slowing or stopping the press. The strobe provides equally simple and valuable checks of other printing equipment such as folders, blankers, box- or bag-making machinery, creasing and scoring equipment, coaters or laminators, slitters-rewinders, stitchers, as well as doctoring, embossing, and perforating equipment. |
| Presses | 1544 1540 with 1540-P4 | Photoelectric and delay triggering for stable synchronization and optimum image positioning. Better choice where a large area is to be illuminated or the ambient light is very bright. |
| Inspection slitter-rewinders | 1544 | Photoelectric trigger capability and delay triggering — an excellent choice for inspection slitter-rewinders. |
| Machine design and maintenance | | Stroboscopes can be used to observe the slippage between two shafts or between a motor and belt, to measure motor slip speed in accordance with IEEE 112A and 114, and to study the effects of cavitation on turbine blades or other hydraulic equipment. They can also be used in the design and checkout of production, handling, and packaging equipment or appliances and for studies of automobile wheel, motor, or chassis vibration. |
| Electro-mechanical design | 1539-A with 1531-P2 1544 | Photoelectric and wide-range delay triggering for optimum image positioning. An economical choice where the delay-triggering range need not be so great. |
| Production inspection | 1531 or 1538 | Accurate calibration provides speed and rpm measurements. |
| Plant maintenance | 1531 or 1538 1542 or 1543 | Best suited where accurate flash rates are necessary. More economical where accurate flash rates are unimportant. |
| Electrical and electronic fields | | The strobe is a valuable aid in the development of loudspeakers and other audio devices and in the design, production and servicing of electric motors, card sorters or punches, and automatic component-handling equipment. Also valuable for monitoring the action of environmental shake tables and to study switch or relay bounce. |
| Electrical inspection | 1531 or 1538 | Provide accurate speed, time, or rpm measurements. |
| Photography and TV | | Effective shutter speeds some 1000 times faster than mechanical shutters are possible by use of a strobe. Permits detailed examinations of such single-action events as the impact of a bullet, an explosion, glass fracture, destructive tests, and other extremely high-speed phenomena. |
| Single or multiframe | 1540 with 1540-P4 1539-A with 1531-P2 | Super-bright light, precise camera synchronization. Provides excellent single-flash photos at an economical price. |



Strobolume® electronic stroboscope

1540

- flash rates to 25,000 per minute
- brilliant white light
- wide-beam flood area for photography and TV

Stopped motion With the aid of a stroboscope you can examine the motion of machines, objects exploding or in flight, fluid spray patterns, and many other events as though they were motionless. With a calibrated stroboscope, you can measure the rate of repeating motion to 1% accuracy up to $\frac{1}{4}$ million rpm.

With the bright-light 1540 Strobolume® electronic stroboscope, you can perform all these tasks, and more, under difficult lighting conditions and even make color stopped-motion photographs or make videotapes. The 1540 is the first stroboscope to generate so much light and also provide the versatility for general-purpose uses. Three control units are available; with the right one for the job, the 1540 can be flashed continuously or synchronized with the motion or camera for single flashes or bursts. Thus, you can "hold" cyclic motion in one chosen position, freeze a once-only event on film or tape, or expose a motion to multiple-flash analysis.

Bright flashes Every one is a pulse of white light lasting less than 15 microseconds and illuminating a 7-by-13-foot area, 10 feet away, with brilliance enough for still or movie photography or TV recording.

The flash can be triggered from a photoelectric pickoff, the opening or closing of a switch contact or camera shutter, or an electrical pulse or sine-wave signal. The flash can occur at the instant of the triggering event or be delayed by any desired time from 100 microseconds to 1 second to catch a subsequent event.

Versatile construction The working part of the Strobolume stroboscope is the lamp head to which one of the three control units attaches, either directly or by extension cables for remote operation. The combination is small and easy to hold or mount on a tripod. A twelve-foot cable brings dc power from the larger power supply/carrying case.

To use, aim the lamp at the object to be studied (from a distance determined by the area to be illuminated and the amount of light needed). Connect the camera (any ordinary type with "X" flash synchronization) and photoelectric pickoff to the control unit and set the controls to "stop" the motion at the right point. Set the strobe for single flash, operate the shutter, and you have a picture.

National stock numbers are listed at the back of the catalog.

SPECIFICATIONS



1540-P1 Strobolume® Oscillator

For speed measurements and general use Provides internally generated flashing rates, accurate to 1%, for general use and is particularly well-suited for speed measurements from 110 to 25,000 rpm.



1540-P3 Strobolume® Control Unit

For use with external equipment Provides flashes only in response to external signals.



1540-P4 Oscillator/Delay Unit

For motion analysis and photography Provides internally-generated flashing rates and is the only unit that provides gated bursts of flashes as well as variable delay between receipt of a trigger and each flash. Well suited to photography; the flash can be synchronized with both motion and camera.

Flash Rate (flashes per minute):

0 to 25,000 external; single flash by means of panel pushbutton; 110 to 25,000 internal by means of calibrated control in 3 overlapping decade ranges with 1%-of-reading accuracy.

0 to 25,000 external; single-flash by means of panel pushbutton.

0 to 25,000 external; single-flash by means of panel pushbutton; ≈ 30 to 25,000 internal by means of uncalibrated control in 3 overlapping ranges. MULTIFLASH MODE permits flash bursts as long as panel pushbutton is depressed or contact closure exists at Camera jack, flash rate is set by panel controls.

Trigger:

INPUT: From 1537 Photoelectric Pickoff; contact closure; $\geq +1$ -V pulse; or ≥ 3.5 V rms sinewave at flash rate of 300, decreasing to 0.35 V at flash rates of 6000 to 25,000. OUTPUT: $> +6$ -V pulse behind 600 Ω .

INPUT: From 1537 Photoelectric Pickoff; contact closure; or $\geq +1$ -V pulse. OUTPUT: None.

INPUT: From 1536 (light-to-dark or dark-to-light transitions) or 1537 Photoelectric Pickoffs; contact closure or opening; $\geq +1$ -V pulse; ≥ 0.35 V rms sinewave. OUTPUT: $> +10$ -V pulse behind 10 k Ω .

Camera:

single flash from contact closure

single flash from contact closure

yes, see below

Delay:

none

none

yes, see below

1540-P4 Characteristics: CAMERA INPUT: Permits "X" contact closure of camera to cause flash at instant of contact closure, delayed flash synchronized to subject by external trigger signal, or multiflash "burst." DELAY: Time from external trigger to flash is continuously adjustable from $\approx 100 \mu\text{s}$ to 1 s, uncalibrated control, 3 overlapping decade ranges. RATE of multiflash: 30 to 25,000 per min, continuously adjustable, 3 overlapping ranges.

Light Output: Measured with silicon photo detector 1 meter from lamp at maximum beam width of $\approx 40 \times 65^\circ$ (7.5x13 ft at a distance of 10 ft); can be narrowed to $\approx 17 \times 65^\circ$ (3x13 ft), intensity increases as beam narrows; beam width measured at $\frac{1}{2}$ -intensity points:

| Intensity Range | Low | Medium | High |
|--------------------------|--------------------|-------------------|---------------------|
| FLASH RATE, per minute | 690 max | 4170 max | 25,000 max |
| FLASH DURATION* | 15 μs | 12 μs | 10 μs |
| ENERGY*, watt-seconds | 10 | 1.8 | 0.25 |
| BEAM INTENSITY*, candela | 16x16 ^b | 4x10 ^b | 0.5x10 ^b |

* For low flash rates. Energy is electrical input to lamp.

Auxiliary input is provided for connecting a booster capacitor to increase single-flash intensity.

Remote Programming: Can be controlled by external signals, applied to rear of lamp assembly, in place of any control unit. INTENSITY: Range selection by switch closures to ground; required ratings 28 V, 60 mA. FLASH: Triggered by pulse of $\geq +0.75$ V, which must not occur while intensity range is being changed.

Environment: VIBRATION: 0.03 in. from 10 to 30 Hz. BENCH HANDLING: 4 in. or 45° (MIL STD-810-VI). SHOCK: 30 g, 11 ms.

Supplied: Power cord, 12-ft flat cable for connection of lamp head to mainframe, pouch containing adjustable neck strap for combination lamp head and control unit, phone plug for trigger input/output jacks, 6-ft cable for remote connection between lamp head and control unit.

Available: 1536 and 1537 Photoelectric Pickoffs; extension cables for greater separation between mainframe, lamp head, and control unit.

Power: 100 to 125 and 195 to 250 V, 50 to 60 Hz, 250 W max.

Mechanical: Mainframe housed in portable cabinet and contains power supply, lamp head in associated storage compartment, and storage space for one control unit and cables. DIMENSIONS (wxhxd): Case (closed), 19x8x13.75 in. (483x203x349 mm); lamp head with control unit attached, 9.25x5.5x8.5 in. (335x140x216 mm). WEIGHT (including one control unit): 32 lb (15 kg) net, 39 lb (18 kg) shipping.

Description

Catalog Number

| | |
|--|------------------|
| 1540 Strobolume® electronic stroboscope mainframe, includes 1540-P2 lamp head and power supply. | 1540-9600 |
| Select at least one of the following control units, unless the 1540 is to be remotely programmed: | |
| 1540-P1 Strobolume® oscillator | 1540-9601 |
| 1540-P3 Strobolume® control unit | 1540-9603 |
| 1540-P4 Oscillator/Delay Unit | 1540-9604 |
| 1540-P2 Strobolume® lamp , additional assembly | 1540-9602 |
| 1540-P5 Strobotron Flash Lamp , replacement | 1540-9605 |

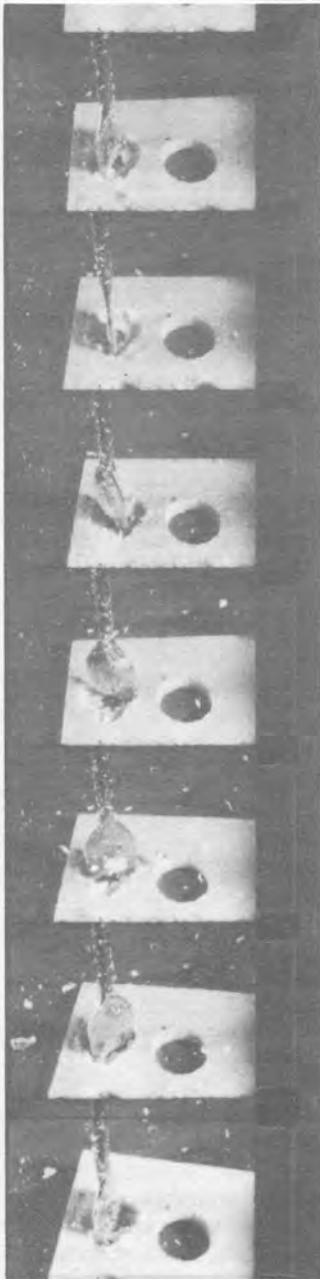

The 1540 is a valuable, economical, high-speed photographic tool. This sequence follows the action of a 2000-rpm wood bit going through a piece of particle board.

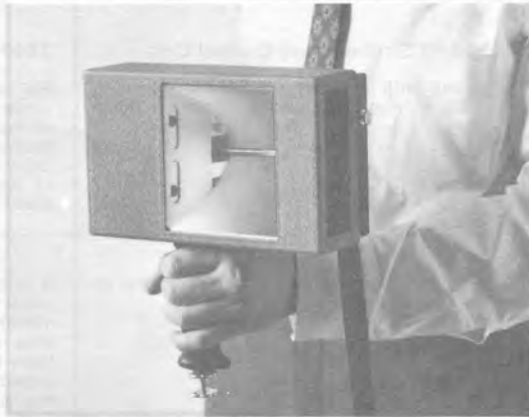

The lamp-head assembly can also be hand-held separately using the pistol-grip handle supplied.



The control unit and lamp-head assembly can be attached together and mounted on a tripod for convenience or, with the neck strap supplied, can be made as portable as you need dictates.



Its brightness and versatility make this strobe a natural for TV applications such as video recordings of rapidly-moving parts in mechanical devices.

National stock numbers are listed at the back of the catalog.

Strobotac[®] electronic stroboscopes

1531-AB and 1538-A

- speed measurements to 1 million rpm; 1% accuracy
- bright white light for high-speed photography, for observations in any normal ambient light
- simple to use, easy to handle

Compact and accurate These stroboscopes are small portable flashing-light sources used to measure the speed of fast-moving devices or to produce the optical effect of stopping or slowing high-speed motion for observation. A built-in system uses the power-line frequency for quick and easy checks and adjustment of the flash-rate calibration. Each flash-lamp/reflector assembly is hinged at the panel and the reflector swivels 360 degrees, for complete flexibility. The cases have standard sockets (0.25x20 threads/inch) for tripod mounting. The instruments are all approved by CSA Testing Laboratories.

Versatile synchronization A variety of trigger inputs can be used for flash synchronization. Contact closures, pulses, or sinewave signals will trigger the flash and an output trigger is provided so the stroboscope, in turn, can trigger another device. A 1536 Photoelectric Pickoff can be used with a 1531-P2 Flash Delay to provide an adjust-



able delay between the time a selected point on a moving object passes the pickoff and the time the strobe flashes. Single-flash photographs of high-speed motion are a snap with any still camera when the 1531-P2 is used.

The difference The 1531 is more economical to buy. On the other hand, the 1538 gives you six times the maximum flash rate of the former and also works with accessories that increase the single-flash light output (for example) by a factor of about 6, provide the convenience of an extension lamp, and enable portable operation with a rechargeable battery.

SPECIFICATIONS

1531-AB: Accurately calibrated flash rates to 25,000 per minute.



1538-A: Accurately calibrated flash rates to 150,000 per minute, accessories for brighter light, extension lamp, and battery operation.



Flash Rate in flashes per minute:

110 to 25,000 in 3 ranges; speeds up to 250,000 rpm can be measured. ACCURACY: $\pm 1\%$ of reading after calibration on one range against 50-to-60 Hz line frequency.

110 to 150,000 in 4 ranges; speeds to 1,000,000 rpm can be measured. ACCURACY: $\pm 1\%$ of reading after calibration on 670-to-4170 rpm range against 50-to-60 Hz line frequency.

External Trigger, input and output connections are phone jacks:

INPUT: Contact opening, pulse $\geq +6$ V pk-pk, or sinewave ≥ 2 V rms for $f > 5$ Hz. OUTPUT: Negative pulse ≥ 500 to 1000 V.

INPUT: Contact closure, pulse $\geq +1$ V pk-pk, or sinewave ≥ 0.35 V rms for $f > 100$ Hz (3.5 V at 10 Hz). OUTPUT: $\geq +6$ V behind 400 Ω .

Light Output: Beam width 10° at $1/2$ -intensity points for both units:

| | Duration* | Energy** watt-seconds | Beam Intensity† candela |
|----------------|-------------|--------------------------|----------------------------|
| at 690 fpm | 3 μ s | 0.5 | 11x10 ⁶ |
| at 4170 fpm | 1.2 μ s | 0.09 | 3.5x10 ⁶ |
| at 25,000 fpm | 0.8 μ s | 0.014 | 0.6x10 ⁶ |
| at 150,000 fpm | | | |

| | Duration* | Energy** watt-seconds | Beam Intensity† candela |
|--|-------------|--------------------------|----------------------------|
| | 3 μ s | 0.5 | 15x10 ⁶ |
| | 1.2 μ s | 0.09 | 5x10 ⁶ |
| | 0.8 μ s | 0.014 | 1x10 ⁶ |
| | 0.5 μ s | 0.0023 | 0.16x10 ⁶ |

* Measured at $1/2$ peak intensity; for 1538 with -P4, duration is 8 μ s.

† Measured with silicon photo detector 1 meter from lamp; single-flash beam intensity for 1531 is $\approx 18x10^6$ and for 1538 with -P4 it is $\approx 44x10^6$ candela.

** Electrical input to lamp.



1538-P2



1538-P3



1538-P4

Supplied: Adjustable neck strap, phone plug for input and output jacks, power cord.

Available: 1536 and 1537 Photoelectric Pickoffs, 1531-P2 Flash Delay.

Power: 100 to 125 or 200 to 250 V, 50 to 400 Hz, 25 W max for 1531, 15 W max for 1538; 1538 can also be powered from 20 to 30 V dc, 12 W max, such as from **1538-P3** Battery and Charger that provides up to 6 h of continuous, completely portable operation and recharges in 14 h.

Mechanical: Flip-Tilt Case. DIMENSIONS (wxhxd): 10.63x6.63x13 in. (270x168x156 mm); 1538 with -P4 is 3 in. (76 mm) higher. WEIGHT: 7.5 lb (3.5 kg) net, 10 lb (4.6 kg) shipping; 1538-P4 is 5 lb (2.3 kg) net, 7 lb (3.2 kg) shipping.

Description

Catalog Number

| | |
|--|-----------|
| 1531-AB Strobotac® electronic stroboscope | |
| 115-V Model | 1531-9430 |
| 230-V Model | 1531-9440 |
| 1538-A Strobotac® electronic stroboscope | |
| 115-V Model | 1538-9701 |
| 230-V Model | 1538-9702 |
| Accessories for 1538-A Only | |
| 1538-P2 Extension Lamp, cannot be used when 1538-P4 is used | 1538-9602 |
| 1538-P3 Battery and Charger | 1538-9603 |
| 1538-P4 High Intensity-Flash Capacitor, increases light output by approx 6 times | 1538-9604 |
| 1531-P2 Flash Delay, for 1531 or 1538 | |
| 115-V Model | 1531-9602 |
| 230-V Model | 1531-9605 |
| 1538-P1 Replacement Strobotron Flash Lamp, for 1531 or 1538 | 1538-9601 |
| Patch Cord , connects one strobe to another or to 1531-P2 Flash Delay | 1560-9676 |
| U.S. Patent Numbers 2,977,508 and 3,339,108. | |

Strobotac® electronic stroboscopes

1542-B, 1543 and 1544

Feature-packed, low-cost capability

- Up to 3800 bright-white flashes per minute — to observe motion as fast as 40,000 rpm
- Wide-range continuous flash-rate control
- Low-cost, excellent OEM strobes, special versions available
- Simple pushbutton operation
- Compact, light-weight, rugged

Tailored for convenient operation These strobes were designed specifically for inspection applications and feature simple pushbutton control with a single knob to control the flash rate — no range switching is ever necessary. These strobes include unique electronically compensated output for visually constant image brightness (as the flash rate decreases, the light intensity increases). All are housed in a tough plastic case that is designed for comfortable hand-held operation and includes a threaded hole for tripod mounting.

National stock numbers are listed at the back of the catalog.

All components are industrial grade and the engineering is completely thorough, including exacting environmental testing to ensure reliable operation under extreme conditions.

The 1542-B — simple, economical The 1542-B is as easy to operate as an extension lamp but is considerably more useful. Plug in the attached power cord, push the On-Off button, point the light at the action, and turn one knob until the visual image of the action slows to the desired rate or stops. That's the sum total of the operation — plug, push, point, and turn!

The 1543 — triggerable In addition to the features of the 1542-B, the 1543 includes provision for external triggering and line sync. The capability of the flash to be triggered by an external contact closure is especially valuable when the motion varies or is erratic and when perfect synchronization is desired, such as with a camera for high-speed photography. A special trigger circuit automatically counts down when the input rate exceeds the normal flash rate (giving you a flash for perhaps every second or third trigger) thereby providing for a sharp, flicker-free view. The line-sync mode allows the internal oscillator to be synchronized to a submultiple of the line frequency (3600, 1800, 1200, 900 fpm, etc). This feature is valuable for studies of line-frequency-related motion, as an accurate time base for graphic studies of acceleration and velocity, or for measurements of motor slip speed in accordance with IEEE 112A and 114.

The 1544 — delay triggerable The 1544 provides all the features of the 1543. In addition, it can be externally triggered by positive pulses and from a photoelectric pick-off, as well as contact closures, and its flash can be delayed from the moment of an external trigger by any dura-



This arm is available as an accessory to position the light conveniently in permanent or semi-permanent installations.

tion from approximately 16 to 330 milliseconds. This delay feature is quite useful to vary the position of the stopped image in order to observe different phases of cyclic motion.

SPECIFICATIONS

1542-B: Simple, most economical NEW bright light



For education and general-purpose inspection and design applications

1543: Line sync and contact-closure trigger



For photographic, educational (especially the physics lab), and general-purpose inspection and design applications

1544: Line sync, contact-closure, photo-electric, and delayed triggers



For printing, textile, photographic, educational (mechanical engineering), mechanical design, and general-purpose inspection applications

| Flash Rate in flashes per minute (fpm): | 1542-B | 1543 | 1544 |
|--|---|---|---|
| 180 to 3800, continuously adjustable over a single range by a 5-turn uncalibrated control. | 180 to 3800, continuously adjustable over a single range by a 10-turn control marked in approximate flash rate. Line-sync mode provides $\approx 0.1\%$ accuracy (60-Hz line in U.S.A.) by synchronizing to integer submultiples of line frequency. | | |
| External Trigger: | None | Contact closure (isolated from ground) applied to phone jack. | Contact closure, positive signal > 2 V peak, or GR 1536 Photoelectric Pickoff. |
| Trigger Delay: | None | None | ≈ 16 to 330 ms from application of external trigger; set by flash-rate control. |

Light Output, Beam width 10° at $\frac{1}{2}$ -intensity points for all units:

| | Duration* | Energy** | Beam Intensity† | Duration* | Energy** | Beam Intensity† |
|--------------|-----------|----------|--------------------|-----------|----------|---------------------|
| at 180 fpm: | 4 μ s | 0.25 Ws | 6×10^6 cd | 6 μ s | 0.75 Ws | 30×10^6 cd |
| at 3800 fpm: | 3 μ s | 0.06 Ws | 1×10^6 cd | 4 μ s | 0.2 Ws | 4×10^6 cd |

* Measured at $\frac{1}{2}$ of peak-intensity points. ** Electrical input to lamp, watt-seconds. † Measured with silicon photo detector 1 meter from lamp, candela.

Environment: TEMPERATURE: 0 to 50°C operating, -40 to $+75^\circ\text{C}$ storage. HUMIDITY: 95% RH at $+40^\circ\text{C}$ (MIL E-16400-4.5.4.6). VIBRATION: 0.03 in. from 10 to 55 Hz. BENCH HANDLING: 4 in. or 45° (MIL-810A-VI). SHOCK: 50 g, 11 ms (MIL 202C-205C).

Power: 105 to 125 V, 50 to 60 Hz, 9 W max for 1542-B, 25 W max for 1543 and 1544.

Mechanical: Molded plastic case with plastic face plate to protect lamp, diffused-finish anodized-aluminum reflector, standard 0.25-20 threaded hole for tripod mounting. 1543 and 1544 also include metal stand/handle. **1542-B DIMENSIONS** (wxhxd): 4.2x4.2x7.8 in. (107x107x198 mm). WEIGHT: 1.8 lb (0.8 kg) net, 2 lb (0.9 kg) shipping. **1543 and 1544 DIMEN-**

SIONS (wxhxd): 4.2x6.19x7.8 in. (107x157x198 mm). WEIGHT: 3.7 lb (1.7 kg) net, 5 lb (2.3 kg) shipping.

| Description | Catalog Number |
|--|------------------|
| 1542-B Stroboscopes® electronic strobe scope | 1542-9701 |
| 1543 Stroboscopes® electronic strobe scope | 1543-9700 |
| 1544 Stroboscopes® electronic strobe scope | 1544-9700 |
| Accessories: | |
| Replacement flash lamp for 1542-B, 1543, and 1544 | 1530-9410 |
| Arm, for 1542-B | 1542-9600 |
| Arm, for 1543 or 1544 | 1544-9600 |
| Used to position light conveniently in permanent or semi-permanent installations | |



Stroboslave® stroboscopic light source

1539

- low cost, compact
- removable lamp on 5-foot cable
- high-intensity light
- choice of trigger sources

Slaved light The Stroboslave® stroboscopic light source satisfies the basic requirements for motion studies and high-speed photography — it produces a bright white light at flash rates up to 25,000 per minute. Since it contains no internal oscillator to establish the flash rate, it is an economical unit and is well suited for use with external inputs.

The lamp and reflector assembly is held in place by a clip from which it can be easily removed and positioned separately from the main unit. A five-foot flexible cable is supplied and cables up to 50 feet can be used. When

the reflector is removed from the assembly, the lamp can be inserted through holes as small as one inch in diameter, thus making it possible to observe objects in otherwise inaccessible areas.

Delayed light — the 1539-Z The Stroboslave strobe can be triggered by a contact closure or a two-volt positive pulse. This capability has proved so useful when used with the 1531-P2 Flash Delay and 1536 Photoelectric Pickoff that the Stroboslave is regularly available with these two accessories as the 1539-Z Motion-Analysis and Photography Set. The Flash Delay provides adjustable delays from 100 μ s to 800 ms from the time of the trigger to the time of the flash, so you can make the flash occur at precisely the desired moment.

SPECIFICATIONS

Flash Rate: 0 to 25,000 flashes per minute, eternally triggered only.

Light Output: Beam width is 10° at 1/2-intensity points.

| | Duration* | Energy** | Beam Intensity† |
|---------------|-------------|----------|---------------------------------|
| at 700 fpm | 3 μ s | 0.5 Ws | 11 \times 10 ⁶ cd |
| at 4200 fpm | 1.2 μ s | 0.09 Ws | 3.5 \times 10 ⁶ cd |
| at 25,000 fpm | 0.8 μ s | 0.014 Ws | 0.6 \times 10 ⁶ cd |

* Measured at 1/2 of peak-intensity points.

** Electrical input to lamp, watt-seconds.

† Measured with silicon photo detector 1 meter from lamp; single-flash beam intensity is 18x10⁶ candela.

External Trigger: Contact closure or pulse of $\geq +2$ V pk applied to phone jack.

Supplied: Phone plug for input jack, mounting bracket, attached power cord.

Available: 1536 Photoelectric Pickoff with 1531-P2 Flash Delay (available as 1539-Z Motion Analysis and Photography Set), 1537 Photoelectric Pickoff.

Power: 100 to 125 or 195 to 250 V, 50 to 400 Hz, 16 W max.

Mechanical: Metal case with detachable lamp housing. DIMENSIONS (wxhxd): 1539-A, 2.5x8.38x4.13 in. (64x213x105 mm). WEIGHT: 1539-A, 3 lb (1.4 kg) net, 8 lb (3.7 kg) shipping; 1539-Z, 6 lb (2.8 kg) net, 17 lb (8 kg) shipping.



A tripod socket is provided on the Stroboslave® case.



The lamp can be removed from its clamp at end of case and hand-held up to 5 feet away.

| Description | Catalog Number |
|--|----------------|
| 1539-A Stroboslave® stroboscopic light source | 1539-9701 |
| 1539-Z Motion Analysis and Photography Set | |
| 115-V Model | 1539-9900 |
| 230-V Model | 1539-9901 |
| 1531-P4 Trigger Cable, for use with 1531 Strobotac | 1531-9604 |
| 1538-P1 Strobotron Flash Lamp, replacement | 1538-9601 |
| U.S. Patent Number 2,977,508. | |

Strobe Accessories



Strobotac shown with Flash Delay and Photoelectric Pickoff.

1531-P2 Flash Delay

- synchronizes and times flash
- stops motion at any point in cycle
- is easily synchronized with camera for single-flash operation
- easily attached to 1531-AB, 1538-A, and 1539-A

Valuable asset The 1531-P2 is a valuable asset to any stroboscopic or high-speed photographic application. The Flash Delay synchronizes the strobe with rapidly moving objects and controls the flash, relative to the position of the object, by introducing a variable time delay in the electrical path between the trigger source (transducer, contact, photocell, etc) and the strobe. In stroboscopic applications this delay allows you to position the stopped motion to any point of interest in the action. By the simple turn of a knob, you can reposition the image to illustrate a dozen, or even a hundred, points in order to analyze completely all aspects of the motion.

For photographic records, a single-flash mode is provided. Once the delay has been set so the image is posi-

tioned properly, the mode is set to Single Flash and the flash will then occur only when the camera shutter is released *and* the action is in the proper position. This mode allows the brightest possible flash and eliminates blur.

SPECIFICATIONS

Delay: 100 μ s to 800 ms in 3 ranges.

Input: 300 mV rms min applied to phone jack.

Output: +13-V pk pulse, sufficient to trigger 1531, 1538, 1539, and 1540; available at phone plug.

Supplied: Trigger cable with pushbutton, phone-plug adaptor, carrying case.

Power: 105 to 125 or 210 to 250 V, 50 to 400 Hz, 5 W max with 1536 connected.

Mechanical: Aluminum case with bracket that clips directly to 1531, 1538, or 1539 stroboscope. DIMENSIONS (wxhxd): 5.13x3.13x3.75 in. (130x79x95 mm). WEIGHT: 2 lb (1 kg) net, 5 lb (2.3 kg) shipping.

| Description | Catalog Number |
|----------------------------|----------------|
| 1531-P2 Flash Delay | |
| 115-V Model | 1531-9602 |
| 230-V Model | 1531-9605 |

1531-P3 Surface-Speed Wheel

Surface-speed measurements simplified The 1531-P3 is used with the 1531, 1538, and 1540 (with 1540-P1 control unit) electronic stroboscopes to make accurate measurements of the linear surface speed of belts, pulleys, wheels, drums, rollers, etc. Two black nylon wheels of different diameters are mounted on the ends of a sectioned steel rod. The selected wheel is held against the moving object and the stroboscope is adjusted until the wheel's rotation appears stopped. The wheel's diameters are sized so the surface speed can be read directly from the stroboscope dial.



SPECIFICATIONS

Speed: 10 to 2500 ft/min with small wheel; 50 to 12,500 ft/min with large wheel.

Mechanical: DIMENSIONS: Wheels, 0.764 and 1.910 in. dia; shaft, 20 in. (533 mm) total length. WEIGHT: 0.5 lb (0.3 kg) net, 2 lb (1 kg) shipping.

| Description | Catalog Number |
|------------------------------------|----------------|
| 1531-P3 Surface-Speed Wheel | 1531-9603 |

Strobe Accessories (Cont'd)

1536 and 1537 Photoelectric Pickoffs

- optical trigger sources
- small, sturdy mounting
- trigger rates to 150,000 rpm



Excellent trigger source These photoelectric pickoffs produce an output whenever the photosensitive element senses a change in light such as that produced by a piece of reflective type on a moving object. The resultant pulses can be used to trigger a stroboscope so the flashes occur in synchronism with the motion, to permit the object to be viewed or photographed as though stationary. They can also be used to trigger oscilloscopes or electronic counters.

The 1536-A Pickoff, in addition to its photocell, contains a light source that can be powered directly from the 1531-P2 Flash Delay, 1540-P4 Oscillator/Delay, or 1544 Strobotac® electronic stroboscope. This pickoff's 8-ft cable is terminated with a 3-wire telephone plug.

The 1536-O pickoff is electronically identical to the 1536-A and can be used with the same equipment. They differ only in mechanical details. The 1536-O is designed to be permanently attached to a machine such as a printing press, processing equipment, etc. It is contained in a 0.75-in.-27 threaded housing to which is attached a removable 15-foot cable terminated with a 3-wire telephone plug.

The 1537-A pickoff will trigger the 1538, 1539, 1540-P1, 1540-P3, or 1540-P4 (but not the 1531) strobes. Since it lacks a built-in lamp, this pickoff must be used with an external light source. The 1537-A pickoff's 8-ft cable is terminated with a 2-wire telephone plug.

SPECIFICATIONS

| | 1536-A, 1536-O, with lamp | 1537-A, no lamp |
|--------------|---|--|
| Rate | ≈2500 pulses/s max; limited by 200-μs time constant of cable and photocell. | >2500 pulses/s |
| Power | 20 to 28 V dc, 40 mA; supplied by 1531-P2, 1540-P4, 1544. | 3 to 25 V dc, 0 to 100 μA depending on rate. |

Supplied: 10-ft roll of 0.38-in black tape, 10-ft roll of 0.38-in silver tape, carrying case (supplied with 1536-A and 1537-A only).

Mechanical: 1536-A and 1537-A: Mounted by C clamp (1.31-in. capacity, flat or round) or 1.5-in. magnet; both supplied. **DIMENSIONS:** Pickoff head, 0.69-in. dia x 2-in. long. Linkage consists of two 0.31-in. dia stainless-steel rods, 6 and 6.25 in. long, and adjustable connecting clamp. Cable is 8 ft (2.4 m) long, terminated in 3-wire phone plug in 1536-A, a 2-wire phone plug in 1537-A. **WEIGHT:** 1.3 lb (0.6 kg) net, 4 lb (1.9 kg) shipping. **1536-O:** Mounted by 0.75-in.-27 nut. **DIMENSIONS:** 0.75-in. dia x 2.063 in. long (19 x 52 mm). Cable is 15 ft (4.6 m) long, terminated in 3-wire phone plug. **WEIGHT:** 0.4 lb (0.2 kg) net, 2 lb (1 kg) shipping.

| Description | Catalog Number |
|---|----------------|
| 1536-A Photoelectric Pickoff, with lamp | 1536-9701 |
| 1536-O Photoelectric Pickoff, with lamp | 1536-9702 |
| 1537-A Photoelectric Pickoff, no lamp | 1537-9701 |

Variac® line-voltage regulators

| GR Variac® automatic line-voltage regulator | Output Current <i>at nominal input voltage of</i> | | Input Frequency (Hz) | | |
|--|--|---------------------|-------------------------|----|-----|
| | <i>115 or 120 V</i> | <i>230 or 240 V</i> | 50 | 60 | 400 |
| 1591 (portable) | 8.7 A | | | ● | |
| 1592 | to 44 A | to 42 A | ● | ● | |
| 1571 (militarized) | to 50 A | | ● | ● | ● |
| 1581 | to 50 A | to 40 A | ● | ● | ★ |
| 1582 | to 85 A | to 85 A | ● | ● | ★ |

★Special Order

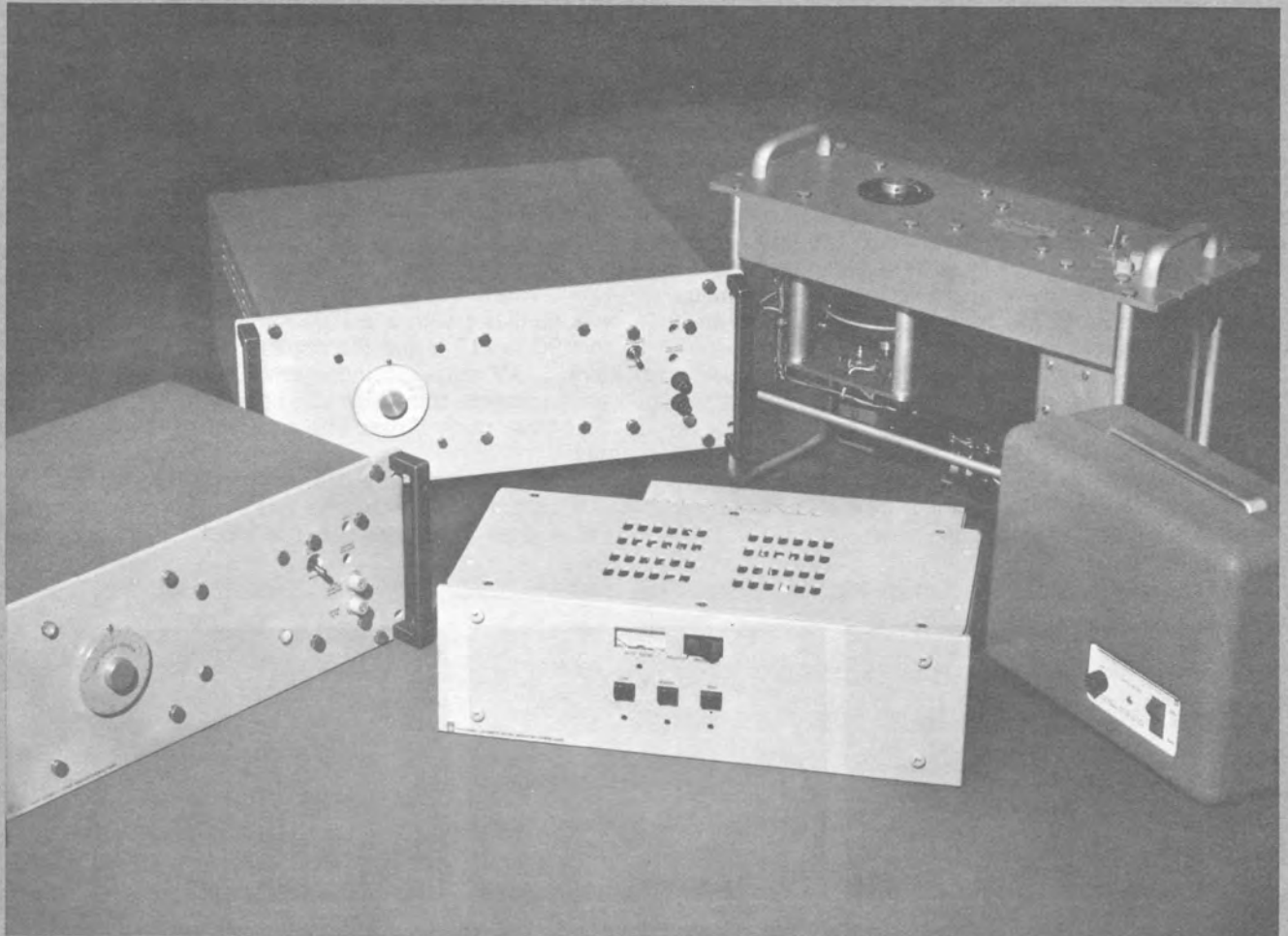

Variac® automatic voltage regulators

The answer to line-voltage problems If your problem is poor process control, computer errors, inaccurate instrumentation, overheated motors, cool heaters, or other assorted equipment aberrations, an excellent solution is a GenRad Variac® automatic line-voltage regulator.

GR regulators have many advantages for both laboratory and industrial use in any application where controlled line voltage is needed, and they are particularly valuable to offset the effects of brownouts.

There are 5 basic models of GR regulators and over 100 variations, plus units built to your specifications. All offer outstanding performance characteristics:

- Regulation to 0.2%
- Insensitive to load type, they work equally well on all loads from open circuit to maximum rating
- Up to 10 times rating for transient surges
- Introduces no distortion or noise
- No power-factor restrictions
- Fast response, comparable with magnetic types
- Reliable solid-state controls

Simple, smooth operation The regulator comprises a motor-driven Variac® adjustable autotransformer, an auxiliary step-down transformer that multiplies the power rating of the autotransformer in the larger models, and a solid-state control unit that automatically positions the autotransformer to hold the output voltage constant.

The regulator's output voltage is compared to a reference voltage and the resultant error signal controls a servo motor to provide a true proportional-control system, rather than an on-off circuit. The accompanying oscillograms illustrate a typical response to a 2% step change in line voltage. The traces are greatly expanded and show only the ac voltage peaks.

The use of a true proportional-control system provides not only fast correction but also smooth control of voltage, completely free of the voltage jumps introduced by an on-off control system. The absence of relays provides long trouble-free life, and tolerance of 1000% transient overloads is made possible by the Duratrak® commutator surface of the Variac autotransformer.

The regulators maintain an undistorted output that is corrected to the limits of the correction range; i.e., if the input to a 10% regulator varies 15%, the output will vary only 5%.

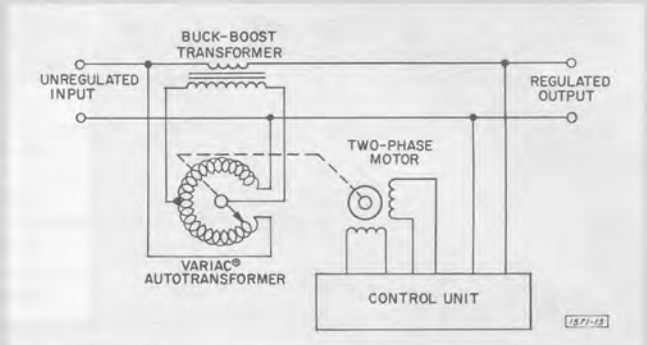

Elementary schematic diagram of GenRad voltage regulators.

Single-phase selection The proper regulator for your application depends on your input-line characteristics and the output characteristics desired from the regulator. GR regulators cover the following conditions:
INPUT Frequency: 50, 60, or 400 Hz.

Nominal Voltage: 115 or 120 (also 230) V.

Range of inputs, with regulation: 72 to 156 V.

OUTPUT Voltage: 100 to 130 V, adjustable

Current: 8.7- to 85-A ratings

The input range for most GR regulators is expressed as a percentage of the output voltage (± 5 , ± 10 , ± 20 , or $+24 - 18\%$). For example, if the output is set to 100 V on a regulator with a $\pm 10\%$ range, the input can vary from 90 to 110 V and the regulator will maintain a constant 100-V output. Under some conditions for three-phase systems, this range can be appreciably increased; see below, under Three-Phase Selection, three-wire inputs.

Output-current rating is a function of the input range — the greater the range, the less the current capability. (For a given voltage model, the input range can easily



Oscillograms of line-voltage peaks show response speed of Variac® automatic voltage regulators: left, 2% step change in line voltage; center and right, resulting output transients for 1581 and 1582 Regulators, respectively.

be changed in the field.) Thus a GR 1592 regulator rated at 44 amperes for a $\pm 10\%$ range is rated at 20 amperes for a $\pm 20\%$ range. Detailed information is included with the descriptions of each GR regulator to allow you to select the best regulator for your application. Additional information or advice is readily available from any GR sales office whenever you may need it. The Regulation Ranges graph and examples on these pages are intended to allow you to select the basic type of GR regulator you may need and to acquaint you with some of the techniques involved in getting the most for your money.

Example 1 Your input is nominally 115 or 120 V, 60 Hz, and your load requires up to 5 A. For this, any basic GR regulator is satisfactory. You specifically desire a 115-V output and you've determined your line voltage varies from 95 to 130 V. This restricts your choice slightly, since the GR 1591 will not regulate with an input below 100 V.

Example 2 Suppose your requirements are similar to example 1 except you've discovered the input may go as low as 90 V. Under these circumstances, no GR regulator appears suitable. However, since your 115-V output requirement is not critical (many devices operate properly over a range of voltages, such as from 105 to 125 V), you decide an output of 110 V is adequate. It is now apparent that any GR regulator, except the 1591, is again suitable.

Example 3 In this case the initial conditions are the same as example 2 except that the output voltage must be exactly 100 V. The 1592 is the only regulator that will provide this output; and the input range is 80 to 120 V.

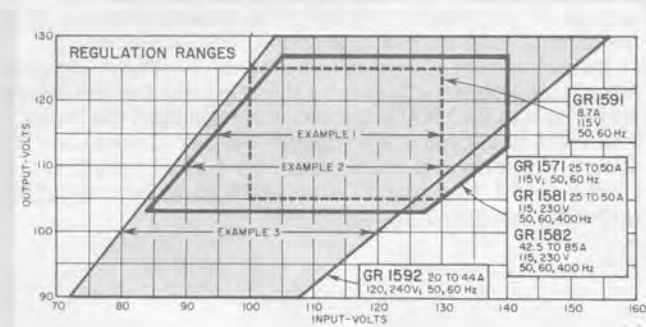

Information is shown for 115- and 120-V, 60-Hz models. For 230-V models, multiply voltages and divide current ratings by 2. The regulation range is slightly less for 400-Hz models but is significantly greater in some three-phase applications. (See Three-Phase Selection, three-wire inputs.) More detailed information, particularly current ratings, is given with the descriptions of the individual regulators.

Three-phase selection All GR regulators can be used in three-phase systems. The choice of the regulator used and the number required depend on the number of input lines (three- or four-wire) and the configuration used to connect the regulators.

For three-wire inputs, the regulators can be connected in either an open-delta or a closed-delta configuration. In open delta, only two regulators are required and their input range is the same as that for single-phase systems. In closed delta, three regulators are required but their input range is increased by slightly over 50%. For four-wire inputs, three regulators are connected in a wye configuration and their input voltage requirements are reduced to about 58% of that normally required.

The individual regulators are selected on the same basis as those used for single-phase systems, once the nominal voltage has been determined.

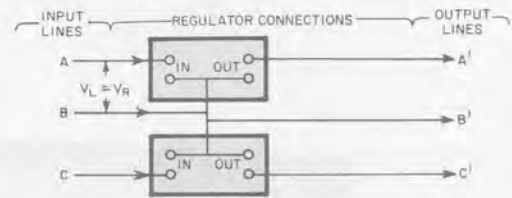

OPEN DELTA The input voltage to each regulator (V_R , A to B or B to C) is equal to the line-to-line voltage (V_L), i.e., $V_R = V_L$.

| V_L Line-to-Line | V_R Input to Regulator | Basic Regulator Required |
|-----------------------|--------------------------------|--------------------------|
| 208 V | 208 V | 230-V nominal voltage |
| 230 to 240 V | 230 to 240 V | 230-V nominal voltage |

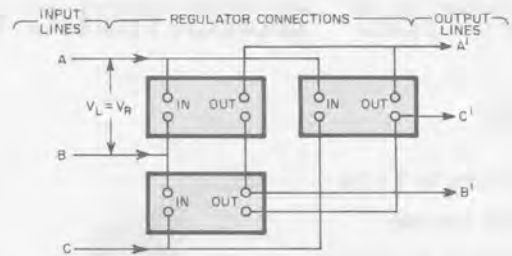

CLOSED DELTA The input voltage to each regulator (V_R , A to B, B to C, or C to A) is equal to the line-to-line voltage (V_L); i.e., $V_R = V_L$. The input range increases by slightly over 50%. Thus, the input range increases to ± 7.5 , ± 15 , ± 31 , and $+37 - 28\%$ from the normal ± 5 , ± 10 , ± 20 , and $+24 - 18\%$, respectively.

| V_L Line-to-Line | V_R Input to Regulator | Basic Regulator Required |
|-----------------------|--------------------------------|--------------------------|
| 208 V | 208 V | 230-V nominal voltage |
| 230 to 240 V | 230 to 240 V | 230-V nominal voltage |

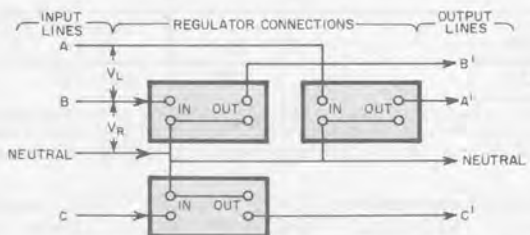

WYE The input voltage to each regulator (V_R , A, B, or C to neutral) is equal to the line-to-line voltage (V_L , A to B, B to C, or C to A) divided by 1.73. This reduces the input voltage requirements to about 58% of that normally required.

| V_L Line-to-Line | V_R Input to Regulator | Basic Regulator Required |
|-----------------------|--------------------------------|------------------------------|
| 208 V | 120 V | 115 or 120-V nominal voltage |
| 230 to 240 V | 133 V | 115 or 120-V nominal voltage |
| 460 to 480 V | 266 V | 230 or 240-V nominal voltage |



Variac[®] automatic voltage regulator

1591

- capacity to 1 kVA
- 115-V models
- accuracy of $\pm 0.2\%$
- low-cost, compact
- portable and rack models



The small size of the 1591 particularly suits it to portable applications.

Low-cost regulation Electromechanical voltage regulators have always offered large power-handling capacity with minimum bulk and cost. These advantages are now available in a 1-kVA regulator, thanks to a special control circuit. Still, as with the larger GR regulators, there is no distortion added to the input waveform; average-voltage and peak-voltage values are therefore constant, as rms voltage is regulated. Accuracy is independent of line frequency, load current variations, and power factor.

Output voltage is controlled by a servo-driven Variac[®] adjustable autotransformer so the regulator has the same ability to handle 1000% transient overloads as the Variac. The 1591 is mechanically rugged and has proved itself in severe vibration and shock tests. Its typical temperature coefficient of 75 ppm/ $^{\circ}\text{C}$ is so small as to be negligible under normal operating conditions.

SPECIFICATIONS

Principal Characteristics

| Description | Type | Input | | Output | | | | |
|-------------|------|--------------------|-------------|-----------------------|----------------|-----|-------------------|-------------|
| | | Variation* (range) | Frequency | Voltage* (adjustable) | Current Rating | kVA | Correction Rate** | Regulation* |
| 115 V | 1591 | 100 to 130 V | 57 to 63 Hz | 105 to 125 V | 8.7 A | 1 | 6 c + 1.5 c/V | $\pm 0.2\%$ |

* Also see curve. Output voltage will remain within regulation with the specified input variation; e.g.: When the output is adjusted to 105 V, it will remain there within $\pm 0.2\%$ (0.21 V) with inputs from 100 to 120 V.

** Correction rate is given in terms of cycles, c, of the power-line frequency.

Output Characteristics: POWER FACTOR: 0 to 1, leading or lagging. RESPONSE: Rms. DISTORTION: None added. REGULATION: Regulation accuracy applies for any combination of line voltage or frequency, load current or power factor. CONTROL: Front-panel screwdriver adjustment.

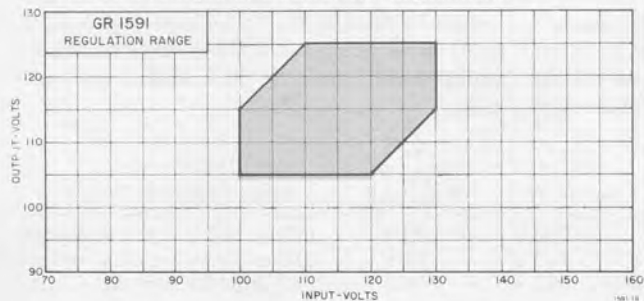

Environment: TEMPERATURE: -20 to $+40^{\circ}\text{C}$ for portable model, -20 to $+52^{\circ}\text{C}$ for rack model; operating. VIBRATION: 0.03 in. from 10 to 55 Hz. BENCH HANDLING: 4 in. or 45° (MIL-810A-VI). SHOCK: 30 g, 11 ms.

Electrical: POWER: ≈ 40 W no load, ≈ 95 W full load.

Mechanical: Portable and rack models. DIMENSIONS (wxhxd): Portable, 12.75x9.5x5.38 in. (324x241x137 mm); rack, 19x5.25x6.38 in. (483x133x162 mm). WEIGHT: Portable, 17 lb (8 kg) net, 25 lb (12 kg) shipping; rack, 22 lb (10 kg) net, 31 lb (15 kg) shipping.

Description

1591 Variac[®] automatic voltage regulators
115-V, 60 Hz

- 1591-A, Portable Model
- 1591-AR, Rack Model

Catalog Number

- 1591-9700
- 1591-9712

National stock numbers are listed at the back of the catalog.

Variac® automatic voltage regulator

1592

- capacity to 5.3 kVA
- 120-V and 230/240-V models
- accuracy to $\pm 0.25\%$
- lowest-cost regulator per kVA
- remotely programmable
- universal cabinet



Economical performance Regardless of load or line variations, the 1592 supplies the voltage necessary for the proper operation and longevity of your equipment — any equipment from light bulbs to computers — because the regulator adds no distortion and operates independently of power factor.

It is virtually unaffected by temperature, is very fast responding, and is so efficiently engineered and built

that only two basic models handle all requirements for 120- to 480-volt, single or multi-phase systems and bench, rack, or wall-mount installations. It is also a versatile test instrument; the output can be programmed manually by means of front-panel pushbuttons, for any sequence of three preset voltages, or remotely with infinite resolution.

SPECIFICATIONS

Principal Characteristics:

| Description | Input | | Output | | | | |
|----------------------|-----------------------------|----------------|-----------------------------|----------------|-----|-------------------|--------------|
| | Variation* (% of output) | Frequency (Hz) | Voltage* (adjustable) | Current Rating | kVA | Correction Rate** | Regulation* |
| 120 V $\pm 10\%$ | $\pm 10\%^{***}$ | 60† | 100 to 130 V ^{***} | 44 A | 5.3 | 25 ms/V | $\pm 0.3\%$ |
| 120 V $\pm 20\%$ | $\pm 20\%^{***}$ | 60† | 100 to 130 V ^{***} | 20 A | 2.4 | 13 | $\pm 0.5\%$ |
| 230/240 V $\pm 5\%$ | $\pm 5\%^{\dagger\dagger}$ | 50 to 60 | 200 to 260 V ^{††} | 42 A | 10. | 50 ms/V | $\pm 0.25\%$ |
| 230/240 V $\pm 10\%$ | $\pm 10\%^{\dagger\dagger}$ | 50 to 60 | 200 to 260 V ^{††} | 18 A | 4.3 | 25 | $\pm 0.3\%$ |
| 230/240 V $\pm 20\%$ | $\pm 20\%^{\dagger\dagger}$ | 50 to 60 | 200 to 260 V ^{††} | 8.5 A | 2. | 13 | $\pm 0.5\%$ |

* Also see curve.

** Correction is slow speed at 60-Hz operation.

† Can be operated at 50 Hz if output is limited to 115 V.

*** Can be increased to 138 V (for use in 240-V, 3-phase, 4-wire systems) with 9 and 18% input variations, respectively.

†† Can be increased to 277 V (for use in 60-Hz, 480-V, 3-phase, 4-wire systems) with 5, 9, and 18% input variations, respectively.

Output Characteristics: POWER FACTOR: 0 to 1, leading or lagging. RESPONSE: Rms. DISTORTION: None added. REGULATION: Regulation accuracy applies for any combination of line voltage or frequency, load current or power factor. CONTROL: Output can be rapidly switched among 3 levels by front-panel pushbuttons, each level independently adjustable by front-panel screwdriver controls or, for remote-control applications, by external resistors connected to rear by push-on terminals.

Voltage can also be sensed remotely by 2 leads connected to rear by push-on terminals; use these to ensure desired voltage at the load and compensation for wiring IR drop. RANGE OF

OUTPUT LEVELS V_o , for specified regulation: See curves. Examples: $\pm 20\%$ model, $90 < V_o < 130$ V for input variation of 104 to 108 V; $100 < V_o < 120$ V for 96 to 120 V; $\pm 5\%$ model, $113 < V_o < 117$ V for 112-to-118 V input variation.

Meter: Front-panel pushbutton permits meter to read input or output. RANGE: 80 to 160 V (160 to 320 V). ACCURACY: $\pm 2\%$ at nominal 120/240-V reading; tracking accuracy, $\pm 5\%$.

Electrical: There are two basic models, 120-V and 230/240-V input, whose only major differences are the meter and Variac adjustable autotransformer. The various versions of each model are achieved by internal wiring changes that can be effected simply in the field if desired. POWER: ≈ 45 W no load, ≈ 120 W full load.

Mechanical: Bench, rack, and wall mount (brackets, handles, and hardware supplied for conversion). DIMENSIONS (wxhxd): 17x5.25x11 in. (432x133x279 mm). WEIGHT: 42 lb (20 kg) net, 56 lb (26 kg) shipping.

Description

Catalog Number

1592 Variac® automatic voltage regulator

120-V $\pm 10\%$ Model

1592-9700

120-V $\pm 20\%$ Model

1592-9701

230/240-V $\pm 5\%$ Model

1592-9702

230/240-V $\pm 10\%$ Model

1592-9703

230/240-V $\pm 20\%$ Model

1592-9704

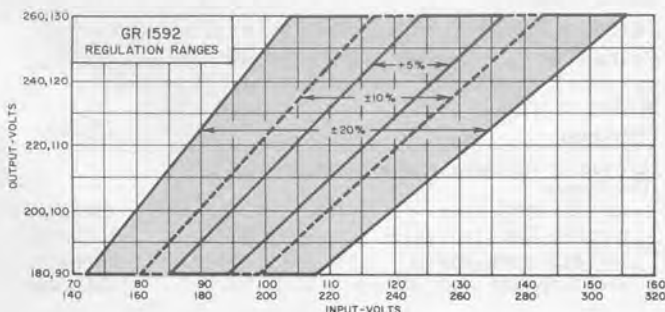



Variac® automatic voltage regulator

1571

- capacity to 5.8 kVA
- 115-V models
- accuracy to $\pm 0.25\%$
- militarized
- rack models

MIL specifications The 1571 regulators are essentially versions of the 1581 which are designed to meet the appropriate sections of military specifications MIL-E-4158B

SPECIFICATIONS

Principal Characteristics:

| Description | Type | Input | | Output | | | | |
|---------------------------|-----------|--------------------------|----------------|-----------------------|----------------|-----|-------------------|--------------|
| | | Variation* (% of output) | Frequency (Hz) | Voltage* (adjustable) | Current Rating | kVA | Correction Rate** | Regulation* |
| 115 V $\pm 10\%$, 60 Hz | 1571-AL | $\pm 10\%$ | 57 to 63† | 103 to 127 | 50 A | 5.8 | 2.5 c + 1.5 c/V | $\pm 0.25\%$ |
| 115 V +24 -18%, 60 Hz | 1571-AL2 | +24 -18% | 57 to 63† | 103 to 127 | 25 A | 2.9 | 2.5 c + 0.7 c/V | $\pm 0.5\%$ |
| 115 V $\pm 10\%$, 400 Hz | 1571-ALJ | $\pm 10\%$ | 350 to 450 | 103 to 127 | 50 A | 5.8 | 17.5 c + 10.5 c/V | $\pm 0.25\%$ |
| 115 V +24 -18%, 400 Hz | 1571-AL2J | +24 -18% | 350 to 450 | 103 to 127 | 25 A | 2.9 | 17.5 c + 4.9 c/V | $\pm 0.5\%$ |

* Also see curve. Output voltage will remain within regulation with the specified input variation; e.g.: When the output of the model in the first row is adjusted to 103 V, it will remain there within $\pm 0.25\%$ (0.26 V) with inputs of 103 V $\pm 10\%$ (93 to 113 V).

** Correction rate is given in cycles of line frequency, c.

† Will operate from 48 to 63 Hz with internal wiring change that incidentally reduces variation by about 1/10, i.e., to $\pm 9\%$, and +19 -16%.

Output Characteristics: POWER FACTOR: 0 to 1, leading or lagging. RESPONSE: Rms. DISTORTION: None added. CONTROL: Front-panel screwdriver adjustment. REGULA-

TION: Regulation accuracy applies for any combination of line voltage or frequency, load current or power factor.

Environment: Appropriate sections of MIL-E-4158B and MIL-E-16400C. TEMPERATURE: -29 to +52°C operating, -54 to +85°C storage.

Electrical: POWER: ≈ 35 W no load, ≈ 115 W full load.

Mechanical: Rack models. DIMENSIONS (wxhxd): 19x7x12 in. (483x178x305 mm). WEIGHT: 53 lb (25 kg) net, 103 lb (47 kg) shipping.

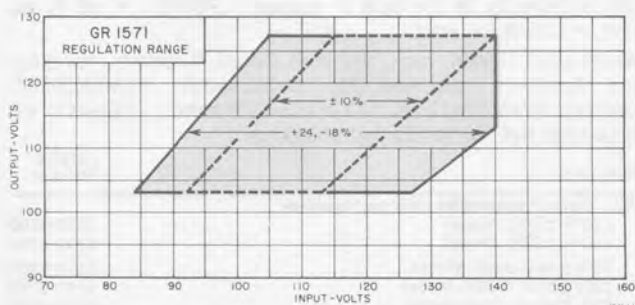

Description

Catalog Number

1571 Variac® automatic voltage regulators

| 115-V Models | Catalog Number |
|-------------------------------|----------------|
| 1571-AL, $\pm 10\%$, 60 Hz | 1571-9831 |
| 1571-AL2, +24 -18%, 60 Hz | 1571-9898 |
| 1571-ALJ, $\pm 10\%$, 400 Hz | 1571-9551 |
| 1571-AL2J, +24 -18%, 400 Hz | 1571-9556 |

National stock numbers are listed at the back of the catalog.



Variac® automatic voltage regulators

1581 and 1582

- capacity to 19.7 kVA
- 115-V and 230-V models
- accuracy to $\pm 0.25\%$
- highest-capacity GR regulators
- wall, bench, and rack models

High capacity, low cost The 1581 and 1582 all-solid-state regulators automatically compensate for ac line-voltage fluctuations to provide a reliable constant-voltage source over a wide correction range. The true propor-

tional control system provides both fast correction and smooth control.

These regulators give you high accuracy with large capacity for both laboratory and industrial installation. They are especially useful for computers, measurement systems, transmitter supplies, and critical industrial processes.

A large variety of models provides you a choice of 115-, or 230-V operation on 50-, 60-, or 400-Hz lines with loads up to 19.7 kVA; models are available for wall, rack, or bench use. The units are described as single-phase regulators but they can regulate three-phase lines. For example, two regulators can be used in an open-delta configuration and three can be used in wye or closed-delta configurations.

SPECIFICATIONS

Principal Characteristics:

| Description | Type | Input | | Voltage* (adjustable) | Current Rating | Output | | |
|---------------------------|----------|--------------------------|------------------|-----------------------|----------------|--------|------------------|--------------|
| | | Variation* (% of output) | Frequency** (Hz) | | | kVA | Correction Rate† | Regulation* |
| 115 V $\pm 10\%$, 50 A | 1581-AL | $\pm 10\%$ | 57 to 63 | 103 to 127 V | 50 A | 5.8 | 2.5 c + 1.5 c/V | $\pm 0.25\%$ |
| 115 V $\pm 10\%$, 85 A | 1582-AL | $\pm 10\%$ | 57 to 63 | 103 to 127 V | 85 A | 9.8 | 2.5 c + 3 c/V | $\pm 0.25\%$ |
| 115 V +24 -18%, 25 A | 1581-AL2 | +24 -18% | 57 to 63 | 103 to 127 V | 25 A | 2.9 | 2.5 c + 0.7 c/V | $\pm 0.5\%$ |
| 115 V +24 -18%, 42.5 A | 1582-AL2 | +24 -18% | 57 to 63 | 103 to 127 V | 42.5 A | 4.9 | 2.5 c + 1.5 c/V | $\pm 0.5\%$ |
| 230 V $\pm 5\%$, 40 A | 1581-AH5 | $\pm 5\%$ | 57 to 63 | 206 to 254 V | 40 A | 9.2 | 2.5 c + 1.5 c/V | $\pm 0.25\%$ |
| 230 V $\pm 5\%$, 85 A | 1582-AH5 | $\pm 5\%$ | 57 to 63 | 206 to 254 V | 85 A | 19.7 | 2.5 c + 3 c/V | $\pm 0.25\%$ |
| 230 V $\pm 10\%$, 20 A | 1581-AH | $\pm 10\%$ | 57 to 63 | 206 to 254 V | 20 A | 4.6 | 2.5 c + 0.7 c/V | $\pm 0.25\%$ |
| 230 V $\pm 10\%$, 42.5 A | 1582-AH | $\pm 10\%$ | 57 to 63 | 206 to 254 V | 42.5 A | 9.8 | 2.5 c + 1.5 c/V | $\pm 0.25\%$ |
| 230 V +24 -18%, 10 A | 1581-AH2 | +24 -18% | 57 to 63 | 206 to 254 V | 10 A | 2.3 | 2.5 c + 0.4 c/V | $\pm 0.5\%$ |
| 230 V +24 -18%, 21.3 A | 1582-AH2 | +24 -18% | 57 to 63 | 206 to 254 V | 21.3 A | 4.9 | 2.5 c + 0.7 c/V | $\pm 0.5\%$ |

* Also see curve. Output voltage will remain within regulation with the specified input variation; e.g.: When the output of the model in the first row is adjusted to 108 V, it will remain there within $\pm 0.25\%$ (0.27 V) with inputs of 108 V $\pm 10\%$ (97 to 119 V).

† Correction rate is given in c cycles of the line frequency. With the 400-Hz option, correction time is about the same, so multiply the tabulated rate by 7.

** Will operate from 48 to 63 Hz with internal wiring change that incidentally reduces variation by about 1/10 (to 5%, 9%, +19 - 16%). With 400-Hz option (special order only), will operate from 350 to 450 Hz.

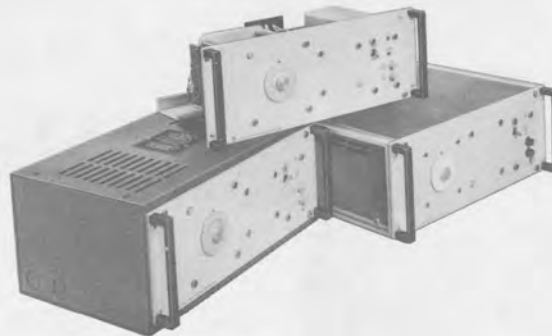

Your choice of regulator enclosures: Top, without cabinet; left, wall-mountable cabinet; right, convertible to either bench or rack-mounted use.

Output Characteristics: POWER FACTOR: 0 to 1, leading or lagging. RESPONSE: Rms. DISTORTION: None added. CONTROL: Front-panel screwdriver adjustment. REGULATION: Regulation accuracy applies for any combination of line voltage or frequency, load current or power factor.

Environment: TEMPERATURE: -20 to +52°C operating; -54 to +85°C storage.

Electrical: POWER: 1581: \approx 35 W no load, \approx 115 W full load. 1582: \approx 45 W no load, \approx 120 W full load.

Mechanical: Bench, rack, or wall mount. 1581: DIMENSIONS: 19x7x10.5 in. (483x178x267 mm); for cabinet add 2 in. (51 mm) to depth. WEIGHT: 42 lb (19 kg) net, 92 lb (42 kg) shipping; for cabinet add 6 lb (3 kg) to net and 12 lb (6 kg) to shipping. 1582: DIMENSIONS: 19x7x14.25 in. (483x178x362 mm); for cabinet add 2 in. (51 mm) to depth. WEIGHT: 61 lb (28 kg) net, 110 lb (50 kg) shipping; for cabinet add 15 lb (7 kg) to net and 16 lb (8 kg) to shipping.

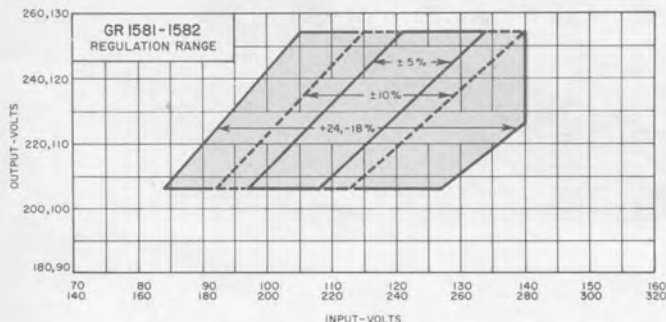

Description

Catalog Number

Variac® automatic voltage regulators
(Unless options are specified, all come for line frequency 60 Hz, without cabinets)

115-V Models

- 1581-AL, \pm 10%, 50 A
- 1582-AL, \pm 10%, 85 A
- 1581-AL2, +24 -18%, 25 A
- 1582-AL2, +24 -18%, 42.5 A

230-V Models

- 1581-AH5, \pm 5%, 40 A
- 1582-AH5, \pm 5%, 85 A
- 1581-AH, \pm 10%, 20 A
- 1582-AH, \pm 10%, 42.5 A
- 1581-AH2, +24 -18%, 10 A
- 1582-AH2, +24 -18%, 21.3 A

Select the following options, as desired

- OP1 Bench Cabinet
- OP2 Rack Cabinet
- OP3 Wall Cabinet

400-Hz Line Frequency - special model, consult factory for pricing

(Describe exactly as shown at the left.)

Variac® autotransformers



Variac® Adjustable Autotransformer

What Is a Variac?

The Variac® autotransformer is an efficient, trouble-free device for controlling ac voltage and any other quantities that derive from ac voltage: heat output, light intensity, motor speed, and the outputs of various power supplies. The name Variac comes from the unit's function—"vary ac"—and is GenRad's registered trade name for its continuously adjustable autotransformer.

Unlike most transformers, the Variac has a transformation ratio that can be smoothly and continuously changed so the output of the unit can be controlled from zero to line voltage or even higher. Because it is a transformer, the Variac is

- efficient—transforms power more efficiently than rheostats
- durable—because it runs cool
- overload-able—withstands 1000% overloads short term
- independent of load size or power factor—voltage to the load changes little from full load to none

- quiet—adds no noise or distortion to the line
- reliable—exclusive Duratrak® contact surface prevents injurious high-temperature oxidation and resultant brushtrack deterioration

In addition, the Variac is

- easy to install. All mounting hardware is included; wiring diagram is on the terminal plate; conduit knock-outs are included on all enclosed models.
- available in hundreds of standard versions to satisfy line frequency, voltage, and phase requirements, load size, mounting demands (including portable and metered models). They can be supplied with motor drives, ball bearings, and in ganged assemblies to increase basic line-voltage and load-current ratings.
- assured safe by Underwriters' Laboratory listing and Canadian Standards approval of many models.
- available in militarized models for 400-hertz operation

Applications

In most applications, a full turn of the Variac control shaft (320°) varies the output voltage, applied to the load, from zero to line voltage or 17% above if connected for "overvoltage" operation. Thus, the light or heat output or speed or torque of the load is varied from zero to rated or above. Some typical applications are shown below.

Typical Applications for Variac® autotransformers

| Type of Load | Function Controlled |
|---|---|
| Incandescent Lamps | Brilliance and color temperature |
| Fluorescent Lamps (both hot- and cold-cathode types) | Brilliance (special circuitry required for best results) |
| Heating Devices (resistive heaters and infra-red lamps) | Temperature |
| Motors | |
| AC Motors | |
| Universal Series | } Use only on fan loads, or where torque is proportional to speed |
| Repulsion | |
| Two-phase | |
| Shaded-pole | |
| Split-phase induction | |
| Capacitor split phase | |
| DC Motors | Use with rectifier for motor-speed control |
| Rectifiers | |
| Electroplating | } Current Voltage |
| Power and plate circuits | |
| Solenoids | Force |
| Test Loads | High and low line-voltage testing, breakdown tests |

Narrow-range control Many times it is sufficient to be able to vary the output voltage over a limited range, for example, from 105 to 135 volts, for line-voltage correction, overvoltage and undervoltage testing and such. In these applications, much smaller Variac units can be used with resulting economy and increased resolution.

Voltage Doubling If the available line voltage is only about half that required by the load, the Variac can double the voltage while providing full control of the output. Units designated by an "H" (W20H) are supplied with an input connection for this use; output current rating of the transformer is one-half its normal value in this case. On special order, similar connections for other multiplying ratios can be supplied.

Other applications The Variac autotransformer can also be used as a phasershifter in three-phase circuits, as a color-temperature control, for calibrating voltmeters, ammeters, and wattmeters, and in many unique applications. It is the basis of a wide line of GenRad automatic line-voltage regulators and can be used in many similar custom applications.

Special models GenRad welcomes inquiries concerning special models. We can, for example, modify taps, include limit switches, change shaft length, add ball bearings, provide for 360° mechanical rotation, add one or more independently controlled brushes, treat the units with fungicide or otherwise prepare them for use in abnormal environments.

How to Select a Variac

The Variac® adjustable autotransformers are grouped by line frequency, voltage, and phase, with brief specifications for each model. Within each group, the units are listed in order of increasing load rating that can be expressed in either current (amperes) or power (kVA). To make the selection you must know the line and load characteristics for your application. A brief look at these quantities may help.

Line frequency Most Variac models in the "W" series are designated for 50-to-60 Hz operation ("L" models are for 60 Hz only). Some "W" models can be used, without being derated, up to at least 400 Hz, but the regulation will be greater than normal and the physical size and weight larger than necessary. Therefore, we offer the "M" series Variac that is designed for operation from 350 to 1200 Hz. The M-series units are smaller and have better regulation at the higher frequencies. When series connected or when ordered specially, these units will also operate from 240-V lines.

Phase Variac models are available for both single- and three-phase operation. In general, three-phase ratings are governed by the ratings of each individual transformer in the assembly. That is, the voltage applied to, or the current drawn from, each individual unit must not exceed that specified for its single-phase uses. Thus, the considerations discussed below for single-phase applications apply separately to each unit in a three-phase assembly. A more detailed discussion on three-phase ratings and how to calculate them is given later in this section.

Line voltage Single-phase lines are normally either 120-volt or 240-volt, and GR Variac models come in two basic families to match. Should your line voltage be less than nominal, a unit rated for the nominal value will operate perfectly with no derating in current. Line voltage up to 17% above the nominal can be applied if overvoltage output is not required. For example, up to 140 volts line voltage can be applied to nominal 120-volt models if the maximum output voltage required is no more than the line voltage applied.

For single-phase line voltages from 480 to 560 volts, two Variac units rated for 240-V operation must be used with their coils connected in series across the line and the load connected one side to each of the Variac outputs. For such use, the load cannot be grounded at any point.

Load rating The load capacity of GR Variac autotransformers is specified in three ways: maximum current, rated current in amperes, and power in kVA (kilovolt-amperes). Although closely related, they are different and the differences are important to the proper selection of your Variac.

An autotransformer cannot supply as much current at midrange settings as it can at full-voltage setting without overheating. Yet some nonlinear loads, incandescent lights for example, may draw nearly as much current at half voltage as they do at rated voltage, while other (lin-

ear) loads will draw current proportional to the applied voltage. As a general rule, if the load is nonlinear, or if the overvoltage connection is used to apply more than line voltage to the load, a Variac should be chosen that has a Rated Current adequate for the load. Otherwise, the larger Maximum Current is the load-rating limit. Special applications may permit higher current to be drawn; for a more complete discussion of ratings, see "Get More Out of Your Variac," later in this section.

The Variac power rating in kVA is given as a convenience in matching the right Variac to the load. It is the product of the rated line voltage and the *maximum* current rating of the Variac. There is a risk of misinterpreting it and exceeding the limits mentioned above; the kVA rating can be used only if the load is linear and the overvoltage connection is *not* used. Otherwise, load *current* must be determined and a Variac selected that has adequate rating.

Power ratings in kVA are given for three-phase Variac applications and must be interpreted as described above.

Trade-offs While some trade-offs, like those mentioned above, are included in the selection tables, there are others you may wish to consider. The load-current capacity of the Variac is limited by temperature and life. Specified ratings assume a maximum ambient temperature of 50°C and a minimum life span of 7 years. If the expected ambient is lower or forced cooling is possible, the autotransformer can be uprated without affecting life. Also, if a shortened life is not a problem in your application, a further uprating can be realized.

Finally, if the load is expected to be switched on and off regularly (as with a thermostatically-controlled heater), the Variac can be uprated. In general, if the time for an on-off cycle is 2 hours or less and the off time is 10% or more of the total cycle time, some significant improvement in rating can be realized.

Calculations and curves for duty-cycle and temperature are given in detail later in this section.

Selecting the proper Variac Autotransformer Knowledge of the line frequency, voltage, and phase of your application will lead you to one of several tables that follow. The considerations above will have helped you determine the current or power that the Variac must be capable of handling. Now, merely scan down the left columns in the table ("Rated Current," "Maximum Current," or "kVA") until you find an entry that equals or exceeds the value determined by your load. It may be rewarding to consider several models, including those with slightly higher ratings than necessary, as there is the possibility of saving money, space, or both. Some models (designated "L" as in W5L) offer higher ratings per dollar and have only the minor restrictions of 60-Hz operation only and no overvoltage connection.

Parallel connections In some instances, the selection tables will indicate that the ganged assembly you have chosen requires parallel connection of the individual

units. Reference is made to a Type W50-P1 Choke, which *must* be used between the output connections of the individual units in the assembly to prevent one unit from forcing current into another, possibly causing excessive temperature and early failure. One choke is needed if two units are to be paralleled; three or more parallel units require one choke for each Variac. The chokes are *not* included with the ganged assembly and must be ordered separately (except for 9- and 12-gang W50 and W50H units which are shipped prewired *with* chokes).

How to order When you have chosen the right Variac autotransformer from the selection tables, record the 8-digit catalog number and type number. Your order should include this information and a complete description of the unit. This permits us to cross-check your order and catch any typographic errors.

Note that there are no 8-digit numbers given for motor-driven or ball-bearing models; ordering should be done by a constructed type number (see below) and full description.

Type Number Terminology

In their various combinations, type numbers for Variac autotransformers consist of letters and numerals that indicate exactly what elements are included in each assembly. The following examples show the various combinations:

| | | | |
|-----------|---|---------|---------------------------------------|
| M | 350-to-1200 Hz operation | | |
| W | 50-to-60 Hz operation | | |
| W5 | Model size, 120 V input | | |
| W5H | 240-V input | | |
| W5L | 60-Hz only, no overvoltage | | |
| W5HG2 | 2-gang W5H (substitute 3 for 3-gang, etc) | | |
| W5HG2BB | Adds ball bearings | | |
| W5HG2BBM | Adds complete enclosure | | |
| W5HG2D4CK | D indicates motor drive; 2, 4, 8, 16, 32, 64, or 128 following D indicates number of seconds for full traverse. C indicates phase-splitter capacitor and K indicates limit switches. Omit BB from motor-drive type numbers since motor-driven units are always equipped with ball bearings. | | |
| | | W5MT | Portable units with 2-wire line cord |
| | | W5MT3 | With 3-wire line cord |
| | | W5MT3VM | With voltmeter |
| | | W5MT3A | With voltmeter and ammeter |
| | | W5MT3W | With voltmeter and wattmeter |
| | | W5MT3AW | With voltmeter, ammeter and wattmeter |

Where Variac Autotransformers are Produced

GenRad manufactures Variac® autotransformers at its plants in Massachusetts and offers them for sale throughout the United States and its territories, Canada, Central and South America, Australia, and Asia.

In Europe, Variac autotransformers are manufactured by EAB Elektroapparatebau AG, Courtelary, Switzerland, a member of the Bircher Group, which firm is licensed by GenRad to use the trademark Variac in connection with its manufacture and sale of autotransformers. These Variacs conform to GR design specifications except for metric threads and dimensions and 127 volts on low-voltage input.

For catalog information relative to the Variac products made in Europe, please direct your inquiries to GenRad, Ltd. in England, at the address given at the front of the catalog.

General Specifications

Ball Bearings Ball bearings at both ends of the shaft are offered for all units. They are useful where more precise alignment, more constant torque, and longer life are required. Ball bearings are standard on all motor-driven Variac® autotransformers, and on all 4- to 12-gang types W30, W30H, W50, and W50H manually-operated models.

Connections, Output "Line-voltage connection" refers to the connection of the Variac autotransformer for an output-voltage range of zero to line voltage. "Overvoltage connection" refers to the input-voltage connection for a range of output voltage from 0 to 117% of line voltage.

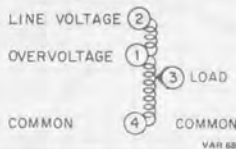

Current, Maximum Maximum current can be drawn at maximum voltage only when the line-voltage connection is used.

Current, Rated This current can be drawn at any dial setting, independent of overvoltage or line-voltage connection.

Dial Dial plates for single units are reversible. They read 0 to 120 volts output on one side and 0 to 140 volts on the other. H models have similar scale readings of 0 to 240 and 0 to 280. Dial plates are calibrated for mounting on a panel or on the front of a case; output voltage increases with clockwise rotation of the knob. All ganged assemblies are supplied with dials calibrated on one side only, reading 0 to 10.

Frequency, Line W-series units are specified for 50-to-60 Hz service except for the L types which are for 60-Hz service only. However, both of these units can be operated at rated values at line frequencies to 400 Hz. For 350-to-1200 Hz service the M-series units are preferred. Models intended for 240-volt, 60-Hz service can be used at 25 Hz at their normal current rating but at one-half their 60-Hz voltage rating.

kVA Ratings The kVA rating is the maximum load current multiplied by the nominal input line voltage.

Resolution Variac resolution is virtually infinite as the resistive brush always spans 2 or more turns of the autotransformer winding.

Motor-Driven Units All Variac autotransformers, both single and ganged units, can be furnished with motor drive.

Mounting Hardware All models are supplied with the necessary mounting hardware.

Special Designs We welcome requests for modifications of any model. These include different windings, shifting taps, different shafts, or basic new designs to furnish output voltages or voltage ranges differing from standard models. On special order, all W-series Variac autotransformers can be manufactured to conform to military requirements that are standard with the M-series units.

Temperature Rise Ratings are based upon operation at ambient temperatures of up to 50°C. When the ambient temperature exceeds this figure, current ratings should be decreased (see Figure 2).

Terminals All models have combined soldering and screw-type terminals with the exception of the types W30 and W50 which are equipped with clamping terminals. Models for 120-volt lines have five terminals for either 120- or 140-volt maximum output connections; 240-volt units have two extra terminals to provide for either 120- or 240-volt input for 280-volt output.

Military Environmental Specifications Most Variac autotransformers have been tested and do meet some or all of the following Military Specifications: MIL-STD-202, MIL-STD-810, MIL-STD-167, MIL-E-4158, MIL-E-4970, MIL-E-5272, MIL-E-5400, MIL-E-16400, MIL-R-23098, MIL-T-945, and MIL-T-5422. "Certification of Compliance" can be furnished at no charge for units tested. For further information on environmental tests, please contact your local GR District Office.

Overload Protection Today's improved core materials permit the use of higher flux densities than were formerly practical. Under certain conditions of core magnetization and line-voltage phase, an inrush transient or surge having an initial value up to ten times the rated current of the unit may occur. This does no harm except to ordinary "quick-blow" fuses. For this reason, time-current integrating circuit breakers or "slow-blow" fuses are recommended for primary protection. They will hold during transients but will protect against sustained and potentially damaging overloads. Such a protective device on the *input* side of the Variac should be capable of handling a 1000% overload for the duration of one cycle of the power-line frequency.

Overload protection for variable-ratio transformers differs from that used with fixed-ratio transformers, where safe primary and secondary currents are determined by the ratio of secondary to primary turns. For example, in a fixed-ratio transformer having 100 primary turns and 20 secondary turns, if the safe secondary current is 10 amperes, the safe primary

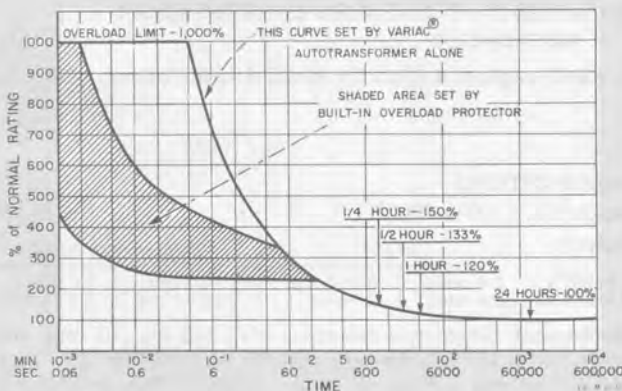

Figure 1. Short-time overload characteristic of Variac autotransformers with line-voltage connection.

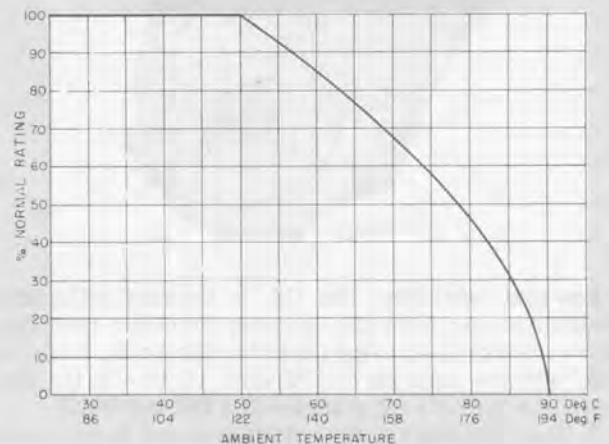

Figure 2. Variac autotransformer derating versus ambient temperature.

General Specifications (Cont'd)

current will be 2 amperes. Equal protection will be provided by a 10-ampere secondary fuse or a 2-ampere primary fuse.

This is not true with Variac autotransformers. As the brush traverses the winding, the transformation ratio continually changes. Under the conditions of a varying transformation ratio, primary protection is of little or no value, but output protection is all important; *it is the output current that must be held within safe limits.* For this reason a Variac autotransformer should be protected by a fuse or circuit breaker in the brush lead, where the load is normally connected.

The nature of the protective devices selected should be partially determined by the service requirements. Variac autotransformers have an inherently high short-time overload capacity because temperature is dependent upon time for a given rise. They can safely absorb relatively infrequent short-time overloads (due to motor starting or lamp inrush) without being derated.

The upper curve in Figure 1 applies to units without built-in fuse protection. Models with built-in protection in the brush arm (models W5L, W20H, W30, W30H, W50, and W50H) have overload characteristics corresponding to the shaded area on the curve. The fuse is purposely made inaccessible to guard against careless replacement with fuses of wrong value. Its basic purpose is to provide thermal protection to the autotransformer, and it is not intended to serve as the sole protective device for the unit. It is essential that the user add external overload protection to the output of the variac, that is, between the brush and the load.

To benefit fully from the short-term overload characteristic, the overload capacity must not be unduly limited by the protective device. Since quick-blow fuses cannot withstand surges, their use is discouraged except for loads not subject to inrush. Slow-blow fuses are better; time-current integrating circuit breakers are better still. Thermal breakers are to be preferred, since they automatically derate with increasing ambient temperature. They most nearly conform to the requirements shown in Figure 2. This type of protector is standard in the Type MT (portable, cased) models of the W-series Variac autotransformers.

Regulation Regulation is defined as the change in output voltage from no load to full load current (varying load resistance), with constant input voltage, and is expressed as a percentage of line voltage.

In an autotransformer, regulation varies with dial setting, largely because of IR drop in the winding, and is minimum at transformation ratios of zero and one. Note that, at zero and line-voltage settings, there is some slight regulation attributable to the resistance of the brush. Regulation is also due in part to leakage reactance caused by stray flux that does not link all the turns. While this is a minor factor at low frequencies, it becomes dominant at some higher frequency and actually imposes an upper-frequency limit on the operation of the autotransformer. This limit depends on the load conditions.

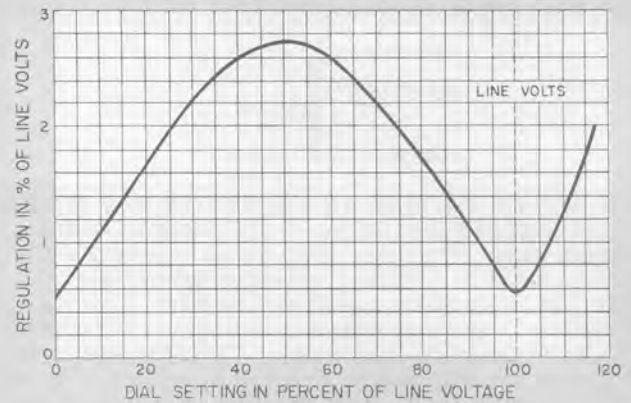

Typical regulation curve with normal rated current.

Paralleling Choke, W50-P1 Many of the Variac autotransformers listed on the following pages are indicated to require one or more Type W50-P1 Chokes (catalog number 3150-5016). This unit is used when two or more autotransformer outputs are to be connected in parallel; it impedes the flow of potentially destructive-circulating currents. Instructions for proper interconnecting are included with each unit.

Variac® adjustable autotransformer – U2



Low-cost versatility The U2, a low-cost adjustable autotransformer from GR, features simplified mounting for a variety of low-current control applications. It can be used with any input up to 120 volts, 60 to 400 Hz, and provides a full 140-volt output with a 120-volt input.

A single nut secures the autotransformer to any panel up to ¼-inch thick. The unit's small size allows it to be used on densely packed front-panel configurations — the U2 is a natural for low-current applications in almost any situation.

National stock numbers are listed at the back of the catalog.

218 VARIAC® ADJUSTABLE AUTOTRANSFORMERS

- lowest cost 2-A unit available
- highest voltage output—up to 140 V
- oversize brush and cooler operation assure extended life
- easily replaced shaft for special applications

SPECIFICATIONS

Input: 120 V, 60 to 400 Hz.

Output:

| | In Air | | On Aluminum Panel | |
|-------------|-----------|------------|-------------------|------------|
| 0 to 120 V: | 2 A rated | 2.25 A max | 2.25 A rated | 3 A max |
| 0 to 140 V: | 2 A rated | 2 A max | 2.25 A rated | 2.25 A max |

Mechanical: Single-hole mounting of 0.375 in. (10 mm) for shaft plus 0.1875-in. (5-mm) hole for anti-rotation stop, max panel thickness 0.25-in. (6 mm). **DIMENSIONS** (wxhxd depth behind panel) 3.25x3.69x2.94 in. (83x94x75 mm). **WEIGHT:** 2.5 lb (1.2 kg) net, 3 lb (1.4 kg) shipping.

Description

Catalog Number

U2 Variac® adjustable autotransformer

3200-5110



U2



W5M
(Enclosed)



W5G3M
(3-Gang)



W5
(Open)

Single-phase, 120-volt input, 50-60 Hz

| Output | | | | Description | | | | | | | | | |
|-----------------------|---------------------|------|--------------------------|-------------|----------|-------------|--|----------------|---------------|----------------|-----------------------------|-----|------|
| Rated Current Amperes | Max Current Amperes | kVA | Max Output Voltage Range | Type | Mounting | Notes | W50-P1 Chokes Req'd for parallel operation | Catalog Number | Net Weight lb | Shipping Wt lb | Outline Dimensions (inches) | | |
| | | | | | | | | | | | W | H | D |
| 2.0 | 3.0 | | 0-140 | U2 | Open | | | 3200-5110 | 2.5 | 3 | 3¼ | 3½ | 2½ |
| 2.0 | 2.6 | 0.31 | 0-140 | W2M | Encl | | | 3010-5111 | 4 | 9 | 4½ | 5½ | 4½† |
| 2.4 | 3.1 | 0.37 | 0-140 | W2 | Open | | | 3010-5110 | 3 | 4 | 3¼ | 3½ | 3½† |
| 5.0 | 6.5 | 0.78 | 0-140 | W5M | Encl | | | 3030-5111 | 7 | 13 | 4¾ | 6¾ | 4¾*† |
| 6.0 | 7.8 | 0.94 | 0-140 | W5 | Open | | | 3030-5110 | 6 | 8 | 4½ | 4¾ | 3¾*† |
| 7.1 | 9.2 | 1.1 | 0-120 | W5LM | Encl | .60 Hz only | | 3050-5111 | 7 | 13 | 4¾ | 6¾ | 4¾ |
| 8.5 | 11.0 | 1.32 | 0-120 | W5L | Open | 60 Hz only | | 3050-5110 | 7 | 8 | 4½ | 4¾ | 4¾* |
| 8.5 | 11.0 | 1.32 | 0-140 | W8 | Open | | | 3038-5110 | 8 | 9 | 4½ | 4¾ | 4¾ |
| 10.0 | 13.0 | 1.56 | 0-120 | W8L | Open | 60 Hz only | | 3058-5110 | 8 | 12 | 4½ | 4¾ | 4¾ |
| 10.0 | 13.0 | 1.56 | 0-140 | W10 | Open | | | 3060-5110 | 12 | 13 | 5¾ | 6¾ | 3¾*† |
| 10.0 | 13.0 | 1.56 | 0-140 | W10M | Encl | | | 3060-5111 | 15 | 17 | 6¾ | 9½ | 5¼*† |
| 14.2 | 18.4 | 2.2 | 0-120 | W5LG2M | Encl | 60 Hz only | 1 | 3050-5121 | 15 | 23 | 5¾ | 6¾ | 8½ |
| 17.0 | 22.0 | 2.6 | 0-120 | W5LG2 | Open | 60 Hz only | 1 | 3050-5120 | 14 | 16 | 4½ | 4¾ | 8 |
| 17.0 | 22.0 | 2.6 | 0-140 | W8G2 | Open | | 1 | 3038-5120 | 16 | 19 | 4½ | 4¾ | 9¾ |
| 20.0 | 26.0 | 3.12 | 0-140 | W20 | Open | | | 3090-5110 | 21 | 24 | 7½ | 8¾ | 4¾*† |
| 20.0 | 26.0 | 3.12 | 0-140 | W20M | Encl | | | 3090-5111 | 24 | 29 | 8¾ | 11¾ | 5¾† |
| 20.0 | 26.0 | 3.1 | 0-120 | W8LG2 | Open | 60 Hz only | 1 | 3058-5120 | 17 | 19 | 4½ | 4¾ | 9¾ |
| 21.3 | 27.6 | 3.3 | 0-120 | W5LG3M | Encl | 60 Hz only | 3 | 3050-5131 | 22 | 32 | 5¾ | 6¾ | 12¼ |
| 25.5 | 33.0 | 4.0 | 0-120 | W5LG3 | Open | 60 Hz only | 3 | 3050-5130 | 20 | 22 | 4½ | 4¾ | 12½ |
| 25.5 | 33.0 | 4.0 | 0-140 | W8G3 | Open | | 3 | 3038-5130 | 25 | 27 | 4½ | 4¾ | 13¾ |
| 28.0 | 32.0 | 3.84 | 0-140 | W30M | Encl | | | 3120-5111 | 37 | 47 | 11 | 14¾ | 5¾ |
| 30.0 | 36.0 | 4.32 | 0-140 | W30 | Open | | | 3120-5110 | 30 | 38 | 10 | 11¾ | 4¾ |
| 30.0 | 39.0 | 4.7 | 0-120 | W8LG3 | Open | 60 Hz only | 3 | 3058-5130 | 25 | 27 | 4½ | 4¾ | 13¾ |
| 40.0 | 52.0 | 6.2 | 0-140 | W20G2M | Encl | | 1 | 3090-5121 | 48 | 56 | 9 | 12¾ | 9¾ |
| 40.0 | 52.0 | 6.2 | 0-140 | W20G2 | Open | | 1 | 3090-5120 | 43 | 48 | 7½ | 8¾ | 9¾ |
| 40.0 | 45.0 | 5.40 | 0-140 | W50M | Encl | | | 3150-5111 | 57 | 74 | 13¾ | 16¾ | 7¼*† |
| 50.0 | 50.0 | 6.00 | 0-140 | W50 | Open | | | 3150-5110 | 50 | 57 | 12½ | 13¾ | 6¼*† |
| 56.0 | 64.0 | 7.7 | 0-140 | W30G2M | Encl | | 1 | 3120-5121 | 67 | 90 | 11¾ | 14¾ | 10¾ |
| 60.0 | 72.0 | 8.6 | 0-140 | W30G2 | Open | | 1 | 3120-5120 | 61 | 80 | 10 | 11¾ | 9¾ |
| 60.0 | 78.0 | 9.4 | 0-140 | W20G3M | Encl | | 3 | 3090-5131 | 71 | 82 | 9 | 12¾ | 13¾ |
| 60.0 | 78.0 | 9.4 | 0-140 | W20G3 | Open | | 3 | 3090-5130 | 65 | 71 | 7½ | 8¾ | 13¾ |
| 80.0 | 90.0 | 10.8 | 0-140 | W50G2M | Encl | | 1 | 3150-5121 | 123 | 160 | 13¾ | 17¾ | 14¾ |
| 84.0 | 96.0 | 11.5 | 0-140 | W30G3M | Encl | | 3 | 3120-5131 | 99 | 125 | 11¾ | 14¾ | 14¾ |
| 90.0 | 108.0 | 13.0 | 0-140 | W30G3 | Open | | 3 | 3120-5130 | 93 | 113 | 10 | 11¾ | 20¾ |
| 100.0 | 100.0 | 12.0 | 0-140 | W50G2 | Open | | 1 | 3150-5120 | 112 | 147 | 12½ | 13¾ | 14¾ |
| 120.0 | 135.0 | 16.2 | 0-140 | W50G3M | Encl | | 3 | 3150-5131 | 179 | 221 | 13¾ | 17¾ | 21¾ |
| 150.0 | 150.0 | 18.0 | 0-140 | W50G3 | Open | | 3 | 3150-5130 | 163 | 206 | 12½ | 13¾ | 20¾ |
| 160.0 | 180.0 | 21.6 | 0-140 | W50G4BBM | Encl | | 4 | 3150-5241 | 240 | 313 | 13¾ | 17¾ | 27¾ |
| 200.0 | 200.0 | 24.0 | 0-140 | W50G4BB | Open | | 4 | 3150-5240 | 215 | 288 | 12½ | 13¾ | 27¼ |
| 240.0 | 270.0 | 32.4 | 0-140 | W50G6BBM | Encl | | 6 | 3150-5261 | 355 | 430 | 13¾ | 17¾ | 40¾ |
| 300.0 | 300.0 | 36.0 | 0-140 | W50G6BB | Open | | 6 | 3150-5260 | 325 | 400 | 12½ | 13¾ | 40 |

* Listed under Re-examination Service of the Underwriters' Laboratory.

† Approved by the Canadian Standards Association.



W8G2
(2-Gang)



W20M
(Enclosed)



W50
(Open)

Single-phase, 240-volt input, 50-60 Hz

| Output | | | | Description | | | | | | | | | |
|-----------------------|---------------------|------|--------------------------|-------------|----------|-------------------|--|----------------|---------------|----------------|-----------------------------|-----|-----|
| Rated Current Amperes | Max Current Amperes | kVA | Max Output Voltage Range | Type | Mounting | Connection | W50-P1 Chokes Req'd for parallel operation | Catalog Number | Net Weight lb | Shipping Wt lb | Outline Dimensions (inches) | | |
| | | | | | | | | | | | W | H | D |
| 2.0 | 2.6 | 0.62 | 0-280 | W5H | Open | | | 3040-5110 | 6 | 8 | 4½ | 4⅜ | 3⅜† |
| 2.0 | 2.6 | 0.62 | 0-280 | W5HM | Encl | | | 3040-5111 | 7 | 13 | 4¾ | 6⅞ | 4¾† |
| 2.4 | 3.1 | 0.74 | 0-280 | W2G2 | Open | Series | | 3010-5120 | 7 | 9 | 3¼ | 3⅜ | 7⅞ |
| 4.0 | 5.2 | 1.25 | 0-280 | W10H | Open | | | 3070-5110 | 11 | 12 | 5¾ | 6⅞ | 4⅜† |
| 4.0 | 5.2 | 1.25 | 0-280 | W10HM | Encl | | | 3070-5111 | 14 | 17 | 6¾ | 9½ | 5¼† |
| 5.0 | 6.5 | 1.56 | 0-280 | W5G2M | Encl | Series | | 3030-5121 | 15 | 23 | 5⅞ | 6¾ | 8⅞ |
| 6.0 | 7.8 | 1.87 | 0-280 | W5G2 | Open | Series | | 3030-5120 | 14 | 15 | 4½ | 4⅜ | 8 |
| 8.0 | 10.4 | 2.50 | 0-280 | W20H | Open | | | 3100-5110 | 20 | 23 | 7½ | 8⅞ | 4⅞† |
| 8.0 | 10.4 | 2.50 | 0-280 | W20HM | Encl | | | 3100-5111 | 23 | 28 | 8⅞ | 11⅜ | 5⅞† |
| 8.5 | 11.0 | 2.64 | 0-280 | W8G2 | Open | Series | | 3038-5120 | 16 | 19 | 4½ | 4⅜ | 9⅞ |
| 10.0 | 13.0 | 3.12 | 0-240 | W8LG2 | Open | Series 60 Hz only | | 3058-5120 | 17 | 19 | 4½ | 4⅜ | 9⅞ |
| 10.0 | 13.0 | 3.12 | 0-280 | W10G2 | Open | Series | | 3060-5120 | 25 | 27 | 5¾ | 6⅞ | 9⅞ |
| 10.0 | 13.0 | 3.12 | 0-280 | W10G2M | Encl | Series | | 3060-5121 | 29 | 34 | 7⅞ | 9⅞ | 9½ |
| 12.0 | 15.6 | 3.74 | 0-280 | W30H | Open | | | 3130-5110 | 29 | 36 | 10 | 11⅜ | 4⅞ |
| 12.0 | 15.6 | 3.74 | 0-280 | W30HM | Encl | | | 3130-5111 | 36 | 45 | 11 | 14¾ | 5¼ |
| 16.0 | 20.8 | 4.99 | 0-280 | W20HG2 | Open | Parallel | 1 | 3100-5120 | 41 | 46 | 7½ | 8⅞ | 9⅞ |
| 16.0 | 20.8 | 4.99 | 0-280 | W20HG2M | Encl | Parallel | 1 | 3100-5121 | 45 | 54 | 9 | 12⅞ | 9⅞ |
| 20.0 | 26.0 | 6.24 | 0-280 | W20G2 | Open | Series | | 3090-5120 | 43 | 48 | 7⅞ | 8⅞ | 9⅞ |
| 20.0 | 26.0 | 6.24 | 0-280 | W20G2M | Encl | Series | | 3090-5121 | 48 | 56 | 9 | 12⅞ | 9⅞ |
| 20.0 | 31.0 | 7.45 | 0-280 | W50HM | Encl | | | 3160-5111 | 60 | 76 | 13⅞ | 16⅞ | 7¼† |
| 24.0 | 31.2 | 7.5 | 0-280 | W30HG2 | Open | Parallel | 1 | 3130-5120 | 59 | 76 | 10 | 11⅜ | 9⅞ |
| 24.0 | 31.2 | 7.5 | 0-280 | W30HG2M | Encl | Parallel | 1 | 3130-5121 | 64 | 87 | 11⅞ | 14⅞ | 10⅞ |
| 25.0 | 32.5 | 7.80 | 0-280 | W50H | Open | | | 3160-5110 | 53 | 60 | 12½ | 13¾ | 6¼† |
| 28.0 | 32.0 | 7.7 | 0-280 | W30G2M | Encl | Series | | 3120-5121 | 67 | 90 | 11⅞ | 14⅞ | 10⅞ |
| 30.0 | 36.0 | 8.6 | 0-280 | W30G2 | Open | Series | | 3120-5120 | 61 | 80 | 10 | 11⅜ | 9⅞ |
| 36.0 | 46.8 | 11 | 0-280 | W30HG3 | Open | Parallel | 3 | 3130-5130 | 90 | 107 | 10 | 11⅜ | 20⅞ |
| 36.0 | 46.8 | 11 | 0-280 | W30HG3M | Encl | Parallel | 3 | 3130-5131 | 97 | 120 | 11¾ | 14⅞ | 14⅞ |
| 40.0 | 62.0 | 14.9 | 0-280 | W50HG2M | Encl | Parallel | 1 | 3160-5121 | 126 | 165 | 13⅞ | 17⅞ | 14⅞ |
| 50.0 | 65.0 | 15.6 | 0-280 | W50HG2 | Open | Parallel | 1 | 3160-5120 | 116 | 153 | 12½ | 13¾ | 14½ |
| 60.0 | 93.0 | 22.3 | 0-280 | W50HG3M | Encl | Parallel | 3 | 3160-5131 | 183 | 230 | 13⅞ | 17⅞ | 21⅞ |
| 75.0 | 97.5 | 23.4 | 0-280 | W50HG3 | Open | Parallel | 3 | 3160-5130 | 167 | 214 | 12½ | 13¾ | 20⅞ |
| 80.0 | 124.0 | 29.8 | 0-280 | W50HG4BBM | Encl | Parallel | 4 | 3160-5241 | 255 | 328 | 13⅞ | 17⅞ | 27⅞ |
| 100.0 | 130.0 | 31.2 | 0-280 | W50HG4BB | Open | Parallel | 4 | 3160-5240 | 230 | 300 | 12½ | 13¾ | 27¼ |
| 120.0 | 186.0 | 44.6 | 0-280 | W50HG6BBM | Encl | Parallel | 6 | 3160-5261 | 385 | 458 | 13⅞ | 17⅞ | 40⅞ |
| 150.0 | 195.0 | 46.8 | 0-280 | W50HG6BB | Open | Parallel | 6 | 3160-5260 | 355 | 428 | 12½ | 13¾ | 40 |

Single-phase, 480-volt input, 50-60Hz

| | | | | | | | | | | | | | |
|------|------|------|-------|-----------|------|----------|---|-----------|-----|-----|-----|-----|-----|
| 2.0 | 2.6 | 1.24 | 0-560 | W5HG2 | Open | Series | | 3040-5120 | 13 | 15 | 4½ | 4⅜ | 8 |
| 2.0 | 2.6 | 1.24 | 0-560 | W5HG2M | Encl | Series | | 3040-5121 | 15 | 23 | 5⅞ | 6¾ | 8⅞ |
| 4.0 | 5.2 | 2.5 | 0-560 | W10HG2 | Open | Series | | 3070-5120 | 24 | 27 | 5¾ | 6⅞ | 9⅞ |
| 4.0 | 5.2 | 2.5 | 0-560 | W10HG2M | Encl | Series | | 3070-5121 | 29 | 33 | 7⅞ | 9⅞ | 9½ |
| 8.0 | 10.4 | 5.0 | 0-560 | W20HG2 | Open | Series | | 3100-5120 | 41 | 46 | 7½ | 8⅞ | 9⅞ |
| 8.0 | 10.4 | 5.0 | 0-560 | W20HG2M | Encl | Series | | 3100-5121 | 45 | 54 | 9 | 12⅞ | 9⅞ |
| 12.0 | 15.6 | 7.48 | 0-560 | W30HG2 | Open | Series | | 3130-5120 | 59 | 76 | 10 | 11⅜ | 9⅞ |
| 12.0 | 15.6 | 7.48 | 0-560 | W30HG2M | Encl | Series | | 3130-5121 | 64 | 87 | 11⅞ | 14⅞ | 10⅞ |
| 20.0 | 31.0 | 14.9 | 0-560 | W50HG2M | Encl | Series | | 3160-5121 | 126 | 165 | 13⅞ | 17⅞ | 14⅞ |
| 25.0 | 32.5 | 15.6 | 0-560 | W50HG2 | Open | Series | | 3160-5120 | 116 | 153 | 12½ | 13¾ | 14½ |
| 40.0 | 62.0 | 29.8 | 0-560 | W50HG4BBM | Encl | Parallel | 2 | 3160-5241 | 255 | 328 | 13⅞ | 17⅞ | 27⅞ |
| 50.0 | 65.0 | 31.2 | 0-560 | W50HG4BB | Open | Parallel | 2 | 3160-5240 | 230 | 300 | 12½ | 13¾ | 27¼ |
| 60.0 | 91.0 | 44.7 | 0-560 | W50HG6BBM | Encl | Parallel | 6 | 3160-5261 | 385 | 458 | 13⅞ | 17⅞ | 40⅞ |
| 75.0 | 97.5 | 46.8 | 0-560 | W50HG6BB | Open | Parallel | 6 | 3160-5260 | 355 | 428 | 12½ | 13¾ | 40 |

* Listed under Re-examination Service of Underwriters' Laboratory.

† Approved by Canadian Standards Association.

National stock numbers are listed at the back of the catalog.

How to Select a Three-Phase Variac

As discussed in an earlier paragraph, selecting the proper Variac® autotransformer depends on your first knowing the conditions imposed by the power line (frequency, voltage, and phase) and by the load (expressed in current or power).

To determine the needed rating for a three-phase Variac assembly, look at the individual units in the assembly and the line voltage and currents that will be imposed upon them. If the voltages and currents are within rating for the individual units, the assembly will do the job.

To control three-phase power, Variac autotransformers can be connected in either a wye configuration, which requires three units ganged (or 6, 9, or 12 for added capacity), or in an open-delta configuration, which requires two units ganged (or 4, 6, etc).

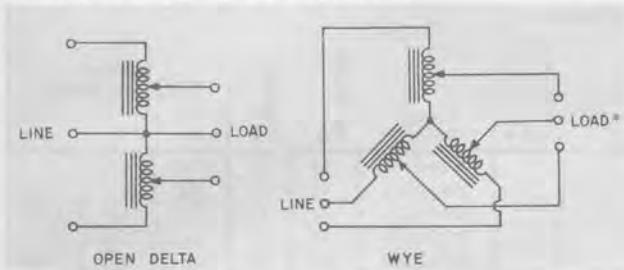

Consider the simplest cases where a single Variac unit is used in each arm. In the **wye** configuration, the full line-to-line voltage is not imposed on each unit, rather it is $1/\sqrt{3}$ or about 58% of the voltage. Thus a 240-volt line will impose about 138 volts on each unit. However, each unit supplies the full line current to the load through its brush. In the **open delta**, the input to each unit is the full voltage from the line and each unit must supply the full line current.

Line voltage Three-phase Variac assemblies are specified for the more common 208-volt, 240-volt, and 480-volt lines. The **open delta** Variac configuration is limited to the 208- and 240-volt applications and must use the Variac units with a basic rating of 240 volts; the over-

voltage connection can be used. If the **wye** is used, the three common line voltages will impose 120, 138, and 277 volts respectively on the individual units in the assembly. So, for 208-volt lines, the Variac units rated for 120 volts can be employed, and the overvoltage connection used, if desired. For 240-volt lines, either 120-volt units can be used (restricted to the line-voltage connection) or 240-volt units can be used (overvoltage permitted). For 480-volt lines, 240-volt units are usable but restricted to line-voltage connection.

Load current The current rating of the individual Variac autotransformers in the ganged assemblies is the same as the maximum line current to the load. Thus, each leg of the wye or open delta can be selected as though it were a single-phase unit. Each leg can consist of as many units paralleled (with required chokes) as is necessary to handle the current. Standard assemblies are offered with up to 12 ganged-units (a wye with four paralleled units in each leg), and even larger ones can be supplied on special order.

Load power An aid to computing the load power from the voltage and current ratings of individual components of a three-phase load, and the reverse calculations, is given in "Get more out of your Variac," later in this section. However, the kVA ratings of the three-phase Variac autotransformers require an explanation. As with single-phase units, three-phase kVA rating is the product of the maximum current and the line voltage (multiplied by $\sqrt{3}$).** It should not be used in selecting a Variac when the overvoltage connection is employed, when nonlinear loads are used, or when the phase loads may be unbalanced. In those cases, the separate line currents should be calculated and compared against the rated current of the Variac.

Line frequency The selection of a W- or M-series Variac based on line frequency will be governed by the same considerations discussed earlier. Three-phase models for operation at 350 Hz and above are listed later, under 400-Hz operation.

*4-wire 3-phase input preferred. When 3-wire input is used, load must be balanced at all times to prevent damage to Variac.

**3 single-phase units, each with $1/\sqrt{3}$ the line voltage.

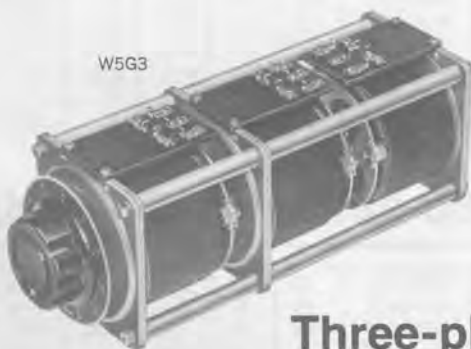

Three-phase, 208-volt input, 60-Hz only

| Output | | | | Description | | | | | | | | | |
|-----------------------|---------------------|------|--------------------------|-------------|----------|------------|--|----------------|---------------|----------------|-----------------------------|-------|--------|
| Rated Current Amperes | Max Current Amperes | kVA | Max Output Voltage Range | Type | Mounting | Connection | W50-P1 Chokes Req'd for parallel operation | Catalog Number | Net Weight lb | Shipping Wt lb | Outline Dimensions (inches) | | |
| | | | | | | | | | | | W | H | D |
| 7.1 | 9.2 | 3.31 | 0-208 | W5LG3M | Encl | Wye | | 3050-5131 | 22 | 32 | 5 1/4 | 6 3/4 | 12 1/4 |
| 8.5 | 11.0 | 3.96 | 0-208 | W5LG3 | Open | Wye | | 3050-5130 | 20 | 23 | 4 1/2 | 4 1/8 | 12 1/8 |
| 10.0 | 13.0 | 4.68 | 0-208 | W8LG3 | Open | Wye | | 3058-5130 | 25 | 27 | 4 1/2 | 4 1/8 | 13 1/8 |

National stock numbers are listed at the back of the catalog.

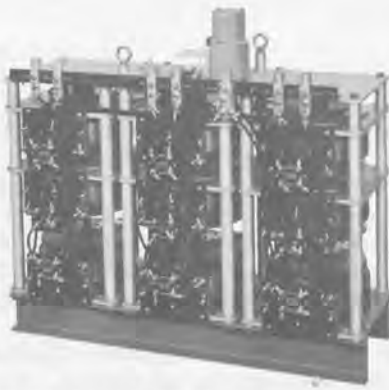

W50G9



W20G3

Overtoltage may be used on open-delta connection or 208-volt input.

Three-phase, 208-240-volt input, 50-60 Hz

| Output | | | | Description | | | | | | | | | |
|-----------------------|---------------------|------|--------------------------|-------------|----------|-----------------------|--|----------------|---------------|----------------|-----------------------------|-----|-----|
| Rated Current Amperes | Max Current Amperes | kVA | Max Output Voltage Range | Type | Mounting | Connection | W50-P1 Chokes Req'd for parallel operation | Catalog Number | Net Weight lb | Shipping Wt lb | Outline Dimensions (inches) | | |
| | | | | | | | | | | | W | H | D |
| 2.0 | 2.6 | 1.08 | 0-280 | W5HG2 | Open | Open Delta | | 3040-5120 | 13 | 15 | 4½ | 4⅝ | 8 |
| 2.0 | 2.6 | 1.08 | 0-280 | W5HG2M | Encl | Open Delta | | 3040-5121 | 15 | 23 | 5¼ | 6¾ | 8¼ |
| 2.0 | 2.6 | 1.08 | 0-240 | W2G3M | Encl | Wye | | 3010-5131 | 12 | 21 | 4¾ | 5⅝ | 12¼ |
| 2.4 | 3.1 | 1.29 | 0-240 | W2G3 | Open | Wye | | 3010-5130 | 11 | 13 | 3¼ | 3⅝ | 12 |
| 4.0 | 5.2 | 2.16 | 0-280 | W10HG2 | Open | Open Delta | | 3070-5120 | 24 | 27 | 5¾ | 6⅝ | 9⅝ |
| 4.0 | 5.2 | 2.16 | 0-280 | W10HG2M | Encl | Open Delta | | 3070-5121 | 29 | 33 | 7¼ | 9⅝ | 9½ |
| 5.0 | 6.5 | 2.70 | 0-240 | W5G3M | Encl | Wye | | 3030-5131 | 22 | 32 | 5½ | 6¼ | 12¼ |
| 6.0 | 7.8 | 3.24 | 0-240 | W5G3 | Open | Wye | | 3030-5130 | 20 | 22 | 4½ | 4⅝ | 12½ |
| 8.0 | 10.4 | 4.32 | 0-280 | W20HG2 | Open | Open Delta | | 3100-5120 | 41 | 46 | 7½ | 8⅝ | 9⅝ |
| 8.0 | 10.4 | 4.32 | 0-280 | W20HG2M | Encl | Open Delta | | 3100-5121 | 45 | 54 | 9 | 12⅝ | 9¾ |
| 8.5 | 11.0 | 4.57 | 0-240 | W8G3 | Open | Wye | | 3038-5130 | 25 | 27 | 4½ | 4⅝ | 13⅝ |
| 10.0 | 13.0 | 5.40 | 0-240 | W10G3 | Open | Wye | | 3060-5130 | 37 | 40 | 5½ | 6⅝ | 14 |
| 10.0 | 13.0 | 5.40 | 0-240 | W10G3M | Encl | Wye | | 3060-5131 | 43 | 47 | 7¼ | 9⅝ | 14¾ |
| 12.0 | 15.6 | 6.48 | 0-280 | W30HG2 | Open | Open Delta | | 3130-5120 | 59 | 76 | 10 | 11⅝ | 9¾ |
| 12.0 | 15.6 | 6.48 | 0-280 | W30HG2M | Encl | Open Delta | | 3130-5121 | 64 | 87 | 11¾ | 14⅝ | 10¼ |
| 20.0 | 26.0 | 10.8 | 0-240 | W20G3 | Open | Wye | | 3090-5130 | 65 | 71 | 7½ | 8⅝ | 13¾ |
| 20.0 | 26.0 | 10.8 | 0-240 | W20G3M | Encl | Wye | | 3090-5131 | 71 | 82 | 9 | 12⅝ | 13⅝ |
| 20.0 | 31.0 | 12.9 | 0-280 | W50HG2M | Encl | Open Delta | | 3160-5121 | 126 | 165 | 13⅝ | 17⅝ | 14⅝ |
| 25.0 | 32.5 | 13.5 | 0-280 | W50HG2 | Open | Open Delta | | 3160-5120 | 116 | 153 | 12½ | 13¾ | 14½ |
| 28.0 | 32.0 | 13.3 | 0-240 | W30G3M | Encl | Wye | | 3120-5131 | 99 | 125 | 11¾ | 14⅝ | 14⅝ |
| 30.0 | 36.0 | 15.0 | 0-240 | W30G3 | Open | Wye | | 3120-5130 | 93 | 113 | 12½ | 13¾ | 20¾ |
| 40.0 | 45.0 | 18.7 | 0-240 | W50G3M | Encl | Wye | | 3150-5131 | 179 | 221 | 13⅝ | 17⅝ | 21⅝ |
| 50.0 | 50.0 | 20.8 | 0-240 | W50G3 | Open | Wye | | 3150-5130 | 163 | 206 | 12½ | 13¾ | 20¾ |
| 40.0 | 62.0 | 25.8 | 0-280 | W50HG4BBM | Encl | Open Delta | 2 | 3160-5241 | 255 | 328 | 13⅝ | 17⅝ | 27⅝ |
| 50.0 | 65.0 | 27.0 | 0-280 | W50HG4BB | Open | Open Delta | 2 | 3160-5240 | 230 | 300 | 12½ | 13¾ | 27¼ |
| 80.0 | 90.0 | 37.4 | 0-240 | W50G6BBM | Encl | Wye | 3 | 3150-5261 | 355 | 430 | 13⅝ | 17⅝ | 40⅝ |
| 100.0 | 100.0 | 41.6 | 0-240 | W50G6BB | Open | Wye | 3 | 3150-5260 | 325 | 400 | 12½ | 13¾ | 40 |
| *150.0 | 150.0 | 62.4 | 0-240 | W50G9BB | Open | Wye (chokes included) | | 3150-5876 | 600 | 720 | 39 | 35 | 17 |
| *200.0 | 200.0 | 83.2 | 0-240 | W50G12BB | Open | Wye (chokes included) | | 3150-5886 | 760 | 880 | 39 | 41 | 17 |

(Overtoltage connection not recommended)

Three-phase, 480-volt input, 50-60 Hz

| | | | | | | | | | | | | | |
|--------|------|-------|-------|-----------|------|-----------------------|---|-----------|-----|-----|-----|-----|-----|
| 2.0 | 2.6 | 2.16 | 0-480 | W5HG3 | Open | Wye | | 3040-5130 | 20 | 22 | 4½ | 4⅝ | 12¼ |
| 2.0 | 2.6 | 2.16 | 0-480 | W5HG3M | Encl | Wye | | 3040-5131 | 22 | 31 | 5¼ | 6¾ | 12¼ |
| 4.0 | 5.2 | 4.32 | 0-480 | W10HG3 | Open | Wye | | 3070-5130 | 36 | 39 | 5¾ | 6⅝ | 14 |
| 4.0 | 5.2 | 4.32 | 0-480 | W10HG3M | Encl | Wye | | 3070-5131 | 42 | 46 | 7¼ | 9⅝ | 14¾ |
| 8.0 | 10.4 | 8.65 | 0-480 | W20HG3 | Open | Wye | | 3100-5130 | 61 | 68 | 7½ | 8⅝ | 13¾ |
| 8.0 | 10.4 | 8.65 | 0-480 | W20HG3M | Encl | Wye | | 3100-5131 | 67 | 79 | 9 | 12⅝ | 13⅝ |
| 12.0 | 15.6 | 13.0 | 0-480 | W30HG3 | Open | Wye | | 3130-5130 | 90 | 107 | 12½ | 13¾ | 20¾ |
| 12.0 | 15.6 | 13.0 | 0-480 | W30HG3M | Encl | Wye | | 3130-5131 | 97 | 120 | 11¾ | 14⅝ | 14⅝ |
| 20.0 | 31.0 | 25.8 | 0-480 | W50HG3M | Encl | Wye | | 3160-5131 | 183 | 230 | 13⅝ | 17⅝ | 21⅝ |
| 25.0 | 32.5 | 27.0 | 0-480 | W50HG3 | Open | Wye | | 3160-5130 | 167 | 214 | 12½ | 13¾ | 20¾ |
| 40.0 | 62.0 | 51.5 | 0-480 | W50HG6BBM | Encl | Wye | 3 | 3160-5261 | 385 | 458 | 13⅝ | 17⅝ | 40⅝ |
| 50.0 | 65.0 | 54.0 | 0-480 | W50HG6BB | Open | Wye | 3 | 3160-5260 | 355 | 428 | 12½ | 13¾ | 40 |
| *75.0 | 97.5 | 81.0 | 0-480 | W50HG9BB | Open | Wye (chokes included) | | 3160-5876 | 610 | 730 | 39 | 35 | 17 |
| *100.0 | 130 | 108.0 | 0-480 | W50HG12BB | Open | Wye (chokes included) | | 3160-5886 | 806 | 926 | 39 | 41 | 17 |

* Motor drive only.

available on request:

Three-phase, 560-volt input, 50-60 Hz

National stock numbers are listed at the back of the catalog.



M20

400-Hz Operation

- small, light, excellent regulation
- high- and low-temperature lubrication
- iridite-treated aluminum parts
- fungicidal treatment of all phenolic parts
- special nickel-plated brush holders

The M-series models are designed for use at frequencies between 350 and 1200 Hz. They are electrically the high-frequency equivalents of the standard W series but are much smaller and lighter than the 60-Hz models. At 400 Hz, the regulation obtained with the M-series is considerably better than with the 60-Hz models.

All M-series units conform to most military specifications for shock, vibration, salt spray, tropicalization, altitude, humidity, and temperature. See General Specifications section for further information regarding military environmental specifications. Operation of the M-series models is possible at 60 Hz if the input is limited to 60 volts. The output current remains the same and the output voltage range is 0 to 70 volts.

Single-phase, 120-volt input, 400-Hz

| Output | | | | Description | | | | | | | | |
|-----------------------|---------------------|------|--------------------------|-------------|----------|------------|----------------|---------------|----------------|-----------------------------|----|----|
| Rated Current Amperes | Max Current Amperes | kVA | Max Output Voltage Range | Type | Mounting | Connection | Catalog Number | Net Weight lb | Shipping Wt lb | Outline Dimensions (inches) | | |
| | | | | | | | | | | W | H | D |
| 2.4 | 3.1 | 0.37 | 0-140 | M2 | Open | | 3410-5110 | 2 | 3 | 3¼ | 3½ | 2½ |
| 6.0 | 7.8 | 0.94 | 0-140 | M5 | Open | | 3430-5110 | 3 | 4 | 4½ | 4½ | 2½ |
| 10.0 | 13.0 | 1.56 | 0-140 | M10 | Open | | 3460-5110 | 6 | 8 | 5½ | 6½ | 3½ |
| 20.0 | 26.0 | 3.12 | 0-140 | M20 | Open | | 3490-5110 | 13 | 15 | 7½ | 8½ | 3½ |

Three-phase, 120-volt input, 400-Hz

| | | | | | | | | | | | | |
|------|------|------|-------|-------|------|------------|-----------|----|----|----|----|----|
| 2.4 | 3.1 | 0.65 | 0-140 | M2G2 | Open | Open Delta | 3410-5120 | 4 | 5 | 3¼ | 3½ | 5½ |
| 6.0 | 7.8 | 1.62 | 0-140 | M5G2 | Open | Open Delta | 3430-5120 | 7 | 8 | 4½ | 4½ | 5½ |
| 10.0 | 13.0 | 2.7 | 0-140 | M10G2 | Open | Open Delta | 3460-5120 | 12 | 16 | 5½ | 6½ | 6½ |
| 20.0 | 26.0 | 5.4 | 0-140 | M20G2 | Open | Open Delta | 3490-5120 | 26 | 30 | 7 | 8½ | 7½ |

Three-phase, 120-208-240-volt, 400-Hz

| | | | | | | | | | | | | |
|------|------|------|--------|-------|------|-----|-----------|----|----|----|----|-----|
| 2.4 | 3.1 | 1.30 | 0-240* | M2G3 | Open | Wye | 3410-5130 | 5 | 7 | 3½ | 3½ | 8¼ |
| 6.0 | 7.8 | 3.24 | 0-240* | M5G3 | Open | Wye | 3430-5130 | 10 | 12 | 4½ | 4½ | 8½ |
| 10.0 | 13.0 | 5.4 | 0-240* | M10G3 | Open | Wye | 3460-5130 | 19 | 23 | 5½ | 6½ | 10½ |
| 20.0 | 26.0 | 10.8 | 0-240* | M20G3 | Open | Wye | 3490-5130 | 38 | 43 | 7½ | 8½ | 10½ |

* 17% overvoltage connection is permitted on 120/208, three-phase lines.

National stock numbers are listed at the back of the catalog.



W8MT3VM



W8MT3

Portable Variac® Autotransformers

Portable, metered, cased units are available in twenty models for use in the laboratory and on the test bench. Each consists of a Variac autotransformer and an overload protector. Some models have a voltmeter, ammeter, and wattmeter in different configurations.

Adequate meter shielding is provided to reduce stray fields sufficiently to give over-all meter accuracy of 3% of full scale (5% of full scale for the powerful W20HMT3A).

The output circuit is protected by either a Klixon* thermal overload breaker, resettable from the panel, or by easily accessible and replaceable fuses.

A double-pole on-off switch disconnects both sides of the line. Where dual-range meters are used, make-before-break range switches permit switching under load. All have convenient carrying handles. Some models come in both 2- and 3-wire versions.

* Registered trademark of Texas Instruments Inc.

Single-phase, 120-volt input, 50-60 Hz

| Rated Current Amperes | Output | | Type | Meter Ranges (full scale) | | | 2- or 3-wire cord and receptacle | Catalog Number | Net Weight lb | Shipping Wt lb | Outline Dimensions (inches) | | |
|-----------------------|---------------------|--------------------------|---------------------|---------------------------|----------|-------|----------------------------------|----------------|---------------|----------------|-----------------------------|------------------|--------------------|
| | Max Current Amperes | Max Output Voltage Range | | Amperes | Watts | Volts | | | | | W | H | D |
| | | | | | | | | | | | | | |
| 5.0 | — | 0-140 | W5MT | — | — | — | 2 | 3030-5118 | 8 | 15 | 4 $\frac{7}{8}$ | 6 $\frac{5}{8}$ | 4 $\frac{3}{8}$ †† |
| 5.0 | — | 0-140 | W5MT3 | — | — | — | 3 | 3030-5119 | 8 | 15 | 4 $\frac{7}{8}$ | 6 $\frac{5}{8}$ | 4 $\frac{3}{8}$ †† |
| 5.0 | — | 0-140 | W5MT3VM | — | — | 150 | 3 | 3030-5015 | 8 | 19 | 4 $\frac{7}{8}$ | 6 $\frac{5}{8}$ | 4 $\frac{3}{8}$ |
| 5.0 | — | 0-140 | W5MT3A | 1/5 | — | 150 | 3 | 3030-5012 | 11 | 19 | 6 $\frac{3}{4}$ | 9 $\frac{1}{2}$ | 5 $\frac{1}{4}$ |
| 5.0 | — | 0-140 | W5MT3W | — | 150/750 | 150 | 3 | 3030-5013 | 12 | 19 | 6 $\frac{3}{4}$ | 9 $\frac{1}{2}$ | 5 $\frac{1}{4}$ |
| 5.0 | — | 0-140 | W5MT3AW | 1/5 | 150/750 | 150 | 3 | 3030-5014 | 12 | 21 | 11 $\frac{1}{8}$ | 8 $\frac{5}{8}$ | 5 $\frac{3}{8}$ |
| 7.1 | — | 0-120 | W5LMT3 ¹ | — | — | — | 3 | 3050-5119 | 8 | 18 | 4 $\frac{7}{8}$ | 6 $\frac{5}{8}$ | 4 $\frac{3}{8}$ |
| 10.0 | — | 0-140 | W8MT3 | — | — | — | 3 | 3038-5119 | 10 | 16 | 5 $\frac{3}{8}$ | 7 | 6 $\frac{1}{8}$ |
| 10.0 | — | 0-140 | W8MT3VM | — | — | 150 | 3 | 3038-5015 | 10 | 16 | 5 $\frac{3}{8}$ | 7 | 6 $\frac{1}{8}$ |
| 10.0 | — | 0-140 | W10MT | — | — | — | 2 | 3060-5118 | 16 | 24 | 6 $\frac{3}{4}$ | 9 $\frac{1}{2}$ | 5 $\frac{1}{4}$ † |
| 10.0 | — | 0-140 | W10MT3 | — | — | — | 3 | 3060-5119 | 16 | 24 | 6 $\frac{3}{4}$ | 9 $\frac{1}{2}$ | 5 $\frac{1}{4}$ † |
| 10.0 | — | 0-140 | W10MT3A | 2/10 | — | 150 | 3 | 3060-5012 | 18 | 30 | 8 $\frac{3}{8}$ | 11 $\frac{1}{8}$ | 5 $\frac{3}{8}$ |
| 10.0 | — | 0-140 | W10MT3W | — | 300/1500 | 150 | 3 | 3060-5013 | 18 | 30 | 8 $\frac{3}{8}$ | 11 $\frac{1}{8}$ | 5 $\frac{3}{8}$ |
| 18.0 | — | 0-140 | W20MT3A | 20 | — | 150 | 3 | 3090-5012 | 27 | 34 | 8 $\frac{3}{8}$ | 11 $\frac{1}{8}$ | 5 $\frac{3}{8}$ |
| 18.0 | — | 0-140 | W20MT3 | — | — | — | 3 | 3090-5119 | 20 | 23 | 8 $\frac{3}{8}$ | 11 $\frac{1}{8}$ | 5 $\frac{3}{8}$ † |

¹ 60 Hz only

Single-phase, 240-volt input, 50-60 Hz

| | | | | | | | | | | | | | |
|-----|---|-------|----------|----|---|-----|---|-----------|----|----|-----------------|------------------|-------------------|
| 2.0 | — | 0-280 | W5HMT | — | — | — | 2 | 3040-5118 | 8 | 15 | 4 $\frac{7}{8}$ | 6 $\frac{5}{8}$ | 4 $\frac{3}{8}$ † |
| 4.0 | — | 0-280 | W10HMT | — | — | — | 2 | 3070-5118 | 15 | 24 | 6 $\frac{3}{4}$ | 9 $\frac{1}{2}$ | 5 $\frac{1}{4}$ |
| 4.0 | — | 0-280 | W10HMT3 | — | — | — | 3 | 3070-5119 | 15 | 24 | 6 $\frac{3}{4}$ | 9 $\frac{1}{2}$ | 5 $\frac{1}{4}$ |
| 8.0 | — | 0-280 | W20HMT3 | — | — | — | 3 | 3100-5119 | 27 | 35 | 8 $\frac{3}{8}$ | 11 $\frac{1}{8}$ | 5 $\frac{3}{8}$ † |
| 8.0 | — | 0-280 | W20HMT3A | 10 | — | 300 | 3 | 3100-5012 | 25 | 31 | 8 $\frac{3}{8}$ | 11 $\frac{1}{8}$ | 5 $\frac{3}{8}$ |

Types MT and MT3 have overvoltage connections and corresponding dial scales, but can be supplied on special order with line-voltage connections and dial scales.

* Listed under Re-examination Service of Underwriters' Laboratory.

† Approved by Canadian Standards Association.

National stock numbers are listed at the back of the catalog.

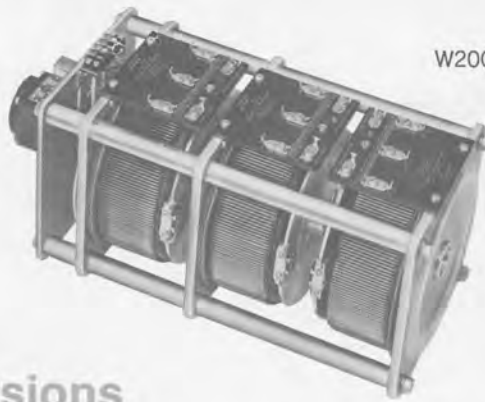

Motor-Drive Versions

ORDERING INFORMATION

From table: yes = available from stock
so = available on special order

Establishing correct type number:

1. Select basic Variac type number; e.g., W5G2 (a 2-gang W5-series Variac)
2. Select time desired for full 320° traverse and insert time in "D-CK"
3. Arrange in following order:
W5G2D8CK (a 2-gang W5-series Variac with motor drive, 8-second traverse)
4. If fully enclosed case is desired, add "M", e.g., W5G2D8CKM.

Dimensions: Width and height are same as for component Variac. Depth is approx 6 inches greater than that of equivalent manually operated model.

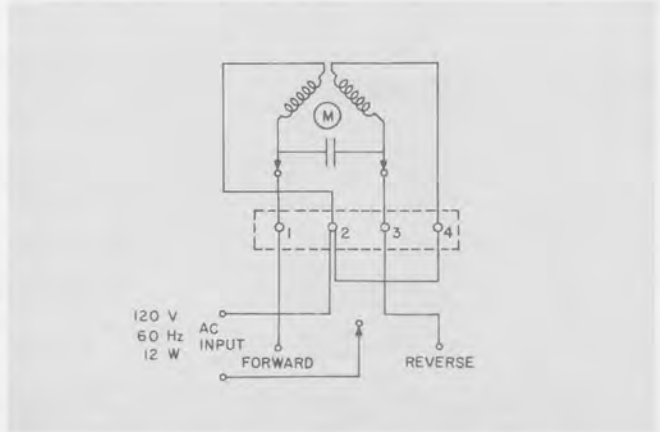

Schematic diagram of motor circuit

| Seconds for full 320° Traverse* | | | | | | | Shipping Weight (lb) | | Seconds for full 320° Traverse* | | | | | | | Shipping Weight (lb) | | | |
|---------------------------------|-----|-----|-----|-----|-----|-----|----------------------|-------|---------------------------------|----------------|-----|-----|-----|-----|-----|----------------------|-----|-------|---------|
| | 2 | 4 | 8 | 16 | 32 | 64 | 128 | Cased | | Uncased | 2 | 4 | 8 | 16 | 32 | 64 | 128 | Cased | Uncased |
| M2 | yes | yes | yes | yes | yes | yes | ... | 9 | ... | W10 | yes | yes | yes | yes | yes | yes | yes | 23 | 30 |
| M2G2 | yes | yes | yes | yes | yes | yes | ... | 11 | ... | W10G2 | so | so | yes | yes | yes | yes | yes | 35 | 43 |
| M2G3 | ... | yes | yes | yes | yes | yes | ... | 14 | ... | W10G3 | so | so | yes | yes | yes | yes | yes | 47 | 56 |
| M5 | yes | yes | yes | yes | yes | yes | ... | 14 | ... | W10H | yes | yes | yes | yes | yes | yes | yes | 23 | 30 |
| M5G2 | yes | yes | yes | yes | yes | yes | ... | 16 | ... | W10HG2 | so | yes | yes | yes | yes | yes | yes | 35 | 43 |
| M5G3 | ... | yes | yes | yes | yes | yes | ... | 19 | ... | W10HG3 | so | so | yes | yes | yes | yes | yes | 47 | 56 |
| M10 | yes | yes | yes | yes | yes | yes | yes | 16 | ... | W20 | so | yes | yes | yes | yes | yes | yes | 35 | 50 |
| M10G2 | so | yes | yes | yes | yes | yes | yes | 22 | ... | W20G2 | so | so | yes | yes | yes | yes | yes | 54 | 71 |
| M10G3 | so | so | yes | yes | yes | yes | yes | 29 | ... | W20G3 | so | so | yes | yes | yes | yes | yes | 78 | 97 |
| M20 | ... | yes | yes | yes | yes | yes | yes | 27 | ... | W20H | so | yes | yes | yes | yes | yes | yes | 35 | 47 |
| M20G2 | so | so | yes | yes | yes | yes | yes | 47 | ... | W20HG2 | so | so | yes | yes | yes | yes | yes | 54 | 69 |
| M20G3 | so | so | yes | yes | yes | yes | yes | 58 | ... | W20HG3 | so | so | yes | yes | yes | yes | yes | 77 | 93 |
| W2 | yes | yes | yes | yes | yes | yes | ... | 13 | 15 | W30 | so | yes | yes | yes | yes | yes | yes | 57 | 79 |
| W2G2 | yes | yes | yes | yes | yes | yes | ... | 15 | 17 | W30G2 | ... | so | so | yes | yes | yes | yes | 89 | 98 |
| W2G3 | ... | yes | yes | yes | yes | yes | ... | 17 | 20 | W30G3 | ... | ... | so | so | yes | yes | yes | 120 | 120 |
| W5 | yes | yes | yes | yes | yes | yes | ... | 17 | 20 | W30H | so | yes | yes | yes | yes | yes | yes | 55 | 78 |
| W5G2 | yes | yes | yes | yes | yes | yes | ... | 23 | 26 | W30HG2 | ... | so | so | yes | yes | yes | yes | 88 | 98 |
| W5G3 | ... | yes | yes | yes | yes | yes | ... | 33 | 39 | W30HG3 | ... | ... | so | so | yes | yes | yes | 120 | 120 |
| W5H | yes | yes | yes | yes | yes | yes | ... | 18 | 20 | W50 | ... | so | so | yes | yes | yes | yes | 95 | 125 |
| W5HG2 | yes | yes | yes | yes | yes | yes | ... | 25 | 28 | W50G2 | ... | ... | so | so | yes | yes | yes | 162 | 194 |
| W5HG3 | ... | yes | yes | yes | yes | yes | ... | 34 | 38 | W50G3 | ... | ... | so | so | yes | yes | yes | 220 | 242 |
| W5L | yes | yes | yes | yes | yes | yes | ... | 17 | 20 | W50G4 | ... | ... | so | so | so | so | yes | 295 | 330 |
| W5LG2 | yes | yes | yes | yes | yes | yes | ... | 24 | 29 | W50G6 | ... | ... | so | so | so | so | yes | 411 | 454 |
| W5LG3 | ... | yes | yes | yes | yes | yes | ... | 27 | 32 | W50G9 | ... | ... | ... | ... | ... | yes | ... | ... | ... |
| W8 | yes | yes | yes | yes | yes | yes | ... | 19 | ... | W50G12 | ... | ... | ... | ... | ... | yes | ... | ... | ... |
| W8G2 | yes | yes | yes | yes | yes | yes | ... | 28 | ... | W50H | ... | so | so | yes | yes | yes | yes | 100 | 130 |
| W8G3 | ... | yes | yes | yes | yes | yes | ... | 37 | ... | W50HG2 | ... | ... | so | so | yes | yes | yes | 167 | 201 |
| W8L | yes | yes | yes | yes | yes | yes | ... | 19 | ... | W50HG3 | ... | ... | so | so | yes | yes | yes | 222 | 246 |
| W8LG2 | yes | yes | yes | yes | yes | yes | ... | 28 | ... | W50HG4 | ... | ... | so | so | so | so | yes | 302 | 334 |
| W8LG3 | ... | yes | yes | yes | yes | yes | ... | 37 | ... | W50HG6 | ... | ... | so | so | so | so | yes | 480 | 526 |
| | | | | | | | | | | W50HG9 | ... | ... | ... | ... | ... | yes | ... | ... | ... |
| | | | | | | | | | | W50HG12 | ... | ... | ... | ... | ... | yes | ... | ... | ... |

* Motor times given for 60-Hz operation. Add 20% more time for 50-Hz operation.

W2 Variac® Autotransformer

Basic data for single section:

| | |
|-----------------------------|--------------------|
| Input | 120 V, 50 to 60 Hz |
| Output as % of input | 0 to 117% |
| Rated Current | 2.4 A |
| Maximum Current | 3.1 A |
| No-Load Loss at 60 Hz | 3.5 W |
| Number of Turns | 403 |
| DC Resistance of Winding | 10.35 Ω |
| Drive Torque (ounce-inches) | 5 to 10 |
| Replacement Brush | VB-1 |

Dimensions Types W2 and W2M

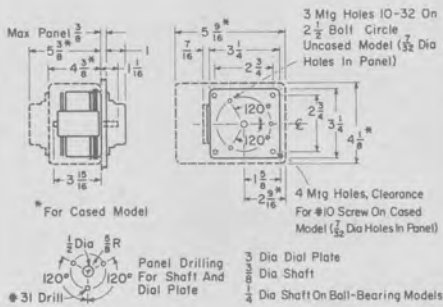

Dimensions Ganged Uncased Types W2G2 and W2G3

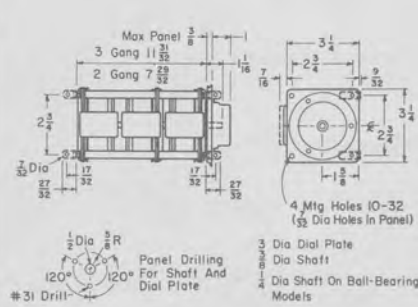

Dimensions Ganged Cased Types W2G2M and W2G3M

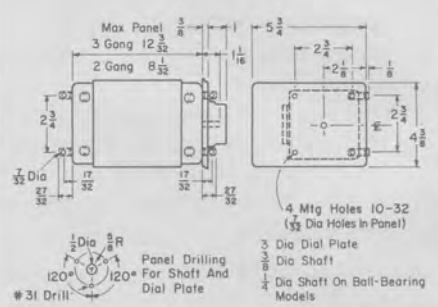

W5 Variac® Autotransformer

Basic data for single section:

| | W5 | W5L | W5H |
|-----------------------------|--------------------|--------------|--------------------|
| Input | 120 V, 50 to 60 Hz | 120 V, 60 Hz | 240 V, 50 to 60 Hz |
| Output as % of input | 0 to 117% | 0 to 100% | 0 to 117% |
| Rated Current | 6 A | 8.5 A | 2 A |
| Maximum Current | 7.8 A | 11 A | 2.6 A |
| No-Load Loss at 60 Hz | 9 W | 12 W | 9 W |
| Number of Turns | 293 | 235 | 590 |
| DC Resistance of Winding | 1.85 Ω | 0.92 Ω | 17 Ω |
| Drive Torque (ounce-inches) | 10 to 20 | 10 to 20 | 10 to 20 |
| Replacement Brush | VB-2 | VB-2 | VB-1 |

Dimensions Types W5, W5L, W5M, W5LM, W5MT, W5MT3, W5LMT3, W5H, W5HM, and W5HMT

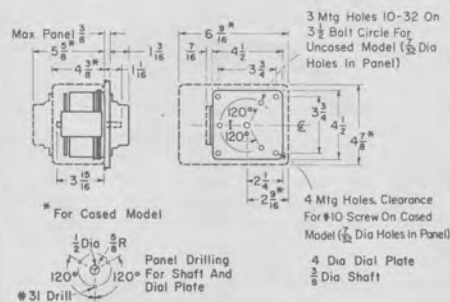

Dimensions Ganged (Uncased) Types W5G2, W5G3, W5HG2, W5HG3, W5LG2 and W5LG3

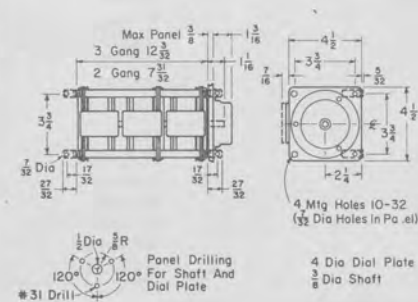

Dimensions Ganged Cased Types W5G2M, W5G3M, W5HG2M, W5HG3M, W5LG2M, and W5LG3M

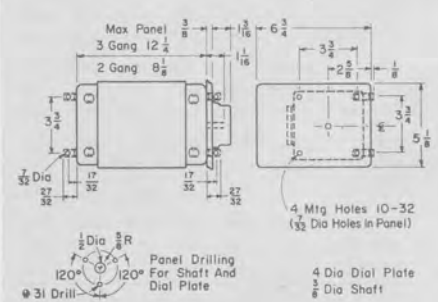

National stock numbers are listed at the back of the catalog.

W8 Variac® Autotransformer

| Basic data for single section: | W8 | W8L |
|--------------------------------|--------------------|--------------|
| Input | 120 V, 50 to 60 Hz | 120 V, 60 Hz |
| Output as % of input | 0 to 117% | 0 to 100% |
| Rated Current | 8.5 A | 10 A |
| Maximum Current | 11 A | 13 A |
| No-Load Loss at 60 Hz | 12 W | 12 W |
| Number of Turns | 236 | 184 |
| DC Resistance of Winding | 1 Ω | 0.5 Ω |
| Drive Torque (ounce-inches) | 10 to 20 | 10 to 20 |
| Replacement Brush | VB-3 | VB-3 |

Dimensions Types W8 and W8L

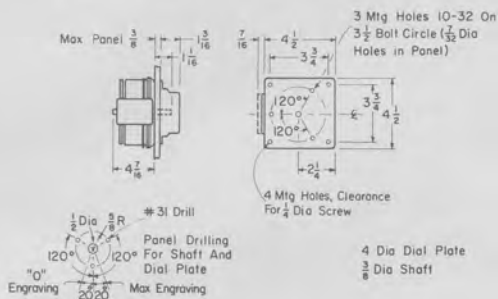

Dimensions Ganged Types W8G2, W8G3, W8LG2, and W8LG3

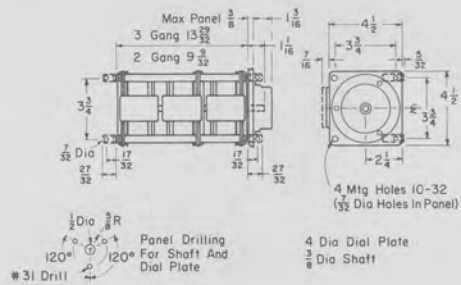

W10 Variac® Autotransformer

| Basic data for single section: | W10 | W10H |
|--------------------------------|--------------------|--------------------|
| Input | 120 V, 50 to 60 Hz | 240 V, 50 to 60 Hz |
| Output as % of Input | 0 to 117% | 0 to 117% |
| Rated Current | 10 A | 4 A |
| Maximum Current | 13 A | 5.2 A |
| No-Load Loss at 60 Hz | 17 W | 17 W |
| Number of Turns | 212 | 430 |
| DC Resistance of Winding | 0.58 Ω | 4.85 Ω |
| Drive Torque (ounce-inches) | 15 to 30 | 15 to 30 |
| Replacement Brush | VBT-10 | VBT-11 |

Dimensions Types W10, W10M, W10MT, W10MT3, W10H, W10HM, W10HMT, and W10HMT3.

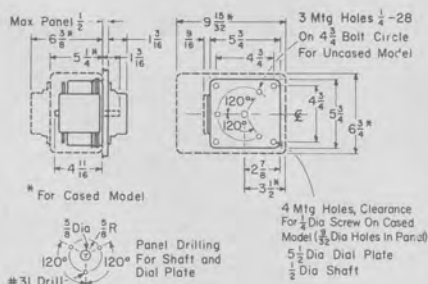

Dimensions Ganged Uncased Types W10G2, W10G3, W10HG2, and W10HG3

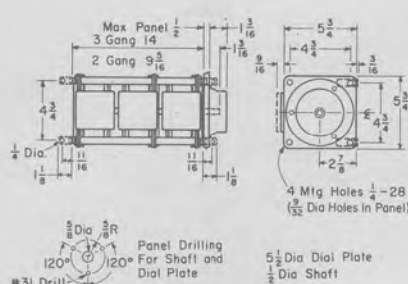

Dimensions Cased Types W10G2M, W10G3M, W10HG2M, and W10HG3M

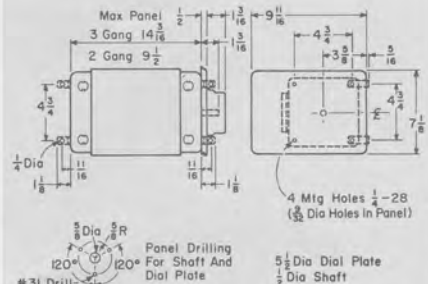

National stock numbers are listed at the back of the catalog.

W20 Variac® Autotransformer

| Basic data for single section: | W20 | W20H |
|--------------------------------|--------------------|--------------------|
| Input | 120 V, 50 to 60 Hz | 240 V, 50 to 60 Hz |
| Output as % of Input | 0 to 117% | 0 to 117% |
| Rated Current | 20 A | 8 A |
| Maximum Current | 26 A | 10.4 A |
| No-Load Loss at 60 Hz | 27 W | 27 W |
| Number of Turns | 169 | 339 |
| DC Resistance of Winding | 0.21 Ω | 1.6 Ω |
| Drive Torque (ounce-inches) | 45 to 90 | 45 to 90 |
| Replacement Brush | VBT-8 | VBT-12 |

Dimensions Types W20, W20M, W20MT3, W20H, W20HM and W20HMT3.

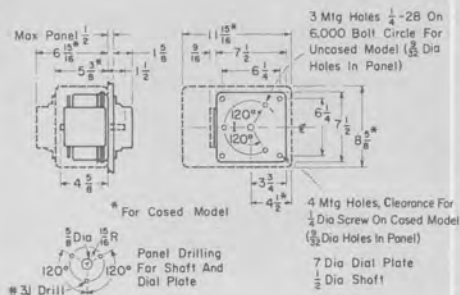

Dimensions Ganged Uncased Types W20G2, W20G3, W20HG2 and W20HG3

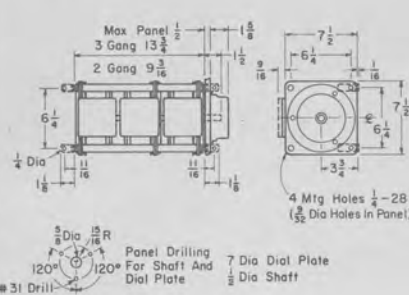

Dimensions Ganged Cased Types W20G2M, W20G3M, W20HG2M, and W20HG3M

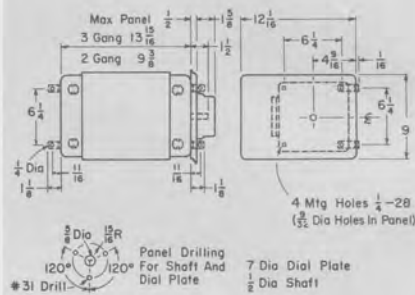

W30 Variac® Autotransformer

| Basic data for single section: | W30 | W30H |
|--------------------------------|--------------------|--------------------|
| Input | 120 V, 50 to 60 Hz | 240 V, 50 to 60 Hz |
| Output as % of Input | 0 to 117% | 0 to 117% |
| Rated Current | 30 A | 12 A |
| Maximum Current | 36 A | 15.6 A |
| No-Load Loss at 60 Hz | 35 W | 35 W |
| Number of Turns | 184 | 367 |
| DC Resistance of Winding | 0.14 Ω | 1.17 Ω |
| Drive Torque (ounce-inches) | 50 to 100 | 50 to 100 |
| Replacement Brush | VBT-13 | VBT-14 |

Dimensions Types W30, W30M, W30H, and W30HM

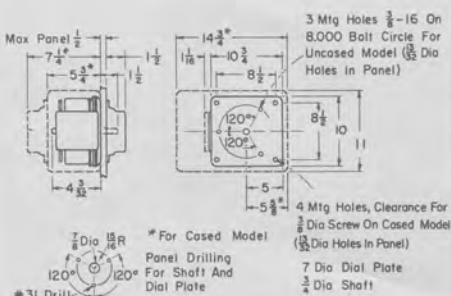

Dimensions Ganged Uncased Types W30G2, W30G3, W30G4, W30G6, W30HG2, W30HG3, W30HG4, and W30HG6

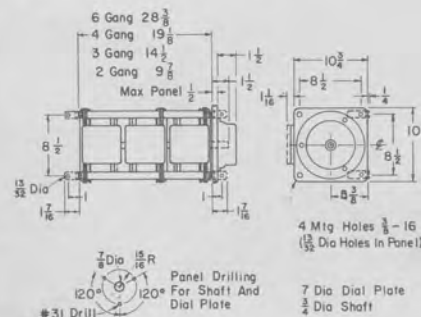

Dimensions Ganged Cased Types W30G2M, W30G3M, W30G4M, W30G6M, W30HG2M, W30HG3M, W30HG4M, and W30HG6M

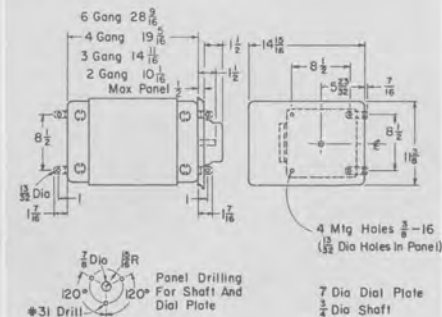

National stock numbers are listed at the back of the catalog.

W50 Variac® Autotransformer

Basic data for single section:

| | W50 | W50H |
|-----------------------------|--------------------|--------------------|
| Input | 120 V, 50 to 60 Hz | 240 V, 50 to 60 Hz |
| Output as % of Input | 0 to 117% | 0 to 117% |
| Rated Current | 50 A | 25 A |
| Maximum Current | 50 A | 32.5 A |
| No-Load Loss at 60 Hz | 50 W | 50 W |
| Number of Turns | 186 | 294 |
| DC Resistance of Winding | 0.08 Ω | 0.3 Ω |
| Drive Torque (ounce-inches) | 150 to 300 | 150 to 300 |
| Replacement Brush | VBT-6 | VBT-7 |

Dimensions Types W50, W50M, W50H and W50HM

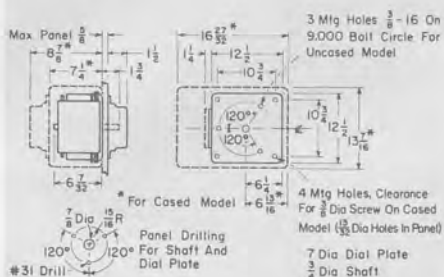

Dimensions Ganged Uncased Types W50G2, W50G3, W50G4, W50G6, W50HG2, W50HG3, W50HG4 and W50HG6

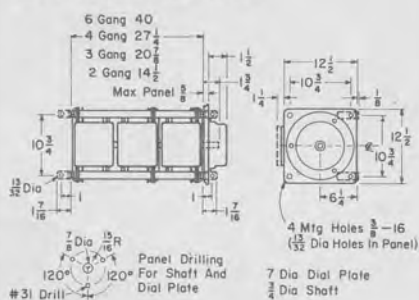

Dimensions Ganged Cased Types W50G2M, W50G3M, W50G4M, W50G6M, W50HG2M, W50HG3M, W50HG4M, and W50HG6M

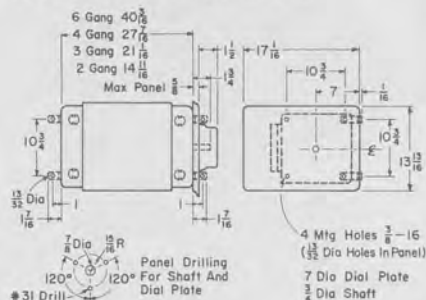

M-Series Variac® Autotransformer

Basic data for single section:

| | M2 | M5 | M10 | M20 |
|-----------------------------|-----------------------|-----------------------|-----------------------|-----------------------|
| Input | 120 V, 350 to 1200 Hz | 120 V, 350 to 1200 Hz | 120 V, 350 to 1200 Hz | 120 V, 350 to 1200 Hz |
| Output as % of Input | 0 to 117% | 0 to 117% | 0 to 117% | 0 to 117% |
| Rated Current | 2.4 A | 6 A | 10 A | 20 A |
| Maximum Current | 3.1 A | 7.8 A | 13 A | 26 A |
| No-Load Loss at 400 Hz | 3.5 W | 9 W | 17 W | 27 W |
| Number of Turns | 403 | 294 | 212 | 169 |
| DC Resistance of Winding | 6.25 Ω | 1.2 Ω | 0.36 Ω | 0.15 Ω |
| Drive Torque (ounce-inches) | 5 to 10 | 10 to 20 | 15 to 30 | 45 to 90 |
| Replacement Brush | VB-1 | VB-2 | VBT-10 | VBT-8 |

Dimensions Type M Variacs

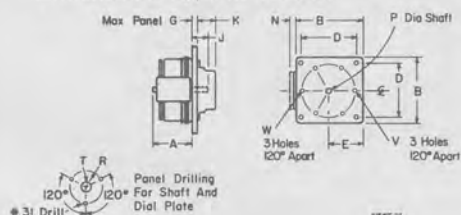

| TYPE | A | B | D | E | G | J | K | N | P | R | T | V | W |
|------|---------|--------|--------|--------|------|----------|---------|-------|------|---------|------|-------|--------|
| M2 | 2 1/16" | 3 1/4" | 2 3/4" | 1 5/8" | 3/8" | 1 1/16" | 1" | 1/16" | 3/8" | 3/8" | 1/2" | 10-32 | — |
| M5 | 2 1/16" | 4 1/2" | 3 3/4" | 2 1/4" | 3/8" | 1 1/16" | 1 1/16" | 1/16" | 3/8" | 3/8" | 1/2" | — | 10-32 |
| M10 | 3 1/16" | 5 3/4" | 4 3/4" | 2 7/8" | 1/2" | 1 11/16" | 1 1/16" | 1/16" | 1/2" | 5/8" | 5/8" | — | 1/4-28 |
| M20 | 3 3/8" | 7 1/2" | 6 1/4" | 3 3/4" | 1/2" | 1 1/2" | 1 3/8" | 1/16" | 1/2" | 1 1/16" | 5/8" | — | 1/4-28 |

Dimensions Type M Ganged Variacs

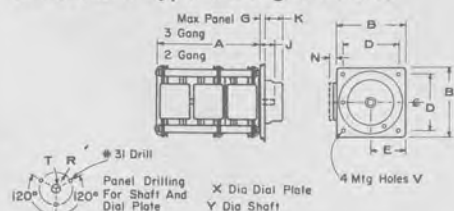

| TYPE | A | B | D | E | G | J | K | N | R | T | V | X | Y |
|-------|---------|--------|--------|--------|------|---------|---------|-------|---------|------|-------|--------|--------|
| M2G2 | 5 1/32" | 3 1/4" | 2 3/4" | 1 5/8" | 3/8" | 1 1/16" | 1" | 1/16" | 3/8" | 1/2" | 10-32 | 3" | 3/8" |
| M2G3 | 8 1/32" | 3 1/4" | 2 3/4" | 1 5/8" | 3/8" | 1 1/16" | 1" | 1/16" | 3/8" | 1/2" | 10-32 | 3" | 3/8" |
| M5G2 | 5 1/32" | 4 1/2" | 3 3/4" | 2 1/4" | 3/8" | 1 1/16" | 1 1/16" | 1/16" | 3/8" | 1/2" | 10-32 | 4" | 3/8" |
| M5G3 | 8 1/32" | 4 1/2" | 3 3/4" | 2 1/4" | 3/8" | 1 1/16" | 1 1/16" | 1/16" | 3/8" | 1/2" | 10-32 | 4" | 3/8" |
| M10G2 | 6 1/16" | 5 3/4" | 4 3/4" | 2 7/8" | 1/2" | 1 1/16" | 1 1/16" | 1/16" | 1/2" | 5/8" | 5/8" | 1/4-28 | 5 1/2" |
| M10G3 | 10 1/4" | 5 3/4" | 4 3/4" | 2 7/8" | 1/2" | 1 1/16" | 1 1/16" | 1/16" | 1/2" | 5/8" | 5/8" | 1/4-28 | 5 1/2" |
| M20G2 | 7 1/16" | 7 1/2" | 6 1/4" | 3 3/4" | 1/2" | 1 1/2" | 1 3/8" | 1/16" | 1 1/16" | 5/8" | 5/8" | 1/4-28 | 7" |
| M20G3 | 10 3/8" | 7 1/2" | 6 1/4" | 3 3/4" | 1/2" | 1 1/2" | 1 3/8" | 1/16" | 1 1/16" | 5/8" | 5/8" | 1/4-28 | 7" |

National stock numbers are listed at the back of the catalog.

Wiring Diagrams

Note: A = line-voltage connection, B = overvoltage connection, C = voltage-doubling connection (terminals 6 and 7 exist on H models only).

Single phase, single unit;

if ground is necessary, it must connect to low load terminal.

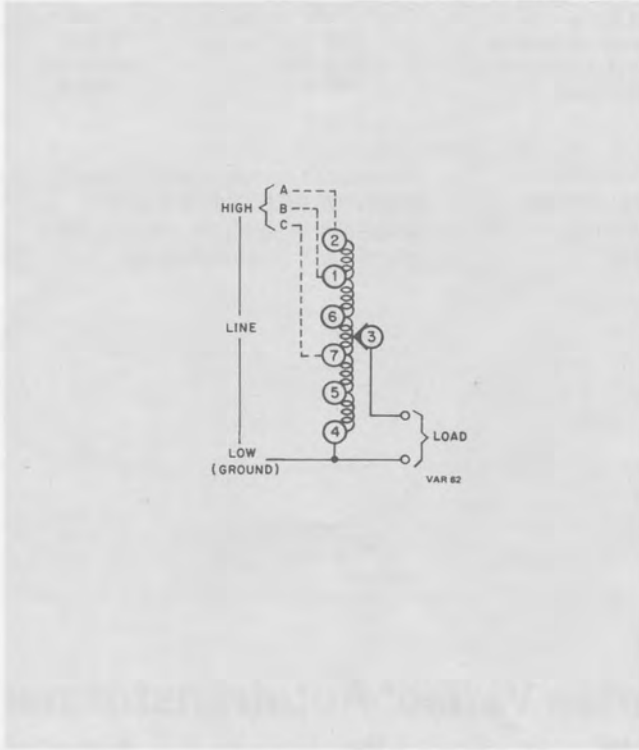

Single phase, two gang; parallel wired.

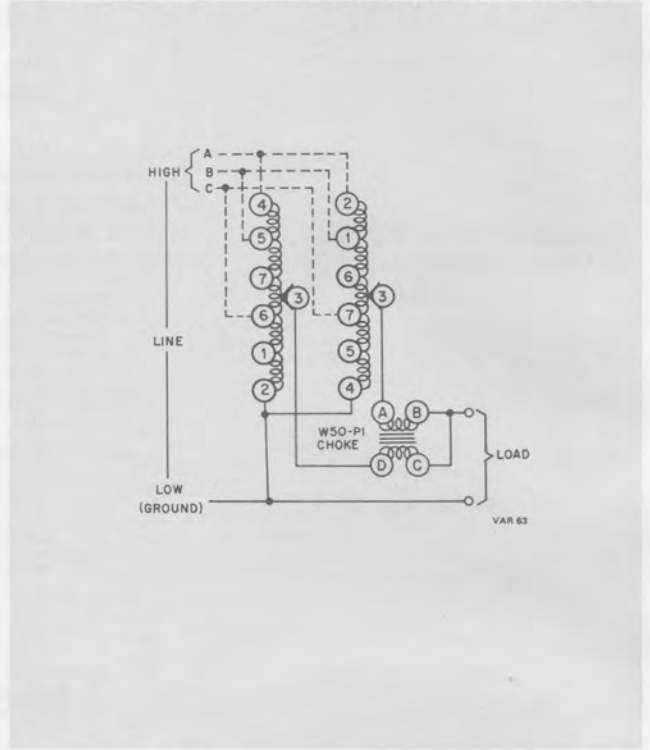

Single phase, two gang; series wired,

load must not be grounded.

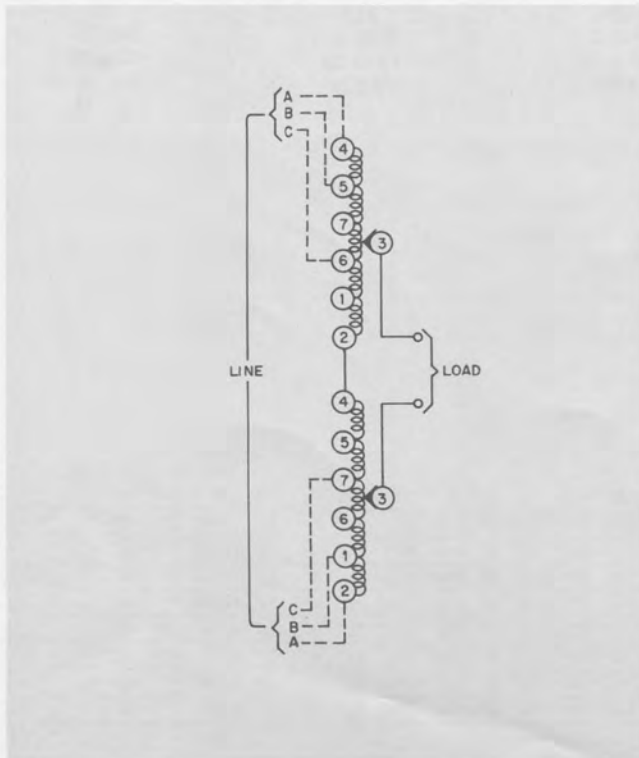

Single phase, four gang; parallel wired.

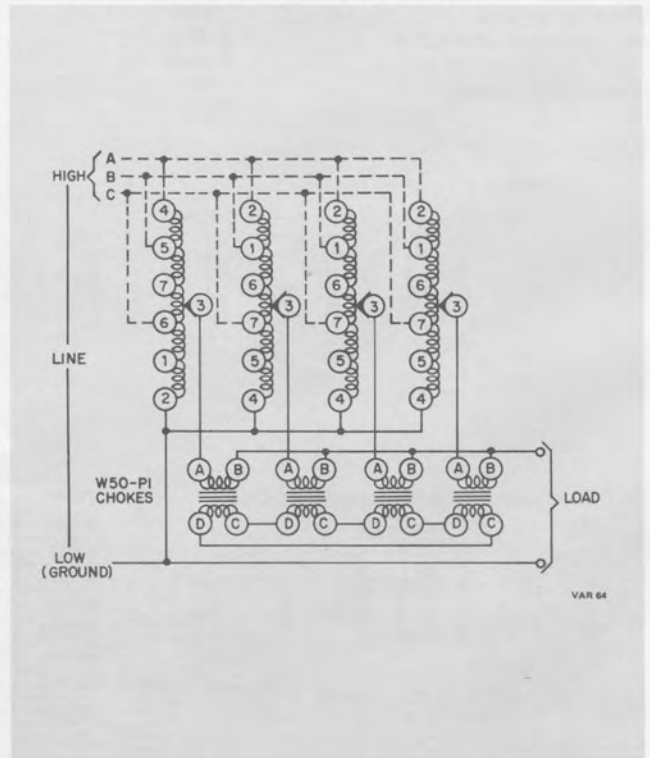

Wiring Diagrams

Note: A = line-voltage connection, B = overvoltage connection, C = voltage-doubling connection (terminals 6 and 7 exist on H models only).

Three phase, three gang; wye.

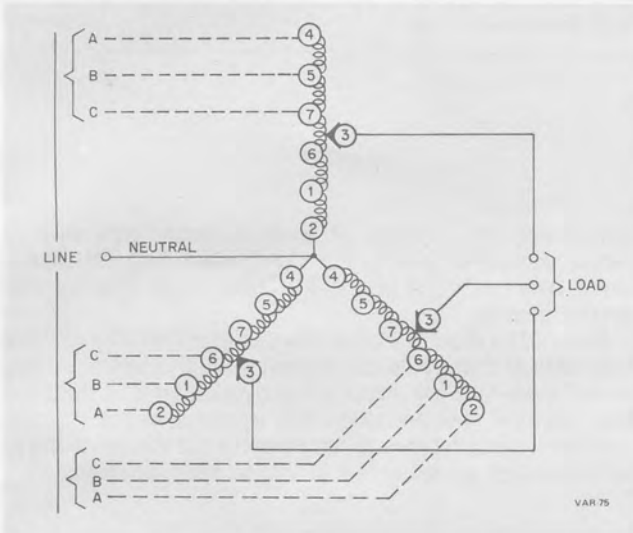

Three phase, two gang; open delta.

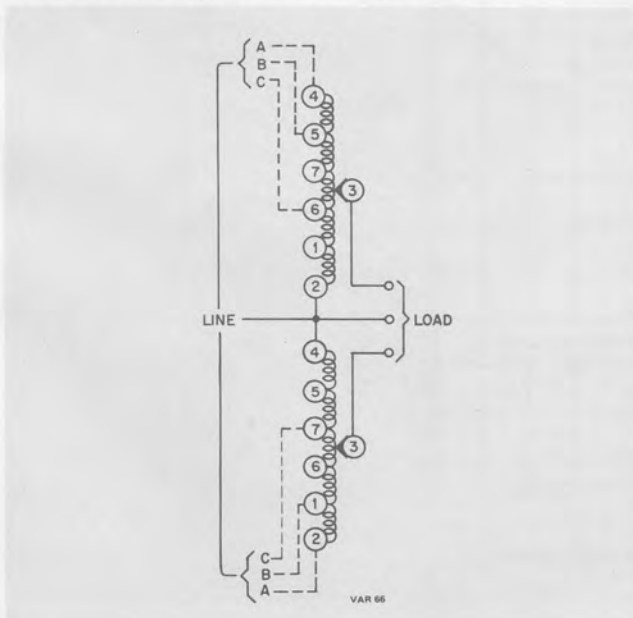

Three phase, six gang; open delta.

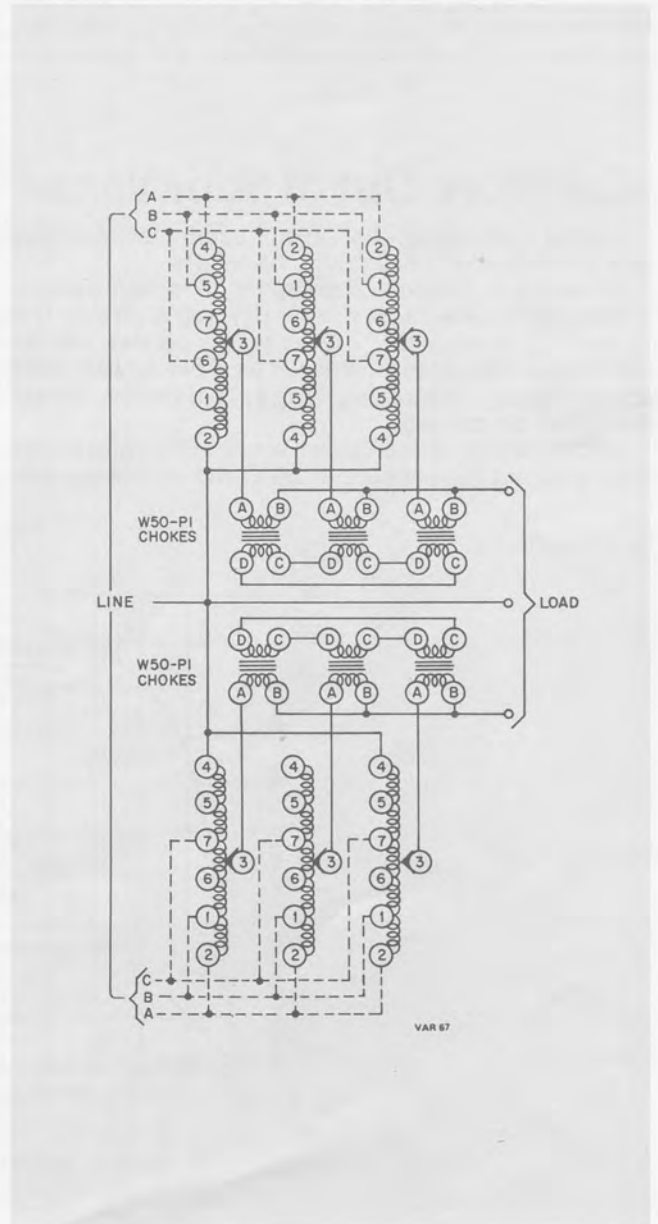

W50-P1 Paralleling Choke



Many of the Variac® autotransformers listed on the preceding pages are indicated to require one or more Type W50-P1 Chokes. This unit is used when two or more autotransformer outputs are to be connected in parallel; it prevents the flow of potentially damaging currents from one unit to the other. Instructions for proper interconnecting are included with each unit.

| Description | Catalog Number |
|--------------|----------------|
| W50-P1 Choke | 3150-5016 |

Replacement Brushes

Occasionally, as a result of accident or excessive wear or current, it may be necessary to replace the autotransformer's carbon brush or brushes. They may be ordered from the table below.

| Description | Catalog Number |
|-----------------------------|----------------|
| VB-1 Brush, for M2, W2, W5H | 3200-5901 |
| VB-2 Brush, for M5, W5, W5L | 3200-5900 |
| VB-3 Brush, for W8, W8L | 3200-5923 |

| Description | Catalog Number |
|-------------------------------|----------------|
| VBT-10 Brush, for M10, W10 | 3200-5910 |
| VBT-11 Brush, for W10H | 3200-5911 |
| VBT-8 Brush Set, for M20, W20 | 3200-5908 |
| VBT-12 Brush Set, for W20H | 3200-5912 |
| VBT-13 Brush Set, for W30 | 3200-5913 |
| VBT-14 Brush Set, for W30H | 3200-5914 |
| VBT-6 Brush Set, for W50 | 3200-5906 |
| VBT-7 Brush Set, for W50H | 3200-5907 |

Get More Out of Your Variac

Careful overloading of a Variac® autotransformer can take advantage of many design trade-offs.

For example, the current ratings of all models assume trouble-free operation 24 hours a day, day after day. If a Variac is to be used only 2 hours or less per day, significantly more than rated current can be drawn for that short period. Figure 1 illustrates how up to 10 times the normal rating can be realized.

Normal ratings of the Variacs are based on operations at an ambient temperature of 50°C and an average life

expectancy of 7 years. If their surroundings will be cooler, or cooled, and/or you don't need long life expectancy, overloading is practical. These trade-offs are discussed below.

Also, if the load is frequently switched on and off, the duty ratio of that cycle can permit enough cooling during the off time to allow intentional overloading. A detailed discussion of this consideration appears below.

Finally, certain types of load permit the Variac rating to be increased, as reflected in Variac specifications.

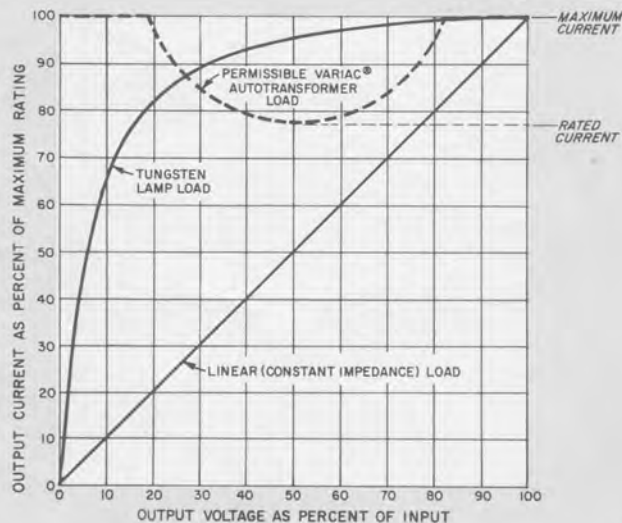

Figure 3. Typical load-current curves.

National stock numbers are listed at the back of the catalog.

Match the Variac to the load To enable the user to get the most out of a Variac autotransformer, GenRad specifies the current rating with two different numbers, rated current and maximum current. Briefly, remember that maximum current can be drawn from the autotransformer only when the output voltage is set near line voltage. Rated current, on the other hand, can be drawn at any setting of the Variac and is the only rating applicable when the overvoltage connection of the Variac is employed.

The two ratings exist because there are two basic categories of load (linear and nonlinear) and because the Variac cannot supply as much current at a mid-range setting as it can near the extremes without overheating. In Figure 3, the sagging dashed line plots the reduction in the current capacity at mid-range. With an output of 50% of line voltage, the greatest current is flowing through the Variac winding causing the greatest heating. The straight black line shows the current that a well-behaved constant-impedance load will draw through the Variac as the voltage is decreased from maximum. Note that, even though maximum current is drawn at maximum voltage, the line stays well below the reduced capacity level at mid-range. Typical of this kind of load is a heating element.

Unfortunately, all loads don't behave so well, incandescent lights in particular. They react to a decreasing voltage much as shown by the curved solid line. The current they draw drops very little even as the voltage is cut to 50% of maximum. If a load of this type is permitted to draw maximum current at maximum voltage, it will obviously exceed the Variac capacity at mid-range, causing overheating and reduced life. A Variac with larger current capacity must be chosen so the load will not exceed its rated current and thus remain within bounds at mid-range.

So, for many loads, the maximum current rating permits greater performance without risk, while for other common loads, the rated current specification is a necessary guard against overheating. To limit the specification to but one number would mean either unnecessary caution or undesirable risk; neither would permit full utilization of the Variac capability.

Effect of duty cycle When the duty-cycle operation is continuous, the rating should be determined as follows: The duty-cycle ratio is defined as the ratio of "off-plus-on" time to "on" time; the rated current can be multiplied by the square root of this ratio to obtain the allowable uprated current. The following examples will illustrate the calculation of permissible overloads for the W5 model, whose rated current is 6 amperes.

Example 1: The load is on for 15 seconds out of every 4 minutes (240 seconds).

$$\text{duty cycle} = \sqrt{\frac{240}{15}} = 4$$

$$\text{duty-cycle uprated current} = 6 \text{ A} \times 4 = 24 \text{ A}$$

From Figure 1, a 15-second overload uprates the current by 500% so that

$$\text{short-term overload current} = 6 \text{ A} \times 5 = 30 \text{ A}$$

Since the lower rating takes precedence, the 24-A limitation imposed by the duty ratio is the maximum current permissible. Note, on the overload curve of Figure 1, the lower curve must be used for models with built-in fuses.

Example 2: The load is on for 6 seconds out of each minute (60 seconds) over a duration of one-half hour.

$$\text{duty cycle} = \sqrt{\frac{60}{6}} = 3.16$$

$$\text{short-term overload for 30 minutes} = 133\%$$

from duty-cycle and 30-minute short-term overload considerations:

$$\text{uprated current} = 6 \text{ A} \times 3.16 \times 1.33 = 24.6 \text{ A}$$

$$\text{short-term overload current} = 6 \text{ A} \times 7.25 = 42.7 \text{ A}$$

Since the lower rating takes precedence, the 24.6-A limitation imposed by the duty-cycle and 30-minute short-term overload is the maximum current permissible.

A trade off—life vs increased rating When the effects of temperature upon rating and upon insulation life are combined, a new life-load-ambient relationship is obtained; Figure 4 illustrates this relationship.

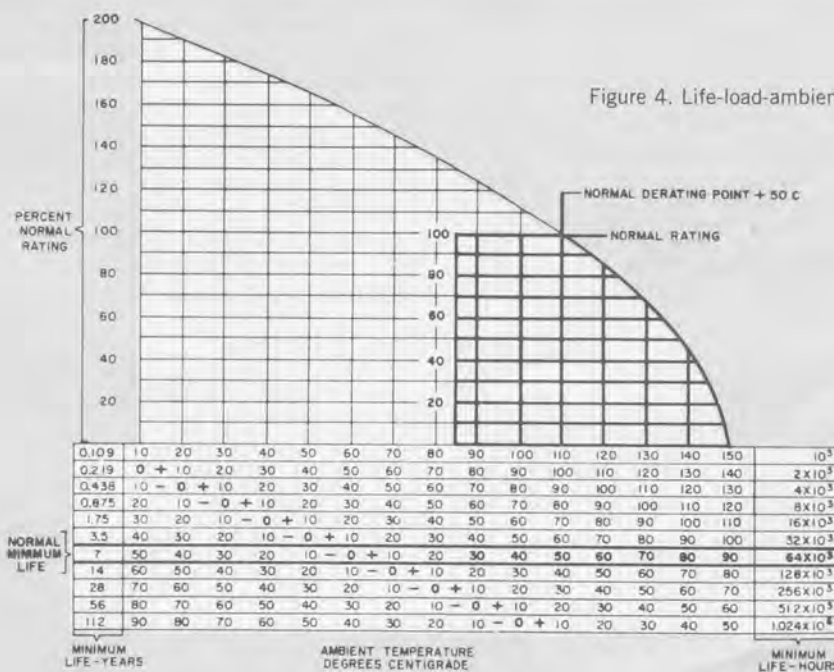

Figure 4. Life-load-ambient curve.

Except for a reference to the effects of duty cycle, all previous rating methods have been based on a steady-state, 24-hours-a-day operation for a calculated minimum seven-year life. However, with these data one can trade minimum life for increased rating or vice-versa. You can do this by following the life-load-ambient curve and uprating or derating as desired. It should be noted that the limit of ten times rated current should *never*, under any circumstance, be exceeded.

As another example, consider the W5 model previously described. In this case, the rating is further modified by a requirement of a 4000-hour minimum life at a 30°C ambient temperature:

| | |
|---|-------|
| Uprating for 30°C ambient, 4000-hour life | 1.65 |
| Duty cycle | × 4 |
| Resultant uprating factor | 6.60 |
| W5 rating | × 6 A |

Allowable current from duty cycle 39.6 A

| | |
|---|-------|
| Uprating for 30°C ambient, 4000-hour life | 1.65 |
| 15-second short-term overload factor | × 5 |
| Resultant uprating | 8.25 |
| W5 rating | × 6 A |

Allowable current from short-term overload 49.5 A

Since 39.6 is the smaller, it is the limiting value; thus the allowable current is 39.6 amperes.

Three-phase load calculations If the three-phase-load unit is marked with rated line-voltage and current or load-power (kVA), you can easily select a Variac.

If, however, the ratings are known only for the individual three elements of the load, you must do some figuring to arrive at the values needed to use the selection tables.

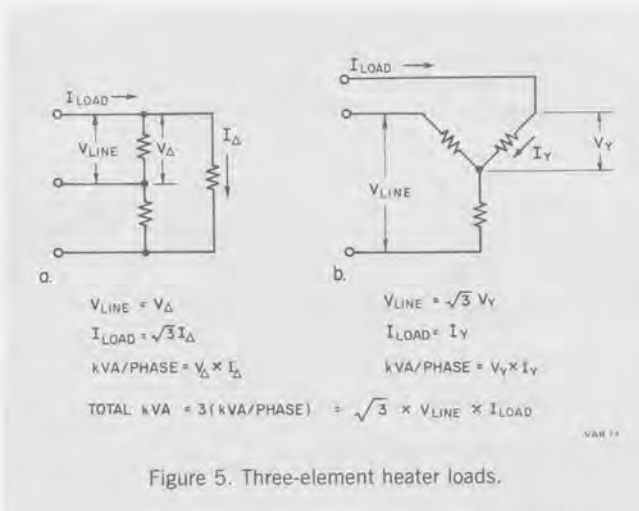

Figure 5. Three-element heater loads.

Consider, for example, three heater elements, each rated at 1.4 kVA and 240 V, which are connected in a delta configuration as in Figure 5a. To deliver full power, they must be connected, through a Variac to provide control, to a 240-V line. The current each Variac must supply, I_{load} , is $\sqrt{3}$ times larger than the current in each element to a delta load:

$$I_{load} = \sqrt{3} \frac{1400\ (VA)}{240\ V} = 10.1\ A$$

In the table of 3-phase, 240-V models, the first model listed with adequate "maximum current" rating is the W20HG2. It has two drawbacks, however: It cannot supply overvoltage output (since that means limiting the output to the "rated current" value), and it is not the most economical selection. The W8G3 Variac is considerably less expensive but cannot supply overvoltage either, for a different reason: It must be wired in a wye configuration in which the maximum voltage allowed, 140 V, will be applied to each unit in the assembly, thus preventing added voltage from being developed for the load. To get over-voltage capability, find, in the table, the next model that is wired in an open delta and has adequate "maximum current" rating: The W30HG2. A quick look at larger open-delta assemblies confirms that this is the least expensive choice.

Now consider three heater elements, each rated at 1.0 kVA and 120 V, which are connected in a wye as in Figure 5b. To deliver full power, each element must have 120 V applied. Since the line voltage across a wye is $\sqrt{3}$ times that across each arm, the needed line voltage is 208 V. Each arm will draw 1000 VA/120 V or 8.3 A from each Variac. From the specifications for 3-phase units, select the W5LG3 as having adequate "maximum current" rating. However, the W5LG3 cannot supply over-voltage. If you want the overvoltage feature, you need a W8G3, based on its rated current.

Note that the configuration, open-delta or wye, of the load and the Variac do not have to match.

Voltage doubling In normal use, a Variac supplies an output of from 0 to line voltage (or slightly higher when the overvoltage connection is used). On the 240-V (H) models, a provision has been made to apply 120 V and get a 0-to-280-V output. This step-up of 2.33 is accomplished by the application of the high side of the line to either terminal 6 or 7 on the input of the Variac.

Because of the step-up action, the current in the "primary" of the autotransformer is approximately twice the output (brush) current rather than equal to the brush current as it is in the normal connection. Therefore the permissible load current is one half the standard rating for the unit. For example, the rated current for a W20H is 4 A for a 240-V input and 0-to-280-V output. But for a 120-V input and 0-to-240-V output, the rated current for the same unit is only 2 A.

Narrow-Range Voltage Adjustment Circuits

The Variac[®] autotransformer is inherently a wide-range device. If the required range of voltage adjustment is narrow, it can most effectively be used with a supplementary transformer (available from any power-transformer manufacturer) having a ratio determined by the ratio of the normal Variac autotransformer range to the required range of adjustment. In this way the whole traverse is used to effect the necessary adjustment, improving resolution and multiplying the available current by the transformation ratio of the supplementary transformer. Such narrow-range operation generally falls into one of two classifications, low voltage or line voltage.

In the *low-voltage* case, either an isolation transformer or a fixed-ratio autotransformer can be used as shown in Figure 6. It is interesting to note that the supplementary transformer in this example allows the use of a unit of about 1/20th the current rating that would be required where the load operated directly from the autotransformer. Furthermore, the resolution or fineness of adjustment is greatly improved by two factors—the control range is spread over the whole traverse and the smaller Variac has more turns per volt.

Line-Voltage Adjustment

Buck OR Boost For many applications a lower-rated model can be used in conjunction with other transformers to provide better resolution at lower or equal cost. The following examples represent a few of the many possibilities.

If the application requires that the voltage should be varied $\pm 30\%$ or less, one of the best solutions is probably to use a buck or boost transformer in conjunction with a Variac, as shown in Figure 7. In such a configuration the load voltage is equal to the line voltage plus or minus the voltage across the fixed-turn-ratio transformer.

For example: What size fixed transformer and Variac are necessary to provide 96 to 120 V from a 120-V line

into a 50-A load? The maximum voltage required across the secondary of the fixed transformer is $120 - 96 = 24$ V. This would occur when it receives the full voltage (120 V) from the Variac. Hence the turns ratio of the fixed transformer is $24/120 = 1/5$. The current in the secondary is the load current (50 A). Therefore the current in the primary is 50 A divided by the turns ratio or 10 A. This would require a Variac rated at 10 A and 120 V, i.e., a W10.

By the reversal of the connections on the primary or secondary of the fixed transformer, the phase of its voltage will be reversed and its output will *boost* rather than *buck* the line voltage so that the voltage across the load will be 120 to 144 V.

Where the regulated line is always high or always low, an autotransformer can also be used as shown in Figures 8 and 9. In the step-down case, the transformation ratio allows a 6-A unit to control a load of $6 \times 13 \times 120 = 9.4$ kVA; in the step-up case, $6 \times 11 \times 120 = 7.9$ kVA.

Buck AND Boost A similar problem is that of being able both to increase or decrease the voltage from the nominal line-voltage input. This can be accomplished by the circuit in Figure 10. The problem in this case is to provide a variable voltage of 110 to 130 V at 50 A from a 120-V supply.

The voltage needs to be varied ± 10 V and we have 0 to 120 V or ± 60 V available. Therefore a 6:1 fixed transformer is required, having a primary rating of 60 V and 8.3 A (50 A/6) and a secondary rating of 10 V and 50 A. The Variac would be a W10 specially ordered with a center tap.

This technique can be extended so that you can obtain a constant voltage output from a varying input. For example, if the input varies from 110 to 130 V and it is desired to maintain an output of 120 V into 50-A load, then the circuit of Figure 11 can be employed.

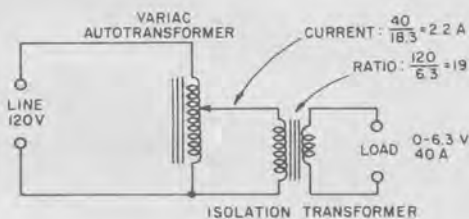

Figure 6. Low-voltage output.

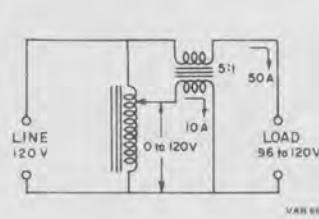

Figure 7. Line-voltage output.

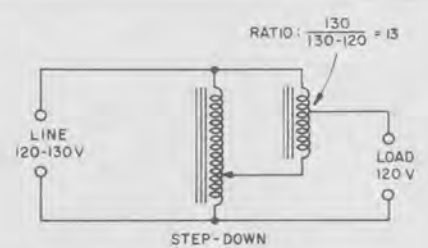

Figure 8. Step-down circuit for high line voltage

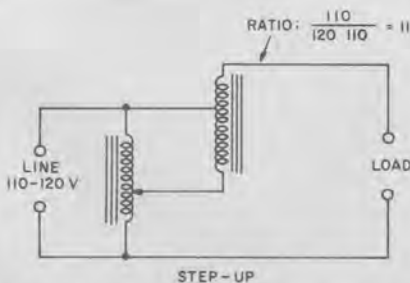

Figure 9. Step-up circuit for low line voltage.

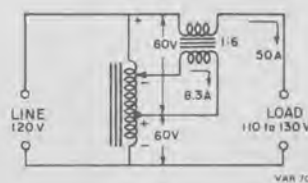

Figure 10. Overtension output.

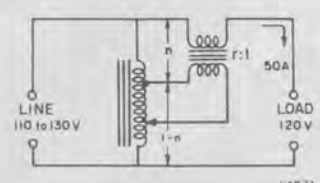

Figure 11. Constant-voltage output.

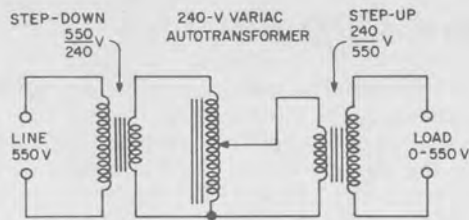

Figure 12. Line-voltage adjustment circuit when line and load voltages are beyond the range of the Variac autotransformer.

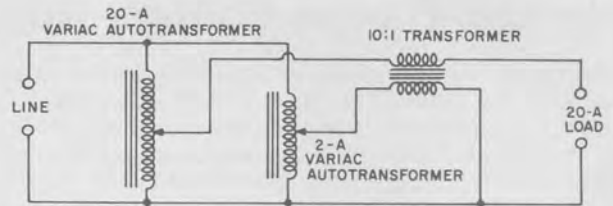

Figure 13. Line-voltage adjustment with a coarse/fine control.

The 110-V input requires an addition of 10 V, and the 130-V input requires a subtraction of 10 V. If we arbitrarily assign the fixed transformer a ratio of r then the output from the Variac will be $10r$ in volts. If the Variac is center tapped, the maximum available voltage would be 55 V for a 110-V input and 65 V for a 130-V input. The Variac can be tapped on special order so that $130n = 110(1-n)$, where n is the location of the tap as a ratio of the total winding. In this example, n is equal to $55/120$ or 0.458 . In the case of 240-V systems, H models have a tap at the 0.429 position ($120\text{ V}/280\text{ V}$), and this tap satisfies most requirements without necessitating a special order. In the example, the voltage available from the Variac would be $0.458 \times 65\text{ V} = 60.8\text{ V}$. Since a 10-V correction is required, the buck-boost transformer ratio should be 6:1, its primary rating would be 61 V at 8.3 A, and its

secondary rating would be 10 V at 50 A. The proper Variac to use would be a W10 with a tap at the 0.458 position.

Where the line and load voltages are vastly dissimilar from the Variac operating voltage, a Variac unit or assembly may be inserted between transformers as shown in Figure 12. The transformers may be either isolation transformers, as shown, or autotransformers. There is, of course, no current gain in this case. In fact, current rating of the Variac autotransformers must be $55/24$ of the load-current requirement.

Two Variac autotransformers can be combined with a supplementary transformer to give a coarse/fine control as shown in Figure 13. The two-ampere model and supplementary transformer make an effective vernier adjustment.

General Parts Counter Scaler

Binding-Posts

Methods of Connection

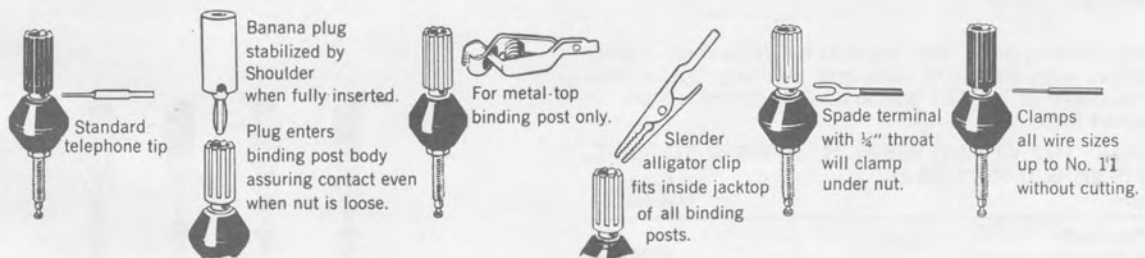

Mechanical Details

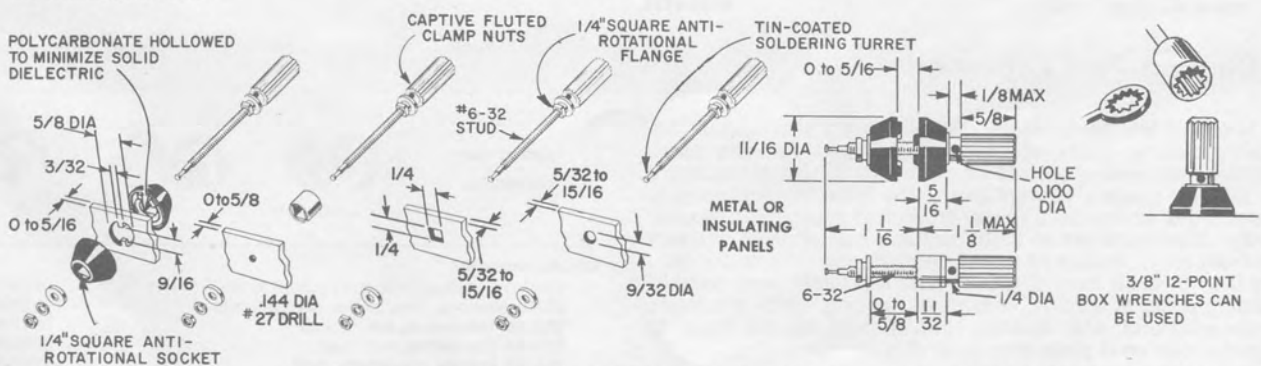

Locking keys in $\frac{5}{16}$ -inch mounting holes can be omitted if only moderate resistance to rotation is needed.

938 Binding Posts

- wide selection
- gold-plated copper for low thermal emf or nickel-plated brass for economy
- four colors in metal and plastic
- excellent electrical characteristics

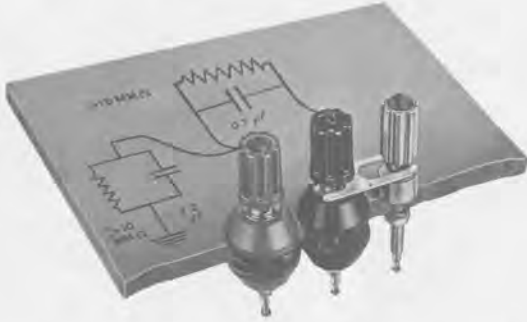

The excellent electrical properties and ingenious mechanical design of the GR 938 Binding Posts provide all the properties needed for modern electronic instruments. Two styles are available: Nickel-plated brass for economy,

and gold-plated copper for high conductivity and low thermal emf with connection to copper wires. Both styles are available with either metal or insulated tops designed for easy hand-tightening, or $\frac{3}{8}$ -in., 12-point wrenches can be used for more permanent connections. The polycarbonate insulation has high insulation resistance and low dissipation factor and is available in red and black, for color coding.

These binding posts can be mounted on metal or non-conducting panels of any thickness up to 0.32 in. (8 mm). There is 0.62-in. clearance between panel insulators when binding posts are mounted at standard spacing, 0.75 in. (19 mm) between centers. Mechanical details and methods of connection are shown in the drawings.

Jack-top The hollow binding post doubles as a banana jack, allowing secure connection even while the nut is loose or clamped onto a wire. The binding post has the same height above a panel as the nonlocking GR874® coaxial connector, the center contact of which will also function as a banana jack. Therefore, a grounded binding post spaced 0.75 in. from a GR874 connector makes a useful combination that will receive either a GR874 connector or a 274-MB double banana plug.

Versatility There is practically universal compatibility among the banana plugs and jacks in the 274-, 777-, and 938-series and adaptors such as 874-MB, -Q2, -Q10, and 900-Q9. Contact resistance, plug to jack, is typically about 1 mΩ.

Binding Posts

Jack-top binding posts, with top nuts for the primary clamping function, with mounting nuts and washers, but without panel insulators or toothed spacers. Gold-plated copper or nickel-plated brass.

Mechanical: NET WEIGHT: 938-A, -H, -K, 0.4 oz (11 g); -C, -D, 0.3g (9 g); -G, 0.55 oz (16 g).

| Description | Catalog Number |
|---------------------------|----------------|
| 938 Binding Posts: | |
| 938-H Black top, copper | 0938-9708 |
| 938-K Red top, copper | 0938-9711 |
| 938-G Metal top, copper | 0938-9707 |
| 938-C Black top, brass | 0938-9733 |
| 938-D Red top, brass | 0938-9734 |
| 938-A Metal top, brass | 0938-9731 |

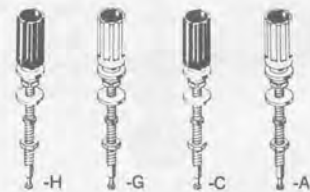

Binding-Post Accessories

Shorting link conveniently makes a direct short circuit between binding posts at standard spacing; remains semi-captive when swung around for open circuit. Panel insulators or toothed spacers convert any of the plain binding posts to insulated or uninsulated (panel-grounded) assemblies, respectively. Use insulators on both front and rear of panel, spacers on front only. Insulators have interdigitating bosses, for panels 0 to 0.32 (8 mm) thick. Double insulators hold pairs of binding posts at 0.75-in. (standard) spacing. Both insulators (polycarbonate) and spacers (brass) have square holes to prevent rotation of posts after assembly.

Mechanical: NET WEIGHT: 0.1 oz (3 g) each, except 938-BB and -BR, 0.1 oz per pair.



| 938 Accessories: | |
|--|-----------|
| 938-LG Shorting link, gold-plated brass | 0938-9503 |
| 938-L Shorting link, nickel-plated brass | 0938-9712 |
| 938-BB Insulators, black, pair | 0938-9818 |
| 938-BR Insulators, red, pair | 0938-9822 |
| 938-YB Double insulators, pair | 0938-9873 |
| 938-FG Spacer, (toothed) gold-plated | 0938-9830 |
| 938-F Spacer, (toothed) nickel-plated | 0938-9706 |

National stock numbers are listed at the back of the catalog.

Banana Plugs and Jacks

Insulated Double Plug

Versatile Stackable, with jack top. Accommodates wires, cables, component leads, etc from either one side or top (up to 0.2-in. dia through formed strain relief). Metal parts float — although captive — for self alignment of mating plugs and jacks, at standard 0.75-in. spacing. Polarity indicator designates plug usually used for inner conductor, "high" side, or + polarity of the pair. Fully compatible with GR banana plugs and jacks, except 274-NK Shielded Double Plug.

Reliable Safety enhanced by enclosure of all metal parts but the banana pins themselves; even tips of wires are insulated. Rugged socket-head setscrews provide secure fastening for wires (without tendency to split like slotted screws). Low-loss molded styrene body.

Convertible Each banana pin is easily removable for conversion from side wiring to top wiring. Wire can be inserted and clamped with pin in place or removed, as you prefer. Use 0.078-in. hex wrench. Wire diameter up to 0.12 in. (3 mm or AWG 9) is accommodated.

Peak Ratings: Up to 4 kV and 15 A. **BREAKDOWN:** 10 kV pk.
Dissipation Factor, at 1 kHz: < 0.0005.
Net Weight: 0.4 oz (11 g).

Description

Catalog Number

274-MB Insulated Double Plug

0274-9875

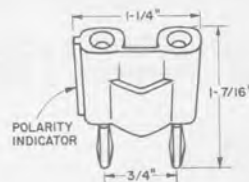

Shielded Double Plug

Double plug in an aluminum case for completely shielded connections to 938 Binding Posts. Accepts cables up to 0.2 in. diameter. Stepped case permits a 938-L(G) Shorting Link to be used between low-terminal binding post and a ground binding post without interfering with proper shielding. High terminal of double plug remains fully shielded. The 274-NK can be locked to binding posts; turning a screw expands one pin inside body of the binding post. This plug terminates the Type 274-NL, 776-A, and 874-R34 Patch Cords.

Peak Ratings: Up to 4 kV and 20 A. **BREAKDOWN:** 10 kV pk.
Dissipation Factor, at 1 kHz: < 0.0005.
Net Weight: 3 oz (85 g).

274-NK Shielded Double Plug

0274-9877

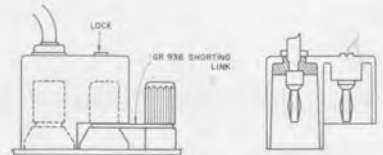

Single Plugs

Nickel-plated brass center pin with 4-leaf beryllium copper spring seats firmly in 274- and 938- series jacks for reliable contact, typically ≈ 1 m Ω . All except 274-P have jack top. Insulated version is like half of double plug (274-MB); pin is removable; strain relief along side accepts wires up to 0.156-in. (4-mm) dia.

Current Rating: 15 A.

Net Weight: 274-P, -DB, 0.2 oz (5.5 g); -U, 0.3 oz (8.5 g).

274-Single Plugs

274-DB1 Insulated, black
274-DB2 Insulated, red
274-U Jack top
274-P Solid stud top

0274-9454

0274-9455

0274-9721

0274-9716



-DB1

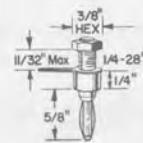

-U

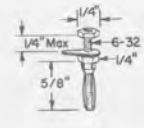

-P

Jacks

Nickel-plated brass, for panel mounting. Two lengths, the longer is available as an assembly with insulators (938-BB, -BR) or can be used with separate toothed spacers (938-F, -FG). Mounting hardware supplied.

Current Rating: 15 A.

Net Weight: Assembly, 0.4 oz (11 g); long version 0.3 oz (8.5 g); short, 0.15 oz (4.2 g).

Jacks

938-XB Insulated assembly black
938-XR Insulated assembly, red

0938-9877

0938-9878

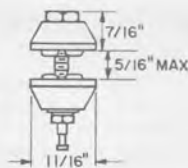

-XB



938-J



274-J

Adaptors

Refer also to the 874-MB and 874-Q series of adaptors.

GR874® Connector and Binding Posts

Connects to GR874 coaxial port from double (or 2 single) 274-series banana plug or patch cord. Has versatility of 938-series binding posts.

Net Weight: 2 oz (57 g).

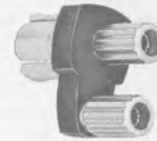

Fits Type
274 Double-
Plug Patch Cords

Description

874-Q2 Adaptor

Catalog
Number

0874-9870

GR874® Connector and Banana Plugs

Connects to a standard-spaced pair of jack-top binding posts (938) from GR874® coaxial connector, with good shielding. Similar to 274-NK plug; can be locked to one post for semi-permanent installation, by a turn of a screw.

Net Weight: 2 oz (57 g).



777-Q3 Adaptor

0777-9703

BNC Jack and Banana Plugs

Connects BNC cable (plug) to standard pair of jack-top binding posts, with good shielding. Adaptor will lock to one post for semi-permanent installation, by a turn of a screw.

Net Weight: 3 oz (85 g).

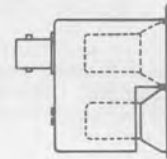

Fits standard
¼-in.-spaced
binding posts

274-QBJ Adaptor

0274-9884

BNC Jack and Phone Plug

Connects BNC cable (plug) to phone jack.

Net Weight: 2 oz (57 g).



777-Q4 Adaptor

0777-9704

Patch Cords and Power Cords

(Refer also to the 874-R series of coaxial patch cords; they have superior SWR and other characteristics of value at high frequencies.)

Shielded Banana Plugs with Cable and BNC Plug

50-Ω cable connects between jack-top binding-post pair and BNC jack, with good shielding. Can be locked in place. (Refer to description of 274-NK Shielded Double Plug.)

Mechanical: LENGTH: 3 ft (920 mm). PLUG SPACING: 0.75 in., standard (19 mm). NET WEIGHT: 3 oz (85 g).



776-A Patch Cord

0776-9701

BNC Plug with Cable and GR874® Connector

50-Ω shielded cable connects between BNC jack and GR874 coaxial connector. The GR874 end has the space-saving hammerhead shape (axis perpendicular to cable), so convenient when your cable runs parallel to the instrument panel.

Mechanical: LENGTH: 3 ft. (920 mm). NET WEIGHT: 3 oz (85 g).



776-B Patch Cord

0776-9702

National stock numbers are listed at the back of the catalog.

240 PARTS

BNC Plugs with Cable

50- Ω shielded cable connects between BNC jacks (popular panel-mounted connectors).

Mechanical: LENGTH: 3 ft (920 mm). NET WEIGHT: 2 oz (57 g).

Description

776-C Patch Cord

Catalog Number

0776-9703



Shielded Double Banana Plugs with Cable

Fully shielded cable and connectors plug conveniently into pairs of 938 binding posts at standard spacing. Can be locked in place. (Refer to description of 274-NK Shielded Double Plug.)

Mechanical: LENGTH: 3 ft (920 mm). NET WEIGHT: 6 oz (170 g).

274-NL Shielded Double-Plug Patch Cord

0274-9883



Banana Plugs with Cable

Shielded wire with double plugs is ideal for jack-top binding posts at standard spacing; single-conductor with single plugs fits any banana jack — 938- and 274-series, 874-Q2, -MB, etc. Right-angle (hammerhead), in-line, and single versions are stackable in any sequence. Plugs fit firmly in jacks for mechanical stability (not dependent on springs); contact resistance, about 1 m Ω . Double plugs have polarity indicator, corresponding to inner conductor of cable. Plug bodies are molded cellulose-acetate-butyrate for outstanding durability; the individual pins of the double plugs are, in addition, first encapsulated in polystyrene for superior insulation. Single versions, wire size: 18 AWG.

Mechanical: LENGTH: 3 ft (920 mm). NET WEIGHT: Double, 3 oz (85 g); single, 1.5 oz (43 g).

Description

Catalog Number

Banana-Plug Patch Cords

274-NQ Double, in-line
274-NP Double, right-angle
274-LLB Single, black
274-LLR Single, red

0274-9860

0274-9880

0274-9468

0274-9492



Double



Single



In-line



Right-angle



Stackable



Power Cords

Well insulated power cable has connector bodies molded integrally with jacket. Will connect from standard power-line outlet to instrument or other electrical device. Similar cables can be stacked with their hammerheads engaged (to accommodate several loads); 2 or more CAP-22 or CAP-35 cords can be connected in series to reach 14 ft or more. Both 2- and 3-wire versions. Socket at load end of 2-wire version fits either 2-pin plug or 2 flat pins of CAP-22.

3-wire versions At power-source end, these cords have 1 round and 2 flat pins, as well as the corresponding socket. This connector is designed for 125-V operation, conforming to the standard for "Grounding Type Attachment Plug Caps and Receptacles," ANSI C73.11-1963. Cord is type SVT, rated by Underwriters Laboratories for 300 V, 7 A rms. At the load end, CAP-22 has a similar socket, permitting series connection.

International At the load end of the IEC version, however, the socket fits 3 flat pins, conforming to the International Electrotechnical Commission's Publication 320. The design has been adopted world-wide for electronic instrumentation and is rated for 250 V, 6 A. Other advantages are convenience and safety (the instrument plug is recessed or shrouded).

For special requirements, you can cut off the hammerhead connector and replace it with your own.

Ratings: 125 V, 7 A. WIRE SIZE: No. 18 AWG.

Mechanical: LENGTH: 7 ft (2.13 m). NET WEIGHT: 7 oz (0.2 kg).



4200-9625



CAP-22

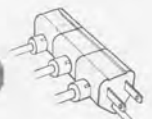

Stackable



2-wire



Stackable

IEC Power Cord, 3-wire
CAP-22 Power Cord, 3-wire
CAP-35 Power Cord, 2-wire

4200-9625

4200-9622

4200-9635



1192-B Counter

- dc to 50 MHz; 500 MHz with scaler
- 10-mV sensitivity
- stable time base
- low cost
- optional 5, 6, or 7 digits and data output
- FCC type — approved for a-m, fm, vhf, and tv monitoring

A winner Thanks to efficient IC design and automated testing, the 1192-B costs substantially less than larger instruments but still provides all their versatility; you receive all five basic measurement capabilities:

- frequency to 50 MHz
- period to a resolution of $0.1 \mu\text{s}$
- time interval to a resolution of $0.1 \mu\text{s}$
- frequency ratio averaged to 10^5
- count up to 50 million events per second

With all features retained The 1192-B is equipped with an internal crystal time base of exceptionally good stability. Its input sensitivity is 10 times that of similar units,

and the input circuits provide operator control of trigger level, coupling, and attenuation for greater immunity to input noise and greater adaptability to unusual signals.

The clear, bright readout includes the units of measurement, an automatically positioned decimal point, and indicators for signal-counting and spill. The measurement modes are controlled by simple unambiguous pushbuttons and gate times are set by a single control. Internal storage permits the readout to display only the final result but can be disabled to permit you to see the actual counting process.

A second input channel permits the measurement of normalized frequencies by the insertion of an external time base of arbitrary frequency. Time interval and count

National stock numbers are listed at the back of the catalog.

242 COUNTER



1192-Z 500-MHz Counter.

measurements can be externally controlled by a variety of signals and, with auxiliary connections, time-interval range can be extended, the time-base can be phase-locked to an external standard frequency and internal standard frequencies can be brought out.

SPECIFICATIONS

Frequency Measurements: DC to 50 MHz; 100- μ s to 10-s counting gate times; displays Hz, kHz, MHz units with positioned decimal point. **ACCURACY:** ± 1 count \pm time-base accuracy.

Period Measurements: 0.1- μ s resolution; single and multiple period of 10^3 ; displays ms, μ s, ns units with positioned decimal point; counts 10-MHz time base, 1 MHz, and 100 kHz. **ACCURACY:** Depends on signal-to-noise ratio of input signal, input noise, and ± 1 -count error \div number of periods counted (see note).

Frequency Ratio Measurements: 1 to 10^5 . Frequency A, dc to 50 MHz, is measured over 1 to 10^5 periods of frequency B, 50 Hz to 10 MHz. **ACCURACY:** ± 1 count of A \pm trigger error of B \div number of ratios counted (see note).

Time Interval and Duration Measurements: **TIME INTERVAL:** 0.1-, 1-, or 10- μ s resolution measured by counting 10-, 1-, or 0.1-MHz signal from internal clock; displays ms with positioned decimal point. Interval measured is between separate commands applied to START and STOP BNC connectors on rear. **PULSE LENGTH:** Measures duration of pulse applied to START connector with STOP connector grounded. Storage is disabled in this mode. Counter will also total many time intervals. **ACCURACY:** ± 1 count \pm time-base accuracy.

Count Measurements: Register capacity, 10^5 , 10^6 , 10^7 depending on version. Events at up to 50-MHz rate accumulated between start/stop commands from manual panel button or by separate start and stop commands applied to rear BNC connectors, or only during start command with stop connector grounded. Counter will also totalize all events during many openings of the gate.

NOTE: Trigger error in time measurements: $\pm 0.3\%$ of one period \div number of periods averaged, for a 40-dB input signal-to-noise ratio. This assumes no noise internal to the counter. For input signals of extremely high signal-to-noise ratio, the trigger error in μ s will be $< 0.0003 \div$ signal slope in V/ μ s.

| | A Input | B Input |
|-----------------------|---|---|
| Frequency | dc to 50 MHz (3 Hz to 50 MHz ac coupled) | 50 Hz to 10 MHz |
| Sensitivity | 10 mV rms to 20 MHz 20 mV rms to 35 MHz 30 mV rms to 50 MHz | 1 V rms, 50 to 400 Hz 100 mV rms to 10 MHz |
| Trigger level | adjustable $\pm 0.1, 1, 10,$ or 100 V depending on attenuator setting | fixed |
| slope | negative-going | negative-going |
| Attenuator | $\times 1, \times 10, \times 100, \times 1000$ (0, 20, 40, 60 dB) | none |
| Maximum signal | 400 V pk ac or dc, ex- cept 300 V when dc coupled at 1:1 atten. | 400 V dc, 80 V rms |
| Impedance | 1 M Ω //27 pF (10 M Ω //7 pF with probe) | 10 k Ω //20 pF |

Start/Stop Inputs: Closure to ground at 6-mA max sink, or pulse with logic 0 of $< +0.3$ -V and logic 1 of $> +2$ -V levels, or 1 W max into 50 Ω for pulses of max -7 to $+12$ V dc, or ± 70 V for short 1% duty ratio.

Data Presentation: DISPLAY: 5, 6, or 7 digits; long-life, high-intensity neon readout tubes with automatically positioned decimal point and measurement dimension; Spill lamp lights if register capacity exceeded; Count lamp lights when meas-

Plus tailored performance Options permit a broad selection of the right model for your application: If 5-digit precision isn't adequate, choose 6 or 7. If data output is required for system use and automatic data reduction, order option 2. If it is to be mounted with other instruments, select a rack model. If pink panels and chartreuse knobs are called for, you may be out of luck but, if measurements to 500 MHz are necessary, use the 1192-Z.

Up to 500 MHz In combination with the 1157-B Scaler, the 1192-B frequency range is extended to 500 MHz. Both units, mounted side by side, are completely assembled as the 1192-Z Counter. They can be supplied as either bench or rack models with all the selection of digits and options available in the 1192-B alone.

urement is in progress. **MEASUREMENT RATE:** Time between measurements adjustable from 10 ms to > 10 s and ∞ . **STORAGE:** Display and Spill lamp can be either stored or not, as controlled by rear pushbutton.

Data-Output Option 2: Fully buffered 8-4-2-1 BCD signals at standard DTL levels (logic 0 $\leq +0.5$ V, logic 1 = $+3.5$ to $+5$ V behind 6 k Ω) available at rear 50-pin type 57 connector.

Time Base: **FREQUENCY:** 10 MHz. **STABILITY:** $< \pm 1.5 \times 10^{-6}$ /month. Room-temperature crystal coefficient, $< \pm 3 \times 10^{-7}/^\circ\text{C}$ from 0 to 55°C . Total deviation from frequency at room temperature, $< \pm 5 \times 10^{-6}$ from 0 to 55°C . With 10% line-voltage variation, $< \pm 2 \times 10^{-6}$. **MANUAL ADJUSTMENT RANGE:** $\pm 1 \times 10^{-5}$ with internal control. **INTERNAL PHASE LOCK:** Time-base oscillator can be locked to external standard frequencies at 1 MHz and 100 kHz of ≥ 100 mV rms into 10 k Ω . Lock range $> \pm 1 \times 10^{-5}$. **OUTPUT:** 100 kHz, and 1 MHz.

Environment: **TEMPERATURE:** 0 to $+55^\circ\text{C}$ operating, -40 to $+75^\circ\text{C}$ non-operating. **HUMIDITY:** 95% RH and $+40^\circ\text{C}$. **VIBRATION:** 0.03 in. from 10 to 55 Hz. **BENCH HANDLING:** 4 in. or 45° (MIL STD-810A-VI). **SHOCK:** 30 G, 11 ms.

Available: 1157-B Scaler to extend frequency range to 500 MHz, data printer, digital-to-analog converter, GR digital acquisition equipment, 1158-9600 10:1 low-capacitance probe.

Power: 100 to 125 and 200 to 250 V, 50-400 Hz, 22 W max. **Mechanical:** Convertible-bench cabinet. **DIMENSIONS (wxhxd):** Bench, 8.5x3.88x12.6 in. (216x99x320 mm); rack, 19x3.5x12.6 in. (483x89x320 mm). **WEIGHT:** Bench, 8.4 lb (3.9 kg) net, 10.6 lb (4.9 kg) shipping; rack, 11 lb (5 kg) net, 15 lb (7 kg) shipping.

1192-Z SPECIFICATIONS

Same as 1192 except:

Frequency: DC to 500 MHz.

Input to 1157-B Scaler above 50 MHz: **SENSITIVITY:** 100 mV rms, 300 mV pk-pk. **MAXIMUM SIGNAL:** 7 V rms (1 W). **IMPEDANCE:** 50 Ω , ac coupled.

Power: 100 to 125 and 200 to 250 V, 50-400 Hz, 36 W max.

Mechanical: Bench or rack models. **DIMENSIONS (wxhxd):** Bench, 17x3.88x14 in. (432x98x356 mm); rack, 19x3.5x12.75 in. (483x89x324 mm). **WEIGHT:** Bench, 15 lb (7 kg) net, 20 lb (9 kg) shipping; rack, 16 lb (8 kg) net, 21 lb (10 kg) shipping.

| Description | Catalog Number |
|--|--|
| 1192-B Counter (50 MHz) Bench Model* Rack Model* | |
| 1192-Z Counter , with scaler (500 MHz) Bench Model* Rack Model* | (Describe exactly as shown at the left.) |
| Select one of the following options | |
| 5-Digit Readout | |
| 6-Digit Readout | |
| 7-Digit Readout | |
| Select the following option, if desired | |
| OP2 Data Output, BCD | |
| Accessory available with counter | |
| Probe (10:1, low capacitance); not sold separately; same as Tektronix P6006, 010-0127-00 | 1158-9600 |

*Your order must specify 5, 6, or 7 digits.

Patent Number: 3,328,564.



1157-B Scaler (500 MHz)

- inputs up to 500 MHz
- 100-mV rms input sensitivity
- 1-V output behind 50 Ω

The 1157-B Scaler will divide input frequencies up to 500 MHz by 10:1 or 100:1. Used as a prescaler, it will extend the upper frequency limit of counters to as much as 500 MHz. It can be mounted side-by-side with the 1191 or 1192 Counter to extend its range to 500 MHz with 10:1 or 100:1 prescaling.

The 1157-B Scaler is a two-decade digital frequency divider complete with input-level meter, attenuator, and internal power supply. One output can be switched for either 1/10 or 1/100 of the input frequency; a sync output supplies 1/100 of the input continuously. The input and output connectors can be moved to the rear for systems applications.



A perfect companion to the 1192 Counter, the 1157-B extends the counter's range to 500 MHz. Equally useful with the 1191-B Counter.

SPECIFICATIONS

Input Frequency: 1 to 500 MHz.

Input Level: MINIMUM: 0.3 V pk-pk (0.1 V rms) on most sensitive setting of attenuator. MAXIMUM: 7 V rms (1 W).

Input Impedance: AC-coupled, 50 Ω .

Attenuator (Sensitivity control): Panel switch of x1, x2, x5 or x10 attenuation.

Meter: Green sector indicates adequate signal levels for easy adjustment of sensitivity control.

Main Output: DC-coupled positive pulse, > 1 V behind 50 Ω . REPETITION RATE: Input frequency divided by 10 or 100 depending on setting of panel switch. DUTY RATIO: 60% for 1/10 output, 40% for 1/100 output.

Sync Output: Positive pulse, > 1 V behind 50 Ω . Repetition rate is input frequency divided by 100. Duty ratio, 60%.

Connectors: Can be moved to rear panel. INPUT: GR874® locking connector. OUTPUT: BNC.

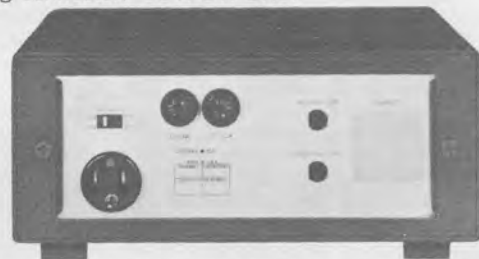

The input and output connectors can be moved to the rear for systems applications.

Supplied: Power cord, patch cord to 1192 Counter.

Power: 100 to 125 or 200 to 250 V, 14 W.

Mechanical: Convertible bench cabinet. DIMENSIONS (wxhxd): Bench, 8.5x3.5x12.6 in. (216x89x309 mm); rack, 19x3.88x12.6 in. (483x98x320 mm). WEIGHT: Bench, 7 lb (3.2 kg) net, 10 lb (4.6 kg) shipping; rack, 10 lb (4.6 kg) net, 13 lb (6 kg) shipping.

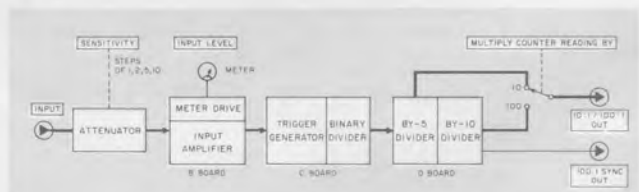

Two frequency-divider circuits allow an output that is one-tenth the input frequency or one-hundredth of it.

| Description | Catalog Number |
|--------------------------------|----------------|
| 1157-B Scaler (500 MHz) | |
| Bench Model | 1157-9700 |
| Rack Model | 1157-9701 |

Appendix

Abbreviations, Symbols and Prefixes

In this catalog, as in other GenRad publications, our use of symbols, prefixes, and abbreviations follows the recommendations of the International Electrotechnical Commission, the American National Standards Institute,

Inc., the Institute of Electrical and Electronics Engineers, and other scientific and engineering organizations. Where there is not agreement among these groups, we generally choose the usage favored by the majority.

ABBREVIATIONS AND SYMBOLS

| | | | |
|--------------------|---|--------------------|---|
| a | atto (10^{-18}) | h_o | open-circuit output admittance |
| A | ampere | h_r | reverse voltage-transfer ratio |
| Å | angstrom | Hz | hertz (cycle per second) |
| ac | alternating current | HTL | hearing threshold level |
| afc | automatic frequency control | I | current |
| a-m | amplitude modulation | IC | integrated circuit |
| ANSI | American National Standards Institute, Inc. | ID | inside diameter |
| APS | American Physical Society | IEC | International Electro-technical Commission |
| ASA | Acoustical Society of America | IEEE | Institute of Electrical and Electronics Engineers |
| ASTM | American Society for Testing and Materials | i-f | intermediate frequency |
| avc | automatic volume control | in. | inch |
| avg | average | ISA | Instrument Society of America |
| B | susceptance | ISO | International Standards Organization |
| bar | bar (10^5N/m^2) | j | $\sqrt{-1}$ |
| BCD | binary-coded decimal | J | joule |
| c | speed of light, centi (10^{-2}) | k | kilo (10^3) |
| C | capacitance, coulomb | $^{\circ}\text{K}$ | degrees Kelvin |
| $^{\circ}\text{C}$ | degrees Celsius (Centigrade) | l | liter (10^{-3}m^3) |
| cd | candela | L | inductance |
| CIF | cost, insurance, freight | lb | pound |
| CML | current-mode logic | LC | inductance-capacitance |
| COD | cash on delivery | lm | lumen |
| cw | continuous wave | log | logarithm |
| d | deci (10^{-1}) | lx | lux |
| D | dissipation factor | m | meter, milli (10^{-3}) |
| da | deka (10) | M | mega (10^6) |
| dB | decibel | max | maximum |
| dBm | decibel referred to one milliwatt | mbar | millibar |
| dc | direct current | mil | 0.001 inch |
| DCTL | direct-coupled transistor logic | min | minimum, minute |
| dia | diameter | mo | month |
| DTL | diode-transistor logic | n | nano (10^{-9}) |
| DUT | device under test | N | newton |
| e | electronic charge | oz | ounce |
| E | voltage | p | page, parallel (as L_p), pico (10^{-12}) |
| EIA | Electronic Industries Association | P | poise ($10^{-5} \text{N} \cdot \text{s/m}^2$) |
| emf | electromotive force | PF | power factor |
| F | farad, Faraday | ppm | parts per million |
| $^{\circ}\text{F}$ | degrees Fahrenheit | pps | pulses per second |
| f | frequency, femto (10^{-15}) | pk-pk | peak-to-peak |
| fm | frequency modulation | PRF | pulse repetition frequency |
| FOB | free on board | Q | quality factor (storage factor) |
| G | conductance, giga (10^9) | R | resistance |
| g | gram, gravitational constant | ® | registered trademark |
| g_m | transconductance | rad | radian |
| H | henry | RC | resistance-capacitance |
| h | hour, Planck's constant, hecto (10^2) | RCTL | resistor-capacitor-transistor logic |
| hf | high frequency | re | referred to |
| h_f | forward current-transfer ratio | rf | radio frequency |
| h_i | short-circuit input impedance | RH | relative humidity |
| | | rms | root-mean-square |

| | |
|-----------|---|
| rpm | revolutions per minute |
| RTL | resistor-transistor logic |
| s | second, series (as L _s) |
| S | siemens |
| shf | super-high frequency |
| sq | square |
| sync | synchronous, synchronizing |
| T | period, Tesla, tera (10^{12}) |
| t | time |
| TTL | transistor-transistor logic |
| TSA | times series analysis |
| uhf | ultra-high frequency |
| v | velocity |
| V | volt |
| VA | volt ampere |
| vhf | very-high frequency |
| vlf | very-low frequency |
| W | watt |
| Wb | Weber |
| wt | weight |
| X | reactance |
| Y | admittance |
| yr | year |
| Z | impedance |
| α | short-circuit forward current-transfer ratio (common base) |
| β | short-circuit forward current-transfer ratio (common emitter) |
| Γ | reflection coefficient |
| Δ | increment |
| δ | loss angle |
| θ | phase angle |
| λ | wavelength |
| μ | micro (10^{-6}) |
| Ω | ohm |
| \bar{u} | mho |
| ω | angular velocity ($2\pi f$) |

PREFIXES

Orders of magnitude from 10^{-18} to 10^{12} are designated by the following prefixes:

| Order | Prefix | Symbol |
|------------|--------|--------|
| 10^{12} | tera | T |
| 10^9 | giga | G |
| 10^6 | mega | M |
| 10^3 | kilo | k |
| 10^2 | hecto | h |
| 10 | deka | da |
| 10^{-1} | deci | d |
| 10^{-2} | centi | c |
| 10^{-3} | milli | m |
| 10^{-6} | micro | μ |
| 10^{-9} | nano | n |
| 10^{-12} | pico | p |
| 10^{-15} | femto | f |
| 10^{-18} | atto | a |

National Stock Numbers of GenRad Products

| Catalog Number | National Stock Number | Catalog Number | National Stock Number | Catalog Number | National Stock Number | Catalog Number | National Stock Number |
|----------------|-----------------------|----------------|-----------------------|----------------|-----------------------|----------------|-----------------------|
| 0274-9454 | 5935-00-636-6868 | 0874-9681 | 6625-00-293-8396 | 0900-9957 | 5985-01-023-1568 | 1218-9724 | 6625-00-172-0381 |
| 0274-9455 | 5935-00-543-8323 | 0874-9682 | 5995-00-738-6331 | 0900-9965 | 6625-00-377-9982 | 1232-9701 | 6625-00-873-6684 |
| 0274-9492 | 6625-00-558-6840 | 0874-9682 | 5995-00-111-2297 | 0900-9971 | 4931-01-019-7889 | 1232-9829 | 6625-01-030-8099 |
| 0274-9710 | 5935-00-187-0700 | 0874-9683 | 5995-00-009-5434 | 0900-9979 | 5985-01-008-9490 | 1234-9701 | 6625-01-032-2045 |
| 0274-9716 | 5935-00-192-4620 | 0874-9683 | 5995-00-935-2561 | 0938-9503 | 5940-00-281-2779 | 1236-9701 | 6625-00-181-1451 |
| 0274-9721 | 5935-00-192-4615 | 0874-9690 | 6625-00-793-1351 | 0938-9503 | 6625-01-024-3574 | 1236-9701 | 6625-00-397-4200 |
| 0274-9721 | 5935-00-258-6302 | 0874-9692 | 6625-00-729-4629 | 0938-9706 | 5940-00-681-9867 | 1236-9701 | 6625-00-489-8998 |
| 0274-9875 | 5935-00-914-8853 | 0874-9700 | 5935-00-765-5481 | 0938-9706 | 5940-00-871-1115 | 1238-9700 | 5895-01-046-4906 |
| 0274-9875 | 5935-00-665-4394 | 0874-9700 | 6625-01-039-5350 | 0938-9708 | 5940-00-469-2295 | 1240-9829 | 6625-00-525-3236 |
| 0274-9877 | 5935-00-403-4647 | 0874-9701 | 5935-00-961-5498 | 0938-9710 | 5935-00-295-5407 | 1263-9703 | 6625-00-061-0214 |
| 0274-9877 | 5935-00-754-5770 | 0874-9702 | 5935-00-243-8484 | 0938-9710 | 5935-01-018-1711 | 1264-9601 | 6625-00-965-5544 |
| 0274-9880 | 5995-00-642-9560 | 0874-9702 | 5935-00-707-2830 | 0938-9712 | 5940-00-177-2618 | 1264-9702 | 6625-00-231-0362 |
| 0274-9883 | 5826-00-837-0699 | 0874-9704 | 5935-00-706-6269 | 0938-9712 | 5940-00-562-3507 | 1264-9702 | 6625-00-872-7838 |
| 0274-9884 | 5935-00-910-9194 | 0874-9710 | 5935-00-833-7247 | 0938-9731 | 5940-00-235-7987 | 1265-9801 | 6130-00-431-5828 |
| 0510-9701 | 6625-00-553-8082 | 0874-9711 | 5935-00-496-1059 | 0938-9733 | 5940-00-258-4719 | 1267-9702 | 4920-01-032-0510 |
| 0510-9702 | 6625-00-311-6104 | 0874-9711 | 5935-00-905-5335 | 0938-9733 | 5940-00-500-8717 | 1267-9702 | 6130-00-596-4580 |
| 0510-9703 | 6625-00-993-1190 | 0874-9716 | 5935-00-758-9529 | 0938-9733 | 5940-00-971-9223 | 1267-9702 | 6625-01-039-6571 |
| 0510-9704 | 6625-00-864-6074 | 0874-9718 | 5935-00-502-8344 | 0938-9734 | 5940-00-401-8752 | 1308-9801 | 5895-01-021-7156 |
| 0510-9705 | 5905-00-561-4150 | 0874-9719 | 5935-00-194-6629 | 0938-9734 | 5940-00-549-9037 | 1310-9702 | 6625-00-213-5812 |
| 0510-9705 | 6625-00-709-0308 | 0874-9719 | 5935-00-933-6420 | 0938-9818 | 5970-00-561-7872 | 1311-9701 | 6625-00-930-3449 |
| 0510-9706 | 5905-00-561-4158 | 0874-9720 | 5935-00-194-6626 | 0938-9818 | 5970-01-023-0354 | 1316-9700 | 6625-01-042-0778 |
| 0510-9706 | 6625-00-709-0310 | 0874-9791 | 5935-00-420-3645 | 0938-9822 | 5970-00-628-7701 | 1316-9700 | 6625-01-040-2312 |
| 0510-9707 | 6625-00-708-7235 | 0874-9800 | 5935-00-984-5563 | 0938-9822 | 5940-00-977-1143 | 1362-9701 | 6625-00-140-8185 |
| 0510-9708 | 5905-00-561-4160 | 0874-9802 | 5935-00-706-2827 | 0938-9822 | 5970-01-023-0353 | 1362-9701 | 6625-00-489-3711 |
| 0510-9806 | 6625-00-690-5156 | 0874-9804 | 5935-00-921-8789 | 0938-9822 | 5970-00-237-5691 | 1363-9701 | 6625-00-170-6555 |
| 0777-9703 | 4931-00-247-0020 | 0874-9810 | 5935-00-225-8768 | 0938-9873 | 5970-00-755-4297 | 1381-9700 | 6625-00-140-8381 |
| 0777-9703 | 5935-00-949-8608 | 0874-9810 | 5935-00-919-5915 | 0938-9873 | 5970-00-869-2294 | 1381-9701 | 6625-00-574-6078 |
| 0874-9099 | 5935-00-370-8549 | 0874-9811 | 5935-00-189-1700 | 0940-9705 | 6625-00-462-7099 | 1382-9700 | 6625-00-190-1299 |
| 0874-9099 | 6625-00-006-6454 | 0874-9811 | 5935-00-194-6628 | 0940-9705 | 6625-00-842-4869 | 1382-9700 | 6625-00-492-6139 |
| 0874-9412 | 5935-00-916-0791 | 0874-9816 | 5935-00-761-0408 | 0940-9706 | 6625-00-455-8715 | 1382-9701 | 6625-00-214-9865 |
| 0874-9413 | 5935-00-789-6031 | 0874-9818 | 5935-00-666-4873 | 0940-9707 | 6625-00-455-8716 | 1383-9700 | 6625-00-141-8673 |
| 0874-9413 | 5935-00-946-4111 | 0874-9870 | 5975-00-104-6840 | 0940-9707 | 6625-00-842-4868 | 1383-9701 | 6625-00-409-6874 |
| 0874-9414 | 5935-00-738-6326 | 0874-9870 | 5935-00-555-1885 | 0940-9708 | 6625-00-842-4868 | 1390-9702 | 6625-00-799-8999 |
| 0874-9414 | 5935-00-981-7264 | 0874-9876 | 5935-00-160-5265 | 0940-9708 | 6625-00-842-4872 | 1390-9702 | 6625-00-942-4260 |
| 0874-9415 | 5935-00-914-8878 | 0874-9902 | 5180-00-145-6139 | 0971-9702 | 5905-00-681-5653 | 1390-9702 | 6625-00-992-0813 |
| 0874-9416 | 5935-00-552-7778 | 0874-9910 | 5935-00-864-9988 | 0971-9703 | 5905-00-752-6916 | 1390-9702 | 6625-01-003-7464 |
| 0874-9417 | 5935-00-253-0749 | 0874-9911 | 5935-00-219-9707 | 0971-9704 | 5905-00-969-5829 | 1390-9703 | 6625-00-799-8999 |
| 0874-9419 | 5935-00-172-8094 | 0874-9912 | 6625-00-498-8956 | 0971-9705 | 5905-00-926-2751 | 1396-9702 | 6625-00-123-3046 |
| 0874-9440 | 5935-00-840-7284 | 0874-9913 | 6625-00-437-9117 | 0971-9706 | 5905-00-762-2548 | 1403-9704 | 5910-00-574-4372 |
| 0874-9442 | 5935-00-965-6178 | 0874-9931 | 5910-00-706-5054 | 0971-9708 | 5905-00-762-2547 | 1403-9704 | 6625-00-804-7402 |
| 0874-9443 | 5935-00-264-5617 | 0874-9941 | 6625-00-577-2378 | 0971-9710 | 5905-00-557-1569 | 1403-9707 | 6625-00-804-7401 |
| 0874-9444 | 5935-00-944-3687 | 0874-9945 | 6625-00-623-0328 | 0971-9711 | 5905-00-583-2759 | 1403-9711 | 6625-00-804-9059 |
| 0874-9447 | 5935-00-028-4147 | 0874-9954 | 5985-00-992-2109 | 0971-9712 | 5905-00-927-7538 | 1404-9701 | 6625-00-916-5948 |
| 0874-9449 | 5935-01-037-8220 | 0874-9955 | 5985-00-494-4745 | 0971-9713 | 5905-00-887-7672 | 1404-9702 | 6625-01-008-6149 |
| 0874-9451 | 5935-00-925-6261 | 0874-9970 | 5985-00-083-4708 | 0971-9714 | 5905-00-581-1724 | 1404-9703 | 6625-01-011-4955 |
| 0874-9465 | 5935-00-925-6262 | 0874-9972 | 5985-00-275-6934 | 0971-9716 | 5905-00-881-8062 | 1408-9702 | 6625-01-012-4105 |
| 0874-9479 | 5935-00-899-8314 | 0874-9980 | 5999-00-888-4296 | 0973-9703 | 5905-00-842-8492 | 1408-9706 | 6625-01-021-9658 |
| 0874-9511 | 5985-00-912-1544 | 0874-9982 | 5985-00-707-2831 | 0973-9704 | 5905-00-052-1927 | 1409-9706 | 6625-00-629-1983 |
| 0874-9513 | 6625-00-623-0067 | 0874-9990 | 5935-00-699-5817 | 0973-9705 | 5905-00-842-8493 | 1409-9712 | 6625-00-585-4053 |
| 0874-9526 | 5935-00-627-0622 | 0880-9500 | 5985-00-378-0145 | 0973-9707 | 5905-00-660-3747 | 1409-9720 | 6625-00-585-4051 |
| 0874-9527 | 5935-00-933-8153 | 0900-9405 | 5935-00-354-2108 | 0973-9708 | 5905-00-827-1899 | 1409-9725 | 6625-00-629-1980 |
| 0874-9528 | 5985-00-185-4466 | 0900-9421 | 5935-00-518-1683 | 0973-9708 | 5905-01-045-8948 | 1412-9410 | 6625-00-465-6861 |
| 0874-9537 | 5915-00-786-9168 | 0900-9451 | 5935-00-004-0103 | 0973-9710 | 5905-00-690-5684 | 1413-9700 | 6625-01-022-3270 |
| 0874-9545 | 5915-00-907-8721 | 0900-9498 | 5935-00-403-1928 | 0973-9711 | 5905-00-815-4552 | 1419-9701 | 6625-00-953-7537 |
| 0874-9560 | 5905-00-103-1876 | 0900-9527 | 5985-01-008-9487 | 0973-9712 | 5905-00-655-1325 | 1419-9702 | 6625-00-124-9382 |
| 0874-9564 | 5985-00-525-3010 | 0900-9635 | 5985-00-009-4579 | 0973-9713 | 5905-00-378-0895 | 1419-9711 | 6625-00-585-1670 |
| 0874-9568 | 5905-00-812-9250 | 0900-9651 | 6625-00-498-0925 | 0973-9714 | 5905-00-583-5254 | 1422-9508 | 5910-00-576-8379 |
| 0874-9569 | 5985-00-623-0327 | 0900-9703 | 5935-01-039-5228 | 0973-9716 | 5905-00-406-9897 | 1422-9704 | 6625-00-987-9060 |
| 0874-9570 | 5905-00-755-2378 | 0900-9711 | 5935-00-838-2722 | 0973-9717 | 5905-00-074-8719 | 1422-9823 | 6625-00-881-8665 |
| 0874-9571 | 5985-00-087-4715 | 0900-9717 | 5935-00-346-7091 | 0975-9710 | 5905-00-681-3390 | 1422-9855 | 6625-00-060-1818 |
| 0874-9572 | 5985-00-080-2122 | 0900-9723 | 5935-00-346-7092 | 0975-9712 | 5905-00-683-2340 | 1422-9916 | 6625-00-891-5939 |
| 0874-9577 | 5840-00-868-1287 | 0900-9723 | 5935-01-015-5757 | 0975-9713 | 5905-00-556-6565 | 1423-9801 | 6625-00-145-2589 |
| 0874-9577 | 5895-00-623-0255 | 0900-9730 | 5935-00-158-8865 | 0975-9714 | 5905-00-781-6713 | 1423-9801 | 6625-00-775-1753 |
| 0874-9596 | 5910-00-224-3783 | 0900-9791 | 5935-00-466-1172 | 0975-9716 | 5905-00-725-0725 | 1423-9811 | 6625-00-145-2589 |
| 0874-9605 | 6625-00-433-2393 | 0900-9801 | 5935-01-039-5257 | 0975-9717 | 5905-00-655-1704 | 1433-9700 | 6625-00-892-4783 |
| 0874-9609 | 6625-00-433-2394 | 0900-9803 | 5935-01-039-5227 | 0975-9717 | 5905-00-806-3715 | 1433-9702 | 6625-00-437-9157 |
| 0874-9627 | 6625-00-003-7033 | 0900-9811 | 5935-00-838-2723 | 0975-9717 | 5905-00-970-5224 | 1433-9704 | 6625-00-173-5441 |
| 0874-9631 | 5985-00-185-4492 | 0900-9811 | 5935-00-884-8229 | 0975-9718 | 5905-00-879-6866 | 1433-9705 | 6625-00-173-5441 |
| 0874-9645 | 4920-00-922-6219 | 0900-9850 | 5905-01-044-4288 | 0975-9718 | 5905-00-617-2109 | 1433-9706 | 6625-00-235-6308 |
| 0874-9645 | 5840-00-868-1288 | 0900-9851 | 5985-00-456-0240 | 1192-9720 | 6625-00-377-6864 | 1433-9708 | 6625-00-098-3712 |
| 0874-9651 | 6625-00-706-9205 | 0900-9883 | 5935-00-432-6479 | 1192-9728 | 6625-00-760-3022 | 1433-9710 | 6625-00-840-4256 |
| 0874-9663 | 6625-00-172-0394 | 0900-9902 | 5180-01-044-4741 | 1192-9730 | 7025-00-095-6450 | 1433-9712 | 6625-00-495-0023 |
| 0874-9666 | 4931-00-404-7388 | 0900-9953 | 4931-00-228-1318 | 1192-9900 | 6625-00-472-1852 | 1433-9712 | 6625-00-431-9236 |
| 0874-9666 | 6625-00-020-9712 | 0900-9953 | 5985-00-472-3976 | 1211-9703 | 5895-00-140-8196 | 1433-9713 | 6625-00-431-9236 |
| 0874-9680 | 6625-00-789-4723 | 0900-9953 | 5985-01-008-9485 | 1211-9703 | 6625-00-777-1384 | 1433-9714 | 6625-00-466-0214 |

| Catalog Number | National Stock Number | Catalog Number | National Stock Number | Catalog Number | National Stock Number | Catalog Number | National Stock Number |
|----------------|-----------------------|----------------|-----------------------|----------------|-----------------------|----------------|-----------------------|
| 1433-9714 | 6625-00-553-7652 | 1560-9666 | 5995-01-024-6588 | 1933-9712 | 6625-01-012-8448 | 3090-5230 | 5950-00-068-5180 |
| 1433-9715 | 6625-00-463-4011 | 1560-9669 | 5935-01-024-6571 | 1933-9713 | 6625-01-012-8448 | 3090-5516 | 6120-00-056-7607 |
| 1433-9716 | 6625-00-228-9918 | 1560-9695 | 5995-00-169-6873 | 1933-9714 | 6625-01-012-8448 | 3100-5012 | 5950-00-926-0742 |
| 1433-9717 | 6625-00-228-9918 | 1560-9696 | 5935-00-169-7248 | 1933-9715 | 6625-01-012-8448 | 3100-5110 | 6120-00-710-6747 |
| 1433-9718 | 6625-00-123-7459 | 1562-9701 | 6625-00-401-5364 | 1933-9716 | 6625-01-012-8448 | 3100-5111 | 6120-00-877-7923 |
| 1433-9719 | 6625-00-137-9995 | 1562-9701 | 6625-00-438-0625 | 1935-9700 | 5835-01-035-2168 | 3100-5130 | 6120-00-717-3660 |
| 1433-9720 | 6625-00-102-9646 | 1564-9701 | 4470-01-039-4124 | 1935-9700 | 7450-01-033-3555 | 3100-5230 | 5950-00-419-4545 |
| 1433-9721 | 6625-00-038-4559 | 1564-9701 | 6625-00-883-8858 | 1945-9640 | 5965-01-040-6844 | 3120-5110 | 6120-00-078-1445 |
| 1433-9722 | 6625-00-947-7534 | 1564-9820 | 6625-00-464-2951 | 1945-9700 | 6625-01-041-0292 | 3120-5121 | 5950-01-138-7787 |
| 1433-9724 | 6625-00-031-3531 | 1564-9820 | 6625-00-495-7884 | 1945-9730 | 6625-01-040-6969 | 3120-5130 | 6120-00-148-5751 |
| 1433-9725 | 6625-00-106-7545 | 1565-9702 | 6625-00-003-9714 | 1952-9801 | 5915-00-481-7364 | 3120-5211 | 6120-00-110-6406 |
| 1433-9726 | 6625-00-140-8183 | 1565-9702 | 6625-01-012-9225 | 1954-9710 | 6625-01-041-0293 | 3130-5111 | 6120-00-849-8928 |
| 1433-9731 | 6625-00-480-0950 | 1565-9703 | 6625-01-016-9395 | 1954-9720 | 6625-01-043-8294 | 3130-5131 | 5950-00-294-4872 |
| 1433-9733 | 6625-00-005-5223 | 1565-9902 | 6625-00-001-4452 | 1962-9602 | 5965-01-024-6137 | 3150-5016 | 5950-00-497-2450 |
| 1434-9707 | 6625-00-067-9025 | 1568-9000 | 6625-00-162-1940 | 1981-9710 | 6625-01-016-1461 | 3150-5016 | 5950-00-502-3464 |
| 1434-9707 | 6625-00-356-3133 | 1568-9000 | 6625-00-319-2945 | 3010-5110 | 5950-00-996-1789 | 3150-5110 | 6120-00-681-6862 |
| 1434-9713 | 6625-00-229-6642 | 1571-9551 | 6110-00-566-7229 | 3010-5110 | 5950-00-606-8682 | 3150-5111 | 6120-00-769-1140 |
| 1434-9714 | 6625-00-935-1470 | 1571-9556 | 6110-00-245-4285 | 3010-5110 | 5950-00-670-2994 | 3150-5120 | 6120-00-911-9777 |
| 1434-9724 | 6625-00-204-0031 | 1571-9556 | 6110-00-412-7960 | 3010-5110 | 5950-00-681-2253 | 3150-5211 | 6120-00-110-6402 |
| 1440-9601 | 6625-00-133-7548 | 1571-9831 | 6110-00-580-0863 | 3010-5110 | 5950-00-581-5189 | 3150-5211 | 6120-00-894-1826 |
| 1440-9621 | 6625-00-169-5861 | 1571-9898 | 6110-00-879-9800 | 3010-5111 | 5950-00-683-3641 | 3150-5221 | 6120-00-927-7826 |
| 1440-9621 | 6625-00-421-1931 | 1581-9974 | 6110-00-172-0226 | 3010-5130 | 6120-00-837-7133 | 3150-5927 | 6120-00-504-9092 |
| 1440-9631 | 6625-00-838-2126 | 1582-9772 | 6110-01-044-4650 | 3010-5536 | 5950-00-850-8346 | 3160-5110 | 6120-00-451-4318 |
| 1440-9641 | 6625-00-855-4283 | 1582-9901 | 6110-01-044-0226 | 3030-5012 | 5950-00-987-5601 | 3160-5130 | 6120-00-811-0505 |
| 1440-9651 | 6625-00-169-5862 | 1591-9700 | 6625-01-040-2313 | 3030-5013 | 4931-00-777-1385 | 3200-5110 | 5950-00-595-8047 |
| 1440-9671 | 6625-01-028-9788 | 1602-9702 | 6625-00-511-0512 | 3030-5014 | 5950-00-137-7789 | 3200-5110 | 5950-01-045-9289 |
| 1450-9891 | 6625-00-201-8779 | 1606-9602 | 6625-00-397-4182 | 3030-5015 | 5950-00-112-3440 | 3200-5900 | 5977-00-400-7985 |
| 1450-9893 | 6625-00-612-1837 | 1606-9702 | 6625-00-423-5415 | 3030-5110 | 5950-00-137-0926 | 3200-5901 | 5999-00-520-6209 |
| 1455-9700 | 6625-00-123-7458 | 1608-9801 | 6625-00-902-8687 | 3030-5110 | 5950-00-578-5592 | 3200-5906 | 5977-00-775-6799 |
| 1455-9706 | 4920-01-021-8513 | 1608-9811 | 6625-00-902-8687 | 3030-5110 | 5950-00-730-7604 | 3200-5907 | 5977-00-357-8000 |
| 1455-9707 | 4920-01-021-8513 | 1608-9812 | 6625-00-139-3246 | 3030-5110 | 5950-00-754-5940 | 3200-5908 | 5977-00-727-9061 |
| 1455-9708 | 6625-00-420-3931 | 1608-9812 | 6625-00-902-8687 | 3030-5110 | 6120-00-572-5861 | 3200-5910 | 5977-00-850-1814 |
| 1482-9702 | 6625-00-583-0040 | 1615-9801 | 4931-00-916-5954 | 3030-5110 | 6120-01-020-5517 | 3200-5911 | 5977-00-033-8550 |
| 1482-9705 | 6625-00-567-2700 | 1615-9801 | 6625-00-005-7274 | 3030-5111 | 5950-00-862-0113 | 3200-5912 | 5977-00-877-6844 |
| 1482-9708 | 6625-00-583-0041 | 1615-9801 | 6625-00-470-8446 | 3030-5118 | 5950-00-688-5722 | 3200-5913 | 5977-00-110-3971 |
| 1482-9712 | 6625-00-556-8584 | 1617-9206 | 6625-01-043-8005 | 3030-5119 | 5950-00-050-1162 | 3200-5923 | 5977-00-433-2716 |
| 1482-9716 | 6625-00-583-0044 | 1617-9701 | 6625-00-451-4321 | 3030-5119 | 5950-00-617-9242 | 3410-5110 | 5950-00-121-5326 |
| 1482-9720 | 6625-00-583-0043 | 1620-9701 | 6625-00-076-6762 | 3030-5130 | 6120-00-681-6930 | 3410-5110 | 5950-00-133-4949 |
| 1491-9704 | 6625-00-251-1158 | 1620-9829 | 6625-00-076-6762 | 3030-5131 | 6120-00-879-3698 | 3410-5110 | 5950-00-519-4767 |
| 1521-9428 | 7530-00-100-2005 | 1630-9827 | 6625-00-476-2025 | 3030-5637 | 5950-00-674-3901 | 3410-5110 | 5950-00-406-6396 |
| 1521-9460 | 6625-01-027-7010 | 1630-9857 | 6625-00-476-2025 | 3030-5816 | 5950-00-402-7584 | 3410-5110 | 5950-00-518-4362 |
| 1521-9464 | 7530-00-180-6393 | 1644-9701 | 6625-00-867-6628 | 3038-5015 | 6120-01-022-1379 | 3410-5110 | 5950-00-538-5662 |
| 1521-9465 | 7530-00-275-8521 | 1644-9711 | 6625-00-867-6628 | 3038-5110 | 5950-00-110-0379 | 3410-5120 | 5950-00-420-0208 |
| 1521-9467 | 6625-00-459-7544 | 1650-9601 | 6625-00-992-9045 | 3038-5130 | 6120-00-357-7520 | 3410-5120 | 5950-00-557-6989 |
| 1521-9469 | 6625-01-027-7011 | 1650-9702 | 6625-00-435-5470 | 3040-5110 | 5950-00-655-0545 | 3410-5120 | 5950-01-036-4721 |
| 1521-9513 | 6105-00-147-8955 | 1656-9701 | 6625-00-861-1393 | 3040-5110 | 5950-00-802-9810 | 3410-5130 | 5950-00-877-4863 |
| 1521-9602 | 5905-00-448-5335 | 1666-9700 | 6625-00-376-5200 | 3040-5110 | 5950-00-809-5379 | 3410-5130 | 6120-00-287-8845 |
| 1521-9603 | 5905-00-448-5334 | 1683-9701 | 6625-00-007-6643 | 3040-5110 | 5950-00-966-6228 | 3410-5210 | 5950-00-993-4904 |
| 1521-9604 | 5905-00-448-5712 | 1683-9800 | 6625-01-021-9678 | 3040-5111 | 5950-00-835-4462 | 3410-5220 | 5950-00-952-0088 |
| 1521-9615 | 6625-00-162-0508 | 1686-9600 | 6625-01-040-6910 | 3040-5118 | 5950-00-681-7431 | 3430-5110 | 5950-00-048-3155 |
| 1521-9619 | 6105-00-448-5828 | 1686-9700 | 6625-01-038-1938 | 3050-5110 | 6120-00-845-1176 | 3430-5110 | 5950-00-193-9917 |
| 1521-9623 | 6105-01-016-9031 | 1790-XXXX | 6625-00-243-7461 | 3050-5111 | 6120-00-242-4865 | 3430-5110 | 5950-00-451-3925 |
| 1521-9802 | 6625-00-161-1827 | 1790-9670 | 4920-01-025-8001 | 3050-5130 | 6120-00-025-7291 | 3430-5110 | 5950-00-504-9090 |
| 1521-9812 | 6625-00-161-1827 | 1790-9707 | 6625-00-148-9388 | 3058-5110 | 6120-00-105-6108 | 3430-5110 | 5950-00-754-6369 |
| 1522-9614 | 6685-00-519-0355 | 1792-9353 | 6625-01-038-9093 | 3058-5120 | 6120-00-376-0338 | 3430-5110 | 5950-00-856-7904 |
| 1522-9615 | 6685-00-519-0347 | 1792-9729 | 6625-01-034-4031 | 3060-5012 | 6120-00-054-7794 | 3430-5110 | 6120-00-015-6728 |
| 1522-9616 | 6685-00-519-0341 | 1792-9870 | 6625-00-575-8024 | 3060-5013 | 6120-01-043-6705 | 3430-5120 | 5950-00-103-7005 |
| 1531-9430 | 6625-00-193-7635 | 1795-9719 | 6625-01-038-3305 | 3060-5110 | 6120-00-849-2588 | 3430-5130 | 5950-00-521-8076 |
| 1531-9601 | 5960-00-844-5968 | 1840-9701 | 6625-00-895-1512 | 3060-5111 | 6120-00-816-1517 | 3430-5130 | 5950-00-997-1261 |
| 1531-9602 | 6625-00-467-0907 | 1840-9701 | 6625-00-937-6156 | 3060-5118 | 6120-00-772-7917 | 3430-5230 | 6120-00-023-3819 |
| 1531-9605 | 6625-00-467-0907 | 1863-9700 | 6625-00-001-8060 | 3060-5119 | 6120-00-682-2557 | 3430-5816 | 5950-00-937-3292 |
| 1536-9701 | 5961-00-619-9213 | 1863-9700 | 6625-00-456-7442 | 3060-5130 | 6120-00-805-0745 | 3460-5110 | 6120-00-812-7681 |
| 1536-9701 | 6625-00-534-8274 | 1864-9700 | 6625-00-393-2573 | 3060-5131 | 6120-00-033-3776 | 3460-5120 | 6120-00-686-6850 |
| 1538-9601 | 6240-00-422-1278 | 1864-9700 | 6625-01-007-9426 | 3070-5110 | 6120-00-660-9211 | 3460-5130 | 5950-00-238-4876 |
| 1538-9602 | 6240-00-297-3892 | 1864-9700 | 6625-01-011-3798 | 3070-5111 | 6120-00-828-1490 | 3460-5130 | 5950-00-481-8353 |
| 1538-9604 | 6625-00-437-9165 | 1912-9700 | 6625-00-185-7288 | 3070-5119 | 5950-00-073-2226 | 3460-5130 | 6120-00-504-9047 |
| 1538-9701 | 6625-00-437-9164 | 1933-9700 | 6625-00-001-6915 | 3070-5119 | 6625-00-143-0784 | 3460-5230 | 5950-00-419-4519 |
| 1539-9701 | 6625-00-185-4764 | 1933-9700 | 6625-01-012-8448 | 3070-5131 | 6120-00-032-1173 | 3460-5230 | 6120-01-036-0134 |
| 1543-9700 | 6625-01-039-4873 | 1933-9701 | 6625-01-012-8448 | 3090-5110 | 6120-00-800-2482 | 3460-5836 | 5950-01-015-1994 |
| 1551-9703 | 6625-00-982-3929 | 1933-9702 | 6625-01-012-8448 | 3090-5111 | 6120-00-503-0632 | 3460-5936 | 6120-00-110-6971 |
| 1560-9521 | 5965-01-022-3484 | 1933-9703 | 6625-01-012-8448 | 3090-5119 | 6120-00-833-0904 | 3490-5110 | 5950-01-005-0066 |
| 1560-9522 | 5965-01-022-3483 | 1933-9710 | 6625-00-259-2781 | 3090-5121 | 6120-00-145-7284 | 3490-5110 | 6120-00-052-3305 |
| 1560-9613 | 6625-00-001-4366 | 1933-9710 | 6625-01-012-8448 | 3090-5130 | 6120-00-669-8565 | 3490-5130 | 5950-00-725-4226 |
| 1560-9613 | 6625-00-169-1701 | 1933-9711 | 6625-01-012-8448 | 3090-5131 | 6120-00-725-2859 | 3490-5210 | 5950-00-689-7734 |
| 1560-9653 | 6625-01-007-6686 | 1933-9712 | 6625-00-327-6585 | 3090-5220 | 5950-00-067-4294 | 3490-5230 | 6120-01-013-8420 |
| | | | | | | 3490-5836 | 5950-00-173-2969 |

Index by Subject and Title

A

Abbreviations, Symbols and Prefixes 245

Acoustic/Vibration Instruments and Systems 165-191

Adaptors

- Coaxial, 50Ω 94-96, 240
- Coaxial, 75Ω 103, 104
- Flange, Precision, Coaxial ... 109
- Low-Frequency 240
- Precision Coaxial, 50Ω 110, 111

Adjustable Autotransformers 213, 236

Adjustable DC Power Supply 61

Adjustable Stubs, Coaxial, 50Ω.. 97

Admittance Meter, UHF 37

Air Lines, Coaxial

- Adjustable, Constant-Impedance, 50Ω 99
- Fixed, Rigid, 50Ω..... 99
- Precision/Reference, 50Ω .. 114
- Rigid, 75Ω..... 105
- Rod and Tube, Precision, 50Ω 116

Amplifiers

- I-F 41
- Multichannel 180
- Power, Audio Oscillator and . 126
- Tuned, and Null Detector ... 48

Amplitude-Regulating Power Supply 123

Analog Limit Comparator 32

Analog Test Systems..... 154, 155

Analyzers

- Community Noise 176
- Digital Signal 186, 188
- Fast-Fourier 186, 188
- Impact/Impulse Noise . 166, 167
- Integrating Real-Time 184
- Motion, Stroboscopic ... 193-204
- Narrow-Band 173, 174, 186, 188
- Noise . 166, 167, 172-174, 184
- Octave-Band 166, 167, 172, 184
- Precision Sound-Level . 166, 167
- Real-Time 184-188
- Signal 166, 167, 172-174, 184-188
- Sound and Vibration .. 166, 167, 172, 184
- Sound-Level 166, 167, 184
- Spectrum.... 173, 174, 184-188

Analyzers (cont'd)

- Structural (Mechanical) 190
- Time-Series 188
- Vibration 166, 167, 172, 184, 186
- Wave 173, 174

Attenuators

- Adjustable, Coaxial, 50Ω ... 98
- Decade 85, 183
- Fixed, Coaxial, 50Ω 98, 113
- Fixed, Coaxial, 75Ω 105

Audio Oscillator 125

Audio Oscillator and Power Amplifier 126

Audiometer Calibration Accessory Kit 170

Audiometer Calibration Set/System 170

Audiometer Calibration Stand Assembly 170

Automatic Impedance Bridges and Meters

- Capacitance 44
- LC, Megahertz 33
- RLC 22-28

Automatic Level Regulator 181

Automatic Line-Voltage Regulators 205-212

Automatic RLC Bridge 26

Automatic Test Equipment (ATE)

- Component/Network/Module 143
- Digital 152
- Digital/Analog (Hybrid) 154
- In-Circuit/Functional 158
- PC Board 151-163
- Software 159

Autotransformers, Adjustable 213-236

B

Banana Plugs and Jacks 239

Basic Connectors

- Coaxial, 50Ω 91, 108
- Coaxial, 75Ω 103, 115

Bias Insertion Unit, Coaxial, 50Ω 102

Binding Posts and Accessories 237, 238

Bridges and Impedance Meters .. 11

- Admittance, UHF 37
- Automatic 22-28, 33, 44
- Capacitance 43

Bridges and Impedance Meters (cont'd)

- Conductance . 17-20, 46, 50, 56
- Digibridges 22, 24, 33
- High-Frequency 33, 36, 37
- Incremental Inductance..... 60
- Inductance 33, 60
- Kelvin 56
- LC, Megahertz 33
- Megohm 56-58
- Portable (Battery) 17, 18, 56
- Precision 20, 46, 50, 56
- Precision Capacitance 46, 50
- Radio-Frequency 33, 36
- Resistance 55
- RLC, Automatic 22-28
- RLC, Manual 17-20
- Wheatstone (DC) .. 17-20, 56, 57

Bridge Detectors 48, 52

Bridge Oscillators 125-127

Bridge Oscillator-Detector 49

Brushes, Replacement, Variac® .. 232

Bug Hound 162

C

Cable Connectors

- Banana Plugs 239
- Coaxial, 50Ω 92
- Coaxial, 75Ω 103
- Precision, Coaxial, 50Ω..... 108

Calibration Sets/Systems, Audiometer 170

Calibrators

- Audiometer 170
- Sound-Level 169
- Vibration 169

Capacitance Bridge, Precision ... 50

Capacitance Bridges 46, 53

Capacitance-Measuring Assembly 47

Capacitance-Measuring Instruments 43

- Automatic 22-28, 33, 44
- Comparator 30
- Digibridges 22, 24, 33
- High-Value 24, 26, 44, 53
- Manual 17-20, 46, 50, 53
- Megahertz 33
- Portable (Battery) 17, 18
- Precision 46, 50

| | |
|--|--------------|
| Capacitance-Measuring System, Precision | 51 |
| Capacitance Meter, Digital | 44 |
| Capacitance Standards and Decades | 63 |
| Air | 66-69, 73 |
| Coaxial, Precision Connector | 68, 69 |
| Decade | 75-78 |
| Four-Terminal | 71 |
| Mica | 70, 76-78 |
| Polystyrene | 75, 76 |
| Reference, Precision .. | 65, 66, 70 |
| Variable Precision | 73 |
| Capacitors | |
| Coupling, Coaxial, 50 Ω | 101 |
| Variable, Coaxial, 50 Ω | 98 |
| Case, Storage, Coaxial | 116 |
| Cassette Data Recorder | 171 |
| Centering Ring, Rotatable, Precision, Coaxial | 109 |
| Ceramic Microphones | 178 |
| Choke, Parallelling, Variac [®] | 232 |
| Cleaning Kit, Coaxial | 116 |
| Coaxial Capacitance Standards .. | 68, 69 |
| Coaxial Components | 90-116 |
| Adaptor Flange, Precision .. | 109 |
| Adaptors, 50 Ω .. 94-96, 110, 240 | |
| Adaptors, 75 Ω | 103, 104 |
| Adjustable Stubs, 50 Ω | 97 |
| Air Lines, 50 Ω | 99, 114, 116 |
| Air Lines, 75 Ω | 105 |
| Attenuators, 50 Ω | 98, 113 |
| Attenuators, 75 Ω | 105 |
| Bias Insertion Unit, 50 Ω .. | 102 |
| Capacitor, Coupling, 50 Ω .. | 98, 101 |
| Centering Ring, Rotatable .. | 109 |
| Cleaning Kit | 116 |
| Component Mount, 50 Ω | 102 |
| Connectors, Air Line, Cable, Panel, 50 Ω | 91, 92, 108 |
| Connectors, Air Line, Cable, Panel, 75 Ω | 103, 115 |
| Coupling Capacitor, 50 Ω | 101 |
| Coupling Elements | 99-102 |
| Coupling Probe, 50 Ω | 101 |
| Crimping Tools | 106 |
| Detector, Voltmeter, 50 Ω .. | 101 |
| Directional Coupler | 106 |
| Ells, 90 $^\circ$, 50 Ω | 100, 116 |
| Insertion Units, 50 Ω .. | 101, 102 |
| Low-Pass Filters, 50 Ω | 100 |
| Matching Pads, 75-to-50 Ω | 104, 115 |
| Mismatches, 50 Ω | 112 |

| | |
|---|--------------------|
| Coaxial Components (cont'd) | |
| Mixer/Rectifier, 50 Ω .. | 100, 101 |
| Panel Mounting Kits | 109 |
| Patch Cords, 50-, 72-, and 75 Ω | 96, 102 |
| Power Dividers, 50 Ω | 100 |
| Rectifiers, Mixer/Voltmeter, 50 Ω | 101 |
| Storage Case | 116 |
| Stubs, Adjustable, 50 Ω | 97 |
| Tees, 50 Ω | 99 |
| Terminations, 50 Ω | 97, 112 |
| Terminations, 75 Ω | 105, 115 |
| Tools, Tool Kits | 106, 116 |
| Tube and Rod, 50 Ω | 116 |
| Tuner, 50 Ω | 113 |
| Tuning Stubs, 50 Ω | 97 |
| U-Line Section, 50 Ω | 100 |
| Variable Capacitor, 50 Ω | 98 |
| Voltmeter Detector/Rectifier .. | 101 |
| Coaxial Instruments | |
| Radio-Frequency Bridge | 36 |
| Slotted Lines | 38, 39 |
| UHF Admittance Meter | 37 |
| Community Noise Analyzer | 176 |
| Comparators | |
| Analog Limit | 32 |
| Impedance | 30 |
| Component Mount, Coaxial, 50 Ω .. | 102 |
| Component/Network/Module Tester | 143 |
| Component Sorting Systems | 24, 28, 30, 33, 44 |
| Component Test System | 143 |
| Condenser Microphones, Electret .. | 177 |
| Conductance Bridges | |
| AC-DC | 17, 18, 20 |
| AC, High-Frequency | 37 |
| AC, Low-Conductance | 46, 50 |
| DC | 56 |
| Connectors | |
| Banana Plugs and Jacks | 239 |
| Binding Post | 237 |
| Coaxial, 50 Ω | 91, 92 |
| Coaxial, 75 Ω | 103 |
| Precision, Coaxial, 50 Ω | 108 |
| Precision, Coaxial, 75 Ω | 115 |
| Controllers, Line Voltage .. | 205, 213 |
| Cords | |
| Patch | 96, 102, 240, 241 |
| Power | 241 |
| Counter, Frequency | 242 |
| Coupler, Precision Directional .. | 106 |
| Coupling Capacitor, Coaxial, 50 Ω .. | 101 |

| | |
|--|--------|
| Coupling Elements, Coaxial, 50 Ω | 99-102 |
| Coupling Probe, Coaxial, 50 Ω .. | 101 |
| Crimping Tools, Coaxial | 106 |

D

| | |
|------------------------------------|----------|
| D/A-A/D Converter Tester | 143 |
| Data Recorder, Cassette | 171 |
| DC Power Supply, Adjustable | 61 |
| DC Recorder | 171 |
| DC Resistance Bridge | 56 |
| Decade Attenuator | 183 |
| Decade Capacitors | 75, 76 |
| Decade Capacitors, Precision .. | 77, 78 |
| Decade Inductors | 88 |
| Decade Inductor Units | 89 |
| Decade Resistance Units | 82 |
| Decade Resistors | 81-83 |
| Decade Resistor, Programmable .. | 84 |
| Decade Voltage Dividers | 85 |
| Decades and Standards | |
| Capacitance | 63 |
| Inductance | 86 |
| Resistance | 79 |
| Decades, Impedance | |
| Capacitors | 75, 76 |
| Capacitors, Precision | 77, 78 |
| Inductors | 88, 89 |
| Resistor, Programmable | 84 |
| Resistors | 81-83 |
| Detectors | |
| Bridge | 52 |
| Coaxial, 50 Ω | 101 |
| Heterodyne | 40 |
| I-F Amplifier | 215 |
| Null, Tuned Amplifier | 48 |
| Oscillator, Bridge | 49 |
| Digibridges | |
| LC, Megahertz | 33 |
| RLC | 22, 24 |
| Digital/Analog Test Systems .. | 154, 155 |
| Digital Capacitance Meter | 44 |
| Digital IC Testers | 134, 138 |
| Digital Impedance Meter | 28 |
| Digital Signal Analysis Systems .. | 188 |
| Directional Coupler, Precision .. | 106 |
| Dividers | |
| Decade Voltage | 85 |
| Frequency | 244 |
| Power, Coaxial, 50 Ω | 100 |
| Dosimeter, Noise | 169 |

Index by Subject and Title (continued)

E

Electret-Condenser Microphones . 177
 Electrolytic Capacitance Bridge .. 53
 Electronic Stroboscopes 193-204
 Ells, 90°
 Coaxial, 50Ω 100
 Precision, Coaxial, 50Ω 116
 Exposure Monitor, Noise 169

F

Fast-Fourier Analyzers 186, 188
 Fault Tracer, PC Boards 162
 Filters
 Low-Pass, Coaxial, 50Ω 100
 Multifilter 172
 Octave-Band 166, 167, 172, 184
 Pink-Noise 182
 Universal 183
 Fixed Attenuators
 Coaxial, 50Ω 98
 Coaxial, 75Ω 105
 Precision, Coaxial, 50Ω 113
 Fixtures, Test 19, 26, 28, 33, 34
 Flange, Adaptor 109
 Flash Delay, Strobe 203
 Flash Lamp, Strobotron 198, 200
 Flash, Stroboscopic 193-204
 Fourier Analyzers 186, 188
 Four-Terminal Capacitance
 Standard 71
 Frequency Meter, Counter 242
 Frequency Oscillators 121-127
 Frequency-Response Recorder 173, 174
 Frequency Scaler/Divider 244
 Frequency Spectrum Analyzers,
 Real-Time 184-188
 Frequency Synthesizers 118, 119

G

Ganged Variac®
 autotransformers 213-236
 Generators
 Random-Noise 181-183
 Signal 117-127
 Tone-Burst 180
 Graphic Level Recorders ... 173, 174
 Guides to Product Selection
 Autotransformers, Variac® ... 215

Guides to Product Selection (cont'd)

Capacitance-Measuring
 Instruments 43
 Capacitance Standards and
 Decades 63
 Impedance Measurement ... 11
 Inductance-Measuring
 Instruments 59
 Line-Voltage Regulators,
 Variac® 205
 PC-Board Testers 151
 Resistance-Measuring
 Instruments 55
 Strobotac® electronic
 stroboscopes 195

H

Heterodyne Detectors 40
 High-Frequency Instruments
 Oscillators 118-122
 Variac® autotransformers 223
 High-Pass Filter 183
 High-Speed Motion Analyzers
 (Stroboscopic) 193-204
 Hybrid Circuit Testers
 Network 143
 PC Boards 154

I

IC Testers
 Digital 134, 138
 Linear 129
 I-F Amplifier 41
 Impact/Impulse Noise
 Analyzers 166, 167
 Impedance Bridges (Automatic) 22-28
 Impedance Bridges (Manual) .. 17-20
 Impedance Comparator 30
 Impedance Measurements 11-16
 Automatic 22-28, 33, 44
 Capacitance 43
 Comparator 30-32
 High-Frequency 33-42
 Inductance 59
 Resistance 55
 RLC, Automatic 22-28, 143
 RLC, Manual 17-20
 Slotted Line 38, 39
 Impedance Meter, Digital 28

Impedance Standards and Decades

Capacitance 63
 Inductance 86
 Resistance 79
 In-Circuit/Functional Test System 158
 Incremental-Inductance Bridge .. 60
 Indicator, Noise-Exposure 169
 Inductance Bridge, Incremental .. 60
 Inductance-Measuring Assembly . 62
 Inductance-Measuring
 Instruments 59
 Automatic 22-28, 33
 Comparator 30
 Digibridges 22, 24, 33
 High-Power 62
 Incremental 60
 Manual 17-20
 Megahertz 33
 Portable (Battery) 17, 18
 Inductance Standards and
 Decades 86
 Decades 88, 89
 Standards 87
 Inner-Conductor Rod, Precision,
 Coaxial, 50Ω 116
 Insertion Unit, Bias,
 Coaxial, 50Ω 102
 Insertion Unit, Coaxial, 50Ω 101
 Insulation Testers 56-58
 Integrating Real-Time Analyzer .. 184
 Integrator System, Vibration 166

J

Jacks and Plugs, Banana 239
 Jigs, Test 19, 26, 28, 33, 44

K

Kit, Panel Mounting, Coaxial, 50Ω 109
 Kit, Tools, Coaxial 106, 116
 Kits, Adaptor, Coaxial, 50Ω . 93, 110

L

Lamps, Flash 198, 200, 201
 LC Digibridge™, Megahertz 33
 Leakage-Current Testers .. 53, 57, 58
 Level Recorder, Graphic 173, 174

Level Regulator, Automatic 181
 Limit Comparator, Analog 32
 Linear IC Tester 129
 Line Stretchers, Coaxial, 50Ω ... 99
 Lines, Air, Coaxial
 Adjustable, Constant-Impedance,
 50Ω 99
 Adjustable, Trombone
 Constant-Impedance, 50Ω . 99
 Fixed, 50Ω 99
 Fixed, 75Ω 105
 Precision/Reference, 50Ω .. 114
 Lines, Slotted 38, 39
 Line-Voltage Regulators 205-212
 Logic Test Systems 152
 Low-Pass Filters, Coaxial, 50Ω .. 100

M

Matching Pads, 75-to-50Ω,
 Coaxial 104, 115
 Measuring-Assembly, Capacitance 47
 Measuring-Assembly, Inductance 62
 Mechanical Structural Analyzer .. 188
 Megahertz LC DigiBridge™ 33
 Megohm Bridge 57
 Megohmmeters 58
 Meters
 Admittance, UHF 37
 Capacitance 43
 Frequency 242
 Impact/Impulse
 Sound-Level 166, 167
 Impedance 11
 Megohm 58
 Output-Power 181
 Precision Sound-Level . 166, 167
 Sound-Level 166-168
 Standing-Wave 42
 Microphone Accessories
 Preamplifiers/Adaptor . 178, 179
 Tripod 179
 Windscreens 179
 Microphone System, Weatherproof 176
 Microphones
 Ceramic 178
 Electret-Condenser 177
 Militarized Variac®
 autotransformers 223
 Mismatches, Precision, Coaxial,
 50Ω 112
 Mixer, Coaxial, 50Ω 100

Mixer/Rectifier,
 Coaxial, 50Ω 100, 101
 Modulating Power Supply 122
 Monitor, Noise-Exposure 169
 Motion Analysis and Photography
 Set 202
 Motion Analyzers, Strobe ... 193-204
 Motor-Driven Autotransformers ... 225
 Mount, Component, Coaxial, 50Ω 102
 Multichannel Amplifier 180
 Multifilter 172

N

Narrow-Band Analyzers 173, 174,
 186, 188
 National Stock Numbers 246
 Network Tester, Thick/Thin-Film . 143
 Noise Analyzer, Community 176
 Noise Analyzers 166, 167,
 172-174, 184, 186
 Noise Dosimeter 169
 Noise Exposure Monitor/Indicator 169
 Noise Generators, Random .. 181-183
 Noise-Measuring Instruments and
 Systems 165-191
 Null Detector, Tuned Amplifier and 48

O

Octave-Band Analyzers
 1/3 and 1/10 Octave 172
 1/3 and Full-Octave 184
 Full-Octave 166, 167, 184
 Real-Time 184
 Open-Circuit Terminations
 Coaxial, 50Ω 97, 112
 Coaxial, 75Ω 105
 Ordering Information 8
 Oscillator-Detector, Bridge 49
 Oscillator Power Supplies 122
 Oscillators
 Audio 124-127
 Audio, and Power Amplifier . 126
 Bridge, Detector 49
 Crystal-Frequency 118, 119
 High-Frequency 121, 122
 Sweep, Recorder Plug-In ... 175
 Outer-Conductor Tube, Precision,
 Coaxial, 50Ω 116
 Output Power Meter 181

P

Pads
 Attenuator, Coaxial, 75Ω ... 105
 Attenuators, Coaxial, 50Ω... 98
 Attenuator, Precision, Coaxial,
 50Ω 113
 Matching, 75-to-50Ω, Coaxial 104
 Matching, Precision,
 50-to-75Ω, Coaxial 115
 Panel Connectors
 Coaxial, 50Ω 92
 Coaxial, 75Ω 103
 Panel Feedthrough Connector,
 Coaxial, 50Ω 92
 Panel Mounting Kits, Precision,
 Coaxial 109
 Parallelling Choke 232
 Patch Cords, Coaxial and
 Low-Frequency 96, 102, 240, 241
 PC-Board Fault Tracer 162
 PC-Board Testers 151-163
 Photoelectric Pickoffs 204
 Photography and Motion Analysis
 Set 202
 Pickoffs, Photoelectric 204
 Pink-Noise Filter 182
 Plugs and Jacks, Banana 239
 Portable Autotransformers 224
 Power Amplifier, Audio Oscillator
 and 126
 Power Cords 241
 Power Divider, Coaxial, 50Ω 100
 Power Meter, Output 181
 Power Supplies
 Adjustable, DC 61
 Amplitude-Regulating 123
 Modulating 122
 Preamplifier 179
 Regulated 61, 122
 Preamplifiers
 Acoustic 178, 179
 Bridge 49
 Plug-in, Recorder 175
 Power Supply 179
 Precision Capacitance Bridge 50
 Precision Capacitance-Measurement
 System 51
 Precision Capacitors 73
 Precision Coaxial Components,
 50Ω 107
 Adaptor Flange 109
 Adaptors 110, 111
 Air Lines/Reference/Set 114
 Attenuators 113

Index by Subject and Title (continued)

Precision Coaxial Components, 50Ω
(cont'd)
 Cleaning Kit 116
 Connectors 108
 Ell, 90° 116
 Mismatches 112
 Panel Mounting Kits 109
 Rotatable Centering Ring ... 109
 Storage Case 116
 Terminations 112, 113
 Tool Kit 116
 Tube and Rod 116
 Tuner 113
 Precision Coaxial Components,
 75Ω 115
 Precision Decade Capacitors .. 77, 78
 Precision Directional Coupler 106
 Precision Slotted Line 39
 Precision Sound-Level
 Meters/Analyzers 166-167
 Probe, Coupling, Coaxial, 50Ω... 101
 Programmable Decade Resistor .. 84
 Programming Station 157

R

Radio-Frequency Bridge 36
 Random-Noise Generators... 181-183
 Range-Extension Unit 62
 Real-Time Analyzers..... 184-188
 Recorders
 Cassette Data 171
 DC 171
 Frequency-Response .. 171, 173,
 174
 Graphic Level 173, 174
 Plug-ins 175
 Potentiometric 173, 174
 Sound-Level 171, 174
 Strip-Chart 171, 173, 174
 Rectifiers, Coaxial, 50Ω
 Mixer 101
 Voltmeter 101
 Reference, Air Lines, Precision,
 Coaxial, 50Ω 114
 Reference Standard Capacitors 65, 66
 Regulated Power Supply 122
 Regulating Power Supply,
 Amplitude 123
 Regulator, Automatic Level 181
 Regulators, Automatic Voltage 205-212
 Resistance Bridge, DC 56

Resistance-Measuring Instruments 55
 Automatic (ac) 22-26
 Automatic (dc) 28
 Comparator (ac) 30
 Digibridges (ac) 22, 24
 Manual (ac-dc) 17-20
 Manual (dc) 56
 Megohm (dc) 57, 58
 Portable (dc) 17, 18, 56
 Precision (dc) 56
 Resistance Standards and Decades 79
 Decades 81-83
 Decade, Programmable 84
 Standards 80
 Resistance Units, Decade 82
 Resistive Attenuator 183
 Resistive Terminations
 Coaxial, 50Ω 97, 112
 Coaxial, 75Ω 105, 115
 Resistive Voltage Divider 85
 Rigid Air Line, 75Ω 105
 RLC Bridges and Meters 11-29
 RLC Bridges, Automatic 22-28
 RLC Bridges, Manual 17-20
 RLC Digibridges 22, 24
 Rod and Tube, Precision, Coaxial,
 50Ω 116
 Rotatable Centering Ring, Precision,
 Coaxial 109

S

Sales and Service Information
 Facilities 4
 Policies 8
 Scaler (500 MHz) 244
 Shaker-Control System 190
 Short-Circuit Terminations
 Coaxial, 50Ω 97, 113
 Coaxial, 75Ω 105
 Signal Analyzers 166, 167, 172,
 173, 184-188
 Signal Sources 117-127
 Frequency Synthesizers 118, 119
 High-Frequency
 Oscillators 121, 122
 Low-Frequency Oscillators 124-127
 Slave, Stroboscope 202
 Slotted Lines 38, 39
 Software, Test System 159
 Sorting Systems, Component ... 24,
 28, 30, 33, 44
 Sound-Analysis Systems/Sets 166, 167

Sound and Vibration Analyzer 172
 Sound-Level Calibrators 169
 Sound-Level Measurement
 Sets 166-168
 Sound-Level Meters/Sets ... 166-168
 Spectrum Analyzers 173, 174,
 184-188
 Standard Capacitors
 Air 66-69, 73
 Coaxial 68, 69
 Four-Terminal 71
 Mica 70
 Reference, Precision . 65, 66, 70
 Standing-Wave Meter 42
 Storage Case, Coaxial Elements .. 116
 Strobe Accessories 203, 204
 Strobe Lamps, Replacement 198,
 200, 201
 Strobolume® electronic
 stroboscope 196
 Stroboscopes 193-204
 Stroboslave® stroboscopic light
 source 202
 Strobotac® electronic
 stroboscopes 199, 200
 Stubs, Adjustable, Coaxial, 50Ω . 97
 Surface-Speed Wheel 203
 Sweep-Oscillator Plug-in, Recorder 175
 SWR Meter, UHF 37
 Synthesizers, Frequency ... 118, 119

T

Tachometers, Stroboscopic .. 193-204
 Tees, Coaxial, 50Ω 99
 Terminations
 Coaxial, 50Ω 97, 112
 Coaxial, 75Ω 105, 115
 Test Fixtures 19, 26, 28, 33, 44
 Test Programming Station 157
 Test System Software 159
 Test Systems
 Component/Network/Module 143
 Digital 152
 Digital/Analog (Hybrid) 154
 In-Circuit/Functional 158
 PC Board 151-163
 Software 159
 Testers
 Component/Network/Module 143
 Digital IC 134, 138
 Linear IC 129
 PC Board 152-155, 158-162
 Thick/Thin-Film Network Tester .. 143

Third-Octave Analyzers 172, 184
 Third-Octave Multifilter 172
 Three-Phase Autotransformers 221-222
 Three-Phase Line-Voltage
 Regulators 207
 Three-Wire Power Cords 241
 Time and Frequency Meter
 (Counter) 242
 Time-Delay, Strobe 203
 Time-Series Analysis System 188
 Tone-Burst Generator 180
 Tools, Coaxial 106, 116
 Triggers, Photoelectric 204
 Tripod, Microphone 179
 Trombone Constant-Impedance
 Adjustable Air Line 99
 Tube and Rod, Precision, Coaxial 116
 Tuned Amplifier and Null Detector 48
 Tuner, Precision, Coaxial, 50Ω .. 113
 Tuning Stubs, Coaxial, 50Ω 97
 TV Strobe Light 196

U

UHF Admittance Meter 37
 U-Line Section, Coaxial, 50Ω ... 100
 Universal Filter 183

V

Variable Capacitors
 Coaxial, 50Ω 98
 Standard 73
 Variac® adjustable
 autotransformers 213-236
 Variac® line-voltage regulators 205-212
 Variac® replacement brushes 232
 Vehicle-Noise Measurement Set .. 168
 Vibration Analyzers .. 166, 167, 172,
 174, 184-188
 Vibration Calibrator 169

Vibration Control System 190
 Vibration Integrator System 166
 Video Strobe Light 196
 Voltage-Control
 Autotransformers 213-236
 Voltage Divider, Decade 85
 Voltage Regulators, Line 205-212
 Voltmeter Rectifier/Detector, Coaxial,
 50Ω 101

W

Wave Analyzer Plug-in, Recorder . 175
 Wave Analyzers 173, 174
 Wearable Noise-Exposure Monitor 169
 Weatherproof Enclosure 176
 Weatherproof Microphone System 176
 Wheel, Surface-Speed 203
 Windscreens, Microphone 179

Index by Type Number

| | | | | | |
|---|------------|--|---------|--|-----|
| CAP-22, -35 Power Cords | 241 | 874-T Tee (50Ω) | 99 | 938 Jacks | 239 |
| IEC Power Cord | 241 | 874-TO Crimping Tools/Kit | 106 | 940 Decade-Inductor Units | 89 |
| M-Series Variac® adjustable autotransformers | 223 | 874-TPD Power Divider (50Ω) | 100 | 1061 Frequency Synthesizer | 119 |
| U2 Variac® adjustable autotransformers | 218 | 874-U U-Line Section (50Ω) | 100 | 1062 Frequency Synthesizer | 118 |
| VB Replacement Brushes (Variac) | 232 | 874-V Voltmeter Rectifier/ Detector (50Ω) | 101 | 1157-B Scaler (500 MHz) | 244 |
| W-Series Variac® adjustable autotransformers | 219 | 874-VCL Variable Capacitor | 98 | 1192-B Counter | 242 |
| W50-P1 Paralleling Choke | 232 | 874-W Terminations (50Ω) | 97 | 1211-C Oscillator | 121 |
| 274 Adaptors, Patch Cords, Plugs | 239-241 | 874-W Terminations (75Ω) | 105 | 1218-BV Oscillator | 122 |
| 510 Decade Resistance Units | 82 | 874-X Insertion Unit (50Ω) | 101 | 1232-A Tuned Amplifier and Null Detector | 48 |
| 776 Patch Cords | 96,240,241 | 880-DCA Precision Directional Coupler | 106 | 1232-P2 Preamplifier | 49 |
| 777 Adaptors | 96,240 | 890-BT Low-Cost Basic Precision Coaxial Connector (50Ω) | 108 | 1234 Standing-Wave Meter | 42 |
| GR874® coaxial components (50Ω) | 90 | GR900® precision coaxial components (50Ω) | 107 | 1236 I-F Amplifier | 41 |
| GR874® coaxial components (75Ω) | 103 | GR900® precision coaxial components (75Ω) | 115 | 1238 Detector | 52 |
| 874-B Basic Connector (50Ω) | 91 | GR900® storage case | 116 | 1240 Bridge Oscillator-Detector | 49 |
| 874-B Basic Connector (75Ω) | 103 | 900 Adaptor Flange | 109 | 1263-C Amplitude-Regulating Power Supply | 123 |
| 874-C Cable Connectors (50Ω) | 92 | 900 Precision Tube and Rod | 116 | 1264-B Modulating Power Supply | 122 |
| 874-C Cable Connectors (75Ω) | 103 | 900 Rotatable Centering Ring | 109 | 1265-A Adjustable DC Power Supply | 61 |
| 874-D Adjustable Stubs (50Ω) | 97 | 900-BT Basic Precision Coaxial Connector (50Ω) | 108 | 1267-B Regulated Power Supply | 122 |
| 874-EL Ells (50Ω) | 100 | 900-BT Precision Coaxial Connector (75Ω) | 115 | 1308-A Audio Oscillator and Power Amplifier | 126 |
| 874-F Low-Pass Filters (50Ω) | 100 | 900-C9 Coaxial Cable Precision Connector (50Ω) | 108 | 1310-B Oscillator | 124 |
| 874-FBL Bias Insertion Unit (50Ω) | 102 | 900-EL Precision 90° Ell (50Ω) | 116 | 1311-A Audio Oscillator | 125 |
| 874-G Attenuators (50Ω) | 98 | 900-G Precision Fixed Attenuators (50Ω) | 113 | 1316 Oscillator | 127 |
| 874-G Fixed Attenuators (75Ω) | 105 | 900-L Precision Air Lines (50Ω) | 114 | 1362 Oscillator | 122 |
| 874-K Coupling Capacitor (50Ω) | 101 | 900-LB Precision Slotted Line | 39 | 1363 Oscillator | 121 |
| 874-L Air Lines (50Ω) | 99 | 900-LZ Reference Air Lines (50Ω) | 114 | 1381 Random-Noise Generator | 181 |
| 874-L Rigid Air Line (75Ω) | 105 | 900-MP Precision Matching Pad 50-to-75Ω | 115 | 1382 Random-Noise Generator | 181 |
| 874-LBB Slotted Line | 38 | 900-PKM Panel Mounting Kits | 109 | 1383 Random-Noise Generator | 183 |
| 874-MB Coupling Probe (50Ω) | 101 | 900-Q Precision Adaptors (50Ω) | 110,111 | 1390-B Random-Noise Generator | 182 |
| 874-ML Component Mount (50Ω) | 102 | 900-TOC Cleaning Kit | 116 | 1390-P2 Pink-Noise Filter | 182 |
| 874-MP Matching Pad, 50-to- 75Ω | 104 | 900-TOK Tool Kit | 116 | 1396-B Tone-Burst Generator | 180 |
| 874-MR Mixer/Rectifier (50Ω) | 100,101 | 900-TUA Tuner (50Ω) | 113 | 1403 Standard Air Capacitors | 67 |
| 874-P Panel Connectors (50Ω) | 92 | 900-W Precision Terminations and Mismatches (50Ω) | 112 | 1404 Reference Standard Capacitor | 66 |
| 874-P Panel Connectors (75Ω) | 103 | 900-W Precision-Standard Termination (75Ω) | 115 | 1405 Coaxial Capacitance Standards | 69 |
| 874-PFL Panel Feedthrough Connector | 92 | 938 Binding Posts and Accessories | 237,238 | 1406 Coaxial Capacitance Standards | 68 |
| 874-Q Adaptors (50Ω) | 94-96,240 | | | 1408 Reference Standard Capacitors | 65 |
| 874-Q Adaptors (75Ω) | 103,104 | | | 1409 Standard Capacitors | 70 |
| 874-R Coaxial Patch Cords | 102 | | | 1412-BC Decade Capacitor | 75 |

| | | | | | |
|-----------------------------------|-----|----------------------------------|-----|----------------------------------|-----|
| 1422 Precision Capacitors | 73 | 1560-P62 Power Supply | 179 | 1686-A Digital Capacitance | |
| 1423-A Precision Decade | | 1562-A Sound-Level Calibrator .. | 169 | Meter | 44 |
| Capacitor | 78 | 1562-Z Audiometer Calibration | | 1686-P1 Test Fixture | 44 |
| 1433 Decade Resistors | 81 | Set..... | 170 | 1687 Megahertz LC Digibridge™ . | 33 |
| 1434 Decade Resistors | 83 | 1564-A Sound and Vibration | | 1687-P1 Test Fixture | 33 |
| 1435 Programmable Decade | | Analyzer | 172 | 1740 Linear IC Tester | 129 |
| Resistor | 84 | 1565-B Sound-Level Meter/Sets .. | 168 | 1742 Digital IC Tester | 134 |
| 1440 Standard Resistors | 80 | 1565-D Sound-Level Meter/Sets .. | 168 | 1744 Digital IC Tester | 138 |
| 1450 Decade Attenuator | 183 | 1566 Multichannel Amplifier | 180 | 1782 Analog Limit Comparator .. | 32 |
| 1455 Decade Voltage Dividers ... | 85 | 1567 Sound-Level Calibrator | 169 | 1795-FD Logic Test System | 153 |
| 1482 Standard Inductors | 87 | 1568-A Wave Analyzer | 173 | 1795-HD Logic Test System | 152 |
| 1491 Decade Inductors..... | 88 | 1569 Automatic Level Regulator . | 181 | 1796 Digital/Analog Test System | 154 |
| 1521-B Graphic Level | | 1571 Variac® automatic voltage | | 1797 Programming Station | 157 |
| Recorder | 173 | regulator | 210 | 1799 Digital/Analog Test System | 155 |
| 1523 Graphic Level Recorder ... | 174 | 1581 Variac® automatic voltage | | 1840-A Output Power Meter | 181 |
| 1523-P1A Preamplifier Plug-in .. | 175 | regulator | 211 | 1863 Megohmmeter | 58 |
| 1523-P2 Sweep-Oscillator Plug-in | 175 | 1582 Variac® automatic voltage | | 1864 Megohmmeter | 58 |
| 1523-P4 Wave Analyzer Plug-in . | 175 | regulator | 211 | 1925 Multifilter | 172 |
| 1531-AB Strobotac® electronic | | 1591 Variac® automatic voltage | | 1933 Precision Sound-Level | |
| stroboscope | 199 | regulator | 208 | Meter and Analyzer/System ... | 166 |
| 1531-P2 Flash Delay | 203 | 1592 Variac® automatic voltage | | 1933 Vibration Integrator System | 166 |
| 1531-P3 Surface-Speed Wheel .. | 203 | regulator | 209 | 1933 Audiometer Calibration | |
| 1536-A, -O Photoelectric | | 1602-B UHF Admittance Meter .. | 37 | System | 170 |
| Pickoffs..... | 204 | 1606-B Radio-Frequency Bridge . | 36 | 1935 Cassette Data Recorder ... | 171 |
| 1537-A Photoelectric Pickoff | 204 | 1608-A Impedance Bridge | 20 | 1945 Community Noise Analyzer | 176 |
| 1538-A Strobotac® electronic | | 1615-A Capacitance Bridge | 46 | 1954 Indicator | 169 |
| stroboscope | 199 | 1616 Precision Capacitance | | 1954 Noise Dosimeter..... | 169 |
| 1538-P1 Replacement Strobotron | | Bridge | 50 | 1954 Noise Exposure Monitor ... | 169 |
| Flash Lamp | 200 | 1617-A Capacitance Bridge | 53 | 1952 Universal Filter..... | 183 |
| 1539-A Stroboslave® | | 1620-A Capacitance-Measuring | | 1961 1-inch Electret-Condenser | |
| stroboscopic light source | 202 | Assembly | 47 | Microphones | 177 |
| 1539-Z Motion Analysis and | | 1621 Precision Capacitance- | | 1962 ½-inch Electret-Condenser | |
| Photography Set | 202 | Measurement System | 51 | Microphones | 177 |
| 1540 Strobolume® electronic | | 1630-AV Inductance-Measuring | | 1971 1-inch Ceramic Microphone | 178 |
| stroboscope | 196 | Assembly | 62 | 1972 Preamplifier/Adaptor..... | 179 |
| 1542-B Strobotac® electronic | | 1633-A Incremental-Inductance | | 1981-B Precision Sound-Level | |
| stroboscope | 200 | Bridge | 60 | Meter/Sets/System..... | 167 |
| 1543 Strobotac® electronic | | 1633-P1 Range-Extension Unit .. | 62 | 1982 Precision Sound-Level | |
| stroboscope | 200 | 1644-A Megohm Bridge | 57 | Meter and Analyzer/System ... | 167 |
| 1544 Strobotac® electronic | | 1650-B Impedance Bridge | 17 | 1983 Sound-Level Meter | 168 |
| stroboscope | 200 | 1650-P1 Test Jig | 19 | 1983 Vehicle-Noise Measurement | |
| 1557-A Vibration Calibrator | 169 | 1654 Impedance Comparator.... | 30 | Set..... | 168 |
| 1560 Audiometer Calibration | | 1654-Z Sorting Systems | 30 | 1985 DC Recorder | 171 |
| Accessory Kit | 170 | 1656 Impedance Bridge | 18 | 1995 Integrating Real-Time | |
| 1560 Audiometer Calibration | | 1657 RLC Digibridge™ | 22 | Analyzer | 184 |
| Stand Assembly | 170 | 1658 RLC Digibridge™ | 24 | 2220 Bug Hound | 162 |
| 1560 Microphone Windscreens .. | 179 | 1666 DC Resistance Bridge | 56 | 2230 Component Test System ... | 143 |
| 1560 Tripod | 179 | 1683 Automatic RLC Bridge | 26 | 2270 In-Circuit/Functional | |
| 1560-P40 Preamplifier | 179 | 1683-P1 Test Fixture | 26 | Test System | 158 |
| 1560-P42 Preamplifier | 178 | 1685 Digital Impedance Meter .. | 28 | 2512 Spectrum Analyzer | 186 |

HPH



GenRad

Catalog 78

