

**Baseline Proposal to Satisfy the Objective:** *Define a physical layer specification that supports 800 Gb/s operation over 4 wavelengths over a single SMF in each direction with lengths up to at least 500m*

Brian Welch (Cisco)

John Johnson (Broadcom)

Piers Dawe (Nvidia)

Frank Chang (Source Photonics)

# Contributors and Supporters

- Zvi Rechtman (Nvidia)
- Vasu Parthasarathy (Broadcom)
- Sridhar Ramesh (Maxlinear)
- Drew Guckenberger (Maxlinear)
- Rang-Chen (Ryan) Yu (InnoLight)
- Kent Lusted (Intel)
- Jeffery Maki (Juniper Networks)
- Ryan Latchman (Macom)
- Dave Cassan (Alphawave Semi)
- David Ofelt (Juniper Networks)
- Matt Brown (Alphawave Semi)
- Mark Kimber (Semtech)
- Roberto Rodes (Coherent)

# Caveats and Disclaimers

- In this presentation we are using the temporary nomenclature **800G-4λ-500m**. This is not a nomenclature presentation, and it is expected this will be changed in the final standard.

# Overview

- Loss budget for 500m duplex
- Baseline proposal for 500m duplex
- Technical feasibility for 500m duplex

# Loss Budget

# Loss Budgets: Legacy

- Since their introduction, 500m and 2km SMF reaches have used a statistical loss budgeting approach (MMF had used this previously for shorter reaches).
  - Double-link cabling channel (see next side)
- Many contributions on this topic in 802.3bs, including from Jonathan King and Paul Kolesar
  - A good example is [kolesar 3bs 01 0514.pdf](#)

# Fiber Plant Constructions

## Double-link cabling channel examples

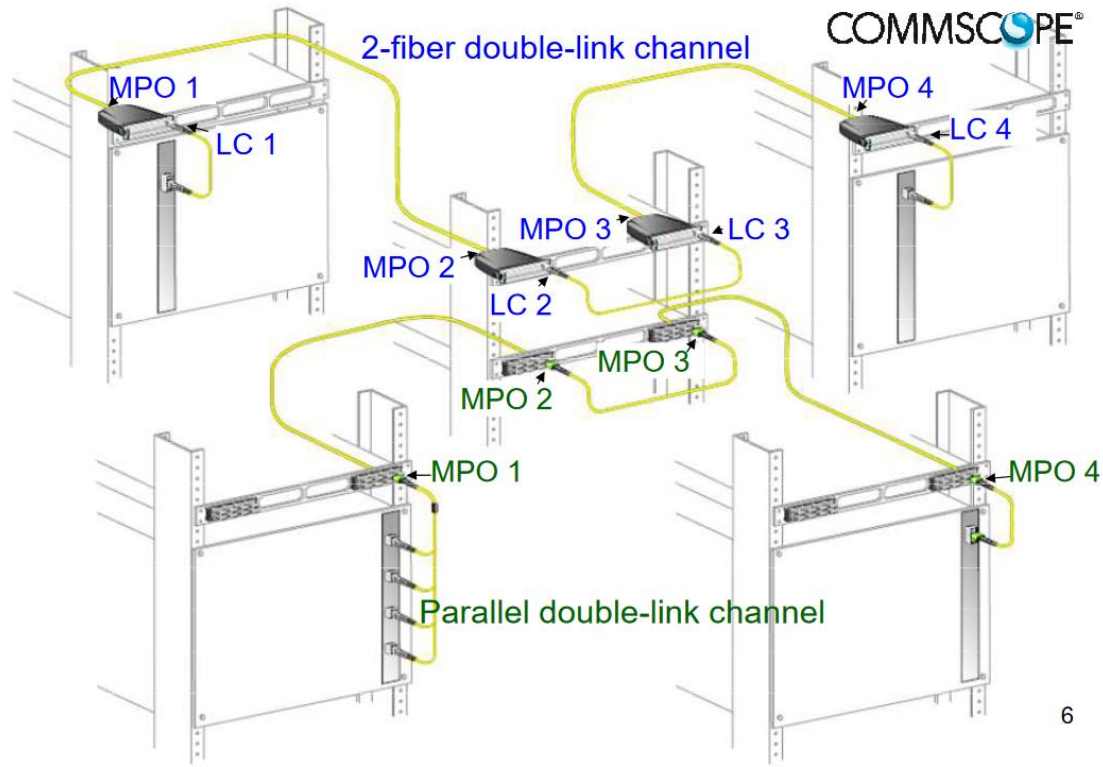

6

## Common channel implementations

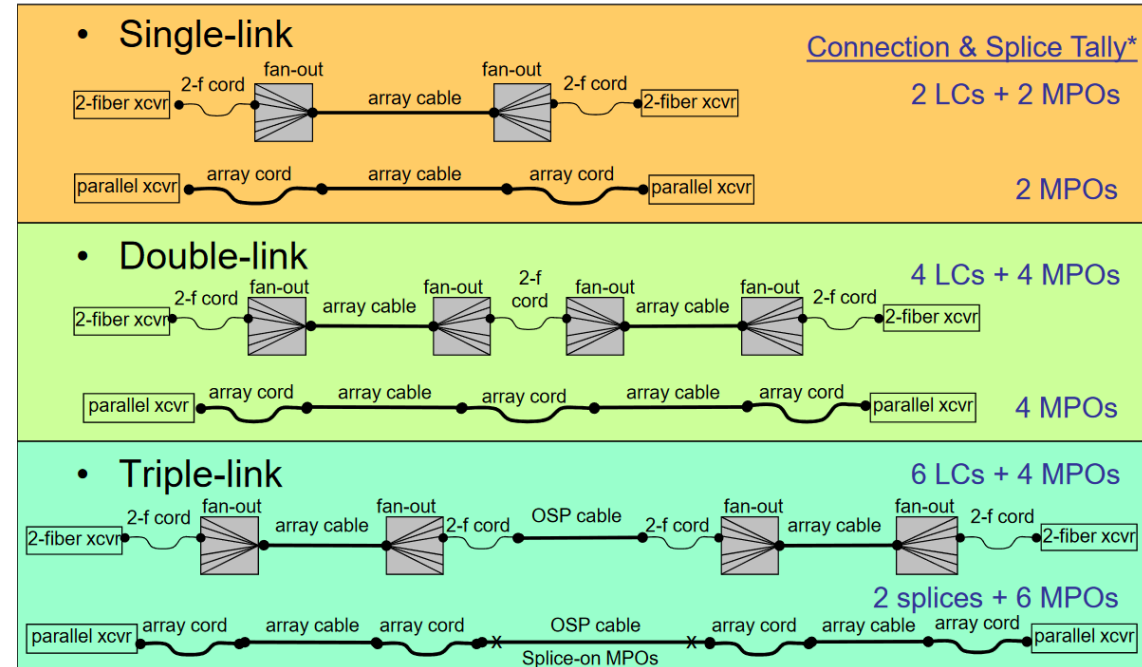

\* Connections to transceivers (at MDI) are not counted in standard loss budget

7

From: [kolesar\\_3bs\\_01\\_0514.pdf](#)

# Fiber Plant: Loss Requirement

Table 122–13—200GBASE-FR4, 200GBASE-LR4, 200GBASE-ER4, 400GBASE-FR8, 400GBASE-LR8, and 400GBASE-ER8 illustrative link power budgets

Parameter	200GBASE-FR4	400GBASE-FR8	200GBASE-LR4	400GBASE-LR8	200GBASE-ER4	400GBASE-ER8	Unit
Power budget (for maximum TDECQ): for extinction ratio $\geq$ 4.5 dB for extinction ratio $<$ 4.5 dB	7.4 7.5	7.2 7.3	10 10.1	9.9 10	21.7 —	21.9 —	dB dB
Operating distance	2		10		30 40 <sup>a</sup>	30 40 <sup>a</sup>	km
Channel insertion loss (max)	4 <sup>b</sup>		6.3		15 18	15 18	dB
Channel insertion loss (min)		0			10	10	dB
Maximum discrete reflectance	See 122.11.2.2						dB
Allocation for penalties <sup>c</sup> (for maximum TDECQ): for extinction ratio $\geq$ 4.5 dB for extinction ratio $<$ 4.5 dB	3.4 3.5	3.2 3.3	3.7 3.8	3.6 3.7	3.7 —	3.9 —	dB dB
Additional insertion loss allowed	0		0		3 0	3 0	dB

<sup>a</sup> Links longer than 30 km are considered engineered links. Attenuation for such links needs to be less than the worst case for cables containing IEC 60793-2-50 type B1.1, type B1.3, or type B6 single-mode cabled optical fiber.

<sup>b</sup> The channel insertion loss is calculated using the maximum distance specified in Table 122–8 for 200GBASE-FR4 and 400GBASE-FR8 and fiber attenuation of 0.5 dB/km plus an allocation for connection and splice loss given in 122.11.2.1.

<sup>c</sup> Link penalties are used for link budget calculations. They are not requirements and are not meant to be tested.

## 122.11.2.1 Connection insertion loss

The maximum link distance for 200GBASE-LR4, 200GBASE-ER4, 400GBASE-LR8, and 400GBASE-ER8 is based on an allocation of 2 dB total connection and splice loss. For example, this allocation supports four connections with an average insertion loss per connection of 0.5 dB. The maximum link distance for 200GBASE-FR4 and 400GBASE-FR8 is based on an allocation of 3 dB total connection and splice loss. Connections with different loss characteristics may be used provided the requirements of Table 122–17 are met.

- 2km duplex defined in the spec as 3 dB of connector + splice loss and 1dB of fiber loss (at 0.5 dB/km) = 4dB total for 2km
- Reducing to 500m yields ~ 3.25 dB total loss
- Proposing to round up 3.5 dB loss budget in baseline proposal, which aligns to prior MSA 500m duplex spec ([cwdm4-ocp-specification](#))

Taken from 802.3-2022



# Baseline Proposal

# Baseline Proposal – Key Details

- Proposal is based on FECo – RS(544,514,10) as the only FEC encoding
- Transmitter min power levels are the same as those adopted in 800GBASE-FR4
  - Differences in data-rate and max TDECQ due to FECo
- Receiver min power levels have been increased by 0.5 dB (vs. 800GBASE-FR4), due to the reduced loss budget.
  - Also changes in baud rate and max TECQ/SECQ due to FECo

# TDECQ/TECQ/SECQ Reference Receiver – Tap Restrictions

	Symbol	Value	Units
Feedforward equalizer (FFE) length	$N_b$	15	UI
Maximum FFE pre-cursors		3	UI
Maximum FFE post-cursors		13	UI
Normalized FFE coefficient maximum limit $n = -3$ $n = -2$ $n = -1$ $n = 0$ $n = 1$ $n = 2$ $n \geq 3$	$bb_{\max}(n)$	TBD <sup>†</sup> TBD TBD TBD TBD TBD TBD <sup>†</sup>	-
Normalized FFE coefficient minimum limit $n = -3$ $n = -2$ $n = -1$ $n = 0$ $n = 1$ $n = 2$ $n \geq 3$	$bb_{\min}(n)$	TBD <sup>†</sup> TBD TBD TBD TBD TBD TBD <sup>†</sup>	-
Sum of all tap weights	$bb_{\text{sum}}$	1	

† Coefficients at +/- 3 and beyond expected to be small

# Location in Ethernet Stack: FECo

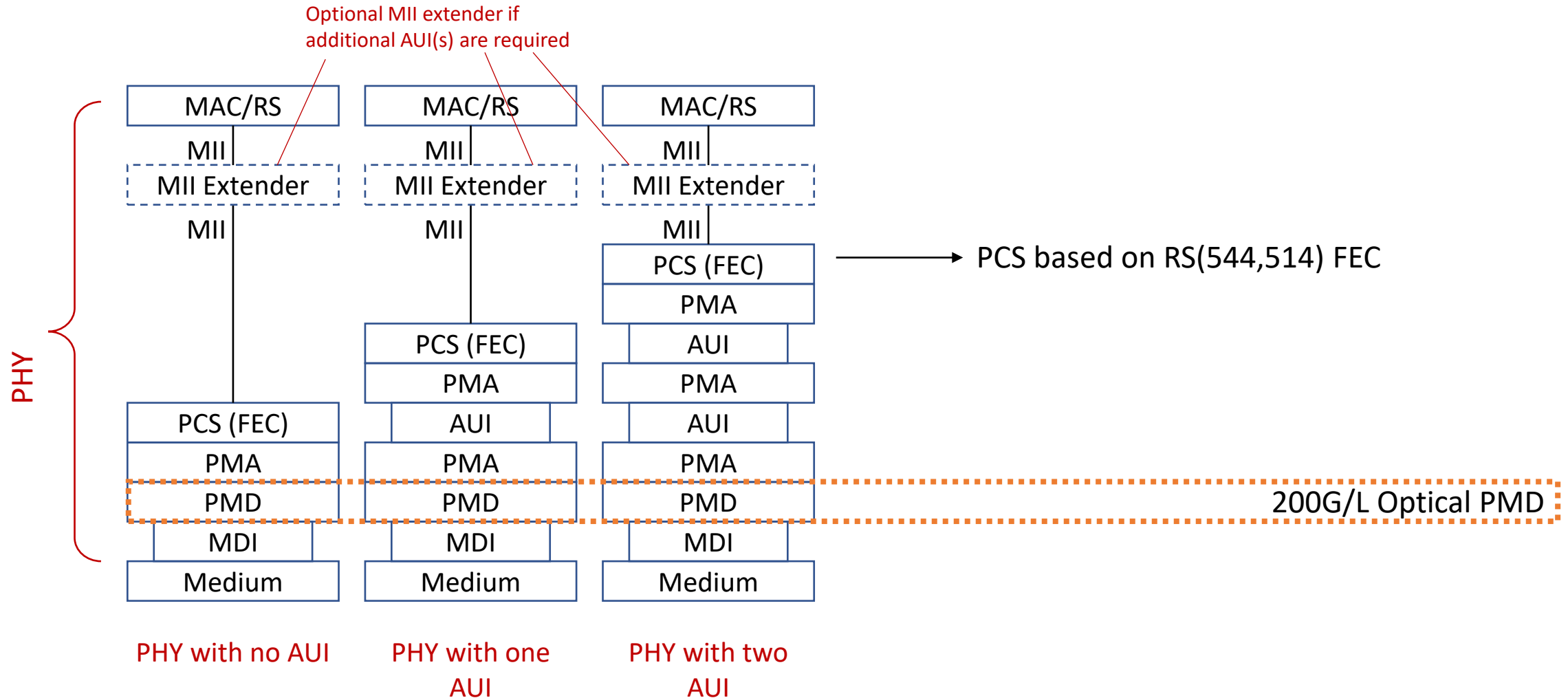

# BER Requirements

- **FEC<sub>o</sub>** : The BER of the PMD link shall be less than  **$2.4 \times 10^{-4}$**  provided that the error statistics are sufficiently random that this results in a frame loss ratio of less than  $1.7 \times 10^{-12}$  for 64-octet frames with minimum interpacket gap when processed with an 800GBASE-R PCS.

# Proposed Transmitter Specifications

Description	800G-4λ-500m	Unit
Signaling rate, each lane (range)	106.25 ± 50 ppm	GBd
Modulation Format	PAM4	
Lane wavelengths (range)	1264.5 to 1277.5 1284.5 to 1297.5 1304.5 to 1317.5 1324.5 to 1337.5	nm
Side-mode suppression ratio (SMSR), (min)	30	dB
Average launch power, each lane (max)	4.9	dBm
Average launch power, each lane (min)	-1.8	dBm
Outer Optical Modulation Amplitude (OMA <sub>outer</sub> ), each lane(max)	4.8	dBm
Outer Optical Modulation Amplitude (OMA <sub>outer</sub> ), each lane(min)	0.8	dBm
for MAX(TECQ,TDECQ) < 0.9 dB		dBm
for 0.9 dB ≤ MAX(TECQ,TDECQ) ≤ 3.4 dB	-0.1+MAX(TECQ,TDECQ)	dBm
Transmitter and dispersion eye closure (TDECQ), each lane (max)	3.4 <sup>a</sup>	dB
TECQ (max)	3.4 <sup>a</sup>	dB
TDECQ - TECQ  (max)	2.5	dB
Average launch power of OFF transmitter, each lane (max)	-15	dBm
Extinction ratio, each lane, (min)	3.5	dB
Transmitter transition time (max)	8	ps
Transmitter over/under-shoot (max)	22	%
RIN <sub>x</sub> OMA (max)	-139	dB/Hz
Optical return loss tolerance (max)	17.1	dB
Transmitter reflectance (max)	-26	dB

<sup>a</sup> Measured with FFE15 reference equalizer with SER = 4.8e-4

# Proposed Receiver Specifications

Description	800G-4λ-500m	Unit
Signaling rate, each lane (range)	106.25 ± 50 ppm	GBd
Modulation Format	PAM4	
Lane wavelengths (range)	1264.5 to 1277.5 1284.5 to 1297.5 1304.5 to 1317.5 1324.5 to 1337.5	nm
Damage threshold, each lane	5.9	dBm
Average receive power, each lane (max)	4.9	dBm
Average receive power, each lane (min)	-5.6	dBm
Receive power, each lane ( $OMA_{outer}$ ) (max)	4.8	dBm
Receiver reflectance (max)	-26	dB
Receiver sensitivity ( $OMA_{outer}$ ), each lane (max) for $TECQ < 0.9$ dB for $0.9 \text{ dB} \leq TECQ \leq SECQ$	-3.2 -4.1 + TECQ	dBm dBm
Stressed receiver sensitivity ( $OMA_{outer}$ ), each lane (max)	-0.7	dBm
Conditions of stressed receiver sensitivity test:		
SECQ	3.4 <sup>a</sup>	dB
$OMA_{outer}$ of each aggressor lane	1.9	dBm

<sup>a</sup> Measured with FFE15 reference equalizer with SER = 4.8e-4

# Proposed Link Budget

Description	800G-4λ-500m	Unit
Power budget (for max TDECQ)	7.6	dB
Operating distance	500	m
Channel insertion loss	3.5	dB
Maximum discrete reflectance	-35	dB
Allocation for penalties (for max TDECQ)	3.9	dB
Additional insertion loss allowed	0	dB

	Dispersion (ps/nm)		Insertion Loss	Optical Return Loss	Max mean DGD
	Minimum	Maximum			
<b>800G-4λ-500m</b>	$0.0115 \times \lambda \times [1 - (1324/\lambda)^4]$	$0.0115 \times \lambda \times [1 - (1300/\lambda)^4]$	Minimum	17.1 dB	0.8 ps

	Dispersion (ps/nm)	
	Minimum	Maximum
<b>800G-4λ-500m</b>	$\geq -2.94$	$\leq 1.66$



# Technical Feasibility

# Technical Feasibility - A

## Receiver demonstrations

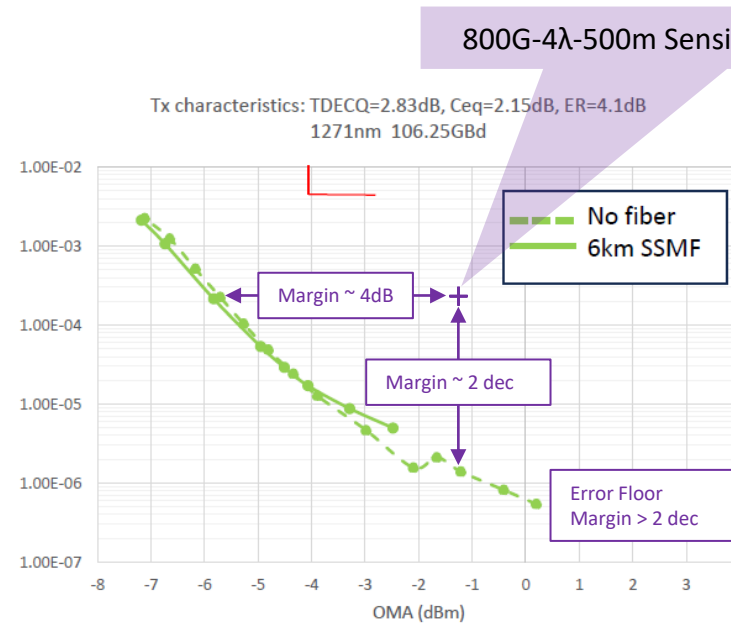
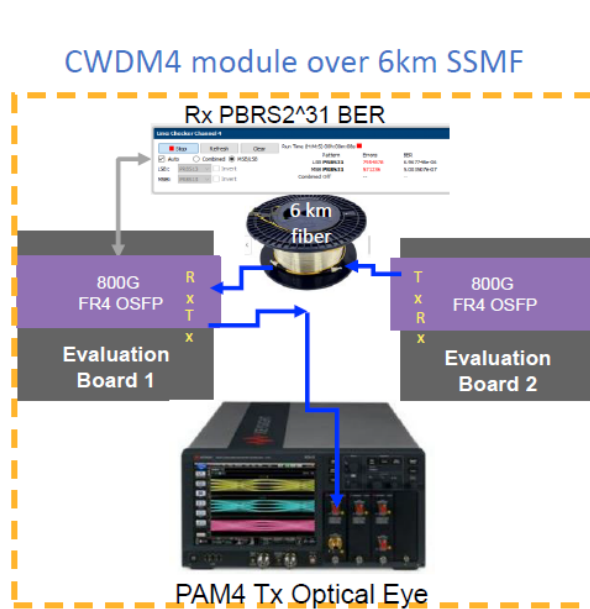

- Demonstration from [rodes 3dj 01a 2311.pdf](https://www.rds.com/3dj_01a_2311.pdf), using an MZI type driver with TECQ = 2.83 dB
- Purple margin labels added

- CWDM4 Lane0 (1271nm) measured after  $\sim -20$ ps/nm similar to worst-case dispersion on 800G-LR4 LWDM
- Slightly lower baudrate than 113.4375GBd, expected to add some penalty on sensitivity

# Technical Feasibility - B

800G-4λ-500m Sensitivity Spec for TECQ = 3.1 dB

212G vs 226G lane2 BER curve

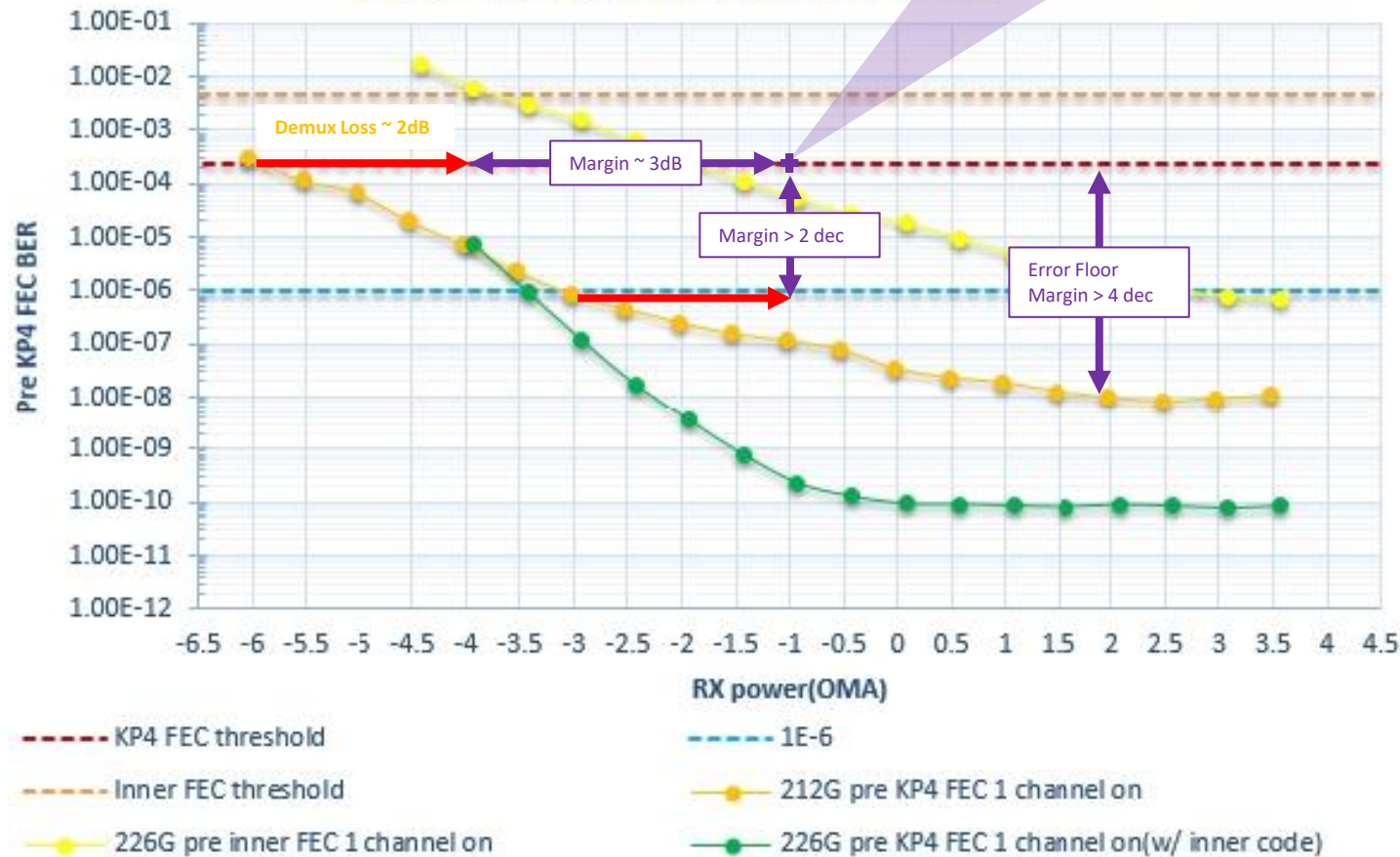

- Pre-production part/testing, results as of Dec 2023.
- Using an EML with integrated driver and TECQ = 3.1 dB
- Part is 800G-DR4 with an additional 2dB MUX loss annotated in the chart (red arrows)

# Technical Feasibility - C

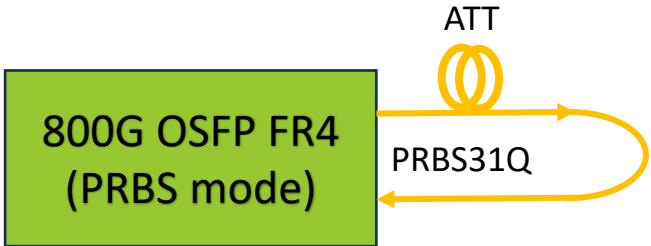
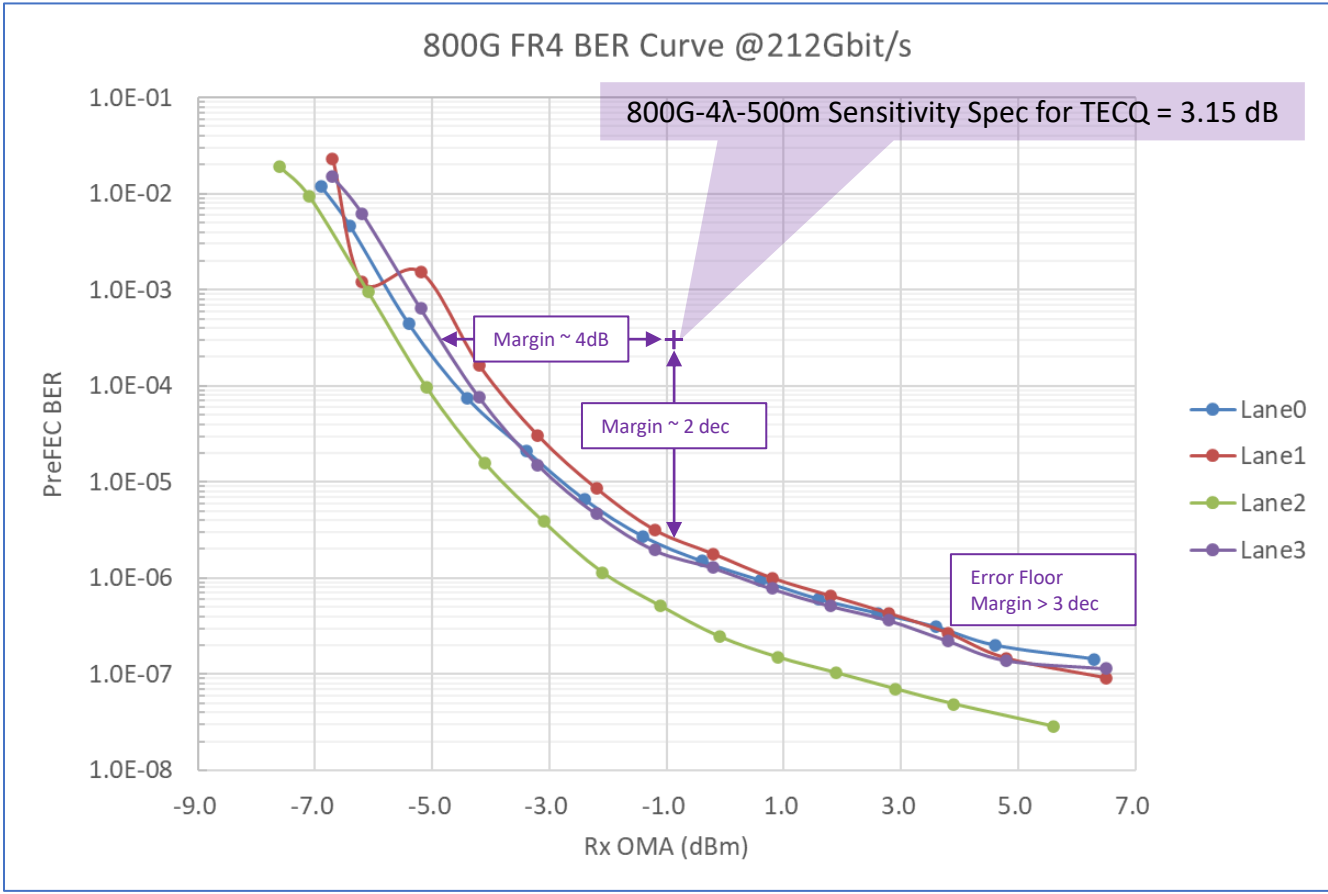

- 800G FR4 OSFP with CWDM4 wavelengths:

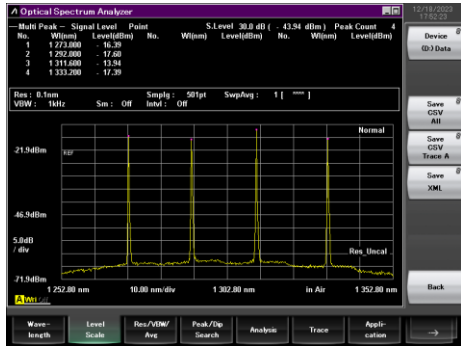

- Continuous work from [liu 3dj\\_optx\\_01a\\_231019.pdf](#) and [chang 3dj\\_01b\\_2311.pdf](#), based on EML type transmitter with  $TECQ \leq 3.15dB @ 2.4E-4$
- Good margin to exceed both Rx sensitivity and BER floor.

# Technical Feasibility - C

Max FEC BIN = 3

800G OSFP FR4 (Mission mode) @ ONT-804

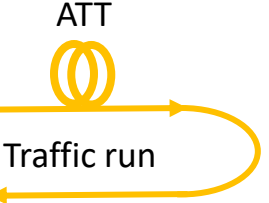

VIAMI ONT 800G FLEX XPM 403002040A0083 Port1 OSFP800g-LR4\_4x200G\_20231204 Module Time: 09:45 AM CET Disk: 15.2GB of 29.2GB free

Selected PHY: All PHYs Lane View Event List

PHY #1 PHY #2 PHY #3 PHY #4

**Total FEC Errors / Count**

PHY#	Uncorr. CW Error	Corr. CW Error	Corr. Symbol Err.	Corr. Bit Error	Corr. Zero Bit Err.	Corr. One Bit Err.
1	0	140,663	140,671	255,993	14,079	241,914
2	0	2	2	4	0	4
3	0	377	377	638	66	572
4	0	9,571	9,571	15,717	1,976	13,741

**Total FEC Errors / Ratio**

PHY#	Uncorr. CW Error	Corr. CW Error	Corr. Symbol Err.	Corr. Bit Error	Corr. Zero Bit Err.	Corr. One Bit Err.
1	*	1.372E-5	2.523E-8	4.591E-9	2.525E-10	4.338E-9
2	*	1.951E-10	3.587E-13	7.174E-14	*	7.174E-14
3	*	3.678E-8	6.761E-11	1.144E-11	1.184E-12	1.026E-11
4	*	9.338E-7	1.716E-9	2.819E-10	3.544E-11	2.464E-10

Note: You can sort the tables by clicking on the header of the appropriate column. Clicking again changes the sort sequence.

VIAMI ONT 800G FLEX XPM 403002040A0083 Port1 OSFP800g-LR4\_4x200G\_20231204 Module Time: 09:46 AM CET Disk: 15.2GB of 29.2GB free

FEC Statistics

Table View

Symbol Error Count	Corrected Count	FEC Correction Rate	Correctable Data Rate	Current
15,717	15,717	100%	100%	OK

VIAMI ONT 800G FLEX XPM 403002040A0083 Port1 OSFP800g-LR4\_4x200G\_20231204 Module Time: 09:46 AM CET Disk: 15.2GB of 29.2GB free

FEC Statistics

Table View

Symbol Error Count	Corrected Count	FEC Correction Rate	Correctable Data Rate	Current
15,717	15,717	100%	100%	OK

VIAMI ONT 800G FLEX XPM 403002040A0083 Port1 OSFP800g-LR4\_4x200G\_20231204 Module Time: 09:46 AM CET Disk: 15.2GB of 29.2GB free

FEC Statistics

Table View

Symbol Error Count	Corrected Count	FEC Correction Rate	Correctable Data Rate	Current
15,717	15,717	100%	100%	OK

VIAMI ONT 800G FLEX XPM 403002040A0083 Port1 OSFP800g-LR4\_4x200G\_20231204 Module Time: 09:46 AM CET Disk: 15.2GB of 29.2GB free

FEC Statistics

Table View

Symbol Error Count	Corrected Count	FEC Correction Rate	Correctable Data Rate	Current
15,717	15,717	100%	100%	OK

# Summary

- A baseline proposal for an 800G duplex solution up to 500m has been proposed.
- Loss budgets have been derived from 2km duplex standards, and made consistent with non-IEEE precedents for 500m duplex.
- Technical feasibility has been demonstrated in different technologies (MZI and EML), and from multiple vendors.

# Thank You