

# Advanced Automation and Sample Introduction Systems

for Thermo Scientific™ iCAP™ Q/RQ/TQ ICPMS



2020 Catalog



**Elemental  
Scientific**

# NEW PRODUCTS FEATURED

## SAMPLESENSE FAST

New inert injection valve with electronic optical detection of the sample for ultra-high throughput and reliability. Maximizes productivity, simplifies method development, monitors sample loading, minimizes sample consumption and compensates for changes in the sample uptake pathway. (Pages 18-23)



## SAMPLETRAX

Barcode reading autosampler and sample preparation systems. Automates sample identification, tracking, preparation, and introduction. Utilizes dedicated barcode scanners to track samples throughout the entire sample handling process. (Pages 28-30)



## GetReady

Automated selection valve which automates ICPMS tuning, mass calibration and carrier solution selection when using FAST and prepFAST systems. (Pages 46-47)



## prepFAST M5

Autocalibration and autodilution system with syringe sample loading for small and viscous samples. (Pages 14-17)



## PCH Peltier Cooler

For HF-resistant PFA Spray Chamber for iCAP™ Q/RQ/TQ. (Page 61)

# TABLE OF CONTENTS

## Automation

DX autosamplers .....	4-5
FAST systems .....	6-7
prepFAST technology .....	8-11
prepFAST autodilution system .....	12-13
prepFAST M5 syringe sample loading autodilution system .....	14-15
prepFAST complete systems comparison .....	16
prepFAST ordering information .....	17
SampleSense for FAST and prepFAST .....	18-23

## Application Systems

prepFAST S5 ultraclean automated sample handling system .....	24-27
SAMPLETRAX automated sample identification system .....	28-30
TRUFAST preconcentration system .....	31
prepFAST IC speciation system .....	32-37
seaFAST seawater analysis system .....	38-41
hydrideICP system .....	42-43
hydride S31 .....	44-45
GetReady automated tuning solution selection .....	46-47

## Autosampler Accessories

Enclosures and UHPA filtered environments .....	48
Mobile autosampler stations .....	49

## Nebulizers, Spray Chambers, Torches and Injectors

PFA nebulizers and accessories .....	50-54
MEINHARD® quartz and glass nebulizers .....	56-57
pergo argon nebulizer gas humidifier .....	58-59
PCH Peltier cooler, spray chambers and accessories .....	60-61
apex desolvation systems .....	62-63
Torches and injectors .....	64

## Peristaltic Pumps

Peristaltic pump tubing .....	65
MP <sup>2</sup> peristaltic pumps .....	66
MP <sup>2</sup> peristaltic pump tubing .....	67

## Consumables

High purity valves, stators and rotors .....	68-70
Spare syringes .....	71
Online mixing kits .....	72
Manual sampling probes / nebulizer lines .....	73
Fittings / tubing / sample loops .....	74-75
High purity HF-resistant sample vials and bottles .....	76-78
Sample vessels .....	79
Microplates .....	80
X-piercing film covers .....	81
Large autosampler racks .....	82
Heated and micro autosampler racks .....	83
Super autosampler racks .....	84-85
Standards autosampler racks .....	86
SAMPLETRAX barcoded racks and vials .....	87

FAST Spares Kits .....	88
Installation and Training .....	89
Autosampler Dimensions .....	90-91
Index .....	92-93
ESI Contact Information .....	95



AUTOMATION

SAMPLE INTRODUCTION

CONSUMABLES

# DX Family of Autosamplers

DX autosamplers are durable, chemically inert, and feature dual flowing rinse stations to reduce carryover. Versatile rack configurations along with the ability to upgrade to any high-throughput *FAST* or autodiluting prep*FAST* system, make the DX autosampler the perfect foundation for automation in any trace metal lab. They are available in seven models having five capacities ranging from the Micro to the 14DX, the largest on the market.

## Benefits:

- Durable dual rail system
- Dual flowing rinse stations
- Precision sampling
- Reset probe – prevents probe damage
- Flexible rack configurations
- Upgradeable to *FAST* or prep*FAST*

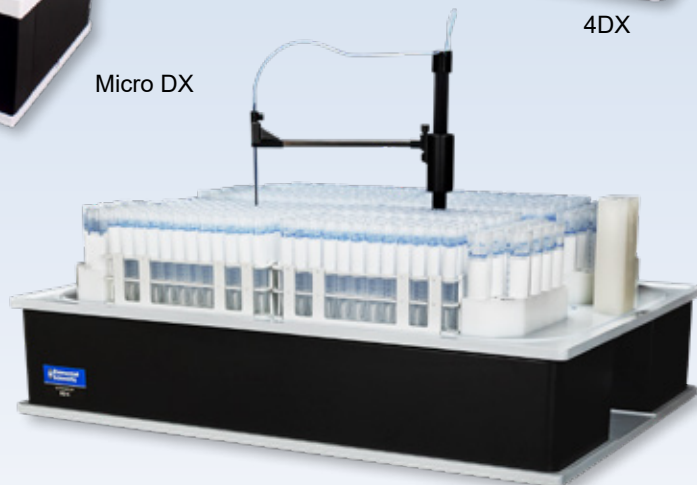
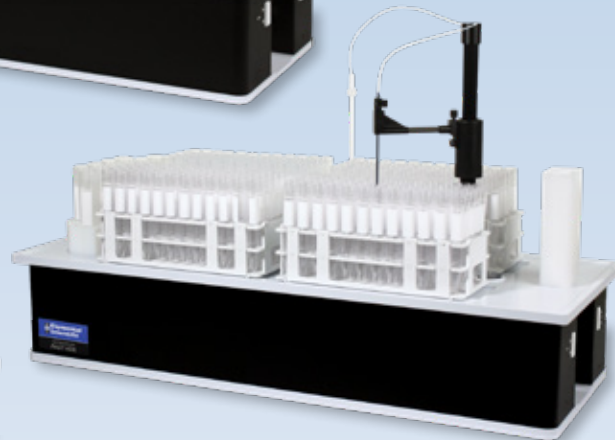
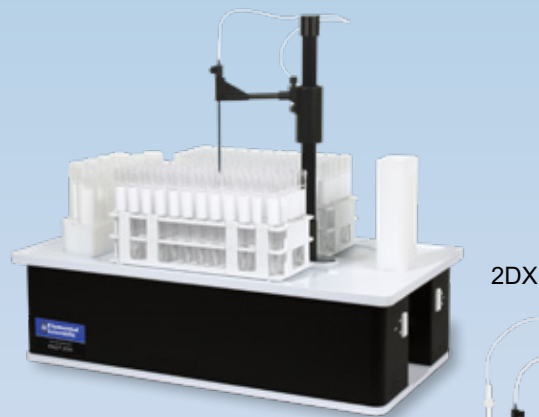

## DX Autosamplers are Engineered to be Precise and Durable

All DX autosamplers are designed for the trace metal lab. They utilize a Dual X-rail design combined with a large diameter Z-rail with theta angular motion for precise sampling. All DX components are constructed using chemically resistant materials for an exceptionally long lifetime.

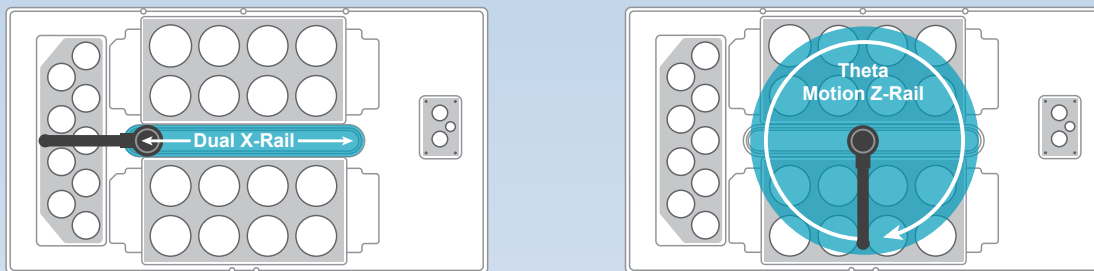

Micro DX autosampler shown

## Dual Rinse Stations Reduce Carryover

Eliminating carryover is vital for accurate data and paramount to the production laboratory.

All DX autosamplers have dual rinse stations to minimize sample-to-sample carryover. Rinse liquid is supplied by a common rinse pump split between two rinse station positions. With independent rinse pumps, each station can use a different rinse solution to effectively rinse wide-ranging sample types while minimizing rinse solution consumption.

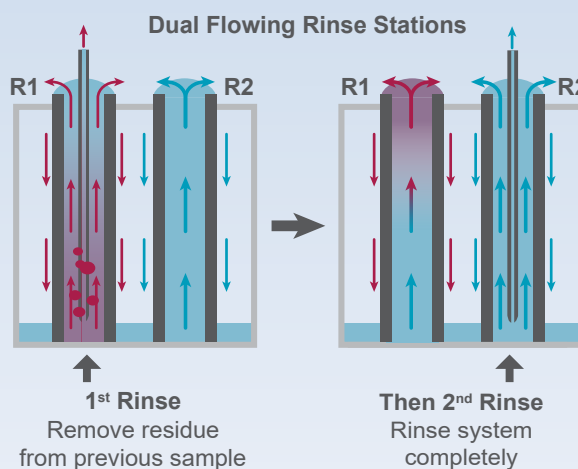

## DX Autosamplers are Versatile and Upgradeable

DX autosamplers are available in a range of sizes, with capacities from 2 micro racks (Micro DX) to 14 large racks (14DX).

Flexible rack configurations permit almost any sample size, from microplates and micro vials up to 500 mL and larger bottles to be automatically analyzed.

All DX autosamplers have the ability to upgrade to any FAST high throughput or prepFAST autodilution system.

### Versatile Rack Configurations

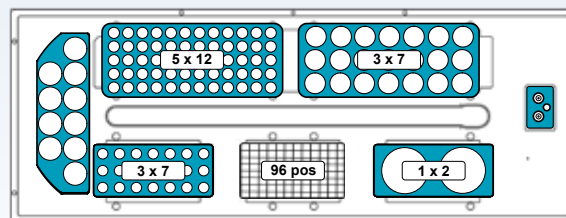

4DX shown with 5 x 12 and 3 x 7 large racks, 3 x 7 micro rack (MR), 96 well microplate, MR bottles - 2 x 250 mL

Model	Part Number	Mobile Stand	Large Rack Capacity	Microplate/ Micro Rack Capacity	MAXIMUM SAMPLE CAPACITY			
					50mL	15mL	8mL	MT-96
Micro DX	m-DX	N/A	-	2	20	42	80	192
2DX	2DX	SC-1210-DX	2	4	52	120	180	384
4DX	4DX	SC-1410-DX	4	6	94	240	360	576
8DX Benchtop	8DX-BT	SC-1810-DX	8	-	208	480	720	-
8DX	8DX	included	8	-	208	480	720	-
14DX	14DX	included	14	30*	304	840	1260	2880*

\*Special version 14DX for microplates

# FAST SYSTEM

for iCAP™ Q/RQ/TQ ICPMS

The FAST is a high-throughput, automated sample introduction system for the iCAP™ Q/RQ/TQ ICPMS. The FAST system uses valve injection with rapid vacuum sample loading to more than double the productivity of the iCAP™ Q/RQ/TQ ICPMS, minimize instrument maintenance, and reduce operating costs.

## FAST Benefits

- High sample throughput
- FAST uptake, stabilization, and washout
- Specially-designed P-Series valve and loop combination has superb washout
- Options with and without segmented air bubbles ensures high precision for every application

## Improved Efficiency

By presenting the sample for a short period of time during the measurement, ICPMS cone deposition is minimized, resulting in long stable analytical runs without maintenance. The FAST reduces consumption of argon, power, and reagents.

## Increased Sample Throughput

In addition to higher throughput gained by using an autosampler, the FAST system analyzes a sample 2-5 times faster than it takes a standard autosampler to perform the same task.

FAST also benefits labs with relatively few samples by reducing operating costs and shortening analytical runs.

### Normal Analysis

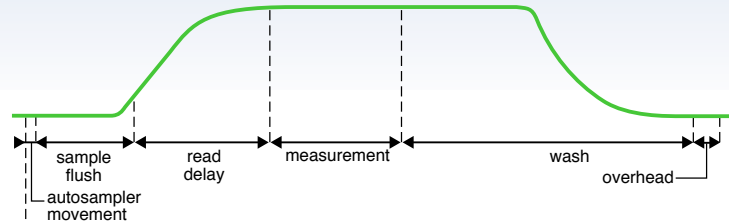

### FAST Analysis

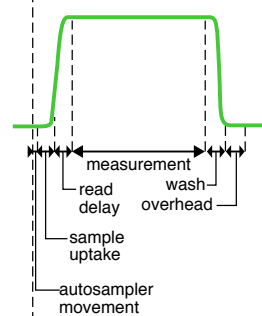

### Six Steps in a Standard Analysis

1. Autosampler Movement
2. Uptake
3. Stabilization
4. Measurement
5. Wash
6. Overhead

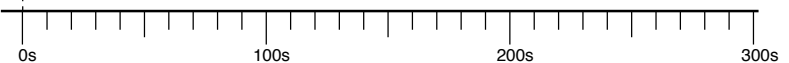

The FAST system has the fastest signal stabilization and most complete rinse-out of any sample introduction system. This reduces uptake and wash times while increasing sample throughput.



STANDARD ANALYSIS  
**96 SAMPLES**

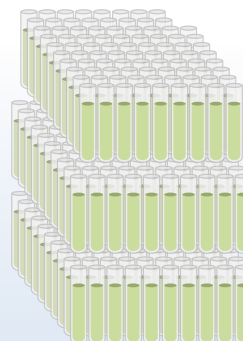

FAST ANALYSIS  
**288 SAMPLES**

**2-5x** HIGHER SAMPLE THROUGHPUT  
WITH FAST SYSTEM  
DEPENDENT ON APPLICATION

## Superior P-Series FAST Valve

- PFA rotors for long life and low maintenance
- Chemically resistant compression ring
  - Uniform pressure
  - Keyed for easy assembly
  - Prevents damage from overtightening
- All fluoropolymer flow path
- Internal components PTFE-coated to prevent corrosion
- In-valve mixing of internal standard (P7 valve)

## Integrated FAST Valve Module

- FAST valve module located directly below iCAP™ Q/RQ/TQ sample introduction area
- Minimizes distance from nebulizer
- Fully integrated with Thermo Scientific™ Qtegra™ software



The FAST loads the sample loop as the nebulizer and tubing are cleaned.

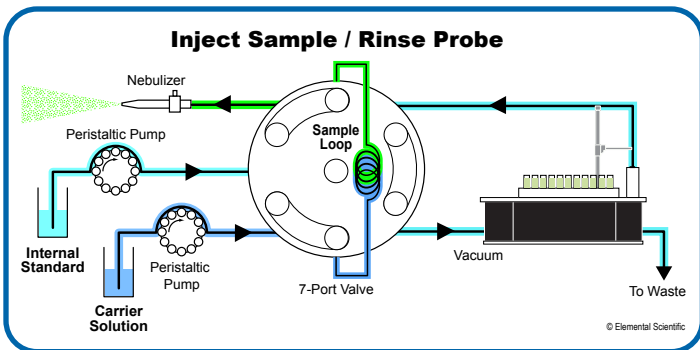

The autosampler probe and tubing are rinsed while the sample is analyzed.

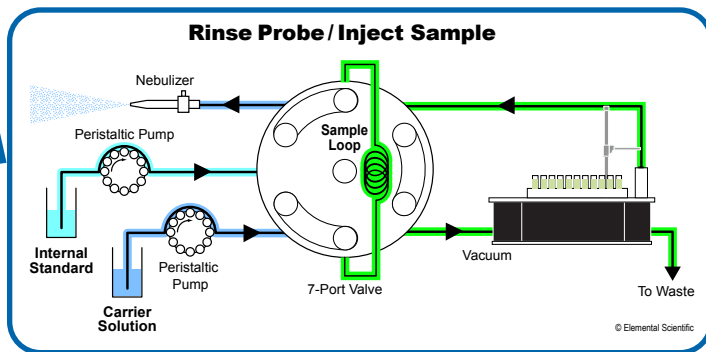

### FAST SYSTEM PART NUMBERS FOR iCAP™ Q/RQ/TQ ICPMS

Description	Nebulizer	Probe	2DX	4DX	8DX	14DX
FAST System for iCAP™ Q/RQ/TQ. Includes DX autosampler. (*Benchmark version available)	✓	✓	2DXF-73A	4DXF-73A	8DXF-73A (*8DXF-BT-73A)	14DXF-73A

See page 4 for more information on DX autosamplers

See page 18 for adding **SampleSense** to your **FAST** system

FAST with SampleSense Valve



## Automated Sample Preparation with Inline Dilution

prepFAST is a line of automated inline dilution systems which eliminates manual dilution, reduces reagent usage, and improves laboratory productivity. These systems combine the DX autosampler, high-throughput FAST technology and a syringe module to perform precise and accurate inline dilutions of standards and samples.

### prepFAST Automates Daily Lab Functions

#### Autodilution

Samples are automatically inline syringe-diluted and prepared for analysis.

- Automatic inline dilution modes
  - Constant dilution (e.g. all samples diluted 10x)
  - Variable dilution (i.e. user-specified dilution factor sample-by-sample)
- Improve precision and accuracy
- Reduce vial and reagent usage
- Improve sample throughput and washout

#### Autocalibration

Automate inline preparation of ICPMS calibration standards.

- Save time and improve laboratory efficiency
- Improve linearity
- Standards rack (9 x 125 mL) holds both calibration and QC compliance standards
- Save time and improve laboratory efficiency

#### Overrange Dilution

Automatically dilute and reanalyze samples having analyte concentrations above the calibration range.

- Autodilute overrange samples
- Automatic serial dilution brings even extremely high concentration samples into range
- Optimize laboratory throughput by generating reportable results from the initial sample run
- Automatically dilute high matrix samples that cause internal standards recoveries to fall out of acceptable ranges



2DX prepFAST



# Autodilution

## prepFAST™ Rapid, Variable, In-valve Autodilution

Samples are quickly loaded into a loop, then mixed with diluent and internal standard using a patented mixing valve at the dilution factor prescribed by Qtegra™ software. The diluted and mixed sample is then introduced into the ICPMS while the sample loop is syringe rinsed and readied for the next sample. This sampling and dilution process takes place in seconds.

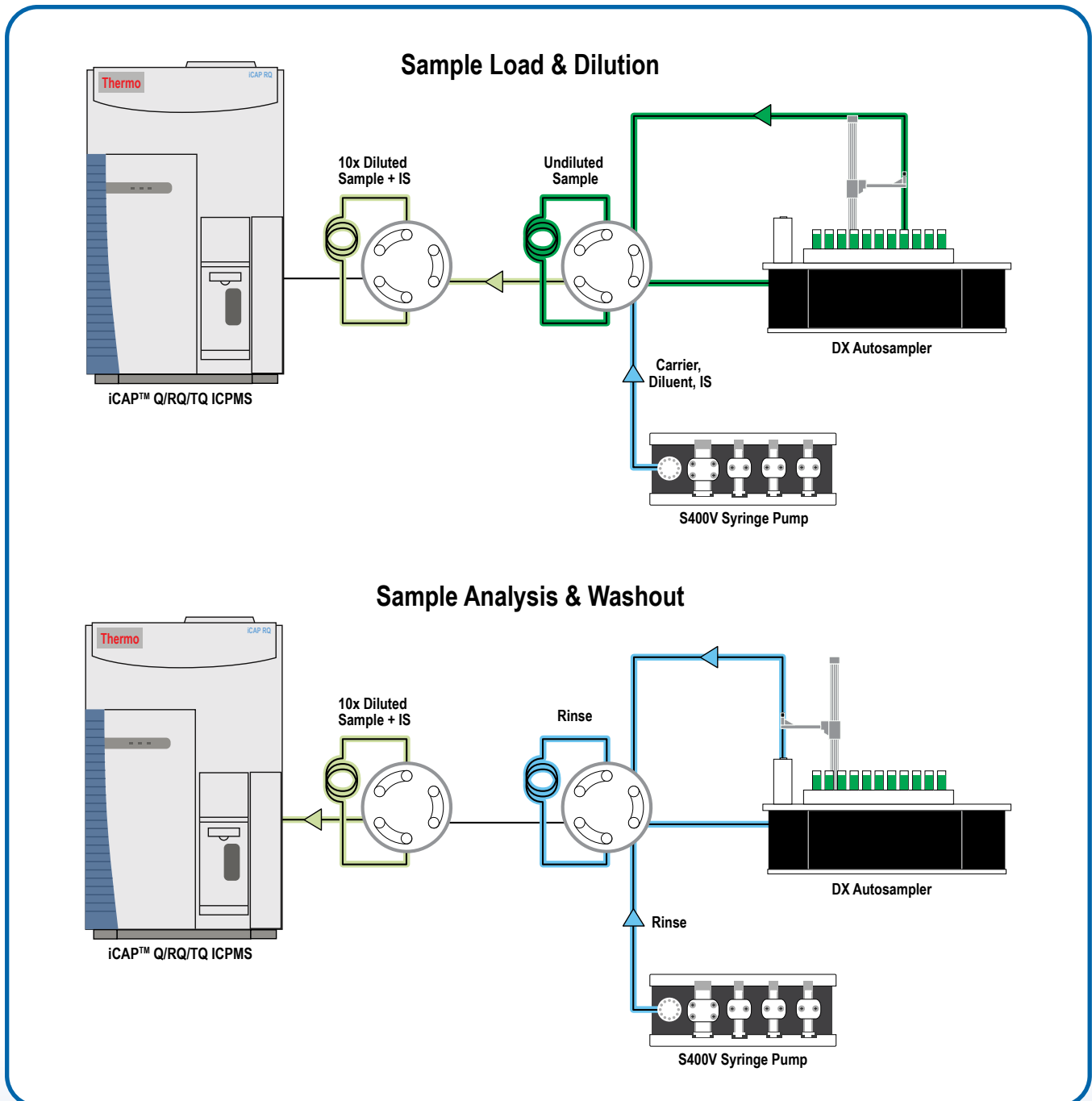

prepFAST dilution diagram for iCAP™ RQ/TQ

# Autocalibration

## prepFAST™ Autocalibration

Every prepFAST model can create multipoint calibration curves from a single bottle of stock standard. Each point of the calibration curve is prepared by autodilution of a single stock calibration standard placed on the autosampler deck. The prepFAST automatically generates highly linear and consistent ICPMS calibration curves. If necessary, multiple standards can be used for large concentration ranges or when standard matrices are incompatible.

### prepFAST Autocalibration

Inline Prep from 1 Blank + 1 Standard

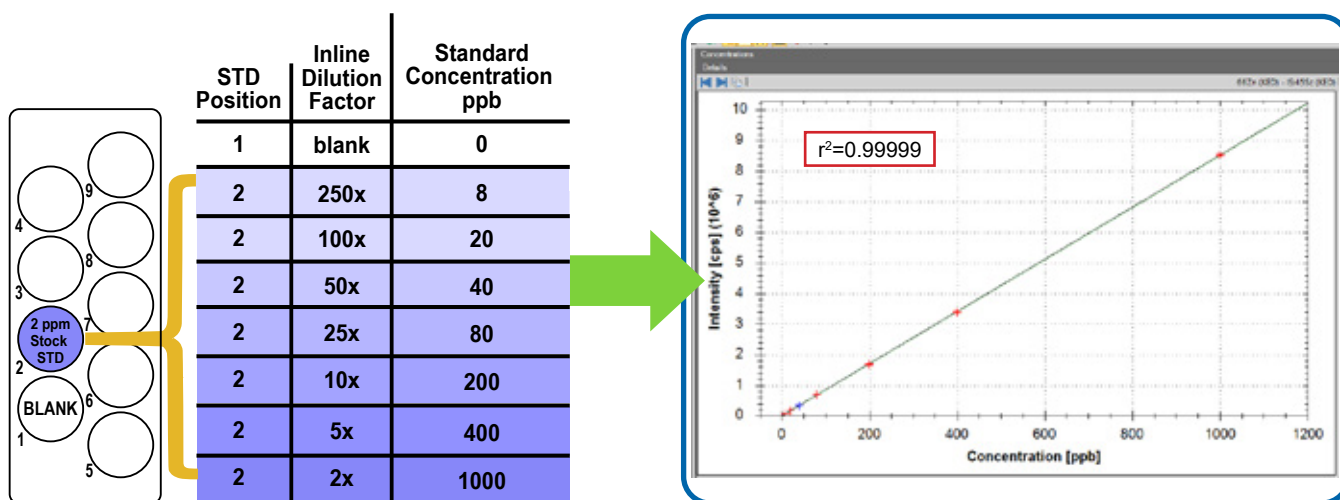

Autocalibration improves laboratory efficiency by eliminating the need for labor-intensive and error prone standard preparation. It reduces laboratory waste by reducing calibration vial, reagent, and standard waste. prepFAST autocalibration is particularly important for low concentration standards near the detection limit.

## Manual Calibration vs. Autocalibration

**30+ MINUTES**  
- Manual Labor -



**5 MINUTES**  
- AUTOMATED -

- High Risk of -  
**HUMAN ERROR**

- Risk of -  
**CONTAMINATION**  
- Airborne, Pipettes,  
Vials -



- Reduced -  
**HUMAN ERROR**

- Reduced Risk of -  
**CONTAMINATION**  
- Single high stock  
standard -

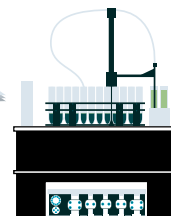

- High use of -  
**CONSUMABLES**

- Reduced use of -  
**CONSUMABLES**

# Overrange Dilution

## prepFAST™ Overage Analyte Autodilution

The prepFAST automatically dilutes samples when an analyte goes above method-specified quality control levels. The sample is automatically reinserted into the sample list and reanalyzed at a higher dilution factor until the determined concentration falls within the specified range.

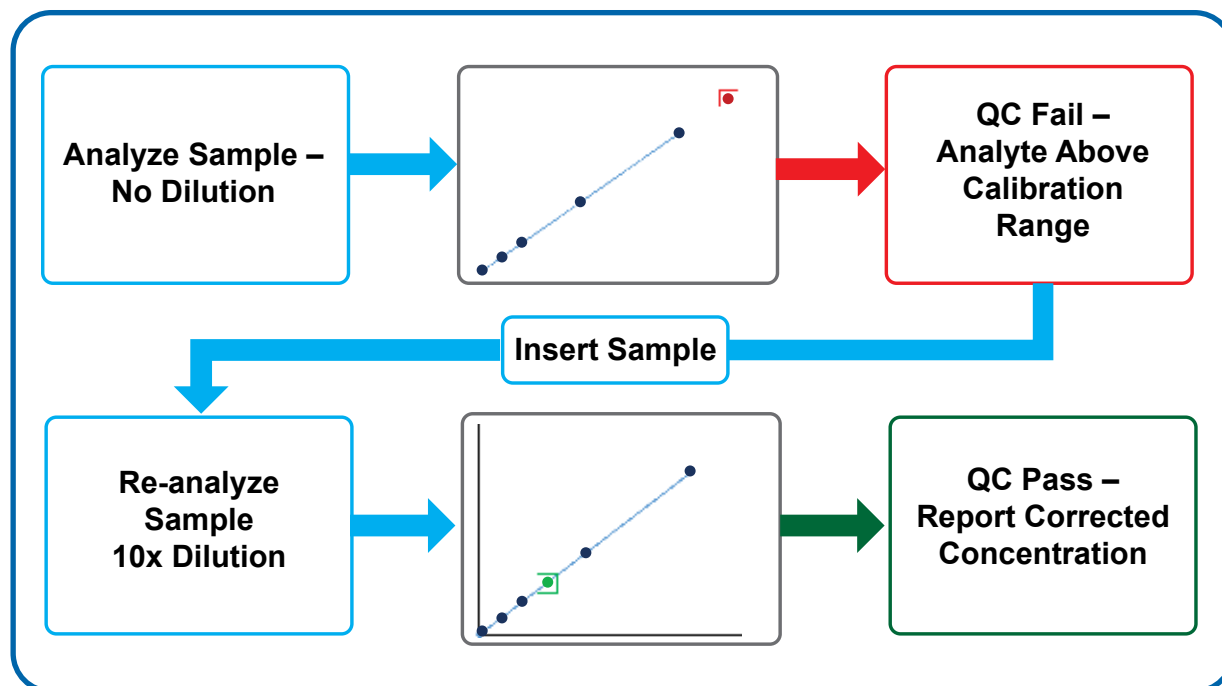

Automated overrange sample dilution maximizes laboratory throughput. Without this feature high concentration samples have to be manually diluted and rerun later. Overage autodilution automatically dilutes samples into the appropriate range without any user input or time lost waiting for a result.

## Out-of-range Internal Standard Autodilution

Internal standard out-of-range conditions occur when a high matrix present in the sample causes response changes in the ICPMS, which is identified by monitoring internal standard recoveries. Qtegra™ can easily be configured to automatically detect these limit failures, and instructs the prepFAST to automatically dilute the sample immediately for reanalysis.

# prepFAST™ for iCAP™ Q/RQ/TQ ICPMS

## Fully Automated Inline Dilution System

The prepFAST inline dilution system fully automates laboratory dilutions while providing high sample throughput. The prepFAST delivers high precision autodilution, syringe-driven internal standard addition, and high speed washout. Capable of dilution factors from 1 to 400, the prepFAST is suggested for labs requiring the highest sample throughput and where the available sample volume is about 2-3 mL or more.

### Features

- Autocalibration
- Autodilution – 1 to 400x
- Auto QC dilution
- Syringe-driven internal standard
- High speed rinse
- FAST vacuum sample loading

### Benefits

- Automate sample dilution
- Improve sample throughput
- Reduce laboratory waste
- Available in 2DX, 4DX, 8DX, and 14DX models



4DX prepFAST



prepFAST with  
SampleSense Valve

See page 18 for adding **SampleSense**  
to your prepFAST system

### prepFAST Features Diagram

#### Weighted Resetting Probe

Reduces Probe Damage

#### Sample Containers

< 1 mL up to 500 mL

#### High-precision DX Autosampler

#### Inline Syringe Sample Preparation

- Sample dilution
- Internal standard addition
- Overage dilution

#### Large Volume Reagent Bottles

#### Optional Vented Enclosure

ULPA filter option

#### Dual Overflowing Rinse Stations

#### Vacuum Pump

Vacuum loaded sampling  
Rapid rinsing & cleaning

#### Small Footprint

#### Portable

Allows for flexible positioning

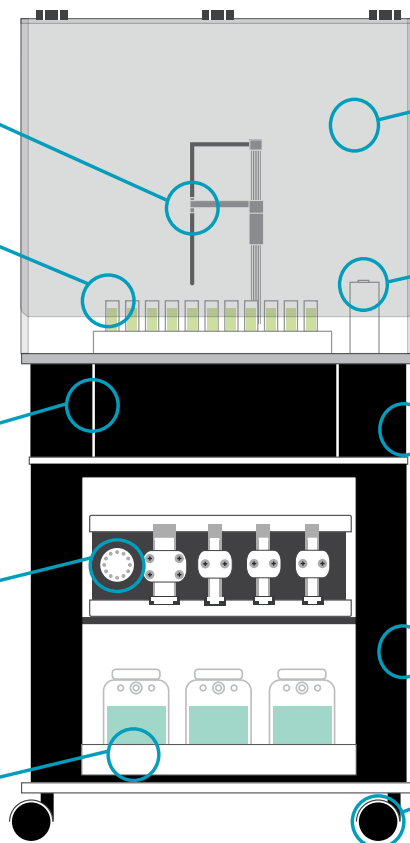

### prepFAST Performance

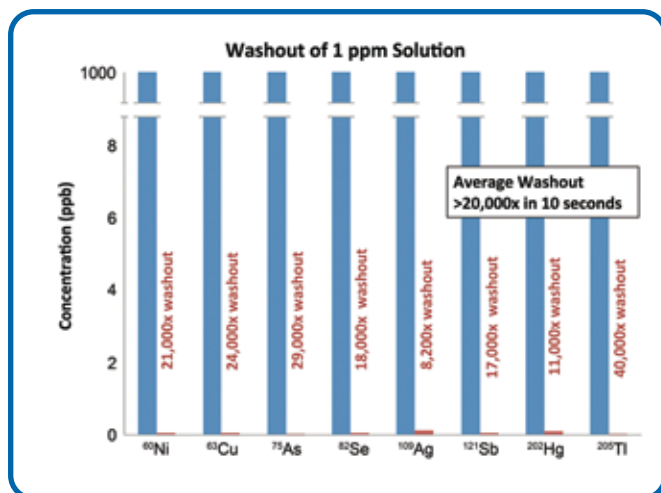

FAST washout even for memory-prone elements

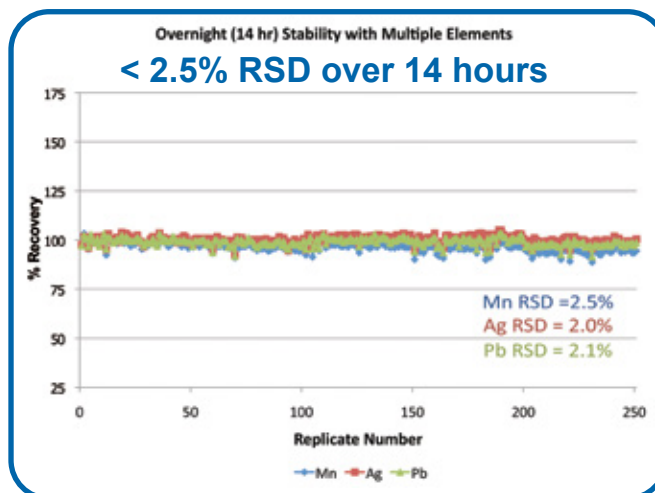

Long-term stability

# prepFAST M5™ for iCAP™ Q/RQ/TQ ICPMS

## Syringe Sample Loading + Syringe-driven Inline Dilution System

The prepFAST M5 inline dilution system delivers maximum laboratory automation. The prepFAST M5 provides precision syringe loading of samples or high-throughput vacuum loading. Syringe loading is used when sample volumes are limited – 2-3 mL – or when sample viscosity becomes an issue, such as organic solvents, viscous brines or biological samples. FAST vacuum loading can be used when sample volumes are large – above 2-3 mL – or when sample viscosity is not an issue. The prepFAST M5 delivers high precision autodilution, syringe-driven internal standard addition, flexible sample loading and ultimate sample washout. Capable of dilution factors from 1 to 400, the prepFAST M5 is perfect for labs requiring high sample throughput and where available sample volumes are as low as 0.1 mL.



S500V2 Syringe Module

### Features

- Autocalibration
- Autodilution – 1 to 400x
- Auto QC dilution
- Syringe-driven internal standard addition
- High speed rinse
- Ultimate washout
- Precision syringe loading or high speed vacuum loading
- High pressure syringe-driven probe rinsing

### Benefits

- Automate sample dilution
- High sample throughput
- Minimize sample use
- Reduce laboratory waste
- Best rinse-out performance
- Available in 2DX, 4DX, 8DX, and 14DX models



4DX prepFAST M5

### prepFAST M5 Features Diagram

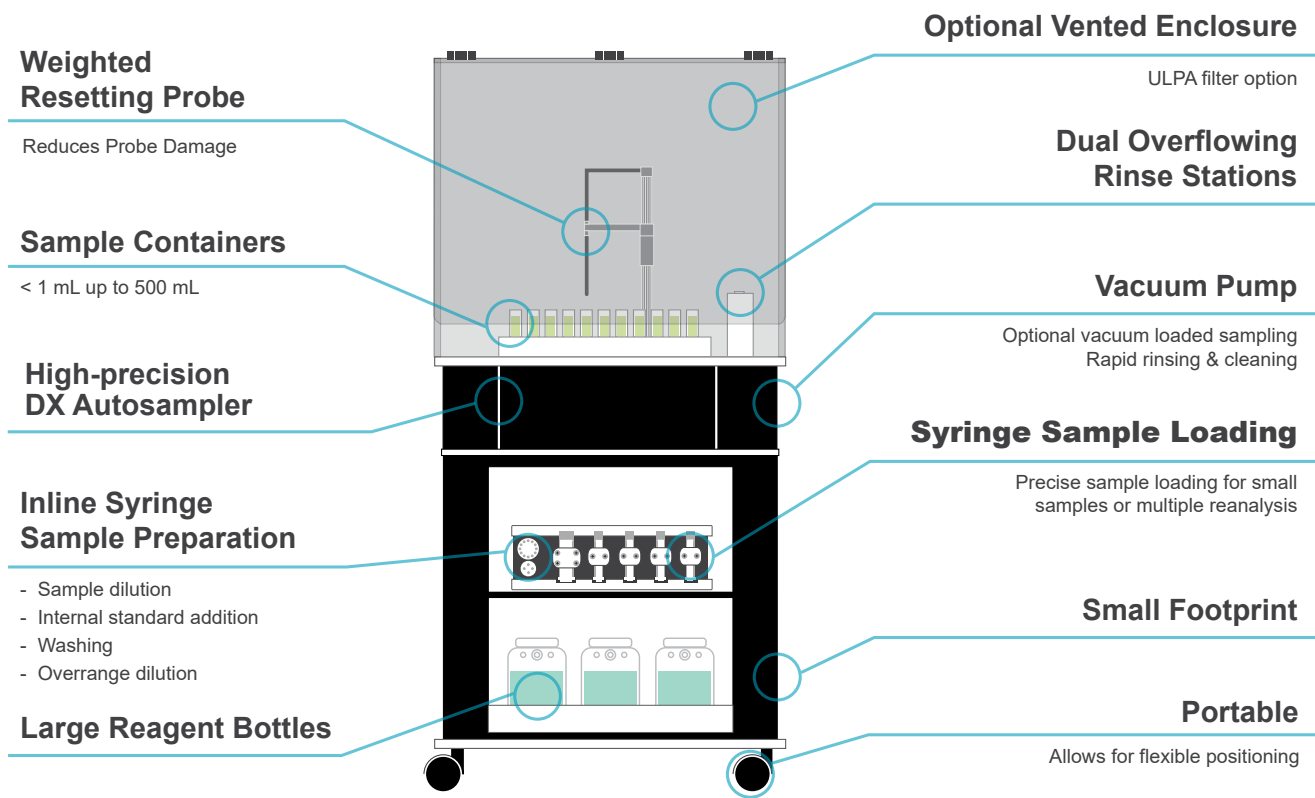

### Automated micro sample analysis in a difficult matrix

#### prepFAST M5 with 100 $\mu$ L Urine Samples

250 Replicate Urine Analysis  
Average RSDs <4%

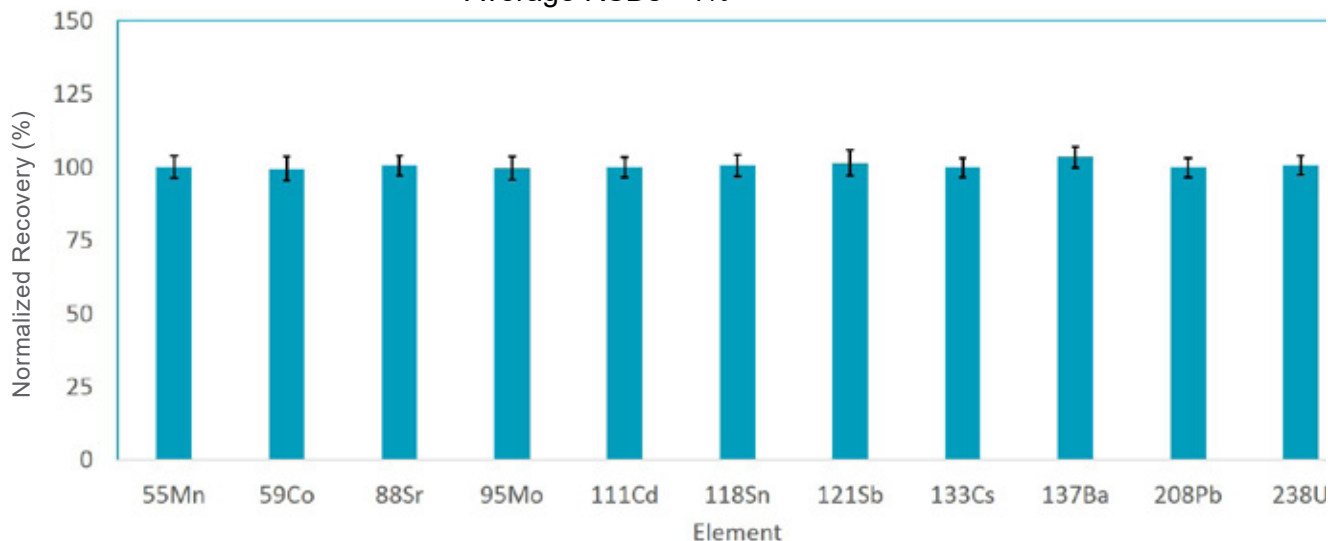

## prepFAST Systems Comparison

prepFAST inline dilution systems automatically perform precise and accurate dilutions for samples and standards, improving laboratory workflow, productivity, and data quality.



4DX Autosampler  
with Mobile Station

### prepFAST Provides:

- Autocalibration
- Autodilution
- Auto overrange dilution
- Improved washout and higher throughput
- Syringe-driven internal standard addition
- Dilution range: 1-400x

### prepFAST M5 Provides:

- Autocalibration
- Autodilution
- Auto overrange dilution
- Precision syringe sample loading for micro or viscous samples
- Best washout performance of any sample introduction system
- Syringe-driven internal standard addition
- Dilution range: 1-400x

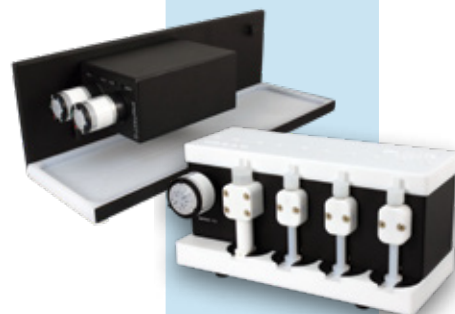

prepFAST

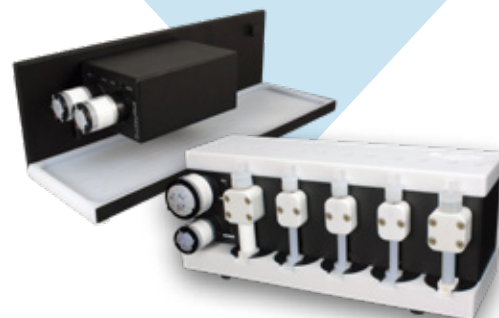

prepFAST M5



# prepFAST™ Ordering Information

## prepFAST Systems Comparison for iCAP™ Q/RQ/TQ

Description	Autocalibration	Autodilution	Auto Overrange Dilution	Syringe-Driven Internal Standard	High Pressure Rinse Ultimate Washout	Micro Volume Sample Analysis	Volatile Organic Solvent Analysis	Dilution Range
prepFAST	✓	✓	✓	✓				1 - 400x
prepFAST M5	✓	✓	✓	✓	✓	✓	✓	1 - 400x

### prepFAST

Description	Part Number
2DX prepFAST System	2ADF-73A-R2
4DX prepFAST System	4ADF-73A-R2
8DX prepFAST System	8ADF-73A-R2
14DX prepFAST System	14ADF-73A-R2

### prepFAST M5

Description	Part Number
2DX prepFAST M5 System	2PF-M5-73A
4DX prepFAST M5 System	4PF-M5-73A
8DX prepFAST M5 System	8PF-M5-73A
14DX prepFAST M5 System	14PF-M5-73A



AUTOMATION

# Revolutionary New Valve for *FAST* & prep*FAST*

# **SAMPLESENSE**

SampleSense is a revolutionary valve for *FAST* and prep*FAST* systems that optimizes introduction of samples into iCAP™ Q/RQ/TQ ICPMS instruments. SampleSense (Patent Pending) utilizes optical sensors to verify a sample loop has been filled.

## Enhance Workflow

- Eliminates method timing parameters
  - Optimizes loading conditions for each sample matrix
  - Automatically loads loop with samples of varying viscosities
- Reduces sample consumption
- Actively detects and reports sample loading issues
- Automatically compensates for drift caused by kinked lines or partial blockages
- SampleSense triggers the ICPMS at exactly the right time



## How it Works

SampleSense simplifies method development by eliminating read delays as well as sample uptake and injection timers, allowing sample loop sizes and sample types to be changed without adjusting method settings. SampleSense also minimizes sample consumption by automatically loading samples of varying viscosities and switching the valve into the inject position immediately after the sample loop is successfully loaded.

## Detect Loading Issues

SampleSense monitors and logs sample loading issues caused by:

- Empty tubes or positions
- Vials inadvertently left capped
- Empty standard or QC
- Bubbles caused by incomplete loading



# SampleSense Advantages



## Innovative Sample Loading

SampleSense accounts for viscosity and automatically adjusts timing. One valve, one loop and one method for multiple sample types.



## Time Savings

Operator time for sample introduction method development is eliminated. Just run samples.



## Sample Savings

The sample is injected at precisely the right time. Every time. Even for small samples.



## Error Notification

Incomplete sample loading or bubbles in the sample are detected and logged.

AUTOMATION

## Maximize Productivity

FAST high-throughput automated sample introduction technology combined with SampleSense maximizes productivity for any lab. It optimizes sample throughput and conserves valuable sample, argon, power, and reagents by drastically shortening analytical runs.



iCAP™ TQ FAST with SampleSense

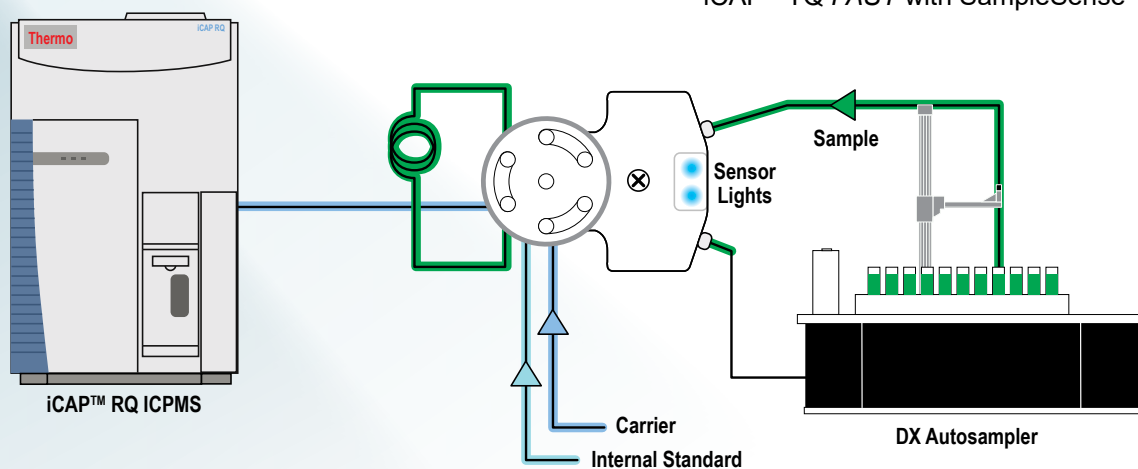

FAST with SampleSense - Sample Load Complete / Rinse Nebulizer

# SAMPLESENSE FAST

**FAST** has been trusted for over a decade in thousands of ICPMS laboratories worldwide.

*FAST* is a valve injection automation system with rapid vacuum sample loading that more than doubles sample throughput, saves time, reagents and utilities.

Combining *FAST* with SampleSense provides an even higher level of automation, ease-of-use and sample throughput. Liquid samples are instantly detected, injected and the analysis is triggered automatically.



iCAP™ Q/RQ/TQ SampleSense *FAST* with in-valve internal standard addition

## SampleSense *FAST* Small Volume Sample Loading from 96 Well microplate

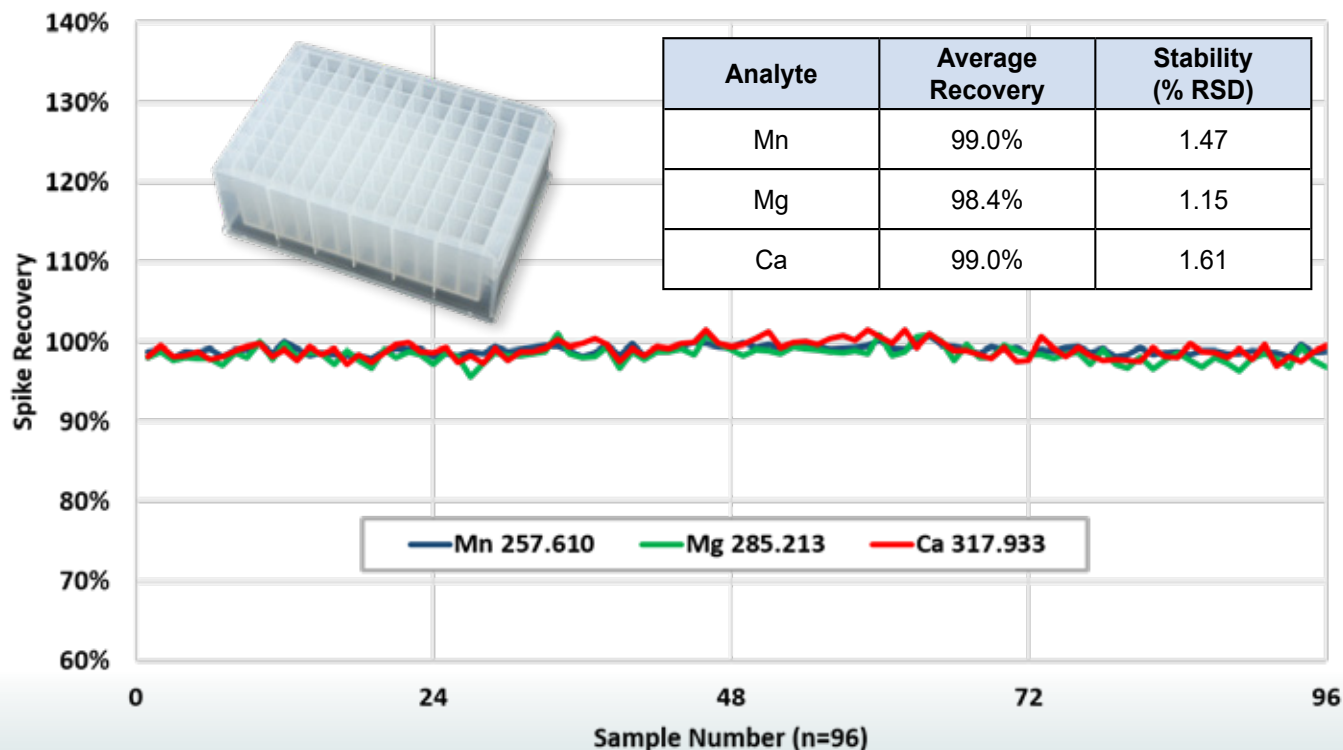

*FAST* with SampleSense demonstrating support for small volume samples. 96 well microplate positions were filled with 750  $\mu$ L of a 1 ppm QC standard and then loaded utilizing SampleSense into 250  $\mu$ L sample loop. Excellent reproducibility exhibited for automated loop loading with SampleSense on ICP-OES system.

# SAMPLESENSE prepFAST

AUTOMATION

prepFAST is an automated inline dilution system for ICPMS sample introduction.

The high-throughput prepFAST system eliminates manual dilution, reduces reagent usage and improves laboratory productivity.

SampleSense integrates fully with the prepFAST for an even higher level of automation and ease-of-use.



iCAP™ Q/RQ/TQ SampleSense prepFAST

## SampleSense prepFAST Viscous Sample Loading of Concentrated Sulfuric Acid

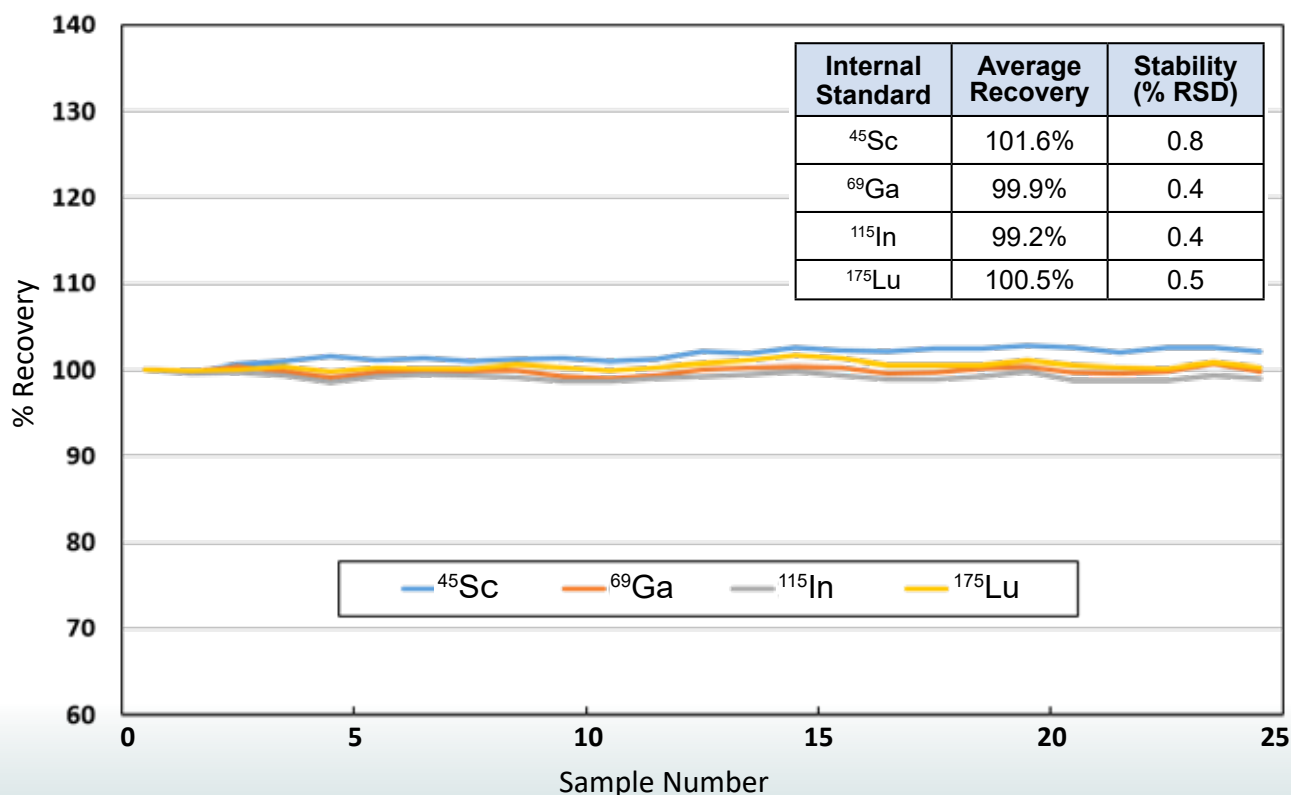

prepFAST with SampleSense for viscous sample loading. Concentrated sulfuric acid (H<sub>2</sub>SO<sub>4</sub>) was loaded without dilution into a 1.5 mL sample loop, then immediately diluted online 50x with prepFAST. The H<sub>2</sub>SO<sub>4</sub> was automatically determined by SampleSense to require 100 sec to fully load the sample loop; water only requires 8 seconds. Results are from analysis by ICPMS over 2.5 hours showing excellent stability in this highly viscous matrix as displayed by the internal standard species.

# SAMPLESENSE

## FAST/prepFAST Ordering Information for iCAP™ Q/RQ/TQ

### Selecting a SampleSense System or Upgrade



= Included



= Required  
*but not included*



= Included with  
Existing System

SampleSense FAST and prepFAST systems are available, as well as SampleSense Upgrades from existing DX autosamplers, FAST systems and prepFAST systems.

Description	FAST-Ready Autosampler	SampleSense Valve	PFA-ICN SampleSense Nebulizer	Valve Enclosure	PTFE Tray	prepFAST Autodilutor & Mobile Station
SampleSense FAST System	✓	✓	✓	✓	✓	
SampleSense prepFAST System	✓	✓	✓	✓	✓	✓
SampleSense FAST Upgrade from DX autosampler	R	✓	✓	✓	✓	
SampleSense Upgrade from FAST	R	✓	✓	✓		
SampleSense Upgrade from prepFAST	R	✓	✓	✓		

### SampleSense FAST System

Automated high-throughput valve injection system with optically-sensed sample loading and triggered analysis. SampleSense eliminates valve timing parameters, reduces sample consumption, automatically compensates for sample viscosity, and records missing or capped samples. Includes DX autosampler, SampleSense SS7 valve with in-valve internal standard addition, PFA-ICN nebulizer, valve enclosure, mounting shelf and PTFE tray, and FAST installation kit.

### SampleSense prepFAST System

Autodilution, autocalibration, high-throughput valve injection system with optically-sensed sample loading and triggered analysis. SampleSense eliminates valve timing parameters, reduces sample consumption, automatically compensates for sample viscosity, and records missing or capped samples. Includes DX autosampler, prepFAST autodilutor, SampleSense SS8 valve with in-valve diluent and internal standard addition, PFA-ICN nebulizer, valve enclosure, mounting shelf and PTFE tray, prepFAST mobile autosampler station, and prepFAST installation kit.

# The only sample introduction valve with optical sensor technology

AUTOMATION



iCAP™ TQ 4DX prepFAST with SampleSense

SampleSense FAST Systems for iCAP™ Q/RQ/TQ	
SampleSense FAST Autosampler	Part Number
2DX	2F-SS7-73
4DX	4F-SS7-73
8DX	8F-SS7-73
14DX	14F-SS7-73

SampleSense prepFAST Systems for iCAP™ Q/RQ/TQ	
SampleSense prepFAST Autosampler	Part Number
2DX	2PF-SS8-73
4DX	4PF-SS8-73
8DX	8PF-SS8-73
14DX	14PF-SS8-73

SampleSense Upgrades for iCAP™ Q/RQ/TQ	
Upgrade Description	Part Number
SampleSense FAST Upgrade for DX Autosampler	SS6F-73
SampleSense FAST Upgrade for DX Autosampler	SS7F-73
SampleSense Upgrade from FAST	SS6UF-73
SampleSense Upgrade from FAST	SS7UF-73
SampleSense Upgrade from prepFAST	SS8UPF-73

## Additional SampleSense Ordering Information

Description	Part Number
PFA Integrated Capillary Valve Nebulizer for iCAP™ Q/RQ/TQ	ICN-73
FAST SampleSense Spares Kit. Includes ICN nebulizer, SS7 valve, PFA F6 rotor, spare fittings	F-0370-SS7
prepFAST SampleSense Spares Kit. Includes ICN nebulizer, SS7+ valve, PFA F6 rotor, spare fittings	PF-0370-SS8
FAST/prepFAST Installation Qualification and Operational Qualification (Basic installation and training not included)	FI-IQOQ
On-Site FAST SampleSense Installation and Implementation. Includes hardware installation, software methods and implementation, necessary method validation, FAST SS7 Installation Spares Kit (F-0370-SS7) and user training	FI-F-SS7
On-Site prepFAST SampleSense Installation and Implementation. Includes hardware installation, software methods and implementation, necessary method validation, prepFAST SS7+ installation/spares kit (PF-0370-SS8) and user training	FI-PF-SS8

# prepFAST S5™

## Automated Sample Preparation and Introduction System for Semiconductor Applications

The prepFAST S5 has revolutionized the way ultrapure semiconductor grade chemicals are analyzed with ICPMS detection. The prepFAST S5 utilizes syringe-driven flows of UPW, semiconductor grade acids, and standard solution to automate both sample dilutions and standard curve generation. It eliminates manual handling of samples to deliver sub-ppt detection limit capabilities.

### prepFAST S5 Features:

- Automated external and MSA calibrations
- Automated ultraclean sample preparation
- Automated acid addition
- Syringe-driven sample introduction
- Automated sample sensing and method adjustment for viscous samples
- Integrated ultraclean sample environment
  - Includes ultraclean air shower
  - Options include:
    - ULPA filter
    - Sample racks for PFA containers (<1 mL to 500 mL)
- Continuously-flowing high purity UPW rinse (user-supplied UPW)
- UPW polishing columns
- PPT/PPQ detection limits for all semiconductor elements
- Capability to analyze all semiconductor grade chemicals



prepFAST S5 System

prepFAST S5 System for iCAP™ Q/RQ/TQ						
System	Integrated Mobile Autosampler & Enclosure	Integrated FAST valve module	FAST valve module and tray	PFA Nebulizer with Integrated Capillary	PFA Sample Probes	S500V2 Syringe Pump Unit
prepFAST S5	✓	✓	✓	✓	✓	✓



## prepFAST S5 Features Diagram

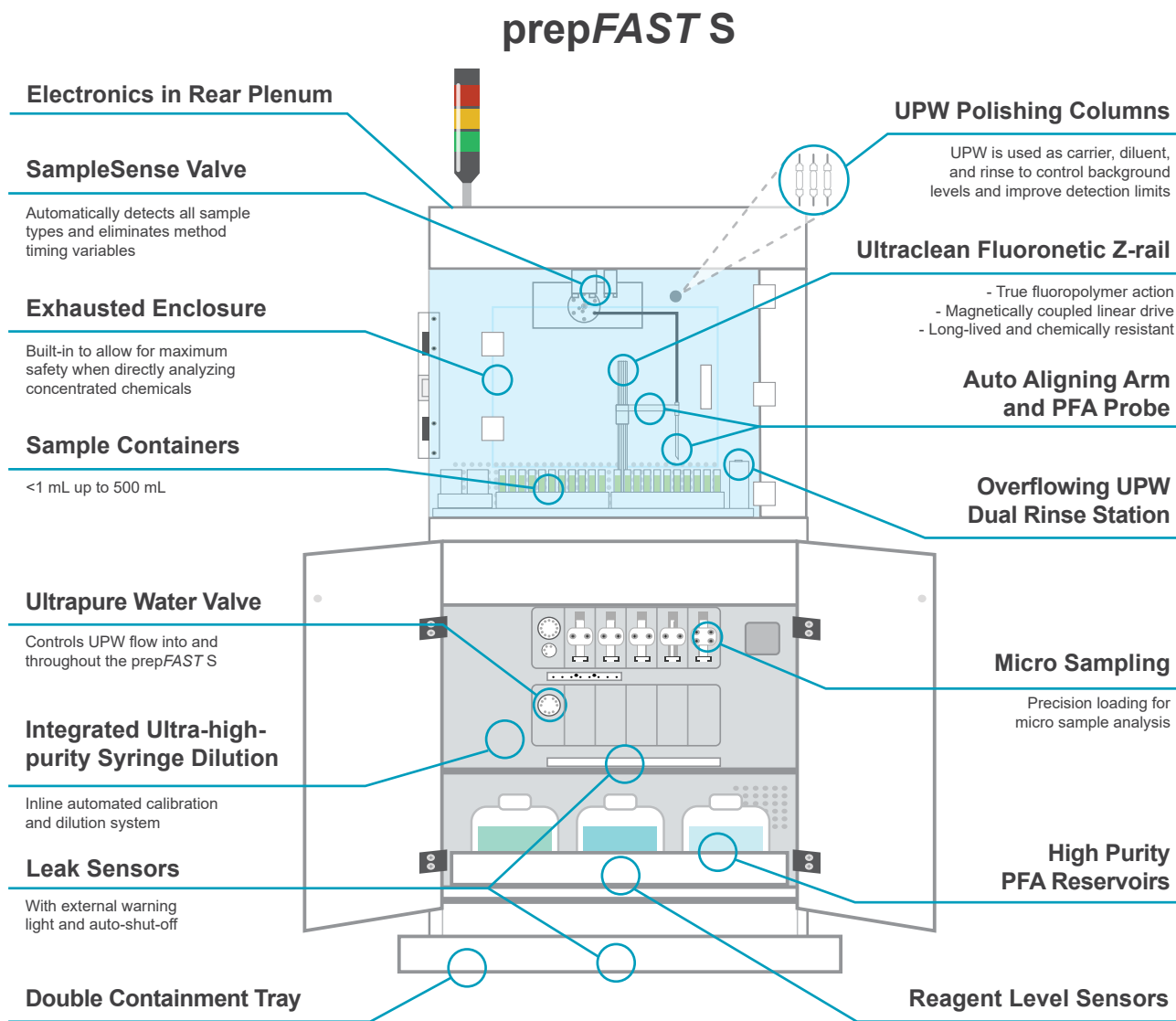

Examples of semiconductor chemicals analyzed at the ppt level with prepFAST S5		
Acids	Bases	Organics
98% H <sub>2</sub> SO <sub>4</sub>	22% NH <sub>4</sub> OH	IPA
89% H <sub>3</sub> PO <sub>4</sub>	2.38% TMAH	PGMEA/PGME
70% HNO <sub>3</sub>	25%TMAH	Photoresist
49% HF	KOH	NMP
35% HCl		Butyl Acetate
30% H <sub>2</sub> O <sub>2</sub>		Cyclohexanone

This table contains only a partial list of chemicals which can be analyzed using prepFAST S5.

# prepFAST S5™

## prepFAST S5 Autocalibration

Na, Mg, Ca, Ti and Fe in UPW at 1, 2, 5, and 10 ppt

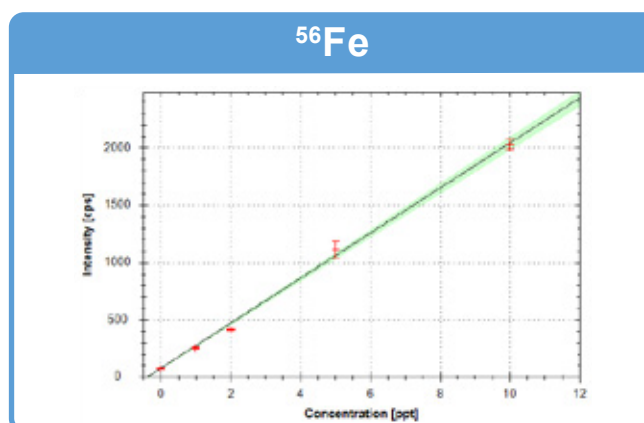
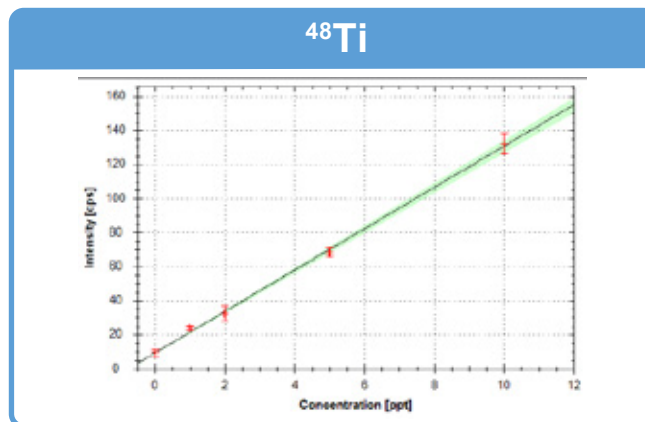
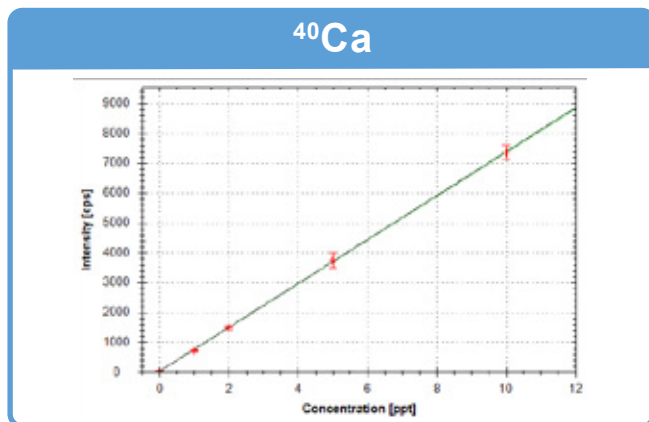
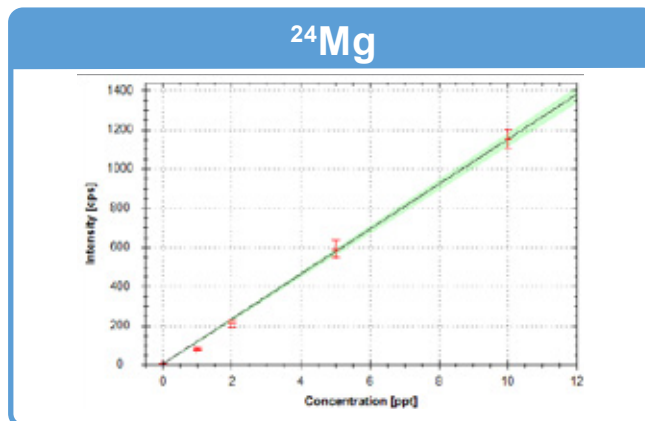
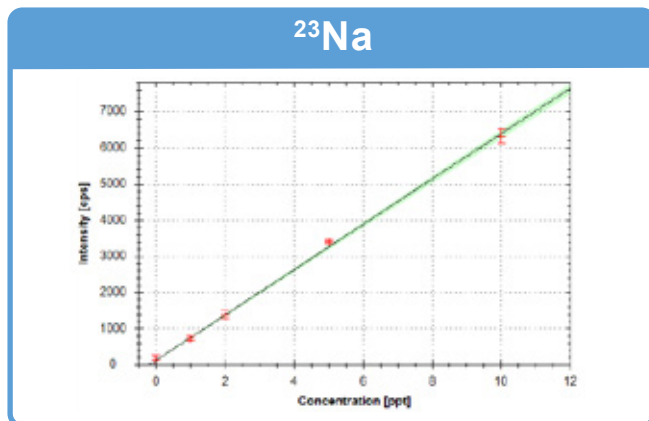

The prepFAST S5 automatically prepares calibration curves for over 40 elements controlled in semiconductor manufacturing processes. Calibrations are generated by automatically diluting an enclosed multielement stock standard. Automation with the high-purity prepFAST S5 achieves low to sub-ppt calibrations. Combined with the interference reduction modes of the iCAP™ Q/RQ/TQ ICPMS systems (e.g. KED, CCT, TQ and cold plasma modes), the prepFAST S5 delivers ppt/ppq detection of ICPMS accessible elements.

## prepFAST S5 Inline Dilution of Semiconductor-grade Chemicals

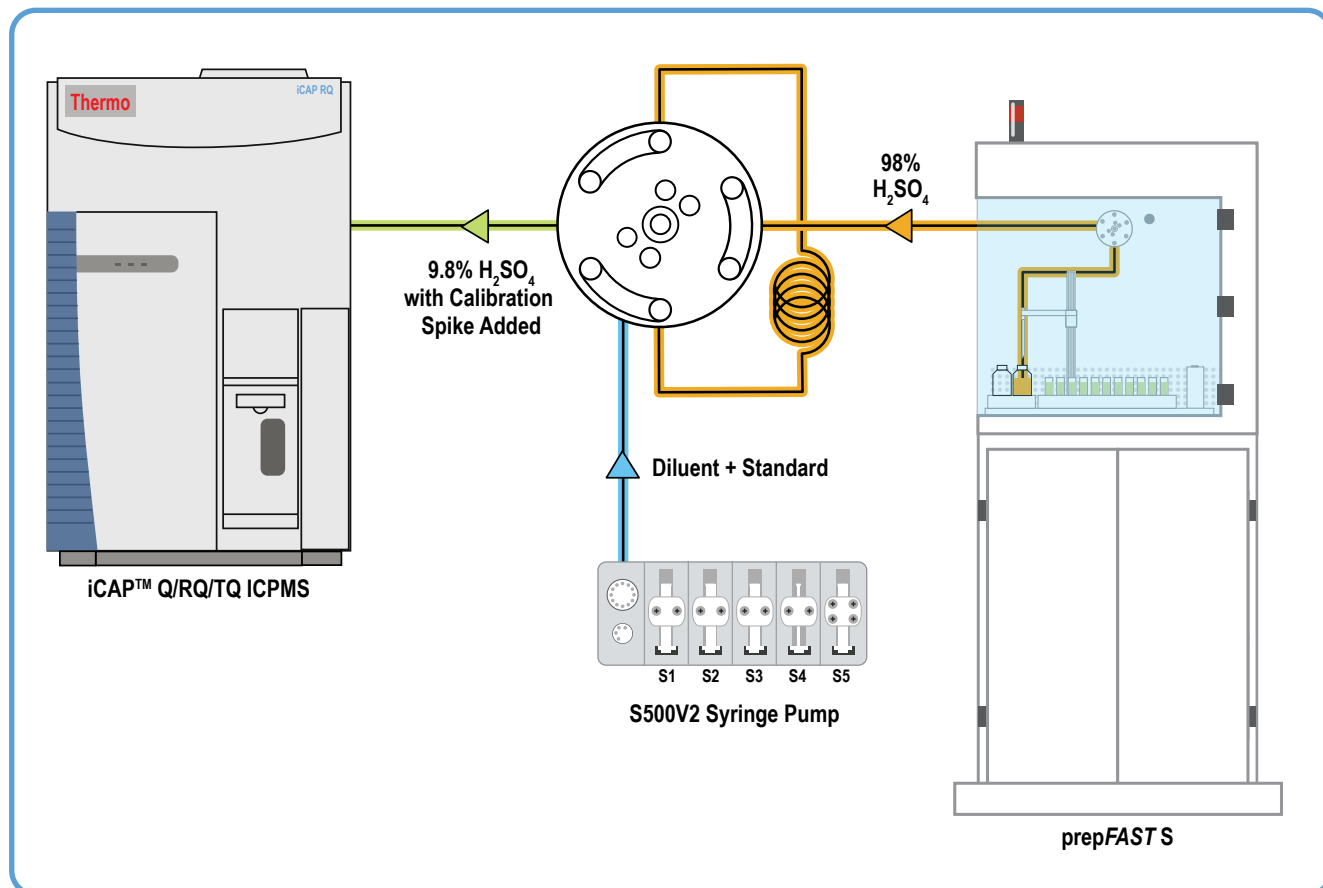

prepFAST S5 10x inline dilution of concentrated  $H_2SO_4$

The prepFAST S5 allows dilution by volume or weight for all semiconductor-grade chemicals. Metals are quantified using automated inline MSA or external calibration. Automated direct analysis of concentrated chemicals eliminates sample contamination caused by manual dilution into a secondary container.

prepFAST S5 Systems	
Description	Part Number
prepFAST S5, 2 FX system, 2 sample rack capacity	2PF-S5-73AI
prepFAST S5, 4 FX system, 4 sample rack capacity	4PF-S5-73AI
ULPA (ultrapure air) Filter for 2 FX prepFAST S5 system	ULPA-2EX
ULPA (ultrapure air) Filter for 4 FX prepFAST S5 system	ULPA-4EX
Semiconductor High Performance Sample Intro Kit for iCAP™ Q/RQ/TQ	PFA-SK-73S
High Performance HF-Resistant Sample Intro Kit for iCAP™ Q/RQ/TQ	PFA-SK-73A
High Performance PFA spray chamber and endcap	ES-2373-5470

# SAMPLETRAX

## Automated Sample Identification, Tracking, Preparation and Introduction System for ICP and ICPMS

SAMPLETRAX is an advanced, automated sample identification system that utilizes barcodes to track samples from time of collection to final analysis and data reporting. The four SAMPLETRAX scanning stations can be combined in a variety of ways, creating a company-specific system that can process samples at key points. Common applications include semiconductor (S5 model), pharmaceutical, environmental and clinical.



### SAMPLETRAX Features:

- Samples are tracked to ensure full confidence in the final results
- High purity samples processed on TRAXmass balance have all their weight information automatically associated with the sample records
- TRAXprep station performs any acid additions without operator contact
- SAMPLETRAX M5 station equipped with prepFAST M5 sample preparation and introduction system designed for direct analysis of samples
- SAMPLETRAX confirms sample identity and tracks samples during analysis, accessing sample information such as:
  - Sample weight
  - Dilution factor
  - Analytical method to be performed

### Analytical stations – M5/S5

- Syringe driven automated sample dilutions with high-purity quartz syringes, followed by automatic introduction to the ICP or ICPMS
- Autocalibration routines prepare required standards in-line, removing manual preparation
- Syringe sample loading for small volume or viscous samples for accurate and precise loading of samples for analysis

### SAMPLETRAX S5

- The SAMPLETRAX S5 is an ultrapure analytical station for direct analysis of all semiconductor grade chemicals by ICPMS with ppt/sub-ppt detection limits

# SAMPLETRAX M5/S5 Analytical Station

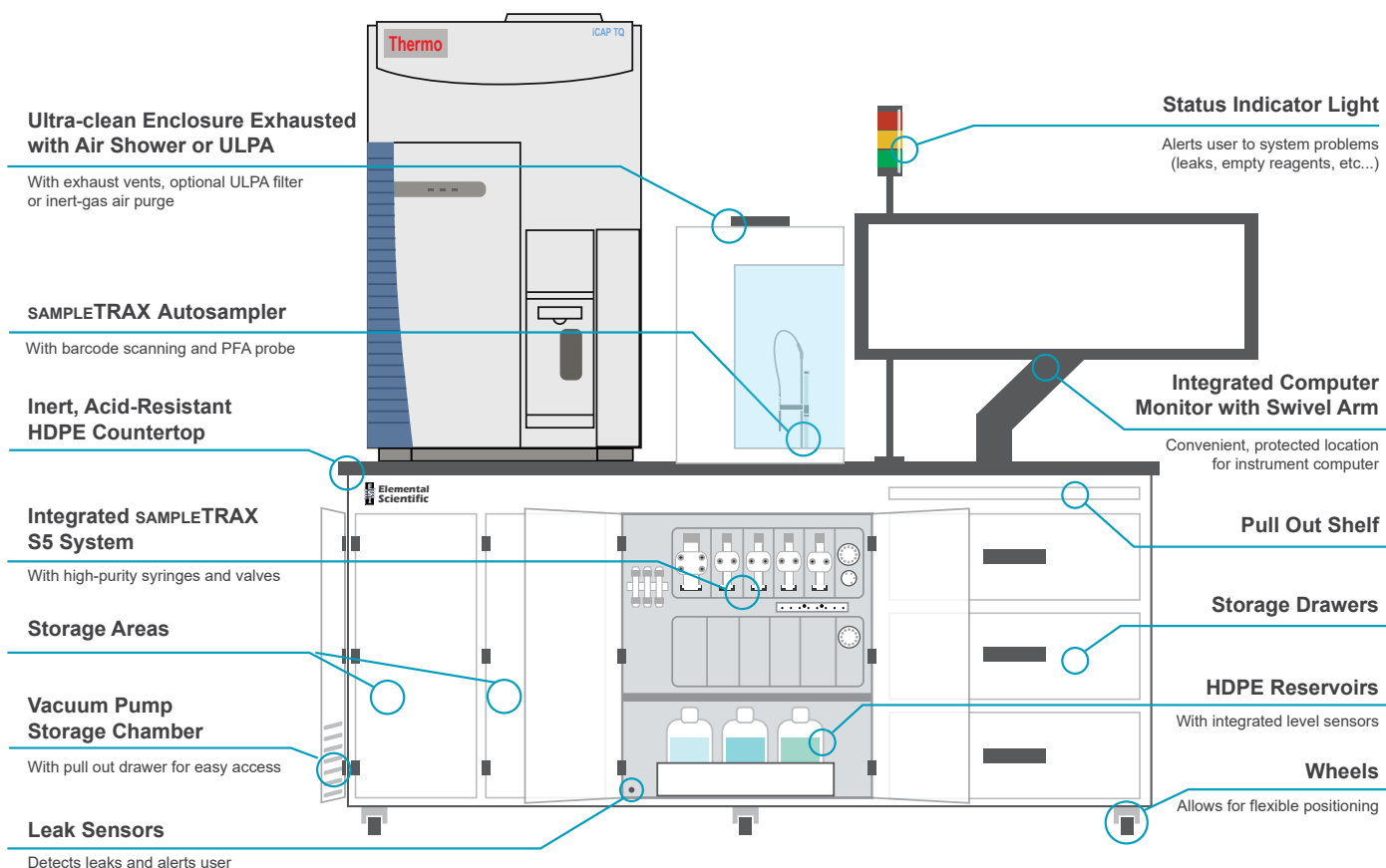

An assortment of racks and vials ensure the appropriate container for every sample type (60 position 10mL tubes are illustrated)

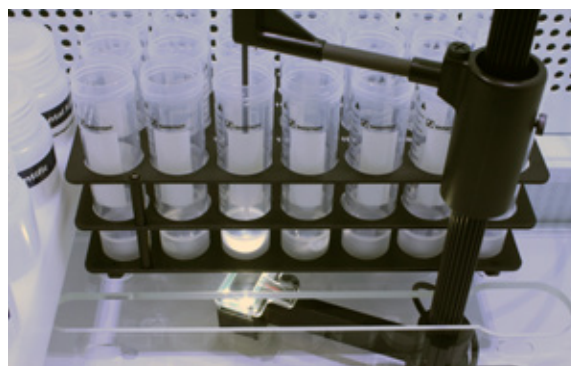

Synchronizing the patented barcode reading arm with the sample probe ensures each sample is positively identified at the time of analysis.

# SAMPLETRAX

## Building and Customizing the SAMPLETRAX Network

### Incorporate multiple scanning and analytical stations

- Network multiple SAMPLETRAX systems
- Network single or multiple labs
- Network SAMPLETRAX with laboratory information management systems (LIMS)

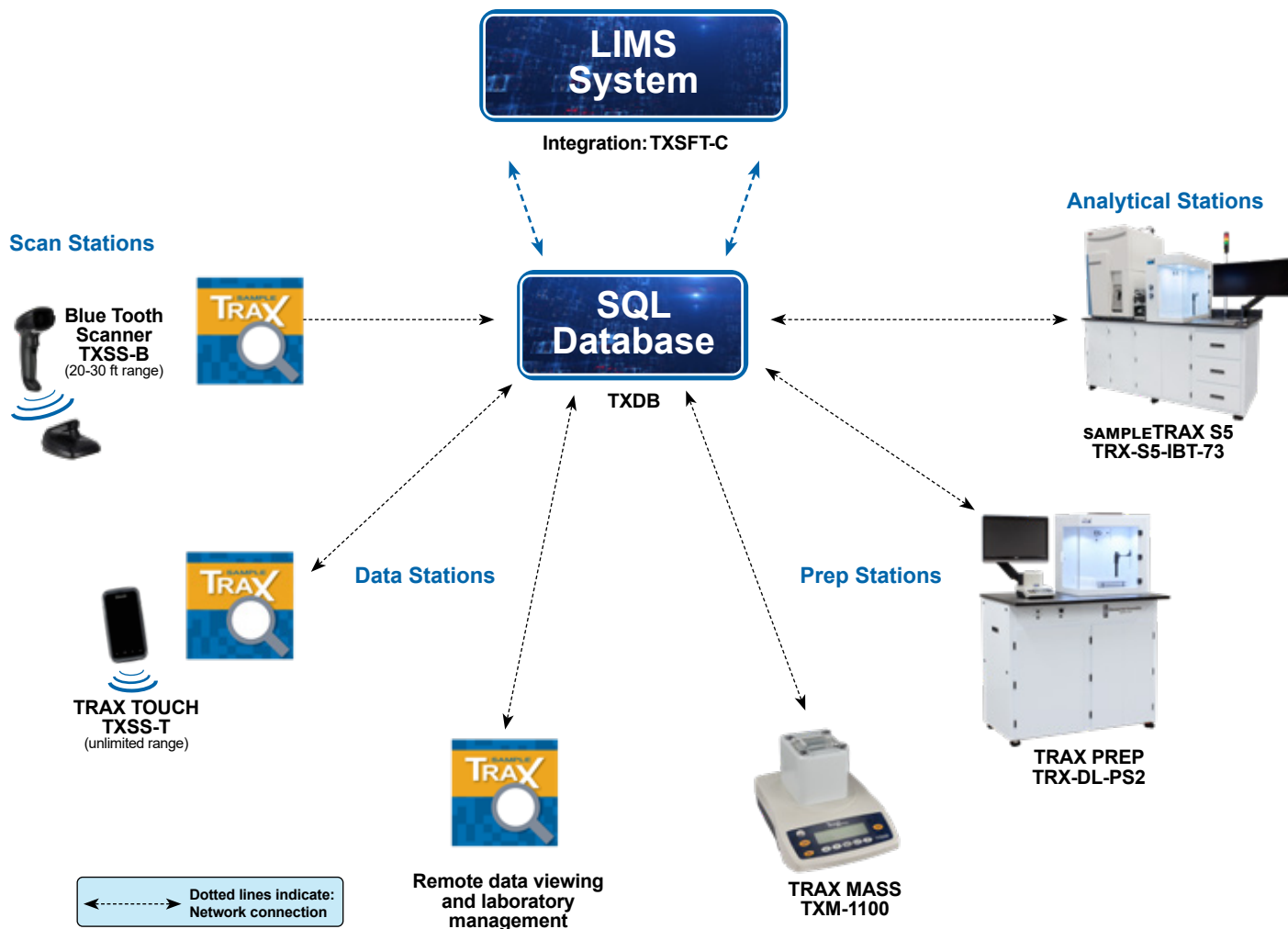

SAMPLETRAX for iCAP Q/RQ/TQ	
Description	Part Number
SAMPLETRAX S5 System with Analytical Station	Contact ESI for ordering information on a custom system
SAMPLETRAX M5 System with Analytical Station	
SAMPLETRAX MASS Balance Station	
SAMPLETRAX PREP Station	
SAMPLETRAX Scan option - Blue Tooth	
SAMPLETRAX Scan option - Mobile	

# TRUFAST SP2™ for iCAP™ Q/RQ/TQ

## Automated Online Preconcentration of Radionuclides

The TRUFAST SP2 automatically performs online preconcentration of specific radionuclides to reduce matrix-related interferences and enhances signal-to-background in real sample matrices by up to two orders of magnitude. TRUFAST can eliminate lengthy offline sample preparation, speed analytical results, provide better control blanks, and improve detection limits for radioisotopes when coupled to the iCAP™ Q/RQ/TQ ICPMS systems.

### Applications

**Thorium in Transition Metal Matrices** – Th impurities in high purity copper can be measured by chelating Th while removing the Cu matrix ions via an ion exchange column. Th is then eluted from the column and measured by ICPMS.



AUTOMATION

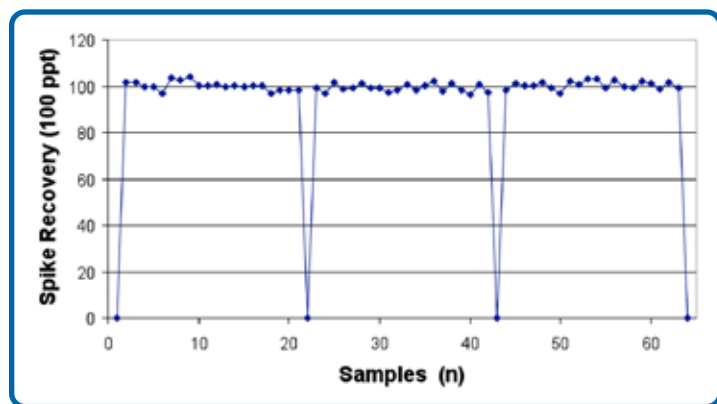

60 replicate determinations of 100 ppt Th in 1% Cu from three 100 mL sample bottles

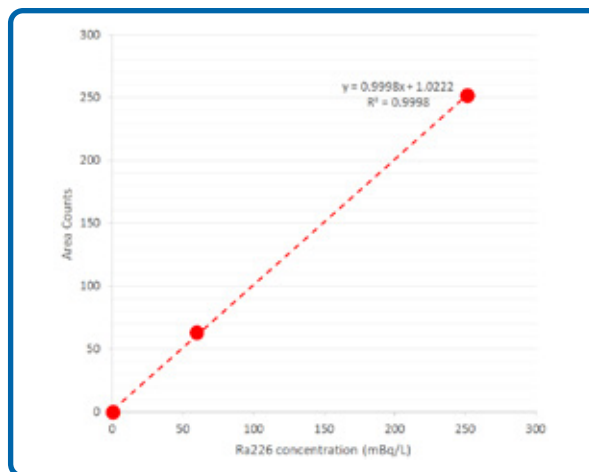

<sup>226</sup>Ra calibration response with TRUFAST SP2 on iCAP™ Q ICPMS

**Radium in Natural Waters** – Elevated concentrations of radium in groundwater can occur as a result of natural geological processes and from mining activities. Polyatomic interferences arising from Ba and Sr are automatically removed by the TRUFAST, which also performs direct analysis of water samples for routine environmental monitoring.

Maximum Allowable Levels	Radium 226
Canada MAC	0.5 Bq/L
WHO Guidance Level in water	1 Bq/L
USEPA MCL	0.19 Bq/L (5 pCi/L)
<b>TRUFAST SP2 detection limit</b>	<b>&lt; 0.005 Bq/L</b>
"1 Bq/L = 27 pCi/L = 27 pq/L"	

TRUFAST Systems for the iCAP™ Q/RQ/TQ							
System	Mobile 4 FX Autosampler and Enclosure	FAST dual valve module	Cation exchange column	Sr preconcentration column	Th/U preconcentration column	Sapphire Injector	PFA-ST Nebulizer
TRUFAST	✓	✓	✓	✓	✓	✓	✓

TRUFAST for iCAP™ Q/RQ/TQ	
Description	Part Number
4 FX TRUFAST SP2 System	4TF-SP2
Ra Preconcentration Column	CF-CX-2000

TRUFAST for iCAP™ Q/RQ/TQ	
Description	Part Number
Sr Preconcentration Column	CF-Sr-1000
Th/U Preconcentration Column	CF-CX-0600

# prepFAST IC™

## Automated Speciation and Total Metal Analysis System

The prepFAST IC integrates ultra-clean high pressure liquid chromatography technology along with an enclosed autosampler for both elemental speciation and total metals analysis.

The system is offered in two models, the prepFAST IC and the FAST IC. The prepFAST IC model fully automates calibration and the analysis of total metals, metal speciation or both techniques combined using ICPMS detection. The prepFAST IC also includes a speciation module along with the prepFAST autodilution module. The autodilution module offers autocalibration, and fully automated inline dilution capability at the time of analysis to eliminate potential species conversion. The FAST IC model offers elemental speciation and total metal analysis without the autodilution capability.

### Features:

- Automated switching between total metal analysis and speciation analysis modes
- High pressure eluent delivery
- Automated, inline sample dilution and syringe-driven sample loading on prepFAST IC
- Micro sample compatible with selectable sample loop loading
- Enclosed mobile station with optional ULPA filter preserves sample integrity
- PFA integrated capillary nebulizer and PFA encased sample probes



### Unique Design Supports Unattended Analysis of Both Trace Metals and Speciation

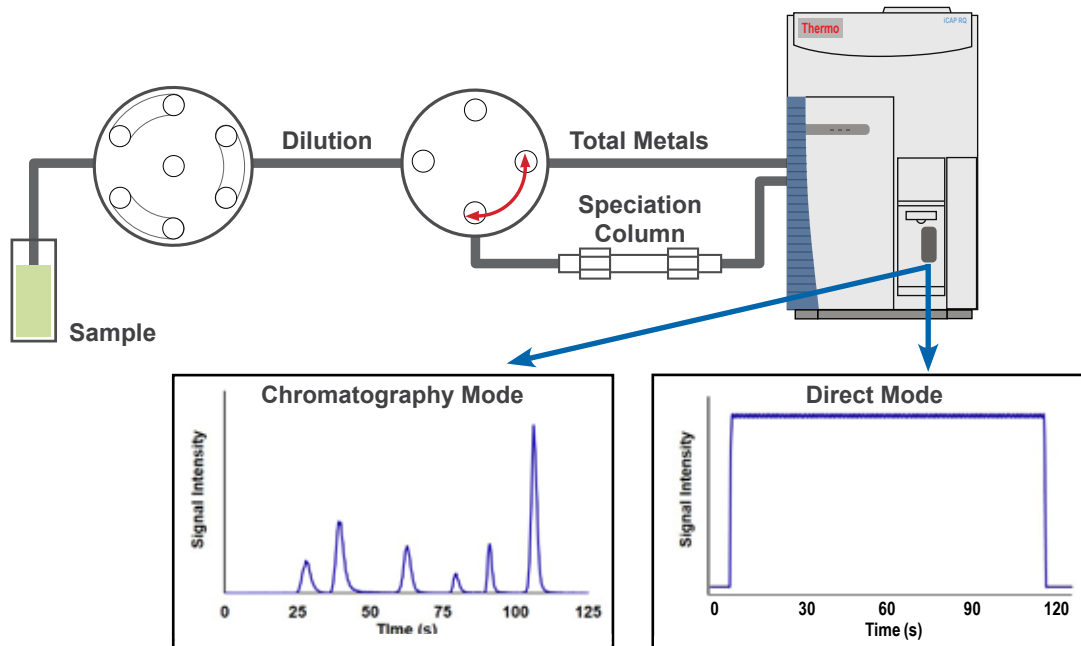

prepFAST IC Autoselects Chromatography Mode or Direct Mode



# prepFAST IC

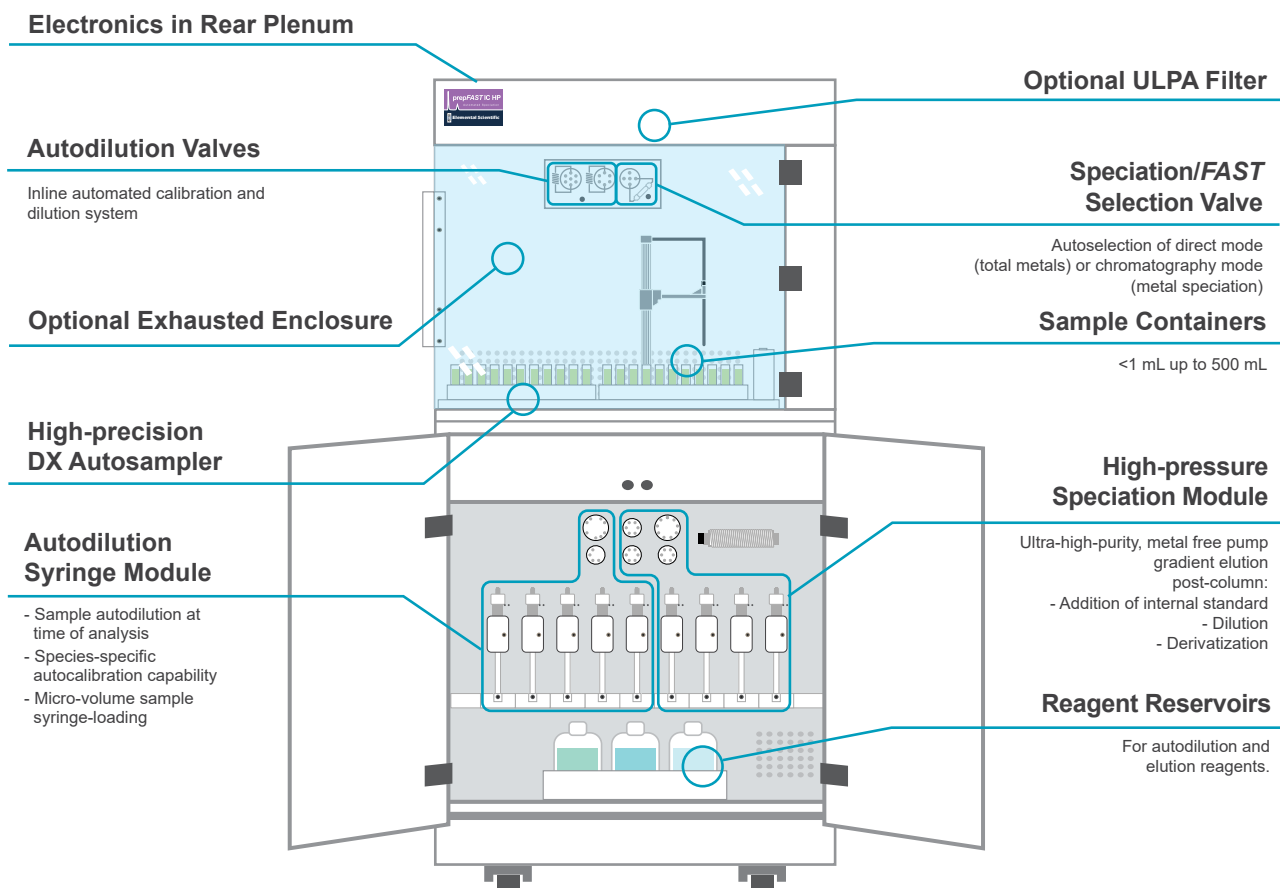

## Species Specific Autocalibration

STD Position	Inline Dilution Factor	Standard Concentration ppt
1	blank	0
2	20x	5
2	10x	10
2	6.6x	15
2	5x	20
2	4x	25
2	2x	50

prepFAST IC provides autodilution of calibration solutions and samples at the time of analysis. This minimizes effects of species conversion after preparation

## prepFAST IC Speciation Kits

Kit Name	Species Separated
Arsenic	As III, As V, AsB, AsC, DMA, MMA
Selenium	Se IV, Se VI, Organic Se
Chromium	Cr III, Cr VI
Mercury	Hg <sup>+</sup> , MeHg <sup>+</sup>
Chlorine	Cl <sup>-</sup> , ClO <sub>2</sub> <sup>-</sup> , ClO <sub>3</sub> <sup>-</sup> , ClO <sub>4</sub> <sup>-</sup>
Bromine	Br <sup>-</sup> , BrO <sub>3</sub> <sup>-</sup>
Iodine	I <sup>-</sup> , IO <sub>3</sub> <sup>-</sup>
Halogens	Cl <sup>-</sup> , ClO <sub>2</sub> <sup>-</sup> , ClO <sub>3</sub> <sup>-</sup> , ClO <sub>4</sub> <sup>-</sup> , Br <sup>-</sup> , BrO <sub>3</sub> <sup>-</sup> , I <sup>-</sup> , IO <sub>3</sub> <sup>-</sup>

prepFAST IC Systems	
Description	Part Number
prepFAST IC high performance automated speciation with autodilution and autocalibration	4PF-IC
FAST IC high performance automated speciation system without autodilution module	4F-IC
Upgrade from FAST IC to prepFAST IC	U-PFIC
On-site, 4-day installation and application development for prepFAST IC systems	FI-PFIC-04

## Chromium Speciation

Chromium exists in the environment in several forms which differ significantly in their effects upon organisms. Chromium (III) is often considered an essential nutrient, but Chromium (VI) is toxic and considered carcinogenic. This makes the identification of the specific forms of Chromium present in a sample very critical. The prepFAST IC provides for fast automated analysis of both total and the speciated forms of Chromium.

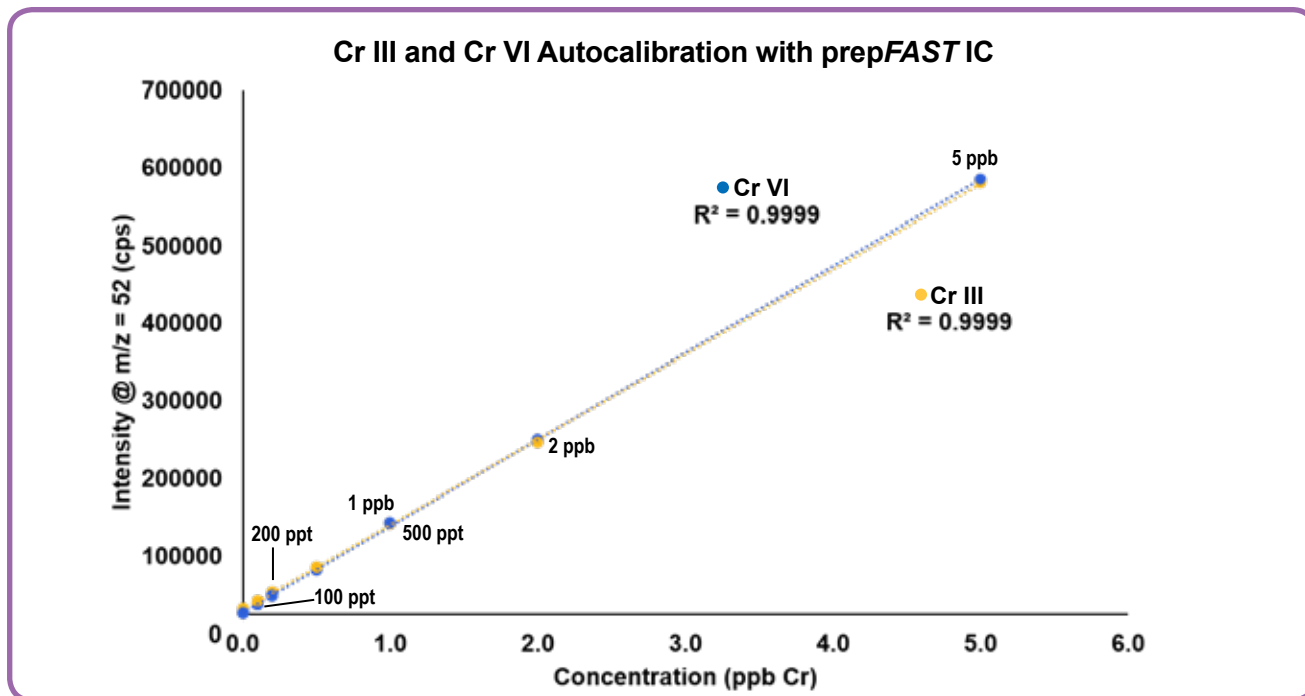

Inline preparation of low-level standards from concentrated stock standards eliminated environmental contamination. This provides linear calibration curves over a wide range. Shown above are the calibration plots displayed for both Cr species.

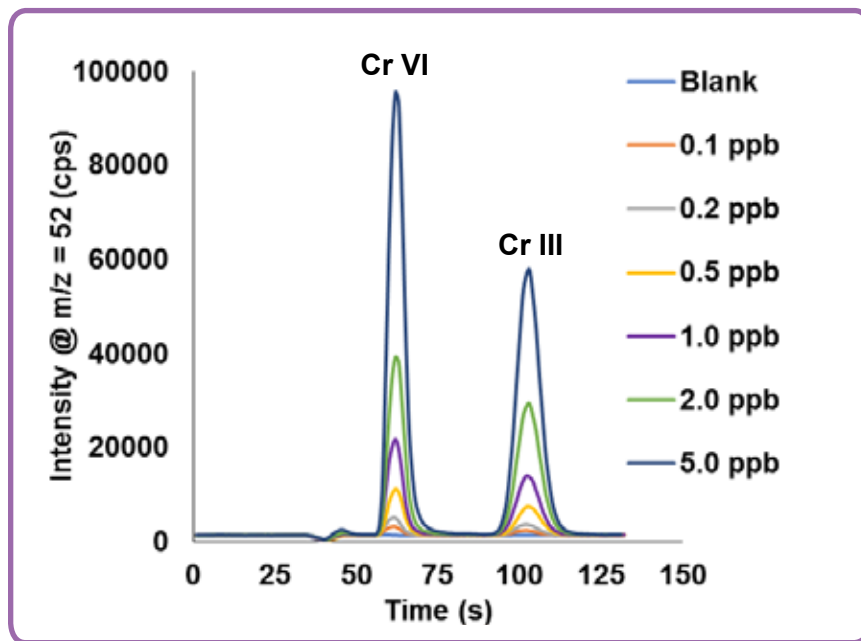

Chromium chromatograms for prepFAST IC calibration

### Detection Limits for Chromium Speciation

Analyte	LOD (ppt)
Cr III	5
Cr VI	5

*\*USEPA MCL for Total Cr currently 100 ppb*

## Chromium Speciation Analysis of Drinking Water

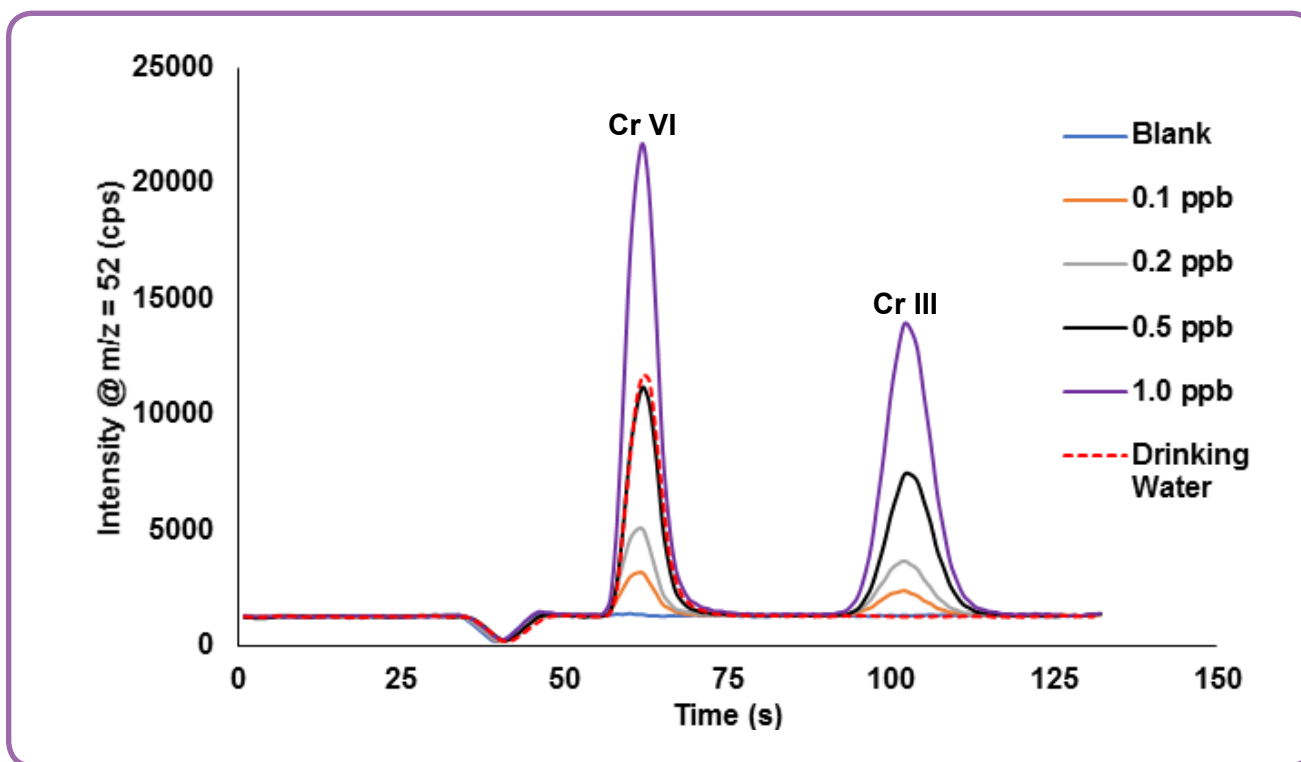

Analysis of Cr VI and Cr III with prepFAST IC and iCAP™ Q ICPMS. Drinking water sampled from Omaha, NE water fountain. Chromatograms above displays overlaid standards and samples response. Duplicate results for drinking water below shows no detection of Cr III and an average of 0.555 ppb for the Cr VI species.

Concentrations							
No.	Time	Sample Type	Label	Cr6+ [ppb]	Cr3+ [ppb]		
28	4/16/2019 4:40:50 PM	BLK			N/A		N/A
29	4/16/2019 4:44:39 PM	STD					
29	4/16/2019 4:44:39 PM	STD	100ppt	0.106 (0.100)	0.097 (0.100)		
30	4/16/2019 4:48:29 PM	STD	200ppt	0.198 (0.200)	0.203 (0.200)		
31	4/16/2019 4:52:18 PM	STD	500ppt	0.493 (0.500)	0.500 (0.500)		
32	4/16/2019 4:56:07 PM	STD	1ppb	1.003 (1.000)	1.000 (1.000)		
				<b>Calibrations</b>			
No.	Time	Sample Type	Label	Cr6+ [ppb]	Cr3+ [ppb]		
33	4/16/2019 4:59:56 PM	UNKNOWN	2ppb	1.898	2.264		
34	4/16/2019 5:03:46 PM	STD					
35	4/16/2019 5:07:35 PM	UNKNOWN	Blank	N/A	N/A		
36	4/16/2019 5:11:25 PM	UNKNOWN	Water ESI	0.558	N/A		
37	4/16/2019 5:15:14 PM	UNKNOWN	Water ESI	0.552	N/A		
38	4/16/2019 5:19:03 PM	UNKNOWN	1ppb RB	1.005	1.153		
39	4/16/2019 5:22:52 PM	UNKNOWN	1ppb RB	1.054	1.189		
40	4/16/2019 5:26:42 PM	UNKNOWN	Blank	N/A	N/A		

Screenshot of Qtegra™ software results

## Arsenic Speciation

Both forms of inorganic Arsenic [As (III) & As (IV)] are considered toxic at low levels, while the organometallic forms are much less toxic. Determination of the chemical form(s) of the total Arsenic metal present in a sample is often critical in sample determinations. The analysis of both total and speciated forms of Arsenic in clinical, pharmaceutical, food, and environmental samples is fully automated with the prepFAST IC.

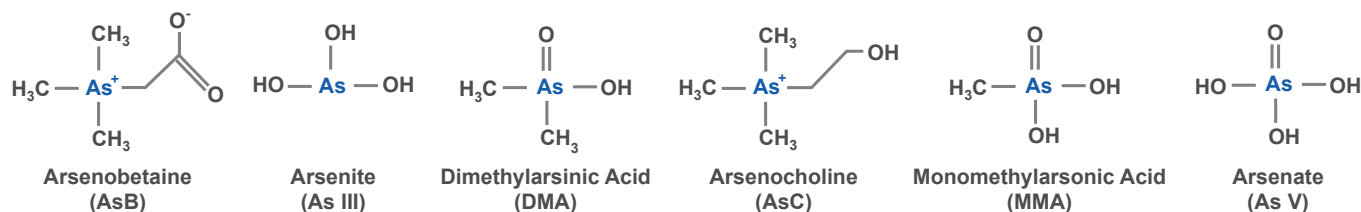

Arsenic Species

## Performance of prepFAST IC for As Speciation

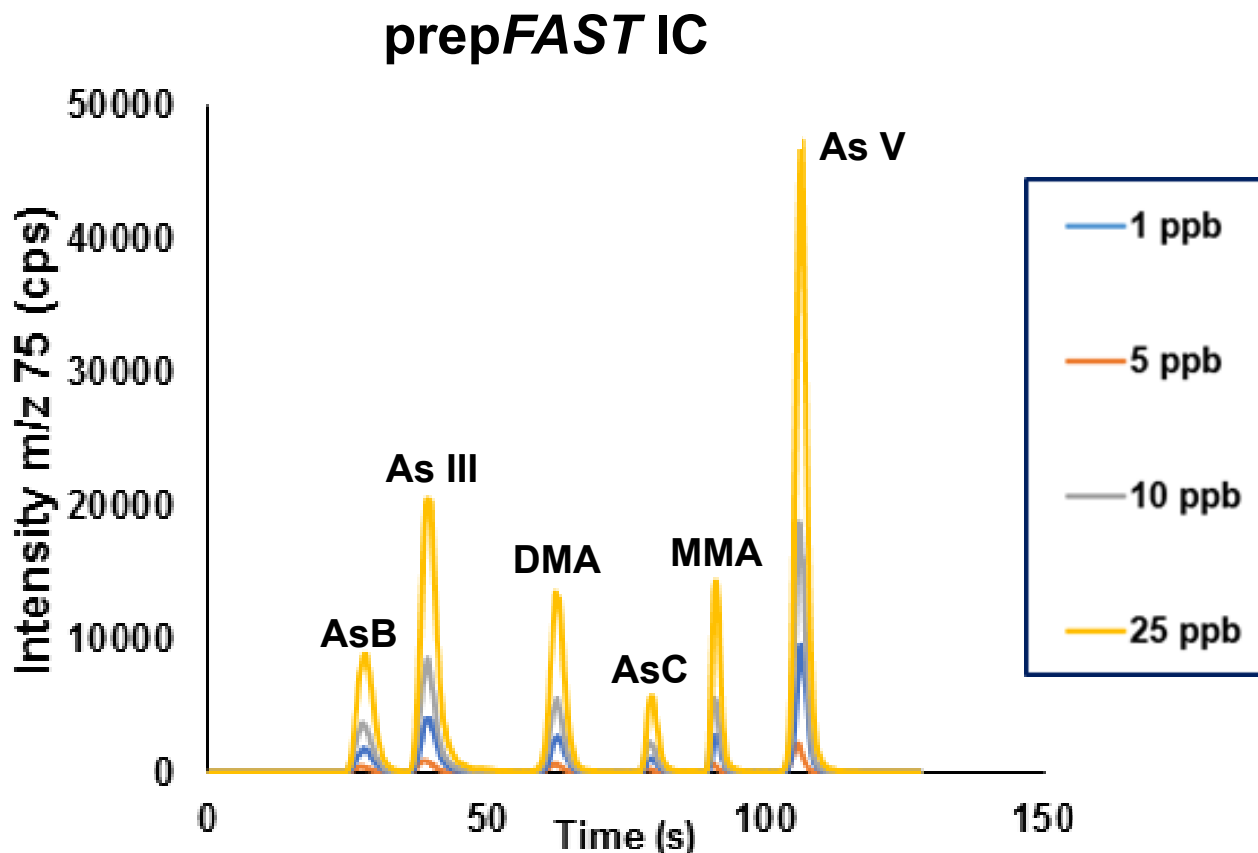

Overlay of arsenic species chromatograms for calibration standard levels. The separation of the six different arsenic species is completed in under 2 minutes with the prepFAST IC system.

## Arsenobetaine in Food with prepFAST IC - Fish and Lobster

Several parts of the world are starting to require testing of seafood for arsenic species. Arsenobetaine (AsB) is often found to be the major As component present in many types of seafood. These large concentrations can overload the column and prevent the separation of the later eluting species, including the more toxic forms of As III and As V. The capability of the prepFAST IC to perform an inline dilution aids in properly performing the speciation analysis. Below is an example of the wide range of arsenic species concentrations that can be successfully determined with the prepFAST IC system.

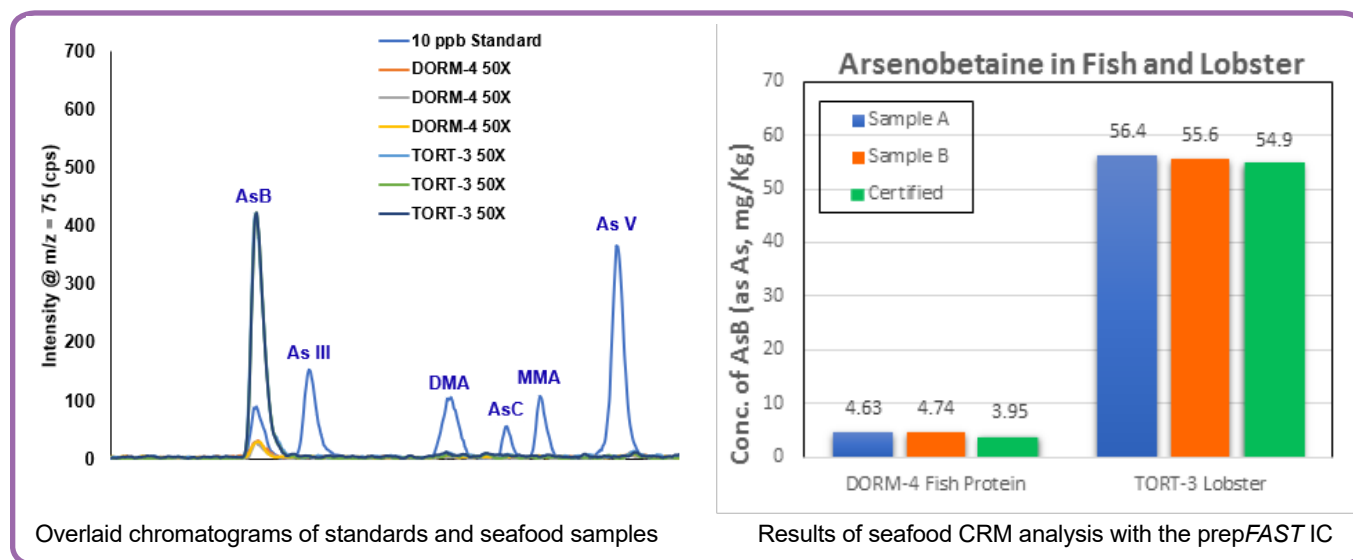

## Arsenic Speciation – Manual Dilution vs. prepFAST IC Inline Dilution

Several oxidation states of metals are not stable when they are diluted into a different matrix. Below is an example of this effect when standards and samples containing arsenic compounds are manually diluted prior to the speciation analysis. This issue of species conversion is addressed by the inline dilution capability of the prepFAST IC, since all required dilutions are performed at the time of analysis.

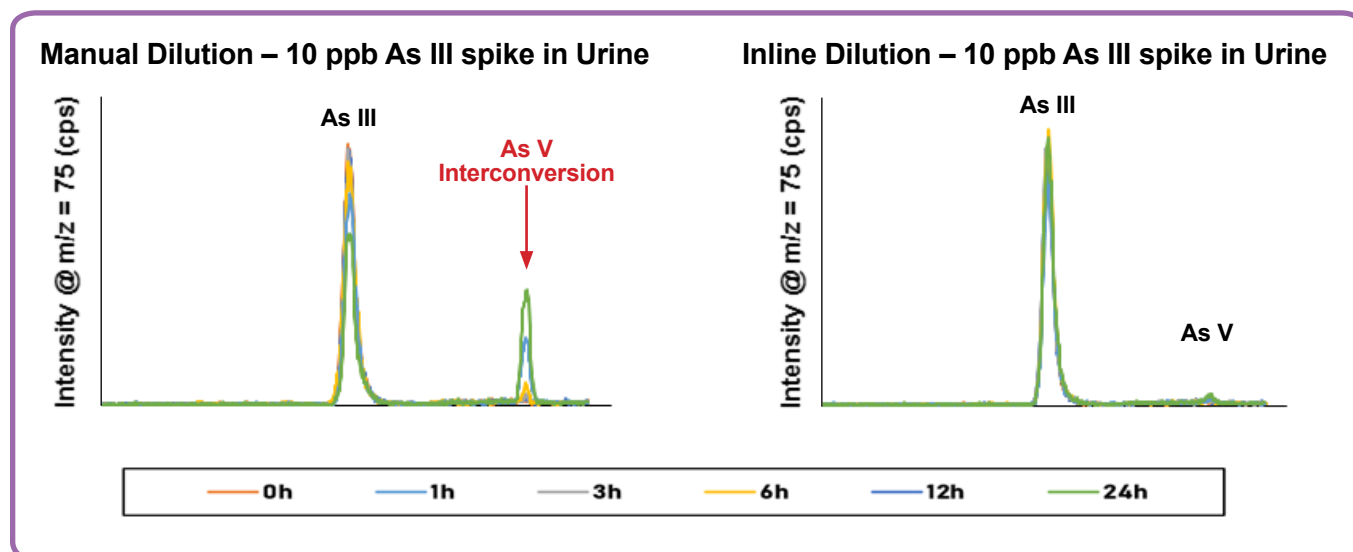

Manual dilution process resulted in loss of As III of 4% in 1 h, 9% in 6 h, and 35% in 24 h (22% of the loss was due to As III converting to As V). Inline dilution provided by the prepFAST IC eliminates the interconversion of As III to As V.

## Automated Seawater Analysis for the iCAP™ Q/RQ/TQ ICPMS

The seaFAST automatically prepares seawater and other high matrix samples for ICPMS analysis in <10 minutes to produce analytical results that might otherwise require time-consuming and contamination-prone offline sample preparation.

The accurate determination of trace metals in seawater is important both for scientific research and environmental monitoring. Because many transition metals and other analytes are present at low to sub-ppt concentrations in seawater, and because the saline matrix suppresses signal and causes mass spectral interferences, it is necessary to separate and concentrate analytes from the seawater matrix prior to ICPMS analysis.

seaFAST S-Series systems are syringe-driven sample introduction systems for multi-mode analysis of high matrix samples. For more complete automation and simple day-to-day usage, the seaFAST SP-Series systems have integrated prepFAST autocalibration and autodilution features.

### High Performance:

- Automated preconcentration
- Automated matrix elimination
- Ultraclean ultra-low blanks
- Applicable to seawater, groundwater, brines, or other high matrix samples



## seaFAST SP3

- Completely syringe-driven
- Multimode:
  - Preconcentration
  - Direct
  - Hydride
- Autocalibration, Autodilution
- Auto matrix matching
- Auto standard addition
- Ultratrace metals determination in high matrix samples

### seaFAST Systems

System	High Purity Autosampler Enclosure	Syringe Sample Loading	Offline Preconcentration	Online Preconcentration	Direct Mode Inline Dilution	Hydride Mode	Auto-calibration	Auto-dilution	Auto Matrix Matching/ Auto MSA
seaFAST S2	✓	✓	✓	✓	✓				
seaFAST S3	✓	✓	✓	✓	✓	✓			
seaFAST SP2	✓	✓	✓	✓	✓		✓	✓	✓
seaFAST SP3	✓	✓	✓	✓	✓	✓	✓	✓	✓

## seaFAST Systems Comparison

### seaFAST S2

#### Preconcentration and Direct Modes:

A chelation column concentrates transition metals and rare earth elements, but allows matrix  $\text{Na}^+$ ,  $\text{Cl}^-$ ,  $\text{Ca}^{2+}$  and  $\text{Mg}^{2+}$  ions to be rinsed out. After the preconcentration step, analytes are eluted and detected. Analytes that are not chelated by the preconcentration column are measured by direct dilution with internal standard during the same analytical run.

### seaFAST S3

#### Preconcentration, Direct and Hydride Modes:

Adds hydride generation to the capabilities of the seaFAST S2 to allow high sensitivity detection of As, Se and other hydride-forming elements.

### seaFAST SP2

#### Preconcentration and Direct Modes with Autodilution:

The capabilities of seaFAST S2 plus autocalibration, autodilution, auto matrix matching, and auto method of standard addition (MSA) in both modes.

### seaFAST SP3

#### Preconcentration, Direct and Hydride Modes with Autodilution:

The capabilities of seaFAST S3 plus autocalibration, autodilution, auto matrix matching, and auto method of standard addition (MSA) in all modes.

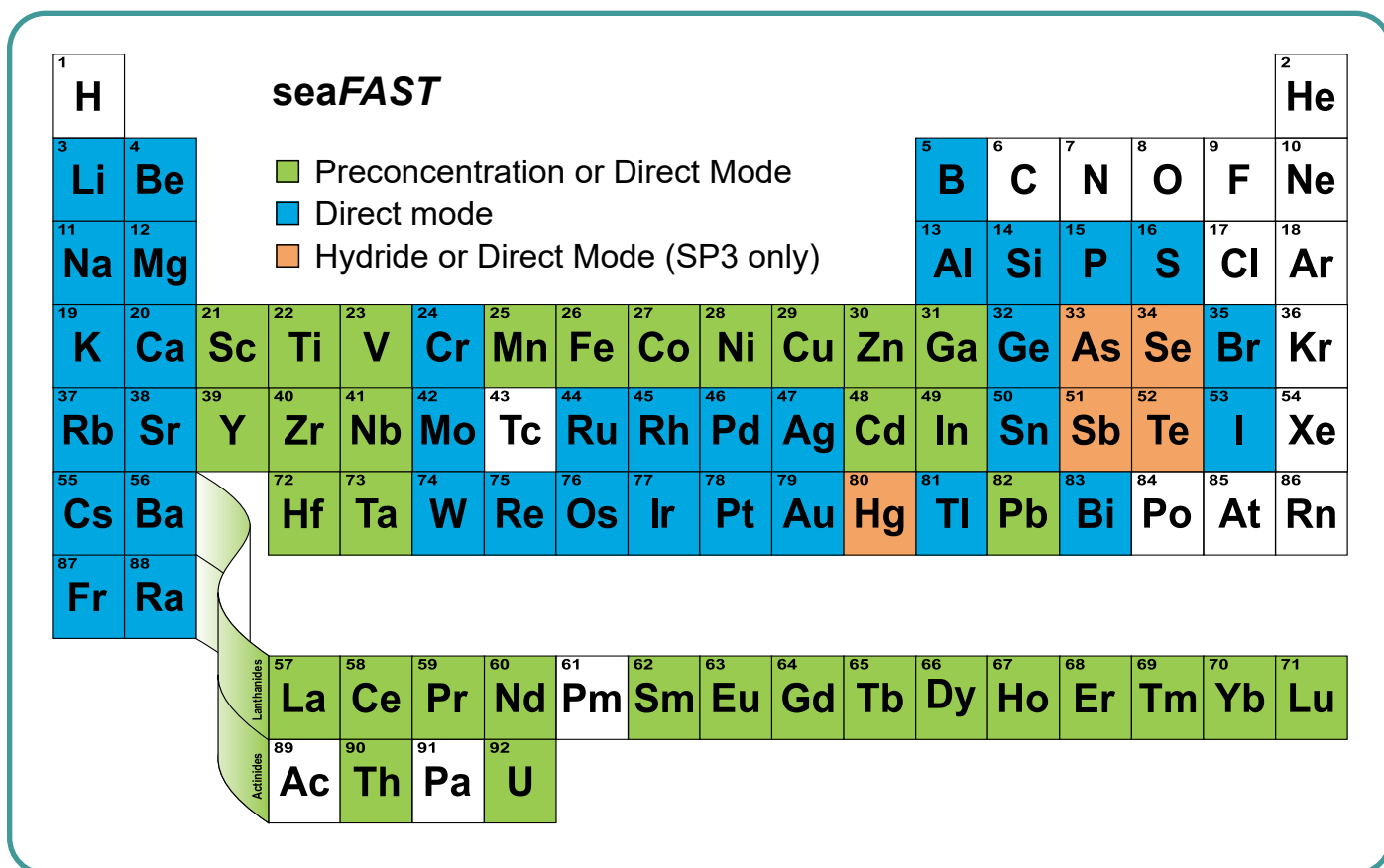

## seaFAST Preconcentration and Matrix Removal Process

- Step 1:** Sample loaded onto complexing column
- Step 2:** Matrix components washed off column
- Step 3:** Analytes eluted from column for analysis

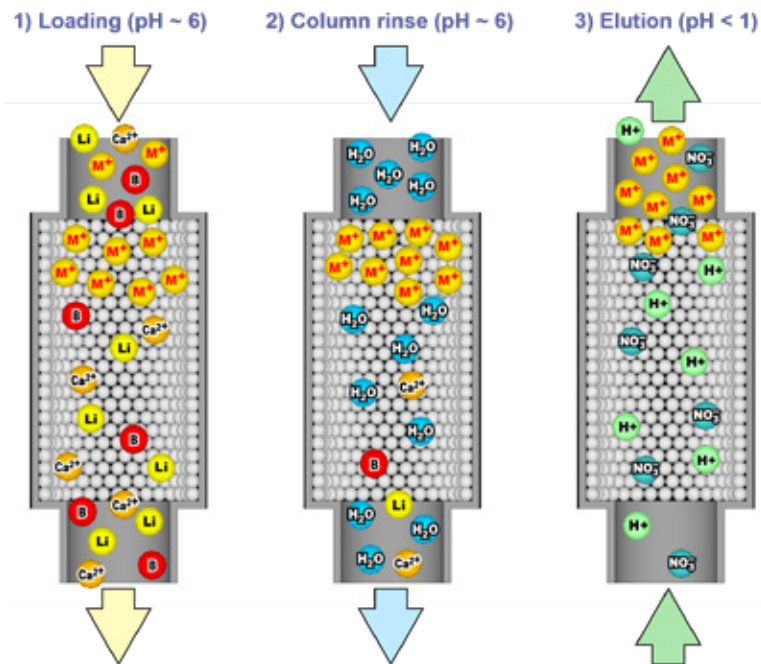

## Multielement Elution – Seawater Reference (NASS-6)

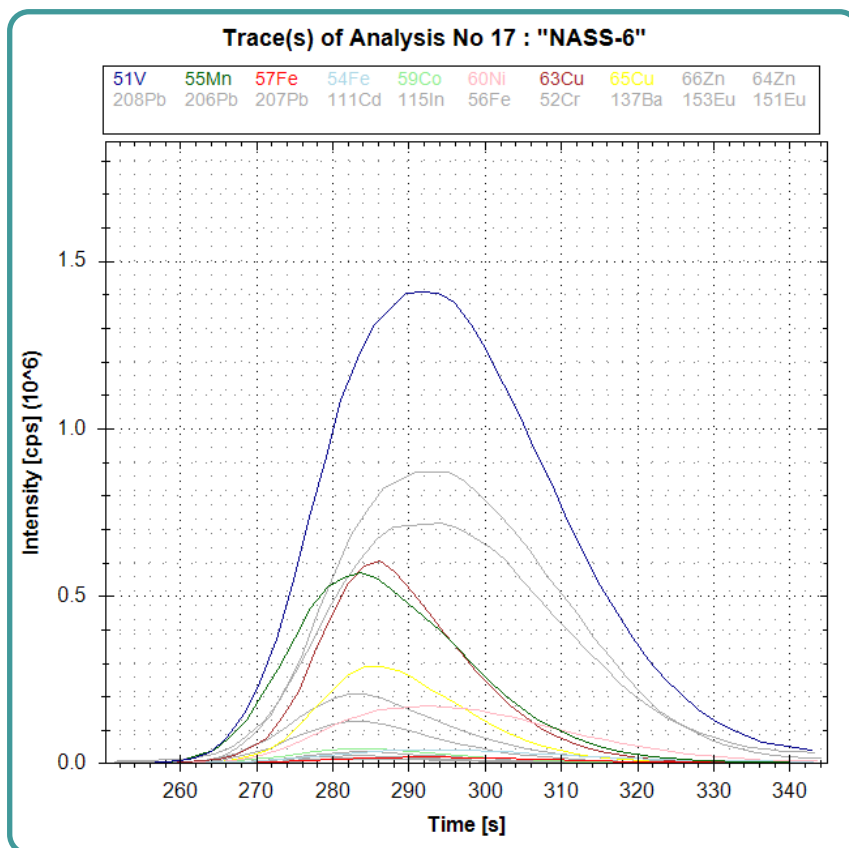

Simultaneous elution of 21 elements in Preconcentration and Matrix Removal mode. Seawater sample SRM is NASS-6, view displaying preconcentration portion of analysis within Qtegra™ time resolved software mode.



## Preconcentration Mode – NASS-6 Results

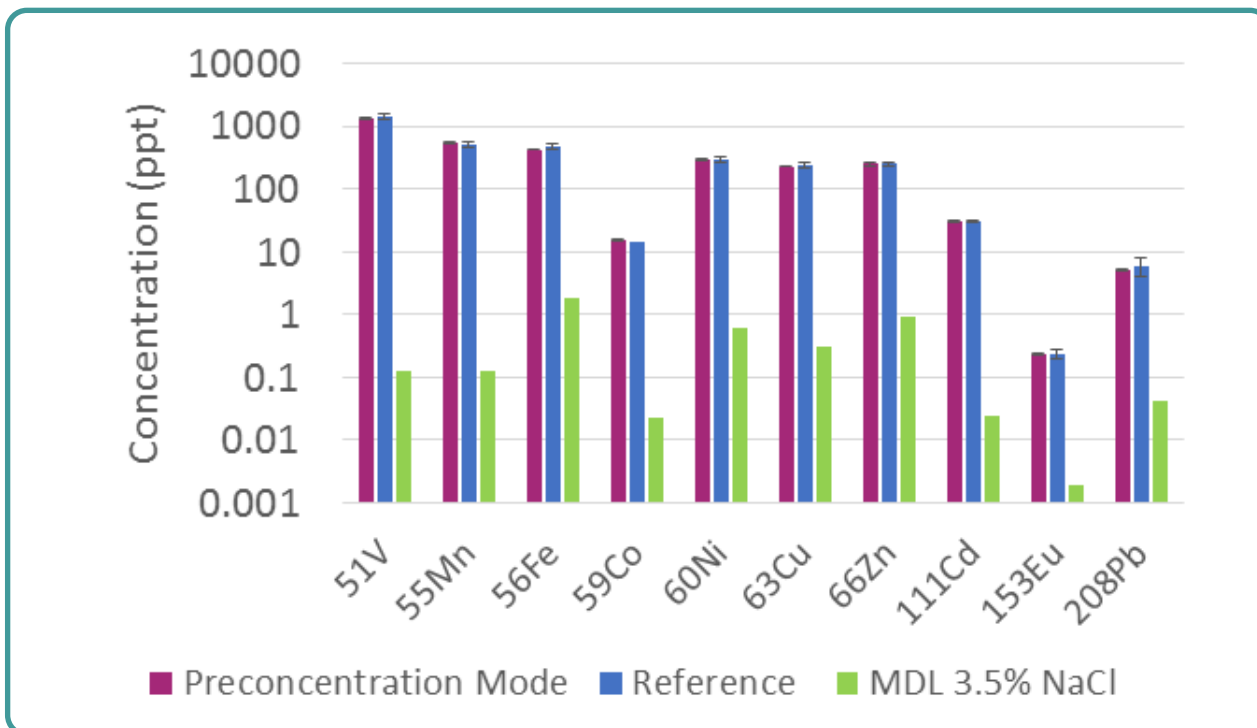

Analysis results and detection limits with seaFAST on NASS-6 Seawater certified reference material. Use of Preconcentration Mode eliminates matrix elements and provides high sensitivity, even for elements present in seawater at concentrations below 1 ppt.

### Syringe-driven Sample Loading

All seaFAST systems include syringe-loading capability to ensure samples and standards are loaded accurately each and every time. Eliminate variable vacuum-loading times for samples with varying viscosities and simplify daily operation.

For offline preconcentration mode, the smaller-volume eluted fraction may be accurately syringe-loaded for analysis by seaFAST direct mode.

seaFAST Systems	
Description	P/N
seaFAST S2 system	4SF-S2-M5-I
seaFAST S3 system	4SF-S3-M5-I
seaFAST SP2 system	4SF-SP2-M5-I
seaFAST SP3 system	4SF-SP3-M5-I

seaFAST System Columns	
Description	Part Number
Spare seaFAST analytical column and cleanup column	CF-N-0200
P-type seaFAST analytical column for enhanced Ag determination	CF-P-0050
P-type seaFAST cleanup column for enhanced Ag determination	CF-P-0200

seaFAST System Reagents	
Description	Part Number
seaBlank 10.5% ultrapure NaCl, 500 mL	seablank-0500
seaFAST S-Series Ultrapure buffer, 1 L	UPB-4M-1L

# hydrideICP™

## Compact Hydride Generation System for iCAP™ Q/RQ/TQ ICPMS

The hydrideICP, a standalone hydride generation system with precision micro peristaltic pump, provides ultralow detection limits for hydride-forming elements such as As, Se, Sb, and Hg.

### Benefits:

- Increased sensitivity, up to 100x for hydride-forming elements
- Improved detection limits for As, Hg, Se, Sb, and other hydride-forming elements
- Improved stability
  - MP<sup>2</sup> micro peristaltic pump precisely mixes sample and reagents, producing a stable formation of H<sub>2</sub> gas and hydrides
- Compact
  - hydrideICP is the smallest system of its kind on the market (95 mm x 118 mm x 140 mm)
- Chemically resistant construction
  - MP<sup>2</sup> micro peristaltic pump with ceramic pins, a PFA mixing block and quartz GLS
- Convenient
  - hydrideICP is completely integrated into the MP<sup>2</sup> pump



hydrideICP system



Universal spray chamber adaptor (P/N HG-USCA-01) used with hydrideICP operating in hydride-only mode.



Dual-Inlet spray chamber (P/N ES-3173-1411-21) used with hydrideICP operating in simultaneous hydride and direct nebulization mode.

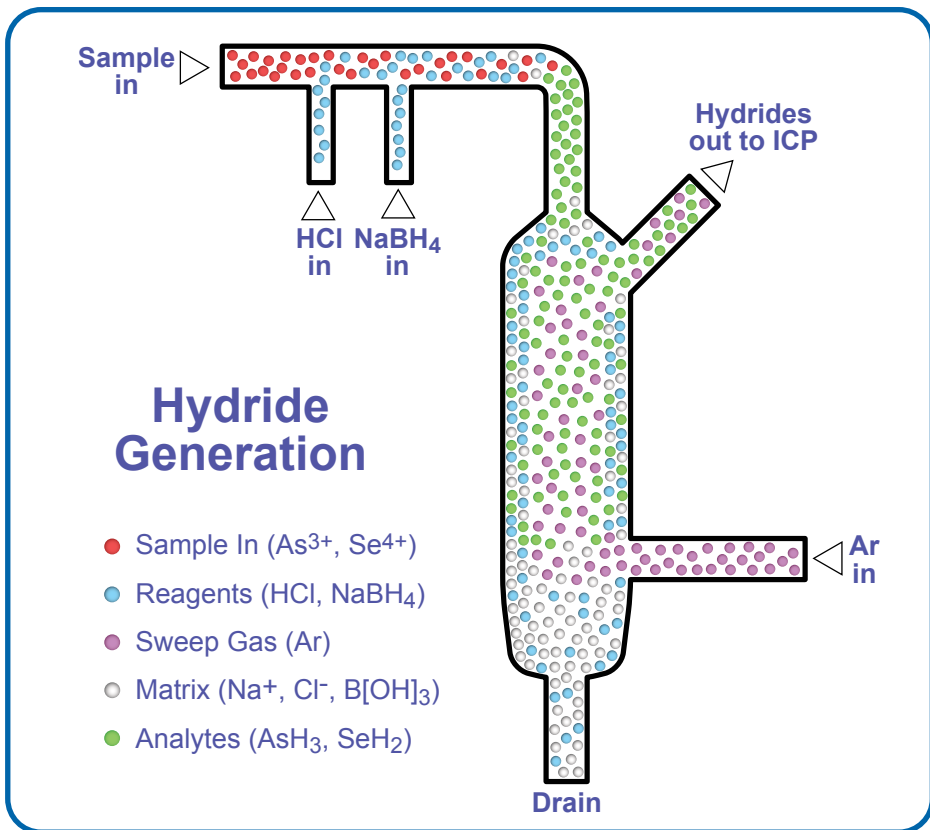

HydrideICP's gas liquid separator is the smallest, highest performing and most stable on the market. The design promotes rapid mixing of sample and reagents, resulting in an efficient reaction and separation of hydride gases from sample liquids in a small volume.

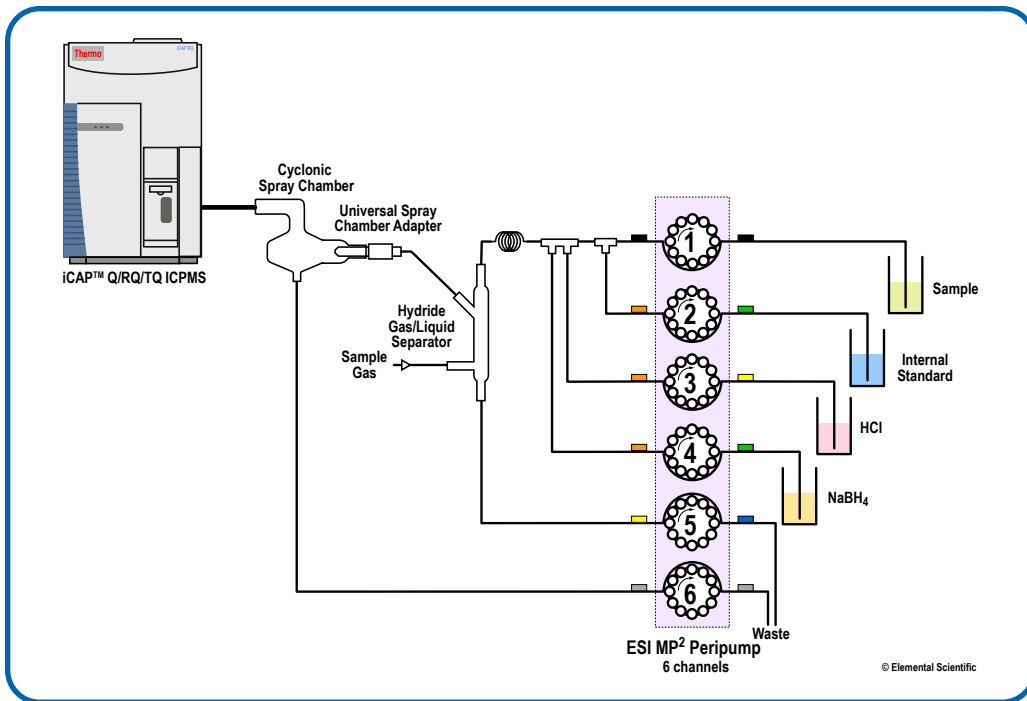

hydrideICP with internal standard system diagram

Description	Part Number
hydrideICP hydride generation system. HydrideICP Generator Kit (hydride quartz gas-liquid separator, four-way tee, MP <sup>2</sup> precision micro peristaltic pump, universal spray chamber adapter and mounting plate).	HG-MP2-6-A
Quartz spray chamber with two inlets, for iCAP™ Q/RQ/TQ. Supports simultaneous hydride and direct nebulization modes with the hydride ICP.	ES-3173-1411-21



## Simultaneous Hydride Generation and Direct Nebulization with hydride S31

The integration of an additional *FAST* valve provides multi-mode functionality to the hydride S31 and the iCAP™ Q/RQ/TQ for the highest flexibility and sample throughput.

- Selection between the following modes of operation:
  - Simultaneous determination of hydride-forming elements with hydride generation and direct nebulization for other elements
  - Hydride and direct nebulization determinations run sequentially
  - Independent analysis by either hydride or direct nebulization



*FAST* valve module for iCAP™ Q/RQ/TQ required for simultaneous hydride and direct nebulization option (not included)

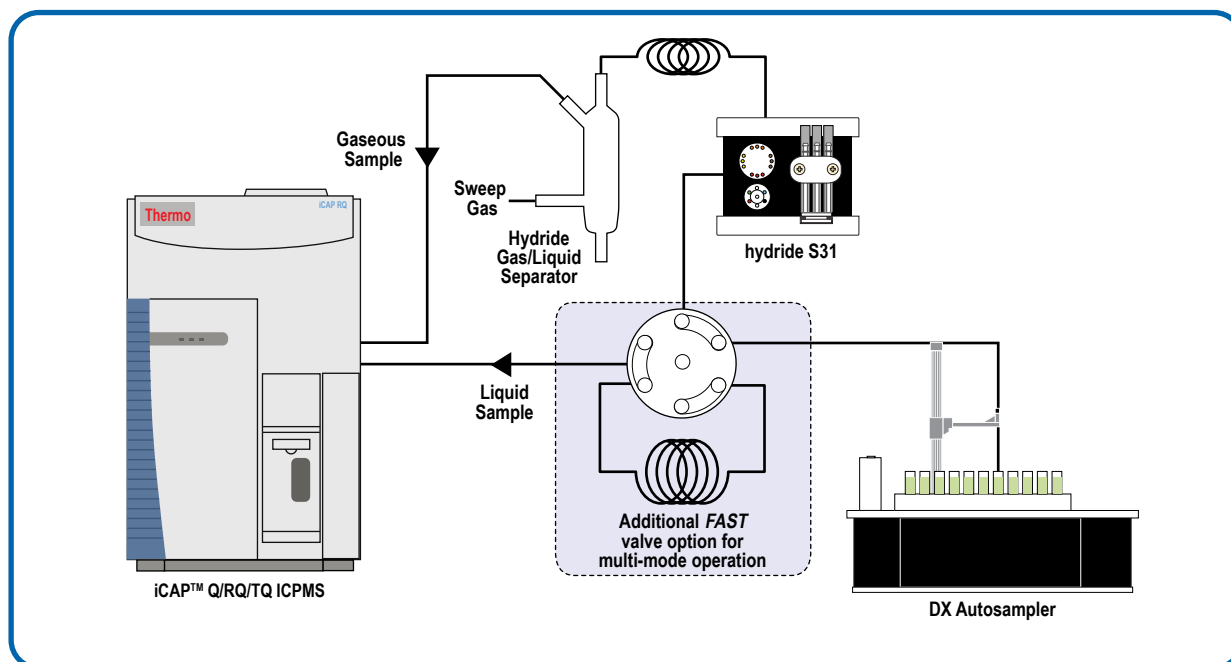

Hydride S31 configuration with additional *FAST* valve for high throughput multi-mode analysis. Non-hydride forming elements are analyzed through the Liquid Sample pathway using a nebulizer. Hydride forming elements benefit from high sensitivity hydride generation through the Gaseous Sample pathway. The iCAP™ Q/RQ/TQ acquisition can be configured to analyze interfered elements (such as As, Se) when the nebulizer is introducing carrier liquid, thus avoiding Cl or other polyatomic interferences. Hydride S31 can also be operated simultaneously or sequentially with direct nebulization.

### hydride S31 System for iCAP™ Q/RQ/TQ

#### Description

Hydride S31 module for any DX *FAST* system. Includes S31 module for hydride generation. (DX *FAST* autosampler and spray chamber required, not included)

#### Part Number

HFX-73

**Turn ANY DX *FAST* System Into a hydride S31 System!**

Just add the hydride S31 module

# GetReady for iCAP™ Q/RQ/TQ ICPMS

## Automated Tuning Solution Selection

The GetReady system combines a multiposition valve with the autotune functions in the Qtegra™ software to automatically perform unattended daily tuning functions on the iCAP™ Q/RQ/TQ systems. GetReady provides rapid and automated ICPMS calibrations from standard solutions kept in enclosed bottles protected from evaporation and contamination. Daily tune, mass calibration, and detector calibrations can be performed without the need for manual introduction of the required solutions. GetReady also selects a customized rinse solution or the carrier solution used in FAST and prepFAST equipped systems.

### GetReady Provides:

- Automated performance testing
- Automated daily tuning procedures
- Automated detector and mass calibration
- Automated selection of carrier solution for FAST and prepFAST during warmup and after tuning actions are completed
- Delivery of specialized rinse solution
- Operation with DX autosamplers, FAST, and prepFAST equipped systems



GetReady installed on iCAP™ RQ.  
GetReady can be used with FAST or prepFAST

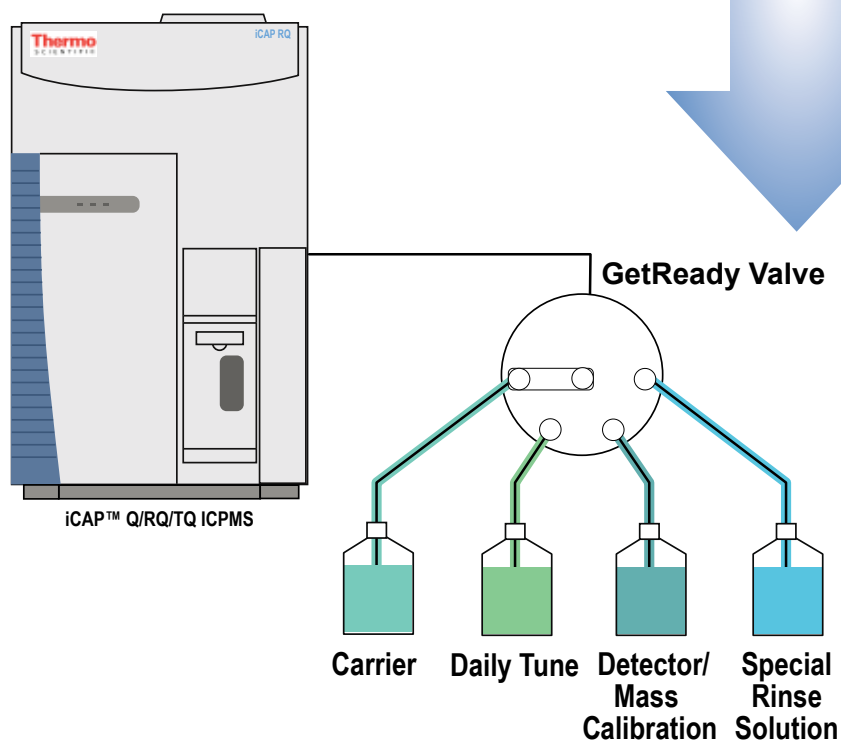

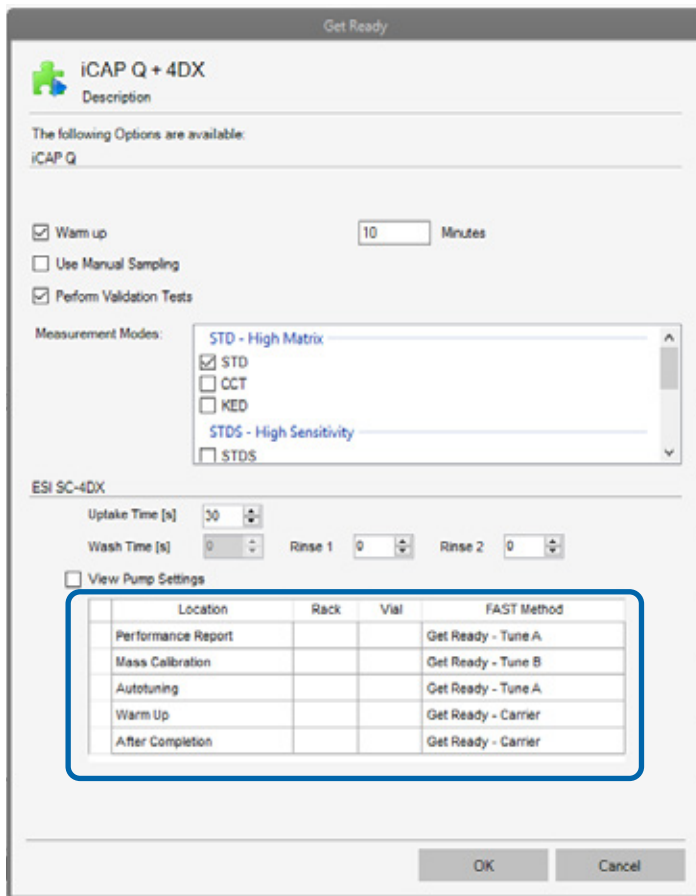

GetReady selection valve and rack support quick and simple installation



GetReady valve control settings with FAST methods shown above in Qtegra™ automated tuning protocols module

### GetReady Delivers:

- Automated selection of the proper tuning solution or FAST and prepFAST carrier solution
- Automated operation with Qtegra™ startup and tuning software module
- Fully unattended daily warm-up, performance checking, and required instrument tuning
- Prevents evaporation or contamination of carrier, tuning, and mass calibration solutions

GetReady for iCAP™ Q/RQ/TQ	
Description	Part Number
GetReady Automated Tuning Selection Valve for iCAP™ Q/RQ/TQ. Includes 4 port selection valve, 1 L carrier solution bottle, 500 mL tuning solution bottle, 150 mL mass calibration solution bottle, and 50 mL optional solution bottle	GR-M4-73

## Autosampler Enclosures and ULPA Filtered Environments

### Autosampler Enclosures

Enclosures protect samples and standards from airborne contamination. An exhaust port (100 mm, included) may be connected to the laboratory ventilation system to exhaust acid fumes and protect the laboratory environment and equipment. Enclosures can be purchased with or without an ULPA filter.



SC-1207-DX-1200  
Enclosure for 2DX autosampler with ULPA Filter (autosampler not included)

Autosampler Model	Enclosure Only	Enclosure with ULPA Filter
Enclosure for Micro DX	SC-1607-DX	SC-1607-DX-1000
Enclosure for 2DX	SC-1207-DX	SC-1207-DX-1200
Enclosure for 4DX	SC-1407-DX	SC-1407-DX-1200
Enclosure for 8DX	SC-1807-DX	SC-1807-DX-1000
Enclosure for 14DX	SC-1107-DX	SC-1107-DX-1030

See pages 90-91 for dimension specifications

### Ultra-Low Particulate Arrester Air Filter and Mounting Plate

The ULPA filter creates a clean, positive pressure environment for samples and standards and prevents airborne contamination. The ULPA filter removes 99.999% of 0.12 micron particles.



SC-0602  
ULPA Filter

ULPA Filter Specifications		
Air Volume	Noise level	Power
1 m <sup>3</sup> /min	56 dBA	25W

Description	Part Number
ULPA filter for autosampler enclosure	SC-0602
ULPA filter mounting plate for 2DX or 4DX	SC-1107-0026

The ULPA filter mounting plate fits the 2DX and 4DX on either the right or left side of the enclosure.

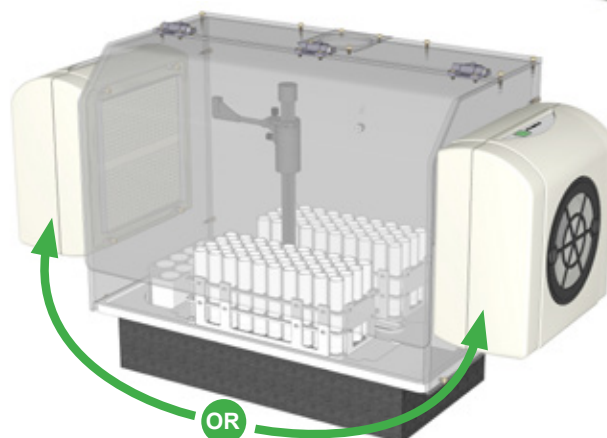



# Mobile Autosampler Stations

## Mobile Stations for 2DX and 4DX Autosamplers

### 2DX and 4DX Mobile Autosampler Stations

The mobile autosampler station provides a small-footprint platform for these autosamplers.

**Benefits:**

- Mobile with locking wheels for flexible positioning
- Frees of valuable laboratory bench space
- Convenient location for rinse, internal standard, and waste containers
- Shelf for additional sample introduction equipment, such as prepFAST



2DX autosampler with mobile station



4DX autosampler with mobile station

Description	Part Number
Mobile autosampler station for 2DX including electrical conduit for D-type valves (autosampler not included)	SC-1210-DX-P
Mobile autosampler station for 2DX (autosampler not included)	SC-1210-DX

Description	Part Number
Mobile autosampler station for 4DX including electrical conduit for D-type valves (autosampler not included)	SC-1410-DX-P
Mobile autosampler station for 4DX (autosampler not included)	SC-1410-DX

Description	Part Number
Mobile autosampler station for 8DX (autosampler not included)	SC-1810-DX



## High-performance PFA nebulizers for the iCAP™ Q/RQ/TQ ICPMS

### PFA Integrated Capillary Nebulizer

These high-performance PFA nebulizers were designed for *FAST* and *prepFAST* applications to minimize the number of connections between the valve and the nebulizer. An integrated fitting on the nebulizer's sample capillary line connects directly into *FAST* and *prepFAST* valves making the systems even more user-friendly. The self-aspirating MicroFlow fluoropolymer nebulizers are chemically resistant and an essential part of the ICPMS laboratory.

PFA integrated capillary nebulizers can produce a fine aerosol from aggressive acids, alkalis, organics, and high-salt solutions. They are resistant to clogging and produce high sensitivity at a low sample flow rate. They are the ideal nebulizer for *FAST* and *prepFAST* systems, ICPMS instruments with a wide range of sample types or when unknown samples are analyzed.



Integrated capillary nebulizer and prepFAST with SampleSense on an iCAP™ RQ

### Benefits:

- Integrated capillary to eliminate additional connection at nebulizer
- Optimized flow rate for use with all *FAST* and *prepFAST* valve-equipped systems
- Custom capillary length to minimize dead volume and uptake delay time on iCAP™ Q/RQ/TQ
- Coded connector for direct and proper port connection to all *FAST* and *prepFAST* valves
- Chemically-resistant, ideal for strong acids, alkalis, and organic solvents
- Produces a fine aerosol for high transport efficiency and high-sensitivity
- Permanent gas line with easy installation on iCAP™ Q/RQ/TQ systems

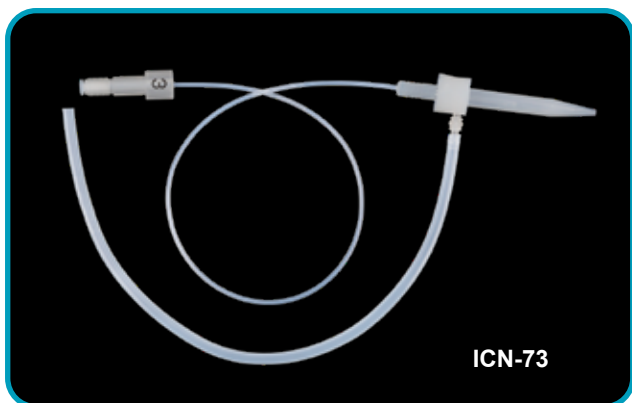

Model	Part Number
PFA Integrated Capillary Valve Nebulizer for iCAP™ Q/RQ/TQ	ICN-73

# PFA ST Nebulizers and Accessories

## High-efficiency MicroFlow Nebulizers and Accessories

MicroFlow nebulizers are resistant to clogging and are reliably self-aspirated or pumped to produce a fine aerosol for high transport efficiency and high sensitivity.

### PFA-ST Nebulizers

The PFA ST MicroFlow nebulizer is made from high purity, HF resistant PFA. It has an exchangeable external sample uptake capillary. The sample uptake rate is controlled by the diameter of the external capillary or probe.

#### Benefits:

- All PFA construction
- Exchangeable uptake capillaries allow one nebulizer to be used at different self-aspiration rates from 20 to 700  $\mu\text{L}/\text{min}$
- Chemically resistant – ideal for strong acids, alkalis and organics
- Can be pumped from  $< 0.02$  to 3.0 mL/min
- Direct analysis of volatile and non-volatile organic solvents
- Longer lifetime than glass or quartz nebulizers

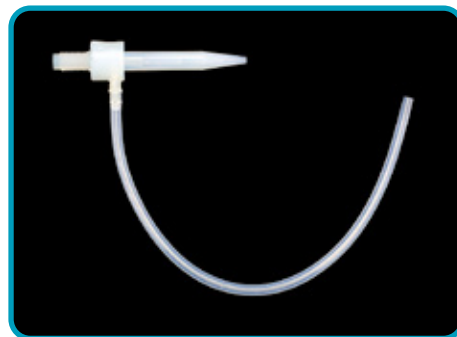

Description	Usage	Part Number
PFA-LP Microflow PFA nebulizer with external 1/4-28 threaded connector and gas line. Includes two sample capillaries (100 & 400 $\mu\text{L}/\text{min}$ )	For general high sensitivity and high performance. Standard nebulizer for iCAP™ Q/RQ/TQ and with FAST systems	ES-2040-73
PFA-ST Microflow PFA nebulizer for prepFAST. Self-aspirating nebulizer with external 1/4-28 threaded connector and gas line	prepFAST	PF-2040
PFA-ST MicroFlow PFA nebulizer with external 1/4-28 threaded connector and gas line	Nebulizer originally standard with iCAP™ Q	ES-2040
PFA-ST Microflow high solids large bore nebulizer with external 1/4-28 threaded connector and gas line	High solids samples Ideal for strong acids, high solids, alkalis, organic solvents, soils and high salts solutions	ES-2030-73

### Syringe Flush Kit for ST Nebulizers

The syringe flush kit is used in two ways. With the white fitting it can back flush the sample capillary leading to the ST nebulizer. With the red fitting it can attach to the sample liquid port on the ST nebulizer for foreflushing.

Description	Part Number
Syringe flush kit. Includes 3 mL syringe, two luer to 1/4-28 adapters.	SC-0599-0109



### Nebulizer Obstruction Removal Kit

While naturally resistant to obstructions, PFA nebulizers may occasionally require maintenance. Use this kit to safely remove obstructions in all PFA-ST nebulizers for long-term high performance. Never back-flush a PFA-ST nebulizer.

Description	Part Number
Fused silica obstruction removal kit for ST-type nebulizers. Includes one guide, 10 pieces of fused silica and instructions.	ES-2046-0001

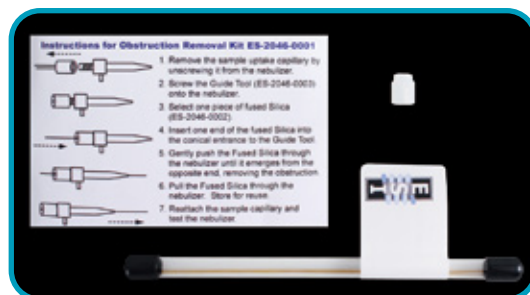

SAMPLE INTRODUCTION

## Sample Capillaries/Probes

### Sample Capillaries for ST Nebulizers

I.D. (mm)	Self-aspiration rate (@1L/m Ar)	Part Number
0.15	20 µL/min ■ (red)	ES-2045
0.20	50 µL/min ■ (purple)	ES-2043
0.25	100 µL/min ■ (green)	ES-2042
0.30	200 µL/min ■ (yellow)	ES-2047
0.50	400 µL/min ■ (orange)	ES-2041
0.80	700 µL/min ■ (blue)	ES-2044
1.00	1 mL/min ■ (gray)	ES-2049



Sample capillary attached to PFA Nebulizer

### Carbon Fiber Supported Autosampler Probes for ST Nebulizers

ST nebulizer probes connect directly to any ST-type nebulizer. The 1/4-28 threaded fitting provides a secure, zero-dead-volume connection with no additional fittings required.

- Shorter 80 cm capillary length normally utilized in small autosamplers (including Micro DX model) to minimize dead volume to nebulizer
- Standard 150 cm capillary length is standard on 2DX, 4DX, 8DX, and 14DX autosamplers
- Probes for DX autosamplers come equipped with a 1/4-28 threaded fitting to connect directly to a PFA-ST nebulizer
- Probes for DX autosamplers equipped with *FAST* and *prepFAST* come equipped to connect directly to the ESI *FAST* valve



Probe I.D. (mm)	Capillary Length (cm)	Self-aspiration rate (@1L/m Ar)	Autosampler Probes		
			DX Autosamplers Part Number	<i>FAST</i> & <i>prepFAST</i> Autosamplers Part Number	Micro DX Autosamplers Part Number
0.25	80	100 µL/min	ES-5037-3255-080	-	ES-5037-3250-080
0.50	80	400 µL/min	ES-5037-3505-080	-	ES-5037-3500-080
0.80	80	700 µL/min	ES-5037-3755-080	-	ES-5037-3750-080
1.00	80	1 mL/min	ES-5037-3995-080	-	-
0.25	150	100 µL/min	ES-5037-3255-150	SC-5037-3255-150	ES-5037-3250-150
0.50	150	400 µL/min	ES-5037-3505-150	SC-5037-3505-150	ES-5037-3500-150
0.80	150	700 µL/min	ES-5037-3755-150	SC-5037-3755-150	ES-5037-3750-150
1.00	150	1 mL/min	ES-5037-3995-150	SC-5037-3995-150	-

Also available with Ultem support

# PFA Microflow Nebulizers

## PFA Nebulizers with Integrated Sample Capillaries for the iCAP™ Q/RQ/TQ

### PFA Nebulizers with Integrated Capillaries

Self-aspirating PFA MicroFlow fluoropolymer nebulizers are chemically resistant and an essential part of the ICPMS laboratory. PFA nebulizers can produce a fine aerosol from aggressive acids, alkalis, organics, and high-salt solutions. They are resistant to clogging and produce high sensitivity at a low sample flow rate. They are the ideal nebulizer for ICPMS instruments with a wide range of sample types or when unknown samples are analyzed.

#### Benefits:

- Integrated capillary for connection-free introduction of samples at low flow rates
- Available with self-aspiration rates between 20 and 400 µL/min
- Chemically-resistant, ideal for strong acids, alkalis, and organic solvents
- Produces a fine aerosol for high transport efficiency and high-sensitivity
- Permanent gas line with easy installation on iCAP™ Q/RQ/TQ
- Can be peristaltic pumped organic solvents



PFA Nebulizers with Integrated Fluoropolymer Capillaries		
Model	Self-aspiration rate (@1L/m Ar)	Part Number
PFA-20	20 µL/min	ES-2020
PFA-50	50 µL/min	ES-2000
PFA-100	100 µL/min	ES-2002
PFA-200	200 µL/min	ES-2003
PFA-400	400 µL/min	ES-2005

Other flow rates made to order

## PFA-ST Microflow Nebulizers for apex

### apex MicroFlow PFA Self-aspirating Nebulizers

apex nebulizers are specially designed to operate at extremely high efficiency and at elevated temperatures. These nebulizers are well-suited for apex applications or with heated spray chamber applications.

Description	Part Number
High temperature apex-ST PFA MicroFlow nebulizer with external ½-28 threaded connector and gas line	ES-2040-7000
High temperature apex-100 PFA nebulizer with integrated 90-150 µL/min self-aspiration capillary and gas line	ES-2002-7000
High temperature apex-100 PFA nebulizer with Ultem manual sampling probe and gas line, 90-150 µL/min, 80 cm capillary	ES-2002-7205-080

See pages 62-63 for more information on particular systems



## PFA Nebulizers with Integrated Autosampler Probes for the iCAP™ Q/RQ/TQ ICPMS

### Self-Aspirating PFA Nebulizers with Integrated Probes

These nebulizers self-aspirate at low flow rates with the same benefits of the PFA MicroFlow nebulizer. The integrated sampling probe is constructed by encapsulating a rigid support material between layers of fluoropolymer to provide a chemically-resistant probe that is mechanically stable and resilient.

Probes can be custom made to specific lengths and materials at no extra charge.

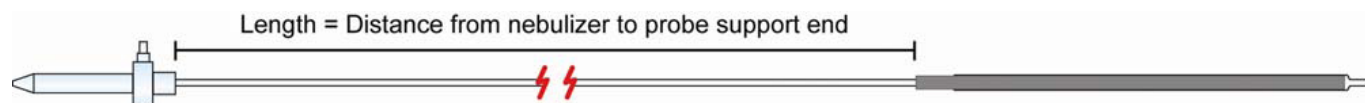
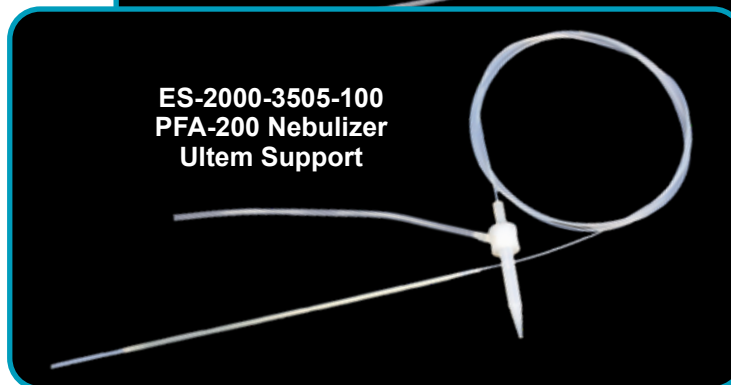

### PFA MicroFlow Nebulizers with Integrated Autosampler Probe

Model	Autosampler Type	Self-aspiration rate (@1L/m Ar)	Length (cm)	Support Material	Application	Part Number
PFA-20	Micro DX	20 µL/min	80	Carbon Fiber	Environmental/Clinical	ES-2020-3503-080
			100	Ultem	High Purity Semiconductor	ES-2020-3505-100
PFA-50	Micro DX	50 µL/min	80	Carbon Fiber	Environmental/Clinical	ES-2000-3503-080
			100	Ultem	High Purity Semiconductor	ES-2000-3505-100
PFA-100	Micro DX	100 µL/min	80	Carbon Fiber	Environmental/Clinical	ES-2002-3503-80
			100	Ultem	High Purity Semiconductor	ES-2002-3505-100
PFA-200	Micro DX	200 µL/min	80	Carbon Fiber	Environmental/Clinical	ES-2003-3503-80
			100	Ultem	High Purity Semiconductor	ES-2003-3505-100
PFA-400	Micro DX	400 µL/min	80	Carbon Fiber	Environmental/Clinical	ES-2005-3503-80
			100	Ultem	High Purity Semiconductor	ES-2005-3505-100

# Direct ICPMS Analysis of Solid Samples

## Laser Ablation

Laser Ablation (LA) is a direct, solid sample introduction technique for ICP and ICPMS. LA can be used to directly analyze any solid sample. The sample is accommodated inside an ablation cell and interrogated by a high power, pulsed laser beam ranging from a few microns in diameter (for high resolution spatial analysis) up to hundreds of microns (for bulk analysis). The solid particle aerosol is swept into the ICP/ICPMS for subsequent vaporization and ionization via a simple transport line.

The NWR laser ablation platform was designed and developed with an emphasis on:

- Superior performance and analytical results
- Application flexibility
- Operating convenience
- Reliability

Elemental Scientific has a complete laser product portfolio including:

- UV Femtosecond
- 193 nm Eximer
- 213 nm Solid State
- 266 nm Solid State
- Infrared
- Imaging Systems
- Automated Sampling



NWR Platform

### Applications Include\*:

Geochemistry  
Geochronology  
Fluid Inclusions  
Elemental ratios  
Isotope ratios  
Purity testing  
Material characterization  
Bulk Analysis  
Failure Analysis  
(Bio-) Imaging/Mapping  
Depth Profiling

### Materials Include\*:

Alloys  
Rocks  
Minerals  
Glasses  
Plastics  
Powders  
Biological  
Thin films  
Ceramics  
Metals

\*The lists above are not exhaustive.



NWR193



NWRfemto

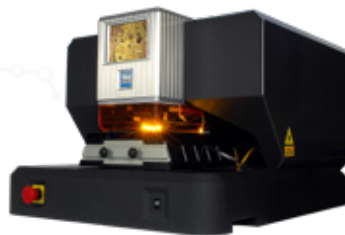

NWR266macro



NWR213

## MEINHARD®

### Concentric Nebulizers for the iCAP™ Q/RQ/TQ ICPMS

MEINHARD® Plus Nebulizers have the lowest dead volume of any glass or quartz nebulizer. The low dead volume and high sensitivity provide excellent detection limits and washout.

Each MEINHARD® Plus nebulizer comes with the FitKit+ gas and sample quick connect fittings. The patented permanent non-degradable PFA connector eliminates contamination risk and risk of leaks. The gas connection fits snugly over the maria on the sidearm of the nebulizer.

#### Features for all MEINHARD® Plus Nebulizers:

- Self aspiration rate 0.5 mL/min with argon flow 1 L/min at 50 PSI (3.4 bar/345 kPa)
- Peristaltic pumped rate 0.1 to 3.0 mL/min
- Includes FG Gas Quick Connect (PFA)

#### SilQ+ Ultra-high Purity Quartz Nebulizer

- Highest purity quartz
- Lowest contamination, especially for Al, Fe, K

Description	Part Number
MEINHARD® SilQ Plus High Sensitivity, High Purity quartz concentric nebulizer	SilQ-30-A0.5



#### TQ+ Quartz Nebulizer

- Quartz construction
- Low blank levels compared to glass nebulizers

Description	Part Number
MEINHARD® TQ+ quartz concentric nebulizer	TQP-30-A0.5



#### TR+ Glass Nebulizer

- Borosilicate glass
- Economical high performance nebulizer

Description	Part Number
MEINHARD® TR+ glass concentric nebulizer	TRP-30-A0.5



#### Nebulizer Cleaner

- Backflushes glass and quartz nebulizers to remove blockages

Description	Part Number
Pearl nebulizer cleaner for all glass and quartz concentric nebulizers	PRL-03



**Note:** Do not use Pearl to clean PFA nebulizers



## SilQ+ High Purity Quartz Plus Nebulizer

The SilQ+ nebulizer by Meinhard is made from the highest purity synthetic quartz. SilQ nebulizers have low levels of Al, Fe, Mg and other contaminants, generating low, stable blanks that can enhance ICPMS detection limits. SilQ nebulizers are recommended for the analysis of high purity chemicals that do not contain HF.

SilQ+ nebulizers come equipped with a patented PFA gas connection (FG+) and FitKit quick sample connector. The fittings can be rapidly attached and removed. The gas quick connect creates a snug seal around the maria on the SilQ+ sidearm.

Each nebulizer is manufactured and tested to exact specifications. The standard SilQ+ nebulizer requires 50 psi for 1 L/min of argon carrier and 0.5 mL/min solution uptake. Other versions are available.



MEINHARD® SilQ+ high purity nebulizer with FG+ PFA gas fitting TQP-50-A0.5



MEINHARD® Plus Nebulizer to micro fitting adapter S033101

### Potential Blank from Nebulizer

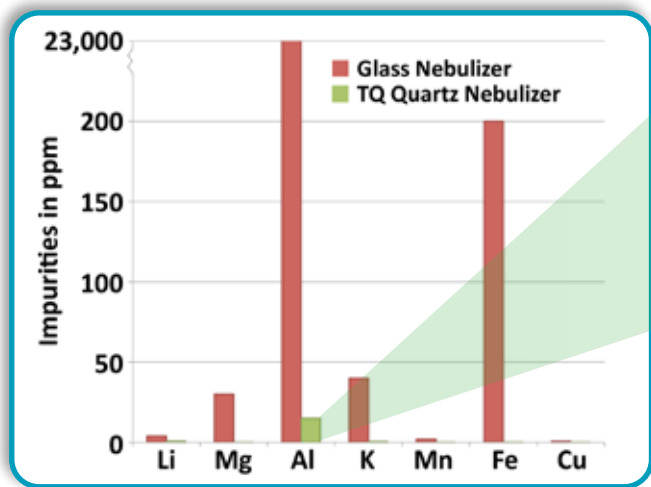

**Comparison of metal impurity in Glass and TQ+ Quartz nebulizers.** Glass nebulizers have high levels of impurity for elements such as Al, Fe, K, Mg.

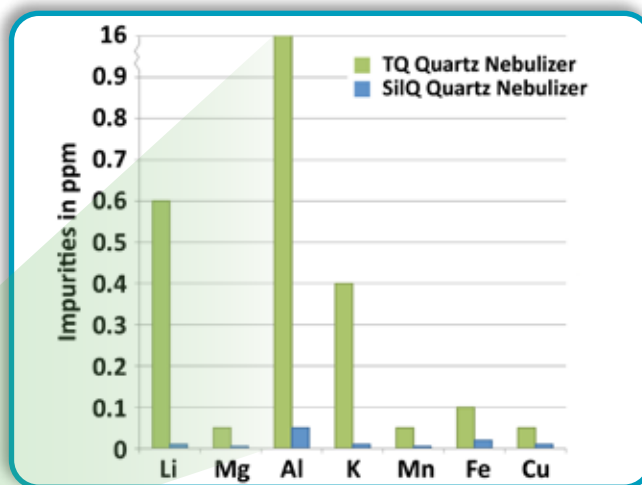

**Comparison of metal impurity in SilQ+ and TQ+ Quartz nebulizers.** SilQ+ impurities on average are 60 times lower than standard quartz nebulizers. Aluminum impurities in SilQ+ nebulizers are more than 400,000 times lower than glass.

## pergo Accessory

The *pergo* contains a water vapor permeable membrane that humidifies the ICPMS nebulizer gas stream. By increasing the humidity in the argon gas nebulizer stream, the *pergo* prevents salt deposits at the nebulizer tip, improving short and long-term signal stability. It can also be utilized to humidify the Argon Gas Dilution (AGD) gas on iCAP™ Q/RQ/TQ systems.

### Benefits:

- Improved RSDs
- Improved short and long-term stability
- Improved detection limits
- Faster washout
- Ability to use high-sensitivity nebulizers for high-TDS samples
- Extends the length of analytical runs

### Advantages:

- Higher, more consistent humidity
- Superior long-term stability
- Safe and easy to use
  - Atmospheric pressure water reservoir; no pressurized vessel utilized
- Optional USB communication for programmable humidity levels

The unique *pergo* design offers many advantages over other types of argon humidifiers.



PRG-01 *pergo* argon nebulizer gas humidifier



4DX

iCAP™ TQ with the *pergo* argon gas humidifier, shown with tray not included. P/N PRG-01

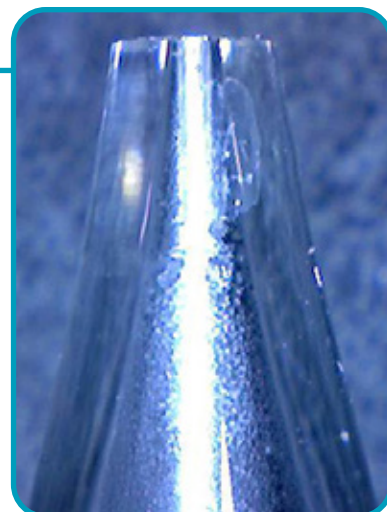
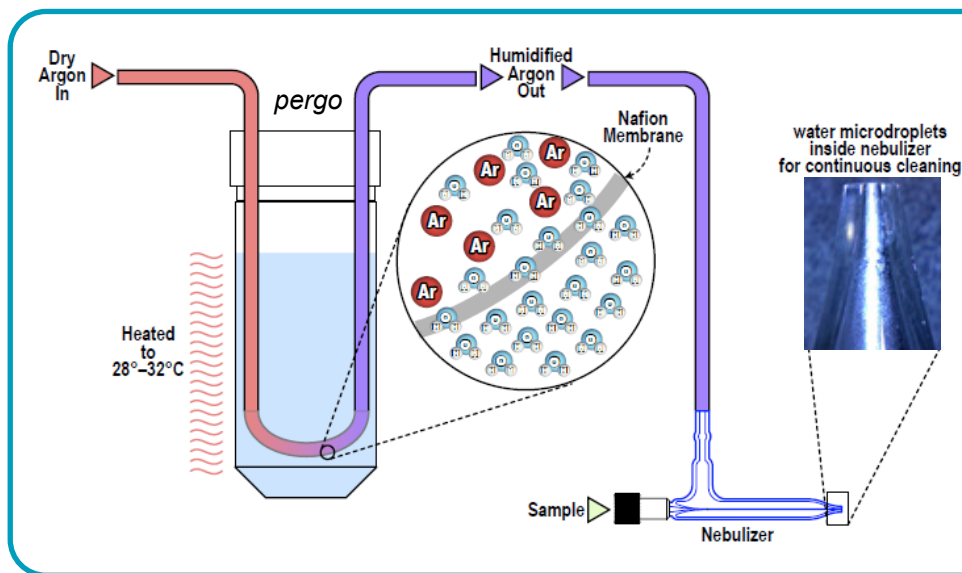

Water microdroplets continuously clean the inside of the nebulizer and prevent salt deposits.

Ar nebulizer gas is humidified using a tube-shaped membrane placed in a PFA water reservoir at atmospheric pressure. The water vapor condenses inside the nebulizer tip, preventing salt build-up.

### pergo 2

The *pergo 2* adds a second humidifier for the Argon Gas Dilution (AGD) flow. *pergo 2* enhances the iCAP™ Q/RQ/TQ performance and long-term stability when high solids samples are analyzed using AGD. With the *pergo 2*, both the nebulizer and AGD gas are humidified.

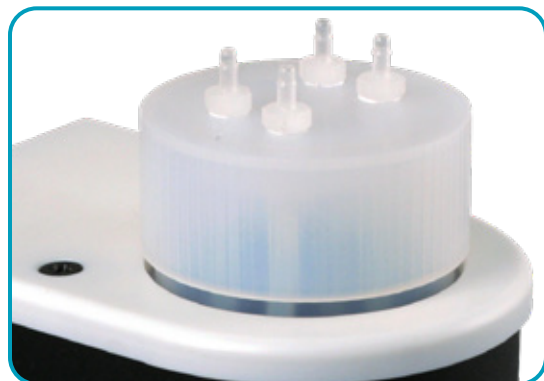

*pergo 2* humidifies both the nebulizer gas and Ar dilution gas flows



iCAP™ TQ with the *pergo 2* argon gas humidifier, shown with tray not included. P/N PRG-02

#### pergo Options

Description	<i>pergo</i> Part Number	<i>pergo 2</i> Part Number
<i>pergo</i> argon high solids accessory	PRG-01	PRG-02
<i>pergo</i> argon high solids kit, includes MEINHARD® TR+ high performance nebulizer	PRG-01-MAPlus	-
<i>pergo</i> iCAP™ Q/RQ/TQ gas line kit	PRGS-003	

## Cyclonic Spray Chambers for iCAP™ Q/RQ/TQ

Description	Application	Material	Part Number
Quartz cyclonic spray chamber, o-ring free (7mm baffle) with auxiliary gas port. Includes PFA elbow and threaded drain line	All-purpose for non-HF samples	Quartz	ES-3173-1111-23
Quartz cyclonic spray chamber, o-ring free (7 mm baffle) with auxiliary gas port and additional hydride inlet (45° horizontal at nebulizer inlet). Includes PFA elbow and threaded drain line	Simultaneously introduce nebulized aerosol and hydride species from hydride ICP and hydride S31 systems	Quartz	ES-3173-1411-21
PFA cyclonic spray chamber, o-ring free (7 mm baffle) with auxiliary gas port. Includes PFA elbow and threaded drain line	HF-containing samples	PFA	ES-3173-3111-21



## Spray Chamber Accessories

### Spray Chamber Accessories

Description	Application	Part Number
Threaded spray chamber drain line kit for iCAP™ Q/RQ/TQ. Includes 3-stop (gray-gray-gray) santoprene pump tubing, 95mm bridge distance	Drain connection for cyclonic and HP HF-resistant spray chambers	ES-2044-0009-B
PFA elbow with additional gas port, spare, for iCAP Q/RQ/TQ	All purpose, including HF-containing samples	ES-3150-0073-L
PFA secure nut, long (6 mm) PFA spray chamber nut	Secures nebulizer to iCAP™ Q/RQ/TQ spray chambers	ES-3199-0003
Addition Gas Line kit for iCAP™ Q/RQ/TQ	Used for adding 20% O <sub>2</sub> /80% Ar when organic solvents are analyzed.	ES-2502-1000

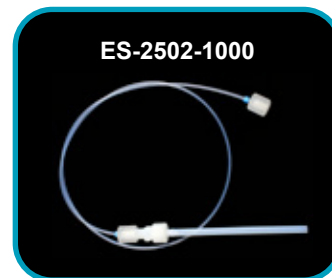
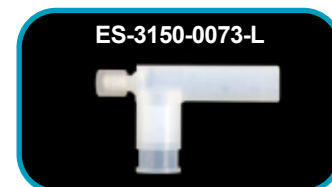

# PCH Peltier Cooler

## PCH Peltier Cooler for HP Spray Chamber – iCAP™ Q/RQ/TQ

### PCH Peltier Cooler for HP PFA Spray Chamber

The PCH Peltier cooler is for the high performance PFA spray chamber. It is a temperature controlled inlet system that offers the advantages of low memory effects, rapid wash-out, and high sample transport efficiency for HF containing samples. The outer walls of the spray chamber can be cooled to reduce the water or solvent vapor loaded on the plasma, achieving enhanced stability and performance. Temperature control is available from -10°C to +20°C. Application specific kits are also available below.

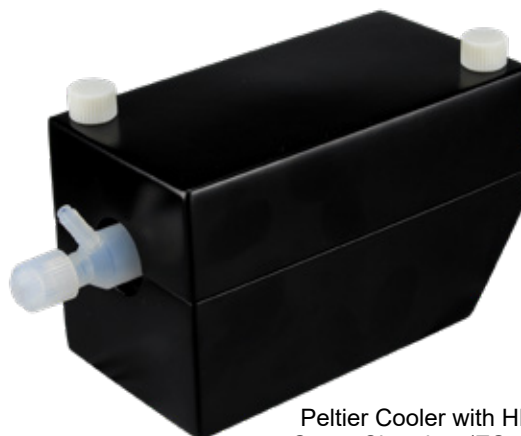

Peltier Cooler with HP PFA Spray Chamber (ES-4773C)

Description	PCH Peltier Cooler	Spray Chamber	PFA Neb/s	Injector	Torch	Part Number
PCH Peltier cooler thermally stabilized inlet system with PFA spray chamber and PFA-ST nebulizer	✓	✓	✓			PFA-SK-73A
PCH Peltier cooler thermally stabilized inlet system with PFA spray chamber (Nebulizer not included)	✓	✓				ES-4773C
PCH Peltier cooler thermally stabilized inlet system for PFA spray chamber (Spray chamber and nebulizer not included)	✓					ES-4773X
Geochem High Performance HF-Resistant sample introduction system includes: PCH Peltier cooler thermally stabilized inlet system for HP PFA spray chamber, PFA-ST nebulizer, and 2 mm sapphire injector.	✓	✓	✓	✓		PFA-SK-73G
Semiconductor High Performance HF-Resistant sample introduction system includes: PCH Peltier cooler thermally stabilized inlet system for HP PFA spray chamber, PFA-ST nebulizer, and 2 mm PT injector.	✓	✓	✓	✓		PFA-SK-73S
Complete Semiconductor High Performance HF-Resistant sample introduction system includes: PCH Peltier cooler for HP PFA spray chamber, PFA-ST nebulizer and PFA-200 nebulizer with 100 cm self-aspiration capillary with integrated probe, SilQ Ultra High Purity Quartz Torch, and 2 mm PT injector.	✓	✓	✓	✓	✓	PFA-SK-73SC

SAMPLE INTRODUCTION

## High Performance HF-Resistant PFA Spray Chamber

### HF-Resistant PFA Spray Chamber

Description	Application	Part Number
High performance PFA spray chamber with o-ring free PFA endcap	HF-containing samples, semiconductor grade reagents and other high purity samples	ES-2373-5470



## apex $\Omega$ and apex 2 High Sensitivity Sample Introduction Systems

The next generation of the highly successful apex systems feature software control of temperatures for the heated spray chamber and Peltier-cooled condenser (and heated membrane for apex  $\Omega$ ) as well as precise MFC control of nitrogen and argon additional gas/sweep gas flows.

The systems maximize ICPMS sensitivity, up to 10x, by nebulizing liquid samples into a heated cyclonic spray chamber. The multi-stage Peltier-cooled condensing systems remove the solvent vapor, reducing oxides. The new apex systems are available in either quartz or HF-resistant PFA models with options for additional membrane desolvation or mixing chambers.

### The new apex Systems:

- Are available with quartz or HF-resistant PFA flow path
- Have complete software control of:
  - Heated spray chamber temperature
  - Peltier-cooled condenser temperature
  - N<sub>2</sub> addition gas mass flow controller
  - Ar addition gas mass flow controller
  - Drain micro peristaltic pump

### Key Differences:

#### apex 2

- Reduces oxides (1% CeO<sup>+</sup>/Ce<sup>+</sup>)
- Does not include membrane desolvator

#### apex $\Omega$

- Significantly reduce oxides and solvent removal (0.01% CeO<sup>+</sup>/Ce<sup>+</sup>)
- Includes software control of heated membrane temperature
- Two stage desolvation (Peltier-cooled and EPTFE membrane) imparts matrix tolerance higher than any membrane desolvator on the market



apex 2 Q



apex  $\Omega$

Model	Description	Part Number
apex $\Omega$	apex Omega high performance membrane desolvation system with quartz spray chamber, Peltier-cooled quartz condenser, and EPTFE membrane desolvator.	APX-O
apex $\Omega$ HF	apex Omega HF high performance membrane desolvation system with PFA spray chamber, Peltier-cooled PFA condenser, and EPTFE membrane desolvator.	APX-O-HF
apex 2 Q	apex 2 Q desolvation system with quartz spray chamber and Peltier-cooled quartz condenser.	APX-2Q
apex 2 HF	apex 2 HF desolvation system with PFA spray chamber and Peltier-cooled PFA condenser.	APX-2HF

## apex Q and apex HF

Classic apex systems still enhance sensitivity up to 10x by nebulizing liquid samples into a heated cyclonic spray chamber. The multi-stage Peltier-cooled condensing systems remove the solvent vapor, reducing oxides. Nitrogen gas flow is manually adjusted while optimizing ICPMS signal with the classic apex systems. Quartz or HF-resistant models are available, each having options for additional membrane desolvation and mixing chambers.

- High sensitivity
- Reduced oxides (1% CeO+/Ce+)
- Two temperature setpoints for spray chamber (140°C and 100°C)
- Two temperature setpoints for Peltier-cooled condenser (2°C and -3°C)
- N<sub>2</sub> addition gas with manual control valve
- Drain peristaltic pump with manual speed control



apex Q

See page 53 for additional information on the apex-100 PFA nebulizers

Model	Description	Part Number
apex Q	apex Q desolvation system with quartz spray chamber and Peltier-cooled quartz condenser.	ES-4373-1000-21
apex HF	apex HF desolvation system with PFA spray chamber and Peltier-cooled PFA condenser.	ES-4473-1000-21

Model	High Sensitivity	Membrane Desolvation	HF-Resistant	Software Control	MFC Control
apex Ω	✓	✓		✓	✓
apex Ω HF	✓	✓	✓	✓	✓
apex 2 Q	✓			✓	✓
apex 2 HF	✓		✓	✓	✓
apex Q	✓				
apex HF	✓		✓		

## Quartz Torches for iCAP™ Q/RQ/TQ

### Quartz Torches for iCAP™ Q/RQ/TQ

The reinforced base of the torch reduces the chance of accidental breakage and allows for the precision alignment of the o-ring-free injector.

Description	Part Number
Demountable quartz torch for iCAP™ Q/RQ/TQ. Use with ESI o-ring-free injectors.	T73
Demountable SilQ torch for iCAP™ Q/RQ/TQ. High Purity quartz. Use with ESI o-ring-free injectors.	T73-SilQ

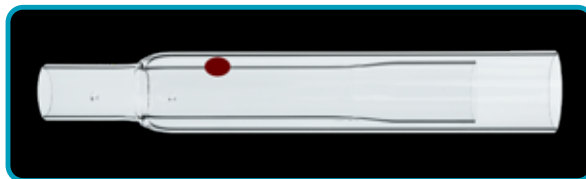

T73

## Injectors for iCAP™ Q/RQ/TQ

### Platinum Injectors for iCAP™ Q/RQ/TQ

Pt injectors are used to measure ppq and low ppt levels of Al in HF-containing samples such as semiconductor-grade ultrapure chemicals.

Description	I.D. Size (mm)	Part Number
Platinum injector, o-ring free	1.0	I73-P10
	1.5	I73-P15
	2.0	I73-P20



I73-P20

### Sapphire Injectors for iCAP™ Q/RQ/TQ

Sapphire injectors are used for introducing environmental, geochemical, and HF-containing samples.

Description	I.D. Size (mm)	Part Number
Sapphire injector, o-ring free. HF-Resistant	1.5	I73-S15
	1.8	I73-S18
	2.0	I73-S20
	2.5	I73-S25



I73-S18

### Quartz Injectors for iCAP™ Q/RQ/TQ

Quartz injectors are used for introducing volatile organic solvents and a wide range of non-HF applications

Description	I.D. Size (mm)	Part Number
Quartz injector, o-ring free	1.0	I73-Q10
	1.5	I73-Q15
	2.0	I73-Q20
	2.5	I73-Q25



I73-Q20



# Peristaltic Pump Tubing



Standard pump on iCAP™ Q/RQ/TQ ICPMS

## 3-Stop Pump Tubing



Tubing for iCAP™ Q/RQ/TQ Peristaltic Pumps (Packs of 12)

i.d.	Stop Colors		Calibration Slope ( $\mu\text{L}/\text{min}$ per RPM)	Non-Flared			Flared*	
				PVC 3-stop	Santoprene 3-stop	Solva 3-stop	PVC 3-stop	SOLVA 3-stop
0.13 mm	Orange	Black	0.6	Q3PT-013-PVC			Q3PT-013-F-PVC	Q3PT-013-F-S
0.19 mm	Orange	Red	1.3	Q3PT-019-PVC			Q3PT-019-F-PVC	Q3PT-019-F-S
0.27 mm	Orange	Blue	2.7	Q3PT-027-PVC			Q3PT-027-F-PVC	Q3PT-027-F-S
0.38 mm	Orange	Green	4.7	Q3PT-038-PVC	Q3PT-038-PHR		Q3PT-038-F-PVC	Q3PT-038-F-S
0.44 mm	Green	Yellow	7.6	Q3PT-044-PVC			Q3PT-044-F-PVC	Q3PT-044-F-S
0.51 mm	Orange	Yellow	9.5	Q3PT-051-PVC			Q3PT-051-F-PVC	Q3PT-051-F-S
0.57 mm	White	Yellow	11	Q3PT-057-PVC			Q3PT-057-F-PVC	Q3PT-057-F-S
0.64 mm	Orange	White	14	Q3PT-064-PVC			Q3PT-064-F-PVC	Q3PT-064-F-S
0.76 mm	Black	Black	19	Q3PT-076-PVC	Q3PT-076-PHR	Q3PT-076-S	Q3PT-076-F-PVC	Q3PT-076-F-S
0.89 mm	Orange	Orange	24	Q3PT-089-PVC		Q3PT-089-S	Q3PT-089-F-PVC	Q3PT-089-F-S
0.95 mm	White	Black	28	Q3PT-095-PVC		Q3PT-095-S	Q3PT-095-F-PVC	Q3PT-095-F-S
1.02 mm	White	White	31	Q3PT-102-PVC		Q3PT-102-S	Q3PT-102-F-PVC	Q3PT-102-F-S
1.09 mm	White	Red	33	Q3PT-109-PVC		Q3PT-109-S	Q3PT-109-F-PVC	Q3PT-109-F-S
1.14 mm	Red	Red	35	Q3PT-114-PVC		Q3PT-114-S	Q3PT-114-F-PVC	
1.22 mm	Red	Gray	46	Q3PT-122-PVC		Q3PT-122-S		
1.30 mm	Gray	Gray	47	Q3PT-130-PVC	Q3PT-130-PHR	Q3PT-130-S		
1.42 mm	Yellow	Yellow	50	Q3PT-142-PVC		Q3PT-142-S		
1.52 mm	Yellow	Blue	51	Q3PT-152-PVC	Q3PT-152-PHR	Q3PT-152-S		
1.65 mm	Blue	Blue	55	Q3PT-165-PVC		Q3PT-165-S		
1.75 mm	Blue	Green	58	Q3PT-175-PVC		Q3PT-175-S		
1.85 mm	Green	Green	61	Q3PT-185-PVC		Q3PT-185-S		
2.06 mm	Purple	Purple	64	Q3PT-206-PVC		Q3PT-206-S		
2.29 mm	Purple	Black	65	Q3PT-220-PVC		Q3PT-220-S		
2.54 mm	Purple	Orange	67	Q3PT-254-PVC		Q3PT-254-S		
2.79 mm	Purple	White	69	Q3PT-279-PVC		Q3PT-279-S		
3.17 mm	Black	White	70	Q3PT-317-PVC	Q3PT-317-PHR	Q3PT-317-S		
<b>Bridge Length</b>				95 mm	95 mm	95 mm	95 mm	95 mm

\*For easy insertion of PFA capillaries

**i.d. = internal diameter**

SAMPLE INTRODUCTION

# Peristaltic Pumps



## Integrated MP<sup>2</sup> High Precision Micro Peristaltic Pump Upgrade for iCAP™ Q/RQ/TQ



The MP<sup>2</sup> is a compact, precise, integrated micro peristaltic pump with a flow rate range of 0.20 µL/min to 10 mL/min. It is available as a four-channel pump upgrade for the iCAP Q/RQ/TQ™ instruments. Optimized for low flow rates and long operational lifetime, the MP<sup>2</sup> uses either MPP tubing or standard 3-stop pump tubing.

- High precision liquid pumping
- Low pulsation with 12 ceramic rollers
  - Closely-spaced rollers improve signal stability
- High chemical resistance
  - Ceramic rollers and PTFE-coated metal components are resistant to acids and organic solvents
- Linear relationship between pump speed and flow rate
- Designed for long lifetime and quiet operation
- Installs within existing peristaltic pump mount location in iCAP™ Q/RQ/TQ instruments



MP<sup>2</sup> peristaltic pump installed on an iCAP™ Q ICPMS

Perilink Fittings Adapts 10/32 to pump tubing			
	Qty	Size	Part Number
	5	Female	S033156-V
	5	Male	S032956-V

Perilink Fittings (Barbed) Adapts 10/32 to pump tubing			
	Qty	Size	Part Number
	5	Female	S032955
	5	Male	S032956

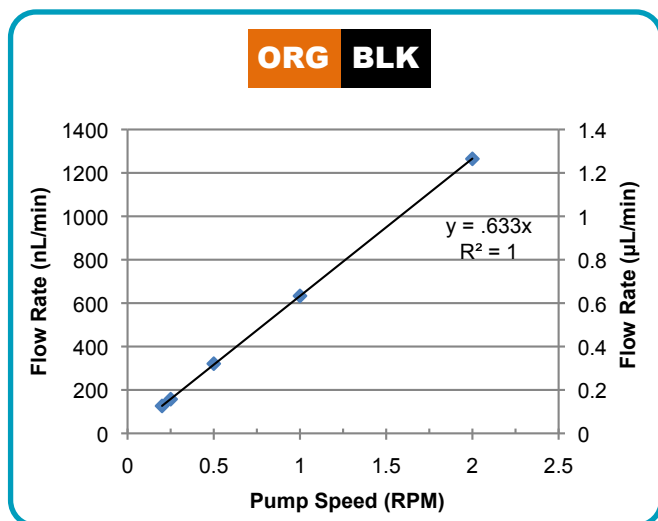

MP<sup>2</sup> pump linearity < 1 µL/min

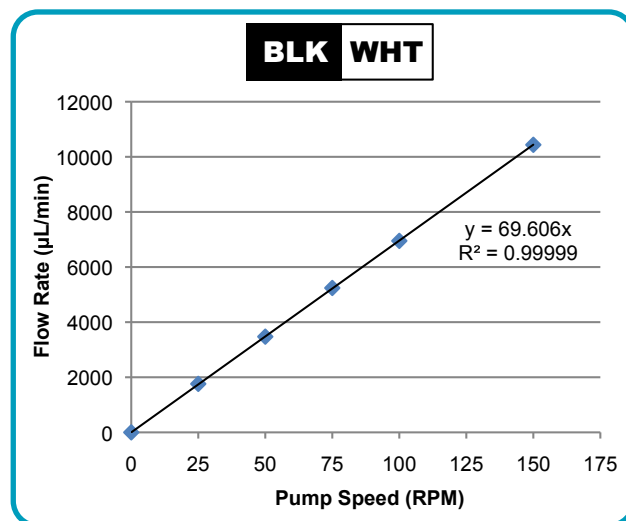

MP<sup>2</sup> pump linearity up to 10 mL/min

Description	Part Number
Integrated precision low-flow 4-channel micro peristaltic pump for iCAP™ Q/RQ/TQ instruments	MP2-4-73

# MP<sup>2</sup> Peristaltic Pump Tubing

## MP<sup>2</sup> Pump Tubing



Tubing for MP<sup>2</sup> Micro Peristaltic Pumps (Packs of 12)

i.d.	Stop Colors		Calibration Slope ( $\mu\text{L}/\text{min}$ per RPM)	Non-Flared			Flared*	
				PVC 2-stop	Santoprene 2-stop	Solva 2-stop	PVC 2-stop	SOLVA 2-stop
0.13 mm	Orange	Black	0.6	MPP-013-PVC			MPP-013-F-PVC	MPP-013-F-S
0.19 mm	Orange	Red	1.3	MPP-019-PVC			MPP-019-F-PVC	MPP-019-F-S
0.27 mm	Orange	Blue	2.7	MPP-027-PVC			MPP-027-F-PVC	MPP-027-F-S
0.38 mm	Orange	Green	4.7	MPP-038-PVC	MPP-038-PHR		MPP-038-F-PVC	MPP-038-F-S
0.44 mm	Green	Yellow	7.6	MPP-044-PVC			MPP-044-F-PVC	MPP-044-F-S
0.51 mm	Orange	Yellow	9.5	MPP-051-PVC			MPP-051-F-PVC	MPP-051-F-S
0.57 mm	White	Yellow	11	MPP-057-PVC			MPP-057-F-PVC	MPP-057-F-S
0.64 mm	Orange	White	14	MPP-064-PVC			MPP-064-F-PVC	MPP-064-F-S
0.76 mm	Black	Black	19	MPP-076-PVC	MPP-076-PHR	MPP-076-S	MPP-076-F-PVC	MPP-076-F-S
0.89 mm	Orange	Orange	24	MPP-089-PVC		MPP-089-S	MPP-089-F-PVC	MPP-089-F-S
0.95 mm	White	Black	28	MPP-095-PVC		MPP-095-S	MPP-095-F-PVC	MPP-095-F-S
1.02 mm	White	White	31	MPP-102-PVC		MPP-102-S	MPP-102-F-PVC	MPP-102-F-S
1.09 mm	White	Red	33	MPP-109-PVC		MPP-109-S	MPP-109-F-PVC	MPP-109-F-S
1.14 mm	Red	Red	35	MPP-114-PVC		MPP-114-S	MPP-114-F-PVC	
1.22 mm	Red	Gray	46	MPP-122-PVC		MPP-122-S		
1.30 mm	Gray	Gray	47	MPP-130-PVC	MPP-130-PHR	MPP-130-S		
1.42 mm	Yellow	Yellow	50	MPP-142-PVC		MPP-142-S		
1.52 mm	Yellow	Blue	51	MPP-152-PVC	MPP-152-PHR	MPP-152-S		
1.65 mm	Blue	Blue	55	MPP-165-PVC		MPP-165-S		
1.75 mm	Blue	Green	58	MPP-175-PVC		MPP-175-S		
1.85 mm	Green	Green	61	MPP-185-PVC		MPP-185-S		
2.06 mm	Purple	Purple	64	MPP-206-PVC		MPP-206-S		
2.29 mm	Purple	Black	65	MPP-220-PVC		MPP-220-S		
2.54 mm	Purple	Orange	67	MPP-254-PVC		MPP-254-S		
2.79 mm	Purple	White	69	MPP-279-PVC		MPP-279-S		
3.17 mm	Black	White	70	MPP-317-PVC	MPP-317-PHR	MPP-317-S		
Bridge Length				72 mm	72 mm	72 mm	72 mm	72 mm

\*For easy insertion of PFA capillaries **i.d. = internal diameter**

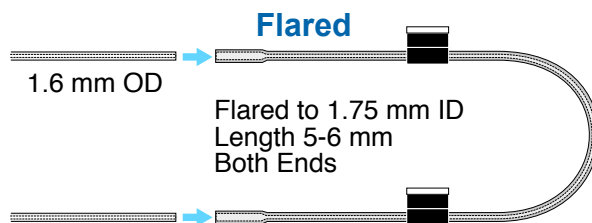

MP <sup>2</sup> PUMP TUBING KIT	
Description	Part Number
MP <sup>2</sup> Pump Tubing Kit comprised of 34 packs of 12 tubes, one package of each yellow highlighted part number in the table above. Includes: 26 packs of PVC tubing (0.13 to 3.17 mm i.d.) 3 packs of Santoprene <sup>®</sup> tubing and 5 packs of Solva tubing. Kit also includes: 30 CTFE Fluoropolymer Peristaltic pump Fittings: 5 small female (ES-2501-PPF1), 5 small male (ES-2501-PPM1), 5 medium female (ES-2501-PPF3), 5 medium male (ES-2501-PPM3), 5 large female (ES-2501-PPF5) and 5 large male (ES-2501-PPM5).	MPP-K-1

\*\*Santoprene<sup>®</sup> is a product of ExxonMobil

## High Purity Valves

High purity valve stators and rotors provide for the selection of liquid flow path with low contamination and low carryover for the optimum ICPMS results.

- P-Series** Two position sampling valves
- V-Series** Syringe pump refill valves
- M-Series** Multiposition stream selector/flow director valves
- S-Series** Semiconductor grade ultra-high purity valves

**8** Port Valve - P7+ Part Number: PF-P7X

**Description:** P7+ CTFE high-flow 8 port valve head for prepFAST  
**Specifications:** CTFE stator, PFA rotor, 1 mm, 0.5 mm  
**Applications:** prepFAST, inline dilution and internal standard addition

**7** Port Valve - P7 Part Number: PF-P7

**Description:** 7 port syringe loading valve  
**Specifications:** CTFE stator, PFA rotor, 1.0 mm  
**Applications:** FAST, prepFAST Offline

**12** Port Syringe Valve - V12 Part Number: PF-V12

**Description:** 12 port syringe loading valve  
**Specifications:** CTFE stator, PFA rotor, 1.0 mm  
**Applications:** S400V, brineFAST syringe valve

**8** Port Valve - M8 Part Number: PF-M8

**Description:** M8 CTFE high-flow 8 port stream selector valve  
**Specifications:** CTFE stator, PFA rotor  
**Applications:** SmartTuner

**11** Port Syringe Valve - S11 Part Number: SDX-S11

**Description:** 11 port syringe loading valve  
**Specifications:** CTFE stator, PFA rotor, 1.0 mm  
**Applications:** prepFAST S and scoutDX

## Examples of a Stator and Rotor

**Description**

CTFE replacement stator for V12 FAST valve

**Description**

1 mm PFA rotor

## High Purity Valves with Spare Stators and Rotors

P-SERIES VALVES WITH REPLACEMENT STATORS AND ROTORS						
# of Ports	Bore Size	Stator Material	Rotor Material	Part Number Complete Valve	Part Number Stator	Part Number Rotor
3 - P3	1.0 mm	CTFE	PFA	PF-P3	PF-P3S	PF-P3R
4 - P4	1.0 mm	CTFE	PFA	PF-P4	PF-P4S	PF-P4R
6 - P6	1.0 mm	CTFE	PFA	PF-P6	PF-P6S	PF-P6R
6 - P6-8	1.0 mm	PPS	PFA	PF-P6-8	PF-P6S-8	PF-P6R
7 - P7	0.5/1.0 mm	CTFE	PFA	PF-P7	PF-P7S	PF-P6R
7 - P7-8	0.5/1.0 mm	PPS	PFA	PF-P7-8	PF-P7S-8	PF-P6R
8 - P7+	0.5/1.0 mm	CTFE	PFA	PF-P7X	PF-P7XS	PF-F6R
P7+IC	1.0 mm	CTFE	PFA	PF-P7XIC	PF-P7XS	PF-P6R
8 - P8	1.0 mm	CTFE	PFA	PF-P8	PF-P8S	PF-P8R
10 - P10	1.0 mm	CTFE	PFA	PF-P10	PF-P10S	PF-P10R
11-P11	1.0 mm	CTFE	PFA	PF-P11	PF-P11S	PF-P10R
11-A11b	0.5/1.0 mm	CTFE	PFA	PF-A11b	PF-A11bS	PF-A11bR
13 - P13	0.5/1.0 mm	CTFE	PFA	PF-P13	PF-P13S	PF-P13R
5 - A5e	0.5/1.0 mm	CTFE	PFA	PF-A5e	PF-A5eS	PF-F6R
7 - A7e	0.5/1.0 mm	CTFE	PFA	PF-A7e	PF-A7eS	PF-F6R
7 - A7 $\mu$	1.0 mm	CTFE	PFA	PF-A7u	PF-A7uS	PF-A7uR
6 - PM6	0.5 mm	CTFE	PFA	PF-PM6	PF-PM6S	PF-PM6R
7 - PM7	0.5 mm	CTFE	PFA	PF-PM7	PF-PM7S	PF-PM6R
8 - PM7+	0.5 mm	CTFE	PFA	PF-PM7X	PF-PM7XS	PF-PM6R
4 - P4H	1.6 mm	CTFE	PFA	PF-P4H	PF-P4HS	PF-P4HR
5 - P5H	1.6 mm	CTFE	PFA	PF-P5H	PF-P5HS	PF-P4HR
6 - P6H	1.6 mm	CTFE	PFA	PF-P6H	PF-P6HS	PF-P6HR
7 - P7H	1.6 mm	CTFE	PFA	PF-P7H	PF-P7HS	PF-P6HR
7 - P7-8H	1.6 mm	PPS	PFA	PF-P7-8H	PF-P7-8HS	PF-P6HR
7 - P7HP	0.5 mm	CTFE	PEEK/PTFE	PF-P7HP	PF-P7HPS	PF-P6HPR

# High Purity Valves, Stators and Rotors

## V-SERIES VALVES WITH REPLACEMENT STATORS AND ROTORS

# of Ports	Bore Size	Stator Material	Rotor Material	Part Number Complete Valve	Part Number Stator	Part Number Rotor
6 - V6	1.0 mm	CTFE	PFA	PF-V6	PF-V6S	PF-V6R
6 - V6H	1.6 mm	CTFE	PFA	PF-V6H	PF-V6HS	PF-V6HR
6 - V6HP	0.5 mm	CTFE	PEEK/PTFE	PF-V6HP	PF-V6HPS	PF-V6HPR
9 - V9	1.0 mm	CTFE	PFA	PF-V9	PF-V9S	PF-V9R
10 - V9(cp)	1.0 mm	CTFE	PFA	PF-V9 (cp)	PF-V9S (cp)	PF-V9R (cp)
12 - V12	1.0 mm	CTFE	PFA	PF-V12	PF-V12S	PF-V12R
12 - V12H	1.6 mm	CTFE	PFA	PF-V12H	PF-V12HS	PF-V12HR
13 - V13	1.0 mm	CTFE	PFA	PF-V13	PF-V13S	PF-V13R
18-V18H	1.6 mm	CTFE	PFA	PF-V18H	PF-V18HS	PF-V18HR
V8C	1.0 mm	CTFE	PFA	PF-V8C	PF-V8CS	PF-V12R
V9H	1.6 mm	CTFE	PFA	PF-V9H	PF-V9HS	PF-V9HR

## M-SERIES STREAM SELECTION VALVE

# of Ports	Bore Size	Stator Material	Rotor Material	Part Number Complete Valve	Part Number Stator	Part Number Rotor
3 - M3	1.0 mm	CTFE	PFA	PF-M3	PF-M3S	PF-M3R
3 - M3H	1.6 mm	CTFE	PFA	PF-M3H	PF-M3HS	PF-M3HR
4 - M4	1.0 mm	CTFE	PFA	PF-M4	PF-M4S	PF-M4R
6 - M6	1.0 mm	CTFE	PFA	PF-M6	PF-M6S	PF-M6R
8 - M8	1.0 mm	CTFE	PFA	PF-M8	PF-M8S	PF-M8R
8 - M8H	1.6 mm	CTFE	PFA	PF-M8H	PF-M8HS	PF-M8HR
8 - M8HP	0.5 mm	CTFE	PEEK/PTFE	PF-M8HP	PF-M8HPS	PF-M8HPR
10 - M10	1.0 mm	CTFE	PFA	PF-M10	PF-M10S	PF-M10R

## S-SERIES VALVES WITH REPLACEMENT STATORS AND ROTORS

# of Ports	Bore Size	Stator Material	Rotor Material	Part Number Complete Valve	Part Number Stator	Part Number Rotor
4 - S4	0.5/1.0 mm	CTFE	PFA	PF-S4	PF-S4S	PF-S4R
9 - S9	1.0 mm	CTFE	PFA	PF-S9	PF-S9S	PF-S9R
11 - S11	1.0 mm	CTFE	PFA	SDX-S11	PF-S11S	PF-S11R

## X-SERIES VALVES WITH REPLACEMENT STATORS AND ROTORS

# of Ports	Bore Size	Stator Material	Rotor Material	Part Number Complete Valve	Part Number Stator	Part Number Rotor
11-X11	1.0 mm	CTFE	PFA	PF-X11	PF-X11S	PF-P10R

# Spare Syringes

## Replacement Syringes for Syringe Pumps

### 0.3 mL Syringes

Description	Part Number
0.3 mL quartz syringe o-ring free quartz syringe for prepFAST Syrix syringe pump	PF-S1003
0.3 mL o-ring free fluoropolymer syringe for prepFAST syringe pump	PF-S3003



PF-S1003

### 3 mL Syringes

Description	Part Number
3 mL quartz syringe	PF-S1030
3 mL quartz syringe, pre-cleaned for prepFAST S	PF-S1030C
3 mL CTFE syringe	PF-S3030
3 mL CTFE syringe, pre-cleaned for prepFAST S	PF-S3030C
3 mL quartz syringe, tall high pressure, for prepFAST IC	PF-HS1030



PF-S1030

### 6 mL Syringes

Description	Part Number
6 mL quartz syringe for prepFAST Offline	PF-S1060
6 mL quartz syringe, pre-cleaned for prepFAST S	PF-S1060C
6 mL CTFE syringe	PF-S3060
6 mL CTFE syringe, pre-cleaned for prepFAST S	PF-S3060C
6 mL quartz syringe, tall high pressure, for prepFAST IC	PF-HS1060



PF-S1060

### 12 mL Syringe

Description	Part Number
12 mL PFA syringe	PF-S3120
12 mL quartz syringe, tall high pressure, for prepFAST IC	PF-HS1120



PF-S3120

## Online Mixing Kits for Addition of Internal Standard

### Online Mixing Kit

The ESI kit for online addition of internal standard is an easy way to use internal standards without having to manually spike each sample with internal standard. The kit can also be used to mix any two reagents for other purposes. The low dead-volume, fluoropolymer mixing tee ensures good mixing at all typical ICP and ICPMS flow rates for a wide variety of liquids, including HF.

#### Includes:

- Low dead-volume, fluoropolymer mixing tee
  - 0.25 mm I.D. (green) for flow rates < 1 mL/min
  - 0.5 mm I.D. (orange) for flow rates > 0.3 mL/min
- Internal standard probe and addition line
- Fluoropolymer peripump fittings
- Peristaltic pump tubing starter pack

#### Online Dilution:

The online mixing kits include a starter pack of peristaltic pump tubing for the MP<sup>2</sup> micro peristaltic pump. Approximate dilution factors are defined by choosing the size of the sample and internal standard peristaltic pump tubing. Other pump tubing sizes are available.

Online mixing kit for addition of internal standard

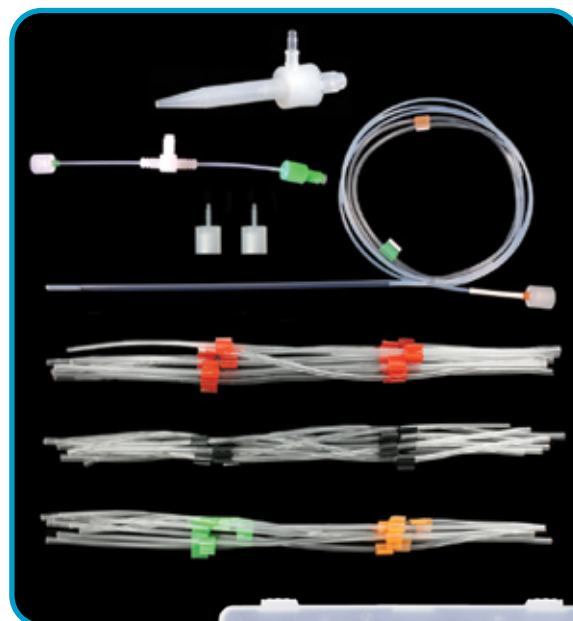

### Dilution Factors with Starter Pack Tubing

Sample Tubing		IS / Diluent Tubing					
		Orange	Green	Black	Black	Red	Red
Orange	Green	2		5		10	
Black	Black	1.25		2		3.25	
Red	Red	1.11		1.44		2	

### Online Mixing Kits

Part Numbers		Description
0.25 mm I.D. (Green)	0.5 mm I.D. (Orange)	
IS-ST-25	IS-ST-50	For use with PFA-ST nebulizers.
IS-MP-25	IS-MP-50	For use with MEINHARD® Plus nebulizers.*
N/A	IS-BRG-50	For use with MiraMist and similar nebulizers.

### Online Mixing Kits with Nebulizer Included

Part Numbers		Description
0.25 mm I.D. (Green)	0.5 mm I.D. (Orange)	
ISN-ST3-25	N/A	For use with PFA-ST nebulizers. Includes PFA-ST nebulizer.
N/A	ISN-TRP-50	For use with MEINHARD® Plus nebulizers. Includes TR+ high sensitivity glass nebulizer.



# Manual Sampling Probes / Nebulizer Lines

## Manual Sampling Probes

### Probes

These probes offer high chemical resistance for applications involving strong acids, alkalis, and organics. A contoured design reduces carryover, while an all-fluoropolymer wetted sample flow path reduces contamination.

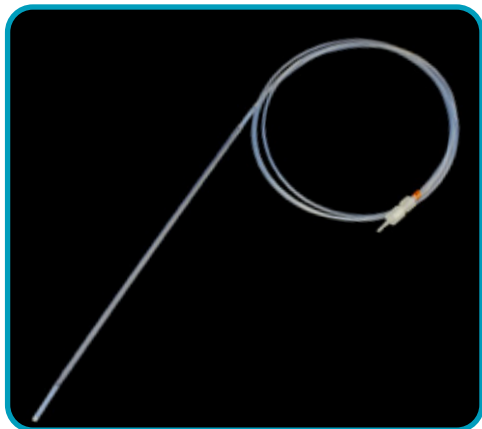

Description	Size	Part Number
Internal standard probe with carbon fiber support for iCAP™ Q/RQ/TQ. Includes fluoropolymer micro fitting.	0.50 mm i.d. ■ (orange), 150 cm	ES-5036-IS-73

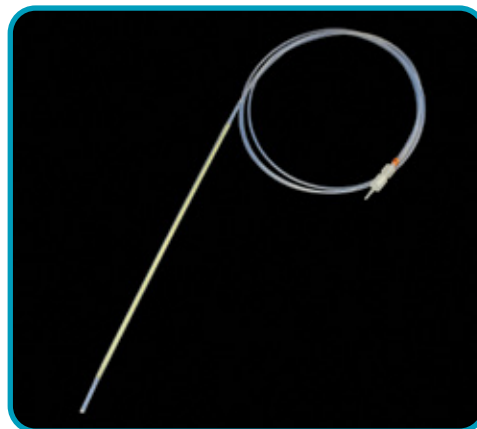

Description	Size	Part Number
Sample probe with Ultem support for iCAP™ Q/RQ/TQ. Includes fluoropolymer micro fitting.	0.50 mm i.d. ■ (orange)	ES-5046-IS-73

## Nebulizer Lines

### Internal Standard Addition Tee for PFA-ST Nebulizer

Specially designed mixing tee is perfect for online addition of internal standard or online dilution with P6 FAST valves. Achieves excellent mixing with minimal dead volume. The 0.5 mm capillary is recommended for applications with flow rates > 0.3 mL/min.

Description	Part Number
Internal Standard addition tee 2.5 mm I.D. ■ (green) for PFA nebulizers. 30 mm length	SC-0317-1250-30
Internal Standard addition tee 0.5 mm I.D. ■ (orange) for PFA nebulizers. 30 mm length	SC-0317-1500-30

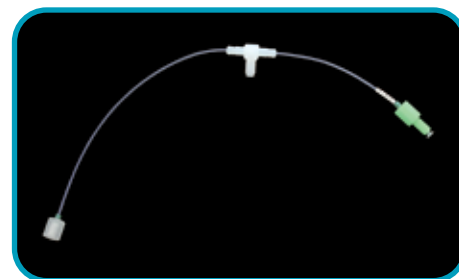





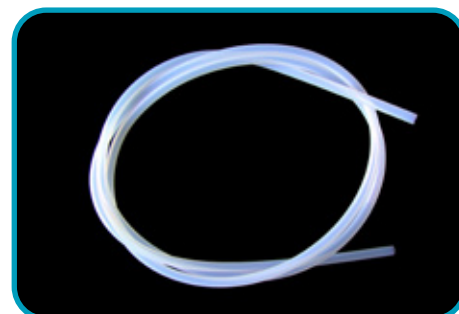







### Nebulizer Gas Line

Description	Part Number
Teflon gas line for PFA nebulizers on iCAP Q/RQ/TQ. 4 mm O.D. x 2.4 mm I.D. x 1 M.	ES-2502

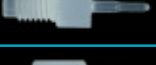
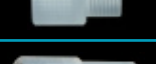

## Fittings/PFA Tubing/Spares Kits

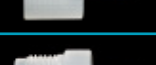
Easy to use, ultra-clean fittings and PFA tubing are ideal for all trace metal analysis applications. Ferrules install quickly and easily for high-flow applications. Low-flow valve fittings have low dead volume, leak-free integrated ferrule connections.

	Description	Qty	Suggested Use	P/N
	Black, high-flow nut (1/4-28) for FAST valve and 1/16" (1.6 mm) ferrule	10	Use with 1/16" (1.6 mm) o.d. PFA tubing for low and moderate flow rates (0.1 mL/min - 2 mL/min)	SC-0599-0116-K
	White, high-flow nut (1/4-28) for FAST valve and 1/8" (3.2 mm) ferrule	10	Use with 1/8" (3.2 mm) o.d. PFA tubing for high-flow rates and vacuum applications (> 2 mL/min)	SC-0599-0108-W
	1/16" (1.6 mm) Ferrule for high-flow fitting (1/4-28)	10	Use with 1/16" (1.6 mm) o.d. PFA tubing	SC-0599-F16
	1/8" (3.2 mm) Ferrule for high-flow fitting (1/4-28)	10	Use with 1/8" (3.2 mm) o.d. PFA tubing	SC-0599-F08
	Black, low-flow nut (M5/10-32) for FAST valve	10	Use with 1/16" (1.6 mm) o.d. PFA tubing for low-flow rates (<0.1 mL/min)	SC-0599-0001
	Female Perilink fitting, barbed	1	Adapts 10/32 to pump tubing	S032955
	Female Perilink fitting	5	Adapts 10/32 to pump tubing	S033156-V
	Male Perilink fitting, barbed	1	Adapts 10/32 to pump tubing and for use with internal standard tee	S032956
	Male Perilink fitting	5	Adapts 10/32 to pump tubing and for use with internal standard tee	S032956-V
	PFA-ST Nebulizer to Micro Fitting Adapter, PFA	1	Allows for use of tubing with 10/32 fitting with PFA-ST nebulizer	S033161
	MEINHARD® Plus Nebulizer to micro fitting adapter	1		S033101
	CTFE peristaltic pump fittings, female	1	For use in low pressure applications.	ES-2501-PPF1
	CTFE peristaltic pump fittings, female, barbed	1	For use in high pressure applications	ES-2501-PPF2
	CTFE peristaltic pump fittings, male	1	For use in low pressure applications	ES-2501-PPM1
	CTFE peristaltic pump fittings, male, barbed	1	For use in high pressure applications	ES-2501-PPM2

High Purity Fluoropolymer Tubing (5 m coil)			
I.D.	O.D.	Color Code	Part Number
0.006" (0.15 mm)	1/16" (1.6 mm)	■ (red)	5MT-015
0.008" (0.20 mm)	1/16" (1.6 mm)	■ (purple)	5MT-02
0.010" (0.25 mm)	1/16" (1.6 mm)	■ (green)	5MT-025
0.014" (0.30 mm)	1/16" (1.6 mm)	■ (yellow)	5MT-03
0.019" (0.50 mm)	1/16" (1.6 mm)	■ (orange)	5MT-05
0.031" (0.80 mm)	1/16" (1.6 mm)	■ (blue)	5MT-08
0.039" (1.00 mm)	1/16" (1.6 mm)	■ (gray)	5MT-1
0.063" (1.60 mm)	1/8" (3.2 mm)		5MT-16



## Sample Loops

PTFE crimp free *FAST* or prep*FAST* loops provide low resistance for fast loading and rinse out.

### Standard for *FAST* Systems

#### 1 mm i.d. *FAST* High-Flow Sample Loops

Description	Size	Part Number
Recommended for use with 1.0 mm i.d. ■ (gray) probe. 1.6 mm o.d., 1/4-28 fittings.	300 µL loop	SC-0318-03
	500 µL loop	SC-0318-05
	1.0 mL loop	SC-0318-10
	1.5 mL loop	SC-0318-15
<b>Applications</b>	2.0 mL loop	SC-0318-20
<i>FAST</i> , prep <i>FAST</i> , prep <i>FAST</i> M5, brine <i>FAST</i> , sea <i>FAST</i>	2.5 mL loop	SC-0318-25
	3.0 mL loop	SC-0318-30
	4.0 mL loop	SC-0318-40



#### 0.8 mm i.d. *FAST* High-Flow Sample Loops

Description	Size	Part Number
Recommended for use with 0.8 mm i.d. ■ (blue) probe. 1.6 mm o.d., 1/4-28 fittings.	100 µL loop	SC-0319-01
	200 µL loop	SC-0319-02
	300 µL loop	SC-0319-03
	500 µL loop	SC-0319-05
	1.0 mL loop	SC-0319-10
<b>Applications</b>	1.5 mL loop	SC-0319-15
Legacy <i>FAST</i> systems, and special applications	2.0 mL loop	SC-0319-20
	2.5 mL loop	SC-0319-25
	3.0 mL loop	SC-0319-30
	4.0 mL loop	SC-0319-40



#### 1.6 mm i.d. *FAST* High-Flow Sample Loops

Description	Size	Part Number
Recommended for use with 1.0 mm i.d. ■ (gray) probes and applications requiring larger sample volumes or high flow rates. 3.2 mm o.d., 1/4-28 fittings.	250 µL loop	SC-0315-025
	500 µL loop	SC-0315-05
	1.0 mL loop	SC-0315-10
	2.0 mL loop	SC-0315-20
<b>Applications</b>	3.0 mL loop	SC-0315-30
soil <i>FAST</i> , oil <i>FAST</i> , and large volume <i>FAST</i>	4.0 mL loop	SC-0315-40
	6.0 mL loop	SC-0315-60
	8.0 mL loop	SC-0315-80



## PFA Sample Vessels

### PFA Vials

PFA vials are ideal for applications that require the highest purity. Made of ultrapure, ultra-chemically resistant material, these vials are an excellent choice for high purity, semiconductor and micro samples.

- Non-contaminating
- Graduated
- Temperature range of -200 °C to 260 °C
- HF-resistant
- Conical bottom
- Self-standing

Vials	Fits Racks
V-14-0311CG	MR-21-14 (pg 83), MR-40-14 (pg 83), SR4-60-14 (pg 85)
V-14-0312CG	
V-14-0314CG	



Part Number	Qty
V-14-0311CG-X	10
Description	Volume
14 mm o.d. graduated PFA micro vial	1 mL Brim full 2 mL



Part Number	Qty
V-14-0309-X	10
Description	PFA cap for 14 mm micro vials



Part Number	Qty
V-14-0312CG-X	10
Description	Volume
14 mm o.d. graduated PFA micro vial	2 mL Brim full 3 mL



Part Number	Qty
V-15-0300-X	10
Description	PFA snap-on cap for 14 mm graduated PFA micro vials



Part Number	Qty
V-14-0314CG-X	10
Description	Volume
14 mm o.d. graduated PFA micro vial	4 mL Brim full 4.5 mL



Part Number	Qty
V-15-0301-X	10
Description	PFA cap with knob for 14 mm graduated PFA micro vials.



Part Number	Qty
ES-7225-0001	1
Description	ETFE tweezers for removal of PFA cap with knob



## PFA Bottles and Vials

PFA bottles and vials are ideal for a wide range of demanding fluid handling and storage applications in general laboratory, semiconductor, and environmental industries.

Bottles / Vials	Fits Racks
V-31-15-X	SR2-21-30 (pg 84), MR-10-30 (pg 83)
V-31-30-X	SR2-27-31 (pg 84), MR-10-30 (pg 83), ST10-31 (pg 86)
V-31-60-X	LR-21-30 (pg 82), LMR-21-30-R (pg 82), SR2-27-31 (pg 84), HR-21-30 (pg 83), ST10-31 (pg 86)
V-28-0360-V	SR2-27-28 (pg 84), ST-10-28 (pg 86)
V-50-0360	SR2-12-50 (pg 84), ST2-9-50 (pg 86), ST4-9-50 (pg 86), SR4x-20-50 (pg 85)



Part Number	Qty
V-28-0360-V	5
Description	Volume
28 mm o.d. PFA bottle and cap	20 mL



Part Number	Qty
V-50-0360	1
Description	Volume
50 mm o.d. PFA bottle and cap with TFM insert	125 mL

- Semiconductor, high-purity, and aggressive chemical applications
- The most translucent PFA vials available
- Low absorption of biological materials for many research applications



Part Number	Qty
V-31-15-X	10
Description	Volume
30 mm o.d. graduated PFA vial	15 mL



Part Number	Qty
V-31-30-X	10
Description	Volume
30 mm o.d. graduated PFA vial	30 mL



Part Number	Qty
V-31-60-X	10
Description	Volume
30 mm o.d. graduated PFA vial	60 mL



Part Number	Qty
PFA-K29-X	10
Description	Screw cap for 30 mm o.d. vials

## 2 mL PVDF Autosampler Vial

A low cost alternative to PFA for many ultra-trace metal analyses

PVDF sample vials are a lower cost alternative to our high-performance PFA vials. These high-tensile-strength, fluoropolymer vials can replace more expensive PFA vials in many applications.

- Semiconductor-grade PVDF fluoropolymer
- High dielectric and mechanical strength, flexible
- Excellent for the analysis of Nitric Acid, Hydrochloric Acid, Hydrofluoric Acid, or Ammonium Hydroxide
- Resistant to most mineral and organic acids, as well as aliphatic and aromatic hydrocarbons, alcohols, halogenated solvents, and oxidizing agents
- Self-standing
- Conical internal bottom for micro-sample analysis
- Suitable for most semiconductor pure chemicals
- Not recommended for ketones, acetone, ethyl acetate, and MIBK
- Optional PFA enclosures
- Available standard or pre-cleaned



VPC-14-0712  
2 mL PVDF  
autosampler vial



VPC-14-0712  
2 mL PVDF autosampler  
vial with PFA cap

### PVDF Vials and PFA Caps

Description	Qty	Part Number
PVDF vial, 2 mL	10	V-14-0712-X
PVDF vial, 2 mL	100	V-14-0712-C
PVDF vial, 2 mL	1000	V-14-0712-M
PFA cap for V-14 vial	10	V-14-0309-X
PFA cap for V-14 vial	100	V-14-0309-C

### Pre-cleaned PVDF Vials and Caps

Description	Qty	Part Number
Pre-cleaned PVDF vial, 2 mL	100	VPC-14-0712-C
Pre-cleaned PFA cap for V-14 vial	100	VPC-14-0309-C

### Bottles/Vials Fits Racks

Bottles/Vials	Fits Racks
VPC-14-0712	MR-21-14 (pg 83), MR-40-14 (pg 83), SR4-60-14 (pg 85)

# Sample Vessels

## Non-PFA Sample Vessels

### Non-PFA Vials, Tubes and Bottles

Non-PFA sample vessels manufactured from plastics, such as polypropylene, polyethylene, and polystyrene, are a sensible alternative to consider when breakage, surface inertness, and/or disposal costs are a concern.

Vials	Fits Racks
V-8-0505	MR-60-08 (pg 83), MR-90-08 (pg 83)
V-13-0200-R	LR-90-13-R (pg 82), LMR-90-13-R (pg 82), LMR-90-13-R-3T (pg 82), ST-PR-5 (pg 86)
V-20-0290	LR-40-20 (pg 82)
V-16-0225	LR-60-16 (pg 82), LMR-60-16-R (pg 82), SR2-80-16 (pg 84), ST-PR-5 (pg 86), HR-60-16 (pg 83)
V-28-0260	ST-10-28 (pg 86), LR-21-30 (pg 82), LMR-21-30-R (pg 82), SR2-27-28 (pg 84), ST-PR-5 (pg 86), ST-EX-5 (pg 86), HR-21-30 (pg 83)
V-50-0460	SR4x-20-50 (pg 85), SR2-12-50 (pg 84), ST-PR-5 (pg 86), ST2-9-50 (pg 86), ST4-9-50 (pg 86)
V-61-0661	SR4x-15-60 (pg 85), ST7-60 (pg 86), ST-PR-5 (pg 86), ST-EX-5 (pg 86)



Part Number	Qty
V-8-0505-C	100
V-8-0505-D	500
Description	Volume
8 mm o.d. centrifuge tube	0.5 mL



Part Number	Qty
V-13-0200-R-XC	90
V-13-0200R-D	500
Description	Volume
13 mm o.d. polypropylene tube with rounded bottom	8 mL



Part Number	Qty
V-16-0225-LX	60
V-16-0225-D	500
Description	Volume
16 mm o.d. polypropylene tube with screw cap	15 mL



Part Number	Qty
V-20-0290-L	50
V-20-0290-D	500
Description	Volume
20 mm o.d. polypropylene tube with screw cap	20 mL



Part Number	Qty
V-28-0260-L	50
V-28-0260-D	500
Description	Volume
28 mm o.d. polypropylene tube with screw cap	50 mL



Part Number	Qty
V-50-0460-XII	12
V-50-0460-XXIV	24
Description	Volume
50 mm o.d. HDPE wide mouth bottle with cap	125 mL



Part Number	Qty
V-61-0661-XII	12
V-61-0661-C	100
Description	Volume
61 mm o.d. polyethylene wide mouth bottle	250 mL

## Microplates

### Microplates

Microplates are ideal for micro-volume applications such as storage and sample transfer.

**All microplates can be used on the following DX autosamplers:**

2DX, 4DX



Description	Part Number
1 Pk (5 ea) 24 well, 10 mL microplate, square well, pyramid bottom	MT-24-10mL-02



Description	Part Number
1 Pk (5 ea) 48 well, 5 mL microplate, square well, pyramid bottom	MT-48-5mL-02



Description	Part Number
1 Pk (3 ea) 48 well, 7.5 mL microplate, square well, pyramid bottom	MT-48-7.5mL-02



Description	Part Number
1 Pk (5 ea) 96 well, 2 mL microplate, square well, pyramid bottom	MT-96-2mL-02
1 Pk (5 ea) 96-well, 500 $\mu$ L microplate, polystyrene	MT-96-500-05-V



# X-Piercing Film Cover/XP Probe Arm

## X-Piercing Microplate Cover

The X-Piercing cover minimizes evaporation of micro samples awaiting analysis and protects against environmental contamination.

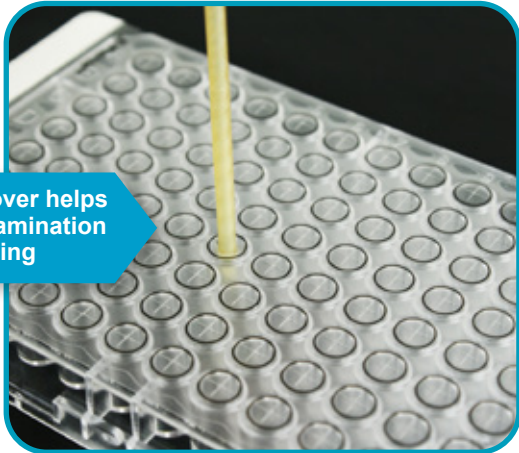
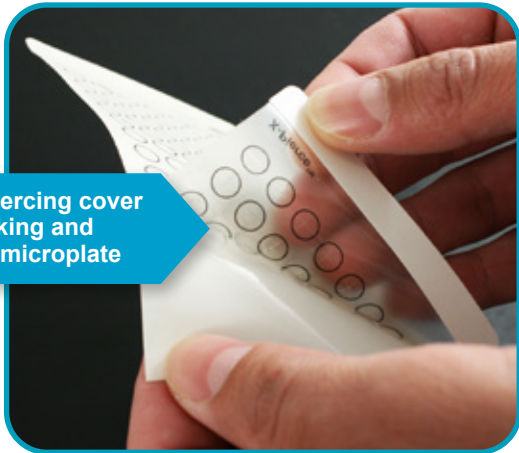

Description	Qty	Part Number
X-Piercing film cover for 96 well microplate	50	MT-96-XP

## XP Probe Arm

The XP probe arm must be used in place of the reset probe arm when an X-Piercing cover has been applied to a 96 well microplate.

Description	Qty	Part Number
XP Probe arm for 2DX/4DX Autosampler	1	SC-0105-DX-XP



CONSUMABLES

# Large Autosampler Racks

## Autosampler Racks (LR Size)

Plastic large racks are recommended for aqueous samples.

All LR racks can be used on the following DX autosamplers: 2DX and 4DX



Description	Diam.	Part Number
90 position large polypropylene sample rack for 8 mL tubes	13 mm	LR-90-13-R

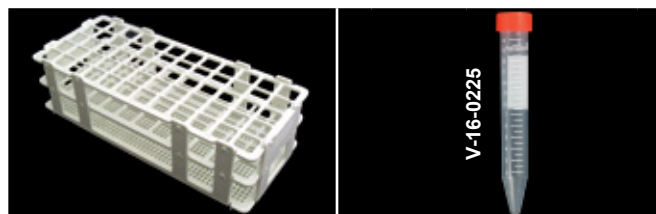

Description	Diam.	Part Number
60 position large polypropylene sample rack for 15 mL tubes	16 mm	LR-60-16



Description	Diam.	Part Number
40 position large polypropylene sample rack for 20 mL tubes	20 mm	LR-40-20

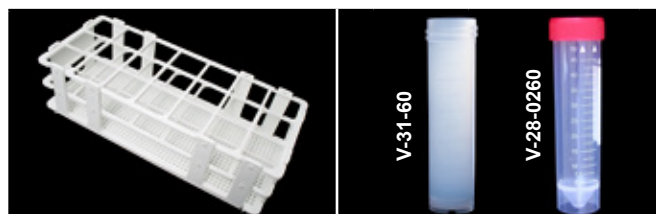

Description	Diam.	Part Number
21 position large polypropylene sample rack for 50 mL and 60 mL tubes	30 mm	LR-21-30

## Autosampler Coated Metal Racks (LR Size)

Metal racks are coated with an epoxy paint that forms a protective barrier over the rack material.

All coated metal racks can be used on the following DX autosamplers: 2DX and 4DX



Description	Diam.	Part Number
90 position metal large sample rack for 8 mL tubes	13 mm	LMR-90-13-R



Description	Diam.	Part Number
90 position 3 tier metal large sample rack for 8 mL tubes	13 mm	LMR-90-13-R-3T



Description	Diam.	Part Number
60 position metal large sample rack for 15 mL tubes	16 mm	LMR-60-16-R



Description	Diam.	Part Number
21 position metal large sample rack for 50 mL and 60 mL tubes	30 mm	LMR-21-30-R

# Heated and Micro Autosampler Racks

## Autosampler Heated Racks (LR Size)

All heated racks can be used on the following DX autosamplers: 2DX and 4DX

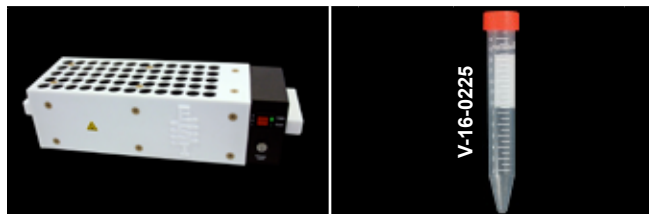

Description	Diam.	Part Number
60 position heated large sample rack for 15 mL tubes	16 mm	HR-60-16

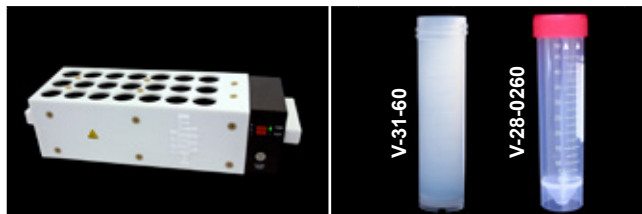

Description	Diam.	Part Number
21 position heated large sample rack for 50 mL and 60 mL tubes	30 mm	HR-21-30

## Autosampler Racks (MR Size)

All MR racks can be used on the following DX autosamplers: 2DX and 4DX

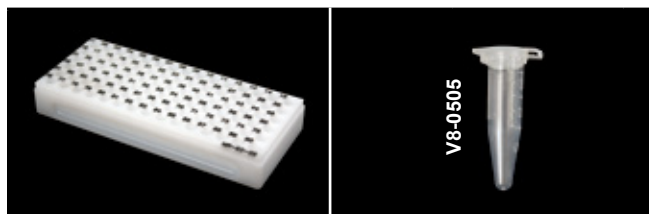

Description	Diam.	Part Number
90 position CPVC micro sample rack for 0.5 mL tubes	8 mm	MR-90-08

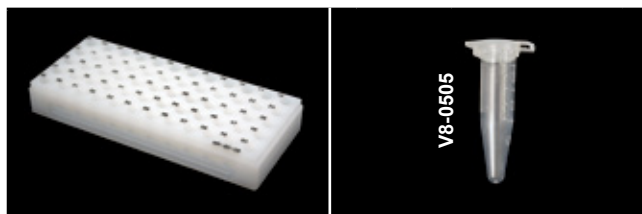

Description	Diam.	Part Number
60 position CPVC micro sample rack for 0.5 mL tubes	8 mm	MR-60-08

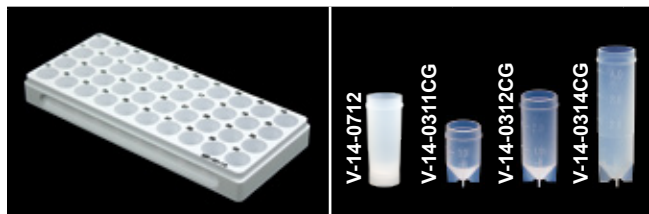

Description	Diam.	Part Number
40 position CPVC micro sample rack for 1 mL, 2 mL and 4 mL tubes	14 mm	MR-40-14

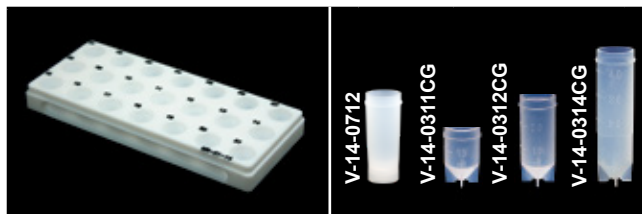

Description	Diam.	Part Number
21 position CPVC micro sample rack for 1 mL, 2 mL and 4 mL tubes	14 mm	MR-21-14



Description	Diam.	Part Number
10 position PVCC micro sample rack for 15 mL and 30 mL tubes	30 mm	MR-10-30



Description	Part Number
PVCC Cover for micro racks	MR-00-01

CONSUMABLES

# Super Autosampler Racks

Large-volume samples can be analyzed using ESI super racks without transferring the sample to a smaller tube, reducing prep time and chance of contamination.

## Autosampler Racks (SR2 Size)

All SR2 racks can be used on the following DX autosamplers: 2DX

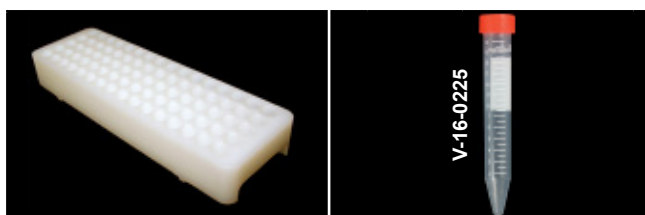

Description	Diam.	Part Number
80 position HMPE super sample rack for 15 mL tubes	16 mm	SR2-80-16

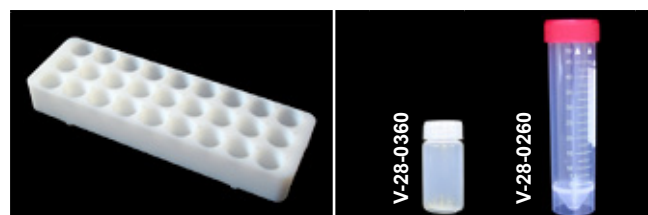

Description	Diam.	Part Number
27 position HMPE super sample rack for 20 mL and 50 mL tubes	28 mm	SR2-27-28

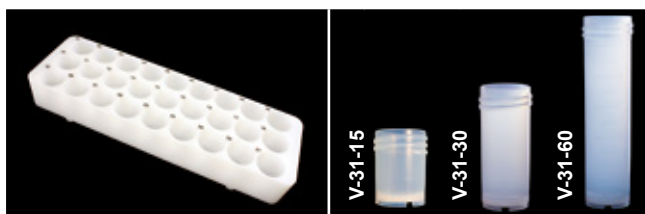

Description	Diam.	Part Number
27 position HMPE super sample rack for 15 mL, 30 mL and 60 mL tubes	31 mm	SR2-27-31



Description	Diam.	Part Number
21 position HMPE super sample rack for 15 mL tubes	30 mm	SR2-21-30



Part Number	Diam.	Description
SR2-21-35	35 mm	21 position super sample rack for 125 mL bottles



Description	Diam.	Part Number
12 position HMPE super sample rack for 125 mL bottles	50 mm	SR2-12-50

### Autosampler Racks (SR4 Size, Type 1)

All SR4 racks can be used on the following DX autosamplers: 2DX and 4DX

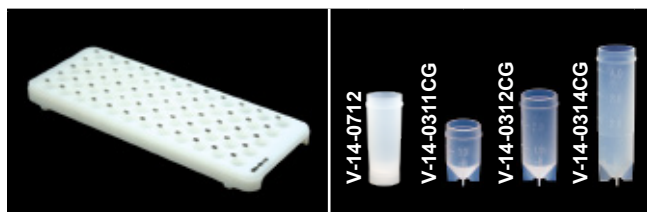

Description	Diam.	Part Number
60 position HMPE super sample rack for 1 mL, 2 mL and 4 mL tubes	14 mm	SR4-60-14



Description	Part Number
PP Cover for 60 position SR-4 super rack	SR4-00-01

### Autosampler Racks (SR4 Size, Type 2)

All SR4 type 2 racks can be used on the following DX autosamplers: 4DX



Description	Diam.	Part Number
15 position HMPE super sample rack for 250 mL bottles	60 mm	SR4x-15-60

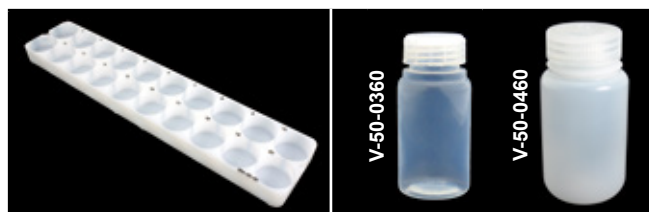

Description	Diam.	Part Number
20 position HMPE super sample rack for 125 mL bottles	50 mm	SR4x-20-50

The SR4x-15-60 super rack will hold fifteen 100 mL volumetric flasks or 250 mL bottles



SR4x-15-60 super rack with 100 mL volumetric flasks

# Standards Autosampler Racks

## Autosampler Racks (ST Size, Type 1) for 2DX and 4DX autosamplers

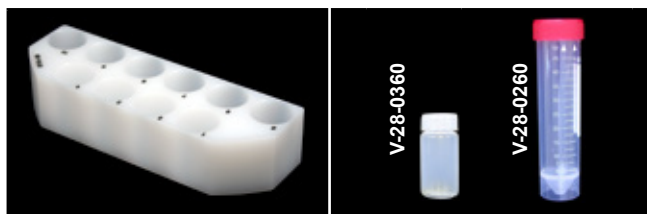

Description	Diam.	Part Number
10 position PVDF standards rack for 20 mL and 50 mL tubes	28 mm	ST-10-28

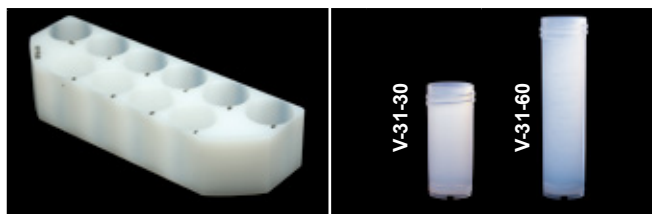

Description	Diam.	Part Number
10 position PP high purity standards rack for 30 mL and 60 mL tubes	30 mm	ST10-31

## Autosampler Racks (ST Size, Type 2) for 2DX autosamplers



Description	Diam.	Part Number
9 position HMPE standards rack for 125 mL bottles. Recommended for prepFAST with DX. Includes 9, 125 mL HDPE bottles w/cap.	50 mm	ST2-9-50

## Autosampler Racks (ST Size, Type 3) for 4DX autosamplers



Description	Diam.	Part Number
7 position HMPE standards rack for 250 mL bottles	60 mm	ST7-60



Description	Diam.	Part Number
9 position HMPE standards rack for 125 mL bottles. Recommended for prepFAST. Includes 9, 125 mL HDPE wide mouth standard bottles w/caps.	50 mm	ST4-9-50

## Autosampler Racks (ST Size, Type 4) for 2DX and 4DX autosamplers

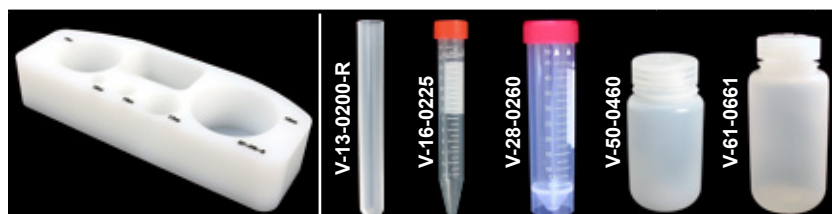

Description	Diam.	Part Number
5 position HMPE priority samples rack for 8 mL, 15 mL, 50 mL, 125 mL and 250 mL bottles. Fits over DX rinse station.	13 mm 16 mm 28 mm 50 mm 60 mm	ST-PR-5





Description	Diam.	Part Number
5 position HMPE extra standards rack for 50 mL and 250 mL bottles. Fits over DX rinse station.	28 mm 60 mm	ST-EX-5

# SAMPLETRAX Barcoded Racks and Vials

TX series vials and racks are designed to work with SAMPLETERAX using a unique barcode permanently affixed to the underside of the vial. All racks can be used on the SAMPLETERAX custom systems (see pages 28-30)

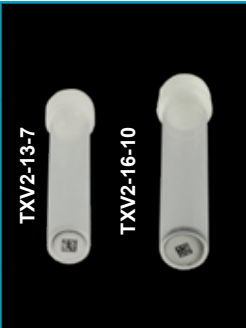
## SAMPLETRAX Barcoded Vials for custom barcoded system



	Part Number	Qty
	TXV2-13-7	1
	TXV2-16-10	1
	Description	Volume
	13 mm o.d. barcoded polypropylene vial with cap	7 mL
	16 mm o.d. barcoded polypropylene vial with cap	10 mL



	Part Number	Qty
	TXV3-12	1
	Description	Volume
	16 mm o.d. barcoded PFA vial	12 mL



	Part Number	Qty
	TXV2-28-50	1
	Description	Volume
	28 mm o.d. barcoded polypropylene vial with cap	50 mL

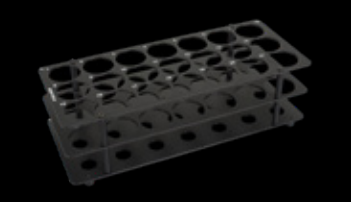

	Part Number	Qty
	TXV2-50-125	1
	Description	Volume
	50 mm o.d. barcoded polypropylene bottle with cap	125 mL

## SAMPLETRAX Racks for custom barcoded system

		Description	Diam.	Part Number
		9 position standards rack for 125 mL vials	50 mm	ST2-9-50-CX

		Description	Diam.	Part Number
		21 position rack for 50 mL vials	28 mm	TXR-21-30

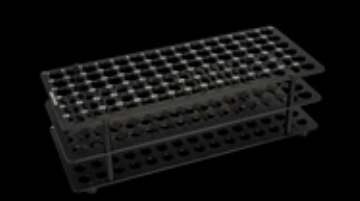
		Description	Diam.	Part Number
		60 position rack for 10 and 12 mL vials	16 mm	TXR-60-16

		Description	Diam.	Part Number
		90 position rack for 7 mL vials	13 mm	TXR-90-13

## FAST Spares Kit

Assorted fittings and tubing for *FAST* systems

Description	Part Number
FAST Spares Kit for iCAP™ Q/RQ/TQ	SC-0380

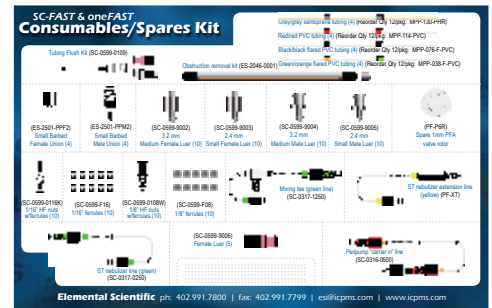

## FAST Deluxe Spares Kit

All of the assorted fittings and tubing in the *FAST* Spares Kit with the addition of a PFA-ST nebulizer, spare *FAST* valve, and internal standard tee.

Description	Part Number
FAST Deluxe Spares Kit for iCAP™ Q/RQ/TQ	SC-0370-73-D

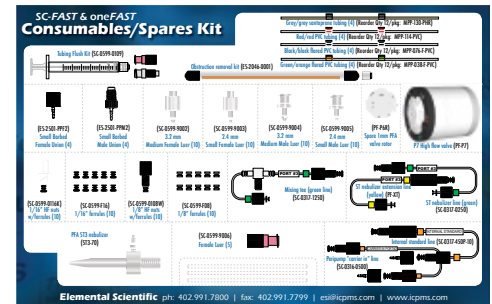

## prepFAST Spares Kit

Includes prepFAST PFA-ST3 nebulizer, P7+ and P6 valves, PFA F6 rotor, tubing flush kit, ST nebulizer line, and spare fittings and tubing for prepFAST.

Description	Part Number
prepFAST Spares Kit for iCAP™ Q/RQ/TQ	PF-0370

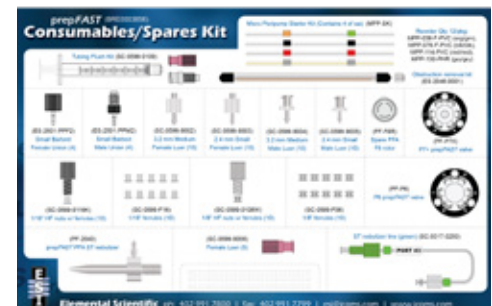

## seaFAST / brineFAST Spares Kit

Includes all of the assorted fittings and tubing in the *FAST* Spares Kit with the addition of a PFA-ST nebulizer, 3 mL quartz syringe, and assorted fittings.

Description	Part Number
seaFAST/brineFAST Spares Kit for iCAP™ Q/RQ/TQ	SF-0370





# Installation and Training

## Silver Level ESI Installation & Training

The silver level installation and training package is a 1-day on-site installation and method development for *FAST*.

- Includes:** Hardware installation  
 Software methods  
 Basic system familiarization  
 Travel time & expenses for ESI employee or contractor  
*FAST* standard spares kit (SC-0370)

Description	Part Number
On-site, 1-day installation and application development for <i>FAST</i> high throughput system	FI-SC-01



## Gold Level ESI Installation & Training

The gold level installation and training package is a 2½-day, on-site installation and method development for the *FAST* and prep*FAST*.

- Includes:** Hardware installation  
 Software methods  
 Basic system familiarization  
 Necessary method validation  
 User training  
 Travel time & expenses for ESI employee or contractor  
 Spares kit (see page 88)

Description	Part Number
On-site, 2½-day installation and application development for <i>FAST</i> systems	FI-SC-02-54
On-site, 2½-day installation and application development for prep <i>FAST</i> systems	FI-PF-02
On-site, 2½-day installation and application development for sea <i>FAST</i> /brine <i>FAST</i> systems	FI-SF-02
On-site, 4-day installation and application development for prep <i>FAST</i> IC systems	FI-PFIC-04



The *FAST* Deluxe, prep*FAST*, or sea*FAST*/brine*FAST* Spares Kit is included with the Gold Installation & Training.



# Autosampler Dimensions

## Micro DX Autosampler with Enclosure and ULPA Filter Dimensions

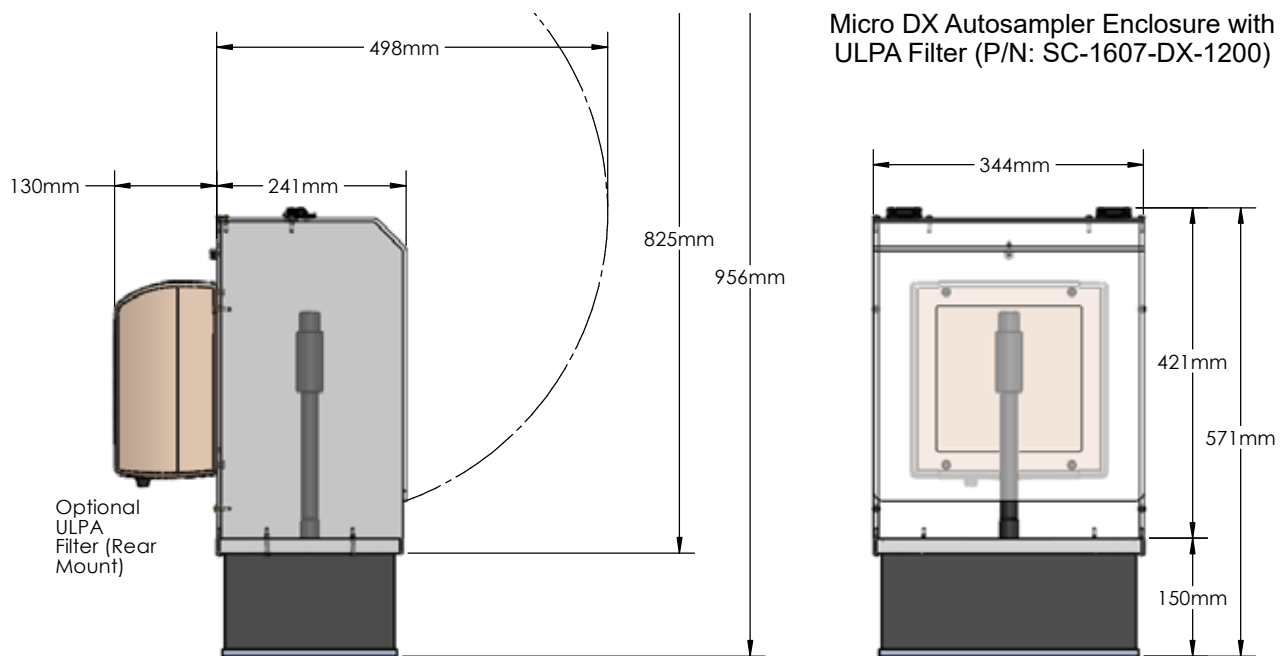

Micro DX autosampler and enclosure and ULPA Filter, W x D X H: 34.4 x 37.1 x 57.1 cm

## 2DX Autosampler with Enclosure and ULPA Filter Dimensions

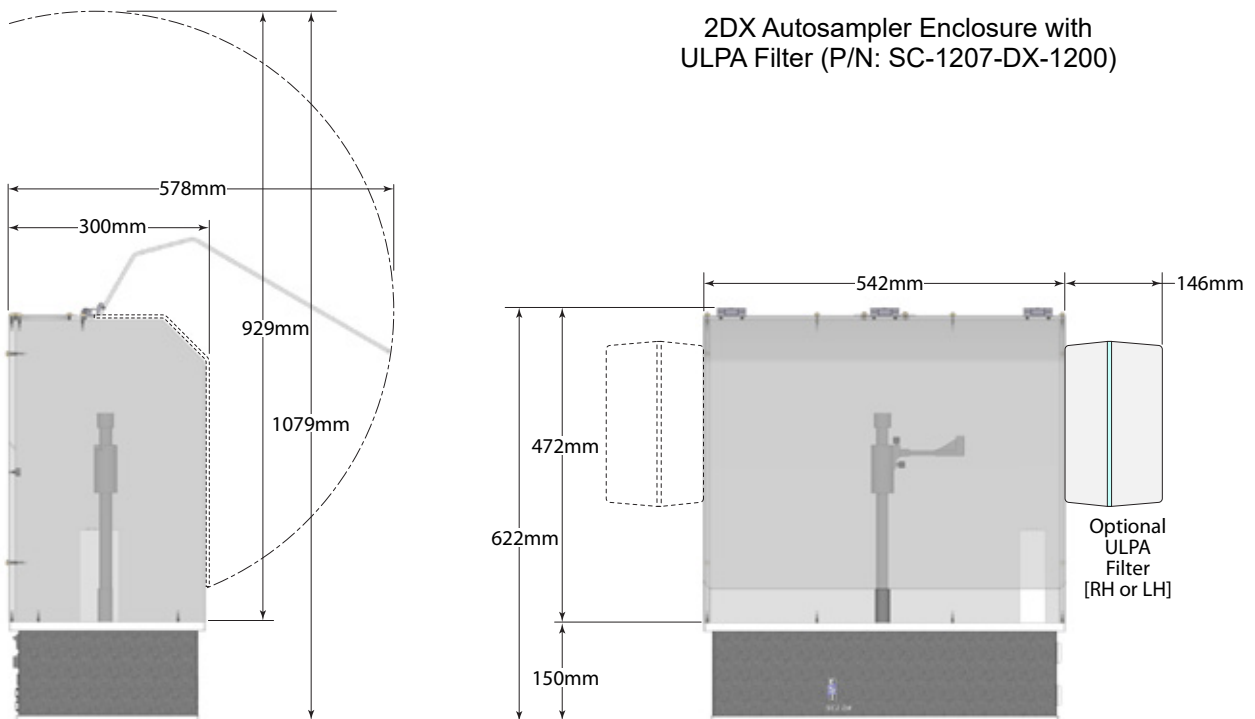

2DX autosampler with mobile stand and enclosure and ULPA Filter, W x D X H: 54.2 x 34.6 x 127.3 cm

## 4DX Autosampler with Enclosure and ULPA Filter Dimensions

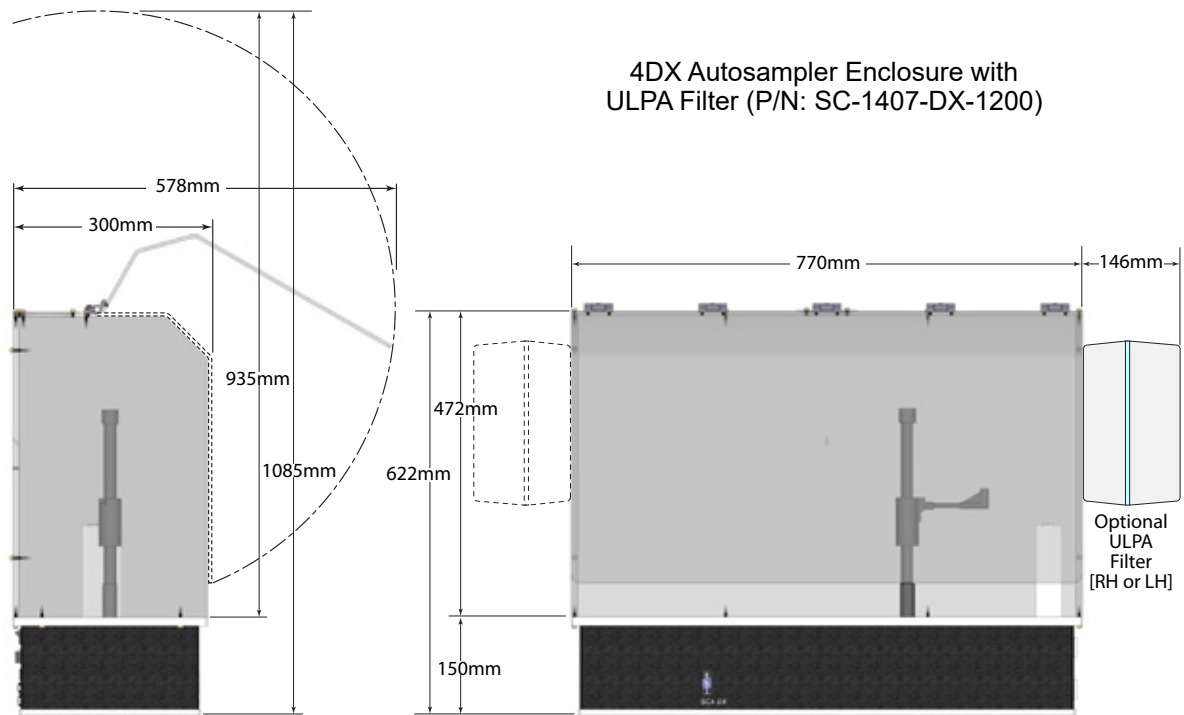

4DX autosampler with mobile stand and enclosure and ULPA filter, W x D X H: 77.0 x 34.6 x 127.3 cm

## 8DX Autosampler with Enclosure and ULPA Filter Dimensions

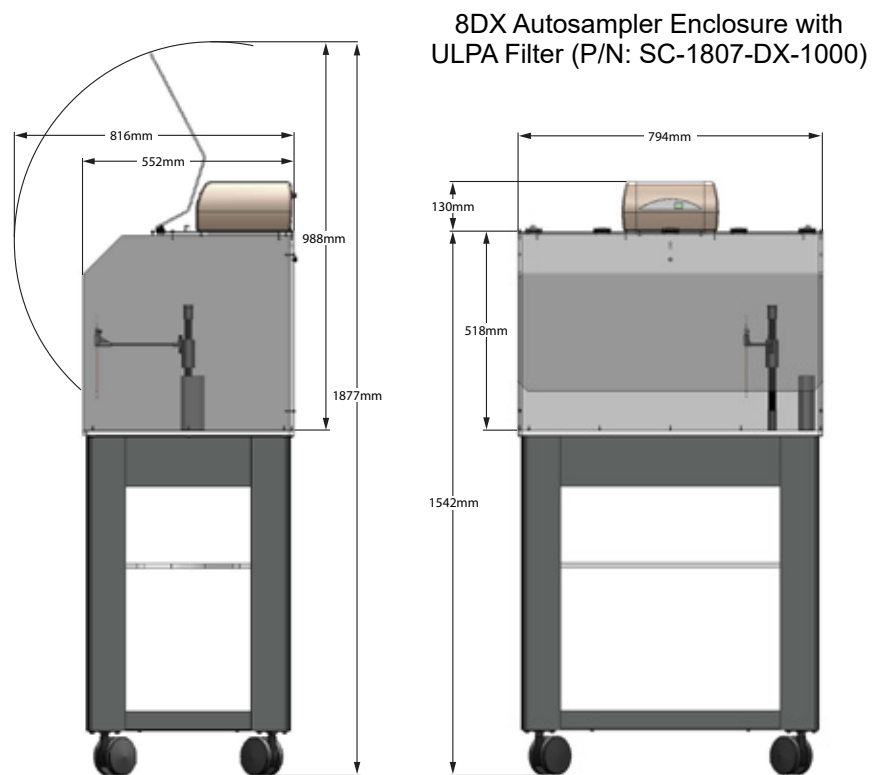

8DX autosampler and ULPA filter, W x D X H: 57.8 x 55.2 x 154.7 cm

P/N.....	Page	P/N.....	Page	P/N.....	Page	P/N.....	Page	P/N.....	Page
2ADF-73A-R2.....	17	ES-2040.....	51	I73-Q10.....	64	MPP-095-S.....	67	PF-A11b.....	69
2DXF-73A.....	7	ES-2040-73.....	51	I73-Q15.....	64	MPP-102-F-PVC.....	67	PF-A11bR.....	69
2F-SS7-73.....	23	ES-2040-7000.....	53	I73-Q20.....	64	MPP-102-F-S.....	67	PF-A11bS.....	69
2PF-M5-73A.....	17	ES-2041.....	52	I73-Q25.....	64	MPP-102-PVC.....	67	PFA-SK-73A.....	27, 61
2PF-S5-73AI.....	27	ES-2042.....	52	I73-S15.....	64	MPP-102-S.....	67	PFA-SK-73G.....	61
4ADF-73A-R2.....	17	ES-2043.....	52	I73-S18.....	64	MPP-109-F-PVC.....	67	PFA-SK-73S.....	27, 61
4DXF-73A.....	7	ES-2044.....	52	I73-S20.....	64	MPP-109-F-S.....	67	PFA-SK-73SC.....	61
4F-IC.....	33	ES-2044-0009-B.....	60	I73-S25.....	64	MPP-109-PVC.....	67	PF-F6R.....	69
4F-SS7-73.....	23	ES-2045.....	52	ICN-73.....	23, 50	MPP-109-S.....	67	PF-HS1030.....	71
4PF-IC.....	33	ES-2046-0001.....	51	IS-BRG-50.....	72	MPP-114-F-PVC.....	67	PF-HS1060.....	71
4PF-M5-73A.....	17	ES-2047.....	52	IS-MP-25.....	72	MPP-114-PVC.....	67	PF-HS1120.....	71
4PF-S5-73AI.....	27	ES-2049.....	52	IS-MP-50.....	72	MPP-114-S.....	67	PF-M3.....	70
4SF-S2-M5-I.....	41	ES-2373-5470.....	27, 61	ISN-ST3-25.....	72	MPP-122-PVC.....	67	PF-M3H.....	70
4SF-S3-M5-I.....	41	ES-2501-PPF1.....	74	ISN-TRP-50.....	72	MPP-122-S.....	67	PF-M3HR.....	70
4SF-SP2-M5-I.....	41	ES-2501-PPF2.....	74	IS-ST-25.....	72	MPP-130-PHR.....	67	PF-M3HS.....	70
4SF-SP3-M5-I.....	41	ES-2501-PPM1.....	74	IS-ST-50.....	72	MPP-130-PVC.....	67	PF-M3R.....	70
4TF-SP2.....	31	ES-2501-PPM2.....	74	LMR-21-30-R.....	82	MPP-130-S.....	67	PF-M3S.....	70
5MT-1.....	74	ES-2502.....	73	LMR-60-16-R.....	82	MPP-142-PVC.....	67	PF-M4.....	70
5MT-02.....	74	ES-2502-1000.....	60	LMR-90-13-R.....	82	MPP-142-S.....	67	PF-M4R.....	70
5MT-03.....	74	ES-3150-0073-L.....	60	LMR-90-13-R-3T.....	82	MPP-152-PHR.....	67	PF-M4S.....	70
5MT-05.....	74	ES-3173-1111-23.....	60	LR-21-30.....	82	MPP-152-PVC.....	67	PF-M6.....	70
5MT-08.....	74	ES-3173-1411-21.....	43, 60	LR-40-20.....	82	MPP-152-S.....	67	PF-M6R.....	70
5MT-015.....	74	ES-3173-3111-21.....	60	LR-60-16.....	82	MPP-165-PVC.....	67	PF-M6S.....	70
5MT-16.....	74	ES-3199-0003.....	60	LR-90-13-R.....	82	MPP-165-S.....	67	PF-M8.....	70
5MT-025.....	74	ES-4373-1000-21.....	63	MP2-4-73.....	66	MPP-175-PVC.....	67	PF-M8H.....	70
8ADF-73A-R2.....	17	ES-4473-1000-21.....	63	MPP-013-F-PVC.....	67	MPP-175-S.....	67	PF-M8HP.....	70
8DXF-73A.....	7	ES-4773C.....	61	MPP-013-F-S.....	67	MPP-185-PVC.....	67	PF-M8HPR.....	70
8DXF-BT-73A).....	7	ES-4773X.....	61	MPP-013-PVC.....	67	MPP-185-S.....	67	PF-M8HPS.....	70
8F-SS7-73.....	23	ES-5036-IS-73.....	73	MPP-019-F-PVC.....	67	MPP-206-PVC.....	67	PF-M8HR.....	70
8PF-M5-73A.....	17	ES-5037-3250-080.....	52	MPP-019-F-S.....	67	MPP-206-S.....	67	PF-M8HS.....	70
14ADF-73A-R2.....	17	ES-5037-3250-150.....	52	MPP-019-PVC.....	67	MPP-220-PVC.....	67	PF-M8R.....	70
14DXF-73A.....	7	ES-5037-3255-080.....	52	MPP-027-F-PVC.....	67	MPP-220-S.....	67	PF-M8S.....	70
14F-SS7-73.....	23	ES-5037-3255-150.....	52	MPP-027-F-S.....	67	MPP-254-PVC.....	67	PF-M10.....	70
14PF-M5-73A.....	17	ES-5037-3500-080.....	52	MPP-027-PVC.....	67	MPP-254-S.....	67	PF-M10R.....	70
APX-2HF.....	62	ES-5037-3500-150.....	52	MPP-038-F-PVC.....	67	MPP-279-PVC.....	67	PF-M10S.....	70
APX-2Q.....	62	ES-5037-3505-080.....	52	MPP-038-F-S.....	67	MPP-279-S.....	67	PF-P3.....	69
APX-O.....	62	ES-5037-3505-150.....	52	MPP-038-PHR.....	67	MPP-317-PHR.....	67	PF-P3R.....	69
APX-O-HF.....	62	ES-5037-3750-080.....	52	MPP-038-PVC.....	67	MPP-317-PVC.....	67	PF-P3S.....	69
CF-CX-0600.....	31	ES-5037-3750-150.....	52	MPP-044-F-PVC.....	67	MPP-317-S.....	67	PF-P4.....	69
CF-CX-2000.....	31	ES-5037-3755-080.....	52	MPP-044-F-S.....	67	MPP-K-1.....	67	PF-P4H.....	69
CF-N-0200.....	41	ES-5037-3755-150.....	52	MPP-044-PVC.....	67	MR-00-01.....	83	PF-P4HR.....	69
CF-P-0050.....	41	ES-5037-3995-080.....	52	MPP-051-F-PVC.....	67	MR-10-30.....	83	PF-P4HS.....	69
CF-P-0200.....	41	ES-5037-3995-150.....	52	MPP-051-F-S.....	67	MR-21-14.....	83	PF-P4R.....	69
CF-Sr-1000.....	31	ES-5046-IS-73.....	73	MPP-051-PVC.....	67	MR-40-14.....	83	PF-P4S.....	69
ES-2000.....	53	ES-7225-0001.....	76	MPP-057-F-PVC.....	67	MR-60-08.....	83	PF-P5H.....	69
ES-2000-3503-080.....	54	FI-PF-02.....	89	MPP-057-F-S.....	67	MR-90-08.....	83	PF-P5HS.....	69
ES-2000-3505-100.....	54	FI-SC-01.....	89	MPP-057-PVC.....	67	MT-24-10mL-02.....	80	PF-P6.....	69
ES-2002.....	53	FI-SC-02-54.....	89	MPP-064-F-PVC.....	67	MT-48-5mL-02.....	80	PF-P6-8.....	69
ES-2002-3503-80.....	54	F-0370-SS7.....	23	MPP-064-F-S.....	67	MT-48-7.5mL-02.....	80	PF-P6H.....	69
ES-2002-3505-100.....	54	FI-F-SS7.....	23	MPP-064-PVC.....	67	MT-96-2mL-02.....	80	PF-P6HPR.....	69
ES-2002-7000.....	53	FI-IQOQ.....	23	MPP-076-F-PVC.....	67	MT-96-500-05-V.....	80	PF-P6HR.....	69
ES-2002-7205-080.....	53	FI-PFIC-04.....	33, 89	MPP-076-F-S.....	67	MT-96-XP.....	81	PF-P6HS.....	69
ES-2003.....	53	FI-PF-SS8.....	23	MPP-076-PHR.....	67	PF-0370.....	88	PF-P6R.....	69
ES-2003-3503-80.....	54	FI-SF-02.....	89	MPP-076-PVC.....	67	PF-0370-SS8.....	23	PF-P6S.....	69
ES-2003-3505-100.....	54	GR-M4-73.....	47	MPP-076-S.....	67	PF-2040.....	51	PF-P6S-8.....	69
ES-2005.....	53	HFX-73.....	45	MPP-089-F-PVC.....	67	PF-A5e.....	69	PF-P7.....	69
ES-2005-3503-80.....	54	HG-MP2-6-A.....	43	MPP-089-F-S.....	67	PF-A5eS.....	69	PF-P7-8.....	69
ES-2005-3505-100.....	54	HR-21-30.....	83	MPP-089-PVC.....	67	PF-A7e.....	69	PF-P7-8H.....	69
ES-2020.....	53	HR-60-16.....	83	MPP-089-S.....	67	PF-A7eS.....	69	PF-P7-8HS.....	69
ES-2020-3503-080.....	54	I73-P10.....	64	MPP-095-F-PVC.....	67	PF-A7u.....	69	PF-P7H.....	69
ES-2020-3505-100.....	54	I73-P15.....	64	MPP-095-F-S.....	67	PF-A7uR.....	69	PF-P7HP.....	69
ES-2030-73.....	51	I73-P20.....	64	MPP-095-PVC.....	67	PF-A7uS.....	69	PF-P7HPS.....	69

P/N.....	Page	P/N.....	Page	P/N.....	Page	P/N.....	Page	P/N.....	Page
PF-P7HS	69	PF-V9S (cp)	70	Q3PT-109-F-PVC	65	SC-0319-05	75	ST-PR-5	86
PF-P7S	69	PF-V12	70	Q3PT-109-F-S	65	SC-0319-10	75	T73	64
PF-P7S-8	69	PF-V12H	70	Q3PT-109-PVC	65	SC-0319-15	75	T73-SilQ	64
PF-P7X	69	PF-V12HR	70	Q3PT-109-S	65	SC-0319-20	75	TQP-30-A0.5	56
PF-P7XIC	69	PF-V12HS	70	Q3PT-114-F-PVC	65	SC-0319-25	75	TRP-30-A0.5	56
PF-P7XS	69	PF-V12R	70	Q3PT-114-PVC	65	SC-0319-30	75	TXR-21-30	87
PF-P8	69	PF-V12S	70	Q3PT-114-S	65	SC-0319-40	75	TXR-60-16	87
PF-P8R	69	PF-V13	70	Q3PT-122-PVC	65	SC-0370-73-D	88	TXR-90-13	87
PF-P8S	69	PF-V13R	70	Q3PT-122-S	65	SC-0380	88	TXV2-13-7	87
PF-P10	69	PF-V13S	70	Q3PT-130-PHR	65	SC-0599-0001	74	TXV2-16-10	87
PF-P10R	69, 70	PF-V18H	70	Q3PT-130-PVC	65	SC-0599-0108-W	74	TXV2-28-50	87
PF-P10S	69	PF-V18HR	70	Q3PT-130-S	65	SC-0599-0109	51	TXV2-50-125	87
PF-P11	69	PF-V18HS	70	Q3PT-142-PVC	65	SC-0599-0116-K	74	TXV3-12	87
PF-P11S	69	PF-X11	70	Q3PT-142-S	65	SC-0599-F08	74	ULPA-2EX	27
PF-P13	69	PF-X11S	70	Q3PT-152-PHR	65	SC-0599-F16	74	ULPA-4EX	27
PF-P13R	69	PRG-01	59	Q3PT-152-PVC	65	SC-0602	48	UPB-4M-1L	41
PF-P13S	69	PRG-01-MAPiplus	59	Q3PT-152-S	65	SC-1107-0026	48	U-PFIC	33
PF-PM6	69	PRG-02	59	Q3PT-165-PVC	65	SC-1107-DX	48	V-8-0505	79
PF-PM6R	69	PRGS-003	59	Q3PT-165-S	65	SC-1107-DX-1030	48	V-8-0505-C	79
PF-PM6S	69	PRL-03	56	Q3PT-175-PVC	65	SC-1207-DX	48	V-8-0505-D	79
PF-PM7	69	Q3PT-013-F-PVC	65	Q3PT-175-S	65	SC-1207-DX-1200	48, 90	V-13-0200-R	79
PF-PM7S	69	Q3PT-013-F-S	65	Q3PT-185-PVC	65	SC-1210-DX-P	49	V-14-0309-C	78
PF-PM7X	69	Q3PT-013-PVC	65	Q3PT-185-S	65	SC-1407-DX	48	V-14-0309-X	76, 78
PF-PM7XS	69	Q3PT-019-F-PVC	65	Q3PT-206-PVC	65	SC-1407-DX-1200	48, 91	V-14-0311CG	76
PF-S4	70	Q3PT-019-F-S	65	Q3PT-206-S	65	SC-1410-DX	49	V-14-0311CG-X	76
PF-S4R	70	Q3PT-019-PVC	65	Q3PT-220-PVC	65	SC-1410-DX-P	49	V-14-0312CG	76
PF-S4S	70	Q3PT-027-F-PVC	65	Q3PT-220-S	65	SC-1607-DX	48	V-14-0312CG-X	76
PF-S9	70	Q3PT-027-F-S	65	Q3PT-254-PVC	65	SC-1607-DX-1000	48	V-14-0314CG	76
PF-S9R	70	Q3PT-027-PVC	65	Q3PT-254-S	65	SC-1607-DX-1200	90	V-14-0314CG-X	76
PF-S9S	70	Q3PT-038-F-PVC	65	Q3PT-279-PVC	65	SC-1807-DX	48	V-14-0712-C	78
PF-S11R	70	Q3PT-038-F-S	65	Q3PT-279-S	65	SC-1807-DX-1000	48, 91	V-14-0712-M	78
PF-S11S	70	Q3PT-038-PHR	65	Q3PT-317-PHR	65	SC-1810-DX	49	V-14-0712-X	78
PF-S1003	71	Q3PT-038-PVC	65	Q3PT-317-PVC	65	SC-5037-3255-150	52	V-15-0300-X	76
PF-S1030	71	Q3PT-044-F-PVC	65	Q3PT-317-S	65	SC-5037-3505-150	52	V-15-0301-X	76
PF-S1030C	71	Q3PT-044-F-S	65	S032955	66, 74	SC-5037-3755-150	52	V-16-0225	79
PF-S1060	71	Q3PT-044-PVC	65	S032956	66, 74	SC-5037-3995-150	52	V-16-0225-D	79
PF-S1060C	71	Q3PT-051-F-PVC	65	S032956-V	66, 74	SDX-S11	70	V-16-0225-LX	79
PF-S3003	71	Q3PT-051-F-S	65	S033101	74	seablanck-0500	41	V-20-0290	79
PF-S3030	71	Q3PT-051-PVC	65	S033156-V	66, 74	SE-0370	88	V-28-0260	79
PF-S3030C	71	Q3PT-057-F-PVC	65	S033161	74	SilQ-30-A0.5	56	V-28-0260-D	79
PF-S3060	71	Q3PT-057-F-S	65	SC-0105-DX-XP	81	SR2-12-50	84	V-28-0260-L	79
PF-S3060C	71	Q3PT-057-PVC	65	SC-0315-05	75	SR2-21-30	84	V-28-0360-V	77
PF-S3120	71	Q3PT-064-F-PVC	65	SC-0315-10	75	SR2-21-35	84	V-31-15-X	77
PF-V6	70	Q3PT-064-F-S	65	SC-0315-20	75	SR2-27-28	84	V-31-30-X	77
PF-V6H	70	Q3PT-064-PVC	65	SC-0315-025	75	SR2-27-31	84	V-31-60-X	77
PF-V6HP	70	Q3PT-076-F-PVC	65	SC-0315-30	75	SR2-80-16	84	V-50-0360	77
PF-V6HPR	70	Q3PT-076-F-S	65	SC-0315-40	75	SR4-00-01	85	V-50-0460	79
PF-V6HPS	70	Q3PT-076-PHR	65	SC-0315-60	75	SR4-60-14	85	V-61-0661	79
PF-V6HR	70	Q3PT-076-PVC	65	SC-0315-80	75	SR4x-15-60	85	V-61-0661-C	79
PF-V6HS	70	Q3PT-076-S	65	SC-0317-1250-30	73	SR4x-20-50	85	V-61-0661-XII	79
PF-V6R	70	Q3PT-089-F-PVC	65	SC-0317-1500-30	73	SS6F-73	23	VPC-14-0309-C	78
PF-V6S	70	Q3PT-089-F-S	65	SC-0318-03	75	SS6UF-73	23	VPC-14-0712	78
PF-V8C	70	Q3PT-089-PVC	65	SC-0318-05	75	SS7F-73	23	VPC-14-0712-C	78
PF-V8CS	70	Q3PT-089-S	65	SC-0318-10	75	SS7UF-73	23		
PF-V9	70	Q3PT-095-F-PVC	65	SC-0318-15	75	SS8UPF-73	23		
PF-V9 (cp)	70	Q3PT-095-F-S	65	SC-0318-20	75	ST2-9-50	86		
PF-V9H	70	Q3PT-095-PVC	65	SC-0318-25	75	ST2-9-50-CX	87		
PF-V9HR	70	Q3PT-095-S	65	SC-0318-30	75	ST4-9-50	86		
PF-V9HS	70	Q3PT-102-F-PVC	65	SC-0318-40	75	ST7-60	86		
PF-V9R	70	Q3PT-102-F-S	65	SC-0319-01	75	ST-10-28	86		
PF-V9R (cp)	70	Q3PT-102-PVC	65	SC-0319-02	75	ST10-31	86		
PF-V9S	70	Q3PT-102-S	65	SC-0319-03	75	ST-EX-5	86		

# CUSTOM ELEMENT STANDARDS

Elemental Scientific offers single element standards, single element kits, common standard mixes, custom standards as well as metal-organic standards. Single and custom element standards are offered from two premier standards manufacturers, providing the ease of purchasing primary and secondary standards with the confidence of two independently-certified sources. Standards are shipped with Certificate of Analysis and MSDS sheets.

## QUALITY ASSURANCE

Our standards have the following accreditations and certifications.

- NIST-traceable to SRM 3100 Series
- ISO 9001 Certified
- ISO 17025 Accredited
- ISO Guide 34 Accredited

All single element standards have a shelf life of 18 months. Standard volumes include 100 mL, 250 mL and 500 mL with special volumes available upon request.



Please visit our website for more information on available concentrations, matrixes and bottles sizes

[WWW.ICPMS.COM](http://WWW.ICPMS.COM)

**E  
S  
I** **Elemental  
Scientific**

# Elemental Scientific

Automation | Sample Introduction | Consumables for ICPMS



Elemental Scientific designs and produces a full range of automation and sample introduction systems for the determination of trace element concentrations in liquid samples by inductively coupled plasma instrumentation. Our extensive product line contains sample introduction devices for all models of ICP instruments, including:

- Fully automated inline and offline dilution / standardization / QC systems
- *FAST* valve systems
- Innovative DX Series clean, intelligent autosamplers
- Inert autosampler and manual sampling probes
- Precision micro peristaltic pumps and syringe pumps
- Inert PFA MicroFlow and MEINHARD® quartz nebulizers
- Inert, chemically resistant spray chambers and end caps
- Peltier-cooled spray chambers
- Demountable o-ring-free injectors made from platinum, sapphire, or quartz
- Precision quartz ICP torches
- apex family of high sensitivity, low contamination sample inlet systems
- Advanced application systems

Our years of experience in the laboratory and in the field are at your disposal to help answer your questions related to elemental analysis. We are pleased to provide our customers complimentary analytical advice from our on-staff chemists.

## Ordering Information:

You may contact us via phone, e-mail, or through our website.

### Phone:

1.402.991.7800

### E-Mail:

[sales@icpms.com](mailto:sales@icpms.com)

### Website:

[www.icpms.com](http://www.icpms.com)

