



Industrial  
Line



Sensors &  
Accessories



Dosing  
Systems



Swimming  
Pool Line



# STEIEL

## PRODUCT LIST 2020



ANAYSIS INSTRUMENTS AND DOSING SYSTEMS  
FOR WATER TREATMENT

## STEIEL... SINCE 1973 THE **ELECTRONICS** WITH PASSION FOR **WATER**



**Studio Tecnico Elettronico Industriale E Laboratorio** (Industrial Electronic Technical Study & Lab), this is how, in 1973, Eng. Ettore Pilotti, together with a high skilled team, starts one of the most historic Italian companies, which deals successfully with the design and production of electronic devices applied to water treatment.

That small reality, today more and more international, from more than forty years is in the market with a wide range of electronic measurement instruments and dosing systems for the treatment of all the types of water, from industrial processes to water purification and conditioning, from the agri-food and livestock industry to swimming pools.

In addition STEIEL is one of the first Italian manufacturers of chlorine dioxide generators, now widely used for the legionella abatement in domestic hot water circuits. From 10 years STEIEL has been sanitizing water distribution systems in many public and private facilities, hospitals, hospices and nursing homes, hotels, agri-food industries and farms, both in Italy and abroad.

The STEIEL team includes highly qualified electronic and mechanical designers; technicians who help the customer with the plant start-up, scheduled maintenance and technical courses; marketing and back office professionals, who take care of all customer requests; technical-commercial officials always attentive to the needs of the market.

Today STEIEL is present in more than 30 countries, with a sales network consisting of national and international distributors (even exclusive), direct and indirect customers, important OEM customers and plant manufacturers. STEIEL was one of the first Italian companies to understand the importance of creating customized products and tailor-made solutions according to the specific needs of the customer.

Accepting challenges is the key of our success and our philosophy...

***“Do not ask us to be what we are not, but help us to not remain what we are”***

*The STEIEL team*

INDUSTRIAL LINE ..... PAGES 4-17



Digital Units



Ready to use Systems



Plug&play Skids



ClO<sub>2</sub> Generators

SENSORS, ACCESSORIES, PORTABLE INSTRUMENTS ..... PAGES 18-35



pH and ORP Electrodes



Amperometric Cells



Probe-holders



Portable Instruments

DOSING SYSTEMS ..... PAGES 36-63



Horizontal Pumps



Wall-mounting Pumps



Complete Stations



Dosing Accessories

ANALYSIS AND CONTROL SYSTEMS FOR SWIMMING POOLS ..... PAGES 64-71



Colorimeters



Compact Systems



pH / Chlorine Control



Pre-assembled Panels

WATER DISINFECTION WITH UV RADIATIONS ..... PAGES 72-77



Swimming Pool Systems



Industrial Systems



HDPE Vessels



Stainless Steel Vessels

Return authorization module ..... 78

Declaration of decontamination ..... 79

General sales conditions ..... 80

## DIGITAL SINGLE-PARAMETER UNITS

### PANEL INSTALLATION

#### S503 SERIES, BASIC LINE

- Input for Pt100 sensor, for temperature measurement and compensation
- Two relay outputs (threshold or alarm, K1 can drive a pump magnet)
- Current output, fully configurable and with galvanic separation
- OFF digital input, for disabling all outputs
- Optional front panel for IP54 protection or version with IP65 housing
- Power supply: 230 V~ (standard), 115 V~, 24 V~, 24 V- (50/60 Hz)



ITEM	DESCRIPTION	PART NO.
S503 pH/RX/T	Input for pH or ORP electrode + Pt100	80050010
S503 CO	Input for 2-electrode conductivity cell + Pt100	80240005
S503 IN	Indicator with 0/4-20 mA input, range to be specified	80710130
Transparent front cover for IP54 protection, for 96x96 mm housing		49000517
Option: models with with IP65 housing		

#### S508 SERIES, PROFESSIONAL LINE

- Input for Pt100 sensor, for temperature measurement and compensation
- Two relay outputs configurable as intervention threshold or alarm
- Current output, fully configurable and with galvanic separation
- Serial port for communication with PC, data recorder, RW14
- OFF/FLOW digital input, for disabling all outputs
- Multi-language menu
- Optional front panel for IP54 protection
- Power supply: 230 V~ (standard), 115 V~, 24 V~, 24 V- (50/60 Hz)



ITEM	DESCRIPTION	PART NO.
S508 pH/RX/T	Input for pH or ORP electrode + Pt100	80050050
S508 CO	Input for 2-electrode conductivity cell + Pt100	80240050
S508 ACL	Input for CLE12 cell, range to be specified upon order	
S508 CAC	Input for CAC (or CP) cell, range to be specified upon order	
S508 TU	Input for turbidity cell	85700050
S508 IN	Indicator with 0/4-20 mA input, range to be specified	80710180
Transparent front cover for IP54 protection, for 72x144 mm housing		49000516

#### C902 COMPACT CONDUCTIVITY METER

- Conductivity measurement up to 9.99, 99.9 or 999  $\mu\text{S}/\text{cm}$  (to be specified)
- Measurements in  $\mu\text{S}/\text{cm}$  or ppm (to be specified upon order)
- Input for two-electrode conductivity cell, with cell constant depending on the full scale value
- One relay output with threshold adjustable through trimmer
- Power supply: 230 V~, 115 V~, 24 V~, 24 V- (50/60 Hz)



ITEM	DESCRIPTION
C902	C902, measure unit and range to be specified upon order



## INSTALLATION ON DIN SLOT

### S504 SERIES

- Input for Pt100 sensor, for temperature measurement and compensation
- Two relay outputs configurable as intervention threshold or alarm
- Current output, fully configurable and with galvanic separation
- OFF digital input, for disabling all outputs
- Power supply: 230 V~ (standard), 115 V~, 24 V~, 24 V- (50/60 Hz)



ITEM	DESCRIPTION	PART NO.
S504 pH/RX/T	Input for pH or ORP electrode + Pt100	80050030
S504 CO	Input for 2-electrode conductivity cell + Pt100	80240020
S504 IN	Indicator with 0/4-20 mA input, range to be specified	80710160
S504 box	Instrument mounted in closed housing, single instrument	
	Instrument mounted in closed housing, double instrument	



## WALL INSTALLATION

### S507 SERIES, PROFESSIONAL LINE

- Input for Pt100 sensor, for temperature measurement and compensation
- Two relay outputs configurable as intervention threshold or alarm
- “Dosing-shot” option for relay K1
- Current output, fully configurable and with galvanic separation
- Serial port for communication with PC, data recorder, RW14
- OFF/FLOW digital input, for disabling all outputs
- Multi-language menu
- Watertight housing suitable to harsh industrial environments
- Can be supplied prewired and assembled on panel
- Power supply: 230 V~ (standard), 115 V~, 24 V~, 24 V- (50/60 Hz)



ITEM	DESCRIPTION	PART NO.
S507 pH/RX/T	Input for pH or ORP electrode + Pt100	80050040
S507 CO	Input for 2-electrode conductivity cell + Pt100	80240040
S507 ACL	Input for CLE12 cell, range to be specified upon order	80600201
S507 CAC	Input for CAC (or CP) cell, range to be specified upon order	
S507 TU	Input for turbidity cell	85700026
S507 IN	Indicator with 0/4-20 mA input, range to be specified	80710170

## DIGITAL MULTI-PARAMETER UNITS

### WALL INSTALLATION

#### MC14 CONTROLLER

- **Inputs for 5 simultaneous readings** (temperature always provided)
- Measurements of pH, ORP, chlorine, conductivity, turbidity, etc.
- Available double input for CAC cells
- **Two configuration levels** (standard and advanced), with password
- Multi-language menu
- **Relays for ON/OFF or proportional control**, or NO/NC alarm
- **Two current outputs**, 0-20 or 4-20 mA
- OFF input, configurable NO or NC for disabling outputs
- Input for water flow sensor for disabling outputs in case of flow lack
- Two level inputs for monitoring the products to be dosed
- Data log downloadable via serial line (internal data logger)
- Serial port, with galvanic insulation, for communication with PC, RW14,  $\mu$ MMC4
- **Optional RS485 port with Modbus RTU communication protocol**
- The unit can be supplied pre-wired and assembled on panel, complete with measurement sensors, dosing pumps and data recording system (see specific section)
- Power supply: 230 V~ (standard), 115 V~ / 50/60 Hz



ITEM	DESCRIPTION
MC14 /2 std.	MC14, 2 channels + temperature (Pt100), RS232
MC14 /3 std.	MC14, 3 channels + temperature (Pt100), RS232
MC14 /4 std.	MC14, 4 channels + temperature (Pt100), RS232

## AUXILIARY INSTRUMENTATION

### SG18 SERIES, GALVANIC SEPARATORS AND SIGNAL AMPLIFIERS

- Series of devices that work as **signal converters** and **pre-amplifiers**
- Signals are **galvanically isolated**
- The ideal device in case of signal transmission problems due to long distances or “noisy” environments
- Input options: pH electrode (0-14 pH), ORP electrode (0-1000 mV), conductivity cell (K=5 or K=1, range to be specified)
- Thermo-compensation of pH readings with separated Pt100 probe, of conductivity measurements with NTC sensor in-built in the cell
- Output: 4-20 mA (standard), or 0-20 mA
- Models with **watertight housing or support for installation on DIN slot**
- Power supply: 230 V~ (standard), 115 V~, 24 V~, 24 V- (50/60 Hz)



ITEM	DESCRIPTION
SG18	Wall-mounting series; Input and output to be specified
SG18/DIN	DIN series; Input and output to be specified

## PROGRAMMERS

### PRG11 MODEL FOR REVERSE OSMOSIS PLANTS

- Can be **wall-mounted or assembled on** the osmosis system **frame**
- **Internal RTC** powered by buffer battery, for scheduling filter cleaning
- **Two inputs for** two-electrode **conductivity cells**, for monitoring water both entering and exiting the osmosis unit
- **Thermo-compensation** of readings with NTC sensor in-built in the cell
- **Serial port** for communication with PC, data recorder, RW14
- Outputs: direct control of filter pump and dosing pump, and alarm
- Digital input for 3-wire sensors (magnetic or capacitive)
- Power supply: 230 V~ (standard), 115 V~ / 50 Hz



### PRG EVO MODEL FOR REVERSE OSMOSIS PLANTS, SOFTENERS AND FILTERS

- Basic supply: electronic boards with support for mounting on DIN slot
- Optional supply: boards assembled in an electric cabinet, dimensions to be agreed with the customer
- Graphic LCD, LED indicators and 5-button keyboard
- **Internal RTC** powered by buffer battery, for scheduling filter cleaning
- **Two inputs for** two-electrode **conductivity cells**
- **Thermo-compensation** of readings with NTC sensor in-built in the cell
- Digital inputs, 12 V, compatibles with PLC PNP outputs at 12 or 24 V
- **Optional serial port**, opto-isolated, RS232 (also double, for duplex configuration) or RS485
- Outputs: direct control of filter pump and dosing pump, and alarm
- Storage of alarms and events
- **Service configuration** function
- Digital input for 3-wire sensors (magnetic or capacitive)
- Power supply: 24 V-, 24 V~, 115 V~, 230 V~ (standard) / 50 Hz

ITEM	DESCRIPTION
PRG11	Programmer for reverse osmosis (RO) plants. Conductivity ranges, cell constant and output (230 V~ or 24 V -) to be specified.
PRG EVO	Programmer for reverse osmosis (RO) plants, softeners and filters. Contact STEIEL for choosing the configuration which better fits your needs.

## DATA RECORDING / MANAGING

### RW14 REMOTE CONTROL SYSTEM VIA WEB

- Remote interaction through PC, Tablet or Smartphone
- Internet connection via LAN port or WiFi module
- Standard model with one RS232 port
- Options: up to 3 additional serial ports, 2 analogic and 4 digital inputs
- Configuration and data visualization through dedicated web pages, using a common web browser
- Wall installation
- Power supply: 100...240 V~ / 50/60 Hz



ITEM	DESCRIPTION	PART NO.
RW14 LAN	Connection via LAN port, one RS232 port	81820010
	Connection via LAN port, two RS232 ports	81820020
	Connection via LAN port, three RS232 ports	81820030
	Connection via LAN port, four RS232 ports	81820040
Kit router	Router + LAN cable (10 m) + antenna cable (2 x 10 m) – only for RW14 LAN	81829001
RW14 WiFi	Connection via WiFi module, one RS232 port	81820110
	Connection via WiFi module, two RS232 ports	81820120
	Connection via WiFi module, three RS232 ports	81820130
	Connection via WiFi module, four RS232 ports	81820140
Optional module with 2 analogic inputs (4-20 mA)		
Optional module with 4 digital inputs		
Expansion board with 1 RS232 port		77001073
CAV/RW-M8-1	Serial cable with M8 connector for PSP/EF160 pumps and Compact controllers, 1.5 m	80099041
CAV/RW-M8-10	Serial cable with M8 connector for PSP/EF160 pumps and Compact controllers, 10 m	80099045
CAV/RW-MP-1	Serial cable with connector for multi-parameter units, 1.5 m	80099111
CAV/RW-MP-10	Serial cable with connector for multi-parameter units, 10 m	80099115
CAV/RW-IND-1	Serial cable with connector for S50x units, 1.5 m	80099121
CAV/RW-IND-10	Serial cable with connector for S50x units, 10 m	80099125

### μMMC SERIES, DATA RECORDING ON MEMORY CARD

#### Items available while stock lasts!

- Recorder-instrument communication via serial line
- Can record up to 1000 days
- Data format compatible with the most common software (e.g. NotePad, Word, Excel)
- Memory card MMC or SD (included) easily readable by a PC
- High efficiency LED indicators



ITEM	DESCRIPTION	PART NO.
μMMC2	Data recorder with connector for S50x units	80509199/A
μMMC4	Data recorder with connector for EF214, MC14, MCO14 units	80509199/C
μMMC-SW	“GENERA” software for daily data processing	80790104



## WATER HARDNESS ANALYSERS

- Qualitative control of the softening system
- Microprocessor-based units
- Plate mounted or IP54 housing
- Power supply: 230 V~ (standard) or 24 V
- Basic version with LED indicators, 3 alarms for threshold exceeding or fault condition, analysis START/STOP input, setting of the analysis interval and washing time
- Professional version with graphic display, 4 relay outputs configurable as alarms, commands of connected devices (washing valve, pump, cooler) or remote signal of fault conditions, 1 analogic output 0/4-20 mA, 2 digital inputs, data transfer through CAN connection or SD card



PRO Model



BASIC Model

DESCRIPTION
Analyser, basic version, plate mounted
Analyser, professional version, plate mounted
Optional mounting in a close housing (IP54 protection)
Set for periodic maintenance
Set for equipment cleaning (road transport)
Set for equipment cleaning (air transport)

REAGENT (500 ml)	MEASUREMENT RANGE PROFESSIONAL VERSION		ALARM THRESHOLDS BASIC VERSION		
	TOTAL HARDNESS				
500S/500	0.04 ... 0.21 °f	0.02 ... 0.12 °dH	0.04 °f	0.02 °dH	0.4 ppm CaCO <sub>3</sub>
500/500	0.04 ... 0.36 °f	0.02 ... 0.2 °dH	0.09 °f	0.05 °dH	0.9 ppm CaCO <sub>3</sub>
501/500	0.05 ... 0.54 °f	0.03 ... 0.3 °dH	0.18 °f	0.1 °dH	1.8 ppm CaCO <sub>3</sub>
502/500	0.11 ... 1.07 °f	0.06 ... 0.6 °dH	0.36 °f	0.2 °dH	3.6 ppm CaCO <sub>3</sub>
503/500	0.16 ... 1.61 °f	0.09 ... 0.9 °dH	0.54 °f	0.3 °dH	5.4 ppm CaCO <sub>3</sub>
505/500	0.27 ... 2.68 °f	0.15 ... 1.5 °dH	0.9 °f	0.5 °dH	9.0 ppm CaCO <sub>3</sub>
510/500	0.54 ... 5.36 °f	0.3 ... 3.0 °dH	1.8 °f	1.0 °dH	18 ppm CaCO <sub>3</sub>
520/500	1.07 ... 10.71 °f	0.6 ... 6.0 °dH	3.6 °f	2.0 °dH	36 ppm CaCO <sub>3</sub>
530/500	1.61 ... 16.07 °f	0.9 ... 9.0 °dH	5.4 °f	3.0 °dH	54 ppm CaCO <sub>3</sub>
550/500	2.68 ... 26.79 °f	1.5 ... 15 °dH	9.0 °f	5.0 °dH	90 ppm CaCO <sub>3</sub>
600/500	5.36 ... 53.57 °f	3.0 ... 30 °dH			
CARBONATE HARDNESS					
C-710/500	0.54 ... 5.36 °f	0.3 ... 3.0 °dH	1.8 °f	1.0 °dH	
C-715/500	0.80 ... 8.04 °f	0.45 ... 4.5 °dH	2.7 °f	1.5 °dH	
C-720/500	1.07 ... 10.71 °f	0.6 ... 6.0 °dH	3.6 °f	2.0 °dH	
C-730/500	1.61 ... 16.07 °f	0.9 ... 9.0 °dH	5.4 °f	3.0 °dH	

## READY TO USE CONTROL SYSTEMS CUSTOMIZED ASSEMBLIES ON SUPPORT

STEIEL offers its customers a wide range of “turnkey” solutions, available on neutral panel (white), with STEIEL logo or with customer logo (even for a few units).

In addition, it is possible to have industrial equipment mounted inside closed fiberglass or steel switchboards (equipped with door with transparent window) or on painted metal frames (also with laser-cut logo).

For these particular solutions or other types of customization, contact STEIEL for a specific evaluation.

ITEM	DESCRIPTION
	High density expanded PVC panel, 650x290 mm, assembling costs included
	High density expanded PVC panel, 500x600 mm, assembling costs included
	PP panel, 495x660 mm, assembling costs included
	AISI 304 steel panel, 500x600 mm, complete with steel mounting plate and door with transparent window; assembling costs included
	High density expanded PVC panel, 595x750 mm, assembling costs included
	High density expanded PVC panel, 900x700 mm, assembling costs included
	PP panel, 900x700 mm, assembling costs included
	AISI 304 steel panel, 900x700 mm, complete with steel mounting plate and door with transparent window; assembling costs included
	Assembly on electrical panel with transparent door and support terminal board; supplied with wiring diagram and certificate

## PRE-ASSEMBLED PANELS

In this section you can find some examples of STEIEL standard panels, for the analysis and control of the main chemical-physical parameters of the water: pH, ORP, temperature, electrical and inductive conductivity, disinfectant concentration (chlorine and chlorine dioxide), turbidity.

Customized solutions are also available upon request.

ITEM	DESCRIPTION	PART NO.
	<b>PNL-pH</b> High density expanded PVC panel (650x290 mm), with S507-pH/RX/T unit, SF78E2 probe-holder, EURO2010-pH glass pH electrode, CAV0 electrode cable; assembling, testing and packaging costs included	S25070533
	<b>PNL-RX</b> High density expanded PVC panel (650x290 mm), with S507-pH/RX/T unit, SF78E2 probe-holder, EURO2110-RX/Pt glass ORP electrode, CAV0 electrode cable; assembling, testing and packaging costs included	S25080533
	<b>PNL Conductivity (CCK5)</b> High density expanded PVC panel (650x290 mm), S507-CO unit, SF78M/CCK probe-holder, CCK5T-PT100 cell; assembling, testing and packaging costs included	S25040438
	<b>PNL Conductivity (CCK1)</b> High density expanded PVC panel (650x290 mm), S507-CO unit, SF78M/CCK probe-holder, CCK1GT-PT100 cell; assembling, testing and packaging costs included	S25040538
	<b>PNL Conductivity (CMK)</b> High density expanded PVC panel (500x600 mm), with S507-IN unit, SF78M/CMK probe-holder, CMK50 cell, CT-01S signal converter ( <b>range to be specified upon order</b> ); assembly, test and packaging included	
	<b>PNL Chlorine CLE12 (1 ppm)</b> High density expanded PVC panel (500x600 mm), with S507-ACL unit, PF17 filter-holder with mesh cartridge, CLE12/2019 cell, PNP flow sensor, PT100 temperature probe, installation kit (Kit B); assembly, test and packaging included	S35013158
	<b>PNL Chlorine CLE12 (1 ppm) with pump</b> High density expanded PVC panel (500x600 mm), with S507-ACL unit, PF17 filter-holder with mesh cartridge, CLE12/2019 cell, PNP flow sensor, PT100 temperature probe, PSP161-PKT/AS 0510 dosing pump, SMP18 mounting bracket, installation kit (Kit B); assembly, test and packaging included	S35013158020

ITEM	DESCRIPTION	PART NO.
	<p><b>PNL Chlorine CLE16 (1 ppm)</b> High density expanded PVC panel (500x600 mm), PSP163B-PKT/AS 0510 pump with built-in chlorine meter, SMP18 mounting bracket, PF17 filter-holder with mesh cartridge, SD-P1 down-flow probe-holder, NPN flow sensor, CLE16 chlorine cell, installation kit (Kit B); assembly, test and packaging included</p>	S37994064B3
	<p><b>PNL Chlorine / PNL-ClO<sub>2</sub> (2 ppm) - cold water</b> High density expanded PVC panel (500x600 mm), with S507-CAC CLB unit, measurement cell (<b>chlorine: CAC-CLI-B / chlorine dioxide: CAC-CDX-B</b>), SD-CAC1 probe-holder, PNP flow sensor, PT100 probe, PF17 filter-holder with mesh cartridge, installation kit (Kit B); assembly, test and packaging included</p>	S35010359 (Cloro)
	<p><b>PNL Chlorine / PNL-ClO<sub>2</sub> (2 ppm) - cold water</b> High density expanded PVC panel (595x750 mm), with S507-CAC CLB unit, measurement cell (<b>chlorine: CAC-CLI-B / chlorine dioxide: CAC-CDX-B</b>), SD-CAC1 probe-holder, PNP flow sensor, PT100 probe, PF17 filter-holder with mesh cartridge, PSP161-PKT/AS 0510 pump, SMP18 mounting bracket, installation kit (Kit B); assembly, test and packaging included</p>	S35010359020 (Cloro)
	<p><b>PNL Chlorine + ClO<sub>2</sub> (2 ppm) - hot water</b> High density expanded PVC panel (750x595 mm), with S507-CAC CLB unit, CAC-HT-B cell, SD-CAC1 probe-holder, PNP flow sensor, PT100 probe, PF16-HT filter-holder with steel cartridge, PSP161-PKT/AS 0510 pump, SMP18 mounting bracket, circulation pump, installation kit (Kit B/HT); assembly, test and packaging included</p>	S65013068020 (Cloro)
	<p><b>PNL-TURB 0-100 NTU</b> High density expanded PVC panel (500x600 mm), with S507-TU unit, CTS07-SS cell with pre-amplifier, ATS96 automatic cleaning group; assembly, test and packaging included</p> <p><b>PNL-TURB 0-500 NTU</b> High density expanded PVC panel (500x600 mm), with S507-TU unit, CTS07-FS cell with pre-amplifier, ATS96 automatic cleaning group; assembly, test and packaging included</p>	S2503011
		S2503021

## MATRIX Series - DOSING SKIDS (MDS)

The MATRIX series skids are a professional and extremely versatile solution for the installation of chemicals dosing stations. They are built following reliability and safety standards, supplied with conformity certificate and technical file complete with mechanical and electrical diagrams.

They are typically used for the reagent dosage in cooling towers, for the legionella control in DHW circuits, for the sanitation with oxidants and, in general, for the treatment of potable, process or waste waters.

- **Fast and safe installation**, thanks to the **Plug & Play** configuration
- Installation **compliant with regulations, guaranteed** by the manufacturer
- **Error-free** electrical wiring and accessories installation
- **Conduction safety** for the operator, **environmentally safe** chemicals storage
- Pumps and instrument provided **already configured according to the requested control logic**
- Guaranteed for indoor installation or in a protected area (e.g. under shed)
- Metering lines in PVC, PVCC, PP, PVDF, depending on the chemical to be dosed
- **PROXIMA PSP** series dosing pumps, flow rate from 2 to 32 l/h, PVDF dosing head, fully configurable
- **IP65 electrical panel**
- Power supply 115 or 230 V~
- Versions with two separated metering lines or double dosage of the same product, with optional standby pump with automatic start
- The standard skid is made of **heat-sealed polypropylene sheet**, provided with electrical control panel or connection box for electrical commands; can include a measurement instrument for driving a dosing pump
- Can include only the pumps section, or pumps with electrical panel and instrument, also mounted on a **painted metallic frame** equipped with wheels and support base for reagent tanks
- The skid can be supplied **with or without front door**, with removable protection shield or with double door
- **Compartment for chemicals, safety container against** accidental spills in the environment (also available with drain valve), product **leakage alert**
- Suction from tank, internal tank (50L) or external equipped with suction lance with level probe; metering line complete with flow meter, dosing points and static mixer
- Available **standard accessories**: calibration cylinder, degassing tool, water and air washing line, delivery safety valve, anti-siphon valve, injection flow control device, drainage of the washing line
- Other **accessories on request**: LED lights, heating of the storage compartment, alarm light tower, GSM remote control, emergency push-button

Contact STEIEL for specific evaluations and for choosing the configuration which better fits to your application needs.





## AUTOMATIC BLEEDING SYSTEMS FOR COOLING TOWERS

- Complete systems including conductivity controller, conductivity cell, motorized valve and hydraulic kit, with or without dosing pump
- Economic version with pump with built-in conductivity meter and specific software, conductivity cell, solenoid valve and hydraulic kit
- Versions available with different sizes for hydraulic kit
- Standard cell with K=1 and range 20 mS/cm
- Power supply standard: 230 V~



Panel with PSP161



Panel with EF161



Panel with two PSP161 pumps



Cabinet without pump

ITEM	DESCRIPTION	PART NO.
STANDARD PANEL with PSP161	PP panel (495x660 mm) with S506 unit, PSP161-PKT 0510 pump, CCK1GT-PT100 cell, motorized valve and 1" hydraulic kit	S24040503018
STANDARD PANEL with two PSP161	PP panel (900x700 mm) with S506 unit, two PSP161-PKT/AS 0510 pumps, CCK1GT-PT100 cell, motorized valve and 1" hydraulic kit	S24040503018018
STANDARD PANEL with EF161	PP panel (495x660 mm) with S506 unit, EF161-PGV 0506 pump, CCK1GT-PT100 cell, motorized valve and 1" hydraulic kit	S24040503004
STANDARD PANEL without pump	PP panel (495x660 mm) with S506 unit, CCK1GT-PT100 cell, motorized valve and 1" hydraulic kit	S24040503
STD CABINET without pump	Fiberglass cabinet (805x615x315 mm), door with transparent window and galvanized steel mounting plate; with S506 unit, CCK1GT-PT100 cell, motorized valve and 1" hydraulic kit	S04040503
ECO PANEL with EF164 EVO	Expanded PVC panel (500x600 mm) with EF164E-PGV 0506 pump with built-in conductivity meter and SW for automatic bleeding, CCK1G cell, solenoid valve and 3/4" hydraulic kit	S2796060237
S506	Conductivity controller with SW for automatic bleeding of cooling towers	80250001
EV STD/PVC	Spare 1" PVC motorized valve, glued assembly type, for standard panels and cabinets	54500264
EV STD	Spare 1" brass motorized valve for standard panels, <b>for productions until January 2020</b>	54500255
EV ECO	Spare solenoid valve for ECO panels	54500259
CCK1GT-PT100	Conductivity cell with PTFE body, K=1, built-in PT100 sensor - spare cell for standard panels	80290003
CCK1G-5S / M8	Conductivity cell with PVC body, K=1 - spare cell for ECO panels	80290045

*Panels with different power supply and 2" hydraulic kit are also available on request.*

## ANTI-LEGIONELLA SYSTEMS

Ready-to-use stations for dosing and / or monitoring filming products and disinfectants in circuits for sanitary hot water treatment.

These systems are suitable for the use of formulations commonly found in the market; it is anyway advisable to contact our technical department before proceeding with the order.

See next pages for info about chlorine dioxide generators.

BASIC SYSTEM





Tank with PSP161 dosing pump and suction lance; to be used with a volumetric water meter.

PROFESSIONAL SYSTEM



Panel designed for the constant monitoring and continuous disinfection of water.

Complete with an electronic unit that measures the oxidant (disinfectant) concentration, and triggers a PSP161 pump for the accurate dosing of a bactericide agent, proportional to reading. Two more PSP161 pumps dose a filming product and a bactericide, respectively, proportionally to the signal of a pulse-emitting water meter. Options: recirculation pump and remote control system with RW14.

ITEM	DESCRIPTION	PART NO.
BASIC System	100 L tank, PSP161-PKT AS 0510 dosing pump, suction lance with PTFE ball valve and built-in level sensor	8900214514/PKT-AS
PRO System, ClO <sub>2</sub>	Pre-assembled panel (900x700 mm) including S507-CAC unit (for ClO <sub>2</sub> or chlorine monitoring), two PSP161-PKT AS 0510 pumps for bactericide dosing, one PSP161-PKT 0510 for filming agent dosing, CAC-HT-B cell and PT100 sensor, probe-holder with flow sensor, mesh filter for hot water and connection box with integrated signal splitter; recirculation pump and RW14 not included	S650930990182222
PRO System, Chlorine	Pre-assembled panel (900x700 mm) including S507-CAC unit (for ClO <sub>2</sub> or chlorine monitoring), two PSP161-PKT AS 0510 pumps for bactericide dosing, one PSP161-PKT 0510 for filming agent dosing, CAC-HT-B cell and PT100 sensor, probe-holder with flow sensor, mesh filter for hot water and connection box with integrated signal splitter; recirculation pump and RW14 not included	S650130990182222
	Brass electro-pump with stainless steel and carbon rotor group, for recovery of sampling line hot water (max 65 °C); flow rate max 1 m <sup>3</sup> /h, pressure max 3 m	94100001
	Pre-assembled panel for recovery of sampling line water; resistant to high temperature of sanitary hot water recirculation plants (max 95 °C); complete with circulation pump; flow rate max 3.4 m <sup>3</sup> /h; pressure max 6 m	Version with filter 80509089 Version without filter 80509088
Black polyethylene (LLDPE) tank, 50 litres		
Black polyethylene (LLDPE) tank, 100 litres		
CRM-012	Pulse-emitting water meter, multi-jet, cold water, 1/2" fittings	94000101
CRM-034	Pulse-emitting water meter, multi-jet, cold water, 3/4" fittings	94000111
CRM-100	Pulse-emitting water meter, multi-jet, cold water, 1" fittings	94000121
CRM-112	Pulse-emitting water meter, multi-jet, cold water, 1.1/2" fittings	94000141

## BG08 - CHLORINE DIOXIDE GENERATORS



Generator with built-in measurement system and two external dosing pumps



Protection shield for the hydraulic part, which allows easy operation on the PLC



Generator mounted on a self-supporting metallic skid

- “In situ” production of chlorine dioxide in aqueous solution, through an acidification process of chlorite
- **PLC unit** with multi-language touch-screen display for the simplified full management of the generator
- Optional measurement system, for readings in cold or hot water
- **Input for gas sensor included;** gas detector to be ordered separately
- **Multipoint** proportional **dosage** with up to three injection points
- Electronic-free dosing pumps, controlled by the PLC unit
- Manual priming function for pumps maintenance and calibration
- Safety controls: level sensors, flow meters and gas detector of chlorine dioxide in air
- Remote **control and management of the PLC** through Internet, included
- Production rate from 4 to 10, 20 or 40 g/h  $\text{ClO}_2$  (depending on model)
- Power supply: 230 V~ (standard), 115 V~

### BG08 GENERATORS

BG08, 10 g/h, with accumulation tank and 1 external dosing pump

BG08, 20 g/h, with accumulation tank and 1 external dosing pump

BG08, 40 g/h, with accumulation tank and 1 external dosing pump

Additional external dosing pump (up to 3 external pumps in total)

Optional S508 unit, CAC-CDX-B cell and probe holder

Optional S508 unit, CAC-HT-B cell (hot water), PT100 sensor and probe-holder with installation kit for hot water (kit B/HT)

## INSTRUMENTS FOR INDUSTRIAL APPLICATIONS

ACCESSORIES AND SPARE PARTS FOR BG08 GENERATORS	PART NO.
Suction lance with level sensor, for 50 L tank, red pipe (acid)	77020040
Suction lance with level sensor, for 50 L tank, blue pipe (chlorite)	77020041
Suction lance with level sensor, for 100 L tank, red pipe (acid)	80509100
Suction lance with level sensor, for 100 L tank, blue pipe (chlorite)	80509101
Suction lance with level sensor, for 300 L tank, red pipe (acid)	80509104
Suction lance with level sensor, for 300 L tank, blue pipe (chlorite)	80509105
Safety / drip vessel for 25 L reagent tank, red	36000080
Safety / drip vessel for 25 L reagent tank, blue	36000081
Flow control with PNP sensor and cable, model for reagent pumps	94831110
Spare hydraulic part for reagent pump flow control	94831100
Flow control with PNP sensor and cable, model for water pump	94851010
Spare hydraulic part for water pump flow control	94851000
Float valve	80509115
Toxic gas detector for chlorine dioxide in air	80509196
Graduated plastic cylinder (500 ml) for pump calibration	35999120
Spare carbons for tank filter, 120 g pack	80509112
Complete spare pump for reagent dosage or external pump	95700417
Spare dosing head for reagent and external pumps	97000276
Complete spare pump for water dosage	95702005
Spare reactor bottom valve, for injection of reagents and water	97000181
O-ring for reactor bottom valve	37030106
Spare outlet fitting for accumulation tank	97000161
Kit for 2018 upgrading of generators with two external pumps	80509122
Kit for periodic maintenance of generators with 1 external pump	80509123
Kit for periodic maintenance of generators with 2 external pumps	80509124
Kit for periodic maintenance of generators with 3 external pumps	80509125
SHP01/CLO2 Plus - Portable photometer for chlorine dioxide analysis	88000038
DPD reagent for analyses with SHP01/CLO2 Plus photometer, 50 tablet pack	87000052
DPD reagent for analyses with SHP01/CLO2 Plus photometer, 250 tablet pack	87010052
Glycine reagent for analyses with SHP01/CLO2 Plus photometer, 250 tablet pack	87020007
PF17 - Filter-holder for cold water (up to 50°C), with 80 µm mesh cartridge	80710026
PF16-HT - Filter-holder for hot water (up to 80°C), with 50 µm mesh cartridge	80710030
PTFE hose, 4x6 mm, 100 m skein, sold by meter	36506003
Spare membrane-cap for CAC-CDX-B cell (CAC-ME-2, transparent)	80611002
Spare electrolyte for CAC-CDX-B cell (CAC-EL-5), 100 ml	80611025
Spare electrolyte for CAC-HT-B cell (CAC-EL-HT), 100 ml	80612005
Plexiglas protective shield for BG08 generators	80509116
Face mask for protection from toxic gases with filter for ClO <sub>2</sub>	80509113
Painted metallic skid for BG08 installation, equipped with wheels and support base for reagent tanks	70201007

## pH and ORP ELECTRODES

### EURO2010-PH AND EURO2110-RX SERIES

- **Combined electrodes for industrial applications**
- Glass body, dia. 12 mm
- Gel or liquid (only for refillable model) electrolyte
- pH electrodes: range 0...14 pH, minimum conductivity of sample 50  $\mu\text{S}/\text{cm}$
- ORP electrodes: range  $\pm 2000$  mV



#### pH Electrodes

ITEM	MEMBRANE	CONNECTION (THREAD)	NOTES	WORKING TEMPERATURE	PRESSURE MAX.	PART NO.
EURO2005-pH	Glass S	Double (S8)	Single ceramic diaphragm, plastic body	0 ... 80 °C	8 bar	80092005
EURO2010-pH	Glass S	Single (S7)	Single ceramic diaphragm	0 ... 80 °C	6 bar	80092010
EURO2015-pH	Glass S	Double (S8)	Single ceramic diaphragm	0 ... 80 °C	6 bar	80092015
EURO2025-pH (*)	Glass S	Double (S8)	Refillable electrode with liquid electrolyte, ground diaphragm, suitable for measurements in conditions of low conductivity (0.2 $\mu\text{S}/\text{cm}$ )	-10 ... 50 °C	Ambiente	80092025
EURO2050-pH	Glass HA	Single (S7)	Triple ceramic diaphragm and salt bridge	0 ... 120 °C	6 bar	80092050
EURO2051-pH	Glass HA	Cable 5 m + tips	Triple ceramic diaphragm and salt bridge	0 ... 120 °C	6 bar	80092051
EURO2052-pH	Glass HA	Cable 5 m + BNC	Triple ceramic diaphragm and salt bridge	0 ... 120 °C	6 bar	80092052
EURO2055-pH	Glass HA	Double (S8)	Triple ceramic diaphragm and salt bridge	0 ... 120 °C	6 bar	80092055
EURO2065-pH	Glass HF resistant	Double (S8)	Single ceramic diaphragm, HF resistant glass body	0 ... 100 °C	6 bar	80092065
EURO2085-pH	Glass S	Single (S7)	Single ceramic diaphragm, electrolyte for solutions at pH > 12.5	0 ... 80 °C	6 bar	80092085

(\*) For the refilling kit, please see the "Solutions" section at page 27.



#### ORP Electrodes

ITEM	SENSOR	CONNECTION (THREAD)	NOTES	WORKING TEMPERATURE	PRESSURE MAX.	PART NO.
EURO2105-RX	Platinum	Double (S8)	Single ceramic diaphragm, plastic body	0 ... 80 °C	8 bar	80192105
EURO2110-RX	Platinum	Single (S7)	Single ceramic diaphragm	0 ... 80 °C	6 bar	80192110
EURO2120-RX	Gold	Single (S7)	Single ceramic diaphragm, suitable for measurements in the presence of salt electrolysis	0 ... 80 °C	6 bar	80192120
EURO2115-RX	Platinum	Double (S8)	Single ceramic diaphragm	0 ... 80 °C	6 bar	80192115
EURO2125-RX	Gold	Double (S8)	Single ceramic diaphragm, suitable for measurements in the presence of salt electrolysis	0 ... 80 °C	6 bar	80192125
EURO2150-RX	Platinum	Single (S7)	Triple ceramic diaphragm and salt bridge	0 ... 120 °C	6 bar	80192150
EURO2151-RX	Platinum	Cable 5 m + tips	Triple ceramic diaphragm and salt bridge	0 ... 120 °C	6 bar	80192151
EURO2155-RX	Platinum	Double (S8)	Triple ceramic diaphragm and salt bridge	0 ... 120 °C	6 bar	80192155
EURO2160-RX	Gold	Single (S7)	Triple ceramic diaphragm, suitable for measurements in the presence of salt electrolysis	0 ... 120 °C	6 bar	80192160
EURO2165-RX	Platinum	Double (S8)	Single ceramic diaphragm, HF resistant glass body	0 ... 100 °C	6 bar	80192065





## CABLES AND CONNECTORS FOR pH and ORP ELECTRODES

High Quality (HQ) coaxial cables, dia. 5 mm, for industrial electrodes, EURO2010-PH and EURO2110-RX series.

ITEM		LENGTH	CONNECTORS	PART NO.
	CAV0	65 cm	S7 screw + tips	80099010
	CAV1	1.2 m	S7 screw + tips	80099011
	CAV3	3 m	S7 screw + tips	80099013
	CAV5	5 m	S7 screw + tips	80099014
	CAV10	10 m	S7 screw + tips	80099015
	CAV15	15 m	S7 screw + tips	80099016
	CAV20	20 m	S7 screw + tips	80099017
	CAV30	30 m	S7 screw + tips	80099018
	CAV50	50 m	S7 screw + tips	80099019
	BNC/CV0	65 cm	S7 screw + BNC	80099000
	BNC/CV1	1 m	S7 screw + BNC	80099001
	BNC/CV2	2 m	S7 screw + BNC	80099002
	BNC/CV3	3 m	S7 screw + BNC	80099003
	BNC/CV5	5 m	S7 screw + BNC	80099004
	BNC/CV10	10 m	S7 screw + BNC	80099005
	BNC/CV15	15 m	S7 screw + BNC	80099006
	BNC/CV20	20 m	S7 screw + BNC	80099007

**Notes:**

- To avoid interferences in the signal transmission, use cables with a maximum length of 20 meters; for longer distances, we recommend the insertion of an SG18 pre-amplifier (see page 6).
- **Cables with tips:** use for connect the sensor to the S503, S504, S507, S508, MC14, EF214 instruments.
- **Cables with BNC:** use for connection to the pool controllers (series EF250, EF260, EF300, EF315, EF117) and dosing pumps with built-in pH/ORP meter (PSP162, EF162 EVO, EF158, EF110).

ITEM		DESCRIPTION	PART NO.
	CV5	S7 screw connector for industrial electrodes with cable dia. 5 mm	51300501
	BNC/M	Male BNC connector	51300005

## pH and ORP ELECTRODES

### EURO2000-PH AND EURO2100-RX SERIES

- **Combined electrodes for swimming pools**
- Shockproof, plastic body, dia. 12 mm
- Gel electrolyte KCl 3M
- pH electrodes: range 0...14 pH, minimum conductivity of sample 50  $\mu\text{S}/\text{cm}$
- ORP electrodes: range  $\pm 2000$  mV



#### Elettrodi pH

ITEM	MEMBRANE	CABLE / CONNECTOR		NOTES	WORKING TEMPERATURE	PRESSURE MAX.	PART NO.
EURO2000-pH	Glass S	1 m	BNC	Single ceramic diaphragm	0 ... 80 °C	8 bar	80092000
EURO2224-pH	Glass S	1 m	Tips	Single ceramic diaphragm	0 ... 80 °C	8 bar	80092224
EURO2221-pH	Glass S	2,5 m	BNC	Single ceramic diaphragm	0 ... 80 °C	8 bar	80092221
EURO2214-pH	Glass S	2,5 m	Tips	Single ceramic diaphragm	0 ... 80 °C	8 bar	80092214
EURO2002-pH	Glass S	5 m	BNC	Single ceramic diaphragm	0 ... 80 °C	8 bar	80092002
EURO2216-pH	Glass S	5 m	Tips	Single ceramic diaphragm	0 ... 80 °C	8 bar	80092216
EURO2206-pH	Glass S	5 m	BNC	Single ceramic diaphragm, green gel, horizontal installation	0 ... 50 °C	2 bar	80092206
EURO2001-pH	Glass S	10 m	BNC	Single ceramic diaphragm	0 ... 80 °C	8 bar	80092001

#### Elettrodi Redox

ITEM	SENSOR	CABLE / CONNECTOR		NOTES	WORKING TEMPERATURE	PRESSURE MAX.	PART NO.
EURO2100-RX	Platinum	1 m	BNC	Single ceramic diaphragm	0 ... 80 °C	8 bar	80192100
EURO2224-RX	Platinum	1 m	Tips	Single ceramic diaphragm	0 ... 80 °C	8 bar	80192224
EURO2221-RX	Platinum	2,5 m	BNC	Single ceramic diaphragm	0 ... 80 °C	8 bar	80192221
EURO2214-RX	Platinum	2,5 m	Tips	Single ceramic diaphragm	0 ... 80 °C	8 bar	80192214
EURO2191-RX	Gold	2,5 m	BNC	Single ceramic diaphragm, suitable for use in the presence of salt electrolysis	0 ... 80 °C	8 bar	80192191
EURO2102-RX	Platinum	5 m	BNC	Single ceramic diaphragm	0 ... 80 °C	8 bar	80192102
EURO2238-RX	Platinum	5 m	Tips	Single ceramic diaphragm	0 ... 80 °C	8 bar	80192238
EURO2206-RX	Platinum	5 m	BNC	Single ceramic diaphragm, horizontal installation	0 ... 50 °C	2 bar	80192206
EURO2101-RX	Platinum	10 m	BNC	Single ceramic diaphragm	0 ... 80 °C	8 bar	80192101

## CONDUCTIVITY CELLS

### CCK SERIES

- Two-electrode cells, with shielded cable (resin-bonded to the cell)
- Models with threaded body for direct in-line installation
- Models with stem body for industrial applications, also available with connector for use with portable meter
- Models with M8 connector for PSP164 and EF164 EVO pumps



ITEM	CELL CONSTANT K	RANGE	BODY	ELECTRODES	TEMP. SENSOR	TEMPERATURE / PRESSURE MAX.	CABLE **	PART NO.
CCK1G-5S	1 cm	20 mS/cm	PVC, ½" GAS	Graphite	-	45°C / 5 bar	5 m	80290001
	1 cm	20 mS/cm	PVC, ½" GAS	Graphite	-	45°C / 5 bar	5 m + M8	80290045
CCK1G-10S	1 cm	20 mS/cm	PVC, ½" GAS	Graphite	-	45°C / 5 bar	10 m	80290006
CCK1GT-PT100	1 cm	20 mS/cm	PTFE, ½" GAS	Graphite	PT100	130°C / 3 bar	5 m	80290003
CCK1GT-NTC	1 cm	20 mS/cm	PTFE, ½" GAS	Graphite	NTC10K	130°C / 3 bar	5 m	80290002
	1 cm	20 mS/cm	PTFE, ½" GAS	Graphite	NTC10K	130°C / 3 bar	5 m + M8	80290052
CCK5	5 cm	2000 µS/cm	PVC, ½" GAS	AISI316	-	45°C / 5 bar	2.5 m *	80290005
CCK5-5S	5 cm	2000 µS/cm	PVC, ½" GAS	AISI316	-	45°C / 5 bar	5 m	80290107
	5 cm	2000 µS/cm	PVC, ½" GAS	AISI316	-	45°C / 5 bar	5 m + M8	80290114
CCK5-10S	5 cm	2000 µS/cm	PVC, ½" GAS	AISI316	-	45°C / 5 bar	10 m	80290106
CCK5T-PT100	5 cm	2000 µS/cm	PTFE, ½" GAS	AISI316	PT100	130°C / 3 bar	5 m	80290009
CCK5T-NTC	5 cm	2000 µS/cm	PTFE, ½" GAS	AISI316	NTC10K	130°C / 3 bar	5 m	80290010
	5 cm	2000 µS/cm	PTFE, ½" GAS	AISI316	NTC10K	130°C / 3 bar	5 m + M8	80290097
CCK0,1J	0,1 cm	200 mS/cm	Glass stem, dia. 12 mm	Platinum	-	100°C / 2 bar	5 m	80291000
CCK1J	1 cm	20 mS/cm	Glass stem, dia. 12 mm	Platinum	-	100°C / 2 bar	5 m	80291001
CCK10J	10 cm	2000 µS/cm	Glass stem, dia. 12 mm	Platinum	-	100°C / 2 bar	5 m	80291010
<b>For portable meters</b>								
CCK0,1P	0.1 cm	200 mS/cm	Glass stem, dia. 12 mm	Platinum	PT1000	60°C / 2 bar	1.5 m + conn.	80291300
CCK1P	1 cm	20 mS/cm	Glass stem, dia. 12 mm	Platinum	PT1000	60°C / 2 bar	1.5 m + conn.	80291301
CCK10P	10 cm	2000 µS/cm	Glass stem, dia. 12 mm	Platinum	PT1000	60°C / 2 bar	1.5 m + conn.	80291302

\* Unshielded cable

\*\* If your installation needs a cable longer than the standard one, please contact STEIEL for a specific evaluation. Extending the cell cable can affect measurement and it is not advisable.

## CONDUCTIVITY CELLS

### CMK SERIES FOR INDUCTIVE MEASUREMENTS

- Conductivity measurement with inductive method, up to 500 mS/cm
- Built-in temperature sensor, automatic temperature compensation
- Standard cable length 10 m
- Immersion installation or in down-flow probe-holder
- In-line mounting with special accessories (PP or steel)
- To be used together with special signal transmitter, available with watertight casing for wall installation or with support for mounting on DIN slot, 4-20 mA output, different options for power supply voltage and full scale values



ITEM	DESCRIPTION	PART NO.
CMK50	Inductive conductivity cell with thread for installation in probe-holder, cable 10 m	80280000
CMK-AS	AISI304 stainless steel fitting, DN50, for in-line installation	80280010
CMK-ADAS	Adapter for mounting the CMK50 cell on CMK-AS	80280020
CMK-PP	PP fitting, DN50, for in-line installation	80280011
CMK-ADPP	Adapter for mounting the CMK50 cell on CMK-PP	80280021
CTI-01 (installation on DIN slot)	Signal transmitter, 230 V~, 4-20 mA output, adjustable range up to 10, 20 or 50 mS/cm	80282010
	Signal transmitter, 230 V~, 4-20 mA output, range up to 100 mS/cm	80282015
	Signal transmitter, 230 V~, 4-20 mA output, range up to 200 mS/cm	80282016
	Signal transmitter, 230 V~, 4-20 mA output, range up to 500 mS/cm	80282017
CTI-01/S (watertight casing, wall installation)	Signal transmitter, 230 V~, 4-20 mA output, range up to 5 mS/cm	80281010
	Signal transmitter, 230 V~, 4-20 mA output, range up to 10 mS/cm	80281011
	Signal transmitter, 230 V~, 4-20 mA output, range up to 20 mS/cm	80281012
	Signal transmitter, 230 V~, 4-20 mA output, range up to 50 mS/cm	80281013
	Signal transmitter, 230 V~, 4-20 mA output, range up to 100 mS/cm	80281015
	Signal transmitter, 230 V~, 4-20 mA output, range up to 200 mS/cm	80281016
	Signal transmitter, 230 V~, 4-20 mA output, range up to 500 mS/cm	80281017

Upon request, transmitters are also available with 24 V ac/dc power supply.

## CLE CELL SERIES

### CLE12, OPEN AMPEROMETRIC CELL

- Measurement of free chlorine, bromine and chlorine dioxide
- Two-electrode cell, copper and platinum (Cu/Pt), with anti-passivation system
- Reading up to 2 ppm, or 5 ppm with saturation error
- Cell assembled in down-flow probe-holder, with flow regulator and housings for two sensors dia. 12 mm, flow and PT100 sensors
- Probe-holder with methacrylate body, connections for hose 6x8 mm and sampling valve
- Working temperature: max 40 °C
- Supplied with installation kit (Kit B)

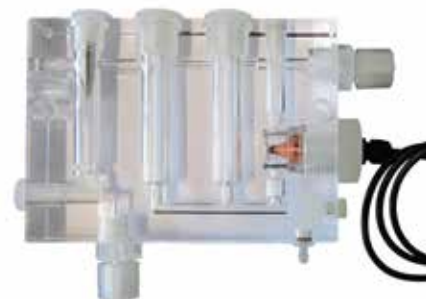

ITEM	DESCRIPTION	PART NO.
CLE12/2019	Open amperometric cell for measurement of chlorine (bromine and chlorine dioxide) in water, with housings for PT100 probe, flow sensor and two electrodes dia. 12 mm	80610130
CLE11	Open amperometric cell for measurement of chlorine (bromine and chlorine dioxide) in water, with housings for PT100 probe and flow sensor	80610140
CLE12-SENS	Spare Cu/Pt electrode group for CLE12, with 1 m cable	80610115
	Spare Cu/Pt electrode group for CLE12, with 2,5 m cable; spare part for BG08 generators	80610116
Option for cells or electrode group: M8 connector, for use with PSP163 and EF163 EVO		
Kit-sfera/CLE	Kit of Pyrex balls (spare part)	80610110
Kit elettrodo	Kit of rings and seals for the installation of one sensor dia. 12 mm	80610265
Spare methacrylate body for CLE12/2019 cell, with PP fittings and flow regulator		80610132
Kit flow	Flow control kit for CLE12 and SD probe-holder series	80610114
Kit grounding	Grounding kit for CLE12 and SD probe-holder series	80610111
Kit B	Installation kit, including 2 PVC valves M/F ½", 2 PP fittings with ½" threaded nut, PE hose 6x8 mm (5 m)	80509915

### CLE16, OPEN AMPEROMETRIC CELL

- Measurement of free chlorine, bromine and chlorine dioxide
- Three-electrode cell, stem dia. 12 mm
- Fixed cable, 1 m
- Measurement range: 0-5 ppm
- Working conditions: temperature max 45 °C, pressure max 3 bar, range pH 5-9
- Suitable to measurement in potable water and swimming pool, even in presence of electrolysis process



ITEM	DESCRIPTION	PART NO.
CLE16	Three-electrode, open amperometric cell, cable 1 m	80610126
CLE16/M8	Three-electrode, open amperometric cell, cable 1 m with M8 connector	80610127



## CAC CELL SERIES

### CLOSED AMPEROMETRIC CELLS

- Full range of cells with ion-selective membrane for measurements of free chlorine (free / active, organic / available, total), chlorine dioxide, chlorite, bromine, hydrogen peroxide, ozone and peracetic acid
- Four-wire direct cable, standard length 1 m
- Conductivity of the sample (aqueous solution): 50 ... 10000  $\mu\text{S}/\text{cm}$
- Model for determining chlorine dioxide & chlorine in hot water (max 70)
- Spare parts: specific membrane-caps and electrolytes



CELL	ANALYSIS OF	RANGE (ppm)	RECOMMENDED USE	TEMPERATURE / PRESSURE MAX	CONNECTION	PART NO.
CAC-CLI-XB	Active chlorine	0.01-0.5	Cooling, industrial and potable water, or with high (constant) pH value	45 °C / 1 bar	Cable 1 m	80611100
CAC-CLI-B	Active chlorine	0.02-2.0		45 °C / 1 bar	Cable 1 m	80611101
CAC-CLI-SW	Active chlorine	0.1-10.0	Analysis in seawater	45 °C / 1 bar	Cable 1 m	80611103
CAC-CLI-M1	Active chlorine	0.2-20.0	Industrial, washing and waste water	45 °C / 1 bar	Cable 1 m	80611104
CAC-CLI-M2	Active chlorine	0.5-50.0		45 °C / 1 bar	Cable 1 m	80611105
CAC-CLI-A1	Active chlorine	1-100		45 °C / 1 bar	Cable 1 m	80611106
CAC-CLI-A2	Active chlorine	10-200		45 °C / 1 bar	Cable 1 m	80611107
CAC-CLO-B	Available chlorine	0.02-2.0		Swimming pool water treated with chlorine-organic disinfectants or "in situ" salt electrolysis	45 °C / 1 bar	Cable 1 m
CAC-CLO-M1	Available chlorine	0.1-10.0	45 °C / 1 bar		Cable 1 m	80611203
			45 °C / 1 bar		Cable 1 m + M8	80611283
CAC-CLO-M2	Available chlorine	0.2-20.0	45 °C / 1 bar		Cable 1 m	80611204
			45 °C / 1 bar	Cable 1 m + M8	80611284	
CAC-CTO-M1	Total chlorine	0.05-5.0	Potable, industrial and waste water	45 °C / 1 bar	Cable 1 m	80611302
CAC-CTO-M2	Total chlorine	0.1-10.0		45 °C / 1 bar	Cable 1 m	80611303
CAC-CDX-B	Chlorine dioxide	0.02-2.0	Chlorine dioxide in cold water	45 °C / 1 bar	Cable 1 m	80611401
					Cable 1 m + M8	80611481
CAC-BRO-M	Bromine (BCDMH)	0.1-10.0	Cooling water, pools and spas disinfected with organic-bromine-based products	45 °C / 1 bar	Cable 1 m	80611503
CAC-HYP-XB	Hydrogen peroxide	0.5-50.0	All types of water, even dirty or chemically contaminated	45 °C / 1 bar	Cable 1 m	80611605
CAC-HYP-B		2-200		45 °C / 1 bar	Cable 1 m	80611607
CAC-HYP-M		20-2000		45 °C / 1 bar	Cable 1 m	80611608
CAC-OX3-B	Ozone	0.02-2.0	Potable and pool water	45 °C / 1 bar	Cable 1 m	80611701
CAC-PAA-B	Peracetic acid	1-200	Aseptic filling for food use	45 °C / 1 bar	Cable 1 m	80611807
CAC-PAA-M		10-2000		45 °C / 1 bar	Cable 1 m	80611808

CELL	ANALYSIS OF	RANGE (ppm)	RECOMMENDED USE	TEMPERATURE / PRESSURE MAX	CONNECTION	PART NO.
CAC-CLT-XB	Chlorite	0.01-0.5	Potable and washing water	45 °C / 1 bar	Cable 1 m	80611900
CAC-CLT-B	Chlorite	0.02-2.0		45 °C / 1 bar	Cable 1 m	80611901
CAC-HT-B	Chlorine / ClO <sub>2</sub>	0.02-2.0	Disinfection of sanitary hot water	70 °C / 8 bar	Cable 1 m	80612101
					Cable 1 m + M8	80612181

**Spare membrane-caps and electrolytes**

ITEM	DESCRIPTION	SPARE PART FOR CELLS	PART NO.
CAC-EL-1	Spare electrolyte, 100 ml	CAC-CLI-XB, CAC-CLI-B, CAC-CLI-SW	80611021
CAC-EL-2	Spare electrolyte, 100 ml	CAC-CLI-M1, CAC-CLI-M2, CAC-CLI-A1, CAC-CLI-A2	80611022
CAC-EL-3	Spare electrolyte, 50 ml	CAC-CLO and CAC-CTO Series	80611023
CAC-EL-4	Spare electrolyte, 50 ml	CAC-BRO-M	80611024
CAC-EL-5	Spare electrolyte, 100 ml	CAC-CDX-B	80611025
CAC-EL-6	Spare electrolyte, 100 ml	CAC-OX3-B	80611026
CAC-EL-7	Spare electrolyte, 50 ml	CAC-HYP Series	80611027
CAC-EL-8	Spare electrolyte, 100 ml	CAC-PAA Series	80611028
CAC-EL-9	Spare electrolyte, 50 ml	CAC-CLT Series	80611029
CAC-EL-HT	Spare electrolyte, 100 ml	CAC-HT-B	80612005
CAC-ME-1	Membrane-cap, blue	CAC-CLI-XB, CAC-CLI-B, CAC-CLI-SW, CAC-CTO-XB, CAC-BRO-M	80611001
CAC-ME-2	Membrane-cap, transparent	CAC-CLI-M1, CAC-CLI-M2, CAC-CLI-A1, CAC-CDX-B, CAC-OX3-B	80611002
CAC-ME-3	Membrane-cap, white	CAC-CLI-A2, CAC-PAA Series	80611003
CAC-ME-4	Membrane-cap, orange	CAC-CLO and CAC-CTO Series	80611004
CAC-ME-5	Membrane-cap, grey	CAC-HYP Series	80611005
CAC-ME-6	Membrane-cap, black	CAC-CLT Series	80611006
Probe regeneration service, with new membrane-cap and electrolyte		All cells for analysis in cold water	
		CAC-HT cell	

## CP CELL SERIES

SPARE ELECTROLYTES AND MEMBRANE-CAPS (items available till stock lasts)

ITEM	DESCRIPTION	PART NO.
CP-CLI-RE	Electrolyte for CP-CLI cells, 100 ml bottle	80610232
CP-CLJ-RE	Electrolyte for CP-CLJ cells, 100 ml bottle	80610235
CP-CLO-RE	Electrolyte for CP-CLO cells, 100 ml bottle	80610231
CP-CTO-RE	Electrolyte for CP-CTO cells, 100 ml bottle	80610236
CP-BC1-RE	Electrolyte for CP-BC1 cells, 100 ml bottle	80610234
CP-X-HT-RE	Electrolyte for CP- x/HT cells, 50 ml bottle	80610230
CP-1-RM	Spare membrane-cap for CP-CLO and CP-CTO cells	80610241
CP-2-RM	Spare membrane-cap for CP-CLI and CP-BC1 cells	80610242
CP-4-RM	Spare membrane-cap for CP-CLJ cell	80610244
	Self-cleaning system for CP cell series	80610200

## TEMPERATURE SENSORS

- Series of temperature probes, of different materials and shapes
- Models with anti-acid Pyrex stem body, steel models, probes with threaded body for installation in probe-holder or in-line mounting
- Sensor PT100, PT1000 or NTC10K
- Welded cable



ITEM	DESCRIPTION	PART NO.	
PT100S	Probe Pt100, anti-acid Pyrex body, dia. 12 mm, cable 2 meters	80390001	
PT100S2	Probe Pt100, anti-acid Pyrex body, dia. 12 mm, double sensor, cable 5 meters	80390002	
PT100A	Probe Pt100, stainless steel, air measurements, with adjustable flange, dia. 8 x L 600 mm	80390005	
PT100I	Probe Pt100, stainless steel, dia. 8 mm, immersion installation, ½" GAS connection	80390003	
PT100P	Probe Pt100, stainless steel, dia. 8 mm, with pocket, immersion installation, ½" GAS connection	80390004	
PT101-CP1	Probe Pt100, threaded PP body, max working temperature 100°C	Cable 0.75 m	80390013
PT101-CP2		Cable 1.5 m	80390014
PT101-CP3		Cable 2.5 m	80390015
PT1000	Probe Pt1000 for SHP series of portable meters, AISI316 sleeve, dia. 4 x L 200 mm, with spiral cable	80390060	
NTC-S	Probe NTC-10K, anti-acid Pyrex body, dia. 12 mm	80390000	
NTC-I	Probe NTC-10K, stainless steel, dia. 8 mm, immersion installation, connection ½" GAS	80390029	

## TURBIDITY CELLS

- Turbidity cells compliant to the ISO7027 international standards
- SS (Side Scattering) and FS (Forward Scattering) models
- Complete system including cell and pre-amplifier, assembled on a panel
- Liquid inlet and outlet with ¼" GAS connection on 12 mm hose-holder
- Light source: high efficiency red LED
- Optional auto-cleaning system
- Signal output: 4-20 mA



ITEM	DESCRIPTION	PART NO.
CTS07-SS	Panel with turbidity cell, range up to 100.0 FTU (NTU)	85700040
CTS07-FS	Panel with turbidity cell, range up to 500.0 FTU	85700041
ATS96	Automatic cleaning system for cells 100 FTU and 500 FTU	85700035

## SOLUTIONS

- Full range of solutions for the calibration and periodic maintenance of sensors.



ITEM	90 ml BOTTLE	500 ml BOTTLE
	PART NO.	PART NO.
Buffer solution pH4	80090095	80090093
Buffer solution pH7	80090096	80090094
Buffer solution pH9	80090097	80090100
ORP solution 220 mV @ 25°C	80190091	80190090
Electrode storage solution	-	80090091
Solution 147 µS/cm @ 25°C	80290156	80290155
Solution 1409 µS/cm @ 25°C	80290154	80290153
Solution 12280 µS/cm @ 25°C	80290152	80290151
Turbidity solution 100 FTU	-	85700100
Turbidity solution 400 FTU	-	85700101
Turbidity solution 4000 FTU	-	85700102

**Note:** the turbidity standard solutions are formazine-based, with a shelf life of 1 month.

ITEM	PART NO.
KRE, Kit of solutions for cleaning and storage of pH & ORP electrodes	80099902
Kit refilling for refillable electrodes	Small bottle (empty)
	Hose, sold by meter
Electrolyte for refillable electrodes, 250 ml bottle	80090088

## PROBE-HOLDERS

### S92 / S94 SERIES, FOR IN-LINE INSTALLATION

- Probe-holders for direct in-line installation of one sensor



ITEM	MATERIAL	CONNECTION	PRESSURE MAX	TEMPERATURE MAX	PART NO.
S92/T	PP	½" GAS	2 bar	70 °C	80820005
S92/P	PVC with PVC protection	½" GAS	2 bar	45 °C	80820001
S94/I	Stainless steel	½" GAS	2 bar	120 °C	80820002
S92/PG13.5 PVC	PVC (ΔL=65 mm)	PG13.5 / 3/4" GAS	5 bar	45 °C	70100211
S92/PG13.5 PP	PP white (ΔL=65 mm)	PG13.5 / 3/4" GAS	5 bar	70 °C	70100311

ITEM	DESCRIPTION	PART NO.
Collar 50	DN50 clamp, to be used with S92 models with ½" connection	36307706
Collar 63	DN63 clamp, to be used with S92 models with ½" connection	36307707

### S86 SERIES, FOR IMMERSION INSTALLATION

- Probe-holders for immersion installation of one or two sensors
- External diameter 60 mm
- Models for CCK or CMK with ½" connection
- Adjustable flange



ITEM	MATERIAL	FLANGE MAX (mm)	SENSOR(S)	TEMPERATURE MAX	PART NO.
S86-60	PVC	710	1 x CCK o CMK	40 °C	80800004
S86-1000	PVC	1000	1 x CCK o CMK	40 °C	80800096
S86-60M	PP	710	1 x CCK o CMK	80 °C	80800010
S86-1000M	PP	1000	1 x CCK o CMK	80 °C	80800015
S86-61	PVC	710	1 x dia. 12 mm	40 °C	80800002
S86-1001	PVC	1000	1 x dia. 12 mm	40 °C	80800090
S86-1501	PVC	1500	1 x dia. 12 mm	40 °C	80800091
S86-62	PVC	710	2 x dia. 12 mm	40 °C	80800003
S86-1002	PVC	1000	2 x dia. 12 mm	40 °C	80800093
S86-1502	PVC	1500	2 x dia. 12 mm	40 °C	80800094
S86-61M	PP	710	1 x dia. 12 mm	80 °C	80800012
S86-1001M	PP	1000	1 x dia. 12 mm	80 °C	80800016
S86-62M	PP	710	2 x dia. 12 mm	80 °C	80800014
S86-1002M	PP	1000	2 x dia. 12 mm	80 °C	80800018

ITEM	PART NO.
Self-cleaning kit	80099900



## SF17 / SF78 SERIES, DOWN-FLOW MODELS WITH CUP

- Probe-holders for installation of one, two or three sensors
- Filter-holder for cold water and for hot water
- Supplied with mounting bracket, IN-OUT connections, and filtering cartridge (“PF” models only)
- Model SF17 supplied with installation kit (Kit B)



ITEM	MATERIAL	FITTINGS	SENSOR(S)	PRESSURE MAX	TEMPERATURE MAX	PART NO.
SF17	Transparent SAN	PP, for hose 6x8 mm	1 x dia. 12 mm	2 bar	50 °C	80810011
SF78E2	Polycarbonate	Hose-fitting 1/4"	2 x dia. 12 mm	2 bar	40 °C	80810003
SF78E3	Polycarbonate		3 x dia. 12 mm	2 bar	40 °C	80810004
SF78E/CCK	Polycarbonate		1 x CCK	2 bar	40 °C	80810005
SF78M3	PP		3 x dia. 12 mm	2 bar	80 °C	80810002
SF78M/CCK	PP	Hose-fitting 1/2"	1 x CCK	2 bar	80 °C	80810006
SF78M/CMK	PP		1 x CMK	2 bar	80 °C	80810000
PF17	Transparent SAN	PP, for hose 6x8 mm	-	8 bar	50 °C	80710026
PF16-HT	Polyamide	PP, for hose 6x8 mm	-	15 bar	80 °C	80710030



DESCRIPTION	PART NO.
Filtering PP cartridge with washable PA mesh, 80 µm, to be used with models SF17 / PF17	80710034
Transparent SAN cup, PP threaded head with brass inserts and NBR70 seals; spare part for SF17 / PF17	80710031
Mounting bracket for SF17 / PF17	80710032
Filtering cartridge with washable AISI304 mesh, 50 µm, to be used with model PF16-HT	80710025
Polyamide filter-holder cup; spare part for PF16-HT	80710021
Mounting bracket for PF16-HT	80710022
PP connection with O-ring for hose 6x8 mm; spare part for SF17 / PF17 / PF16-HT	97000164
Spare polycarbonate cup for SF78E series	33000010
Kit B: Installation kit, including 2 PVC valves M/F 1/2", 2 PP fittings with 1/2" threaded nut, PE hose 6x8 mm (5 m)	80509915
Kit B/HT: Installation kit, including 2 PP valves M/F 1/2", 2 PP fittings with 1/2" threaded nut, PE hose 6x8 mm (5 m); max 70 °C	80509916

## SD SERIES, DOWN-FLOW MODELS WITH METHACRYLATE BODY



- Models with housings for PT100 sensor, and micro-magnetic sensor for water flow control
- **PP fittings for hose 6x8 mm**
- Supplied with installation kit (Kit B)
- If the probe-holder is intended to be used with hot water (max 70 °C), you also need to buy two PP valves (part no. 36316592)



ITEM	SENSOR(S)		PRESSURE MAX	TEMPERATURE MAX	PART NO.
	MEASUREMENT	PT100 + FLOW			
SDE	2 x dia. 12 mm	-	2 bar	70 °C	80610258
SD-P1	1 x dia. 12 mm	x	2 bar	70 °C	80610270
SD-P2	2 x dia. 12 mm	x	2 bar	70 °C	80610272
SD-CAC1	1 x CAC	x	5 bar	70 °C	80610255
SD-CAC2	1 x CAC + 2 x dia. 12 mm	x	2 bar	70 °C	80610256
SD-CAC3	2 x CAC + 2 x dia. 12 mm	x	2 bar	70 °C	80610257

ITEM	DESCRIPTION	PART NO.
Kit electrode	Kit of threaded rings & seals for the installation of one sensor dia. 12 mm	80610265
Kit cell	Kit of threaded rings & seals for the installation of one CAC cell	80610264
Kit flow	 Flow control kit for CLE12 and SD probe-holder series	80610114
Kit grounding	 Grounding kit for CLE12 and SD probe-holder series	80610111
Kit B	 Installation kit, including 2 PVC valves M/F 1/2", 2 PP fittings with 1/2" threaded ring, PE hose 6x8 mm (5 m)	80509915
Kit B/HT		80509916
Valve HT	PP valve M/F 1/2", for hot water (max 70 °C)	36316592
Hose PE 6x8	PE hose, 6x8 mm, 100 m skein, <b>sold by meter</b>	36501008

FLOW SENSORS FOR PROBE-HOLDERS

ITEM	DESCRIPTION		PART NO.
IL-SF		“In-line” flow sensor	97009202
Flow control SDE		Flow sensor for SDE	97009203
		SDE electrode-holder with pre-assembled flow sensor; connections for hose 8x12 mm; supplied with installation kit (Kit B 8x12)	80610248
SD-SF/PNP		PNP flow-sensor for SD series and CLE12 probe-holders, for use with S507 / S508 / EF300 / EF315 instrument series	54500009
SD-SF/NPN		NPN flow-sensor for SD series and CLE12 probe-holders, for use with MC14 / EF214 instruments	54500010
SD-SF/NPN M8		NPN flow-sensor for SD series and CLE12 probe-holders, with M8 connector, for use with PROXIMA PSP / EF160 EVO pumps	80610000

## PORTABLE INSTRUMENTS

### SHP02 SERIES

- Portable digital instruments
- Manual or automatic temperature compensation
- Two-row alphanumeric LCD, with backlight
- Models for measurements of pH/redox/temperature and conductivity
- Supplied in hard carrying case, w/ measurement sensors & calibration solutions (pH/ORP only)
- Battery-powered (1 x 9V, included)



ITEM	DESCRIPTION	PART NO.
SHP02-pH/RX	pH/ORP meter supplied with plastic pH electrode, PT1000 probe and calibration solutions	S49070143
	pH/ORP meter supplied with plastic ORP electrode and calibration solution	S49080143
	pH/ORP meter supplied with plastic pH and ORP electrodes, PT1000 probe and calibration solutions	S49030343
	pH/ORP meter supplied with glass pH and ORP electrodes, PT1000 probe and calibration solutions	S49030243
SHP02-CO	Conductivity meter with adjustable cell constant and automatic /manual measurement range; with CCK0,1P cell (200 mS/cm)	S49041243
	Conductivity meter with adjustable cell constant and automatic /manual measurement range; with CCK1P cell (20 mS/cm)	S49041343
	Conductivity meter with adjustable cell constant and automatic /manual measurement range; with CCK10P cell (2000 μS/cm)	S49041443

### SHP01 PLUS SERIES

- Portable digital photometers
- Backlit LCD, automatic selection of wavelength
- IP67 protection, suitable to field use
- Supplied in hard carrying case, with plastic cuvettes, crushing rods and starting kit of reagents
- Battery-powered (2 x 1.5V AA, included), with automatic shut-down



ITEM	DESCRIPTION	PART NO.
SHP01/3 Plus	Analysis of free & total chlorine (0-5 ppm), pH (6.5-8.4 pH), cyanuric acid (2-200 ppm)	88000037
SHP01/6 Plus	Analysis of free & total chlorine (0-5 ppm), bromine (0-5 ppm), pH (6.5-8.4 pH), cyanuric acid (2-200 ppm), alkalinity (10-500 ppm with Alkaphot), calcium hardness (5-500 ppm with Calcicol)	88000050
SHP01/NH Plus	Analysis of ammonia	88000026
SHP01/CLO2 Plus	Analysis of chlorine dioxide (0-10 ppm), free and total chlorine (0-5 ppm)	88000038
SHP01/O3 Plus	Analysis of ozone in water (0-3 ppm)	88000036
SHP01/AS	Digital instrument for arsenic analysis	88000027
SHP01/TURB	Portable turbidity meter (0.01-1050 NTU)	88000025
CUV-RI-SHP01	Plastic cuvettes for SHP01 Plus photometers, 5 pcs.	88000042
Crush-kit	Crushing / stirring rods, 10 pcs.	87000001

## S7000 PLUS SERIES

- Portable digital photometers for professional use
- Backlit LCD, automatic selection of wavelength, several analysis methods and internal data log
- IP67 protection, suitable to field use
- Models with USB and Bluetooth SMART interfaces
- Supplied in hard carrying case, with glass cuvettes and crushing rods
- Battery-powered (3 x 1.5V AA, included), with automatic shut-down



ITEM	DESCRIPTION	PART NO.
S7009 Plus	Multi-parameter photometer for pools and spa, internal data log up to 100 tests, USB and Bluetooth SMART interfaces	88000032
S7025 Plus	Multi-parameter photometer for pools and spa, internal data log up to 1000 tests, USB and Bluetooth SMART interfaces	88000029
S7100 Plus	Multi-parameter photometer for analysing potable water, wastewater and process water; selectable measure unit	88000031
S7500 Plus	Multi-parameter photometer, internal data log up to 500 tests, USB and Bluetooth SMART interfaces, full range of analyses for wastewater and process water, up to 30 custom methods may be memorized	88000028
CUV-RI-G	Glass cuvettes for S7000 Plus photometers, 5 pcs.	88000040
Crush-kit	Crushing / stirring rods, 10 pcs.	87000001

## SHP EVO TESTING PLATFORM

- The next generation measurement, with patented technology of single-use sensors
- Multiparameter testing platform for the analysis of main disinfection parameters: chlorine dioxide, chlorine, chlorite and peracetic acid
- A sophisticated electrochemical technique which removes complexity for the user
- Reduced chance of errors for reliable and highly repeatable results
- Traceable data with integrated data log that can store up to 10'000 results
- No glassware required
- Electronic measurement not affected by ambient light, sample colour, turbidity or floating particles
- Supplied in soft carrying case including check standards, USB cable and international power adapter (sensors to be ordered separately)



ITEM	DESCRIPTION
SHP EVO	Multiparameter platform for chlorine dioxide, free & total chlorine, chlorite and peracetic acid analyses
Chlorine sensors - Low Range	Sensors for 100 analyses of free (10 ppm) & total (75 ppm) chlorine
	Sensors for 500 analyses of free (10 ppm) & total (75 ppm) chlorine
Chlorine sensors - High Range	Sensors for 100 analyses of free (25 ppm) & total (500 ppm) chlorine
	Sensors for 500 analyses of free (25 ppm) & total (500 ppm) chlorine
Chlorine dioxide & chlorite sensors	Sensors for 100 analyses of ClO <sub>2</sub> (50 ppm) & chlorite (50 ppm)
	Sensors for 500 analyses of ClO <sub>2</sub> (50 ppm) and chlorite (50 ppm)
Peracetic acid sensors	Sensors for 100 analyses of peracetic acid (2000 ppm)
	Sensors for 500 analyses of peracetic acid (2000 ppm)
Reagent 1 for chlorite analysis	
Reagent 2 for chlorite analysis	
Reagent glycine, to eliminate chlorine and copper interference in chlorine dioxide and chlorite analysis	



**TABLET REAGENTS FOR PHOTOMETERS**

PARAMETER	DESCRIPTION	50 TEST PACK	250 TEST PACK
		PART NO.	PART NO.
Alkalinity, total	Total alkalinity, 0-500 mg/l CaCO <sub>3</sub> (Alkaphot)	87000188	87010188
Alkalinity, M	Alkalinity M, 0-500 mg/l CaCO <sub>3</sub> (Alkaphot M)	87000250	87010250
Alkalinity, P	Alkalinity P, 0-500 mg/l CaCO <sub>3</sub> (Alkaphot P)	87000251	87010251
Aluminium	Aluminium, 0-0.5 mg/l Al	87000166	87010166
Ammonia	Ammonia, 0-1.0 mg/l N	87000152	87010152
Bromine	Bromine, 0-10.0 mg/l Br (free, total, combined)	87000060	87010060
Calcium hardness	Calcium hardness, 0-500 mg/l CaCO <sub>3</sub> (Calcicol)	87000252	87010252
Chloride	Chloride, 0-50 / 0-10000 / 0-50000 mg/l NaCl (Chloridol)	87000268	87010268
Chlorine, DPD1	Free chlorine (DPD1), 0-5.0 mg/l Cl <sub>2</sub>	87000011	87010011
Chlorine, DPD1	Free chlorine (DPD1) XF, 0-10.0 mg/l Cl <sub>2</sub> - extended range	-	87010013
Chlorine, DPD2	Chlorine (DPD2), 0-5.0 mg/l Cl <sub>2</sub> (free chlorine, mono chloramine, dichloramine)	87000021	87008021
Chlorine, DPD3	Total chlorine (DPD3), 0-5.0 mg/l Cl <sub>2</sub>	87000031	87010031
Chlorine, DPD3	Total chlorine (DPD3) XT, 0-10.0 mg/l Cl <sub>2</sub> - extended range	-	87010033
Chlorine, DPD4	Chlorine (DPD4), 0-5.0 mg/l Cl <sub>2</sub>	87000041	87010041
Chlorine HR	Total chlorine HR, 0-250 mg/l Cl <sub>2</sub>	87000162	87010162
Chlorine dioxide	Chlorine dioxide, 0-4.0 mg/l ClO <sub>2</sub> (DPD) DPD Glycine tablets	87000052	87010052
	Chlorine dioxide, 0-2.5 mg/l ClO <sub>2</sub> (Lissamine Green)	-	87020007
	Chlorine dioxide, 2.5-20.0 mg/l ClO <sub>2</sub> (Lissamine Green)	-	87010064
	Chlorine dioxide, 2.5-20.0 mg/l ClO <sub>2</sub> (Lissamine Green)	-	87010065
Chromium VI	Chromium VI, 0-1.0 mg/l Cr VI (Chromicol)	87000281	87010281
Copper	Copper, 0-5.0 mg/l Cu (Coppercol)	87000186	87010186
Colour / Turbidity	Colour/ Turbidity, 10-500 Hazen units	87000269	-
Cyanuric acid	Cyanuric acid, 0-200 mg/l	87000087	87010087
Fluoride	Fluoride, 0-1.5 mg/l F-	87000179	87010179
Hardness, total	Total water hardness, 0-500 mg/l CaCO <sub>3</sub> (Hardicol)	87000254	87010254
Hydrazine	Hydrazine, 0-0.5 mg/l N <sub>2</sub> H <sub>4</sub>	87000103	87010103
H <sub>2</sub> O <sub>2</sub> LR	Hydrogen peroxide LR, 0-2.0 mg/l H <sub>2</sub> O <sub>2</sub>	87000104	87010104
H <sub>2</sub> O <sub>2</sub> HR	Hydrogen peroxide HR, 0-100 mg/l H <sub>2</sub> O <sub>2</sub>	87000105	87010105
Iron HR	Iron HR, 0-10 mg/l Fe	87000156	87010156
Iron MR	Iron MR, 0-5 mg/l Fe	87000292	87010292
Magnesium	Magnesium, 0-100 mg/l Mg (Magnecol)	87000193	87010193
Manganese	Manganese, 0-0.03 mg/l Mn	87000173	87010173
Molybdate LR	Molybdate LR, 0-15 mg/l MoO <sub>4</sub>	87000258	87010258
Molybdate HR	Molybdate HR, 0-100 mg/l MoO <sub>4</sub>	87000175	87010175
Nickel	Nickel, 0-10 mg/l Ni (Nickel-test)	87000284	87010284

PARAMETER	DESCRIPTION	50 TEST PACK	250 TEST PACK
		PART NO.	PART NO.
Nitrate	Nitrate, 0-20 mg/l N (Nitra-test)	87000163	87010163
Nitrite	Nitrite, 0-0.5 mg/l N / 0-1.6 mg/l NO <sub>2</sub> (Nitricol)	87000109	87010109
Nitrite	Nitrite, 0-1500 mg/l NaNO <sub>2</sub> (Nitriphot)	87000260	87010260
Organic Phosphate	Organic Phosphate, 0-20 mg/l PO <sub>4</sub> (+ SetFilt-GF/B)	87000262	87010262
Ozone	Ozone, 0-2.0 mg/l O <sub>2</sub>	87000056	87010056
pH	pH 6.8-8.4 (Phenol Red)	87000130	87010130
Phenol	Phenol, 0-5 mg/l (Phenol-test)	87000287	87010287
PHMB	PHMB, 0-100 mg/l	87000272	87010272
Phosphate LR	Phosphate LR, 0-4.0 mg/l PO <sub>4</sub>	87000177	87010177
Phosphate HR	Phosphate HR, 0-100 mg/l PO <sub>4</sub>	87000114	87010114
Potassium	Potassium, 0-12 mg/l K	87000189	87010189
Silica	Silica, 0-4.0 mg/l SiO <sub>2</sub>	87000181	87010181
Silica HR	Silica HR, 0-150 mg/l SiO <sub>2</sub>	87000290	87010290
Sulphate	Sulphate, 0-200 mg/l SO <sub>4</sub>	87000154	87010154
Sulphite	Sulphite, 0-0.5 mg/l S	87000168	87010168
Sulphite	Sulphite, 0-500 mg/l NaSO <sub>2</sub> (Sulphi-test)	87000266	87010266
Zinc	Zinc, 0-4.0 mg/l Zn	87000148	87010148

## LIQUID REAGENTS FOR PHOTOMETERS

PARAMETER	DESCRIPTION	PART NO.
Ammonia	Ammonia, 0-15 mg/l N - Nessler method(pack of 25 test tubes)	
	Ammonia, 0-50 mg/l N - Nessler method(pack of 25 test tubes)	
	Ammonia, 0-100 mg/l N - Nessler method(pack of 25 test tubes)	
D.O. 0.8	Dissolved Oxygen, 0-0.8 mg/l (pack of 30 test tubes)	87000553
D.O. 2.0	Dissolved Oxygen, 0-2.0 mg/l (pack of 30 test tubes)	87000503

## ELECTROMAGNETIC DOSING PUMPS WITH DIAPHRAGM HORIZONTAL INSTALLATION

### PROXIMA PSP SERIES, PROFESSIONAL LINE

- Advanced, **multifunctional electronics**, with backlit alphanumeric display
  - **Mechanical adjustment** of stroke length (injection volume)
  - Multilingual interface (Italian, English, French, Spanish, German)
  - Two configuration levels, standard and advanced, password-protected
  - Dosing schedule at set hours and days (internal clock)
  - Counters of injected litres, working hours and strokes of the membrane
  - **“Service” menu**
  - **“Autoset” function**
  - **Self-priming** (only available with optional injection flow control)
  - Internal system for **overheating control / safety**
  - Dosing chamber with **anti-spill system**
  - Multi-voltage power supply: 100-240 V~ (cable w/ Schuko plug)
  - Standard digital inputs for external consent and level control
  - Optional input for injection flow control
  - Optional output, to be chosen among: relay, mA, pulse repetition (SSR)
  - Optional RS485 port with **Modbus** RTU communication protocol
  - Dosing head with **FDA certification** can be requested upon order
- 
- These pumps are supplied with standard accessory kit (foot filter; injection valve; hoses for suction, delivery and bleed lines), fitting kit, cables with M8 connector for input / output wiring



MODEL	DESCRIPTION
PSP161	Multifunctional pump, with pulse and mA inputs
PSP162	Pump with pH/ORP meter and electrode input on BNC
PSP163A	Pump with chlorine meter and input for CLE12 cell
PSP163B	Pump with chlorine meter and input for CLE16 cell
PSP164	Pump with conductivity meter and input for two-electrode cell with integrated NTC sensor

## Technical Characteristics

MODEL	STANDARD INPUTS			OPTIONS UPON REQUEST	
	Level	Ext. Consent / Pulse	Analogic Input	Injection Flow Control	Relay, mA, Pulse Rep. Output or Serial Port
PSP161	x	x	4-20 mA	x	x
PSP162	x	x	pH/ORP (BNC)	x	x
PSP163A	x	x	Chlorine (with CLE12 cell) *	x	x
PSP163B	x	x	Chlorine (with CLE16 cell) *	x	x
PSP164	x	x	Electrical Conductivity *	x	x

\* Range to be specified upon order.

## Dosing Head Materials

TYPE	DOSING HEAD	VALVE BODY	VALVE BALL	SEALS
PKT	PVDF	PVDF	CERAMIC	PTFE
PTT	PVDF	PVDF	PTFE	PTFE
MKV	METHACRYLATE	PVC	CERAMIC	FPM

Upon request, these pumps can also be provided with a different colour housing and / or customized front panel.

## Available sizes

VERSION	FLOW RATE	PRESSURE MAX	HOSE	DOSING HEAD
0216	2 l/h	16 bar	4x6 mm	PKT
0416 (*)	4 l/h	16 bar	4x6 mm	PKT
0425 (*)	4 l/h	25 bar	4x6 mm	PKT
0510	5 l/h	10 bar	4x6 mm	PKT
0516	5 l/h	16 bar	4x6 mm	PKT
0807	8 l/h	7 bar	5x8 mm	PKT
0810	8 l/h	10 bar	5x8 mm	PKT
1304	13 l/h	4 bar	5x8 mm	PKT
1307	13 l/h	7 bar	5x8 mm	PKT
2002	20 l/h	2 bar	5x8 mm	PKT
2004	20 l/h	4 bar	5x8 mm	PKT
3202	32 l/h	2 bar	9x12 mm	PKT

(\*) Size available upon order

Note: the hydraulic specifications refer to standard dosing heads, dosage of no viscous liquids, temperature 25 °C, mechanical stroke 100%, injection rate 180 pulses/minute.

**DESCRIPTION**

Optional self-bleeding dosing head (only for 0216, 0510, 0516 models)
Optional MKV dosing head (only for 0216, 0510, 0516 models)
Optional PKT dosing head for viscous liquids, up to 500 mPa•s
Optional PTT dosing head for viscous liquids, up to 500 mPa•s
Optional “high viscosity” (up to 3000 mPa•s) dosing head, for pumps with flow rate $\geq 5$ l/h
Optional dosing head with FDA certification
Optional valves with PTFE ball
Optional relay output, complete with connection cable
Optional mA output, complete with connection cable
Optional pulse repetition output
Optional RS232 serial port
Optional RS485 serial port with Modbus communication protocol
Optional injection flow control input
Optional pump with PTFE hose 4x6 mm (10 m)
Optional pump with PTFE hose 5x8 mm (10 m)
Optional pump with PTFE hose 9x12 mm (10 m)



PKT standard dosing head



MKV dosing head



Head for high viscosity (HV)



## Coding system

Using the below diagram, you can build the pump part number, with the desired characteristics. Options in bold refer to the standard version of the pump.

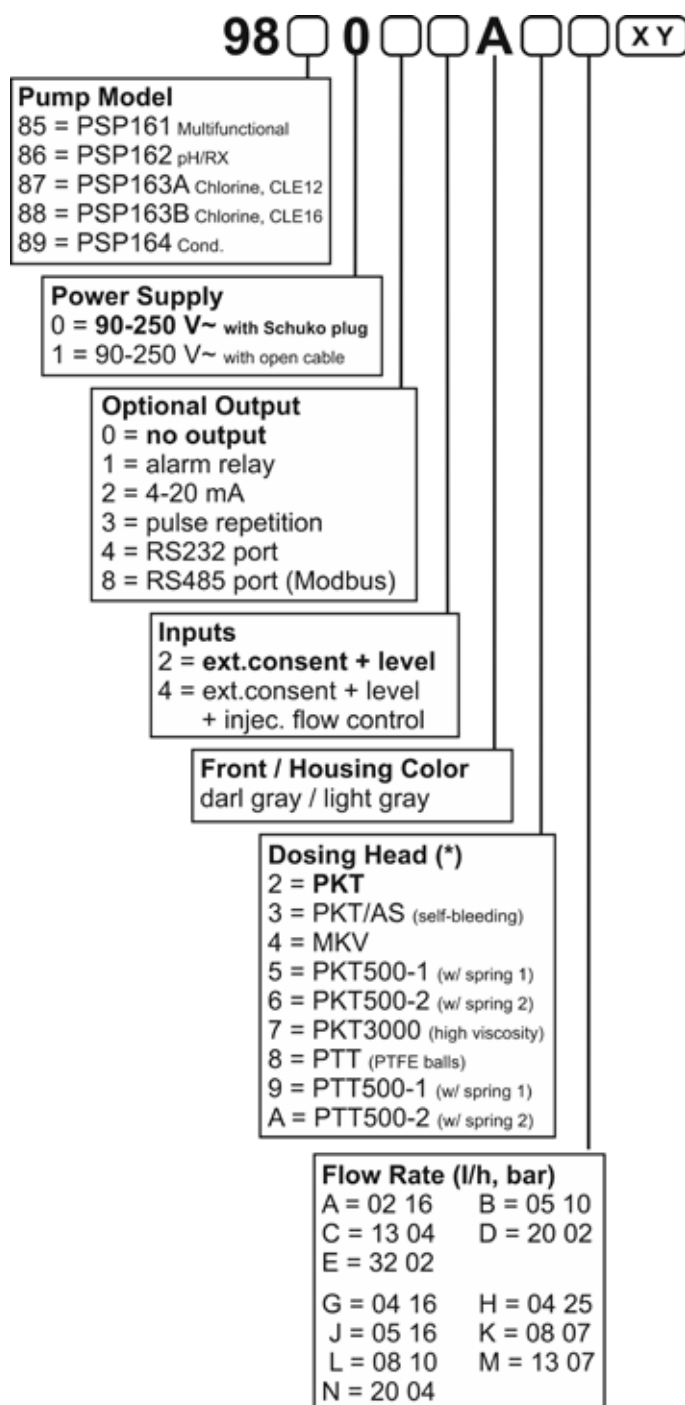







### (\*) Dosing head - Notes:

- PKT/AS = PKT dosing head with self-bleeding option, available for models 0216, 0510, 0516
- MKV = methacrylate dosing head, available for models 0216, 0510, 0516
- PKT500-1 / PTT500-1 = PKT or PTT head with spring 1, suitable for dosing liquids of medium viscosity, for pumps with flow rate  $\leq 5$  l/h
- PKT500-2 / PTT500-2 = PKT or PTT head with spring 2, suitable for dosing liquids of medium viscosity, for pumps with flow rate  $\geq 8$  l/h
- PKT3000 = PKT head for dosing high-viscosity liquids (up to 3000 mPa·s), for pumps with flow rate  $\geq 5$  l/h

The “XY” field is used only for models PSP163 and PSP164, to indicate measurement range and cell constant. Contact STEIEL for further details.

## PROXIMA SERIES, LIST OF SPARE PARTS

ITEM	DESCRIPTION	PART NO.
Kit 02 PKT	 <p>Kit for the complete maintenance of standard dosing head, including: suction and delivery valves with threaded nut, locking ring, hose-holder nozzle and seals; 2 ceramic balls and seals for a second maintenance; purge valve, diaphragm and safety membrane</p>	97003000/PKT
Kit 02 PKT/AS		
Kit 04 PKT		97003006/PKT
Kit 05 PKT		97003001/PKT
Kit 05 PKT/AS		
Kit 08 PKT		97003005/PKT
Kit 13 PKT		97003002/PKT
Kit 20 PKT		97003003/PKT
Kit 32 PKT		97003004/PKT
Kit fittings	 <p>Kit of fittings for hose 4x6 mm</p>	70110052
	Kit of fittings for hose 5x8 mm	70110055
	Kit of fittings for hose 9x12 mm	70110058
Diaphragm 02	 <p>Spare diaphragm: high quality EPDM, tissue-reinforced, steel core and PTFE coating on the side in contact with the liquid</p>	97003010
Diaphragm 04		97003016
Diaphragm 05		97003011
Diaphragm 08		97003015
Diaphragm 13		97003012
Diaphragm 20		97003013
Diaphragm 32		97003014
Injection valve	 <p>PKT valve w/ fitting for hose 4x6 mm</p>	97003030/PKT
	PKT valve w/ fitting for hose 5x8 mm	97003031/PKT
	PKT valve w/ fitting for hose 9x12 mm	97003032/PKT
Spring for injection valve	Spring Hastelloy C, 1 bar	70110080
	Spring Hastelloy C, 2 bar	70110081
	Spring Hastelloy C, with FEP coating, 1 bar	70110085
Foot filter	 <p>PKT foot filter w/ fitting for hose 4x6</p>	97003020/PKT
	PKT foot filter w/ fitting for hose 5x8	97003021/PKT
	PKT foot filter w/ fitting for hose 9x12	97003022/PKT

ITEM	DESCRIPTION		PART NO.
Complete dosing head, with ring nuts and screws		Version 0216 PKT	9700310A/PKT
		Version 0416 / 0425 PKT	9700310H/PKT
		Version 0510 / 0516 PKT	9700310B/PKT
		Version 0807 / 0810 PKT	9700310L/PKT
		Version 1304 / 1307 PKT	9700310C/PKT
		Version 2002 / 2004 PKT	9700310D/PKT
		Version 3202 PKT	9700310E/PKT
PKT/AS dosing head with self-bleeding option, for versions 0216			9700311A/PKT
PKT/AS dosing head with self-bleeding option, for versions 0510 and 0516			9700311B/PKT
Optional PKT dosing head for viscous liquids, up to 500 mPa•s			
Optional PTT dosing head for viscous liquids, up to 500 mPa•s			
Optional “high viscosity” (up to 3000 mPa•s) dosing head, for pumps with flow rate ≥ 5 l/h			
Standard kit 4x6		PVC Crystal suction hose (2 m), PE delivery hose (5 m), PVC Crystal (2 m, 4x6 mm) purge hose, PKT foot filter and PKT injection valve	97003200/PKT
Standard kit 5x8			97003201/PKT
Standard kit 9x12			97003202/PKT
Optional valves with PTFE ball			

## ROTATING BRACKET

- Exclusive new STEIEL bracket with **rotating support**
- Wall-mounting of PROXIMA PSP pumps
- **Rotation up to 360°** for easy operations on the pump dosing head
- Slots for suction and drain **tubes housing**
- Supplied complete with screws and dowels for wall mounting, screws and nuts for fixing pump on bracket



ITEM	DESCRIPTION		PART NO.
SMP18		Mounting bracket with rotating support for PROXIMA PSP dosing pumps	97000504

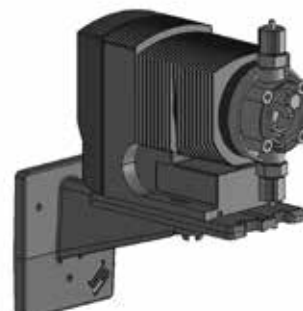
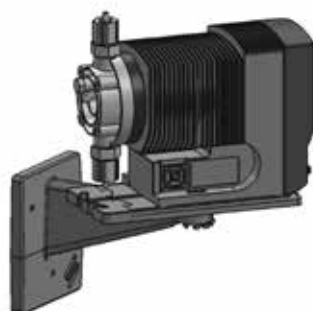
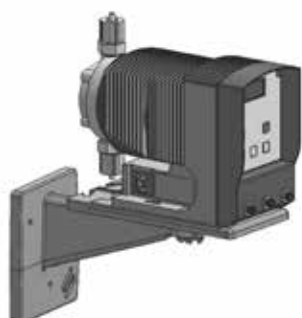

## “FLOW CONTROL” SENSOR



- **New flow sensor, designed and patented by STEIEL**
- **Accurate and reliable monitoring** of the injection liquid flow
- Supplied assembled, tested and complete with cable with M8 connector
- Direct mounting on delivery valve or with proper accessory (70100340) in case of dosing head with self-bleeding option
- Connection to the FLOW (injection flow) input of the pump (contact closed for normal operation; contact open upon fault / alarm)
- **Working conditions: temperature 1...55 °C, pressure 0.5...25 bar, density of the dosed liquid max 1.25 g/cm<sup>3</sup>**
- Three models available, depending on the requested flow rate



**Warning! To choose the correct sensor, it is necessary to know the flow rate at the sensor inlet.**

The nominal flow rate (Q<sub>n</sub>) of the pump is that of a standard dosing head, which works at standard conditions, i.e. dosing a no viscous liquid at an ambient temperature of 25 °C and maximum working frequency.

Under these conditions, the nominal flow rate is obtained from the characteristic curve of the specific model, and corresponds to the effective one (Q<sub>e</sub>).

For the PROXIMA PSP series, which also includes the mechanical stroke adjustment, follow the instruction below:

- Minimum stroke for standard heads: 50%
- Minimum stroke for heads with self-bleeding option: 60%
- Calculate the actual flow rate at the flow sensor inlet by multiplying the effective (actual) flow rate by the percentage of stroke adjustment:  $Q_e = Q_n \times \% \text{ stroke}$

Furthermore, in the case of dosing **head with self-bleeding option**, the effective flow rate is lower than the nominal one and is calculated by applying the following correction:  $Q_e = Q_n \times 0.85 \times \% \text{ stroke}$

DESCRIPTION	ACTUAL FLOW RATE (Q <sub>e</sub> )	PART NO.
Flow sensor with connections for PROXIMA PSP series pumps, NPN sensor and 50 cm cable with M8 connector	0.8 ... 2l/h	94812221
	2 ... 7 l/h	94832221
	7 ... 20 l/h	94852221

ITEM	DESCRIPTION	PART NO.
Adapter AS / Flow Control		Adapter (white PVC) for the installation of a “Flow Control” sensor on PSP pumps with self-bleeding option
Adapter AS / MF valve		Adapter (white PVC) for the installation of an MF valve on PSP pumps with self-bleeding option

## MULTIFUNCTIONAL VALVE

- **Protect the dosing line from over-pressures** in case of interruptions along the line
- **Prevent the siphon effect** from the suction tank
- **Help the pump priming** in case of start in the presence of back pressure
- **Useful to vent the dosing line** during maintenance
- Working temperature: -10 ... +45 °C
- Supplied with double kit of seals, FPM and EPDM
- Hydraulic connections for direct installation on the delivery valve of the PROXIMA PSP pumps
- Assembly with special adapter in case of dosing head with self-bleeding option

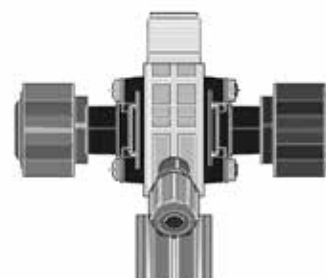

DESCRIPTION	PART NO.
MF valve, purge fitting for 4x6 hose, opening pressure 16 bar; to be used with PROXIMA PSP models 0216, 0416, 0510, 0516, 0807, 0810, 1304, 2002	97003910
MF valve, purge fitting for 4x6 hose, opening pressure 10 bar; to be used with PROXIMA PSP models 0216, 0416, 0510, 0516, 0807, 0810, 1304, 2002	97003911
MF valve, purge fitting for 4x6 hose, opening pressure 6 bar; to be used with PROXIMA PSP models 0216, 0416, 0510, 0516, 0807, 0810, 1304, 2002	97003912
MF valve, purge fitting for 4x6 hose, opening pressure 10 bar; to be used with PROXIMA PSP models 0425, 1307, 2004, 3202	97003921
MF valve, purge fitting for 4x6 hose, opening pressure 6 bar; to be used with PROXIMA PSP models 0425, 1307, 2004, 3202	97003922



Assembly of the flow sensor and multifunctional valve directly on the pump delivery valve, on a standard dosing head.



Example of assembly on "AS" head with special adapter.



## ELECTROMAGNETIC DOSING PUMPS WITH DIAPHRAGM WALL INSTALLATION

### EF150 SERIES, BASIC LINE

- **Three-digit, red LED display**
  - **ON/OFF basic model with adjustment of the dosing frequency**
  - Three flow rates available; hose 4x6
  - PP (standard) or PVDF (upon request) dosing head, with Pyrex ball valves
  - Dosing head with self-bleeding option
  - Dosing-shot, electronic-free version
  - Power supply: 230 V~
  - Housing colour: green (standard) and blue
- These pumps are supplied with standard accessory kit (foot filter; injection valve; hoses for suction, delivery and bleed lines) and bracket for wall installation



ITEM	DOSING HEAD	SEALS	FLOW RATE	ELECTRONICS	LEVEL INPUT	PART NO.
EF150 SGV 0212	PP	FPM	2 l/h @ 12 bar	DIGITAL	x	961001320
					-	961000320
EF150 SGE 0212	PP	EPDM	2 l/h @ 12 bar	DIGITAL	x	961001330
					-	961000330
EF150 SGV 0506	PP	FPM	5 l/h @ 6 bar	DIGITAL	x	961001321
					-	961000321
EF150 SGE 0506	PP	EPDM	5 l/h @ 6 bar	DIGITAL	x	961001331
					-	961000331
EF150 SGV 1002	PP	FPM	10 l/h @ 2 bar	DIGITAL	x	961001322
					-	961000322
EF150 SGE 1002	PP	EPDM	10 l/h @ 2 bar	DIGITAL	x	961001332
					-	961000332
EF145 SGV 0212	PP	FPM	2 l/h @ 12 bar	DOSING-SHOT PUMP	-	95730520
EF145 SGE 0212		EPDM			-	95730530
EF145 SGV 0506	PP	FPM	5 l/h @ 6 bar	DOSING-SHOT PUMP	-	95730521
EF145 SGE 0506		EPDM			-	95730531
EF145 SGV 1002	PP	FPM	10 l/h @ 2 bar	DOSING-SHOT PUMP	-	95730522
EF145 SGE 1002		EPDM			-	95730532
Optional PVDF dosing head						
Optional self-bleeding dosing head (only for PVDF version and models 0506 & 1002)						

These pumps can also be provided with a different colour housing and / or customized front panel.

## EF155 SERIES, SEMI-PROFESSIONAL LINE

- **Three-digit, red LED display**
  - **Input for level control**, optional input for external consent
  - **ON/OFF basic model, version with pause-work schedule, pump with pulse input, model with built-in pH/ORP meter**
  - Three flow rates available; hose 4x6
  - PP (standard) or PVDF (upon request) dosing head, with Pyrex ball valves
  - Dosing head with self-bleeding option
  - Power supply: 230 V~ (with Schuko plug, upon request)
  - Housing colour: grey (standard), green and blue
- These pumps are supplied with standard accessory kit (foot filter; injection valve; hoses for suction, delivery and bleed lines) and bracket for wall installation



ITEM	DESCRIPTION	DOSING HEAD	SEALS	FLOW RATE	PART NO.
EF155 SGV 0212	ON/OFF pump with adjustment of the dosing frequency	PP	FPM	2 l/h @ 12 bar	965001120
EF155 SGE 0212			EPDM		965001130
EF155 SGV 0506		PP	FPM	5 l/h @ 6 bar	965001121
EF155 SGE 0506			EPDM		965001131
EF155 SGV 1002		PP	FPM	10 l/h @ 2 bar	965001122
EF155 SGE 1002			EPDM		965001132
EF156 SGV 0212	Pump with timer for scheduling pause-work times	PP	FPM	2 l/h @ 12 bar	966001120
EF156 SGE 0212			EPDM		966001130
EF156 SGV 0506		PP	FPM	5 l/h @ 6 bar	966001121
EF156 SGE 0506			EPDM		966001131
EF156 SGV 1002		PP	FPM	10 l/h @ 2 bar	966001122
EF156 SGE 1002			EPDM		966001132
EF157 SGV 0212	Pump with pulse input	PP	FPM	2 l/h @ 12 bar	967002120
EF157 SGE 0212			EPDM		967002130
EF157 SGV 0506		PP	FPM	5 l/h @ 6 bar	967002121
EF157 SGE 0506			EPDM		967002131
EF157 SGV 1002		PP	FPM	10 l/h @ 2 bar	967002122
EF157 SGE 1002			EPDM		967002132
EF158 SGV 0212	Pump with built-in pH/ORP meter and electrode input on BNC connector	PP	FPM	2 l/h @ 12 bar	968001120
EF158 SGE 0212			EPDM		968001130
EF158 SGV 0506		PP	FPM	5 l/h @ 6 bar	968001121
EF158 SGE 0506			EPDM		968001131
EF158 SGV 1002		PP	FPM	10 l/h @ 2 bar	968001122
EF158 SGE 1002			EPDM		968001132
Optional PVDF dosing head					
Optional self-bleeding dosing head (only for PVDF version and models 0506 & 1002)					

These pumps can also be provided with a different colour housing and / or customized front panel.

## EF160 EVO SERIES, PROFESSIONAL LINE

- Advanced, **multifunctional electronics**, with backlit alphanumeric display
- Multilingual interface (Italian, English, French, Spanish)
- Two configuration levels, standard and advanced
- Dosing schedule at set hours and days (internal clock)
- Counters of injected litres, working hours and strokes of the membrane
- **“Service” menu**
- **“Autoset” function**
- **Self-priming** (only available with optional injection flow control)
- Three flow rates available; hose 4x6
- PVDF dosing head (standard) with Pyrex ball valves
- Power supply: 230 V~ (cable with Schuko plug)
- Standard digital inputs for external consent and level control
- Optional input for injection flow control
- Optional output, to be chosen among: relay, mA, pulse repetition (SSR)
- RS232 serial port, upon request
- Housing colour: grey (standard), green and blue



- These pumps are supplied with standard accessory kit (foot filter; injection valve; hoses for suction, delivery and bleed lines) and bracket for wall installation

### Technical Characteristics

MODEL	STANDARD INPUTS			OPTIONS UPON REQUEST		
	Level	Ext. Consent / Pulse	Analogic Input	Injection Flow Control	Relay or mA or Pulse Rep. Output	Serial Port RS232
EF161 EVO	x	x	4-20 mA	x	x	x
EF162 EVO	x	x	pH/RX (BNC)	x	x	x
EF163 EVO	x	x	Chlorine (CLE12 or CLE16) *	x	x	x
EF164 EVO	x	x	Electrical Conductivity *	x	x	x

\* Range to be specified upon order.

ITEM	DESCRIPTION	DOSING HEAD	SEALS	FLOW RATE	PART NO.
EF161 PGV 0212	Multifunctional pump with pulse and 4-20 mA inputs	PVDF	FPM	2 l/h @ 12 bar	972502100
EF161 PGE 0212			EPDM		972502110
EF161 PGV 0506		PVDF	FPM	5 l/h @ 6 bar	972502101
EF161 PGE 0506			EPDM		972502111
EF161 PGV 1002		PVDF	FPM	10 l/h @ 2 bar	972502102
EF161 PGE 1002			EPDM		972502112
EF162 PGV 0212	Pump with built-in pH/ORP meter and electrode input on BNC connector	PVDF	FPM	2 l/h @ 12 bar	973502100
EF162 PGE 0212			EPDM		973502110
EF162 PGV 0506		PVDF	FPM	5 l/h @ 6 bar	973502101
EF162 PGE 0506			EPDM		973502111
EF162 PGV 1002		PVDF	FPM	10 l/h @ 2 bar	973502102
EF162 PGE 1002			EPDM		973502112

ITEM	DESCRIPTION	DOSING HEAD	SEALS	FLOW RATE	PART NO.
EF163A PGV 0212	Pump with built-in chlorine meter and input for CLE12 cell	PVDF	FPM	2 l/h @ 12 bar	974502100
EF163A PGE 0212			EPDM		974502110
EF163A PGV 0506		PVDF	FPM	5 l/h @ 6 bar	974502101
EF163A PGE 0506			EPDM		974502111
EF163A PGV 1002		PVDF	FPM	10 l/h @ 2 bar	974502102
EF163A PGE 1002			EPDM		974502112
EF163B PGV 0212	Pump with built-in chlorine meter and input for CLE16 cell	PVDF	FPM	2 l/h @ 12 bar	975502100
EF163B PGE 0212			EPDM		975502110
EF163B PGV 0506		PVDF	FPM	5 l/h @ 6 bar	975502101
EF163B PGE 0506			EPDM		975502111
EF163B PGV 1002		PVDF	FPM	10 l/h @ 2 bar	975502102
EF163B PGE 1002			EPDM		975502112
EF164 PGV 0212	Pump with built-in conductivity meter and input for two-electrode cell	PVDF	FPM	2 l/h @ 12 bar	976502100
EF164 PGE 0212			EPDM		976502110
EF164 PGV 0506		PVDF	FPM	5 l/h @ 6 bar	976502101
EF164 PGE 0506			EPDM		976502111
EF164 PGV 1002		PVDF	FPM	10 l/h @ 2 bar	976502102
EF164 PGE 1002			EPDM		976502112

#### DESCRIPTION

Optional PTFE seals

Optional ceramic balls

Optional self-bleeding dosing head (only for PVDF version and models 0506 & 1002)

Optional relay output

Optional mA output













Optional pulse repetition output

Optional RS232 serial port

Optional injection flow control



*These pumps can also be provided with a different colour housing and / or customized front panel.*

## EF150, EF155, EF160 SERIES, LIST OF SPARE PARTS

ITEM	DESCRIPTION	PART NO.	
EFK1 SGV 0212		Spare dosing head, SGV 0212	97002100/SGV
EFK1 SGE 0212		Spare dosing head, SGE 0212	97002100/SGE
EFK1 SGV 0506 / 1002		Spare dosing head, SGV 0506 / 1002	97002101/SGV
EFK1 SGE 0506 / 1002		Spare dosing head, SGE 0506 / 1002	97002101/SGE
EFK1 PGV 0212		Spare dosing head, PGV 0212	97002100/PGV
EFK1 PGE 0212		Spare dosing head, PGE 0212	97002100/PGE
EFK1 PGV 0506 / 1002		Spare dosing head, PGV 0506 / 1002	97002101/PGV
EFK1 PGE 0506 / 1002		Spare dosing head, PGE 0506 / 1002	97002101/PGE
EFK1/AS PGV		Dosing head with self-bleeding valve (only PVDF, models 0506 & 1002)	97002106/PGV
EFK1/AS PGE			97002106/PGE
EFK2 SGV		Kit valves, suction and delivery, SGV	97002000/SGV
EFK2 SGE		Kit valves, suction and delivery, SGE	97002000/SGE
EFK2 PGV		Kit valves, suction and delivery, PGV	97002000/PGV
EFK2 PGE		Kit valves, suction and delivery, PGE	97002000/PGE
Kit fittings		Kit PVDF, including hose-holder, locking ring and threaded nut (10 pc.)	
EFK3 SGV		Kit valves, suction / delivery / purge, and O-ring for dosing head - SGV	97002001/SGV
EFK3 SGE		Kit valves, suction / delivery / purge, and O-ring for dosing head - SGE	97002001/SGE
EFK3 PGV		Kit valves, suction / delivery / purge, and O-ring for dosing head - PGV	97002001/PGV
EFK3 PGE		Kit valves, suction / delivery / purge, and O-ring for dosing head - PGE	97002001/PGE
EFK4 FPM 0212			97002020
EFK4 FPM 0506 / 1002			97002021
EFK4 EPDM 0212			97002040
EFK4 EPDM 0506 / 1002			97002041
EFK5 SV		Kit purge PP, with FPM seals	97002026
EFK5 SE		Kit purge PP, with EPDM seals	97002046
EFK5 PV		Kit purge PVDF, with FPM seals	97002025
EFK5 PE		Kit purge PVDF, with EPDM seals	97002045
EFK6 SGV		Standard accessory kit: PP foot filter, PP injection valve, 4x6 mm PVC Crystal hose (4 m), 4x6 mm PE hose (2 m)	97002010/SGV
EFK6 SGE			97002010/SGE
EFK6 PGV		Standard accessory kit: PVDF foot filter, PVDF injection valve, 4x6 mm PVC Crystal hose (2+2 m), 4x6 mm PE hose (2 m)	97002010/PGV
EFK6 PGE			97002010/PGE





ITEM	DESCRIPTION	PART NO.
Foot filter SGV	 Foot filter PP / FPM	97002013/SGV
Foot filter SGE	Foot filter PP / EPDM	97002013/SGE
Foot filter PGV	 Foot filter PVDF / FPM	97002013/PGV
Foot filter PGE	Foot filter PVDF / EPDM	97002013/PGE
Injection valve SGV	 Injection valve PP / FPM	97002012/SGV
Injection valve SGE	Injection valve PP / EPDM	97002012/SGE
Injection valve PGV	 Injection valve PVDF / FPM	97002012/PGV
Injection valve PGE	Injection valve PVDF / EPDM	97002012/PGE
Optional PTFE seals		
Optional ceramic balls		
Magnet	 Magnet for pumps 0212	97002130
	Magnet for pumps 0506	
	Magnet for pumps 1002	97002131
Mounting bracket	 Bracket with screws for wall installation of pumps with EF150 / EF155 / EF160 housing	97002140
SMP19	 Bracket with screws for horizontal installation (on tank) of pumps with EF150 / EF155 / EF160 housing	97000505

## LEVEL PROBES

DESCRIPTION	PART NO.
 SLP2 - Level probe with 2 m cable and connector for pumps EF110, EF125, EF145, EF150, EF155	97009002
 SLP3 - Level probe with 2 m cable and M8 connector for pumps PROXIMA PSP and EF160 series	97009006
 Level probe with built-in PVDF foot filter, connection for hose 4x6 mm, 2 m cable and connector for pumps EF110, EF125, EF145, EF150, EF155	94916189
Level probe with built-in PVDF foot filter, connection for hose 4x6 mm, 2 m cable and M8 for pumps PROXIMA PSP and EF160 series	94936189



## ACCESSORIES FOR ELECTROMAGNETIC DOSING PUMPS

ITEM	DESCRIPTION	PART NO.
Dosing Extension	 Anti-siphon, PVDF, short dosing extension, with Hastelloy C spring pre-loaded @ 1 bar, 1/2" connection and fittings for hose 4x6, 5x8, 9x12; pressure max 16 bar @ 25°C, PTFE seals	
	Version with FEP coated spring	
CAV2M8D	 PVC cable with M8 female connector, L = 2 m	80099142
CAV2M8-M8	 PVC cable with double M8 female connector, L = 2 m	80099090
CON16/F	 M8 female connector	51300526
Signal Splitter 2	 Two-channel signal splitter	80620001
	Two-channel signal splitter, model with 230 V power supply	80620011
Signal Splitter 4	Four-channel signal splitter	80620002
	Four-channel signal splitter, model with 230 V power supply	80620012

## HOSES FOR DOSING PUMPS

MATERIAL	ID x OD (mm)	SKEIN	PART NO.
PVC Crystal	4 x 6	100 m	36502103
	5 x 8	100 m	36502106
	9 x 12	50 m	36502115
PE semi-rigid	4 x 6	100 m	36501003
	5 x 8	100 m	36501006
	9 x 12	100 m	36501015
PTFE (*)	4 x 6	100 m	36506003
	5 x 8	50 m	36506006
	9 x 12	25 m	36506015

(\*) The skein length of PTFE hoses could differ from the standard one. Ask for check upon order.

## SUCTION LANCES

- **Adjustable length** suction lances
- Suitable to dosing stations with tanks up to 1000 litres
- **Flow rate max 100 litres/h**
- Mounting with 1" threaded ring or sleeve
- **Built-in check ball valve**
- PP-PVC-NBR body, FPM (standard) or EPDM seals
- **Level probe with totally protected cable** and soldering connector
- Ring colour: black (standard), blue, red, yellow
- Connection for hose 4x6 (standard), 5x8, 9x12 mm
- Working temperature max 50 °C



ITEM	LENGTH (mm)		TANK	PART NO.
	TOTAL (B)	ADJUSTABLE (A)		
Suction lance with <b>soldering connector for level probe (for EF150 / EF155)</b> , FPM seals, Pyrex ball valve, connection for hose 4x6 mm and black ring	400	115...300	25 L	94912100
	490	115...390	50 L	94912101
	700	115...600	100 L	94912102
	940	115...840	150-300 L	94912103
	1420	115...1320	500-1000 L	94912104
Suction lance with <b>M8 connector for level probe (for EF160 EVO / PSP series)</b> , FPM seals, Pyrex ball valve, connection for hose 4x6 and black ring	400	115...300	25 L	94932100
	490	115...390	50 L	94932101
	700	115...600	100 L	94932102
	940	115...840	150-300 L	94932103
	1420	115...1320	500-1000 L	94932104

ITEM
Optional lance with EPDM seals
Optional lance with PTFE ball valve
Optional lance with ceramic ball valve
Optional lance with connection for hose 5x8 mm
Optional lance with connection for hose 9x12 mm
Optional lance with blue, red or yellow ring

## INJECTION EXTENSION

- Adjustable length, injection extension, for use up to 6 bar
- PVC body, FPM seals, ½" GAS connections



ITEM	PART NO.
Adjustable and removable injection extension. L max = 250 mm. Connections ½".	97009015

## MOTOR DOSING PUMPS WITH DIAPHRAGM ST SERIES

- Electronic-free, motor pumps, with **mechanical adjustment of the stroke length**
- **Rigid, multi-layer membrane**; parts in contact with the liquid are in PTFE for ensure the maximum chemical compatibility
- Simple use, basic maintenance
- Safe operation, without external moving parts
- **Flow rates from 14 up to 1000 l/h** at the maximum counterpressure
- **Pressure from 3 to 8 bar**, depending on model
- Manual micrometric adjustment of stroke (injection volume)
- Aluminium pump housing, mechanical parts in oil bath
- **Available standard heads: PP, PVDF and AISI316L** (other materials upon request, for special use)
- **Standard motor: asynchronous, three-phase, 230/400 V, 50 Hz** (optional single-phase)



### STANDARD VERSIONS, MATERIALS OF WET PARTS

VERSION	DOSING HEAD	VALVE BALL	CAGE	VALVE SEAT	CASING	DIAPHRAGM	SEALS	INTENDED USE
B	PP*	Pyrex	PP	PVC	PP*	PTFE	FPM	Process and waste water treatment (sulphuric acid, aluminium chloride, hypochlorite), fertigation, pulp & paper industry, acid or neutral products
F	PVDF	PTFE	PVDF	PVDF	PVDF	PTFE	PTFE	Process and waste water treatment (fluoride, chromium), strong acids and alkalis
A	AISI316L	AISI316L	PP	AISI316L	AISI316L	PTFE	FPM	Process and waste water treatment (peroxides, poly-electrolytes, nitric acid), food and beverage industry, alkaline or neutral chemicals

### SPECIAL VERSIONS, MATERIALS OF WET PARTS

VERSION	DOSING HEAD	VALVE BALL	CAGE	VALVE SEAT	CASING	DIAPHRAGM	SEALS	INTENDED USE
B33	PP*	AISI316L	PP	AISI316L	PP*	PTFE	FPM	Poly-electrolyte, sodium hydroxide, ferrous sulphate, ferric sulphate up to 10%, lime milk, etc.
B2	PP*	PTFE	PP	PVC	PP*	PTFE	FPM	Hydrochloric acid
B56	PP*	Hastelloy	PP	Incoloy	PP*	PTFE	FPM	Sulphuric acid, conc. 96-98%
F5	PVDF	Hastelloy	PVDF	PVDF	PVDF	PTFE	PTFE	Diluted sulphuric acid
A331	AISI316L	AISI316L	PP	AISI316L	AISI316L	PTFE	PTFE	Peroxides, acetic acid, food industry

\* Glass reinforced Polypropylene

MODEL	FLOW RATE (l/h) @ 2 bar		DIAPHRAGM (DIA. mm)	STROKE (mm)	STROKES/ MINUTE	MOTOR (kW)
	50Hz	60Hz				
ST14.08	18	22	110	2	34	0.18
ST30.08	38	45	110	2	71	0.18
ST40.08	60	72	110	2	106	0.18
ST65.08	80	-	110	2	150	0.18
ST35.08	42	50	110	4	34	0.18
ST75.08	87	105	110	4	71	0.18
ST105.08	120	144	110	4	106	0.18
ST150.08	180	-	110	4	150	0.18
ST50.08	65	78	110	6	34	0.18
ST110.08	126	152	110	6	71	0.18
ST170.08	200	240	110	6	106	0.18
ST250.08	275	-	110	6	150	0.18
ST140.05	170	204	170	6	34	0.37
ST300.05	330	396	170	6	71	0.37
ST430.05	498	598	170	6	106	0.37
ST670.05	700	-	170	6	150	0.37
ST200.05	215	258	170	9	34	0.37
ST450.05	505	606	170	9	71	0.37
ST700.04	765	918	170	9	106	0.37
ST1000.03	1020	-	170	9	150	0.37

Suction-delivery hydraulic connections	B	F	A
Models with diaphragm dia. 110 mm	3/8"	3/4"	3/8"
Models with diaphragm dia. 170 mm	1"	1.1/2"	1"

DESCRIPTION
Optional single-phase, asynchronous motor, 0.37 kW, 230 V, 50 Hz
Optional 3-phase, asynchronous motor, 0.37 kW, 230/400 V, 50 Hz, pumps ST14 ... ST250 (P max 10 bar)
Optional EPDM seals
Optional PTFE seals
Optional ceramic valves
Deduction for pumps without motor

*Versions are also available with ATEX II motor.*

## PERISTALTIC DOSING PUMPS

### EF100 SERIES, PUMPS WITH FIX FLOW RATE & OPEN CASING

- PP/talc housing, polycarbonate front panel, PBT roller-holder with Delrin (self-lubricant) rollers, PP fittings
- Internal tube: Santoprene
- Panel installation
- Power supply: 230 V~ or 24 V- (see table)



ITEM	DESCRIPTION
EF100/A	EF100 pump @ 230 V~. Specify the flow rate (0.6, 1.2, 1.8, 2.4 l/h @ 1 bar)
EF100/C	EF100 pump @ 24 V-. Flow rate 2.4 l/h @ 1 bar

### EF105 SERIES, PUMPS WITH FIX FLOW RATE & CLOSED CASING

- PP casing reinforced with glass fibre, polycarbonate front panel, PBT roller-holder with Delrin (self-lubricant) rollers, PP fittings
- Internal tube: Santoprene or silicone
- Wall installation with supplied mounting bracket
- Power supply: 230 V~ or 24 V- (see table)
- Available colours: green (standard) and blue
- Supplied with standard accessory kit (part no. 96000100)



ITEM	DESCRIPTION
EF105/A	EF105 pump @ 230 V~. Specify flow rate (1.5, 3 l/h @ 1 bar); Santoprene (S) internal tube
	EF105 pump @ 230 V~. Specify flow rate (1.5, 3 l/h @ 1 bar); silicone (N) internal tube
	EF105 pump @ 230 V~. Specify flow rate (4, 6 l/h @ 1 bar), and internal tube material (S=Santoprene, N=silicone)
EF105/C	EF105 pump @ 24 V-. Specify flow rate (1 l/h @ 3 bar; 4, 6, 12 l/h @ 1 bar), and internal tube material (S=Santoprene, N=silicone)
EF105/C-200-S	EF105 pump @ 24 V-. Flow rate 20 l/h @ 1 bar, Santoprene (S) internal tube









### EF106 SERIES, PUMPS WITH ADJUSTABLE FLOW RATE & CLOSED CASING

- PP casing reinforced with glass fibre, polycarbonate front panel, PBT roller-holder with Delrin (self-lubricant) rollers, PP fittings
- Internal tube: Santoprene or silicone
- Wall installation with supplied mounting bracket
- Flow rate adjustment via front trimmer
- Power supply: 230 V~ or multi-voltage 20-230 V~ (see table)
- Available colours: green (standard) and blue
- Supplied with standard accessory kit (part no. 96000100)



ITEM	DESCRIPTION
EF106/A	EF106 pump @ 230 V~. Specify max flow rate (1 l/h @ 3 bar; 4, 6 l/h @ 1 bar), and internal tube material (S=Santoprene, N=silicone)
EF106/M	EF106 pump with 20-230 V~ multi-voltage power supply. Specify max flow rate (1 l/h @ 3 bar; 4, 6 l/h @ 1 bar), and internal tube material (S=Santoprene, N=silicone)

PERISTALTIC PUMPS - LIST OF SPARE PARTS

ITEM	DESCRIPTION		PART NO.
Standard accessory kit		Kit of accessories for peristaltic pumps: 4x6 PVC Crystal hose (2 m), 4x6 PE hose (2 m), injection valve and foot filter	96000100
Injection valve		Injection valve for peristaltic pumps	97002012/SLV
Foot filter		Foot filter for peristaltic pumps	97002013/SLV
Dosing head		Dosing head complete with inserts for EF100 / EF110 / EF125 pumps	96000140
		Green dosing head complete with inserts for EF105 / EF106 pumps	96000145
		Blue dosing head complete with inserts for EF105 / EF106 pumps	96000141
Front panel		Protective front panel for EF100 / EF110 / EF125 pumps	96000130
		Protective front panel for EF105 / EF106	96000131
Internal tube		Santoprene tube for EF100 pumps	96000201
		Santoprene tube for EF105 / EF106 pumps, 1l/h @ 3 bar	96000230
		Santoprene tube for EF105 / EF106 pumps @ 1 bar	96000232
		Silicone tube for EF105 / EF106 pumps, 1l/h @ 3 bar	96000240
		Silicone tube for EF105 / EF106 pumps @ 1 bar	96000242
Roller-holder		Roller-holder for EF100 pumps	96000401
		Roller-holder for EF105 / EF106, Santoprene	96000411
		Roller-holder for EF105 / EF106, silicone	96000410
Motor (specify the model for which you need the spare part)		Spare motor for EF100 / EF110 / EF125 pumps	
		Spare motor for EF105 / EF106 pumps	



## DOSING ACCESSORIES

### STIRRERS FOR AQUEOUS SOLUTIONS

- Electromechanical stirrers, **slow (70 rpm)** and **fast (1400 rpm)** series
- Models with **PVC or AISI A2 steel** shaft and screw
- Three-phase 380-420 V~ or single-phase 220-240 V~ motor
- Several shaft lengths available
- **Manual PVC** stirrers
- Three models available, with different length



### ALS SERIES - SLOW STIRRING MODELS

ITEM	MATERIAL OF SHAFT & SCREW	LENGTH OF SHAFT (cm)	TANK	MOTOR	PART NO.
ALS-06TP	PVC	60	100 L	Three-phase	89000021
ALS-07TP	PVC	70	150 L	Three-phase	89000022
ALS-08TP	PVC	80	300 L	Three-phase	89000023
ALS-09TP	PVC	90	500-1000 L	Three-phase	89000024

### AVS SERIES - FAST STIRRING MODELS

ITEM	MATERIAL OF SHAFT & SCREW	LENGTH OF SHAFT (cm)	TANK	MOTOR	PART NO.
AVS-06TP	PVC	60	100 L	Three-phase	89000029
AVS-07TP	PVC	70	150 L	Three-phase	89000030
AVS-08TP	PVC	80	300 L	Three-phase	89000031
AVS-09TP	PVC	90	500-1000 L	Three-phase	89000032

#### ITEM

Optional with AISI A2 steel shaft & screw

Optional stirrers with single-phase motor, 220-240 V~

### AM SERIES - MANUAL STIRRERS

ITEM	MATERIAL OF SHAFT & SCREW	TANK	PART NO.
AM-1	PVC	100-150 L	89000060
AM-2	PVC	300 L	89000022
AM-3	PVC	500-1000 L	89000064



## MIXERS FOR INDUSTRIAL USE

- Electromechanical mixers, **slow (70 / 108 rpm)** and **fast (700 / 950 / 1400 rpm)**
- Models with shaft and screw in **PP, PVC, PVDF** (on request) or **AISI 304**
- Parts in contact with the liquid are coated with **corrosion-resistant** thermoplastic material or stainless steel (depending on model)
- **Three-phase motor 400 V~ 50 Hz** (standard) or single-phase 230 V~
- **ATEX II motor** available on request for some models
- Several shaft lengths available, for tanks from 50 up to 1000 litres
- Slow mixers: **high efficiency impeller, multiple impellers** on request; max liquid viscosity 500 cPs
- Fast mixers: **reversible marine impeller** (PP, PVC, PVDF) or three blades (for AISI 304 models); max liquid viscosity 50 cPs



## MLS SERIES - SLOW STIRRING MODELS (with gear reducer)

ITEM	MATERIAL OF SHAFT & SCREW	LENGTH OF SHAFT (cm)	TANK	MOTOR	VELOCITÀ (rpm)
Mixer MLS-036	PP or PVC	360	50 L	Three-phase / 0.18 kW	108
	AISI 304				
Mixer MLS-055	PP or PVC	550	100 L	Three-phase / 0.18 kW	108
	AISI 304				
Mixer MLS-075	PP or PVC	750	150 L	Three-phase / 0.12 kW	70
	AISI 304				
Mixer MLS-085	PP or PVC	850	300 L	Three-phase / 0.18 kW	108
	AISI 304				
Mixer MLS-105	PP or PVC	1050	500 L	Three-phase / 0.18 kW	70
	AISI 304				
Mixer MLS-110	PP or PVC	1100	1000 L	Three-phase / 0.25 kW	108
	AISI 304				

## MVS SERIES - FAST STIRRING MODELS (without gear reducer)

ITEM	MATERIAL OF SHAFT & SCREW	LENGTH OF SHAFT (cm)	TANK	MOTOR	VELOCITÀ (rpm)
Mixer MVS-038	PP or PVC	380	50 L	3-phase / 0.09 kW	1400
	AISI 304			3-phase / 0.12 kW	950
Mixer MVS-055	PP or PVC	550	100 L	Three-phase / 0.12 kW	950
	AISI 304				
Mixer MVS-075	PP or PVC	750	150 L	Three-phase / 0.12 kW	950
	AISI 304				
Mixer MVS-085	PP or PVC	850	300 L	Three-phase / 0.18 kW	950
	AISI 304				
Mixer MVS-105	PP or PVC	1050	500 L	Three-phase / 0.18 kW	700
	AISI 304				
Mixer MVS-110	PP or PVC	1100	1000 L	Three-phase / 0.37 kW	700
	AISI 304				

### ITEM

Optional single-phase motor 230 V~

## DOSING ACCESSORIES

### TANKS, CONTAINERS AND ACCESSORIES

- Series of semi-transparent polyethylene (LLDPE) tanks
- **Drain outlet**
- **Visual indication of liquid level**
- Filling hole with screw cap
- Series of safety / drip containers
- Assembled, complete dosing stations



### TANKS

ITEM	VOLUME	B (Ø)	H	CAP (Ø)	PART NO.
S50	50 L	40 cm	45,5 cm	14 cm	36000003
S100	100 L	46 cm	64 cm	14 cm	36000004
S150	150 L	48 cm	86 cm	14 cm	36000005
S300	300 L	67 cm	95 cm	21,5 cm	36000006
S500	500 L	76 cm	118,5 cm	21,5 cm	36000007
S1000	1000 L	108.5 cm	122 cm	31,5 cm	36000008



### SAFETY CONTAINERS

ITEM	TANK	A (Ø)	B (Ø)	H	PART NO.
TIN80	S50	49 cm	45 cm	60 cm	36000009
TIN150	S100	55 cm	51 cm	61 cm	36000010
TIN200	S150	60 cm	55 cm	86 cm	36000011
TIN400	S300	80 cm	72 cm	99 cm	36000013
TIN800	S500	85 cm	81 cm	110 cm	36000015
TIN1500	S1000	119 cm	122 cm	134 cm	36000016



### ACCESSORIES

ITEM	PART NO.
T25, polyethylene hopper, 25 litres, filling hole with screw cap	36000002
PVC half-moon panel for S100 and S150 tanks, with screws and fittings	89000075
PVC half-moon panel for S300 and S500 tanks, with screws and fittings	89000076
PVC half-moon panel for S1000 tank, with screws and fittings	89000077

The tanks can be supplied already assembled with the accessories that best fit your needs, in order to provide a tailor-made dosing station. Contact STEIEL for specific proposals.



## ELECTROMAGNETIC FLOW METERS

- **Accurate and bidirectional measurements**
- Robust, fully welded and potted construction, with **flanged connections**
- External coating for offshore or subsoil installation
- **AISI304 flow tube, painted carbon steel flanges, Hastelloy C electrodes**
- Protection rate: IP68 (continuous immersion at 1.5 m)
- **“Zero diameters” models for installations also in curves or reduced spaces,** negligible pressure loss
- **Approved for drinking water, WRAS, FDA, DM174**
- Flanges PN16 (PN10 on request)
- Compact standard version, with integrated converter
- Version upon request with separated converter (at a max distance of 100 m)
- Converter with aluminium IP68 housing, graphical LCD, 4-20 mA analogic output, pulse output, RS485 serial port with Modbus RTU communication protocol, 90 ... 264 V~ power supply



## STANDARD INSTALLATION (U5-D3) FLOW METERS

ITEM	DIAMETER		INTERNAL COATING	TEMPERATURE OF THE LIQUID	PART NO.
STM2200-012	1/2"	DN15	PTFE	-40 ... +130 °C *	9420000000
STM2200-034	3/4"	DN20	PTFE	-40 ... +130 °C *	9420001000
STM2200-100	1"	DN25	PTFE	-40 ... +130 °C *	9420002000
STM2200-114	1.1/4"	DN32	PTFE	-40 ... +130 °C *	9420003000
STM2200-112	1.1/2"	DN40	PTFE	-40 ... +130 °C *	9420004000
STM2200-200	2"	DN50	PTFE	-40 ... +130 °C *	9420005000
STM2200-212	2.1/2"	DN65	PTFE	-40 ... +130 °C *	9420006000
STM2200-300	3"	DN80	PTFE	-40 ... +130 °C *	9420007000
STM2200-400	4"	DN100	PTFE	-40 ... +130 °C *	9420008000
STM2200-500	5"	DN125	Ebanite	-40 ... +80 °C	9420009000
STM2200-600	6"	DN150	Ebanite	-40 ... +80 °C	9420010010
STM2200-800	8"	DN200	Ebanite	-40 ... +80 °C	9420011010

\* Temperature max 80°C for compact version; temperature max 180°C with extra potting (upon request).

## “ZERO DIAMETERS” (U0-D0) FLOW METERS

ITEM	DIAMETER		INTERNAL COATING	TEMPERATURE OF THE LIQUID	PART NO.
STM2300-200	2"	DN50	Ebanite	-40 ... +80 °C	9430005010
STM2300-212	2.1/2"	DN65	Ebanite	-40 ... +80 °C	9430006010
STM2300-300	3"	DN80	Ebanite	-40 ... +80 °C	9430007010
STM2300-400	4"	DN100	Ebanite	-40 ... +80 °C	9430008010
STM2300-500	5"	DN125	Ebanite	-40 ... +80 °C	9430009010
STM2300-600	6"	DN150	Ebanite	-40 ... +80 °C	9430010010

Meters are also available with larger diameters and different materials for flow tube, flanges and electrodes. Contact STEIEL for specific evaluations.

ITEM
Optional version with separated converter
Converter-meter connection cable (lengths multiple of 5 m)

## DOSING ACCESSORIES

### PULSE-EMITTING WATER METERS

- **Full range of volumetric water meter with reed standard pulse emitting device, MID approved according to the European Directive 2004/22/CE (modules B+D)**
- Models with single-jet (CRU series) and multi-jet (CRM series) turbine
- Woltmann models with helical vane (CFW series), and removable measurement unit
- Accuracy class 2, direct reading with 5 counter rollers, dry dial, magnetic transmission, different pulse rate options (litres/pulse), reed emitting device with 2 meter standard cable
- **Product code to be completed with the desired pulse rate**



### TURBINE WATER METERS WITH THREADED CONNECTIONS

ITEM	CONNECTIONS		LENGTH	JET	TEMPERATURE MAX	PRESSURE MAX	PART NO.
CRU-012	1/2"	DN15	110 mm	Single	30 °C	16 bar	9400000x
CRM-012				Multiple			9400010x
CRU-034	3/4"	DN20	130 mm	Single	30 °C	16 bar	9400001x
CRM-034				Multiple			9400011x
CRM-100	1"	DN25	260 mm	Multiple	30 °C	16 bar	9400012x
CRM-114	1.1/4"	DN32	260 mm	Multiple	30 °C	16 bar	9400013x
CRM-112	1.1/2"	DN40	300 mm	Multiple	30 °C	16 bar	9400014x
CRM-200	2"	DN50	300 mm	Multiple	30 °C	16 bar	9400015x
CRM-012HT	1/2"	DN15	110 mm	Multiple	90 °C	16 bar	9400110x
CRM-034HT	3/4"	DN20	130 mm	Multiple	90 °C	16 bar	9400111x
CRM-100HT	1"	DN25	260 mm	Multiple	90 °C	16 bar	9400112x
CRM-114HT	1.1/4"	DN32	260 mm	Multiple	90 °C	16 bar	9400113x
CRM-112HT	1.1/2"	DN40	300 mm	Multiple	90 °C	16 bar	9400114x
CRM-200HT	2"	DN50	300 mm	Multiple	90 °C	16 bar	9400115x

#### *Turbine water meter for aggressive liquids and special water (demi, industrial wastewater, etc.)*

CRM-012HR	1/2"	DN15	110 mm	Multiple	90 °C	16 bar	9400310x
CRM-034HR	3/4"	DN20	130 mm	Multiple	90 °C	16 bar	9400311x
CRM-100HR	1"	DN25	260 mm	Multiple	90 °C	16 bar	9400312x
CRM-114HR	1.1/4"	DN32	260 mm	Multiple	90 °C	16 bar	9400313x
CRM-112HR	1.1/2"	DN40	300 mm	Multiple	90 °C	16 bar	9400314x
CRM-200HR	2"	DN50	300 mm	Multiple	90 °C	16 bar	9400315x

ITEM	DESCRIPTION	PART NO.
CAV-REED 2	Cable for pulse-emitting device of CRU / CRM series, L = 2 m	94002000
CAV-REED 3	Cable for pulse-emitting device of CRU / CRM series, L = 3 m	94002001

## HELICAL VANE (WOLTMANN) MODELS WITH CONNECTION FLANGES

ITEM	CONNECTIONS		LENGTH	TEMPERATURE MAX	PRESSURE MAX	PART NO.
CFW-200	2"	DN50	200 mm	50 °C	16 bar	9400020x
CFW-212	2.1/2"	DN65	200 mm	50 °C	16 bar	9400021x
CFW-300	3"	DN80	225 mm	50 °C	16 bar	9400022x
CFW-400	4"	DN100	250 mm	50 °C	16 bar	9400023x
CFW-500	5"	DN125	250 mm	50 °C	16 bar	9400024x
CFW-600	6"	DN150	300 mm	50 °C	16 bar	9400025x
CFW-800	8"	DN200	350 mm	50 °C	16 bar	9400026x
CFW-1000	10"	DN250	450 mm	50 °C	16 bar	9400027x

*Upon request, flanged models are also available for use with sanitary hot water, up to 130°C.*

ITEM	PART NO.
Pulse-emitting sensor for CFW series water meters	94002002

*For each model of water meter you can choose different pulse rate, by completing the product part number as follows:*

X	K REED (Litres/pulse)	FREQUENCY OF EMITTED PULSES	TURBINE MODELS	FLANGED MODELS
0	K0.25	4 imp / 1 L	All models	-
1	K1	1 imp / 1 L	All models	-
2	K2.5	4 imp / 10 L	All models	-
3	K10	1 imp / 10 L	All models	DN50, DN65, DN80
4	K25	4 imp / 100 L	All models	-
5	K100	1 imp / 100 L	All models	DN100, DN125, DN150
6	K250	4 imp / 1000 L	All models	-
7	K1000	1 imp / 1000 L	All models	DN200, DN250



## DOSING UNIT FOR GRANULAR PRODUCTS

### POOL-CHEM FLEX

- Dissolution and dosage of granular products
- Folding system for loading standard drums from 15 to 40 kg
- **Production rate: 3 kg/h** (standard metering screw) **or 6 kg/h** (bigger screw)
- **On-board electronic controller**
- Independent operation or controlled by analysis unit
- **Standard version with 4-20 mA input** (ON-OFF input upon request)



ITEM	DESCRIPTION	PART NO.
POOL-CHEM FLEX std.	System for the dissolution and dosage of granular chemicals; standard metering screw 3 kg/h; 4-20 mA	80508001
POOL-CHEM FLEX plus	System for the dissolution and dosage of granular chemicals; bigger metering screw 6 kg/h; 4-20 mA	80508002
S210	Electronic controller for Pool-Chem Flex	80508015
Suction Kit	PVC shaft, PVC Crystal hose, level control and cap	77020012
Acid Pump	Peristaltic pump for acid dosage, with mounting kit	77020011
Circ. Pump	Circulation pump, AISI316, 230 V~	54500243
Cyclone	Complete cyclone	77020002
Ejector Group	Ejector, check valve, flow-switch, hose tail (the group is supplied assembled, wired and tested)	77020003
Cartridge	Filter cartridge, 9" mesh	80710013
Valve	Float valve for Pool-Chem Flex	80508006
Level Sensor	Sensor for min and max level of the water tank	97009005
Striker	Complete striker group, wired and tested	77020006
Standard Screw	Complete metering screw group (3 kg/h), assembled and tested	77020007
Plus Screw	Complete metering screw group (6 kg/h), assembled and tested	77020015
Guide	Metering screw guide	77020012
Motor	Spare gear motor for metering screws	54500230
Heater	Heating nozzle group complete with cable	77020008
Chlorine sensor	Sensor for detection of powder chlorine	54500007
Guide Tube	Guide tube for powder chlorine	70200025

## PROPORTIONAL VOLUMETRIC DOSING

### DOSAMIX

- Dispenser for water treatment applications
- Mixing and dosing of additives and disinfectants
- **Precise and constant percentage dosing**
- Integrated mixing chamber
- Hydraulic supply that exploits the pressure and flow rate of the mains water
- **Working pressure 0.3 ... 6 bar; water temperature 5 ... 40 ° C**
- Quick installation, 3/4" BSP connections
- AISI316 ball valve, AISI316 metal parts
- Simple maintenance
- Supplied with installation bracket and reinforced suction hose (1.5 m)



ITEM	FLOW RATE	DOSAGE *	PART NO.
DOSAMIX 075	5 ... 750 litres/h ; 0.005 ... 0.75 m <sup>3</sup> /h	0.2 ... 2 %	95000010
DOSAMIX 150	5 ... 1500 litres/h ; 0.005 ... 1.50 m <sup>3</sup> /h	0.2 ... 2 %	95000011
DOSAMIX 250	10 ... 2500 litres/h ; 0.010 ... 2.50 m <sup>3</sup> /h	0.2 ... 2 %	95000012
DOSAMIX 300	10 ... 3000 litres /h ; 0.010 ... 3.00 m <sup>3</sup> /h	0.2 ... 2 %	95000013

\* Other dosage percentage ranges available on request (0.03 ... 2 % ; 0.5 ... 4 % ; 1 ... 5 % ; 1 ... 10 %).

#### ITEM

Kit ON-OFF : cap with valve for on-off dosage

Kit filter + regulator + manometer (no-return valve not included)

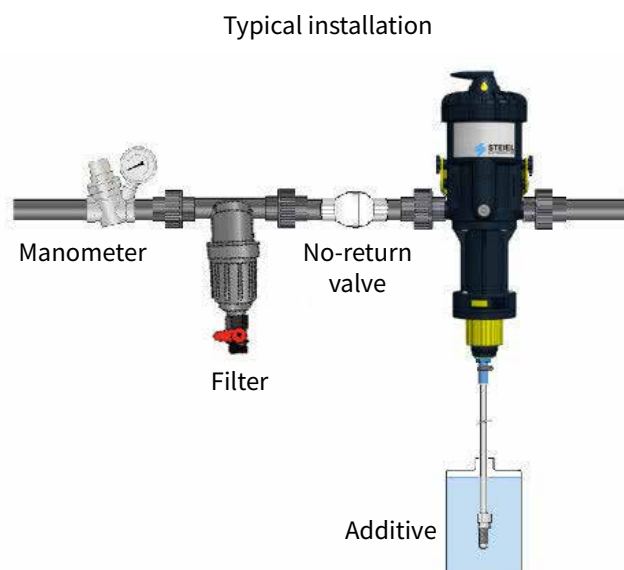
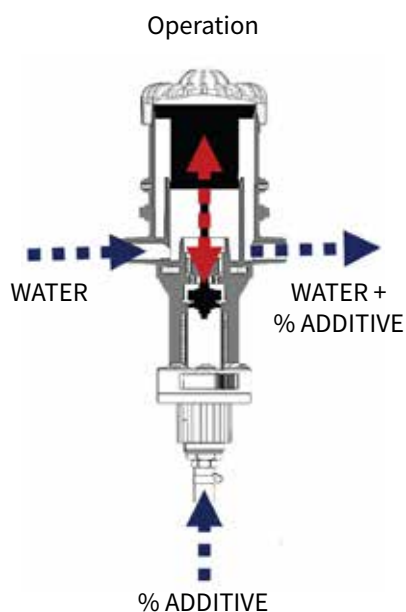

## COLORIMETRIC ANALYSIS

### MCO14 DIGITAL COLORIMETRIC UNIT

- Basic measurements always provided: **pH, ORP, free chlorine** (colorimetric analysis)
- Additional measurements: **temperature, total chlorine** (colorimetric analysis) **and combined chlorine** (calculated)
- Housing for reagent bottles (and level probes)
- **Two configuration levels** (standard and advanced), with password
- Multilingual menu
- Relays for ON/OFF or proportional control, or NO/NC alarm
- Two current outputs, 0-20 or 4-20 mA
- OFF input, configurable NO or NC, for disabling outputs
- Two (or three) level inputs for monitoring reagents to be dosed
- Data log downloadable through serial line (internal data logger)
- Serial port, with galvanic insulation, for communication with PC, RW14 or  $\mu$ MMC4
- Optional RS485 serial port with Modbus RTU communication protocol
- Power supply: 230 V~ (standard), 115 V~
- **Version with K4 and K5 pulse outputs, upon order**



ITEM	DESCRIPTION	PART NO.
MCO14/3	Measurements of pH, ORP and free chlorine; RCO-R1 and RCO-R2 reagents required (not included)	816301049901
MCO14/5	Measurements of pH, ORP, temperature, free and total (combined) chlorine; RCO-R1, RCO-R2, RCO-R3 reagents required (not included)	816301049904
RCO-R1	Reagent 1 for free chlorine analysis with DPD1 method, 1 L	80090103
RCO-R2	Reagent 2 for free chlorine analysis with DPD1 method, 1 L	80090104
RCO-R3	Reagent 3 for total chlorine analysis with DPD3 method, 0.5 L	80090105
EV-MCO07	Solenoid valve for hydraulic group	80509910
TB-MCO07	Santoprene tube for peristaltic pump	96000200
Pump	Spare peristaltic pump; flow rate 0.25 l/h, Santoprene internal tube, 24 V-	80509912
MX-MCO07	Mixer for hydraulic group	80509901
FT-MCO07	Impurity filter for colorimetric units	70109069
Valve	Spare valve, 1/4" M/F	36306590
Optic Group	Spare complete optic group for MCO14 units	80509913
	Cap for bottle of reagent 1, with level sensor	96000116
	Cap for bottle of reagent 2, with level sensor	96000121
	Cap for bottle of reagent 3, with level sensor	96000122
Kit A	Installation kit: 1 valve M/F 1/2", 2 fittings with 1/2" ring nut, PVC Crystal hose 8x12 mm (5 m)	80509907

For pH, ORP and temperature sensors, please refer to the specific section "Sensors & Accessories".

## MULTI-PARAMETRIC UNITS

### EF214 DIGITAL UNITS

- **Inputs for 5 simultaneous measurements** (temperature always provided)
- Measurement of pH, ORP, chlorine, conductivity, turbidity, etc.
- **Available double input for CAC cells**
- **Two configuration levels** (standard and advanced), with password
- Multilingual menu
- Relays for ON/OFF or proportional control, or NO/NC alarm
- Two current outputs, 0-20 or 4-20 mA
- OFF input, configurable NO or NC, for disabling outputs
- Flow sensor input for disabling outputs upon lack of water flow to the sensors
- Two level inputs for monitoring reagents to be dosed
- Data log downloadable through serial line (internal data logger)
- Serial port, with galvanic insulation, for communication with PC, RW14 or  $\mu$ MMC4
- Optional RS485 serial port with Modbus RTU communication protocol
- The unit is generally supplied prewired and assembled on a panel, complete with measurement sensors, dosing pumps and data recording system
- Power supply: 230 V~ (standard), 115 V~ / 50/60 Hz



ITEM	DESCRIPTION
EF214 /3 std.	EF214, 3 channels (pH/RX/CLE12) + temperature, RS232
EF214 /3 std.	EF214, 3 channels (pH/RX/CAC) + temperature, RS232
EF214 /4 std.	EF214, 4 channels + temperature, RS232

### EF315 DIGITAL UNITS FOR pH/CHLORINE CONTROL IN SWIMMING POOLS





- **Two inputs for simultaneous measurements** (temperature always provided)
- Measurement of pH, ORP, chlorine (CLE12 or CAC signal)
- Multilingual menu
- Control outputs for driving “dosing-shot” pumps / 230 V / pulses
- Flow sensor input for disabling outputs upon lack of water flow to the sensors
- Two level inputs for monitoring reagents to be dosed
- Optional serial port
- **Configurable maintenance schedule**
- The unit is generally supplied prewired and assembled on a panel, complete with measurement sensors, dosing pumps and data recording system
- Power supply: 230 V~ (50/60 Hz)



ITEM	DESCRIPTION
EF315 pH/RX/T	EF315 with pH, ORP and temperature inputs
EF315 pH/CL/T	EF315 with pH, CLE12 and temperature inputs
EF315 pH/CAC/T	EF315 with pH, CAC signal and temperature inputs
Optional RS232 serial port for communication with RW14	

## READY TO USE CONTROL SYSTEMS

### CUSTOMIZED ASSEMBLIES ON PANEL

ITEM	DESCRIPTION
	High density expanded PVC panel, 650x290 mm, assembling costs included
	High density expanded PVC panel, 500x600 mm, assembling costs included
	High density expanded PVC panel, 595x750 mm, assembling costs included
	High density expanded PVC panel, 900x700 mm, assembling costs included

SWIMMING POOL

## CONTROL of pH and CHLORINE

- Two-parameter control panel, ready-to-use, including dosing pumps with built-in meter, measurement sensors, probe-holder, flow sensor, mesh filter and connection box
- Version pH/chlorine with EF163A (chlorine) and EF162 (pH) pumps
- Version with two EF162 pumps, pH and ORP
- Supplied with standard accessories for two dosing pumps and calibration solutions
- Panel dimensions: 500x600 mm
- Power supply: 230V~



PNL pH-RX

PNL pH-Cloro

ITEM	PART NO.
Panel PNL-EF162pH-EF162RX 1002, pH electrode, ORP electrode, flow sensor; assembling costs included	E3703022443939
Panel PNL-EF162-EF163A 1002, pH electrode, CLE12 cell (5 ppm), flow sensor; assembling costs included	E370121003939

## COMPACT SYSTEMS

### EF300 / EF270 / EF260 SERIE, FOR pH / CHLORINE CONTROL



EF300 pH/RX

EF300 pH/CLE

EF300 pH/CAC

EF270 pH/RX

EF265

EF267

- **All models feature a pH input with BNC connector for electrode**
- **Chlorine measurement may be indirect** (via ORP, with electrode input on BNC connector) **or direct** (input for CLE12 or CAC cell, depending on model)
- Standard chlorine range : 0-5 ppm (others upon request)
- Two control outputs for adjustment of pH and chlorine levels, available in various configurations
- Multilingual menu
- Digital inputs: OFF/FLOW input, and two level inputs for monitoring reagents to be dosed
- RS232 serial port for communication with RW14
- **Two different casing sizes, L (large 350 x 380 x 175 mm) and S (small 290 x 280 x 175 mm)**
- Power supply: 230 V~ (standard)
- Supplied with standard accessories for dosing heads (if present) and calibration solutions

ITEM	CHLORINE SENSOR	PROBE-HOLDER	PT100	RS232 PORT	CONTROL OUTPUTS	CASE	PART NO.
EF300 pH/RX C11	RX/Pt	x	-	Optional	Two electromagnetic dosing heads PGV 0506	L	84003010303
EF300 pH/RX C12	RX/Pt	x	-	Optional	Two electromagnetic dosing heads PGV 1002	L	84003011010
EF270	RX/Pt	x	-	Optional	Two peristaltic heads, 1.5 l/h pH, 6 l/h chlorine	L	84001015761
EF265	RX/Pt	-	-	-		S	84008015761
EF300 pH/CLE/T	CLE12	x	x	Optional	Two 230V outputs	L	841031104
EF300 pH/CAC Chlorine/T	CAC-CLO-M1	x	x	x	Two 230V outputs	L	842030502
EF300 pH/CAC Bromine/T	CAC-BRO-M	x	x	x	Two 230V outputs	L	842032302
EF266	RX/Pt	x	-	-	One peristaltic + one 230V output (relay)	S	84009010359
EF267	RX/Pt	x	-	-	One dosing head PGV 1002 + one 230V output (relay)	S	84010010310

#### DESCRIPTION

Optional software EF310 in EF300 pH/Chlorine

Optional EF266 / EF267 with RX/Au electrode



## EF253 / EF254, pH or ORP CONTROL

- **Single-parameter, compact units** for the analysis and adjustment of pH and ORP levels in swimming pools
- Digital inputs: OFF/FLOW and LEV (level)
- Small casing, size 290 x 280 x 175 mm
- Power supply: 230 V~
- Supplied with standard accessories for dosing head, electrode holder with DN50 clamp for direct in-line installation of the electrode, calibration solutions



ITEM	SENSOR	DOSING HEAD	PART NO.
EF253 pH	pH electrode with 2.5 m cable and BNC	Peristaltic	840060459
EF253 RX	RX/Pt electrode with 2.5 m cable and BNC	Peristaltic	840060559
EF254 pH C11	pH electrode with 2.5 m cable and BNC	Electromagnetic PGV 0506	840070406
EF254 pH C12		Electromagnetic PGV 1002	840070410
EF254 RX C11	RX/Pt electrode with 2.5 m cable and BNC	Electromagnetic PGV 0506	840070506
EF254 RX C12		Electromagnetic PGV 1002	840070510

## EF110 / EF158, DIGITAL PUMPS WITH pH/ORP METER

- Designed for wall installation
- User selectable pH or ORP range
- Electrode input on BNC connector
- Input for level sensor
- Available pH and ORP kits
- Power supply: 230 V~



ITEM	DESCRIPTION	PART NO.
EF110	Version with peristaltic pump, 1.8 l/h @ 1 bar, IP54	95930503
EF158 0212	Version with electromagnetic pump, 2 l/h @ 12 bar, PP head / FPM seals, IP65	968001320
EF158 0506	Version with electromagnetic pump, 5 l/h @ 6 bar, PP head / FPM seals, IP65	968001321
EF158 1002	Version with electromagnetic pump, 10 l/h @ 2 bar, PP head / FPM seals, IP65	968001322
Optional PVDF dosing head for EF158 models		
Kit-pH	pH electrode (2.5 m cable and BNC), electrode holder with DN50 clamp, pH4 and pH7 buffers (90 ml each)	80099903
Kit-RX/Pt	RX/Pt electrode (2.5 m cable and BNC), electrode holder with DN50 clamp, 220 mV calibration solution (90 ml)	80099904
Kit-RX/Au	RX/Au electrode (2.5 m cable and BNC), electrode holder with DN50 clamp, 220 mV calibration solution (90 ml)	80099905

## WATER DISINFECTION WITH HYDROGEN PEROXIDE

- Professional digital peristaltic pump, with Santoprene internal tube
- Standard flow rate 2.4 l/h @ 1 bar (other options upon request)
- **Software designed for pool water disinfection with hydrogen peroxide**
- LCD with backlight and multilingual menu
- **Manual, semi-automatic or automatic working mode**
- Daily dosing program with automatic adjustment depending on water temperature
- Temperature input for Pt100 sensor (not included, to be ordered separately)
- Input for level sensor
- Power supply: 230 V~



ITEM	DESCRIPTION	PART NO.
EF125	Digital peristaltic pump for H <sub>2</sub> O <sub>2</sub> dosage; 2.4 l/h @ 1 bar	983002304

## WATER DISINFECTION WITH OZONE

- Three models with different ozone production rates
- Modular systems
- Corona-discharge technology
- Effective and environmentally safe ozone generators
- Available installation kit and booster pump
- Power supply: 110 ... 250 V~



ITEM	DESCRIPTION	PART NO.
S21	Ozone system with production rate max 0.25 g/h	85202101
S22	Ozone system with production rate max 0.5 g/h	85202102
S23	Ozone system with production rate max 1.0 g/h	85202103
3OX-KIT	Installation kit, including: Venturi injector, contact chamber, degassing system, 5 m of 7x10 PVC Crystal hose, tube for connecting the generator to Venturi injector (with two check valves), hydraulic fittings, 1 flow meter and 1 spare check valve	85200101
3-OX PUMP	Booster pump for ozone systems	54500241
Spare contact chamber		85200006
Spare ozone module (cell)		85200301
Spare check valve for ozone systems		85200104
Flow meter for ozone systems		85200004
3OX-MDV	Charcoal filter for the excess ozone removal	85200005
3OX-IV	Venturi injector for ozone systems	85200002
3OX-AV	Venturi injector adapter for ozone systems	85200003
3OX-TU	Ozone tube 1/4" x 3/8"; sold by meter	85200007

## EF117, CONTROL UNIT FOR SALT CHLORINATOR

- Digital unit with built-in redox meter
- Double-pitch Schuko socket for powering a dosing unit (e.g. salt chlorinator)
- Electrode input on BNC connector
- LED display
- Prewired power cable with Schuko plug
- Power supply: 230 V~



ITEM	DESCRIPTION	PART NO.
EF117	Control unit for salt chlorinator, with ORP meter	95940520

## EF-J KIT, GROUNDING KIT

- Eliminates interferences or electric noise coming from plastic pipes (no conductive)
- Available two sizes, DN50 and DN63
- Complete with gaskets, screws and cable lugs for electric wirings



ITEM	DESCRIPTION	PART NO.
EFJ_KIT50_MT	Grounding kit with DN50 clamp	85007820
EFJ_KIT63_MT	Grounding kit with DN63 clamp	85007821

## TE07, TEMPERATURE CONTROL

- Digital thermometers, range 0-50 °C
- Adjustable threshold, relay output
- Casing IP56
- Power supply: 230 V~



ITEM	DESCRIPTION	PART NO.
TE07 / SI	Digital thermometer with built-in temperature sensor, installation through ½" threaded sensor	80320005
TE07 / SE	Digital thermometer with prewired external probe (3 m cable), wall installation	80320010

## POOL TIMER PLUS, TIMED DOSAGE

- Timed dosing system
- Timer for weekly scheduling the daily dosing times
- Built-in peristaltic pump, with Santoprene internal tube
- Power supply: 230 V~



ITEM	DESCRIPTION	PART NO.
Pool Timer Plus	Compact system for timed dosage, complete with configurable timer and peristaltic pump (4 l/h)	95050023

## SIZING GUIDE FOR DOING PUMPS

The chlorine dosing pump has to be sized according to the expected chlorine demand of the swimming pool, which is affected by several factors, as the pool volume, the filtration flow rate, the private or public use, the indoor or outdoor location, the chlorine concentration in the dosed disinfectant.

In other words, to keep a disinfectant level of about 1 ppm, an outdoor swimming pool requires more chlorine than an indoor one, and a public pool will demand more chlorine than a private one.

To simplify, suppose the following average demand of chlorine:

Use	Private	Public
Indoor pool	1.5 ppm	2 ppm
Outdoor pool	2.5 - 3.5 ppm	3 - 4 ppm

The needed dosing flow rate for the chlorine pump is calculated as follows:

$$\text{Dosing flow rate (l/h)} = [ \text{filtration flow rate (m}^3\text{/h)} \times \text{chlorine-demand (ppm)} ] / [ \text{chlorine conc. (\%)} / 10 ]$$

It is recommended to choose a pump with a flow rate bigger (double) than the calculated theoretical value.

For the pH correction, the acid dosing pump is sized proportionally to the estimated chlorine consumption.

Here below you can find an useful guide for selecting the pump right size for an outdoor swimming pool with a complete recirculation of about 3 hours, depending on the pool volume and chlorine concentration in the dosed product.

Pool volume m <sup>3</sup>	Circul. flow rate m <sup>3</sup> /h	Sodium hypochlorite Concentration 14%		Calcium hypochlorite 65% (1:10) Concentration 6.5%		Di-chloro 55% (diluted 1:10) Conc. 5,5%		Electrolytic Chlorine Concentration 2%		Sulphuric acid 30-36%	
		Pump size (l/h)		Pump size (l/h)		Pump size (l/h)		Pump size (l/h)		Pump size (l/h)	
		Private	Public	Private	Public	Private	Public	Private	Public	Private	Public
40	12	2	2	2	2	2	2	4	5	2	2
60	20	2	2	2	4	2	4	8	8	2	2
80	25	2	2	2	4	2	4	8	10	2	2
100	35	2	2	4	5	4	5	13	13	2	2
150	50	2	4	4	8	4	8	20	20	4	4
200	65	4	4	8	8	8	8	20	32	4	4
300	100	4	5	8	13	8	13	32	40	5	8
400	120	4	8	10	20	10	20	40	50	5	8
500	150	5	8	13	20	13	20	50	60	8	8
1000	300	10	20	20	40	20	40	100	120	13	20
1500	500	20	32	32	70	32	70	150	200	20	32

## WATER DISINFECTION SYSTEMS WITH UV RADIATIONS

STEIEL offers a full range of systems for water sterilization and debacterization with UV-C radiations.

Models are available for treating installations with a flow rate from 1 to 1000 m<sup>3</sup>/h, with stainless steel (AISI304 or AISI316L) or HDPE vessel, with mercury vapour (low or medium pressure) or amalgam lamps.

Each system is equipped with a microprocessor-based control unit.

The below tables provide to the customer an useful guide for choosing the model which better fits its needs, depending on the type and flow rate of the water to be treated.

Treatable flow rate (m <sup>3</sup> /h)	EF-U200 SERIES	EF-U900 PE SERIES	EF-U100 SERIES	UV-S300 SERIES	UV-S700 SERIES	UV-S510 SERIES	UV-S900 PE SERIES	UV-S600 SERIES
1000								
800								
600								
400								
200								
100								
60								
50								
40								
30								
20								
10								
5								
2,5								
1								
Intended use	EF-U200 SERIES	EF-U900 PE SERIES	EF-U100 SERIES	UV-S300 SERIES	UV-S700 SERIES	UV-S510 SERIES	UV-S900 PE SERIES	UV-S600 SERIES
Potable water								
Salt water								
Swimming pool (disinfection)								
Swimming pool (abatement of combined Cl)								

## EF-U200 AND EF-U900 SERIES

- Microprocessor-based control unit with counter of lamp working hours, remote ON/OFF, alarm relay and switching on / off timer
- Starter with stabilization function of the power voltage
- Working pressure max: 9 bar for steel vessels, 6 bar for HDPE vessels
- Power supply: 230 V~ (standard)
- **Low pressure, mercury vapour lamps**
- Models with **AISI316L steel vessel**
- Models with **HDPE vessel**: optional radiation sensor (“H” version)



### Models with AISI316L vessel - Sized for swimming pools with recirculation system

ITEM	FLOW RATE MAX (m <sup>3</sup> /h)	LAMPS	HYDRAULIC CONNECTIONS	UV-C DOSE (J/m <sup>2</sup> )	PART NO.
EF-U 201	4.0	1 x 40 W	1.1/2” M	250	85104221
EF-U 202	6.9	1 x 40 W	2” M		85104222
EF-U 203	14	1 x 80 W	2” M		85104223
EF-U 204	18	1 x 80 W	2” M		85104224
EF-U 205	34	2 x 80 W	2.1/2” m		85104225

### Models with HDPE vessel, for sea water - Sized for turbid water recirculation or clear water continuous consumption

ITEM	FLOW RATE MAX (m <sup>3</sup> /h)	LAMPS	HYDRAULIC CONNECTIONS	UV-C DOSE (J/m <sup>2</sup> )	STANDARD MODEL	“H” MODEL
					PART NO.	PART NO.
EF-U 900 PE	3.5	1 x 40 W	1.1/2” M	400	85106231	85107231
EF-U 901 PE	5	1 x 80 W	1.1/2” M		85106232	85107232
EF-U 902 PE	8	2 x 40 W	2.1/2” M		85106233	85107233
EF-U 903 PE	15	2 x 80 W	2.1/2” M		85106234	85107234

DESCRIPTION	PART NO.
Low pressure lamp, 40 Watt (minimum order quantity: 4 pcs.)	85100105
Low pressure lamp, 80 Watt (minimum order quantity: 4 pcs.)	85100106
Quartz for 40 / 80 Watt lamp (minimum order quantity: 4 pcs.)	85100205



## EF-U100 AND UV-S300 SERIES

- Standard microprocessor-based control unit with counter of lamp working hours, remote ON/OFF, alarm relay and switching on / off timer
- UV-S300 Control panel “H” version with monitoring of irradiation / temperature of water, check of panel temperature and shutdown function upon overheating of the vessel / electronic unit
- EF-U100 series, “H” version with radiation sensor
- Working pressure max 9 bar
- Power supply: 230 V~ (standard)
- **Low pressure, mercury vapour lamps**
- **Steel vessels:** polished AISI304 or AISI316L



### EF-U100 Series

ITEM	FLOW RATE MAX (m <sup>3</sup> /h)	LAMPS	HYDRAULIC CONNECTIONS	UV-C DOSE (J/m <sup>2</sup> )	AISI304 VESSEL	AISI316L VESSEL	
					PART NO.	PART NO.	
EF-U 105	1.2	1 x 30 W	3/4" M	300	85102211	85102221	
EF-U 105 H					85103211	85103221	
EF-U 106	2.7	1 x 40 W	1" M		85102212	85102222	
EF-U 016 H					85103212	85103222	
EF-U 107	3.6	1 x 40 W	1.1/2" M		85102213	85102223	
EF-U 107 H					85103213	85103223	
EF-U 108	4.5	2 x 40 W	1" M		85102214	85102224	
EF-U 109	5.1	1 x 80 W	1.1/2" M		85102215	85102225	
EF-U 109 H					85103215	85103225	
EF-U 110 +	6.0	2 x 40 W	1.1/2" M		400	85102216	85102226
EF-U 110 + H						85103216	85103226
EF-U 111 +	12.0	2 x 80 W	1.1/2" M			85102217	85102227
EF-U 111 + H				85103217		85103227	

### UV-S300 Series

ITEM	FLOW RATE MAX (m <sup>3</sup> /h)	LAMPS	HYDRAULIC CONNECTIONS	UV-C DOSE (J/m <sup>2</sup> )	AISI304 VESSEL	AISI316L VESSEL
					PART NO.	PART NO.
UV-S 305	30	4 x 80 W	2" M	400	85108215	85108225
UV-S 305 H					85109215	85109225
UV-S 306	40	5 x 80 W	DN80		85108216	85108226
UV-S 306 H					85109216	85109226
UV-S 307	20	3 x 80 W	DN80		85108217	85108227
UV-S 307 H					85109217	85109227

DESCRIPTION	PART NO.
Optional manual cleaning system, only for AISI316L vessels, UV-S300 series	
Low pressure lamp, 30 Watt (minimum order quantity: 4 pcs.)	85100104
Low pressure lamp, 40 Watt (minimum order quantity: 4 pcs.)	85100105
Low pressure lamp, 80 Watt (minimum order quantity: 4 pcs.)	85100106
Quartz for 30 Watt lamp (minimum order quantity: 4 pcs.)	85100204
Quartz for 40 / 80 Watt lamp (minimum order quantity: 4 pcs.)	85100205

## UV-S510 AND UV-S700 SERIES - BACTERICIDE ACTION WITH AMALGAM LAMPS

- UV-S700 series (models 701, 702, 703): microprocessor-based control unit with graphic LCD, available standard version (with monitoring of lamp operation, alarm relay, and counter of lamp total and working hours) or “H” version (with monitoring of irradiation / temperature of water, check of panel temperature and shutdown function upon overheating of the vessel / electronic unit)
- UV-S510 series and models UV-S704 / 705: microprocessor-based control unit with colour touch-screen interface, only available “H” version
- Working pressure max 9 bar
- Power supply: 230 V~ (standard)
- **Steel vessels** can be mounted both horizontally and vertically
- **Amalgam lamps** guarantee a 100% yield of the emission even with hot water, with a temperature between 30 and 60 °C



ITEM	FLOW RATE MAX (m³/h)	LAMPS	HYDRAULIC CONNECTIONS	DOSE UV-C (J/m²)	AISI304 VESSEL	AISI316L VESSEL
					PART NO.	PART NO.
UV-S 701	24	1 x 200 W	2" M	> 400	85114211	85114221
UV-S 701 H					85115211	85115221
UV-S 702	50	2 x 200 W	DN80		85114212	85114222
UV-S 702 H					85115212	85115222
UV-S 703	60	2 x 200 W	DN80		85114213	85114223
UV-S 703 H					85115213	85115223
UV-S 704 H	96	3 x 200 W	DN100		-	85115224
UV-S 705 H	125	4 x 200 W	DN150		-	85115225

ITEM	FLOW RATE MAX (m³/h)	LAMPS	HYDRAULIC CONNECTIONS	UV-C DOSE (J/m²)	AISI316L VESSEL
					PART NO.
UV-S 511 H	150	3 x 400 W	DN150	> 400	85117221
UV-S 512 H	250	4 x 400 W	DN200		85117222
UV-S 513 H	300	5 x 400 W	DN250		85117223
UV-S 514 H	420	6 x 400 W	DN250		85117224
UV-S 515 H	600	8 x 400 W	DN250		85117225
UV-S 516 H	830	10 x 400 W	DN300		85117226
UV-S 517 H	980	12 x 400 W	DN350		85117227

DESCRIPTION	PART NO.
Amalgam lamps, 200 Watt (life max 12000 hours)	85100110
Amalgam lamps, 400 Watt (life max 14000 hours)	85100109
Quartz for 200 Watt lamp, UV-S700 series (minimum order quantity: 4 pcs.)	85100213
Quartz for 400 Watt lamp, UV-S510 series (minimum order quantity: 4 pcs.)	85100207

## UV-S900 PE SERIES - FOR AGGRESSIVE LIQUIDS AND SEAWATER

- Standard microprocessor-based control unit with monitoring of lamp operation, alarm relay, and counter of lamp total and working hours
- Control panel “H” version with monitoring of irradiation / temperature of water, check of panel temperature and shutdown function upon overheating of the vessel / electronic unit
- Working conditions: pressure max 6 bar, temperature max 35 °C
- Power supply: 230 V~ (standard)
- **Low pressure, mercury vapour lamps**
- **HDPE vessels** for aggressive liquids and seawater



ITEM	FLOW RATE MAX (m <sup>3</sup> /h)	LAMPS	HYDRAULIC CONNECTIONS	UV-C DOSE (J/m <sup>2</sup> )	STANDARD MODEL	“H” MODEL
					PART NO.	PART NO.
UV-S 904 PE	22	3 x 80 W	DN65	> 400	85118231	85119231
UV-S 905 PE	35	4 x 80 W	DN80		85118232	85119232
UV-S 906 PE	45	5 x 80 W	DN100		85118233	85119233
UV-S 907 PE	60	6 x 80 W	DN100		85118234	85119234
UV-S 908 PE	110	2 x 400 W	DN150		-	85119235
UV-S909 PE	150	3 x 400 W	DN200		-	85119236
UV-S 910 PE	250	4 x 400 W	DN250		-	85119237
UV-S 911 PE	340	5 x 400 W	DN250		-	85119238
UV-S 912 PE	470	7 x 400 W	DN300		-	85119239
UV-S 913 PE	600	8 x 400 W	DN350		-	
UV-S 914 PE	830	10 x 400 W	DN400		-	
UV-S 915 PE	980	12 x 400 W	DN450		-	

## UV-S600 ECO SERIES - FOR ABATEMENT OF COMBINED CHLORINE

- Microprocessor-based control unit with monitoring of lamp operation, alarm relay, counter of lamp total and working hours, monitoring of irradiation / temperature of water, check of panel temperature and shutdown function upon overheating of the vessel / electronic unit
- **AISI316L stainless steel vessels**
- Working pressure max 10 bar
- UV dose: 600 J/m<sup>2</sup>
- **Medium pressure, mercury vapour lamps**
- Manual rack cleaning system



ITEM	FLOW RATE MAX (m <sup>3</sup> /h)	LAMPS	HYDRAULIC CONNECTIONS	POWER SUPPLY	PART NO.
UV-S 600 ECO XS	24	1 x 250 W	2" M	230 V~	85120250
UV-S 600 ECO (*)	33	1 x 1000 W	2.1/2" M		85120251
UV-S 601 ECO	55	1 x 1000 W	DN100		85120252
UV-S 602 ECO	120	1 x 2000 W	DN150	400 V 3 ph-N	85120453
UV-S 603 ECO	170	1 x 2500 W	DN200		85120454
UV-S 604 ECO	333	1 x 3500 W	DN200		85120455

DESCRIPTION	PART NO.
Optional 4-20 mA output + remote on / off switching	
Automatic cleaning system of quartz	
Medium pressure lamp, 250 Watt (life 6000 hours)	85100111
Medium pressure lamp, 1000 Watt (life 6000...8000 hours)	85100112
Medium pressure lamp, 2000 Watt (life 6000...8000 hours)	85100113
Medium pressure lamp, 2500 Watt (life 6000...8000 hours)	85100114
Medium pressure lamp, 3500 Watt (life 6000...8000 hours)	85100115
Quartz for model UV-S 600 ECO XS (minimum order quantity: 4 pcs.)	85100210
Quartz for model UV-S 600 ECO (minimum order quantity: 4 pcs.)	85100208
Quartz for models UV-S 601 ECO and UV-S 602 ECO (minimum order quantity: 4 pcs.)	85100209

(\*) For this model, the lamp consumption is reduced to 600 W by the starter.

# RETURN AUTHORIZATION MODULE

Return c/ replacement

Return c/ vision

Return c/ repair

COMPANY: \_\_\_\_\_

CONTACT PERSON: \_\_\_\_\_ PHONENO.: \_\_\_\_\_

Your reference in STEIEL: \_\_\_\_\_

ITEM PART NO. : \_\_\_\_\_ SERIAL NUMBER S/N: \_\_\_\_\_

ITEM DESCRIPTION: \_\_\_\_\_

REF. PURCHASE INVOICE: \_\_\_\_\_

PERIOD OF WORKING TIME C/O INSTALLATION: \_\_\_\_\_

REASON FOR RETURN (please describe briefly the problem and attach any pictures / videos):

--

All the above fields must be filled entirely. The lack of requested information will make the report null and, therefore, the return will not be authorized. In case the material is sent without authorization, upon receipt we reserve the right to reject the package. The completed form must be returned by e-mail to [service@steiel.it](mailto:service@steiel.it) and attached to the delivery bill.

## Important Notes:

- Pack the goods appropriately (if possible, with the original packaging) after decontamination and, if bulky goods, place it on a pallet to prevent damage during transport.
- In case of dispatch of an article used for dosage, also fill the form on the next page.
- Make sure that a copy of the delivery bill is ALWAYS present also inside the package. The delivery bill must be sent in advance via e-mail to [service@steiel.it](mailto:service@steiel.it) together with this form

## TERMS AND CONDITIONS:

The material sent to be repaired in STEIEL, must ALWAYS be sent ex-works (at your charge) unless otherwise indicated.

1. If the material is considered under warranty, upon our communication, the repair and return of the material will be fully borne by STEIEL without charge.
2. If the material will not be considered under warranty, after a repair estimate, the repair will be debited and sent back in charged forwards or ex-stocks with invoice charge.
3. In the event that the repair estimate is not accepted, the unrepaired material will be returned with a charge of €30.00 as handling costs, and the shipment will be in charged forwards or ex-works with invoice charge.
4. For amounts below € 50.00 the repair will take place automatically without waiting for authorization, the payment will be a bank transfer in advance or cash on delivery, unless otherwise agreed.

\_\_\_\_\_  
Place, date

\_\_\_\_\_  
Company stamp and signature

# DECLARATION OF DECONTAMINATION

In compliance with legal regulations and for the safety of our employees, we need this declaration of decontamination, with your stamp and signature, before Your request can be handled.





This declaration must be attached to the delivery bill, together with the first page of this document.

The declaration must be provided for each item sent to us, for which the decontamination has been carried out.

ITEM: \_\_\_\_\_ SERIAL NUMBER S/N: \_\_\_\_\_

DOSED PRODUCT: \_\_\_\_\_

DOSED VOLUME [l/h]: \_\_\_\_\_ WORKING PRESSURE [bar]: \_\_\_\_\_

WARNINGS:								
	Concentration	CAS No.	Flammable	Toxic	Corrosive	Harmful	Other	Harmless
Process liquid								
Cleaning liquid								
Liquid for final cleaning								

Please, tick the applicable warnings. If necessary, include safety data sheet and additional handling instructions.

WE HEREBY CERTIFY THAT THE RETURNED PARTS HAVE BEEN CAREFULLY CLEANED. TO THE BEST OF OUR KNOWLEDGE, THEY ARE FREE FROM ANY RESIDUES IN DANGEROUS QUANTITIES.

\_\_\_\_\_  
Place, date

\_\_\_\_\_  
Operator name  
(in block letters)

\_\_\_\_\_  
Company stamp and signature



# GENERAL SALES CONDITIONS





## CONTACT US

 Viale Europa, 24  
35020 Ponte San Nicolò (PD) - ITALY

 +39 049.8961488

 [info@steiel.it](mailto:info@steiel.it)

 [www.steiel.it](http://www.steiel.it)

