

IBM Spectrum Virtualize High Density 5U Expansion Enclosure Getting Started Guide



Sign up

If you own an IBM Spectrum® Virtualize product, you need to sign up to get started.

About this task

What you need to know about signing up:

Procedure

1. You need an IBM® ID. Go to [Create your IBM account](#) and complete the form.
2. Register your hardware product.
3. Go to [Subscribe now!](#) for notification alert.

Overview

This document describes the installation procedure for the IBM Spectrum Virtualize High Density 5U Expansion Enclosure. The expansion enclosure holds up to ninety-two SAS drives in a 5U, 19-inch rack mount enclosure, which can greatly increase the density and capacity of the system.

Many IBM FlashSystem® systems support the 5U expansion enclosure. The following table lists the machine type and model (MTM) numbers for the control enclosures and the 5U expansion enclosure. This document is applicable to all of the MTMs.

5U Expansion Enclosure MTMs	System	Control Enclosure MTMs
2072-92G / 2072-F92	IBM FlashSystem 5015	2072-2N2 / 2072-W12; 2072-2N4 / 2072-W24
2072-92G / 2072-F92	IBM FlashSystem 5035	2072-3N2 / 2072-X12; 2072-3N4 / 2072-X24
2076-92G or 4664-92G	FlashSystem 7200	2076-824 / 2076-U7C
4657-92G	FlashSystem 7300	4657-924 / 4657-U7D
4662-92G	FlashSystem 5200	4662-6H2 / 4662-UH6 / 4662-Y12
2145-92F / 2147-92F	IBM SAN Volume Controller	2145-SV3 / 2147-SV3
9846/9848-A9F or 4666-A9F	IBM FlashSystem 9110	9846-AF7 / 9846-UF7 / 9848-UF7
	IBM FlashSystem 9150	9846-AF8 / 9846-UF8 / 9848-UF8
	FlashSystem 9200	9846-AG8 / 9848-AG8 / 9848-UG8
4666-A9F	FlashSystem 9500	4666-AH8 / 4666-UH8

Important: This document is intended to be used by persons who are experienced with installing these systems. Before you unpack, move, and install the 5U expansion enclosure and its parts, always complete the following tasks:

- Read and follow the guidelines that are described in [Weight considerations](#) on page 14.
- Read and follow the safety notices and instructions that are described in [Safety notices and considerations](#) on page 17.
- Read and follow the guidelines in *IBM Environmental Notices and User Guide* and *IBM Safety Notices* (provided on a DVD with your product order).
- Ensure that two or more persons and a suitably rated mechanical lift are available to support the weight of the 5U expansion enclosure as it inserted into the rack for installation.

IBM Documentation ([HTTP://IBM.biz?BdqxdY](http://ibm.biz?BdqxdY)) contains more information about preparing the physical environment before the installation; it also provides information about configuring, managing, and servicing the system after installation. IBM Documentation is updated between product releases to provide the most current information.

Before you begin

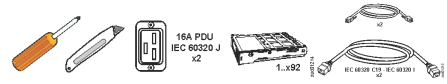

Before you start the installation process, ensure that the following items are available.

- Two people and a server lift
- Screw driver (PZ2)
- Box cutter
- Two 16 A power distribution units (PDU) IEC 60320 J and power cables
- 1 - 92 drives

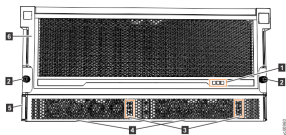
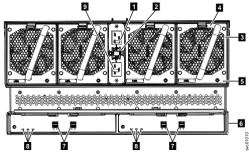

Identifying the hardware components

During the installation process, you must work with several components of the 5U expansion enclosure. Review the following images and features as you go through the installation procedures.

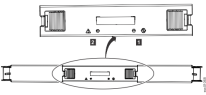
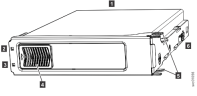

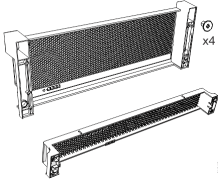
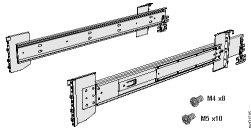
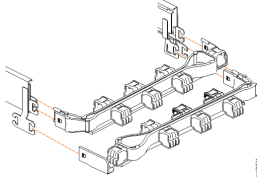
Component	Example	Features
Front of the expansion enclosure		<ol style="list-style-type: none"> 1 Display panel indicators 2 Rack retention thumb screws 3 Power supply unit indicators 4 Power supply units (PSUs) 5 PSU fascia (1U) 6 Front fascia (4U)
Rear of the expansion enclosure Four fan modules and two expansion enclosures are accessible from the back of the enclosure. The power cables for each PSU are also attached to the back of the enclosure.		<ol style="list-style-type: none"> 1 Power cable connector for PSU 2 2 Power cable retention clamps 3 Fan module 4 Fan release latch 5 Fan fault indicator 6 Expansion canister 7 SAS ports and indicators 8 Expansion canister indicators 9 Power cable connector for PSU 1
Fan module The 5U expansion enclosure contains four fan modules, which must be removed and reinstalled as part of the installation procedure.		<ol style="list-style-type: none"> 1 Fault LED indicator (amber)
Expansion canisters The 5U expansion enclosure contains two expansion canisters. The canister release handles are located at the top of each canister.		<ol style="list-style-type: none"> 1 Canister fault indicator 2 Canister status 3 Canister power indicator 4 and 6 SAS link fault indicators 5 and 7 SAS link operational indicators
Secondary expander modules The 5U expansion enclosure contains two secondary expander modules, which must not be removed and reinstalled as part of the installation procedure. Secondary expander modules provide SAS connectivity between the expansion canisters and the drives. They can be easily damaged by handling.		<ol style="list-style-type: none"> 1 Power LED indicator (green) 2 Fault LED indicator (amber)
Drives (1 - 92) Drives are packaged separately from the enclosure. The packaging consists of an anti-static bag for each drive, an inner carton with slots for 20 drives, and an outer carton to hold three inner cartons of drives.		<ol style="list-style-type: none"> 1 Disk drive 2 Online LED indicator 3 Fault LED indicator 4 Release latch 5 Drive latch toes 6 Drive carrier

Component	Example	Features
Front fascia components: 4U and 1 fascia		<p>The 4U and 1U fascia components and the attachment screws are packaged separately from the enclosure.</p> <p>You must attach the fascia to the front of the 5U expansion enclosure as part of the initial installation process.</p>
Support rails		<p>The support rails are packaged separately from the expansion enclosure.</p> <p>The screws that are needed to assemble the rails are also provided.</p>
Cable management arm For more details, see Installing the cable management arm on page 10.		<p>The cable management arm (CMA) consists of an upper and lower assembly.</p> <p>Each CMA assembly is attached to the rear end of the support rails.</p>

Installing the 5U expansion enclosure

Before you unpack and install the 5U expansion enclosure, ensure that you review and follow the safety notices. The following section provides an overview of the installation process. Detailed information about the steps is provided in the references.

About this task

 	<p>CAUTION: The weight of this part or unit is more than 55 kg (121.2 lb). It takes specially trained persons, a lifting device, or both to safely lift this part or unit. (C011)</p> <p>CAUTION: To avoid personal injury, before lifting this unit, remove all appropriate subassemblies per instructions to reduce the system weight. (C012)</p>
--	---

The 5U expansion enclosure and most parts are included in one large box. Drives are provided in a separate package. A tray on the top of the enclosure contains three boxes for the front fascia, cable management arm, and the slide rail kit; you attach these parts during the installation process. Other parts are installed in the enclosure. However, due to weight considerations you must remove some parts and then reinstall them as part of the initial installation process if you do not use a server lift. The following figure shows how the expansion enclosure is packaged for shipment.

Procedure

1. Remove the cardboard tray that contains the slide rail kit, cable management arm, and fascia from the box in which the expansion enclosure was shipped.

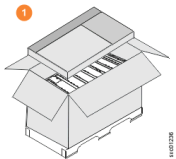

2. Remove the foam end pieces from the top of the 5U expansion enclosure.
3. Cut the corners of the shipping box.

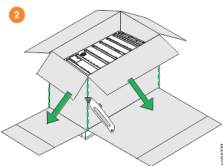

4. Fold down the sides of the shipping box to uncover the sides and faces of the expansion enclosure.

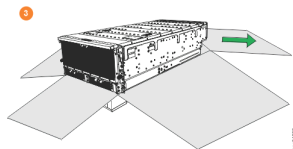

5. Remove the cover, as described in [Removing the cover](#) on page 4.
6. Remove the support rail kit from the shipping container.
7. Separate the inner section of the support rails and attach them to each side of the expansion enclosure, as described in [Installing the support rails](#) on page 6.
8. Carefully push the expansion enclosure sideways onto an adjacent server lift. Keep the remaining foam block protectors attached to the enclosure (If you do not have a server lift then you can remove the expansion canisters, fans, and Power supply units to make the machine light enough for two people to lift. However, this is not recommended and might cause damage).



9. Attach the remaining sections of the support rails to the rack, as described in [Installing the support rails](#) on page 6.
10. Move the mechanical lift to the front of the rack. Align the inner section of the rails with the mid section of the rails that are extending from the rack.

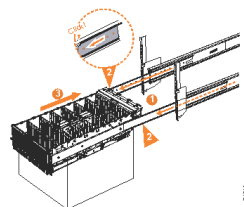

11. On each side, push the inner section and middle section of the rails together until they click and no longer separate, as described in [Installing the enclosure in a rack](#) on page 7.
12. Remove the 4U and 1U fascia from the boxes in which they were shipped.
13. Attach the 4U and 1U fascia to the front of the enclosure, as described in [Installing the fascia](#) on page 9.
14. Install the drives, as described in [Installing the drives](#) on page 7.
15. Replace the cover, as described in [Installing the cover](#) on page 8.
16. Lower the mechanical lift so that you can remove the remaining foam blocks away from the expansion enclosure.
17. Slide the latch on the side of each rail and push the expansion enclosure securely into the rack, as described in [Installing the enclosure in a rack](#) on page 7.
18. Remove the cable management arm assembly from its packaging.
19. Attach the cable management arm, as described in [Installing the cable management arm](#) on page 10.
20. Connect the SAS cables, as described in [Installing the SAS cables](#) on page 11.
21. Connect the power cables, as described in [Powering on the 5U expansion enclosure](#) on page 13.
22. Verify that the installation is complete and the system recognizes the new expansion enclosure.

Removing the cover

To complete the installation tasks, you need to remove the cover from the 5U expansion enclosure and access parts.

Procedure

1. Slide the release latch (1), which is at the front of the enclosure, to the right.

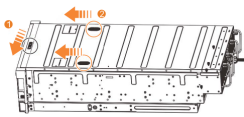

2. Slide the cover toward the front of the expansion enclosure (2).
3. Carefully lift the cover up, as shown. Then, place the cover in a safe location.

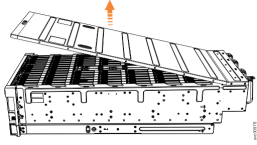

Removing the power supply units

The 5U expansion enclosure has two redundant power supply units (PSUs) that provide cooling to the lower part of the enclosure. Redundant power supplies operate in parallel; one continues to provide power to the enclosure if the other fails. To reduce the weight, you must remove both PSUs before you lift the enclosure into the rack.

About this task

Review and follow the procedures for handling static-sensitive devices before you remove the power supply unit (PSU).



Follow recommended procedures for handling electrostatic discharge (ESD)-sensitive devices.

Procedure

1. Press on the handle lock to release the handles on the PSU.
2. Rotate the handles outward, as shown.

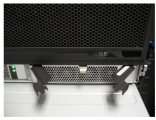

3. Carefully pull the PSU out of the expansion enclosure chassis and place it in a safe location.



Removing the fan modules

To reduce weight during the installation process, you must remove the fan modules from the 5U expansion enclosure. Then, you must reinstall the fan modules when the expansion enclosure is securely in the rack.

Procedure

1. Press the release tab on the fan module.



2. Use the handle to pull the fan module straight out of the expansion enclosure chassis.
3. Repeat steps [1](#) on page 5 and [2](#) on page 5 for each additional fan module to remove.

Removing the expansion canisters

If you do not have a server lift, you must remove the two expansion canisters from the 5U expansion enclosure before the enclosure is installed in the rack. An expansion canister provides SAS connectivity between the 5U expansion enclosure and control enclosure system. If either of the expansion canisters fails, the other expansion canister assumes the full I/O load.

Procedure

1. Read all safety information.
2. Locate the expansion canister to be removed.
3. Rotate the handles on the expansion canister outward, as shown.



4. Carefully pull the expansion canister out of the chassis and place it on a safe, level surface.
5. Repeat the steps for the second expansion canister.

Installing the support rails

You must install the support rails to the 5U expansion enclosure before you can install it in a rack.

Procedure

1. Locate the hardware rail kit that is provided to install the rails, including the M4xL6 and M5xL13 screws.
2. Select an available 5U space in your rack to install the expansion enclosure.

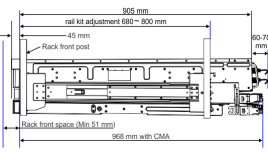

- Ensure that the enclosure and its parts are easily accessible. Allow space for the cover to be easily removed and for internal components, such as drives and secondary expansion modules, to be serviced later.
- When all components and drives are installed, the expansion enclosure is heavy. Install the support rails and enclosure at the lowest available position. Do not install the rails and enclosure above position U25 in the rack.

3. Remove the inner section of the support rail. Push the tab (a) and slide the middle rail member back, as shown.

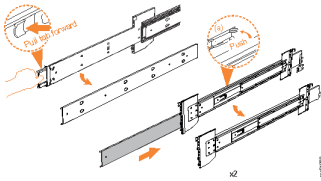

4. Use four M4 screws to attach the inner rail to the side of the enclosure. The following figure shows the screw locations.

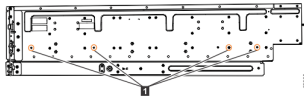

5. Install the inner section of the rail onto each side of the expansion enclosure.

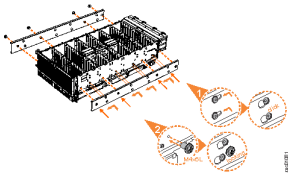

6. Use the M5 screws to install the outer rail member and bracket assembly to the rack.

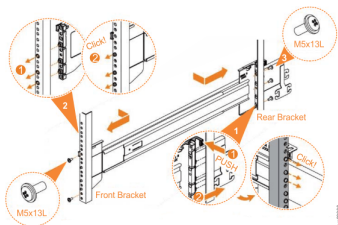

7. Repeat Steps 4 on page 6 and 6 on page 6 to install the opposite rail.

Installing the drives

Use the following procedure to install drives in the 5U expansion enclosure. The 5U expansion enclosure can support up to 92 drives.

Procedure

1. Use the label on the enclosure cover to locate the drive slot to receive the drive. The drive slots are numbered 1-14 from left to right and A-G from the back to the front of the enclosure. The label also shows the location of the secondary expander modules.

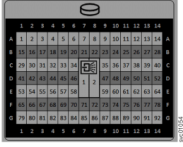

2. Populate the drive slots sequentially, starting from the back-left corner position (slot 1, grid A1).

Install the drives in the slots from left to right and back row to front row. Always complete a full row before you install drives in the next row.

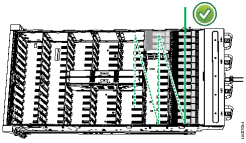
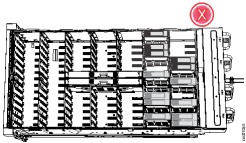
Correct Installation	Incorrect Installation
 <p>The drives are installed in slots 1 -14 of row A and the installation continues in slot 15 in row B.</p>	 <p>Slot 1 (A1) does not contain a drive. Also, drives are installed in row B even though row A contains empty drive slots.</p>

3. Touch the static-protective package that contains the drive to any unpainted metal surface on the enclosure. Wear an anti-static wrist strap to remove the drive from the package.
4. Ensure that the drive handle (1) of the drive assembly is in the open (unlocked) position.
5. Hold the drive by the two top corners so that it hangs squarely over the appropriate drive slot.

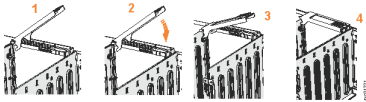

6. Lower the drive latch (2) down, without pushing, until it stops and the bottom of the latch is aligned with the top of the partition. Ensure that the handle is not open more than 45 degrees from the drive carrier. If the drive does not slide down easily, then inform IBM Remote Technical Support.
7. Rotate the handle down to lock the drive assembly into the chassis.
8. Ensure the toe on the bottom of the latch is fully engaged with the partition in the chassis (3).
9. Ensure that the top toe of the latch is also fully engaged when the latch is closed (4).
10. Repeat steps 3 on page 7 through 9 on page 7 for each drive you are installing.

Installing the enclosure in a rack

Use the following procedure to place the expansion enclosure in a rack during the installation process.

About this task



Important: Follow the information in [Safety notices and considerations](#) on page 17 and [Weight considerations](#) on page 14. Always use a suitably rated mechanical lift or three persons to raise the expansion enclosure to install it in the rack.

- Install the expansion enclosure in the lowest available position in the rack, as shown in the following example.

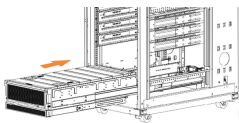

- Ensure that the drives are easily accessible. Avoid installing the 5U expansion enclosure above position 22U in the rack.

Procedure

1. Ensure that you have correctly reinstalled the secondary expander modules, by following the procedure described in [Installing the secondary expander modules](#).
2. Ensure that you have correctly installed all of the drives, as described in [Installing the drives](#) on page 7.
3. Fully extend the left and right drawer sections from the rack to lock the rails in the extended position.
4. Ensure that the ball bearing retainer clicks into place inside the front of the left and right drawer sections.
5. Replace the cover of the expansion enclosure, as described in [Installing the cover](#).
6. Install the fascia, as described in [Installing the fascia](#).
7. Reinstall the remaining enclosure parts, as described in the following topics. You can reinstall the parts in any order.
 - [Installing the power supplies](#)
 - [Installing the expansion canisters](#)
 - [Installing the fan modules](#)
8. Locate the left and right blue release tabs near the front of the enclosure. Press both release tabs forward to unlock the drawer mechanism **(1)**.

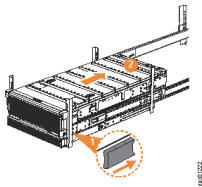

9. Push the enclosure firmly into the rack **(2)**.
10. Tighten the locking thumb screws **(3)** to secure the enclosure in the rack.

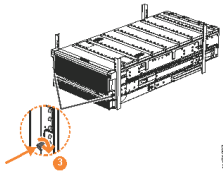

Installing the cover

As part of the installation process, you must replace the cover of the 5U expansion enclosure before it is inserted in the rack.

Procedure

1. Carefully lower the cover and ensure that it is aligned correctly with the back of the enclosure.

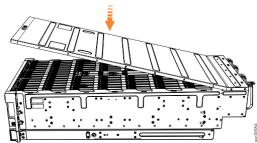

2. Push the cover release lever to the right side **(2)**.
3. Slide the cover towards the back of the enclosure **(3)** back until it stops.

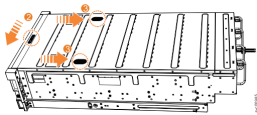

4. Verify that the cover correctly engages the cover release latch and all of the inset tabs on the expansion enclosure.
5. Lock the cover into position by sliding the release lever **(4)** to the left.

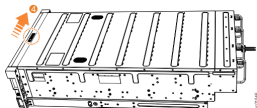

Installing the fascia

During the initial installation process, you must install the fascia components on the front of a 5U expansion enclosure. The 4U fascia covers the display panel of the expansion enclosure. It is attached to the enclosure by four screws. The bottom 1U fascia covers both of the power supply units (PSUs) on the enclosure.

Procedure

1. Align the front 4U fascia with the enclosure so that the thumbscrews go through the holes on each side. The screw holes on the back of the fascia must align with the screw holes on the front flange of the enclosure.
2. Use the four screws to attach the 4U fascia. Secure the screws from the back of the flange and into the rear of the fascia. Each side of the 4U fascia contains two screws.

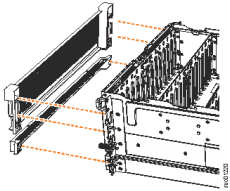

3. Attach the bottom 1U fascia that covers the PSUs. Align the tab on each side of the 1U fascia with the corresponding slots on the enclosure flange. Pins on each flange must also align with a hole in each side of the 1U fascia. Gently push the fascia until it clicks into place on the chassis.

Installing the expansion canisters

Complete the following steps to reinstall the expansion canisters in a 5U expansion enclosure.

Procedure

1. Carefully align the expansion canister with the expansion enclosure.
2. Rotate both the handles outward and insert the expansion canister into the expansion enclosure.

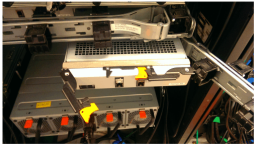

3. When the expansion canister is fully inserted, rotate each handle inward to lock it into position.
4. Repeat the steps to install the second expansion canister.

Installing the fan modules

Complete the following procedure to reinstall each fan module in the 5U expansion enclosure.

Procedure

1. Hold the fan module with the release tab on top and the connector pin on the bottom.

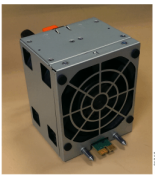

2. Carefully insert the fan module into the chassis until it clicks in place.

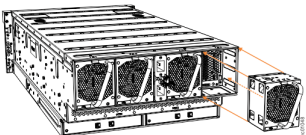

- Repeat steps 1 on page 9 and 2 on page 9 for each fan module to be replaced.

Installing the power supplies

Use the following procedures to install each of the redundant power supplies in the 5U expansion enclosure.

About this task

Review and follow the procedures for handling static-sensitive devices before you remove the power supply unit (PSU).



Follow recommended procedures for handling electrostatic discharge (ESD)-sensitive devices.

Procedure

- Rotate the handles on the PSU outward, as shown.



- Slide the PSU forward into the chassis until it clicks in to place.



- Close the handles on the PSU and ensure the handle lock clicks in to place.

Installing the cable management arm

As part of the initial installation, you must attach the cable management arm (CMA). The CMA consists of an upper arm and a lower arm assembly. The support rail connectors of each CMA assembly are installed on the rail hooks at the end of the support rails.

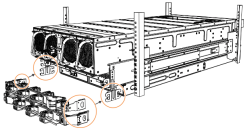

Procedure

- Remove the loop straps from the upper and lower CMA assemblies. The straps are used only for shipping.

Installing the upper CMA assembly

- Review the parts and connectors on the upper CMA assembly.

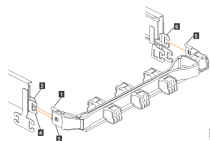

- Inner connector on upper CMA
- Connector base on inner rail member
- Outer connector on upper CMA
- Connector base on outer rail member
- Support rail connector on upper CMA
- Connector base on outer rail member

- Install the inner connector of the upper CMA assembly (1) to the inner member of the left support rail (2), as shown.

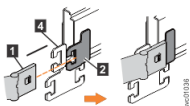

- Install the outer connector of the upper CMA assembly (3) to the outer member of the left support rail (4), as shown.

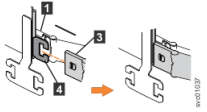

- Attach the support rail connector on the upper CMA assembly (5) to the connector base on the right support rail (6) as shown. Ensure the cable-management arm connector attaches securely to the hooks on the rails.

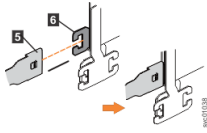

Installing the lower CMA assembly

The procedure for attaching the lower CMA assembly is the same as the procedure to attach the upper CMA assembly. However, the connector locations are reversed.

The following image shows the upper and lower CMA assemblies as they are aligned to the support rails. The support rail connector of the upper CMA attaches to the right rail. The support rail connector of the lower CMA (11) attaches to the left rail.

- Review the parts and connectors on the lower CMA assembly.

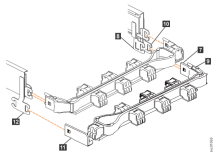

- 7 Inner connector on lower CMA
- 8 Connector base on inner rail member
- 9 Outer connector on lower CMA
- 10 Connector base on outer rail member
- 11 Support rail connector the lower CMA
- 12 Connector base on outer rail member

- Install the inner connector of the lower CMA assembly (7) to the inner member of the right support rail (8).
- Install the outer connector of the lower CMA assembly (9) to the outer member of the right support rail (10).
- Attach the support rail connector on the lower CMA assembly (11) to the connector on the left support rail (12).
- Ensure that the lower CMA assembly is securely attached to the hooks on the end of the support rails.

Installing the SAS cables

Use the following procedure to attach SAS cables to the 5U expansion enclosure during the initial installation process.

About this task

The system cannot operate if the SAS cabling to the expansion enclosure is incorrect. When the 5U expansion enclosure is installed in the rack, the expansion canisters are upside down. The input cable connects to the right port (port 1) on the expansion canister. The output cable connects to the left port (port 2) on the canister. As you add SAS cables, record the ports, canisters, and enclosures to which each cable connects. If you have to replace cables later, you can use this information to match the connections with the replacement cables.

Procedure

- Ensure that the SAS connector is oriented correctly. The blue tab must face towards the top of the enclosure canister.

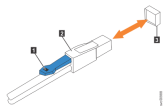

- 1 Blue pull tab
- 2 SAS cable
- 3 SAS port

- Connect the SAS cable to the SAS port with blue tab **above** the connector (facing towards the top of the enclosure). If you feel resistance, the connector is probably oriented the wrong way
You hear or feel a click when the cable is successfully inserted. You cannot disconnect the cable without pulling on the blue tag.
- Route the SAS cables through the cable management arms to reduce the risk of disconnecting the cables between the enclosures.

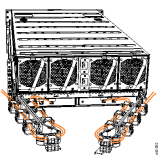

- Allow slack in all of the SAS cables to avoid tension as the CMA moves.
- Use the cable straps that are provided on the rear of the enclosure to retain the SAS cables and prevent them from sagging.
- Arrange the SAS cables so that you can access the components at the rear of the enclosure, as needed.
- Do not connect a SAS cable between a port on a left canister and a port on a right canister of the expansion enclosures

4. When both ends of a SAS cable are correctly connected to the enclosures, the green link-LEDs next to the connected SAS ports are lit.

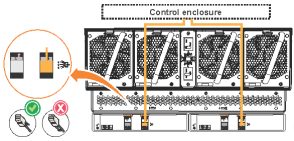

5. For examples of how to connect the SAS cables to control enclosures, see [Connecting SAS cables to control enclosures](#) on page 12.

6. For examples of how to connect the 5U expansion enclosure to 2U expansion enclosures, see [Combining 2U and 5U expansion enclosures](#) on page 12.

Connecting SAS cables to control enclosures

Many systems support the 5U expansion enclosure. Because the backs of the control enclosures differ, the orientation of the SAS cables might also differ. The following table shows examples of the SAS cabling between different control enclosures and a 5U expansion enclosure.

Example SAS Connections	Systems	Control Enclosure MTMs
	FlashSystem 7200 FlashSystem 9200	2076-824 / 2076-U7C 9846-AG8 / 9848-AG8 / 9848-UG8
	FlashSystem 9110 FlashSystem 9150	9846-AF7 / 9846-UF7 / 9848-UF7 9846-AF8 / 9846-UF8 / 9848-UF8
	IBM SAN Volume Controller FlashSystem V9000	2145-SV1 / 2147-SV1 9846-AC3 / 9848-AC3
	IBM SAN Volume Controller	2145-DH8 / 2147-DH8
	FlashSystem 5035	2072-312 / 2072-324 2072-3H2 / 2072-U12; 2072-3H4 / 2072-U24 2072-3N2 / 2072-X12; 2072-3N4 / 2072-X24
	FlashSystem 5015	2072-212 / 2072-224 2072-2H2 / 2072-U12; 2072-2H4 / 2072-U24 2072-W24 / 2072-2N2; 2072-W12 / 2072-2N4 These systems support one SAS chain.

Combining 2U and 5U expansion enclosures

You can combine 2U (12 or 24 drives) and 5U expansion enclosures in a SAS chain. However, you must consider the orientation of the SAS ports and the combined *chain weight* of the enclosures.

SAS ports

The location and orientation of the SAS ports on the 2U and 5U expansion enclosures differ. The following figures show the orientation of the SAS ports and SAS cables on the expansion enclosures. Ensure that you orient the SAS cables for each type of expansion enclosure.

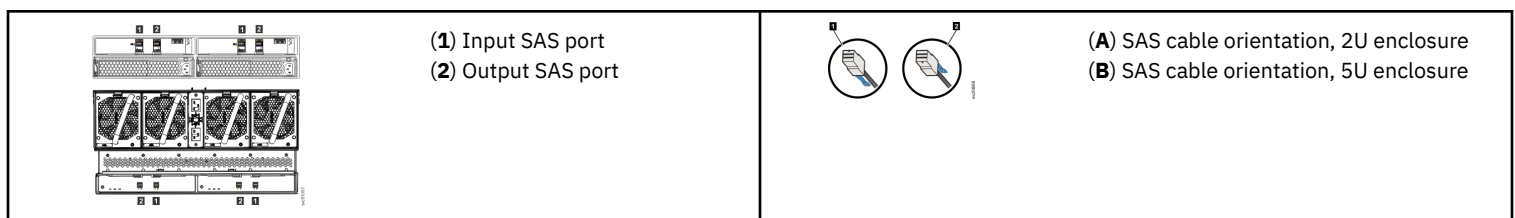

Chain weight

The maximum SAS chain weight that can be attached the SAS port of a control enclosure is 10. A 5U expansion enclosure has a chain weight of 2.5. A 2U expansion enclosure has a chain weight of 1. The following table shows examples of different combinations of chain weights.

2U Enclosures (12 drives)	2U Enclosures (24 drives)	5U Enclosures (92 drives)	Combined Chain Weight
2	0	3	9.5
2	3	2	10
0	7	1	9.5
1	1	1	4.5

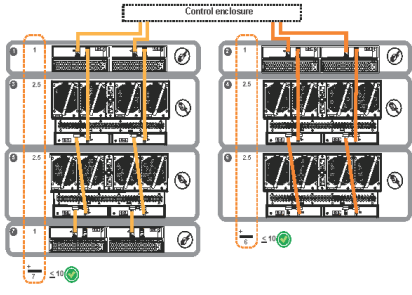

Most control enclosure can support two SAS chains. Some control enclosures, however, can support only one SAS chain.

In this example, the control enclosure supports two SAS chains. Each SAS chain has a combination of 2U and 5U expansion enclosures. The combination of expansion enclosures is valid because the combined chain weight of each SAS chain is less than 10.

Also, note the orientation of the SAS cables on each SAS connection.

Powering on the 5U expansion enclosure

Use the following procedure to provide power to the 5U expansion enclosure. The 5U expansion enclosure has two power supply units (PSUs) that are covered by the 1U fascia at front of the enclosure. Each PSU has a power supply connector and power cable, which are accessible from the back. Power is provided by plugging a C19-C20 power cable into each power supply unit and, if necessary, turning on the power source. The expansion enclosure does not have a power button.

Before you begin



Important: Before you connect the power cables to the rear of the enclosure, always check that the expansion enclosure is secured in the rack. If needed, tighten the thumbscrews on the front of the enclosure to ensure that the enclosure drawer does not roll open.

Procedure

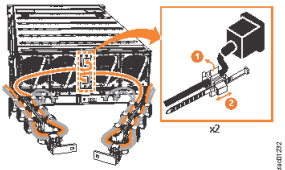

1. Connect the C19-C20 power cables to the power connectors on the rear of the expansion enclosure.
If the power source is on, the enclosure automatically powers on and begins its Power On Self-Tests (POST).
2. Secure the power cables in the cable retainer at each power connector on the rear of the enclosure. Also, ensure that each cable is installed along one of the cable management arms. The cable management arms also support the SAS cables.

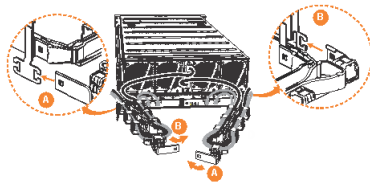

3. Close the cable management arms so that both are connected to the end of the rail at the back of the enclosure.

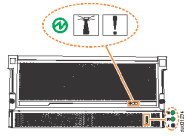

4. Verify that the expansion enclosure and its components are operating as expected.

	<p>LED indicators on the front display panel and each PSU are lit when the power is connected.</p>		<p>On the back of the enclosure, the expansion canister indicators become active.</p>
		<ol style="list-style-type: none"> 1 Canister fault 2 Canister status 3 Canister power 4 and 6 SAS link fault 5 and 7 SAS link operational 	<p>All four fans also become active.</p>

5. Access the management GUI to verify that the system recognizes the expansion enclosure and review the system status.

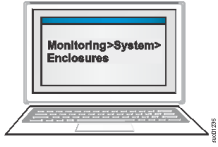

Weight considerations

Before you install or move a 5U expansion enclosure, you must be prepared to handle the weight of the enclosure and its parts.



Important: Always read and follow the safety notices and instructions before you install, move, or service the expansion enclosure and its parts. See [Safety notices and considerations](#) on page 17 for information.

- Do not exceed the specified maximum load of the rack where the enclosure is to be installed.
- Do not exceed any load limit of the building and flooring where the enclosure is to be installed.
- Always use a suitably rated mechanical lift or four persons when you are performing any of the following tasks:
 - Removing the expansion enclosure from its packing material
 - Lifting and installing the expansion enclosure in the rack for the first time
 - Reinstalling the expansion enclosure after you complete a service task (for example, replacing the enclosure FRU).
- At least three persons are required to move the enclosure while it is in the rack (if you are moving the enclosure off the rails). Even after the drives, power supply units, secondary expander modules, canisters, fans, and top cover are removed, the enclosure weighs approximately 43 kg (95 lbs).
- To maximize rack stability, always install the expansion enclosure in the lowest possible position in the rack.
- This enclosure is too heavy to be safely lifted by people.
 - It is best to use a server lift.
 - If you cannot get a server lift then as an exception you can remove most of the FRU parts from the enclosure in order to make it safe to lift by two people.
 - However removing the FRU parts from the enclosure is not desirable as they might get damaged. For example, by Electrical Discharge.
 - If you must take out FRUs to lift this enclosure then do not remove the SEM FRUs because these are more likely to be damaged than the other FRUs.

Weight of expansion enclosure parts

The following table summarizes the weight and quantity of the parts (FRUs) that are shipped with the 5U expansion enclosure.

FRU description	Weight per unit		Quantity shipped	Total weight	
	kg	lbs		kg	lb
Enclosure FRU	42.500	93.696	1	42.500	93.696
Rail kit	9.231	20.351	1	9.231	20.351
Front fascia (4U front cover)	0.303	0.668	1	0.303	0.668
Display panel assembly	0.020	0.044	1	0.020	0.044
PSU fascia (1U cover)	0.010	0.022	1	0.010	0.022
Power supply unit (PSU)	3.335	7.352	2	6.670	14.705
Secondary expansion module	0.826	1.821	2	1.652	3.642
Fan module	0.890	1.962	4	3.560	7.848
Expansion canister	1.588	3.501	2	3.176	7.002

FRU description	Weight per unit		Quantity shipped	Total weight	
	kg	lbs		kg	lb
Cable management arm (lower and upper arms)	1.373	3.027	1	1.373	3.027
Top cover	3.720	8.201	1	3.720	8.201
Fan interface board	0.118	0.260	1	0.236	0.260

Weight of expansion enclosure drives

The SAS drives are shipped in a separate package from the 5U expansion enclosure. The enclosure can support up to 92 SAS drives; however, the quantity that needs to be installed depends on the number of drives ordered. Substantial weight is added to the 5U expansion enclosure when all of the drives are installed. The following table shows the weight of the individual drives and the maximum weight increase when 92 drives are installed.

Note: Some drives are not supported by all of the systems that support the 5U expansion enclosure. For more information, including the part number of the drive FRUs, see IBM Documentation (<https://ibm.biz/BdqxdY>) for the system.

FRU description	Approximate weigh per unit		Maximum	Approximate extra weight	
	kg	lb		kg	lb
2.5-inch tier 0 flash drives <ul style="list-style-type: none"> 1.6 TB 2.5-inch tier 0 flash drive 1.92 TB 2.5-inch tier 1 flash drive 15.36 TB 2.5-inch tier 1 flash drive 3.2 TB 2.5-inch tier 0 flash drive 3.84 TB 2.5-inch tier 1 flash drive 7.68 TB 2.5-inch tier 1 flash drive 	0.224	0.494	92	20.608	45.433
2.5-inch hard disk drives <ul style="list-style-type: none"> 600 GB 15 K 2.5-inch hard disk drive 1.2 TB 10 K 2.5-inch hard disk drive 1.8 TB 10 K 2.5-inch hard disk drive 2.4 TB 10K 2.5-inch hard disk drive 	0.304	0.670	92	27.968	61.659
3.5-inch drives <ul style="list-style-type: none"> 1.92 TB 3.5-inch Flash drive 3.84 TB 3.5-inch Flash drive 6 TB 7.2 K 3.5-inch Near-Line SAS hard disk drive 7.68 TB 3.5-inch Flash drive 8 TB 7.2 K 3.5-inch Near-Line SAS hard disk drive 10 TB 7.2 K 3.5-inch Near-Line SAS hard disk drive 12 TB 7.2K 3.5-inch Near-Line HDD in HD carrier 14 TB 7.2K 3.5-inch Near-Line SAS hard disk drive 15.36 TB 3.5-inch Flash drive 30 TB 3.5-inch Flash drive 	0.876	1.931	92	80.592	177.675

Weight increases as FRUs are installed

As you install FRUs, the overall weight of the expansion enclosure increases. The following table shows the weight progression as different combinations of FRUs are installed.

Enclosure assembly		Approximate weight	
FRUs installed	FRUs not installed	kg	lb
<ul style="list-style-type: none"> Enclosure 	<ul style="list-style-type: none"> Secondary expansion modules Fascia (1U and 4U) PSUs Expansion canisters Fan modules Fan interface board Display assembly Drives Cover 	42.5	93.7
<ul style="list-style-type: none"> Enclosure Secondary expansion modules 	<ul style="list-style-type: none"> Fascia (1U and 4U) PSUs Expansion canisters Fan modules Fan interface board Display assembly Drives Cover 	44.3	97.7
<ul style="list-style-type: none"> Enclosure Secondary expansion modules Fascia (1U and 4U) PSUs Expansion canisters Fan modules Fan interface board Display assembly 	<ul style="list-style-type: none"> Drives Cover 	58	127.9
<p>Note: The following FRUs are installed when the enclosure is shipped.</p> <ul style="list-style-type: none"> Enclosure Secondary expansion modules PSUs Expansion canisters Fan modules Fan interface board Display assembly Cover 	<ul style="list-style-type: none"> Fascia (1U and 4U) Drives 	61.5	135.4
<ul style="list-style-type: none"> Enclosure Secondary expansion modules Fascia (1U and 4U) PSUs Expansion canisters Fan modules Fan interface boards 92 2.5-inch tier 1 flash drives 	<ul style="list-style-type: none"> Cover 	78.6	173.3
<ul style="list-style-type: none"> Enclosure Secondary expansion modules Fascia PSUs Expansion canisters Fan modules Fan interface board 92 2.5-inch hard disk drives 	<ul style="list-style-type: none"> Cover 	86	189.6

Enclosure assembly		Approximate weight	
FRUs installed	FRUs not installed	kg	lb
<ul style="list-style-type: none"> • Enclosure • Secondary expansion modules • Fascia • PSUs • Expansion canisters • Fan modules • Fan interface board • 92 3.5-inch Near-Line SAS hard disk drives 	<ul style="list-style-type: none"> • Cover 	138.6	305.6

Conversely, the overall weight of the expansion enclosure is reduced as you remove parts. However, even with parts removed, the 5U expansion enclosure is heavy. Depending on the number of parts that remain, you might need four persons or a mechanical lift to support the weight of the expansion enclosure.

Safety notices and considerations

Before you install or move a 5U expansion enclosure, always read and follow the safety notices and guidelines.

Safety notices

Use the reference numbers in parentheses at the end of each notice (for example, D010) to find the matching translated notice in [IBM Systems Safety Notices](#).



DANGER: Serious injury or death can occur if loaded lift tool falls over or if a heavy load falls off the lift tool. Always completely lower the lift tool load plate and properly secure the load on the lift tool before moving or using the lift tool to lift or move an object. (D010)



DANGER: Multiple power cords. The product might be equipped with multiple AC power cords or multiple DC power cables. To remove all hazardous voltages, disconnect all power cords and power cables. (L003)



DANGER: DANGER: Hazardous voltage present. Voltages present constitute a shock hazard, which can cause severe injury or death. (L004)



DANGER: DANGER: Hazardous energy present. Voltages with hazardous energy might cause heating when shorted with metal, which might result in splattered metal, burns, or both. (L005)



DANGER: Observe the following precautions when working on or around your IT rack system:

- Heavy equipment—personal injury or equipment damage might result if mishandled.
- Always lower the leveling pads on the rack cabinet.
- Always install stabilizer brackets on the rack cabinet.
- To avoid hazardous conditions due to uneven mechanical loading, always install the heaviest devices in the bottom of the rack cabinet. Always install servers and optional devices starting from the bottom of the rack cabinet.
- Rack-mounted devices are not to be used as shelves or work spaces. Do not place objects on top of rack-mounted devices. 
- Each rack cabinet might have more than one power cord. Be sure to disconnect all power cords in the rack cabinet when directed to disconnect power during servicing.
- Connect all devices installed in a rack cabinet to power devices installed in the same rack cabinet. Do not plug a power cord from a device installed in one rack cabinet into a power device installed in a different rack cabinet.
- An electrical outlet that is not correctly wired could place hazardous voltage on the metal parts of the system or the devices that attach to the system. It is the responsibility of the customer to ensure that the outlet is correctly wired and grounded to prevent an electrical shock. (R001 part 1 of 2)

CAUTION:

- Do not install a unit in a rack where the internal rack ambient temperatures will exceed the manufacturer's recommended ambient temperature for all your rack-mounted devices.
- Do not install a unit in a rack where the air flow is compromised. Ensure that air flow is not blocked or reduced on any side, front, or back of a unit used for air flow through the unit.
- Consideration should be given to the connection of the equipment to the supply circuit so that overloading of the circuits does not compromise the supply wiring or overcurrent protection. To provide the correct power connection to a rack, refer to the rating labels located on the equipment in the rack to determine the total power requirement of the supply circuit.
- (For sliding drawers) Do not pull out or install any drawer or feature if the rack stabilizer brackets are not attached to the rack. Do not pull out more than one drawer at a time. The rack might become unstable if you pull out more than one drawer at a time.
- (For fixed drawers) This drawer is a fixed drawer and must not be moved for servicing unless specified by the manufacturer. Attempting to move the drawer partially or completely out of the rack might cause the rack to become unstable or cause the drawer to fall out of the rack. (R001 part 2 of 2)



CAUTION: Removing components from the upper positions in the rack cabinet improves rack stability during a relocation. Follow these general guidelines whenever you relocate a populated rack cabinet within a room or building.

- Reduce the weight of the rack cabinet by removing equipment starting at the top of the rack cabinet. When possible, restore the rack cabinet to the configuration of the rack cabinet as you received it. If this configuration is not known, you must observe the following precautions.
 - Remove all devices in the 32U position and above.
 - Ensure that the heaviest devices are installed in the bottom of the rack cabinet.
 - Ensure that there are no empty U-levels between devices installed in the rack cabinet below the 32U level.
- If the rack cabinet you are relocating is part of a suite of rack cabinets, detach the rack cabinet from the suite.
- If the rack cabinet you are relocating was supplied with removable outriggers they must be reinstalled before the cabinet is relocated.
- Inspect the route that you plan to take to eliminate potential hazards.
- Verify that the route that you choose can support the weight of the loaded rack cabinet. Refer to the documentation that comes with your rack cabinet for the weight of a loaded rack cabinet.
- Verify that all door openings are at least 760 x 230 mm (30 x 80 in.).
- Ensure that all devices, shelves, drawers, doors, and cables are secure.
- Ensure that the four leveling pads are raised to their highest position.
- Ensure that there is no stabilizer bracket installed on the rack cabinet during movement.
- Do not use a ramp inclined at more than 10 degrees.
- When the rack cabinet is in the new location, complete the following steps:
 - Lower the four leveling pads.
 - Install stabilizer brackets on the rack cabinet.
 - If you removed any devices from the rack cabinet, repopulate the rack cabinet from the lowest position to the highest position.
- If a long-distance relocation is required, restore the rack cabinet to the configuration of the rack cabinet as you received it. Pack the rack cabinet in the original packaging material, or equivalent. Also lower the leveling pads to raise the casters off the pallet and bolt the rack cabinet to the pallet. (R002)



DANGER: Racks with a total weight of > 227 kg (500 lb.), Use Only Professional Movers! (R003)



DANGER: Do not transport the rack via fork truck unless it is properly packaged, secured on top of the supplied pallet. (R004)



DANGER: ⚡ Main Protective Earth (Ground):

This symbol is marked on the frame of the rack.

The PROTECTIVE EARTHING CONDUCTORS should be terminated at that point. A recognized or certified closed loop connector (ring terminal) should be used and secured to the frame with a lock washer using a bolt or stud. The connector should be properly sized to be suitable for the bolt or stud, the locking washer, the rating for the conducting wire used, and the considered rating of the breaker. The intent is to ensure the frame is electrically bonded to the PROTECTIVE EARTHING CONDUCTORS. The hole that the bolt or stud goes into where the terminal conductor and the lock washer contact should be free of any non-conductive material to allow for metal to metal contact. All PROTECTIVE EARTHING CONDUCTORS should terminate at this main protective earthing terminal or at points marked with ⚡. (R010)



CAUTION: The weight of this part or unit is more than 55 kg (121.2 lb). It takes specially trained persons, a lifting device, or both to safely lift this part or unit. (C011)



CAUTION: To avoid personal injury, before lifting this unit, remove all appropriate subassemblies per instructions to reduce the system weight. (C012)



CAUTION: CAUTION regarding IBM provided VENDOR LIFT TOOL:

- Operation of LIFT TOOL by authorized personnel only
- LIFT TOOL intended for use to assist, lift, install, remove units (load) up into rack elevations. It is not to be used loaded transporting over major ramps nor as a replacement for such designated tools like pallet jacks, walkies, fork trucks and such related relocation practices. When this is not practicable, specially trained persons or services must be used (for instance, riggers or movers). Read and completely understand the contents of LIFT TOOL operator's manual before using.
- Read and completely understand the contents of LIFT TOOL operator's manual before using. Failure to read, understand, obey safety rules, and follow instructions may result in property damage and/or personal injury. If there are questions, contact the vendor's service and support. Local paper manual must remain with machine in provided storage sleeve area. Latest revision manual available on vendor's website.
- Test verify stabilizer brake function before each use. Do not over-force moving or rolling the LIFT TOOL with stabilizer brake engaged.
- Do not raise, lower or slide platform load shelf unless stabilizer (brake pedal jack) is fully engaged. Keep stabilizer brake engaged when not in use or motion.
- Do not move LIFT TOOL while platform is raised, except for minor positioning.
- Do not exceed rated load capacity. See LOAD CAPACITY CHART regarding maximum loads at center versus edge of extended platform.
- Only raise load if properly centered on platform. Do not place more than 200 lb (91 kg) on edge of sliding platform shelf also considering the load's center of mass/gravity (CoG).
- Do not corner load the platform tilt riser accessory option. Secure platform riser tilt option to main shelf in all four (4x) locations with provided hardware only, prior to use. Load objects are designed to slide on/off smooth platforms without appreciable force, so take care not to push or lean. Keep riser tilt option flat at all times except for final minor adjustment when needed.
- Do not stand under overhanging load.
- Do not use on uneven surface, incline or decline (major ramps).
- Do not stack loads. (C048, part 1 of 2)

CAUTION:

- Do not operate while under the influence of drugs or alcohol.
- Do not support ladder against LIFT TOOL.
- Tipping hazard. Do not push or lean against load with raised platform.
- Do not use as a personnel lifting platform or step. No riders.
- Do not stand on any part of lift. Not a step.
- Do not climb on mast.
- Do not operate a damaged or malfunctioning LIFT TOOL machine.
- Crush and pinch point hazard below platform. Only lower load in areas clear of personnel and obstructions. Keep hands and feet clear during operation.
- No Forks. Never lift or move bare LIFT TOOL MACHINE with pallet truck, jack or fork lift.
- Mast extends higher than platform. Be aware of ceiling height, cable trays, sprinklers, lights, and other overhead objects.
- Do not leave LIFT TOOL machine unattended with an elevated load.
- Watch and keep hands, fingers, and clothing clear when equipment is in motion.
- Turn Winch with hand power only. If winch handle cannot be cranked easily with one hand, it is probably over-loaded. Do not continue to turn winch past top or bottom of platform travel. Excessive unwinding will detach handle and damage cable. Always hold handle when lowering, unwinding. Always assure self that winch is holding load before releasing winch handle.
- A winch accident could cause serious injury. Not for moving humans. Make certain clicking sound is heard as the equipment is being raised. Be sure winch is locked in position before releasing handle. Read instruction page before operating this winch. Never allow winch to unwind freely. Freewheeling will cause uneven cable wrapping around winch drum, damage cable, and may cause serious injury. (C048, part 2 of 2)



CAUTION: If the System slide rails are installed above EIA location 29U, the [ServerLIFT®] tool (or other qualified lift tool) must be used as a safety precaution for servicing. Position the lift tool platform slightly below the bottom of the System drawer to account for the slight downward flex when the drawer is extended out fully on its slides. Then gently raise the lift tool platform to stably contact the bottom of the drawer, minding not to over force it as it could put upward stress to the slide rails. A service-qualified ladder may have to be used to reach or properly work around the System at such heights. While using a ladder, do not lean on or against the system drawer or lift tool during service, and follow safe practices. (C051)

Safety and environmental notices

Review all safety notices, environmental notices, and electronic emission notices before you install and use the product.

Suitability for telecommunication environment: This product is not intended to connect directly or indirectly by any means whatsoever to interfaces of public telecommunications networks.

To find the converted text for a caution or danger notice, complete the following steps.

1. Look for the identification number at the end of each caution notice or each danger notice. In the following examples, the numbers (C001) and (D002) are the identification numbers.

CAUTION: A caution notice indicates the presence of a hazard that has the potential of causing moderate or minor personal injury. (C001)

DANGER: A danger notice indicates the presence of a hazard that has the potential of causing death or serious personal injury. (D002)

2. Locate the *IBM Systems Safety Notices* document with the user publications that were provided with your system hardware.
3. Find the matching identification number in *IBM Systems Safety Notices*. Then, review the topics about the safety notices to ensure that you are in compliance.
4. (Optional) Read the multilingual safety instructions on the system website.
 - a. Go to www.ibm.com/support
 - b. Enter the name of your system in the Search field (for example, " SAN Volume Controller ").
 - c. Click the documentation link.

For more information on Safety and environmental notices, see [Environmental and safety notices](#) in IBM Documentation.

Environmental notices

This information contains all the required environmental notices for IBM Systems products in English and other languages.

The [IBM Systems Environmental Notices](#) information includes statements on limitations, product information, product recycling and disposal, battery information, flat panel display, refrigeration and water-cooling systems, external power supplies, and safety data sheets.

Compliance standards

Note: This product was designed, tested, manufactured, and certified for safe operation. It complies with IEC 60950-1 and/or IEC 62368-1 and where required, to relevant national differences/deviations (NDs) to these IEC base standards. This includes, but is not limited to: EN (European Norms including all Amendments under the Low Voltage Directive), UL/CSA (North America bi-national harmonized and marked per accredited NRTL agency listings), and other such derivative certifications according to corporate determinations and latest regional publication compliance standardized requirements.

Regulatory Model ID (RMID) or Machine Type - Modelsl (MT-Ms) may also be used to supplement identification (ID) for worldwide (WW) co-compliance filings or registrations with regulatory bodies.

Caution notices for the system

Ensure that you understand the caution notices for the system.

Use the reference numbers in parentheses at the end of each notice (for example, D005) to find the matching translated notice in *IBM Systems Safety Notices*.

CAUTION: The battery contains lithium. To avoid possible explosion, do not burn or charge the battery.

Do not throw or immerse into water, heat to more than 100°C (212°F), repair or disassemble. (C003)

CAUTION:

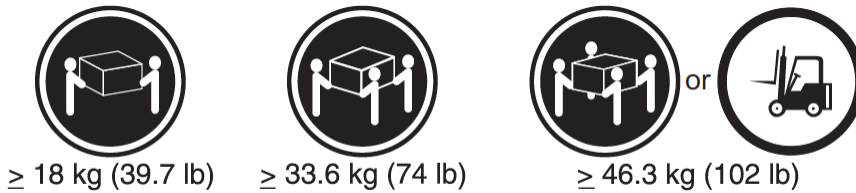

The weight of this part or unit is between 32 and 55 kg (70.5 and 121.2 lb). It takes three persons to safely lift this part or unit. (C010)

CAUTION: To avoid personal injury, before lifting this unit, remove all appropriate subassemblies per instructions to reduce the system weight. (C012)

CAUTION: The doors and covers to the product are to be closed at all times except for service by trained service personnel. All covers must be replaced and doors closed at the conclusion of the service operation. (C013)

CAUTION: CAUTION regarding IBM provided VENDOR LIFT TOOL:

- Operation of LIFT TOOL by authorized personnel only
- LIFT TOOL intended for use to assist, lift, install, remove units (load) up into rack elevations. It is not to be used loaded transporting over major ramps nor as a replacement for such designated tools like pallet jacks, walkies, fork trucks and such related relocation practices. When this is not practicable, specially trained persons or services must be used (for instance, riggers or movers). Read and completely understand the contents of LIFT TOOL operator's manual before using.
- Read and completely understand the contents of LIFT TOOL operator's manual before using. Failure to read, understand, obey safety rules, and follow instructions may result in property damage and/or personal injury. If there are questions, contact the vendor's service and support. Local paper manual must remain with machine in provided storage sleeve area. Latest revision manual available on vendor's website.
- Test verify stabilizer brake function before each use. Do not over-force moving or rolling the LIFT TOOL with stabilizer brake engaged.
- Do not raise, lower or slide platform load shelf unless stabilizer (brake pedal jack) is fully engaged. Keep stabilizer brake engaged when not in use or motion.
- Do not move LIFT TOOL while platform is raised, except for minor positioning.
- Do not exceed rated load capacity. See LOAD CAPACITY CHART regarding maximum loads at center versus edge of extended platform.
- Only raise load if properly centered on platform. Do not place more than 200 lb (91 kg) on edge of sliding platform shelf also considering the load's center of mass/gravity (CoG).
- Do not corner load the platform tilt riser accessory option. Secure platform riser tilt option to main shelf in all four (4x) locations with provided hardware only, prior to use. Load objects are designed to slide on/off smooth platforms without appreciable force, so take care not to push or lean. Keep riser tilt option flat at all times except for final minor adjustment when needed.
- Do not stand under overhanging load.
- Do not use on uneven surface, incline or decline (major ramps).
- Do not stack loads. (C048, part 1 of 2)

- **Do not operate while under the influence of drugs or alcohol.**
- **Do not support ladder against LIFT TOOL.**
- **Tipping hazard. Do not push or lean against load with raised platform.**
- **Do not use as a personnel lifting platform or step. No riders.**
- **Do not stand on any part of lift. Not a step.**
- **Do not climb on mast.**
- **Do not operate a damaged or malfunctioning LIFT TOOL machine.**
- **Crush and pinch point hazard below platform. Only lower load in areas clear of personnel and obstructions. Keep hands and feet clear during operation.**
- **No Forks. Never lift or move bare LIFT TOOL MACHINE with pallet truck, jack or fork lift.**
- **Mast extends higher than platform. Be aware of ceiling height, cable trays, sprinklers, lights, and other overhead objects.**
- **Do not leave LIFT TOOL machine unattended with an elevated load.**
- **Watch and keep hands, fingers, and clothing clear when equipment is in motion.**
- **Turn Winch with hand power only. If winch handle cannot be cranked easily with one hand, it is probably over-loaded. Do not continue to turn winch past top or bottom of platform travel. Excessive unwinding will detach handle and damage cable. Always hold handle when lowering, unwinding. Always assure self that winch is holding load before releasing winch handle.**
- **A winch accident could cause serious injury. Not for moving humans. Make certain clicking sound is heard as the equipment is being raised. Be sure winch is locked in position before releasing handle. Read instruction page before operating this winch. Never allow winch to unwind freely. Freewheeling will cause uneven cable wrapping around winch drum, damage cable, and may cause serious injury. (C048, part 2 of 2)**

CAUTION:

- Do not install a unit in a rack where the internal rack ambient temperatures will exceed the manufacturer's recommended ambient temperature for all your rack-mounted devices.
- Do not install a unit in a rack where the air flow is compromised. Ensure that air flow is not blocked or reduced on any side, front, or back of a unit used for air flow through the unit.
- Consideration should be given to the connection of the equipment to the supply circuit so that overloading of the circuits does not compromise the supply wiring or overcurrent protection. To provide the correct power connection to a rack, refer to the rating labels located on the equipment in the rack to determine the total power requirement of the supply circuit.
- (For sliding drawers) Do not pull out or install any drawer or feature if the rack stabilizer brackets are not attached to the rack. Do not pull out more than one drawer at a time. The rack might become unstable if you pull out more than one drawer at a time.

- (For fixed drawers) This drawer is a fixed drawer and must not be moved for servicing unless specified by the manufacturer. Attempting to move the drawer partially or completely out of the rack might cause the rack to become unstable or cause the drawer to fall out of the rack. (R001 part 2 of 2)

CAUTION: Removing components from the upper positions in the rack cabinet improves rack stability during a relocation. Follow these general guidelines whenever you relocate a populated rack cabinet within a room or building.

- Reduce the weight of the rack cabinet by removing equipment starting at the top of the rack cabinet. When possible, restore the rack cabinet to the configuration of the rack cabinet as you received it. If this configuration is not known, you must observe the following precautions.
 - Remove all devices in the 32U position and above.
 - Ensure that the heaviest devices are installed in the bottom of the rack cabinet.
 - Ensure that there are no empty U-levels between devices installed in the rack cabinet below the 32U level.
- If the rack cabinet you are relocating is part of a suite of rack cabinets, detach the rack cabinet from the suite.
- If the rack cabinet you are relocating was supplied with removable outriggers they must be reinstalled before the cabinet is relocated.
- Inspect the route that you plan to take to eliminate potential hazards.
- Verify that the route that you choose can support the weight of the loaded rack cabinet. Refer to the documentation that comes with your rack cabinet for the weight of a loaded rack cabinet.
- Verify that all door openings are at least 760 x 230 mm (30 x 80 in.).
- Ensure that all devices, shelves, drawers, doors, and cables are secure.
- Ensure that the four leveling pads are raised to their highest position.
- Ensure that there is no stabilizer bracket installed on the rack cabinet during movement.
- Do not use a ramp inclined at more than 10 degrees.
- When the rack cabinet is in the new location, complete the following steps:
 - Lower the four leveling pads.
 - Install stabilizer brackets on the rack cabinet.
 - If you removed any devices from the rack cabinet, repopulate the rack cabinet from the lowest position to the highest position.
- If a long-distance relocation is required, restore the rack cabinet to the configuration of the rack cabinet as you received it. Pack the rack cabinet in the original packaging material, or equivalent. Also lower the leveling pads to raise the casters off the pallet and bolt the rack cabinet to the pallet. (R002)

Danger notices for the system

Ensure that you are familiar with the danger notices for your system.

Use the reference numbers in parentheses at the end of each notice (for example, D005) to find the matching translated notice in *IBM Systems Safety Notices*.

DANGER: When working on or around the system, observe the following precautions:

Electrical voltage and current from power, telephone, and communication cables are hazardous. To avoid a shock hazard: If IBM supplied the power cord(s), connect power to this unit only with the IBM provided power cord. Do not use the IBM provided power cord for any other product. Do not open or service any power supply assembly. Do not connect or disconnect any cables or perform installation, maintenance, or reconfiguration of this product during an electrical storm.



- The product might be equipped with multiple power cords. To remove all hazardous voltages, disconnect all power cords. For AC power, disconnect all power cords from their AC power source. For racks with a DC power distribution panel (PDP), disconnect the customer's DC power source to the PDP.
- When connecting power to the product ensure all power cables are properly connected. For racks with AC power, connect all power cords to a properly wired and grounded electrical outlet. Ensure that the outlet supplies proper voltage and phase rotation according to the system rating plate. For racks with a DC power distribution panel (PDP), connect the customer's DC power source to the PDP. Ensure that the proper polarity is used when attaching the DC power and DC power return wiring.
- Connect all power cords to a properly wired and grounded electrical outlet. Ensure that the outlet supplies proper voltage and phase rotation according to the system rating plate.
- Connect any equipment that will be attached to this product to properly wired outlets.
- When possible, use one hand only to connect or disconnect signal cables.
- Never turn on any equipment when there is evidence of fire, water, or structural damage.
- Do not attempt to switch on power to the machine until all possible unsafe conditions are corrected.
- When performing a machine inspection: Assume that an electrical safety hazard is present. Perform all continuity, grounding, and power checks specified during the subsystem installation procedures to ensure that the machine meets safety requirements. Do not attempt to switch power to the machine until all possible unsafe conditions are corrected. Before you open the device covers, unless instructed otherwise in the installation and configuration procedures: Disconnect the attached AC

power cords, turn off the applicable circuit breakers located in the rack power distribution panel (PDP), and disconnect any telecommunications systems, networks, and modems.

- Disconnect the attached power cords, telecommunications systems, networks, and modems before you open the device covers, unless instructed otherwise in the installation and configuration procedures.
- Connect and disconnect cables as described in the following procedures when installing, moving, or opening covers on this product or attached devices.

To disconnect:

1. Turn off everything (unless instructed otherwise).
2. Remove the power cords from the outlets.
3. Remove the signal cables from the connectors.
4. Remove all cables from the devices.

To connect:

1. Turn off everything (unless instructed otherwise).
2. Attach all cables to the devices.
3. Attach the signal cables to the connectors.
4. Attach the power cords to the outlets.
5. Turn on the devices.

-  Sharp edges, corners and joints might be present in and around the system. Use care when handling equipment to avoid cuts, scrapes and pinching. (D005)

DANGER: Heavy equipment—personal injury or equipment damage might result if mishandled. (D006)

DANGER: Serious injury or death can occur if loaded lift tool falls over or if a heavy load falls off the lift tool. Always completely lower the lift tool load plate and properly secure the load on the lift tool before moving or using the lift tool to lift or move an object. (D010)

DANGER: Multiple power cords. The product might be equipped with multiple AC power cords or multiple DC power cables. To remove all hazardous voltages, disconnect all power cords and power cables. (L003)

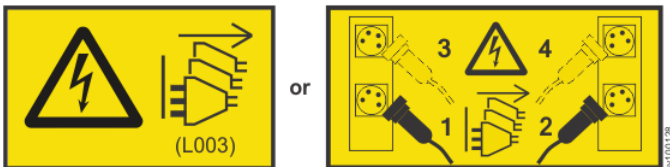

DANGER: Observe the following precautions when working on or around your IT rack system:

- Heavy equipment—personal injury or equipment damage might result if mishandled.
- Always lower the leveling pads on the rack cabinet.
- Always install stabilizer brackets on the rack cabinet.
- To avoid hazardous conditions due to uneven mechanical loading, always install the heaviest devices in the bottom of the rack cabinet. Always install servers and optional devices starting from the bottom of the rack cabinet.
- Rack-mounted devices are not to be used as shelves or work spaces. Do not place objects on top of rack-mounted devices.



- Each rack cabinet might have more than one power cord. Be sure to disconnect all power cords in the rack cabinet when directed to disconnect power during servicing.
- Connect all devices installed in a rack cabinet to power devices installed in the same rack cabinet. Do not plug a power cord from a device installed in one rack cabinet into a power device installed in a different rack cabinet.
- An electrical outlet that is not correctly wired could place hazardous voltage on the metal parts of the system or the devices that attach to the system. It is the responsibility of the customer to ensure that the outlet is correctly wired and grounded to prevent an electrical shock. (R001 part 1 of 2)

DANGER: Racks with a total weight of > 227 kg (500 lb.), Use Only Professional Movers! (R003)

DANGER: Do not transport the rack via fork truck unless it is properly packaged, secured on top of the supplied pallet. (R004)

DANGER:



Main Protective Earth (Ground):

This symbol is marked on the frame of the rack.

The **PROTECTIVE EARTHING CONDUCTORS** should be terminated at that point. A recognized or certified closed loop connector (ring terminal) should be used and secured to the frame with a lock washer using a bolt or stud. The connector should be properly sized to be suitable for the bolt or stud, the locking washer, the rating for the conducting wire used, and the considered rating of the breaker. The intent is to ensure the frame is electrically bonded to the **PROTECTIVE EARTHING CONDUCTORS**. The hole that the bolt or stud goes into where the terminal conductor and the lock washer contact should be free of any non-conductive material to allow for metal to metal contact. All **PROTECTIVE EARTHING CONDUCTORS** should terminate at this main protective earthing terminal or at points marked with . (R010)

Notices

This information was developed for products and services offered in the US. This material might be available from IBM in other languages. However, you may be required to own a copy of the product or product version in that language in order to access it.

IBM may not offer the products, services, or features discussed in this document in other countries. Consult your local IBM representative for information on the products and services currently available in your area. Any reference to an IBM product, program, or service is not intended to state or imply that only that IBM product, program, or service may be used. Any functionally equivalent product, program, or service that does not infringe any IBM intellectual property right may be used instead. However, it is the user's responsibility to evaluate and verify the operation of any non-IBM product, program, or service.

IBM may have patents or pending patent applications covering subject matter described in this document. The furnishing of this document does not grant you any license to these patents. You can send license inquiries, in writing, to:

*IBM Director of Licensing
IBM Corporation
North Castle Drive
Armonk, NY 10504-1785
U.S.A.*

For license inquiries regarding double-byte character set (DBCS) information, contact the IBM Intellectual Property Department in your country or send inquiries, in writing, to:

*Intellectual Property Licensing
Legal and Intellectual Property Law
IBM Japan, Ltd.
19-21, Nihonbashi-Hakozakicho, Chuo-ku
Tokyo 103-8510, Japan*

INTERNATIONAL BUSINESS MACHINES CORPORATION PROVIDES THIS PUBLICATION "AS IS" WITHOUT WARRANTY OF ANY KIND, EITHER EXPRESS OR IMPLIED, INCLUDING, BUT NOT LIMITED TO, THE IMPLIED WARRANTIES OF NON-INFRINGEMENT, MERCHANTABILITY OR FITNESS FOR A PARTICULAR PURPOSE. Some jurisdictions do not allow disclaimer of express or implied warranties in certain transactions, therefore, this statement may not apply to you.

This information could include technical inaccuracies or typographical errors. Changes are periodically made to the information herein; these changes will be incorporated in new editions of the publication. IBM may make improvements and/or changes in the product(s) and/or the program(s) described in this publication at any time without notice.

Any references in this information to non-IBM websites are provided for convenience only and do not in any manner serve as an endorsement of those websites. The materials at those websites are not part of the materials for this IBM product and use of those websites is at your own risk.

IBM may use or distribute any of the information you provide in any way it believes appropriate without incurring any obligation to you.

Licensees of this program who wish to have information about it for the purpose of enabling: (i) the exchange of information between independently created programs and other programs (including this one) and (ii) the mutual use of the information which has been exchanged, should contact:

*IBM Director of Licensing
IBM Corporation
North Castle Drive, MD-NC119*

Armonk, NY 10504-1785
US

Such information may be available, subject to appropriate terms and conditions, including in some cases, payment of a fee.

The licensed program described in this document and all licensed material available for it are provided by IBM under terms of the IBM Customer Agreement, IBM International Program License Agreement or any equivalent agreement between us.

The performance data discussed herein is presented as derived under specific operating conditions. Actual results may vary.

Information concerning non-IBM products was obtained from the suppliers of those products, their published announcements or other publicly available sources. IBM has not tested those products and cannot confirm the accuracy of performance, compatibility or any other claims related to non-IBM products. Questions on the capabilities of non-IBM products should be addressed to the suppliers of those products.

Statements regarding IBM's future direction or intent are subject to change or withdrawal without notice, and represent goals and objectives only.

All IBM prices shown are IBM's suggested retail prices, are current and are subject to change without notice. Dealer prices may vary.

This information is for planning purposes only. The information herein is subject to change before the products described become available.

This information contains examples of data and reports used in daily business operations. To illustrate them as completely as possible, the examples include the names of individuals, companies, brands, and products. All of these names are fictitious and any similarity to the names and addresses used by an actual business enterprise is entirely coincidental.

COPYRIGHT LICENSE:

This information contains sample application programs in source language, which illustrate programming techniques on various operating platforms. You may copy, modify, and distribute these sample programs in any form without payment to IBM, for the purposes of developing, using, marketing or distributing application programs conforming to the application programming interface for the operating platform for which the sample programs are written. These examples have not been thoroughly tested under all conditions. IBM, therefore, cannot guarantee or imply reliability, serviceability, or function of these programs. The sample programs are provided "AS IS", without warranty of any kind. IBM shall not be liable for any damages arising out of your use of the sample programs.

If you are viewing this information softcopy, the photographs and color illustrations may not appear.

Trademarks

IBM, the IBM logo, and ibm.com[®] are trademarks or registered trademarks of International Business Machines Corp., registered in many jurisdictions worldwide. Other product and service names might be trademarks of IBM or other companies. The current list of IBM trademarks is available on the web at Copyright and trademark information at www.ibm.com/legal/copytrade.html.

Microsoft and Windows are trademarks of Microsoft Corporation in the United States, other countries, or both.

Homologation statement

This product may not be certified in your country for connection by any means whatsoever to interfaces of public telecommunications networks. Further certification may be required by law prior to making any such connection. Contact an IBM representative or reseller for any questions.

Where to find the Statement of Limited Warranty

The *Statement of Limited Warranty* is available in both hardcopy format and in the IBM Documentation for each product.

Electromagnetic compatibility Class A notices

The following Class A statements apply to IBM products and their features unless designated as electromagnetic compatibility (EMC) Class B in the feature information.

When attaching a monitor to the equipment, you must use the designated monitor cable and any interference suppression devices that are supplied with the monitor.

Canada Notice

CAN ICES-3 (A)/NMB-3(A)

European Community and Morocco Notice

This product is in conformity with the protection requirements of Directive 2014/30/EU of the European Parliament and of the Council on the harmonization of the laws of the Member States relating to electromagnetic compatibility. IBM cannot accept responsibility for any failure to satisfy the protection requirements resulting from a non-recommended modification of the product, including the fitting of non-IBM option cards.

This product may cause interference if used in residential areas. Such use must be avoided unless the user takes special measures to reduce electromagnetic emissions to prevent interference to the reception of radio and television broadcasts.

Warning: This equipment is compliant with Class A of CISPR 32. In a residential environment this equipment may cause radio interference.

Germany Notice

Deutschsprachiger EU Hinweis: Hinweis für Geräte der Klasse A EU-Richtlinie zur Elektromagnetischen Verträglichkeit

Dieses Produkt entspricht den Schutzanforderungen der EU-Richtlinie 2014/30/EU zur Angleichung der Rechtsvorschriften über die elektromagnetische Verträglichkeit in den EU-Mitgliedsstaaten und hält die Grenzwerte der EN 55032 Klasse A ein.

Um dieses sicherzustellen, sind die Geräte wie in den Handbüchern beschrieben zu installieren und zu betreiben. Des Weiteren dürfen auch nur von der IBM empfohlene Kabel angeschlossen werden. IBM übernimmt keine Verantwortung für die Einhaltung der Schutzanforderungen, wenn das Produkt ohne Zustimmung von IBM verändert bzw. wenn Erweiterungskomponenten von Fremdherstellern ohne Empfehlung von IBM gesteckt/eingebaut werden.

EN 55032 Klasse A Geräte müssen mit folgendem Warnhinweis versehen werden:

"Warnung: Dieses ist eine Einrichtung der Klasse A. Diese Einrichtung kann im Wohnbereich Funk-Störungen verursachen; in diesem Fall kann vom Betreiber verlangt werden, angemessene Maßnahmen zu ergreifen und dafür aufzukommen."

Deutschland: Einhaltung des Gesetzes über die elektromagnetische Verträglichkeit von Geräten

Dieses Produkt entspricht dem "Gesetz über die elektromagnetische Verträglichkeit von Geräten (EMVG)." Dies ist die Umsetzung der EU-Richtlinie 2014/30/EU in der Bundesrepublik Deutschland.

Zulassungsbescheinigung laut dem Deutschen Gesetz über die elektromagnetische Verträglichkeit von Geräten (EMVG) (bzw. der EMC Richtlinie 2014/30/EU) für Geräte der Klasse A

Dieses Gerät ist berechtigt, in Übereinstimmung mit dem Deutschen EMVG das EG-Konformitätszeichen - CE - zu führen.

Verantwortlich für die Einhaltung der EMV-Vorschriften ist der Hersteller:

International Business Machines Corp.
New Orchard Road
Armonk, New York 10504
Tel: 914-499-1900

Der verantwortliche Ansprechpartner des Herstellers in der EU ist:

IBM Deutschland GmbH
Technical Relations Europe, Abteilung M456
IBM-Allee 1, 71139 Ehningen, Germany
Tel: +49 800 225 5426
e-mail: Halloibm@de.ibm.com

Generelle Informationen:

Das Gerät erfüllt die Schutzanforderungen nach EN 55024 und EN 55032 Klasse A.

Japan Electronics and Information Technology Industries Association (JEITA) Notice

(一社) 電子情報技術産業協会 高調波電流抑制対策実施
要領に基づく定格入力電力値 : IBM Documentationの各製品
の仕様ページ参照

This statement applies to products less than or equal to 20 A per phase.

高調波電流規格 JIS C 61000-3-2 適合品

This statement applies to products greater than 20 A, single phase.

高調波電流規格 JIS C 61000-3-2 準用品

本装置は、「高圧又は特別高圧で受電する需要家の高調波抑制対策ガイドライン」対象機器（高調波発生機器）です。

- 回路分類：6（単相、PFC回路付）
- 換算係数：0

This statement applies to products greater than 20 A per phase, three-phase.

高調波電流規格 JIS C 61000-3-2 準用品

本装置は、「高圧又は特別高圧で受電する需要家の高調波抑制対策ガイドライン」対象機器（高調波発生機器）です。

- 回路分類：5（3相、PFC回路付）
- 換算係数：0

Japan Voluntary Control Council for Interference (VCCI) Notice

この装置は、クラスA機器です。この装置を住宅環境で使用すると電波妨害を引き起こすことがあります。この場合には使用者が適切な対策を講ずるよう要求されることがあります。

VCCI - A

Korea Notice

이 기기는 업무용 환경에서 사용할 목적으로 적합성평가를 받은 기기로서 가정용 환경에서 사용하는 경우 전파간섭의 우려가 있습니다.

People's Republic of China Notice

警告:在居住环境中,运行此设备可能会造成无线电干扰。

Russia Notice

ВНИМАНИЕ! Настоящее изделие относится к классу А. В жилых помещениях оно может создавать радиопомехи, для снижения которых необходимы дополнительные меры

Taiwan Notice

警告使用者：

此為甲類資訊技術設備，
於居住環境中使用時，
可能會造成射頻擾動，在此種情況下，
使用者會被要求採取某些適當的對策。

IBM Taiwan Contact Information:

台灣IBM 產品服務聯絡方式：
台灣國際商業機器股份有限公司
台北市松仁路7號3樓
電話：0800-016-888

United Kingdom Notice

This product may cause interference if used in residential areas. Such use must be avoided unless the user takes special measures to reduce electromagnetic emissions to prevent interference to the reception of radio and television broadcasts.

United States Federal Communications Commission (FCC) Notice

This equipment has been tested and found to comply with the limits for a Class A digital device, pursuant to Part 15 of the FCC Rules. These limits are designed to provide reasonable protection against harmful interference when the equipment is operated in a commercial environment. This equipment generates, uses, and can radiate radio frequency energy and, if not installed and used in accordance with the instruction manual, may cause harmful interference to radio communications. Operation of this equipment in a residential area is likely to cause harmful interference, in which case the user will be required to correct the interference at his own expense.

Properly shielded and grounded cables and connectors must be used in order to meet FCC emission limits. IBM is not responsible for any radio or television interference caused by using other than recommended cables and connectors, or by unauthorized changes or modifications to this equipment. Unauthorized changes or modifications could void the user's authority to operate the equipment.

This device complies with Part 15 of the FCC Rules. Operation is subject to the following two conditions:

(1) this device might not cause harmful interference, and (2) this device must accept any interference received, including interference that might cause undesired operation.

Responsible Party:

International Business Machines Corporation

New Orchard Road

Armonk, NY 10504

Contact for FCC compliance information only: fccinfo@us.ibm.com

Electromagnetic compatibility Class B notices

The following Class B statements apply to features designated as electromagnetic compatibility (EMC) Class B in the feature installation information.

When attaching a monitor to the equipment, you must use the designated monitor cable and any interference suppression devices supplied with the monitor.

Canada Notice

CAN ICES-3 (B)/NMB-3(B)

European Community and Morocco Notice

This product is in conformity with the protection requirements of Directive 2014/30/EU of the European Parliament and of the Council on the harmonization of the laws of the Member States relating to electromagnetic compatibility. IBM cannot accept responsibility for any failure to satisfy the protection requirements resulting from a non-recommended modification of the product, including the fitting of non-IBM option cards.

Germany Notice

Deutschsprachiger EU Hinweis: Hinweis für Geräte der Klasse B EU-Richtlinie zur Elektromagnetischen Verträglichkeit

Dieses Produkt entspricht den Schutzanforderungen der EU-Richtlinie 2014/30/EU zur Angleichung der Rechtsvorschriften über die elektromagnetische Verträglichkeit in den EU-Mitgliedsstaaten und hält die Grenzwerte der EN 55022/ EN 55032 Klasse B ein.

Um dieses sicherzustellen, sind die Geräte wie in den Handbüchern beschrieben zu installieren und zu betreiben. Des Weiteren dürfen auch nur von der IBM empfohlene Kabel angeschlossen werden. IBM übernimmt keine Verantwortung für die Einhaltung der Schutzanforderungen, wenn das Produkt ohne Zustimmung von IBM verändert bzw. wenn Erweiterungskomponenten von Fremdherstellern ohne Empfehlung von IBM gesteckt/eingebaut werden.

Deutschland: Einhaltung des Gesetzes über die elektromagnetische Verträglichkeit von Geräten

Dieses Produkt entspricht dem "Gesetz über die elektromagnetische Verträglichkeit von Geräten (EMVG)". Dies ist die Umsetzung der EU-Richtlinie 2014/30/EU in der Bundesrepublik Deutschland.

Zulassungsbescheinigung laut dem Deutschen Gesetz über die elektromagnetische Verträglichkeit von Geräten (EMVG) (bzw. der EMC Richtlinie 2014/30/EU) für Geräte der Klasse B

Dieses Gerät ist berechtigt, in Übereinstimmung mit dem Deutschen EMVG das EG-Konformitätszeichen - CE - zu führen.

Verantwortlich für die Einhaltung der EMV Vorschriften ist der Hersteller:
International Business Machines Corp.
New Orchard Road
Armonk, New York 10504
Tel: 914-499-1900

Der verantwortliche Ansprechpartner des Herstellers in der EU ist:
IBM Deutschland GmbH
Technical Relations Europe, Abteilung M456
IBM-Allee 1, 71139 Ehningen, Germany
Tel: +49 (0) 800 225 5426
email: HalloIBM@de.ibm.com

Generelle Informationen:

Das Gerät erfüllt die Schutzanforderungen nach EN 55024 und EN 55032 Klasse B

Japan Electronics and Information Technology Industries Association (JEITA) Notice

(一社) 電子情報技術産業協会 高調波電流規格
要領に基づく定格入力電力値 : IBM Document Center
の仕様ページ

This statement applies to products less than or equal to 20 A per phase.

高調波電流規格 JIS C 61000-3-2 適合品

These statements apply to products greater than 20 A, single phase.

高調波電流規格 JIS C 61000-3-2 準用品

本装置は、「高圧又は特別高圧で受電する需要
策ガイドライン」対象機器（高調波発生機器）

- 回路分類 : 6 (単相、PFC回路付)
- 換算係数 : 0

This statement applies to products greater than 20 A per phase, three-phase.

高調波電流規格 JIS C 61000-3-2 準用品

本装置は、「高圧又は特別高圧で受電する需要策ガイドライン」対象機器（高調波発生機器）

- 回路分類：5（3相、PFC回路付）
- 換算係数：0

Japan Voluntary Control Council for Interference (VCCI) Notice

この装置は、クラスB機器です。この装置は、住宅環境で使用することを目的としていますが、この装置がラジオやテレビジョン受信機に近接して使用されると、受信障害を引き起こすことがあります。

取扱説明書に従って正しい取り扱いをして下さい。

VCCI - B

Taiwan Notice

IBM Taiwan Contact Information:

台灣IBM 產品服務聯絡方式：
台灣國際商業機器股份有限公司
台北市松仁路7號3樓
電話：0800-016-888

f2c00790

United States Federal Communications Commission (FCC) Notice

This equipment has been tested and found to comply with the limits for a Class B digital device, pursuant to Part 15 of the FCC Rules. These limits are designed to provide reasonable protection against harmful interference in a residential installation. This equipment generates, uses, and can radiate radio frequency energy and, if not installed and used in accordance with the instructions, may cause harmful interference to radio communications. However, there is no guarantee that interference will not occur in a particular installation. If this equipment does cause harmful interference to radio or television reception, which can be determined by turning the equipment off and on, the user is encouraged to try to correct the interference by one or more of the following measures:

- Reorient or relocate the receiving antenna.
- Increase the separation between the equipment and receiver.
- Connect the equipment into an outlet on a circuit different from that to which the receiver is connected.
- Consult an IBM-authorized dealer or service representative for help.

Properly shielded and grounded cables and connectors must be used in order to meet FCC emission limits. Proper cables and connectors are available from IBM-authorized dealers. IBM is not responsible for any radio or television interference caused by using other than recommended cables and connectors or by unauthorized changes or modifications to this equipment. Unauthorized changes or modifications could void the user's authority to operate the equipment.

This device complies with Part 15 of the FCC Rules. Operation is subject to the following two conditions: (1) this device might not cause harmful interference, and (2) this device must accept any interference received, including interference that might cause undesired operation.

Responsible Party:
International Business Machines Corporation
New Orchard Road
Armonk, NY 10504
Contact for FCC compliance information only: fccinfo@us.ibm.com

For your reference

For more information, explore these resources.

- For **IBM Documentation**, see <https://www.ibm.com/docs/en/products>.
- For **IBM Support**, see <https://www.ibm.com/support/home/?lnk=ushpv18hcwh1&lnk2=support>.
- For **IBM Fix Central**, see <https://www.ibm.com/support/fixcentral?lc=en&lot=153>.

This edition applies to version 8, release 5, modification x, and to all subsequent modifications until otherwise indicated in new editions.

© **Copyright International Business Machines Corporation 2016, 2022.**

US Government Users Restricted Rights – Use, duplication or disclosure restricted by GSA ADP Schedule Contract with IBM Corp.

(1P) P/N: 03LG495

