



Storwize V5000E Control Enclosures Getting Started Guide



Overview

This document describes the installation procedures for the following IBM Storwize® control enclosures. It also contains information to help you plan the system configuration. This information applies to the following machine type and model (MTM) numbers.

System		MTM
	IBM Storwize V5010E LFF Control Enclosure IBM Storwize V5030E LFF Control Enclosure	2072-212 2072-312
	IBM Storwize V5010E SFF Control Enclosure IBM Storwize V5030E SFF Control Enclosure	2072-224 2072-324

Important: This document is intended to be used by persons who are experienced with installing these systems. Before you use this information and the product it supports, read the following topics:

- [Installation worksheets](#) on page 10
- [Safety and environmental notices](#) on page 12
- [Notices](#) on page 15
- [IBM Systems Environmental Notices](#) and [IBM Systems Safety Notices](#) (provided on a DVD with your product order)

IBM Knowledge Center (<https://ibm.biz/BdqxdY>) contains more information about preparing the physical environment before the installation; it also provides information about configuring, managing, and servicing the system after installation. The IBM Knowledge Center is updated between product releases to provide the most current documentation.

Unpacking and verifying the contents

Before you start the installation process, ensure that the following items are available.

- Philips screw driver
- Box knife
- Flat-blade screw driver (optional)
- Three Ethernet cables

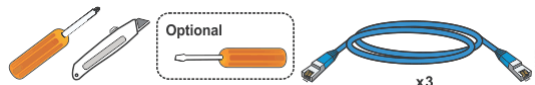

The control enclosure and the following related parts are included in one box. The enclosed inventory sheet lists the part numbers of the items that were ordered. Items, such as drives and networking adapters, are preinstalled inside each node canister.

- Control enclosure with the following components preinstalled:
 - Two node canisters with optional networking adapters, small form-factor pluggable transceivers (SFPs), and memory
 - Two power supply units (PSUs). The system supports AC or DC power supply units.
 - A combination of drives and drive blanks

The number of drives and drive blanks varies, according to the system model and the number of drives that were ordered. For example, if 12 SFF drives were ordered, the drives and 12 drive blanks are preinstalled in the 24-drive SFF control enclosure.

- Rail kit, which includes the left and right rails and springs, 8 securing M5 screws, and locating pins.
- Cables, if they were ordered, for the type of networking adapter that is installed in each node canister.
- Two power cables.

Installing support rails for the system

Before you install a control enclosure, you must first install the support rails. The same rails are used for the control enclosures and the 2U expansion enclosures.

Procedure

1. Locate the assembly kit (two rails, springs, and screws) that must be installed in the rack cabinet.

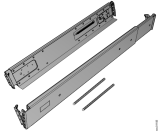

Note: For Network Equipment-Building System (NEBS) compliant installations, follow the requirements that are described in [Guidelines for NEBS compliance](#) on page 14.

2. Install a spring on the rail.

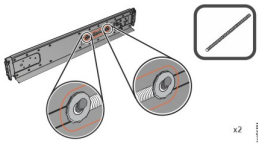

- a. Push one looped end of a spring over one stud on the inside of the rail.
- b. Stretch the spring slightly and push the other looped end of the spring onto the other stud on the inside of the rail.

3. On the front of the rack cabinet, identify two standard rack units (2U) of space in the rack where you want to install the support rails.

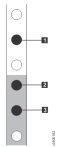

- **1** Upper rail-mounting bracket pin
- **2** Lower rail-mounting bracket pin
- **3** Rack mounting screw hole

4. Ensure that the appropriate bracket pins are installed in the front and rear bracket of each rail.

Each rail comes with four medium pins preinstalled (two in the front bracket and two in the rear bracket). Large and small pins are provided separately. Use the pins that are appropriate for the mounting holes in your rack.

Mounting holes	Bracket pins
Round, unthreaded	Use the preinstalled medium pins.
Round, threaded	Unscrew the medium pins and replace them with the smaller pins that are supplied with the rails.
Square	Unscrew the medium pins and replace them with the large pins that are supplied with the rails.

5. At each end of the rail, grasp the tab and pull *firmly* to open the hinge bracket.

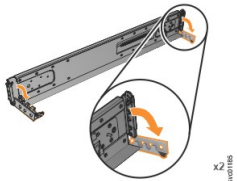

6. Align the holes in the rail bracket with the holes on the front and rear rack cabinet flanges. Ensure that the rails are aligned on the inside of the rack cabinet.

7. On the rear of the rail, press the two bracket pins into the holes in the rack flanges.

8. Close the rear hinge bracket to secure the rail to the rack cabinet flange.

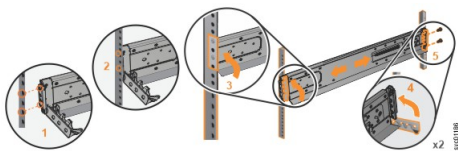

9. On the front of the rail, press the two bracket pins into the holes in the rack flanges.

10. Close the front hinge bracket to secure the rail to the rack cabinet flange.

11. Repeat Step 2 on page 2 through Step 10 on page 2 to secure the opposite rail to the rack cabinet.

12. Repeat the procedure to install the rails for each additional control enclosure.

Installing enclosures

Following your enclosure location plan, install the control enclosure (and optionally, one or more 2U expansion enclosures).

Before you begin



CAUTION:

- This part or unit is heavy but has a weight smaller than 18 kg (39.7 lb). Use care when lifting, removing, or installing this part or unit. (C008)
- If drives are installed, at least three people are required to lift a control enclosure into the rack.
- Load the rack from the bottom up to ensure rack stability. Empty the rack from the top down.

Procedure

1. On either side of the drive assemblies, remove the enclosure end caps. Grasp the handle and pull the bottom of the end cap free. Then, clear the tab on the top of the enclosure.

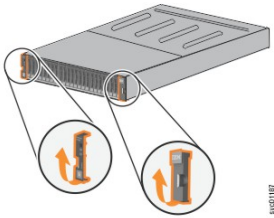

2. Align the enclosure with the front of the rack cabinet.
3. Carefully lift and slide the enclosure into the rack along the rails until it is fully inserted.

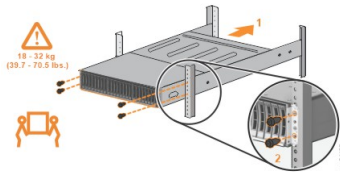

Note: The rails are not designed to hold an enclosure that is partially inserted. Always fully insert the enclosure in the rack.

4. Secure the enclosure with a screw in each of the rack mounting screw holes.
5. Reinstall the left and right end caps.

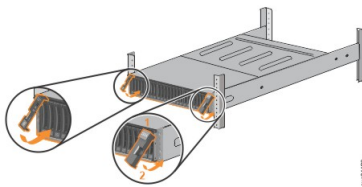

- a. Ensure that the serial number of the end cap matches the serial number on the rear of the enclosure.
- b. Fit the slot on the top of the end cap over the tab on the chassis flange.
- c. Rotate the end cap down until it snaps into place.
- d. Ensure that the inside surface of the end cap is flush with the chassis.

Note: Indicator windows on the left end cap align with the status LEDs (light-emitting diodes) on the edge of the enclosure.

Connecting SAS cables

This task applies if you are installing one or more SAS-attached 2U expansion enclosures to your system. For information about 5U expansion enclosures, see IBM Knowledge Center (<https://ibm.biz/BdqxdY>).

About this task

The following table summarizes the supported SAS chains and enclosures for each system. Before you connect SAS cables, read [SAS cabling guidelines](#) on page 4. Follow the guidelines to ensure that your configuration is valid.

System	Onboard SAS Ports	SAS Chains	Expansion Enclosures per Chain	I/O Groups	Maximum Enclosures
Storwize V5010E	Port 1 only	1	<ul style="list-style-type: none"> 2U enclosure (10) 5U enclosure (4) 	1	<ul style="list-style-type: none"> 2U enclosure (10) 5U enclosure (4)
Storwize V5030E	Port 1 and Port 2	2	<ul style="list-style-type: none"> 2U enclosure (10) 5U enclosure (4) 	2	<ul style="list-style-type: none"> 2U enclosure (40) 5U enclosure (16)

Procedure

- Using the supplied SAS cables, complete the following steps to connect the control enclosure to the expansion enclosure.
 - Connect SAS port 1 of the left node canister in the control enclosure to SAS port 1 of the left expansion canister in the first expansion enclosure.
 - Connect SAS port 1 of the right node canister in the control enclosure to SAS port 1 of the right expansion canister in the first expansion enclosure.
- On Storwize V5030E systems, complete the following steps to add a second expansion chain.
 - Connect SAS port 2 of the left node canister in the control enclosure to SAS port 1 of the left expansion canister in the second expansion enclosure.
 - Connect SAS port 2 of the right node canister in the control enclosure to SAS port 1 of the right expansion canister in the second expansion enclosure.
- If more expansion enclosures are installed, connect each one to the previous expansion enclosure in a chain.

Results

The following figures show SAS connections between 2U expansion enclosures and each system. SAS chain one (1) is below the control enclosure. If the system supports a second SAS chain, SAS chain two (2) is above the control enclosure.

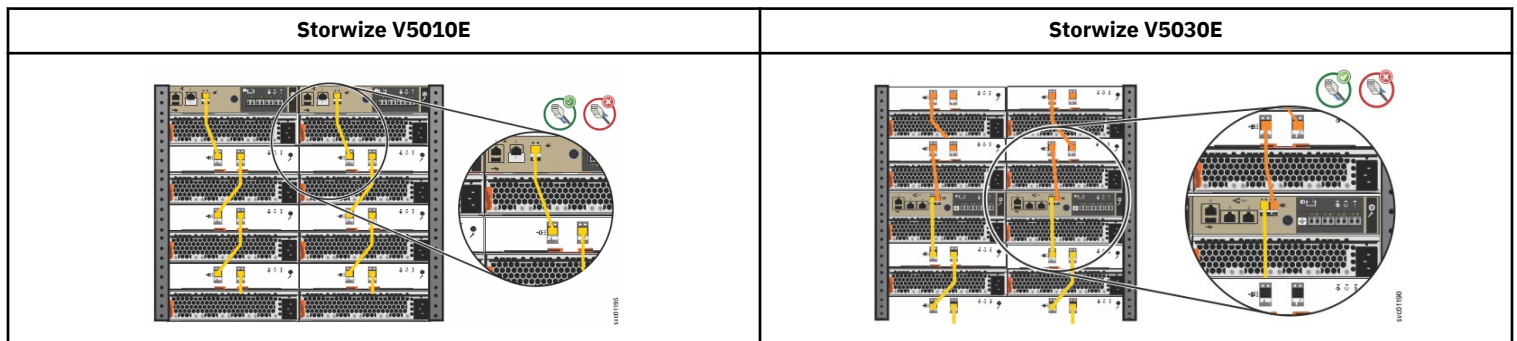

SAS cabling guidelines

Review the following guidelines to ensure that your SAS connections and configuration are valid.

Orienting the connector

When you insert SAS cables, make sure that the connector is oriented correctly.

- The orientation of the connector must match the orientation of the port before you push the connector into the port. The cable connector and socket are keyed and must be aligned when the cable is inserted.
- The blue pull tab must be **below** the connector.

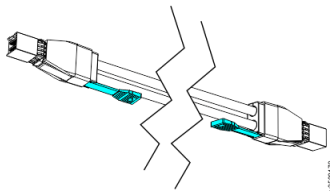

- Insert the connector **gently** until it clicks into place. If you feel resistance, the connector might be oriented incorrectly. Do **not** force it.
- When inserted correctly, the connector can be removed only by pulling the tab.
- When both ends of a SAS cable are inserted correctly and power is connected, the green LEDs next to the SAS ports are lit.

Guidelines

Review the following guidelines when you attach the cables to the SAS ports in 2U expansion enclosures.

- Ensure that cables are installed in an orderly way to reduce the risk of cable damage when replaceable units are removed or inserted.
- Do not connect a cable between a port on the left node canister and a port on the right node canister.
- Attach cables serially between enclosures; do not skip an enclosure.
- No more than 10 expansion enclosures can be chained to SAS port 1 of a node canister. The expansion enclosures in this chain must be installed below the control enclosure.
- For Storwize V5030E systems, no more than 10 expansion enclosures can be chained to SAS port 2 of a node canister. The expansion enclosures in this chain must be installed above the control enclosure.

If an odd number of expansion enclosures is attached to a control enclosure, SAS chain 1 must contain one more expansion enclosure than SAS chain 2 of the node canister.

- A port on the node canister must connect to one port on an expansion canister. Cables that split the connector into separate physical connections are not supported.
- Attach cables serially between enclosures; do not skip an enclosure.
- The last enclosure in a chain must not have cables in port 2 of canister 1 and port 2 of canister 2.

Connect networking cables

To provide connectivity for the system, you must connect networking cables to the appropriate ports on the control enclosure.

Ethernet ports on each node canister provide system management connections and iSCSI host connectivity. The onboard 10 Gbps Ethernet ports use RJ-45 connections. The 10 Gbps ports operate at 1 Gbps when connected to a 1 Gbps switch. The technician port provides access to initialization and service assistant functions.

Storwize V5010E onboard ports

Use the figure and the following table to identify the location and purpose of the onboard ports on the back of the Storwize V5010E system.



Port	Type	Function
1	1 GbE	Management IP, service IP, host I/O (iSCSI only).
2 / T	1 GbE	Technician port - DHCP/DNS for system installation and for direct-attach service management. After the system initializes, the technician port on port 2 is disabled. Port 2 can then be connected to the Ethernet switch for host iSCSI connectivity, IP replication, or to act as a second management port.
3	12 Gb SAS	SAS Expansion only

Ethernet Port 2: Do not connect onboard port 2 to an Ethernet switch until the system initialization or service is complete. After the system initializes, the technician port is automatically disabled; port 2 can then be connected to the Ethernet switch.

To use the technician port again, disconnect port 2 from the Ethernet switch. Enter the following command to re-enable the technician port:

```
satask chserviceip -techport enable
```

Before you reconnect port 2 to an Ethernet switch, disable the technician port. To do so, enter the following command:

```
satask chserviceip -techport disable
```

Storwize V5030E onboard ports

Use the figure and the following table to identify the location and purpose of the onboard ports on the back of the Storwize V5030E system.



Port	Type	Function
T	1 GbE	Dedicated technician port (Dynamic Host Configuration Protocol (DHCP) / Domain Name System (DNS) for direct-attach service management).
1	10 GbE	Management IP, service IP, and host I/O (iSCSI only).
2	10 GbE	Secondary management IP, service IP, and host I/O (iSCSI only).
3	12 Gb SAS ports 1 and 2	SAS Expansion only (arrow that points away from the port indicates expansion).

Connecting Ethernet cables

1. Connect Ethernet port 1 of each node canister to the IP network that provides the connection to the system management interfaces.

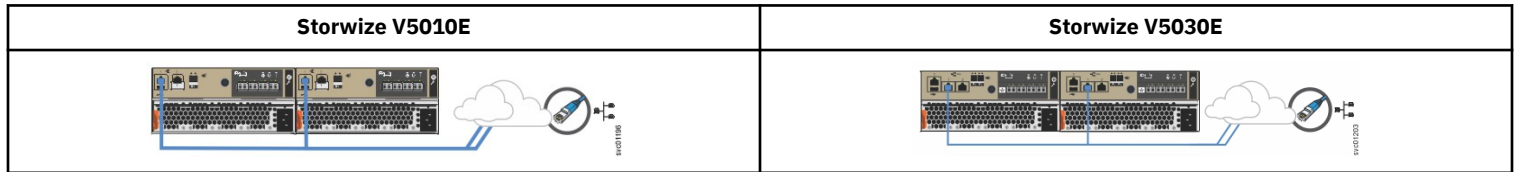

Ethernet port 1 can be used for iSCSI connectivity to the system by hosts on the network. If the Storwize V5030E system contains another control enclosure, ensure that port 1 of each node canister is connected to the same network to provide access if the configuration node fails.

2. On Storwize V5030E systems, you can optionally connect Ethernet port 2 of each node canister to a second IP network to provide a redundant connection to the system management interfaces.

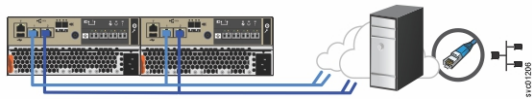

Port 2 can also be used for iSCSI connectivity to the system by hosts on the network. If the system contains more than one control enclosure, ensure that port 2 of every node canister is connected to the same network to provide access if the configuration node fails.

Connecting other networking cables

Each node canister in a control enclosure has one PCIe slot that can support one of the following optional networking adapters. The following figures show examples of the supported networking connections for each system.

Ports	Protocol	Notes
4	16 Gbps Fibre Channel	
4	10 Gbps Ethernet	iSCSI only
2	25 Gbps Ethernet - RDMA over Converged Ethernet (RoCE)	iSCSI only
2	25 Gbps Ethernet - Internet Wide Area RDMA Protocol (iWARP)	iSCSI only
4	12 Gbps SAS	Host attach only

1. Ensure that the appropriate networking adapters are installed in the PCIe slot of each node canister.
2. Ensure that the appropriate number and type of networking cables are connected to the ports on each node canister. Both node canisters must have the same number of cables connected.

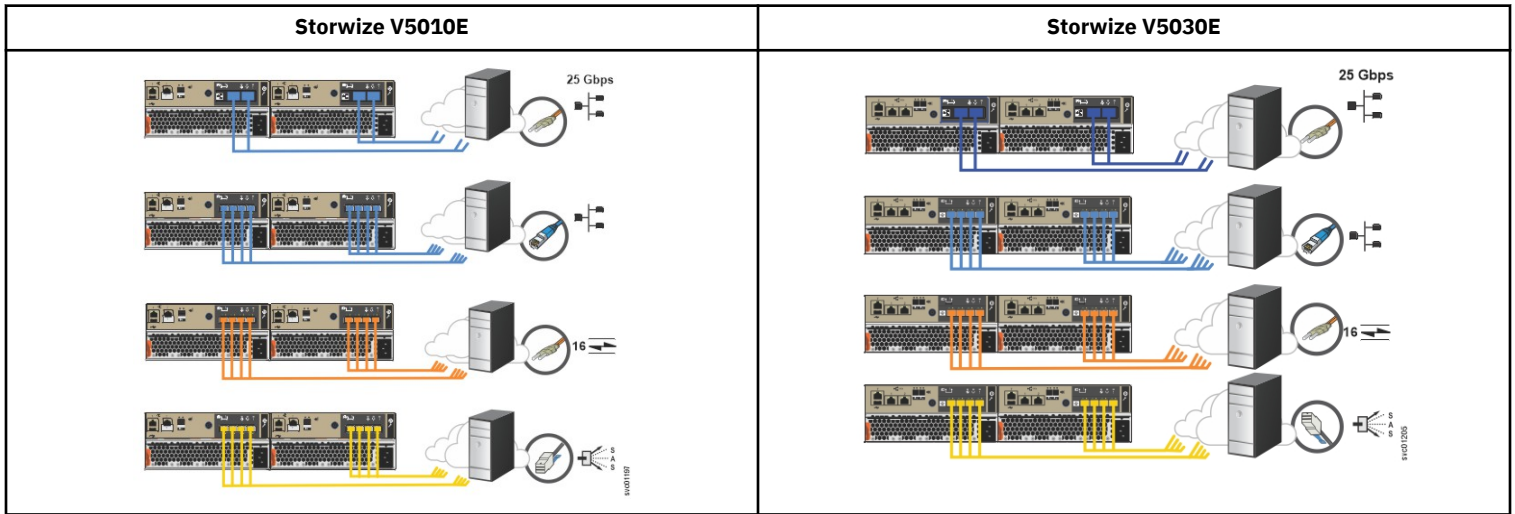

Powering on the system

After you install all hardware components, you must power on the system and check its status. Each control enclosure has two power supply units (PSUs). To provide redundancy in a power failure, connect the power cords to separate power circuits.



Attention: Do not power on the system with any open drive bays or host interface adapter slots. Open bays or PCIe slots disrupt the internal air flow, causing the drives to receive insufficient cooling. Filler panels must be installed in all empty drive bays and PCIe slots.

1. Ensure that the circuit breakers or switches of the power sources are turned on.
2. Ensure that each power cable is secured to each PSU on the back of the node. To do so, route each power cable through the retainer.

The cable retainer has a curved opening that faces the rear of the PSU. After you plug the power cable in to the PSU, slip the power cable behind the retainer. Pull the cable back into the retainer opening to secure it. Then, route each power cable through the cable retainer.



For PSU 1, hook the power cable underneath the cable retainer so the cable can extend to the left.

For PSU 2, make a loop to secure the cable under the retainer and extend the power cable to the right side of the node.

To remove a power cable, push the cable forward to unhook it from the cable retainer. Then, unplug the cable from the PSU.

3. Connect the PSUs of the control enclosure and each expansion enclosure to their power sources.
4. Check the status LED indicators to verify the status of the enclosure. The control enclosure is ready and running without critical errors when the LEDs indicate the following status.

Location	LEDs	Indicator Status		
Back of each node canister (and 2U expansion enclosures, if applicable)		Power LED is on (1) .	Status LED is blinking (2) .	Fault LED is off (3) .
Front of the control enclosure, left end cap		Node operational LED is on.	Identify node LED is off (default).	Node fault LED is off.

Connecting a DC power supply

A control enclosure that is DC powered contains two DC power supply units (PSUs). Each unit must be connected to a suitable -48V DC power source. To provide redundancy in a power circuit failure, connect the two PSUs to different DC power sources.

Note: The connection to the DC power source must be made by trained service personnel. Ensure that the connection is made in accordance with all the requirements of the equipment that is being used.

Use the supplied cables to connect the DC PSUs to the power sources. Use only the IBM supplied DC power cables to connect the unit to a DC power source. The supplied power must meet the following input requirements.

Requirement	Min	Max
Voltage (V DC)	-48	-60
Instantaneous (V DC for < 1 second)	-36	-75
Inrush current at initial turn on (-48V DC)	34 A	
Out of spec time before power off is signaled.	5 ms	

Important: Each PSU cable must be protected by a 20A circuit breaker that is separate from the DC power distribution unit. Read the documentation that is supplied with the DC power distribution unit and circuit breaker. Follow the instructions for connecting the circuit breaker to the power distribution unit and for connecting the DC power cable to the circuit breaker.

One end of the cable ends in a plug that fits the DC PSU. At the other end of the cable, the individual wires end with a 6 mm diameter ring terminal that is designed to fit an M6 stud. Provide adequate strain relief after you attach the ring terminals to the power source. The following table lists the wire colors.

If you need to replace the ring terminals with a different connector, choose a suitably sized and rated UL-listed connector that is appropriate for the wire gauge and available current. Install the ring terminals according to the instructions provided by the manufacturer.

Color	Function
Blue	Return
Green / Yellow	Ground
Brown	-48V

The DC power cables are 4 m long. They must be contained in one rack and must not extend outside the rack. Connect each cable to the DC power source before you connect it to the PSU. The PSU does not have a power switch. When power is connected, the outlets and the enclosure become live. Ensure that the cables are securely attached to the enclosure.

Initializing the system

Storwize V5010E systems contain one I/O group (control enclosure). Storwize V5030E systems can contain two I/O groups (two control enclosures). To set up and initialize a new system, complete the following procedure and run the initialization tool. If you are adding a second Storwize V5030E control enclosure, go to [Adding a Storwize V5030E control enclosure to an existing system](#) on page 10.

Before you begin

- Ensure that a supported browser is installed on a notebook computer.
 - Browser security features might prompt you to accept the self-signed certificate that the system issues.
 - You might need to remove old certificates that are stored in the browser before it accepts the request.
 - The web browser might display a warning about a potential security risk. It is safe to accept the risk and continue.
 - See [Browser considerations](#) on page 10 for more information.
- Ensure that an Ethernet cable is available to connect the notebook computer to the technician port.
 - After the technician port physical connection is completed (that is, connected both ends), it can take up to 45 seconds before the port is fully able to process requests. Submitting requests before this interval might result in 404 error responses.
 - Do not connect the technician port to a switch. If a switch is detected, the technician port connection might shut down, causing a 746 node error.
 - See [Ethernet cable standards](#) on page 11 for more information.

Note: If you are unable to connect to the system through the technician port, you can use the service assistant tool or the service CLI to initialize the system. To do so, complete the following steps.

Procedure

1. Configure an Ethernet port on the notebook computer to enable Dynamic Host Configuration Protocol (DHCP) configuration of its IP address and DNS settings. If you do not have DHCP, use the following information to manually configure the notebook computer.



Static IPv4 Address	Subnet Mask	Gateway	DNS
192.168.0.2	255.255.255.0	192.168.0.1	192.168.0.1

2. Locate the Ethernet port that is labeled T on the rear of the node canister. On Storwize V5010E systems, Ethernet port 2 also serves as the technician port. Storwize V5030E systems have a dedicated technician port.

Table 1: Location of the technician port on a node canister

Storwize V5010E	Storwize V5030E
	

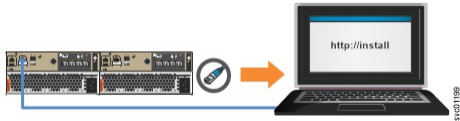
3. Connect an Ethernet cable between the port of the notebook computer and the technician port. The cable must be long enough to connect easily to the computer.

Storwize V5010E	Storwize V5030E
	

After the connection is made, the system automatically configures the IP and DNS settings for the notebook computer, if DHCP is available. If it is not available, the system uses the values that you provided in step 1 on page 8.

4. After the Ethernet port of the notebook computer is connected, open a supported browser and go to address `http://install`. The browser is automatically directed to the initialization tool.
If you do not have DHCP, open a supported browser and go to static IP address `192.168.0.1`.
5. Follow the instructions in the initialization tool to configure the system with a name and management IP address.
Use the information that you provided in [Management and service address worksheet](#) on page 12.
6. If you experience a problem during the process due to a change in system states, wait 5 - 10 seconds. Then, either reopen the SSH connection or reload the service assistant.
7. After you complete the initialization process, disconnect the cable between the notebook computer and the technician port.
 - On Storwize V5010E systems, continue to step 8 on page 9.
 - On Storwize V5030E systems, go to step 10 on page 9.
8. On Storwize V5010E systems, connect the notebook computer to the network.

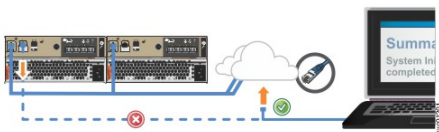

Ethernet port 1 remains connected to the network, as shown. Ethernet port 2 no longer acts as the technician port.

9. Optional: On Storwize V5010E systems, connect onboard Ethernet port 2 to the network.

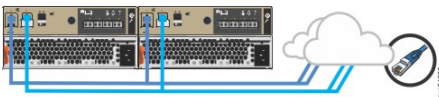

After the system initializes, the technician port is automatically disabled. Ethernet port 2 can then be connected to the Ethernet switch.

10. Enter the management IP address in a web browser to access the management GUI for the first time.

- a) Log in with the following credentials to start the initial setup process.

User ID	Password
superuser	passw0rd

Using an alternative method to initialize the node

11. If you are unable to connect to the system through the technician port, you can use the service assistant tool or the service CLI to initialize the system. To do so, complete the following steps.

- a. Access the command line by using the credentials that are listed in Step 10 on page 9.
- b. Enter the following CLI command to create the system:

```
mkcluster -clusterip x.x.x.x -mask m.m.m.m -gw g.g.g.g -name name
```

Adding a Storwize V5030E control enclosure to an existing system

If the system was set up on another Storwize V5030E control enclosure, do not install it again on this control enclosure. Instead, use the management GUI to add the control enclosure to the system. You cannot add a second control enclosure to a Storwize V5010E system.

Procedure

1. Install the support rails for the new control enclosure, as described in [Installing support rails for the system](#) on page 1.
2. Install the new control enclosure in the rack, as described in [Installing enclosures](#) on page 3.
3. Connect the node canisters to the storage area network (SAN) or, if applicable to your system, to a 25 Gbps (or faster) Ethernet.
4. Configure the zoning on the SAN switches to allow Fibre Channel (FC) ports to connect to each other.
5. Start the management GUI on the existing system.
 - a) In the management GUI, select **Monitoring > System**.
 - b) On the **System - Overview** page, select **Add Enclosure**.

When a new enclosure is cabled correctly to the system, the **Add Enclosure** action automatically displays on the **System - Overview** page. If this action does not appear, review the installation instructions to ensure that the new enclosure is cabled correctly.
 - c) Complete the instructions in the **Add Enclosures** wizard until the control enclosure is added to the system.
 - d) You can also add an enclosure by selecting **Add Enclosure** from the **System Actions** menu.
6. If two control enclosures are in the system, you must set up a quorum disk or application outside of the system. If the control enclosures lose communication with each other, the quorum disk prevents both I/O groups from going offline. For more information, see the "Configuring quorum" topic in the IBM Knowledge Center.

Browser considerations

The management GUI supports the following HTML5-compliant browsers. Certain features must be enabled on the browser. Review the documentation that is provided with your browser to determine how to enable each item.

Browser	Required enabled features
<ul style="list-style-type: none">• Mozilla Firefox 80.0.1• Mozilla Firefox Extended Support Release (ESR) 78.2.0• Microsoft Edge 85.0• Google Chrome 85.0	<ul style="list-style-type: none">• JavaScript• Cookies• Scripts allowed to disable or replace context menus (Mozilla Firefox only)

In addition, review the following considerations about browser security features and certificates.

- Browser security features might prompt you before the browser accepts the self-signed certificate that the system issues.
- You might need to remove old certificates that are stored in the browser before the browser accepts the request.
- The web browser might display a warning about a potential security risk. It is safe to accept the risk and continue.
- After the technician port physical connection is completed (that is, connected both ends), it can take up to 45 seconds before the port is fully up and able to process requests. Submitting requests before this interval might result in 404 error responses.
- If the `http://service` request causes a 404 error or does not produce a response, you might need to use URL `https://192.168.0.1` to connect to the system.

Installation worksheets

Worksheets can help you plan and install the system. Complete the worksheets for each system that you are installing.

Network cable connection worksheet

Use the following tables to plan and record the cable connections for each control enclosure in your system.

Ethernet connections

Each node canister in the control enclosure can contain up to six Ethernet ports. Review the following information about the ports. Then, record information about each Ethernet port connection for each node canister in the following table.

- Each control enclosure has two onboard Ethernet ports, which are labeled port 1 and port 2.

Ethernet port 1 of each node canister connects over an Ethernet cable to an enabled port on your Ethernet switch or router. Ethernet port 1 is used for accessing the management GUI, the service assistant GUI for the node canister, and iSCSI host attachment.

Optionally, you can attach an Ethernet cable from Ethernet port 2 on the canister to your Ethernet network. On Storwize V5010E systems, Ethernet port 2 also serves as the technician port. You must first disable port 2 from acting as a technician port before you can use it to access other functions. Storwize V5030E systems have a dedicated technician port.

- Ethernet ports 3 and 4 are present if an optional 2-port 25 Gbps Ethernet adapter (RoCE or iWARP) is installed. This adapter is used for iSCSI connections.
- Ethernet ports 3, 4, 5 and 6 are present if the optional 4-port 10 Gbps Ethernet adapter is installed. The 10 Gbps Ethernet host interface adapter can be used for iSCSI connections only.

Ethernet cable standards

The following table describes Ethernet cable standards. Ethernet cables are not supplied as part of your order. Ensure the cables that are used meet the minimum standards for the Ethernet port type.

Port Type	Cable	Minimum Standard	Connector
1 Gbps Ethernet port	Unshielded twisted pair (UTP)	Cat 5e or Cat 6 (up to 100 meters)	RJ45
10 Gbps Ethernet port	Unshielded twisted pair (UTP)	Cat 6a or Cat 7 (up to 100 meters)	RJ45
10 or 25 Gbps Ethernet port (optional)	Optical fiber	OM2 (up to 60 meters) or OM3 (60 - 150 meters)	LC

Note: The 10 Gbps Ethernet RJ45 port works at 1 Gbps, if it is connected to a 1 Gbps Ethernet switch port.

Ethernet port connections

Use the following table to plan and record information about the Ethernet connections that are made to the onboard ports and ports on the optional Ethernet networking adapters.

Control Enclosure 1: Storwize V5010E or Storwize V5030E												
Left Node Canister 1						Link Details	Right Node Canister 2					
Onboard		Optional Adapter					Onboard		Optional Adapter			
Port 1	Port 2	Port 3	Port 4	Port 5	Port 6		Port 1	Port 2	Port 3	Port 4	Port 5	Port 6
						Switch						
						Port						
						Speed						

Control Enclosure 2: Storwize V5030E												
Left Node Canister 1						Link Details	Right Node Canister 2					
Onboard		Optional Adapter					Onboard		Optional Adapter			
Port 1	Port 2	Port 3	Port 4	Port 5	Port 6		Port 1	Port 2	Port 3	Port 5	Port 5	Port 6
						Switch						
						Port						
						Speed						

Fibre Channel connections

Record the Fibre Channel (FC) port connections in the following table. FC connectivity is optional and requires a 4-port 16 Gbps FC host interface adapter.

Control Enclosure 1: Storwize V5010E or Storwize V5030E									
Left Node Canister 1				Link Details	Right Node Canister 2				
Port 1	Port 2	Port 3	Port 4		Port 1	Port 2	Port 3	Port 4	
					Switch				
				Port					
				Speed					

Control Enclosure 2: Storwize V5030E									
--------------------------------------	--	--	--	--	--	--	--	--	--

Control Enclosure 1: Storwize V5010E or Storwize V5030E								
Left Node Canister 1				Link Details	Right Node Canister 2			
Port 1	Port 2	Port 3	Port 4		Port 1	Port 2	Port 3	Port 4
Left Node Canister 1				Link Details	Right Node Canister 2			
Port 1	Port 2	Port 3	Port 4		Port 1	Port 2	Port 3	Port 4
				Switch				
				Port				
				Speed				

SAS connections

Record the SAS port connections in the following table. SAS connectivity to hosts is provided by the optional 4-port 12 Gbps SAS adapter.

Control Enclosure 1: Storwize V5010E or Storwize V5030E								
Left Node Canister 1				Link Details	Right Node Canister 2			
Port 1	Port 2	Port 3	Port 4		Port 1	Port 2	Port 3	Port 4
				Switch				
				Port				
				Speed				

Control Enclosure 2: Storwize V5030E								
Left Node Canister 1				Link Details	Right Node Canister 2			
Port 1	Port 2	Port 3	Port 4		Port 1	Port 2	Port 3	Port 4
				Switch				
				Port				
				Speed				

Management and service address worksheet

Use the following table to record the management address and service addresses for each control enclosure. The primary system address is bound to Ethernet port 1. The secondary system address, if specified, is bound to Ethernet port 2. Both IPv4 and IPv6 addresses can be used. Specify the type of installation and the serial number (S/N) of the control enclosure.

- If you are installing a new system installation, designate new, unused IP addresses.
- If you are adding an I/O group (control enclosure) to an existing system, use the management address of the existing system.

Control Enclosure S/N:	Are you adding this control enclosure to an existing system? <input type="checkbox"/> Yes <input type="checkbox"/> No		
Address Type	IP Address	Network Mask	Default Gateway
Primary system address (required)			
Secondary system address (optional)			
Node canister 1 service address (required)			
Node canister 2 service address (required)			

Safety and environmental notices

Review all safety notices, environmental notices, and electronic emission notices before you install and use the product.

Suitability for telecommunication environment: This product is not intended to connect directly or indirectly by any means whatsoever to interfaces of public telecommunications networks.

To find the translated text for a caution or danger notice, complete the following steps.

1. Look for the identification number at the end of each caution notice or each danger notice. In the following examples, the numbers (C001) and (D002) are the identification numbers.

CAUTION: A caution notice indicates the presence of a hazard that has the potential of causing moderate or minor personal injury. (C001)

DANGER: A danger notice indicates the presence of a hazard that has the potential of causing death or serious personal injury. (D002)

2. Locate the *IBM Systems Safety Notices* document with the user publications that were provided with your system hardware.
3. Find the matching identification number in *IBM Systems Safety Notices*. Then, review the topics about the safety notices to ensure that you are in compliance.
4. (Optional) Read the multilingual safety instructions on the system website.
 - a. Go to www.ibm.com/support
 - b. Enter the name of your system in the Search field (for example, " Storwize V5000E ").
 - c. Click the documentation link.

Direct current power supply units

This section describes information about control enclosure models that use direct current (DC) power.

DANGER: When working on or around the system, observe the following precautions:

Electrical voltage and current from power, telephone, and communication cables are hazardous. To avoid a shock hazard: If IBM supplied the power cord(s), connect power to this unit only with the IBM provided power cord. Do not use the IBM provided power cord for any other product. Do not open or service any power supply assembly. Do not connect or disconnect any cables or perform installation, maintenance, or reconfiguration of this product during an electrical storm.



- The product might be equipped with multiple power cords. To remove all hazardous voltages, disconnect all power cords. For AC power, disconnect all power cords from their AC power source. For racks with a DC power distribution panel (PDP), disconnect the customer's DC power source to the PDP.
- When connecting power to the product ensure all power cables are properly connected. For racks with AC power, connect all power cords to a properly wired and grounded electrical outlet. Ensure that the outlet supplies proper voltage and phase rotation according to the system rating plate. For racks with a DC power distribution panel (PDP), connect the customer's DC power source to the PDP. Ensure that the proper polarity is used when attaching the DC power and DC power return wiring.
- Connect all power cords to a properly wired and grounded electrical outlet. Ensure that the outlet supplies proper voltage and phase rotation according to the system rating plate.
- Connect any equipment that will be attached to this product to properly wired outlets.
- When possible, use one hand only to connect or disconnect signal cables.
- Never turn on any equipment when there is evidence of fire, water, or structural damage.
- Do not attempt to switch on power to the machine until all possible unsafe conditions are corrected.
- When performing a machine inspection: Assume that an electrical safety hazard is present. Perform all continuity, grounding, and power checks specified during the subsystem installation procedures to ensure that the machine meets safety requirements. Do not attempt to switch power to the machine until all possible unsafe conditions are corrected. Before you open the device covers, unless instructed otherwise in the installation and configuration procedures: Disconnect the attached AC power cords, turn off the applicable circuit breakers located in the rack power distribution panel (PDP), and disconnect any telecommunications systems, networks, and modems.
- Disconnect the attached power cords, telecommunications systems, networks, and modems before you open the device covers, unless instructed otherwise in the installation and configuration procedures.
- Connect and disconnect cables as described in the following procedures when installing, moving, or opening covers on this product or attached devices.

To disconnect:

1. Turn off everything (unless instructed otherwise).
2. Remove the power cords from the outlets.
3. Remove the signal cables from the connectors.
4. Remove all cables from the devices.

To connect:

1. Turn off everything (unless instructed otherwise).
2. Attach all cables to the devices.
3. Attach the signal cables to the connectors.
4. Attach the power cords to the outlets.
5. Turn on the devices.

-  Sharp edges, corners and joints might be present in and around the system. Use care when handling equipment to avoid cuts, scrapes and pinching. (D005)



DANGER: Hazardous voltage, current, or energy levels are present inside any component that has this label attached. Do not open any cover or barrier that contains this label. (L001)

CAUTION: The power-control button on the device does not turn off the electrical current supplied to the device. The device might also have more than one connection to DC power. To remove all electrical current from the device, ensure that all connections to DC power are disconnected at the DC power input terminals. (C031)

Statement 34:



CAUTION: To reduce the risk of electric shock or energy hazards:

- This equipment must be installed by trained service personnel in a restricted-access location, as defined by the NEC and IEC 60950-1, Second Edition Amendment 1, The Standard for Safety of Information Technology Equipment.
- Connect the equipment to a properly grounded safety extra low voltage (SELV) source. A SELV source is a secondary circuit that is designed so that normal and single fault conditions do not cause the voltages to exceed a safe level (60 V direct current).
- Incorporate a readily available approved and rated disconnect device in the field wiring.
- See the specifications in the product documentation for the required circuit-breaker rating for branch circuit overcurrent protection.
- Use copper wire conductors only. See the specifications in the product documentation for the required wire size.
- See the specifications in the product documentation for the required torque values for the wiring-terminal screws.

Note: In Statement 34 above:

- The required circuit breaker rating is 20 amps.

Environmental notices

This information contains all the required environmental notices for IBM Systems products in English and other languages.

The [IBM Systems Environmental Notices](#) information includes statements on limitations, product information, product recycling and disposal, battery information, flat panel display, refrigeration and water-cooling systems, external power supplies, and safety data sheets.

Compliance standards

Note: This product was designed, tested, manufactured, and certified for safe operation. It complies with IEC 60950-1 and/or IEC 62368-1 and where required, to relevant national differences/deviations (NDs) to these IEC base standards. This includes, but is not limited to: EN (European Norms including all Amendments under the Low Voltage Directive), UL/CSA (North America bi-national harmonized and marked per accredited NRTL agency listings), and other such derivative certifications according to corporate determinations and latest regional publication compliance standardized requirements.

Regulatory Model ID (RMID) or Machine Type - Models (MT-Ms) may also be used to supplement identification (ID) for worldwide (WW) co-compliance filings or registrations with regulatory bodies.

Guidelines for NEBS compliance

Review the following information to ensure that your enclosure is in a Network Equipment-Building System (NEBS) compliant installation.

Creating a NEBS-compliant earth connection

Each enclosure must have a reliable electrical earth connection that is separate from any earth connections that are provided by power supply cables. This connection is made by using the front enclosure mounting screws that are used during the standard installation process. To provide a reliable electrical earth connection, the upright mounting rails of the racks into which enclosures are installed must meet the following requirements before you install the support rails and enclosures:

- Upright mounting rails must not be painted, oxidized, or otherwise insulated from the enclosure flanges and mounting rails. If paint, oxidation or other insulation is present, it must be removed and the metal must be brought to a bright, non-corroding finish.
- Upright mounting rails must have their own NEBS-compliant connection to earth, independent of the earth connections provided by any power supply cables.

Configuring a system to be NEBS-compliant

Configuring the system to be NEBS-compliant only changes the way that the system responds to raised temperature.

- To extend the operational temperature range of all enclosures in the system to meet NEBS operating temperature requirements, enter the following CLI command. After it is set, `high_temp_mode` value is applied to all enclosures in the system.

```
chsystem -hightempmode on
```

- To configure the default ranges for the operating temperature, enter the following CLI command.

```
chsystem -hightempmode off
```

- To determine which mode is configured, enter the following command and see the `high_temp_mode` value in the command output.

```
lssystem
```

Note: The system might not be able to save its cache and state data if the power fails while it is operating within the extended temperature range. The battery capacity decreases as temperature rises. If the save of cache and state data cannot be completed, an extended service action is required to recover the system and data might be lost. Keep the temperature within the normal operating range, if possible, and maintain a reliable power supply.

For more information, see the following website: <https://www.ibm.com/support/pages/node/5690331>

Accessibility features for the system

Accessibility features help users who have a disability, such as restricted mobility or limited vision, to use information technology products successfully.

Accessibility features

These are the major accessibility features for the system:

- You can use screen-reader software and a digital speech synthesizer to hear what is displayed on the screen. HTML documents are tested by using JAWS version 15.0.
- This product uses standard Windows navigation keys.
- Interfaces are commonly used by screen readers.
- Industry-standard devices, ports, and connectors.

For information about the accessibility features of the online documentation, see IBM Knowledge Center (<https://ibm.biz/BdqxdY>).

Keyboard navigation

You can use keys or key combinations for operations and to initiate menu actions that can also be done through mouse actions. You can go to the system online documentation from the keyboard by using the keyboard shortcuts for your browser or screen-reader software. See your browser or screen-reader software Help for a list of keyboard shortcuts that it supports.

IBM and accessibility

See the [IBM Human Ability and Accessibility Center](#) for more information about the commitment that IBM has to accessibility.

Notices

This information was developed for products and services offered in the US. This material might be available from IBM in other languages. However, you may be required to own a copy of the product or product version in that language in order to access it.

IBM may not offer the products, services, or features discussed in this document in other countries. Consult your local IBM representative for information on the products and services currently available in your area. Any reference to an IBM product, program, or service is not intended to state or imply that only that IBM product, program, or service may be used. Any functionally equivalent product, program, or service that does not infringe any IBM intellectual property right may be used instead. However, it is the user's responsibility to evaluate and verify the operation of any non-IBM product, program, or service.

IBM may have patents or pending patent applications covering subject matter described in this document. The furnishing of this document does not grant you any license to these patents. You can send license inquiries, in writing, to:

*IBM Director of Licensing
IBM Corporation
North Castle Drive
Armonk, NY 10504-1785
U.S.A.*

For license inquiries regarding double-byte character set (DBCS) information, contact the IBM Intellectual Property Department in your country or send inquiries, in writing, to:

*Intellectual Property Licensing
Legal and Intellectual Property Law
IBM Japan, Ltd.
19-21, Nihonbashi-Hakozakicho, Chuo-ku
Tokyo 103-8510, Japan*

INTERNATIONAL BUSINESS MACHINES CORPORATION PROVIDES THIS PUBLICATION "AS IS" WITHOUT WARRANTY OF ANY KIND, EITHER EXPRESS OR IMPLIED, INCLUDING, BUT NOT LIMITED TO, THE IMPLIED WARRANTIES OF NON-INFRINGEMENT, MERCHANTABILITY OR FITNESS FOR A PARTICULAR PURPOSE. Some jurisdictions do not allow disclaimer of express or implied warranties in certain transactions, therefore, this statement may not apply to you.

This information could include technical inaccuracies or typographical errors. Changes are periodically made to the information herein; these changes will be incorporated in new editions of the publication. IBM may make improvements and/or changes in the product(s) and/or the program(s) described in this publication at any time without notice.

Any references in this information to non-IBM websites are provided for convenience only and do not in any manner serve as an endorsement of those websites. The materials at those websites are not part of the materials for this IBM product and use of those websites is at your own risk.

IBM may use or distribute any of the information you provide in any way it believes appropriate without incurring any obligation to you.

Licensees of this program who wish to have information about it for the purpose of enabling: (i) the exchange of information between independently created programs and other programs (including this one) and (ii) the mutual use of the information which has been exchanged, should contact:

*IBM Director of Licensing
IBM Corporation
North Castle Drive, MD-NC119
Armonk, NY 10504-1785
US*

Such information may be available, subject to appropriate terms and conditions, including in some cases, payment of a fee.

The licensed program described in this document and all licensed material available for it are provided by IBM under terms of the IBM Customer Agreement, IBM International Program License Agreement or any equivalent agreement between us.

The performance data discussed herein is presented as derived under specific operating conditions. Actual results may vary.

Information concerning non-IBM products was obtained from the suppliers of those products, their published announcements or other publicly available sources. IBM has not tested those products and cannot confirm the accuracy of performance, compatibility or any other claims related to non-IBM products. Questions on the capabilities of non-IBM products should be addressed to the suppliers of those products.

Statements regarding IBM's future direction or intent are subject to change or withdrawal without notice, and represent goals and objectives only.

All IBM prices shown are IBM's suggested retail prices, are current and are subject to change without notice. Dealer prices may vary.

This information is for planning purposes only. The information herein is subject to change before the products described become available.

This information contains examples of data and reports used in daily business operations. To illustrate them as completely as possible, the examples include the names of individuals, companies, brands, and products. All of these names are fictitious and any similarity to the names and addresses used by an actual business enterprise is entirely coincidental.

COPYRIGHT LICENSE:

This information contains sample application programs in source language, which illustrate programming techniques on various operating platforms. You may copy, modify, and distribute these sample programs in any form without payment to IBM, for the purposes of developing, using, marketing or distributing application programs conforming to the application programming interface for the operating platform for which the sample programs are written. These examples have not been thoroughly tested under all conditions. IBM, therefore, cannot guarantee or imply reliability, serviceability, or function of these programs. The sample programs are provided "AS IS", without warranty of any kind. IBM shall not be liable for any damages arising out of your use of the sample programs.

If you are viewing this information softcopy, the photographs and color illustrations may not appear.

Trademarks

IBM, the IBM logo, and ibm.com® are trademarks or registered trademarks of International Business Machines Corp., registered in many jurisdictions worldwide. Other product and service names might be trademarks of IBM or other companies. The current list of IBM trademarks is available on the web at Copyright and trademark information at www.ibm.com/legal/copytrade.html.

Microsoft and Windows are trademarks of Microsoft Corporation in the United States, other countries, or both.

Where to find the Statement of Limited Warranty

The *Statement of Limited Warranty* is available in both hardcopy format and in the Storwize V5000E IBM Knowledge Center.

Homologation statement

This product may not be certified in your country for connection by any means whatsoever to interfaces of public telecommunications networks. Further certification may be required by law prior to making any such connection. Contact an IBM representative or reseller for any questions.

Electromagnetic compatibility notices

The following Class A statements apply to IBM products and their features unless designated as electromagnetic compatibility (EMC) Class B in the feature information.

When attaching a monitor to the equipment, you must use the designated monitor cable and any interference suppression devices that are supplied with the monitor.

Canada Notice

CAN ICES-3 (A)/NMB-3(A)

European Community and Morocco Notice

This product is in conformity with the protection requirements of Directive 2014/30/EU of the European Parliament and of the Council on the harmonization of the laws of the Member States relating to electromagnetic compatibility. IBM cannot accept responsibility for any failure to satisfy the protection requirements resulting from a non-recommended modification of the product, including the fitting of non-IBM option cards.

This product may cause interference if used in residential areas. Such use must be avoided unless the user takes special measures to reduce electromagnetic emissions to prevent interference to the reception of radio and television broadcasts.

Warning: This equipment is compliant with Class A of CISPR 32. In a residential environment this equipment may cause radio interference.

Germany Notice

Deutschsprachiger EU Hinweis: Hinweis für Geräte der Klasse A EU-Richtlinie zur Elektromagnetischen Verträglichkeit

Dieses Produkt entspricht den Schutzanforderungen der EU-Richtlinie 2014/30/EU zur Angleichung der Rechtsvorschriften über die elektromagnetische Verträglichkeit in den EU-Mitgliedsstaaten und hält die Grenzwerte der EN 55032 Klasse A ein.

Um dieses sicherzustellen, sind die Geräte wie in den Handbüchern beschrieben zu installieren und zu betreiben. Des Weiteren dürfen auch nur von der IBM empfohlene Kabel angeschlossen werden. IBM übernimmt keine Verantwortung für die Einhaltung der Schutzanforderungen, wenn das Produkt ohne Zustimmung von IBM verändert bzw. wenn Erweiterungskomponenten von Fremdherstellern ohne Empfehlung von IBM gesteckt/eingebaut werden.

EN 55032 Klasse A Geräte müssen mit folgendem Warnhinweis versehen werden:

"Warnung: Dieses ist eine Einrichtung der Klasse A. Diese Einrichtung kann im Wohnbereich Funk-Störungen verursachen; in diesem Fall kann vom Betreiber verlangt werden, angemessene Maßnahmen zu ergreifen und dafür aufzukommen."

Deutschland: Einhaltung des Gesetzes über die elektromagnetische Verträglichkeit von Geräten

Dieses Produkt entspricht dem "Gesetz über die elektromagnetische Verträglichkeit von Geräten (EMVG)." Dies ist die Umsetzung der EU-Richtlinie 2014/30/EU in der Bundesrepublik Deutschland.

Zulassungsbescheinigung laut dem Deutschen Gesetz über die elektromagnetische Verträglichkeit von Geräten (EMVG) (bzw. der EMC Richtlinie 2014/30/EU) für Geräte der Klasse A

Dieses Gerät ist berechtigt, in Übereinstimmung mit dem Deutschen EMVG das EG-Konformitätszeichen - CE - zu führen.

Verantwortlich für die Einhaltung der EMV-Vorschriften ist der Hersteller:

International Business Machines Corp.
New Orchard Road
Armonk, New York 10504
Tel: 914-499-1900

Der verantwortliche Ansprechpartner des Herstellers in der EU ist:

IBM Deutschland GmbH
Technical Relations Europe, Abteilung M456
IBM-Allee 1, 71139 Ehningen, Germany
Tel: +49 800 225 5426
e-mail: Halloibm@de.ibm.com

Generelle Informationen:

Das Gerät erfüllt die Schutzanforderungen nach EN 55024 und EN 55032 Klasse A.

Japan Electronics and Information Technology Industries Association (JEITA) Notice

(一社) 電子情報技術産業協会 高調波電流抑制対策実施
要領に基づく定格入力電力値： Knowledge Centerの各製品の
仕様ページ参照

This statement applies to products less than or equal to 20 A per phase.

高調波電流規格 JIS C 61000-3-2 適合品

This statement applies to products greater than 20 A, single phase.

高調波電流規格 JIS C 61000-3-2 準用品

本装置は、「高圧又は特別高圧で受電する需要家の高調波抑制対策ガイドライン」対象機器（高調波発生機器）です。

- 回路分類：6（単相、PFC回路付）
- 換算係数：0

This statement applies to products greater than 20 A per phase, three-phase.

高調波電流規格 JIS C 61000-3-2 準用品

本装置は、「高圧又は特別高圧で受電する需要家の高調波抑制対策ガイドライン」対象機器（高調波発生機器）です。

- 回路分類：5（3相、PFC回路付）
- 換算係数：0

Japan Voluntary Control Council for Interference (VCCI) Notice

この装置は、クラスA情報技術装置です。この装置を家庭環境で使用すると電磁妨害を引き起こすことがあります。この場合には使用者が適切な対策を講ずるよう要求されることがあります。

VCCI-A

Korea Notice

이 기기는 업무용 환경에서 사용할 목적으로 적합성평가를 받은 기기로서 가정용 환경에서 사용하는 경우 전파간섭의 우려가 있습니다.

People's Republic of China Notice

声 明

此为 A 级产品,在生活环境中,
该产品可能会造成无线电干扰。
在这种情况下,可能需要用户对其
干扰采取切实可行的措施。

Russia Notice

ВНИМАНИЕ! Настоящее изделие относится к классу А.
В жилых помещениях оно может создавать
радиопомехи, для снижения которых необходимы
дополнительные меры

12c00790

Taiwan Notice

警告使用者：

此為甲類資訊技術設備，
於居住環境中使用時，
可能會造成射頻擾動，在此種情況下，
使用者會被要求採取某些適當的對策。

IBM Taiwan Contact Information:

台灣IBM產品服務聯絡方式：
台灣國際商業機器股份有限公司
台北市敦仁路7號3樓
電話：0800-016-888

12c00790

United States Federal Communications Commission (FCC) Notice

This equipment has been tested and found to comply with the limits for a Class A digital device, pursuant to Part 15 of the FCC Rules. These limits are designed to provide reasonable protection against harmful interference when the equipment is operated in a commercial environment. This equipment generates, uses, and can radiate radio frequency energy and, if not installed and used in accordance with the instruction manual, may cause harmful interference to radio communications. Operation of this equipment in a residential area is likely to cause harmful interference, in which case the user will be required to correct the interference at his own expense.

Properly shielded and grounded cables and connectors must be used in order to meet FCC emission limits. IBM is not responsible for any radio or television interference caused by using other than recommended cables and connectors, or by unauthorized changes or modifications to this equipment. Unauthorized changes or modifications could void the user's authority to operate the equipment.

This device complies with Part 15 of the FCC Rules. Operation is subject to the following two conditions:

(1) this device might not cause harmful interference, and (2) this device must accept any interference received, including interference that might cause undesired operation.

Responsible Party:

International Business Machines Corporation
New Orchard Road
Armonk, NY 10504

Contact for FCC compliance information only: fccinfo@us.ibm.com

This edition applies to version 8, release 4, modification 0, and to all subsequent modifications until otherwise indicated in new editions.

© **Copyright International Business Machines Corporation 2019, 2020.**

US Government Users Restricted Rights – Use, duplication or disclosure restricted by GSA ADP Schedule Contract with IBM Corp.

(1P) P/N: 03GU856

