



One Switch. A World of Options™

# Mellanox Spectrum™

## 1U Switch Systems

### Hardware User Manual

---

Models: SN2700, SN2410 and SN2100  
Rev 1.7



NOTE:

THIS HARDWARE, SOFTWARE OR TEST SUITE PRODUCT ("PRODUCT(S)") AND ITS RELATED DOCUMENTATION ARE PROVIDED BY MELLANOX TECHNOLOGIES "ASIS" WITH ALL FAULTS OF ANY KIND AND SOLELY FOR THE PURPOSE OF AIDING THE CUSTOMER IN TESTING APPLICATIONS THAT USE THE PRODUCTS IN DESIGNATED SOLUTIONS. THE CUSTOMER'S MANUFACTURING TEST ENVIRONMENT HAS NOT MET THE STANDARDS SET BY MELLANOX TECHNOLOGIES TO FULLY QUALIFY THE PRODUCT(S) AND/OR THE SYSTEM USING IT. THEREFORE, MELLANOX TECHNOLOGIES CANNOT AND DOES NOT GUARANTEE OR WARRANT THAT THE PRODUCTS WILL OPERATE WITH THE HIGHEST QUALITY. ANY EXPRESS OR IMPLIED WARRANTIES, INCLUDING, BUT NOT LIMITED TO, THE IMPLIED WARRANTIES OF MERCHANTABILITY, FITNESS FOR A PARTICULAR PURPOSE AND NONINFRINGEMENT ARE DISCLAIMED. IN NO EVENT SHALL MELLANOX BE LIABLE TO CUSTOMER OR ANY THIRD PARTIES FOR ANY DIRECT, INDIRECT, SPECIAL, EXEMPLARY, OR CONSEQUENTIAL DAMAGES OF ANY KIND (INCLUDING, BUT NOT LIMITED TO, PAYMENT FOR PROCUREMENT OF SUBSTITUTE GOODS OR SERVICES; LOSS OF USE, DATA, OR PROFITS; OR BUSINESS INTERRUPTION) HOWEVER CAUSED AND ON ANY THEORY OF LIABILITY, WHETHER IN CONTRACT, STRICT LIABILITY, OR TORT (INCLUDING NEGLIGENCE OR OTHERWISE) ARISING IN ANY WAY FROM THE USE OF THE PRODUCT(S) AND RELATED DOCUMENTATION EVEN IF ADVISED OF THE POSSIBILITY OF SUCH DAMAGE.



Mellanox Technologies  
350 Oakmead Parkway Suite 100  
Sunnyvale, CA 94085  
U.S.A.  
[www.mellanox.com](http://www.mellanox.com)  
Tel: (408) 970-3400  
Fax: (408) 970-3403

© Copyright 2017. Mellanox Technologies Ltd. All Rights Reserved.

Mellanox®, Mellanox logo, Accelio®, BridgeX®, CloudX logo, CompustorX®, Connect-IB®, ConnectX®, CoolBox®, CORE-Direct®, EZchip®, EZchip logo, EZappliance®, EZdesign®, EZdriver®, EZsystem®, GPUDirect®, InfiniHost®, InfiniBridge®, InfiniScale®, Kotura®, Kotura logo, Mellanox CloudRack®, Mellanox CloudXMellanox®, Mellanox Federal Systems®, Mellanox HostDirect®, Mellanox Multi-Host®, Mellanox Open Ethernet®, Mellanox OpenCloud®, Mellanox OpenCloud Logo®, Mellanox PeerDirect®, Mellanox ScalableHPC®, Mellanox StorageX®, Mellanox TuneX®, Mellanox Connect Accelerate Outperform logo, Mellanox Virtual Modular Switch®, MetroDX®, MetroX®, MLNX-OS®, NP-1c®, NP-2®, NP-3®, Open Ethernet logo, PhyX®, PlatformX®, PSIPHY®, SiPhy®, StoreX®, SwitchX®, Tiler®, Tiler logo, TestX®, TuneX®, The Generation of Open Ethernet logo, UFM®, Unbreakable Link®, Virtual Protocol Interconnect®, Voltaire® and Voltaire logo are registered trademarks of Mellanox Technologies, Ltd.

All other trademarks are property of their respective owners.

For the most updated list of Mellanox trademarks, visit <http://www.mellanox.com/page/trademarks>

# Table of Contents

## Chapter 1 Introduction to Mellanox SN2000 Spectrum™ Ethernet Switch Systems 11

- 1.1 Overview . . . . . 11
- 1.2 Speed and Switching . . . . . 12
- 1.3 Management Interfaces, PSUs and Fans . . . . . 13
- 1.4 Features . . . . . 13
- 1.5 Certifications . . . . . 13
- 1.6 Ordering Information . . . . . 14

## Chapter 2 Installation . . . . . 17

- 2.1 Safety Warnings . . . . . 17
- 2.2 System Installation and Initialization . . . . . 17
- 2.3 Air Flow . . . . . 18
- 2.4 Package Contents . . . . . 19
- 2.5 19" Systems Mounting Options . . . . . 20
  - 2.5.1 Static Rail Kit for SN2700 . . . . . 20
  - 2.5.2 Telescopic Rail Kit for SN2700 . . . . . 25
  - 2.5.3 Static Rail Kit for SN2410 . . . . . 31
  - 2.5.4 Side by Side Mounting for SN2100 Rail Kit . . . . . 35
- 2.6 Cable Installation . . . . . 43
  - 2.6.1 Breakout Cables and Adapters . . . . . 44
- 2.7 Initial Power On . . . . . 46
- 2.8 System Bring-Up . . . . . 48
  - 2.8.1 Configuring Network Attributes Using MLNX-OS . . . . . 48
  - 2.8.2 Configuring Network Attributes Using Cumulus Linux . . . . . 52
- 2.9 FRU Replacements . . . . . 53
  - 2.9.1 Power Supply . . . . . 53
  - 2.9.2 Fans . . . . . 54

## Chapter 3 Interfaces . . . . . 56

- 3.1 Supported Interfaces . . . . . 56
  - 3.1.1 Data Interfaces . . . . . 56
  - 3.1.2 Speed . . . . . 57
  - 3.1.3 RS232 (Console) . . . . . 57
  - 3.1.4 Management . . . . . 57
  - 3.1.5 USB . . . . . 57
  - 3.1.6 Reset Button . . . . . 58
  - 3.1.7 Status and Port LEDs . . . . . 58
- 3.2 LEDs . . . . . 58

3.2.1	LED Notifications . . . . .	58
3.3	Inventory Information . . . . .	65
<b>Chapter 4</b>	<b>Software Management . . . . .</b>	<b>68</b>
4.1	Upgrading Software . . . . .	68
4.1.1	MLNX-OS Software Upgrade . . . . .	68
4.1.2	Switch Firmware Update . . . . .	68
4.1.3	Cumulus Linux Software Upgrade . . . . .	68
<b>Chapter 5</b>	<b>Troubleshooting . . . . .</b>	<b>69</b>
5.1	Troubleshooting Instructions . . . . .	69
<b>Chapter 6</b>	<b>Specifications . . . . .</b>	<b>71</b>
6.1	SN2700 Series . . . . .	71
6.2	SN2410 Series . . . . .	72
6.3	SN2100 Series . . . . .	73

## List of Tables

Table 1:	Revision History Table . . . . .	8
Table 2:	References . . . . .	9
Table 3:	Speed and Switching Capabilities . . . . .	12
Table 4:	Management Interfaces, PSUs and Fans . . . . .	13
Table 5:	Ordering Part Numbers (OPNs) . . . . .	14
Table 6:	Air Flow Color Legend . . . . .	18
Table 7:	Installation Kit . . . . .	20
Table 8:	Installation Kit . . . . .	25
Table 9:	Installation Kit . . . . .	31
Table 10:	Installation Kit . . . . .	35
Table 11:	Serial Terminal Program Configuration . . . . .	49
Table 12:	Configuration Wizard Session . . . . .	49
Table 13:	Configuration Wizard Session - Static IP Configuration . . . . .	50
Table 14:	High Power/LR4 Transceivers Support . . . . .	56
Table 15:	LEDs Symbols . . . . .	58
Table 16:	System Status LED Assignments . . . . .	60
Table 17:	Fan Status Front LED Assignments . . . . .	61
Table 18:	Fan Status Rear LED Assignments (One LED per Fan) . . . . .	61
Table 19:	Power Supply Unit Status Front LED Assignments for SN2700 and SN2410 . . . . .	63
Table 20:	Power Supply Unit Status Front LED Assignments for SN2100 . . . . .	63
Table 21:	Power Supply Unit Status Rear LED Assignments . . . . .	63
Table 22:	Bad Port LED Assignments . . . . .	64
Table 23:	Port LEDs in Ethernet System Mode . . . . .	65
Table 24:	Troubleshooting . . . . .	69
Table 25:	SN2700 Specifications . . . . .	71
Table 26:	SN2410 Specifications . . . . .	72
Table 27:	SN2100 Specifications . . . . .	73
Table 28:	OPNs for Replacement Parts . . . . .	74
Table 29:	QSFP Interface Pins 1-23 . . . . .	76
Table 30:	QSFP Interface Pins 24-38 . . . . .	77

## List of Figures

Figure 1:	SN2700 Front Side View .....	12
Figure 2:	SN2410 Front Side View .....	12
Figure 3:	SN2100 Front Side View .....	12
Figure 4:	SN2700 and SN2410 Rear Side View .....	12
Figure 5:	SN2100 Rear Side View .....	12
Figure 6:	Air Flow Direction Marking - Power Side Inlet to Connector Side Outlet .....	19
Figure 7:	Air Flow Direction Marking - Connector Side Inlet to Power Side Outlet .....	19
Figure 8:	Rack Rail Kit Parts .....	21
Figure 9:	Installation Options .....	22
Figure 10:	Attaching the Rails to the Chassis .....	22
Figure 11:	Attaching the Brackets to the Chassis .....	23
Figure 12:	Installing the Cage Nuts .....	23
Figure 13:	Attaching the Brackets to the Rack .....	24
Figure 14:	Sliding the Blades in the Rails .....	24
Figure 15:	Rack Rail Kit Parts .....	26
Figure 16:	Rails Separation .....	26
Figure 17:	Installing the Cage Nuts .....	27
Figure 18:	Mounting the Outer Rails into the Rack .....	27
Figure 19:	Attaching the Inner Rails to the Chassis .....	28
Figure 20:	Securing the Chassis in the Inner Rails .....	28
Figure 21:	Sliding the Switch into the Rack .....	29
Figure 22:	Pulling the Unit Outwards .....	30
Figure 23:	Locking Mechanism .....	30
Figure 24:	Rack Rail Kit Parts .....	32
Figure 25:	Installation Options .....	33
Figure 26:	Attaching the Rails to the Chassis .....	33
Figure 27:	Installing the Cage Nuts .....	34
Figure 28:	Attaching the Rails to the Rack .....	34
Figure 29:	Sliding the Blades in the Rails .....	35
Figure 30:	Rack Rail Kit Parts .....	37
Figure 31:	Coupling the Cables with Cable-ties .....	38
Figure 32:	Coupled Cables - Rear View .....	38
Figure 33:	Cables within the Rail .....	39
Figure 34:	Attach the Blades to the System .....	40
Figure 35:	Attached Rail with Threaded Cables - Top View .....	40

Figure 36: Sliding the Frame Sliders into the Rails .....	41
Figure 37: Installing the Cage Nuts .....	41
Figure 38: Attaching the Frame to the Rack .....	42
Figure 39: Sliding the System’s Blades in the Rails .....	42
Figure 40: SN2700 and SN2100 Cable Orientation .....	43
Figure 41: SN2410 Cable Orientation .....	44
Figure 42: Breakout or Fanout Cables .....	45
Figure 43: SN2700 Splitting Options .....	45
Figure 44: SN2410 Splitting Options .....	46
Figure 45: SN2100 Splitting Options .....	46
Figure 46: System Status LEDs 5 Minutes After Power On in SN2700 .....	47
Figure 47: System Status LEDs 5 Minutes After Power On in SN 2410 .....	47
Figure 48: System Status LEDs 5 Minutes After Power On in SN 2100 .....	47
Figure 49: Two Power Inlets - Electric Caution Notifications .....	48
Figure 50: PS Unit Pulled Out .....	54
Figure 51: Fan Module Latches .....	55
Figure 52: Using 4.5W Modules on Ports 49, 50, 55, 56 in SN2410 .....	56
Figure 53: System Status LEDs - Front and Rear Sides in SN2700 .....	59
Figure 54: System Status LEDs - Front and Rear Sides in SN2410 .....	59
Figure 55: System Status LED in SN2100 .....	60
Figure 56: Fan Status LED in SN2700 - Front and Rear Sides .....	60
Figure 57: Fan Status LED in SN2410 - Front and Rear Sides .....	61
Figure 58: Fan Status LED in SN2100 .....	61
Figure 59: Power Status LED .....	62
Figure 60: SN2700 and SN2410 Rear Side Panel .....	62
Figure 61: SN2700 Port LEDs .....	64
Figure 62: SN2410 SFP28 Port LEDs .....	64
Figure 63: SN2410 QSFP28 Port LEDs .....	64
Figure 64: SN2100 Port LEDs .....	65
Figure 65: SN2700 Pull-out Tab .....	66
Figure 66: SN2410 Inventory Information Illustration .....	67
Figure 67: SN2100 Pull-out Tab .....	67
Figure 68: Rear View of Module With Pin Placement .....	78
Figure 69: RJ45 to DB9 Harness Pinout .....	80

## Revision History

**Table 1 - Revision History Table**

Date	Revision	Description
February 2017	1.7	Updated: <ul style="list-style-type: none"> <li>• <a href="#">“Data Interfaces”</a></li> <li>• <a href="#">“Specifications”</a></li> <li>• <a href="#">“RJ45 to DB9 Harness Pinout”</a></li> </ul>
November 2016	1.6	Updated: <ul style="list-style-type: none"> <li>• <a href="#">“Specifications”</a></li> </ul>
September 2016	1.5	Updated: <ul style="list-style-type: none"> <li>• <a href="#">“Reset Button”</a></li> <li>• <a href="#">“Status and Port LEDs”</a></li> </ul> Added: <ul style="list-style-type: none"> <li>• “Noise Level” to <a href="#">“Specifications”</a></li> </ul>
June 2016	1.4	Updated: <ul style="list-style-type: none"> <li>• <a href="#">“Introduction to Mellanox SN2000 Spectrum™ Ethernet Switch Systems”</a></li> <li>• <a href="#">“Ordering Information”</a></li> <li>• <a href="#">“Side by Side Mounting for SN2100 Rail Kit”</a></li> </ul>
May 2016	1.3	Added SX1012 to the following sections: <ul style="list-style-type: none"> <li>• <a href="#">“Introduction to Mellanox SN2000 Spectrum™ Ethernet Switch Systems”</a></li> <li>• <a href="#">“Installation”</a></li> <li>• <a href="#">“Interfaces”</a></li> <li>• <a href="#">“Specifications”</a></li> <li>• <a href="#">“Accessory and Replacement Parts”</a></li> </ul>
March 2016	1.2	Updated: <ul style="list-style-type: none"> <li>• <a href="#">“Introduction to Mellanox SN2000 Spectrum™ Ethernet Switch Systems”</a></li> <li>• <a href="#">“Software Management”</a></li> <li>• <a href="#">“Troubleshooting Instructions”</a></li> <li>• <a href="#">“Specifications”</a></li> <li>• <a href="#">“Accessory and Replacement Parts”</a></li> </ul> Added: <ul style="list-style-type: none"> <li>• Taiwan BSMI Class A Statement in Safety Warnings</li> </ul>
December 2015	1.1	Added SN2410
August 2015	1.0	Initial revision



## About this Manual

This manual describes the installation and basic use of the Mellanox Ethernet systems.

## Intended Audience

This manual is intended for IT managers and system administrators.

## References

*Table 2 - References*

Document	Description
MLNX-OS® User Manual	This document contains information regarding the configuration and management of the MLNX-OS software. See <a href="http://www.mellanox.com/page/mlnx_os">http://www.mellanox.com/page/mlnx_os</a> .
Cumulus Linux User Guide	This document contains information regarding the configuration and management of the Cumulus® Linux® software. See <a href="https://docs.cumulusnetworks.com/display/DOCS">https://docs.cumulusnetworks.com/display/DOCS</a> .
Open Network Install Environment (ONIE) Quick Start Guide	See <a href="https://github.com/opencomputeproject/onie/wiki/Quick-Start-Guide/">https://github.com/opencomputeproject/onie/wiki/Quick-Start-Guide/</a> .

## Conventions

The following icons are used throughout this document to indicate information that is important to the user.



This icon makes recommendations to the user.



This icon indicates information that is helpful to the user.



This icon indicates a situation that can potentially cause damage to hardware or software.



This icon indicates a situation that can potentially cause personal injury.



This icon indicates a situation that can potentially cause personal injury.

# 1 Introduction to Mellanox SN2000 Spectrum™ Ethernet Switch Systems

## 1.1 Overview

Mellanox Spectrum™ based 1U switch systems are an ideal spine and Top of Rack (ToR) solution, allowing maximum flexibility, with port speeds spanning from 10Gb/s to 100Gb/s per port, and port density that enables full rack connectivity to any server at any speed. The uplink ports allow a variety of blocking ratios that suit any application requirement. Powered by the Spectrum ASIC, the systems carry whopping switching and processing capacities in a compact 1U form factor.

Keeping with the Mellanox tradition of setting performance record switch systems, the Spectrum based systems introduce the world's lowest latency for 100GbE switching and routing elements, and do so while having the lowest power consumption in the market. They enable the use of 10, 25, 40, 50 and 100GbE in a large scale without changing power infrastructure facilities.

The Spectrum™ based 1U switch systems are a part of Mellanox's complete end-to-end solution, which provides 10GbE through 100GbE interconnectivity within the data center. Other devices in this solution include ConnectX-4 based network interface cards, and LinkX copper or fiber cabling. This end-to-end solution is topped with NEO, a management application that relieves some of the major obstacles standing in the way when deploying a network. NEO enables a fully certified and interoperable design, speeds up time to service and RoI. The systems introduce hardware capabilities for multiple tunneling protocols that enable increased reachability and scalability for today's data centers. Implementing MPLS, NVGRE and VXLAN tunneling encapsulations in the network layer of the data center allows more flexibility for terminating a tunnel by the network, in addition to termination on the server endpoint.

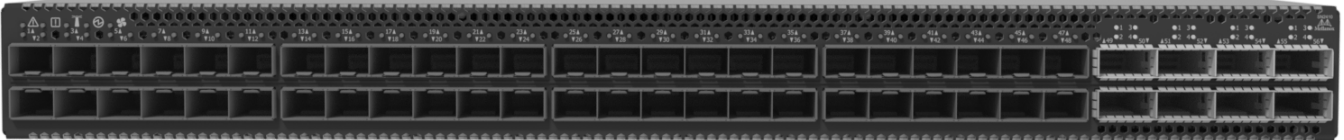
While Spectrum provides the thrust and acceleration that powers the switch systems, they get yet another angle of capabilities, running with a powerful x86-based processor, which allows them to not only be the highest performing switch fabric elements, but also grants them the ability to incorporate a Linux running server into the same device. This opens up multiple application aspects of utilizing the high CPU processing power and the best switching fabric, to create a powerful machine with unique appliance capabilities that can improve numerous network implementation paradigms.

The Spectrum™ based 1U switch systems support the Open Network Install Environment (ONIE) for zero touch installations of network operating systems. While all Ethernet systems can be purchased preloaded with MLNX-OS, the SN2700, SN2410 and SN2100 switches (in both the 100GbE and the 40GbE versions) are offered, in addition, with Cumulus Linux support, as an alternative operating system. For a full list of all available ordering options, see [“Ordering Information”](#).

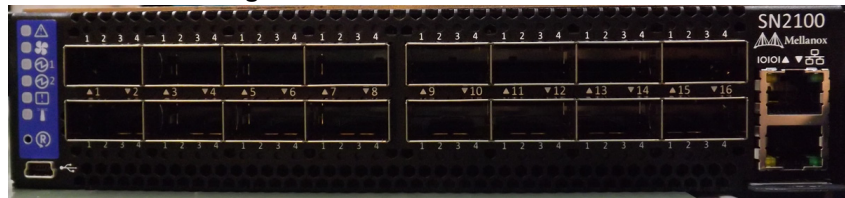
**Figure 1: SN2700 Front Side View**



**Figure 2: SN2410 Front Side View**



**Figure 3: SN2100 Front Side View**



**Figure 4: SN2700 and SN2410 Rear Side View**



**Figure 5: SN2100 Rear Side View**



## 1.2 Speed and Switching

[Table 3](#) describes maximum throughput and interface speed per system model.

**Table 3 - Speed and Switching Capabilities**

System Model	10/25GbE SFP28 Interfaces*	40/50/56/100GbE QSFP28 Interfaces*	Max Throughput
SN2700	64 (using QSFP to SFP breakout cables)	32	3.2Tb/s
SN2410	Total 64, 48zSFP+ 16 (using QSFP to SFP breakout cables)	8	2Tb/s

**Table 3 - Speed and Switching Capabilities**

System Model	10/25GbE SFP28 Interfaces*	40/50/56/100GbE QSFP28 Interfaces*	Max Throughput
SN2100	64 (using QSFP to SFP breakout cables)	16 (or 32 50GbE interfaces when using QSFP to 2xQSFP breakout cables).	1.6Tb/s

\*The system can support different interfaces and speed rates using QSFP to SFP adapters or hybrid cables. For further information, see [“Breakout Cables and Adapters”](#).

### 1.3 Management Interfaces, PSUs and Fans

[Table 4](#) lists the various management interfaces, PSUs and fans per system model.

**Table 4 - Management Interfaces, PSUs and Fans**

System Model	USB	MGT	Console	PSU	Fan
SN2700	Rear	Rear (2 ports)	Rear	2 units	4 units
SN2410	Rear	Rear (2 ports)	Rear	2 units	4 units
SN2100	Front (mini USB)	Front (1 port)	Front	2 units (non-replaceable)	4 units (non-replaceable)

### 1.4 Features

For a full feature list, please refer to the system’s product brief. Go to <http://www.mellanox.com>. In the main menu, click on Products--> Ethernet Switch Systems, and select the desired product page.

### 1.5 Certifications

The list of certifications (such as EMC, Safety and others) per system for different regions of the world is located on the Mellanox website at:

[http://www.mellanox.com/page/environmental\\_compliance](http://www.mellanox.com/page/environmental_compliance)

## 1.6 Ordering Information

The following table lists ordering information for the available systems. Please pay attention to the airflow direction when ordering your system. For more details, see [“Air Flow”](#).

**Table 5 - Ordering Part Numbers (OPNs)**

System Model	OPN	Description
SN2700	MSN2700-CS2F	Spectrum™ based 100GbE 1U Open Ethernet Switch with MLNX-OS, 32 QSFP28 ports, 2 Power Supplies (AC), Standard depth, x86 CPU, P2C airflow, Rail Kit, RoHS6
	MSN2700-BS2FO	Spectrum™ based 40GbE, 1U Open Ethernet Switch with ONIE, 32 QSFP28 ports, 2 Power Supplies (AC), x86 CPU, Standard depth, P2C airflow, Rail Kit, RoHS6
	MSN2700-CS2R	Spectrum™ based 100GbE 1U Open Ethernet Switch with MLNX-OS, 32 QSFP28 ports, 2 Power Supplies (AC), Standard depth, x86 CPU, C2P airflow, Rail Kit, RoHS6
	MSN2700-CS2FO	Spectrum™ based 100GbE 1U Open Switch with ONIE, 32 QSFP28 ports, 2 Power Supplies (AC), Standard depth, x86 CPU, P2C airflow, Rail Kit, RoHS6
	MSN2700-BS2F	Spectrum™ based 40GbE, 1U Open Ethernet Switch with MLNX-OS, 32 QSFP28 ports, 2 Power Supplies (AC), x86 CPU, Standard depth, P2C airflow, Rail Kit, RoHS6
	MSN2700-BS2FC	Spectrum™ based 40GbE, 1U Open Ethernet Switch with Cumulus Linux, 32 QSFP28 ports, 2 Power Supplies (AC), Standard depth, x86 CPU, P2C airflow, Rail Kit, RoHS6
	MSN2700-CS2FC	Spectrum™ based 100GbE 1U Open Ethernet Switch with Cumulus Linux, 32 QSFP28 ports, 2 Power Supplies (AC), Standard depth, x86 CPU, P2C airflow, Rail Kit, RoHS6
	MSN2700-CS2FE	Spectrum™ based 100GbE 1U Development System with SDK, 32 QSFP28 ports, 2 Power Supplies (AC), Standard depth, x86 CPU, P2C airflow, Rail Kit, RoHS6

**Table 5 - Ordering Part Numbers (OPNs)**

System Model	OPN	Description
SN2410	MSN2410-CB2F	Spectrum™ based 25GbE/100GbE 1U Open Ethernet switch with MLNX-OS, 48 SFP28 ports, 8 QSFP28 ports, 2 power supplies (AC), x86 dual core, Short depth, P2C airflow, Rail Kit, RoHS6
	MSN2410-CB2R	Spectrum™ based 25GbE/100GbE 1U Open Ethernet switch with MLNX-OS, 48 SFP28 ports, 8 QSFP28 ports, 2 power supplies (AC), x86 dual core, Short depth, C2P airflow, Rail Kit, RoHS6
	MSN2410-BB2F	Spectrum™ based 10GbE/100GbE 1U Open Ethernet switch with MLNX-OS, 48 SFP28 ports, 8 QSFP28 ports, 2 power supplies (AC), x86 dual core, Short depth, P2C airflow, Rail Kit, RoHS6
	MSN2410-BB2FC	Spectrum™ based 10GbE/100GbE 1U Open Ethernet switch with Cumulus Linux, 48 SFP28 ports, 8 QSFP28 ports, 2 power supplies (AC), x86 dual core, Short depth, P2C airflow, Rail Kit, RoHS6
	MSN2410-CB2FO	Spectrum™ based 25GbE/100GbE 1U Open Ethernet switch with ONIE, 48 SFP28 ports, 8 QSFP28 ports, 2 power supplies (AC), x86 dual core, Short depth, P2C airflow, Rail Kit, RoHS6
	MSN2410-BB2FO	Spectrum™ based 10GbE/100GbE 1U Open Ethernet switch with ONIE, 48 SFP28 ports, 8 QSFP28 ports, 2 power supplies (AC), x86 dual core, Short depth, P2C airflow, Rail Kit, RoHS6
	MSN2410-CB2FC	Spectrum™ based 25GbE/100GbE 1U Open Ethernet switch with Cumulus Linux, 48 SFP28 ports, 8 QSFP28 ports, 2 power supplies (AC), x86 dual core, Short depth, P2C airflow, Rail Kit, RoHS6
	MSN2410-CB2FE	Spectrum™ based 25GbE/100GbE 1U Development System with SDK, 48 SFP28 ports, 8 QSFP28 ports, 2 power supplies (AC), x86 dual core, Short depth, P2C airflow, Rail Kit, RoHS6

**Table 5 - Ordering Part Numbers (OPNs)**

System Model	OPN	Description
SN2100	MSN2100-CB2FO	Spectrum™ based 100GbE 1U Open Switch with ONIE, 16 QSFP28 ports, 2 Power Supplies (AC), Short depth, Rangeley CPU, P2C airflow, Rail Kit must be purchased separately, RoHS6
	MSN2100-BB2FO	Spectrum™ based 40GbE 1U Open Ethernet switch with ONIE, 16 QSFP28 ports, 2 power supplies (AC), x86 dual core, Short depth, P2C airflow, Rail Kit, RoHS6
	MSN2100-BB2F	Spectrum™ based 40GbE, 1U Open Ethernet Switch with MLNX-OS, 16 QSFP28 ports, 2 Power Supplies (AC), short depth, Rangeley CPU, P2C airflow, Rail Kit must be purchased separately, RoHS6
	MSN2100-CB2F	Spectrum™ based 100GbE, 1U Open Ethernet Switch with MLNX-OS, 16 QSFP28 ports, 2 Power Supplies (AC), short depth, Rangeley CPU, P2C airflow, Rail Kit must be purchased separately, RoHS6
	MSN2100-CB2FC	Spectrum™ based 100GbE, 1U Open Ethernet Switch with Cumulus, 16 QSFP28 ports, 2 Power Supplies (AC), short depth, Rangeley CPU, P2C airflow, Rail Kit must be purchased separately, RoHS6
	MSN2100-CB2FE	Spectrum™ based 100GbE 1U Development System with SDK, 16 QSFP28 ports, 2 Power Supplies (AC), Short depth, Rangeley CPU, P2C airflow, Rail Kit must be purchased separately, RoHS6
	MSN2100-CB2R	Spectrum™ based 100GbE, 1U Open Ethernet Switch with MLNX-OS, 16 QSFP28 ports, 2 Power Supplies (AC), short depth, Rangeley CPU, C2P airflow, Rail Kit must be purchased separately, RoHS6
	MSN2100-BB2FC	Spectrum™ based 40GbE, 1U Open Ethernet Switch with Cumulus, 16 QSFP28 ports, 2 Power Supplies (AC), short depth, Rangeley CPU, P2C airflow, Rail Kit must be purchased separately, RoHS6



## 2 Installation

### 2.1 Safety Warnings

Prior to the installation, please review the safety warnings as follows:

- For Nordic Countries Notices, see [Section E.1, “Nordic Countries Notices,” on page 82.](#)
- For Safety Warnings in English, see [Section E.2, “Installation Safety Warnings \(English\),” on page 82.](#)
- For Safety Warnings in Hebrew, see [Section E.3, “הוראות בטיחות בהתקנה \(Hebrew\),” on page 85.](#)
- For Safety Warnings in Chinese, see [Section 1 on page 89.](#)
- For Safety Warnings in French, see [Section E.5, “Avertissements de sécurité pour l'installation \(French\),” on page 94.](#)
- For Safety Warnings in German, [Section E.6, “Installation Sicherheitshinweise\(German\),” on page 97.](#)
- For Safety Warnings in Spanish, see [Section E.7, “Advertencias de seguridad de instalación \(Spanish\),” on page 100.](#)
- For Safety Warnings in Russian, see [Section E.8, “Предупреждения по технике безопасности при установке \(Russian\),” on page 104.](#)
- For Safety Warnings in Romanian, see [Section E.9, “Avertismente privind siguranța la instalare \(Romanian\),” on page 108.](#)
- For Safety Warnings in Croatian, see [Section E.10, “Sigurnosna upozorenja za instaliranje \(Croatian\),” on page 111.](#)
- For Safety Warnings in Italian, see [Section E.11, “Avvertenze di sicurezza per l'installazione \(Italian\),” on page 115.](#)
- For Safety Warnings in Turkish see [Section E.12, “Montaj Güvenlik Uyarıları \(Turkish\),” on page 119.](#)

### 2.2 System Installation and Initialization

Installation and initialization of the system require attention to the normal mechanical, power, and thermal precautions for rack-mounted equipment.



The rack mounting holes conform to the EIA-310 standard for 19-inch racks. Take precautions to guarantee proper ventilation in order to maintain good airflow at ambient temperature.

➤ *The installation procedure for the system involves the following phases:*

1. Follow the safety warnings in [Section 2.1.](#)

2. Pay attention to the air flow consideration within the system and rack - refer to [“Air Flow” on page 18](#).
3. Make sure that none of the package contents is missing or damaged - see [“Package Contents” on page 19](#).
4. Mount the system into a rack enclosure - see [“19” Systems Mounting Options” on page 20](#).
5. Power on the system - refer to [“Initial Power On” on page 46](#).
6. Perform system bring-up - see [“System Bring-Up” on page 48](#).
7. [Optional]: FRU replacements are described in [Section 2.9 on page 53](#).

## 2.3 Air Flow



The following information does not apply to SN2100. In the SN2100 systems, the fan units are non-replaceable.

Mellanox systems are offered with two air flow patterns:

- Power (rear) side inlet to connector side outlet - marked with blue power supplies/fans-FRUs’ handles, as shown in [Figure 6](#).
- Connector (front) side inlet to power side outlet - marked with red power supplies/fans FRUs’ handles, as shown in [Figure 7](#).

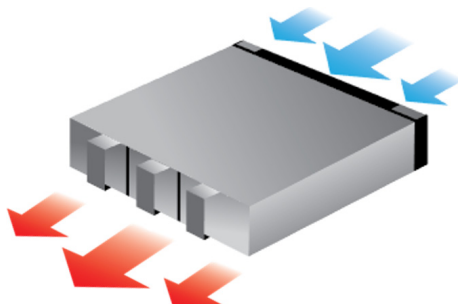


All servers and systems in the same rack should be planned with the same airflow direction.

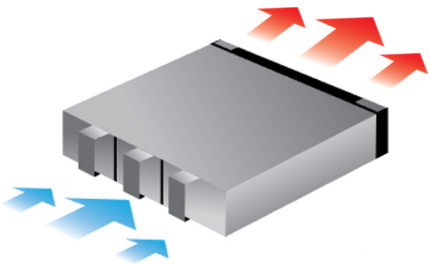
All FRU components need to have the same air flow direction. A mismatch in the air flow will affect the heat dissipation.

Table 6 provides an air flow color legend and respective OPN designation

**Table 6 - Air Flow Color Legend**

Direction	OPN Designation	Description
	Ending with “-R”	Connector side inlet to power side outlet. Red latches are placed on the power inlet side.

**Table 6 - Air Flow Color Legend**

Direction	OPN Designation	Description
	Ending with “-F”	Power side inlet to connector side outlet. Blue latches are placed on the power inlet side.

**Figure 6: Air Flow Direction Marking - Power Side Inlet to Connector Side Outlet**



**Figure 7: Air Flow Direction Marking - Connector Side Inlet to Power Side Outlet**



## 2.4 Package Contents

Before installing your new system, unpack it and check against the parts list below that all the parts have been sent. Check the parts for visible damage that may have occurred during shipping.

The SN2700 and SN2410 package content is as follows:

- 1 – System
- 1 – Rail kit
- 1 – Power cable for each power supply unit – Type C13-C14
- 1 – Cable retainer for each power supply unit
- 1 – DB9 to RJ-45 2m harness

The SN2100 package content is as follows:

- 1 – System
- 1 – Power cable for each power supply unit – Type C13-C14
- 1 – DB9 to RJ-45 2m harness



A designated rail kit for the SN2100 systems can be purchased separately.



If anything is damaged or missing, contact your sales representative at [support@mellanox.com](mailto:support@mellanox.com).

## 2.5 19" Systems Mounting Options

By default, the SN2700 system is sold with the static rail kit described in [Section 2.5.1](#). The SN2410 system is sold with the static rail kit described in [Section 2.5.3](#). For the telescopic rail kit installation instructions (can be used with SN2700 only), see [Section 2.5.2](#).

The SN2100 system is sold without a rail kit. A designated rail kit can be purchased separately. For installation instructions, see [Section 2.5.4](#).

### 2.5.1 Static Rail Kit for SN2700



At least two people are required to safely mount the system in the rack.

**Table 7 - Installation Kit**

Kit OPN	Rack Size and Rack Depth Range
MTEF-KIT-A	Short (17"-24") or Standard (24"-34")

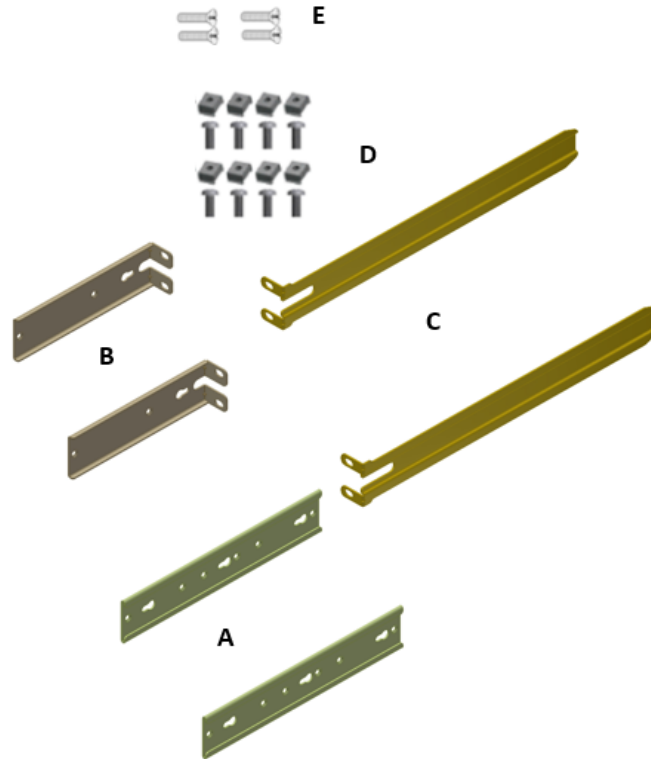
The following parts are included in the static rail kit (see [Figure 8](#)):

- 2x Rack mount rails (A)
- 2x Rack mount brackets (B)
- 2x Rack mount blades (C)
- 8x M6 Standard cage nuts<sup>1 2</sup> and 8x M6 Standard pan-head Phillips screws<sup>1</sup> (D)
- 4x Phillips100 DEG F.H TYPE-I ST.ST 6-32 X 1/4 screw with around patch (E)

<sup>1</sup> Other threads are available by special order: M5, 10-32, 12-24

<sup>2</sup> G-type cage-nut is available by special order.

**Figure 8: Rack Rail Kit Parts**



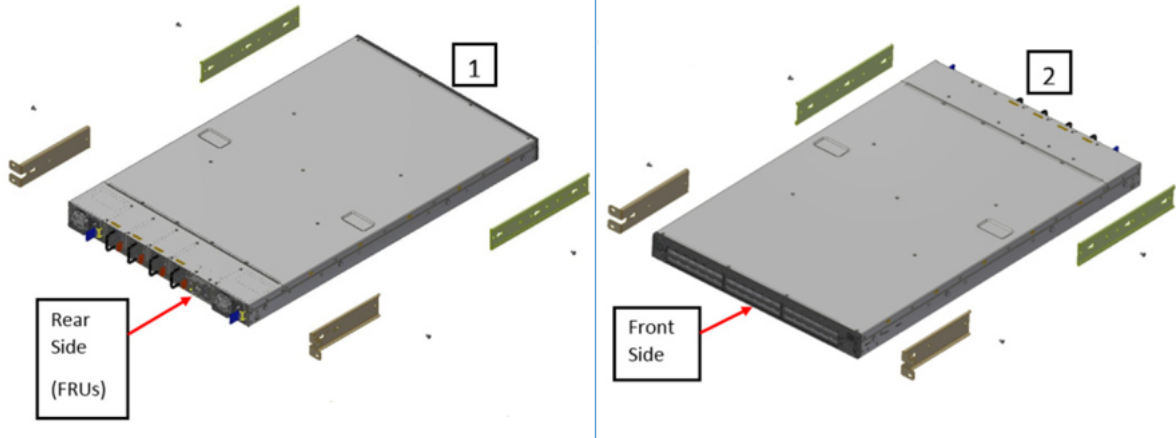
➤ ***To mount the system into the rack:***

Before mounting the system to the rack, select the way you wish to place the system. Pay attention to the airflow within the rack cooling, connector and cabling options.

While planning how to place the system, consider the two installation options shown in [Figure 9](#), and review the following points:

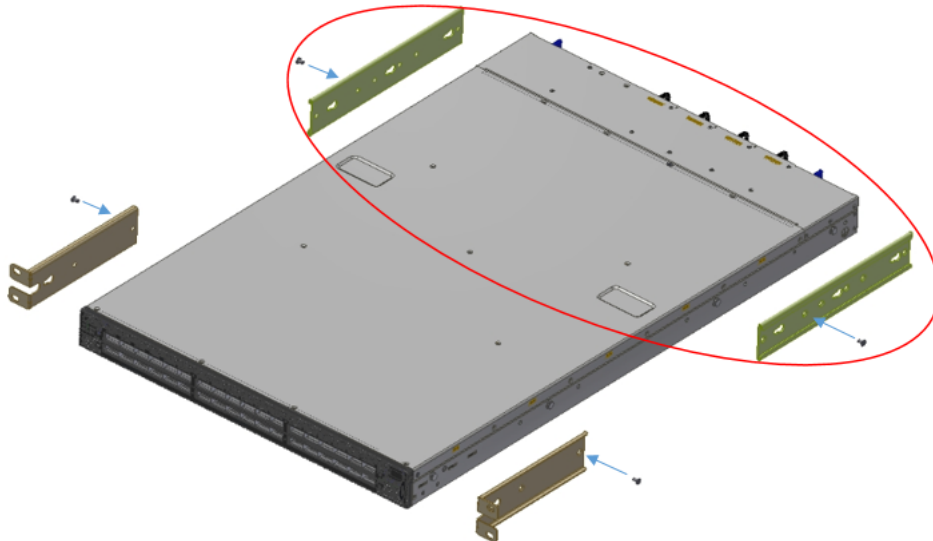
- Make sure the system air flow is compatible with your installation selection. It is important to keep the airflow within the rack in the same direction.
- Note that the part of the system to which you choose to attach the rails (the front panel direction, as demonstrated in Option 1 or the FRUs direction, as demonstrated in Option 2) will determine the system’s adjustable side. The system’s part to which the brackets are attached will be adjacent to the cabinet.
- The FRU side is extractable. Mounting the rack brackets inverted to the FRU side (Option 2) will allow you to slide the FRUs, in and out.

**Figure 9: Installation Options**



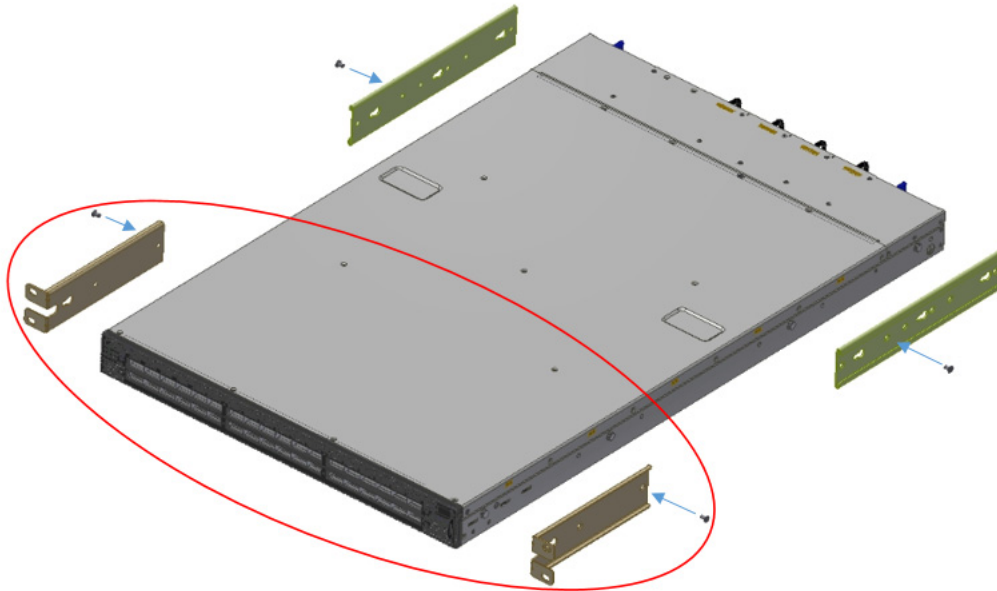
- Step 1.** Attach the left and right rack mount rails (A) to the switch, by gently pushing the switch chassis' pins through the slider key holes, until locking occurs.
- Step 2.** Secure the chassis in the rails by screwing 2 flat head Phillips screws (E) in the designated points with a torque of  $1.5 \pm 0.2$  Nm. See [Figure 10](#).

**Figure 10: Attaching the Rails to the Chassis**



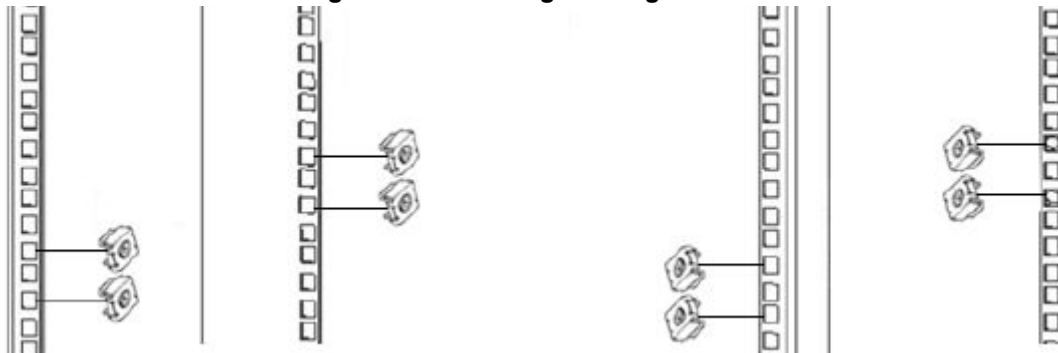
- Step 3.** Attach the left and right rack mount brackets (B) to the switch, by gently pushing the switch chassis' pins through the slider key holes, until locking occurs. Secure the system in the brackets by screwing the remaining 2 flat head Phillips screws (E) in the designated points with a torque of  $1.5 \pm 0.2$  Nm. See [Figure 11](#).

**Figure 11: Attaching the Brackets to the Chassis**



- Step 4.** Install 8 cage nuts in the desired 1U slots of the rack: 4 cage nuts in the non-extractable side (in the top and bottom holes only) and 4 cage nuts in the extractable side.

**Figure 12: Installing the Cage Nuts**



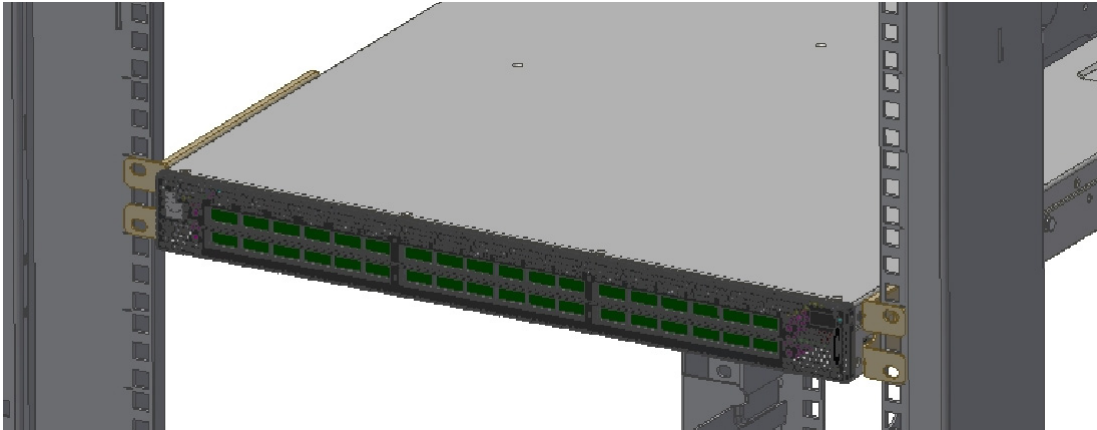
While each rack U (unit) consists of three holes, the cage nut should be installed vertically with its ears engaging the top and bottom holes only.

While your installation partner is supporting the system's weight, perform the following steps:

- Step 5.** Mount the system into the rack enclosure, and attach the brackets installed on the system to the rack's posts. Secure the brackets to the rack's posts by inserting four M6 screws in the designated cage nuts, as described in [Figure 13](#). Do not tighten the screws yet.

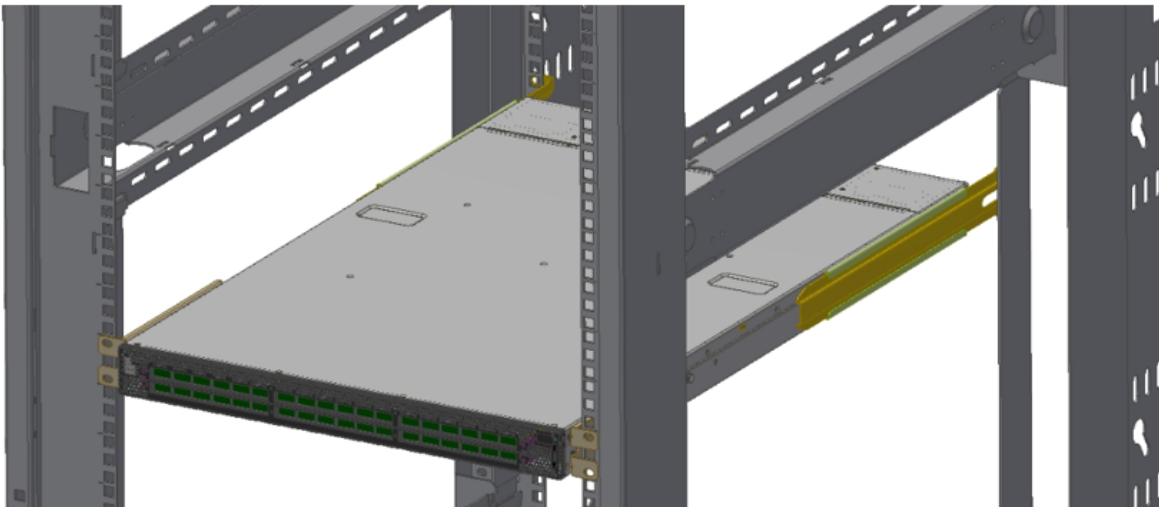


**Figure 13: Attaching the Brackets to the Rack**



- Step 6.** Slide the two blades into the left and right rails, and adjust them to fit your rack's depth. Use four M6 screws (D) to fix the blades into the rack. Do not tighten the screws yet.

**Figure 14: Sliding the Blades in the Rails**



- Step 7.** Secure the system in the rack by tightening the 8 screws inserted in Step 5 and Step 6 with a torque of  $4.5 \pm 0.5$  Nm.

### 2.5.1.1 Removing the System from the Rack

➤ *To remove a unit from the rack:*

- Step 1.** Turn off the system and disconnect it from peripherals and from the electrical outlet.

While your installation partner is supporting the system's weight:

- Step 2.** Loosen the screws attaching the brackets to the rack. Do not remove them yet.

- Step 3.** Loosen the screws attaching the blades to the rack, and pull the blades towards you, while your partner is holding the system.

- Step 4.** Extract the loosened screws from Step 2 and dismount the system from the rack.



**Step 5.** Remove the rails and brackets from the chassis by unscrewing 8 screws.

## 2.5.2 Telescopic Rail Kit for SN2700



The Telescopic rail kit is not included in the system's package, and can be purchased separately.

There are two installation kit options:

- Standard depth systems should be mounted using the standard rail kit.
- Short depth systems can be mounted using either of the rail kits.

**Table 8 - Installation Kit**

Kit OPN	Rack Size and Rack Depth Range
MTEF-KIT-B	Short (17"-24" \ 43.1 to 61 cm)
MTEF-KIT-S	Standard (24"-34" \ 61 to 86.3 cm)

The following parts are included in the rail kit package (see [Figure 15](#)):

- 1x Right inner rail (A)
- 1x Left inner rail (B)
- 2x Outer rails (C)
- 2x Outer rails (D)
- 10x M6 Standard cage nuts<sup>1 2</sup> and 10x M6 Standard pan-head Phillips screws<sup>1</sup> (E)
- 2x Phillips100 DEG F.H TYPE-I ST.ST 6-32 X 1/4 screw with around patch (F)

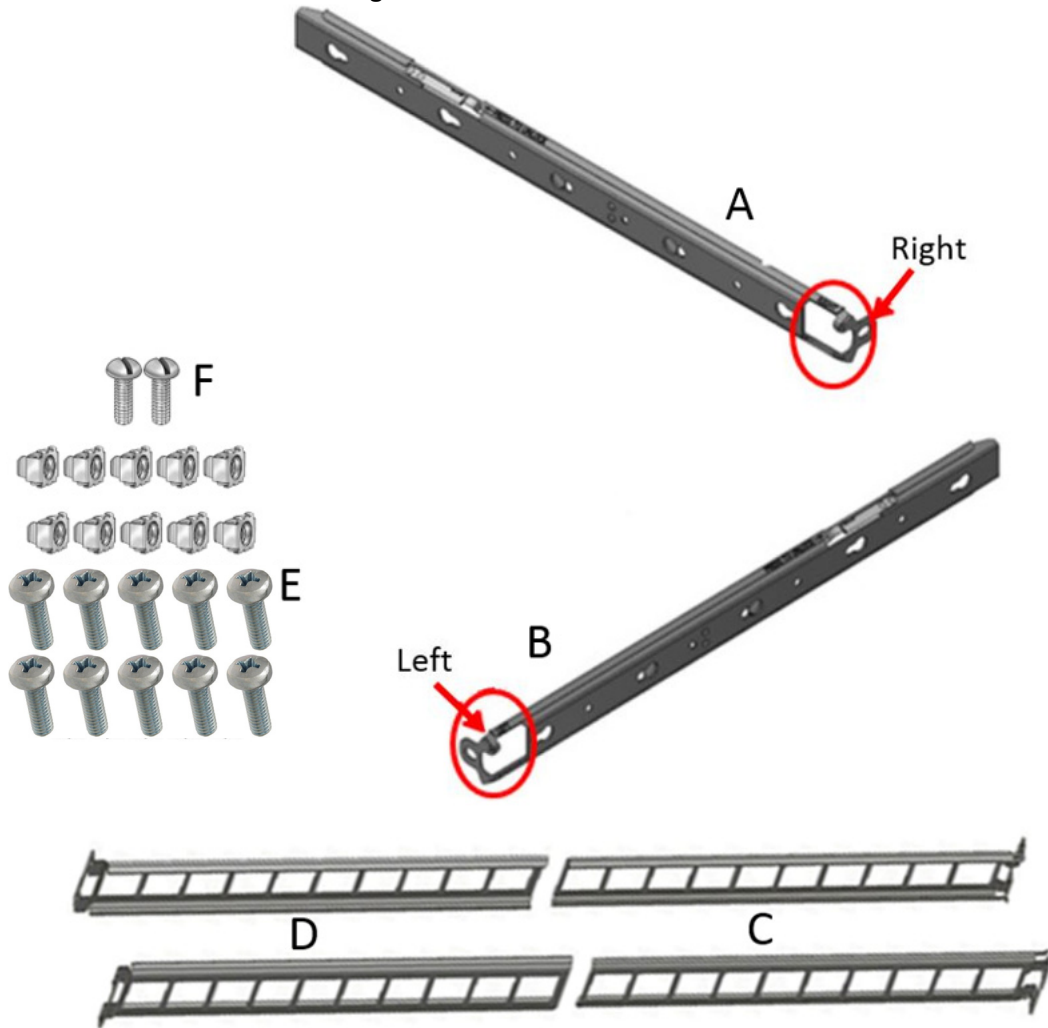
<sup>1</sup> Other threads are available by special order: M5, 10-32, 12-24

<sup>2</sup> G-type cage-nut is available by special order.

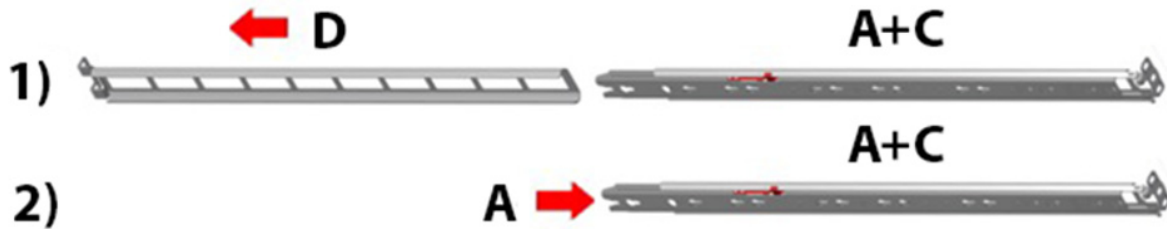


The rails must be separated prior to the installation procedure. See [Figure 16](#).

**Figure 15: Rack Rail Kit Parts**



**Figure 16: Rails Separation**



**To separate the rails:**

1. Extend the rail assembly by pulling the extension outwards (D).
2. Extract rail A from rail C by pushing it outside from the rear part of the assembly. To allow complete separation of rail A from rail C, press the quick-release latch.

Before mounting the system to the rack, select the way you wish to place the system. Pay attention to the airflow within the rack cooling, connector and cabling options.

While planning how to place the system, review the following points:

- Make sure the system air flow is compatible with your installation selection. It is important to keep the airflow within the rack in the same direction.
- In case there are cables that cannot bend within the rack, or in case more space is needed for cable bending radius, it is possible to recess the connector side or the FRU side by 3" or 4" (7.62 or 10.16cm) by optional placement of the system's rails.
- The FRU side is extractable. Mounting the sliding rail inverted to the system will allow you to slide the FRU side of the system, in and out.

**Step 1.** Install 10 cage nuts into the desired 1U slots of the rack: 4 cage nuts in the non-extractable side and 6 cage nuts in the extractable side.

**Figure 17: Installing the Cage Nuts**



**Step 2.** Mount both of the outer rails (C+D) into the rack (as illustrated in [Figure 18](#)), and use 8 standard pan-head screws (E) to fix them to the rack. Do not tighten the screws yet.

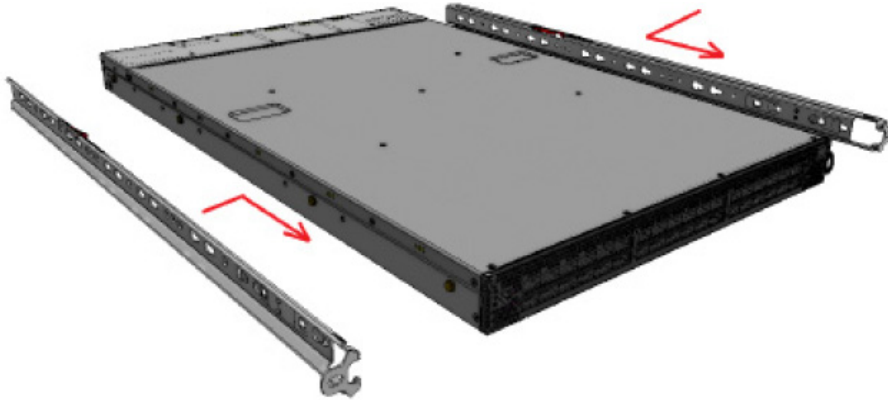
**Figure 18: Mounting the Outer Rails into the Rack**



**Step 3.** If cable accommodation is required, route the power cable and/or Eth cable through either of the outer rails.

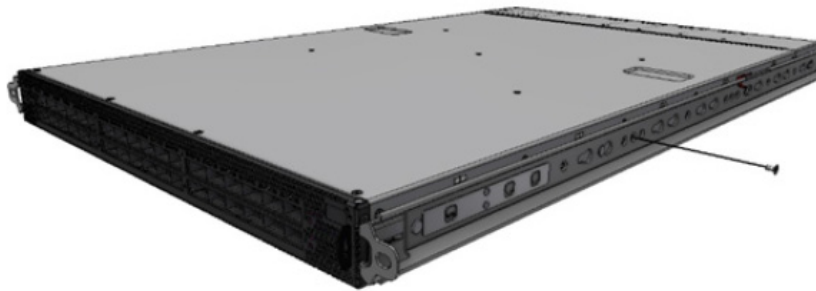
**Step 4.** Attach the switch to the left and right inner rails (A+B), by gently pushing the switch chassis' pins through the slider key holes, until locking occurs.

**Figure 19: Attaching the Inner Rails to the Chassis**



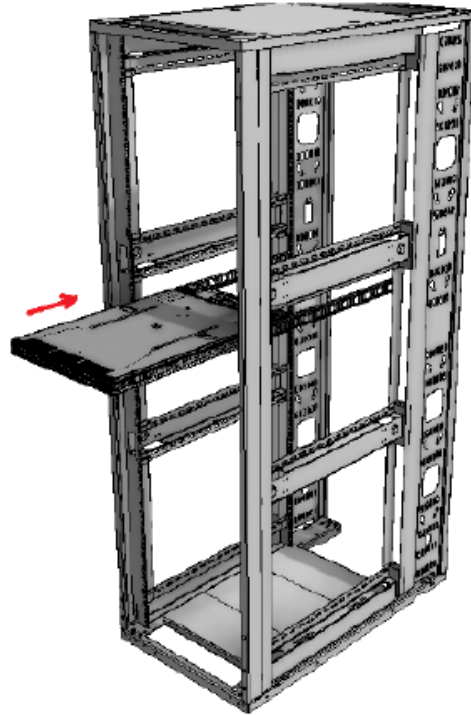
- Step 5.** Secure the chassis in the inner rails by screwing the 2 flat head Phillips screws (F) in the designated points with a torque of  $1.5 \pm 0.2$  Nm.

**Figure 20: Securing the Chassis in the Inner Rails**



- Step 6.** Slide the switch into the rack by carefully pushing the inner rails into the outer rails installed on the rack.

**Figure 21: Sliding the Switch into the Rack**



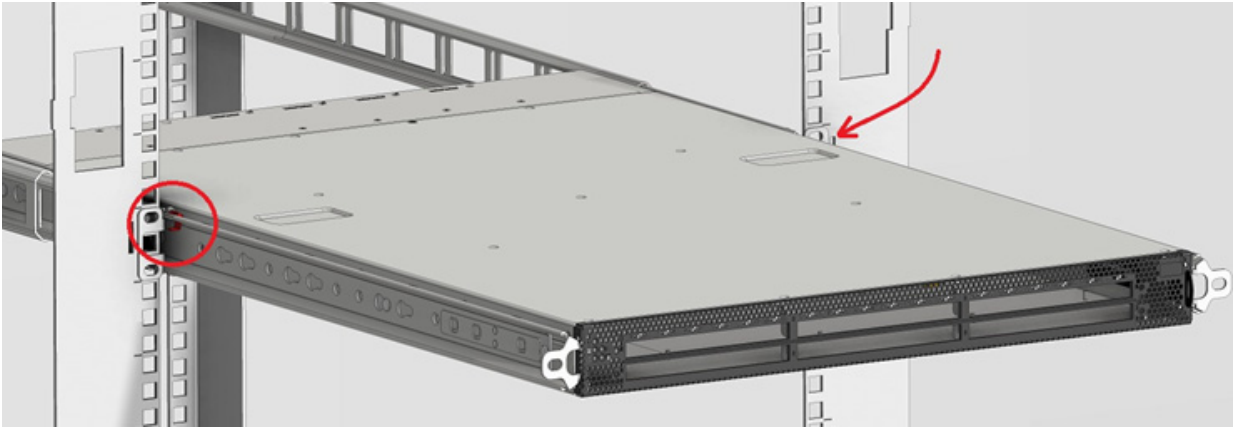
- Step 7.** When fully inserted, fix the switch by closing the remaining 2 screws in the middle and tightening the 8 screws inserted in Step 2 with a torque of  $4.5\pm 0.5$  Nm.

### 2.5.2.1 Removing the System from the Rack

➤ *To remove a unit from the rack:*

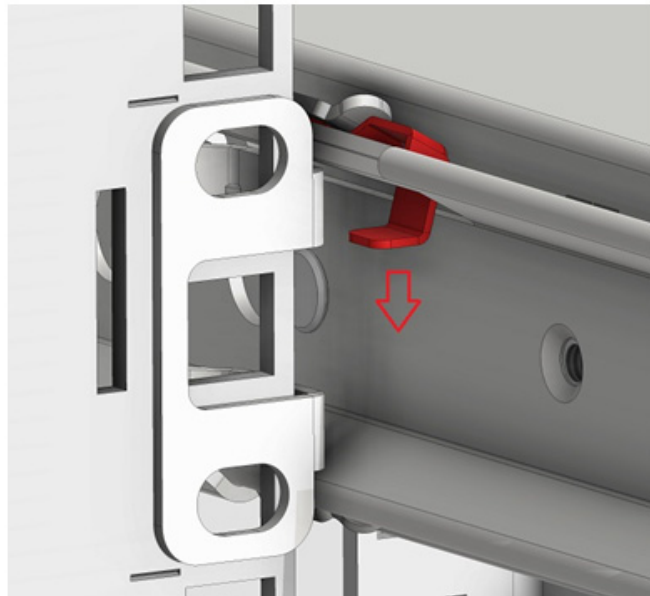
- Step 1.** Turn off the system and disconnect it from peripherals and from the electrical outlet.
- Step 2.** Unscrew the two M6 screws securing the front of the inner rails' ears to the outer rails and to the rack.
- Step 3.** Pull the unit out until braking is felt. For safety purposes, the locking mechanism will not allow a complete removal of the unit at this stage.

**Figure 22: Pulling the Unit Outwards**



- Step 4.** Press on the locking spring (appears in red in [Figure 23](#)) on both sides simultaneously, and continue pulling the unit towards you until it is fully removed.

**Figure 23: Locking Mechanism**



### 2.5.3 Static Rail Kit for SN2410



At least two people are required to safely mount the system in the rack.



By default, the system is sold with the standard-depth rail kit. The short-depth rail kit can be supplied upon request.

**Table 9 - Installation Kit**

Kit OPN	Rack Size and Rack Depth Range
MTEF-KIT-BP	Short (15.7"-23.6" \ 40 to 60 cm)
MTEF-KIT-SP	Standard (23.6"-31.5" \ 60 to 80 cm)

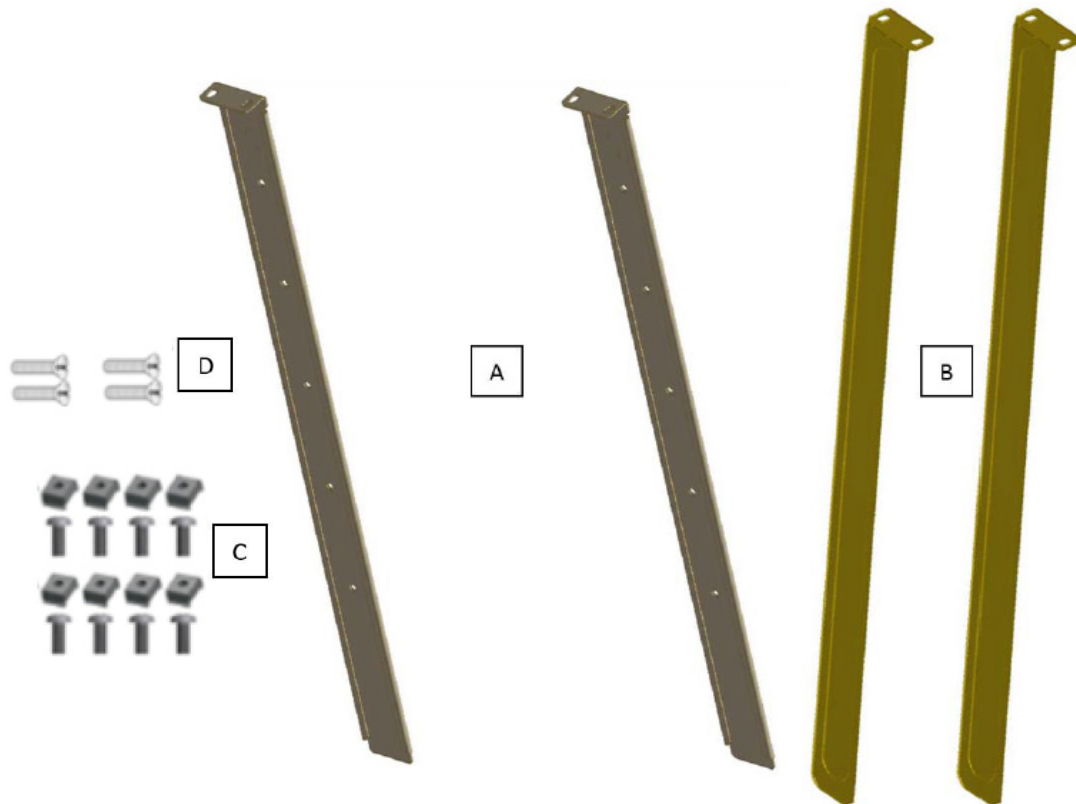
The following parts are included in the static rail kit (see Figure 8):

- 2x Rack mount rails (A)
- 2x Rack mount blades (B)
- 8x M6 Standard cage nuts<sup>1 2</sup> and 8x M6 Standard pan-head Phillips screws<sup>1</sup> (C)
- 4x Phillips100 DEG F.H TYPE-I ST.ST 6-32 X 1/4 screw with around patch (D).

<sup>1</sup> Other threads are available by special order: M5, 10-32, 12-24

<sup>2</sup> G-type cage-nut is available by special order.

**Figure 24: Rack Rail Kit Parts**



Before mounting the system to the rack, select the way you wish to place the system. Pay attention to the airflow within the rack cooling, connector and cabling options.

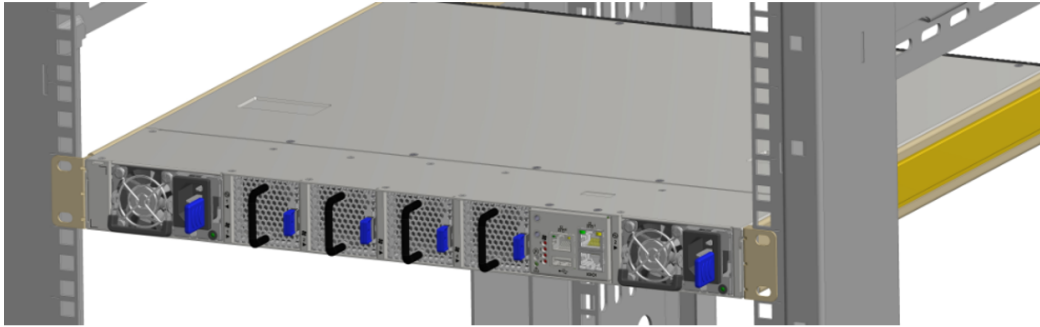
While planning how to place the system, consider the two installation options shown in [Figure 25](#), and review the following points:

- Make sure the system air flow is compatible with your installation selection. It is important to keep the airflow within the rack in the same direction.
- Note that the part of the system to which you choose to attach the rails (the front panel direction, as demonstrated in Option 1 or the FRUs direction, as demonstrated in Option 2) will determine the system's adjustable side. The system's part to which the blades are attached, will be adjacent to the cabinet.
- In case there are cables that cannot bend within the rack, or in case more space is needed for cable bending radius, it is possible to recess the connector side or the FRU side by 3.5" (8.9 cm), by optional placement of the system's rails.
- The FRU side is extractable. Mounting the rack blades inverted to the FRU side (Option 2) will allow you to slide the FRUs, in and out.

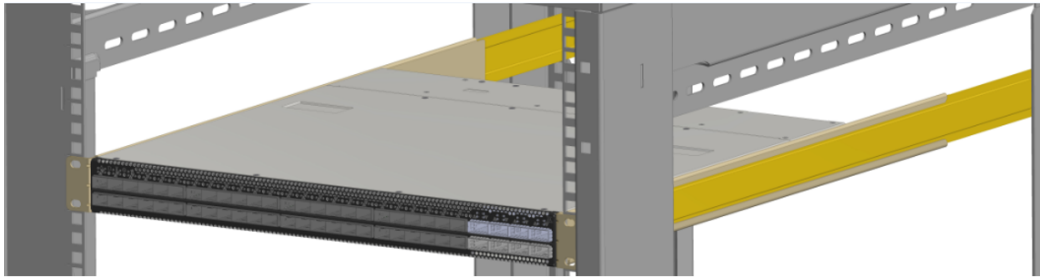


**Figure 25: Installation Options**

Option 1:

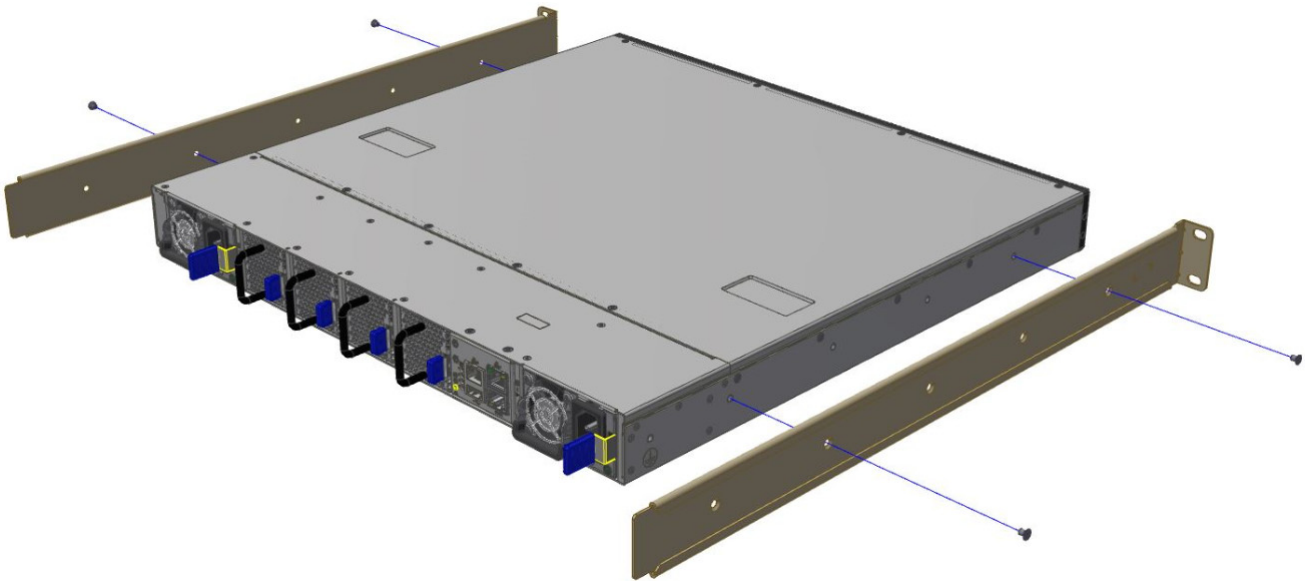


Option 2:



**Step 1.** Attach the left and right rack mount rails (A) to the switch, and secure the chassis in the rails by screwing 2 flat head Phillips screws (D) in the designated points on each side (a total of 4 screws). See [Figure 26](#). To tighten the screws, use a torque of  $1.5 \pm 0.2$  Nm.

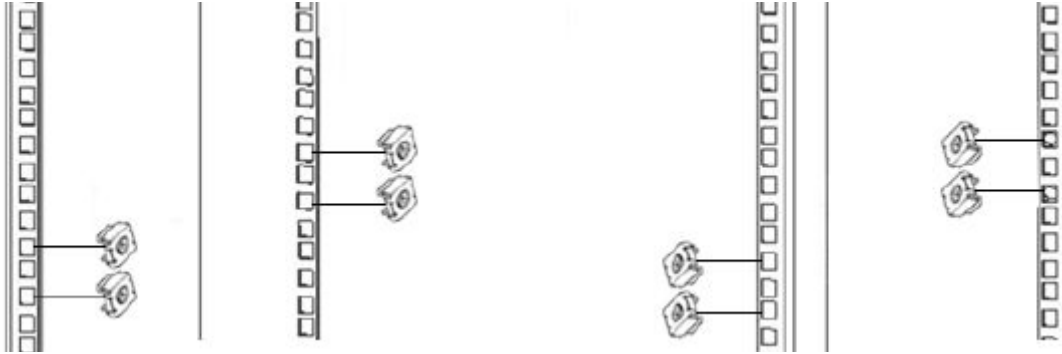
**Figure 26: Attaching the Rails to the Chassis**



**Step 2.** Install 8 cage nuts (C) in the desired 1U slots of the rack: 4 cage nuts in the non-extractable side and 4 cage nuts in the extractable side. Note that while each rack U (unit) consists of

three holes, the cage nut should be installed vertically with its ears engaging the top and bottom holes only. See [Figure 27](#).

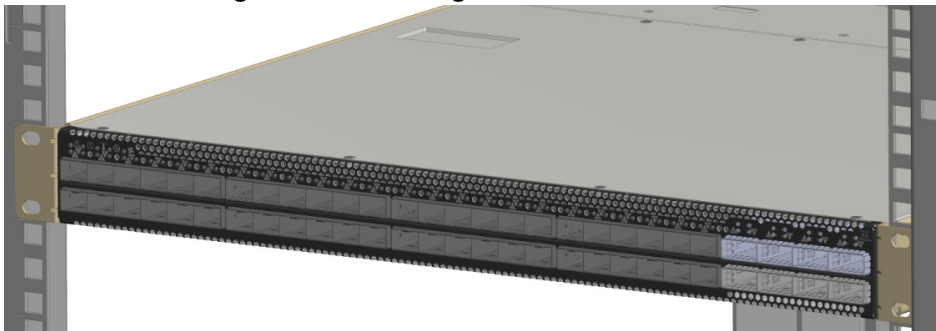
**Figure 27: Installing the Cage Nuts**



While your installation partner is supporting the system's weight, perform steps 3, 4 and 5:

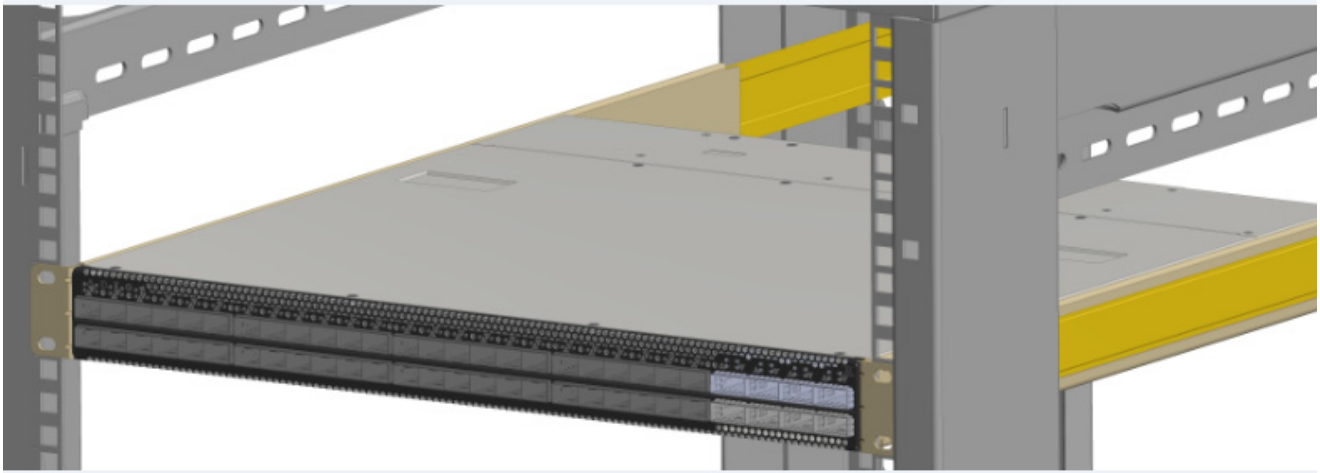
- Step 3.** On the rear side of the cabinet, install the two blades (B) in the selected rack unit, using four M6 screws (C). Do not tighten the screws yet. See [Figure 28](#).

**Figure 28: Attaching the Rails to the Rack**



- Step 4.** Slide the two blades into the left and right rails, and adjust them to fit your rack's depth. Use four M6 screws (D) to fix the blades into the rack. Do not tighten the screws yet. See [Figure 29](#).

**Figure 29: Sliding the Blades in the Rails**



**Step 5.** Secure the system in the rack by tightening the 8 screws inserted in Step 3 and Step 4 with a torque of  $4.5 \pm 0.5$  Nm.

### 2.5.4 Side by Side Mounting for SN2100 Rail Kit



A designated rail kit for the SN2100 systems can be purchased separately.



This section is relevant to short-depth systems that allow such form of installation only.



At least two people are required to safely mount the system in the rack.

**Table 10 - Installation Kit**

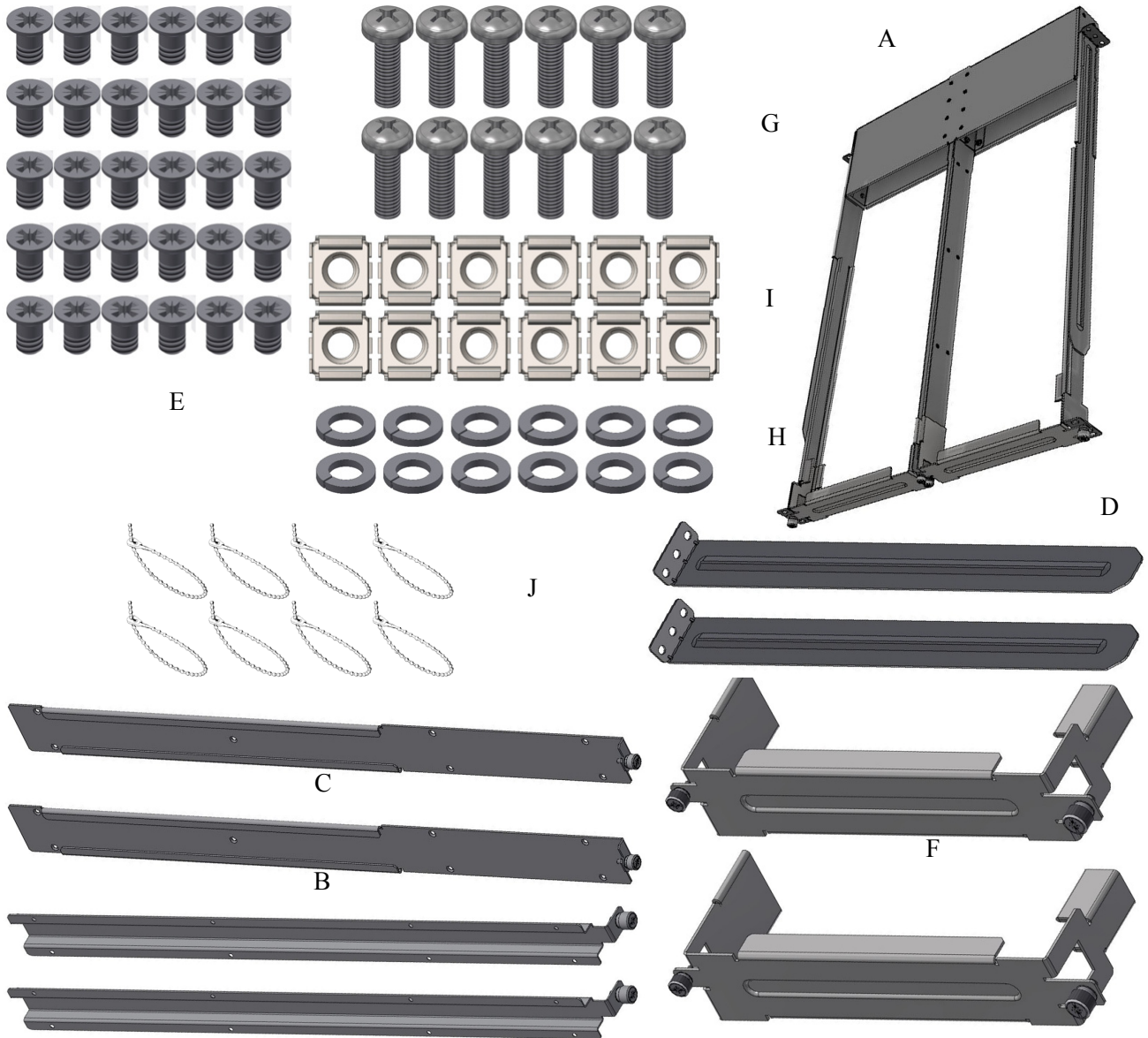
Kit OPN	Rack Size and Rack Depth Range
MTEF-KIT-D	Rack installation kit for SN2100 series short depth 1U switches, allows installation of one or two switches side-by-side into standard depth racks

The following parts are included in the rail kit (see Figure 30):

- 1 metal frame for two systems (A)

- 2 system mounting blades with 8 screw holes - the kit contains enough rails to install 2 systems (B)
- 2 system mounting blades with 7 screw holes - the kit contains enough rails to install 2 systems (C)
- 2 frame rail slides (D)
- 30 flat head 4-40 screws - the kit contains enough screws to install 2 systems (E)
- 2 blank covers (F)
- 10 (+2 spare units) M6 pan head screws (G)
- 10 (+2 spare units) M6 spring washers (H)
- 10 (+2 spare units) M6 spring steel cage nuts (I)
- 6 (+2 spare units) cable-ties (J)

**Figure 30: Rack Rail Kit Parts**



Before mounting the system to the rack, select the way you wish to place the system. Pay attention to the airflow within the rack cooling, connector and cabling options.

- The installation kits come with enough system mounted rails and flat head screws to install two systems.
- The 2 system metal frame will fit into racks with from 23.6" (600mm) to 31.5" (800mm) space between the vertical supports.
- You may choose to install your system in the right or in the left part of the metal frame. The following instructions apply to installation in the right part. For installation in the

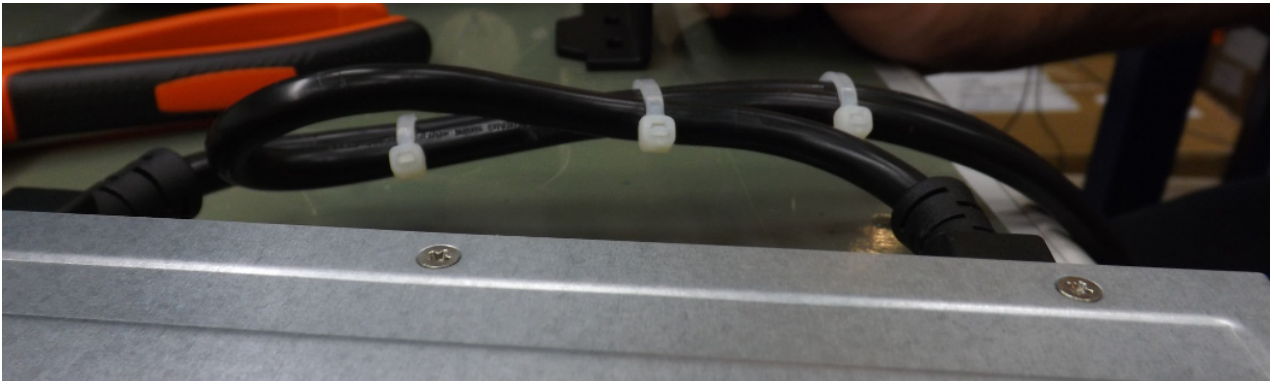
frame's left part, follow the same instructions, while replacing "right" with "left", and vice versa.

- Step 1.** Insert the SE (single ended) plugs to the dedicated inlets in the system's rear panel.
- Step 2.** Carefully position the SE (single ended) cables one on top of the other, and use three cable-ties to pair them together, as shown in [Figure 31](#).

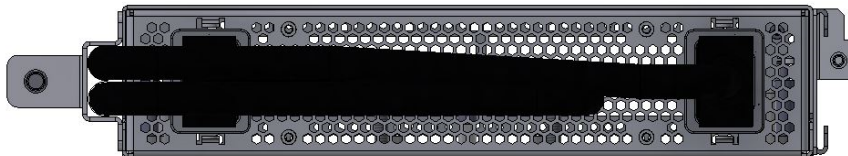


While pairing the cables, make sure the cables are paired in symmetry to the switch, in order to avoid damaging the cables.

**Figure 31: Coupling the Cables with Cable-ties**



**Figure 32: Coupled Cables - Rear View**



- Step 3.** Place the coupled cables in the designated area within the right flat blade (the blade with 7 screw holes) as shown in [Figure 31](#).



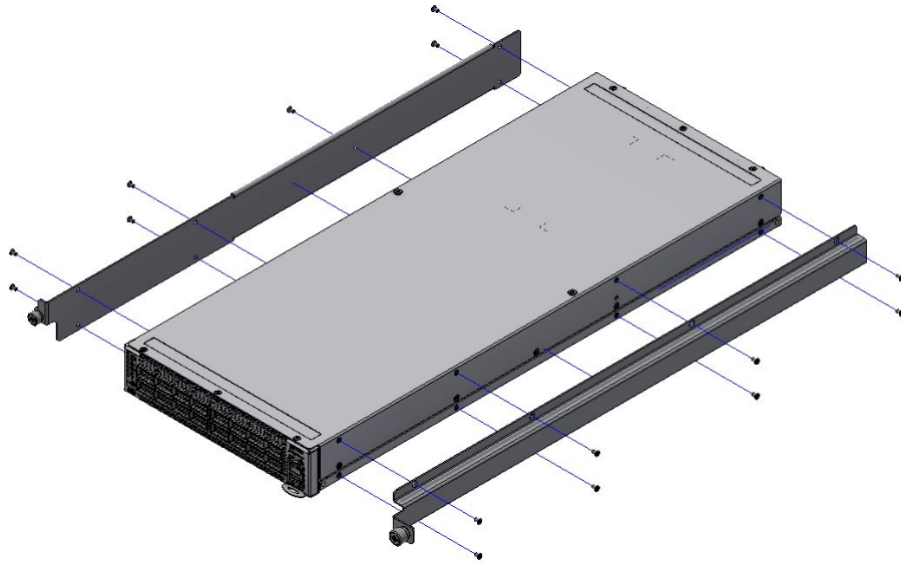
**Figure 33: Cables within the Rail**



In the next you will be attaching the rails to the chassis, before doing that, make sure the cables are laid properly within them. Avoid using excessive pressure, as it can damage the cables.

- Step 4.** While holding the cables stably together in the blade's rail with one hand, use your other hand to secure the blades to the chassis. Screw the right blade with eight 4-40 flathead screws, and the left blade with seven 4-40 flathead screws. The recommended torque is 0.49-0.54 Nm.

**Figure 34: Attach the Blades to the System**



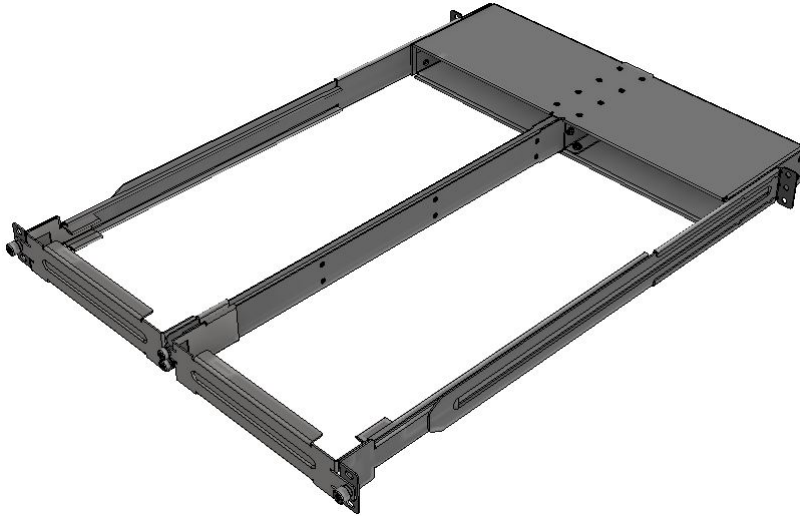
**Figure 35: Attached Rail with Threaded Cables - Top View**



**Step 5.** Slide the two frame slides into the dedicated rails in the metal frame. See [Figure 36](#).

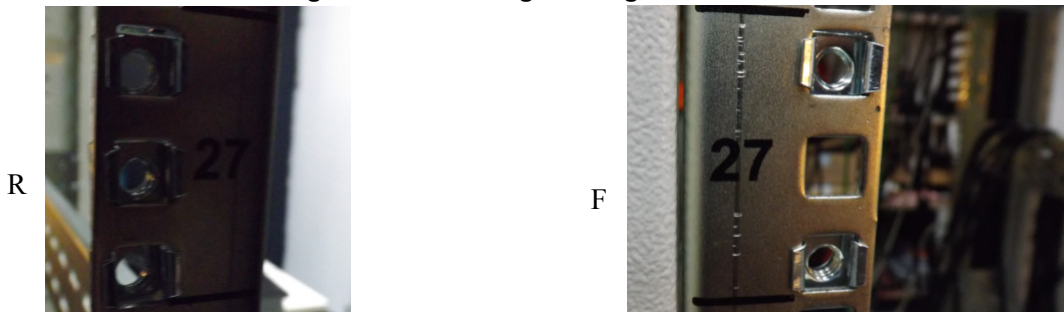


**Figure 36: Sliding the Frame Sliders into the Rails**



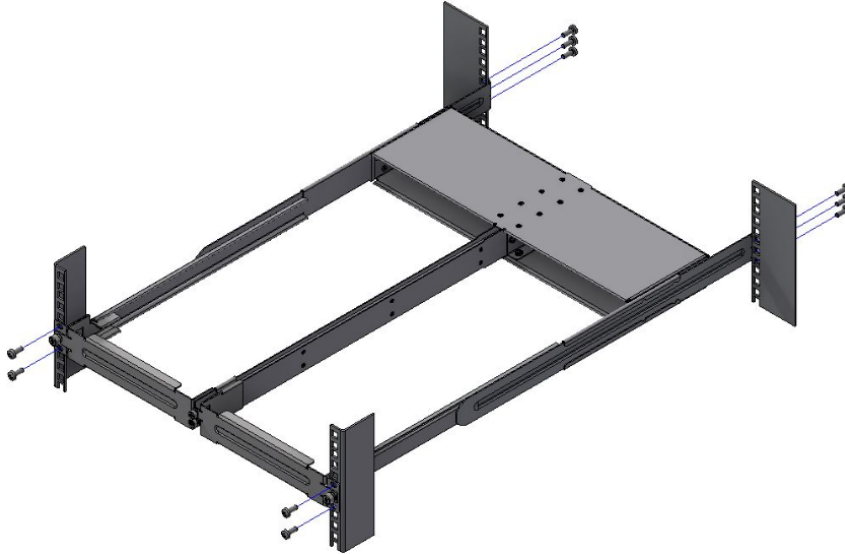
- Step 6.** Place the frame in the cabinet, and install ten cage nuts in the desired 1U slots of the rack: three cage nuts in the front part of each cabinet post, and two cage nuts in the rear part of each cabinet post.

**Figure 37: Installing the Cage Nuts**



- Step 7.** Attach the frame to the rack by using ten spacer cage nut to adapt the square openings in the vertical support, and screwing ten M6 pan head screws - four in the front part of the rack, and 6 in its rear part. The recommended torque is 6.55-7.35 Nm. See [Figure 37](#).

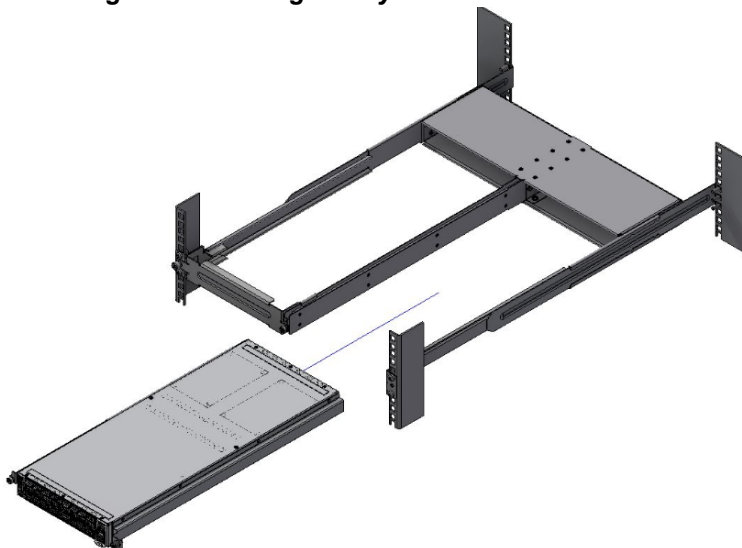
**Figure 38: Attaching the Frame to the Rack**



Do not remove both of the blank covers at the same time. When no system is installed, at least one of them should be present to support the frame's partition.

- Step 8.** Remove the blank cover from the selected slot in the frame, and mount the system by sliding its mounting blades into the frame. Repeat this step to install an additional system in the other side of the frame, if needed.
- Step 9.** Tighten the capture nuts to secure the system in the frame. The recommended torque on the right screw is 3.0-3.36 Nm while on the left screw recommended torque is 0.89-0.98 Nm.

**Figure 39: Sliding the System's Blades in the Rails**



## 2.6 Cable Installation

All cables can be inserted or removed with the unit powered on.

To insert a cable, press the connector into the port receptacle until the connector is firmly seated. The LED indicator, corresponding to each data port, will light when the physical connection is established. When a logical connection is made, the relevant port LED will turn on.

To remove a cable, disengage the locks and slowly pull the connector away from the port receptacle. The LED indicator for that port will turn off when the cable is unseated.

For full cabling guidelines, ask your Mellanox representative for a copy of Mellanox Cable Management Guidelines and FAQ.

For more information about port LEDs, refer to [“Port LEDs”](#).

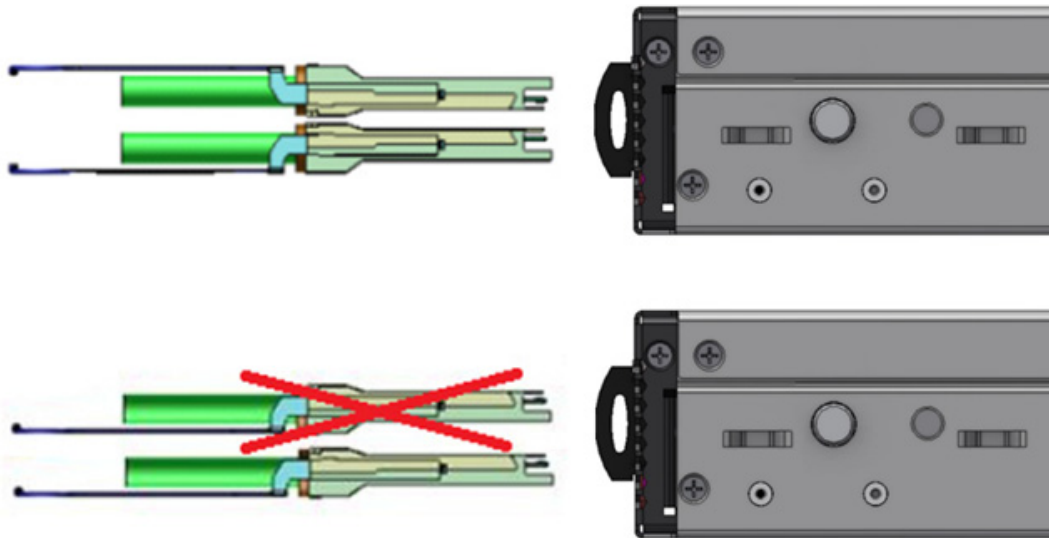


Do not force the cable into the cage with more than 40 newtons / 9.0 pounds / 4kg force. Greater insertion force may cause damage to the cable or to the cage.



The SN2410 system includes ports of different types. Figure 43 does not apply to the SFP28 ports. See [Figure 44](#).

**Figure 40: SN2700 and SN2100 Cable Orientation**



**Figure 41: SN2410 Cable Orientation**



## 2.6.1 Breakout Cables and Adapters

A 100GbE port can be split to two 50GbE ports, or to four (or less) 25GbE ports, using a Mellanox breakout cable.

Splitting a 100GbE QSFP28 port to 4 separate 25GbE ports (using a breakout cable) disables (unmaps) the 100GbE port below it. See [Figure 43, “SN2700 Splitting Options”](#).

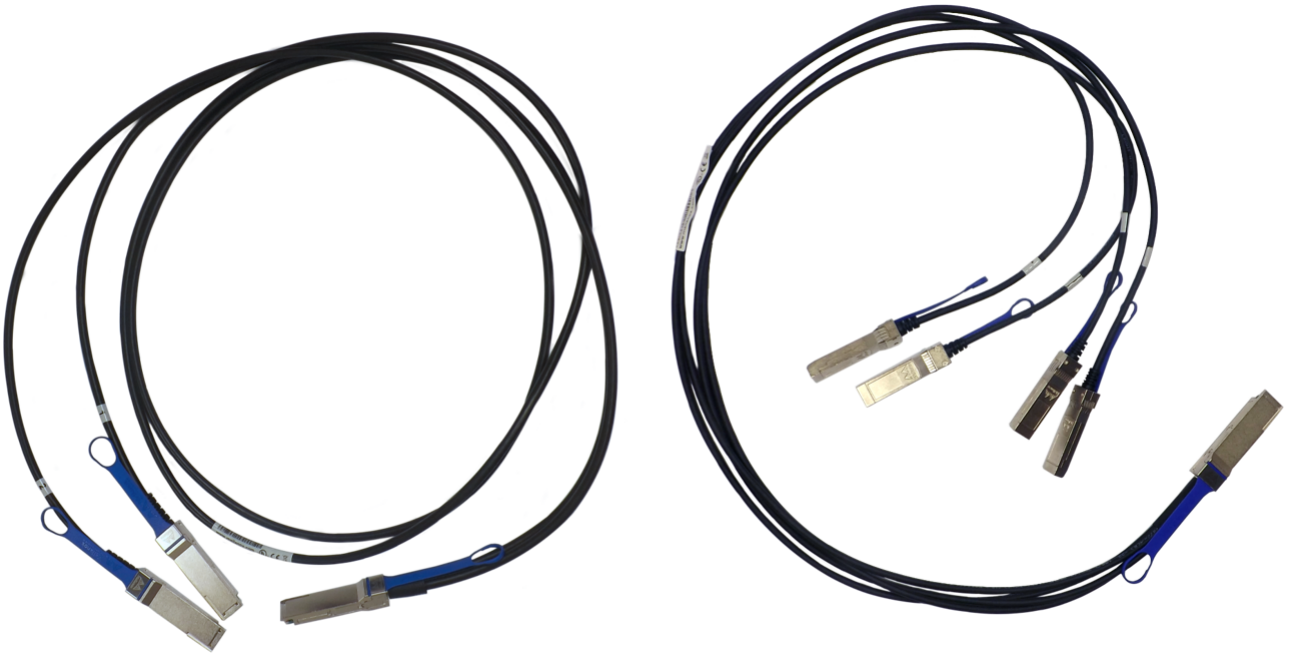
### 2.6.1.1 Using Breakout Cables with MLNX-OS

When using this feature, you should log into the MLNX-OS® CLI and configure the individual ports to be ‘split-2’ or ‘split-4’. For further information on Mellanox’s cable, visit [http://www.mellanox.com/page/interconnect\\_overview](http://www.mellanox.com/page/interconnect_overview).

### 2.6.1.2 Using Breakout Cables with Cumulus Linux

If you are using 4x10G direct attach copper cables or active optical cables, edit the `/etc/cumulus/ports.conf` to enable support for these cables, then restart the `switchd` service using the `sudo systemctl restart switchd` command. For more details, see [Layer 1 and Switch Port Attributes](#) in the [Cumulus Linux User Guide](#).

**Figure 42: Breakout or Fanout Cables**



### 2.6.1.3 SN2700 Splitting Options

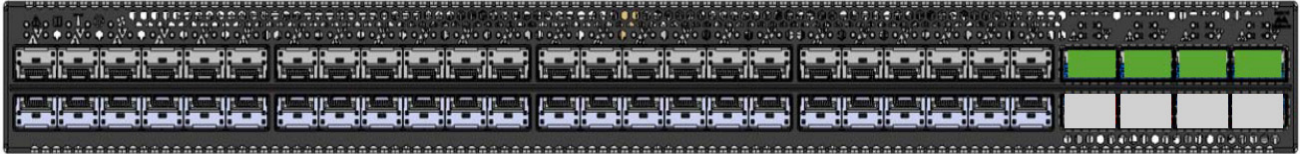
**Figure 43: SN2700 Splitting Options**



The top QSFP28 ports marked in green are splittable to 4 SFP28 ports, each. The bottom QSFP28 ports (gray) are blocked when the upper ports are in split mode. All QSFP28 ports marked in yellow can be split to 2 SFP28 ports.

### 2.6.1.4 SN2410 Splitting Options

**Figure 44: SN2410 Splitting Options**



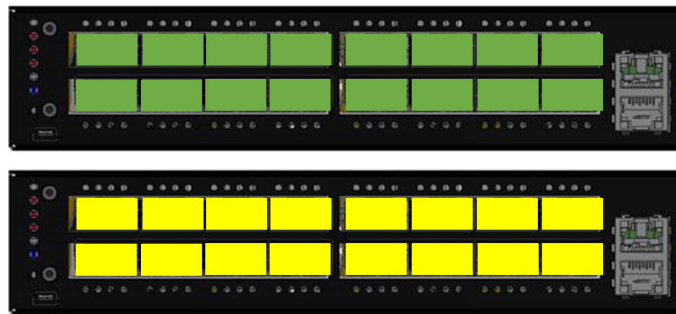
The top QSFP28 ports - 49,51,53,55 (green) are splittable to 4 SFP28 ports each.

All QSFP28 ports can be split into two SFP28 ports.

The bottom QSFP28 ports - 50,52,54,56 (gray) are blocked when the upper ports are in split mode.

### 2.6.1.5 SN2100 Splitting Options

**Figure 45: SN2100 Splitting Options**



All QSFP28 ports are splittable. Each port can be split to 4xSFP28 (10/25G) or 2xQSFP28 (50G) ports each. There are no blocking requirements.

## 2.7 Initial Power On

Each system's input voltage is specified in the [“Specifications”](#) chapter. The power cords should be standard 3-wire AC power cords including a safety ground and rated for 15A or higher.



The system platform will automatically power on when AC power is applied. There is no power system. Check all boards, power supplies, and fan tray modules for proper insertion before plugging in a power cable.

- Step 1.** Plug in the first power cable.
- Step 2.** Plug in the second power cable.
- Step 3.** Wait for the System Status LED to turn green.

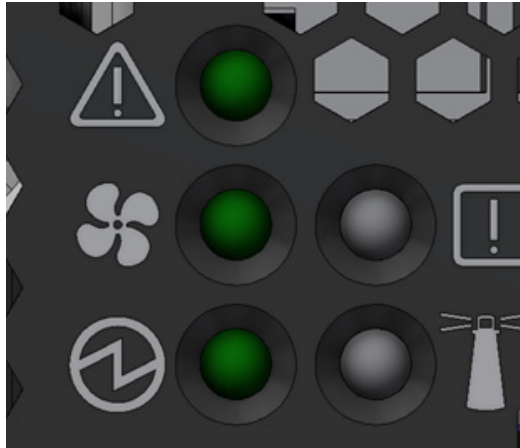




It may take up to five minutes to turn on the system. If the System Status LED shows red after five minutes, unplug the system and call your Mellanox representative for assistance.

- Step 4.** Check the System Status LEDs and confirm that all of the LEDs show status lights consistent with normal operation (initially flashing, and then moving to a steady color) as shown in [Figure 46](#) below. For more information, refer to [“LEDs”](#).

**Figure 46: System Status LEDs 5 Minutes After Power On in SN2700**



**Figure 47: System Status LEDs 5 Minutes After Power On in SN 2410**



**Figure 48: System Status LEDs 5 Minutes After Power On in SN 2100**





After inserting a power cable and confirming the green System Status LED light is on, make sure that the Fan Status LED shows green.

If the Fan Status LED is not green, unplug the power connection and check that the fan module is inserted properly and that the mating connector of the fan unit is free of any dirt and/or obstacles. If no obstacles were found and the problem persists, call your Mellanox representative for assistance.

**Figure 49: Two Power Inlets - Electric Caution Notifications**

**Risk of electric shock and energy hazard.** The two power supply units are independent.

Disconnect all power supplies to ensure a powered down state inside of the switch platform.

Gefahr des elektrischen Schocks. Entfernen des Netzsteckers eines Netzteils spannungsfrei. Um alle Einheiten spannungsfrei zu machen sind die Netzstecker aller Netzteile zu entfernen

Risque de choc et de danger e'lectriques. Le de'branchement d'une seule alimentation stabilise'e ne de'branch uniquement qu'un module "Alimentation Stabilise'e". Pour isoler completement le module en cause, Il faut de'brancher toutes les alimentations stabilise'es.

## 2.8 System Bring-Up

For bring-up of a switch system with MLNX-OS operating system installed, refer to [Section 2.8.1](#).



For bring-up of a switch system with Cumulus Linux operating system installed, refer to [Section 2.8.2](#).

### 2.8.1 Configuring Network Attributes Using MLNX-OS

The procedures described in this chapter assume that you have already installed and powered on the system according to the instructions in this document. The system comes with a pre-configured DHCP. If you wish to disable it, refer to [“Disable Dynamic Host Configuration Protocol \(DHCP\)”](#). In case a manual configuration is required, please refer to the instructions in [Section 2.8.1.1](#).

#### 2.8.1.1 Manual Host Configuration

➤ *To perform initial configuration of the system:*

- Step 1.** Connect a host PC to the Console RJ45 (  ) port of the system, using the supplied harness cable (DB9 to RJ45). Make sure to connect to the Console RJ45 port and not to the (Ethernet) MGT (  ) port.



- Step 2.** Configure a serial terminal program (for example, HyperTerminal, minicom, or Tera Term) on your host PC with the settings described in [Table 11](#). Once you perform that, you should get the CLI prompt of the system.

**Table 11 - Serial Terminal Program Configuration**

Parameter	Setting
Baud Rate	115200
Data bits	8
Stop bits	1
Parity	None
Flow Control	None

**Step 3.** Login as *admin* and use *admin* as password. On the first login, the MLNX-OS configuration wizard will start.

- Step 4.** To configure network attributes and other initial parameters to the system, follow the configuration wizard as shown in [Table 12](#).

**Table 12 - Configuration Wizard Session**

Wizard Session Display	Comments
Mellanox configuration wizard Do you want to use the wizard for initial configuration? yes	You must perform this configuration the first time you operate the system or after resetting the system. Type 'y' and then press <Enter>.
Step 1: Hostname? [switch-1]	If you wish to accept the default hostname, press <Enter>. Otherwise, type a different hostname and press <Enter>.
Step 2: Use DHCP on mgmt0 interface? [no] yes	Perform this step to obtain an IP address for the system. (mgmt0 is the management port of the system). If you wish the DHCP server to assign the IP address, type 'yes' and press <Enter>. If you type 'no' (no DHCP), then you will be asked whether you wish to use the 'zeroconf' configuration or not. If you enter 'no' (no Zeroconf), you must enter a <i>static</i> IP, and the session will continue.
Step 3: Enable IPv6? [yes]	The management interface will be able to use IPv6 addresses. If you enter "no" (no IPv6), you will automatically be referred to Step 6.
Step 4: Enable IPv6 auto-config (SLAAC) on mgmt0 interface? [no]	This turns on auto-configuration of the IPv6 addresses. This is unsuitable for DHCPv6.
Step 5: Enable DHCPv6 on mgmt0 interface? [no]	To enable DHCPv6 on the MGMT0 interface.

**Table 12 - Configuration Wizard Session**

Wizard Session Display	Comments
Step 6: Admin password (Press <Enter> to leave unchanged)? <new_password> Step 6: Confirm admin password? <new_password>	To avoid illegal access to the machine, please type a password and then press <Enter>. Then confirm the password by re-entering it.  Note that password characters are <i>not</i> printed.
You have entered the following information:  <A summary of the configuration is now displayed.> To change an answer, enter the step number to return to or hit <enter> to save changes and exit. Choice: <Enter> Configuration changes saved.	The wizard displays a summary of your choices and then asks you to confirm the choices or to re-edit them.  Either press <Enter> to save changes and exit, or enter the configuration step number that you wish to return to.  Note: To re-run the configuration wizard, run the command “configuration jump-start” in Config mode.

The table below shows an example of static IP configuration for mgmt0 interface.

**Table 13 - Configuration Wizard Session - Static IP Configuration**

Wizard Session Display - Static IP Configuration (Example)
<pre> Mellanox configuration wizard  Do you want to use the wizard for initial configuration? yes  Step 1: Hostname? [] Step 2: Use DHCP on mgmt0 interface? [yes] no Step 3: Use zeroconf on mgmt0 interface? [no] Step 4: Primary IP address? [for example 192.168.10.4] 10.10.10.10 Mask length may not be zero if address is not zero (interface eth0) Step 5: Netmask? [0.0.0.0] 255.255.255.0 Step 6: Default gateway? [for example 192.168.10.1] 10.10.10.255 Step 7: Primary DNS server? Step 8: Domain name? Step 9: Enable IPv6? [yes] Step 10: Enable IPv6 autoconfig (SLAAC) on mgmt0 interface? [no] Step 11: Admin password (Enter to leave unchanged)?  To change an answer, enter the step number to return to. Otherwise hit &lt;enter&gt; to save changes and exit. Choice: Configuration changes saved.  To return to the wizard from the CLI, enter the “configuration jump-start” command from configure mode. Launching CLI... &gt;           </pre>

- Step 5.** Before attempting a remote (for example, SSH) connection to the system, check the mgmt0 interface configuration. Specifically, verify the existence of an IP address. To check the current mgmt0 configuration, enter the following command:

```
r-qa-sit-switch01 (config) # show interfaces mgmt0
Interface mgmt0 status:
  Comment:
  Admin up:          yes
  Link up:           yes
  DHCP running:     yes
  IP address:        192.168.1.100
  Netmask:           255.255.255.0
  IPv6 enabled:     yes
  Autoconf enabled: no
  Autoconf route:   yes
  Autoconf privacy: no
  DHCPv6 running:   no
  IPv6 addresses:   1
  IPv6 address:     fe80::202:c9ff:fe63:b55a/64
  Speed:             1000Mb/s (auto)
  Duplex:            full (auto)
  Interface type:   ethernet
  Interface source: physical
  MTU:               1500
  HW address:        00:02:C9:63:B5:5A

  RX bytes:          968810197      TX bytes:          1172590194
  RX packets:        10982099      TX packets:        10921755
  RX mcast packets: 0              TX discards:       0
  RX discards:       0              TX errors:          0
  RX errors:         0              TX overruns:        0
  RX overruns:       0              TX carrier:         0
  RX frame:          0              TX collisions:      0
  TX queue len:      1000

r-qa-sit-switch01 (config) #
```

- Step 6.** Check the software version embedded in your system, using the command ‘show version’. Compare this version to the latest version that can be retrieved from Mellanox support site. To upgrade software, please refer to the MLNX-OS User Manual.

### 2.8.1.1.1 Disable Dynamic Host Configuration Protocol (DHCP)

DHCP is used for automatic retrieval of management IP addresses.



If a user connects through SSH, runs the wizard and turns off DHCP, the connection is immediately terminated, as the management interface loses its IP address.

```
<localhost># ssh admin@<ip-address>
Mellanox MLNX-OS Switch Management
Password:
Mellanox Switch
Mellanox configuration wizard
Do you want to use the wizard for initial configuration?
yes
Step 1: Hostname? [my-switch]
Step 2: Use DHCP on mgmt0 interface? [yes] no
<localhost>#
```

In such case the serial connection should be used.

### 2.8.1.2 Remote Connection with MLNX-OS

Once the network attributes are set, you can access the CLI via SSH or the WebUI via HTTP/HTTPS.

➤ *To access the CLI, perform the following steps:*

**Step 1.** Set up an Ethernet connection between the system and a local network machine using a standard RJ45 connector.

**Step 2.** Start a remote secured shell (SSH) using the command: “ssh -l <username> <IP\_address>”,

```
# ssh -l <username> <ip_address>
Mellanox MLNX-OS Switch Management

Password:
```

**Step 3.** Login as admin (default username is *admin*, password *admin*).

**Step 4.** Once you get the CLI prompt, you are ready to use the system.

For additional information about MLNX-OS, refer to MLNX-OS User Manual located on Mellanox support web.

## 2.8.2 Configuring Network Attributes Using Cumulus Linux

For Cumulus Linux initial configuration instructions, see [Configuring Cumulus Linux](#) on the [Cumulus Linux Quick Start Guide](#).

### 2.8.2.1 Remote Connection with Cumulus Linux

Cumulus Linux uses the OpenSSH package to provide SSH functionality. To securely access a Cumulus Linux switch remotely, please follow the instructions on the [SSH for Remote Access](#) page in the [Cumulus Linux User Guide](#).

## 2.9 FRU Replacements



The following information does not apply to the SN2100 series. The SN2100 systems include two non-replaceable power supply units and four non-replaceable fan units.

### 2.9.1 Power Supply

Mellanox systems that are equipped with two replaceable power supply units work in a redundant configuration. Either unit may be extracted without bringing down the system.



Make sure that the power supply unit that you are NOT replacing is showing all green, for both the power supply unit and System Status LEDs.



Power supply units have directional air flows similar to the fan module. The fan module airflow must coincide with the airflow of all of the power supply units. If the power supply unit airflow direction is different from the fan module airflow direction, the system's internal temperature will be affected.

For power supply unit air flow direction, refer to [Section 2.3 on page 18](#).

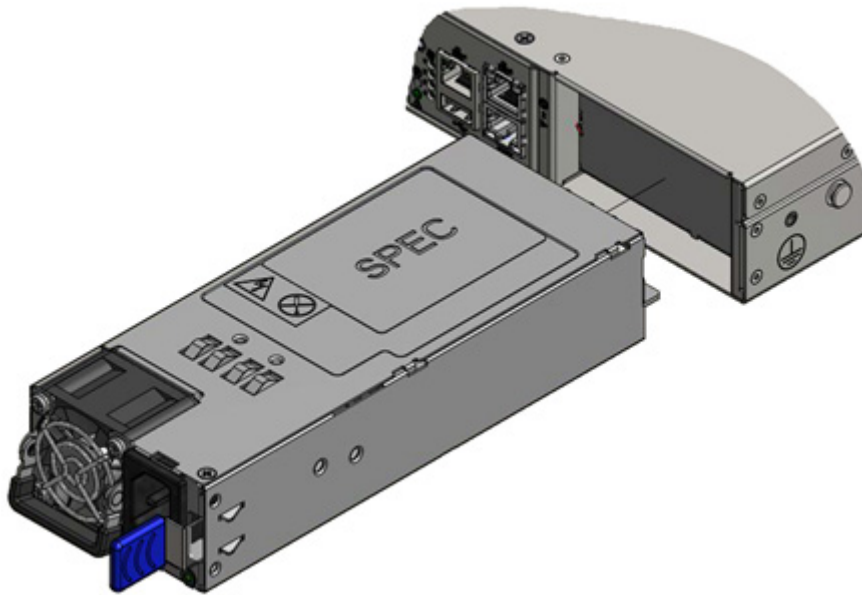
#### ➤ *To extract a power supply unit:*



The power supply slots of SN2410 should not be left empty for more than 5 minutes.

- Step 1.** Remove the power cord from the power supply unit.
- Step 2.** Grasping the handle with your hand, push the latch release with your thumb while pulling the handle outward. As the power supply unit unseats, the power supply unit status LEDs will turn off.
- Step 3.** Remove the power supply unit.

**Figure 50: PS Unit Pulled Out**



➤ **To insert a power supply unit:**

**Step 1.** Make sure the mating connector of the new unit is free of any dirt and/or obstacles.



Do not attempt to insert a power supply unit with a power cord connected to it.

**Step 2.** Insert the power supply unit by sliding it into the opening, until a slight resistance is felt.

**Step 3.** Continue pressing the power supply unit until it seats completely. The latch will snap into place, confirming the proper installation.

**Step 4.** Insert the power cord into the supply connector.

**Step 5.** Insert the other end of the power cord into an outlet of the correct voltage.



The green power supply unit indicator should light. If it does not, repeat the whole procedure to extract the power supply unit and re-insert it.

## 2.9.2 Fans

The system can fully operate if one fan FRU is dysfunctional or missing. Failure of more than one fan is not supported.



Make sure that the fans have the air flow that matches the model number. An air flow opposite to the system design will cause the system to operate at a higher (less than optimal) temperature.

For power supply unit air flow direction, refer to [Section 2.3 on page 18](#).

➤ **To remove a fan unit:**

**Step 1.** Grasping the handle with your right hand, push the latch release with your thumb while pulling the handle outward. As the fan unit unseats, the fan unit status LEDs will turn off.

**Step 2.** Remove the fan unit.

➤ **To insert a fan unit:**

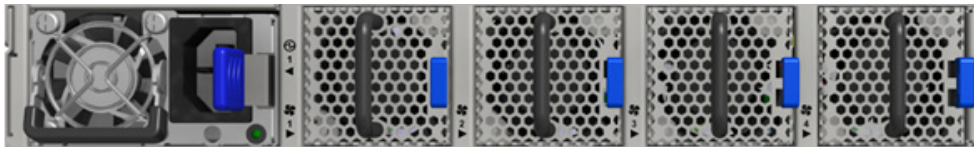
**Step 1.** Make sure the mating connector of the new unit is free of any dirt and/or obstacles.

**Step 2.** Insert the fan unit by sliding it into the opening until slight resistance is felt. Continue pressing the fan unit until it seats completely.



The green Fan Status LED should light. If not, extract the fan unit and reinsert it. After two unsuccessful attempts to install the fan unit, power off the system before attempting any system debug.

**Figure 51: Fan Module Latches**



## 3 Interfaces

### 3.1 Supported Interfaces

The systems support the following interfaces:

- Data interfaces - Ethernet
- 10/100/1000 MbE speed rates
- USB port (mini USB in SN2100)
- RS232 Console port
- RJ45 management interface(s)
- Reset button
- Status and Port LEDs

In order to review the full configuration options matrix, refer to [Table 4, “Management Interfaces, PSUs and Fans”](#).

#### 3.1.1 Data Interfaces

The data interfaces use QSFP28 connectors. The full list of interfaces per system is provided in [Table 3, “Speed and Switching Capabilities”](#). Each QSFP28 port can be connected with a QSFP28 cable or connector for 25/40/50/56/100GbE, or 1/10/25GbE when connecting through Mellanox QSFP28 to SFP28 (QSA) adapters, hybrid or split cables. The systems offer High Power/LR4 transceivers support (up to 3.5W) in all QSFP28 ports. Some QSFP28 ports support 4.5W transceivers, as detailed in the following table:

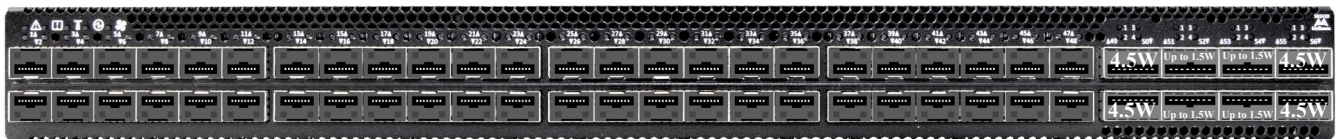
**Table 14 - High Power/LR4 Transceivers Support**

Model Family	Ports	Maximum High Power Support
SN2700	1, 2, 31, 32	4.5W <sup>1</sup>
SN2410 <sup>2</sup>	49, 50, 55, 56	
SN2100	1, 2, 15, 16	

1. 4.5W high power modules are supported on MLNX-OS from version 3.6.3004 onwards.
2. When using 4.5W modules on the specified four ports, only cables and transceivers with lower power than 1.5W can be used on ports 51, 52, 53 and 54. See illustration in [Figure 52](#).

The SFP28 ports in SN2410 support Level II (up to 1.5W) transceivers.

**Figure 52: Using 4.5W Modules on Ports 49, 50, 55, 56 in SN2410**






### 3.1.2 Speed

Ethernet speed must be set manually. The system's ports can be manually configured to run at speeds ranging from 10GbE to 100GbE (for more details, see [“Specifications”](#)). To change the port speed configuration, use the command “speed” under interface configuration mode. Refer to the MLNX-OS User Manual for instructions on port speed re-configuration.

### 3.1.3 RS232 (Console)

The port labeled “Console” **IOIOI** is an RS232 serial port on the back side of the chassis in SN700 and SN2410, and on the front side in SN100. It is used for initial configuration and debugging. Upon first installation of the system, you need to connect a PC to this interface and configure network parameters for remote connections. Refer to [Section 2.8.1](#) to view the full procedure.

### 3.1.4 Management

The RJ45 Ethernet ports labeled “MGT”  provide access for remote management. The management ports are configured with auto-negotiation capabilities by default (100MbE to 1000GbE). The management ports' network attributes (such as IP address) need to be pre-configured via the RS232 serial console port or by DHCP before use. Refer to [Section 2.8.1](#) to view the full procedure.



In the SN2100 systems there is only one MGT port.



Make sure you use only FCC compliant Ethernet cables.

### 3.1.5 USB

The USB interface is USB 2.0 (mini USB in SN2100) compliant (USB 1.0 is not supported) and can be used by MLNX-OS software to connect to an external disk for software upgrade or file management. The connector comes in a standard USB shape.

To view the full matrix of the USB configuration options, refer to [Table 4, “Management Interfaces, PSUs and Fans”](#).



Do not use excessive force when inserting or extracting the USB disk to and from the connector.

### 3.1.6 Reset Button

The reset button is located on the rear side of the system next to the fan status LEDs in SN2700 and SN2410, and on the front side in SN2100. This reset button requires a tool to be pressed.



Do not use a sharp pointed object such as a needle or a push pin for pressing the reset button. Use a flat object to push the reset button.

To reset the system and the CPU of its management board, push the reset button and keep it pressed for up to 15 seconds.

To reset the system, the CPU of its management board, and the “admin” password, push the reset button and keep it pressed for at least 15 seconds. When using a MLNX-OS based system, this should allow you to enter without a password and set a new password for the user “admin”.

For Cumulus® Linux® password reset instructions, please refer to the [Single User Mode - Boot Recovery](#) section in the [Cumulus Linux User Guide](#).

### 3.1.7 Status and Port LEDs





See [“LEDs” on page 58](#).

## 3.2 LEDs


### 3.2.1 LED Notifications

The system’s LEDs are an important tool for hardware event notification and troubleshooting.

**Table 15 - LEDs Symbols**

Symbol	Name	Description	Normal Conditions
	System Status LED	Shows the health of the system.	Green/Flashing green when booting
	Fan Status LED	Shows the health of the fans.	Green
<sup>a</sup> 	Power supply units LEDs	Shows the health of the power supply units.	Green
	Bad Port LED	Lights up when a symbol error is detected on one of the ports.	Off

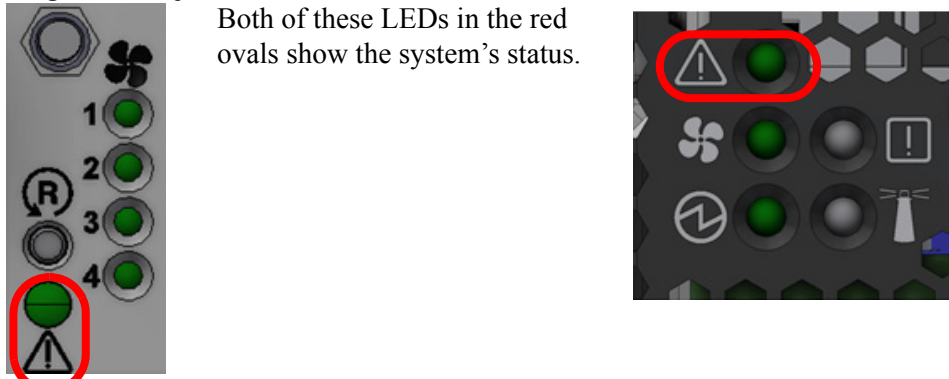
**Table 15 - LEDs Symbols**

Symbol	Name	Description	Normal Conditions
	Unit Identifier LED	Lights up on command through the CLI.	Off or blue when identifying a port

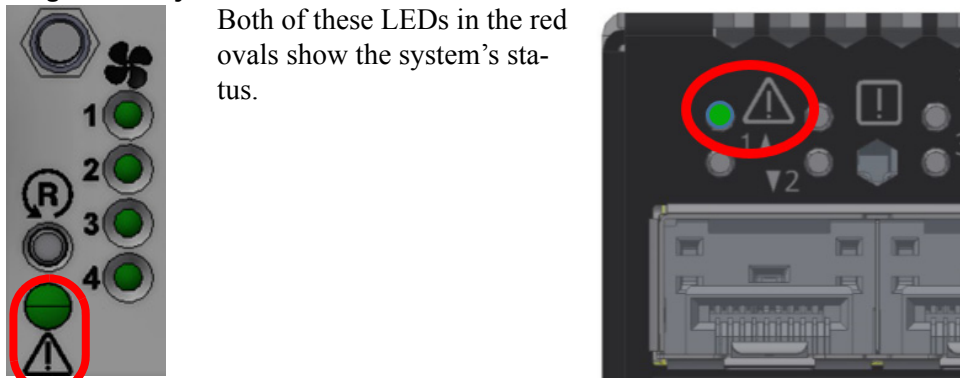
- a. There are two PSU LEDs in SN2100.

### 3.2.1.1 System Status LED

**Figure 53: System Status LEDs - Front and Rear Sides in SN2700**



**Figure 54: System Status LEDs - Front and Rear Sides in SN2410**



**Figure 55: System Status LED in SN2100**



The LED in the red oval is located on the front panel of SN2100. There are no LEDs in the rear panel of SN2100.

Both of the System Status LEDs (front and back, if exist) supply identical information.



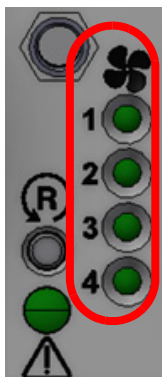
It may take up to five minutes to turn on the system. If the System Status LED shows red after five minutes, unplug the system and call your Mellanox representative for assistance.

**Table 16 - System Status LED Assignments**

LED Behavior	Description	Action Required
Solid Green	The system is up and running normally.	N/A
Flashing Green	The system is booting up.	Wait up to five minutes for the end of the booting process.
Solid Red	Major error has occurred. For example, corrupted firmware, system is overheated etc.	If the System Status LED shows red five minutes after starting the system, unplug the system and call your Mellanox representative for assistance.

### 3.2.1.2 Fan Status LED

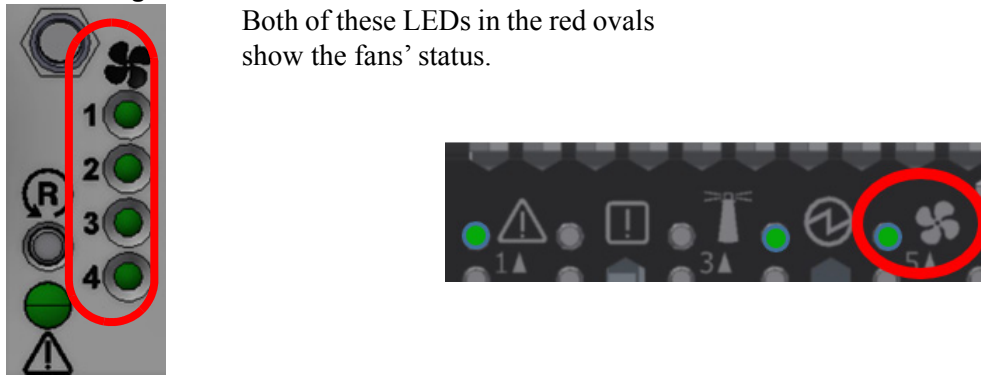
**Figure 56: Fan Status LED in SN2700 - Front and Rear Sides**



Both of these LEDs in the red ovals show the fans' status.



**Figure 57: Fan Status LED in SN2410 - Front and Rear Sides**



Both of these LEDs in the red ovals show the fans' status.

**Figure 58: Fan Status LED in SN2100**

The SN2100 systems have a front fan LED only.



**Table 17 - Fan Status Front LED Assignments**

LED Behavior	Description	Action Required
Solid Green	All fans are up and running.	N/A
Solid Red	Error, one or more fans are not operating properly.	The faulty FRUs should be replaced.
Off	System boot	N/A



[Table 18](#) does not apply to the SN2100 systems.

**Table 18 - Fan Status Rear LED Assignments (One LED per Fan)**

LED Behavior	Description	Action Required
Solid Green	A specific fan unit is operating.	N/A

LED Behavior	Description	Action Required
Solid Red	A specific fan unit is missing or not operating properly.	The fan unit should be replaced.
Off	System boot	N/A



**Risk of Electric Shock!**

With the fan module removed, power pins are accessible within the module cavity. Do not insert tools or body parts into the fan module cavity.

**3.2.1.3 Power Supply Status LEDs**



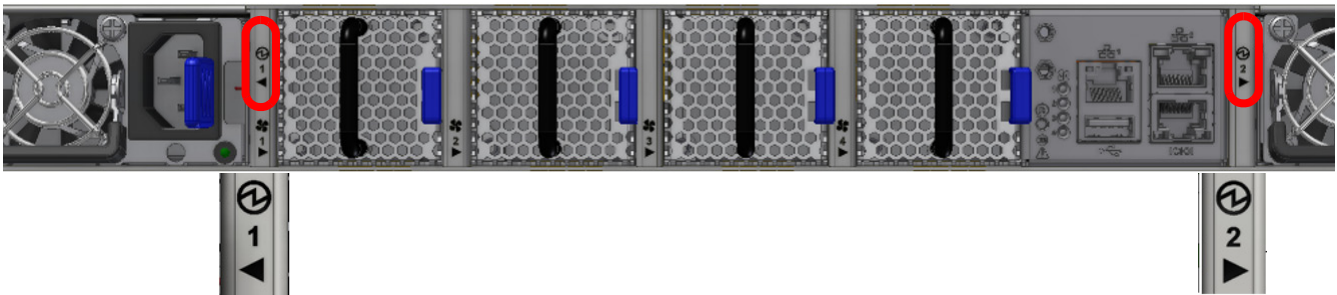
The following information does not apply to the SN2100 systems. In these systems, the power supply units are non-replaceable, and there is a designated LED for each unit in the system's front panel. See [Figure 3](#) and [Figure 5](#).

**Figure 59: Power Status LED**



There are two power supply inlets in the system (for redundancy). The system can operate with only one power supply connected. In case the power supply is an FRU, a second power supply unit can be added to support hot-swap ability. Each power supply unit has a single 2 color LED on the right side of the unit, that indicates the status of the unit.

**Figure 60: SN2700 and SN2410 Rear Side Panel**



The primary power supply (PS) unit is located on the left side, and the secondary unit is located on the right side.

**Table 19 - Power Supply Unit Status Front LED Assignments for SN2700 and SN2410**

LED Behavior	Description	Action Required
Solid Green	All plugged (one or two) power supplies are running normally.	N/A
Solid Red	PSU is faulty or disconnected	Make sure the AC cable is plugged in and active. If the problem resumes, the FRUs might be faulty, and should then be replaced.
Off	N/A	N/A

**Table 20 - Power Supply Unit Status Front LED Assignments for SN2100**

LED Behavior	Description	Action Required
Solid Green	Power supply is running normally.	N/A
Solid Red	PSU is faulty or disconnected	Make sure the AC cable is plugged in and active. If the problem resumes, the PSU might be faulty.
Off	PSU not present	N/A

The power supply status LEDs on the rear side of the system (in SN2700 and SN2410 only) are located on the PSUs themselves. Each PSU has one LED of its own



[Table 21](#) does not apply to the SN2100 systems.

**Table 21 - Power Supply Unit Status Rear LED Assignments**

LED Behavior	Description	Action Required
Solid Green	The PSU is running normally.	N/A
Flashing Green 1Hz	AC present / Only 12VSB on (PSU off) or PSU in Smart-on state.	Call your Mellanox representative for assistance.
Amber	AC cord unplugged or AC power lost while the second power supply still has AC input power.	Plug in the AC cord of the faulty PSU.
	PS failure (including voltage out of range and power cord disconnected).	Check voltage. If OK, call your Mellanox representative for assistance.
Flashing Amber	Power supply warning events where the power supply continues to operate; high temp, high power, high current, slow fan.	Call your Mellanox representative for assistance.

**Table 21 - Power Supply Unit Status Rear LED Assignments**

LED Behavior	Description	Action Required
Off	No AC power to all power supplies.	Call your Mellanox representative for assistance.

### 3.2.1.4 UID LED

The UID LED is a feature that can be used to find a particular system within a cluster. The specific system is signified by the blue UID LED.

### 3.2.1.5 Bad Port LED

The Bad Port LED indicator is used to indicate symbol errors in one or more system ports. Table 22 shows the bad port status LED assignment.

**Table 22 - Bad Port LED Assignments**

LED Configuration	Description	Action Required
Off	No symbol errors have been received in last few seconds (normal condition).	N/A
Flashing Amber	Error, one or more ports have received symbol errors. Possible causes are: <ul style="list-style-type: none"> <li>• Bad cable</li> <li>• Bad connection</li> <li>• Bad connector</li> </ul>	Check symbol error counters on the system UI to identify the ports. Replace the cable on these ports.

### 3.2.1.6 Port LEDs

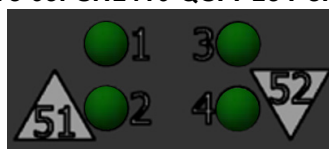
**Figure 61: SN2700 Port LEDs**



**Figure 62: SN2410 SFP28 Port LEDs**



**Figure 63: SN2410 QSFP28 Port LEDs**





**Figure 64: SN2100 Port LEDs**



In the SN2410 systems, the status of each pair of adjacent QSFP28 ports is indicated by four LEDs, as shown in the picture above:

- While the bottom LEDs signify the port status in regular condition, the upper LEDs operate only when the port is split.
- When one port is split to two, a connection of 100GbE can be utilized in its adjacent port.
- When one port is split to four, its adjacent port is canceled.
- If the ports run at a 100GbE/40GbE speed each, the two lower LEDs (2 and 4) will light green.
- If the ports run at a 50GbE speed each, the left LEDs (1 and 2) will light green for the upper port, and the right LEDs (3 and 4) will light green for the lower port.
- If the ports run at a 25GbE/10GbE speed each, all LEDs may light green, according to the selected lane.

**Table 23 - Port LEDs in Ethernet System Mode**

LED Behavior	Description	Action Required
Off	Link is down.	Check the cable
Solid Green	Link is up with no traffic.	N/A
Flashing Green	Link is up with traffic.	N/A
Flashing Amber	A problem with the link.	Check the cable, and replace it if needed.

### 3.3 Inventory Information

The system’s inventory parameters (such as Serial Number, Part Number, GUID and MAC address) can be extracted from the inventory pull-out tab on the lower right side of the front panel. In some systems, there is no pull-out tab, and the information is provided on labels in several locations.

Figure 65: SN2700 Pull-out Tab



Figure 66: SN2410 Inventory Information Illustration



Figure 67: SN2100 Pull-out Tab



## 4 Software Management

The systems include an embedded management CPU card that runs a management software. The system management software is called Mellanox Operating System (MLNX-OS). MLNX-OS® includes a CLI, WebUI, SNMP, system management software, Ethernet protocols and IB management software (OpenSM)

- For MLNX-OS systems management package and related documentation, visit the product page:  
[http://www.mellanox.com/page/mlnx\\_os](http://www.mellanox.com/page/mlnx_os).
- For Cumulus® Linux® software management instructions, refer to the [Cumulus Linux User Guide](#).



The Ethernet ports for remote management connect to Ethernet systems. These systems must be configured to 100Mb/1Gb auto-negotiation.



No more than two subnet managers are recommended for any single fabric.

### 4.1 Upgrading Software

#### 4.1.1 MLNX-OS Software Upgrade

Software and firmware updates are available from the Mellanox Support website. Check that your current revision is the latest one available on the Mellanox Support website. If you do not have the latest revision, upgrade your software using the CLI or the GUI. Copy the updated software to a known location on a remote server within the user's LAN.

For further information please refer to the MLNX-OS Software User Manual section *Upgrading MLNX-OS® Software*.

Prior to updating, read and follow all of the instructions regarding the updating of the software on your system.

#### 4.1.2 Switch Firmware Update

The systems do not require firmware updating. Firmware updating is done through the MLNX-OS management software.

#### 4.1.3 Cumulus Linux Software Upgrade

For Cumulus Linux software upgrade instructions, see [Upgrading Cumulus Linux](#) in the [Cumulus Linux User Guide](#).

## 5 Troubleshooting

### 5.1 Troubleshooting Instructions

*Table 24 - Troubleshooting*

Problem Indicator	Symptoms	Cause and Solution
LEDs	System Status LED is blinking for more than 5 minutes	<p><b>Cause:</b> MLNX-OS software did not boot properly and only firmware is running.</p> <p><b>Solution:</b> Connect to the system via the console port, and check the software status. You might need to contact an FAE if the MLNX-OS software did not load properly</p>
	System Status LED is red	<p><b>Cause:</b></p> <ul style="list-style-type: none"> <li>• Critical system fault (CPU error, bad firmware)</li> <li>• Over Temperature</li> </ul> <p><b>Solution:</b></p> <ul style="list-style-type: none"> <li>• Check environmental conditions (room temperature)</li> </ul>
	Fan Status LED is red	<p><b>Cause:</b> Possible fan issue</p> <p><b>Solution:</b></p> <ul style="list-style-type: none"> <li>• Check that the FAN is fully inserted and nothing blocks the airflow</li> <li>• Replace the FAN FRU if needed (possible in SN2700 and SN2410 only)</li> </ul>
	PSU Status LED is red	<p><b>Cause:</b> Possible PSU issue</p> <p><b>Solution:.</b></p> <ul style="list-style-type: none"> <li>• Check/replace the power cable</li> <li>• Replace the PSU if needed (possible in SN2700 and SN2410 only)</li> </ul>

**Table 24 - Troubleshooting**

Problem Indicator	Symptoms	Cause and Solution
System boot failure while using MLNX-OS	Software upgrade failed on x86 based systems	<p><b>Solution:</b></p> <ul style="list-style-type: none"> <li>• Connect the RS232 connector (CONSOLE) to a laptop.</li> <li>• Push the system's reset button.</li> <li>• Press the ArrowUp or ArrowDown key during the system boot. GRUB menu will appear. For example:</li> </ul> <pre> Default image: 'SX_X86_64 SX_3.4.0008 2014-11-10 20:07:51 x86_64' Press enter to boot this image, or any other key for boot menu Booting default image in 3 seconds.  Boot Menu ----- ----- 0: SX_X86_64 SX_3.4.0008 2014-11-10 20:07:51 x86_64 1: SX_X86_64 SX_3.4.0007 2014-10-23 17:27:34 x86_64 ----- -----  Use the ArrowUp and Arrowdown keys to select which entry is highlighted. Press enter to boot the selected image or 'p' to enter a password to unlock the next set of features.  Highlighted entry is 0: " </pre> <ul style="list-style-type: none"> <li>• Select previous image to boot by pressing an arrow key and choosing the appropriate image.</li> </ul>
System boot failure while using Cumulus Linux	Software upgrade failed on x86 based systems	See <a href="#">Monitoring and Troubleshooting</a> in <a href="#">Cumulus Linux User Guide</a> .

## 6 Specifications

### 6.1 SN2700 Series

**Table 25 - SN2700 Specifications**

Feature	Value
Mechanical	<b>Size:</b> <b>Standard</b> - 1.72” (H) x 16.84” (W) x 27” (D), 43.8mm (H) x 427.83mm (W) x 686.8mm (D) <b>Mounting:</b> 19” Rack mount
	<b>Mounting:</b> 19” Rack mount
	<b>Weight:</b> 1 PSU: 10.23kg, 2 PSUs: 11.1kg
	<b>Speed:</b> 10/25/40/50/56/100GbE per port
	<b>Connector cage:</b> 32 QSFP28
Environmental	<b>Temperature:</b> Operational: 0° to 40°C Non-Operational: -40° to 70°C
	<b>Humidity:</b> Operational: 10% - 85% non-condensing Non-Operational: 10% - 90% non-condensing
	<b>Altitude:</b> 3050m
	<b>Noise level:</b> 71.6 dB(A)
Regulatory	<b>Safety:</b> CS, cTUVus, CE, CU, <b>EMC:</b> CE, FCC, VCCI, ICES, RCM
	RoHS6
Power	<b>Input Voltage:</b> 100-127VAC; 50/60Hz 3.5A; 200-240 50/60Hz 2.9A/ 192-288VDC (not certified)
	<b>Global Power Consumption:</b> <b>40GbE Models -</b> Max power with optical cables (assuming 2W per port): 308.5W <b>100GbE Models -</b> Typical power with passive cables (ATIS): 150W Max power with optical cables (assuming 3.5W per port): 398W
Main Devices	<b>CPU:</b> Intel x86 1.40GHZ Dual Core <b>PCIe:</b> 4x Gen2.0
	<b>Switch:</b> Mellanox Spectrum™
	<b>Memory:</b> 8GB DDR3 RAM, 32GB SSD
Switching	<b>Capacity:</b> 3.2Tb/s



## 6.2 SN2410 Series

**Table 26 - SN2410 Specifications**

Feature	Value
Mechanical	<b>Size:</b> 43.8mm (H) x 438mm (W) x 436mm (D) 1.72"(H) x 17.24"(W) x 17"(D)
	<b>Mounting:</b> 19" Rack mount
	<b>Weight:</b> 2 PSUs: 8.52kg
	<b>Speed:</b> 10/25GbE per port (ports 1-48), 10/25/40/50/56/100GbE per port (ports 49-56)
	<b>Connector cage:</b> 48xSFP28 and 8xQSFP28
Environmental	<b>Temperature:</b> Operational: 0° to 40°C Non-Operational: -40° to 70°C
	<b>Humidity:</b> Operational: 10% - 85% non-condensing Non-Operational: 10% - 90% non-condensing
	<b>Altitude:</b> 3050m
	<b>Noise level:</b> 70.9 dB(A)
Regulatory	<b>Safety:</b> CS, cTUVus, CE, CU <b>EMC:</b> CE, FCC, VCCI, ICES, RCM
	RoHS6
Power	<b>Input Voltage:</b> 100-127Vac 50/60Hz 4.5A; 200-240 50/60Hz 2.9A/ 192-288VDC (not certified)
	<b>Global Power Consumption:</b> 40GbE Models: Max power with optical cables (assuming 2W per each QSFP28 port, and 1W per each SFP28 port): 295.1 100GbE Models: Typical power with passive cables (ATIS): 165W Max power with optical cables (assuming 3.5W per each QSFP28 port, and 1.5W per each SFP28 port): 362W
Main Devices	<b>CPU:</b> Intel x86 1.40GHZ Dual Core <b>PCIe:</b> 4x Gen2.0
	<b>Switch:</b> Mellanox Spectrum™
	<b>Memory:</b> 8GB DDR3 RAM 32GB SSD
Switching	<b>Capacity:</b> 2Tb/s



## 6.3 SN2100 Series

**Table 27 - SN2100 Specifications**

Feature	Value
Mechanical	<b>Size:</b> 43.8mm (H) x 200mm (W) x 508mm (D) 1.72" (H) x 7.87" (W) x 20" (D)
	<b>Mounting:</b> 19" Rack mount
	<b>Weight:</b> 4.540kg
	<b>Speed:</b> 10/25/40/50/56/100GbE per port
	<b>Connector cage:</b> 16xQSFP28
Environmental	<b>Temperature:</b> Operational: 0° to 40°C Non-Operational: -40° to 70°C
	<b>Humidity:</b> Operational: 10% - 85% non-condensing Non-Operational: 10% - 90% non-condensing
	<b>Altitude:</b> 3050m
	<b>Noise level:</b> 73.7 dB(A)
Regulatory	<b>Safety:</b> CS, cTUVus, CE, CU <b>EMC:</b> CE, FCC, VCCI, ICES, RCM
	RoHS6
Power	<b>Input Voltage:</b> 100-127VAC 50/60Hz 4.5A; 200-240 50/60Hz 2.9A
	<b>Global Power Consumption:</b> Typical power with passive cables (ATIS): 94.3W Max power with optical cables (assuming 3.5W per each QSFP28 port): 248.6W
Main Devices	<b>CPU:</b> Intel x86 2.40GHZ QUAD CORE <b>PCIe:</b> 4x Gen2.0
	<b>Switch:</b> Mellanox Spectrum™
	<b>Memory:</b> SDRAM: 8GB DDR3L 1600 MT/s SO-DIMM Storage: 16GB Dual Channel MLC M.2-SATA SSD
Switching	<b>Capacity:</b> 1.6Tb/s

## Appendix A: Accessory and Replacement Parts

**Table 28 - OPNs for Replacement Parts**

OPN	Part Description
MTEF-KIT-A	Rack installation kit for 1U systems to be mounted into short or standard depth racks
MTEF-KIT-S	Rack installation kit for standard depth 1U systems to be mounted into standard depth racks
MTEF-KIT-BP	Rack installation kit for 1U wide systems to be mounted into short depth racks
MTEF-KIT-SP	Rack installation kit for 1U wide systems to be mounted into standard depth racks
MTEF-KIT-D	Rack installation kit for SN2100 series short depth 1U switches, allows installation of one or two switches side-by-side into standard depth racks
MTEF-PSF-AC-A	460W AC Power Supply w/ rear to front air flow
MTEF-PSR-AC-A	460W AC Power Supply w/ front to rear air flow
HAR000028	Harness RS232 2M cable – DB9 to RJ-45
ACC000501	Power cord Type C13-C14
MTEF-FANF-A	Fan module w/rear to front airflow
MTEF-FANR-A	Fan module w/front to rear airflow fan for SX67X0/SX1710 switch systems

## Appendix B: Thermal Threshold Definitions

There are three thermal threshold definitions for the switch device which impact the overall switch system operation state:

- Warning – 105°C: On managed systems only: When the device crosses the 100°C threshold, a Warning Threshold message will be issued by the management SW, indicating to system administration that the switch has crossed the Warning threshold. Note that this temperature threshold does not require nor lead to any action by hardware (such as switch shutdown).
- Critical – 120°C: When the device crosses this temperature, the firmware will automatically shut down the device.
- Emergency – 130°C: In case the firmware fails to shut down the device upon crossing the Critical threshold, the device will auto-shutdown upon crossing the Emergency (130°C) threshold.



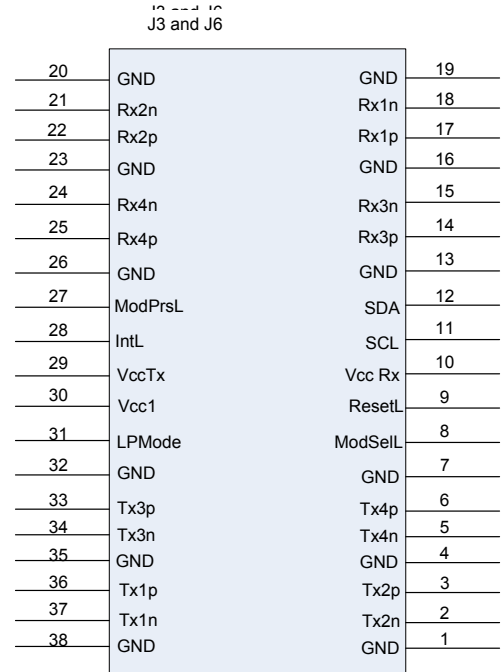
For thermal threshold definitions in Cumulus Linux, see [Configuring Net-SNMP Event Notification Traps](#) in the [Cumulus Networks Help Center](#).

# Appendix C: Interface Specifications

## C.1 SFP28 Interface

Table 29 - QSFP Interface Pins 1-23

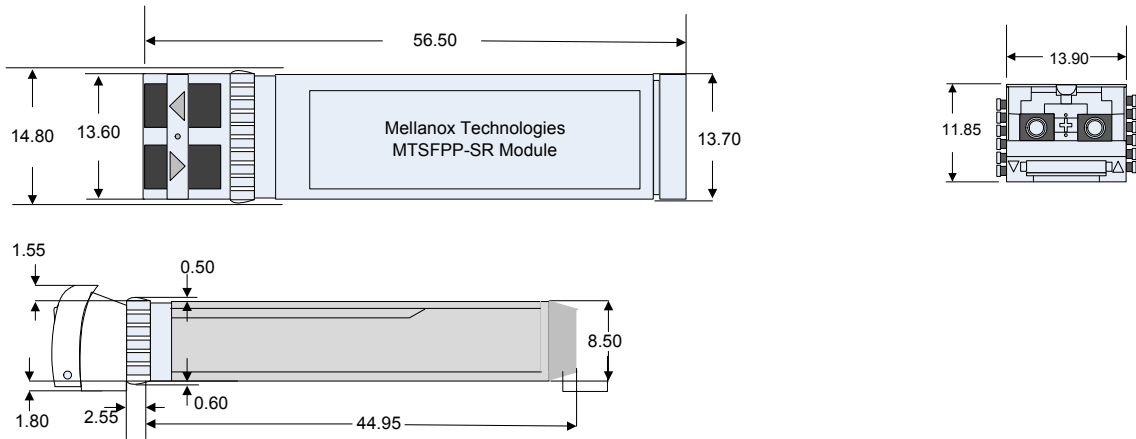
Connector Pin Number	Connector Pin Name	Signal Description
1	GND	Ground
2	Tx2n	Transmitter Inverted Data Input
3	Tx2p	Transmitter Non-Inverted Data Input
4	GND	Ground
5	Tx4n	Transmitter Inverted Data Input
6	Tx4p	Transmitter Non-Inverted Data Input
7	GND	Ground
8	ModSelL	Module Select
9	ResetL	Module Reset
10	Vcc Rx	+3.3 V Power supply receiver
11	SCL	2-wire serial interface clock
12	SDA	2-wire serial interface data
13	GND	Ground
14	Rx3p	Receiver Non-Inverted Data Output
15	Rx3n	Receiver Inverted Data Output
16	GND	Ground
17	Rx1p	Receiver Non-Inverted Data Output
18	Rx1n	Receiver Inverted Data Output
19	GND	Ground
20	GND	Ground
21	Rx2n	Receiver Inverted Data Output 3
22	Rx2p	Receiver Non-Inverted Data Output 3
23	GND	Ground



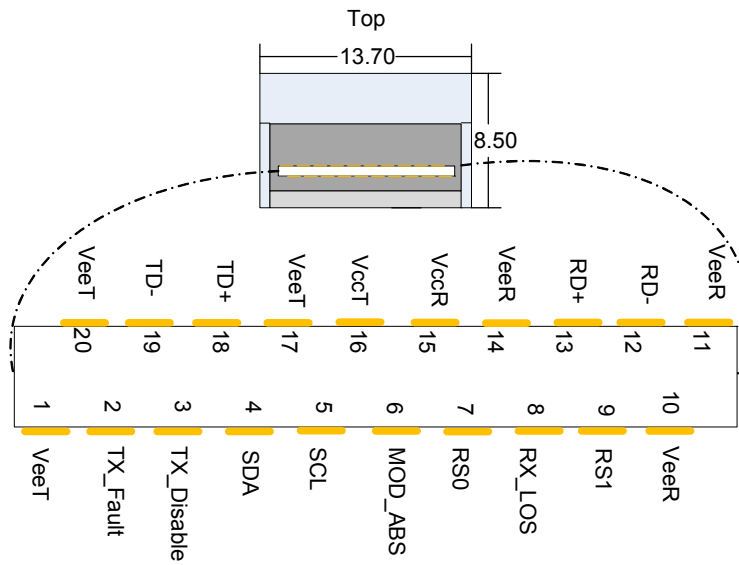
**Table 30 - QSFP Interface Pins 24-38**

Connector Pin Number	Connector Pin Name	Signal Description
24	Rx4n	Receiver Inverted Data Output 3
25	Rx4p	Receiver Non-Inverted Data Output 3
26	GND	Ground
27	ModPrsL	Module Present
28	IntL	Interrupt
29	Vcc Tx	+3.3 V Power supply transmitter
30	Vcc 1	+3.3 V Power Supply
31	LPMode	Low Power Mode
32	GND	Ground
33	Tx3p	Transmitter Non-Inverted Data Input
34	Tx3n	Transmitter Inverted Data Input
35	GND	Ground
36	Tx1p	Transmitter Non-Inverted Data Input
37	Tx1n	Transmitter Inverted Data Input
38	GND	Ground

## C.2 SFP28 Interface



**Figure 68: Rear View of Module With Pin Placement**



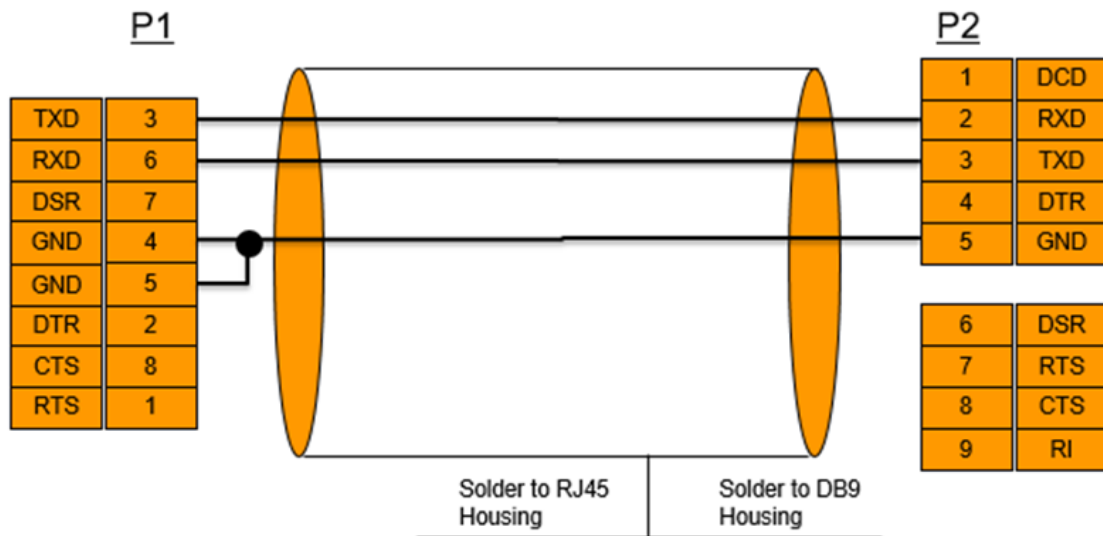
Pin	Symbol Name	Description
1	VeeT	Transmitter Ground (Common with Receiver Ground) <sup>a</sup>
2	TX_Fault	Transmitter Fault. <sup>b</sup>
3	TX_Disable	Transmitter Disable. Laser output disabled on high or open. <sup>c</sup>
4	SDA	2-wire Serial Interface Data Line <sup>d</sup>
5	SCL	2-wire Serial Interface Clock Line <sup>d</sup>
6	MOD_ABS	Module Absent. Grounded within the module <sup>d</sup>
7	RS0	No connection required
8	RX_LOS	Loss of Signal indication. Logic 0 indicates normal operation. <sup>e</sup>
9	RS1	No connection required
10	VeeR	Receiver Ground (Common with Transmitter Ground) <sup>a</sup>
11	VeeR	Receiver Ground (Common with Transmitter Ground) <sup>a</sup>
12	RD-	Receiver Inverted DATA out. AC Coupled
13	RD+	Receiver Non-inverted DATA out. AC Coupled
14	VeeR	Receiver Ground (Common with Transmitter Ground) <sup>a</sup>
15	VccR	Receiver Power Supply
16	VccT	Transmitter Power Supply
17	VeeT	Transmitter Ground (Common with Receiver Ground) <sup>a</sup>
18	TD+	Transmitter Non-Inverted DATA in. AC Coupled.
19	TD-	Transmitter Inverted DATA in. AC Coupled.
20	VeeT	Transmitter Ground (Common with Receiver Ground) <sup>a</sup>

- a. Circuit ground is internally isolated from chassis ground.
- b. T<sub>FAULT</sub> is an open collector/drain output, which should be pulled up with a 4.7k – 10k Ohms resistor on the host board if intended for use. Pull up voltage should be between 2.0V to Vcc + 0.3V. A high output indicates a transmitter fault caused by either the TX bias current or the TX output power exceeding the preset alarm thresholds. A low output indicates normal operation. In the low state, the output is pulled to <0.8V.
- c. Laser output disabled on TDIS >2.0V or open, enabled on TDIS <0.8V
- d. Should be pulled up with 4.7kΩ – 10kΩ on host board to a voltage between 2.0V and 3.6V. MOD\_ABS pulls line low to indicate module is plugged in.
- e. LOS is open collector output. Should be pulled up with 4.7kΩ – 10kΩ on host board to a voltage between 2.0V and 3.6V. Logic 0 indicates normal operation; logic 1 indicates loss of signal.

### C.3 RJ45 to DB9 Harness Pinout

In order to connect a host PC to the Console RJ45 port of the system, a RS232 harness cable (DB9 to RJ45) is supplied.

**Figure 69: RJ45 to DB9 Harness Pinout**





## Appendix D: Disassembly and Disposal

### D.1 Disassembly Procedure

➤ *To disassemble the system from the rack:*

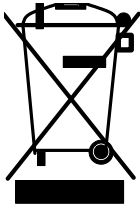
1. Unplug and remove all connectors.
2. Unplug all power cords.
3. Remove the ground wire.
4. Unscrew the center bolts from the side of the system with the bracket.



Support the weight of the system when you remove the screws so that the system does not fall.

5. Slide the system from the rack.
6. Remove the rail slides from the rack.
7. Remove the caged nuts.

### D.2 Disposal



According to the WEEE Directive 2002/96/EC, all waste electrical and electronic equipment (EEE) should be collected separately and not disposed of with regular household waste.

Dispose of this product and all of its parts in a responsible and environmentally friendly way.

Follow the instructions found at [http://www.mellanox.com/page/dismantling\\_procedures](http://www.mellanox.com/page/dismantling_procedures) for proper disassembly and disposal of the switch, according to the WEEE directive.

## Appendix E: Safety Warnings (Multiple Languages)

### E.1 Nordic Countries Notices



In Finland: "Laitte on liitettävä suojakoskettimilla varustettuun pistorasiaan"  
 In Norway: "Apparatet må tilkoples jordet stikkontakt"  
 In Sweden: "Apparaten skall anslutas till jordat uttag"

### E.2 Installation Safety Warnings (English)

#### 1. Installation Instructions

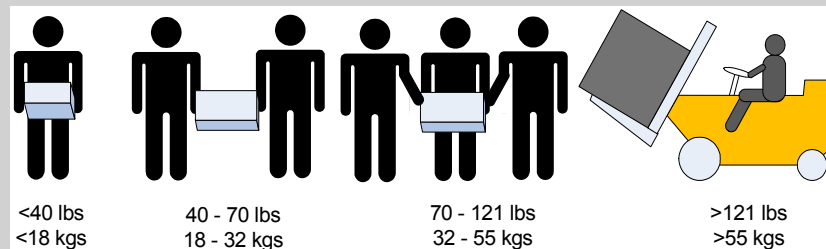


Read all installation instructions before connecting the equipment to the power source.

#### 2. Bodily Injury Due to Weight



Use enough people to safely lift this product.



#### 3. Heavy Equipment



This equipment is heavy and should be moved using a mechanical lift to avoid injuries.

#### 4. Risk of Electric Shock!



##### Risk of Electric Shock!

With the fan module removed power pins are accessible within the module cavity. Do not insert tools or body parts into the fan module cavity.

#### 5. Over-temperature



This equipment should not be operated in an area with an ambient temperature exceeding the maximum recommended: 45°C (113°F). Moreover, to guarantee proper , allow at least 8cm (3 inches) of clearance around the ventilation openings.

## 6. Stacking the Chassis



The chassis should not be stacked on any other equipment. If the chassis falls, it can cause bodily injury and equipment damage.

## 7. Redundant Power Supply Connection - Electrical Hazard



This product includes a redundant power or a blank in its place. In case of a blank power supply, do not operate the product with the blank cover removed or not securely fastened.

## 8. Double Pole/Neutral Fusing



This system has double pole/neutral fusing. Remove all power cords before opening the cover of this product or touching any internal parts.

## 9. Multiple Power Inlets



### **Risk of electric shock and energy hazard.**

The PSUs are all independent.

Disconnect all power supplies to ensure a powered down state inside of the switch platform.

## 10. During Lightning - Electrical Hazard



During periods of lightning activity, do not work on the equipment or connect or disconnect cables.

## 11. CopperCable Connecting/Disconnecting



Copper cables are heavy and not flexible, as such they should be carefully attached to or detached from the connectors. Refer to the cable manufacturer for special warnings/instructions.

## 12. Rack Mounting and Servicing



When this product is mounted or serviced in a rack, special precautions must be taken to ensure that the system remains stable. In general you should fill the rack with equipment starting from the bottom to the top.

## 13. Equipment Installation



This equipment should be installed, replaced, and/or serviced only by trained and qualified personnel.

#### 14. Equipment Disposal



Disposal of this equipment should be in accordance to all national laws and regulations.

#### 15. Local and National Electrical Codes



This equipment should be installed in compliance with local and national electrical codes.

#### 16. Installation Codes



This device must be installed according to the latest version of the country national electrical codes. For North America, equipment must be installed in accordance to the applicable requirements in the US National Electrical Code and the Canadian Electrical Code.

#### 17. Battery Replacement



Warning: Replace only with UL Recognized battery, certified for maximum abnormal charging current not less than 4mA

There is a risk of explosion should the battery be replaced with a battery of an incorrect type.

Dispose of used batteries according to the instructions.

#### 18. UL Listed and CSA Certified Power Supply Cord



For North American power connection, select a power supply cord that is UL Listed and CSA Certified, 3 - conductor, [16 AWG], terminated with a molded plug rated at 125 V, [13 A], with a minimum length of 1.5m [six feet] but no longer than 4.5m.

For European connection, select a power supply cord that is internationally harmonized and marked “<HAR>”, 3 - conductor, minimum 1.0 mm<sup>2</sup> wire, rated at 300 V, with a PVC insulated jacket. The cord must have a molded plug rated at 250 V, 10 A.

#### 19. Installation codes



This device must be installed according to the latest version of the country national electrical codes. For North America, equipment must be installed in accordance to the applicable requirements in the US National Electrical Code and the Canadian Electrical Code.

#### 20. Interconnection Of Units



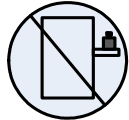
Cables for connecting to the unit RS232 and Ethernet Interfaces must be UL certified type DP-1 or DP-2. (Note- when residing in non LPS circuit)

## 21. Overcurrent Protection



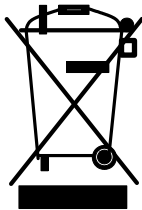
A readily accessible Listed branch circuit overcurrent protective device rated 20 A must be incorporated in the building wiring.

## 22. Do Not Use the Switch as a Shelf or Work Space



Caution: Slide/rail mounted equipment is not to be used as a shelf or a work space. The rails are not intended for sliding the unit away from the rack. It is for permanent installation at final resting place only, not used for service and maintenance

## 23. WEEE Directive



According to the WEEE Directive 2002/96/EC, all waste electrical and electronic equipment (EEE) should be collected separately and not disposed of with regular household waste.

Dispose of this product and all of its parts in a responsible and environmentally friendly way.

## 24. Country of Norway Power Restrictions



This unit is intended for connection to a TN power system and an IT power system of Norway only.

## הוראות בטיחות בהתקנה (Hebrew)

E.3

### 1. הוראות התקנה

קרא היטב את כל הוראות ההתקנה לפני חיבור המוצר לחשמל.



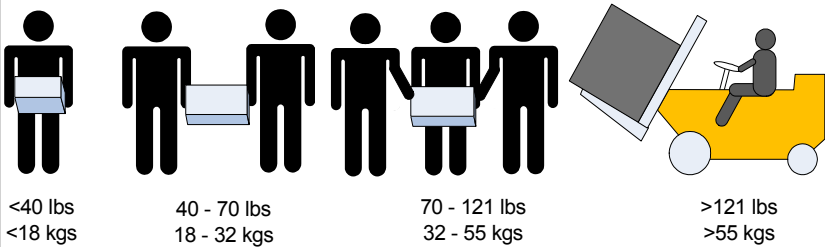
### 2. תקן ישראלי

יש להתקין את המוצר תוך הקפדה על תקנות החשמל הנהוגות בישראל, ולעשות שימוש ביחידת חלוקת כוח העומדת בתקן ישראל (ת"י) 32.



### 3. חבלת גוף כתוצאה מנשיאת משקל יתר

נדרשת נוכחותם של מספר מתקינים כדי להרים את המוצר בבטחה.



<40 lbs <18 kgs	40 - 70 lbs 18 - 32 kgs	70 - 121 lbs 32 - 55 kgs	>121 lbs >55 kgs
--------------------	----------------------------	-----------------------------	---------------------



### 4. ציוד כבד

המוצר כבד, ויש לשנעו באמצעות מעלית מכאנית כדי למנוע חבלה.



### 5. סכנת התחשמלות!

סכנת התחשמלות!  
בעת שיחידת המאוורר מפורקת, רכיבי חשמל נחשפים בחלל הריק. אין להחדיר כלים או איברי גוף לחלל המיועד להרכבת היחידה.



### 6. התחממות יתר

אין להפעיל את המוצר באיזור שבו טמפרטורת החדר עולה על הטמפרטורה המקסימלית (המומלצת: 45°C (113°F)). בנוסף, כדי להבטיח כניסת אוויר תקינה, יש לוודא כי קיים שטח פנוי של 8 ס"מ (3 אינץ') לפחות סביב פתחי האוורור.



### 7. ערימת המערכת

אין לערום את המערכת על גבי ציוד אחר. במקרה של נפילה, עשויים להגרם נזקי גוף ורכוש.



### 8. חיבור ספק כוח נוסף-סכנת התחשמלות

המערכת מכילה ספק כוח נוסף לגיבוי, או, בחלק מהמקרים, חלל ריק המאפשר הרכבת ספק כזה. אין לעשות שימוש במערכת כשהמכסה החוסם את החלל הריק אינו סגור כהלכה.



### 9. מספר שקעים חשמליים

סכנת התחשמלות ואזהרת אנרגיה  
כל אחד מספקי הכוח פועל באופן עצמאי. יש לנתק את כל ספקי הכוח, כדי להבטיח ניתוק מוחלט של המערכת מזרם חשמלי.



## 10. בעת סופות ברקים - סכנת התחשמלות!

בעת סופות ברקים, אין להפעיל את המערכת או לחבר/לנתק כבלים



## 11. חיבור או ניתוק של כבלי נחושת

כבלי נחושת הם כבדים וקשיחים. לפיכך, יש לחברם ולנתקם מהמחברים בזהירות רבה. לאזהרות נוספות, יש לעיין בעלון לצרכן מטעם יצרן הכבלים.



## 12. הרכבה על גבי מדף בארון

כאשר מרכיבים מוצר זה על גבי מדף בארון, יש לנקוט באמצעי זהירות מיוחדים בכדי להבטיח שיוותר יציב. ככלל, יש להתחיל למלא את הארון מהמדף התחתון, ולהתקדם כלפי מעלה.



## 13. התקנת המוצר

כל התקנה, החלפה או טיפול במוצר זה חייבות להתבצע על ידי איש צוות מיומן ומוסמך בלבד.



## 14. השלכה לאשפה בתום השימוש

השלכת המוצר בתום השימוש חייבת להיעשות בהתאם לכל התקנות והחוקים המקומיים.



## 15. תקנות חשמל מקומיות

יש להתקין מערכת זו בהתאם לתקנות החשמל המקומיות.



## 16. כבל אספקת חשמל

על מנת לחבר את המוצר לחשמל בצפון אמריקה, יש לבחור כבל חשמלי ובעל הסמכת CSA, מוליך 3- [AWG 16], שבקצהו תקע מובנה A13 V125, אורכו המינימלי 1.5 מטר (6 אינץ') ואורכו המקסימלי 4.5 מטר. לחיבור אירופאי, בחר כבל חשמלי בעל התאמה בינלאומית וסימון "<HAR>" מוליך - 3, גידים פנימיים באורך מינימלי של 1.0 מילימטר<sup>2</sup>, 300V, עם עטיפת PVC מבודדת. על הכבל לכלול תקע מובנה A10, V250.



### 17. תקנות התקנה

יש להתקין מערכת זו על פי הגרסה האחרונה של תקנות החשמל המקומיות הנהוגות במדינה. עבור צפון אמריקה, יש להתקין את המערכת בהתאם לתקנות החשמל הלאומיות המיושמות בארה"ב ובקנדה.



### 18. חיבור בין מערכות

על כבלים לחיבור היחידה לממשקי RS232 ו-Ethernet להיות בעלי הסמכת UL מסוג DP-1 או DP-2 (כאשר הם מצויים במעגל חשמלי שאינו מקור כוח מוגבל).



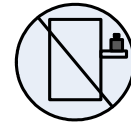
### 19. הגנה מפני מתח גבוה

יש להקפיד על המצאותם בבניין ועל זמינותם של אמצעים להגנה מפני מתח גבוה בתקן 20A.



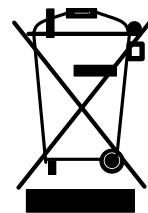
### 20. אין להשתמש במערכת כמדף או כשטח עבודה

זהירות: אין להשתמש בצידוד כמדף או כשטח עבודה. המסילות לא נועדו לשליפת המערכת מהארון, אלא להתקנת המערכת במיקומה הקבוע והסופי בארון.



### 21. תקנת WEEE

על פי תקנות WEEE 2002/96/EC, יש להשליך את כל פסולת הציוד החשמלי והאלקטרוני בנפרד מפסולת ביתית רגילה. בתום השימוש, השלך לאשפה את המוצר הזה ואת כל חלקיו באופן אחראי וידידותי לסביבה.



### 22. מגבלות חשמליות בנורבגיה

בנורבגיה בלבד, יחידה זו מיועדת לחיבור למערכת אספקת חשמל מסוג TN, ולמערכת אספקת חשמל מסוג IT.





## E.4 安裝安全性警告 (Chinese)

### 1. 安裝指示

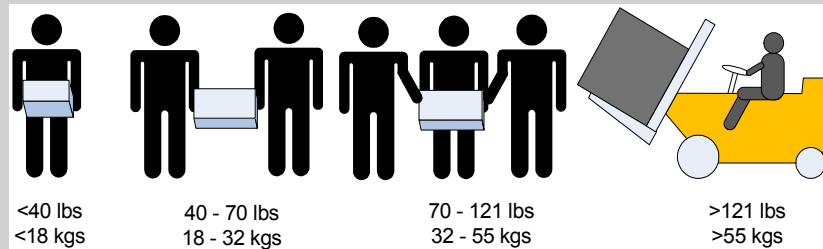


本設備附有備援電源供應器或在適當位置配有空白蓋板。

### 2. 因重量導致的人身受傷



為了安全起見，請安排足夠的人員以合力抬起本產品。



### 3. 重設備



本設備極重，應使用機械式起重機來搬移，以避免人員受傷。

### 4. 有觸電的危險



有觸電的危險！

拆除風扇模組後，即可接觸到模組空腔內的電源針腳。  
請勿將工具或機身零件插入到風扇模組空腔內。

### 5. 溫度過高



本設備不應在超過所建議的最高環境溫度的區域中運作：45°C (113°F)。此外，為了保證氣流的流通正常，請在通風口旁保留至少 8 公分 (3 英吋) 的間距。

### 6. 堆疊機箱



機箱不應堆疊在任何其他設備上。如果機箱掉落，可能造成人員受傷與設備損壞。

## 7. 複式電源連接時的電擊危險



本設備附有備援電源供應器或在適當位置配有空白蓋板。如果是電源供應器空白蓋板，在空白蓋板已取下或未牢牢固訂的情況下，請勿操作本產品。

## 8. 雙極 / 中性保險絲



本系統具有雙極 / 中性保險絲。請拔掉所有電源線後，再打開本產品的蓋板或碰觸任何內部零件。

## 9. 多電源輸入座



電擊與能源危害的危險。  
所有 PSU 均各自獨立。  
將所有電源供應器斷電，確保交換器平台內部在電源關閉狀態。

## 10. 閃電時的電擊危險



在閃電期間，不要使用本設備或連接或拔下纜線。

## 11. 機架安裝與維修



此產品已安裝在機架中或在機架中維修時，必須採取特定預防措施以確保系統維持穩定。一般您應該將設備從底部到頂端放滿機架。

## 12. 設備安裝



本設備僅限由經過訓練與 / 或合格的人員安裝、更換或維修。

## 13. 設備棄置



棄置本設備應遵照所有國內法規。

## 14. 當地與國家電氣法規



請遵照當地與國家電氣法規安裝本設備。

## 15. 安裝法規



請務必遵循最新版的國家電氣法規，安裝本設備。在北美地區，請務必遵循美國國家電工法規和加拿大電工法規中的適用規定，安裝本設備。

## 16. 更換電池



警告：只能以 UL 認可電池，且取得最大異常充電電流低於 4mA 認證的電池進行更換。

若更換錯誤類型的電池，會有爆炸的危險。

請依據指示棄置廢電池。

## 17. UL 列名和 CSA 認證電源線



北美地區在接上電源時，請選用獲得 UL 列名和 CSA 認證、三個導體、[16 AWG] 附成型插頭，額定值為 125 V、[13 A]，長度至少 1.5 公尺 [六英尺]，但不超過 4.5 公尺的電源線。

歐洲地區在接上電源時，請選用國際協調式且標示有 <HAR> 字樣、三個導體、標稱截面至少 1.0 平方公厘，額定值為 300 V，採用 PVC 絕緣的電源線。電源線需有成型插頭，額定值為 250 V，10 A。

## 18. 高漏電流



警告：高漏電流；必須執行地線連接，然後再連接電源供應器。

## 19. 安裝法規



請務必遵循最新版的國家電氣法規，安裝本設備。在北美地區，請務必遵循美國國家電工法規和加拿大電工法規中的適用規定，安裝本設備。

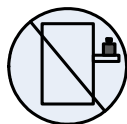
## 20. 互連設備



連接至 RS232 設備和乙太網路介面的纜線必須是 UL 認證類型 DP-1 或 DP-2。  
(請注意位於非 LPS 電路時)

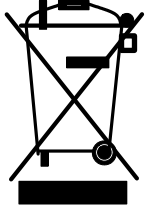
過電流保護：準備好使用的列名分支電路過電流保護裝置最大額定值 20 A 必須整合在配線中。

## 21. 切換開關不可用作機架或工作空間



小心：滑軌 / 導軌安裝設備不可用作機架或工作空間。導軌不適用於將設備滑出機架使用。僅限永久安裝在最後安置區域時使用，不可用於維修和保養。

## 22. WEEE 指令



根據 WEEE 指令 2002/96/EC，所有廢棄的電氣與電子設備 (EEE)，應分開集中，而且不應與一般家庭廢棄物一起棄置。  
請以負責和環保的方式棄置本產品及其所有零件。

## 23. 挪威國家電源限制



本設備僅限連接至挪威的 TN 電源系統和 IT 電源系統。



## E.5 Avertissements de sécurité pour l'installation (French)

### 1. Instructions d'installation

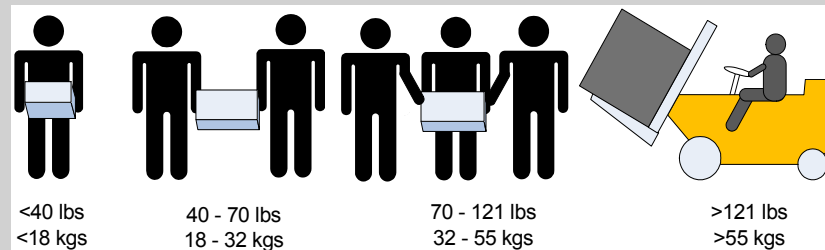


Veillez lire la totalité des instructions d'installation avant de relier l'équipement au secteur.

### 2. Blessures à cause du poids



Prévoyez assez de personnel pour soulever ce produit en toute sécurité.



### 3. Équipement lourd



Cet équipement est lourd et doit être déplacé avec un système de levage mécanique pour éviter les blessures.

### 4. Danger d'électrocution



Danger d'électrocution !

Lorsque le module de ventilation est retiré, les broches d'alimentation sont exposées dans l'emplacement du module.

NE PAS insérer d'outils ou la main dans l'emplacement du module.

### 5. Surchauffe



Cet équipement ne doit pas être en service dans un local dont la température dépasse le maximum recommandé de 45°C (113°F). En outre et pour garantir une circulation d'air correcte, laisser un espace d'au moins 8 cm (3") autour des orifices de ventilation.

### 6. Châssis empilé sur d'autres équipements



Le châssis ne doit pas être empilé sur d'autres équipements. S'il tombe, il peut endommager l'équipement ou entraîner des blessures.

### 7. Connexion de l'alimentation redondante : danger d'électrocution



Ce produit est équipé d'une alimentation redondante ou d'un cache si elle est absente. Dans ce dernier cas, ne pas faire fonctionner le produit si le cache est retiré ou mal fixé.

## 8. Fusibles phase/neutre



Ce système dispose de fusibles phase/neutre. Débranchez tous les cordons d'alimentation avant d'ouvrir le capot ou de toucher tout élément à l'intérieur.

## 9. Plusieurs prises d'alimentation



Risque et danger d'électrocution.  
Les alimentations sont toutes indépendantes.  
Pour s'assurer que le commutateur est bien hors tension, débranchez toutes les alimentations.

## 10. En cas d'orage, danger d'électrocution



Pendant un orage, ne pas travailler sur l'équipement ni brancher ou débrancher des câbles.

## 11. Connexion et déconnexion du câble en cuivre



Les câbles en cuivre sont lourds et peu flexibles. Par conséquent, il faut procéder avec soin pour les brancher ou les débrancher des connecteurs. Consulter le fabricant du câble pour obtenir des instructions ou des avertissements spécifiques.

## 12. Montage en rack et maintenance



Lors du montage ou de la maintenance de ce produit dans un rack, il faut faire spécialement attention pour s'assurer que l'ensemble reste stable. En règle générale, le rack doit être rempli en commençant par le bas.

## 13. Installation de l'équipement



Cet équipement ne doit être installé, remplacé et maintenu que par un personnel formé et qualifié.

## 14. Mise au rebut de l'équipement



La mise au rebut de cet équipement doit se faire conformément à toutes les lois et réglementations nationales.

## 15. Codes électriques locaux et nationaux



Cet équipement doit être installé conformément aux codes électriques locaux et nationaux.

## 16. Codes d'installation



Cet appareil doit être installé conformément à la version la plus récente des codes électrique nationaux. En Amérique du Nord, l'équipement doit être installé en respectant les exigences de l'US National Electrical Code et du Code canadien de l'électricité.

## 17. Remplacement de la batterie



**Avertissement :** ne remplacer qu'avec une batterie UL, certifiée pour accepter un courant de charge anormal maximal supérieur ou égal à 4 mA.

Si la batterie n'est pas remplacée par un type correct, il y a un risque d'explosion. Les batteries usagées doivent être mises au rebut conformément aux instructions.

## 18. Cordon d'alimentation UL Listed et certifié CSA



Pour le branchement électrique en Amérique du Nord, utiliser un cordon d'alimentation UL Listed et CSA Certified, à 3 conducteurs [calibre 16 AWG], avec une prise moulée 125 V [13 A], faisant au moins 1,5 m de long [six pieds] et au plus 4,5 m.

Pour le branchement électrique en Europe, utiliser un cordon d'alimentation au format international harmonisé (marqué <HAR>), à 3 conducteurs d'au moins 1 mm<sup>2</sup> de section, 300 V, avec une gaine isolante en PVC. Le cordon doit avoir une prise moulée 250 V 10 A.

## 19. Courant de fuite élevé



**Avertissement :** courant de fuite élevé, une connexion à la terre est indispensable avant de brancher l'alimentation.

## 20. Codes d'installation



Cet appareil doit être installé conformément à la version la plus récente des codes électrique nationaux. En Amérique du Nord, l'équipement doit être installé en respectant les exigences de l'US National Electrical Code et du Code canadien de l'électricité.

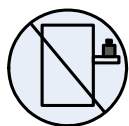
## 21. Interconnexion des unités



Les câbles de connexion aux interfaces RS232 et Ethernet de l'appareil doivent être certifié UL de type DP-1 ou DP-2. (Note : en cas d'installation sur un circuit dont la puissance n'est pas limitée)

Protection contre les surintensités : le câblage de l'immeuble doit intégrer un dispositif certifié de protection contre les surintensités, calibré à 20 A et aisément accessible.

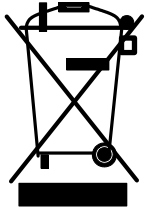
## 22. Ne pas utiliser comme étagère ou plan de travail



**Attention :** un équipement coulissant ou monté sur rail ne doit pas servir d'étagère ni de plan de travail. Les rails ne sont pas destinés à faire coulisser l'unité hors du rack. Ils sont destinés à une installation permanente à l'emplacement final, pas pour l'entretien ni la maintenance.



### 23. Directive DEEE



Selon la Directive 2002/96/CE (DEEE), tous les déchets d'équipements électriques et électroniques (EEE) doivent être collectés séparément et ne pas être mis au rebut avec les déchets ménagers habituels.  
Ce produit et toutes ses pièces doivent être mis au rebut d'une manière responsable, respectant l'environnement.

### 24. Restrictions concernant l'alimentation pour la Norvège



Cet appareil est prévu pour être relié à un système d'alimentation TN et un système d'alimentation informatique de Norvège uniquement.

## E.6 Installation Sicherheitshinweise(German)

### 1. Installationsanleitungen

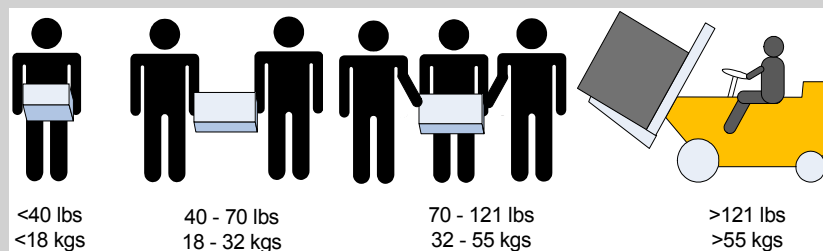


Lesen Sie alle Installationsanleitungen, bevor Sie das Gerät an die Stromversorgung anschließen.

### 2. Verletzungsgefahr wegen des Gewichts



Um das Produkt sicher anzuheben, genügend Personen einsetzen.



### 3. Schweres Gerät



Dieses Gerät ist schwer und muss mit einem mechanischen Hebegerät verschoben werden, um Verletzungen zu vermeiden.

#### 4. Stromschlagrisiko



Stromschlagrisiko!

Bei abgenommenem Ventilatormodul sind die Stromkontakte in der Modulvertiefung zugänglich.

Es dürfen KEINE Werkzeuge oder Körperteile in die Vertiefung des Ventilatormoduls gelangen.

#### 5. Übertemperatur



Dieses Gerät sollte nicht in einem Bereich mit einer Umgebungstemperatur über der maximal empfohlenen Temperatur von 45°C (113°F) betrieben werden. Es ist ein Luftstrom von 200 LFM bei maximaler Umgebungstemperatur erforderlich. Außerdem sollten mindestens 8 cm (3 in.) Freiraum um die Belüftungsöffnungen sein, um einen einwandfreien Luftstrom zu gewährleisten.

#### 6. Stapeln des Chassis



Das Chassis sollte nicht auf andere Geräte gestapelt werden. Wenn das Chassis heruntermfällt, kann es zu Verletzungen und Beschädigungen an Geräten führen.

#### 7. Zweipolig/Neutrale Sicherung



Achtung:

Zweipolige bzw. Neutralleiter-Sicherung im Netzteil. Netzstecker ziehen, um sicherzustellen, daß keine Spannung am Gerät anliegt. Entfernen Sie alle Netzkabel vor dem Öffnen der Abdeckung dieses Produkts oder dem Berühren der Innenteile.

#### 8. Mehrere Stromeingänge



Risiko eines Stromschlags und Stomgefahr.

Alle Stromversorgungseinheiten sind unabhängig.

Trennen Sie alle Stromversorgungen, um einen abgeschalteten Zustand im Inneren der Switch-Plattform sicherzustellen.

#### 9. Bei Gewitter - Elektrische Gefahr



Arbeiten Sie während eines Gewitters und Blitzschlag nicht am Gerät, schließen Sie keine Kabel an oder ab.

#### 10. Anschließen/Trennen von Kupferkabel



Kupferkabel sind schwer und nicht flexible. Deshalb müssen sie vorsichtig an die Anschlüsse angebracht bzw. davon getrennt werden. Lesen Sie die speziellen Warnungen und Anleitungen des Kabelherstellers.

## 11. Rack-Montage und Wartung



Wenn dieses Produkt in einem Rack montiert oder gewartet wird, sind besondere Vorichtsmaßnahmen zu ergreifen, um die Stabilität des Systems zu gewährleisten. Im Allgemeinen sollten Sie das Gestell von unten nach oben mit Geräten füllen.

## 12. Geräteinstallation



Dieses Gerät sollte nur von geschultem und qualifiziertem Personal installiert, ausgetauscht oder gewartet werden.

## 13. Geräteentsorgung



Die Entsorgung dieses Geräts sollte unter Beachtung aller nationalen Gesetze Bestimmungen erfolgen.

## 14. Regionale und nationale elektrische Bestimmungen



Dieses Gerät sollte unter Beachtung der regionalen und nationalen elektrischen Bestimmungen installiert werden.

## 15. Installationscodes



Dieses Gerät muss entsprechend der aktuellsten Version des National Electrical Code installiert werden. In Nordamerika muss das Gerät gemäß den geltenden Anforderungen des US National Electrical Code und des Canadian Electrical Code installiert werden.

## 16. Akkuaustausch



Warnung: Nur durch von UL anerkannten Akkus ersetzen, die für maximalen anormalen Ladestrom von nicht weniger als 4mA zertifiziert sind.

Es besteht Explosionsgefahr, wenn der Akku durch einen Akku eines falschen Typs ersetzt wird.

Akkus gemäß den Anweisungen entsorgen.

## 17. UL- und CSA-zertifiziertes Netzkabel



Für Nordamerika Stromanschluss, wählen Sie ein Netzkabel, das UL- und CSA Zertifiziert

3 - Leiter, [18 AWG], mit einem angespritztem Stecker bewertet bei 125 V, [15], mit einer Mindestlänge von 1,5 m [Six Feet] aber nicht mehr als 4,5 m.

Für die europäischen Zusammenhang, wählen Sie ein Netzkabel, das international harmonisiert und der Aufschrift "<HAR>",

3 - Leiter, mindestens 0,75 mm<sup>2</sup> Draht, bewertet mit 300 V, mit einem PVC-Mantel isoliert. Das Kabel muss eine angespritztem Stecker bewertet bei 250 V, 10 A. "

## 18. Hoher Ableitstrom



WARNUNG: Hohe Ableitstrom; Earth Verbindung, bevor Sie die Verbindung von wesentlicher Bedeutung werden.

## 19. Installationscodes



Dieses Gerät muss installiert sein, entsprechend auf die neueste Version des Landes National Electrical Code. Für Nordamerika, müssen in Übereinstimmung mit den geltenden Vorschriften in der US-amerikanischen National Electrical Code und dem Canadian Electrical Code.

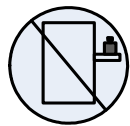
## 20. Verbindung der Geräte untereinander



Kabel für den Anschluss an das Gerät RS232- und Ethernet-Schnittstellen müssen UL zertifiziert Typ DP-1 oder DP-2. (Hinweis-, wenn nicht mit Wohnsitz in LPS-Schaltung)

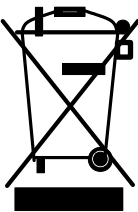
Überstromschutz: Eine leicht zugängliche Auflistung Abzweigung Überstrom-Schutzeinrichtung 20 A bewertet werden müssen in dem Gebäude Verkabelung.

## 21. Switch nicht als Regal oder Arbeitsplatz nutzen



Achtung: Auf Schieber/Schienen montiertes Gerät ist nicht als Regal oder Arbeitsbereich zu nutzen. Die Schienen sind nicht dafür bestimmt, die Einheit aus dem Gestell weg zu ziehen. Sie sind nur für die permanente Installation an einem endgültigen Standort gedacht, nicht für Instandhaltung und Wartung.

## 22. WEEE-Direktive



Gemäß WEEE Directive 2002/96/EC müssen alle elektrischen und elektronischen Abfallgeräte (EEE) separat gesammelt und nicht mit normalem Haushaltsmüll entsorgt werden.

Dieses Produkt und alle seine Teile in verantwortungsvoller und umweltfreundlicher Art und Weise entsorgen.

## E.7 Advertencias de seguridad de instalación (Spanish)

### 1. Instrucciones de instalación

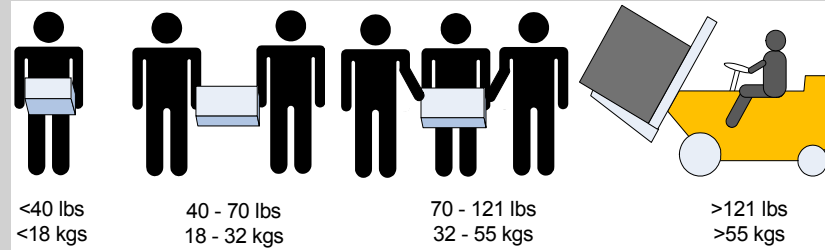


Antes de conectar el equipo a la fuente de alimentación, leer todas las instrucciones de instalación.

## 2. Lesión corporal a causa de peso



Recorra a suficientes personas para levantar este producto sin



## 3. Equipos pesados



Dado que el equipo es pesado, se debe mover únicamente mediante un elevador mecánico, para evitar lesiones.

## 4. Riesgo de descarga eléctrica



Riesgo de descarga eléctrica!

Con el módulo del ventilador quitado, se obtiene acceso a las clavijas de alimentación desde dentro de la cavidad del módulo.

NO introducir herramientas ni partes del cuerpo en la cavidad del módulo del ventilador.

## 5. Sobretemperatura



No se debe utilizar el equipo en un área con una temperatura ambiente superior a la máxima recomendada: 45°C. Además, para garantizar una circulación de aire adecuada, se debe dejar como mínimo un espacio de 8 cm (3 pulgadas) alrededor de las aberturas de ventilación.

## 6. Apilamiento del chasis



Los chasis no se deben apilar sobre otros equipos. La caída del chasis podría causar lesiones corporales, así como daños al equipo.

## 7. Conexión redundante de fuente de alimentación: peligro de descarga



Este producto incluye una fuente de alimentación redundante o, en su lugar, una vacía. Si se dispone de una fuente de alimentación vacía, no utilizar el producto si su tapa está quitada o no está bien cerrada.

## 8. Fusible neutro o de polo doble



Dos fusibles, uno en el polo y otro en el neutro. Quitar los cables de corriente antes de abrir la tapa de este producto o tocar cualquier componente interno.

## 9. Tomas de alimentación múltiples



Riesgo de descarga eléctrica y peligro de corriente.  
Todas las fuentes de alimentación son independientes.  
Desconecte todas las fuentes de alimentación, para asegurar que no haya corriente alguna dentro de la plataforma de conmutación.

## 10. Al haber rayos: peligro de descarga



No utilizar el equipo ni conectar o desconectar cables durante períodos de actividad de rayos.

## 11. La conexión y desconexión de cables de cobre



Dado que los cables de cobre son pesados y no son flexibles, su conexión a los conectores y su desconexión se deben efectuar con mucho cuidado. Para ver advertencias o instrucciones especiales, consultar al fabricante del cable.

## 12. Montaje y mantenimiento del bastidor



Al instalar o realizar el mantenimiento de este aparato en un bastidor, es preciso adoptar precauciones especiales para garantizar que el sistema se mantenga estable. En general, en un bastidor, los equipos se deben instalar comenzando desde abajo hacia arriba.

## 13. Instalación del equipo



La instalación, el reemplazo y el mantenimiento de este equipo estarán a cargo únicamente de personal capacitado y competente.

## 14. Eliminación del equipo



La eliminación definitiva de este equipo se debe efectuar conforme a todas las leyes y reglamentaciones nacionales.

## 15. Códigos eléctricos locales y nacionales



Este equipo se debe instalar conforme a los códigos eléctricos locales y nacionales.

## 16. Códigos de instalación



Este dispositivo se debe instalar conforme a la versión más reciente de los códigos eléctricos nacionales del país en cuestión. En América del Norte, el equipo se debe instalar de acuerdo con las disposiciones vigentes del Código Eléctrico Nacional de los EE.UU. y del Código Eléctrico de Canadá.

## 17. Cambio de batería



Il y a danger d'explosion s'il y a remplacement incorrect de la batterie. Remplacer uniquement avec une batterie du même type ou d'un type équivalent recommandé par le constructeur.

Mette au rebut les batteries usagées conformément aux instructions du fabricant.

## 18. Cable de alimentación homologado por UL y con certificación CSA



En conexiones de América del Norte, seleccionar un cable de alimentación homologado por UL y con certificación CSA de tres conductores, [16 AWG], terminado en un enchufe moldeado con capuchón de 125 voltios nominal, [13 A], con una longitud mínima de 1,5 metros, pero no más de 4,5 metros.

En conexiones europeas, seleccionar un cable de alimentación armonizado internacionalmente y marcado "<HAR>", de tres conductores, hilo de 1,0 mm<sup>2</sup> como mínimo, 300 voltios nominal, con cobertura protectora aislante de PVC. El cable debe tener un enchufe moldeado con capuchón de 250 voltios nominal, 10 A.

## 19. Alta corriente de fuga



ADVERTENCIA: Alta corriente de fuga. Es esencial efectuar la conexión a tierra antes de conectar la alimentación.

## 20. Códigos de instalación



Este dispositivo se debe instalar conforme a la versión más reciente de los códigos eléctricos nacionales del país en cuestión. En América del Norte, el equipo se debe instalar de acuerdo con las disposiciones vigentes del Código Eléctrico Nacional de los EE.UU. y del Código Eléctrico de Canadá.

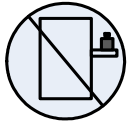
## 21. Interconexión de unidades



Los cables para la conexión con las interfaces RS232 y Ethernet de la unidad deben estar homologados por UL tipo DP-1 o DP-2. (Nota: cuando residen en circuito no de tipo LPS)

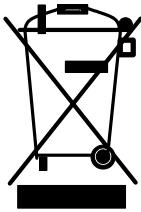
Protección contra sobrecargas: Al cableado del edificio se debe incorporar un dispositivo de protección contra sobrecargas de circuito derivado, de fácil acceso, con una corriente nominal de 20 A.

## 22. No utilizar el conmutador como estante ni como espacio de trabajo



Cuidado: Equipos montados en deslizadores o rieles no se deben utilizar como estantes ni como espacio de trabajo. La finalidad de los rieles no es deslizar la unidad hacia afuera del bastidor. Sirven solo para la instalación permanente en el lugar de destino final, no para fines de servicio o mantenimiento

## 23. Directiva WEEE



Conforme a la Directiva 2002/96/CE sobre RAEE, todos los residuos de equipos eléctricos y electrónicos (EEE) se deben recolectar por separado y no se deben eliminar junto con residuos domésticos.

Al deshacerse de este producto y de todas sus partes, hágalo de una manera responsable y respetuosa con el medio ambiente.

## E.8 Предупреждения по технике безопасности при установке (Russian)

### 1. Инструкция по установке

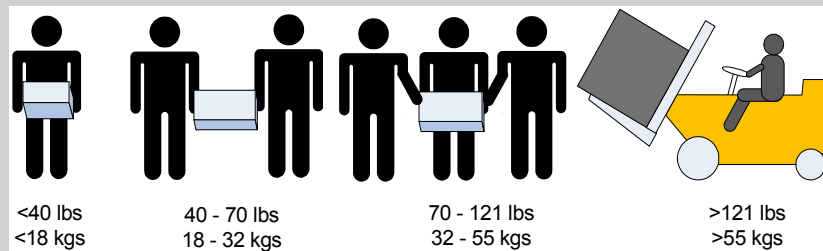


Перед подключением оборудования к источнику питания следует ознакомиться с инструкцией по установке.

### 2. Травмы при переносе тяжелых предметов



Для поднятия этого изделия следует задействовать достаточное количество людей.



### 3. Тяжелое оборудование



Это тяжелое оборудование, поэтому его следует перемещать с помощью механического подъемника во избежание травм.



#### 4. Опасность поражения электрическим током



Опасность поражения электрическим током!

Когда снят вентиляторный модуль, существует возможность повреждения контактов питания в его углублении.

НЕ вставлять инструменты или части тела в углубление вентиляторного модуля.

#### 5. Перегрев



Не эксплуатировать это оборудование в помещении с температурой окружающей среды, превышающей максимально рекомендуемое значение: 45 °C (113 °F).

Более того, для надлежащей вентиляции следует обеспечить зазор вокруг вентиляционных отверстий не менее 8 см (3 дюйма).

#### 6. Установка шасси поверх другого оборудования



Не устанавливать шасси поверх другого оборудования. Падение шасси может привести к травмам и повреждению оборудования.

#### 7. Опасность поражения электрическим током резервного источника питания



В этом изделии установлен резервный источник питания или модуль-заглушка.

Если установлен модуль-заглушка, не эксплуатировать изделие со снятой или ненадежно закрепленной крышкой модуля-заглушки.

#### 8. Двухполюсный предохранитель на фазном и нейтральном проводах



В этой системе установлен двухполюсный предохранитель на фазном и нейтральном проводах. Открывать кожух этого изделия или касаться внутренних деталей можно только после отсоединения всех шнуров питания.

#### 9. Несколько источников питания



Опасность поражения электрическим током и опасные энергетические воздействия.

Блоки питания независимы друг от друга.

Чтобы обесточить все компоненты внутри платформы коммутации, следует отсоединить все блоки питания.

#### 10. Опасность поражения электрическим током во время грозы



Во время грозы запрещается использовать оборудование и подключать или отключать кабели.

## 11. Подсоединение и отсоединение медных кабелей



Медные кабели тяжелые и негибкие, поэтому следует осторожно их подсоединять и отсоединять. За особыми предупреждениями и указаниями следует обратиться к производителю кабеля.

## 12. Установка или обслуживание в стойке



При установке или обслуживании этого изделия в стойке следует обеспечить устойчивость системы. Как правило, стойка заполняется оборудованием снизу вверх.

## 13. Установка оборудования



Устанавливать, заменять и/или обслуживать это оборудование должен только подготовленный и квалифицированный персонал.

## 14. Утилизация оборудования



Это оборудование утилизируется в соответствии с национальными законами и постановлениями.

## 15. Местные и национальные правила установки электрооборудования



Это оборудование устанавливается в соответствии с местными и национальными правилами установки электрооборудования.

## 16. Правила установки электрооборудования



Это устройство устанавливается в соответствии с последним изданием национальных правил установки электрооборудования. В Северной Америке оборудование устанавливается в соответствии с действующими требованиями Национальных правил эксплуатации и обслуживания электрических установок США и Канады.

## 17. Замена аккумулятора



Осторожно! Заменять только аккумулятором, одобренным организацией UL и рассчитанным на максимальный аномальный зарядный ток не менее 4 мА. Существует риск взрыва при замене аккумулятора другим аккумулятором неправильного типа.

Отработавшие аккумуляторы утилизируются в соответствии с указаниями.

## 18. Шнур питания, включенный в номенклатуру UL и сертифицированный Канадской ассоциацией стандартизации (CSA)



Подключение к электропитанию в Северной Америке выполняется с помощью шнура питания, включенного в номенклатуру UL и сертифицированного Канадской ассоциацией стандартизации (CSA), 3-жильного, [16 AWG], длиной от 1,5 м [6 футов] до 4,5 м, с литой вилкой, рассчитанной на 125 В [13 А].

Подключение к электропитанию в Европе выполняется с помощью гармонизированного шнура питания с маркировкой <HAR>, 3-жильного, с сечением жилы не менее 1,0 мм<sup>2</sup>, рассчитанного на номинальное напряжение 300 В, с ПВХ оболочкой. Шнур должен иметь литую вилку, рассчитанную на 250 В, 10 А.

## 19. Высокий ток утечки



Осторожно! Высокий ток утечки. Заземлить перед подключением к электропитанию.

## 20. Правила установки электрооборудования



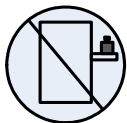
Это устройство устанавливается в соответствии с последним изданием национальных правил установки электрооборудования. В Северной Америке оборудование устанавливается в соответствии с действующими требованиями Национальных правил эксплуатации и обслуживания электрических установок США и Канады.

## 21. Подсоединение устройств



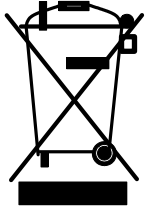
Для подключения к разъемам RS232 и Ethernet используются кабели типа DP-1 или DP-2, сертифицированные организацией UL. (Примечание. При подключении к сети без ограниченного источника электропитания) Максимальная токовая защита. В проводку здания в легкодоступном месте следует включить устройство защиты от перегрузки по току номиналом 20 А.

## 22. Не использовать коммутатор как полку или рабочую



Внимание! Оборудование, установленное на направляющих, не должно использоваться как полка или рабочая поверхность. Направляющие не предназначены для удерживания устройства, выдвинутого из стойки. Они предназначены для стационарной установки только в конечном положении и не используются для обслуживания устройства.

## 23. Директива WEEE



В соответствии с Директивой 2002/96/ЕС (WEEE) отходы электрического и электронного оборудования должны собираться и утилизироваться отдельно от обычных бытовых отходов.

Следует утилизировать это изделие и все его части ответственным и экологически безопасным способом.

## E.9 Avertismente privind siguranța la instalare (Romanian)

### 1. Instrucțiuni de instalare

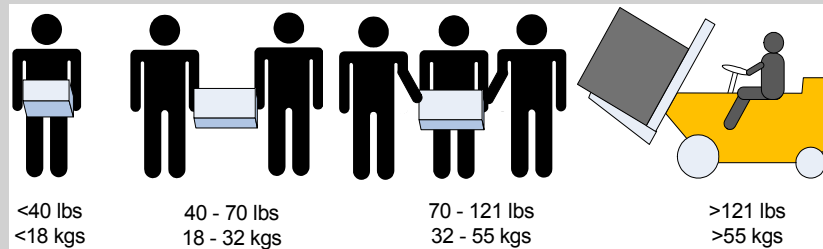


Citiți toate instrucțiunile de instalare înainte de a conecta.

### 2. Accidentare cauzată de greutate



Apelați la un număr suficient de persoane pentru a ridica în siguranță acest produs.



### 3. Echipament greu



Acest echipament este greu și trebuie să fie mutat folosind un dispozitiv mecanic de ridicare pentru a evita producerea de leziuni.

### 4. Risc de șoc electric



Risc de șoc electric!

Odată ce modulul ventilator este îndepărtat, pinii electrici sunt accesibili în cavitatea modulului.

NU introduceți instrumente sau părți din corp în cavitatea modulului ventilator.

### 5. Temperatură în exces



Acest echipament nu trebuie să fie acționat într-o zonă unde temperatura ambiantă depășește valoarea maximă recomandată: 45°C (113°F). În plus, pentru a asigura un flux de aer adecvat, lăsați un spațiu liber de cel puțin 8 cm (3 inch) în jurul fanțelor de ventilare.

## 6. Suprapunerea cadrului



Cadrul nu trebuie să fie suprapus peste niciun alt echipament. În cazul în care cadrul cade, poate cauza leziuni corporale și deteriorări ale echipamentului.

## 7. Conexiunea la o sursă de alimentare electrică suplimentară - pericol electric



Acest produs include o sursă de alimentare suplimentară sau un spațiu gol în locul acesteia. În cazul în care spațiul pentru sursa de alimentare este gol, nu operați produsul când capacul orb este îndepărtat sau nu este fixat în mod sigur.

## 8. Siguranță fuzibilă bipolară/neutră



Acest sistem este prevăzut cu siguranță fuzibilă bipolară/neutră. Îndepărtați toate cordoanele de alimentare înainte de a deschide capacul acestui produs sau înainte de a atinge orice componente interne.

## 9. Multiple mufe electrice



Risc de șoc electric și pericol electric.  
Toate aparatele cu alimentare de la rețea sunt independente.  
Deconectați toate sursele de alimentare cu energie pentru a asigura decuplarea în interiorul platformei de comutare.

## 10. În timpul descărcărilor electrice - pericol electric



În timpul perioadelor cu descărcări electrice luminoase, nu lucrați cu echipamentul sau nu conectați sau deconectați cablurile.

## 11. Conectarea/deconectarea cablului din cupru



Cablurile din cupru sunt grele și inflexibile, de aceea trebuie să fie atașate sau detașate de conectori cu grijă. Consultați producătorul de cabluri pentru avertismente/instrucțiuni speciale.

## 12. Montarea sau depanarea într-un rack



Când acest produs este montat sau depanat într-un rack, trebuie să fie luate măsuri de precauție speciale pentru a se asigura că sistemul rămâne stabil. În general, trebuie să umpleți rack-ul cu echipamente începând de jos în sus.

## 13. Instalarea echipamentului



Acest echipament trebuie să fie instalat, înlocuit și/sau depanat numai de către personal instruit și calificat.

#### 14. Eliminarea echipamentului



Eliminarea acestui echipament trebuie să se realizeze în conformitate cu toate legile și regulamentele naționale.

#### 15. Codurile electrice locale și naționale



Acest echipament trebuie să fie instalat conform codurilor electrice locale și naționale.

#### 16. Codurile de instalare



Acest dispozitiv trebuie să fie instalat în conformitate cu ultima versiune a codurilor electrice naționale ale țării în cauză. Pentru America de Nord, echipamentul trebuie să fie instalat conform cerințelor aplicabile din Codul electric național al SUA și Codul electric canadian.

#### 17. Înlocuirea bateriei



Avertisment: Înlocuiți numai cu o baterie recunoscută UL, certificată pentru curent de încărcare anormal maxim de minimum 4 mA

Există risc de explozie în cazul în care bateria este înlocuită cu o baterie necorespunzătoare.

Eliminați bateriile folosite în conformitate cu instrucțiunile.

#### 18. Cordon de alimentare electrică înregistrat UL și certificat CSA



Pentru conectarea la o sursă de alimentare pentru America de Nord, selectați un cordon de alimentare care este înregistrat UL și certificat CSA, cu 3 conductoare, [16 AWG], terminat cu o fișă turnată, cu putere nominală egală cu 125 V, [13 A], cu o lungime de minimum 1,5 m [șase picioare], dar nu mai lung de 4,5 m.

Pentru conectarea la o sursă de alimentare în Europa, selectați un cordon de alimentare care este armonizat la nivel internațional și marcat „<HAR>”, cu 3 conductoare, cu minimum 2 fire de 1,0 mm, cu putere nominală egală cu 300 V și cu o manta izolantă din PVC. Cordonul de alimentare trebuie să fie prevăzut cu o fișă turnată cu putere nominală egală cu 250 V, 10 A.

#### 19. Curent de scurgere de înaltă frecvență



Avertisment: Curent de scurgere de înaltă frecvență; Împământarea este esențială înainte de a conecta sursa de alimentare.

#### 20. Codurile de instalare



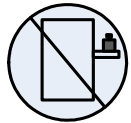
Acest dispozitiv trebuie să fie instalat în conformitate cu ultima versiune a codurilor electrice naționale ale țării în cauză. Pentru America de Nord, echipamentul trebuie să fie instalat conform cerințelor aplicabile din Codul electric național al SUA și Codul electric canadian.

## 21. Interconectarea unităților



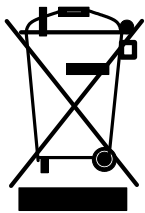
Cablurile pentru conectarea la unitatea RS232 și la interfețele Ethernet trebuie să fie de tipul DP-1 sau DP-2 certificate UL. (Notă- când se regăsesc într-un circuit non-LPS) Protecție la supracurent: Un dispozitiv de protecție la supracurent, înregistrat în circuitul de ramificare, ușor accesibil și cu o putere nominală egală cu 20 A trebuie să fie integrat în cablajul clădirii.

## 22. Nu utilizați comutatorul ca raft sau spațiu de lucru



Atenție: Echipamentul montat pe o linie de alunecare/șină nu va fi utilizat ca raft sau spațiu de lucru. Scopul șinelor nu este de a glisa unitatea de pe rack. Acestea sunt destinate instalării permanente numai la punctul final de oprire și nu vor fi folosite pentru depanare și întreținere

## 23. Directiva DEEE



În conformitate cu Directiva DEEE 2002/96/CE, toate deșeurile de echipamente electrice și electronice (EEE) trebuie colectate separat și nu trebuie eliminate împreună cu deșeurile menajere obișnuite.  
Eliminați acest produs și toate componentele sale în mod responsabil și ecologic.

## 24. Restrictione Restricții electrice pentru Norvegia



This unit is intended for connection to a TN power system and an IT power system of Norway only.

## E.10 Sigurnosna upozorenja za instaliranje (Croatian)

### 1. Upute za instaliranje

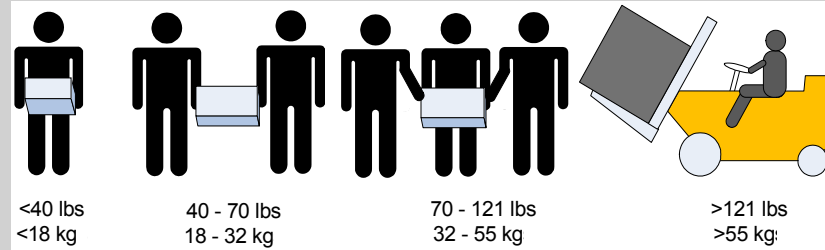


Pažljivo pročitajte upute za instaliranje prije spajanja opreme na izvor električne energije.

## 2. Tjelesne ozljede uslijed težine



Kako biste sigurno podignuli ovaj proizvod, koristite dovoljan broj ljudi.



## 3. Teška oprema



Ova oprema je vrlo teška i treba se premještati pomoću mehaničkog dizala kako bi se izbjegle ozljede.

## 4. Rizik od strujnog udara!



Rizik od strujnog udara!

S uklonjenim modulom ventilatora, perima napajanja se može pristupiti u otvoru modula.

NEMOJTE umetati alat ili dijelove tijela u otvor modula ventilatora.

## 5. Pregrijavanje



Ovom se opremom ne bi trebalo rukovati u područjima s temperaturom okoline koja premašuje najviše preporučene vrijednosti: 45°C (113°F). Osim toga, kako bi se osigurao odgovarajući protok zraka, omogućite najmanje 8 cm (3 inča) razmaka oko otvora ventilatora.

## 6. Slaganje kućišta



Kućiče se ne bi trebalo slagati na drugu opremu. Ako kućiče padne, može izazvati tjelesne ozljede i oštećenje opreme.

## 7. Redundantno napajanje - Opasnost od električne energije



Ovaj proizvod uključuje redundantno napajanje ili prazan prostor na njegovu mjestu. U slučaju praznog prostora za napajanje, nemojte rukovati proizvodom ako je poklopac uklonjen ili ako nije dobro pričvršćen.

## 8. Dvopolni/neutralni osigurači



Ovaj sustav raspolaže dvopolnim/neutralnim osiguračima. Uklonite sve kabele napajanja prije otvaranja poklopca proizvoda ili dodirivanja unutarnjih dijelova.



## 9. Višestruki ulazi za napajanje



Rizik od strujnog udara i opasnost od električne energije. PSU jedinice su neovisne. Odspojite sva napajanja kako biste osigurali stanje bez napajanja unutar platforme preklopnika.

## 10. Tijekom udara munje - Opasnost od električne energije



Tijekom djelovanja munja, nemojte raditi na opremi ili spajati ili odspajati kabele.

## 11. Spajanje/Odspajanje bakrenog kabela



Bakreni kabele su teški i nesavjetljivi i kao takvi se moraju pažljivo priključiti na ili isključiti iz konektora. Obratite se proizvođaču kabela za posebna upozorenja/upute.

## 12. Montaža ormarića i servisiranje



Kad se proizvod montira ili se servisira u ormariću, moraju se poduzeti posebne mjere opreza kako bi se osiguralo da sustav ostane stabilan. Općenito, trebali biste ispunjavati ormarić s opremom počevši od dna prema vrhu.

## 13. Instaliranje opreme



Ovu bi opremu trebalo instalirati, zamjenjivati i/ili servisirati samo obučeno i kvalificirano osoblje.

## 14. Odlaganje opreme



Odlaganje opreme trebalo bi se vršiti sukladno nacionalnim zakonima i propisima.

## 15. Lokalni i nacionalni električni kodovi



Ova oprema trebala bi se instalirati u skladu s lokalnim i nacionalnim električnim kodovima.

## 16. Instalacijski kodovi



Ovaj se uređaj mora instalirati sukladno najnovijoj verziji nacionalnih električnih kodova države. U Sjevernoj Americi oprema se mora instalirati sukladno važećim zahtjevima navedenim u US National Electrical Code i Canadian Electrical Code.

## 17. Zamjena baterije



**Upozorenje:** Bateriju zamijenite samo baterijom iz serije UL koja je certificirana za maksimalnu nepravilnu struju punjenja ne manju od 4 mA  
Postoji rizik od eksplozije ako se baterija zamijeni neodgovarajućom vrstom.  
Odložite prazne baterije sukladno uputama.

## 18. UL CSA kabel napajanja



Za sjevernoameričku mrežu odaberite kabel napajanja koji je na UL listi i sa CSA certifikatom, 3 - žilni, [16 AWG] (16 AWG) koji završava lijevanim utikačem nazivnog napona od 125 V, [13 A], minimalne duljine od 1,5 m [six feet] (šest stopa), ali ne dulji od 4,5 m.

Za europsku mrežu odaberite kabel napajanja koji je međunarodno usklađen i označen “<HAR>”, 3 - žilni, s najmanje 1,0 mm<sup>2</sup> žice, nazivnog napona od 300 V, s PVC izolacijom. Kabel mora imati lijevani utikač nazivnog napona od 250 V, nazivne struje od 10 A.

## 19. Veliko curenje struje



**Upozorenje:** Veliko curenje struje; Prije spajanja napajanja nužno je spojiti uzemljenje.

## 20. Instalacijski kodovi



Ovaj se uređaj mora instalirati sukladno najnovijoj verziji nacionalnih električnih kodova države. U Sjevernoj Americi oprema se mora instalirati sukladno važećim zahtjevima navedenim u US National Electrical Code i Canadian Electrical Code.

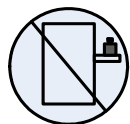
## 21. Interkonekcija uređaja



Kabeli za spajanje na jedinicu RS232 i Ethernet sučelja moraju biti s UL certifikatom vrste DP-1 ili DP-2. (Napomena - kad se nalazi u krugu bez LPS vodiča)

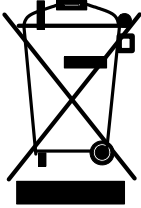
Zaštita od strujnog preopterećenja: Uvijek dostupni odobreni zaštitni uređaji od strujnog preopterećenja nazivne struje od 20 A moraju se ugraditi u ožičenje zgrade.

## 22. Nemojte koristiti preklopnik kao policu ili radnu površinu



**Pozor:** Oprema montirana na klizače/vodilice ne bi se trebala koristiti kao policu ili radna površina. Vodilice nisu namijenjene za povlačenje uređaja iz ormarića. Služe samo za trajnu instalaciju na konačnom položaju, a ne za servisiranje i održavanje.

### 23. WEEE direttiva



Sukladno WEEE direktivi 2002/96/EZ, sav električni i elektronički otpad (EEE) trebao bi se prikupljati zasebno i ne bi se trebao odlagati kao običan kućanski otpad. Odlaganje ovog proizvoda i svih njegovih dijelova vršite na odgovoran i ekološki način.

### 24. Električna ograničenja države Norveške



Ovaj je uređaj namijenjen samo za spajanje na električni sustav s TN uzemljenjem i na električni sustav s IT uzemljenjem države Norveške.

## E.11 Avvertenze di sicurezza per l'installazione (Italian)

### 1. Istruzioni di installazione

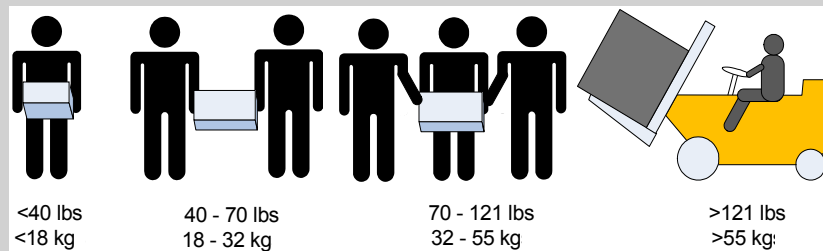


Leggere tutte le istruzioni di installazione prima di collegare l'apparecchiatura all'alimentazione.

### 2. Lesioni a causa del peso



Usare un numero di persone sufficiente per sollevare in sicurezza questo prodotto.



### 3. Apparecchiatura pesante



Questa apparecchiatura è molto pesante e va spostata mediante un sollevatore meccanico, per evitare lesioni.

#### 4. Rischio di scosse elettriche!



Rischio di scosse elettriche!

Con il modulo ventola rimosso, i pin di alimentazione sono accessibili all'interno della cavità del modulo.

NON inserire strumenti o parti del corpo nella cavità del modulo della ventola.

#### 5. Temperatura eccessiva



Questa apparecchiatura non va utilizzata in un'area con una temperatura ambiente superiore a quella massima consigliata: 45 °C (113 °F). Inoltre, per assicurare un flusso d'aria adeguato, lasciare almeno 8 cm (3 pollici) di spazio attorno alle aperture di ventilazione.

#### 6. Impilare lo chassis



Kućište se ne bi trebalo slagati na drugu opremu. Ako kućište padne, može izazvati tjelesne ozljede i oštećenje opreme.

#### 7. Collegamento di alimentazione ridondante - Pericoli elettrici



Questo prodotto è dotato di un alimentatore ridondante o, qualora esso non sia installato, di uno spazio vuoto. Qualora l'alimentatore non sia installato, non utilizzare il prodotto con il coperchio rimosso o non fissato correttamente.

#### 8. Fusibili fase/neutro



Questo sistema dispone di fusibili fase/neutro. Rimuovere tutti i cavi di alimentazione prima di aprire il coperchio di questo prodotto o di toccare parti interne.

#### 9. Prese di alimentazione multiple



Rischio e pericolo di scosse elettriche.

Gli alimentatori sono tutti indipendenti.

Scollegare tutti gli alimentatori per assicurarsi che il commutatore non sia sotto tensione

#### 10. Durante i temporali, pericolo di scosse elettriche



Durante i temporali, non effettuare interventi sull'apparecchiatura e non collegare o scollegare i cavi.

#### 11. Collegamento/scollegamento del cavo di rame



I cavi di rame sono pesanti e non flessibili. Di conseguenza, vanno collegati o scollegati con cura dai connettori. Per avvertenze/istruzioni speciali, rivolgersi al produttore di cavi.

## 12. Montaggio su rack e manutenzione



Quando questo prodotto viene montato o sottoposto a manutenzione su un rack, è necessario adottare delle precauzioni speciali per assicurarsi che il sistema resti stabile. In generale, il rack va riempito con apparecchiature, procedendo dal basso verso l'alto.

## 13. Installazione dell'apparecchiatura



Questa apparecchiatura va installata, sostituita e/o sottoposta a manutenzione solo da personale addestrato e qualificato.

## 14. Smaltimento dell'apparecchiatura



Lo smaltimento di questa apparecchiatura va effettuato in conformità con tutte le leggi e le normative nazionali.

## 15. Codici elettrici locali e nazionali



Questa apparecchiatura va installata in conformità con le norme elettriche locali e nazionali.

## 16. Codici di installazione



Questo dispositivo va installato in conformità con l'ultima versione dei codici elettrici nazionali del Paese. Per il Nord America, l'apparecchiatura va installata in conformità con i requisiti applicabili del "codice elettrico nazionale USA" e del "codice elettrico canadese".

## 17. Sostituzione della batteria



Avvertenza: Sostituire solo con una batteria UL, certificata per accettare una corrente di ricarica anomala massima non inferiore a 4 mA.  
Se la batteria non viene sostituita con una batteria di tipo corretto, vi è il rischio di esplosione.  
Smaltire le batterie usate in conformità con le istruzioni.

## 18. Cavo di alimentazione UL e munito di certificazione CSA



Per una connessione di alimentazione nordamericana, selezionare un cavo di alimentazione di tipo UL e munito di certificazione CSA, a 3 conduttori, [16 AWG], terminato con una spina stampata con tensione nominale pari a 125 V, [13 A], di lunghezza minima pari a 1,5 m [sei piedi] ma non più lunga di 4,5 m.  
Per una connessione europea, selezionare un cavo di alimentazione armonizzato a livello internazionale e contrassegnato da "<HAR>", a 3 conduttori, minimo 1,0 mm<sup>2</sup> fili, con guaina isolante in PVC. Il cavo deve disporre di una spina stampata di potenza nominale pari a 250 V, 10 A.

## 19. Corrente di dispersione elevata



**Avvertenza:** corrente di dispersione elevata; il collegamento a terra è essenziale prima di collegare l'alimentazione.

## 20. Codici di installazioni



Questo dispositivo va installato in conformità con l'ultima versione dei codici elettrici nazionali del Paese. Per il Nord America, l'apparecchiatura va installata in conformità con i requisiti applicabili del "codice elettrico nazionale USA" e del "codice elettrico canadese".

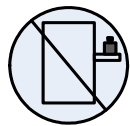
## 21. Interconnessione delle unità



I cavi per il collegamento all'unità RS232 e alle interfacce Ethernet devono disporre della certificazione UL ed essere del tipo DP-1 o DP-2. (Nota: in caso di installazione su un circuito la cui potenza non è limitata)

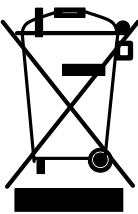
Protezione contro le sovracorrenti: la cablatura dell'edificio deve integrare un dispositivo di protezione contro le sovracorrenti di potenza nominale pari a 20.

## 22. Non utilizzare lo switch come scaffale o piano di lavoro



Attenzione: un'apparecchiatura scorrevole o montata su binari non va utilizzata come scaffale o piano di lavoro. I binari non sono progettati per far scorrere e allontanare l'unità dal rack. Essi sono destinati all'installazione permanente solo nel luogo di lavoro e non vengono utilizzati per assistenza e manutenzione

## 23. Direttiva RAEE



Secondo la direttiva RAEE 2002/96/EC, tutti i rifiuti da apparecchiature elettriche ed elettroniche (RAEE) vanno raccolti separatamente e non smaltiti nei normali rifiuti domestici.

Smaltire questo prodotto e tutte le sue parti in modo responsabile e rispettoso dell'ambiente

## 24. Limitazioni relative all'alimentazione per la Norvegia



Questa apparecchiatura è progettata esclusivamente per il collegamento a un sistema di alimentazione TN e a un sistema di alimentazione IT.

## E.12 Montaj Güvenlik Uyarıları (Turkish)

### 1. Montaj Talimatları

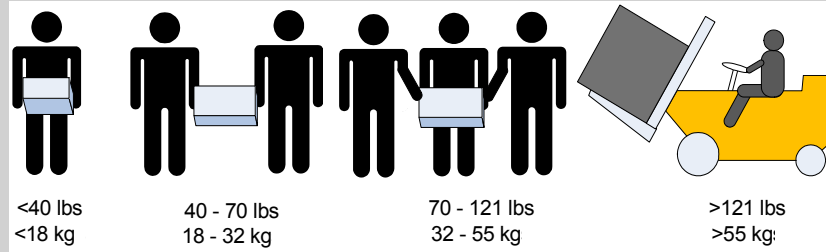


Ekipmanı güç kaynağına bağlamadan önce tüm montaj talimatlarını okuyun.

### 2. Ağırlık Nedeniyle Fiziksel Yaralanma



Bu ürünü güvenli bir şekilde kaldırmak için yeterli sayıda insandan yardım alın.



### 3. Ağır Ekipman



Bu ekipman çok ağırdır ve yaralanmaları önlemek için ekipmanın mekanik asansör kullanılarak taşınması gerekir.

### 4. Elektrik Çarpması Riski!



Bu ekipman, önerilen maksimum ortam sıcaklığını aşan alanlarda çalıştırılmamalıdır: 45 °C (113 °F). Ayrıca, düzgün hava akışı sağlamak için havalandırma deliklerinin etrafında en az 8 cm (3 inç) açıklık bırakılmalıdır.

### 5. Aşırı Isınma



Bu ekipman, önerilen maksimum ortam sıcaklığını aşan alanlarda çalıştırılmamalıdır: 45 °C (113 °F). Ayrıca, düzgün hava akışı sağlamak için havalandırma deliklerinin etrafında en az 8 cm (3 inç) açıklık bırakılmalıdır.

### 6. Şasi İstif



Şasinin diğer herhangi bir ekipmanın üzerine istiflenmemesi gerekir. Şasi düşerse, fiziksel yaralanmalara ve ekipmanda hasara neden olabilir.

## 7. Yedekli Güç Kaynađı Bađlantýsý -Elektrik Çarpma Tehlikesi



Bu ürün, yedekli güç kaynađı veya onun yerine boş elektrik kutusu içerir. Güç kaynađı için boş elektrik kutusu varsa, kutunun kapađı açıkken veya tam olarak kapatılmamýşken ürünü çalıştırmayın.

## 8. Çift Kutuplu/Nötr Kesmeli Sigorta



Bu sistemde çift kutuplu/nötr kesmeli sigorta kullanılmaktadır. Ürünün kapađını açmadan veya herhangi bir iç parçaya dokunmadan önce bütün güç kablolarını çıkartın.

## 9. Çoklu Güç Girişleri



Elektrik çarpması riski ve enerji tehlikesi.  
Bütün PSU'lar (Güç Kaynađı Üniteleri) ayrıdır.  
Anahtar platformundaki gücü kapatmak için tüm güç kaynaklarının bađlantılarını kesin.

## 10. Şimşek - Elektrik Çarpma Tehlikesi



Gökyüzünde şimşek çaktığı zamanlarda, ekipman üzerinde çalışmayın veya kablo bađlamayın ya da kablo bađlantısı kesmeyin.

## 11. İskele Montajı ve Bakım



Bu ürün bir iskelede monte edildiye veya bir iskele ile sunulduysa, sistemin sabit kalması için özel önlemler alınmalıdır. Genelde, ekipmanları iskeleye aşıđıdan yukarı doğru doldurmanız gerekir.

## 12. Ekipman Montajı



Ekipmanın yalnızca eğitilmiş ve nitelikli personel tarafından monte edilmesi, deđiştirilmesi ve/veya bakımının yapılması gerekir.

## 13. Ekipmanın Atılması



Bu ekipmanın imhasında tüm ulusal yasalara ve düzenlemelere uyulması gerekir.

## 14. Yerel ve Ulusal Elektrik Kodları



Bu ekipmanın montajında yerel ve ulusal elektrik kodlarına uyulması gerekir.



## 15. Montaj Kodları



Bu cihazın, ülke ulusal elektrik kodlarının son sürümüne göre monte edilmesi gerekir. Kuzey Amerika için, ekipmanın ABD Ulusal Elektrik Kodu ve Kanada Elektrik Kodu'nun uygulama koşullarına göre monte edilmesi gerekir.

## 16. Pilin Değiştirilmesi



Uyarı: Yalnızca, maksimum düzgümsüz şarj akımı 4mA'dan az olmayan, UL Onaylı pillerle değiştirin.  
Yanlış pil türü ile değiştirildiğinde patlama tehlikesi bulunmaktadır.  
Kullanılmış pillerden talimatlara uygun bir şekilde kurtulun.

## 17. UL Kayıtlı ve CSA Onaylı Güç Kaynağı Kablosu



Kuzey Amerika'da güç bağlantısı için, UL Kayıtlı ve CSA Onaylı bir güç kaynağı kablosu seçin, 3 - iletken, [16 AWG], 125 V değerinde, kalıplanmış bir fişle biten, [13 A], en az 1,5 m (altı fit) uzunluğunda fakat 4,5 m'den uzun olmayan bir kablo. Avrupa'da güç bağlantısı için, uluslararası uyumlu ve “<HAR>” işaretli, 3 - iletken, en az 1,0 mm<sup>2</sup> tel, 300 V değerinde ve PVC yalıtımlı bir güç kaynağı kablosu seçin. Kablonun 250 V, 10 A değerinde bir kalıplanmış fişi olması gerekmektedir.

## 18. Yüksek Kaçak Akım



Yüksek kaçak akım varsa; güç kaynağına bağlanmadan önce mutlaka topraklama bağlantısı yapılmalıdır.

## 19. Montaj Kodları



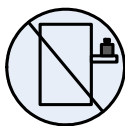
Bu cihazın, ülke ulusal elektrik kodlarının son sürümüne göre monte edilmesi gerekir. Kuzey Amerika için, ekipmanın ABD Ulusal Elektrik Kodu ve Kanada Elektrik Kodu'nun uygulama koşullarına göre monte edilmesi gerekir.

## 20. Ünitelerin Ara Bağlantısı



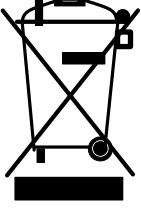
RS232 ünitesini ve Ethernet Arabirimlerini bağlayacak olan kabloların UL onaylı DP-1 veya DP-2 tipi olması gerekir. (Not- LPS olmayan devreye aitse)  
Aşırı Akım Koruması: Kolayca erişilebilecek 20 V Kayıtlı devre parçası aşırı akım koruma cihazının bina elektrik şebekesinde kurulu olması gerekir.

## 21. Anahtarı Raf veya Çalışma Alanı olarak kullanmayın!



Dikkat: Sürgülü/raylı ekipman raf veya çalışma alanı olarak kullanılamaz. Raylar üniteyi iskeleden uzağa kaydırmak için yapılmamıştır. Sadece, ekipmanın son olarak duracağı yerdeki kalıcı montaj içindir, servis veya bakım için kullanılamaz.

## 22. WEEE Yönergesi



WEEE Yönergesi 2002/96/EC uyarınca, tüm elektrikli ve elektronik ekipman atıkları (EEE) ayrı olarak toplanmalı ve evsel atıklarla birlikte çöpe atılmamalıdır. Bu ürün ve tüm parçaları çevreye dost ve sorumlu bir şekilde imha edilmelidir.

## 23. Norveç Güç Kısıtlamaları



Bu ünite, bir TN güç sistemine ve sadece Norveç'in IT güç sistemine bağlanmak içindir.

## E.13 Japan VCCI Statement

この装置は、クラス A 情報技術装置です。この装置を家庭環境で使用すると電波妨害を引き起こすことがあります。この場合には使用者が適切な対策を講ずるよう要求されることがあります。 VCCI-A