

HYDRAULIC CYLINDERS INC.®

HYDRAULIC CYLINDER CATALOG

ENGINEERED TO DEMOLISH DOWNTIME

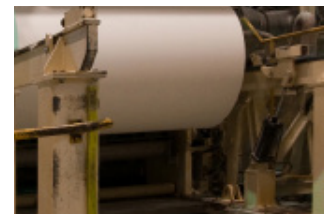

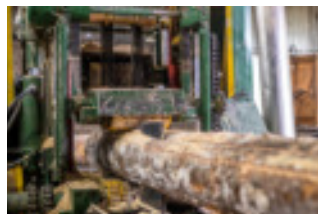

SERIES 'H' (Heavy-Duty Hydraulics)	2-3 Days
SERIES 'M' (Medium-Duty Hydraulics)	2-3 Days
SERIES 'TS' (Heavy-Duty Pneumatics)	2-3 Days
Rod Clevis, Pins & Mounts, Alignment Couplers.	1 Day
Balluff Strokemaster/Micropulse	5-7 Days
MTS Temposonics	10-12 Days

Delivery for 1-10 pieces. Contact Hydraulics Cylinders, Inc for larger orders.

HYDRAULIC CYLINDERS INC.® warrants its cylinders for a full three years to be free from defects in material and workmanship. HYDRAULIC CYLINDERS INC.® must be notified prior to returning product for warranty evaluation. A Returned Goods Authorization (RGA) number will be issued for proper tracking and expedite service on all warranty evaluations. HYDRAULIC CYLINDERS INC.® will repair or replace free of charge any products returned to the factory within three years of shipment that is proven to be defective in material and/or workmanship.

A complete explanation of defects is required with the returned product. The HYDRAULIC CYLINDERS INC.® warranty applies only to products used properly and under normal operating conditions. All products are to be used in a safe manner, in properly designed systems. Safeguards to prevent personal injury or equipment damage must be used and are the sole responsibility of the user.

In no event shall HYDRAULIC CYLINDERS INC.® be liable for any consequential damages or installation costs resulting from delay or failure of delivery, defective material/workmanship or out of breach by HYDRAULIC CYLINDERS INC.® of any contract.

HYDRAULIC CYLINDERS INC.®
p. 888-771-1894 | f. 888-693-8681
PO Box 490517 | Minneapolis, MN 55449
1225 187th Lane NE | East Bethel, MN 55011
www.HydraulicCylindersInc.com

Warranty & Delivery Schedule 2

SERIES ‘H’ (Heavy-Duty Hydraulics) 4-37

SERIES ‘H’ Variations 38-45

SERIES ‘M’ (Medium-Duty Hydraulics) 47-77

SERIES ‘M’ Variations 78-86

SERIES ‘TS’ (Heavy-Duty Pneumatics) 87-109

SERIES ‘TS’ Variations 112-120

Accessories 122-125

Balluff End of Stroke Sensors 126-129

Balluff Transducers 130-131

MTS Temposonics® Transducers 132

Technical Data: Seal Kits 134-139

Technical Data: Force, Torque & Rating Charts 140-142

Technical Data: Hydraulic Cylinder Speeds 143

Technical Data: Cylinder & Accessories Weight Charts 144-145

Technical Data: Seal Compatibility 146

Conversion Charts & Common Fluid Power Formulas 147-148



The source for all your hydraulic cylinder needs

All our cylinders are proudly Made in USA

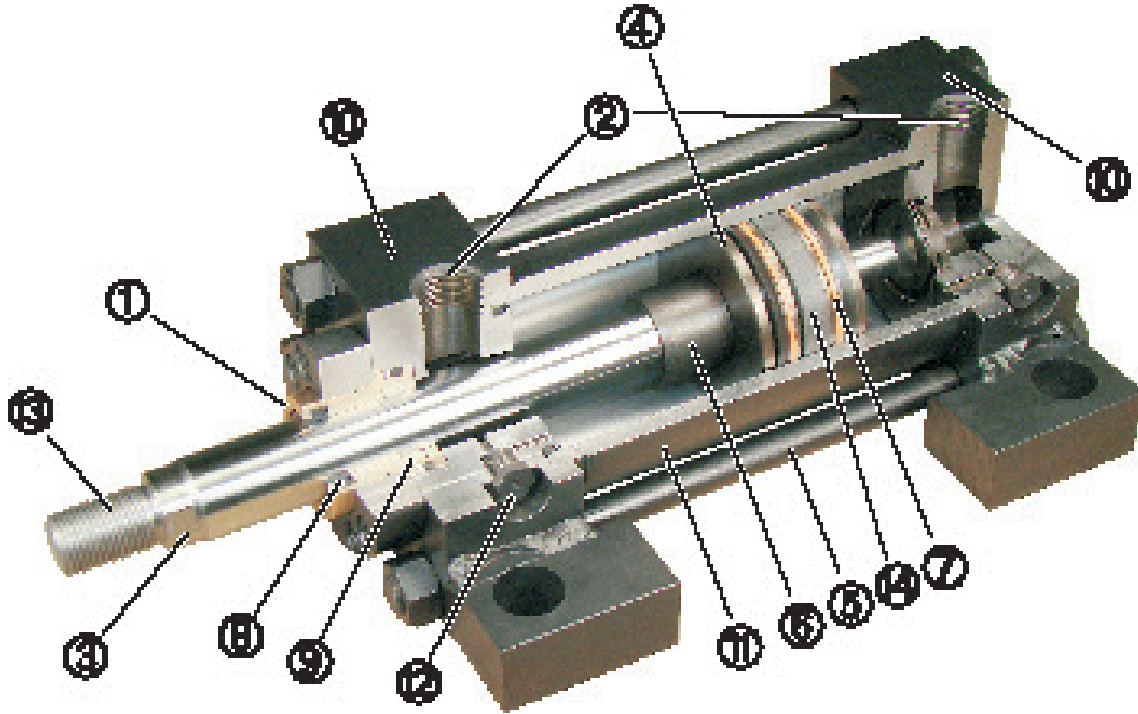

- ① – Precision machined from 150,000 PSI rated graphite filled ductile iron and PTFE coated to reduce friction and extend cycle life. Bushing design traps lubrication in effective bearing area. Bronze bushings also available.
- ② – NPTF and SAE ports available standard. Non-standard locations, sizes and other port styles can be made-to-order to fit any application needs.
- ③ – Steel piston rod provides high strength and damage resistance. Induction hardened and chrome plated for maximum wear resistance and long life (100K min. yield up to 5" rod; 75K min. yield for 5 1/2" rod).
- ④ – Precision machined ductile iron provides high strength and an excellent bearing surface for extended cylinder life.
- ⑤ – Pre-stressed, high carbon steel tie rod construction eliminates axial loading of cylinder tube and maintains compression on tube (100K min. yield).
- ⑥ – Precision machined cushion are available at either end and provide smooth deceleration, which helps reduce end of stroke shock.
- ⑦ – Heavy lip design, Carboxylated Nitrile seals with back-up rings are pressure activated and wear compensating for extended life. Cast ring, EP, PTFE and fluorocarbon designs available.
- ⑧ – Flocked nitrile wiper removes contaminants on retract stroke, helping insure long life for all internal components.

- ⑨ – Polyurethane seals offer high abrasion resistance and strength. Pressure activated double lip and wear compensating for extended life.
- ⑩ – Precision machined steel head and cap are held to tight tolerances and insure accurate alignment for a truly square cylinder.
- ⑪ – Precision machined steel tube with hard chrome I.D. is honed and micro finished for extended seal life and improved cycle rates.
- ⑫ – Adjustable steel needle design has fine thread metering and is positively captured to prevent needle ejection during adjustment.
- ⑬ – Standard on KK1 and KK2 threads for .625" - 2.00" rods (125K min. yield). Available up to two times standard "A" thread length.
- ⑭ – Wear Guard Nylon (standard); reinforced PTFE for E and V seal option.
- ⑮ – Acts as a shear pin between the piston and rod threads, eliminating any chance of a piston coming loose from the rod. Also referred to as Dutch Key or Skotch Key.
- ⑯ – Black urethane paint.

3000 PSI HYD (207 BAR)

Standard Seals: -20°F to 200°F (-29°C to 93°C)
 Fluorocarbon: 0°F to 400°F (-18°C to 204°C)

SERIES 'H' HEAVY DUTY HYDRAULIC CYLINDERS

HOW TO ORDER



H	-	MS2	-	200	x	15	-	H2C6	-	062	-	KK5	-	P15	=	N375	-	S S S S	-	
SERIES		NFPA MOUNTS		BORE		STROKE		CUSHIONS		ROD SIZE		ROD END		PORT LOC		PORT SIZE		SEALS		VARIATIONS

SERIES	
H	HEAVY DUTY HYDRAULIC

NFPA MOUNTS	
MX0	NO MOUNT (1.50" to 8.00" Bore)
MF1	HEAD RECTANGULAR FLANGE (1.50" to 8.00" Bore)
MF2	CAP RECTANGULAR FLANGE (1.50" to 8.00" Bore)
MF5	HEAD SQUARE FLANGE (1.50" to 8.00" Bore)
MF6	CAP SQUARE FLANGE (1.50" to 8.00" Bore)
ME5	HEAD RECTANGULAR MOUNTING HOLES (1.50" to 8.00" Bore)
ME6	CAP RECTANGULAR MOUNTING HOLES (1.50" to 8.00" Bore)
MP1	FIXED CAP PIVOT CLEVIS (1.50" to 8.00" Bore)
MS2	SIDE LUGS (1.50" to 8.00" Bore)
MS3	CENTER LINE LUGS (1.50" to 8.00" Bore)
MS4	BOTTOM TAPPED HOLES (1.50" to 8.00" Bore)
MS7	END LUGS (1.50" to 6.00" Bore)
MT1	HEAD TRUNNION (1.50" to 8.00" Bore)
MT2	CAP TRUNNION (1.50" to 8.00" Bore)
MT4	INTERMEDIATE (CENTER) TRUNNION (1.50" to 8.00" Bore)
MX1	EXTENDED TIE RODS - HEAD & CAP (1.50" to 8.00" Bore)
MX2	EXTENDED TIE RODS - CAP (1.50" to 8.00" Bore)
MX3	EXTENDED TIE RODS - HEAD (1.50" to 8.00" Bore)
SB	SPHERICAL BEARING (1.50" to 6.00" Bore)

STYLE	
(BLANK)	SINGLE ROD
D	DOUBLE ROD

BORE	
150	1.50" Bore
200	2.00" Bore
250	2.50" Bore
325	3.25" Bore
400	4.00" Bore
500	5.00" Bore
600	6.00" Bore
800	8.00" Bore

STROKE
0" to 120" MADE TO ORDER (Use decimals for fractional strokes)

MAXIMUM STROKE RECOMMENDATIONS			
BORE	NO CENTER SUPPORT	WITH CENTER SUPPORTS (CS OPTION)	
		ONE SUPPORT	TWO SUPPORTS
1.50"	44 INCHES	STROKES OVER 44 INCHES	STROKES OVER 89 INCHES
2.00"	74 INCHES	STROKES OVER 74 INCHES	STROKES OVER 99 INCHES
2.50"	84 INCHES	STROKES OVER 84 INCHES	NOT REQUIRED
3.25" - 8.00"	99 INCHES	STROKES OVER 99 INCHES	

CUSHIONS	
H	1
	2
	3
	4
C	5
	6
	7
	8

Call out 'H' for head cushion, 'C' for cap cushion, followed by the desired location(s).

ROD SIZE	
062	0.625" Rod Dia.
100	1.000" Rod Dia.
137	1.375" Rod Dia.
175	1.750" Rod Dia.
200	2.000" Rod Dia.
250	2.500" Rod Dia.
300	3.000" Rod Dia.
350	3.500" Rod Dia.
400	4.000" Rod Dia.
450	4.500" Rod Dia.
500	5.000" Rod Dia.
550	5.500" Rod Dia.

ROD END	
KK1	Small Male Thread
KK2	Large Male Thread
KK3	Female Thread
KK3M	Female Metric Rod Thread
KK3X	Female Special Thread
KK4	Full Dia. Male Thread
KK5	Plain End
KK10	Rod Coupler End
KKM	Metric Thread
KKX	Non-Std Thread

When additional thread details are required, use format: "Rod End" = "Modification"
Example: KKM=1.00x8

PORT LOC	
P	1
	2
	3
	4
	5
	6
	7
	8
	9

Call out 'P' followed by all desired locations.

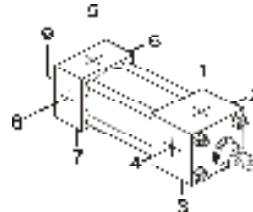

Location 9 is center of cap face.

PORT SIZE	
N062	1/16" NPTF
N125	1/8" NPTF
N250	1/4" NPTF
N375	3/8" NPTF
N500	1/2" NPTF
N750	3/4" NPTF
N1000	1" NPTF
N1500	1 1/2" NPTF
S2	#2 SAE
S3	#3 SAE
S4	#4 SAE
S5	#5 SAE
S6	#6 SAE
S8	#8 SAE
S10	#10 SAE
S12	#12 SAE
S16	#16 SAE
S24	#24 SAE

Port Note:
For complex port designs, multiple port locations & sizes can be ordered.
Call out locations and sizes for all sets using the following format.
Example: -P15=N375 -P26=N500
(3/8" NPTF Ports at 1 & 5 and 1/2" NPTF Ports at 2 & 6)

SEALS			
S	S	S	S
PISTON SEAL	ROD SEAL	TUBE SEAL	ROD WIPER

PISTON SEAL	
S	STANDARD (Carboxylated)
C	Cast-Ring
E	EP
T	PTFE
V	Fluorocarbon

ROD SEAL	
S	STANDARD (Polyurethane)
E	EP
V	Fluorocarbon

TUBE SEAL	
S	STANDARD (Buna)
E	EP
V	Fluorocarbon

ROD WIPER*	
S	STANDARD (Flocked Nitrile)
M	Metallic Scraper
T	PTFE
V	Fluorocarbon

*Note: When cylinder design calls for all EP seals, use PTFE rod wiper.

VARIATIONS	
A=	EXTENDED PISTON ROD THREAD (Example: A = 2") (MAX = 2 TIMES ST'D "A" DIM.)
ABP=	AIR BLEED PORTS (Example ABP=15)
AS=	ADJUSTABLE STROKE - RETRACT (SPECIFY LENGTH, Example: AS = 4")
C=	EXTENDED PISTON ROD (Example: IF C = 0.50", THEN 1" ROD EXTENSION IS C = 1.50")
CS	CENTER SUPPORT
DBB=	DRAIN BACK BUSHING (Example: DBB=1)
EK	EXTENDED KEY PLATE
HLP	HIGH LOAD PISTON
HSS	HIGH SHOCK SEALS
LRB	LIFT RING BOSS
NR	NON-ROTATING
RBB	ROD BUSHING MATERIAL: BRONZE
SSR	STAINLESS STEEL PISTON ROD
ST=	STOP TUBE NOTE: Specify STOP TUBE length (in inches) Specify Stroke as ES (effective stroke) Example: (H-MS2-250x48ES-H2C6-ST=3")
4WF	FOUR WRENCH FLATS (ROD SIZES: .625"-3.50")
XX=	SPECIAL VARIATION (SPECIFY)

*Note: Stop Tube length adds directly to the overall cylinder length.

SERIES 'H' HEAVY DUTY HYDRAULIC CYLINDERS

NFPA MOUNTS



No Mount

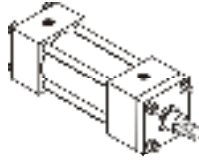

MX0 1.50"-8.00" Bores

Trunnion Mounts

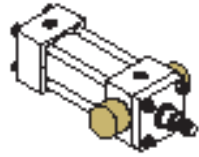

MT1 1.50"-8.00" Bores

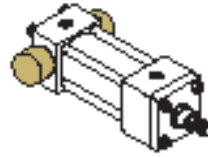

MT2 1.50"-8.00" Bores

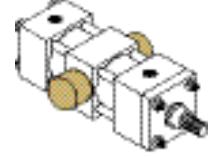

MT4 1.50"-8.00" Bores

Extended Tie Rod Mounts

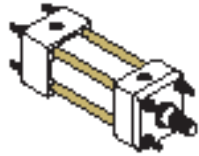

MX1 1.50"-8.00" Bores

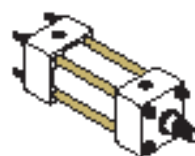

MX2 1.50"-8.00" Bores

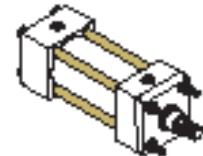

MX3 1.50"-8.00" Bores

Flange Mounts

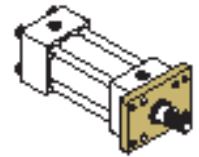

MF1 1.50"-8.00" Bores

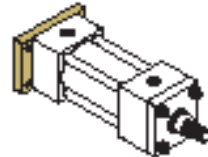

MF2 1.50"-8.00" Bores

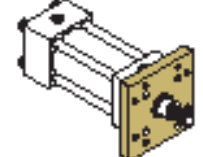

MF5 1.50"-8.00" Bores

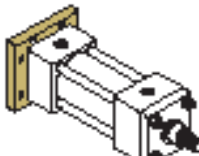

MF6 1.50"-8.00" Bores

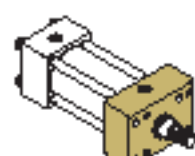

ME5 1.50"-8.00" Bores

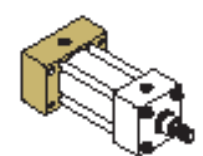

ME6 1.50"-8.00" Bores

Lug Mounts

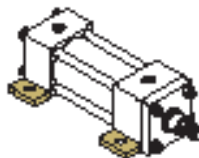

MS2 1.50"-8.00" Bores

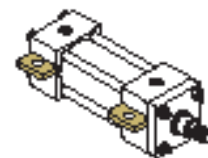

MS3 1.50"-8.00" Bores

Bottom Mounts

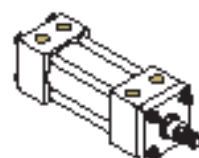

MS4 1.50"-8.00" Bores

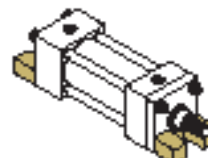

MS7 1.50"-6.00" Bores

All our cylinders are proudly Made in USA

SERIES 'H' HEAVY DUTY HYDRAULIC CYLINDERS

NFPA MOUNTS & THREADS



Pivot Mounts

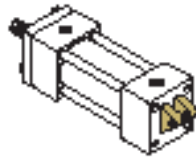

MP1 1.50"-8.00" Bores

Spherical Bearing Mount

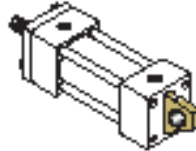

SB 1.50"-6.00" Bores

Threads

KK1
KK2

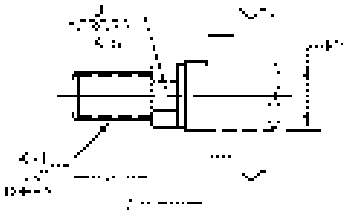

KK3

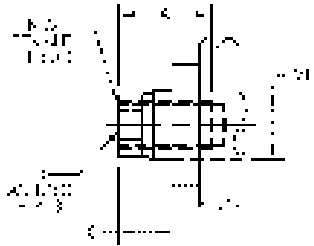

KK4

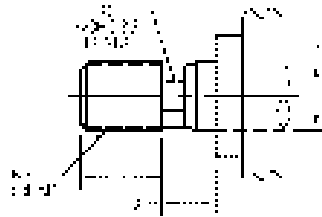

KK5

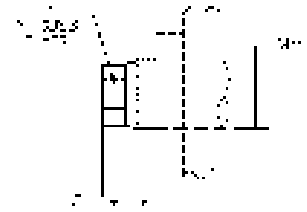

KK10

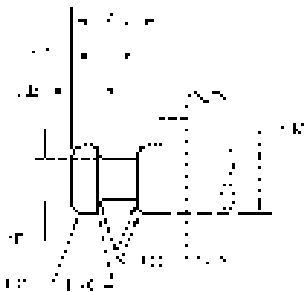

Spanner Holes

(4.00-5.50 Rods)
(Shown on KK1-KK2)

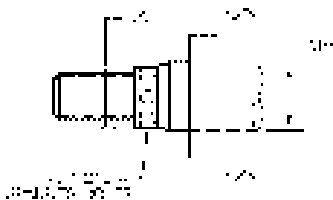

ROD DIA. (MM)	A	C	D	AC	AD	AE	AF	KK1	KK2	KK3	KK4	NA ±.002
0.625	0.750	0.375	0.500	1.125	0.625	0.250	0.375	7/16 - 20*	1/2 - 20*	7/16 - 20	5/8 - 18	—
1.000	1.125	0.500	0.875	1.625	0.938	0.375	0.688	3/4 - 16*	7/8 - 14*	3/4 - 16	1 - 14	—
1.375	1.625	0.625	1.125	1.750	1.062	0.375	0.875	1 - 14*	1 1/4 - 12*	1 - 14	1 3/8 - 12	—
1.750	2.000	0.750	1.500	2.000	1.313	0.500	1.125	1 1/4 - 12*	1 1/2 - 12*	1 1/4 - 12	1 3/4 - 12	—
2.000	2.250	0.875	1.750	2.625	1.688	0.625	1.375	1 1/2 - 12*	1 3/4 - 12*	1 1/2 - 12	2 - 12	—
2.500	3.000	1.000	2.125	3.250	1.938	0.750	1.750	1 7/8 - 12	2 1/4 - 12	1 7/8 - 12	2 1/2 - 12	—
3.000	3.500	1.000	2.625	3.625	2.438	0.875	2.250	2 1/4 - 12	2 3/4 - 12	2 1/4 - 12	3 - 12	—
3.500	3.500	1.000	3.000	4.375	2.688	1.000	2.500	2 1/2 - 12	3 1/4 - 12	2 1/2 - 12	3 1/2 - 12	—
4.000	4.000	1.000	—	4.500	2.688	1.000	3.000	3 - 12	3 3/4 - 12	3 - 12	4 - 12	3.937
4.500	4.500	1.000	—	5.250	3.188	1.500	3.500	3 1/4 - 12	4 1/4 - 12	3 1/4 - 12	4 1/2 - 12	4.421
5.000	5.000	1.000	—	5.375	3.188	1.500	3.875	3 1/2 - 12	4 3/4 - 12	3 1/2 - 12	5 - 12	4.921
5.500	5.500	1.000	—	6.250	3.938	1.875	4.375	4 - 12	5 1/4 - 12	4 - 12	5 1/2 - 12	5.421

*Studded rod end.
(4) Wrench flats is an option.
Note: Rods larger than 3.50" dia. utilize (4) 0.50" dia. spanner holes 0.50" deep.

SERIES 'H' HEAVY DUTY HYDRAULIC CYLINDERS

DIMENSIONS FOR BASIC CYLINDER - NO MOUNT

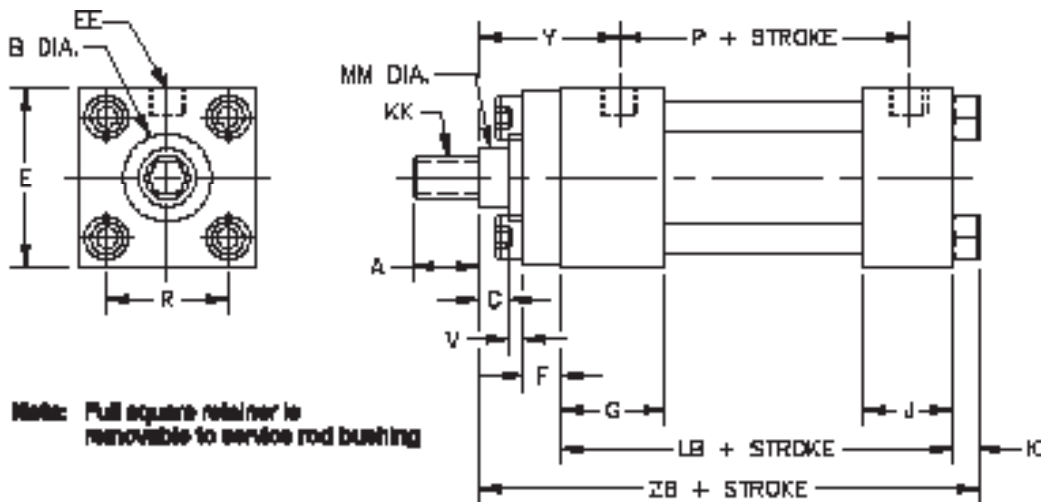

BORE	ROD DIA. (MM)	I MAX PSI RATING	E	A	B	C	EE		F	G	J	K	KK	R	RD	V	Y	ADD TO STROKE		
							NPTF	SAE										LB	P	ZB
1.50	0.625	3000	2.500	0.750	1.124	0.375	1/2	10	0.375	1.750	1.500	0.375	1.625	—	0.250	2.000	4.625	2.938	6.000	
1.50	1.000	3000	2.500	1.125	1.499	0.500	1/2	8	0.375	1.750	1.500	0.375	1.625	—	0.500	2.375	4.625	2.938	6.375	
2.00	1.000	3000	3.000	1.125	1.499	0.500	1/2	10	0.625	1.750	1.500	0.438	2.050	—	0.250	2.375	4.625	2.938	6.438	
2.00	1.375	3000	3.000	1.625	1.999	0.625	1/2	8	0.625	1.750	1.500	0.438	2.050	—	0.375	2.625	4.625	2.938	6.688	
2.50	1.000	3000	3.500	1.125	1.499	0.500	1/2	10	0.625	1.750	1.500	0.438	2.550	2.625	0.250	2.375	4.750	3.063	6.563	
2.50	1.375	3000	3.500	1.625	1.999	0.625	1/2	10	0.625	1.750	1.500	0.438	2.550	—	0.375	2.625	4.750	3.063	6.813	
2.50	1.750	3000	3.500	2.000	2.374	0.750	1/2	10	0.625	1.750	1.500	0.438	2.550	—	0.500	2.875	4.750	3.063	7.063	
3.25	1.375	3000	4.500	1.625	1.999	0.625	3/4	12	0.750	2.000	1.750	0.563	3.250	3.250	0.250	2.750	5.500	3.500	7.688	
3.25	1.750	3000	4.500	2.000	2.374	0.750	3/4	12	0.750	2.000	1.750	0.563	3.250	—	0.375	3.000	5.500	3.500	7.938	
3.25	2.000	3000	4.500	2.250	2.624	0.875	3/4	12	0.750	2.000	1.750	0.563	3.250	—	0.375	3.125	5.500	3.500	8.063	
4.00	1.750	3000	5.000	2.000	2.374	0.750	3/4	12	0.875	2.000	1.750	0.563	3.820	3.875	0.250	2.938	5.750	3.875	8.188	
4.00	2.000	3000	5.000	2.250	2.624	0.875	3/4	12	0.875	2.000	1.750	0.563	3.820	4.250	0.250	3.063	5.750	3.875	8.313	
4.00	2.500	3000	5.000	3.000	3.124	1.000	3/4	12	0.875	2.000	1.750	0.563	3.820	—	0.375	3.313	5.750	3.875	8.563	
5.00	2.000	3000	6.500	2.250	2.624	0.875	3/4	12	0.875	2.000	1.750	0.813	4.950	4.250	0.250	3.125	6.250	4.250	9.063	
5.00	2.500	3000	6.500	3.000	3.124	1.000	3/4	12	0.875	2.000	1.750	0.813	4.950	4.625	0.375	3.375	6.250	4.250	9.313	
5.00	3.000	3000	6.500	3.500	3.749	1.000	3/4	12	0.875	2.000	1.750	0.813	4.950	5.250	0.375	3.375	6.250	4.250	9.313	
5.00	3.500	3000	6.500	3.500	4.249	1.000	3/4	12	0.875	2.000	1.750	0.813	4.950	—	0.375	3.375	6.250	4.250	9.313	
6.00	2.500	3000	7.500	3.000	3.124	1.000	1	16	0.875	2.250	2.250	0.875	5.730	4.625	0.375	3.500	7.375	5.000	10.500	
6.00	3.000	3000	7.500	3.500	3.749	1.000	1	16	0.875	2.250	2.250	0.875	5.730	5.250	0.375	3.500	7.375	5.000	10.500	
6.00	3.500	3000	7.500	3.500	4.249	1.000	1	16	0.875	2.250	2.250	0.875	5.730	5.625	0.375	3.500	7.375	5.000	10.500	
6.00	4.000	3000	7.500	4.000	4.749	1.000	1	16	1.000	2.250	2.250	0.875	5.730	6.438	0.250	3.500	7.375	5.000	10.500	
8.00	3.500	3000	9.500	3.500	4.249	1.000	1 1/2	24	0.875	3.000	3.000	1.250	7.500	5.625	0.375	3.938	9.500	6.313	13.000	
8.00	4.000	3000	9.500	4.000	4.749	1.000	1 1/2	24	1.000	3.000	3.000	1.250	7.500	6.438	0.250	3.938	9.500	6.313	13.000	
8.00	4.500	3000	9.500	4.500	5.249	1.000	1 1/2	24	1.000	3.000	3.000	1.250	7.500	7.125	0.250	3.938	9.500	6.313	13.000	
8.00	5.000	3000	9.500	5.000	5.749	1.000	1 1/2	24	1.000	3.000	3.000	1.250	7.500	7.625	0.250	3.938	9.500	6.313	13.000	
8.00	5.500	3000	9.500	5.500	6.249	1.000	1 1/2	24	1.000	3.000	3.000	1.250	7.500	8.375	0.250	3.938	9.500	6.313	13.000	

SEE ROD END DETAIL CHART ON PAGE 7

I Max pressure rating (NON-SHOCK).

∅: 'B' dimension tolerance is +.000 / -.002

∩ Where no dimension is shown, cylinder utilizes a full square retainer.

⊕ Standard port sizes.

SERIES 'H' HEAVY DUTY HYDRAULIC CYLINDERS

DIMENSIONS FOR BASIC CYLINDER - NO MOUNT



FULL SQUARE RETAINER USED ON:	
BORE	ROD DIA.
1.50	0.625
1.50	1.000
2.00	1.000
2.00	1.375
2.50	1.375
2.50	1.750
3.25	1.750
3.25	2.000
4.00	2.500
5.00	3.500

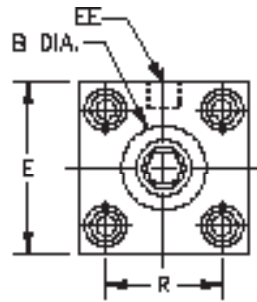

Note: Full square retainer is removable to service rod bushing

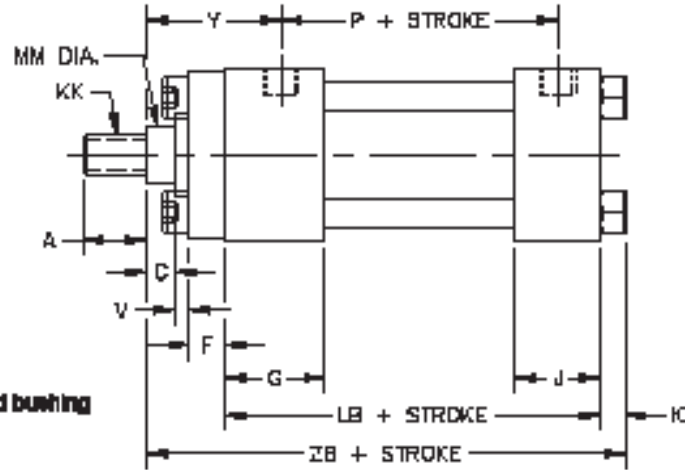

ROUND RETAINER USED ON:	
BORE	ROD DIA.
2.50	1.000
3.25	1.375
4.00	1.750
4.00	2.000
5.00	2.000
5.00	2.500
6.00	2.500

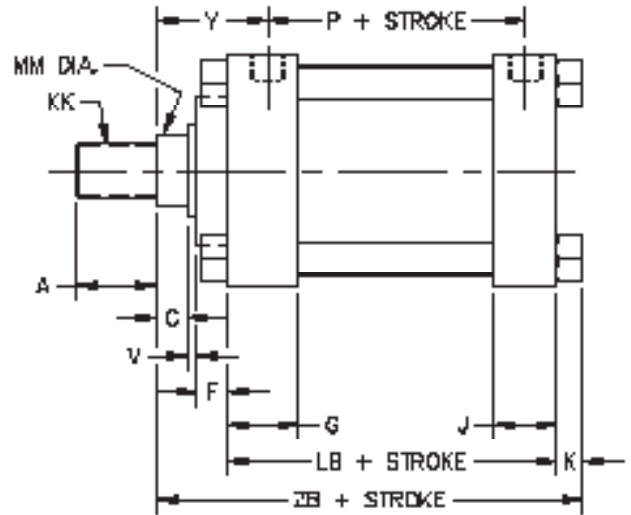
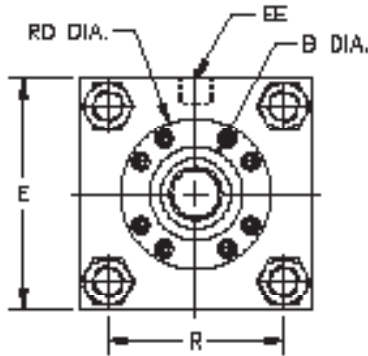

LARGE ROUND RETAINER USED ON:	
BORE	ROD DIA.
5.00	3.000
6.00	3.000
6.00	3.500
6.00	4.000
8.00	3.500
8.00	4.000
8.00	4.500
8.00	5.000
8.00	5.500

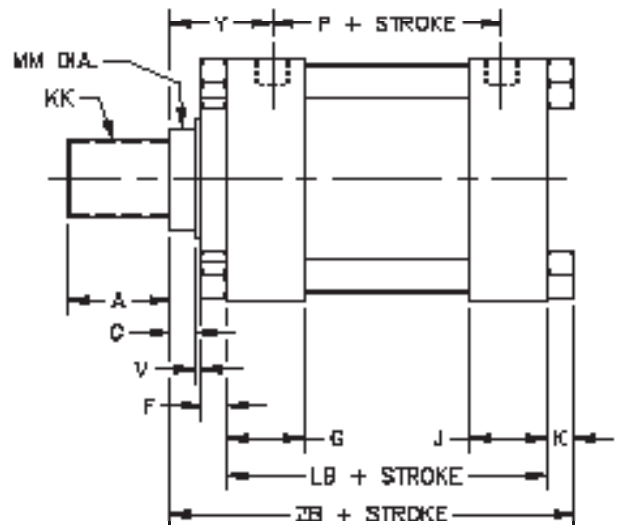
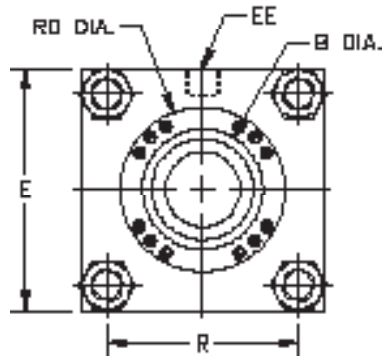



MT1: HEAD TRUNNION

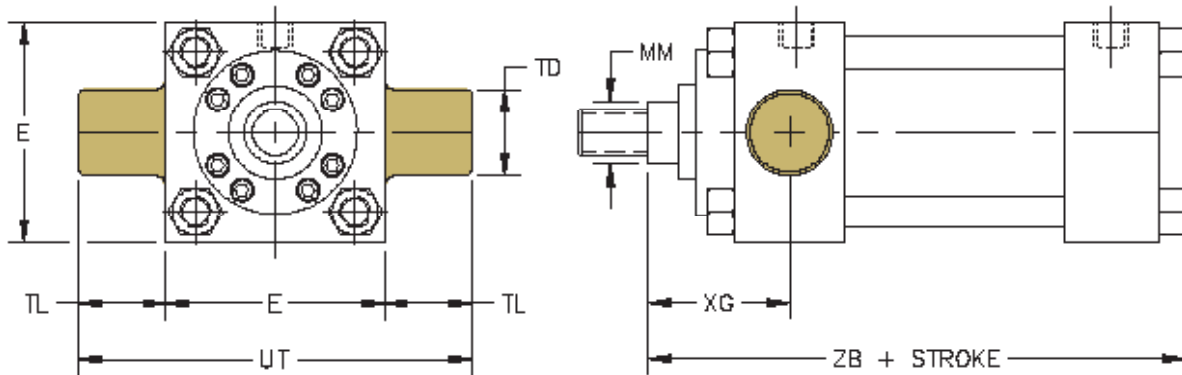

MT2: CAP TRUNNION

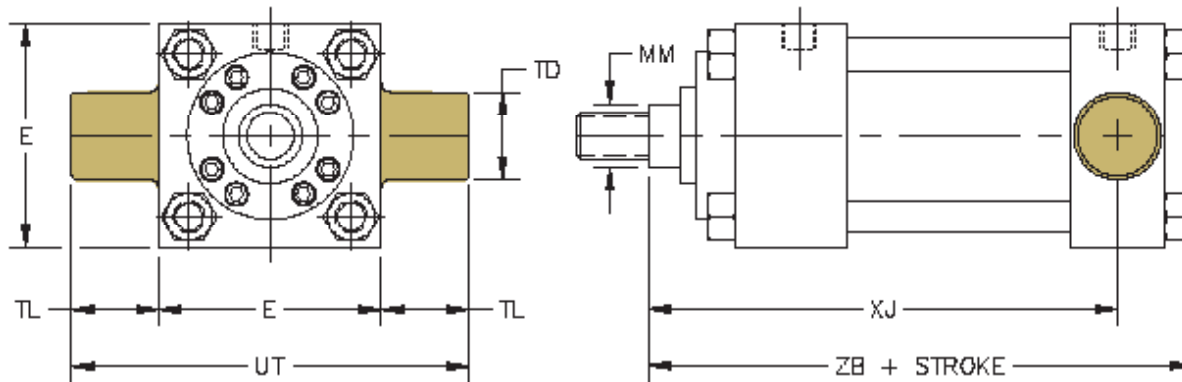

MT4: INTERMEDIATE TRUNNION

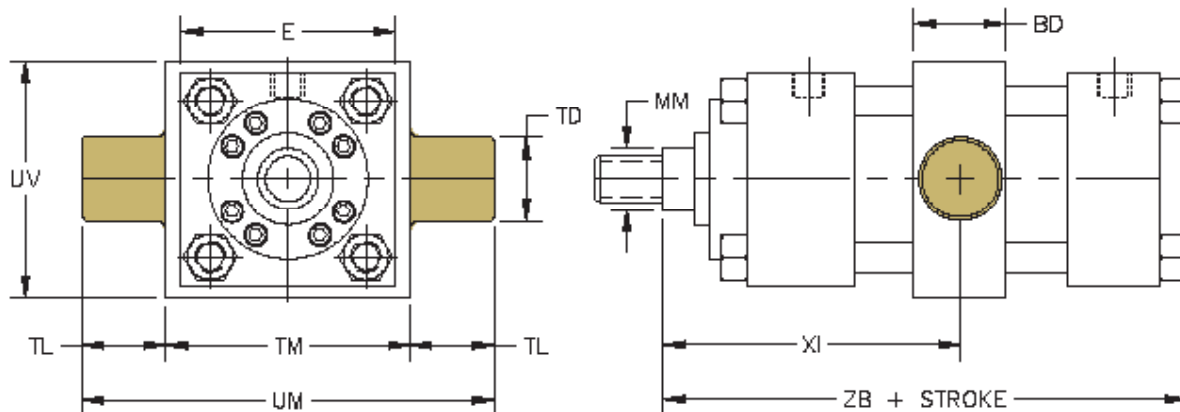

NOTE:
 'XI' DIMENSION TO BE SPECIFIED AT END OF PART NUMBER

SERIES 'H' HEAVY DUTY HYDRAULIC CYLINDERS



DIMENSIONS FOR TRUNNION MOUNTS

BORE	ROD DIA. (MM)	 MAX PSI RATING	E	BD	TD	TL	TM	UM	UT	UV	XG	XI	MT4 Min Stroke	ADD TO STROKE		
														XI Max	XJ	ZB
1.50	0.625	3000	2.500	1.500	1.000	1.000	3.000	5.000	4.500	3.000	1.875	3.560	0.250	3.250	4.875	6.000
1.50	1.000	3000	2.500	1.500	1.000	1.000	3.000	5.000	4.500	3.000	2.250	3.875	0.250	3.625	5.250	6.375
2.00	1.000	3000	3.000	1.500	1.375	1.375	3.500	6.250	5.750	3.500	2.250	4.000	0.250	3.750	5.250	6.438
2.00	1.375	3000	3.000	1.500	1.375	1.375	3.500	6.250	5.750	3.500	2.500	4.250	0.250	4.000	5.500	6.688
2.50	1.000	3000	3.500	1.500	1.375	1.375	4.000	6.750	6.250	4.000	2.250	4.125	0.375	3.750	5.375	6.563
2.50	1.375	3000	3.500	1.500	1.375	1.375	4.000	6.750	6.250	4.000	2.500	4.375	0.375	4.000	5.625	6.813
2.50	1.750	3000	3.500	1.500	1.375	1.375	4.000	6.750	6.250	4.000	2.750	4.625	0.375	4.250	5.875	7.063
3.25	1.375	2800	4.500	2.000	1.750	1.750	5.000	8.500	8.000	5.000	2.625	5.000	0.875	4.125	6.250	7.688
3.25	1.750	2800	4.500	2.000	1.750	1.750	5.000	8.500	8.000	5.000	2.875	5.250	0.875	4.375	6.500	7.938
3.25	2.000	2800	4.500	2.000	1.750	1.750	5.000	8.500	8.000	5.000	3.000	5.375	0.875	4.500	6.625	8.063
4.00	1.750	1800	5.000	2.000	1.750	1.750	5.500	9.000	8.500	5.500	2.875	5.500	1.125	4.375	6.750	8.188
4.00	2.000	1800	5.000	2.000	1.750	1.750	5.500	9.000	8.500	5.500	3.000	5.625	1.125	4.500	6.875	8.313
4.00	2.500	1800	5.000	2.000	1.750	1.750	5.500	9.000	8.500	5.500	3.250	5.875	1.125	4.750	7.125	8.563
5.00	2.000	1200	6.500	2.500	1.750	1.750	7.000	10.500	10.000	7.250	3.000	5.875	1.125	4.750	7.375	9.063
5.00	2.500	1200	6.500	2.500	1.750	1.750	7.000	10.500	10.000	7.250	3.250	6.125	1.125	5.000	7.625	9.313
5.00	3.000	1200	6.500	2.500	1.750	1.750	7.000	10.500	10.000	7.250	3.250	6.125	1.125	5.000	7.625	9.313
5.00	3.500	1200	6.500	2.500	1.750	1.750	7.000	10.500	10.000	7.250	3.250	6.125	1.125	5.000	7.625	9.313
6.00	2.500	1000	7.500	3.000	2.000	2.000	8.500	12.500	11.500	8.750	3.375	6.250	1.250	5.375	8.375	10.500
6.00	3.000	1000	7.500	3.000	2.000	2.000	8.500	12.500	11.500	8.750	3.375	6.250	1.250	5.375	8.375	10.500
6.00	3.500	1000	7.500	3.000	2.000	2.000	8.500	12.500	11.500	8.750	3.375	6.250	1.250	5.375	8.375	10.500
6.00	4.000	1000	7.500	3.000	2.000	2.000	8.500	12.500	11.500	8.750	3.375	6.250	1.250	5.375	8.375	10.500
8.00	3.500	1000	9.500	3.500	3.000	3.000	11.000	17.000	15.500	11.750	3.750	8.125	2.125	6.000	10.250	13.000
8.00	4.000	1000	9.500	3.500	3.000	3.000	11.000	17.000	15.500	11.750	3.750	8.125	2.125	6.000	10.250	13.000
8.00	4.500	1000	9.500	3.500	3.000	3.000	11.000	17.000	15.500	11.750	3.750	8.125	2.125	6.000	10.250	13.000
8.00	5.000	1000	9.500	3.500	3.000	3.000	11.000	17.000	15.500	11.750	3.750	8.125	2.125	6.000	10.250	13.000
8.00	5.500	1000	9.500	3.500	3.000	3.000	11.000	17.000	15.500	11.750	3.750	8.125	2.125	6.000	10.250	13.000

| Max pressure rating (NON-SHOCK).

⊕: 'TD' dimension tolerance is + .000 / - .001

⊖: 'XI' dimension is the minimum that can be supplied (customer to specify 'XI' dimension).

All our cylinders are proudly Made in USA



MX1: EXTENDED TIE-RODS - HEAD & CAP

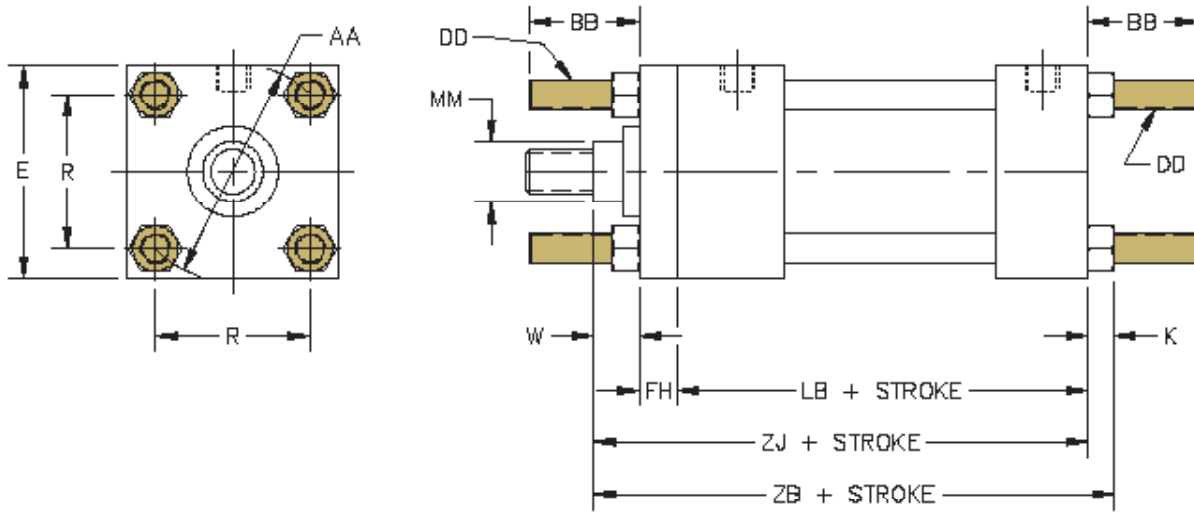

MX2: EXTENDED TIE-RODS - CAP END

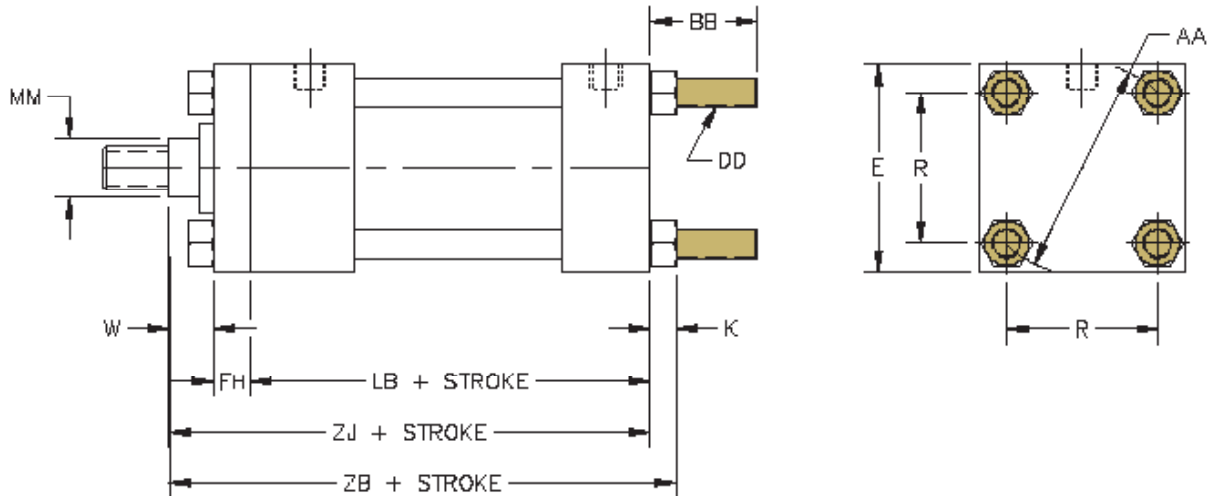

MX3: EXTENDED TIE-RODS - HEAD END

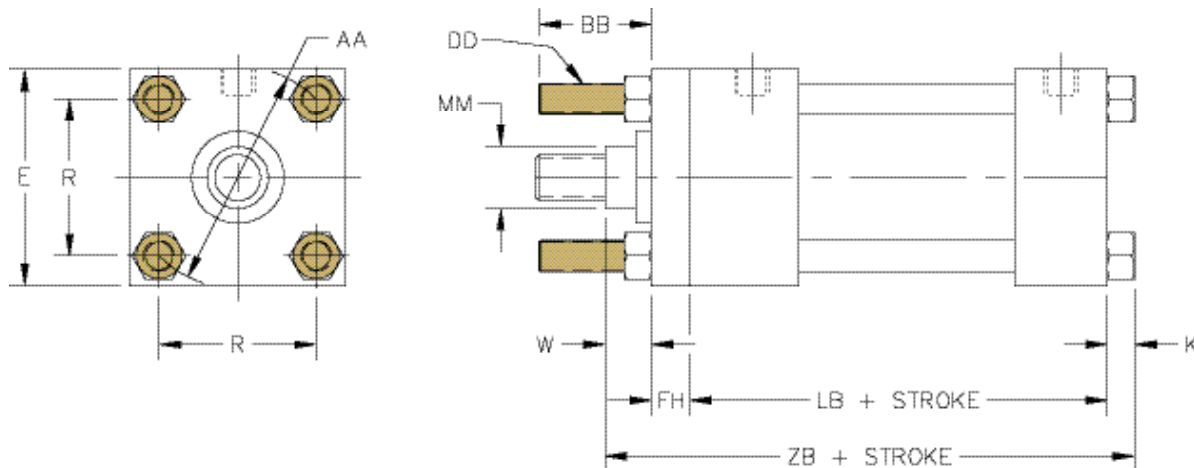

SERIES 'H' HEAVY DUTY HYDRAULIC CYLINDERS

DIMENSIONS FOR EXTENDED TIE ROD MOUNTS



BORE	ROD DIA. (MM)	I MAX PSI RATING	E	AA	BB	DD	F	FH	K	R	W	ADD TO STROKE		
												LB	ZB	ZJ
1.50	0.625	3000	2.500	2.300	1.375	3/8 - 24	0.375	0.375	0.375	1.625	0.625	4.625	6.000	5.625
1.50	1.000	3000	2.500	2.300	1.375	3/8 - 24	0.375	0.375	0.375	1.625	1.000	4.625	6.375	6.000
2.00	1.000	3000	3.000	2.900	1.813	1/2 - 20	0.625	0.625	0.438	2.047	0.750	4.625	6.438	6.000
2.00	1.375	3000	3.000	2.900	1.813	1/2 - 20	0.625	0.625	0.438	2.047	1.000	4.625	6.688	6.250
2.50	1.000	3000	3.500	3.600	1.813	1/2 - 20	0.625	0.625	0.438	2.547	0.750	4.750	6.563	6.128
2.50	1.375	3000	3.500	3.600	1.813	1/2 - 20	0.625	0.625	0.438	2.547	1.000	4.750	6.813	6.375
2.50	1.750	3000	3.500	3.600	1.813	1/2 - 20	0.625	0.625	0.438	2.547	1.250	4.750	7.063	6.625
3.25	1.375	3000	4.500	4.600	2.313	5/8 - 18	0.750	0.750	0.563	3.250	0.875	5.500	7.688	7.125
3.25	1.750	3000	4.500	4.600	2.313	5/8 - 18	0.750	0.750	0.563	3.250	1.125	5.500	7.938	7.375
3.25	2.000	3000	4.500	4.600	2.313	5/8 - 18	0.750	0.750	0.563	3.250	1.250	5.500	8.063	7.500
4.00	1.750	3000	5.000	5.400	2.313	5/8 - 18	0.875	0.875	0.563	3.813	1.000	5.750	8.188	7.625
4.00	2.000	3000	5.000	5.400	2.313	5/8 - 18	0.875	0.875	0.563	3.813	1.125	5.750	8.313	7.750
4.00	2.500	3000	5.000	5.400	2.313	5/8 - 18	0.875	0.875	0.563	3.813	1.375	5.750	8.563	8.000
5.00	2.000	3000	6.500	7.000	3.188	7/8 - 14	0.875	0.875	0.813	4.953	1.125	6.250	9.063	8.250
5.00	2.500	3000	6.500	7.000	3.188	7/8 - 14	0.875	0.875	0.813	4.953	1.375	6.250	9.313	8.500
5.00	3.000	3000	6.500	7.000	3.188	7/8 - 14	0.875	0.875	0.813	4.953	1.375	6.250	9.313	8.500
5.00	3.500	3000	6.500	7.000	3.188	7/8 - 14	0.875	0.875	0.813	4.953	1.375	6.250	9.313	8.500
6.00	2.500	3000	7.500	8.100	3.625	1 - 14	0.875*	1.000	0.875	5.734	1.250**	7.375	10.500	9.625
6.00	3.000	3000	7.500	8.100	3.625	1 - 14	0.875*	1.000	0.875	5.734	1.250**	7.375	10.500	9.625
6.00	3.500	3000	7.500	8.100	3.625	1 - 14	0.875*	1.000	0.875	5.734	1.250**	7.375	10.500	9.625
6.00	4.000	3000	7.500	8.100	3.625	1 - 14	1.000	1.000	0.875	5.734	1.250	7.375	10.500	9.625
8.00	3.500	3000	9.500	10.600	4.500	1 1/4 - 12	0.875*	1.000	1.250	7.500	1.250**	9.500	13.000	11.750
8.00	4.000	3000	9.500	10.600	4.500	1 1/4 - 12	1.000	1.000	1.250	7.500	1.250	9.500	13.000	11.750
8.00	4.500	3000	9.500	10.600	4.500	1 1/4 - 12	1.000	1.000	1.250	7.500	1.250	9.500	13.000	11.750
8.00	5.000	3000	9.500	10.600	4.500	1 1/4 - 12	1.000	1.000	1.250	7.500	1.250	9.500	13.000	11.750
8.00	5.500	3000	9.500	10.600	4.500	1 1/4 - 12	1.000	1.000	1.250	7.500	1.250	9.500	13.000	11.750

I Max pressure rating (NON-SHOCK).

* On MX2, MX1 & MX3, a round retainer is used; a square retainer is 1.00" thick.

** On MX2 mount, dimension is 1.375" with a round retainer.



MF1: HEAD FLANGE

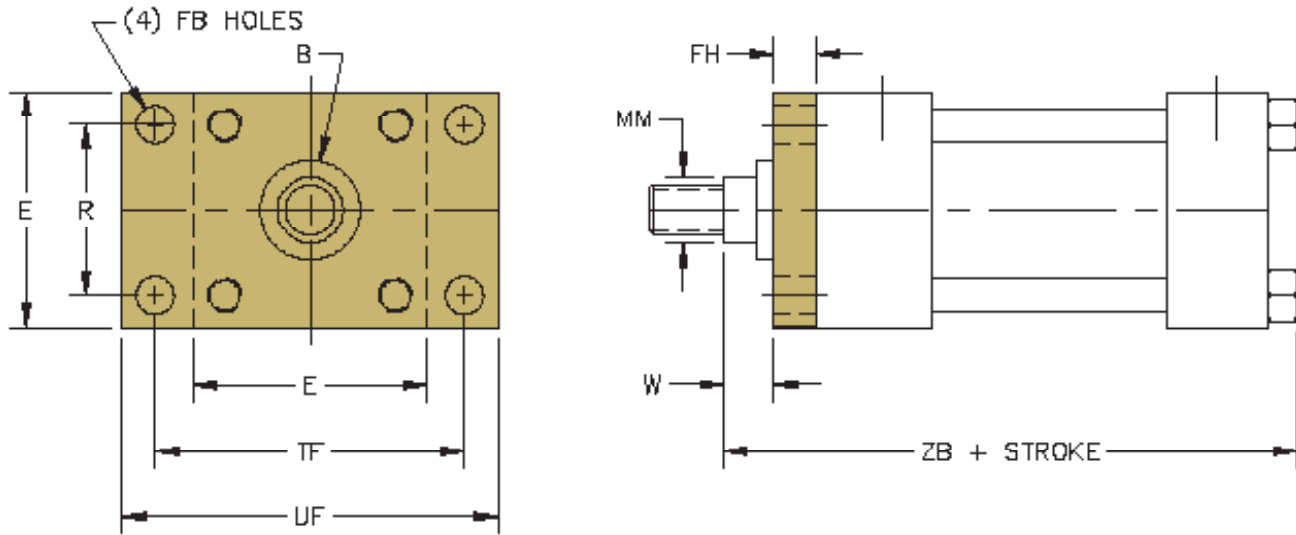

MF2: CAP FLANGE

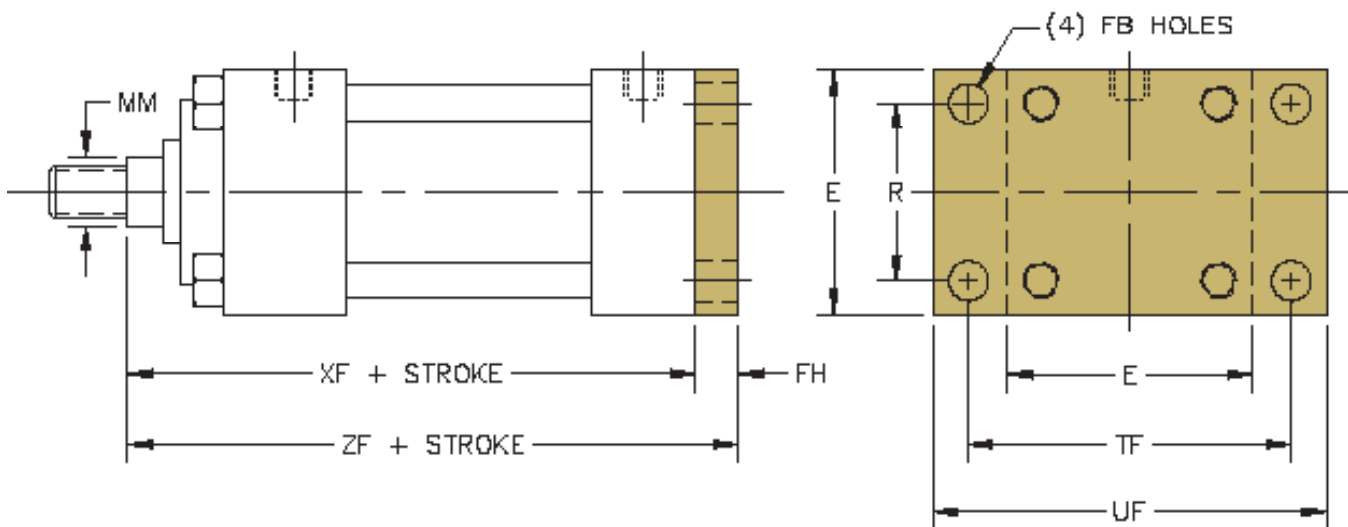

SERIES 'H' HEAVY DUTY HYDRAULIC CYLINDERS

DIMENSIONS FOR FLANGE MOUNTS



BORE	ROD DIA. (MM)	I MAX PSI RATING		B	E	F	FB	FH	R	RD	TF	UF	W	ADD TO STROKE		
		MF1	MF2											XF	ZB	ZF
1.50	0.625	2600	3000	1.124	2.500	0.375	0.438	0.375	1.625	2.375	3.438	4.250	0.625	5.625	6.000	6.000
1.50	1.000	1600	3000	1.499	2.500	0.375	0.438	0.375	1.625	2.563	3.438	4.250	1.000	6.000	6.375	6.375
2.00	1.000	2600	3000	1.499	3.000	0.625	0.563	0.625	2.047	2.625	4.125	5.125	0.750	6.000	6.438	6.625
2.00	1.375	1600	3000	1.999	3.000	0.625	0.563	0.625	2.047	3.250	4.125	5.125	1.000	6.250	6.688	6.875
2.50	1.000	2600	3000	1.499	3.500	0.625	0.563	0.625	2.546	2.625	4.625	5.625	0.750	6.125	6.563	6.750
2.50	1.375	2000	3000	1.999	3.500	0.625	0.563	0.625	2.546	3.250	4.625	5.625	1.000	6.375	6.813	7.000
2.50	1.750	1600	3000	2.374	3.500	0.625	0.563	0.625	2.546	3.875	4.625	5.625	1.250	6.625	7.063	7.250
3.25	1.375	2600	3000	1.999	4.500	0.750	0.688	0.750	3.250	3.250	5.875	7.125	0.875	7.125	7.688	7.875
3.25	1.750	2200	3000	2.374	4.500	0.750	0.688	0.875	3.250	3.875	5.875	7.125	1.125	7.375	7.943	8.125
3.25	2.000	1600	3000	2.624	4.500	0.750	0.688	0.875	3.250	4.250	5.875	7.125	1.250	7.500	8.063	8.250
4.00	1.750	2600	3000	2.374	5.000	0.875	0.688	0.875	3.820	3.875	6.375	7.625	1.000	7.625	8.188	8.500
4.00	2.000	1900	3000	2.624	5.000	0.875	0.688	0.875	3.820	4.250	6.375	7.625	1.125	7.750	8.313	8.625
4.00	2.500	1600	3000	3.124	5.000	0.875	0.688	0.875	3.820	4.625	6.375	7.625	1.375	8.000	8.563	8.875
5.00	2.000	2200	2000	2.624	6.500	0.875	0.943	0.875	4.953	4.250	8.188	9.750	1.125	8.250	9.063	9.125
5.00	2.500	1600	2500	3.124	6.500	0.875	0.943	0.875	4.953	4.625	8.188	9.750	1.375	8.500	9.313	9.375
5.00	3.000	1200	2800	3.749	6.500	0.875	0.943	0.875	4.953	5.250	8.188	9.750	1.375	8.500	9.313	9.375
5.00	3.500	750	3000	4.249	6.500	0.875	0.943	0.875	4.953	5.625	8.188	9.750	1.375	8.500	9.313	9.375
6.00	2.500	1800	2000	3.124	7.500	0.875	1.063	1.000	5.734	4.625	9.438	11.250	1.250	9.625	10.500	10.625
6.00	3.000	1450	2500	3.749	7.500	0.875	1.063	1.000	5.734	5.250	9.438	11.250	1.250	9.625	10.500	10.625
6.00	3.500	1100	2800	4.249	7.500	0.875	1.063	1.000	5.734	5.625	9.438	11.250	1.250	9.625	10.500	10.625
6.00	4.000	750	3000	4.749	7.500	1.000	1.063	1.000	5.734	6.438	9.438	11.250	1.250	9.625	10.500	10.625
8.00	3.500	900	1500	4.249	9.500	0.875	1.313	1.000	7.500	5.625	11.813	14.000	1.250	11.750	13.000	12.750
8.00	4.000	800	1700	4.749	9.500	1.000	1.313	1.000	7.500	6.438	11.813	14.000	1.250	11.750	13.000	12.750
8.00	4.500	700	1800	5.249	9.500	1.000	1.313	1.000	7.500	7.125	11.813	14.000	1.250	11.750	13.000	12.750
8.00	5.000	500	1900	5.749	9.500	1.000	1.313	1.000	7.500	7.625	11.813	14.000	1.250	11.750	13.000	12.750
8.00	5.500	500	2000	6.249	9.500	1.000	1.313	1.000	7.500	8.375	11.813	14.000	1.250	11.750	13.000	12.750

I Max pressure rating (NON-SHOCK).

± 'B' dimension tolerance is +.000 / -.002



ME5: HEAD RECTANGULAR MOUNTING HOLES

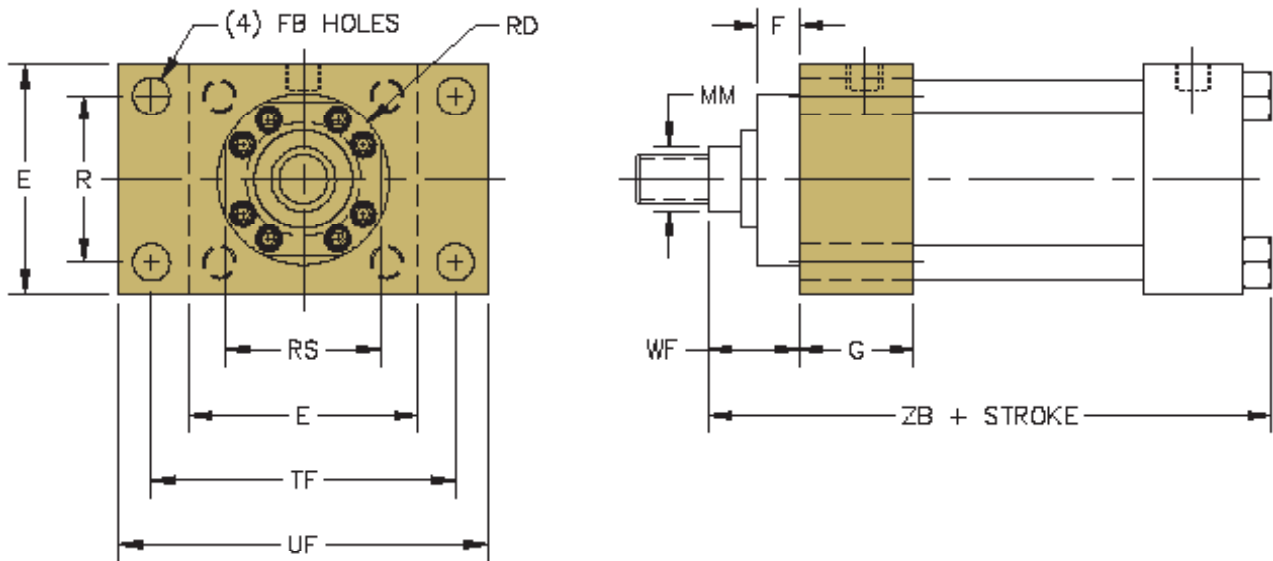

ME6: CAP RECTANGULAR MOUNTING HOLES

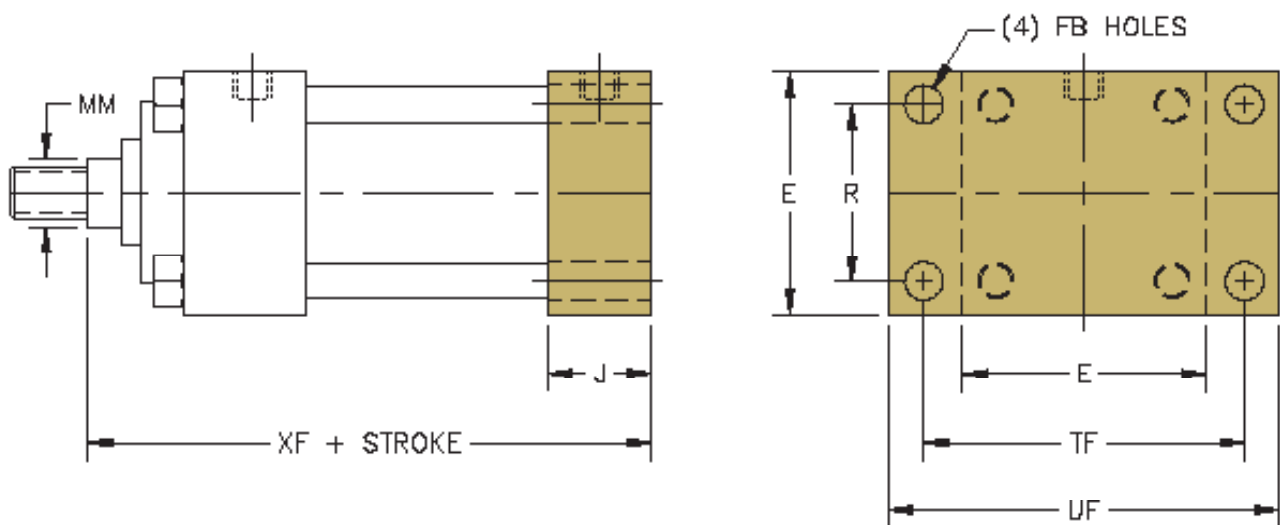

SERIES 'H' HEAVY DUTY HYDRAULIC CYLINDERS

DIMENSIONS FOR FLANGE MOUNTS



BORE	ROD DIA. (MM)	I MAX PSI RATING	E	F	FB	G	J	R	RD	RS	TF	UF	WF	ADD TO STROKE	
														XF	ZB
1.50	0.625	3000	2.500	0.375	0.438	1.750	1.500	1.625	2.375	—	3.438	4.250	1.000	5.625	6.000
1.50	1.000	3000	2.500	0.375	0.438	1.750	1.500	1.625	2.563	2.438	3.438	4.250	1.375	6.000	6.375
2.00	1.000	3000	3.000	0.625	0.563	1.750	1.500	2.047	2.625	—	4.125	5.125	1.375	6.000	6.438
2.00	1.375	3000	3.000	0.625	0.563	1.750	1.500	2.047	3.250	2.943	4.125	5.125	1.625	6.250	6.688
2.50	1.000	3000	3.500	0.625	0.563	1.750	1.500	2.546	2.625	—	4.625	5.625	1.375	6.125	6.563
2.50	1.375	3000	3.500	0.625	0.563	1.750	1.500	2.546	3.250	—	4.625	5.625	1.625	6.375	6.813
2.50	1.750	3000	3.500	0.625	0.563	1.750	1.500	2.546	3.875	3.438	4.625	5.625	1.875	6.625	7.063
3.25	1.375	3000	4.500	0.750	0.688	2.000	1.750	3.250	3.250	—	5.875	7.125	1.625	7.125	7.688
3.25	1.750	3000	4.500	0.750	0.688	2.000	1.750	3.250	3.875	—	5.875	7.125	1.875	7.375	7.943
3.25	2.000	3000	4.500	0.750	0.688	2.000	1.750	3.250	4.250	—	5.875	7.125	2.000	7.500	8.063
4.00	1.750	3000	5.000	0.875	0.688	2.000	1.750	3.820	3.875	—	6.375	7.625	1.875	7.625	8.188
4.00	2.000	3000	5.000	0.875	0.688	2.000	1.750	3.820	4.250	—	6.375	7.625	2.000	7.750	8.313
4.00	2.500	3000	5.000	0.875	0.688	2.000	1.750	3.820	4.625	—	6.375	7.625	2.250	8.000	8.563
5.00	2.000	3000	6.500	0.875	0.943	2.000	1.750	4.953	4.250	—	8.188	9.750	2.000	8.250	9.063
5.00	2.500	3000	6.500	0.875	0.943	2.000	1.750	4.953	4.625	—	8.188	9.750	2.250	8.500	9.313
5.00	3.000	3000	6.500	0.875	0.943	2.000	1.750	4.953	5.250	—	8.188	9.750	2.250	8.500	9.313
5.00	3.500	3000	6.500	0.875	0.943	2.000	1.750	4.953	5.625	—	8.188	9.750	2.250	8.500	9.313
6.00	2.500	3000	7.500	0.875	1.063	2.250	2.250	5.734	4.625	—	9.438	11.250	2.250	9.625	10.500
6.00	3.000	3000	7.500	0.875	1.063	2.250	2.250	5.734	5.250	—	9.438	11.250	2.250	9.625	10.500
6.00	3.500	3000	7.500	0.875	1.063	2.250	2.250	5.734	5.625	—	9.438	11.250	2.250	9.625	10.500
6.00	4.000	3000	7.500	1.000	1.063	2.250	2.250	5.734	6.438	—	9.438	11.250	2.250	9.625	10.500
8.00	3.500	3000	9.500	0.875	1.313	3.000	3.000	7.500	5.625	—	11.813	14.000	2.250	11.750	13.000
8.00	4.000	3000	9.500	1.000	1.313	3.000	3.000	7.500	6.438	—	11.813	14.000	2.250	11.750	13.000
8.00	4.500	3000	9.500	1.000	1.313	3.000	3.000	7.500	7.125	—	11.813	14.000	2.250	11.750	13.000
8.00	5.000	3000	9.500	1.000	1.313	3.000	3.000	7.500	7.625	—	11.813	14.000	2.250	11.750	13.000
8.00	5.500	3000	9.500	1.000	1.313	3.000	3.000	7.500	8.375	—	11.813	14.000	2.250	11.750	13.000

I Max pressure rating (NON-SHOCK).

All our cylinders are proudly Made in USA



MF5: HEAD SQUARE FLANGE

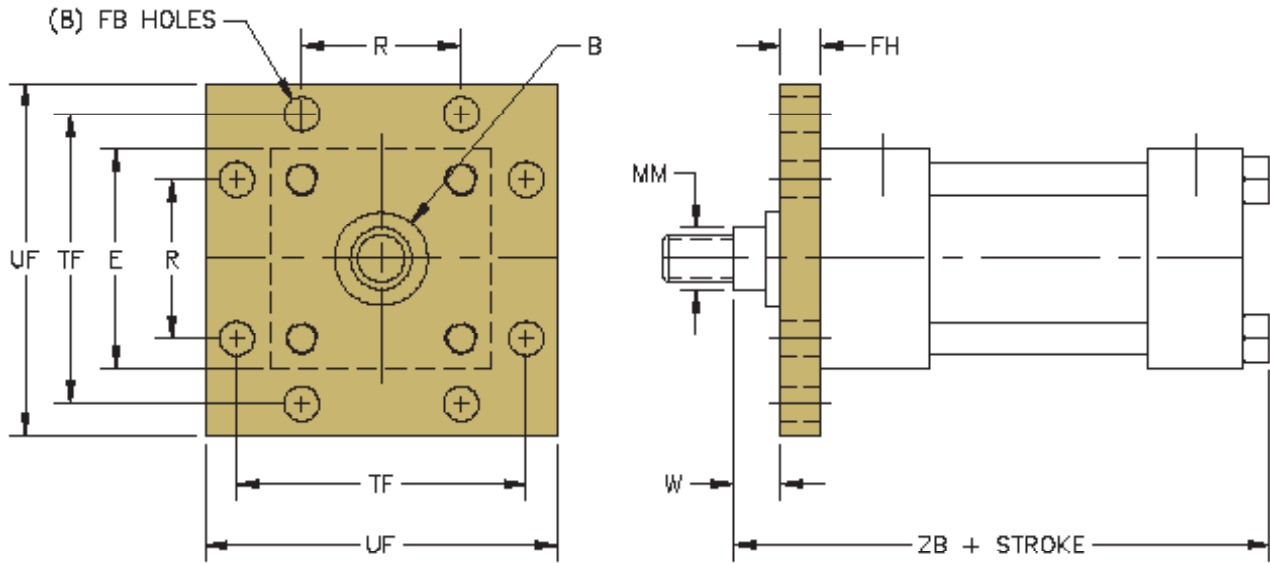

MF6: CAP SQUARE FLANGE

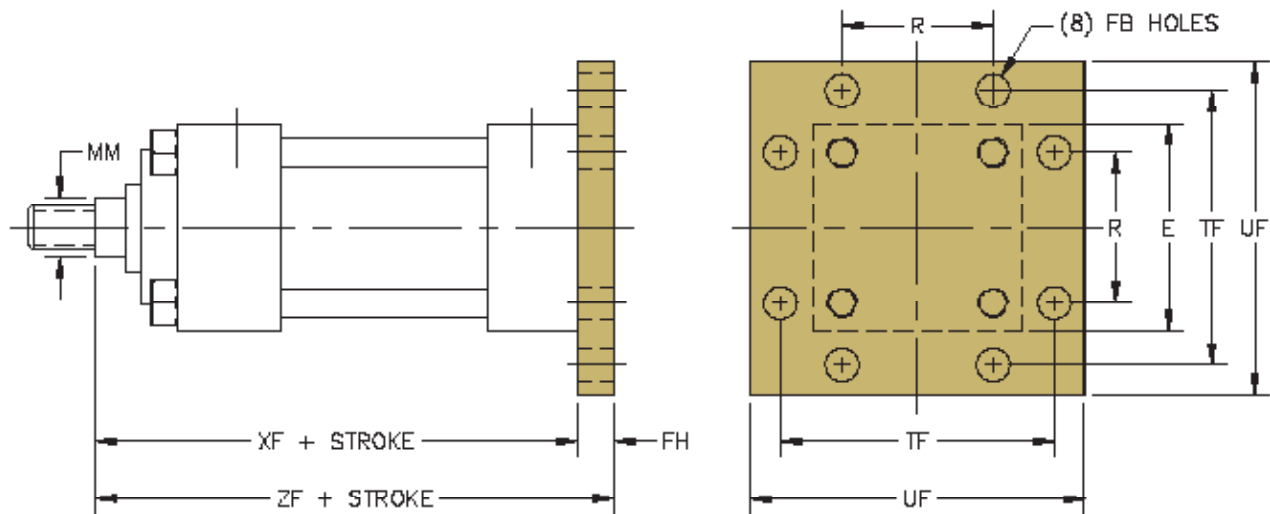

SERIES 'H' HEAVY DUTY HYDRAULIC CYLINDERS

DIMENSIONS FOR SQUARE FLANGE MOUNTS



BORE	ROD DIA. (MM)	I MAX PSI RATING		B	E	F	FB	FH	R	RD	TF	UF	W	ADD TO STROKE		
		MF5	MF6											XF	ZB	ZF
1.50	0.625	3000	3000	1.124	2.500	0.375	0.438	0.375	1.625	—	3.438	4.250	0.625	5.625	6.000	6.000
1.50	1.000	2500	3000	1.499	2.500	0.375	0.438	0.375	1.625	—	3.438	4.250	1.000	6.000	6.375	6.375
2.00	1.000	3000	3000	1.499	3.000	0.625	0.563	0.625	2.047	—	4.125	5.125	0.750	6.000	6.438	6.625
2.00	1.375	3000	3000	1.999	3.000	0.625	0.563	0.625	2.047	—	4.125	5.125	1.000	6.250	6.688	6.875
2.50	1.000	3000	3000	1.499	3.500	0.625	0.563	0.625	2.547	2.625	4.625	5.625	0.750	6.125	6.563	6.750
2.50	1.375	3000	3000	1.999	3.500	0.625	0.563	0.625	2.547	—	4.625	5.625	1.000	6.375	6.813	7.000
2.50	1.750	2700	3000	2.374	3.500	0.625	0.563	0.625	2.547	—	4.625	5.625	1.250	6.625	7.063	7.250
3.25	1.375	2900	3000	1.999	4.500	0.750	0.688	0.750	3.250	3.250	5.875	7.125	0.875	7.125	7.688	7.875
3.25	1.750	2700	3000	2.374	4.500	0.750	0.688	0.750	3.250	—	5.875	7.125	1.125	7.375	7.938	8.125
3.25	2.000	2500	3000	2.624	4.500	0.750	0.688	0.750	3.250	—	5.875	7.125	1.250	7.500	8.063	8.250
4.00	1.750	2700	3000	2.374	5.000	0.875	0.688	0.875	3.820	3.875	6.375	7.625	1.000	7.625	8.188	8.500
4.00	2.000	2600	3000	2.624	5.000	0.875	0.688	0.875	3.820	4.250	6.375	7.625	1.125	7.750	8.313	8.625
4.00	2.500	2400	3000	3.124	5.000	0.875	0.688	0.875	3.820	—	6.375	7.625	1.375	8.000	8.563	8.875
5.00	2.000	2000	2600	2.624	6.500	0.875	0.938	0.875	4.953	4.250	8.188	9.750	1.125	8.250	9.063	9.125
5.00	2.500	1800	2600	3.124	6.500	0.875	0.938	0.875	4.953	4.625	8.188	9.750	1.375	8.500	9.313	9.375
5.00	3.000	1200	2600	3.749	6.500	0.875	0.938	0.875	4.953	5.250	8.188	9.750	1.375	8.500	9.313	9.375
5.00	3.500	1200	2600	4.249	6.500	0.875	0.938	0.875	4.953	—	8.188	9.750	1.375	8.500	9.313	9.375
6.00	2.500	1700	2100	3.124	7.500	0.875	1.063	1.000	5.734	4.625	9.438	11.250	1.250	9.625	10.500	10.625
6.00	3.000	1000	2100	3.749	7.500	0.875	1.063	1.000	5.734	5.250	9.438	11.250	1.250	9.625	10.500	10.625
6.00	3.500	1000	2100	4.249	7.500	0.875	1.063	1.000	5.734	5.625	9.438	11.250	1.250	9.625	10.500	10.625
6.00	4.000	1000	2100	4.749	7.500	1.000	1.063	1.000	5.734	6.438	9.438	11.250	1.250	9.625	10.500	10.625
8.00	3.500	1000	1300	4.249	9.500	0.875	1.313	1.000	7.500	5.625	11.813	14.000	1.250	11.750	13.000	12.750
8.00	4.000	800	1300	4.749	9.500	1.000	1.313	1.000	7.500	6.438	11.813	14.000	1.250	11.750	13.000	12.750
8.00	4.500	700	1300	5.249	9.500	1.000	1.313	1.000	7.500	7.125	11.813	14.000	1.250	11.750	13.000	12.750
8.00	5.000	700	1300	5.749	9.500	1.000	1.313	1.000	7.500	7.625	11.813	14.000	1.250	11.750	13.000	12.750
8.00	5.500	700	1300	6.249	9.500	1.000	1.313	1.000	7.500	8.375	11.813	14.000	1.250	11.750	13.000	12.750

I Max pressure rating (NON-SHOCK).

±: 'B' dimension tolerance is +.000 / -.002

∅: Where no dimension is shown, cylinder utilizes a full square retainer.



MS2: SIDE LUGS

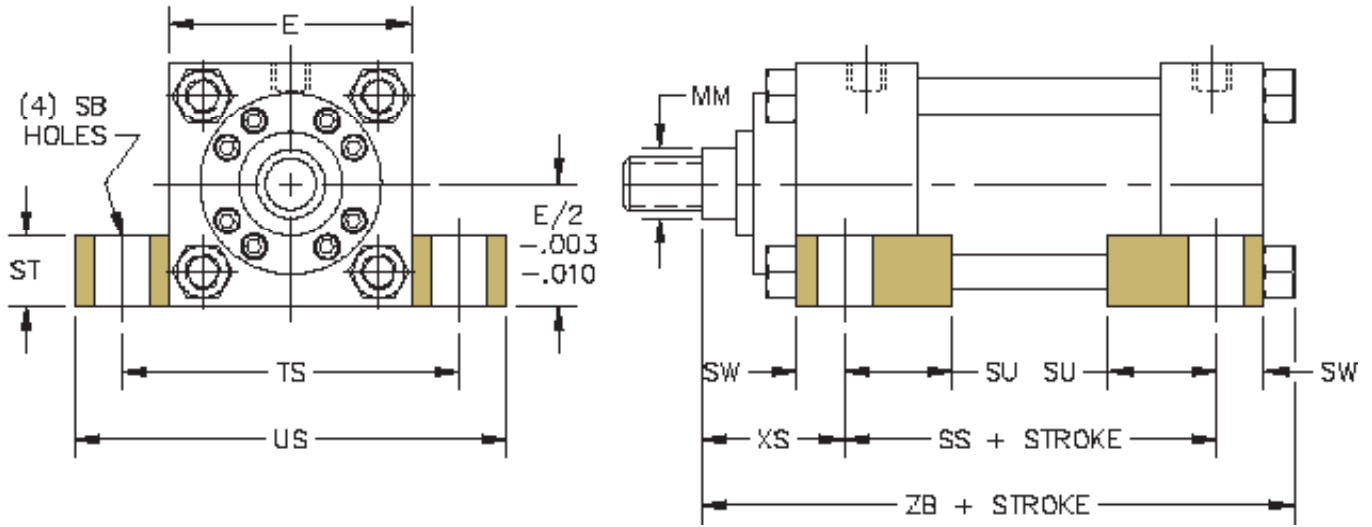

MS3: CENTER LINE LUGS

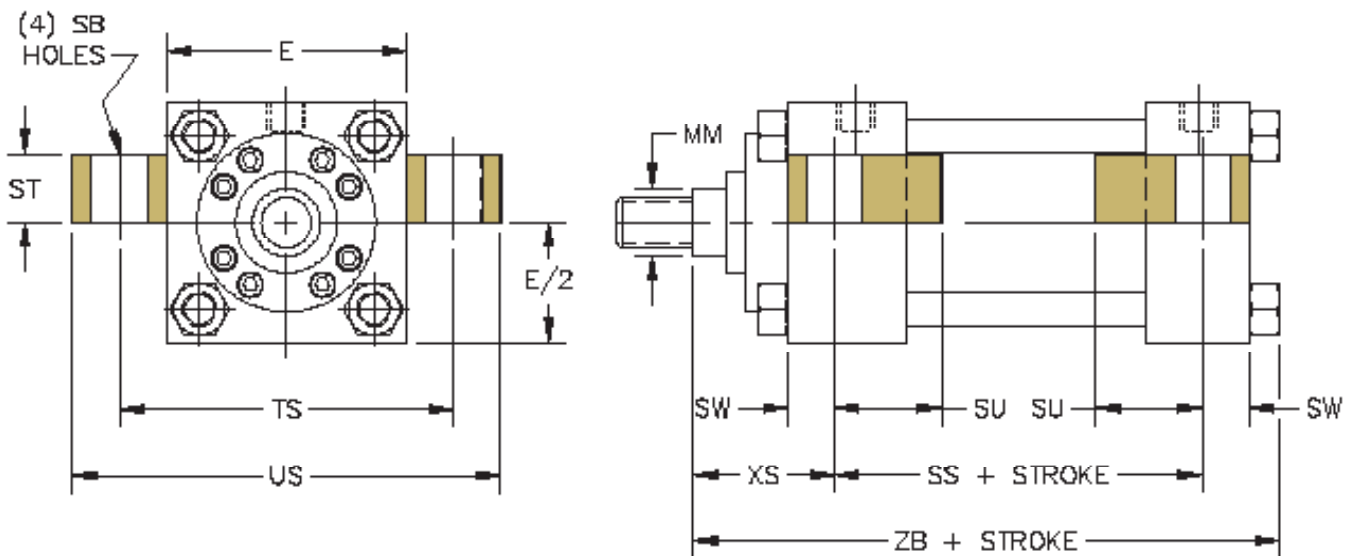

SERIES 'H' HEAVY DUTY HYDRAULIC CYLINDERS

DIMENSIONS FOR LUG MOUNTS



BORE	ROD DIA. (MM)	I MAX PSI RATING	E	E / 2	SB	ST	SU	SW	TS	US	XS	ADD TO STROKE	
												SS	ZB
1.50	0.625	3000	2.500	1.250	0.438	0.500	0.938	0.375	3.250	4.000	1.375	3.875	6.000
1.50	1.000	3000	2.500	1.250	0.438	0.500	0.938	0.375	3.250	4.000	1.750	3.875	6.375
2.00	1.000	3000	3.000	1.500	0.563	0.750	1.250	0.500	4.000	5.000	1.875	3.625	6.438
2.00	1.375	3000	3.000	1.500	0.563	0.750	1.250	0.500	4.000	5.000	2.125	3.625	6.688
2.50	1.000	3000	3.500	1.750	0.813	1.000	1.563	0.688	4.875	6.250	2.063	3.375	6.563
2.50	1.375	3000	3.500	1.750	0.813	1.000	1.563	0.688	4.875	6.250	2.313	3.375	6.813
2.50	1.750	3000	3.500	1.750	0.813	1.000	1.563	0.688	4.875	6.250	2.563	3.375	7.063
3.25	1.375	3000	4.500	2.250	0.813	1.000	1.563	0.688	5.875	7.250	2.313	4.125	7.688
3.25	1.750	3000	4.500	2.250	0.813	1.000	1.563	0.688	5.875	7.250	2.563	4.125	7.943
3.25	2.000	3000	4.500	2.250	0.813	1.000	1.563	0.688	5.875	7.250	2.688	4.125	8.063
4.00	1.750	3000	5.000	2.500	1.063	1.250	2.000	0.875	6.750	8.500	2.750	4.000	8.188
4.00	2.000	3000	5.000	2.500	1.063	1.250	2.000	0.875	6.750	8.500	2.875	4.000	8.313
4.00	2.500	3000	5.000	2.500	1.063	1.250	2.000	0.875	6.750	8.500	3.125	4.000	8.563
5.00	2.000	3000	6.500	3.250	1.063	1.250	2.000	0.875	8.250	10.000	2.875	4.500	9.063
5.00	2.500	3000	6.500	3.250	1.063	1.250	2.000	0.875	8.250	10.000	3.125	4.500	9.313
5.00	3.000	3000	6.500	3.250	1.063	1.250	2.000	0.875	8.250	10.000	3.125	4.500	9.313
5.00	3.500	3000	6.500	3.250	1.063	1.250	2.000	0.875	8.250	10.000	3.125	4.500	9.313
6.00	2.500	3000	7.500	3.750	1.313	1.500	2.500	1.125	9.750	12.000	3.375	5.125	10.500
6.00	3.000	3000	7.500	3.750	1.313	1.500	2.500	1.125	9.750	12.000	3.375	5.125	10.500
6.00	3.500	3000	7.500	3.750	1.313	1.500	2.500	1.125	9.750	12.000	3.375	5.125	10.500
6.00	4.000	3000	7.500	3.750	1.313	1.500	2.500	1.125	9.750	12.000	3.375	5.125	10.500
8.00	3.500	3000	9.500	4.750	1.563	1.750	2.875	1.375	12.250	15.000	3.625	6.750	13.000
8.00	4.000	3000	9.500	4.750	1.563	1.750	2.875	1.375	12.250	15.000	3.625	6.750	13.000
8.00	4.500	3000	9.500	4.750	1.563	1.750	2.875	1.375	12.250	15.000	3.625	6.750	13.000
8.00	5.000	3000	9.500	4.750	1.563	1.750	2.875	1.375	12.250	15.000	3.625	6.750	13.000
8.00	5.500	3000	9.500	4.750	1.563	1.750	2.875	1.375	12.250	15.000	3.625	6.750	13.000

I Max pressure rating (NON-SHOCK).

All our cylinders are proudly Made in USA

SERIES 'H' HEAVY DUTY HYDRAULIC CYLINDERS

DIMENSIONS FOR MS4: BOTTOM TAPPED HOLES

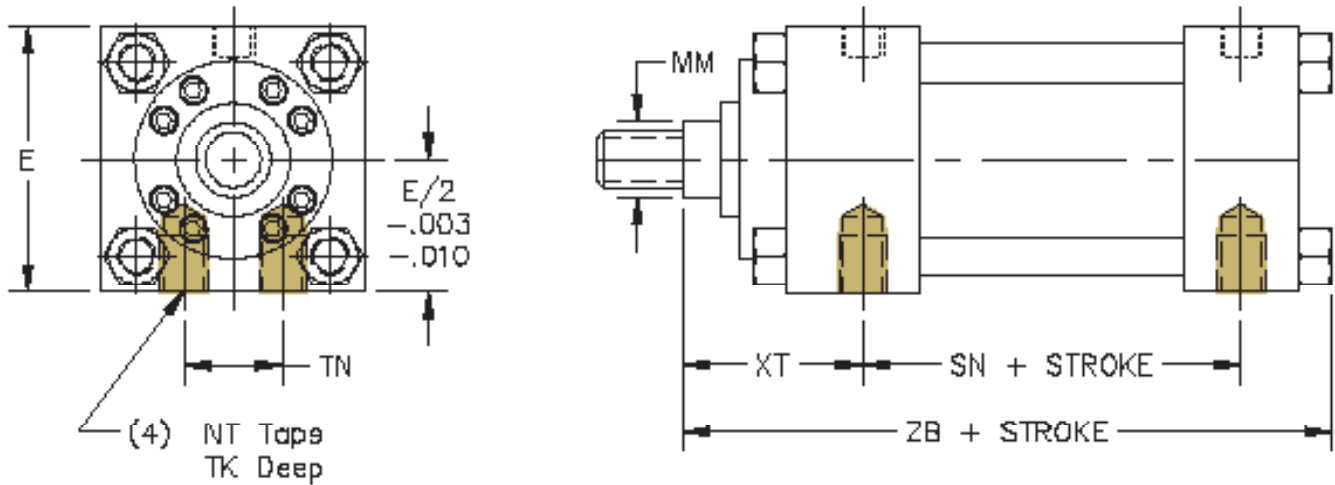

BORE	I ROD DIA. (MM)	MAX PSI RATING	E	E / 2	MS4 DIMENSIONS					
					NT	TK	TN	XT	SN	ZB
1.50	0.625	3000	2.500	1.250	3/8 - 16	0.375	0.750	2.000	2.875	6.000
1.50	1.000	3000	2.500	1.250	3/8 - 16	0.375	0.750	2.375	2.875	6.375
2.00	1.000	3000	3.000	1.500	1/2 - 13	0.438	0.938	2.375	2.875	6.438
2.00	1.375	3000	3.000	1.500	1/2 - 13	0.438	0.938	2.625	2.875	6.688
2.50	1.000	3000	3.500	1.750	5/8 - 11	0.750	1.313	2.375	3.000	6.563
2.50	1.375	3000	3.500	1.750	5/8 - 11	0.625	1.313	2.625	3.000	6.813
2.50	1.750	3000	3.500	1.750	5/8 - 11	0.500	1.313	2.875	3.000	7.063
3.25	1.375	3000	4.500	2.250	3/4 - 10	1.000	1.500	2.750	3.500	7.688
3.25	1.750	3000	4.500	2.250	3/4 - 10	0.875	1.500	3.000	3.500	7.938
3.25	2.000	3000	4.500	2.250	3/4 - 10	0.750	1.500	3.125	3.500	8.063
4.00	1.750	3000	5.000	2.500	1 - 8	0.875	2.063	3.000	3.750	8.188
4.00	2.000	3000	5.000	2.500	1 - 8	0.750	2.063	3.125	3.750	8.313
4.00	2.500	3000	5.000	2.500	1 - 8	0.750	2.063	3.375	3.750	8.563
5.00	2.000	3000	6.500	3.250	1 - 8	1.000	2.938	3.125	4.250	9.063
5.00	2.500	3000	6.500	3.250	1 - 8	1.000	2.938	3.375	4.250	9.313
5.00	3.000	3000	6.500	3.250	1 - 8	1.000	2.938	3.375	4.250	9.313
5.00	3.500	3000	6.500	3.250	1 - 8	1.000	2.938	3.375	4.250	9.313
6.00	2.500	3000	7.500	3.750	1 1/4 - 7	1.250	3.313	3.500	5.125	10.500
6.00	3.000	3000	7.500	3.750	1 1/4 - 7	1.250	3.313	3.500	5.125	10.500
6.00	3.500	3000	7.500	3.750	1 1/4 - 7	1.250	3.313	3.500	5.125	10.500
6.00	4.000	3000	7.500	3.750	1 1/4 - 7	0.750	3.313	3.500	5.125	10.500
8.00	3.500	3000	9.500	4.750	1 1/2 - 6	1.500	4.250	3.938	6.625	13.000
8.00	4.000	3000	9.500	4.750	1 1/2 - 6	1.500	4.250	3.938	6.625	13.000
8.00	4.500	3000	9.500	4.750	1 1/2 - 6	1.500	4.250	3.938	6.625	13.000
8.00	5.000	3000	9.500	4.750	1 1/2 - 6	1.250	4.250	3.938	6.625	13.000
8.00	5.500	3000	9.500	4.750	1 1/2 - 6	1.000	4.250	3.938	6.625	13.000

I Max pressure rating (NON-SHOCK).

All our cylinders are proudly Made in USA

SERIES 'H' HEAVY DUTY HYDRAULIC CYLINDERS

DIMENSIONS FOR MS7: END LUGS BOTTOM MOUNT

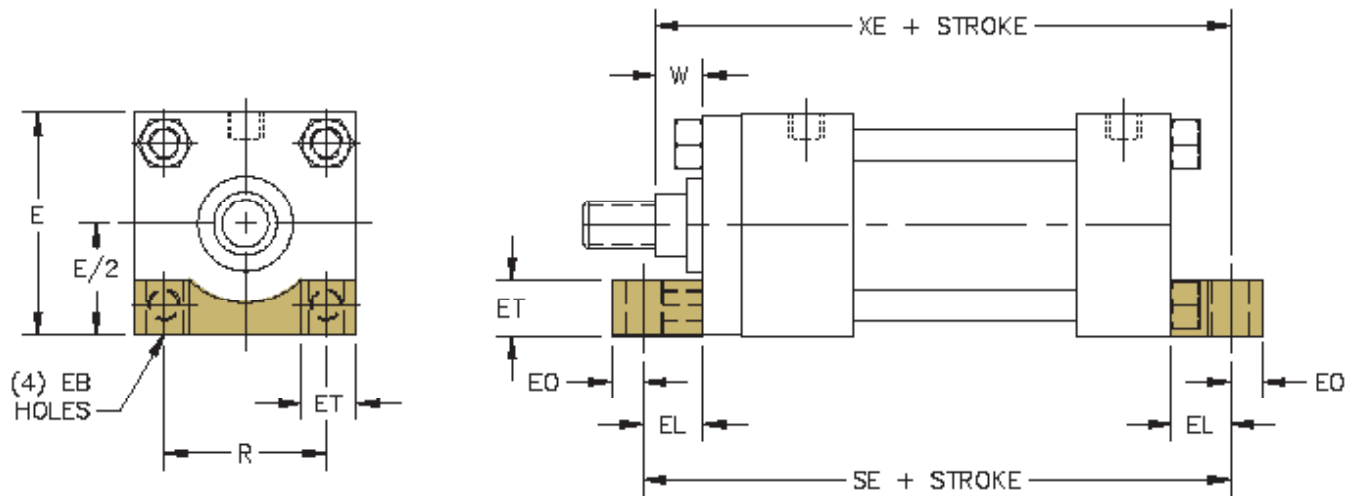

BORE	ROD DIA. (MM)	I MAX PSI RATING	E	E / 2	MS7 DIMENSIONS							
					EB	EL	EO	ET	R	W	ADD TO STROKE	
											SE	XE
1.50	0.625	3000	2.500	1.250	0.438	0.875	0.375	0.750	1.625	0.625	6.750	6.500
1.50	1.000	3000	2.500	1.250	0.438	0.875	0.375	0.750	1.625	1.000	6.750	6.875
2.00	1.000	3000	3.000	1.500	0.563	0.938	0.500	0.875	2.047	0.750	7.125	6.938
2.00	1.375	3000	3.000	1.500	0.563	0.938	0.500	0.875	2.047	1.000	7.125	7.188
2.50	1.000	3000	3.500	1.750	0.563	0.938	0.500	0.875	2.550	0.750	7.250	7.063
2.50	1.375	3000	3.500	1.750	0.563	0.938	0.500	0.875	2.550	1.000	7.250	7.313
2.50	1.750	3000	3.500	1.750	0.563	0.938	0.500	0.875	2.550	1.250	7.250	7.563
3.25	1.375	3000	4.500	2.250	0.688	1.125	0.625	1.188	3.250	0.875	8.500	8.250
3.25	1.750	3000	4.500	2.250	0.688	1.125	0.625	1.188	3.250	1.125	8.500	8.500
3.25	2.000	3000	4.500	2.250	0.688	1.125	0.625	1.188	3.250	1.250	8.500	8.625
4.00	1.750	3000	5.000	2.500	0.688	1.125	0.625	1.188	3.820	1.000	8.875	8.750
4.00	2.000	3000	5.000	2.500	0.688	1.125	0.625	1.188	3.820	1.125	8.875	8.875
4.00	2.500	3000	5.000	2.500	0.688	1.125	0.625	1.188	3.820	1.375	8.875	9.125
5.00	2.000	3000	6.500	3.250	0.938	1.500	0.750	1.500	4.953	1.125	10.125	9.750
5.00	2.500	3000	6.500	3.250	0.938	1.500	0.750	1.500	4.953	1.375	10.125	10.000
5.00	3.000	3000	6.500	3.250	0.938	1.500	0.750	1.500	4.953	1.375	10.125	10.000
5.00	3.500	3000	6.500	3.250	0.938	1.500	0.750	1.500	4.953	1.375	10.125	10.000
6.00	2.500	3000	7.500	3.750	1.063	1.688	0.875	1.750	5.734	1.250	11.750	11.313
6.00	3.000	3000	7.500	3.750	1.063	1.688	0.875	1.750	5.734	1.250	11.750	11.313
6.00	3.500	3000	7.500	3.750	1.063	1.688	0.875	1.750	5.734	1.250	11.750	11.313
6.00	4.000	3000	7.500	3.750	1.063	1.688	0.875	1.750	5.734	1.250	11.750	11.313
8.00	3.500	3000	9.500	4.750	—	—	—	—	—	—	—	—
8.00	4.000	3000	9.500	4.750	—	—	—	—	—	—	—	—
8.00	4.500	3000	9.500	4.750	—	—	—	—	—	—	—	—
8.00	5.000	3000	9.500	4.750	—	—	—	—	—	—	—	—
8.00	5.500	3000	9.500	4.750	—	—	—	—	—	—	—	—

I Max pressure rating (NON-SHOCK).

All our cylinders are proudly Made in USA

SERIES 'H' HEAVY DUTY HYDRAULIC CYLINDERS

DIMENSIONS FOR MP1: REAR PIVOT CLEVIS MOUNT

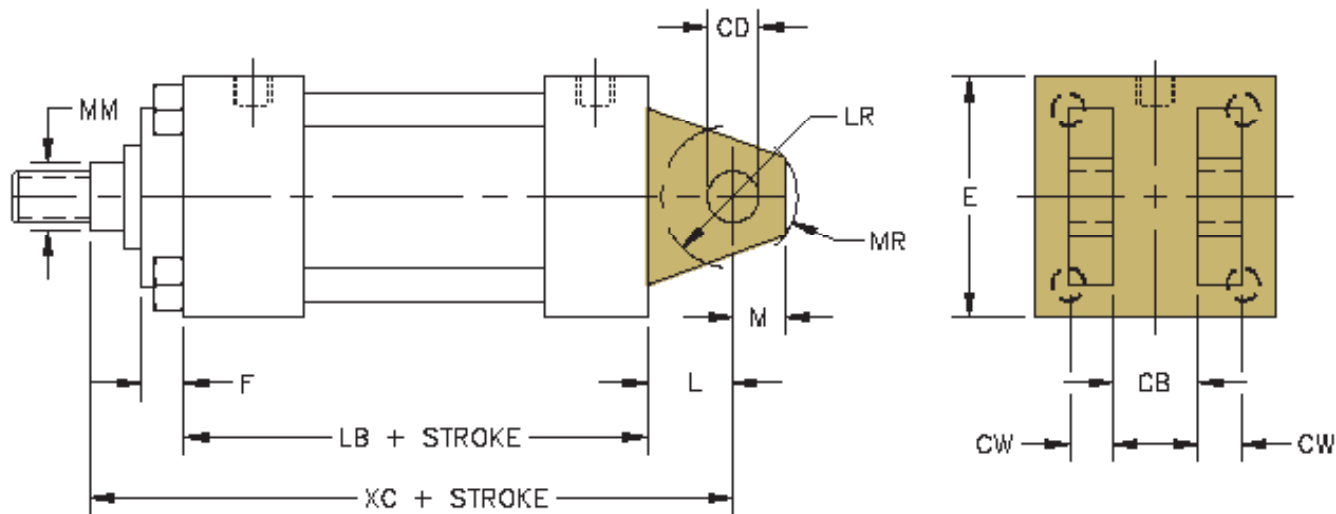

NOTE: PIVOT PIN INCLUDED WITH CYLINDER

BORE	ROD DIA. (MM)	I MAX PSI RATING	E	CB	CD	CW	F	L	LR	M	MR	ADD TO STROKE	
												LB	XC
1.50	0.625	3000	2.500	0.750	0.500	0.500	0.375	0.750	0.563	0.500	0.625	4.625	6.375
1.50	1.000	3000	2.500	0.750	0.500	0.500	0.375	0.750	0.563	0.500	0.625	4.625	6.750
2.00	1.000	3000	3.000	1.250	0.750	0.625	0.625	1.250	1.000	0.750	0.938	4.625	7.250
2.00	1.375	3000	3.000	1.250	0.750	0.625	0.625	1.250	1.000	0.750	0.938	4.625	7.500
2.50	1.000	3000	3.500	1.250	0.750	0.625	0.625	1.250	1.000	0.750	0.938	4.750	7.375
2.50	1.375	3000	3.500	1.250	0.750	0.625	0.625	1.250	1.000	0.750	0.938	4.750	7.625
2.50	1.750	3000	3.500	1.250	0.750	0.625	0.625	1.250	1.000	0.750	0.938	4.750	7.875
3.25	1.375	3000	4.500	1.500	1.000	0.750	0.750	1.500	1.250	1.000	1.188	5.500	8.625
3.25	1.750	3000	4.500	1.500	1.000	0.750	0.750	1.500	1.250	1.000	1.188	5.500	8.875
3.25	2.000	3000	4.500	1.500	1.000	0.750	0.750	1.500	1.250	1.000	1.188	5.500	9.000
4.00	1.750	3000	5.000	2.000	1.375	1.000	0.875	2.125	1.875	1.375	1.625	5.750	9.750
4.00	2.000	3000	5.000	2.000	1.375	1.000	0.875	2.125	1.875	1.375	1.625	5.750	9.875
4.00	2.500	3000	5.000	2.000	1.375	1.000	0.875	2.125	1.875	1.375	1.625	5.750	10.125
5.00	2.000	3000	6.500	2.500	1.750	1.250	0.875	2.250	2.000	1.750	2.125	6.250	10.500
5.00	2.500	3000	6.500	2.500	1.750	1.250	0.875	2.250	2.000	1.750	2.125	6.250	10.750
5.00	3.000	3000	6.500	2.500	1.750	1.250	0.875	2.250	2.000	1.750	2.125	6.250	10.750
5.00	3.500	3000	6.500	2.500	1.750	1.250	0.875	2.250	2.000	1.750	2.125	6.250	10.750
6.00	2.500	3000	7.500	2.500	2.000	1.250	0.875	2.500	2.063	2.000	2.375	7.375	12.125
6.00	3.000	3000	7.500	2.500	2.000	1.250	0.875	2.500	2.188	2.000	2.375	7.375	12.125
6.00	3.500	3000	7.500	2.500	2.000	1.250	0.875	2.500	2.188	2.000	2.375	7.375	12.125
6.00	4.000	3000	7.500	2.500	2.000	1.250	1.000	2.500	2.188	2.000	2.375	7.375	12.125
8.00	3.500	3000	9.500	3.000	3.000	1.500	0.875	3.250	2.938	2.750	3.125	9.500	15.000
8.00	4.000	3000	9.500	3.000	3.000	1.500	1.000	3.250	2.938	2.750	3.125	9.500	15.000
8.00	4.500	3000	9.500	3.000	3.000	1.500	1.000	3.250	2.938	2.750	3.125	9.500	15.000
8.00	5.000	3000	9.500	3.000	3.000	1.500	1.000	3.250	2.938	2.750	3.125	9.500	15.000
8.00	5.500	3000	9.500	3.000	3.000	1.500	1.000	3.250	2.938	2.750	3.125	9.500	15.000

I Max pressure rating (NON-SHOCK).

⊕ 'CD' dimension tolerance for pin is ±.001.

⊕: 'CB' dimension tolerance is +.010 to +.030 depending on bore size.

All our cylinders are proudly Made in USA

SERIES 'H' HEAVY DUTY HYDRAULIC CYLINDERS

DIMENSIONS FOR SB: SPHERICAL BEARING MOUNT

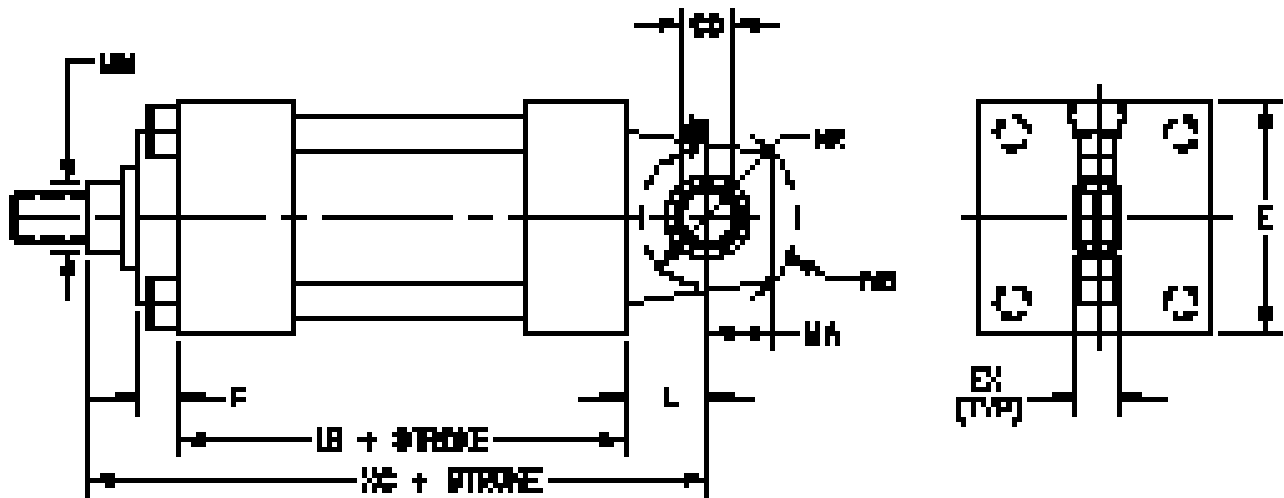

NOTE: PIVOT PIN INCLUDED WITH CYLINDER CAP END ONLY.

BORE	ROD DIA. (MM)	I MAX PSI RATING	E	CD	EX	F	L	NR	MA	MS	ADD TO STROKE	
											LB	XC
1.50	0.625	1650	2.500	0.500	0.437	0.375	0.750	0.625	0.750	0.938	4.625	6.375
1.50	1.000	1650	2.500	0.500	0.437	0.375	0.750	0.625	0.750	0.938	4.625	6.750
2.00	1.000	2200	3.000	0.750	0.656	0.625	1.250	1.000	1.000	1.375	4.625	7.250
2.00	1.375	2200	3.000	0.750	0.656	0.625	1.250	1.000	1.000	1.375	4.625	7.500
2.50	1.000	1400	3.500	0.750	0.656	0.625	1.250	1.000	1.000	1.375	4.750	7.375
2.50	1.375	1400	3.500	0.750	0.656	0.625	1.250	1.000	1.000	1.375	4.750	7.625
2.50	1.750	1400	3.500	0.750	0.656	0.625	1.250	1.000	1.000	1.375	4.750	7.875
3.25	1.375	1500	4.500	1.000	0.875	0.750	1.500	1.250	1.250	1.688	5.500	8.625
3.25	1.750	1500	4.500	1.000	0.875	0.750	1.500	1.250	1.250	1.688	5.500	8.875
3.25	2.000	1500	4.500	1.000	0.875	0.750	1.500	1.250	1.250	1.688	5.500	9.000
4.00	1.750	1750	5.000	1.375	1.188	0.875	2.125	1.625	1.875	2.438	5.750	9.750
4.00	2.000	1750	5.000	1.375	1.188	0.875	2.125	1.625	1.875	2.438	5.750	9.875
4.00	2.500	1750	5.000	1.375	1.188	0.875	2.125	1.625	1.875	2.438	5.750	10.125
5.00	2.000	1900	6.500	1.750	1.531	0.875	2.250	2.063	2.500	2.875	6.250	10.500
5.00	2.500	1900	6.500	1.750	1.531	0.875	2.250	2.063	2.500	2.875	6.250	10.750
5.00	3.000	1900	6.500	1.750	1.531	0.875	2.250	2.063	2.500	2.875	6.250	10.750
5.00	3.500	1900	6.500	1.750	1.531	0.875	2.250	2.063	2.500	2.875	6.250	10.750
6.00	2.500	1700	7.500	2.000	1.750	0.875	2.500	2.375	2.500	3.313	7.375	12.125
6.00	3.000	1700	7.500	2.000	1.750	0.875	2.500	2.375	2.500	3.313	7.375	12.125
6.00	3.500	1700	7.500	2.000	1.750	0.875	2.500	2.375	2.500	3.313	7.375	12.125
6.00	4.000	1700	7.500	2.000	1.750	1.000	2.500	2.375	2.500	3.313	7.375	12.125

I Max pressure rating (NON-SHOCK).

CD: 'CD' dimension tolerance for pin is ±.001.

All our cylinders are proudly Made in USA

SERIES 'H' HEAVY DUTY HYDRAULIC CYLINDERS

DIMENSIONS FOR DOUBLE END MOUNTS



MX0D: NO MOUNT

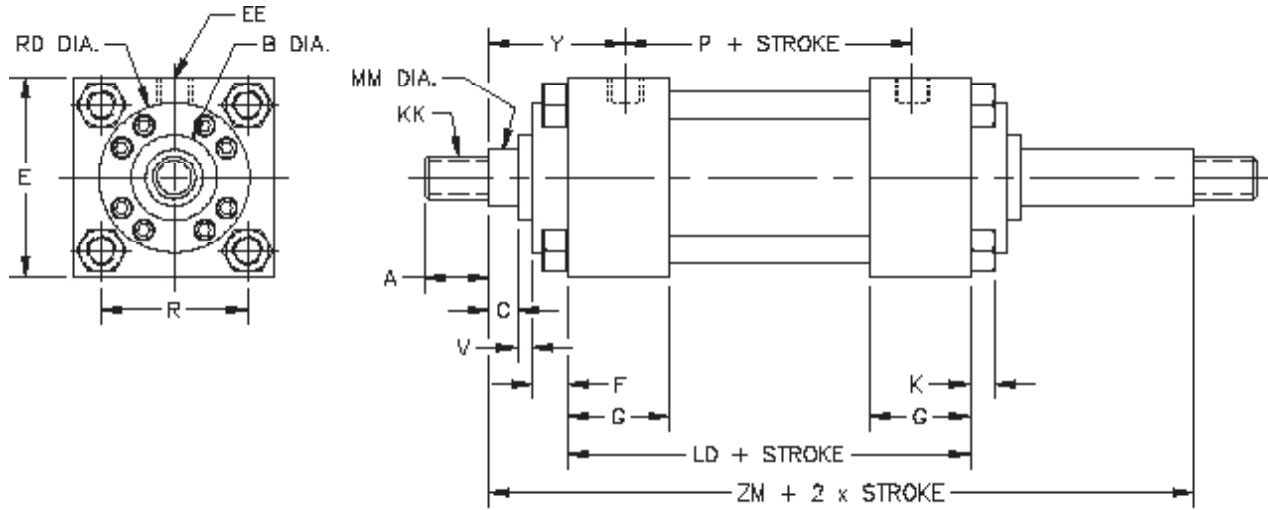

BORE	ROD DIA. (MM)	I MAX PSI RATING	E	A	B	C	EE		F	G	K	KK	R	RD	V	Y	ADD TO STROKE		ADD 2x STROKE ZM
							NPTF	SAE									LD	P	
1.50	0.625	3000	2.500	0.750	1.124	0.375	1/2	10	0.375	1.750	0.375	1.625	—	0.250	2.000	4.875	2.875	6.875	
1.50	1.000	3000	2.500	1.125	1.499	0.500	1/2	8	0.375	1.750	0.375	1.625	—	0.500	2.375	4.875	2.875	7.625	
2.00	1.000	3000	3.000	1.125	1.499	0.500	1/2	10	0.625	1.750	0.438	2.047	—	0.250	2.375	4.875	2.875	7.625	
2.00	1.375	3000	3.000	1.625	1.999	0.625	1/2	8	0.625	1.750	0.438	2.047	—	0.375	2.625	4.875	2.875	8.125	
2.50	1.000	3000	3.500	1.125	1.499	0.500	1/2	10	0.625	1.750	0.438	2.547	2.625	0.250	2.375	5.000	3.000	7.750	
2.50	1.375	3000	3.500	1.625	1.999	0.625	1/2	10	0.625	1.750	0.438	2.547	—	0.375	2.625	5.000	3.000	8.250	
2.50	1.750	3000	3.500	2.000	2.374	0.750	1/2	10	0.625	1.750	0.438	2.547	—	0.500	2.875	5.000	3.000	8.750	
3.25	1.375	3000	4.500	1.625	1.999	0.625	3/4	12	0.750	2.000	0.563	3.250	3.250	0.250	2.750	5.750	3.500	9.000	
3.25	1.750	3000	4.500	2.000	2.374	0.750	3/4	12	0.750	2.000	0.563	3.250	—	0.375	3.000	5.750	3.500	9.500	
3.25	2.000	3000	4.500	2.250	2.624	0.875	3/4	12	0.750	2.000	0.563	3.250	—	0.375	3.125	5.750	3.500	9.750	
4.00	1.750	3000	5.000	2.000	2.374	0.750	3/4	12	0.875	2.000	0.563	3.820	3.875	0.250	2.938	6.000	3.875	9.750	
4.00	2.000	3000	5.000	2.250	2.624	0.875	3/4	12	0.875	2.000	0.563	3.820	4.250	0.250	3.063	6.000	3.875	10.000	
4.00	2.500	3000	5.000	3.000	3.124	1.000	3/4	12	0.875	2.000	0.563	3.820	—	0.375	3.313	6.000	3.875	10.500	
5.00	2.000	3000	6.500	2.250	2.624	0.875	3/4	12	0.875	2.000	0.813	4.953	4.250	0.250	3.125	6.500	4.250	10.500	
5.00	2.500	3000	6.500	3.000	3.124	1.000	3/4	12	0.875	2.000	0.813	4.953	4.625	0.375	3.375	6.500	4.250	11.000	
5.00	3.000	3000	6.500	3.500	3.749	1.000	3/4	12	0.875	2.000	0.813	4.953	5.250	0.375	3.375	6.500	4.250	11.000	
5.00	3.500	3000	6.500	3.500	4.249	1.000	3/4	12	0.875	2.000	0.813	4.953	—	0.375	3.375	6.500	4.250	11.000	
6.00	2.500	3000	7.500	3.000	3.124	1.000	1	16	0.875	2.250	0.875	5.734	4.625	0.375	3.500	7.375	4.875	11.875	
6.00	3.000	3000	7.500	3.500	3.749	1.000	1	16	0.875	2.250	0.875	5.734	5.250	0.375	3.500	7.375	4.875	11.875	
6.00	3.500	3000	7.500	3.500	4.249	1.000	1	16	0.875	2.250	0.875	5.734	5.625	0.375	3.500	7.375	4.875	11.875	
6.00	4.000	3000	7.500	4.000	4.749	1.000	1	16	1.000	2.250	0.875	5.734	6.438	0.250	3.500	7.375	4.875	11.875	
8.00	3.500	3000	9.500	3.500	4.249	1.000	1 1/2	24	0.875	3.000	1.250	7.500	5.625	0.375	3.938	9.500	6.125	14.000	
8.00	4.000	3000	9.500	4.000	4.749	1.000	1 1/2	24	1.000	3.000	1.250	7.500	6.438	0.250	3.938	9.500	6.125	14.000	
8.00	4.500	3000	9.500	4.500	5.249	1.000	1 1/2	24	1.000	3.000	1.250	7.500	7.125	0.250	3.938	9.500	6.125	14.000	
8.00	5.000	3000	9.500	5.000	5.749	1.000	1 1/2	24	1.000	3.000	1.250	7.500	7.625	0.250	3.938	9.500	6.125	14.000	
8.00	5.500	3000	9.500	5.500	6.249	1.000	1 1/2	24	1.000	3.000	1.250	7.500	8.375	0.250	3.938	9.500	6.125	14.000	

SEE ROD END DETAIL CHART ON PAGE 7

I Max pressure rating (NON-SHOCK).

Where no dimension is shown, cylinder utilizes a full square retainer.

∅ 'B' dimension tolerance is +.000 / -.002

SERIES 'H' HEAVY DUTY HYDRAULIC CYLINDERS

DIMENSIONS FOR DOUBLE END MOUNTS



ME5D: HEAD RECTANGULAR MOUNTING HOLES

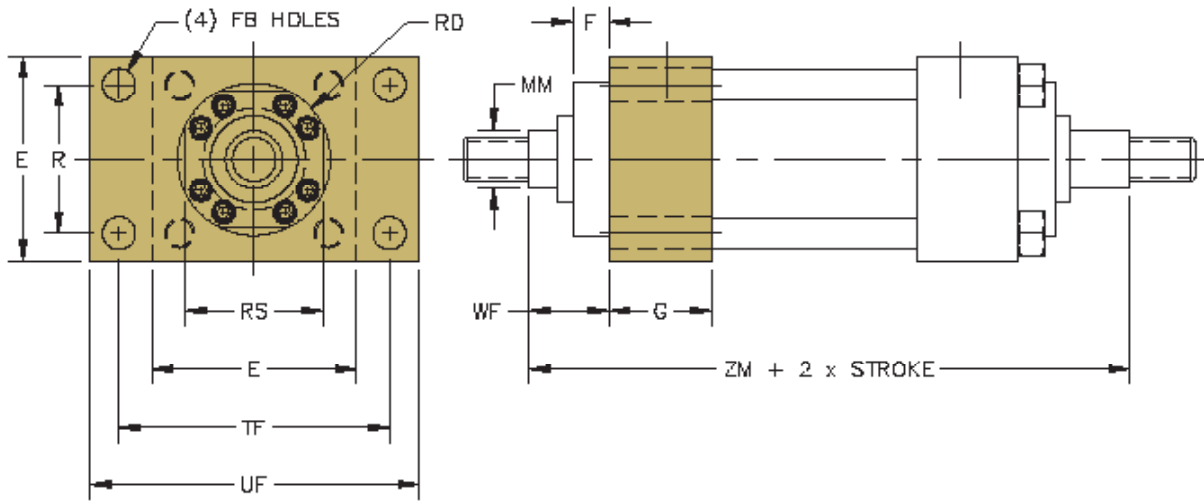

BORE	ROD DIA. (MM)	I MAX PSI RATING	E	F	FB	G	R	RD	RS	TF	UF	WF	ADD 2x STROKE
													ZM
1.50	0.625	3000	2.500	0.375	0.438	1.750	1.625	2.375	—	3.438	4.250	1.000	6.875
1.50	1.000	3000	2.500	0.375	0.438	1.750	1.625	2.563	2.438	3.438	4.250	1.375	7.625
2.00	1.000	3000	3.000	0.625	0.563	1.750	2.047	2.625	—	4.125	5.125	1.375	7.625
2.00	1.375	3000	3.000	0.625	0.563	1.750	2.047	3.250	2.938	4.125	5.125	1.625	8.125
2.50	1.000	3000	3.500	0.625	0.563	1.750	2.547	2.625	—	4.625	5.625	1.375	7.750
2.50	1.375	3000	3.500	0.625	0.563	1.750	2.547	3.250	—	4.625	5.625	1.625	8.250
2.50	1.750	3000	3.500	0.625	0.563	1.750	2.547	3.875	3.438	4.625	5.625	1.875	8.750
3.25	1.375	3000	4.500	0.750	0.688	2.000	3.250	3.250	—	5.875	7.125	1.625	9.000
3.25	1.750	3000	4.500	0.750	0.688	2.000	3.250	3.875	—	5.875	7.125	1.875	9.500
3.25	2.000	3000	4.500	0.750	0.688	2.000	3.250	4.250	—	5.875	7.125	2.000	9.750
4.00	1.750	3000	5.000	0.875	0.688	2.000	3.820	3.875	—	6.375	7.625	1.875	9.750
4.00	2.000	3000	5.000	0.875	0.688	2.000	3.820	4.250	—	6.375	7.625	2.000	10.000
4.00	2.500	3000	5.000	0.875	0.688	2.000	3.820	4.625	—	6.375	7.625	2.250	10.500
5.00	2.000	3000	6.500	0.875	0.938	2.000	4.953	4.250	—	8.188	9.750	2.000	10.500
5.00	2.500	3000	6.500	0.875	0.938	2.000	4.953	4.625	—	8.188	9.750	2.250	11.000
5.00	3.000	3000	6.500	0.875	0.938	2.000	4.953	5.250	—	8.188	9.750	2.250	11.000
5.00	3.500	3000	6.500	0.875	0.938	2.000	4.953	5.625	—	8.188	9.750	2.250	11.000
6.00	2.500	3000	7.500	0.875	1.063	2.250	5.725	4.625	—	9.438	11.250	2.250	11.875
6.00	3.000	3000	7.500	0.875	1.063	2.250	5.725	5.250	—	9.438	11.250	2.250	11.875
6.00	3.500	3000	7.500	0.875	1.063	2.250	5.725	5.625	—	9.438	11.250	2.250	11.875
6.00	4.000	3000	7.500	1.000	1.063	2.250	5.725	6.438	—	9.438	11.250	2.250	11.875
8.00	3.500	3000	9.500	0.875	1.313	3.000	7.500	5.625	—	11.813	14.000	2.250	14.000
8.00	4.000	3000	9.500	1.000	1.313	3.000	7.500	6.438	—	11.813	14.000	2.250	14.000
8.00	4.500	3000	9.500	1.000	1.313	3.000	7.500	7.125	—	11.813	14.000	2.250	14.000
8.00	5.000	3000	9.500	1.000	1.313	3.000	7.500	7.625	—	11.813	14.000	2.250	14.000
8.00	5.500	3000	9.500	1.000	1.313	3.000	7.500	8.375	—	11.813	14.000	2.250	14.000

| Max pressure rating (NON-SHOCK).

All our cylinders are proudly Made in USA



MF1D: HEAD FLANGE

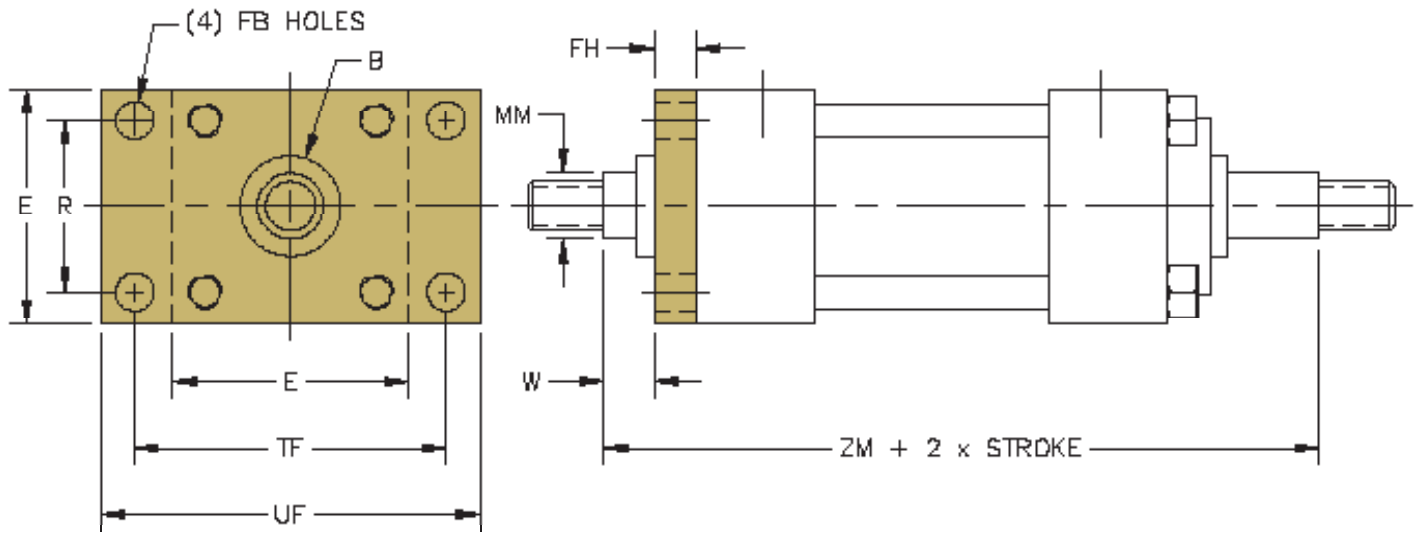

MF5D: HEAD SQUARE FLANGE

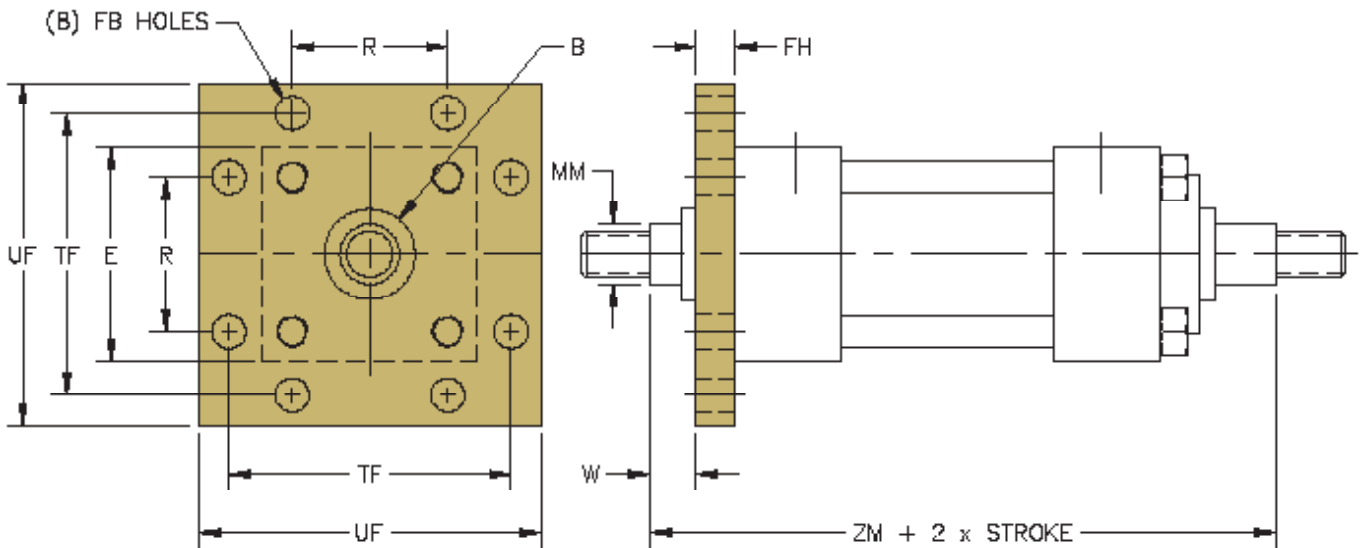

SERIES 'H' HEAVY DUTY HYDRAULIC CYLINDERS

DIMENSIONS FOR DOUBLE END MOUNTS



BORE	ROD DIA. (MM)	I MAX PSI RATING		E	B	FH	FB	R	TF	UF	W	ADD 2x STROKE
		MF1D	MF5D									ZM
1.50	0.625	2600	3000	2.500	1.124	0.375	0.438	1.625	3.438	4.250	0.625	6.875
1.50	1.000	1600	2500	2.500	1.499	0.375	0.438	1.625	3.438	4.250	1.000	7.625
2.00	1.000	2600	3000	3.000	1.499	0.625	0.563	2.047	4.125	5.125	0.750	7.625
2.00	1.375	1600	3000	3.000	1.999	0.625	0.563	2.047	4.125	5.125	1.000	8.125
2.50	1.000	2600	3000	3.500	1.499	0.625	0.563	2.547	4.625	5.625	0.750	7.750
2.50	1.375	2000	3000	3.500	1.999	0.625	0.563	2.547	4.625	5.625	1.000	8.250
2.50	1.750	1600	2700	3.500	2.374	0.625	0.563	2.547	4.625	5.625	1.250	8.750
3.25	1.375	2600	2900	4.500	1.999	0.750	0.688	3.250	5.875	7.125	0.875	9.000
3.25	1.750	2200	2700	4.500	2.374	0.750	0.688	3.250	5.875	7.125	1.125	9.500
3.25	2.000	1600	2500	4.500	2.624	0.750	0.688	3.250	5.875	7.125	1.250	9.750
4.00	1.750	2600	2700	5.000	2.374	0.875	0.688	3.820	6.375	7.625	1.000	9.750
4.00	2.000	1900	2600	5.000	2.624	0.875	0.688	3.820	6.375	7.625	1.125	10.000
4.00	2.500	1600	2400	5.000	3.124	0.875	0.688	3.820	6.375	7.625	1.375	10.500
5.00	2.000	2200	2000	6.500	2.624	0.875	0.938	4.953	8.188	9.750	1.125	10.500
5.00	2.500	1600	1800	6.500	3.124	0.875	0.938	4.953	8.188	9.750	1.375	11.000
5.00	3.000	1200	1200	6.500	3.749	0.875	0.938	4.953	8.188	9.750	1.375	11.000
5.00	3.500	750	1200	6.500	4.249	0.875	0.938	4.953	8.188	9.750	1.375	11.000
6.00	2.500	1800	1700	7.500	3.124	1.000	1.063	5.725	9.438	11.250	1.250	11.875
6.00	3.000	1450	1000	7.500	3.749	1.000	1.063	5.725	9.438	11.250	1.250	11.875
6.00	3.500	1100	1000	7.500	4.249	1.000	1.063	5.725	9.438	11.250	1.250	11.875
6.00	4.000	750	1000	7.500	4.749	1.000	1.063	5.725	9.438	11.250	1.250	11.875
8.00	3.500	900	1000	9.500	4.249	1.000	1.313	7.500	11.813	14.000	1.250	14.000
8.00	4.000	800	800	9.500	4.749	1.000	1.313	7.500	11.813	14.000	1.250	14.000
8.00	4.500	700	700	9.500	5.249	1.000	1.313	7.500	11.813	14.000	1.250	14.000
8.00	5.000	500	700	9.500	5.749	1.000	1.313	7.500	11.813	14.000	1.250	14.000
8.00	5.500	500	700	9.500	6.249	1.000	1.313	7.500	11.813	14.000	1.250	14.000

I Maximum pressure rating

B: 'B' dimension tolerance is +.000 / -.002

All our cylinders are proudly Made in USA



MS2D: SIDE LUGS

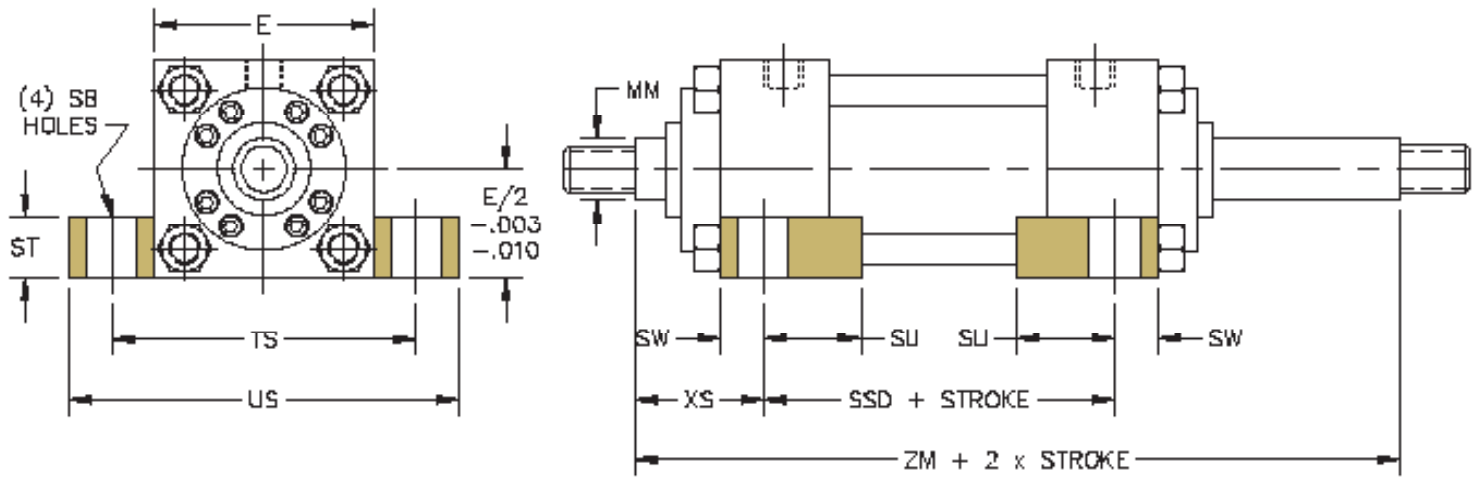

MS3D: CENTER LINE LUGS

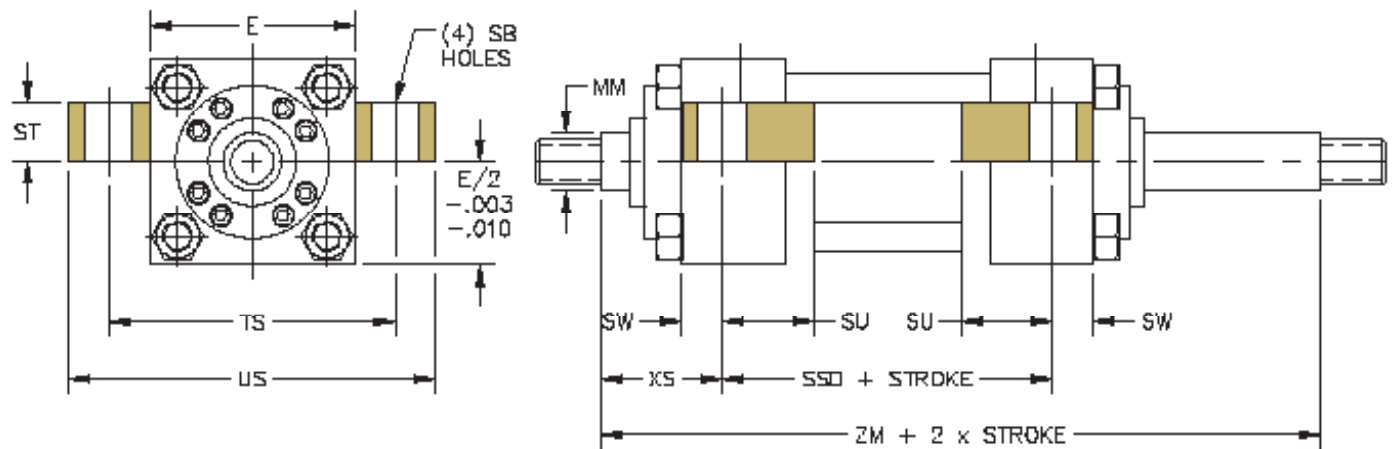

SERIES 'H' HEAVY DUTY HYDRAULIC CYLINDERS

DIMENSIONS FOR DOUBLE END MOUNTS



BORE	ROD DIA. (MM)	I MAX PSI RATING	E	E / 2	SB	ST	SU	SW	TS	US	XS	ADD TO	ADD
												STROKE	2x STROKE
												SSD	ZM
1.50	0.625	3000	2.500	1.250	0.438	0.500	0.938	0.375	3.250	4.000	1.375	4.125	6.875
1.50	1.000	3000	2.500	1.250	0.438	0.500	0.938	0.375	3.250	4.000	1.750	4.125	7.625
2.00	1.000	3000	3.000	1.500	0.563	0.750	1.250	0.500	4.000	5.000	1.875	3.875	7.625
2.00	1.375	3000	3.000	1.500	0.563	0.750	1.250	0.500	4.000	5.000	2.125	3.875	8.125
2.50	1.000	3000	3.500	1.750	0.813	1.000	1.563	0.688	4.875	6.250	2.063	3.625	7.750
2.50	1.375	3000	3.500	1.750	0.813	1.000	1.563	0.688	4.875	6.250	2.313	3.625	8.250
2.50	1.750	3000	3.500	1.750	0.813	1.000	1.563	0.688	4.875	6.250	2.563	3.625	8.750
3.25	1.375	3000	4.500	2.250	0.813	1.000	1.563	0.688	5.875	7.250	2.313	4.375	9.000
3.25	1.750	3000	4.500	2.250	0.813	1.000	1.563	0.688	5.875	7.250	2.563	4.375	9.500
3.25	2.000	3000	4.500	2.250	0.813	1.000	1.563	0.688	5.875	7.250	2.688	4.375	9.750
4.00	1.750	3000	5.000	2.500	1.063	1.250	2.000	0.875	6.750	8.500	2.750	4.250	9.750
4.00	2.000	3000	5.000	2.500	1.063	1.250	2.000	0.875	6.750	8.500	2.875	4.250	10.000
4.00	2.500	3000	5.000	2.500	1.063	1.250	2.000	0.875	6.750	8.500	3.125	4.250	10.500
5.00	2.000	3000	6.500	3.250	1.063	1.250	2.000	0.875	8.250	10.000	2.875	4.750	10.500
5.00	2.500	3000	6.500	3.250	1.063	1.250	2.000	0.875	8.250	10.000	3.125	4.750	11.000
5.00	3.000	3000	6.500	3.250	1.063	1.250	2.000	0.875	8.250	10.000	3.125	4.750	11.000
5.00	3.500	3000	6.500	3.250	1.063	1.250	2.000	0.875	8.250	10.000	3.125	4.750	11.000
6.00	2.500	3000	7.500	3.750	1.313	1.500	2.500	1.125	9.750	12.000	3.375	5.125	11.875
6.00	3.000	3000	7.500	3.750	1.313	1.500	2.500	1.125	9.750	12.000	3.375	5.125	11.875
6.00	3.500	3000	7.500	3.750	1.313	1.500	2.500	1.125	9.750	12.000	3.375	5.125	11.875
6.00	4.000	3000	7.500	3.750	1.313	1.500	2.500	1.125	9.750	12.000	3.375	5.125	11.875
8.00	3.500	3000	9.500	4.750	1.563	1.750	2.875	1.375	12.250	15.000	3.625	6.750	14.000
8.00	4.000	3000	9.500	4.750	1.563	1.750	2.875	1.375	12.250	15.000	3.625	6.750	14.000
8.00	4.500	3000	9.500	4.750	1.563	1.750	2.875	1.375	12.250	15.000	3.625	6.750	14.000
8.00	5.000	3000	9.500	4.750	1.563	1.750	2.875	1.375	12.250	15.000	3.625	6.750	14.000
8.00	5.500	3000	9.500	4.750	1.563	1.750	2.875	1.375	12.250	15.000	3.625	6.750	14.000

I Max pressure rating (NON-SHOCK).

SERIES 'H' HEAVY DUTY HYDRAULIC CYLINDERS

DIMENSIONS FOR DOUBLE END MOUNTS



MS4D: BOTTOM TAPPED HOLES

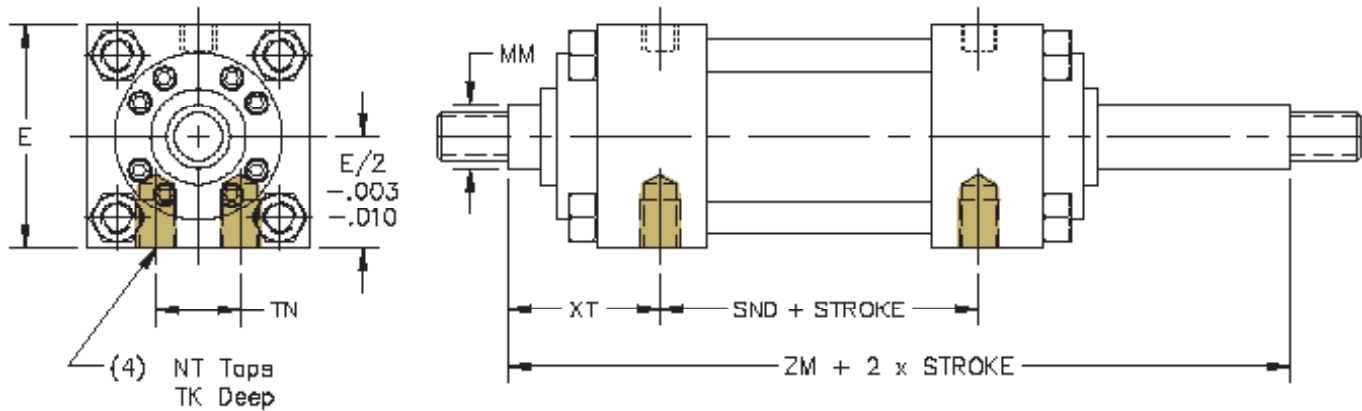

BORE	ROD DIA. (MM)	I MAX PSI RATING	E	E / 2	NT	TK	TN	XT	ADD TO STROKE	ADD 2x STROKE
									SND	ZM
1.50	0.625	3000	2.500	1.250	3/8 - 16	0.375	0.750	2.000	2.875	6.875
1.50	1.000	3000	2.500	1.250	3/8 - 16	0.375	0.750	2.375	2.875	7.625
2.00	1.000	3000	3.000	1.500	1/2 - 13	0.438	0.938	2.375	2.875	7.625
2.00	1.375	3000	3.000	1.500	1/2 - 13	0.438	0.938	2.625	2.875	8.125
2.50	1.000	3000	3.500	1.750	5/8 - 11	0.750	1.313	2.375	3.000	7.750
2.50	1.375	3000	3.500	1.750	5/8 - 11	0.625	1.313	2.625	3.000	8.250
2.50	1.750	3000	3.500	1.750	5/8 - 11	0.500	1.313	2.875	3.000	8.750
3.25	1.375	3000	4.500	2.250	3/4 - 10	1.000	1.500	2.750	3.500	9.000
3.25	1.750	3000	4.500	2.250	3/4 - 10	0.875	1.500	3.000	3.500	9.500
3.25	2.000	3000	4.500	2.250	3/4 - 10	0.750	1.500	3.125	3.500	9.750
4.00	1.750	3000	5.000	2.500	1 - 8	0.875	2.063	3.000	3.750	9.750
4.00	2.000	3000	5.000	2.500	1 - 8	0.750	2.063	3.125	3.750	10.000
4.00	2.500	3000	5.000	2.500	1 - 8	0.750	2.063	3.375	3.750	10.500
5.00	2.000	3000	6.500	3.250	1 - 8	1.000	2.938	3.125	4.250	10.500
5.00	2.500	3000	6.500	3.250	1 - 8	1.000	2.938	3.375	4.250	11.000
5.00	3.000	3000	6.500	3.250	1 - 8	1.000	2.938	3.375	4.250	11.000
5.00	3.500	3000	6.500	3.250	1 - 8	1.000	2.938	3.375	4.250	11.000
6.00	2.500	3000	7.500	3.750	1 1/4 - 7	1.250	3.313	3.500	4.875	11.875
6.00	3.000	3000	7.500	3.750	1 1/4 - 7	1.250	3.313	3.500	4.875	11.875
6.00	3.500	3000	7.500	3.750	1 1/4 - 7	1.250	3.313	3.500	4.875	11.875
6.00	4.000	3000	7.500	3.750	1 1/4 - 7	0.750	3.313	3.500	4.875	11.875
8.00	3.500	3000	9.500	4.750	1 1/2 - 6	1.500	4.250	3.938	6.125	14.000
8.00	4.000	3000	9.500	4.750	1 1/2 - 6	1.500	4.250	3.938	6.125	14.000
8.00	4.500	3000	9.500	4.750	1 1/2 - 6	1.500	4.250	3.938	6.125	14.000
8.00	5.000	3000	9.500	4.750	1 1/2 - 6	1.250	4.250	3.938	6.125	14.000
8.00	5.500	3000	9.500	4.750	1 1/2 - 6	1.000	4.250	3.938	6.125	14.000

I Max pressure rating (NON-SHOCK).

All our cylinders are proudly Made in USA

SERIES 'H' HEAVY DUTY HYDRAULIC CYLINDERS

DIMENSIONS FOR DOUBLE END MOUNTS



MS7D: END LUGS ¹

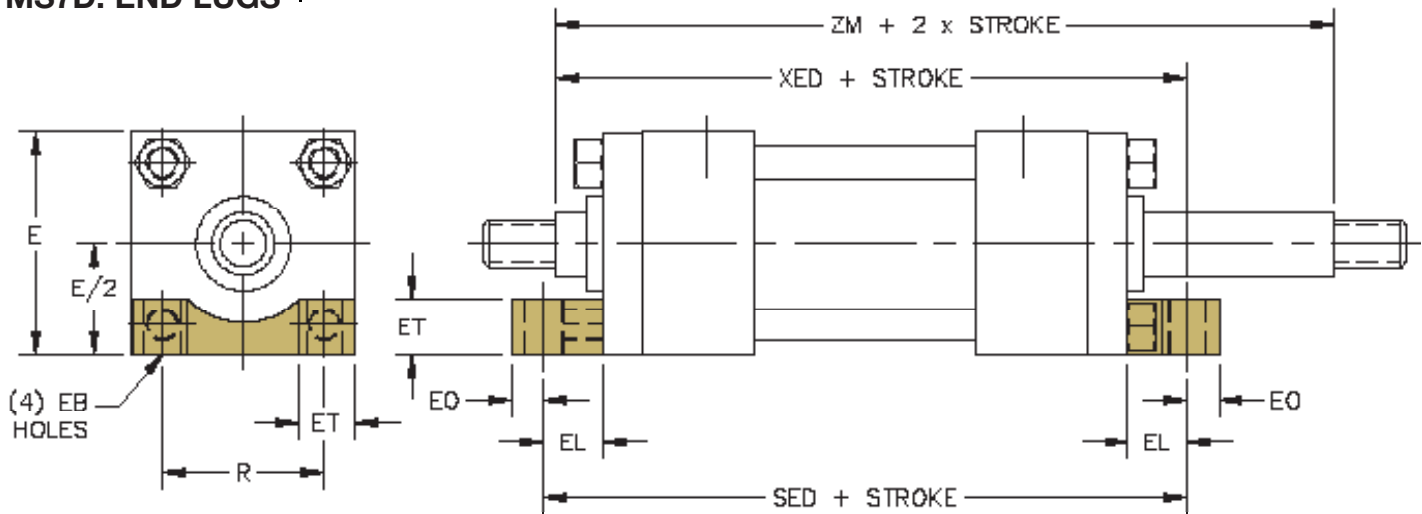

BORE	ROD DIA. (MM)	MAX PSI RATING	E	E / 2	EB	EL	EO	ET	R	ADD TO STROKE		
										SED	XED	ZM
1.50	0.625	3000	2.500	1.250	0.438	0.875	0.375	0.750	1.625	7.375	7.125	6.875
1.50	1.000	Not Available										
2.00	1.000	3000	3.000	1.500	0.563	0.938	0.500	0.875	2.047	8.000	7.687	7.625
2.00	1.375	Not Available										
2.50	1.000	3000	3.500	1.750	0.563	0.938	0.500	0.875	2.547	8.125	7.938	7.750
2.50	1.375	3000	3.500	1.750	0.563	0.938	0.500	0.875	2.547	8.125	8.188	8.250
2.50	2.000	Not Available										
3.25	1.375	3000	4.500	2.250	0.688	1.125	0.625	1.188	3.250	9.500	9.250	9.000
3.25	1.750	Not Available										
3.25	2.000	Not Available										
4.00	1.750	3000	5.000	2.500	0.688	1.125	0.625	1.188	3.820	10.000	9.875	9.750
4.00	2.000	Not Available										
4.00	2.500	Not Available										
5.00	2.000	3000	6.500	3.250	0.938	1.500	0.750	1.500	4.953	11.250	10.875	10.500
5.00	2.500	3000	6.500	3.250	0.938	1.500	0.750	1.500	4.953	11.250	11.125	11.000
5.00	3.000	3000	6.500	3.250	0.938	1.500	0.750	1.500	4.953	11.250	11.125	11.000
5.00	3.500	Not Available										
6.00	2.500	3000	7.500	3.750	1.063	1.688	0.875	1.750	5.734	12.750	12.313	11.875
6.00	3.000	3000	7.500	3.750	1.063	1.688	0.875	1.750	5.734	12.750	12.313	11.875
6.00	3.500	3000	7.500	3.750	1.063	1.688	0.875	1.750	5.734	12.750	12.313	11.875
6.00	4.000	Not Available										

¹ When using this mount, the cylinder feet, head & cap are to be firmly supported.

⊕: Max pressure rating (NON-SHOCK).



MT1D: HEAD TRUNNION

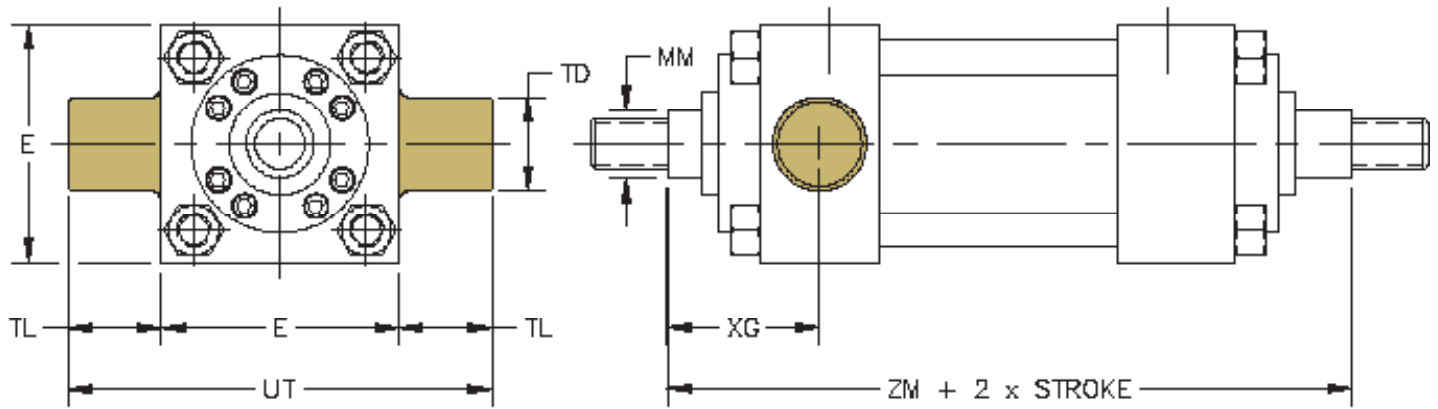

MT4D: INTERMEDIATE TRUNNION

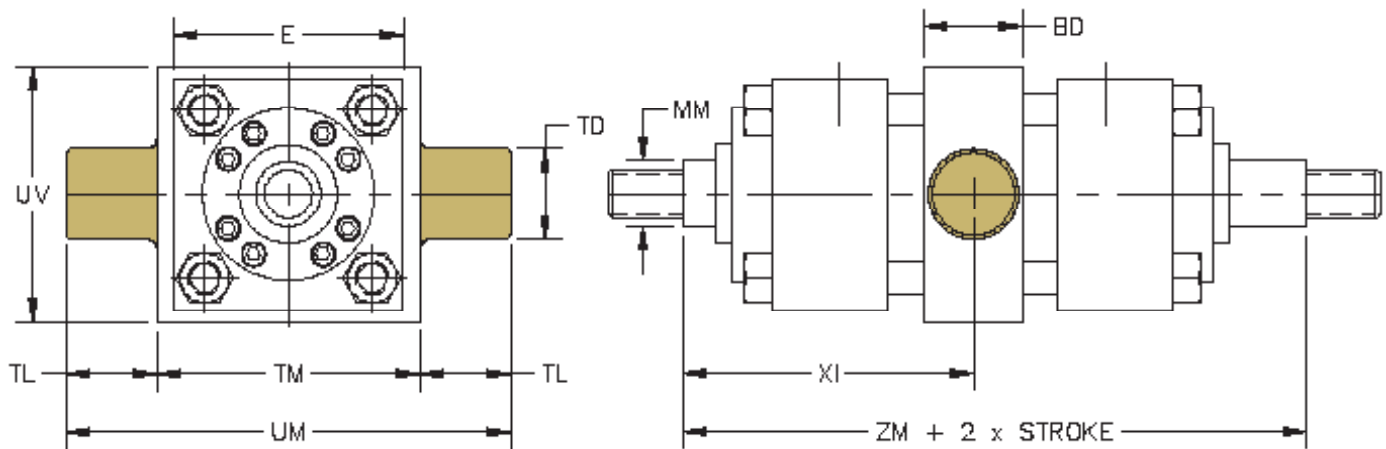

SERIES 'H' HEAVY DUTY HYDRAULIC CYLINDERS

DIMENSIONS FOR DOUBLE END MOUNTS



BORE	ROD DIA. (MM)	MAX PSI RATING		E	BD	TD	TL	TM	UM	UT	UV	XG	MT4 MIN STROKE	MT4 XI MIN	ADD TO STROKE	ADD 2x STROKE
		MT1D	MT4D												MT4 XI MAX	ZM
1.50	0.625	3000	3000	2.500	1.500	1.000	1.000	3.000	5.000	4.500	3.000	1.875	0.250	3.500	3.250	6.875
1.50	1.000	3000	3000	2.500	1.500	1.000	1.000	3.000	5.000	4.500	3.000	2.250	0.250	3.875	3.625	7.625
2.00	1.000	3000	3000	3.000	1.500	1.375	1.375	3.500	6.250	5.750	3.500	2.250	0.250	4.000	3.750	7.625
2.00	1.375	3000	3000	3.000	1.500	1.375	1.375	3.500	6.250	5.750	3.500	2.500	0.250	4.250	4.000	8.125
2.50	1.000	3000	3000	3.500	1.500	1.375	1.375	4.000	6.750	6.250	4.000	2.250	0.375	4.102	3.750	7.750
2.50	1.375	3000	3000	3.500	1.500	1.375	1.375	4.000	6.750	6.250	4.000	2.500	0.375	4.375	4.000	8.250
2.50	1.750	3000	3000	3.500	1.500	1.375	1.375	4.000	6.750	6.250	4.000	2.750	0.375	4.625	4.250	8.750
3.25	1.375	2800	2800	4.500	2.000	1.750	1.750	5.000	8.500	8.000	5.000	2.625	0.875	5.000	4.125	9.000
3.25	1.750	2800	2800	4.500	2.000	1.750	1.750	5.000	8.500	8.000	5.000	2.875	0.875	5.250	4.375	9.500
3.25	2.000	2800	2800	4.500	2.000	1.750	1.750	5.000	8.500	8.000	5.000	3.000	0.875	5.375	4.500	9.750
4.00	1.750	1800	1800	5.000	2.000	1.750	1.750	5.500	9.000	8.500	5.500	2.875	1.125	5.500	4.375	9.750
4.00	2.000	1800	1800	5.000	2.000	1.750	1.750	5.500	9.000	8.500	5.500	3.000	1.125	5.625	4.500	10.000
4.00	2.500	1800	1800	5.000	2.000	1.750	1.750	5.500	9.000	8.500	5.500	3.250	1.125	5.875	4.750	10.500
5.00	2.000	1200	1200	6.500	2.500	1.750	1.750	7.000	10.500	10.000	7.250	3.000	1.125	5.875	4.750	10.500
5.00	2.500	1200	1200	6.500	2.500	1.750	1.750	7.000	10.500	10.000	7.250	3.250	1.125	6.125	5.000	11.000
5.00	3.000	1200	1200	6.500	2.500	1.750	1.750	7.000	10.500	10.000	7.250	3.250	1.125	6.125	5.000	11.000
5.00	3.500	1200	1200	6.500	2.500	1.750	1.750	7.000	10.500	10.000	7.250	3.250	1.125	6.125	5.000	11.000
6.00	2.500	1000	1000	7.500	3.000	2.000	2.000	8.500	12.500	11.500	8.750	3.375	1.250	6.625	5.375	11.875
6.00	3.000	1000	1000	7.500	3.000	2.000	2.000	8.500	12.500	11.500	8.750	3.375	1.250	6.625	5.375	11.875
6.00	3.500	1000	1000	7.500	3.000	2.000	2.000	8.500	12.500	11.500	8.750	3.375	1.250	6.625	5.375	11.875
6.00	4.000	1000	1000	7.500	3.000	2.000	2.000	8.500	12.500	11.500	8.750	3.375	1.250	6.625	5.375	11.875
8.00	3.500	1000	1000	9.500	3.500	3.000	3.000	11.000	17.000	15.500	11.750	3.750	2.125	8.125	6.000	14.000
8.00	4.000	1000	1000	9.500	3.500	3.000	3.000	11.000	17.000	15.500	11.750	3.750	2.125	8.125	6.000	14.000
8.00	4.500	1000	1000	9.500	3.500	3.000	3.000	11.000	17.000	15.500	11.750	3.750	2.125	8.125	6.000	14.000
8.00	5.000	1000	1000	9.500	3.500	3.000	3.000	11.000	17.000	15.500	11.750	3.750	2.125	8.125	6.000	14.000
8.00	5.500	1000	1000	9.500	3.500	3.000	3.000	11.000	17.000	15.500	11.750	3.750	2.125	8.125	6.000	14.000

| Max pressure rating (NON-SHOCK).



MX1D: EXTENDED TIE-RODS - HEAD & CAP

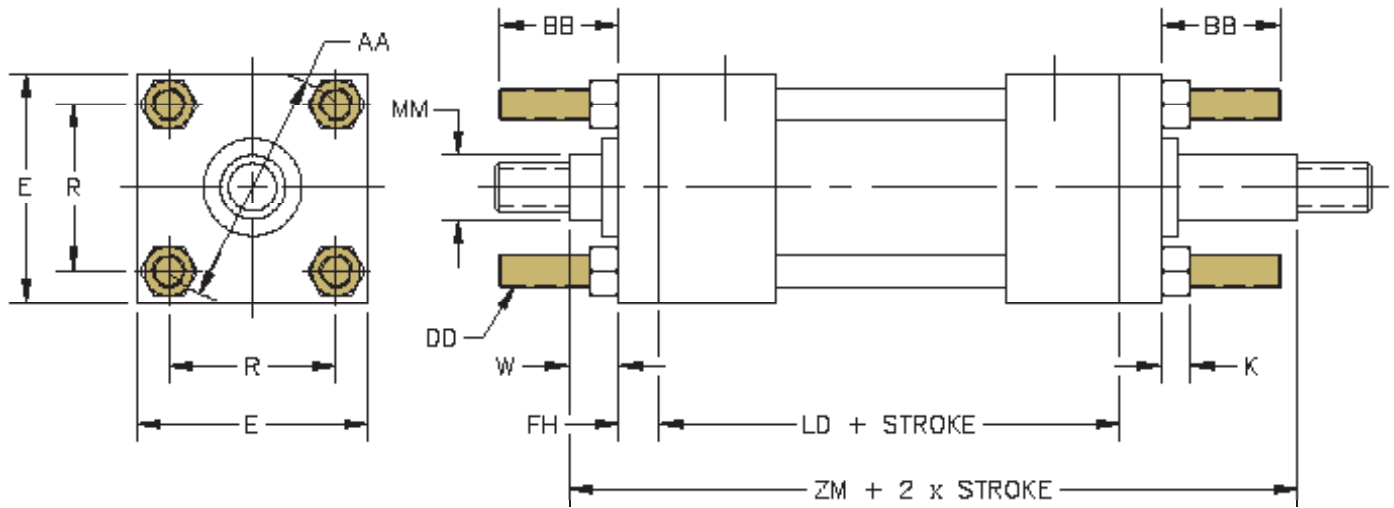

MX3D: EXTENDED TIE-RODS - HEAD END

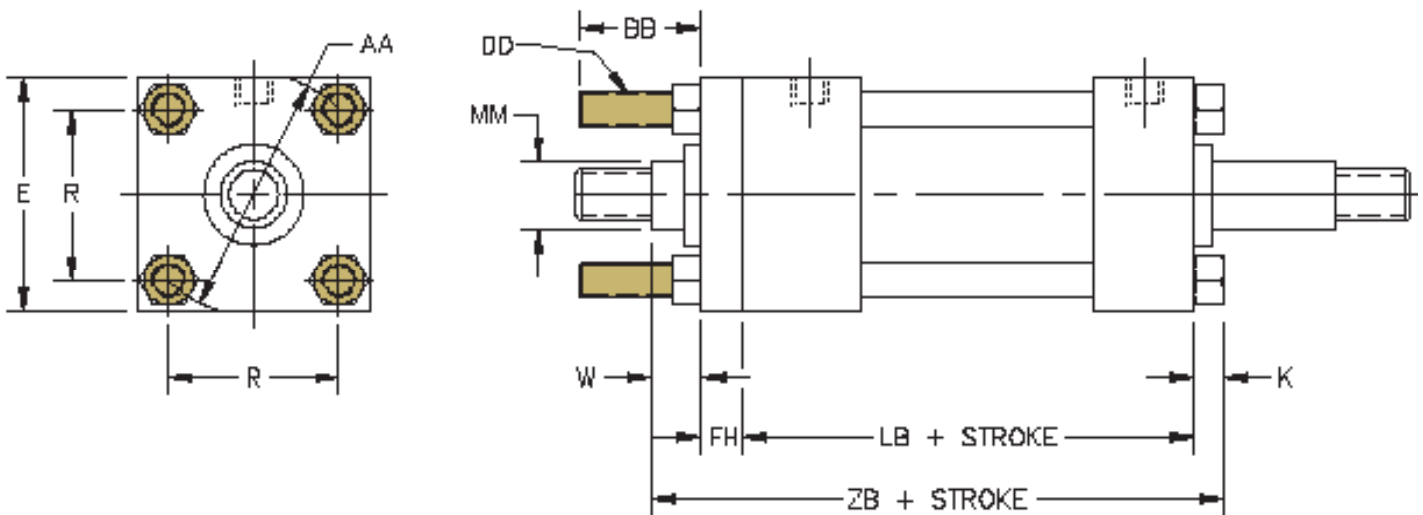

SERIES 'H' HEAVY DUTY HYDRAULIC CYLINDERS

DIMENSIONS FOR DOUBLE END MOUNTS



BORE	ROD DIA. (MM)	I MAX PSI RATING	E	AA	BB	DD	FH	K	R	W	ADD TO STROKE	ADD 2x STROKE
											LD	ZM
1.50	0.625	3000	2.500	2.300	1.375	3/8 - 24	0.375	0.375	1.625	0.625	4.875	6.875
1.50	1.000	3000	2.500	2.300	1.375	3/8 - 24	0.375	0.375	1.625	1.000	4.875	7.625
2.00	1.000	3000	3.000	2.900	1.813	1/2 - 20	0.625	0.438	2.047	0.750	4.875	7.625
2.00	1.375	3000	3.000	2.900	1.813	1/2 - 20	0.625	0.438	2.047	1.000	4.875	8.125
2.50	1.000	3000	3.500	3.600	1.813	1/2 - 20	0.625	0.438	2.547	0.750	5.000	7.750
2.50	1.375	3000	3.500	3.600	1.813	1/2 - 20	0.625	0.438	2.547	1.000	5.000	8.250
2.50	1.750	3000	3.500	3.600	1.813	1/2 - 20	0.625	0.438	2.547	1.250	5.000	8.750
3.25	1.375	3000	4.500	4.600	2.313	5/8 - 18	0.750	0.563	3.250	0.875	5.750	9.000
3.25	1.750	3000	4.500	4.600	2.313	5/8 - 18	0.750	0.563	3.250	1.125	5.750	9.500
3.25	2.000	3000	4.500	4.600	2.313	5/8 - 18	0.750	0.563	3.250	1.250	5.750	9.750
4.00	1.750	3000	5.000	5.400	2.313	5/8 - 18	0.875	0.563	3.820	1.000	6.000	9.750
4.00	2.000	3000	5.000	5.400	2.313	5/8 - 18	0.875	0.563	3.820	1.125	6.000	10.000
4.00	2.500	3000	5.000	5.400	2.313	5/8 - 18	0.875	0.563	3.820	1.375	6.000	10.500
5.00	2.000	3000	6.500	7.000	3.188	7/8 - 14	0.875	0.813	4.953	1.125	6.500	10.500
5.00	2.500	3000	6.500	7.000	3.188	7/8 - 14	0.875	0.813	4.953	1.375	6.500	11.000
5.00	3.000	3000	6.500	7.000	3.188	7/8 - 14	0.875	0.813	4.953	1.375	6.500	11.000
5.00	3.500	3000	6.500	7.000	3.188	7/8 - 14	0.875	0.813	4.953	1.375	6.500	11.000
6.00	2.500	3000	7.500	8.100	3.625	1 - 14	1.000	0.875	5.734	1.250	7.375	11.875
6.00	3.000	3000	7.500	8.100	3.625	1 - 14	1.000	0.875	5.734	1.250	7.375	11.875
6.00	3.500	3000	7.500	8.100	3.625	1 - 14	1.000	0.875	5.734	1.250	7.375	11.875
6.00	4.000	3000	7.500	8.100	3.625	1 - 14	1.000	0.875	5.734	1.250	7.375	11.875
8.00	3.500	3000	9.500	10.600	4.500	1 1/4 - 12	1.000	1.250	7.500	1.250	9.500	14.000
8.00	4.000	3000	9.500	10.600	4.500	1 1/4 - 12	1.000	1.250	7.500	1.250	9.500	14.000
8.00	4.500	3000	9.500	10.600	4.500	1 1/4 - 12	1.000	1.250	7.500	1.250	9.500	14.000
8.00	5.000	3000	9.500	10.600	4.500	1 1/4 - 12	1.000	1.250	7.500	1.250	9.500	14.000
8.00	5.500	3000	9.500	10.600	4.500	1 1/4 - 12	1.000	1.250	7.500	1.250	9.500	14.000

I Max pressure rating (NON-SHOCK).

All our cylinders are proudly Made in USA



A= Extended Piston Rod Thread

"A=" refers to the length of piston rod thread.

Shorter than standard lengths can be furnished at no charge.
 Longer than standard lengths can be furnished at a nominal price adder.
Special length threads do not delay orders!

Note: Maximum thread length is double the standard "A" length.

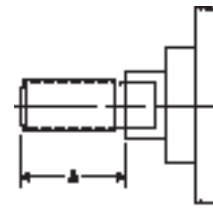

AS Adjustable Stroke (Retract)

Consists of a threaded rod in the cylinder cap, non-removable. Provides an adjustable positive stop on the cylinder retract.

To order, specify "AS" and length of adjustment (Example: AS=3").

ADJUSTABLE STROKE	
BORE	MAX "AS"
1.50	Up to 8 inch
2.00-3.25	Up to 6 inch
4.00-6.00	Up to 5 inch
8.00	Up to 4 inch

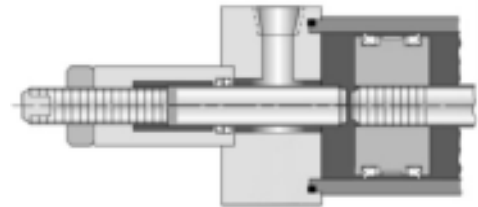

ABP= Air Bleed Ports

Air bleeds can be provided at either or both ends of the cylinder. Air bleeds should be located at the highest point in the cylinder for maximum effectiveness. The location needs to be specified, similar to port locations.

Example: ABP=15

(Air Bleed ports at position 1 & 5)

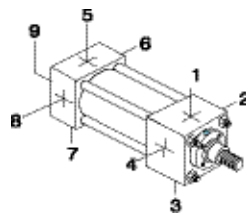

Location 9 is center of cap face.

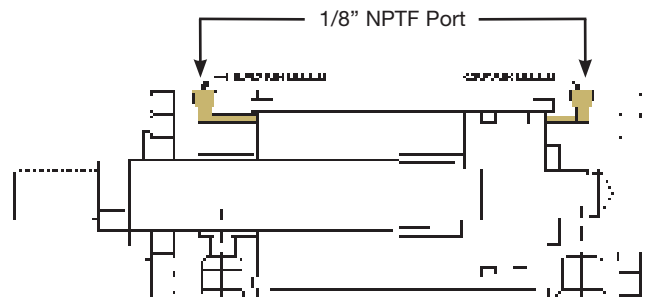

C= Extended Piston Rod

"C=" is commonly referred to as piston rod extension. Piston rods can be extended to any length up to 120" total piston rod length, including stroke portion. Cylinders with long "C" lengths can be mounted away from obstacles or outside hazardous environments.

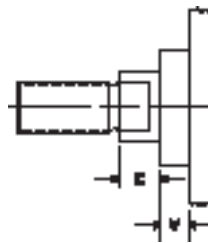

Piston rods can be made to any length up to 120 inches total OAL. Rods can be easily extended to move a cylinder to a more accessible location or away from a less desirable environment.

Be sure to check piston rod column strength charts to properly size the rod and prevent buckling.

Extended piston rods do not delay delivery.

CS Center Supports

Center supports are recommended for long stroke cylinders to support tube and prevent the tie rods from sagging. Properly supported cylinders will eliminate premature cylinder wear and eliminate tie rod vibration.

Center supports can include MS2 mounts.

CENTER SUPPORT RECOMMENDATIONS		
BORE	ONE SUPPORT	TWO SUPPORTS
1.50"	STROKES OVER 44 INCHES	STROKES OVER 89 INCHES
2.00"	STROKES OVER 74 INCHES	STROKES OVER 99 INCHES
2.50"	STROKES OVER 84 INCHES	NOT REQUIRED
3.25" - 8.00"	STROKES OVER 99 INCHES	

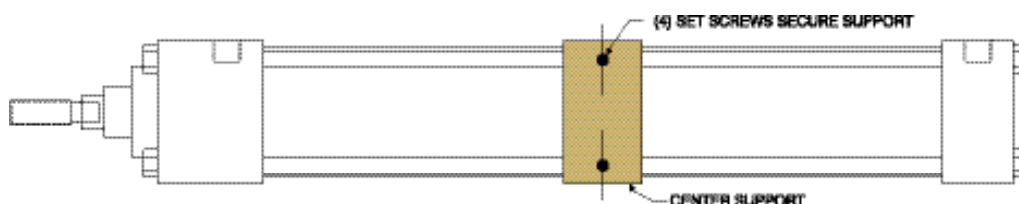

VARIATIONS

Cushions

Cushion design features industry proven technology and ultra fine adjustment needles for perfect deceleration and long life. Cushion adjustment needle positions need to be specified.

Example: H2C6

CUSHION LOCATIONS	
HEAD CUSHION	CAP CUSHION
H1	C5
H2	C6
H3	C7
H4	C8

STANDARD CUSHION LOCATIONS	
MOST MOUNTS	H2 C6
MS3 MOUNT	H3 C7
MT1 MOUNT	H3 C6
MT2 MOUNT	H2 C7

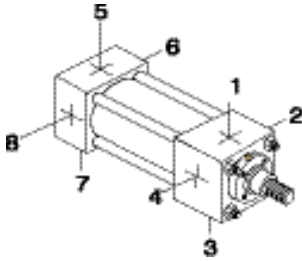

UNAVAILABLE CUSHION LOCATIONS BY MOUNT		
MOUNT	HEAD CUSHION	CAP CUSHION
ME5	H2, H4	-
ME6	-	C6, C8
MS3	H2, H4	C6, C8
MT1	H2, H4	-
MT2	-	C6, C8

DBB= Drain Back Bushing

When oil leakage cannot be tolerated, a rod bushing drain port can be provided. Since there isn't any pressure in the drain line, clear tubing can offer a visual inspection of any leakage. A constant leak indicates that the rod seal is worn and needs to be replaced.

Example: DBB=1 (drain port at position 1)

1/16" or 1/8" NPTF Port

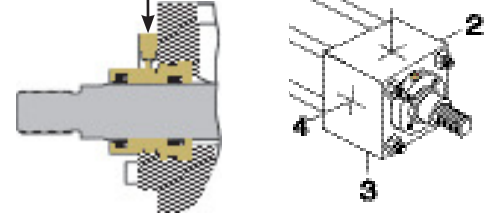

EK Extended Key Plate

Extended key plate or thrust key is made from a full square bushing retainer plate. The key is designed to fit in a milled slot on the equipment to prevent the cylinder from shifting.

An additional mount needs to be specified to secure cylinder.

Available bore sizes: H - 1.50" to 8.00" Bore

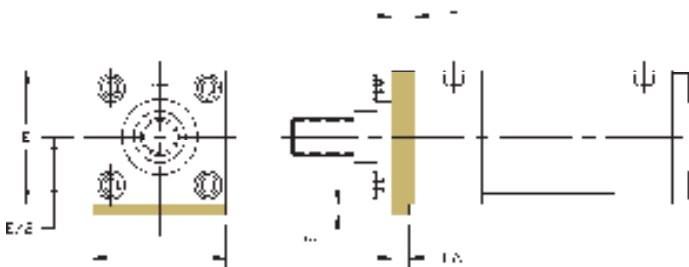

'H' DIMENSIONS FOR EXTENDED KEY PLATE				
BORE	E	FA	FH	PA
1.50	2.500	0.312 / 0.314	0.375	0.188
2.00	3.000	0.562 / 0.564	0.625	0.313
2.50	3.500	0.562 / 0.564	0.625	0.313
3.25	4.500	0.687 / 0.689	0.750	0.375
4.00	5.000	0.812 / 0.814	0.875	0.438
5.00	6.500	0.812 / 0.814	0.875	0.438
6.00	7.500	0.937 / 0.939	1.000	0.500
8.00	9.500	0.937 / 0.939	1.000	0.500



High Load Piston

Long stroke cylinders and pivot type mounting can create severe cylinder piston-to-tube side loads. The high load piston option provides increased side load capacity without increasing the cylinder base dimensions.

Design Benefits

- Bi-direction piston seal offers low to zero leakage rating.
- Piston seal design offers lower friction than cast iron rings or lip seals, which eliminate stick/slip breakaway issues.
- Glass filled PTFE piston seal is 20% stronger than bronze filled seals.
- High contamination tolerant; offers the longest life of any seal type.
- Temperature Rating: -20°F to 200°F (-29°C to 93°C)
- Other temperature ratings are available; HYDRAULIC CYLINDERS INC.® for more information

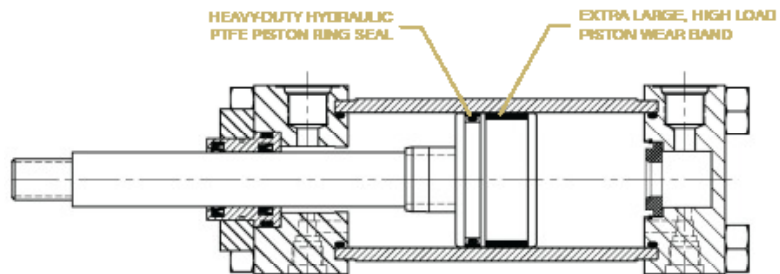

High Load Piston Wear Band - Our superior design is 35% to 80% wider than competitive models and we locate the wearband at the furthest point from the rod bearing to increase overall effectiveness.

Piston Ring Seal - Glass filled PTFE with Nitrile expander.

HSS High Shock Seals

High shock seal option provides shock protection to the rod and piston seal.

Piston Seal - Consists of (2) bidirectional sealing, step-cut, cast iron piston rings to buffer the shock and (2) heavy-lip design Carboxilated Nitrile seals (with back-up rings), to provide near leak-free operation.

Rod Seals - Consists of a buffer seal to handle the shock and a double lip polyurethane block vee seal for leak free operation.

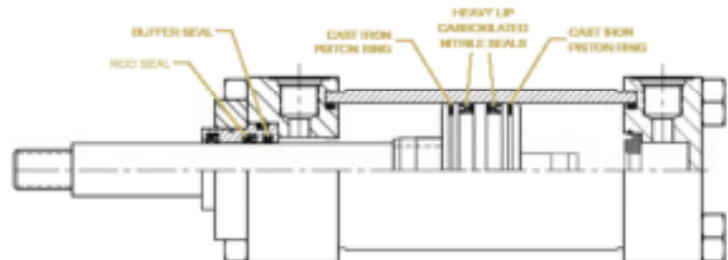

KKX Non-Standard Rod Threads

Cylinders piston rods can be furnished with non-standard rod threads.

Ordering Example: H - MF1 - 150 X 24 - 100 - KKX - 7/8 - 9UNC - P15 = N375 - SSSS

↑ Add special thread to part number

KK3M Female Metric Rod Threads

Equipment that is imported to the United States will typically contain metric tie-rod cylinders. In general, ISO tie rod cylinders are not as robust as NFPA cylinder designs and some customers prefer to replace the metric cylinders with NFPA designs that will provide longer life.

HYDRAULIC CYLINDERS INC.® can provide cylinders with metric piston rod end threads to assist customers in mating replacement cylinders to existing equipment.

Ordering Example: H - MF1 - 150 X 24 - 100 - KK3M = M8 X 1 - P15 = N375 - SSSS

KK3X Female Special Rod Threads

HYDRAULIC CYLINDERS INC.® can machine a wide range of female rod threads. Standard NFPA rod threads are UNF (fine), class 2 threads. Common alternative choices are UNC (coarse) threads.

Note: unless otherwise specified, the rod thread will be standard catalog "A" dimension lengths.

Ordering Example: H - MF1 - 150 X 24 - 100 - KK3X = 1 - 8 - P15 = N375 - SSSS

VARIATIONS

LRB Lift Ring Boss

A steel, tapped lug is welded to the center of the cylinder cap.

UNC coarse threads are provided to accept high load type lifting eyes (lift eyes are not provided).

Not available on MF2, MF6, ME6, MP1 & SB mounts.

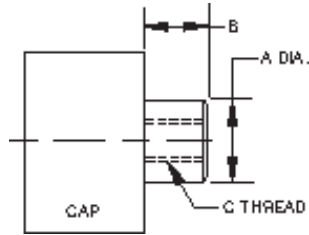

LIFT LUG DIMENSIONS				
BORE	A	B	C	STRAIGHT PULL LIFTING CAPACITY*
1.50	1.120	1.000	1/2-13	2500
2.00	1.500	1.250	5/8-11	4000
2.50	1.500	1.250	5/8-11	4000
3.25	2.000	1.500	3/4-10	6000
4.00	2.000	1.500	3/4-10	6000
5.00	2.000	1.500	3/4-10	6000
6.00	2.500	2.000	1-8	9000
8.00	2.500	2.000	1-8	9000

*Lifting capacity is the maximum capacity for intermittent lifting and placement of cylinder only. It is NOT intended to be used as the primary cylinder mount.

NR Non-Rotating (NFPA) Cylinders

Two internal guide rods throughout stroke

High repeatability at each end of stroke (+/- 1 degree)

All external dimensions are the same as standard cylinder (no additional length or width required)

Standard diameter guide rod seals & bronze Bearings for long life and reliable operation

Available in double rod end models

Eliminates the need for external guide shafts in many positioning applications

Guide rods are internal, self-cleaning and not subject to harsh cleaners

Compact design saves space; no larger than standard NFPA cylinders!

Durable, self-contained construction

Clamping

Marking

Pressing

Multiple Mounts

Cylinders can be furnished with a wide selection of multiple mounts.

Ordering Example: H - MF1 - MS2 - 250 X 12 - 100 - KK1 - P15 - SSSS

↑ Add additional mount to part number

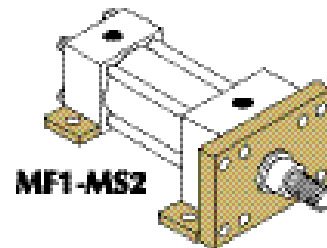

Port Options

Cylinders can be furnished with NPTF or SAE O-Ring Boss (SAEJ514) ports at no-charge.

Cylinders can be furnished with BSPP, BSPT or SAE Flange Ports for additional cost.

BSPT British Standard Pipe Taper

British Standard Pipe Taper (BSPT) threads have the same taper as American NPT tapered threads, but use a 55° Whitworth thread form and different diameters. (Not interchangeable with NPT)

BSPP British Standard Pipe Parallel

British Standard Pipe Parallel (BSPP), also referred to as BSP "Straight" Thread. (Not interchangeable with NPT)



RBB Bronze Rod Bushings

Cylinders can be furnished with bronze rod bushings (standard material: 150,000 PSI ductile iron, PTFE coated).

SSR 17-4 Stainless Steel Hard Chrome Plated Piston Rod

Cylinders can be furnished with hard chrome plated stainless steel piston rods.

Seals

The 'H' Series allows for the use of different types of seal design and material compounds in every area, for maximum flexibility and performance.

How to Order Seals

S S S S

PISTON SEAL	
S	STANDARD (Carboxilated)
C	Cast-Ring
E	EP
T	PTFE
V	Fluorocarbon

ROD SEAL	
S	STANDARD (Polyurethane)
E	EP
V	Fluorocarbon

TUBE SEAL	
S	STANDARD (Buna)
E	EP
V	Fluorocarbon

ROD WIPER	
S	STANDARD (Flocked Nitrile)
M	Metallic Scraper
T	PTFE
V	Fluorocarbon

S Standard Seals

Piston: Carboxilated Nitrile Rod Seal: Polyurethane
 Tube Seals: Buna Rod Wiper: Flocked Nitrile
 Temperature Rating: -20°F to 200°F (-29°C to 93°C)
 Compatible with: Mineral based hydraulic fluids

C Cast Iron Piston Rings

Temperature Range: -20°F to 200°F (-29°C to 93°C)
 Compatible with: Virtually all fluids
 Uses: Hydraulic shock protection

M Metallic Rod Scraper

Aggressively scrapes the piston rod, removing foreign material such as spatter, sprays and powders (*brass construction*).

E Ethylene Propylene

Temperature Rating: -50°F to 300°F (-45°C to 149°C)
 Compatible with: Most Phosphate Ester (Skydrol 500 and 7000, type 2) fluids

T Glass Filled PTFE

Temperature Rating: -100°F to 400°F (-73°C to 204°C)
 Compatible with: All hydraulic fluids and almost any fluid
 Contact HYDRAULIC CYLINDERS INC.® for specific compatibility
 Use: Low friction and high side load

V Fluorocarbon

Temperature Rating: 0°F to 300°F (-18°C to 149°C)
 (Up to 400°F with reduced service life)
 Compatible with: Some Phosphate Ester (Houghto-Safe 1000, 1120; Pyrogard 42, 43, 53, 55) fluids; mineral based petroleum, halogenated hydrocarbons, silicate ester and diester fluids

XX Special

Non-standard seals can be furnished.

VARIATIONS

ST Stop Tube and Rod Size Selection

Stop tubes are designed to reduce the piston rod bushing stress to within the designed range of the bearing material. This will ensure proper cylinder performance in any given application. Stop tubes lower the cylinder bearing stress by adding length to the piston, which increases the overall length of the cylinder (Note: HYDRAULIC CYLINDERS INC.® uses a double piston design when possible).

Stop Tube Selection

To determine the proper amount of stop tube for your application, you must first find the value of "D", which represents the stroke (*adjusted for mounting condition*). Each mounting condition creates different levels of bushing stress, which has direct impact on the amount of stop tube required (see Chart 1). Once the value of "D" is known, refer to Chart 2 for the recommended amount of stop tube.

To order a stop tube:

- Add the stop tube prefix "ST=" and the stop tube length to the cylinder model number.
- Add "ES" after the cylinder stroke to indicate that the stroke is the effective stroke.

Example: H-MS2-2.50 X 42ES-100-KK2-P15=N375-SSSS-ST=2

Using the value of "D", find the recommended amount of stop tube

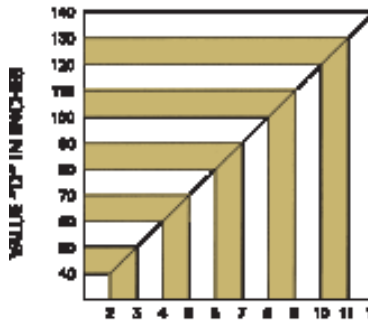

Standard rod sizes are usually suitable for shorter stroke applications at lower hydraulic pressures. With high thrust force or long stroke applications, you must check the column strength of the rod in the mounting style to determine the proper rod diameter size.

1. Determine the total axial thrust by multiplying the bore area size (in inches) by the operating pressure (in PSI).
2. Determine the value of "D" for the application.
3. Find the value of "D" in the chart below. Follow the value of "D" vertically on the graph until it intersects with the axial thrust value of the cylinder. The intersection of these two values will fall within one of the shaded areas representing the piston rod diameter size required for the application.

Find the value of "D" for your application

D = Stroke, adjusted for mounting condition
 S = Actual cylinder stroke
 T = Axial thrust (refer to Chart 3)

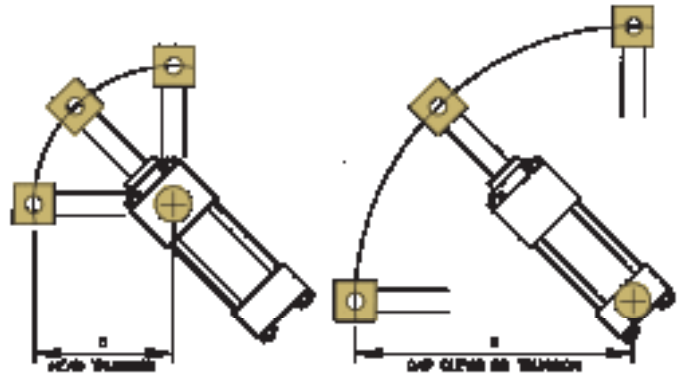
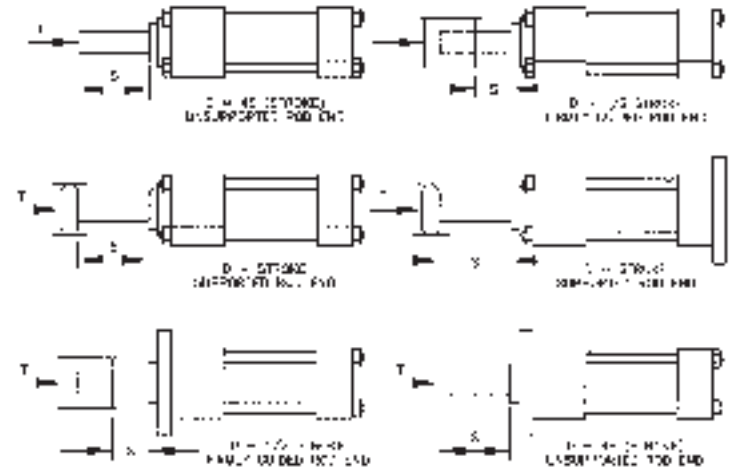

Note: Measure "D" when cylinder is fully extended.

Chart 3 (Piston Rod Diameter Selection)

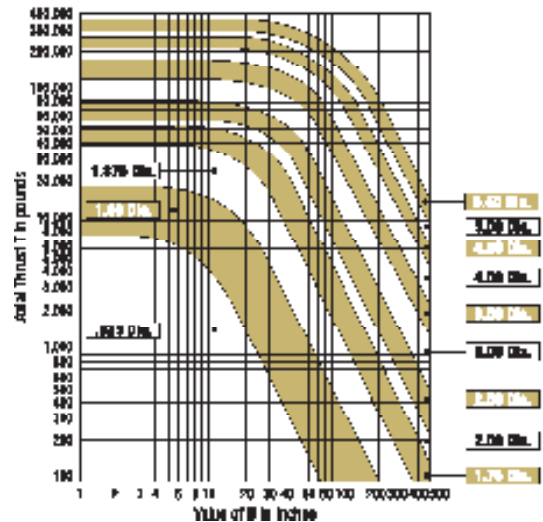



3P Three-Position Cylinder

You can create a 3-Position cylinder from two of the same bore size cylinders.

3-Position cylinders consist of multiple cylinders built as one unit having one exposed working rod end, capable of delivering three rod positions.

3-POSITIONS IN ONE CYLINDER — One cylinder produces three different rod end positions. By varying stroke lengths, a multitude of positions can be created.

SIMPLIFIES MACHINE DESIGNS — Eliminates the need for an additional cylinder to create a third position. 3-Position cylinders reduce space and the cost to mount multiple cylinders.

Note: Piston rods are not connected.

BTB Back-To-Back Cylinders

Back-to-Back cylinders consist of two individual cylinders built as one unit. These cylinders can act as a four position cylinder.

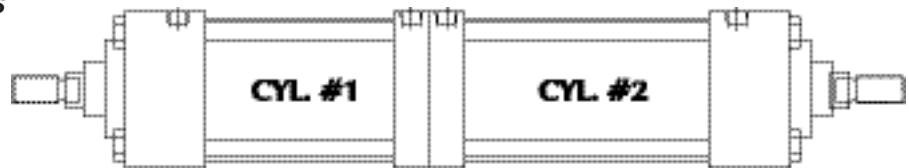

TM Tandem Cylinders

You can tandem different cylinders together to create unlimited design possibilities.

Note: Piston rods are connected.

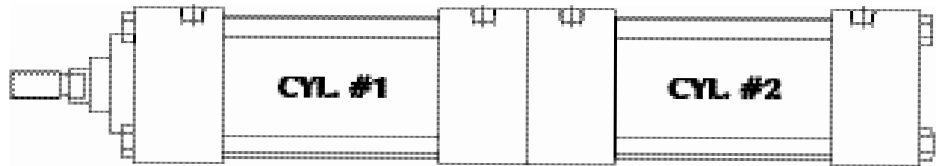

Special Finishes

Standard Finish: Black Urethane Paint (suitable for indoor or outdoor use).

Optional Paint: Black Epoxy Paint (suitable for indoor use only).

Additional Paint Choices: HYDRAULIC CYLINDERS INC.® can provide paint in any color or type.

Additional Finishes: HYDRAULIC CYLINDERS INC.® can provide special finishes, i.e. Nutride Plate or Heavy Chrome Plated Piston Rods.

Rod Boots

Rod boots are common in dirty environments; a standard spec for many applications

(Note: Rod boots add length to cylinder rod extension).





Flange Ports

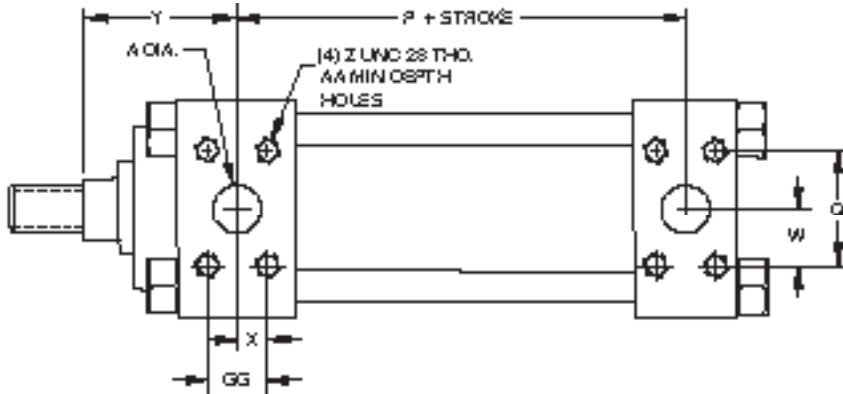

Ref Port Call Out Information

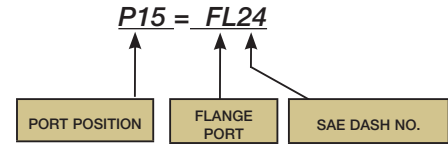

Note:
Flanges overhang caps on 2.50" through 5.00" Bore

Affected Mounts:
ME5 and MF6 Mounts are not available
MF2 Mount is not available with ports at positions 6 and/or 8

FLANGE PORT (3000 PSI Rating)
(available on 'H' Series only)

BORE	ROD DIA. (MM)	MAX PSI RATING	SAE DASH NO.	Y	P	A	Q	W	X	Z	AA	GG	REF. MAIN FLANGE SIZE
2.50	1.000	3000	8	2.250	3.125	0.500	1.500	0.750	0.340	5/16 - 18	0.810	0.690	1/2
3.25	1.375	3000	12	2.625	3.750	0.750	1.870	0.938	0.438	3/8 - 16	0.750	0.870	3/4
3.25	1.750	3000	12	2.875	3.750	0.750	1.870	0.938	0.438	3/8 - 16	0.750	0.870	3/4
3.25	2.000	3000	12	3.000	3.750	0.750	1.870	0.938	0.438	3/8 - 16	0.750	0.870	3/4
4.00	1.750	3000	12	2.875	4.000	0.750	1.870	0.938	0.438	3/8 - 16	0.750	0.870	3/4
4.00	2.000	3000	12	3.000	4.000	0.750	1.870	0.938	0.438	3/8 - 16	0.750	0.870	3/4
4.00	2.500	3000	12	3.250	4.000	0.750	1.870	0.938	0.438	3/8 - 16	0.750	0.870	3/4
5.00	2.000	3000	12	3.000	4.500	0.750	1.870	0.938	0.438	3/8 - 16	0.750	0.870	3/4
5.00	2.500	3000	12	3.250	4.500	0.750	1.870	0.938	0.438	3/8 - 16	0.750	0.870	3/4
5.00	3.000	3000	12	3.250	4.500	0.750	1.870	0.938	0.438	3/8 - 16	0.750	0.870	3/4
5.00	3.500	3000	12	3.250	4.500	0.750	1.870	0.938	0.438	3/8 - 16	0.750	0.870	3/4
6.00	2.500	3000	16	3.375	5.125	1.000	2.060	1.030	0.520	3/8 - 16	0.870	1.030	1
6.00	3.000	3000	16	3.375	5.125	1.000	2.060	1.030	0.520	3/8 - 16	0.870	1.030	1
6.00	3.500	3000	16	3.375	5.125	1.000	2.060	1.030	0.520	3/8 - 16	0.870	1.030	1
6.00	4.000	3000	16	3.375	5.125	1.000	2.060	1.030	0.520	3/8 - 16	0.870	1.030	1
8.00	3.500	3000	24	3.750	6.500	1.500	2.750	1.370	0.700	1/2 - 13	1.060	1.410	1 1/2
8.00	4.000	3000	24	3.750	6.500	1.500	2.750	1.370	0.700	1/2 - 13	1.060	1.410	1 1/2
8.00	4.500	3000	24	3.750	6.500	1.500	2.750	1.370	0.700	1/2 - 13	1.060	1.410	1 1/2
8.00	5.000	3000	24	3.750	6.500	1.500	2.750	1.370	0.700	1/2 - 13	1.060	1.410	1 1/2
8.00	5.500	3000	24	3.750	6.500	1.500	2.750	1.370	0.700	1/2 - 13	1.060	1.410	1 1/2



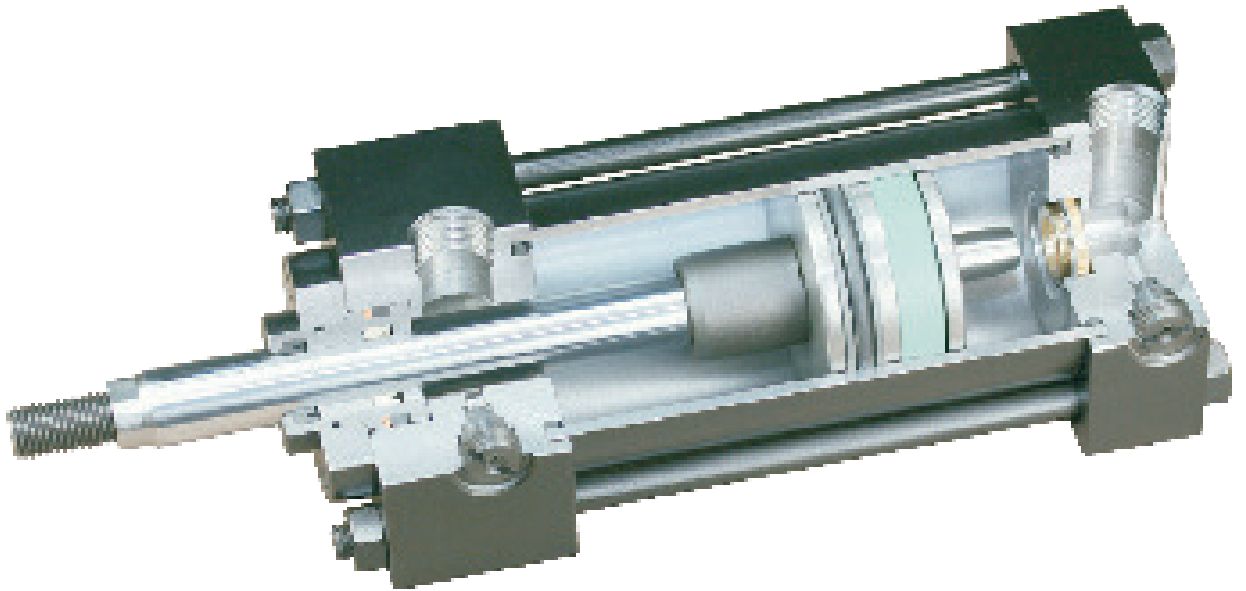

M SERIES

MEDIUM DUTY INDUSTRIAL HYDRAULICS | 1.50"–8.00" BORE

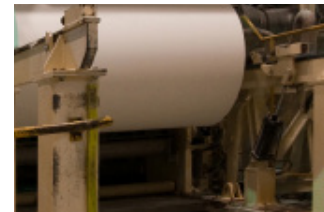

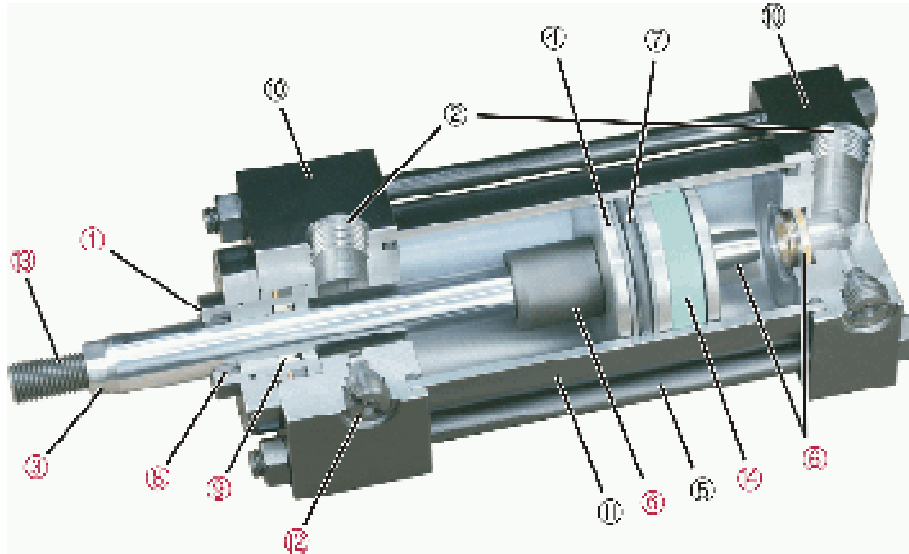

① – Precision machined from 150,000 PSI rated graphite-filled ductile iron and PTFE coated to reduce friction and extend cycle life. Bushing design traps lubrication in effective bearing area. Bronze bushings also available.

② – NPTF and SAE ports available standard. Non-standard locations, sizes and other port styles can be made-to-order to fit any application needs.

– Steel piston rod provides high strength and damage resistance. Induction hardened and chrome plated for maximum wear resistance and long life (100K min. yield up to 5" rod; 75K min. yield for 5 1/2" rod).

④ – Precision machined ductile iron provides high strength and an excellent bearing surface for extended cylinder life.

⑤ – Pre-stressed high carbon steel tie rod construction eliminates axial loading of cylinder tube and maintains compression on tube (100K min. yield).

– Precision machined cushions are available at either end and provide smooth deceleration which helps reduce end of stroke shock.

⑦ – Heavy-duty, bi-directional Carboxilated Nitrile T-Seal with double back-up. Rated for shock loads and incorporates anti-extrusion technology. EP, PTFE and fluorocarbon designs available.

– Flocked nitrile wiper removes contaminants on retract stroke, helping insure long life for all internal components.

– Polyurethane seals offer high abrasion resistance and strength. Pressure activated double lip and wear compensating for extended life.

⑩ – Precision machined steel head and cap are held to tight tolerances and insure accurate alignment for a truly square cylinder.

⑪ – Precision machined steel tube with hard chrome I.D. is honed and micro finished for extended seal life and improved cycle rates.

⑫ – Adjustable steel needle design has fine thread metering and is positively captured to prevent needle ejection during adjustment.

⑬ – Standard on KK1 and KK2 threads for 5/8" - 2" rods (125K min. yield). Available up to two times standard "A" thread length.

⑭ – Wear Guard Nylon (standard); reinforced PTFE for E and V seal option.

– Black urethane paint.

– Acts as a shear pin between the piston and rod threads, eliminating any chance of a piston coming loose from the rod. Also referred to as Dutch Key or Skotch Key.

Refer to page 52-79 for specific PSI rating by bore size and mount.

Standard Seals: -20°F to 200°F (-29°C to 93°C)

Fluorocarbon: 0°F to 400°F (-18°C to 204°C)

SERIES 'M' MEDIUM DUTY HYDRAULIC CYLINDERS



HOW TO ORDER

M	-	MF1	-	250	x	10	-	H2C6	-	100	-	KK1	-	P15	=	N375	-	S S S S	-	
SERIES		NFPA MOUNTS		BORE		STROKE		CUSHIONS		ROD SIZE		ROD END		PORT LOC		PORT SIZE		SEALS		VARIATIONS

SERIES	
M	MEDIUM DUTY HYDRAULIC

NFPA MOUNTS	
MX0	NO MOUNT (1.50" to 8.00" Bore)
MF1	HEAD RECTANGULAR FLANGE (1.50" to 6.00" Bore)
MF2	CAP RECTANGULAR FLANGE (1.50" to 6.00" Bore)
MF5	HEAD SQUARE FLANGE (1.50" to 6.00" Bore)
MF6	CAP SQUARE FLANGE (1.50" to 6.00" Bore)
ME3	HEAD MOUNTING HOLES (1.50" to 8.00" Bore)
ME4	CAP MOUNTING HOLES (1.50" to 8.00" Bore)
MP1	FIXED CAP PIVOT CLEVIS (1.50" to 8.00" Bore)
MP2	DETACHABLE CAP PIVOT CLEVIS (1.50" to 8.00" Bore)
MS2	SIDE LUGS (1.50" to 8.00" Bore)
MS3	CENTER LINE LUGS (1.50" to 8.00" Bore)
MS4	BOTTOM TAPPED HOLES (1.50" to 8.00" Bore)
MS7	END LUGS (1.50" to 8.00" Bore)
MT1	HEAD TRUNNION (1.50" to 8.00" Bore)
MT2	CAP TRUNNION (1.50" to 8.00" Bore)
MT4	INTERMEDIATE (CENTER) TRUNNION (1.50" to 8.00" Bore)
MX1	EXTENDED TIE RODS - HEAD & CAP (1.50" to 8.00" Bore)
MX2	EXTENDED TIE RODS - CAP (1.50" to 8.00" Bore)
MX3	EXTENDED TIE RODS - HEAD (1.50" to 8.00" Bore)
SB	SPHERICAL BEARING CAP PIVOT (1.50" to 8.00" Bore)

STYLE	
(BLANK)	SINGLE ROD
D	DOUBLE ROD

BORE	
150	1.50" Bore
200	2.00" Bore
250	2.50" Bore
325	3.25" Bore
400	4.00" Bore
500	5.00" Bore
600	6.00" Bore
800	8.00" Bore

STROKE
0" to 120" MADE TO ORDER (Use decimals for fractional strokes)

MAXIMUM STROKE RECOMMENDATIONS			
BORE	NO CENTER SUPPORT	WITH CENTER SUPPORTS (CS OPTION)	
		ONE SUPPORT	TWO SUPPORTS
1.50", 2.00", 2.50"	48 INCHES	STROKES OVER 48 INCHES	STROKES OVER 729 INCHES
3.25", 4.00", 5.00"	65 INCHES	STROKES OVER 65 INCHES	STROKES OVER 92 INCHES
6.00" & 8.00"	72 INCHES	STROKES OVER 72 INCHES	NOT REQUIRED

CUSHIONS	
H	1
	2
	3
	4
C	5
	6
	7
	8
Call out 'H' for head cushion, 'C' for cap cushion, followed by the desired location(s).	

ROD SIZE	
062	0.625" Rod Dia.
100	1.000" Rod Dia.
137	1.375" Rod Dia.
175	1.750" Rod Dia.
200	2.000" Rod Dia.
250	2.500" Rod Dia.
300	3.000" Rod Dia.
350	3.500" Rod Dia.
400	4.000" Rod Dia.
450	4.500" Rod Dia.
500	5.000" Rod Dia.
550	5.500" Rod Dia.

ROD END	
KK1	Small Male Thread
KK2	Large Male Thread
KK3	Female Thread
KK3M	Female Metric Rod Thread
KK3X	Female Special Thread
KK4	Full Dia. Male Thread
KK5	Plain End
KK10	Rod Coupler End
KKM	Metric Thread
KKX	Non-Std Thread
When additional thread details are required, use format: "Rod End" = "Modification" Example: KKM=M12 X 1.75	

PORT LOC	
P	1
	2
	3
	4
	5
	6
	7
	8
	9
Call out 'P' followed by all desired locations.	

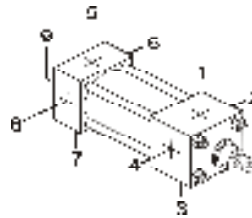

Location 9 is center of cap face.

PORT SIZE	
N062	1/16" NPTF
N125	1/8" NPTF
N250	1/4" NPTF
N375	3/8" NPTF
N500	1/2" NPTF
N750	3/4" NPTF
S6	#6 SAE
S8	#8 SAE
S10	#10 SAE
S12	#12 SAE

Port Note:
For complex port designs, multiple port locations & sizes can be ordered.
Call out locations and sizes for all sets using the following format.
Example: -P15=N375 -P26=N500 (3/8" NPTF Ports at 1 & 5 and 1/2" NPTF Ports at 2 & 6)

SEALS			
S	S	S	S
PISTON SEAL	ROD SEAL	TUBE SEAL	ROD WIPER

PISTON SEAL	
S	STANDARD (Carboxylated)
C	Cast-Ring
E	EP
T	PTFE
V	Fluorocarbon

ROD SEAL	
S	STANDARD (Polyurethane)
E	EP
V	Fluorocarbon

TUBE SEAL	
S	STANDARD (Buna)
E	EP
V	Fluorocarbon

ROD WIPER*	
S	STANDARD (Flocked Nitrile)
M	Metallic Scraper
T	PTFE
V	Fluorocarbon

*Note: When cylinder design calls for all EP seals, use PTFE rod wiper.

VARIATIONS	
A=	EXTENDED PISTON ROD THREAD (Example: A = 2") (MAX = 2 TIMES ST'D "A" DIM.)
ABP=	AIR BLEED PORTS (Example ABP=15)
AS=	ADJUSTABLE STROKE - RETRACT (SPECIFY LENGTH, Example: AS = 4")
C=	EXTENDED PISTON ROD (Example: IF C = 0.50", THEN 1" ROD EXTENSION IS C = 1.50")
CS	CENTER SUPPORT
DBB=	DRAIN BACK BUSHING (Example: DBB=1)
EK	EXTENDED KEY PLATE
HLP	HIGH LOAD PISTON
HSS	HIGH SHOCK SEALS
LRB	LIFT RING BOSS
NR	NON-ROTATING
RBB	ROD BUSHING MATERIAL: BRONZE
SSR	STAINLESS STEEL PISTON ROD
ST=	STOP TUBE NOTE: Specify STOP TUBE length (in inches) Specify Stroke as ES (effective stroke) Example: (M-MS2-250x48ES-H2C6-ST=3")*
4WF	FOUR WRENCH FLATS (ROD SIZES: .625"-3.50")
XX=	SPECIAL VARIATION (SPECIFY)

*Note: Stop Tube length adds directly to the overall cylinder length.

SERIES 'M' MEDIUM DUTY HYDRAULIC CYLINDERS

NFPA MOUNTS



No Mount

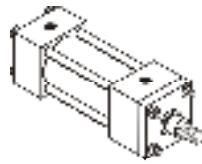

MX0 1.50"-8.00" Bores

Trunnion Mounts

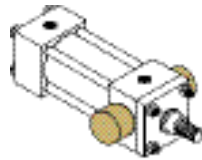

MT1 1.50"-8.00" Bores

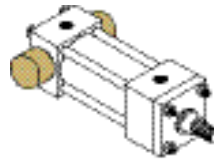

MT2 1.50"-8.00" Bores

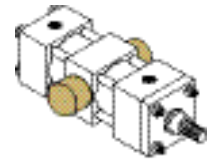

MT4 1.50"-8.00" Bores

Extended Tie Rod Mounts

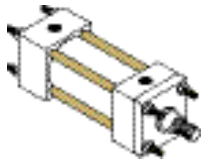

MX1 1.50"-8.00" Bores

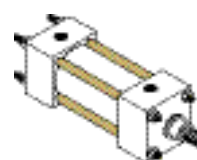

MX2 1.50"-8.00" Bores

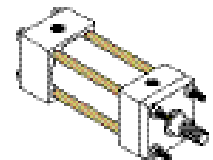

MX3 1.50"-8.00" Bores

Flange Mounts

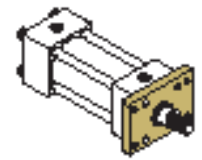

MF1 1.50"-6.00" Bores

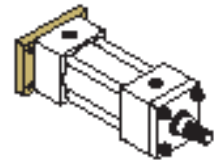

MF2 1.50"-6.00" Bores

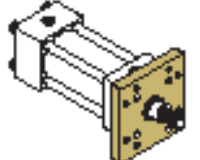

MF5 1.50"-6.00" Bores

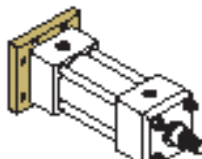

MF6 1.50"-6.00" Bores

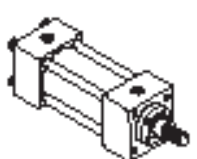

ME3 8.00" Bore

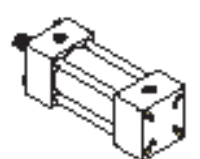

ME4 8.00" Bore

Lug Mounts

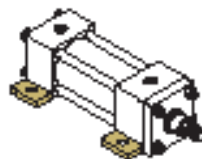

MS2 1.50"-8.00" Bores

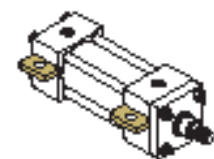

MS3 1.50"-8.00" Bores

Bottom Mounts

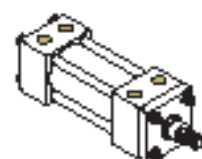

MS4 1.50"-8.00" Bores

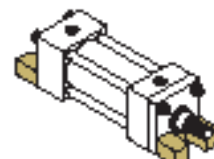

MS7 1.50"-8.00" Bores

All our cylinders are proudly Made in USA

SERIES 'M' MEDIUM DUTY HYDRAULIC CYLINDERS

NFPA MOUNTS & THREADS



Pivot Mounts

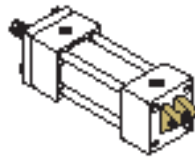

MP1 1.50"-8.00" Bores

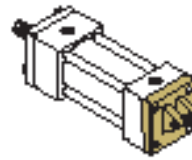

MP2 1.50"-6.00" Bores

Spherical Bearing Mount

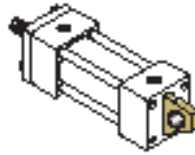

SB 1.50"-8.00" Bores

Threads

KK1
KK2

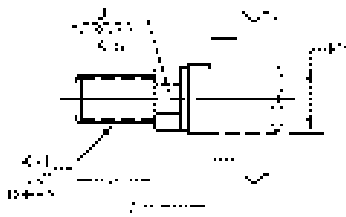

KK3

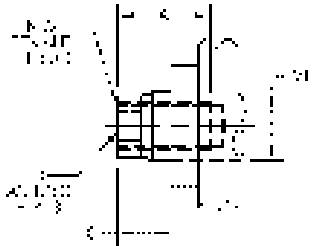

KK4

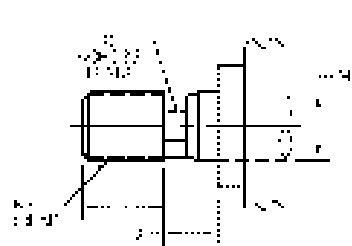

KK5

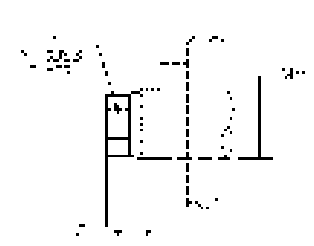

KK10

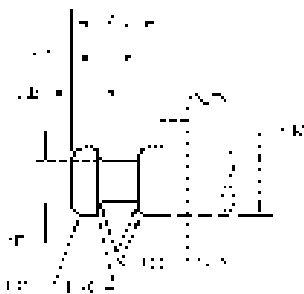

Spanner Holes

(4.00-5.50 Rods)
(Shown on KK1-KK2)

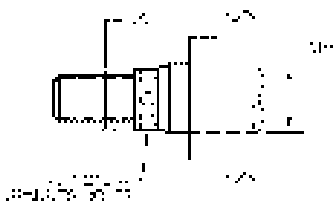

ROD DIA. (MM)	A	C	D	AC	AD	AE	AF	KK1	KK2	KK3	KK4	NA ±.002
0.625	0.750	0.375	0.500	1.125	0.625	0.250	0.375	7/16 - 20*	1/2 - 20*	7/16 - 20	5/8 - 18	—
1.000	1.125	0.500	0.875	1.625	0.938	0.375	0.688	3/4 - 16*	7/8 - 14*	3/4 - 16	1 - 14	—
1.375	1.625	0.625	1.125	1.750	1.062	0.375	0.875	1 - 14*	1 1/4 - 12*	1 - 14	1 3/8 - 12	—
1.750	2.000	0.750	1.500	2.000	1.313	0.500	1.125	1 1/4 - 12*	1 1/2 - 12*	1 1/4 - 12	1 3/4 - 12	—
2.000	2.250	0.875	1.750	2.625	1.688	0.625	1.375	1 1/2 - 12*	1 3/4 - 12*	1 1/2 - 12	2 - 12	—
2.500	3.000	1.000	2.125	3.250	1.938	0.750	1.750	1 7/8 - 12	2 1/4 - 12	1 7/8 - 12	2 1/2 - 12	—
3.000	3.500	1.000	2.625	3.625	2.438	0.875	2.250	2 1/4 - 12	2 3/4 - 12	2 1/4 - 12	3 - 12	—
3.500	3.500	1.000	3.000	4.375	2.688	1.000	2.500	2 1/2 - 12	3 1/4 - 12	2 1/2 - 12	3 1/2 - 12	—
4.000	4.000	1.000	—	4.500	2.688	1.000	3.000	3 - 12	3 3/4 - 12	3 - 12	4 - 12	3.937
4.500	4.500	1.000	—	5.250	3.188	1.500	3.500	3 1/4 - 12	4 1/4 - 12	3 1/4 - 12	4 1/2 - 12	4.421
5.000	5.000	1.000	—	5.375	3.188	1.500	3.875	3 1/2 - 12	4 3/4 - 12	3 1/2 - 12	5 - 12	4.921
5.500	5.500	1.000	—	6.250	3.938	1.875	4.375	4 - 12	5 1/4 - 12	4 - 12	5 1/2 - 12	5.421

*Studded rod end.

(4) Wrench flats is an option.

Note: Rods larger than 3.50" dia. utilize (4) 0.50" dia. spanner holes 0.50" deep.

RETAINER CONSTRUCTION

FULL SQUARE RETAINER USED ON:	
BORE	ROD DIA.
1.50	0.625
1.50	1.000
2.00	1.000
2.00	1.375
2.50	1.000
2.50	1.375
2.50	1.750
3.25	1.375
3.25	1.750
3.25	2.000
4.00	2.000
4.00	2.500
5.00	2.500
5.00	3.000
5.00	3.500
6.00	4.000

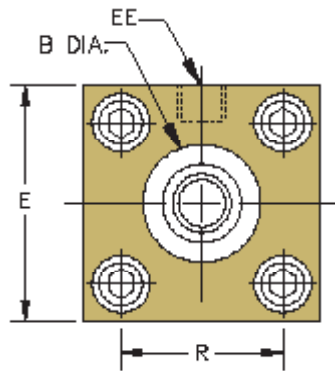

Note: Full square retainer is removable to service rod bushing

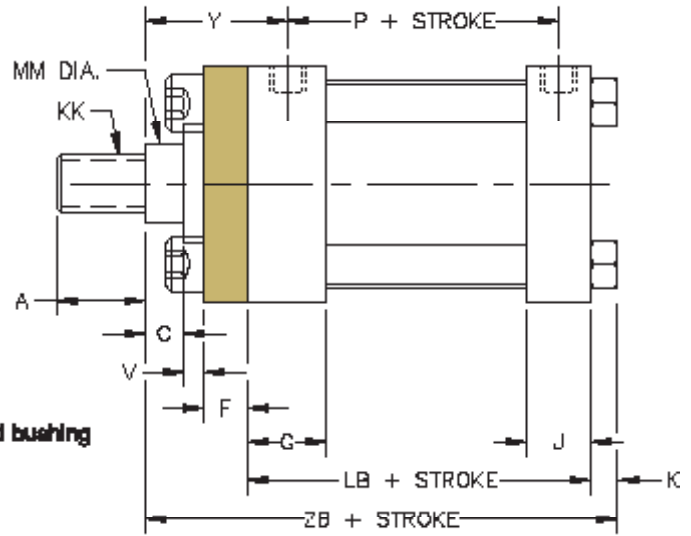

ROUND RETAINER USED ON:	
BORE	ROD DIA.
2.00	0.625
2.50	0.625
3.25	1.000
4.00	1.000
4.00	1.375
4.00	1.750
5.00	1.000
5.00	1.375
5.00	1.750
5.00	2.000
6.00	1.375
6.00	1.750
6.00	2.000
6.00	2.500
6.00	3.000
6.00	3.500
8.00	1.375
8.00	1.750
8.00	2.000
8.00	2.500
8.00	3.000
8.00	3.500
8.00	4.000
8.00	4.500
8.00	5.000
8.00	5.500

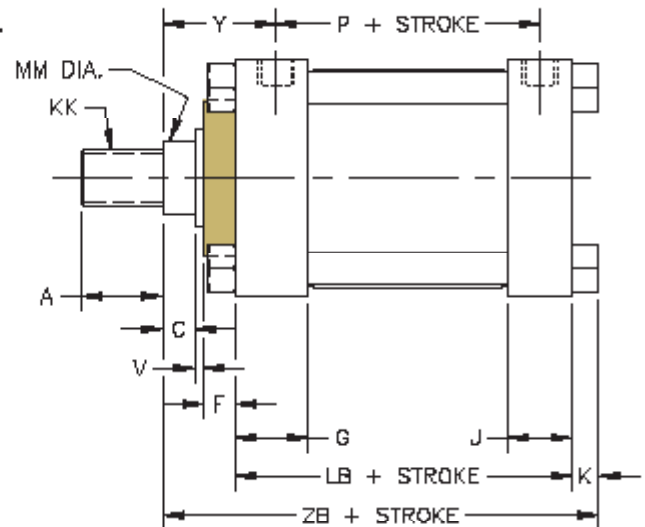
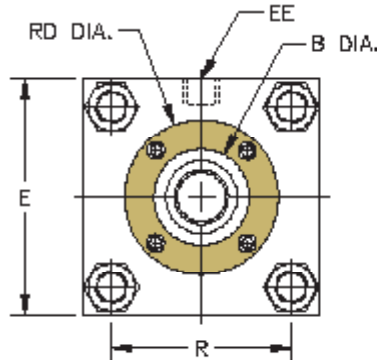



MT1: HEAD TRUNNION

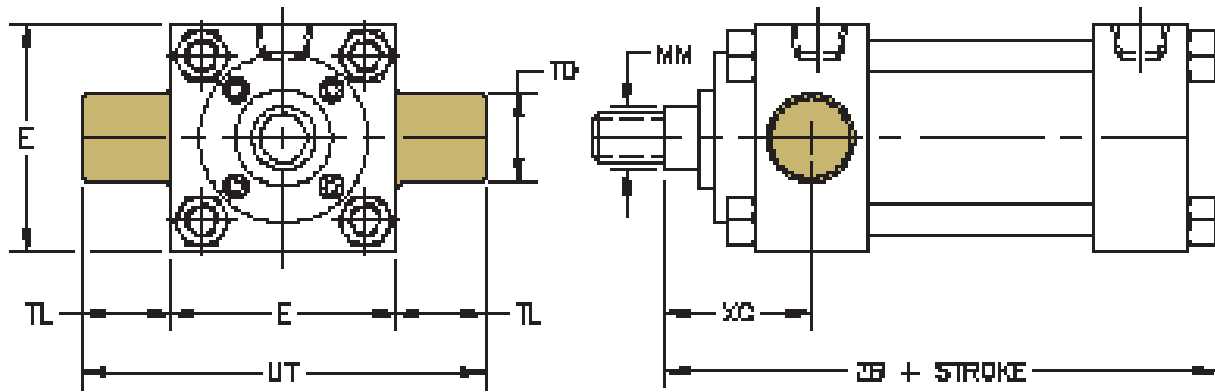

MT2: CAP TRUNNION

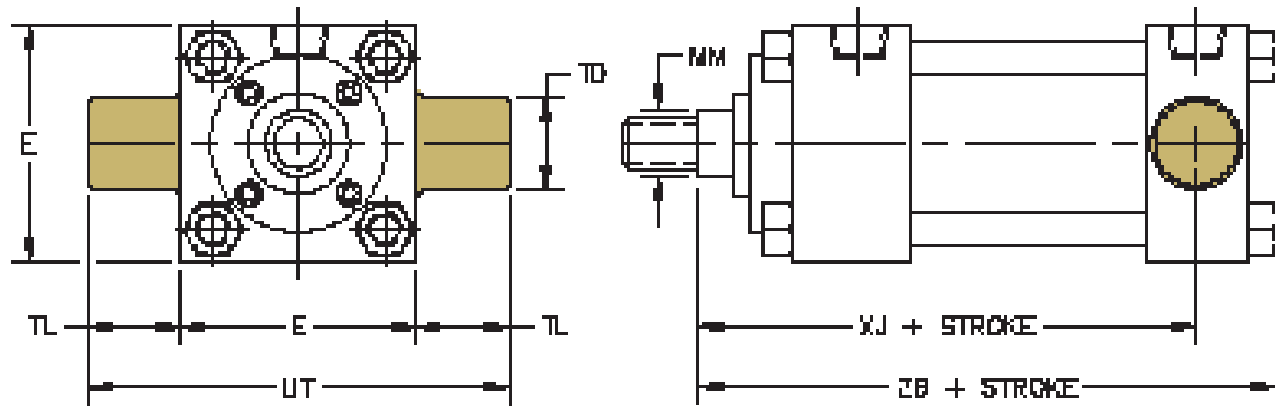

MT4: INTERMEDIATE TRUNNION

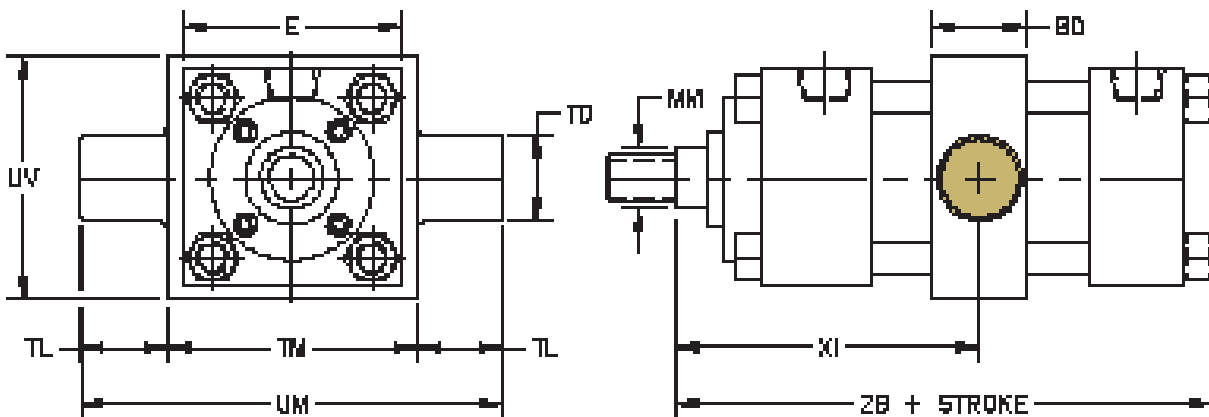

NOTE:
XJ DIMENSION TO BE SPECIFIED BY CUSTOMER

SERIES 'M' MEDIUM DUTY HYDRAULIC CYLINDERS

DIMENSIONS FOR TRUNNION MOUNTS



BORE	ROD DIA. (MM)	I MAX PSI RATING	E	BD	TD	TL	TM	UM	UT	UV	XG	XI	MT4 MIN STROKE	ADD TO STROKE	
														XJ	ZB
1.50	0.625	1500	2.000	1.250	1.000	1.000	2.500	4.500	4.000	2.500	1.750	3.375	0.250	4.125	4.875
1.50	1.000	1500	2.000	1.250	1.000	1.000	2.500	4.500	4.000	2.500	2.125	3.750	0.250	4.500	5.250
2.00	0.625	1500	2.500	1.500	1.000	1.000	3.000	5.000	4.500	3.000	1.750	3.500	0.250	4.125	4.938
2.00	1.000	1500	2.500	1.500	1.000	1.000	3.000	5.000	4.500	3.000	2.125	3.875	0.250	4.500	5.313
2.00	1.375	1500	2.500	1.500	1.000	1.000	3.000	5.000	4.500	3.000	2.375	4.125	0.250	4.750	5.563
2.50	0.625	1000	3.000	1.500	1.000	1.000	3.500	5.500	5.000	3.500	1.750	3.500	0.375	4.250	5.063
2.50	1.000	1500	3.000	1.500	1.000	1.000	3.500	5.500	5.000	3.500	2.125	3.875	0.375	4.625	5.438
2.50	1.375	1500	3.000	1.500	1.000	1.000	3.500	5.500	5.000	3.500	2.375	4.125	0.375	4.875	5.688
2.50	1.750	1500	3.000	1.500	1.000	1.000	3.500	5.500	5.000	3.500	2.625	4.375	0.375	5.125	5.938
3.25	1.000	1500	3.750	2.000	1.000	1.000	4.500	6.500	5.750	4.250	2.250	4.375	0.875	5.000	6.000
3.25	1.375	1500	3.750	2.000	1.000	1.000	4.500	6.500	5.750	4.250	2.500	4.625	0.875	5.250	6.250
3.25	1.750	1500	3.750	2.000	1.000	1.000	4.500	6.500	5.750	4.250	2.750	4.875	0.875	5.500	6.500
3.25	2.000	1500	3.750	2.000	1.000	1.000	4.500	6.500	5.750	4.250	2.875	5.000	0.875	5.625	6.625
4.00	1.000	1000	4.500	2.000	1.000	1.000	5.250	7.250	6.500	5.000	2.250	4.375	1.125	5.000	6.000
4.00	1.375	1000	4.500	2.000	1.000	1.000	5.250	7.250	6.500	5.000	2.500	4.625	1.125	5.250	6.250
4.00	1.750	1000	4.500	2.000	1.000	1.000	5.250	7.250	6.500	5.000	2.750	4.875	1.125	5.500	6.500
4.00	2.000	1000	4.500	2.000	1.000	1.000	5.250	7.250	6.500	5.000	2.875	5.000	1.125	5.625	6.625
4.00	2.500	1000	4.500	2.000	1.000	1.000	5.250	7.250	6.500	5.000	3.125	5.250	1.125	5.875	6.875
5.00	1.000	750	5.500	2.000	1.000	1.000	6.250	8.250	7.500	6.000	2.250	4.375	1.125	5.250	6.313
5.00	1.375	1000	5.500	2.000	1.000	1.000	6.250	8.250	7.500	6.000	2.500	4.625	1.125	5.500	6.563
5.00	1.750	1000	5.500	2.000	1.000	1.000	6.250	8.250	7.500	6.000	2.750	4.875	1.125	5.750	6.813
5.00	2.000	1000	5.500	2.000	1.000	1.000	6.250	8.250	7.500	6.000	2.875	5.000	1.125	5.875	6.938
5.00	2.500	1000	5.500	2.000	1.000	1.000	6.250	8.250	7.500	6.000	3.125	5.250	1.125	6.125	7.188
5.00	3.000	1000	5.500	2.000	1.000	1.000	6.250	8.250	7.500	6.000	3.125	5.250	1.125	6.125	7.188
5.00	3.500	1000	5.500	2.000	1.000	1.000	6.250	8.250	7.500	6.000	3.125	5.250	1.125	6.125	7.188
6.00	1.375	750	6.500	2.000	1.375	1.375	7.625	10.375	9.250	7.000	2.625	5.125	1.250	5.875	7.063
6.00	1.750	750	6.500	2.000	1.375	1.375	7.625	10.375	9.250	7.000	2.875	5.375	1.250	6.125	7.313
6.00	2.000	750	6.500	2.000	1.375	1.375	7.625	10.375	9.250	7.000	3.000	5.500	1.250	6.250	7.438
6.00	2.500	750	6.500	2.000	1.375	1.375	7.625	10.375	9.250	7.000	3.250	5.750	1.250	6.500	7.688
6.00	3.000	750	6.500	2.000	1.375	1.375	7.625	10.375	9.250	7.000	3.250	5.750	1.250	6.500	7.688
6.00	3.500	750	6.500	2.000	1.375	1.375	7.625	10.375	9.250	7.000	3.250	5.750	1.250	6.500	7.688
6.00	4.000	750	6.500	2.000	1.375	1.375	7.625	10.375	9.250	7.000	3.250	5.750	1.250	6.500	7.688
8.00	1.375	500	8.500	2.500	1.375	1.375	9.750	12.500	11.250	9.500	2.625	5.125	2.125	6.000	7.313
8.00	1.750	500	8.500	2.500	1.375	1.375	9.750	12.500	11.250	9.500	2.875	5.375	2.125	6.250	7.563
8.00	2.000	675	8.500	2.500	1.375	1.375	9.750	12.500	11.250	9.500	3.000	5.500	2.125	6.375	7.688
8.00	2.500	675	8.500	2.500	1.375	1.375	9.750	12.500	11.250	9.500	3.250	5.750	2.125	6.625	7.938
8.00	3.000	675	8.500	2.500	1.375	1.375	9.750	12.500	11.250	9.500	3.250	5.750	2.125	6.625	7.938
8.00	3.500	675	8.500	2.500	1.375	1.375	9.750	12.500	11.250	9.500	3.250	5.750	2.125	6.625	7.938
8.00	4.000	675	8.500	2.500	1.375	1.375	9.750	12.500	11.250	9.500	3.250	5.750	2.125	6.625	7.938
8.00	4.500	675	8.500	2.500	1.375	1.375	9.750	12.500	11.250	9.500	3.250	5.750	2.125	6.625	7.938
8.00	5.000	675	8.500	2.500	1.375	1.375	9.750	12.500	11.250	9.500	3.250	5.750	2.125	6.625	7.938
8.00	5.500	675	8.500	2.500	1.375	1.375	9.750	12.500	11.250	9.500	3.250	5.750	2.125	6.625	7.938

I Max pressure rating (NON-SHOCK).

** 'TD' dimension tolerance is + .000 / - .001

*** 'XI' dimension is the minimum that can be supplied and leaves 1/4" gap between head & trunnion block (customer to specify 'XI' dimension).



MX1: EXTENDED TIE-RODS - HEAD & CAP

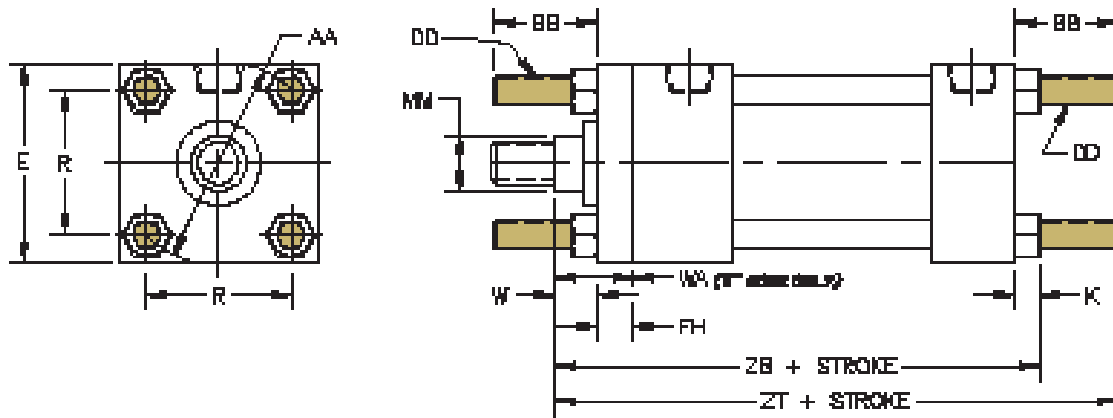

MX2: EXTENDED TIE-RODS - CAP END

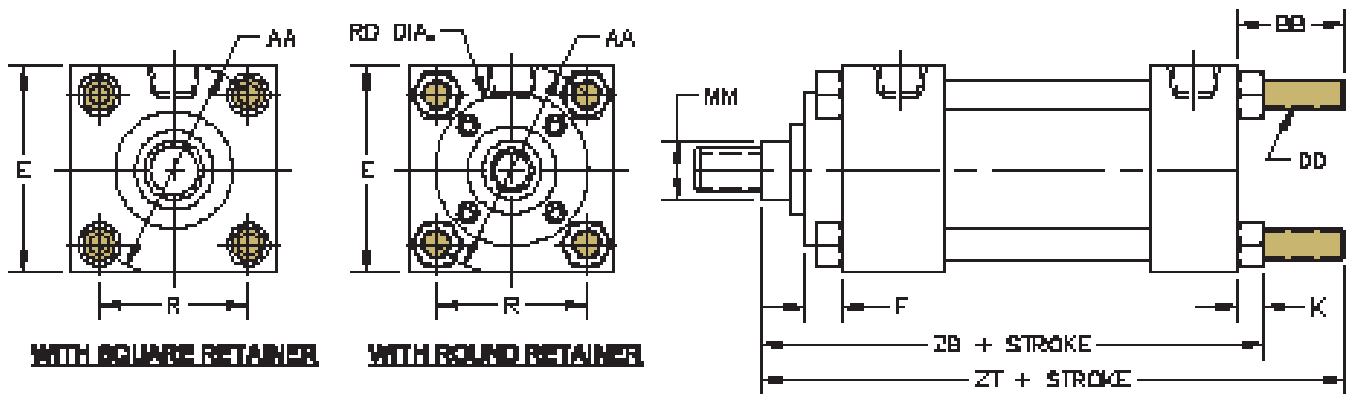

MX3: EXTENDED TIE-RODS - HEAD END

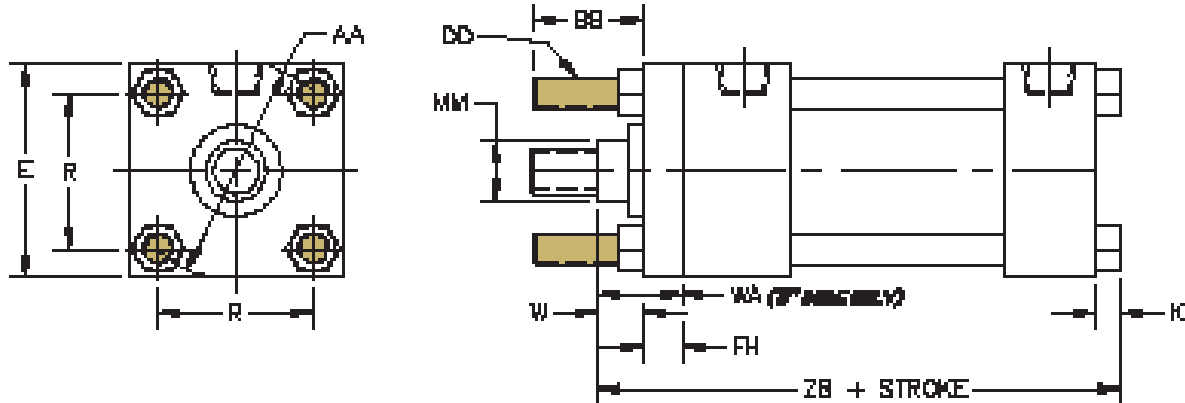

SERIES 'M' MEDIUM DUTY HYDRAULIC CYLINDERS

DIMENSIONS FOR EXTENDED TIE ROD MOUNTS



BORE	ROD DIA. (MM)	I MAX PSI RATING	E	FH	AA	BB	DD	F	K	R	RD	W or WA (8")	ADD TO STROKE	
													ZB	ZT
1.50	0.625	1500	2.000	0.375	2.020	1.000	1/4 - 28	0.375	0.250	1.430	SQ	0.625	4.875	5.625
1.50	1.000	1500	2.000	0.375	2.020	1.000	1/4 - 28	0.375	0.250	1.430	SQ	1.000	5.250	6.000
2.00	0.625	1500	2.500	0.375	2.600	1.125	5/16 - 24	0.375	0.313	1.840	2.000	0.625	4.938	5.750
2.00	1.000	1500	2.500	0.375	2.600	1.125	5/16 - 24	0.375	0.313	1.840	SQ	1.000	5.313	6.125
2.00	1.375	1500	2.500	0.375	2.600	1.125	5/16 - 24	0.375	0.313	1.840	SQ	1.250	5.563	6.375
2.50	0.625	1000	3.000	0.375	3.100	1.125	5/16 - 24	0.375	0.313	2.190	2.000	0.625	5.063	5.875
2.50	1.000	1500	3.000	0.375	3.100	1.125	5/16 - 24	0.375	0.313	2.190	SQ	1.000	5.438	6.250
2.50	1.375	1500	3.000	0.375	3.100	1.125	5/16 - 24	0.375	0.313	2.190	SQ	1.250	5.688	6.500
2.50	1.750	1500	3.000	0.375	3.100	1.125	5/16 - 24	0.375	0.313	2.190	SQ	1.500	5.938	6.750
3.25	1.000	1500	3.750	0.625	3.900	1.375	3/8 - 24	0.625	0.375	2.760	2.750	0.750	6.000	7.000
3.25	1.375	1500	3.750	0.625	3.900	1.375	3/8 - 24	0.625	0.375	2.760	SQ	1.000	6.250	7.250
3.25	1.750	1500	3.750	0.625	3.900	1.375	3/8 - 24	0.625	0.375	2.760	SQ	1.250	6.500	7.500
3.25	2.000	1500	3.750	0.625	3.900	1.375	3/8 - 24	0.625	0.375	2.760	SQ	1.375	6.625	7.625
4.00	1.000	1000	4.500	0.625	4.700	1.375	3/8 - 24	0.625	0.375	3.320	2.750	0.750	6.000	7.000
4.00	1.375	1000	4.500	0.625	4.700	1.375	3/8 - 24	0.625	0.375	3.320	3.500	1.000	6.250	7.250
4.00	1.750	1000	4.500	0.625	4.700	1.375	3/8 - 24	0.625	0.375	3.320	3.500	1.250	6.500	7.500
4.00	2.000	1000	4.500	0.625	4.700	1.375	3/8 - 24	0.625	0.375	3.320	SQ	1.375	6.625	7.625
4.00	2.500	1000	4.500	0.625	4.700	1.375	3/8 - 24	0.625	0.375	3.320	SQ	1.625	6.875	7.875
5.00	1.000	750	5.500	0.625	5.800	1.813	1/2 - 20	0.625	0.438	4.100	2.750	0.750	6.313	7.688
5.00	1.375	1000	5.500	0.625	5.800	1.813	1/2 - 20	0.625	0.438	4.100	3.500	1.000	6.563	7.938
5.00	1.750	1000	5.500	0.625	5.800	1.813	1/2 - 20	0.625	0.438	4.100	3.500	1.250	6.813	8.188
5.00	2.000	1000	5.500	0.625	5.800	1.813	1/2 - 20	0.625	0.438	4.100	4.250	1.375	6.938	8.313
5.00	2.500	1000	5.500	0.625	5.800	1.813	1/2 - 20	0.625	0.438	4.100	SQ	1.625	7.188	8.563
5.00	3.000	1000	5.500	0.625	5.800	1.813	1/2 - 20	0.625	0.438	4.100	SQ	1.625	7.188	8.563
5.00	3.500	1000	5.500	0.625	5.800	1.813	1/2 - 20	0.625	0.438	4.100	SQ	1.625	7.188	8.563
6.00	1.375	750	6.500	0.750	6.900	1.813	1/2 - 20	0.750	0.438	4.880	3.500	0.875	7.063	8.438
6.00	1.750	750	6.500	0.750	6.900	1.813	1/2 - 20	0.750	0.438	4.880	3.875	1.125	7.313	8.688
6.00	2.000	750	6.500	0.750	6.900	1.813	1/2 - 20	0.750	0.438	4.880	4.250	1.250	7.438	8.813
6.00	2.500	750	6.500	0.750	6.900	1.813	1/2 - 20	0.750	0.438	4.880	4.625	1.500	7.688	9.063
6.00	3.000	750	6.500	0.750	6.900	1.813	1/2 - 20	0.750	0.438	4.880	5.250	1.500	7.688	9.063
6.00	3.500	750	6.500	0.750	6.900	1.813	1/2 - 20	0.750	0.438	4.880	5.750	1.500	7.688	9.063
6.00	4.000	750	6.500	0.750	6.900	1.813	1/2 - 20	0.750	0.438	4.880	SQ	1.500	7.688	9.063
8.00	1.375	500	8.500	0.625*	9.10	2.313*	5/8 - 18	0.750	0.563	6.440	3.500	1.625	7.313	9.063
8.00	1.750	500	8.500	0.625*	9.10	2.313*	5/8 - 18	0.750	0.563	6.440	3.875	1.875	7.563	9.313
8.00	2.000	675	8.500	0.625*	9.10	2.313*	5/8 - 18	0.750	0.563	6.440	4.250	2.000	7.688	9.438
8.00	2.500	675	8.500	0.625*	9.10	2.313*	5/8 - 18	0.750	0.563	6.440	4.625	2.250	7.938	9.688
8.00	3.000	675	8.500	0.625*	9.10	2.313*	5/8 - 18	0.750	0.563	6.440	5.250	2.250	7.938	9.688
8.00	3.500	675	8.500	0.625*	9.10	2.313*	5/8 - 18	0.750	0.563	6.440	5.750	2.250	7.938	9.688
8.00	4.000	675	8.500	0.625*	9.10	2.313*	5/8 - 18	0.750	0.563	6.440	6.500	2.250	7.938	9.688
8.00	4.500	675	8.500	0.625*	9.10	2.313*	5/8 - 18	0.750	0.563	6.440	7.250	2.250	7.938	9.688
8.00	5.000	675	8.500	0.625*	9.10	2.313*	5/8 - 18	0.750	0.563	6.440	7.500	2.250	7.938	9.688
8.00	5.500	675	8.500	0.625*	9.10	2.313*	5/8 - 18	0.750	0.563	6.440	7.500	2.250	7.938	9.688

I Max pressure rating (NON-SHOCK).

‡ Where SQ is shown in chart, cylinder utilizes a full square retainer. ALL MX1 & MX3 MOUNTS USE FULL SQ. RETAINER.

* Round retainer used to retain bushing, not a full front plate as other bores. 'BB' is dimension from head on the 8.00" bore.

All our cylinders are proudly Made in USA



MF1: HEAD FLANGE

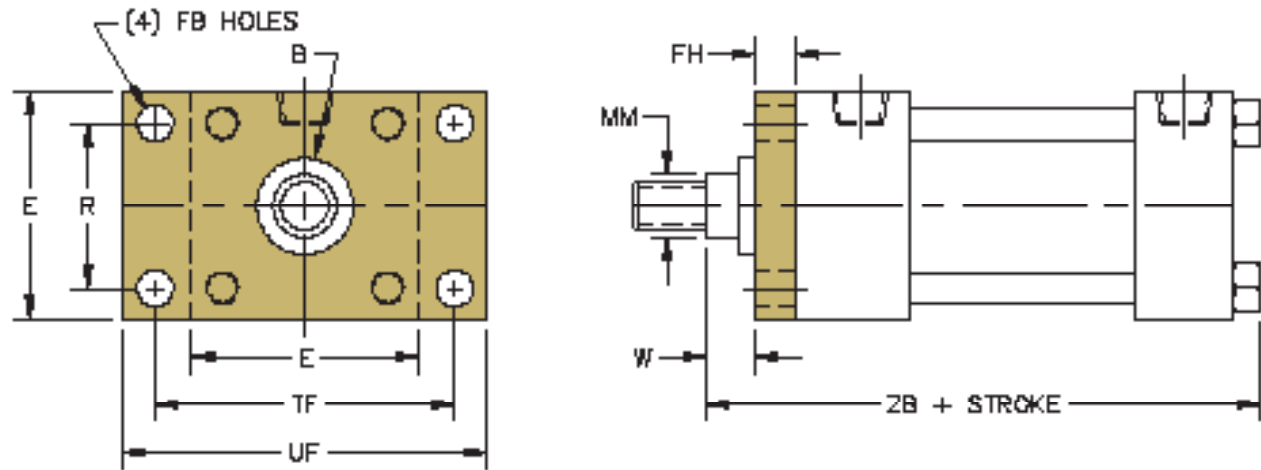

MF2: CAP FLANGE

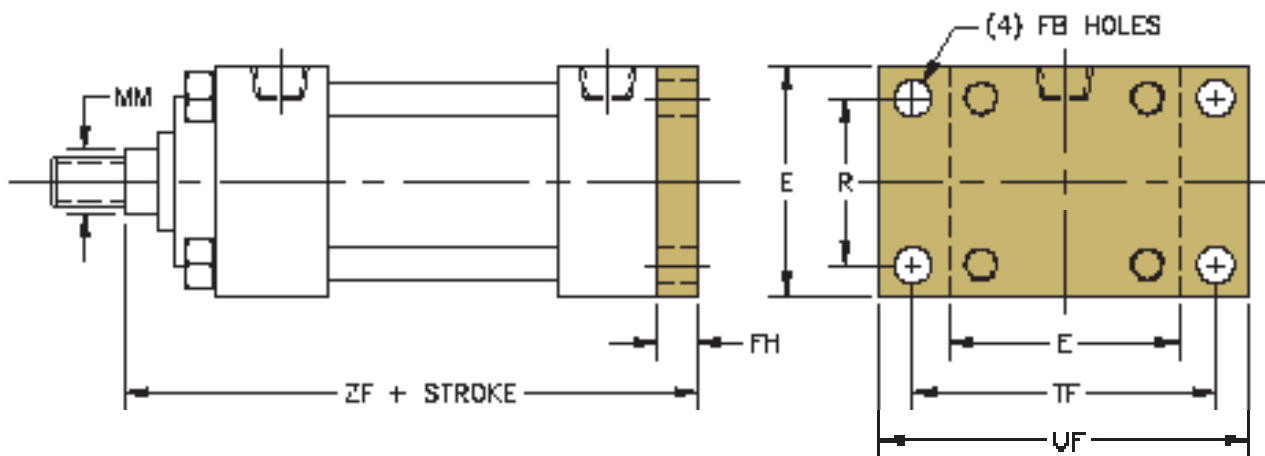

MF5: HEAD SQUARE FLANGE

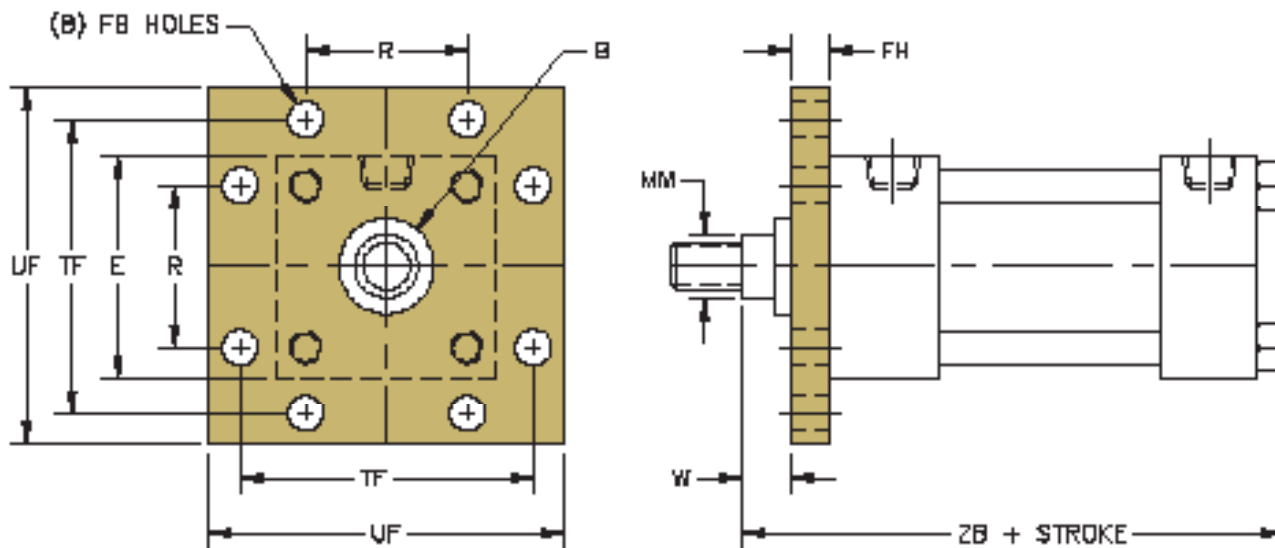



MF6: CAP SQUARE FLANGE

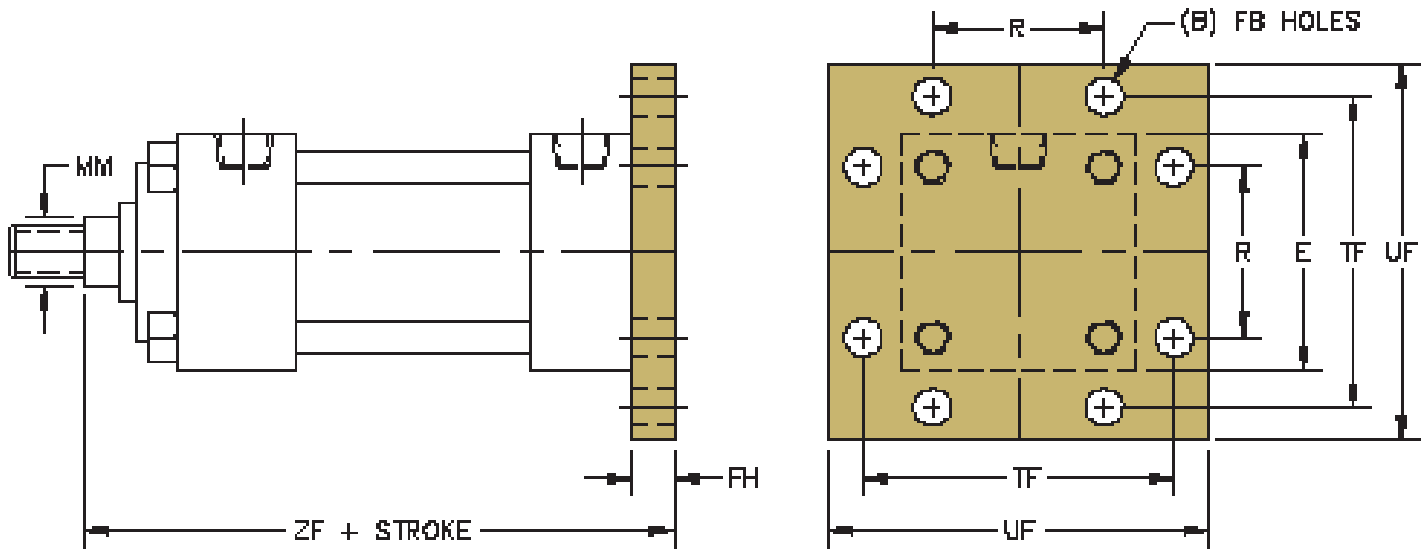

BORE	ROD DIA. (MM)	I MAX PSI RATING	ZB	E	FB	FH	R	TF	UF	W	ADD TO STROKE	
											ZB	ZF
1.50	0.625	1500	1.124	2.000	0.313	0.375	1.438	2.750	3.375	0.625	4.875	5.000
1.50	1.000	1500	1.499	2.000	0.313	0.375	1.438	2.750	3.375	1.000	5.250	5.375
2.00	0.625	1500	1.124	2.500	0.375	0.375	1.844	3.375	4.125	0.625	4.938	5.000
2.00	1.000	1500	1.499	2.500	0.375	0.375	1.844	3.375	4.125	1.000	5.313	5.375
2.00	1.375	1500	1.999	2.500	0.375	0.375	1.844	3.375	4.125	1.250	5.563	5.625
2.50	0.625	1000	1.124	3.000	0.375	0.375	2.188	3.875	4.625	0.625	5.063	5.125
2.50	1.000	1500	1.499	3.000	0.375	0.375	2.188	3.875	4.625	1.000	5.438	5.500
2.50	1.375	1500	1.999	3.000	0.375	0.375	2.188	3.875	4.625	1.250	5.688	5.750
2.50	1.750	1500	2.374	3.000	0.375	0.375	2.188	3.875	4.625	1.500	5.938	6.000
3.25	1.000	1500	1.499	3.750	0.438	0.625	2.766	4.688	5.500	0.750	6.000	6.250
3.25	1.375	1500	1.999	3.750	0.438	0.625	2.766	4.688	5.500	1.000	6.250	6.500
3.25	1.750	1500	2.374	3.750	0.438	0.625	2.766	4.688	5.500	1.250	6.500	6.750
3.25	2.000	1500	2.624	3.750	0.438	0.625	2.766	4.688	5.500	1.375	6.625	6.875
4.00	1.000	1000	1.499	4.500	0.438	0.625	3.328	5.438	6.250	0.750	6.000	6.250
4.00	1.375	1000	1.999	4.500	0.438	0.625	3.328	5.438	6.250	1.000	6.250	6.500
4.00	1.750	1000	2.374	4.500	0.438	0.625	3.328	5.438	6.250	1.250	6.500	6.750
4.00	2.000	1000	2.624	4.500	0.438	0.625	3.328	5.438	6.250	1.375	6.625	6.875
4.00	2.500	1000	3.124	4.500	0.438	0.625	3.328	5.438	6.250	1.625	6.875	7.125
5.00	1.000	750	1.499	5.500	0.563	0.625	4.109	6.625	7.625	0.750	6.313	6.500
5.00	1.375	1000	1.999	5.500	0.563	0.625	4.109	6.625	7.625	1.000	6.563	6.750
5.00	1.750	1000	2.374	5.500	0.563	0.625	4.109	6.625	7.625	1.250	6.813	7.000
5.00	2.000	1000	2.624	5.500	0.563	0.625	4.109	6.625	7.625	1.375	6.938	7.125
5.00	2.500	1000	3.124	5.500	0.563	0.625	4.109	6.625	7.625	1.625	7.188	7.375
5.00	3.000	1000	3.749	5.500	0.563	0.625	4.109	6.625	7.625	1.625	7.188	7.375
5.00	3.500	1000	4.249	5.500	0.563	0.625	4.109	6.625	7.625	1.625	7.188	7.375
6.00	1.375	750	1.999	6.500	0.563	0.750	4.875	7.625	8.625	0.875	7.063	7.375
6.00	1.750	750	2.374	6.500	0.563	0.750	4.875	7.625	8.625	1.125	7.313	7.625
6.00	2.000	750	2.624	6.500	0.563	0.750	4.875	7.625	8.625	1.250	7.438	7.750
6.00	2.500	750	3.124	6.500	0.563	0.750	4.875	7.625	8.625	1.500	7.688	8.000
6.00	3.000	750	3.749	6.500	0.563	0.750	4.875	7.625	8.625	1.500	7.688	8.000
6.00	3.500	750	4.249	6.500	0.563	0.750	4.875	7.625	8.625	1.500	7.688	8.000
6.00	4.000	750	4.749	6.500	0.563	0.750	4.875	7.625	8.625	1.500	7.688	8.000

I Max pressure rating (NON-SHOCK).

⌘ 'B' dimension tolerance is +.000 / -.002



ME3: HEAD SQUARE MOUNTING HOLES

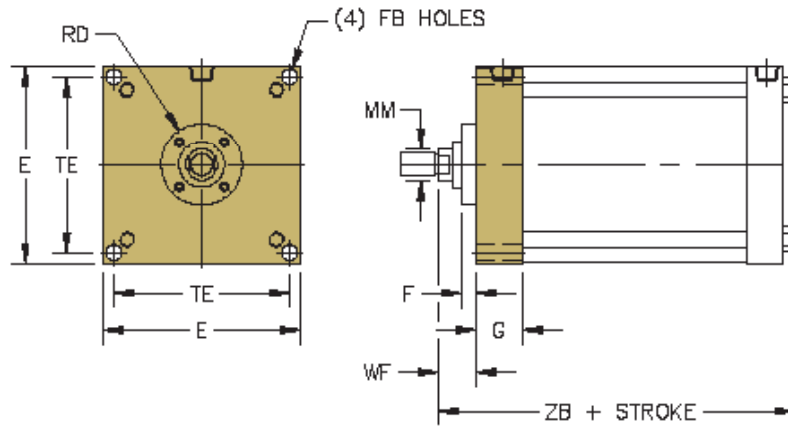

ME4: CAP SQUARE MOUNTING HOLES

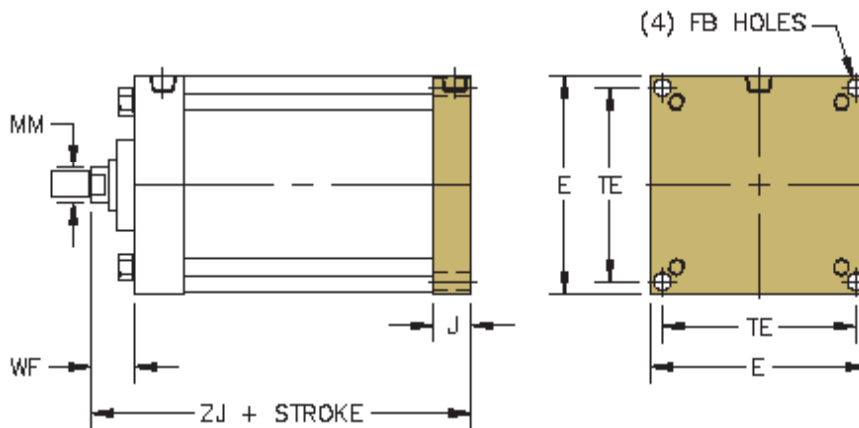

BORE	ROD DIA. (MM)	I MAX PSI RATING	E	F	FB	G	J	TE	RD	WF	ADD TO STROKE	
											ZB	ZJ
8.00	1.375	500	8.500	0.750	0.688	2.000	1.500	7.570	3.500	1.625	7.313	6.750
8.00	1.750	500	8.500	0.750	0.688	2.000	1.500	7.570	3.875	1.875	7.563	7.000
8.00	2.000	675	8.500	0.750	0.688	2.000	1.500	7.570	4.250	2.000	7.688	7.125
8.00	2.500	675	8.500	0.750	0.688	2.000	1.500	7.570	4.625	2.250	7.938	7.375
8.00	3.000	675	8.500	0.750	0.688	2.000	1.500	7.570	5.250	2.250	7.938	7.375
8.00	3.500	675	8.500	0.750	0.688	2.000	1.500	7.570	5.750	2.250	7.938	7.375
8.00	4.000	675	8.500	0.750	0.688	2.000	1.500	7.570	6.500	2.250	7.938	7.375
8.00	4.500	675	8.500	0.750	0.688	2.000	1.500	7.570	7.250	2.250	7.938	7.375
8.00	5.000	675	8.500	0.750	0.688	2.000	1.500	7.570	7.500	2.250	7.938	7.375
8.00	5.500	675	8.500	0.750	0.688	2.000	1.500	7.570	7.500	2.250	7.938	7.375

I Max pressure rating.

SERIES 'M' MEDIUM DUTY HYDRAULIC CYLINDERS

DIMENSIONS FOR SB: SPHERICAL BEARING MOUNT

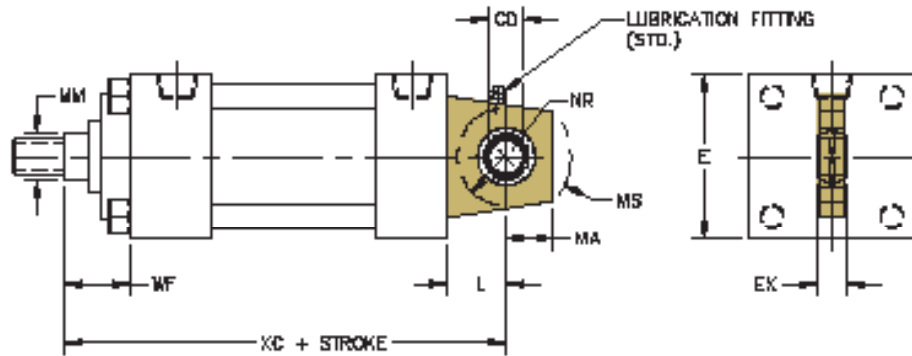

BORE	ROD DIA. (MM)	I MAX PSI RATING	CD	E	EX	L	MA	MS	NR	WF	ADD TO STROKE
											XC
1.50	0.625	1500	0.500	2.000	0.437	0.750	0.750	0.938	0.625	1.000	5.375
1.50	1.000	1500	0.500	2.000	0.437	0.750	0.750	0.938	0.625	1.375	5.750
2.00	0.625	1500	0.500	2.500	0.437	0.750	0.750	0.938	0.625	1.000	5.375
2.00	1.000	1500	0.500	2.500	0.437	0.750	0.750	0.938	0.625	1.375	5.750
2.00	1.375	1500	0.500	2.500	0.437	0.750	0.750	0.938	0.625	1.625	6.000
2.50	0.625	1000	0.500	3.000	0.437	0.750	0.750	0.938	0.625	1.000	5.500
2.50	1.000	1500	0.500	3.000	0.437	0.750	0.750	0.938	0.625	1.375	5.875
2.50	1.375	1500	0.500	3.000	0.437	0.750	0.750	0.938	0.625	1.625	6.125
2.50	1.750	1500	0.500	3.000	0.437	0.750	0.750	0.938	0.625	1.875	6.375
3.25	1.000	1500	0.750	3.750	0.656	1.250	1.000	1.375	1.000	1.375	6.875
3.25	1.375	1500	0.750	3.750	0.656	1.250	1.000	1.375	1.000	1.625	7.125
3.25	1.750	1500	0.750	3.750	0.656	1.250	1.000	1.375	1.000	1.875	7.375
3.25	2.000	1500	0.750	3.750	0.656	1.250	1.000	1.375	1.000	2.000	7.500
4.00	1.000	1000	0.750	4.500	0.656	1.250	1.000	1.375	1.000	1.375	6.875
4.00	1.375	1000	0.750	4.500	0.656	1.250	1.000	1.375	1.000	1.625	7.125
4.00	1.750	1000	0.750	4.500	0.656	1.250	1.000	1.375	1.000	1.875	7.375
4.00	2.000	1000	0.750	4.500	0.656	1.250	1.000	1.375	1.000	2.000	7.500
4.00	2.500	1000	0.750	4.500	0.656	1.250	1.000	1.375	1.000	2.250	7.750
5.00	1.000	750	0.750	5.500	0.656	1.250	1.000	1.375	1.000	1.375	7.125
5.00	1.375	1000	0.750	5.500	0.656	1.250	1.000	1.375	1.000	1.625	7.375
5.00	1.750	1000	0.750	5.500	0.656	1.250	1.000	1.375	1.000	1.875	7.625
5.00	2.000	1000	0.750	5.500	0.656	1.250	1.000	1.375	1.000	2.000	7.750
5.00	2.500	1000	0.750	5.500	0.656	1.250	1.000	1.375	1.000	2.250	8.000
5.00	3.000	1000	0.750	5.500	0.656	1.250	1.000	1.375	1.000	2.250	8.000
5.00	3.500	1000	0.750	5.500	0.656	1.250	1.000	1.375	1.000	2.250	8.000
6.00	1.375	750	1.000	6.500	0.875	1.500	1.250	1.688	1.250	1.625	8.125
6.00	1.750	750	1.000	6.500	0.875	1.500	1.250	1.688	1.250	1.875	8.375
6.00	2.000	750	1.000	6.500	0.875	1.500	1.250	1.688	1.250	2.000	8.500
6.00	2.500	750	1.000	6.500	0.875	1.500	1.250	1.688	1.250	2.250	8.750
6.00	3.000	750	1.000	6.500	0.875	1.500	1.250	1.688	1.250	2.250	8.750
6.00	3.500	750	1.000	6.500	0.875	1.500	1.250	1.688	1.250	2.250	8.750
6.00	4.000	750	1.000	6.500	0.875	1.500	1.250	1.688	1.250	2.250	8.750
8.00	1.375	500	1.000	8.500	0.875	1.500	1.250	1.688	1.250	1.625	8.250
8.00	1.750	500	1.000	8.500	0.875	1.500	1.250	1.688	1.250	1.875	8.500
8.00	2.000	675	1.000	8.500	0.875	1.500	1.250	1.688	1.250	2.000	8.625
8.00	2.500	675	1.000	8.500	0.875	1.500	1.250	1.688	1.250	2.250	8.875
8.00	3.000	675	1.000	8.500	0.875	1.500	1.250	1.688	1.250	2.250	8.875
8.00	3.500	675	1.000	8.500	0.875	1.500	1.250	1.688	1.250	2.250	8.875
8.00	4.000	675	1.000	8.500	0.875	1.500	1.250	1.688	1.250	2.250	8.875
8.00	4.500	675	1.000	8.500	0.875	1.500	1.250	1.688	1.250	2.250	8.875
8.00	5.000	675	1.000	8.500	0.875	1.500	1.250	1.688	1.250	2.250	8.875
8.00	5.500	675	1.000	8.500	0.875	1.500	1.250	1.688	1.250	2.250	8.875

I Max pressure rating (NON-SHOCK).

Note 1: Pivot pin included with cylinder cap end only; 5.00", 6.00" & 8.00" bores have tie rod nuts exposed on cap end.

Note 2: Must specify KK3 rod end if to be used with 'HH-MSRE' series rod eye.

All our cylinders are proudly Made in USA



MS2: SIDE LUGS

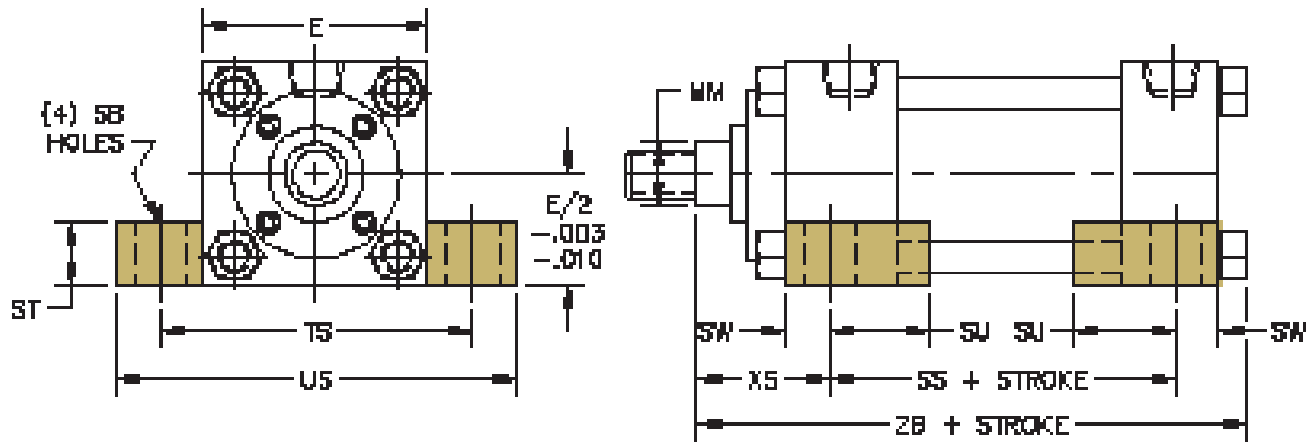

MS3: CENTER LINE LUGS

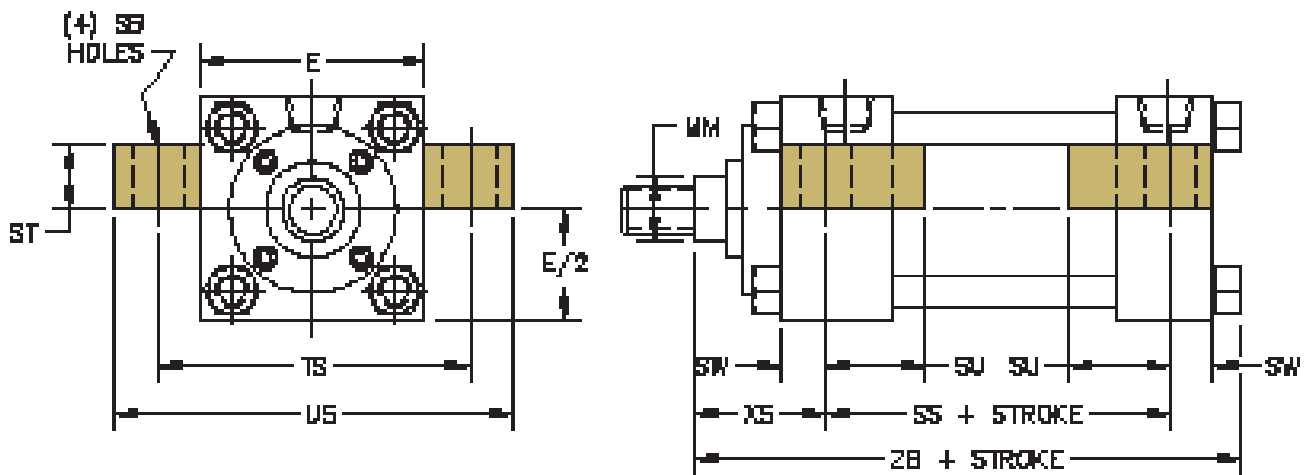

SERIES 'M' MEDIUM DUTY HYDRAULIC CYLINDERS

DIMENSIONS FOR LUG MOUNTS



BORE	ROD DIA. (MM)	I MAX PSI RATING	E	SB	ST	SU	SW	TS	US	XS	ADD TO STROKE	
											SS	ZB
1.50	0.625	1500	2.000	0.438	0.500	1.125	0.375	2.750	3.500	1.375	2.875	4.875
1.50	1.000	1500	2.000	0.438	0.500	1.125	0.375	2.750	3.500	1.750	2.875	5.250
2.00	0.625	1500	2.500	0.438	0.500	1.125	0.375	3.250	4.000	1.375	2.875	4.938
2.00	1.000	1500	2.500	0.438	0.500	1.125	0.375	3.250	4.000	1.750	2.875	5.313
2.00	1.375	1500	2.500	0.438	0.500	1.125	0.375	3.250	4.000	2.000	2.875	5.563
2.50	0.625	1000	3.000	0.438	0.500	1.125	0.375	3.750	4.500	1.375	3.000	5.063
2.50	1.000	1500	3.000	0.438	0.500	1.125	0.375	3.750	4.500	1.750	3.000	5.438
2.50	1.375	1500	3.000	0.438	0.500	1.125	0.375	3.750	4.500	2.000	3.000	5.688
2.50	1.750	1500	3.000	0.438	0.500	1.125	0.375	3.750	4.500	2.250	3.000	5.938
3.25	1.000	1500	3.750	0.563	0.750	1.250	0.500	4.750	5.750	1.875	3.250	6.000
3.25	1.375	1500	3.750	0.563	0.750	1.250	0.500	4.750	5.750	2.125	3.250	6.250
3.25	1.750	1500	3.750	0.563	0.750	1.250	0.500	4.750	5.750	2.375	3.250	6.500
3.25	2.000	1500	3.750	0.563	0.750	1.250	0.500	4.750	5.750	2.500	3.250	6.625
4.00	1.000	1000	4.500	0.563	0.750	1.250	0.500	5.500	6.500	1.875	3.250	6.000
4.00	1.375	1000	4.500	0.563	0.750	1.250	0.500	5.500	6.500	2.125	3.250	6.250
4.00	1.750	1000	4.500	0.563	0.750	1.250	0.500	5.500	6.500	2.375	3.250	6.500
4.00	2.000	1000	4.500	0.563	0.750	1.250	0.500	5.500	6.500	2.500	3.250	6.625
4.00	2.500	1000	4.500	0.563	0.750	1.250	0.500	5.500	6.500	2.750	3.250	6.875
5.00	1.000	750	5.500	0.813	1.000	1.063	0.688	6.875	8.250	2.063	3.125	6.313
5.00	1.375	1000	5.500	0.813	1.000	1.063	0.688	6.875	8.250	2.313	3.125	6.563
5.00	1.750	1000	5.500	0.813	1.000	1.063	0.688	6.875	8.250	2.563	3.125	6.813
5.00	2.000	1000	5.500	0.813	1.000	1.063	0.688	6.875	8.250	2.688	3.125	6.938
5.00	2.500	1000	5.500	0.813	1.000	1.063	0.688	6.875	8.250	2.938	3.125	7.188
5.00	3.000	1000	5.500	0.813	1.000	1.063	0.688	6.875	8.250	2.938	3.125	7.188
5.00	3.500	1000	5.500	0.813	1.000	1.063	0.688	6.875	8.250	2.938	3.125	7.188
6.00	1.375	750	6.500	0.813	1.000	1.313	0.688	7.875	9.250	2.313	3.625	7.063
6.00	1.750	750	6.500	0.813	1.000	1.313	0.688	7.875	9.250	2.563	3.625	7.313
6.00	2.000	750	6.500	0.813	1.000	1.313	0.688	7.875	9.250	2.688	3.625	7.438
6.00	2.500	750	6.500	0.813	1.000	1.313	0.688	7.875	9.250	2.938	3.625	7.688
6.00	3.000	750	6.500	0.813	1.000	1.313	0.688	7.875	9.250	2.938	3.625	7.688
6.00	3.500	750	6.500	0.813	1.000	1.313	0.688	7.875	9.250	2.938	3.625	7.688
6.00	4.000	750	6.500	0.813	1.000	1.313	0.688	7.875	9.250	2.938	3.625	7.688
8.00	1.375	500	8.500	0.813	1.000	1.313	0.688	9.875	11.250	2.313	3.750	7.313
8.00	1.750	500	8.500	0.813	1.000	1.313	0.688	9.875	11.250	2.563	3.750	7.563
8.00	2.000	675	8.500	0.813	1.000	1.313	0.688	9.875	11.250	2.688	3.750	7.688
8.00	2.500	675	8.500	0.813	1.000	1.313	0.688	9.875	11.250	2.938	3.750	7.938
8.00	3.000	675	8.500	0.813	1.000	1.313	0.688	9.875	11.250	2.938	3.750	7.938
8.00	3.500	675	8.500	0.813	1.000	1.313	0.688	9.875	11.250	2.938	3.750	7.938
8.00	4.000	675	8.500	0.813	1.000	1.313	0.688	9.875	11.250	2.938	3.750	7.938
8.00	4.500	675	8.500	0.813	1.000	1.313	0.688	9.875	11.250	2.938	3.750	7.938
8.00	5.000	675	8.500	0.813	1.000	1.313	0.688	9.875	11.250	2.938	3.750	7.938
8.00	5.500	675	8.500	0.813	1.000	1.313	0.688	9.875	11.250	2.938	3.750	7.938

I Max pressure rating (NON-SHOCK).

All our cylinders are proudly Made in USA



MS4: BOTTOM TAPPED HOLES

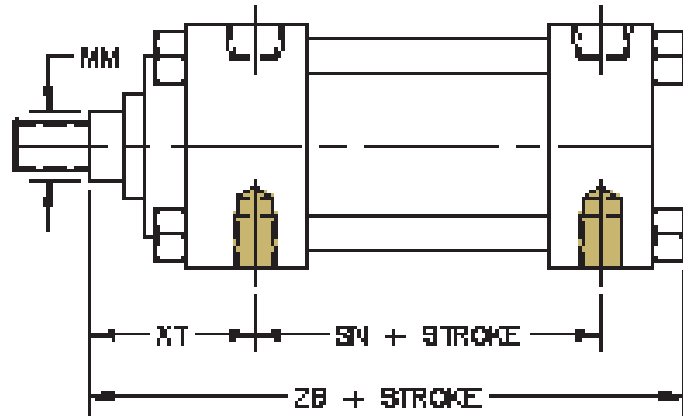
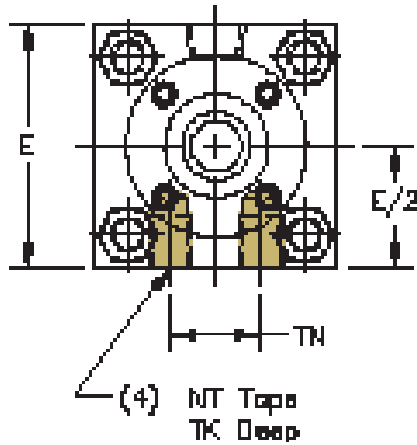

MS7: END LUGS

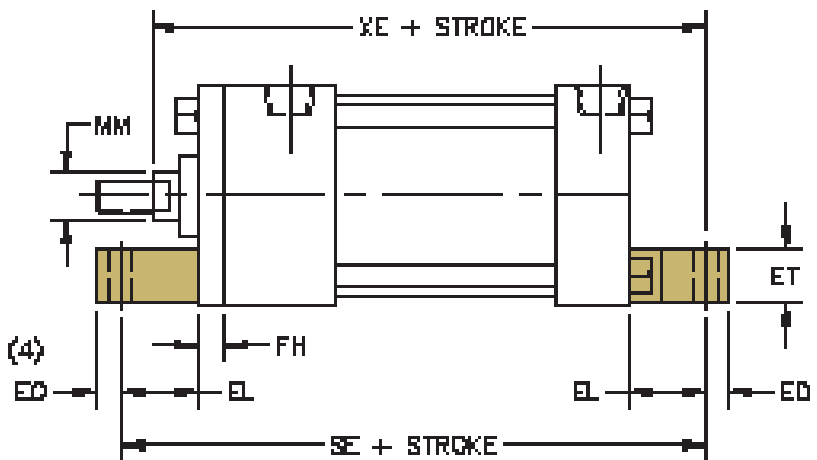
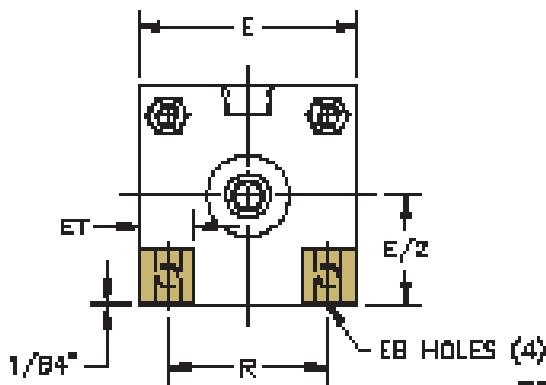

SERIES 'M' MEDIUM DUTY HYDRAULIC CYLINDERS

DIMENSIONS FOR BOTTOM MOUNTS



BORE	ROD DIA. (MM)	I MAX PSI RATING	E	EB	EL	EO	ET	FH	NT	R	TN	TK	XT	ADD TO STROKE			
														SN	ZB	SE	XE
1.50	0.625	1500	2.000	0.281	0.750	0.250	0.563	0.375	1/4 - 20	1.438	0.625	0.375	1.938	2.250	4.875	5.500	5.375
1.50	1.000	1500	2.000	0.281	0.750	0.250	0.563	0.375	1/4 - 20	1.438	0.625	0.375	2.313	2.250	5.250	5.500	5.750
2.00	0.625	1500	2.500	0.344	0.938	0.313	0.625	0.375	5/16 - 18	1.844	0.875	0.406	1.938	2.250	4.938	5.875	5.563
2.00	1.000	1500	2.500	0.344	0.938	0.313	0.625	0.375	5/16 - 18	1.844	0.875	0.406	2.313	2.250	5.313	5.875	5.938
2.00	1.375	1500	2.500	0.344	0.938	0.313	0.625	0.375	5/16 - 18	1.844	0.875	0.406	2.563	2.250	5.563	5.875	6.188
2.50	0.625	1000	3.000	0.344	1.063	0.313	0.750	0.375	3/8 - 16	2.188	1.250	0.438	1.938	2.375	5.063	6.250	5.813
2.50	1.000	1500	3.000	0.344	1.063	0.313	0.750	0.375	3/8 - 16	2.188	1.250	0.438	2.313	2.375	5.438	6.250	6.188
2.50	1.375	1500	3.000	0.344	1.063	0.313	0.750	0.375	3/8 - 16	2.188	1.250	0.438	2.563	2.375	5.688	6.250	6.438
2.50	1.750	1500	3.000	0.344	1.063	0.313	0.750	0.375	3/8 - 16	2.188	1.250	0.438	2.813	2.375	5.938	6.250	6.688
3.25	1.000	1500	3.750	0.406	0.875	0.375	0.938	0.625	1/2 - 13	2.766	1.500	0.500	2.438	2.625	6.000	6.625	6.500
3.25	1.375	1500	3.750	0.406	0.875	0.375	0.938	0.625	1/2 - 13	2.766	1.500	0.500	2.688	2.625	6.250	6.625	6.750
3.25	1.750	1500	3.750	0.406	0.875	0.375	0.938	0.625	1/2 - 13	2.766	1.500	0.500	2.938	2.625	6.500	6.625	7.000
3.25	2.000	1500	3.750	0.406	0.875	0.375	0.938	0.625	1/2 - 13	2.766	1.500	0.500	3.063	2.625	6.625	6.625	7.125
4.00	1.000	1000	4.500	0.406	1.000	0.375	1.125	0.625	1/2 - 13	3.328	2.063	0.625	2.438	2.625	6.000	6.875	6.625
4.00	1.375	1000	4.500	0.406	1.000	0.375	1.125	0.625	1/2 - 13	3.328	2.063	0.625	2.688	2.625	6.250	6.875	6.875
4.00	1.750	1000	4.500	0.406	1.000	0.375	1.125	0.625	1/2 - 13	3.328	2.063	0.625	2.938	2.625	6.500	6.875	7.125
4.00	2.000	1000	4.500	0.406	1.000	0.375	1.125	0.625	1/2 - 13	3.328	2.063	0.625	3.063	2.625	6.625	6.875	7.250
4.00	2.500	1000	4.500	0.406	1.000	0.375	1.125	0.625	1/2 - 13	3.328	2.063	0.625	3.313	2.625	6.875	6.875	7.500
5.00	1.000	750	5.500	0.531	1.063	0.500	1.375	0.625	5/8 - 11	4.109	2.688	0.750	2.438	2.875	6.313	7.250	6.938
5.00	1.375	1000	5.500	0.531	1.063	0.500	1.375	0.625	5/8 - 11	4.109	2.688	0.750	2.688	2.875	6.563	7.250	7.188
5.00	1.750	1000	5.500	0.531	1.063	0.500	1.375	0.625	5/8 - 11	4.109	2.688	0.750	2.938	2.875	6.813	7.250	7.438
5.00	2.000	1000	5.500	0.531	1.063	0.500	1.375	0.625	5/8 - 11	4.109	2.688	0.750	3.063	2.875	6.938	7.250	7.563
5.00	2.500	1000	5.500	0.531	1.063	0.500	1.375	0.625	5/8 - 11	4.109	2.688	0.750	3.313	2.875	7.188	7.250	7.813
5.00	3.000	1000	5.500	0.531	1.063	0.500	1.375	0.625	5/8 - 11	4.109	2.688	0.750	3.313	2.875	7.188	7.250	7.813
5.00	3.500	1000	5.500	0.531	1.063	0.500	1.375	0.625	5/8 - 11	4.109	2.688	0.750	3.313	2.875	7.188	7.250	7.813
6.00	1.375	750	6.500	0.531	1.000	0.500	1.563	0.750	3/4 - 10	4.875	3.250	1.000	2.813	3.125	7.063	7.750	7.625
6.00	1.750	750	6.500	0.531	1.000	0.500	1.563	0.750	3/4 - 10	4.875	3.250	1.000	3.063	3.125	7.313	7.750	7.875
6.00	2.000	750	6.500	0.531	1.000	0.500	1.563	0.750	3/4 - 10	4.875	3.250	1.000	3.188	3.125	7.438	7.750	8.000
6.00	2.500	750	6.500	0.531	1.000	0.500	1.563	0.750	3/4 - 10	4.875	3.250	1.000	3.438	3.125	7.688	7.750	8.250
6.00	3.000	750	6.500	0.531	1.000	0.500	1.563	0.750	3/4 - 10	4.875	3.250	1.000	3.438	3.125	7.688	7.750	8.250
6.00	3.500	750	6.500	0.531	1.000	0.500	1.563	0.750	3/4 - 10	4.875	3.250	1.000	3.438	3.125	7.688	7.750	8.250
6.00	4.000	750	6.500	0.531	1.000	0.500	1.563	0.750	3/4 - 10	4.875	3.250	1.000	3.438	3.125	7.688	7.750	8.250
8.00	1.375	500	8.500	0.688	1.125	0.625	2.000	∩	3/4 - 10	6.438	4.500	1.250	2.813	3.250	7.313	7.375	7.875
8.00	1.750	500	8.500	0.688	1.125	0.625	2.000	∩	3/4 - 10	6.438	4.500	1.250	3.063	3.250	7.563	7.375	8.125
8.00	2.000	675	8.500	0.688	1.125	0.625	2.000	∩	3/4 - 10	6.438	4.500	1.250	3.188	3.250	7.688	7.375	8.250
8.00	2.500	675	8.500	0.688	1.125	0.625	2.000	∩	3/4 - 10	6.438	4.500	1.250	3.438	3.250	7.938	7.375	8.500
8.00	3.000	675	8.500	0.688	1.125	0.625	2.000	∩	3/4 - 10	6.438	4.500	1.250	3.438	3.250	7.938	7.375	8.500
8.00	3.500	675	8.500	0.688	1.125	0.625	2.000	∩	3/4 - 10	6.438	4.500	1.250	3.438	3.250	7.938	7.375	8.500
8.00	4.000	675	8.500	N/A	N/A	N/A	N/A	N/A	3/4 - 10	N/A	4.500	1.250	3.438	3.250	7.938	N/A	N/A
8.00	4.500	675	8.500	N/A	N/A	N/A	N/A	N/A	3/4 - 10	N/A	4.500	1.250	3.438	3.250	7.938	N/A	N/A
8.00	5.000	675	8.500	N/A	N/A	N/A	N/A	N/A	3/4 - 10	N/A	4.500	1.250	3.438	3.250	7.938	N/A	N/A
8.00	5.500	675	8.500	N/A	N/A	N/A	N/A	N/A	3/4 - 10	N/A	4.500	1.250	3.438	3.250	7.938	N/A	N/A

I Max pressure rating (NON-SHOCK).

∩ (1) piece MS7 brackets bolted directly to head & cap (uses round retainer).

All our cylinders are proudly Made in USA

SERIES 'M' MEDIUM DUTY HYDRAULIC CYLINDERS

DIMENSIONS FOR PIVOT MOUNTS



MP1: REAR PIVOT CLEVIS

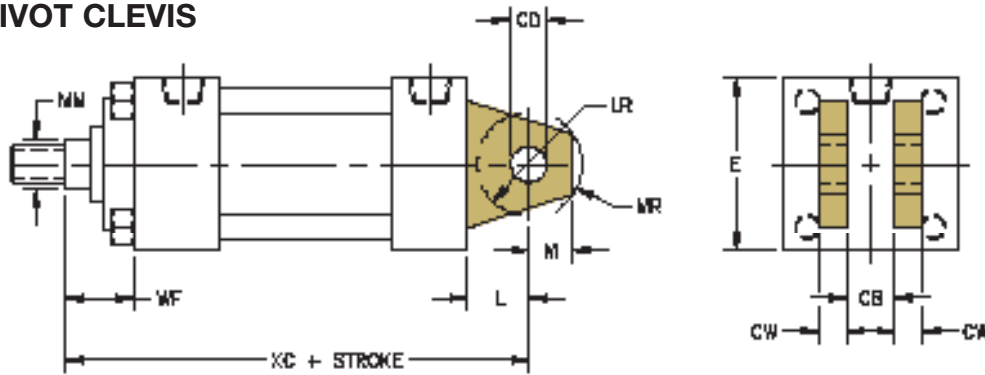

BORE	ROD DIA. (MM)	I MAX PSI RATING	CB	CD	CW	E	L	LR	M	MR	WF	ADD TO STROKE
												XC
1.50	0.625	1500	0.750	0.500	0.500	2.000	0.750	0.750	0.500	0.625	1.000	5.375
1.50	1.000	1500	0.750	0.500	0.500	2.000	0.750	0.750	0.500	0.625	1.375	5.750
2.00	0.625	1500	0.750	0.500	0.500	2.500	0.750	0.750	0.500	0.625	1.000	5.375
2.00	1.000	1500	0.750	0.500	0.500	2.500	0.750	0.750	0.500	0.625	1.375	5.750
2.00	1.375	1500	0.750	0.500	0.500	2.500	0.750	0.750	0.500	0.625	1.625	6.000
2.50	0.625	1000	0.750	0.500	0.500	3.000	0.750	0.750	0.500	0.625	1.000	5.500
2.50	1.000	1500	0.750	0.500	0.500	3.000	0.750	0.750	0.500	0.625	1.375	5.875
2.50	1.375	1500	0.750	0.500	0.500	3.000	0.750	0.750	0.500	0.625	1.625	6.125
2.50	1.750	1500	0.750	0.500	0.500	3.000	0.750	0.750	0.500	0.625	1.875	6.375
3.25	1.000	1500	1.250	0.750	0.625	3.750	1.250	1.000	0.750	0.938	1.375	6.875
3.25	1.375	1500	1.250	0.750	0.625	3.750	1.250	1.000	0.750	0.938	1.625	7.125
3.25	1.750	1500	1.250	0.750	0.625	3.750	1.250	1.000	0.750	0.938	1.875	7.375
3.25	2.000	1500	1.250	0.750	0.625	3.750	1.250	1.000	0.750	0.938	2.000	7.500
4.00	1.000	1000	1.250	0.750	0.625	4.500	1.250	1.000	0.750	0.938	1.375	6.875
4.00	1.375	1000	1.250	0.750	0.625	4.500	1.250	1.000	0.750	0.938	1.625	7.125
4.00	1.750	1000	1.250	0.750	0.625	4.500	1.250	1.000	0.750	0.938	1.875	7.375
4.00	2.000	1000	1.250	0.750	0.625	4.500	1.250	1.000	0.750	0.938	2.000	7.500
4.00	2.500	1000	1.250	0.750	0.625	4.500	1.250	1.000	0.750	0.938	2.250	7.750
5.00	1.000	750	1.250	0.750	0.625	5.500	1.250	1.000	0.750	0.938	1.375	7.125
5.00	1.375	1000	1.250	0.750	0.625	5.500	1.250	1.000	0.750	0.938	1.625	7.375
5.00	1.750	1000	1.250	0.750	0.625	5.500	1.250	1.000	0.750	0.938	1.875	7.625
5.00	2.000	1000	1.250	0.750	0.625	5.500	1.250	1.000	0.750	0.938	2.000	7.750
5.00	2.500	1000	1.250	0.750	0.625	5.500	1.250	1.000	0.750	0.938	2.250	8.000
5.00	3.000	1000	1.250	0.750	0.625	5.500	1.250	1.000	0.750	0.938	2.250	8.000
5.00	3.500	1000	1.250	0.750	0.625	5.500	1.250	1.000	0.750	0.938	2.250	8.000
6.00	1.375	750	1.500	1.000	0.750	6.500	1.500	1.250	1.000	1.188	1.625	8.125
6.00	1.750	750	1.500	1.000	0.750	6.500	1.500	1.250	1.000	1.188	1.875	8.375
6.00	2.000	750	1.500	1.000	0.750	6.500	1.500	1.250	1.000	1.188	2.000	8.500
6.00	2.500	750	1.500	1.000	0.750	6.500	1.500	1.250	1.000	1.188	2.250	8.750
6.00	3.000	750	1.500	1.000	0.750	6.500	1.500	1.250	1.000	1.188	2.250	8.750
6.00	3.500	750	1.500	1.000	0.750	6.500	1.500	1.250	1.000	1.188	2.250	8.750
6.00	4.000	750	1.500	1.000	0.750	6.500	1.500	1.250	1.000	1.188	2.250	8.750
8.00	1.375	500	1.500	1.000	0.750	8.500	1.500	1.250	1.000	1.188	1.625	8.250
8.00	1.750	500	1.500	1.000	0.750	8.500	1.500	1.250	1.000	1.188	1.875	8.500
8.00	2.000	675	1.500	1.000	0.750	8.500	1.500	1.250	1.000	1.188	2.000	8.625
8.00	2.500	675	1.500	1.000	0.750	8.500	1.500	1.250	1.000	1.188	2.250	8.875
8.00	3.000	675	1.500	1.000	0.750	8.500	1.500	1.250	1.000	1.188	2.250	8.875
8.00	3.500	675	1.500	1.000	0.750	8.500	1.500	1.250	1.000	1.188	2.250	8.875
8.00	4.000	675	1.500	1.000	0.750	8.500	1.500	1.250	1.000	1.188	2.250	8.875
8.00	4.500	675	1.500	1.000	0.750	8.500	1.500	1.250	1.000	1.188	2.250	8.875
8.00	5.000	675	1.500	1.000	0.750	8.500	1.500	1.250	1.000	1.188	2.250	8.875
8.00	5.500	675	1.500	1.000	0.750	8.500	1.500	1.250	1.000	1.188	2.250	8.875

I Max pressure rating (NON-SHOCK).

Note: Pivot pin included with cylinder cap end only.

All our cylinders are proudly Made in USA

SERIES 'M' MEDIUM DUTY HYDRAULIC CYLINDERS

DIMENSIONS FOR PIVOT MOUNTS



MP2: REAR PIVOT DETACHABLE CLEVIS

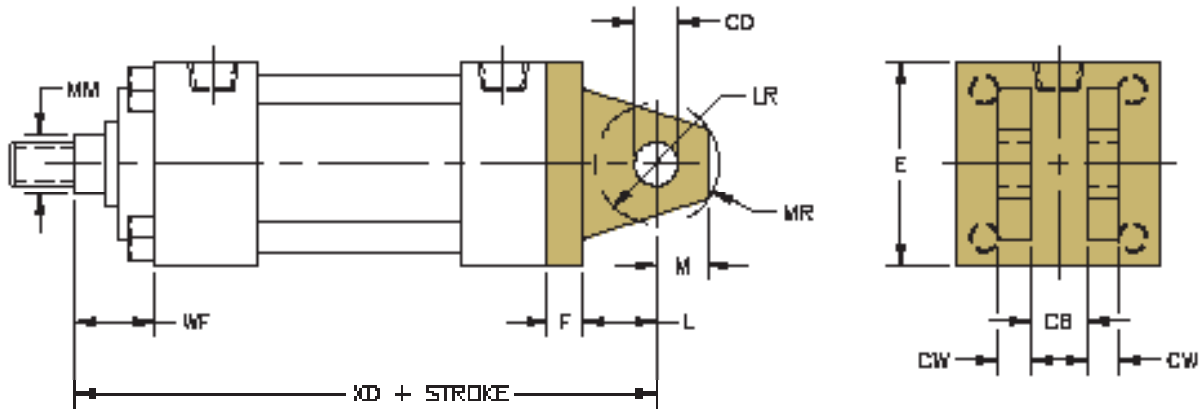

BORE	ROD DIA. (MM)	I MAX PSI RATING	CB	CD	CW	E	F	L	LR	M	MR	WF	ADD TO STROKE
													XD
1.50	0.625	1500	0.750	0.500	0.500	2.000	0.375	0.750	0.750	0.500	0.625	1.000	5.750
1.50	1.000	1500	0.750	0.500	0.500	2.000	0.375	0.750	0.750	0.500	0.625	1.375	6.125
2.00	0.625	1500	0.750	0.500	0.500	2.500	0.375	0.750	0.750	0.500	0.625	1.000	5.750
2.00	1.000	1500	0.750	0.500	0.500	2.500	0.375	0.750	0.750	0.500	0.625	1.375	6.125
2.00	1.375	1500	0.750	0.500	0.500	2.500	0.375	0.750	0.750	0.500	0.625	1.625	6.375
2.50	0.625	1000	0.750	0.500	0.500	3.000	0.375	0.750	0.750	0.500	0.625	1.000	5.875
2.50	1.000	1500	0.750	0.500	0.500	3.000	0.375	0.750	0.750	0.500	0.625	1.375	6.250
2.50	1.375	1500	0.750	0.500	0.500	3.000	0.375	0.750	0.750	0.500	0.625	1.625	6.500
2.50	1.750	1500	0.750	0.500	0.500	3.000	0.375	0.750	0.750	0.500	0.625	1.875	6.750
3.25	1.000	1500	1.250	0.750	0.625	3.750	0.625	1.250	1.000	0.750	0.938	1.375	7.500
3.25	1.375	1500	1.250	0.750	0.625	3.750	0.625	1.250	1.000	0.750	0.938	1.625	7.750
3.25	1.750	1500	1.250	0.750	0.625	3.750	0.625	1.250	1.000	0.750	0.938	1.875	8.000
3.25	2.000	1500	1.250	0.750	0.625	3.750	0.625	1.250	1.000	0.750	0.938	2.000	8.125
4.00	1.000	1000	1.250	0.750	0.625	4.500	0.625	1.250	1.000	0.750	0.938	1.375	7.500
4.00	1.375	1000	1.250	0.750	0.625	4.500	0.625	1.250	1.000	0.750	0.938	1.625	7.750
4.00	1.750	1000	1.250	0.750	0.625	4.500	0.625	1.250	1.000	0.750	0.938	1.875	8.000
4.00	2.000	1000	1.250	0.750	0.625	4.500	0.625	1.250	1.000	0.750	0.938	2.000	8.125
4.00	2.500	1000	1.250	0.750	0.625	4.500	0.625	1.250	1.000	0.750	0.938	2.250	8.375
5.00	1.000	750	1.250	0.750	0.625	5.500	0.625	1.250	1.000	0.750	0.938	1.375	7.750
5.00	1.375	1000	1.250	0.750	0.625	5.500	0.625	1.250	1.000	0.750	0.938	1.625	8.000
5.00	1.750	1000	1.250	0.750	0.625	5.500	0.625	1.250	1.000	0.750	0.938	1.875	8.250
5.00	2.000	1000	1.250	0.750	0.625	5.500	0.625	1.250	1.000	0.750	0.938	2.000	8.375
5.00	2.500	1000	1.250	0.750	0.625	5.500	0.625	1.250	1.000	0.750	0.938	2.250	8.625
5.00	3.000	1000	1.250	0.750	0.625	5.500	0.625	1.250	1.000	0.750	0.938	2.250	8.625
5.00	3.500	1000	1.250	0.750	0.625	5.500	0.625	1.250	1.000	0.750	0.938	2.250	8.625
6.00	1.375	750	1.500	1.000	0.750	6.500	0.750	1.500	1.250	1.000	1.188	1.625	8.875
6.00	1.750	750	1.500	1.000	0.750	6.500	0.750	1.500	1.250	1.000	1.188	1.875	9.125
6.00	2.000	750	1.500	1.000	0.750	6.500	0.750	1.500	1.250	1.000	1.188	2.000	9.250
6.00	2.500	750	1.500	1.000	0.750	6.500	0.750	1.500	1.250	1.000	1.188	2.250	9.500
6.00	3.000	750	1.500	1.000	0.750	6.500	0.750	1.500	1.250	1.000	1.188	2.250	9.500
6.00	3.500	750	1.500	1.000	0.750	6.500	0.750	1.500	1.250	1.000	1.188	2.250	9.500
6.00	4.000	750	1.500	1.000	0.750	6.500	0.750	1.500	1.250	1.000	1.188	2.250	9.500

I Max pressure rating (NON-SHOCK).

Note: Pivot pin included with cylinder cap end only.

All our cylinders are proudly Made in USA

SERIES 'M' MEDIUM DUTY HYDRAULIC CYLINDERS

DIMENSIONS FOR DOUBLE END MX0D: NO MOUNT

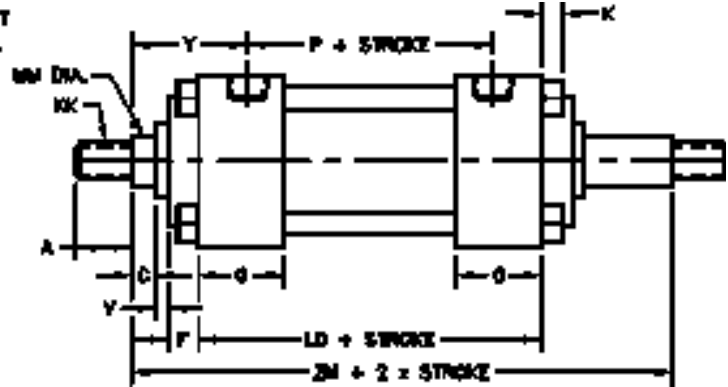
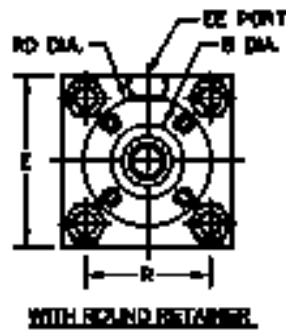
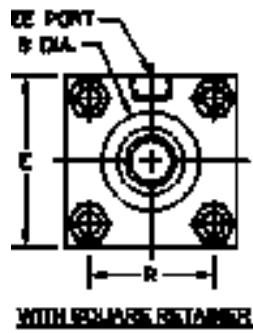

BORE	ROD DIA. (MM)	MAX PSI RATING	E	A	B	C	EE		F	G	K	KK	R	RD	V	Y	ADD TO STROKE		ADD 2x STROKE
							NPTF	SAE									LD	P	ZM
1.50	0.625	1500	2.000	0.750	1.124	0.375	3/8	#6	0.375	1.500	0.250		1.438	SQ	0.250	1.875	4.125	2.375	6.125
1.50	1.000	1500	2.000	1.125	1.499	0.500	3/8	#6	0.375	1.500	0.250		1.438	SQ	0.500	2.250	4.125	2.375	6.875
2.00	0.625	1500	2.500	0.750	1.124	0.375	3/8	#6	0.375	1.500	0.313		1.844	2.000	0.250	1.875	4.125	2.375	6.125
2.00	1.000	1500	2.500	1.125	1.499	0.500	3/8	#6	0.375	1.500	0.313		1.844	SQ	0.500	2.250	4.125	2.375	6.875
2.00	1.375	1500	2.500	1.625	1.999	0.625	3/8	#6	0.375	1.500	0.313		1.844	SQ	0.625	2.500	4.125	2.375	7.375
2.50	0.625	1000	3.000	0.750	1.124	0.375	3/8	#6	0.375	1.500	0.313		2.188	2.000	0.250	1.875	4.250	2.500	6.250
2.50	1.000	1500	3.000	1.125	1.499	0.500	3/8	#6	0.375	1.500	0.313		2.188	SQ	0.500	2.250	4.250	2.500	7.000
2.50	1.375	1500	3.000	1.625	1.999	0.625	3/8	#6	0.375	1.500	0.313		2.188	SQ	0.625	2.500	4.250	2.500	7.500
2.50	1.750	1500	3.000	2.000	2.374	0.750	3/8	#6	0.375	1.500	0.313		2.188	SQ	0.750	2.750	4.250	2.500	8.000
3.25	1.000	1500	3.750	1.125	1.499	0.500	1/2	#10	0.625	1.750	0.375		2.766	2.750	0.250	2.375	4.750	2.750	7.500
3.25	1.375	1500	3.750	1.625	1.999	0.625	1/2	#10	0.625	1.750	0.375		2.766	SQ	0.375	2.625	4.750	2.750	8.000
3.25	1.750	1500	3.750	2.000	2.374	0.750	1/2	#10	0.625	1.750	0.375		2.766	SQ	0.500	2.875	4.750	2.750	8.500
3.25	2.000	1500	3.750	2.250	2.624	0.875	1/2	#10	0.625	1.750	0.375		2.766	SQ	0.500	3.000	4.750	2.750	8.750
4.00	1.000	1000	4.500	1.125	1.499	0.500	1/2	#10	0.625	1.750	0.375		3.328	2.750	0.250	2.375	4.750	2.750	7.500
4.00	1.375	1000	4.500	1.625	1.999	0.625	1/2	#10	0.625	1.750	0.375		3.328	3.500	0.375	2.625	4.750	2.750	8.000
4.00	1.750	1000	4.500	2.000	2.374	0.750	1/2	#10	0.625	1.750	0.375		3.328	3.500	0.500	2.875	4.750	2.750	8.500
4.00	2.000	1000	4.500	2.250	2.624	0.875	1/2	#10	0.625	1.750	0.375		3.328	SQ	0.500	3.000	4.750	2.750	8.750
4.00	2.500	1000	4.500	3.000	3.124	1.000	1/2	#10	0.625	1.750	0.375		3.328	SQ	0.625	3.250	4.750	2.750	9.250
5.00	1.000	750	5.500	1.125	1.499	0.500	1/2	#10	0.625	1.750	0.438		4.109	2.750	0.250	2.375	5.000	3.000	7.750
5.00	1.375	1000	5.500	1.625	1.999	0.625	1/2	#10	0.625	1.750	0.438		4.109	3.500	0.375	2.625	5.000	3.000	8.250
5.00	1.750	1000	5.500	2.000	2.374	0.750	1/2	#10	0.625	1.750	0.438		4.109	3.500	0.500	2.875	5.000	3.000	8.750
5.00	2.000	1000	5.500	2.250	2.624	0.875	1/2	#10	0.625	1.750	0.438		4.109	4.250	0.500	3.000	5.000	3.000	9.000
5.00	2.500	1000	5.500	3.000	3.124	1.000	1/2	#10	0.625	1.750	0.438		4.109	SQ	0.625	3.250	5.000	3.000	9.500
5.00	3.000	1000	5.500	3.500	3.749	1.000	1/2	#10	0.625	1.750	0.438		4.109	SQ	0.625	3.250	5.000	3.000	9.500
5.00	3.500	1000	5.500	3.500	4.249	1.000	1/2	#10	0.625	1.750	0.438		4.109	SQ	0.625	3.250	5.000	3.000	9.500
6.00	1.375	750	6.500	1.625	1.999	0.625	3/4	#12	0.750	2.000	0.438		4.875	3.500	0.250	2.750	5.500	3.250	8.750
6.00	1.750	750	6.500	2.000	2.374	0.750	3/4	#12	0.750	2.000	0.438		4.875	3.875	0.375	3.000	5.500	3.250	9.250
6.00	2.000	750	6.500	2.250	2.624	0.875	3/4	#12	0.750	2.000	0.438		4.875	4.250	0.375	3.125	5.500	3.250	9.500
6.00	2.500	750	6.500	3.000	3.124	1.000	3/4	#12	0.750	2.000	0.438		4.875	4.625	0.500	3.375	5.500	3.250	10.000
6.00	3.000	750	6.500	3.500	3.749	1.000	3/4	#12	0.750	2.000	0.438		4.875	5.250	0.500	3.375	5.500	3.250	10.000
6.00	3.500	750	6.500	3.500	4.249	1.000	3/4	#12	0.750	2.000	0.438		4.875	5.750	0.500	3.375	5.500	3.250	10.000
6.00	4.000	750	6.500	4.000	4.749	1.000	3/4	#12	0.750	2.000	0.438		4.875	SQ	0.500	3.375	5.500	3.250	10.000
8.00	1.375	500	8.500	1.625	1.999	0.625	3/4	#12	0.750	2.000	0.563		6.438	3.500	0.250	2.750	5.625	3.375	8.875
8.00	1.750	500	8.500	2.000	2.374	0.750	3/4	#12	0.750	2.000	0.563		6.438	3.875	0.375	3.000	5.625	3.375	9.375
8.00	2.000	675	8.500	2.250	2.624	0.875	3/4	#12	0.750	2.000	0.563		6.438	4.250	0.375	3.125	5.625	3.375	9.625
8.00	2.500	675	8.500	3.000	3.124	1.000	3/4	#12	0.750	2.000	0.563		6.438	4.625	0.500	3.375	5.625	3.375	10.125
8.00	3.000	675	8.500	3.500	3.749	1.000	3/4	#12	0.750	2.000	0.563		6.438	5.250	0.500	3.375	5.625	3.375	10.125
8.00	3.500	675	8.500	3.500	4.249	1.000	3/4	#12	0.750	2.000	0.563		6.438	5.750	0.500	3.375	5.625	3.375	10.125
8.00	4.000	675	8.500	4.000	4.749	1.000	3/4	#12	0.750	2.000	0.563		6.438	6.500	0.500	3.375	5.625	3.375	10.125
8.00	4.500	675	8.500	4.500	5.249	1.000	3/4	#12	0.750	2.000	0.563		6.438	7.250	0.500	3.375	5.625	3.375	10.125
8.00	5.000	675	8.500	5.000	5.749	1.000	3/4	#12	0.750	2.000	0.563		6.438	7.500	0.500	3.375	5.625	3.375	10.125
8.00	5.500	675	8.500	5.500	6.249	1.000	3/4	#12	0.750	2.000	0.563		6.438	7.500	0.500	3.375	5.625	3.375	10.125

SEE ROD END DETAIL CHART ON PAGE 51

1 Max pressure rating (NON-SHOCK).
 2 'B' dimension tolerance is +.000 / -.002

3 Where SQ is shown in chart, cylinder utilizes a full square retainer.

SERIES 'M' MEDIUM DUTY HYDRAULIC CYLINDERS



DIMENSIONS FOR DOUBLE END ME3D: HEAD SQUARE MOUNTING HOLES MOUNT

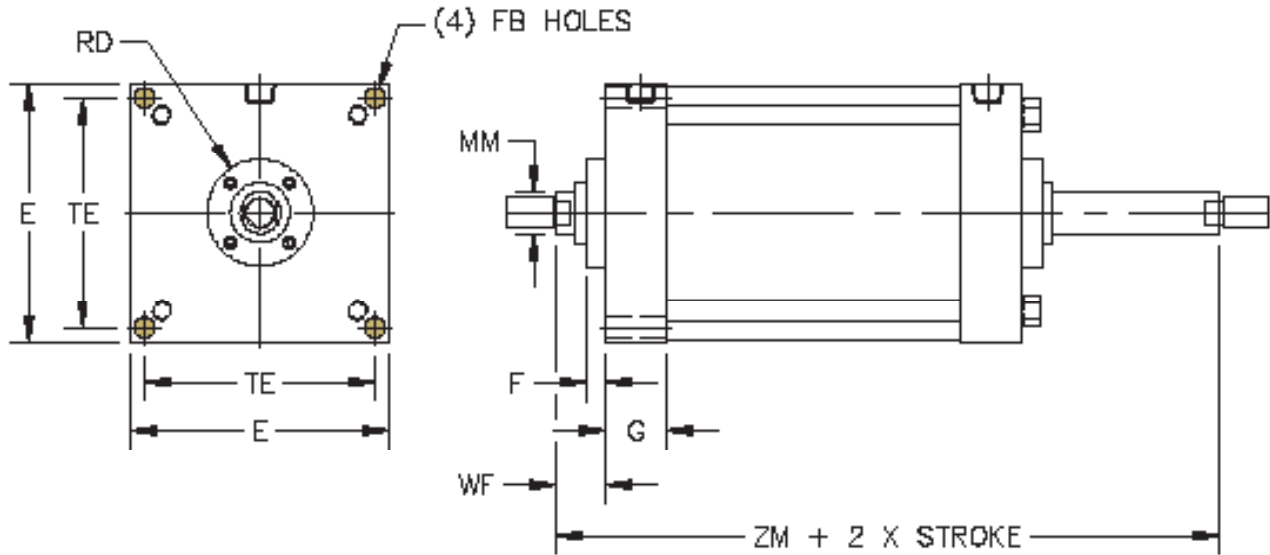

BORE	ROD DIA. (MM)	I MAX PSI RATING	E	F	FB	G	TE	RD	WF	ADD 2x STROKE
										ZM
8.00	1.375	500	8.500	0.750	0.688	2.000	7.570	3.500	1.625	8.875
8.00	1.750	500	8.500	0.750	0.688	2.000	7.570	3.875	1.875	9.375
8.00	2.000	675	8.500	0.750	0.688	2.000	7.570	4.250	2.000	9.625
8.00	2.500	675	8.500	0.750	0.688	2.000	7.570	4.625	2.250	10.125
8.00	3.000	675	8.500	0.750	0.688	2.000	7.570	5.250	2.250	10.125
8.00	3.500	675	8.500	0.750	0.688	2.000	7.570	5.750	2.250	10.125
8.00	4.000	675	8.500	0.750	0.688	2.000	7.570	6.500	2.250	10.125
8.00	4.500	675	8.500	0.750	0.688	2.000	7.570	7.250	2.250	10.125
8.00	5.000	675	8.500	0.750	0.688	2.000	7.570	7.500	2.250	10.125
8.00	5.500	675	8.500	0.750	0.688	2.000	7.570	7.500	2.250	10.125

I Max pressure rating (NON-SHOCK).



MT1D: HEAD TRUNNION

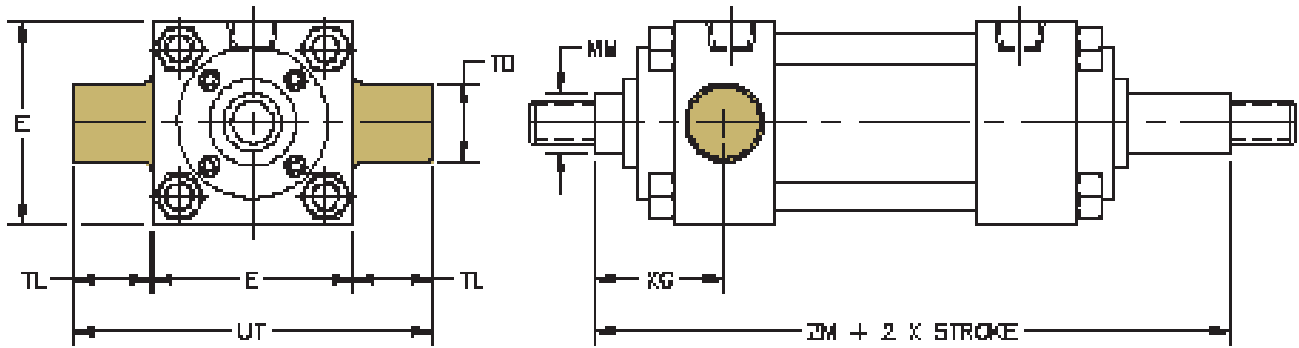

MT4D: INTERMEDIATE TRUNNION

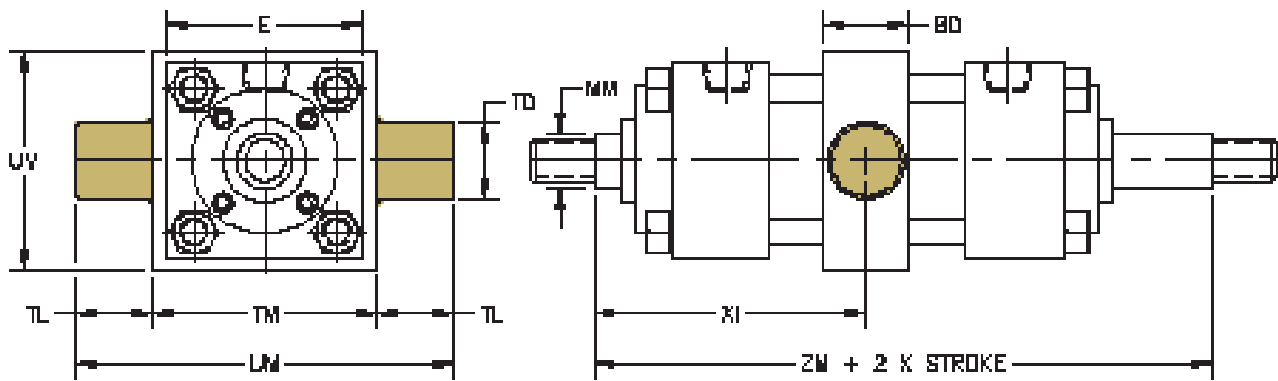

NOTE:
 1/2" DIMENSION TO BE SPECIFIED BY CUSTOMER

SERIES 'M' MEDIUM DUTY HYDRAULIC CYLINDERS

DIMENSIONS FOR DOUBLE END TRUNNION MOUNTS



BORE	ROD DIA. (MM)	I MAX PSI RATING	E	BD	TD	TL	TM	UM	UT	UV	XG	XI	MT4D MIN STROKE	ADD 2x STROKE
														ZM
1.50	0.625	1500	2.000	1.250	1.000	1.000	2.500	4.500	4.000	2.500	1.750	3.375	0.250	6.125
1.50	1.000	1500	2.000	1.250	1.000	1.000	2.500	4.500	4.000	2.500	2.125	3.750	0.250	6.875
2.00	0.625	1500	2.500	1.500	1.000	1.000	3.000	5.000	4.500	3.000	1.750	3.500	0.250	6.125
2.00	1.000	1500	2.500	1.500	1.000	1.000	3.000	5.000	4.500	3.000	2.125	3.875	0.250	6.875
2.00	1.375	1500	2.500	1.500	1.000	1.000	3.000	5.000	4.500	3.000	2.375	4.125	0.250	7.375
2.50	0.625	1000	3.000	1.500	1.000	1.000	3.500	5.500	5.000	3.500	1.750	3.500	0.375	6.250
2.50	1.000	1500	3.000	1.500	1.000	1.000	3.500	5.500	5.000	3.500	2.125	3.875	0.375	7.000
2.50	1.375	1500	3.000	1.500	1.000	1.000	3.500	5.500	5.000	3.500	2.375	4.125	0.375	7.500
2.50	1.750	1500	3.000	1.500	1.000	1.000	3.500	5.500	5.000	3.500	2.625	4.375	0.375	8.000
3.25	1.000	1500	3.750	2.000	1.000	1.000	4.500	6.500	5.750	4.250	2.250	4.375	0.875	7.500
3.25	1.375	1500	3.750	2.000	1.000	1.000	4.500	6.500	5.750	4.250	2.500	4.625	0.875	8.000
3.25	1.750	1500	3.750	2.000	1.000	1.000	4.500	6.500	5.750	4.250	2.750	4.875	0.875	8.500
3.25	2.000	1500	3.750	2.000	1.000	1.000	4.500	6.500	5.750	4.250	2.875	5.000	0.875	8.750
4.00	1.000	1000	4.500	2.000	1.000	1.000	5.250	7.250	6.500	5.000	2.250	4.375	1.125	7.500
4.00	1.375	1000	4.500	2.000	1.000	1.000	5.250	7.250	6.500	5.000	2.500	4.625	1.125	8.000
4.00	1.750	1000	4.500	2.000	1.000	1.000	5.250	7.250	6.500	5.000	2.750	4.875	1.125	8.500
4.00	2.000	1000	4.500	2.000	1.000	1.000	5.250	7.250	6.500	5.000	2.875	5.000	1.125	8.750
4.00	2.500	1000	4.500	2.000	1.000	1.000	5.250	7.250	6.500	5.000	3.125	5.250	1.125	9.250
5.00	1.000	750	5.500	2.000	1.000	1.000	6.250	8.250	7.500	6.000	2.250	4.375	1.125	7.750
5.00	1.375	1000	5.500	2.000	1.000	1.000	6.250	8.250	7.500	6.000	2.500	4.625	1.125	8.250
5.00	1.750	1000	5.500	2.000	1.000	1.000	6.250	8.250	7.500	6.000	2.750	4.875	1.125	8.750
5.00	2.000	1000	5.500	2.000	1.000	1.000	6.250	8.250	7.500	6.000	2.875	5.000	1.125	9.000
5.00	2.500	1000	5.500	2.000	1.000	1.000	6.250	8.250	7.500	6.000	3.125	5.250	1.125	9.500
5.00	3.000	1000	5.500	2.000	1.000	1.000	6.250	8.250	7.500	6.000	3.125	5.250	1.125	9.500
5.00	3.500	1000	5.500	2.000	1.000	1.000	6.250	8.250	7.500	6.000	3.125	5.250	1.125	9.500
6.00	1.375	750	6.500	2.000	1.375	1.375	7.625	10.375	9.250	7.000	2.625	5.125	1.250	8.750
6.00	1.750	750	6.500	2.000	1.375	1.375	7.625	10.375	9.250	7.000	2.875	5.375	1.250	9.250
6.00	2.000	750	6.500	2.000	1.375	1.375	7.625	10.375	9.250	7.000	3.000	5.500	1.250	9.500
6.00	2.500	750	6.500	2.000	1.375	1.375	7.625	10.375	9.250	7.000	3.250	5.750	1.250	10.000
6.00	3.000	750	6.500	2.000	1.375	1.375	7.625	10.375	9.250	7.000	3.250	5.750	1.250	10.000
6.00	3.500	750	6.500	2.000	1.375	1.375	7.625	10.375	9.250	7.000	3.250	5.750	1.250	10.000
6.00	4.000	750	6.500	2.000	1.375	1.375	7.625	10.375	9.250	7.000	3.250	5.750	1.250	10.000
8.00	1.375	500	8.500	2.500	1.375	1.375	9.750	12.500	11.250	9.500	2.625	5.125	2.125	8.875
8.00	1.750	500	8.500	2.500	1.375	1.375	9.750	12.500	11.250	9.500	2.875	5.375	2.125	9.375
8.00	2.000	675	8.500	2.500	1.375	1.375	9.750	12.500	11.250	9.500	3.000	5.500	2.125	9.625
8.00	2.500	675	8.500	2.500	1.375	1.375	9.750	12.500	11.250	9.500	3.250	5.750	2.125	10.125
8.00	3.000	675	8.500	2.500	1.375	1.375	9.750	12.500	11.250	9.500	3.250	5.750	2.125	10.125
8.00	3.500	675	8.500	2.500	1.375	1.375	9.750	12.500	11.250	9.500	3.250	5.750	2.125	10.125
8.00	4.000	675	8.500	2.500	1.375	1.375	9.750	12.500	11.250	9.500	3.250	5.750	2.125	10.125
8.00	4.500	675	8.500	2.500	1.375	1.375	9.750	12.500	11.250	9.500	3.250	5.750	2.125	10.125
8.00	5.000	675	8.500	2.500	1.375	1.375	9.750	12.500	11.250	9.500	3.250	5.750	2.125	10.125
8.00	5.500	675	8.500	2.500	1.375	1.375	9.750	12.500	11.250	9.500	3.250	5.750	2.125	10.125

I Max pressure rating (NON-SHOCK).

TD dimension tolerance is + .000 / - .001

XI dimension is the minimum that can be supplied and leaves 1/4" gap between head & trunnion block (customer to specify 'XI' dimension).



MX1D: EXTENDED TIE RODS - HEAD & CAP

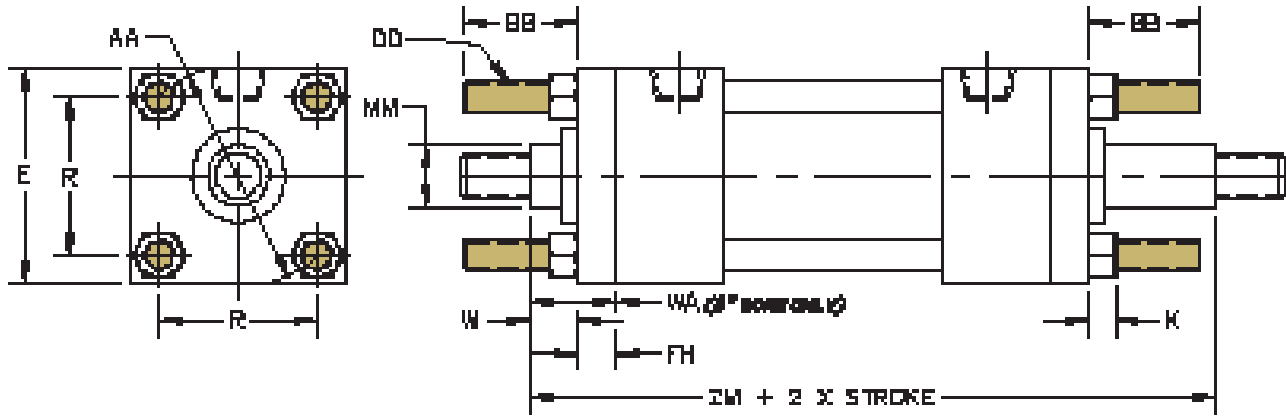

MX3D: EXTENDED TIE RODS - HEAD END

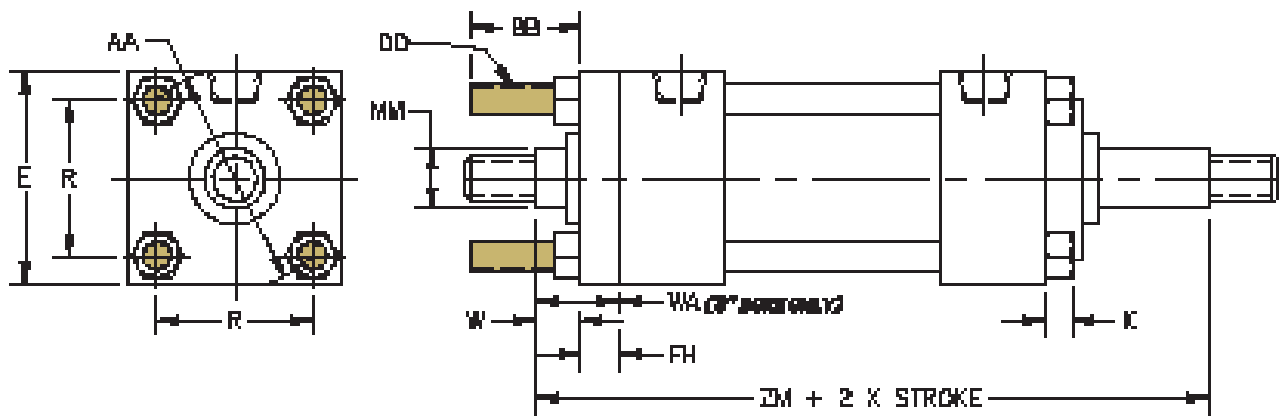

SERIES 'M' MEDIUM DUTY HYDRAULIC CYLINDERS

DIMENSIONS FOR DOUBLE END TIE ROD MOUNTS



BORE	ROD DIA. (MM)	I MAX PSI RATING	E	FH	AA	BB	DD	K	R	W or WA (8")	ADD 2x STROKE
											ZM
1.50	0.625	1500	2.000	0.375	2.020	1.000	1/4 - 28	0.250	1.430	0.625	6.125
1.50	1.000	1500	2.000	0.375	2.020	1.000	1/4 - 28	0.250	1.430	1.000	6.875
2.00	0.625	1500	2.500	0.375	2.600	1.125	5/16 - 24	0.313	1.840	0.625	6.125
2.00	1.000	1500	2.500	0.375	2.600	1.125	5/16 - 24	0.313	1.840	1.000	6.875
2.00	1.375	1500	2.500	0.375	2.600	1.125	5/16 - 24	0.313	1.840	1.250	7.375
2.50	0.625	1000	3.000	0.375	3.100	1.125	5/16 - 24	0.313	2.190	0.625	6.25
2.50	1.000	1500	3.000	0.375	3.100	1.125	5/16 - 24	0.313	2.190	1.000	7.000
2.50	1.375	1500	3.000	0.375	3.100	1.125	5/16 - 24	0.313	2.190	1.250	7.500
2.50	1.750	1500	3.000	0.375	3.100	1.125	5/16 - 24	0.313	2.190	1.500	8.000
3.25	1.000	1500	3.750	0.625	3.900	1.375	3/8 - 24	0.375	2.760	0.750	7.500
3.25	1.375	1500	3.750	0.625	3.900	1.375	3/8 - 24	0.375	2.760	1.000	8.000
3.25	1.750	1500	3.750	0.625	3.900	1.375	3/8 - 24	0.375	2.760	1.250	8.500
3.25	2.000	1500	3.750	0.625	3.900	1.375	3/8 - 24	0.375	2.760	1.375	8.750
4.00	1.000	1000	4.500	0.625	4.700	1.375	3/8 - 24	0.375	3.320	0.750	7.500
4.00	1.375	1000	4.500	0.625	4.700	1.375	3/8 - 24	0.375	3.320	1.000	8.000
4.00	1.750	1000	4.500	0.625	4.700	1.375	3/8 - 24	0.375	3.320	1.250	8.500
4.00	2.000	1000	4.500	0.625	4.700	1.375	3/8 - 24	0.375	3.320	1.375	8.750
4.00	2.500	1000	4.500	0.625	4.700	1.375	3/8 - 24	0.375	3.320	1.625	9.250
5.00	1.000	750	5.500	0.625	5.800	1.813	1/2 - 20	0.438	4.100	0.750	7.750
5.00	1.375	1000	5.500	0.625	5.800	1.813	1/2 - 20	0.438	4.100	1.000	8.250
5.00	1.750	1000	5.500	0.625	5.800	1.813	1/2 - 20	0.438	4.100	1.250	8.750
5.00	2.000	1000	5.500	0.625	5.800	1.813	1/2 - 20	0.438	4.100	1.375	9.000
5.00	2.500	1000	5.500	0.625	5.800	1.813	1/2 - 20	0.438	4.100	1.625	9.500
5.00	3.000	1000	5.500	0.625	5.800	1.813	1/2 - 20	0.438	4.100	1.625	9.500
5.00	3.500	1000	5.500	0.625	5.800	1.813	1/2 - 20	0.438	4.100	1.625	9.500
6.00	1.375	750	6.500	0.750	6.900	1.813	1/2 - 20	0.438	4.880	0.875	8.750
6.00	1.750	750	6.500	0.750	6.900	1.813	1/2 - 20	0.438	4.880	1.125	9.250
6.00	2.000	750	6.500	0.750	6.900	1.813	1/2 - 20	0.438	4.880	1.250	9.500
6.00	2.500	750	6.500	0.750	6.900	1.813	1/2 - 20	0.438	4.880	1.500	10.000
6.00	3.000	750	6.500	0.750	6.900	1.813	1/2 - 20	0.438	4.880	1.500	10.000
6.00	3.500	750	6.500	0.750	6.900	1.813	1/2 - 20	0.438	4.880	1.500	10.000
6.00	4.000	750	6.500	0.750	6.900	1.813	1/2 - 20	0.438	4.880	1.500	10.000
8.00	1.375	500	8.500	0.625*	9.100	2.313	5/8 - 18	0.563	6.440	1.500	8.875
8.00	1.750	500	8.500	0.625*	9.100	2.313	5/8 - 18	0.563	6.440	1.750	9.375
8.00	2.000	675	8.500	0.625*	9.100	2.313	5/8 - 18	0.563	6.440	1.875	9.625
8.00	2.500	675	8.500	0.625*	9.100	2.313	5/8 - 18	0.563	6.440	2.125	10.125
8.00	3.000	675	8.500	0.625*	9.100	2.313	5/8 - 18	0.563	6.440	2.125	10.125
8.00	3.500	675	8.500	0.625*	9.100	2.313	5/8 - 18	0.563	6.440	2.125	10.125
8.00	4.000	675	8.500	0.625*	9.100	2.313	5/8 - 18	0.563	6.440	2.125	10.125
8.00	4.500	675	8.500	0.625*	9.100	2.313	5/8 - 18	0.563	6.440	2.125	10.125
8.00	5.000	675	8.500	0.625*	9.100	2.313	5/8 - 18	0.563	6.440	2.125	10.125
8.00	5.500	675	8.500	0.625*	9.100	2.313	5/8 - 18	0.563	6.440	2.125	10.125

I Max pressure rating (NON-SHOCK).

* Round retainer used to retain bushing, not a full front plate as other bores. 'BB' is dimension from head on the 8.00" bore.



MF1D: HEAD FLANGE

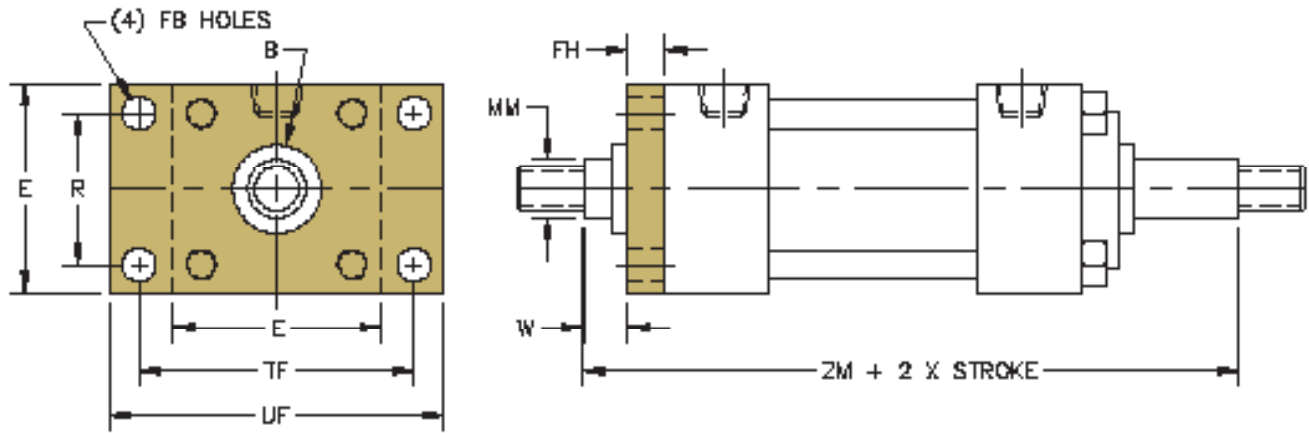

MF5D: HEAD SQUARE FLANGE

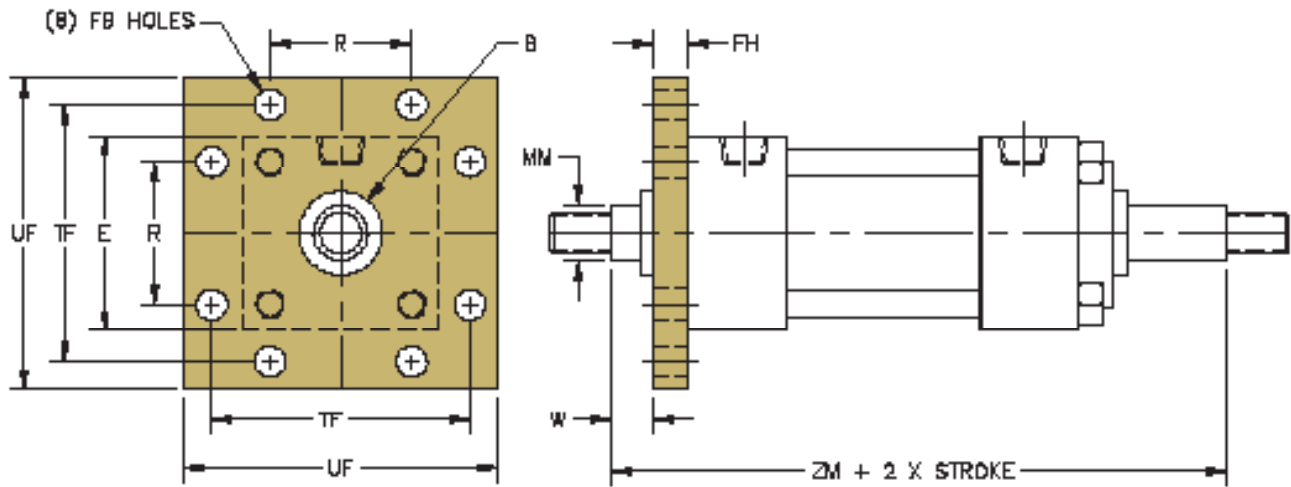

SERIES 'M' MEDIUM DUTY HYDRAULIC CYLINDERS

DIMENSIONS FOR DOUBLE END FLANGE MOUNTS



BORE	ROD DIA. (MM)	I MAX PSI RATING	B	E	FB	FH	R	TF	UF	W	ADD 2x STROKE
											ZM
1.50	0.625	1500	1.124	2.000	0.313	0.375	1.430	2.750	3.375	0.625	6.125
1.50	1.000	1500	1.499	2.000	0.313	0.375	1.430	2.750	3.375	1.000	6.875
2.00	0.625	1500	1.124	2.500	0.375	0.375	1.840	3.375	4.125	0.625	6.125
2.00	1.000	1500	1.499	2.500	0.375	0.375	1.840	3.375	4.125	1.000	6.875
2.00	1.375	1500	1.999	2.500	0.375	0.375	1.840	3.375	4.125	1.250	7.375
2.50	0.625	1000	1.124	3.000	0.375	0.375	2.190	3.875	4.625	0.625	6.250
2.50	1.000	1500	1.499	3.000	0.375	0.375	2.190	3.875	4.625	1.000	7.000
2.50	1.375	1500	1.999	3.000	0.375	0.375	2.190	3.875	4.625	1.250	7.500
2.50	1.750	1500	2.374	3.000	0.375	0.375	2.190	3.875	4.625	1.500	8.000
3.25	1.000	1500	1.499	3.750	0.438	0.625	2.760	4.688	5.500	0.750	7.500
3.25	1.375	1500	1.999	3.750	0.438	0.625	2.760	4.688	5.500	1.000	8.000
3.25	1.750	1500	2.374	3.750	0.438	0.625	2.760	4.688	5.500	1.250	8.500
3.25	2.000	1500	2.624	3.750	0.438	0.625	2.760	4.688	5.500	1.375	8.750
4.00	1.000	1000	1.499	4.500	0.438	0.625	3.320	5.438	6.250	0.750	7.500
4.00	1.375	1000	1.999	4.500	0.438	0.625	3.320	5.438	6.250	1.000	8.000
4.00	1.750	1000	2.374	4.500	0.438	0.625	3.320	5.438	6.250	1.250	8.500
4.00	2.000	1000	2.624	4.500	0.438	0.625	3.320	5.438	6.250	1.375	8.750
4.00	2.500	1000	3.124	4.500	0.438	0.625	3.320	5.438	6.250	1.625	9.250
5.00	1.000	750	1.499	5.500	0.563	0.625	4.100	6.625	7.625	0.750	7.750
5.00	1.375	1000	1.999	5.500	0.563	0.625	4.100	6.625	7.625	1.000	8.250
5.00	1.750	1000	2.374	5.500	0.563	0.625	4.100	6.625	7.625	1.250	8.750
5.00	2.000	1000	2.624	5.500	0.563	0.625	4.100	6.625	7.625	1.375	9.000
5.00	2.500	1000	3.124	5.500	0.563	0.625	4.100	6.625	7.625	1.625	9.500
5.00	3.000	1000	3.749	5.500	0.563	0.625	4.100	6.625	7.625	1.625	9.500
5.00	3.500	1000	4.249	5.500	0.563	0.625	4.100	6.625	7.625	1.625	9.500
6.00	1.375	750	1.999	6.500	0.563	0.750	4.880	7.625	8.625	0.875	8.750
6.00	1.750	750	2.374	6.500	0.563	0.750	4.880	7.625	8.625	1.125	9.250
6.00	2.000	750	2.624	6.500	0.563	0.750	4.880	7.625	8.625	1.250	9.500
6.00	2.500	750	3.124	6.500	0.563	0.750	4.880	7.625	8.625	1.500	10.000
6.00	3.000	750	3.749	6.500	0.563	0.750	4.880	7.625	8.625	1.500	10.000
6.00	3.500	750	4.249	6.500	0.563	0.750	4.880	7.625	8.625	1.500	10.000
6.00	4.000	750	4.749	6.500	0.563	0.750	4.880	7.625	8.625	1.500	10.000

I Max pressure rating (NON-SHOCK).
 † 'B' dimension tolerance is +.000 / -.002



MS2D: SIDE LUGS

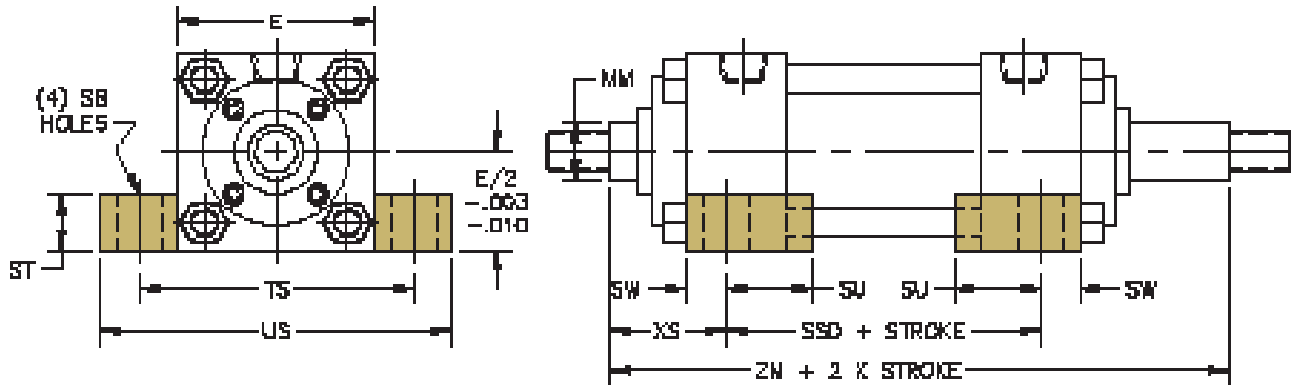

MS3D: CENTER LINE LUGS

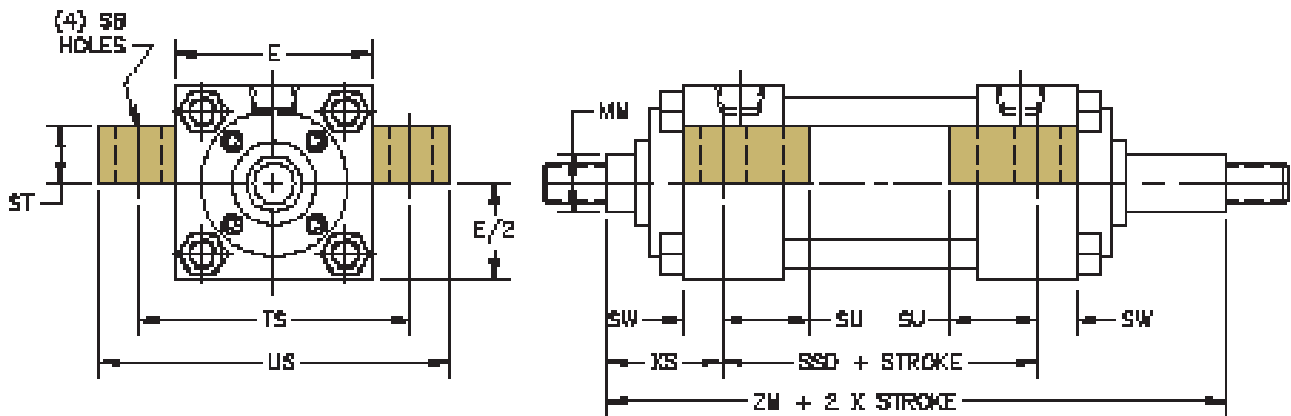

SERIES 'M' MEDIUM DUTY HYDRAULIC CYLINDERS

DIMENSIONS FOR DOUBLE END LUG MOUNTS



BORE	ROD DIA. (MM)	I MAX PSI RATING	E	SB	ST	SU	SW	TS	US	XS	ADD TO STROKE	ADD 2x STROKE
											SSD	ZM
1.50	0.625	1500	2.000	0.438	0.500	1.125	0.375	2.750	3.500	1.375	3.375	6.125
1.50	1.000	1500	2.000	0.438	0.500	1.125	0.375	2.750	3.500	1.750	3.375	6.875
2.00	0.625	1500	2.500	0.438	0.500	1.125	0.375	3.250	4.000	1.375	3.375	6.125
2.00	1.000	1500	2.500	0.438	0.500	1.125	0.375	3.250	4.000	1.750	3.375	6.875
2.00	1.375	1500	2.500	0.438	0.500	1.125	0.375	3.250	4.000	2.000	3.375	7.375
2.50	0.625	1000	3.000	0.438	0.500	1.125	0.375	3.750	4.500	1.375	3.500	6.250
2.50	1.000	1500	3.000	0.438	0.500	1.125	0.375	3.750	4.500	1.750	3.500	7.000
2.50	1.375	1500	3.000	0.438	0.500	1.125	0.375	3.750	4.500	2.000	3.500	7.500
2.50	1.750	1500	3.000	0.438	0.500	1.125	0.375	3.750	4.500	2.250	3.500	8.000
3.25	1.000	1500	3.750	0.563	0.750	1.250	0.500	4.750	5.750	1.875	3.750	7.500
3.25	1.375	1500	3.750	0.563	0.750	1.250	0.500	4.750	5.750	2.125	3.750	8.000
3.25	1.750	1500	3.750	0.563	0.750	1.250	0.500	4.750	5.750	2.375	3.750	8.500
3.25	2.000	1500	3.750	0.563	0.750	1.250	0.500	4.750	5.750	2.500	3.750	8.750
4.00	1.000	1000	4.500	0.563	0.750	1.250	0.500	5.500	6.500	1.875	3.750	7.500
4.00	1.375	1000	4.500	0.563	0.750	1.250	0.500	5.500	6.500	2.125	3.750	8.000
4.00	1.750	1000	4.500	0.563	0.750	1.250	0.500	5.500	6.500	2.375	3.750	8.500
4.00	2.000	1000	4.500	0.563	0.750	1.250	0.500	5.500	6.500	2.500	3.750	8.750
4.00	2.500	1000	4.500	0.563	0.750	1.250	0.500	5.500	6.500	2.750	3.750	9.250
5.00	1.000	750	5.500	0.813	1.000	1.063	0.688	6.875	8.250	2.063	3.625	7.750
5.00	1.375	1000	5.500	0.813	1.000	1.063	0.688	6.875	8.250	2.313	3.625	8.250
5.00	1.750	1000	5.500	0.813	1.000	1.063	0.688	6.875	8.250	2.563	3.625	8.750
5.00	2.000	1000	5.500	0.813	1.000	1.063	0.688	6.875	8.250	2.688	3.625	9.000
5.00	2.500	1000	5.500	0.813	1.000	1.063	0.688	6.875	8.250	2.938	3.625	9.500
5.00	3.000	1000	5.500	0.813	1.000	1.063	0.688	6.875	8.250	2.938	3.625	9.500
5.00	3.500	1000	5.500	0.813	1.000	1.063	0.688	6.875	8.250	2.938	3.625	9.500
6.00	1.375	750	6.500	0.813	1.000	1.313	0.688	7.875	9.250	2.313	4.125	8.750
6.00	1.750	750	6.500	0.813	1.000	1.313	0.688	7.875	9.250	2.563	4.125	9.250
6.00	2.000	750	6.500	0.813	1.000	1.313	0.688	7.875	9.250	2.688	4.125	9.500
6.00	2.500	750	6.500	0.813	1.000	1.313	0.688	7.875	9.250	2.938	4.125	10.000
6.00	3.000	750	6.500	0.813	1.000	1.313	0.688	7.875	9.250	2.938	4.125	10.000
6.00	3.500	750	6.500	0.813	1.000	1.313	0.688	7.875	9.250	2.938	4.125	10.000
6.00	4.000	750	6.500	0.813	1.000	1.313	0.688	7.875	9.250	2.938	4.125	10.000
8.00	1.375	500	8.500	0.813	1.000	1.313	0.688	9.875	11.250	2.313	4.250	8.875
8.00	1.750	500	8.500	0.813	1.000	1.313	0.688	9.875	11.250	2.563	4.250	9.375
8.00	2.000	675	8.500	0.813	1.000	1.313	0.688	9.875	11.250	2.688	4.250	9.625
8.00	2.500	675	8.500	0.813	1.000	1.313	0.688	9.875	11.250	2.938	4.250	10.125
8.00	3.000	675	8.500	0.813	1.000	1.313	0.688	9.875	11.250	2.938	4.250	10.125
8.00	3.500	675	8.500	0.813	1.000	1.313	0.688	9.875	11.250	2.938	4.250	10.125
8.00	4.000	675	8.500	0.813	1.000	1.313	0.688	9.875	11.250	2.938	4.250	10.125
8.00	4.500	675	8.500	0.813	1.000	1.313	0.688	9.875	11.250	2.938	4.250	10.125
8.00	5.000	675	8.500	0.813	1.000	1.313	0.688	9.875	11.250	2.938	4.250	10.125
8.00	5.500	675	8.500	0.813	1.000	1.313	0.688	9.875	11.250	2.938	4.250	10.125

I Max pressure rating (NON-SHOCK).

All our cylinders are proudly Made in USA



MS4D: BOTTOM TAPPED HOLES

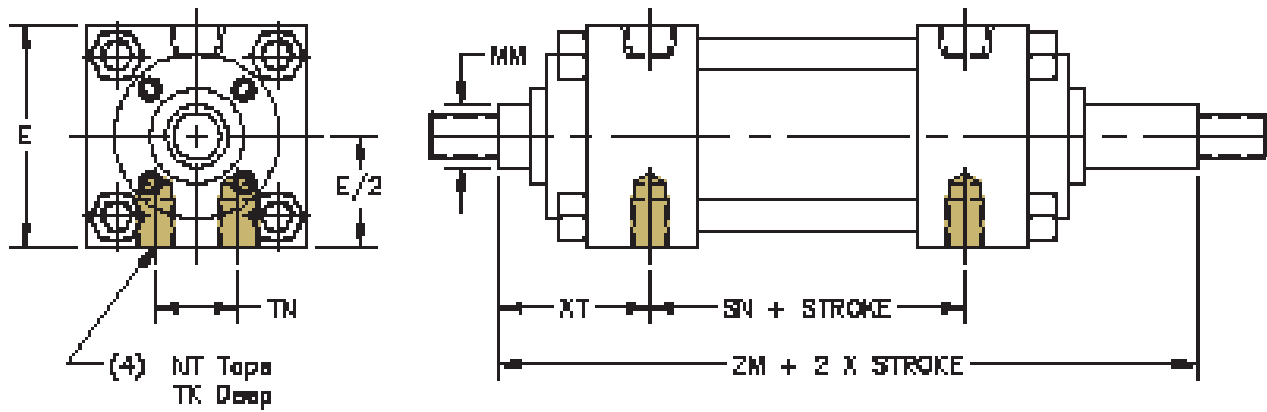

MS7D: END LUGS

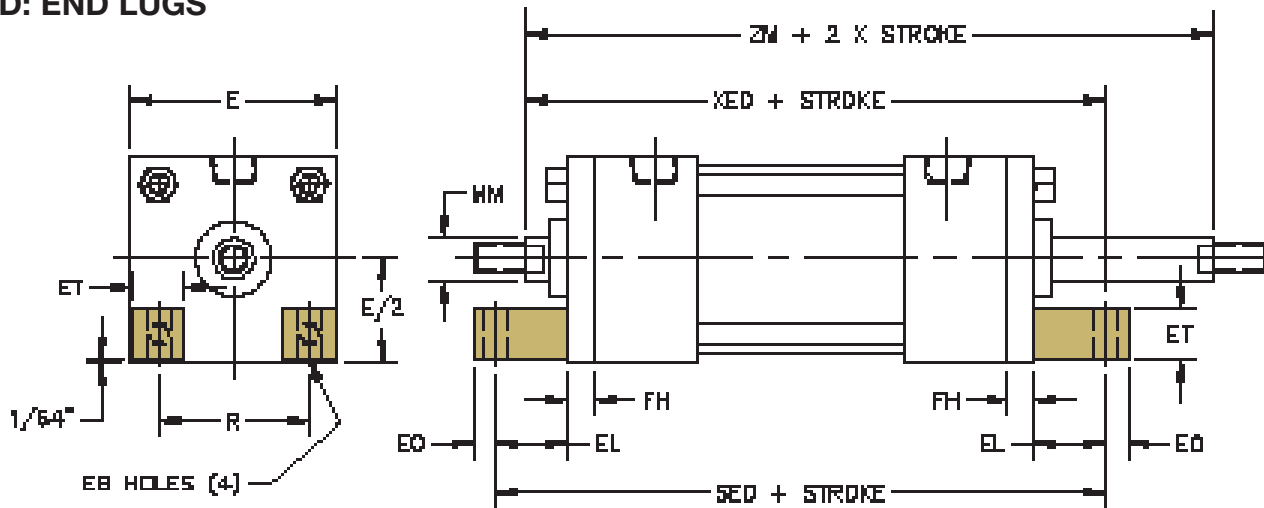

SERIES 'M' MEDIUM DUTY HYDRAULIC CYLINDERS

DIMENSIONS FOR DOUBLE END MOUNTS



BORE	ROD DIA. (MM)	I MAX PSI RATING	E	EB	EL	EO	ET	FH	NT	R	TN	TK	XT	ADD TO STROKE			ADD 2x STROKE
														SN	SED	XED	ZM
1.50	0.625	1500	2.000	N/A	N/A	N/A	N/A	0.375	1/4 - 20	1.438	0.625	0.375	1.938	2.250	N/A	N/A	6.125
1.50	1.000	1500	2.000	N/A	N/A	N/A	N/A	0.375	1/4 - 20	1.438	0.625	0.375	2.313	2.250	N/A	N/A	6.875
2.00	0.625	1500	2.500	0.344	0.938	0.313	0.375	0.375	5/16 - 18	1.844	0.875	0.406	1.938	2.250	6.750	6.438	6.125
2.00	1.000	1500	2.500	0.344	0.938	0.313	0.375	0.375	5/16 - 18	1.844	0.875	0.406	2.313	2.250	6.750	6.813	6.875
2.00	1.375	1500	2.500	N/A	N/A	N/A	N/A	0.375	5/16 - 18	1.844	0.875	0.406	2.563	2.250	N/A	N/A	7.375
2.50	0.625	1000	3.000	0.344	1.063	0.313	0.750	0.375	3/8 - 16	2.188	1.250	0.438	1.938	2.375	7.125	6.688	6.250
2.50	1.000	1500	3.000	N/A	N/A	N/A	N/A	0.375	3/8 - 16	2.188	1.250	0.438	2.313	2.375	N/A	N/A	7.000
2.50	1.375	1500	3.000	N/A	N/A	N/A	N/A	0.375	3/8 - 16	2.188	1.250	0.438	2.563	2.375	N/A	N/A	7.500
2.50	1.750	1500	3.000	N/A	N/A	N/A	N/A	0.375	3/8 - 16	2.188	1.250	0.438	2.813	2.375	N/A	N/A	8.000
3.25	1.000	1500	3.750	0.406	0.875	0.375	0.938	0.625	1/2 - 13	2.766	1.500	0.500	2.438	2.625	7.750	7.625	7.500
3.25	1.375	1500	3.750	N/A	N/A	N/A	N/A	0.625	1/2 - 13	2.766	1.500	0.500	2.688	2.625	N/A	N/A	8.000
3.25	1.750	1500	3.750	N/A	N/A	N/A	N/A	0.625	1/2 - 13	2.766	1.500	0.500	2.938	2.625	N/A	N/A	8.500
3.25	2.000	1500	3.750	N/A	N/A	N/A	N/A	0.625	1/2 - 13	2.766	1.500	0.500	3.063	2.625	N/A	N/A	8.750
4.00	1.000	1000	4.500	0.406	1.000	0.375	1.125	0.625	1/2 - 13	3.328	2.063	0.625	2.438	2.625	8.000	7.750	7.500
4.00	1.375	1000	4.500	0.406	1.000	0.375	1.125	0.625	1/2 - 13	3.328	2.063	0.625	2.688	2.625	8.000	8.000	8.000
4.00	1.750	1000	4.500	N/A	N/A	N/A	N/A	0.625	1/2 - 13	3.328	2.063	0.625	2.938	2.625	N/A	N/A	8.500
4.00	2.000	1000	4.500	N/A	N/A	N/A	N/A	0.625	1/2 - 13	3.328	2.063	0.625	3.063	2.625	N/A	N/A	8.750
4.00	2.500	1000	4.500	N/A	N/A	N/A	N/A	0.625	1/2 - 13	3.328	2.063	0.625	3.313	2.625	N/A	N/A	9.250
5.00	1.000	750	5.500	0.531	1.063	0.500	1.375	0.625	5/8 - 11	4.109	2.688	0.750	2.438	2.875	8.375	8.063	7.750
5.00	1.375	1000	5.500	0.531	1.063	0.500	1.375	0.625	5/8 - 11	4.109	2.688	0.750	2.688	2.875	8.375	8.313	8.250
5.00	1.750	1000	5.500	0.531	1.063	0.500	1.375	0.625	5/8 - 11	4.109	2.688	0.750	2.938	2.875	8.375	8.563	8.750
5.00	2.000	1000	5.500	N/A	N/A	N/A	N/A	0.625	5/8 - 11	4.109	2.688	0.750	3.063	2.875	N/A	N/A	9.000
5.00	2.500	1000	5.500	N/A	N/A	N/A	N/A	0.625	5/8 - 11	4.109	2.688	0.750	3.313	2.875	N/A	N/A	9.500
5.00	3.000	1000	5.500	N/A	N/A	N/A	N/A	0.625	5/8 - 11	4.109	2.688	0.750	3.313	2.875	N/A	N/A	9.500
5.00	3.500	1000	5.500	N/A	N/A	N/A	N/A	0.625	5/8 - 11	4.109	2.688	0.750	3.313	2.875	N/A	N/A	9.500
6.00	1.375	750	6.500	0.531	1.000	0.500	1.563	0.750	3/4 - 10	4.875	3.250	1.000	2.813	3.125	9.000	8.875	8.750
6.00	1.750	750	6.500	0.531	1.000	0.500	1.563	0.750	3/4 - 10	4.875	3.250	1.000	3.063	3.125	9.000	9.125	9.250
6.00	2.000	750	6.500	0.531	1.000	0.500	1.563	0.750	3/4 - 10	4.875	3.250	1.000	3.188	3.125	9.000	9.250	9.500
6.00	2.500	750	6.500	0.531	1.000	0.500	1.563	0.750	3/4 - 10	4.875	3.250	1.000	3.438	3.125	9.000	9.500	10.000
6.00	3.000	750	6.500	N/A	N/A	N/A	N/A	0.750	3/4 - 10	4.875	3.250	1.000	3.438	3.125	N/A	N/A	10.000
6.00	3.500	750	6.500	N/A	N/A	N/A	N/A	0.750	3/4 - 10	4.875	3.250	1.000	3.438	3.125	N/A	N/A	10.000
6.00	4.000	750	6.500	N/A	N/A	N/A	N/A	0.750	3/4 - 10	4.875	3.250	1.000	3.438	3.125	N/A	N/A	10.000
8.00	1.375	500	8.500	0.688	1.125	0.625	2.000	2.000	3/4 - 10	6.438	4.500	1.250	2.813	3.250	7.875	8.375	8.875
8.00	1.750	500	8.500	0.688	1.125	0.625	2.000	2.000	3/4 - 10	6.438	4.500	1.250	3.063	3.250	7.875	8.625	9.375
8.00	2.000	675	8.500	0.688	1.125	0.625	2.000	2.000	3/4 - 10	6.438	4.500	1.250	3.188	3.250	7.875	8.750	9.625
8.00	2.500	675	8.500	0.688	1.125	0.625	2.000	2.000	3/4 - 10	6.438	4.500	1.250	3.438	3.250	7.875	9.000	10.125
8.00	3.000	675	8.500	0.688	1.125	0.625	2.000	2.000	3/4 - 10	6.438	4.500	1.250	3.438	3.250	7.875	9.000	10.125
8.00	3.500	675	8.500	0.688	1.125	0.625	2.000	2.000	3/4 - 10	6.438	4.500	1.250	3.438	3.250	7.875	9.000	10.125
8.00	4.000	675	8.500	N/A	N/A	N/A	N/A	N/A	3/4 - 10	N/A	4.500	1.250	3.438	3.250	N/A	N/A	10.125
8.00	4.500	675	8.500	N/A	N/A	N/A	N/A	N/A	3/4 - 10	N/A	4.500	1.250	3.438	3.250	N/A	N/A	10.125
8.00	5.000	675	8.500	N/A	N/A	N/A	N/A	N/A	3/4 - 10	N/A	4.500	1.250	3.438	3.250	N/A	N/A	10.125
8.00	5.500	675	8.500	N/A	N/A	N/A	N/A	N/A	3/4 - 10	N/A	4.500	1.250	3.438	3.250	N/A	N/A	10.125

† Max pressure rating (NON-SHOCK).

‡ MS7 bracket bolted directly to head (uses round retainer).

All our cylinders are proudly Made in USA



A= Extended Piston Rod Thread

"A=" refers to the length of piston rod thread.

Shorter than standard lengths can be furnished at no charge.
 Longer than standard lengths can be furnished at a nominal price adder.
Special length threads do not delay orders!

Note: Maximum thread length is double the standard "A" length.

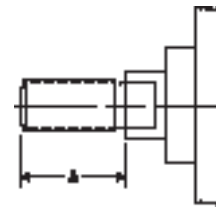

AS Adjustable Stroke (Retract)

Consists of a threaded rod in the cylinder cap, non-removable. Provides an adjustable positive stop on the cylinder retract.

To order, specify "AS" and length of adjustment (Example: AS=3").

ADJUSTABLE STROKE	
BORE	MAX "AS"
1.50	Up to 8 inch
2.00-3.25	Up to 6 inch
4.00-6.00	Up to 5 inch
8.00	Up to 4 inch

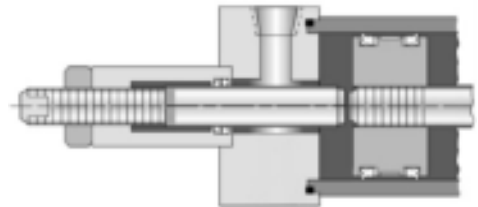

ABP= Air Bleed Ports

Air bleeds can be provided at either or both ends of the cylinder. Air bleeds should be located at the highest point in the cylinder for maximum effectiveness. The location needs to be specified, similar to port locations.

Example: ABP=15
 (Air Bleed ports at position 1 & 5)

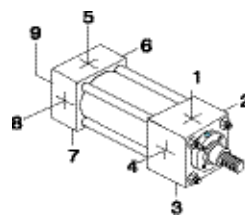

Location 9 is center of cap face.

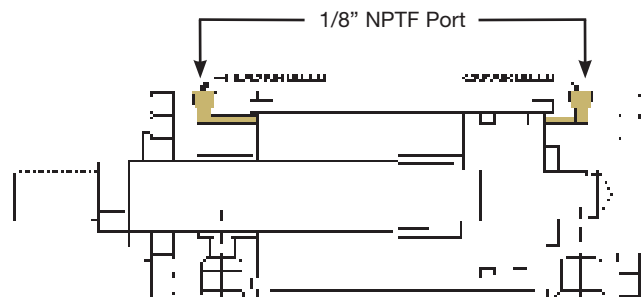

C= Extended Piston Rod

"C=" is commonly referred to as piston rod extension. Piston rods can be extended to any length up to 120" total piston rod length, including stroke portion. Cylinders with long "C" lengths can be mounted away from obstacles or outside hazardous environments.

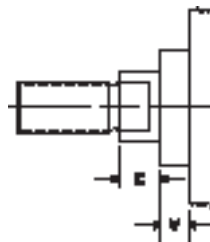

Piston rods can be made to any length up to 120 inches total OAL. Rods can be easily extended to move a cylinder to a more accessible location or away from a less desirable environment.

Be sure to check piston rod column strength charts to properly size the rod and prevent buckling.

Extended piston rods do not delay delivery.

CS Center Supports

Center supports are recommended for long stroke cylinders to support tube and prevent the tie rods from sagging. Properly supported cylinders will eliminate premature cylinder wear and eliminate tie rod vibration.

Center supports can include MS2 mounts.

CENTER SUPPORT RECOMMENDATIONS		
BORE	ONE SUPPORT	TWO SUPPORTS
1.50"	STROKES OVER 44 INCHES	STROKES OVER 89 INCHES
2.00"	STROKES OVER 74 INCHES	STROKES OVER 99 INCHES
2.50"	STROKES OVER 84 INCHES	NOT REQUIRED
3.25" - 8.00"	STROKES OVER 99 INCHES	

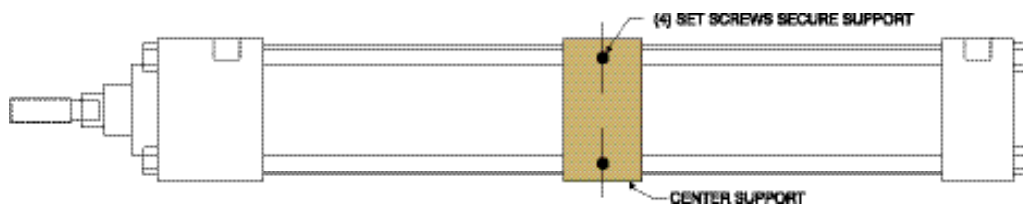

VARIATIONS

Cushions

Cushion design features industry proven technology and ultra fine adjustment needles for perfect deceleration and long life. Cushion adjustment needle positions need to be specified.

Example: H2C6

CUSHION LOCATIONS	
HEAD CUSHION	CAP CUSHION
H1	C5
H2	C6
H3	C7
H4	C8

STANDARD CUSHION LOCATIONS	
MOST MOUNTS	H2 C6
MS3 MOUNT	H3 C7
MT1 MOUNT	H3 C6
MT2 MOUNT	H2 C7

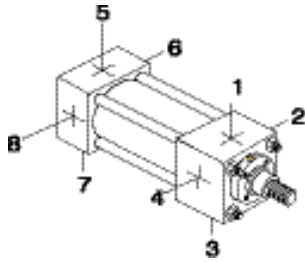

UNAVAILABLE CUSHION LOCATIONS BY MOUNT		
MOUNT	HEAD CUSHION	CAP CUSHION
ME5	H2, H4	-
ME6	-	C6, C8
MS3	H2, H4	C6, C8
MT1	H2, H4	-
MT2	-	C6, C8

DBB= Drain Back Bushing

When oil leakage cannot be tolerated, a rod bushing drain port can be provided. Since there isn't any pressure in the drain line, clear tubing can offer a visual inspection of any leakage. A constant leak indicates that the rod seal is worn and needs to be replaced.

Example: DBB=1 (drain port at position 1)

1/16" or 1/8" NPTF Port

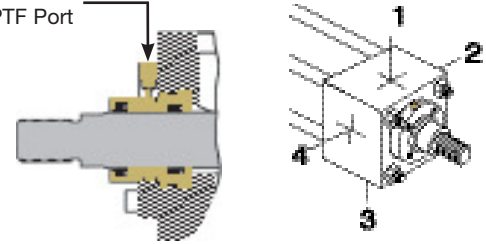

EK Extended Key Plate

Extended key plate or thrust key is made from a full square bushing retainer plate. The key is designed to fit in a milled slot on the equipment to prevent the cylinder from shifting.

An additional mount needs to be specified to secure cylinder.

Available bore sizes: H - 1.50" to 8.00" Bore

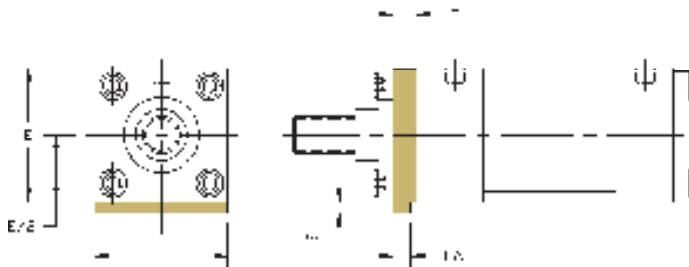

'H' DIMENSIONS FOR EXTENDED KEY PLATE				
BORE	E	FA	FH	PA
1.50	2.500	0.312 / 0.314	0.375	0.188
2.00	3.000	0.562 / 0.564	0.625	0.313
2.50	3.500	0.562 / 0.564	0.625	0.313
3.25	4.500	0.687 / 0.689	0.750	0.375
4.00	5.000	0.812 / 0.814	0.875	0.438
5.00	6.500	0.812 / 0.814	0.875	0.438
6.00	7.500	0.937 / 0.939	1.000	0.500
8.00	9.500	0.937 / 0.939	1.000	0.500



High Load Piston

Long stroke cylinders and pivot type mounting can create severe cylinder piston-to-tube side loads. The high load piston option provides increased side load capacity without increasing the cylinder base dimensions.

Design Benefits

- Bi-direction piston seal offers low to zero leakage rating.
- Piston seal design offers lower friction than cast iron rings or lip seals, which eliminate stick/slip breakaway issues.
- Glass filled PTFE piston seal is 20% stronger than bronze filled seals.
- High contamination tolerant; offers the longest life of any seal type.
- Temperature Rating: -20°F to 200°F (-29°C to 93°C)
- Other temperature ratings are available; contact HYDRAULIC CYLINDERS INC.® for more information.

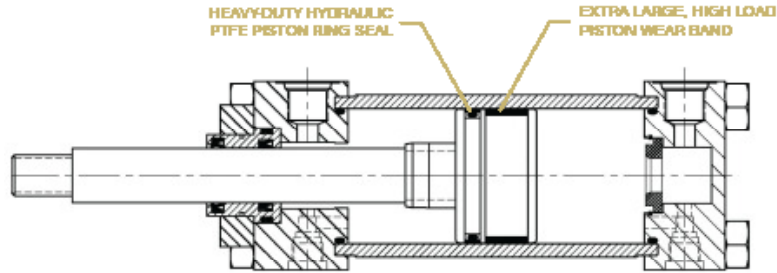

High Load Piston Wear Band - Our superior design is 35% to 80% wider than competitive models and we locate the wearband at the furthest point from the rod bearing to increase overall effectiveness.

Piston Ring Seal - Glass filled PTFE with Nitrile expander.

HSS High Shock Seals

High shock seal option provides shock protection to the rod and piston seal.

Piston Seal - Consists of (2) bidirectional sealing, step-cut, cast iron piston rings to buffer the shock and (2) heavy-lip design Carboxylated Nitrile seals (with back-up rings), to provide near leak-free operation.

Rod Seals - Consists of a buffer seal to handle the shock and a double lip polyurethane block vee seal for leak free operation.

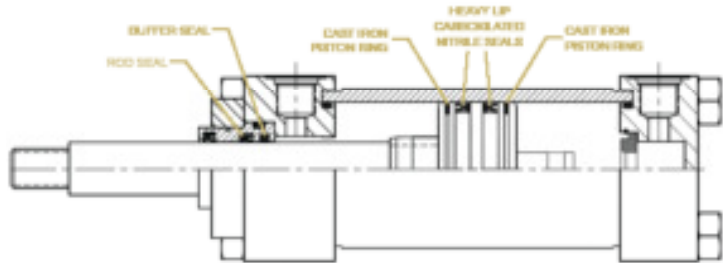

KKX Non-Standard Rod Threads

Cylinders piston rods can be furnished with non-standard rod threads.

Ordering Example: H - MF1 - 150 X 24 - 100 - KKX - 7/8 - 9UNC - P15 = N375 - SSSS

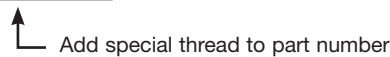

KK3M Female Metric Rod Threads

Equipment that is imported to the United States will typically contain metric tie-rod cylinders. In general, ISO tie rod cylinders are not as robust as NFPA cylinder designs and some customers prefer to replace the metric cylinders with NFPA designs that will provide longer life.

HYDRAULIC CYLINDERS INC.® can provide cylinders with metric piston rod end threads to assist customers in mating replacement cylinders to existing equipment.

Ordering Example: H - MF1 - 150 X 24 - 100 - KK3M = M8 X 1 - P15 = N375 - SSSS

KK3X Female Special Rod Threads

HYDRAULIC CYLINDERS INC.® can machine a wide range of female rod threads. Standard NFPA rod threads are UNF (fine), class 2 threads. Common alternative choices are UNC (coarse) threads.

Note: unless otherwise specified, the rod thread will be standard catalog "A" dimension lengths.

Ordering Example: H - MF1 - 150 X 24 - 100 - KK3X = 1 - 8 - P15 = N375 - SSSS



VARIATIONS

LRB Lift Ring Boss

A steel, tapped lug is welded to the center of the cylinder cap.

UNC coarse threads are provided to accept high load type lifting eyes (lift eyes are not provided).

Not available on MF2, MF6, ME6, MP1 & SB mounts.

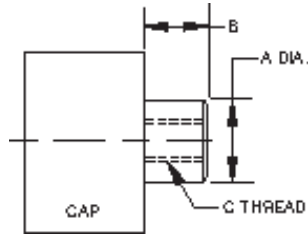

LIFT LUG DIMENSIONS				
BORE	A	B	C	STRAIGHT PULL LIFTING CAPACITY*
1.50	1.120	1.000	1/2-13	2500
2.00	1.500	1.250	5/8-11	4000
2.50	1.500	1.250	5/8-11	4000
3.25	2.000	1.500	3/4-10	6000
4.00	2.000	1.500	3/4-10	6000
5.00	2.000	1.500	3/4-10	6000
6.00	2.500	2.000	1-8	9000
8.00	2.500	2.000	1-8	9000

*Lifting capacity is the maximum capacity for intermittent lifting and placement of cylinder only. It is NOT intended to be used as the primary cylinder mount.

NR Non-Rotating (NFPA) Cylinders

Two internal guide rods throughout stroke

High repeatability at each end of stroke (+/- 1 degree)

All external dimensions are the same as standard cylinder (no additional length or width required)

Standard diameter guide rod seals & bronze Bearings for long life and reliable operation

Available in double rod end models

Eliminates the need for external guide shafts in many positioning applications

Guide rods are internal, self-cleaning and not subject to harsh cleaners

Compact design saves space; no larger than standard NFPA cylinders!

Durable, self-contained construction

AVAILABLE BORE SIZES WITH 'NR' GUIDE ROD SIZES AND MAX STROKE		
BORE	ROD DIA. (MM)	CUSHIONS
4.00	1.000 & 1.375	No Cushions
5.00	1.000, 1.375, 1.750 & 2.000	Cap Cushions Only
6.00	1.375 - 3.000	Both Cushioned (3.000" Rod - Cap Only)
8.00	1.375 - 3.500	Both Cushioned (3.500" Rod - Cap Only)

Multiple Mounts

Cylinders can be furnished with a wide selection of multiple mounts.

Ordering Example: H - MF1 - MS2 - 250 X 12 - 100 - KK1 - P15 - SSSS

↑ Add additional mount to part number

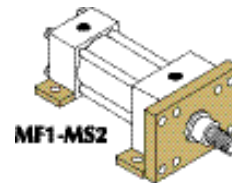

Port Options

Cylinders can be furnished with NPTF or SAE O-Ring Boss (SAEJ514) ports at no-charge.

Cylinders can be furnished with BSPP, BSPT or SAE Flange Ports for additional cost.

BSPT British Standard Pipe Taper

British Standard Pipe Taper (BSPT) threads have the same taper as American NPT tapered threads, but use a 55° Whitworth thread form and different diameters. (Not interchangeable with NPT)

BSPP British Standard Pipe Parallel

British Standard Pipe Parallel (BSPP), also referred to as BSP "Straight" Thread. (Not interchangeable with NPT)



VARIATIONS

RBB Bronze Rod Bushings

Cylinders can be furnished with bronze rod bushings (standard material: 150,000 PSI ductile iron, PTFE coated).

SSR 17-4 Stainless Steel Hard Chrome Plated Piston Rod

Cylinders can be furnished with hard chrome plated stainless steel piston rods.

Seals

The 'H' Series allows for the use of different types of seal design and material compounds in every area, for maximum flexibility and performance.

How to Order Seals

S S S S

PISTON SEAL	
S	STANDARD (Carboxilated)
C	Cast-Ring
E	EP
T	PTFE
V	Fluorocarbon

ROD SEAL	
S	STANDARD (Polyurethane)
E	EP
V	Fluorocarbon

TUBE SEAL	
S	STANDARD (Buna)
E	EP
V	Fluorocarbon

ROD WIPER	
S	STANDARD (Flocked Nitrile)
M	Metallic Scraper
T	PTFE
V	Fluorocarbon

S Standard Seals

Piston: Carboxilated Nitrile Rod Seal: Polyurethane
 Tube Seals: Buna Rod Wiper: Flocked Nitrile
 Temperature Rating: -20°F to 200°F (-29°C to 93°C)
 Compatible with: Mineral based hydraulic fluids

C Cast Iron Piston Rings

Temperature Range: -20°F to 200°F (-29°C to 93°C)
 Compatible with: Virtually all fluids
 Uses: Hydraulic shock protection

M Metallic Rod Scraper

Aggressively scrapes the piston rod, removing foreign material such as spatter, sprays and powders (*brass construction*).

E Ethylene Propylene

Temperature Rating: -50°F to 300°F (-45°C to 149°C)
 Compatible with: Most Phosphate Ester (Skydrol 500 and 7000, type 2) fluids

T Glass Filled PTFE

Temperature Rating: -100°F to 400°F (-73°C to 204°C)
 Compatible with: All hydraulic fluids and almost any fluid
 Contact HYDRAULIC CYLINDERS INC.® for specific compatibility
 Use: Low friction and high side load

V Fluorocarbon

Temperature Rating: 0°F to 300°F (-18°C to 149°C)
 (Up to 400°F with reduced service life)
 Compatible with: Some Phosphate Ester (Houghto-Safe 1000, 1120; Pyrogard 42, 43, 53, 55) fluids; mineral based petroleum, halogenated hydrocarbons, silicate ester and diester fluids

XX Special

Non-standard seals can be furnished.

VARIATIONS

ST Stop Tube and Rod Size Selection

Stop tubes are designed to reduce the piston rod bushing stress to within the designed range of the bearing material. This will ensure proper cylinder performance in any given application. Stop tubes lower the cylinder bearing stress by adding length to the piston, which increases the overall length of the cylinder (Note: HYDRAULIC CYLINDERS INC.® uses a double piston design when possible).

Stop Tube Selection

To determine the proper amount of stop tube for your application, you must first find the value of "D", which represents the stroke (adjusted for mounting condition). Each mounting condition creates different levels of bushing stress, which has direct impact on the amount of stop tube required (see Chart 1). Once the value of "D" is known, refer to Chart 2 for the recommended amount of stop tube.

To order a stop tube:

- Add the stop tube prefix "ST=" and the stop tube length to the cylinder model number.
- Add "ES" after the cylinder stroke to indicate that the stroke is the effective stroke.

Example: M-MS2-2.50 X 42ES-100-KK2-P15=N375-SSSS-ST=2

Using the value of "D", find the recommended amount of stop tube

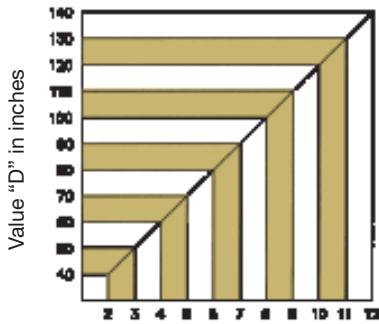

Standard rod sizes are usually suitable for shorter stroke applications at lower hydraulic pressures. With high thrust force or long stroke applications, you must check the column strength of the rod in the mounting style to determine the proper rod diameter size.

1. Determine the total axial thrust by multiplying the bore area size (in inches) by the operating pressure (in PSI).
2. Determine the value of "D" for the application.
3. Find the value of "D" in the chart below. Follow the value of "D" vertically on the graph until it intersects with the axial thrust value of the cylinder. The intersection of these two values will fall within one of the shaded areas representing the piston rod diameter size required for the application.

Find the value of "D" for your application
 D = Stroke, adjusted for mounting condition
 S = Actual cylinder stroke
 T = Axial thrust (refer to Chart 3)

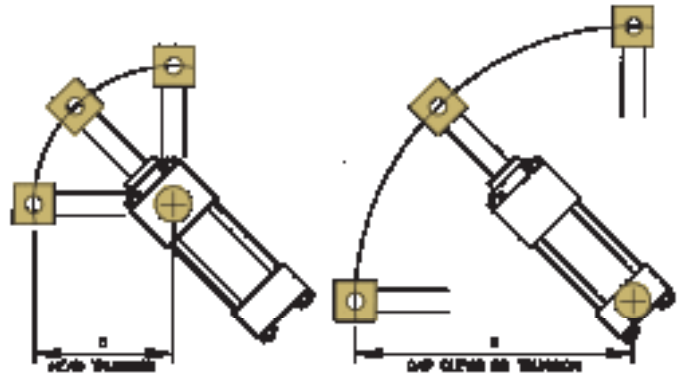
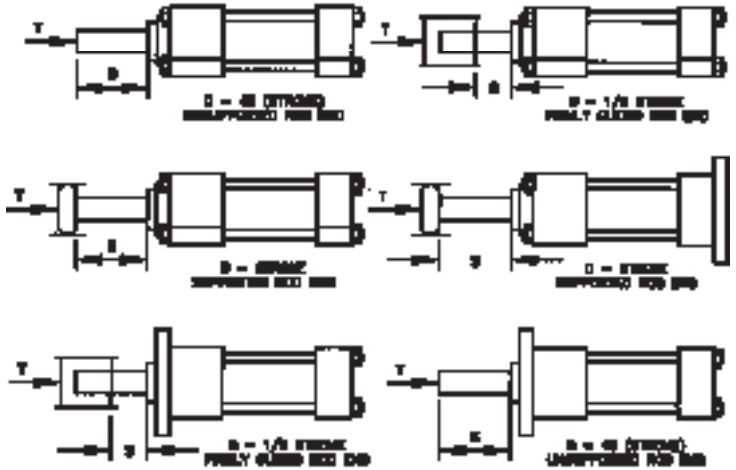

Note: Measure "D" when cylinder is fully extended.

Chart 3 (Piston Rod Diameter Selection)

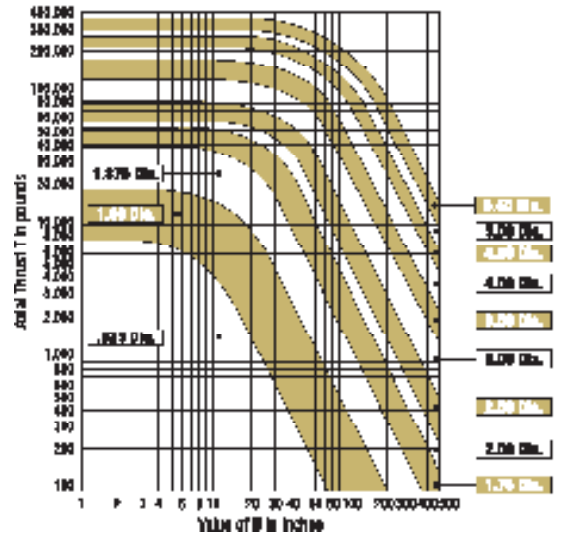



3P Three-Position Cylinder

You can create a 3-Position cylinder from two of the same bore size cylinders.

3-Position cylinders consist of multiple cylinders built as one unit having one exposed working rod end, capable of delivering three rod positions.

3-POSITIONS IN ONE CYLINDER — One cylinder produces three different rod end positions. By varying stroke lengths, a multitude of positions can be created.

SIMPLIFIES MACHINE DESIGNS — Eliminates the need for an additional cylinder to create a third position. 3-Position cylinders reduce space and the cost to mount multiple cylinders.

Note: Piston rods are not connected.

BTB Back-To-Back Cylinders

Back-to-Back cylinders consist of two individual cylinders built as one unit. These cylinders can act as a four position cylinder.

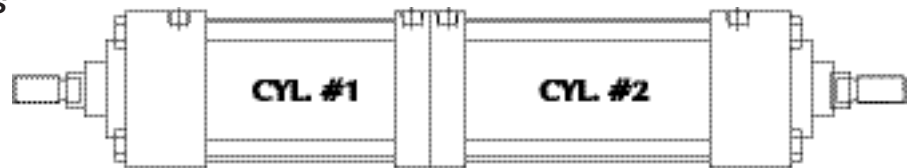

TM Tandem Cylinders

You can tandem different cylinders together to create unlimited design possibilities.

Note: Piston rods are connected.

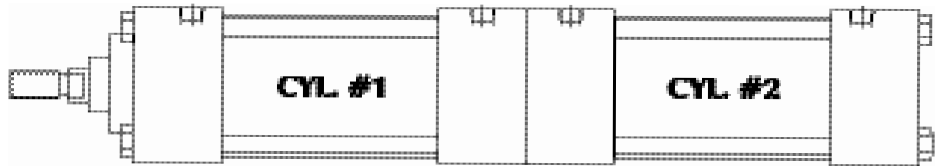

Special Finishes

Standard Finish: Black Urethane Paint (suitable for indoor or outdoor use).

Optional Paint: Black Epoxy Paint (suitable for indoor use only).

Additional Paint Choices: HYDRAULIC CYLINDERS INC.® can provide paint in any color or type.

Additional Finishes: HYDRAULIC CYLINDERS INC.® can provide special finishes, i.e. Nutride Plate Heavy Chrome Plated Piston Rods.

Rod Boots

Rod boots are common in dirty environments; a standard spec for many applications

(Note: Rod boots add length to cylinder rod extension).



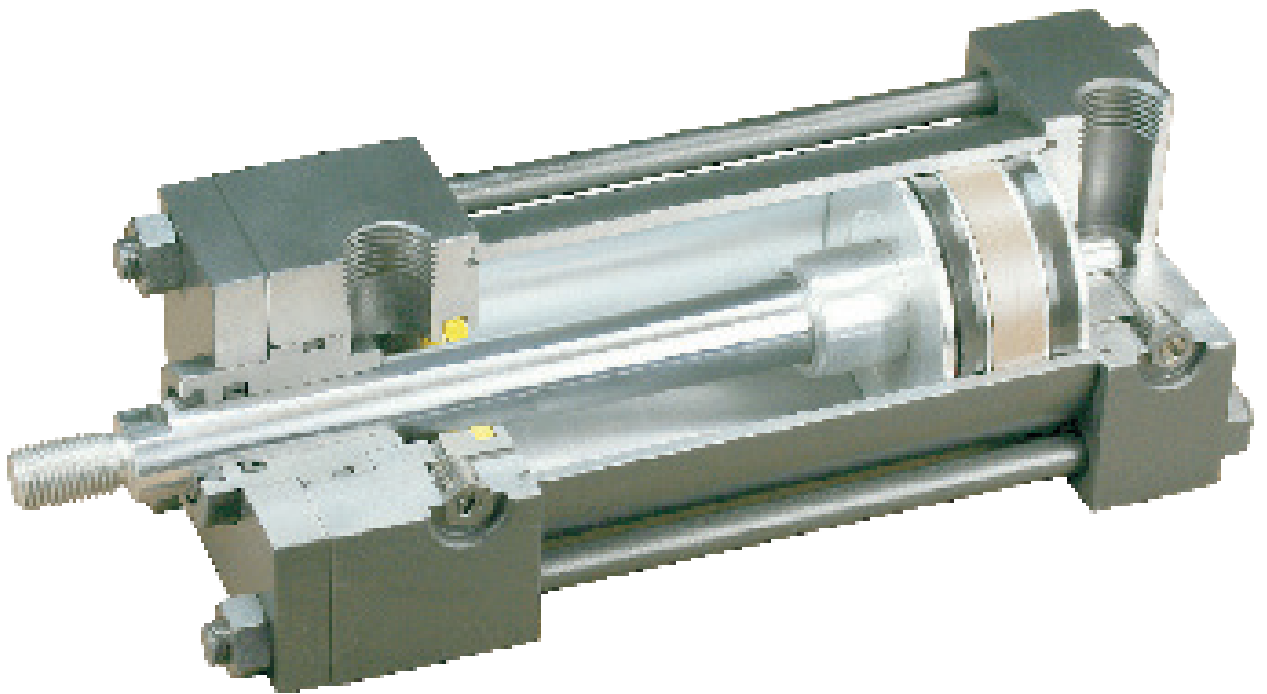

TS SERIES

HEAVY DUTY INDUSTRIAL PNEUMATICS | 1.50"–8.00" BORE

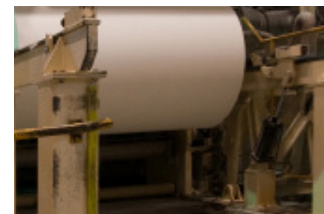
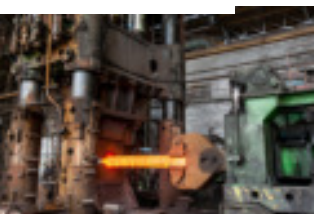

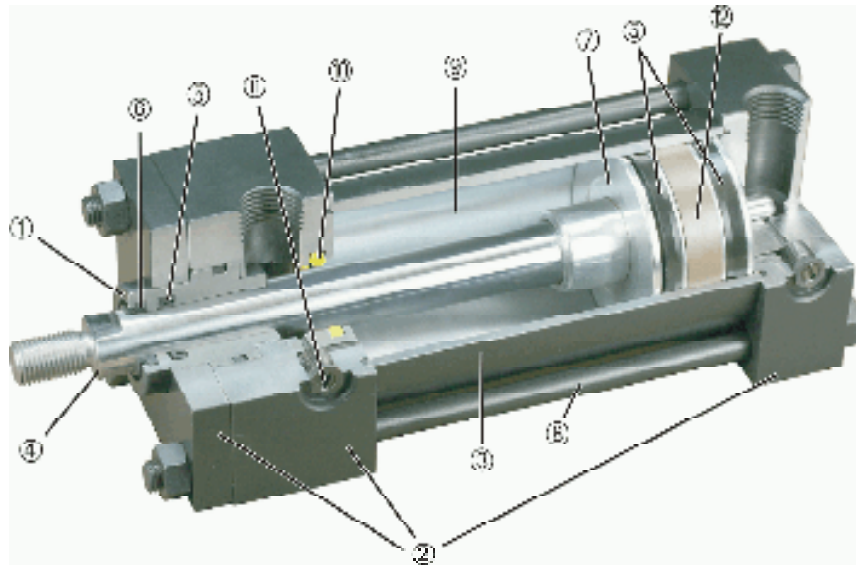

- ① – Precision machined from 150,000 PSI rated graphite filled cast iron and PTFE coated to reduce friction and extend cycle life. Bushing design traps lubrication in effective bearing area.
- ② – Precision machined steel head, cap and retainer are held to close tolerances and insure accurate alignment for a truly square cylinder.
- ③ – Precision machined steel tube with hard chrome I.D., is honed and micro finished for extended seal life and improved cycle rates.
- ④ – Precision machined from high yield, polished and hard chrome plated steel.
- ⑤ – Heavy lip design Carboxilated Nitrile construction. Seals are pressure activated and wear compensating for long life (self-lubricating material).
- ⑥ – Abrasion resistant urethane provides aggressive wiping action in all environments. External lip design prevents debris from entering cylinder.
- ⑦ – Precision machined from 6061-T651 alloy aluminum, provides an excellent bearing surface for extended cylinder life.

- ⑧ – Pre-stressed high carbon steel tie rod construction eliminates axial loading of cylinder tube and maintains compression on tube and end seals.
- ⑨ – Permanently lubricated with Magnalube-G PTFE based grease on all internal components. This is a non-migratory type high performance grease providing outstanding service life. No additional lubrication is required.
- ⑩ – (Options H & C) Floating cushion seal designed for maximum cushion performance, quick return stroke break-away and extended life.
- ⑪ – Adjustable steel needle design has fine thread metering and is positively captured to prevent needle ejection during adjustment.
- ⑫ – 90% Virgin PTFE and 10% Polyphenylene Sulfide material provides extended life due to extremely low wear factor.
- Black urethane paint.

250 PSI AIR (17 BAR)

Standard Seals: -20°F to 200°F (-25°C to 90°C)
 Fluorocarbon: 0°F to 400°F (-20°C to 200°C)

SERIES 'TS' HEAVY DUTY PNEUMATIC CYLINDERS



HOW TO ORDER

TS	-	MS2	-	2.00	x	15	-	HC	-	A=3 - KK10
<small>SERIES</small>		<small>NFPA MOUNTS</small>	<small>STYLE</small>	<small>BORE</small>		<small>STROKE</small>		<small>CUSHIONS</small>		<small>VARIATIONS</small>

SERIES	
TS	HEAVY DUTY PNEUMATIC

STROKE
0" to 120" MADE TO ORDER (Use decimals for fractional strokes)

VARIATIONS	
A=	EXTENDED PISTON ROD THREAD (Example: A = 2")
AS=	ADJUSTABLE STROKE - RETRACT (SPECIFY LENGTH, Example: AS = 4")
A / O	AIR / OIL PISTON
B	0.250" URETHANE BUMPER BOTH ENDS
BC	0.250" URETHANE BUMPER CAP ONLY
BH	0.250" URETHANE BUMPER HEAD ONLY
BP	BUMPER PISTON SEALS (1.50" - 8" Bore)
BSP	BSP PORTS (SPECIFY SIZE, Example: BSP = .25")
C=	EXTENDED PISTON ROD (Example: IF C = 0.50", THEN 1" ROD EXTENSION IS C = 1.50")
KK2	LARGE MALE ROD THREAD
KK3	FEMALE ROD THREAD
KK3S	STUDDED PISTON ROD (KK3 with Stud, Loctite in place)
KK4	FULL DIAMETER MALE ROD THREAD
KK5	BLANK ROD END (NO THREADS, "A" = 0")
KK10	ROD COUPLER END
KKM	METRIC THREAD
KKX	NON-STANDARD THREAD
LF	LOW FRICTION SEALS
MA	MICRO-ADJUST (6" MAX. STROKE) Available on Double Rod End Models
MAB	MICRO-ADJUST WITH SOUND DAMPENING BUMPER (6" MAX. STROKE)
MS	METALLIC ROD SCRAPER (BRASS CONSTRUCTION)
NR	NON-ROTATING
OP	OPTIONAL PORT LOCATION (Example: Ports @ 3 & 7)
OS	OVERSIZE ROD DIAMETER (SPECIFY SIZE, Example: OS = 1.375")
SAE	SAE PORTS (SPECIFY SIZE, Example: SAE #10)
SSA	STAINLESS STEEL PISTON ROD, TIE RODS & NUTS, AND FASTENERS
SSC	STAINLESS STEEL CUSHION NEEDLES
SSF	STAINLESS STEEL FASTENERS
SSR	STAINLESS STEEL PISTON ROD
SST	STAINLESS STEEL TIE RODS & NUTS
ST=	STOP TUBE Specify length (in inches) Specify Stroke as ES (effective stroke) Example: TS-MS4-2x48ES-ST=3"
TH	400 PSI HYDRAULIC NON-SHOCK
VS	FLUOROCARBON SEALS
XX=	SPECIAL VARIATION (SPECIFY)

NFPA MOUNTS	
MX0	NO MOUNT (1.50" to 8.00" Bore)
MF1	HEAD RECTANGULAR FLANGE (1.50" to 6.00" Bore)
MF2	REAR FLANGE (1.50" to 6.00" Bore)
ME3	FRONT MOUNTING HOLES (8.00" Bore)
ME4	REAR MOUNTING HOLES (8.00" Bore)
MP1	REAR PIVOT CLEVIS (1.50" to 8.00" Bore)
MP2	REAR PIVOT CLEVIS (1.50" to 6.00" Bore)
MP4	REAR PIVOT EYE (1.50" to 6.00" Bore)
MS1	FRONT & REAR END ANGLE (1.50" to 8.00" Bore)
MS2	SIDE LUGS (1.50" to 8.00" Bore)
MS4	BOTTOM TAPPED HOLES (1.50" to 8.00" Bore)
MT1	FRONT TRUNNION (1.50" to 8.00" Bore)
MT2	REAR TRUNNION (1.50" to 8.00" Bore)
MT4	INTERMEDIATE TRUNNION (1.50" to 8.00" Bore)
MX1	EXTENDED TIE RODS - HEAD & CAP (1.50" to 8.00" Bore)
MX2	EXTENDED TIE RODS - CAP (1.50" to 8.00" Bore)
MX3	EXTENDED TIE RODS - HEAD (1.50" to 8.00" Bore)
SB	SPHERICAL BEARING CAP PIVOT (1.50" to 8.00" Bore)

CUSHIONS	
H	HEAD CUSHION STANDARD: POSITION 2 SPECIFY FOR: POSITIONS 1, 3 & 4
LH	LONG HEAD CUSHION STANDARD: POSITION 2 SPECIFY FOR: POSITIONS 1, 3 & 4
C	CAP CUSHION STANDARD: POSITION 6 SPECIFY FOR: POSITIONS 5, 7 & 8
LC	LONG CAP CUSHION STANDARD: POSITION 6 SPECIFY FOR: POSITIONS 5, 7 & 8
FCH	FIXED HEAD CUSHION NON-ADJUSTABLE
FCLH	FIXED LONG HEAD CUSHION NON-ADJUSTABLE
FCC	FIXED CAP CUSHION NON-ADJUSTABLE
FCLC	FIXED LONG CAP CUSHION NON-ADJUSTABLE
FC	FIXED HEAD & CAP CUSHION NON-ADJUSTABLE

STYLE	
(BLANK)	SINGLE ROD
D	DOUBLE ROD

BORE	
1.50	1.50" Bore
2.00	2.00" Bore
2.50	2.50" Bore
3.25	3.25" Bore
4.00	4.00" Bore
5.00	5.00" Bore
6.00	6.00" Bore
8.00	8.00" Bore

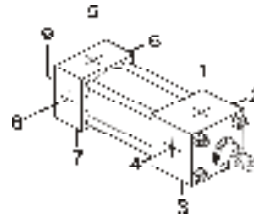

Location 9 is center of cap face.

*Note: Stop Tube length adds directly to the overall cylinder length.

VARIATIONS THAT ADD LENGTH (ADD TO CATALOG BASIC OVERALL LENGTH DIMENSIONS)				
BORE	VARIATIONS			
	B	BC	BH	ST* (STOP TUBE) Example: ST=2
1.50	0.500	0.250	0.250	2
2.00	0.500	0.250	0.250	2
2.50	0.500	0.250	0.250	2
3.25	0.500	0.250	0.250	2
4.00	0.500	0.250	0.250	2
5.00	0.500	0.250	0.250	2
6.00	0.500	0.250	0.250	2
8.00	0.500	0.250	0.250	2

SERIES 'TS' HEAVY DUTY PNEUMATIC CYLINDERS

NFPA MOUNTS



No Mount

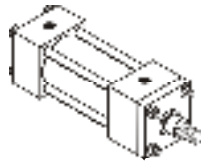

MX0 1.50"-8.00" Bores

Pivot Mounts

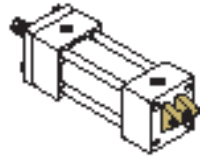

MP1 1.50"-8.00" Bores

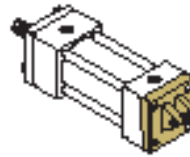

MP2 1.50"-6.00" Bores

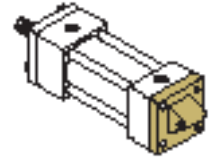

MP4 1.50"-6.00" Bores

Trunnion Mounts

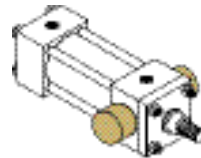

MT1 1.50"-8.00" Bores

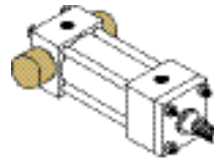

MT2 1.50"-8.00" Bores

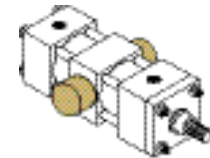

MT4 1.50"-8.00" Bores

Extended Tie Rod Mounts

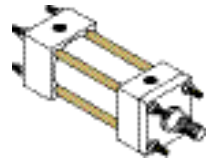

MX1 1.50"-8.00" Bores

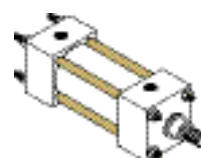

MX2 1.50"-8.00" Bores

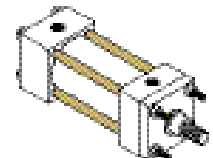

MX3 1.50"-8.00" Bores

Flange Mounts

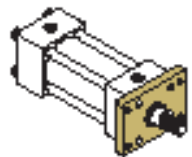

MF1 1.50"-6.00" Bores

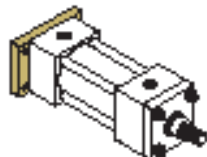

MF2 1.50"-6.00" Bores

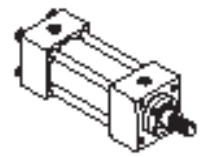

ME3 8.00" Bore

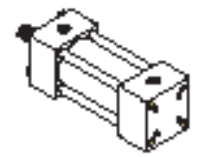

ME4 8.00" Bore

Lug Mounts

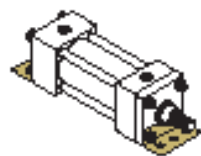

MS1 1.50"-8.00" Bores

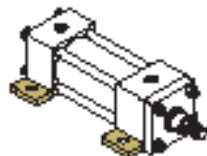

MS2 1.50"-8.00" Bores

All our cylinders are proudly Made in USA

SERIES 'TS' HEAVY DUTY PNEUMATIC CYLINDERS

NFPA MOUNTS & THREADS



Bottom Mounts

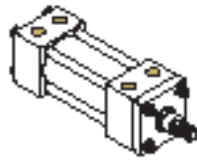

MS4 1.50"-8.00" Bores

Spherical Bearing Mount

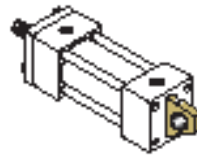

SB 1.50"-8.00" Bores

Threads

KK1
KK2

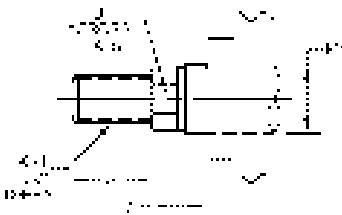

KK3

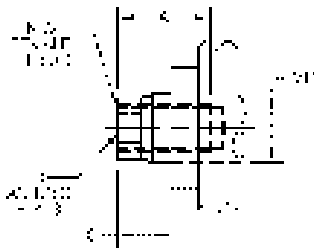

KK4

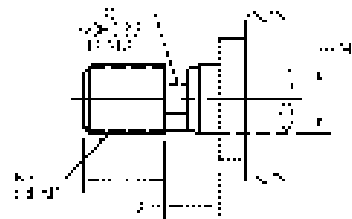

KK5

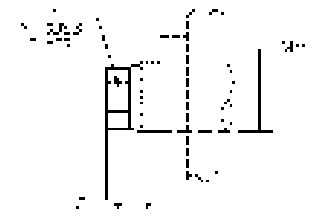

KK10

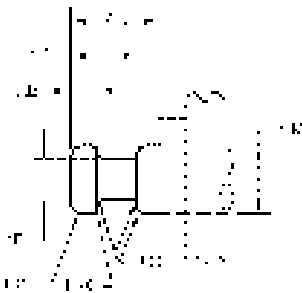

ROD DIA. (MM)	A	C	D	AC	AD	AE	AF	KK1	KK2	KK3	KK4
0.625	0.750	0.375	0.500	1.125	0.625	0.250	0.375	7/16 - 20	1/2 - 20	7/16 - 20	5/8 - 18
1.000	1.125	0.500	0.875	1.625	0.938	0.375	0.688	3/4 - 16	7/8 - 14	3/4 - 16	1 - 14
1.375	1.625	0.625	1.125	1.750	1.062	0.375	0.875	1 - 14	1 1/4 - 12	1 - 14	1 3/8 - 12
1.750	2.000	0.750	1.500	2.000	1.313	0.500	1.125	1 1/4 - 12	1 1/2 - 12	1 1/4 - 12	1 3/4 - 12

(4) Wrench flats is an option.

SERIES 'TS' HEAVY DUTY PNEUMATIC CYLINDERS

DIMENSIONS FOR BASIC CYLINDER - NO MOUNT

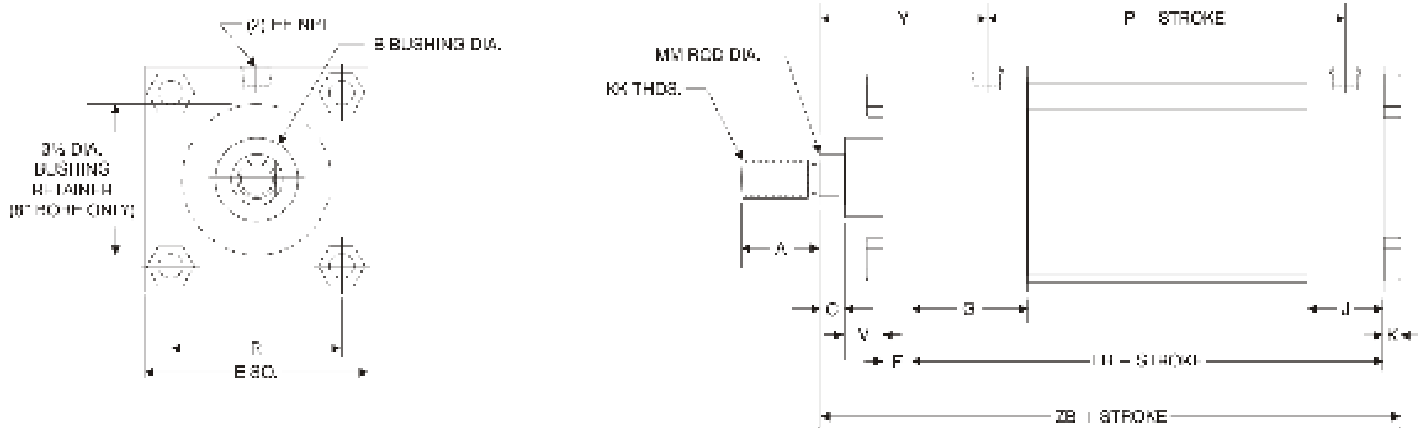

BORE	ROD DIA. (MM)	A	B	C	E	EE	F	G	J	K	KK	MM	R	V	Y	ADD TO STROKE		
																LB	P	ZB
1.50	0.625	0.750	1.125	0.375	2.000	0.375	0.375	1.500	1.000	0.250	7/16 - 20	0.625	1.438	0.250	1.875	3.625	2.375	4.875
1.50	1.000	1.125	1.500	0.500	2.000	0.375	0.375	1.500	1.000	0.250	3/4 - 16	1.000	1.438	0.500	2.250	3.625	2.375	5.250
2.00	0.625	0.750	1.125	0.375	2.500	0.375	0.375	1.500	1.000	0.313	7/16 - 20	0.625	1.844	0.250	1.875	3.625	2.375	4.938
2.00	1.000	1.125	1.500	0.500	2.500	0.375	0.375	1.500	1.000	0.313	3/4 - 16	1.000	1.844	0.500	2.250	3.625	2.375	5.313
2.50	0.625	0.750	1.125	0.375	3.000	0.375	0.375	1.500	1.000	0.313	7/16 - 20	0.625	2.188	0.250	1.875	3.750	2.500	5.063
2.50	1.000	1.125	1.500	0.500	3.000	0.375	0.375	1.500	1.000	0.313	3/4 - 16	1.000	2.188	0.500	2.250	3.750	2.500	5.438
3.25	1.000	1.125	1.500	0.500	3.750	0.500	0.625	1.750	1.250	0.375	3/4 - 16	1.000	2.766	0.250	2.375	4.250	2.750	6.000
3.25	1.375	1.625	2.000	0.625	3.750	0.500	0.625	1.750	1.250	0.375	1 - 14	1.375	2.766	0.375	2.625	4.250	2.750	6.250
4.00	1.000	1.125	1.500	0.500	4.500	0.500	0.625	1.750	1.250	0.375	3/4 - 16	1.000	3.328	0.250	2.375	4.250	2.750	6.000
4.00	1.375	1.625	2.000	0.625	4.500	0.500	0.625	1.750	1.250	0.375	1 - 14	1.375	3.328	0.375	2.625	4.250	2.750	6.250
5.00	1.000	1.125	1.500	0.500	5.500	0.500	0.625	1.750	1.250	0.438	3/4 - 16	1.000	4.109	0.250	2.375	4.500	3.000	6.313
5.00	1.375	1.625	2.000	0.625	5.500	0.500	0.625	1.750	1.250	0.438	1 - 14	1.375	4.109	0.375	2.625	4.500	3.000	6.563
6.00	1.375	1.625	2.000	0.625	6.500	0.750	0.750	2.000	1.500	0.438	1 - 14	1.375	4.875	0.250	2.750	5.000	3.250	7.063
6.00	1.750	2.000	2.375	0.750	6.500	0.750	0.750	2.000	1.500	0.438	1 1/4 - 12	1.750	4.875	0.375	3.000	5.000	3.250	7.313
8.00	1.375	1.625	2.000	0.625	8.500	0.750	0.625	2.000	1.500	0.563	1 - 14	1.375	6.438	0.375	2.750	5.125	3.375	7.313
8.00	1.750	2.000	2.375	0.750	8.500	0.750	0.625	2.000	1.500	0.563	1 1/4 - 12	1.750	6.438	0.500	3.000	5.125	3.375	7.563

All our cylinders are proudly Made in USA

SERIES 'TS' HEAVY DUTY PNEUMATIC CYLINDERS

DIMENSIONS FOR SB: SPHERICAL BEARING MOUNT

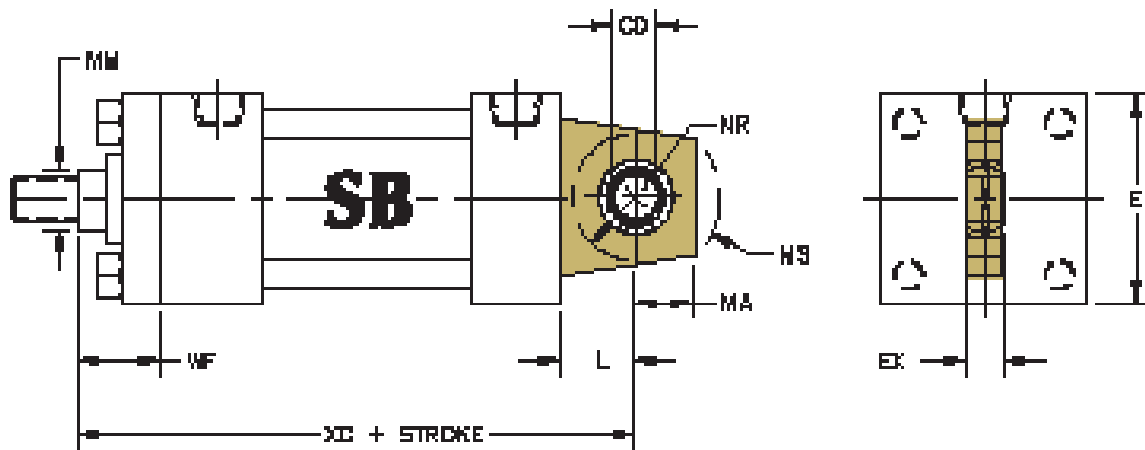

BORE	ROD DIA. (MM)	CD	E	EX	L	MA	MS	NR	WF	ADD TO STROKE
										XC
1.50	0.625	0.500	2.000	0.437	0.750	0.750	0.938	0.625	1.000	5.375
1.50	1.000	0.500	2.000	0.437	0.750	0.750	0.938	0.625	1.375	5.750
2.00	0.625	0.500	2.500	0.437	0.750	0.750	0.938	0.625	1.000	5.375
2.00	1.000	0.500	2.500	0.437	0.750	0.750	0.938	0.625	1.375	5.750
2.50	0.625	0.500	3.000	0.437	0.750	0.750	0.938	0.625	1.000	5.500
2.50	1.000	0.500	3.000	0.437	0.750	0.750	0.938	0.625	1.375	5.875
3.25	1.000	0.750	3.750	0.656	1.250	1.000	1.375	1.000	1.375	6.875
3.25	1.375	0.750	3.750	0.656	1.250	1.000	1.375	1.000	1.625	7.125
4.00	1.000	0.750	4.500	0.656	1.250	1.000	1.375	1.000	1.375	6.875
4.00	1.375	0.750	4.500	0.656	1.250	1.000	1.375	1.000	1.625	7.125
5.00	1.000	0.750	5.500	0.656	1.250	1.000	1.375	1.000	1.375	7.125
5.00	1.375	0.750	5.500	0.656	1.250	1.000	1.375	1.000	1.625	7.375
6.00	1.375	1.000	6.500	0.875	1.500	1.250	1.688	1.250	1.625	8.125
6.00	1.750	1.000	6.500	0.875	1.500	1.250	1.688	1.250	1.875	8.375
8.00	1.375	1.000	8.500	0.875	1.500	1.250	1.688	1.250	1.625	8.250
8.00	1.750	1.000	8.500	0.875	1.500	1.250	1.688	1.250	1.875	8.500

Notes: Pivot pin included with cylinder cap end only; 3.25"- 8.00" bores have tie rod nuts exposed on cap end.

8.00" bore utilizes round retainer.

Must specify KK3 rod end if to be used with "MSRE" rod eye.

SERIES 'TS' HEAVY DUTY PNEUMATIC CYLINDERS

DIMENSIONS FOR PIVOT MOUNTS



**WELDED
MP1
MOUNT**

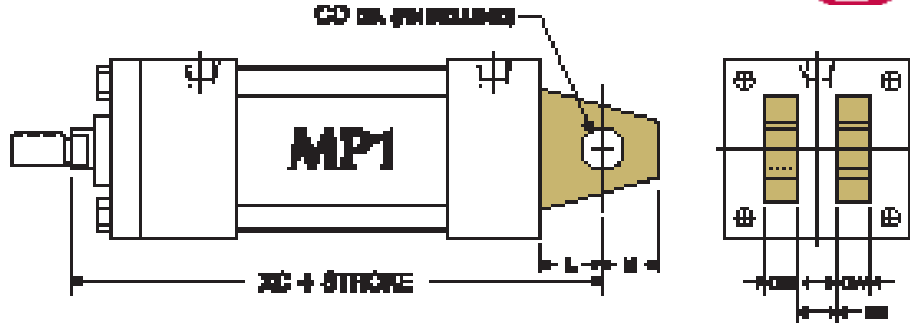

**IRON
CASTING
MP1
MOUNT
(OPTIONAL)**

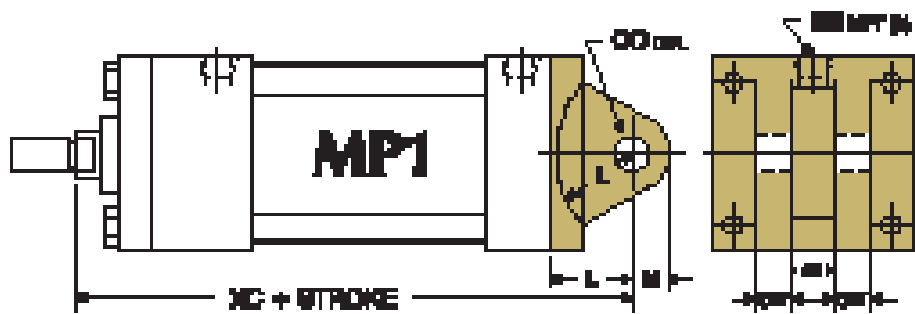

**MP2
MOUNT
(IRON CASTING)**

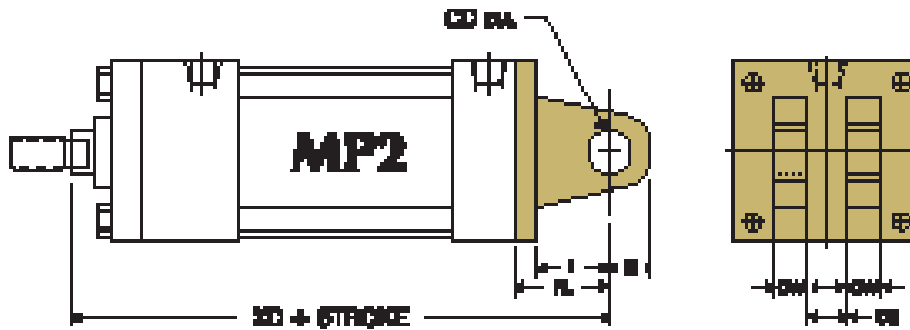

**MP4
MOUNT
(IRON CASTING:
1.50" - 4" BORES,
WELDMENT:
5" - 6" BORES)**

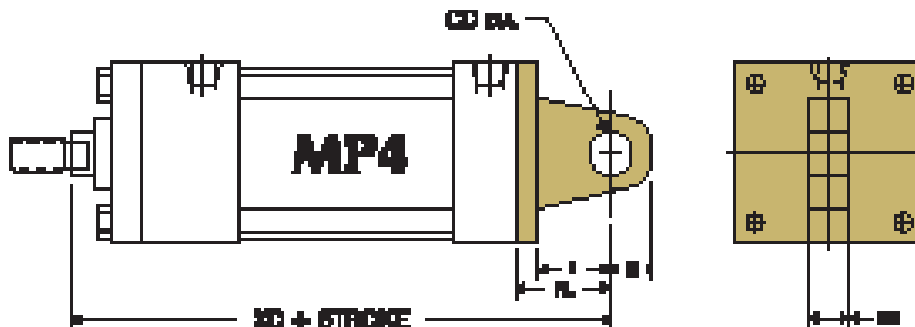

All our cylinders are proudly Made in USA

SERIES 'TS' HEAVY DUTY PNEUMATIC CYLINDERS

DIMENSIONS FOR PIVOT MOUNTS



BORE	ROD DIA. (MM)	CB	CD	CW	FL	L	M	XC	XD
1.50	0.625	0.750	0.500	0.500	1.125	0.750	0.625	5.375	5.750
1.50	1.000	0.750	0.500	0.500	1.125	0.750	0.625	5.750	6.125
2.00	0.625	0.750	0.500	0.500	1.125	0.750	0.625	5.375	5.750
2.00	1.000	0.750	0.500	0.500	1.125	0.750	0.625	5.750	6.125
2.50	0.625	0.750	0.500	0.500	1.125	0.750	0.625	5.500	5.875
2.50	1.000	0.750	0.500	0.500	1.125	0.750	0.625	5.875	6.250
3.25	1.000	1.250	0.750	0.625	1.875	1.250	0.875	6.875	7.500
3.25	1.375	1.250	0.750	0.625	1.875	1.250	0.875	7.125	7.750
4.00	1.000	1.250	0.750	0.625	1.875	1.250	0.875	6.875	7.500
4.00	1.375	1.250	0.750	0.625	1.875	1.250	0.875	7.125	7.750
5.00	1.000	1.250	0.750	0.625	1.875	1.250	0.875	7.125	7.750
5.00	1.375	1.250	0.750	0.625	1.875	1.250	0.875	7.375	8.000
6.00	1.375	1.500	1.000	0.750	2.250	1.500	1.000	8.125	8.875
6.00	1.750	1.500	1.000	0.750	2.250	1.500	1.000	8.375	9.125
8.00	1.375	1.500	1.000	0.750	N/A	1.500	1.000	8.250	N/A
8.00	1.750	1.500	1.000	0.750	N/A	1.500	1.000	8.500	N/A

Clevis pins are provided with pivot mounts.
 *MP4 5.00"-6.00" bores are 3-5 day delivery.
 For dimensions not shown, see page 92.

Cast Iron removable mounts are optional and must be requested when ordering (1.50"-6.00" bores).
 Specify "CAST MP1" when ordering.

ACCESSORIES (SEE PAGES 122-125 FOR DIMENSIONS)						
BORE	ROD DIA. (MM)	ROD CLEVIS	ROD EYE	CLEVIS PIN	EYE BRACKET (FOR MP1)	CLEVIS BRACKET (FOR MP4)
1.50	0.625	RC437	RE437	CP500	EB500	CB500
1.50	1.000	RC750	RE750	CP750	EB500	CB500
2.00	0.625	RC437	RE437	CP500	EB500	CB500
2.00	1.000	RC750	RE750	CP750	EB500	CB500
2.50	0.625	RC437	RE437	CP500	EB500	CB500
2.50	1.000	RC750	RE750	CP750	EB500	CB500
3.25	1.000	RC750	RE750	CP750	EB750	CB750
3.25	1.375	RC1000	RE1000	CP1000	EB750	CB750
4.00	1.000	RC750	RE750	CP750	EB750	CB750
4.00	1.375	RC1000	RE1000	CP1000	EB750	CB750
5.00	1.000	RC750	RE750	CP750	EB750	CB750
5.00	1.375	RC1000	RE1000	CP1000	EB750	CB750
6.00	1.375	RC1000	RE1000	CP1000	EB1000	CB1000
6.00	1.750	RC1250	RE1250	CP1375	EB1000	CB1000
8.00	1.375	RC1000	RE1000	CP1000	EB1000	CB1000
8.00	1.750	RC1250	RE1250	CP1375	EB1000	CB1000

All our cylinders are proudly Made in USA

SERIES 'TS' HEAVY DUTY PNEUMATIC CYLINDERS

DIMENSIONS FOR TRUNNION MOUNTS

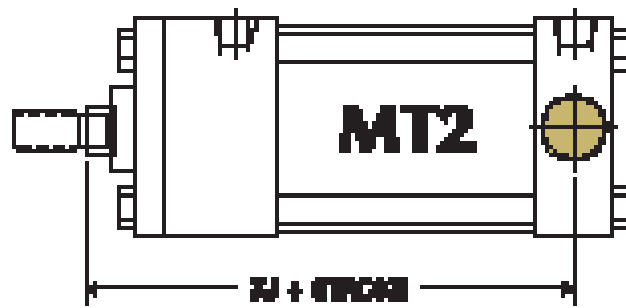
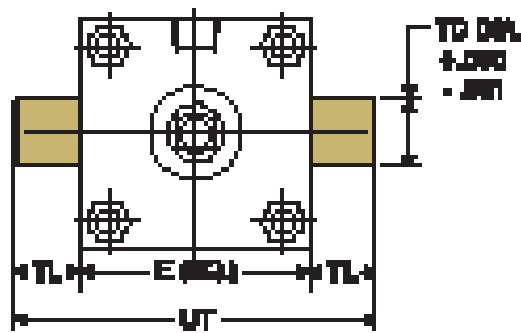
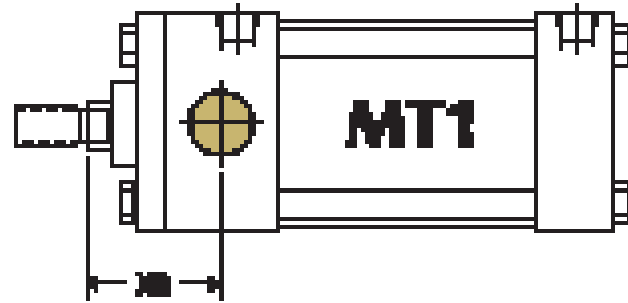
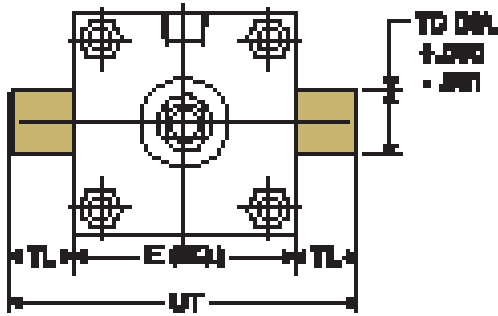

Note: MT1 and MT2 Trunnions are one-piece solid steel construction.

BORE	ROD DIA. (MM)	E	TD	TL	UT	XG	ADD TO STROKE
							XJ
1.50	0.625	2.000	1.000	1.000	4.000	1.750	4.125
1.50	1.000	2.000	1.000	1.000	4.000	N/A*	4.500
2.00	0.625	2.500	1.000	1.000	4.500	1.750	4.125
2.00	1.000	2.500	1.000	1.000	4.500	2.125	4.500
2.50	0.625	3.000	1.000	1.000	5.000	1.750	4.250
2.50	1.000	3.000	1.000	1.000	5.000	2.125	4.625
3.25	1.000	3.750	1.000	1.000	5.750	2.250	5.000
3.25	1.375	3.750	1.000	1.000	5.750	2.500	5.250
4.00	1.000	4.500	1.000	1.000	6.500	2.250	5.000
4.00	1.375	4.500	1.000	1.000	6.500	2.500	5.250
5.00	1.000	5.500	1.000	1.000	7.500	2.250	5.250
5.00	1.375	5.500	1.000	1.000	7.500	2.500	5.500
6.00	1.375	6.500	1.375	1.375	9.250	2.625	5.875
6.00	1.750	6.500	1.375	1.375	9.250	2.875	6.125
8.00	1.375	8.500	1.375	1.375	11.250	2.625	6.000
8.00	1.750	8.500	1.375	1.375	11.250	2.875	6.250

*No oversize rod available on 1.50" bore MT1.
For dimensions not shown, see page 92.

SERIES 'TS' HEAVY DUTY PNEUMATIC CYLINDERS

DIMENSIONS FOR TRUNNION MOUNTS



MT4

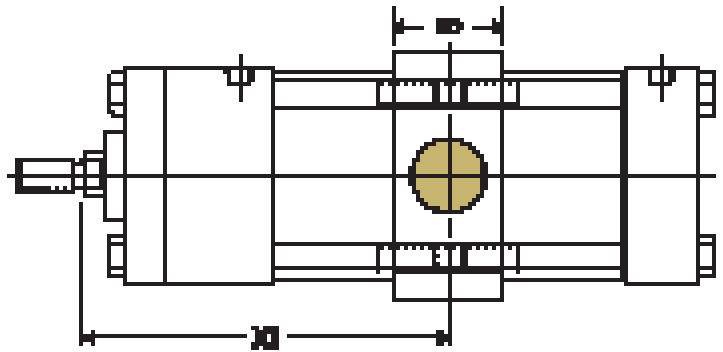
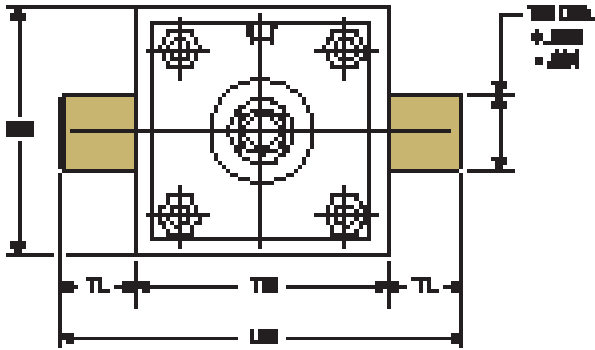

(Customer to Specify)

Example: TM - MT4 4 X 12 - XI = 6"

Note: MT4 Trunnions and Intermediate Section are one-piece solid steel construction.

BORE	BD	EB	TD	TL	TM	UM	XI
1.50	1.250	2.500	1.000	1.000	2.500	4.500	CUSTOMER TO SPECIFY
2.00	1.500	3.000	1.000	1.000	3.000	5.000	
2.50	1.500	3.500	1.000	1.000	3.500	5.500	
3.25	2.000	4.250	1.000	1.000	4.500	6.500	
4.00	2.000	5.000	1.000	1.000	5.250	7.250	
5.00	2.000	6.000	1.000	1.000	6.250	8.250	
6.00	2.000	7.000	1.375	1.375	7.625	10.375	
8.00	2.500	9.500	1.375	1.375	9.750	12.500	

'MT1', 'MT2', 'MT4' STANDARD CUSHION LOCATIONS		
MOUNT	HEAD CUSHION	CAP CUSHION
MT1	3	6
MT2	2	7
MT4	2	6

Note: Ports or cushions cannot be on same side as MT1 & MT2 Trunnions.

ACCESSORIES (SEE PAGES 122-125 FOR DIMENSIONS)				
BORE	ROD DIA. (MM)	ROD CLEVIS	ROD EYE	CLEVIS PIN
1.50	0.625	RC437	RE437	CP500
1.50	1.000	RC750	RE750	CP750
2.00	0.625	RC437	RE437	CP500
2.00	1.000	RC750	RE750	CP750
2.50	0.625	RC437	RE437	CP500
2.50	1.000	RC750	RE750	CP750
3.25	1.000	RC750	RE750	CP750
3.25	1.375	RC1000	RE1000	CP1000
4.00	1.000	RC750	RE750	CP750
4.00	1.375	RC1000	RE1000	CP1000
5.00	1.000	RC750	RE750	CP750
5.00	1.375	RC1000	RE1000	CP1000
6.00	1.375	RC1000	RE1000	CP1000
6.00	1.750	RC1250	RE1250	CP1375
8.00	1.375	RC1000	RE1000	CP1000
8.00	1.750	RC1250	RE1250	CP1375

All our cylinders are proudly Made in USA

SERIES 'TS' HEAVY DUTY PNEUMATIC CYLINDERS

DIMENSIONS FOR TIE ROD MOUNTS

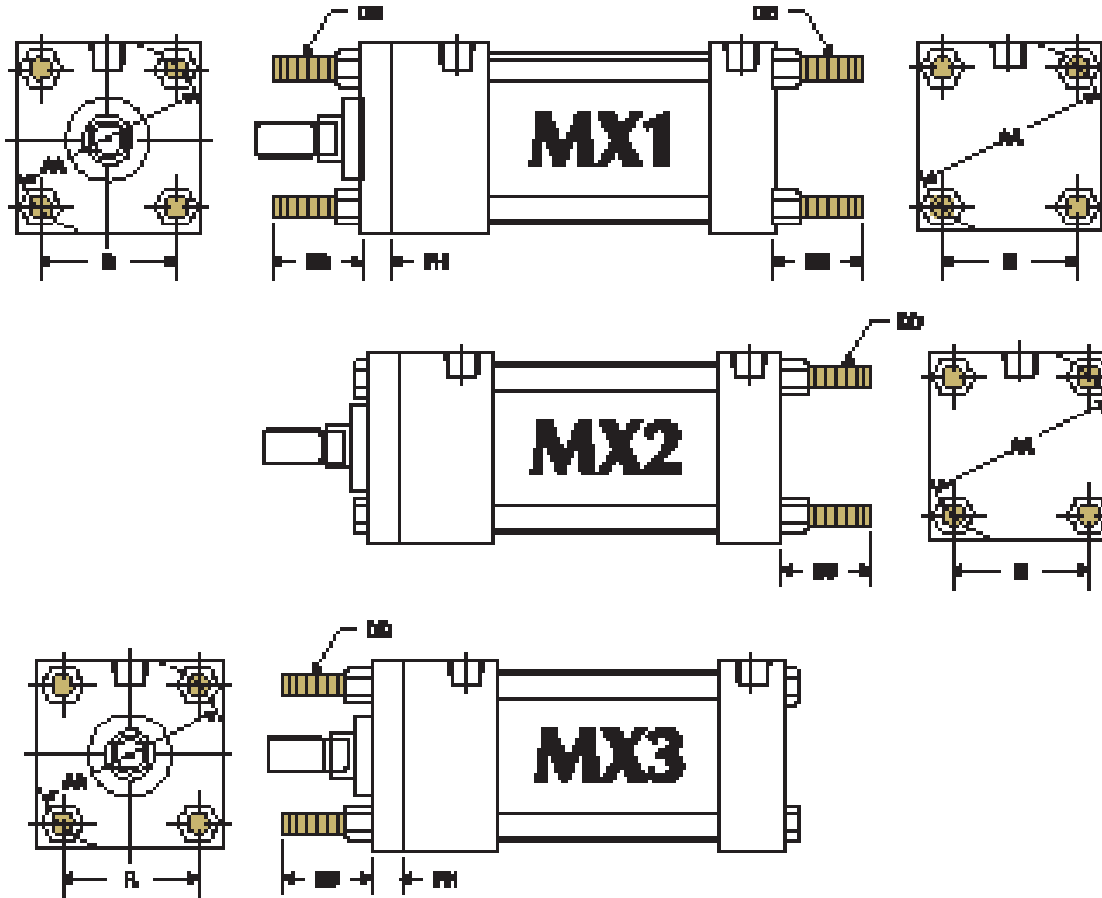

BORE	ROD DIA. (MM)	AA	BB	DD	FH	R
1.50	0.625	2.020	1.000	1/4 - 28	0.375	1.438
1.50	1.000	2.020	1.000	1/4 - 28	0.375	1.438
2.00	0.625	2.600	1.125	5/16 - 24	0.375	1.844
2.00	1.000	2.600	1.125	5/16 - 24	0.375	1.844
2.50	0.625	3.100	1.125	5/16 - 24	0.375	2.188
2.50	1.000	3.100	1.125	5/16 - 24	0.375	2.188
3.25	1.000	3.900	1.375	3/8 - 24	0.625	2.766
3.25	1.375	3.900	1.375	3/8 - 24	0.625	2.766
4.00	1.000	4.700	1.375	3/8 - 24	0.625	3.328
4.00	1.375	4.700	1.375	3/8 - 24	0.625	3.328
5.00	1.000	5.800	1.813	1/2 - 20	0.625	4.109
5.00	1.375	5.800	1.813	1/2 - 20	0.625	4.109
6.00	1.375	6.900	1.813	1/2 - 20	0.750	4.875
6.00	1.750	6.900	1.813	1/2 - 20	0.750	4.875
8.00	1.375	9.100	**2.313	5/8 - 18	*0.625	6.438
8.00	1.750	9.100	**2.313	5/8 - 18	*0.625	6.438

*8.00" bore utilizes a 3.50" diameter round retainer.

**BB dimension from face of head.

For dimensions not shown, see page 92.

All our cylinders are proudly Made in USA

SERIES 'TS' HEAVY DUTY PNEUMATIC CYLINDERS

DIMENSIONS FOR FLANGE MOUNTS

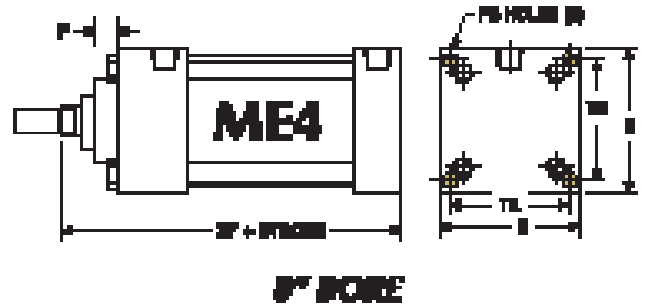
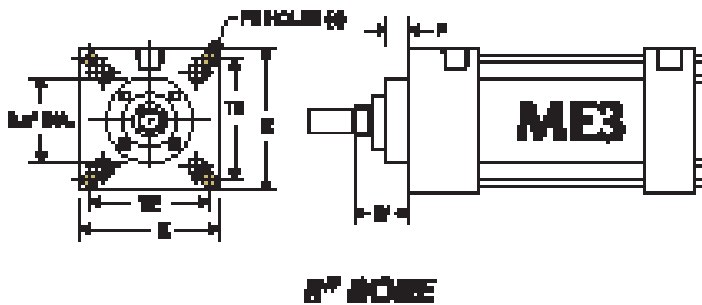
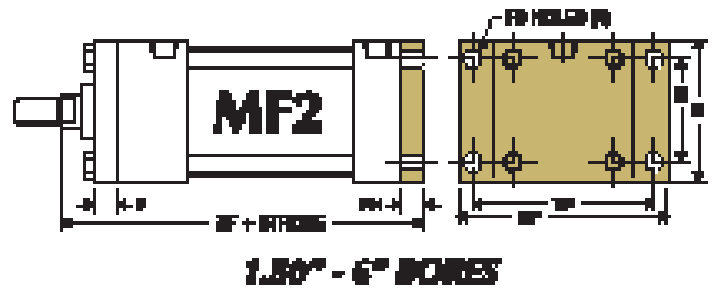
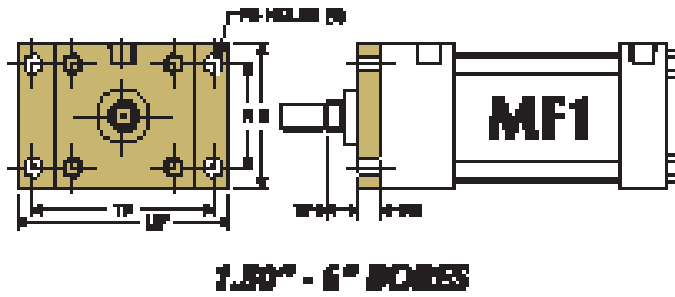

BORE	ROD DIA. (MM)	E	F	FB	FH	R	TE	TF	UF	W	ADD TO STROKE
											ZF
1.50	0.625	2.000	0.375	0.313	0.375	1.438	—	2.750	3.375	0.625	5.000
1.50	1.000	2.000	0.375	0.313	0.375	1.438	—	2.750	3.375	1.000	5.375
2.00	0.625	2.500	0.375	0.375	0.375	1.840	—	3.375	4.125	0.625	5.000
2.00	1.000	2.500	0.375	0.375	0.375	1.840	—	3.375	4.125	1.000	5.375
2.50	0.625	3.000	0.375	0.375	0.375	2.188	—	3.875	4.625	0.625	5.125
2.50	1.000	3.000	0.375	0.375	0.375	2.188	—	3.875	4.625	1.000	5.500
3.25	1.000	3.750	0.625	0.438	0.625	2.760	—	4.688	5.500	0.750	6.250
3.25	1.375	3.750	0.625	0.438	0.625	2.760	—	4.688	5.500	1.000	6.500
4.00	1.000	4.500	0.625	0.438	0.625	3.313	—	5.438	6.250	0.750	6.250
4.00	1.375	4.500	0.625	0.438	0.625	3.313	—	5.438	6.250	1.000	6.500
5.00	1.000	5.500	0.625	0.563	0.625	4.125	—	6.625	7.625	0.750	6.500
5.00	1.375	5.500	0.625	0.563	0.625	4.125	—	6.625	7.625	1.000	6.750
6.00	1.375	6.500	0.625	0.563	0.750	4.875	—	7.625	8.625	0.875	7.375
6.00	1.750	6.500	0.625	0.563	0.750	4.875	—	7.625	8.625	1.125	7.625
8.00	1.375	8.500	0.625	0.688	N/A	N/A	7.570	N/A	N/A	1.625	6.750
8.00	1.750	8.500	0.625	0.688	N/A	N/A	7.570	N/A	N/A	1.875	7.000

For dimensions not shown, see page 92.

All our cylinders are proudly Made in USA

SERIES 'TS' HEAVY DUTY PNEUMATIC CYLINDERS

DIMENSIONS FOR MS1: BASE MOUNTS

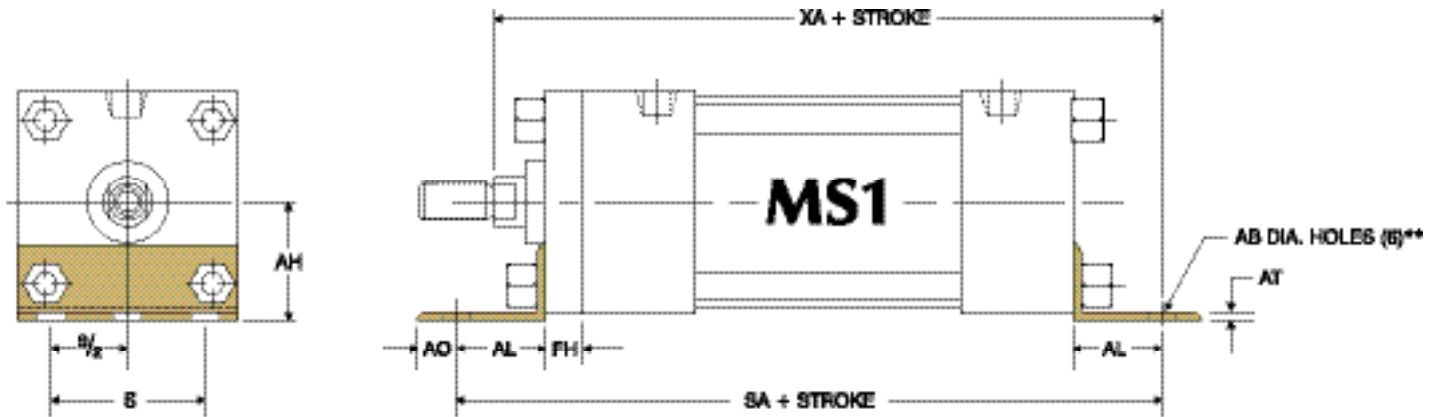

BORE	ROD DIA. (MM)	AB	AH	AL	AO	AT	FH	S	ADD TO STROKE	
									SA	XA
1.50	0.625	0.438	1.188	1.000	0.375	0.188	0.375	1.250	6.000	5.625
1.50	1.000	0.438	1.188	1.000	0.375	0.188	0.375	1.250	6.000	6.000
2.00	0.625	0.438	1.438	1.000	0.375	0.188	0.375	1.750	6.000	5.625
2.00	1.000	0.438	1.438	1.000	0.375	0.188	0.375	1.750	6.000	6.000
2.50	0.625	0.438	1.625	1.000	0.375	0.188	0.375	2.250	6.125	5.750
2.50	1.000	0.438	1.625	1.000	0.375	0.188	0.375	2.250	6.125	6.125
3.25	1.000	0.563	1.938	1.250	0.500	0.125	0.625	2.750	7.375	6.875
3.25	1.375	0.563	1.938	1.250	0.500	0.125	0.625	2.750	7.375	7.125
4.00	1.000	0.563	2.250	1.250	0.500	0.125	0.625	3.500	7.375	6.875
4.00	1.375	0.563	2.250	1.250	0.500	0.125	0.625	3.500	7.375	7.125
5.00	1.000	0.688	2.750	1.375	0.625	0.188	0.625	4.250	7.875	7.250
5.00	1.375	0.688	2.750	1.375	0.625	0.188	0.625	4.250	7.875	7.500
6.00	1.375	0.813	3.250	1.375	0.625	0.188	0.750	5.250	8.500	8.000
6.00	1.750	0.813	3.250	1.375	0.625	0.188	0.750	5.250	8.500	8.250
8.00	1.375	0.813	4.250	1.813	0.688	0.250	*0.625	7.125	8.750	8.563
8.00	1.750	0.813	4.250	1.813	0.688	0.250	*0.625	7.125	8.750	8.813

*8.00" bore utilizes a round retainer.
 Note: 1.50" bore has (4) AB diameter holes.

All our cylinders are proudly Made in USA

SERIES 'TS' HEAVY DUTY PNEUMATIC CYLINDERS

DIMENSIONS FOR MS4: BASE MOUNTS

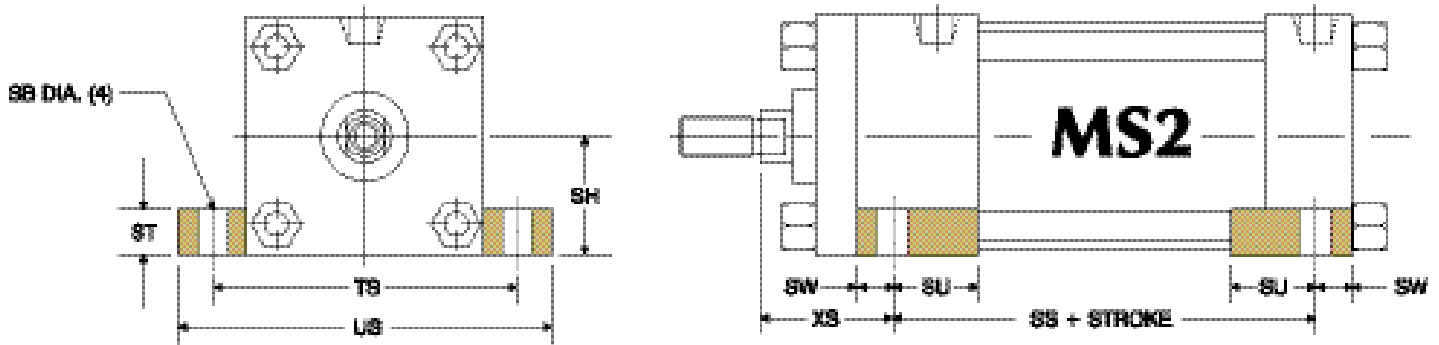

BORE	ROD DIA. (MM)	SB	SH	ST	SU	SW	TS	US	XS	ADD TO STROKE
										SS
1.50	0.625	0.438	1.000	0.500	1.125	0.375	2.750	3.500	1.375	2.875
1.50	1.000	0.438	1.000	0.500	1.125	0.375	2.750	3.500	1.750	2.875
2.00	0.625	0.438	1.250	0.500	1.125	0.375	3.250	4.000	1.375	2.875
2.00	1.000	0.438	1.250	0.500	1.125	0.375	3.250	4.000	1.750	2.875
2.50	0.625	0.438	1.500	0.500	1.125	0.375	3.750	4.500	1.375	3.000
2.50	1.000	0.438	1.500	0.500	1.125	0.375	3.750	4.500	1.750	3.000
3.25	1.000	0.563	1.875	0.750	1.250	0.500	4.750	5.750	1.875	3.250
3.25	1.375	0.563	1.875	0.750	1.250	0.500	4.750	5.750	2.125	3.250
4.00	1.000	0.563	2.250	0.750	1.250	0.500	5.500	6.500	1.875	3.250
4.00	1.375	0.563	2.250	0.750	1.250	0.500	5.500	6.500	2.125	3.250
5.00	1.000	0.813	2.750	1.000	1.063	0.688	6.875	8.250	2.063	3.125
5.00	1.375	0.813	2.750	1.000	1.063	0.688	6.875	8.250	2.313	3.125
6.00	1.375	0.813	3.250	1.000	1.313	0.688	7.875	9.250	2.313	3.625
6.00	1.750	0.813	3.250	1.000	1.313	0.688	7.875	9.250	2.563	3.625
8.00*	1.375	0.813	4.250	1.000	1.313	0.688	9.875	11.250	2.313	3.750
8.00*	1.750	0.813	4.250	1.000	1.313	0.688	9.875	11.250	2.563	3.750

*8.00" bore utilizes a round retainer.
For dimensions not shown, see page 92.

SERIES 'TS' HEAVY DUTY PNEUMATIC CYLINDERS

DIMENSIONS FOR MS4: BASE MOUNTS

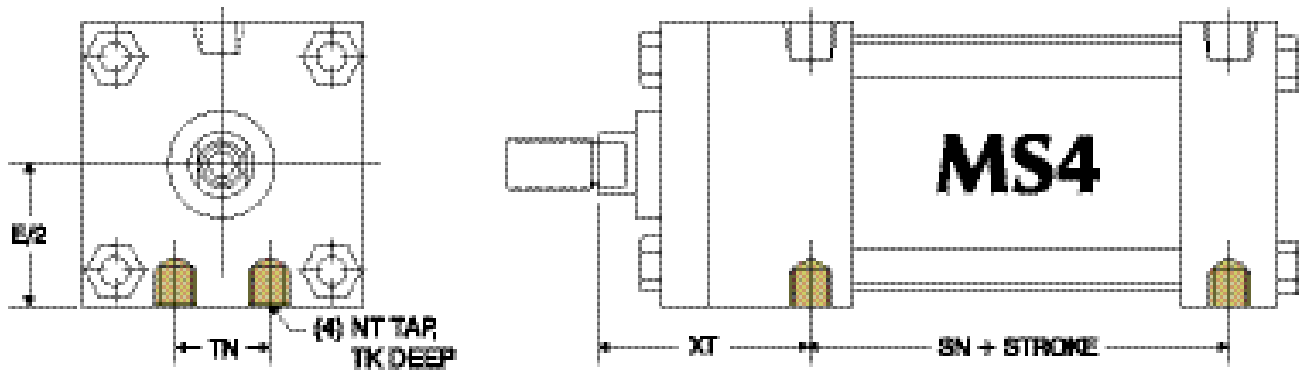

BORE	ROD DIA. (MM)	E/2	NT	TK	TN	XT	ADD TO STROKE
							SN
1.50	0.625	1.000	1/4 - 20	0.375	0.625	1.938	2.250
1.50	1.000	1.000	1/4 - 20	0.375	0.625	2.313	2.250
2.00	0.625	1.250	5/16 - 18	0.500	0.875	1.938	2.250
2.00	1.000	1.250	5/16 - 18	0.500	0.875	2.313	2.250
2.50	0.625	1.500	3/8 - 16	0.625	1.250	1.938	2.375
2.50	1.000	1.500	3/8 - 16	0.625	1.250	2.313	2.375
3.25	1.000	1.875	1/2 - 13	0.750	1.500	2.438	2.625
3.25	1.375	1.875	1/2 - 13	0.750	1.500	2.688	2.625
4.00	1.000	2.250	1/2 - 13	0.750	2.063	2.438	2.625
4.00	1.375	2.250	1/2 - 13	0.750	2.063	2.688	2.625
5.00	1.000	2.750	5/8 - 11	1.000	2.688	2.438	2.875
5.00	1.375	2.750	5/8 - 11	1.000	2.688	2.688	2.875
6.00	1.375	3.250	3/4 - 10	1.125	3.250	2.813	3.125
6.00	1.750	3.250	3/4 - 10	1.125	3.250	3.063	3.125
8.00	1.375	4.250	3/4 - 10	1.125	4.500	2.813	3.250
8.00	1.750	4.250	3/4 - 10	1.125	4.500	3.063	3.250

For dimensions not shown, see page 92.

All our cylinders are proudly Made in USA



Standard and oversize piston rods available.

Full range of standard options.

Durable design. Full rod bearing at each end of cylinder.

Can be provided with hollow piston rods (gun-drilled through, to your size requirements).

Can be used in adjustable extend stroke applications (by adding a stop collar on one rod end, or option 'MA' - Refer to page 114).

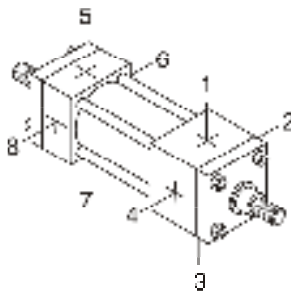

STANDARD PORT AND CUSHION ADJUSTMENT POSITIONS

Ports - Positions 1 and 5

Cushion Adjustment - Positions 2 and 6

Specify Non-Standard Positions When Ordering

Threads

**KK1
KK2**

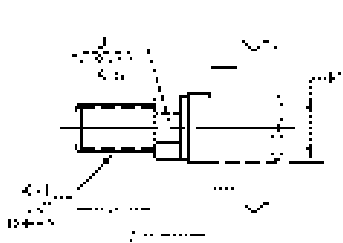

KK3

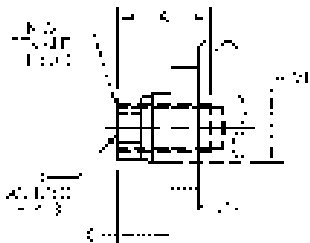

KK4

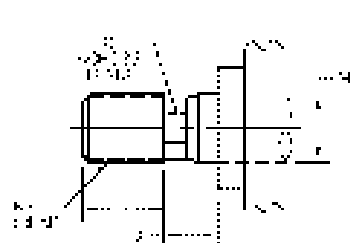

KK5

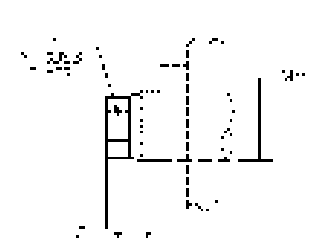

KK10

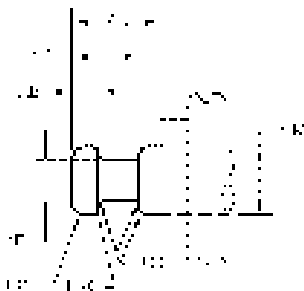

ROD DIA. (MM)	A	C	D	AC	AD	AE	AF	KK1	KK2	KK3	KK4
0.625	0.750	0.375	0.500	1.125	0.625	0.250	0.375	7/16 - 20	1/2 - 20	7/16 - 20	5/8 - 18
1.000	1.125	0.500	0.875	1.625	0.938	0.375	0.688	3/4 - 16	7/8 - 14	3/4 - 16	1 - 14
1.375	1.625	0.625	1.125	1.750	1.062	0.375	0.875	1 - 14	1 1/4 - 12	1 - 14	1 3/8 - 12
1.750	2.000	0.750	1.500	2.000	1.313	0.500	1.125	1 1/4 - 12	1 1/2 - 12	1 1/4 - 12	1 3/4 - 12

(4) Wrench flats is an option.

SERIES 'TS' HEAVY DUTY PNEUMATIC CYLINDERS

DIMENSIONS FOR DOUBLE ROD END NO MOUNTS

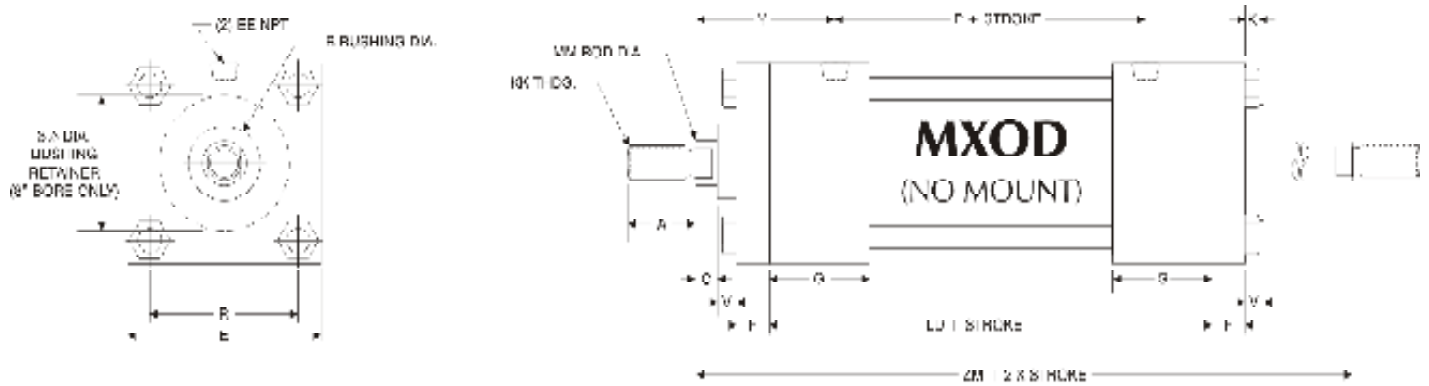

BORE	ROD DIA. (MM)	A	B	C	E	EE	F	G	K	KK	MM	R	V	Y	ADD TO STROKE		ADD 2x STROKE
															LD	P	ZM
1.50	0.625	0.750	1.125	0.375	2.000	0.375	0.375	1.500	0.250	7/16 - 20	0.625	1.438	0.250	1.875	4.125	2.375	6.125
1.50	1.000	1.125	1.500	0.500	2.000	0.375	0.375	1.500	0.250	3/4 - 16	1.000	1.438	0.500	2.250	4.125	2.375	6.875
2.00	0.625	0.750	1.125	0.375	2.500	0.375	0.375	1.500	0.313	7/16 - 20	0.625	1.844	0.250	1.875	4.125	2.375	6.125
2.00	1.000	1.125	1.500	0.500	2.500	0.375	0.375	1.500	0.313	3/4 - 16	1.000	1.844	0.500	2.250	4.125	2.375	6.875
2.50	0.625	0.750	1.125	0.375	3.000	0.375	0.375	1.500	0.313	7/16 - 20	0.625	2.188	0.250	1.875	4.250	2.500	6.250
2.50	1.000	1.125	1.500	0.500	3.000	0.375	0.375	1.500	0.313	3/4 - 16	1.000	2.188	0.500	2.250	4.250	2.500	7.000
3.25	1.000	1.125	1.500	0.500	3.750	0.500	0.625	1.750	0.375	3/4 - 16	1.000	2.766	0.250	2.375	4.750	2.750	7.500
3.25	1.375	1.625	2.000	0.625	3.750	0.500	0.625	1.750	0.375	1 - 14	1.375	2.766	0.375	2.625	4.750	2.750	8.000
4.00	1.000	1.125	1.500	0.500	4.500	0.500	0.625	1.750	0.375	3/4 - 16	1.000	3.328	0.250	2.375	4.750	2.750	7.500
4.00	1.375	1.625	2.000	0.625	4.500	0.500	0.625	1.750	0.375	1 - 14	1.375	3.328	0.375	2.675	4.750	2.750	8.000
5.00	1.000	1.125	1.500	0.500	5.500	0.500	0.625	1.750	0.438	3/4 - 16	1.000	4.109	0.250	2.375	5.000	3.000	7.750
5.00	1.375	1.625	2.000	0.625	5.500	0.500	0.625	1.750	0.438	1 - 14	1.375	4.109	0.375	2.625	5.000	3.000	8.250
6.00	1.375	1.625	2.000	0.625	6.500	0.750	0.750	2.000	0.438	1 - 14	1.375	4.875	0.250	2.750	5.500	3.250	8.750
6.00	1.750	2.000	2.375	0.750	6.500	0.750	0.750	2.000	0.438	1 1/4 - 12	1.750	4.875	0.375	3.000	5.500	3.250	9.250
8.00	1.375	1.625	2.000	0.625	8.500	0.750	0.625	2.000	0.563	1 - 14	1.375	6.438	0.375	2.750	5.625	3.375	8.875
8.00	1.750	2.000	2.375	0.750	8.500	0.750	0.625	2.000	0.563	1 1/4 - 12	1.750	6.438	0.500	3.000	5.625	3.375	9.375

All our cylinders are proudly Made in USA

SERIES 'TS' HEAVY DUTY PNEUMATIC CYLINDERS

DIMENSIONS FOR DOUBLE ROD END BASE MOUNTS

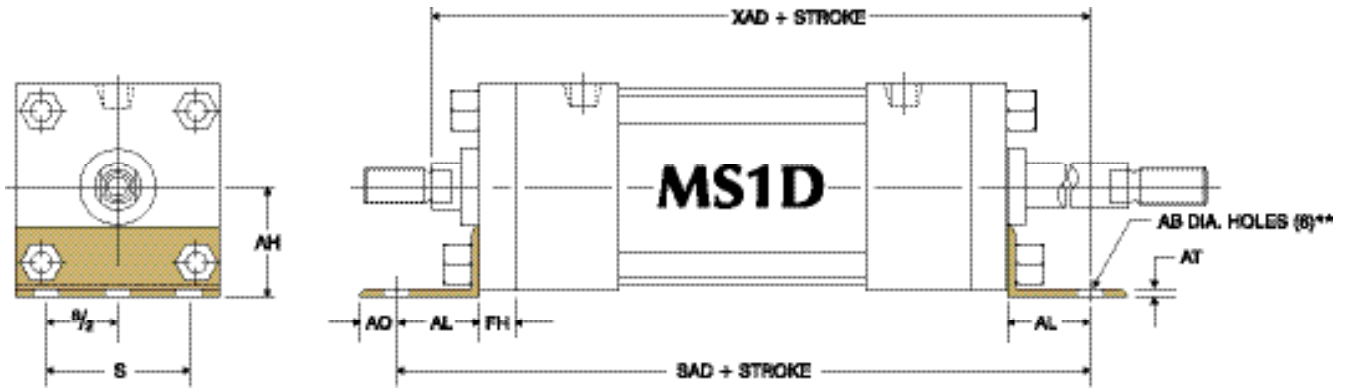

BORE	ROD DIA. (MM)	AB	AH	AL	AO	AT	FH	S	ADD TO STROKE	
									SAD	XAD
1.50	0.625	0.438	1.188	1.000	0.375	0.188	0.375	1.250	6.875	6.500
1.50	1.000	0.438	1.188	1.000	0.375	0.188	0.375	1.250	6.875	6.875
2.00	0.625	0.438	1.438	1.000	0.375	0.188	0.375	1.750	6.875	6.500
2.00	1.000	0.438	1.438	1.000	0.375	0.188	0.375	1.750	6.875	6.875
2.50	0.625	0.438	1.625	1.000	0.375	0.188	0.375	2.250	7.000	6.625
2.50	1.000	0.438	1.625	1.000	0.375	0.188	0.375	2.250	7.000	7.000
3.25	1.000	0.563	1.980	1.250	0.500	0.125	0.625	2.750	8.500	8.000
3.25	1.375	0.563	1.980	1.250	0.500	0.125	0.625	2.750	8.500	8.250
4.00	1.000	0.563	2.250	1.250	0.500	0.125	0.625	3.500	8.500	8.000
4.00	1.375	0.563	2.250	1.250	0.500	0.125	0.625	3.500	8.500	8.250
5.00	1.000	0.688	2.750	1.375	0.625	0.188	0.625	4.250	9.000	8.375
5.00	1.375	0.688	2.750	1.375	0.625	0.188	0.625	4.250	9.000	8.625
6.00	1.375	0.813	3.250	1.375	0.625	0.188	0.750	5.250	9.750	9.250
6.00	1.750	0.813	3.250	1.375	0.625	0.188	0.750	5.250	9.750	9.500
8.00	1.375	0.813	4.250	1.813	0.688	0.250	*0.625	7.125	9.250	9.063
8.00	1.750	0.813	4.250	1.813	0.688	0.250	*0.625	7.125	9.250	9.313

*8.00" bore utilizes round retainer.
 Note: 1.50" bore uses (4) "AB" holes.
 For dimensions not shown, see page 104.

SERIES 'TS' HEAVY DUTY PNEUMATIC CYLINDERS

DIMENSIONS FOR DOUBLE ROD END BASE MOUNTS

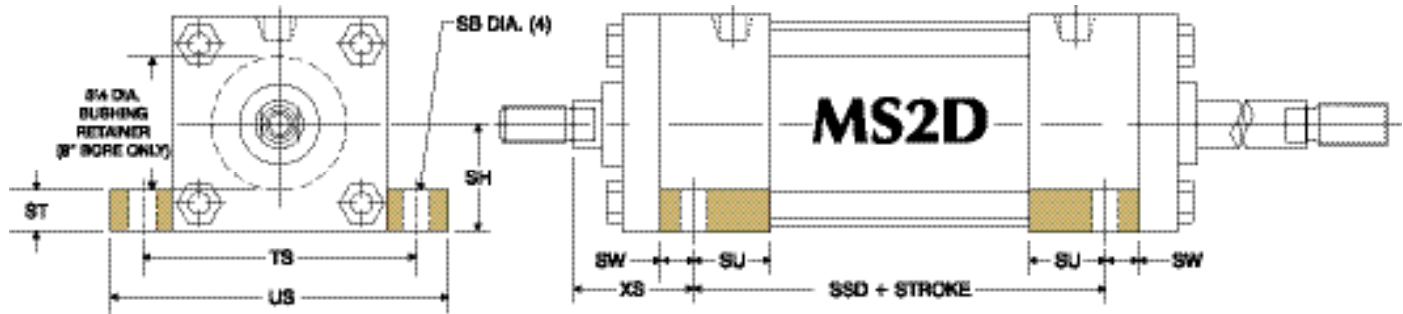

BORE	ROD DIA. (MM)	SB	SH	ST	SU	SW	TS	US	XS	ADD TO STROKE
										SSD
1.50	0.625	0.438	1.000	0.500	1.125	0.375	2.750	3.500	1.375	3.375
1.50	1.000	0.438	1.000	0.500	1.125	0.375	2.750	3.500	1.750	3.375
2.00	0.625	0.438	1.250	0.500	1.125	0.375	3.250	4.000	1.375	3.375
2.00	1.000	0.438	1.250	0.500	1.125	0.375	3.250	4.000	1.750	3.375
2.50	0.625	0.438	1.500	0.500	1.125	0.375	3.750	4.500	1.375	3.500
2.50	1.000	0.438	1.500	0.500	1.125	0.375	3.750	4.500	1.750	3.500
3.25	1.000	0.563	1.875	0.750	1.250	0.500	4.750	5.750	1.875	3.750
3.25	1.375	0.563	1.875	0.750	1.250	0.500	4.750	5.750	2.125	3.750
4.00	1.000	0.563	2.250	0.750	1.250	0.500	5.500	6.500	1.875	3.750
4.00	1.375	0.563	2.250	0.750	1.250	0.500	5.500	6.500	2.125	3.750
5.00	1.000	0.813	2.750	1.000	1.063	0.688	6.875	8.250	2.063	3.625
5.00	1.375	0.813	2.750	1.000	1.063	0.688	6.875	8.250	2.313	3.625
6.00	1.375	0.813	3.250	1.000	1.313	0.688	7.875	9.250	2.313	4.125
6.00	1.750	0.813	3.250	1.000	1.313	0.688	7.875	9.250	2.563	4.125
8.00	1.375	0.813	4.250	1.000	1.563	0.688	9.875	11.250	2.313	4.250
8.00	1.750	0.813	4.250	1.000	1.563	0.688	9.875	11.250	2.563	4.250

For dimensions not shown, see page 104.

All our cylinders are proudly Made in USA

SERIES 'TS' HEAVY DUTY PNEUMATIC CYLINDERS

DIMENSIONS FOR DOUBLE ROD END BASE MOUNTS

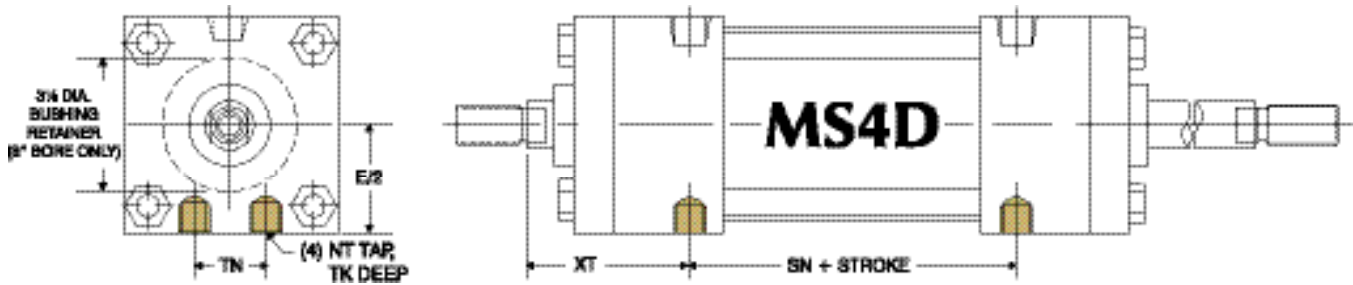

BORE	ROD DIA. (MM)	E/2	NT	TK	TN	XT	ADD TO STROKE
							SN
1.50	0.625	1.000	1/4 - 20	0.375	0.625	1.938	2.250
1.50	1.000	1.000	1/4 - 20	0.375	0.625	2.313	2.250
2.00	0.625	1.250	5/16 - 18	0.500	0.875	1.938	2.250
2.00	1.000	1.250	5/16 - 18	0.500	0.875	2.313	2.250
2.50	0.625	1.500	3/8 - 16	0.625	1.250	1.938	2.375
2.50	1.000	1.500	3/8 - 16	0.625	1.250	2.313	2.375
3.25	1.000	1.875	1/2 - 13	0.750	1.500	2.438	2.625
3.25	1.375	1.875	1/2 - 13	0.750	1.500	2.688	2.625
4.00	1.000	2.250	1/2 - 13	0.750	2.063	2.438	2.625
4.00	1.375	2.250	1/2 - 13	0.750	2.063	2.688	2.625
5.00	1.000	2.750	5/8 - 11	1.000	2.688	2.438	2.875
5.00	1.375	2.750	5/8 - 11	1.000	2.688	2.688	2.875
6.00	1.375	3.250	3/4 - 10	1.125	3.250	2.813	3.125
6.00	1.750	3.250	3/4 - 10	1.125	3.250	3.063	3.125
8.00	1.375	4.250	3/4 - 10	1.125	4.500	2.813	3.250
8.00	1.750	4.250	3/4 - 10	1.125	4.500	3.063	3.250

For dimensions not shown, see page 104.

SERIES 'TS' HEAVY DUTY PNEUMATIC CYLINDERS

DIMENSIONS FOR DOUBLE ROD END TIE ROD MOUNTS

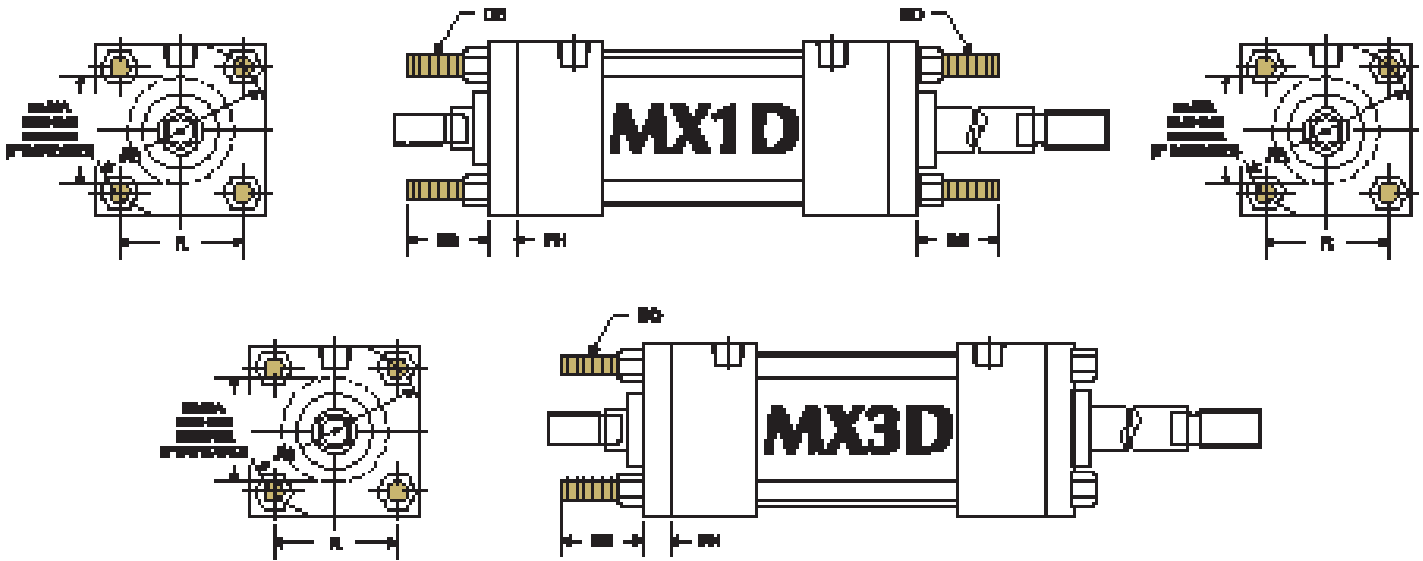

BORE	ROD DIA. (MM)	AA	BB	DD	FH	R
1.50	0.625	2.016	1.000	1/4 -28	0.375	1.438
1.50	1.000	2.016	1.000	1/4 -28	0.375	1.438
2.00	0.625	2.594	1.125	5/16 -24	0.375	1.844
2.00	1.000	2.594	1.125	5/16 -24	0.375	1.844
2.50	0.625	3.109	1.125	5/16 -24	0.375	2.188
2.50	1.000	3.109	1.125	5/16 -24	0.375	2.188
3.25	1.000	3.906	1.375	3/8 -24	0.625	2.766
3.25	1.375	3.906	1.375	3/8 -24	0.625	2.766
4.00	1.000	4.719	1.375	3/8 -24	0.625	3.328
4.00	1.375	4.719	1.375	3/8 -24	0.625	3.328
5.00	1.000	5.813	1.813	1/2 -20	0.625	4.109
5.00	1.375	5.813	1.813	1/2 -20	0.625	4.109
6.00	1.375	6.906	1.813	1/2 -20	0.750	4.875
6.00	1.750	6.906	1.813	1/2 -20	0.750	4.875
8.00	1.375	9.125	*2.313	5/8 -18	*0.625	6.438
8.00	1.750	9.125	*2.313	5/8 -18	*0.625	6.438

**BB' dimension from head on 8.00" bore.
For dimensions not shown, see page 104.

All our cylinders are proudly Made in USA

SERIES 'TS' HEAVY DUTY PNEUMATIC CYLINDERS

DIMENSIONS FOR DOUBLE ROD END FLANGE MOUNTS

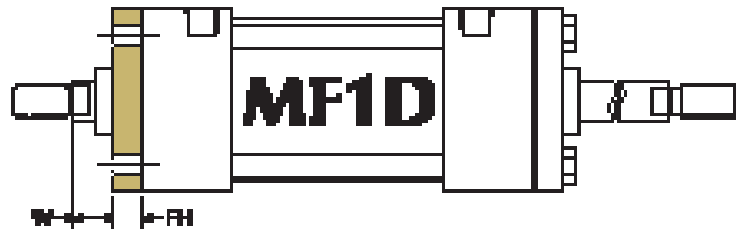
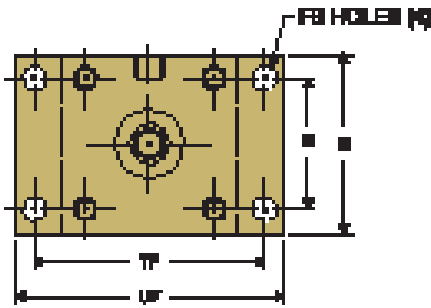

1.50" - 6" BORES

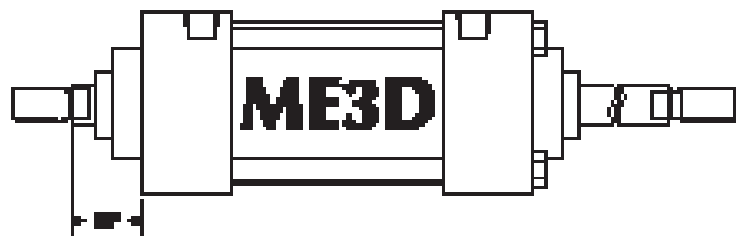
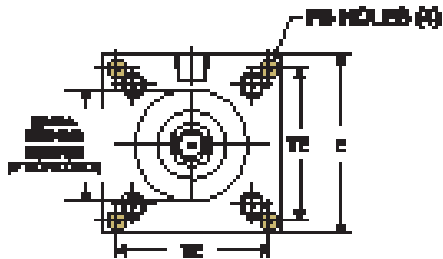

8" BORE ONLY

BORE	ROD DIA. (MM)	E	FB	FH	R	TE	TF	UF	W	WF
1.50	0.625	2.000	0.313	0.375	1.438	—	2.750	3.375	0.625	N/A
1.50	1.000	2.000	0.313	0.375	1.438	—	2.750	3.375	1.000	N/A
2.00	0.625	2.500	0.375	0.375	1.844	—	3.375	4.125	0.625	N/A
2.00	1.000	2.500	0.375	0.375	1.844	—	3.375	4.125	1.000	N/A
2.50	0.625	3.000	0.375	0.375	2.188	—	3.875	4.625	0.625	N/A
2.50	1.000	3.000	0.375	0.375	2.188	—	3.875	4.625	1.000	N/A
3.25	1.000	3.750	0.438	0.625	2.766	—	4.688	5.500	0.750	N/A
3.25	1.375	3.750	0.438	0.625	2.766	—	4.688	5.500	1.000	N/A
4.00	1.000	4.500	0.438	0.625	3.328	—	5.438	6.250	0.750	N/A
4.00	1.375	4.500	0.438	0.625	3.328	—	5.438	6.250	1.000	N/A
5.00	1.000	5.500	0.563	0.625	4.109	—	6.625	7.625	0.750	N/A
5.00	1.375	5.500	0.563	0.625	4.109	—	6.625	7.625	1.000	N/A
6.00	1.375	6.500	0.563	0.750	4.875	—	7.625	8.625	0.875	N/A
6.00	1.750	6.500	0.563	0.750	4.875	—	7.625	8.625	1.125	N/A
8.00	1.375	8.500	0.688	N/A	N/A	7.563	N/A	N/A	1.625	1.625
8.00	1.750	8.500	0.688	N/A	N/A	7.563	N/A	N/A	1.875	1.875

For dimensions not shown, see page 104.

All our cylinders are proudly Made in USA

SERIES 'TS' HEAVY DUTY PNEUMATIC CYLINDERS

DIMENSIONS FOR DOUBLE ROD END PIVOT MOUNTS

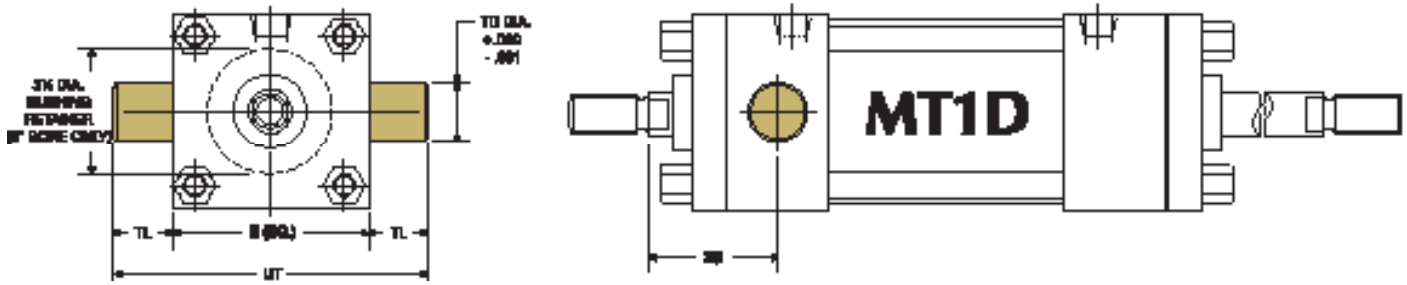

Note: MT1D Trunnions are one-piece solid steel construction.

BORE	ROD DIA. (MM)	E	TD	TL	UT	XG
1.50	0.625	2.000	1.000	1.000	4.000	1.750
1.50	N/A*	2.000	1.000	1.000	4.000	N/A
2.00	0.625	2.500	1.000	1.000	4.500	1.750
2.00	1.000	2.500	1.000	1.000	4.500	2.125
2.50	0.625	3.000	1.000	1.000	5.000	1.750
2.50	1.000	3.000	1.000	1.000	5.000	2.125
3.25	1.000	3.750	1.000	1.000	5.750	2.250
3.25	1.375	3.750	1.000	1.000	5.750	2.500
4.00	1.000	4.500	1.000	1.000	6.500	2.250
4.00	1.375	4.500	1.000	1.000	6.500	2.500
5.00	1.000	5.500	1.000	1.000	7.500	2.250
5.00	1.375	5.500	1.000	1.000	7.500	2.500
6.00	1.375	6.500	1.375	1.375	9.250	2.625
6.00	1.750	6.500	1.375	1.375	9.250	2.875
8.00	1.375	8.500	1.375	1.375	11.250	2.625
8.00	1.750	8.500	1.375	1.375	11.250	2.875

*No oversize rod available on 1.50" bore MT1D.
For dimensions not shown, see page 104.

SERIES 'TS' HEAVY DUTY PNEUMATIC CYLINDERS

DIMENSIONS FOR DOUBLE ROD END PIVOT MOUNTS

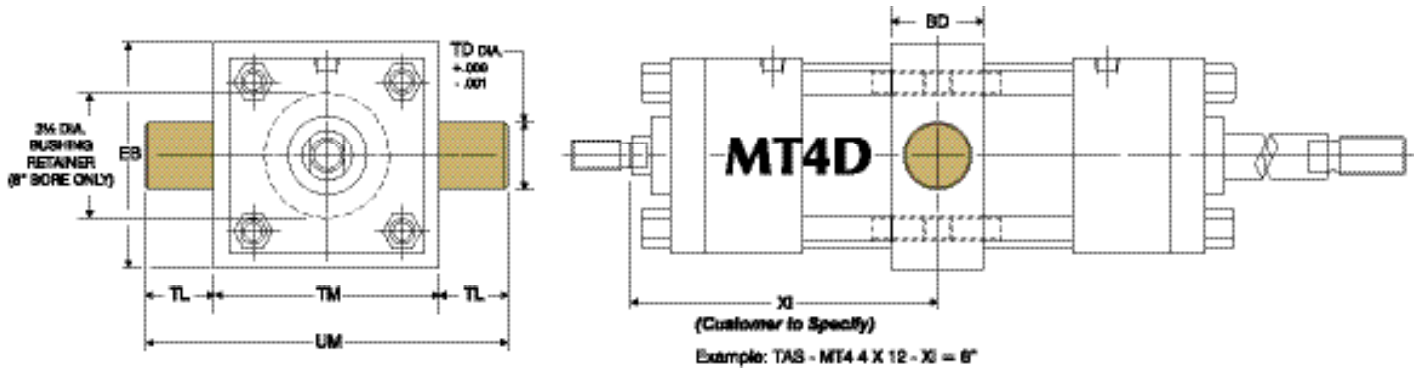

Note: MT4D Trunnions and Intermediate Section are one-piece solid steel construction.

BORE	BD	EB	TD	TL	TM	UM	XI
1.50	1.250	2.500	1.000	1.000	2.500	4.500	CUSTOMER TO SPECIFY
2.00	1.500	3.000	1.000	1.000	3.000	5.000	
2.50	1.500	3.500	1.000	1.000	3.500	5.500	
3.25	2.000	4.250	1.000	1.000	4.500	6.500	
4.00	2.000	5.000	1.000	1.000	5.250	7.250	
5.00	2.000	6.000	1.000	1.000	6.250	8.250	
6.00	2.000	7.000	1.375	1.375	7.625	10.375	
8.00	2.500	9.500	1.375	1.375	9.750	12.500	

8" bore utilizes round retainer.

'MT1D', 'MT4D' STANDARD CUSHION LOCATIONS		
MOUNT	HEAD CUSHION	CAP CUSHION
MT1D	3	6
MT4D	2	6

Note: Ports or cushions cannot be on same side as MT1D Trunnions.



A= Extended Piston Rod Thread

"A=" refers to the length of piston rod thread.

Shorter than standard lengths can be furnished at no charge. Longer than standard lengths can be furnished at a nominal price adder. *Special length threads do not delay orders!*

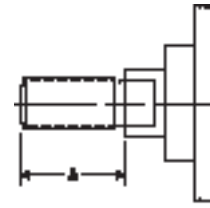

AS Adjustable Stroke (Retract)

Consists of a threaded rod in the cylinder cap, non-removable. Provides an adjustable positive stop on the cylinder retract.

To order, specify "AS" and length of adjustment (Example: AS=3").

A / O Air/Oil Piston

Air/Oil pistons allow for the combination of pneumatic supply air with the precise control of oil.

The basic A/O piston is designed for oil on the cylinder cap end and a meter out flow control (not provided) for precise return stroke control.

For applications that require the oil to be on the cylinder rod end, specify the "TH" option.

Note: Due to the nature of oil to remain in the tubing finish recesses, a condition called collaring will allow oil to seep past the A/O seal over time, escaping in the air valve exhaust.

B BC BH Bumpers

Urethane impact dampening bumpers, used when cylinder speeds do not allow for standard cushions.

BC=Cap Bumper **BH**=Head Bumper **B**=Head & Cap Bumper

(Note: Each bumper adds .25" to cylinder length)



Bumper Piston Seals

Our bumper piston seal, when used with our advanced cushion design, decelerates the cylinder at end of stroke, reducing noise and extending cylinder life. Available in Fluorocarbon Seals for 1.50"-8.00" bore

Cushions can be used to achieve optimum performance on longer strokes (HC & BP).

Use BP seals without cushions on short strokes requiring fast cycles.

Due to compressibility, BP seals are not recommended for applications that require 100% repeatable stroke increments.

Benefits of Bumper Piston Seals:

Reduces Cycle Rates - Higher piston velocities can be achieved due to rapid deceleration feature, increasing productivity.

Provides Maximum Impact Dampening - Reduces machine vibration.

Reduces Cylinder End-of-Stroke Noise

Bumper piston seals will shorten the cylinder stroke when operated at less than 90 PSI supply air.

The charts below show the approximate (average) stroke reduction at various pressure (for new cylinders). As the cylinders are cycled, the seals will take a slight set. Tests have shown that after 1,500,000 cycles, the seals will have between .001" and .008" compression set per seal. After that, there is no noticeable compression set.

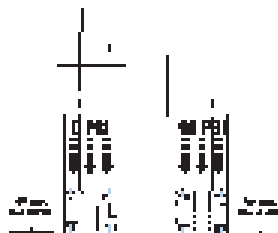

Standard Material: Nitrile

Operating Temp: -20°F to 200°F (-25°C to 90°C)

Optional Material: Fluorocarbon

Available in 1.50" - 8.00" Bores

Operating Temp: 0°F to 400°F (-18°C to 205°C)

Operating Pressure: 250 PSI Air (17 BAR)

PER END STROKE REDUCTION ("A" DIMENSION IN INCHES)						
BORE	0 PSI	10 PSI	30 PSI	50 PSI	70 PSI	90 PSI
1.50	.048	.043	.035	.028	.021	.00
2.00	.069	.056	.037	.020	.010	.00
2.50	.091	.070	.042	.024	.008	.00
3.25	.071	.059	.039	.020	.002	.00
4.00	.087	.069	.045	.026	.009	.00
5.00	.092	.072	.036	.013	.005	.00
6.00	.113	.091	.051	.023	.003	.00
8.00	.154	.132	.076	.037	.016	.00



VARIATIONS

H C LH LC Cushions

- H** Head Cushion
- LH** Long Head Cushion
- C** Cap Cushion
- LC** Long Cap Cushion

Advanced cushion design that features a unique, one piece seal that is allowed to float in a precision machined groove. This type of seal design provides consistent cushion performance and maximum seal life. Oversized flow paths molded in the periphery of the seal provide full flow on the return stroke without the use of ball checks.

Cylinders with air cushions provide a possible solution to destructive energies. The air cushion traps a small amount of exhaust air at the end of stroke, providing an air pocket that decelerates the load. This reduces the potentially destructive energy being transmitted to the cylinder and other components. The following is a brief explanation on how to determine the energy level of your application and determine if an air cushion can provide adequate energy absorption. *Air cushions do not build heat since the heat generated is dissipated with the exhausted air flow.*

Determine the total load to be stopped by the cylinder. Include the piston rod weight (see *Piston Rod Weight Chart* below).
 Determine the velocity (in feet per second) at which the load impacts the cylinder end caps.
 Use the following formula to calculate the energy the cylinder generates.
 Using the table below, select the proper cushion length. You can choose a larger bore size to increase cushion capacities.

$$\text{energy} = \left(\frac{W}{64} \times v^2\right) + (p \times k)$$

- W = Total weight of load in pounds (including piston rod)
- V = Velocity (in feet per second)
- P = Driving pressure in PSI (usually the air line pressure)
- K = Bore constant value (see chart below for "K" values)

Sizing Example:

How to figure the energy for a 2.50" bore cylinder, 10" stroke, .63" piston rod, moving a 25 lb. load at 6 feet per second with 80 PSI air.

$$P=80 \text{ PSI} \quad W=26.25 \text{ lbs.} \quad V=6 \text{ FPS.} \quad K=.17$$

$$\text{Energy} = (26.25/64) \times (6^2) + (36) + (80 \times .17)$$

$$\text{Energy} = 28.36 \text{ ft/lbs.}$$

The Maximum Energy Data Chart indicates that the long cushion at 38.6 maximum energy value would be the right choice for this application.

MAXIMUM ENERGY DATA CHART			
BORE	K	H or C	LH or LC
		Standard Cushion Series Max Energy (FT-LBS)	Long Cushion Series Max Energy (FT-LBS)
1.50	.06	8.2	12.8
2.00	.11	13.8	21.7
2.50	.17	24.6	38.6
3.25	.25	45.7	83.6
4.00	.38	57.3	137.1
5.00	.59	94.6	226.0
6.00	1.37	225.5	334.4
8.00	2.43	411.3	609.8

PISTON ROD WEIGHT CHART	
ROD DIA.	Piston Rod Weight*
0.625	.35 lb. + .09 lb./in. of stroke
1.000	1.1 lb. + .22 lb./in. of stroke
1.375	2.3 lb. + .42 lb./in. of stroke
1.750	5.0 lb. + .68 lb./in. of stroke
2.000	6.1 lb. + .88 lb./in. of stroke
2.500	10.4 lb. + 1.39 lb./in. of stroke

*Double weight for double rod end cylinders.

C= Extended Piston Rod

"C=" is commonly referred to as piston rod extension. Piston rods can be extended to any length up to 120" total piston rod length, including stroke portion. Cylinders with long "C" lengths can be mounted away from obstacles or outside hazardous environments.

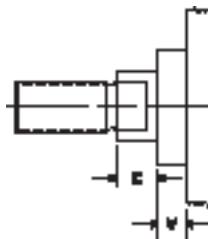

Piston rods can be made to any length up to 120 inches total OAL. Rods can be easily extended to move a cylinder to a more accessible location or away from a less desirable environment.

Be sure to check piston rod column strength charts to properly size the rod and prevent buckling.

Extended piston rods do not delay delivery.

KK3S Studded Piston Rod

KK3S option combines the KK3 female threaded rod end design and a case-hardened stud, with permanent Loctite. When assembled, the KK3S has the same dimensions as a KK1 rod end.

This option is useful in applications that typically break standard KK1 rod ends due to high load impacting.

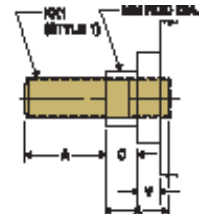

SERIES 'TS' HEAVY DUTY PNEUMATIC CYLINDERS

VARIATIONS



LF Low Friction

"LF" option incorporates the use of round-lip, extremely low friction Carboxylated Nitrile seals. Round-lip seals hydroplane on opposed sealing surfaces and have a lower running and break-away friction.

Bore Sizes: 1.50" to 8.00" Bore

Material: Carboxylated Nitrile

Operating Temperature: -20°F to 200°F (-25°C to 90°C)

Operating Pressure: 250 PSI AIR (17 BAR)

MA Micro-Adjust

- Allows precise adjustment of cylinder extend stroke
- Easy to read precision scale (.001" calibration)
- Enclosed; no pinch point design
- Available on all cylinder models with "D" double rod end option
- Up to 6.00" stroke and adjustment*

*Note: The adjustment range is throughout entire stroke. Consult HYDRAULIC CYLINDERS INC.® for longer stroke requirements or modifications not listed.

MICRO-ADJUST DIMENSIONS					
BORE	A	B	C	D	E
1.50	1.000	1.875	3.719	1/2 - 20	0.050
2.00	1.000	1.875	3.719	1/2 - 20	0.050
2.50	1.000	1.875	3.719	1/2 - 20	0.050
3.25	1.000	2.813	3.719	3/4 - 16	0.063
4.00	0.750	2.813	3.469	3/4 - 16	0.063
5.00	0.750	2.813	3.469	3/4 - 16	0.063
6.00	0.750	3.750	3.469	3/4 - 16	0.063
8.00	0.750	3.750	3.469	3/4 - 16	0.063

Note: See double rod end cylinder drawings for dimensions not shown.

- 1) Set actuator to desired stroke
- 2) Turn stop collar until it makes contact with stop
- 3) Tighten set screw
- 4) Tighten jam nut for positive lock of stop collar

Do **NOT** apply torque to stop collar retainer bolt.

Hold stop collar by hand to tighten jam nut.

Stroke adjustments to be made while cylinder is in the retract position only.

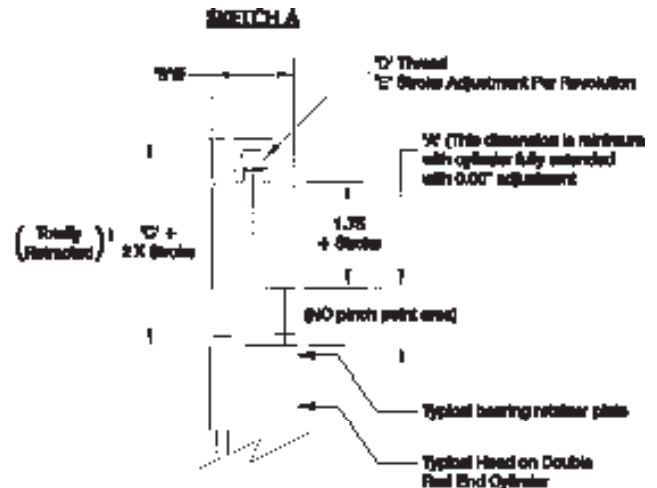

Construction: Anodized Aluminum

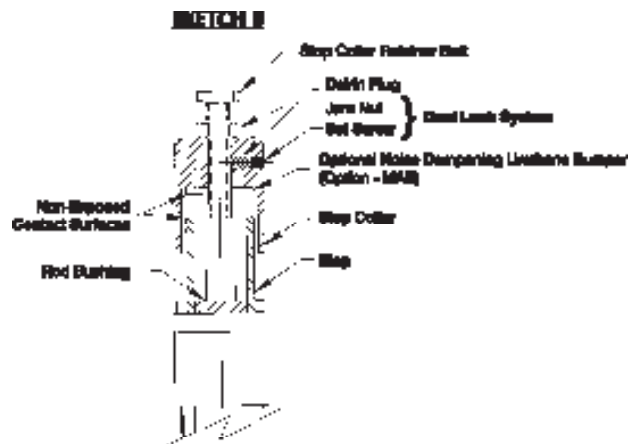

MAB Micro-Adjust with Urethane Bumper

A noise dampening urethane bumper is added between the metal contact points, minimizing noise (see Sketch B above).

MS Metallic Rod Scraper

Aggressively scrapes the piston rod, removing foreign material such as spatter, sprays and powders (brass construction).

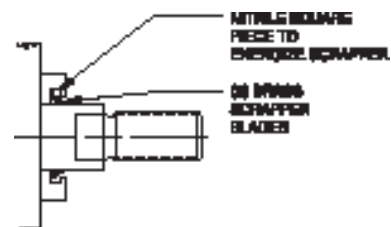

All our cylinders are proudly Made in USA



VARIATIONS

NR Non-Rotating (NFPA) Cylinders

2.00" - 8.00" Bore, 200 PSI Air, 400 PSI Hydraulic (Non-Shock)

Two internal guide rods throughout stroke

Eliminates the need for external guide shafts in many positioning applications

High repeatability at each end of stroke (+/- 1 degree)

Guide rods are internal, self-cleaning and not subject to harsh cleaners

All external dimensions are the same as standard cylinder (no additional length or width required)

Compact design saves space; no larger than standard NFPA cylinders!

Standard diameter guide rod seals & bronze Bearings for long life and reliable operation

Durable, self-contained construction

Available in double rod end models

AVAILABLE BORE SIZES WITH 'NR' GUIDE ROD SIZES AND MAX STROKE		
BORE	ROD DIA. (MM)	CUSHIONS
4.00	1.000 & 1.375	No Cushions
5.00	1.000, 1.375, 1.750 & 2.000	Cap Cushions Only
6.00	1.375 - 3.000	Both Cushioned (3.000" Rod - Cap Only)
8.00	1.375 - 3.500	Both Cushioned (3.500" Rod - Cap Only)

OP Optional Port Location

Optional port locations can be ordered simply by calling out the location numbers:

Example:

TS - MS4 - 2 X 10 - OP= 2 & 6

Note: When optional port locations are ordered, specify both port locations, even if one port is in the standard location.

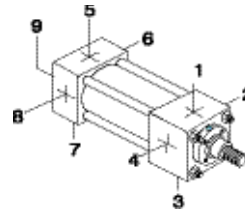

Standard Port Positions at 1 & 5

Standard Cushion Positions at 2 & 6

Specify Non-Standard locations when ordering

Optional Port and Cushion at Same Location

Specify ports and cushions on the same cylinder side.

Ordering Examples:

TS - MS4 - 2 X 10 - H1C5 - OP= 1 & 5
(Ports and Cushions @ 1 & 5)

TS - MS4 - 2 X 10 - H2C6 - OP= 2 & 6
(Ports and Cushions @ 2 & 6)

TS - MS4 - 2 X 10 - H1C6 - OP= 1 & 6
(Ports @ 1 & 6, Cushions @ 1 & 6)

Note: When optional port & cushion locations are ordered. Specify both port & cushion locations, even if a port or cushion is in the standard location.

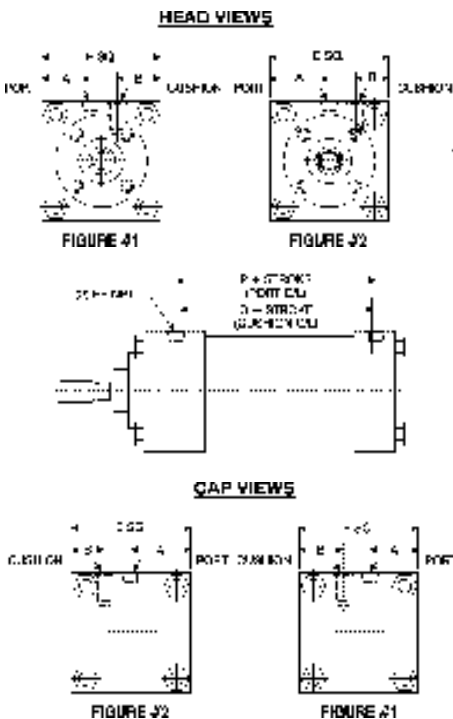

BORE	ROD DIA. (MM)	FIGURE	A	B	E	P	Q	EE
1.50	0.625	1	0.750	0.625	2.000	2.375	2.125	0.250
1.50	1.000	N/A	N/A	N/A	N/A	2.375	2.125	0.250
2.00	0.625	1	0.875	0.938	2.500	2.375	2.125	0.375
2.00	1.000	1	1.000	0.750	2.500	2.375	2.125	0.375
2.50	0.625	1	1.125	1.125	3.000	2.500	2.250	0.375
2.50	1.000	1	1.125	1.000	3.000	2.500	2.250	0.375
3.25	1.000	1	1.500	1.375	3.750	2.750	2.500	0.500
3.25	1.375	2	1.875	1.000	3.750	2.750	2.500	0.500
4.00	1.000	2	2.250	1.250	4.500	2.750	2.500	0.500
4.00	1.375	2	2.250	1.125	4.500	2.750	2.500	0.500
5.00	1.000	2	2.750	1.750	5.500	3.000	3.000	0.500
5.00	1.375	2	2.750	1.625	5.500	3.000	3.000	0.500
6.00	1.375	2	3.250	1.875	6.500	3.250	3.000	0.750
6.00	1.750	2	3.250	1.875	6.500	3.250	3.000	0.750
8.00	1.375	2	4.250	2.750	8.500	3.375	3.125	0.750
8.00	1.750	2	4.250	2.750	8.500	3.375	3.125	0.750

SERIES 'TS' HEAVY DUTY PNEUMATIC CYLINDERS

VARIATIONS



OS Oversize Rod

Applications requiring long strokes may require oversize piston rod diameters to prevent sagging or buckling. To determine the recommended rod diameter, refer to Chart 3 on page 117.

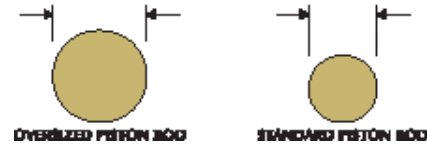

Port Options

Cylinders can be furnished with NPTF or SAE O-Ring Boss (SAEJ514) ports at no-charge.

Cylinders can be furnished with BSPP, BSPT or SAE Flange Ports for additional cost.

BSPT British Standard Pipe Taper

British Standard Pipe Taper (BSPT) threads have the same taper as American NPT tapered threads, but use a 55° Whitworth thread form and different diameters. (Not interchangeable with NPT)

BSPP British Standard Pipe Parallel

British Standard Pipe Parallel (BSPP), also referred to as BSP "Straight" Thread. (Not interchangeable with NPT)

SAE "O"-Ring Boss Ports (SAE J514)

SAE ports can be ordered in place of NPT ports. Order by SAE number. (Example: SAE #6)

RECOMMENDED SAE PORT SIZE BY CYLINDER BORE					
BORE	SAE#	BORE	SAE#	BORE	SAE#
1.50	#4 (7/16-20)	3.25	#6 (9/16-18)	6.00	#8 (3/4-16)
2.00	#4 (7/16-20)	4.00	#6 (9/16-18)	8.00	#10 (7/8-14)
2.50	#4 (7/16-20)	5.00	#6 (9/16-18)		

SE Spring Extend 1.50" - 2.50" Bore

"SE" Option is designed to provide a spring bias to extend cylinder in the event of air pressure loss.

Springs add length to cylinder and provide a modest amount of extend spring force (see chart below for application design specs).

Note: Cylinders are furnished with standard head and cap.

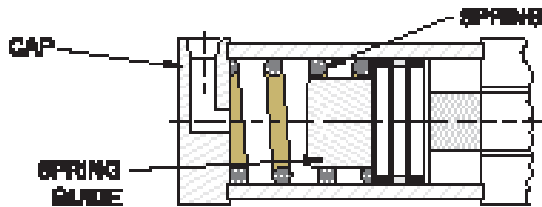

1.50", 2.00" AND 2.50" BORE SPECS			
STROKE (INCHES)	OVERALL LENGTH ADDER (INCHES)	SPRING RATE (LBS PER IN)	SPRING FORCE AT FULL EXTEND (LBS)
0.50	.63	18	16
1.00	.88	12	13
1.50	1.13	9	12
2.00	1.38	7	11
2.50	1.50	7	12

Note: Spring rates are for reference only; actual rates may vary from spring to spring.

SR Spring Retract 1.50" - 2.50" Bore

"SR" Option is designed to provide a spring bias to retract cylinder in the event of air pressure loss.

Springs add length to cylinder and provide a modest amount of retract spring force (see chart below for application design specs).

Note: Cylinders are furnished with standard head and cap.

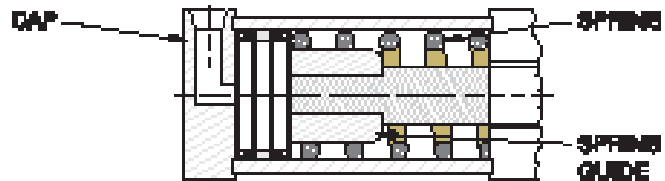

1.50", 2.00" AND 2.50" BORE SPECS			
STROKE (INCHES)	OVERALL LENGTH ADDER (INCHES)	SPRING RATE (LBS PER IN)	SPRING FORCE AT FULL RETRACT (LBS)
0.50	.75	18	16
1.00	1	12	13
1.50	1.50	9	12
2.00	1.50	7	11
2.50	1.63	7	12
3.00	2.50	6	10
3.50	3	6	10
4.00	3.25	6	10
4.50	3.75	6	9
5.00	4	6	9
5.50	4	5	8
6.00	4	5	8

Note: Spring rates are for reference only; actual rates may vary from spring to spring.



ST Stop Tube and Rod Size Selection

Stop tubes are designed to reduce the piston rod bushing stress to within the designed range of the bearing material. This will ensure proper cylinder performance in any given application. Stop tubes lower the cylinder bearing stress by adding length to the piston, which increases the overall length of the cylinder.

(Note: HYDRAULIC CYLINDERS INC.® uses a double piston design for 2" and longer stop tubes.)

Stop Tube Selection

To determine the proper amount of stop tube for your application, you must first find the value of "D", which represents the stroke (*adjusted for mounting condition*). Each mounting condition creates different levels of bushing stress, which has direct impact on the amount of stop tube required (see Chart 1).

Once the value of "D" is known, refer to Chart 2 for the recommended amount of stop tube.

To order a stop tube:

- Add the stop tube prefix "ST=" and the stop tube length to the end of your cylinder model number.
- Add "ES" after the cylinder stroke to indicate that the stroke is the effective stroke.

Example: TS-MP1-3.25 X 40ES -ST=2

Using the value of "D", find the recommended amount of stop tube

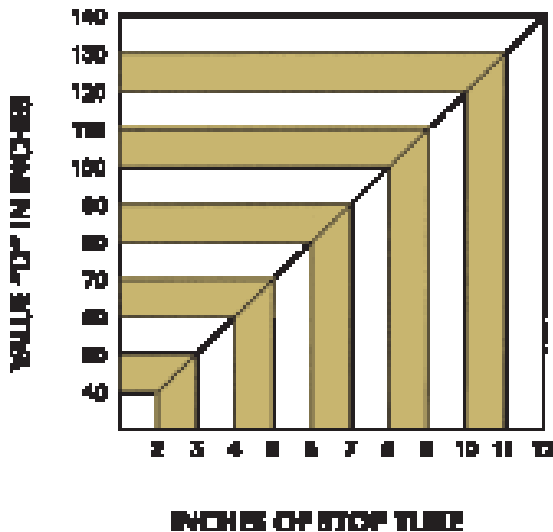

Find the value of "D" for your application

D = Stroke, adjusted for mounting condition
 S = Actual cylinder stroke
 T = Axial thrust (refer to Chart 3)

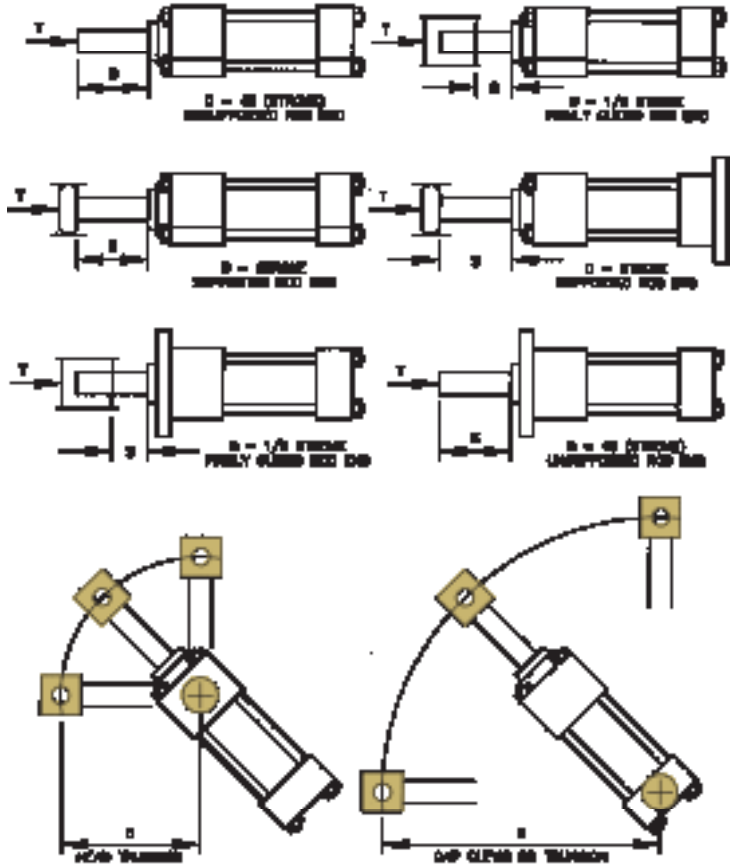

Note: Measure "D" when cylinder is fully extended.

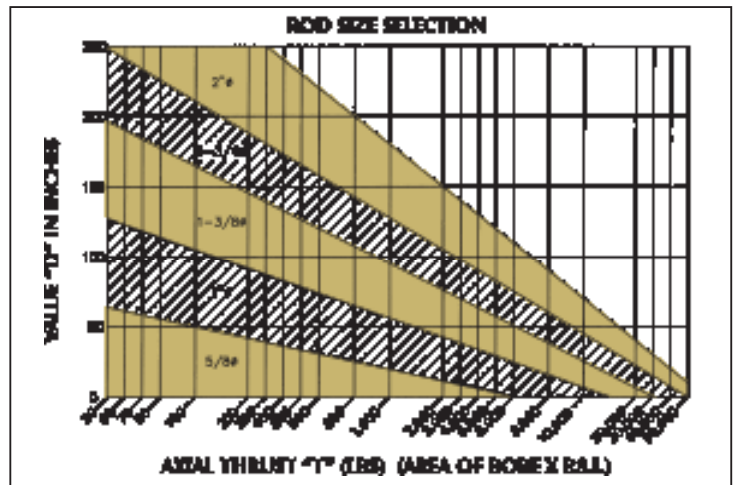



Stainless Steel Options

Stainless Steel, when used in conjunction with Painted Steel Heads, Caps and Tube, provide added corrosion resistance in outdoor applications and wet environments. Customize your cylinder by choosing from Stainless Steel Fasteners, Piston Rod, Cushion Needles or Tie Rods & Nuts.

SSA Stainless Steel Piston Rod (Hard-Chrome Plated), Stainless Steel Fasteners, Stainless Steel Tie Rods & Nuts

SSC Stainless Steel Cushion Needle External Adjustment Components

SSR Stainless Steel Piston Rod (Hard-Chrome Plated)

SSF Stainless Steel Piston Rod (Hard-Chrome Plated)

SST Stainless Steel Tie Rods and Nuts

VS Fluorocarbon Seals

Benefits of Fluorocarbon Seals:

Higher temperature performance $0^{\circ}F$ to $400^{\circ}F$ ($-20^{\circ}C$ to $200^{\circ}C$)

Higher chemical resistance (*resists most wash down solutions*)

Many other seal materials are available. Contact HYDRAULIC CYLINDERS INC.® for proper seal material selection in tough applications or environments.

TH 400 PSI Hydraulic (Non-Shock)

Rating: 400 PSI Hydraulic, Non-Shock

Seals: Piston Seals - (1) Poly-Pak, (1) Square-lip
Rod Seal - Poly-Pak

Many other seal materials are available. Contact HYDRAULIC CYLINDERS INC.® for proper seal material selection in tough applications or environments.



AS3POS Adjustable Mid Stroke (3-Position)

Double piston design allows for adjustment of the mid stroke position. Three ported cylinder with adjustable stop collar.

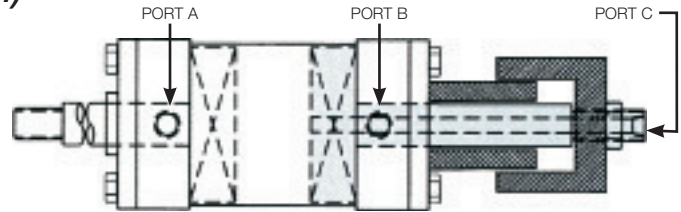

DAS Double Rod Adjustable Stroke (Extend)

Consists of a double rod end cylinder and an adjustable stop collar. Used to adjust the extend cylinder stroke.

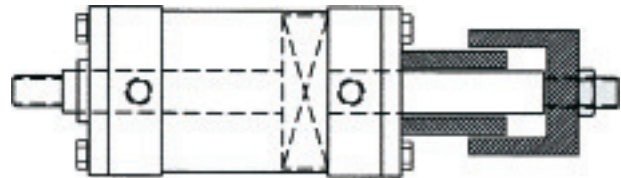

Manifold Block or Plate

For OEM's, we can design and provide custom made manifolds in high quantity.

Extra Wide Multiple Wear Bands

3/4" or 1" wide wear bands available. Multiple wear bands can be used.
Special piston thickness adds length to cylinder.

Hollow Piston Rods

This cylinder shows a multitude of options:

Double Oversize Piston Rod, Gun-Drilled, Double Rod End with rod extension, special female rod thread, and special side drilled angle hole in piston rod.

Rod Boots

Rod boots are common in dirty environments; a standard spec for many applications
(Note: Rod boots add length to cylinder rod extension).



Special Finishes

Standard Finish: Black Urethane Paint (suitable for indoor or outdoor use).

Optional Paint: Black Epoxy Paint (suitable for indoor use only).

Additional Paint Choices: HYDRAULIC CYLINDERS INC.® can provide paint in any color or type.

Additional Finishes: HYDRAULIC CYLINDERS INC.® can provide special finishes, i.e. Nutride Plate Heavy Chrome Plated Piston Rods.



3P Three-Position Cylinder

You can create a 3-Position cylinder from two of the same bore size cylinders.

3-Position cylinders consist of multiple cylinders built as one unit having one exposed working rod end, capable of delivering three rod positions.

3-POSITIONS IN ONE CYLINDER — One cylinder produces three different rod end positions. By varying stroke lengths, a multitude of positions can be created.

SIMPLIFIES MACHINE DESIGNS — Eliminates the need for an additional cylinder to create a third position. 3-Position cylinders reduce space and the cost to mount multiple cylinders.

Note: Piston rods are not connected.

BTB Back-To-Back Cylinders

Back-to-Back cylinders consist of two individual cylinders built as one unit. These cylinders can act as a four position cylinder.

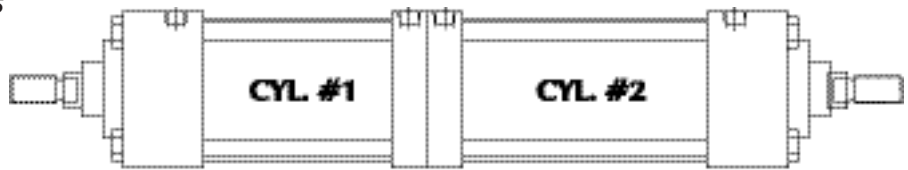

TM Tandem Cylinders

You can tandem different cylinders together to create unlimited design possibilities.

Note: Piston rods are connected.

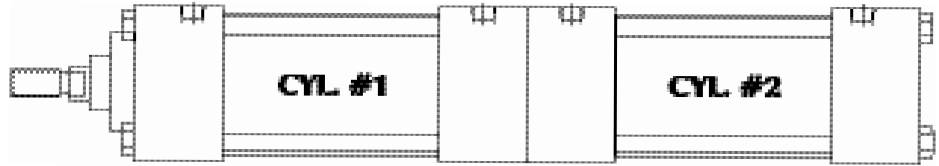

ABP= Air Bleed Ports

Air bleeds can be provided at either or both ends of the cylinder. Air bleeds should be located at the highest point in the cylinder for maximum effectiveness. The location needs to be specified, similar to port locations.

Example: ABP=15
(Air Bleed ports at position 1 & 5)

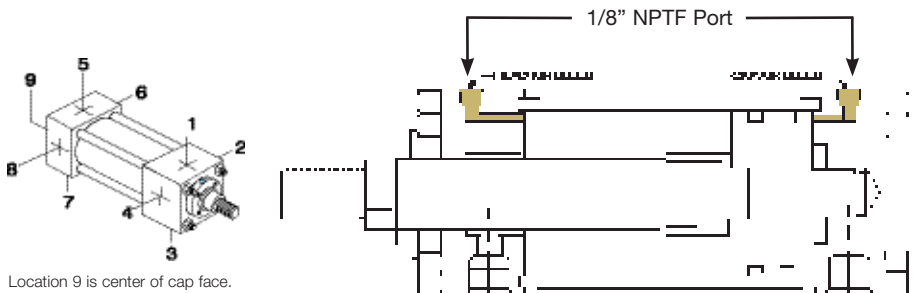

Location 9 is center of cap face.

DBB= Drain Back Bushing

When oil leakage cannot be tolerated, a rod bushing drain port can be provided. Since there isn't any pressure in the drain line, clear tubing can offer a visual inspection of any leakage. A constant leak indicates that the rod seal is worn and needs to be replaced.

Example: DBB=1 (drain port at position 1)

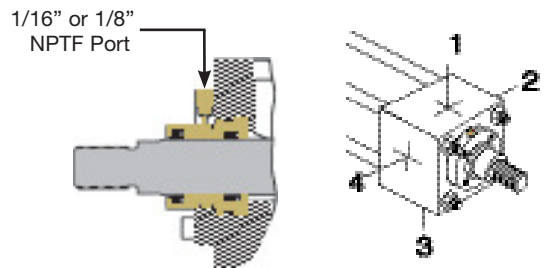



304°

304°

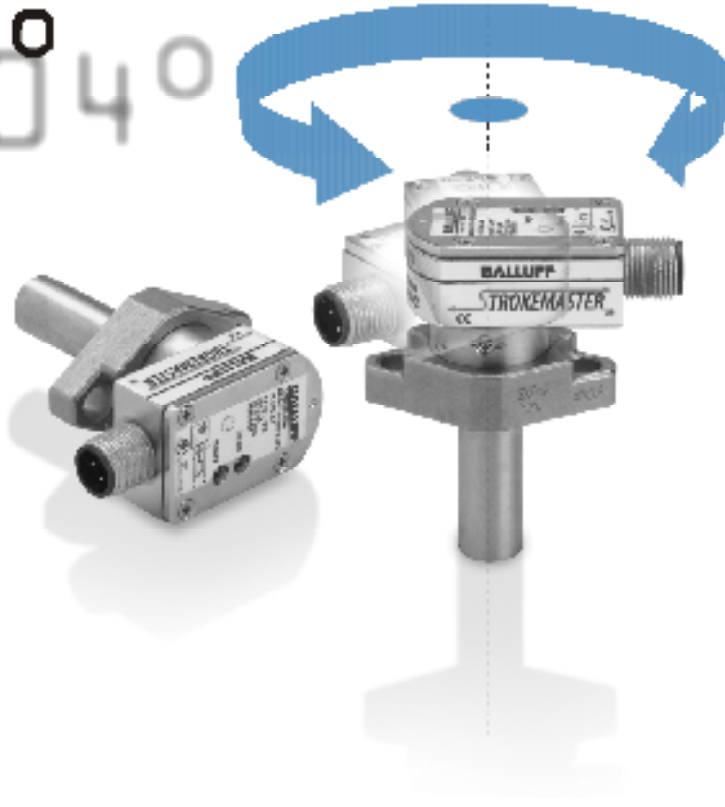

ACCESSORIES

BALLUFF SENSORS | BALLUFF TRANSDUCERS | MTS TEMPOSONICS TRANSDUCERS

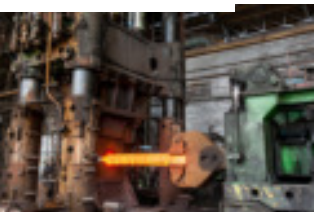

CLEVIS PINS & MOUNTS



Rod Clevis

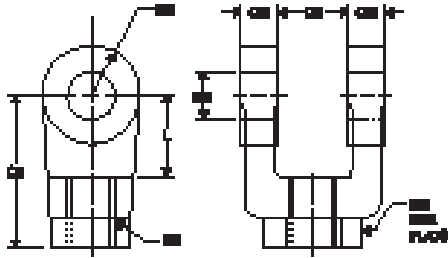

Clevis Pins sold separately from Rod Clevises

Note: When using a rod clevis in combination with an eye bracket, the operating angle is limited to +/-75° from the bracket center line.

MATERIAL: CAST STEEL
FINISH: BLACK OXIDE

PART NO.	MAXLOAD (TENSION) RATED IN LBS	CB	CD (DIA.)	CE	CH	CW	ER (RADIUS)	KK	L
RC437	2950	0.750	0.500	1.500	1.000	0.500	0.500	7/16 - 20	0.750
RC500	4000	0.750	0.500	1.500	1.000	0.500	0.500	1/2 - 20	0.750
RC750	11200	1.250	0.750	2.375	1.250	0.625	0.750	3/4 - 16	1.250
RC1000	19500	1.500	1.000	3.125	1.500	0.750	1.000	1 - 14	1.500
RC1250	26800	2.000	1.375	4.125	2.000	1.000	1.375	1 1/4 - 12	2.125
RC1375	26800	2.000	1.375	4.125	2.000	1.000	1.375	1 3/8 - 12	2.125
RC1500	39500	2.500	1.750	4.500	2.375	1.250	1.750	1 1/2 - 12	2.250
RC1750	54700	2.500	1.750	4.500	2.375	1.250	1.750	1 3/4 - 12	2.250
RC1875	56000	2.500	2.000	5.500	3.000	1.250	2.000	1 7/8 - 12	2.500
RC2250	84000	3.031	2.500	6.500	3.500	1.500	2.500	2 1/4 - 12	3.000
RC2500	84000	3.031	3.000	6.750	3.875	1.500	2.750	2 1/2 - 12	3.250
RC3250	155000	4.031	3.500	8.500	5.000	2.000	3.500	3 1/4 - 12	4.000
RC4000	200000	4.531	4.000	10.000	6.125	2.250	4.000	4 - 12	4.500

Rod Eye

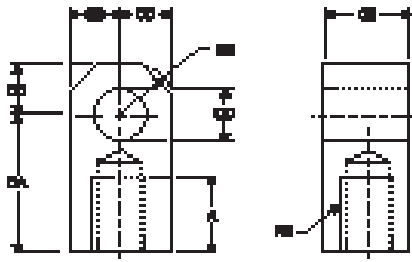

Clevis Pins sold separately from Rod Eyes

Note: When using a rod eye in combination with a clevis bracket, the operating angle is +/-90° from the bracket center line.

MATERIAL: 1018 CRS
FINISH: BLACK OXIDE

PART NO.	MAXLOAD (TENSION) RATED IN LBS	A	CA	CB	CD (DIA.)	ER (RADIUS)	KK
RE437	2950	0.750	1.500	0.750	0.500	0.625	7/16 - 20
RE500	3350	0.750	1.500	0.750	0.500	0.625	1/2 - 20
RE750	8400	1.125	2.063	1.250	0.750	0.875	3/4 - 16
RE1000	13500	1.625	2.813	1.500	1.000	1.187	1 - 14
RE1250	24500	2.000	3.438	2.000	1.375	1.563	1 1/4 - 12
RE1500	39000	2.250	4.000	2.500	1.750	2.000	1 1/2 - 12
RE1875	45000	3.000	5.000	2.500	2.000	2.500	1 7/8 - 12
RE2250	67000	3.500	5.812	3.000	2.500	2.813	2 1/4 - 12
RE2500	81000	3.500	6.125	3.000	3.000	3.250	2 1/2 - 12
RE3250	125000	4.500	7.625	4.000	3.500	3.875	3 1/4 - 12
RE3500	125000	5.000	7.625	4.000	3.500	3.875	3 1/2 - 12
RE4000	162000	5.500	9.125	4.500	4.000	4.438	4 - 12

Clevis Bracket

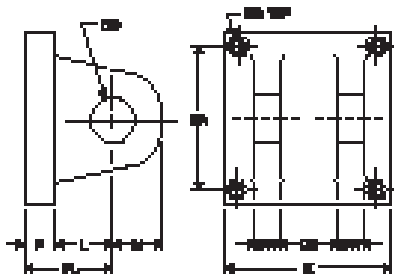

Clevis Pins sold separately from Clevis Brackets

MATERIAL: CAST STEEL
FINISH: BLACK OXIDE

PART NO.	MAXLOAD (TENSION) RATED IN LBS	BA	CB	CD (DIA.)	CW	DD	E	F	FL	L	M
CB500	4500	1.625	0.750	0.500	0.500	3/8 - 24	2.500	0.375	1.125	0.750	0.500
CB750	8400	2.563	1.250	0.750	0.625	1/2 - 20	3.500	0.625	1.875	1.250	0.750
CB1000	13500	3.250	1.500	1.000	0.750	5/8 - 18	4.500	0.750	2.250	1.500	1.000
CB1375	34000	3.813	2.000	1.375	1.000	5/8 - 18	5.000	0.875	3.000	2.125	1.375
CB1750	54000	4.938	2.500	1.750	1.250	7/8 - 14	6.500	0.875	3.125	2.250	1.750
CB2000	89000	5.750	2.500	2.000	1.250	1 - 14	7.500	1.000	3.500	2.500	2.000
CB2500	124000	6.594	3.000	2.500	1.500	1 1/8 - 12	8.500	1.000	4.000	3.000	2.500
CB3000	126000	7.500	3.000	3.000	1.500	1 1/4 - 12	9.500	1.000	4.250	3.250	2.750
CB3500	126000	9.625	4.000	3.500	2.000	1 3/4 - 12	12.625	1.688	5.688	4.000	3.500
CB4000		11.500	4.500	4.000	2.250	2 - 12	14.875	1.840	6.440	4.500	4.000

Eye Bracket

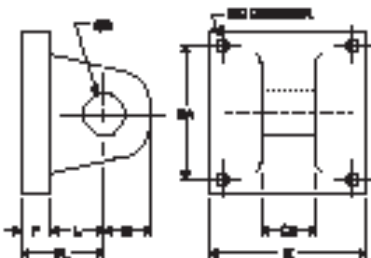

Clevis Pins sold separately from Eye Brackets

MATERIAL: CAST STEEL
FINISH: BLACK OXIDE

PART NO.	MAXLOAD (TENSION) RATED IN LBS	BA	CB	CD (DIA.)	DD	E	F	FL	L	M
EB500	3375	1.625	0.750	0.500	0.406	2.500	0.375	1.125	0.750	0.500
EB750	8400	2.563	1.250	0.750	0.531	3.500	0.625	1.875	1.250	0.750
EB1000	13500	3.250	1.500	1.000	0.656	4.500	0.750	2.250	1.500	1.000
EB1375	25000	3.813	2.000	1.375	0.656	5.000	0.875	3.000	2.125	1.375
EB1750	45000	4.938	2.500	1.750	0.906	6.500	0.875	3.125	2.250	1.750
EB2000	45000	5.750	2.500	2.000	1.063	7.500	1.000	3.500	2.500	2.000
EB2500	67000	6.594	3.000	2.500	1.188	8.500	1.000	4.000	3.000	2.500
EB3000	115000	7.500	3.000	3.000	1.313	9.500	1.000	4.250	3.250	2.750
EB3500	162000	9.625	4.000	3.500	1.813	12.625	1.688	5.688	4.000	3.500
EB4000	200000	11.500	4.500	4.000	2.063	14.875	1.938	6.440	4.500	4.000

All our cylinders are proudly Made in USA



Pivot Pin

INCLUDES COTTER PINS

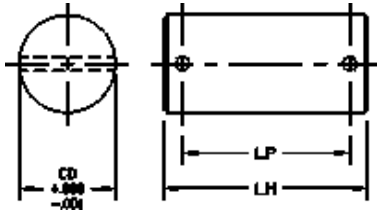

PART NO.	MAX LOAD (TENSION) RATED IN LBS	CD	LP	LH	PART NO.	MAX LOAD (TENSION) RATED IN LBS	CD	LP	LH
CP500C	5800	0.500	1.938	2.281	CP2000C	94000	2.000	6.031	5.719
CP750C	13250	0.750	2.719	3.094	CP2500C	145000	2.500	6.313	6.781
CP1000C	23500	1.000	3.219	3.594	CP3000C	210000	3.000	6.348	6.844
CP1375C	44500	1.375	4.250	4.656	CP3500C	285000	3.500	8.406	8.969
CP1750C	72000	1.750	5.532	5.656	CP4000C	375000	4.000	9.406	9.969

Pivot Pin

INCLUDES E-CLIPS

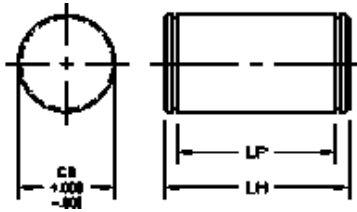

PART NO.	MAX LOAD (TENSION) RATED IN LBS	CD	LP	LH	PART NO.	MAX LOAD (TENSION) RATED IN LBS	CD	LP	LH
CP500E	5800	0.500	1.875	2.094	CP2000E	94000	2.000	5.188	5.547
CP750E	13250	0.750	2.625	2.938	CP2500E	145000	2.500	6.188	6.641
CP1000E	23500	1.000	3.125	3.375	CP3000E	210000	3.000	6.188	6.781
CP1375E	44500	1.375	4.188	4.484	CP3500E	285000	3.500	8.188	8.859
CP1750E	72000	1.750	5.188	5.547	CP4000E	375000	4.000	9.188	9.859

Weld Plate

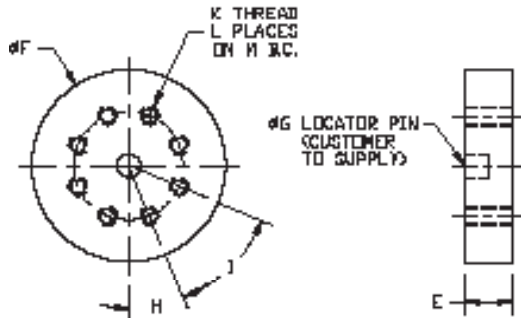

PART NO.	ROD DIA.	E	F	G (DIA.)	H	I	K	L	M
WP625	0.625	0.500	2.000	0.250	45.0°	90.0°	10 - 24	4	1.125
WP1000	1.000	0.500	2.500	0.250	30.0°	60.0°	1/4 - 20	6	1.500
WP1375	1.375	0.625	3.000	0.250	30.0°	60.0°	5/16 - 18	6	2.000
WP1750	1.750	0.625	4.000	0.250	22.5°	45.0°	5/16 - 18	8	2.375
WP2000	2.000	0.750	4.000	0.375	15.0°	30.0°	3/8 - 16	12	2.688
WP2500	2.500	0.750	4.500	0.375	15.0°	30.0°	3/8 - 16	12	3.188
WP3000	3.000	1.000	5.500	0.375	15.0°	30.0°	1/2 - 13	12	4.000
WP3500	3.500	1.000	7.000	0.375	15.0°	30.0°	5/8 - 11	12	4.688
WP4000	4.000	1.000	7.000	0.375	15.0°	30.0°	5/8 - 11	12	5.188
WP4500	4.500	1.000	8.000	0.375	15.0°	30.0°	5/8 - 11	12	5.688
WP5000	5.000	1.000	8.000	0.375	15.0°	30.0°	5/8 - 11	12	6.188
WP5500	5.500	1.250	9.000	0.375	15.0°	30.0°	3/4 - 10	12	6.875

Flange End Coupler

TO BE USED WITH KK10 STYLE ROD END

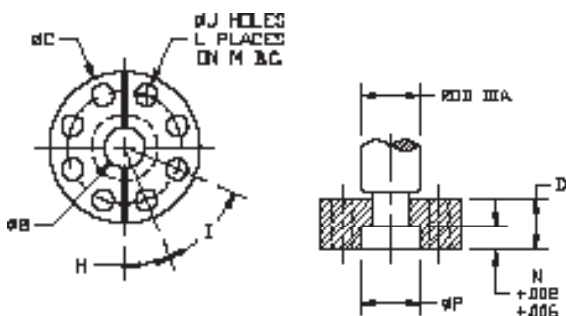

PART NO.	ROD DIA.	B	C	D	H	I	J	L	M	N	P
FEC625	0.625	0.406	1.500	0.563	45.0°	90.0°	0.219	4	1.125	0.250	0.656
FEC1000	1.000	0.750	2.000	0.875	30.0°	60.0°	0.281	6	1.500	0.375	1.063
FEC1375	1.375	0.938	2.500	1.000	30.0°	60.0°	0.344	6	2.000	0.375	1.438
FEC1750	1.750	1.188	3.000	1.250	22.5°	45.0°	0.344	8	2.375	0.500	1.813
FEC2000	2.000	1.438	3.500	1.625	15.0°	30.0°	0.406	12	2.688	0.625	2.063
FEC2500	2.500	1.875	4.000	1.875	15.0°	30.0°	0.406	12	3.188	0.750	2.625
FEC3000	3.000	2.375	5.000	2.375	15.0°	30.0°	0.531	12	4.000	0.875	3.125
FEC3500	3.500	2.625	5.875	2.625	15.0°	30.0°	0.656	12	4.688	1.000	3.625
FEC4000	4.000	3.125	6.375	2.625	15.0°	30.0°	0.656	12	5.188	1.000	4.125
FEC4500	4.500	3.625	6.875	3.125	15.0°	30.0°	0.656	12	5.688	1.500	4.625
FEC5000	5.000	4.000	7.375	3.125	15.0°	30.0°	0.656	12	6.188	1.500	5.125
FEC5500	5.500	4.500	8.250	3.875	15.0°	30.0°	0.781	12	6.875	1.875	5.625



Alignment couplers that can virtually pay for themselves by eliminating the need to precisely mount cylinders in your applications. Our couplers prevent binding and erratic movement that misalignment causes, extending the bearing and seal life of your cylinders. Proper use of alignment couplers will allow cylinders to stroke in the shortest time possible, increasing production!

Rod alignment couplers eliminate expensive machining for mounting fixed or rigid cylinders on guided or slide applications.

Simplifies alignment problems in the field.

Alignment couplers can be exposed to high stresses that are not apparent in an application. Always use the largest thread size practical in your application (see chart for maximum pull yields).

Use jam nut to lock coupler to rod when used with full diameter threads (example: 1.00" thread on 1.00" rod).

Large thread sizes can be pinned in tough duty applications, eliminating unwanted loosening of coupler from rod. Always use the smallest pin possible to avoid weakening the piston rod thread.

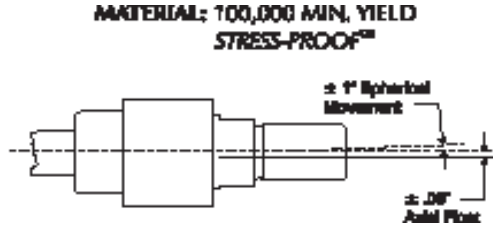

Standard AC Coupler
AC250 - AC5000



ACH Coupler
ACH250 - ACH1250

RECOMMENDED MAXIMUM STROKE FOR CYLINDERS WITH ALIGNMENT COUPLERS IN HORIZONTAL APPLICATIONS							
BORE	MAX STROKE	BORE	MAX STROKE	BORE	MAX STROKE	BORE	MAX STROKE
1.50	27	2.50	50	4.00	55	6.00	55
2.00	43	3.25	50	5.00	55	8.00	55



PART NO.	A	B	C	D	E	F	G	H	H HEX	J	MAX PULL POUNDS (3:1 SAFETY FACTOR)
AC250	1/4 -28	1.125	1.750	0.375	0.500	0.500	0.375	0.688	1.250	2.000	886
AC312	5/16 -24	1.125	1.750	0.375	0.500	0.500	0.375	0.688	1.250	2.000	1,623
AC375	3/8 -24	1.125	1.750	0.375	0.500	0.500	0.375	0.688	1.250	2.000	2,532
AC437	7/16 -20	1.250	2.000	0.438	0.750	0.625	0.500	0.813	1.250	2.156	3,526
AC500	1/2 -20	1.250	2.000	0.438	0.750	0.625	0.500	0.813	1.125	2.156	4,841
AC625	5/8 -18	1.250	2.000	0.438	0.750	0.625	0.500	0.813	1.250	2.156	7,862
AC750	3/4 -16	1.750	2.313	0.438	1.125	0.968	0.813	1.125	1.750	2.500	11,543
AC875	7/8 -14	1.750	2.313	0.438	1.125	0.968	0.813	1.125	1.750	2.500	15,846
AC1000	1-14	2.500	2.938	0.438	1.625	1.344	1.156	1.625	2.500	2.938	21,206
AC1250	1 1/4-12	2.500	2.938	0.438	1.625	1.344	1.156	1.625	2.500	2.938	34,024
AC1375	1 3/8-12	2.500	2.938	0.438	1.625	1.344	1.156	1.625	—	—	40,710
AC1500	1 1/2-12	3.250	4.375	0.875	2.250	1.968	1.750	2.375	—	—	49,857
AC1750	1 3/4-12	3.250	4.375	0.875	2.250	1.968	1.750	2.375	—	—	69,558
AC1875	1 7/8-12	3.750	5.625	1.000	3.000	2.468	2.125	2.750	—	—	79,354
AC2000	2-12	3.750	5.625	1.000	3.000	2.468	2.125	2.750	—	—	92,531
AC2250	2 1/4-12	4.500	6.375	1.000	3.500	2.968	2.625	3.375	—	—	118,776
AC2500	2 1/2-12	5.000	6.563	1.000	3.500	3.938	SPANNER HOLES	—	—	—	149,543
AC2750	2 3/4-12	5.000	6.563	1.000	3.500	3.938		—	—	—	182,464
AC3000	3-12	5.000	6.563	1.000	3.500	3.938		—	—	—	218,658
AC3250	3 1/4-12	6.250	8.125	1.000	4.500	4.938		—	—	—	258,124
AC3500	3 1/2-12	6.250	8.125	1.000	4.500	4.938		—	—	—	300,863
AC3750	3 3/4-12	6.250	8.125	1.000	4.500	4.938		—	—	—	346,875
AC4000	4-12	7.500	9.500	1.000	5.500	5.938		—	—	—	396,158
AC4500	4 1/2-12	7.500	9.500	1.000	5.500	5.938		—	—	—	504,544
AC5000	5-12	7.500	9.500	1.000	5.500	5.938		—	—	—	626,019

Notes: Please specify AC or ACH coupler when ordering: i.e.: AC750 (Std. Coupler) or ACH750 (Hex Coupler). Spanner holes are used on AC2500 and larger, (2) 1/2" dia. holes, 1/2" deep, 180° apart (each end).



TO BE USED WITH KK10
STYLE ROD END

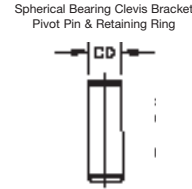
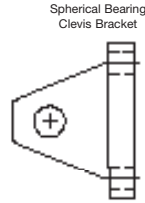
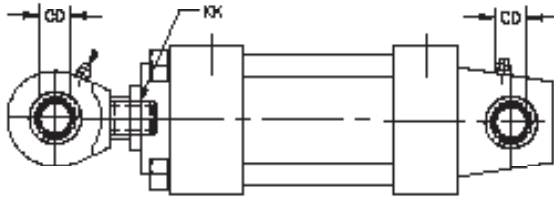

BORE	ROD DIAMETER (MM)	KK	CD	SPHERICAL BEARING ROD EYE PART NO.	SPHERICAL BEARING CLEVIS BRACKET PART NO.	SPHERICAL BEARING CLEVIS BRACKET PIVOT PIN PART NO.	SPHERICAL BEARING PIVOT PIN RETAINING RING PART NO.
1.50	0.625	7/16 - 20	0.500	H-MSRE-500	CB500-SB	CP500-SB	SH-50 STPA
1.50	1.000	7/16 - 20	0.500				
2.00	1.000	3/4 - 16	0.750	H-MSRE-750	CB750-SB	CP750-SB	SH-75 STPA
2.00	1.375	3/4 - 16	0.750				
2.50	1.000	3/4 - 16	0.750	H-MSRE-750	CD750-SB	CP750-SB	SH-75 STPA
2.50	1.375	3/4 - 16	0.750				
2.50	1.750	3/4 - 16	0.750				
3.25	1.375	1 - 14	1.000	H-MSRE-1000	CB1000-SB	CP1000-SB	SH-100 STPA
3.25	1.750	1 - 14	1.000				
3.25	2.000	1 - 14	1.000				
4.00	1.750	1 1/4 - 12	1.375	H-MSRE-1375	CB1375-SB	CP1375-SB	SH-137 STPA
4.00	2.000	1 1/4 - 12	1.375				
4.00	2.500	1 1/4 - 12	1.375				
5.00	2.000	1 1/2 - 12	1.750	H-MSRE-1750	CB1750-SB	CP1750-SB	SH-175 STPA
5.00	2.500	1 1/2 - 12	1.750				
5.00	3.000	1 1/2 - 12	1.750				
5.00	3.500	1 1/2 - 12	1.750				
6.00	2.500	1 7/8 - 12	2.000	H-MSRE-2000	CB2000-SB	CP2000-SB	SH-200 STPA
6.00	3.000	1 7/8 - 12	2.000				
6.00	3.500	1 7/8 - 12	2.000				
6.00	4.000	1 7/8 - 12	2.000				

Clevis Bracket

MATERIAL: CAST STEEL
FINISH: BLACK OXIDE

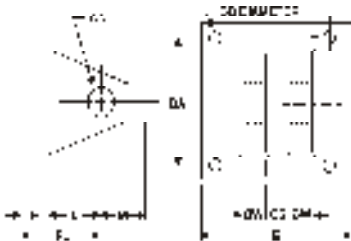

Clevis Pins sold separately from Clevis Brackets

PART NO.	MAX LOAD (TENSION) RATED IN LBS	BA	CB	CD (DIA.)	CW	DD (DIA.)	E	F	FL	L	M
CB500-SB	5770	2.050	0.440	0.500	0.500	0.410	3.000	0.500	1.500	1.000	0.500
CB750-SB	9450	2.760	0.660	0.750	0.620	0.530	3.750	0.625	2.000	1.375	0.875
CB1000-SB	14300	4.100	0.880	1.000	0.750	0.530	5.500	0.750	2.500	1.750	1.000
CB1375-SB	20300	4.950	1.190	1.375	1.000	0.660	6.500	0.875	3.500	2.625	1.380
CB1750-SB	37800	6.580	1.530	1.750	1.250	0.910	8.500	1.250	4.500	3.250	1.750
CB2000-SB	50375	7.920	1.750	2.000	1.500	0.910	10.620	1.500	5.000	3.500	2.000

Male Spherical Rod Eye

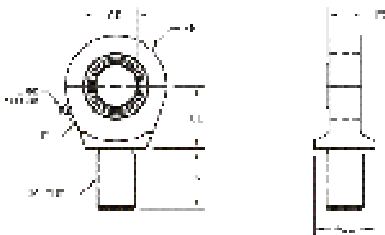

PART NO.	BORE (REF.)	A	CD	CE	ER	EX	JL	KK	LE	LOAD CAPACITY LBS
H-MSRE-500	1.50	0.688	0.500	0.875	0.875	0.437	0.875	7/16-20	0.750	2600
H-MSRE-750	2.00	1.000	0.750	1.250	1.250	0.656	1.313	3/4-16	1.063	9400
H-MSRE-750	2.50	1.000	0.750	1.250	1.250	0.656	1.313	3/4-16	1.063	9400
H-MSRE-1000	3.25	1.500	1.000	1.875	1.375	0.875	1.500	1-14	1.438	16800
H-MSRE-1375	4.00	2.000	1.375	2.125	1.813	1.188	2.000	1 1/4-12	1.875	28500
H-MSRE-1750	5.00	2.125	1.750	2.500	2.188	1.531	2.250	1 1/2-12	2.125	43000
H-MSRE-2000	6.00	2.875	2.000	2.750	2.625	1.750	2.750	1 7/8-12	2.500	70200

Pivot Pin

INCLUDES E-CLIPS



PART NO.	MAX LOAD (TENSION) RATED IN LBS	CD	LP	LH	PART NO.	MAX LOAD (TENSION) RATED IN LBS	CD	LP	LH
CP500-SB	8600	0.499	1.562	1.780	CP1375-SB	65000	1.374	3.312	3.610
CP750-SB	19300	0.749	2.031	2.281	CP1750-SB	105200	1.749	4.218	4.578
CP1000-SB	34300	0.999	2.500	2.750	CP2000-SB	137400	1.999	4.937	5.295

All our cylinders are proudly Made in USA

BALLUFF STROKEMASTER

Inductive Sensors

Balluff's new Strokemaster® cylinder-piston sensors provide precision end-of-stroke sensing for hydraulic cylinders. It also eliminates post-installation cable management problems with 304° of rotational freedom on the connector.

Strokemaster® sensors allow infinitely adjustable and lockable cable positioning anytime after mounting to the cylinder. Without breaking the seal, Strokemaster® enables quicker installation of the sensor *and* neat cable runs.

A high-pressure, inductive proximity switch, the Strokemaster® sensor provides a 2mm (0.8") sensing range to pick up the spud of hydraulic cylinders and indicate fully retracted or extended position. It mounts with just two screws, and seals with an O-ring. Withstanding cylinder pressures to 3000 PSI (207 BAR), the embeddable design keeps most of the switch protected within the cylinder, with only a 0.62" (16mm) high housing exposed outside. The rotating housing can be locked in the desired position with either one of two set screws.

Strokemaster® sensors are available in 3-wire or 4-wire DC and 3-wire AC/DC versions, mini or micro connectors. Switching frequency is 50 Hz in the AC/DC versions. All units are weld-field immune and short-circuit and reverse polarity protected. They fit all popular cylinder designs, with standard probe lengths of 0.912" - 4.560" (23.165mm - 115.8mm), along with available custom probe lengths and spacers. Probes are made of stainless steel with a ceramic face. Both DC and AC/DC sensors have all metal housings.

Strokemaster® is CE-certified, and its housing is sealed to IP67 requirements.

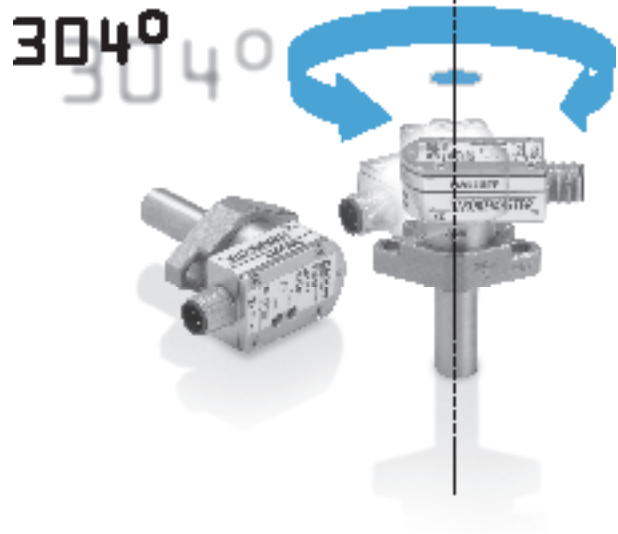

DC INDUCTIVE SENSORS



Inductive cylinder switch for piston position feedback in cylinders.

Magnetic field immune, for use with welding equipment

Available in DC or all current (AC/DC) versions

Easy installation - sensor mounts to cylinder with (2) fasteners

Sealed directly at flange, connector can be oriented after installation

Various lengths available for different cylinder sizes

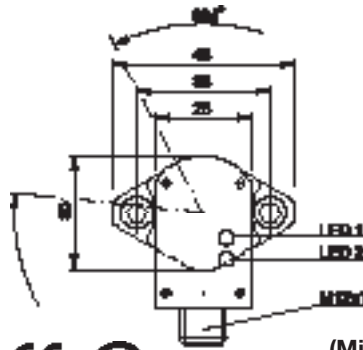

(Micro M12DC Connector)

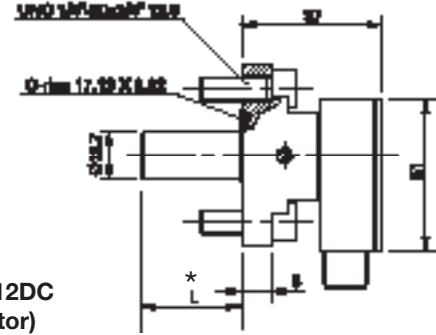

Bolt sensor to cylinder.

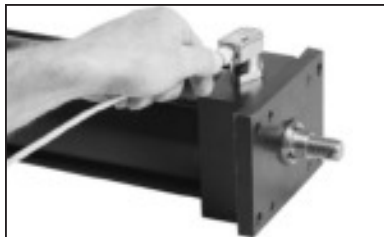

Position cable to desired orientation (even over mounting bolts).

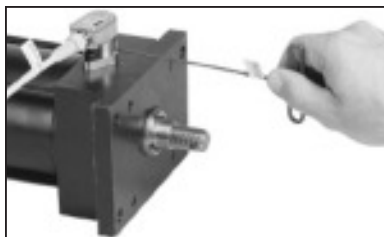

Lock chosen position with one or both of the two integral set screws.

PNP	Normally-open
Rated operational voltage U_o	
Supply voltage U_s	
Voltage drop U_a at I_o	
Rated insulation voltage U_i	
Rated operational current I_o	
No-load supply current I_r damped/undamped	
Off-state current I_r	
Protected against polarity reversal	
Short circuit/overload protected	
Load capacitance	
Repeat accuracy R	
Ambient temperature range T_a	
Frequency of operating cycles f	
Utilization categories	
Function/Operating voltage indication	
Degree of protection per IEC 529	
Housing material	
Material of sensing face	
Connection	
Approvals	
High pressure rated up to	
Recommended connector	

BES 516-300-S 295-S 4	
24 V DC	
10...30 V DC	
≤ 2.5 V	
75 V DC	
200 mA	
≤ 18 mA/ ≤ 10 mA	
≤ 80 μ A	
yes	
yes/yes	
≤ 1.0 μ F	
≤ 5 %	
-25...+70°C	
10 Hz	
DC 13	
yes/yes	
IP 67/connector IP 65	
stainless steel/aluminum	
ceramic	
Micro connector	
cULus	
207 bar (3000 PSI)	
C04 AEL-00-VY-050M	

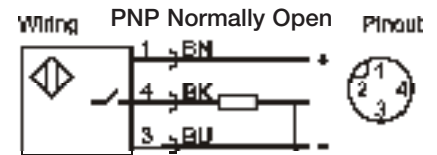

*HYDRAULIC CYLINDERS INC.® will supply the correct length probe and spacer combination (if required) for each cylinder. Using the combination of standard probe lengths & spacers, will give the appropriate .030" gap between sensor and cylinder spud. The spacers supplied have the same base profile as the sensor (material: stainless steel).

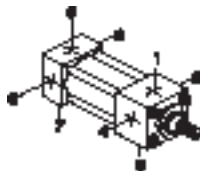

STANDARD LOCATIONS:

- Ports at 1 and 5
- Cushions at 2 and 6
- Sensors at 4 and 8

(Specify non-standard locations)

- H-MS2-325-100-KK1-N500
- BES 516-300-S 295-S4 (Head)
- BES 516-300-S 295-S4 (Cap)
- Sensors at 4 & 8

Note: HYDRAULIC CYLINDERS INC.® will include the Strokemaster® probe length on your order and any sensor spacers required. (Example: H-MS2-325-100-KK1-N500- BES 516-300-S4 /1.025-S21 (Head) -BES 516-300-S4 /1.75-S21 (Cap) - Sensors at 4 & 8.

Refer to page 129 for available cable connector sets.

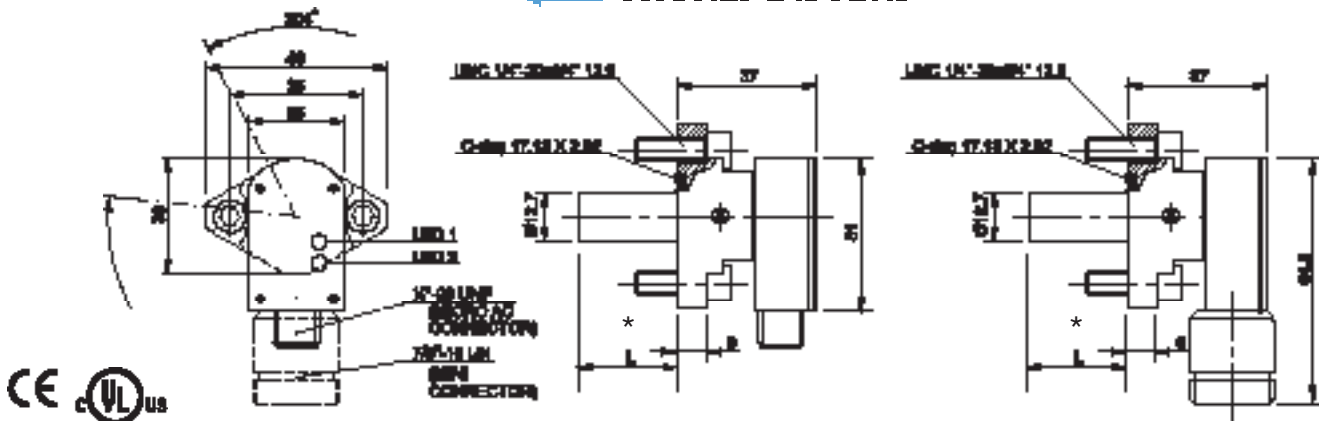

Normally-open
Rated operational voltage U_o
Supply voltage U_b
Voltage drop U_d at I_o
Rated insulation voltage U_i
Rated operational current I_o
Minimum operational current I_m
Off-state current I_r
Inrush current I_k (t = 20 ms)
Protected against polarity reversal
Short circuit protected
Repeat accuracy R
Ambient temperature range T_a
Frequency of operating cycles f
Utilization categories
Function/Operating voltage indication
Degree of protection per IEC 529
Insulation class
Housing material
Material of sensing face
Connection
Approvals
High pressure rated up to
Recommended connector

BES 516-200-S 2-S21
110 V AC
20...250 V AC/DC
≤ 6 V
250 V AC
500 mA
5 mA
≤ 1.7 mA @ 110 V AC
3 A max/1 Hz
yes
yes
≤ 5 %
-25...+70°C
≤ 50 Hz
AC 140/DC 13
yes/yes
IP 67
1
stainless steel/aluminum
ceramic
Mini connector
cULus
207 bar (3000 PSI)
C21 AE1-00-VY-150F

BES 516-200-S 2-S5
110 V AC
20...250 V AC/DC
≤ 6 V
250 V AC
500 mA
5 mA
≤ 1.7 mA @ 110 V AC
3 A max/1 Hz
yes
yes
≤ 5 %
-25...+70°C
≤ 50 Hz
AC 140/DC 13
yes/yes
IP 67
1
stainless steel/aluminum
ceramic
Mini connector
cULus
207 bar (3000 PSI)
C05 AE1-00-VY-150F

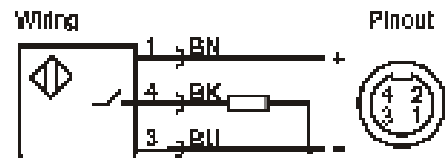
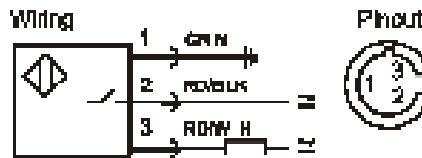

*HYDRAULIC CYLINDERS INC.® will supply the correct length probe and spacer combination (if required) for each cylinder. Using the combination of standard probe lengths & spacers, will give the appropriate .030" gap between sensor and cylinder spud. The spacers supplied have the same base profile as the sensor (material: stainless steel).

Refer to page 129 for available cable connector sets.

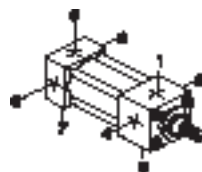

STANDARD LOCATIONS:

- Ports at 1 and 5
 - Cushions at 2 and 6
 - Sensors at 4 and 8
- (Specify non-standard locations)

- H-MS2-325-100-KK1-N500
- BES 516-200-S 2-S21 (Head)
- BES 516-200-S 2-S21 (Cap)
- Sensors at 4 & 8

Note:
HYDRAULIC CYLINDERS INC.® will include the Strokemaster® probe length on your order, and any sensor spacers required.
(Example: H-MS2-325-100-KK1-N500- BES 516-200-S 2 /1.025-S21 (Head) -BES 516-200-S 2 /1.75-S21 (Cap) - Sensors at 4 & 8.



Connector	3-5 Pole Mini
Style	Mini Size A
Configuration	Straight Female
Recommended Connector	C05 AE1-00-VY-150F

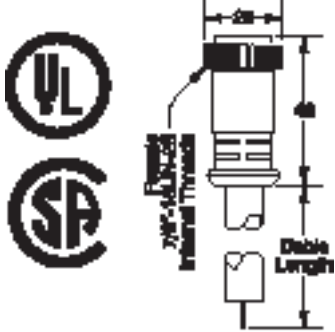

Connector	Micro AC .50" x 20 UNF
Style	3 Pin Dual Keyway
Configuration	Straight Female
Recommended Connector	C21 AE3-00-VY-150F

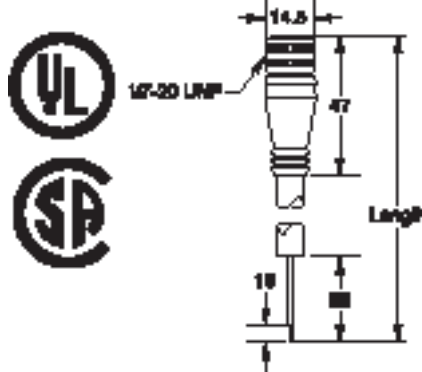

Connector	Micro
Style	M12 DC Single Keyway
Configuration	Straight Female
Recommended Connector	C04 AEL-00-VY-050M

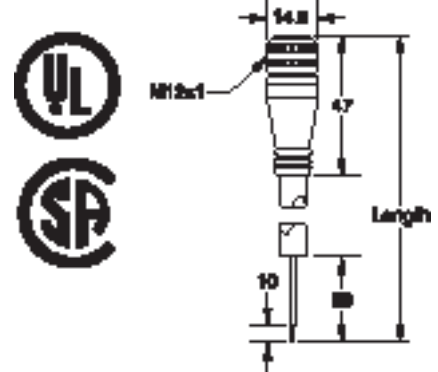

	ORDER NUMBER
3 Pole	C05 AE1 00 * Y 150
Voltage Rating	300 V AC/DC
Amperage	10A
Wire Gauge	16 AWG
Jacket	PVC
Coupling Nut	Black Epoxy Coated Zinc
Protection	IP68 / NEMA 6P
Ambient Operating Temp.	-4 - 221°F (-21 to 105°C)
UL Listed	Yes
CSA Certified	Yes

* Insert V = PVC Cable
T = TPE Cable
For 3 pole versions only

	ORDER NUMBER
3 Pin Dual Keyway	C21 AE3 00 * Y 150F
Voltage Rating	250 V AC/DC
Amperage	4A
Wire Gauge	22 AWG
Jacket	Yellow PVC or TPE
Coupling Nut	Black Epoxy Coated Zinc
O-Ring	Viton
Overmold Head	TPE
Protection	IP68 / NEMA 6P
Ambient Operating Temp.	-4 - 221°F (-21 to 105°C)
UL Listed	Yes
CSA Certified	Yes

Note: 15 ft cable is standard (other lengths available - contact factory)
* Insert V = PVC Cable
T = TPE Cable
For 3 pole versions only

	Note	ORDER NUMBER
3 Wire DC		
3 Wire Normally Open, non-LED 1,2,3		C04 AEC 00 * Y 050M
3 Wire Normally Open PNP w/LED		C04 AEH 00 * Y 050M
4 Wire DC (NO/NC) Recommended		
4 Wire (Universal), non-LED 1,2,3		C04 AEL 00 * Y 050M
4 Wire PNP w/LED 1,3		C04 AEM 00 * Y 050M
Voltage Rating	10 - 30 V DC	
Amperage	4 Amps	
Wire Gauge	22 AWG	
Jacket	Yellow PVC or TPE	
Coupling Nut	Black Epoxy Coated Zinc	
*Optional Stainless Steel	*Stainless Type 303	
Protection	IP68 / NEMA 6P	
Ambient Operating Temp.	-4 - 221°F (-21 to 105°C)	
UL Listed	Yes	
CSA Certified	Yes	

Note: 5 meter cable is standard (other lengths available - contact factory)
* Insert V = PVC Cable
T = TPE Cable
For 3 pole versions only

Female 3-pin - Face view



Female - Face view



Refer to Balluff Catalog for additional cable connectors.

- Notes: 1 Add B = Braided 80% Metallic Braid, i.e. 050 MB
- 2 Add S = S-Shielded 360 Degree Shield through Coupling Nut, i.e. 050 MS
- 3 Stainless Steel Coupling Nut: Change E to S, i.e. C04ASC00TY050M

Female - Face view

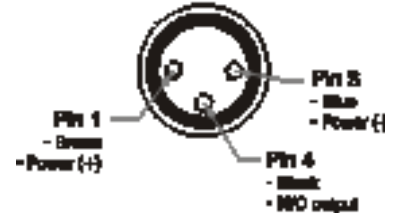

Female - Face view





The waveguide consists of a special nickel-iron alloy with 0.7 mm O.D. and 0.5 mm I.D.

A copper conductor is introduced through the length of this tube. The start of measurement is initiated by a short current pulse. This current generates a circular magnetic field which rotates around the waveguide.

A permanent magnet at the point of measurement is used as the marker element, whose lines of field run at right angles to the electromagnetic field.

In the area on the waveguide where the two fields intersect, a magnetostrictive effect causes an elastic deformation of the

waveguide, which propagates along the waveguide in both directions in the form of a mechanical wave.

The mechanical wave is converted to an electrical signal by the signal converter. The propagation time of the mechanical wave is determined by the position of the permanent magnet and can be determined to resolutions down to 5 μm.

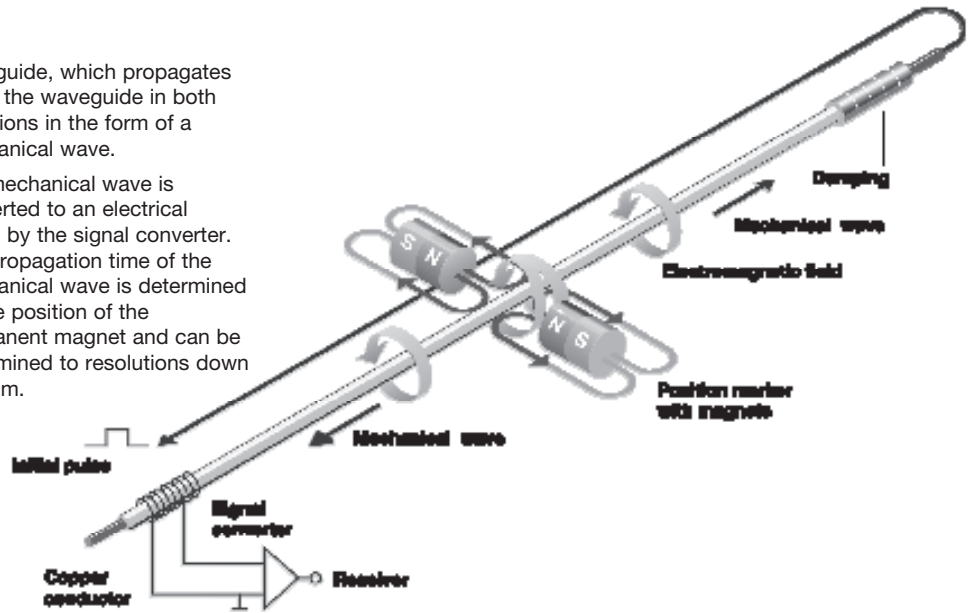

Balluff has the right transducer for any application!

- Rod styles
- Profile styles
- Tubular styles
- Embeddable style
- Explosion-proof style

Rod Style

3/4" x 16 UNF threads
 Pressure rated to 8700 PSI for use in hydraulic cylinders
 Replaceable electronics head
 Analog signal adjustable in field

Rugged, Compact Rod Style

Rugged all stainless steel housing
 Eliminates the need for protective cover
 Designed for demanding applications
 3/4" - 16 UNF threads
 Pressure rated to 8700 PSI

Compact, Bolt-in Rod Style

Rugged all stainless steel housing
 Bolt in design
 Pressure rated to 8700 PSI
 Eliminates the need for protective cover

Sensor Output Options	Rod Style	Rugged, Compact Rod Style	Compact, Bolt-in Rod Style
Analog			
0...10 V and 10...0 V	•	•	•
-5...+5 V and +5...-5 V	•	•	•
-10...+10 V and +10...-10 V	•	•	•
4...20 mA or 20...4 mA	•	•	•
0...20 mA or 20...0 mA	•	•	•
Digital			
Start/Stop, RS422	•	•	•
Pulse-Width Modulated, RS422	•	•	•
PWM (w/ recirculations), RS422	•	•	•
Specialized			
Synchronous Serial Interface*	•	•	•
CANopen	•	•	•
Profibus DP	•	•	•
Quadrature	•	•	•
Resolution			
0.1 mV (analog)	•	•	•
0.2 μA (analog)	•	•	•
16 bit (analog)	•	•	•
Controller-dependent (Start/Stop & PWM)	•	•	•
1,2,3,5,10 μm selectable (Quadrature output)	•	•	•
1,5,10,20,40 μm selectable (SSI output)	•	•	•
5 μm increments selectable (CANopen & Profibus)	•	•	•
Stroke Length			
Active measurement area: 2" to 156" (Consult factory for longer lengths)	2" - 156"	2" - 156"	2" - 156"
Wiring Options			
Quick disconnect	•	•	•
Cable-out	•	•	•
Operating Voltage			
24 V DC (±20%)	•	•	•
±15 V DC (±2%)	•	•	•

*(24 or 25 bit binary or gray code)

**We will build your cylinder with the proper magnet, spacer plates (if required), drilling and tapping, intermediate supports (if required) and furnish the transducer as a complete unit.
All cylinder/transducer assemblies are 100% tested before shipping.**

Not available on MP1 and MP2 Mounts

1.50" to 8.00" Bores

Gun-drilled piston rod
(Requires 1" piston rod or larger)

Balluff Magnet (Installed on piston)

May require additional cap length

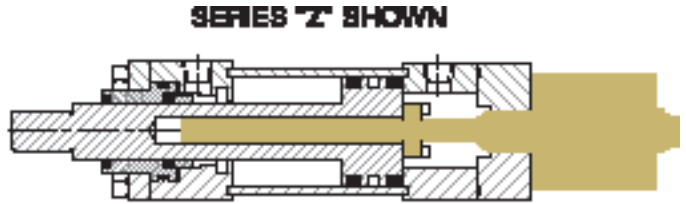

Complete Balluff MICROPULSE™ Transducer information is available in catalog form or electronic PDF downloads. Visit

Other Balluff models are available. Call HYDRAULIC CYLINDERS INC.® for information cylinder design assistance.



BALLUFF Sensor Solutions Superior Service Dedicated to our Customer's Success
1-800-543-8390

PRODUCTS SOLUTIONS NEWS ABOUT BALLUFF SALES & SERVICE HOME

PRODUCTS SOLUTIONS SALES & SERVICE

2008 Photoelectrics

MICROPULSE

Micropulse Linear Position Transducers Catalog

- RTL Product Description
- RTL Rod Style Series: RTL Z
- RTL Compact Rugged Rod Style Thread-in: RTL W
- RTL Compact Rugged Rod Style Bolt-in: RTL K
- RTL Explosion Proof Rod Style Series: RTL EX
- RTL Embeddable Rod Style Series: RTL E
- RTL Profile Series: RTL P
- RTL Low Profile Series: RTL B

Micropulse Catalog Contents



SERIES "Z" SHOWN

We will provide hydraulic cylinders built to your specifications and can incorporate MTS Temposonics® Transducers in a wide variety of models.

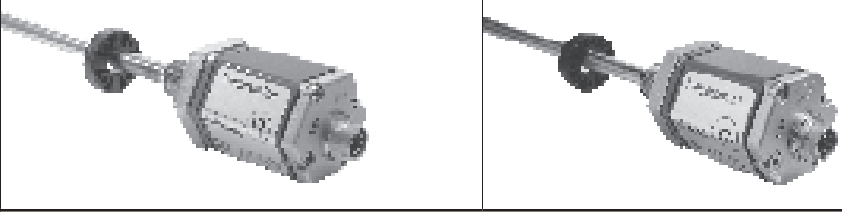
		
	<p><i>H STYLE</i> Hydraulic/pneumatic sensor housing with integral electronics</p>	
<p><i>DIRECT SENSOR OUTPUTS</i></p>	Voltage 0 to +10V, +10 to 0V -10 to +10V, +10 to -10V (1)	Voltage 0 to +10V, +10 to 0V -10 to +10V, +10 to -10V (1)
	Current 0 or 4 to 20 mA, 20 to 4 or 0 mA	Current 0 or 4 to 20 mA, 20 to 4 or 0 mA
	SSI, Synchronous Serial Interface, (absolute encoder format)	
	Fieldbus - CANbus (2), DeviceNet, Profibus DP	
		Digital Pulse Start/Stop or PWM
<p><i>STROKE LENGTH</i></p>	50 to 7,620 mm (2 to 300 in.)	Voltage or Current 50 to 2,540 mm (2 to 100 in.) Digital Pulse 50 to 7,620 mm (2 to 300 in.)
<p><i>RESOLUTION</i></p>	16 bit, as low as 0.01 mm (0.0004 in.) (Analog)	Infinite (6)
	as low as 0.002mm (0.00008 in.) (Digital) (5)	Controller Dependent (Digital Pulse)
<p><i>MEASUREMENT FEATURES</i></p>	Position / Displacement	Position / Displacement
	Velocity	
	Multiple magnets to 15	Multiple magnets to 15
	Analog Zero and Span Scale Adjustment	Analog Zero and Span Scale Adjustment
<p><i>EXTERNAL INTERFACES</i></p>		TDU-200 Digital Display (for digital pulse outputs)
		MK-292 (Parallel 24 Bit Binary, BCD or Gray Code)

Hydraulic/Pneumatic “H Style”

- Sensing element pressure housing threads into standard size port on cylinder end cap.
- Industry standard for position feedback in fluid power cylinders.
- Convenient sensor cartridge field replacement without need to break oil seal.
- High pressure flange and isolation tube (5000 PSI static, 10,000 PSI spike).

(1) Additional output ranges available.

(2) Includes CANOpen and MTS multiple-magnet position, velocity and programmable limit switch output.

(3) R-Series SSI available with 0.001mm (0.00004 in.) resolution.

(4) Analog (Voltage or Current) resolution restricted by output ripple.

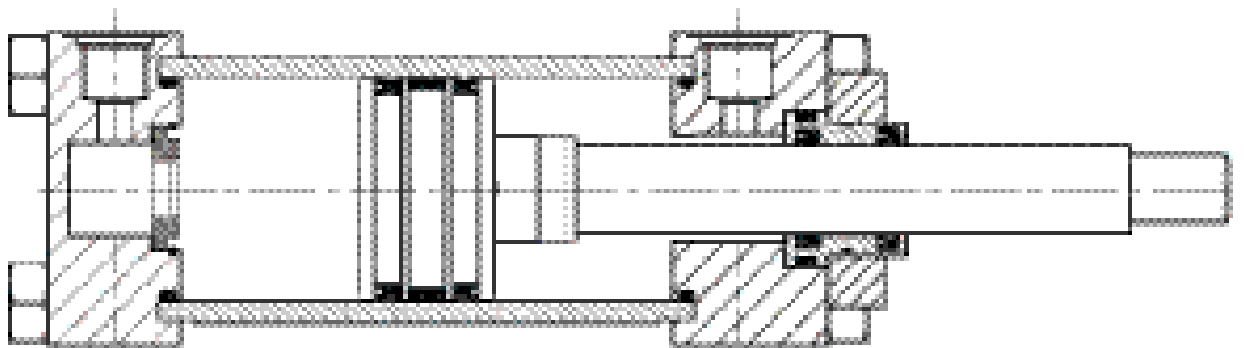

TECHNICAL DATA & INFORMATION

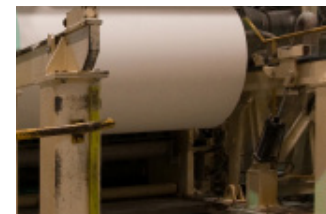
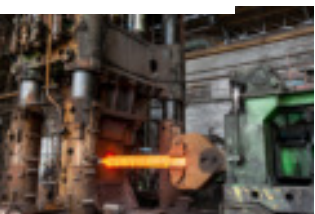

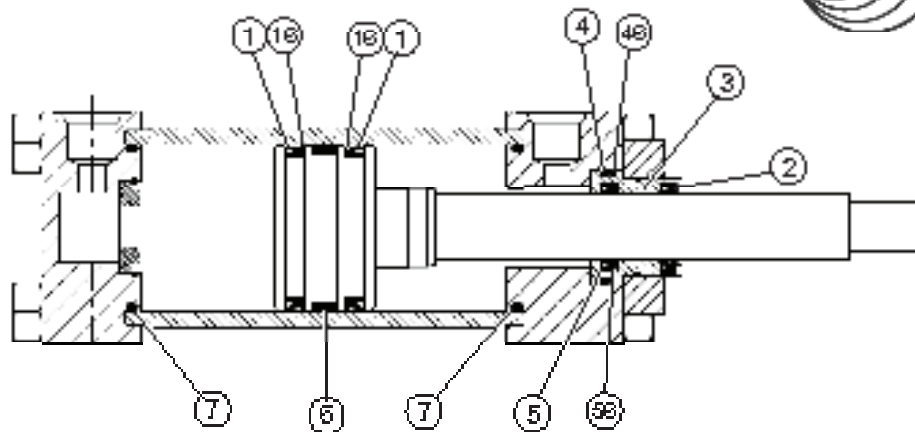

PARTS WITH THIS COLOR SCHEME ARE NON-STOCK ITEMS. CONTACT HYDRAULIC CYLINDERS INC.® FOR DELIVERY.

(1) PISTON SEAL					
BORE	CARBOXILATED NITRILE (STANDARD)	FLUOROCARBON (V OPTION)	ETHYLENE PROPYLENE (E OPTION)	CAST IRON RINGS (C OPTION)	PTFE W/ GLASS (T OPTION)
1.50	H-PS-15-CN	H-PS-15-V	H-PS-15-EP	H-PS-CR-15-TFP	H-PS-R5-15-T-B
2.00	H-PS-20-CN	H-PS-20-V	H-PS-20-EP	H-PS-CR-20-TFP	H-PS-R5-20-T-B
2.50	H-PS-25-CN	H-PS-25-V	H-PS-25-EP	H-PS-CR-25-TFP	H-PS-R5-25-T-B
3.25	H-PS-32-CN	H-PS-32-V	H-PS-32-EP	H-PS-CR-32-TFP	H-PS-R5-32-T-B
4.00	H-PS-40-CN	H-PS-40-V	H-PS-40-EP	H-PS-CR-40-TFP	H-PS-R5-40-T-B
5.00	H-PS-50-CN	H-PS-50-V	H-PS-50-EP	H-PS-CR-50-TFP	H-PS-R5-50-T-B
6.00	H-PS-60-CN	H-PS-60-V	H-PS-60-EP	H-PS-CR-60-TFP	H-PS-R5-60-T-B
8.00	H-PS-80-CN	H-PS-80-V	H-PS-80-EP	H-PS-CR-80-TFP	H-PS-R5-80-T-B

(1B) PISTON SEAL BACKUP		
BORE	HYTREL (BACKUP FOR S)	PTFE (BACKUP FOR E & V)
1.50	H-BU-PS-15-PM	H-BU-PS-15-T
2.00	H-BU-PS-20-PM	H-BU-PS-20-T
2.50	H-BU-PS-25-PM	H-BU-PS-25-T
3.25	H-BU-PS-32-PM	H-BU-PS-32-T
4.00	H-BU-PS-40-PM	H-BU-PS-40-T
5.00	H-BU-PS-50-PM	H-BU-PS-50-T
6.00	H-BU-PS-60-PM	H-BU-PS-60-T
8.00	H-BU-PS-80-PM	H-BU-PS-80-T

(3) ROD BUSHING (DUCTILE IRON)			
ROD DIA.	DUCTILE IRON BUSHING (STANDARD)	METALLIC SCRAPER (M OPTION)	PTFE WIPER (E OPTION)
0.625	H-30-625	H-30-625-MS	H-30-625-T
1.000	H-30-1000	H-30-1000-MS	H-30-1000-T
1.375	H-30-1375	H-30-1375-MS	H-30-1375-T
1.750	H-30-1750	H-30-1750-MS	H-30-1750-T
2.000	H-30-2000	H-30-2000-MS	H-30-2000-T
2.500	H-30-2500	H-30-2500-MS	H-30-2500-T
3.000	H-30-3000	H-30-3000-MS	H-30-3000-T
3.500	H-30-3500	H-30-3500-MS	H-30-3500-T
4.000	H-30-4000	H-30-4000-MS	H-30-4000-T
4.500	H-30-4500	H-30-4500-MS	H-30-4500-T
5.000	H-30-5000	H-30-5000-MS	H-30-5000-T
5.500	H-30-5500	H-30-5500-MS	H-30-5500-T

(4) ROD BUSHING O-RING			
ROD DIA.	BUNA (STANDARD)	FLUOROCARBON (V OPTION)	ETHYLENE PROPYLENE (E OPTION)
0.625	H-BO-625-B	H-BO-625-V	H-BO-625-EP
1.000	H-BO-1000-B	H-BO-1000-V	H-BO-1000-EP
1.375	H-BO-1375-B	H-BO-1375-V	H-BO-1375-EP
1.750	H-BO-1750-B	H-BO-1750-V	H-BO-1750-EP
2.000	H-BO-2000-B	H-BO-2000-V	H-BO-2000-EP
2.500	H-BO-2500-B	H-BO-2500-V	H-BO-2500-EP
3.000	H-BO-3000-B	H-BO-3000-V	H-BO-3000-EP
3.500	H-BO-3500-B	H-BO-3500-V	H-BO-3500-EP
4.000	H-BO-4000-B	H-BO-4000-V	H-BO-4000-EP
4.500	H-BO-4500-B	H-BO-4500-V	H-BO-4500-EP
5.000	H-BO-5000-B	H-BO-5000-V	H-BO-5000-EP
5.500	H-BO-5500-B	H-BO-5500-V	H-BO-5500-EP

(4B) ROD BUSHING O-RING BACKUP		
ROD DIA.	POLYMYTE (BACKUP FOR S)	PTFE (BACKUP FOR E&V)
0.625	H-BU-BO-625-PM	H-BU-BO-625-T
1.000	H-BU-BO-1000-PM	H-BU-BO-1000-T
1.375	H-BU-BO-1375-PM	H-BU-BO-1375-T
1.750	H-BU-BO-1750-PM	H-BU-BO-1750-T
2.000	H-BU-BO-2000-PM	H-BU-BO-2000-T
2.500	H-BU-BO-2500-PM	H-BU-BO-2500-T
3.000	H-BU-BO-3000-PM	H-BU-BO-3000-T
3.500	H-BU-BO-3500-PM	H-BU-BO-3500-T
4.000	H-BU-BO-4000-PM	H-BU-BO-4000-T
4.500	H-BU-BO-4500-PM	H-BU-BO-4500-T
5.000	H-BU-BO-5000-PM	H-BU-BO-5000-T
5.500	H-BU-BO-5500-PM	H-BU-BO-5500-T

(3) ROD BUSHING (BRONZE)			
ROD DIA.	BRONZE BUSHING (RBB OPTION)	METALLIC SCRAPER (M OPTION)	PTFE WIPER (E OPTION)
0.625	H-30-625-BZ	H-30-625-BZ-MS	H-30-625-BZ-T
1.000	H-30-1000-BZ	H-30-1000-BZ-MS	H-30-1000-BZ-T
1.375	H-30-1375-BZ	H-30-1375-BZ-MS	H-30-1375-BZ-T
1.750	H-30-1750-BZ	H-30-1750-BZ-MS	H-30-1750-BZ-T
2.000	H-30-2000-BZ	H-30-2000-BZ-MS	H-30-2000-BZ-T
2.500	H-30-2500-BZ	H-30-2500-BZ-MS	H-30-2500-BZ-T
3.000	H-30-3000-BZ	H-30-3000-BZ-MS	H-30-3000-BZ-T
3.500	H-30-3500-BZ	H-30-3500-BZ-MS	H-30-3500-BZ-T
4.000	H-30-4000-BZ	H-30-4000-BZ-MS	H-30-4000-BZ-T
4.500	H-30-4500-BZ	H-30-4500-BZ-MS	H-30-4500-BZ-T
5.000	H-30-5000-BZ	H-30-5000-BZ-MS	H-30-5000-BZ-T
5.500	H-30-5500-BZ	H-30-5500-BZ-MS	H-30-5500-BZ-T

(5) PART LIST - ROD SEAL			
ROD DIA.	POLYURETHANE (STANDARD)	FLUOROCARBON (V OPTION)	ETHYLENE PROPYLENE (E OPTION)
0.625	H-RS-625-HT	H-RS-625-V	H-RS-625-EP
1.000	H-RS-1000-HT	H-RS-1000-V	H-RS-1000-EP
1.375	H-RS-1375-HT	H-RS-1375-V	H-RS-1375-EP
1.750	H-RS-1750-HT	H-RS-1750-V	H-RS-1750-EP
2.000	H-RS-2000-HT	H-RS-2000-V	H-RS-2000-EP
2.500	H-RS-2500-HT	H-RS-2500-V	H-RS-2500-EP
3.000	H-RS-3000-HT	H-RS-3000-V	H-RS-3000-EP
3.500	H-RS-3500-HT	H-RS-3500-V	H-RS-3500-EP
4.000	H-RS-4000-HT	H-RS-4000-V	H-RS-4000-EP
4.500	H-RS-4500-HT	H-RS-4500-V	H-RS-4500-EP
5.000	H-RS-5000-HT	H-RS-5000-V	H-RS-5000-EP
5.500	H-RS-5500-HT	H-RS-5500-V	H-RS-5500-EP

(5B) ROD SEAL BACKUP		
ROD DIA.	POLYMYTE	PTFE (BACKUP FOR E&V)
0.625	H-BU-RS-625-PM	H-BU-RS-625-T
1.000	H-BU-RS-1000-PM	H-BU-RS-1000-T
1.375	H-BU-RS-1375-PM	H-BU-RS-1375-T
1.750	H-BU-RS-1750-PM	H-BU-RS-1750-T
2.000	H-BU-RS-2000-PM	H-BU-RS-2000-T
2.500	H-BU-RS-2500-PM	H-BU-RS-2500-T
3.000	H-BU-RS-3000-PM	H-BU-RS-3000-T
3.500	H-BU-RS-3500-PM	H-BU-RS-3500-T
4.000	H-BU-RS-4000-PM	H-BU-RS-4000-T
4.500	H-BU-RS-4500-PM	H-BU-RS-4500-T
5.000	H-BU-RS-5000-PM	H-BU-RS-5000-T
5.500	H-BU-RS-5500-PM	H-BU-RS-5500-T

All our cylinders are proudly Made in USA



PARTS WITH THIS COLOR SCHEME ARE NON-STOCK ITEMS. CONTACT HYDRAULIC CYLINDERS INC.® FOR DELIVERY.

(2) PART LIST - ROD WIPER

ROD DIA.	FLOCKED NITRILE (STANDARD)	FLUOROCARBON (V OPTION)	ETHYLENE PROPYLENE (E OPTION)	METALLIC SCRAPER (M OPTION)	PTFE WIPER (T OPTION)
0.625	H-RW-625-FN	H-RW-625-V	ETHYLENE PROPYLENE ROD WIPER IS NOT AVAILABLE. WHEN CYLINDER DESIGN CALLS FOR EP ROD WIPERS, HYDRAULIC CYLINDERS INC.® RECOMMENDS: 'T' PTFE ROD WIPER.	H-RW-625-MS	H-RW-625-T
1.000	H-RW-1000-FN	H-RW-1000-V		H-RW-1000-MS	H-RW-1000-T
1.375	H-RW-1375-FN	H-RW-1375-V		H-RW-1375-MS	H-RW-1375-T
1.750	H-RW-1750-FN	H-RW-1750-V		H-RW-1750-MS	H-RW-1750-T
2.000	H-RW-2000-FN	H-RW-2000-V		H-RW-2000-MS	H-RW-2000-T
2.500	H-RW-2500-FN	H-RW-2500-V		H-RW-2500-MS	H-RW-2500-T
3.000	H-RW-3000-FN	H-RW-3000-V		H-RW-3000-MS	H-RW-3000-T
3.500	H-RW-3500-FN	H-RW-3500-V		H-RW-3500-MS	H-RW-3500-T
4.000	H-RW-4000-FN	H-RW-4000-V		H-RW-4000-MS	H-RW-4000-T
4.500	H-RW-4500-FN	H-RW-4500-V		H-RW-4500-MS	H-RW-4500-T
5.000	H-RW-5000-FN	H-RW-5000-V		H-RW-5000-MS	H-RW-5000-T
5.500	H-RW-5500-FN	H-RW-5500-V		H-RW-5500-MS	H-RW-5500-T

(6) PART LIST - WEAR BAND

BORE	GLASS REINFORCED NYLON (FOR PISTON SEAL S)	GLASS REINFORCED NYLON WIDE (FOR PISTON SEAL T)	BRONZE FILLED PTFE (FOR PISTON SEAL E & V)
1.50	H-PWR-15-WG	H-PWR-15-WG-1	H-PWR-15-T
2.00	H-PWR-20-WG	H-PWR-20-WG-1	H-PWR-20-T
2.50	H-PWR-25-WG	H-PWR-25-WG-1	H-PWR-25-T
3.25	H-PWR-32-WG	H-PWR-32-WG-1	H-PWR-32-T
4.00	H-PWR-40-WG	H-PWR-40-WG-1	H-PWR-40-T
5.00	H-PWR-50-WG	H-PWR-50-WG-1	H-PWR-50-T
6.00	H-PWR-60-WG	H-PWR-60-WG	H-PWR-60-T
8.00	H-PWR-80-WG	H-PWR-80-WG	H-PWR-80-T

(7) PART LIST - TUBE SEAL

BORE	BUNA (STANDARD)	FLUOROCARBON (V OPTION)	ETHYLENE PROPYLENE (E OPTION)
1.50	H-OTS-15-B	H-OTS-15-V	H-OTS-15-EP
2.00	H-OTS-20-B	H-OTS-20-V	H-OTS-20-EP
2.50	H-OTS-25-B	H-OTS-25-V	H-OTS-25-EP
3.25	H-OTS-32-B	H-OTS-32-V	H-OTS-32-EP
4.00	H-OTS-40-B	H-OTS-40-V	H-OTS-40-EP
5.00	H-OTS-50-B	H-OTS-50-V	H-OTS-50-EP
6.00	H-OTS-60-B	H-OTS-60-V	H-OTS-60-EP
8.00	H-OTS-80-B	H-OTS-80-V	H-OTS-80-EP

HOW TO ORDER: SEAL KITS

NOTE: To insure proper seals are supplied for all models, **ALWAYS** supply serial number.

H - **SK** **137** - **250** - **S S S S**

SEAL KIT SERIES	ROD SIZE	BORE	PISTON SEAL	ROD SEAL	TUBE SEAL	ROD WIPER*
H - SK	062 0.625" ROD DIA.	150 1.50" BORE	S STANDARD (CARBOXILATED)	S STANDARD (POLYURETHANE)	S STANDARD (BUNA)	S STANDARD (FLOCKED NITRILE)
H SERIES SEAL KIT	100 1.000" ROD DIA.	200 2.00" BORE	C CAST-RING	E EP	E EP	M METALLIC SCRAPER
	137 1.375" ROD DIA.	250 2.50" BORE	E EP	V FLUOROCARBON	V FLUOROCARBON	T PTFE
	175 1.750" ROD DIA.	325 3.25" BORE	T PTFE			V FLUOROCARBON
	200 2.000" ROD DIA.	400 4.00" BORE	V FLUOROCARBON			
	250 2.500" ROD DIA.	500 5.00" BORE				
	300 3.000" ROD DIA.	600 6.00" BORE				
	350 3.500" ROD DIA.	800 8.00" BORE				
	400 4.000" ROD DIA.					
	450 4.500" ROD DIA.					
	500 5.000" ROD DIA.					
	550 5.500" ROD DIA.					

*Note: When cylinder design calls for all EP seals, use PTFE rod wiper.

All seal kits come with proper backup rings when required.
To order replacement seal kits, call out the rod size, bore size and the seal selection from the original order.

Examples:
H-SK137-400-SSSS
H-SK100-250-VVVT
H-SK-300-600-CSSM

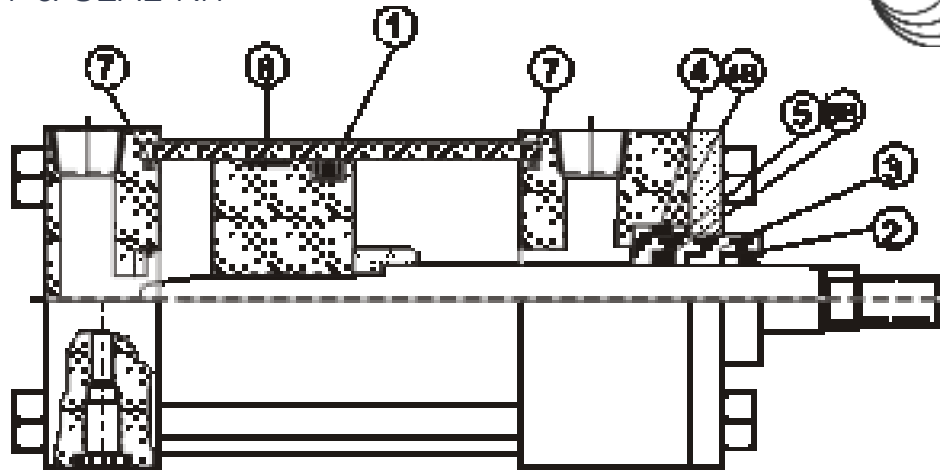

(1) PISTON SEALS				
BORE	CARBOXILATED NITRILE (Standard)	FLUOROCARBON (V OPTION)	ETHYLENE PROPYLENE (E OPTION)	CAST IRON RINGS (C OPTION)
1.50	M-PS-15-TP	M-PS-15-TP-V	M-PS-15-TP-EP	H-PS-CR-15-TFP
2.00	M-PS-20-TP	M-PS-20-TP-V	M-PS-20-TP-EP	H-PS-CR-20-TFP
2.50	M-PS-25-TP	M-PS-25-TP-V	M-PS-25-TP-EP	H-PS-CR-25-TFP
3.25	M-PS-32-TP	M-PS-32-TP-V	M-PS-32-TP-EP	H-PS-CR-32-TFP
4.00	M-PS-40-TP	M-PS-40-TP-V	M-PS-40-TP-EP	H-PS-CR-40-TFP
5.00	M-PS-50-TP	M-PS-50-TP-V	M-PS-50-TP-EP	H-PS-CR-50-TFP
6.00	M-PS-60-TP	M-PS-60-TP-V	M-PS-60-TP-EP	H-PS-CR-60-TFP
8.00	M-PS-80-TP	M-PS-80-TP-V	M-PS-80-TP-EP	H-PS-CR-80-TFP

(3) ROD BUSHING (CAST IRON)			
ROD DIAMETER	CAST IRON BUSHING (STANDARD)	METALLIC SCRAPPER (M OPTION)	PTFE WIPER (E OPTION)
0.625	H-30-625	H-30-625-MS	H-30-625-T
1.000	M-30-1000	M-30-1000-MS	M-30-1000-T
1.375	M-30-1375	M-30-1375-MS	M-30-1375-T
1.750	M-30-1750	M-30-1750-MS	M-30-1750-T
2.000	H-30-2000	H-30-2000-MS	H-30-2000-T
2.500	H-30-2500	H-30-2500-MS	H-30-2500-T
3.000	H-30-3000	H-30-3000-MS	H-30-3000-T
3.500	H-30-3500	H-30-3500-MS	H-30-3500-T
4.000	M-30-4000	M-30-4000-MS	M-30-4000-T
4.500	M-30-4500	M-30-4500-MS	M-30-4500-T
5.000	M-30-5000	M-30-5000-MS	M-30-5000-T
5.500	M-30-5500	M-30-5500-MS	M-30-5500-T

(4) ROD BUSHING O-RINGS			
ROD DIAMETER	BUNA (STANDARD)	FLUOROCARBON (V OPTION)	ETHYLENE PROPYLENE (E OPTION)
0.625	H-BO-625-B	H-BO-625-V	H-BO-625-EP
1.000	M-BO-1000-B	M-BO-1000-V	M-BO-1000-EP
1.375	M-BO-1375-B	M-BO-1375-V	M-BO-1375-EP
1.750	M-BO-1750-B	M-BO-1750-V	M-BO-1750-EP
2.000	H-BO-2000-B	H-BO-2000-V	H-BO-2000-EP
2.500	H-BO-2500-B	H-BO-2500-V	H-BO-2500-EP
3.000	H-BO-3000-B	H-BO-3000-V	H-BO-3000-EP
3.500	H-BO-3500-B	H-BO-3500-V	H-BO-3500-EP
4.000	H-BO-4000-B	H-BO-4000-V	H-BO-4000-EP
4.500	H-BO-4500-B	H-BO-4500-V	H-BO-4500-EP
5.000	H-BO-5000-B	H-BO-5000-V	H-BO-5000-EP
5.500	M-BO-5500-B	M-BO-5500-V	M-BO-5500-EP

(4B) ROD BUSHING O-RING BACKUP		
ROD DIAMETER	POLYMYTE (BACKUP FOR S)	PTFE (BACKUP FOR E&V)
0.625	H-BU-BO-625-PM	H-BU-BO-625-T
1.000	M-BU-BO-1000-PM	M-BU-BO-1000-T
1.375	M-BU-BO-1375-PM	M-BU-BO-1375-T
1.750	M-BU-BO-1750-PM	M-BU-BO-1750-T
2.000	H-BU-BO-2000-PM	H-BU-BO-2000-T
2.500	H-BU-BO-2500-PM	H-BU-BO-2500-T
3.000	H-BU-BO-3000-PM	H-BU-BO-3000-T
3.500	H-BU-BO-3500-PM	H-BU-BO-3500-T
4.000	H-BU-BO-4000-PM	H-BU-BO-4000-T
4.500	H-BU-BO-4500-PM	H-BU-BO-4500-T
5.000	H-BU-BO-5000-PM	H-BU-BO-5000-T
5.500	M-BU-BO-5500-PM	M-BU-BO-5500-T

(3) ROD BUSHING (BRONZE)			
ROD DIAMETER	BRONZE BUSHING (RBB OPTION)	METALLIC SCRAPPER (M OPTION)	PTFE WIPER (E OPTION)
0.625	H-30-625-BZ	H-30-625-BZ-MS	H-30-625-BZ-T
1.000	M-30-1000-BZ	M-30-1000-BZ-MS	M-30-1000-BZ-T
1.375	M-30-1375-BZ	M-30-1375-BZ-MS	M-30-1375-BZ-T
1.750	M-30-1750-BZ	M-30-1750-BZ-MS	M-30-1750-BZ-T
2.000	H-30-2000-BZ	H-30-2000-BZ-MS	H-30-2000-BZ-T
2.500	H-30-2500-BZ	H-30-2500-BZ-MS	H-30-2500-BZ-T
3.000	H-30-3000-BZ	H-30-3000-BZ-MS	H-30-3000-BZ-T
3.500	H-30-3500-BZ	H-30-3500-BZ-MS	H-30-3500-BZ-T
4.000	M-30-4000-BZ	M-30-4000-BZ-MS	M-30-4000-BZ-T
4.500	M-30-4500-BZ	M-30-4500-BZ-MS	M-30-4500-BZ-T
5.000	M-30-5000-BZ	M-30-5000-BZ-MS	M-30-5000-BZ-T
5.500	M-30-5500-BZ	M-30-5500-BZ-MS	M-30-5500-BZ-T

(5) PART LIST - ROD SEALS			
ROD DIAMETER	POLYURETHANE (STANDARD)	FLUOROCARBON (V OPTION)	ETHYLENE PROPYLENE (E OPTION)
0.625	H-RS-625-HT	H-RS-625-V	H-RS-625-EP
1.000	H-RS-1000-HT	H-RS-1000-V	H-RS-1000-EP
1.375	H-RS-1375-HT	H-RS-1375-V	H-RS-1375-EP
1.750	H-RS-1750-HT	H-RS-1750-V	H-RS-1750-EP
2.000	H-RS-2000-HT	H-RS-2000-V	H-RS-2000-EP
2.500	H-RS-2500-HT	H-RS-2500-V	H-RS-2500-EP
3.000	H-RS-3000-HT	H-RS-3000-V	H-RS-3000-EP
3.500	H-RS-3500-HT	H-RS-3500-V	H-RS-3500-EP
4.000	H-RS-4000-HT	H-RS-4000-V	H-RS-4000-EP
4.500	H-RS-4500-HT	H-RS-4500-V	H-RS-4500-EP
5.000	H-RS-5000-HT	H-RS-5000-V	H-RS-5000-EP
5.500	H-RS-5500-HT	H-RS-5500-V	H-RS-5500-EP

(5B) ROD SEAL BACKUPS		
ROD DIAMETER	POLYMYTE	PTFE (BACKUP FOR E&V)
0.625	H-BU-RS-625-PM	H-BU-RS-625-T
1.000	H-BU-RS-1000-PM	H-BU-RS-1000-T
1.375	H-BU-RS-1375-PM	H-BU-RS-1375-T
1.750	H-BU-RS-1750-PM	H-BU-RS-1750-T
2.000	H-BU-RS-2000-PM	H-BU-RS-2000-T
2.500	H-BU-RS-2500-PM	H-BU-RS-2500-T
3.000	H-BU-RS-3000-PM	H-BU-RS-3000-T
3.500	H-BU-RS-3500-PM	H-BU-RS-3500-T
4.000	H-BU-RS-4000-PM	H-BU-RS-4000-T
4.500	H-BU-RS-4500-PM	H-BU-RS-4500-T
5.000	H-BU-RS-5000-PM	H-BU-RS-5000-T
5.500	H-BU-RS-5500-PM	H-BU-RS-5500-T

All our cylinders are proudly Made in USA



(2) PART LIST - ROD WIPER

ROD DIAMETER	FLOCKED NITRILE (STANDARD)	FLUOROCARBON (V OPTION)	ETHYLENE PROPYLENE (E OPTION)	METALLIC SCRAPER (M OPTION)	PTFE WIPER (T OPTION)
0.625	H-RW-625-FN	H-RW-625-V	ETHYLENE PROPYLENE ROD WIPER IS NOT AVAILABLE. WHEN CYLINDER DESIGN CALLS FOR EP ROD WIPERS, HYDRAULIC CYLINDERS INC.® RECOMMENDS: 'T' PTFE ROD WIPER.	H-RW-625-MS	H-RW-625-T
1.000	H-RW-1000-FN	H-RW-1000-V		H-RW-1000-MS	H-RW-1000-T
1.375	H-RW-1375-FN	H-RW-1375-V		H-RW-1375-MS	H-RW-1375-T
1.750	H-RW-1750-FN	H-RW-1750-V		H-RW-1750-MS	H-RW-1750-T
2.000	H-RW-2000-FN	H-RW-2000-V		H-RW-2000-MS	H-RW-2000-T
2.500	H-RW-2500-FN	H-RW-2500-V		H-RW-2500-MS	H-RW-2500-T
3.000	H-RW-3000-FN	H-RW-3000-V		H-RW-3000-MS	H-RW-3000-T
3.500	H-RW-3500-FN	H-RW-3500-V		H-RW-3500-MS	H-RW-3500-T
4.000	H-RW-4000-FN	H-RW-4000-V		H-RW-4000-MS	H-RW-4000-T
4.500	H-RW-4500-FN	H-RW-4500-V		H-RW-4500-MS	H-RW-4500-T
5.000	H-RW-5000-FN	H-RW-5000-V		H-RW-5000-MS	H-RW-5000-T
5.500	H-RW-5500-FN	H-RW-5500-V		H-RW-5500-MS	H-RW-5500-T

(6) PART LIST - WEAR BANDS

BORE	GLASS REINFORCED NYLON (FOR PISTON SEAL S)	GLASS REINFORCED NYLON WIDE (FOR PISTON SEAL T)	BRONZE FILLED PTFE (FOR PISTON SEAL E & V)
1.50	H-PWR-15-WG	H-PWR-15-WG-1	H-PWR-15-T
2.00	H-PWR-20-WG	H-PWR-20-WG-1	H-PWR-20-T
2.50	H-PWR-25-WG	H-PWR-25-WG-1	H-PWR-25-T
3.25	H-PWR-32-WG	H-PWR-32-WG-1	H-PWR-32-T
4.00	H-PWR-40-WG	H-PWR-40-WG-1	H-PWR-40-T
5.00	H-PWR-50-WG	H-PWR-50-WG-1	H-PWR-50-T
6.00	H-PWR-60-WG	H-PWR-60-WG	H-PWR-60-T
8.00	H-PWR-80-WG	H-PWR-80-WG	H-PWR-80-T

(7) PART LIST - TUBE SEALS

BORE	BUNA (STANDARD)	FLUOROCARBON (V OPTION)	ETHYLENE PROPYLENE (E OPTION)
1.50	M-OTS-15-B	M-OTS-15-V	M-OTS-15-EP
2.00	M-OTS-20-B	M-OTS-20-V	M-OTS-20-EP
2.50	M-OTS-25-B	M-OTS-25-V	M-OTS-25-EP
3.25	M-OTS-32-B	M-OTS-32-V	M-OTS-32-EP
4.00	M-OTS-40-B	M-OTS-40-V	M-OTS-40-EP
5.00	M-OTS-50-B	M-OTS-50-V	M-OTS-50-EP
6.00	M-OTS-60-B	M-OTS-60-V	M-OTS-60-EP
8.00	M-OTS-80-B	M-OTS-80-V	M-OTS-80-EP

HOW TO ORDER: SEAL KITS

NOTE: To insure proper seals are supplied for all models, **ALWAYS** supply serial number.

M - SK 137 - 250 - S S S S

SEAL KIT SERIES		ROD SIZE		BORE		PISTON SEALS		ROD SEALS		TUBE SEALS		ROD WIPER*	
M - SK	M SERIES SEAL KIT	062	0.625" ROD DIA.	150	1.50" BORE	S	STANDARD (CARBOXILATED)	S	STANDARD (POLYURETHANE)	S	STANDARD (BUNA)	S	STANDARD (FLOCKED NITRILE)
		100	1.000" ROD DIA.	200	2.00" BORE	C	CAST-RING	E	EP	E	EP	M	METALLIC SCRAPPER
		137	1.375" ROD DIA.	250	2.50" BORE	E	EP	V	FLUOROCARBON	V	FLUOROCARBON	T	PTFE
		175	1.750" ROD DIA.	325	3.25" BORE	T	PTFE					V	FLUOROCARBON
		200	2.000" ROD DIA.	400	4.00" BORE	V	FLUOROCARBON						
		250	2.500" ROD DIA.	500	5.00" BORE								
		300	3.000" ROD DIA.	600	6.00" BORE								
		350	3.500" ROD DIA.	800	8.00" BORE								
		400	4.000" ROD DIA.										
		450	4.500" ROD DIA.										
		500	5.000" ROD DIA.										
		550	5.500" ROD DIA.										

*Note: When cylinder design calls for all EP seals, use PTFE rod wiper.

All seal kits come with proper backup rings when required.

To order replacement seal kits, call out the rod size, bore size and the seal selection from the original order.

Examples:

M-SK137-400-SSSS

M-SK100-250-VVVT

M-SK-300-600-CSSM

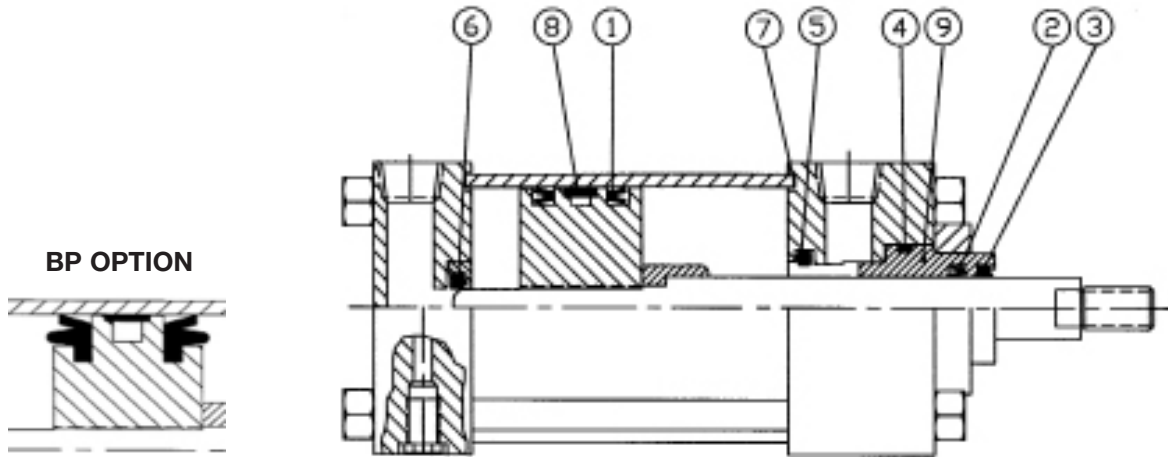

(1) PISTON SEALS				
BORE	STANDARD	BP OPTION	AO OR TH OPTION	LF OPTION
1.50	(2) PS-15	(2) BPS-15B	(1) PSP-15, (1) PS-15	(2) PS-15-LF
2.00	(2) PS-20	(2) BPS-20B	(1) PSP-20, (1) PS-20	(2) PS-20-LF
2.50	(2) PS-25	(2) BPS-25B	(1) PSP-25, (1) PS-25	(2) PS-25-LF
3.25	(2) PS-32	(2) BPS-32B	(1) PSP-32, (1) PS-32	(2) PS-32-LF
4.00	(2) PS-40	(2) BPS-40B	(1) PSP-40, (1) PS-40	(2) PS-40-LF
5.00	(2) PS-50	(2) BPS-50B	(1) PSP-50, (1) PS-50	(2) PS-50-LF
6.00	(2) PS-60	(2) BPS-60B	(1) PSP-60, (1) PS-60	(2) PS-60-LF
8.00	(2) PS-80	(2) BPS-80B	(1) PSP-80, (1) PS-80	(2) PS-80-LF

(1) PISTON SEALS WITH VS OPTION				
BORE	STANDARD	BP OPTION	AO OR TH OPTION	LF OPTION
1.50	(2) PS-15-V	(2) BPS-15-V	(1) PSP-15-V, (1) PS-15-V	N/A
2.00	(2) PS-20-V	(2) BPS-20-V	(1) PSP-20-V, (1) PS-20-V	N/A
2.50	(2) PS-25-V	(2) BPS-25-V	(1) PSP-25-V, (1) PS-25-V	N/A
3.25	(2) PS-32-V	(2) BPS-32-V	(1) PSP-32-V, (1) PS-32-V	N/A
4.00	(2) PS-40-V	(2) BPS-40-V	(1) PSP-40-V, (1) PS-40-V	N/A
5.00	(2) PS-50-V	(2) BPS-50-V	(1) PSP-50-V, (1) PS-50-V	N/A
6.00	(2) PS-60-V	(2) BPS-60-V	(1) PSP-60-V, (1) PS-60-V	N/A
8.00	(2) PS-80-V	(2) BPS-80-V	(1) PSP-80-V, (1) PS-80-V	N/A

(2) ROD SEAL				
ROD DIAMETER	STANDARD	VS OPTION	TH OPTION	TH OPTION & VS OPTION
0.625	RS-625	RS-625-V	RSP-625	RSP-625-V
1.000	RS-1000	RS-1000-V	RSP-1000	RSP-1000-V
1.375	RS-1375	RS-1375-V	RSP-1375	RSP-1375-V
1.750	RS-1750	RS-1750-V	RSP-1750	RSP-1750-V

(3) ROD WIPER				
ROD DIAMETER	STANDARD	VS OPTION	TH OPTION	TH OPTION & VS OPTION
0.625	RW-625	RW-625-V	QRW-625	QRW-625-V
1.000	RW-1000	RW-1000-V	QRW-1000	QRW-1000-V
1.375	RW-1375	RW-1375-V	QRW-1375	QRW-1375-V
1.750	RW-1750	RW-1750-V	QRW-1750	QRW-1750-V

(4) ROD BUSHING O-RINGS			
BORE SIZE	ROD SIZE	STANDARD	VS OPTION
All Bore Sizes	0.625	BO-1	BO-1-V
1.50" Bore Only	1.000	BO-2-OS	BO-2-OS-V
All except 1.50"	1.000	BO-2	BO-2-V
All Bore Sizes	1.375	BO-3	BO-3-V
All Bore Sizes	1.750	BO-4	BO-4-V

CUSHIONS				
ROD DIAMETER	Head (5)	CAP (6)	HEAD WITH VS OPTION (5)	CAP WITH VS OPTION (6)
0.625	CS-3	CS-1	CS-3-V	CS-1-V
1.000	CS-4	CS-2	CS-4-V	CS-2-V
1.375	CS-5	CS-3	CS-5-V	CS-3-V
1.750	CS-6	CS-3	CS-6-V	CS-3-V



'TS' PART LIST & SEAL KIT

(7) TUBE SEALS		
BORE	STANDARD	VS OPTION
1.50	(2) OTS-15	(2) OTS-15-V
2.00	(2) OTS-20	(2) OTS-20-V
2.50	(2) OTS-25	(2) OTS-25-V
3.25	(2) OTS-32	(2) OTS-32-V
4.00	(2) OTS-40	(2) OTS-40-V
5.00	(2) OTS-50	(2) OTS-50-V
6.00	(2) OTS-60	(2) OTS-60-V
8.00	(2) OTS-80	(2) OTS-80-V

(9) BUSHING				
BORE SIZE	ROD SIZE	STANDARD	MS OPTION	TH OPTION
All Bore Sizes	0.625	A-30-1	A-30-1-MS-C	TH-30-1-C
1.50" Bore Only	1.000	A-30-2-OS	A-30-2-MS-C-OS	TH-30-2-OS-C
All except 1.50"	1.000	A-30-2	A-30-2-MS-C	TH-30-2-C
All Bore Sizes	1.375	A-30-3	A-30-3-MS-C	TH-30-3-C
All Bore Sizes	1.750	A-30-4	A-30-4-MS-C	TH-30-4-C

(8) WEARBAND	
BORE	PART
1.50	TWB-15
2.00	TWB-20
2.50	TWB-25
3.25	TWB-32
4.00	TWB-40
5.00	TWB-50
6.00	TWB-60
8.00	TWB-80

(9) BUSHING - RBB OPTION				
BORE SIZE	ROD SIZE	STANDARD	MS OPTION	TH OPTION
All Bore Sizes	0.625	A-30-1-BZ	A-30-1-MS-BZ	TH-30-1-BZ
1.50" Bore Only	1.000	A-30-2-OS-BZ	A-30-2-MS-BZ-OS	TH-30-2-OS-BZ
All except 1.50"	1.000	A-30-2-BZ	A-30-2-MS-BZ	TH-30-2-BZ
All Bore Sizes	1.375	A-30-3-BZ	A-30-3-MS-BZ	TH-30-3-BZ
All Bore Sizes	1.750	A-30-4-BZ	A-30-4-MS-BZ	TH-30-4-BZ

HOW TO ORDER: SEAL KITS

NOTE: To insure proper seals are supplied for all models, **ALWAYS** supply TRD serial number.

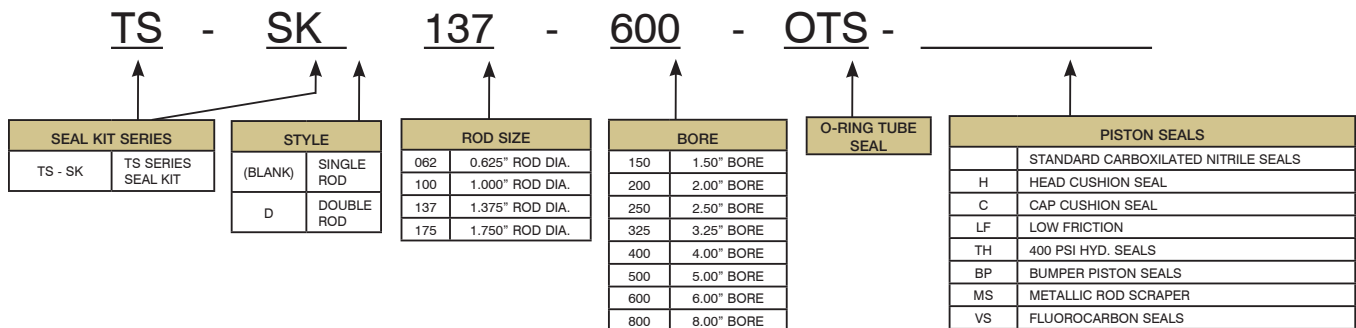

All seal kits come with proper backup rings when required.
To order replacement seal kits, call out the rod size, bore size, and the seal selection from the original order.

Examples:
TS-SK 137-400-OTS
TS-SK 100-250-OTS-HC
TS-SKD 100-600-OTS



BORE	ROD DIA. (MM)	EFFECTIVE PISTON AREA	POUNDS OF FORCE AT PSI										DISPLACEMENT PER INCH OF STROKE (GALLONS)
			100	150	200	250	500	1000	1500	2000	2500	3000	
1.50	EXTEND	1.77	177	265	353	442	884	1767	2651	3534	4418	5301	.00765
	0.625	1.46	146	219	292	365	730	1460	2191	2921	3651	4381	.00635
	1.000	0.98	98	147	196	245	491	982	1473	1964	2454	2945	.00425
2.00	EXTEND	3.14	314	471	628	785	1571	3142	4712	6283	7854	9425	.0136
	1.000	2.36	236	353	471	589	1178	2356	3534	4712	5891	7069	.0102
	1.375	1.66	166	249	331	414	828	1657	2485	3313	4142	4970	.0071
2.50	EXTEND	4.91	491	736	982	1227	2454	4909	7363	9818	12272	14726	.0213
	1.000	4.12	412	619	825	1031	2062	4123	6185	8247	10308	12370	.0179
	1.375	3.42	342	514	685	856	1712	3424	5136	6848	8560	10272	.0148
	1.750	2.50	250	376	501	626	1252	2503	3755	5007	6259	7510	.0109
3.25	EXTEND	8.30	830	1244	1659	2074	4148	8296	12444	16592	20739	24887	.0359
	1.375	6.81	681	1022	1362	1703	3405	6811	10216	13622	17027	20433	.0294
	1.750	5.89	589	884	1178	1473	2945	5891	8836	11781	14726	17672	.0255
	2.000	5.15	515	773	1031	1289	2577	5154	7731	10308	12885	15463	.0223
4.00	EXTEND	12.57	1257	1885	2513	3142	6283	12566	18850	25133	31416	37699	.0544
	1.750	10.16	1016	1524	2032	2540	5081	10161	15242	20322	25403	30483	.0440
	2.000	9.42	942	1414	1885	2356	4712	9425	14137	18850	23562	28274	.0408
	2.500	7.66	766	1149	1532	1914	3829	7658	11486	15315	19144	22973	.0331
5.00	EXTEND	19.64	1964	2945	3927	4909	9818	19635	29453	39270	49088	58905	.0850
	2.000	16.49	1649	2474	3299	4123	8247	16493	24740	32987	41234	49480	.0714
	2.500	14.73	1473	2209	2945	3682	7363	14726	22089	29453	36816	44179	.0637
	3.000	12.57	1257	1885	2513	3142	6283	12566	18850	25133	31416	37699	.0544
	3.500	10.02	1002	1503	2004	2505	5009	10019	15028	20038	25047	30056	.0434
6.00	EXTEND	28.27	2827	4241	5655	7069	14137	28274	42412	56549	70686	84823	.1224
	2.500	23.37	2337	3505	4673	5841	11683	23366	35048	46731	58414	70097	.1011
	3.000	21.21	2121	3181	4241	5301	10603	21206	31809	42412	53015	63617	.0918
	3.500	18.65	1865	2798	3730	4663	9325	18650	27975	37300	46625	55950	.0808
	4.000	15.70	1570	2355	3140	3925	7850	15700	23550	31400	39250	47100	.0680
8.00	EXTEND	50.27	5027	7540	10053	12566	25133	50266	75398	100531	125664	150797	.2176
	3.500	40.64	4064	6097	8129	10161	20322	40644	60967	81289	101611	121933	.1760
	4.000	37.70	3770	5655	7540	9425	18850	37699	56549	75398	94248	113098	.1632
	4.500	34.36	3436	5154	6872	8590	17181	34361	51542	68723	85903	103084	.1488
	5.000	30.63	3063	4595	6126	7658	15315	30631	45946	61261	76577	91892	.1326
	5.500	26.51	2651	3976	5301	6627	13254	26507	39761	53015	66268	79522	.1148

*Theoretical force. Actual force will be reduced by friction.

TIE ROD TORQUE SPECS		
BORE	TIE ROD SIZE	TORQUE (FT-LBS)
1.50	.375 DIA.	25 FT-LBS
2.00	.500 DIA.	50 FT-LBS
2.50	.500 DIA.	50 FT-LBS
3.25	.625 DIA.	120 FT-LBS
4.00	.625 DIA.	130 FT-LBS
5.00	.875 DIA.	300 FT-LBS
6.00	1.000 DIA.	450 FT-LBS
8.00	1.250 DIA.	900 FT-LBS

BUSHING RETAINER SCREWS TORQUE SPECS	
SHCS SIZE	TORQUE (FT-LBS)
1/4" THREAD	15 FT-LBS
5/16" THREAD	20 FT-LBS
3/8" THREAD	30 FT-LBS
7/16" THREAD	40 FT-LBS

BUSHING RETAINER HEX HEAD SCREWS TORQUE SPECS	
HEX HEAD SCREW SIZE	TORQUE (FT-LBS)
3/8" THREAD	30 FT-LBS
1/2" THREAD	40 FT-LBS
5/8" THREAD	50 FT-LBS
7/8" THREAD	90 FT-LBS
1" THREAD	125 FT-LBS

All Torque Specs are based upon using anti-seize thread lubricant.

SPEC: LPS Premium Copper Anti-Seize
 Temperature Rating: -65°F to 1800°F
 Military Spec: MIL-PRF-907-E

Torque Tolerance: -0% to +5%



BORE	ROD DIA. (MM)	EFFECTIVE PISTON AREA	POUNDS OF FORCE AT PSI													DISPLACEMENT PER INCH OF STROKE (GALLONS)
			250	350	440	500	550	630	675	750	830	980	1000	1300	1500	
1.50	EXTEND	1.767	442	618	777	884	972	1113	1193	1325	1467	1732	1767	2297	2651	0.00765
	0.625	1.460	365	511	642	730	803	920	986	1095	1212	1431	1460	1898	2190	0.00635
	1.000	0.982	246	344	432	491	540	619	663	737	815	962	982	1277	1473	0.00425
2.00	EXTEND	3.142	786	1100	1382	1571	1728	1979	2121	2357	2608	3079	3142	4085	4713	0.0136
	0.625	2.835	709	992	1247	1418	1559	1786	1914	2126	2353	2778	2835	3686	4253	0.0123
	1.000	2.357	589	825	1037	1179	1296	1485	1591	1768	1956	2310	2357	3064	3536	0.0102
	1.375	1.657	414	580	729	829	911	1044	1118	1243	1375	1624	1657	2154	2486	0.0071
2.50	EXTEND	4.909	1227	1718	2160	2455	2700	3093	3314	3682	4074	4811	4909	6382	7364	0.0213
	0.625	4.602	1151	1611	2025	2301	2531	2899	3106	3452	3820	4510	4602	5983	6903	0.0200
	1.000	4.124	1031	1443	1815	2062	2268	2598	2784	3093	3423	4042	4124	5361	6186	0.0179
	1.375	3.424	856	1198	1507	1712	1883	2157	2311	2568	2842	3356	3424	4451	5136	0.0148
	1.750	2.504	626	876	1102	1252	1377	1578	1690	1878	2078	2454	2504	3255	3756	0.0109
3.25	EXTEND	8.296	2074	2904	3650	4148	4563	5226	5600	6222	6886	8130	8296	10785	12444	0.0359
	1.000	7.511	1878	2629	3305	3756	4131	4732	5070	5633	6234	7361	7511	9764	11267	0.0325
	1.375	6.811	1703	2384	2997	3406	3746	4291	4597	5108	5653	6675	6811	8854	10217	0.0294
	1.750	5.891	1473	2062	2592	2946	3240	3711	3976	4418	4890	5773	5891	7658	8837	0.0255
	2.000	5.154	1289	1804	2268	2577	2835	3247	3479	3866	4278	5051	5154	6700	7731	0.0223
4.00	EXTEND	12.566	3142	4398	5529	6283	6911	7917	8482	9425	10430	12315	12566	16336	18849	0.0544
	1.000	11.781	2945	4123	5184	5891	6480	7422	7952	8836	9778	11545	11781	15315	17672	0.0510
	1.375	11.081	2770	3878	4876	5541	6095	6981	7480	8311	9197	10859	11081	14405	16622	0.0479
	1.750	10.161	2540	3556	4471	5081	5589	6401	6859	7621	8434	9958	10161	13209	15242	0.0440
	2.000	9.424	2356	3298	4147	4712	5183	5937	6361	7068	7822	9236	9424	12251	14136	0.0408
	2.500	7.657	1914	2680	3369	3829	4211	4824	5168	5743	6355	7504	7657	9954	11486	0.0331
5.00	EXTEND	19.635	4909	6872	8639	9818	10799	12370	13254	14726	16297	19242	19635	25526	29453	0.0850
	1.000	18.850	4713	6598	8294	9425	10368	11876	12724	14138	15646	18473	18850	24505	28275	0.0816
	1.375	18.150	4538	6353	7986	9075	9983	11435	12251	13613	15065	17787	18150	23595	27225	0.0785
	1.750	17.230	4308	6031	7581	8615	9477	10855	11630	12923	14301	16885	17230	22399	25845	0.0746
	2.000	16.493	4123	5773	7257	8247	9071	10391	11133	12370	13689	16163	16493	21441	24740	0.0714
	2.500	14.726	3682	5154	6479	7363	8099	9277	9940	11045	12223	14431	14726	19144	22089	0.0637
	3.000	12.566	3142	4398	5529	6283	6911	7917	8482	9425	10430	12315	12566	16336	18849	0.0544
	3.500	10.014	2504	3505	4406	5007	5508	6309	6759	7511	8312	9814	10014	13018	15021	0.0434
6.00	EXTEND	28.274	7069	9896	12441	14137	15551	17813	19085	21206	23467	27709	28274	36756	42411	0.1224
	1.375	26.789	6697	9376	11787	13395	14734	16877	18083	20092	22235	26253	26789	34826	40184	0.1159
	1.750	25.869	6467	9054	11382	12935	14228	16297	17462	19402	21471	25352	25869	33630	38804	0.1112
	2.000	25.132	6283	8796	11058	12566	13823	15833	16964	18849	20860	24629	25132	32672	37698	0.1088
	2.500	23.365	5841	8178	10281	11683	12851	14720	15771	17524	19393	22898	23365	30375	35048	0.1011
	3.000	21.205	5301	7422	9330	10603	11663	13359	14313	15904	17600	20781	21205	27567	31808	0.0918
	3.500	18.653	4663	6529	8207	9327	10259	11751	12591	13990	15482	18280	18653	24249	27980	0.0808
	4.000	15.708	3927	5498	6912	7854	8639	9896	10603	11781	13038	15394	15708	20420	23562	0.0680
8.00	EXTEND	50.265	12566	17593	22117	25133	27646	31667	33929	37699	41720	49260	50265	65345	75398	0.2176
	1.375	48.780	12195	17073	21463	24390	26829	30731	32927	36585	40487	47804	48780	63414	73170	0.2111
	1.750	47.860	11965	16751	21058	23930	26323	30152	32306	35895	39724	46903	47860	62218	71790	0.2072
	2.000	47.123	11781	16493	20734	23562	25918	29687	31808	35342	39112	46181	47123	61260	70685	0.2040
	2.500	45.356	11339	15875	19957	22678	24946	28574	30615	34017	37645	44449	45356	58963	68034	0.1963
	3.000	43.196	10799	15119	19006	21598	23758	27213	29157	32397	35853	42332	43196	56155	64794	0.1870
	3.500	40.644	10161	14225	17883	20322	22354	25606	27435	30483	33735	39831	40644	52837	60966	0.1760
	4.000	37.699	9425	13195	16588	18850	20734	23750	25447	28274	31290	36945	37699	49009	56549	0.1632
	4.500	34.361	8590	12026	15119	17181	18899	21647	23194	25771	28520	33674	34361	44669	51542	0.1488
	5.000	30.630	7658	10721	13477	15315	16847	19297	20675	22973	25423	30017	30630	39819	45945	0.1326
	5.500	26.507	6627	9277	11663	13254	14579	16699	17892	19880	22001	25977	26507	34459	39761	0.1148

*Theoretical force. Actual force will be reduced by friction.

'M' MEDIUM DUTY HYDRAULIC TIE ROD TORQUE SPECS	
BORE	TORQUE (FT-LBS)
1.50	8 FT-LBS
2.00	15 FT-LBS
2.50	15 FT-LBS
3.25	30 FT-LBS
4.00	30 FT-LBS
5.00	55 FT-LBS
6.00	60 FT-LBS
7.00	140 FT-LBS
8.00	140 FT-LBS

'M' MEDIUM DUTY HYDRAULIC SQUARE RETAINER PLATE TORQUE SPECS	
HEX HEAD SCREW SIZE	TORQUE (FT-LBS)
1/4 - 28	7 FT-LBS
5/16 - 24	12 FT-LBS
3/8 - 24	30 FT-LBS
1/2 - 20	50 FT-LBS
5/8 - 18	50 FT-LBS

'M' MEDIUM DUTY HYDRAULIC ROUND RETAINER PLATE TORQUE SPECS	
SOCKET HEAD CAP SCREW SIZE	TORQUE (FT-LBS)
#10 - 32	5 FT-LBS
1/4 - 28	15 FT-LBS
5/16 - 24	20 FT-LBS

All Torque Specs are based upon using anti-seize thread lubricant. Tighten cylinders using an "X" tightening pattern on tie rods.

SPEC: LPS Premium Copper Anti-Seize
 Temperature Rating: -65°F to 1800°F
 Military Spec: MIL-PRF-907-E

Torque Tolerance: -0% to +5%

All our cylinders are proudly Made in USA



BORE	ROD DIA. (MM)	STROKE TYPE	EFFECTIVE PISTON AREA	POUNDS OF FORCE AT PSI						DISPLACEMENT PER INCH OF STROKE (GALLONS)
				60	80	100	200	250	400	
1.50	ALL	PUSH	1.767	106	142	177	353	442	706	0.00102
	0.625	PULL	1.460	88	117	146	292	365	584	0.00084
	1.000	PULL	0.982	59	79	98	196	246	392	0.00057
2.00	ALL	PUSH	3.142	188	251	314	628	785	1256	0.0182
	0.625	PULL	2.835	170	227	284	567	708	1134	0.0164
	1.000	PULL	2.357	141	189	236	471	589	942	0.0136
2.50	ALL	PUSH	4.909	295	393	491	981	1227	1962	0.0284
	0.625	PULL	4.602	276	368	460	920	1150	1840	0.0266
	1.000	PULL	4.124	247	330	412	825	1031	1650	0.0239
3.25	ALL	PUSH	8.296	498	664	830	1659	2074	3318	0.0480
	1.000	PULL	7.511	451	601	751	1502	1877	3004	0.0435
	1.375	PULL	6.811	409	545	681	1362	1702	2724	0.0394
4.00	ALL	PUSH	12.566	754	1005	1257	2513	3141	5026	0.0727
	1.000	PULL	11.781	707	942	1178	2356	2945	4712	0.0682
	1.375	PULL	11.081	665	886	1108	2216	2770	4432	0.0641
5.00	ALL	PUSH	19.635	1178	1571	1964	3927	4908	7854	0.01136
	1.000	PULL	18.850	1131	1508	1885	3770	4712	7540	0.01090
	1.375	PULL	18.150	1089	1452	1815	3630	4537	7260	0.01050
6.00	ALL	PUSH	28.274	1696	2262	2827	5655	7068	11310	0.01636
	1.375	PULL	26.789	1607	2144	2679	5358	6697	10716	0.01550
	1.750	PULL	25.869	1552	2070	2587	5174	6467	10348	0.01497
8.00	ALL	PUSH	50.265	3016	4021	5026	10053	12566	20106	0.02908
	1.375	PULL	48.780	2927	3902	4878	9756	12195	19512	0.02832
	1.750	PULL	47.860	2872	3829	4786	9572	11965	19144	0.02770

*Theoretical force. Actual force will be reduced by friction.

'TS' HYDRAULIC TIE ROD TORQUE SPECS		
BORE	TIE ROD THREAD SIZE	TORQUE (FT-LBS)
1.50	1/4 - 28	7 FT-LBS
2.00	5/16 - 24	12 FT-LBS
2.50	5/16 - 24	14 FT-LBS
3.25	3/8 - 24	30 FT-LBS
4.00	3/8 - 24	35 FT-LBS
5.00	1/2 - 20	45 FT-LBS
6.00	1/2 - 20	50 FT-LBS
8.00	5/8 - 18	125 FT-LBS

'TS' HYDRAULIC RETAINER PLATE TORQUE SPECS		
BORE	SOCKET HEAD CAP SCREW SIZE	TORQUE (FT-LBS)
2 & 2.50	#10 - 32	5 FT-LBS
3.25 TO 8	1/4 - 28	12 FT-LBS

All Torque Specs are based upon using anti-seize thread lubricant. Tighten cylinders using an "X" tightening pattern on tie rods.

SPEC: LPS Premium Copper Anti-Seize
 Temperature Rating: -65°F to 1800°F
 Military Spec: MIL-PRF-907-E

Torque Tolerance: -0% to +5%



BORE	ROD DIA. (MM)	1 GPM	3 GPM	5 GPM	8 GPM	12 GPM	15 GPM	20 GPM	25 GPM	30 GPM	40 GPM	50 GPM	75 GPM
1.50	NONE	130	392	654	1034	—	—	—	—	—	—	—	—
	0.625	158	476	792	1265	—	—	—	—	—	—	—	—
	1.000	235	706	1176	1880	—	—	—	—	—	—	—	—
2.00	NONE	73	221	368	588	883	1120	—	—	—	—	—	—
	1.000	97	294	490	782	1175	1465	—	—	—	—	—	—
	1.375	139	418	697	1115	1673	2090	—	—	—	—	—	—
2.50	NONE	47	131	235	376	565	675	940	1175	—	—	—	—
	1.000	56	168	280	448	672	840	1120	1400	—	—	—	—
	1.375	67	203	339	542	813	1015	1355	1695	—	—	—	—
	1.750	92	277	463	740	1110	1385	1850	2310	—	—	—	—
3.25	NONE	28	83	139	223	334	417	557	696	836	1115	—	—
	1.375	34	102	170	271	407	510	680	850	1020	1360	—	—
	1.750	39	118	196	313	472	588	784	980	1176	1568	—	—
	2.000	44	134	224	358	537	672	896	1120	1344	1792	—	—
4.00	NONE	18	55	92	147	220	276	368	460	552	736	920	—
	1.750	22	68	113	182	273	339	452	565	678	904	1130	—
	2.000	24	73	122	196	294	366	488	610	732	976	1220	—
	2.500	30	90	150	241	362	450	600	750	900	1200	1500	—
5.00	NONE	12	35	58	94	141	174	232	290	348	464	580	870
	2.000	14	42	70	112	168	210	280	350	420	560	700	1050
	2.500	16	47	78	125	188	235	315	390	470	630	780	1170
	3.000	18	55	92	147	220	275	365	460	550	730	920	1380
	3.500	22	66	111	178	266	333	444	555	665	888	1110	1665
6.00	NONE	8	24	41	65	98	123	162	202	245	320	405	606
	2.500	10	30	50	79	118	150	200	250	300	400	495	750
	3.000	11	33	54	87	130	165	206	270	325	435	545	810
	3.500	12	37	62	99	148	185	245	310	370	495	615	830
	4.000	15	44	73	117	176	220	295	365	440	585	735	1095
8.00	NONE	4	14	23	36	55	69	92	115	135	185	230	345
	3.500	5.5	17	28	45	68	85	115	140	170	230	285	420
	4.000	6	18	30	49	73	90	122	150	180	240	305	450
	4.500	6.5	20	33	53	80	100	135	165	200	265	335	495
	5.000	7.5	22	38	60	90	114	150	185	225	300	375	555
	5.500	8.5	26	43	70	104	129	172	215	255	345	430	645

Data shown are cylinder rod travel speeds in inches per minute. The extension speeds represent the net piston area for rod diameters shown.

'H' SERIES BASIC CYLINDER WEIGHT CHART



WEIGHT IN POUNDS

BORE	ROD DIA. (MM)	MOUNT														ADD PER INCH OF STROKE
		MXO	MXO with KP	ME5	ME6	MF1	MF2	MF5	MF6	MP1	MS2 MS3 MS7	MS4	MT1 MT2	MT4	MX1 MX2 MX3	
1.50	0.625	7.2	7.3	9.1	8.8	7.6	8.2	8.6	9.0	7.6	7.8	7.2	7.6	9.5	7.4	.6
	1.000	7.6	7.7	9.5	9.2	7.9	8.6	8.9	9.3	8.0	8.0	7.6	8.0	10	7.8	.8
2.00	1.000	11.5	11.7	14.2	13.8	12.6	13.9	14.7	15.6	12.7	12.8	11.4	12.7	16.5	12.1	1.0
	1.375	12.3	12.5	15.2	14.6	13.7	14.7	15.5	16.4	13.5	13.6	12.2	13.5	17.0	12.9	1.4
2.50	1.000	16.1	17.3	19.3	18.8	17.1	19.5	19.4	20.8	17.3	19.4	15.8	17.2	22	16.8	1.3
	1.375	16.7	16.9	19.9	19.4	17.7	19.9	19.6	21.3	17.9	19.9	16.4	17.8	22.5	17.2	1.8
	1.750	18.1	18.3	21.3	20.8	19.1	21.3	21.2	22.7	19.3	21.2	17.5	19.2	24	18.6	2.3
3.25	1.375	32.8	35.3	38.6	37.9	35	38.9	39.6	42.5	36.2	36	32.2	35.4	42	33.7	2.3
	1.750	33.7	34	39.5	38.8	35.9	39.8	40.5	43.4	37	37	33.1	36.1	43	34.6	2.9
	2.000	34.3	34.6	40.1	39.4	36.5	40.4	41.1	44.0	37.7	38	33.7	36.7	43	35.3	3.2
4.00	1.750	44	47.3	50.6	49.8	47	52.5	53	57	50	50	43	47	54	45	3.1
	2.000	45	47.7	51.6	50.8	48	53.5	54	58	51	51	44	48	55	46	3.4
	2.500	47	47.5	54	53	50	55	56	60	52.5	53	46	49	56	48	4.4
5.00	2.000	79	87	89	88	83.5	93	92	100	86.5	85	78	80	93	82	4.8
	2.500	81	88	91	90	85.5	95	94	102	90	87	80	83	96	84	5.2
	3.000	85	90	95	94	89	99	98	105	92	91	84	87	99	88	7.0
	3.500	86	87	96	95	90	100	99	106	93	92	85	88	100	89	8.4
6.00	2.500	124	134	140	140	131	145	145	153	137	136	122	127	143	128	6.5
	3.000	126	135	142	142	133	147	147	159	139	138	124	129	145	130	7.8
	3.500	128	136	144	144	135	149	149	160	141	140	126	131	147	132	9.2
	4.000	132	139	148	148	139	153	152	164	145	144	130	135	151	136	10.9
8.00	3.500	256	275	288	288	266	290	285	305	282	277	253	263	288	265	11.7
	4.000	261	277	293	293	271	295	290	310	286	282	258	268	293	270	13.3
	4.500	264	279	296	296	274	298	293	313	289	285	261	271	296	273	14.4
	5.000	268	281	300	300	278	302	297	317	294	289	265	275	301	277	17.5
	5.500	276	285	308	308	285	309	304	324	301	297	273	282	308	285	19.7

Note: Add 20% to mount and stroke weight for double rod end cylinders.

WEIGHT IN POUNDS

ROD CLEVIS		ROD EYES		EYE BRACKETS		CLEVIS BRACKETS		CLEVIS PINS				WELD PLATE		FLNG. END CPL.	
PART NO.	WEIGHT	PART NO.	WEIGHT	PART NO.	WEIGHT	PART NO.	WEIGHT	PART NO.	WEIGHT	PART NO.	WEIGHT	PART NO.	WEIGHT	PART NO.	WEIGHT
RC437	.40	RE437	.30	EB500	.86	CB500	.90	CP500C	.12	CP500E	.12	WP625	.45	FEC625	.41
RC500	.40	RE500	.30	EB750	3.00	CB750	3.10	CP750C	.38	CP750E	.38	WP1000	.69	FEC1000	.65
RC750	1.22	RE625	.30	EB1000	6.36	CB1000	6.20	CP1000C	.80	CP1000E	.80	WP1375	1.26	FEC1375	1.22
RC1000	2.58	RE750	1.10	EB1375	11.22	CB1375	9.70	CP1375C	1.22	CP1375E	1.22	WP1750	2.25	FEC1750	2.25
RC1250	6.28	RE1000	2.40	EB1750	17.5	CB1750	17	CP1750C	4.1	CP1750E	3.78	WP2000	2.67	FEC2000	2.59
RC1375	6.28	RE1250	5.58	EB2000	25	CB2000	26	CP2000C	5.36	CP2000E	4.93	WP2500	3.38	FEC2500	3.30
RC1500	11.6	RE1375	5.58	EB2500	39	CB2500	37	CP2500C	9.42	CP2500E	9.22	WP3000	6.74	FEC3000	6.66
RC1750	12.7	RE1500	10.52	EB3000	44	CB3000	44	CP3000C	13.69	CP3000E	13.57	WP3500	10.91	FEC3500	10.83
RC1875	18	RE1875	11.5	EB3500	113	CB3500	113	CP3500C	24.42	CP3500E	24.12	WP4000	10.91	FEC4000	10.83
RC2250	27	RE2250	23	EB4000	179	CB4000	—	CP4000C	35.45	CP4000E	35.06	WP4500	14.26	FEC4500	14.86
RC2500	36	RE2500	32	—	—	—	—	—	—	—	—	WP5000	14.26	FEC5000	14.86
RC3250	71	RE3250	36	—	—	—	—	—	—	—	—	WP5500	22.55	FEC5500	22.47
RC4000	107	RE3500	36	—	—	—	—	—	—	—	—	—	—	—	—
—	—	RE4000	84	—	—	—	—	—	—	—	—	—	—	—	—

All our cylinders are proudly Made in USA



'M' & 'TS' SERIES BASIC CYLINDER WEIGHT CHART

WEIGHT IN POUNDS

BORE	ROD DIA. (MM)	MOUNT											ME3 ME4	SB	ADD PER INCH OF STROKE
		MS4 MXO	MX1 MX2 MX3	MF1	MF2	MF5	MF6	MP1	MP2	MS2 MS3 MS7	MT1 MT2	MT4			
1.50	0.625	3.9	4.3	4.6	4.6	5.0	4.2	4.8	4.4	4.4	5.8		4.1	0.6	
1.50	1.000	4.7	5.0	5.4	5.4	5.8	5.0	5.6	5.2	5.2	6.6		4.9	0.8	
2.00	0.625	6.4	6.9	7.3	7.4	8.0	6.7	7.3	6.9	7.0	8.7		6.6	1.0	
2.00	1.000	6.9	7.3	7.8	7.9	8.5	7.2	7.8	7.4	7.5	9.2		7.1	1.3	
2.00	1.375	8.4	8.7	9.3	9.4	10.0	8.7	9.3	8.9	9.0	10.7		8.6	1.5	
2.50	0.625	8.9	9.6	10.2	10.0	11.0	9.3	9.8	9.4	9.6	11.7		9.2	1.2	
2.50	1.000	9.4	10.0	10.7	10.5	11.5	9.8	10.3	9.9	10.1	12.2		9.7	1.4	
2.50	1.375	11.0	11.5	12.3	12.1	13.1	11.4	11.9	11.5	11.7	13.8		11.3	1.6	
2.50	1.750	13.1	13.6	14.4	14.2	15.2	13.5	14.0	13.6	13.8	15.9		13.4	1.9	
3.25	1.000	16.4	18.4	19.9	19.1	21.6	17.8	19.5	17.7	17.8	20.0		17.2	1.6	
3.25	1.375	16.9	18.8	20.4	19.5	22.1	18.3	20.0	18.2	18.3	20.5		17.7	1.8	
3.25	1.750	19.1	20.9	22.6	21.5	24.3	20.5	22.2	20.4	20.5	22.7		19.9	2.1	
3.25	2.000	26.8	28.5	30.3	29.1	32.0	28.2	29.9	28.1	28.2	30.4		27.6	2.3	
4.00	1.000	25.9	28.7	30.7	29.0	32.6	27.3	29.0	27.2	27.3	29.8		26.7	2.0	
4.00	1.375	26.3	28.9	31.1	29.1	33.0	27.7	29.4	27.6	27.7	30.2		27.1	2.2	
4.00	1.750	28.6	31.0	33.4	31.3	35.3	30.0	31.7	29.9	30.0	32.5		29.4	2.5	
4.00	2.000	32.5	34.7	37.3	35.1	39.2	33.9	35.6	33.8	33.9	36.4		33.3	2.7	
4.00	2.500	35.8	37.9	40.6	38.3	42.5	37.2	38.9	37.1	37.2	39.7		36.6	3.2	
5.00	1.000	38.8	42.8	45.8	43.4	48.7	40.5	41.9	41.9	40.2	44.5		39.7	2.2	
5.00	1.375	39.3	42.9	46.3	43.7	49.2	41.0	42.4	42.4	40.7	45.0		40.2	2.4	
5.00	1.750	41.9	45.1	48.9	46.1	51.8	43.6	45.0	45.0	43.3	47.6		42.8	2.7	
5.00	2.000	45.5	48.5	52.5	49.4	55.4	47.2	48.6	48.6	46.9	51.2		46.4	2.9	
5.00	2.500	49.5	52.3	56.5	53.1	59.4	51.2	52.6	52.6	50.9	55.2		50.4	3.4	
5.00	3.000	56.3	58.9	63.3	59.4	66.2	58.0	59.4	59.4	57.7	62.0		57.2	4.0	
5.00	3.500	62.7	65.1	69.7	65.3	72.6	64.4	65.8	65.8	64.1	68.4		63.6	4.7	
6.00	1.375	67.8	74.8	79.3	74.2	83.2	69.9	74.0	70.9	69.5	78.3		68.9	3.0	
6.00	1.750	72.0	78.6	83.5	78.2	87.4	74.1	78.2	75.1	73.7	82.5		73.1	3.3	
6.00	2.000	75.0	81.2	86.5	80.9	90.4	77.1	81.2	78.1	76.7	85.5		76.1	3.5	
6.00	2.500	77.7	83.5	89.2	82.6	93.1	79.8	83.9	80.8	79.4	88.2		78.8	4.0	
6.00	3.000	84.9	90.3	96.4	89.3	100.3	87.0	91.1	88.0	86.6	95.4		86.0	4.6	
6.00	3.500	92.3	97.3	103.8	96.2	107.7	94.4	98.5	95.4	94.0	102.8		93.4	5.3	
6.00	4.000	99.7	104.3	111.2	103.1	115.1	101.8	105.9	102.8	101.4	110.2		100.8	6.3	
8.00	1.375	96.0					99.0		99.5	98.0	113.0	95.0	97.7	4.0	
8.00	1.750	103.0					106.0		106.5	105.0	120.0	102.0	104.7	4.3	
8.00	2.000	111.0					114.0		114.5	113.0	128.0	110.0	112.7	4.5	
8.00	2.500	121.0					124.0		124.5	123.0	138.0	120.0	122.7	5.0	
8.00	3.000	133.0					136.0		136.5	135.0	150.0	132.0	134.7	5.6	
8.00	3.500	139.0					142.0		142.5	141.0	156.0	138.0	140.7	6.4	
8.00	4.000	145.0					148.0		148.5	147.0	162.0	144.0	146.7	7.3	
8.00	4.500	152.0					155.0		155.5	154.0	169.0	151.0	153.7	8.2	
8.00	5.000	160.0					163.0		163.5	162.0	177.0	159.0	161.7	9.2	
8.00	5.500	168.0					171.0		171.5	170.0	185.0	167.0	169.7	10.5	

Note: Add 20% to mount and stroke weight for double rod end cylinders. Add 1% for cushions.

WEIGHT IN POUNDS

PART NO.	WEIGHT	PART NO.	WEIGHT	PART NO.	WEIGHT	PART NO.	WEIGHT	PART NO.	WEIGHT
AC250	.30	AC625	.40	AC1375	7.50	AC2250	8.50	AC3500	39.5
AC312	.30	AC750	1.10	AC1500	7.60	AC2500	28	AC3750	40.2
AC375	.30	AC875	1.10	AC1750	7.60	AC2750	29.2	AC4000	55
AC437	.30	AC1000	2.90	AC1875	8.00	AC3000	30.4	AC4500	60
AC500	.30	AC1250	2.90	AC2000	8.30	AC3250	38	AC5000	66

All our cylinders are proudly Made in USA



R = RECOMMENDED S = SATISFACTORY M = MARGINAL U = UNSATISFACTORY = INSUFFICIENT DATA

FLUID NAME	MFG. CODE	MILITARY SPECIFICATION	TRADE NAME/ NUMBER	COLOR	TYPE OF SEAL COMPOUND - COMMON NAME								
					BUNA-N	BUTYL	CORFAM	EP	VITON	SILICONE	NEOPRENE	NAT. RUBBER	POLYURENE
Water-Glycol	1		Houghto-Safe 600 Series	red	R	R	R	R	R	S	S	R	U
	1		Houghto-Safe 500 Series	red	R	R	R	R	R	S	S	R	U
	1	MIL-H22072	Houghto-Safe 271	red	R	R	R	R	R	S	S	—	U
	4		Ucon Hydrolube	yel. or red	R	R	R	R	R	R/S	S	R	U
	4		Ucon M1	yellow	R	R	R	R	R	S	S	S	U
	5		Cellugard	red	R	R	R	R	R	S	S	—	U
	10		Safety Fluid 200	bright pink	R	R	R	R	R	S	S	—	U
Water/Oil	1		Houghto-Safe 5000 Series	white	R	U	R	U	R	—	S	U	U
Emulsion	3		FR	creamy	R	U	R	U	R	—	S	U	U
	7		Irus 902	yellow	R	U	R	U	R	U	S	U	M
	8		Pyrogard C & D	pale yellow	R	U	R	U	R	—	S	U	U
Water-Soluble Oil	—		—	milky	R	M	R	—	R	—	S	S	M/U
Water-Fresh	—		—	—	R	R	R	R	R	R	M	R	M/U
Water-Salt	—		—	—	R	R	R	R	R	R	M	R	M/U
Phosphate Ester	1		Houghto-Safe 1000 Series	green	U	R	M/U	R	R	M	U	U	M
	1	MIL-H-19547B	Houghto-Safe 1120	green	U	R	M/U	R	R	M	U	U	M
	2		Pydraul F-9, 150, 625	cloudy bl.	U	R/S	M/U	S	R	R	U	U	S
	5		Fyrquel	lt. green	U	R	M/U	R	R	M	U	U	M
	7		Shell SRF B.C.D.	aqua gr.	U	R	M/U	R	R	M	U	U	M
	8		Pyrogard 42, 43, 53, 55, 190, 600	pale yel.	U	R	M/U	R	R/S	M	U	U	M
	2		Skydrol 500B	purple	U	S	U	R	U	M	U	U	U
	2		Skydrol 7000	green	U	S	U	R	U	M	U	U	U
	2		Pydraul 312, 135 (2)	blue gr.	U	M	M	M	R	R	U	U	—
	2		Pydraul AC	cloudy bl.	U	S	M/U	S	R	R	U	U	M/U
	2		Pydraul 60	cloudy bl.	U	R	M/U	R	U	S	U	U	M/U
	8		Pydraul 210 (3)	yellow	U	M	—	M	R	R	U	U	M/U
Diester	—	MIL-H-7808	Lube Oil-Aircraft	amber	S	U	R	U	R	U	U	U	U
Chlorinat. Hydrocarb	2		Aroclor 1200 Series 1	clear	M	S	—	S	R	S	U	U	U
	2		Pydraul A-200	cloudy bl.	U	M	M	M	R	R	U	U	M/U
Silicate Ester	2		OS-45 Type 4	clear	S	U	—	S	R	U	R	U	R
	6	MIL-O-8200	Oronite 8200	clear	S	U	—	U	R	U	R	U	R
	6	MIL-8515	Oronite 8515	clear	S	U	—	U	R	U	R	U	R
	9	MIL-H-8446B	Brayco 846	red brown	S	U	—	U	R	U	R	U	R
Kerosene	—		—	clear	R	U	R	U	R	U	M/U	U	R
Jet Fuel	—	MIL-J-5624	JP-3, 4, 5 (RP-1)	lt. straw	R	U	R	U	R	U	U	U	S
Diesel Fuel	—		—	clear	R	U	R	U	R	U	M/U	U	R
Gasoline	—		Gasoline	various	R	U	R/S	U	R	U	U	U	R
Petroleum Base	—	MIL-H-6083	Preservative Oil	red	R	U	R	U	R	U	R	S	R
Petroleum Base	—	MIL-H-5606	Aircraft Hyd. Fluid	red	R	U	R	U	R	U	S	U	R

Notes: (1) Halogenated
 (2) Petroleum and halogenated hydrocarbon and phosphate ester mixture
 (3) Chlorinated phosphate ester

Manufacturer's Code Numbers	No. Manufacturer	Manufacturer
1. E.F. Houghton	4.	Union Carbide & Chemical
2. Monsanto	5.	Stauffer Chemical
3. Gulf	6.	Standard Oil (Ortho Chemical)
	7.	Shell Chemical
	8.	Mobile Oil
	9.	Bray Oil - Royal
	10.	Texaco

ELASTOMER	STYRENE BUTADIENE	BUTYL	CHLOROSULPHONATED POLYETHYLENE	ETHYLENE PROPYLENE	FLUOROCARBON	FLUOROSILICONE	NATURAL	POLYCHLOROPRENE	NITRILE	POLYACRYLIC	POLYSULPHIDE	POLYURETHANE	SILICONE	EPICHLOROHYDRIN	POLYIMIDE	POLYTETRAFLUOROETHYLENE
SYMBOL	SBR	IIR	CSM	EPM	V	FPM	FSI	NR	NBR		ACM	TR	AU-EU	SI	ECD	
UPPER TEMP. LIMIT °F	194	500	212	248	284	347	392	176	230	266	320	221	212	392	284	896
LOWER TEMP. LIMIT °F	-58	-148	-22	-4	-49	5	-76	-76	-40	-49	-4	-67	-58	-76	-40	-400
ABRASION RESISTANCE	S	U	M	R	•	S	•	R	R	S	•	•	R	•	S	R
COMPRESSION SET RESIST.	•	•	U	M	M	S	U	R	S	R	U	U	S	S	M	•
RESILIENCE	M	U	U	U	U	M	U	R	S	M	M	U	S	U	S	U
RADIATION	U	U	•	•	•	•	M	•	•	•	•	•	S	U	U	R
WEATHER RESISTANCE	M	R	R	R	R	R	R	U	U	U	R	R	R	R	S	R
OZONE RESISTANCE	M	R	R	R	R	R	R	M	•	M	R	S	R	R	S	•
ADHESION TO METAL	R	S	S	R	S	R	R	R	•	R	S	R	R	R	S	S

R = RECOMMENDED S = SATISFACTORY M = MARGINAL U = UNSATISFACTORY • = CONSULT MANUFACTURER

All our cylinders are proudly Made in USA



FRACTION EQUIVALENTS

FRACTION (INCHES)	DECIMAL (INCHES)	METRIC (MM) (x 25.4)	FRACTION (INCHES)	DECIMAL (INCHES)	METRIC (MM) (x 25.4)	FRACTION (INCHES)	DECIMAL (INCHES)	METRIC (MM) (x 25.4)	FRACTION (INCHES)	DECIMAL (INCHES)	METRIC (MM) (x 25.4)
1/64	.016	.4	17/64	.266	6.8	33/64	.516	13.1	49/64	.766	19.5
1/32	.031	.8	9/32	.281	7.1	17/32	.531	13.5	25/32	.781	19.8
3/64	.047	1.2	19/64	.297	7.5	35/64	.547	13.9	51/64	.797	20.2
1/16	.062	1.6	5/16	.312	7.9	9/16	.562	14.3	13/16	.812	20.6
5/64	.078	2.0	21/64	.328	8.3	37/64	.578	14.7	53/64	.828	21.0
3/32	.094	2.4	11/32	.344	8.7	19/32	.594	15.1	27/32	.844	21.4
7/64	.109	2.8	23/64	.359	9.1	39/64	.609	15.5	55/64	.859	21.8
1/8	.125	3.2	3/8	.375	9.5	5/8	.625	15.9	7/8	.875	22.2
9/64	.141	3.6	25/64	.391	9.9	41/64	.641	16.3	57/64	.891	22.6
5/32	.156	4.0	13/32	.406	10.3	21/32	.656	16.7	29/32	.906	23.0
11/64	.172	4.4	27/64	.422	10.7	43/64	.672	17.1	59/64	.922	23.4
3/16	.187	4.7	7/16	.437	11.1	11/16	.687	17.4	15/16	.937	23.8
13/64	.203	5.2	29/64	.453	11.5	45/64	.703	17.9	61/64	.953	24.2
7/32	.219	5.6	15/32	.469	11.9	23/32	.719	18.3	31/32	.969	24.6
15/64	.234	5.9	31/64	.484	12.3	47/64	.734	18.6	63/64	.984	25.0
1/4	.250	6.3	1/2	.500	12.7	3/4	.750	19.0	1	1.000	25.4

TEMPERATURE EQUIVALENTS

FAHRENHEIT TO CELSIUS CONVERSION						CELSIUS TO FAHRENHEIT CONVERSION					
F°	C°	F°	C°	F°	C°	C°	F°	C°	F°	C°	F°
-30	-34.4	80	26.7	190	87.8	-30	-22	40	104	95	203
-20	-28.9	90	32.2	200	93.3	-20	-4	45	113	100	212
-10	-23.3	100	37.8	210	98.9	-10	14	50	122	105	221
0	-17.8	110	43.3	220	104.4	0	32	55	131	110	230
10	-12.2	120	48.9	230	110.0	5	41	60	140	115	239
20	-6.7	130	54.4	240	115.6	10	50	65	149	120	248
30	-1.1	140	60.0	250	121.1	15	59	70	158	125	257
40	4.4	150	65.6	300	148.9	20	68	75	167	130	266
50	10.0	160	71.1	350	176.7	25	77	80	176	150	302
60	15.6	170	76.7	400	204.4	30	86	85	185	200	392
70	21.1	180	82.2			35	95	90	194		

C° = (F° - 32) ÷ 1.8

F° = C° x 1.8 + 32

PRESSURE CONVERSIONS

PSI	KG/CM ²	BARS	KG/CM ²	PSI	BARS
60	4.2	4.1	4	56.9	3.9
70	4.9	4.8	5	71.1	4.9
80	5.6	5.5	6	85.3	5.9
90	6.3	6.2	7	99.5	6.9
100	7.0	6.9	8	113.8	7.8
150	10.5	10.3	9	128.0	8.8
200	14.0	13.8	10	142.2	9.8
250	17.6	17.2	20	284.4	19.6
300	21.1	20.7	30	426.6	29.4
350	24.6	24.1	40	568.8	39.2
400	28.1	27.6	50	711.0	49.0
450	31.6	31.0	60	853.2	58.8
500	35.1	34.4	70	995.4	68.6
550	38.7	37.9	80	1137.6	78.4
600	42.2	41.3	90	1279.8	88.2
650	45.7	44.8	100	1422.0	98.0
700	49.2	48.2	150	2133.0	147.0
750	52.7	51.7	200	2844.0	196.0
800	56.2	55.1	250	3555.0	245.0
850	59.8	58.6	300	4266.0	294.0
900	63.3	62.0	350	4977.0	343.0
950	66.8	65.5	—	—	—
1000	70.3	68.9	—	—	—
1500	105.5	103.4	—	—	—
2000	140.6	137.8	—	—	—
2500	175.8	172.3	—	—	—
3000	210.9	206.7	—	—	—
3500	246.1	241.2	—	—	—
4000	281.2	275.6	—	—	—
4500	316.4	310.1	—	—	—
5000	351.5	344.5	—	—	—

Kg/cm² = PSI x .0703
Bars = PSI x .0689

PSI = Kg/cm² x 14.22
Bars = Kg/cm² x .98

MEASUREMENT CONVERSIONS

INCHES	CM	MM	CM	INCHES
1	2.5	25.4	1	.4
2	5.1	50.8	2	.8
3	7.6	76.2	3	1.2
4	10.2	101.6	4	1.6
5	12.7	127.0	5	2.0
6	15.2	152.4	6	2.4
7	17.8	177.8	7	2.8
8	20.3	203.2	8	3.1
9	22.9	228.6	9	3.5
10	25.4	254.0	10	3.9
15	38.1	381.0	20	7.9
20	50.8	508.0	30	11.8
25	63.5	635.0	40	15.8
30	76.2	762.0	50	19.7
35	88.9	889.0	60	23.6
40	101.6	1016.0	70	27.6
45	114.3	1143.0	80	31.5
50	127.0	1270.0	90	35.5
55	139.7	1397.0	100	39.4
60	152.4	1524.0	110	43.3
65	165.1	1651.0	120	47.3
70	177.8	1778.0	130	51.2
75	190.5	1905.0	140	55.2
80	203.2	2032.0	150	59.1
85	215.9	2159.0	160	63.0
90	228.6	2286.0	170	67.0
95	241.3	2413.0	180	70.9
100	254.0	2540.0	190	74.9
—	—	—	200	78.8
—	—	—	210	82.7
—	—	—	220	86.7
—	—	—	230	90.6
—	—	—	240	94.6
—	—	—	250	98.5
—	—	—	260	102.4

cm = in. x 2.54 mm = in. x 25.4 in. = cm x .394



PROPERTY	WORD FORMULA	MATHEMATIC EQUATION
FLUID PRESSURE PSI (POUNDS PER SQUARE INCH)	Pressure = $\frac{\text{Force (lbs)}}{\text{Area (in}^2\text{)}}$	$P = \frac{F}{A}$
CYLINDER AREA EXTEND IN ² (SQUARE INCHES)	Area = $\frac{\pi}{4} \times \text{Diameter}^2$ (inches)	$A = .7854 D^2$
CYLINDER AREA RETRACT IN ² (SQUARE INCHES)	Area = $(\frac{\pi}{4} \times \text{Bore Diameter}^2) - (\frac{\pi}{4} \times \text{Rod Diameter}^2)$	$A = (.7854 D_c^2) - (.7854 D_r^2)$
CYLINDER FORCE LBS. (POUNDS OF FORCE)	Force = Pressure (PSI) x Net Area (in ²)	$F = PA$
CYLINDER VELOCITY FT/S (FEET PER SECOND)	Velocity = $\frac{231 \times \text{Flow Rate (GPM)}}{12 \times 60 \times \text{Net Area (in}^2\text{)}}$	$v = \frac{.3208 Q}{A}$
CYLINDER VOLUME G (GALLONS OF FLUID)	Volume = $\frac{\text{Net Area (in}^2\text{)} \times \text{Stroke (in)}}{231}$	$V = \frac{A L}{231}$
CYLINDER FLOW RATE GPM (GALLONS PER MINUTE)	Flow Rate = $\frac{12 \times 60 \times \text{Velocity (ft/s)} \times \text{Net Area (in}^2\text{)}}{231}$	$Q = 3.117 v A$
CYLINDER POWER HP (HORSEPOWER)	Horsepower = $\frac{\text{Pressure (PSI)} \times \text{Flow Rate (GPM)}}{1714}$	$hp = \frac{P Q}{1714}$
FLUID MOTOR TORQUE LB-IN (INCH POUNDS)	Torque = $\frac{\text{Pressure (PSI)} \times \text{F.M. Displacement (in}^3\text{/rev.)}}{2\pi}$	$T = \frac{P d}{2\pi}$
	Torque = $\frac{\text{Horsepower} \times 63025}{\text{RPM}}$	$T = \frac{63025 hp}{n}$
	Torque = $\frac{\text{Flow Rate (GPM)} \times \text{Pressure (PSI)} \times 36.77}{\text{RPM}}$	$T = \frac{36.77 Q P}{N}$
FLUID MOTOR SPEED RPM (REVOLUTIONS PER MINUTE)	Speed = $\frac{231 \times \text{Flow Rate (GPM)}}{\text{F.M. Displacement (in}^3\text{/rev.)}}$	$n = \frac{231 Q}{d}$
FLUID MOTOR POWER HP (HORSEPOWER)	Horsepower = $\frac{\text{Torque (lbs-in)} \times \text{RPM}}{63025}$	$hp = \frac{T n}{63025}$
PUMP OUTLET FLOW GPM (GALLONS PER MINUTE)	Flow = $\frac{\text{RPM} \times \text{Pump Displacement (in}^3\text{/rev.)}}{231}$	$Q = \frac{n d}{231}$
FLOW RATE THROUGH PIPING FT/S VELOCITY (FEET PER SECOND)	Velocity = $\frac{.3208 \times \text{Flow Rate Through I.D. (GPM)}}{\text{Internal Area (in}^2\text{)}}$	$v = \frac{.3208 Q}{A}$
TORQUE REQUIREMENT LB-IN (INCH POUNDS)	Torque = Lever Length (in.) x Pull (lbs.)	$T = L \times F$





PO Box 490517 • Minneapolis, MN 55449
Toll Free: 1-888-771-1894 • **Phone:** 763-452-0540 • **Fax:** 1-888-693-8681
sales@hydrauliccylindersinc.com • www.HydraulicCylindersInc.com