



**BASSETT™**



**2013 Edition**

***Solid Carbide Cutting Tools***  
***End Mills • Drills • Thread Mills • Burs***



**GREENFIELD  
INDUSTRIES**



<i>Style</i>	<i>Page Number</i>	<i>Style</i>	<i>Page Number</i>	<i>Style . . .</i>	<i>Page Number</i>
BA . . . . .	51	HP-DEM-5-TC . . . .	9	MSE-2B-TC . . . .	23-24
BAE . . . . .	51	HPEM-3 . . . . .	10	MSE-2-TC . . . .	21-22
BC . . . . .	52	HPEM-3-TC . . . .	10	MSE-3 . . . . .	25
BD . . . . .	52	HPEM-5 . . . . .	11	MSE-3-TC . . . .	25
BE . . . . .	53	HPEM-5-TC . . . .	11	MSE-4 . . . . .	26-28
BF . . . . .	53	HPEM-6 . . . . .	12	MSE-4B . . . . .	29-30
BG . . . . .	54	MCH-2D . . . . .	32	MSE-4B-TC . . . .	29-30
BH . . . . .	54	MCH-2R . . . . .	32	MSE-4-TC . . . .	26-28
BL . . . . .	55	MCH-4D . . . . .	32	MSEST-2 . . . . .	31
BM . . . . .	55	MCH-4R . . . . .	32	MSE-V-4B . . . . .	5
BN . . . . .	56	MDE-2 . . . . .	19	MSE-V-4B-TA . . . .	5
DC . . . . .	42	MDE-2B . . . . .	19	MSE-V-4R . . . . .	3-4
DHP-5 . . . . .	35	MDE-2B-TC . . . .	19	MSE-V-4R-TA . . . .	3-4
DHPCF-5 . . . . .	36	MDE-2-TC . . . . .	19	MSE-V2-5R . . . . .	6-7
DHPCF-8 . . . . .	37	MDE-4 . . . . .	20	MSE-V2-5R-TA . . . .	6-7
DM . . . . .	41-42	MDE-4B . . . . .	20	TM . . . . .	45
DR . . . . .	38-39	MDE-4B-TC . . . .	20	TMBPP . . . . .	46
DRS . . . . .	39-40	MDE-4-TC . . . . .	20	TMBPPC . . . . .	46
DS . . . . .	42	MEG-2-TC . . . . .	31	TMBPT . . . . .	46
HPAM-2 . . . . .	14	MRA . . . . .	17	TMBPTC . . . . .	46
HPAM-2-TC . . . . .	14	MRA-TC . . . . .	17	TMC . . . . .	45
HPAM-3 . . . . .	15	MRS . . . . .	16	TMM . . . . .	47
HPAM-3-TC . . . . .	15	MRS-TC . . . . .	16	TMMC . . . . .	47
HP-DEM-5 . . . . .	9	MSE-2 . . . . .	21-22	TMNP . . . . .	46
		MSE-2B . . . . .	23-24	TMNPC . . . . .	46

**Metalcutting Safety** (read this before using Bassett products)

Modern metalcutting operations involve high energy, high spindle or cutter speeds, and high temperatures and cutting forces. Hot, flying chips may be projected from the workpiece during metalcutting. Although advanced cutting tool materials are designed and manufactured to withstand the high cutting forces and temperatures that normally occur in these operations, they are susceptible to fragmenting in service, particularly if they are subjected to over-stress, severe impact or otherwise abused. Therefore, precautions should be taken to adequately protect workers, observers and equipment against hot, flying chips, fragmented cutting tools, broken workpieces or other similar projectiles. Machines should be fully guarded and personal protective equipment should be used at all times.

When grinding advanced cutting tool materials, a suitable means for collection and disposal of dust, mist or sludge should be provided. Overexposure to dust or mist containing metallic particles can be hazardous to health particularly if exposure continues over an extended period of time and may cause eye, skin and mucous membrane irritation and temporary or permanent respiratory disease. Certain existing pulmonary and skin conditions may be aggravated by exposure to dust or mist. Adequate ventilation, respiratory protection and eye protection should be provided when grinding and workers should avoid breathing of and prolonged skin contact with dust or mist. General Industry Safety and Health Regulations, Part 1910. U.S. Department of Labor, published in Title 29 of the Code of Federal Regulations should be consulted. Obtain from Bassett and read the applicable Material Safety Data Sheet before grinding.

Cutting tools are only one part of the worker-machine-tool system. Many variables exist in machining operations, including the metal removal rate; the workpiece size, shape, strength and rigidity; the chucking and fixturing; the load carrying capability of centers; the cutter and spindle speed and torque limitations; the holder and boring bar overhang; the available power; and the condition of the tooling and the machine. A safe metalcutting operation must take all of these variables, and others, into consideration.

Bassett has no control over the end use of its products or the environment into which those products are placed. Bassett urges that its customers adhere to the recommended standards of use of their metalcutting machines and tools, and that they follow procedures that ensure safe metalcutting operations. The information included throughout this catalog under the heading "Technical Data" and other recommendations on machining practices referred to herein are only advisory in nature and do not constitute representations or warranties and are not necessarily appropriate for any particular work environment or application.



**BASSETT**™

Bassett has manufactured the highest quality carbide cutting tools for six decades. Today, we serve clients throughout North America and the world from our modern, high-tech manufacturing facilities in Seneca, South Carolina, and world-wide. Our mission: to invest in the resources, technology, and people that enable us to provide world-class solid carbide round cutting tools for your most demanding applications.

A good tool begins with a good foundation. With Bassett, quality begins with a tradition of excellence. As part of the TDC Group, a vertically integrated company, Bassett has access to the finest raw materials from our own mines, which are refined in our own mills, and made into the blanks used in the manufacture of Bassett solid carbide cutting tools. All Bassett products conform to the strictest quality standards for your satisfaction.

***Bassett Solid Carbide Cutting Tools***

End Mills . . . . .	1-32
Drills. . . . .	33-42
Thread Mills. . . . .	43-48
Burs . . . . .	49-56
Index by EDP Number. . . . .	57-65



**GREENFIELD  
INDUSTRIES**

*a brand of*



**BASSETT™**



***Solid Carbide End Mills***



Style No.	Flutes	Description	Finish	Page No.
<b>High-Performance Variable Index End Mills</b>				
Operating Parameters				2
MSE-V-4R	.4-flute	.corner radius	bright, TiAlN	3-4
MSE-V-4B	.4-flute	.ball nose	bright, TiAlN	5
MSE-V2-5R	.5-flute	.corner radius	bright, TiAlN	6-7
<b>High-Performance End Mills for Steel and Stainless Steel</b>				
Operating Parameters				8
HPDEM-5	.5-flute	.square end, double end	bright, TiCN, TiAlN	9
HPEM-3	.3-flute	.square end	bright, TiCN, TiAlN	10
HPEM-5	.5-flute	.square end	bright, TiCN, TiAlN	11
HPEM-6	.6-flute	.square end	bright, TiAlN	12
<b>High-Performance End Mills for Aluminum</b>				
Operating Parameters				13
HPAM-2	.2-flute	.square end	bright, TiCN	14
HPAM-3	.3-flute	.square end	bright, TiCN	15
<b>High-Performance Roughing End Mills</b>				
Operating Parameters				16
MRS	.multi-flute	.square end . . . for steel	bright, TiCN	16
MRA	.multi-flute	.square end . . . for aluminum	bright, TiCN	17
<b>General-Purpose End Mills</b>				
Operating Parameters				18
<b>Double End</b>				
MDE-2	.2-flute	.square end	bright, TiCN	19
MDE-2B	.2-flute	.ball nose	bright, TiCN	19
MDE-4	.4-flute	.square end	bright, TiCN	20
MDE-4B	.4-flute	.ball nose	bright, TiCN	20
<b>Single End</b>				
MSE-2	.2-flute	.square end	bright, TiCN	21-22
MSE-2B	.2-flute	.ball nose	bright, TiCN	23-24
MSE-3	.3-flute	.square end	bright, TiCN	25
MSE-4	.4-flute	.square nose	bright, TiCN	26-28
MSE-4B	.4-flute	.ball nose	bright, TiCN	29-30
<b>Straight Flute</b>				
MSEST-2	.2-flute	.square end	bright	31
<b>Engraving Tool</b>				
MEG-2	.2-flute	.ball nose	TiCN	31
<b>Chamfer Tools</b>				
MCH-2R	.2-flute	.single end	bright	32
MCH-2D	.2-flute	.double end	bright	32
MCH-4R	.4-flute	.single end	bright	32
MCH-4D	.4-flute	.double end	bright	32

CARBIDE END MILLS

CARBIDE DRILLS

CARBIDE THREAD MILLS

CARBIDE BURS

INDEX



## Variable Index End Mills

### Operating Parameters for Series MSE-V-4\* Variable Index End Mills

#### regular and stub length

side milling axial 1.5 x D • side milling radial .5 x D • slotting axial 1 x D

INCH SIZES	Speed	feed per tooth (inches)								
	sfm	5/32	3/16	1/4	5/16	3/8	1/2	5/8	3/4	1
easy to cut stainless steel (303)	340	0.0010	0.0012	0.0016	0.0020	0.0024	0.0026	0.0028	0.0028	0.0030
moderately difficult to cut stainless (304)	290	0.0008	0.0010	0.0014	0.0018	0.0020	0.0022	0.0024	0.0026	0.0028
difficult to cut stainless steels (316L)	240	0.0006	0.0010	0.0012	0.0016	0.0018	0.0020	0.0022	0.0024	0.0024
soft steels (1020)	600	0.0010	0.0012	0.0016	0.0024	0.0024	0.0028	0.0030	0.0031	0.0039
titanium alpha beta alloys (Ti6Al4V)	200	0.0005	0.0006	0.0008	0.0012	0.0012	0.0016	0.0018	0.0020	0.0028
gray cast iron (GG)	600	0.0010	0.0012	0.0016	0.0024	0.0024	0.0028	0.0030	0.0031	0.0039

#### long length

side milling axial 1.3 x D • side milling radial .2 - .3 x D • slotting axial .3 - .5 x D

INCH SIZES	Speed	feed per tooth (inches)								
	sfm	5/32	3/16	1/4	5/16	3/8	1/2	5/8	3/4	1
easy to cut stainless steel (303)	340	0.0009	0.0011	0.0014	0.0018	0.0022	0.0023	0.0025	0.0025	0.0027
moderately difficult to cut stainless (304)	290	0.0007	0.0009	0.0013	0.0016	0.0018	0.0020	0.0022	0.0023	0.0025
difficult to cut stainless steel (316L)	240	0.0005	0.0009	0.0011	0.0014	0.0016	0.0018	0.0020	0.0022	0.0022
soft steels (1020)	600	0.0009	0.0011	0.0014	0.0022	0.0022	0.0025	0.0027	0.0028	0.0035
titanium alpha beta alloys (Ti6Al4V)	200	0.0005	0.0005	0.0007	0.0011	0.0011	0.0014	0.0016	0.0018	0.0025
gray cast iron (GG)	600	0.0009	0.0011	0.0014	0.0022	0.0022	0.0025	0.0027	0.0028	0.0035

### Operating Parameters for Series MSE-V2-5\* Variable Index End Mills



side milling axial 1.5 x D • side milling radial 0.5 x D • slotting axial 1 x D

INCH SIZES material	speed	chip load per tooth (inches)							
	sfm	3/16	1/4	5/16	3/8	1/2	5/8	3/4	1
medium and high carbon steels >0.3% C	600-750	0.0015	0.0021	0.0023	0.0026	0.0028	0.0030	0.0031	0.0039
alloy steels and tool steels <330HB, <35HRc	600-700	0.0011	0.0017	0.0020	0.0023	0.0028	0.0030	0.0031	0.0039
alloy steels and tool steels 340-450 HB, 36-48 HRc	525-625	0.0010	0.0015	0.0016	0.0020	0.0028	0.0030	0.0031	0.0039
austenitic stainless steel 302, 303, 304	350-445	0.0011	0.0017	0.0020	0.0023	0.0022	0.0024	0.0026	0.0028
austenitic stainless steel 316, 316L	225-315	0.0009	0.0013	0.0016	0.0019	0.0020	0.0024	0.0024	0.0024
austenitic stainless steel duplex	190-230	0.0008	0.0010	0.0014	0.0015	0.0020	0.0024	0.0024	0.0024
cast iron, gray GG	520-660	0.0014	0.0022	0.0025	0.0030	0.0028	0.0030	0.0031	0.0039
ductile and maleable cast iron CGI < 80 KSI	430-660	0.0009	0.0013	0.0018	0.0019	0.0028	0.0030	0.0031	0.0039
nickel-based heat-resistant alloys	100-160	0.0004	0.0007	0.0011	0.0015	0.0016	0.0019	0.0023	0.0028
alpha-beta titanium alloys Ti6Al4V	195-240	0.0008	0.0010	0.0014	0.0015	0.0016	0.0018	0.0020	0.0028



# Variable Index End Mills for Ferrous Materials

Series MSE-V-4R

**Applications |**



**Features |**

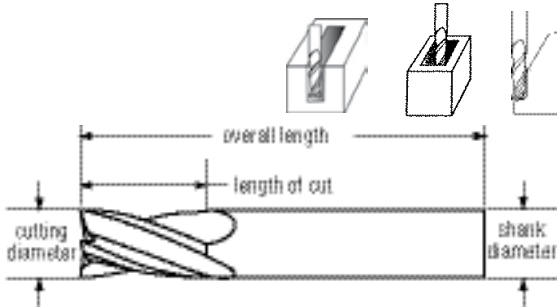

cutting diameter			shank diameter	length of cut	overall length	no. of flutes	corner radius	EDP Number	
fractional	decimal	metric						bright	TiAlN
1/8	.1250	3.18	1/8	1/4	1-1/2	4	0.000	B40165	B60165
1/8	.1250	3.18	1/8	1/4	1-1/2	4	0.010	B40140	B60140
1/8	.1250	3.18	1/8	3/8	1-1/2	4	0.000	B40166	B60166
1/8	.1250	3.18	1/8	3/8	1-1/2	4	0.010	B40141	B60141
1/8	.1250	3.18	1/8	1/2	1-1/2	4	0.000	B40231	B60231
1/8	.1250	3.18	1/8	1/2	1-1/2	4	0.010	B40232	B60232
3/16	.1875	4.76	3/16	3/8	2	4	0.000	B40167	B60167
3/16	.1875	4.76	3/16	3/8	2	4	0.010	B40142	B60142
3/16	.1875	4.76	3/16	7/16	2	4	0.000	B40168	B60168
3/16	.1875	4.76	3/16	7/16	2	4	0.010	B40143	B60143
3/16	.1875	4.76	3/16	3/4	2-1/2	4	0.000	B40169	B60169
3/16	.1875	4.76	3/16	3/4	2-1/2	4	0.010	B40170	B60170
1/4	.2500	6.35	1/4	1/2	2	4	0.000	B40171	B60171
1/4	.2500	6.35	1/4	1/2	2	4	0.020	B40144	B60144
1/4	.2500	6.35	1/4	3/4	2-1/2	4	0.000	B40172	B60172
1/4	.2500	6.35	1/4	3/4	2-1/2	4	0.020	B40145	B60145
1/4	.2500	6.35	1/4	3/4	2-1/2	4	0.040	-----	B60234
1/4	.2500	6.35	1/4	1-1/8	3	4	0.000	B40173	B60173
1/4	.2500	6.35	1/4	1-1/8	3	4	0.020	B40146	B60146
1/4	.2500	6.35	1/4	1-1/4	3	4	0.000	B40233	B60233
5/16	.3125	7.94	5/16	1/2	2	4	0.000	B40174	B60174
5/16	.3125	7.94	5/16	1/2	2	4	0.020	B40147	B60147
5/16	.3125	7.94	5/16	13/16	2-1/2	4	0.000	B40175	B60175
5/16	.3125	7.94	5/16	13/16	2-1/2	4	0.020	B40148	B60148
5/16	.3125	7.94	5/16	1-1/4	3	4	0.000	B40176	B60176
5/16	.3125	7.94	5/16	1-1/4	3	4	0.020	B40177	B60177
3/8	.3750	9.53	3/8	5/8	2	4	0.000	B40178	B60178
3/8	.3750	9.53	3/8	5/8	2	4	0.020	B40149	B60149
3/8	.3750	9.53	3/8	7/8	2-1/2	4	0.000	B40179	B60179
3/8	.3750	9.53	3/8	7/8	2-1/2	4	0.020	B40150	B60150
3/8	.3750	9.53	3/8	1-1/8	3	4	0.000	B40180	B60180
3/8	.3750	9.53	3/8	1-1/8	3	4	0.020	B40151	B60151
3/8	.3750	9.53	3/8	2	4	4	0.000	B40181	B60181
3/8	.3750	9.53	3/8	2	4	4	0.020	B40182	B60182
7/16	.4375	11.11	7/16	5/8	2-1/2	4	0.000	B40183	B60183
7/16	.4375	11.11	7/16	5/8	2-1/2	4	0.020	B40152	B60152
7/16	.4375	11.11	7/16	1	3	4	0.000	B40184	B60184
7/16	.4375	11.11	7/16	1	3	4	0.020	B40153	B60153
7/16	.4375	11.11	7/16	2	4	4	0.000	B40185	B60185
1/2	.5000	12.70	1/2	5/8	2-1/2	4	0.000	B40186	B60186
1/2	.5000	12.70	1/2	5/8	2-1/2	4	0.020	B40237	B60237

continued on next page

CARBIDE END MILLS

CARBIDE DRILLS

CARBIDE THREAD MILLS

CARBIDE BURS

INDEX





# Variable Index End Mills for Ferrous Materials

Series **MSE-V-4R** (continued)

	cutting diameter			shank diameter	length of cut	overall length	no. of flutes	corner radius	EDP Number		
	fractional	decimal	metric						bright	TiAlN	
CARBIDE END MILLS	1/2	.5000	12.70	1/2	5/8	2-1/2	4	0.030	B40154	B60154	
	1/2	.5000	12.70	1/2	1	3	4	0.000	B40187	B60187	
	1/2	.5000	12.70	1/2	1	3	4	0.030	B40155	B60155	
	1/2	.5000	12.70	1/2	1	3	4	0.060	B40188	B60188	
	1/2	.5000	12.70	1/2	1	3	4	0.090	B40189	B60189	
	1/2	.5000	12.70	1/2	1	3	4	0.125	B40190	B60190	
	1/2	.5000	12.70	1/2	1-1/4	3	4	0.000	B40191	B60191	
	1/2	.5000	12.70	1/2	1-1/4	3	4	0.020	B40238	B90238	
	1/2	.5000	12.70	1/2	1-1/4	3	4	0.020	-----	B60235	
	1/2	.5000	12.70	1/2	1-1/4	3	4	0.030	B40192	B60192	
	1/2	.5000	12.70	1/2	1-1/4	3	4	0.060	B40193	B60193	
	1/2	.5000	12.70	1/2	1-1/4	3	4	0.090	B40194	B60194	
	CARBIDE DRILLS	1/2	.5000	12.70	1/2	1-1/4	3	4	0.125	B40195	B60195
		1/2	.5000	12.70	1/2	2	4	4	0.000	B40196	B60196
		1/2	.5000	12.70	1/2	2	4	4	0.030	B40156	B60156
1/2		.5000	12.70	1/2	2	4	4	0.060	B40197	B60197	
1/2		.5000	12.70	1/2	2	4	4	0.090	B40198	B60198	
1/2		.5000	12.70	1/2	2	4	4	0.125	B40199	B60199	
5/8		.6250	15.88	5/8	3/4	3	4	0.000	B40200	B60200	
5/8		.6250	15.88	5/8	3/4	3	4	0.030	B40157	B60157	
5/8		.6250	15.88	5/8	1-1/4	3-1/2	4	0.000	B40201	B60201	
5/8		.6250	15.88	5/8	1-1/4	3-1/2	4	0.030	B40158	B60158	
5/8		.6250	15.88	5/8	1-1/4	3-1/2	4	0.060	B40202	B60202	
5/8		.6250	15.88	5/8	1-1/4	3-1/2	4	0.090	B40203	B60203	
5/8		.6250	15.88	5/8	1-1/4	3-1/2	4	0.125	B40204	B60204	
5/8		.6250	15.88	5/8	2-1/4	5	4	0.000	B40205	B60205	
5/8		.6250	15.88	5/8	2-1/4	5	4	0.030	B40159	B60159	
CARBIDE THREAD MILLS	5/8	.6250	15.88	5/8	2-1/4	5	4	0.060	B40206	B60206	
	5/8	.6250	15.88	5/8	2-1/4	5	4	0.090	B40207	B60207	
	5/8	.6250	15.88	5/8	2-1/4	5	4	0.125	B40208	B60208	
	3/4	.7500	19.05	3/4	7/8	3	4	0.030	-----	B60236	
	3/4	.7500	19.05	3/4	1	3	4	0.000	B40209	B60209	
	3/4	.7500	19.05	3/4	1	3	4	0.030	B40160	B60160	
	3/4	.7500	19.05	3/4	1-1/2	4	4	0.000	B40210	B60210	
	3/4	.7500	19.05	3/4	1-1/2	4	4	0.030	B40161	B60161	
	3/4	.7500	19.05	3/4	1-1/2	4	4	0.060	B40211	B60211	
	3/4	.7500	19.05	3/4	1-1/2	4	4	0.090	B40212	B60212	
	3/4	.7500	19.05	3/4	1-1/2	4	4	0.125	B40213	B60213	
	3/4	.7500	19.05	3/4	2-1/4	5	4	0.000	B40214	B60214	
	3/4	.7500	19.05	3/4	2-1/4	5	4	0.030	B40162	B60162	
	3/4	.7500	19.05	3/4	2-1/4	5	4	0.060	B40215	B60215	
	3/4	.7500	19.05	3/4	2-1/4	5	4	0.090	B40216	B60216	
CARBIDE BURS	3/4	.7500	19.05	3/4	2-1/4	5	4	0.125	B40217	B60217	
	1	1.0000	25.40	1	1-1/2	4	4	0.000	B40218	B60218	
	1	1.0000	25.40	1	1-1/2	4	4	0.030	B40163	B60163	
	1	1.0000	25.40	1	1-1/2	4	4	0.060	B40219	B60219	
	1	1.0000	25.40	1	1-1/2	4	4	0.090	B40220	B60220	
	1	1.0000	25.40	1	1-1/2	4	4	0.125	B40221	B60221	
	1	1.0000	25.40	1	2-1/4	5	4	0.000	B40222	B60222	
	1	1.0000	25.40	1	2-1/4	5	4	0.030	B40164	B60164	
	1	1.0000	25.40	1	2-1/4	5	4	0.060	B40223	B60223	
	1	1.0000	25.40	1	2-1/4	5	4	0.090	B40224	B60224	
	1	1.0000	25.40	1	2-1/4	5	4	0.125	B40225	B60225	
	1	1.0000	25.40	1	3	6	4	0.000	B40226	B60226	
	1	1.0000	25.40	1	3	6	4	0.030	B40227	B60227	
	1	1.0000	25.40	1	3	6	4	0.060	B40228	B60228	
	1	1.0000	25.40	1	3	6	4	0.090	B40229	B60229	
1	1.0000	25.40	1	3	6	4	0.125	B40230	B60230		



# Variable Index End Mills for Ferrous Materials

## Series MSE-V-4B

### Applications |

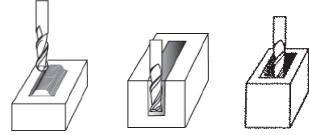

### Features |

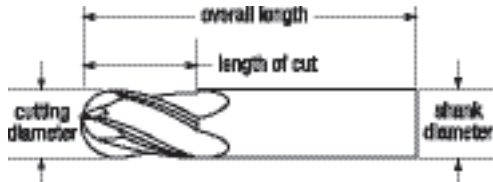

cutting diameter			shank diameter	length of cut	overall length	no. of flutes	EDP Number	
fractional	decimal	metric					bright	TiAIN
1/8	.1250	3.18	1/8	3/8	1-1/2	4	B40308	B60308
3/16	.1875	4.76	3/16	7/16	2	4	B40309	B60309
1/4	.2500	6.35	1/4	3/4	2-1/2	4	B40310	B60310
5/16	.3125	7.94	5/16	13/16	2-1/2	4	B40311	B60311
3/8	.3750	9.53	3/8	7/8	2-1/2	4	B40312	B60312
7/16	.4375	11.11	7/16	1	3	4	B40313	B60313
1/2	.5000	12.70	1/2	5/8	2-1/2	4	-----	B70190
1/2	.5000	12.70	1/2	1	3	4	B40314	B60314
5/8	.6250	15.88	5/8	1-1/4	3-1/2	4	B40315	B60315
3/4	.7500	19.05	3/4	1-1/2	4	4	B40316	B60316
1	1.0000	25.40	1	2-1/4	5	4	B40317	B60317



# V2 Variable Index End Mills for Ferrous Materials

**BASSETT™**

Series MSE-V2-5R

**Applications**

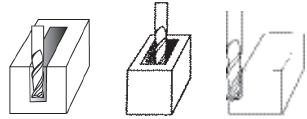
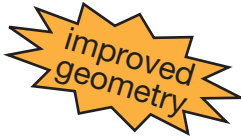

**Features**



- for slotting up to 1 x D
- minimized chatter from unequal flute spacing
- use one tool for roughing and finishing operations

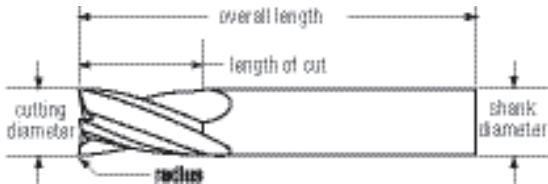

cutting diameter			shank diameter	length of cut	overall length	no. of flutes	corner radius	EDP Number	
fractional	decimal	metric						bright	TiAIN
3/16	.1875	4.76	3/16	3/8	2	5	0.000	B40410	B60410
3/16	.1875	4.76	3/16	3/8	2	5	0.010	B40411	B60411
3/16	.1875	4.76	3/16	7/16	2	5	0.000	B40434	B60434
3/16	.1875	4.76	3/16	7/16	2	5	0.010	B40412	B60412
3/16	.1875	4.76	3/16	3/4	2-1/2	5	0.000	B40435	B60435
3/16	.1875	4.76	3/16	3/4	2-1/2	5	0.010	B40436	B60436
1/4	.2500	6.35	1/4	1/2	2	5	0.000	B40437	B60437
6mm	.2362	6mm	6mm	13mm	50mm	5	.5mm	-----	B70199
1/4	.2500	6.35	1/4	1/2	2	5	0.020	B40413	B60413
1/4	.2500	6.35	1/4	3/4	2-1/2	5	0.000	B40438	B60438
1/4	.2500	6.35	1/4	3/4	2-1/2	5	0.020	B40414	B60414
1/4	.2500	6.35	1/4	1-1/8	3	5	0.010	B40439	B60439
1/4	.2500	6.35	1/4	1-1/8	3	5	0.020	B40415	B60415
1/4	.2500	6.35	1/4	1-1/4	3	5	0.000	B40440	B60440
5/16	.3125	7.94	5/16	1/2	2	5	0.000	B40441	B60441
5/16	.3125	7.94	5/16	1/2	2	5	0.020	B40416	B60416
5/16	.3125	7.94	5/16	13/16	2-1/2	5	0.000	B40442	B60442
5/16	.3125	7.94	5/16	13/16	2-1/2	5	0.020	B40417	B60417
5/16	.3125	7.94	5/16	1-1/4	3	5	0.000	B40443	B60443
5/16	.3125	7.94	5/16	1-1/4	3	5	0.020	B40444	B60444
3/8	.3750	9.53	3/8	1/2	2	5	0.030	B40320	B60320
3/8	.3750	9.53	3/8	5/8	2	5	0.000	B40445	B60445
3/8	.3750	9.53	3/8	5/8	2	5	0.020	B40418	B60418
3/8	.3750	9.53	3/8	7/8	2-1/2	5	0.000	B40446	B60446
3/8	.3750	9.53	3/8	7/8	2-1/2	5	0.020	B40419	B60419
3/8	.3750	9.53	3/8	1-1/8	3	5	0.000	B40447	B60447
3/8	.3750	9.53	3/8	1-1/8	3	5	0.020	B40420	B60420
3/8	.3750	9.53	3/8	2	4	5	0.000	B40448	B60448
3/8	.3750	9.53	3/8	2	4	5	0.000	B40449	B60449
7/16	.4375	11.11	7/16	5/8	2-1/2	5	0.000	B40450	B60450
7/16	.4375	11.11	7/16	5/8	2-1/2	5	0.020	B40421	B60421
7/16	.4375	11.11	7/16	1	3	5	0.000	B40451	B60451
7/16	.4375	11.11	7/16	1	3	5	0.020	B40422	B60422
7/16	.4375	11.11	7/16	2	4	5	0.000	B40452	B60452
1/2	.5000	12.70	1/2	5/8	2-1/2	5	0.000	B40453	B60453
1/2	.5000	12.70	1/2	5/8	2-1/2	5	0.030	B40423	B60423
1/2	.5000	12.70	1/2	1	3	5	0.000	B40454	B60454
1/2	.5000	12.70	1/2	1	3	5	0.020	B40321	B60321
1/2	.5000	12.70	1/2	1	3	5	0.030	B40424	B60424
1/2	.5000	12.70	1/2	1	3	5	0.030	B40322	B60322

continued on next page

CARBIDE END MILLS

CARBIDE DRILLS

CARBIDE THREAD MILLS

CARBIDE BURS

INDEX



# V2 Variable Index End Mills for Ferrous Materials

## Series MSE-V2-5R (continued)

cutting diameter			shank diameter	length of cut	overall length	no. of flutes	corner radius	EDP Number	
fractional	decimal	metric						bright	TiAIN
1/2	.5000	12.70	1/2	1	3	5	0.060	B40455	B60455
1/2	.5000	12.70	1/2	1	3	5	0.090	B40456	B60456
1/2	.5000	12.70	1/2	1	3	5	0.125	B40457	B60457
1/2	.5000	12.70	1/2	1-1/4	3	5	0.000	B40458	B60458
1/2	.5000	12.70	1/2	1-1/4	3	5	0.020	B40323	B60323
1/2	.5000	12.70	1/2	1-1/4	3	5	0.030	B40459	B60459
1/2	.5000	12.70	1/2	1-1/4	3	5	0.030	B40324	B60324
1/2	.5000	12.70	1/2	1-1/4	3	5	0.045	B40325	B60325
1/2	.5000	12.70	1/2	1-1/4	3	5	0.060	B40460	B60460
1/2	.5000	12.70	1/2	1-1/4	3	5	0.090	B40461	B60461
1/2	.5000	12.70	1/2	1-1/4	3	5	0.125	B40462	B60462
1/2	.5000	12.70	1/2	2	4	5	0.000	B40463	B60463
1/2	.5000	12.70	1/2	2	4	5	0.030	B40425	B60425
1/2	.5000	12.70	1/2	2	4	5	0.060	B40464	B60464
1/2	.5000	12.70	1/2	2	4	5	0.090	B40465	B60465
1/2	.5000	12.70	1/2	2	4	5	0.125	B40466	B60466
5/8	.6250	15.88	5/8	3/4	3	5	0.000	B40467	B60467
5/8	.6250	15.88	5/8	3/4	3	5	0.030	B40426	B60426
5/8	.6250	15.88	5/8	1-1/4	3-1/2	5	0.000	B40468	B60468
5/8	.6250	15.88	5/8	1-1/4	3-1/2	5	0.030	B40427	B60427
5/8	.6250	15.88	5/8	1-1/4	3-1/2	5	0.060	B40469	B60469
5/8	.6250	15.88	5/8	1-1/4	3-1/2	5	0.090	B40470	B60470
5/8	.6250	15.88	5/8	1-1/4	3-1/2	5	0.125	B40471	B60471
5/8	.6250	15.88	5/8	2-1/4	5	5	0.000	B40472	B60472
5/8	.6250	15.88	5/8	2-1/4	5	5	0.030	B40428	B60428
5/8	.6250	15.88	5/8	2-1/4	5	5	0.060	B40473	B60473
5/8	.6250	15.88	5/8	2-1/4	5	5	0.090	B40474	B60474
5/8	.6250	15.88	5/8	2-1/4	5	5	0.125	B40475	B60475
3/4	.7500	19.05	3/4	1	3	5	0.000	B40476	B60476
3/4	.7500	19.05	3/4	1	3	5	0.030	B40429	B60429
3/4	.7500	19.05	3/4	1	3	5	0.030	-----	B60498
3/4	.7500	19.05	3/4	1-1/2	4	5	0.000	B40477	B60477
3/4	.7500	19.05	3/4	1-1/2	4	5	0.030	B40430	B60430
3/4	.7500	19.05	3/4	1-1/2	4	5	0.060	B40478	B60478
3/4	.7500	19.05	3/4	1-1/2	4	5	0.090	B40479	B60479
3/4	.7500	19.05	3/4	1-1/2	4	5	0.125	B40480	B60480
3/4	.7500	19.05	3/4	2-1/4	5	5	0.000	B40481	B60481
3/4	.7500	19.05	3/4	2-1/4	5	5	0.030	B40431	B60431
3/4	.7500	19.05	3/4	2-1/4	5	5	0.060	B40482	B60482
3/4	.7500	19.05	3/4	2-1/4	5	5	0.090	B40483	B60483
3/4	.7500	19.05	3/4	2-1/4	5	5	0.125	B40484	B60484
1	1.0000	25.40	1	1-1/2	4	5	0.000	B40485	B60485
1	1.0000	25.40	1	1-1/2	4	5	0.030	B40432	B60432
1	1.0000	25.40	1	1-1/2	4	5	0.060	B40486	B60486
1	1.0000	25.40	1	1-1/2	4	5	0.090	B40487	B60487
1	1.0000	25.40	1	1-1/2	4	5	0.125	B40488	B60488
1	1.0000	25.40	1	2-1/4	5	5	0.000	B40489	B60489
1	1.0000	25.40	1	2-1/4	5	5	0.030	B40433	B60433
1	1.0000	25.40	1	2-1/4	5	5	0.060	B40490	B60490
1	1.0000	25.40	1	2-1/4	5	5	0.090	B40491	B60491
1	1.0000	25.40	1	2-1/4	5	5	0.125	B40492	B60492
1	1.0000	25.40	1	3	6	5	0.000	B40493	B60493
1	1.0000	25.40	1	3	6	5	0.030	B40494	B60494
1	1.0000	25.40	1	3	6	5	0.060	B40495	B60495
1	1.0000	25.40	1	3	6	5	0.090	B40496	B60496

CARBIDE END MILLS

CARBIDE DRILLS

CARBIDE THREAD MILLS

CARBIDE BURS

INDEX



# High-Performance End Mills for Steel

## Operating Parameters: HPEM High-Performance End Mills for Steel

Material	Hardness		Surface Feet per Minute		Chip Load per Tooth		
	Brinell	HRC	Speed Range	SFM	1/32" - 1/4"	1/4" - 1/2"	1/2" - 1"
low alloy steels	<220 HB	<19	Low	600	.0005	.0010	.0020
			High	750	.0010	.0020	.0030
medium alloy steels O1 to O7, W1 to W3, M1 to M3, T1 to T5, A2 to A3, S1 to S7, P2 to P3	225-286	20-30	Low	600	.0003	.0005	.0010
			High	750	.0005	.0010	.0015
high alloy steels M4 to M7, T6 to T15, D2 to D7, A4 to A7, P4	294-371	31-40	Low	525	.0003	.0005	.0008
			High	625	.0005	.0010	.0015
stainless steels 200/300 series	135-275	<28	Low	250	.0005	.0010	.0020
			High	350	.0010	.0020	.0030
stainless steels 400/500 series	135-330	<35	Low	340	.0003	.0008	.0010
			High	400	.0005	.0010	.0015
nickel-based alloys	140-475	<32-50	Low	100	.0005	.0010	.0015
			High	160	.0010	.0015	.0040
titanium alloys	110-450	<48	Low	195	.0005	.0010	.0025
			High	240	.0010	.0030	.0050
inconel	140-475	<48	Low	100	.0005	.0010	.0015
			High	160	.0010	.0015	.0030
aluminum, low silicon	—	—	Low	800	.0030	.0040	.0060
			High	1600	.0040	.0060	.0080

Higher values for surface speed should be used for radial depths of cut less than 25% of the diameter. Lower values for surface speed should be used for radial depths of cut greater than 25% of the diameter. The above recommendations are for axial lengths of cut not to exceed 1 times the cutter diameter for profiling and .5 times the diameter for slotting. Recommended speeds above are for uncoated tools only and should be adjusted when using coated

tools. Generally, speeds can be increased by the following factors: TiCN-coated tools – 20-25% increase; TiAlN-coated tools – 40-50% increase. The above speeds are a recommended starting point only. If the tool is working well, without vibrations or significant noise, increase the SFM in 5-10% increments. Ultimate speeds will depend upon setup conditions. Higher or lower parameters may be required to achieve optimum conditions.

## Series HPEM for stainless steels and exotic materials

### Features and Benefits of HPEM End Mills

- Maximized strength due to increased cross-sectional area in the core and flute body.
- Combination of micrograin carbide substrate with high-performance coatings.
- Achieve 50% greater chip loads and 20% to 40% higher speeds than conventional end mills.

### Applications for HPEM End Mills

- Designed for cutting applications involving excessive mechanical stress.
- Ideally suited for use in stainless steel and exotics such as hastalloy, waspalloy, and inconel.
- 3-flute square end for pocketing, slotting, or roughing.
- 3-flute ball nose gives enhanced surface finish in contour cutting and rapid chip removal in plunge cutting.
- 5-flute design for profiling and finishing applications.

### Tolerances for Solid Carbide End Mills

Cutting Diameter:

1/32" through 1/4" +.000 –.002

17/64" through 1" +.000 –.003

Shank Diameter:

+.0000 –.0005

# High-Performance End Mills For Steel

Series HPDEM-5 • Double End

Applications |



Features |

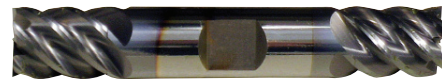
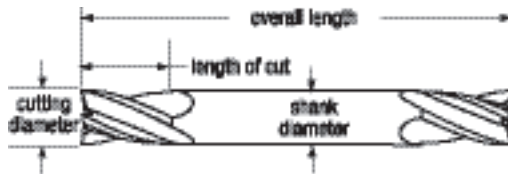
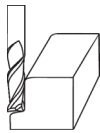

cutting diameter			shank diameter	length of cut	overall length	no. of flutes	EDP Number		
fractional	decimal	metric					bright	TiCN	TiAlN
1/8	.1250	3.18	1/8	1/4	1 1/2	5	B05100	B05605	B66100
3/16	.1875	4.76	3/16	5/16	2	5	B05101	B05609	B66101
1/4	.2500	6.35	1/4	3/8	2 1/2	5	B05103	B05613	B66103
5/16	.3125	7.94	5/16	7/16	2 1/2	5	B05104	B05617	B66104
3/8	.3750	9.53	3/8	1/2	2 1/2	5	B05106	B05621	B66106
7/16	.4375	11.11	7/16	9/16	3	5	B05108	B05625	B66108
1/2	.5000	12.70	1/2	5/8	3	5	B05110	B05629	B66110



# High-Performance End Mills For Steel

## Series HPEM-3

### Applications |

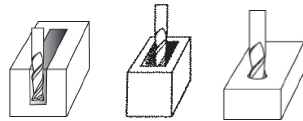

### Features |

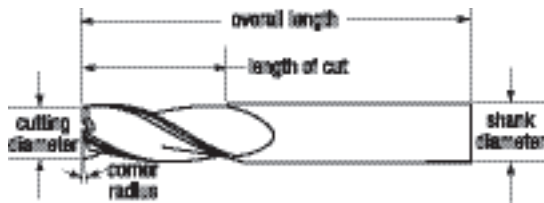

cutting diameter			shank diameter	length of cut	overall length	no. of flutes	corner radius	EDP Number		
fractional	decimal	metric						bright	TiCN	TiAlN
1/8	.1250	3.18	1/8	1/4	1 1/2	3	0.010	B05305	B05005	B05105
1/8	.1250	3.18	1/8	1/2	1 1/2	3	0.010	B05340	B05040	B05140
5/32	.1562	3.97	3/16	5/16	1 1/2	3	0.010	B05307	B05007	B05107
5/32	.1562	3.97	3/16	9/16	2	3	0.010	B05342	B05042	B05142
3/16	.1875	4.76	3/16	5/16	2	3	0.010	B05309	B05009	B05109
3/16	.1875	4.76	3/16	5/8	2	3	0.010	B05344	B05044	B05144
7/32	.2188	5.56	1/4	1/2	2	3	0.020	B05311	B05011	B05111
7/32	.2188	5.56	1/4	3/4	2 1/2	3	0.020	B05346	B05046	B05146
1/4	.2500	6.35	1/4	3/8	2	3	0.020	B05313	B05013	B05113
1/4	.2500	6.35	1/4	3/4	2 1/2	3	0.020	B05348	B05048	B05148
9/32	.2812	7.14	5/16	7/16	2	3	0.020	B05315	B05015	B05115
9/32	.2812	7.14	5/16	13/16	2 1/2	3	0.020	B05350	B05050	B05150
5/16	.3125	7.94	5/16	7/16	2	3	0.020	B05317	B05017	B05117
5/16	.3125	7.94	5/16	13/16	2 1/2	3	0.020	B05352	B05052	B05152
11/32	.3438	8.73	3/8	1/2	2	3	0.020	B05319	B05019	B05119
11/32	.3438	8.73	3/8	7/8	2 1/2	3	0.020	B05354	B05054	B05154
3/8	.3750	9.53	3/8	1/2	2	3	0.020	B05321	B05021	B05121
3/8	.3750	9.53	3/8	7/8	2 1/2	3	0.020	B05356	B05056	B05156
13/32	.4062	10.32	7/16	9/16	2 1/2	3	0.020	B05323	B05023	B05123
13/32	.4062	10.32	7/16	1	2 1/2	3	0.020	B05358	B05058	B05158
7/16	.4375	11.11	7/16	9/16	2 1/2	3	0.020	B05325	B05025	B05125
7/16	.4375	11.11	7/16	1	2 1/2	3	0.020	B05360	B05060	B05160
15/32	.4688	11.91	1/2	5/8	2 1/2	3	0.020	B05327	B05027	B05127
15/32	.4688	11.91	1/2	1 1/4	3	3	0.020	B05362	B05062	B05162
1/2	.5000	12.70	1/2	5/8	2 1/2	3	0.030	B05329	B05029	B05129
1/2	.5000	12.70	1/2	1 1/4	3	3	0.030	B05364	B05064	B05164
5/8	.6250	15.88	5/8	3/4	3	3	0.030	B05331	B05031	B05131
5/8	.6250	15.88	5/8	1 5/8	4	3	0.030	B05366	B05066	B05166
3/4	.7500	19.05	3/4	7/8	3	3	0.030	B05332	B05032	B05133
3/4	.7500	19.05	3/4	1 5/8	4	3	0.030	B05367	B05067	B05168
1	1.0000	25.40	1	1 1/8	3	3	0.030	B05334	B05034	B05135
1	1.0000	25.40	1	2	4	3	0.030	B05369	B05069	B05170

CARBIDE END MILLS

CARBIDE DRILLS

CARBIDE THREAD MILLS

CARBIDE BURS

INDEX



# High-Performance End Mills For Steel

## Series HPEM-5

### Applications |

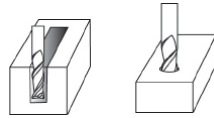

### Features |

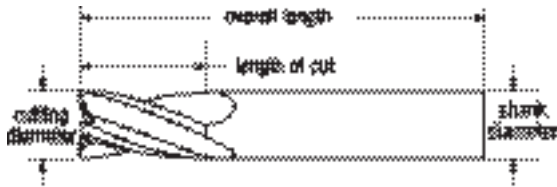

cutting diameter			shank diameter	length of cut	overall length	no. of flutes	bright	EDP Number		
fractional	decimal	metric						TiCN	TiAlN	
1/8	.1250	3.18	1/8	1/4	1 1/2	5	B05112	B05405	B05805	
1/8	.1250	3.18	1/8	1/2	1 1/2	5	B05141	B05440	B05840	
1/8	.1250	3.18	1/8	1/2	2	5	B05098	-----	B70175	
5/32	.1562	3.97	3/16	5/16	2	5	B05114	B05407	B05807	
5/32	.1562	3.97	3/16	9/16	2	5	B05143	B05442	B05842	
3/16	.1875	4.76	3/16	5/16	2	5	B05116	B05409	B05809	
3/16	.1875	4.76	3/16	9/16	2	5	B05145	B05444	B05844	
7/32	.2188	5.56	1/4	3/8	2	5	B05118	B05411	B05811	
7/32	.2188	5.56	1/4	3/4	2 1/2	5	B05147	B05446	B05846	
1/4	.2500	6.35	1/4	3/8	2	5	B05120	B05413	B05813	
1/4	.2500	6.35	1/4	3/4	2 1/2	5	B05149	B05448	B05848	
1/4	.2500	6.35	1/4	1 1/4	4	5	B05171	B05513	B05913	
9/32	.2812	7.14	5/16	7/16	2	5	B05122	B05415	B05815	
9/32	.2812	7.14	5/16	13/16	2 1/2	5	B05151	B05450	B05850	
5/16	.3125	7.94	5/16	7/16	2	5	B05124	B05417	B05817	
5/16	.3125	7.94	5/16	13/16	2 1/2	5	B05153	B05452	B05852	
5/16	.3125	7.94	5/16	1 1/4	4	5	B05173	B05517	B05917	
3/8	.3750	9.53	3/8	1/2	2	5	B05126	B05421	B05821	
3/8	.3750	9.53	3/8	7/8	2 1/2	5	B05155	B05456	B05856	
3/8	.3750	9.53	3/8	1 1/2	4	5	B05175	B05521	B05921	
7/16	.4375	11.11	7/16	9/16	2 1/2	5	B05128	B05425	B05825	
7/16	.4375	11.11	7/16	1	2 1/2	5	B05157	B05460	B05860	
7/16	.4375	11.11	7/16	2	4	5	B05177	B05525	B05925	
1/2	.5000	12.70	1/2	5/8	2 1/2	5	B05130	B05429	B05829	
1/2	.5000	12.70	1/2	1 1/4	3	5	B05159	B05464	B05864	
1/2	.5000	12.70	1/2	2	4	5	B05179	B05529	B05929	
9/16	.5625	14.29	9/16	1 1/2	3 1/2	5	B05161	B05465	B05865	
5/8	.6250	15.88	5/8	3/4	3	5	B05132	B05431	B05831	
5/8	.6250	15.88	5/8	1 5/8	4	5	B05163	B05466	B05866	
5/8	.6250	15.88	5/8	2 1/2	5	5	B05181	B05531	B05931	
3/4	.7500	19.05	3/4	7/8	3	5	B05134	B05432	B05832	
3/4	.7500	19.05	3/4	1 5/8	4	5	B05165	B05467	B05867	
3/4	.7500	19.05	3/4	3 1/4	6	5	B05183	B05532	B05932	
7/8	.8750	22.23	7/8	2	4	5	B05167	B05468	B05868	
1	1.0000	25.40	1	1 1/8	3	5	B05136	B05434	B05834	
1	1.0000	25.40	1	2	4	5	B05169	B05469	B05869	
1	1.0000	25.40	1	3 1/4	6	5	B05185	B05533	B05933	



Series HPEM-6

Applications |



Features |

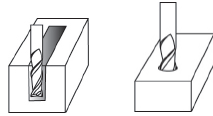

cutting diameter			shank diameter	length of cut	overall length	no. of flutes	bright	EDP Number	
fractional	decimal	metric						TiCN	TiAlN
3/16	.1875	4.76	3/16	5/8	2	6	-----	-----	B70180
1/4	.2500	6.35	1/4	3/4	2 1/2	6	B70186	-----	B70187
3/8	.375	9.52	3/8	7/8	2 1/2	6	-----	-----	B70181
1/2	.5000	12.70	1/2	1 1/4	3	6	B70185	-----	-----

CARBIDE END MILLS

CARBIDE DRILLS

CARBIDE THREAD MILLS

CARBIDE BURS

INDEX

# High-Performance End Mills for Aluminum

## Operating Parameters: HPAM High-Performance End Mills for Aluminum

Type of Cut	Aluminum Alloys 6061-T6, 7075-T6, 440, 356, 380, C61300	Depth of Cut % of tool diameter	SFM (speed)	End Mill Diameter Chip Load per Tooth					
				1/4"	3/8"	1/2"	5/8"	3/4"	1"
shallow slotting	< 32 HRC	< 50%	1200 +	.0045	.0071	.0100	.0123	.0149	.0200
	> 32 HRC		600 +	.0036	.0057	.0080	.0098	.0119	.0160
deep slotting	< 32 HRC	75-100%	1200 +	.0036	.0057	.0080	.0098	.0119	.0160
	> 32 HRC		600 +	.0027	.0043	.0060	.0074	.0089	.0120
medium radial 1.0 x dia depth	< 32 HRC	30% x dia. radial	1200 +	.0045	.0071	.0100	.0123	.0149	.0200
	> 32 HRC		600 +	.0036	.0057	.0080	.0098	.0119	.0160
heavy radial 1.0 x dia depth	< 32 HRC	50% x dia. radial	1200 +	.0036	.0057	.0080	.0098	.0119	.016
medium radial 2.0 x dia depth	< 32 HRC	30% x dia. radial	1200 +	.0045	.0071	.0100	.0123	.0149	.0200
	> 32 HRC		600 +	.0036	.0057	.0080	.0098	.0119	.0160
heavy radial 2.0 x dia depth	< 32 HRC	50% x dia. radial	1200 +	.0036	.0057	.0080	.0098	.0119	.0160
finishing medium radial	< 32 HRC	< 25% of dia.	1200 +	.0045	.0071	.0100	.0123	.0149	.0200
	> 32 HRC		600 +	.0036	.0057	.0080	.0098	.0119	.0160
finishing light radial	< 32HRC	< 10% of dia.	1200 +	.0045	.00713	.0100	.01225	.01485	.0200
finishing	< 32 HRC	< .010 radial depth	1200 +	.0054	.0086	.0120	.0147	.0178	.0240
	> 32 HRC		600 +	.0045	.0071	.0100	.0123	.0149	.0200

This chart represents starting points based on a coated tool. Reduce rates up to 50% when using an uncoated tool.

These speed and feed rates are suggested as general guidelines. Machine type, horsepower, spindle speed limitations, toolholding and workholding devices all may impact a cutting tool's ability to perform properly. Greenfield Industries is not responsible for tool failure, part damage, or injury that may be caused by following these general recommendations..

### Formulae

$$RPM = (SFM \times 3.82) / \text{tool diameter}$$

$$IPM = \text{number of flutes} \times RPM \times \text{chip load per tooth}$$

## Series HPAM for aluminum and nonferrous materials

### Features and Benefits of HPAM End Mills

- Delivers superior performance, providing increased tool life and improved part finish.
- Concentric margins stabilize the tool in the cut and reduce chatter at elevated speeds.
- Greater resistance to chipping with increased feed and speed rates over conventional carbide tools.
- Design incorporates rake enhancements in the flute for improved chip flow and higher feed rates at high and low spindle speeds.
- Tool design eliminates excess pressure that causes chip packing.

### Applications for HPAM End Mills

- 2-flute square end offers excellent performance in roughing and finishing, in ramp cutting and in plunging.
- 2-flute ball nose designed for contouring aluminum, copper, and other non-ferrous materials.
- 3-flute square end gives superior surface finishes without sacrificing metal removal rates in high-speed slotting, profiling, and ramping.



# High-Performance End Mills for Aluminum

**BASSETT™**

Series HPAM-2 • square end

Applications |

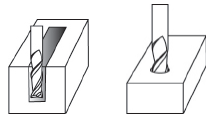

Features |

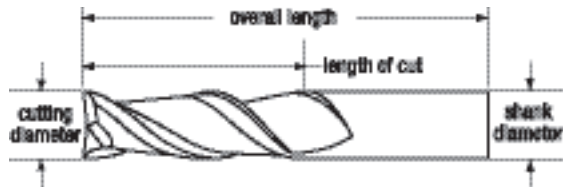
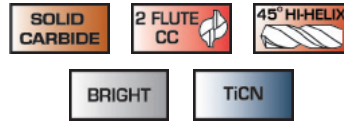

cutting diameter			shank diameter	length of cut	overall length	no. of flutes	EDP number	
fractional	decimal	metric					bright	TiCN
1/8	.1250	3.18	1/8	1/4	1 1/2	2	B04440	B06440
1/8	.1250	3.18	1/8	3/8	1 1/2	2	B04405	B06405
3/16	.1875	4.76	3/16	5/16	2	2	B04444	B06444
3/16	.1875	4.76	3/16	9/16	2	2	B04409	B06409
1/4	.2500	6.35	1/4	3/8	2 1/2	2	B04448	B06448
1/4	.2500	6.35	1/4	3/4	2 1/2	2	B04413	B06413
1/4	.2500	6.35	1/4	1 1/4	3	2	B04548	B06548
5/16	.3125	7.94	5/16	7/16	2 1/2	2	B04452	B06452
5/16	.3125	7.94	5/16	13/16	2 1/2	2	B04417	B06417
5/16	.3125	7.94	5/16	1 1/4	3 1/2	2	B04552	B06552
5/16	.3125	7.94	5/16	2 1/8	4	2	B04617	B06617
3/8	.3750	9.53	3/8	1/2	2 1/2	2	B04456	B06456
3/8	.3750	9.53	3/8	1	2 1/2	2	B04421	B06421
3/8	.3750	9.53	3/8	1 1/2	4	2	B04556	B06556
3/8	.3750	9.53	3/8	2 1/2	6	2	B04621	B06621
7/16	.4375	11.11	7/16	9/16	2 1/2	2	B04460	B06460
7/16	.4375	11.11	7/16	1	2 1/2	2	B04425	B06425
7/16	.4375	11.11	7/16	2	4	2	B04560	B06560
1/2	.5000	12.70	1/2	5/8	3	2	B04464	B06464
1/2	.5000	12.70	1/2	1 1/4	3	2	B04429	B06429
1/2	.5000	12.70	1/2	2	4	2	B04564	B06564
1/2	.5000	12.70	1/2	3 1/8	6	2	B04629	B06629
5/8	.6250	15.88	5/8	3/4	3 1/2	2	B04466	B06466
5/8	.6250	15.88	5/8	1 5/8	4	2	B04431	B06431
5/8	.6250	15.88	5/8	2 1/2	5	2	B04566	B06566
5/8	.6250	15.88	5/8	3 3/4	6	2	B04631	B06631
3/4	.7500	19.05	3/4	1	4	2	B04467	B06467
3/4	.7500	19.05	3/4	1 5/8	4	2	B04432	B06432
3/4	.7500	19.05	3/4	3 1/4	6	2	B04567	B06567
3/4	.7500	19.05	3/4	4	6 1/2	2	B04632	B06632
1	1.0000	25.40	1	1 1/4	5	2	B04469	B06469
1	1.0000	25.40	1	2	5	2	B04434	B06434
1	1.0000	25.40	1	3 1/4	6	2	B04569	B06569
1	1.0000	25.40	1	4 1/8	7	2	B04634	B06634

CARBIDE END MILLS

CARBIDE DRILLS

CARBIDE THREAD MILLS

CARBIDE BURS

INDEX



# High-Performance End Mills for Aluminum

Series HPAM-3 • square end

Applications |



Features |

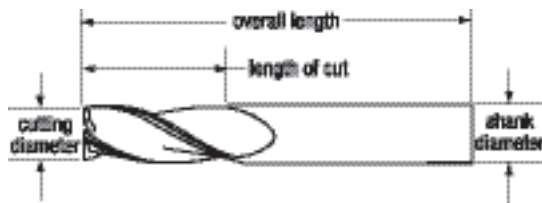
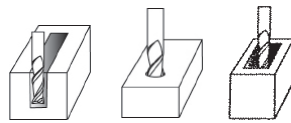

cutting diameter			shank diameter	length of cut	overall length	no. of flutes	bright	EDP number	
fractional	decimal	metric							TiCN
1/8	.1250	3.18	1/8	1/4	1 1/2	3	B04005	B06005	
1/8	.1250	3.18	1/8	3/8	1 1/2	3	B04040	B06040	
3/16	.1875	4.76	3/16	5/16	2	3	B04009	B06009	
3/16	.1875	4.76	3/16	9/16	2	3	B04044	B06044	
1/4	.2500	6.35	1/4	3/8	2	3	B04013	B06013	
1/4	.2500	6.35	1/4	5/8	2 1/2	3	B04048	B06048	
1/4	.2500	6.35	1/4	1 1/4	3	3	B04148	B06148	
5/16	.3125	7.94	5/16	7/16	2	3	B04017	B06017	
5/16	.3125	7.94	5/16	5/8	2 1/2	3	B04052	B06052	
5/16	.3125	7.94	5/16	1 1/4	3 1/2	3	B04152	B06152	
5/16	.3125	7.94	5/16	2 1/8	4	3	B04217	B06217	
3/8	.3750	9.53	3/8	1/2	2	3	B04021	B06021	
3/8	.3750	9.53	3/8	1	2 1/2	3	B04056	B06056	
3/8	.3750	9.53	3/8	1 1/2	3 1/2	3	B04156	B06156	
3/8	.3750	9.53	3/8	2 1/2	6	3	B04221	B06221	
7/16	.4375	11.11	7/16	9/16	2 1/2	3	B04025	B06025	
7/16	.4375	11.11	7/16	1 1/4	2 1/2	3	B04060	B06060	
7/16	.4375	11.11	7/16	2	4	3	B04160	B06160	
1/2	.5000	12.70	1/2	5/8	2 1/2	3	B04029	B06029	
1/2	.5000	12.70	1/2	1 1/4	3	3	B04064	B06064	
1/2	.5000	12.70	1/2	2	4	3	B04164	B06164	
1/2	.5000	12.70	1/2	3 1/8	6	3	B04229	B06229	
5/8	.6250	15.88	5/8	3/4	3	3	B04031	B06031	
5/8	.6250	15.88	5/8	1 5/8	4	3	B04066	B06066	
5/8	.6250	15.88	5/8	2 1/2	5	3	B04166	B06166	
5/8	.6250	15.88	5/8	3 3/4	6	3	B04231	B06231	
3/4	.7500	19.05	3/4	1	3	3	B04032	B06032	
3/4	.7500	19.05	3/4	1 5/8	4	3	B04067	B06067	
3/4	.7500	19.05	3/4	3 1/4	6	3	B04167	B06167	
1	1.0000	25.40	1	1 1/4	4	3	B04034	B06034	
1	1.0000	25.40	1	2	5	3	B04069	B06069	
1	1.0000	25.40	1	3 1/4	6	3	B04169	B06169	

CARBIDE END MILLS

CARBIDE DRILLS

CARBIDE THREAD MILLS

CARBIDE BURS

INDEX



# High-Performance Roughers

## Operating Parameters for High-Performance Roughers

CARBIDE END MILLS

Material	Hardness		Surface Feet per Minute			Chip Load per Tooth	
	Brinell	HRC	Uncoated	TiCN	TiAlN	1/4" to 1/2"	1/2" - 1"
low and plain carbon, alloy, and tool steels	<220 HB	<19	-	325 - 500	430 - 575	.0015 - .0030	.0030 - .0045
plain carbon, alloy and tool steels	225 - 286	20 - 30	-	215 - 375	350 - 430	.0015 - .0030	.0030 - .0045
	294 - 371	31 - 40	-	180 - 280	210 - 320	.0011 - .0021	.0021 - .0032
austenitic stainless steels 200 and 300 series	135 - 275	<28	-	215 - 440	250 - 500	.0010 - .0025	.0025 - .0040
ferritic, martensitic, 400/500 series and PH stainless steels	135 - 330	<35	-	190 - 375	225 - 430	.0015 - .0030	.0030 - .0045
aluminum, low silicon and other non-ferrous alloys	50 -150	600	2000	2400 - 2500	-	.0020 - .0038	.0038 - .0077
			600 - 2000	720 - 2500	-	.0018 - .0035	.0035 - .0071

CARBIDE DRILLS

Series **MRS** Rougher • multi-flute • center cutting • square end

**Applications |**



**Features |**

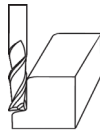

CARBIDE THREAD MILLS

CARBIDE BURS

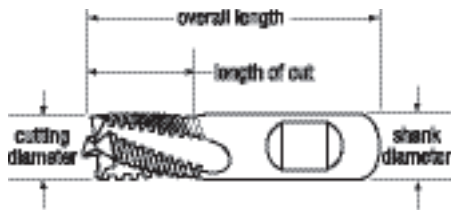

INDEX

cutting diameter			shank diameter	length of cut	overall length	no. of flutes	EDP number		
fractional	decimal	metric					bright	TiCN	TiAlN
1/4	.2500	6.35	1/4	3/8	2	3	B03416	B03816	B66416
1/4	.2500	6.35	1/4	3/4	2 1/2	3	B03216	B03316	B66215
3/8	.3750	9.53	3/8	1/2	2	4	B03424	B03824	B66424
3/8	.3750	9.53	3/8	7/8	2 1/2	4	B03224	B03324	B66223
1/2	.5000	12.70	1/2	5/8	2 1/2	4	B03432	B03832	B66432
1/2	.5000	12.70	1/2	1	3	4	B03232	B03332	B66232
5/8	.6250	15.88	5/8	3/4	3	4	B03440	B03840	B66440
5/8	.6250	15.88	5/8	1-1/4	3 1/2	4	B03240	B03340	B66240
3/4	.7500	19.05	3/4	7/8	3 1/2	4	B03448	B03848	B66448
3/4	.7500	19.05	3/4	1-1/2	4	4	B03248	B03348	B66248
1	1.0000	25.40	1	1	3 1/2	4	B03464	B03864	B66464
1	1.0000	25.40	1	1-1/2	4	4	B03264	B03364	B66264

# High-Performance Roughers

Series MRA Rougher • square end

Applications | **ALUMINUM** **NON-FERROUS MATERIALS**

Features | **SOLID CARBIDE** **3 FLUTE CC** **BRIGHT** **TiCN**

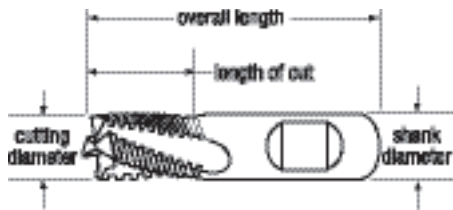
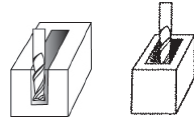

cutting diameter			shank diameter	length of cut	overall length	no. of flutes	EDP number	
fractional	decimal	metric					bright	TiCN
1/4	.2500	6.35	1/4	3/8	2	3	B10117	B03117
1/4	.2500	6.35	1/4	3/4	2 1/2	3	B03016	B03116
3/8	.3750	9.53	3/8	1/2	2	3	B10118	B03118
3/8	.3750	9.53	3/8	7/8	2 1/2	3	B03024	B03124
1/2	.5000	12.70	1/2	5/8	2 1/2	3	B10119	B03119
1/2	.5000	12.70	1/2	1	3	3	B03032	B03132
1/2	.5000	12.70	1/2	2	4 1/2	3	B03532	B03632
5/8	.6250	15.88	5/8	3/4	3	3	B10120	B03120
5/8	.6250	15.88	5/8	1 1/4	3 1/2	3	B03040	B03140
5/8	.6250	15.88	5/8	2 1/4	5	3	B03540	B03640
3/4	.7500	19.05	3/4	1	3 1/2	3	B10121	B03121
3/4	.7500	19.05	3/4	1 1/2	4	3	B03048	B03148
3/4	.7500	19.05	3/4	2 1/4	5	3	B03548	B03648
1	1.0000	25.40	1	1 1/8	3 1/2	3	B10122	B03122
1	1.0000	25.40	1	1 1/2	4	3	B03064	B03164
1	1.0000	25.40	1	2 1/4	5	3	B03564	B03664

CARBIDE END MILLS

CARBIDE DRILLS

CARBIDE THREAD MILLS

CARBIDE BURS

INDEX



## General-Purpose End Mills

### Features and Benefits of General-Purpose End Mills

- 10% cobalt submicron grain carbide substrate.
- 30° right-hand spiral, right-hand cut helix designed for maximum chip clearance.
- 2-, 3-, and 4-flute configurations available.
- Square end and ball nose end geometries available.
- Multiple lengths in select styles and sizes.
- TiCN-coated tools available in most styles.

### Applications for General-Purpose End Mills

- Use in general milling applications in medium to low-carbon steels, cast iron, non-ferrous light metals, and plastics.
- Double-end end mills economically increase productivity.
- 2-flute end mills are generally used for plunging, slotting, and heavy peripheral cuts.
- 3-flute end mills provide a compromise between the chip clearance of a 2-flute tool and the rigidity and wear resistance of a 4-flute tool; especially useful for many slotting operations.
- 4-flute end mills are most commonly used in profiling and in harder materials; stiffer construction results in minimal deflection. They also provide good surface finishes and wear-resistant characteristics for excellent size control.

## Cutting Data for General-Purpose Solid Carbide End Mills

Material	Hardness		Surface Feet per Minute	Chip Load per Tooth										
	Brinell	HRc		1/16"	1/8"	3/16"	1/4"	5/16"	3/8"	1/2"	5/8"	3/4"	1"	
low and plain carbon, alloy and tool steels	<220 HB	<19	Low	270	.0004	.0006	.0010	.0015	.0020	.0025	.0030	.0035	.0040	.0045
			High	360										
plain carbon, alloy, and tool steels	225-286	20-30	Low	180	.0004	.0006	.0010	.0015	.0020	.0025	.0030	.0035	.0040	.0045
			High	270										
			Low	135	.0003	.0004	.0007	.0011	.0014	.0018	.0021	.0025	.0028	.0032
			High	180										
austenitic stainless steels 200 and 300 series	135-275	<28	Low	180	.0002	.0004	.0006	.0010	.0015	.0020	.0025	.0030	.0035	.0040
			High	315										
ductile and malleable cast iron	120-320	<35	Low	160	.0003	.0004	.0007	.0011	.0014	.0018	.0021	.0025	.0028	.0032
			High	270										
cast iron (gray)	120-220	<18	Low	315	.0008	.0012	.0020	.0030	.0040	.0050	.0060	.0070	.0080	.0090
			High	450										
	220-320	19-34	Low	225	.0005	.0007	.0012	.0018	.0024	.0030	.0036	.0042	.0048	.0055
High			315											
low-silicon aluminum & other non-ferrous alloys	50-150	—	Low	720	.0006	.0010	.0016	.0024	.0032	.0040	.0048	.0560	.0064	.0072
			High	900										
cobalt-based high-temperature alloys	150-425	<45	Low	30	.0004	.0006	.0010	.0015	.0020	.0025	.0030	.0035	.0040	.0045
			High	45										
nickel-based high-temperature alloys	140-300	<32	Low	45	.0002	.0004	.0006	.0009	.0012	.0015	.0018	.0021	.0024	.0027
			High	90										
			Low	40	.0002	.0004	.0006	.0009	.0012	.0015	.0018	.0021	.0024	.0027
			High	70										

Higher values for surface speed should be used for radial depths of cut less than 25% of the diameter. Lower values for surface speed should be used for radial depths of cut greater than 25% of the diameter. The above recommendations are for axial lengths of cut not to exceed 1 times the cutter diameter for profiling and .5 times the diameter for slotting.

Recommended speeds above are for uncoated tools only and should be adjusted when using coated tools. Generally, speeds can be increased by the following factors:

- TiCN-coated tools – 20-25% increase
- TiAlN-coated tools – 40-50% increase

The above speeds are a recommended starting point only. If the tool is working well, without vibrations or significant noise, increase the SFM in 5-10% increments. Ultimate speeds will depend upon setup conditions. Higher or lower parameters may be required to achieve optimum conditions.



# Double End General-Purpose

## Series MDE-2

### Applications |



### Features |

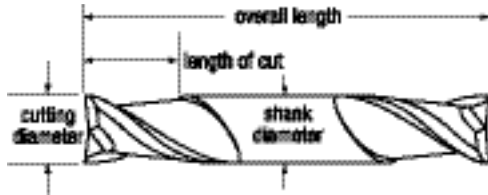
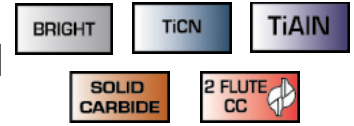

cutting diameter			shank diameter	length of cut	overall length	no. of flutes	EDP number		
fractional	decimal	metric					bright	TiCN	TiAlN
1/16	.0625	1.59	1/8	1/8	1 1/2	2	B52801	B01681	B00207
3/32	.0938	2.38	1/8	3/16	1 1/2	2	B52803	B01682	B00208
1/8	.1250	3.18	1/8	1/4	1 1/2	2	B52805W	B01683W	B00209
1/8	.1250	3.18	3/8	3/8	3	2	B52401	B01577	B00220
5/32	.1562	3.97	3/16	5/16	2	2	B52807	B01684	B00210
5/32	.1562	3.97	3/8	7/16	3	2	B52403	B01578	B00221
3/16	.1875	4.76	3/16	3/8	2	2	B52809	B01685	B00211
3/16	.1875	4.76	3/8	1/2	3	2	B52405	B01579	B11987
7/32	.2188	5.56	3/8	9/16	3 1/2	2	B52407	B01580	B00212
1/4	.2500	6.35	1/4	1/2	2 1/2	2	B52814	B01687	B00213
1/4	.2500	6.35	3/8	5/8	3 1/2	2	B52410	B01581	B00222
9/32	.2812	7.14	3/8	11/16	3 1/2	2	B52412	B01582	B00215
5/16	.3125	7.94	3/8	3/4	3 1/2	2	B52414	B01583	B00224
3/8	.3750	9.53	3/8	9/16	3	2	B52818	B01689	B40779
3/8	.3750	9.53	3/8	3/4	3 1/2	2	B52418	B01585	B00225
7/16	.4375	11.11	1/2	7/8	4	2	B52420	B01586	B00226
1/2	.5000	12.70	1/2	5/8	3	2	B52823	B01691	B00217
1/2	.5000	12.70	1/2	1	4	2	B52423	B01587	B00227

## Series MDE-2-B

### Applications |

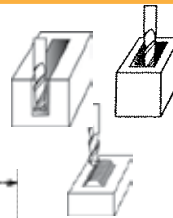

### Features |

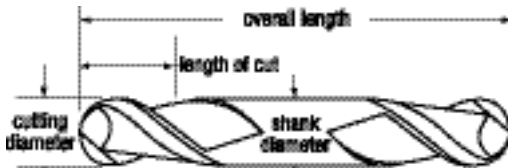
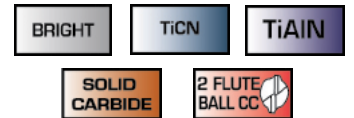

cutting diameter			shank diameter	length of cut	overall length	no. of flutes	EDP number		
fractional	decimal	metric					bright	TiCN	TiAlN
1/16	.0625	1.59	1/8	1/8	1 1/2	2	B52881	B01703	B69881
3/32	.0938	2.38	1/8	3/16	1 1/2	2	B52883	B01704	B69883
1/8	.1250	3.18	3/8	3/8	3	2	B52481	B01599	B69481
5/32	.1562	3.97	3/8	7/16	3	2	B52483	B01600	B69483
3/16	.1875	4.76	3/8	1/2	3	2	B52485	B01601	B69485
7/32	.2188	5.56	3/8	9/16	3 1/2	2	B52487	B01602	B69487
1/4	.2500	6.35	3/8	5/8	3 1/2	2	B52490	B01603	B69490
9/32	.2812	7.14	3/8	11/16	3 1/2	2	B52492	B01604	B69492
5/16	.3125	7.94	3/8	3/4	3 1/2	2	B52494	B01605	B69494
3/8	.3750	9.53	3/8	3/4	3 1/2	2	B52498	B01607	B69498
7/16	.4375	11.11	1/2	7/8	4	2	B52500	B01608	B69500
1/2	.5000	12.70	1/2	1	4	2	B52503	B01609	B69503



# Double End General-Purpose

**BASSETT™**

## Series MDE-4

### Applications |



### Features |

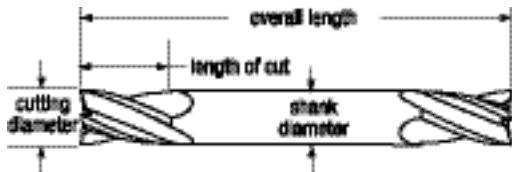

cutting diameter			shank diameter	length of cut	overall length	no. of flutes	EDP number		
fractional	decimal	metric					bright	TiCN	TiAlN
1/16	.0625	1.59	1/8	1/8	1 1/2	4	B52841	B01692	B00342
3/32	.0938	2.38	1/8	3/16	1 1/2	4	B52843	B01693	B69843
1/8	.1250	3.18	1/8	1/4	1 1/2	4	B52845W	B01694W	B69846
1/8	.1250	3.18	3/16	1/4	2	4	B52845	B01694	B69845
1/8	.1250	3.18	3/8	7/16	3	4	B52441	B01588	B11999
5/32	.1562	3.97	3/16	5/16	2	4	B52847	B01695	B00345
5/32	.1562	3.97	3/8	7/16	3	4	B52443	B01589	B69443
3/16	.1875	4.76	3/16	3/8	2	4	B52849	B01696	B00346
3/16	.1875	4.76	3/8	1/2	3	4	B52445	B01590	B12000
7/32	.2188	5.56	3/8	9/16	3 1/2	4	B52447	B01591	B69447
1/4	.2500	6.35	1/4	1/2	2 1/2	4	B52854	B01698	B00348
1/4	.2500	6.35	3/8	5/8	3 1/2	4	B52450	B01592	B00357
9/32	.2812	7.14	3/8	11/16	3 1/2	4	B52452	B01593	B69452
5/16	.3125	7.94	5/16	1/2	2 1/2	4	B52856	B01699	B00349
5/16	.3125	7.94	3/8	3/4	3 1/2	4	B52454	B01594	B00359
3/8	.3750	9.53	3/8	9/16	3	4	B52858	B01700	B40780
3/8	.3750	9.53	3/8	3/4	3 1/2	4	B52458	B01596	B00360
7/16	.4375	11.11	1/2	7/8	4	4	B52460	B01597	B69460
1/2	.5000	12.70	1/2	5/8	3	4	B52863	B01702	B00352
1/2	.5000	12.70	1/2	1	4	4	B52463	B01598	B00362

## Series MDE-4B

### Applications |

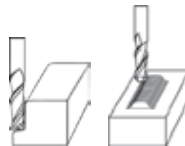
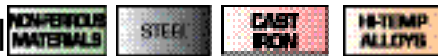

### Features |

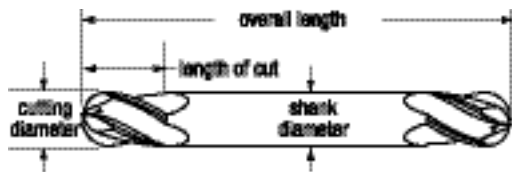
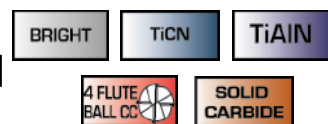

cutting diameter			shank diameter	length of cut	overall length	no. of flutes	EDP number		
fractional	decimal	metric					bright	TiCN	TiAlN
1/16	.0625	1.59	1/8	1/8	1 1/2	4	B52921	B01714	B69921
3/32	.0938	2.38	1/8	3/16	1 1/2	4	B52923	B01715	B69923
1/8	.1250	3.18	3/8	3/8	3	4	B52521	B01610	B69521
5/32	.1562	3.97	3/8	7/16	3	4	B52523	B01611	B69523
3/16	.1875	4.76	3/8	1/2	3	4	B52525	B01612	B69525
7/32	.2188	5.56	3/8	9/16	3 1/2	4	B52527	B01613	B69527
1/4	.2500	6.35	3/8	5/8	3 1/2	4	B52530	B01614	B69530
9/32	.2812	7.14	3/8	11/16	3 1/2	4	B52532	B01615	B69532
5/16	.3125	7.94	3/8	3/4	3 1/2	4	B52534	B01616	B69534
3/8	.3750	9.53	3/8	3/4	3 1/2	4	B52538	B01618	B69538
7/16	.4375	11.11	1/2	7/8	4	4	B52540	B01619	B69540
1/2	.5000	12.70	1/2	1	4	4	B52543	B01620	B69543

# Single End General-Purpose

## Series MSE-2

### Applications |

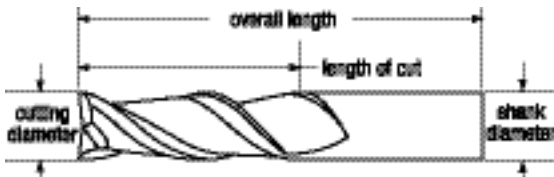
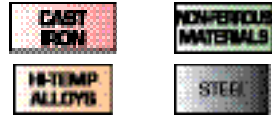

### Features |

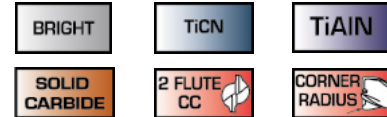

cutting diameter			shank diameter	length of cut	overall length	no. of flutes	corner radius	EDP number		
fractional	decimal	metric						bright	TiCN	TiAlN
1/32	.0312	0.79	1/8	1/8	1 1/2	2		B52601	B01621	B69601
3/64	.0469	1.19	1/8	1/8	1 1/2	2		B52602	B01622	B69602
1/16	.0625	1.59	1/8	1/8	1 1/2	2		B52604	B01623	B69604
1/16	.0625	1.59	1/8	3/4	1 1/2	2		B52001	B01441	B69001
5/64	.0781	1.98	1/8	3/4	1 1/2	2		B52002	B01442	B69002
3/32	.0938	2.38	1/8	3/4	1 1/2	2		B52606	B01624	B69606
3/32	.0938	2.38	1/8	3/8	1 1/2	2		B52004	B01443	B69004
7/64	.1094	2.78	1/8	3/8	1 1/2	2		B52005	B01444	B69005
1/8	.1250	3.18	1/8	1/4	1 1/2	2		B52608	B01625	B69608
1/8	.1250	3.18	1/8	1/2	1 1/2	2		B52007	B01445	B69007
1/8	.1250	3.18	1/8	1/2	1 1/2	2	0.010	B52060	B06800	B69060
1/8	.1250	3.18	1/8	3/4	2 1/4	2		B51200	B01329	B68200
1/8	.1250	3.18	1/8	1	3	2		B51400	B01318	B68400
9/64	.1406	3.57	3/16	9/16	2	2		B52008	B01446	B69008
5/32	.1562	3.97	3/16	9/16	2	2		B52010	B01447	B69010
11/64	.1719	4.37	3/16	5/8	2	2		B52011	B01448	B00059
3/16	.1875	4.76	3/16	5/16	2	2		B52612	B01627	B69602
3/16	.1875	4.76	3/16	5/8	2	2		B52013	B01449	B69013
3/16	.1875	4.76	3/16	5/8	2	2	0.010	B52061	B06801	B69061
3/16	.1875	4.76	3/16	3/4	2 1/2	2		B51202	B01330	B68202
3/16	.1875	4.76	3/16	1 1/8	3	2		B51402	B01386	B68402
13/64	.2031	5.16	1/4	5/8	2 1/2	2		B52014	B01450	B69014
7/32	.2188	5.56	1/4	5/8	2 1/2	2		B52016	B01451	B10575
15/64	.2344	5.95	1/4	3/4	2 1/2	2		B52017	B01452	B69017
6mm	.2362	6.00	6mm	25mm	75mm	2		B52019	----	B69112
1/4	.2500	6.35	1/4	1/2	2	2		B52617	B01629	B81577
1/4	.2500	6.35	1/4	3/4	2 1/2	2		B52020	B01453	B69020
1/4	.2500	6.35	1/4	3/4	2 1/2	2	0.020	B52062	B06802	B69062
1/4	.2500	6.35	1/4	3/4	2 1/2	2	0.030	B52063	B06803	B69063
1/4	.2500	6.35	1/4	1 1/8	3	2		B51204	B01331	B68204
1/4	.2500	6.35	1/4	1 1/2	4	2		B51404	B01319	B68404
1/4	.2500	6.35	1/4	1 1/2	6	2		B51405	B01388	B68405
17/64	.2656	6.75	5/16	3/4	2 1/2	2		B52021	B01454	B69021
9/32	.2812	7.14	5/16	3/4	2 1/2	2		B52023	B01455	B69023
5/16	.3125	7.94	5/16	1/2	2	2		B52619	B01630	B81578
5/16	.3125	7.94	5/16	13/16	2 1/2	2		B52026	B01457	B69026
5/16	.3125	7.94	5/16	13/16	2 1/2	2	0.020	B52065	B06805	B69065
5/16	.3125	7.94	5/16	13/16	2 1/2	2	0.030	B52066	B06806	B69066
5/16	.3125	7.94	5/16	1 1/8	3	2		B51206	B01333	B68206

continued on next page



# Single End General-Purpose

**BASSETT™**

Series **MSE-2** (continued)

	cutting diameter			shank diameter	length of cut	overall length	no. of flutes	corner radius	bright	EDP number		
	fractional	decimal	metric							TiCN	TiAlN	
CARBIDE END MILLS	5/16	.3125	7.94	5/16	1 5/8	4	2		B51406	B01389	B68406	
	3/8	.3750	9.53	3/8	5/8	2	2		B52621	B01631	B81579	
	3/8	.3750	9.53	3/8	1	2 1/2	2		B52032	B01461	B00062	
	3/8	.3750	9.53	3/8	1	2 1/2	2	0.020	B52068	B06808	B69068	
	3/8	.3750	9.53	3/8	1	2 1/2	2	0.030	B52069	B06809	B69069	
	3/8	.3750	9.53	3/8	1	2 1/2	2	0.040	B52070	B06810	B69070	
	3/8	.3750	9.53	3/8	1 1/8	3	2		B51208	B01334	B68208	
	3/8	.3750	9.53	3/8	1 3/4	4	2		B51408	B01320	B68408	
CARBIDE DRILLS	3/8	.3750	9.53	3/8	1 1/2	6	2		B51409	B01391	B68409	
	7/16	.4375	11.11	7/16	5/8	2 1/2	2		B52623	B01632	B69623	
	7/16	.4375	11.11	7/16	1	2 1/2	2		B52038	B01465	B69038	
	7/16	.4375	11.11	7/16	2	4	2		B51210	B01321	B68210	
	7/16	.4375	11.11	7/16	3	6	2		B51410	B01322	B68410	
	1/2	.5000	12.70	1/2	5/8	2 1/2	2		B52626	B01633	B81581	
	1/2	.5000	12.70	1/2	1	3	2		B52045	B01469	B69045	
	1/2	.5000	12.70	1/2	1	3	2	0.030	B52072	B06812	B69072	
CARBIDE THREAD MILLS	1/2	.5000	12.70	1/2	1	3	2	0.060	B52073	B06813	B69073	
	1/2	.5000	12.70	1/2	1	3	2	0.090	B52074	B06814	B69074	
	1/2	.5000	12.70	1/2	2	4	2		B51212	B01338	B68212	
	1/2	.5000	12.70	1/2	1 1/2	6	2		B51411	B01323	B68411	
	1/2	.5000	12.70	1/2	3	6	2		B51412	B01394	B68412	
	9/16	.5625	14.29	9/16	1 1/4	3	2		B52047	B01470	B69047	
	5/8	.6250	15.88	5/8	3/4	3	2		B52628	B01634	B69628	
	5/8	.6250	15.88	5/8	1 1/4	3 1/2	2		B52049	B01471	B00064	
CARBIDE BURS	5/8	.6250	15.88	5/8	1 1/4	3 1/2	2	0.030	B52076	B06816	B69076	
	5/8	.6250	15.88	5/8	1 1/4	3 1/2	2	0.060	B52077	B06817	B69077	
	5/8	.6250	15.88	5/8	1 1/4	3 1/2	2	0.090	B52078	B06818	B69078	
	5/8	.6250	15.88	5/8	2 1/4	5	2		B51214	B01324	B68214	
	5/8	.6250	15.88	5/8	3	6	2		B51414	B01395	B68414	
	3/4	.7500	19.05	3/4	1	3	2		B52631	B01635	B81583	
	3/4	.7500	19.05	3/4	1 1/2	4	2		B52051	B01472	B00065	
	3/4	.7500	19.05	3/4	1 1/2	4	2	0.030	B52080	B06820	B69080	
INDEX	3/4	.7500	19.05	3/4	1 1/2	4	2	0.060	B52081	B06821	B69081	
	3/4	.7500	19.05	3/4	1 1/2	4	2	0.090	B52082	B06822	B69082	
	3/4	.7500	19.05	3/4	2 1/4	5	2		B51216	B61216	B68216	
	3/4	.7500	19.05	3/4	3	6	2		B51416	B01396	B68416	
	7/8	.8750	22.23	7/8	1 1/2	4	2		B52053	B01473	B69053	
	7/8	.8750	22.23	7/8	2 1/4	5	2		B51218	B01325	B68218	
	7/8	.8750	22.23	7/8	3	6	2		B51418	B01326	B68418	
	1	1.0000	25.40	1	1 1/2	4	2		B52057	B01474	B00067	
1	1.0000	25.40	1	1 1/2	4	2	0.030	B52084	B06824	B69084		
1	1.0000	25.40	1	1 1/2	4	2	0.060	B52085	B06825	B69085		
1	1.0000	25.40	1	1 1/2	4	2	0.090	B52086	B06826	B69086		
1	1.0000	25.40	1	2 1/4	5	2		B51220	B01327	B68220		
1	1.0000	25.40	1	3	6	2		B51420	B01398	B68420		



# Single End General-Purpose

Series MSE-2B

## Applications |

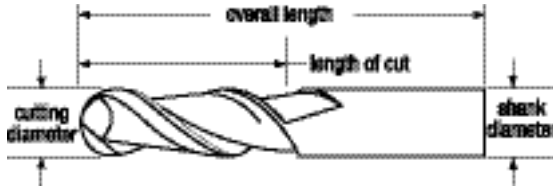
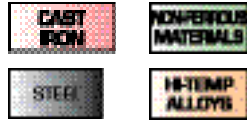

## Features |



cutting diameter			shank diameter	length of cut	overall length	no. of flutes	EDP number		
fractional	decimal	metric					bright	TiCN	TiAlN
1/32	.0312	0.79	1/8	1/8	1 1/2	2	B52681	B01651	B69681
3/64	.0469	1.19	1/8	1/8	1 1/2	2	B52682	B01652	B69682
1/16	.0625	1.59	1/8	1/8	1 1/2	2	B52684	B01653	B69684
1/16	.0625	1.59	1/8	3/4	1 1/2	2	B52201	B01509	B69201
5/64	.0781	1.98	1/8	3/4	1 1/2	2	B52202	B01564	B69202
3/32	.0938	2.38	1/8	3/8	1 1/2	2	B52204	B01511	B69204
7/64	.1094	2.78	1/8	3/8	1 1/2	2	B52205	B01512	B69205
1/8	.1250	3.18	1/8	1/4	1 1/2	2	B52688	B01655	B69688
1/8	.1250	3.18	1/8	1/2	1 1/2	2	B52207	B01513	B69207
1/8	.1250	3.18	1/8	3/4	2 1/4	2	B51300	B01360	B68300
1/8	.1250	3.18	1/8	1	3	2	B51500	B01414	B68500
9/64	.1406	3.57	3/16	9/16	2	2	B52208	B01566	B69208
5/32	.1562	3.97	3/16	9/16	2	2	B52210	B01515	B69210
11/64	.1719	4.37	3/16	5/8	2	2	B52211	B01516	B69211
3/16	.1875	4.76	3/16	5/16	2	2	B52692	B01657	B69602
3/16	.1875	4.76	3/16	5/8	2	2	B52213	B01517	B00236
3/16	.1875	4.76	3/16	3/4	2 1/2	2	B51302	B01363	B68302
3/16	.1875	4.76	3/16	1 1/8	3	2	B51502	B01415	B68502
13/64	.2031	5.16	1/4	5/8	2 1/2	2	B52214	B01364	B69214
7/32	.2188	5.56	1/4	5/8	2 1/2	2	B52216	B01568	B69216
15/64	.2344	5.95	1/4	3/4	2 1/2	2	B52217	B01570	B69217
1/4	.2500	6.35	1/4	1/2	2	2	B52697	B01659	B69697
1/4	.2500	6.35	1/4	3/4	2 1/2	2	B52220	B01521	B69220
1/4	.2500	6.35	1/4	1 1/8	3	2	B51304	B01359	B68304
1/4	.2500	6.35	1/4	1 1/2	4	2	B51504	B01427	B68504
1/4	.2500	6.35	1/4	1 1/2	6	2	B51505	B01416	B68505
17/64	.2656	6.75	5/16	3/4	2 1/2	2	B52221	B01572	B69221
9/32	.2812	7.14	5/16	3/4	2 1/2	2	B52223	B01575	B69223
5/16	.3125	7.94	5/16	1/2	2	2	B52699	B01660	B69699
5/16	.3125	7.94	5/16	13/16	2 1/2	2	B52226	B01525	B00241
5/16	.3125	7.94	5/16	1 1/8	3	2	B51306	B01361	B68306
5/16	.3125	7.94	5/16	1 5/8	4	2	B51506	B01417	B68506
3/8	.3750	9.53	3/8	5/8	2	2	B52701	B01661	B69701
3/8	.3750	9.53	3/8	1	2 1/2	2	B52232	B01529	B12014
3/8	.3750	9.53	3/8	1 1/8	3	2	B51308	B01362	B68308
3/8	.3750	9.53	3/8	1 3/4	4	2	B51508	B01418	B68508
3/8	.3750	9.53	3/8	1 1/2	6	2	B51509	B01419	B68509

continued on next page

CARBIDE END MILLS  
CARBIDE DRILLS  
CARBIDE THREAD MILLS  
CARBIDE BURS  
INDEX





# Single End General-Purpose

Series **MSE-2B** (continued)

	cutting diameter			shank diameter	length of cut	overall length	no. of flutes	bright	EDP number	
	fractional	decimal	metric						TiCN	TiAIN
	7/16	.4375	11.11	7/16	5/8	2 1/2	2	B52703	B01662	B69703
	7/16	.4375	11.11	7/16	7/8	2 1/2	2	B52238	B01584	B12015
	7/16	.4375	11.11	7/16	2	4	2	B51310	B01365	B68310
	7/16	.4375	11.11	7/16	3	6	2	B51510	B01420	B68510
	1/2	.5000	12.70	1/2	5/8	2 1/2	2	B52706	B01663	B69706
	1/2	.5000	12.70	1/2	1	3	2	B52245	B01537	B00244
	1/2	.5000	12.70	1/2	2	4	2	B51312	B01367	B68312
	1/2	.5000	12.70	1/2	3	6	2	B51512	B01422	B68512
	1/2	.5000	12.70	1/2	1 1/2	6	2	B51511	B01366	B68511
	9/16	.5625	14.29	9/16	1 1/4	3	2	B52247	B01617	B69247
	5/8	.6250	15.88	5/8	3/4	3	2	B52708	B01664	B69708
	5/8	.6250	15.88	5/8	1 1/4	3 1/2	2	B52249	B01539	B00246
	5/8	.6250	15.88	5/8	2 1/4	5	2	B51314	B01368	B68314
	5/8	.6250	15.88	5/8	3	6	2	B51514	B01423	B68514
	3/4	.7500	19.05	3/4	1	3	2	B52711	B01665	B69711
	3/4	.7500	19.05	3/4	1 1/2	4	2	B52251	B01540	B69251
	3/4	.7500	19.05	3/4	2 1/4	5	2	B51316	B01369	B68316
	3/4	.7500	19.05	3/4	3	6	2	B51516	B01424	B68516
	7/8	.8750	22.23	7/8	1 1/2	4	2	B52253	B01595	B69253
	7/8	.8750	22.23	7/8	2 1/4	5	2	B51318	B01370	B68318
	7/8	.8750	22.23	7/8	3	6	2	B51518	B01425	B68518
	1	1.0000	25.40	1	1 1/2	4	2	B52257	B01542	B00250
	1	1.0000	25.40	1	2 1/4	5	2	B51320	B01371	B68320
	1	1.0000	25.40	1	3	6	2	B51520	B01426	B68520



# Single End General-Purpose

Series MSE-3

Applications |

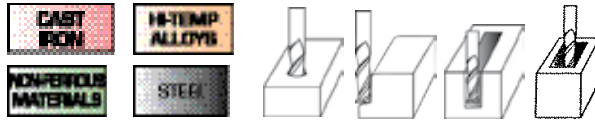

Features |

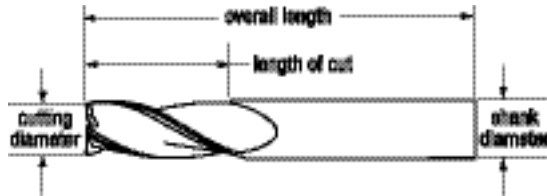
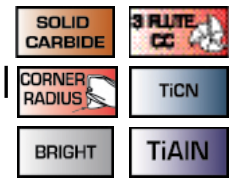

cutting diameter			shank diameter	length of cut	overall length	no. of flutes	corner radius	EDP number		
fractional	decimal	metric						bright	TiCN	TiAlN
1/16	.0625	1.59	1/8	3/4	1 1/2	3		B27104	B37104	B67104
5/64	.0781	1.98	1/8	3/4	1 1/2	3		B27105	B37105	B67105
3/32	.0938	2.38	1/8	3/8	1 1/2	3		B27106	B37106	B67106
7/64	.1094	2.78	1/8	3/8	1 1/2	3		B27107	B37107	B67107
1/8	.1250	3.18	1/8	1/2	1 1/2	3		B27108	B37108	B67108
1/8	.1250	3.18	1/8	1/2	1 1/2	3	0.010	B27200	B37200	B67200
9/64	.1406	3.57	3/16	9/16	2	3		B27109	B37109	B67109
5/32	.1562	3.97	3/16	9/16	2	3		B27110	B37110	B67110
11/64	.1719	4.37	3/16	5/8	2	3		B27111	B37111	B67111
3/16	.1875	4.76	3/16	5/8	2	3		B27112	B37112	B67112
3/16	.1875	4.76	3/16	5/8	2	3	0.010	B27201	B37201	B67201
13/64	.2031	5.16	1/4	5/8	2 1/2	3		B27113	B37113	B67113
7/32	.2188	5.56	1/4	5/8	2 1/2	3		B27114	B37114	B67114
15/64	.2344	5.95	1/4	3/4	2 1/2	3		B27115	B37115	B67115
1/4	.2500	6.35	1/4	3/4	2 1/2	3		B27116	B11971	B67116
1/4	.2500	6.35	1/4	3/4	2 1/2	3	0.020	B27202	B37202	B67202
1/4	.2500	6.35	1/4	3/4	2 1/2	3	0.030	B27203	B37203	B67203
17/64	.2656	6.75	5/16	3/4	2 1/2	3		B27117	B37117	B67117
9/32	.2812	7.14	5/16	3/4	2 1/2	3		B27118	B37118	B67118
5/16	.3125	7.94	5/16	13/16	2 1/2	3		B27120	B11972	B67120
5/16	.3125	7.94	5/16	13/16	2 1/2	3	0.020	B27205	B37205	B67205
5/16	.3125	7.94	5/16	13/16	2 1/2	3	0.030	B27206	B37206	B67206
3/8	.3750	9.53	3/8	7/8	2 1/2	3		B27124	B11973	B67124
3/8	.3750	9.53	3/8	7/8	2 1/2	3	0.020	B27208	B37208	B67208
3/8	.3750	9.53	3/8	7/8	2 1/2	3	0.030	B27209	B37209	B67209
3/8	.3750	9.53	3/8	7/8	2 1/2	3	0.040	B27210	B37210	B67210
7/16	.4375	11.11	7/16	7/8	2 1/2	3		B27128	B11974	B67128
1/2	.5000	12.70	1/2	1	3	3		B27132	B11975	B67132
1/2	.5000	12.70	1/2	1	3	3	0.030	B27212	B37212	B67212
1/2	.5000	12.70	1/2	1	3	3	0.060	B27213	B37213	B67213
1/2	.5000	12.70	1/2	1	3	3	0.090	B27214	B37214	B67214
9/16	.5625	14.29	9/16	1 1/4	3	3		B27136	B37136	B67136
5/8	.6250	15.88	5/8	1 1/4	3 1/2	3		B27140	B11976	B67140
5/8	.6250	15.88	5/8	1 1/4	3 1/2	3	0.030	B27216	B37216	B67216
5/8	.6250	15.88	5/8	1 1/4	3 1/2	3	0.060	B27217	B37217	B67217
5/8	.6250	15.88	5/8	1 1/4	3 1/2	3	0.090	B27218	B37218	B67218
3/4	.7500	19.05	3/4	1 1/2	4	3		B27148	B11977	B67148
3/4	.7500	19.05	3/4	1 1/2	4	3	0.030	B27220	B37220	B67220
3/4	.7500	19.05	3/4	1 1/2	4	3	0.060	B27221	B37221	B67221
3/4	.7500	19.05	3/4	1 1/2	4	3	0.090	B27222	B37222	B67222
7/8	.8750	22.23	7/8	1 1/2	4	3		B27156	B11986	B67156
1	1.0000	25.40	1	1 1/2	4	3		B27164	B11978	B67164
1	1.0000	25.40	1	1 1/2	4	3	0.030	B27224	B37224	B67224
1	1.0000	25.40	1	1 1/2	4	3	0.060	B27225	B37225	B67225
1	1.0000	25.40	1	1 1/2	4	3	0.090	B27226	B37226	B67226

CARBIDE END MILLS

CARBIDE DRILLS

CARBIDE THREAD MILLS

CARBIDE BURS

INDEX





# Single End General-Purpose

**BASSETT™**

Series **MSE-4**

Applications |



Features |

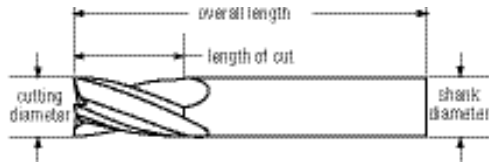
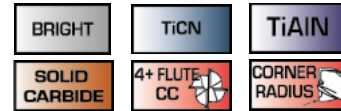

cutting diameter			shank diameter	length of cut	overall length	no. of flutes	corner radius	EDP number		
fractional	decimal	metric						bright	TiCN	TiAlN
1/32	.0312	0.79	1/8	1/16	1 1/2	4	-----	-----	B69643	
1/32	.0312	0.79	1/8	1/8	1 1/2	4	B52641	B01636	B69641	
3/64	.0469	1.19	1/8	1/8	1 1/2	4	B52642	B01637	B69642	
1/16	.0625	1.59	1/8	1/8	1 1/2	4	B52644	B01638	B69644	
1/16	.0625	1.59	1/8	3/4	1 1/2	4	B52101	B01475	B69101	
1/16	.0625	1.59	1/8	1/4	1 1/2	4	0.010	B52645	-----	B69645
5/64	.0781	1.98	1/8	3/4	1 1/2	4	B52102	B01476	B69102	
3/32	.0938	2.38	1/8	3/4	1 1/2	4	B52646	B01639	B69646	
3/32	.0938	2.38	1/8	3/8	1 1/2	4	B52104	B01477	B69104	
3/32	.0938	2.38	1/8	3/8	1 1/2	4	0.010	B52106	-----	B69106
3/32	.0938	2.38	1/8	3/8	1 1/2	4	0.020	-----	-----	B69157
7/64	.1094	2.78	1/8	3/8	1 1/2	4	B52105	B01478	B69105	
1/8	.1250	3.18	1/8	1/4	1 1/2	4	B52648	B01640	B69648	
1/8	.1250	3.18	1/8	1/2	1 1/2	4	B52107	B01479	B69107	
1/8	.1250	3.18	1/8	1/2	1 1/2	4	0.010	B52160	B01750	B69160
1/8	.1250	3.18	1/8	1/2	1 1/2	4	0.015	-----	-----	B69158
1/8	.1250	3.18	1/8	1/2	1 1/2	4	0.020	B52095	-----	B62095
1/8	.1250	3.18	1/8	1/2	1 1/2	4	0.030	-----	-----	B69159
1/8	.1250	3.18	1/8	3/4	2 1/4	4	B51250	B01343	B68250	
1/8	.1250	3.18	1/8	1	3	4	B51450	B01399	B68450	
1/8	.1250	3.18	1/8	1	3	4	0.045	B52096	-----	B62096
9/64	.1406	3.57	3/16	9/16	2	4	B52108	B01480	B69108	
5/32	.1562	3.97	3/16	5/16	2	4	B52650	B01641	B69650	
5/32	.1562	3.97	3/16	9/16	2	4	B52110	B01481	B69110	
11/64	.1719	4.37	3/16	5/8	2	4	B52111	B01482	B69111	
3/16	.1875	4.76	3/16	3/4	2 1/2	4	B51252	B01344	B68252	
3/16	.1875	4.76	3/16	5/8	2	4	B52113	B01483	B69113	
3/16	.1875	4.76	3/16	5/8	2	4	0.010	B52162	B01751	B69162
3/16	.1875	4.76	3/16	5/8	2	4	0.015	B52087	-----	B62087
3/16	.1875	4.76	3/16	5/8	2	4	0.020	B52088	-----	B62088
3/16	.1875	4.76	3/16	5/8	2	4	0.030	B52089	-----	B62089
3/16	.1875	4.76	3/16	5/16	2	4	B52652	B01642	B69652	
3/16	.1875	4.76	3/16	1	3	4	B52090	-----	B62090	
3/16	.1875	4.76	3/16	1	3	4	0.045	-----	-----	B69163
3/16	.1875	4.76	3/16	1 1/8	3	4	B51452	B01400	B68452	
3/16	.1875	4.76	3/16	1	4	4	B51451	-----	B68451	
3/16	.1875	4.76	3/16	1	4	4	0.045	B52091	-----	B62091
13/64	.2031	5.16	1/4	5/8	2 1/2	4	B52114	B01484	B69114	
7/32	.2188	5.56	1/4	5/8	2 1/2	4	B52116	B01485	B69116	
15/64	.2344	5.95	1/4	3/4	2 1/2	4	B52117	B01486	B69117	
6mm	.2362	6.00	6mm	32mm	100mm	4	-----	-----	B69115	

continued on next page

CARBIDE END MILLS

CARBIDE DRILLS

CARBIDE THREAD MILLS

CARBIDE BURS

INDEX



# Single End General-Purpose

Series **MSE-4** (continued)

cutting diameter			shank diameter	length of cut	overall length	no. of flutes	corner radius	bright	EDP number	
fractional	decimal	metric							TICN	TiAIN
1/4	.2500	6.35	1/4	1/2	2	4		B52657	B01644	B69657
1/4	.2500	6.35	1/4	3/4	2 1/2	4		B52120	B01487	B69120
1/4	.2500	6.35	1/4	3/4	2 1/2	4	0.010	B52092	-----	B62092
1/4	.2500	6.35	1/4	3/4	2 1/2	4	0.015	B52093	-----	B62093
1/4	.2500	6.35	1/4	3/4	2 1/2	4	0.020	B52164	B01752	B69164
1/4	.2500	6.35	1/4	3/4	2 1/2	4	0.030	B52165	B01753	B69165
1/4	.2500	6.35	1/4	3/4	2 1/2	4	0.040	-----	-----	B69119
1/4	.2500	6.35	1/4	3/4	2 1/2	4	0.045	-----	-----	B69122
1/4	.2500	6.35	1/4	3/4	2 1/2	4	0.060	B69118	-----	B62094
1/4	.2500	6.35	1/4	1 1/8	3	4		B51254	B01340	B68254
1/4	.2500	6.35	1/4	1 1/2	4	4		B51454	B01732	B68454
1/4	.2500	6.35	1/4	1 1/2	6	4		B51455	B01402	B68455
17/64	.2656	6.75	5/16	3/4	2 1/2	4		B52121	B01730	B69121
9/32	.2812	7.14	5/16	3/4	2 1/2	4		B52123	B01489	B69123
19/64	.2969	7.54	5/16	7/8	2 1/4	4		-----	-----	B69124
5/16	.3125	7.94	5/16	1/2	2	4		B52659	B01645	B81587
5/16	.3125	7.94	5/16	13/16	2 1/2	4		B52126	B01491	B69126
5/16	.3125	7.94	5/16	13/16	2 1/2	4	0.020	B52167	B01755	B69167
5/16	.3125	7.94	5/16	13/16	2 1/2	4	0.030	B52168	B01756	B69168
5/16	.3125	7.94	5/16	1	4	4		B52097	-----	B68457
5/16	.3125	7.94	5/16	1 1/8	3	4		B51256	B01347	B68256
5/16	.3125	7.94	5/16	1 5/8	4	4		B51456	B01403	B68456
11/32	.3438	8.73	3/8	7/8	2 1/2	4		-----	-----	B69129
3/8	.3750	9.53	3/8	5/8	2	4		B52661	B01646	B81588
3/8	.3750	9.53	3/8	1	2 1/2	4		B52132	B01495	B69132
3/8	.3750	9.53	3/8	1	2 1/2	4	0.010	-----	-----	B69130
3/8	.3750	9.53	3/8	1	2 1/2	4	0.015	-----	-----	B69131
3/8	.3750	9.53	3/8	1	2 1/2	4	0.020	B52170	B01758	B69170
3/8	.3750	9.53	3/8	1	2 1/2	4	0.030	B52171	B01759	B69171
3/8	.3750	9.53	3/8	1	2 1/2	4	0.040	B52172	B01760	B69172
3/8	.3750	9.53	3/8	1	2 1/2	4	0.045	-----	-----	B69133
3/8	.3750	9.53	3/8	1	2 1/2	4	0.060	-----	-----	B69134
3/8	.3750	9.53	3/8	1 1/8	3	4		B51258	B01348	B68258
3/8	.3750	9.53	3/8	1	4	4		-----	-----	B68472
3/8	.3750	9.53	3/8	1	4	4	0.020	-----	-----	B69136
3/8	.3750	9.53	3/8	1 3/4	4	4		B51458	B01733	B68458
3/8	.3750	9.53	3/8	1 1/2	6	4		B51459	B01405	B68459
13/32	.4062	10.32	7/16	7/8	2 3/4	4		B52098	-----	B62098
27/64	.4218	10.71	7/16	7/8	2 3/4	4		B52099	-----	B62099
7/16	.4375	11.11	7/16	5/8	2 1/2	4		B52663	B01647	B69663
7/16	.4375	11.11	7/16	1	2 1/2	4		B52138	B01499	B69138
7/16	.4375	11.11	7/16	2	4	4		B51260	B01341	B68260
7/16	.4375	11.11	7/16	3	6	4		B51460	B01734	B68460
1/2	.5000	12.70	1/2	5/8	2 1/2	4		B52666	B01648	B81590
1/2	.5000	12.70	1/2	1	3	4		B52145	B01503	B69145
1/2	.5000	12.70	1/2	1	3	4	0.015	-----	-----	B69143
1/2	.5000	12.70	1/2	1	3	4	0.020	-----	-----	B69144
1/2	.5000	12.70	1/2	1	3	4	0.030	B52173	B01762	B69173
1/2	.5000	12.70	1/2	1	3	4	0.040	-----	-----	B69146
1/2	.5000	12.70	1/2	1	3	4	0.060	B52174	B01763	B69174

continued on next page

CARBIDE END MILLS  
 CARBIDE DRILLS  
 CARBIDE THREAD MILLS  
 CARBIDE BURS  
 INDEX



# Single End General-Purpose

Series **MSE-4** (continued)

	cutting diameter			shank diameter	length of cut	overall length	no. of flutes	corner radius	EDP number		
	fractional	decimal	metric						bright	TiCN	TiAlN
	1/2	.5000	12.70	1/2	1	3	4	0.090	B52175	B01764	B69175
	1/2	.5000	12.70	1/2	1	3	4	0.125	B52185	-----	B62100
	1/2	.5000	12.70	1/2	2	4	4		B51262	B01352	B68262
	1/2	.5000	12.70	1/2	3	6	4		B51462	B01408	B68462
	1/2	.5000	12.70	1/2	1 1/2	6	4		B51461	B01407	B68461
	9/16	.5625	14.29	9/16	1 1/4	3	4		B52147	B01765	B69147
	5/8	.6250	15.88	5/8	3/4	3	4		B52668	B01649	B81591
	5/8	.6250	15.88	5/8	1 1/4	3 1/2	4		B52149	B01505	B69149
	5/8	.6250	15.88	5/8	1 1/4	3 1/2	4	0.030	B52176	B01766	B69176
	5/8	.6250	15.88	5/8	1 1/4	3 1/2	4	0.060	B52177	B01767	B69177
	5/8	.6250	15.88	5/8	1 1/4	3 1/2	4	0.090	B52178	B01768	B69178
	5/8	.6250	15.88	5/8	2 1/4	5	4		B51264	B01342	B68264
	5/8	.6250	15.88	5/8	3	6	4		B51464	B01409	B68464
	3/4	.7500	19.05	3/4	1	3	4		B52671	B01650	B81592
	3/4	.7500	19.05	3/4	1 1/2	4	4		B52151	B01506	B69151
	3/4	.7500	19.05	3/4	1 1/2	4	4	0.030	B52179	B01770	B69179
	3/4	.7500	19.05	3/4	1 1/2	4	4	0.060	B52180	B01771	B69180
	3/4	.7500	19.05	3/4	1 1/2	4	4	0.090	B52181	B01772	B69181
	3/4	.7500	19.05	3/4	2 1/4	5	4		B51266	B01351	B68266
	3/4	.7500	19.05	3/4	3	6	4		B51466	B01410	B68466
	7/8	.8750	22.23	7/8	1 1/2	4	4		B52153	B01507	B69153
	7/8	.8750	22.23	7/8	2 1/4	5	4		B51268	B01355	B68268
	7/8	.8750	22.23	7/8	3	6	4		B51468	B01735	B68468
	1	1.0000	25.40	1	1 1/2	4	4		B52157	B01508	B00046
	1	1.0000	25.40	1	1 1/2	4	4	0.030	B52182	B01774	B69182
	1	1.0000	25.40	1	1 1/2	4	4	0.060	B52183	B01775	B69183
	1	1.0000	25.40	1	1 1/2	4	4	0.090	B52184	B01776	B69184
	1	1.0000	25.40	1	2 1/4	5	4		B51270	B01356	B68270
	1	1.0000	25.40	1	3	6	4		B51470	B01412	B68470



# Single End General-Purpose

## Series MSE-4B

### Applications



### Features

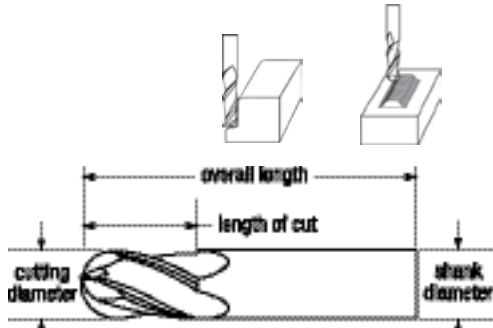

cutting diameter			shank diameter	length of cut	overall length	no. of flutes	EDP number		
fractional	decimal	metric					bright	TiCN	TiAIN
1/32	.0312	0.79	1/8	1/16	1 1/2	4	-----	-----	B69716
1/32	.0312	0.79	1/8	1/8	1 1/2	4	B52721	B01434	B69721
1/32	.0312	0.79	1/8	3/32	1 1/2	4	-----	-----	B69717
1mm	.0394	1mm	3mm	2mm	38mm	4	-----	-----	B69718
1mm	.0394	1mm	3mm	4mm	38mm	4	-----	-----	B69719
3/64	.0469	1.19	1/8	1/8	1 1/2	4	B52722	B01435	B69722
1.5mm	.0591	1mm	3mm	6mm	38mm	4	-----	-----	B69720
1/16	.0625	1.59	1/8	1/8	1 1/2	4	B52724	B01668	B69724
1/16	.0625	1.59	1/8	3/4	1 1/2	4	B52301	B01901	B69301
5/64	.0781	1.98	1/8	3/4	1 1/2	4	B52302	B01902	B69302
2mm	.0790	2mm	3mm	8mm	38mm	4	B52187	-----	B69303
3/32	.0938	2.38	1/8	3/8	1 1/2	4	B52304	B01904	B69304
3/32	.0938	2.38	1/16	3/8	1 1/2	4	-----	-----	B69306
7/64	.1094	2.78	1/8	3/8	1 1/2	4	B52305	B01905	B69305
1/8	.1250	3.18	1/8	1/4	1 1/2	4	B52728	B01670	B69728
1/8	.1250	3.18	1/8	1/2	1 1/2	4	B52307	B01547	B00018
1/8	.1250	3.18	1/8	5/8	2	4	-----	-----	B68499
1/8	.1250	3.18	1/8	3/4	2 1/4	4	B51350	B01374	B68350
1/8	.1250	3.18	1/8	1	3	4	B51550	B01850	B68550
9/64	.1406	3.57	3/16	9/16	2	4	B52308	B01908	B69308
5/32	.1562	3.97	3/16	5/16	2	4	-----	-----	B69309
5/32	.1562	3.97	3/16	9/16	2	4	B52310	B01549	B69310
11/64	.1719	4.37	3/16	5/8	2	4	B52311	B01911	B69311
3/16	.1875	4.76	3/16	5/16	2	4	B52732	B01672	B69732
3/16	.1875	4.76	3/16	5/8	2	4	B52313	B01551	B69313
3/16	.1875	4.76	3/16	3/4	2 1/2	4	B51352	B01377	B68352
3/16	.1875	4.76	3/16	1 1/8	3	4	B51552	B01852	B68552
13/64	.2031	5.16	1/4	5/8	2 1/2	4	B52314	B01914	B69314
7/32	.2188	5.56	1/4	5/8	2 1/2	4	B52316	B01553	B69316
15/64	.2344	5.95	1/4	3/4	2 1/2	4	B52317	B01917	B69317
1/4	.2500	6.35	1/4	1/2	2	4	B52737	B01674	B69737
1/4	.2500	6.35	1/4	3/4	2 1/2	4	B52320	B01555	B69320
1/4	.2500	6.35	1/4	1	4	4	-----	-----	B68503
1/4	.2500	6.35	1/4	1 1/8	3	4	B51354	B01373	B68354
1/4	.2500	6.35	1/4	1 1/2	4	4	B51554	B01854	B68554
1/4	.2500	6.35	1/4	1 1/2	6	4	B51555	B01430	B68555
17/64	.2656	6.75	5/16	3/4	2 1/2	4	B52321	B01921	B69321

continued on next page

CARBIDE END MILLS  
CARBIDE DRILLS  
CARBIDE THREAD MILLS  
CARBIDE BURS  
INDEX



# Single End General-Purpose

Series **MSE-4B** (continued)

CARBIDE END MILLS

CARBIDE DRILLS

CARBIDE THREAD MILLS

CARBIDE BURS

INDEX

cutting diameter			shank diameter	length of cut	overall length	no. of flutes	bright	EDP number	
fractional	decimal	metric						TiCN	TiAlN
9/32	.2812	7.14	5/16	3/4	2 1/2	4	B52323	B01557	B69323
5/16	.3125	7.94	5/16	1/2	2	4	B52739	B01675	B69739
5/16	.3125	7.94	5/16	13/16	2 1/2	4	B52326	B01559	B69326
5/16	.3125	7.94	5/16	1 1/8	3	4	B51356	B01375	B68356
5/16	.3125	7.94	5/16	1 5/8	4	4	B51556	B01856	B68556
23/64	.3594	9.13	3/8	7/8	2 1/2	4	-----	-----	B01857
3/8	.3750	9.53	3/8	5/8	2	4	B52741	B01676	B69741
3/8	.3750	9.53	3/8	1	2 1/2	4	B52332	B01563	B00025
3/8	.3750	9.53	3/8	1 1/8	3	4	B51358	B01376	B68358
3/8	.3750	9.53	3/8	1 1/2	6	4	B51559	B01433	B68559
3/8	.3750	9.53	3/8	1 3/4	4	4	B51558	B01858	B68558
25/64	.3906	9.92	7/16	7/8	2 3/4	4	B52188		B68574
27/64	.4219	10.71	7/16	7/8	2 3/4	4	-----	-----	B68575
7/16	.4375	11.11	7/16	5/8	2 1/2	4	B52743	B01439	B69743
7/16	.4375	11.11	7/16	1	2 1/2	4	B52338	B01567	B35859
7/16	.4375	11.11	7/16	2	4	4	B51360	B01378	B68360
7/16	.4375	11.11	7/16	3	6	4	B51560	B01860	B68560
31/64	.4844	12.30	1/2	1	3	4	-----	-----	B68563
1/2	.5000	12.70	1/2	5/8	2 1/2	4	B52746	B01678	B69746
1/2	.5000	12.70	1/2	1	3	4	B52345	B01571	B69345
1/2	.5000	12.70	1/2	2	4	4	B51362	B01380	B68362
1/2	.5000	12.70	1/2	1 1/2	6	4	B51561	B01431	B68561
1/2	.5000	12.70	1/2	3	6	4	B51562	B01436	B68562
9/16	.5625	14.29	9/16	1 1/4	3	4	B52347	B01947	B69347
5/8	.6250	15.88	5/8	3/4	3	4	B52748	B01679	B69748
5/8	.6250	15.88	5/8	1 1/4	3 1/2	4	B52349	B01573	B00028
5/8	.6250	15.88	5/8	2 1/4	5	4	B51364	B01379	B68364
5/8	.6250	15.88	5/8	3	6	4	B51564	B01437	B68564
3/4	.7500	19.05	3/4	1	3	4	B52751	B01680	B69751
3/4	.7500	19.05	3/4	1 1/2	4	4	B52351	B01574	B00030
3/4	.7500	19.05	3/4	2 1/4	5	4	B51366	B01381	B68366
3/4	.7500	19.05	3/4	3	6	4	B51566	B01438	B68566
7/8	.8750	22.23	7/8	1 1/2	4	4	B52353	B01953	B69353
7/8	.8750	22.23	7/8	2 1/4	5	4	B51368	B01382	B68368
7/8	.8750	22.23	7/8	3	6	4	B51568	B01868	B68568
1	1.0000	25.40	1	1 1/2	4	4	B52357	B01576	B00032
1	1.0000	25.40	1	2 1/4	5	4	B51370	B01383	B68370
1	1.0000	25.40	1	3	6	4	B51570	B01440	B68570

# Single End General-Purpose

Series MEST-2 • straight flutes

Applications | **CAST IRON** **NON-FERROUS MATERIALS** **STEEL** **HI-TEMP ALLOYS**

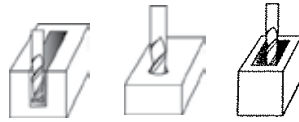

Features | **SOLID CARBIDE** **2 FLUTE CC**

**TiAIN** **BRIGHT**

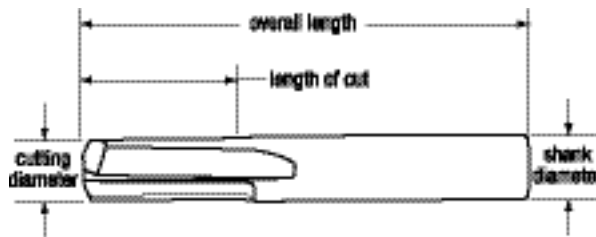

cutting diameter			shank diameter	length of cut	overall length	no. of flutes	EDP number	
fractional	decimal	metric					bright	TiAIN
1/16	.0625	1.59	1/8	3/16	1 1/2	2	B53201	B70201
1/8	.1250	3.18	1/8	1/2	1 1/2	2	B53203	B70203
3/16	.1875	4.76	3/16	5/8	2	2	B53205	B70205
1/4	.2500	6.35	1/4	3/4	2 1/2	2	B53207	B70207
5/16	.3125	7.94	5/16	13/16	2 1/2	2	B53210	B70210
3/8	.3750	9.53	3/8	7/8	2 1/2	2	B53212	B70212
1/2	.5000	12.70	1/2	1	3	2	B53215	B70215

Series MEG-2 Engraving Tool

Applications | **CAST IRON** **NON-FERROUS MATERIALS** **STEEL**

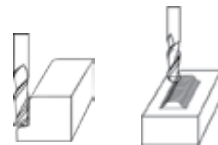

Features | **SOLID CARBIDE** **2 FLUTE BALL CC** **TiCN**

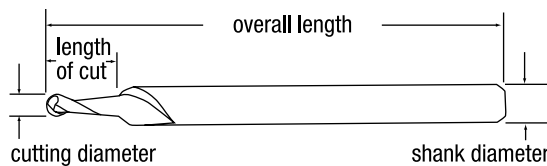

cutting diameter		shank diameter	length of cut	overall length	no. of flutes	EDP number
decimal	metric					TiCN
.021	0.53	1/8	.040	1 1/2	2	B10901
.025	0.64	1/8	.040	1 1/2	2	B10903
.030	0.76	1/8	.040	1 1/2	2	B10906





# Chamfer Tools

Series **MCH-2R Single End and MCH-2D Double End Chamfer Tool** • 60°, 82°, 90°, and 120° point

Applications |



Features |

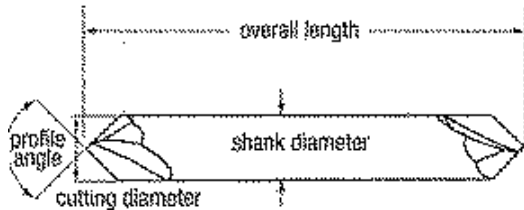

cutting diameter			shank diameter	overall length	no. of flutes	profile angle (°)	EDP number	
fractional	decimal	metric					single end	double end
1/8	.1250	3.18	1/8	1 1/2	2	82	B10013	
1/8	.1250	3.18	1/8	1 1/2	2	90	B10014	B10026
3/16	.1875	4.76	3/16	2	2	90	B10016	B10027
1/4	.2500	6.35	1/4	2 1/2	2	60	B10017	
1/4	.2500	6.35	1/4	2 1/2	2	82	B10018	
1/4	.2500	6.35	1/4	2 1/2	2	90	B10019	B10028
3/8	.3750	9.53	3/8	2 1/2	2	60	B10020	
3/8	.3750	9.53	3/8	2 1/2	2	82	B10021	
3/8	.3750	9.53	3/8	2 1/2	2	90	B10022	B10029
1/2	.5000	12.70	1/2	3	2	60	B10023	
1/2	.5000	12.70	1/2	3	2	82	B10024	
1/2	.5000	12.70	1/2	3	2	90	B10025	B10030
1/2	.5000	12.70	1/2	3	2	120	B10232	
3/4	.7500	19.05	3/4	4	2	90	B10233	B10231

Series **MCH-4R Single End and MCH-4D Double End Chamfer Tool** • 60°, 82°, 90°, and 120° point

Applications |



Features |



cutting diameter			shank diameter	overall length	no. of flutes	profile angle (°)	EDP number	
fractional	decimal	metric					single end	double end
1/4	.2500	6.35	1/4	2 1/2	4	60	B10219	
1/4	.2500	6.35	1/4	2 1/2	4	82	B10220	
1/4	.2500	6.35	1/4	2 1/2	4	90	B10221	B10228
3/8	.3750	9.53	3/8	2 1/2	4	60	B10222	
3/8	.3750	9.53	3/8	2 1/2	4	82	B10223	
3/8	.3750	9.53	3/8	2 1/2	4	90	B10224	B10229
1/2	.5000	12.70	1/2	3	4	60	B10225	
1/2	.5000	12.70	1/2	3	4	82	B10226	
1/2	.5000	12.70	1/2	3	4	90	B10227	B10230
1/2	.5000	12.70	1/2	3	4	120	B10235	
3/4	.7500	19.05	3/4	4	4	90	B10236	B10234



**BASSETT™**



***Carbide Drills***



# Contents

Style No.	Description	Page No.
	Operating Parameters . . . . .	34
DHP-5 . . .	High-Performance 5xD Jobber Length Drill . . . . .	35
DHPCF-5 . .	Coolant-Feed High-Performance 5xD Jobber Length Drill . . .	36
DHPCF-8 . .	Coolant-Feed High-Performance 8xD Jobber Length Drill . . .	37
DR . . . . .	Jobber Length, fractional, wire, letter sizes . . . . .	.38-39
DRS . . . . .	Stub Length, fractional, wire sizes. . . . .	.39-40
DM . . . . .	Straight Flute Stub Length, fractional, wire sizes . . . . .	.41-42
DS . . . . .	Spade Stub Length, fractional sizes. . . . .	42
DC . . . . .	Combination Drill and Countersink, fractional sizes. . . . .	42

CARBIDE END MILLS

CARBIDE DRILLS

CARBIDE THREAD MILLS

CARBIDE BURS

INDEX

## Feeds and Speeds for Bassett General Purpose Solid Carbide Drills

Material Group	Recommended Speed (SFM)	Feed (IPR)			
		1/16-in.	1/8-in.	1/4-in.	1/2-in
Low Carbon Steels, Annealed	85-150	.0005	.0010	.0020	.0040
Medium Carbon Steels 275-425 BHn	65-120	.0005	.0010	.0020	.0030
Stainless Steel, Soft 135-275 BHn	50-150	.0005	.0005	.0020	.0040
Stainless Steel, Hard 275-425 BHn	30-90	.0005	.0005	.0010	.0015
Cast Iron, Soft 120-220 BHn	100-300	.0010	.0020	.0040	.0050
Cast Iron, Hard 220-320 BHn	60-200	.0015	.0010	.0020	.0030
Ductile Iron	70-250	.0010	.0020	.0030	.0050
Malleable iron	80-250	.0010	.0020	.0030	.0050
Aluminum / Aluminum Alloys	150-400	.0010	.0020	.0030	.0050
Brass / Bronze	100-300	.0005	.0010	.0020	.0040
Copper / Copper Alloys	150-400	.0010	.0030	.0050	.0060
Magnesium / Magnesium Alloys	200-650	.0015	.0030	.0050	.0080
Plastics - Glass Filled	150-300	.0010	.0020	.0030	.0050
Plastics	250-600	.0015	.0030	.0040	.0060

# High-Performance

## Series DHP-5 High-Performance Jobber Length Drill

### Applications |



### Features |

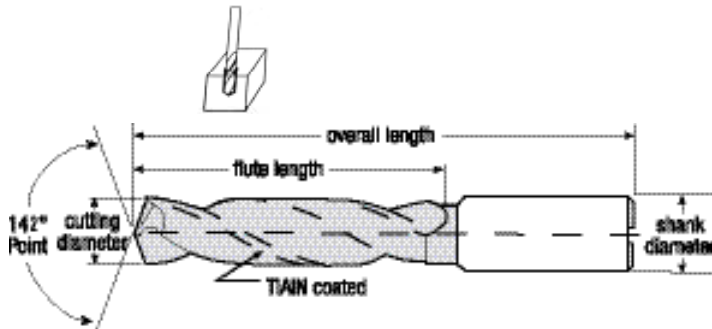

fraction	cutting diameter			shank diameter		flute length		overall length		EDP number
	metric	dec equiv	mm equiv	inch	metric	inch	mm	inch	mm	
	3.0	.1181		.118	3.0	.94	24.0	2.48	63.0	B56000
	3.3	.1299		.157	4.0	1.26	32.0	2.72	69.0	B56006
	3.8	.1496		.157	4.0	1.26	32.0	2.72	69.0	B56017
	4.2	.1654		.197	5.0	1.50	38.0	3.15	80.0	B56027
	5.0	.1969		.197	5.0	1.50	38.0	3.15	80.0	B56046
	5.5	.2165		.236	6.0	1.57	40.0	3.23	82.0	B56058
	6.0	.2362		.236	6.0	1.57	40.0	3.23	82.0	B56068
1/4		.2500	6.4	.250	6.4	2.00	50.8	3.75	95.3	B56075
	6.5	.2559		.315	8.0	1.89	48.0	3.58	91.0	B56077
	6.8	.2677		.315	8.0	1.89	48.0	3.58	91.0	B56084
	7.0	.2756		.315	8.0	1.89	48.0	3.58	91.0	B56087
9/32		.2813	7.1	.438	11.1	2.00	50.8	3.75	95.3	B56091
19/64		.2969	7.5	.438	11.1	2.00	50.8	3.75	95.3	B56098
5/16		.3125	7.9	.438	11.1	2.00	50.8	3.75	95.3	B56104
	8.0	.3150		.315	8.0	1.89	48.0	3.58	91.0	B56105
21/64		.3281	8.3	.375	9.5	2.00	50.8	4.00	101.6	B56111
	8.5	.3346		.394	10.0	2.17	55.0	4.06	103.0	B56115
	9.0	.3543		.394	10.0	2.17	55.0	4.06	103.0	B56123
23/64		.3594	9.1	.375	9.5	2.00	50.8	4.00	101.6	B56126
3/8		.3750	9.5	.375	9.5	2.00	50.8	4.00	101.6	B56132
25/64		.3906	9.9	.375	9.5	2.00	50.8	4.00	101.6	B56139
	10.0	.3937		.394	10.0	2.17	55.0	4.06	103.0	B56140
13/32		.4063	10.3	.500	12.7	2.50	63.5	4.75	120.7	B56144
	10.5	.4134		.472	12.0	2.36	60.0	4.72	120.0	B56146
	11.0	.4331		.472	12.0	2.36	60.0	4.72	120.0	B56149
7/16		.4375	11.1	.500	12.7	2.50	63.5	4.75	120.7	B56150
29/64		.4531	11.5	.500	12.7	2.50	63.5	4.75	120.7	B56153
15/32		.4688	11.9	.500	12.7	2.50	63.5	4.75	120.7	B56155
	12.0	.4724		.472	12.0	2.60	66.0	4.72	120.0	B56156
31/64		.4844	12.3	.500	12.7	3.00	76.2	5.00	127.0	B56158
	12.5	.4921		.551	14.0	2.83	72.0	4.96	126.0	B56159
1/2		.5000	12.7	.500	12.7	3.00	76.2	5.00	127.0	B56160

**TOLERANCE** - Drill Diameter: h6; Shank Diameter: h7

# High-Performance

## Series DHPCF-5 High-Performance Coolant Fed Jobber Length Drill

### Applications



### Features

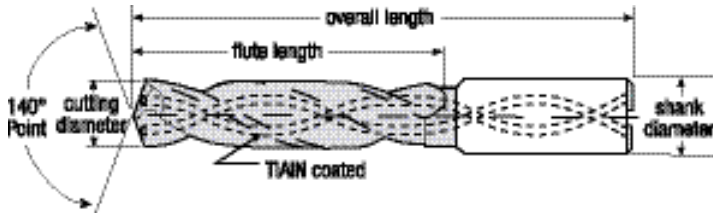

	cutting diameter			shank diameter		flute length		overall length		EDP number	
	fraction	metric	dec equiv	mm equiv	inch	metric	inch	mm	inch		mm
		3.0	.1181		.236	6.0	1.102	28.0	2.598	66.0	B54300
		3.3	.1299		.236	6.0	1.102	28.0	2.598	66.0	B54306
		3.8	.1496		.236	6.0	1.417	36.0	2.913	74.0	B54317
		4.2	.1654		.236	6.0	1.417	36.0	2.913	74.0	B54327
		5.0	.1969		.236	6.0	1.732	44.0	3.228	82.0	B54346
		5.5	.2165		.236	6.0	1.732	44.0	3.228	82.0	B54358
		6.0	.2362		.236	6.0	1.732	44.0	3.228	82.0	B54368
1/4		6.4	.2500	6.4	.250	6.4	2.080	52.8	3.580	90.9	B54375
		6.5	.2559		.315	8.0	2.087	53.0	3.583	91.0	B54377
		6.8	.2677		.315	8.0	2.087	53.0	3.583	91.0	B54384
		7.0	.2756		.315	8.0	2.087	53.0	3.583	91.0	B54387
9/32		7.1	.2813	7.1	.313	7.9	2.080	52.8	3.580	90.9	B54391
19/64		7.5	.2969	7.5	.313	7.9	2.080	52.8	3.580	90.9	B54398
5/16		7.9	.3125	7.9	.313	7.9	2.080	52.8	3.580	90.9	B54404
		8.0	.3150		.315	8.0	2.087	53.0	3.583	91.0	B54405
21/64		8.3	.3281	8.3	.375	9.5	2.400	61.0	4.050	102.9	B54412
		8.5	.3346		.394	10.0	2.402	61.0	4.055	103.0	B54415
		8.8	.3465		.394	10.0	2.402	61.0	4.055	103.0	B54420
		9.0	.3543		.394	10.0	2.402	61.0	4.055	103.0	B54423
3/8		9.5	.3750	9.5	.375	9.5	2.400	61.0	4.050	102.9	B54432
		10	.3937		.394	10.0	2.402	61.0	4.055	103.0	B54440
13/32		10.3	.4063	10.3	.438	11.1	2.800	71.1	4.640	117.9	B54444
		10.5	.4134		.472	12.0	2.795	71.0	4.646	118.0	B54446
		10.8	.4252		.472	12.0	2.795	71.0	4.646	118.0	B54448
		11.0	.4331		.472	12.0	2.795	71.0	4.646	118.0	B54449
7/16		11.1	.4375	11.1	.438	11.1	2.800	71.1	4.640	117.9	B54450
29/64		11.5	.4531	11.5	.500	12.7	3.030	77.0	4.875	123.8	B54453
15/32		11.9	.4688	11.9	.500	12.7	3.030	77.0	4.875	123.8	B54455
		12.0	.4724		.472	12.0	2.795	71.0	4.646	118.0	B54456
31/64		12.3	.4844	12.3	.500	12.7	3.030	77.0	4.875	123.8	B54458
		12.5	.4921		.551	14.0	3.031	77.0	4.882	124.0	B54459
1/2		12.7	.5000	12.7	.500	12.7	3.030	77.0	4.875	123.8	B54460

**TOLERANCE** - Drill Diameter: h6; Shank Diameter: h7

CARBIDE END MILLS

CARBIDE DRILLS

CARBIDE THREAD MILLS

CARBIDE BURS

INDEX

# High-Performance

## Series DHPCF-8 High-Performance Coolant Fed Jobber Length Drill

Applications | **STAINLESS STEEL** **ALLOY-HARD STEEL** **CARBON STEEL** **HARDENED STEEL**

Features | **140°** **TiAIN**  
**EXTRA DEPTH** **FB SHANK TOLERANCE** **HEAT TREAT TOLERANCE**

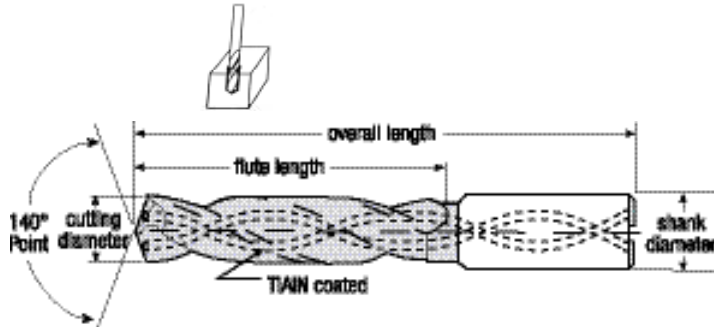

fraction	cutting diameter			shank diameter		flute length		overall length		EDP number
	metric	dec equiv	mm equiv	inch	metric	inch	mm	inch	mm	
	3.5	.1378		.236	6.0	1.34	34.0	2.83	72.0	B54509
	3.8	.1496		.236	6.0	1.69	43.0	3.19	81.0	B54517
	4.2	.1654		.236	6.0	1.69	43.0	3.19	81.0	B54527
	4.5	.1772		.236	6.0	1.69	43.0	3.19	81.0	B54535
	4.8	.1890		.236	6.0	2.24	57.0	3.74	95.0	B54541
	5.0	.1969		.236	6.0	2.24	57.0	3.74	95.0	B54546
	5.5	.2165		.236	6.0	2.24	57.0	3.74	95.0	B54558
	6.0	.2362		.236	6.0	2.24	57.0	3.74	95.0	B54568
1/4		.2500	6.4	.250	6.4	3.00	76.2	4.50	114.3	B54575
	6.5	.2559		.315	8.0	2.99	76.0	4.49	114.0	B54577
	6.8	.2677		.315	8.0	2.99	76.0	4.49	114.0	B54584
	7.0	.2756		.315	8.0	2.99	76.0	4.49	114.0	B54587
9/32		.2813	7.1	.313	7.9	3.00	76.2	4.50	114.3	B54591
	7.5	.2953		.315	8.0	2.99	76.0	4.49	114.0	B54597
19/64		.2969	7.5	.313	7.9	3.00	76.2	4.50	114.3	B54598
5/16		.3125	7.9	.313	7.9	3.00	76.2	4.50	114.3	B54604
	8.0	.3150		.315	8.0	2.99	76.0	4.49	114.0	B54605
	8.5	.3346		.394	10.0	3.74	95.0	5.59	142.0	B54615
	8.8	.3465		.394	10.0	3.74	95.0	5.59	142.0	B54620
	9.0	.3543		.394	10.0	3.74	95.0	5.59	142.0	B54623
	9.5	.3740		.394	10.0	3.74	95.0	5.59	142.0	B54631
3/8		.3750	9.5	.375	9.5	3.75	95.3	5.75	146.1	B54632
	10.0	.3937		.394	10.0	3.74	95.0	5.59	142.0	B54640
	10.2	.4016		.472	12.0	4.49	114.0	6.38	162.0	B54642
	10.5	.4134		.472	12.0	4.49	114.0	6.38	162.0	B54646
	10.8	.4252		.472	12.0	4.49	114.0	6.38	162.0	B54648
	11.0	.4331		.472	12.0	4.49	114.0	6.38	162.0	B54649
7/16		.4375	11.1	.438	11.1	4.50	114.3	6.50	165.1	B54650
	11.5	.4528		.472	12.0	4.49	114.0	6.38	162.0	B54652
	12.0	.4724		.472	12.0	4.49	114.0	6.38	162.0	B54656
	12.5	.4921		.551	14.0	5.24	133.0	7.01	178.0	B54659
1/2		.5000	12.7	.500	12.7	5.25	133.4	7.00	177.8	B54660

**TOLERANCE** - Drill Diameter: h6; Shank Diameter: h7





# Jobber Length

**BASSETT™**

Series DR Jobber Length Drill

CARBIDE END MILLS

CARBIDE DRILLS

CARBIDE THREAD MILLS

CARBIDE BURS

INDEX

Applications |



Features |

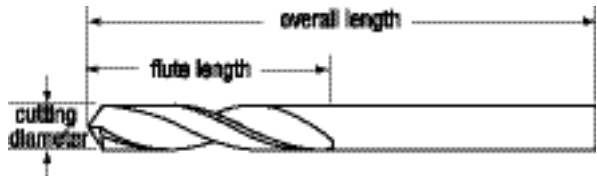

cutting diameter frac	wire/let	decimal	flute length	overall length	EDP number
	60	.0400	5/8	1 1/2	B53511
	59	.0410	3/4	1 1/2	B53512
	58	.0420	3/4	1 1/2	B53514
	57	.0430	3/4	1 1/2	B53515
	56	.0465	3/4	1 1/2	B53518
3/64		.0469	3/4	1 1/2	B53521
	55	.0520	3/4	1 1/2	B53523
	54	.0550	3/4	1 1/2	B53525
	53	.0595	3/4	1 1/2	B53529
1/16		.0625	3/4	1 1/2	B53531
	52	.0635	3/4	1 1/2	B53533
	51	.0670	3/4	1 1/2	B53536
	50	.0700	7/8	1 3/4	B53538
	49	.0730	7/8	1 3/4	B53541
	48	.0760	7/8	1 3/4	B53543
5/64		.0781	7/8	1 3/4	B53545
	47	.0785	7/8	1 3/4	B53546
	46	.0810	7/8	1 3/4	B53549
	45	.0820	7/8	1 3/4	B53550
	44	.0860	1	2	B53553
	43	.0890	1	2	B53556
	42	.0935	1	2	B53559
3/32		.0938	1	2	B53560
	41	.0960	1	2	B53562
	40	.0980	1	2	B53564
	39	.0995	1 1/4	2 1/4	B53566
	38	.1015	1 1/4	2 1/4	B53567
	37	.1040	1 1/4	2 1/4	B53569
	36	.1065	1 1/4	2 1/4	B53571
7/64		.1094	1 1/4	2 1/4	B53573
	35	.1100	1 1/4	2 1/4	B53574
	34	.1110	1 1/4	2 1/4	B53576
	33	.1130	1 1/4	2 1/4	B53577
	32	.1160	1 1/4	2 1/4	B53579
	31	.1200	1 1/4	2 1/4	B53581
1/8		.1250	1 1/4	2 1/4	B53583
	30	.1285	1 1/4	2 1/4	B53586
	29	.1360	1 3/8	2 1/2	B53589
	28	.1405	1 3/8	2 1/2	B53591
9/64		.1406	1 3/8	2 1/2	B53592
	27	.1440	1 3/8	2 1/2	B53594

cutting diameter frac	wire/let	decimal	flute length	overall length	EDP number
	25	.1495	1 3/8	2 1/2	B53598
	24	.1520	1 3/8	2 1/2	B53600
	23	.1540	1 3/8	2 1/2	B53602
5/32		.1563	1 3/8	2 1/2	B53603
	22	.1570	1 3/8	2 1/2	B53604
	21	.1590	1 3/8	2 1/2	B53606
	20	.1610	1 3/8	2 1/2	B53607
	19	.1660	1 5/8	2 3/4	B53610
	18	.1695	1 5/8	2 3/4	B53613
11/64		.1719	1 5/8	2 3/4	B53614
	17	.1730	1 5/8	2 3/4	B53615
	16	.1770	1 5/8	2 3/4	B53617
	15	.1800	1 5/8	2 3/4	B53619
	14	.1820	1 5/8	2 3/4	B53621
	13	.1850	1 5/8	2 3/4	B53622
3/16		.1875	1 5/8	2 3/4	B53625
	12	.1890	1 5/8	2 3/4	B53626
	11	.1910	1 5/8	2 3/4	B53628
	10	.1935	1 5/8	2 3/4	B53630
	9	.1960	1 3/4	3	B53631
	8	.1990	1 3/4	3	B53633
	7	.2010	1 3/4	3	B53635
13/64		.2031	1 3/4	3	B53637
	6	.2040	1 3/4	3	B53638
	5	.2055	1 3/4	3	B53640
	4	.2090	1 3/4	3	B53643
	3	.2130	1 3/4	3	B53645
7/32		.2188	1 3/4	3	B53647
	2	.2210	1 3/4	3	B53649
	1	.2280	1 3/4	3	B53652
	A	.2340	2	3 1/4	B53655
15/64		.2344	2	3 1/4	B53657
	B	.2380	2	3 1/4	B53660
	C	.2420	2	3 1/4	B53662
	D	.2460	2	3 1/4	B53664
1/4		.2500	2	3 1/4	B53666
	E	.2500	2	3 1/4	B53666
	F	.2570	2	3 1/4	B53670
	G	.2610	2 1/8	3 1/2	B53672
17/64		.2656	2 1/8	3 1/2	B53675
	H	.2660	2 1/8	3 1/2	B53677
	I	.2720	2 1/8	3 1/2	B53678

continued on next page

# Jobber Length • Stub Length

## Series DR Jobber Length Drill (continued)

cutting diameter frac	cutting diameter		flute length	overall length	EDP number
	wire/let	decimal			
	J	.2770	2 1/8	3 1/2	B53681
	K	.2810	2 1/8	3 1/2	B53683
9/32		.2812	2 1/8	3 1/2	B53685
	L	.2900	2 1/8	3 1/2	B53688
	M	.2950	2 3/8	3 3/4	B53689
19/64		.2969	2 3/8	3 3/4	B53691
	N	.3020	2 3/8	3 3/4	B53693
	O	.3160	2 3/8	3 3/4	B53696
	P	.3230	2 3/8	3 3/4	B53698
	21/64		.3281	2 1/2	4
	Q	.3320	2 1/2	4	B53704
	11/32		.3438	2 1/2	4
	S	.3480	2 1/2	4	B53710
	T	.3580	2 1/2	4	B53713
23/64		.3594	2 1/2	4	B53715

cutting diameter frac	cutting diameter		flute length	overall length	EDP number
	wire/let	decimal			
3/8	U	.3680	2 3/4	4 1/4	B53718
		.3750	2 3/4	4 1/4	B53720
	V	.3770	2 7/8	4 1/4	B53722
	W	.3860	2 7/8	4 1/2	B53724
25/64		.3906	2 7/8	4 1/2	B53725
	X	.3970	2 7/8	4 1/2	B53727
	Y	.4040	2 7/8	4 1/2	B53729
13/32		.4062	2 7/8	4 1/2	B53731
	Z	.4130	2 7/8	4 1/2	B53732
	27/64		.4219	2 7/8	4 1/2
7/16		.4375	3	4 1/2	B53737
29/64		.4531	3	4 3/4	B53739
15/32		.4688	3	4 3/4	B53741
31/64		.4844	3	4 3/4	B53742
1/2		.5000	3	4 3/4	B53744

## Series DRS Stub Length Drill

### Applications |



### Features |

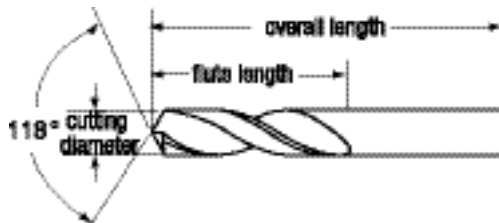

cutting diameter frac	cutting diameter		flute length	overall length	EDP number
	wire	decimal			
	60	.0400	3/8	1 1/2	B36060
	59	.0410	3/8	1 1/2	B36059
	58	.0420	3/8	1 1/2	B36058
	57	.0430	3/8	1 1/2	B36057
	56	.0465	3/8	1 1/2	B36056
	55	.0520	3/8	1 1/2	B36055
	54	.0550	3/8	1 1/2	B36054
	53	.0595	3/8	1 1/2	B36053
1/16		.0625	3/8	1 1/2	B36404
	52	.0635	3/8	1 1/2	B36052
	51	.0670	3/8	1 1/2	B36051
	50	.0700	3/8	1 1/2	B36050
	49	.0730	3/8	1 1/2	B36049
	48	.0760	1/2	1 1/2	B36048
	5/64		.0781	1/2	1 1/2
	47	.0785	1/2	1 1/2	B36047
	46	.0810	1/2	1 1/2	B36046
	45	.0820	1/2	1 1/2	B36045

cutting diameter frac	cutting diameter		flute length	overall length	EDP number
	wire	decimal			
	44	.0860	1/2	2	B36044
	43	.0890	1/2	2	B36043
3/32	42	.0935	1/2	2	B36042
		.0938	1/2	2	B36406
	41	.0960	1/2	2	B36041
	40	.0980	5/8	2	B36040
	39	.0995	5/8	2	B36039
	38	.1015	5/8	2	B36038
	37	.1040	5/8	2	B36037
	36	.1065	5/8	2	B36036
7/64		.1094	5/8	2	B36407
	35	.1100	5/8	2	B36035
	34	.1110	5/8	2	B36034
	33	.1130	5/8	2	B36033
	32	.1160	5/8	2	B36032
	31	.1200	5/8	2	B36031
	1/8		.1250	5/8	2
	30	.1285	5/8	2	B36030

continued on next page

CARBIDE END MILLS  
CARBIDE DRILLS  
CARBIDE THREAD MILLS  
CARBIDE BURS  
INDEX



# Stub Length

Series DRS Stub Length Drill (continued)

CARBIDE END MILLS

	cutting diameter			flute length	overall length	EDP number
	frac	wire	decimal			
9/64		29	.1360	5/8	2	B36029
			.1406	5/8	2	B36409
		28	.1405	5/8	2	B36028
		27	.1440	5/8	2	B36027
		26	.1470	5/8	2	B36026
		25	.1495	5/8	2	B36025
		24	.1520	5/8	2	B36024
		23	.1540	5/8	2	B36023
	5/32		.1563	3/4	2	B36410
			.1570	3/4	2	B36022
		.1590	3/4	2	B36021	
		.1610	3/4	2	B36020	
	11/64		.1660	3/4	2 1/8	B36019
			.1695	3/4	2 1/8	B36018
		.1719	3/4	2 1/8	B36411	
		.1730	3/4	2 1/8	B36017	
		.1770	3/4	2 1/8	B36016	
		.1800	3/4	2 3/16	B36015	
	3/16		.1820	3/4	2 3/16	B36014
			.1850	3/4	2 3/16	B36013
		.1875	3/4	2 3/16	B36412	
		.1890	3/4	2 3/16	B36012	
		.1910	3/4	2 3/16	B36011	
		.1935	3/4	2 3/16	B36010	
		.1960	3/4	2 1/4	B36009	
	.1990	3/4	2 1/4	B36008		

CARBIDE DRILLS

	cutting diameter			flute length	overall length	EDP number
	frac	wire/letter	decimal			
13/64		7	.2010	3/4	2 1/4	B36007
			.2031	3/4	2 1/4	B36413
		6	.2040	3/4	2 1/4	B36006
		5	.2055	3/4	2 1/4	B36005
		4	.2090	3/4	2 1/4	B36004
		3	.2130	1	2 1/2	B36003
	7/32		.2188	1	2 1/2	B36414
			.2210	1	2 1/2	B36002
		1	.2280	1	2 1/2	B36001
	15/64		.2344	1	2 1/2	B36415
		.2500	1	2 1/2	B36416	
	17/64		.2656	1	2 1/2	B36417
	9/32		.2813	1	2 1/2	B36418
	19/64		.2969	1 1/4	2 1/2	B36419
	5/16		.3125	1 1/4	2 1/2	B36420
		.3281	1 1/4	2 1/2	B36421	
	11/32		.3438	1 1/4	2 1/2	B36422
	23/64		.3594	1 1/4	2 1/2	B36423
	25/64		.3906	1 1/4	2 3/4	B36425
	13/32		.4063	1 1/4	2 3/4	B36426
		.4219	1 1/4	2 3/4	B36427	
	7/16		.4375	1 1/4	2 3/4	B36428
	29/64		.4531	1 1/4	3	B36429
	15/32		.4688	1 1/4	3	B36430
	31/64		.4844	1 1/4	3	B36431
	1/2		.5000	1 1/4	3	B36432

CARBIDE THREAD MILLS

CARBIDE BURS

INDEX

# Straight Flute

## Series DM Straight Flute Drill

### Applications



### Features

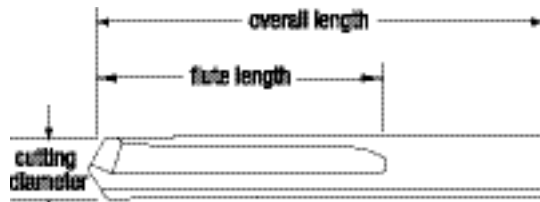

Tolerances for Series DM Drills  
 Cutting Diameter: +.000, -.0005  
 Shank Diameter: +.0000, -.0005

cutting diameter		flute length	overall length	EDP number
frac	wire/mm decimal			
1/32	.0313	1/2	1 1/2	B54100
	.0400	1/2	1 1/2	B54101
	.0410	1/2	1 1/2	B54102
	.0420	1/2	1 1/2	B54104
	.0430	1/2	1 1/2	B54105
	.0465	1/2	1 1/2	B54108
3/64	.0469	1/2	1 1/2	B54112
	.0520	1/2	1 1/2	B54113
	.0550	1/2	1 1/2	B54115
	.0595	1/2	1 1/2	B54119
1/16	.0625	5/8	1 5/8	B54121
	.0635	11/16	1 11/16	B54123
	.0670	11/16	1 11/16	B54126
	.0700	11/16	1 11/16	B54128
	.0730	11/16	1 11/16	B54131
	.0760	11/16	1 11/16	B54133
5/64	.0781	11/16	1 11/16	B54135
	.0785	3/4	1 3/4	B54136
	.0810	3/4	1 3/4	B54139
	.0820	3/4	1 3/4	B54140
	.0860	3/4	1 3/4	B54143
	.0890	3/4	1 3/4	B54146
	.0935	3/4	1 3/4	B54149
	.0938	3/4	1 3/4	B54150
3/32	.0960	13/16	1 13/16	B54152
	.0980	13/16	1 13/16	B54154
	.0995	13/16	1 13/16	B54156
	.1015	13/16	1 13/16	B54157
	.1040	13/16	1 13/16	B54159
	.1065	13/16	1 13/16	B54161
7/64	.1094	13/16	1 13/16	B54163
	.1100	7/8	1 7/8	B54164
	.1110	7/8	1 7/8	B54166
	.1130	7/8	1 7/8	B54167
	.1160	7/8	1 7/8	B54169
	.1200	7/8	1 7/8	B54171
	1/8	.1250	7/8	1 7/8
.1285		15/16	1 15/16	B54176
.1360		15/16	1 15/16	B54179
.1405		15/16	1 15/16	B54181
9/64	.1406	15/16	1 15/16	B54182
	.1440	1	2 1/16	B54184

cutting diameter		flute length	overall length	EDP number
frac	wire/mm decimal			
26	.1470	1	2 1/16	B54186
	.1495	1	2 1/16	B54188
	.1520	1	2 1/16	B54190
	.1540	1	2 1/16	B54192
	.1563	1	2 1/16	B54193
5/32	.1570	1 1/16	2 1/8	B54194
	.1590	1 1/16	2 1/8	B54196
3/16	.1610	1 1/16	2 1/8	B54197
	.1660	1 1/16	2 1/8	B54200
	.1695	1 1/16	2 1/8	B54203
	.1719	1 1/16	2 1/8	B54204
11/64	.1730	1 1/8	2 3/16	B54205
	.1770	1 1/8	2 3/16	B54207
	.1800	1 1/8	2 3/16	B54209
	.1820	1 1/8	2 3/16	B54211
	.1850	1 1/8	2 3/16	B54212
	.1875	1 1/8	2 3/16	B54215
3/16	.1890	1 3/16	2 1/4	B54216
	.1910	1 3/16	2 1/4	B54218
	.1935	1 3/16	2 1/4	B54220
	.1960	1 3/16	2 1/4	B54221
	.1990	1 3/16	2 1/4	B54223
	.2010	1 3/16	2 1/4	B54225
	.2031	1 3/16	2 1/4	B54227
	.2040	1 1/4	2 3/8	B54228
6/32	.2055	1 1/4	2 3/8	B54230
	.2090	1 1/4	2 3/8	B54233
	.2130	1 1/4	2 3/8	B54235
7/32	.2188	1 1/4	2 3/8	B54237
	.2210	1 5/16	2 7/16	B54239
15/64	.2280	1 5/16	2 7/16	B54245
	.2344	1 5/16	2 7/16	B54242
1/4	.2500	1 3/8	2 1/2	B54247
	.2656	1 7/16	2 5/8	B54248
9/32	.2813	1 1/2	2 11/16	B54250
	.2969	1 9/16	2 3/4	B54251
5/16	.3125	1 5/8	2 13/16	B54253
	.3281	1 11/16	2 15/16	B54254
11/32	.3438	1 11/16	3	B54256
	.3594	1 3/4	3 1/16	B54257
3/8	.3750	1 13/16	3 1/8	B54259
	.3906	1 7/8	3 1/4	B54260

continued on next page



# Straight Flute • Spade • Drill and Countersink

**BASSETT™**

## Series **DM** Straight Flute Drill (continued)

cutting diameter		flute length	overall length	EDP number
frac	decimal			
13/32	.4063	1 15/16	3 5/16	B54262
27/64	.4219	2	3 3/8	B54263
7/16	.4375	2 1/16	3 7/16	B54265
29/64	.4531	2 1/8	3 9/16	B54266

cutting diameter		flute length	overall length	EDP number
frac	decimal			
15/32	.4688	2 1/8	3 5/8	B54267
31/64	.4844	2 3/16	3 11/16	B54268
1/2	.5000	2 1/4	3 3/4	B54270

## Series **DS** Spade Stub Length Drill

### Applications |

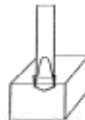

### Features |

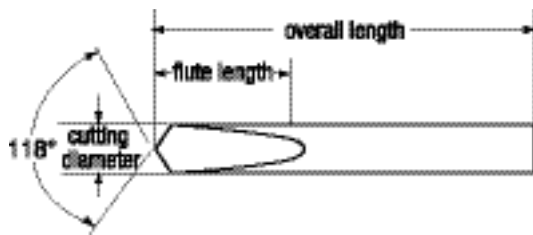

cutting diameter	flute length		overall length	EDP number
	fractional	decimal		
1/32	.0313	3/16	1 1/2	B53451
1/16	.0625	5/16	1 1/2	B53454
3/32	.0938	7/16	1 1/2	B53456
1/8	.1250	7/16	1 1/2	B53458
5/32	.1563	15/32	2	B53460
3/16	.1875	9/16	2	B53462

cutting diameter	flute length		overall length	EDP number
	fractional	decimal		
7/32	.2188	19/32	2	B53464
1/4	.2500	11/16	2	B53467
3/8	.3750	1	2 1/2	B53475

## Series **DC** Combination Stub Length Drill and Countersink

### Applications |



### Features |

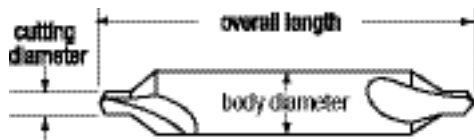

tool number	cutting diameter		body diameter	overall length	EDP number
	fraction	decimal			
1	3/64	.125	1/8	1 1/2	B53431
2	5/64	.188	3/16	2	B53432
3	7/64	.250	1/4	2	B53433
4	1/8	.313	5/16	2 1/8	B53434
5	3/16	.438	7/16	2 3/4	B53435
6	7/32	.500	1/2	3	B53436



**BASSETT™**



***Thread Mills***





# Contents

CARBIDE END MILLS

CARBIDE DRILLS

CARBIDE THREAD MILLS

CARBIDE BURS

INDEX

Style No.	Description	Page No.
	Operating Parameters . . . . .	.44
TM/TMC . . . . .	UN Thread Mills, with and without coolant . . . . .	.45
TMNP/TMNPC . . . . .	NPT / NPTF Thread Mills, with and without coolant . . . . .	.46
TMBPP/TMBPPC . . . . .	BSPP Thread Mills, with and without coolant . . . . .	.46
TMBPT/TMBPTC . . . . .	BSPT Thread Mills, with and without coolant . . . . .	.46
TMM/TMMC . . . . .	Metric Thread Mills, with and without coolant . . . . .	.47
	Thread Mill Programming Request Form. . . . .	.48

## Features

- Helical flute design reduces thread chatter, improving product thread finish and quality
- Advanced TiAlN coating is standard for increasing speeds
- Ideal for internal and external threads
- Full range of sizes available
  - Internal threads #4 to 1" UNC and UNF
  - Pipe threads 1/16" to 1" NPT, NPTF and NPSM
  - Metric internal threads M4.5 x .75 through M20 x 3
- Specials program for nonstandard sizes and other coatings

## Benefits

- Thread milling is a superior process for threading most materials
- More economical than using taps:
  - One thread mill can produce several diameters of threaded holes of the same pitch
  - Same tool makes right or left-hand threads
  - Avoid chip packing in blind holes, a primary cause of tap breakage
  - One tool for through and blind holes
  - Pitch diameter can be controlled by CNC offset

## Applications

- Bassett thread mills are the ideal choice when:
- Machine tool has helical interpolation capabilities
  - Thread specification calls for full threads close to bottom of hole
  - Thread specification requires a special tap
  - Small lot size is to be threaded
  - Need to cut large diameter threads on low horsepower machines
  - Workpiece is thin walled which can be milled more easily than tapped
  - CNC machine has a slower RPM capability below what is recommended for carbide thread mills

## Calculating Thread Mill Feed Rate

**For internal threads:**  $(D1 - d1) / D1 \times \text{RPM} \times \text{ipr}$   
**For external threads:**  $(D1 + d1) / D1 \times \text{RPM} \times \text{ipr}$   
 where  
 D1 is the major diameter of the thread  
 d1 is the cutting diameter  
 RPM is the calculated speed rate =  $(3.82 \times \text{SFM}) / \text{Diameter}$   
 ipr is the calculated feed rate =  $\text{IPT (inches per tooth)} \times \text{number of flutes per cutter}$   
 Example: to cut an internal 7/8-14 thread using a four-flute, 1/2" diameter cutter in bronze, the programmed feed rate would be  $((.875 - .500) / .875) \times (3438 \text{ RPM} \times .016)$  or 23.6 ipm

## Operating Parameters for Helical Thread Mills

material	surface feet per minute (SFM)	cutter diameter (inches)					
		0.125	0.250	0.375	0.500	0.750	1.000
Al-Si Alloys	600	0.0010	0.0020	0.0030	0.0040	0.0050	0.0060
cast iron	600	0.0008	0.0015	0.0020	0.0030	0.0040	0.0050
brass or bronze	450	0.0010	0.0020	0.0030	0.0040	0.0050	0.0060
steel <200 Bhn	600	0.0007	0.0015	0.0020	0.0030	0.0040	0.0050
steel <325 Bhn	575	0.0005	0.0010	0.0015	0.0020	0.0030	0.0040
stainless steel	525	0.0005	0.0008	0.0015	0.0020	0.0030	0.0040
tool steels, annealed	125	0.0005	0.0008	0.0012	0.0015	0.0020	0.0030

Series **TM Solid** and **TMC Coolant-Thru** Thread Mills for Internal Threads

Applications | STEEL STAINLESS STEEL HI-TEMP ALLOYS NONFERROUS MATERIALS

Features | SOLID CARBIDE UNC TiAIN

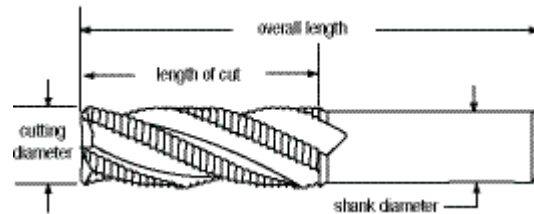

thread size	shank diameter	cutting diameter	length of cut	overall length	number of flutes	EDP number	
						non-coolant	coolant-thru
6-32	1/8	.095	.218	2	3	B71000	—
8-32	1/8	.115	.250	2	3	B71002	—
8-36	1/8	.115	.250	2	3	B71003	—
10-24	3/16	.120	.312	2	3	B71004	—
10-32	3/16	.120	.312	2	3	B71005	—
1/4-20	3/16	.180	.500	2 1/2	3	B71008	B71508
1/4-28	3/16	.180	.500	2 1/2	3	B71009	B71509
5/16-18	1/4	.240	.625	2 1/2	3	B71010	B71510
5/16-24	1/4	.240	.625	2 1/2	3	B71011	B71511
3/8-16	5/16	.290	.750	3	4	B71012	B71512
3/8-24	5/16	.290	.750	3	4	B71013	B71513
7/16-14	3/8	.340	.875	3	4	B71014	B71514
7/16-20	3/8	.340	.875	3	4	B71015	B71515
1/2-13	3/8	.350	.875	3 1/2	4	B71016	B71516
1/2-20	3/8	.350	.875	3 1/2	4	B71017	—
9/16-12	1/2	.370	.875	3 1/2	4	B71018	B71518
9/16-18	1/2	.370	.875	3 1/2	4	B71019	B71519
5/8-11	1/2	.470	1.250	3 1/2	5	B71020	B71520
5/8-18	1/2	.470	1.250	3 1/2	5	B71021	B71521
3/4-10	1/2	.495	1.250	3 1/2	5	B71022	B71522
3/4-12	1/2	.495	1.250	3 1/2	5	B71023	B71523
3/4-16	1/2	.495	1.250	3 1/2	5	B71025	B71525
7/8-9	1/2	.495	1.250	3 1/2	5	B71026	B71526
7/8-14	1/2	.495	1.250	3 1/2	5	B71027	B71527
1-8	3/4	.620	1.375	4	5	B71028	B71528
1-12	3/4	.620	1.375	4	5	B71029	B71529

CARBIDE END MILLS

CARBIDE DRILLS

CARBIDE THREAD MILLS

CARBIDE BURS

INDEX



**NPT / NPTF • BSPP • BSPT**

**BASSETT™**

Series **TMNP Solid** and **TMNPC Coolant-Thru** Thread Mills for Internal Threads

**Applications**



**Features**

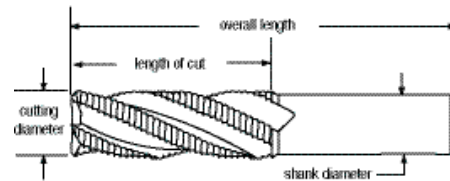

thread size	shank diameter	cutting diameter	length of cut	overall length	number of flutes	EDP number	
						non-coolant	coolant-thru
1/16-27	1/4	.245	.437	2 1/2	3	B71050	B71550
1/8-27	5/16	.310	.437	2 1/2	4	B71051	B71551
1/4, 3/8-18	3/8	.305	.625	3	4	B71052	B71552
1/2, 3/4-14	1/2	.495	.875	3 1/2	4	B71055	B71555
1-11.5	3/4	.620	1.125	4	5	B71056	B71556

Series **TMBPP Solid** and **TMBPPC Coolant-Thru** Thread Mills for Internal Threads

**Applications**



**Features**

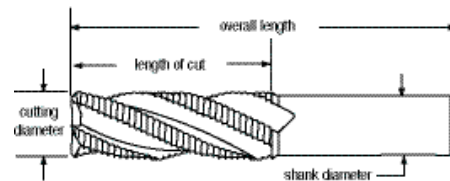

thread size	shank diameter	cutting diameter	length of cut	overall length	number of flutes	EDP number	
						non-coolant	coolant-thru
1/16, 1/8-28	1/4	.240	.572	2 1/2	3	B71100	B71600
1/4-19	5/16	.312	.737	3	4	B71101	B71601
1/2-14	1/2	.470	1.143	3 1/2	4	B71102	B71602
1-11	5/8	.620	1.546	4	5	B71104	B71604

Series **TMBPT Solid** and **TMBPTC Coolant-Thru** Thread Mills for Internal Threads

**Applications**



**Features**

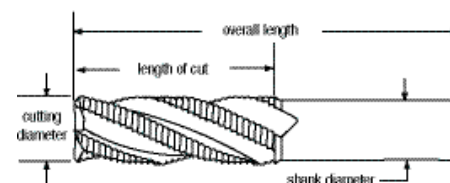

thread size	shank diameter	cutting diameter	length of cut	overall length	number of flutes	EDP number	
						non-coolant	coolant-thru
1/16, 1/8-28	1/4	.240	.401	2 1/2	3	B71120	B71620
1/4-19	5/16	.312	.578	3	4	B71121	B71621
1/2-14	1/2	.470	.785	3 1/2	4	B71122	B71622
1-11	5/8	.620	1.546	4	5	B71123	B71623

CARBIDE END MILLS

CARBIDE DRILLS

CARBIDE THREAD MILLS

CARBIDE BURS

INDEX

Series **TMM Solid** and **TMMC Coolant-Thru** Thread Mills for Internal Threads

Applications |



Features |

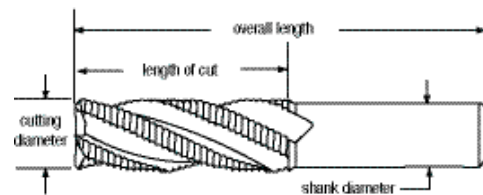

thread size	shank diameter	cutting diameter	length of cut	overall length	number of flutes	EDP number	
						non-coolant	coolant-thru
M4 X 0.70	1/8	.120	.250	2	2	B71070	—
M4.5 X 0.75	1/8	.120	.250	2	3	B71071	—
M5 X 0.80	3/16	.120	.312	2	3	B71072	B71572
M6 X 1.00	3/16	.170	.500	2 1/2	3	B71073	B71573
M8 X 0.75	1/4	.235	.625	2 1/2	3	B71074	B71574
M8 X 1.00	1/4	.235	.625	2 1/2	3	B71075	B71575
M8 X 1.25	1/4	.235	.625	2 1/2	3	B71076	B71576
M10 X 1.25	5/16	.300	.750	3	4	B71077	B71577
M10 X 1.50	5/16	.300	.750	3	4	B71078	B71578
M12 X 1.00	3/8	.360	.875	3 1/2	4	B71079	B71579
M12 X 1.25	3/8	.360	.875	3 1/2	4	B71080	B71580
M12 X 1.75	3/8	.360	.875	3 1/2	4	B71081	B71581
M14 X 1.50	3/8	.360	.875	3 1/2	4	B71082	B71582
M16 X 2.00	1/2	.470	1.250	3 1/2	5	B71083	B71583
M18 X 2.50	1/2	.470	1.250	3 1/2	5	B71084	B71584
M20 X 3.00	1/2	.470	1.250	3 1/2	5	B71085	B71585



# Thread Mill Programming Request Form

Bassett offers free programming assistance to users of any Bassett thread milling product. If you are not familiar with thread milling, we highly recommend that you complete this program request form and fax it to 1-800-892-4290. The Technical Support department will return a suggested CNC program.

CARBIDE END MILLS

Enduser Company Name \_\_\_\_\_

Contact \_\_\_\_\_

Telephone Number \_\_\_\_\_

Email Address \_\_\_\_\_

Distributor Name \_\_\_\_\_

Distributor Telephone Number \_\_\_\_\_

Distributor or Enduser  
Purchase Order Number \_\_\_\_\_

CARBIDE DRILLS

## Thread Specifications:

Thread Type \_\_\_\_\_

RH/LH \_\_\_\_\_

Thread Diameter \_\_\_\_\_

TPI or Pitch (mm) \_\_\_\_\_

Class of Thread (1B, 2B, 3B) \_\_\_\_\_

Minimum Drilling Depth \_\_\_\_\_

Full Thread Length Min \_\_\_\_\_

Material \_\_\_\_\_

Material Hardness \_\_\_\_\_

CARBIDE THREAD MILLS

CARBIDE BURS

## CNC Machine Info

Brand \_\_\_\_\_

Model \_\_\_\_\_

Lathe \_\_\_\_\_

Milling Machine \_\_\_\_\_

Is machine capable of helical interpolation?  
\_\_\_\_\_ yes \_\_\_\_\_ no

(if "no", machine cannot thread mill)

## Tool Specs

Description \_\_\_\_\_

EDP MNumber \_\_\_\_\_

Tool Diameter \_\_\_\_\_

Number of Flutes \_\_\_\_\_

INDEX

**FAX TO**  
**1-800-892-4290**



**BASSETT™**



***Solid Carbide Burs***



# Contents & Technical Information

HPCARBIDE END MILLS

GP CARBIDE END MILLS

CARBIDE DRILLS

CARBIDE BURS

INDEX

Style No.	Shape	Page No.
BA . .	Cylindrical, No End Cut . . . . .	51
BAE . .	Cylindrical with End Cut . . . . .	51
BC . .	Cylindrical, Ball Nose . . . . .	52
BD . .	Ball Shape . . . . .	52
BE . .	Egg Shape . . . . .	53
BF . .	Round Nose Tree Shape . . . . .	53
BG . .	Pointed Tree Shape . . . . .	54
BH . .	Flame Shape . . . . .	54
BL . .	Included Cone Radius Shape . . . . .	55
BM . .	Pointed Cone Shape . . . . .	55
BN . .	Inverted Taper, No End Cut . . . . .	56

## Standard Shank Styles



Shank A — 1/8" solid carbide



Shank B — 1/8" hardened steel



Shank C — 1/4" hardened steel



Shank D — 1/4" solid carbide

## Recommended Bur Speeds (RPM)

Bur Dia.	Standard Cut		Monarch Cut	
	stainless titanium	all other materials in chart (right)	stainless titanium	all other materials in chart (right)
1/16	75,000	50,000	37,500	25,000
1/8	53,000	35,000	26,500	17,500
3/16	38,000	26,000	19,000	13,000
1/4	33,000	22,000	16,500	11,000
5/16	30,000	20,000	15,000	10,000
3/8	27,000	18,000	13,500	9,000
1/2	24,000	16,000	12,000	8,000
5/8	23,000	15,300	11,500	7,650
3/4	21,000	14,000	10,500	7,000
7/8	20,000	13,000	10,000	6,500
1	18,000	12,000	9,000	6,000

Run aluminum cut burs at approximately the same speed as end mills designed for aluminum when machine milling.

## Bur Selection

when selecting a bur for a particular application, several factors must be taken into consideration.

The first is the selection of an appropriate shape and diameter that will be most suitable to the part being deburred. If working inside a slot, be certain that the maximum diameter of the bur is smaller than the slot. Secondly, shank size must be selected. The correct shank will be determined by the size of the equipment being used and considering the diameter and length of the fluted portion of the bur.

The last decision is which cut, or flute pattern, to select. This is determined by the hardness of the material being removed and the finish required.

- Standard (right-hand spiral) cut is a general-purpose flute pattern which is designed for use in cast iron, steel, and other ferrous metals.
- Double cut, a general-purpose tooth pattern, gives better control than the standard cut in off-band grinding. It minimizes slivers while producing a better finish. It can be used with slower speed grinders than standard cut.
- Aluminum (end mill) cut can be used for deburring softer, non-ferrous metals and non-metallic materials. The wide clearance and end mill type geometry of the flutes promotes fast stock removal with minimum loading.



standard cut



double cut



aluminum cut

## Bur Selection by Material

Workpiece Material	First Choice	Alternative
aluminum	aluminum cut	—
brass	double cut	standard cut
bronze	double cut	standard cut
cast iron	double cut	standard cut
copper	aluminum cut	—
fiberglass	double cut	standard cut
inconel	double cut	standard cut
malleable iron	double cut	standard cut
magnesium	aluminum cut	—
masonite	double cut	standard cut
plastic	standard cut	—
steel alloy	double cut	—
carbon steel	double cut	—
stainless steel	double cut	—
titanium	double cut	—
zinc	aluminum cut	standard cut

# Cylindrical

## Series BA, Cylindrical Burs without End Cut

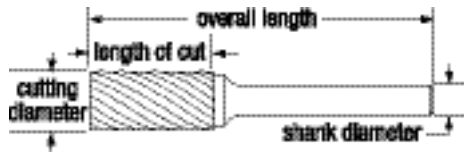

Applications |



Features |



Applications |

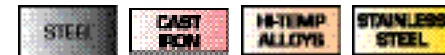

Features |



SCTI reference	cutting diameter		length of cut	overall length	shank diameter	shank type	EDP number	
	inch	decimal					standard	double
SA-41	1/16	.0625	1/4	1 1/2	1/8	A	B55600	B55601
SA-42	3/32	.0938	7/16	1 1/2	1/8	A	B55608	B55609
SA-43	1/8	.1250	9/16	1 1/2	1/8	A	B54801	B54810
SA-51	1/4	.2500	1/2	1 3/4	1/8	B	B55700	B55712
SA-1	1/4	.2500	5/8	2	1/4	D	B54802	B54811
SA-3	3/8	.3750	3/4	2 1/2	1/4	C	B54803	B54812
SA-5	1/2	.5000	1	2 3/4	1/4	C	B54804	B54813
SA-6	5/8	.6250	1	2 3/4	1/4	C	B54805	B54814
SA-7	3/4	.7500	1	2 3/4	1/4	C	B54806	B54815
SA-9	1	1.0000	1	2 3/4	1/4	C	B54807	B54816

## Series BAE, Cylindrical Burs with End Cut

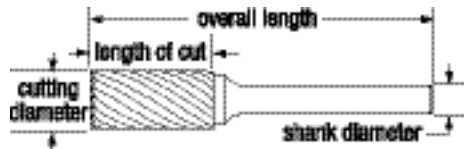

Applications |



Features |



Applications |



Applications |



Features |



Features |



SCTI reference	cutting diameter		length of cut	overall length	shank diameter	shank type	EDP number		
	inch	decimal					standard	double	aluminum
SB-41	1/16	.0625	1/4	1 1/2	1/8	A	B55604	-	-
SB-42	3/32	.0938	7/16	1 1/2	1/8	A	B55612	-	-
SB-43	1/8	.1250	9/16	1 1/2	1/8	A	B54837	-	-
SB-51	1/4	.2500	1/2	1 3/4	1/8	B	B55701	B55713	-
SB-1	1/4	.2500	5/8	2	1/4	D	B54838	B54847	B55856
SB-3	3/8	.3750	3/4	2 1/2	1/4	C	B54839	B54848	B55857
SB-5	1/2	.5000	1	2 3/4	1/4	C	B54840	B54849	B55858
SB-6	5/8	.6250	1	2 3/4	1/4	C	-	B54850	B55859
SB-7	3/4	.7500	1	2 3/4	1/4	C	-	B54851	B55860
SB-9	1	1.0000	1	2 3/4	1/4	C	B54843	-	-

Shank Type: A – 1/8" solid carbide. B – 1/8" hardened steel. C – 1/4" hardened steel. D – 1/4" solid carbide.



# Cylindrical • Ball

**BASSETT™**

Series BC, Cylindrical Burs with Ball Nose

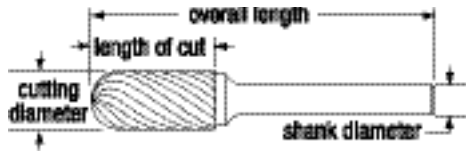

**Applications** | **NON-FERROUS MATERIALS**

**Features** | **SOLID CARBIDE** **ALUMINUM CUT** **BRIGHT**



**Applications** | **STEEL** **CAST IRON** **NON-FERROUS MATERIALS** **STAINLESS STEEL**

**Features** | **SOLID CARBIDE** **STANDARD CUT** **BRIGHT**



**Applications** | **STEEL** **CAST IRON** **HI-TEMP ALLOYS** **STAINLESS STEEL**

**Features** | **SOLID CARBIDE** **DOUBLE CUT** **BRIGHT**

SCTI reference	cutting diameter		length of cut	overall length	shank diameter	shank type	standard	EDP number		
	inch	decimal						double	aluminum	
SC-41	3/32	.0938	7/16	1 1/2	1/8	A	B55620	B55621	-	-
SC-42	1/8	.1250	9/16	1 1/2	1/8	A	B54873	B54882	-	-
SC-51	1/4	.2500	1/2	1 3/4	1/8	B	B55704	B55716	-	-
SC-1	1/4	.2500	5/8	2	1/4	D	B54874	B54883	B55862	-
SC-3	3/8	.3750	3/4	2 1/2	1/4	C	B54875	B54884	B55863	-
SC-5	1/2	.5000	1	2 3/4	1/4	C	B54876	B54885	B55864	-
SC-6	5/8	.6250	1	2 3/4	1/4	C	B54877	B54886	-	-
SC-7	3/4	.7500	1	2 3/4	1/4	C	B54878	B54887	B55865	-

Series BD, Ball Shape

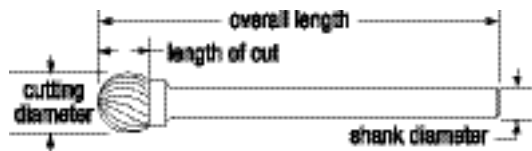

**Applications** | **NON-FERROUS MATERIALS**

**Features** | **SOLID CARBIDE** **ALUMINUM CUT** **BRIGHT**



**Applications** | **STEEL** **CAST IRON** **NON-FERROUS MATERIALS** **STAINLESS STEEL**

**Features** | **SOLID CARBIDE** **STANDARD CUT** **BRIGHT**



**Applications** | **STEEL** **CAST IRON** **HI-TEMP ALLOYS** **STAINLESS STEEL**

**Features** | **SOLID CARBIDE** **DOUBLE CUT** **BRIGHT**

SCTI reference	cutting diameter		length of cut	overall length	shank diameter	shank type	standard	EDP number		
	inch	decimal						double	aluminum	
SD-41	3/32	.0938	3/32	1 1/2	1/8	A	B55624	B55625	-	-
SD-42	1/8	.1250	1/8	1 1/2	1/8	A	B54909	B54918	-	-
SD-51	1/4	.2500	1/4	1 3/4	1/8	B	B55705	B55717	-	-
SD-1	1/4	.2500	1/4	2	1/4	D	B54910	B54919	B55867	-
SD-3	3/8	.3750	3/8	2 5/64	1/4	C	B54911	B54920	B55868	-
SD-5	1/2	.5000	1/2	2 13/64	1/4	C	B54912	B54921	B55869	-
SD-6	5/8	.6250	5/8	2 5/16	1/4	C	B54913	B54922	-	-
SD-7	3/4	.7500	3/4	2 7/16	1/4	C	B54914	B54923	-	-
SD-9	1	1.0000	1	2 11/16	1/4	C	B54915	B54924	-	-

Shank Type: A — 1/8" solid carbide. B — 1/8" hardened steel. C — 1/4" hardened steel. D — 1/4" solid carbide.

HPCARBIDE END MILLS

GP CARBIDE END MILLS

CARBIDE DRILLS

CARBIDE BURS

INDEX

# Egg • Round Nose Tree

## Series BE, Egg Shape

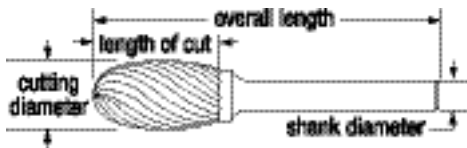

**Applications** | **NON-FERROUS MATERIALS**

**Features** | **SOLID CARBIDE** **ALUMINUM CUT** **BRIGHT**



**Applications** | **STEEL** **CAST IRON** **NON-FERROUS MATERIALS** **STAINLESS STEEL**

**Features** | **SOLID CARBIDE** **STANDARD CUT** **BRIGHT**



**Applications** | **STEEL** **CAST IRON** **HI-TEMP ALLOYS** **STAINLESS STEEL**

**Features** | **SOLID CARBIDE** **DOUBLE CUT** **BRIGHT**

SCTI reference	cutting diameter		length of cut	overall length	shank diameter	shank type	standard	EDP number	
	inch	decimal						double	aluminum
SE-41	1/8	.1250	7/32	1 1/2	1/8	A	B54945	B54954	-
SE-51	1/4	.2500	3/8	1 5/8	1/8	B	-	B55718	-
SE-1	1/4	.2500	3/8	2	1/4	D	B54946	B54955	-
SE-3	3/8	.3750	5/8	2 3/8	1/4	C	B54947	B54956	B55873
SE-5	1/2	.5000	7/8	2 5/8	1/4	C	B54948	B54957	B55874
SE-6	5/8	.6250	1	2 3/4	1/4	C	-	-	B55875
SE-7	3/4	.7500	1	2 3/4	1/4	C	B54950	B54959	-

## Series BF, Round Nose Tree Shape

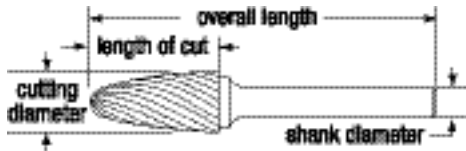

**Applications** | **NON-FERROUS MATERIALS**

**Features** | **SOLID CARBIDE** **ALUMINUM CUT** **BRIGHT**



**Applications** | **STEEL** **CAST IRON** **NON-FERROUS MATERIALS** **STAINLESS STEEL**

**Features** | **SOLID CARBIDE** **STANDARD CUT** **BRIGHT**



**Applications** | **STEEL** **CAST IRON** **HI-TEMP ALLOYS** **STAINLESS STEEL**

**Features** | **SOLID CARBIDE** **DOUBLE CUT** **BRIGHT**

SCTI reference	cutting diameter		length of cut	overall length	shank diameter	shank type	standard	EDP number	
	inch	decimal						double	aluminum
SF-41	1/8	.1250	1/4	1 1/2	1/8	A	B55628	B55629	-
SF-42	1/8	.1250	1/2	1 1/2	1/8	A	B54981	B54990	-
SF-51	1/4	.2500	1/2	1 3/4	1/8	B	B55707	B55719	-
SF-1	1/4	.2500	5/8	2	1/4	D	B54982	B54991	B55878
SF-3	3/8	.3750	3/4	2 1/2	1/4	C	B54983	B54992	B55879
SF-5	1/2	.5000	1	2 3/4	1/4	C	B54984	B54993	B55880
SF-6	5/8	.6250	1	2 3/4	1/4	C	B54985	B54994	B55881
SF-7	3/4	.7500	1	2 3/4	1/4	C	B54986	B54995	-

Shank Type: A – 1/8" solid carbide. B – 1/8" hardened steel. C – 1/4" hardened steel. D – 1/4" solid carbide.



# Pointed Tree • Flame Shape

**BASSETT™**

Series BG, Pointed Tree Shape

HPCARBIDE END MILLS

GP CARBIDE END MILLS

CARBIDE DRILLS

CARBIDE BURS

INDEX

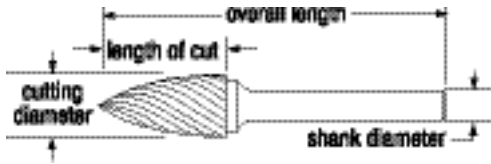

**Applications** |



**Features** |



**Applications** |



**Features** |



SCTI reference	cutting diameter		length of cut	overall length	shank diameter	shank type	EDP number	
	inch	decimal					standard	double
SG-42	1/8	.1250	5/16	1 1/2	1/8	A	B55636	B55637
SG-43	1/8	.1250	3/8	1 1/2	1/8	A	B55017	B55026
SG-41	1/8	.1250	1/4	1 1/2	1/8	A	B55632	B55633
SG-51	1/4	.2500	1/2	1 3/4	1/8	B	-	B55720
SG-1	1/4	.2500	5/8	2	1/4	D	B55018	B55027
SG-3	3/8	.3750	3/4	2 1/2	1/4	C	B55019	B55028
SG-5	1/2	.5000	1	2 3/4	1/4	C	B55020	B55029
SG-6	5/8	.6250	1	2 3/4	1/4	C	B55021	B55030

Series BH, Flame Shape

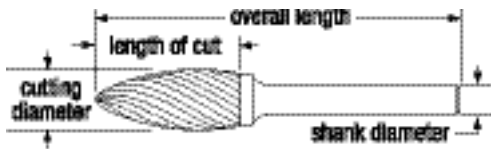

**Applications** |



**Features** |



**Applications** |



**Features** |



SCTI reference	cutting diameter		length of cut	overall length	shank diameter	shank type	EDP number	
	inch	decimal					standard	double
SH-41	1/8	.1250	1/4	1 1/2	1/8	A	B55053	B55060
SH-2	5/16	.3125	3/4	2 1/2	1/4	C	B55054	B55061
SH-5	1/2	.5000	1 1/4	3	1/4	C	B55055	B55062

Shank Type: A — 1/8" solid carbide. B — 1/8" hardened steel. C — 1/4" hardened steel. D — 1/4" solid carbide.



# 14° Included Cone, Radius • Pointed Cone

Series BL, 14° Included Cone Radius Shape

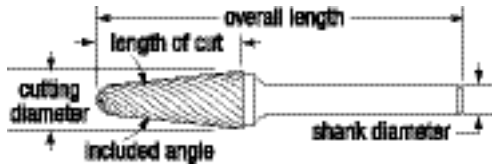

- Applications** | STEEL CAST IRON NON-FERROUS MATERIALS STAINLESS STEEL
- Features** | SOLID CARBIDE STANDARD CUT BRIGHT



- Applications** | NON-FERROUS MATERIALS
- Features** | SOLID CARBIDE ALUMINUM CUT BRIGHT



- Applications** | STEEL CAST IRON HI-TEMP ALLOYS STAINLESS STEEL
- Features** | SOLID CARBIDE DOUBLE CUT BRIGHT

SCTI reference	cutting diameter		length of cut	overall length	shank diameter	shank type	standard	EDP number		
	inch	decimal						double	aluminum	
SL-41	1/8	.1250	3/8	1 1/2	1/8	A	B55640	B55641	-	
SL-42	1/8	.1250	1/2	1 1/2	1/8	A	B55145	B55154	-	
SL-1	1/4	.2500	5/8	2	1/4	D	B55146	B55155	-	
SL-3	3/8	.3750	1 1/16	2 15/16	1/4	C	B55147	B55156	-	
SL-4	1/2	.5000	1 1/8	3	1/4	C	B55148	B55157	B55884	
SL-6	5/8	.6250	1 5/16	3 3/16	1/4	C	B55149	B55158	B55885	

Series BM, Pointed Cone Shape

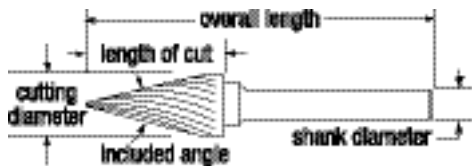

- Applications** | STEEL CAST IRON NON-FERROUS MATERIALS STAINLESS STEEL
- Features** | SOLID CARBIDE STANDARD CUT BRIGHT



- Applications** | STEEL CAST IRON HI-TEMP ALLOYS STAINLESS STEEL
- Features** | SOLID CARBIDE DOUBLE CUT BRIGHT

SCTI reference	included angle	cutting diameter		length of cut	overall length	shank diameter	shank type	EDP number	
		inch	decimal					standard	double
SM-41	12°	1/8	.1250	3/8	1 1/2	1/8	A	B55644	B55645
SM-42	14°	1/8	.1250	7/16	1 1/2	1/8	A	B55181	B55190
SM-43	7°	1/8	.1250	5/8	1 1/2	1/8	A	B55648	B55649
SM-51	22°	1/4	.2500	1/2	1 7/8	1/8	B	B55709	B55721
SM-1	22°	1/4	.2500	1/2	2	1/4	D	B55182	B55191
SM-3	10°	1/4	.2500	1	2	1/4	D	B55183	B55192
SM-4	28°	3/8	.3750	5/8	2 1/2	1/4	C	B55184	B55193
SM-5	28°	1/2	.5000	7/8	2 3/4	1/4	C	B55185	B55194

Shank Type: A — 1/8" solid carbide. B — 1/8" hardened steel. C — 1/4" hardened steel. D — 1/4" solid carbide.



# Inverted Taper

Series BN, Inverted Taper Shape



**Applications** | STEEL | CAST IRON | NON-FERROUS MATERIALS | STAINLESS STEEL

**Features** | SOLID CARBIDE | STANDARD CUT | BRIGHT



**Applications** | STEEL | CAST IRON | HI-TEMP ALLOYS | STAINLESS STEEL

**Features** | SOLID CARBIDE | DOUBLE CUT | BRIGHT

SCTI reference	included angle	cutting diameter		length of cut	overall length	shank diameter	shank type	EDP number	
		inch	decimal					standard	double
SN-41	–	3/32	.0938	3/16	1 1/2	1/8	A	B55652	–
SN-51	10°	1/4	.2500	1/4	1 1/2	1/8	A	B55710	B55722

Shank Type: A – 1/8" solid carbide. B – 1/8" hardened steel. C – 1/4" hardened steel. D – 1/4" solid carbide.



**BASSETT™**



***Index by EDP Number***



EDP Number	Style Number	Page Number	EDP Number	Style Number	Page Number	EDP Number	Style Number	Page Number	EDP Number	Style Number	Page Number
B00018	MSE-4B	28	B01365	MSE-2B-TC	24	B01454	MSE-2-TC	21	B01583	MDE-2-TC	19
B00025	MSE-4B	29	B01366	MSE-2B-TC	24	B01455	MSE-2-TC	21	B01584	MSE-2B-TC	24
B00046	MSE-4	28	B01367	MSE-2B-TC	24	B01457	MSE-2-TC	21	B01585	MDE-2-TC	19
B00059	MSE-2	21	B01368	MSE-2B-TC	24	B01461	MSE-2-TC	22	B01586	MDE-2-TC	19
B00062	MSE-2	22	B01369	MSE-2B-TC	24	B01465	MSE-2-TC	22	B01587	MDE-2-TC	19
B00064	MSE-2	22	B01370	MSE-2B-TC	24	B01469	MSE-2-TC	22	B01588	MDE-4-TC	20
B00065	MSE-2	22	B01371	MSE-2B-TC	24	B01470	MSE-2-TC	22	B01589	MDE-4-TC	20
B00067	MSE-2	22	B01373	MSE-4B-TC	28	B01471	MSE-2-TC	22	B01590	MDE-4-TC	20
B00207	MDE-2	19	B01374	MSE-4B-TC	28	B01472	MSE-2-TC	22	B01591	MDE-4-TC	20
B00208	MDE-2	19	B01375	MSE-4B-TC	28	B01473	MSE-2-TC	22	B01592	MDE-4-TC	20
B00209	MDE-2	19	B01376	MSE-4B-TC	28	B01474	MSE-2-TC	22	B01593	MDE-4-TC	20
B00210	MDE-2	19	B01377	MSE-4B-TC	28	B01475	MSE-4-TC	26	B01594	MDE-4-TC	20
B00211	MDE-2	19	B01378	MSE-4B-TC	29	B01476	MSE-4-TC	26	B01595	MSE-2B-TC	24
B00212	MDE-2	19	B01379	MSE-4B-TC	29	B01477	MSE-4-TC	26	B01596	MDE-4-TC	20
B00213	MDE-2	19	B01380	MSE-4B-TC	29	B01478	MSE-4-TC	26	B01597	MDE-4-TC	20
B00215	MDE-2	19	B01381	MSE-4B-TC	29	B01479	MSE-4-TC	26	B01598	MDE-4-TC	20
B00217	MDE-2	19	B01382	MSE-4B-TC	29	B01480	MSE-4-TC	26	B01599	MDE-2B-TC	19
B00220	MDE-2	19	B01383	MSE-4B-TC	29	B01481	MSE-4-TC	26	B01600	MDE-2B-TC	19
B00221	MDE-2	19	B01386	MSE-2-TC	21	B01482	MSE-4-TC	26	B01601	MDE-2B-TC	19
B00222	MDE-2	19	B01388	MSE-2-TC	21	B01483	MSE-4-TC	26	B01602	MDE-2B-TC	19
B00224	MDE-2	19	B01389	MSE-2-TC	21	B01484	MSE-4-TC	26	B01603	MDE-2B-TC	19
B00225	MDE-2	19	B01391	MSE-2-TC	22	B01485	MSE-4-TC	26	B01604	MDE-2B-TC	19
B00226	MDE-2	19	B01394	MSE-2-TC	22	B01486	MSE-4-TC	26	B01605	MDE-2B-TC	19
B00227	MDE-2	19	B01395	MSE-2-TC	22	B01487	MSE-4-TC	25	B01607	MDE-2B-TC	19
B00236	MSE-2B	23	B01396	MSE-2-TC	22	B01489	MSE-4-TC	25	B01608	MDE-2B-TC	19
B00241	MSE-2B	23	B01398	MSE-2-TC	22	B01491	MSE-4-TC	25	B01609	MDE-2B-TC	19
B00244	MSE-2B	24	B01399	MSE-4-TC	26	B01495	MSE-4-TC	26	B01610	MDE-4B-TC	20
B00246	MSE-2B	24	B01400	MSE-4-TC	26	B01499	MSE-4-TC	26	B01611	MDE-4B-TC	20
B00250	MSE-2B	24	B01402	MSE-4-TC	25	B01503	MSE-4-TC	26	B01612	MDE-4B-TC	20
B00342	MDE-4	20	B01403	MSE-4-TC	26	B01505	MSE-4-TC	28	B01613	MDE-4B-TC	20
B00345	MDE-4	20	B01405	MSE-4-TC	26	B01506	MSE-4-TC	28	B01614	MDE-4B-TC	20
B00346	MDE-4	20	B01407	MSE-4-TC	28	B01507	MSE-4-TC	28	B01615	MDE-4B-TC	20
B00348	MDE-4	20	B01408	MSE-4-TC	28	B01508	MSE-4-TC	28	B01616	MDE-4B-TC	20
B00349	MDE-4	20	B01409	MSE-4-TC	28	B01509	MSE-2B-TC	23	B01617	MSE-2B-TC	24
B00352	MDE-4	20	B01410	MSE-4-TC	28	B01511	MSE-2B-TC	23	B01618	MDE-4B-TC	20
B00357	MDE-4	20	B01412	MSE-4-TC	28	B01512	MSE-2B-TC	23	B01619	MDE-4B-TC	20
B00359	MDE-4	20	B01414	MSE-2B-TC	23	B01513	MSE-2B-TC	23	B01620	MDE-4B-TC	20
B00360	MDE-4	20	B01415	MSE-2B-TC	23	B01515	MSE-2B-TC	23	B01621	MSE-2-TC	21
B00362	MDE-4	20	B01416	MSE-2B-TC	23	B01516	MSE-2B-TC	23	B01622	MSE-2-TC	21
B01318	MSE-2-TC	21	B01417	MSE-2B-TC	23	B01517	MSE-2B-TC	23	B01623	MSE-2-TC	21
B01319	MSE-2-TC	21	B01418	MSE-2B-TC	23	B01521	MSE-2B-TC	23	B01624	MSE-2-TC	21
B01320	MSE-2-TC	22	B01419	MSE-2B-TC	23	B01525	MSE-2B-TC	23	B01625	MSE-2-TC	21
B01321	MSE-2-TC	22	B01420	MSE-2B-TC	24	B01529	MSE-2B-TC	23	B01627	MSE-2-TC	21
B01322	MSE-2-TC	22	B01422	MSE-2B-TC	24	B01537	MSE-2B-TC	24	B01629	MSE-2-TC	21
B01323	MSE-2-TC	22	B01423	MSE-2B-TC	24	B01539	MSE-2B-TC	24	B01630	MSE-2-TC	21
B01324	MSE-2-TC	22	B01424	MSE-2B-TC	24	B01540	MSE-2B-TC	24	B01631	MSE-2-TC	22
B01325	MSE-2-TC	22	B01425	MSE-2B-TC	24	B01542	MSE-2B-TC	24	B01632	MSE-2-TC	22
B01326	MSE-2-TC	22	B01426	MSE-2B-TC	24	B01547	MSE-4B-TC	28	B01633	MSE-2-TC	22
B01327	MSE-2-TC	22	B01427	MSE-2B-TC	23	B01549	MSE-4B-TC	28	B01634	MSE-2-TC	22
B01329	MSE-2-TC	21	B01430	MSE-4B-TC	28	B01551	MSE-4B-TC	28	B01635	MSE-2-TC	22
B01330	MSE-2-TC	21	B01431	MSE-4B-TC	29	B01553	MSE-4B-TC	28	B01636	MSE-4-TC	26
B01331	MSE-2-TC	21	B01433	MSE-4B-TC	28	B01555	MSE-4B-TC	28	B01637	MSE-4-TC	26
B01333	MSE-2-TC	21	B01434	MSE-4B-TC	28	B01557	MSE-4B-TC	28	B01638	MSE-4-TC	26
B01334	MSE-2-TC	22	B01435	MSE-4B-TC	28	B01559	MSE-4B-TC	28	B01639	MSE-4-TC	26
B01338	MSE-2-TC	22	B01436	MSE-4B-TC	29	B01563	MSE-4B-TC	28	B01640	MSE-4-TC	26
B01340	MSE-4-TC	25	B01437	MSE-4B-TC	29	B01564	MSE-2B-TC	23	B01641	MSE-4-TC	26
B01341	MSE-4-TC	26	B01438	MSE-4B-TC	29	B01566	MSE-2B-TC	23	B01642	MSE-4-TC	26
B01342	MSE-4-TC	28	B01439	MSE-4B-TC	29	B01567	MSE-4B-TC	29	B01644	MSE-4-TC	25
B01343	MSE-4-TC	26	B01440	MSE-4B-TC	29	B01568	MSE-2B-TC	23	B01645	MSE-4-TC	26
B01344	MSE-4-TC	26	B01441	MSE-2-TC	21	B01570	MSE-2B-TC	23	B01646	MSE-4-TC	25
B01347	MSE-4-TC	26	B01442	MSE-2-TC	21	B01571	MSE-4B-TC	29	B01647	MSE-4-TC	26
B01348	MSE-4-TC	26	B01443	MSE-2-TC	21	B01572	MSE-2B-TC	23	B01648	MSE-4-TC	26
B01351	MSE-4-TC	28	B01444	MSE-2-TC	21	B01573	MSE-4B-TC	29	B01649	MSE-4-TC	28
B01352	MSE-4-TC	28	B01445	MSE-2-TC	21	B01574	MSE-4B-TC	29	B01650	MSE-4-TC	28
B01355	MSE-4-TC	28	B01446	MSE-2-TC	21	B01575	MSE-2B-TC	23	B01651	MSE-2B-TC	23
B01356	MSE-4-TC	28	B01447	MSE-2-TC	21	B01576	MSE-4B-TC	29	B01652	MSE-2B-TC	23
B01359	MSE-2B-TC	23	B01448	MSE-2-TC	21	B01577	MDE-2-TC	19	B01653	MSE-2B-TC	23
B01360	MSE-2B-TC	23	B01449	MSE-2-TC	21	B01578	MDE-2-TC	19	B01655	MSE-2B-TC	23
B01361	MSE-2B-TC	23	B01450	MSE-2-TC	21	B01579	MDE-2-TC	19	B01657	MSE-2B-TC	23
B01362	MSE-2B-TC	23	B01451	MSE-2-TC	21	B01580	MDE-2-TC	19	B01659	MSE-2B-TC	23
B01363	MSE-2B-TC	23	B01452	MSE-2-TC	21	B01581	MDE-2-TC	19	B01660	MSE-2B-TC	23
B01364	MSE-2B-TC	23	B01453	MSE-2-TC	21	B01582	MDE-2-TC	19	B01661	MSE-2B-TC	23



EDP Number	Style Number	Page Number	EDP Number	Style Number	Page Number	EDP Number	Style Number	Page Number	EDP Number	Style Number	Page Number
B01662	MSE-2B-TC	24	B01904	MSE-4B-TC	28	B04052	HPAM-3	15	B05046	HPEM-3-TC	10
B01663	MSE-2B-TC	24	B01905	MSE-4B-TC	28	B04056	HPAM-3	15	B05048	HPEM-3-TC	10
B01664	MSE-2B-TC	24	B01908	MSE-4B-TC	28	B04060	HPAM-3	15	B05050	HPEM-3-TC	10
B01665	MSE-2B-TC	24	B01911	MSE-4B-TC	28	B04064	HPAM-3	15	B05052	HPEM-3-TC	10
B01668	MSE-4B-TC	28	B01914	MSE-4B-TC	28	B04066	HPAM-3	15	B05054	HPEM-3-TC	10
B01670	MSE-4B-TC	28	B01917	MSE-4B-TC	28	B04067	HPAM-3	15	B05056	HPEM-3-TC	10
B01672	MSE-4B-TC	28	B01921	MSE-4B-TC	28	B04069	HPAM-3	15	B05058	HPEM-3-TC	10
B01674	MSE-4B-TC	28	B01947	MSE-4B-TC	29	B04148	HPAM-3	15	B05060	HPEM-3-TC	10
B01675	MSE-4B-TC	28	B01953	MSE-4B-TC	29	B04152	HPAM-3	15	B05062	HPEM-3-TC	10
B01676	MSE-4B-TC	28	B03016	MRA	17	B04156	HPAM-3	15	B05064	HPEM-3-TC	10
B01678	MSE-4B-TC	29	B03024	MRA	17	B04160	HPAM-3	15	B05066	HPEM-3-TC	10
B01679	MSE-4B-TC	29	B03032	MRA	17	B04164	HPAM-3	15	B05067	HPEM-3-TC	10
B01680	MSE-4B-TC	29	B03040	MRA	17	B04166	HPAM-3	15	B05069	HPEM-3-TC	10
B01681	MDE-2-TC	19	B03048	MRA	17	B04167	HPAM-3	15	B05098	HPEM-5	11
B01682	MDE-2-TC	19	B03064	MRA	17	B04169	HPAM-3	15	B05100	HPDEM-5	9
B01683W	MDE-2-TC	19	B03116	MRA-TC	17	B04217	HPAM-3	15	B05101	HPDEM-5	9
B01684	MDE-2-TC	19	B03117	MRA-TC	17	B04221	HPAM-3	15	B05103	HPDEM-5	9
B01685	MDE-2-TC	19	B03118	MRA-TC	17	B04229	HPAM-3	15	B05104	HPDEM-5	9
B01687	MDE-2-TC	19	B03119	MRA-TC	17	B04231	HPAM-3	15	B05105	HPEM-3	10
B01689	MDE-2-TC	19	B03120	MRA-TC	17	B04405	HPAM-2	14	B05107	HPEM-3	10
B01691	MDE-2-TC	19	B03121	MRA-TC	17	B04409	HPAM-2	14	B05108	HPDEM-5	9
B01692	MDE-4-TC	20	B03122	MRA-TC	17	B04413	HPAM-2	14	B05109	HPEM-3	10
B01693	MDE-4-TC	20	B03124	MRA-TC	17	B04417	HPAM-2	14	B05110	HPDEM-5	9
B01694	MDE-4-TC	20	B03132	MRA-TC	17	B04421	HPAM-2	14	B05111	HPEM-3	10
B01694W	MDE-4-TC	20	B03140	MRA-TC	17	B04425	HPAM-2	14	B05112	HPEM-5	11
B01695	MDE-4-TC	20	B03148	MRA-TC	17	B04429	HPAM-2	14	B05113	HPEM-3	10
B01696	MDE-4-TC	20	B03164	MRA-TC	17	B04431	HPAM-2	14	B05114	HPEM-5	11
B01698	MDE-4-TC	20	B03216	MRS	16	B04432	HPAM-2	14	B05115	HPEM-3	10
B01699	MDE-4-TC	20	B03224	MRS	16	B04434	HPAM-2	14	B05116	HPEM-5	11
B01700	MDE-4-TC	20	B03232	MRS	16	B04440	HPAM-2	14	B05117	HPEM-3	10
B01702	MDE-4-TC	20	B03240	MRS	16	B04444	HPAM-2	14	B05118	HPEM-5	11
B01703	MDE-2B-TC	19	B03248	MRS	16	B04448	HPAM-2	14	B05119	HPEM-3	10
B01704	MDE-2B-TC	19	B03264	MRS	16	B04452	HPAM-2	14	B05120	HPEM-5	11
B01714	MDE-4B-TC	20	B03316	MRS-TC	16	B04456	HPAM-2	14	B05121	HPEM-3	10
B01715	MDE-4B-TC	20	B03324	MRS-TC	16	B04460	HPAM-2	14	B05122	HPEM-5	11
B01730	MSE-4-TC	25	B03332	MRS-TC	16	B04464	HPAM-2	14	B05123	HPEM-3	10
B01732	MSE-4-TC	25	B03340	MRS-TC	16	B04466	HPAM-2	14	B05124	HPEM-5	11
B01733	MSE-4-TC	26	B03348	MRS-TC	16	B04467	HPAM-2	14	B05125	HPEM-3	10
B01734	MSE-4-TC	26	B03364	MRS-TC	16	B04469	HPAM-2	14	B05126	HPEM-5	11
B01735	MSE-4-TC	28	B03416	MRS	16	B04548	HPAM-2	14	B05127	HPEM-3	10
B01750	MSE-4-TC	26	B03424	MRS	16	B04552	HPAM-2	14	B05128	HPEM-5	11
B01751	MSE-4-TC	26	B03432	MRS	16	B04556	HPAM-2	14	B05129	HPEM-3	10
B01752	MSE-4-TC	25	B03440	MRS	16	B04560	HPAM-2	14	B05130	HPEM-5	11
B01753	MSE-4-TC	25	B03448	MRS	16	B04564	HPAM-2	14	B05131	HPEM-3	10
B01755	MSE-4-TC	25	B03464	MRS	16	B04566	HPAM-2	14	B05132	HPEM-5	11
B01756	MSE-4-TC	25	B03532	MRA	17	B04567	HPAM-2	14	B05133	HPEM-3	10
B01758	MSE-4-TC	26	B03540	MRA	17	B04569	HPAM-2	14	B05134	HPEM-5	11
B01759	MSE-4-TC	26	B03548	MRA	17	B04617	HPAM-2	14	B05135	HPEM-3	10
B01760	MSE-4-TC	26	B03564	MRA	17	B04621	HPAM-2	14	B05136	HPEM-5	11
B01762	MSE-4-TC	26	B03632	MRA-TC	17	B04629	HPAM-2	14	B05140	HPEM-3	10
B01763	MSE-4-TC	28	B03640	MRA-TC	17	B04631	HPAM-2	14	B05141	HPEM-5	11
B01764	MSE-4-TC	28	B03648	MRA-TC	17	B04632	HPAM-2	14	B05142	HPEM-3	10
B01765	MSE-4-TC	28	B03664	MRA-TC	17	B04634	HPAM-2	14	B05143	HPEM-5	11
B01766	MSE-4-TC	28	B03816	MRS-TC	16	B05005	HPEM-3-TC	10	B05144	HPEM-3	10
B01767	MSE-4-TC	28	B03824	MRS-TC	16	B05007	HPEM-3-TC	10	B05145	HPEM-5	11
B01768	MSE-4-TC	28	B03832	MRS-TC	16	B05009	HPEM-3-TC	10	B05146	HPEM-3	10
B01770	MSE-4-TC	28	B03840	MRS-TC	16	B05011	HPEM-3-TC	10	B05147	HPEM-5	11
B01771	MSE-4-TC	28	B03848	MRS-TC	16	B05013	HPEM-3-TC	10	B05148	HPEM-3	10
B01772	MSE-4-TC	28	B03864	MRS-TC	16	B05015	HPEM-3-TC	10	B05149	HPEM-5	11
B01774	MSE-4-TC	28	B04005	HPAM-3	15	B05017	HPEM-3-TC	10	B05150	HPEM-3	10
B01775	MSE-4-TC	28	B04009	HPAM-3	15	B05019	HPEM-3-TC	10	B05151	HPEM-5	11
B01776	MSE-4-TC	28	B04013	HPAM-3	15	B05021	HPEM-3-TC	10	B05152	HPEM-3	10
B01850	MSE-4B-TC	28	B04017	HPAM-3	15	B05023	HPEM-3-TC	10	B05153	HPEM-5	11
B01852	MSE-4B-TC	28	B04021	HPAM-3	15	B05025	HPEM-3-TC	10	B05154	HPEM-3	10
B01854	MSE-4B-TC	28	B04025	HPAM-3	15	B05027	HPEM-3-TC	10	B05155	HPEM-5	11
B01856	MSE-4B-TC	28	B04029	HPAM-3	15	B05029	HPEM-3-TC	10	B05156	HPEM-3	10
B01857	MSE-4B	29	B04031	HPAM-3	15	B05031	HPEM-3-TC	10	B05157	HPEM-5	11
B01858	MSE-4B-TC	28	B04032	HPAM-3	15	B05032	HPEM-3-TC	10	B05158	HPEM-3	10
B01860	MSE-4B-TC	29	B04034	HPAM-3	15	B05034	HPEM-3-TC	10	B05159	HPEM-5	11
B01868	MSE-4B-TC	29	B04040	HPAM-3	15	B05040	HPEM-3-TC	10	B05160	HPEM-3	10
B01901	MSE-4B-TC	28	B04044	HPAM-3	15	B05042	HPEM-3-TC	10	B05161	HPEM-5	11
B01902	MSE-4B-TC	28	B04048	HPAM-3	15	B05044	HPEM-3-TC	10	B05162	HPEM-3	10

CARBIDE END MILLS

CARBIDE DRILLS

CARBIDE THREAD MILLS

CARBIDE BURS

INDEX



CARBIDE END MILLS

CARBIDE DRILLS

CARBIDE THREAD MILLS

CARBIDE BURS

INDEX

EDP Number	Style Number	Page Number	EDP Number	Style Number	Page Number	EDP Number	Style Number	Page Number	EDP Number	Style Number	Page Number
B05163	HPEM-5	11	B05466	HPEM-5-TC	11	B06066	HPAM-3-TC	15	B10016	MCH-2R	32
B05164	HPEM-3	10	B05467	HPEM-5-TC	11	B06067	HPAM-3-TC	15	B10017	MCH-2R	32
B05165	HPEM-5	11	B05468	HPEM-5-TC	11	B06069	HPAM-3-TC	15	B10018	MCH-2R	32
B05166	HPEM-3	10	B05469	HPEM-5-TC	11	B06148	HPAM-3-TC	15	B10019	MCH-2R	32
B05167	HPEM-5	11	B05513	HPEM-5-TC	11	B06152	HPAM-3-TC	15	B10020	MCH-2R	32
B05168	HPEM-3	10	B05517	HPEM-5-TC	11	B06156	HPAM-3-TC	15	B10021	MCH-2R	32
B05169	HPEM-5	11	B05521	HPEM-5-TC	11	B06160	HPAM-3-TC	15	B10022	MCH-2R	32
B05170	HPEM-3	10	B05525	HPEM-5-TC	11	B06164	HPAM-3-TC	15	B10023	MCH-2R	32
B05171	HPEM-5	11	B05529	HPEM-5-TC	11	B06166	HPAM-3-TC	15	B10024	MCH-2R	32
B05173	HPEM-5	11	B05531	HPEM-5-TC	11	B06167	HPAM-3-TC	15	B10025	MCH-2R	32
B05175	HPEM-5	11	B05532	HPEM-5-TC	11	B06169	HPAM-3-TC	15	B10026	MCH-2D	32
B05177	HPEM-5	11	B05533	HPEM-5-TC	11	B06217	HPAM-3-TC	15	B10027	MCH-2D	32
B05179	HPEM-5	11	B05605	HPDEM-5-TC	9	B06221	HPAM-3-TC	15	B10028	MCH-2D	32
B05181	HPEM-5	11	B05609	HPDEM-5-TC	9	B06229	HPAM-3-TC	15	B10029	MCH-2D	32
B05183	HPEM-5	11	B05613	HPDEM-5-TC	9	B06231	HPAM-3-TC	15	B10030	MCH-2D	32
B05185	HPEM-5	11	B05617	HPDEM-5-TC	9	B06405	HPAM-2-TC	14	B10117	MRA	17
B05305	HPEM-3	10	B05621	HPDEM-5-TC	9	B06409	HPAM-2-TC	14	B10118	MRA	17
B05307	HPEM-3	10	B05625	HPDEM-5-TC	9	B06413	HPAM-2-TC	14	B10119	MRA	17
B05309	HPEM-3	10	B05629	HPDEM-5-TC	9	B06417	HPAM-2-TC	14	B10120	MRA	17
B05311	HPEM-3	10	B05805	HPEM-5	11	B06421	HPAM-2-TC	14	B10121	MRA	17
B05313	HPEM-3	10	B05807	HPEM-5	11	B06425	HPAM-2-TC	14	B10122	MRA	17
B05315	HPEM-3	10	B05809	HPEM-5	11	B06429	HPAM-2-TC	14	B10219	MCH-4R	32
B05317	HPEM-3	10	B05811	HPEM-5	11	B06431	HPAM-2-TC	14	B10220	MCH-4R	32
B05319	HPEM-3	10	B05813	HPEM-5	11	B06432	HPAM-2-TC	14	B10221	MCH-4R	32
B05321	HPEM-3	10	B05815	HPEM-5	11	B06434	HPAM-2-TC	14	B10222	MCH-4R	32
B05323	HPEM-3	10	B05817	HPEM-5	11	B06440	HPAM-2-TC	14	B10223	MCH-4R	32
B05325	HPEM-3	10	B05821	HPEM-5	11	B06444	HPAM-2-TC	14	B10224	MCH-4R	32
B05327	HPEM-3	10	B05825	HPEM-5	11	B06448	HPAM-2-TC	14	B10225	MCH-4R	32
B05329	HPEM-3	10	B05829	HPEM-5	11	B06452	HPAM-2-TC	14	B10226	MCH-4R	32
B05331	HPEM-3	10	B05831	HPEM-5	11	B06456	HPAM-2-TC	14	B10227	MCH-4R	32
B05332	HPEM-3	10	B05832	HPEM-5	11	B06460	HPAM-2-TC	14	B10228	MCH-4D	32
B05334	HPEM-3	10	B05834	HPEM-5	11	B06464	HPAM-2-TC	14	B10229	MCH-4D	32
B05340	HPEM-3	10	B05840	HPEM-5	11	B06466	HPAM-2-TC	14	B10230	MCH-4D	32
B05342	HPEM-3	10	B05842	HPEM-5	11	B06467	HPAM-2-TC	14	B10231	MCH-2D	32
B05344	HPEM-3	10	B05844	HPEM-5	11	B06469	HPAM-2-TC	14	B10232	MCH-2R	32
B05346	HPEM-3	10	B05846	HPEM-5	11	B06548	HPAM-2-TC	14	B10233	MCH-2R	32
B05348	HPEM-3	10	B05848	HPEM-5	11	B06552	HPAM-2-TC	14	B10234	MCH-4D	32
B05350	HPEM-3	10	B05850	HPEM-5	11	B06556	HPAM-2-TC	14	B10235	MCH-4R	32
B05352	HPEM-3	10	B05852	HPEM-5	11	B06560	HPAM-2-TC	14	B10236	MCH-4R	32
B05354	HPEM-3	10	B05856	HPEM-5	11	B06564	HPAM-2-TC	14	B10575	MSE-2	21
B05356	HPEM-3	10	B05860	HPEM-5	11	B06566	HPAM-2-TC	14	B10901	MEG-2-TC	31
B05358	HPEM-3	10	B05864	HPEM-5	11	B06567	HPAM-2-TC	14	B10903	MEG-2-TC	31
B05360	HPEM-3	10	B05865	HPEM-5	11	B06569	HPAM-2-TC	14	B10906	MEG-2-TC	31
B05362	HPEM-3	10	B05866	HPEM-5	11	B06617	HPAM-2-TC	14	B11971	MSE-3-TC	25
B05364	HPEM-3	10	B05867	HPEM-5	11	B06621	HPAM-2-TC	14	B11972	MSE-3-TC	25
B05366	HPEM-3	10	B05868	HPEM-5	11	B06629	HPAM-2-TC	14	B11973	MSE-3-TC	25
B05367	HPEM-3	10	B05869	HPEM-5	11	B06631	HPAM-2-TC	14	B11974	MSE-3-TC	25
B05369	HPEM-3	10	B05913	HPEM-5	11	B06632	HPAM-2-TC	14	B11975	MSE-3-TC	25
B05405	HPEM-5-TC	11	B05917	HPEM-5	11	B06634	HPAM-2-TC	14	B11976	MSE-3-TC	25
B05407	HPEM-5-TC	11	B05921	HPEM-5	11	B06800	MSE-2-TC	21	B11977	MSE-3-TC	25
B05409	HPEM-5-TC	11	B05925	HPEM-5	11	B06801	MSE-2-TC	21	B11978	MSE-3-TC	25
B05411	HPEM-5-TC	11	B05929	HPEM-5	11	B06802	MSE-2-TC	21	B11986	MSE-3-TC	25
B05413	HPEM-5-TC	11	B05931	HPEM-5	11	B06803	MSE-2-TC	21	B11987	MDE-2	19
B05415	HPEM-5-TC	11	B05932	HPEM-5	11	B06805	MSE-2-TC	21	B11999	MDE-4	20
B05417	HPEM-5-TC	11	B05933	HPEM-5	11	B06806	MSE-2-TC	21	B12000	MDE-4	20
B05421	HPAM-5-TC	11	B06005	HPAM-3-TC	15	B06808	MSE-2-TC	22	B12014	MSE-2B	23
B05425	HPAM-5-TC	11	B06009	HPAM-3-TC	15	B06809	MSE-2-TC	22	B12015	MSE-2B	24
B05429	HPAM-5-TC	11	B06013	HPAM-3-TC	15	B06810	MSE-2-TC	22	B27104	MSE-3	25
B05431	HPAM-5-TC	11	B06017	HPAM-3-TC	15	B06812	MSE-2-TC	22	B27105	MSE-3	25
B05432	HPAM-5-TC	11	B06021	HPAM-3-TC	15	B06813	MSE-2-TC	22	B27106	MSE-3	25
B05434	HPAM-5-TC	11	B06025	HPAM-3-TC	15	B06814	MSE-2-TC	22	B27107	MSE-3	25
B05440	HPAM-5-TC	11	B06029	HPAM-3-TC	15	B06816	MSE-2-TC	22	B27108	MSE-3	25
B05442	HPAM-5-TC	11	B06031	HPAM-3-TC	15	B06817	MSE-2-TC	22	B27109	MSE-3	25
B05444	HPAM-5-TC	11	B06032	HPAM-3-TC	15	B06818	MSE-2-TC	22	B27110	MSE-3	25
B05446	HPAM-5-TC	11	B06034	HPAM-3-TC	15	B06820	MSE-2-TC	22	B27111	MSE-3	25
B05448	HPAM-5-TC	11	B06040	HPAM-3-TC	15	B06821	MSE-2-TC	22	B27112	MSE-3	25
B05450	HPAM-5-TC	11	B06044	HPAM-3-TC	15	B06822	MSE-2-TC	22	B27113	MSE-3	25
B05452	HPAM-5-TC	11	B06048	HPAM-3-TC	15	B06824	MSE-2-TC	22	B27114	MSE-3	25
B05456	HPAM-5-TC	11	B06052	HPAM-3-TC	15	B06825	MSE-2-TC	22	B27115	MSE-3	25
B05460	HPAM-5-TC	11	B06056	HPAM-3-TC	15	B06826	MSE-2-TC	22	B27116	MSE-3	25
B05464	HPAM-5-TC	11	B06060	HPAM-3-TC	15	B10013	MCH-2R	32	B27117	MSE-3	25
B05465	HPAM-5-TC	11	B06064	HPAM-3-TC	15	B10014	MCH-2R	32	B27118	MSE-3	25





EDP Number	Style Number	Page Number	EDP Number	Style Number	Page Number	EDP Number	Style Number	Page Number	EDP Number	Style Number	Page Number
B27120	MSE-3	25	B36042	DRS.	39	B37212	MSE-3-TC	25	B40200	MSEV4R	4
B27124	MSE-3	25	B36043	DRS.	39	B37213	MSE-3-TC	25	B40201	MSEV4R	4
B27128	MSE-3	25	B36044	DRS.	39	B37214	MSE-3-TC	25	B40202	MSEV4R	4
B27132	MSE-3	25	B36045	DRS.	39	B37216	MSE-3-TC	25	B40203	MSEV4R	4
B27136	MSE-3	25	B36046	DRS.	39	B37217	MSE-3-TC	25	B40204	MSEV4R	4
B27140	MSE-3	25	B36047	DRS.	39	B37218	MSE-3-TC	25	B40205	MSEV4R	4
B27148	MSE-3	25	B36048	DRS.	39	B37220	MSE-3-TC	25	B40206	MSEV4R	4
B27156	MSE-3	25	B36049	DRS.	39	B37221	MSE-3-TC	25	B40207	MSEV4R	4
B27164	MSE-3	25	B36050	DRS.	39	B37222	MSE-3-TC	25	B40208	MSEV4R	4
B27200	MSE-3	25	B36051	DRS.	39	B37224	MSE-3-TC	25	B40209	MSEV4R	4
B27201	MSE-3	25	B36052	DRS.	39	B37225	MSE-3-TC	25	B40210	MSEV4R	4
B27202	MSE-3	25	B36053	DRS.	39	B37226	MSE-3-TC	25	B40211	MSEV4R	4
B27203	MSE-3	25	B36054	DRS.	39	B40140	MSEV4R	3	B40212	MSEV4R	4
B27205	MSE-3	25	B36055	DRS.	39	B40141	MSEV4R	3	B40213	MSEV4R	4
B27206	MSE-3	25	B36056	DRS.	39	B40142	MSEV4R	3	B40214	MSEV4R	4
B27208	MSE-3	25	B36057	DRS.	39	B40143	MSEV4R	3	B40215	MSEV4R	4
B27209	MSE-3	25	B36058	DRS.	39	B40144	MSEV4R	3	B40216	MSEV4R	4
B27210	MSE-3	25	B36059	DRS.	39	B40145	MSEV4R	3	B40217	MSEV4R	4
B27212	MSE-3	25	B36060	DRS.	39	B40146	MSEV4R	3	B40218	MSEV4R	4
B27213	MSE-3	25	B36404	DRS.	39	B40147	MSEV4R	3	B40219	MSEV4R	4
B27214	MSE-3	25	B36405	DRS.	39	B40148	MSEV4R	3	B40220	MSEV4R	4
B27216	MSE-3	25	B36406	DRS.	39	B40149	MSEV4R	3	B40221	MSEV4R	4
B27217	MSE-3	25	B36407	DRS.	39	B40150	MSEV4R	3	B40222	MSEV4R	4
B27218	MSE-3	25	B36408	DRS.	39	B40151	MSEV4R	3	B40223	MSEV4R	4
B27220	MSE-3	25	B36409	DRS.	40	B40152	MSEV4R	3	B40224	MSEV4R	4
B27221	MSE-3	25	B36410	DRS.	40	B40153	MSEV4R	3	B40225	MSEV4R	4
B27222	MSE-3	25	B36411	DRS.	40	B40154	MSEV4R	4	B40226	MSEV4R	4
B27224	MSE-3	25	B36412	DRS.	40	B40155	MSEV4R	4	B40227	MSEV4R	4
B27225	MSE-3	25	B36413	DRS.	40	B40156	MSEV4R	4	B40228	MSEV4R	4
B27226	MSE-3	25	B36414	DRS.	40	B40157	MSEV4R	4	B40229	MSEV4R	4
B36001	DRS.	40	B36415	DRS.	40	B40158	MSEV4R	4	B40230	MSEV4R	4
B36002	DRS.	40	B36416	DRS.	40	B40159	MSEV4R	4	B40231	MSEV4R	3
B36003	DRS.	40	B36417	DRS.	40	B40160	MSEV4R	4	B40232	MSEV4R	3
B36004	DRS.	40	B36418	DRS.	40	B40161	MSEV4R	4	B40233	MSEV4R	3
B36005	DRS.	40	B36419	DRS.	40	B40162	MSEV4R	4	B40237	MSE-V-4R	4
B36006	DRS.	40	B36420	DRS.	40	B40163	MSEV4R	4	B40238	MSE-V-4R	4
B36007	DRS.	40	B36421	DRS.	40	B40164	MSEV4R	4	B40308	MSE-V-4B	5
B36008	DRS.	40	B36422	DRS.	40	B40165	MSEV4R	3	B40309	MSE-V-4B	5
B36009	DRS.	40	B36423	DRS.	40	B40166	MSEV4R	3	B40310	MSE-V-4B	5
B36010	DRS.	40	B36424	DRS.	40	B40167	MSEV4R	3	B40311	MSE-V-4B	5
B36011	DRS.	40	B36425	DRS.	40	B40168	MSEV4R	3	B40312	MSE-V-4B	5
B36012	DRS.	40	B36426	DRS.	40	B40169	MSEV4R	3	B40313	MSE-V-4B	5
B36013	DRS.	40	B36427	DRS.	40	B40170	MSEV4R	3	B40314	MSE-V-4B	5
B36014	DRS.	40	B36428	DRS.	40	B40171	MSEV4R	3	B40315	MSE-V-4B	5
B36015	DRS.	40	B36429	DRS.	40	B40172	MSEV4R	3	B40316	MSE-V-4B	5
B36016	DRS.	40	B36430	DRS.	40	B40173	MSEV4R	3	B40317	MSE-V-4B	5
B36017	DRS.	40	B36431	DRS.	40	B40174	MSEV4R	3	B40320	MSE-V2-5R	6
B36018	DRS.	40	B36432	DRS.	40	B40175	MSEV4R	3	B40321	MSE-V2-5R	7
B36019	DRS.	40	B37104	MSE-3-TC	25	B40176	MSEV4R	3	B40322	MSE-V2-5R	7
B36020	DRS.	40	B37105	MSE-3-TC	25	B40177	MSEV4R	3	B40324	MSE-V2-5R	7
B36021	DRS.	40	B37106	MSE-3-TC	25	B40178	MSEV4R	3	B40325	MSE-V2-5R	7
B36022	DRS.	40	B37107	MSE-3-TC	25	B40179	MSEV4R	3	B40410	MSEV25R	6
B36023	DRS.	40	B37108	MSE-3-TC	25	B40180	MSEV4R	3	B40411	MSEV25R	6
B36024	DRS.	40	B37109	MSE-3-TC	25	B40181	MSEV4R	3	B40412	MSEV25R	6
B36025	DRS.	40	B37110	MSE-3-TC	25	B40182	MSEV4R	3	B40413	MSEV25R	6
B36026	DRS.	40	B37111	MSE-3-TC	25	B40183	MSEV4R	3	B40414	MSEV25R	6
B36027	DRS.	40	B37112	MSE-3-TC	25	B40184	MSEV4R	3	B40415	MSEV25R	6
B36028	DRS.	40	B37113	MSE-3-TC	25	B40185	MSEV4R	3	B40416	MSEV25R	6
B36029	DRS.	40	B37114	MSE-3-TC	25	B40186	MSEV4R	4	B40417	MSEV25R	6
B36030	DRS.	39	B37115	MSE-3-TC	25	B40187	MSEV4R	4	B40418	MSEV25R	6
B36031	DRS.	39	B37117	MSE-3-TC	25	B40188	MSEV4R	4	B40419	MSEV25R	6
B36032	DRS.	39	B37118	MSE-3-TC	25	B40189	MSEV4R	4	B40420	MSEV25R	6
B36033	DRS.	39	B37136	MSE-3-TC	25	B40190	MSEV4R	4	B40421	MSEV25R	6
B36034	DRS.	39	B37200	MSE-3-TC	25	B40191	MSEV4R	4	B40422	MSEV25R	6
B36035	DRS.	39	B37201	MSE-3-TC	25	B40192	MSEV4R	4	B40423	MSEV25R	6
B36036	DRS.	39	B37202	MSE-3-TC	25	B40193	MSEV4R	4	B40424	MSEV25R	6
B36037	DRS.	39	B37203	MSE-3-TC	25	B40194	MSEV4R	4	B40425	MSEV25R	7
B36038	DRS.	39	B37205	MSE-3-TC	25	B40195	MSEV4R	4	B40426	MSEV25R	7
B36039	DRS.	39	B37206	MSE-3-TC	25	B40196	MSEV4R	4	B40427	MSEV25R	7
B36040	DRS.	39	B37208	MSE-3-TC	25	B40197	MSEV4R	4	B40428	MSEV25R	7
B36041	DRS.	39	B37209	MSE-3-TC	25	B40198	MSEV4R	4	B40429	MSEV25R	7
			B37210	MSE-3-TC	25	B40199	MSEV4R	4	B40430	MSEV25R	7

CARBIDE END MILLS

CARBIDE DRILLS

CARBIDE THREAD MILLS

CARBIDE BURS

INDEX



CARBIDE END MILLS

CARBIDE DRILLS

CARBIDE THREAD MILLS

CARBIDE BURS

INDEX

EDP Number	Style Number	Page Number	EDP Number	Style Number	Page Number	EDP Number	Style Number	Page Number	EDP Number	Style Number	Page Number
B40431	MSEV25R	7	B51204	MSE-2	21	B51502	MSE-2B	23	B52086	MSE-2	22
B40432	MSEV25R	7	B51206	MSE-2	21	B51504	MSE-2B	23	B52087	MSE-4	26
B40433	MSEV25R	7	B51208	MSE-2	22	B51505	MSE-2B	23	B52088	MSE-4	26
B40434	MSEV25R	6	B51210	MSE-2	22	B51506	MSE-2B	23	B52089	MSE-4	26
B40435	MSEV25R	6	B51212	MSE-2	22	B51508	MSE-2B	23	B52090	MSE-4	26
B40436	MSEV25R	6	B51214	MSE-2	22	B51509	MSE-2B	23	B52091	MSE-4	26
B40437	MSEV25R	6	B51216	MSE-2	22	B51510	MSE-2B	24	B52092	MSE-4	27
B40438	MSEV25R	6	B51218	MSE-2	22	B51511	MSE-2B	24	B52093	MSE-4	27
B40439	MSEV25R	6	B51220	MSE-2	22	B51512	MSE-2B	24	B52095	MSE-4	26
B40440	MSEV25R	6	B51250	MSE-4	26	B51514	MSE-2B	24	B52096	MSE-4	26
B40441	MSEV25R	6	B51252	MSE-4	26	B51516	MSE-2B	24	B52097	MSE-4	27
B40442	MSEV25R	6	B51254	MSE-4	27	B51518	MSE-2B	24	B52098	MSE-4	27
B40443	MSEV25R	6	B51256	MSE-4	27	B51520	MSE-2B	24	B52099	MSE-4	27
B40444	MSEV25R	6	B51258	MSE-4	27	B51550	MSE-4B	28	B52101	MSE-4	26
B40445	MSEV25R	6	B51260	MSE-4	27	B51552	MSE-4B	28	B52102	MSE-4	26
B40446	MSEV25R	6	B51262	MSE-4	28	B51554	MSE-4B	28	B52104	MSE-4	26
B40447	MSEV25R	6	B51264	MSE-4	28	B51555	MSE-4B	28	B52105	MSE-4	26
B40448	MSEV25R	6	B51266	MSE-4	28	B51556	MSE-4B	28	B52106	MSE-4	26
B40449	MSEV25R	6	B51268	MSE-4	28	B51558	MSE-4B	28	B52107	MSE-4	26
B40450	MSEV25R	6	B51270	MSE-4	28	B51559	MSE-4B	28	B52108	MSE-4	26
B40451	MSEV25R	6	B51300	MSE-2B	23	B51560	MSE-4B	29	B52110	MSE-4	26
B40452	MSEV25R	6	B51302	MSE-2B	23	B51561	MSE-4B	29	B52111	MSE-4	26
B40453	MSEV25R	6	B51304	MSE-2B	23	B51562	MSE-4B	29	B52113	MSE-4	26
B40454	MSEV25R	6	B51306	MSE-2B	23	B51564	MSE-4B	29	B52114	MSE-4	26
B40455	MSEV25R	6	B51308	MSE-2B	23	B51566	MSE-4B	29	B52116	MSE-4	26
B40456	MSEV25R	6	B51310	MSE-2B	24	B51568	MSE-4B	29	B52117	MSE-4	26
B40457	MSEV25R	6	B51312	MSE-2B	24	B51570	MSE-4B	29	B52120	MSE-4	27
B40458	MSEV25R	7	B51314	MSE-2B	24	B52001	MSE-2	21	B52121	MSE-4	27
B40459	MSEV25R	7	B51316	MSE-2B	24	B52002	MSE-2	21	B52123	MSE-4	27
B40460	MSEV25R	7	B51318	MSE-2B	24	B52004	MSE-2	21	B52126	MSE-4	27
B40461	MSEV25R	7	B51320	MSE-2B	24	B52005	MSE-2	21	B52132	MSE-4	27
B40462	MSEV25R	7	B51350	MSE-4B	28	B52007	MSE-2	21	B52138	MSE-4	27
B40463	MSEV25R	7	B51352	MSE-4B	28	B52008	MSE-2	21	B52145	MSE-4	27
B40464	MSEV25R	7	B51354	MSE-4B	28	B52010	MSE-2	21	B52147	MSE-4	28
B40465	MSEV25R	7	B51356	MSE-4B	28	B52011	MSE-2	21	B52149	MSE-4	28
B40466	MSEV25R	7	B51358	MSE-4B	28	B52013	MSE-2	21	B52151	MSE-4	28
B40467	MSEV25R	7	B51360	MSE-4B	29	B52014	MSE-2	21	B52153	MSE-4	28
B40468	MSEV25R	7	B51362	MSE-4B	29	B52016	MSE-2	21	B52157	MSE-4	28
B40469	MSEV25R	7	B51364	MSE-4B	29	B52017	MSE-2	21	B52160	MSE-4	26
B40470	MSEV25R	7	B51366	MSE-4B	29	B52019	MSE-2	21	B52162	MSE-4	26
B40471	MSEV25R	7	B51368	MSE-4B	29	B52020	MSE-2	21	B52164	MSE-4	27
B40472	MSEV25R	7	B51370	MSE-4B	29	B52021	MSE-2	21	B52165	MSE-4	27
B40473	MSEV25R	7	B51400	MSE-2	21	B52023	MSE-2	21	B52167	MSE-4	27
B40474	MSEV25R	7	B51402	MSE-2	21	B52026	MSE-2	21	B52168	MSE-4	27
B40475	MSEV25R	7	B51404	MSE-2	21	B52032	MSE-2	22	B52170	MSE-4	27
B40476	MSEV25R	7	B51405	MSE-2	21	B52038	MSE-2	22	B52171	MSE-4	27
B40477	MSEV25R	7	B51406	MSE-2	21	B52045	MSE-2	22	B52172	MSE-4	27
B40478	MSEV25R	7	B51408	MSE-2	22	B52047	MSE-2	22	B52173	MSE-4	27
B40479	MSEV25R	7	B51409	MSE-2	22	B52049	MSE-2	22	B52174	MSE-4	28
B40480	MSEV25R	7	B51410	MSE-2	22	B52051	MSE-2	22	B52175	MSE-4	28
B40481	MSEV25R	7	B51411	MSE-2	22	B52053	MSE-2	22	B52176	MSE-4	28
B40482	MSEV25R	7	B51412	MSE-2	22	B52057	MSE-2	22	B52177	MSE-4	28
B40483	MSEV25R	7	B51414	MSE-2	22	B52060	MSE-2	21	B52178	MSE-4	28
B40484	MSEV25R	7	B51416	MSE-2	22	B52061	MSE-2	21	B52179	MSE-4	28
B40485	MSEV25R	7	B51418	MSE-2	22	B52062	MSE-2	21	B52180	MSE-4	28
B40486	MSEV25R	7	B51420	MSE-2	22	B52063	MSE-2	21	B52181	MSE-4	28
B40487	MSEV25R	7	B51450	MSE-4	26	B52065	MSE-2	21	B52182	MSE-4	28
B40488	MSEV25R	7	B51451	MSE-4	26	B52066	MSE-2	21	B52183	MSE-4	28
B40489	MSEV25R	7	B51452	MSE-4	26	B52068	MSE-2	22	B52184	MSE-4	28
B40490	MSEV25R	7	B51454	MSE-4	27	B52069	MSE-2	22	B52185	MSE-4	28
B40491	MSEV25R	7	B51455	MSE-4	27	B52070	MSE-2	22	B52187	MSE-4B	28
B40492	MSEV25R	7	B51456	MSE-4	27	B52072	MSE-2	22	B52201	MSE-2B	23
B40493	MSEV25R	7	B51458	MSE-4	27	B52073	MSE-2	22	B52202	MSE-2B	23
B40494	MSEV25R	7	B51459	MSE-4	27	B52074	MSE-2	22	B52204	MSE-2B	23
B40495	MSEV25R	7	B51460	MSE-4	27	B52076	MSE-2	22	B52205	MSE-2B	23
B40496	MSEV25R	7	B51461	MSE-4	28	B52077	MSE-2	22	B52207	MSE-2B	23
B40497	MSEV25R	7	B51462	MSE-4	28	B52078	MSE-2	22	B52208	MSE-2B	23
B40779	MDE-2	19	B51464	MSE-4	28	B52080	MSE-2	22	B52210	MSE-2B	23
B40780	MDE-4	20	B51466	MSE-4	28	B52081	MSE-2	22	B52211	MSE-2B	23
B50106	HPDEM-5	9	B51468	MSE-4	28	B52082	MSE-2	22	B52213	MSE-2B	23
B51200	MSE-2	21	B51470	MSE-4	28	B52084	MSE-2	22	B52214	MSE-2B	23
B51202	MSE-2	21	B51500	MSE-2B	23	B52085	MSE-2	22	B52216	MSE-2B	23





EDP Number	Style Number	Page Number	EDP Number	Style Number	Page Number	EDP Number	Style Number	Page Number	EDP Number	Style Number	Page Number
B52217	MSE-2B	23	B52532	MDE-4B	20	B52856	MDE-4	20	B53598	DR	38
B52220	MSE-2B	23	B52534	MDE-4B	20	B52858	MDE-4	20	B53600	DR	38
B52221	MSE-2B	23	B52538	MDE-4B	20	B52863	MDE-4	20	B53602	DR	38
B52223	MSE-2B	23	B52540	MDE-4B	20	B52881	MDE-2B	19	B53603	DR	38
B52226	MSE-2B	23	B52543	MDE-4B	20	B52883	MDE-2B	19	B53604	DR	38
B52232	MSE-2B	23	B52601	MSE-2	21	B52921	MDE-4B	20	B53606	DR	38
B52238	MSE-2B	24	B52602	MSE-2	21	B52923	MDE-4B	20	B53607	DR	38
B52245	MSE-2B	24	B52604	MSE-2	21	B53201	MSEST-2	31	B53610	DR	38
B52247	MSE-2B	24	B52606	MSE-2	21	B53203	MSEST-2	31	B53613	DR	38
B52249	MSE-2B	24	B52608	MSE-2	21	B53205	MSEST-2	31	B53614	DR	38
B52251	MSE-2B	24	B52612	MSE-2	21	B53207	MSEST-2	31	B53615	DR	38
B52253	MSE-2B	24	B52617	MSE-2	21	B53210	MSEST-2	31	B53617	DR	38
B52257	MSE-2B	24	B52619	MSE-2	21	B53212	MSEST-2	31	B53619	DR	38
B52301	MSE-4B	28	B52621	MSE-2	22	B53215	MSEST-2	31	B53621	DR	38
B52302	MSE-4B	28	B52623	MSE-2	22	B53431	DC	42	B53622	DR	38
B52304	MSE-4B	28	B52626	MSE-2	22	B53432	DC	42	B53625	DR	38
B52305	MSE-4B	28	B52628	MSE-2	22	B53433	DC	42	B53626	DR	38
B52307	MSE-4B	28	B52631	MSE-2	22	B53434	DC	42	B53628	DR	38
B52308	MSE-4B	28	B52641	MSE-4	26	B53435	DC	42	B53630	DR	38
B52310	MSE-4B	28	B52642	MSE-4	26	B53436	DC	42	B53631	DR	38
B52311	MSE-4B	28	B52644	MSE-4	26	B53451	DS	42	B53633	DR	38
B52313	MSE-4B	28	B52645	MSE-4	26	B53454	DS	42	B53635	DR	38
B52314	MSE-4B	28	B52646	MSE-4	26	B53456	DS	42	B53637	DR	38
B52316	MSE-4B	28	B52648	MSE-4	26	B53458	DS	42	B53638	DR	38
B52317	MSE-4B	28	B52650	MSE-4	26	B53460	DS	42	B53640	DR	38
B52320	MSE-4B	28	B52652	MSE-4	26	B53462	DS	42	B53643	DR	38
B52321	MSE-4B	28	B52657	MSE-4	27	B53464	DS	42	B53645	DR	38
B52323	MSE-4B	28	B52659	MSE-4	27	B53467	DS	42	B53647	DR	38
B52326	MSE-4B	28	B52661	MSE-4	27	B53475	DS	42	B53649	DR	38
B52332	MSE-4B	28	B52663	MSE-4	27	B53509	DR	38	B53652	DR	38
B52338	MSE-4B	29	B52666	MSE-4	27	B53511	DR	38	B53655	DR	38
B52345	MSE-4B	29	B52668	MSE-4	28	B53512	DR	38	B53657	DR	38
B52347	MSE-4B	29	B52671	MSE-4	28	B53514	DR	38	B53660	DR	38
B52349	MSE-4B	29	B52681	MSE-2B	23	B53515	DR	38	B53662	DR	38
B52351	MSE-4B	29	B52682	MSE-2B	23	B53518	DR	38	B53664	DR	38
B52353	MSE-4B	29	B52684	MSE-2B	23	B53521	DR	38	B53666	DR	38
B52357	MSE-4B	29	B52688	MSE-2B	23	B53523	DR	38	B53670	DR	38
B52401	MDE-2	19	B52692	MSE-2B	23	B53525	DR	38	B53672	DR	38
B52403	MDE-2	19	B52697	MSE-2B	23	B53529	DR	38	B53675	DR	38
B52405	MDE-2	19	B52699	MSE-2B	23	B53531	DR	38	B53677	DR	38
B52407	MDE-2	19	B52701	MSE-2B	23	B53533	DR	38	B53678	DR	38
B52410	MDE-2	19	B52703	MSE-2B	24	B53536	DR	38	B53681	DR	39
B52412	MDE-2	19	B52706	MSE-2B	24	B53538	DR	38	B53683	DR	39
B52414	MDE-2	19	B52708	MSE-2B	24	B53541	DR	38	B53685	DR	39
B52418	MDE-2	19	B52711	MSE-2B	24	B53543	DR	38	B53688	DR	39
B52420	MDE-2	19	B52721	MSE-4B	28	B53545	DR	38	B53689	DR	39
B52423	MDE-2	19	B52722	MSE-4B	28	B53546	DR	38	B53691	DR	39
B52441	MDE-4	20	B52724	MSE-4B	28	B53549	DR	38	B53693	DR	39
B52443	MDE-4	20	B52728	MSE-4B	28	B53550	DR	38	B53694	DR	39
B52445	MDE-4	20	B52732	MSE-4B	28	B53553	DR	38	B53696	DR	39
B52447	MDE-4	20	B52737	MSE-4B	28	B53556	DR	38	B53698	DR	39
B52450	MDE-4	20	B52739	MSE-4B	28	B53559	DR	38	B53701	DR	39
B52452	MDE-4	20	B52741	MSE-4B	28	B53560	DR	38	B53704	DR	39
B52454	MDE-4	20	B52743	MSE-4B	29	B53562	DR	38	B53708	DR	39
B52458	MDE-4	20	B52746	MSE-4B	29	B53564	DR	38	B53710	DR	39
B52460	MDE-4	20	B52748	MSE-4B	29	B53566	DR	38	B53713	DR	39
B52463	MDE-4	20	B52751	MSE-4B	29	B53567	DR	38	B53715	DR	39
B52481	MDE-2B	19	B52801	MDE-2	19	B53569	DR	38	B53718	DR	39
B52483	MDE-2B	19	B52803	MDE-2	19	B53571	DR	38	B53720	DR	39
B52485	MDE-2B	19	B52805W	MDE-2	19	B53573	DR	38	B53722	DR	39
B52487	MDE-2B	19	B52807	MDE-2	19	B53574	DR	38	B53724	DR	39
B52490	MDE-2B	19	B52809	MDE-2	19	B53576	DR	38	B53725	DR	39
B52492	MDE-2B	19	B52814	MDE-2	19	B53577	DR	38	B53727	DR	39
B52494	MDE-2B	19	B52818	MDE-2	19	B53579	DR	38	B53729	DR	39
B52498	MDE-2B	19	B52823	MDE-2	19	B53581	DR	38	B53731	DR	39
B52500	MDE-2B	19	B52841	MDE-4	20	B53583	DR	38	B53732	DR	39
B52503	MDE-2B	19	B52843	MDE-4	20	B53586	DR	38	B53735	DR	39
B52521	MDE-4B	20	B52845	MDE-4	20	B53589	DR	38	B53737	DR	39
B52523	MDE-4B	20	B52845W	MDE-4	20	B53591	DR	38	B53739	DR	39
B52525	MDE-4B	20	B52847	MDE-4	20	B53592	DR	38	B53741	DR	39
B52527	MDE-4B	20	B52849	MDE-4	20	B53594	DR	38	B53742	DR	39
B52530	MDE-4B	20	B52854	MDE-4	20	B53596	DR	38	B53744	DR	39

CARBIDE END MILLS

CARBIDE DRILLS

CARBIDE THREAD MILLS

CARBIDE BURS

INDEX



	EDP Number	Style Number	Page Number	EDP Number	Style Number	Page Number	EDP Number	Style Number	Page Number	EDP Number	Style Number	Page Number
	B54100	DM	41	B54242	DM	41	B54632	DHPCF-8	37	B54982	BF	53
	B54101	DM	41	B54245	DM	41	B54640	DHPCF-8	37	B54983	BF	53
	B54102	DM	41	B54247	DM	41	B54642	DHPCF-8	37	B54984	BF	53
	B54104	DM	41	B54248	DM	41	B54646	DHPCF-8	37	B54985	BF	53
	B54105	DM	41	B54250	DM	41	B54648	DHPCF-8	37	B54986	BF	53
	B54108	DM	41	B54251	DM	41	B54649	DHPCF-8	37	B54990	BF	53
	B54112	DM	41	B54253	DM	41	B54650	DHPCF-8	37	B54991	BF	53
	B54113	DM	41	B54254	DM	41	B54652	DHPCF-8	37	B54992	BF	53
	B54115	DM	41	B54256	DM	41	B54656	DHPCF-8	37	B54993	BF	53
	B54119	DM	41	B54257	DM	41	B54659	DHPCF-8	37	B54994	BF	53
	B54121	DM	41	B54259	DM	41	B54660	DHPCF-8	37	B54995	BF	53
	B54123	DM	41	B54260	DM	41	B54801	BA	51	B55017	BG	54
	B54126	DM	41	B54262	DM	42	B54802	BA	51	B55018	BG	54
	B54128	DM	41	B54263	DM	42	B54803	BA	51	B55019	BG	54
	B54131	DM	41	B54265	DM	42	B54804	BA	51	B55020	BG	54
	B54133	DM	41	B54266	DM	42	B54805	BA	51	B55021	BG	54
	B54135	DM	41	B54267	DM	42	B54806	BA	51	B55026	BG	54
	B54136	DM	41	B54268	DM	42	B54807	BA	51	B55027	BG	54
	B54139	DM	41	B54270	DM	42	B54810	BA	51	B55028	BG	54
	B54140	DM	41	B54300	DHPCF-5	36	B54811	BA	51	B55029	BG	54
	B54143	DM	41	B54306	DHPCF-5	36	B54812	BA	51	B55030	BG	54
	B54146	DM	41	B54317	DHPCF-5	36	B54813	BA	51	B55053	BH	54
	B54149	DM	41	B54327	DHPCF-5	36	B54814	BA	51	B55054	BH	54
	B54150	DM	41	B54346	DHPCF-5	36	B54815	BA	51	B55055	BH	54
	B54152	DM	41	B54358	DHPCF-5	36	B54816	BA	51	B55060	BH	54
	B54154	DM	41	B54368	DHPCF-5	36	B54837	BAE	51	B55061	BH	54
	B54156	DM	41	B54375	DHPCF-5	36	B54838	BAE	51	B55062	BH	54
	B54157	DM	41	B54377	DHPCF-5	36	B54839	BAE	51	B55145	BL	55
	B54159	DM	41	B54384	DHPCF-5	36	B54840	BAE	51	B55146	BL	55
	B54161	DM	41	B54387	DHPCF-5	36	B54843	BAE	51	B55147	BL	55
	B54163	DM	41	B54391	DHPCF-5	36	B54847	BAE	51	B55148	BL	55
	B54164	DM	41	B54398	DHPCF-5	36	B54848	BAE	51	B55149	BL	55
	B54166	DM	41	B54404	DHPCF-5	36	B54849	BAE	51	B55154	BL	55
	B54167	DM	41	B54405	DHPCF-5	36	B54850	BAE	51	B55155	BL	55
	B54169	DM	41	B54412	DHPCF-5	36	B54851	BAE	51	B55156	BL	55
	B54171	DM	41	B54415	DHPCF-5	36	B54873	BC	52	B55157	BL	55
	B54173	DM	41	B54420	DHPCF-5	36	B54874	BC	52	B55158	BL	55
	B54176	DM	41	B54423	DHPCF-5	36	B54875	BC	52	B55181	BM	55
	B54179	DM	41	B54432	DHPCF-5	36	B54876	BC	52	B55182	BM	55
	B54181	DM	41	B54440	DHPCF-5	36	B54877	BC	52	B55183	BM	55
	B54182	DM	41	B54444	DHPCF-5	36	B54878	BC	52	B55184	BM	55
	B54184	DM	41	B54446	DHPCF-5	36	B54882	BC	52	B55185	BM	55
	B54186	DM	41	B54448	DHPCF-5	36	B54883	BC	52	B55190	BM	55
	B54188	DM	41	B54449	DHPCF-5	36	B54884	BC	52	B55191	BM	55
	B54190	DM	41	B54450	DHPCF-5	36	B54885	BC	52	B55192	BM	55
	B54192	DM	41	B54453	DHPCF-5	36	B54886	BC	52	B55193	BM	55
	B54193	DM	41	B54455	DHPCF-5	36	B54887	BC	52	B55194	BM	55
	B54194	DM	41	B54456	DHPCF-5	36	B54909	BD	52	B55600	BA	51
	B54196	DM	41	B54458	DHPCF-5	36	B54910	BD	52	B55601	BA	51
	B54197	DM	41	B54459	DHPCF-5	36	B54911	BD	52	B55604	BAE	51
	B54200	DM	41	B54460	DHPCF-5	36	B54912	BD	52	B55608	BA	51
	B54203	DM	41	B54509	DHPCF-8	37	B54913	BD	52	B55609	BA	51
	B54204	DM	41	B54517	DHPCF-8	37	B54914	BD	52	B55612	BAE	51
	B54205	DM	41	B54527	DHPCF-8	37	B54915	BD	52	B55620	BC	52
	B54207	DM	41	B54535	DHPCF-8	37	B54918	BD	52	B55621	BC	52
	B54209	DM	41	B54541	DHPCF-8	37	B54919	BD	52	B55624	BD	52
	B54211	DM	41	B54546	DHPCF-8	37	B54920	BD	52	B55625	BD	52
	B54212	DM	41	B54558	DHPCF-8	37	B54921	BD	52	B55628	BF	53
	B54215	DM	41	B54568	DHPCF-8	37	B54922	BD	52	B55629	BF	53
	B54216	DM	41	B54575	DHPCF-8	37	B54923	BD	52	B55632	BG	54
	B54218	DM	41	B54577	DHPCF-8	37	B54924	BD	52	B55633	BG	54
	B54220	DM	41	B54584	DHPCF-8	37	B54945	BE	53	B55636	BG	54
	B54221	DM	41	B54587	DHPCF-8	37	B54946	BE	53	B55637	BG	54
	B54223	DM	41	B54591	DHPCF-8	37	B54947	BE	53	B55640	BL	55
	B54225	DM	41	B54597	DHPCF-8	37	B54948	BE	53	B55641	BL	55
	B54227	DM	41	B54598	DHPCF-8	37	B54950	BE	53	B55644	BM	55
	B54228	DM	41	B54604	DHPCF-8	37	B54954	BE	53	B55645	BM	55
	B54230	DM	41	B54605	DHPCF-8	37	B54955	BE	53	B55648	BM	55
	B54233	DM	41	B54615	DHPCF-8	37	B54956	BE	53	B55649	BM	55
	B54235	DM	41	B54620	DHPCF-8	37	B54957	BE	53	B55652	BN	56
	B54237	DM	41	B54623	DHPCF-8	37	B54959	BE	53	B55700	BA	51
	B54239	DM	41	B54631	DHPCF-8	37	B54981	BF	53	B55701	BAE	51



EDP Number	Style Number	Page Number	EDP Number	Style Number	Page Number	EDP Number	Style Number	Page Number	EDP Number	Style Number	Page Number
B55704	BC	52	B60145	MSEV4R-TA	3	B60217	MSEV4R-TA	4	B60444	MSEV25R-TA	6
B55705	BD	52	B60146	MSEV4R-TA	3	B60218	MSEV4R-TA	4	B60445	MSEV25R-TA	6
B55707	BF	53	B60147	MSEV4R-TA	3	B60219	MSEV4R-TA	4	B60446	MSEV25R-TA	6
B55709	BM	55	B60148	MSEV4R-TA	3	B60220	MSEV4R-TA	4	B60447	MSEV25R-TA	6
B55710	BN	56	B60149	MSEV4R-TA	3	B60221	MSEV4R-TA	4	B60448	MSEV25R-TA	6
B55712	BA	51	B60150	MSEV4R-TA	3	B60222	MSEV4R-TA	4	B60449	MSEV25R-TA	6
B55713	BAE	51	B60151	MSEV4R-TA	3	B60223	MSEV4R-TA	4	B60450	MSEV25R-TA	6
B55716	BC	52	B60152	MSEV4R-TA	3	B60224	MSEV4R-TA	4	B60451	MSEV25R-TA	6
B55717	BD	52	B60153	MSEV4R-TA	3	B60225	MSEV4R-TA	4	B60452	MSEV25R-TA	6
B55718	BE	53	B60154	MSEV4R-TA	4	B60226	MSEV4R-TA	4	B60453	MSEV25R-TA	6
B55719	BF	53	B60155	MSEV4R-TA	4	B60227	MSEV4R-TA	4	B60454	MSEV25R-TA	6
B55720	BG	54	B60156	MSEV4R-TA	4	B60228	MSEV4R-TA	4	B60455	MSEV25R-TA	6
B55721	BM	55	B60157	MSEV4R-TA	4	B60229	MSEV4R-TA	4	B60456	MSEV25R-TA	6
B55722	BN	56	B60158	MSEV4R-TA	4	B60230	MSEV4R-TA	4	B60457	MSEV25R-TA	6
B55856	BAE	51	B60159	MSEV4R-TA	4	B60231	MSEV4R-TA	3	B60458	MSEV25R-TA	7
B55857	BAE	51	B60160	MSEV4R-TA	4	B60232	MSEV4R-TA	3	B60459	MSEV25R-TA	7
B55858	BAE	51	B60161	MSEV4R-TA	4	B60233	MSEV4R-TA	3	B60460	MSEV25R-TA	7
B55859	BAE	51	B60162	MSEV4R-TA	4	B60234	MSE-V-4R	3	B60461	MSEV25R-TA	7
B55860	BAE	51	B60163	MSEV4R-TA	4	B60234	MSE-V-4R	4	B60462	MSEV25R-TA	7
B55862	BC	52	B60164	MSEV4R-TA	4	B60235	MSE-V-4R	4	B60463	MSEV25R-TA	7
B55863	BC	52	B60165	MSEV4R-TA	3	B60236	MSE-V-4R	4	B60464	MSEV25R-TA	7
B55864	BC	52	B60166	MSEV4R-TA	3	B60237	MSE-V-4R	4	B60465	MSEV25R-TA	7
B55865	BC	52	B60167	MSEV4R-TA	3	B60308	MSE-V-4B-TA	5	B60466	MSEV25R-TA	7
B55867	BD	52	B60168	MSEV4R-TA	3	B60309	MSE-V-4B-TA	5	B60467	MSEV25R-TA	7
B55868	BD	52	B60169	MSEV4R-TA	3	B60310	MSE-V-4B-TA	5	B60468	MSEV25R-TA	7
B55869	BD	52	B60170	MSEV4R-TA	3	B60311	MSE-V-4B-TA	5	B60469	MSEV25R-TA	7
B55873	BE	53	B60171	MSEV4R-TA	3	B60312	MSE-V-4B-TA	5	B60470	MSEV25R-TA	7
B55874	BE	53	B60172	MSEV4R-TA	3	B60313	MSE-V-4B-TA	5	B60471	MSEV25R-TA	7
B55875	BE	53	B60173	MSEV4R-TA	3	B60314	MSE-V-4B-TA	5	B60472	MSEV25R-TA	7
B55878	BF	53	B60174	MSEV4R-TA	3	B60315	MSE-V-4B-TA	5	B60473	MSEV25R-TA	7
B55879	BF	53	B60175	MSEV4R-TA	3	B60316	MSE-V-4B-TA	5	B60474	MSEV25R-TA	7
B55880	BF	53	B60176	MSEV4R-TA	3	B60317	MSE-V-4B-TA	5	B60475	MSEV25R-TA	7
B55881	BF	53	B60177	MSEV4R-TA	3	B60320	MSE-V2-5R	6	B60476	MSEV25R-TA	7
B55884	BL	55	B60178	MSEV4R-TA	3	B60321	MSE-V2-5R	7	B60477	MSEV25R-TA	7
B55885	BL	55	B60179	MSEV4R-TA	3	B60322	MSE-V2-5R	7	B60478	MSEV25R-TA	7
B56000	DHP-5	35	B60180	MSEV4R-TA	3	B60323	MSE-V2-5R	7	B60479	MSEV25R-TA	7
B56006	DHP-5	35	B60181	MSEV4R-TA	3	B60324	MSE-V2-5R	7	B60480	MSEV25R-TA	7
B56017	DHP-5	35	B60182	MSEV4R-TA	3	B60325	MSE-V2-5R	7	B60481	MSEV25R-TA	7
B56027	DHP-5	35	B60183	MSEV4R-TA	3	B60410	MSEV25R-TA	6	B60482	MSEV25R-TA	7
B56046	DHP-5	35	B60184	MSEV4R-TA	3	B60411	MSEV25R-TA	6	B60483	MSEV25R-TA	7
B56058	DHP-5	35	B60185	MSEV4R-TA	3	B60412	MSEV25R-TA	6	B60484	MSEV25R-TA	7
B56068	DHP-5	35	B60186	MSEV4R-TA	4	B60413	MSEV25R-TA	6	B60485	MSEV25R-TA	7
B56075	DHP-5	35	B60187	MSEV4R-TA	4	B60414	MSEV25R-TA	6	B60486	MSEV25R-TA	7
B56077	DHP-5	35	B60188	MSEV4R-TA	4	B60415	MSEV25R-TA	6	B60487	MSEV25R-TA	7
B56084	DHP-5	35	B60189	MSEV4R-TA	4	B60416	MSEV25R-TA	6	B60488	MSEV25R-TA	7
B56087	DHP-5	35	B60190	MSEV4R-TA	4	B60417	MSEV25R-TA	6	B60489	MSEV25R-TA	7
B56091	DHP-5	35	B60191	MSEV4R-TA	4	B60418	MSEV25R-TA	6	B60490	MSEV25R-TA	7
B56098	DHP-5	35	B60192	MSEV4R-TA	4	B60419	MSEV25R-TA	6	B60491	MSEV25R-TA	7
B56104	DHP-5	35	B60193	MSEV4R-TA	4	B60420	MSEV25R-TA	6	B60492	MSEV25R-TA	7
B56105	DHP-5	35	B60194	MSEV4R-TA	4	B60421	MSEV25R-TA	6	B60493	MSEV25R-TA	7
B56111	DHP-5	35	B60195	MSEV4R-TA	4	B60422	MSEV25R-TA	6	B60494	MSEV25R-TA	7
B56115	DHP-5	35	B60196	MSEV4R-TA	4	B60423	MSEV25R-TA	6	B60495	MSEV25R-TA	7
B56123	DHP-5	35	B60197	MSEV4R-TA	4	B60424	MSEV25R-TA	6	B60496	MSEV25R-TA	7
B56126	DHP-5	35	B60198	MSEV4R-TA	4	B60425	MSEV25R-TA	7	B60497	MSEV25R-TA	7
B56132	DHP-5	35	B60199	MSEV4R-TA	4	B60426	MSEV25R-TA	7	B60498	MSE-V2-5R	7
B56139	DHP-5	35	B60200	MSEV4R-TA	4	B60427	MSEV25R-TA	7	B61216	MSE-2-TC	22
B56140	DHP-5	35	B60201	MSEV4R-TA	4	B60428	MSEV25R-TA	7	B62087	MSE-4	26
B56144	DHP-5	35	B60202	MSEV4R-TA	4	B60429	MSEV25R-TA	7	B62088	MSE-4	26
B56146	DHP-5	35	B60203	MSEV4R-TA	4	B60430	MSEV25R-TA	7	B62089	MSE-4	26
B56149	DHP-5	35	B60204	MSEV4R-TA	4	B60431	MSEV25R-TA	7	B62090	MSE-4	26
B56150	DHP-5	35	B60205	MSEV4R-TA	4	B60432	MSEV25R-TA	7	B62091	MSE-4	26
B56153	DHP-5	35	B60206	MSEV4R-TA	4	B60433	MSEV25R-TA	7	B62092	MSE-4	27
B56155	DHP-5	35	B60207	MSEV4R-TA	4	B60434	MSEV25R-TA	6	B62093	MSE-4	27
B56156	DHP-5	35	B60208	MSEV4R-TA	4	B60435	MSEV25R-TA	6	B62094	MSE-4	27
B56158	DHP-5	35	B60209	MSEV4R-TA	4	B60436	MSEV25R-TA	6	B62095	MSE-4	26
B56159	DHP-5	35	B60210	MSEV4R-TA	4	B60437	MSEV25R-TA	6	B62096	MSE-4	26
B56160	DHP-5	35	B60211	MSEV4R-TA	4	B60438	MSEV25R-TA	6	B62097	MSE-4	27
B60140	MSEV4R-TA	3	B60212	MSEV4R-TA	4	B60439	MSEV25R-TA	6	B62098	MSE-4	27
B60141	MSEV4R-TA	3	B60213	MSEV4R-TA	4	B60440	MSEV25R-TA	6	B62099	MSE-4	27
B60142	MSEV4R-TA	3	B60214	MSEV4R-TA	4	B60441	MSEV25R-TA	6	B62100	MSE-4	28
B60143	MSEV4R-TA	3	B60215	MSEV4R-TA	4	B60442	MSEV25R-TA	6	B66100	HPDEM-5	9
B60144	MSEV4R-TA	3	B60216	MSEV4R-TA	4	B60443	MSEV25R-TA	6	B66101	HPDEM-5	9

CARBIDE END MILLS

CARBIDE DRILLS

CARBIDE THREAD MILLS

CARBIDE BURS

INDEX



CARBIDE END MILLS

CARBIDE DRILLS

CARBIDE THREAD MILLS

CARBIDE BURS

INDEX

EDP Number	Style Number	Page Number	EDP Number	Style Number	Page Number	EDP Number	Style Number	Page Number	EDP Number	Style Number	Page Number
B66103	HPDEM-5	9	B68220	MSE-2	22	B68516	MSE-2B	24	B69123	MSE-4	27
B66104	HPDEM-5	9	B68250	MSE-4	26	B68518	MSE-2B	24	B69124	MSE-4	27
B66106	HPDEM-5	9	B68252	MSE-4	26	B68520	MSE-2B	24	B69126	MSE-4	27
B66108	HPDEM-5	9	B68254	MSE-4	27	B68550	MSE-4B	28	B69129	MSE-4	27
B66110	HPDEM-5	9	B68256	MSE-4	27	B68552	MSE-4B	28	B69130	MSE-4	27
B66215	MRS	16	B68258	MSE-4	27	B68554	MSE-4B	28	B69131	MSE-4	27
B66223	MRS	16	B68260	MSE-4	27	B68555	MSE-4B	28	B69132	MSE-4	27
B66232	MRS	16	B68262	MSE-4	28	B68556	MSE-4B	29	B69133	MSE-4	27
B66240	MRS	16	B68264	MSE-4	28	B68558	MSE-4B	29	B69134	MSE-4	27
B66248	MRS	16	B68266	MSE-4	28	B68559	MSE-4B	29	B69136	MSE-4	27
B66264	MRS	16	B68268	MSE-4	28	B68563	MSE-4B	29	B69138	MSE-4	27
B66416	MRS	16	B68270	MSE-4	28	B68574	MSE-4B	29	B69143	MSE-4	27
B66424	MRS	16	B68300	MSE-2B	23	B68575	MSE-4B	29	B69144	MSE-4	27
B66432	MRS	16	B68302	MSE-2B	23	B69001	MSE-2	21	B69145	MSE-4	27
B66440	MRS	16	B68304	MSE-2B	23	B69002	MSE-2	21	B69146	MSE-4	27
B66448	MRS	16	B68306	MSE-2B	23	B69004	MSE-2	21	B69147	MSE-4	28
B66464	MRS	16	B68308	MSE-2B	23	B69005	MSE-2	21	B69149	MSE-4	28
B67104	MSE-3	25	B68310	MSE-2B	24	B69007	MSE-2	21	B69151	MSE-4	28
B67105	MSE-3	25	B68312	MSE-2B	24	B69008	MSE-2	21	B69153	MSE-4	28
B67106	MSE-3	25	B68314	MSE-2B	24	B69010	MSE-2	21	B69157	MSE-4	26
B67107	MSE-3	25	B68316	MSE-2B	24	B69013	MSE-2	21	B69158	MSE-4	26
B67108	MSE-3	25	B68318	MSE-2B	24	B69014	MSE-2	21	B69159	MSE-4	26
B67109	MSE-3	25	B68320	MSE-2B	24	B69017	MSE-2	21	B69160	MSE-4	26
B67110	MSE-3	25	B68350	MSE-4B	28	B69020	MSE-2	21	B69162	MSE-4	26
B67111	MSE-3	25	B68352	MSE-4B	28	B69021	MSE-2	21	B69163	MSE-4	26
B67112	MSE-3	25	B68354	MSE-4B	28	B69023	MSE-2	21	B69164	MSE-4	25
B67113	MSE-3	25	B68356	MSE-4B	29	B69026	MSE-2	21	B69165	MSE-4	25
B67114	MSE-3	25	B68358	MSE-4B	29	B69038	MSE-2	22	B69167	MSE-4	27
B67115	MSE-3	25	B68400	MSE-2	21	B69045	MSE-2	22	B69168	MSE-4	27
B67116	MSE-3	25	B68402	MSE-2	21	B69047	MSE-2	22	B69170	MSE-4	27
B67117	MSE-3	25	B68404	MSE-2	21	B69053	MSE-2	22	B69171	MSE-4	27
B67118	MSE-3	25	B68405	MSE-2	21	B69060	MSE-2	21	B69172	MSE-4	27
B67120	MSE-3	25	B68406	MSE-2	22	B69061	MSE-2	21	B69173	MSE-4	27
B67124	MSE-3	25	B68408	MSE-2	22	B69062	MSE-2	21	B69174	MSE-4	28
B67128	MSE-3	25	B68409	MSE-2	22	B69063	MSE-2	21	B69175	MSE-4	28
B67132	MSE-3	25	B68410	MSE-2	22	B69065	MSE-2	21	B69176	MSE-4	28
B67136	MSE-3	25	B68411	MSE-2	22	B69066	MSE-2	21	B69177	MSE-4	28
B67140	MSE-3	25	B68412	MSE-2	22	B69068	MSE-2	22	B69178	MSE-4	28
B67148	MSE-3	25	B68414	MSE-2	22	B69069	MSE-2	22	B69179	MSE-4	28
B67156	MSE-3	25	B68416	MSE-2	22	B69070	MSE-2	22	B69180	MSE-4	28
B67164	MSE-3	25	B68418	MSE-2	22	B69072	MSE-2	22	B69181	MSE-4	28
B67200	MSE-3	25	B68420	MSE-2	22	B69073	MSE-2	22	B69182	MSE-4	28
B67201	MSE-3	25	B68450	MSE-4	26	B69074	MSE-2	22	B69183	MSE-4	28
B67202	MSE-3	25	B68451	MSE-4	26	B69076	MSE-2	22	B69184	MSE-4	28
B67203	MSE-3	25	B68452	MSE-4	26	B69077	MSE-2	22	B69201	MSE-2B	23
B67205	MSE-3	25	B68454	MSE-4	27	B69078	MSE-2	22	B69202	MSE-2B	23
B67206	MSE-3	25	B68455	MSE-4	27	B69080	MSE-2	22	B69204	MSE-2B	23
B67208	MSE-3	25	B68456	MSE-4	27	B69081	MSE-2	22	B69205	MSE-2B	23
B67209	MSE-3	25	B68457	MSE-4	27	B69082	MSE-2	22	B69207	MSE-2B	23
B67210	MSE-3	25	B68458	MSE-4	27	B69084	MSE-2	22	B69208	MSE-2B	23
B67212	MSE-3	25	B68459	MSE-4	27	B69085	MSE-2	22	B69210	MSE-2B	23
B67213	MSE-3	25	B68460	MSE-4	27	B69086	MSE-2	22	B69211	MSE-2B	23
B67214	MSE-3	25	B68461	MSE-4	28	B69101	MSE-4	26	B69214	MSE-2B	23
B67216	MSE-3	25	B68462	MSE-4	28	B69102	MSE-4	26	B69216	MSE-2B	23
B67217	MSE-3	25	B68464	MSE-4	28	B69104	MSE-4	26	B69217	MSE-2B	23
B67218	MSE-3	25	B68466	MSE-4	28	B69105	MSE-4	26	B69220	MSE-2B	23
B67220	MSE-3	25	B68468	MSE-4	28	B69106	MSE-4	26	B69221	MSE-2B	23
B67221	MSE-3	25	B68470	MSE-4	28	B69107	MSE-4	26	B69223	MSE-2B	23
B67222	MSE-3	25	B68472	MSE-4	27	B69108	MSE-4	26	B69247	MSE-2B	24
B67224	MSE-3	25	B68499	MSE-4B	28	B69110	MSE-4	26	B69251	MSE-2B	24
B67225	MSE-3	25	B68500	MSE-2B	23	B69111	MSE-4	26	B69253	MSE-2B	24
B67226	MSE-3	25	B68502	MSE-2B	23	B69112	MSE-2	21	B69301	MSE-4B	28
B68200	MSE-2	21	B68503	MSE-4B	28	B69113	MSE-4	26	B69302	MSE-4B	28
B68202	MSE-2	21	B68504	MSE-2B	23	B69114	MSE-4	26	B69303	MSE-4B	28
B68204	MSE-2	21	B68505	MSE-2B	23	B69115	MSE-4	26	B69304	MSE-4B	28
B68206	MSE-2	21	B68506	MSE-2B	23	B69116	MSE-4	26	B69305	MSE-4B	28
B68208	MSE-2	22	B68508	MSE-2B	23	B69117	MSE-4	26	B69306	MSE-4B	28
B68210	MSE-2	22	B68509	MSE-2B	23	B69118	MSE-4	27	B69308	MSE-4B	28
B68212	MSE-2	22	B68510	MSE-2B	24	B69119	MSE-4	27	B69309	MSE-4B	28
B68214	MSE-2	22	B68511	MSE-2B	24	B69120	MSE-4	27	B69310	MSE-4B	28
B68216	MSE-2	22	B68512	MSE-2B	24	B69121	MSE-4	27	B69311	MSE-4B	28
B68218	MSE-2	22	B68514	MSE-2B	24	B69122	MSE-4	27	B69313	MSE-4B	28



EDP Number	Style Number	Page Number	EDP Number	Style Number	Page Number	EDP Number	Style Number	Page Number	EDP Number	Style Number	Page Number
B69314	MSE-4B	28	B69737	MSE-4B	28	B71100	TMBPP	46			
B69316	MSE-4B	28	B69739	MSE-4B	29	B71101	TMBPP	46			
B69317	MSE-4B	28	B69741	MSE-4B	29	B71102	TMBPP	46			
B69320	MSE-4B	28	B69843	MDE-4	20	B71104	TMBPP	46			
B69321	MSE-4B	28	B69845	MDE-4	20	B71120	TMBPT	46			
B69323	MSE-4B	29	B69846	MDE-4	20	B71121	TMBPT	46			
B69326	MSE-4B	29	B69881	MDE-2B	19	B71122	TMBPT	46			
B69443	MDE-4	20	B69883	MDE-2B	19	B71123	TMBPT	46			
B69447	MDE-4	20	B69921	MDE-4B	20	B71508	TMC	45			
B69452	MDE-4	20	B69923	MDE-4B	20	B71509	TMC	45			
B69460	MDE-4	20	B70175	HPEM-5	11	B71510	TMC	45			
B69481	MDE-2B	19	B70180	HPEM-6	12	B71511	TMC	45			
B69483	MDE-2B	19	B70181	HPEM-6	12	B71512	TMC	45			
B69485	MDE-2B	19	B70185	HPEM-6	12	B71513	TMC	45			
B69487	MDE-2B	19	B70186	HPEM-6	12	B71514	TMC	45			
B69490	MDE-2B	19	B70187	HPEM-6	12	B71515	TMC	45			
B69492	MDE-2B	19	B70190	MSE-V-4B	5	B71516	TMC	45			
B69494	MDE-2B	19	B70199	MSE-V2-5R	6	B71518	TMC	45			
B69498	MDE-2B	19	B70201	MSEST-2	31	B71519	TMC	45			
B69500	MDE-2B	19	B70203	MSEST-2	31	B71520	TMC	45			
B69503	MDE-2B	19	B70205	MSEST-2	31	B71521	TMC	45			
B69521	MDE-4B	20	B70207	MSEST-2	31	B71522	TMC	45			
B69523	MDE-4B	20	B70210	MSEST-2	31	B71523	TMC	45			
B69525	MDE-4B	20	B70212	MSEST-2	31	B71525	TMC	45			
B69527	MDE-4B	20	B70215	MSEST-2	31	B71526	TMC	45			
B69530	MDE-4B	20	B71000	TM	45	B71527	TMC	45			
B69532	MDE-4B	20	B71002	TM	45	B71528	TMC	45			
B69534	MDE-4B	20	B71003	TM	45	B71529	TMC	45			
B69538	MDE-4B	20	B71004	TM	45	B71550	TMNPC	46			
B69540	MDE-4B	20	B71005	TM	45	B71551	TMNPC	46			
B69543	MDE-4B	20	B71008	TM	45	B71552	TMNPC	46			
B69601	MSE-2	21	B71009	TM	45	B71555	TMNPC	46			
B69602	MSE-2	21	B71010	TM	45	B71556	TMNPC	46			
B69602	MSE-2	21	B71011	TM	45	B71572	TMMC	47			
B69602	MSE-2B	23	B71012	TM	45	B71573	TMMC	47			
B69604	MSE-2	21	B71013	TM	45	B71574	TMMC	47			
B69606	MSE-2	21	B71014	TM	45	B71575	TMMC	47			
B69608	MSE-2	21	B71015	TM	45	B71576	TMMC	47			
B69623	MSE-2	21	B71016	TM	45	B71577	TMMC	47			
B69628	MSE-2	21	B71017	TM	45	B71578	TMMC	47			
B69641	MSE-4	26	B71018	TM	45	B71579	TMMC	47			
B69642	MSE-4	26	B71019	TM	45	B71580	TMMC	47			
B69643	MSE-4	26	B71020	TM	45	B71581	TMMC	47			
B69644	MSE-4	26	B71021	TM	45	B71582	TMMC	47			
B69645	MSE-4	26	B71022	TM	45	B71583	TMMC	47			
B69646	MSE-4	26	B71023	TM	45	B71584	TMMC	47			
B69648	MSE-4	26	B71025	TM	45	B71585	TMMC	47			
B69650	MSE-4	26	B71026	TM	45	B71600	TMBPPC	46			
B69652	MSE-4	26	B71027	TM	45	B71601	TMBPPC	46			
B69657	MSE-4	25	B71028	TM	45	B71602	TMBPPC	46			
B69663	MSE-4	27	B71029	TM	45	B71604	TMBPPC	46			
B69681	MSE-2B	23	B71050	TMNP	46	B71620	TMBPTC	46			
B69682	MSE-2B	23	B71051	TMNP	46	B71621	TMBPTC	46			
B69684	MSE-2B	23	B71052	TMNP	46	B71622	TMBPTC	46			
B69688	MSE-2B	23	B71055	TMNP	46	B71623	TMBPTC	46			
B69697	MSE-2B	23	B71056	TMNP	46	B81577	MSE-2	21			
B69699	MSE-2B	23	B71070	TMM	47	B81578	MSE-2	21			
B69701	MSE-2B	23	B71071	TMM	47	B81579	MSE-2	22			
B69703	MSE-2B	24	B71072	TMM	47	B81581	MSE-2	22			
B69706	MSE-2B	24	B71073	TMM	47	B81583	MSE-2	22			
B69708	MSE-2B	24	B71074	TMM	47	B81587	MSE-4	27			
B69711	MSE-2B	24	B71075	TMM	47	B81588	MSE-4	27			
B69716	MSE-4B	28	B71076	TMM	47	B81590	MSE-4	27			
B69717	MSE-4B	28	B71077	TMM	47	B81591	MSE-4	28			
B69718	MSE-4B	28	B71078	TMM	47	B81592	MSE-4	28			
B69719	MSE-4B	28	B71079	TMM	47	B90238	MSE-V-4R	4			
B69720	MSE-4B	28	B71080	TMM	47						
B69721	MSE-4B	28	B71081	TMM	47						
B69722	MSE-4B	28	B71082	TMM	47						
B69724	MSE-4B	28	B71083	TMM	47						
B69728	MSE-4B	28	B71084	TMM	47						
B69732	MSE-4B	28	B71085	TMM	47						

CARBIDE END MILLS

CARBIDE DRILLS

CARBIDE THREAD MILLS

CARBIDE BURS

INDEX





**BASSETT™**

## Solid Carbide Cutting Tools

End Mills • Thread Mills • Drills • Burs



A MEMBER OF THE TDC GROUP

### Greenfield Industries Inc.

2501 Davis Creek Road, Seneca, SC 29678

#### *Distributor Customer Service:*

telephone 800.348.2885  
fax USA 800.892.4290 • Canada 800.696.8938  
email USA – standard.distributors@gfii.com  
Canada – canada.distributors@gfii.com

#### *International Sales:*

telephone 706.706.650.4196  
fax 706.854.4054  
email international.distributors@gfii.com

#### *Technical Support:*

telephone 800.892.4281  
fax 800.892.4290  
email greenfield.information@gfii.com

#### *Distributed by:*



©2012 Greenfield Industries, Inc., Seneca, SC USA  
All rights reserved. Catalog Number BAS2013