

Life Is On

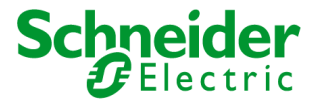

EPC3000 FM Programmable Controllers

EPC3016, EPC3008, EPC3004

User Guide

HA033650ENG Issue 1

August 2021



Eurotherm®

Expertise in systems and solutions, services and support.

Table of Contents

- Table of Contents** 3
- Safety Information** 11
 - Important Information.....11
- Safety and EMC** 12
 - Hazardous Substances 18
- Cybersecurity** 19
 - Introduction 19
 - Cybersecurity Good Practices 19
 - Security Features..... 19
 - Principle of Secure by Default 19
 - HMI Access Level / Comms Config Mode 21
 - HMI Passwords..... 21
 - OEM Security Password 21
 - Comms Configuration Level Password..... 21
 - Ethernet security features 22
 - Communications watchdog..... 23
 - Configuration backup and recovery 23
 - User Sessions..... 23
 - Memory/Data Integrity..... 24
 - Achilles® Communications Certification..... 24
 - Decommissioning..... 24
- Legal Information** 25
- Introduction** 26
 - Controller Concept..... 26
 - User Guide Concept 26
 - How to Videos..... 26
 - Issue Status of this Manual..... 27
- Installation** 28
 - What Instrument Do I Have?..... 29
 - EPC3000 FM (Factory Mutual) version..... 29
 - Order Code 30
 - Unpacking Your Controller 31
 - Dimensions 32
 - Installation..... 35
 - Panel Mounting the Controller 35
 - Panel Cut Out Sizes 36
 - Recommended minimum spacing of controllers..... 36
- Terminal Wiring** 38
 - Terminal Layout EPC3016 Controller..... 39
 - EPC3016 Options 39
 - Terminal Layout EPC3008 and EPC3004 Controller 40
 - EPC3008 and EPC3004 Options..... 40
 - Isolation Boundaries..... 41
 - EPC3008/EPC3004 Isolation..... 41
 - EPC3016 Isolation 41
 - Wire Sizes..... 42
 - Controller Power Supply 42
 - Fuse Protection..... 43
 - Line/Mains Voltage Power Supply 43
 - Low Voltage Power Supply 43
 - Sensor Inputs (Measuring Input)..... 44
 - Primary Sensor Input (Measuring Input)..... 45
 - Secondary Sensor Input (Measuring Input) 46

- Inputs/Outputs (IO)..... 47
 - Input/Output 1 (I/O1) 47
 - Input/Output 2 (IO2) 49
 - Input/Output 4 (IO4) 51
 - Output 3 (OP3)..... 52
- General Information About Relays and Triacs and Inductive Loads 53
- Current Transformer 54
- Contact Closure Inputs (DI1 and DI2) 55
- Transmitter Power Supply 56
- Digital Inputs/Outputs 1 to 8..... 56
 - Example 1 BCD Switch Wiring 56
 - Example 2 Digital Inputs Wiring 57
 - Example 3 Digital Outputs Wiring 57
- Digital Communications Connections 58
 - EIA-232 Wiring 58
 - Serial Communications EIA-485 59
 - EIA-422 Wiring 60
 - Ethernet Wiring 60
- Wiring Examples 61
 - Heat/Cool Controller 61
 - CT Wiring Diagram 62
- Start Up Modes 63**
 - Start up..... 63
 - Start up Diagnostic mode 63
 - General Description of Front Panel Displays 64
 - EPC3016..... 64
 - EPC3008..... 64
 - EPC3004..... 65
 - General Description of Operator Buttons 66
 - Button Layout..... 66
 - Button Operation..... 66
 - Start Up—New Unconfigured Controller 68
 - Quick Start Tables 69
 - Quick Code Set 1 69
 - Quick Code Set 2..... 70
 - Quick Codes DIO 70
 - To Save or Discard Quick Codes 72
 - Configure the Communications Protocol 73
 - To Re-Enter Quick Code mode 74
 - Start Up - New Configured Controller 75
 - Bar Graph 75
 - Setpoint..... 75
 - Subsequent Start-ups 76
 - Start-up Modes 76
 - Standby..... 77
 - Auto-scaling of decimal point..... 78
- Operator Levels 79**
 - Overview 79
 - Operator Level 1 80
 - Auto/Manual Mode..... 80
 - System Messages..... 81
 - Setting the Comms Password 81
 - Comms Configuration Active 81
 - Bargraph 81
 - Level 1 Operator Parameters..... 82
 - Level 1 Programmer Display..... 83
 - Programmer List 83
 - Programmer Status Indicator 84
 - Operator Level 2 85
 - To Select Operator Level 2 85
 - Level 2 Operator Parameters..... 86

- Level 2 Programmer Display 88
 - Programmer List 88
 - Program Setup List 89
- Operator Level 3 90
 - To Enter Level 3 90
 - Level 3 Operator Parameters 91
 - To Return to a Lower Level 91
- Navigation Diagram 92**
 - Toolkit Blocks 92
 - Features 93
 - Navigation Diagram 94
- Configuration Level 96**
 - Function Blocks 96
 - Configuration Level Parameters 97
 - To Select Configuration Level 98
 - To Return to Level 1 98
 - Configuration and Level 3 Navigation Diagram 99
 - Examples 99
 - Analog Input List (a1 a2) 102
 - Units 105
 - Status 106
 - I/O List (io) 107
 - Output Splitting 111
 - Cycle Time and Minimum OnTime Algorithms 112
 - DI/O List (O.d.IO) 113
 - CT List (Ct) 114
 - Loop List (LOOP) 116
 - Loop - Main Sub-list 117
 - Configuration Sub-List 119
 - Setpoint Sub-list 121
 - Feedforward Sub-list 124
 - Autotune Sub-list 126
 - PID Sub-list 128
 - OP Sub-list 131
 - Diagnostics Sub-list 133
 - Programmer List (PROG) 135
 - Program Setup List (P.SET) 138
 - Alarms List (ALm) 141
 - BCD List (bCd) 145
 - Recipe List (RECP) 147
 - To Save Recipes 149
 - To Load a Recipe 149
 - Communications List (COmm) 150
 - Main Sub List (mAIN) 151
 - Network Sub List (nWrk) 153
 - Broadcast Sub List (bCSt) 154
 - EtherNet/IP Sub List 155
 - BACnet Sub List (b.NET) 156
 - Modbus Master List (mOd.m) 157
 - Main Sub List (mAIN) 158
 - Diagnostics Sub List (dlag) 161
 - DataPoint Sub List (DATA) 163
 - Maths List (mAth) 169
 - Select Input 171
 - Logic Operator List (LGC2) 172
 - 8 Input Logic Operator List (LGC8) 174
 - Timer List (tmr) 176
 - Timer Modes 177
 - Counter List (Cntr) 180
 - Totalizer List (tOtL) 182
 - 8 Input Analog MUX List (AN.SW) 184

- User Value List (u.VAL) 186
- Input Monitor List (I.mon) 187
- Switchover List (SW.OV)..... 189
- Logic OR List (OR)..... 191
- Instrument List (INST) 193
 - Information Sub-List (INFO)..... 194
 - Display Functionality Sub-List (Hml)..... 195
 - Security Sub-List (SEC)..... 197
 - Diagnostics Sub-List (diAG)..... 199
 - Modules Sub-List (mOdS) 202
 - Enables 202
 - Calibration Sub-List (CAL) 203
- Input Linearization (LIN16)..... 204
 - LIN16 Parameter Navigation 204
 - Linearization Block Parameters 205
- Remote Input List (REm.1) 207
- Comms Indirection Table 208
- Q Code List 210
- Configuration Using iTools 212**
 - What is iTools? 212
 - What is an IDM?..... 212
 - To Load an IDM..... 212
 - Connecting a PC to the Controller 213
 - Using the Configuration Clip 213
 - Using the Communications Port 214
 - Using Option Comms 214
 - Starting iTools..... 215
 - The 'Browser' List..... 216
 - Configuration Access 217
 - Setting Comms Configuration Password 218
 - To Put iTools into Configuration Mode 219
 - Instrument List 221
 - Terminal Editor 222
 - Graphical Wiring 223
 - Example 1: To Wire an Alarm..... 224
 - Example 2: To Connect an Alarm to a Physical Output 224
 - Example 3: To Wire Sensor Break 225
 - Example 4: To Configure a Bargraph..... 225
 - Example 5: To Wire a Retransmission Output 226
 - Applications..... 228
 - EPC3000 FM Limit Alarm - High 228
 - EPC3000 FM Limit Alarm - Low..... 230
 - Flash Memory Editor 232
 - Parameter Promotion..... 233
 - User Defined Messages 235
 - Recipes 237
 - Watch Recipe Editor 240
 - To Load a Custom Linearization Table..... 242
 - Cloning..... 243
 - Save to File..... 243
 - To Clone a New Controller 243
 - Clone Load Unsuccessful 244
 - Cold Start..... 244
- Alarms 245**
 - What are Alarms?..... 245
 - Alarm Types 246
 - Absolute High 246
 - Absolute Low 246
 - Deviation High 246
 - Deviation Low 247
 - Deviation Band 247

- Rising Rate of Change..... 247
- Falling Rate of Change 248
- Digital High 248
- Digital Low 248
- Sensor Break 248
- Hysteresis 249
- Delay..... 249
- Effects of Delay and Hysteresis 249
- Inhibit 251
- Standby Inhibit 251
- Latching 252
- Blocking 252
- To Set Alarm Threshold..... 253
- Alarm Indication 253
- To Acknowledge an Alarm 254
- Alarms Advanced 256
- Programmer 257**
- What is a Programmer? 257
- Programs..... 258
- Segments..... 258
 - Ramp Time..... 258
 - Dwell 258
 - Step..... 258
 - Call..... 259
 - End..... 259
- Standard Functionality 260
 - Recovery Strategy after a reset or power outage 260
 - Ramp back (Dwell Segments) 260
 - Ramp back (Ramp or Time-to-target segments)..... 261
 - Sensor Break Recovery 261
 - Holdback 261
 - Servo To PV/SP 261
 - Event Outputs 261
 - Digital Inputs 262
 - Program Cycles 262
 - Configuration Mode Reset 262
 - Program Selection 262
 - Rules for Program Creation / Editing 263
 - Program & Segment Times..... 263
 - Resolution 264
 - Programmer Time Base Accuracy 264
 - Typical Loop to Programmer Graphical Wiring 265
 - Communications 266
 - Modbus Address Ranges..... 266
 - EI-Bisynch Mnemonics 267
 - To Setup a Program from the HMI 268
 - To Run/Hold the Program from the HMI 270
 - To Setup a Program Using iTools..... 271
 - To Name Programs and Segments..... 274
 - To Save and Load Stored Program Files (*.uip) 275
 - To Run, Reset and Hold a Program in iTools 276
- Programmer Parameters in iTools..... 278
 - Programmer.Run..... 278
 - Programmer.Setup..... 280
 - WorkingProgram 282
 - WorkingSegment 284

Control	286
Types of Control	287
PID Control	287
Reverse/Direct Action	292
Loop Break	292
Gain scheduling	292
Motorized Valve Positioning Control	293
Boundless Valve Position (VPU).....	293
Motorized Valve Control in Manual mode	293
On-Off Control.....	294
Feedforward	295
Disturbance feedforward	295
Setpoint feedforward	296
Static or dynamic compensation	297
Split Range (heat/cool).....	298
Cooling Algorithm.....	299
Non-linear cooling	299
Channel 2 (heat/cool) Deadband	300
Bumpless Transfer	301
Sensor Break	301
Operating Modes.....	302
Start-up and Recovery	302
Setpoint subsystem.....	303
Remote/Local Setpoint Source Selection	304
Local Setpoint Selection	304
Remote Setpoint	304
Setpoint limits.....	305
Setpoint Rate Limit.....	305
Target SP	305
Tracking	306
Back-calculated SP and PV	306
Setpoint Integral Balance	306
Output Subsystem.....	307
Output selection (including Manual Station)	307
Output Limiting.....	307
Rate limiting	308
Power feedforward (line voltage compensation).....	308
Autotuning.....	309
Autotuning multiple zones.....	314
Digital Communications	315
Serial Communications	315
EI-Bisynch.....	315
EI-Bisynch Limitations	317
Modbus RTU.....	318
Serial Comms Parameters.....	318
Ethernet Communications.....	319
Setting Up the Ethernet Module.....	319
Ethernet Parameters.....	320
Protocols	327
EtherNet/IP	327
EPC3000 Controller EtherNet/IP Features	327
CIP Object Support.....	328
Setting Up The EtherNet/IP Scanner	328
Configure Scanner Connection Settings to the EPC3000 Controller	
EtherNet/IP Adapter	333
Establishing Communications.....	339
Data Formats	339
The EDS File	339
Troubleshooting	339
BACnet.....	341
BACnet Objects	341

BACnet Services	341
BACnet Object Mapping	341
Configuring BACnet	342
Modbus Master	344
Overview	344
Modbus Master Configuration.....	344
Comms Indirection Table	357
Fieldbus IO Gateway.....	358
Input Linearization (LIN16)	360
Custom Linearization	360
Example 1: Custom Linearization - Increasing Curve.....	361
To Setup the Parameters	361
Example 2: Custom Linearization - Skipped Points Curve	363
Example 3: Custom Linearization - Decreasing Curve	365
Adjustment of the Process Variable	366
User Calibration	369
Controller only Calibration.....	369
To Calibrate the Analog Input.....	369
Using iTools	370
To Return to Factory Calibration	371
Two Point Offset.....	372
Using the Controller HMI.....	373
Calibration using a Dry Block or Equivalent.....	374
To Calibrate a Voltage or Current Analog Output.....	375
Using the Controller HMI.....	375
Using iTools.....	376
To Calibrate the Current Transformer.....	377
Notification Messages	378
OEM Security	380
Implementation	380
OEM Configuration List.....	382
OEM Operator List	382
Effect of the 'OEM ParamList' Parameter	383
'OEMParamLists' On	384
'OEMParaLists' Off	384
Technical Specification	385
General	385
Function Blocks Available	386
Environmental specifications, standards, approvals and certifications	387
EN ISO 13849 Assessment Declaration	387
Mechanical.....	388
Dimensions	388
Weight.....	388
Input and Outputs	389
I/O and Communication types	389
I/O Specifications	389
Inputs and Outputs	390
Remote Setpoint (Aux) Analog input (EPC3016 only)	390
Current transformer input.....	390
Contact closure inputs LA and LB.....	390
Logic I/O modules	391
Logic I/O open collector type (EPC3008/3004 controllers only)	391
TRIAC module	393
Isolated DC output module	393
Power supply and transmitter power supply	393
Communications	393
Operator interface	394

Appendix: EI-BISYNCH Parameters	395
Appendix: EPC3000 Factory Mutual (FM)	400
FM Limit function (Low & High) - Overview	400
Setting up	401
Wiring and Connections	401
FM Relay (Output 3, OP3)	401
Application (FM Limit Alarm High / Low) selection	401
Alarm Types (FM)	402
Setting an Alarm (FM)	402
Acknowledging an Alarm (FM)	403

Safety Information

Important Information

Read these instructions carefully and look at the equipment to become familiar with the device before trying to install, operate, service, or maintain it. The following special messages may appear throughout this manual or on the equipment to warn of potential hazards or to call attention to information that clarifies or simplifies a procedure.



The addition of either symbol to a “Danger” or “Warning” safety label indicates that an electrical hazard exists which will result in personal injury if the instructions are not followed.



This is the safety alert symbol. It is used to alert you to potential personal injury hazards. Obey all safety messages that follow this symbol to avoid possible injury or death.

⚠ DANGER
DANGER indicates a hazardous situation which, if not avoided, will result in death or serious injury.

⚠ WARNING
WARNING indicates a hazardous situation which, if not avoided, could result in death or serious injury.

⚠ CAUTION
CAUTION indicates a hazardous situation which, if not avoided, could result in minor or moderate injury.

NOTICE
NOTICE is used to address practices not related to physical injury. The safety alert symbol shall not be used with this signal word.

Notes:

1. Electrical equipment must be installed, operated, serviced and maintained only by qualified personnel. No responsibility is assumed by Schneider Electric for any consequences arising out of the use of this material.
2. A qualified person is one who has skills and knowledge related to the construction, and operation of electrical equipment and its installation, and has received safety training to recognize and avoid the hazards involved.

Safety and EMC

DANGER

HAZARD OF ELECTRIC SHOCK, EXPLOSION OR ARC FLASH

Power down all equipment before starting the installation, removal, wiring, maintenance or inspection of the product.

For permanently connected equipment, include a disconnecting device such as an isolating switch or circuit breaker in the installation.

Use a properly rated voltage sensing device to confirm the power is off.

Power line and output circuits must be wired and fused in compliance with local and national regulatory requirements for the rated current and voltage of the particular equipment. i.e. UK, the latest IEE wiring regulations, (BS7671), and USA, NEC Class 1 wiring methods.

Failure to follow these instructions will result in death or serious injury.

Reasonable use and responsibility

The safety of any system incorporating this product is the responsibility of the assembler/installer of the system.

The disconnecting device must be in close proximity to the equipment and within easy reach of the operator, and it must be marked as the disconnecting device for the equipment.

The information contained in this manual is subject to change without notice. While every effort has been made to ensure the accuracy of the information, your supplier shall not be held liable for errors contained herein.

This controller is intended for industrial temperature and process control applications which meet the requirements of the European Directives on Safety and EMC.

Use in other applications, or failure to observe the installation instructions of this manual may compromise safety or EMC. The installer must ensure the safety and EMC of any particular installation.

Failure to use approved software/hardware with our hardware products may result in injury, harm, or improper operating results.

PLEASE NOTE

Electrical equipment must be installed, operated, serviced, and maintained only by qualified personnel.

No responsibility is assumed by Schneider Electric for any consequences arising out of the use of this material.

A qualified person is one who has skills and knowledge related to the construction and operation of electrical equipment and its installation, and has received safety training to recognize and avoid the hazards involved.

QUALIFICATION OF PERSONNEL

Only appropriately trained persons who are familiar with and understand the contents of this manual and all other pertinent product documentation are authorized to work on and with this product.

The qualified person must be able to detect possible hazards that may arise from parameterization, modifying parameter values and generally from mechanical, electrical, or electronic equipment.

The qualified person must be familiar with the standards, provisions, and regulations for the prevention of industrial accidents, which they must observe when designing and implementing the system.

INTENDED USE

The products described or affected by this document, together with software and options, are EPC3016, EPC3008, EPC3004 Programmable Controllers (referred to herein as “controller”). They are intended for industrial use according to the instructions, directions, examples, and safety information contained in the present document and other supporting documentation.

The product must only be used in compliance with all applicable safety regulations and directives, the specified requirements, and the technical data.

Prior to using the product, a risk assessment must be performed in respect of the planned application. Based on the results, the appropriate safety-related measures must be implemented.

Since the product is used as a component within an overall machine or process, you must ensure the safety of the overall system.

Operate the product only with the specified cables and accessories. Use only genuine accessories and spare parts.

Any use other than that explicitly permitted is prohibited and can result in unanticipated hazards.

 **DANGER****HAZARD OF ELECTRIC SHOCK, EXPLOSION OR ARC FLASH**

Electrical equipment must be installed, operated and maintained by only qualified personnel.

Turn off all power to product and all I/O circuitry (alarms, control I/O etc.) before starting the installation, removal, wiring, maintenance or inspection of the product.

Power line and output circuits must be wired and fused in compliance with local and national regulatory requirements for the rated current and voltage of the particular equipment, i.e. UK, the latest IEE wiring regulations, (BS7671), and USA, NEC class 1 wiring methods.

The unit must be installed in an enclosure or a cabinet. Failure to do this impairs the safety of the unit. An enclosure or a cabinet should provide fire enclosure and/or restriction of access to hazards.

Do not exceed the device's ratings.

This product must be installed, connected and used in compliance with prevailing standards and/or installation regulations. If this product is used in a manner not specified by the manufacturer, the protection provided by the product may be impaired.

The controller is designed to operate if a temperature sensor is connected directly to an electrical heating element. The Primary Sensor Input IP1 is not isolated from the logic outputs and digital inputs DI1 and DI2, therefore, these terminals could be at line potential. You must ensure that service personnel do not touch connections to these inputs while they are live.

With a live sensor, all cables, connectors and switches for connecting the sensor must be mains rated for use in 230Vac +15% CATII.

Do not insert anything through the case apertures.

Tighten terminal screws in conformance with the torque specifications.

A maximum of two wires, identical in type and cross sectional size can be inserted per terminal. Strip the insulation from the cables by a minimum of 6mm (0.24") in order to ensure good contact with the terminal. Do not exceed a maximum exposed cable conductor length of 2mm (0.08").

If a current transformer (CT) is used in the installation, a voltage limiting device fitted across the CT terminals, will help to prevent high voltages appearing at the CT terminals if the controller is unplugged. A suitable device is two back-to-back zener diodes rated between 3 and 10V, 50mA.

Apply appropriate personal protective equipment (PPE) and follow safe electrical work practices. See NFPA 70E or CSA Z462.

Failure to follow these instructions will result in death or serious injury.

⚠ DANGER**FIRE HAZARD**

If upon receipt, the unit or any part within is damaged, do not install but contact your supplier.

Do not allow anything to fall through the case apertures and ingress the controller.

Ensure the correct wire gauge size is used per circuit and it is rated for the current capacity of the circuit.

When using ferrules (cable ends) ensure the correct size is selected and each is securely fixed to the wire using a crimping tool.

The controller must be connected to the correct rated power supply unit or supply voltage in accordance with the supply voltage rating displayed on the controller label. or in the User guide. Use only isolating PELV or SELV power supplies to supply power to the equipment.

EPC3000 ("Line Voltage" intimates 230v only, but what if its 12, 24 48Volt:
The controller must be connected to the correct line voltage in accordance with the order code and line voltage shown on the controller label. Use only isolating PELV or SELV power supplies to supply power to the equipment.

EPC2000 (24v Only):

Do not connect the controller directly to line voltage. Use only isolating PELV or SELV power supplies to supply power to the equipment.

Failure to follow these instructions will result in death or serious injury.

⚠ WARNING**UNINTENDED EQUIPMENT OPERATION**

Do not use the product for critical control or protection applications where human or equipment safety relies on the operation of the control circuit.

Observe all electrostatic discharge precautions before handling the unit.

Electrically conductive pollution must be excluded from the cabinet in which the controller is mounted for example, carbon dust. In conditions of conductive pollution in the environment, fit an air filter to the air intake of the cabinet. Where condensation is likely, for example, at low temperature, include a thermostatically controlled heater in the cabinet.

Avoid ingress of conductive materials during installation.

Use appropriate safety interlocks where personnel and/or equipment hazards exist.

Install and operate this equipment in an enclosure appropriately rated for its intended environment.

Routing of wires, to minimize the pick-up of EMI (Electromagnetic interference), the low voltage DC connections and the sensor input wiring must be routed away from high-current power cables. Where it is impractical to do this, use shielded cables with the shield grounded. In general keep cable lengths to a minimum.

Do not disassemble, repair or modify the equipment. Contact your supplier for repair.

Ensure all cables and wiring harness are secured using a relevant strain relief mechanism.

Wiring, it is important to connect the unit in accordance with the data in this User guide and use copper cables (except the thermocouple wiring).

Only connect wires to identified terminals shown on the product warning label, the wiring section of the product User guide or Installation sheet.

Safety and EMC protection can be seriously impaired if the unit is not used in the manner specified. The installer must ensure the safety and EMC of the installation.

If the output is not wired, but written to by communications, it will continue to be controlled by the communications messages. In this case take care to allow for the loss of communications.

The application of this product requires expertise in the design and programming of control systems. Only persons with such expertise must be allowed to program, install, alter and commission this product.

During commissioning ensure all operating states and potential fault conditions are carefully tested.

Do not use, or implement a controller configuration (control strategy) into service without ensuring the configuration has completed all operational tests, been commissioned and approved for service.

It is the responsibility of the person commissioning the controller to ensure the configuration is correct.

The controller must not be configured while it is connected to a live process as entering Configuration Mode pauses all outputs. The controller remains in Standby until Configuration Mode is exited.

Failure to follow these instructions can result in death, serious injury or equipment damage.

WARNING

UNINTENDED EQUIPMENT OPERATION

Actuators that are sensitive to switching pulse or cycle times should be fitted with a protective device. For example, refrigeration compressors should be fitted with a lockout timer to add additional protection against switching too quickly.

Any changes made to the controllers flash memory require the controller to enter configuration mode. The controller will not control the process when in configuration mode. Ensure that the controller is not connected to an active process when in configuration mode.

Failure to follow these instructions can result in death, serious injury or equipment damage.

CAUTION

EQUIPMENT OPERATION HAZARD

If being stored before use, store within the specified environmental conditions.

A Cold Start function erases ALL settings, removes the existing configuration and returns the controller to its original state. To minimize data loss the controller's configuration should be saved using a backup file, before committing a Cold Start.

A cold start of the controller must only be carried out under exceptional circumstances as it will erase ALL previous settings and return the controller to its original state.

"A controller must not be connected to any equipment when performing a cold start."

Cleaning. Isopropyl alcohol may be used to clean labels. A mild soap solution may be used to clean other exterior surfaces.

To minimize any potential loss of control or controller status when communicating across a network or being controlled via a third party master (i.e. another controller, PLC or HMI) ensure all system hardware, software, network design, configuration and cybersecurity robustness have been correctly configured, commissioned and approved for operation.

Failure to follow these instructions can result in injury or equipment damage.

Symbols

Various symbols may be used on the controller label. They have the following meaning:

 Risk of electric shock

 Take precautions against static

 Regulatory compliance mark for Australia (ACA) and New Zealand (RSM)

 Complies with the 40 year Environment Friendly Usage Period

 Dispose of in accordance with WEEE Directive

 Mandatory conformity marking for certain products sold within the European Economic Area

 South Korea KC Certification for Electrical and Electronic Products

Hazardous Substances

This product conforms to European **R**estriction **o**f **H**azardous **S**ubstances (RoHS) (using exemptions) and **R**egistration, **E**valuation, **A**uthorisation and Restriction of **C**hemicals (REACH) Legislation.

RoHS Exemptions used in this product involve the use of lead. China RoHS legislation does not include exemptions and so lead is declared as present in the China RoHS Declaration.

Californian law requires the following notice:

 **WARNING:** This product can expose you to chemicals including lead and lead compounds which are known to the State of California to cause cancer and birth defects or other reproductive harm. For more information go to:

<http://www.P65Warnings.ca.gov>

Cybersecurity

What is in this Chapter?

This chapter outlines some good practice approaches to cybersecurity as they relate to use of EPC3000 series controllers, and draws attention to several features that could assist in implementing robust cybersecurity.

CAUTION

EQUIPMENT OPERATION HAZARD

To minimize any potential loss of control or controller status when communicating across a network or being controlled via a third party master (i.e. another controller, PLC or HMI) ensure all system hardware, software, network design, configuration and cybersecurity robustness have been correctly configured, commissioned and approved for operation.

Failure to follow these instructions can result in injury or equipment damage.

Introduction

When utilizing Eurotherm EPC3000 series controllers in an industrial environment, it is important to take 'cybersecurity' into consideration: in other words, the installation's design should aim to prevent unauthorized and malicious access. This includes both physical access (for instance via the front panel or HMI screens), and electronic access (via network connections and digital communications).

Cybersecurity Good Practices

Overall design of a site network is outside the scope of this manual. The Cybersecurity Good Practices Guide, Part Number HA032968 provides an overview of principles to consider. This is available from www.eurotherm.com.

Typically, an industrial controller such as the EPC3000 controller together with any associated HMI screens and controlled devices should *not* be placed on a network with direct access to the public Internet. Rather, good practise involves locating these devices on a firewalled network segment, separated from the public Internet by a so-called 'demilitarized zone' (DMZ).

Security Features

The sections below draw attention to some of the cybersecurity features of EPC3000 series controllers.

Principle of Secure by Default

Some of the digital communication features on the EPC3000 series controllers can provide greater convenience and ease-of-use (particularly in regards to initial configuration), but also can potentially make the controller more vulnerable. For this reason, these features are turned off by default:

Comms Ports and Channels Disabled by Default

EPC3000 series controllers support a variety of digital communications (see "EPC3016 Options" on page 39, "EPC3008 and EPC3004 Options" on page 40 and "Communications List (COmm)" on page 150). When a controller is unconfigured the type of digital comms is set up with the Quick Start Codes, see section "Configure the Communications Protocol" on page 73. **By default, the ports and channels associated with any digital comms are closed to traffic**, unless that method of communication is explicitly selected using the parameters in the *mAI* Π menu (see "Main Sub List (mAIN)" on page 151) or by using the Comms Setup at first start up (see "Configure the Communications Protocol" on page 73).

The only exception to this principle is for the configuration port on the left side, as viewed from the front fascia. This is a USB connection via a bespoke Eurotherm-supplied 'config clip' cable, for communication with Eurotherm's iTools software (see "Using the Configuration Clip" on page 213). Whilst this port is always enabled, it is physically inaccessible when the controller is installed and mounted. It can only be accessed by removing the controller from its mounting, thus disconnecting all other I/O connections.

Bonjour auto-discovery disabled by default

Ethernet connectivity is available as an option on EPC3000 series controllers (see "EPC3016 Options" on page 39 and "AutoDiscovery" on page 320), including the Bonjour service discovery protocol (see "Bonjour" on page 320). Bonjour enables the controller to be automatically discovered by other devices on the network without the need for manual intervention. However, for cybersecurity reasons, it is disabled by default, as it could be exploited by a malicious user to gain access to the controller.

See also section "AutoDiscovery" on page 320 and information on how to turn it on, if required.

Port Use

The following ports are being used:

Port	Protocol
44818 TCP/UDP	EtherNet/IP (see below)
22112 UDP	EtherNet/IP (see below)
2222 UDP	EtherNet/IP (see below)
502 TCP	Modbus (Master and Slave)
47808 UDP	BACNET
5353 UDP	Zeroconf

The following should be noted about the EtherNet/IP ports:

- Ports are always closed by default and are only opened when the corresponding comms protocol is set.
- UDP Port 5353 (Auto-discovery/ZeroConf/Bonjour, open only when Comms.Option.Network.AutoDiscovery parameter is ON).

HMI Access Level / Comms Config Mode

As described in "Operator Levels" on page 79, EPC3000 series controllers feature tiered, password-restricted operator levels, so that available functions and parameters can be restricted to appropriate personnel.

Level 1 functions are the only ones that do not require password access, and are typically appropriate for routine operator use. The controller powers up in this level. All other levels are password-restricted. Level 2 makes an extended set of operational parameters available, typically intended for use by a supervisor. Level 3 parameters would typically be set when an authorized person was commissioning the device for use in a particular installation. Config level allows access to all the controller's parameters. password-restricted access to these parameters is also possible over digital communications, using Eurotherm's iTools software ("Configuration Using iTools" on page 212),

At config level, it is also possible to customize the other levels from their defaults, restricting certain parameters to only be available at a higher level, or making certain parameters available at lower levels (see "Parameter Promotion" on page 233). In addition, you can configure the availability of setpoint program parameters such as Run/Reset, Program Edit and Program Mode and control parameters, such as Auto/Manual, Setpoint, and Manual Output.

HMI Passwords

When entering passwords via the HMI, the following features help protect against unauthorized access:

- Each digit is obscured (replaced with an underscore character) after entry, to help protect against an unauthorized person seeing the password as it's typed in.
- Password entry is locked after three invalid attempts. The time it stays locked for is configurable (see "Security Sub-List (SEC)" on page 197). This helps protect against "brute force" attempts to guess the password.
- The controller records the number of successful and unsuccessful login attempts for each level of password (see "Diagnostics Sub-list" on page 133). Regular auditing of these diagnostics is recommended, as a means to help detect unauthorized access to the controller.

OEM Security Password

An optional OEM security feature is provided to give Original Equipment Manufacturers (OEMs) a layer of protection against theft of their intellectual property, and is designed to help prevent unauthorized cloning of controller configurations. This protection includes application-specific internal (soft) wiring and limited access to certain parameters via comms (by iTools or a third party comms package).

Comms Configuration Level Password

The password for Config Level access via iTools has the following features to help protect against unauthorized access (see "Instrument List" on page 221 for more details):

- There is no default password for comms configuration level.

- User needs to set the comms configuration password on first connect from iTools.
- If password is not set Fixed comms and Options comms will be in Comms Lockdown mode (see below).
- Comms configuration password is encrypted before sending via comms.
- Passwords are salted and hashed before being stored.
- Number of password attempts is 5. If more than 5 unsuccessful attempts are made, the Password Lock function is triggered.
- Tools will enforce a minimum password length of 8 characters.

Comms Lockdown mode

In Comms Lockdown mode, Fixed comms and Option comms will only have read/write access to a limited set of parameters, see the following table. Config clip connection and HMI will not be affected.

Table 1: Comms Lockdown Limited Parameter Set

Parameter	Modbus Address	Access	String length
CNOMO Manufacturing ID	0x0079(121)	Read-only	-
CNOMO Instrument ID	0x007A(122)	Read-only	-
Instrument firmware version	0x006B(107)	Read-only	-
CommsPasswordIsSet	0x0080(128)	Read-only	-
KeyExchange	0x53F4(21492)	Read/Write	35
CommsPassword	0x5621(22049)	Write-only	96

Ethernet security features

Ethernet connectivity is available as an option in EPC3000 series controllers (see "EPC3016 Options" on page 39 and "EPC3008 and EPC3004 Options" on page 40). The following security features are specific to Ethernet:

Ethernet rate protection

One form of cyberattack is to try to make a controller process so much Ethernet traffic that it drains systems resources and useful control is compromised. For this reason, the EP3000 series includes an Ethernet rate protection algorithm, which will detect excessive network activity and help to ensure the controller's resources are prioritized on the control strategy rather than servicing the Ethernet traffic. If this algorithm is running, the *RATE PROTECTION* diagnostic parameter will be set to ON (see "Network Sub List (nWrk)" on page 153).

Broadcast Storm protection

A 'broadcast storm' is a condition which may be created by cyberattack whereby spurious network messages are sent to devices which cause them to respond with further network messages, creating a chain reaction that escalates until the network is unable to transport normal traffic. The EPC3000 series controllers includes a broadcast storm protection algorithm, which will automatically detect this condition, stopping the controller from responding to the spurious traffic. If this algorithm is active, the *BROADCAST STORM* diagnostic parameter will be set to ON (see "Network Sub List (nWrk)" on page 153).

Communications watchdog

EPC3000 series controllers include a 'comms watchdog' feature. This can be configured to raise an alert if any of the supported digital communications are not received for a specified period of time. See the four *WATCHDOG* parameters in "Main Sub List (mAIN)" on page 151. These provide a way to configure appropriate action if malicious action interrupts the controller's digital communications.

Configuration backup and recovery

Using Eurotherm's iTools software, you can 'clone' an EPC3000 series controller, saving all its configuration and parameter settings to a file. This can then be copied onto another controller, or used to restore the original controller's settings—see "Cloning" on page 243.

For cybersecurity reasons, password-restricted parameters are not saved in the clone file when in operator mode (Level 1).

Clone files include a cryptographic integrity hash, meaning that if the file contents is tampered with, it will not load back into a controller.

A clone file cannot be generated or loaded if the OEM Security feature option is configured and active.

User Sessions

Communication connections only have two permission levels - an 'Operator mode' and a 'Configuration mode'. Any connection via comms (Ethernet or serial) is separated into its own unique session. A user logged in via the TCP socket will not share permissions with a different user logged in, for example, via the serial port and vice versa.

In addition, only a single user can be logged into an EPC3000 series controller in Configuration mode at any one time. If another user attempts to connect and select Configuration mode, the request will be denied until the other user exits the Configuration mode.

If a power cycle occurs all sessions will be in Operator Mode when connections are re-established.

Memory/Data Integrity

FLASH Integrity

When an EPC3000 series controller powers up, it automatically performs an integrity check on the entire contents of its internal flash memory. Additional periodic integrity checks are also performed in 256 byte blocks during normal runtime. If any integrity check detects a difference from what is expected, the controller will stop running and display a *FL.Er* alert (see "Notification Messages" on page 378).

Non-volatile Data Integrity

When an EPC3000 series controller powers up, it automatically performs an integrity check on the contents of its internal non-volatile memory devices. Additional periodic integrity checks are performed during normal runtime and when non-volatile data is being written. If any integrity check detects a difference from what is expected, the controller enters Standby mode and displays a *FRM.S*, *PAR.S*, *REG.S* or *OPT.S* alert as appropriate (see "Notification Messages" on page 378 for more details).

Cryptography Usage

Cryptography usage is employed in the following areas:

- ROM startup integrity checking.
- Promote/Message table checksum security.
- Clone files.
- Custom linearization tables.
- Firmware upgrade signing.

Achilles[®] Communications Certification

The EPC3000 series of controllers have been certified to Level 1 under the Achilles[®] Communications Robustness Test Certification scheme. This is an established industry benchmark for the deployment of robust industrial devices recognized by the major automation vendors and operators.

Decommissioning

When an EPC3000 series controller is at the end of its life and being decommissioned, Eurotherm advises reverting all parameters to their default settings (see "Cold Start" on page 244 for instructions). This can help to protect against subsequent data and intellectual property theft if the controller is then acquired by another party.

Legal Information

The information provided in this documentation contains general descriptions and/or technical characteristics of the performance of the products contained herein. This documentation is not intended as a substitute for and is not to be used for determining suitability or reliability of these products for specific user applications. It is the duty of any such user or integrator to perform the appropriate and complete risk analysis, evaluation and testing of the products with respect to the relevant specific application or use thereof. Schneider Electric, Eurotherm Limited or any of its affiliates or subsidiaries shall not be responsible or liable for misuse of the information contained herein.

If you have any suggestions for improvements or amendments or have found errors in this publication, please notify us.

You agree not to reproduce, other than for your own personal, noncommercial use, all or part of this document on any medium whatsoever without permission of Eurotherm Limited, given in writing. You also agree not to establish any hypertext links to this document or its content. Eurotherm Limited does not grant any right or license for the personal and noncommercial use of the document or its content, except for a non-exclusive license to consult it on an "as is" basis, at your own risk. All other rights are reserved.

All pertinent state, regional, and local safety regulations must be observed when installing and using this product. For reasons of safety and to help ensure compliance with documented system data, only the manufacturer should perform repairs to components.

When devices are used for applications with technical safety requirements, the relevant instructions must be followed.

Failure to use Eurotherm Limited software or approved software with our hardware products may result in injury, harm, or improper operating results.

Failure to observe this information can result in injury or equipment damage.

Life Is On Schneider Electric, Eurotherm, EurothermSuite, ECAT, EFit, EPack, EPower, Eycon, Chessell, Mini8, nanodac, optivis, piccolo and versadac are trademarks of Eurotherm Limited SE, its subsidiaries and affiliated companies. All other trademarks are the property of their respective owners.

© 2021 Eurotherm Limited. All rights reserved.

Introduction

Controller Concept

EPC3000 controllers are a range of programmable single loop process controllers which are certified for cybersecurity communications robustness. A range of math, logic, totalizer and specialized functions is also available.

A simple "Quick Start" code is used to configure standard applications essential for controlling specific processes. This enables fast commissioning "Out of the Box" without the need for configuration software. Applications include (but are not limited to) heat or heat/cool temperature control, carbon potential control, dew point control, etc. These applications are pre-configured, providing the user with a starting point for customizing to an individual process.

Eurotherm iTools is a software package which is designed for this purpose by providing user function block wiring in addition to a range of other features. It is available as a free download from www.eurotherm.com or can be ordered on a DVD.

User Guide Concept

This User Guide is generally laid out in the following manner:

- The first part explains mechanical and electrical installation and covers the same topics as in the Installation and wiring sheet supplied with each instrument but in more detail.
- Operation of the instrument, including Quick Start Configuration. In general the descriptions in the manual assume that the controller is configured with no application loaded or with a heat or heat cool controller application loaded.
- Configuration of the instrument from the front panel.
- Configuration of the instrument using Eurotherm iTools configuration package.
- Description of different function blocks in the instrument, such as Control Loop, Programmer, Digital Communications, OEM Security, and Input Linearization.
- Calibration procedure.
- Technical specification.

This User Guide describes general control applications which may be configured using the Quick Start Codes.

Specific applications such as Temperature control (Quick Start codes 1, 2 and 3), Carbon Potential control (Quick Start code 4) and Dew Point control (Quick Start code 5) are described in supplements to this manual. The supplement part numbers are HA033033, HA032987 and HA032994 respectively and are available from www.eurotherm.com.

How to Videos

"How To" video demonstrations may be found at www.eurotherm.com, which will help to demonstrate the information that is being provided in this User Guide. They are also available on YouTube.

Issue Status of this Manual

Issue 1 created for the addition of the EPC3000 FM (Factory Mutual) version of the EPC3000 series controllers and meets the requirements of FM Approval Standard **FM 3545 - Temperature Limit and Supervisory Switches**.

The following are topics included or revised specifically for EPC3000 FM:

- "Applications" on page 228
- "Appendix: EPC3000 Factory Mutual (FM)" on page 400

Installation

DANGER

HAZARD OF ELECTRIC SHOCK, EXPLOSION OR ARC FLASH

Electrical equipment must be installed, operated and maintained by only qualified personnel.

Turn off all power to product and all I/O circuitry (alarms, control I/O etc.) before starting the installation, removal, wiring, maintenance or inspection of the product.

Failure to follow these instructions will result in death or serious injury.

WARNING

UNINTENDED EQUIPMENT OPERATION

The application of this product requires expertise in the design and programming of control systems. Only persons with such expertise must be allowed to program, install, alter and commission this product.

During commissioning ensure all operating states and potential fault conditions are carefully tested.

Failure to follow these instructions can result in death, serious injury or equipment damage.

In typical temperature control processes there may be issues when heating is constantly on. Reasons why the heating might remain constantly on include:

- The temperature sensor becoming detached from the process.
- Thermocouple wiring becoming short circuit.
- The controller heating being constantly on.
- An external valve or contactor sticking in the heating condition.
- The controller setpoint too high.
- Loss of communications.

Where damage or injury is possible we recommend fitting a separate over-temperature protection unit with an independent temperature sensor which, will isolate the heating circuit.

Alarm relays do not provide protection under all failure conditions and should not be relied on.

What is in this Chapter?

- A general description of the instrument.
- What is in the package.
- Order codes.
- Instrument dimensions and mounting in a panel.

What Instrument Do I Have?

The EPC programmable controller range provides precise control of industrial processes and is available in three standard DIN sizes:

- $\frac{1}{16}$ DIN Model Number EPC3016, nominal size W 48mm x H 48mm (1.89in x 1.89in)
- $\frac{1}{8}$ DIN Model Number EPC3008, nominal size W 48mm x H 96mm (1.89in x 3.78in)
- $\frac{1}{4}$ DIN Model Number EPC3004, nominal size W 96mm x H 96mm (3.78in x 3.78in)

Universal input(s) accept various thermocouples, RTDs or process inputs.

Universal input/output (I/O) can be configured for control, alarm, re-transmission outputs or contact inputs.

A changeover relay is available as standard in all controllers.

Controllers may be powered from either an AC line supply [100 - 230Vac +/-15%] or low voltage [24Vac/dc (nominal) supply] depending on the order code.

EIA-485 (RS-485) digital communications is available in EPC3008 and EPC3004 as standard and as an option in EPC3016.

Options available are:

1. A current transformer (CT) input plus a further contact input.
2. Ethernet communications protocol.
3. EIA-232/422 (RS-232/422) digital communications using MODBUS or EI-Bisynch protocols is available in EPC3016 to provide compatibility with previous products.

More detailed functionality can be configured if the EPC3000 controller is put into configuration mode. Configuration mode is password protected (see "Configuration Level" on page 96).

Two panel sealing versions are available:

- Curved front. Panel sealing to NEMA 12X/IP65 qualified with indoor use only.
- Washdown. Panel sealing to NEMA 4X/IP66 qualified with indoor use only.

EPC3000 FM (Factory Mutual) version

The EPC3000 is also available as a Factory Mutual approved version - EPC3000 FM - that is specifically designed to meet the Over Limit (High or Low) requirements for industrial processes, and has the FM Approval Standard **FM 3545 - Temperature Limit and Supervisory Switches**.

The 2 versions, EPC3000 and EPC3000 FM do differ, so attention should be paid when defining, ordering and configuring the different controllers.

For further information see the following User Guides

- EPC3000 FM Programmable Controllers - User Guide (HA033650ENG Issue 1)
- EPC3000 Programmable Controllers - User Guide (HA032842ENG Issue 5).

Order Code

The controller may be ordered against a hardware ordering code only. In this case when it is new and first switched on 'out of the box' it will start in a 'Quick Configuration' mode ("Start Up—New Unconfigured Controller" on page 68). Alternatively, it may be ordered against both hardware and software codes, in which case it will be supplied configured and will start up directly showing the operator display ("Start Up - New Configured Controller" on page 75).

Labels fitted to the sleeve show the ordering code, serial number, date of manufacture, and terminal connections for the hardware fitted. For the latest order codes please refer to the EPC3000 Data Sheet (HA032952) which can be found at www.eurotherm.com.

Unpacking Your Controller

The controller is supplied with:

- Controller, as ordered, fitted in its sleeve, two panel retaining clips and sealing gasket mounted on the sleeve. The views below show the washdown version.



EPC3016



EPC3008



EPC3004

- Component packet containing snubbers (as ordered) for relay and triac outputs (See "General Information About Relays and Triacs and Inductive Loads" on page 53) and a 2.49Ω resistor for a current input (See "Linear Input (mA, mV or V)" on page 45). The quantity depends on the fitted modules.

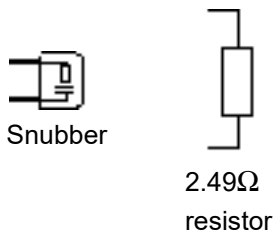

- Installation sheet Part Number HA032934 in English, French, German, Spanish, Italian, Chinese and Russian.

⚡ ⚠ DANGER

FIRE HAZARD
 If upon receipt, the unit or any part within is damaged, do not install but contact your supplier.

Ensure only the originally supplied connectors are used.

Ensure the correct wire gauge size is used per circuit and it is rated for the current capacity of the circuit.

Failure to follow these instructions will result in death or serious injury.

Dimensions

General views of the controllers are shown below together with overall dimensions.

EPC3016 Controller

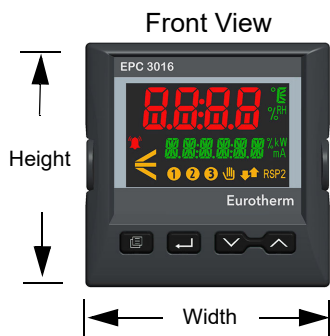

	Curved front	Washdown	Width including latching clips
Width	49.4 mm 1.94 inch	48.1 mm 1.89 inch	50 mm 1.97 inch
Height	49.4 mm 1.94 inch	48.1 mm 1.89 inch	

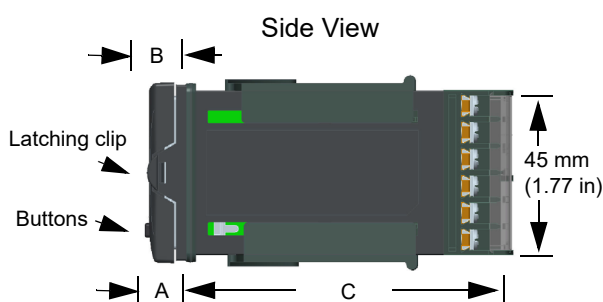

A Distance from panel to latching lug	13.7 mm 0.54 inch
B Distance from panel to button top	13.2 mm 0.52 inch
C Distance behind panel	90 mm 3.54 inch

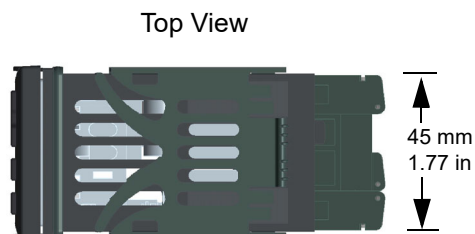

EPC3008 Controller

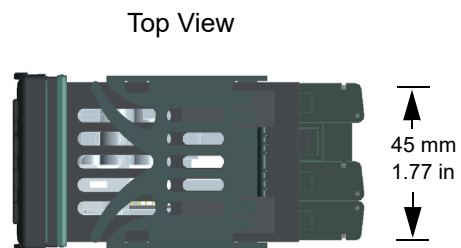
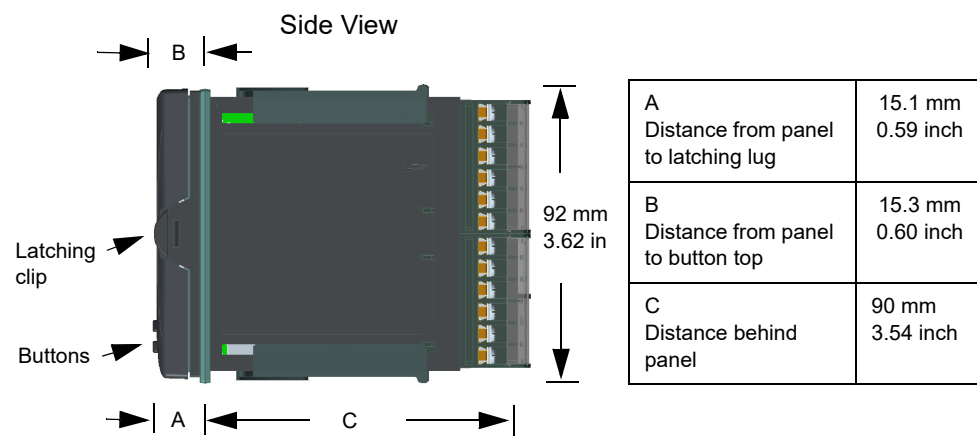
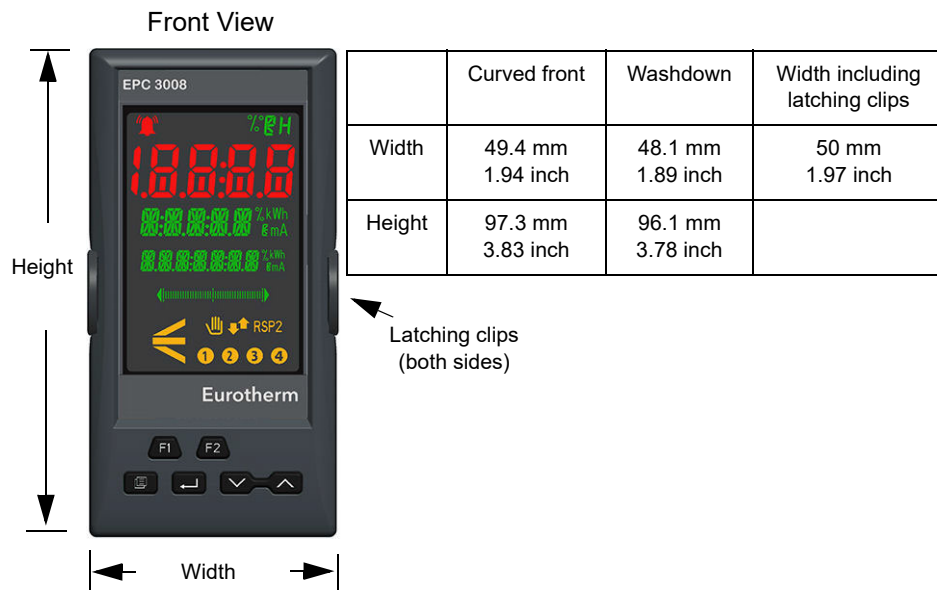

EPC3004 Controller

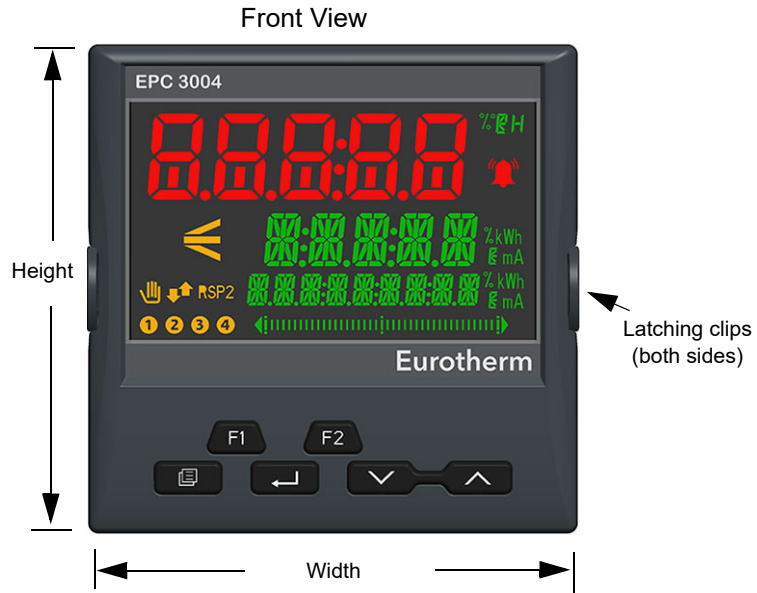

	Curved front	Washdown	Width including latching clips
Width	97.3 mm 3.83 inch	97.3 mm 3.83 inch	98 mm 3.85 inch
Height	97.3 mm 3.83 inch	97.3 mm 3.83 inch	

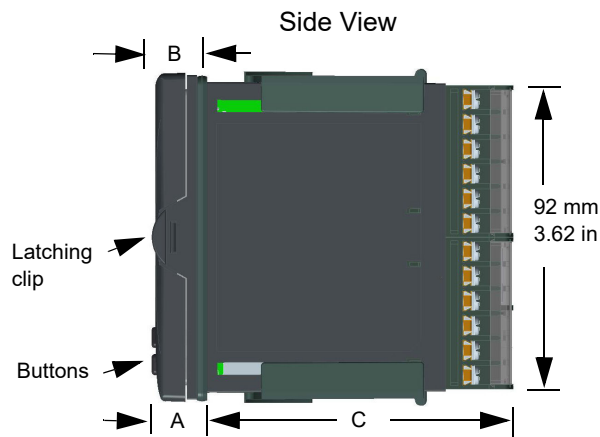

A Distance from panel to latching lug	15.3 mm 0.60 inch
B Distance from panel to button top	15.3 mm 0.60 inch
C Distance behind panel	90 mm 3.54 inch

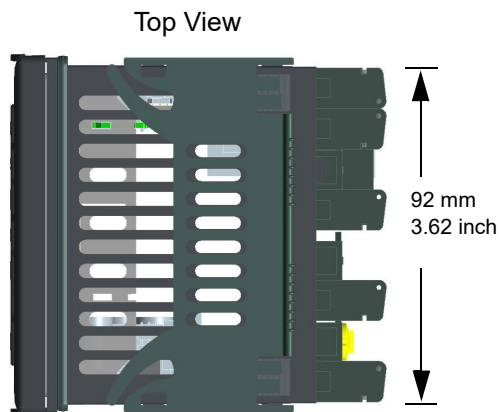

Installation

DANGER

HAZARD OF ELECTRIC SHOCK, EXPLOSION OR ARC FLASH

Electrical equipment must be installed, operated and maintained by only qualified personnel.

Turn off all power to product and all I/O circuitry (alarms, control I/O etc.) before starting the installation, removal, wiring, maintenance or inspection of the product.

Failure to follow these instructions will result in death or serious injury.

This instrument is intended for permanent installation, for indoor use only, and enclosed in an electrical panel.

Select a location which is subject to minimum vibrations, the ambient operating temperature is between 0 and 55°C (32 - 131°F) and operating humidity of 0 to 90% RH non condensing.

The instrument can be mounted on a panel up to 15mm (0.6") thickness. A minimum panel thickness of 2mm (0.08in) mild steel is recommended to maintain a correct IP rating.

To ensure effective panel sealing, mount on a non-textured surface.

Please read the safety information in "Safety and EMC" on page 12 before proceeding.

Panel Mounting the Controller

1. Prepare a cut-out in the mounting panel to the size shown. If a number of controllers are to be mounted in the same panel observe the minimum spacing shown, see "Recommended minimum spacing of controllers" on page 36.
2. Carefully remove the panel retaining clips from the sleeve.
3. To achieve effective panel sealing, make sure the gasket is not twisted and is fitted behind the front bezel of the controller.
4. Insert the controller through the cut-out.
5. Make sure that the panel retaining clips spring back into place to maintain the panel sealing. Secure the controller in position by holding it level and pushing both retaining clips forward.
6. Peel off the protective film from the display.
7. In the unlikely event that it should be necessary to remove the sleeve from the panel, make sure that all power is turned off. Remove the controller from its sleeve. Very carefully unhook the panel retaining clips from the side. A small insulated screwdriver may be used to help unhook the clips.

The instrument includes polarizing features to help prevent the following:

- a. The instrument being inserted upside down into sleeve.
- b. Insertion of Low-Voltage PSU unit into High-Voltage PSU sleeve.
- c. Insertion of other instruments into a sleeve with non compatible terminal assignment.

Panel Cut Out Sizes

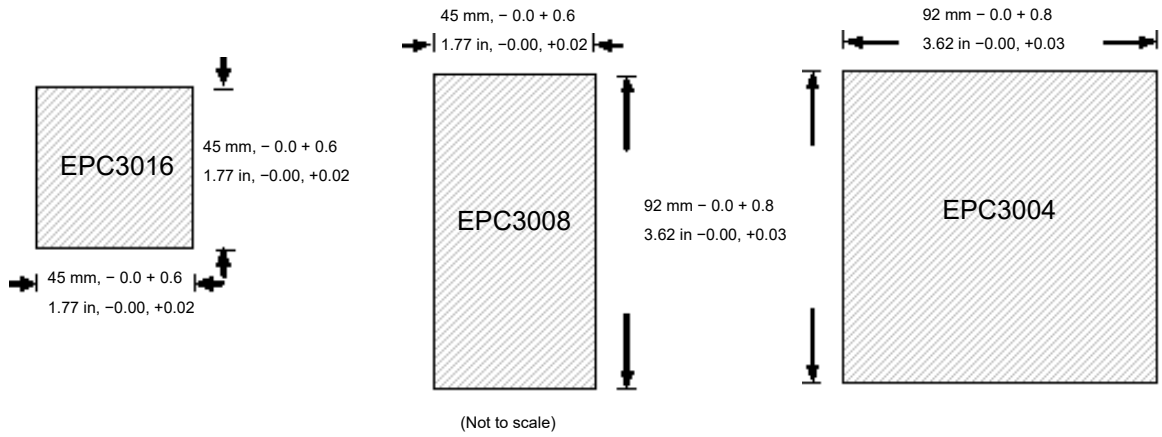

Recommended minimum spacing of controllers

Applies to all models.

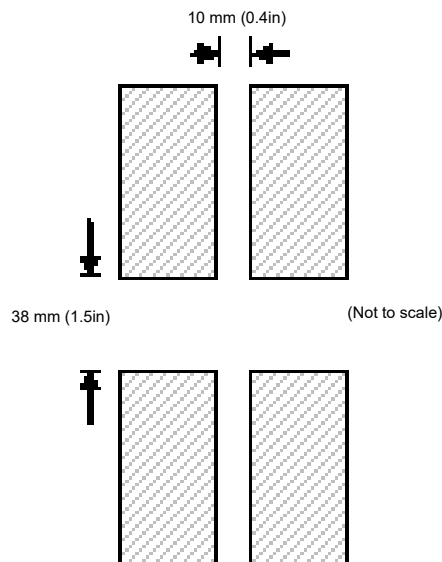

To Remove the Controller from its Sleeve

DANGER

HAZARD OF ELECTRIC SHOCK, EXPLOSION OR ARC FLASH

Electrical equipment must be installed, operated and maintained by only qualified personnel.

Turn off all power to product and all I/O circuitry (alarms, control I/O etc.) before starting the installation, removal, wiring, maintenance or inspection of the product.

Failure to follow these instructions will result in death or serious injury.

Ensure that the controller is powered down before attempting to remove it from its sleeve. It can then be removed from its sleeve by easing the latching clips outwards and pulling it forward out of the sleeve. When plugging it back into its sleeve, ensure that the latching clips click back into place to maintain the panel sealing.

If the Ethernet option is fitted, ensure that the Ethernet cable is removed from the rear of the controller before removing it from its sleeve.

Terminal Wiring

What is in this Chapter?

This chapter describes terminal connections and wiring.

WARNING

UNINTENDED EQUIPMENT OPERATION

Ensure all cables and wiring harness are secured using a relevant strain relief mechanism.

Avoid ingress of conductive materials during installation.

Only connect wires to identified terminals shown on the product warning label, the wiring section of the product User guide or Installation sheet.

Failure to follow these instructions can result in death, serious injury or equipment damage.

Terminal Layout EPC3016 Controller

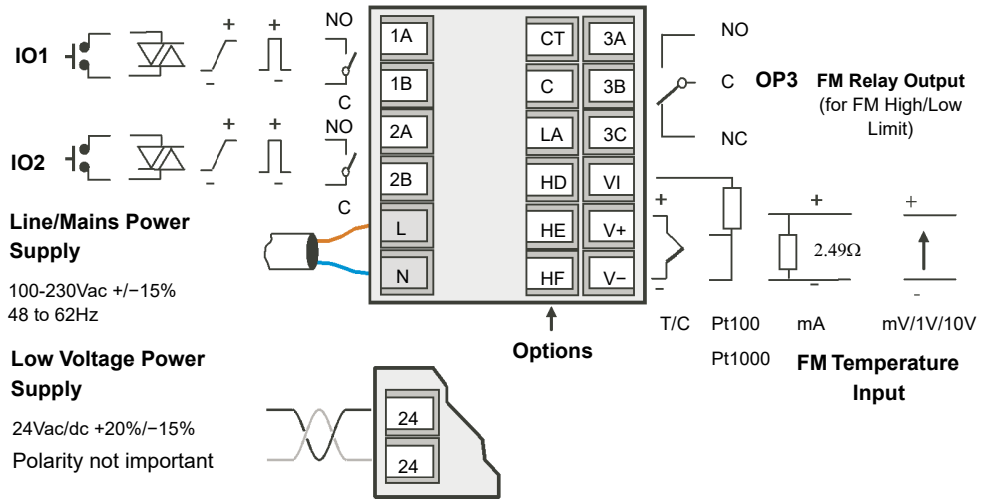

EPC3016 Options

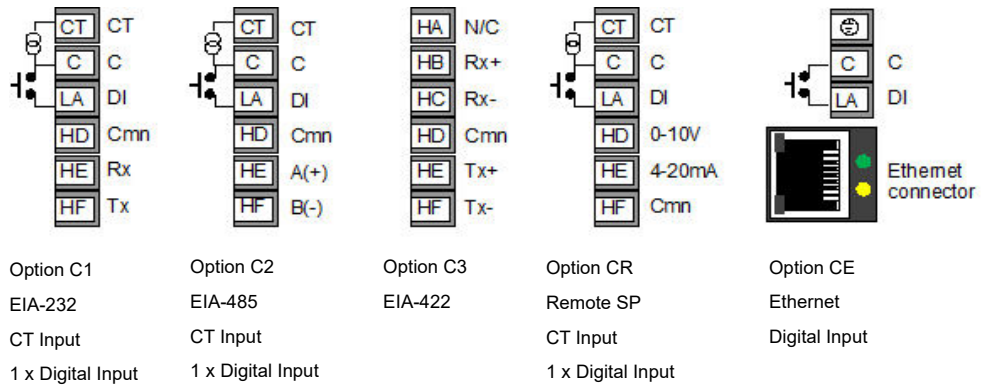

Key to symbols used in the wiring diagrams

	Logic (SSR drive) output		Relay output		Changeover relay output
	0-10V/0-20mA analog output		Triac output		
	Current transformer input		Contact input		

Terminal Layout EPC3008 and EPC3004 Controller

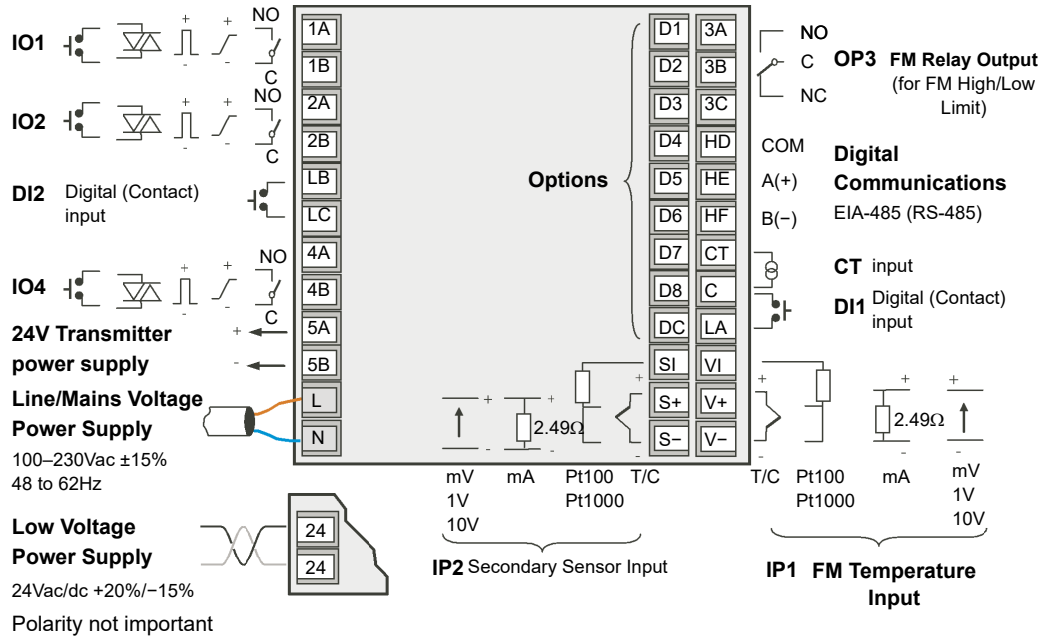

EPC3008 and EPC3004 Options

Digital I/O

D1 - D8
Voltage input
On (1) >4V, <35V
Off (0) >-1V, <+1V
Contact input On <100Ω
Off >28KΩ

Secondary Sensor Input

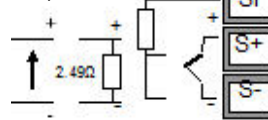

Option I8
PV Input
8 × Digital I/O

Digital I/O

D1 - D4
Voltage input
On (1) >4V, <35V
Off (0) >-1V, <+1V
Contact input
On <100Ω
Off >28KΩ

Secondary Sensor Input

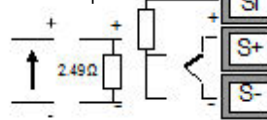

Option IE
PV Input
Ethernet
4 × Digital I/O

Isolation Boundaries

The drawings show double and basic isolation boundaries.

EPC3008/EPC3004 Isolation

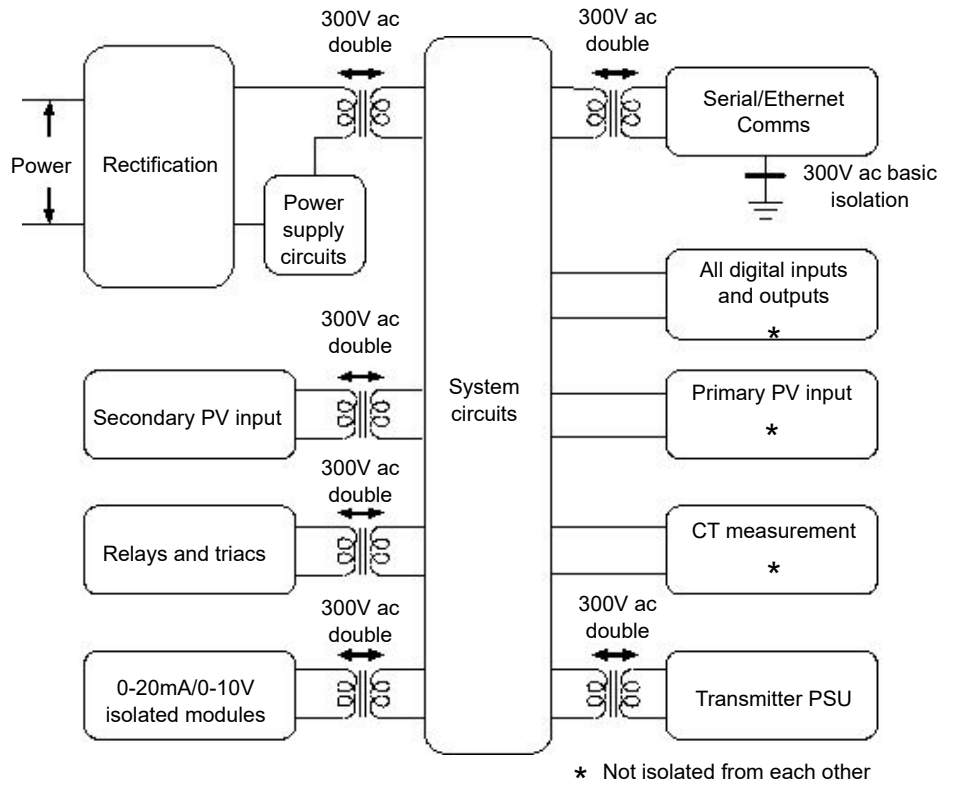

EPC3016 Isolation

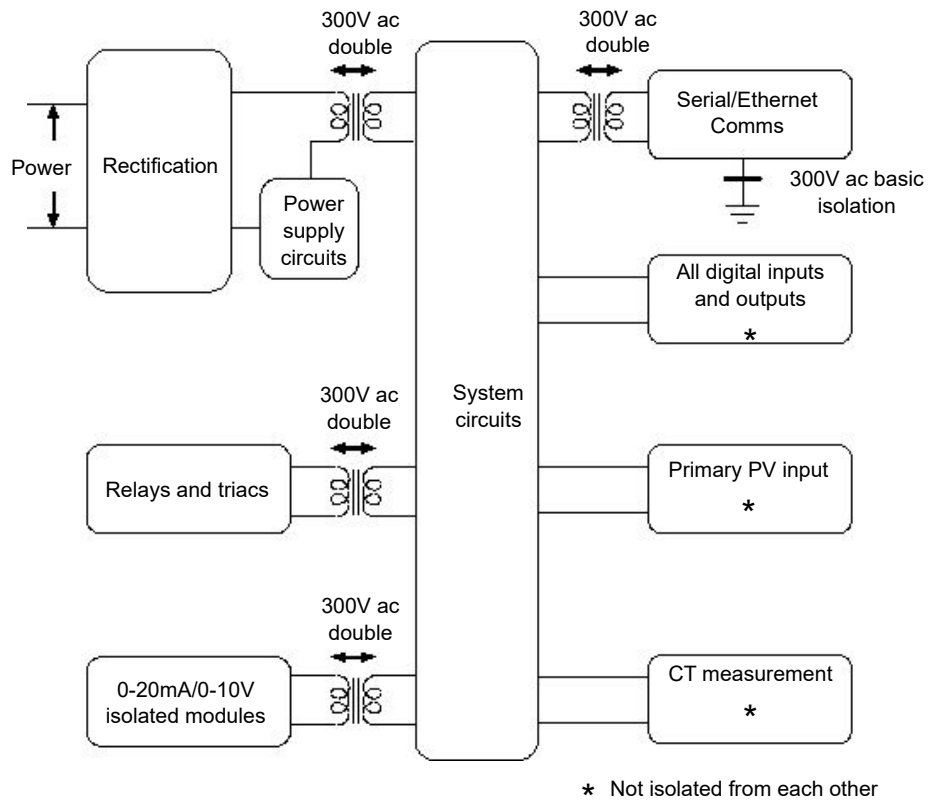

Wire Sizes

The screw terminals accept wire sizes from 0.5 to 1.5 mm (16 to 22AWG). Hinged covers help prevent hands or metal making accidental contact with live wires. The rear terminal screws must be tightened to 0.5 N-m (4.4 lb-in).

DANGER

HAZARD OF ELECTRIC SHOCK, EXPLOSION OR ARC FLASH

Tighten terminal screws in conformance with the torque specifications.

A maximum of two wires, identical in type and cross sectional size can be inserted per terminal. Strip the insulation from the cables by a minimum of 6mm (0.24") in order to ensure good contact with the terminal. Do not exceed a maximum exposed cable conductor length of 2mm (0.08").

Failure to follow these instructions will result in death or serious injury.

Controller Power Supply

DANGER

HAZARD OF ELECTRIC SHOCK, EXPLOSION OR ARC FLASH

Power line and output circuits must be wired and fused in compliance with local and national regulatory requirements for the rated current and voltage of the particular equipment, i.e. UK, the latest IEE wiring regulations, (BS7671), and USA, NEC class 1 wiring methods.

Failure to follow these instructions will result in death or serious injury.

DANGER

FIRE HAZARD

The controller must be connected to the correct rated power supply unit or supply voltage in accordance with the supply voltage rating displayed on the controller label. or in the User guide. Use only isolating PELV or SELV power supplies to supply power to the equipment.

EPC3000 ("Line Voltage" intimates 230v only, but what if its 12, 24 48Volt:
The controller must be connected to the correct line voltage in accordance with the order code and line voltage shown on the controller label. Use only isolating PELV or SELV power supplies to supply power to the equipment.

EPC2000 (24v Only):
Do not connect the controller directly to line voltage. Use only isolating PELV or SELV power supplies to supply power to the equipment.

Failure to follow these instructions will result in death or serious injury.

WARNING

UNINTENDED EQUIPMENT OPERATION

Wiring, it is important to connect the unit in accordance with the data in this User guide and use copper cables (except the thermocouple wiring).

Failure to follow these instructions can result in death, serious injury or equipment damage.

Fuse Protection

External fuse protection must be provided to the power supply input to the controller.

Recommended external fuse ratings are as follows:

- For 24V ac/dc, 48 to 62Hz, fuse type: T rated 2A 250V.
- For 100–230Vac, fuse type: T rated 2A 250V.

Line/Mains Voltage Power Supply

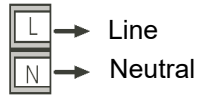

- 100 to 230Vac, $\pm 15\%$, 48 to 62Hz.
- Power rating EPC3016: 6W; EPC3008 and EPC3004: max 9W.

Low Voltage Power Supply

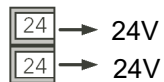

- 24Vac, +10/-15%, 48 to 62Hz.
- 24Vdc, -15%, +20% \pm 5% ripple voltage.
- The polarity is not important.
- Power rating EPC3016: 6W; EPC3008 and EPC3004: max 9W.

Sensor Inputs (Measuring Input)

This input is available on all models.

DANGER

HAZARD OF ELECTRIC SHOCK, EXPLOSION OR ARC FLASH

The Primary Sensor Measuring Input is not isolated from Digital Inputs/Outputs (DI1 to 2 and DI1 to 8) and the CT input. If the sensor is not at ground or a safe potential then IP1/2, Digital Inputs and CT will be at the same potential and care needs to be taken in components ratings and instruction to personnel to ensure safety.

Failure to follow these instructions will result in death or serious injury.

WARNING

POTENTIAL INJURY OR EQUIPMENT DAMAGE

Do not run input wires directly alongside power cables.

When shielded cable is used, it must be grounded at one end only.

Failure to follow these instructions can result in death, serious injury or equipment damage.

NOTICE

MEASUREMENT INACCURACIES

There are several factors that can potentially cause measurement inaccuracies.

Failure to follow these instructions can result in equipment damage.

To mitigate these factors:

- Do not run input wires together with power cables.
- When shielded cable is used, it must be grounded at one point only.
- Any external components (such as zener barriers, etc.) connected between sensor and input terminals may cause incorrect measurement due to excessive and/or un-balanced line resistance or possible leakage currents.
- The Primary Sensor Input is not isolated from the logic outputs & digital inputs.
- Pay attention to line resistance; a high line resistance may cause measurement inaccuracies.
- Do not connect a single sensor to more than one instrument. Sensor break operation could be severely compromised.

Primary Sensor Input (Measuring Input)

Thermocouple Input



- Use the correct compensating cable (preferably shielded) to extend thermocouple cabling, ensure that polarity is strictly followed throughout and that thermal junctions are avoided in any intermediate connections.

RTD Input

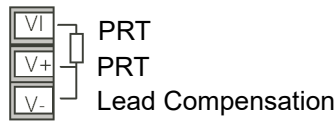

- The resistance of the three wires must be the same. The line resistance may cause measurement inaccuracies if it is greater than 22Ω.

Linear Input (mA, mV or V)

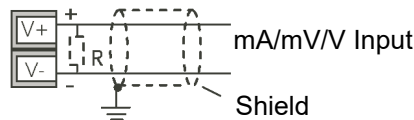

- If shielded cable is used it should only be grounded in one place as shown.
- For a mA input connect the 2.49Ω burden resistor (R) supplied between the + and - input terminals as shown. The resistor supplied is 1% accuracy 50 ppm.

Two-Wire Transmitter Inputs

Using internal 24V power supply (1/8 DIN and 1/4 DIN only).

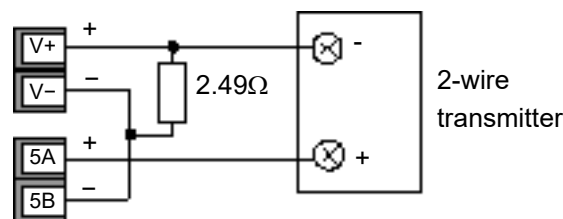

All models using an external power supply.

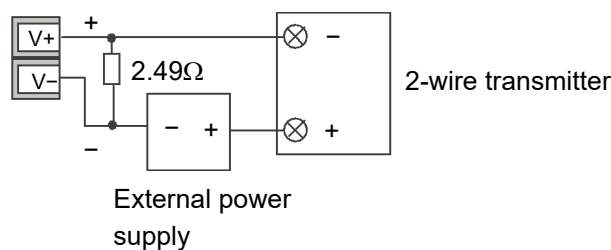

Secondary Sensor Input (Measuring Input)

The secondary sensor input is not available in EPC3016 controller whereas it is an orderable option for both the EPC3008 and EPC3004 controllers. It is protected by Feature Security see section "Feature passwords" on page 221.

Secondary Thermocouple Input



Use the correct compensating cable (preferably shielded) to extend thermocouple cabling, ensure that polarity is strictly followed throughout and that thermal junctions are avoided in any intermediate connections.

Secondary RTD Input

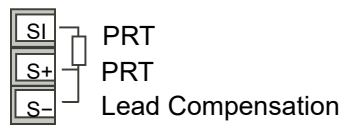

The resistance of the three wires must be the same. The line resistance may cause measurement inaccuracies if it is greater than 22Ω.

Secondary Linear Input (mA, mV or V)

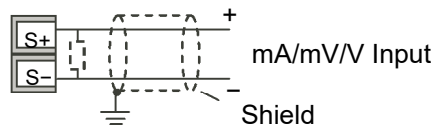

If shielded cable is used it should be grounded in one place only as shown

For a mA input connect the 2.49Ω burden resistor (R) supplied between the + and - input terminals as shown. The resistor supplied is 1% accuracy 50 ppm.

Secondary Two-Wire Transmitter Inputs

Using internal 24V power supply (1/8 DIN and 1/4 DIN only)

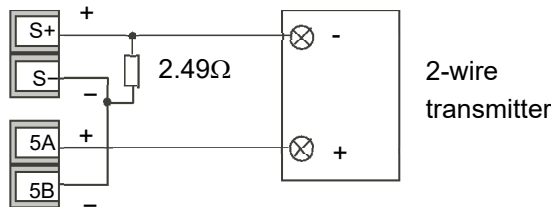

All models using an external power supply.

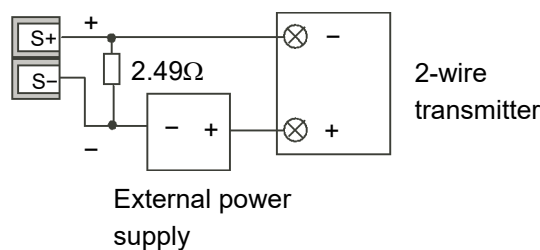

Inputs/Outputs (IO)

DANGER

HAZARD OF ELECTRIC SHOCK, EXPLOSION OR ARC FLASH

Electrical equipment must be installed, operated and maintained by only qualified personnel.

Turn off all power to product and all I/O circuitry (alarms, control I/O, etc.) before starting the installation, removal, wiring, maintenance or inspection of the product.

Failure to follow these instructions will result in death or serious injury.

I/O1 and I/O2 are available as standard in all models. I/O4 is available as standard in models EPC3008 and EPC3004. This I/O may be ordered as Contact Input, Triac Output, Logic Output, Analog Output or Form A Relay Output.

I/O3 is a changeover relay and is available as standard in all models

The function of the I/O is pre-configured by the application ordered, or configured using the Quick Start Codes, "Start Up—New Unconfigured Controller" on page 68. Alternatively, the function can be changed in Configuration level ("I/O List (io)" on page 107) or through iTools ("The 'Browser' List" on page 216).

Input/Output 1 (I/O1)

I/O1 Relay Output (Form A, normally open)

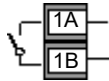

- Isolated output 300Vac CAT II.
- Contact rating: 2A 230Vac +15% resistive.
- Contact rating minimum: 100mA 12V.
- The output switching rate must be set to prevent damage to relay and the output device in use. See "Cycle Time and Minimum OnTime Algorithms" on page 112.

I/O1 Logic (SSR drive) Output



- Not isolated from the sensor input, the current transformer input or the digital inputs.
- Output ON state: 12Vdc at 44mA max.
- Output OFF state: <300mV, <100µA.
- The output switching rate must be set to prevent damage to the output device in use. See "Cycle Time and Minimum OnTime Algorithms" on page 112.

I/O1 Triac Output

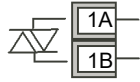

- Isolated output 300Vac CATII.
- Rating: 40mA to 0.75A rms, 30V rms to 230V rms +15% resistive load.

I/O1 Analog Output

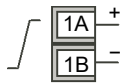

- Output isolated 300Vac.
- Software configurable: 0–10Vdc, 0–20mA or 4–20mA.
- Max load resistance: Voltage >450Ω; Current <550Ω.
- Calibration accuracy: % of reading + Offset.
 - Voltage better than $\pm(0.5\% + 50\text{mV})$.
 - Current better than $\pm(0.5\% + 100\mu\text{A})$.
- If additional isolated contact inputs are required, Analog Output modules can be configured to provide this in Configuration level (Parameter *dI* see section "I/O List (io)" on page 107 or using iTools ("Configuration Using iTools" on page 212)
 - Contact open > 365Ω. Contact closed < 135Ω.

I/O1 Contact Input



- Not isolated from the current transformer input, sensor input 1 or logic outputs.
- Switching: 12Vdc at 40mA max.
- Contact open > 500Ω. Contact closed < 150Ω.

Input/Output 2 (IO2)

I/O2 Relay Output (Form A, normally open)

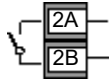

- Isolated output 300Vac CAT II.
- Contact rating maximum: 2A 230Vac +15% resistive.
- Contact rating minimum: 100mA 12V.
- The output switching rate must be set to prevent damage to the relay and output device in use. See "Cycle Time and Minimum OnTime Algorithms" on page 112.

I/O2 Logic (SSR drive) Output

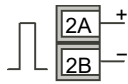

- Not isolated from the sensor input, the current transformer input or the digital inputs.
- Output ON state: 12Vdc at 44mA max.
- Output OFF state: <300mV, <100μA.
- The output switching rate must be set to prevent damage to the output device in use. See "Cycle Time and Minimum OnTime Algorithms" on page 112.

I/O2 Triac Output

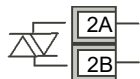

- Isolated output 300Vac CATII.
- Rating: 40mA to 0.75A rms, 30V rms to 230V rms +15% resistive load.

I/O2 Analog Output

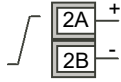

- Output isolated 300Vac
- Software configurable: 0–10Vdc, 0–20mA or 4–20mA.
- Max load resistance: Voltage >450Ω; Current <550Ω.
- Calibration accuracy: % of reading + Offset.
 - Voltage better than $\pm(0.5\% + 50\text{mV})$.
 - Current better than $\pm(0.5\% + 100\mu\text{A})$.
- If additional isolated contact inputs are required Analog Output modules can be configured to provide this in Configuration level (Parameter **dI** see section "I/O List (io)" on page 107 or using iTools ("Configuration Using iTools" on page 212).
 - Contact open > 365Ω. Contact closed < 135Ω.

I/O2 Contact Input

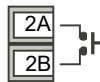

- Not isolated from the current transformer input, sensor input 1 or logic outputs.
- Switching: 12Vdc at 40mA max.
- Contact open > 500Ω. Contact closed < 150Ω.

Input/Output 4 (IO4)

I/O4 Relay Output (Form A, normally open)

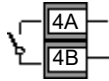

- Isolated output 300Vac CAT II.
- Contact rating maximum: 2A 230Vac +15% resistive.
- Contact rating minimum: 100mA 12V.
- The output switching rate must be set to prevent damage to the relay and output device in use. See "Cycle Time and Minimum OnTime Algorithms" on page 112.

I/O4 Logic (SSR drive) Output

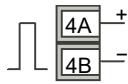

- Not isolated from the sensor input, the current transformer input or the digital inputs.
- Output ON state: 12Vdc at 44mA max.
- Output OFF state: <300mV, <100μA.
- The output switching rate must be set to prevent damage to the output device in use. See "Cycle Time and Minimum OnTime Algorithms" on page 112.

I/O4 Triac Output



- Isolated output 300Vac CATII.
- Rating: 40mA to 0.75A rms, 30V rms to 230V rms +15% resistive load.

I/O4 Analog Output

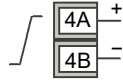

- Output isolated 300Vac
- Software configurable: 0–10Vdc, 0–20mA or 4–20mA.
- Max load resistance: Voltage >450Ω; Current <550Ω.
- Calibration accuracy: % of Analog reading + Offset.
 - Voltage better than $\pm(0.5\% + 50\text{mV})$.
 - Current better than $\pm(0.5\% + 100\mu\text{A})$.
- If additional isolated contact inputs are required Analog Output modules can be configured to provide this in Configuration level (Parameter **dI** see section "I/O List (io)" on page 107 or using iTools ("Configuration Using iTools" on page 212).
 - Contact open > 365Ω. Contact closed < 135Ω.

I/O4 Contact Input

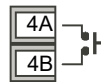

- Not isolated from the current transformer input, the sensor input or logic outputs.
- Switching: 12Vdc at 40mA max.
- Contact open > 500Ω. Contact closed < 150Ω.

Output 3 (OP3)

Output 3 is available in all models. It is a Form C (changeover) relay. (In some earlier models this was referred to as AA Relay).

The function of the I/O is fixed by the application ordered, or configured using the Quick Start Codes, "Start Up—New Unconfigured Controller" on page 68.

Alternatively, the function can be changed in Configuration level ("I/O List (io)" on page 107) or through iTools ("The 'Browser' List" on page 216).

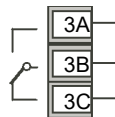

- Isolated output 300Vac CAT II.
- Contact rating: 2A 230Vac +15% resistive.
- The output switching rate must be set to prevent damage to the output device in use. See "Cycle Time and Minimum OnTime Algorithms" on page 112.

General Information About Relays and Triacs and Inductive Loads

⚠ WARNING

UNINTENDED EQUIPMENT OPERATION

High voltage transients may occur when switching inductive loads such as some contactors or solenoid valves. These transients may introduce disturbances which could affect the performance of the controller.

Failure to follow these instructions can result in death, serious injury or equipment damage.

For these types of load it is recommended that a snubber is connected across the normally open contact of the relay switching the load. The recommended snubber consists of a series connected resistor and capacitor (typically 15nF/100Ω). The snubber is intended to prolong the life of the relay contacts.

⚠ CAUTION

FALSE TRIGGERING OF TRIAC OUTPUTS

A snubber should be connected across the triac output terminals to help prevent false triggering under line transient conditions.

Failure to follow these instructions can result in injury or equipment damage.

⚠ WARNING

UNINTENDED EQUIPMENT OPERATION

Do not connect snubbers in certain high impedance loads.

Failure to follow these instructions can result in death, serious injury or equipment damage.

When the relay contact is open or a high impedance load is connected to it, the snubber passes a current (typically 0.6mA at 100Vac and 1.2mA at 230Vac). You must ensure that this current will not hold on low power electrical loads. If the load is of this type the snubber should not be connected.

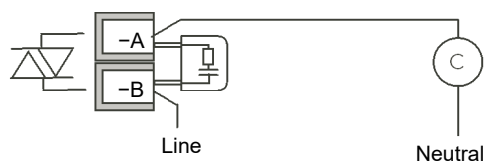
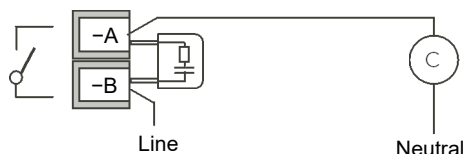

Current Transformer

⚠ DANGER

HAZARD OF ELECTRIC SHOCK, EXPLOSION OR ARC FLASH

The CT input and Digital Inputs are not isolated from the Primary Sensor Input terminals. If the sensor is not at ground or a safe potential then the CT and Digital Inputs will be at the same potential and care needs to be taken in components ratings and instruction to personnel to ensure safety.

Failure to follow these instructions will result in death or serious injury.

The current transformer input is an option in EPC3016 controller. It is supplied as standard in EPC3008 and EPC3004 controllers.

A further contact input (LA) shares a common terminal (C) with the CT providing up to three (EPC3016 controller) and five (EPC3008 and EPC3004 controllers) contact inputs.



- CT input current: 0–50mA rms (sine wave, calibrated) 50/60Hz.
- CT input resolution: 0.1A for scale up to 10A, 1A for scale 100A, 10A for scale up to 1000A.
- CT input accuracy: +1% of reading.
- A burden resistor, value 10Ω, is fitted inside the controller.

⚠ DANGER

RISK OF ELECTRIC SHOCK

A voltage limiting device fitted across the CT terminals, will help to prevent high voltages appearing at the CT terminals if the controller is unplugged. A suitable device is two back-to-back zener diodes rated between 3 and 10V, 50mA.

Failure to follow these instructions will result in death or serious injury.

Contact Closure Inputs (DI1 and DI2)

Up to two digital inputs are available which may be connected to external contacts.

DANGER

HAZARD OF ELECTRIC SHOCK, EXPLOSION OR ARC FLASH

The Digital Inputs and CT input are not isolated from the Primary Sensor Input terminals. If the sensor is not at ground or a safe potential then the CT and Digital Inputs will be at the same potential and care needs to be taken in components ratings and instruction to personnel to ensure safety.

Failure to follow these instructions will result in death or serious injury.

Digital input 1 is supplied with the current transformer, except on the Ethernet option in EPC3016 where LA is available but the CT is not.

Digital Input 2 is only available in EPC3004 and EPC3008.

Digital Input 1



Digital Input 2



- Switching: 12Vdc at 13mA max.
- Contact open > 400Ω. Contact closed < 100Ω.
- The function of the I/O is fixed by the application ordered, or configured using the Quick Start Codes, "Start Up—New Unconfigured Controller" on page 68. Alternatively, the function can be changed in Configuration level ("I/O List (io)" on page 107) or through iTools ("The 'Browser' List" on page 216).

Transmitter Power Supply

The Transmitter power supply is not available in the Model EPC3016.

It is fitted as standard in the Models EPC3008 and EPC3004.

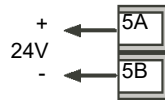

- Isolated output 300Vac CAT II.
- Output: 24Vdc, $\pm 10\%$. 28mA max.

Digital Inputs/Outputs 1 to 8

Up to 8 digital inputs/outputs are available on the options terminals depending on the option fitted. These are marked D1 to D8.

DANGER

HAZARD OF ELECTRIC SHOCK, EXPLOSION OR ARC FLASH

The Digital Inputs/Outputs and CT input are not isolated from the Primary Sensor Input terminals. If the sensor is not at ground or a safe potential then the CT and Digital Inputs will be at the same potential and care needs to be taken in components ratings and instruction to personnel to ensure safety.

Failure to follow these instructions will result in death or serious injury.

- Current sinking output. External DC PSU 15V minimum, 35V maximum.
- Voltage sensing logic input. High level input voltage 4V minimum. 35V maximum. Low level input voltage $-1V$ minimum, $+1V$ maximum.
- Contact closure input. Contact closed 0Ω to 100Ω . Contact open $>28k\Omega$.

Example 1 BCD Switch Wiring

The diagram below shows an example of wiring a typical BCD switch using the first four digital inputs of EPC3008 or EPC3004 controllers which could be used to select a program number.

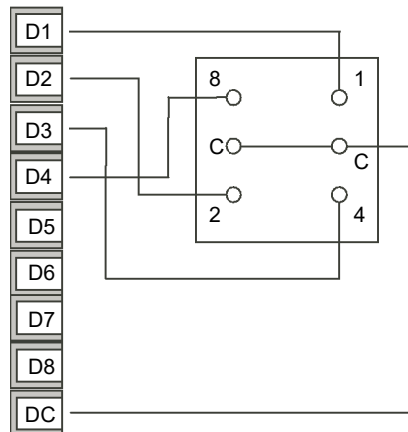

The BCD Inputs can be turned on in Level 3 or Configuration level, see "BCD List (bCd)" on page 145.

Example 2 Digital Inputs Wiring

Digital Inputs (Logic Inputs or Contact Closure in any combination).

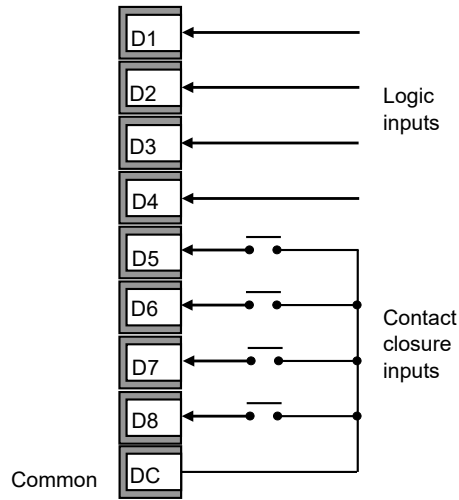

Example 3 Digital Outputs Wiring

Digital Outputs (Relay, Thyristor or SSR Drive in any combination).

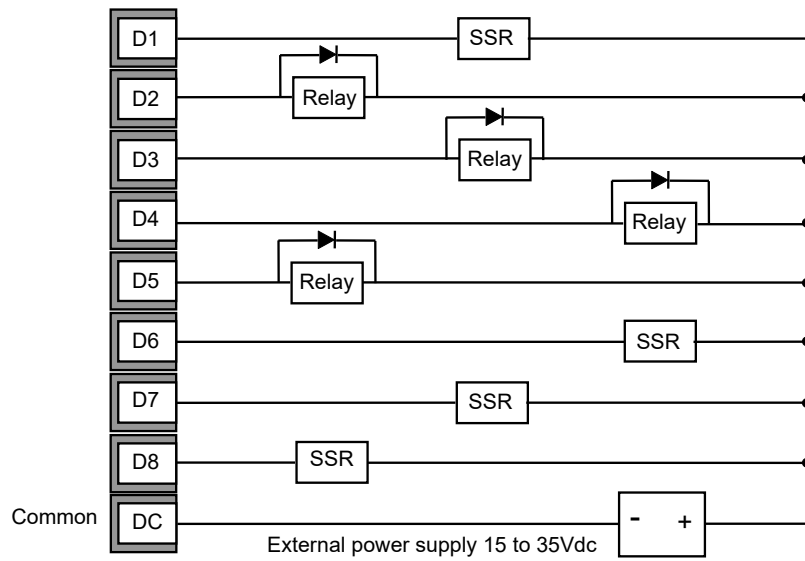

Digital Communications Connections

In the EPC3008 controller and the EPC3004 controller, EIA-485 (RS-485) is standard. EIA-232 (RS-232) and EIA-422 (RS-422) are not supported.

In the EPC3016 controller, EIA-485 (RS-485), EIA-422 (RS-422) and EIA-232 (RS-232) are supported via the option board.

ModbusRTU or EI-Bisynch protocol is used for compatibility with existing controllers.

Ethernet (ModbusTCP) is also supplied as an option in all controllers.

When connecting a computer to EIA-232 a USB adaptor is typically used. It is good practice to use electrically isolated adaptors, since electrical noise from an industrial situation may otherwise be transmitted to the computer damaging it.

To help prevent earth ground loops, the cable shield should be grounded at one point only.

Isolated 300Vac CAT II.

Note: In the following wiring diagrams, the terminal functions are correct, but the terminal layout may not be in the same order as on the instrument.

EIA-232 Wiring

EIA-232 is available in EPC3016 controller only and is used to connect one master and one slave.

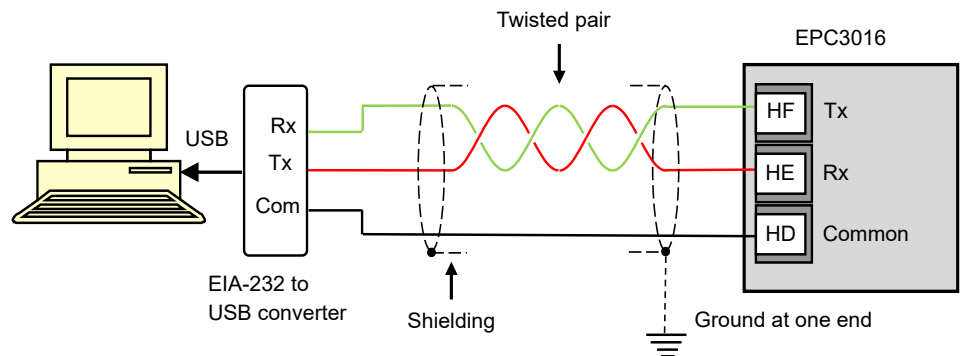

Serial Communications EIA-485

The EIA-485 Modbus RTU function of an EPC3016, EPC3008, EPC3004 controller provides an alternative digital communications method to Ethernet. It is independent of Ethernet and can be used at the same time that Ethernet communications are active. Data transmission is slower than Ethernet, but it is an effective communications method in some situations.

It may be used in the following example contexts:

1. Connection to legacy EIA-485 Automation networks for SCADA or data acquisition.
2. Direct connection to Programmable Logic Controllers using a serial network.
3. To interconnect an EPC3016, EPC3008, EPC3004 controller, for example to use the broadcast master function to send a digital master setpoint profile to downstream slave devices.
4. To connect Eurotherm iTools, typically in situations where older types of instruments such as Series 3000 controllers are being replaced and EIA-485 infrastructure is already present. Ethernet will always be a better connection method for new installations.

When connecting a computer to EIA-485, a USB adaptor is typically used. It is good practice to use electrically isolated adaptors, since electrical noise from an industrial situation may otherwise be transmitted to the computer damaging it.

EIA-485 supports up to 32 devices per network segment. Segment repeaters may be used to increase the number of devices in an EIA-485 network. Note that 220Ω termination resistors are required at the start and end of the RS485 line. Without these, communications will suffer intermittent faults.

Connections using a suitable converter are shown in the following diagram.

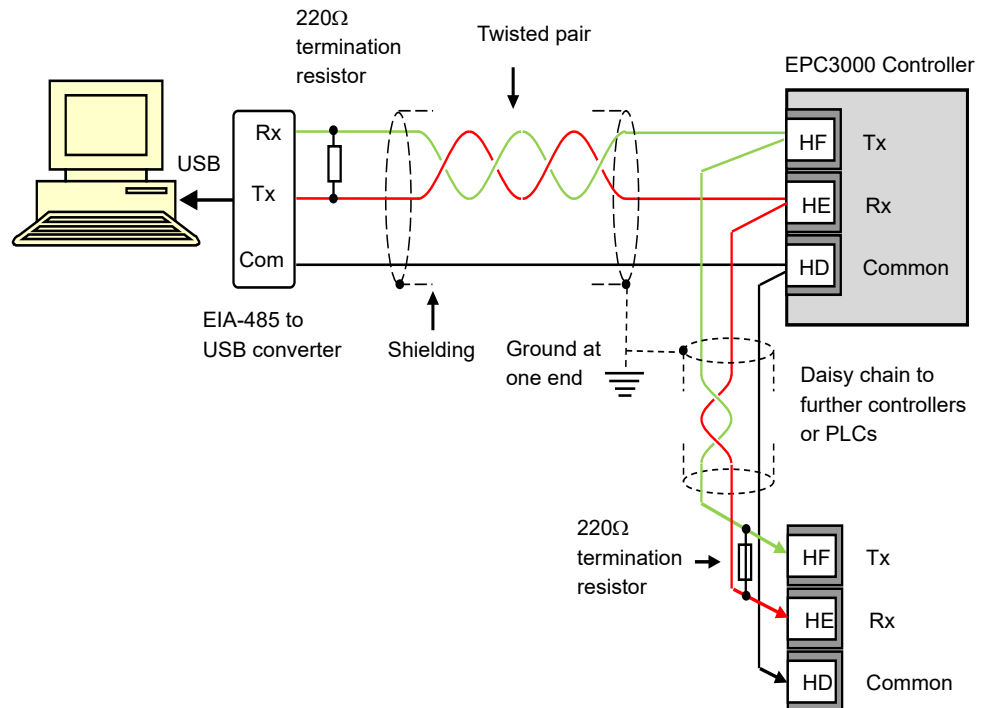

EIA-422 Wiring

EIA-422 (sometimes referred to as EIA-485 4-wire) is available as an option in EPC3016 only. It allows up to 31 slaves to be connected to the network using separate transmit and receive twisted pairs. As with the previous example the use of a suitable communication converter is recommended to convert EIA-422 to USB. The wiring connections are shown below.

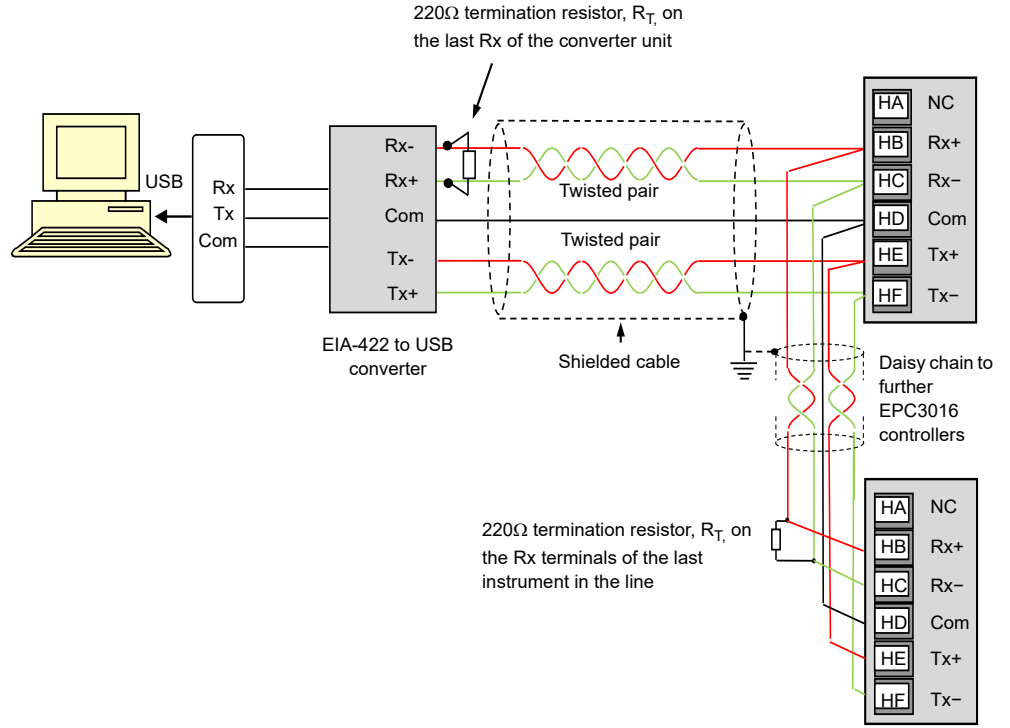

Ethernet Wiring

An Ethernet network port is available via an RJ45 connector, provided on the options board if ordered.



The connector has a pair of LED indicators.

Green = network speed. ON = 100, Off = 10.

Flashing amber = network activity.

The connection is 10/100BASE-T, autosensing.

Wiring Examples

Heat/Cool Controller

This example shows a heat/cool temperature controller where the heater control uses a SSR, triggered by a logic output on IO1, and the cooling control uses the relay, IO2.

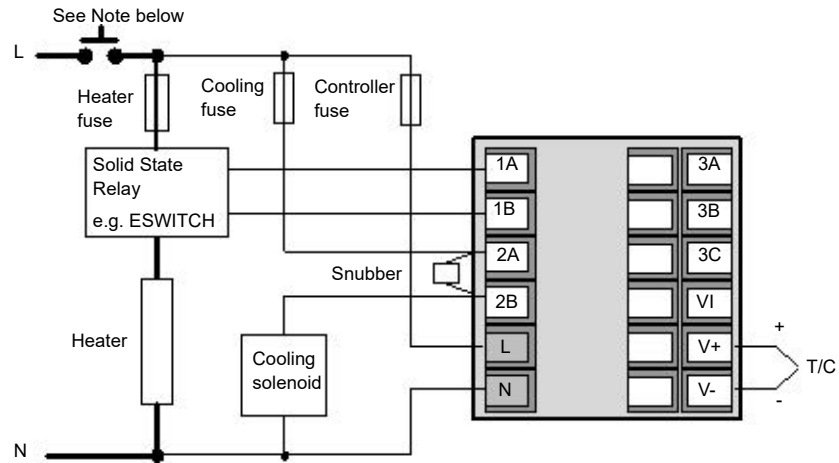

⚡ ⚠ DANGER

RISK OF ELECTRIC SHOCK

For permanently connected equipment, include a disconnecting device such as an isolating switch or circuit breaker in the installation.

Failure to follow these instructions will result in death or serious injury.

- The disconnecting device must be in close proximity to the equipment and within easy reach of the operator.
- The disconnecting device must be marked as the disconnecting device for the equipment.

Note: A single switch or circuit breaker can drive more than one instrument.

CT Wiring Diagram

This diagram shows an example of wiring for a CT input.

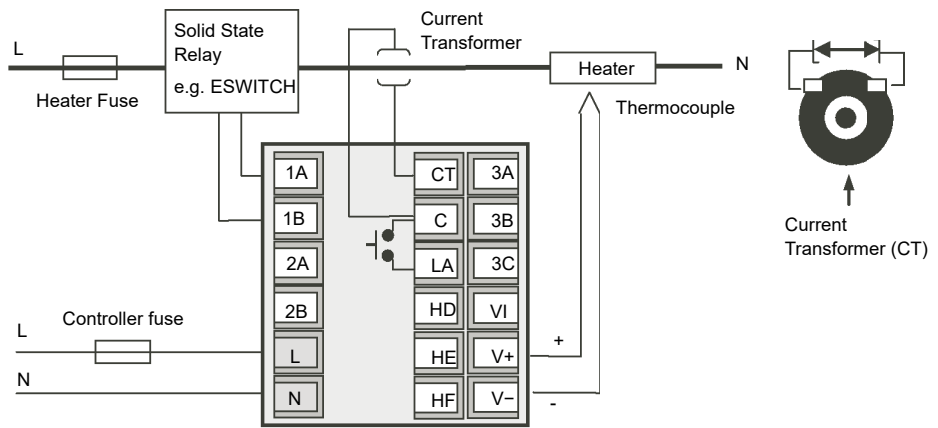

Note: A burden resistor value 10Ω is mounted inside the controller.

⚡ ⚠ DANGER

RISK OF ELECTRIC SHOCK

To help prevent a build up of high voltages at the output of the CT, if it is disconnected from the controller, it is recommended that a voltage limiting device be connected directly across the output of the CT. A suitable device is two back to back zener diodes, rated between 3 and 10V at 50mA, as shown in the diagram above.

Failure to follow these instructions will result in death or serious injury.

Start Up Modes

What is in this Chapter?

This chapter describes:

- What to expect when the controller is first switched on from new out of the box.
- A general description of the display and button functions.
- Power up after the instrument has been configured or commissioned.

Start up

Start Up (or Power Up) refers to the operation of the controller when switched on.

EPC3000 range controllers are designed to be application based. Their start up modes will, therefore, vary depending on what was ordered. This chapter will describe, in more detail, the different ways in which the controller operates at power up.

1. Controller new 'out of the box' supplied unconfigured. "Start Up—New Unconfigured Controller" on page 68.
2. Controller new 'out of the box' supplied fully configured according to the order code. "Start Up - New Configured Controller" on page 75.
3. Subsequent start ups - Controller previously configured. Go to section "Subsequent Start-ups" on page 76.

Start up Diagnostic mode

In all cases the controller display will perform a diagnostic in which all bars of each character and every beacon is illuminated. In a configured controller the diagnostic display is followed by the firmware version number and the instrument type number, then a short summary of the Quick Codes. (A new unconfigured controller shows the Quick Codes only, see section "Start Up—New Unconfigured Controller" on page 68). In general the start up diagnostics is the same for each model.

The opening display is dependent upon its configuration status and is described in subsequent sections.

The controller will scan for the types of the hardware fitted. If different hardware is detected from that expected, then a message will be displayed and the instrument will go into standby mode. To clear this message, either arrange to have the module replaced with the expected module type OR configure the expected module parameter value to match the fitted module parameter value.

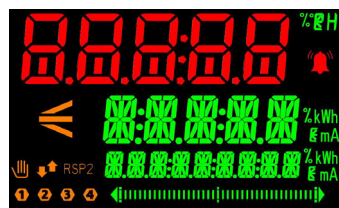

A keyboard check will also be carried out. The controller will go into standby if the check does not complete as expected.

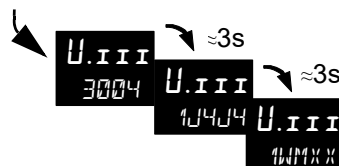

General Description of Front Panel Displays

EPC3016

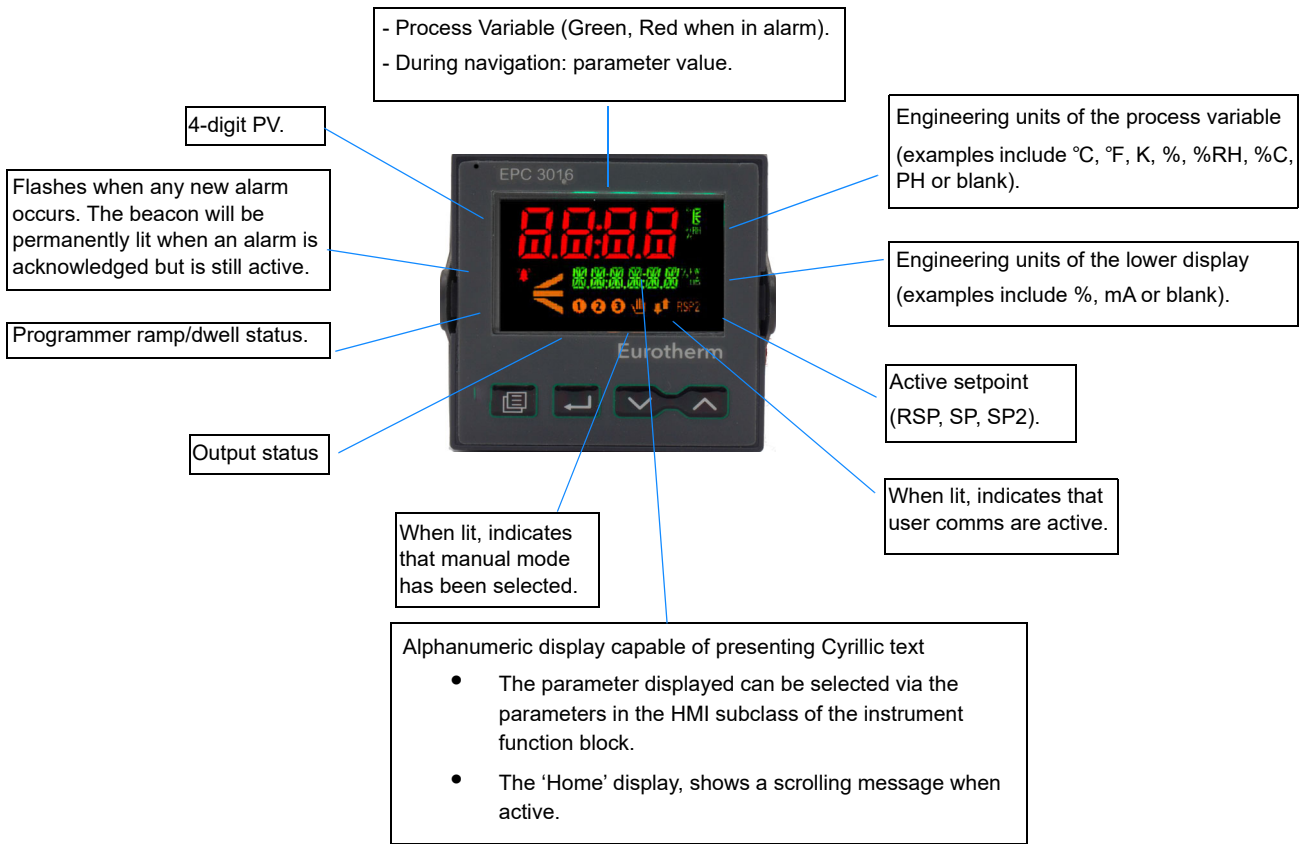

EPC3008

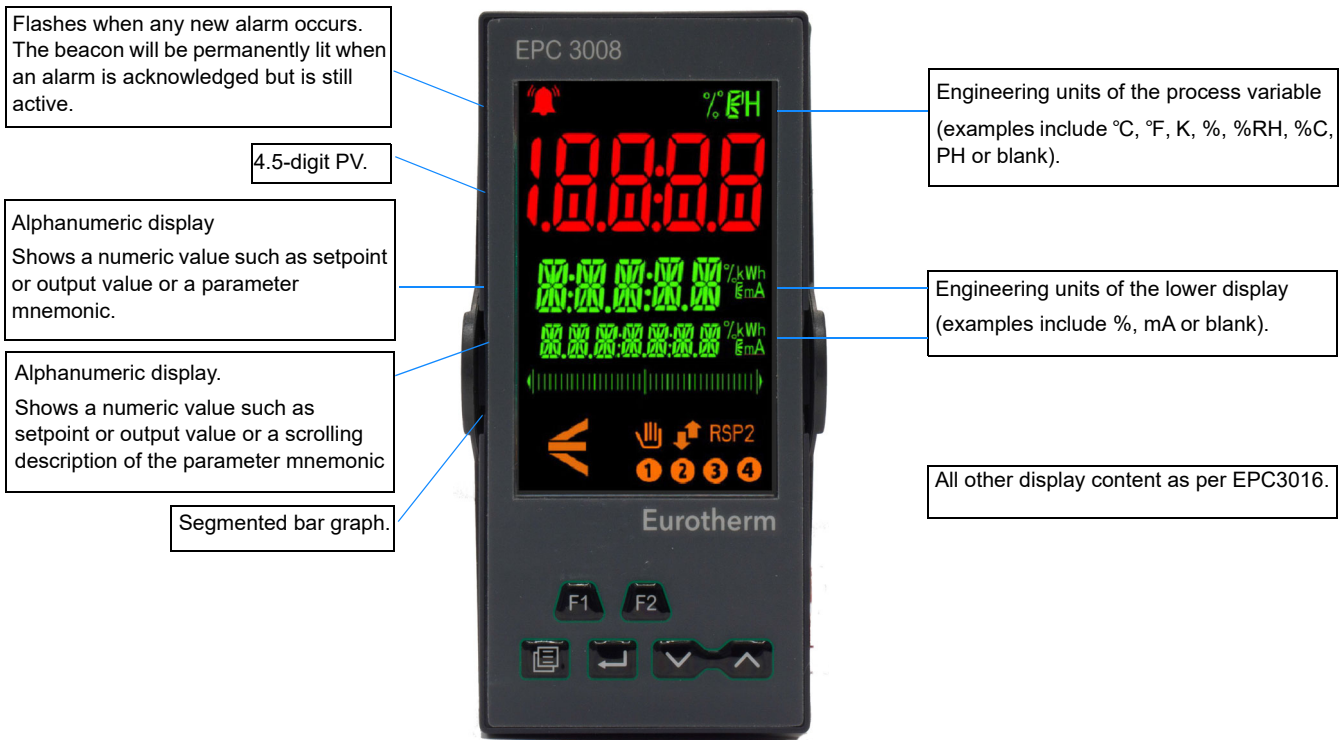

EPC3004



The start up display depends on the controller configuration and is described in subsequent sections.

General Description of Operator Buttons

On EPC3016 only the 4 navigation buttons (Page, Scroll, Down, Up) are available.
On EPC3008 and EPC3004 all 6 buttons (4 navigation and 2 function) are available.

Button Layout



Button Operation

Raise

The raise button increments parameter values to limits.
Parameter enumerations, however, do wrap-around.

Lower

The lower button decrements parameter values to limits.
Parameter enumerations, however, do wrap-around.

Page

In Operator levels 1 or 2 the Page button will select between the Home display or the Programmer Edit and Run lists (if one of the programmer features is enabled).

In Levels 3 or Config the Page button will scroll through list headers (no auto-repeat). If the Page button is pressed within a list, the display reverts to the top of the list. The top of the list shows the list header only with no initial parameters.

Page (held for >3 seconds)

The Goto parameter is selected directly. This operation can be performed from any display. If the Page is held for >3 seconds at power-up the Quick Start Mode is selected following the entry of a password.

Page+Raise

Scroll back the list headers (with auto-repeat).

Scroll

Select parameters in turn, returning to the first parameter in the list or to a list header if Level 3 or Configuration level is selected. If the button is held down the list will auto-repeat. In levels 1 and 2 this button also scrolls through promoted parameters when the HOME screen is selected.

Scroll+Raise

Scroll back through parameters from bottom to top (with auto-repeat).

Page+Scroll - all variants

Jump directly to the "HOME page". The current operating level remains unchanged. If the HOME page is already selected, these buttons will perform the custom function as detailed in "Functionality of the F1 and F2 and Page + Scroll buttons" on page 196. The default is Alarm Acknowledge.

Raise+Lower (Run/Hold)

If a programmer option is enabled and a program is configured, a momentary press of these keys toggles between Run and Hold modes.

Raise+Lower (hold for >3 seconds - Mode)

If a programmer option is enabled and a configured program is running, holding these buttons will abort the program.

If the HOME page is selected and the Programmer is not running, holding these buttons will invoke the 'Mode' display where the Loop Mode parameter will allow selection of Auto or Manual mode.

F1 and F2

F1 and F2 buttons are not available in EPC3016.

The functionality of these buttons is set by the Instrument function block. The default settings are:



- F1: Auto/Man.
- F2: Run/Hold.

Note: A time-out applies to all displays. If no button presses are detected within a timeout period (default 60s), the display will revert back to the Level 1 "HOME page".

Start Up—New Unconfigured Controller

If the controller is new and ordered as unconfigured it will start up in 'Quick Start Mode'. This is a built in tool which is provided to allow users to configure the product for the most commonly used functions such as the application type, input type, range, and digital input functions. The Quick Configuration code consists of two 'SETS' of five characters each. The upper section of the display shows the set selected, the lower section shows the five digits which make up the set. Each digit may result in multiple parameter values being set. The opening set is SET1 as shown.



Initially all characters are shown as an '#'. This is generally the default character for 'not fitted/none' or 'use default'. The first character, initially flashing, selects the Application Type as listed in the Quick Start Tables in the following sections. To select the required application type press  or .

Note: Quick Code 1 will only be available if the correct hardware is fitted for the application. For example, the VPU application must have IO1 and IO2 as relay, triac or logic outputs.

Press  to select the second character. The second character selects the 'Input 1 Type' as listed in the Quick Start Tables in the following sections. If hardware or features are not available then the character is skipped over when pressing scroll.

Continue to set up all 5 characters using the Quick Start Tables.

When the last character in SET1 has been entered the display will automatically go to SET2.

Adjust these in the same way as SET1.

At any time to return to the start of SET1, press .

⚠ WARNING
HAZARD OF INCORRECT CONFIGURATION
Incorrect configuration can result in damage to the process and/or personal injury and must be carried out by a competent person authorized to do so. It is the responsibility of the person commissioning the controller to ensure the configuration is correct.
Failure to follow these instructions can result in death, serious injury, or equipment damage.

More detailed features available in the product may also be configured by entering a Configuration Level. This is explained in "Configuration Level" on page 96, or by using iTools as explained in "Configuration Using iTools" on page 212. iTools is a configuration package available free of charge from Eurotherm by accessing www.eurotherm.com.

Quick Start Tables

The first digit in SET 1 will select an application which automatically configures relevant function block parameters and creates connections between them to make a complete control strategy relevant to that application.

The *Configuration Using iTools* chapter has a section called "Applications" on page 228, which provides a general description of the available applications and their associated graphical wiring (as diagrams).

Descriptions of each EPC3000 FM application are available in:

- "Applications" on page 228
- "Appendix: EPC3000 Factory Mutual (FM)" on page 400

Quick Code Set 1

Digit 1	Digit 2	Digit 3	Digit 4	Digit 5
Application	Analog Input 1 Type	Analog Input 1 Range	Analog Input 2 Type	Analog Input 2 Range
X = None 1 = EPC3000 FM Limit Alarm - High 2 = EPC3000 FM Limit Alarm - Low	X = Use Default Thermocouple B = Type B J = Type J K = Type K L = Type L N = Type N R = Type R S = Type S T = Type T RTD P = Pt100 W = Pt1000 Linear M = 0-80mV V = 0-10V 2 = 0-20mA 4 = 4-20mA	X = Use Default 1 = 0-100°C 2 = 0-200°C 3 = 0-400°C 4 = 0-600°C 5 = 0-800°C 6 = 0-1000°C 7 = 0-1200°C 8 = 0-1300°C 9 = 0-1600°C A = 0-1800°C F = Full range	X = Not fitted or Use Default Thermocouple B = Type B J = Type J K = Type K L = Type L N = Type N R = Type R S = Type S T = Type T RTD P = Pt100 W = Pt1000 Linear M = 0-80mV V = 0-10V 2 = 0-20mA 4 = 4-20mA Z = HiZ	X = Not fitted or Use Default 1 = 0-100°C 2 = 0-200°C 3 = 0-400°C 4 = 0-600°C 5 = 0-800°C 6 = 0-1000°C 7 = 0-1200°C 8 = 0-1300°C 9 = 0-1600°C A = 0-1800°C F = Full range

Notes:

1. If no application is selected (1st character in SET 1 = X) the display will go directly to the EXIT screen. If accepted the controller will take on a set of default values. Any further configuration may be carried out by accessing the Configuration Level ("Configuration Level" on page 96) or through iTools configuration software ("Configuration Using iTools" on page 212).
2. For linear inputs the minimum/maximum input voltage/current will cause the display to read range low/high respectively.
3. If the input 2 is not fitted Set 2 will be selected immediately after Input 1 Range has been set.

* Temperature, Carbon potential and dew point control are described as separate supplements to this manual and are available from www.eurotherm.com. Part numbers HA033033, HA032987 and HA032994 respectively.

Quick Code Set 2

Digit 1	Digit 2	Digit 3	Digit 4	Digit 5
CT Input Range	LA Function	LB Function	Option DIO Function	Temperature Units
X = Not fitted or not used 1 = 10A 2 = 25A 5 = 50A 6 = 100A 7 = 1000A	X = Not used W = Alarm Acknowledge M = Auto/Manual R = Program Run/Hold L = Key Lock P = Setpoint Select T = Program Reset U = Remote/Local Select V = Recipe Load Select K = Loop Track	X = Not fitted or not used W = Alarm Acknowledge M = Auto/Manual R = Program Run/Hold L = Key Lock P = Setpoint Select T = Program Reset U = Remote/Local Select V = Recipe Load Select K = Loop Track	X = Not fitted or not used 1 = Config 1 2 = Config 2 3 = Config 3 4 = Config 4 5 = Config 5 6 = Config 6 7 = Config 7 8 = Config 8 9 = Config 9	X = Use Default C = Celsius F = Fahrenheit K = Kelvin

Notes:

1. The Quick Code assumes that the CT input is monitoring the current of the heat channel load which in all applications is wired to IO1.PV.
2. If IO.1 module is a DC Output module then CT Input digit is not alterable.
3. If CT input is not set to X, the CT Input will be enabled and will monitor the current; however, CT alarms will not be configured. This means that if CT alarms are required they must be wired by the user. A typical example of wiring alarms is shown in section "Example 1: To Wire an Alarm" on page 224.

Quick Codes DIO

If the Options module has been fitted then the function of the module is defined by fixed configurations. These are selected by Digit 4 in the previous table. The fixed configurations are listed in the table below:

Config	Function	Config	Function	Config	Function
Config 1	DIO1 = Programmer Event Output 1 DIO2 = Programmer Event Output 2 DIO3 = Programmer Event Output 3 DIO4 = Programmer Event Output 4 DIO5 = Programmer Event Output 5 DIO6 = Programmer Event Output 6 DIO7 = Programmer Event Output 7 DIO8 = Programmer Event Output 8	Config 4	DIO1 = BCD Input 1 DIO2 = BCD Input 2 DIO3 = BCD Input 3 DIO4 = BCD Input 4 DIO5 = Programmer Run/Hold DIO6 = Programmer Reset DIO7 = Programmer Advance DIO8 = Not Used BCD Output wired to Program Number	Config 7	DIO1 = Programmer Run DIO2 = Programmer Hold DIO3 = Programmer Reset DIO4 = Programmer Advance DIO5 = Not Used DIO6 = Not Used DIO7 = Not Used DIO8 = Not Used
Config 2	DIO1 = Programmer Event Output 1 DIO2 = Programmer Event Output 2 DIO3 = Programmer Event Output 3 DIO4 = Programmer Event Output 4 DIO5 = BCD Input 1 DIO6 = BCD Input 2 DIO7 = BCD Input 3 DIO8 = Programmer Run/Hold BCD Output wired to Program Number	Config 5	DIO1 = BCD Input 1 DIO2 = BCD Input 2 DIO3 = BCD Input 3 DIO4 = BCD Input 4 DIO5 = BCD Input 5 DIO6 = BCD Input 6 DIO7 = BCD Input 7 DIO8 = BCD Input 8 BCD Output wired to Recipe Load	Config 8	DIO1 = Programmer Run DIO2 = Programmer Hold DIO3 = Programmer Reset DIO4 = Not Used DIO5 = Not Used DIO6 = Not Used DIO7 = Not Used DIO8 = Not Used
Config 3	DIO1 = Programmer Event Output 1 DIO2 = Programmer Event Output 2 DIO3 = Programmer Event Output 3 DIO4 = Programmer Event Output 4 DIO5 = Programmer Run DIO6 = Programmer Hold DIO7 = Programmer Reset DIO8 = Programmer Advance	Config 6	DIO1 = BCD Input 1 DIO2 = BCD Input 2 DIO3 = BCD Input 3 DIO4 = BCD Input 4 DIO5 = Not Used DIO6 = Not Used DIO7 = Not Used DIO8 = Not Used BCD Output wired to Recipe Load	Config 9	DIO1 = Programmer Event Output 1 DIO2 = Programmer Event Output 2 DIO3 = Programmer Event Output 3 DIO4 = Programmer Event Output 4 DIO5 = Not Used DIO6 = Not Used DIO7 = Not Used DIO8 = Not Used

Example of Quick Codes

SET1: 1. 1. 3. X. X

SET2: X. M. W. 7. C



The controller is configured for PID Heat Only, Input 1 Thermocouple Type J, Range 0–400°C, Input 2 and Range not used, CT Input not used, Digital Input LA will select Auto/Manual, Digital Input LB will select Global Acknowledge of Alarms, the optional digital IO will be configured in accordance with 'Config 7 in the above table, Temperature Units Degrees Celsius.

To Save or Discard Quick Codes



When all characters have been entered the display will show:



If **No** is selected (by pressing ) the display returns to SET1.

Press  or  to select **SAVE** then either press  to save immediately or wait for 2 seconds to save automatically. This accepts the Quick Configuration Codes and the controller enters Operator Level 1.











OR



Press  or  to select **di Sc** then either press  to select or wait for 2 seconds to accept. This discards the last entered codes and returns the controller to its previous settings.

Selecting either SAVE or diSc will result in the instrument performing a restart.

Configure the Communications Protocol

From firmware versions V3.01 and above, the communications protocol and associated selections may be chosen during the start-up sequence. This is to simplify access to Digital Communications when the instrument is being configured. When the controller is new and first switched on, or following a cold start, the following sequence is displayed at start up and after the Quick Codes have been saved:

Operation	Action	Display	Notes
Digital comms setup is selected			
Select the required serial protocol	1. Press  to select the serial Protocol to be used for your process		<i>NONE</i> - No serial comms <i>mRTU</i> - ModbusRTU <i>EI bS</i> - EI-Bisynch This list only appears for serial comms (EPC3004, EPC3008, EPC3016 with Serial Option board).
If Modbus or EI-Bisynch is selected	2. Press  to select the node address		
Select Ethernet protocol	3. Press  to select Ethernet Protocol		<i>NONE</i> = No Ethernet <i>mTCP</i> - ModbusTCP Slave only <i>EIPm</i> - EtherNet/IP Slave and Modbus TCP Slave <i>BACm</i> - BACnet Slave and Modbus TCP Slave <i>mMSE</i> - Modbus TCP Master and Slave This list only appears if the Ethernet option module is installed and the features have been purchased.
Turn Auto discovery on or off	4. Press  to select Auto Discovery		See "AutoDiscovery" on page 320. <i>OFF</i> - No auto discovery <i>On</i> - Auto discovery enabled
Save and exit comms set up	5. Press 		<i>No</i> - Return to comms set up <i>SAVE</i> - Save the comms settings <i>dSc</i> - Discard comms settings. The questions will be asked again at the next power up.

Note: In all cases the option is selected using  or  .

To Re-Enter Quick Code mode

It is possible to re-enter Quick Start mode, by holding down the Page key during power up. Enabling Comms Protocol does not appear when the quick code is re-entered.

It is then necessary to enter the configuration level password. See "To Select Configuration Level" on page 98.

If the configuration of the instrument is subsequently modified by a change made via Configuration Mode this will be shown by the quick code digits being separated by the decimal place dot (indicating that the codes shown may not reflect the current configuration). If the codes are then accepted the instrument is re-configured to satisfy the code settings.

Notes:

1. If the config clip is connected the instrument may be powered from the USB port of the PC. In this case it is necessary to disconnect the config clip to re-enter Quick Start Mode. Alternatively, disconnect the power pins from the config clip. See "Using the Configuration Clip" on page 213.
2. If a Cold Start (See "Cold Start" on page 244) has been invoked the instrument will always start in Quick Code Mode without the need to enter the configuration password. Enabling Comms Protocol will then be displayed.

Start Up - New Configured Controller

If a product has been ordered using the Order Code it will already be configured. When new, 'out of the box', it will then power up in operating Level 1.

Also, if it has previously been configured, for example, using the Quick Codes then it will start up in Operating mode.

The start up display is dependent upon the application or the way in which the controller is configured, see 'Start-up Modes' in the following section.



The view shown above is generally referred to as the 'HOME' Display.

In EPC3008 and EPC3004 the HOME display normally consists of three lines. The upper line normally shows the Process Value "PV",

The center line normally shows the Working Setpoint "WSP" if the controller is working in its normal Auto Mode or the Output demand if it is in Manual Mode. (Auto/Manual control is explained in section "Auto/Manual Mode" on page 80.

The lower line shows a scrolling message providing a longer description of the selected parameter. It may also display a further parameter value if this has been set up in the instrument block, see "Display Functionality Sub-List (Hml)" on page 195.

Bar Graph

In EPC3008 and EPC3004 a bargraph may also be configured using iTools. The bargraph may be 'soft' wired to any convenient source such as PV input or output demand, see "Example 4: To Configure a Bargraph" on page 225.

EPC3016 has two lines of display. The line below the top one alternates between a mnemonic and the scrolling message. A bargraph is not available.

Setpoint

The Setpoint is defined as the value which the process is required to attain. The value of the setpoint may be obtained from a number of sources, for example, manually using the front panel keys, via the programmer function block, via an external analog source, via digital communications. The working setpoint is, therefore, defined as the current setpoint derived from any of these sources.

Subsequent Start-ups

When the controller is no longer new and has been in normal use it will start up in Level 1, even when it has been powered down in Operator level 2 or 3. If, however, it was powered down when in Configuration level it will power up in 'Standby' and show a message - *'POWERED DOWN WHILST IN CONFIG MODE'*. To clear the message re-enter configuration level (with password - see "To Select Configuration Level" on page 98), then, either continue with changes to the configuration or accept existing changes by exiting configuration level. The reason for this is that the controller may have been part configured prior to shut down and either needs completion of the configuration or confirmation that no further changes are required.

Start-up Modes

The controller may start in Manual or in Auto Mode depending on the setting of the 'Recovery Mode' parameter, see section "Configuration Sub-List" on page 119.

If the Recovery Mode has been set to Manual (default) the controller will start in 'Man' mode. It will show the letter 'M' and the 'hand' symbol in the display. Initially the output will be at the 'Fallback Value', see section "OP Sub-list" on page 131, but may then be changed using the raise or lower buttons. Auto mode may also be selected.

If the Recovery Mode has been set to 'Last' the controller will start in either in Manual mode or Auto mode depending on whatever mode it was in prior to being powered off. 'Auto' mode is shown in the EPC3004 controller view in the previous section.

For further information on start up modes see section "Start-up and Recovery" on page 302.

Standby

Standby is the term given when the instrument strategy is not controlling due to the following reasons:

- If the instrument is being configured i.e. in Quick Code Mode, Configuration Mode or a clone file is being loaded.
- If the instrument has detected an unexpected condition (for example, was powered down whilst in configuration mode, or fitted hardware does not match expected hardware). See "Start up Diagnostic mode" on page 63 for more information on unexpected conditions that will place the instrument into standby.
- If the instrument is forced into standby via the Instrument.Diagnostics.ForceStandby parameter, see "Subsequent Start-ups" on page 76.

When the instrument is in standby, the following occurs:

- All relay, logic or triac outputs are placed into their 'Off' state, unless being used as Valve Raise (Up) / Lower (Down). In this case the Standby Action is configurable by the 'StandbyAction' parameter (Rest, Up, Down) found in the 'IO' list, (section "I/O List (io)" on page 107).
- Analog outputs will go to the 'OutputLow' limit found in the 'IO' list.
- The control loop will be placed into Hold.
- If an alarm has the 'StandbyInhibit' parameter set to 'On' (section "Alarms List (ALm)" on page 141), then the alarm is inhibited (active alarms will be turned Off and new alarm conditions will not be acted upon).
- If in standby due to the instrument being configured, a running program will reset.

WARNING

LOSS OF COMMUNICATIONS

If an output is not internally wired by the application, but is written to by communications, ensure that the appropriate action is taken in the event that communications is lost.

Failure to follow these instructions can result in death, serious injury, or equipment damage.

Auto-scaling of decimal point

The range of values displayed on the 'top line' will vary for each instrument version. If a value exceeds the display capabilities, the resolution will automatically be reduced by a factor of 10, up to the display limit in the table below. If the value cannot be displayed, HHHH or LLLL will be shown.

Auto-scaling is applied to parameter values being edited via the HMI.

Instrument	Decimal points	Minimum	Maximum
EPC3016	0	-1999	9999
	1	-199.9	999.9
	2	-19.99	99.99
	3	-1.999	9.999
EPC3008	0	-1999	19999
	1	-199.9	1999.9
	2	-19.99	199.99
	3	-1.999	19.999
EPC3004	0	-19999	99999
	1	-1999.9	9999.9
	2	-199.99	999.99
	3	-19.999	99.999
	4	-1.9999	9.9999

Operator Levels

What is in this Chapter?

This chapter describes the different operator levels:

- Operator Level 1.
- Operator Level 2.
- Introduction to Operator Level 3.
- Return from a higher level to a lower level of operation.

Overview

There are 5 levels of operation:-

1. **LEU1** - Level 1 has no password, the control is active and only the home list is accessible.
2. **LEU2** - Level 2. The control is active and an extended home list is accessible.
3. **LEU3** - Level 3. The control is active and the complete operator parameter set is shown and modifiable; the complete Configuration parameter set is shown, (read only); the user calibration (two point cal) facility is available.
4. **CONF** - Configuration level is used to setup the whole controller; the configuration parameters are accessible; the operator parameters are available, without the need to switch to operator mode. The instrument calibration parameters are also available in this mode. See "User Calibration" on page 369.

Levels 2, 3 and Configuration can be restricted by passwords.

5. In addition the Quick Start Mode (See "Start Up—New Unconfigured Controller" on page 68) is provided to allow users to configure the product in the minimum number of operations. It is only available at power up after the instrument is cold started or by holding the Page key during power up.

Operator Level 1

Operator Level 1 is entered:

1. After the Quick Code has been entered for those controllers supplied unconfigured.
2. After power up when the controller has been configured.

The display shown below is for a typical temperature controller.





Process Value (PV)

Manual output level (%) or Setpoint (SP) (Required Temperature)

Scrolling messages (when applicable)

Bargraph (not EPC3016)

Press  to increase the setpoint

Press  to decrease the setpoint

The new setpoint is entered when the button is released and is indicated by a brief flash of the SP value

In general the current value of the process is shown in the upper display.

By default the controller will start in 'Manual' Mode. This is shown by 'M' in the display, the 'Hand' symbol, the value of the output (in %) and the bargraph (if available).

In 'Auto' mode, the required value (Setpoint) is shown in the lower display.





Additional scrolling messages are shown, for example, when operator parameters are selected (see section "Level 1 Operator Parameters" on page 82). These may be standard descriptions of the parameter currently selected or they may be user specific messages which have been set up using iTools. (See "Parameter Promotion" on page 233).

Auto/Manual Mode

In Manual mode the value of the output is increased or decreased directly by the operator using the Up and Down buttons.



In Auto mode the process is adjusted automatically by the controller in response to differences between the setpoint and the actual measured value.

In Operator Level 1 the controller may be placed into manual operation as follows:

- By default in EPC3008 and EPC3004 controllers, Auto/Manual may be selected by the user by toggling the F1 button.
- By default in EPC3016 controller Auto/Manual may be selected by the user by pressing and holding the  and  buttons for longer than 3 seconds. This will show the A-M (Auto-manual select) parameter. Then press  or  to toggle between auto and manual.



Manual is indicated in the HMI by showing the 'Hand' symbol and the character 'M'.

The current level of the output demand is shown as a percentage. This may be increased or decreased by pressing the  or  buttons respectively.

Note: Alternative ways to select Auto/Manual may be configured and will be explained in subsequent chapters of this manual.

System Messages

In addition to standard (or customized) scrolling messages, System Messages may be shown at any time. A list of these is shown in "Notification Messages" on page 378. The following two messages are typical and could appear at start up.

Setting the Comms Password

If the comms password has not been set and either Fixed comms or Option comms has been configured then this notification message will be scrolled across the HMI 'PLEASE SET THE COMMS PASSWORD VIA ITOOLS'. Until the comms password is set, Fixed comms and Option comms will have a limited parameter read/write access. This security feature is described in section "Comms Configuration Level Password" on page 21.

Comms Configuration Active

The scrolling message 'COMMS CONFIGURATION ACTIVE' will be displayed if, for example, iTools is connected to the controller and has been placed in configuration mode by iTools. The controller will be placed into standby mode.

The character 'H' signifies that the controller has been placed into Hold mode and is displayed as shown below.



Note: The displays shown above also apply if the controller is in Operator Levels 1, 2 or 3.

Bargraph

In EPC3008 and EPC3004 a bargraph may also be shown which displays the configured value as a horizontal bar. This is set up in Configuration Level (See "Display Functionality Sub-List (Hmi)" on page 195).

Level 1 Operator Parameters

A minimal list of parameters is available in Operator Level 1 which is designed for day to day use. Access to these parameters is not restricted by a password.

Press **←** to step through the list of available parameters. The mnemonic of the parameter is shown in the lower display. Alternatively, press and hold **←** then press **▲** to scroll forward through parameters and **▼** to scroll back.

Press **☰** to return to the Home display.

The value of the parameter is shown in the upper display. If the value is read/write press **▲** or **▼** to adjust. If no key is pressed for 60 seconds the controller returns to the HOME display. The navigation is shown diagrammatically for the first two parameters in the example below:

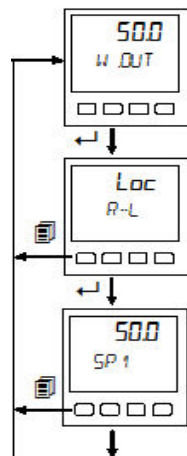

The parameters that appear depend upon the functions configured. The list can also be customized using iTools by adding or removing parameters. The table below shows an example of the list of parameters in Level 1. Parameters may be added to or deleted from this list, see "Parameter Promotion" on page 233.

Parameter Mnemonic	Scrolling name	Description	Further information
W.OUT	WORKING OUTPUT	The output demand – 0% to 100% or –100% to +100%.	
R-L	REMOTE-LOCAL SELECT	Selects the Remote or Local setpoint source.	"Loop - Main Sub-list" on page 117.
SP 1	SETPOINT 1	The value which the process is required to attain as set by setpoint 1.	
SP2	SETPOINT 2	The value which the process is required to attain as set by setpoint 2 if selected.	
RI 1PV	PV	The current value of the process (read only) read by the primary input IP1.	
RI2PV	PV	The current value of the process (read only) read by the secondary input IP2.	If the secondary input is used.
L.I.I	CT LOAD CURRENT	The current being supplied to the heater as measured by the CT.	If the CT is being used.

Level 1 Programmer Display

By default, if the controller has the programmer installed, the status of a running program can be displayed.

Programmer List

Press the page button , the display will show



Repeatedly press  to read the currently running program.











Parameters displayed depend on the program and the type of segment configured but generally include the following:

Parameter Mnemonic	Scrolling name	Description
P.NUM	PROGRAM NUMBER	Alterable but does not affect the running program.
P.NAME	PROGRAM NAME	Read only. This parameter is available in firmware versions V3.01 and above.
P.CUR	CURRENT PROGRAM	Read only.
C.NAME	CURRENT PROG NAME	Read only. This parameter is available in firmware versions V3.01 and above.
P.MODE	PROGRAM MODE	Displays the current mode e.g. Run, Hold, Reset.
P.SP	PROGRAM SETPOINT	Read only.
P.TIML	PROGRAM TIME LEFT	Read only.
P.CYCL	PROGRAM CYCLES LEFT	Read only.
S.NUM	CURRENT SEGMENT NUMBER	Read only.
S.NAME	SEGMENT NAME	Read only. This parameter is available in firmware versions V3.01 and above.
S.TYPE	CURRENT SEGMENT TYPE	Read only.
S.TIML	SEGMENT TIME LEFT	Read only.
T.SP	TARGET SETPOINT	Read only.
R.RATE	RAMP RATE	Read only.
EVT.X	EVENT X	Event off or on. Further events are shown if configured.
P.ADVN	PROGRAM ADVANCE	Read only.

By default the programmer parameters available in Level 1 are read only. It is possible, however, to provide programmer edit access to Level 1, see "Programmer List (PROG)" on page 135. If this has been done the lists of parameters is shown in section "Level 2 Programmer Display" on page 88.

Programmer Status Indicator











The current status of the running program is displayed as follows:

State	Ramp/Step Up	Dwell		Ramp/Step Down	
Reset					
Run					
Hold/Holdback		Flashing (1 second period 66% duty cycle) 	Flashing (1 second period 66% duty cycle)		Flashing (1 second period 66% duty cycle)
Complete (Dwell End)	Not applicable		Flashing (2 seconds period 66% duty cycle)	Not applicable	

Operator Level 2



To Select Operator Level 2



Operator level 2 is normally restricted by a password. By default the password is 0002 in a new controller. Enter Level 2 as follows:

Operation	Action	Display	Notes
Select Level 2	<ol style="list-style-type: none"> 1. Press and hold  until GOTO is shown. 2. Press  to choose LEV 2 (Level 2). 3. Press  to enter. 		
Enter the password	<ol style="list-style-type: none"> 4. Press  or  to enter the correct digit value of the password. 5. Press  to accept the value and move to the next digit. 6. The controller will now show the top of the HOME list in Level 2. 		<p>Press  to move to the next digit.</p> <p>The default password for level 2 is '0002'.</p> <p>A special case exists if a security code has been configured as '0000'. If this has been done it is not necessary to enter a code and the controller will enter the chosen level immediately.</p> <p>If an incorrect code is entered the display will return to HOME. After three wrong attempts the password entry system will lock out for a time set by the 'password Lockout Time' set in the "Security Sub-List (SEC)" on page 197.</p>
Select Level 2 parameters	<ol style="list-style-type: none"> 7. Repeatedly press  . 		The list of available parameters is given in the table in the next section.

Level 2 Operator Parameters

Parameters available in level 1 are also available in level 2, but level 2 includes additional parameters for commissioning purposes and for more detailed operation.

Press  to step through the list of available parameters. The mnemonic of the parameter is shown in the lower display. Press  to return to the previous parameter.

The value of the parameter is shown in the upper display. If the value is read/write press  or  to adjust. If no key is pressed for 60 seconds the controller returns to the top of the HOME list.

By default the following table lists all possible parameters available in both Levels 1 and 2. Parameters associated with a particular feature will only be shown if that feature is configured.

Parameter Mnemonic	Scrolling name	Description	Further information
WOOUT	WORKING OUTPUT	The output current demand – 0% to 100% or -100% to +100%.	Level 1 & 2
R-L	LOOP REMOTE/LOCAL	Selects the Remote or Local setpoint source.	Level 1 & 2
SP.HI	SETPOINT HIGH	Maximum value allowed for the local setpoints (SP1 and SP2).	
SP.LO	SETPOINT LOW	Minimum value allowed for the local setpoints (SP1 and SP2).	
SP1	SETPOINT 1	The value which the process is required to attain as set by setpoint 1	Level 1 & 2
SP2	SETPOINT 2	The value which the process is required to attain as set by setpoint 2 if selected.	Level 1 & 2
SP.UP	SETPOINT RATE UP	Limits the maximum rate at which the working setpoint can change in an increasing (upwards) direction. Setpoint rate limiting is often used to prevent rapid bumps in controller output that may damage equipment or product, or cause upset to downstream processes.	
SP.DOWN	SETPOINT RATE DOWN	Limits the maximum rate at which the working setpoint can change in an increasing (downwards) direction.	
RI1PV	PV	The current value of the process (read only) read by the primary input IP1.	Level 1 & 2
RI2PV	PV	The current value of the process (read only) read by the secondary input IP2.	Level 1 & 2
TUNE	AUTOTUNE ENABLE	Starts an autotune.	"Autotuning" on page 309
P.BH	CH1 PROPORTIONAL BAND	Channel 1 (heat) proportional band.	
P.BC	CH2 PROPORTIONAL BAND	Channel 2 (cool) proportional band.	
TI	INTEGRAL TIME	Integral time.	
TD	DERIVATIVE TIME	Derivative time.	
C.BH	CUTBACK HIGH THRESHOLD	High cutback.	
C.BL	CUTBACK LOW THRESHOLD	Low cutback.	

Parameter Mnemonic	Scrolling name	Description	Further information
MR	CONTROL MANUAL RESET	If the integral parameter is turned off the controller is working in proportional only or proportional + derivative. This parameter allows the output to be adjusted manually to offset and difference between SP and PV.	
HYS.H	CONTROL CH1 ON OFF HYSTERESIS	If channel 1 is configured for On/Off control this parameter allows a difference to be set between the output being on or off.	
HYS.C	CONTROL CH2 ON OFF HYSTERESIS	If channel 2 is configured for On/Off control this parameter allows a difference to be set between the output being on or off.	
C.DB	CONTROL CH2 DEADBAND	The Ch1/Ch2 Deadband is a gap in percent between output 1 going off and output 2 coming on and vice versa. For on/off control this is taken as a percentage of the hysteresis.	
OUT.HI	OUTPUT HIGH LIMIT	To limit the maximum controller output.	
OUT.LO	OUTPUT LOW LIMIT	To limit the minimum controller output.	
L.I	LOAD CURRENT	This is the sampled RMS current measured during the on time of the heater.	Level 1 & 2
LK.I	LOAD LEAK CURRENT	The RMS current measured flowing through the load during the off states of the controller.	
L.SP	LOAD THRESHOLD	Sets a threshold to trigger an alarm if the load current is exceeded.	
LK.SP	LOAD LEAK THRESHOLD	Sets a threshold to trigger an alarm if the leak current is exceeded.	
OC.SP	OVERCURRENT THRESHOLD	Sets a threshold to trigger an over current alarm if the current measured exceeds a maximum limit set by the process.	
CS.I	CUSTOMER ID	A user configurable non-volatile identification parameter.	
REC.NO	DATASET TO LOAD	Selects which recipe dataset to load.	
STORE	DATASET TO SAVE	Selects which of the 5 recipe dataset in which to store the current active parameters.	

The home list can be customized by adding up to 60 parameters; iTools will be required to configure the promoted parameters, see "Parameter Promotion" on page 233.

Level 2 Programmer Display

If the controller has the programmer installed, by default, the programmer can be edited and operated from the HMI. A step by step guide to setting up a program is given in "To Setup a Program from the HMI" on page 268.

Programmer List

Press the page button , the display will show



Repeatedly press  to read the currently running program. The program can be Run, Held or Reset from this list.

Parameters displayed are (but not limited to depending on the program):

Parameter Mnemonic	Scrolling name	Description
P.NUM	PROGRAM NUMBER	Alterable, but does not run a program.
P.NAME	PROGRAM NAME	Read only. This parameter has been added in firmware versions V3.01 and above.
P.CUR	CURRENT PROGRAM	Read only.
C.NAME	CURRENT PROG NAME	Read only. This parameter has been added in firmware versions V3.01 and above.
P.MODE	PROGRAM MODE	The programmer can be changed to Run, Hold, Reset,
P.SP	PROGRAM SETPOINT	Read only.
P.TIML	PROGRAM TIME LEFT	Read only.
P.CYCL	PROGRAM CYCLES LEFT	Read only.
S.NUM	CURRENT SEGMENT NUMBER	Read only.
S.NAME	SEGMENT NAME	Read only. This parameter has been added in firmware versions V3.01 and above.
S.TYPE	CURRENT SEGMENT TYPE	Read only.
S.TIML	SEGMENT TIME LEFT	Read only.
T.SP	TARGET SETPOIN	Read only.
R.RATE	RAMP RATE	Read only.
EVT.X	EVENT X	Event off or on. Further events are shown if configured.
P.ADVN	PROGRAM ADVANCE	Alterable YES/NO. Advances the program to the next segment.

Program Setup List

By default programs can be set up in Level 2.

Press the page button , the display will show



Repeatedly press  to read the currently running program. Programs can be edited from this list.

Parameter Mnemonic	Scrolling name	Description
P.NUM	PROGRAM NUMBER	Alterable but does not run a program. If the program is running WORK is shown signifying the working program.
P.NAME	PROGRAM NAME	Read only. This parameter has been added in firmware versions V3.01 and above.
HBSTY	HOLDBACK STYLE	Alterable: PROG (holdback applies to the whole program). SEGm (holdback applies to each segment).
HB.TYP	HOLDBACK TYPE	Alterable: OFF, LOW, HIGH, bANd. For a full definition see "Holdback" on page 261.
RAMP.U	RAMP UNITS	Alterable: P.SEC (per second), P.mIN (per minute), P.HR (per hour).
DWEL.U	DWELL UNITS	Alterable: SECS, mINS, HrS.
P.CYC	PROGRAM CYCLES	Alterable: The number of time a program repeats. CONT (continuous) or 1 to 9999. Default 1
P.END	PROGRAM END TYPE	Alterable: Behavior when the program ends dwEL (dwell at current setpoint). RSEt (reset). tRAK (track).
S.NUM	CURRENT SEGMENT NUMBER	Alterable:
S.NAME	SEGMENT NAME	Read only. This parameter has been added in firmware versions V3.01 and above.
S.TYP	SEGMENT TYPE	RAtE, tImE, dWEL, Step, CALL, ENd.
TSP	TARGET SETPOINT	Alterable:
R.RATE	RAMP RATE	Alterable:
EV.OP	EVENT OUTPUT	Alterable:
DUR	DURATION	Alterable: Appears if the segment type is Dwell or Time.
R.TIME	TIME TO TARGET	Alterable: Appears if the segment type is Time.
C.PROG	CALL PROGRAM	Alterable: Appears if the segment type is Call.
C.CYC	CALL CYCLES	Alterable: Appears if the segment type is Call.

The above is a summary the parameters which are displayed (but not limited to) and depends on the program. A full description of the parameter meanings and how to set up programs is given in the following sections:

- Configuration chapter "Programmer List (PROG)" on page 135.
- Programmer chapter "Programmer" on page 257.















Operator Level 3

In Operator level 3 (and in Configuration Level) all parameters are organized in lists (or groups). Only parameters related to enabled functions are shown.

Each list may contain operator level and configuration parameters; the parameters are only shown when the instrument is in the appropriate mode. If a list does not contain at least one displayable parameter, it is skipped completely.

During navigation, the lower display shows the mnemonic code of the parameter or the List header. After 6 seconds, a scrolling string with either the parameter or the List description will be displayed.

To Enter Level 3

Operation	Action	Display	Notes
Select Level 3	<ol style="list-style-type: none"> 1. Press and hold  until LEU 3 is shown. 2. Press  to enter. 		<p>LEU 1 is displayed first. Continue to hold the button to obtain LEU 3.</p>
Enter the password	<ol style="list-style-type: none"> 3. Press  or  to enter the correct digit value of the password. 4. Press  to accept the value and move onto the next digit. 5. If the correct password has been entered the message PASS will be displayed momentarily. The controller is now operating in Level 3. 	 	<p>Press  to move to the next digit.</p> <p>The default password for level 3 is '0003'.</p> <p>A special case exists if a pass code has been configured as '0000'. If this has been done it is not necessary to enter a code and the controller will enter the chosen level immediately.</p> <p>If an incorrect code is entered the display will return to HOME.</p> <p>If an incorrect code is entered the display will return to HOME. After three wrong attempts the password entry system will lock out for a time set by the 'password Lockout Time' set in the "Security Sub-List (SEC)" on page 197.</p>
Select list headers	<ol style="list-style-type: none"> 6. Repeatedly press  		<p>This shows the Analog Input List.</p> <p>Press  +  to return to the previous list header.</p>
Select parameters in the list	<ol style="list-style-type: none"> 7. Repeatedly press  		<p>This shows the Input Type.</p>

To return to the HOME page relevant to the controller mode press the 'Home' key combination (Page+Scroll).





The HOME display is also selected after a timeout period with no key presses. The timeout defaults to 60 seconds but can be adjusted between 0 and 60 seconds. A setting of 0 means no timeout (see "Display Functionality Sub-List (Hml)" on page 195), so that the HMI remains in the selected level.

Level 3 Operator Parameters

The Operator Level 3 lists are essentially the same as configuration level. These are shown in the next chapter.

To Return to a Lower Level

From Level 3 you can select Level 1 or Level 2 as follows:

1. Press and hold  until *GOTO* is displayed.
2. Press  or  to select *LEU 1* (or *LEU 2*).
3. Press  to accept.

The display will briefly show *PASS* and will return to the selected level default display.



A security code is not required when going from a higher level to a lower level.

Note: if the controller had been switched off whilst operating in levels 2 or 3 it will return to operator level 1 when switched on again. If it was switched off when in configuration level it will start up with a message - *P.LnF - POWERED DOWN WHILST IN CONFIG MODE*. See section "Subsequent Start-ups" on page 76.

Navigation Diagram

The Navigation Diagram shows the series of operations of the front panel buttons which are required to navigate to specific parameters.

For ease of access parameters are arranged in lists. Each list has a header and each header is selected by repeated presses of the 'Page' button . Each list header has a title, for example, the first header is the Analog Input (AI LIST).

A list may have a number of instances. For example, if two Analog Inputs are supplied then the list is split into 1 INST and 2 INST selected using the 'Raise' and 'Lower' buttons  / .

Similarly a list may have a number of Sub-Lists. For example, the LOOP list. The sub-lists are selected by entering the first sub-list, using the 'Scroll' button , then using the 'Raise' or 'Lower' buttons to select the following sub-lists.

When the appropriate list or sub-list has been selected use the 'Scroll' button to scroll through a list of parameters. Use the Page button to scroll back.

The Navigation Diagram which follows shows these button presses diagrammatically.

The Navigation Diagram generally includes all lists and all parameters available in configuration level. Some parameters may not be shown in Level 3 and only those lists and parameters which are required for a particular application are displayed on the controller.

Toolkit Blocks

Toolkit blocks are orderable features which consist of a number of function blocks. These may be added later using 'Feature Security' see section "Security Sub-List (SEC)" on page 197.

Two types of Toolkit blocks may be ordered:

- Standard. This is available in all firmware versions.
- Enhanced. This is available in firmware versions 3.01 and above.

A maximum of 200 wires are available regardless of which toolkit block option has been purchased. A "standard" instrument may be upgraded to an "enhanced" variant using an online feature code purchase.

The table below lists the function which are available depending upon which toolkit option is ordered:

Features

Function Block	No Toolkit	Standard	Enhanced
• Maths Operators	0	4	8
• Logic Operators Lgc2	0	4	8
• Logic Operators Lgc8	0	2	4
• Timer	0	3	4
• Counter	0	4	12
• Totalizer	0	1	2
• Analog Multiplexers	0	1	2
• User Values	0	1	1
• Input Monitors	0	2	2
• Switchover Block	0	1	1
• Input Linearization	0	2	2

The function blocks are described in the Configuration chapter.

Navigation Diagram

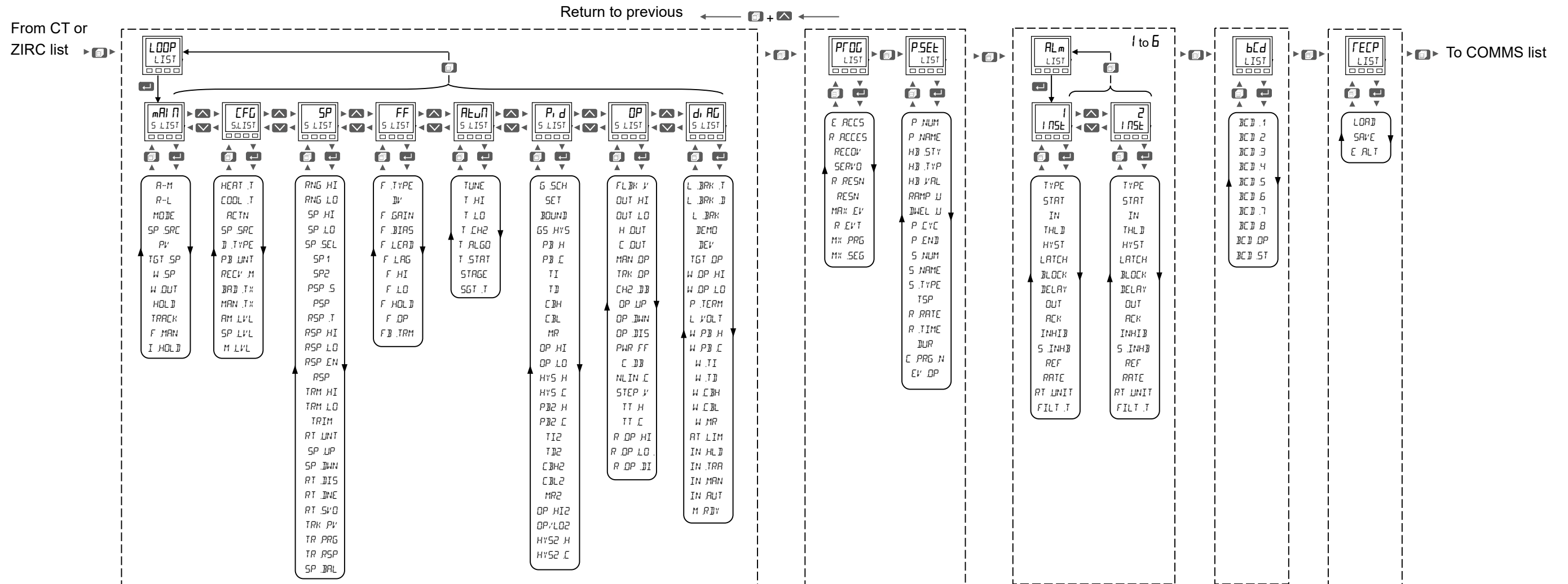
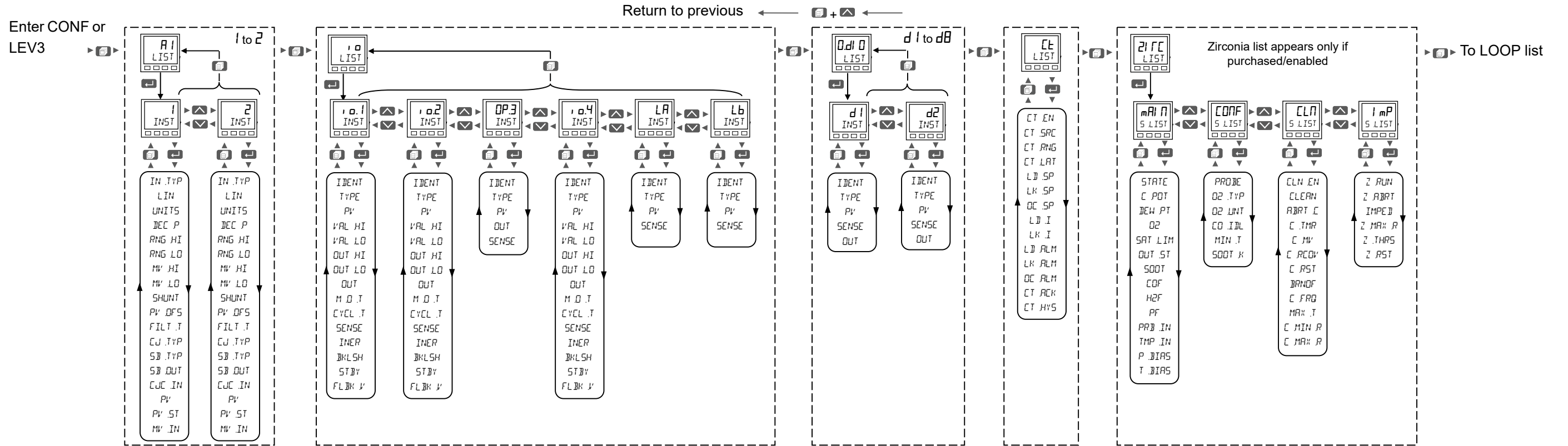

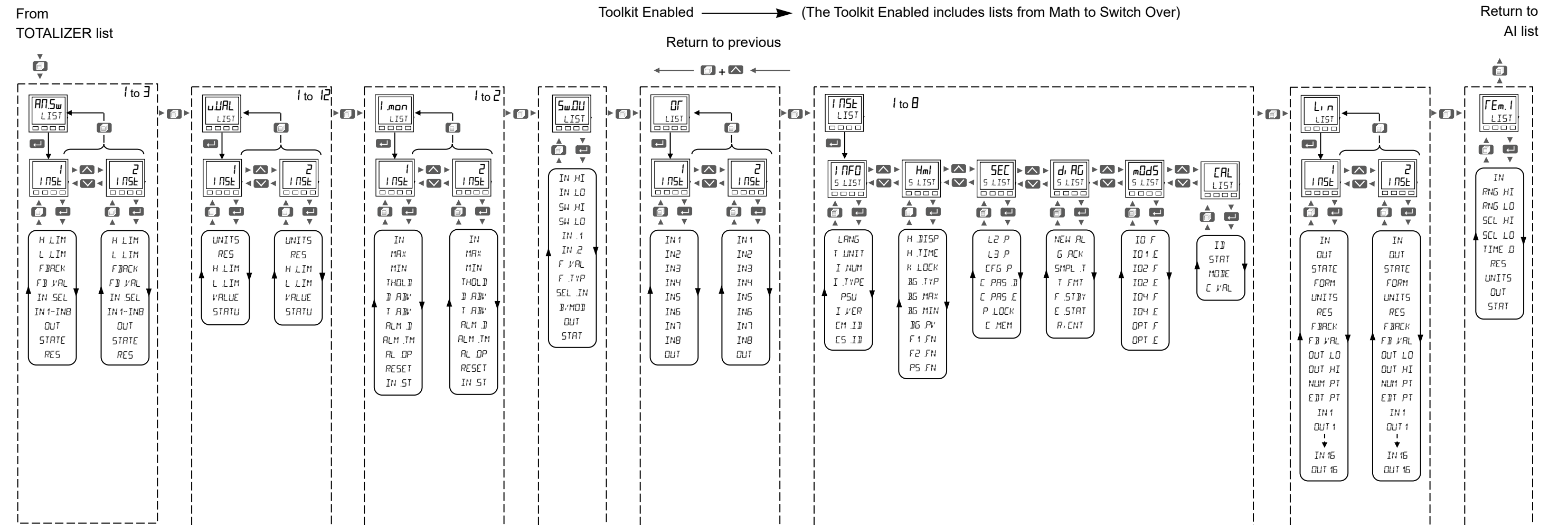
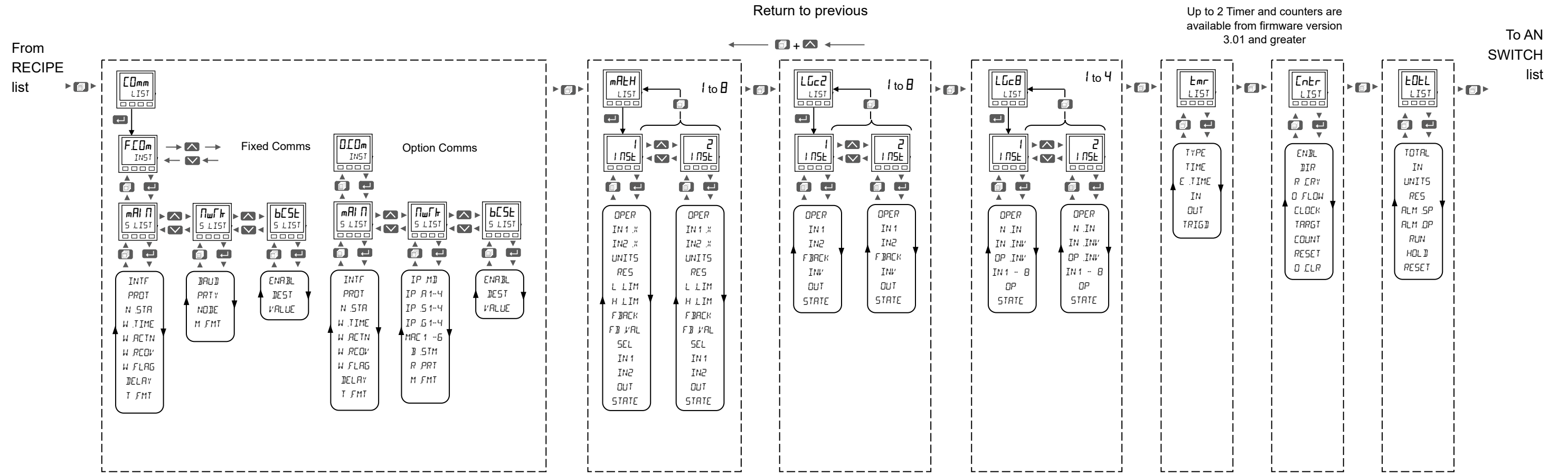

Configuration Level

Configuration of the instrument through the front panel is particularly useful where relatively small changes are required on site, possibly during commissioning. For larger or more detailed changes the use of Eurotherm iTools configuration package is recommended and this is described in the next chapter.

What is in this Chapter

- This chapter describes how to configure the controller through the HMI.
- Lists all parameters which are available in each function block.

Function Blocks

The controller is made up of a number of hardware and software function blocks. Each block has inputs and outputs which are wired together in software (soft wired) to match the application for which the controller is intended.

The following diagram shows an example of function blocks which make up a typical controller:

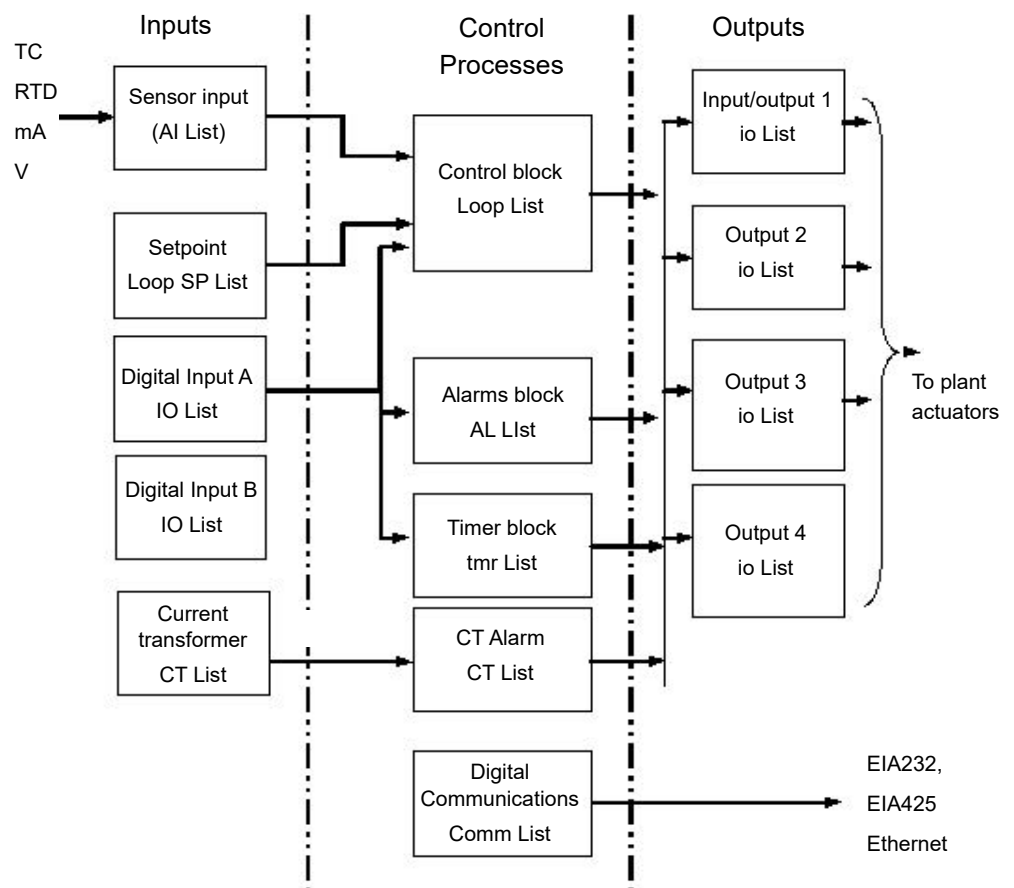

The Temperature (or Process Value (PV) is measured by the sensor and compared with a Setpoint (SP) set by the user.

The purpose of the control block is to reduce the difference between SP and PV to zero by providing a compensating output to the plant via the output driver blocks.

The timer and alarms blocks may be made to operate on a number of parameters within the controller, and digital communications provides an interface for data collection, monitoring and remote control.

The way in which each block performs is defined by its internal parameters. Some of these parameters are available to the user so that they can be adjusted to suit the characteristics of the process which is to be controlled.

These parameters are found in lists in Configuration Level.

The controller can also be configured using iTools as described in "Configuration Using iTools" on page 212. iTools is proprietary software designed to configure Eurotherm instruments and may be downloaded from www.eurotherm.com.

Configuration Level Parameters

In Configuration Level all parameters are organized in lists (in the same way as Operator Level 3). Only parameters related to enabled functions are shown.

Each list may contain operator level and configuration parameters; the parameters are only shown when the instrument is in the appropriate mode. If a list does not contain at least one displayable parameter, it is not shown.

During navigation, the center display (lower display in EPC3016) shows the mnemonic code of the parameter or the List header. A scrolling string with either the parameter or the List description is displayed in the lower section of the display.

To Select Configuration Level

⚠ WARNING

















HAZARD OF INCORRECT CONFIGURATION

Incorrect configuration can result in damage to the process and/or personal injury and must be carried out by a competent person authorized to do so. It is the responsibility of the person commissioning the controller to ensure the configuration is correct.

In configuration level the controller does not control the process or provide alarm indication. Do not select configuration level during a live process.



Failure to follow these instructions can result in death, serious injury or equipment damage.

The procedure is similar to that shown in "To Enter Level 3" on page 90.

Operation	Action	Display	Notes
Select Level 3	<ol style="list-style-type: none"> Press and hold  until <code>LEU 3</code> is shown. Press  to select <code>CONF</code> Press  to enter 		<code>LEU 1</code> is displayed first. Continue to hold the button to obtain <code>LEU 3</code> .
Enter the password	<ol style="list-style-type: none"> Press  to move along to the next digit. Press  or  to select the correct digit value of the password. If the correct password has been entered the message <code>PASS</code> will be displayed momentarily. The controller is now operating in Configuration Level. 	  	<p>The default password for Configuration level is '0004'.</p> <p>A special case exists if a security code has been configured as '0000'. It is then not necessary to enter a code and the controller will enter the chosen level immediately.</p> <p>If an incorrect code is entered the display will return to HOME.</p> <p>After three wrong attempts the password entry system will lock out for a time set by the 'password Lockout Time' set in the "Security Sub-List (SEC)" on page 197, and the scrolling message 'HMI CONFIG LEVEL LOCKED TOO MANY INCORRECT PASSWORD ATTEMPTS' will be displayed.</p>
Select list headers	<ol style="list-style-type: none"> Repeatedly press  		<p>This shows the first list - Analog Input List.</p> <p>Press  +  to return to the previous list header.</p>
Select parameters in the list	<ol style="list-style-type: none"> Repeatedly press  		This shows the Input Type.

To Return to Level 1

From Configuration level it is not possible to select Level 2 or Level 3.

- Press and hold  until `GOTO LEU 1` is displayed.
- Press  to accept.

Configuration and Level 3 Navigation Diagram

The full navigation diagram for Level 3 and Configuration Levels is shown in section "Navigation Diagram" on page 94.

Press  to scroll through each list header (the name of the function block) in turn.

Pressing  on one of these headers will do the following depending upon the function block being accessed:

1. Display the first parameter (see Recipes).
2. Display the instance selection (see IO for named instances or Alarm for numbered instances).
3. Display the subclass selection (see Loop).





When at 2 or 3 above, pressing up and down will cycle through the instances/subclasses.

Examples

The following examples show how to navigate through different function blocks.

Example 1: no additional instances and no sub-classes

The CT list is an example of a class which contains no additional instances and no sub-classes. In other words it is a simple list of parameters under the heading CT which set up the current transformer.



1. Press  until the list is displayed.
2. Then  press to scroll through the parameters.
3. To change the value of a selected read/write (R/W) parameter press  or .



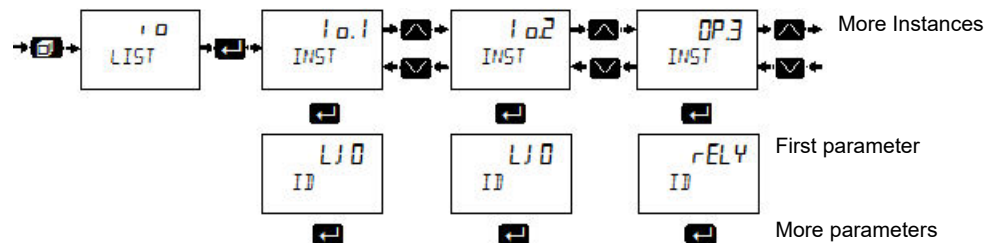

Example 2: multiple instances and no sub-classes (named)

The I/O List is an example of a class which contains multiple instances and no sub-classes. The instances are named instances, such as io.1, io.2, OP.3, etc. (see "I/O List (io)" on page 107). The list of parameters for each instance are not necessarily the same.

The navigation diagram for this type of function block is shown below:



1. Press  to scroll to the I/O List.
2. Press  to select the first instance of the I/O parameters. This is displayed as io.1 and INST and denotes that this is the first instance of parameters in that category.

3. Press  again to scroll through parameters for *i.d.* or, to select the next and subsequent instances press .
4. Press  to scroll back.
5. To change the value of a selected read/write (R/W) parameter press  or .

Example 3: multiple instances and no sub-classes (numbered)

The Alarm List is also an example of a class which contains multiple instances and no sub-classes. The instances in this case are numbered instances, such as 1 to 6 "Alarms List (ALm)" on page 141. The list of parameters for each instance are not necessarily the same.

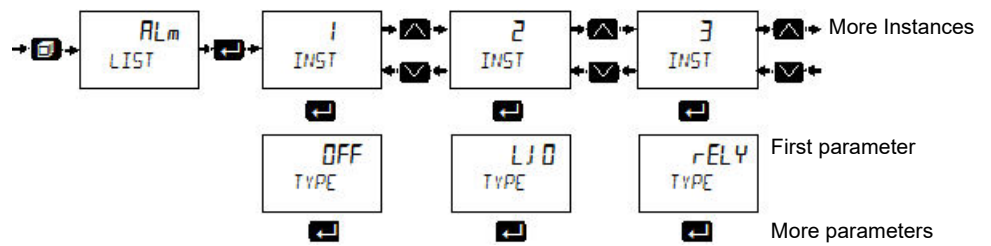

Example 4: single instance and multiple sub-classes

The Loop List is an example of a class that has a single instance and multiple sub-classes. A sub-class (or List) groups parameters under meaningful sub-headings. For example, all parameters associated with the setpoint are grouped together in the SP List (displayed as *S LIST*). Each subclass will be different.

The navigation diagram for this type of function block is shown below:

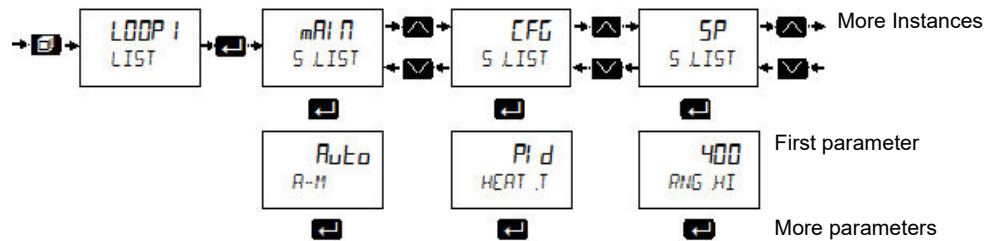

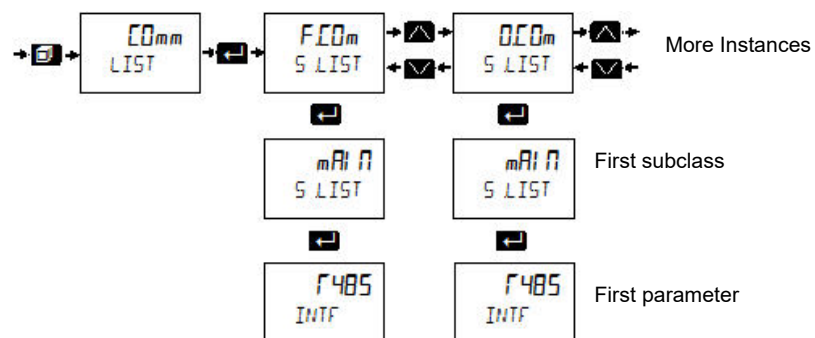

Example 5: multiple instances and multiple sub-classes

The communications list is an example of a class which has multiple instances and multiple sub-classes. The instances are Fixed and Option and the Sub Lists are Main, Network, Broadcast.



Parameter Navigation

1. Press  to select parameters in a list.
2. Press  or  to change the parameter value (if not read only).

Some parameters are analog in which case the value can be changed between limits.

Some parameters are enumerated which means they have a mnemonic associated with them which can be selected from a list.

The following pages list all parameters which are available in the controller in their respective lists. Parameters are only shown in the controller if the feature has been supplied and enabled.

Notes:

1. R/O = Read Only in all levels.
2. Conf R/W = Read/Write in Configuration level only.
3. L3 R/W = Read/Write in Level 3 (and Config).
4. L3 R/O = Read Only in Level 3 (and all lower levels).

Enumerated values

In the value column for enumerated values in the following tables, the associated numeric value is shown. This is the value that would need to be written if a 3rd party comms master was being used. For example:

- tC (0)
- mV (1)
- V (2)
- mA (3)
- RTD (4)

Analog Input List (A1 A2)



The first press of  after entering Level 3 or Configuration, will show the 'ANALOG INPUT' list. From this list you can configure the input type and other characteristics of Input 1 (and Input 2, if fitted).

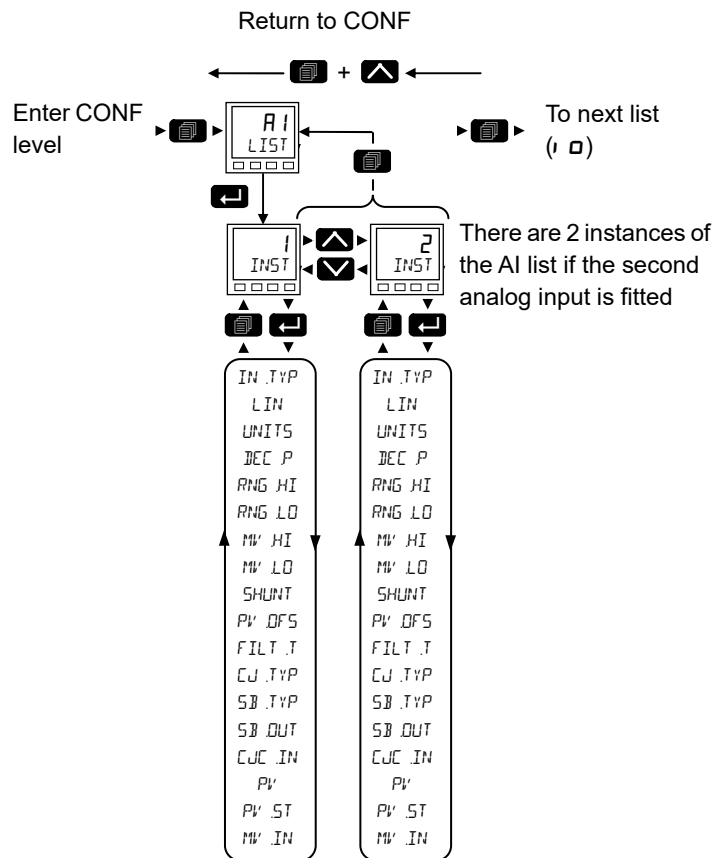

- **A1** instance 1 of the AI list contains the parameters available for IP1.
- **A2** instance 2 of the AI list contains the parameters available for IP2. The IP2 input is an orderable option in EPC3008 and EPC3004. It is not available in EPC3016.



Access to the Analog Input parameter list is summarized below. The full Navigation Diagram is shown in section "Navigation Diagram" on page 94.



The parameters in the following list are identical for both 1 and 2.



Parameter Mnemonic	Parameter Name	Value	Description	Access
Press 		Press  or 		
INST	ANALOGUE INPUT	1	Input 1 List (IP1).	Conf R/W
		2	Input 2 List (IP2) EPC3008 and EPC3004 only.	L3 R/O

Parameter Mnemonic	Parameter Name	Value		Description	Access		
Press  to select in turn		Press  or  to change values (if read/write, R/W)					
INTYP	INPUT TYPE	tc	0	Thermocouple. Default: Thermocouple	Conf R/W L3 R/O.		
		mV	1	milli volts.			
		V	2	Volts.			
		mA	3	milliamps.			
		RTD	4	Platinum resistance thermometer.			
		ZrO ₂	5	High Impedance Zirconia probe (only available on the secondary input).			
LIN	LINEARISATION TYPE	J	0	Thermocouple type J.	Conf R/W L3 R/O. Not shown if the input type is RTD.		
		K	1	Thermocouple type K. Default: Type K			
		L	2	Thermocouple type L.			
		R	3	Thermocouple type R.			
		B	4	Thermocouple type B.			
		N	5	Thermocouple type N.			
		T	6	Thermocouple type T.			
		S	7	Thermocouple type S.			
		CS1	8	Custom linearization 1. To download special linearization tables see "To Load a Custom Linearization Table" on page 242.	Conf R/W L3 R/O.		
		CS2	9	Custom linearization 2. Two tables may be downloaded into the EPC3000 series controllers.			
				PT100	10	Resistance thermometer type PT100.	Shown if the input is RTD, mV, V or mA.
				PT1000	11	Resistance thermometer type PT1000.	
				LI	12	Linear.	Shown for mV, V or mA inputs.
		SQR	13	Square root.			
UNITS	UNITS			See section "Units" on page 105 for a list of units used throughout.	Conf R/W L3 R/W		
DECP	RESOLUTION	nnnnn	0	The number of decimal points shown in the display.	Conf R/W L3 R/O		
		nnnn.n	1	Range none to four decimal points.			
		nnn.nnn	2	Default: nnnn.n			
		nn.nnnn	3				
		n.nnnn	4				
RNGHI	RANGE HIGH			Range high limit. Used to limit ranges of Thermocouple and RTD input types, and scale mV, V and mA inputs. AI2 also includes Zirconia. Default tc 500; mV 40; V 10; mA 20; RTD 500; Zirconia 2000	Conf R/W L3 R/O		
RNGLO	RANGE LOW			Range low limit. Used to limit ranges of Thermocouple and RTD input types, and scale mV, V and mA inputs. AI2 also includes Zirconia. Default tc 0; mV 0; V 0; mA 4; RTD 0; Zirconia 0			
MVHI	INPUT HIGH LIMIT	mV: -800.0 to 800.0		High limit for mV, mA or V inputs. Default: mV 40; V 10; mA 20	Conf R/W Not shown for thermocouple or RTD inputs.		
MVLO	INPUT LOW LIMIT	V: -10.00 to 10.00 mA: -800.00 to 800.00		Low limit for mV, mA or V inputs. Default: mV 0; V 0; mA 4			
SHUNT	SHUNT VALUE	100 to 1000.00		Value of the shunt resistor for mA inputs. Default: 2.49Ω.	Conf R/W		

Parameter Mnemonic	Parameter Name	Value		Description	Access
Press  to select in turn		Press  or  to change values (if read/write, R/W)			
PV.OFS	PV OFFSET	00		<p>A simple offset is provided to adjust the process variable by a fixed amount across its span. This can be used to compensate for known thermocouple and other tolerances which may exist in multi instrument installation so that all instruments read the same value.</p> <p>See also "Calibration using a Dry Block or Equivalent" on page 374 which describes the two point calibration adjust method. This may be used to apply a linear correction to the temperature reading.</p> <p>Default: 0.0</p>	Conf R/W L3 R/W
FILT.T	FILTER TIME CONSTANT	0 to 60		<p>Some industrial installations can cause electrical noise to be introduced into the process measurement. This could be due, for example, to EMC or mechanical linkages. A filter is provided to reduce the frequency of electrical noise seen by the instrument. The effect of electrical noise can be reduced by increasing the filter time constant, but a compromise must be achieved as it could affect the closed loop response of the system.</p> <p>The larger the number, the slower the measured temperature will be to respond to fluctuations.</p> <p>Default: 1.6s</p>	Conf R/W L3 R/W
CJ.TYP	CJC TYPE	Auto	0	<p>A thermocouple measures the temperature difference between the measuring junction (hot junction) and the reference junction (cold junction). Auto uses the measurement of the temperature made by the instrument where the thermocouple is connected to its rear terminals.</p> <p>Default: Auto</p>	Conf R/W L3 R/O Only shown for thermocouple inputs.
		0	1	The reference junction is held at a fixed known temperature of 0 degrees usually by an external ice point method.	
		50	2	The reference junction is held at a fixed known temperature of 50 degrees usually by an external hot box method.	
		OFF	3	CJC is turned off. This could be used, for example, where a thermocouple measurement is made by an external transmitter which does not linearize the thermocouple curve.	
SB.TYP	SENSOR BREAK TYPE	OFF	0	The controller continuously monitors the impedance of a transducer or sensor connected to the input. Off means sensor break is not detected.	Conf R/W L3 R/O
		LO	1	Sensor break is detected if impedance at the terminals is above a low threshold (typically between 3 to 5kOhms). Default: Low	
		HI	2	Sensor break is detected if impedance at the terminals is above a high threshold (typically between 12 to 20kOhms)	
SB.OUT	SENSOR BREAK OUTPUT	OFF	0	No sensor break detected	R/O
		On	1	Sensor break detected. If the sensor break requires to activate a soft alarm the sensor break output parameter can be wired to a Digital High Alarm. (see section "Example 1: To Wire an Alarm" on page 224.	
CJC.IN	CJC TEMPERATURE			The CJC temperature is a measure of the temperature at the instrument terminals. It is relevant only for thermocouple inputs and is provided as a diagnostic aid.	R/O
PV	PV			Process value is the displayed value on the instrument, usually the measured temperature when the instrument is controlling a temperature loop.	Conf R/O L3 R/O
PV.ST	PV STATUS			The state of the PV is continuously monitored. See section "Status" on page 106 for a list of enumerated values	Conf R/O L3 R/O
MV.IN	MEASURED VALUE			This is the measured value in units of mV or ohms, dependent upon input type. The value measured at the rear terminals can be useful as a diagnostic aid to determine if the thermocouple or linear input sensor is wired correctly.	Conf R/O L3 R/O



Units

The list below applies to all function blocks which contain Units

Parameter Mnemonic	Parameter Name	Value	Description	Access	
Press  to select in turn		Press  or  to change values (if read/write, R/W)			
UNITS	UNITS	None	0	No units will be displayed.	Conf R/W L3 R/W
		TEMP	1	Temperature units. °C, °F, K are set in the Instrument Info list section "Instrument List (INST)" on page 193.	
		V	2	Volts.	
		mV	3	Millivolts.	
		A	4	Amps.	
		mA	5	Milliamps.	
		PH	6	pH.	
		mmHG	7	Millimeter of mercury.	
		PSI	8	Pounds per square inch.	
		BAR	9	Bar.	
		mBAR	10	millibar.	
		RFH	11	Per cent relative humidity.	
		PERC	12	Per cent.	
		mmWG	13	Millimeter Water Gauge.	
		inWG	14	Inches water gauge.	
		inww	15	Not used.	
		OHMS	16	Resistance (ohms).	
		PSIG	17	Pounds per square inch gauge.	
		PO2	18	Per cent O ₂ .	
		PPM	19	Parts per million.	
		PCO2	20	Per cent CO ₂ .	
		PCP	21	Per cent carbon.	
PSEC	22	Per cent per second.			

Status

The list below applies to all function blocks which contain global status enumeration.

Parameter Mnemonic	Parameter Name	Value	Description	Access	
Press  to select in turn		Press  or  to change values (if read/write, R/W)			
		<i>Good</i>	0	The process variable is working correctly.	Conf R/W L3 R/W
		<i>OFF</i>	1	Channel is configured to be off.	
		<i>Over</i>	2	When the input signal exceeds the upper input limit by more than 5% the PV will flash indicating over range. If the value is too high to fit the number of digits on the display "HHHH" will flash (refer to "Auto-scaling of decimal point" on page 78 for display capability for each instrument size).	
		<i>Under</i>	3	When the input signal exceeds the lower input limit by more than 5% the PV will flash indicating under range. If the value is too high to fit the number of digits on the display "LLLL" will flash (refer to "Auto-scaling of decimal point" on page 78 for display capability for each instrument size).	
		<i>HW.S</i>	4	Input hardware status is unknown.	
		<i>rng</i>	5	The input status is set to Ranging at the point of an analog input configuration change. It will remain in Ranging until an exit from a config induced instrument restart.	
		<i>DFLw</i>	6	Process variable overflow, possibly due to calculation attempting to divide a number by a relatively small number.	
		<i>bad</i>	7	The PV is not reading correctly which could be due to an open sensor.	
		<i>HWc</i>	8	The hardware capabilities have been exceeded at the point of configuration, for example configuration set to 0 to 40V when input hardware is capable of up to 10V.	
		<i>ndAt</i>	9	Insufficient input samples to perform calculation.	

I/O List (I O)

The following modules may be fitted in the controller:

- None.
- Logic I/O module.
- Form A relay.
- Triac.
- Isolated DC output.

Output 1 beacon is operated from IO(1) when it is configured as an output.

Output 2 beacon is operated from IO(2) when it is configured as an output.

Output 3 beacon is operated from OP(3).



Output 4 beacon is operated from IO(4) when it is configured as an output.

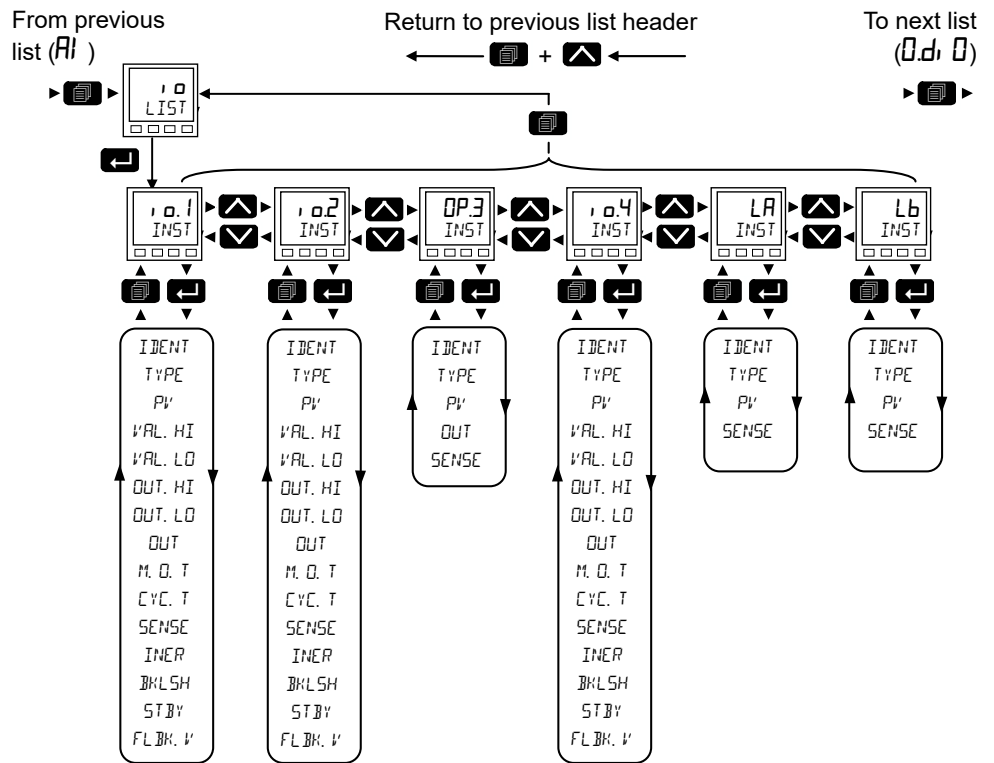

Access to the Input/Output parameter list is summarized below. The full Navigation Diagram is shown in section "Navigation Diagram" on page 94.



The following table includes all available input/output parameters but the ones displayed depend on how each I/O is configured.

Parameter Mnemonic	Parameter Name	Value		Description	Access
		Press to select in turn		Press or to change values (if read/write, R/W)	
IDENT	IO HARDWARE ID	None	0	This displays the type of IO hardware fitted. Choices are:	Conf R/O L3 R/O
		LIO	1	Logic input/output.	
		RELAY	2	Relay.	
		SSr	3	Triac.	
		dc.OP	4	DC output.	
		LIP	5	Logic input.	
TYPE	TYPE OF IO	OnOff	10	On off output.	Conf R/W L3 R/O
		EPo	11	Time proportioning output.	
		uP	15	Valve position raise.	
		down	16	Valve position lower.	
				Valve positioning UP/DOWN works across pairs of outputs ie:- UP : DOWN IO.1 : IO.2 IO.2 : OP3 OP3 : IO.4	
		di	5	Contact closure input.	
		mAOP	0	mA output.	
		VOP	1	Voltage output.	
PV	PROCESS VARIABLE			For an Input type : The measured process variable. For an Output type : The demanded output value.	Conf R/W L3 R/W
VALHI	DEMAND HIGH			Percentage PID demand value giving maximum output - "OUT.H" - Allows for "Output Splitting" Default: 100.0	Conf R/W L3 R/W Only shown for DC or time proportioning output
VALLO	DEMAND LOW			Percentage PID demand value giving minimum output - "OUT.L" - Allows for "Output Splitting". Default: 0.0	
OUTHI	OUTPUT HIGH			The maximum average output power that can be supplied from this output - Allows for "Output Splitting" Default: 100% for TPO; 20 for mA; 10 for V i.e. the highest possible value for selected type.	
OUTLO	OUTPUT LOW			The minimum average output power that can be supplied from this output - Allows for "Output Splitting" Default: 0	
OUT	OUTPUT			For Digital Output Types: A value of 0 indicates that the output is low (relay de-energized) A value of 1 indicates that the output is high (relay energized). For DC Output Types: This is the physical output value after the PV has been mapped via the demand range parameters onto the output range.	Conf R/O L3 R/O

Parameter Mnemonic	Parameter Name	Value		Description	Access
		Press  to select in turn		Press  or  to change values (if read/write, R/W)	
M.O.T	MIN ON TIME	Auto to 150.00	0	<p>Minimum pulse time in seconds. This value sets the minimum duration between any two switching events. Although it is named 'MinOnTime', it applies to both on and off pulses equally.</p> <p>A contactor datasheet will often specify the minimum pulse time that will help to ensure correct energizing and de-energizing of the contactor. This may be the lowest value you should consider using as a MinOnTime.</p> <p>Auto(0) - Automatically sets the minimum on time for the output hardware as follows: Relay = 1s (time proportioning) or 0.1s (VP raise/lower) Logic = 0.05s (time proportioning), 0.1s (VP raise/lower)</p> <p>Alternatively, a value may be set manually but it should be noted that this value will be clipped if it is below the minimum permissible value for the hardware that is fitted (relay or logic - see settings above).</p> <p>For VP raise/lower outputs, smaller values of MinOnTime may actually produce less actuator activity. This is because the larger the MinOnTime, the larger the valve movement, and thus the lower the output resolution. This may lead to increased hunting. Generally values less than 0.5s should be used.</p> <p>Default: Auto</p>	Conf R/W L3 R/W
CYCL.T	CYCLE TIME	Auto to 600	0	<p>This value sets the time proportioning output (TPO) and cycle time in seconds. It is defined as the period of time between output repetitions.</p> <p>When this parameter is Auto (0), which is the default setting, the TPO algorithm will run in a so-called Constant Ripple Mode. Under this regime, the cycle time will be automatically and continuously adjusted depending on the output demand. This is to maintain the amount of ripple in the process at an approximately constant amplitude. The benefit of this is that actuations are reduced on average, which can increase the lifetime of contactors and relays. As suggested, a demand of 50% will produce the shortest cycle time of 4*MinOnTime, and the cycle time is extended the further the demand moves away from 50%. You should therefore choose a MinOnTime that gives an appropriate minimum cycle time.</p> <p>Alternatively, you can set a value of cycle time directly. When a value is set, the algorithm will run in a so-called Constant Cycle Time Mode. Under this regime, the algorithm will try to keep the cycle time constant, assuming constant demand. Note that the cycle time will be extended if the demand is such that the cycle time cannot be achieved without violating the MinOnTime. In this case, the effective cycle time will be extended just enough to help ensure the MinOnTime and the demand are both achieved.</p> <p>There are a number of factors that may influence the setting of an appropriate CycleTime and it is often a trade off. For example, a longer cycle time may extend the lifetime of contactors but reduce the lifetime of heating elements. A longer cycle time will also increase the amount of ripple in the process variable.</p> <p>Default: Auto</p>	Conf R/W L3 R/W
SENSE	SENSE OF IO	NOF m	0	<p>Output normal.</p> <p>This is the normal setting for control.</p> <p>Output off when the PID demand is off. For control this is when PV>SP.</p> <p>For a Digital Input the input is active when the input is = 1.</p> <p>Default: Normal</p>	Conf R/W
		INU	1	<p>Output inverted</p> <p>This is the normal setting for alarms.</p> <p>Output off is when the alarm is active.</p> <p>Output on is when the alarm is in-active.</p> <p>For a Digital Input the input is active when the input is = 0.</p>	

Parameter Mnemonic	Parameter Name	Value		Description	Access
Press  to select in turn		Press  or  to change values (if read/write, R/W)			
INER	INERTIA	00 to 300		Time taken in seconds for the valve motor to stop after power is removed. 0.0 to 30.0 seconds. Applies to valve position outputs only. Default: 0.0	L3 R/W
BKLSH	BACKLASH	00 to 300		Time in seconds to take up any backlash in the valve actuator linkage. 0.0 to 30.0 seconds. Applies to valve position outputs only. Default: 0.0	L3 R/W
STBY	STANDBY ACTION			Determines the valve positioning output action (Rest, Raise, Lower) when the instrument is in Standby Mode.	Conf R/W
		REST	0	The valve will remain in the current position. Default: Reset	
		UP	1	The valve will open. Applies to io1.	
		down	2	The valve will close. Applies to io2.	
				Valve positioning UP/DOWN works across pairs of outputs ie:- UP : DOWN IO.1 : IO.2 IO.2 : OP3 OP3 : IO.4	
FLBKV	FALLBACK VALUE	00		Fallback value which is to be outputted when the status is BAD Default: the value of OUT.L	Conf R/W

Output Splitting

Output splitting is the process of having more than one output being driven from a single control loop. For this to be possible the single loop output signal is divided between two output channels.

This splitting of outputs is not done as a part of the control loop but rather as a part of the output blocks.

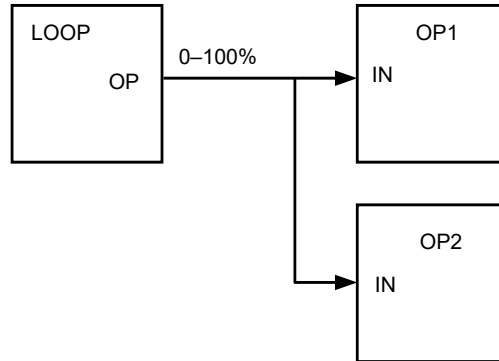

Functionality

- The control loop is not affected by the use of output splitting, it will still give its output in the form of a 0–100% value.
- Each output block can be tailored individually in terms of turn on/off points and percentage power output.
- The output from the loop is "wired" to the inputs of two output blocks.
- Each output block has a "ValHigh" and "ValLow" parameter. These values represent the PID demand percentage giving maximum and minimum output power respectively.
- Each output block also has a "OutHigh" and "OutLow" parameter. The values of which determine the percentage limits of output power.
- The relationship between output power and input value can be seen in the graph below:

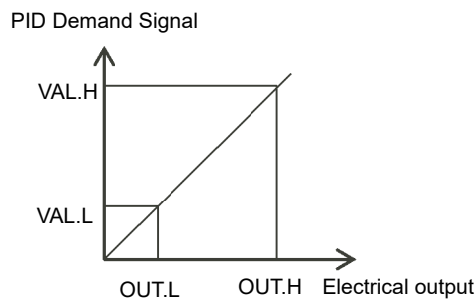

Cycle Time and Minimum OnTime Algorithms

The 'Cycle Time' algorithm and the 'Min OnTime' algorithm are mutually exclusive and provide compatibility with existing controller systems. Both algorithms apply to time proportioning outputs only and are not shown for on/off control.

A fixed cycle time allows the output to switch on and off within the time period set by the parameter. For example, for a cycle time of 20 seconds, 25% power demand would turn the output on for 5 seconds and off for 15 seconds, 50% power demand would turn the output on and off for 10 seconds, for 75% power demand the output is on for 15 seconds and off for 5 seconds.

Fixed cycle time may be preferred when driving mechanical devices such as refrigeration compressors.

⚠ CAUTION

PROTECTION AGAINST SHORT CYCLING

Actuators that are sensitive to switching pulse or cycle times should be fitted with a protective device. For example, refrigeration compressors should be fitted with a lockout timer to add additional protection against switching too quickly.

Failure to follow these instructions can result in injury or equipment damage.

The 'Min OnTime' is described in the table in the previous section.

If the control device is a relay or contactor the minimum on time should be set greater than 10 seconds (for example) to prolong relay life. By way of illustration, for a setting of 10 seconds the relay will switch (approximately) as shown in the table below:-

Power demand	Relay ON time	Relay OFF time
10%	10	100
25%	13	39
50%	20	20
75%	39	13
90%	100	10

It should be noted that the cycle time setting sets the nominal cycle time. The actual cycle time may be extended or shortened under certain conditions, usually at the extremes of the operating range, subject to MinOnTime. For example using the above settings, if the power demand is 1% and the MinOnTime is set to 10 seconds then the off time will have to extend approximately to 1000 seconds. Similarly, if the demand is close to 100% then the on time must correspondingly increase.

The Minimum OnTime algorithm is often preferred for control of switching devices using triac, logic or relay outputs in a temperature control application. It also applies to valve position outputs.

Note: Consideration should be given to the number of operations which the relay is expected to endure during its lifetime. See section "Relay Electrical Endurance" on page 392.

D/I/O List (O.d/I O)

This list only appears for an EPC3008 or EPC3004 if an option module is fitted that has Digital Input/Output capabilities. EPC3016 does not support this list.

These digital I/O points can only be used as Logic Input or On/Off Outputs (ie : not control outputs).

Access to the Digital Input/Output parameter list is summarized below. The full Navigation Diagram is shown in section "Navigation Diagram" on page 94.

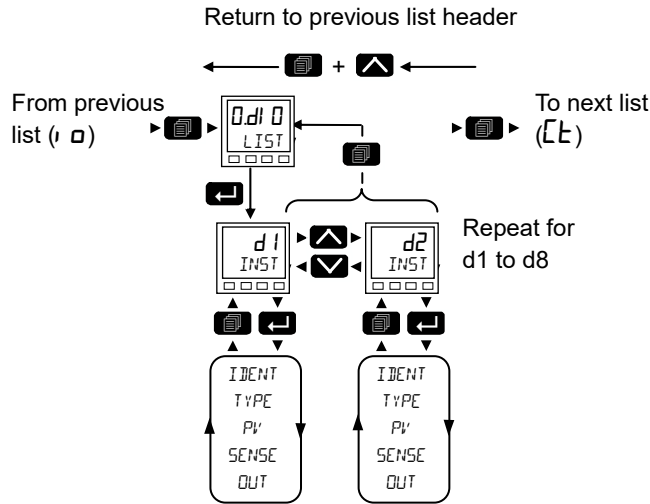

Parameter Mnemonic	Parameter Name	Value	Description	Access	
Press to select in turn					
Press or to change values (if read/write, R/W)					
IDENT	HW IDENT		Hardware fitted:	Conf R/O	
		E.NET	2		E.NET: Ethernet comms + Secondary PV + 4 DIO Option module.
		AI.d8	1		AI.D8: Secondary PV + 8 DIO Option module.
		None	0		No options board.
TYPE	TYPE OF IO	d I	0	Logic input.	Conf R/W
		OnOff	1	On Off output.	
PV	PROCESS VARIABLE	OFF	0	If the type of IO is an input this shows the state of the digital input.	R/O
		On	1	If the type is an output this shows the demand state of the output.	
SENSE	SENSE OF IO	NOFm	0	Output normal. This is the normal setting for control. Output off when the PID demand is off. For control this is when PV>SP. For a Digital Input the input is active when the input is = 1. Default: Norm	Conf R/W
		Inv	1	Output inverted. This is the normal setting for alarms. Output off is when the alarm is active. Output on is when the alarm is in-active. For a Digital Input the input is active when the input is = 0.	
OUT	OUTPUT	OFF	0	A value of 0 indicates that the output is low (relay de-energized).	Conf R/O L3 R/O
		On	1	A value of 1 indicates that the output is high (relay energized).	

CT List (LT)



This option can measure, via an external current transformer, the current flowing through the electrical load when the heat output is 'on' (load current) and also when it is 'off' (leakage current).

If the load current is lower than a threshold limit or the leakage current is higher than a threshold limit, then an alarm triggers. The hysteresis to exit from either of these conditions is user configurable between 0...5% of CT range, defaulted to 2%.

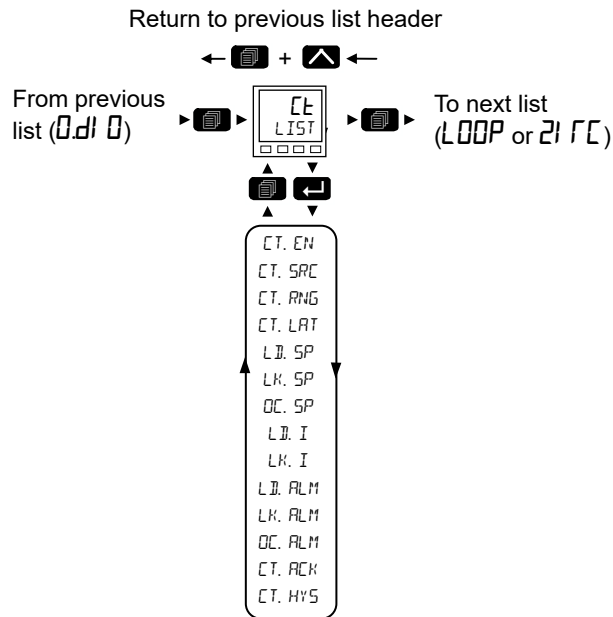
Access to the Current Transformer parameter list is summarized below. The full Navigation Diagram is shown in section "Navigation Diagram" on page 94.



Parameter Mnemonic	Parameter Name	Value		Description	Access
Press to select in turn		Press or to change values (if read/write, R/W)			
CT.EN	CURRENT TRANSFORMER	NO	0	CT module disabled. If set to NO, no further parameters are shown. Default: No	Conf R/W L3 R/O
		YES	1	CT module enabled.	
CT.SRC	CT SOURCE	NONE	0	None Default: None	
		IO.1	1	Input/Output 1.	
		IO.2	2	Input/Output 2.	
		REL.3	3	Relay output.	
		IO.4	4	Input/Output 4.	
CT.RNG	CT RANGE	100.0		Sets the CT range from 0 to the full range of the CT (1000). Default: 100.0	Conf R/W
CT.LAT	CT ALARM LATCH TYPE	NONE	0	No latching. Default: None	Conf R/W
		Auto	1	Latched with automatic reset.	
		MAN	2	Latched with manual reset.	
LD.SP	LOAD THRESHOLD	OFF to CT full scale value (1000)	0	Load open circuit current alarm threshold - low alarm. Default: Off	Conf R/W

Parameter Mnemonic	Parameter Name	Value		Description	Access
Press  to select in turn		Press  or  to change values (if read/write, R/W)			
LK.SP	LEAK THRESHOLD	OFF to CT full scale value (1000)	0	Leakage current in the off state alarm threshold - high alarm. Default: Off	Conf R/W
OC.SP	OVER THRESHOLD	OFF to CT full scale value (1000)	0	Over current alarm threshold - high alarm. Default: Off	Conf R/W
LI.I	LOAD CURRENT			Measured load current.	L3 R/O
LK.I	LEAK CURRENT			CT input leakage current.	L3 R/O
LL.ALM	LOAD CURRENT ALARM	NO	0	The low load current alarm status is set high when the detected load current is lower than the LI.SP threshold. This may indicate a partial or total failure condition in the load (for example, a defective heating element).	L3 R/O
		YES	1		
LK.ALM	LEAK CURRENT ALARM	NO	0	The leak current alarm is set high when the measured current exceeds the threshold during the controllers off states.	L3 R/O
		YES	1		
OC.ALM	OVER ALARM	NO	0	The over current alarm is set true if the measured current exceeds the over-current threshold.	L3 R/O
		YES	1		
CT Alarms should be soft wired to the input of an alarm block as generally described in section "Example 1: To Wire an Alarm" on page 224.					
CT.ACK	CT ALARM ACKNOWLEDGE	NO	0	Acknowledge all CT alarms.	L3 R/O
		YES	1		
CT.HYS	CT ALARM HYSTERESIS	2		To help prevent active/inactive alarm conditions due to electrical noise. The alarm conditions moving from active to inactive are evaluated using a hysteresis value as a percentage of the CT Range (0...5%). Default: 2%	Conf R/W

Loop List (LOOP)

For a further explanation of the way in which the loop operates and further descriptions of parameters please refer to "Control" on page 286.



This list contains eight sub-lists: Main (mAl N), Configuration (CFG), Setpoint (SP), Feedforward (FF), Autotune (ALUN), PID (Pi d), Output (OP), Diagnostics (di AG).

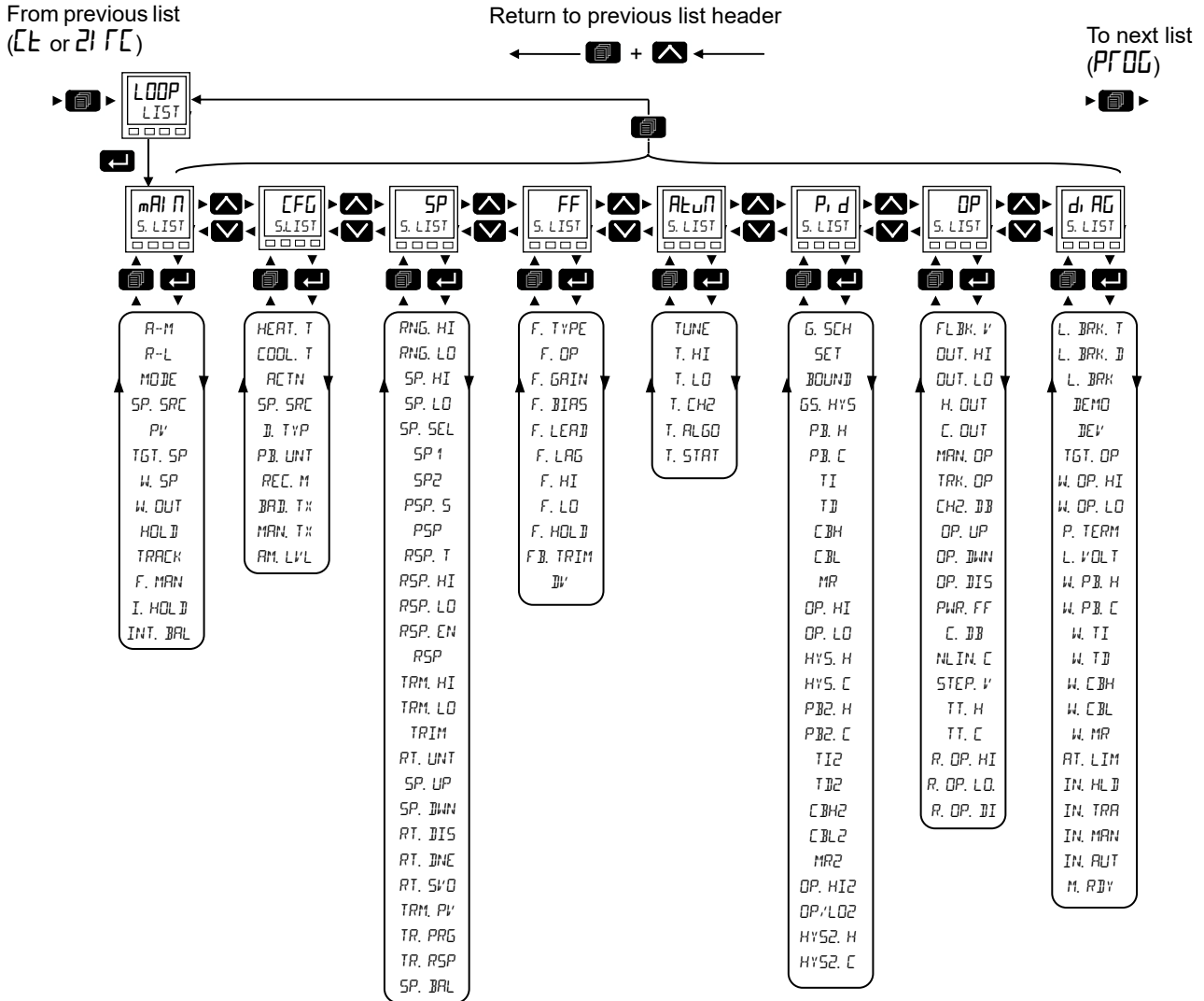

Access to the Loop parameter list is summarized below. The full Navigation Diagram is shown in section "Navigation Diagram" on page 94.



Loop - Main Sub-list



The main sub-list defines how the control loop behaves under different modes.



Parameter Mnemonic	Parameter Name	Value	Description	Access	
Press  to select in turn		Press  or  to change values (if read/write, R/W)			
A-M	AUTO-MANUAL SELECT	AUTO	0	Select automatic (closed loop) control.	L3 R/O
		MAN	1	Select manual operation (output power adjusted by the user). Default: Manual	
R-L	REMOTE-LOCAL SELECT	LOC	1	Local Setpoint. In Auto mode, the loop uses one of its local setpoints (SP1/SP2) which is alterable via the front panel or over comms. Default: Local	L3 R/O
		REM	0	Remote Setpoint. This selects the remote setpoint source. This mode is commonly used, for example, in a cascade topology or with a multi-zone furnace. Although this parameter is used to select the remote setpoint, it will not necessarily become active. The RSP_En input must be true and the RSP must have a good status before it will become active. If either of these conditions are not met, the loop will fallback to using the local setpoint.	
MODE	LOOP MODE			Reports the currently active operating mode. The loop has a number of possible operating modes which can be selected by the application. It is possible for the application to request several modes at once, so the active mode is determined by a priority model, whereby the mode with the highest priority wins. The modes shown below are listed in their priority order.	R/O
		Hold	0	Hold. Priority 0: The controller Working Output will be maintained at its current value.	
		Track	1	Track. Priority 1: The controller output will follow the track output parameter. The track output can either be a constant value or be derived from an external source (e.g. an analog input).	
		Forced Manual	2	Forced Manual. Priority 2: This mode behaves in the same way as Manual but it indicates that Auto mode cannot currently be selected. This mode is selected if the PV status is not good (e.g. sensor break) and, optionally, if a process alarm has triggered. When transferring to Forced Manual from Auto mode, the output will go to the Fallback Value (unless the hold action has been selected). Transferring to Forced Manual from any other mode will always be bumpless. This is used in a number conditions, further described in "Operating Modes" on page 302.	
		MAN	3	Manual. Priority 3: In manual mode, the controller passes authority over the output to the operator. The output is alterable via the HMI or over comms.	
		TUNE	4	Tune. Priority 4: This mode indicates that the autotuner is running and has authority over the output.	
		AUTO	5	Auto mode. Priority 5 (lowest): In Auto mode, the automatic control algorithm has authority over the output.	
SPSRC	SETPOINT SOURCE			Indicates the currently active setpoint source.	L3 R/O
		FLOC	0	Forced local setpoint. The setpoint has fallen back to the local source because the remote setpoint is not being accessed correctly.	
		REM	1	The setpoint is derived from a remote source.	
		LOC	2	The setpoint is derived locally.	
PV	PROCESS VARIABLE			The process variable. This is typically wired from an analog input.	R/W

Parameter Mnemonic	Parameter Name	Value		Description	Access
Press  to select in turn		Press  or  to change values (if read/write, R/W)			
TGT.SP	TARGET SETPOINT			Adjust and display the current target setpoint. The target setpoint is the value before rate limiting.	L3 R/O
W.SP	WORKING SETPOINT			Displays the current working setpoint. This setpoint may be derived from a number of sources depending on the application. Examples are from the programmer function block or a remote setpoint source.	R/O
W.OUT	WORKING OUTPUT			The current output demand in %.	R/O
HOLD	OUTPUT HOLD	OFF	0	When on is selected the controller output will maintain its current value.	L3 R/W
		On	1		
TRACK	OUTPUT TRACK	OFF	0	Used to select Track mode. In this mode, the controller output will follow the Track Output value. The Track output may be a constant value or come from an external source (e.g. an analog input). Track has priority 1 and so overrides all other modes apart from HOLD.	R/O
		On	1		
F.MAN	FORCED MANUAL	OFF	0	When On is selected this mode behaves in the same way as Manual but whilst active it indicates that Auto cannot currently be selected. When transferring to this mode from Auto, and this input is asserted, the output will jump to the Fallback Value. This input can be wired to alarms or digital inputs and used during abnormal process conditions. This mode has priority 2 and so will override all modes, except for Hold and Track.	R/O
		On	1		
				When any of the above modes are selected they will be indicated by the <i>MODE</i> parameter above.	
I.HOLD	INTEGRAL HOLD	No	0	If asserted the integral component of the PID calculation will be frozen.	L3 R/W
		YES	1		
INT.BAL	INTEGRAL BALANCE	No	0	This is a feature included in the controller which is not accessible via the HMI but is available in iTools and is, therefore, included here. This rising edge-triggered input can be used to force an integral balance. This recalculates the integral term in the controller so that the previous output is maintained, balancing out any change in the other terms. This can be used to minimize bumps in output when it is known that, for example, an artificial step change in PV will occur. For example, a compensation factor has just changed in an oxygen probe calculation. The integral balance is intended to prevent any proportional or derivative kick, instead allowing the output to be smoothly adjusted under integral action.	Available in iTools only
		YES	1		

Configuration Sub-List



The configuration sub-list defines control type and how certain parameters behave for particular conditions. These parameters are unlikely to require changing once the application has been configured.



Parameter Mnemonic	Parameter Name	Value		Description	Access
Press  to select in turn		Press  or  to change values (if read/write, R/W)			
HEAT.T	CH1 CONTROL TYPE	Pi d	2	PID Proportional, Integral, derivative, full three term control. Default: PID	Conf R/W L3 R/O
		UPU	3	Valve position unbounded (no feedback potentiometer is required).	
		OFF	0	Control loop channel inoperative.	
		OnOff	1	On Off control.	
COOL.T	CH2 CONTROL TYPE	Pi d	2	PID Proportional, Integral, derivative, full three term control. Default: Off	Conf R/W L3 R/O
		UPU	3	Valve position unbounded (no feedback potentiometer is required).	
		OFF	0	Control loop channel inoperative.	
		OnOff	1	On Off control	
ACTN	CONTROL ACTION	FEU	0	Reverse acting. Output decreases as PV increases. This is the normal setting for heating processes. Not applicable to on/off control. Default: Reverse	Conf R/W L3 R/O
		dir	1	Direct acting. Output increases as PV increases.	
D.TYP	DERIVATIVE TYPE	PV	0	Only changes in PV cause a derivative output. Generally used for process systems particularly using valve control where it reduces wear on valve mechanics. Not applicable to on/off control. Default: PV	Conf R/W L3 R/O
		Err	1	Changes to either PV or SP will cause a derivative output. The derivative term will responds to the rate of change of the difference between PV and the setpoint. Not applicable to on/off control.	
PBUNT	PROPORTIONAL BAND UNITS	Eng	0	The proportional band is set in engineering (PV) units. For example, degrees C. Default: Eng	Conf R/W L3 R/O
		PErc	1	The proportional band is set in percent of loop span (RangeHigh minus RangeLow).	
RECV.M	RECOVERY MODE			This parameter configures the loop recovery strategy. This strategy is followed in the following circumstances: <ul style="list-style-type: none"> • Upon instrument start-up, after a power cycle or power outage. • Upon exit from Instrument Configuration or Standby conditions. • Upon exit from Forced Manual (F.MAN) mode to a lower priority mode (e.g. when the PV recovers from a bad status or an alarm condition goes away). 	Conf R/W L3 R/W
		LASt	0	Last Mode with Last Output. The loop will assume the last mode with the last output value. Default: Last	
		mAn	1	Manual Mode with Fallback Output. The loop will assume MANUAL mode with the fallback output value, unless exiting from Forced Manual (F_MAN) in which case the current output will be maintained.	



Parameter Mnemonic	Parameter Name	Value	Description	Access	
Press  to select in turn		Press  or  to change values (if read/write, R/W)			
BADTX	PV BAD TRANSFER TYPE		If the PV goes 'bad' (e.g. due to a sensor break) this parameter configures the type of transfer to Forced Manual (F_Man). Note that this is only followed if transitioning to F_Man from Auto. Transitioning from any other mode will always be bumpless and transitioning due to the F_Man input being asserted will always go to the Fallback Value.	Conf R/W L3 R/W	
		FALL	0		The FallbackValue will be applied to the output. Default: Fall
		Hold	1		The last good output will be applied. This will be an output value from approximately 1 second before the transition.
MANTX	MANUAL TRANSFER TYPE		Type of auto/manual transfer	Conf R/W L3 R/W	
		TrAc	0		The Manual Output will track the Working Output while the mode is not MANUAL. This helps to ensure a bumpless transfer when the mode does go into MANUAL. Default: Trac
		StEP	1		The Manual Output will be set to the Manual Step Value while the mode is not MANUAL.
		LAST	2	The Manual Output will remain at the last value used.	
AMLVL	AUTOMAN ACCESS LEVEL		Used to set the access level at which the AutoMan parameter can be changed from the HMI. It is often used to help prevent unauthorized use of manual mode.	Conf R/W L3 R/W	
		LEu1	0		Auto/manual select is available in level 1. Default: Lev1
		LEu2	1		Auto/manual select is available in level 2.
		LEu3	2	Auto/manual select is available in level 3.	
SPLVL	SETPOINT ACCESS LEVEL		This sets the access level at which the setpoint can be altered from the HMI. It is often used to help prevent unauthorized changing of setpoints.	Conf R/W L3 R/W	
		LEu1	0		Target setpoint is available in level 1. Default: Lev1
		LEu2	1		Target setpoint is available in level 2.
		LEu3	2	Target setpoint is available in level 3.	
MLVL	MANOPACCESS		This parameter sets the access level at which the manual output can be changed from the home screen.	Conf R/W L3 R/W	
		LEu1	0		Manual output can be changed in level 1. Default: Lev1
		LEu2	1		Manual output can be changed in level 2.
		LEu3	2	Manual output can be changed in level 3.	

Setpoint Sub-list

The setpoint sub-list defines setpoint parameters such as limits, rates of change, trims and tracking strategies.

Parameter Mnemonic	Parameter Name	Value		Description	Access
Press  to select in turn		Press  or  to change values (if read/write, R/W)			
RNG.HI	RANGE HIGH			Range high limit. Selectable between the high limit of the selected input type to the 'Range Low' limit parameter. Default: 1372.0	Conf RW L3 RO
RNG.LO	RANGE LOW			Range low limit. Selectable between the low limit of the selected input type to the 'Range High' limit parameter.	Conf RW L3 RO
SP.HI	SETPOINT HIGH LIMIT			Maximum allowable setpoint setting. Range is between 'Range High' limit and 'Range Low' limit. Default: 1372.0	Conf RW L3 RW
SP.LO	SETPOINT LOW LIMIT			Minimum allowable setpoint setting. Range is between 'Range High' limit and 'Range Low' limit.	Conf RW L3 RW
SP.SEL	SETPOINT SELECT	SP 1	0	Select setpoint 1. Default: SP1	Conf RW L3 RW
		SP 2	1	Select setpoint 2.	
SP 1	SETPOINT 1			The current value of setpoint 1. Range from Low to high setpoint limits.	Conf RW L3 RW
SP 2	SETPOINT 2			The current value of setpoint 2. Range from Low to high setpoint limits.	Conf RW L3 RW
PSP.S	PSP select	OFF	0	Program setpoint not selected.	Not available on HMI
		On	1	Program setpoint selected.	
PSP	Program Setpoint			The current value of the programmer setpoint.	Not available on HMI
RSP.T	REMOTE SETPOINT TYPE	SETP	0	The remote setpoint (RSP) is used as a setpoint for the control algorithm. If required, a local trim can be applied. Default: Setp	
		Trim	1	The local setpoint (SP1/SP2) is used as the setpoint for the control algorithm. The remote setpoint (RSP) acts as a remote trim on this local setpoint.	
RSP.HI	RSP HIGH LIMIT			Sets the maximum range limit for the remote setpoint. Default: 1572.0	Conf RW L3 RW
RSP.LO	RSP LOW LIMIT			Sets the minimum range limit for the remote setpoint. Default: -1572.0	
RSP.EN	REMOTE SETPOINT ENABLE	On	1	This input is used to enable the remote setpoint (RSP). The remote setpoint cannot become active unless this input is asserted. This is typically used in a cascade arrangement and allows the master to signal to the slave that it is providing a valid output. I.e. the master controller's Loop.Diagnostics.MasterReady parameter should be wired into here.	Conf RW L3 RW
		OFF	0	Disable the remote setpoint.	
RSP	REMOTE SETPOINT			The remote setpoint (RSP) is typically used in a cascade control arrangement or in a multi-zone process, where a master controller is transmitting a setpoint to the slave. For the remote setpoint to become active, the RSP status must be good, the RSP_En input must be true and RemLocal must be set to Remote. The RSP can either be used as a setpoint itself (with a local trim if required) or as a remote trim on a local setpoint.	Conf RW L3 RW

Parameter Mnemonic	Parameter Name	Value		Description	Access
Press  to select in turn		Press  or  to change values (if read/write, R/W)			
TRMHI	SETPOINT TRIM HIGH			Local setpoint trim upper limit. Lower range limit is set by the TRMLD.	Conf R/W L3 RW
TRMLD	SETPOINT TRIM LOW			Local setpoint trim lower limit. Upper range limit is set by the TRMHI	
TRIM	SETPOINT TRIM			To adjust the value by which the setpoint is being trimmed between TRMHI and TRMLD	Conf R/W L3 RW
RTUNT	SETPOINT RATE LIMIT UNITS	P.Sec	0	Set the setpoint rate limit to units per second, units per minute or units per hour. Default: P.Sec	Conf R/W L3 RW
		P.min	1		
		P.hr	2		
SPUP	SETPOINT RATE UP	OFF.	0	Limits the rate at which the setpoint can increase when setpoint ramp rate is used. OFF means no rate limit is applied. Default: Off	Conf R/W L3 R/W
SPDWN	SETPOINT RATE DOWN	OFF.	0	Limits the rate at which the setpoint can decrease when setpoint ramp rate is used. OFF means no rate limit is applied. Default: Off	Conf R/W L3 R/W
				The next three parameters are only shown if either of the setpoint rate limit parameters above are set to a value.	
RTDIS	SETPOINT RATE LIMIT DISABLE	NO	0	Setpoint rate limit enabled.	Conf R/W
		YES	1	Disable setpoint rate limit.	L3 R/W
RTDNE	RATE LIMIT DONE	NO	0	Indicates that the working setpoint has reached the target setpoint. If the setpoint is subsequently changed it will ramp at the set rate until the new value is reached.	R/O
YES	1				
RTSVO	RATE LIMIT SERVO TO PV			When the setpoint is being rate limited and servo-to-PV is enabled, changing the target SP will cause the working SP to servo (step) to the current PV before ramping to the new target. This feature is only applied to SP1 and SP2 and not to the program or remote setpoints.	Conf R/W L3 R/W
		OFF	0	Disabled.	
		ON	1	The selected setpoint will servo to the current value of the PV.	
TRKPV	SP TRACKS PV IN MANUAL	OFF	0	No setpoint tracking when in manual.	Conf R/W
		ON	1	When the controller is operating in manual mode the currently selected SP (SP1 or SP2) tracks the PV. When the controller resumes automatic control there will be no step change in the working SP. Manual tracking does not apply to the remote setpoint or programmer setpoint.	L3 R/W
TRPRG	SP TRACKS PROGRAM	OFF	0	No setpoint tracking of the programmer.	Conf R/W
		ON	1	SP1/SP2 tracks the programmer setpoint while the program is running, so that there will no step change in the Working SP when the program ends and the programmer is reset. This is sometimes referred to as 'Program Tracking'.	L3 R/W
TRRSP	SP TRACKS RSP IN REMOTE	ON	1	When the remote setpoint is selected SP1/SP2 tracks the remote setpoint, so that there will be no step change in the Working SP when transitioning to the local setpoint source. The selected setpoint returns to its set value at the rate set by the SPUP and SPDWN parameters.	Conf R/W L3 R/W
		OFF	0	Disabled.	
SPBAL	SP CHANGE INTEGRAL BALANCE			When enabled, this causes the control algorithm to perform an integral balance whenever the target setpoint is changed. It only applies when the local setpoint is in use. The effect of this option is to suppress proportional and derivative kicks whenever the setpoint changes, so that the output moves smoothly to its new value under integral action. This option is similar to having both proportional and derivative terms act on PV only, and not error.	Conf R/W L3 R/W
		OFF	0	Disabled.	
		ON	1	Enable. To suppress proportional and derivative kick.	

Parameter Mnemonic	Parameter Name	Value	Description	Access
Press  to select in turn		Press  or  to change values (if read/write, R/W)		
BackCalcPV	Back-calculated PV		<p>This output is the back-calculated PV. It is the value of PV minus the setpoint trim.</p> <p>This is typically wired to the PV input of a setpoint programmer. Wiring this input, rather than the PV itself, helps to ensure that the holdback feature can take account of any setpoint trim that may be applied and also allows setpoint programs to start smoothly with the working setpoint equal to the PV, if configured.</p>	Not available on HMI
BackCalcSP	Back-calculated SP		<p>This output is the back-calculated SP. It is the working setpoint minus the setpoint trim.</p> <p>This is typically wired to the servo input of a setpoint programmer, so that it can start smoothly without bumping the working setpoint, if configured.</p>	Not available on HMI

Setpoint Limits

The figure below shows a pictorial overview of setpoint limits.

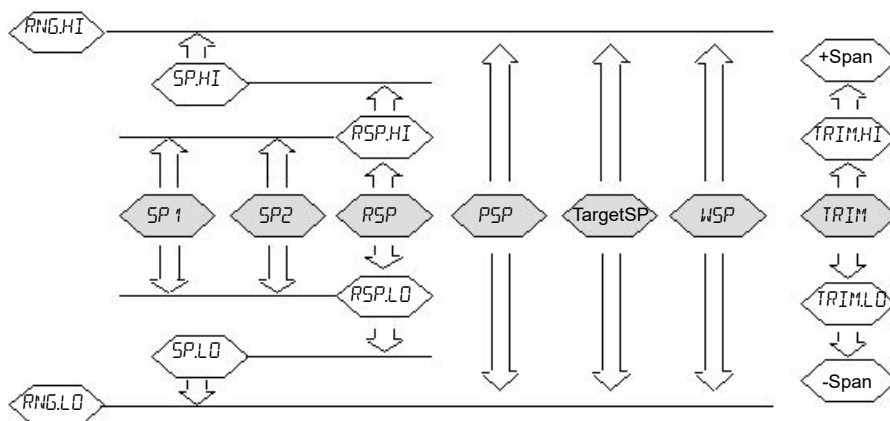









Span is taken to be the value given by Range High Limit - Range Low Limit.

Note: Whilst it is possible to set the RSP Limits outside the Range Limits, the RSP value will still be clipped to the Range Limits.

Feedforward Sub-list



Feedforward is described in "Feedforward" on page 295. This list defines the strategy to be adopted for a particular application.



Parameter Mnemonic	Parameter Name	Value		Description	Access
Press  to select in turn		Press  or  to change values (if read/write, R/W)			
F.TYPE	FEEDFORWARD TYPE	OFF	0	No signal fed forward.	Conf R/W
		SP	1	The working setpoint is used as the input to the feedforward compensator.	
		PV	2	The PV is used as the input to the feedforward compensator. This is sometimes used as an alternative to 'Delta-T' control.	
		Em	3	The remote Disturbance Variable (DV) is used as the input to the feedforward compensator. This is usually a secondary process variable that can be used to head-off disturbances in the PV before they have a chance to occur.	
F.OP	FEEDFORWARD CONTRIBUTION	0.0		Feedforward compensator output in percent.	R/O
The following parameters are available if F.Type is not set to OFF					
F.GAIN	COMPENSATOR GAIN	1.000		Defines the gain of the feedforward value, the feed forward value is multiplied by the gain. Default: 1.0	L3 R/W
F.BIAS	COMPENSATOR OFFSET	0.0		The feedforward compensator bias/offset. This value is added to the feedforward input. Note that the bias is applied after the gain.	L3 R/W
F.LEAD	LEAD TIME CONSTANT	0		The feedforward compensator lead time constant in seconds can be used to 'speed-up' the feedforward action. Set to 0 to disable the lead component. In general, the lead component should not be used on its own without any lag. The lead and lag time constants allow dynamic compensation of the feedforward signal. The values are usually determined by characterizing the effect of the input on the process (e.g. by a bump test). In the case of a Disturbance Variable, the values are chosen so that the disturbance and the correction 'arrive' at the process variable at the same instant, thereby minimizing any perturbation. As a rule of thumb, the lead time should be set equal to the lag between the controller output and the PV, while the lag time should be set equal to the lag between the DV and the PV.	L3 R/W
F.LAG	LAG TIME CONSTANT	0		The feedforward compensator lag time constant can be used to slow down the feedforward action. Set to 0 to disable the lag component. The lead and lag time constants allow dynamic compensation of the feedforward signal. The values are usually determined by characterizing the effect of the input on the process (e.g. by a bump test). In the case of a Disturbance Variable, the values are chosen so that the disturbance and the correction 'arrive' at the process variable at the same instant, thereby minimizing any perturbation. As a rule of thumb, the lead time should be set equal to the lag between the controller output and the PV, while the lag time should be set equal to the lag between the DV and the PV.	L3 R/W
F.HI	FEEDFORWARD HIGH LIMIT	+/-200.0 %		The maximum allowed value of feedforward output. This limit is applied to the feedforward output prior to it being added to the PID output. Default: 200.0%	L3 R/W
F.LO	FEEDFORWARD LOW LIMIT	+/-200.0 %		The minimum allowed value of feedforward output. This limit is applied to the feedforward output prior to it being added to the PID output. Default: -200%	L3 R/W
F.HOLD	HOLD FEEDFORWARD	NO	0	When true, the feedforward output will maintain its current value. This can be used to temporarily halt feedforward action.	L3 R/W
		YES	1		

Parameter Mnemonic	Parameter Name	Value	Description	Access
Press  to select in turn		Press  or  to change values (if read/write, R/W)		
<i>F.TRM</i>	<i>PID TRIM LIMIT</i>	<p></p> <p>Range 0.0 to 400.0</p>	<p>The PID trim limit limits the effect of the PID output.</p> <p>The implementation of Feedforward allows the Feedforward component to make the dominant contribution to the control output. The PID contribution can then be used as a trim on the Feedforward value. This arrangement is sometimes known as "Feedforward with Feedback Trim".</p> <p>This parameter defines symmetrical limits (expressed as a percentage of output) around the PID output, to limit the magnitude of the PID contribution.</p> <p>If it is required to allow PID contribution to dominate, set a large value for this parameter (400.0).</p> <p>Default: 400.0</p>	L3 R/W
If F.type is set to Remote the following additional parameter is available				
<i>DV</i>	<i>DISTURBANCE VARIABLE</i>		<p>The remote Disturbance Variable is typically a secondary measured process variable. This is usually a secondary process variable that can be used to head-off disturbances in the PV before they have a chance to occur.</p>	L3 R/W

Autotune Sub-list



Autotune is used to automatically tune the PID loop to match the characteristics of the process. See also "Autotuning" on page 309.



Parameter Mnemonic	Parameter Name	Value		Description	Access
Press  to select in turn		Press  or  to change values (if read/write, R/W)			
TUNE	AUTOTUNE	OFF	0	Autotune not enabled or abort an autotune.	L3 R/W
		On	1	Enable autotune.	
T.HI	AUTOTUNE MAXIMUM OUTPUT	-100 to +100%		To set a maximum limit on the output during tuning. Default: 100	L3 R/W
T.LO	AUTOTUNE MINIMUM OUTPUT	-100 to +100%		To set a minimum limit on the output during tuning. Default: -100	L3 R/W
T.CH2	CH2 TUNE TYPE			Configures which experiment will be used to determine the relationship between channel 1 and channel 2 proportional bands.	
		Std	0	Standard. Tunes the ch2 proportional band using the standard relative ch2 tuning algorithm. Default: Std	
		Alt	1	Alternative relative ch2 tuning. Uses a model-based tuning algorithm that has been shown to give enhanced results with higher-order, low-loss plants. In particular, it performs well with heavily-lagged temperature processes.	
		OFF	2	Do not try to determine the relative gain. This option can be used to help prevent the autotune trying to determine the ch2 proportional band. Instead, it will maintain the existing ratio between the ch1 and ch2 proportional bands. In general, this option is not recommended unless there is a known reason to select it (e.g. the relative gain is already known and the tuner gives an incorrect value).	
T.ALGO	TUNE ALGORITHM			This parameter reports which autotuning algorithm is available for the current control configuration. The appropriate tuning algorithm is automatically determined. See also "Autotuning" on page 309 for further information on self tuning.	R/O
		none	0	There is no autotuner available for the current control configuration.	
		Pid	1	The standard autotuner based on a modified relay method. It requires two cycles to complete (not including the relative ch2 tune). This is used for PID-only configurations and where there is no output rate limiting configured.	
		Fourier	2	This algorithm uses the same modified relay method but uses a more complex analysis based on the work of Joseph Fourier. It requires three cycles to complete (not including the relative ch2 tune). This algorithm is used for VP or mixed channel configurations and is also used whenever there is an output rate limit set.	



Parameter Mnemonic	Parameter Name	Value		Description	Access
Press  to select in turn		Press  or  to change values (if read/write, R/W)			
T.STA	AUTOTUNE STATUS			This parameter displays the current state of the autotune.	R/O
		OFF	0	Unavailable.	
		rdY	1	Ready to run an autotune.	
		Er, G	2	Triggered. An autotune has been triggered but a higher priority mode is preventing it from starting. When the higher priority mode is no longer active the tune will start.	
		run	3	Running. The autotuner is running and currently has authority over the controller outputs.	
		donE	4	Complete. The autotune successfully completed and has updated the tuneset parameters.	
		Abor	5	Aborted. Autotune aborted.	
		EOUt	6	Time Out. If any stage of the autotune sequence exceeds two hours in duration, the sequence will timeout and be aborted. It could be due to the loop being open or not responding to the demands from the controller. Very heavily lagged systems may produce a timeout if the cooling rate is very slow. The Stage Time parameter counts up the time in each stage.	
		OFLw	7	Overflow. A buffer overflow occurred while collecting process data. Contact your supplier for support.	
STAGE	STAGE OF AUTOTUNE			This reports the stage of the current autotuning sequence.	R/O
		ldLE	0	Idle. Not autotuning	
		moni	1	Monitor. The process is being monitored. This stage lasts one minute. The setpoint can be changed during this stage.	
		ln t	2	Initial. An initial oscillation is being established.	
		Hi	3	Max. Maximum output applied.	
		Lo	4	Min. Minimum output applied.	
		r2G	5	R2G. Relative channel 2 gain test is running. If the calculated proportional band ratio is outside the range 0.1 and 10.0, The Ch1/Ch2 Proportional Band ratio will be clipped to these limits but all other PID parameters are updated. R2G limit may occur if the gain difference between heating and cooling is too large. This could also occur if the controller is configured for heat/cool but the cooling medium is turned off or not working correctly. It could similarly occur if the cooling medium is on but heating is off or not working correctly.	
		Pd	6	PD Control. The autotuner is trying to control to setpoint and is examining the response.	
AnLS	7	Analysis. The autotuner is calculating the new tuning parameters.			
STG.T	TIME ELAPSED IN STAGE			The time elapsed in the current autotune stage. This is reset each time the autotuner advances a stage. If this exceeds two hours, a timeout will occur.	

PID Sub-list

The PID is used to display and set the current PID values. See also "PID Control" on page 287.

Parameter Mnemonic	Parameter Name	Value		Description	Access
Press  to select in turn		Press  or  to change values (if read/write, R/W)			
G.SCH	GAIN SCHEDULER TYPE			Gain scheduling is provided so that processes which change their characteristics can be controlled. For example, in some temperature processes, the dynamical response may be very different at low temperatures from that at high temperatures. Gain Scheduling typically uses one of the loop's parameters to select the active PID set -- this parameter is known as the scheduling variable (SV). Two sets are available as standard and a boundary is provided which defines the switching point. The number of sets, and hence the number of boundaries, has been increased from 2 to 8 in firmware versions V3.01 and above.	Conf R/W
		OFF	0	Gain scheduling not active.	
		SET	1	The PID set can be selected by the operator. It is possible to use soft wiring to control the selection of the gain sets. This could be linked to the programmer segment, changing the PID settings for individual segments or it could be wired to a digital input so that the working PID set can be set remotely.	
		PV	2	The transfer between one set and the next depends on the value of the process variable.	
		SP	3	The transfer between one set and the next depends on the value of the working setpoint.	
		OP	4	The transfer between one set and the next depends on the value of the output.	
		dEU	5	The transfer between one set and the next depends on the value of the difference between the SP and PV.	
mode	6	This parameter selects set 2 when the remote setpoint is active, and set 1 when the local setpoint is active.			
N.SET	NUMBER OF SETS	1 - 8		Number of enabled tunesets. This is fixed at 2 unless the 8 gain set feature has been ordered or unlocked using feature security.	L3 R/W
SET	ACTIVE TUNE SET	SET 1	0	This shows the set being tuned and is displayed if g.sch = SET, PV, SP, OP or dev.	L3 R/W
		SET 2	1		
		SET 3	2		
		SET 4	3		
		SET 5	4		
		SET 6	5		
		SET 7	6		
		SET 8	7		
BND.1	TUNE SET SWITCHING POINT 1	0.0		Sets the level at which PID set 1 changes to PID Set 2. This only applies when the schedule type = PV, SP, OP, dev. The gain scheduler compares the scheduling variable against the specified boundary. If the scheduling variable is below the boundary then Set 1 is active. If above the boundary then Set 2 is active and so on. See also section "Gain scheduling" on page 292. Default: 0.0	L3 R/W
BND.2	TUNE SET SWITCHING POINT 2	0.0		Sets the level at which PID set 2 changes to PID set 3.	L3 R/W
If 8 sets are available up to 8 boundaries are shown as BND.3 to BND.8.					L3 R/W



Parameter Mnemonic	Parameter Name	Value		Description	Access
Press  to select in turn		Press  or  to change values (if read/write, R/W)			
GS.HYS	SWITCHING HYSTERESIS	10		This specifies the amount of hysteresis around the gain scheduling boundary. This is used to avoid continuous switching as the scheduling variable passes through the boundary.	L3 R/W
PB.H	CH1 PROPORTIONAL BAND	20.0		The proportional band for channel 1. This may be in % or engineering units as set by the parameter PB.UNT. Default: 20.0%	L3 R/W These parameters are displayed on the HMI if gain scheduling is off.
PB.C	CH2 PROPORTIONAL BAND	20.0		The proportional band for channel 2. This may be in % or engineering units as set by the parameter PB.UNT. Default: 20.0%	
TI	INTEGRAL TIME	360		The integral time in seconds for channel 1. Set to 0 to disable integral action. Default: 360 seconds	
TD	DERIVATIVE TIME	60		The derivative time in seconds for channel 1. Set to 0 to disable derivative action. Default: 60 seconds	
CB.H	CUTBACK HIGH THRESHOLD	Auto	0	Defines a High Cutback threshold in the same units as the proportional band (either engineering units or percent of span, depending on configuration).	
CB.L	CUTBACK LOW THRESHOLD	Auto	0	Defines a Low Cutback threshold in the same units as the proportional band (either engineering units or percent of span, depending on configuration).	
MR	MAN RESET	0.0 to 100.0% (heat only) -100.0 to 100.0% (heat/cool)		Manual reset. This parameter only appears if the control algorithm is PID or VPU, AND the integral time is set to 0 (Off). It is used to manually adjust the output power to offset for any difference between SP and PV. See also "Manual Reset (PD Control)" on page 290.	L3 R/W
OP.HI	OUTPUT HIGH	+100.0% to OP.LO		Gain scheduled output upper limit. Default: 100	L3 R/W
OP.LO	OUTPUT LOW	-100.0% and OP.HI		Gain scheduled output lower limit. Default: -100	L3 R/W
HYS.H	CH 1 ON/OFF HYSTERESIS	OFF 1 to 99999	0	This parameter is only available if channel 1(heat) is configured for On/OFF control. It sets the hysteresis between the output being on and the output being off. Default: 10	L3 R/W
HYS.C	CH 2 ON/OFF HYSTERESIS	OFF 1 to 99999	0	This parameter is only available if channel 2 (cool) is configured for On/OFF control. It sets the hysteresis between the output being on and the output being off. Default: 10	L3 R/W
PB2.H	CH1 PROPORTIONAL BAND 2	20.0		The proportional band for channel 1, for tuneset 2. This may be in % or engineering units as set by the parameter PB.UNT. Default: 20.0%	L3 R/W
PB2.C	CH2 PROPORTIONAL BAND 2	20.0		The proportional band for channel 2, for tuneset 2. This may be in % or engineering units as set by the parameter PB.UNT. Default: 20.0%	L3 R/W
TI2	INTEGRAL TIME 2	360		The integral time in seconds for tuneset 2. Set to 0 to disable integral action. Default: 360 seconds	L3 R/W
TD2	DERIVATIVE TIME 2	60		The derivative time in seconds for tuneset 2. Set to 0 to disable derivative action. Default: 60 seconds	L3 R/W
CBH2	CUTBACK HIGH THRESHOLD 2	Auto	0	Defines a High Cutback threshold, for tuneset 2, in the same units as the proportional band (either engineering units or percent of span, depending on configuration).	L3 R/W



Parameter Mnemonic	Parameter Name	Value		Description	Access
Press  to select in turn		Press  or  to change values (if read/write, R/W)			
CBL2	CUTBACK LOW THRESHOLD 2	Auto	0	Defines a Low Cutback threshold, for tuneset 2, in the same units as the proportional band (either engineering units or percent of span, depending on configuration).	L3 R/W
MR2	MAN RESET 2	0.0 to 100.0% (heat only) -100.0 to 100.0% (heat/cool)		Manual reset for tuneset 2. This parameter only appears if the control algorithm is PID or VPU, AND the integral time is set to 0 (Off). It is used to manually adjust the output power to offset any for any difference between SP and PV. See also "Manual Reset (PD Control)" on page 290.	L3 R/W
OPHI2	OUTPUT HIGH 2	100.0		Gain scheduled output upper limit for tuneset 2. Range between +100.0% to OP.LO 2.	L3 R/W
OPLO2	OUTPUT LOW 2	- 100.0		Gain scheduled output lower limit for tuneset 2. Range between -100.0% and OP.HI 2.	L3 R/W
HYS2.H	CH 1 ON/OFF HYSTERESIS 2	OFF 1 to 99999	0	On-Off Hysteresis for channel 1/heat, for tuneset 2. This is set in the units of the PV. It defines the point below setpoint where the channel 1 output will turn on. The output will turn off when the PV is at setpoint. The hysteresis is used to minimize the chattering of the output at the control setpoint. If the hysteresis is set to 0 then even the smallest change in the PV, when at setpoint, will cause the output to switch. The hysteresis should be set to a value which provides an acceptable life for the output contacts, but which does not cause unacceptable oscillations in the PV. If this performance is unacceptable, it is recommended that PID control with a time proportioning output is used. Default: 10	
HYS2.C	CH 2 ON/OFF HYSTERESIS 2	OFF 1 to 99999	0	On-Off Hysteresis for channel 2/cool, for tuneset 2. This parameter is only available if channel 2 (cool) is configured for On/OFF control. It sets a second value of the hysteresis, for tuneset 2, between the output being on and the output being off. The comments above are also applicable to this parameter. Default: 10	L3 R/W
Parameters from PB2.H to HYS2.C above are repeated for every set configured. That is PB3.H to PB8.H and HYS3.C to HYS8.C.					

A further description of the above parameters is given in "Control" on page 286.

OP Sub-list



The output sub-list is used to display and set the output parameters. For further descriptions of parameters see "Control" on page 286.



Parameter Mnemonic	Parameter Name	Value		Description	Access
				Press  to select in turn	
				Press  or  to change values (if read/write, R/W)	
FLBKV	FALLBACK OUTPUT VALUE	00%		<p>The Fallback Output Value is used in a number of circumstances:</p> <ul style="list-style-type: none"> If the PV status goes bad (e.g. sensor break), the loop will enter Forced Manual mode (F_Man) with either the fallback value or the last good output. This depends on the configured PV Bad Transfer type. If Forced Manual (F_Man) mode is activated by an external signal (e.g. a process alarm) then the fallback output value is always applied. If the Recovery Mode is configured as 'ManualModeFallbackOP', then the controller will always start up in Manual mode with the fallback output value. This is also true when exiting Instrument Config or Standby modes. 	Conf R/W
OUT.HI	OUTPUT HIGH LIMIT	100.0% to - 100.0%		<p>Maximum output power delivered by channels 1 and 2.</p> <p>By reducing the high power limit, it is possible to reduce the rate of change of the process, however, care should be taken as reducing the power limit will reduce the controllers ability to react to disturbances.</p> <p>Range between Output Lo and 100.0%.</p> <p>This parameter does not affect the Fallback Value being achieved in Manual mode.</p> <p>Default: 100</p>	L3 R/W
OUT.LO	OUTPUT LOW LIMIT	- 100.0% to 100.0%		<p>Minimum (or maximum negative) output power delivered by channels 1 and 2. Range between Output Hi and -100.0%.</p> <p>Default: 0</p>	L3 R/W
H.OUT	CHANNEL 1 OUTPUT	00 to 100.0%		<p>The current value of channel 1 output demand. Channel 1 (Heat) output.</p> <p>The Ch1 output is the positive power values (0 to Output Hi) used by the heat output. Typically this is wired to the control output (time proportioning or DC output). Range between Output Hi and Output Lo.</p>	R/O
C.OUT	CHANNEL 2 OUTPUT	-00 to - 100.0%		<p>The current value of channel 2 output demand. The Ch2 output is negative portion of the control output (0 – Output Lo) for heat/cool applications. It is inverted to be a positive number so that it can be wired into one of the outputs (time proportioning or DC outputs). Range between Output Hi and Output Lo.</p>	R/O. Shown only if Channel 2 is configured
MAN.OP	MANUAL OUTPUT VALUE	00 to 100.0%		The output value when in manual or forced manual modes.	R/O
TRK.OP	OUTPUT TRACK VALUE	- 100.0% to 100.0%		This value will be used as the output when in track mode.	L3 R/W
CH2.DB	CHANNEL DEADBAND	OFF or 00 to 100.0%	0	<p>The Ch1/Ch2 Deadband is a gap in percent between output 1 going off and output 2 coming on and vice versa.</p> <p>For on/off control this is taken as a percentage of the hysteresis.</p>	L3 R/W. Not applicable to VPU outputs.
OP.UP	OUTPUT RATE UP	OFF	0	<p>Increasing output rate limit %/second. Limits the rate at which the output from the PID can change. Output rate limit can be useful in helping to prevent rapid changes in output from damaging the process or the heater elements. However, it should be used with care since the higher setting could significantly affect the process performance.</p> <p>Range OFF or 0.1%/Sec to display range.</p>	L3 R/W. Not applicable to VPU outputs.
OP.DOWN	OUTPUT RATE DOWN	OFF	0	<p>Decreasing output rate limit %/second. Comments listed for Output Rate Up apply.</p>	L3 R/W

Parameter Mnemonic	Parameter Name	Value		Description	Access
Press  to select in turn		Press  or  to change values (if read/write, R/W)			
OP.DIS	DISABLE OUTPUT RATE LIMITS			When an output rate limit has been configured, this input can be used as part of the strategy to temporarily disable rate limiting.	Conf R/W if OP.UP or OP.DWN is enabled
		No	0	Enable.	
		YES	1	Disable.	
PWR.FF	POWER FEEDFORWARD	OFF	0	Power Feedforward is a feature which monitors the line voltage and adjusts the output signal to compensate for fluctuations before they affect the process temperature. It is assumed that the supply to the controller is the same as the supply to the load.	Conf R/W L3 R/O Not applicable to VPU outputs.
		On	1		
C.DB	CHANNEL 2 DEADBAND			Ch1/Ch2 De22.0adband is a gap in percent between output 1 going off and output 2 coming on and vice versa. For on/off control this is taken as a percentage of the hysteresis.	L3 R/W. Not applicable to VPU outputs.
NLINC	NON-LINEAR COOLING			Channel 2 non-linear cooling algorithm. Selects the type of cooling channel characterization to be used.	Conf R/W. L3 R/O Not applicable to VPU outputs.
		OFF	0	No non-linear cooling algorithm used. Ch2 output will be linear.	
		Oil	1	Often used in an extruder to provide cooling using oil.	
		H2O	2	Often used in an extruder to provide flash cooling using water.	
FRn		3		Often used in an extruder to provide on/off cooling using air or an analog output to a VFD driving fan.	
STEP.V	MANUAL STEP VALUE			If the Manual Transfer type has been configured as 'Step' then this value will be applied to the output on the transition from Auto to Manual.	R/O
TT1	CH1 VALVE TRAVEL TIME	22.0		The valve travel time in seconds for the channel 1 output. This parameter must be set if the Ch1 Control Type is set to VP. The valve travel time is the time taken for the valve to move from fully-closed to fully-open. This must be the measured time to move from endstop to endstop. This not necessarily the time printed on the valve label. In a Heat/Cool application Channel 1 is the heat valve. Default: 22.0	L3 R/W. Only shown if Ch1 is VPU output.
TT2	CH2 VALVE TRAVEL TIME			The valve travel time in seconds for the channel 2 output. This parameter must be set if the Ch2 Control Type is set to VP. The valve travel time is the time taken for the valve to move from fully-closed to fully-open. This must be the measured time to move from endstop to endstop. This not necessarily the time printed on the valve label. In a Heat/Cool application, Channel 2 is the cool valve. Default: 22.0	L3 R/W. Only shown if Ch2 is VPU output.
R.OP.HI	REMOTE OUTPUT HIGH LIMIT	100.0%		Can be used to limit the output of the loop from a remote source or calculation. Default: 100.0	L3 R/W
R.OP.LO	REMOTE OUTPUT LOWER LIMIT	- 100.0%		Can be used to limit the output of the loop from a remote source or calculation. Default: 0.0	L3 R/W
R.OP.DI	DISABLE REMOTE OUTPUT LIMITS	No	0		L3 R/W
		YES	1	Disable remote output limits.	

Diagnostics Sub-list

The diagnostic list contains parameters which may be used for troubleshooting or may be soft wired as part of a control strategy.

Parameter Mnemonic	Parameter Name	Value		Description	Access
Press  to select in turn		Press  or  to change values (if read/write, R/W)			
L.BRK.T	LOOP BREAK TIME	OFF	0	<p>Sets the loop break time. This parameter, along with L.BRK.D, sets the condition for loop break detection.</p> <p>The loop break alarm attempts to detect loss of control in the control loop by checking the control output, the process value and its rate of change.</p> <p>Loop break detection works for all control algorithms: PID, VP and ON-OFF.</p> <p>Note: This is not to be confused with load failure and partial load failure.</p>	Conf R/W
L.BRK.D	LOOP BREAK DELTA PV	10.0		<p>If the controller output is saturated, this is the minimum change in PV that the system would expect to see in 2× loop break times.</p> <p>If the output is saturated and the PV has not moved by this amount in 2×LoopBreakTime then the loop break alarm will be activated.</p> <p>Default: 10.0</p>	Conf R/W
L.BRK	LOOP BREAK DETECTED	No	0		R/O
		YES	1	This flag indicates the a loop break has been detected.	
DEMO	ENABLE DEMO MODE	OFF	0		Conf R/W
		On	1	Turns on the simulated plant for demonstration purposes.	
DEV	DEVIATION			<p>This is the process deviation (sometimes called error).</p> <p>It is calculated as PV minus SP. Therefore, a positive deviation implies that the PV is above Setpoint, while a negative deviation implies that the PV is below Setpoint.</p>	R/O
TGT.OP	TARGET OUTPUT			The requested control output. This is the output taken before rate any limiting.	R/O
WOP.HI	WORKING HIGH OUTPUT LIMIT			This is the resolved upper output limit that is currently in use. It is derived from the gain scheduled limit, the remote limits and the global limits.	R/O
WOP.LO	WORKING LOW OUTPUT LIMIT			This is the resolved lower output limit that is currently in use. It is derived from the gain scheduled limit, the remote limits and the global limits.	R/O
P.TERM	PROPORTIONAL OUTPUT TERM			This is the output contribution from the proportional term. This diagnostic is not available for VP.	R/O
I.TERM	INTEGRAL OUTPUT TERM			This is the output contribution from the integral term. This diagnostic is not available for VP.	R/O
D.TERM	DERIVATIVE OUTPUT TERM			This is the output contribution from the derivative term. This diagnostic is not available for VP.	R/O
LVOLT	MEASURED LINE VOLTAGE			This is the line voltage measured by the instrument (in volts). This is the value used for Power Feedforward if enabled.	R/O
W.P.B.H	SCHEDULED CH1 PROP BAND			The currently active channel 1 proportional band.	R/O
W.P.B.C	SCHEDULED CH2 PROPORTIONAL BAND			The currently active channel 2 proportional band.	R/O
W.T.I	SCHEDULED INTEGRAL TERM	OFF	0	The currently active integral time.	R/O
W.T.D	SCHEDULED DERIVATIVE TERM	OFF	0	The currently active derivative time	R/O
W.C.B.H	SCHEDULED CUTBACK HIGH	Auto	0	The currently active cutback high threshold.	R/O

Parameter Mnemonic	Parameter Name	Value		Description	Access
Press  to select in turn		Press  or  to change values (if read/write, R/W)			
W.CBL	SCHEDULED CUTBACK LOW	Auto	0	The currently active cutback low threshold.	R/O
W.MR	SCHEDULED MANUAL RESET	OFF	0	The currently active manual reset value.	R/O
ATLIM	OUTPUT IS SATURATED	No	0	This flag will be asserted whenever the controller output is saturated (has hit a limit). This may be useful for a cascade strategy.	R/O
		YES	1		
INHLD	HOLD MODE ACTIVE	No	0	Hold mode is active.	R/O
		YES	1		
INTRA	TRACK MODE ACTIVE	No	0	Track mode is active.	R/O
		YES	1		
IN MAN	MAN OR F_MAN MODE SELECTED	No	0	Manual or F-mode selected.	R/O
		YES	1		
IN AUT	AUTO OR F_AUTO MODE SELECTED	No	0	Auto mode is selected.	R/O
		YES	1		
N.REM	NOT REMOTE	No	0	When true, this flag indicates that the controller is not ready to receive a remote setpoint. Typically this is wired back to the Track output value of a cascade master, such that the master can track the slave SP if the slave is switched to local setpoint.	R/O
		YES	1		
M.RDY	MASTER READY	No	0	When true, this flag indicates that the controller is not able to run as a cascade master. Typically this is wired to the RSP_En input of a cascade slave, such that the slave can control to a local setpoint if the master is taken out of Auto mode.	R/O
		YES	1		

Programmer List (PFDG)

In this list you set up the 'fixed' programmer conditions which are unlikely to change from program to program, that is, they are generally set once for a particular process.



The actual creation and editing of programs is done in the PROGRAM SETUP list which follows this section.

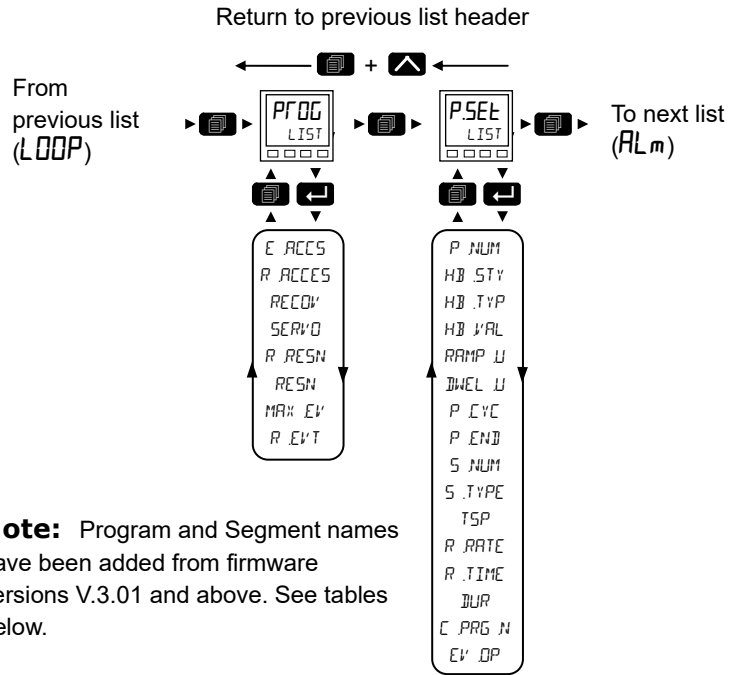

Access to the Programmer and Program Setup parameter list is summarized below. The full Navigation Diagram is shown in section "Navigation Diagram" on page 94.



For details of the programmer feature see "Programmer" on page 257.

Parameter Mnemonic	Parameter Name	Value		Description	Access	
		Press to select in turn				
		Press or to change values (if read/write, R/W)				
E.ACCS	EDIT ACCESS	LEU1	0	This parameter sets the lowest HMI access level in which a program may be set up.	Conf R/W	
		LEU2	1			Default: Level 2
		LEU3	2			
		CONF	3			
R.ACCES	RUN ACCESS	LEU1	0	This parameter sets the lowest HMI access level at which programs can be run, held or reset from the front panel.	Conf R/W	
		LEU2	1			Default: Level 2
		LEU3	2			

Parameter Mnemonic	Parameter Name	Value		Description	Access
		Press  to select in turn		Press  or  to change values (if read/write, R/W)	
RECOV	RECOVERY STRATEGY			When a program is running and the power to the instrument is interrupted, the status of the program is retained during the power down period. Upon power being restored the programmer can be configured to recover the program as listed below.	Conf R/W
		RAMP	0	Upon recovery the programmer will servo the programmer setpoint to the current PV and then ramp to the target setpoint at the rate set prior to the power outage. Then depending on the current segment type, the ramping behavior to the target setpoint (TSP) will be as follows: If the segment is a Ramp Rate then the time remaining for the segment will be recalculated using the rate prior to the power outage. If the segment is a Ramp Time segment, the calculated ramp rate prior to power outage will be used. If the interrupted segment was a dwell, then the ramp rate will be determined by the previous ramp segment. On achieving the dwell setpoint, the dwell period will continue. If there is no previous ramp segment e.g. the interrupted segment is the first segment of a program, then the dwell will continue at the current programmer setpoint. Default: Ramp	
		RESET	1	Reset. The process is aborted by resetting the program. All event outputs will take the reset state.	
		CONT	2	Continue. The program setpoint returns immediately to its last value prior to the power interruption or sensor break, then continues to dwell or ramp to the target setpoint at the ramp rate set for that segment. This may cause full power to be applied to the process for a short period to heat the process back to its value prior to the power outage.	
SERVO	SERVO TO	PU	0	The programmer setpoint (PSP) will start at the current level of the process variable input (PV input). Default: PV	Conf R/W
		SP	1	The programmer setpoint (PSP) will start at the setpoint input (SP input).	
RRESN	RAMP RATE RESOLUTION			Configures the display resolution of segment ramp rate parameters when read/written via scaled integer comms.	Conf R/W
		nnnnn	0	No decimal places.	
		nnnn.n	1	One decimal place. Default: nnnn.n	
		nnn.nn	2	Two decimal places.	
		nnn.nnn	3	Three decimal places.	
		n.nnnnn	4	Four decimal places.	
RESN	PROGRAM RESOLUTION			Configures the time resolution of the segment time left and the program time left. When read/written via scaled integer comms, the time format displayed on the HMI is shown as: SEC will be MM:SS. MIN will be HH:MM. HOUR will be HHH.H.	Conf R/W
		SEC	0	Seconds. Default: Seconds	
		mi n	1	Minutes.	
		HOuR	2	Hours.	
MAXEV	MAX EVENTS	0 to 8		Configures the maximum number of events which are available in the program. Default: 1	Conf R/W

Parameter Mnemonic	Parameter Name	Value	Description	Access	
Press  to select in turn		Press  or  to change values (if read/write, R/W)			
R E V T	RESET EVENT		<p>This parameter sets which event outputs are to be turned on when the program is in its reset state. This is a bit field where the decimal value entered into the HMI converts to binary, as shown in the table below, to determine which events are turned on.</p> <p>For example, set the value to 15 to turn on event outputs 1,2, 3,and 4 in reset. If iTools is used to set the event outputs it is only necessary to tick which events are to be switched on in a segment, see "Event Outputs" on page 272.</p> <p>Default: 0 (all off)</p>		
MX.PRG	MAX PROGRAMS		<p>Shows the maximum number of programs that can be configured.</p> <p>This parameter has been added from firmware versions V3.02 and greater.</p>	R/O	
MX.SEG	MAX SEGMENTS		<p>Shows the maximum number of segments that can be configured. The number includes the End segment.</p> <p>This parameter has been added from firmware versions V3.02 and greater.</p>	R/O	

Enable block number								Value
8	7	6	5	4	3	2	1	
0	0	0	0	0	0	0	0	0
0	0	0	0	0	0	0	1	1
0	0	0	0	0	0	1	0	2
0	0	0	0	0	0	1	1	3
0	0	0	0	0	1	0	0	4
0	0	0	0	0	1	0	1	5
0	0	0	0	0	1	1	0	6
0	0	0	0	0	1	1	1	7
0	0	0	0	1	0	0	0	8
0	0	0	0	1	1	1	1	15
0	0	0	1	1	1	1	1	31
0	0	1	1	1	1	1	1	63
0	1	1	1	1	1	1	1	127
1	1	1	1	1	1	1	1	255



Note: A running program shows further parameters in Operator Levels 1 and 2. These are shown in sections "Level 1 Programmer Display" on page 83 and "Level 2 Operator Parameters" on page 86.

Program Setup List (P5E1)

The Program setup list allows you to set up and edit the profiles of one to ten stored programs and the profile of the currently running program. The list, therefore, has one instance and multiple numbered sub lists.

Access to the Program Setup parameter list is summarized in section "Programmer List (PROG)" on page 135.

See also "Programmer" on page 257 for further details of the programmer feature.

Parameter Mnemonic	Parameter Name	Value		Description	Access
Press  to select in turn		Press  or  to change values (if read/write, R/W)			
P.NUM	PROGRAM NUMBER	1 to 10		Select the program number to configure or to run. The parameters which follow apply to the selected program number. Default: 1	L3 R/W
P.NAME	PROGRAM NAME			This parameter has been added from firmware versions V3.02 and greater. It is set up in iTools.	R/O
H.BSTY	HOLDBACK STYLE			To set the holdback style.	L3 R/W
		PrOG	0	Holdback is applied to the whole program. Default: Programmer	
		SEgm	1	Holdback is applied to every segment.	
H.BTYP	HOLDBACK TYPE	OFF	0	Holdback is disabled. This parameter is shown only if Holdback style = PrOG. Default: Off	L3 R/W
		Low	1	Holdback is entered when the PV is lower than the Program Setpoint minus Holdback Value.	
		Hi GH	2	Holdback is entered when the PV is greater than the Program Setpoint plus Holdback Value.	
		bAnd	3	Holdback is entered when the PV is either greater than the Program Setpoint plus Holdback Value or lower than the Program Setpoint minus Holdback Value.	
H.BVAL	HOLDBACK VALUE	0.0		To set the value at which holdback will be entered. This parameter is not shown if Holdback Type = OFF. Default: 0.0	L3 R/W
RAMP.U	RAMP UNITS			Sets the units for segment ramp rate and ramp time values when read/written via scaled integer comms.	
		P.SEc	0	The setpoint will ramp at units per second. Default: Per second	
		P.mi n	1	The setpoint will ramp at units per minute.	
		P.Hr	2	The setpoint will ramp at units per hour.	
DWELL.U	DWELL UNITS			Sets the units for dwell duration values when read/written via scaled integer comms.	L3 R/W
		SECS	0	Each dwell period will be in seconds. Default: Secs	
		mi nS	1	Each dwell period will be in minutes.	
		HrS	2	Each dwell period will be in hours.	
P.CYC	PROGRAM CYCLES	CONT or 1 to 9999	0	The program will repeat continuously or for the set number of times. Default: 1	L3 R/W

Parameter Mnemonic	Parameter Name	Value		Description	Access
		Press to select in turn			
		Press or to change values (if read/write, R/W)			
P.END	PROGRAM END TYPE	dwEL	0	At the end of the program the programmer setpoint (PSP) will dwell (remain) at its current value until manual intervention. Default: Dwell	L3 R/W
		rSEt	1	At the end of the program the programmer will go into reset state and the program setpoint will servo to either the PVInput or the SPInput depending on the ServoTo parameter value	
		tFAt	2	At the end of the program the programmer setpoint (PSP) will dwell at its current value and the control loop will be placed in Track mode.	
S.NUM	CURRENT SEGMENT NUMBER	1 to 25		This shows which segment number is currently running. The controller supports 24 segments plus an END segment.	R/O
S.NAME	SEGMENT NAME			This parameter has been added from firmware versions V.xxx and greater. It is set up in iTools.	R/O
S.TYPE	SEGMENT TYPE	End	0	Program ends. Default: End	L3 R/W
		rAtE	1	Ramp to the target value using a configured ramp rate.	
		tImE	2	Ramp to the target value within a configured TimeToTarget value.	
		dwEL	3	Dwell at the current programmer setpoint (PSP) for a configured time duration.	
		SLEP	4	Immediate change of the programmer setpoint from the current value to the target setpoint value (followed by a 1s dwell period to allow event outputs to be triggered).	
		CALL	5	A call segment allows the main program to call another program as a subroutine. See also C.PRG.N below.	
TSP	TARGET SETPOINT			To set the level which the programmer setpoint (PSP) will reach at the end of the segment. Default: 0.0	L3 R/W
R.RATE	RAMP RATE			This applies if the Segment Type = 'rAtE'. It sets the ramp rate, in units/time, at which the programmer setpoint (PSP) is to change to reach the target setpoint (TSP). Default: 0.1	L3 R/W
R.TIME	TIME TO TARGET	00:00		This applies if the Segment Type = 'tImE'. It sets the ramp time, which is the time it will take, in the selected segment, for the programmer setpoint (PSP) to move from the current level to the target setpoint (TSP). Default: 0	L3 R/W
DUR	DWELL DURATION	00:00		This applies if the segment type is Dwell. It sets the time for a soak period in that segment. Default: 0.0	L3 R/W
C.PRG.N	CALL PROGRAM	2 to 10		To select a program number to be run as a subroutine of the current program. The Call program number will be defaulted to the next higher program number, for example, when configuring a Call segment in Program 5, the Call Program Number will default to Program 6. Programs can only call program numbers greater than its own to prevent cyclic calls.	L3 R/W
EV.OP	EVENT OUTPUTS			This parameter sets which event outputs are to be turned on in a particular segment. This is a bit field where the decimal value entered into the HMI converts to binary, as shown in the table below, to determine which events are turned on. For example, set the value to 6 to turn on event outputs 2 and 3 in the selected segment. If iTools is used to set the event outputs it is only necessary to tick which events are to be switched on in a segment, see "Event Outputs" on page 272. Default: 0 (all off)	L3 R/W
When a segment has been set up the next segment will be selected and the above parameters will be repeated.					

Enable block number								Value
8	7	6	5	4	3	2	1	
0	0	0	0	0	0	0	0	0
0	0	0	0	0	0	0	1	1
0	0	0	0	0	0	1	0	2
0	0	0	0	0	0	1	1	3
0	0	0	0	0	1	0	0	4
0	0	0	0	0	1	0	1	5
0	0	0	0	0	1	1	0	6
0	0	0	0	0	1	1	1	7
0	0	0	0	1	0	0	0	8
0	0	0	0	1	1	1	1	15
0	0	0	1	1	1	1	1	31
0	0	1	1	1	1	1	1	63
0	1	1	1	1	1	1	1	127
1	1	1	1	1	1	1	1	255

Alarms List (ALM)



See also Chapter "Alarms" on page 245 which describes alarm features.

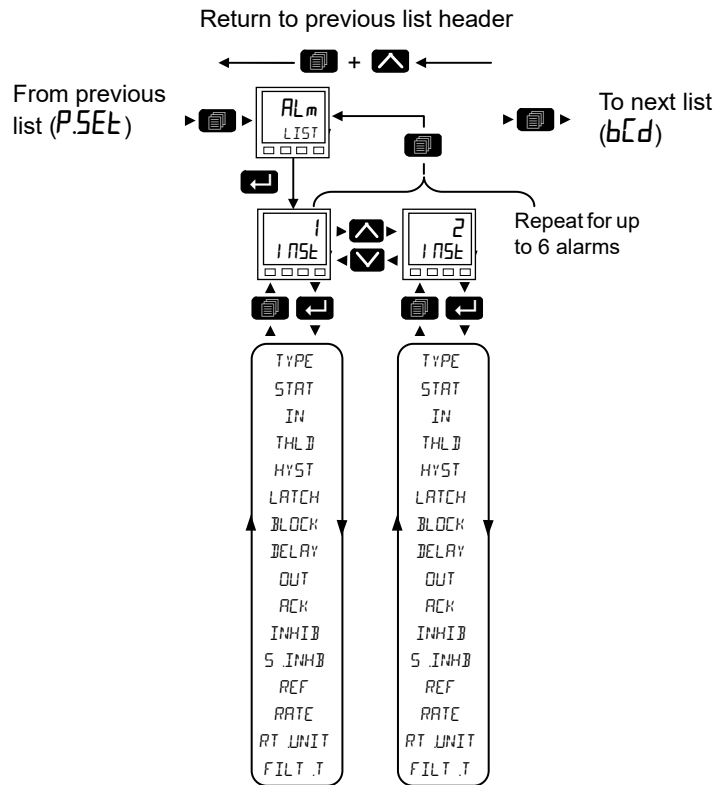

Access to the Alarms parameter list is summarized below. The full Navigation Diagram is shown in section "Navigation Diagram" on page 94.



The following parameters are available in the Alarms Menu.

Parameter Mnemonic	Parameter Description	Value		Description	Access	
		Press to select in turn				
		Press or to change values (if read/write, R/W)				
<i>INST</i>	<i>ALARM NUMBER</i>	<i>1 to 6</i>		Up to 6 alarms may be configured. Select each alarm as required. The parameters in the following list apply to each alarm number.	L3 R/W Conf R/W	
<i>TYPE</i>	<i>ALARM TYPE</i>	<i>OFF</i>	0	The alarm is disabled. Default: Off	L3 R/O Conf RW	
		<i>AbSH</i>	1	The alarm is triggered when the input value becomes greater than the threshold.		
		<i>AbSL</i>	2	The alarm is triggered when the input becomes less than the threshold		
		<i>dEUH</i>	3	The alarm is triggered when the input becomes higher than the reference by the amount of the deviation.		
		<i>dEUL</i>	4	The alarm is triggered when the input becomes lower than the reference by the amount of the deviation.		
		<i>dEUb</i>	5	The alarm is triggered when the input differs from the reference by the amount of the deviation.		
		<i>FfOC</i>	6	The alarm is triggered when the input changes positively by more than a specified amount within a specified period (second, minute, hour). It will remain active until the input value's positive rate of change falls below the specified rate.		
		<i>FfOC</i>	7	The alarm is triggered when the input changes negatively by more than a specified amount within a specified period (second, minute, hour). It will remain active until the input value's negative rate of change falls below the specified rate.		
		<i>d.GH</i>	8	The alarm is triggered when the input is equivalent to a Boolean '1' i.e. ≥ 0.5 .		
<i>d.GL</i>	9	The alarm is triggered when the input is equivalent to a Boolean '0' i.e. < 0.5 .				
<i>STAT</i>	<i>ALARM STATUS</i>			This shows that the alarm is Off, Active, InactiveNotAcked or ActiveNotAcked.	R/O	
		<i>OFF</i>	0	No alarm. Always shows 'Off' when the alarm is inhibited.		
		<i>Act</i>	1	Active. The alarm is still present but has been acknowledged.		
		<i>INNA</i>	2	Inactive Not Acknowledged means that the alarm trigger source has returned to a non-alarm state, but the alarm is still active because it has not been acknowledged. applies to 'Auto' and 'Manual' latching alarms only,		
		<i>ANNA</i>	3	Active not acknowledged means that the source is still active and the alarm has not been acknowledged.		
<i>IN</i>	<i>INPUT</i>			The value being monitored.	R/O	
<i>THLD</i>	<i>THRESHOLD</i>	<i>1.0</i>		For absolute alarms only, this is the trip point for the alarm. For absolute high alarms, if the input value exceeds the threshold value, then the alarm becomes active, and remains active until the input falls below the value (threshold - hysteresis). For absolute low alarms, if the input falls below the threshold value, then the alarm becomes active and remains active until the input rises above (Threshold + Hysteresis). Default: 1.0	L3 R/W Conf R/W	
<i>HYST</i>	<i>HYSTERESIS</i>	<i>0.0</i>		Hysteresis is the difference between the point at which the alarm switches 'ON' and the point at which it switches 'OFF'. It is used to provide a definite indication of the alarm condition and to help prevent alarm relay chatter. A value of 0.0 disables hysteresis. Default: 0.0		

Parameter Mnemonic	Parameter Description	Value		Description	Access
		Press  to select in turn			
		Press  or  to change values (if read/write, R/W)			
LATCH	LATCHING TYPE	None	0	No latching methodology i.e. when the alarm condition is removed the alarm will become inactive without being acknowledged. Default: None	L3 R/W Conf R/W
		Auto	1	The alarm will remain active until the alarm condition has been removed and the alarm has been acknowledged. The alarm can be acknowledged at any time after the alarm has become active.	
		man	2	The alarm will remain active until the alarm condition has been removed and the alarm has been acknowledged. The alarm can only be acknowledged after the alarm condition has been removed.	
		EUnt	3	Same as a non-latching alarm except the alarm is used as a trigger and therefore will not be announced.	
BLOCK	BLOCKING ENABLE	OFF	0	Blocking disabled. Default: Off	L3 R/W Conf R/W
		On	1	Alarms with 'Block' set to 'On' are inhibited until the monitored value has entered the working condition after a start-up. This helps to prevent such alarms from becoming active whilst the process is brought into control. If a latching alarm is not acknowledged then the alarm is reasserted (not blocked), unless the alarm threshold or reference value is changed, in which case the alarm is blocked again.	
DELAY	DELAY	0.0 to 9999.9		Initiates a delay in seconds between the trigger source becoming active, and the alarm becoming active. If the trigger source returns to a non alarm state before the delay time has elapsed, then the alarm is not triggered and the delay timer is reset. A value of 0 turns off the delay timer. Default: 0.0.	L3 R/W Conf R/W
OUT	OUTPUT	OFF	0	Boolean output which is set to '1' when status is not 'off'.	R/O
		On	1		
ACK	ACKNOWLEDGE	No	0	Not acknowledged.	L3 R/W
		YES	1	Select YES to acknowledge the alarm. The display then returns to No.	Conf R/W
INHIB	INHIBIT THE ALARM	OFF	0	Alarm not inhibited.	L3 R/W
		On	1	When 'Inhibit' is enabled, the alarm is inhibited and Status is set to 'Off'. If the alarm is active when inhibit is enabled, then it becomes inactive until inhibit is disabled, when its status depends on its configuration. Similarly if the alarm trigger becomes active when the alarm is inhibited, the alarm remains 'off' until inhibit is disabled, when its status depends on its configuration. Default: Off	Conf R/W
S.INHB	INHIBIT IN STANDBY	OFF	0	When the instrument is in standby mode, the alarm will be inhibited if this parameter is On. Default: Off	L3 R/W Conf R/W
		On	1		
REF	REFERENCE	1		For deviation alarms only, this provides a 'center point' for the deviation band. For 'deviation high' alarms, the alarm becomes active if the input rises above the value (Reference + Deviation) and remains active until the input falls below (Reference + Deviation - Hysteresis). For 'deviation low' alarms, the alarm becomes active if the input falls below the value (Reference - Deviation) and remains active until the input rises above (Reference - Deviation + Hysteresis). For 'deviation band' alarms, the alarm is active whenever the input lies outside the value (Reference ± Deviation) and remains active until the input returns to within the band, minus or plus Hysteresis as appropriate. Default: 1.0 Note: If blocking is enabled, changing this parameter will activate alarm blocking. This includes when being wired to. You must ensure that the source value is not noisy, otherwise the alarm will always be blocked. Range -19999 to 99999.	L3 R/W Conf R/W

Parameter Mnemonic	Parameter Description	Value		Description	Access
		Press  to select in turn		Press  or  to change values (if read/write, R/W)	
DEV	DEVIATION	1		Used in deviation alarms. The deviation value added to or subtracted from the reference value at which the input is evaluated against. Range -19999 to 99999. Default: 1.0	L3 R/W Conf R/W
RATE	RATE	100		For rate-of-change alarms only. The alarm becomes active if the input rises (Rising ROC) or falls (Falling ROC) at a rate that is greater than the specified 'Rate' per 'Rate Unit'. The alarm remains active until the rate of change falls below the set 'Rate'. Range -19999 to 99999. Default: 1.0	R/O Conf R/W
RTUNIT	RATE UNITS	SEc	0	The rate units, used in rate of change alarms, selects the units for the rate parameter in seconds, minutes or hours. Default: Seconds	L3 R/W Conf R/W
		mi n	1		
		Hr	2		
FILT.T	FILTER TIME	0.0		For rate-of-change alarms only. This allows a filter period (for the input) to be entered to reduce nuisance trips due to electrical signal noise, or if the rate of change is hovering around the trip value. Range 0.0 to 9999.9 seconds. Default: 0.0	L3 R/W Config RW

BCD List (bCd)

The BCD Input Function block takes eight digital inputs and combines them to make a single numeric value, typically used to select a program or a recipe.



The block uses 4 bits to generate a single digit.

Two groups of four bits are used to generate a two digit value (0 to 99).

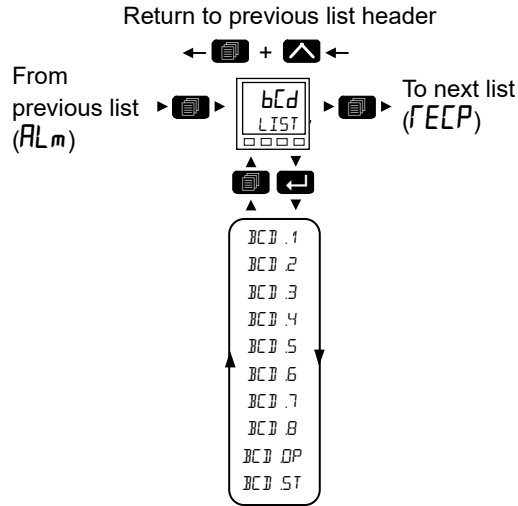
Access to the BCD parameter list is summarized below. The full Navigation Diagram is shown in section "Navigation Diagram" on page 94.



Parameter Mnemonic	Parameter Name	Value		Description	Access
Press to select in turn		Press or to change values (if read/write, R/W)			
BCD.1	BCD INPUT 1	OFF	0	Digital input 1.	L2 R/O Conf R/W
		On	1		
BCD.2	BCD INPUT 2	OFF	0	Digital input 2.	
		On	1		
BCD.3	BCD INPUT 3	OFF	0	Digital input 3.	
		On	1		
BCD.4	BCD INPUT 4	OFF	0	Digital input 4.	
		On	1		
BCD.5	BCD INPUT 5	OFF	0	Digital input 5.	
		On	1		
BCD.6	BCD INPUT 6	OFF	0	Digital input 6.	
		On	1		
BCD.7	BCD INPUT 7	OFF	0	Digital input 7.	
		On	1		
BCD.8	BCD INPUT 8	OFF	0	Digital input 8.	
		On	1		
BCD.OP	BCD OUTPUT			Reads the value (in BCD) of the switch as it appears on the digital inputs. See the examples in the table below.	R/O

Parameter Mnemonic	Parameter Name	Value	Description	Access	
Press  to select in turn		Press  or  to change values (if read/write, R/W)			
<i>BCD.ST</i>	<i>BCD SETTLE TIME</i>	<i>1.0</i> Range 0.0 to 10.0 seconds	As a BCD switch is turned from the current value to another, intermediate values may be seen on the output parameters of the block. These could cause issues in some applications. The Settle Time can be used to filter out these intermediate values by applying a settling period between the inputs changing and the converted values appearing at the outputs. Default: 1s		

in1	In2	In3	In4	In5	In6	In7	In8	BCD.OP
1	0	0	0	0	0	0	0	1
1	0	0	1	0	0	0	0	9
0	0	0	0	1	0	0	1	90
1	0	0	0	1	0	0	1	91
1	0	0	1	1	0	0	1	99

For BCD Switch wiring example, refer to "Example 1 BCD Switch Wiring" on page 56.

Recipe List (RECP)

A recipe is a list of parameters whose values can be captured and stored in a dataset. This dataset can then be loaded into the controller at any time to restore the recipe parameters, thus providing a means of altering the configuration of an instrument in a single operation even in operator mode.

A maximum of 5 datasets are supported, referenced by its name, defaulted to be the dataset number i.e. 1...5.

Access to the Recipe parameter list is summarized below. The full Navigation Diagram is shown in section "Navigation Diagram" on page 94.

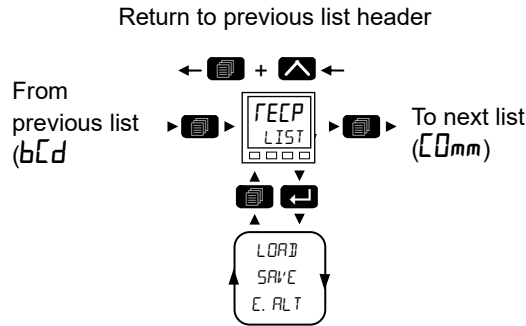

Parameter Mnemonic	Parameter Name	Value		Description	Access	
Press to select in turn		Press or to change values (if read/write, R/W)				
LOAD	DATASET TO LOAD	NONE	0	Selects which recipe dataset to load. Once selected, the values stored in the dataset will be copied back over the active parameters. Default: None		
		1 to 5		Dataset 1 to 5.		
		DONE	101	Load completed successfully.		
		u.Suc	102	Dataset selection unsuccessful .		
SAVE	DATASET TO SAVE	NONE	0	Selects which of the 5 recipe datasets in which to store the current active parameters. When selected, this parameter initiates a snapshot of the current parameter set into the selected recipe dataset.		
		1 to 5		Dataset 1 to 5.		
		DONE	101	Save completed successfully.		
		u.Suc	102	Unsuccessful will be displayed if the values were not saved successfully. If it completes OK, then the display does not change.		
E.ALT	ENABLE ALTERABILITY CHECKS	YES	1	Enabled. Set to 'Yes' to check all parameters can be written in the current mode before loading a recipe dataset. Default: Yes		
		No	0	Disabled. Set to 'No' to write all parameters regardless of their 'config-only' status. See Note below.		

Note: Changing configurations and certain parameters whilst in Operator mode can cause disturbances in the process and, therefore, by default, a dataset will not be loaded (no parameters written to) if a parameter contained in the recipe is not writeable in operator mode. To cater for users who require the loading to operate in a similar manner to the 3200 controller (no parameter checking), this functionality can be disabled. However, to reduce disturbances in the process, whilst loading a dataset which contains configuration parameters the Instrument will be forced into standby whilst the loading is in progress.

If the recipe load cannot be completed for any reason (values are invalid or out of range), the instrument will be half configured. The instrument will put itself into Standby and display the "REC.S - INCOMPLETE RECIPE LOAD" message. This will continue after a power cycle, but can be cleared by entering and exiting config mode.

There is no default list of parameters for the EPC3000 series controllers. The parameters required to be held in recipe are defined using iTools, see "Recipes" on page 237.

To Save Recipes

1. Add your required parameters to the Recipe Definition list as described in "Recipe Definitions" on page 237.
2. In the controller adjust any of the parameters in the above list (or in your customized list) as required for a particular process or batch.
3. Scroll to the Recipe List, and select '*DATASET TO SAVE*'.
4. Select a recipe number (1 to 5) in which to store the current parameter values. When the current values have been successfully saved the display will show *DONE*.
5. Repeat the above for a second or subsequent process or batch and save under a different recipe number.

To Load a Recipe

To recall a saved recipe:

1. Scroll to the Recipe List, and select '*DATASET TO LOAD*'.
2. Select the required Recipe number. The display will flicker once to show that the selected recipe has been loaded.

Notes:

1. Recipes may be saved and recalled in Operator Levels 2, 3 and Configuration by default. It is also possible to Promote the Recipe parameters to Level 1 if required. This is done using iTools as explained in "Parameter Promotion" on page 233.
2. Recipes can also be saved and recalled using iTools as described in "Recipes" on page 237.

Communications List (Cmm)

There are three communications ports available in EPC3000 series controllers. These are:

- Configuration communication port accessed by the Config clip, see "Using the Configuration Clip" on page 213. The configuration communication port has fixed settings and is used in conjunction with iTools to configure the controller. No passwords are required to place the controller into configuration mode via the CPI clip.
- Fixed communication port accessed via the rear terminal connections HD to HF. This supports the RS-485 interface on EPC3008 and EPC3004. EPC3016 has no Fixed communication port but has an Option communication port (see below). The Fixed communications port is used, for example, to communicate with SCADA packages via Modbus RTU or EI-Bisynch protocols. It can also be used to configure the controller using iTools but passwords are required to place the controller into configuration mode.
- Option communication port currently supports serial RS-232, RS-422, RS-485 and Ethernet (RJ45) interfaces for the EPC3016 and Ethernet interface for the EPC3004 and EPC3008.

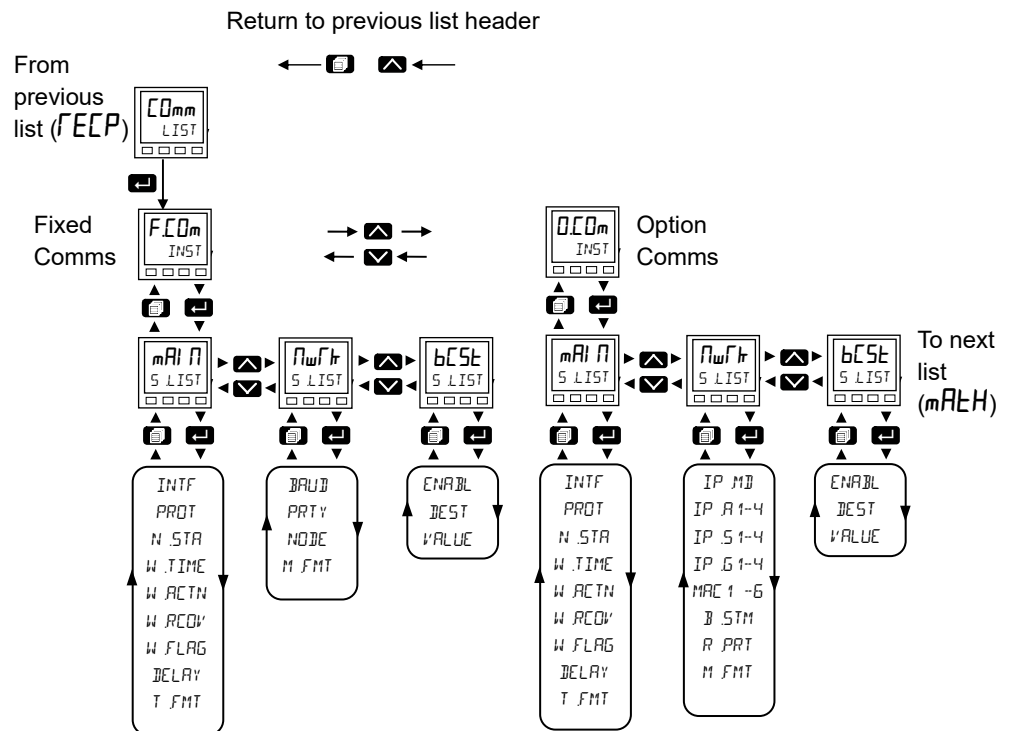

Communication settings for Fixed and Option communication ports, sometimes referred to as "User Comms", can be configured via the HMI and iTools using the Comms list. The Fixed and Option lists contain the same parameters, however some parameters may become available/unavailable depending on the interfaces and protocols selected

Access to the Digital Communications parameter list is summarized below. The full Navigation Diagram is shown in section "Navigation Diagram" on page 94.





Main Sub List (mFI Π)

Parameter Mnemonic	Parameter Name	Value	Description	Access	
		Press to select in turn			
		Press or to change values (if read/write, R/W)			
INTF	INTERFACE		Communications interface. For the Fixed communication port, interface is set according to the hardware fitted. For the Option communication port, it is set according to the configured expected option board in the Instrument function block.	R/O	
		nonE	0		No interface.
		r485	1		EIA485 (RS-485).
		r232	2		EIA232 (RS-232). EPC3016 option only.
		r422	3		EIA422 (RS-422). EPC3016 option only.
		EtH	4		Ethernet (only shown if the Ethernet options is expected). See also section "IP Mode Settings" on page 324.
		r5P	7		Remote setpoint. In EPC3016 this enumeration will not be shown
PROT	PROTOCOL		Protocol running on the comms interface.	Conf R/W	
		nonE	0		No protocol - when a serial interface is fitted. (No further parameters are shown). Default: None serial
		mSLU	1		Modbus RTU (slave) protocol enabled.
		El b5	2		EI-Bisynch protocol enabled.
		m.m5t	3		Modbus RTU master protocol enabled.
		nonE	10		No protocol - when Ethernet interface is fitted. Default: Ethernet
		m.t.cP	11		Modbus TCP protocol enabled - only shown if the Ethernet option is fitted.
		El P.m	12		EthernetIP and Modbus TCP protocol enabled - available in firmware versions V4.01 and above.
		bAC.m	13		BACnet protocol enabled - available in firmware versions V4.01 and above.
m.m5t	15	Modbus TCP master and slave protocol enabled.			
NSTR	STATUS		Status of the communications used by Modbus TCP.	R/O	
		OFFL	0		Offline and not communicating.
		INI t	1		Initializing communications.
		r dY	2		Ready to accept connection. Not used by Modbus TCP.
		r un	3		Ready to accept connections or controller communicating.
The following 4 parameters configure the Comms Watchdog Strategy. Used by Modbus RTU and Modbus TCP.					
W.TIME	WATCHDOG TIMEOUT	00	If the communications stop addressing the instrument longer than this configurable period, the Watchdog Flag will become active. A value of 0 disables the watchdog. Default: 0	Conf R/W	
W.ACTN	WATCHDOG ACTION	mAN	0	The Watchdog Flag may be cleared Automatically upon reception of valid messages or Manually by clearing the Watchdog Flag parameter. Default: Manual	Conf R/W
		Auto	1		
W.RECV	WATCHDOG RECOVERY	00	This parameter is only shown when the Watchdog Action is set to Auto. It is a timer that determines the delay, after reception of valid messages recommences, before the Watchdog Flag is cleared. A value of 0 will reset the Watchdog Flag upon the first valid message received. Other values will wait for at least 2 valid messages to be received within the set time before clearing the Watchdog Flag. Default: 0	Conf R/W	
W.FLAG	WATCHDOG FLAG	OFF	0	The Watchdog Flag will become active if the communications stop addressing the instrument longer than the Watchdog Timeout period,	L3 R/O
		On	1		
DELAY	DELAY	No	0	Introduces a delay between end of receive and beginning of transmit. This is sometimes necessary if the line transceivers require an extended time to switch to tristate. Comms delay is used by Modbus RTU and EI-Bisynch communication protocols. Default: No	Conf R/W
		YES	1		

Parameter Mnemonic	Parameter Name	Value	Description	Access	
Press  to select in turn		Press  or  to change values (if read/write, R/W)			
T.FMT	TIME FORMAT	mSEC	0	Sets the resolution of time parameters on this communications port when read/written via scaled integer comms (Milliseconds, Seconds, Minutes, Hours). Default: ms	L3 R/W
		SEC	1		
		mi N	2		
		HOuF	3		

Network Sub List (ከሠራተ)

Parameter Mnemonic	Parameter Name	Value	Description	Access	
Press  to select in turn		Press  or  to change values (if read/write, R/W)			
The first three parameters apply to Modbus and EI-Bisynch Communications protocols.					
BAUD	BAUD RATE		Baud rate of the network communications.		
		19200	Default for ModbusRTU		
		9600	Default for EI-bisynch		
		4800	Applies to EI-Bisynch protocol only.		
PARITY	PARITY		Parity of the network communications. Default: None		
		NONE	0		No parity.
		EVEN	1		Even parity.
		ODD	2		Odd parity.
NODE	NODE ADDRESS	1 254	The address used by the instrument to identify itself on the network. Default: 1		
The following parameters apply to Ethernet in the Option Communications sub-list. See also section "IP Mode Settings" on page 324.					
A.DISC	AUTO DISCOVERY		The controller and iTools software supports automatic discovery of MODBUS TCP enabled instruments. Default: Off	Conf R/W	
		OFF	0		For cyber security reasons the auto discovery feature is turned OFF by default.
		On	1		To enable this feature set this parameter to ON. Please ensure that your network interface card is set to local. If, for any reason, the controller is not auto-detected and Wi-Fi is enabled on your PC, turn off Wi-Fi and re-start iTools.
IP.MD	IP MODE	Static	0	Static. The IP address, subnet mask and default gateway are set manually. Default: Static	Conf R/W
		DHCP	1	DHCP. The IP address, subnet mask and default gateway are supplied by a DHCP server on the network.	
IP.A1	IP ADDRESS 1		1st byte of the IP Address: XXX.xxx.xxx.xxx. Default: 192	Conf R/W	
IP.A2	IP ADDRESS 2		2nd byte of the IP Address: xxx.XXX.xxx.xxx. Default: 168	Conf R/W	
IP.A3	IP ADDRESS 3		3rd byte of the IP Address: xxx.xxx.XXX.xxx. Default: 111	Conf R/W	
IP.A4	IP ADDRESS 4		4th byte of the IP Address: xxx.xxx.xxx.XXX. Default: 222	Conf R/W	
IP.S1	SUBNET MASK 1		1st byte of the Subnet Mask: XXX.xxx.xxx.xxx. Default: 255	Conf R/W	
IP.S2	SUBNET MASK 2		2nd byte of the Subnet Mask: xxx.XXX.xxx.xxx. Default: 255	Conf R/W	
IP.S3	SUBNET MASK 3		3rd byte of the Subnet Mask: xxx.xxx.XXX.xxx. Default: 255	Conf R/W	
IP.S4	SUB NET MASK 4		4th byte of the Subnet Mask: xxx.xxx.xxx.XXX. Default: 0	Conf R/W	
IP.G1	DEFAULT GATEWAY 1		1st byte of the Default Gateway: XXX.xxx.xxx.xxx. Default: 0	Conf R/W	
IP.G2	DEFAULT GATEWAY 2		2nd byte of the Default Gateway: xxx.XXX.xxx.xxx. Default: 0	Conf R/W	
IP.G3	DEFAULT GATEWAY 3		3rd byte of the Default Gateway: xxx.xxx.XXX.xxx. Default: 0	Conf R/W	
IP.G4	DEFAULT GATEWAY 4		4th byte of the Default Gateway: xxx.xxx.xxx.XXX. Default: 0	Conf R/W	
MAC1	MAC 1		1st byte of the MAC address in decimal: XX:xx:xx:xx:xx:xx	Conf R/O	
MAC2	MAC 2		2nd byte of the MAC address in decimal: xx:XX:xx:xx:xx:xx	Conf R/O	
MAC3	MAC 3		3rd byte of the MAC address in decimal: xx:xx:XX:xx:xx:xx	Conf R/O	
MAC4	MAC 4		4th byte of the MAC address in decimal: xx:xx:xx:XX:xx:xx	Conf R/O	
MAC5	MAC 5		5th byte of the MAC address in decimal: xx:xx:xx:xx:XX:xx	Conf R/O	
MAC6	MAC 6		6th byte of the MAC address in decimal: xx:xx:xx:xx:xx:XX	Conf R/O	
B.STM	BROADCAST STORM	No	0	Broadcast storm active. If the reception rate of Ethernet broadcast packets rises too high, broadcast storm mode will become active and the reception of broadcast packets will be disabled until the rate drops.	R/O
		YES	1		

Parameter Mnemonic	Parameter Name	Value		Description	Access
Press to select in turn		Press or to change values (if read/write, R/W)			
<i>R.PRT</i>	<i>RATE PROTECTION</i>	<i>No</i>	0	Rate protection active. If rate at which Ethernet unicast packets are received becomes too high, the instrument will enter a special mode that slows down Ethernet processing to preserve core functionality.	R/O
		<i>YES</i>	1		
<i>MFMT</i>	<i>MSGFORMAT</i>			Defines the format of EI-Bisynch messages.	
		<i>FrEE</i>	0	Messages are right aligned within 6 characters including padding spaces if necessary. For example, the value -3.45 will be represented as "-<space>3.45". Default: Free	
		<i>Fl Fm</i>	1	Messages consist of 5 characters between 0 and 3 decimal places using zeroes as padding if necessary. Decimal point is replaced with minus symbol for negative values. For example, the value -5.30 will be represented as "05-30".	

Note: IP Addresses are usually presented in the form "xxx.xxx.xxx.xxx". Within the instrument each element of the IP Address is shown and configured separately.

Note: It is recommended that the communications settings for each instrument are set up before connecting it to any Ethernet network. This is not essential but network conflicts may occur if the default settings interfere with equipment already on the network. By default the instruments are set to a static IP address of 192.168.111.222 with a default subnet mask setting of 255.255.255.0.

Broadcast Sub List (bC5t)

Broadcast comms applies to serial Modbus only. In EPC3016 this requires the relevant option board to be fitted.



Parameter Mnemonic	Parameter Name	Value		Description	Access
Press to select in turn		Press or to change values (if read/write, R/W)			
<i>ENABL</i>	<i>ENABLE</i>	<i>No</i>	0	Broadcast comms not enabled. Default: No	Conf R/W
		<i>YES</i>	1	Enable single value Modbus broadcast.	
<i>DEST</i>	<i>DESTINATION</i>	<i>0</i>		If the Modbus broadcast facility is enabled, this address will be used as the destination register for the value to be written. For example, if the remote instrument requires a setpoint at register address 26 decimal, the parameter should be set to this value. Default: 0	Conf R/W
<i>VALUE</i>	<i>BROADCAST VALUE</i>	<i>0</i>		If the Modbus broadcast facility is enabled, this value will be sent to the slave devices, after being transformed into a 'scaled integer' 16 bit value. To use the feature, enable broadcast using BroadcastEnable, and wire any instrument value to this parameter. Default: 0	Conf R/W

EtherNet/IP Sub List

Parameter Mnemonic	Parameter Name	Value		Description	Access
Press to select in turn		Press or to change values (if read/write, R/W)			
H.NAME	ETHERNET/IP HOST NAME				
C.STAT	ETHERNET/IP COMMS STATUS			Status of the EtherNet/IP Comms.	R/O
		DFLN	0	Not Started.	
		rdY	1	Ready.	
		SEbY	2	Standby.	
		run	3	Running.	
TO.STA	ETHERNET/IP TO STATUS			Displays the EtherNet/IP Target to Originator comms status.	R/O
		dALR	0	Data Correctly Exchanged.	
		CONN	1	Connection in Progress.	
		n.CON	2	No Connection Detected.	
		EDUE	3	Connection Timed Out.	
		mAC	4	Unknown MAC Address.	
		n.CSm	5	Consumption Timeout.	
		CLSD	6	Connection Closed.	
		SEOP	7	Module Stopped.	
		ENCE	8	Encapsulation Error Detected.	
		ECPE	9	TCP Connection Error Detected.	
		n.RSC	10	No Resource.	
		bAdF	11	Bad Format.	
		ldLE	12	Idle Mode.	
UNrN	13	Unknown Status.			
OT.STA	ETHERNET/IP OT STATUS	Same As Above		Displays the EtherNet/IP Originator to Target comms status.	R/O
N.STAT	ETHERNET/IP NETWORK STATUS			Status of the EtherNet/IP network.	R/O
		nDjP	0	No IP Address Found.	
		n.CON	1	No Connection Established.	
		CONN	2	Connection Established.	
		EDUE	3	Connection Timed Out.	
EFF	4	Error Detected in Network Comms.			
M.STAT	ETHERNET/IP MODULE STATUS			Status of the EtherNet/IP comms module.	R/O
		n.PwF	0	No Power.	
		n.EFG	1	Not Configured.	
		run	2	Running.	
		EFF	3	Module Error Detected.	
m.EFF	4	Major Error Detected.			
T.OUT	ETHERNET/IP TCP TIMEOUT		1 to 3600	EtherNet/IP TCP comms timeout in seconds. If no exchange during this time, TCP connection will be closed by EPC3000. Can be configured using Attribute 13 of TCP/IP Object via EtherNet/IP comms.	R/O

BACnet Sub List (bNET)

BACnet is configured through the HMI or through iTools using the parameters in this list. The list is only shown if the BACnet comms option has been ordered or enabled using feature codes. BACnet is described in section "BACnet" on page 341.

Parameter Mnemonic	Parameter Name	Value		Description	Access
Press  to select in turn		Press  or  to change values (if read/write, R/W)			
ID	DEVICE ID	0-9999		The instance ID for this instrument. Must be unique on the network. Default: 0	Conf R/W
PORT	PORT	7808		The BACnet standard port is 7808. Range 0 to 9999. Default: 7808	Conf R/W
PASS	PASSWORD	100		The BACnet password for Remote Device Management. Default: 100	Conf R/W
BBREV	BACNET DATABASE REVISION	0-65535		Revision number of BACnet database, increments upon change of device name.	Conf R/W
STATE	BBMD STATUS	OFF	0	Enable/Disable registration of the instrument as a foreign device. Default: OFF (disabled)	L3 R/W
		On	1	Enabled	
B.IP.A1	BBMD IP ADDRESS 1	0		The first byte of the BACnet Broadcast Management device (BBMD) IP address. Range 0 to 255. Default: 0.0.0.0.	Conf R/W
B.IP.A2	BBMD IP ADDRESS 2	0		The second byte of the BBMD IP address. Range 0 to 255. Default: 0.0.0.0.	Conf R/W
B.IP.A3	BBMD IP ADDRESS 3	0		The third byte of the BBMD IP address. Range 0 to 255. Default: 0.0.0.0.	Conf R/W
B.IP.A4	BBMD IP ADDRESS 4	0		The fourth byte of the BBMD IP address. Range 0 to 255. Default: 0.0.0.0.	Conf R/W
B.PORT	BBMD PORT	7808		The port number of the BBMD device. Range 1024 to 9999. Default: 7808	Conf R/W
B.TTL	BBMD TTL	0		Timeout in seconds for registering as a foreign device with BBMD device. Range 0 to 9999. Default: 0	Conf R/W

Modbus Master List (mDd.m)

From firmware version V4.xx the Modbus Master list is available when the communication protocol Modbus Master (Modbus Master TCP/IP) has been ordered (or additionally purchased). Modbus Master can be configured using either the products HMI or using Eurotherm’s iTools software, iTools being the preferred method.

Access to the Modbus Master and ‘master slave’ configuration parameter list is summarized in the following diagram. The full Navigation Diagram is shown in section "Navigation Diagram" on page 94.

The communication protocol Modbus Master allows a product to be configured as a Modbus Master to either Ethernet (TCP) or serial (RTU) Modbus slaves which extends the functionality of the modbus communications protocol as it allows the instrument to send data transactions (dL.1 to dL.32) to user configured slave instruments.

The following sub lists are used to configure Modbus Master:

- Main (mAi N) sub list used to add and configure a maximum of three slaves (SLU.1, SLU.2, SLU.3), see page 158.
- Diagnostic (dI AG) sub list, used to diagnose the Modbus Master configuration see page 161.
- Data (dAeA) sub list, used to configure the data type requests to the slave devices added to the Modbus Master configuration see page 163.

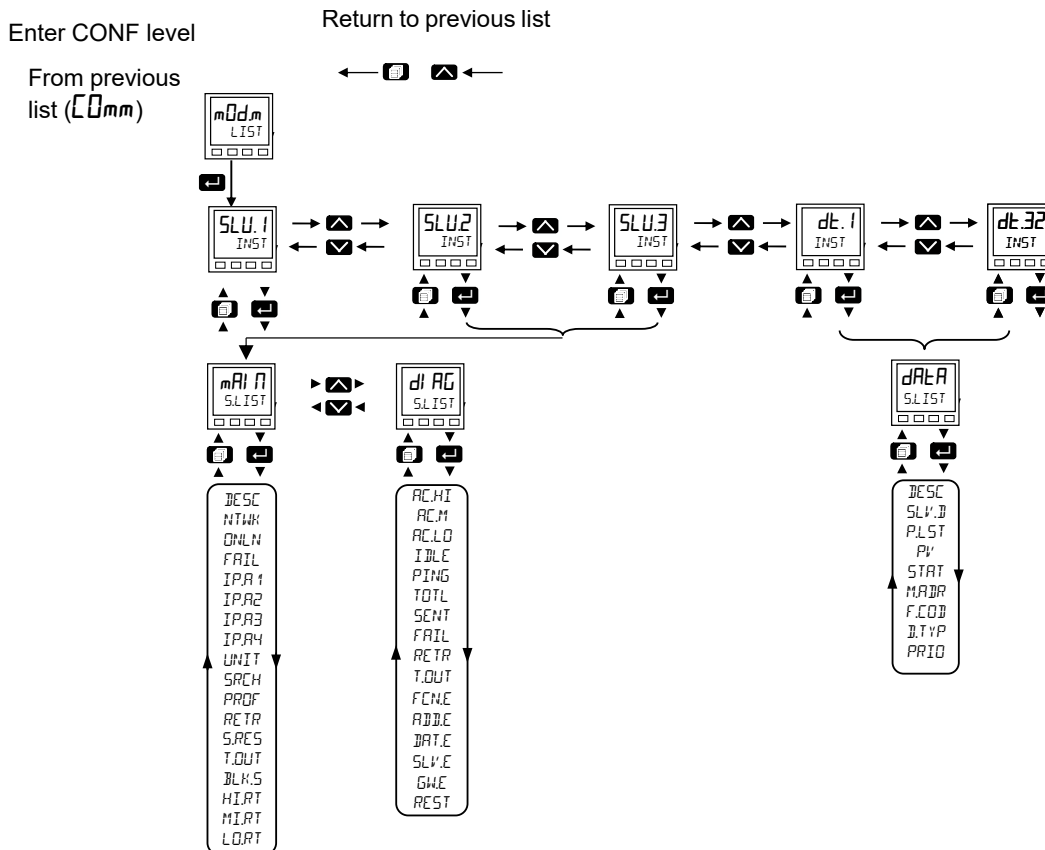

For further information see "Modbus Master" on page 344.





Main Sub List (mAl Π)

The multiple slave lists, one for each slave device configured contain the same parameters, however parameter availability may differ depending on the interfaces and slave profile selected.



Parameter Mnemonic	Parameter Name	Value		Description	Access
Press to select in turn		Press or to change values (if read/write, R/W)			
SLV.1	DESCRIPTION			The devices unique string name description used for each Modbus slave device. Defaults: SLV.n where n is the instance number	Conf R/W
NTWK	NETWORK			Network Hardware choice:	Conf R/W
		ENE	1	Ethernet	
		SER	2	Serial	
ONLN	ONLINE			If the EPC3000 is in Operator mode, it will always attempt to communicate with a slave device using cyclic communications while online. When not online all cyclic communications with the slave device will be suspended, and no cyclic transactions will be sent. Acyclic transaction however can still be sent even when the EPC3000 is in Configuration mode.	Conf R/W
		OFF	0	Off	
		On	1	On	
FRIL	COMMS FAILURE			If communications with the slave device have been lost for whatever reason then this output is set high.	Conf R/W
		No	0	Off	
		YES	1	On	
IP.1	IP ADDRESS 1			The Internet Protocol (IP) address of the slave device. IP Address format is xxx.xxx.xxx.xxx. This parameter represents the first byte, i.e. XXX.xxx.xxx.xxx.	Conf R/W
IP.1	IP ADDRESS 2			The Internet Protocol (IP) address of the slave device. IP Address format is xxx.xxx.xxx.xxx. This parameter represents the second byte, i.e. xxx.XXX.xxx.xxx.	Conf R/W
IP.1	IP ADDRESS 3			The Internet Protocol (IP) address of the slave device. IP Address format is xxx.xxx.xxx.xxx. This parameter represents the third byte, i.e. xxx.xxx.XXX.xxx.	Conf R/W
IP.1	IP ADDRESS 4			The Internet Protocol (IP) address of the slave device. IP Address format is xxx.xxx.xxx.xxx. This parameter represents the fourth byte, i.e. xxx.xxx.xxx.XXX.	Conf R/W
UNIT	UNIT ID			The Modbus unit ID used in transactions to identify a specific slave on a Modbus TCP network. A separate parameter (Modbus slave address) is used for identifying a specific slave in a Modbus RTU network.	Conf R/W
SLAVE	SLAVE ADDRESS			The Modbus slave address of the instrument to communicate to in a Modbus RTU network. A separate parameter (Modbus Unit ID) will be used for Modbus TCP communications.Modbus slave address.	Conf R/W
SRCH	DETECT NOW			Attempts to determine the type of slave device using the configured Internet Protocol (IP) address or, if serial, the Modbus slave address. If successful the device profile will be automatically selected for recognised devices otherwise the device profile will remain at default (Third Party). Determines a slave device type. Default: No	Conf R/W
		No	0	Off.	
		YES	1	On.	

Parameter Mnemonic	Parameter Name	Value	Description	Access	
Press  to select in turn		Press  or  to change values (if read/write, R/W)			
PRDF	PROFILE TYPE		A profile that defines the device type. A profile provides the user with a list of pre configured parameters that can be read/written to a specific slave device. This greatly simplifies the need for the user to know detailed information about a specific parameter in a particular slave device. Default: 3	Conf R/W	
		3rdP	0		A 3rd party device for which no information is known.
		3200	3		A 3200 device.
		EPwf	4		An ePower device.
		EPAh	5		An ePack device.
		EPC	6		An EPC device.
RETR	RETRIES		Transaction retries. The number of attempts at sending a transaction to a slave device before giving up. Retries are only attempted after the first transaction failure.	Conf R/W	
S.RES	STATUS		Current search status. The current status of a slave device search. Note also that an attempt to recognise a slave device may take several seconds.	Conf R/W	
		SFCH	0		Searching - Searching for selected device on network.
		AVAIL	1		Available - The device is available for communicating.
		UNAV	2		Unavailable - The device was unavailable for communicating.
		UNRC	3		Unreachable - The device was unreachable on the network
		ABFT	4		Aborted - The user aborted the current search
T.OUT	TIMEOUT		The configurable time in milliseconds the master will wait for a response from a slave device before attempting the next retry. Time in milliseconds the master will wait for a response. Default: 250 milliseconds	Conf R/W	
BLKS	BLOCK SIZE		Maximum amount of data in a single transaction. The maximum amount of 16bit words that can be transferred between the master and slave device, in any single transaction. Default: 124	Conf R/W	
HI.PT	DEVICE HIGH PRIORITY		High priority rate interval. The interval between each transaction in this queue. It is not guaranteed that this rate will be maintained and is highly dependent upon the complexity of the master comms configuration.	Conf R/W	
		0.125	0		125 milliseconds.
		0.250	1		250 milliseconds.
		0.500	2		500 milliseconds.
		1.5	3		1 second.
		2.5	4		2 seconds.
		5.5	5		5 seconds.
		10.5	6		10 seconds.
		20.5	7		20 seconds.
		30.5	8		30 seconds.
		1.m	9		1 minute.
		2.m	10		2 minutes.
		5.m	11		5 minutes.
		10.m	12		10 minutes.
		20.m	13		20 minutes.
30.m	14	30 minutes.			
1H	15	1 hour.			



Parameter Mnemonic	Parameter Name	Value		Description	Access
Press  to select in turn		Press  or  to change values (if read/write, R/W)			
MIRT	DEVICE MEDIUM PRIORITY			Medium priority rate interval. The interval between each transaction in this queue. It is not guaranteed that this rate will be maintained and is highly dependent upon the complexity of the master comms configuration.	Conf R/W
		0.125	0	125 milliseconds.	
		0.250	1	250 milliseconds.	
		0.500	2	500 milliseconds.	
		1.5	3	1 second.	
		2.5	4	2 seconds.	
		5.5	5	5 seconds.	
		10.5	6	10 seconds.	
		20.5	7	20 seconds.	
		30.5	8	30 seconds.	
		1.m	9	1 minute.	
		2.m	10	2 minutes.	
		5.m	11	5 minutes.	
		10.m	12	10 minutes.	
		20.m	13	20 minutes.	
		30.m	14	30 minutes.	
1H	15	1 hour.			
LORT	DEVICE LOW PRIORITY			Low priority rate interval. The interval between each transaction in this queue. It is not guaranteed that this rate will be maintained and is highly dependent upon the complexity of the master comms configuration.	Conf R/W
		0.125	0	125 milliseconds.	
		0.250	1	250 milliseconds.	
		0.500	2	500 milliseconds.	
		1.5	3	1 second.	
		2.5	4	2 seconds.	
		5.5	5	5 seconds.	
		10.5	6	10 seconds.	
		20.5	7	20 seconds.	
		30.5	8	30 seconds.	
		1.m	9	1 minute.	
		2.m	10	2 minutes.	
		5.m	11	5 minutes.	
		10.m	12	10 minutes.	
		20.m	13	20 minutes.	
		30.m	14	30 minutes.	
1H	15	1 hour.			



Diagnostics Sub List (di AG)



Parameter Mnemonic	Parameter Name	Value		Description	Access
Press to select in turn		Press or to change values (if read/write, R/W)			
<i>AC.HI</i>	<i>HIGH</i>			Actual high priority rate for this device. The actual rate in seconds between each transaction in the high priority queue.	R/O
<i>AC.M</i>	<i>MEDIUM</i>			Actual medium priority interval for this device. The actual rate in seconds between each transaction in the medium priority queue.	R/O
<i>AC.LO</i>	<i>LOW</i>			Actual low priority interval for this device. The actual rate in seconds between each transaction in the low priority queue.	R/O
<i>DEV.S</i>	<i>DEVICE STATUS</i>			The status of the last transaction for this slave device.	R/O
		<i>SUCS</i>	0	Success. The transaction was successfully actioned by the slave device.	
		<i>I.FNC</i>	1	Illegal function. The request to the slave device contained an invalid function code.	
		<i>I.AdI</i>	2	Illegal Address. The request to the slave device contained an invalid Modbus address. The address may be for a read only parameter.	
		<i>I.VAl</i>	3	Illegal Value. The request to the slave device contained invalid data for the specified parameter.	
		<i>bUSY</i>	6	Slave Busy. The slave device is currently busy and was unable to action the request.	
		<i>PAR.E</i>	8	Parity Error detected. The request was not received in the correct format.	
		<i>bAdS</i>	9	Bad Sub. The sub function code in the request was invalid.	
		<i>bAdG</i>	10	Bad Gateway. There was no suitable gateway or route to send the request to the specified slave device.	
		<i>nRSP</i>	11	No Response. There was no response from the slave device to a given request.	
		<i>I.dLE</i>	12	Idle. This data item is currently idle and not communicating with the slave device.	
		<i>PENd</i>	13	Pending. The request is waiting to be sent, likely cause is the slave device has not been set to online.	
		<i>t.OUt</i>	14	Timeout. There was no response from the slave device to a given request in the configured time.	
		<i>UNt.H</i>	15	Unknown Host. The slave device being used is not recognised.	
<i>bAdC</i>	16	Connect Fail. The connection to the specified slave device was unsuccessful.			
<i>nO.Sr</i>	17	No Sockets. There are currently no available free sockets to establish a connection to the slave device.			
<i>LbF</i>	18	Loopback Fail. The loopback request to the slave device failed.			



Parameter Mnemonic	Parameter Name	Value		Description	Access
Press  to select in turn		Press  or  to change values (if read/write, R/W)			
DEV.S	DEVICE STATUS	LOGF	19	Login Fail. An attempt to login to the slave device was unsuccessful.	R/O
		UNkE	20	Unknown Error. An unknown error occurred.	
		bAdw	22	Write Fail, the write request failed.	
		mFEJ	23	Master Reject, the request was rejected by the master prior to sending to the slave device, due to a malformed request	
TOTL	TOTAL REQUESTS			Total number of requests sent to the slave device. The total number of transactions sent to the slave device, including all good and failed and retries.	R/O
SENT	SUCCESSFUL REQUESTS			Successful requests sent to the slave device. The number of transactions sent to the slave device that did not produce an exception response.	R/O
FAIL	UNSUCCESSFUL REQUESTS			Number of unsuccessful requests sent to this slave.	R/O
RETR	RETRIES			Retries. The number of transactions that were resent due to timed out responses from the slave device.	R/O
T.OUT	TIMEOUTS			Timeouts. The number of transactions that have had no response from the slave device and have exceeded their configured timeout value.	R/O
FCNE	ILLEGAL FUNCTION			Illegal Function Exception. The number of illegal function exception responses from the slave device.	R/O
ADDE	ILLEGAL ADDRESS			Illegal Address. The number of illegal address exception responses from the slave device.	R/O
DAT.E	ILLEGAL DATA			Illegal Data. The number of illegal data exception responses from the slave device.	R/O
SLV.E	SLAVE FAILURE			Slave Failure. The number of times that the slave device has failed to communicate.	R/O
GWE	NO GATEWAY			No gateway path found. The number of times no gateway or route to the slave device was found.	R/O
REST	RESET COUNT			Resets the diagnostics counts. On selection resets all the diagnostics count values. Note that counts are never retained over a power cycle, and once actioned the current count values are lost forever.	Conf R/W
		No	0	No.	
		YES	1	Yes.	



DataPoint Sub List (dPAA)



Parameter Mnemonic	Parameter Name	Value		Description	Access
Press  to select in turn		Press  or  to change values (if read/write, R/W)			
<i>DESC</i>	<i>DESCRIPTION</i>	<i>dt.n</i>		Descriptive data name for the data being read or written. Default: dt.n where n is the instance number.	Conf R/W
<i>SLV.D</i>	<i>SLAVE DEVICE</i>			Slave device to communicate with. A list of available slave devices to which a parameter can be associated.	Conf R/W
		<i>SLU1</i>	0	Slave 1. Slave device 1.	
		<i>SLU2</i>	1	Slave 2. Slave device 2.	
		<i>SLU3</i>	2	Slave 3. Slave device 3.	
<i>PLST</i>	<i>PARAMETER LIST</i>			Parameter list for a specific slave device. Provides a list of parameters that the user can choose to read/write without having to know the Modbus address, data type, etc.	Conf R/W
For EPower Controller:					
		<i>LPPU</i>	30	Control PV. Reads a process value from a control network in an EPower.	Conf R/W
		<i>ESP.S</i>	31	Control SP. Reads a set point value from a control network in an EPower.	
		<i>ESP.S</i>	32	Control SP (set). Writes a set point value to a control network in an EPower.	
		<i>VOLT</i>	33	Voltage. Reads a voltage value from a power module in an EPower.	
		<i>CUF</i>	34	Current. Reads a current value from a power module in an EPower.	
		<i>POWF</i>	35	Power. Reads a power value from a power module in an EPower.	
		<i>USF.d</i>	36	User Defined. The user can specify all configuration data required to read any parameter from an EPower.	
		<i>OFF</i>	37	Off. No data to be exchanged.	

Parameter Mnemonic	Parameter Name	Value		Description	Access
Press  to select in turn		Press  or  to change values (if read/write, R/W)			
For EPC controller:					
	<i>LPPV</i>	40	Loop PV. Reads the control loop process value from an EPC instrument.	Conf R/W	
	<i>wSP</i>	41	Working SP. Reads the working setpoint value from an EPC instrument.		
	<i>wOP</i>	42	Working OP. Reads the working output value from an EPC instrument.		
	<i>AI PV</i>	43	Analog Input PV. Reads the analog input process value of an EPC instrument.		
	<i>AI St</i>	44	Analog Input PV Status. Reads the analog input status of an EPC instrument.		
	<i>AL OP</i>	45	Alarm output. Reads the alarm output of an EPC instrument.		
	<i>PmOd</i>	46	Programmer running mode. Reads the current running mode of an EPC programmer.		
	<i>PLFt</i>	47	Programmer program time left. Reads the running time left of an EPC program.		
	<i>SLFt</i>	48	Programmer segment time left. Reads the running time left of an EPC program segment.		
	<i>rmEJ</i>	49	Remote input value. Reads the remote input value of an EPC instrument.		
	<i>LmOd</i>	50	Loop auto/manual mode. Reads the loop auto/manual mode of an EPC instrument.		
	<i>tSPS</i>	51	Set loop target setpoint. Set loop target setpoint of an EPC instrument.		
	<i>A-m.S</i>	52	Set loop auto/manual mode. Set loop auto/manual mode of an EPC instrument.		
	<i>mOPS</i>	53	Set loop manual output. Set loop manual output of an EPC instrument.		
	<i>rUN.S</i>	54	Set programmer run. Set EPC instrument programmer run digital input.		
	<i>HLd.S</i>	55	Set programmer hold. Set EPC instrument programmer hold digital input.		
	<i>rSt.S</i>	56	Set programmer reset. Set EPC instrument programmer reset digital input.		
	<i>tUN.S</i>	57	Set loop autotune enable. Set EPC instrument loop autotune enable.		
	<i>uSf.d</i>	58	User defined. The user can specify the data required to read/write to an EPC instrument.		
	<i>OFF</i>	59	Off. No data to be exchanged.		

Parameter Mnemonic	Parameter Name	Value		Description	Access
Press  to select in turn		Press  or  to change values (if read/write, R/W)			
	For EPack series controller:				
		<i>LPPU</i>	81	Control PV. Reads a process value from a control network in an EPack.	Conf R/W
		<i>ESP</i>	82	Control SP. Reads a set point value from a control network in an EPack.	
		<i>ESPS</i>	83	Control SP (set). Writes a set point value to a control network in an EPack.	
		<i>VOLT</i>	84	Voltage. Reads a voltage value from a power module in an EPack.	
		<i>CUR</i>	85	Current. Reads a current value from a power module in an EPack.	
		<i>POW</i>	86	Power. Reads a power value from a power module in an EPack.	
		<i>USD</i>	87	User Defined. The user can specify all configuration data required to read any parameter from an EPack.	
		<i>OFF</i>	88	Off. No data to be exchanged.	
	Third Party device:				
		<i>USD</i>	100	User Defined. The user can specify all configuration data required to read any parameter from any 3rd party device.	Conf R/W
		<i>OFF</i>	101	Off. No data to be exchanged.	
<i>PV</i>	<i>PROCESS VALUE</i>			Process value received from slave device. The process value received for the data items read transaction.	R/O
<i>DIGST</i>	<i>DIGITAL STATUS</i>			Digital status. The status of the digital being read from the slave device.	R/O
		<i>OFF</i>	0		
		<i>On</i>	1		
<i>ONOFF</i>	<i>SET</i>			Sets a value to on or off. The on/off value to write to a digital parameter in the configured slave device.	Conf R/W
		<i>OFF</i>	0		
		<i>On</i>	1		
<i>A-M</i>	<i>MODE</i>			Auto Manual mode selection. Allows selection of auto manual mode.	Conf R/W
		<i>AUTO</i>	0	Auto. Set to auto mode.	
		<i>MAN</i>	1	Manual. Set to manual mode.	
<i>VALUE</i>	<i>VALUE TO WRITE</i>			The value to be written to the slave device. The value that is to be written to the slave device, this may be wired from another parameter or manually configured.	Conf R/W
<i>FALL</i>	<i>FALLBACK VALUE</i>			Fall back value to be written to the slave device. If configured as a write request and the parameter has a status other than OK, then this value will be written instead. It is not possible to wire from another parameter and can only be manually configured.	Conf R/W

Parameter Mnemonic	Parameter Name	Value		Description	Access
Press  to select in turn		Press  or  to change values (if read/write, R/W)			
SEND	SEND NOW			If selected will send the write value to the slave If selected or triggered via a wire, the data in the value parameter or the fall back parameter (if the write value status is not OK) will be written to the slave device once only.	Conf R/W
		NO	0	No.	
		YES	1	Yes.	
STAT	TRANSACTION STATUS			Transaction status. The status of the transaction. This may differ to the status of the process value at the slave device, as this status is determined by the communications status.	R/O
		SUCS	0	Success. The transaction was successfully actioned by the slave device.	
		I FNC	1	Illegal function. The request to the slave device contained an invalid function code.	
		I AdF	2	Illegal Address. The request to the slave device contained an invalid Modbus address. The address may be for a read only parameter.	
		I VAL	3	Illegal Value. The request to the slave device contained invalid data for the specified parameter.	
		bUSY	6	Slave Busy. The slave device is currently busy and was unable to action the request.	
		PAR E	8	Parity Error Detected. The request was not received in the correct format.	
		bAdS	9	Bad Sub. The sub function code in the request was invalid.	
		bAdG	10	Bad Gateway. There was no suitable gateway or route to send the request to the specified slave device.	
		nRSP	11	No Response. There was no response from the slave device to a given request.	
		I dLE	12	Idle. This data item is currently idle and not communicating with the slave device.	
		PENd	13	Pending. The request is waiting to be sent, likely cause is the slave device has not been set to online.	
		t.OUT	14	Timeout. There was no response from the slave device to a given request in the configured time.	
		UNr.H	15	Unknown Host. The slave device being used is not recognised.	
		bAdC	16	Connect Fail. The connection to the specified slave device was unsuccessful.	
nO.Sr	17	No Sockets. There are currently no available free sockets to establish a connection to the slave device.			
LbF	18	Loopback Fail. The loopback request to the slave device failed.			
LOGF	19	Login Fail. An attempt to login to the slave device was unsuccessful.			

Parameter Mnemonic	Parameter Name	Value		Description	Access
Press  to select in turn		Press  or  to change values (if read/write, R/W)			
		<i>Unk.E</i>	20	Unknown Error Detected. An unknown error occurred.	
		<i>bAd.w</i>	22	Write Fail, the write request failed.	
		<i>mREJ</i>	23	Master Reject. The request was rejected by the master prior to sending to the slave device, due to a malformed request.	
<i>INSTC</i>	<i>NUMBER</i>			Parameter instance number. Used for parameters in the slave device that have multiple instances.	Conf R/W
<i>RADDR</i>	<i>REGISTER ADDRESS</i>			Modbus register address of the data to be read/written. The Modbus register address at the slave device where this data is to be read/written.	Conf R/W
<i>F.CODE</i>	<i>FUNCTION CODE</i>			The Modbus function code. The function code required to read/write data to the slave device.	Conf R/W
		<i>1</i>	1	Read Coil. Read contiguous status coils.	
		<i>2</i>	2	Read Discrete. Read contiguous discrete inputs.	
		<i>3</i>	3	Read Holding. Read contiguous holding registers.	
		<i>4</i>	4	Read Input. Read contiguous input registers.	
		<i>5</i>	5	Write Coil. Write a single coil to on/off.	
		<i>6</i>	6	Write Single. Write to a single register.	
		<i>16</i>	16	Write Multiple. Write to contiguous registers.	

Parameter Mnemonic	Parameter Name	Value		Description	Access
		Press  to select in turn		Press  or  to change values (if read/write, R/W)	
DTYPE	DATA TYPE			Data type of the data being read/written The data type is very important as it determines how the data is to be interpreted by the Modbus master and displayed to the user as a process value.	Conf R/W
		REAL	0	REAL. 32-bit floating point.	
		DINT	1	DINT. 32-bit signed double integer.	
		INT	2	INT. 16 bit signed integer.	
		BYTE	3	BYTE. 8-bit signed byte.	
		UDINT	4	UDINT. 32-bit unsigned double integer.	
		UINT	5	UINT. 16-bit unsigned integer.	
		UBYTE	6	UBYTE. 8-bit unsigned byte.	
		REALsw	8	REAL (swap). 32-bit floating point, with MSW and LSW swapped.	
		DINTsw	9	DINT (swap). 32-bit signed double integer, with MSW and LSW swapped.	
		UDINTsw	10	UDINT (swap). 32-bit unsigned double integer, with MSW and LSW swapped.	
		BIT	11	BIT. A specific bit from a 16-bit unsigned integer, range of 0 - 15.	
SCALE	SCALING	I	0	Scaling in decimal places for non floating point data types.	Conf R/W
		I.I	1	A zero represents no scaling is required for the specified data type.	
		I.II	2		
		I.III	3		
		I.IIII	4		
PRIO	PRIORITY			Frequency at which the data is read/written. There are 4 priorities at which data can be assigned, high, medium, low and acyclic, which determines the frequency at which data is transferred. All read/write data is placed in a priority queue and these queues are processed in order of priority.	Conf R/W
		HIGH	0	High. Adds the data item to the high priority queue.	
		Medium	1	Medium. Adds the data item to the medium priority queue.	
		LOW	2	Low. Adds the data item to the low priority queue.	
		ACYCLIC	3	Acyclic. Does not add the data item to any queue, the request must be manually sent.	

Maths List (mATH)



From firmware version 3.01, one Maths Operator is available as standard. If the Enhanced Toolkit option has been ordered this may be increased up to eight Maths Operators (the Standard Toolkit option has four).

Maths Operators (sometimes known as Analog Operators) allow the controller to perform mathematical operations on two input values. These values can be sourced from any available parameter including Analog Values, User Values and Digital Values. Each input value can be scaled using a multiplying factor or scalar.

The parameters to use, the type of calculation to be performed and the acceptable limits of the calculation are determined in Configuration level. In access level 3 the values of each of the scalars can be changed.

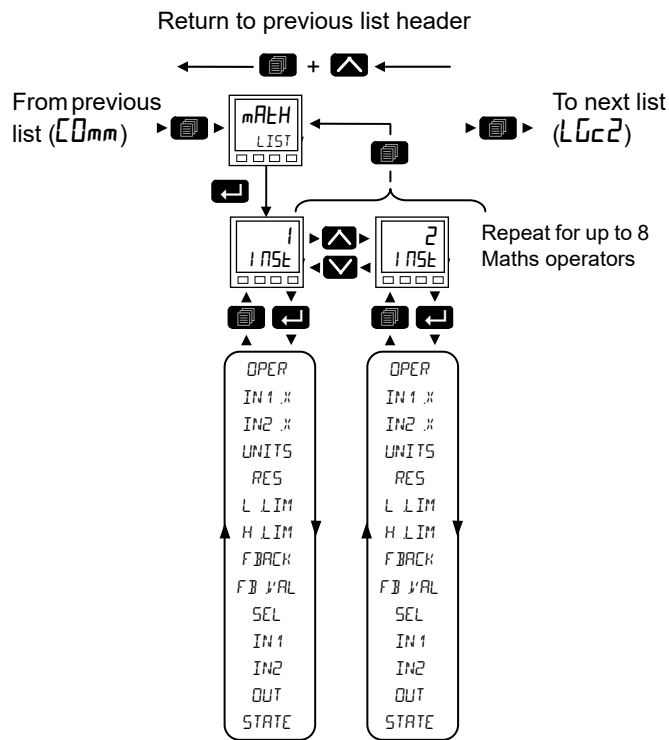
Access to the Maths parameter list is summarized below. The full Navigation Diagram is shown in section "Navigation Diagram" on page 94.



Parameter Mnemonic	Parameter Name	Value		Description	Access
		Press  to select in turn		Press  or  to change values (if read/write, R/W)	
OPER	OPERATION	OFF	0	The selected Analog Operator is turned off. Default: Off	Conf R/W L3 R/O
		Add	1	The output result is the addition of Input 1 and Input 2.	
		Sub	2	Subtract. The output result is the difference between Input 1 and Input 2 where Input 1 > Input 2.	
		mUL	3	Multiply. The output result is Input 1 multiplied by Input 2.	
		d ÷	4	Divide. The output result is Input 1 divided by Input 2.	
		Absd	5	Absolute Difference. The output result is the absolute difference between Input 1 and Input 2.	
		SH	6	Select Max. The output result is the maximum of Input 1 and Input 2.	
		SLo	7	Select Min. The output result is the minimum of Input 1 and Input 2.	
		HSwP	8	HotSwap. Input 1 appears at the output provided input 1 is 'good'. If input 1 is 'bad' then input 2 value will appear at the output. An example of a bad input occurs during a sensor break condition.	
		SHLd	9	Sample and Hold. Normally input 1 will be an analog value and input B will be digital. The output tracks input 1 when input 2 = 1 (Sample). The output will remain at the current value when input 2 = 0 (Hold). If input 2 is an analog value then any non zero value will be interpreted as 'Sample'.	
		Pwr	10	The output is the value at input 1 raised to the power of the value at input 2, i.e. Input 1 ^{Input 2} .	
		SqrT	11	Square Root. The output result is the square root of Input 1. Input 2 has no effect.	
		LoG	12	The output is the logarithm (base 10) of Input 1. Input 2 has no effect.	
		Ln	13	The output is the logarithm (base n) of Input 1. Input 2 has no effect.	
E	14	The output result is the exponential of Input 1. Input 2 has no effect.			
10	15	The output result is 10 raised to the power of Input 1 value. i.e. 10 ^{input 1} . Input 2 has no effect.			
SEL	51	Select input is used to control which Analog Input is switched to the output of the Analog Operator. If the select input is true input 2 is switched through to the output. If false input 1 is switched through to the output. See "Select Input" on page 171.			
IN1.%	INPUT 1 SCALE	1.0		Input 1 scaling factor. Default: 1.0	L3 R/W
IN2.%	INPUT 2 SCALE	1.0		Input 2 scaling factor. Default: 1.0	L3 R/W
UNITS	OUTPUT UNITS			See section "Units" on page 105 for a list of units used throughout.	Conf R/W
RES	OUTPUT RESOLUTION			Resolution of the output value.	Conf R/W L3 R/O
		nnnnn	0	No decimal places. Default: nnnnn	
		nnnn.n	1	One decimal place.	
		nnnn.nn	2	Two decimal places.	
		nnnn.nnn	3	Three decimal places.	
nnnn.nnnn	4	Four decimal places.			
LLIM	OUTPUT LOW LIMIT	-999		To apply a low limit to the output. Default: -999	Conf R/W
HLIM	OUTPUT HIGH LIMIT	9999		To apply a high limit to the output Default: 9999	Conf R/W

Parameter Mnemonic	Parameter Name	Value		Description	Access	
		Press to select in turn				
		Press or to change values (if read/write, R/W)				
FBACK	FALLBACK STRATEGY			The fallback strategy will come into effect if the status of the input value is bad or if the input value is outside the range of Input Hi and Input Lo.	Conf R/W	
		CbAd	0	If the input value is above 'High Limit' or below 'Low Limit', then the output value is set to the appropriate limit, and 'Status' is set to 'Bad'. If the input signal is within the limits, but its status is bad, the output is set to the 'Fallback' value. Default: Cbad		
		Cd	1	If the input value is above 'High Limit' or below 'Low Limit', then the output value is set to the appropriate limit, and 'Status' is set to 'Good'. If the input signal is within the limits, but its status is bad, the output is set to the 'Fallback' value.		
		FbAd	2	If the input value is above 'High Limit' or below 'Low Limit', then the output value is set to the 'Fallback' value, and the 'Status' is set to 'Bad'.		
		Fd	3	If the input value is above 'High Limit' or below 'Low Limit', then the output value is set to the 'Fallback' value, and the 'Status' is set to 'Good'.		
		ubAd	4	If the input status is bad, or if the input signal is above 'High Limit' or below 'Low Limit', the output value is set to the 'High Limit'.		
		dbAd	6	If the input status is bad, or if the input signal is above 'High Limit' or below 'Low Limit', the output value is set to the 'Low Limit'.		
FVAL	FALLBACK VALUE	0.0		Defines (in accordance with Fallback) the output value when fallback strategy is active. Default: 0	Conf R/W	
SEL	select	IP1	0	Select between input 1 and Input 2.	Comms only parameter	
		IP2	1			
IN1	INPUT 1 VALUE	0		Input 1 value (normally wired to an input source). Range -99999 to 99999 (decimal point depends on resolution).	L3 R/W	
IN2	INPUT 2 VALUE	0		Input 2 value (normally wired to an input source). Range -99999 to 99999 (decimal point depends on resolution).	L3 R/W	
OUT	OUTPUT VALUE			The analog value of the output, Between high and low limits.	R/O	
STATE	STATUS			This parameter is used in conjunction with Fallback to indicate the status of the operation. Typically, it is used to flag the status of the operation and used in conjunction with the fallback strategy. It may be used as an interlock for other operations.	R/O	
				See section "Status" on page 106 for a list of enumerated values.		

Select Input

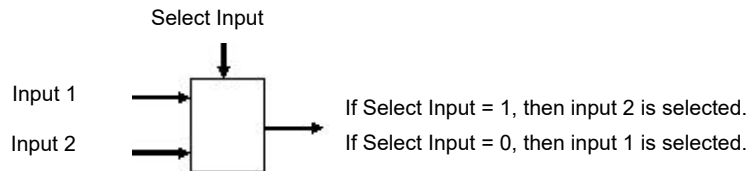

Logic Operator List (LGC2)

The Logic Operator is only available if a Toolkit option has been ordered. From firmware version 3.01 and greater up to eight Logic Operators are available with the Enhanced Toolkit option (the Standard Toolkit option has four).



The two-input Logic Operator allows the controller to perform logical calculations on two input values. These values can be sourced from any available parameter including Analog Values, User Values and Digital Values.

The parameters to use, the type of calculation to be performed, invert the input value and 'fallback' type are determined in Configuration level. In levels 1 to 3 you can view the values of each input and read the result of the calculation.

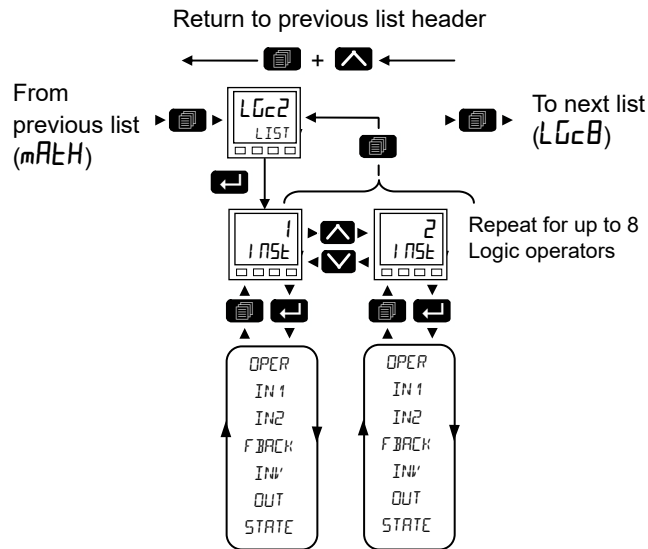
Access to the Logic Operator parameter list is summarized below. The full Navigation Diagram is shown in section "Navigation Diagram" on page 94.



Parameter Mnemonic	Parameter Name	Value		Description	Access
		Press to select in turn		Press or to change values (if read/write, R/W)	
OPER	OPERATION	OFF	0	The selected logic operator is turned off Default: Off	Conf L3 R/O
		AND	1	The output result is ON when both Input 1 and Input 2 are ON.	
		OR	2	The output result is ON when either Input 1 or Input 2 is ON.	
		EO	3	Exclusive OR. The output result is true when one and only one input is ON. If both inputs are ON the output is OFF.	
		LECH	4	Input 1 sets the latch, Input 2 resets the latch.	
		EQL	5	Equal. The output result is ON when Input 1 = Input 2.	
		NEQL	6	Not equal. The output result is ON when Input 1 ≠ Input 2.	
		GT	7	Greater than. The output result is ON when Input 1 > Input 2.	
		LT	8	Less than. The output result is ON when Input 1 < Input 2.	
		GT=	9	Greater than or equal. The output result is ON when Input 1 ≥ Input 2.	
LT=	10	Less than or equal. The output result is ON when Input 1 ≤ Input 2.			
IN1	INPUT 1	0		Normally wired to a logic, analog or user value. May be set to a constant value if not wired.	L3
IN2	INPUT 2				

Parameter Mnemonic	Parameter Name	Value	Description	Access	
Press  to select in turn		Press  or  to change values (if read/write, R/W)			
FBACK	FALLBACK TYPE	FbAd	0	The output value is FALSE and the status is BAD. Default: Fbad	Conf L3 R/O
		tbAd	1	The output value is TRUE and the status is BAD.	
		Fgd	2	The output value is FALSE and the status is GOOD.	
		tgd	3	The output value is TRUE and the status is GOOD.	
INV	INVERT	None	0	The sense of the input value, may be used to invert one or both of the inputs. Default: None	Conf L3 R/O
		in1	1	Invert input 1.	
		in2	2	Invert input 2.	
		both	3	Invert both inputs.	
OUT	OUTPUT	On	1	The output from the operation is a Boolean (true/false) value.	R/O
		OFF	0		
STATE	OUTPUT STATUS			The status of the result value (good/bad). See section "Status" on page 106 for a list of enumerated values.	R/O

8 Input Logic Operator List (LGC8)



The 8 Input Logic Operators are only available if a Toolkit option has been ordered. From firmware version 3.01, up to four 8 Input Logic Operators are available with the Enhanced Toolkit option (the Standard Toolkit option has two).

The eight input Logic Operator allows the controller to perform logical calculations on up to eight input values. These values can be sourced from any available parameter including Analog Values, User Values and Digital Values. Up to two eight input logic operators are available.

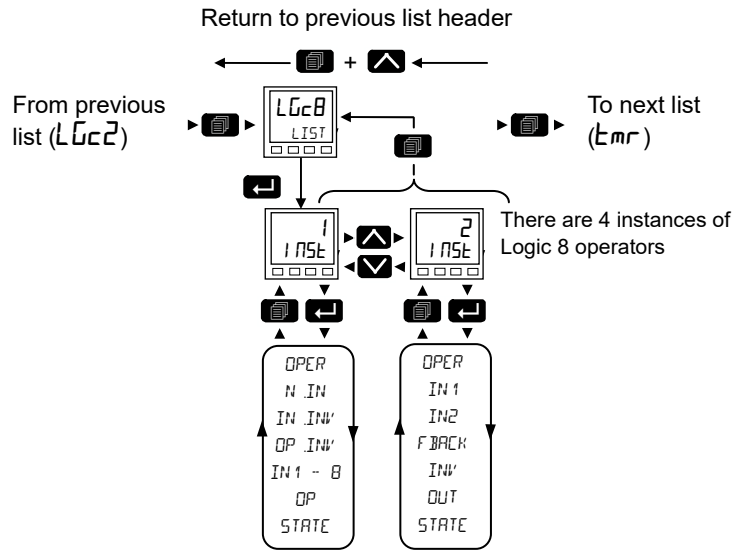
Access to the 8 Input Logic Operator parameter list is summarized below. The full Navigation Diagram is shown in section "Navigation Diagram" on page 94.



Parameter Mnemonic	Parameter Name	Value		Description	Access
				Press [Back] to select in turn	
				Press [Up] or [Down] to change values (if read/write, R/W)	
OPER	OPERATION	OFF	0	Operator is turned off. Default: Off	Conf R/W L3 R/O
		AND	1	Output is ON when ALL inputs are ON.	
		OR	2	Output is ON when one or more of the 8 inputs are ON.	
		EOR	3	Exclusive OR. The output is based on the inputs being cascaded XOR'd together (True logical XOR equation) i.e: Cascading XOR performs an odd parity function, so if an even number of inputs are on, the output is off. If and odd number of inputs are on, the output is on.	
N.IN	NUMBER OF INPUTS	2 to 8		This parameter is used to configure the number of inputs for the operation. Default: 2	Conf R/W L3 R/O

Parameter Mnemonic	Parameter Name	Value		Description	Access
		Press  to select in turn		Press  or  to change values (if read/write, R/W)	
IN.INV	INVERT INPUTS	0 to 255		Invert selected inputs. This is a status word with one bit per input. 0x1 - input 1 0x2 - input 2 0x4 - input 3 0x8 - input 4 0x10 - input 5 0x20 - input 6 0x40 - input 7 0x80 - input 8	L3 R/W
OP.INV	INVERT OUTPUT	No	0	Output not inverted. Default: No	L3 R/W
		YES	1	Output inverted.	
IN 1 to INB	INPUT 1 to INPUTB			Normally wired to a logic, analog or user value. All values are interpreted as follows: <0.5 = Off, >=0.5 = On May be set to a constant value if not wired.	L3 R/W
		OFF	0	Input is false.	
		On	1	Input is true.	
OP	OUTPUT	OFF	0	Output result of the operator (output not activated).	R/O
		On	1	Output result of the operator (output activated).	

Timer List (Emr)

The Timer list is only available if a Toolkit option has been ordered. From firmware version 3.01 and greater up to two timers are available with the Enhanced Toolkit option (the Standard Toolkit option has one).

Access to the Timer parameter list is summarized below. The full Navigation Diagram is shown in section "Navigation Diagram" on page 94.

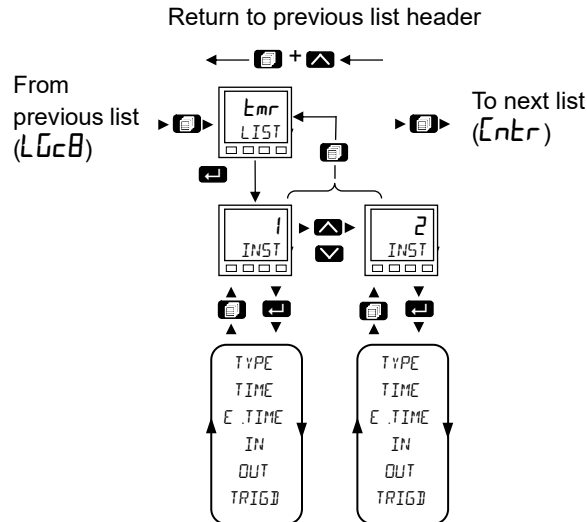

Parameter Mnemonic	Parameter Name	Value		Description	Access
Press [Left Arrow] to select in turn		Press [Up Arrow] or [Down Arrow] to change values (if read/write, R/W)			
TYPE	TYPE	OFF	0	Timer not activated. Default: Off	Conf R/W
		OnPS	1	On Pulse. Generates a fixed length pulse from an edge trigger.	
		OnD	2	On delay. Provides a delay between input trigger event and timer output.	
		OnES	3	One shot. Simple oven timer which reduces to zero before switching off	
		minD	4	Minimum on time. Compressor timer so that the output remains ON for a time after the input signal has been removed.	
TIME	TIME	00:00		Duration of the timer. For re-trigger timers this value is entered once and copied to the time remaining parameter whenever the timer starts. For pulse timers the time value itself is decremented. Range 00:00 to 999:59 minutes. Default: 0	Conf R/W L3 R/W
E.TIME	ELAPSED TIME	00:00		Elapsed time. Range 00:00 to 999:59 minutes.	R/O
IN	INPUT	OFF	0	Trigger/Gate input. Default: Off	Conf R/W L3 R/W
		On	1	Turn On to start timing.	
OUT	OUTPUT	OFF	0	Timer output is off.	R/O
		On	1	Timer output is on.	
TRIGD	TRIGGERED			This is a status output to indicate that the input to the timer has been detected.	L3 R/O
		OFF	0	Not timing.	
		On	1	Timer has been triggered and is operational.	

Timer Modes

On Pulse Timer Mode

Output goes 'on' as soon as the trigger input goes active, and remains on until the time period has elapsed. If the timer is re-triggered during the timing period, the timer restarts.

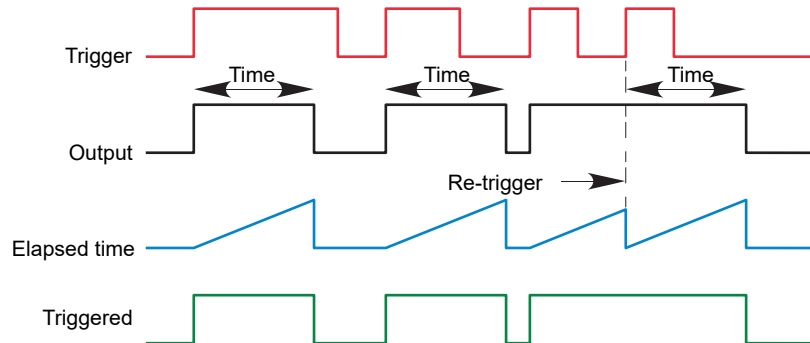

On Delay Timer Mode

Provides a delay between the trigger point and the timer output becoming active.

This type of timer is used to help ensure that the output is not set unless the input has been valid for a pre-determined period of time, thus acting as a kind of input filter.

Rules

1. After the trigger goes active, the output switches on after the delay time has elapsed, and stays on until the trigger goes inactive.
2. If the trigger goes inactive before the delay time has elapsed, the output does not switch on.

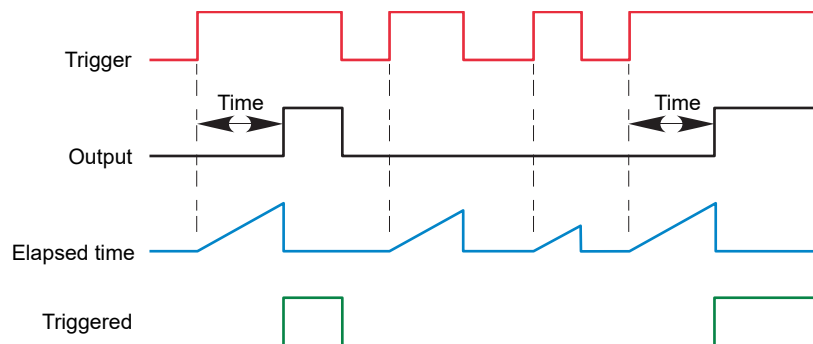

One Shot Timer Mode

- The Time value is decremented on each tick until it reaches zero. When the timer reaches zero the Output is cleared to OFF.
- The Time value can be edited at any instant to increase/decrease the duration of the On time.
- Once set to zero, the Time is not reset to a previous value, it must be edited by the operator to start the next On-Time.
- The input is used to gate the output. If the Input is set, the Time will count down to zero. If the Input is cleared to OFF, then the Time will Hold and the Output will switch OFF until the Input is next set.
- Since the Input is a Digital Wire, it is possible for the operator to NOT wire it, and set the Input value to ON which permanently enables the timer.
- The Triggered variable will be set to ON as soon as the Time is edited. It will reset when the Output is cleared to OFF.

The behavior under different conditions is shown below:

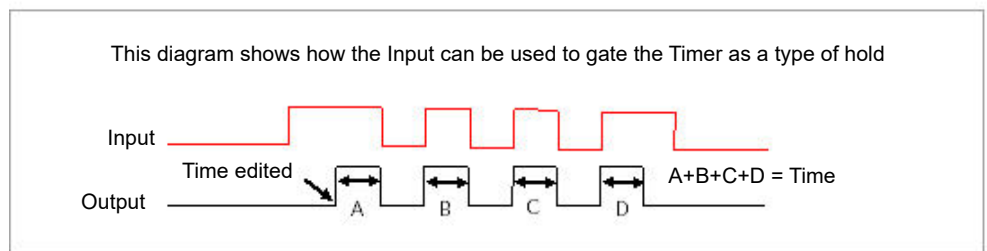
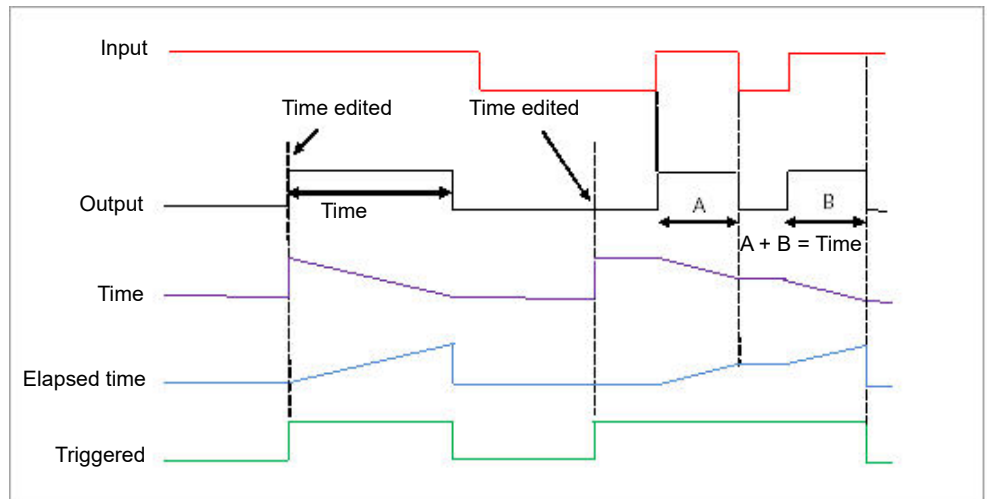

Minimum On Timer Mode or Compressor

The input goes active and remains on for a specified period after the input goes inactive.

It may be used, for example, to help ensure that a compressor is not cycled excessively.

- The output will be set to On when the Input changes from Off to On.
- When the Input changes from On to Off, the elapsed time will start incrementing towards the set Time.
- The Output will remain On until the elapsed time has reached the set Time. The Output will then switch Off.
- If the Input signal returns to On while the Output is On, the elapsed time will reset to 0, ready to begin incrementing when the Input switches Off.
- The Triggered variable will be set while the elapsed time is >0 . It will indicate that the timer is counting.

The diagram illustrates the behavior of the timer under different input conditions:

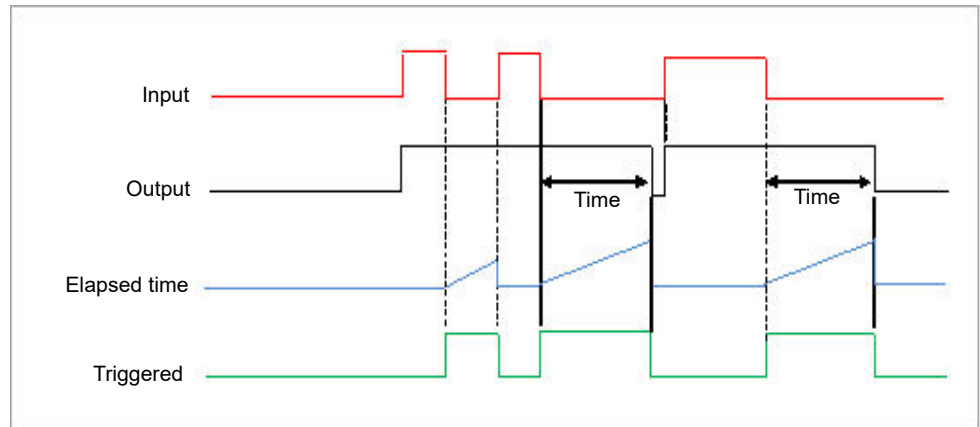

Counter List (CntL)

The Counter list is only available if a Toolkit option has been ordered. From firmware version 3.01 and greater up to two counters are available with the Enhanced Toolkit option (the Standard Toolkit option has one).



Each time the 'Clock' input is triggered the 'Count' output is incremented by 1 for an Up Counter and decremented by 1 for a Down Counter. A target value can be set and when this is reached the Ripple Carry flag is set. This flag can be wired to operate an event or other output.

A simple wiring example is shown in the iTools chapter. "Graphical Wiring" on page 223.

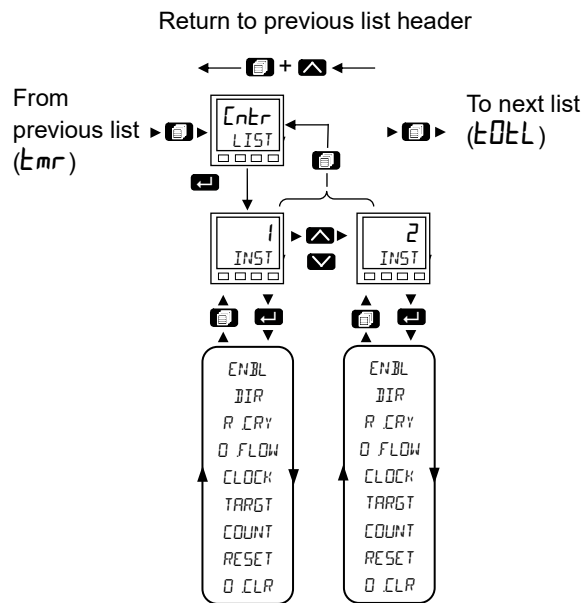
Access to the Counter parameter list is summarized below. The full Navigation Diagram is shown in section "Navigation Diagram" on page 94.



Parameter Mnemonic	Parameter Name	Value		Description	Access
				Press to select in turn	
				Press or to change values (if read/write, R/W)	
ENBL	ENABLE	NO	0	Count is frozen while Enable is FALSE. Default: No	Conf R/W L3 R/W
		YES	1	Count responds to Clock events when Enable is TRUE.	
DIR	DIRECTION OF COUNT	UP	0	Up counter. See note below. Default: Up	Conf R/W L3 R/W
		down	1	Down counter. See note below.	
R.CRY	RIPPLE CARRY			Ripple carry is normally used to act as an enabling input to the next counter. However, in EPC3000 series controllers only one counter is available. Ripple carry is turned On when the counter reaches the target set. This can be wired to operate an event or alarm or other function as required.	R/O
		OFF	0	Off.	
		ON	1	On.	
O.FLOW	OVERFLOW FLAG	NO	0	Overflow flag is held true (Yes) when the counter reaches zero (Down) or passes target (Up).	R/O
		YES	1		

Parameter Mnemonic	Parameter Name	Value		Description	Access
Press  to select in turn		Press  or  to change values (if read/write, R/W)			
CLOCK	CLOCK	0 1		Clock input to counter. The counter will increment (for an UP Counter) on a positive going edge (FALSE to TRUE). This is normally wired to an input source such as a digital input.	Read only if wired
TARGET	COUNTER TARGET	0 to 99999		Level count to which the counter is aiming. Default: 9999	Conf R/W L3 R/W
COUNT	COUNT	0		Counts each time a clock input occurs until the target is reached. Range 0 to 99999.	R/O
RESET	COUNTER RESET	NO	0	Counter not reset.	Conf R/W
		YES	1	When the Reset is set TRUE, the Count is set to 0 in 'up' mode or to Target in 'down' mode. The Reset also clears the overflow flag.	L3 R/W
OCLR	CLEAR OVERFLOW	NO	0	Not cleared.	Conf R/W
		YES	1	Clears the overflow flag.	L3 R/W

Note: When configured as an Up counter, Clock events increment Count until reaching the Target. On reaching Target RippleCarry is set true. At the next clock pulse, Count returns to zero. Overflow is latched true and RippleCarry is returned false.

When configured as a down counter, Clock events decrement Count until it reaches zero. On reaching zero RippleCarry is set true. At the next clock pulse, Count returns to the Target count. Overflow is latched true and RippleCarry is reset false.

Totalizer List (٤٠٤٤)

The Totalizer list is only available if a Toolkit option has been ordered.

A totalizer is an electronic integrator, primarily used to record the numeric total over time of a measured value that is expressed as a rate. For example, the number of litres (since reset), based on a flow rate in litres per minute.

One totalizer function block is available in EPC3000 series controllers. A totalizer can, by soft wiring, be connected to any measured value. The outputs from the totalizer are its integrated value and an alarm state. The user may set a setpoint which causes the alarm to activate once the integration exceeds the setpoint.

The totalizer has the following attributes:-

1. Run/Hold/Reset
 - In Run the totalizer will integrate its input and continuously test against an alarm setpoint. The higher the value of the input the faster the integrator will run.
 - In Hold the totalizer will stop integrating its input but will continue to test for alarm conditions.
 - In Reset the totalizer will be zeroed, and alarms will be reset.
2. Alarm Setpoint
 - If the setpoint is a positive number, the alarm will activate when the total is greater than the setpoint.
 - If the setpoint is a negative number, the alarm will activate when the total is lower than the setpoint.
 - If the totalizer alarm setpoint is set to 0.0, the alarm will be off. It will not detect values above or below.
 - The alarm output is a single state output. It may be cleared by resetting the totalizer, stopping the Run condition, or by changing the alarm setpoint.
3. The total is limited to max and min 32-bit floating point values.
4. The totalizer helps ensure that resolution is maintained when integrating small values onto a large total. However, very small values will not be integrated into a relatively very large value i.e. 0.000001 will not be integrated into 455500.0 this is due to the limitations of 32-bit floating point resolution.

One totalizer function block is available in an EPC3000 controller.

Access to the Totalizer parameter list is summarized below. The full Navigation Diagram is shown in section "Navigation Diagram" on page 94.

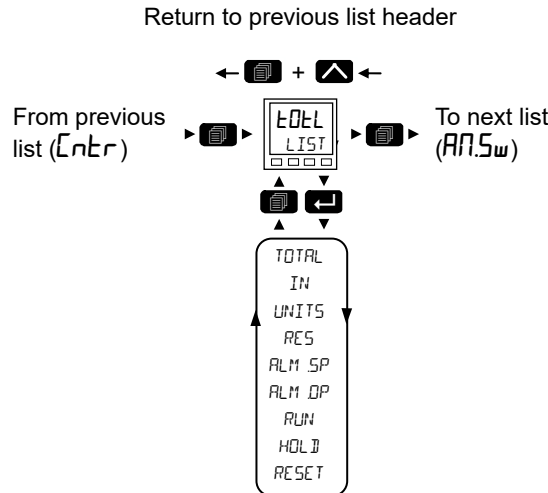

Parameter Mnemonic	Parameter Name	Value		Description	Access	
Press to select in turn		Press or to change values (if read/write, R/W)				
TOTAL	TOTAL OUTPUT	0		The totalized value.	L3 R/O	
IN	INPUT	00		The value to be totalized. The totalizer stops accumulating if the input is 'Bad'.	Conf R/W L3 R/W	
UNITS	UNITS			See section "Units" on page 105 for a list of units used throughout.	Conf R/W	
RES	RESOLUTION	nnnnn	0	Totalizer resolution. Default: nnnnn - no decimal places	Conf R/W	
		nnnn.n	1	One decimal place.		
		nnnn.nn	2	Two decimal places.		
		nn.nnnn	3	Three decimal places.		
		n.nnnnn	4	Four decimal places.		
ALM.SP	ALARM SETPOINT	0.0000		Sets the totalized value at which an alarm will occur.		
ALM.OP	ALARM OUTPUT			This is a read only value which indicates the alarm output On or Off. The totalized value can be a positive number or a negative number. If the number is positive the alarm occurs when: Total > Alarm Setpoint If the number is negative the alarm occurs when: Total < Alarm Setpoint	Conf R/O L3 R/O	
		OFF	0	Off		
		On	1	On		
RUN	RUN	No	0	Totalizer not running. See note below.	Conf R/W L3 R/W	
		YES	1	Select to run the totalizer.		
HOLD	HOLD	No	0	Totalizer not in hold. See note below.	Conf R/W L3 R/W	
		YES	1	Holds the totalizer at its current value.		
RESET	RESET	No	0	Totalizer not in reset.	Conf R/W L3 R/W	
		YES	1	Resets the totalizer.		

Note: The Run & Hold parameters are designed to be wired to (for example) digital inputs. Run must be 'on' and Hold must be 'off' for the totalizer to operate.

8 Input Analog MUX List (AN5w)

The 8 Input Analog Multiplexer list is only available if a Toolkit option has been ordered. From firmware version 3.01, up to four Analog Multiplexers are available with the Enhanced Toolkit option (the Standard Toolkit has three).



The 8 Input Analog Multiplexer may be used to switch one of eight inputs to an output. It is usual to wire inputs to a source within the controller which selects that input at the appropriate time or event.

Access to the 8 Input Analog Multiplexer parameter list is summarized below. The full Navigation Diagram is shown in section "Navigation Diagram" on page 94.

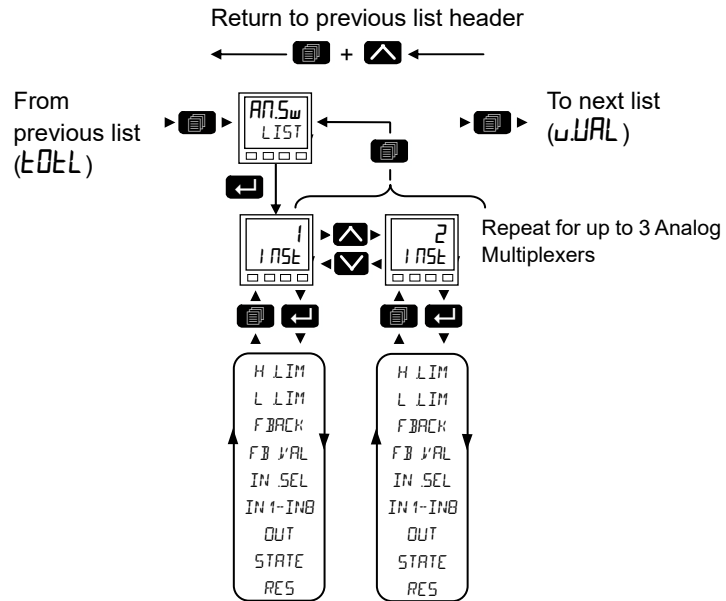
The following parameters are available.



Parameter Mnemonic	Parameter Name	Value	Description	Access	
Press to select in turn		Press or to change values (if read/write, R/W)			
HLIM	HIGH LIMIT	9999.0	The high limit for all inputs and the fall back value. Range Low Limit to Max 32-bit floating point value (decimal point depends on resolution). Default: 9999	Conf R/W	
LLIM	LOW LIMIT	-999.0	The low limit for all inputs and the fall back value. Range Min 32-bit floating point value to High Limit (decimal point depends on resolution). Default: -999	Conf R/W	

Parameter Mnemonic	Parameter Name	Value		Description	Access
Press  to select in turn		Press  or  to change values (if read/write, R/W)			
FBACK	FALLBACK STRATEGY			The state of the Output and Status parameters when either input is bad or operation cannot be completed. This parameter could be used in conjunction with fallback value.	Conf R/W
		CbAd	0	Clip Bad. If the input value is above 'High Limit' or below 'Low Limit', then the output value is set to the appropriate limit, and 'Status' is set to 'Good'. If the input signal is within the limits, but its status is bad, the output is set to the 'Fallback' value. Default: C.bad	
		CgD	1	Clip Good. If the input value is above 'High Limit' or below 'Low Limit', then the output value is set to the appropriate limit, and 'Status' is set to 'Bad'. If the input signal is within the limits, but its status is bad, the output is set to the 'Fallback' value.	
		FbAd	2	Fall Bad. If the input value is above 'High Limit' or below 'Low Limit', then the output value is set to the 'Fallback' value, and the 'Status' is set to 'Bad'.	
		FgD	3	Fall Good. If the input value is above 'High Limit' or below 'Low Limit', then the output value is set to the 'Fallback' value, and the 'Status' is set to 'Good'.	
		uBAd	4	Upscale. If the input status is bad, or if the input signal is above 'High Limit' or below 'Low Limit', the output value is set to the 'High Limit'.	
		dBAd	6	Downscale. If the input status is bad, or if the input signal is above 'High Limit' or below 'Low Limit', the output value is set to the 'Low Limit'.	
FVAL	FALLBACK VALUE	00		Used (in accordance with Fallback Strategy) to define the output value when fallback strategy is active. Range Low Limit to High Limit (decimal point depends on resolution).	Conf R/W
INSEL	INPUT SELECTION	In1 to In8		Input values (normally wired to an input source). Default: In1	Conf R/W L3 R/W
IN1	INPUT 1	00	1	To input values if not wired. Range Min 32-bit floating point value to Max 32-bit floating point value.	Conf R/W L3 R/W
IN2	INPUT 2	00	2		
IN3	INPUT 3	00	3		
IN4	INPUT 4	00	4		
IN5	INPUT 5	00	5		
IN6	INPUT 6	00	6		
IN7	INPUT 7	00	7		
IN8	INPUT 8	00	8		
OUT	OUTPUT			Indicates the analog value of the output between high and low limits.	R/O
STATE	STATUS			Used in conjunction with Fallback to indicate the status of the operation. Typically, status is used to flag the status of the operation and used in conjunction with fallback strategy. May be used as an interlock for other operations. See section "Status" on page 106 for a list of enumerated values.	R/O
RES	RESOLUTION			Indicates the resolution of the output. The resolution of the output is taken from the selected input. If the selected input is not wired, or if its status is 'bad' then the resolution will be set to 1dp.	R/O
		nnnnn	0	No decimal places. Default: nnnnn	
		nnnn.n	1	One decimal place.	
		nnn.nn	2	Two decimal places.	
		nn.nnn	3	Three decimal places.	
		n.nnnn	4	Four decimal places.	

User Value List (UVAL)

The User Value list is only available if a Toolkit option has been ordered. From firmware version 3.01 and greater up to twelve User Values are available with the Enhanced Toolkit option (the Standard Toolkit option has four).

User values are registers provided for use in calculations. They may be used as constants in equations or temporary storage in extended calculations.

Access to the User Value parameter list is summarized below. The full Navigation Diagram is shown in section "Navigation Diagram" on page 94.

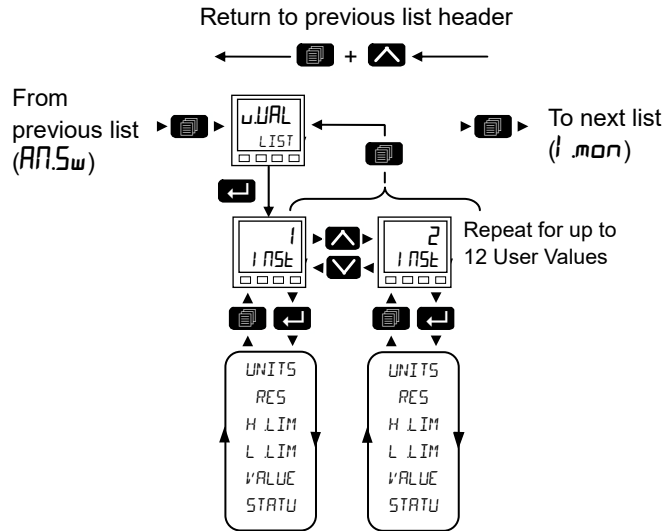

Parameter Mnemonic	Parameter Name	Value		Description	Access
UNITS	UNITS			See section "Units" on page 105 for a list of units used throughout.	Conf
RES	RESOLUTION	nnnnn	0	User value resolution..	Conf
		nnnn.n	1	One decimal place.	
		nnn.nn	2	Two decimal places. Default: nnn.nn	
		nn.nnn	3	Three decimal places.	
		n.nnnn	4	Four decimal places.	
H.LIM	HIGH LIMIT	9999.0		The high limit may be set for each user value to help prevent the value being set to an out-of-bounds value. Range Low Limit to Max 32-bit floating point value (decimal point depends on resolution). Default: 99999	L3 and Conf
L.LIM	LOW LIMIT	-999.0		The low limit of the user value may be set to help prevent the user value from being edited to an illegal value. This is important if the user value is to be used as a setpoint. Range Min 32-bit floating point value to High Limit (decimal point depends on resolution). Default: -99999	L3 and Conf
VALUE	VALUE			To set the value within the range limits. See note below.	L3 and Conf
STATU	STATUS			Can be used to force a good or bad status onto a user value. This is useful for testing status inheritance and fallback strategies. See note below. See section "Status" on page 106 for a list of enumerated values.	L3 and Conf

Note: If 'Value' parameter is wired but 'Status' parameter is not wired, then, instead of being used to force the Status, it will indicate the value which is inherited from the wired connection to the 'Value' parameter.

Input Monitor List (I MON)

The Input Monitor list is only available if a Toolkit option has been ordered.



The input monitor may be wired to any variable in the controller. It then provides three functions:-

1. Maximum detect.
2. Minimum detect.
3. Time above threshold.

There are two instances of the Input Monitor.

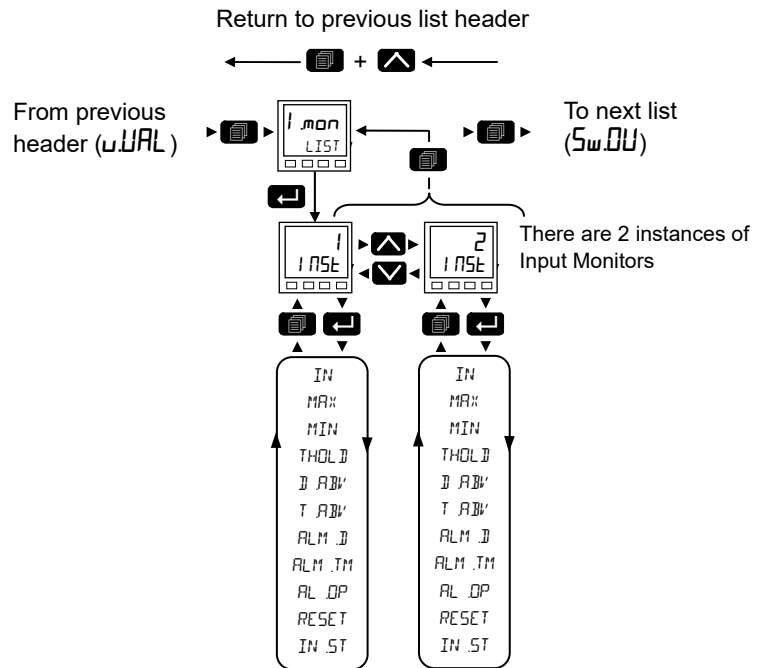
Access to the Input Monitor parameter list is summarized below. The full Navigation Diagram is shown in section "Navigation Diagram" on page 94.



Parameter Mnemonic	Parameter Name	Value		Description	Access
Press  to select in turn		Press  or  to change values (if read/write, R/W)			
IN	INPUT	00		Monitored input value.	Conf R/W L3 RW
MAX	MAXIMUM	00		This function continuously monitors the input value. If the value is higher than the previously recorded maximum, it becomes the new maximum. This value is retained following a power outage.	R/O
MIN	MINIMUM	00		This function continuously monitors the input value. If the value is lower than the previously recorded minimum, it becomes the new minimum. This value is retained following a power outage.	R/O
THOLD	THRESHOLD			The input timer accumulates the time the input PV spends above this trigger value. Default: 1.0	Conf R/W L3 RW
DABV	DAYS ABOVE	0		Accumulated days the input has spent above threshold since the last reset. Days is an integer count of the 24 hour periods only. The Days value should be combined with the Time value to make the total time above threshold.	R/O
TABV	TIME ABOVE	00:00		Accumulated time above the timer threshold since last reset. The time value accumulates from 00:00.0 to 23:59.59. Overflows are added to the days value.	R/O
ALMD	ALARM DAYS	0		Days threshold for the monitors time alarm. Used in combination with the TimeAbove parameter. The AlmOut is set to true if the inputs accumulated time above threshold is higher than the timer high parameters. Default: 0	Conf R/W L3 RW
ALMTM	ALARM TIME	00:00		Time threshold for the monitors time alarm. Used in combination with the AlmDay parameter. The AlmOut is set to true if the inputs accumulated time above threshold is higher than the timer high parameters. Default: 0	Conf R/W L3 RW
ALOP	ALARM OUTPUT	OFF	0		R/O
		On	1	Set true if the accumulated time that the input spends above the threshold value is higher than the alarm setpoint.	
RESET	RESET	No	0	Default: No	Conf R/W L3 RW
		YES	1	Resets the Max and Min values and resets the time above threshold to zero.	
INST	INPUT STATUS			Displays the status of the input. See section "Status" on page 106 for a list of enumerated values.	R/O

Switchover List (SwDU)

The Switchover list is only available if a Toolkit option has been ordered.

This facility is commonly used in temperature applications which operate over a wide range of temperatures. For example, a thermocouple may be used to control at lower temperatures and a pyrometer then controls at very high temperatures. Alternatively two thermocouples of different types may be used.

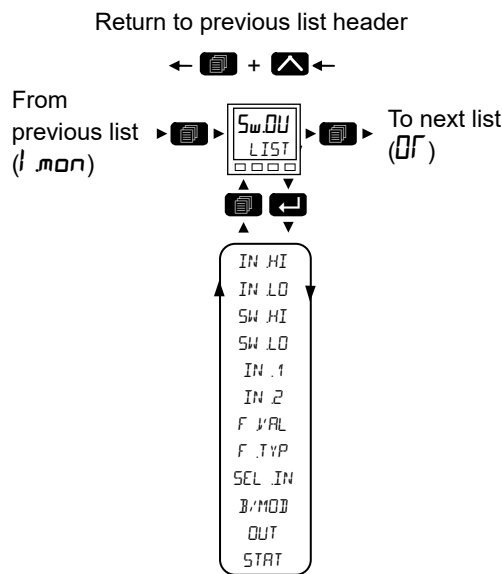

The diagram below shows a process heating over time with boundaries which define the switching points between the two devices. The higher boundary is normally set towards the top end of the thermocouple range and this is determined by the 'Switch Hi' parameter. The lower boundary is set towards the lower end of the pyrometer (or second thermocouple) range using the parameter 'Switch Lo'. The controller calculates a smooth transition between the two devices.

Access to the Switchover parameter list is summarized below. The full Navigation Diagram is shown in section "Navigation Diagram" on page 94.

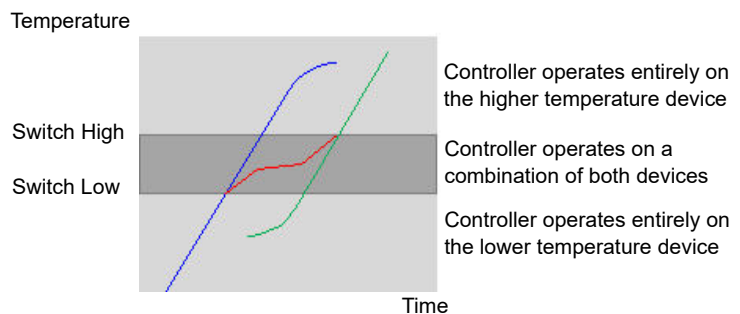
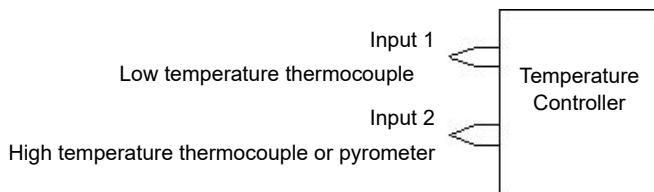

From this list you can configure the switchover function block. This is only appears if the function has been enabled.



Parameter Mnemonic	Parameter Name	Value		Description	Access
Press  to select in turn		Press  or  to change values (if read/write, R/W)			
INH1	INPUT HIGH	9999.0		Sets the high limit for the switch high. It is the highest reading from input 2 because input 2 is the high range input sensor. Default: 9999.0	Conf R/W L3 R/W
INLO	INPUT LOW	-999.0		Sets the low limit for the switch low. It is the lowest reading from input 1 since input 1 is the low range input sensor. Default: -999.0	
SWHI	SWITCH HIGH	0.0		Defines the higher boundary of the switchover region.	
SWLO	SWITCH LOW	0.0		Defines the lower boundary of the switchover region.	
IN.1	INPUT 1	0.0		The first input value. This is taken from the low range sensor.	
IN.2	INPUT 2	0.0		The second input value. This is taken from the high range sensor.	
F.VAL	FALLBACK VALUE	0.0		Defines (in accordance with Fallback Type) the output value when fallback strategy is active. Range between Input High and Input Low.	
F.TYP	FALLBACK TYPE	c.bAd	0	Clip Bad. The measurement is clipped to the limit it has exceeded and its status is set to BAD, such that any function block using this measurement can operate it's own fallback strategy. For example the control loop may hold its output. Default: c.bad	L3 R/O
		c.Gd	1	Clip Good. The measurement is clipped to the limit it has exceeded and its status is set to GOOD, such that any function block using this measurement may continue to calculate and not employ its own fallback strategy.	
		F.bAd	2	Fallback Bad. The measurement will adopt the configured fallback value. Which has been set by the user. In addition the status of the measured value will be set to BAD, such that any function block using this measurement can operate its own fallback strategy. For example the control loop may hold its output.	
		F.Gd	3	Fallback Good. The measurement will adopt the configured fallback value. Which has been set by the user. In addition the status of the measured value will be set to GOOD, such that any function block using this measurement may continue to calculate and not employ its own fallback strategy.	
		u.bAd	4	Up Scale. The measurement will be forced to adopt its high limit, this is like having a resistive pull up on an input circuit. In addition the status of the measurement is set to BAD, such that any function block using this measurement can operate its own fallback strategy. For example the control loop may hold its output.	
		d.bAd	6	Down Scale. The measurement will be forced to adopt it's low limit, this is like having a resistive pull down on an input circuit. In addition the status of the measurement is set to BAD, such that any function block using this measurement can operate its own fallback strategy. For example the control loop may hold its output.	
		SEL.IN	SELECTED INPUT	in2	
in1	1				
both	2				
B.MDI	BAD MODE	SGd	0	If the currently selected input is BAD the output will assume the value of the other input if it is GOOD.	L3 R/O
		SbAd	1	If selected input is BAD the output is BAD.	
OUT	OUTPUT			The process variable produced from the 2 input measurements.	R/O
STAT	STATUS			The status of the input block. See section "Status" on page 106 for a list of enumerated values.	R/O

Logic OR List (OR)



The Logic OR function block allows multiple parameters to be wired to a single Boolean parameter without the need to enable toolkit blocks for the LGC2 or LGC8 'OR' functionality.

There are 8 Logic OR blocks available.

Each block consists of 8 inputs which are OR'd together into one output. It may be used, for example, to take the outputs from a number of alarm blocks and OR them together to operate a single general alarm output.

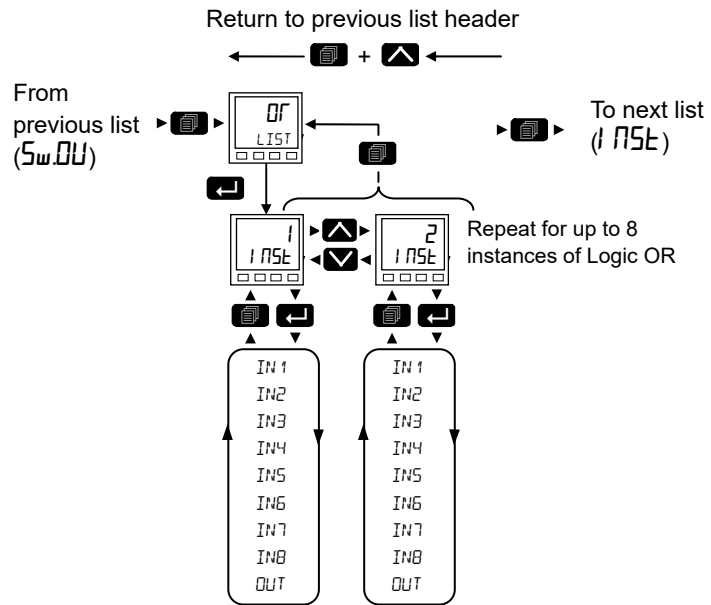
Access to the Logic OR parameter list is summarized below. The full Navigation Diagram is shown in section "Navigation Diagram" on page 94.



Parameter Mnemonic	Parameter Name	Value		Description	Access
Press  to select in turn		Press  or  to change values (if read/write, R/W)			
IN 1	INPUT 1	OFF	0	Input 1 to the OR block.	R/O
		On	1		
IN 2	INPUT 2	OFF	0	Input 2 to the OR block.	
		On	1		
IN 3	INPUT 3	OFF	0	Input 3 to the OR block.	
		On	1		
IN 4	INPUT 4	OFF	0	Input 4 to the OR block.	
		On	1		
IN 5	INPUT 5	OFF	0	Input 5 to the OR block.	
		On	1		
IN 6	INPUT 6	OFF	0	Input 6 to the OR block.	
		On	1		
IN 7	INPUT 7	OFF	0	Input 7 to the OR block.	
		On	1		
IN 8	INPUT 8	OFF	0	Input 8 to the OR block.	
		On	1		
OUT	OUTPUT	OFF	0	Output result .	
		On	1		

Instrument List (I NSE)

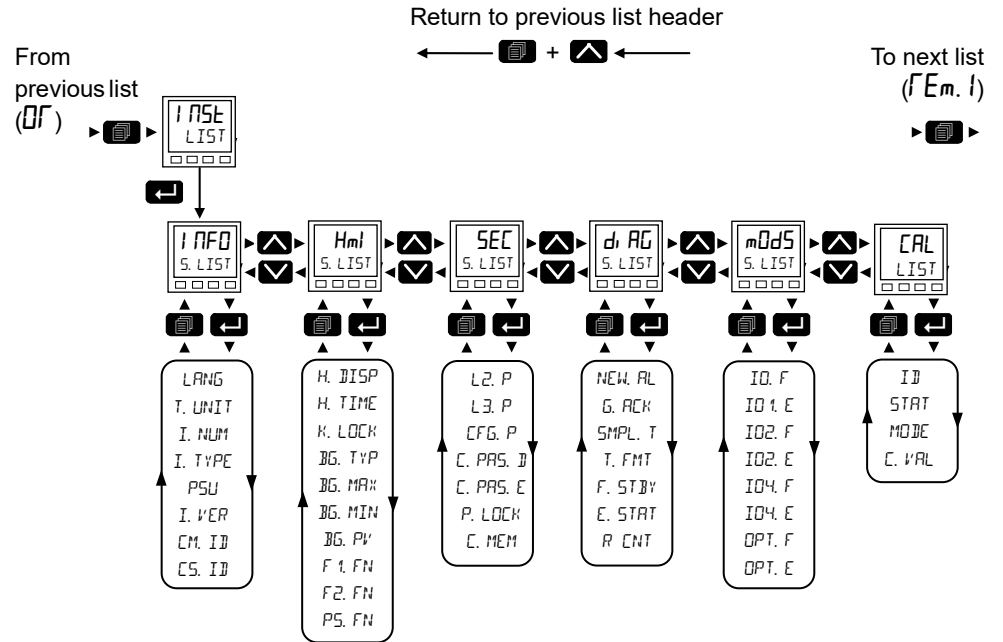

This list contains five sub-lists: Information (I NFD), HMI (HmI), Security (SEC), Diagnostics (dI AG), Modules (mOdS), Calibration (CAL).

Access to the Instrument parameter list is summarized below. The full Navigation Diagram is shown in section "Navigation Diagram" on page 94.





Information Sub-List (i NFD)

From this list you can read and adjust information such as Instrument Language, Temperature Units, Customer ID, etc., as shown in the following table.

Parameter Mnemonic	Parameter Name	Value	Description	Access	
Press  to select in turn		Press  or  to change values (if read/write, R/W)			
LANG	LANGUAGE	EN	0	English Default: English	Config RW
		FF	1	French	
		dE	2	German	
		It	3	Italian	
		ES	4	Spanish	
TUNIT	TEMP UNITS	dEGC	0	Sets the temperature units (°C). When temperature units is changed, those parameters which are flagged as having a temperature type (Absolute or relative) will have their values converted to reflect the new temperature units. Default: deg.C	Config RW L3 RO
		dEGF	1	Sets the temperature units (°F).	
		h	2	Sets the temperature units (K).	
INUM	INSTRUMENT NUMBER			Unique instrument serial number.	RO
I.TYPE	TYPE	3016	0	Instrument type EPC3016 1/16 DIN.	RO
		3008	1	Instrument type EPC3008 1/8 DIN.	
		3004	2	Instrument type EPC3004 1/4 DIN.	
	Native Type			Comms parameter. Used by iTools.	
PSU	PSU TYPE	HU	0	100 to 230Vac +/- 15% voltage PSU option.	RO
		LU	1	24Vac/dc voltage PSU option.	
IVER	VERSION			Firmware version number.	RO
				Comms parameter. Used by iTools.	
CMID	COMPANY ID	1280		Eurotherm CNOMO identifier.	RO
CSID	CUSTOMER ID			A non-volatile value for customer use: it has no effect on the instrument functionality. Default: 0	Config RW Lev 3 RO
EVER	EIP VERSION	U 1.1		EtherNet/IP version.	R/O

Display Functionality Sub-List (Hmi)

Parameter Mnemonic	Parameter Name	Value	Description	Access	
Press  to select in turn		Press  or  to change values (if read/write, R/W)			
H.DISP	HOME DISPLAY		This configures which parameters are shown in the HOME display for Levels 1 and 2.	Conf R/W L3 R/W	
		PUSP	0		The HOME display will show Loop PV, Setpoint when in Auto mode and Output power when in Manual mode. Default: PV.SP
		PUPt	1		The HOME display will show Loop PV and program time left.
		LPU	2		The HOME display will show Loop PV only.
		PV1	3		The HOME display will show analog input 1 PV1 only.
		PUP5	4		The HOME display will show PV and the currently running program number and segment number.
		PV1.2	5		The HOME display will show Analog input 1 PV1 and PV2
		PV2	6		The HOME display will show PV2.
VAL.3	HOME DISPLAY 3RD VALUE		An extra parameter value may be displayed on the home display. If the Home Display is set to LPV/SP, LPV/Time Left or PV1/PV2 the 1/8 and 1/4 DIN displays will display the parameter value on the 3rd line. The 1/16 DIN display will not show the parameter value. If the Home Display parameter is set to display only LPV, PV1 or PV2, then, the value of this parameter will be displayed on the second line. This parameter is typically wired from the parameter which is to be displayed.	Conf R/W	
H.TIME	HOME TIMEOUT	0 to 60	Configures the timeout period (in seconds) for the home page - a value of 0 disables the Home Page Timeout. Range 0 to 60s. Default: 60		
K.LOCK	KEYLOCK	OFF	0	Front panel buttons are active (normal operation). Default: Off	
		On	1	Lock the front panel buttons.	
BG.TYP	BARGRAPH TYPE		Select the type of bargraph to be displayed. The bargraph is not available in EPC3016.	Conf R/W L3 R/W	
		L2F	0		Left to Right. Minimum value is on the left, maximum value is on the right. The bar starts at the minimum value and extends to the right, to the current value. Default: Left to right
		CEnt	1		Centered. Minimum value is on the left, maximum value is on the right. The bar starts at the midpoint between maximum and minimum and extends either left or right, to the current value.
BG.MAX	BARGRAPH MAX	1000	Scaling for maximum on the bar graph. Bargraph Max and Bargraph Min can be wired as shown in the example in section "Example 4: To Configure a Bargraph" on page 225. Default: 1000	Conf R/W L3 R/W	
BG.MIN	BARGRAPH MIN	0	Scaling for minimum on the bar graph. Default: 0		
BG.PV	BARGRAPH PV		The current value being displayed on the bar graph.	RO	
F1FN	F1 FUNCTION	A-m	1	To configure the F1 function button. Not available in EPC3016. Default: Loop Auto/Manual	Conf R/W
F2FN	F2 FUNCTION	PHLd	12	To configure the F2 function button. Not available in EPC3016. Default: Programmer Run/Hold	Conf R/W
PSFN	PAGE + SCROLL FUNCTION	ALAck	2	To configure the action when the Page + Scroll buttons are pressed together. Default: Alarm acknowledge	Conf R/W



Functionality of the F1 and F2 and Page + Scroll buttons



The functionality of the above three function buttons can be configured from the following list:

Function	Mnemonic	Value	Description
None	<i>NONE</i>	0	
Auto/Manual select	<i>A-m</i>	1	Put Loop into Auto or Manual mode.
Alarm acknowledge	<i>AAck</i>	2	Acknowledge all active alarms.
Segment advance	<i>PAdu</i>	3	Advance program by one segment.
SP1/SP2 select	<i>SPSEL</i>	4	Select SP1 or SP2.
RSP select	<i>RSRSP</i>	5	Remote or Local auto mode.
Loop track	<i>LETr</i>	6	Put the Loop into Track mode.
SP rate limit disable	<i>SPTL</i>	7	Enable/Disable the Sepoint Rate Limits.
Recipe select	<i>SEEC</i>	8	Switch between recipe 1 and 2.
PID set select	<i>SPId</i>	9	Switch between PID set 1 and 2.
Tune enable	<i>TUNE</i>	10	Start the auto-tune process.
Standby enable	<i>ESbY</i>	11	Put instrument into standby mode.
Program Run/Hold	<i>PHLd</i>	12	Switches the Programmer between Run and Hold mode.
Program Run/Reset	<i>PRSE</i>	13	Switches the Programmer between Run and Reset mode.
Probe clean	<i>ZCLN</i>	14	Start a clean of the Zirconia probe. Only applies if the application is Carbon Potential..

Security Sub-List (SEC)

The security list sets up security settings as listed in the following table:

Parameter Mnemonic	Parameter Name	Value		Description	Access
Press  to select in turn		Press  or  to change values (if read/write, R/W)			
L2P	L2 PASSWORD	2		The password that will be required to place the instrument into HMI level 2. Note: a value of 0 will disable the need to enter a password to enter level 2. Default: 2	Conf R/W
L3P	L3 PASSWORD	3		The password that will be required to place the instrument into HMI level 3. Note: a value of 0 will disable the need to enter a password to enter level 3. Default: 3	Conf R/W
CFG.P	CONF PASSWORD	4		The password that will be required to place the instrument into HMI configuration mode. Note: a value of 0 will disable the need to enter a password to enter configuration level. Default: 4	Conf R/W
C.PARSE	C.PASS EXPIRY DAYS	90		The number of days after which the comms configuration password will expire generating a notification message. This is to inform the user that the password needs changing. It should be noted that a value of 0 will disable the expiry feature. Default: 90	Conf R/W
P.LOCK	PASSWORD LOCK TIME	00:30		After the maximum number of invalid attempts to login, the HMI level passcode and comms password entry mechanism will be locked out for the period set. This lockout time affects all access level passwords and the comms config password. Note: A value of 0 will disable the lockout mechanism. The lock can be cleared by entering a higher level. Note: This does not apply to the OEM password and feature passcodes which will always be locked out for 30 minutes. Default: 30 minutes	Conf R/W
C.MEM	CLEAR MEMORY	YES	1	See CAUTION table below.	Conf R/W
		NO	0	Clear memory will force all parameters to be set to their factory default values. This parameter is only shown if the 'Configuration password is set 9999.	
IM				Instrument mode.	Comms parameter
MaxIM				Maximum instrument mode.	
CommsPassword				The configured password that will be required to place the instrument into comms configuration mode when connected via Fixed comms or Option comms. This password is encrypted before being transmitted via comms and is hashed with a random salt before being stored. See also section "Comms Configuration Level Password" on page 21. Default: Empty (must be set on first connect from iTools)	
CommsPasswordEntry	Yes No	1 0		Write the correct password to this parameter to enter configuration mode. The password entered should match the password configured in CommsPassword. The entered password is encrypted before sending via comms. Default: Empty	
ConfigAccess	Operator Standby Config	0 1 2		Indication that comms configuration mode can be accessed. A value of '0' indicates that to enter instrument configuration mode via Modbus communications it will be necessary to write a value of 2 (configuration/engineer) to Instrument.Security.IM within a period of 5 seconds of writing the Comms Config password to Instrument.Security.Commspassword parameter.	
CommsPasswordExpiry	Off	0		The number of days after which the comms configuration password will expire. This will generate a notification message informing the user that the password needs changing. It should be noted that a value of 0 will disable the expiry feature. Default: 90	
CommsPasswordsSet	No Yes	0 1		Flag to indicate if the comms password is set. Default: No	

Parameter Mnemonic	Parameter Name	Value	Description	Access
Press  to select in turn		Press  or  to change values (if read/write, R/W)		
EnableUnencryptedLogin		No Yes	0 1 When this parameter is set, a string parameter (Modbus address 0x5500) becomes available via comms for entering plain text passwords to enter configuration mode. Note: Unlike the encrypted password, the entered string is transmitted as plain text via comms. Upon receipt, instrument hashes the message with the saved random salt before comparing it to the saved hashed password. Default: No	
CommsUnencryptedLogin			A comms-only parameter (Modbus address 0x5500) which is to be written to with the comms password string which is transmitted in plain text to place the instrument in configuration mode. Note: Upon receipt, instrument hashes the plain text password with the saved random salt before comparing it to the saved hashed password. Default: Empty	
ClearCommsPassword		No Yes	0 1 When set, the comms configuration password will be cleared. Note: Clearing the comms configuration password will limit Fixed comms and Option comms read/write access to a small set of parameters until a new comms password is set. Default: No	
PassLockTime		0 to 24 hrs	Password lockout time. The password entry mechanism will be locked out for this period after the maximum number of invalid attempts to login. This lockout time affects all access level passwords and the comms config password. A value of 0 will disable the lockout mechanism. Default: 30 minutes	Comms parameter
FeaturePasscode1			Feature passcodes are required to enable chargeable features. These can be added after the controller has been supplied. Examples of chargeable features include Programmer Types, Toolkit Blocks, some Digital Communications protocols, etc. The passcodes can only be added through iTools. To request a feature, contact your supplier and provide the current values of the feature passcodes. Your supplier will provide new values to be entered to update the new feature. Enter these to enable your selected features. Three login attempts are allowed before lockout followed by a lockout period of 30 minutes.	
FeaturePasscode2				
FeaturePasscode3				
FeaturePasscode4				
FeaturePasscode5				
OEMPassword			These parameters are only shown of the OEM Security feature has been supplied. See Chapter "OEM Security" on page 380 for further information	
OEMEntry				
OEMStatus				
OEMParamLists				
IMGlobal			Comms config locked	

 **CAUTION**



CLEAR MEMORY PARAMETER

The clear memory parameter will force all parameters to be set to their factory default values. This will cause all values previously set by the user to be lost and it should, therefore, only be used in exceptional circumstances. This parameter is only available if the CFG.P parameter has been set to 9999.

Failure to follow these instructions can result in injury or equipment damage.



Diagnostics Sub-List (d, AG)

The diagnostics list provides general diagnostic information as shown in the following table:

Parameter Mnemonic	Parameter Name	Value		Description	Access
Press  to select in turn		Press  or  to change values (if read/write, R/W)			
NEWAL	NEW ALARM	OFF	0	This shows ON when a process alarm (see Alarm List) becomes active and remains on until the alarm has become inactive (and acknowledged depending upon the latching strategy of the alarm).	Conf R/O L3 R/O
		ON	1		
GACK	GLOBAL ACK	No	0	A rising edge will acknowledge all active process alarms (see the Alarm List).	Conf R/W L3 R/W
		YES	1		
SMPLT	SAMPLE TIME			Indicates the sample period (in seconds). This is the period between each execution cycle.	Conf R/O L3 R/O
TFMT	TIME FORMAT	mSEC	0	Sets the resolution of time parameters on the config comms channel when read/written via scaled integer comms Default: msec	Conf R/W L3 R/W
		SEC	1		
		mi n	2		
		HOuR	3		
F.STBY	FORCE STANDBY MODE	No	0	Default: No Sets the instrument into Standby Mode (see "Standby" on page 77).	Conf R/W L3 R/W
		YES	1		
E.STAT	EXECUTION STATUS			Indicates the status of the execution engine. This parameter can be used to determine if the instrument execution is running, in standby or starting up.	Conf R/O L3 R/O
		Run	0	Running	
		StBY	1	Standby	
		StUP	2	Start up	
R.CNT	RESET COUNTER			This indicates the number of times the instrument has reset due to a power cycle, exit from configuration mode, exit from quick start, or an unexpected software reset. The count value can be reset by writing a value of 0. Default: 0	Conf R/W L3 R/W
V.LINE				Line voltage measurement, not available on low voltage instruments.	Conf R/O L3 R/O
MBVER	MICROBOARD VERSION			Version number of the microprocessor board fitted.	R/O

The following parameters are comms only parameters available in iTools

InstStatusWord			Instrument Status Word. This is a 16-bit bitmapped parameter that provides instrument status information. It is mapped as shown in the next section.
AlarmStatusWord			Alarm Status Word. This is a 16-bit bitmapped parameter that provides alarm status information. It is mapped as shown in the following section.
NotificationStatus			Notifications Status Word. This is a 16-bit bitmapped parameter that provides instrument notification status information. It is mapped as shown in the following section.
StandbyCondStatus			Standby Conditions Status Word (include the bit map table).
L2PassUnsuccess			Number of HMI Level 2 unsuccessful login attempts since the last successful login.
L2PassSuccess			Number of HMI Level 2 successful logins.
L3PassUnsuccess			Number of HMI Level 3 unsuccessful login attempts since the last successful login.
L3PassSuccess			Number of HMI Level 3 successful logins.

Parameter Mnemonic	Parameter Name	Value	Description	Access
Press  to select in turn		Press  or  to change values (if read/write, R/W)		
CfgPassUnsuccess			Number of HMI Configuration Mode unsuccessful login attempts since the last successful login.	
CfgPassSuccess			Number of HMI Configuration Mode successful logins.	
CommsPassUnsuccess			Number of Communications Configuration Mode unsuccessful login attempts since the last successful login.	
CommsPassSuccess			Number of Communications Configuration Mode successful logins.	

Instrument Status Word Bitmap

Bit Number	Description
0	Alarm 1 State (0=Off, 1=On)
1	Alarm 2 State (0=Off, 1=On)
2	Alarm 3 State (0=Off, 1=On)
3	Alarm 4 State (0=Off, 1=On)
4	Manual Mode (0=Auto, 1=Manual)
5	Global (PV1 or PV2) Sensor Break (0=Off, 1=On)
6	Loop Break (0=Good closed loop, 1=Open loop)
7	CT Load Alarm (0=Off, 1=On)
8	Auto Tune (0=Off, 1=On)
9	Program End (0=No, 1=Yes)
10	PV1 out of range (0=No, 1=Yes)
11	CT Over Current Alarm (0=Off, 1=On)
12	New Alarm (0=No, 1=Yes)
13	Programmer Running (0=No, 1=Yes)
14	PV2 out of range (0=No, 1=Yes)
15	CT Leak Alarm (0=Off, 1=On)

Alarm Status Word Bitmap

Bit Number	Description
0	Alarm 1 in active region (0=No,1=Yes)
1	Alarm 1 not acknowledged (0=No,1=Yes)
2	Alarm 2 in active region (0=No,1=Yes)
3	Alarm 1 not acknowledged (0=No,1=Yes)
4	Alarm 3 in active region (0=No,1=Yes)
5	Alarm 3 not acknowledged (0=No,1=Yes)
6	Alarm 4 in active region (0=No,1=Yes)
7	Alarm 4 not acknowledged (0=No,1=Yes)
8	Alarm 5 in active region (0=No,1=Yes)
9	Alarm 5 not acknowledged (0=No,1=Yes)
10	Alarm 6 in active region (0=No,1=Yes)
11	Alarm 6 not acknowledged (0=No,1=Yes)
12	Reserved
13	CT Load Alarm (0=No, 1=Yes)
14	CT Leak Alarm (0=No, 1=Yes)
15	CT Over Current Alarm (0=No, 1=Yes)

Notification Status Word Bitmap



Bit Number	Description
0	Set comms password in iTools
1	Password has expired.
2	HMI level 2 access locked out.
3	HMI level 3 access locked out.
4	HMI configuration access locked out.
5	Comms configuration access locked out.
6	Control loop in demo mode.
7	Control loop in auto tune mode.
8	Comms in configuration mode.
9	Loop Autotune requested, but cannot run.
10	Reserved.
11	Reserved.
12	Reserved.
13	Reserved.
14	Reserved.
15	Reserved.

Standby Status Word Bitmap

Bit Number	Description
0	Invalid RAM image of NVOL.
1	NVOL parameter database load/store was unsuccessful.
2	NVOL region load/store was unsuccessful.
3	Option NVOL load/store was unsuccessful.
4	Factory Calibration not detected.
5	Unexpected CPU condition.
6	Hardware Ident Unknown.
7	Fitted hardware differs from expected hardware.
8	Unexpected Keyboard condition during startup.
9	Instrument powered down, in config mode.
10	Recipe load was unsuccessful.
11	Reserved.
12	Reserved.
13	Reserved.
14	Reserved.
15	Reserved.



Modules Sub-List (m0d5)

This list provides information about the modules fitted in the controller as shown in the following table:

Parameter Mnemonic	Parameter Name	Value		Description	Access
Press  to select in turn		Press  or  to change values (if read/write, R/W)			
IO1.F	IO1 FITTED	NONE	0	The module type that is actually fitted in IO1.	Conf R/O
		LIO	1		
		RELY	2		
		SSr	3		
		dCOP	4		
IO1.E	IO1 EXPECTED	as above		The module type that is expected in IO1.	Conf R/W
IO2.F	IO2 FITTED	as above		The module type that is actually fitted in IO2.	Conf R/O
IO2.E	IO2 EXPECTED	as above		The module type that is expected in IO2.	Conf R/W
IO4.F	IO4 FITTED	as above		The module type that is actually fitted in IO4.	Conf R/O
IO4.E	IO4 EXPECTED	as above		The module type that is expected in IO4.	Conf R/W
OPT.F	OPTION FITTED			The module type that is actually fitted in the options slot.	Conf R/O
		NONE	0	None - EPC3004 and EPC3008.	
		AI dB	1	Eight digital input - EPC3004 and EPC3008.	
		ENET	2	Ethernet - EPC3004 and EPC3008.	
		NONE	10	None - EPC3016.	
		RSP	11	Remote SP - EPC3016.	
		C232	12	EIA232 - EPC3016.	
		C485	13	EIA485 - EPC3016.	
		C422	14	EIA422 - EPC3016.	
ENET	15	Ethernet -EPC3016.			
OPT.E	OPTION EXPECTED	as above		The module type that is expected in the options slot.	Conf R/W

Enables

Enables parameters are not shown on the controller HMI. They are comms only shown in iTools.

Parameter Mnemonic	Parameter Name	Value		Description	Access
Press  to select in turn		Press  or  to change values (if read/write, R/W)			
WireMode		Run	1	FOR TOOLS USE ONLY - Mode of the Wiring/Execution Engine.	R/O
		Reset	2		
		Restoring	3		
		Validate	4		
MaxWires				Maximum number of wires.	R/O

Calibration Sub-List (CAL)

Calibration information and instructions for User Calibration are given in "User Calibration" on page 369.

Access to the Calibration parameter list is summarized below. The full Navigation Diagram is shown in section "Navigation Diagram" on page 94.

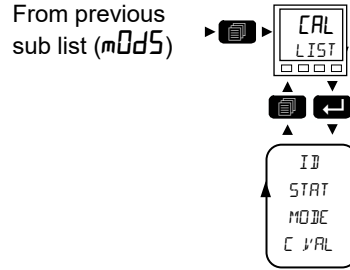

The calibration list provides user calibration status information and a means of input and output calibration.

Parameter Mnemonic	Parameter Name	Value	Description	Access	
Press to select in turn		Press or to change values (if read/write, R/W)			
ID	ID	AI.1	0	Analog input 1.	Conf R/W L3 R/W
		AI.2	1	Analog input 2.	
		dC.1	2	Analog output 1.	
		dC.2	3	Analog output 2.	
		dC.3	4	Analog output 3.	
		Ct	5	Current transformer.	
		r mA	6	Remote setpoint milliamps.	
		rSPV	7	Remote setpoint Volts.	
STAT	STATUS	FACt	0	Factory.	R/O
		ADJ.d	1	Adjusted.	
MODE	MODE	IdLE	0	Idle.	Conf R/W L3 R/W
		StRt	1	Start calibration.	
		USUC	2	Unsuccessful.	
		Lo	3	Low calibration point.	
		SEtL	4	Set low point.	
		d, SC	5	Discard calibration.	
		Hi	6	High calibration point.	
		SEtH	7	Set high point.	
		d, SC	8	Discard calibration.	
		ADJ.d	9	Adjusted.	
		d, SC	10	Discard calibration.	
CVAL	CAL VALUE			This parameter only appears if MODE is equal to Low and High calibration point. For input user calibration this is the value the input is expected to be at the point of calibration. For output user calibration this is the externally measured output value at the point of calibration.	Conf R/W L3 R/W

Input Linearization (LIN16)

The LIN16 list is only available if a Toolkit option has been ordered.

A LIN16 function block converts an input signal into an output PV using a series of up to 14 straight lines (16 points) to characterize the conversion.

In EPC3000 series controllers, from firmware versions V3.01 and above, two instances of the linearization function block have been added. It is an orderable option protected by Feature Security see section "Security Sub-List (SEC)" on page 197.

The LIN16 function block allows a user to create a their own linearization to match the characteristics of a particular sensor not covered by any of the standard inputs. It can also be used for the adjustment of the process variable to account for differences introduced by the overall measurement system or to derive a different process variable. These may be set up using the controller HMI and the parameters listed below, but it may be found more convenient to use iTools. For this reason the configuration of the LIN16 block is described in the iTools section "Input Linearization (LIN16)" on page 360.



The Parameter navigation using the HMI and parameter descriptions for the LIN16 block are shown in the following sections:

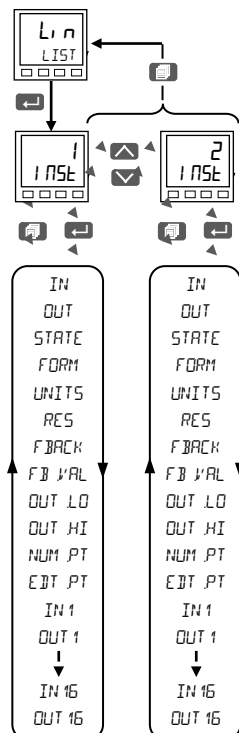

LIN16 Parameter Navigation

Access to the parameter list is summarized below. The full Navigation Diagram is shown in section "Navigation Diagram" on page 94.



Linearization Block Parameters

Parameter Mnemonic	Parameter Name	Value	Description	Access
Press  to select in turn		Press  or  to change values (if read/write, R/W)		
INST	16 POINT LINEARIZATION TABLE	1 2	Select the input to linearize.	L3 R/W
IN	INPUT		The Input Value to linearize through the Linearization Table.	L3 R/W
OUT	OUTPUT		The Output Value that is the result of the linearization of the Input Value through the Linearization Table.	R/O
STATE	STATUS		Status of the linearization block.	R/O
		<i>Good</i> 0	Good status indicates a correct linearization of the Input..	
		<i>bad</i> 1	May be caused by a bad input signal. Examples are, sensor break, output out of range or invalid series of points, the output is over/under range or the list of points does not define a correct curve.	
FORM	CURVE FORM		Automatically reads the format of the curve configured.	R/O
		<i>FFEE</i>	Freeform Curve All the selected input points are used to generate a freeform curve.	
		<i>INCF</i>	Increasing Curve All the selected input points are used to generate an increasing curve.	
		<i>dEEF</i>	Decreasing Curve All the selected input points are used to generate a decreasing curve.	
		<i>SkIP</i>	Skipped Points from list At least one input point has been skipped because of not expected order with respect to the previous ones.	
		<i>none</i>	No Form No valid pair of points has been found that has strictly monotonically increasing input values.	
UNITS	OUTPUT UNITS		See "Units" on page 105 for the list of available units.	Conf R/W
RES	OUTPUT RESOLUTION	<i>nnnn</i> 0	No decimal places.	Conf R/W
		<i>nnn.n</i> 1	One decimal place.	
		<i>nn.nn</i> 2	Two decimal places.	
		<i>n.nnn</i> 3	Three decimal place.	
		<i>.nnnn</i> 4	Four decimal place.	

Parameter Mnemonic	Parameter Name	Value	Description	Access	
Press  to select in turn		Press  or  to change values (if read/write, R/W)			
F.BACK	FALLBACK TYPE		Selected Output Fallback Strategy that is actuated when the input status is bad the output is over its limits or the table contains an invalid series of points.	R/O	
	ClipBad	0	Clip Bad The measurement is clipped to the limit it has exceeded and its status is set to BAD, such that any function block using this measurement can operate its own fallback strategy. For example the control loop may hold its output.		
	ClipGood	1	Clip Good The measurement is clipped to the limit it has exceeded and its status is set to GOOD, such that any function block using this measurement may continue to calculate and not employ its own fallback strategy.		
	F.Bad	2	Fallback Bad The measurement will adopt the configured fallback value. Which has been set by the user. In addition the status of the measured value will be set to BAD, such that any function block using this measurement can operate its own fallback strategy. For example the control loop may hold its output.		
	F.Good	3	Fallback Good The measurement will adopt the configured fallback value. Which has been set by the user. In addition the status of the measured value will be set to GOOD, such that any function block using this measurement may continue to calculate and not employ its own fallback strategy.		
	u.Bad	4	Up Scale The measurement will be forced to adopt it's high limit, this is like having a resistive pull up on an input circuit. In addition the status of the measurement is set to BAD, such that any function block using this measurement can operate its own fallback strategy. For example the control loop may hold its output.		
	d.Bad	6	Down Scale The measurement will be forced to adopt it's low limit, this is like having a resistive pull down on an input circuit. In addition the status of the measurement is set to BAD, such that any function block using this measurement can operate its own fallback strategy. For example the control loop may hold its output.		
F.VAL	FALLBACK VALUE		In the event of a bad status, the output may be configured to adopt the fallback value. This allows the strategy to dictate a known output value.	Conf R/W	
INT.BAL	Integral Balance Request	No Yes	0 1	The Integral Balance output can be wired to the PID Loop; The function block will issue a bumpless transfer of the Loop should there be any change of the linearization table that can cause an undesired step change on its output.	Comms parameter
OUT.LO	OUTPUT LOW LIMIT		Minimum Value allowed for the Output. If the linearization table would result in an output value that is less than the low limit, then the Fallback strategy will be actuated.	L3 R/W	
OUT.HI	OUTPUT HIGH LIMIT		Maximum Value allowed for the Output. If the linearization table would result in an output value that is greater than the low limit, then the Fallback strategy will be actuated.		
NUMPT	NUMBER OF POINTS		Number of Points selected to define the linearization table. It can be set between 2 and 16.		
EDIT.PT	INSERT OR DELETE POINT		A point can be added or deleted by specifying the desired position. Set EditPoint equal to 1, 2, ..., 16 in order to insert a point at the associated position; each following point will be moved into the next position. Set EditPoint equal to -1, -2, ..., -16 in order to remove the point at the associated position; each following point will be moved into the previous position and the last one is maintained.		
IN1	INPUT POINT 1		Input Coordinate of Point 1 of the linearization table.		
OUT1	OUTPUT POINT 1		Output Coordinate of Point 1 of the linearization table.		
Up to 16 Input and output points are available depending on the setting of the Number of Points parameter.					
IN16	INPUT POINT 16		Input Coordinate of Point 1 of the linearization table.		
OUT16	OUTPUT POINT 16		Output Coordinate of Point 1 of the linearization table.		

Remote Input List (REM.I)

This list configures the remote input as shown in the following table.

Access to the Remote Input parameter list is summarized below. The full Navigation Diagram is shown in section "Navigation Diagram" on page 94.

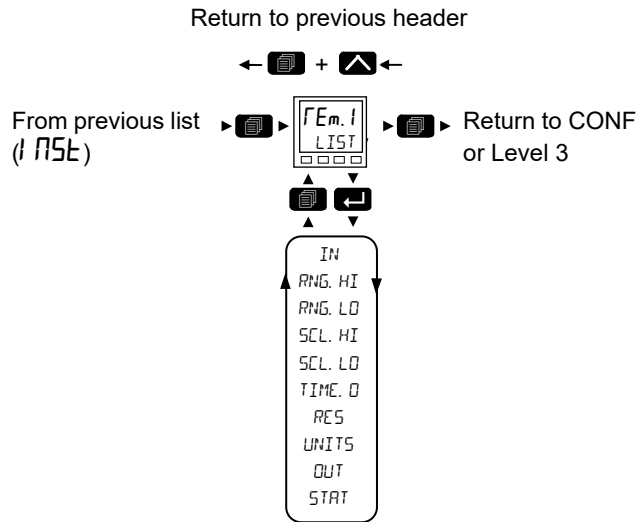

Parameter Mnemonic	Parameter Name	Value		Description	Access
Press to select in turn		Press or to change values (if read/write, R/W)			
IN	REMOTE INPUT			This parameter can be written to via a remote master, or by the Remote Setpoint Module (if fitted). The Modbus address is 277 if being written to by an external master.	Conf R/W L3 R/W
RNG.HI	RANGE HIGH			Maximum value of the input. Default: 100	Conf R/W L3 R/O
RNG.LO	RANGE LOW			Minimum value of the input. Default: 0	Conf R/W L3 R/O
SCL.HI	SCALE HIGH			The maximum value of the scaled output PV. Default: 100	Conf R/W L3 R/O
SCL.LO	SCALE LO			The minimum value of the scaled output PV. Default: 0	Conf R/W L3 R/O
TIME.O	TIMEOUT			This is the period in which the input has to be written to (in seconds). If this period is exceeded the output PV status will be set to Bad. If this period is set to 0, the timeout strategy is disabled. Default: 1s	Conf R/W L3 R/O
RES	RESOLUTION	nnnnn	0	Resolution of the input /output. No decimal places.	Conf R/W L3 R/O
		nnnn.n	1	One decimal place. Default: nnnn.n	
		nnn.nn	2	Two decimal places.	
		nn.nnn	3	Three decimal places.	
		n.nnnn	4	Four decimal places.	
UNITS	UNITS			See section "Units" on page 105 for a list of units used throughout. Default: AbsTemp	
OUT	PV			The output PV that has been linearly scaled Range High to Scale High and Range Low to Scale Low.	Conf R/O
STAT	STATUS			Status of the output PV. See section "Status" on page 106 for a list of enumerated values.	Conf R/O

Comms Indirection Table



EPC3000 controllers make a fixed set of parameters available over digital communications using Modbus addresses. This is known as the SCADA Table. The SCADA Modbus address area is 0 to 15615 (0x3CFF). There are three addresses reserved to allow iTools to detect the instrument: 107, 121 and 122 - these cannot be set as a Destination value. The following Modbus addresses have been reserved for use via the Comms Indirection Table. By default the addresses have no associated parameters:



Modbus Range (Decimal)	Modbus Range (Hex)
15360 to 15615	3C00 to 3CFF

The programmer area (2000h - 27BFh) within the SCADA table is not supported.

When accessed here, the parameter may be presented as scaled integer, minutes or Native format and may be flagged as read-only. The Comms IndirectionTable allows additional parameters which are not in the SCADA table to be made available over Modbus communications for specific applications. It is recommended that iTools is used to set up the Comms Indirection Table using the Commstab function block.



The following parameters are available in the Commstab function block:



Parameter Name	Value		Description	Access
Press  to select in turn	Press  or  to change values (if read/write, R/W)			
Dest	The Modbus address where the selected parameter will appear in the SCADA table area. Range is 0 to 15615. A value of -1 indicates not used.	Not Used	Modbus destination	Configuration
Source	The parameter that will be mapped into the Destination Modbus address. It should be noted that setting this parameter via iTools will allow sources that are unavailable to the HMI. If such a setting is subsequently examined using the front panel it cannot be edited, only deleted.		Source parameter	Configuration
Native	The data format in which the source parameter will be presented at the destination address. 0 Integer - causes a scaled integer representation of the value to appear at the Modbus address. 1 Native - causes the native format of the value to appear at the Modbus address. It should be noted that if a 32 bit value is returned, it will use two adjacent 16 bit Modbus addresses.	Integer	Native data format	Configuration
ReadOnly	This parameter may be used to override the normal alterability rule for the parameter and force it to be Read Only. Setting this value to 'Read/Write' enables the normal alterability rule(s). 0 Read/Write - Allow the value's normal alterability rule to be applied at the selected Modbus address 1 Read-Only- Overrides the parameter's normal alterability rule to present it as read only at the selected Modbus address		Read only Read/Write only if source is R/W	Configuration

Parameter Name	Value		Description	Access
Press  to select in turn	Press  or  to change values (if read/write, R/W)			
Minutes	This allows for Time parameters to be presented in alternate resolutions, for example 1/10th of minutes or 1/10th of seconds. 0 Seconds- the Time parameter will be presented as sss.s 1 Minutes - the Time parameter will be presented as mmm.m	Seconds	Time parameter resolution	Configuration

Q Code List

These are the Quick Start Code function block parameters which are available via comms. They are the Quick Codes shown on the HMI when the instrument starts-up. They can be seen in iTools but there is no separate list on the controller HMI.

Parameter Name	Value	Description	Access	
Press  to select in turn	Press  or  to change values (if read/write, R/W)			
Quick Start Code Set 1			Comms only	
Application		Defines the application.		
	None	0		No application configured. The controller has no soft wiring.
	PID heat only	1		PID heat only controller.
	PID heat/cool	2		PID heat/cool controller.
	VPU heat only	3		Valve position heat only controller.
	Carbon potential	4		Carbon potential controller.
	Dew point control	5		Dew point controller.
Input 1 Sensor Type		Defines the type of the input sensor connected to input 1.		
	X	0		Use Default.
	B	1		Type B.
	J	2		Type J.
	K	3		Type K.
	L	4		Type L.
	N	5		Type N.
	R	6	Type R.	
	S	7	Type S.	
	T	8	Type T.	
	Pt100	20	PT100.	
	Pt1000	21	PT1000.	
	80mV	30	0-80mV.	
	10V	31	0-10V.	
20mA	32	0-20mA.		
4-20mA	33	4-20mA.		
Input 1 Range		Defines the range of the input 1.		
	X	0	Use Default.	
	1	1	0-100°C.	
	2	2	0-200°C.	
	3	3	0-400°C.	
	4	4	0-600°C.	
	5	5	0-800°C.	
	6	6	0-1000°C.	
	7	7	0-1200°C.	
	8	8	0-1300°C.	
	9	9	0-1600°C.	
	A	10	0-1800°C.	
	F	11	Full Range.	
Input 2 Sensor Type		Defines the type of the input sensor connected to input 2. The enumerated values are the same for Input 1 Type above with the following addition available on input 2 only.		
	HiZ	40	High Impedance (Zirconia).	
Input 2 Range		Defines the range of the input 2. The enumerated values are the same for Input 1 range.		

Parameter Name	Value		Description	Access
Press  to select in turn	Press  or  to change values (if read/write, R/W)			
Quick Start Code Set 2				Comms only
CT input	Not used	0	Defines the range of the current transformer input.	
	10A	1	10 Amps.	
	25A	2	25 Amps.	
	50A	5	50 Amps.	
	100A	6	100 Amps.	
	1000A	7	1000 Amps.	
Digital input A	Not used	0	Defines the functionality of digital input A.	
	Alarm acknowledge	1		
	Loop Auto/Manual	2		
	Programmer Run/Hold	3		
	Keylock	4		
	Setpoint Select	5		
	Programmer Run/Reset	6		
	Loop Remote/Local	7		
	Recipe Select	8		
	Loop Track	9		
Digital input B			Defines the functionality of digital input B. The enumerated values are the same as for Input A above.	
D1-D8	Not used	0	Digital inputs 1 to 8. (See also "Quick Codes DIO" on page 70).	
	Config1	1		
	Config2	2		
	Config3	3		
	Config4	4		
	Config5	5		
	Config6	6		
	Config7	7		
	Config8	8		
	Config9	9		
Temperature units	Default	0	Default temperature units.	
	Celsius	1	Degrees Celsius.	
	Fahrenheit	2	Degrees Fahrenheit.	
	Kelvin	3	Kelvin.	
Save and exit	NoExit	0	Do not exit quick start mode.	
	Save	1	Save quick start settings.	
	Discard	2	Discard quick start settings.	

Configuration Using iTools

What is in this Chapter?

This chapter describes how to configure the controller using iTools.

This chapter describes those feature which are specific to the EPC series controllers. iTools is generally described in the iTools Help Manual Part No. HA028838 which can be obtained from www.eurotherm.com.

What is iTools?

iTools is a configuration and monitoring package which can be used to edit, store and 'clone' complete controller configurations. It is a free downloadable package available from www.eurotherm.com.

iTools can be used to configure all the functions of the controller already described in this manual. It is also possible using iTools to configure additional functions such as Customized Messages, Recipe Storage and Download and Parameter Promotion. These features are described in this chapter.

What is an IDM?

The Instrument Descriptor Module (IDM) is a Windows file that is used by iTools to determine the properties of a specific device. Each version of a device requires its own IDM file. This is normally included with the iTools software and allows iTools to recognize the software version of your instrument.

To Load an IDM

In the unlikely event that the build of your instrument is a non-standard, it may be necessary for you to obtain the IDM from the Eurotherm web site www.eurotherm.com. The file will be of the format IDxxx_v106.exe, where IDxxx is the instrument and v--- is the software version number of the instrument.

Having downloaded the new IDM installer, ensure all of iTools and the iTools OPC Server have been stopped. Then launch the installer and follow the instructions to complete the IDM installation onto your system.

Once installed, start iTools as usual. If the installation was successful, the new device details should be listed under the "New" dialog under the appropriate tab.

Connecting a PC to the Controller

This may be done using the configuration CPI clip, the Fixed Communications port (EPC3004/EPC3008) or by Option Comms modules (if fitted).

Using the Configuration Clip

A Configuration Clip is available with iTools by quoting USB in the iTools ordering code. Alternatively, it may be ordered with the controller by quoting EPCACC/USBCONF in the Accessory Order Code. The clip can be fitted into the side of a controller as shown and has a USB interface to a PC.

Connecting via the Configuration Clip offers the simplest and quickest method of establishing communications to the controller, as it provides easy access whatever configuration the controller is set to.

Ensure that the controller is powered down before the clip is attached.

The benefit of using this arrangement is that it is not necessary to power the controller, since the clip provides the power to the internal memory of the controller.



Note: In some cases it may be preferable to have the configuration clip connected but not power the instrument from the USB port. For example, when the controller is powered by the standard Low Voltage (24Vdc) or Mains (110Vac -240Vac) and iTools is connected to monitor, configure or clone it. The power can be disconnected by removing Pins 1 & 5 in the following diagram.



Note: An existing earlier version of this clip with a serial interface to a PC may also be used.

Using the Communications Port

Connect the controller to the EIA485 serial communications port of the PC shown in "Serial Communications EIA-485" on page 59.

Using Option Comms

In EPC3016, if the relevant options board is fitted, the controller may be connected using EIA232, EIA422 or Ethernet as shown in "Digital Communications Connections" on page 58.

In EPC3008 and EPC3004, if the relevant options board is fitted, the controller may be connected using the Ethernet connector, see "Ethernet Wiring" on page 60.

Note: Ensure that the Comms block in the controller is suitably configured - i.e. in the Comm/Main Sub List the Protocol parameter is configured to "m.tCP" (MODBUS/TCP), and in the Comm/Network Sub List the IP Mode parameter is correctly set (STAT/dHCP - depending on whether there is a DHCP server).

Also, to enable iTools to automatically Discover the controller, ensure that the Auto Discovery parameter found in the Comm/Network Sub List is turned to 'On'.

Refer to sections "Main Sub List (mAIN)" on page 151 and "Network Sub List (nWrk)" on page 153.

Starting iTools

Open iTools and, with the controller connected, press 'Scan' on the iTools menu bar. iTools will search the communications ports and TCP/IP connections for recognisable instruments. Controllers connected with the configuration clip (CPI), will be found at address 255 regardless of the address configured in the controller.

Note: The Scan will only find the devices if the configuration clip or serial comms is used. If Ethernet is used then it will be necessary to add the IP address to the iTools control Panel list. This is described in section "Ethernet Parameters" on page 320.

When the controller is detected a screen view similar to the one shown below will be displayed. The browser on the left shows the List Headers. To display parameters within a list double click the Header or select 'Parameter Explorer'. Click on a list header to display parameters associated with this list.

The controller view may be turned on or off using the 'View' menu and selecting 'Panel Views'. This view mimics the connected controller HMI. The buttons are active which means that the controller can be operated directly from these buttons in exactly the same way as the connected instrument.

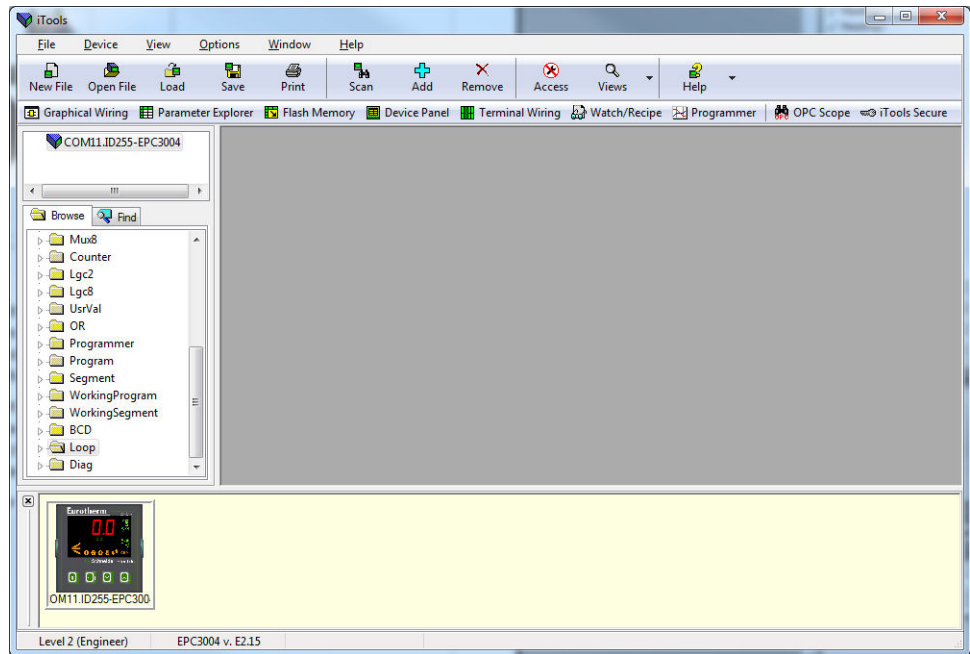

The controller may be configured using the Browser view above. The following pages show a number of examples of how to configure various functions.

It is assumed that the user is generally familiar with iTools and has a general understanding of Windows.

If the controller uses Ethernet comms, iTools needs to be set up to communicate with the controller. This is described in "IP Mode Settings" on page 324.

The 'Browser' List

Parameters are available under list headings in the same way as in the controller Level 3 or Configuration level.

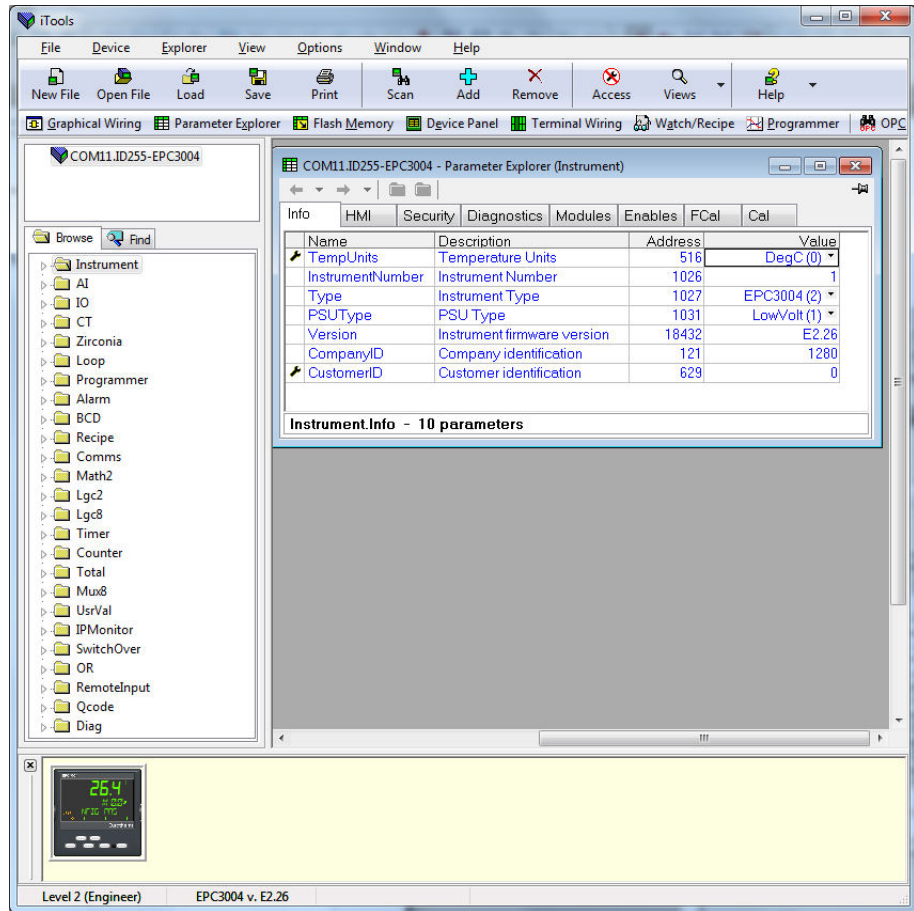

Double click on a heading to display parameters associated with the selected heading in the right hand side of the iTools view.

Parameters colored blue are read only in the selected level.

Parameters shown in black may be modified within preset limits. Enumerated parameters are selected from a drop-down list and analog parameters may be modified by typing in the new value.

The actual controller HMI may be displayed in the top or bottom section of the iTools display as shown. The controller may be operated from this view. The controller HMI may also be displayed by pressing 'Device Panel' in the menu bar.

Configuration Access

The controller may be configured from the front panel (HMI) as described in "Configuration Level" on page 96 or it may be configured over comms using more than one serial or Ethernet channel (if ordered). In order to avoid multiple users from writing to the same configuration parameter at the same time, comms connections are separated into a maximum of five sessions (1x config comms, 1x serial comms, 3x Ethernet). When a session is created it restricts access to another channel also being in Configuration mode simultaneously.

Access levels are Operator/Configuration.

By default, a connection has operator privilege. Upon disconnection (or timeout) the session will be deleted, with the associated mode reverted back to operator level.

If a power cycle occurs while any session is in configuration mode, the instrument will start up in standby mode with the HMI displaying the standard $P.L.N.F$ notification. All sessions will be disconnected during startup. When connections are re-established, all will be in operator mode. Any session (or HMI) must then enter and exit configuration mode to remove this notification.

When one comms session puts the instrument into configuration mode, all other sessions will report the instrument in standby mode, but will not provide configuration level privilege. All other sessions will also be prevented from accessing configuration mode.

Setting Comms Configuration Password

For EPC3000 V5.xx and later, the password will require configuration on first connection to iTools via Option/Fixed comms. This can be done in two ways:

1. The user selects the "Add Devices" (using the "Add" button), the device will display a padlock icon to the left of the device description.

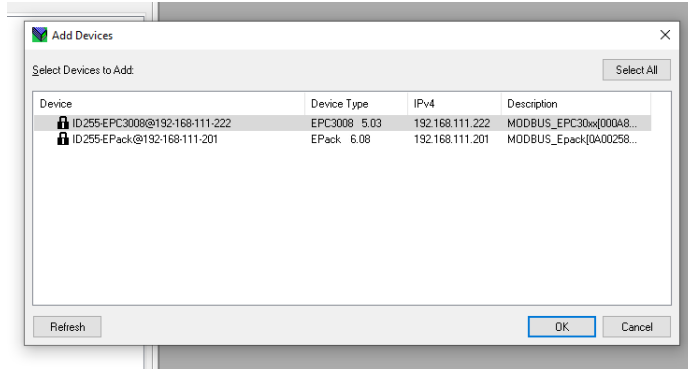

If they select to add the device, iTools will display a message informing them that they need to configure the Comms Configuration password before being able to proceed.

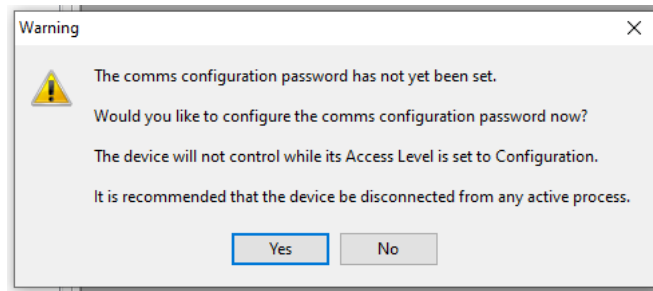

Selecting 'Yes' will automatically launch the iDevPWSetup tool.

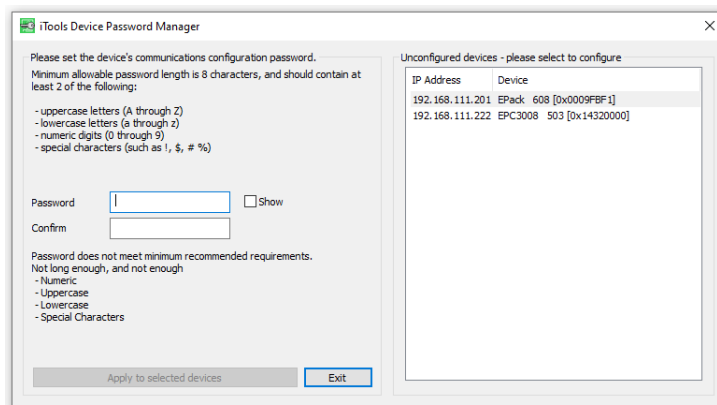

- The user chooses to perform a network “Scan”, on detecting the device, iTools will display a message:

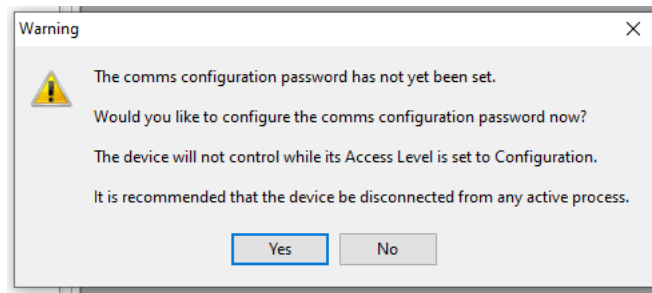

informing the user that they need to configure the Comms Configuration password before being able to proceed. Selecting ‘Yes’ will automatically launch the iDevPWSetup tool.

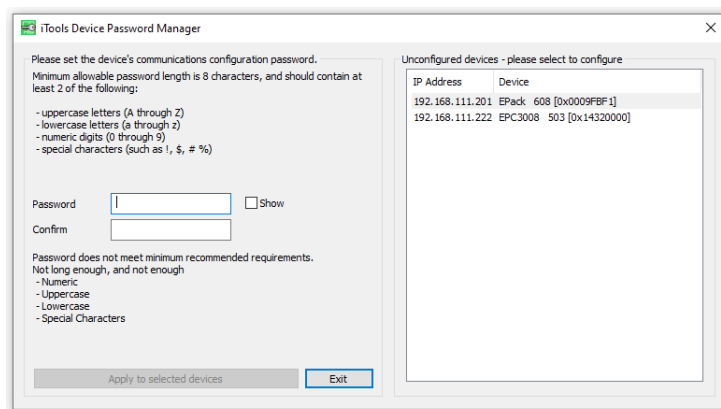

Note the following:

- Passwords are required to be at least eight characters in length
- It is required that the password uses two out of the four following character types:
 - UPPER CASE [A-Z]
 - lower case [a-z]
 - numeric [0-9]
 - special characters [! \$ # %, etc]
- Enforce a lockout period after five unsuccessful attempts

To Put iTools into Configuration Mode

⚠ WARNING
UNINTENDED EQUIPMENT OPERATION
Do not attempt to configure the controller while it is connected to a active process.
Failure to follow these instructions can result in death, serious injury or equipment damage.

In configuration level the controller is in standby mode and does not control the process or provide alarm indication.

Click on  . A dialog message is displayed as shown.

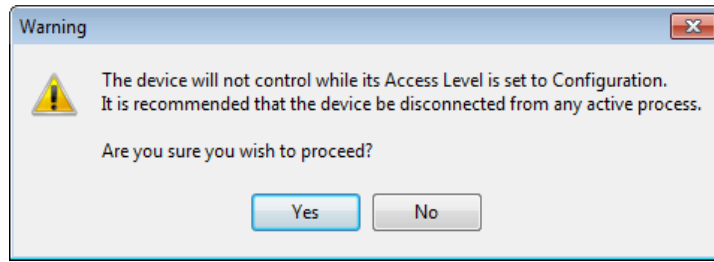

If another session already has the controller in Configuration Mode, a different dialog message is displayed, advising that the request to enter Configuration mode from this session may not be successful.

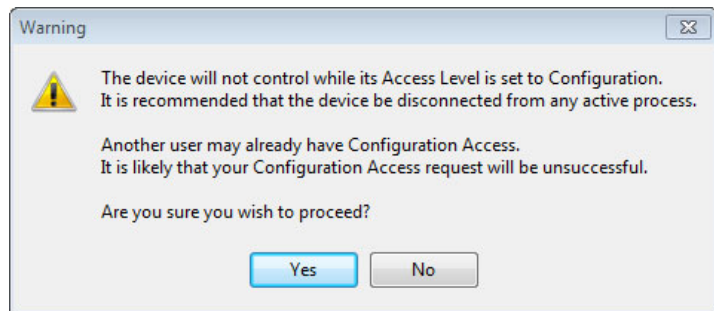

Select 'Yes' if the process is not on line. You will be prompted to enter the Comms password.

If connected via the CPI clip, no Comms password will be required.

The controller will display the scrolling message COMMS CONFIG ACTIVE together with the letter H.

The controller may now be configured using iTools.

The controller may also be put into configuration mode.

If the controller is already in Configuration level and then  is selected in iTools a warning is message is shown to alert the user that the controller has configuration access:

It may be possible to continue to put iTools into Configuration level by selecting 'Yes'. The comms password is required as above.

The controller can be configured from both iTools and the HMI but only the last change will be accepted. If Access in iTools is then switched back the controller will also return to Operator Level 1.

Instrument List

The Instrument List is the first list shown in the Browser section of iTools. It allows further features which are not available in the instrument HMI to be set. In particular Security related features including the Comms Config password.

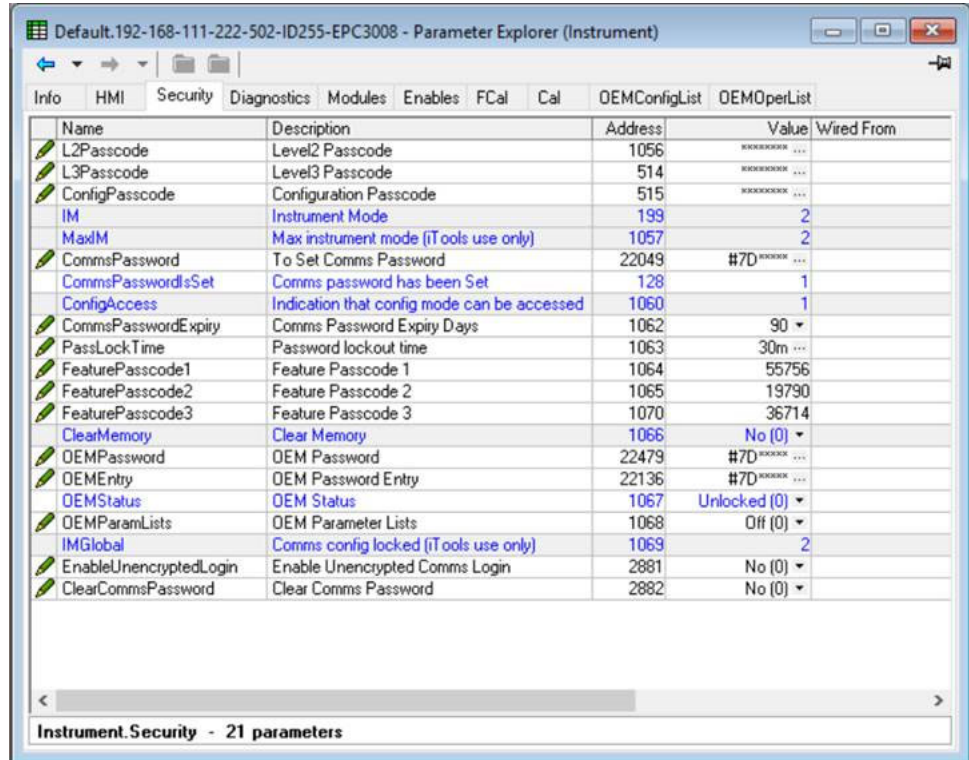

To change the Comms Config password, click on the ellipsis in the value cell on the password dialog window and enter a new value.

The parameter 'Comms password Expiry Days' defaults to 90 days. This parameter sets the number of days after which the comms configuration password will expire. This will generate a message informing the user that the password needs changing.

The 'COMMS CONFIG password EXPIRED' notification appears as a scrolling message in the display if password expires but can be disabled by setting Instrument.Security.CommspasswordExpiry to '0'.

Note: However, this is not recommended as it potentially could lead to unauthorized access to the instrument's configuration.

Feature passwords

Feature passwords are required to enable chargeable features. These can be added after the controller has been supplied. Examples of chargeable features include Programmer Types, Toolkit Blocks, some Digital Communications protocols, etc.

To add a new chargeable feature contact your supplier who will request the current values of the feature passwords. New values will then be provided to be entered to update to the new feature.

Three login attempts are allowed before lockout followed by a lockout period of 30 minutes.

Terminal Editor

Select 'Terminal Wiring' on the main tool bar.

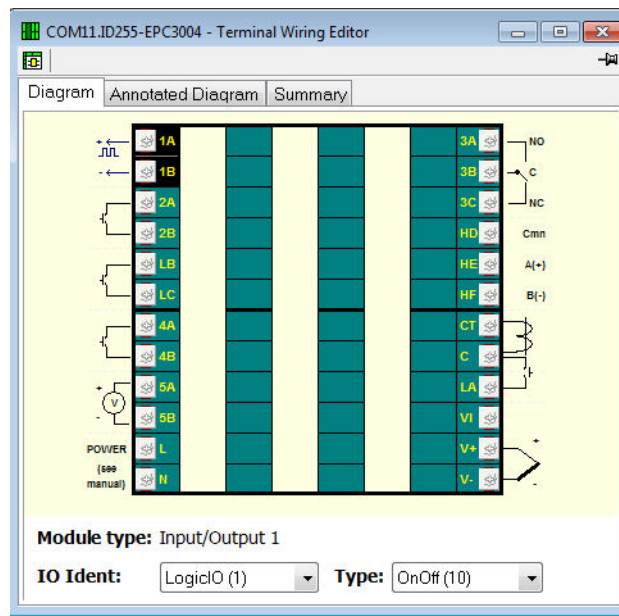

From this view click on a set of terminals representing an IO module. In the 'IO Ident' drop down select an IO type. The diagram of the type of IO will be shown against the chosen terminal set.

An Annotated Diagram and Summary of wiring can also be viewed.

Graphical Wiring

Graphical wiring provides a means of connecting function blocks together to produce a unique process. If the controller has been ordered or configured using the Quick Codes for a particular application then an example of the application has already been produced and is intended as a starting point for the user to modify as required, where permitted.

Select 'Graphical Wiring' on the main toolbar.

⚠ WARNING

UNINTENDED EQUIPMENT OPERATION

This operation will require the controller to enter configuration mode. Ensure that the controller is not connected to an active process.

Failure to follow these instructions can result in death, serious injury or equipment damage.

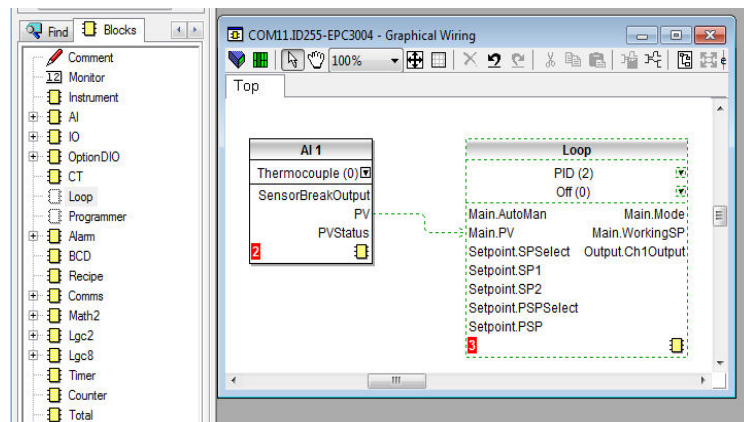

A list of function blocks is shown in the left hand side. Blocks are dragged and dropped from the list into the Graphical Wiring section on the right.

They are 'soft wired' together to produce the application. The above example shows the Analog Input 1 block wired to the PV input of the loop. This is produced by clicking on the 'PV' parameter of the Analog Input block and dragging to the 'Main PV' parameter of the Loop block. It is important to note that the value of a wired parameter cannot be manually changed since it takes on the value of the parameter it is wired from. The blocks and wires are shown dotted until the controller is updated using the 'Download Wiring to Instrument' button in the top left corner of the Graphical Wiring section.

For a full description of graphical wiring, please refer to the iTools User Manual HA028838.

50 wires are available as standard, with 200 wires available if the enhanced Toolkit option has been ordered.

If a controller is ordered or configured for a specific application it will already have the wiring in place. Examples are displayed in "Applications" on page 228. Generally Application specific wiring is intended as a starting point which can be modified by the user to suit a particular process, with the exception to the Factory Mutual (FM) approved version.

Note: The EPC3000 FM version is only available with preconfigured applications to order/load, which are mandatory, hardcoded and comply with the approved FM associated functionality - see "Applications" on page 228, for further details.

If the controller is ordered unconfigured it will be necessary for the user to wire the function blocks to suit the particular application.

Some examples of graphical wiring are shown in the following sections.

Note: The following examples may differ depending on the version of controller. The EPC3000 FM version may differ, with regard to the function block numbering as AI1, Alarm 1 and Alarm 2, OR1 and IO OP3 will already be utilized for specific pre-configured application. The examples demonstrate the graphical wiring and function block and associated connections, see "Applications" on page 228 for further details.

Example 1: To Wire an Alarm

Unless specifically produced in an application, any alarm which is required must be wired by the user.

The example below shows an absolute high alarm monitoring the Process Variable. This is a 'soft' alarm in that it does not operate a physical output.

1. Drag and drop an alarm function block into the graphical wiring editor.
2. Drag and drop an analog input block into the graphical wiring editor.
3. Click on 'PV' of the input block and drag a wire to 'input' of the alarm block.
4. At this stage the wire is shown dotted and it must be transferred to the controller by clicking the 'Download Wiring to Instrument' button  in the top left hand corner of the Graphical Wiring view.

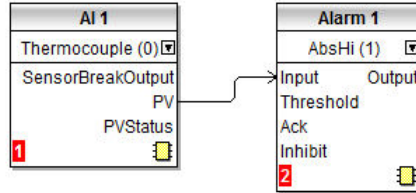

Example 2: To Connect an Alarm to a Physical Output

To make a soft alarm operate an output it must be 'wired'.

1. Drag and drop an alarm function block into the graphical wiring editor.
2. Drag and drop an output block into the graphical wiring editor.
3. Click on the 'Output' of the Alarm block and drag the wire to the 'PV' input of the output block.
4. At this stage the wire is shown dotted and it must be transferred to the controller by clicking the 'Download Wiring to Instrument' button

The example shown below uses Alarm 4 and IO2 (configured for On/Off output).

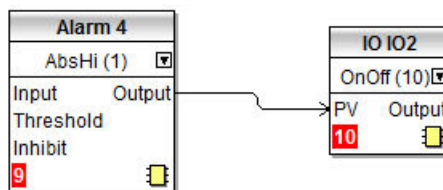

Example 3: To Wire Sensor Break

If a sensor condition is required to operate an output it must be wired as shown in the example below.

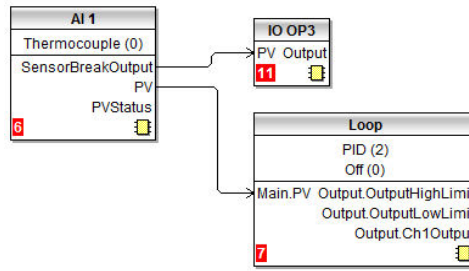

Sensor Break Alarm with Latching

In the above example a sensor break alarm has no latching ability. If latching is required the sensor break output can be wired to an alarm function block configured as a digital alarm which can be configured for auto or manual latching. A wiring example is shown below:

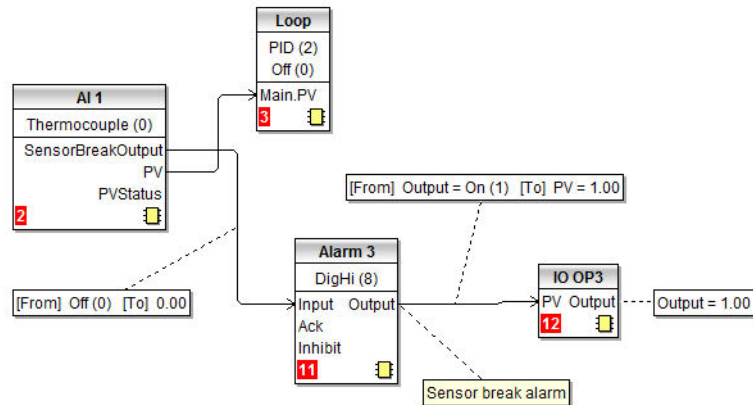



Example 4: To Configure a Bargraph

In this example the bargraph will be wired to the PV input connected to Analog Input 1.

1. Drag and drop the 'Instrument' function block into the graphical wiring editor.
2. Drag and drop an 'AI1' block into the graphical wiring editor.
3. Click on the 'PV' of the AI1 block and drag the wire to the 'HMI.BargraphPV' in the Instrument block.

To apply limits to the bargraph:

4. In the AI1 function block click  to open the list of parameters. Then click  to show all connections.
5. Drag InputHigh to HMI.BargraphMax in the Instrument block.
6. Drag InputLow to HMI.BargraphMin in the Instrument block.

- 7. Click the 'Download Wiring to Instrument' button.

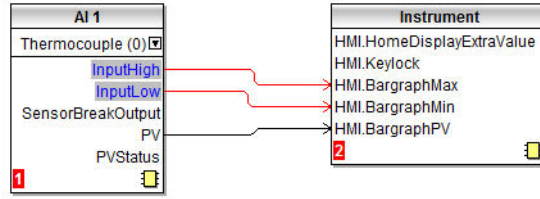

The above example will cause the bargraph to display the PV from AI1. Another typical requirement is for the bargraph to show the output demand value. This may be wired in a similar way by wiring the channel output to the HMI.BargraphPV as shown below.

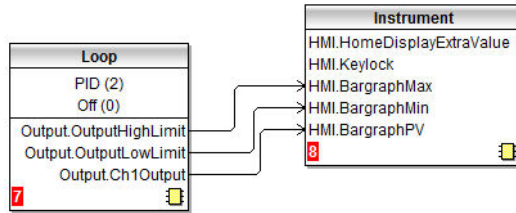

Example 5: To Wire a Retransmission Output

In this example, Analog Output 1 (IO1) is required to read 0 volts for a PV input of 0.0 and 10 volts for a PV of 500.0.

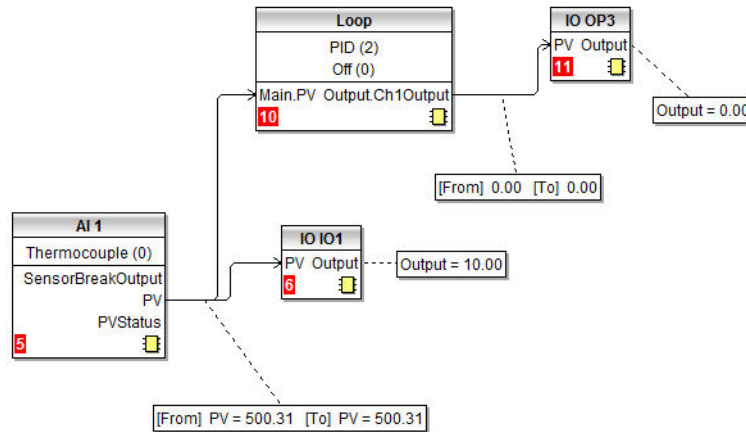

The diagram shows a simple loop where the control output is connected to Output 3 and the PV is wired to Analog Output 1 configured for 0 - 10V.

Name	Description	Address	Value
Ident	IO hardware ID	12672	DCOut (4)
Type	Type of input/output	12675	VOP (1)
PV	Process variable	1952	500.37
Status	PV Status	1953	Good (0)
DemandHigh	Demand High	12686	500.00
DemandLow	Demand low	12687	0.00
OutputHigh	Output high	12688	10.00
OutputLow	Output low	12689	0.00
Output	Output	1958	10.00

IO.I01 - 17 parameters

In the IO1 settings adjust Demand Low to 0.0 and Demand High to 500.0.

The Output High and Output Low parameters may be adjusted to limit the analog output if required. For example, set OutputHigh to 8.0V and OutputLow to 1.0V. The retransmission will then read 1.0V for a PV of 0.0 and 8.0V for a PV of 500.0.

Applications

The EPC3000 Factory Mutual (FM) controller is supplied with 2 default applications, which are preconfigured and both contain five function blocks that are hardcoded and interlinked, therefore cannot be removed, deleted or separated - even if the product is cold started. Some user configuration is possible, see below for further details.

EPC3000 FM Limit Alarm - High

Once selected at start up stage (see [Start Up Modes](#) and [Start Up—New Unconfigured Controller](#)) the EPC3000 FM Limit Alarm - High application, automatically configures the controller and provides the following functionality;

- provides a High limit alarm function, which meets the requirements of Factory Mutual (FM) Approval Standard **FM 3545 - Temperature Limit and Supervisory Switches**
- monitors the temperature Process Variable (PV) value, as well as the sensor status
- alarms, when the PV input is higher than the alarm threshold, or if a sensor break event happens
- high limit alarm events, when triggered must be reset manually and will only change when PV returns within the setpoint limit

Note: Additional wiring maybe added to the application, to provide further design but the function blocks providing the FM High limit alarm function cannot be removed, and will be reinstated if removed by mistake.

FM Limit Alarm (High) - Wiring

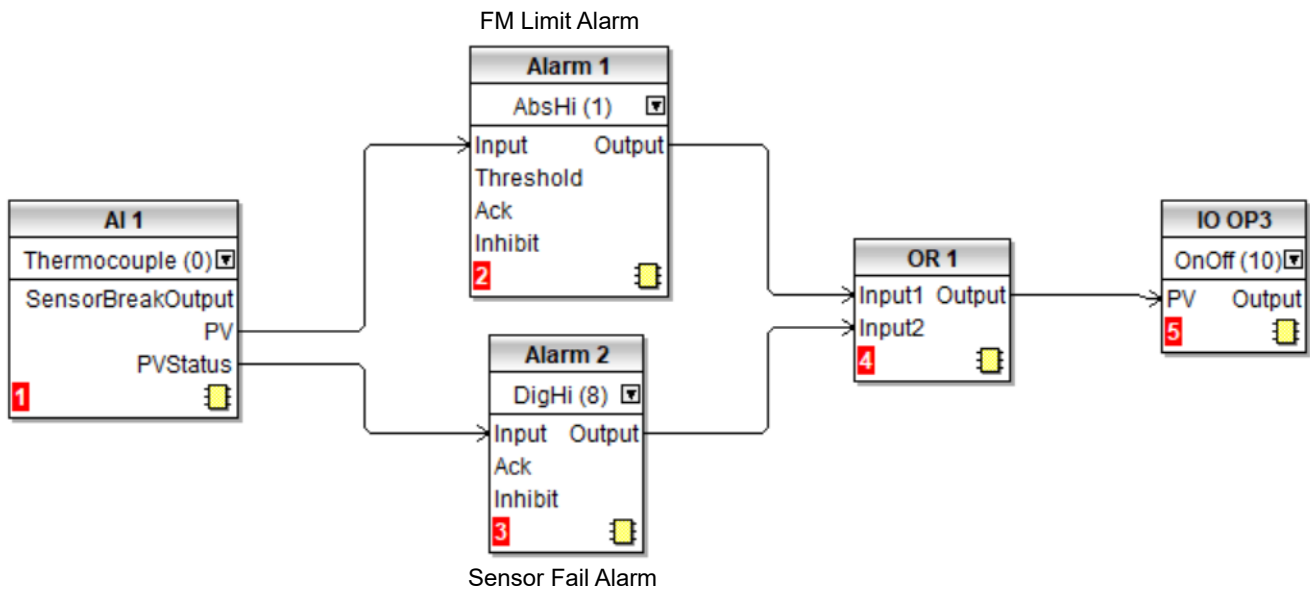

Analog Input 1 (AI 1)

A thermocouple is connected to Analog Input AI1 (1) and in turn the;

- PV output from AI1 is supplied to the Input of Alarm 1 (2), see [Alarm 1 - FM Limit Alarm \(High\)](#)
- PVStatus from AI1 is supplied to Input of Alarm 2 (3), see [Alarm 2 - Sensor Fail Alarm](#).

Alarm 1 - FM Limit Alarm (High)

In this application Alarm 1 (2) function block, is the Factory Mutual (FM) Limit Alarm - High. The function block is preconfigured as an Absolute High alarm that monitors the Process Variable and alarms when the PV input is higher than the alarm threshold.

This is a 'hard' alarm meaning it operates, controls a physical output - see [Output 3 \(IO OP3\) Alarm connections](#).

Note: PV for FM Limit alarm high fails upscale, so this is not configurable only selectable at startup - see [Start Up—New Unconfigured Controller](#).

Alarm 2 - Sensor Fail Alarm

In this application the Sensor Fail Alarm function block monitors the Process Variable status (PVStatus) of Analog Input 1(AI 1) (1), constantly checking the PV is operating and alarms if the sensor becomes open circuit or reads out of range.

This is a 'hard' alarm meaning it operates, controls a physical output - see [Output 3 \(IO OP3\) Alarm connections](#).

OR Function Block (OR1)

A Logic OR function block modified for the FM Limit Alarm High application, which only allows the 2 preconfigured inputs (Input1, from Alarm 1 and Input2, from Alarm 2) to be wired to a single Boolean parameter OR 1 (4).

NOTE: No user configuration is required - default configuration only. (All Read/Write availability is locked and the input settings are hardcoded as Input1: Wired from Alarm.1.Output and Input2: Wired from Alarm.2.Output.

Output 3 (IO OP3) Alarm connections

Both alarms, Alarm 1 (2) and Alarm 2 (3) are wired, via an OR 1 (4) block to output IO OP3 (5), which is mandatory configured as an On/Off output.

Therefore, the relay that is connected to output IO OP3 (5), goes high whenever;

- an alarm event is determined by Alarm 1 (2)
- and/or a sensor break or PV Status alarm is determined by Alarm 2 (3).

EPC3000 FM Limit Alarm - Low

Once selected at start up stage (see [Start Up Modes](#) and [Start Up—New Unconfigured Controller](#)) the EPC3000 FM Limit Alarm - Low application, automatically configures the controller and provides the following functionality;

- provides a Low limit alarm function, which meets the requirements of Factory Mutual (FM) Approval Standard **FM 3545 - Temperature Limit and Supervisory Switches**
- monitors the temperature Process Variable (PV) value, as well as the sensor status
- alarms when the PV input is less than the alarm threshold, or if a sensor break event happens
- low limit alarm events, when triggered must be reset manually and will only change when PV returns within the setpoint limit

Note: Additional wiring may be added to the application, to provide further design but the function blocks providing the FM Low limit alarm function cannot be removed, and will be reinstated if removed by mistake.

FM Limit Alarm (Low) - Wiring

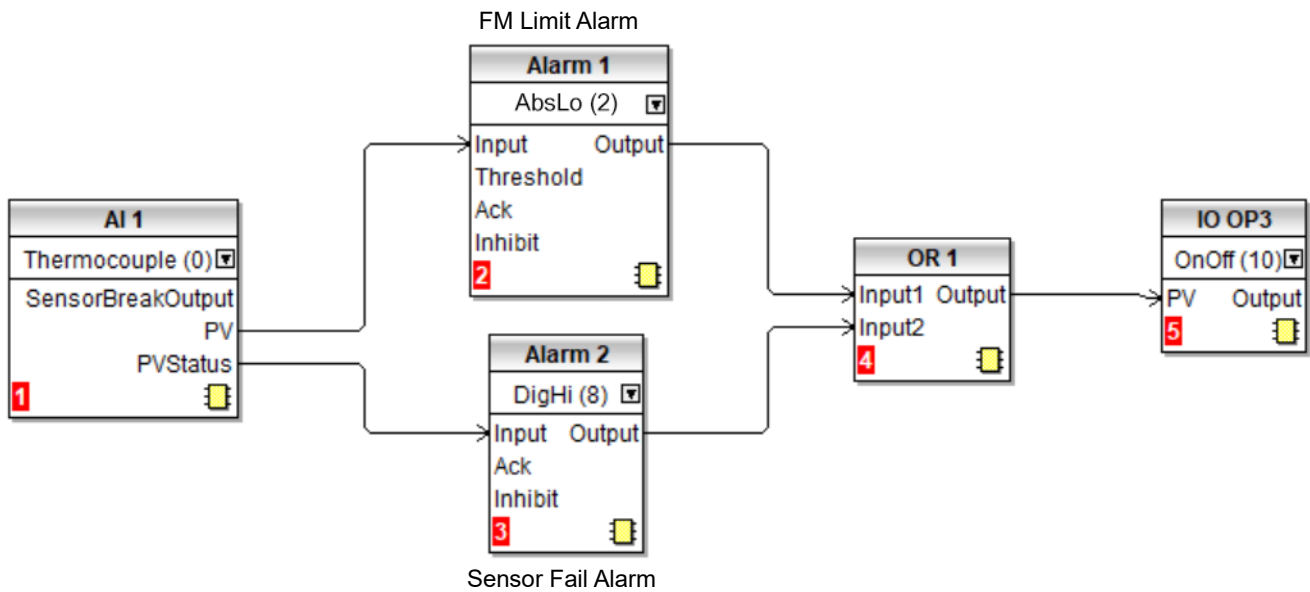

Analog Input 1 (AI 1)

A thermocouple is connected to Analog Input AI1 (1) and in turn the;

- PV output from AI1 is supplied to the Input of Alarm 1 (2), see [Alarm 1 - FM Limit Alarm \(High\)](#)
- PVStatus from AI1 is supplied to Input of Alarm 2 (3), see [Alarm 2 - Sensor Fail Alarm](#).

Alarm 1 - FM Limit Alarm (Low)

In this application Alarm 1 (2) function block, is the Factory Mutual (FM) Limit Alarm - Low. The function block is preconfigured as an Absolute Low alarm that monitors the Process Variable and alarms when the PV input is less than the alarm threshold.

This is a 'hard' alarm meaning it operates, controls a physical output - see [Output 3 \(IO OP3\) Alarm connections](#).

Note: PV for FM Limit alarm Low fails downscale, this is not configurable only selectable at startup - see [Start Up—New Unconfigured Controller](#).

Alarm 2 - Sensor Fail Alarm

In this application the Sensor Fail Alarm function block monitors the Process Variable status (PVStatus) of Analog Input 1(AI 1) **1**, constantly checking the PV is operating and alarms if the sensor becomes open circuit or reads out of range.

This is a 'hard' alarm meaning it operates, controls a physical output - see [Output 3 \(IO OP3\) Alarm connections](#).

OR Function Block (OR1)

A Logic OR function block modified for FM Limit Alarm Low application, which only allows the 2 preconfigured inputs (Input1, from Alarm 1 and Input2, from Alarm 2) to be wired to a single Boolean parameter OR 1 **4**.

NOTE: No user configuration is required - default configuration only. (All Read/Write availability is locked and the input settings are hardcoded as Input1: Wired from Alarm.1.Output and Input2: Wired from Alarm.2.Output.

Output 3 (IO OP3) Alarm connections

Both alarms, Alarm 1 **2** and Alarm 2 **3** are wired, via an OR 1 **4** block to output IO OP3 **5**, which is mandatory configured as an On/Off output.

Therefore, the relay that is connected to output IO OP3 **5**, goes high whenever;

- an alarm event is determined by Alarm 1 **2**
- and/or a sensor break or PV Status alarm is determined by Alarm 2 **3**.

Flash Memory Editor

The Flash Memory Editor edits any device data that needs to be saved to the device flash memory in addition to the OPC function block parameter editing mechanism used for most configuration editing.

This includes:

1. Promote Parameters.
2. User Message Table.
3. Recipe Definition and Recipe data sets.

All these sets of data are presented on a series of tabs as shown in the following views.

WARNING

UNINTENDED EQUIPMENT OPERATION

Any changes made to the controllers flash memory require the controller to enter configuration mode. The controller will not control the process when in configuration mode. Ensure that the controller is not connected to an active process when in configuration mode.

Failure to follow these instructions can result in death, serious injury or equipment damage.

Parameter Promotion

Parameters which are available in Level 1 and Level 2 may be configured to suit the preferences of a particular user.

The name for each parameter can be changed (maximum 5 characters + '.').

⚠ **WARNING**

UNINTENDED EQUIPMENT OPERATION

Ensure that parameters to be promoted are given user defined names.

Failure to follow these instructions can result in death, serious injury or equipment damage.

Some parameters, such as alarm thresholds, have the same default name. This is described in section "User Defined Messages" on page 235.

Select 'Flash Memory' followed by 'Promote Parameters'.

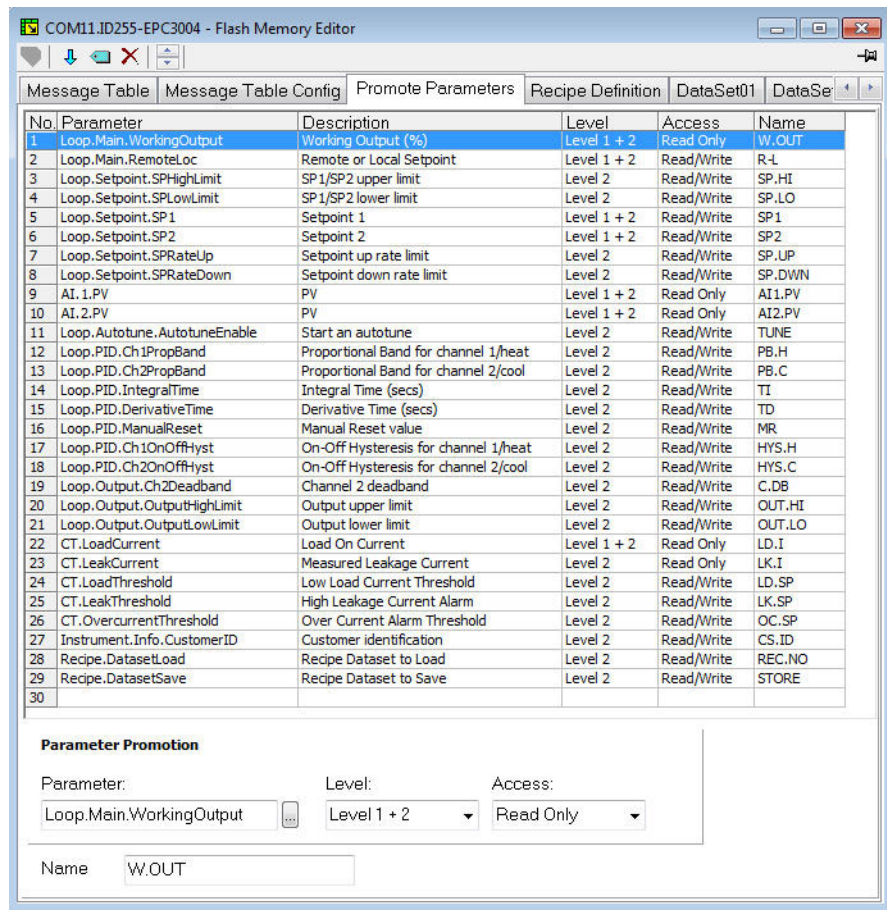

The list shows the parameters which are available in Levels 1 & 2, Level 2 only and whether they are Read Only or Read/Write.

To change the level select the parameter. In the 'Level' drop down select 'Level 1 + 2' or 'Level 2'.

In the Access drop down select 'Read Only' or 'Read/Write'.

Parameters can be added to or removed from the list as follows:

To add a parameter to the list click in the list where you want the item to appear then right click and select 'Insert Item'. A pop up box will appear from which the required parameter can be selected. To remove a parameter from the list, right click on the parameter and select 'Remove Item'.

Alternatively, highlight the blank line at the end of the list or at the point in the list where the item is to appear (in the above example, line 30).

Press the ellipsis in the 'Parameter' drop down. This will open the full list of parameters from which the new parameter can be chosen.

After changes have been made, press the "Download" button  which is located in the top left hand corner of the Flash Memory Editor view.

In order for the controller to be updated it needs to be put into configuration mode. A confirmation message will be shown asking if you wish to proceed.

Changes will not be saved unless the Download button is pressed.

User Defined Messages

Process messages which scroll in the controller display may be customized. Default user messages are overridden if an application is selected via Quick Codes.

Example 1: To Customize Alarm 1 Message

In this example the alarm 1 message will read 'HIGH TEMPERATURE'.

1. Press the Flash Memory  option from the menu bar.
2. Select and press the 'Message Table' tab.
3. Select Parameter 'ALARM1 #1'.

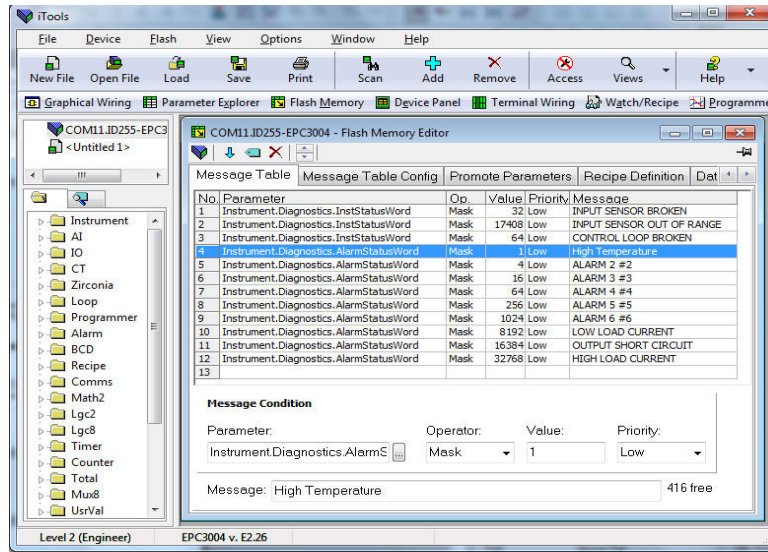

4. In the 'Message' area change 'Message' to HIGH TEMPERATURE.
5. Press 'Update Device Flash Memory' button  to download the new message into the controller. To update the controller it needs to be put into configuration mode. A confirmation message will be shown asking if you wish to proceed.

Note: # is a mechanism which allows values from parameters to be displayed in accordance with the table below:

Escape code	Inserted text
#1	Alarm 1 type (None, High, Low, Deviation High, etc)
#2	Alarm 2 type (None, High, Low, Deviation High, etc)
#3	Alarm 3 type (None, High, Low, Deviation High, etc)
#4	Alarm 4 type (None, High, Low, Deviation High, etc)
#5	Alarm 5 type (None, High, Low, Deviation High, etc)
#6	Alarm 6 type (None, High, Low, Deviation High, etc)
#T	PV value
#U	PV2 value
#O	Active output power value
#S	Working setpoint
#L	CT leak current
#I	CT load current
#C	Custom ID
#Mnnnn	Parameter Mnemonic, where nnnn = parameter modbus address in Hex
##	Displays a single # character

Example 2: To Add Further Parameters

By default iTools shows 12 parameters which can have customized messages. This default message table is overridden if an application has been selected via quick codes.

The user can add further parameters and messages as follows:

Either double click in the next available parameter or click on the ellipsis button.

This opens a list of all available parameters.

In this example the message 'VENT OPEN' will be applied to the LA digital input.

1. Select IO.LA.PV.
2. Type the required message into the 'Message' Area.
3. Press the 'Update Flash Memory' button to download the message to the controller. To update the controller it needs to be put into configuration mode. A confirmation message will be shown asking if you wish to proceed.

When Digital Input LA is activated the scrolling message 'VENT OPEN' will now be displayed in the controller display.

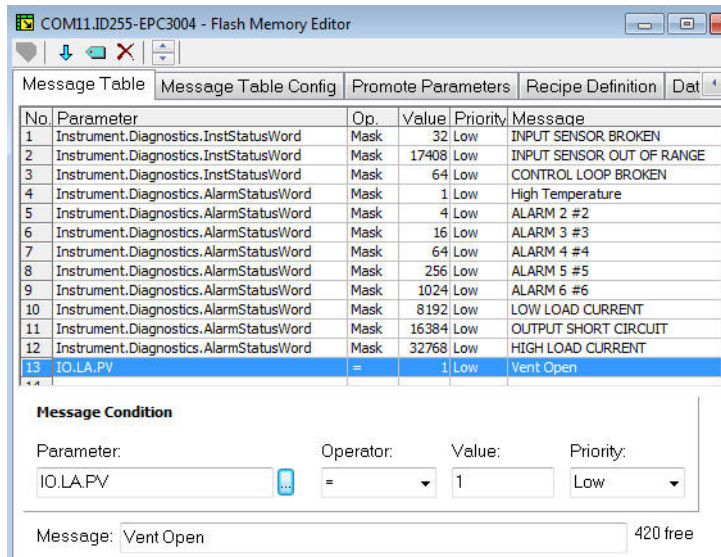

In the 'Operator' drop down it is possible to select:

- = equals the 'Value'
- <> is greater or less than the 'Value'
- > is greater than the 'Value'
- < is less than the 'Value'

Mask is generally used to activate a message for a number of parameters when using a bitmap field.

Recipes

A recipe is a list of parameters whose values can be captured and stored in a dataset which can then be loaded at any time to restore the recipe parameters, thus providing a means of altering the configuration of an instrument in a single operation even in operator mode. Recipes can be set up and loaded using iTools or in the controller itself, see "To Save Recipes" on page 149.

A maximum of 5 datasets are supported, referenced by name, and defaulted to be the dataset number i.e. 1...5.

By default each dataset consists of 40 parameters which must be populated by the user, see "Recipe List (RECP)" on page 147. A recipe can take a snapshot of the current values and store these into a recipe dataset.

Each dataset can be given a name using iTools configuration software.

Recipe Definitions

Select 'Flash Memory' from the main toolbar to open the Flash Editor. Select the 'Recipe Definitions' and 'Recipe Dataset' tabs as required.

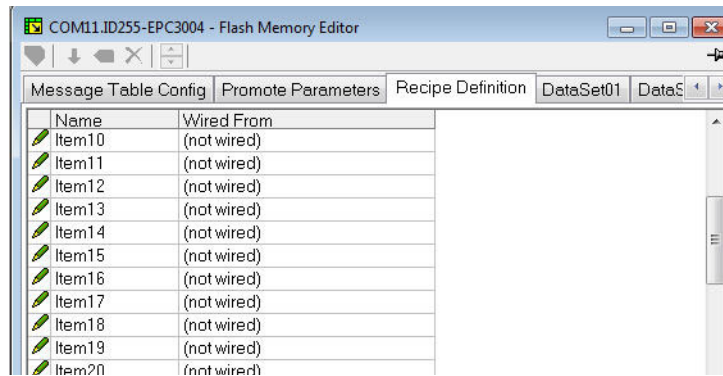

The Recipe Definition table contains a set of 40 parameters. Not all 40 parameters need to be wired.

The Recipe Definition tab allows the user to produce a customized list.

To add parameters:

1. Double click in the next empty item.
2. This opens the parameter list to choose from.
3. Adding a parameter to the list will automatically populate the 5 datasets with the current value of the added parameter.

Data Sets

Up to 5 DataSets are available each being a recipe for a particular batch or process.

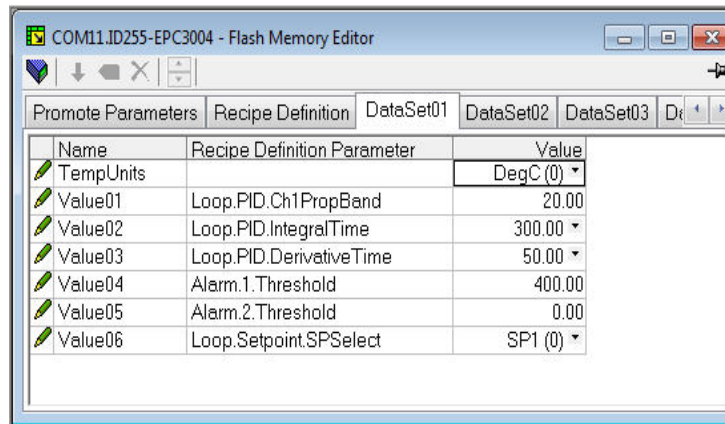

To Save the Data Set

1. Set up the required values in the selected data set—see the example above.
2. Press Enter.
3. Press the 'Update device flash memory' (Ctrl+F) button in the top left of the Flash Memory Editor display to update the controller. This sets the values into all five of the controller datasets. (Note: saving in the controller will save the current values into one dataset).

Since this operation may involve one or more switches between Operator Level and Configuration Level it is recommended that the controller is disconnected from the process. A warning message is shown.

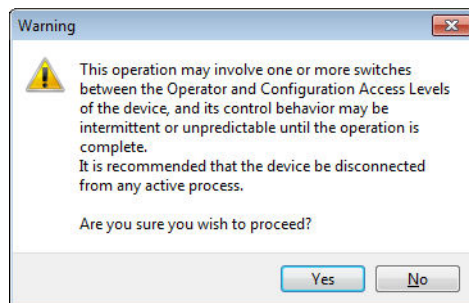

To Load a Data Set

1. In the browser list select 'Recipe'.

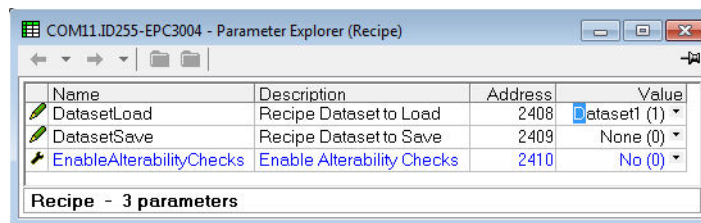

2. Select the required Dataset.

Recipe Names

This tab simply allows a name to be assigned to each of the 5 Recipe data sets. This name will be shown in the controller display.

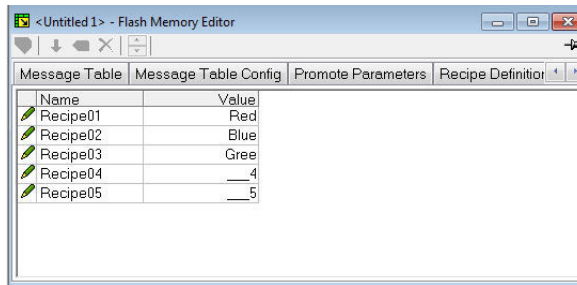

Watch Recipe Editor

Click on the Watch/Recipe tool button, by selecting 'Watch/Recipe' in the Views menu, or via the shortcut (Alt+A). The window is in two parts: the left part contains the watch list; the right-hand part contains a data set, initially empty and unnamed.

Watch Recipes are run from iTools, and are not stored or run from the device, i.e. iTools must be running and connected to a specific device.

The window is used:

1. To monitor a so-called 'watch list' of parameter values. The watch list can contain parameters from many different lists within the same device.
2. To create 'data sets' of parameter values which can be selected and downloaded to the device, in the sequence defined by the recipe. The same parameter may be used more than once in a recipe.

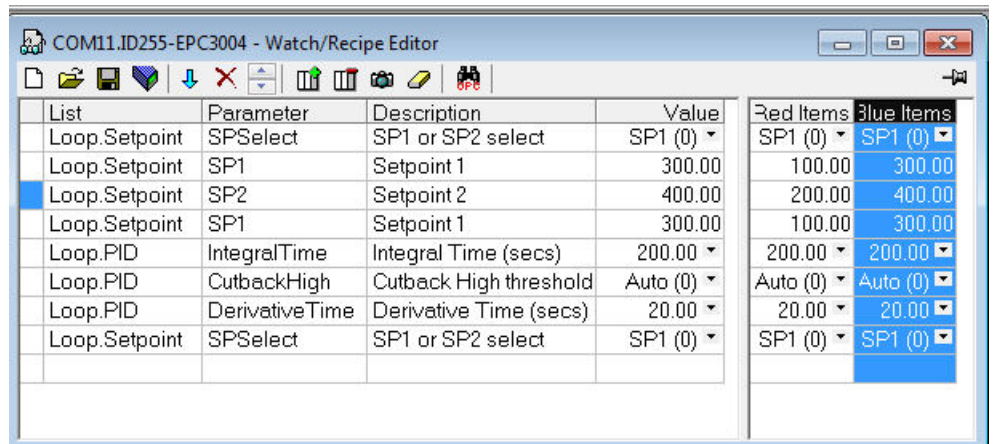

Creating a Watch List

After opening the window parameters can be added to it as described below. Parameters can be added only from the device to which the Watch/Recipe window relates (that is, parameters from more than one device cannot be placed in one Watch list). The values of the parameters update in real time, allowing the user to monitor, simultaneously, a number of parameters which might otherwise be unrelated.

Adding Parameters To The Watch List

1. Parameters can be clicked and dragged into the watch list grid from elsewhere in iTools (for example: the main browse tree, the Parameter Explorer window, the Graphical Wiring Editor (if applicable)). The parameter is placed either in the empty row at the bottom of the list, or 'on top' of an existing parameter, in which case it is inserted above this parameter in the list, the remaining parameters moving down one place.
2. Parameters can be dragged from one position in the list to another. In such a case, a copy of the parameter is produced: the source parameter remains in place. Parameters can be also be copied by using the 'Copy Parameter' item in the Recipe or right mouse-click menu, or by using the short cut (Ctrl+C). Data set values are not included in the copy.

3. The 'Insert item...' tool button, the 'Insert Parameter' Recipe menu item or the shortcut <Insert> can be used to open a browse window from which a parameter can be selected. The selected parameter is inserted above the currently active parameter.
4. A parameter can be 'copied' from (for example) the Graphical Wiring Editor and subsequently 'pasted' into the watch list using the 'Paste Parameter' item in the Recipe menu, or the right mouse click context menu (short cut = Ctrl+V).

Creating a Data Set

All the parameters required for the recipe should be added to the watch list, described above.

Once this has been done, if the empty data set is selected (by clicking on the column header), the 'Snapshot' tool button (Ctrl+A) can be used to fill the data set with the current values. Alternatively, the 'Snapshot Values' item in the Recipe or context (right click) menu or the shortcut + can be used to fill the data set.

Individual data values can now be edited by typing directly into the grid cells. Data values can be left blank or cleared, in which case, when the recipe is downloaded, no value will be written for those values. Data values can be cleared by deleting all the characters in the field, then, either moving to a new cell, or typing <Enter>.

The set is called 'Set 1' by default. The name can be edited by using the 'Rename Data Set...' item in the Recipe or right mouse-click menu, or by using the shortcut (Ctrl+R).

New data sets can be added and edited in the same way, by using the 'Create a new empty....' tool button (Ctrl+W), or by selecting the 'New Data Set' item in the Recipe or right mouse-click menu, or by using the shortcut +

Once all the data sets required for the Recipe have been created, and saved, they can be downloaded to the device, one at a time, using the download tool (Ctrl+D), or equivalent Recipe/context menu item.

To Load a Custom Linearization Table

In addition to the built in standard linearization tables, custom tables can be downloaded from files.



1. Press .
2. Select the linearization table to be loaded from files with the extension .mtb. Linearization files for different sensor types are supplied with iTools and may be found in Program Files → Eurotherm → iTools → Linearisations → Thermocouple etc.

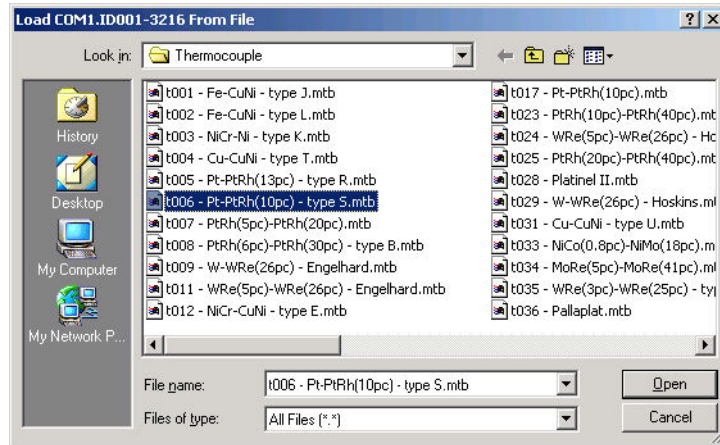

In this example a Pt-PtRh(10%) thermocouple has been loaded into the controller.



The controller will display the linearization table downloaded:-

Cloning

The cloning feature allows the configuration and parameter settings of one instrument to be copied into another. Alternatively a configuration may be saved to file and this used to load into connected instruments. The feature allows new instruments to be rapidly set up using a known reference source or standard instrument. Every parameter is downloaded to the new instrument which means that if the new instrument is used as a replacement it will contain exactly the same information as the original. Cloning is generally only possible if the following applies:

- The target instrument has the same hardware configuration as the source instrument.
- The target instrument firmware (i.e. Software built into the instrument) is the same as or a later version than that of the source instrument. The instrument firmware version is displayed on the instrument when power is applied.
- Generally, cloning will copy all operational, engineering and configuration parameters that are writable. The communications address is not copied.
- A clone file cannot be generated if the OEM Security option is configured and active.

WARNING

UNINTENDED EQUIPMENT OPERATION

It is the users responsibility to ensure that the information cloned from one instrument to another is correct for the process to be controlled, and that all parameters are correctly replicated into the target instrument

Failure to follow these instructions can result in death, serious injury or equipment damage

Every effort has been made to ensure that the information contained within the clone files is a replica of that configured in the instrument.

Below is a brief description of how to use this feature. Further details are available in the iTools Manual.

Save to File

The configuration of the controller made in the previous sections may be saved as a clone file. This file can then be used to transfer the configuration to further instruments.

From the File menu use 'Save to File' or use the 'Save' button on the Toolbar.

To Clone a New Controller

Connect the new controller to iTools and Scan to find this instrument as described at the beginning of this chapter.

From the File menu select 'Load Values From File' or select 'Load' from the toolbar. Choose the required file and follow the instruction. The configuration of the original controller will now be transferred to the new controller.

Clone Load Unsuccessful

A Message Log is produced during the cloning process. The log may show a message such as 'Cloning of device completed with 1 unsuccessful entry'. This can be caused by writing a parameter using iTools that is outside of the resolution of a parameter. For example, the parameter Filter Time Constant is stored in the controller to one decimal place (1.6 seconds by default). If it is entered as an IEEE float value using iTools, as, for example, 1.66 it will be rounded up in the controller to 1.7 seconds. Under these circumstances it is possible that 'Clone Load Unsuccessful' can occur because iTools expects a value of 1.66 and the instrument contains 1.7. Values should, therefore, be entered, when using iTools, within the resolution of the parameter.

This cannot happen from values entered via the front panel but only if entered over communications.

Cold Start

A Cold Start may be necessary if it is required to return the controller to its default conditions when it left the factory. A cold start can only be carried out when the controller is in configuration mode.

⚠ CAUTION	
COLD START	
A cold start of the controller must only be carried out under exceptional circumstances as it will erase ALL previous settings and return the controller to its original state.	
A controller must not be connected to an active process when performing a cold start.	
Failure to follow these instructions can result in injury or equipment damage.	

To Perform a Cold Start

In the 'Instrument' list 'Security' tab set the Configuration Passcode to 9999. The parameter 'Clear Memory' will become available. Set this to Yes. The controller restarts, resulting in the quickcode setup screen on the HMI (see "Start Up—New Unconfigured Controller" on page 68).

Alarms

What is in this Chapter

- This chapter provides a description of alarm types used in the controllers.
- Definitions of alarm parameters.

What are Alarms?

For the purposes of this section alarms alert an operator when a pre-set threshold, determined by the user as applicable to his particular process, has been exceeded.

Unless they have been produced in a particular application, in EPC3000 series controllers there are no specific alarms. It is then necessary to wire alarm blocks using iTools (see "Graphical Wiring" on page 223).

They are indicated by flashing the red  beacon in the display. The green PV value will also turn red. If using the default user messages, a message will scroll indicating which alarm is active. The scrolling message may be customized using iTools (see "User Defined Messages" on page 235).

Alarms may also switch an output, usually a relay, to allow external devices to be activated when an alarm is active (see "Example 2: To Connect an Alarm to a Physical Output" on page 224).

Up to 6 process related alarms can be configured in all models.

Alarms can also be configured as 'Events'. If an alarm has been configured as an event, when it is active it will not be annunciated on the HMI or in the Instrument Alarm Status Word. Events may be used to operate an output.

Alarm Types

There are 4 distinct types of alarm; Absolute, Deviation, Rate of Change and Digital. These are split into the following 9 alarm types. The descriptions for these 9 alarm types are for the algorithms only, blocking and latching is applied separately, after the active/working state has been determined (See "Blocking" on page 252).

Absolute High

The Absolute High alarm is active when the input is greater than the threshold. It remains active until the input falls below the threshold minus the hysteresis value.

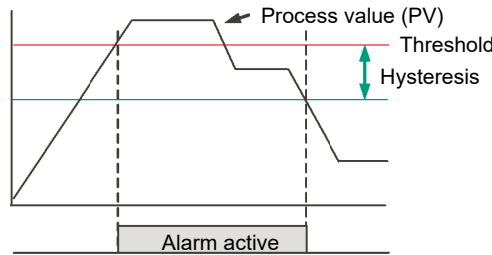

Absolute Low

The Absolute Low alarm is active when the input is less than the threshold. It remains active until the input increases above the threshold plus the hysteresis value.

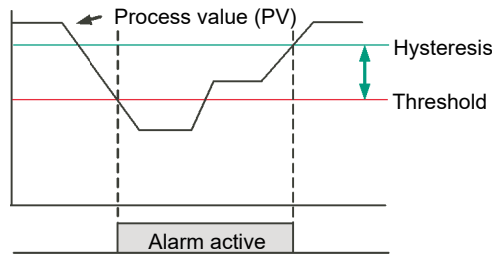

Deviation High

The alarm is triggered when the input becomes higher than the reference by the amount of the deviation. It remains active until the input falls below the hysteresis value.

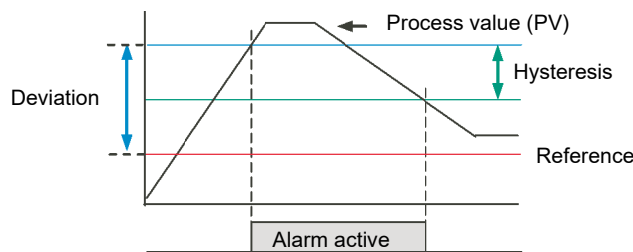

Deviation Low

The alarm is triggered when the input becomes lower than the reference by the amount of the deviation. It remains active until the input increases above the hysteresis value.

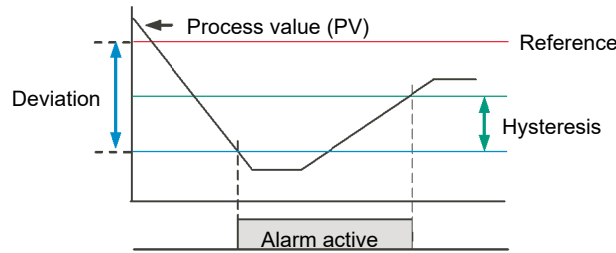

Deviation Band

The Deviation Band alarm is a combination of Deviation High and Deviation Low alarms. The alarm will be active when the input goes outside the deviation band i.e. is greater than the reference plus the deviation OR is less than the reference minus the deviation. It remains active until the input returns to within the reference value, plus/minus the deviation, minus/plus the hysteresis value.

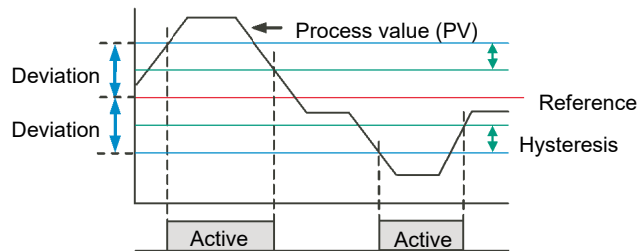

Rising Rate of Change

The Rising Rate of Change alarm sets the alarm active when the rate at which the input increases exceeds the configured maximum rate of change (per change time). It will remain active until the rising rate of the input falls below the configured rate of change.

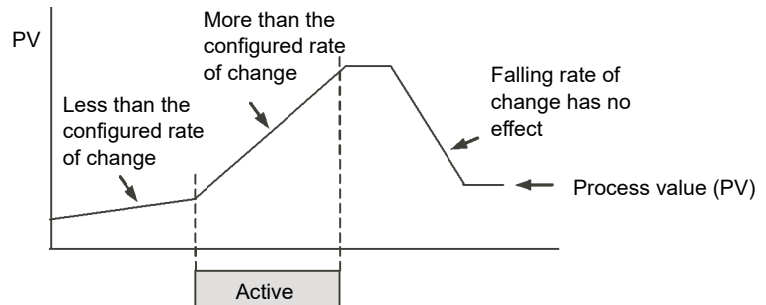

Falling Rate of Change

The Falling Rate of Change alarm sets the alarm active when the rate at which the input decreases exceeds the configured maximum rate of change (per change time). It will remain active until the falling rate of the input falls below the configured rate of change.

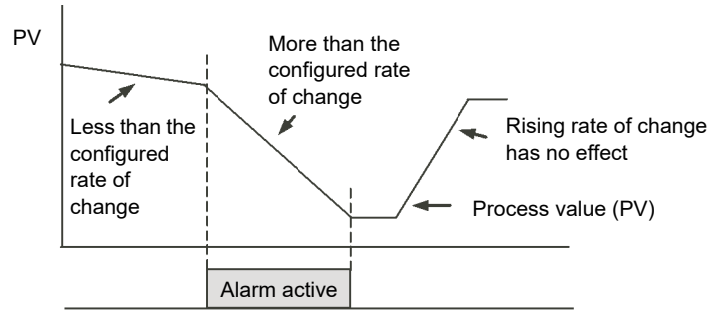

Digital High

The Digital High alarm is effectively an Absolute High alarm with a fixed threshold of 0.5 and 0 hysteresis. It sets the alarm to active when the input is greater than 0.5 (HIGH/TRUE for a digital/boolean input).

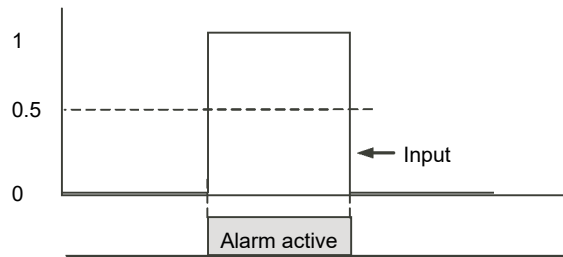

Digital Low

The Digital Low alarm is effectively an Absolute Low alarm with a fixed threshold of 0.5 and 0 hysteresis. It sets the alarm to active when the input is less than 0.5 (LOW/FALSE for a digital/boolean input).

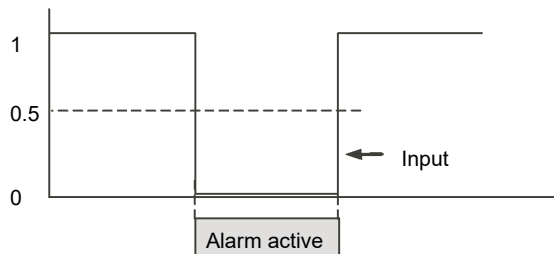

Sensor Break

If the process sensor becomes open circuit an alarm can be generated. The chosen application may already do this, but, if not it must be wired. This is shown in section "Example 3: To Wire Sensor Break" on page 225.

Hysteresis

Hysteresis helps to prevent an alarm output from oscillating (rapidly switching between active and non active) due to electrical 'noise' on the monitored parameter. As illustrated in the diagram below, the alarm will become active as soon as the alarm condition has been met (that is, the monitored parameter crosses the threshold value), however, it will only become inactive when the monitored parameter has gone into the region defined by the hysteresis amount.

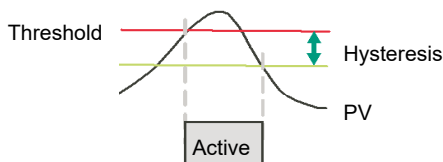

Hysteresis can be disabled by setting a value of 0.0, this is the default value.

Hysteresis is supported for the following analog alarm types: AbsHi, AbsLo, DevHi, DevLo, DevBand.

Delay

Alarm Delay is supported for all alarm types. This is a small delay between sensing the alarm condition and acting upon it. If in the time between the two, the measured value returns to below the threshold, then the alarm will not be activated and the delay timer is reset.

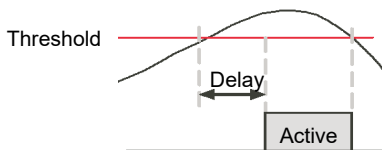

Effects of Delay and Hysteresis

The following diagrams show the effect of delay on hysteresis (for a very out of control process!).

Deviation High

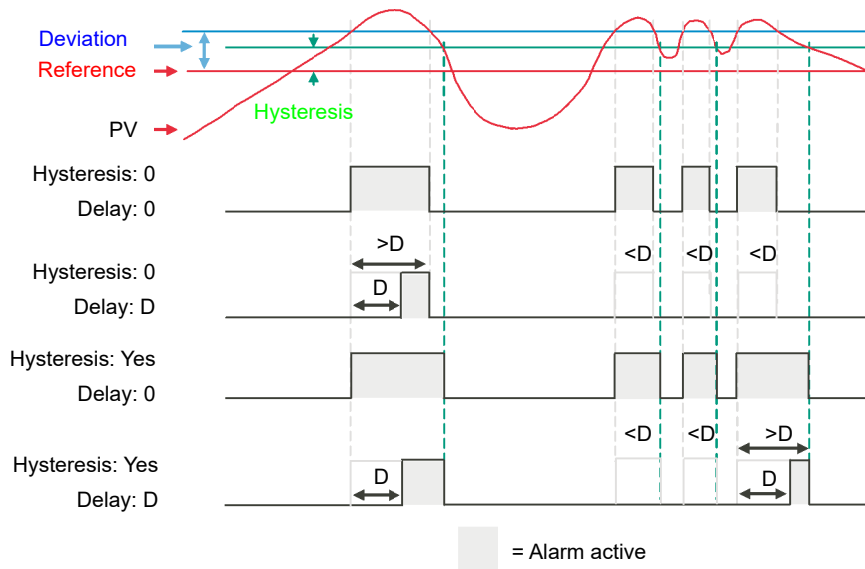

Deviation Low

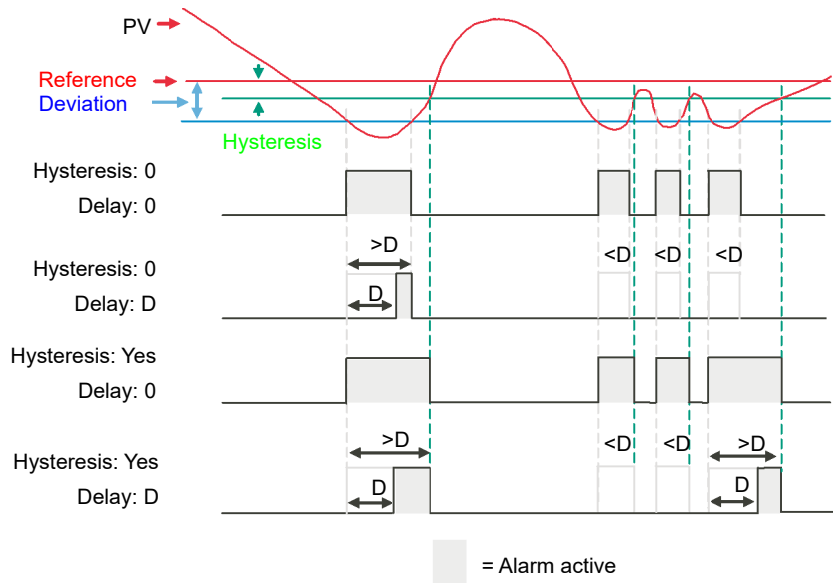

Deviation Band

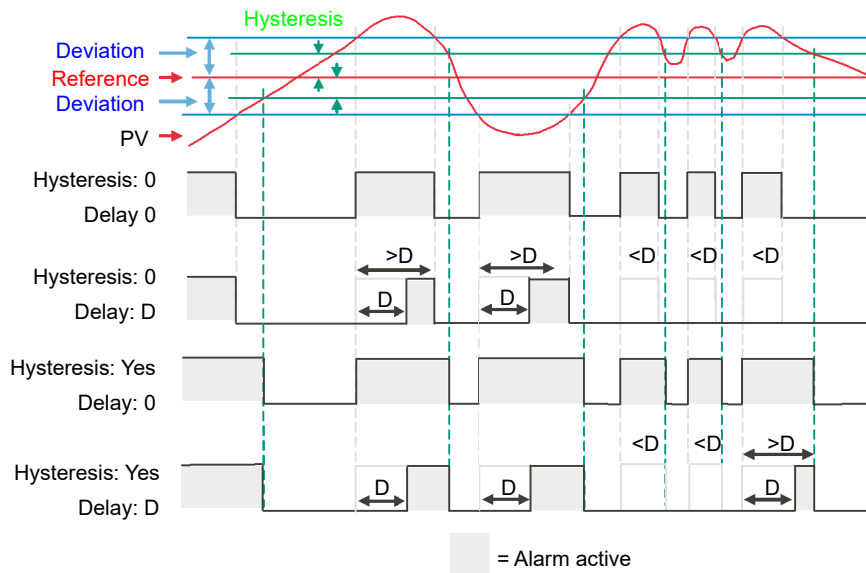

Inhibit

Inhibit helps to prevent an alarm from activating when the Alarm Inhibit input is held High. Alarm Inhibit is supported for all alarm types.

Standby Inhibit

Standby inhibit helps to prevent an alarm from activating when the instrument is in Standby "Standby" on page 77. This includes when the instrument is in configuration mode. Alarm Standby Inhibit is supported for all alarm types.

Latching

Alarm latching is used to hold the alarm condition active once an alarm has been detected.

The following latching types are supported for all alarm types:

Type	Description
None	No latching methodology i.e. when the alarm condition is removed the alarm will become inactive without being acknowledged.
Auto	The alarm will remain active until the alarm condition has been removed and the alarm has been acknowledged. The alarm can be acknowledged at any time after the alarm has become active.
Manual	The alarm will remain active until the alarm condition has been removed and the alarm has been acknowledged. The alarm can only be acknowledged after the alarm condition has been removed.
Event	Same as a non-latching alarm except the alarm is used as a trigger and therefore will not be displayed.

Blocking

Blocking stops an alarm from being activated until the value of the monitored parameter (for example PV) has first achieved the desired working state. It is typically used to ignore start-up conditions which are not representative of running conditions. Blocking of alarms is supported for all alarm types.

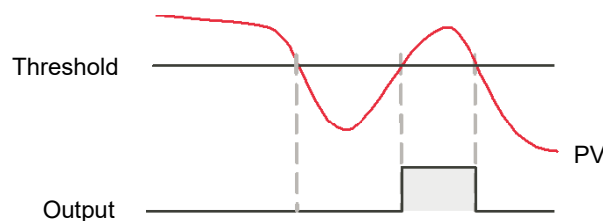

Blocking will be enforced after a power-cycle or after exit from configuration depending upon the latching status of the alarm as follows:

- For a non-latching alarm or an event alarm, blocking will be enforced.
- For an auto-latching alarm, blocking will be enforced only if the alarm had been acknowledged prior to the power cycle or exit from configuration level.
- For a manual-latching alarm, blocking will not be enforced.
- Blocking will be enforced for a Deviation alarm if the reference value is changed. It should be noted that if the reference value is wired from an electrically 'noisy' input then blocking should be disabled otherwise the alarm will continually be blocked.
- Blocking will be enforced, regardless of current active state and latching method, if the alarm is inhibited (either inhibit or standby inhibit).



To Set Alarm Threshold

The levels at which absolute high and absolute low process alarms operate are adjusted by the **threshold** parameter, *THL*, found, by default, in Level 3 or Configuration Level.

It is also possible to 'promote' the threshold parameters to Levels 1 and 2 using iTools (see "Parameter Promotion" on page 233).

Select the appropriate operating level as described in "Operator Levels" on page 79.

Press  until the required alarm threshold is shown.

Press  or  to raise or lower the alarm threshold.

Alarm Indication

If any alarm is active and not acknowledged, the red  beacon will flash and the scrolling message will show the alarm number and its type, for example *ALARM 1 RISH*. When any alarm is active and not acknowledged then the PV value on the top line will be red.

If more than one alarm is present each alarm message is scrolled in turn.

The alarm beacon will only turn off when all alarms are not active and have been acknowledged (if required).

Any output (usually a relay) attached to an alarm will operate and its corresponding beacon will be lit. To attach an output to an alarm see "Example 2: To Connect an Alarm to a Physical Output" on page 224.



It is normal to configure the relay to be de-energized in alarm so that an alarm can be indicated externally if power to the controller is removed.

To Acknowledge an Alarm





When on the Home page, by default press  and  together. This is true unless the functionality of these buttons has been changed using the PS.Fn parameter, see "Display Functionality Sub-List (Hml)" on page 195.

If the alarm is still active the  beacon will go steady but the scrolling message still shows.

There are other ways in which an alarm can be acknowledged:

1. In Level 3 or Configuration level select the list header which applies to the alarm then scroll to the parameter *ACK* - acknowledge. Then press  or  to *YES*. This reverts to *NO* as soon as the command is confirmed.
2. The ACK parameter can be 'promoted' to levels 1 or 2 using iTools in which case it appears in the chosen operator list. See "Parameter Promotion" on page 233.
3. F1 or F2 function keys can be configured to alarm acknowledge. See "Display Functionality Sub-List (Hml)" on page 195.
4. A digital input can be wired using iTools to alarm acknowledge. The procedure is the same as described in section "Example 2: To Connect an Alarm to a Physical Output" on page 224.
5. Use the "Global Ack" parameter in the instrument block to acknowledge all alarms.

The action which takes place depends on the latching type of the alarm configured. The following table shows a step by step action which takes place in the controller:

<i>NonE</i>	Non latching	A non latching alarm will reset itself when the alarm condition is removed. If it is still present when acknowledged the  beacon illuminates constantly, the scrolling alarm messages remain and the output remains active.	
<i>Auto</i>	Automatic	An auto latching alarm requires acknowledgement before it is reset. The acknowledgement can occur BEFORE the condition causing the alarm is removed. An example of the action for Alarm 1 attached to OP3 is described below:	
		Alarm occurs	 will flash. The top row changes to red. A scrolling message will be displayed. Output 3 is active and beacon 3 is ON.
		Acknowledge (the alarm is still present)	 is constant. The scrolling message remains. Output 3 is active and Beacon 3 is ON.
		Alarm condition is removed.	All conditions are reset.
		Alarm occurs	 will flash. The top row changes to red. A scrolling message will be displayed. Output 3 is active and beacon 3 is ON.
		Alarm 1 condition is removed	No change from the above.
	Acknowledge (the alarm condition has been removed)	The alarm indication and output are reset.	

mAn	Manual	The alarm continues to be active until both the alarm condition is removed AND the alarm is acknowledged. The acknowledgement can only occur AFTER the condition causing the alarm is removed. An example of the action for Alarm 1 attached to OP3 is described below:	
		Alarm occurs	 will flash. The top row changes to red. A scrolling message will be displayed. Output 3 is active and Beacon 3 is ON.
		Acknowledge (the alarm is still present)	No change from above.
		Alarm condition is removed	No change from above.
		Acknowledge (the alarm condition has been removed)	The alarm indication and output are reset.
Event	Event	No alarm indication and no latching. An example of the action for Alarm 1 attached to OP3 is described below:	
		Alarm occurs	Beacon 3 is ON. Output 3 is active.
		Acknowledge (the condition is still present)	No change from above.
		Alarm 1 condition is removed.	The output is reset.

By default alarms are configured as non-latching, de-energized during an alarm.

It is possible to mix alarms between any of the latching types listed above. Each alarm configured will behave independently.

A 'Global Alarm Acknowledge' parameter is available by default in Level 3 in the 'Instrument - Diagnostics' list. This may be wired in the same way as other parameters (for example, to a digital input) and is used to acknowledge all alarms.

Alarms Advanced

Behavior of Alarms after a Power Cycle

The response of an alarm after a power cycle depends upon the latching type, whether it has been configured to be a blocking alarm, the state of the alarm and the acknowledge status of the alarm.

The response of active alarms after a power cycle is as follows:

For a non-latching alarm, blocking, if configured, will be re-instated. If blocking is not configured the active alarm will remain 'active'. If the alarm condition has returned to within the threshold value during the down time, then the alarm will return 'inactive'.

For an auto-latching alarm, blocking, if configured, will be re-instated, only if the alarm had been acknowledged prior to the power cycle. If blocking is not configured or the alarm had not been acknowledged the active alarm will remain 'active'. If the alarm condition has returned to within the threshold value during the downtime, then the alarm will return 'inactive' if it had been acknowledged prior to the power cycle else it will return 'inactive but not acknowledged'. If the alarm was 'inactive but not acknowledged' prior to the power cycle the alarm will return 'inactive but not acknowledged'.

For a manual-latching alarm, blocking will not be re-instated and the active alarm will remain 'active'. If the alarm condition has returned to within the threshold value during the downtime, then the alarm will return 'inactive but not acknowledged'. If the alarm was 'inactive but not acknowledged' prior to the power cycle the alarm will return 'inactive but not acknowledged'.

Programmer

What is in this Chapter?

This chapter describes the functionality of a setpoint programmer.

NOTE: The Programmer function is not available for EPC3000 FM.

What is a Programmer?

A programmer provides a means of being able to vary the setpoint in a controlled manner over a set period of time. This varying setpoint can then be used in the control process.

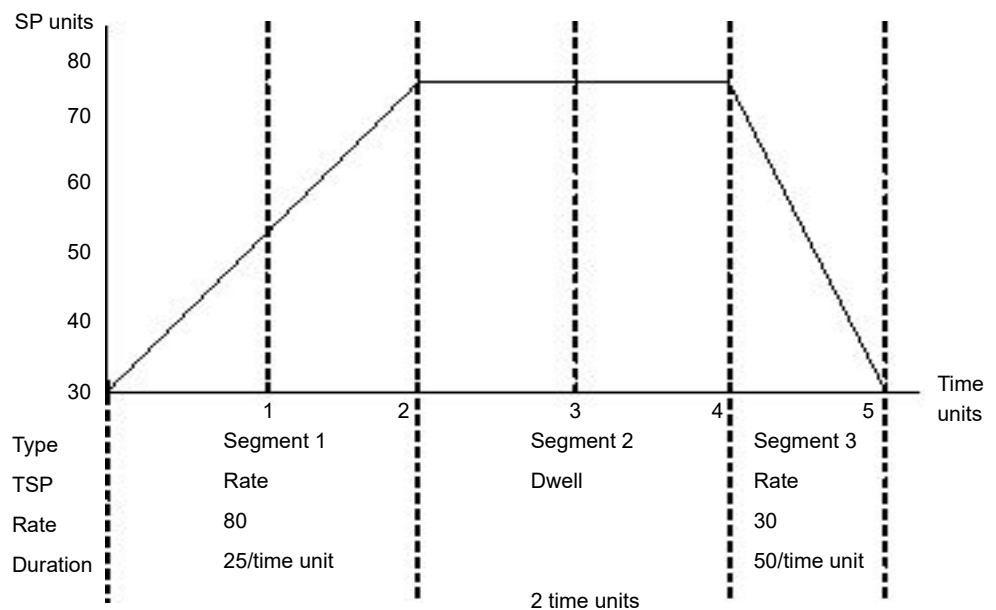

The example above shows a simple three segment program in which the programmer setpoint (PSP) increases at a controlled rate of 25/time unit to a value of 75. It then dwells at that setpoint for 2 time units before decreasing to 30 at a controlled rate of 50/time unit.

The programmer in the EPC range is a single channel programmer and can be ordered in four different options. These are:

- 1 x 8 Basic Programmer (One program of 8 configurable segments, no event outputs).
- 1 x 24 Advanced Programmer (One program of 24 configurable segments with up to 8 event outputs).
- 10 x 24 Advanced Programmer (Ten programs of 24 configurable segments with up to 8 event outputs).
- From firmware versions 3.01 and above,
 - 20 x 8 Advanced Programmer (Twenty programs of 8 segments with up to 8 event outputs).
- For all options, an additional End segment is provided which may also have event outputs if it is an Advanced Programmer.

The above programmer types are orderable options. They may be upgraded using the feature codes described in section "Feature passwords" on page 221.

⚠ WARNING

UNINTENDED EQUIPMENT OPERATION

If the programmer option is changed from 24-segment programs to 8-segment programs or vice versa, then previously stored programs will be lost. All segments will be defaulted to End type segments. It is recommended to clone the controller prior to upgrade so that a copy of the stored programs are retained before the Feature Security change is implemented.

Failure to follow these instructions can result in death, serious injury or equipment damage.

Programs

A program is a sequence of varying setpoints which executes with reference to time. Up to a maximum of 20 programs are supported, the actual number of programs depends on the programmer option ordered but may be upgraded using Feature passwords (see "Feature passwords" on page 221). Program options are listed in the previous section.

Programs are identifiable by a program number i.e. 1...20.

Segments

A segment is a single step within a program, typically it has a specified target setpoint and either a duration to maintain that setpoint, or a ramp rate (or time) to achieve that setpoint, however other segment types instruct the programmer to perform additional tasks.

Up to 24 configurable segments are supported, plus a fixed end segment, in each program. Each segment (in a program) is identifiable by a segment number i.e. 1...25.

The following types of segments are supported:

Ramp Time

A Ramp Time segment is specified by a target setpoint and a time in which to achieve the ramp to target setpoint.

Dwell

A dwell segment specifies how long the setpoint is to be maintained.

Step

A step segment causes the programmer setpoint to change to the target setpoint in a single execution cycle.

Note: the step will occur immediately followed by a 1 second dwell period to allow event outputs to be set.

Call

A call segment allows the main program to call another program as a subroutine. The number of times the program is called is configurable, 1...9999 or continuous.

Note: A program can only call other programs which have a program number greater than itself. This helps to prevent cyclic programs from being created.

This segment type is only available if multiple programs are enabled via Feature passwords and the program is not the last program i.e. Program 10. All configurable segments (1–24) can be configured as a call segment.

CAUTION

CALL SEGMENTS

If a call segment is selected the controller will default to calling the next program number. This may not necessarily be the correct program so you must ensure that the correct call program number is selected manually.

Failure to follow these instructions can result in injury or equipment damage.

End

An end segment is the very last segment in a program and using the Program.ProgramEndType parameter, (this can be found in iTools in the Programmer Editor, Program Parameters tab) the user can specify the programmer behavior when the program ends, as follows:

- Dwell—the programmer setpoint (PSP) is maintained indefinitely and event outputs remain at the states configured for the End segment.
- Reset—the program is reset and the programmer setpoint (PSP) will servo either to PVInput value or SPInput value as configured by the Programmer.Setup.ServoTo parameter. The event outputs will return to the states specified by the Programmer.Setup.ResetEventOP parameter.
- Track - the programmer setpoint (PSP) is maintained indefinitely and event outputs remain at the states configured for the End segment. If the Programmer is wired to the Loop, the Loop will be forced into Track mode.

Note: The 1st end segment will terminate the program in the configured manner if there no more program cycles left to run.

Standard Functionality

The EPC3000 process controller supports the following standard functionality:

Recovery Strategy after a reset or power outage

The recovery strategy after an instrument reset or a power outage can be configured to be:

- Ramp Back—the programmer setpoint will servo (jump to) the input Process Value (PV), and ramp to the target set-point at the rate prior to the power outage.
- Reset—the programmer will reset the program.
- Continue—the programmer setpoint will return immediately to its last value prior to the reset and the program will continue to run.

This is shown diagrammatically in the following sections.

Ramp back (Dwell Segments)

If the interrupted segment was a during a Dwell, then the setpoint will ramp back at the rate set in the previous ramp segment. The dwell period will continue when the target setpoint is reached.

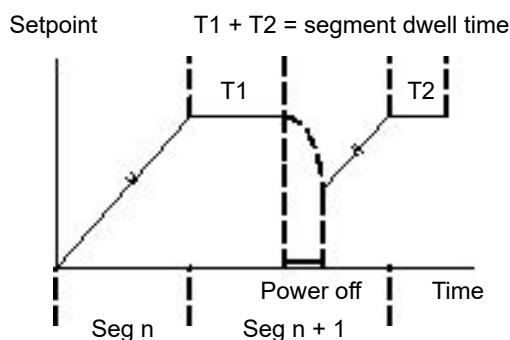

If a previous ramp segment does not exist, i.e. the first segment of a program is a dwell, then the Dwell will continue at the "servo to PV" setpoint.

Ramp back (Ramp or Time-to-target segments)

If the interrupt occurred during a ramp, then the programmer will servo the programmer setpoint to the PV, then ramp towards the target setpoint using the ramp rate prior to the power outage.

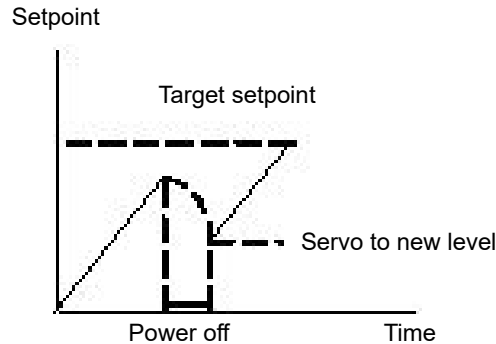

Sensor Break Recovery

If the recovery strategy is set to Reset, then, upon sensor break of the PV input, the program will be reset. If the recovery strategy is other than Reset, then the program will be placed in Hold. When the PV input goes out of sensor break, the programmer will apply the recovery strategy described above.

Holdback

When the PV deviates from the Programmer Setpoint (PSP) by more than a specified amount the program will temporarily hold until the PV returns to within the specified deviation.

Holdback Style configures Holdback to operate over the entire program or on a per segment basis (mutually exclusive).

Holdback Type may be set to Off, Low, High or Band.

- Off: Holdback disabled.
- Low: Active if $PV < (PSP - \text{Holdback Value})$.
- High: Active if $PV > (PSP + \text{Holdback Value})$.
- Band: Active if $PV < (PSP \pm \text{Holdback Value})$.

Servo To PV/SP

The programmer can be set to servo (jump to) the PV input or the Setpoint input at the start of a program.

Event Outputs

Up to 8 digital 'event' outputs can be configured for each segment within a program. These event outputs will remain at their configured value for the entire duration of the segment.

Digital Inputs

The following digital inputs are supported:

- Run - start the current program on the rising edge of this input.
- Hold - hold the current program whilst this input is High.
- Reset - current program is in reset whilst this input signal is High.
- Run/Hold - This is a dual action input. A rising edge will run the current program, but hold the current running program whilst the input is Low.
- Run/Reset - This is a dual action input. A rising edge starts the current program, but reset the current program whilst input is Low.
- Advance - a rising edge initiates the following sequence of actions:
 - go to the end of the current segment.
 - set the programmer setpoint to the target setpoint.
 - start the next segment.

Program Cycles

A program can be configured to repeat 1...9999 times or to run continuously.

Configuration Mode Reset

It is not permissible to run a program whilst the instrument is in configuration mode. If a program is running and the instrument is placed into configuration mode (either by comms or HMI) the running program will be reset.

Program Selection

When multiple programs are configured, selecting the program to be run is done by setting the Programmer.ProgramNumber parameter to the required program number. This selection can be performed via the HMI or Comms.

It is often convenient to use a BCD switch physically connected to digital inputs as shown in the "Example 1 BCD Switch Wiring" on page 56.

The program selected can then be run using Mode parameter or any of the Run digital input parameters, i.e., Run, RunHold or RunReset digital input.

Rules for Program Creation / Editing

It is possible to create and edit a stored program, i.e., Programs 1-10, (via Comms or the HMI) when the programmer is in RUN, HOLD or RESET mode, with the changes being retained.

When running one of the stored programs it will first be copied into the 'working' program which will then be run. It is NOT possible to edit the working program when the programmer is in RESET, but it can be edited when the programmer is in RUN or HOLD, however, the changes will be overwritten when a different program is loaded to be run. Edits to the working program will not change the stored programs. The working program will be overwritten when the next stored program is copied into it, either as a result of running a new program or calling another program as a subroutine.

A Programmer Run list is provided (both via Comms and HMI) which can edit a copy of the working program segment that is currently running when the programmer is in HOLD mode, however the changes will be overwritten when the next segment is loaded and run.

The minimum operator HMI access level at which programs can be run, placed on hold or reset can be configured as Level 1, Level 2 or Level 3 using the Programmer.List.RunAccess parameter (see "Programmer List (PROG)" on page 135).

Program & Segment Times

Segment Time Left is always available whilst a program is running.

The Programmer will attempt to calculate Program Time left when the program is running or when the working program is edited while the program is on Hold. If the calculation takes too long, it will be aborted and the Program Time Left parameter will not be available.

Resolution

When read/written via scaled integer comms, the units of the following segment parameters can be configured as follows:

- Segment.Duration (sec/min/hour) configured by Program.DwellUnits.
- Segment.TimeToTarget (sec/min/hour) configured by Program.RampUnits.
- Segment.RampRate (per sec/per min/per hour) configured by Program.RampUnits.

In addition, when read/written via scaled integer comms, it is possible to configure the units for the following time remaining parameters:

- Programmer.Run.ProgramTimeLeft (sec/min/hour) configured by Programmer.Setup.Resolution.
- Programmer.Run.SegmentTimeLeft (sec/min/hour) configured by Programmer.Setup.Resolution.

On the HMI, time-based parameters are displayed, depending on their configured units, as follows:

- sec - MM:SS
- min - HH:MM
- hour- HHH.H

Times are stored as 32-bit integer millisecond values, and as such times will be capped at 500hrs i.e. 1,800,000,000ms. When a program exceeds this value, the displayed program time left will remain at 500hrs until such time that the accumulative segment times is 500hrs or less. It will then start to count down.

Programmer Time Base Accuracy

The programmer timebase accuracy is dependent upon the timebase accuracy of the microcontroller which is specified as ± 50 ppm between the temperature range -40 to +85 degrees C. This equates to a worst case of ± 4.3 s in 24hrs.

Typical Loop to Programmer Graphical Wiring

'Soft' wiring is carried out using iTools as described in section "Graphical Wiring" on page 223.

The figure below shows a simple soft wiring diagram for a programmer.

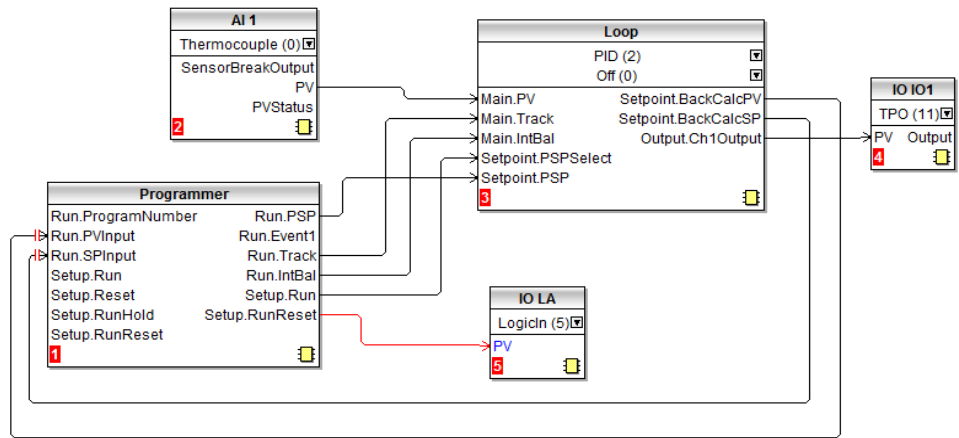

In the figure a thermocouple is connected to Analog Input AI1. The PV output from AI1 provides the input to the control loop. The setpoint for the control loop is provided by the programmer block using the parameter Run.PSP. The programmer will run when the Setup.Run parameter changes to true. In this example the LA digital input may be used to Run/Reset the programmer from an external source.

Integral balance is required so that there is no sudden change of output when the programmer is operated.

The loop heat output is connected to output IO1.

As previously mentioned program selection can be wired to a BCD switch. An example of the soft wiring for this for EPC3008 or EPC3004 using a four or eight digital input option is shown in the diagram below.

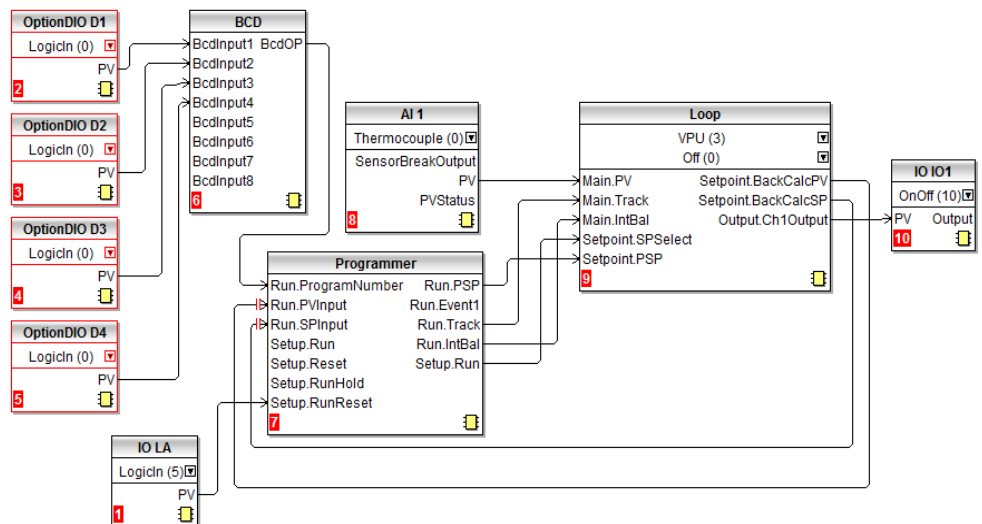

Communications

Programs can be configured and run via Modbus and EI-Bisynch and EtherNet/IP communications.

The Modbus parameter addresses and EI-Bisynch Mnemonics for the programmer parameters, program parameters, and the segment parameters (for the 1st 16 segments) are compatible with the 2400 series controllers. EtherNet/IP communications can read and write to programmer parameters using the same Modbus parameter addresses via Explicit messaging to the Modbus object (0x44).

Note: In the 2400 series controllers, (and therefore in the EPC3000 process controller to allow compatibility), several parameters within segments are mutually exclusive and are accessed via comms using the same Modbus Address and EI-Bisynch Mnemonic.

Modbus Address Ranges

1x8, 1x24 and 10x24 programmers are 2400 Compatible - Program General Data & Segments 1...16 Parameters.

Area	Base Address - Decimal	Base address - HEX
Program 0 (Currently running program)	8192	2000
Program 1	8328	2088
Program 2	8464	2110
Program 3	8600	2198
Program 4	8736	2220
Program 5	8872	22A8
Program 6	9008	2330
Program 7	9144	23B8
Program 8	9280	2440
Program 9	9416	24C8
Program 10	9552	2550
Non-compatible - Segments 17...26 & Additional Programmer Parameters		
Area	Base Address - Decimal	Base address - HEX
Program 0	9688	25D8
Program 1	9768	2628
Program 2	9848	2678
Program 3	9928	26C8
Program 4	10008	2718
Program 5	10088	2768
Program 6	10168	27B8
Program 7	10248	2808
Program 8	10328	2858
Program 9	10408	28A8
Program 10	10488	28F8
Programmer (additional parameters)	10568 - 11007	2948 - 2AFF

Note: In 20x8 programmer the number of segments is fixed as is the assignment of Modbus Addresses. The mapping from segment instance to program/segment is different from all existing EPC3000 controller programmer types. Modbus addresses do not match 2400 series.

EI-Bisynch Mnemonics

EI-Bisynch Mnemonics: *n* is dependent upon segment number i.e.































Segment 1, n is 1	Segment 2, n is 2	Segment 3, n is 3	Segment 4, n is 4
Segment 5, n is 5	Segment 6, n is 6	Segment 7, n is 7	Segment 8, n is 8
Segment 9, n is 9	Segment 10, n is :	Segment 11, n is ;	Segment 12, n is <
Segment 13, n is =	Segment 14, n is >	Segment 15, n is ?	Segment 16, n is @















It should be noted that EI-Bisynch is intended for 2400 series controller compatibility only and as such it is not extended to include mnemonics for segments 17–25.

To Setup a Program from the HMI

By default programs can be set up and run via the controller HMI in Operator Level 2 or higher. Access levels can be configured using Edit access and Run access parameters, refer to "Programmer List (PROG)" on page 135.

For the purposes of this example, it is assumed that parameters in the PROGRAMMER LIST (PROG) have been set up and the HMI is in Operator Level 2.

Operation	Action	Display	Notes
Select PROGRAM SETUP List	1. Press  until <i>P.SET</i> is shown 2. Press  to enter 3. Press  or  to select the program number		Up to 10 programs may be selected.
Programmer Name	4. Press  to view a name		From firmware version 3.01 each program can be given a 4 character name using iTools.
Select the Holdback style	5. Press  6. Press  or  to select the style		Prog = Holdback is applied to the whole program. SEGm = Holdback is applied separately to each segment.
Select Holdback type	7. Press  8. Press  or  to select the Holdback type		Low - in Holdback when $PV < (PSP - Holdback\ value)$ High - in Holdback when $PV > (PSP + Holdback\ value)$ Band - in Holdback when $(PV < (PSP +/- Holdback\ Value))$ OR $(PV > (PSP + Holdback\ Value))$ Off - No Holdback
Set Holdback value	9. Press  10. Press  or  to select the Holdback value		The program will hold if the low deviation is greater than 10.0 and $PSP > PV$.
Set Ramp Units	11. Press  12. Press  or  to select the Ramp units		Per second Per minute Per hour
Set Dwell units	13. Press  14. Press  or  to select the Dwell units		secs/ mins/ hrs
Set the number of times the program is to repeat	15. Press  16. Press  or  to select the number of cycles		1 = The program will execute once Cont = the program will repeat continuously.

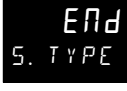
Operation	Action	Display	Notes
Set the action at the end of a program	17. Press  18. Press  or  to select the End action		DweL = dwell at the last setpoint Rset = reset Trak = dwell at the last setpoint but also places the loop in Track mode provided Loop is wired to Programmer.
Set up the first segment	19. Press  20. Press  or  to select the segment number		Segment number 1
Segment name	21. Press  to view a segment name		From firmware version 3.01 each segment can be given a 4 character name using iTools.
Set up the segment type	22. Press  23. Press  or  to select the Segment type		Can be configured to Ramp rate, Ramp time, Dwell, Step, End or Call segments (for multiple-program Programmers with Program number < 10). These are described earlier in this section.
<p>The parameters which follow depend on the type of segment set but will include:</p> <p>Target Setpoint, Ramp Rate for Rate type segments. Target Setpoint, Ramp Time for Time type segments Duration for Dwell type segments Target Setpoint for Step type segments Call Program number and Call Cycles for Call type segments Event Outputs will be shown at the end of each segment if Programmer.Setup.MaxEvents > 0 When the currently selected segment has been set up the next parameter will automatically choose the next segment number.</p>			
Set up the end segment	24. Press 		The last segment is an end type

The previous example shows how to configure a stored program (Program 1). When a program is running, the working program parameters will become available and can be configured in the same manner.

To Run/Hold the Program from the HMI

Assuming the program has been set up as described above, from the HOME display











1. Press  to PROGRAMMER list (PRG)
2. Press  to select the Program number
3. Press  again to PROGRAM MODE
4. Press  or  to select *Run* or *Hold*

Alternatively, press a function key if configured as Program Run/Hold or Program Run/Reset or activate a digital input, configured as Run, Hold, Run/Hold and Run/Reset.



The status of the program is shown by the HMI program status indicator

The current status of the program is displayed as follows:

State	Ramp/Step Up	Dwell	Ramp/Step Down
Reset			
Run			
Hold/Holdback	 Flashing (1 second period 66% duty cycle)	 Flashing (1 second period 66% duty cycle)	 Flashing (1 second period 66% duty cycle)
Complete (Dwell End)	Not applicable	 Flashing (2 seconds period 66% duty cycle)	Not applicable

To Setup a Program Using iTools

The EPC3000 controller can support up to 20 stored programs as stated at the beginning of this chapter.

Programs are identifiable by a program number (1-10, for example). Each program may also be given a name but it must be noted that only the last four characters will be shown on the HMI.

Select 'Programmer' in the menu bar.

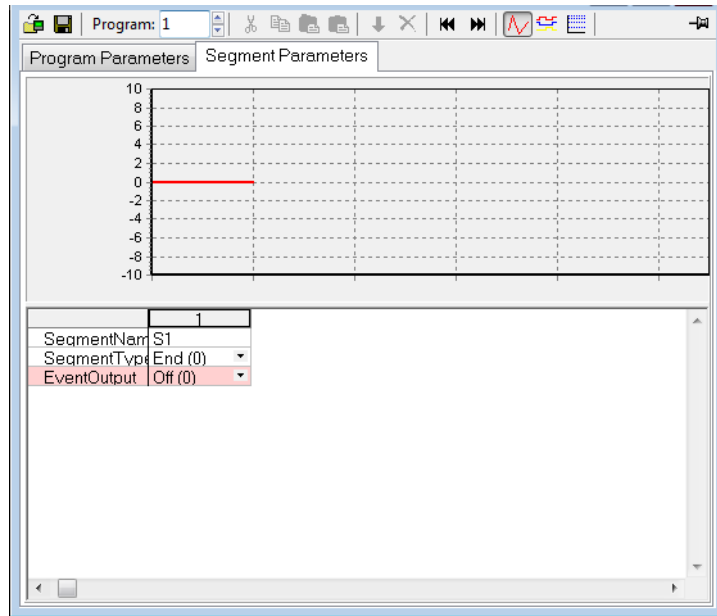

Menu options are shown in the bar above the graph and are also available as a context menu by right clicking in the segment table. They are from left to right:



Select a segment by clicking into the top of the list (1, 2, 3, 4, etc.):

- Cut (Ctrl+X) : Removes the selected segment(s) and copies to the clipboard.
- Copy (Ctrl+C): Copies the selected segment(s) and places into the clipboard.
- Paste Insert (Ctrl+V): The copied segment(s) will be pasted to the right of a selected segment(s).
- Paste Over (Shift+Ctrl+V): Replaces the selected segment(s) with segments from the clipboard.
- Insert (Ins): Copies segment(s) and inserts the copied segment(s) to the right of those selected.
- Delete (Ctrl+Del): Removes the selected segment(s).

To Set up Segments

By default, a program will consist of a single End segment as shown in the opening view above.

To add a segment click in the segment column (1) and select the 'SegmentType' using the segment type drop-down menu. A new segment of the required type will be inserted and the End segment will be shifted to the right. Note that changes to the program will be automatically written to the controller. Continue with further segments.

The following diagram shows a program (Program 1) of 5 segments plus an End segment. Segment 5 calls a another program (in this case program 2 consisting of a ramp up and a ramp down) to repeat 3 times before the program ends. Four digit segment names have been configured. Segment types are described in the Programmer chapter, "Segments" on page 258.

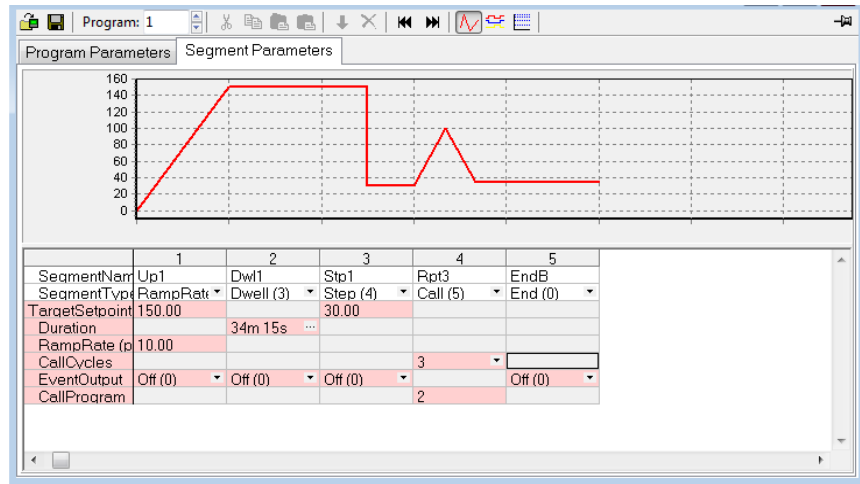

⚠ CAUTION

CALL SEGMENTS

If a call segment is selected the controller will default to calling the next program number. This may not necessarily be the correct program so you must ensure that the correct call program number is selected manually.

Failure to follow these instructions can result in injury or equipment damage.

Event Outputs

In an Advanced Programmer up to 8 event outputs may be enabled using Programmer.Setup.MaxEvents parameter in the iTools browser.

If more than one event is configured 'EventOutput' is shown as an ellipsis ('...'), see the diagram above.

If no events are configured then 'EventOutput' is not shown in the list.

If one event is configured, 'EventOutput' allows the event to be turned on or off directly.

Click on the ellipsis to display a bit map:

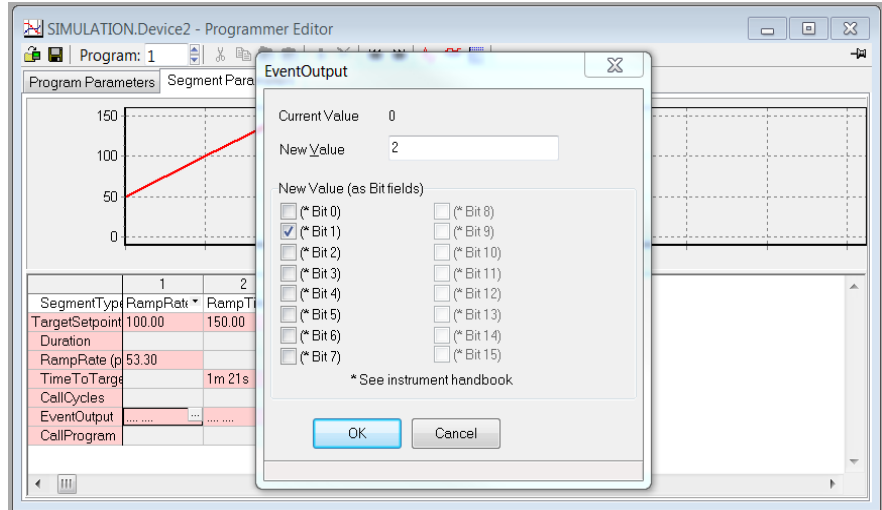

Tick bit 0 to turn on event 1 in the selected segment.

Tick bit 1 to turn on event 2 in the selected segment.

Alternatively, click on 'Digital Event Outputs' (Ctrl+D)  to turn the events On or Off directly in each segment including the End segment.

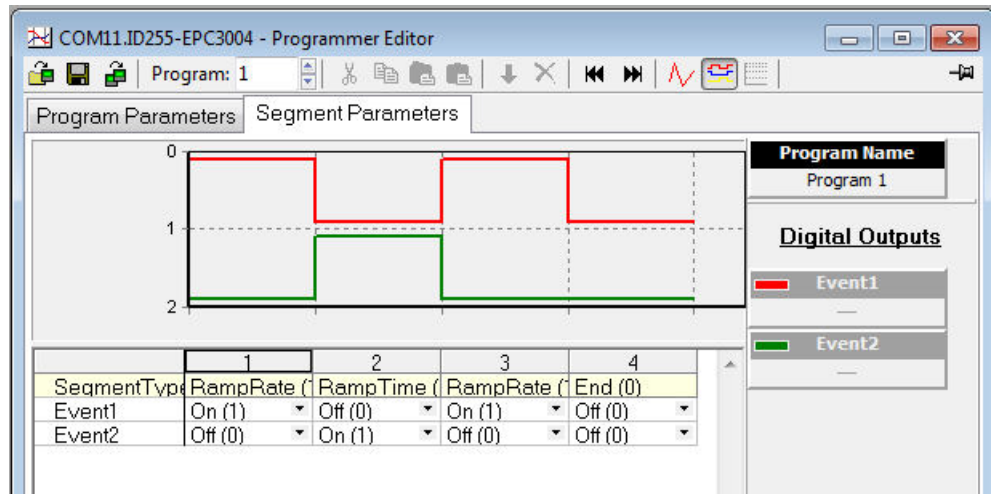

The above view shows 2 events configured.

Events may be indication only or may be soft wired to a function block input parameter, including an IO block to operate external devices. This is explained in section "Typical Loop to Programmer Graphical Wiring" on page 265.

To Name Programs and Segments

From Firmware versions V3.01 and above programs and segments can be named. The names are limited by the HMI to four characters as supported by the HMI.

Program Name

1. Select the Program Parameters tab.
2. In 'ProgramName' change the default text (P1) to a four character name.
3. A comment may be added in the Comment field as a reminder. This comment does not affect the operation and is not visible on the controller HMI.

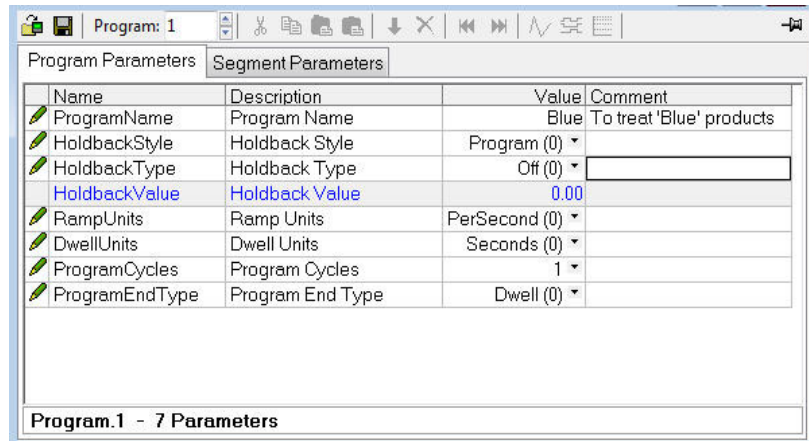

Segment Name

1. Select the Segment Parameters tab.
2. In 'SegmentName' enter a four character name to each segment.
3. When the program is run this name will be shown on the controller HMI.

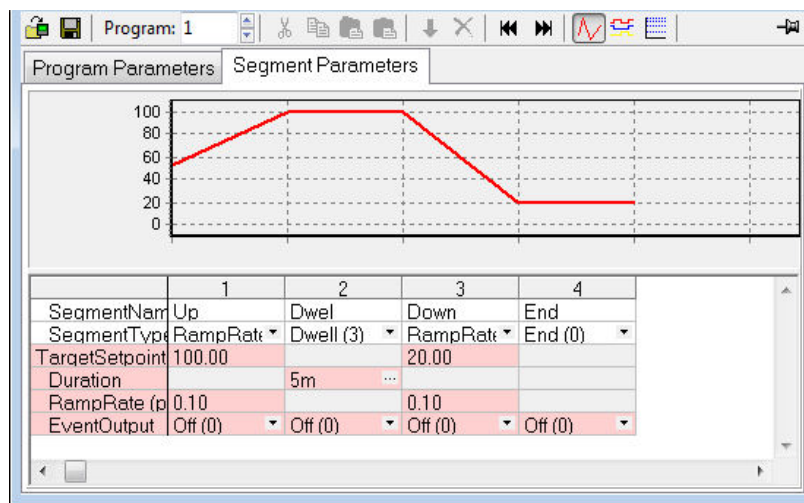

Note: Although more than 4 characters may be entered, the controller HMI will limit the text to the last 4 characters. Unsupported characters, such as X, will be shown on the HMI as blank.

To Save and Load Stored Program Files (*.uip)

A configured Program can be saved to a named file. In a multi-program Programmer, each Program will need to be saved individually. A saved Program may be re-loaded into any Program location in the iTools Programmer Editor. In the case that similar production processes are to be defined, a saved Program may be re-loaded, modified and renamed.

To Save a Program

1. In the Programmer Editor, select the program number to be saved using the program selector.
2. There are two ways to save a program. In the Programmer Editor click on "Save current program to file (Ctrl+S)". Alternatively, in the main menu click on Programmer and from the drop down menu select "Save current program to file (Ctrl+S)".



Do not confuse this with  on the main toolbar which saves a full configuration to a Clone file.

To Load a Previously Saved Program

1. In the Programmer Editor, select the stored program number where the saved program is to be loaded using the program selector.
2. There are two ways to load a program. In the Programmer Editor click on "Load Program (Ctrl+L)". Alternatively, in the main menu click on Programmer and from the drop down menu select "Load...(Ctrl+L)".



Do not confuse this with  on the main toolbar as this will load a full configuration from a Clone file.

Notes:

1. If an attempt is made to load a program which contains a Call segment into the last stored program (e.g. program 10) iTools will prohibit the action and report a message as follows:
'Unable to load: Program 10' (the last program) cannot contain a call segment'.
2. A 1x8 or 1x25 programmer cannot contain any call segments.

To Run, Reset and Hold a Program in iTools

In the browser view, open the Program Run list.

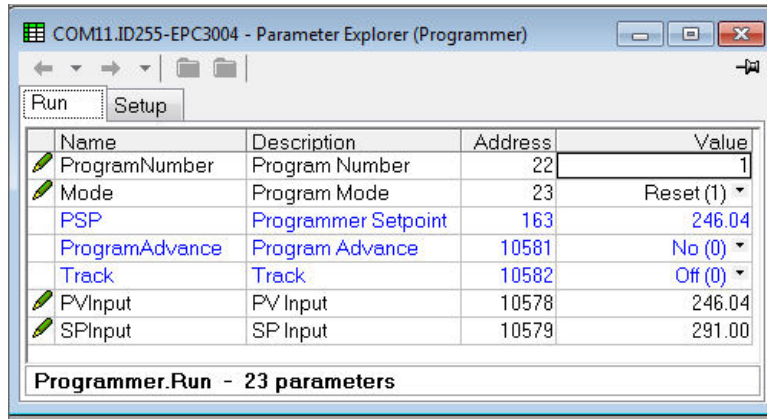

To run a program make sure that the controller is in Operator mode. Select the program number of the program to run and select Run(2) from the Mode parameter drop down enumeration. The program may also be put into Hold or Reset from the mode Parameter.

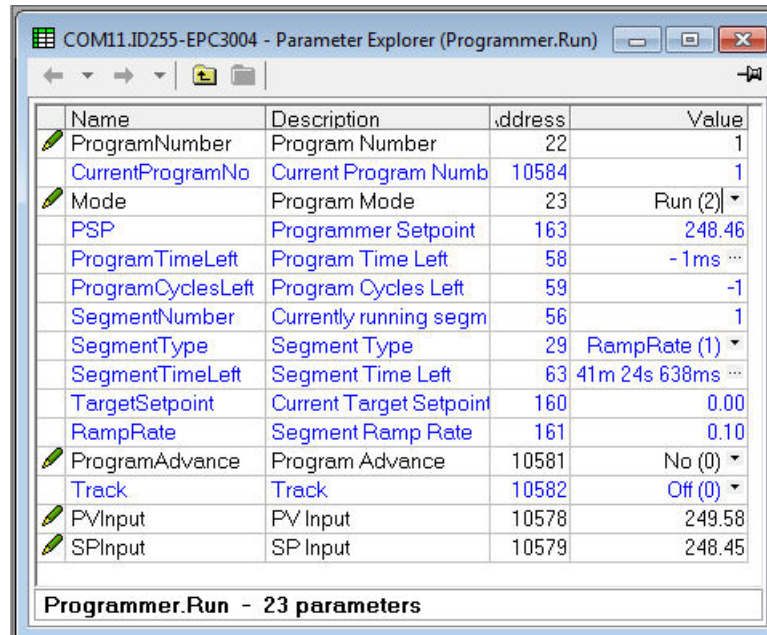

When one of the programs (Program 1 to 10) is run, the program parameters are copied into the working program. The Working Program and Working Segment parameters are then made available to the user for monitoring and/or editing.

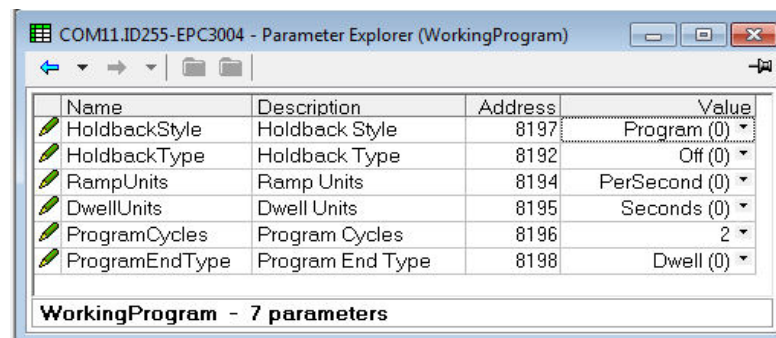

The programmer loads each segment from the working program before it is run. If the programmer is currently running segment 2 of the working program and working segment 3 is edited, then the changes will be executed when working segment 3 is run. If working segment 1 is edited, then the changes will be executed in the next program cycle, (assuming there are any program cycles left). However, if the running program completes or is reset and then run again, the stored program will be copied to the working program thereby overwriting any changes made to the working program. The working program can also be overwritten as a result of running another program or calling another program as a subroutine.

Stored programs are always available and configurable via the HMI and iTools even when a program is currently running. Working program parameters, however, are only available and configurable via HMI and iTools when a program is not in reset.

Note: For a running program set for Continuous cycles (using the ProgramCycles parameter in the Programmer Parameters tab) the 'Program Time Left' parameter shows 'CONT' in the controller HMI. In iTools this is shown as -1. Similarly, in iTools the Program Cycles Left parameter shows -1 but the controller HMI shows CONT. If the program cycles is set to repeat for a set number of times, then the 'Program Time Left' parameter and the Program Cycles Left parameter will count down in both iTools and the controller HMI.

The Working Program provides the user read/write access to the program parameters of the currently running program (which can be the main program or a subroutine resulting from a call segment).

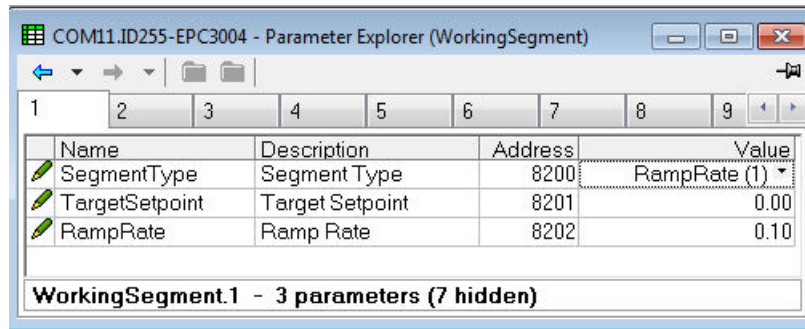

The Working Segment provides the user read/write access to the segment parameters of the currently running program (which can be the main program or a subroutine resulting from a call segment).

Programmer Parameters in iTools

The browser list contains the following:

- Programmer.
 - Run.
 - Setup.
- WorkingProgram.
- WorkingSegment.

Programmer.Run

The Run parameters are used to monitor and control the running program and the table which follows details each parameter.

Name	Description	Address	Value	Wire
ProgramNumber	Program Number	22	1	
ProgramName	Program Name	21351	Program	
CurrentProgramNo	Current Program Number	10584	1	
CurrentProgramName	Current Program Name	21372	Program	
Mode	Program Mode	23	Reset (1)	
PSP	Programmer Setpoint	163	28.01	
ProgramTimeLeft	Program Time Left	58	0 ...	
ProgramCyclesLeft	Program Cycles Left	59	0	
SegmentNumber	Currently running segment	56	1	
SegmentName	Segment Name	21393		
SegmentType	Segment Type	29	End (0)	
SegmentTimeLeft	Segment Time Left	63	0 ...	
TargetSetpoint	Current Target Setpoint	160	100.00	
RampRate	Segment Ramp Rate	161	0.50	
Event1	Event 1	464	Off (0)	
Event2	Event 2	465	Off (0)	
Event3	Event 3	466	Off (0)	
Event4	Event 4	467	Off (0)	
Event5	Event 5	468	Off (0)	
Event6	Event 6	469	Off (0)	
Event7	Event 7	470	Off (0)	
Event8	Event 8	471	Off (0)	
ProgramAdvance	Program Advance	10581	No (0)	
Track	Track	10582	Off (0)	
PVInput	PV Input	10578	28.01	Loop
SPInput	SP Input	10579	0.00	Loop
IntBal	Integral Balance request	10586	No (0)	

Parameter Name	Description	Available Values	Value Description
ProgramNumber	Program Number		The number of the program to be run.
ProgramName	Program Name		The name of the program to be run.
CurrentProgramNo	Current Program Number		The number of the program currently running.
CurrentProgramName	Current Program Name		The name of the program currently running.
Mode	Program Mode	Allows users to perform actions to change the current program state (Run, Hold, Reset – additionally indicates when a program is in Holdback or has Completed). Reset (1) Default: Reset (1) Run (2) Hold (4) Holdback (8) Complete (16)	
PSP	Programmer Setpoint		Current setpoint in the program.

Parameter Name	Description	Available Values	Value Description
ProgramTimeLeft	Program Time Left		The amount of time left in the current program or -1 if the program cycles is set to 'Continuous'.
ProgramCyclesLeft	Program Cycles Left		The number of cycles left in the current program or -1 if the program cycles is set to 'Continuous'.
SegmentNumber	Currently running segment number		The number of the currently running segment.
SegmentName	Segment Name		The name of the currently running segment.
SegmentType	Segment Type		The type of the currently running segment.
		End (0)	The very last segment in a program.
		RampRate (1)	This is specified by a target setpoint and a rate at which to ascend/descend to the setpoint.
		RampTime (2)	This is specified by a target setpoint and a time in which to achieve the ramp to setpoint.
		Dwell (3)	This is specified by how long the setpoint is to be maintained.
		Step (4)	This allows a step change in the target setpoint. Note: The step will occur immediately followed by a 1 second dwell period to allow event outputs to be set.
		Call (5)	This allows the main program to call another program as a subroutine. The number of times the program is called will be configurable, 1...9999. A program can only call other programs with a program number greater than itself, this prevents cyclic programs from being created. This segment type will only be available if multiple programs are enabled via Feature Security, and it should be noted that all configurable segments (1-24) can be configured as a call segment.
SegmentTimeLeft	Segment Time Left		The remaining time for the segment to complete.
TargetSetpoint	Current Target Setpoint		The target setpoint for the current segment.
RampRate	Segment Ramp Rate		The current ramp rate to achieve the target setpoint.
Event (n)	Event (n)		Event Output (n) value for the current segment.
		Off (0)	The event is Off.
		On (1)	The event is On.
ProgramAdvance	Program Advance		Sets the Programmer Setpoint to the target setpoint of the current segment and advances to the next segment in the program.
		No (0)	Default value.
		Yes (1)	Advances the segment to the next one with the Programmer Setpoint assuming the Target Setpoint of the original segment.
Track	Track		Output parameter which is typically wired to the Loop Track parameter which is used to force the Loop into Track mode when the program completes and the program end type has been configured to Track.
		Off (0)	Default value. Program has not completed.
		On (1)	Program has completed.
PVInput	PV Input		The PV Input used for Servo to PV, typically wired from the Loop's Track PV parameter.
SPInput	SP Input		The SP Input used for Servo to SP, typically wired from the Loop's Track SP parameter.
IntBal	Integral Balance Requested		This flag is set briefly when the Programmer performs a servo to PV, which would require the Loop to perform an integral balance in order to stop the working output from reacting to the change in setpoint. This parameter should be wired into the Loop.Main.IntBal parameter.
		No (0)	Integral balance is not requested.
		Yes (1)	Integral balance is requested.

Programmer.Setup

Programmer setup is used to configure programmer parameters which are unlikely to change between programs used on the same or similar processes. In addition the setup list also contains digital parameters which can be wired to Run, Reset and Hold a program.

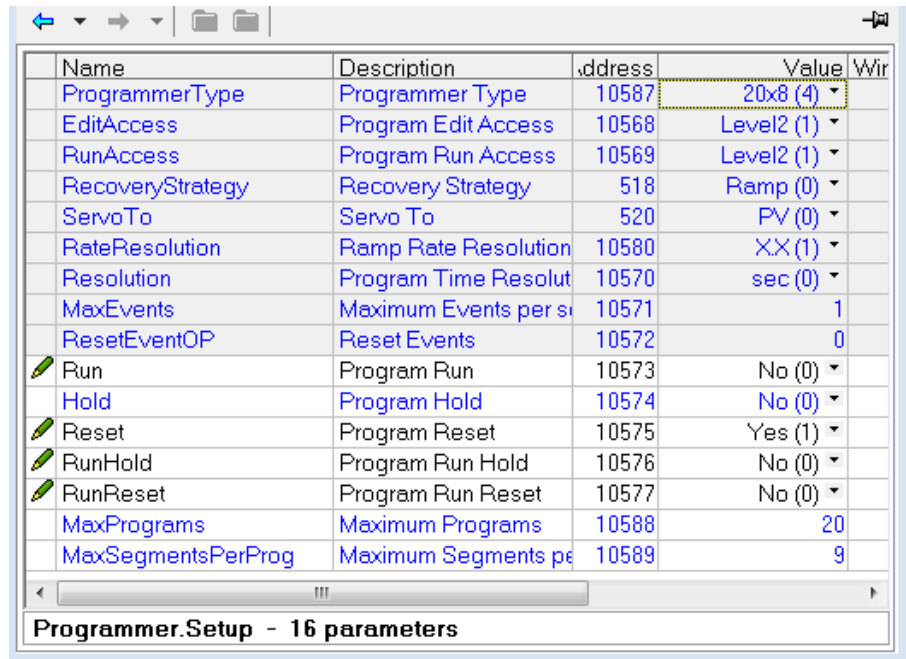

ProgrammerType	Programmer Type	The type of programmer	
		Disabled (0)	
		1x8 (1)	Single program of up to 8 segments
		1x24 (2)	Single program of up to 24 segments
		10x24 (3)	Up to ten programs of up to 24 segments
		20x8 (4)	Up to twenty programs of up to eight segments
EditAccess	Program Edit Access	Sets the minimum local HMI user access level allowed to edit programs.	
		Level1 (0)	
		Level2 (1)	Default: Level2 (1)
		Level3 (2)	
		Config (4)	
RunAccess	Program Run Access	Sets the minimum local HMI user access level allowed to run programs.	
		Level1 (0)	
		Level2 (1)	Default: Level2 (1)
		Level3 (2)	
RecoveryStrategy	Recovery Strategy	Configures the Power Fail and Sensor Break recovery strategy.	
		Ramp (0)	
		Reset (1)	Default: Reset (1)
		Track (2)	
ServoTo	Servo To	Configures the programmer to start from either the PV Input or the SP Input.	
		PV (0)	Default: PV (0)
		SP (1)	

RateResolution	Ramp Rate Resolution	Configures the resolution (number of decimal places) of the rate used in ramp rate segments.	
		X (0)	
		X.X (1)	Default: X.X (1)
		X.XX (2)	
		X.XXX (3)	
		X.XXXX (4)	
Resolution	Program Time Resolution	Configures the resolution of Program & Segment Time Left.	
		sec (0)	Default: sec (0)
		min (1)	
		hour (2)	
MaxEvents	Maximum Events per segment	Range (0 to 8)	Default: 1 Note: This parameter is not available if Programmer Type is 1x8.
ResetEventOP	Reset Events	Range (0 to 8)	Defines the event output states when the program is in the reset.
Run	Program Run	The digital input to start the program running.	
		No (0)	
		Yes (1)	
Hold	Program Hold	The digital input to hold the running program.	
		No (0)	
		Yes (1)	
Reset	Program Reset	The digital input to reset (abort) the running program.	
		No (0)	
		Yes (1)	
RunHold	Program Run Hold	Dual functionality digital input, going from LOW to HIGH will start the program, whilst LOW the program is in Hold.	
		No (0)	
		Yes (1)	
RunReset	Program Run Reset	Dual functionality digital input, going from LOW to HIGH will start the program, whilst LOW the program is in Reset.	
		No (0)	
		Yes (1)	
MaxPrograms	Maximum Programs	Range (1 to 20)	The maximum number of programs allowed. Read only.
MaxSegmentsPerProg	Maximum Segments per Program	Range (1 to 24)	The maximum number of programs allowed. Read only.

WorkingProgram

Parameters in the WorkingProgram function block are only available when the controller is in Operator level and a program is actually running. The function block is used to define parameters that are global to the program. The figure below shows the parameters and the table which follows details each parameter.

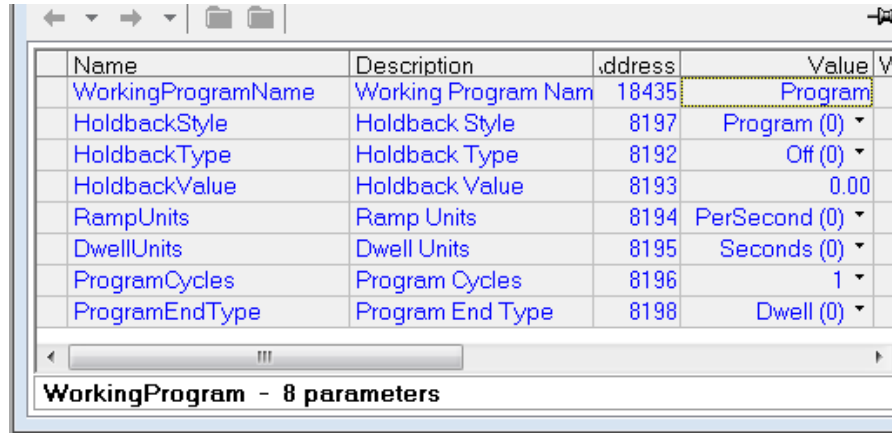

Parameter Name	Description	Available Values	Value Description
WorkingProgramName	Working Program Name	A text field which contains the name of the currently running program. The default name is the character 'P' followed by the program number. If you have named the program, that name is displayed here instead.	
HoldbackStyle	Holdback Style	Holdback is when the PV deviates from the setpoint by more than the holdback value, the program will temporarily hold until the PV returns to within the specified value. It is possible to set holdback either for the entire program or on a per-segment basis.	
		Program (0)	Default: Holdback set for the entire program.
HoldbackType	Holdback Type	Holdback prohibits the program from advancing faster than the load can react. Holdback continuously monitors the difference between the PV and the programmer setpoint. The holdback type specifies whether holdback tests for deviations above, below, or above and below the setpoint.	
		Off (0)	Default: Off. No holdback tests are performed
		Low (1)	Holdback tests for deviations below the setpoint.
		High (2)	Holdback tests for deviations above the setpoint.
HoldbackValue	Holdback Value	Holdback is used to stop the program rates from exceeding the maximum rate for the load.	
		A holdback value can be entered so that if the program setpoint differs from the PV, then the program will pause until the PV has caught up. This feature is useful for achieving the soak times of dwell segments. i.e, the Dwell does not start until the PV has reached the target setpoint.	
RampUnits	Ramp Units	Ramp units can be defined as per second, per minute, or per hour. Ramp units are set for the entire program. Changing ramp units will convert the ramp rate parameter values of all Ramp Rate segments in the program.	
		PerSecond (0)	Default: PerSecond(0). Ramp units are defined as per second
		PerMinute (1)	Ramp units are defined as per minute.
		PerHour (2)	Ramp units are defined as per hour.

Parameter Name	Description	Available Values	Value Description
DwellUnits	Dwell Units	Dwell units can be defined as per second, per minute, or per hour. Dwell units are set for the entire program.	
		PerSecond (0)	Default: PerSecond(0). Dwell units are defined as per second
		PerMinute (1)	Dwell units are defined as per minute.
		PerHour (2)	Dwell units are defined as per hour.
ProgramCycles	Program Cycles	If a program is called from another program, then this value is ignored and the calling segment defines the number of sub-program loops.	
		Continuous (-1)	The program cycles continuously.
		1-9999	Default. The program cycles this number of times.
ProgramEndType	Program End Type	Defines the action to be taken after the final segment.	
		Dwell (0)	The programmer setpoint is maintained indefinitely and the event outputs remain at the states configured for the end segment.
		Reset (1)	The program is reset at the programmer setpoint will servo either to the PVInput value or the SPInput value as configured by the Programmer.Setup.ServoTo parameter. The event outputs will return to the states specified by the Programmer.Setup.ResetEventOP parameter.
		Track (2)	The programmer setpoint is maintained indefinitely and event outputs remain at the states configured for the end segment. If the programmer is wired to the Loop, the Loop will be forced into Track mode.

WorkingSegment

Parameters in the WorkingSegment function block only become available when the controller is in Operator level and a program is actually running. The function block is used to define the behavior of the working segments. The figure below shows the parameters and the table which follows details each parameter.

Name	Description	Address	Value
WorkingSegmentName	Working Segment Name	18456	S1
SegmentType	Segment Type	8200	Dwell (3)
TargetSetpoint	Target Setpoint	8201	0.00
Duration	Dwell Duration	8202	1m
RampRate	Ramp Rate	8202	0.00
TimeToTarget	Time To Target	8202	1m
CallCycles	Call Cycles	8204	1
EventOutput	Event Output	8204	1
HoldbackType	Holdback Type	8205	Off (0)
HoldbackValue	Holdback Value	8206	0.00
CallProgram	Call Program	8203	1

Parameter Name	Description	Available Values	Value Description
WorkingSegmentName	Working Segment Name	A text field which contains the name of the working segment. The default name is the character 'S' followed by the working segment number. If you have named the segments, that name is displayed here instead.	
SegmentType	Segment Type	Specifies the type of the current segment.	
		End (0)	Default: The current segment is of type 'End'.
		Ramp Rate(1)	The current segment is of type 'Ramp Rate'.
		Ramp Time (2)	The current segment is of type 'Ramp Time'.
		Dwell (3)	The current segment is of type 'Dwell'.
		Step (4)	The current segment is of type 'Step'.
Call (5)	The current segment is of type 'Call'.		
TargetSetpoint	Target SetPoint	Shows the current setpoint, or can be used to define the desired setpoint to be achieved by the end of the segment.	
Duration	Dwell Duration	A dwell segment is specified by a duration, the length of time that the setpoint (inherited from the previous segment) is to be maintained.	
RampRate	Ramp Rate	Specifies the rate at which the setpoint is to be achieved. The units of the ramp rate (per second, per minute, or per hour) is specified by the Program Edit parameter RampUnits.	
TimeToTarget	Time to Target	For Time to Target ramp segments, this parameter specifies the time to take to achieve the setpoint.	
CallCycles	Call Cycles	Defines the number of times the sub-program is run. To loop continuously, set cycles to 0 (Continuous).	
		Continuous (0)	The sub-program runs continuously.
1-9999	Default: 1. The number of times the sub-program is to run.		
EventOutput	Event Output	Defines the event output states. These event states can be wired to physical outputs for driving external events.	
HoldbackType	Holdback Type	Holdback prohibits the program from advancing faster than the load can react. Holdback continuously monitors the difference between the PV and the programmer setpoint. The holdback type specifies which type of deviation to check.	
		Off (0)	Default: Off. No holdback tests are performed
		Low (1)	Holdback tests for deviations below the setpoint.
		High (2)	Holdback tests for deviations above the setpoint.
Band (3)	Holdback tests for deviations above and below the setpoint.		

Parameter Name	Description	Available Values	Value Description
HoldbackValue	Holdback Value		<p>A holdback value can be entered so that if the program setpoint differs from the PV, then the program will pause until the PV has caught up. This feature is useful for achieving the soak times of dwell segments. i.e, the Dwell does not start until the PV has reached the target setpoint.</p> <p>In the Programmer, the holdback value can be set once per program or for every segment depending on the holdback style set.</p>
CallProgram	Call Program		<p>The sub-program to call. This only applies to call segments. Only program numbers greater than the calling program can be called.</p>

Control

The 'Loop' function block contains and coordinates the various control and output algorithms. The diagram below shows the top-level structure of the Loop function block for a heat only or heat/cool temperature controller.

The actual temperature measured at the process (PV) is connected to the input of the controller. This is compared with a setpoint (or required) temperature (SP). The controller calculates an output value to call for heating or cooling so that the difference between set and measured temperature is minimized. The calculation depends on the process being controlled but normally uses a PID algorithm. The output(s) from the controller are connected to devices on the plant which deliver the demanded heating (or cooling). This, in turn, is detected by the temperature sensor. This is referred to as the control loop or closed loop control.

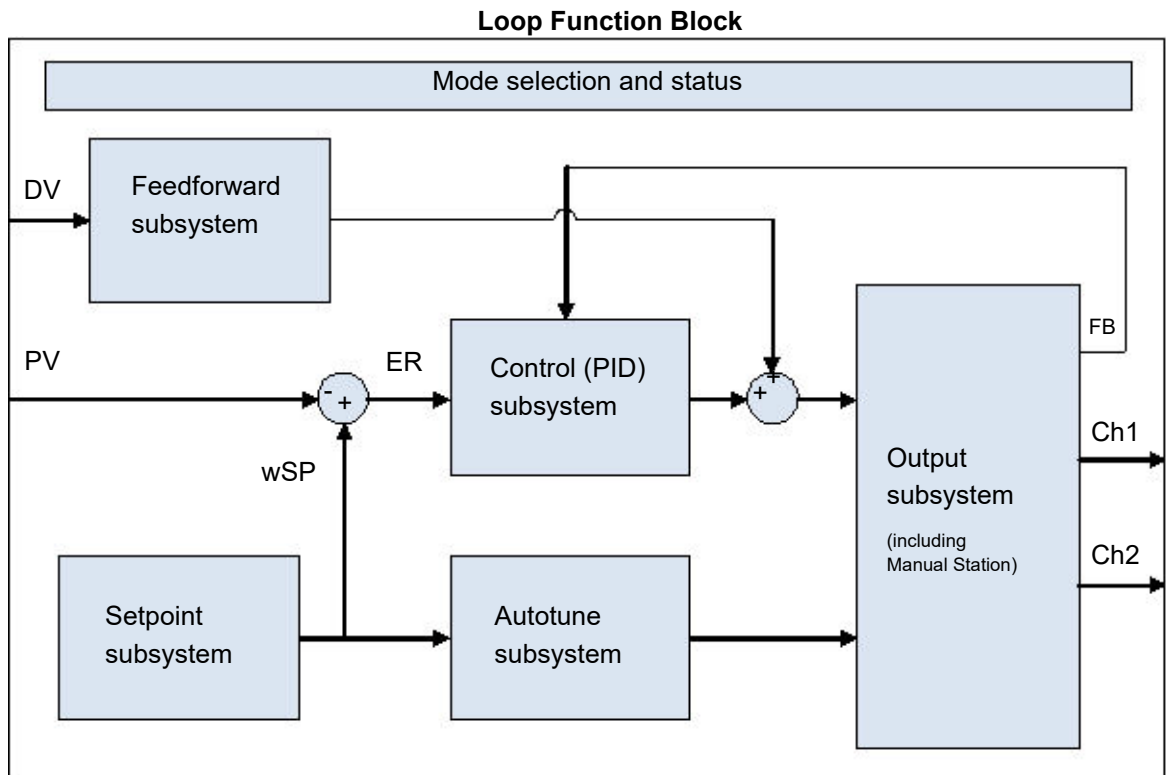

Types of Control

Three types of control loop may be configured. These are PID control, On/Off control, or control of motorized valves

PID Control

PID, also referred to as 'Three Term Control', is an algorithm which continuously adjusts the output, according to a set of rules, to compensate for changes in the process variable. It provides more stable control but the parameters need to be set up to match the characteristics of the process under control.

The three terms are:

Proportional term PB.

Integral term TI.

Derivative term TD.

The Eurotherm PID algorithm is based upon an ISA type algorithm in its positional (non-incremental) form. The output from the controller is the sum of the contributions from these three terms. The simplified Laplace transform is:

$$OP/ER = (100/PB) (1 + 1/sTI + sTD).$$

The combined output is a function of the magnitude and duration of the error signal, and the rate of change of the process value.

It is possible to turn off integral and derivative terms and control on proportional only (P), proportional plus integral (PI) or proportional plus derivative (PD).

An example of where PI control might be used i.e. D is turned off, is process plants (flows, pressures, liquid levels), which are inherently turbulent and noisy, causing valves to fluctuate wildly.

PD control may be used, for example, on servo mechanisms.

In addition to the three terms described above, there are other parameters which determine how well the control loop performs. These include High and Low Cutback and Manual Reset and are described in detail in subsequent sections.

Proportional Term 'PB'

The proportional term, or gain, delivers an output which is proportional to the size of the difference between SP and PV. It is the range over which the output power is continuously adjustable in a linear fashion from 0% to 100% (for a heat only controller). Below the proportional band the output is full on (100%), above the proportional band the output is full off (0%) as shown in the diagram below.

The width of the proportional band determines the magnitude of the response to the error. If it too narrow (high gain) the system oscillates by being over responsive. If it is too wide (low gain) the control is sluggish. The ideal situation is when the proportional band is as narrow as possible without causing oscillation.

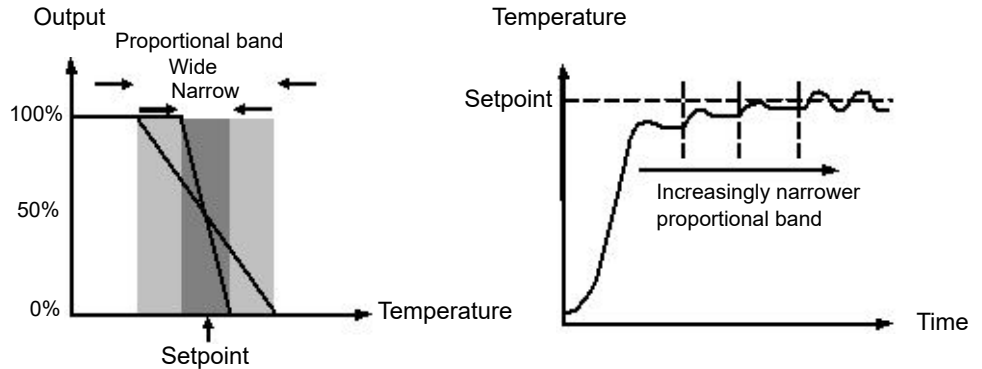

The diagram also shows the effect of narrowing proportional band to the point of oscillation. A wide proportional band results in straight line control but with an appreciable initial error between setpoint and actual temperature. As the band is narrowed the temperature gets closer to setpoint until finally becoming unstable.

The proportional band can be specified in engineering units or in percent of span ($\text{RangeHigh} - \text{RangeLow}$). Engineering Units is recommended for its ease of use.

Previous controllers had the parameter Relative Cool Gain (R2G) to adjust the cool proportional band relative to the heat. This has been replaced by separate proportional bands for Channel 1 (Heat) and Channel 2 (Cool).

Integral Term 'TI'

In a proportional only controller, a difference between setpoint and PV must exist for the controller to deliver power. Integral is used to reduce this to a zero steady state control.

The integral term slowly shifts the output level as a result of a difference between setpoint and measured value. If the measured value is below setpoint the integral action gradually increases the output in an attempt to correct the difference. If it is above setpoint integral action gradually decreases the output or increases the cooling power to correct the difference.

The diagram below shows the result of introducing integral action.

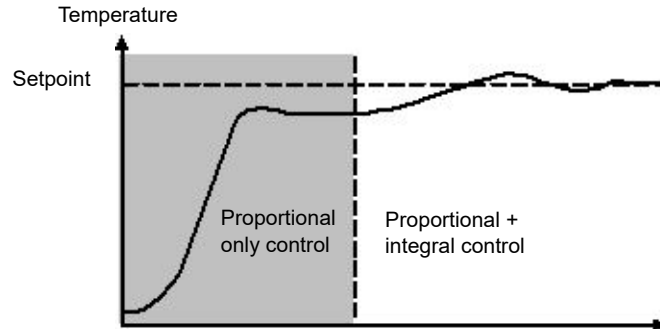

The units for integral are measured in time. The longer the integral time constant, the more slowly the output is shifted and results in a sluggish response. Too small an integral time will cause the process to overshoot and even oscillate. The integral action may be disabled by setting its value to Off(0), in which case manual reset will be made available.

The integral time is always specified in seconds. In US nomenclature, the integral time is equivalent to 'seconds per repeat'.

Integral Hold

When the IntegralHold parameter is turned on, the output value contained in the integrator will be frozen. It will be maintained even through mode changes. This can sometimes be useful e.g. in a cascade to stop the master integral winding up when the slave is saturated.

Derivative Term 'TD'

Derivative action, or rate, provides a sudden shift in output as a result of a rapid change in error. If the measured value falls quickly derivative provides a large change in output in an attempt to correct the perturbation before it goes too far. It is most beneficial in recovering from small perturbations.

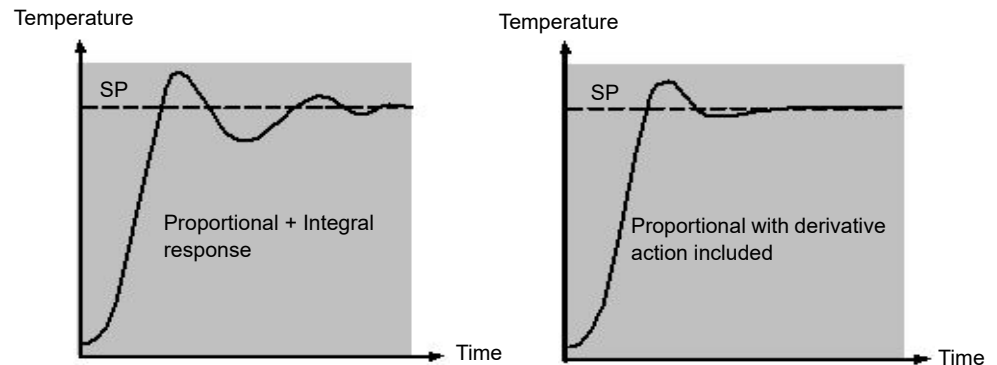

The derivative modifies the output to reduce the rate of change of the difference. It reacts to changes in the PV by changing the output to remove the transient. Increasing the derivative time will reduce the settling time of the loop after a transient change.

Derivative is often mistakenly associated with overshoot inhibition rather than transient response. In fact, derivative should not be used to curb overshoot on start up since this will inevitably affect the steady state performance of the system. Overshoot inhibition is best left to the approach control parameters, High and Low Cutback, described below.

Derivative is generally used to increase the stability of the loop, however, there are situations where derivative may be the cause of instability. For example, if the PV is electrically noisy, then derivative can amplify that electrical noise and cause excessive output changes, in these situations it is often better to disable the derivative and re-tune the loop.

Derivative time is always specified in seconds. Derivative action can be turned off by setting the derivative time to Off(0).

Derivative on PV or Error (SP - PV)

By default, derivative action is applied to the PV only and not to the error (SP - PV). This helps to prevent large derivative kicks when the setpoint is changed.

If required, derivative can be switched to error using the DerivativeType parameter. This is not usually recommended but can, for example, reduce overshoot at the end of SP ramps.

Manual Reset (PD Control)

In a full three-term controller (that is, a PID controller), the integral term automatically removes the steady state error from the setpoint. Turn off the integral term to set the controller to PD. Under these conditions the measured value may not settle precisely at setpoint. The Manual Reset parameter (MR) represents the value of the power output that will be delivered when the error is zero.

This value must be set manually in order to remove the steady state error.

Cutback

Cutback is a system of approach control for process start-up and for large setpoint changes. It allows the response to be tuned independently of the PID controller, thereby allowing optimum performance for both large and small setpoint changes and disturbances. It is available for all control types except OnOff.

The cutback high and low thresholds, CBH and CBL, define two regions above and below the working setpoint. They are specified in the same units as the proportional band. Operation can be explained in three rules:

1. When the PV is more than *CBL* units *below* WSP, *maximum* output is always applied.
2. When the PV is more than *CBH* units *above* WSP, *minimum* output is always applied.
3. When the PV exits a cutback region, the output is returned *bumplessly* to the PID algorithm.

The effect of rule 1 and 2 is to bring the PV towards the WSP as rapidly as possible whenever there exists a significant deviation, just as an experienced operator might do manually.

The effect of 3 is to allow the PID algorithm to immediately start 'cutting back' the power from maximum or minimum when the PV passes the cutback threshold. Remember that, due to 1 and 2, the PV should be moving rapidly towards WSP, and it is this that causes the PID algorithm to start cutting back the output.

By default, CBH and CBL are set to *Auto (0)*, which means that they are automatically taken to be 3 times the proportional band. This is a reasonable starting point for most processes, but rise time to setpoint on start-up or large setpoint changes may be improved by tuning them manually.

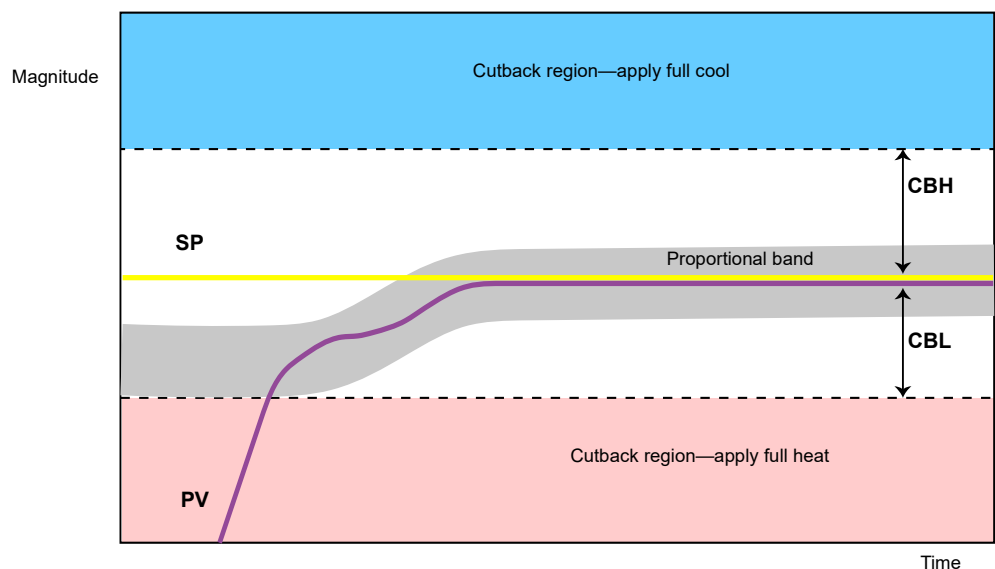

Note: Because cutback is a type of non-linear controller, a set of CBH and CBL values that are tuned for one particular operating point may not be satisfactory for another operating point. It is always advisable therefore not to try to tune the cutback values *too* tightly, or otherwise to use gain scheduling to schedule different values of CBH and CBL at different operating points. All the PID tuning parameters can be gain scheduled.

Reverse/Direct Action

For single-channel loops, the concept of reverse and direct action is important.

The ControlAction parameter should be set appropriately:

1. If an increase in control output causes a corresponding increase in PV, such as in a heating process, then set ControlAction to Reverse.
2. If an increase in control output causes a corresponding decrease in PV, such as in a refrigeration process, then set ControlAction to Direct.

The ControlAction parameter is not available for split-range configurations, where channel 1 is always reverse acting and channel 2 is always direct acting.

Loop Break

The loop is considered to be broken if the PV does not respond to a change in the output. An alarm may be initiated but in EPC3000 series controllers this must be explicitly wired using the 'LoopBreak' parameter. Since the time of response will vary from process to process the Loop Break Time parameter allows a time to be set before a Loop Break Alarm is initiated. In these circumstances the output power will drive to high or low limit. For a PID controller, two parameters under diagnostics are used to determine if the loop is broken, 'Loop Break Time' and 'Loop Break Delta PV'.

If the control loop is broken, the output will tend to wind up and eventually hit a limit.

Once the output is at the limit, the loop break detection algorithm will monitor the PV. If the PV has not moved by a specified amount (LoopBreakDeltaPV) in twice the specified time (LoopBreakTime), then a loop break will be flagged.

Gain scheduling

Some processes exhibit non-linear dynamics. For example, a heat treatment furnace may behave quite differently at low temperatures than at high temperatures. This is commonly due to the effects of radiant heat transfer, which start to appear above about 700°C. This is illustrated in the diagram below.

It is often unfeasible, then, for a single set of PID tuning constants to perform well over the entire process operating range. To combat this, several sets of tuning constants can be used and 'scheduled' according to the process operating point.

Each set of constants is called a 'gain set' or a 'tune set'. The gain scheduler selects the active gain set by comparing the value of the Scheduling Variable (SV) against a set of boundaries.

An integral balance is issued whenever the active gain set changes. This helps to prevent discontinuities ('bumps') in the controller output.

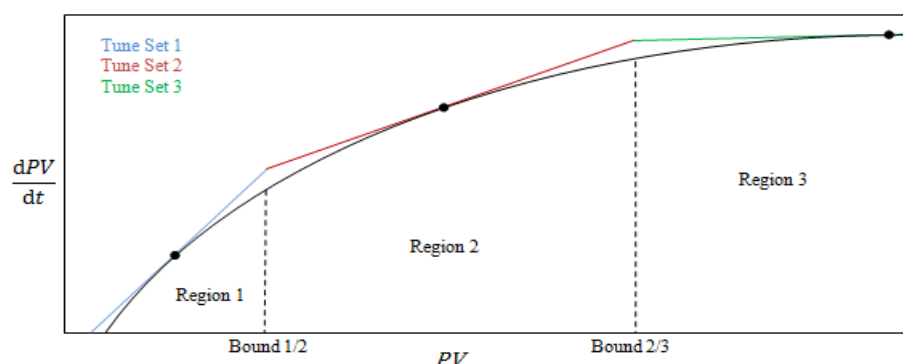

Motorized Valve Positioning Control

Valve Positioning control is used for 'three-step' motorized valve actuators that are driven with a digital 'raise' and 'lower' signal. A common example is a valve modulating the firing rate of a gas-fired furnace or oven. Some valves are already fitted with positioners, in which case these algorithms are not suitable and PID should be used.

The EPC series contains the Boundless (VPU) (or Unbounded) algorithm which does not require a feedback potentiometer.

This type of valve has an inherent travel time – that is the time needed to slew from end-stop to end-stop. This time should be measured as accurately as possible in both directions and the average entered into the appropriate travel time parameter.

Boundless Valve Position (VPU)

The Valve Positioner boundless (VPU) algorithm operates *without knowledge* of the actual valve position. Therefore, it *does not* require a potentiometer on the valve.

VPU contains a special incremental form of the PID algorithm. It uses the valve itself as an accumulator, to 'add up' the increments calculated by the algorithm. Because of this special formulation, it can be treated as a positional algorithm, just like PID itself.

It contains a simple software model of the valve, based on the entered Travel Time, which estimates the valve position (the Working Output). It is important to realize that this estimation is just that, and that over time, particularly long cycles, the displayed Working Output and the real valve position may be completely different. This has no effect on control performance—it is purely a display problem. This model is also used in non-auto modes such as Manual.

With VPU, it is important that the valve travel time is measured and set as accurately as possible. This helps to ensure that the tuning parameters retain their real physical meanings and also helps to ensure proper autotuning, which may otherwise give an unsatisfactory tune. Motor travel time is defined as valve fully open - valve fully closed - it is not necessarily the time printed on the motor since, if mechanical stops have been set on the motor, the travel time of the actual valve may be different.

Note: EPC series supports valve position but only without a potentiometer.

Motorized Valve Control in Manual mode

When manual is selected, the algorithm predicts where the valve will move to based on the value of the manual power. The manual output is set as normal, and the controller will position the valve according to the internal estimated position.

Every time the valve is driven to its end stops the estimated and real positions will tend to realign themselves.

Parameters shown in this section are relevant to the subject being described. Further information is available in the Configuration chapter.

On-Off Control

Each of the two control channels can be configured for On-Off control. This is a simple type of control often found in basic thermostats.

The control algorithm takes the form of a simple hysteretic relay.

For channel 1 (heat):

1. When $PV > WSP$, $OP = 0\%$
2. When $PV < (WSP - Ch1OnOffHyst)$, $OP = 100\%$

For channel 2 (cool):

1. When $PV > (WSP + Ch2OnOffHyst)$, $OP = 100\%$
2. When $PV < WSP$, $OP = 0\%$

This form of control will lead to oscillation about setpoint but it is by far the easier to tune. The hysteresis should be set according to the trade-off between oscillation amplitude and actuator switching frequency. The two hysteresis values can be gain scheduled.

Feedforward

The block diagram for the feedforward subsystem structure is shown below.

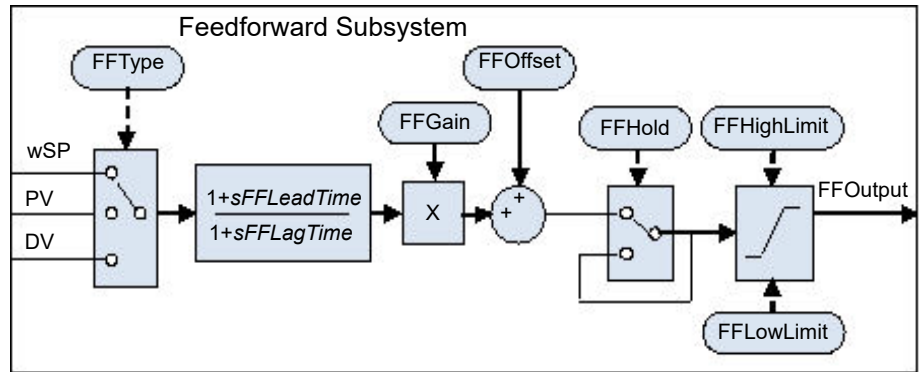

The Loop incorporates a feedforward controller in addition to the normal feedback (PID) controller; it is capable of static or dynamic feedforward compensation. Broadly, there are three common uses for feedforward in these instruments and are described in turn below.

Disturbance feedforward

A disadvantage of a feedback (PID) controller is that it responds only to deviations between PV and SP. By the time a PID controller first starts to react to a process disturbance, it is already too late and the disturbance is in progress; all that can be done is to try to minimize the extent of the disruption as much as possible.

Feedforward control is often used to overcome this disadvantage. It uses a measurement of the disturbance variable itself and *a priori* knowledge of the process to predict the controller output that will exactly counter the disturbance *before* it has a chance to affect the PV.

Feedforward on its own also has a major disadvantage. It is an open-loop strategy that relies entirely on a model of the process. Modelling error, uncertainty and process variation all help to prevent zero tracking error being achieved in practice. Further, the feedforward controller can only respond to disturbances that are explicitly measured and modelled.

To counter the relative disadvantages, the Loop combines both types of control in an arrangement known as “Feedforward with Feedback Trim”. The Feedforward controller gives the principal control output and the Feedback controller can trim this output appropriately to give zero tracking error.

The diagram below shows the feedforward with feedback trim structure.

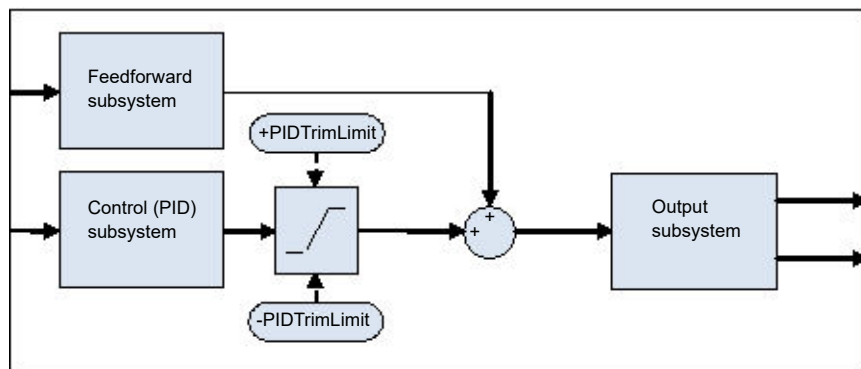

A symmetrical trim limit is provided around the PID component such that the influence of the feedback trim can be restricted.

Setpoint feedforward

Setpoint feedforward is arguably the type most often seen in instrument applications. A signal that is proportional to the working setpoint is fed-forward directly to the controller output. The most common scenario is dead-time dominant processes.

Dead times are common in process control. Flow lines, packaging lines, food processing lines and similar can all involve some amount of transport delay; that is to say that there is a finite period of time between an actuation being made by the final control element and a change being observed by the sensor.

Where this time delay is large with respect to other process dynamics, stable feedback control becomes increasingly difficult. A solution to this is often to detune the gain of the controller. Whilst this may well achieve stability, it also results in a sluggish system response to setpoint changes.

The 'Feedforward with Feedback Trim' arrangement shown above can be used to significantly improve the situation. The feedforward controller immediately gives an output value close to the final value and the PID controller can then trim this to give zero tracking error. The maximum amount of trim can be limited to help prevent the PID component having too much influence.

First, obtain the static characteristics of the plant. This can be achieved by putting the controller into Manual and, at a number of output values, record the final steady-state PV. Determine values of Gain and Bias that approximate the relationship, such that $OP = Gain * PV + Bias$.

If required, dynamic compensation can be used to change the feedforward output response. For example, it may speed things up even more if the output gives an initial kick *in excess* of its final value before settling back down. A lead compensation can achieve this as discussed later.

Static or dynamic compensation

An example of Feedforward output response to SPchange with Static (left) and Dynamic (right) compensation is shown below.

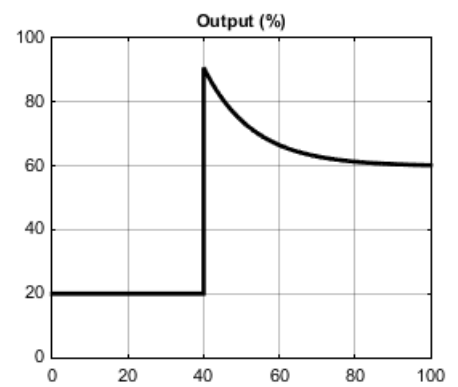
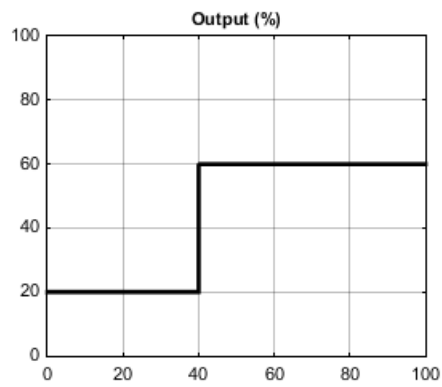

Split Range (heat/cool)

Inherent in the Loop is the concept of split-range for heat/cool.

Each Loop has a single setpoint and single PV, but can have *two* outputs. These two outputs operate in opposite directions. For example, consider a chamber with both a heater and a chiller. Both of these actuators are used to influence the temperature (the 'process variable', PV), but they operate in different directions: increasing heat output causes increasing PV, whereas increasing chiller output causes decreasing PV. Another example might be a gas carburizing furnace where the atmosphere is either enriched with methane (channel 1) or diluted with air (channel 2).

The way that the loop implements this is to allow the control output to extend over the span -100 to $+100\%$. In this way, the range is split so that 0 to $+100\%$ is output on channel 1 (heat) and -100 to 0% is output on channel 2 (cool). The diagram below shows Split Range Outputs (Heat/Cool)

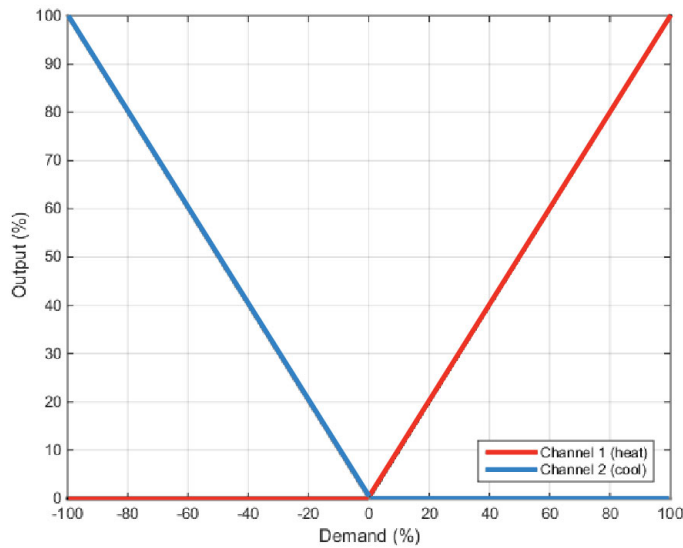

In addition, the loop allows each of the two channels to use different control types. The available control algorithm types are:

1. PID with an absolute output.
2. PID with valve positioning (without measured position and VPU).
3. Hysteretic On-Off ('bang-bang') control.

For example, a process may have an electrical heater on channel 1, controlled with the PID algorithm, whereas the flow of coolant through a jacket is modulated by a valve which is controlled by the VPU algorithm on channel 2. Transfer between the different algorithms is handled automatically.

In addition, different actuator gains are handled by having a separate proportional band for each channel.

Cooling Algorithm

The method of cooling may vary from application to application.

For example, an extruder barrel may be cooled by forced air (from a fan), or by circulating water or oil around a jacket. The cooling effect will be different depending on the method. The cooling algorithm may be set to linear where the controller output changes linearly with the PID demand signal, or it may be set to water, oil or fan where the output changes non-linearly against the PID demand. The algorithm provides optimum performance for these methods of cooling.

Non-linear cooling

The loop provides a set of curves that can be applied to the cooling (ch2) output. These can be used to compensate for cooling non-linearities thereby making the process 'look' linear to the PID algorithm. Curves for *Oil*, *Fan* and *Water* cooling are provided.

Curves are always scaled to fit between 0 and the output low limit. Tuning the curve to the process is an important step in commissioning and can be achieved by adjusting the output low limit. The low limit should be set to the point at which the cooling effect is maximum, before it starts to drop off again.

Be aware that any output rate limiting is applied to the output *before* non-linear cooling. Therefore, the actual controller output may change faster than any configured rate limit, but the power being delivered to the process will move at the correct rate, provided the curve has been correctly applied.

Air or Oil cooling

At low temperatures, the rate of heat transfer from one body to another can be considered linear and is proportional to the temperature difference between them. In other words, as the cooling media heats up, the rate of heat transfer slows down. So far, this is linear.

The non-linearity arises when a *flow* of cooling media is introduced. The higher the rate of flow (mass transfer), the less time a given 'unit' of media is in contact with the process and so the greater the average rate of heat transfer.

The air and oil characteristic is shown in the diagram below.

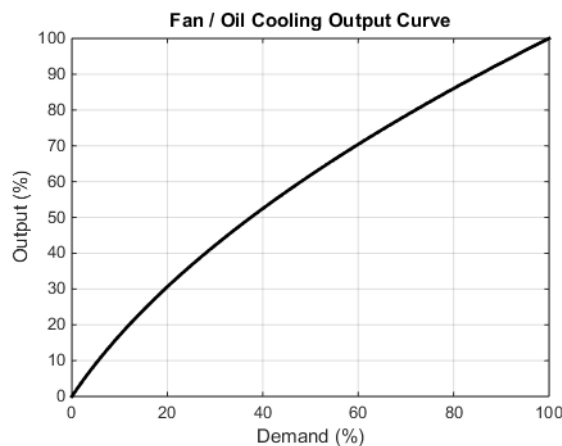

Evaporative Water cooling

Vaporizing water requires about five times as much energy as is required to raise its temperature from 0–100°C. This difference represents a large non-linearity, where at low cooling demands, the principal cooling effect is evaporative, but at higher cooling demands only the first few pulses of water flash off to steam.

To compound this, the mass transfer non-linearity described above for oil and air cooling is also true for water cooling.

Evaporative water cooling is often used in plastics extruder barrels and so this feature is ideal for that application. The evaporative water cooling characteristic is shown below.

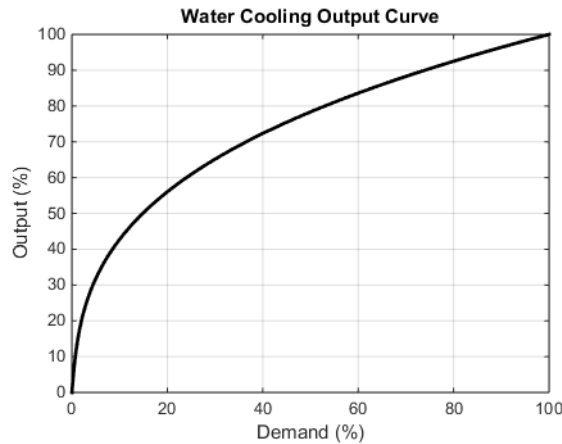

Channel 2 (heat/cool) Deadband

The channel 2 deadband introduces a gap between the point at which channel 1 switches off and the point at which channel 2 switches on, and vice versa. This is sometimes used to help prevent small and fleeting demands for cooling during normal process operation.

For a PID control channel, the deadband is specified in % output. For example, if the deadband is set to 10%, then the PID algorithm must demand -10% before ch2 will begin to switch on.

For an On/Off control channel, the deadband is specified in % of hysteresis. The diagram shows heat/cool with 20% deadband.

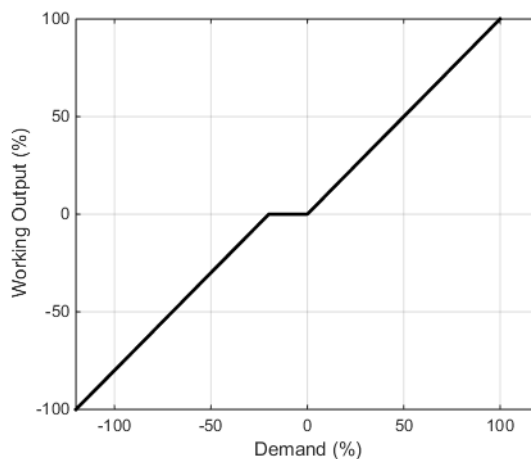

Bumpless Transfer

Where possible, the transfer to an Auto control mode from a non-Auto control mode will be 'bumpless'. This means that the transition will go smoothly without large discontinuities.

Bumpless transfer relies on there being an integral term in the control algorithm to 'balance out' the step change. For this reason, it is sometimes called an 'integral balance'.

The *IntBal* parameter allows the external application to request an integral balance. This is often useful if it is known that a step change in PV is to occur, for example a compensation factor has just changed in an oxygen probe calculation. The integral balance will help to prevent any proportional or derivative kick, instead allowing the output to be smoothly adjusted under integral action.

Sensor Break

'Sensor Break' is an instrument condition that occurs when the input sensor is broken or out of range. The Loop reacts to this condition by putting itself in Forced Manual mode (see above description). The type of transfer when entering Forced Manual, when the PV status is not good, can be selected using the *PVBadTransfer* parameter. The options are:

- Enter Forced Manual mode with the output set to the Fallback Value.
- Enter Forced Manual mode with the output held at the last good value (typically a value from about one second ago).

Operating Modes

The Loop has a number of possible operating modes. It is quite possible for several modes to be requested by the application at once. The active mode is therefore determined by a priority model, whereby the mode with the highest priority will always win.

For details of the modes and their priorities, refer to "Loop - Main Sub-list" on page 117.

Start-up and Recovery

Proper start up is an important consideration and varies depending on the process. The Loop recovery strategy is followed under any of the following circumstances:

- Upon instrument start-up, after a power cycle, power outage event or power disruption.
- Upon exit from Instrument Configuration or Standby conditions.
- Upon exit from Forced Manual (F_MAN) mode to a lower priority mode (e.g. when the PV recovers from a bad status or an alarm condition goes away).

The strategy to follow is configured by the *RecoveryMode* parameter. The two available options are:

1. Last mode with last output
The loop will return to Auto or Manual mode, whichever was last active. The working output will be initialized to the last used output value.
2. Manual mode with fallback output
The loop will always enter Manual mode. The initial output will be the configured Fallback Value, unless recovering from Forced Manual where the transfer will be bumpless.

Setpoint subsystem

The diagrams below show Setpoint function block. The first shows the 'Remote Setpoint with local trim' configuration.

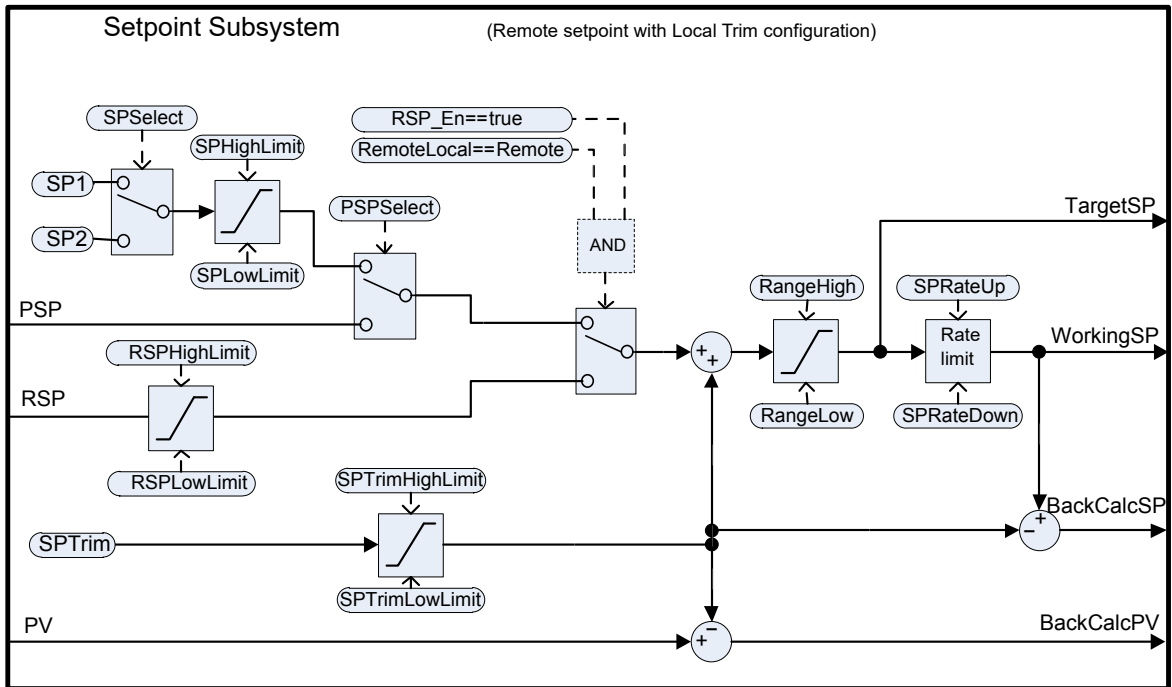

The second diagram shows Setpoint subsystem in the 'Local Setpoint with remote trim' configuration.

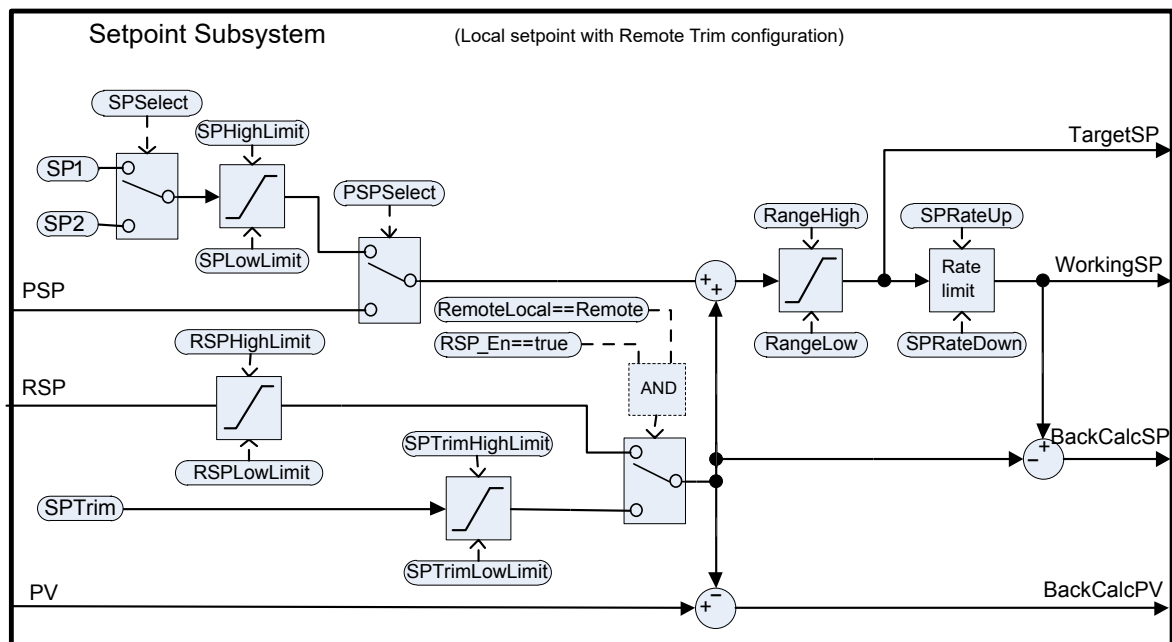

The setpoint subsystem resolves and generates the working setpoint for the control algorithms. The working setpoint can ultimately come from several different sources, programmer, local or remote, have local or remote trims applied, and be limited and rate limited.

Remote/Local Setpoint Source Selection

The RemoteLocal parameter selects between the remote or local setpoint source.

The SPSource parameter reports which source is currently active. The three values are:

- Local – the local setpoint source is active.
- Remote – the remote setpoint source is active.
- F_Local – the remote setpoint source has been selected but it cannot become active. The local setpoint source is active until the exceptional condition is resolved.

In order for the remote setpoint source to become active, the following conditions need to be fulfilled:

1. The RemoteLocal parameter has been set to 'Remote'.
2. The RSP_En input is true.
3. The status of the RSP input is Good.

Note: The 'RemoteLoc' parameter is enumerated as 0 = Remote and 1 = Local.

In previous instruments such as 2400 series and 3200 series 0 = Local and 1 = Remote.

This difference may be noticed if, for example, a digital input is used to select between local and remote. In 2400/3200 the contact must be open for local, closed for remote. In an EPC3000 controller it must be open for remote and closed for local.

Local Setpoint Selection

There are three local setpoint sources: the two operator setpoints, SP1 and SP2; and the program setpoint, PSP. For selection parameters and priorities, refer to the above diagram.

Remote Setpoint

RSP is the remote setpoint source. It can be configured by the *RSPT* parameter in one of two ways:

1. Remote setpoint (RSP) with a local trim (SPTrim).
For example, in a continuous oven with several temperature zones, the master controller can transmit its setpoint to each slave's RSP, and then a local trim can be applied in each slave to achieve the desired temperature gradient through the oven.
2. Local setpoint (SP1, SP2 or PSP) with a remote trim (RSP).
For example, in a combustion air/fuel ratio application where the ratio setpoint is fixed, but a remote controller analyses the excess oxygen in the flue gases and is allowed to trim the ratio within a given band.

The remote setpoint is always limited by the RSPHighLimit and RSPLowLimit parameters.

Setpoint limits

The various setpoint parameters are subjected to limits according to the diagram below. Some of the limits themselves are also subjected to limits.

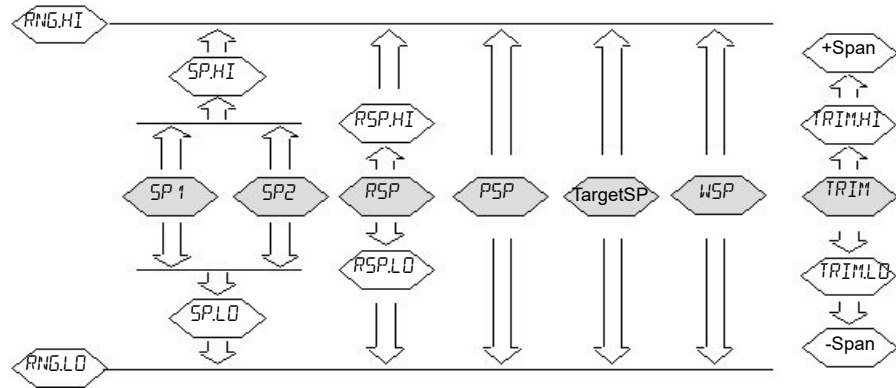

The *Span* is taken to be the value given by $(RangeHigh - RangeLow)$.

Note: Whilst it is possible to set the RSP Limits outside the Range Limits, the RSP value will still be clipped to the Range Limits.

Setpoint Rate Limit

Rate limits can be applied to the final setpoint value. This can sometimes be useful to help prevent sudden step changes in controller output, and therefore help to prevent damage to the process or product.

Asymmetric rate limits are available. That is to say that the increasing rate limit can be set independently of the decreasing rate limit. This is often useful, for example in a reactor application whereby a sudden increase in flow should be reduced so that an exothermic event does not overwhelm the cooling control loop. On the other hand, a sudden decrease in flow should be permitted.

The setpoint rate limits may be set in units per hour, per minute or per second, according to the SPRateUnits parameter.

Note: When transitioning into an automatic control mode from a non-automatic control mode such as manual, the WSP will be set equal to the PV whenever a rate limit is set. It will then move towards the target setpoint from there at the configured rate.

In addition, if the SPRateServo parameter is enabled, the WSP will be set equal to the PV whenever the Target SP is changed and will then move towards the target from there. This only applies in Auto (including the transition to Auto) when SP1 or SP2 is active. It does not apply when using a remote or program setpoint.

Target SP

The Target SP is the setpoint value immediately prior to rate limiting (the Working SP is the value immediately after it). In many instruments it is possible to write to the Target SP directly. The effect of this is to trigger a back-calculation, which takes into account the trim value (either a local or remote trim), and then to write the back-calculated value to the selected setpoint source. This is so that the calculated Target SP on the next execution is equal to the entered value.

This usefully allows the target setpoint to be set to a desired value immediately, without having to manually make the calculations and determine which setpoint source is active.

Writing to the TargetSP is not possible when a remote setpoint is active.

Tracking

There are three setpoint tracking modes available. They can each be turned on by enabling the appropriate parameter.

1. SP1/SP2 tracks PV
Whilst the mode is MANUAL, whichever of SP1 or SP2 is active will track the PV (less the trim). This is so that the operating point is maintained whenever the mode is changed to Auto.
2. SP1/SP2 tracks PSP
Whilst PPSSelect is enabled, whichever of SP1 or SP2 is active will track the PSP. This is so that the operating point is maintained when the programmer is reset and PPSSelect goes false.
3. SP1/SP2/SPTrim tracks RSP
When the RSP is active and acting as a Remote Setpoint, whichever of SP1 or SP2 is active will track RSP. If RSP is acting as a Remote Trim, then it is SPTrim that will track RSP. This is so that the operating point is maintained if the setpoint is switched to local.

Back-calculated SP and PV

Back-calculated versions of WSP and PV are provided as outputs. These are simply WSP/PV minus the active trim value. These outputs are given so that an external setpoint source (such as a setpoint programmer or a cascade master) can track their output to them as necessary, thus helping to prevent bumps on mode changes and switchovers.

Setpoint Integral Balance

When the SPIntBal parameter is enabled, the setpoint subsystem will issue an integral balance request to the PID/VPU algorithms whenever a step change in SP1 or SP2 occurs. This will cause any proportional or derivative kick to be suppressed and the PV will move smoothly to the new setpoint with the integral as the driving force and with minimum overshoot. The effect is the same as what is sometimes called 'proportional and derivative on PV' instead of error, but only applies to step changes in SP1 or SP2 and on transition to local setpoint from remote.

Output Subsystem

The diagram shows the block diagram of the Output subsystem.

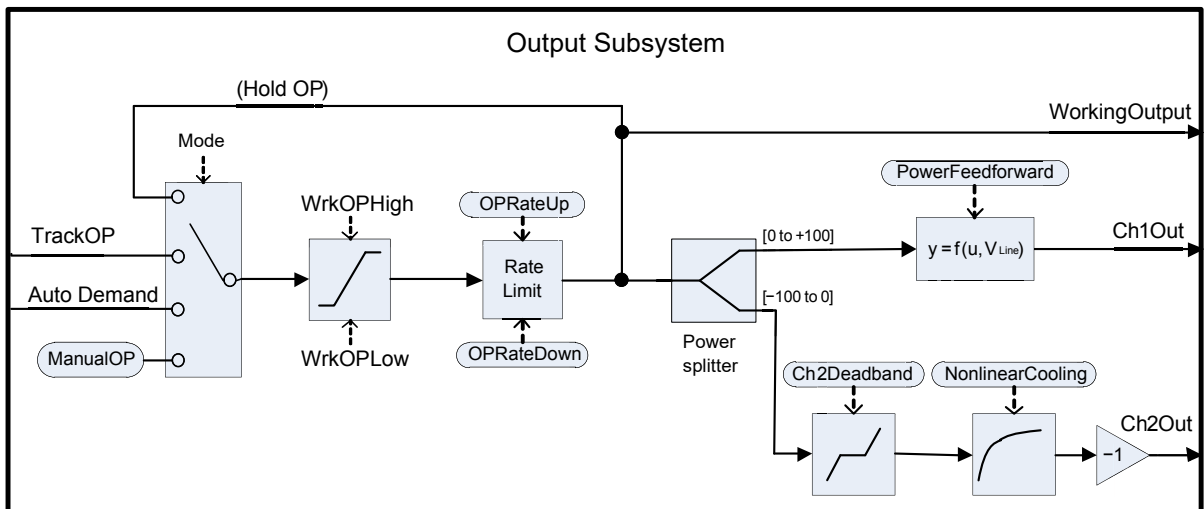

Output selection (including Manual Station)

The source of the output demand is resolved according to which controller mode is active. In HOLD, the previous Working Output is held. In TRACK, the output demand is taken from TrackOP. In MANUAL and F_MAN, the output is taken from ManualOP. In other modes, the output is taken from the control subsystems output.

Output Limiting

The resolved demand is subject to position limiting. There are several different sources of position limits:

- The master limits, *OutputHighLimit* and *OutputLowLimit*.
- The active gain scheduled limits: *OutputHigh(n)* and *OutputLow(n)*.
- The remote limits, *RemoteOPHigh* and *RemoteOPLow*.
- The tune limits (only during auto-tuning), *TuneOutputHigh* and *TuneOutputLow*.

The most restrictive limits always take priority. That is to say, the minimum of the upper limits and the maximum of the lower limits are used. These become the working output limits, *WrkOPHigh* and *WrkOPLow*.

The output limits are always applied in Auto modes. In non-Auto modes such as Manual, the *FallbackValue* may override a limit if that limit would help prevent the *FallbackValue* being achieved. For example, if the *OutputLowLimit* is 20% and the *FallbackValue* is 0%, then in Auto the working low limit will be 20%, while in Manual it will be 0%.

The remote output limits are only applied in Auto mode.

Rate limiting

The working output can be rate limited by setting the two parameters, *OPRateUp* and *OPRateDown*. They are always specified in % per second. Output rate limiting is only available for PID control channels and should be used only where necessary since it can significantly degrade process performance.

Power feedforward (line voltage compensation)

Power Feedforward is a feature that compensates for fluctuations in mains supply voltage. This can be useful for processes being heated by an electrical heater, where the heater is driven by the controller directly (e.g. via a relay or SSR).

Any fluctuation in line voltage can be immediately compensated for by adjusting the output power appropriately, thereby attenuating any resultant deviation in PV. Its effectiveness is illustrated below:

Power Feedforward Enabled

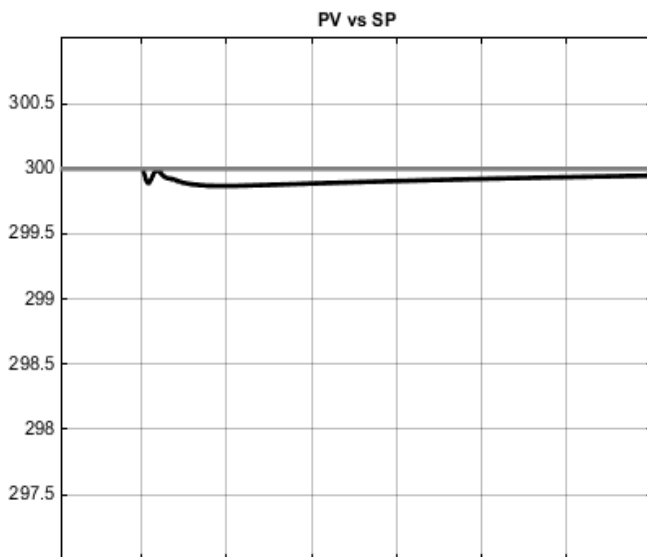

Power Feedforward Disabled

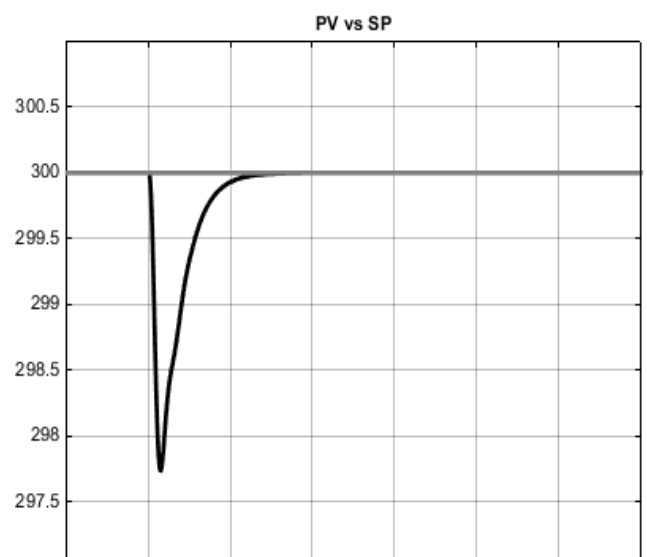

Here, it can be seen that enabling power feedforward has greatly reduced the magnitude of the process disturbance. However, the smaller disturbance persists for a longer period of time.

Power Feedforward is usually available in mid-range instruments but only where they are fitted with a 'high volts' power supply option. The controller measures its own power supply input to determine the heater voltage, therefore, it should be powered from the same supply as the heater itself. It should *not* be enabled if an intelligent power controller is driving the heater, since the power controller will itself provide compensation.

When enabled, power feedforward is applied to the heat channel (channel 1) only and is active while the controller is in Auto mode. It has no effect in other operating modes.

Autotuning

The diagram below shows a simplified structure of a relay-based Autotuner.

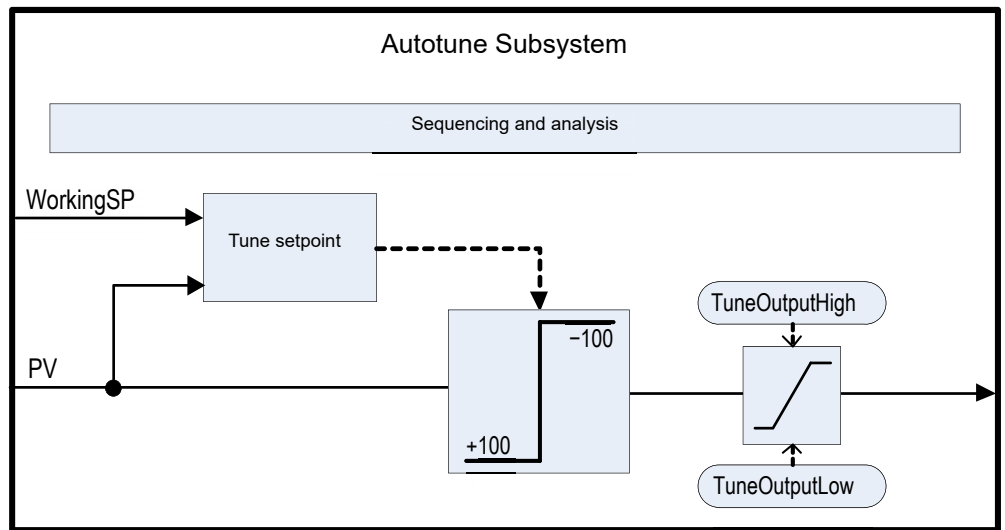

The function block contains sophisticated autotuning algorithms that can tune the controller to the process. They work by performing experiments on the plant, by inducing perturbations, and observing and analysing the response. The autotuning sequence is described in detail below.

The diagram shows an example of heat/cool Autotune with 'alternative' CH2 Tune Type.

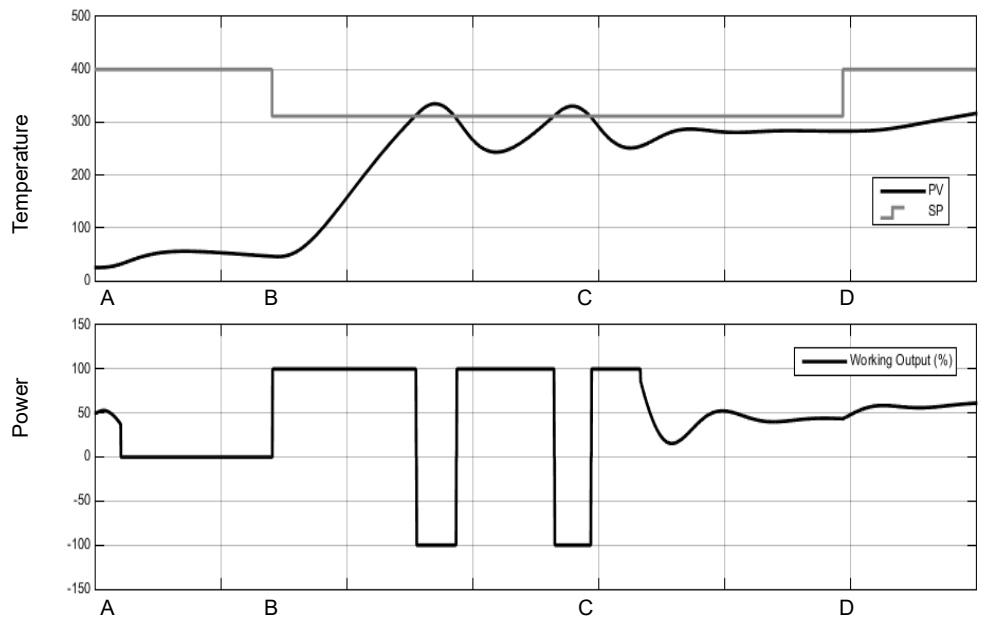

Time	Description
A	<p>Autotune Begins</p> <p>Setting the <i>AutotuneEnable</i> parameter to On and the controller mode to Auto will cause the autotune to begin.</p> <p>Before starting an autotune, you should turn off the PID terms that you do not want to use. For example, setting TD to Off will disable derivative action and the autotuner will therefore tune for a PI controller. If you do not want any integral, set TI to Off and the autotuner will tune for a PD controller.</p> <p>If the cutback thresholds, CBH and CBL, are set to Auto then the autotuner will not attempt to tune them.</p> <p>An autotune may be triggered at any time, but it will not begin until the mode goes to Auto. If autotune is triggered but the controller is not in Auto mode the scrolling message <i>AUTOTUNE TRIGGERED BUT CANNOT RUN</i> is displayed. In this case put the controller into Auto mode, the message <i>AUTOTUNE ACTIVE</i> will be displayed and the controller will begin the autotune process. Similarly, autotune will abort if the mode is changed away from Auto at any time during the tune, including reasons such as sensor status is bad. In this case it will be necessary to start autotune again.</p> <p>Note that the PID tuning constants will be written to whichever gain set is active when tuning completes.</p>
A to B	<p>Initial Delay</p> <p>This period always persists for precisely one minute.</p> <p>If the PV is already at the WSP then the working output will be frozen. Otherwise, the output is set to 0 and the process is allowed to drift while some initial measurements are made.</p> <p>The target setpoint may be changed during this initial delay, but not after it. You should set the target setpoint to the operating point at which you would like to tune. Care should be taken in setting the setpoint, to help to ensure that oscillations of the process will not damage the process or load. For some processes, it may be necessary to use a setpoint for tuning purposes that is below the normal operating point.</p>
B	<p>Calculate Tune Setpoint</p> <p>Once the initial delay has elapsed, the tune setpoint is determined. It is calculated by:</p> <p>If PV = Target SP: Tune SP = Target SP</p> <p>If PV < Target SP: Tune SP = PV + 0.75(Target SP – PV)</p> <p>If PV > Target SP: Tune SP = PV – 0.75(PV – Target SP)</p> <p>Once determined, this tune setpoint will be used for the duration of the autotune and any changes to the target setpoint will be ignored until the autotune has completed. If you wish to change the tuning setpoint, abort and restart the autotune.</p>

Time	Description
B to C	<p data-bbox="419 165 651 199">Relay Experiment</p> <p data-bbox="419 215 1469 282">The autotuner will now insert a relay into the closed-loop. This establishes the limit-cycle oscillations in PV.</p> <p data-bbox="419 304 767 338">The relay operates such that:</p> <p data-bbox="539 360 863 394">If $PV > SP$: $OP = \text{minimum}$.</p> <p data-bbox="539 416 871 450">If $PV < SP$: $OP = \text{maximum}$.</p> <p data-bbox="419 472 1469 573">The minimum and maximum outputs are determined by the various limits. There is also a small amount of hysteresis, not described, around the relay switching point to help prevent electrical noise from causing nuisance switching.</p> <p data-bbox="419 595 1417 663">The number of oscillations required before moving to the next stage depends on the controller configuration:</p> <p data-bbox="419 685 1406 786">If either channel is configured for VPU, or OnOff control, or if output rate limiting is enabled, then the 'Fourier' autotune algorithm will run. This requires three cycles of oscillation.</p> <p data-bbox="419 808 1406 887">If only PID is configured and there is no output rate limiting, then the 'PID' autotune algorithm will run. Only two cycles of oscillation are required.</p> <p data-bbox="419 909 1426 976">There will be an additional half-cycle of oscillation at the beginning of this stage if the initial PV is above the SP.</p> <p data-bbox="419 999 1458 1032">Once the required number of cycles is achieved, the algorithm moves to the next stage.</p>
C to D	<p data-bbox="419 1037 911 1070">Relative Channel 2 Tuning Experiment</p> <p data-bbox="419 1081 1390 1149">This stage is only used for dual-channel heat/cool configurations. For heat-only or cool-only, it is skipped.</p> <p data-bbox="419 1171 1469 1384">The purpose of this stage is to determine the relative gain between channel 1 and channel 2. This is used to set the correct proportional bands. For example, in a heat/cool process, the heater and the chiller are typically not equally rated, e.g. the heater might be capable of putting much more energy into the process in a given period of time than the chiller is capable of removing. This non-linearity needs accounting for and the purpose of this additional experiment is to collect the necessary information to make that correction.</p> <p data-bbox="419 1406 1449 1440">The type of experiment that is used can be selected with the Ch2TuneType parameter:</p> <p data-bbox="419 1462 1469 1608">The <i>Standard</i> experiment is the default and gives good results for most processes. It will put the process into an additional cycle of oscillation but instead of applying minimum output, it will apply 0 output and allow the PV to drift. This option is not available if TuneAlgo is Fourier.</p> <p data-bbox="419 1630 1469 1776">The <i>Alternative</i> experiment is recommended for processes that do not exhibit significant losses—for example, a very well-lagged tank or oven. It attempts to control the PV to the SP and collects data about the process input required to do so. The length of this stage is equivalent to between 1.5 and 2 oscillation cycles.</p> <p data-bbox="419 1798 1469 2011">The <i>KeepRatio</i> option should only be selected when the relative gain of the two channels is well known. It causes this stage to be skipped and instead the existing proportional band ratio will be maintained. So, for example, if you know that the heating channel will deliver a maximum of 20kW and the cooling channel will deliver a maximum of -10kW, then setting the proportional bands such that the ratio $Ch2PB/Ch1PB = 2$ before autotuning will allow the correct ratio to be maintained.</p>

Time	Description
D	<p>Analysis and Completion</p> <p>The autotune experiments are now complete. Finally, some analysis will be performed on the collected data and the controller tuning constants will be chosen and written to whichever gain set is active. This analysis may take a number of seconds, typically less than 15, during which the output will be frozen.</p> <p>After the tune has completed, the working setpoint is released and can be modified in the usual manner. Authority over the output is returned bumplessly to the control algorithms.</p>

Notes:

1. If any stage of the autotune sequence exceeds two hours in duration, the sequence will timeout and be aborted. The StageTime parameter counts up the time in each stage.
2. Channels configured for OnOff control cannot be autotuned but they will be exercised during the experiments if the opposite channel is not OnOff.
3. For VPU channels, it is important that the associated Travel Time parameter is set as accurately as possible before commencing the autotune.
4. Carbon Potential loops, which have a setpoint in the range 0–2.0% (and other loops with small setpoint ranges), cannot be autotuned if the proportional band type is set to 'Engineering Units'. For these loops, proportional band type should be set to 'Percent' and the RangeHigh and RangeLow set correctly. This allows autotune to work.

A number of further examples under different conditions are pictured below.

The first shows an example Heat-only Autotune.

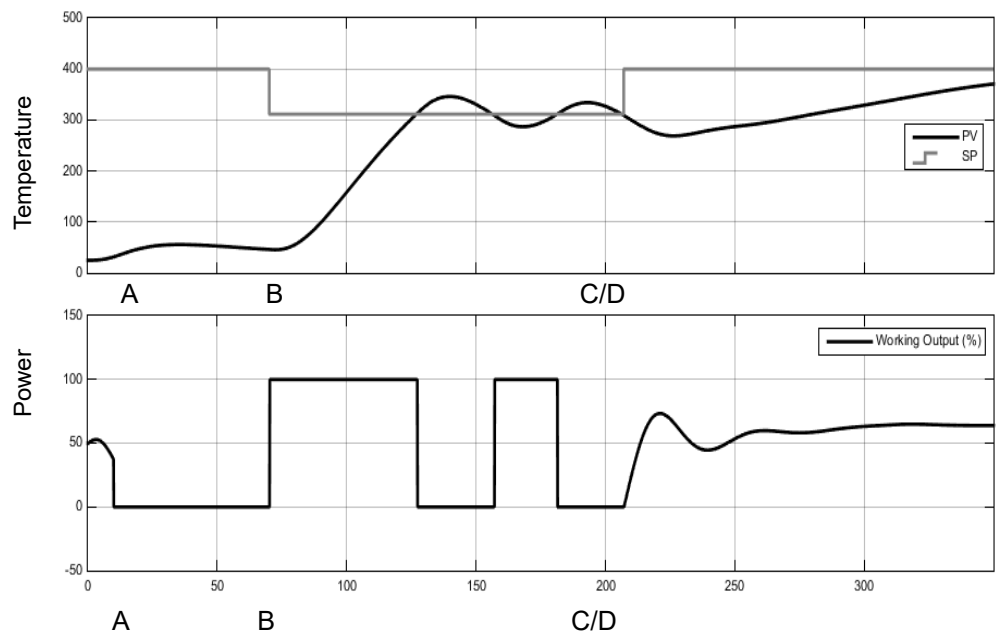

The second example shows Heat/Cool Autotune with 'Standard' Ch2 tune type.

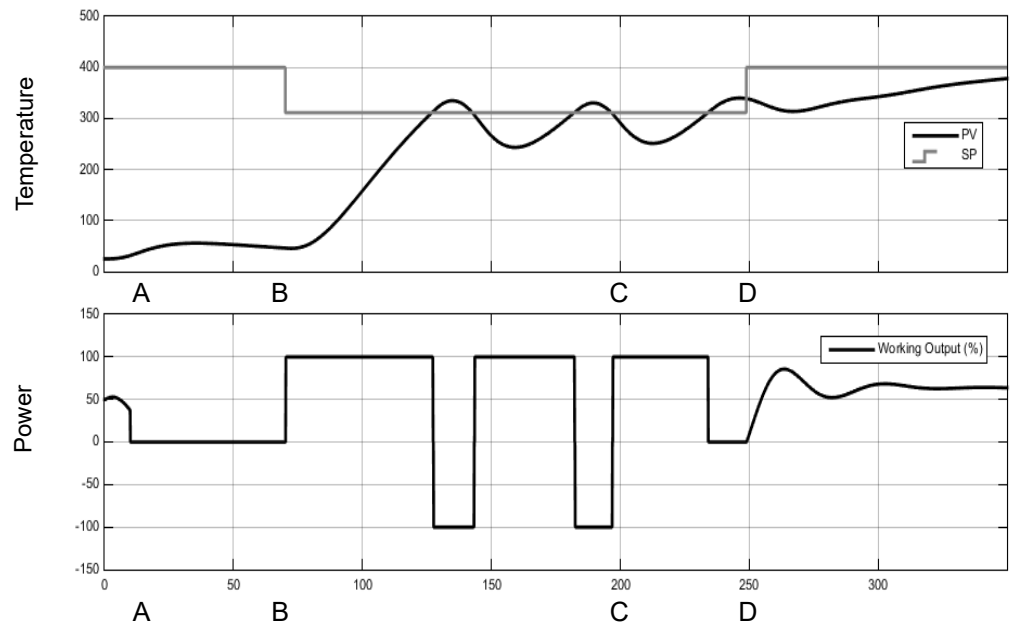

The third shows an example of Heat/Cool Autotune from above with output rate limiting.

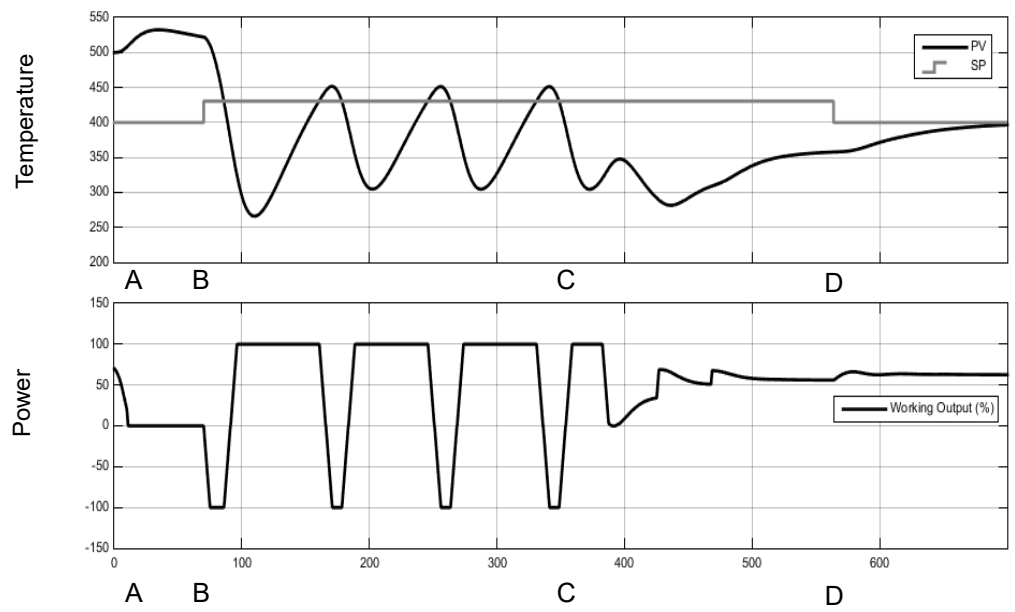

Autotuning multiple zones

Autotune relies completely on the principle of cause and effect. It perturbs the process and then watches for what the effect will be. It is therefore essential that all external influences and disturbances are minimized as much as possible during an autotune.

When autotuning a process that has multiple interacting loops, for example a furnace with multiple temperature zones, each loop should be autotuned separately. They *should not* under any circumstances be autotuned at the same time, since the algorithms will not be able to ascertain what cause produced what effect. The procedure below should be followed:

1. Place all loops in manual and set the outputs to the approximate steady state value for the desired operating point. Allow the process to settle.
2. Enable autotune on a *single zone*. Allow the tune to complete.
3. After the zone has finished autotuning, allow it to settle out in auto and then place it back into manual.
4. Repeat steps 2 and 3 for each zone.

Digital Communications

Digital Communications (or 'comms' for short) allows the controller to communicate with a PC or a networked computer system or any type of communications master using the protocols supplied. Connections to the PC are shown in "Digital Communications Connections" on page 58. A data communication protocol defines the rules and structure of messages used by all devices on a network for data exchange. Communications can be used for many purposes - SCADA packages; PLCs; data logging for archiving and plant diagnostic purposes; cloning for saving instrument set ups for future expansion of the plant or to allow a controller to be replaced by a spare. EPC3000 can have three available communications ports: Config, Fixed and Option.

Config communications port uses the serial configuration clip to be able to connect to the device from a PC using iTools software. Comms settings (baud rate, parity, etc.) for the Config comms is fixed and user will need physical access to the physical device.

The other two ports, Fixed and Option communications, can be accessed by a PC using iTools (or any Modbus Master) from a distance without having physical access to the device via serial (RS232, RS422, RS485) or Ethernet connections. Comms settings (baud rate, parity, comms address, IP address, subnet, etc.) for Fixed and Option comms can be configured depending on the network where the device is installed.

Note: From EPC3000 firmware version v5.xx, default comms configuration passcodes have been removed and users are prompted to set a password when first connecting from iTools. Until a password is set, only a limited set of parameters will be available to read and write via Fixed and Option comms.

NOTICE
<p>COMMS SETTINGS SECURITY</p> <p>To prevent Fixed and Option comms settings from being changed, rendering the connection unusable, Fixed and Option comms setting can only be changed using the front panel HMI or Config comms port using the serial configuration clip via PC with iTools software (or any Modbus Master).</p> <p>Failure to follow these instructions can result in equipment damage.</p>

Serial Communications

EPC3000 supports EI-Bisynch and Modbus RTU serial comms protocols as a slave. In controllers V4.01 and above, support for a Modbus RTU master has been added as a chargeable option.

EI-Bisynch

EI-Bisynch is a proprietary Eurotherm protocol based on the ANSI X3.28-2.5 A4 standard for message framing. It is included in the EPC3000 series controller as an EI-Bisynch slave so that it can replace earlier instruments such as 2000 series. Despite its name, it is an ASCII based asynchronous protocol. Data is transferred using 7 data bits, even parity, 1 stop bit.

EI-Bisynch identifies parameters within an instrument using (usually) two letter abbreviations for a given parameter, for example, PV for Process Variable, OP for Output, SP for Setpoint, and so on. The list of supported parameters is given in "Appendix: EI-BISYNCH Parameters" on page 395.

Further information is available for both protocols in the Series Communications Handbook part no. HA026230. This may be accessed via www.eurotherm.com.

EI-Bisynch Limitations

In the case of the detection of read or write message failures the instrument will respond with the following single character replies:

Write message failure detected: 0x15 (Negative Acknowledge or NAK).

Read message failure detected: 0x04 (End of transmission or EOT).

iTools will display a generic notification "Failed to write data to device" or "Failed to read data from device".

The actual reason for the error is saved in the mnemonic "EE". This special mnemonic may then be read to give the status of the last communications transaction. It is a hex format parameter, whose value corresponds to the following status and errors:

EE Mnemonic value	Description
0	No error
1	Invalid mnemonic
2	Parameter is read only
7	Incorrect message
8	Limit error

Further information on EI-Bisynch may be found in the 2000 Series Communications manual part number HA026230 available from www.eurotherm.com.

Modbus RTU

MODBUS (JBUS) Protocol defines a digital communication network to have only one MASTER and one or more SLAVE devices. Either a single or multi-drop network is possible. All message transactions are initiated by the MASTER. Eurotherm instruments communicate using the Modbus RTU binary protocol.

The JBUS protocol is identical in most respects to Modbus protocol - the main difference being that Modbus uses a 0-based register addressing whereas JBUS uses 1-based register addressing.

The list of Modbus addresses is available in iTools by opening the browser list.

A full description of the Modbus protocol can be found on www.modbus.org.

In EPC3000 V4.01 and above, Modbus RTU master feature will be available in addition to the existing Modbus RTU slave.

For Modbus RTU master configuration please refer to Modbus TCP master configuration.

Serial Comms Parameters

The parameters which follow are applicable to EI-Bisynch and Modbus RTU slave while only Baud Rate and Parity are applicable to the Modbus RTU master.

Baud Rate

The baud rate of a communications network specifies the speed that data is transferred between instrument and master. A baud rate of 9600 equates to 9600 Bits per second. Since a single character requires 8 bits of data plus start, stop, and optional parity, up to 11 bits per byte may be transmitted. 9600 baud equates approximately to 1000 Bytes per second. 4800 baud is half the speed - approx. 500 Bytes per second.

In calculating the speed of communications in your system it is often the Latency between a message being sent and a reply being started that dominates the speed of the network.

For example, if a message consists of 10 characters (10msec at 9600 Baud) and the reply consists of 10 characters, then the transmission time would be 20 msec. However, if the Latency is 20msec, then the transmission time has become 40msec.

Parity

Parity is a method of ensuring that the data transferred between devices has not been corrupted.

Parity ensures that every single byte in the received message contains the same number of ones or zeros when it was received as when it was transmitted.

In industrial protocols, there are usually layers of checking to ensure that the first byte transmitted is good. Modbus protocol applies a CRC (Cyclic Redundancy Check) to the data to ensure that the package is correct.

Communication Address

On a network of instruments a comms address is used to identify a particular instrument. Each instrument on a network should have a unique comms address. Address 255 is reserved for the configuration port.

Comms Delay

In some systems it is necessary to introduce a delay between the instrument receiving a message and sending its reply. This is sometimes necessary if the line transceivers require an extended time to switch to tristate.

Ethernet Communications

From firmware versions V4.01 and above EPC3000 series controllers will support an EtherNet/IP Adapter or a Modbus Master alongside the existing Modbus slave.

Setting Up the Ethernet Module

It is recommended that the communications settings for each instrument are set up before connecting it to any Ethernet network. This is not essential but network conflicts may occur if the default settings interfere with equipment already on the network.

The IP address, subnet mask, default gateway and DHCP enable need to be configured. This can be done via HMI or the config clip, but not via Option or Fixed Comms.

Changing any one of these parameters may immediately move the instrument to a new state. For this reason, it is recommended that such changes are made offline, before connecting to an Ethernet network.

IP Addresses are usually presented in the form "abc.def.ghi.jkl".

Name	Description	Address	Value	Wired From
Baud	Baud Rate	1248	9600_baud (1)	
Parity	Parity	1249	None (0)	
Address	Node Address	1250	1	
AutoDiscovery	Enables automatic discovery of instrument on a network	1272	Off (0)	
IPMode	IP Mode	1251	Static (0)	
IPAddress1	1st byte of IP Address	1252	192	
IPAddress2	2nd Byte of IP address	1253	168	
IPAddress3	3rd Byte of IP address	1254	111	
IPAddress4	4th byte of IP address	1255	222	
SubnetMask1	1st byte of Subnet mask	1256	255	
SubnetMask2	2nd byte of Subnet mask	1257	255	
SubnetMask3	3rd byte of Subnet mask	1258	255	
SubnetMask4	4th byte of Subnet mask	1259	0	
DefaultGateway1	1st byte of Default gateway	1260	0	
DefaultGateway2	2nd byte of Default gateway	1261	0	
DefaultGateway3	3rd byte of Default gateway	1262	0	
DefaultGateway4	4th byte of Default gateway	1263	0	
MAC1	MAC address 1	1264	0	
MAC2	MAC address 2	1265	10	
MAC3	MAC address 3	1266	141	
MAC4	MAC address 4	1267	3	
MAC5	MAC address 5	1268	135	
MAC6	MAC address 6	1269	25	
UnitIDType	Unit Identity Type	1270	Strict (0)	
MsgFormat	Message format	1271	Free (0)	
BroadcastStormActive	Broadcast Storm Active	1274	No (0)	
RateProtectionActive	Rate Protection Active	1275	No (0)	

Comms.Option.Network - 27 parameters

Ethernet Parameters

The parameters which follow are applicable to Ethernet communications.

AutoDiscovery

The 'AutoDiscovery' flag set to True (On) implements Bonjour™, which means it is not necessary to add the EPC3000 controller IP address to the iTools control panel applet.

Bonjour

Bonjour™ is an implementation of Zeroconf, which allows a plug 'n' play type feel to instrument connectivity by providing a method of auto discovery of a device on an Ethernet network and therefore negates the need for network configuration by the user. It is used to provide an easy route for Ethernet connectivity configuration in the EPC3000 controller range.

Bonjour™ is released under a terms-of-limited-use license by Apple.

Note: For cybersecurity reasons, the Bonjour™ service is disabled by default, as it makes it easier for a malicious user to discover and access the controller via the network. To turn on Bonjour™ auto-discovery, use the `AUTO DISCOVERY` parameter as follows.

To Turn AutoDiscovery On or Off

When the controller is first switched on from new (or following a Cold Start) the option to turn AutoDiscovery On or Off is given in the Quick Start codes, see section "Configure the Communications Protocol" on page 73.

The option to turn AutoDiscovery on/off from the controller HMI may also be made in Configuration mode.

Using the controller buttons: Page , Scroll , Up , Down 

1. Enter Configuration level as described in section "To Select Configuration Level" on page 98.
2. Press the Page button until *Comm* is shown.
3. Press the Scroll button. If *F.Comm* is shown press the Up button to select *O.Comm* (Optional communications).
4. Press the Scroll button. *Modbus* will be displayed.
5. Press the Scroll button again to show *ETHER* (Ethernet).
6. Press the Scroll button again. If *NONE* is shown use the UP button to select *Modbus TCP*.
7. Press the Page button to return to *Modbus*.
8. Press the Up button to show *Network*.
9. Continue to press the Scroll button until *ADISC* is shown.
10. Press the Up or Down button to select *OFF* or *On*

Note: Make sure that the controller and PC are on the same subnet. At this point it is possible to communicate with iTools but you must exit configuration level first to apply configuration changes.

11. Exit configuration level and wait for a few seconds for iTools (version V9.79 or later) to receive the controller broadcasts.
12. In iTools select 'Add'. If AutoDiscovery is turned 'On' the controller will appear in the list of devices connected via Ethernet.

Note: The EPC3000 controller will not appear in the list if it is in Configuration Mode.

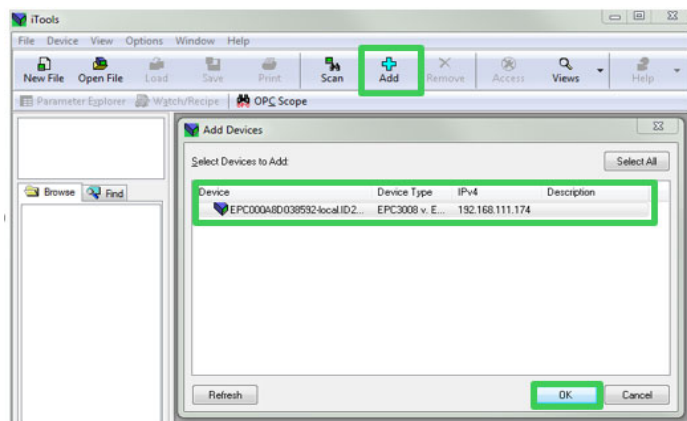

For security reasons, however, it may be advisable to turn AutoDiscovery off. In this case, if AutoDiscovery and DHCP is not used, iTools must be set up for Ethernet. This is described in the instructions which follow. iTools configuration package, version V9.79 or later, may be used to configure Ethernet communications.

Manually Setup the Controller

To allow the iTools Scan function to find devices, they must be manually added to the iTools Control Panel.

1. Ensure iTools is NOT running before taking the following steps.
2. Open the iTools control panel (Start ' All Programs ' Eurotherm iTools Advanced ' iTools Control Panel).

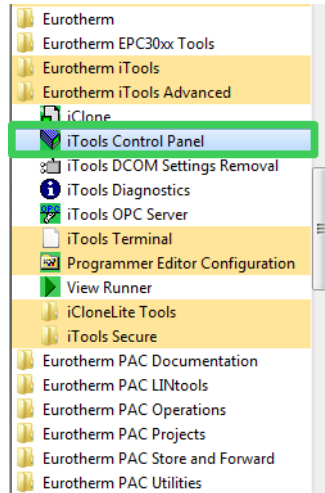

3. Within the iTools configuration settings select the 'TCP/IP' tab.

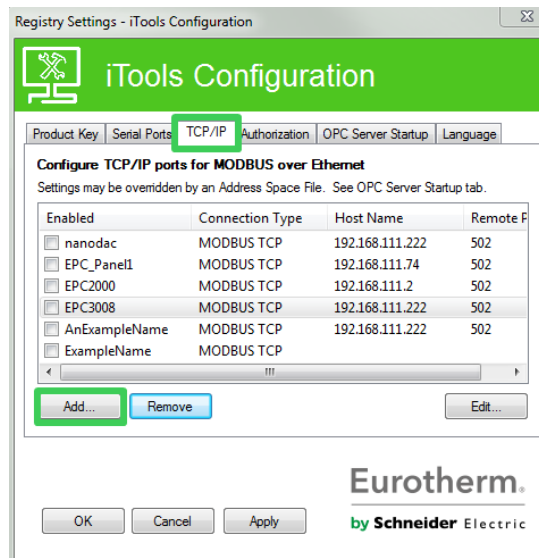

- Click the 'Add' button to add a new connection. Type in a name of your choice, eg EPC3000, and press Add. (Ensure that no duplicate IP address entries are enabled at the same time).

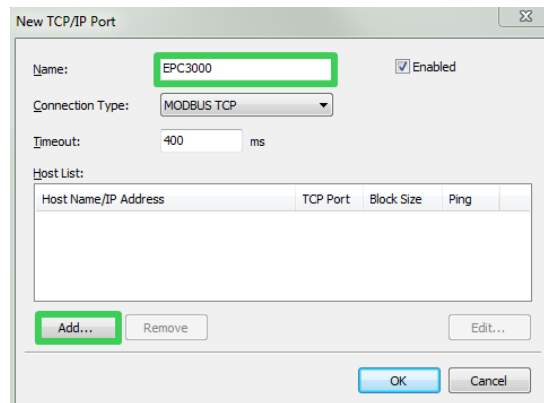

- Enter the correct IP address of the device ensuring that the PC IP address is in the same range as the controller, then click OK.

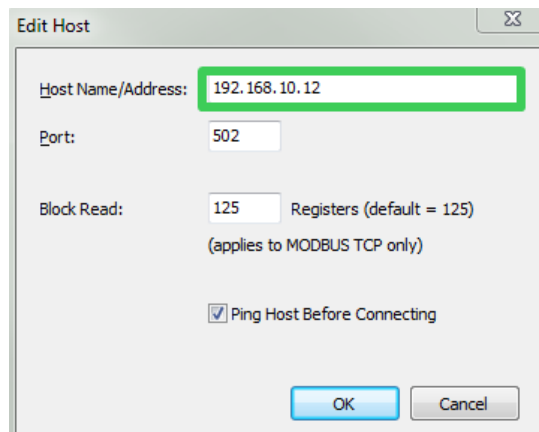

Note: The controller default address is 192.168.111.222; subnet mask 255.255.255.0.

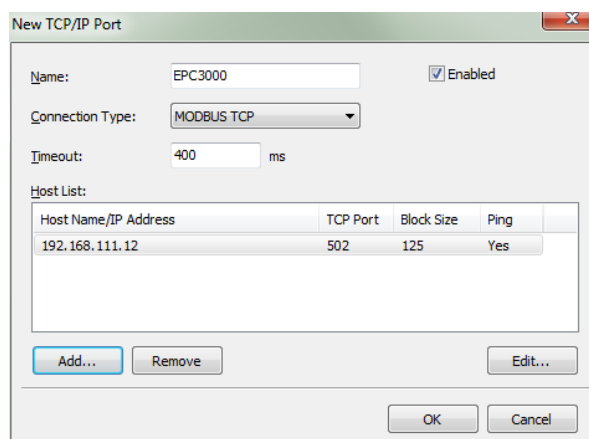

6. Click OK, the entries will appear in the iTools Control Panel.

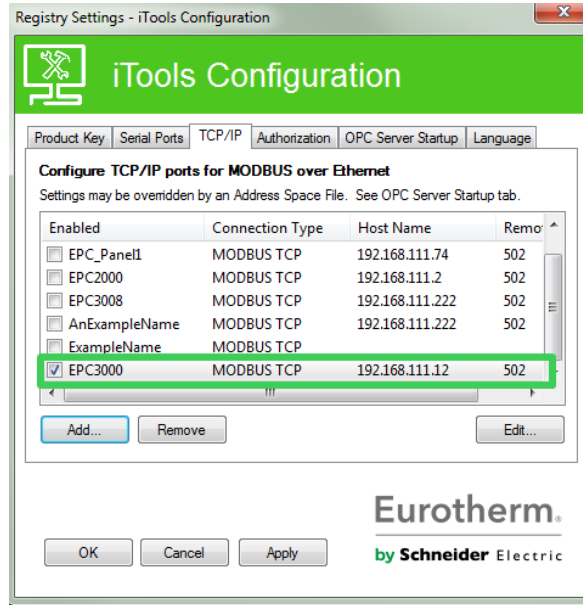

iTools is now ready to communicate with an instrument at the Host Name/IP Address configured.

7. Open iTools and press 'Scan'.

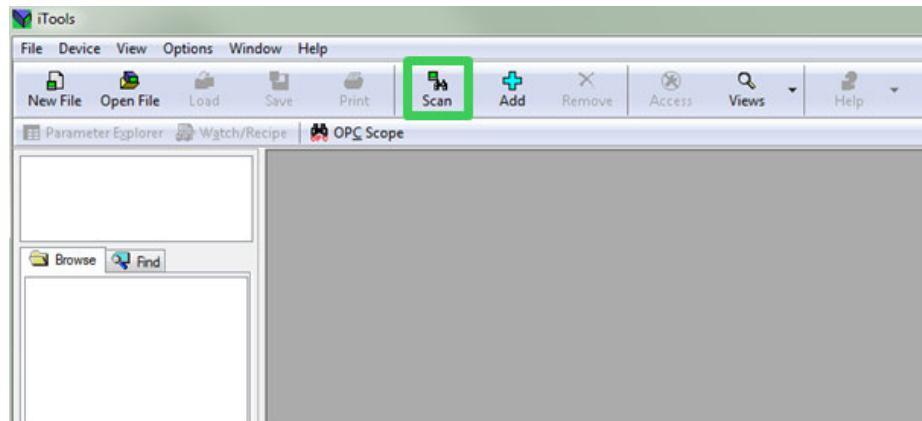

The scan will find devices if they have been added to the iTools Control Panel. (And if they are in the same range as the IP address of the PC).

IP Mode Settings

It will generally be necessary to consult with your network administrator to determine if the IP addresses, Subnet mask and Default gateway for the instruments should be static or dynamically allocated by a DHCP server.

Dynamic IP Addressing

IP addresses may dynamically allocated by a DHCP server on the network. When IP addresses are dynamically allocated the server uses the instrument MAC address to uniquely identify them.

To configure dynamic IP addressing, the user must first set the IPMode parameter in the "Option Comms" list to DHCP.

Once connected to the network and powered, the instrument will acquire its "IP address", "Subnet Mask" and "Default gateway" from the DHCP Server and display this information within a few seconds.

If DHCP is active but the DHCP server cannot be contacted then the IP address will be set to 0.0.0.0.

Similarly, if a valid DHCP IP address lease expires and the server is not contactable then the IP address will be set to 0.0.0.0.

Note: There will be a time delay (around 30 seconds) before the new address will appear.

Static IP Addressing

IP addresses may be 'fixed' ('Static') - meaning the user manually enters the IP address and SubNet Mask values, which will remain unchanged, before connecting the instrument to the network.

Within the "Comms.Option.Network" list of the instrument ensure that the "IP Mode" parameter is set to "Static", then set the IP address and Subnet Mask and Default gateway as required (and defined by your network administrator).

See section "Network Sub List (nWrk)" on page 153.

To set up an IP address for Ethernet via the front panel

If DHCP is not used the IP address, Subnet mask and Default gateway addresses can be set up manually (the MAC addresses are set up in production and are read only).

The default IP address is 192.168.111.222 and the default subnet mask is 255.255.255.0.

8. From 13 above press the Scroll button to scroll through the Ethernet options. The Up and Down buttons allow the values to be altered.
9. Scroll through *IP A1*, *IP A2*, *IP A3*, and *IP A4* to set each part of the IP address, e.g. IP.A1 = 192, IP.A2 = 168, IP.A3 = 111, IP.A4 = 222.

The Subnet mask and Default gateway can be set in a similar way except the MAC address which is read only.

Default Gateway

The "Comms.Option.Network" list also includes configuration settings for "Default Gateway". These parameters will be set automatically when DHCP IP mode is used. When static IP mode is used these settings are only required if the instrument needs to communicate wider than the local area network- see your network administrator for the required setting.

MAC address display

Each Ethernet module contains a unique MAC address, normally presented as a 12 digit hexadecimal number in the format "aa-bb-cc-dd-ee-ff".

In EPC3000 controllers MAC addresses are shown as 6 separate decimal values in the "COMMS" list. MAC1 shows the first pair of digits (example "170"), MAC2 shows the second pair of digits and so on.

The MAC address is only available for communications port with Ethernet interfaces. It can be found in the Option Comms list shown in section "Network Sub List (nWrk)" on page 153.

Broadcast Storm Protection

Broadcast Storm Protection discards all broadcast packets if the broadcast rate climbs too high. Broadcast Storm and Ethernet Rate Protection are intended to favour maintaining the control strategy in certain high traffic network environments.

The diagnostic parameters Broadcast Storm and Rate Protection, see section "Network Sub List (nWrk)" on page 153, which indicates when the protection is active.

Ethernet Rate Protection

Certain excessive network loads on embedded products have the potential to impact processor availability to the point that useful control is compromised and the product restarts as there is no longer CPU to service the device watchdog.

The EPC3000 series controllers incorporate an Ethernet Rate Protection algorithm which will de-prioritize Ethernet comms in very heavy traffic environments so that the control strategy continues and the instrument does not watchdog reset.

Protocols

From firmware version V4.01 and above, Modbus TCP master has been added in addition to the existing Modbus TCP slave in earlier versions.

EtherNet/IP



EtherNet/IP Adapter (slave) is available in firmware versions V3.01 and above. The controller has been conformance tested to CT15.

EtherNet/IP (Ethernet/Industrial Protocol) is a 'producer-consumer' communication system used to allow industrial devices to exchange time-critical data. Such devices range from simple I/O devices such as sensors/actuators, to complex control devices such as robots and PLCs. The producer-consumer model allows the exchange of information between a single sending device (producer) and a large number of receiving devices (consumers) without having to send data multiple times to multiple destinations.

EtherNet/IP makes use of the CIP (Common Industrial Protocol), common network, transport and application layers currently implemented by DeviceNet and ControlNet. Standard Ethernet and TCP/IP technology is used to transport CIP communications packets. The result is a common, open application layer on top of Ethernet and TCP/IP protocols. With EtherNet/IP option enabled, an EPC3000 controller can act as an EtherNet/IP Adapter (slave) in an EtherNet/IP configured installation. This is a chargeable feature protected by Feature Security, section "Security Sub-List (SEC)" on page 197. Note that an EPC3000 controller is NOT available as an EtherNet/IP Scanner (master).

EPC3000 series controllers, in common with other Eurotherm controllers, have available a large number of potential parameters but practical systems are constrained by the total I/O space available in the EtherNet/IP Scanner (master) being used and by the amount of traffic permissible on the network. The EPC3000 controller implicit IO exchange communications will be limited to a maximum of 64 configurable input and 64 configurable output parameters. A Fieldbus IO Gateway tool is provided within iTools software to configure the IO exchange parameters (section "Fieldbus IO Gateway" on page 358).

The EPC3000 controller EtherNet/IP adapter has been conformance tested and certified by the ODVA (certificate number 11761). It is able to communicate to a variety of ODVA approved EtherNet/IP Scanners.

EPC3000 Controller EtherNet/IP Features

The EtherNet/IP implementation features include:

- 10/100Mbit, full / half duplex operation: auto sensing.
- Galvanically isolated bus electronics.
- A selectable software option, at configuration.
- 3x Implicit IO messaging connections available.
- 6x Explicit messaging connections available.

CIP Object Support

Class (hex)	Name
01	Identity Object
02	Message Router Object
04	Assembly Object (64 inputs / 64 outputs <=> EPC3000 Fieldbus I/O Gateway)
06	Connection Manager Object
F5	TCP/IP Interface Object
F6	Ethernet Link Object
44	Modbus object

Setting Up The EtherNet/IP Scanner

This section is included for guidance only and you should refer to the instructions provided by the manufacturer of the master. The EtherNet/IP Scanner used in the following example is a CompactLogix L23E QB1B PLC from Allen Bradley.

Prerequisites:

1. FactoryTalk Activation Manager, RSLinx Classic and RSLogix 5000 software must be installed in your PC.
2. Connect Allen Bradley CompactLogix L23E to PC via serial port.
3. Connect PC, Allen Bradley CompactLogix L23E and EPC3000 controller on the same local Ethernet network using a hub or a switch.
4. Configure PC and EPC3000 controller to be on the same subnet.
5. Power up CompactLogix L23E with key set to PROG.

Checking Software Licenses:

6. Click on Start/All Programs/Rockwell Software/FactoryTalk Activation/FactoryTalk Activation Manager (needs Internet connection to verify activation). The FactoryTalk Activation Manager window opens.
7. Click “Find Available Activations” and make sure that licenses for RSLogix 5000 and RSNetWorx for EtherNet/IP are present in the Available Activations table.

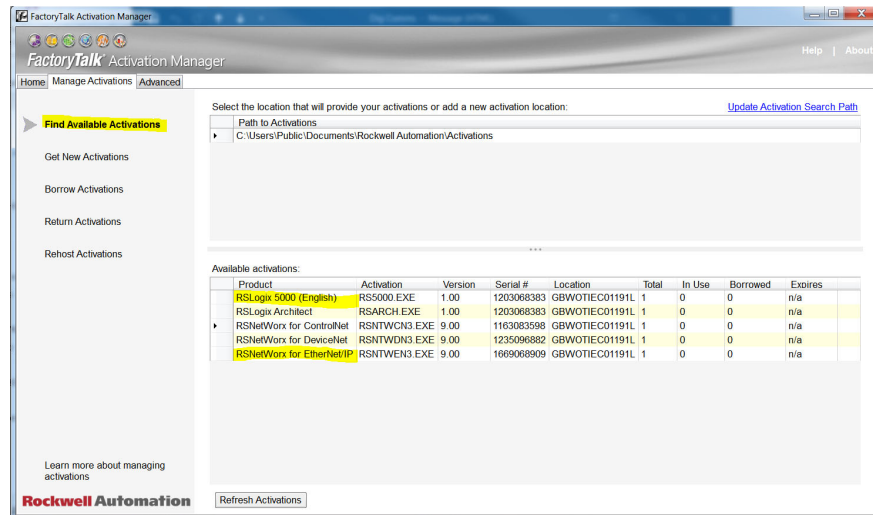

Configuration Of PC Interfaces

8. Click on Start/All Programs/Rockwell Software/RSLink/RSLink Classic. The 'RSLink Classic' window opens.
9. Click on 'Communications' and select 'Configure Drivers'. When the 'Configure Drivers' window opens, select 'RS-232 DF1 devices' in the 'Available Drive Types' pull down menu and click "Add New".

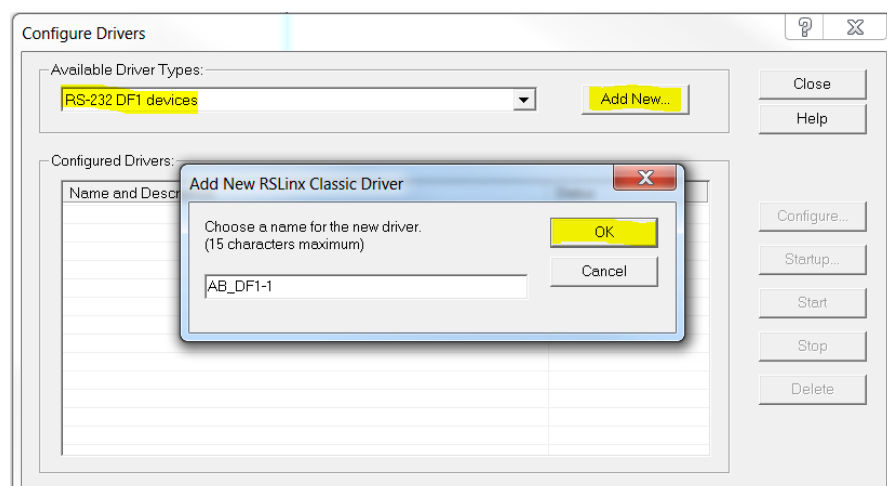

10. Click OK.

- 11. Select PC Comm Port connection and the Device type connected to the port and the click Auto-Configure. Make sure that auto-configuration was successful then click OK.

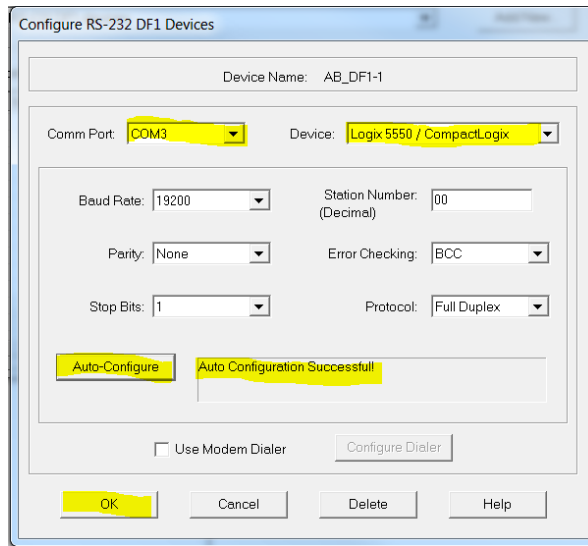

- 12. Select 'EtherNet/IP driver' in the 'Available Drive Types' pull down menu and click "Add New".

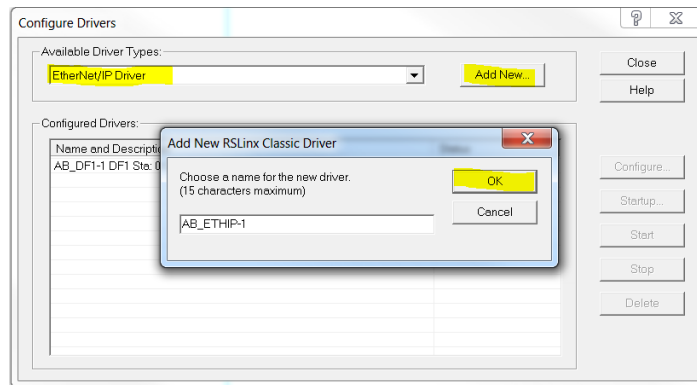

- 13. Select "Browse Local Subnet" and select local PC network card to be used to connect to the EtherNet/IP network then click OK.

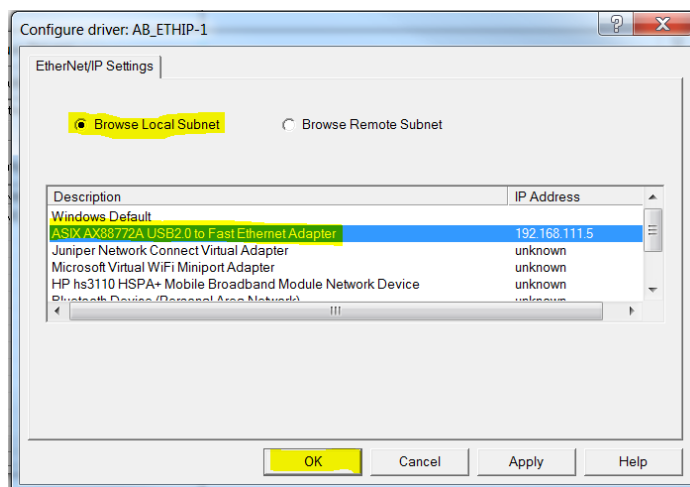

14. PC Serial and EtherNet/IP drivers must now be running. Minimize window.

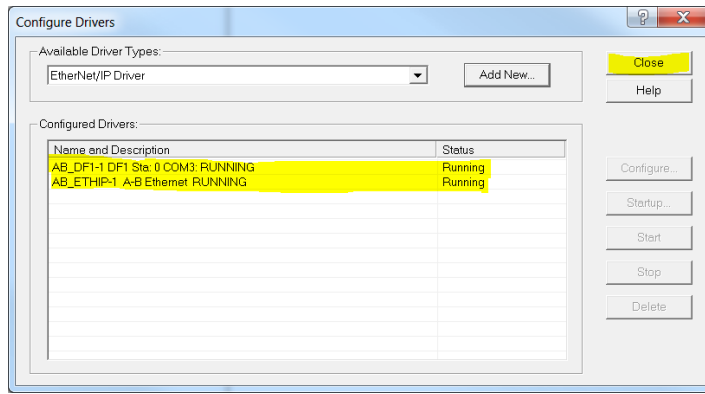

Configuration Of RSLOGIX 5000 Application

The following describes the configuration of the CompactLogix L23E EtherNet/IP Scanner network settings using the RXLogix 5000 software:

15. Start the RSLogix 5000 program (from 'Start/All programs/... /RSLogix 5000'). When the 'Quick Start' window opens, close it.
16. In the 'File' menu select 'New', or click on the 'New Tool' icon. The 'New Controller' window opens.
17. Select the relevant PLC from the drop-down menu. Enter a name for the configuration and click on 'OK'. After a few seconds, the window opens for the selected controller.

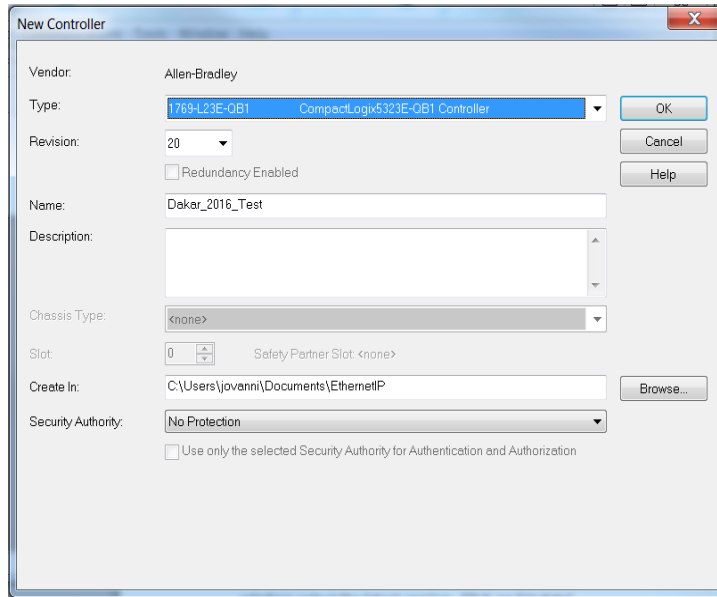

18. Configure the Ethernet port settings of the CompactLogix L23E by right clicking on the relevant Ethernet port in the left pane 'tree', and select 'Properties'.

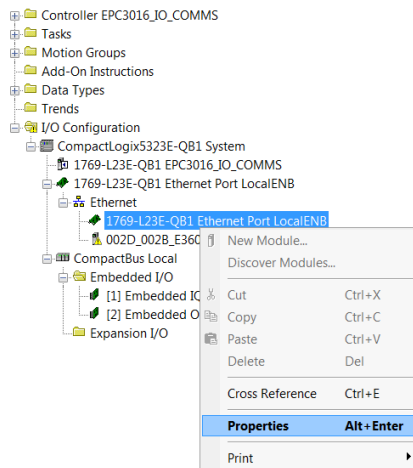

19. In the Module Properties window, configure the IP address and click OK.

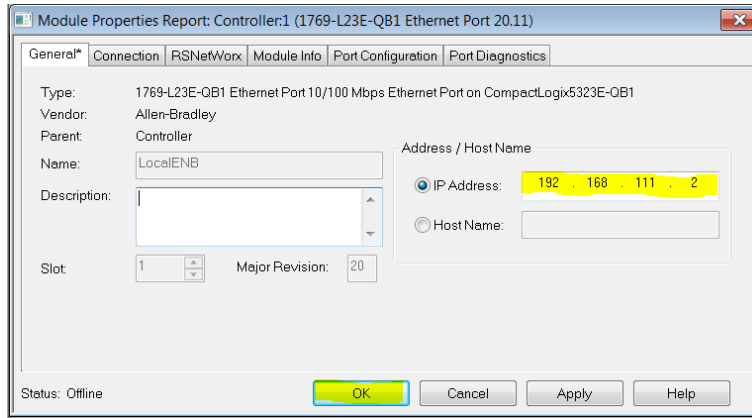

Configure Scanner Connection Settings to the EPC3000 Controller EtherNet/IP Adapter

Method 1 (Without EDS File)

20. Configure the EPC3000 Adapter by creating a new module under the CompactLogix L23E Ethernet node.

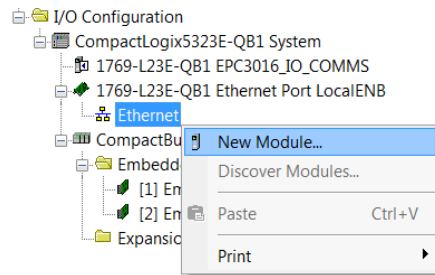

21. Select "Generic Ethernet Module" as module type and click "Create" button.

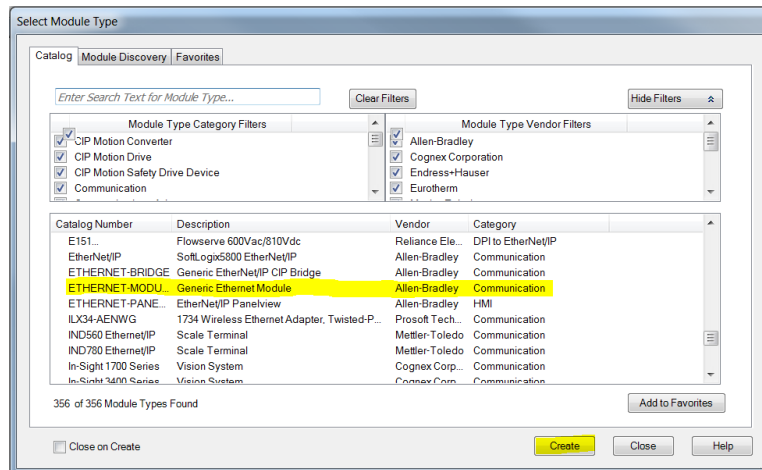

22. Fill in Module properties with EPC3016 Adapter settings then click OK.

Comm Format (Data - INT)

IP Address (xxx.xxx.xxx.xxx)

Description	Assembly Instance	Size
Input	100	16 x 16-bit (EPC3000 default)
Output	150	7 x 16-bit (EPC3000 default)
Configuration	199	0 (EPC3000 default)

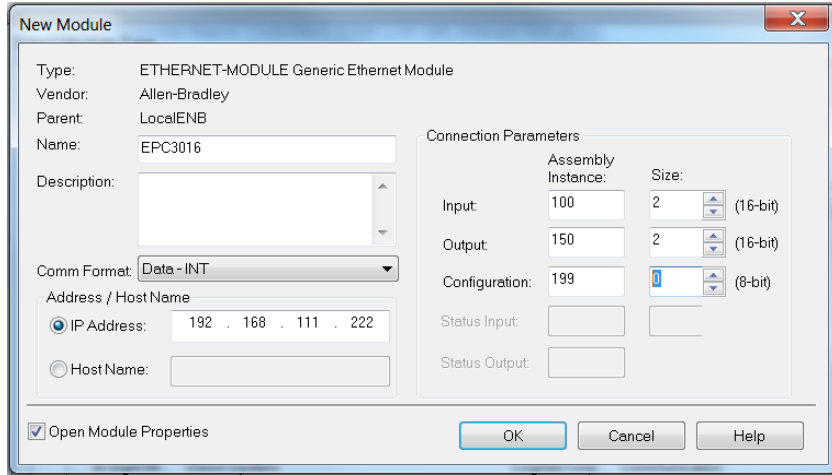

23. Configure connection properties of the newly created module by right-clicking it and selecting “Properties”.

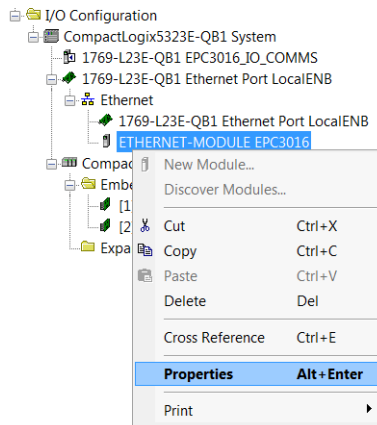

24. Set Requested Packet Interval (RPI) using Module Properties “Connection” tab making sure that it is within 50 to 3200 ms then click OK.

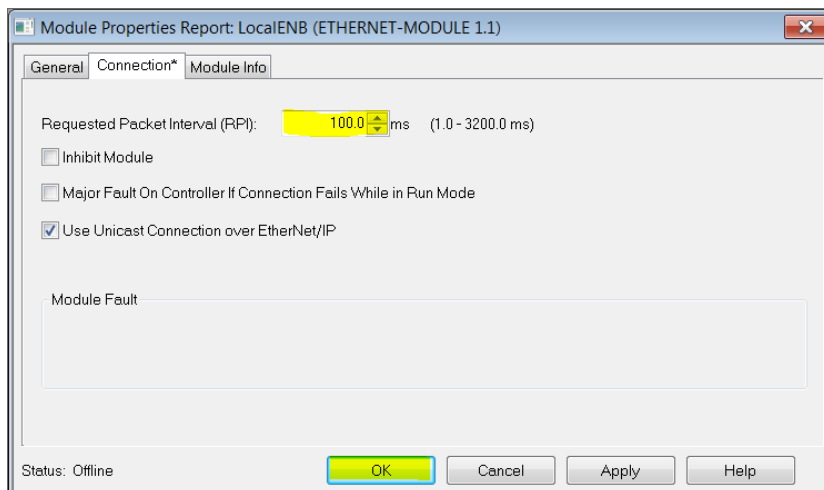

Method 2 (With EDS File)

To install the EPC3000 EDS, proceed as follows:

- 25. Click on Start/All Programs/Rockwell software/RSLinx/Tools/EDS Hardware Installation Tool. The 'EDS Hardware Installation Tool' window opens.
- 26. Click Add to open the EDS Wizard window and then select the "Register a single file" radio button. Browse to the EPC3000 EDS file and then click "Next".

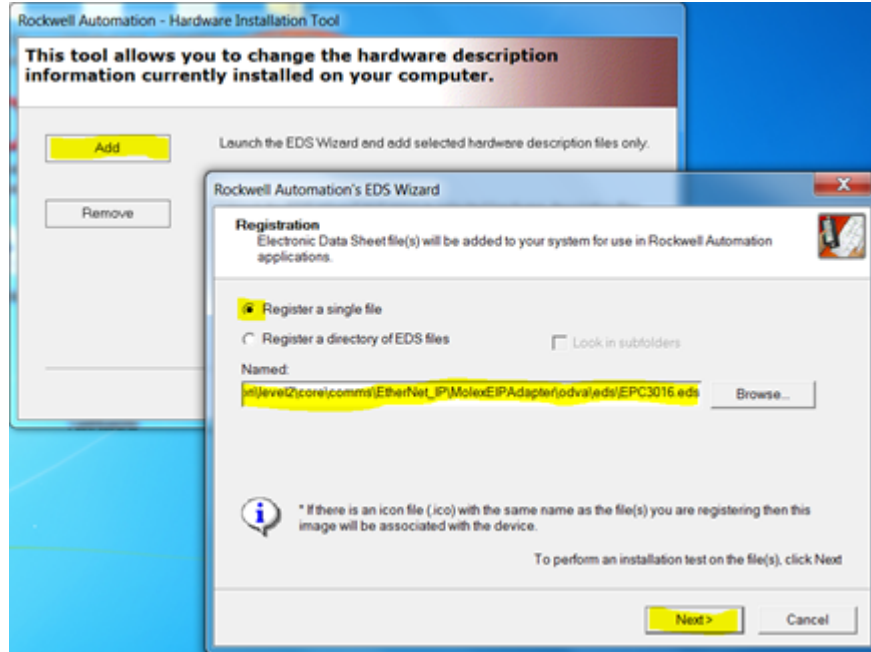

- 27. Click "Next" button on the next 3 windows and then click "Finish" on the final window.

Configure Scanner Connection Settings to the EPC3000 Adapter

- 28. In the RSLogix 5000 Scanner Program, configure EPC3000 Adapter connection settings by creating a new module under the CompactLogix L23E Ethernet node. Right click Ethernet node and select "New Module" from context menu. On the pop-up window "Select Module Type". Click "Show Filters" button.

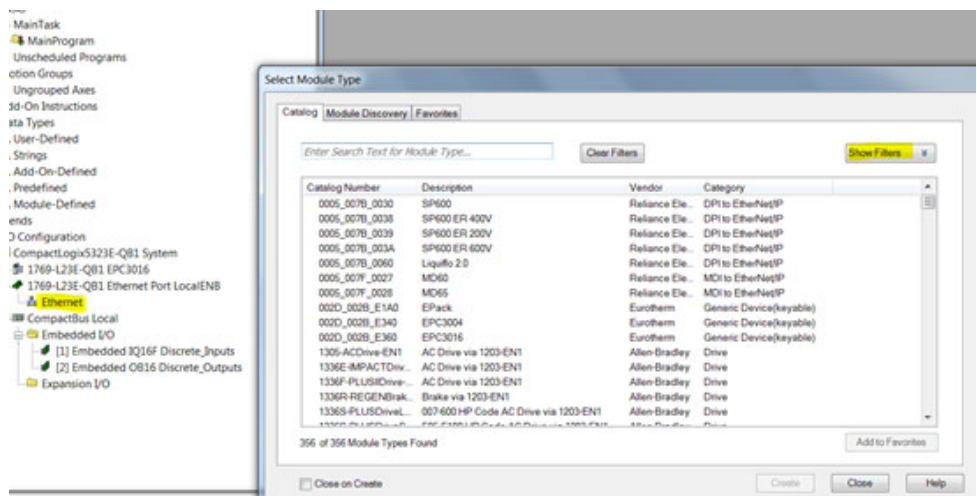

29. Filter for Eurotherm devices and then select the EPC3000 device module required (module installed in the previous section via EDS file) and then click “Create” button.

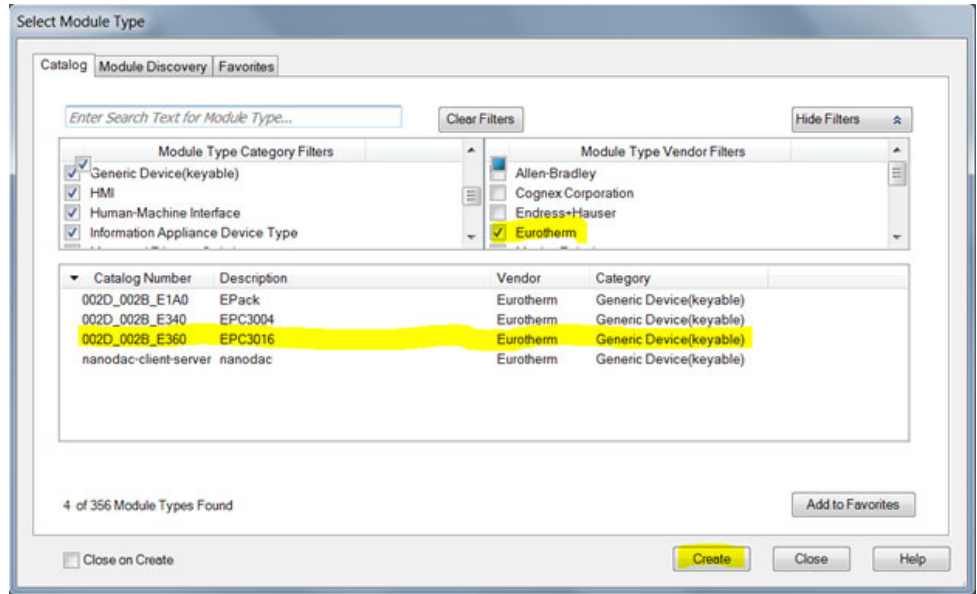

30. A “New Module” window will pop up. Click “Change” button to configure the:
Connection type: Exclusive Owner / Input Only / Listen Only
Input Size: Default length of EPC3000 inputs in INT (16 x 16-bit)
Output Size: Default length of EPC3000 outputs in INT (7 x 16-bit)
Then click “OK”.

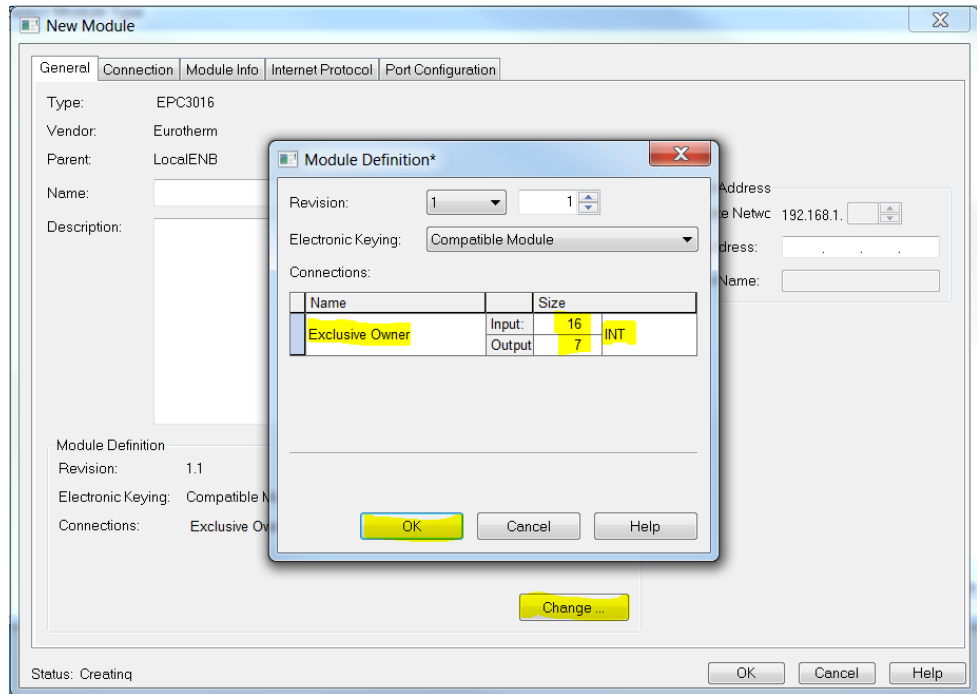

31. On the “New Module” window, configure the IP address of the EPC3000 EtherNet/IP adapter. Enter a descriptive name and then click “OK” button.

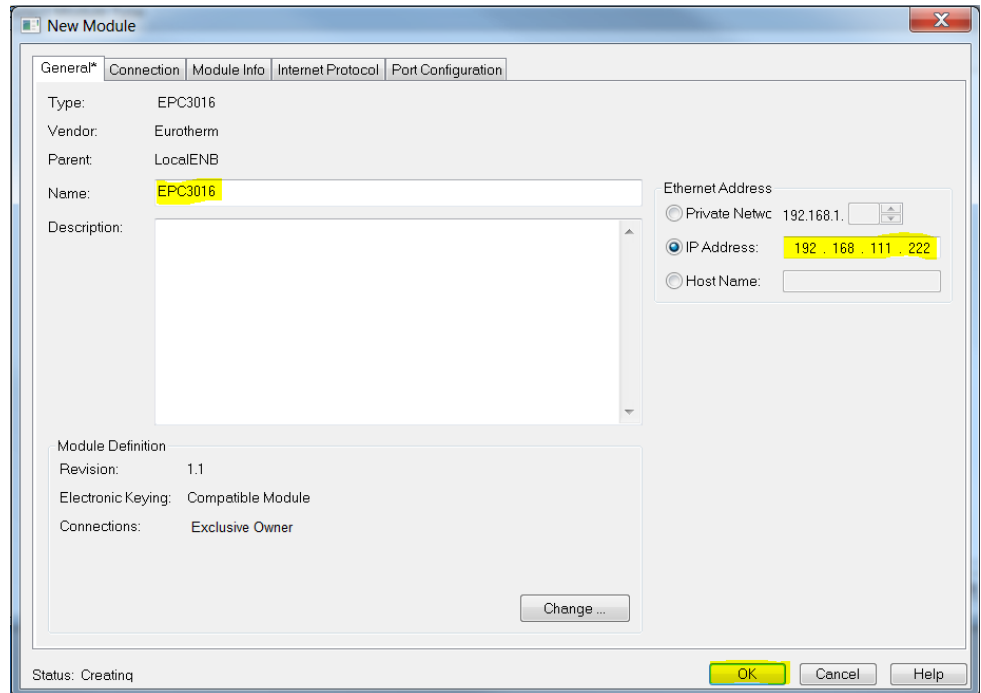

32. Close the “Select Module Type” window.

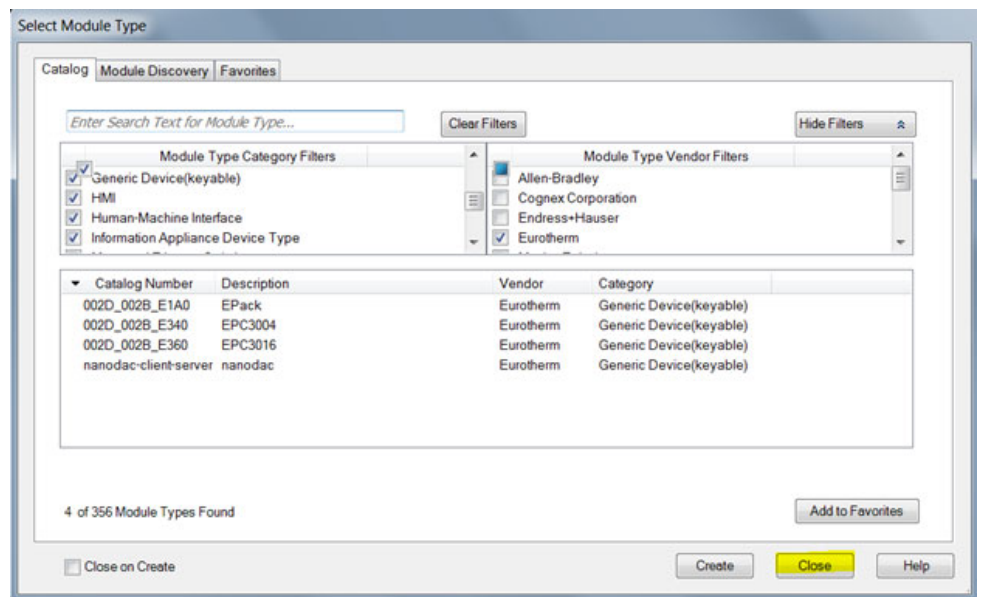

Downloading and Running the RSLOGIX 5000 Application to the Scanner

33. Make sure that the Mode key of the CompactLogix hardware is set to "PROG" and start download by clicking on the drop-down Offline menu and selecting "Download".

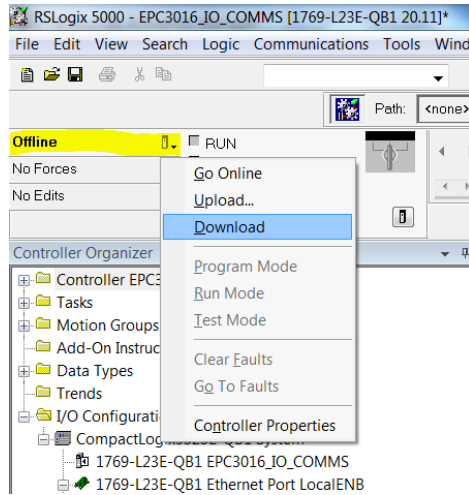

34. Go Online to the CompactLogix L23E by clicking on the drop-down Offline menu and selecting “Go Online”.

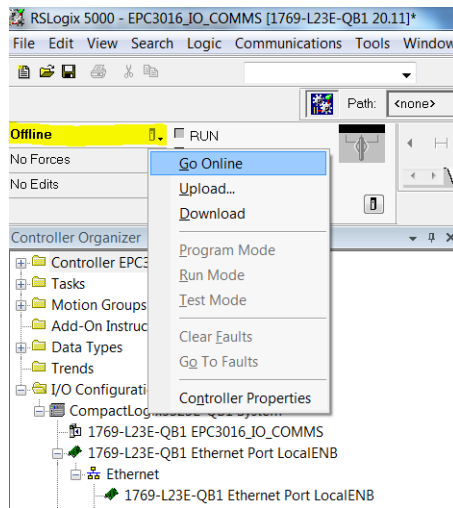

If there is a problem with the path, use RSLogix 5000>Communications > Who Active, select AB_DF1 and select “Download”.

35. Now, select Port Configuration tab and configure CompactLogix L23E port settings making sure that there is no duplication of IP address and it is in the same subnet as the PC and EPC3016. Then click OK.

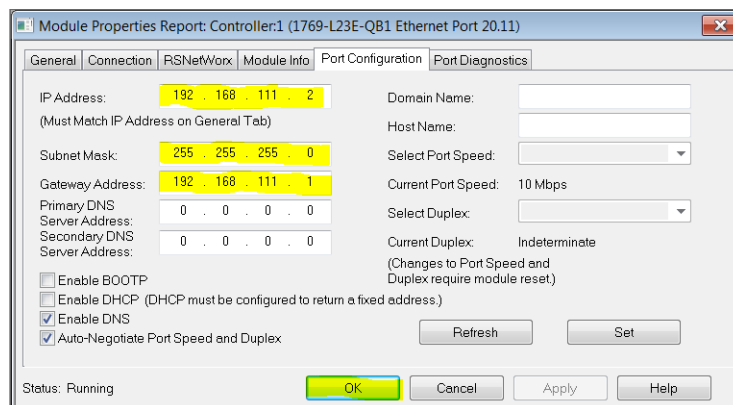

36. Switch CompactLogix L23E mode key to “RUN” and the CompactLogix L23E Ethernet/IP scanner should start connecting to the EPC3000 Ethernet/IP immediately.

Establishing Communications

EtherNet/IP I/O messaging will commence when the EtherNet/IP network is correctly cabled and powered, the EtherNet/IP scanner and adapter (EPC3000 controller) are configured with valid and unique IP addresses in the same subnet and I/O parameter data definitions are setup correctly.

The EPC3000 Input/Output definitions need to be matched with the EtherNet/IP Scanner (e.g. PLC) data registers.

Parameters are either INPUT parameters read by the EtherNet/IP Scanner or OUTPUT parameters written by the EtherNet/IP scanner.

Data Formats

16-bit data read from the EPC3000 controller EtherNet/IP are "scaled integers" and the value will depend on the resolution of the parameter being read. A 32-bit float value of 12.34 with resolution 2 will be encoded as 1234 while if the resolution is changed to 1, it will be encoded as 123.

32-bit float and 32-bit time integers can also be read from the EPC3000 using I/O exchange when the same parameter is configured in consecutive rows in the Fieldbus I/O Gateway Input definition table. 32-bit values can also be read using Explicit messaging via Modbus object when reading from the IEEE region (Modbus address > 0x8000).

The EDS File

The EtherNet/IP EDS (Electronic Data Sheet) files for EPC3016, EPC3008, EPC3004 controller are available by going to web site www.eurotherm.com or from your supplier.

The EDS file is designed to automate the EtherNet/IP network configuration process by defining the required device parameter information. Software configuration tools utilize the EDS files to configure an EtherNet/IP network.

Notes:

1. There is a separate EDS file for each of the EPC3000 controller variants (EPC3016, EPC3008 and EPC3004 controllers).
2. Selected parameters may be configured to exchange Input and Output data across a network. These may be configured using iTools, see section "Fieldbus IO Gateway" on page 358.

Troubleshooting

No Communications:

- Check the cabling carefully and ensure that the RJ45 connectors are fully plugged into the sockets.
- Confirm that EtherNet/IP is available and enabled in the EPC3000 controller by setting the Comms>Option>Main>Protocol to EipAndModTCP(12) in iTools or EIP.m via HMI. If the enumeration is not available from the Protocol parameter, then the controller does not have the EIP option available, contact your local distributor.

- Check that the EPC3000 controller network settings, 'IP Address', 'Subnet Mask' and 'Gateway' in the 'Comms' list are correct and unique for the network configuration in use, and that the EPC3000 controller and the EtherNet/IP Scanner (master) are in the same subnet.
- Ensure that the configured EtherNet/IP Scanner Input and Output data length matches the data length of the EPC3000 Adapter Input and Output definitions configured using the Fieldbus I/O Gateway Editor. If the master is attempting to read (input) or write (output) more or less data than has been registered on the EPC3000 Adapter, using the iTools Fieldbus I/O Gateway Editor, the EPC3000 controller Adapter will refuse the connection.

BACnet

BACnet protocol is designed to exchange information for automation and control applications in buildings. BACnet is available in controllers with firmware versions V3.01 and above.

In EPC3000 series controllers, protocol selection is protected by feature security, section "Feature passwords" on page 221. It is mutually exclusive with EtherNet/IP but can coexist with Modbus TCP slave on the same internet connection.

Note: BACnet MS/TP is not supported in EPC3000 series controllers.

BACnet Objects

In BACnet, objects are collections of properties, each representing some item of information. In addition to standard defined properties, objects may include vendor-defined properties as long as they function in accordance with the standard. BACnet also defines the expected behavior from each property for that object. What makes the object-oriented approach work is that every object and every property as defined by the system is accessible in exactly the same manner.

BACnet Services

The process of reading or writing to a property is what BACnet calls a service. Services are the methods used by any BACnet device when it communicates with another BACnet device, including retrieving information, transmitting information or communicating an action. The standard defines a wide range of services for accessing objects and their properties.

Examples of services required are:

Application Service	Description	Service Type
ReadProperty	Request the value of one property of a BACnet object	Object Access
WriteProperty	Modify value of a single property (if permitted)	Object Access
DeviceCommunicationControl	Allows an operator to take device communications on or off-line. With support for optional password.	Remote Device Management
Who-Is	Asks about the presence of specified BACnet devices	Remote Device Management
Who-Has	Asks about the presence of specified Objects either by type and instance or by name	Remote Device Management

BACnet Object Mapping

Please refer to the Protocol Implementation Conformance Statement, document number HA033299, for further details. This document is available from www.eurotherm.com.

Configuring BACnet

BACnet is configured using the parameters listed in the Comms.Option.BACnet list shown below. BACnet parameters are also available on the instrument HMI. The description of these is given in section "BACnet Sub List (b.NEt)" on page 156.

Name	Description	.address	Value	Wired From
DeviceID	Device ID	2928	0	
Port	Port number	2930	7808	
Password	Remote Device Management password	21582	100	
BBMDStatus	BBMD status	2932	Off (0)	
BBMDIPAddress1	1st Byte of BBMD IP address	2933	0	
BBMDIPAddress2	2nd Byte of BBMD IP address	2934	0	
BBMDIPAddress3	3rd Byte of BBMD IP address	2935	0	
BBMDIPAddress4	4th Byte of BBMD IP address	2936	0	
BBMDPort	BBMD port number	2937	7808	
BBMDTTL	BBMD TTL in seconds	2907	0	
ResetCounts	Reset BACnet counts	2944	No (0)	
RxCount	BACnet receive count	2941	0	
TxCount	BACnet transmit count	2942	0	

Comms.Option.BACnet - 13 parameters

The Device Name is fixed by the Instrument Type parameter found in the "Information Sub-List (INFO)" on page 194.

Read/Write Access to Internal Modbus Registers

Read/write access to any internal Modbus register is provided using pairs of BACnet objects named 'User Parameters' as shown below.

30 User Parameter pairs (numbered 1 to 30) are supported.

This functionality allows the BACnet user to access any internal parameter that is available in the standard Modbus address space. Pairs of values as shown in the table above are implemented as two BACnet Analog Value objects. The BACnet client (typically a BMS) will write the first value with the Modbus address for the data parameter required as shown in the figure below. The user may obtain the Modbus address from iTools.



The BMS client may then read or write to the data referenced by this address



Note: The data value will always be represented over BACnet as a floating point, even if the internal source data is of a different type (e.g. Bool). Strings are not accessible using this mechanism.

Note: Values written to device parameters via BACnet may be overwritten (with different values) internally by the device firmware under certain device configurations. Due to this, when the values of the BACnet objects are read back, they may be different to the value requested via the preceding BACnet write command.

Foreign Device Registration

A 'foreign device' has a different subnet address from the devices on the BACnet network that it wishes to join. The device must register with a BBMD (BACnet Broadcast Management Device) which then forwards broadcast messages allowing full participation in the BACnet network.

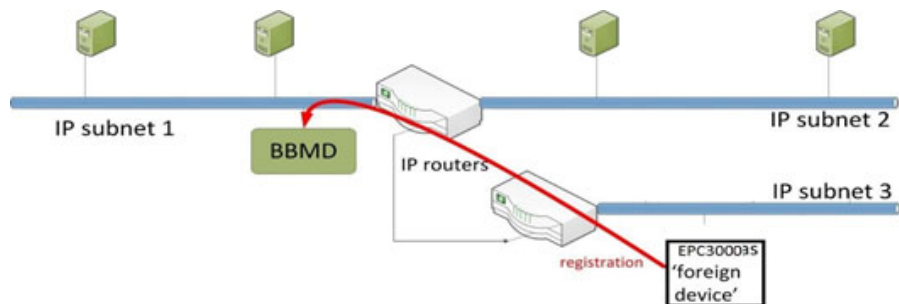

Modbus Master

Overview

Modbus Master feature is available over serial (Modbus RTU) and over Ethernet (Modbus TCP). Over Ethernet, it is mutually exclusive with EtherNet/IP but is available in conjunction with Modbus TCP slave.

Modbus TCP Master is protected by feature security.

Slave profiles for Eurotherm products (EPCx (EPC3000 & EPC2000 generic), ePack, 3200, and ePower devices are supported for ease of configuration.

A maximum of three Modbus slave devices can be configured with timeouts and retries configurable per slave. The slaves can be 3x Modbus TCP slaves, 3x RTU slaves or any combination of RTU and TCP Modbus slaves.

A maximum of 32 data points are supported to be shared among the three slave devices. These data points can be configured for writing to or reading from a configured Modbus slave.

Modbus Master Configuration

Modbus Master can be configured using the EPC3000 HMI or via a PC using iTools software.

Once the Modbus Master feature is enabled via Feature Security, Comms.Option.Main.Protocol must be set to ModMstAndSlv(15) and/or Comms.Fixed.Main.Protocol set to ModbusMaster(3). The instrument must then be restarted to reinitialise comms settings and make the ModbusMaster function block available.

Modbus Master configuration is divided into two parts:

- Setting up the Modbus Master slave(s)
- Defining the required slave data that will be read from or written to the configured slave(s).

Notes:

1. Slave profiles are supported for some Eurotherm controllers. This simplifies the configuration and minimizes the need to know detailed data information, for example the Modbus address, data type and resolution for frequently used parameters.
2. The Network configuration of the Modbus TCP Master is the same as the Modbus TCP Slave and can be found in Comms.Option.Network. Confirm that the IP address and subnet mask are configured correctly to be able to communicate with Modbus slave devices within the subnet. If the slave device is outside the subnet then the Comms.Option.Network.DefaultGateway must be configured correctly.

The screenshot shows the iTools software interface. The main window displays a project tree for 'ModbusMaster'. The tree is organized as follows:

- Comms
 - ModbusMaster
 - Slave1
 - Main
 - Descriptor
 - Network
 - Online
 - CommsFailure
 - IPAddress1
 - IPAddress2
 - IPAddress3
 - IPAddress4
 - UnitId
 - SearchDevice
 - Profile
 - Retries
 - SearchResult
 - Timeout
 - MaxBlockSize
 - HighPriority
 - MediumPriority
 - LowPriority
 - Slave2
 - Slave3
 - 1
 - Data
 - Descriptor
 - SlaveDevice
 - ParameterList
 - PV
 - Status
 - Number
 - Priority
 - 2
 - 3

Two 'Parameter Explorer' windows are open, showing parameter details for 'ModbusMaster.Slave1.Main' and 'ModbusMaster.1.Data'. Both windows show a table with columns: Name, Description, Address, Value, and Wired From.

ModbusMaster.Slave1.Main - 20 parameters

Name	Description	Address	Value	Wired From
Descriptor	Device descriptor	21605		Fur1
Network	Network comms connection	3217	Ethernet (0)	
Online	Allows communications to a	3200	Off (0)	
CommsFailure	Indicates a device communic	3215	No (0)	
IPAddress1	1st byte of slave device IP A	3201	192	
IPAddress2	2nd byte of slave device IP A	3202	168	
IPAddress3	3rd byte of slave device IP A	3203	111	
IPAddress4	4th byte of slave device IP A	3204	221	
UnitId	Unit id for a slave device	3205	255	
SearchDevice	Determines a slave device ty	3209	No (0)	
Profile	A profile that defines the dev	3214	Min8 (1)	
Retries	Transaction retries	3206	3	
SearchResult	Current search status	3210	Unavailable (2)	
Timeout	Time in milliseconds the mast	3207	338.00	
MaxBlockSize	Maximum amount of data in a	3208	124	
HighPriority	High priority rate in seconds	3211	PRIORITY_1HOUR (15)	
MediumPriority	Medium priority rate in secon	3212	PRIORITY_1SEC (3)	
LowPriority	Low priority rate in seconds	3213	PRIORITY_2SEC (4)	

ModbusMaster.1.Data - 20 parameters

Name	Description	Address	Value	Wired From
Descriptor	Description for this data item	21617	DT.1	
SlaveDevice	Slave device to communicat	3263	Slave1 (0)	
ParameterList	Parameter list for a specific s	3273	TargetSetpoint (15)	
PV	Process value received from	3264	0.00	
Status	Transaction status	3272	Idle (12)	
Number	Used for multiple instance pa	3274	1	
Priority	Frequency at which the data	3268	Medium (1)	

Configuring Modbus Slaves

To configure communications to Modbus slaves, proceed as follows:

1. From iTools, place the instrument in Config mode and open ModbusMaster>Slave1>Main to configure the first slave. Make sure that the Network parameter is set to Ethernet(1) because we want to communicate to the slave using the Option Comms Ethernet interface. It can also be Serial(2) if we want to communicate with a slave through a serial interface.

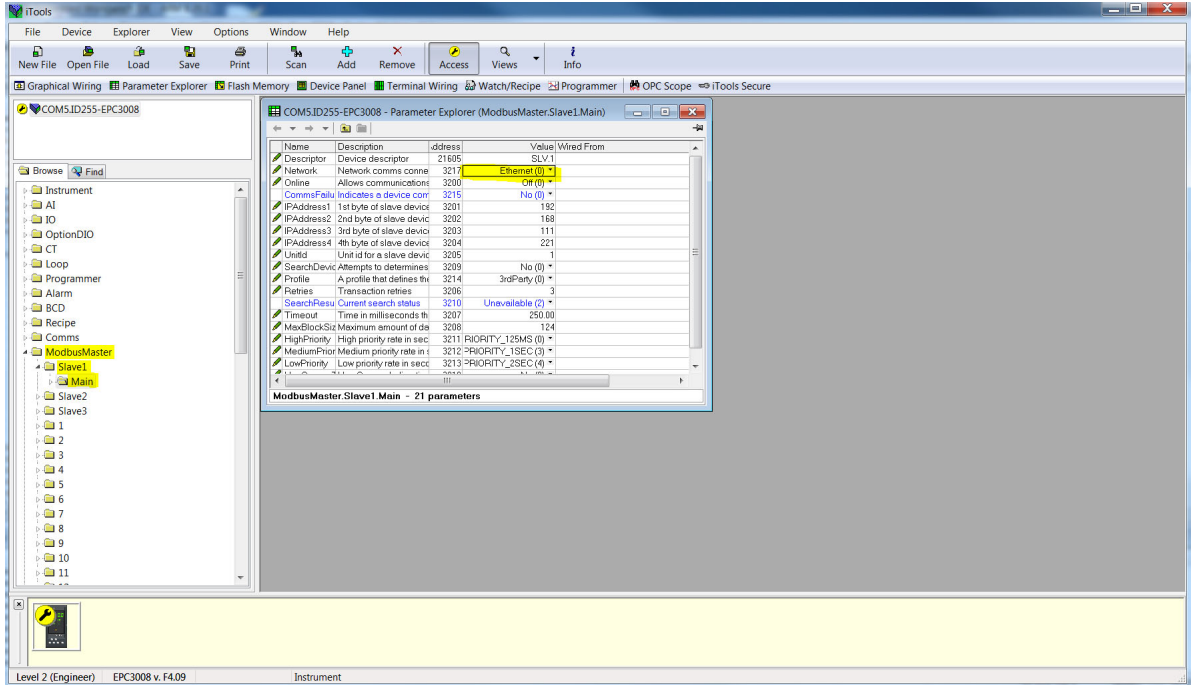

2. Configure the slave's IP Address and unit ID.

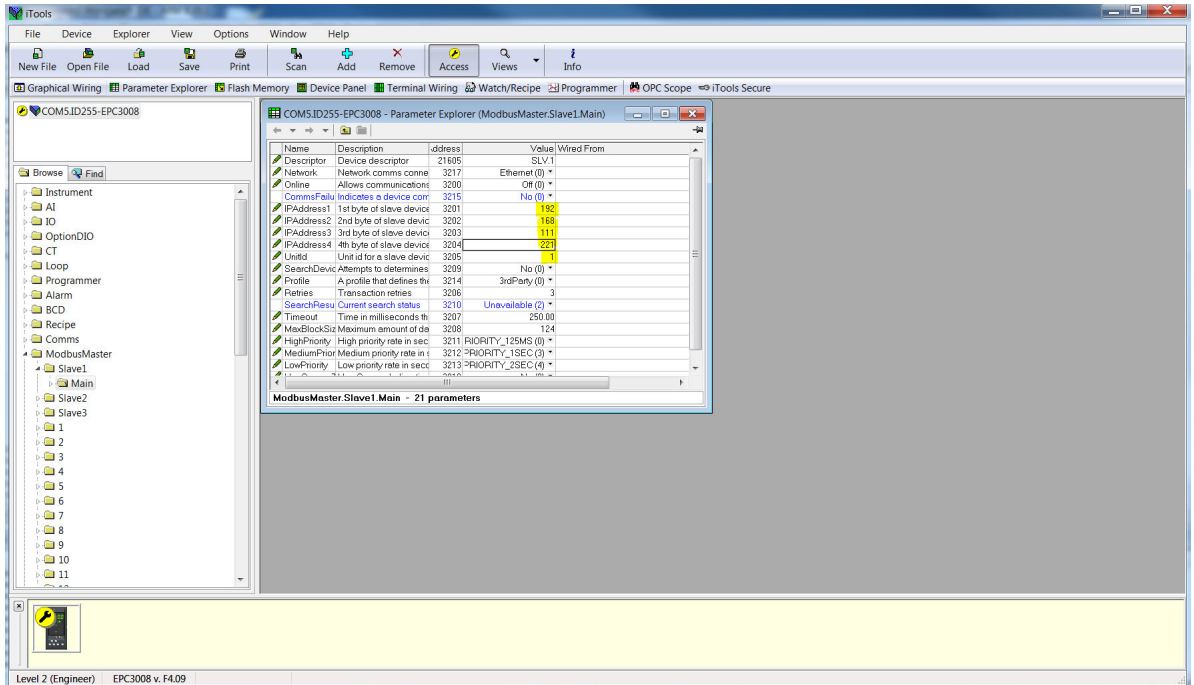

3. You can now check if the device is online via the “Search device” parameter by setting its value to “Yes”. The search status should change to “Searching(0)”.

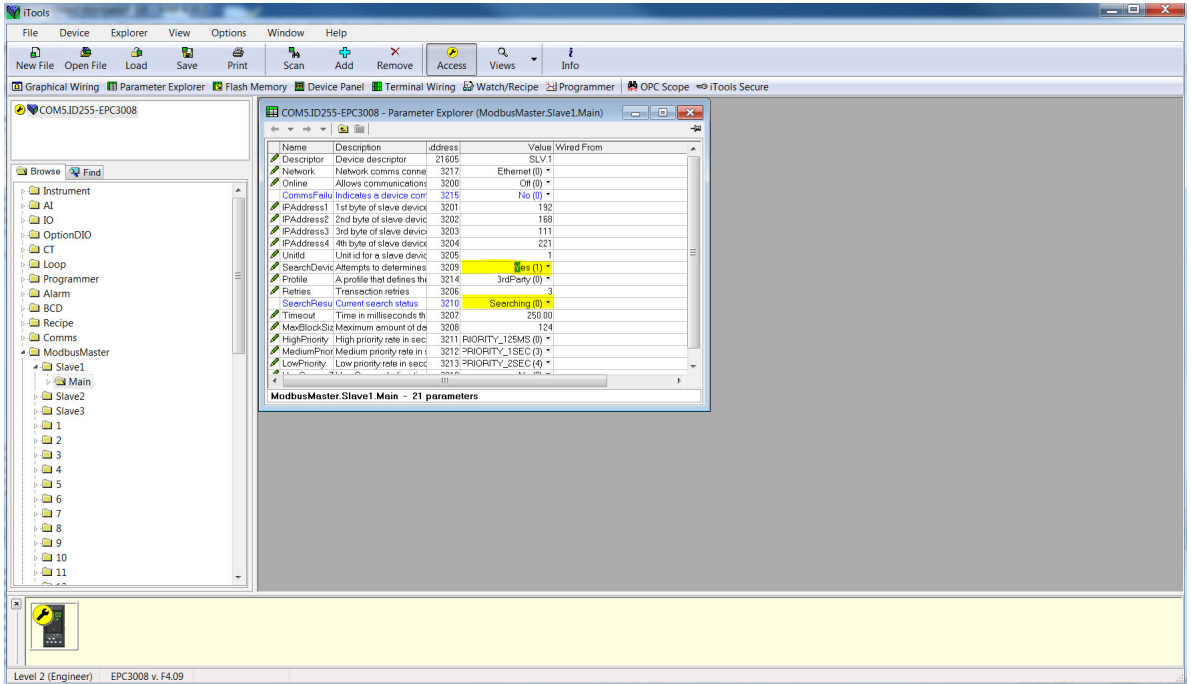

4. If the Modbus slave is online then the search result will be “Available(1)” otherwise the result will be “Unreachable(3)”. If it is a Eurotherm instrument with a supported profile, the “Profile” parameter will display the Modbus slave’s profile otherwise it will display “3rdParty(0)”.

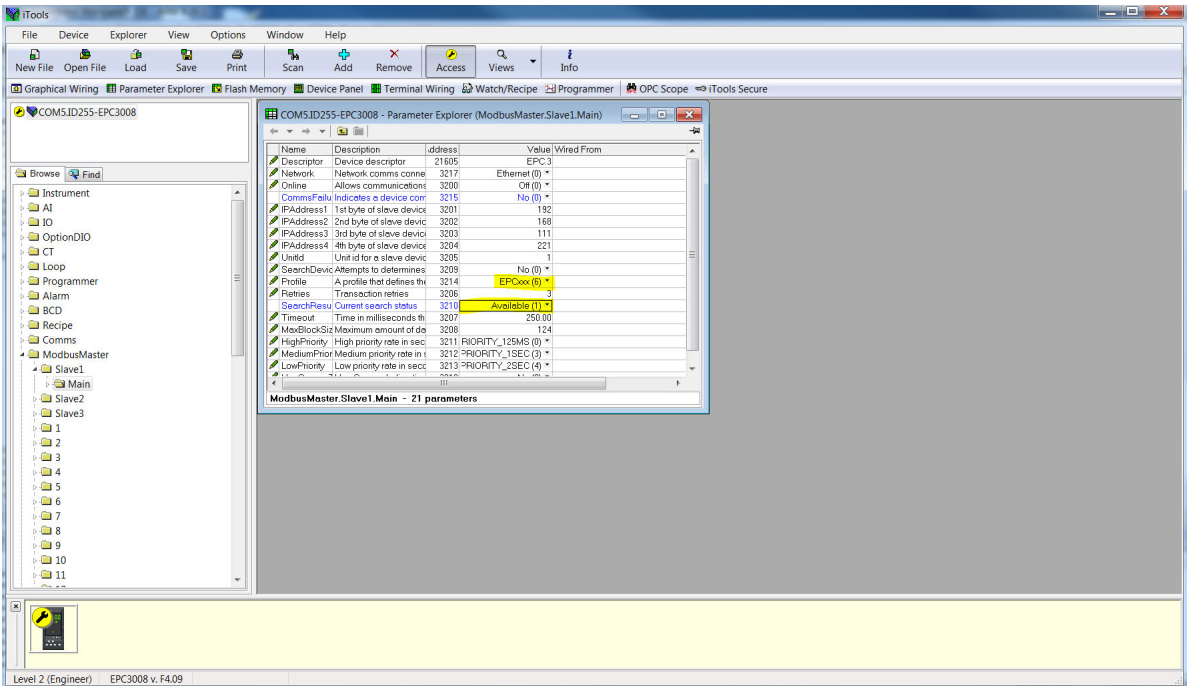

- We will now configure a second slave but this time using the Fixed comms serial interface making sure that we select “Serial(2)” enumeration for the Network parameter and set the correct Modbus slave address.

Note: Serial(2) can only be selected if Comms.Fixed.Main.Protocol is set to ModbusMaster(3).

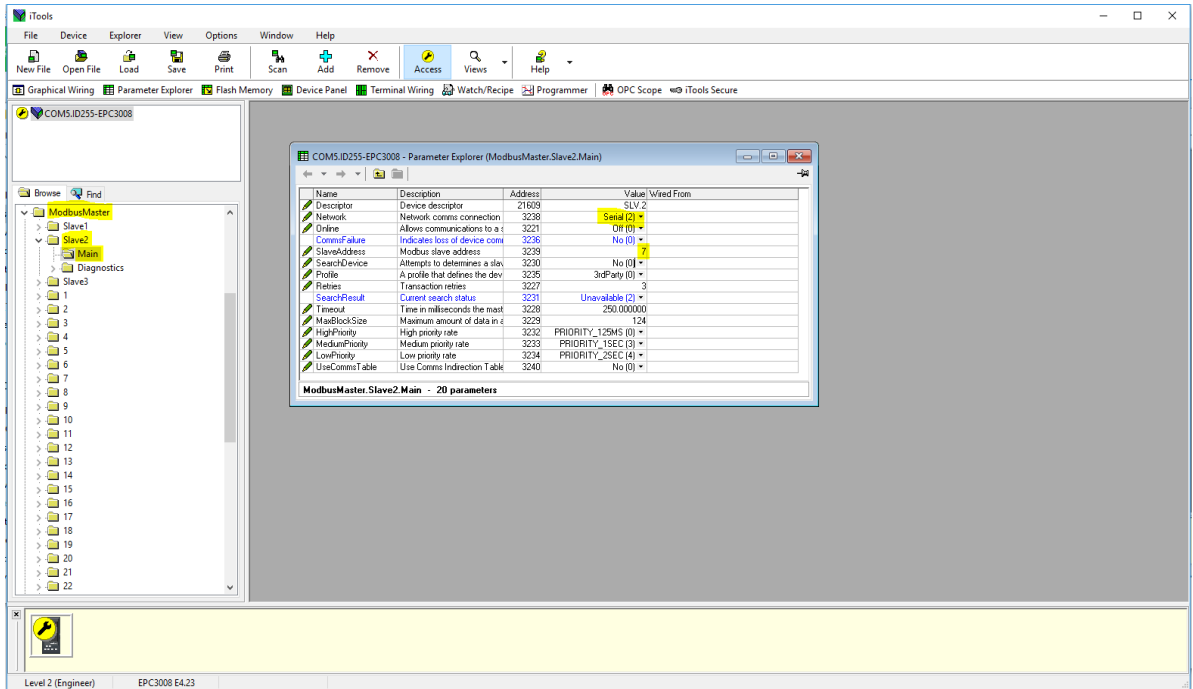

- You can now check if the device is online via the “Search device” parameter by setting its value to “Yes”. The search status should change to “Searching(0)”.

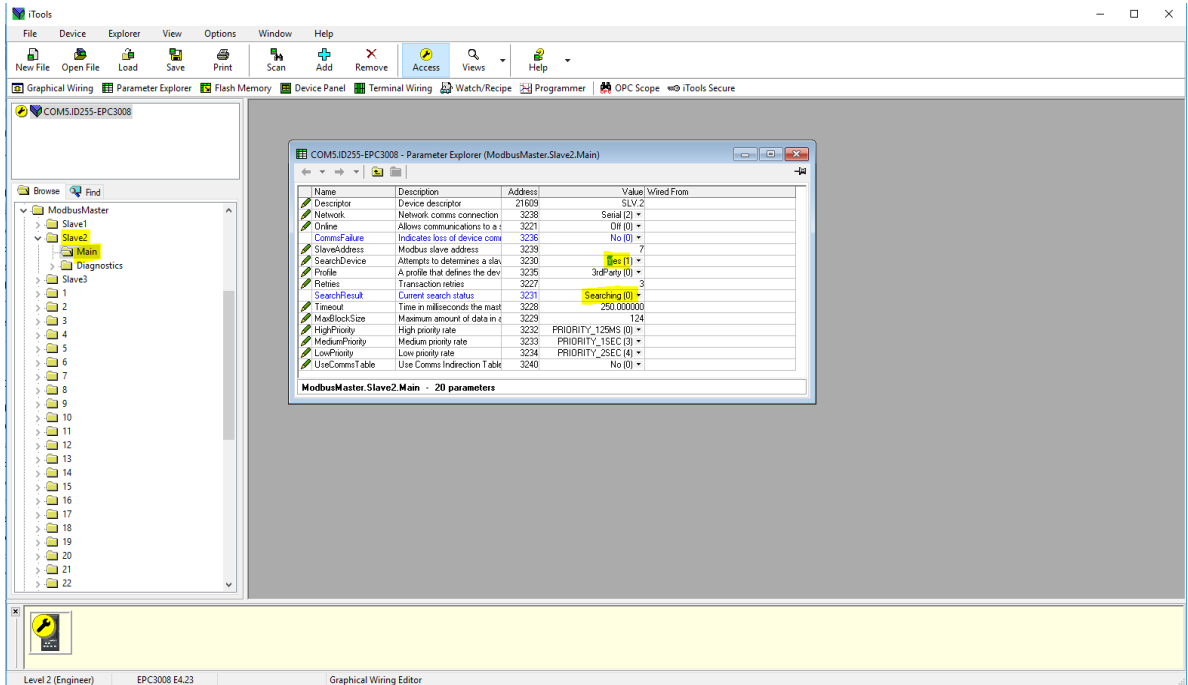

- If the Modbus slave is online then the search result will be “Available(1)” otherwise the result will be “Unreachable(3). If it is a Eurotherm instrument with a supported profile, the “Profile” parameter will display the Modbus slave’s profile otherwise it will display “3rdParty(0)”.

Note: Changes to the slave profile will default previous data configured to be read from or written to the slave.

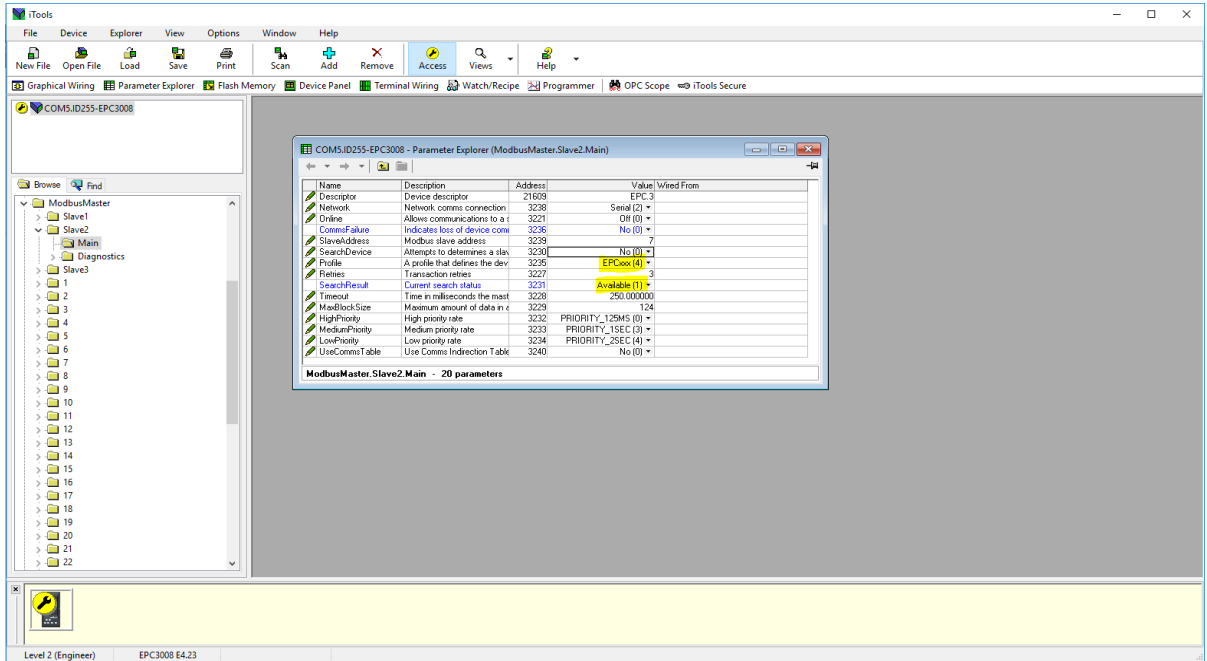

8. For the third slave we can configure a serial slave with an unsupported profile by configuring the Modbus slave address and then starting "SearchDevice".

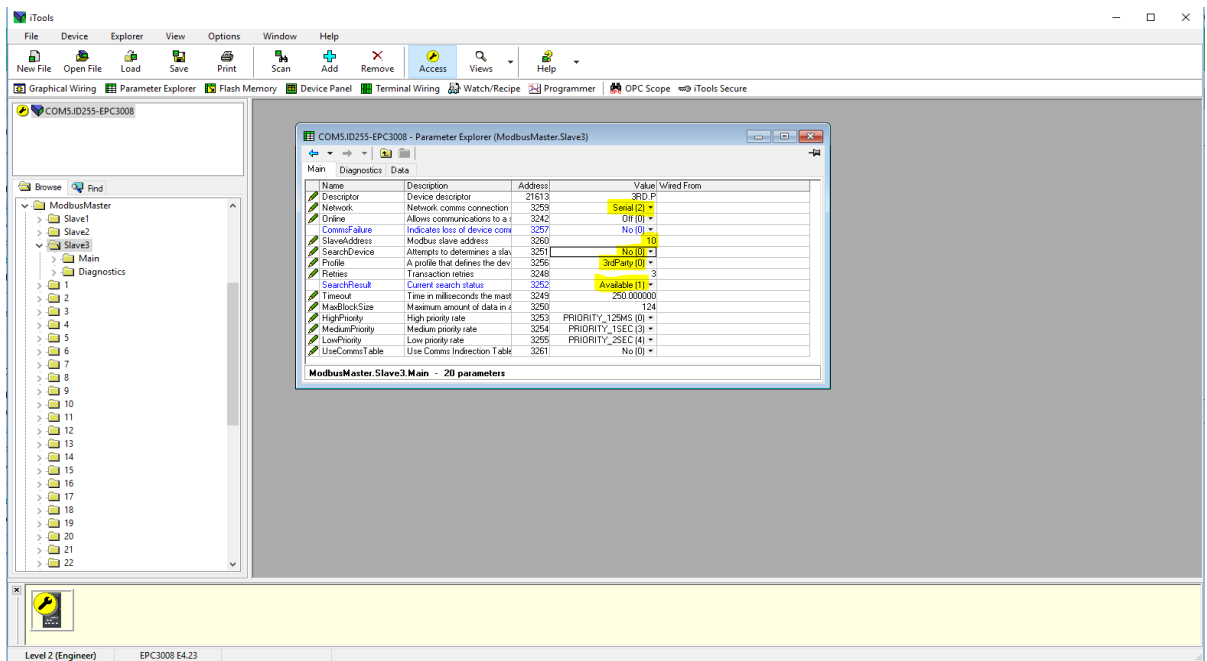

Data Configuration for Cyclic Read/Writes

To configure data for cyclic read/writes:

1. A maximum of 32 data points can be configured. These data points can be shared among all three slaves or it can be used for a single slave.
2. For a slave with a known profile, a data read can be configured by selecting the slave and then select the required parameter from the Parameter list drop-down box. The register address, function code, data type and priority for the parameter will be automatically configured. You still have the option to change the recommended priority.

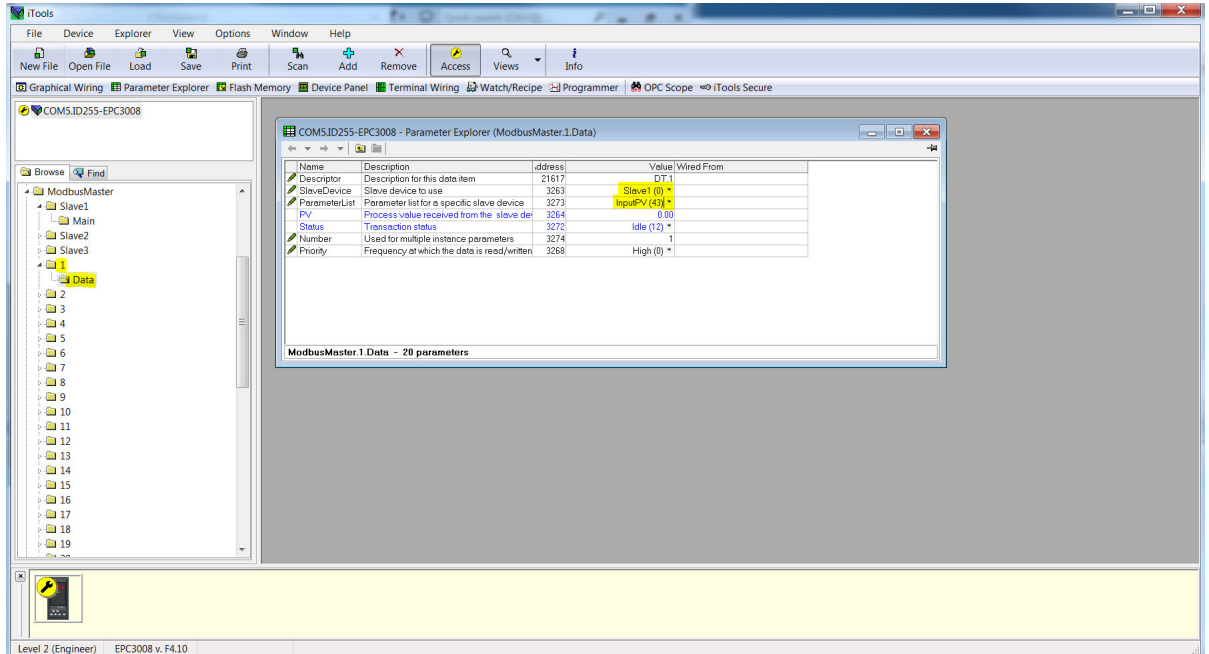

3. To configure a write for a known profile, select parameter to write from the Parameter List drop-down box.

Note: The 'Value' parameter is usually wired from the source parameter of the values to be written to the slave.

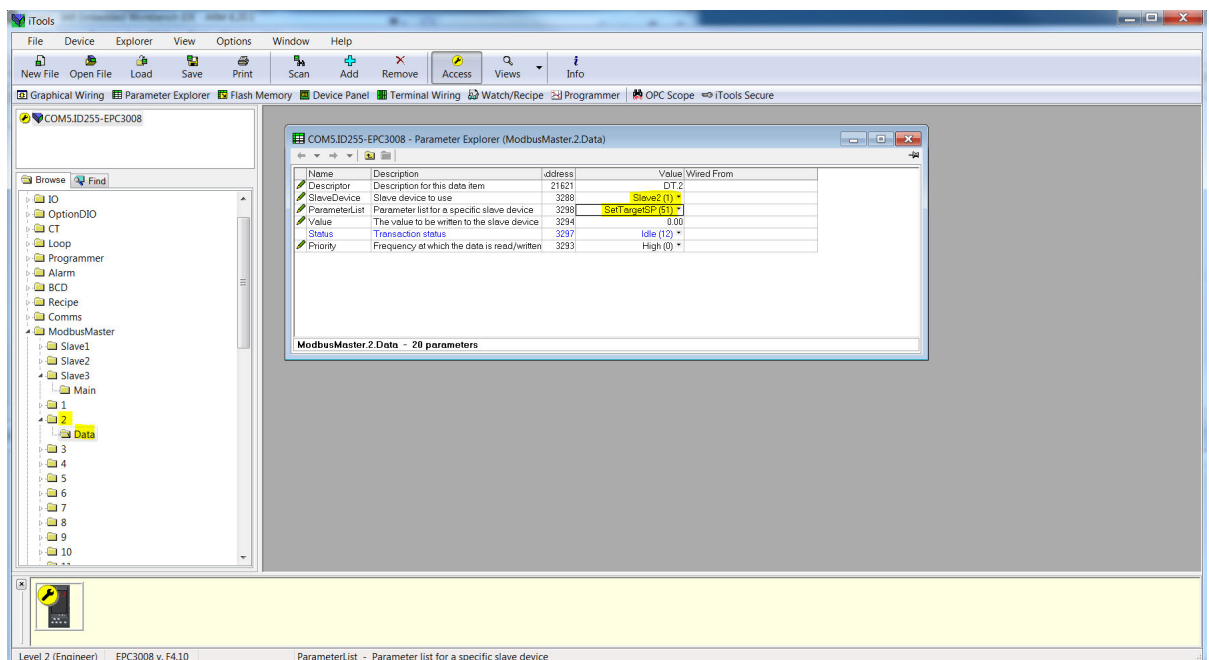

- For a parameter that is not on the Parameter List. The data configuration has to be done manually. Select "UserDefined" from the Parameter List and configure the register address, function code, the data type and priority of data read/write.

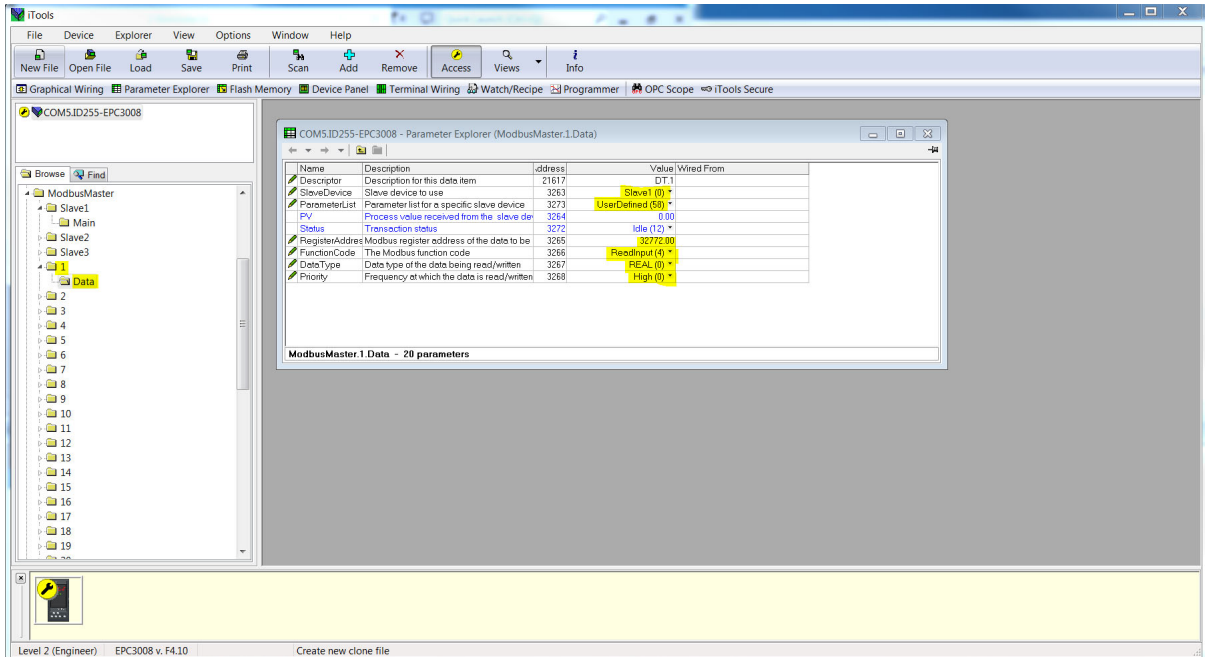

- For a third party slave (unsupported profile), select "UserDefined" from the Parameter List drop-down and configure the register address, function code, the data type and priority of data read/write.

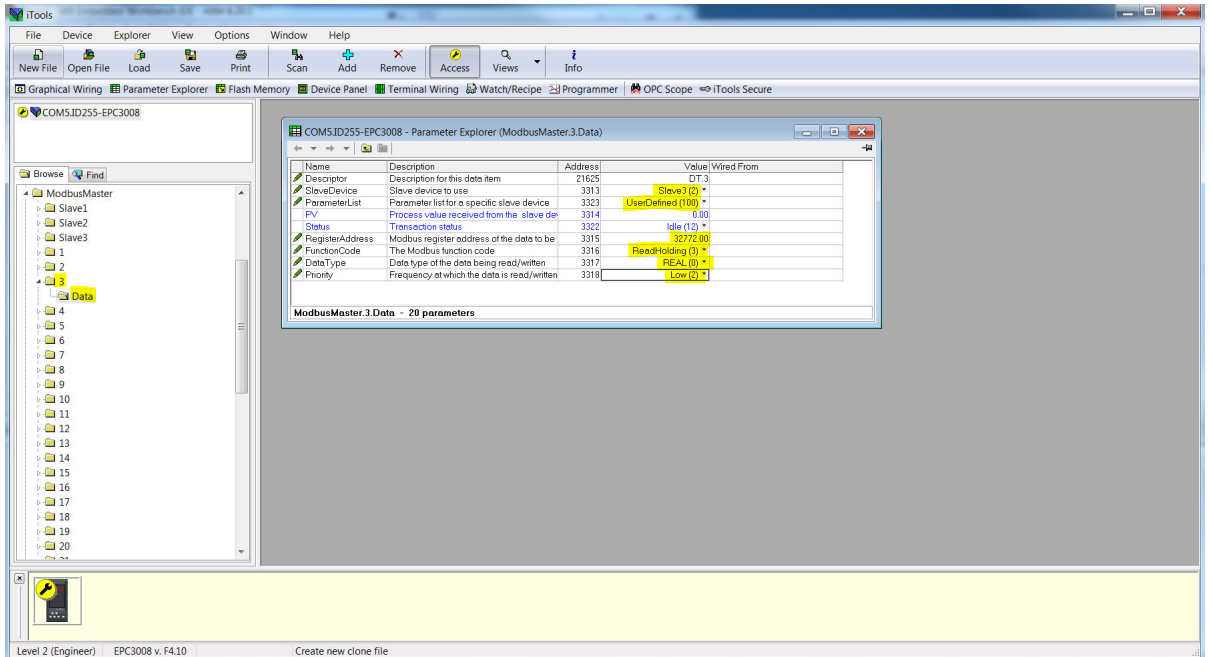

- To start cyclic communications to the slaves. Take the Modbus Master device out of Config mode and set the Online parameter for each of the slaves.

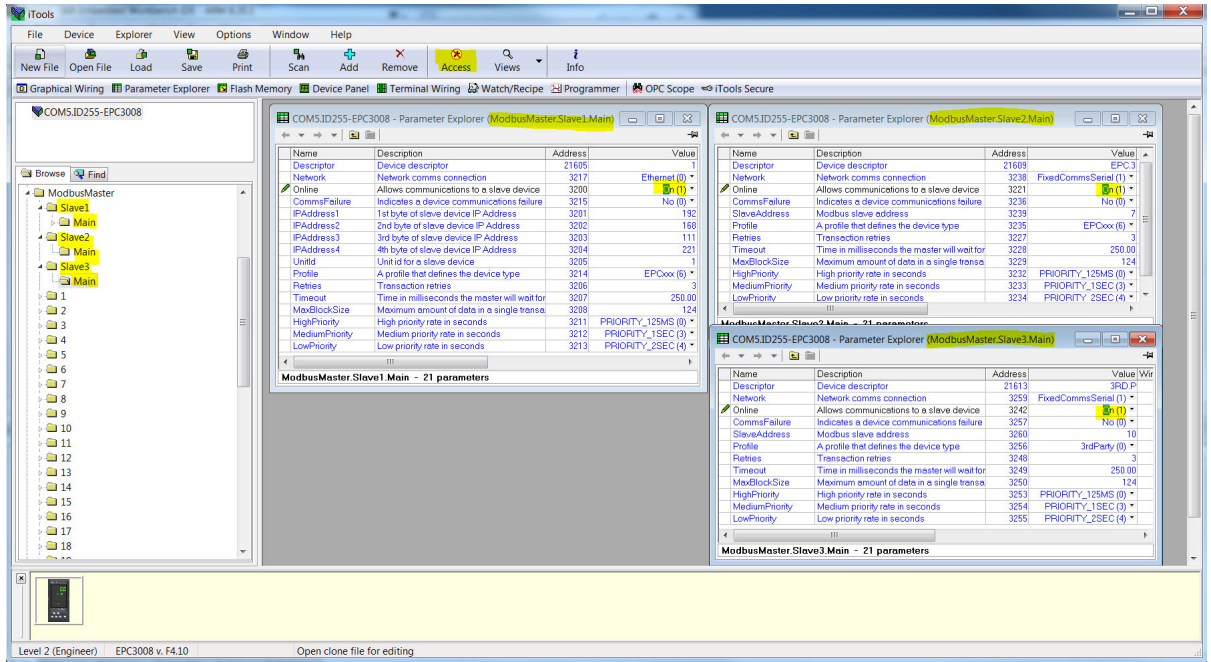

- The data read and write status should succeed if the wiring, comms configuration, slave configuration and data configuration are correct. The PV read will be shown in the Data PV parameter.

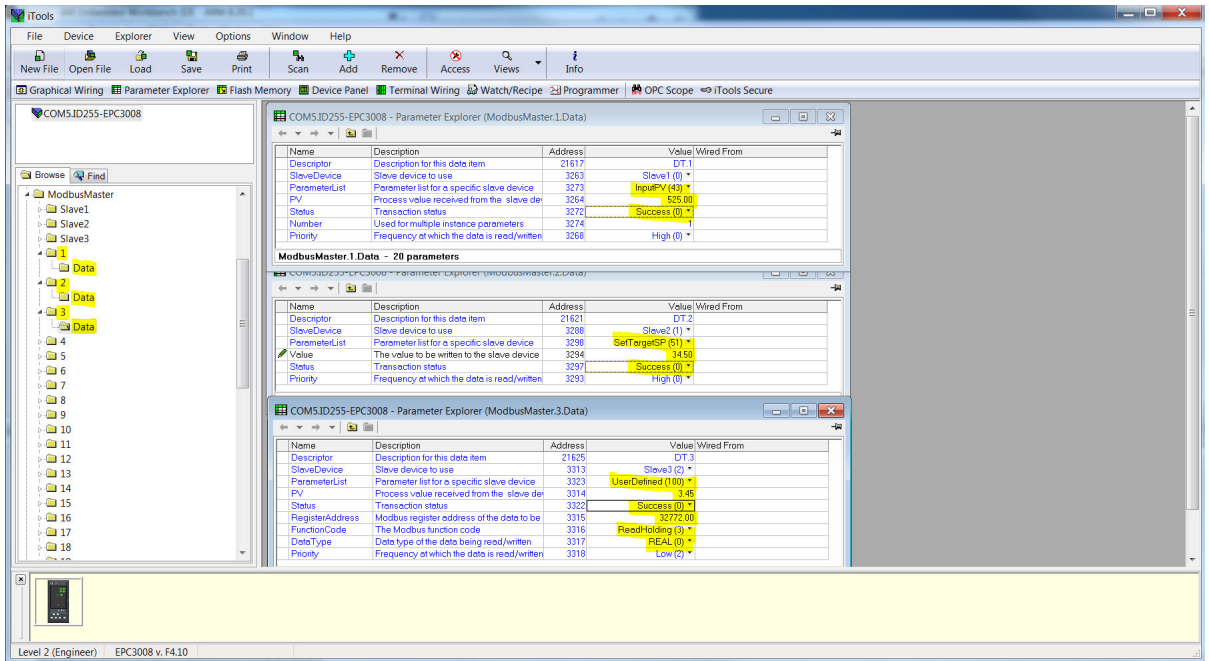

Data Configuration for Acyclic Data Writes

To configure data for Acyclic Data writes:

1. Place the Modbus Master device in Configuration mode.

Note: Cyclic communications to all slaves will stop in Configuration mode. We can only set the slave online parameter in Operator mode.

2. For a supported slave profile select the slave and parameter to write to as well as the value to write and then set the Priority to “Acyclic(3)”.

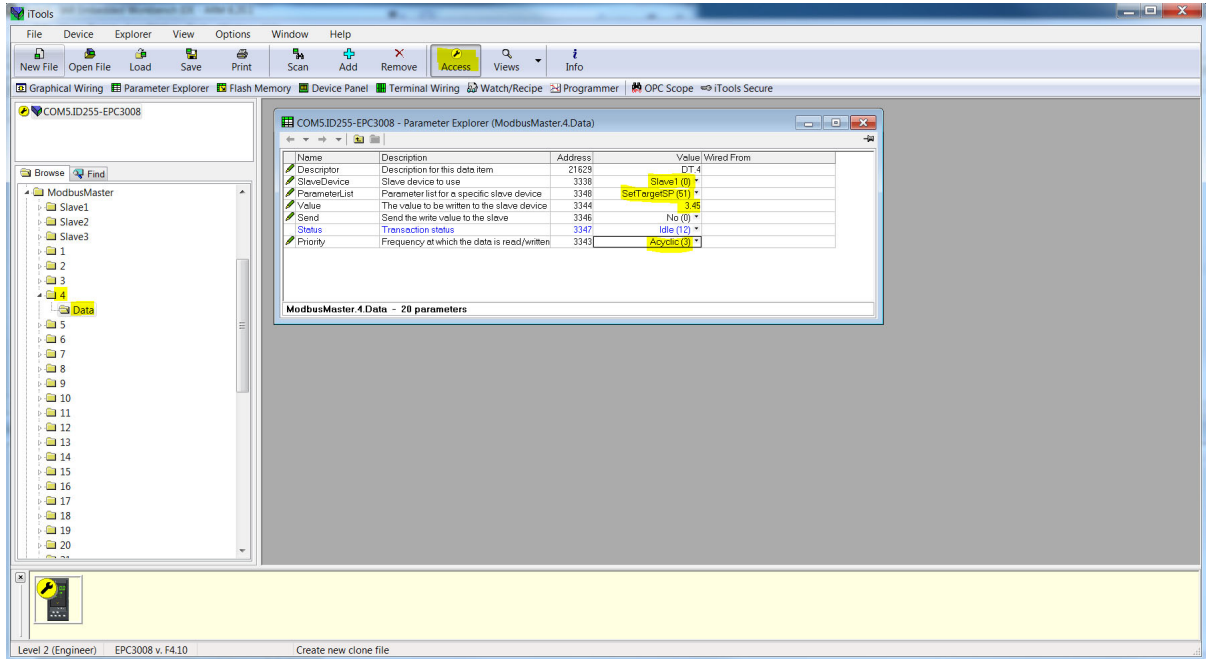

3. To send a write request, set the “Send” parameter. The Status will go to “Pending(13)” briefly before going to “Success” when the parameter has been written. If the write has failed then the Status will show the reason for the failure.

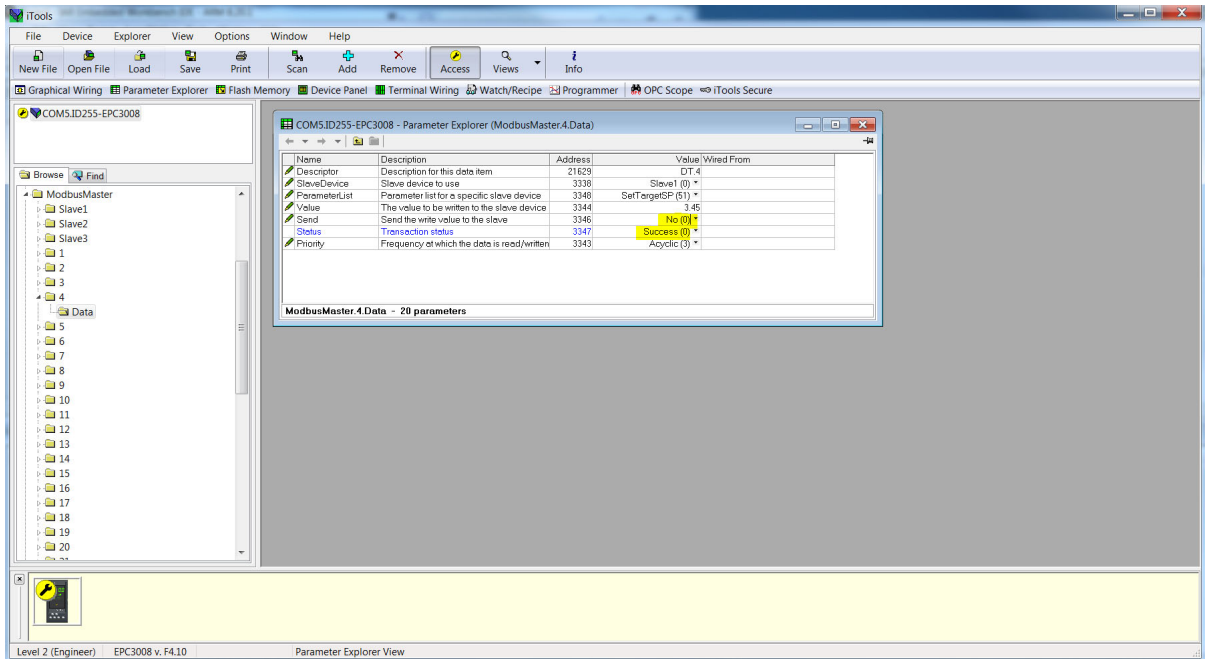

- For an unsupported slave profile (Third party) select the slave, select “UserDefined” from the Parameter List drop-down and configure the register address, function code (must be a write), the data type, the value to write and then set the Priority to “Acyclic(3)”.

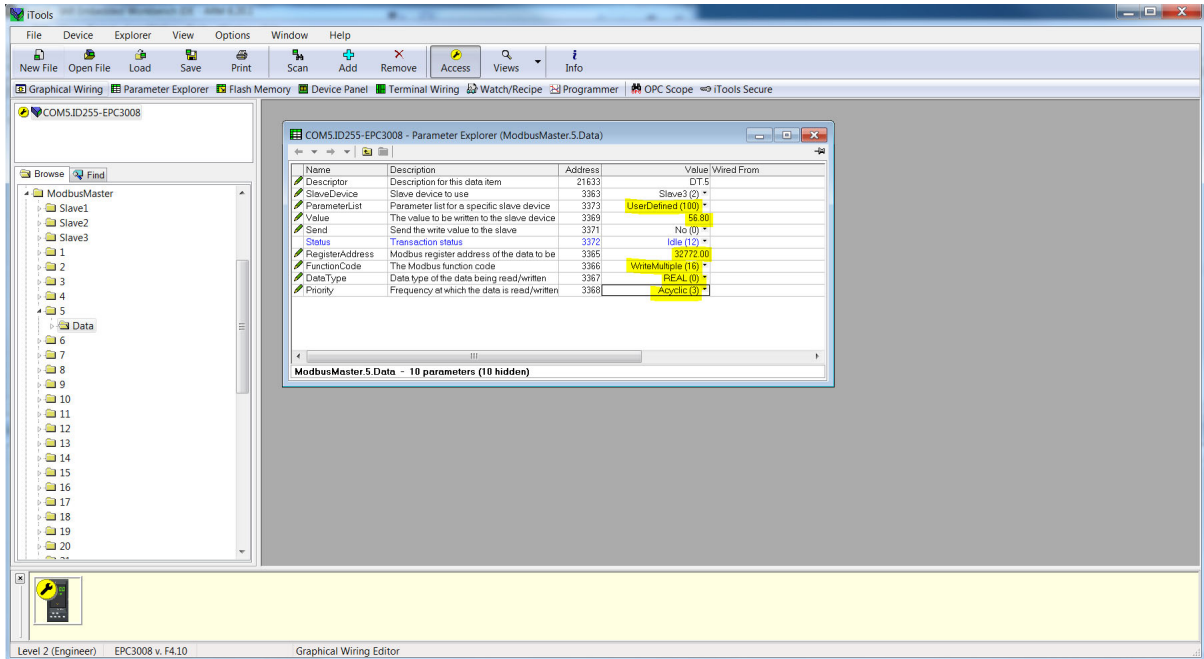

- To send a write request, set the “Send” parameter. The Status will go to “Pending(13)” briefly before going to “Success” when the parameter has been written. If the write has failed then the Status will show the reason for the failure.

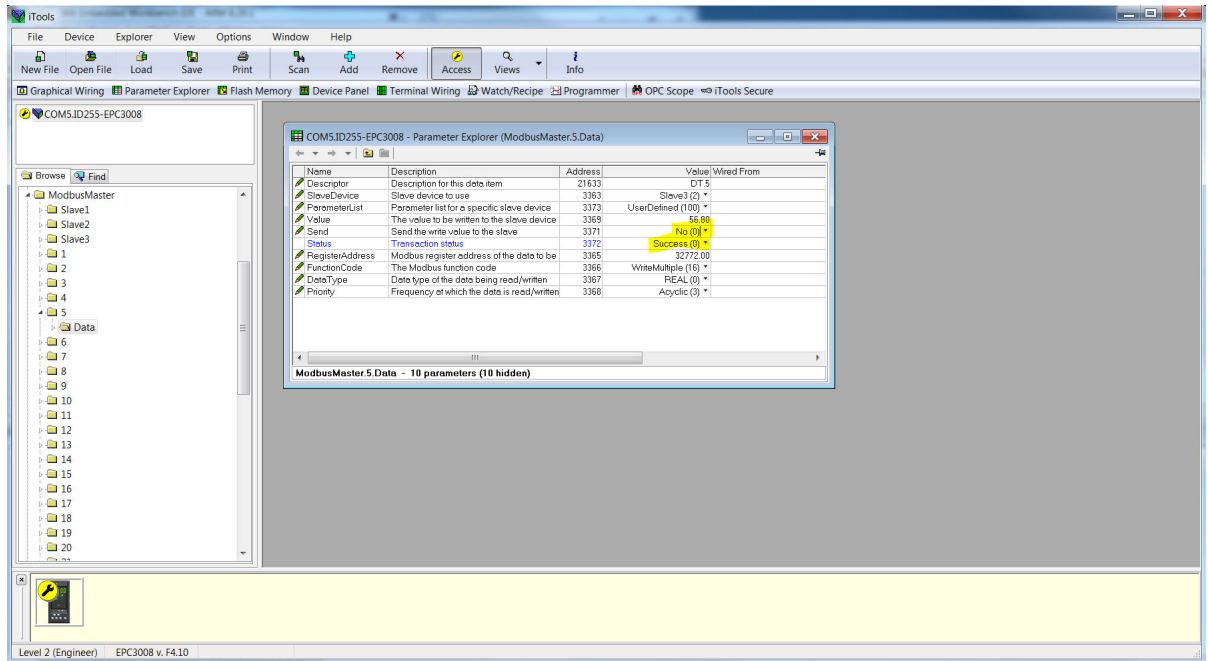

Accessing Modbus Master Data from Modbus Indirection Table

To allow efficient reads from and writes to Modbus Master data, CommsTab Function Block can be used to map Modbus Master data into a contiguous block of Modbus addresses in the range:

15360(0x3C00) to 15615(0x3CFF)

1. Modbus Master data can be auto-configured to be accessible from the Modbus Indirection table by placing the Modbus Master device into Configuration mode and setting the UseCommsTable parameter from any one of the slave configuration window and then taking the Modbus Master device out of Configuration mode to initialize the CommsTab Function Block settings.

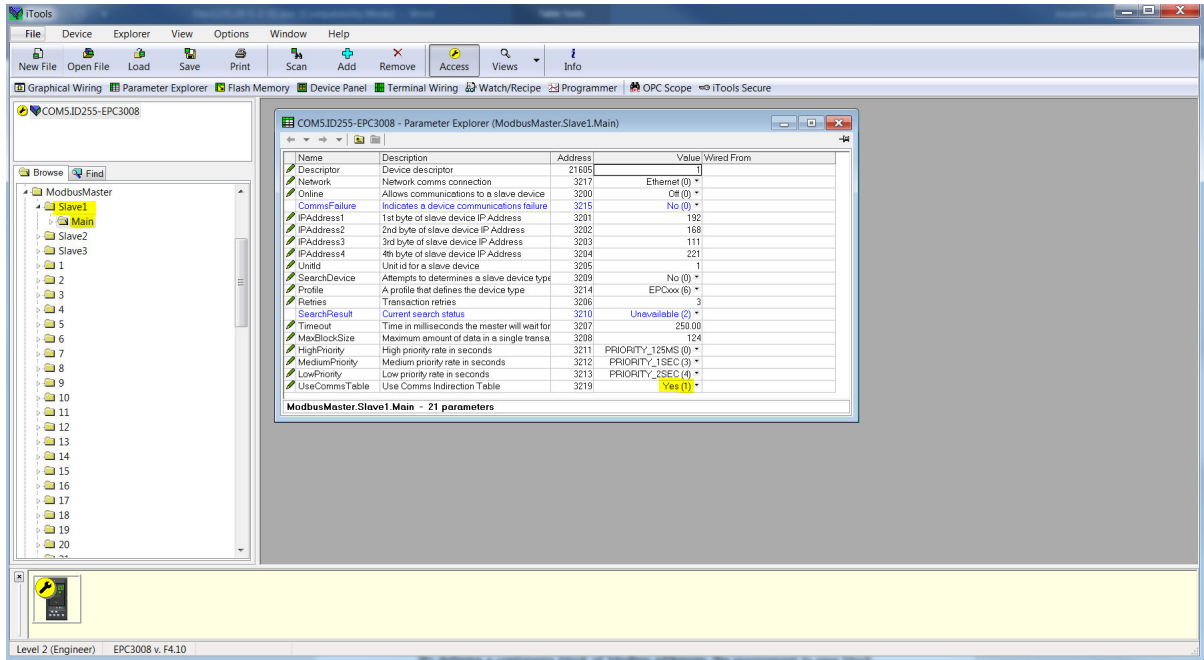

2. In Operator mode, the CommsTab Function Block should now show every configured Modbus Master data. The user can then change Native, ReadOnly and Minutes parameters from default to configure how the data is presented from the Modbus indirection table.

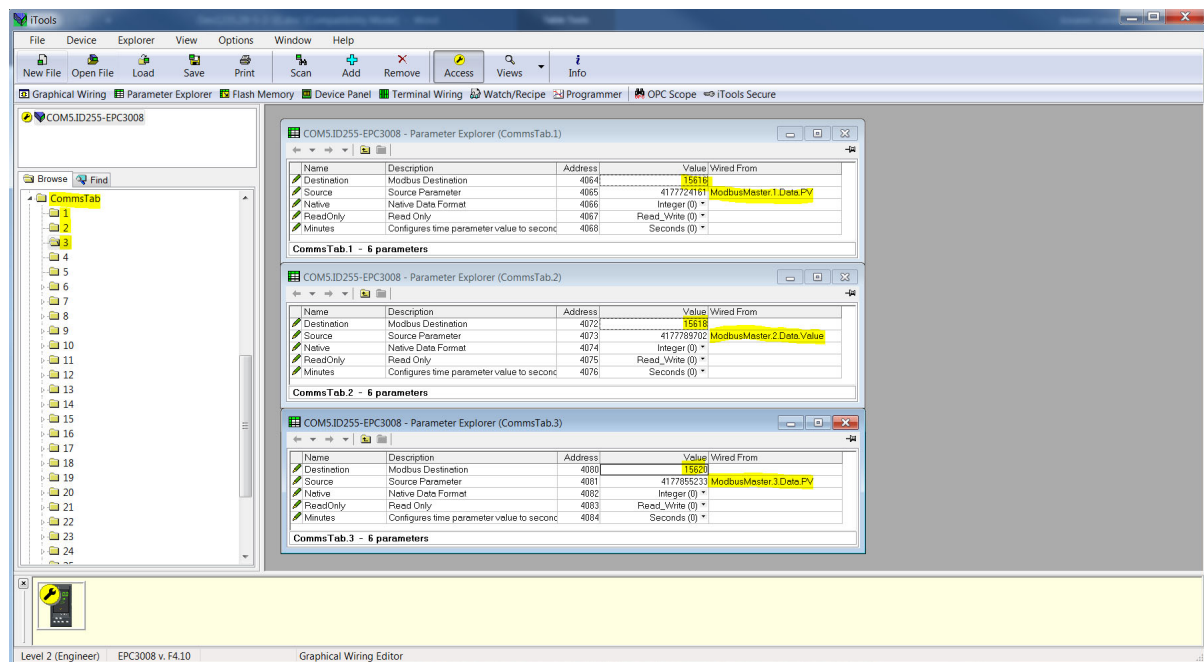

3. Screenshots below show Modbus Master data auto-configured to appear at the Modbus Indirection table and the values read by a 3rd party Modbus Master from our Modbus Master device:

Third party Modbus TCP Master read data	Modbus Master device data
0x0686	16.70
0x0D7A	34.50
0x1630	56.80

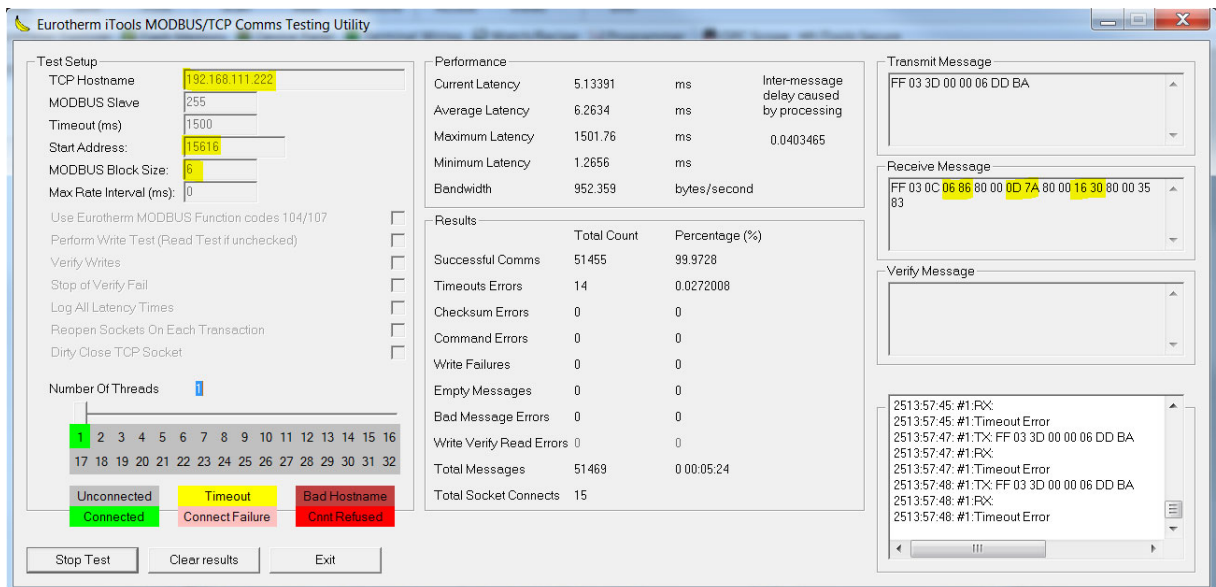
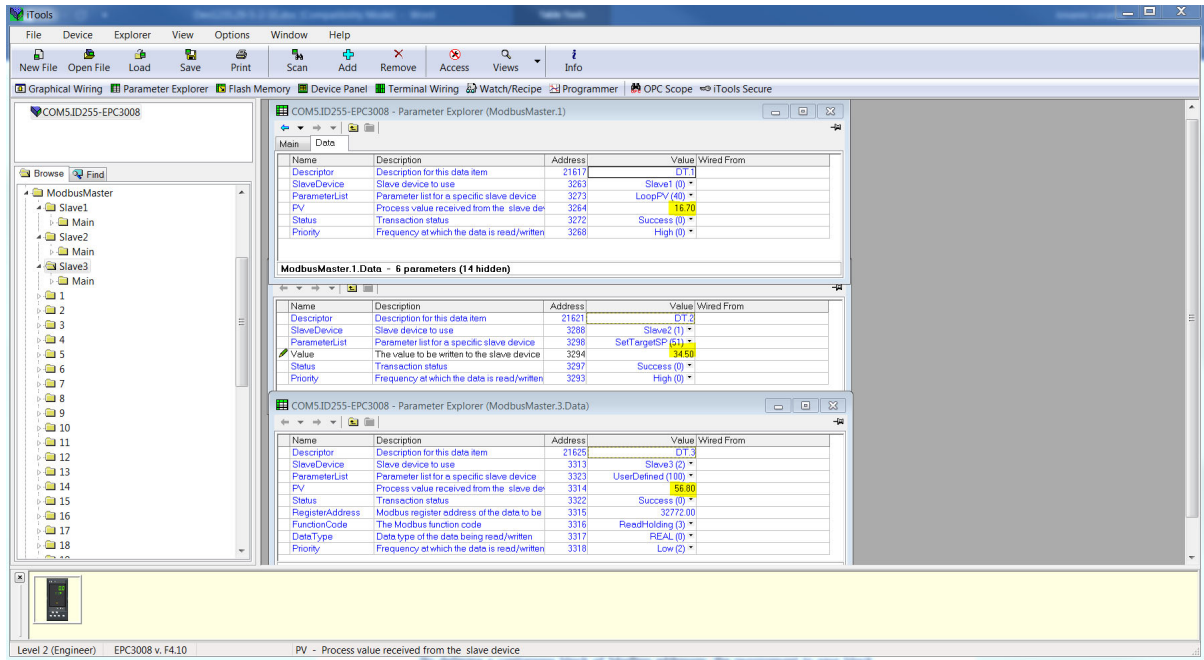

Note: There are 32 parameters available for configuration in the CommsTab Function Block, one for each Modbus Master data. It is left to the user to partition the Modbus Indirection table for reads and writes for efficient data access.

Comms Indirection Table

EPC3000 controllers make a fixed set of parameters available over digital communications using Modbus addresses. This is known as the SCADA Table. The SCADA Modbus address area is 0 to 15615 (0x3CFF).

Commstab function block allows a Source parameter value to be available(read/write) from a Destination Modbus address.

The following parameters however cannot be set as a Destination Modbus address:

- Instrument Number
- Instrument Type
- Instrument Firmware Version
- Company ID
- Feature Security Words

The following contiguous Modbus addresses have been reserved for use by the Commstab function block. By default the addresses have no associated parameters:

Modbus Range (Decimal)	Modbus Range (Hex)
15360 to 15615	3C00 to 3CFF

Fieldbus IO Gateway

The EPC3000 controller contains a large number of parameters and some protocols, such as EtherNet/IP, need a way of configuring a few selected parameters to exchange Input and Output data across a network. The Fieldbus I/O tool available in iTools allows the configuration of an Input and Output table definition which can be used by the relevant protocol for I/O communications.

Select the 'Fieldbus I/O Gateway' tool from the lower toolbar, and an editor screen will appear similar to that shown below:

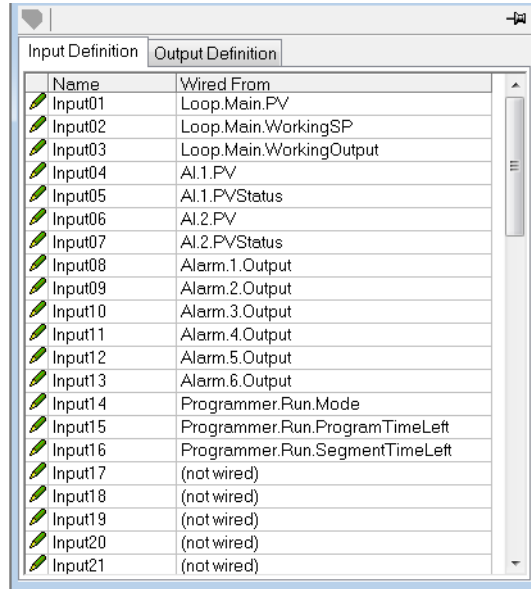

By default, the Input and Output Definition tables are configured with the most frequently used parameters.

There are two tabs within the editor, one for the definition of Inputs, and the other for Outputs. 'Inputs' are values read from the EPC3000 controller and sent to the EtherNet/IP scanner (master), for example, alarm status information or measured values, i.e. they are readable values.

Note: The Input and Output buffer should not be empty. At least one parameter should be selected so the data cyclic exchange functions correctly.

'Outputs' are values received from the master and are written to the controller, for example, setpoints written from the master to the controller. Input and Output parameter values are read and written cyclically. The frequency of the I/O data exchange is determined by the Requested Packet Interval (RPI) which is set by the EtherNet/IP master.

The EPC3000 controller EtherNet/IP adapter (slave) supports an RPI range from 50 - 3200 milliseconds. The procedure for selecting and replacing variables is the same for both input and output tabs. Double click the row to be edited in the input or output table and select the variable to assign to it. A pop-up provides a browser from which a list of parameters can be selected. Double click the parameter to assign it to the selected row. Note that you should assign inputs and outputs contiguously, as a 'not wired' entry will terminate the list even if there are assignments following it.

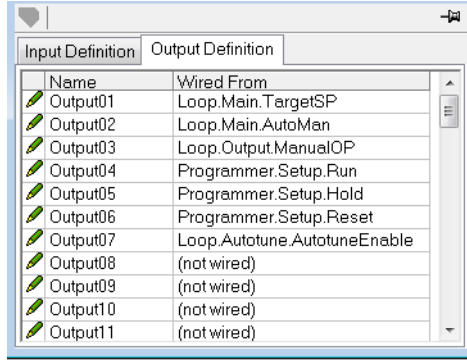

When the definition tables are populated with the variables required, note how many 'wired' entries are included in the input and output areas as this will be needed when setting up the EtherNet/IP scanner (master). Input and Output Parameters are 16 bits (2 bytes) each. In the example above, there are 16 input parameters (32 bytes) and 7 output parameters (14 bytes), so a total of 46 bytes of data. Make a note of this number, as it is required when setting the I/O length when configuring the EtherNet/IP scanner (master). Note that 32-bit float and 32-bit time parameters can also be configured on the Input and Output tables by adding the same parameter in consecutive rows.

Note: All the parameters in the Input table are assumed to be readable and Output table writeable. If going through the Input/Output tables during I/O messaging a parameter is not readable/writeable, the read/write aborts. Read parameter values are sent along with 0 values for parameters that were not read. If the table read or write is aborted, the EtherNet/IP diagnostic parameter Comms>Option>EtherNetIP>EIP_ModuleStatus will show a value of ErrorDetected(3).

Once the changes have been made to the Input and Output definitions, they must be downloaded to the EPC3000 controller.

This is done with the button on the top left of the Fieldbus I/O Gateway Editor marked



Note: iTools can place the EPC3000 controller in and out of Configuration mode while downloading Fieldbus I/O Gateway changes.

Input Linearization (LIN16)

The linearization block converts an analog input into an analog output through a user-defined table. This linearization table consists of a series of 16 points defined by input breakpoints (In1 to In16) and output values (Out1 to Out16). In other words, the linearization block implements a piecewise linear curve (a connected sequence of line segments) defined by a series of input coordinates (In1 to In16) and associated output coordinates (Out1 to Out16).

Two of the most typical applications for the LIN16 function block are:

1. Custom linearization of a sensor input
2. Adjustment of the process variable to account for differences introduced by the overall measurement system or to derive a different process variable.

Custom Linearization

This application allows the user to create their own linearization table.

In the following example the LIN16 block is placed between the Loop block and an Analog Input set to linear and Linearization Type to mV, V, mA, Ohms, etc. In the following example the AI block is set to mV.

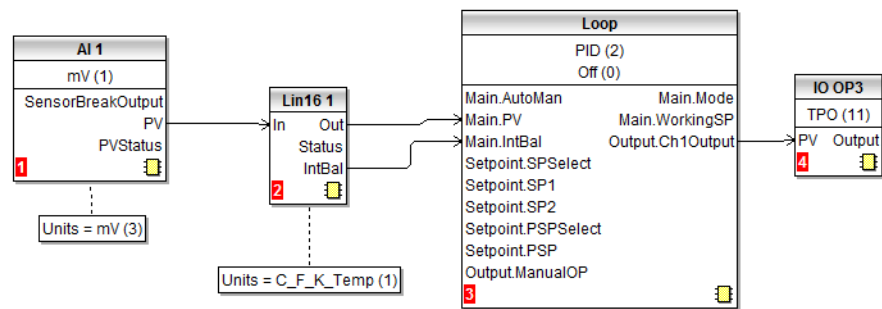

The following graph shows a typically increasing linearization curve. The decision of the actual number of points depends of the required accuracy in converting the input electrical signal into the required output value: the higher the number of points, the higher accuracy can be obtained; conversely a lower number of points requires less time to configure the function block. If less than 16 points are used, set the 'NumPoints' parameter to the required number. Points not selected will then be ignored, the curve will continue in a straight line fit to the levels set in 'OutHighLimit' or 'OutLowLimit' and the 'CurveForm' output will be 'Increasing'.

Example 1: Custom Linearization - Increasing Curve

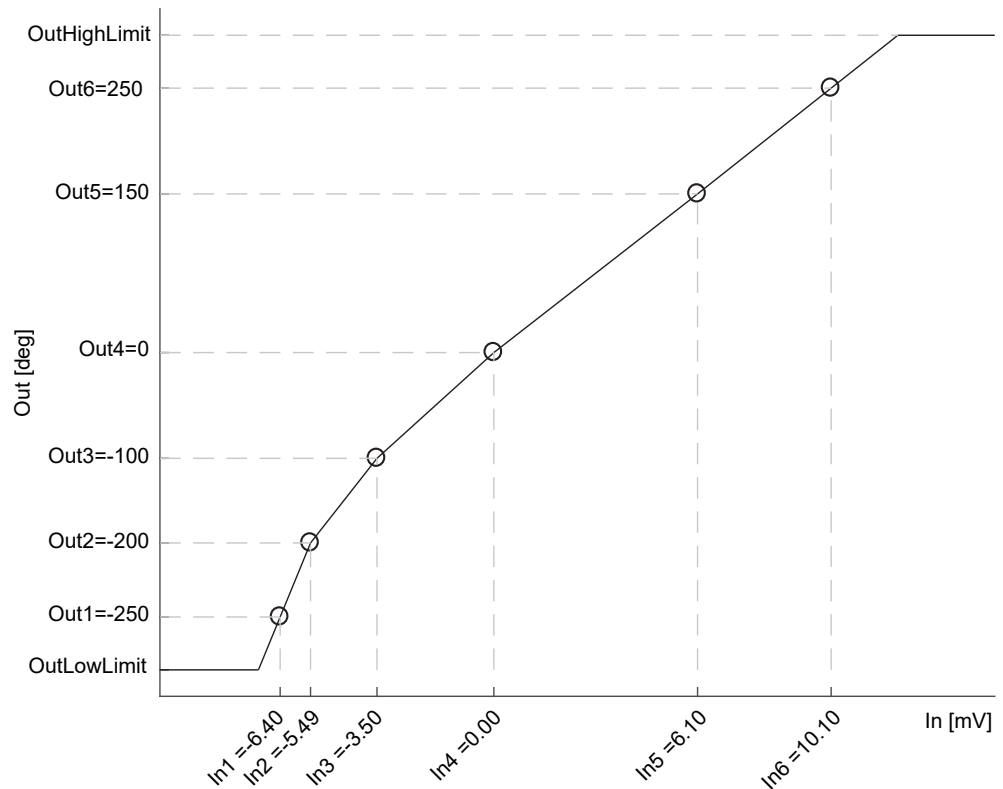

To Setup the Parameters

1. Set the appropriate Fallback type and value, Output units and resolution (editable only in Config mode); Units and resolution of the input and the input breakpoints will be derived by the source wired to 'In'.
2. Set the 'OutHighLimit' and 'OutLowLimit' to restrict the output of the linearization curve. The 'OutHighLimit' must be greater than the 'OutLowLimit'.
3. Set the 'NumPoints' (6 in this example) to the required number of points for the linearization table. This is an important and required step and the effects of skipping it are reported in the Example 2.
4. Enter values of the first Input breakpoint 'In1' and Output value 'Out1'.
5. Continue with the remaining Input breakpoints and Output values.
6. Wire the 'IntBal' parameter to the 'Loop.Main.IntBal' parameter. This prevents any proportional or derivative kick in the controller output when any change occurs in the LIN16 configuration parameters.

Points on the linearization curve can be derived from reference tables or can be found by associating the measurements of an external reference (e.g. temperature in degrees Celsius) to the AI electrical readings (e.g. mV or mA).

The iTools view reproduced below shows how the parameters are set up in LIN block 1 for the above example. The list corresponds to the parameters shown on the controller HMI, see section "Linearization Block Parameters" on page 205.

Parameter help is also available by right clicking the parameter in the iTools list.

Name	Description	Address	Value	Width
In	Input Measurement to Linearize	3075	0.00	
Out	Linearization Result	3076	0.00	
Status	Status of the Block	3077	Good (0)	
CurveForm	Linearization Table Curve Form	3074	Increasing (1)	
Units	Output Units	3072	None (0)	
Resolution	Output Resolution	3073	XX (1)	
FallbackType	Fallback Type	3078	ClipBad (0)	
FallbackValue	Fallback Value	3079	0.00	
IntBal	Integral Balance request	3084	No (0)	
OutLowLimit	Output Low Limit	3080	-300.00	
OutHighLimit	Output High Limit	3081	300.00	
NumPoints	Number of Selected Points	3082	6	
EditPoint	Insert or Delete Point	3083	0	
In1	Input Point 1	3085	-6.40	
Out1	Output Point 1	3086	-250.00	
In2	Input Point 2	3087	-5.49	
Out2	Output Point 2	3088	-200.00	
In3	Input Point 3	3089	-3.50	
Out3	Output Point 3	3090	-100.00	
In4	Input Point 4	3091	0.00	
Out4	Output Point 4	3092	0.00	
In5	Input Point 5	3093	6.10	
Out5	Output Point 5	3094	150.00	
In6	Input Point 6	3095	10.10	
Out6	Output Point 6	3096	250.00	
In7	Input Point 7	3097	0.00	
Out7	Output Point 7	3098	0.00	
In8	Input Point 8	3099	0.00	

The function block will automatically skip points that do not follow strictly monotonically increasing order of the 'In' coordinates. If at least one point has been skipped the 'CurveForm' parameter will show 'SkippedPoints'. If no valid interval is found the 'CurveForm' parameter will show 'NoForm' and the Fallback strategy will be applied. Other conditions when the Fallback strategy is applied are input source bad status (e.g. sensor break or sensor over-range) and calculated LIN16 output over-range (i.e. less than OutLowLimit or greater than InHighLimit).

Example 2: Custom Linearization - Skipped Points Curve

If points defaulted to zero have not been disabled, by reducing 'NumPoints', - AND assuming that at least one of the previous input breakpoints is positive (see the curve below) - then those points will be automatically skipped. The output characteristics will be the same as those obtained by disabling the points defaulted to zero but the 'CurveForm' will be 'SkippedPoints'.

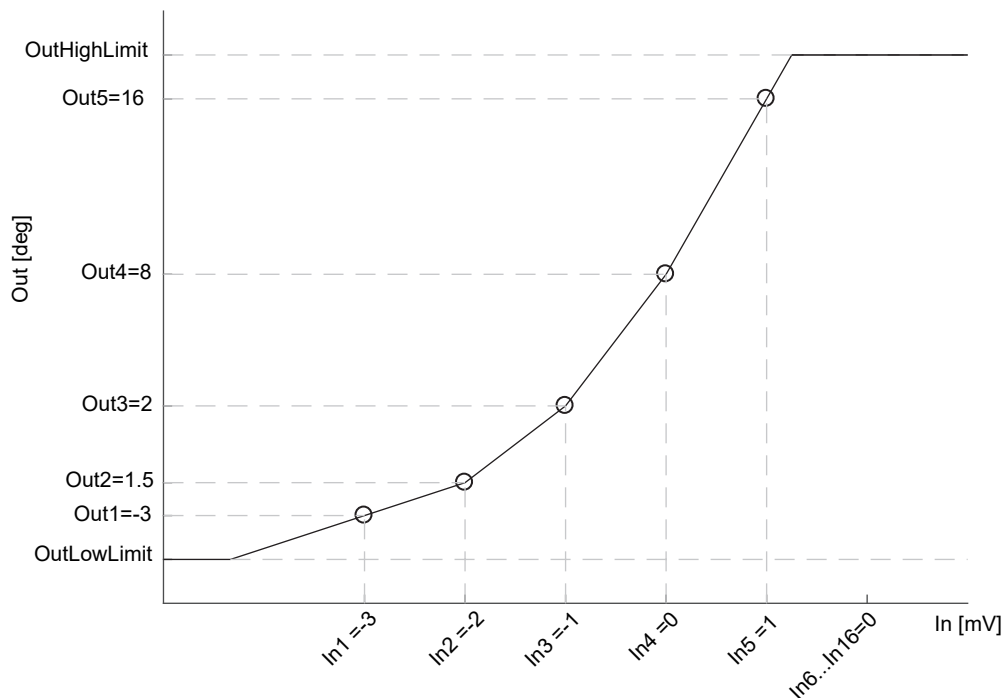

In1 to In5 will be used. In6 to In16 will be ignored. 'CurveForm' will be 'SkippedPoints'

However, when the 'CurveForm' parameter is 'SkippedPoints' (because the number of points 'NumPoints' has not been reduced to the required set) it is not guaranteed that the output characteristics will be increasing or decreasing. In fact, for example, if the input breakpoints are all negative and the final points are zero, then the first "zero" point will be included in the characteristics - see the following picture. Therefore, always set 'NumPoints' to the required value in order to get the expected sensor linearization curve type - increasing, decreasing or free form.

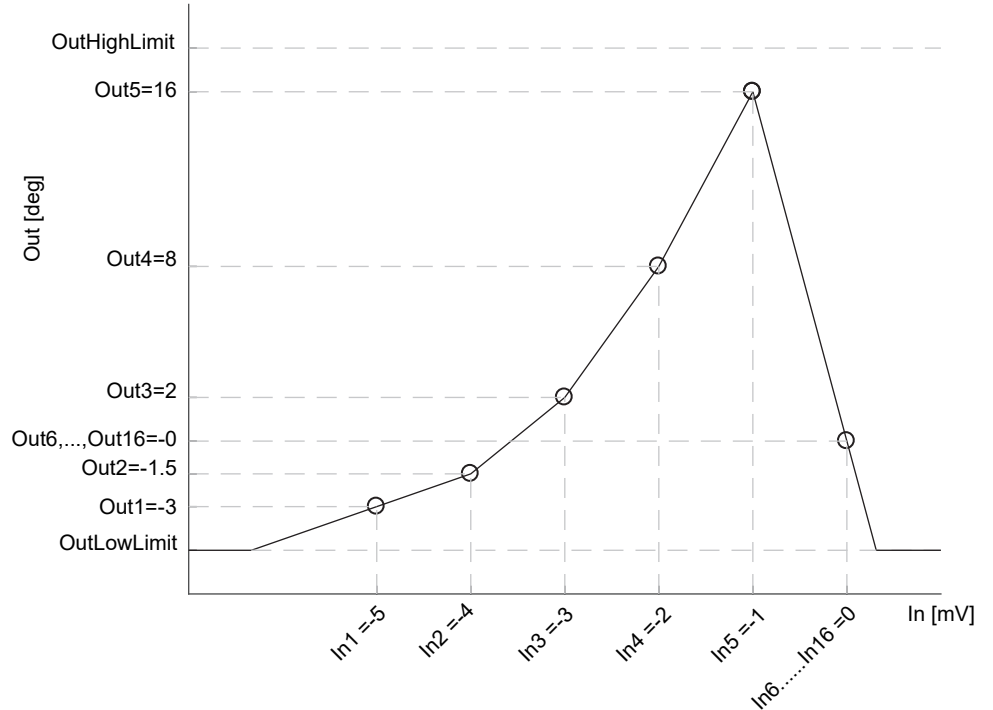

In1 to In5 will be used as well as In6, possibly resulting in a not expected curve. In7, ..., In16 will be ignored. CurveForm will be SkippedPoints.

Example 3: Custom Linearization - Decreasing Curve

The curve may also be a decreasing form as shown below.

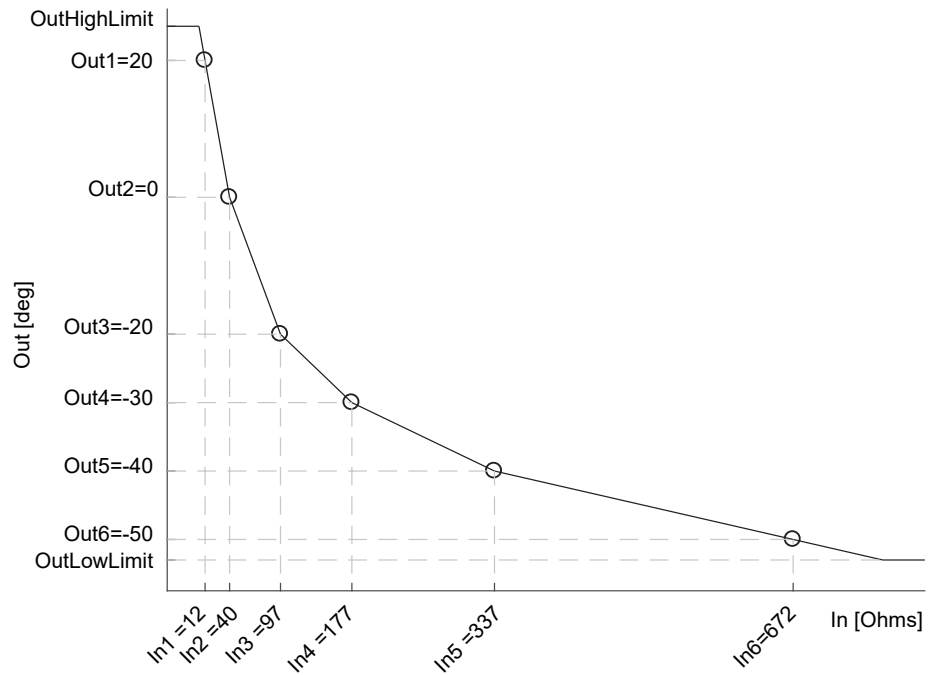

The procedure to setup the parameters is the same as in the previous example.

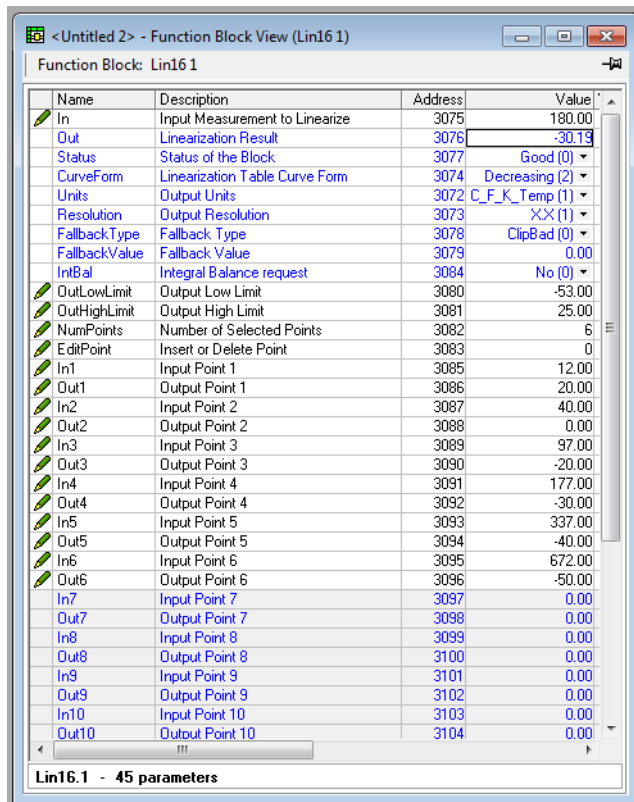

Adjustment of the Process Variable

This application allows the user to compensate for known inaccuracies introduced by the overall measurement system. This not only includes the sensor but also the overall measurement chain. Furthermore, this can also be used to derive a different process variable, for instance, a temperature measured in a different place from where the actual sensor is positioned. The adjustment is made directly on the value, and in the units, of the process variable measured by the controller.

The process variable can be adjusted in different operating conditions (e.g. different temperatures), by using the LIN16 multiple point adjustment curve: this extends the simple PV Offset feature present in the AI block, which just adds or subtracts a single value to the measured PV in all operating conditions.

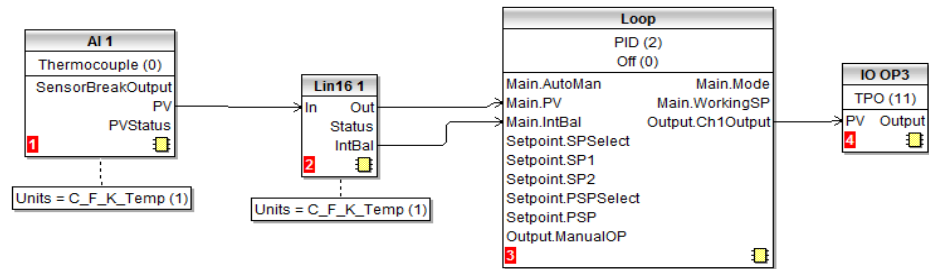

Two alternative configurations can be used:

In the first case the LIN16 table contains the process variable values ‘In1’ to ‘In16’, measured by the controller, and the reference values, ‘Out1’ to ‘Out16’, measured by an external reference.

An example is shown below. The same setup procedure detailed before also applies here apart from the different configuration of the AI block. As shown in the graph and in the wiring diagram, the units of both the input and the output of LIN16 are absolute temperatures.

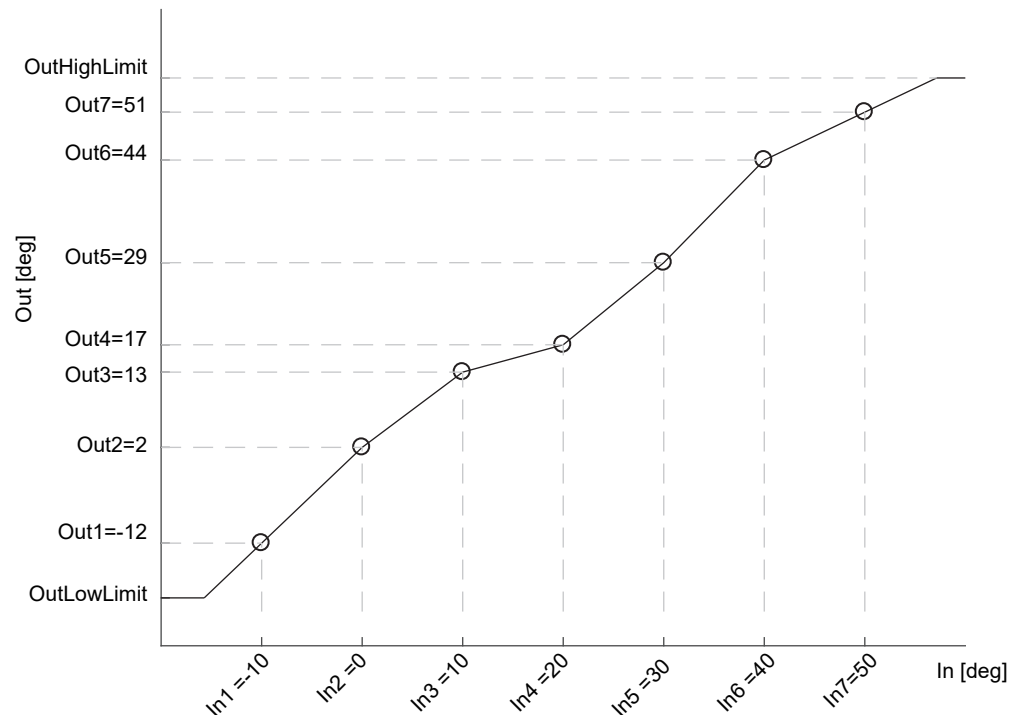

In the second case, for the same application, the LIN16 table stores the offsets between the process variable values measured in the controller and a Math block, set to Add, placed between the Analog Input (AI) and the Loop block. The adjustment is made by adding the offset calculated by the LIN16 block to the measured process variable. In the case of temperature adjustment (and differently from the previous case) the output units of LIN16 should be set to relative temperature. This is in order to select the correct conversion equation when a temperature units change is applied to the offsets (e.g. from degrees Celsius to Fahrenheit).

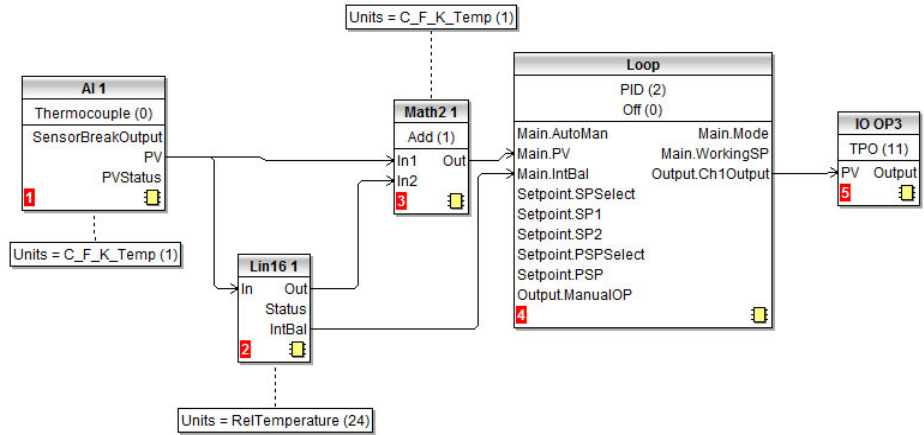

Because offsets do not follow in general a continuously increasing or decreasing trend, then the 'CurveForm' parameter will be 'FreeForm', 'Increasing' or 'Decreasing' depending on their values: see the following graph as an example of a free form offset curve.

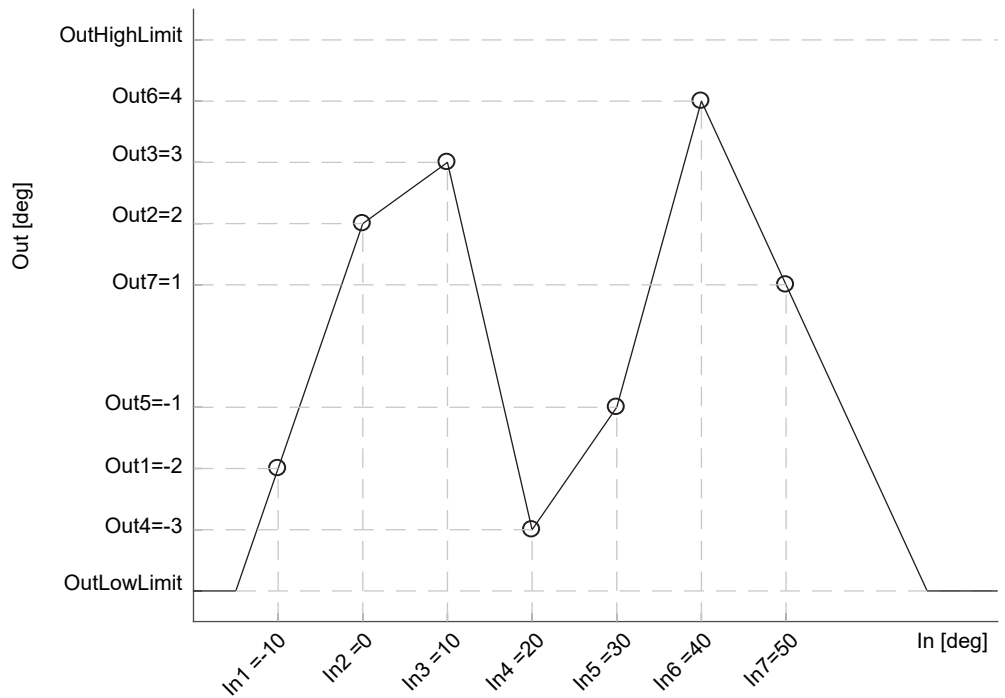

Both the two above mentioned configurations provide the control Loop function block with the same adjusted PV. The values are reported in table for the two examples. The high values of the offsets are only to accentuate in the pictures the action of the adjustment.

Input Breakpoints	Output values: absolute temperature	Alternative output values: relative temperature
-10 deg	-12 deg	-2 deg
0 deg	2 deg	2 deg
10 deg	13 deg	3 deg
20 deg	17 deg	-3 deg
30 deg	29 deg	-1 deg
40 deg	44 deg	4 deg
50 deg	51 deg	1 deg

User Calibration

The controller is calibrated during manufacture using traceable standards for every input range. It is, therefore, not necessary to calibrate the controller when changing ranges. Furthermore, the use of a continuous automatic zero correction of the input ensures that the calibration of the instrument is optimized during normal operation.

To comply with statutory procedures such as the Heat Treatment Specification AMS2750, the calibration of the instrument can be verified and re-calibrated if considered necessary in accordance with the instructions given in this chapter.

For example AMS2750 states:- "Instructions for calibration and recalibration of "field test instrumentation" and "control monitoring and recording instrumentation" as defined by the NADCAP Aerospace Material Specification for pyrometry AMS2750E clause 3.3.1 (3.2.5.3 and sub clauses)" Including Instruction for the application and removal of offsets defined in clause 3.2.4.

User calibration allows the controller to be calibrated at any part of its range (not just span and zero) or to allow for fixed known measuring offsets such as sensor tolerances.

Note: The RSP option module in the EPC3016 can only be calibrated at high and low points (4mA, 20mA, 0V, 10V) due to backwards compatibility. Calibrating at other values may be unsuccessful, causing the RSP module to revert to Factory Calibration.

Factory calibration is stored within the controller and can be returned to at any time.

In some cases it is only required to calibrate the controller itself, however, it is often necessary to compensate for tolerances in the sensor and its connections as well. This is particularly true for temperature measurement which uses, typically, thermocouple or PRT sensors. In the latter case this may be done using an ice cell or hot bath or dry block calibrator. The different methods are described in the following sections

Controller only Calibration

To Calibrate the Analog Input

This can be done through the HMI or using iTools. The following points should be observed:

- Place the controller into Operator Level 3 (or Configuration level).
- Allow at least 10 minutes for the controller to settle after switching on.
- Connect the input of the controller to a millivolt source. If the controller is configured for thermocouple ensure that the millivolt source is set to the correct CJC compensation for the thermocouple in use and that the correct compensating cable is used.
- If the input to be calibrated is mV, mA or volts the measurement will be linear mV, mA or volts. If it is configured for thermocouple or RTD the measurement will be in degrees in accordance with the instrument configuration.

Using iTools

Open the Instrument list and select the Cal tab.

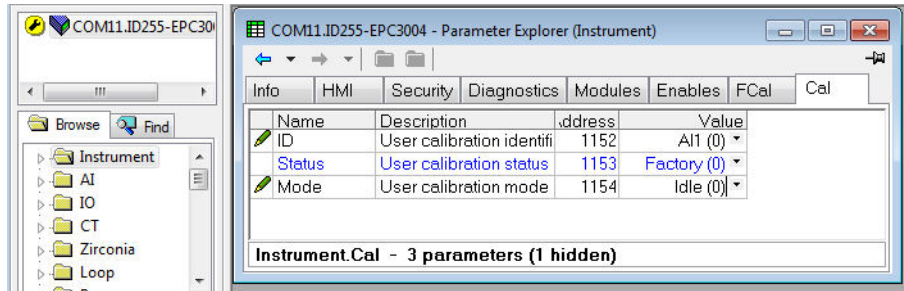

Status will show 'Factory' if user calibration has not been carried out before.

To Start User Calibration

Click the 'Mode' parameter and select 'Start'.

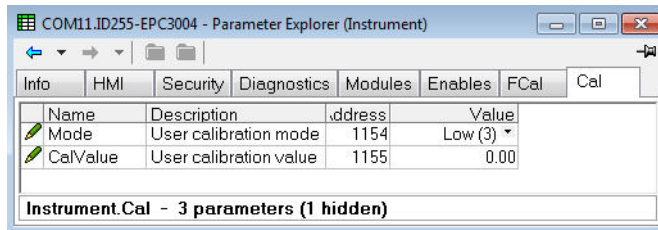

The Mode will change to 'Low'

1. In 'CalValue' enter a value which represents the low reading required on the controller display, in this case 0.00.
2. Set the mV source to 0.00mV. If the input is a thermocouple make sure that the mV source is set to compensate for the type of thermocouple configured. It is not necessary to calibrate for other thermocouple types.
3. In 'Mode' select 'SetLow'. This will calibrate the controller to the selected input mV (0.00). Discard will return to Factory calibration.

The 'Mode' will change to 'High'

1. In 'CalValue' enter a value which represents the high reading required on the controller display, in this case 300.00
2. Set the mV source to the correct input level. If the input is a thermocouple this will be the mV equivalent to 300.00°C. It is not necessary to calibrate for other thermocouple types.
3. In 'Mode' select 'SetHigh'. This will calibrate the controller to the selected input mV. Discard will return to Factory calibration.

The 'Status' and 'Mode' will show 'Adjusted' which indicates that the controller has been calibrated by the user.

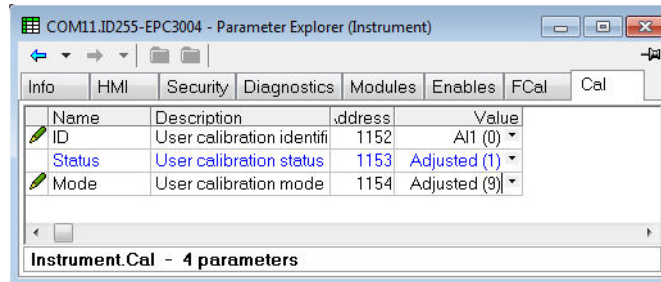

It may be found useful to open the AI1 browser list when carrying out the calibration since the PV can be read directly during the calibration procedure. This also allows the input measurement settling to be viewed during the calibration process.

Note: If, at the end of a calibration process, the calibration has been unsuccessful the Status will return to Factory and the Mode will show 'Unsuccessful' (U.SUC)

To Return to Factory Calibration

In 'Mode' drop down select 'Discard'.

Two Point Offset

A two point offset enables the controller display to be offset by different amounts at the low end of the scale and at the high end of the scale. The basic calibration of the controller is unaffected but the two point offset provides a compensation for sensor or inter-connection errors. The diagrams below show that a line is drawn between the low and high offsets values. Any readings above and below the calibration points will be an extension of this line. For this reason it is good practice to calibrate with the two points as far apart as possible.

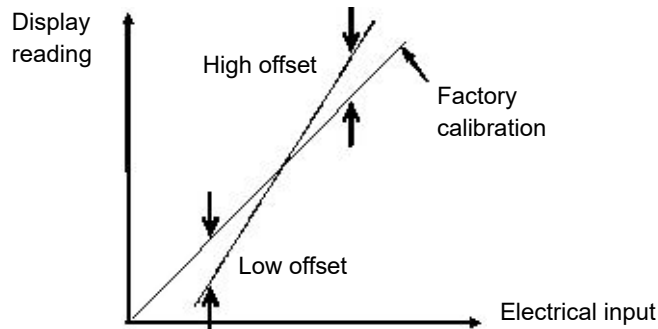

The procedure is exactly the same as shown in the previous section. For the minimum input set the 'CalValue' to the reading required on the controller display as shown in the Low offset in the diagram above.

Similarly, for the maximum input set the 'CalValue' to the reading required on the controller display as shown in the High offset in the above diagram.



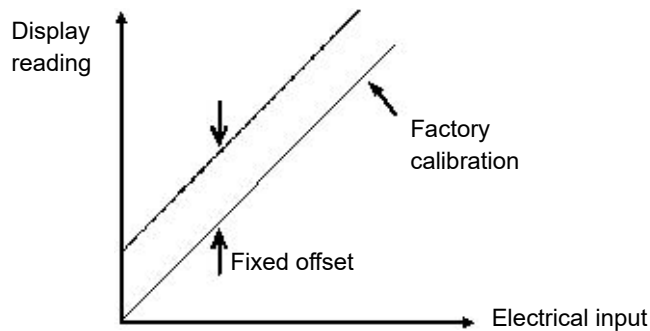





















Note: A 'PvOffset' parameter is available in the Analog Input list which provides a fixed value to be added to or subtracted from the process variable. This is not part of the User Calibration procedure but applies a single offset over the full display range of the controller and can be adjusted in Level 3. It has the effect of moving the curve up a down about a central point as shown in the example below:-



Using the Controller HMI

The procedure is the same as using iTools. Observe the precautions listed in "To Calibrate the Analog Input" on page 369.

The example below shows a step by step procedure using the controller HMI. In this example a two point offset is applied

Operation	Action	Display	Notes
In Level 3 or Configuration level select the Instrument List then CAL S.LIST			
Select the Analog input AI.1	1. Press  to until the Mode parameter is displayed		If the MODE shows 'Adj.d' (adjusted) select 'diSc' (discard). This returns the controller to Factory Calibration.
Select Start	2. Press  or  to select	 	The display will change to Lo
Set the mV source to the input value representing the required offset. In this example +1.80mV			
Enter the value of the reading required on the controller display for an input of 1.80mV	3. Press  to scroll to C.VAL 4. Press  or  to enter the value		In this example the controller display will read 0.00 for an input of +1.80 mV
Scroll back to Lo	5. Press  Scroll back to Lo 6. Press  or  to SET.L	 	The low calibration point will be entered and the display will change to Hi
Set the mV source to 17.327. This is the offset value (+1.00mv) at which a type J thermocouple is required to read 300.0 (in this example).			
Enter the value of the reading required on the controller display for an input of 17.327mV.	7. Press  to scroll to C.VAL 8. Press  or  to enter the value		The display will read 300.00C for an input of 17.327mv (an offset of +1.000 mV)
Scroll back to Hi	9. Press  Scroll back to Hi 10. Press  or  to SET.H	 	The high calibration will be entered and the display will change Adj.d. showing that the controller has been calibrated by the user
To return to Factory calibration select diSc (discard) in place of Adj.d. If the calibration is unsuccessful the controller will revert to Factory Cal.			

Calibration using a Dry Block or Equivalent

A dry block, ice cell or hot bath are heated or cooled to a specific temperature and accurately maintained at that temperature. Calibration is a comparison between two devices. The first device is the unit to be calibrated, often called the unit under test. The second device is the standard, which has a known accuracy. Using the standard as a guide, the unit under test is adjusted until both units display the same results while exposed to the same temperature. Using this method the tolerance of the temperature sensor, CJC, etc is included in the calibration.

The procedure is essentially the same as that already described but the millivolt source is replaced by the temperature sensor under test.

To Calibrate a Voltage or Current Analog Output

Using the Controller HMI

The procedure is generally the same as for the Analog input except it requires the output to be connected to a voltage or current meter.

In this example the output to be calibrated is OP2.

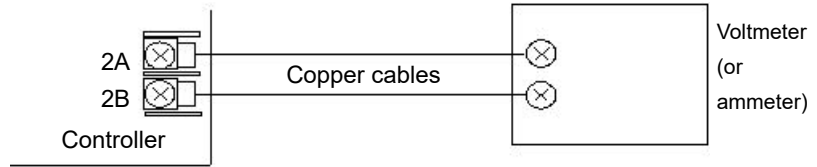

Operation	Action	Display	Notes
In Level 3 or Configuration level select the Instrument List then CAL S.LIST			
Select the Analog output dC.1 (2 or 3)	1. Press until the Mode parameter is displayed		If MODE shows 'Adj.d' (adjusted) select 'diSc' (discard). This returns the controller to Factory Cal.
Select Start	2. Press or to select	 	The display will change to Lo
Read the DC output on the meter. For a voltage output, this should read 2.00 volts. (For a mA output this should read 4.00mA). If, for example, the voltage reading is 1.90V, enter this value - the instrument works out the difference as part of the calibration process.			
Enter the meter reading, e.g. 1.9V	3. Press to scroll to C.VAL 4. Press or to enter the value		In this example the user calibrated output will output 2V instead of 1.9V
Scroll back to Lo	5. Press Scroll back to Lo 6. Press or to SEt.L	 	The low calibration point will be entered and the display will change to Hi
As above read the DC output on the meter. For a voltage output, this should read 10.00 volts. (For a mA output this should read 20.00mA). If the voltage reading is 9.80V, enter this value into the C.VAL parameter as shown below.			
Enter the meter reading e.g. 9.80V	7. Press to scroll to C.VAL 8. Press or to enter the value		In this example the user calibrated output will output 10V instead of 9.8V
Scroll back to Hi	9. Press Scroll back to Hi 10. Press or to SEt.Hi	 	The high calibration will be entered and the display will change Adj.d.
To return to Factory calibration select diSc (discard) in place of Adj.d. If the calibration is unsuccessful the controller will revert to Factory Cal.			

Using iTools

Open the Instrument list and select the Cal tab.

Assuming that user calibration has not been carried out before the Status will show Factory.

In 'Mode' select 'Start'. The Mode parameter will change to 'Low'.

Name	Description	.ddress	Value
ID	User calibration identifi	1152	DCOP2 (3)
Status	User calibration status	1153	Factory (0)
Mode	User calibration mode	1154	Low (3)
CalValue	User calibration value	1155	0.01
isUnsuccessful	Is unsuccessful status	1156	0
ModeHi	Mode limit high	1157	5
ModeLo	Mode limit low	1158	3

1. Read the DC output on the meter. For a voltage output, this should read 2.00 volts. (For a mA output this should read 4.00mA). If the voltage reading is 1.90V, enter this value, into the C.VAL parameter as shown below.

Name	Description	.ddress	Value
ID	User calibration identifi	1152	DCOP2 (3)
Status	User calibration status	1153	Factory (0)
Mode	User calibration mode	1154	Low (3)
CalValue	User calibration value	1155	1.90
isUnsuccessful	Is unsuccessful status	1156	0
ModeHi	Mode limit high	1157	5
ModeLo	Mode limit low	1158	3

Instrument.Cal - 7 parameters

2. Change 'Mode' to 'SetLo'. The new cal value will be stored and the 'Mode' will change to 'High'.

Repeat Step 1 above for the High Calibration point entering the required meter reading for the high calibration point.

The 'Mode' parameter will now show 'Adjusted' signifying that calibration has been adjusted by the user.

To Calibrate the Current Transformer

The procedure is similar to the calibration of the Analog Input as described in section "Using iTools" on page 370.

It is recommended to use a DC current source connected as shown in the diagram. That is the +ve terminal of the source connected to 'C' and the -ve terminal of the source to 'CT'.

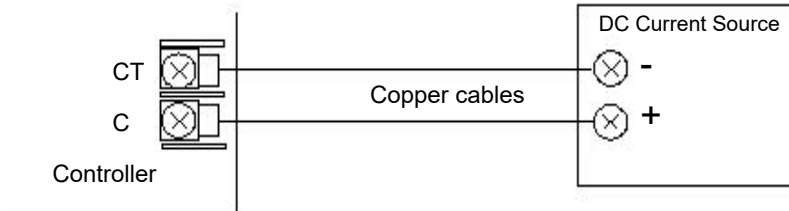

1. Connect a current source to the current transformer terminals C and CT
2. In the 'Instrument Cal' list, set the ID to CT

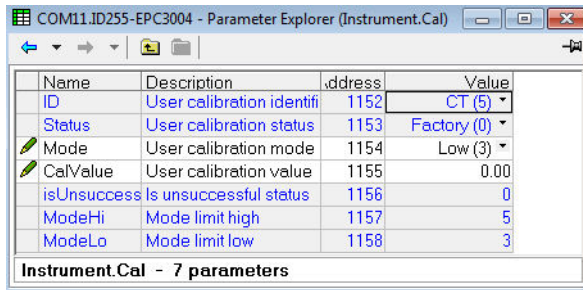

3. Adjust the 'Mode' parameter to 'Low'.
4. Inject a current from the current source, for example, 35mA.
5. Enter 35.00 into the 'CalValue' parameter
6. Adjust the 'Mode' parameter to 'SetLow'.
7. The CT low calibration point will be stored and the 'Mode' parameter will change to 'High'
8. Inject a current from the current source, for example, 70mA.
9. Enter 70.00 into the 'CalValue' parameter
10. Adjust the 'Mode' parameter to 'SetHigh'.
11. On successful calibration the 'Mode' parameter will change to 'Adjusted' as in the previous examples.

Notification Messages

Notification messages indicate specific conditions within the controller or connected devices.

The following messages can be displayed depending upon value, notifications, or standby conditions:

Note: Scrolling messages can be customized using iTools, (see "User Defined Messages" on page 235) so they may not be identical to those shown in the table below.

Mnemonic	Scrolling Message	Description of notification / unexpected condition	Possible Solutions
HHHH	--	Parameter value is greater than the maximum display limit	
LLLL	--	Parameter value less than the minimum display limit	
Sbrk	INPUT SENSOR BROKEN	If the sensor becomes open circuit a message in the upper display which alternates between Sbrk and brk. The controller will be placed into Manual mode. The lower display will scroll the message 'Input Sensor Broken'. This message can be customized using iTools. The actual message is defined in default message table. The Sensor Break Output parameter can be wired to a process alarm to provide latching strategies.	Typical reasons for this alarm may be caused by the connections between the instrument and the sensor becoming disconnected or a detected break of the sensor itself. Change the sensor and check the wiring and connections.
SRNG ORNG	INPUT SENSOR OUT OF RANGE	A sensor is out of range. If the PV input value rises above 5% of the input range, alarm messages will be shown. O.RNG (over range in green) will alternate with S.RNG (sensor out of range in red) and the controller will be put into Manual mode. A scrolling message, as defined in default message table, will also appear.	Reconfigure the Range High parameter in the Analog Input list in accordance with the application requirements.
SRNG URNG	INPUT SENSOR OUT OF RANGE	A sensor is out of range. If the PV input value falls below 5% of the input range, alarm messages will be shown. u.RNG (under range in green) will alternate with S.RNG (sensor out of range in red) and the controller will be put into Manual mode. A scrolling message as defined in default message table will also appear.	Reconfigure the Range Low parameter in the Analog Input list in accordance with the application requirements.
EUNE	--	Control loop auto tune has timed out and did not complete.	Retry tune or clear by entering and exiting configuration level.
	PLEASE SET COMMS PASSWORD VIA ITOOLS	The comms configuration password needs setting. Fixed comms and Option comms will have limited read/write access until the comms password has been configured.	Configure the Instrument>Security>Comm sPassword parameter using iTools.
	COMMS CONFIG PASSWORD EXPIRED	The instrument contains user comms (fixed and/or option) and the 'Comms Config password' has expired	
	HMI LEVEL 2 LOCKED. TOO MANY INCORRECT PASSWORD ATTEMPTS	HMI Level 2 access has been locked due to too many incorrect password entries.	Enter level 3 or config to clear the lock, or wait for the timeout period to expire.
	HMI LEVEL 3 LOCKED. TOO MANY INCORRECT PASSWORD ATTEMPTS	HMI Level 3 access has been locked due to too many incorrect password entries.	Enter config level to clear the lock, or wait for the timeout period to expire.

	HMI CONF LEVEL LOCKED. TOO MANY INCORRECT PASSWORD ATTEMPTS	HMI Config access has been locked due to too many incorrect password entries.	Use config clip to connect and reset the timer to 0, to clear, then back to the required timeout period. Or wait for the timeout period to expire.
	COMMS CONF LEVEL LOCKED. TOO MANY INCORRECT PASSWORD ATTEMPTS	Comms Config access has been locked due to too many incorrect password entries.	
	LOOP DEMO MODE	Control loop is in demo mode (controlling a simulated load)	
	AUTO TUNE ACTIVE	Control loop auto tune is active	
	AUTOTUNE TRIGGERED BUT CANNOT RUN	Control loop auto tune requested but can not run.	Put the loop into auto.
	COMMS CONFIG ACTIVE	The instrument is in config mode via comms. This will typically be displayed if the controller has been put into configuration mode using iTools. The controller will be in standby	Disconnect the comms source or take the controller out of config mode (if using iTools).
OFF		Channel is Off	
HwE		Detected hardware error	
rng		Input Ranging	
OFLw		Input Overflow	
bad		Bad Input	
HwL		Hardware Exceeded	
ndat		The PV has no data	
TRmS	INVALID RAM IMAGE OF NVOL	Periodic check of non-volatile memory has detected a corruption. This condition places the instrument in standby mode.	Clear by going in and out of config mode. If problem persists, return to factory
OPES	OPTION NVOL LOAD OR STORE WAS UNSUCCESSFUL	Option Board Non-Volatile Memory load or store was unsuccessful.	Return unit to factory.
PAS	NVOL PARAMETER DATABASE LOAD OR STORE WAS UNSUCCESSFUL	Option Board Non-Volatile Memory load or store was unsuccessful.	Return unit to factory.
REGS	NVOL REGION LOAD OR STORE WAS UNSUCCESSFUL	Option Board Non-Volatile Memory load or store was unsuccessful.	Return unit to factory.
CALS	FACTORY CALIBRATION NOT DETECTED	AI or IO module has lost, or gone out of calibration.	Return to factory for calibration.
CPUS	UNEXPECTED CPU CONDITION	Unexpected internal CPU fuse settings.	Return unit to factory.
IdS	HARDWARE IDENT UNKNOWN	Unsupported hardware detected.	Return unit to factory
Hwds	FITTED HARDWARE DIFFERS FROM EXPECTED HARDWARE	Detected hardware does not match the expected hardware.	Clear by ensuring the expected hardware matches the fitted hardware in Instrument.Modules parameter list.
KEYS	UNEXPECTED KEYBOARD CONDITION	Unexpected keyboard condition detected at startup.	Clear by power cycling. If problem persists, return to factory
PLnf	POWERED DOWN WHILST IN CONFIG MODE	The instrument lost power while in config mode	Clear by entering and exiting config mode
RECS	INCOMPLETE RECIPE LOAD	If the recipe load cannot be completed for any reason (values are invalid or out of range), the instrument will be half configured. The instrument will go into Standby	Enter config mode and re-enter Operator Level to clear the message
FLEr		Firmware will not run. Only shown at start up.	Return to factory

OEM Security

OEM security has been added from Firmware Versions V.3.01 and above. It is available as an orderable option and is protected by Feature Security ("Security Sub-List (SEC)" on page 197).

OEM security allows users, typically OEMs or distributors, to protect their intellectual property and is designed to prevent unauthorized viewing, reverse engineering or cloning of controller configurations. This protection includes application specific internal (soft) wiring, limited access to certain Configuration level and Operator level parameters either via comms (by iTools or a third party comms package) or via the instrument's user interface.

When 'OEM Security' is enabled, users are prevented from accessing soft wiring from any source, and it is not possible to Load or Save the configuration of the instrument via iTools or by using the Save/Restore facility.

Altering configuration and/or operator parameters via HMI or Comms may also be restricted when OEM security is implemented.

Once the security function has been set up for a particular application it may be cloned into every other identical application without further configuration.

Implementation

When OEM Security is supplied four OEM parameters are displayed in the 'Instrument - Security' list. These parameters are only available in iTools - they are not shown in the controller HMI.

Name	Description	Address	Value
L2Passcode	Level2 Passcode	1056	2
L3Passcode	Level3 Passcode	514	3
ConfigPasscode	Configuration Passcode	515	4
IM	Instrument Mode	199	2
MaxIM	Max instrument mode (iTools use only)	1057	2
CommsConfigPasscode	Comms Config Passcode	1058	1234567890
CommsPasscode	Comms Passcode	1059	0
ConfigAccess	Indication that config mode can be accessed	1060	1
CommsPasscodeDefault	Comms Passcode Default Notification	1061	Yes (1) ▾
CommsPasscodeExpiry	Comms Passcode Expiry Days	1062	90 ▾
PassLockTime	Passcode lockout time	1063	30m ...
FeaturePasscode1	Feature Passcode 1	1064	29042
FeaturePasscode2	Feature Passcode 2	1065	40019
ClearMemory	Clear Memory	1066	No (0) ▾
OEMPassword	OEM Password	21402
OEMEntry	OEM Password Entry	21447
OEMStatus	OEM Status	1067	Locked (1) ▾
OEMParamLists	OEM Parameter Lists	1068	Off (0) ▾
IMGlobal	Comms config locked (iTools use only)	1069	2
FeaturePasscode3	Feature Passcode 3	1070	7657
FeaturePasscode4	Feature Passcode 4	1071	819
FeaturePasscode5	Feature Passcode 5	2880	52986

Instrument.Security - 22 parameters

OEMPassword This password is selected by the OEM. Any alpha/numeric text can be used and the field is editable whilst the OEM Status is 'Unlocked'. A minimum of 8 characters should be used. It is not possible to clone the OEM Security Password. (Highlight the complete row before entering).

OEMEntry Enter the OEM security password to enable and disable OEM security. The controller must be in configuration level

to enter this password. When the correct password is entered the OEM Status will toggle between 'Locked' and 'Unlocked'. (Highlight the complete row before entering). Three login attempts are allowed before lockout which is followed by a 90 minute password lockout period.

OEMStatus	<p>Read only showing 'Locked' or 'Unlocked'.</p> <p>If Unlocked two lists are available which allow an OEM to restrict which parameters are alterable when the controller is in Operator and Configuration Access levels.</p> <p>Parameters added in the 'OEMConfigList' WILL be available to the operator when the controller is in Configuration level. Parameters not added in this list will not be available to the operator.</p> <p>Parameters added to the 'OEMOperList' will NOT be available to the operator when the controller is in Operator access level.</p> <p>If the 'OEMStatus' is 'Locked' these two lists are not shown. The controller configuration is prevented from being cloned and the internal wiring cannot be accessed via comms.</p>
OEMParameterLists	<p>This parameter is only writeable when the 'OEM Status' is 'Unlocked'.</p> <p>When 'Off', Operator type parameters are alterable in Operator access level and Config parameters are alterable in Configuration access level (all within other limitations such as high and low limits). This applies both through the HMI or comms.</p> <p>When 'On', parameters added to the OEMConfigList WILL be available to the operator when the controller is in configuration level. Parameters not added in this list will not be available to the operator. Parameters added to the OEMOperList will NOT be available to the operator when the controller is in Operator access level.</p> <p>The table at the end of this section shows an example for just two parameters 'Alarm 1 Type' (configuration type parameter) and 'Alarm 1 Threshold' (operator type parameter).</p>

Note: When entering or exiting OEM Security a few seconds should be allowed for iTools to synchronize.

OEM Configuration List

The 'OEMConfigList' allows the OEM to choose up to 100 configuration parameters which are to remain Read/Write while in Configuration level and OEM Security is enabled (locked). In addition to these the following parameters are always writeable in configuration mode:

OEM Security Password Entry, HMI Level 2 password, HMI Level 3 password, HMI Configuration Level password, Comms Configuration password, Controller Coldstart parameter.

The required parameters may be by dragged and dropped from a browser list (on the left hand side) into the Wired From cell in the 'OEMConfigList'. Alternatively, double click into the 'WiredFrom' cell and select the parameter from the pop up list. These parameters are those chosen by the OEM which are to remain alterable when OEM Security is enabled and the controller is in Configuration access level.

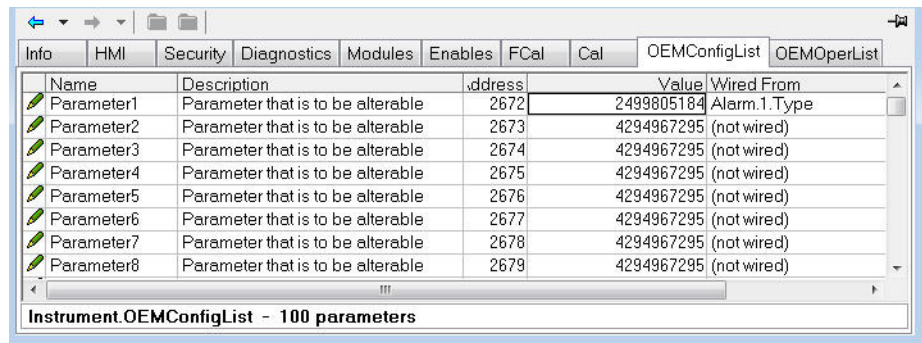

The view shows the first 8 parameters of which Parameter 1 has been populated with a configuration parameter (Alarm 1 Type). Examples of configuration parameters include Alarm Types, Input Types, Range Hi/Lo, Modules Expected, etc.

When the OEM Status is Locked, this list is not shown.

OEM Operator List

The OEM Operator List operates in the same way as the OEM Configuration list except the parameters selected are those which are available in Operator access level. Examples are programmer mode, alarm setting parameters, etc. The example below shows 'Alarm 1 Threshold' which is to be read only in Operator access level.

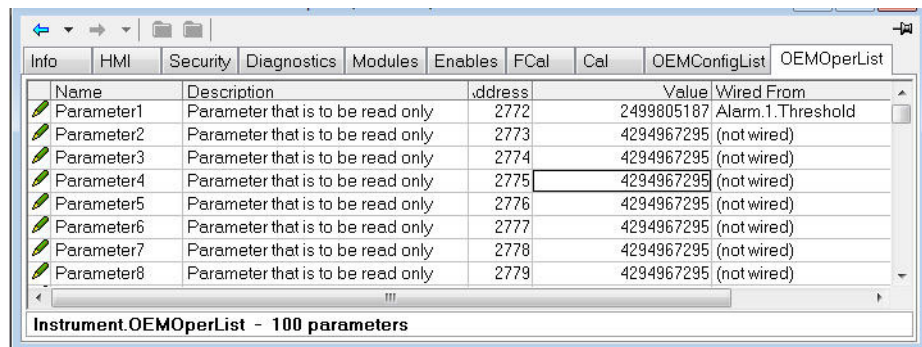

The example shows the first 8 of 100 parameters of which the first has been selected as 'Alarm 1 Threshold'. This parameter is to be read only when OEM Security is enabled and the controller is in Operator access level.

When the OEM Status is Locked, this list is not shown.

Effect of the 'OEM ParamList' Parameter

The table below shows the availability of the two 'Alarm 1' parameters set up in the previous pages when the 'OEMParamList' parameter is turned On or Off.

'Alarm 2' is used as an example of all parameters which have not been included in OEM Security.

'OEMParamLists'	Parameter	Controller in Configuration Access		Controller in Operator Access	
		Alterable	Not alterable	Alterable	Not alterable
On	A1 Type	✓			✓
	A2 Type		✓		✓
	A1 Threshold		✓		✓
	A2 Threshold	✓		✓	
Off	A1 Type	✓			✓
	A2 Type	✓			✓
	A1 Threshold	✓		✓	
	A2 Threshold	✓		✓	

The iTools views shown in the next page show how this example is presented in the iTools browser:-

'OEMParamLists' On

The iTools views shown below show the alterability of the alarm parameters used in the previous examples. Alarm 1 has been set up in OEM Security. Alarm 2 is used as an example of parameters not set up in OEM Security.

Text in black shows parameters are alterable. Text in blue is not alterable.

Controller in Configuration Mode

'Alarm 1 Type' is alterable
'Alarm 1 Threshold' is not alterable

1	2	3	4	5	6
Name	Description	.address	Value		
Type	Alarm type	536	AbsHi (1)		
Status	Alarm status	2113	Off (0)		
Input	Input to be evaluated	2114	47.50		
Threshold	Threshold	13	999.70		
Hysteresis	Hysteresis	47	2.30		

'Alarm 2 Type' is not alterable
'Alarm 2 Threshold' is alterable

1	2	3	4	5	6
Name	Description	.address	Value		
Type	Alarm type	537	AbsLo (2)		
Status	Alarm status	2137	Off (0)		
Input	Input to be evaluated	2138	47.49		
Threshold	Threshold	14	-10.00		
Hysteresis	Hysteresis	68	1.00		

Controller in Operator Mode

'Alarm 1 Type' is not alterable
'Alarm 1 Threshold' is not alterable

1	2	3	4	5	6
Name	Description	.address	Value		
Type	Alarm type	536	AbsHi (1)		
Status	Alarm status	2113	Off (0)		
Input	Input to be evaluated	2114	47.48		
Threshold	Threshold	13	999.70		
Hysteresis	Hysteresis	47	2.30		

'Alarm 2 Type' is not alterable
'Alarm 2 Threshold' is alterable

1	2	3	4	5	6
Name	Description	.address	Value		
Type	Alarm type	537	AbsLo (2)		
Status	Alarm status	2137	Off (0)		
Input	Input to be evaluated	2138	47.45		
Threshold	Threshold	14	-10.00		
Hysteresis	Hysteresis	68	1.00		

'OEMParaLists' Off

Controller in Configuration Mode

'Alarm 1 Type' is alterable
'Alarm 1 Threshold' is alterable

1	2	3	4	5	6
Name	Description	.address	Value		
Type	Alarm type	536	AbsHi (1)		
Status	Alarm status	2113	Off (0)		
Input	Input to be evaluated	2114	47.46		
Threshold	Threshold	13	999.70		

'Alarm 2 Type' is alterable
'Alarm 2 Threshold' is alterable

1	2	3	4	5	6
Name	Description	.address	Value		
Type	Alarm type	537	AbsLo (2)		
Status	Alarm status	2137	Off (0)		
Input	Input to be evaluated	2138	47.47		
Threshold	Threshold	14	-10.00		

Controller in Operator Mode

'Alarm 1 Type' is not alterable
'Alarm 1 Threshold' is alterable

1	2	3	4	5	6
Name	Description	.address	Value		
Type	Alarm type	536	AbsHi (1)		
Status	Alarm status	2113	Off (0)		
Input	Input to be evaluated	2114	47.56		
Threshold	Threshold	13	999.70		

'Alarm 2 Type' is not alterable
'Alarm 2 Threshold' is alterable

1	2	3	4	5	6
Name	Description	.address	Value		
Type	Alarm type	537	AbsLo (2)		
Status	Alarm status	2137	Off (0)		
Input	Input to be evaluated	2138	47.50		
Threshold	Threshold	14	-10.00		

Notes:

- Parameters are alterable within other set limits.
- The availability applies to access both through the controller HMI or through comms.

Technical Specification

General

Controller Function	<ul style="list-style-type: none"> • Single loop panel mount PID controller range with autotune, ON/OFF, Valve Positioning (no slidewire required) • Zirconia probe atmosphere control • Single loop profile/program • AC mains voltage and 24Vdc options
Measurement Inputs	<ul style="list-style-type: none"> • 1 or 2 inputs. Accuracy $\pm 0.1\%$ reading (refer to detailed specification)
PID Control	<ul style="list-style-type: none"> • 2 PID sets are available as standard with 8 as an optional extension. Each PID set offers separate proportional band for heat and cool operation • Enhanced Autotuning control with cutback to minimize overshoot and oscillation. Fast reacting precision control to setpoint changes or after process disturbances • Enhanced valve positioning (unbounded) algorithm • Gain scheduling allows PID selection for a wide range of operating situations, including deviation from setpoint, absolute temperature, output level and others • AC supply voltage monitoring for feedforward. PV and SP feedforward functions
Setpoint Program/Profiler	<ul style="list-style-type: none"> • Options include 20 profiles of 8 steps (20x8), 10x24, 1x24 and 1x8 • Holdback ("guaranteed soak"), event outputs, time to target, ramp rate, dwell, step and call segment types • Communications compatible with Eurotherm 2400 programmer • Additional timer functions available
User function block wiring	<ul style="list-style-type: none"> • Optional Totalizer • Math • Logic and multiplexing • BCD conversion • Counter/Timer, and many other special function blocks available including 16 point linearization, zirconia and dual input switchover
Additional Functions	<ul style="list-style-type: none"> • Digital and analog retransmission functions • CT Input - Monitor partial load failure, load short and open circuit; Dual input functions including switchover, redundant sensor, average, min, max, zirconia • 6 Freely configurable alarms with manual, automatic, non-latching and event types plus alarm delay function and blocking • Alarms may be inhibited in standby • 5 Recipes with 40 freely selectable parameters switchable from front panel or digital input • Scrolling parameter help and user messages displayed on event • USB Backup lead and free configuration software
Backup and Configuration Tools	<ul style="list-style-type: none"> • Free Eurotherm iTools software for backup and configuration • USB Backup lead available for convenient desktop configuration and back up, (lead powers the controller independently) • iTools connects also using Ethernet Modbus TCP and serial Modbus RTU
OEM Security	<ul style="list-style-type: none"> • Helps protect instrument configurations from unauthorized viewing, cloning or backwards engineering

Function Blocks Available

Function Blocks	Function	Standard*	Standard Toolkit Blocks*	Enhanced Toolkit Blocks*
Instrument	Interface to Instrument wide settings	1	-	-
Loop	Enhanced Eurotherm PID Loop	1	-	-
Programmer	Ramp/Dwell Programmer	1	-	-
BCD	BCD Conversion	1	-	-
Alarm	General purpose analog alarm monitoring	6	-	-
Recipe	General purpose recipe function	1	-	-
Comms	Interface to serial and Ethernet communications	2	-	-
AI	Interface to main analog input	2	-	-
IP Monitor	Input monitoring (min, max, other functions)	2	-	-
IO	Interface to Inputs and Outputs	6	-	-
Modbus Master	Maximum of 3 Modbus slaves and 32 data points	35		
Option DIO	Digital I/O options	8	-	-
Remote Input	Interface to remote (communications) input	1	-	-
OR	Eight input logical "OR" operation	8	-	-
Commstab	Comms Indirection Table configuration	32		
CT	Current transformer	1	-	-
Zirconia	Zirconia Probe input	1	-	-
Wires	User wiring	50	200	200
Math2	Two input math functions	-	4	8
Lgc2	Two input logical operations	-	4	8
Lgc8	Eight input logical operations	-	2	4
Timer	Timer based functions	-	1	2
SwitchOver	Input switchover	-	1	1
Mux8	Eight Input multiplexor	-	3	4
Total	Totalizer	-	1	1
Counter	Counter block (32-bit)	-	1	2
UsrVal	User values (freely assignable)	-	4	12
Lin16	16 point linearization	-	2	2

* Dependent on Instrument/options ordered

Environmental specifications, standards, approvals and certifications

Operating Temperature		0°C to 55°C (32°F to 131°F)
Storage Temperature		-20°C to 70°C (-4°F to 158°F)
Operating/storage humidity		5% to 90% RH non-condensing
Atmosphere		Non-corrosive, non-explosive
Altitude		<2000 Metres (<6562 feet)
Vibration / Shock		EN61131-2 (5 to 11.9Hz @ 7mm peak to peak displacement, 11.9-150Hz @ 2g, 0.5 octave min.). EN60068-2-6 Test FC, Vibration. EN60068-2-27 Test Ea and guidance, Shock.
Front of panel sealing protection		Standard bezel: EN60529 IP65, UL50E Type 12 (equivalent to NEMA12). Washdown bezel: EN60529 IP66, UL50E Type 4X (indoor use) (equivalent to NEMA4X)
Rear of panel protection		EN60529 IP10
Electromagnetic compatibility (EMC)	Emissions	HV PSU units to EN61326-1 Class B – Light industrial LV PSU units to EN61326-1 Class A – Heavy industrial
	Immunity	EN61326-1 Industrial
Approvals and certification	Europe	CE (EN61326), RoHS (EN50581), REACH, WEEE, EN14597 TR Type Approval
	USA, Canada	UL, cUL
	Russia	EAC (CUTR) pending
	China	RoHS, CCC: Exempt (Product not listed in catalogue of products subject to China Compulsory Certification)
	Global	When subject to the necessary field calibration, EPC3000 series controllers manufactured by Eurotherm are suitable for use in Nadcap applications in all furnace classes, defined in AMS2750E clause 3.3.1. Meets accuracy requirements of CQI-9 Achilles® Level 1 CRT Cyber Security Assessment Schneider Electric Green Premium
Electrical safety		EN61010-1: 2010 and UL 61010-1: 2012. Pollution Degree 2 Insulation Category II

EN ISO 13849 Assessment Declaration

The EPC3000 has been assessed against the following standards:

- EN ISO 13849-1:2015 – Safety of Machinery – Safety Related Parts of Control Systems
- EN ISO 13849-2:2012 – Safety of Machinery – Safety Related Parts of Control Systems – Part 2: Validation

The results are shown in the following table.

Key safety values	Value	Standard
Performance Level (PL) ¹	c	EN ISO 13849-1
Diagnostic Coverage _{avg}	None	
Mean Time to Dangerous Failure (MTTFd)	100 years ³	
Category ²	1	
Maximum service life	10 years	
1. The Performance Level is defined for the safety function of the EPC3000. A process can be monitored via the PV inputs. In the event of a value being read outside of the acceptable band, the alarm relay will be activated. 2. The EN ISO 13849-1 performance level (PL) and safety category (Cat) of the overall system depends on multiple factors, including the selected modules, wiring practices, the physical environment, and the application. 3. For the level of assessment, 100 years is the maximum acceptable MTTFd which is exceeded by all modular variants of the EPC3000.		

Mechanical

Dimensions

Dimensions given as Width (tolerance -x.xx, +x.xx) × Height (tolerance -x.xx, +x.xx).

EPC3004 ¼ DIN	Cut out	92 (-0.0, +0.8) mm x 92 (-0.0, +0.8) mm 3.62 (-0.0, +0.03) inch x 3.62 (-0.0, +0.03) inch
	Front panel	96 (-0.0, +1.0) mm x 96 (-0.0, +2.0) mm 3.78 (-0.0, +0.05) inch x 3.78 (-0.0, +0.05) inch
EPC3008 ⅙ DIN	Cut out	45 (-0.0, +0.6) mm x 92 mm (-0.0, +0.8) mm 1.77 (-0.0, +0.02) inch x 3.62 (-0.0, +0.03) inch
	Front panel	48 (-0.0, +1.0) mm x 96 (-0.0, +1.0) mm 1.89 (-0.0, +0.04) inch x 3.78 (-0.0, +0.04) inch
EPC3016 1/16 DIN	Cut out	45 (-0.0, +0.6) mm x 45 (-0.0, +0.6) mm 1.77 (-0.0, +0.02) inch x 1.77 (-0.0, +0.02) inch
	Front panel	48 (-0.0, +1.0) mm x 48 (-0.0, +1.0) mm 1.89 (-0.0, +0.04) inch x 1.89 (-0.0, +0.04) inch

Depth behind panel (all controllers) 90 mm (3.54 inch)

Depth Total (all controllers) 101 mm (3.97 inch)

Weight

EPC3004	420 grams; 14.81 oz
EPC3008	350 grams; 12.34 oz
EPC3016	250 grams; 8.81 oz

Input and Outputs

I/O and Communication types

I/O and Comms	EPC3016	EPC3008/3004
Analog inputs	1 universal input 20Hz 1 auxiliary input 4-20mA, 0-10V 4Hz (option)	1 or 2 (option) universal input 20Hz
Optional I/O modules	Up to 2, freely selectable: <ul style="list-style-type: none"> • Form A relay output • Logic I/O • DC analog output • TRIAC output 	Up to 3, freely selectable: <ul style="list-style-type: none"> • Form A relay output • Logic I/O • DC analog output • TRIAC output
Form C relay output	1	1
Contact closure logic input	1 (option)	2
Logic I/O (open collector)	-	4 or 8 (option)
Current transformer	1 (option)	1
24V Transmitter PSU	-	1
Communications	1 of the following options: <ul style="list-style-type: none"> • EIA-485 • EIA-422 • EIA-232 • Modbus RTU slave (EI Bisynch available with serial comms) • Modbus TCP slave • Modbus TCP Slave + EtherNet/IP Server, or Modbus TCP Slave + BACnet Slave 	2 of the following options: <ul style="list-style-type: none"> • EIA-485 Modbus (or EI Bisynch) and Modbus TCP • Modbus TCP Slave + EtherNet/IP Server, or Modbus TCP Slave + BACnet Slave

I/O Specifications

Input types	Thermocouples, Pt100/Pt1000 RTD, 4-20mA, 0-20mA, 10V, 2V, 0.8V, 80mV, 40mV, zirconia (oxygen probe), Pyrometers. For other input types contact your Eurotherm supplier for advice. Accuracy ±0.1% reading. When subject to the necessary field calibration, EPC3000 series controllers manufactured by Eurotherm are suitable for use in Nadcap applications in furnace classes as defined in AMS2750E clause 3.3.1.
Sample time	<ul style="list-style-type: none"> • Process Inputs: 50ms (20Hz) • Thermocouple: 62.5ms (16Hz) • RTD: Automatic cycle time selection 100ms (10Hz) • Automatic cycle time selection
Mains rejection (48-62Hz)	<ul style="list-style-type: none"> • Series mode rejection: >80dB • Common mode rejection: >150dB
Sensor break	AC sensor break, detected within 3 seconds worst case.
Input filtering	OFF to 60 seconds filter time constant.
User calibration	User 2 point input adjust (offset/gradient), transducer scaling.
Thermocouple	<ul style="list-style-type: none"> • K, J, N, R, S, B, L, T as standard, plus 2 downloadable custom curves • Linearization accuracy • Cold Junction (CJ) calibration accuracy: ±1.0°C at 25°C (±1.8°F at 77°F) ambient • CJ ambient rejection ratio: better than 40:1 from 25°C (77°F) ambient • External CJ selectable as 0, 45, 50°C (32, 113, 122°F) or measurable for EPC3004/EPC3008

Inputs and Outputs

Input ranges		40mV	80mV	0.8V	2V	10V	RTD (Pt100/ Pt1000)	mA
Range	Min	-40mV	-80mV	-800mV	-2V	-10V	0Ω (-200°C; -328°F)	-32mA
	Max	+40mV	+80mV	+800mV	+2V	+10V	400Ω/4000Ω (850°C; 1562°F)	+32mA
Thermal stability from 25°C (77°F) ambient		±0.4μV/°C ±13ppm/°C	±0.4μV/°C ±13ppm/°C	±0.4μV/°C ±13ppm/°C	±0.4μV/°C ±13ppm/°C	±0.8μV/°C ±70ppm/°C	±0.01°C/°C ±25ppm/°C	±0.16μA/°C ±113ppm/°C
Resolution		1.0μV unfiltered	1.6μV	16μV	41μV	250μV	0.05°C (0.09°F)	0.6μA
Electrical noise (pk to pk with 1.6s input filter)		0.8μV	3.2μV	32μV	82μV	250μV	0.05°C (0.09°F)	1.3μA
Linearity accuracy (best fit straight line)		0.003%	0.003%	0.003%	0.003%	0.007%	0.033%	0.003%
Calibration accuracy at 25°C (77°F) ambient		±4.6μV ±0.053%	±7.5μV ±0.052%	±75μV ±0.052%	±420μV ±0.044%	±1.5mV ±0.063%	±0.31°C (±0.56°F) ±0.023%	±3μA ±1.052%
Input resistance		100MΩ	100MΩ	100MΩ	100MΩ	57kΩ	-	2.49Ω (1% shunt)
Bulb current							190μA/180μA	

Remote Setpoint (Aux) Analog input (EPC3016 only)

Range	0 to 10V and 4 to 20mA. Max ranges -1V to 11V and 3.36mA to 20.96mA.
Accuracy	±0.25% of reading ± 1LSD, 14 Bits.
Sample Rate	4Hz (250ms).
Functions	<ul style="list-style-type: none"> • Remote setpoint input • Auxiliary analog input
Thermal Stability	100ppm (typical) < 150ppm (worst case).
Mains Rejection	Common Mode (48-62Hz) >120dB. Series Mode >90dB.
Input Impedance	Voltage 223kΩ. Current 2.49Ω.

Current transformer input

Input range	<ul style="list-style-type: none"> • 0 - 50mA RMS, 48 to 62Hz • 10Ω burden resistor fitted inside module
Measurement Scaling	10, 25, 50 or 100 Amps
Calibration accuracy	<1% of reading (typical), <4 % of reading (worst case)
Input Functions	<ul style="list-style-type: none"> • Partial load failure. SSR open or short circuit • Other functions including power usage totalization using soft wiring

Contact closure inputs LA and LB

Thresholds	Open >400Ω, Closed <100Ω
Input functions	<ul style="list-style-type: none"> • Auto/Manual select • SP2 select • Integral Hold • Control inhibit • Program run functions • Keylock • Recipe select • PID select • BCD Bit • Autotune enable • Standby • PV Select plus other functions using soft wiring

Logic I/O modules

Output Rating	ON 12Vdc 44mA max. Minimum control cycle time 50mS (auto).
Output Functions	Time proportioned heat, Time proportioned cool. SSR Drive Alarm and event outputs, interlock outputs, other functions using soft wiring.
Contact Closure (input)	Open >500Ω. Closed <150Ω.
Input Functions	<ul style="list-style-type: none"> • Auto/Manual select • SP2 select • Integral Hold • Control inhibit • Program run functions • Keylock • Recipe select • PID select • BCD bit • Autotune enable • Standby • PV Select, plus other functions using soft wiring

Logic I/O open collector type (EPC3008/3004 controllers only)

Output Rating	15 to 35Vdc
Output limit	Maximum current sinking 40mA
Output Functions	Alarm and event outputs, interlock outputs, other functions available using soft wiring. Cannot be used as a control output.
Voltage sensing input	OFF <1V, ON >4V. Max 35V, Min -1V
Contact Closure (input)	OFF >28kΩ ON <100Ω
Input Functions	<ul style="list-style-type: none"> • Auto/Manual select • SP2 select • Integral hold • Control inhibit • Program run functions • Keylock • Recipe select • PID select • BCD bit • Autotune enable • Standby • PV select plus other functions available using soft wiring

Relays (form A modules and form C fixed built in)

Types	Form A (normally open) Form C (changeover)
Output Functions	Time proportioned heat, time proportioned cool. SSR Drive. Direct Valve raise/lower. Alarm and event outputs, interlock outputs, other functions using soft wiring.
Rating	Min 100mA @ 12V, Max 2A @ 264V AC resistive. External Snubber recommended.

Relay Electrical Endurance

The number of operations which the relays are expected to endure is limited in accordance with the graph shown below. Typically at a load of 2A, 250Vac resistive at 23°C this is 500,000 operations – see below. Differences in load current, ambient temperature, load type and switching frequency will impact the number of operations.

Electrical Endurance

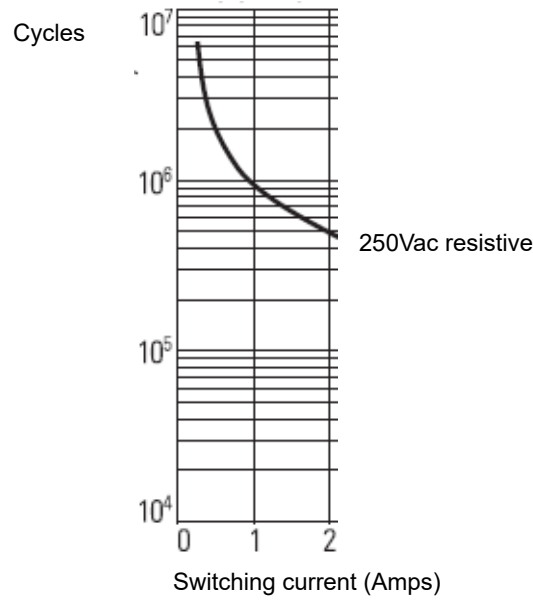

TRIAC module

Rating	Min. 40mA, 30V RMS Max. 0.75A :@ 264V, AC resistive
Output Functions	Time proportioned heat, time proportioned cool. SSR drive. Alarm and event outputs, interlock outputs, other functions using soft wiring.
Surge Rating	Max. current surge 30A (<10mS). Max. continuous operating voltage 540V peak, 385V RMS. Max surge voltage 800V peak, 565V RMS (<10mS)

Isolated DC output module

	Current Output	Voltage output
Range	0-20mA	0-10V
Load resistance	<550Ω	>450Ω
Calibration accuracy	±(0.5% of reading + 100µA offset)	±(0.5% of reading + 50mV offset)
Resolution	13.5 Bits resolution	
Output Functions	<ul style="list-style-type: none"> • SCR/Power control drive • Proportional valve • Retransmission to chart recorder or other instrumentation. • Other functions using soft wiring 	
Digital Input (DI), where configured	The DC output module can be configured as contact closure input see "I/O List (io)" on page 107. In this case: <ul style="list-style-type: none"> • Open state >365 Ohms • Closed state <135 Ohms 	

Power supply and transmitter power supply

Controller supply voltage	100-230Vac +/- 15%, 48 to 62Hz or 24Vac +10/-15%, 48 to 62Hz 24Vdc +20/-15%, max 5% ripple voltage.
Power Supply Rating	EPC3016 controller 6W EPC3008/3004 controller 9W
Power Measurement	Only available in 100-230Vac powered instruments. Measures direct from power supply (no additional connections). Uncalibrated. Electrical noise 0.5V filtered, used by the PID function for power feedforward.
Transmitter Power supply	24Vdc. 2 to 28mA load. Isolated from system (300Vac insulation) (EPC3008, EPC3004 controllers only)

Communications

Ethernet	<ul style="list-style-type: none"> • Ground shielded RJ45 Jack supporting 10/100Base-T auto sensing • Modbus/TCP, BACnet and EtherNet/IP Protocols • Fixed IP address or DHCP • Bonjour Auto-Discovery • Certified to Achilles® communications robustness testing level 1
Serial	<ul style="list-style-type: none"> • EIA-485 Half duplex • EIA-422/EIA-232 Full duplex • Baud rates 4800 (EI-Bisynch only), 9600, 19200 • Modbus RTU 8 data bits, odd/even/no parity selectable • EI-Bisynch 7 data bits even parity fixed

Operator interface

Type	High Visibility LCD with backlight. Flat “washdown” membrane bezel with superior panel sealing, or sculpted bezel with fully tactile keys.
Keyboard	100,000 Operations typical.
Main PV	All - Green/Red Bicolor (Red in alarm); EPC3016 4 Digits, 3 decimal places. EPC3008 4.5 Digits, 4 decimal places. EPC3004 5 Digits, 4 decimal places.
Second Line	5 Character 16 segment text or numeric.
Third Line (EPC3004/3008 only)	16 Segment scrolling text or numeric display.
Text Character Sets	Roman, Simplified Cyrillic.
Additional Display Functions	<ul style="list-style-type: none"> • Program status indicator (ramp up, ramp down or dwell) • Output indicators • Alarm indication • Units • Bar graph (EPC3004, EPC3008 only) • Communications activity indicator
HMI Functions	<ul style="list-style-type: none"> • Configurable display contents • Configurable scroll lists for operator/supervisor • Configurable scrolling event messages • Password level protection with lockout period • Two Programmable function keys (EPC3004, EPC3008 only)

Appendix: EI-BISYNCH Parameters

The following table lists the EI-Bisynch parameters which are supported by EPC3000 series controllers.

Parameter	Mnemonics
Loop.Main.PV	PV
Loop.OP.ManualOP	OP
Loop.Main.TargetSP	SL
Loop.Main.AutoMan	mA
CurrentTransformer.LoadCurrent	LI
Instrument.Info.CustomerID	ID
Loop.Main.WorkingSP	SP
Loop.Main.WorkingOutput	OO
Loop.OP.ManualOP	VM
Loop.Main.WorkingOutput	VP
Programmer.Run.ProgramNumber	PN
Programmer.Run.ProgramMode	PC
Programmer.Run.ProgramSetpoint	PS
Programmer.Run.ProgramCyclesLeft	CL
Programmer.Run.SegmentNumber	SN
Programmer.Run.SegmentType	CS
Programmer.Run.SegmentTimeLeft	TS
Programmer.Run.TargetSetpoint	CT
Programmer.Run.RampRate	CR
Programmer.Run.ProgramTimeLeft	TP
Programmer.Run.Event1	z1
Programmer.Run.Event2	z2
Programmer.Run.Event3	z3
Programmer.Run.Event4	z4
Programmer.Run.Event5	z5
Programmer.Run.Event6	z6
Programmer.Run.Event7	z7
Programmer.Run.Event8	z8
Alarm.1.Threshold	A1
Alarm.2.Threshold	A2
Alarm.3.Threshold	A3
Alarm.4.Threshold	A4
Alarm.1.Hysteresis	n5
Alarm.2.Hysteresis	n6
Alarm.3.Hysteresis	n7
Alarm.4.Hysteresis	n8
Loop.Diags.LoopBreakTime	lt
Loop.Atune.AutotuneEnable	AT
Loop.PID.Boundary	GS
Loop.PID.ActiveSet	Gn
Loop.PID.Ch1PropBand	XP
Loop.PID.IntegralTime	TI
Loop.PID.DerivativeTime	TD
Loop.PID.ManualReset	MR
Loop.PID.CutbackHigh	HB
Loop.PID.CutbackLow	LB

Parameter	Mnemonics
Loop.PID.Ch2PropBand	RG
Loop.PID.Ch1PropBand2	P2
Loop.PID.IntegralTime2	I2
Loop.PID.DerivativeTime2	D2
Loop.PID.ManualReset2	M2
Loop.PID.CutbackHigh2	hb
Loop.PID.CutbackLow2	lb
Loop.PID.Ch2PropBand2	G2
Loop.FF.FFGain	FP
Loop.FF.FFOffset	FO
Loop.FF.PIDTrimLimit	FD
Loop.PID.Ch1OnOffHyst	HH
Loop.PID.Ch2OnOffHyst	hc
Loop.OP.Ch2Deadband	HC
Loop.OP.SafeValue	BO
Loop.OP.Ch1TravelTime	TT
Loop.OP.SafeValue	VS
Loop.SP.SPSelect	SS
Loop.Main.RemoteLoc	rE
Loop.SP.SP1	S1
Loop.SP.SP2	S2
Loop.SP.RSP	uq
Loop.SP.RSP	ur
Loop.SP.SPTrim	LT
Loop.SP.SPLowLimit	LS
Loop.SP.SPHighLimit	HS
Loop.SP.SPLowLimit	L2
Loop.SP.SPHighLimit	H2
Loop.SP.SPTTrimLowLimit	TL
Loop.SP.SPTTrimHighLimit	TH
Loop.SP.SPRateUp	RR
AI.1.MVIn	VA
AI.2.MVIn	VD
AI.1.CJCTemp	t5
AI.2.CJCTemp	t6
AI.1.PV	QY
AI.2.PV	QZ
Loop.OP.OutputLowLimit	LO
Loop.OP.OutputHighLimit	HO
Loop.OP.RemoteOPLow	RC
Loop.OP.RemoteOPHigh	RH
Loop.OP.OPRateUp	OR
Loop.OP.ManualStepValue	FM
IO.1.CycleTime	CH
IO.1.MinOnTime	MH
IO.2.CycleTime	C2
IO.2.MinOnTime	MC
Loop.OP.SafeValue	BP
Comms.Network.Address	Ad
Instrument.HMI.HomeDisplay	WC
Loop.Main.WorkingOutput	WO
Loop.FF.FFOutput	FN
Loop.Diags.ProportionalOP	Xp
Loop.Diags.IntegralOP	xi

Parameter	Mnemonics
Loop.Diags.DerivativeOP	xD
Loop.OP.Ch1 Output	Vv
RemotInput.input	RI
Loop.Diags.Deviation	ER
Instrument.Info.NativeVersion	V0 (HEX Format)
Instrument.Info.NativeType	II (HEX Format)
Instrument.Security.InstrumentMode	IM
Programmer.Set.EditProgram	EP
Loop.Main.Hold	FC
AI.1.SensorBreakOutput	sb
Loop.Diags.LoopBreak	Lb
Loop.Main.IntegralHold	IH
Instrument.Diagnostics.GlobalAck	AK
Loop.SP.SPRateDone	Rc
Instrument.HMI.Keylock	DK
RemotInput.RemStatus	RF
AI.2.SensorBreakOutput	IF
Loop.SP.RangeHigh	QL
Loop.SP.RangeLow	QM
Instrument.Diagnostics.InstrumentStatus	SO (HEX Format)
Loop.Setup.Ch1 ControlType	Q0
Loop.Setup.ControlAction	CA
Loop.OP.NonLinearCooling	Q9
Loop.Setup.DerivativeType	Qe
Loop.OP.PowerFeedforward	Pe
Loop.FF.FFType	QO
Loop.OP.SafeValue	QP
Loop.OP.ManualStepValue	QR
BCD.BcdOP	BF
Loop.PID.GainScheduler	QW
Instrument.Info.TemperatureUnits	Q1
Loop.SP.SPTracksRSP	QE
Loop.SP.SPTracksPV	QF
Loop.SP.SPTracksPSP	QG
Loop.SP.SPRateUnits	QJ
Loop.SP.RSPTType	QA
*WorkingProgram.HoldbackType	\$0
*WorkingProgram.HoldbackValue	s0
*WorkingProgram.RampUnits	d0
*WorkingProgram.DwellUnits	p0
*WorkingProgram.ProgramCycles	o0
*WorkingSegment.1.SegmentType	\$1
*WorkingSegment.1.TargetSetpoint	s1
*WorkingSegment.1.Duration/RampRate/RampTime	d1
*WorkingSegment.1.CallProgramNo/WorkingProgram.ProgramEndType	p1
*WorkingSegment.1.EventOutput/CallCycle	o1 (HEX Format)
*WorkingSegment.2.SegmentType	\$2
*WorkingSegment.2.TargetSetpoint	s2
*WorkingSegment.2.Duration/RampRate/RampTime	d2
*WorkingSegment.2.CallProgramNo/WorkingProgram.ProgramEndType	p2
*WorkingSegment.2.EventOutput/CallCycle	o2 (HEX Format)
*WorkingSegment.3.SegmentType	\$3
*WorkingSegment.3.TargetSetpoint	s3
*WorkingSegment.3.Duration/RampRate/RampTime	d3

Parameter	Mnemonics
*WorkingSegment.3.CallProgramNo/WorkingProgram.ProgramEndType	p3
*WorkingSegment.3.EventOutput/CallCycle	o3 (HEX Format)
*WorkingSegment.4.SegmentType	\$4
*WorkingSegment.4.TargetSetpoint	s4
*WorkingSegment.4.Duration/RampRate/RampTime	d4
*WorkingSegment.4.CallProgramNo/WorkingProgram.ProgramEndType	p4
*WorkingSegment.4.EventOutput/CallCycle	o4 (HEX Format)
*WorkingSegment.5.SegmentType	\$5
*WorkingSegment.5.TargetSetpoint	s5
*WorkingSegment.5.Duration/RampRate/RampTime	d5
*WorkingSegment.5.CallProgramNo/WorkingProgram.ProgramEndType	p5
*WorkingSegment.5.EventOutput/CallCycle	o5 (HEX Format)
*WorkingSegment.6.SegmentType	\$6
*WorkingSegment.6.TargetSetpoint	s6
*WorkingSegment.6.Duration/RampRate/RampTime	d6
*WorkingSegment.6.CallProgramNo/WorkingProgram.ProgramEndType	p6
*WorkingSegment.6.EventOutput/CallCycle	o6 (HEX Format)
*WorkingSegment.7.SegmentType	\$7
*WorkingSegment.7.TargetSetpoint	s7
*WorkingSegment.7.Duration/RampRate/RampTime	d7
*WorkingSegment.7.CallProgramNo/WorkingProgram.ProgramEndType	p7
*WorkingSegment.7.EventOutput/CallCycle	o7 (HEX Format)
*WorkingSegment.8.SegmentType	\$8
*WorkingSegment.8.TargetSetpoint	s8
*WorkingSegment.8.Duration/RampRate/RampTime	d8
*WorkingSegment.8.CallProgramNo/WorkingProgram.ProgramEndType	p8
*WorkingSegment.8.EventOutput/CallCycle	o8 (HEX Format)
*WorkingSegment.9.SegmentType	\$9
*WorkingSegment.9.TargetSetpoint	s9
*WorkingSegment.9.Duration/RampRate/RampTime	d9
*WorkingSegment.9.CallProgramNo/WorkingProgram.ProgramEndType	p9
*WorkingSegment.9.EventOutput/CallCycle	o9 (HEX Format)
*WorkingSegment.10.SegmentType	;\$
*WorkingSegment.10.TargetSetpoint	;\$
*WorkingSegment.10.Duration/RampRate/RampTime	;\$
*WorkingSegment.10.CallProgramNo/WorkingProgram.ProgramEndType	;\$
*WorkingSegment.10.EventOutput/CallCycle	o; (HEX Format)
*WorkingSegment.11.SegmentType	;\$;
*WorkingSegment.11.TargetSetpoint	;\$;
*WorkingSegment.11.Duration/RampRate/RampTime	;\$;
*WorkingSegment.11.CallProgramNo/WorkingProgram.ProgramEndType	;\$;
*WorkingSegment.11.EventOutput/CallCycle	o; (HEX Format)
*WorkingSegment.12.SegmentType	;\$<
*WorkingSegment.12.TargetSetpoint	;\$<
*WorkingSegment.12.Duration/RampRate/RampTime	;\$<
*WorkingSegment.12.CallProgramNo/WorkingProgram.ProgramEndType	;\$<
*WorkingSegment.12.EventOutput/CallCycle	o< (HEX Format)
*WorkingSegment.13.SegmentType	;\$=
*WorkingSegment.13.TargetSetpoint	;\$=
*WorkingSegment.13.Duration/RampRate/RampTime	;\$=
*WorkingSegment.13.CallProgramNo/WorkingProgram.ProgramEndType	;\$=
*WorkingSegment.13.EventOutput/CallCycle	o= (HEX Format)
*WorkingSegment.14.SegmentType	;\$>
*WorkingSegment.14.TargetSetpoint	;\$>

Parameter	Mnemonics
*WorkingSegment.14.Duration/RampRate/RampTime	d>
*WorkingSegment.14.CallProgramNo/WorkingProgram.ProgramEndType	p>
*WorkingSegment.14.EventOutput/CallCycle	o> (HEX Format)
*WorkingSegment.15.SegmentType	\$?
*WorkingSegment.15.TargetSetpoint	s?
*WorkingSegment.15.Duration/RampRate/RampTime	d?
*WorkingSegment.15.CallProgramNo/WorkingProgram.ProgramEndType	p?
*WorkingSegment.15.EventOutput/CallCycle	o? (HEX Format)
*WorkingSegment.16.SegmentType	\$@
*WorkingSegment.16.TargetSetpoint	s@
*WorkingSegment.16.Duration/RampRate/RampTime	d@
*WorkingSegment.16.CallProgramNo/WorkingProgram.ProgramEndType	p@
*WorkingSegment.16.EventOutput/CallCycle	o@ (HEX Format)

Appendix: EPC3000 Factory Mutual (FM)

The EPC3000 FM variant provides a FM Limit function (high or Low), that meets the requirements of FM Approval Standard **FM 3545 - Temperature Limit and Supervisory Switches**.

This Appendix will help aid the initial setup of the EPC3000 FM and will also help explain functionality. (To see further information click the blue links).

Note: The name Factory Mutual is abbreviated to FM, for example EPC3000 FM.

Note: The Programmer function is not available for EPC3000 FM.

FM Limit function (Low & High) - Overview

The EPC3000 FM function provides a high or low limit function that meets the requirements of FM Approval Standard **FM 3545 - Temperature Limit and Supervisory Switches**.

The FM Limit function monitors the process temperature input, and when a threshold temperature is exceeded, will activate an “FM” alarm relay. In EPC3000 the monitored input is always the main PV input, and the FM relay is the fixed Form C changeover relay, Output 3.

Note: No additional I/O options are required to use the function.

A single EPC3000 FM may be used either as an FM approved high limit, with the alarm relay triggering when the measured temperature is greater than the threshold value, or an FM approved low limit, triggering when the measured temperature is less than the threshold.

Selection of the limit type (High or Low) is made during the instrument set up.

The FM function is supplied in instruments ordered with “FM” in field 1, “Type”. The instruments will be supplied bearing the FM approval mark on the side label.

Note: It is not possible to use the EPC3000 Ramp/Soak functions with controllers supplied as FM versions.

Other I/O and communications options may be ordered using the standard EPC3000 order code as required.

Additional monitoring and control configuration, including PID control, may be added to the EPC3000 FM controller, using function block wiring. However, any additional alarm function added in this way will NOT be FM Approved.

The FM function is fixed and cannot be deleted or modified.

Setting up

Wiring and Connections

For further details on Connections, Wiring Input types see:

- [Sensor Inputs \(Measuring Input\)](#)
- [Primary Sensor Input \(Measuring Input\)](#)
- [Terminal Wiring](#)
Describes details of the controllers terminal wiring, which terminal connections should be used, why and how they are wired, see page 38
- [Terminal Layout EPC3016 Controller](#)
Displays details of the terminal layout for the EPC3016 Controller for example the FM Temperature Input and the FM Relay output, see page 39
- [Terminal Layout EPC3008 and EPC3004 Controller](#)
Displays details of the terminal layout for the EPC3008 and EPC3004 Controller for example the FM Temperature Input and the FM Relay output, see page 40.

FM Relay (Output 3, OP3)

For further information regarding the FM Relay, such as:

- Location and connection, see [Terminal Layout EPC3016 Controller](#) on page 39
- Controller Inputs, see [Inputs/Outputs \(IO\)](#) on page 47
- FM Relay, also called [Output 3 \(OP3\)](#) on page 52

Application (FM Limit Alarm High / Low) selection

For details on how to select the required FM application at startup, see the following:

- [Start Up—New Unconfigured Controller](#) on page 68:
- [Quick Start Tables](#) on page 69
- [Quick Code Set 1](#) on page 69 and [Quick Code Set 2](#) on page 70
- If preconfigured, ordered as an EPC300 FM see [Start Up - New Configured Controller](#) on page 75
- [Applications](#) on page 228, provides a summary of the FM applications, available to select at startup for unconfigured controllers.

Alarm Types (FM)

The FM Applications (FM Limit - High/Low) contain different default preconfigured alarm types. The following will provide further information:

- [What are Alarms?](#) on page 245
- [Alarm Types](#) on page 246, explains all Alarm types
- Different default Alarm types are utilized for each FM Application - [Absolute High](#) (for FM Limit High) and [Absolute Low](#) (for FM Limit Low)
- Alarm type [Digital High](#) on page 248, is utilized in both FM Limit Applications for the Sensor break functionality
- See [Applications](#), specifically [EPC3000 FM Limit Alarm - High](#) on page 228 and [EPC3000 FM Limit Alarm - Low](#) on page 230 - this displays and explains the 3 reconfigured alarm types.

Setting an Alarm (FM)

The levels at which absolute high/low alarm types operate are adjustable (known as a Threshold) and will need adjusting - by the relevant operator level.

The FM approvals standard requires adjustment of alarm thresholds to be protected, only the relevant level of operator, usually Operator Level 2 or 3, may gain access to adjust Alarms (and Threshold) settings, by entering a configured password.

The following provides further detail:

- [To Set Alarm Threshold](#) on page 253
- [To Select Operator Level 2](#) on page 85, describes how to enter and gain Operator Level 2 access
- [To Enter Level 3](#) on page 90, describes how to enter and gain Operator Level 3 access
- See [Alarms List \(ALm\)](#) on page 141, which list and defines the Alarm parameters, including Threshold, Hysteresis and Latch type

Note: Observe the default values. Not all of the parameters will be available/configurable for EPC3000 FM.

Acknowledging an Alarm (FM)

The FM Approvals Standard requires alarms can only be reset, or acknowledged when the process variable (i.e.temperature) is within the high or low threshold - referred to as manual latching.

Note: This latching alarm function may not be changed for the EPC3000 FM alarm function block.

The following provides further detail:

- [Alarm Indication](#) on page 253
- [To Acknowledge an Alarm](#) on page 254
- Only *Manual* latching is supported, see [Latching](#) on page 252 for a description of how this works.

Life Is On

Schneider
Electric

Scan for Local contacts

Eurotherm Ltd

Faraday Close
Worthing, West Sussex, BN13 3PL
Phone: +44 (0) 1903 268500

www.eurotherm.com

HA033650ENG Issue 1



©2021 Schneider Electric. All Rights Reserved. Life Is On, Schneider Electric, EcoStruxure, Eurotherm, EurothermSuite, EFit, EPack, EPower, Eycon, Chessell, Mini8, nanodac, piccolo and versadac are trademarks and property of Schneider Electric SE, its subsidiaries and affiliated companies. All other trademarks are the property of their respective owners.