

120 A, 3 GHz, 50 Ω , 0.5 V/A Pulse Current Sensor CS-0V5-A

Advanced TLP/HMM/HBM Solutions

1 Features

- Advanced current sensor for TLP/HMM measurements
- High magnetic Amp x Second rating 70 A μ s, which results in max. 120 A at 580 ns pulse width
- Very fast rise time <150 ps
- 1.5 kHz to >3 GHz bandwidth
- Very low parasitic load impedance 28 m Ω (port 1-2)
- 0.5 V/A sensitivity at 50 Ω output (port 3)
- Three 50 Ω SMA ports
- Compact size: 41 mm x 34 mm x 16 mm
- High reliability

2 Description

The transformer-based CS-0V5-A pulse current sensor is used to measure the current in a 50 Ω transmission line.

The Amp x Second rating is typical 70 A μ s which results in e.g. max. 120 A at max. 580 ns pulse width, 100 A at 700 ns or 40 A at 1.75 μ s pulse width, respectively (Fig. 3).

The sensitivity of the sensor is typ. 0.5 V/A at the current sensor output (Fig. 5, Fig. 6).

The CS-0V5-A can be used also as general purpose current sensor. The device has three 50 Ω SMA terminals. It can be used for replacement of the Tektronix™ CT-1, CT-2 and CT-6 current sensors in order to cover both high currents and high bandwidth using a single sensor.

Please note, that in contrast to port 1 and port 2, the port 3 (sensor output) must be terminated with 50 Ω . For example: at 100 A the sensor output results to 50 V. Therefore, in case of high currents up to 100 A a 20 dB attenuator is recommended to connect in front of the digital oscilloscope input in order to avoid overload.

3 Electrical Data

Nominal Impedance	:	50	Ω
Nominal Sensitivity ¹⁾	:	0.5	V/A
Pulse Response (Rise Time)	:	< 150	ps
Maximum Pulse Current ²⁾	:	± 120	A
Amp x Second Rating ³⁾	:	70	A μ s
Maximum DC Current ³⁾	:	± 0.5	A
Parasitic Load Impedance (Port 1 to Port 2)	:	28	m Ω
Lower Cut-Off Frequency ⁴⁾	:	1.5	kHz
Upper Cut-Off Frequency ⁴⁾	:	> 3	GHz

¹⁾ $\pm 3\%$ into 50 Ω

²⁾ max. 0.58 μ s pulse width (Fig. 3)

³⁾ when this value is exceeded, the sensor will not damage or degrade, but the output signal suddenly drops to zero or may represent wrong measurement results.

⁴⁾ ± 3 dB

50 Ω Current Sensor Output (PORT 3)

50 Ω Pulse Input (PORT 1)

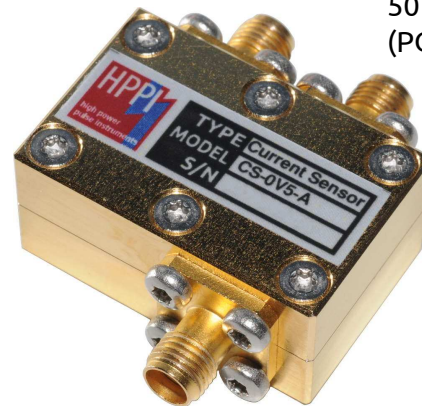

50 Ω Pulse Output (PORT 2)

4 Electrical Characteristics

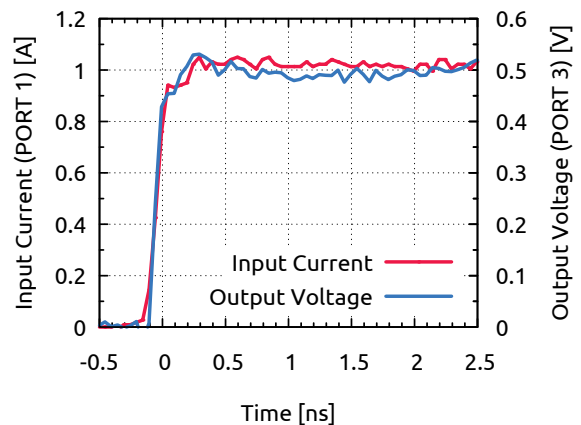

Figure 1: Typical pulse rise time

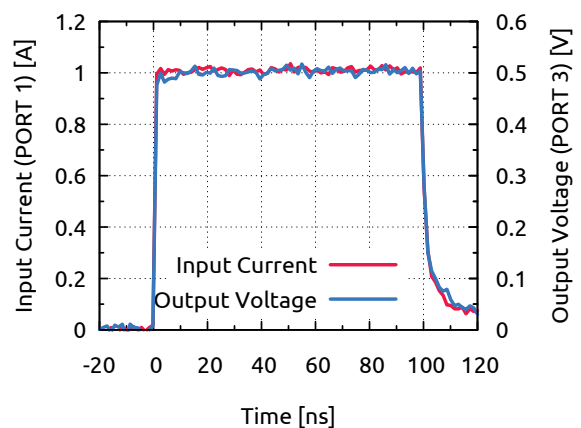

Figure 2: Typical pulse response (100 ns)

120 A, 3 GHz, 50 Ω , 0.5 V/A Pulse Current Sensor CS-0V5-A

Advanced TLP/HMM/HBM Solutions

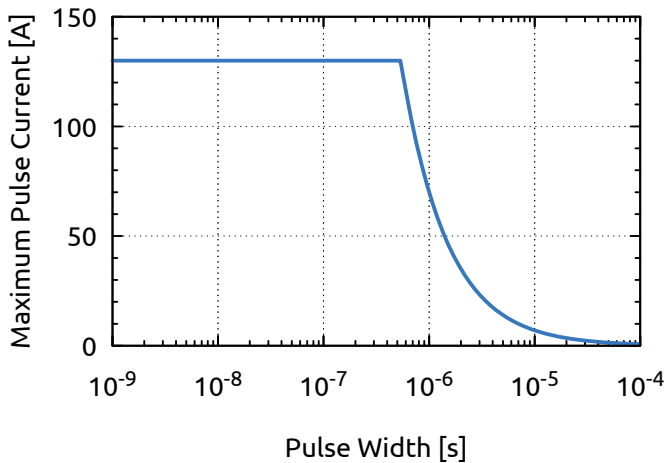

Figure 3: Maximum pulse current versus pulse width

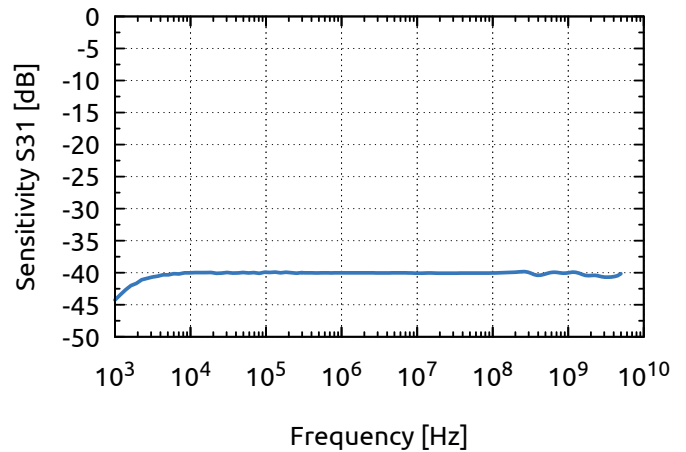

Figure 6: Typical transfer function (port 1 to port 3)

5 Physical Dimensions

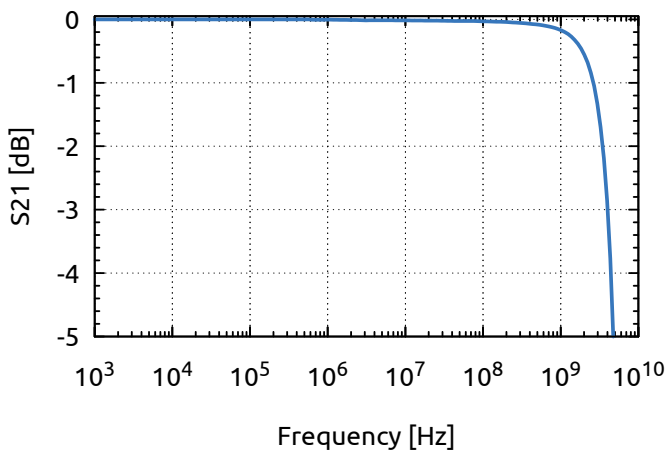

Figure 4: Typical frequency response (port 1 to port 2)

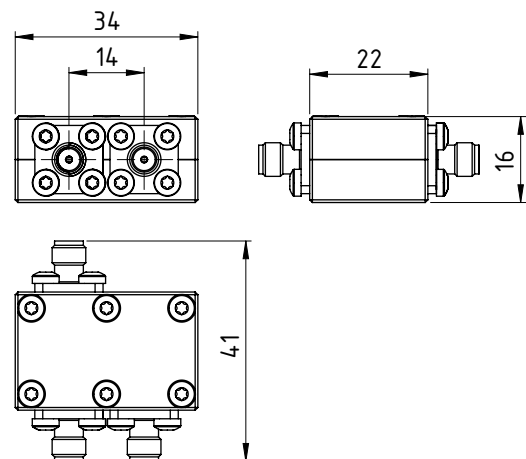

Figure 7: Dimensions in [mm]

6 Ordering Information

Pos.	Description	Part No.
01	120 A, 3 GHz, 50 Ω , 0.5 V/A Pulse Current Sensor	CS-0V5-A

General

The product data contained in this data-sheet is exclusively intended for technically trained staff. You and your technical departments will have to evaluate the suitability of the product for the intended application and the completeness of the product data with respect to such application. Our products are solely intended to be commercially used internally and should not be sold to consumers. This data-sheet is describing the specifications of our products for which a warranty is being granted by HPPI GmbH. Any such warranty is granted exclusively pursuant the terms and conditions of the respective supply agreement. There will be no guarantee of any kind for the product and its specifications. For further information on technology, specific applications of our product, delivery terms, conditions and prices please contact HPPI:

High Power Pulse Instruments GmbH
 Stadlerstrasse 6A
 D-85540 Haar, Germany
 Phone : +49 (0)89 8780698 - 440
 Fax : +49 (0)89 8780698 - 444
 E-Mail : info@hppi.de

Due to technical requirements our products and/or their application may be harmful. For information please read carefully the manual or contact HPPI. Safety notes in the manual will inform you about possible risks that result from any foreseeable application of our products. Changes of this data-sheet are reserved.

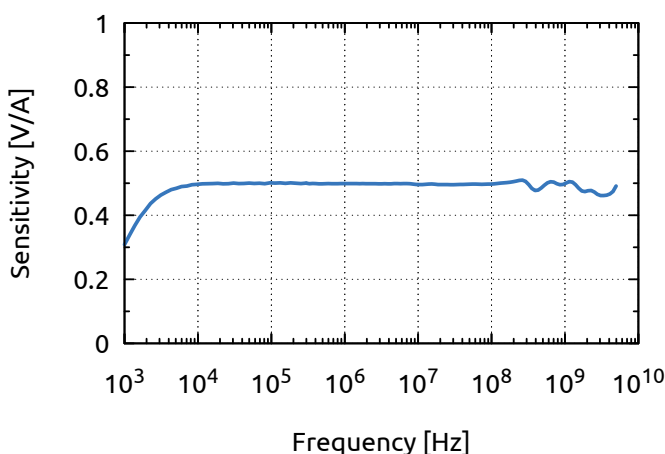

Figure 5: Typical sensitivity at port 3