

S-Parameters....

circuit analysis and
design

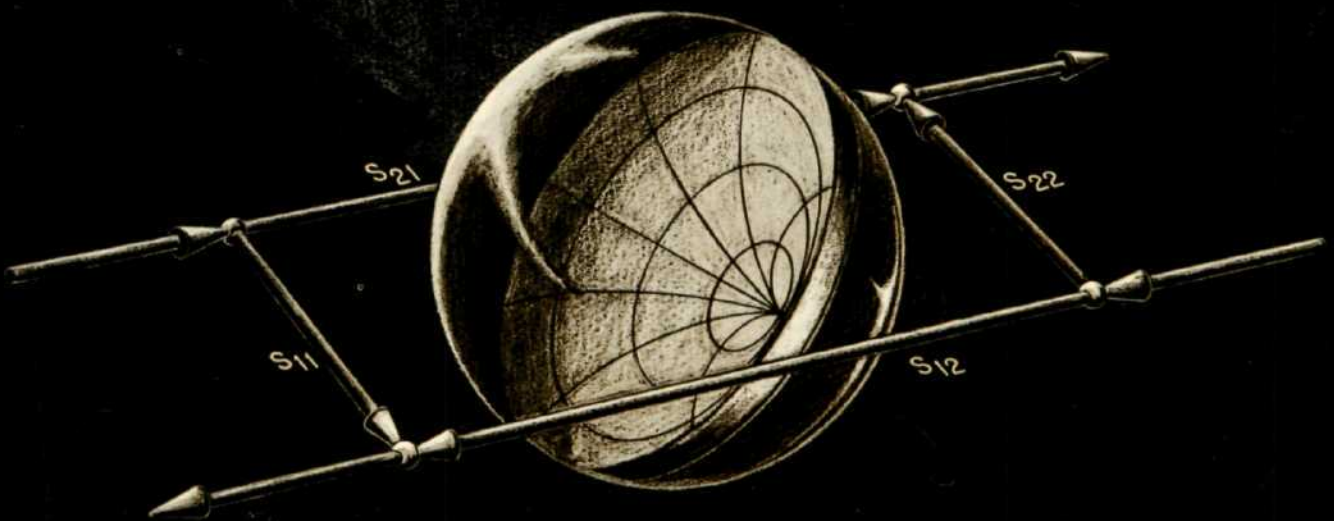

WHAT ARE "S" PARAMETERS?

"S" parameters are reflection and transmission coefficients, familiar concepts to RF and microwave designers. Transmission coefficients are commonly called gains or attenuations; reflection coefficients are directly related to VSWR's and impedances.

Conceptually they are like "h," "y," or "z" parameters because they describe the inputs and outputs of a black box. The inputs and outputs are in terms of power for "s" parameters, while they are voltages and currents for "h," "y," and "z" parameters. Using the convention that "a" is a signal into a port and "b" is a signal out of a port, the figure below will help to explain "s" parameters.

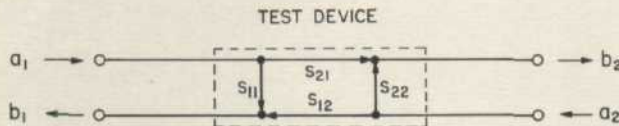

In this figure, "a" and "b" are the square roots of power; $(a_1)^2$ is the power incident at port 1, and $(b_2)^2$ is the power leaving port 2. The diagram shows the relationship between the "s" parameters and the "a's" and "b's." For example, a signal a_1 is partially reflected at port 1 and the rest of the signal is transmitted through the device and out of port 2. The fraction of a_1 that is reflected at port 1 is s_{11} , and the fraction of a_1 that is transmitted is s_{21} . Similarly, the fraction of a_2 that is reflected at port 2 is s_{22} , and the fraction s_{12} is transmitted.

The signal b_1 leaving port 1 is the sum of the fraction of a_1 that was reflected at port 1 and the fraction of a_2 that was transmitted from port 2.

Thus, the outputs can be related to the inputs by the equations:

$$b_1 = s_{11} a_1 + s_{12} a_2$$

$$b_2 = s_{21} a_1 + s_{22} a_2$$

When $a_2 = 0$,

and when $a_1 = 0$,

$$s_{11} = \frac{b_1}{a_1}, s_{21} = \frac{b_2}{a_1}$$

$$s_{12} = \frac{b_1}{a_2}, s_{22} = \frac{b_2}{a_2}$$

The setup below shows how s_{11} and s_{21} are measured.

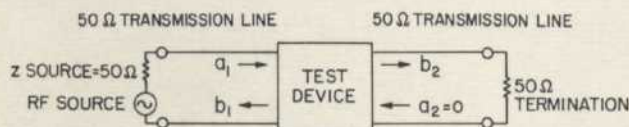

Port 1 is driven and a_2 is made zero by terminating the 50 Ω transmission line coming out of port 2 in its characteristic 50 Ω impedance. This termination ensures that none of the transmitted signal, b_2 , will be reflected toward the test device.

Similarly, the setup for measuring s_{12} and s_{22} is:

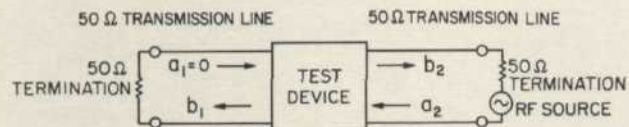

If the usual "h," "y," or "z" parameters are desired, they can be calculated readily from the "s" parameters. Electronic computers and calculators make these conversions especially easy.

WHY "S" PARAMETERS

Total Information

"S" parameters are vector quantities; they give magnitude and phase information. Most measurements of microwave components, like attenuation, gain, and VSWR, have historically been measured only in terms of magnitude. Why? Mainly because it was too difficult to obtain both phase and magnitude information.

"S" parameters are measured so easily that obtaining accurate phase information is no longer a problem. Measurements like electrical length or dielectric coefficient can be determined readily from the phase of a transmission coefficient. Phase is the difference between only knowing a VSWR and knowing the exact impedance. VSWR's have been useful in calculating mismatch uncertainty, but when components are characterized with "s" parameters there is no mismatch uncertainty. The mismatch error can be precisely calculated.

Easy To Measure

Two-port "s" parameters are easy to measure at high frequencies because the device under test is terminated in the characteristic impedance of the measuring system. The characteristic impedance termination has the following advantages:

1. **The termination is accurate at high frequencies . . .** it is possible to build an accurate characteristic impedance load. "Open" or "short" terminations are required to determine "h," "y," or "z" parameters, but lead inductance and capacitance make these terminations unrealistic at high frequencies.

2. **No tuning is required to terminate a device in the characteristic impedance . . .** positioning an "open" or "short" at the terminals of a test device requires precision tuning. A "short" is placed at the end of a transmission line, and the line length is precisely varied until an "open" or "short" is reflected to the device terminals. On the other hand, if a characteristic impedance load is placed at the end of the line, the device will see the characteristic impedance regardless of line length.

3. **Broadband swept frequency measurements are possible . . .** because the device will remain terminated in the characteristic impedance as frequency changes. However, a carefully reflected "open" or "short" will move away from the device terminals as frequency is changed, and will need to be "tuned-in" at each frequency.

4. **The termination enhances stability . . .** it provides a resistive termination that stabilizes many negative resistance devices, which might otherwise tend to oscillate.

An advantage due to the inherent nature of "s" parameters is:

5. **Different devices can be measured with one setup . . .** probes do not have to be located right at the test device. Requiring probes to be located at the test device imposes severe limitations on the setup's ability to adapt to different types of devices.

Easy To Use

Quicker, more accurate microwave design is possible with "s" parameters. When a Smith Chart is laid over a polar display of s_{11} or s_{22} , the input or output impedance is read directly. If a swept-frequency source is used, the display becomes a graph of input or output impedance versus frequency. Likewise, CW or swept-frequency displays of gain or attenuation can be made.

"S" parameter design techniques have been used for some time. The Smith Chart and "s" parameters are used to optimize matching networks and to design transistor amplifiers. Amplifiers can be designed for maximum gain, or for a specific gain over a given frequency range. Amplifier stability can be investigated, and oscillators can be designed.

These techniques are explained in the literature listed at the bottom of this page. Free copies can be obtained from your local Hewlett-Packard Sales Representative.

References:

- "Transistor Parameter Measurements," Application Note 77-1, February 1, 1967.
- "Scattering Parameters Speed Design of High Frequency Transistor Circuits," by Fritz Weinert, *Electronics*, September 5, 1966.
- "S" Parameter Techniques for Faster, More Accurate Network Design," by Dick Anderson, *Hewlett-Packard Journal*, February 1967.
- "Two Port Power Flow Analysis Using Generalized Scattering Parameters," by George Bodway, *Microwave Journal*, May 1967.
- "Quick Amplifier Design with Scattering Parameters," by William H. Froehner, *Electronics*, October 16, 1967.

S-Parameters

Circuit Analysis and Design

APPLICATION NOTE 95

A Collection of Articles Describing
S-Parameter Circuit Design and Analysis

SEPTEMBER 1968

INTRODUCTION

THE STATE OF HIGH-FREQUENCY CIRCUIT DESIGN

The designer of high-frequency circuits can now do in hours what formerly took weeks or months. For a long time there has been no simple, accurate way to characterize high-frequency circuit components. Now, in a matter of minutes, the frequency response of the inputs and outputs of a device can be measured as s parameters.

As shown in some of the articles in this application note, an amplifier circuit can be completely designed on a Smith Chart with s -parameter data. Circuit design is greatly accelerated by using small computers or calculators to solve lengthy vector design equations. This leads to some creative man-machine interactions where the designer can "tweek" his circuit via the computer and see how its response is affected. The computer can search through hundreds of thousands of possible designs and select the best one. An even more powerful approach that makes one's imagination run away with itself is to combine the measuring equipment and the computer as in the HP 8541A. Theoretically, one could plug in a transistor, specify the type of circuit to be designed, and get a readout of the optimal design.

This note consists primarily of a collection of recent articles describing the s -parameter design of high-frequency circuits. Following the articles is a brief section describing the rather straightforward technique of measuring s parameters. Many useful design equations and techniques are contained in this literature, and amplifier design, stability, and high-frequency transistor characterization are fully discussed.

TABLE OF CONTENTS

Section	Page
I Microwave Transistor Characterization	1-1
II Scattering Parameters Speed Design of High Frequency Transistor Circuits	2-1
III S-Parameter Techniques for Faster, More Accurate Network Design	3-1
IV Combine S Parameters with Time Sharing	4-1
V Quick Amplifier Design with Scattering Parameters	5-1
VI Two-Port Flow Analysis Using Generalized Scattering Parameters	6-1
VII Circuit Design and Characterization of Transistors by Means of Three-Port Scattering Parameters.	7-1
APPENDIX	A-1

SECTION I

MICROWAVE TRANSISTOR CHARACTERIZATION

Julius Lange describes the parameters he feels are most important for characterizing microwave transistors. These include the two-port s parameters, MSG (maximum stable gain), G_{\max} (maximum tuned or maximum available gain), K (Rollett's stability factor), and U (unilateral gain). The test setups used for measuring these parameters are described and a transistor fixture for TI-line transistors plus a slide screw tuner designed by Lange are shown. The article concludes with equations relating y parameters, h parameters, MSG, G_{\max} , K , and U to the two-port s parameters.

Introduction	1-1
S Parameter Measurements	1-2
Gain and Stability Measurements	1-5
MSG (Maximum Stable Gain)	1-6
GMAX (Maximum Available Gain)	1-6
K (Rollett's Stability Factor)	1-6
U (Unilateral Gain - Mason Invariant)	1-7
Test Fixtures	1-8
Special S Parameter Relationships	1-12



TEXAS INSTRUMENTS
INCORPORATED
13500 NORTH CENTRAL EXPRESSWAY • DALLAS, TEXAS
COMPONENTS GROUP

MICROWAVE TRANSISTOR CHARACTERIZATION INCLUDING S-PARAMETERS*

by

Julius Lange

A. INTRODUCTION

Since introduction of transistors with much improved high frequency capabilities, new techniques and hardware for transistor characterization have been developed. Older methods, such as characterization by H or Y parameters, are not suitable above 1 GHz since at these frequencies the package parasitics affect the response significantly. Also, test equipment for measuring those parameters directly is not available.

When measurements above 1 GHz are made on discrete components such as transistors or diodes the following basic difficulties arise:

- 1) Terminals of the intrinsic device (semiconductor chip) are not directly accessible; that is, between the device and the measurement apparatus there is interposed a network consisting of package parasitics, transmission lines, etc. Thus, the device properties have to be measured with respect to some convenient external terminals, and then referred back to the intrinsic device via a mathematical transformation. This makes characterization in terms of invariant parameters such as maximum available gain (maximum tuned gain), maximum stable gain, and unilateral gain very attractive.
- 2) Special care must be taken to ensure that the tuning and dc bias networks do not present reactive, that is non-dissipative, impedances to the transistor at low frequencies causing insufficient loading, which can easily result in oscillations. The use of slide-screw tuners and

* The majority of the data presented in this paper was developed by Texas Instruments Incorporated under Contract No. DA 28-043 AMC-01371(E) for the United States Army Electronics Command, Fort Monmouth, New Jersey.

characterization in terms of S-parameters greatly alleviates this problem.

- 3) If open or short circuit terminations are desired, as is necessary for H, Y, or Z parameter measurements, resonant lines must be used. This causes a high degree of frequency sensitivity which makes broadband swept frequency measurements impossible and may allow the transistor to oscillate. Since broadband 50Ω terminations are easily obtainable using standard components, S-parameter measurements are more practical.
- 4) The sources of error are multiplied and special attention must be paid to consistency and accurate calibration. A consistent set of reference planes must be established and losses and discontinuities must be held to a minimum.

B. S-PARAMETER MEASUREMENTS

The small signal response of a discrete two-port device is defined in terms of four variables v_1 , i_1 , v_2 , and i_2 , the voltages, and currents at the input and output terminals respectively as shown in Figure 1. Any two of the variables can be chosen as the independent variables making the other two dependent variables. This gives rise to the familiar Z, Y, and H parameters. In the S-parameter representation linear combinations of the currents and voltages are used as the independent and dependent variables. The independent variables are defined as:

$$a_1 = \frac{1}{2\sqrt{Z_o}} (v_1 + Z_o i_1)$$

$$a_2 = \frac{1}{2\sqrt{Z_o}} (v_2 + Z_o i_2)$$

the dependent variables as:

$$b_1 = \frac{1}{2\sqrt{Z_o}} (v_1 - Z_o i_1)$$

$$b_2 = \frac{1}{2\sqrt{Z_o}} (v_2 - Z_o i_2)$$

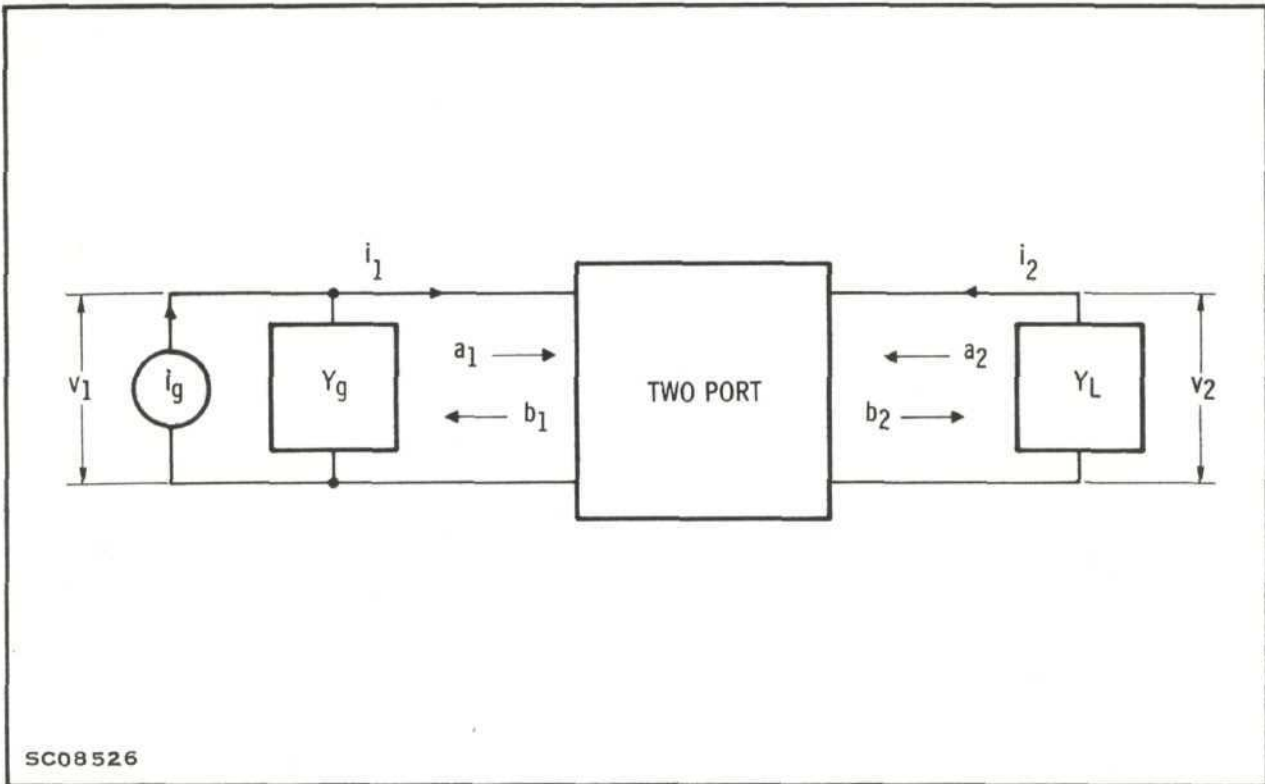

Figure 1. Two-Port Relations

Here Z_0 is a real impedance called the characteristic impedance. Thus, the S-parameter matrix is defined by:

$$b_1 = S_{11} a_1 + S_{12} a_2$$

$$b_2 = S_{21} a_1 + S_{22} a_2$$

By slightly changing the definitions, complex values of Z_0 different for the two ports can be used. But these have theoretical significance only and are impractical for measurements. Since 50Ω coaxial transmission line components such as slotted lines and directional couplers are readily available, Z_0 is generally taken to be 50Ω .

At times a_1 and a_2 are referred to as the "incident voltage waves" and b_1 and b_2 as the "reflected voltage waves". If the device is terminated in Z_0 at the input and output, S_{11} and S_{22} are the input and output reflection coefficients, $|S_{21}|^2$ and $|S_{12}|^2$ are the forward and reverse insertion gains, and $\angle S_{21}$ and $\angle S_{12}$ are the insertion phase shifts. Also $|a_1|^2$ is the power available from the generator (internal impedance = Z_0) and $|b_2|^2$ is the power dissipated in the load (load = Z_0). A derivation of these relationships is given in the appendix.

The S-parameters completely determine the small signal behavior of a device. Formulas for deriving the Y and H parameters and various gain and stability relationships from the S-parameters are given in the appendix.

The S-parameters can be measured using commercial test sets such as the -hp-8410A network analyzer. A block diagram of the measurement setups is shown in Figures 2 and 3. Figure 2 illustrates the measurement of the transmission coefficients S_{12} and S_{21} . A swept-frequency source feeds a power divider which has two outputs, a reference channel and a test channel. The device to be measured is inserted into the test channel and a line stretcher is inserted into the reference channel. Both channels are then fed to the test set which measures the complex ratio between the two signals. This ratio is the desired parameter.

The reflection coefficients S_{11} and S_{22} are measured using the setup shown in Figure 3. There the swept-frequency source is fed into a dual-directional coupler. One port of the device is connected to the measurement port of the coupler the other port is terminated in a 50Ω load. The reference output of the coupler which samples the incident wave is fed to the complex ratio test set via a line stretcher. The test output which samples the wave reflected from the device is fed directly to the test set. The line stretcher allows the plane at which the measurement is made to be extended past the connector to the unknown device.

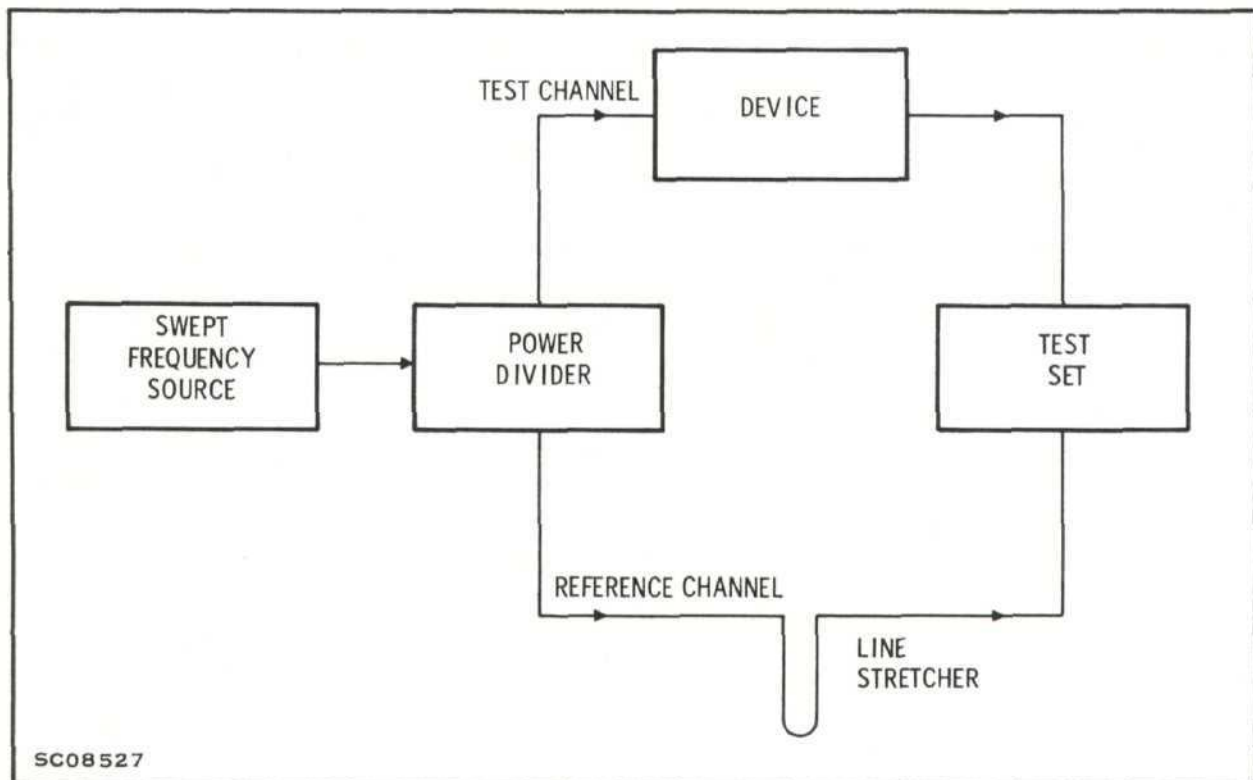

Figure 2. Setup for Measuring S_{12} and S_{21}

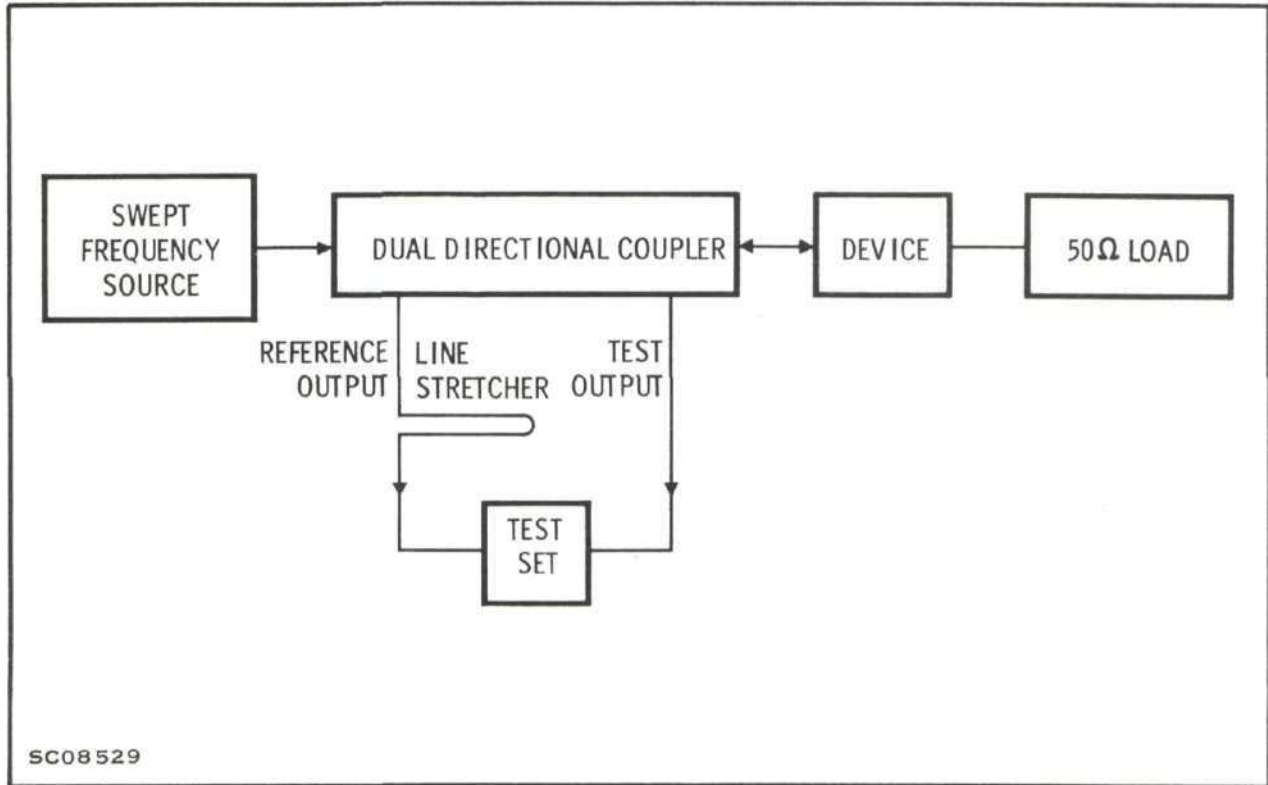

Figure 3. Setup for Measuring S_{11} and S_{22}

The stretchable lines in the measurement setups, Figures 2 and 3, allow the input and output measurement planes to be placed anywhere. Care must be taken to ensure that all four S-parameters are measured with reference to the same planes. Sexless connectors such as GR900 or APC-7 are used to establish the reference planes. These connectors allow precision shorts to be placed exactly at the mating planes of the connectors.

Since S_{11} and S_{22} are reflection coefficients. They can be measured with a slotted line. This is the most accurate method; it is, however, cumbersome and unsuited for swept frequency measurements. The reflectometer method described above is much more convenient. The transmission coefficients, S_{12} and S_{21} cannot be measured with a slotted line.

Test fixtures and dc bias injection networks used for S-parameter measurements must have low loss and very low VSWR. Design principles will be discussed below in the section on test fixtures.

C. GAIN AND STABILITY MEASUREMENTS

While it is true that the S-parameters of transistor completely and uniquely characterize it for the small signal condition several gain and stability parameters (MSG, GMAX, K, and U) are measured for the following reasons:

The S-parameters do not give any direct indication of the level of performance of the device as an amplifier.

Even though these parameters can be calculated from the S-parameters, direct measurement is preferable to calculation by formula because of round-off errors.

These parameters are invariant under various transformations. This makes them insensitive to header parasitics and reference plane location. Thus the parameters are the same for the bare chip as for the packaged device. This allows one to evaluate the intrinsic capabilities of the chip itself.

Gain and stability parameters are defined below:

1. MSG (Maximum Stable Gain)-- is the square root of the ratio of the forward to the reverse power gain. The only requirement is that the device terminations be the same for both measurements. MSG is unaffected by input or output parasitics but it is sensitive to feedback parasitics such as common lead inductance or feedthrough capacitance.

2. GMAX (Maximum Tuned Gain-Maximum Available Gain) -- is the forward power gain when the input and the output are simultaneously conjugately matched. GMAX is only defined for an unconditionally stable device ($K > 1$, see below). It is unaffected by lossless input or output parasitics but it is sensitive to loss or feedback.

3. K (Rollett's Stability Factor $\frac{1}{K}$) is a measure of oscillatory tendency. For $K < 1$ the device is potentially unstable and can be induced into oscillation by the application of some combination of passive load and source admittances. For $K > 1$ the transistor is unconditionally stable, that is in the absence of an external feedback path, no passive load or source admittance will induce oscillations. K is the inverse of Linvill's C factor and plays an important part in amplifier design.

For $K > 1$, K can be computed from the MSG and GMAX by the formula:

$$K = \frac{1}{2} \left(\frac{MSG}{GMAX} + \frac{GMAX}{MSG} \right)$$

For $K < 1$, K must be computed from the S-parameters as shown in the appendix.

4. U (Unilateral Gain-Mason Invariant^{2/}) is the most unique figure of merit for a device. It is defined as the forward power gain in a feedback amplifier whose reverse gain has been adjusted to zero by a lossless reciprocal feedback network. Because of the feedback loop employed in the measurement of U , the transistor may be imbedded in any lossless-reciprocal network without changing its unilateral gain. This makes unilateral gain invariant with respect to any lossless header parasitics or changes in common lead configuration.

Alternately U can be derived from MSG , K , and θ , the difference between forward and reverse phase shift. This difference, being the "phase of MSG " is invariant under input and output transformations like the MSG itself. The formula for U is^{4/}:

$$U = \frac{MSG - 2 \cos \theta + MSG^{-1}}{2 (K - \cos \theta)} \approx \frac{MSG}{2 (K - \cos \theta)}$$

Figure 4 shows a setup for measuring MSG , G_{MAX} , K , and U in one simple procedure as follows:

Tune for maximum forward gain and record gain (which is G_{MAX}) and phase.

Turn device and tuners around and record gain and phase.

Get gain ratio and phase difference, as described above, and calculate MSG , K , and U .

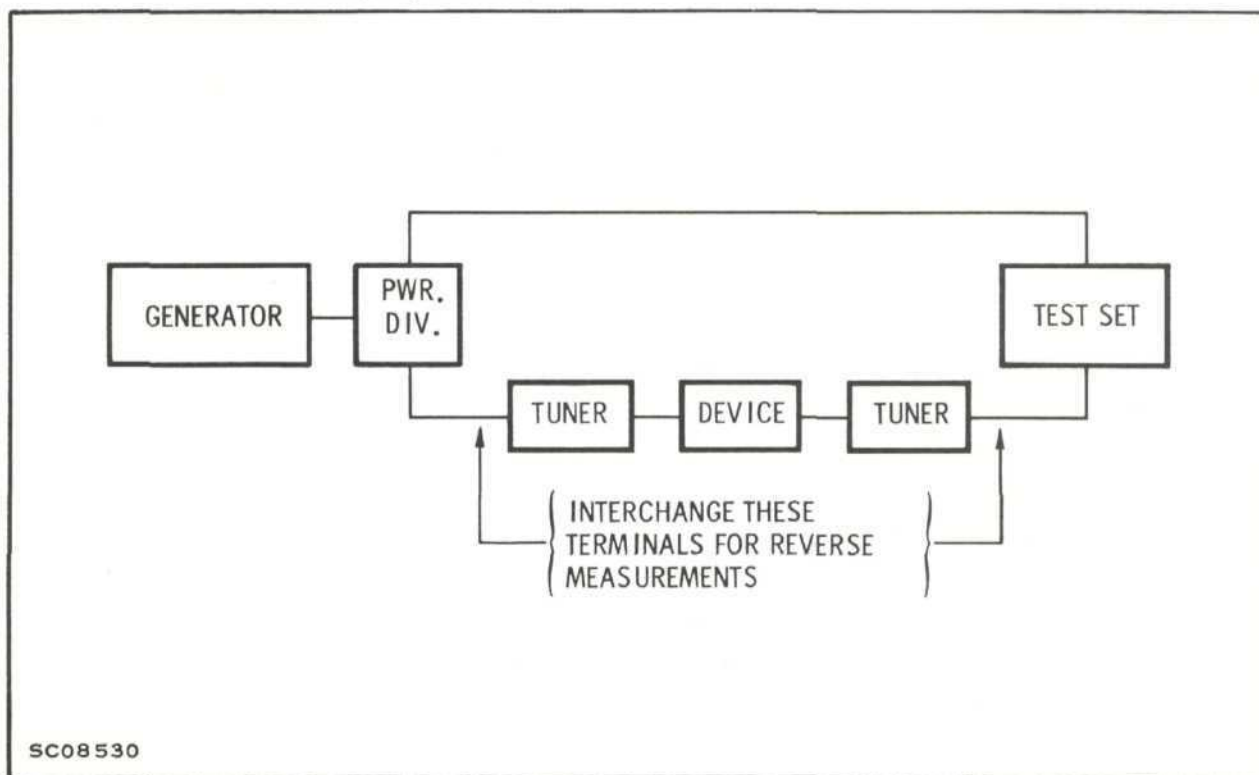

Figure 4. Setup for Measuring MSG , G_{MAX} , K , U

D. TEST FIXTURES

Measurements at frequencies above 1 GHz require test fixtures which have low loss and VSWR. An example which fulfills these requirements is the improved mount for TI-Line[®] packages shown in Figure 5. This mount contains two low VSWR coax to stripline adaptors which feed the input and output 50 Ω tri-plate strip transmission lines. These lines are carried to the very edge of the package. Contact to the input and output leads is made by clamping the flat leads between the striplines and the upper dielectric.

Another important feature of the mount is the grounding scheme. For a three-terminal device in a tri-plate structure, it is very important to ground the device to both ground planes at the same point. Therefore, the flange of the transistor package is clamped between the two ground planes. The ground lead of the package serves no purpose other than mechanical alignment.

When designing tuning and bias insertion networks for use above 1 GHz the low frequency response must be taken into account, since most devices have high gain at low frequencies and will break into oscillations when insufficiently loaded. For S-parameter measurements the device terminations should present 50 Ω at least down to 10 MHz. This can best be accomplished by inserting high capacitance dc blocks into the outer conductors of the transmission lines leading to the device and providing dc returns through T-pad attenuators. High quality wide-band bias tees can also be used.

For making tuned power gain measurements, such as MAG and U, the special slide-screw tuner shown in Figure 6 has been built. It consists of a coaxial 50- Ω characteristic impedance slab line (round center conductor; two slabs as outer conductor ground return) provided with an anodized aluminum tuning slug whose position and penetration are adjustable. This tuner has the following advantages over the conventional multiple-stub tuners.

The distance between the device terminals and the tuning elements (movable slugs) can be made very small. This discourages parasitic oscillations and extends the usable frequency range to 9 GHz, the limiting frequency of the connectors.

The tuning elements are "transparent" at dc and low frequencies. Thus the dc bias elements can be placed outside of the tuning elements in a low VSWR portion of the system. Consequently losses are reduced and made independent of the VSWR of the transistor, making it easy to account for them.

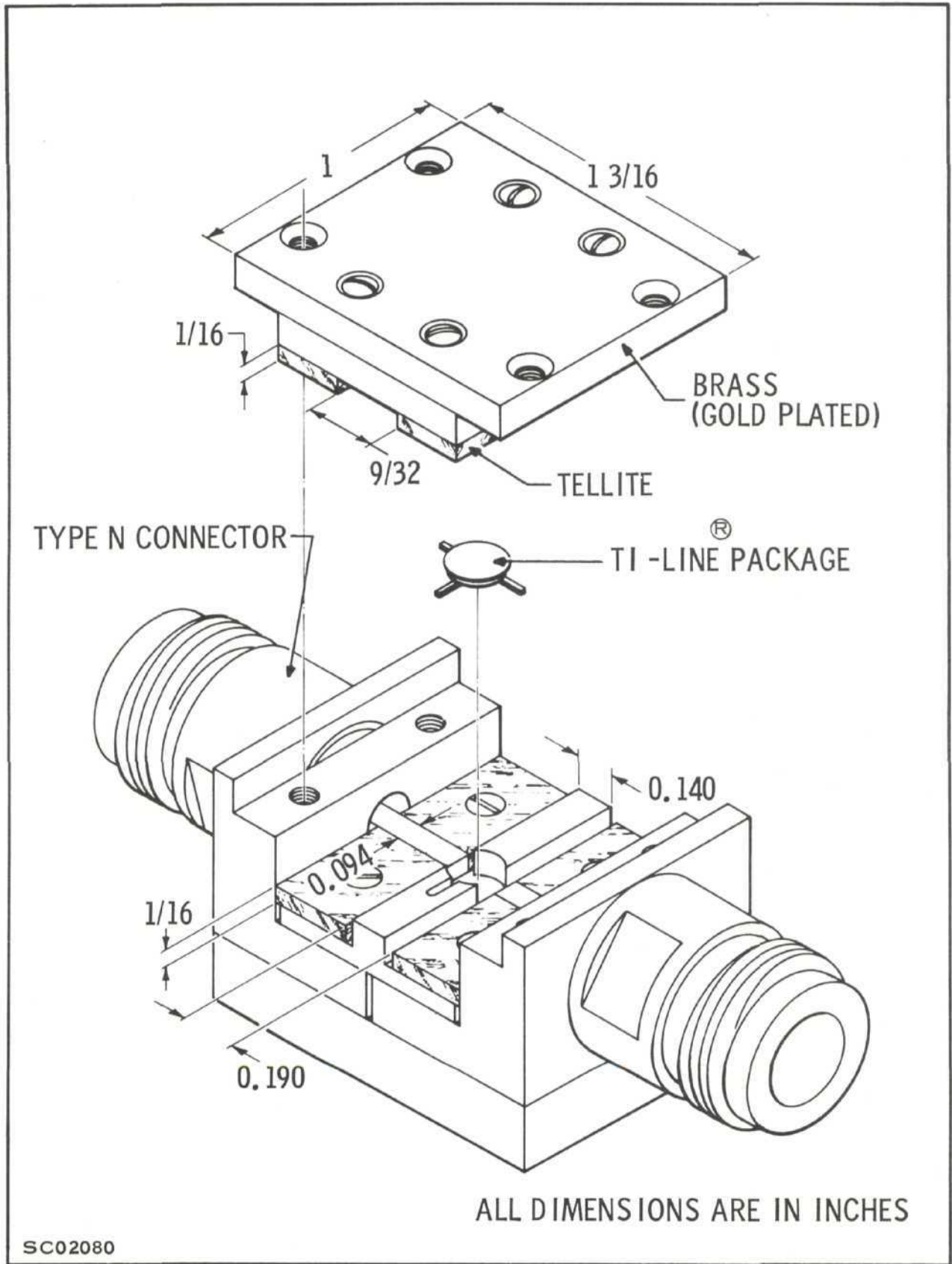

Figure 5. Improved TI-Line[®] Mount

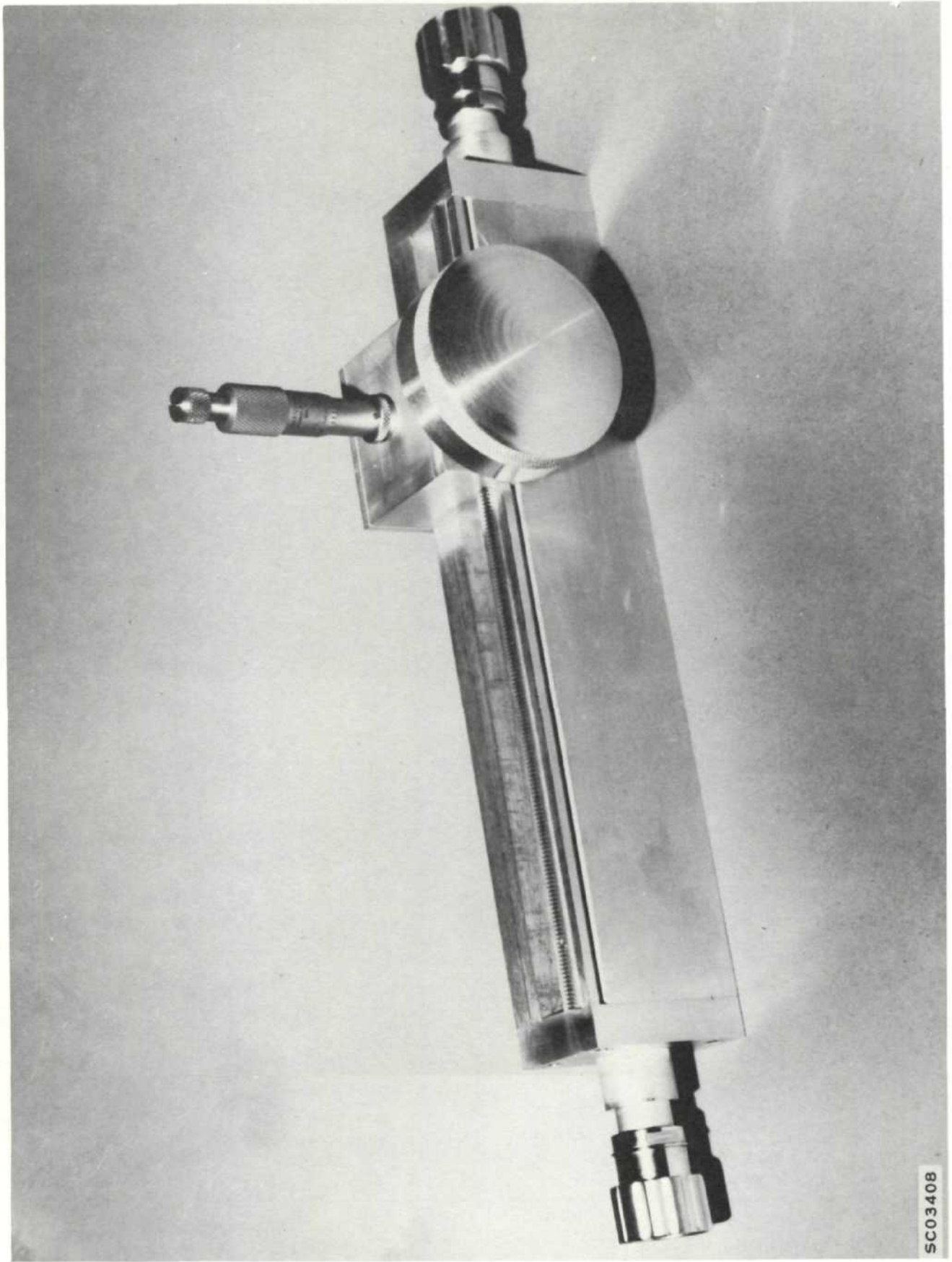

Figure 6. Slide-Screw Tuner

SC03408

If high-capacitance outer blocks and T-pad attenuators are used for biasing the transistor sees 50Ω at both input and output at low frequencies, resulting in heavy loading which very effectively suppresses oscillatory tendencies.

VSWRs as high as 30 have been achieved at 1 GHz while still maintaining low loss.

LITERATURE CITED

1. J. M. Rollett, "Stability and Power-Gain Invariants of Linear Twoports," IRE Transactions on Circuit Theory, Vol. CT-9, pp. 29-32; March, 1962.
2. S. J. Mason, "Power Gain in Feedback Amplifiers," MIT Research Lab of Electronics, Tech. Rep. 257; August 25, 1953. Also IRE Trans., Vol. CT-1, pp. 20-25; June 1954.
3. J. Lange, "A Much Improved Apparatus for Measuring the Gain of Transistors at GHz Frequencies", IEEE Transactions on Circuit Theory, Vol. CT-13, December, 1966.
4. A. Singhakowinta and A. R. Boothroyd, IEEE Transon Circuit Theory, Vol. CT-11 p. 169, March 1964.

APPENDIX

SPECIAL S-PARAMETER RELATIONSHIPS

$$\text{Let } Y_g = Y_L = Z_0^{-1}$$

S_{11} = input reflection coefficient

S_{22} = output reflection coefficient

$$|a_1|^2 = \frac{i_g}{4 Y_g} = \text{power available from generator}$$

$$|b_2|^2 = Y_L |v_2|^2 = \text{output power}$$

therefore

$$|S_{21}|^2 = \text{forward transducer (insertion) gain}$$

$$|S_{12}|^2 = \text{reverse transducer gain}$$

Derivations:

$$\text{Let } Z_1 = \text{input impedance with } Y_L = Z_0^{-1}$$

Then

$$S_{11} = \frac{b_1}{a_1} = \frac{v_1 - Z_0 i_1}{v_1 + Z_0 i_1} = \frac{Z_1 - Z_0}{Z_1 + Z_0}$$

$$i_2 = -Y_L v_2$$

$$b_2 = \frac{1}{2\sqrt{Z_0}} [v_2 - Z_0 (-Y_L v_2)] = v_2 \sqrt{Y_L}$$

$$i_1 = i_g - Y_g v_1$$

$$a_1 = \frac{1}{2\sqrt{Z_0}} (v_1 + Z_0 i_g - Z_0 Y_g v_1) = \frac{1}{2} i_g \sqrt{Z_0} = \frac{i_g}{2\sqrt{Y_g}}$$

Conversion Formulas

$$Y_{11} = \frac{S_{12} S_{21} + (1 - S_{11})(1 + S_{22})}{-S_{12} S_{21} + (1 + S_{11})(1 + S_{22})} Z_0^{-1}$$

$$Y_{12(21)} = \frac{-2S_{12(21)}}{-S_{12} S_{21} + (1 + S_{11})(1 + S_{22})} Z_0^{-1}$$

$$Y_{22} = \frac{S_{12} S_{21} + (1 + S_{11})(1 - S_{22})}{-S_{12} S_{21} + (1 + S_{11})(1 + S_{22})} Z_0^{-1}$$

$$H_{11} = \frac{-S_{12} S_{21} + (1 + S_{11})(1 + S_{22})}{S_{12} S_{21} + (1 - S_{11})(1 + S_{22})} Z_0$$

$$H_{12} = \frac{2S_{12}}{S_{12} S_{21} + (1 - S_{11})(1 + S_{22})}$$

$$H_{21} = \frac{-2S_{21}}{S_{12} S_{21} + (1 - S_{11})(1 + S_{22})}$$

$$H_{22} = \frac{-S_{12} S_{21} + (1 - S_{11})(1 - S_{22})}{S_{12} S_{21} + (1 - S_{11})(1 + S_{22})} Z_0^{-1}$$

$$\text{MSG} = \left| \frac{S_{21}}{S_{12}} \right|$$

$$K = \frac{|S_{11} S_{22} - S_{12} S_{21}|^2 - |S_{11}|^2 - |S_{22}|^2}{2 |S_{12}| |S_{21}|}$$

$$\text{MAG} = \left| \frac{S_{21}}{S_{12}} \right| \left(K - \sqrt{K^2 - 1} \right)$$

$$U = \frac{1/2 \left| \frac{S_{21}}{S_{12}} - 1 \right|^2}{K \left| \frac{S_{21}}{S_{12}} \right| - \text{Re} \left(\frac{S_{21}}{S_{12}} \right)}$$

SECTION II

SCATTERING PARAMETERS SPEED DESIGN OF HIGH-FREQUENCY TRANSISTOR CIRCUITS

Fritz Weinert's article gives the neophyte a particularly good understanding of s parameters and how they relate to transistors and transistor circuit design. Weinert lucidly explains how to design a stable amplifier for a given gain over a specified bandwidth. He concludes by discussing the accuracy and limitations of his measuring system.

S Parameter Definitions	2-2
Physical Meaning of S Parameters.....	2-2
Three Step Amplifier Design on the Smith Chart.....	2-6
Stability Criterion	2-8
Using the Smith Chart	2-9
Using S Parameters in Amplifier Design	2-9
Unilateral Circuit Definitions	2-10
Measuring S Parameters	2-11
Accuracy and Limitations.....	2-11

Scattering parameters speed design of high-frequency transistor circuits

At frequencies above 100 Mhz scattering parameters are easily measured and provide information difficult to obtain with conventional techniques that use h, y or z parameters

By Fritz Weinert

Hewlett-Packard Co., Palo Alto, Calif.

Performance of transistors at high frequencies has so improved that they are now found in all solid-state microwave equipment. But operating transistors at high frequencies has meant design problems:

- Manufacturers' high-frequency performance data is frequently incomplete or not in proper form.

- Values of h, y or z parameters, ordinarily used in circuit design at lower frequencies, can't be measured accurately above 100 megahertz because establishing the required short and open circuit conditions is difficult. Also, a short circuit frequently causes the transistor to oscillate under test.

These problems are yielding to a technique that uses scattering or s parameters to characterize the high-frequency performance of transistors. Scattering parameters can make the designer's job easier.

- They are derived from power ratios, and consequently provide a convenient method for measuring circuit losses.

- They provide a physical basis for understanding what is happening in the transistor, without need for an understanding of device physics.

- They are easy to measure because they are based on reflection characteristics rather than short- or open-circuit parameters.

The author



Fritz K. Weinert, who joined the technical staff of Hewlett-Packard in 1964, is project leader in the network analysis section of the microwave laboratory. He holds patents and has published papers on pulse circuits, tapered-line transformers, digital-tuned circuits and shielding systems.

Like other methods that use h, y or z parameters, the scattering-parameter technique does not require a suitable equivalent circuit to represent the transistor device. It is based on the assumption that the transistor is a two-port network—and its terminal behavior is defined in terms of four parameters, s_{11} , s_{12} , s_{21} and s_{22} , called s or scattering parameters.

Since four independent parameters completely define any two-port at any one frequency, it is possible to convert from one known set of parameters to another. At frequencies above 100 Mhz, however, it becomes increasingly difficult to measure the h, y or z parameters. At these frequencies it is difficult to obtain well defined short and open circuits and short circuits frequently cause the device to oscillate. However, s parameters may be measured directly up to a frequency of 1 gigahertz. Once obtained, it is easy to convert the s parameters into any of the h, y or z terms by means of tables.

Suggested measuring systems

To measure scattering parameters, the unknown transistor is terminated at both ports by pure resistances. Several measuring systems of this kind have been proposed. They have these advantages:

- Parasitic oscillations are minimized because of the broadband nature of the transistor terminations.

- Transistor measurements can be taken remotely whenever transmission lines connect the semiconductor to the source and load—especially when the line has the same characteristic impedance as the source and load respectively.

- Swept-frequency measurements are possible instead of point-by-point methods. Theoretical work shows scattering parameters can simplify design.

Scattering-parameter definitions

To measure and define scattering parameters the two-port device, or transistor, is terminated at both ports by a pure resistance of value Z_0 , called the reference impedance. Then the scattering parameters are defined by s_{11} , s_{12} , s_{21} and s_{22} . Their physical meaning is derived from the two-port network shown in first figure below.

Two sets of parameters, (a_1, b_1) and (a_2, b_2) , represent the incident and reflected waves for the two-port network at terminals 1-1' and 2-2' respectively. Equations 1a through 1d define them.

$$a_1 = \frac{1}{2} \left(\frac{V_1}{\sqrt{Z_0}} + \sqrt{Z_0} I_1 \right) \quad (1a)$$

$$b_1 = \frac{1}{2} \left(\frac{V_1}{\sqrt{Z_0}} - \sqrt{Z_0} I_1 \right) \quad (1b)$$

$$a_2 = \frac{1}{2} \left(\frac{V_2}{\sqrt{Z_0}} + \sqrt{Z_0} I_2 \right) \quad (1c)$$

$$b_2 = \frac{1}{2} \left(\frac{V_2}{\sqrt{Z_0}} - \sqrt{Z_0} I_2 \right) \quad (1d)$$

The scattering parameters for the two-port network are given by equation 2.

$$b_1 = s_{11} a_1 + s_{12} a_2$$

$$b_2 = s_{21} a_1 + s_{22} a_2 \quad (2)$$

In matrix form the set of equations of 2 becomes

$$\begin{bmatrix} b_1 \\ b_2 \end{bmatrix} = \begin{bmatrix} s_{11} & s_{12} \\ s_{21} & s_{22} \end{bmatrix} \begin{bmatrix} a_1 \\ a_2 \end{bmatrix} \quad (3)$$

where the matrix

$$[s] = \begin{bmatrix} s_{11} & s_{12} \\ s_{21} & s_{22} \end{bmatrix} \quad (4)$$

is called the scattering matrix of the two-port network. Therefore the scattering parameters of the two-port network can be expressed in terms of the incident and reflected parameters as:

$$\begin{aligned} s_{11} &= \left. \frac{b_1}{a_1} \right|_{a_2=0} & s_{12} &= \left. \frac{b_1}{a_2} \right|_{a_1=0} \\ s_{21} &= \left. \frac{b_2}{a_1} \right|_{a_2=0} & s_{22} &= \left. \frac{b_2}{a_2} \right|_{a_1=0} \end{aligned} \quad (5)$$

In equation 5, the parameter s_{11} is called the input reflection coefficient; s_{21} is the forward transmission coefficient; s_{12} is the reverse transmission coefficient; and s_{22} is the output reflection coefficient. All four scattering parameters are expressed as ratios of reflected to incident parameters.

Physical meaning of parameters

The implications of setting the incident parameters a_1 and a_2 at zero help explain the physical

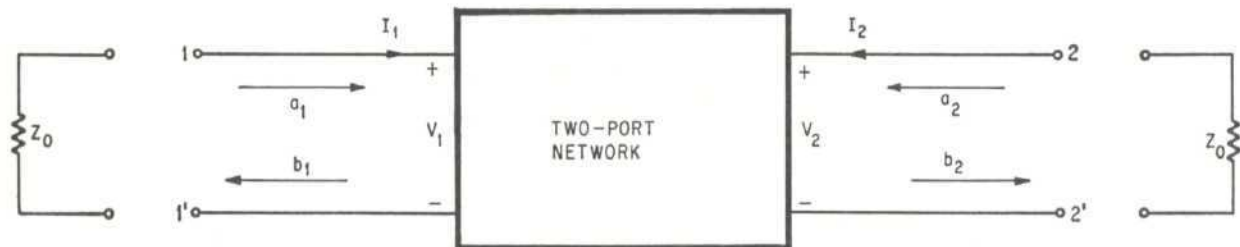

Scattering parameters are defined by this representation of a two-port network. Two sets of incident and reflected parameters (a_1, b_1) and (a_2, b_2) appear at terminals 1-1' and 2-2' respectively.

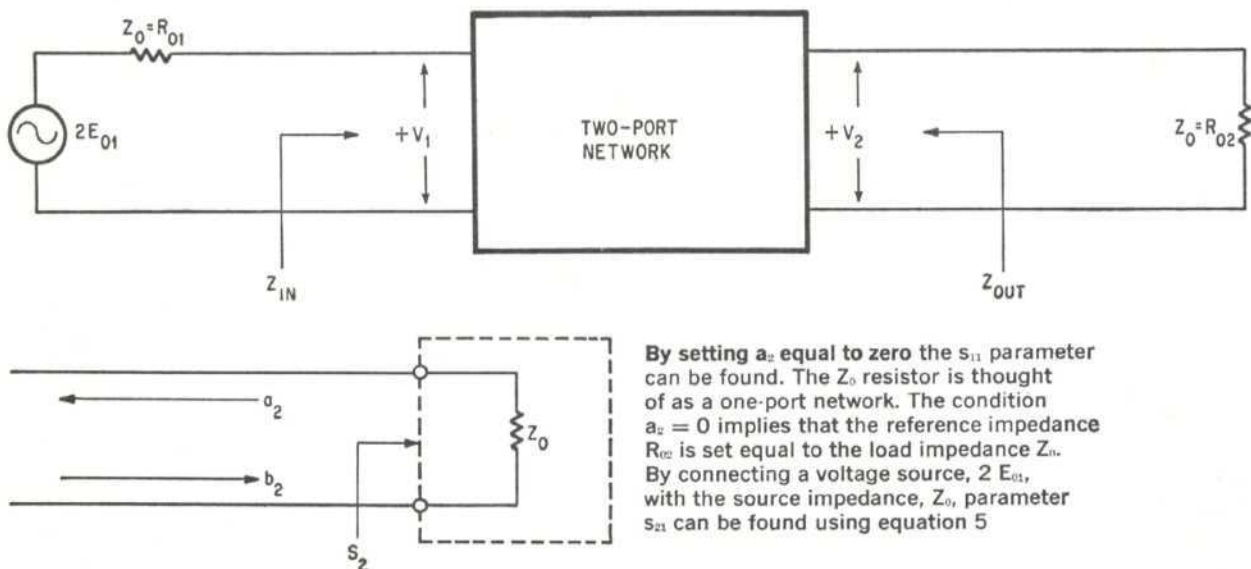

By setting a_2 equal to zero the s_{11} parameter can be found. The Z_0 resistor is thought of as a one-port network. The condition $a_2 = 0$ implies that the reference impedance R_{02} is set equal to the load impedance Z_0 . By connecting a voltage source, $2 E_{01}$, with the source impedance, Z_0 , parameter s_{21} can be found using equation 5

meaning of these scattering parameters.

By setting $a_2 = 0$, expressions for s_{11} and s_{22} can be found. The terminating section of the two-port network is at bottom of page 79 with the parameters a_2 and b_2 of the 2-2' port. If the load resistor Z_0 is thought of as a one-port network with a scattering parameter

$$s_2 = \frac{Z_0 - R_{02}}{Z_0 + R_{02}} \quad (6)$$

where R_{02} is the reference impedance of port 2, then a_2 and b_2 are related by

$$a_2 = s_2 b_2 \quad (7)$$

When the reference impedance R_{02} is set equal to the local impedance Z_0 , then s_2 becomes

$$s_2 = \frac{Z_0 - Z_0}{Z_0 + Z_0} = 0 \quad (8)$$

so that $a_2 = 0$ under this condition. Similarly, when $a_1 = 0$, the reference impedance of port 1 is equal to the terminating impedance; that is, $R_{01} = Z_0$. The conditions $a_1 = 0$ and $a_2 = 0$ merely imply that the reference impedances R_{01} and R_{02} are chosen to be equal to the terminating resistors Z_0 .

In the relationship between the driving-point impedances at ports 1 and 2 and the reflection coefficients s_{11} and s_{22} , the driving-point impedances can be denoted by:

$$Z_{in} = \frac{V_1}{I_1}; \quad Z_{out} = \frac{V_2}{I_2} \quad (9)$$

From the relationship

$$s_{11} = \left. \frac{b_1}{a_1} \right|_{a_2 = 0}$$

$$s_{11} = \frac{\frac{1}{2} [(V_1/\sqrt{Z_0}) - \sqrt{Z_0} I_1]}{\frac{1}{2} [(V_1/\sqrt{Z_0}) + \sqrt{Z_0} I_1]} \quad (10)$$

which reduces to

$$s_{11} = \frac{Z_{in} - Z_0}{Z_{in} + Z_0} \quad (11)$$

Similarly,

$$s_{22} = \frac{Z_{out} - Z_0}{Z_{out} + Z_0} \quad (12)$$

These expressions show that if the reference impedance at a given port is chosen to equal the ports driving-point impedance, the reflection coefficient will be zero, provided the other port is terminated in its reference impedance.

In the equation

$$s_{21} = \left. \frac{b_2}{a_1} \right|_{a_2 = 0}$$

the condition $a_2 = 0$ implies that the reference impedance R_{02} is set equal to the load impedance R_2 , center figure page 79. If a voltage source 2 E_{01} is connected with a source impedance $R_{01} = Z_0$, a_1

can be expressed as:

$$a_1 = \frac{E_{01}}{\sqrt{Z_0}} \quad (13)$$

Since $a_2 = 0$, then

$$a_2 = 0 = \frac{1}{2} \left(\frac{V_2}{\sqrt{Z_0}} + \sqrt{Z_0} I_2 \right)$$

from which

$$\frac{V_2}{\sqrt{Z_0}} = -\sqrt{Z_0} I_2$$

Consequently,

$$b_2 = \frac{1}{2} \left(\frac{V_2}{\sqrt{Z_0}} - \sqrt{Z_0} I_2 \right) = \frac{V_2}{\sqrt{Z_0}}$$

Finally, the forward transmission coefficient is expressed as:

$$s_{21} = \frac{V_2}{E_{01}} \quad (14)$$

Similarly, when port 1 is terminated in $R_{01} = Z_0$ and when a voltage source 2 E_{02} with source impedance Z_0 is connected to port 2,

$$s_{12} = \frac{V_1}{E_{02}} \quad (15)$$

Both s_{12} and s_{21} have the dimensions of a voltage-ratio transfer function. And if $R_{01} = R_{02}$, then s_{12} and s_{21} are simple voltage ratios. For a passive reciprocal network, $s_{21} = s_{12}$.

Scattering parameters s_{11} and s_{22} are reflection coefficients. They can be measured directly by means of slotted lines, directional couplers, voltage-standing-wave ratios and impedance bridges. Scattering parameters s_{12} and s_{21} are voltage transducer gains. All the parameters are frequency-dependent, dimensionless complex numbers. At any one frequency all four parameters must be known to describe the two-port device completely.

There are several advantages for letting $R_{01} = R_{02} = Z_0$.

- The s_{11} and s_{22} parameters are power reflection coefficients that are difficult to measure under normal loading. However, if $R_{01} = R_{02} = Z_0$, the parameters become equal to voltage reflection coefficients and can be measured directly with available test equipment.

- The s_{12} and s_{21} are square roots of the transducer power gain, the ratio of power absorbed in the load over the source power available. But for $R_{01} = R_{02} = Z_0$, they become a voltage ratio and can be measured with a vector voltmeter.

- The actual measurement can be taken at a distance from the input or output ports. The measured scattering parameter is the same as the parameter existing at the actual location of the particular port. Measurement is achieved by connecting input and output ports to source and load by means of transmission lines having the same impedance, Z_0 ,

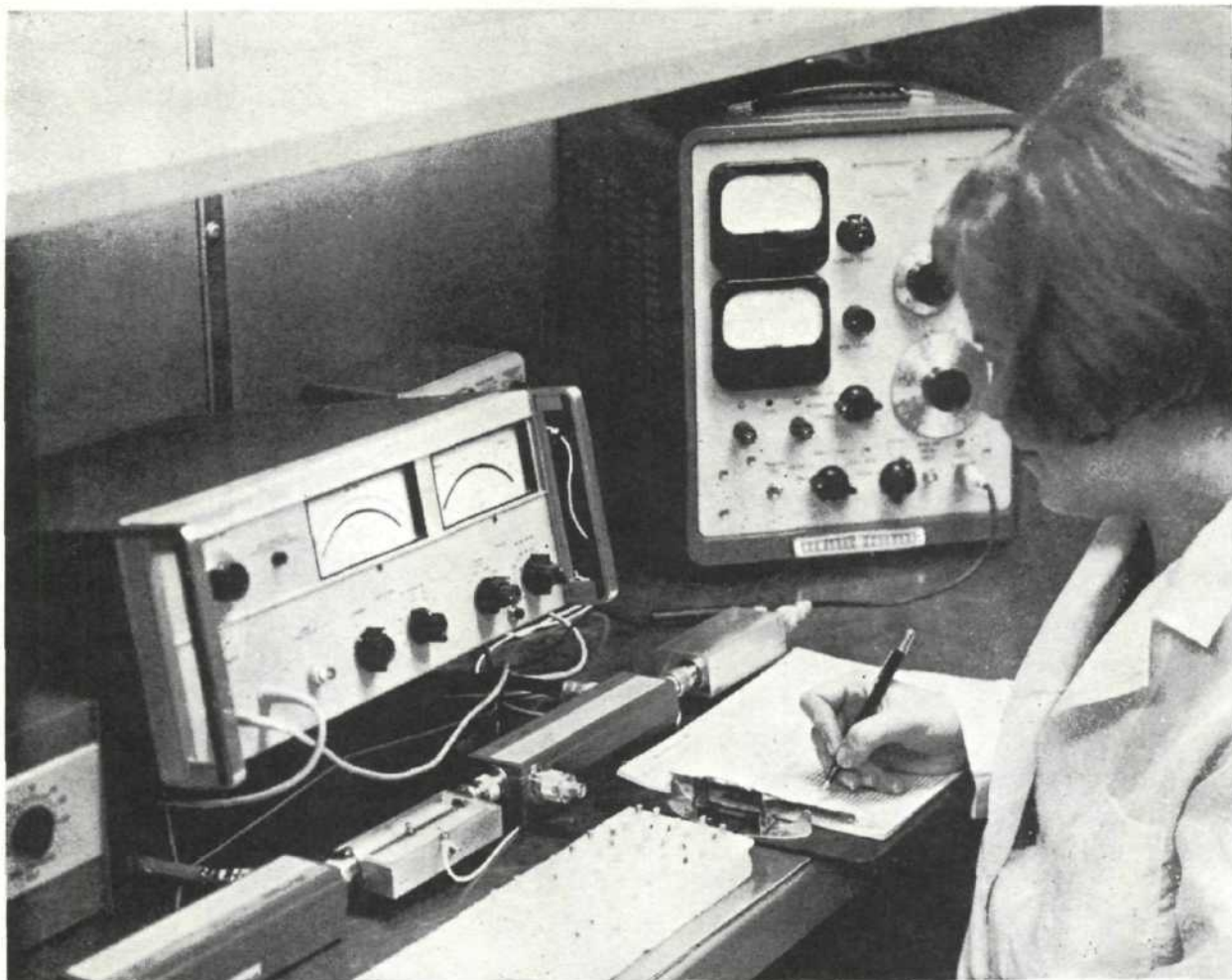

25°C	100 Mhz	300 Mhz	100°C	100 Mhz	300 Mhz
S_{11}	0.62 < -44.0°	0.305 < -81.0°	S_{11}	0.690 < -40°	0.372 < -71°
S_{12}	0.0115 < $+75.0^\circ$	0.024 < $+93.0^\circ$	S_{12}	0.0125 < $+76.0^\circ$	0.0254 < $+89.5^\circ$
S_{21}	9.0 < $+130^\circ$	3.85 < $+91.0^\circ$	S_{21}	8.30 < $+133.0^\circ$	3.82 < $+94.0^\circ$
S_{22}	0.955 < -6.0°	0.860 < -14.0°	S_{22}	0.955 < -6.0°	0.880 < -15.0°
25°C	590 Mhz	1,000 Mhz	100°C	500 Mhz	1,000 Mhz
S_{11}	0.238 < -119.0°	0.207 < $+175.0^\circ$	S_{11}	0.260 < -96.0°	0.196 < $+175.0^\circ$
S_{12}	0.0385 < $+110.0^\circ$	0.178 < $+110.0^\circ$	S_{12}	0.0435 < $+100.0^\circ$	0.165 < $+103.0^\circ$
S_{21}	2.19 < $+66.0^\circ$	1.30 < $+33.0^\circ$	S_{21}	2.36 < $+69.5^\circ$	1.36 < $+35.0^\circ$
S_{22}	0.830 < -26.0°	0.838 < -49.5°	S_{22}	0.820 < -28.0°	0.850 < -53.0°

Scattering parameters can be measured directly using the Hewlett-Packard 8405A vector voltmeter. It covers the frequency range of 1 to 1,000 megahertz and determines s_{21} and s_{12} by measuring ratios of voltages and phase difference between the input and output ports. Operator at Texas Instruments Incorporated measures s-parameter data for TI's 2N3571 transistor series. Values for $V_{CB} = 10$ volts; $I_C = 5$ milliamperes.

as the source and load. In this way compensation can be made for added cable length.

Transistors can be placed in reversible fixtures to measure the reverse parameters s_{22} and s_{12} with the equipment used to measure s_{11} and s_{21} .

The Hewlett-Packard Co.'s 8405A vector voltmeter measures s parameters. It covers the frequency range of 1 to 1,000 megahertz and determines s_{21} and s_{12} by measuring voltage ratios and phase differences between the input and output ports directly on two meters, as shown above. A dual-directional coupler samples incident and reflected voltages to measure the magnitude and phase of the reflection coefficient.

To perform measurements at a distance, the setup

on page 86 is convenient. The generator and the load are the only points accessible for measurement. Any suitable test equipment, such as a vector voltmeter, directional coupler or slotted line can be connected. In measuring the s_{21} parameter as shown in the schematic, the measured vector quantity V_2/E_0 is the voltage transducer gain or forward gain scattering parameter of the two-port and cables of length L_1 and L_2 . The scattering parameter s_{21} of the two-port itself is the same vector V_2/E_0 but turned by an angle of $360^\circ (L_1 + L_2)/\lambda$ in a counterclockwise direction.

Plotting s_{11} in the complex plane shows the conditions for measuring s_{11} . Measured vector r_1 is the reflection coefficient of the two-port plus

Amplifier design with unilateral s parameters

Step 1

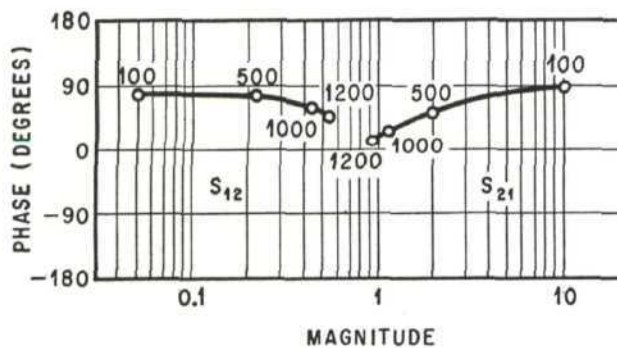
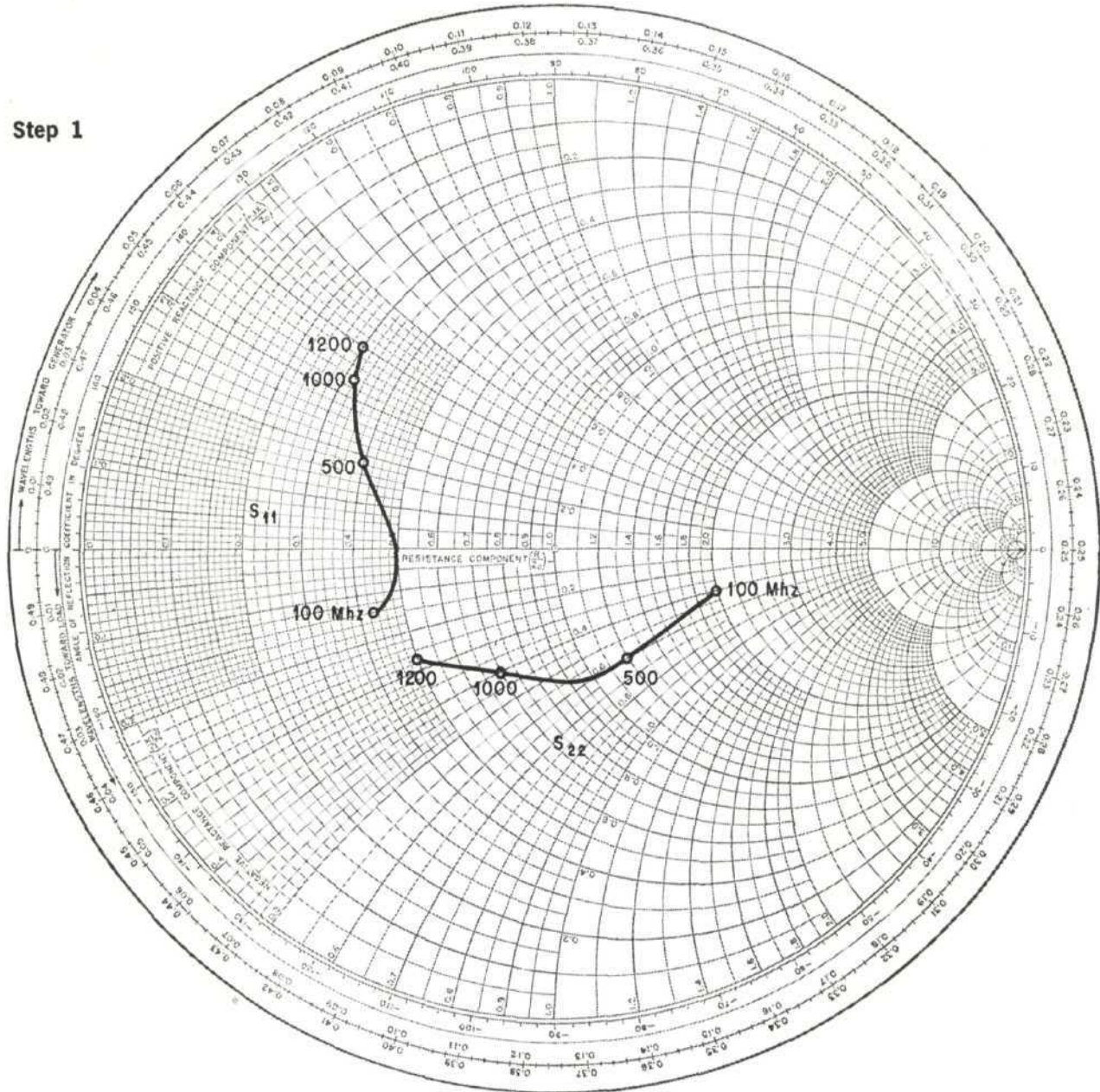

Step 2

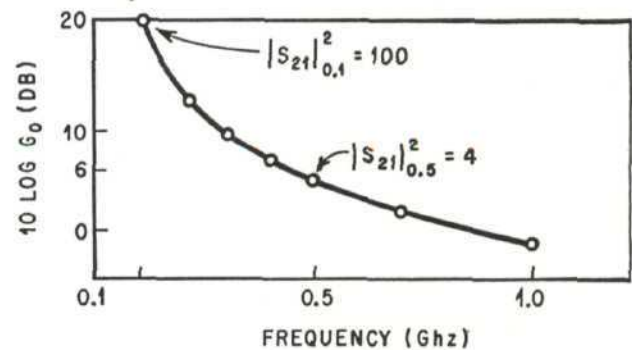

From the measured data transducer power gain is plotted as decibels versus frequency. From the plot an amplifier of constant gain is designed. Smith chart is used to plot the scattering parameters.

To design an amplifier stage, a source and load impedance combination must be found that gives the gain desired. Synthesis can be accomplished in three stages.

Step 1

The vector voltmeter measures the scattering parameters over the frequency range desired.

Step 2

Transducer power gain is plotted versus frequency using

equation 19 and the measured data from step 1. This determines the frequency response of the uncompensated transistor network so that a constant-gain amplifier can be designed.

Step 3

Source and load impedances must be selected to provide the proper compensation of a constant power gain from 100 to 500 Mhz. Such a constant-gain amplifier is de-

signed according to the following:

- Plot s_{11}^* on the Smith chart. The magnitude of s_{11}^* is the linear distance measured from the center of the Smith chart. Radius from the center of the chart to any point on the locus of s_{11}^* represents a reflection coefficient r . The value of r can therefore be determined at any frequency by drawing a line from the origin of the chart to a value of s_{11}^* at the frequency of

Step 3

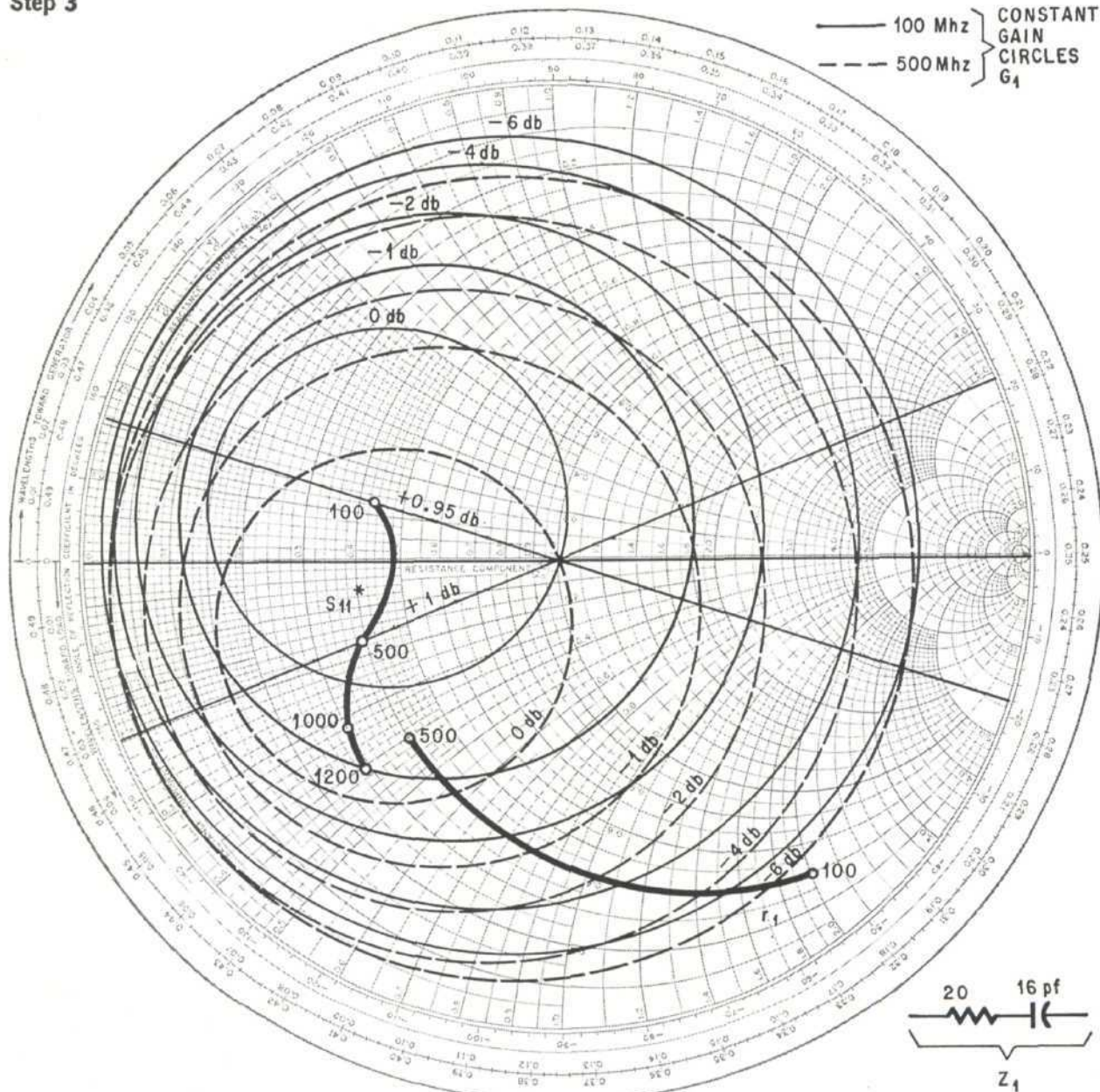

Source impedance is found by inspecting the input plane for realizable source loci that give proper gain. Phase angle is read on the peripheral scale "angle of reflection coefficient in degrees."

interest. The value of r is scaled proportionately with a maximum value of 1.0 at the periphery of the chart. The phase angle is read on the peripheral scale "angle of reflection coefficient in degrees." Constant-gain circles are plotted using equations 24 and 25 for G_1 . These correspond to values of 0, -1, -2, -4 and -6 decibels for s_{11} at 100 and 500 Mhz. Construction procedure is shown on page 83.

▪ Constant-gain circles for s_{22} at 100 and 500 Mhz are constructed similarly to that below.

▪ The gain G_0 drops from 20 db at 100 Mhz to 6 db at 500 Mhz, a net reduction of 14 db. It is desirable to find source and load impedances that will flatten this slope over this frequency range. For this case it is accomplished by choosing a value of r_1 and r_2 on the constant-gain circle at 100 Mhz, each corresponding to a loss of -7 db. If this value of r_1 and r_2 falls on circles of 0-db gain at 500 Mhz, the over-all gain will be:

$$\begin{aligned} \text{At 100 Mhz,} \\ G_T(\text{db}) &= G_0 + G_1 + G_2 \\ &= 20 - 7 - 7 = +6 \text{ db} \end{aligned}$$

At 500 Mhz,

$$G_T(\text{db}) = 6 + 0 + 0 = +6 \text{ db}$$

▪ A source impedance of 20 ohms resistance in series with 16 picofarads of capacitance is chosen. Its value is equal to $50(0.4 - j2)$ ohms at 100 Mhz. This point crosses the r_1 locus at about the -7 db constant-gain circle of G_1 as illustrated on page 83. At 500 Mhz this impedance combination equals $50(0.4 - j0.4)$ ohms and is located at approximately the +0.5 db constant-gain circle. The selection of source impedance is an iterative process of inspection of

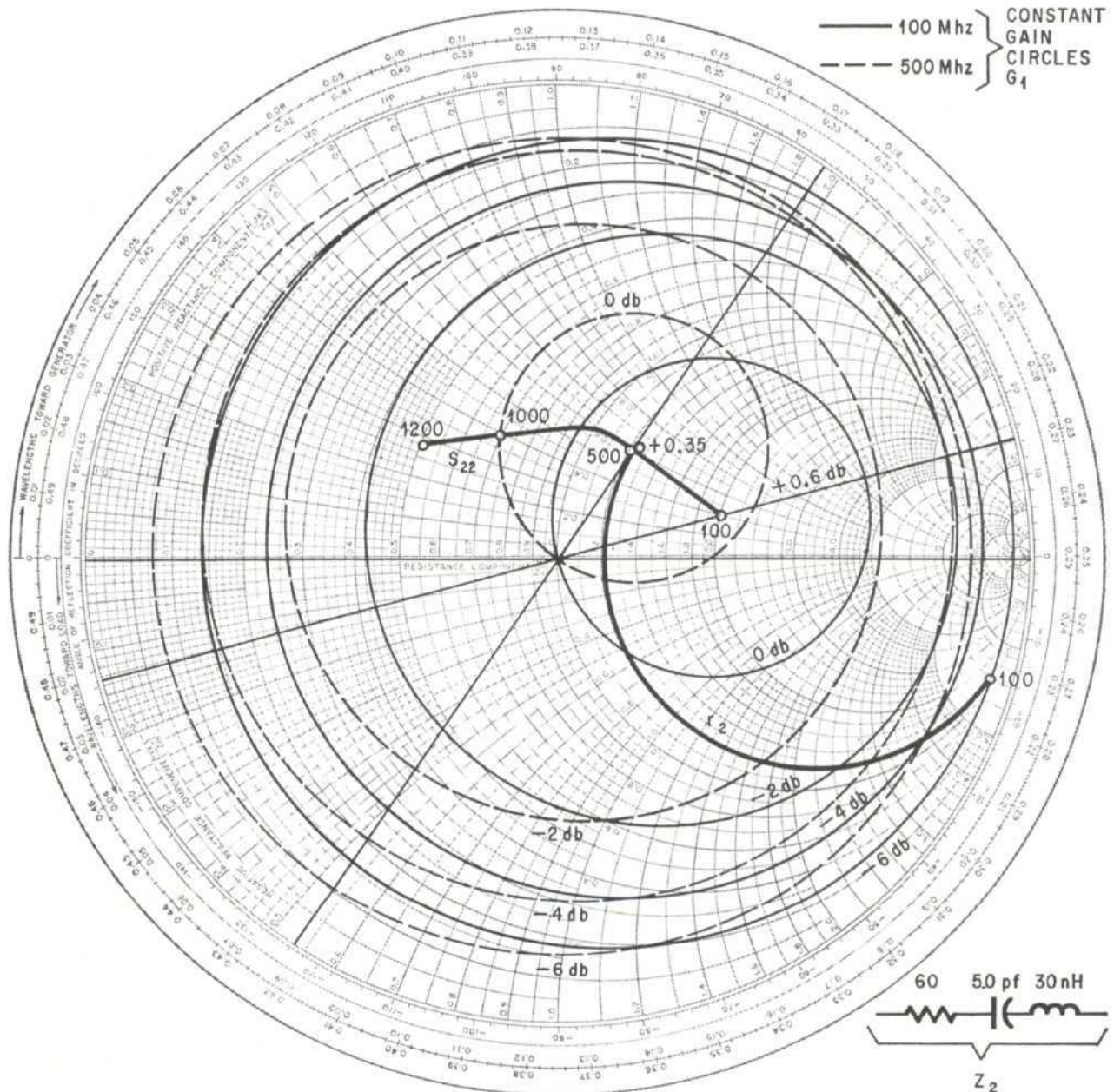

Load impedance is found by inspecting the output plane for loci that give proper gain.

the input r_1 plane on the Smith chart. The impedance values at various frequencies between 100 and 500 Mhz are tried until an impedance that corresponds to an approximate constant—gain circle necessary for constant power gain across the band is found.

- At the output port a G_2 of -6 db at 100 Mhz and $+0.35$ db at 500 Mhz is obtained by selecting a load impedance of 60 ohms in series with 5 pf and 30 nanohenries.

- The gain is:
At 100 Mhz,

$$G_T(\text{db}) = G_0 + G_1 + G_2$$

$$= 20 - 7 - 6 = +7 \text{ db}$$

At 500 Mhz,
 $6 + 0.5 + 0.35 = +6.85 \text{ db}$

Thus the 14-db variation from 100 to 500 Mhz is reduced to 0.15 db by selecting the proper source and load impedances.

Stability criterion. Important in the design of amplifiers is stability, or resistance to oscillation. Stability is determined for the unilateral case from the measured s parameters and the synthesized source and load impedances. Oscillations

are only possible if either the input or the output port, or both, have negative resistances. This occurs if s_{11} or s_{22} are greater than unity. However, even with negative resistances the amplifier might be stable. The condition for stability is that the locus of the sum of input plus source impedance, or output plus load impedance, does not include zero impedance from frequencies zero to infinity [shown in figure below]. The technique is similar to Nyquist's feedback stability criterion and has been derived directly from it.

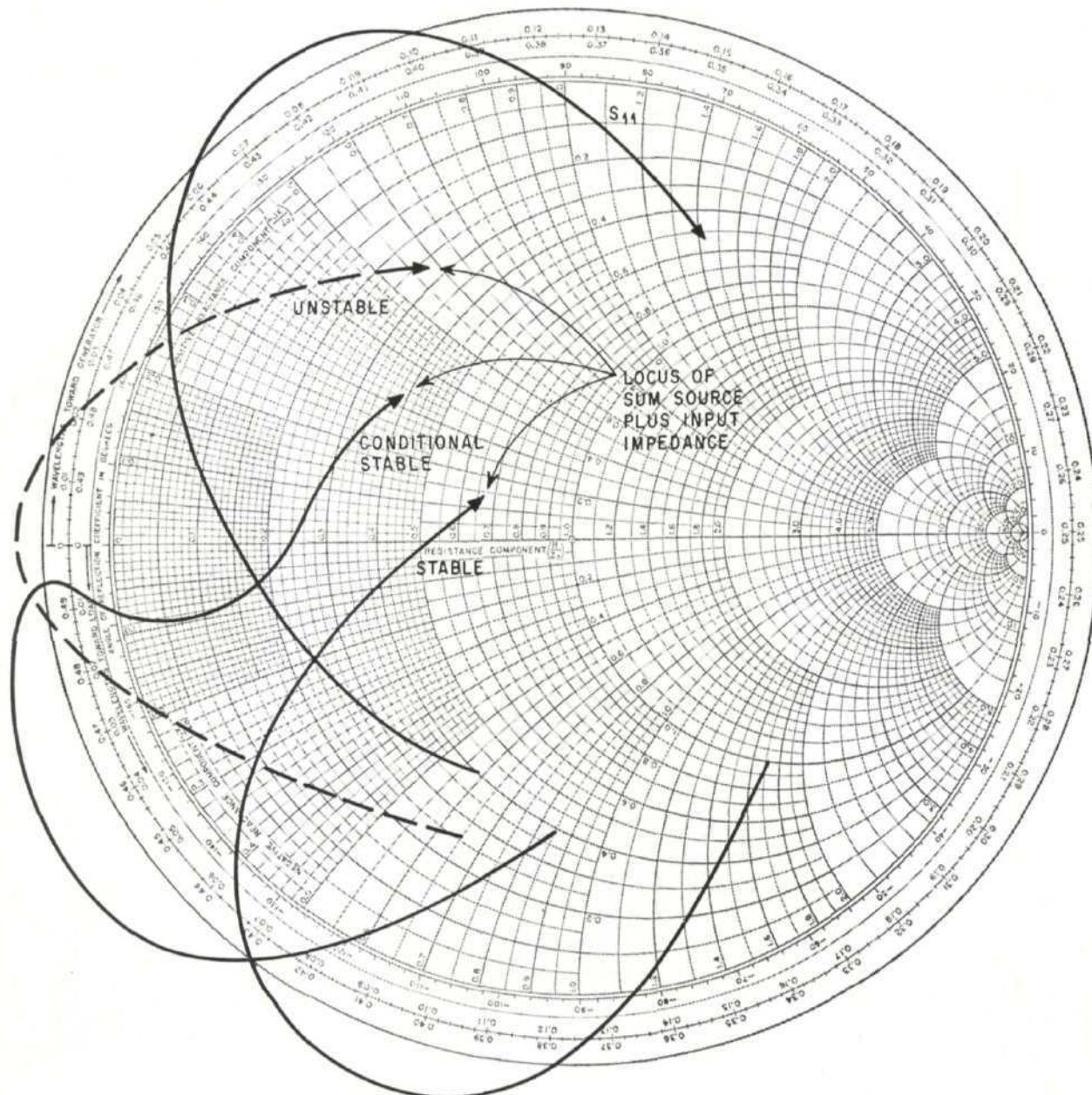

Amplifier stability is determined from scattering parameters and synthesized source and load impedances.

input cable L_1 (the length of the output cable has no influence). The scattering parameter s_{11} of the two-port is the same vector r_1 but turned at an angle $720^\circ L_1/\lambda$ in a counterclockwise direction.

Using the Smith chart

Many circuit designs require that the impedance of the port characterized by s_{11} or the reflection coefficient r be known. Since the s parameters are in units of reflection coefficient, they can be plotted directly on a Smith chart and easily manipulated to establish optimum gain with matching networks. The relationship between reflection coefficient r and the impedance R is

$$r = \frac{R - Z_0}{R + Z_0} \quad (16)$$

The Smith chart plots rectangular impedance coordinates in the reflection coefficient plane. When the s_{11} or s_{22} parameter is plotted on a Smith chart, the real and imaginary part of the impedance may be read directly.

It is also possible to chart equation 1 on polar

coordinates showing the magnitude and phase of the impedance R in the complex reflection coefficient plane. Such a plot is termed the Charter chart. Both charts are limited to impedances having positive resistances, $|r_1| < 1$. When measuring transistor parameters, impedances with negative resistances are sometimes found. Then, extended charts can be used.

Measurement of a device's s parameters provides data on input and output impedance and forward and reverse gain. In measuring, a device is inserted between known impedances, usually 50 ohms. In practice it may be desirable to achieve higher gain by changing source or load impedances or both.

An amplifier stage may now be designed in two steps. First, source and load impedances must be found that give the desired gain. Then the impedances must be synthesized, usually as matching networks between a fixed impedance source or between the load and the device [see block diagram top of p. 87].

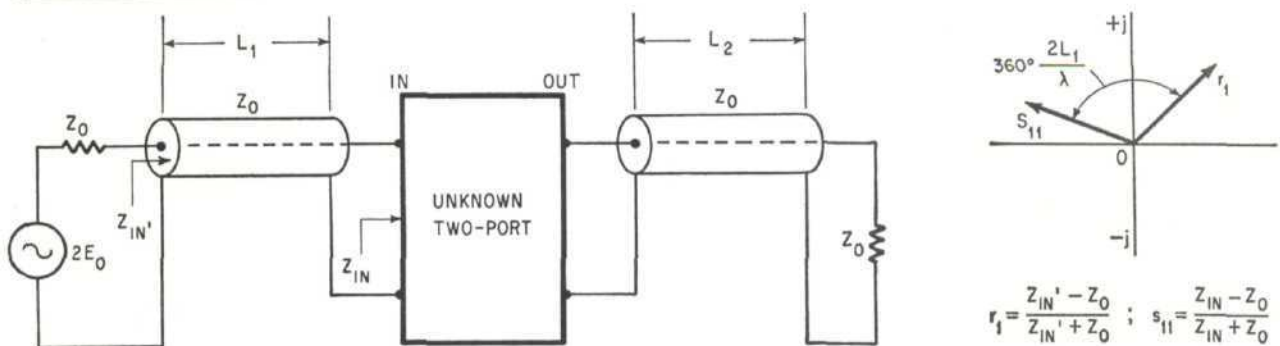
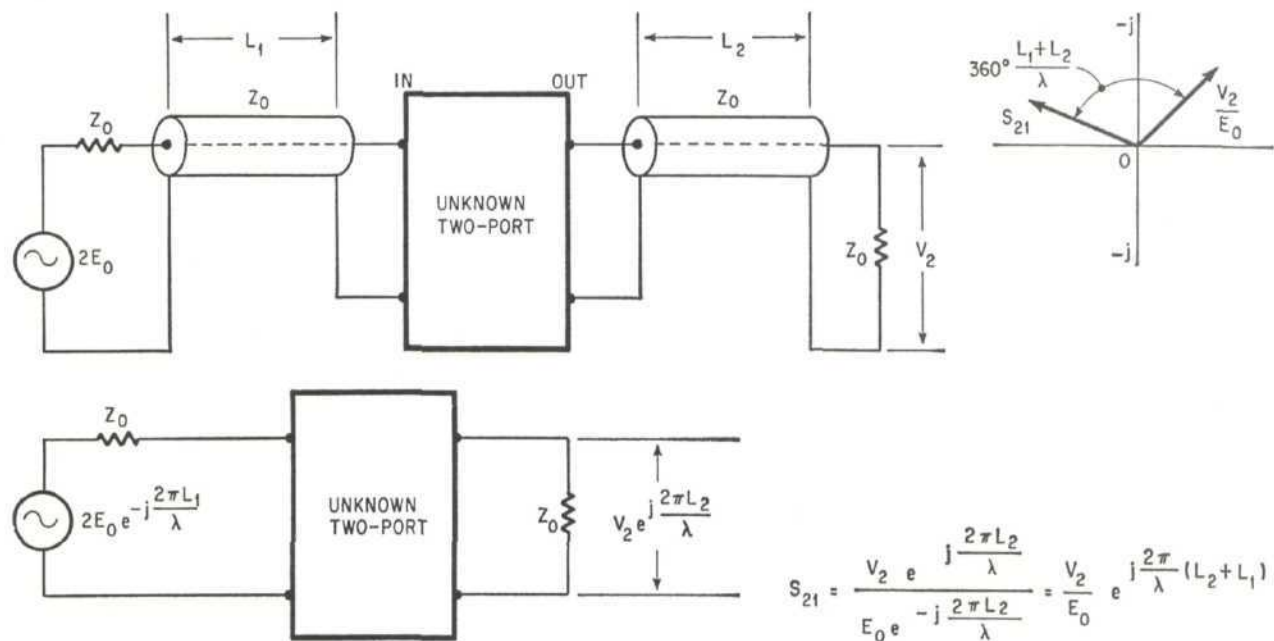

S parameters can be measured remotely. Top test setup is for measuring s_{21} ; bottom, for s_{11} . Measured vector V_2/E_0 is the voltage transducer gain of the two-port and cables L_1 and L_2 . The measured vector r_1 is the reflection coefficient of the two-port plus input cable $L_1 + L_2$. Appropriate vectors for r_1 and s parameters are plotted.

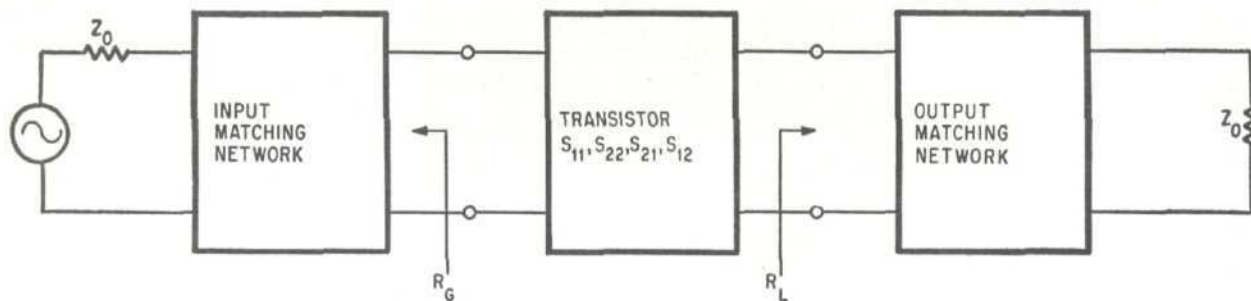

To design an amplifier stage, source and load impedances are found to give the gain desired. Then impedances are synthesized, usually as matching networks between a fixed impedance source or the load and the device. When using s parameters to design a transistor amplifier, it is advantageous to distinguish between a simplified or unilateral design for times when s_{12} can be neglected and when it must be used.

When designing a transistor amplifier with the aid of s parameters, it is advantageous to distinguish between a simplified or unilateral design for instances where the reverse-transmission parameter s_{12} can be neglected and the more general case in which s_{21} must be shown. The unilateral design is much simpler and is, for many applications, sufficient.

Unilateral-circuit definitions

Transducer power gain is defined as the ratio of amplifier output power to available source power.

$$G_T = \frac{I_2^2 \cdot R_{e2}}{E_0^2 / 4R_{e1}} \quad (17)$$

For the unilateral circuit G_T is expressed in terms of the scattering parameters s_{11} , s_{21} and s_{12} with $s_{12} = 0$.

$$G_T = G_0 \cdot G_1 \cdot G_2 \quad (18)$$

where:

$$G_0 = |s_{21}|^2 = \text{transducer power gain for } R_1 = Z_0 = R_2 \quad (19)$$

$$G_1 = \frac{|1 - |r_1|^2|}{|1 - r_1 s_{11}|^2} \quad (20)$$

= power gain contribution from change of source impedance from Z_0 to R_1

$$r_1 = \frac{R_1 - Z_0}{R_1 + Z_0} \quad (21)$$

= reflection coefficient of source impedance with respect to Z_0

$$G_2 = \frac{|1 - |r_2|^2|}{|1 - r_2 s_{22}|^2} \quad (22)$$

= power gain contribution from change of load impedance from Z_0 to R_2

$$r_2 = \frac{R_2 - Z_0}{R_2 + Z_0} \quad (23)$$

= reflection coefficient of load impedance with respect to Z_0

In designing an amplifier stage the graphical procedure shown at the bottom is helpful. The measured values of parameter s_{11} and its complex conjugate s_{11}^* are plotted on the Smith chart together with radius distances. Center of the constant-gain circles located on the line through s_{11}^* and the origin at a distance

$$r_{01} = \frac{G_1}{G_{1 \max}} \left[\frac{|s_{11}|}{1 - |s_{11}|^2 (1 - G_1/G_{1 \max})} \right] \quad (24)$$

The radius of circles on which G_1 is constant is

$$\rho_{01} = \frac{\sqrt{1 - G_1/G_{1 \max}} (1 - |s_{11}|^2)}{1 - |s_{11}|^2 (1 - G_1/G_{1 \max})} \quad (25)$$

If the source reflection coefficient r_1 is made equal

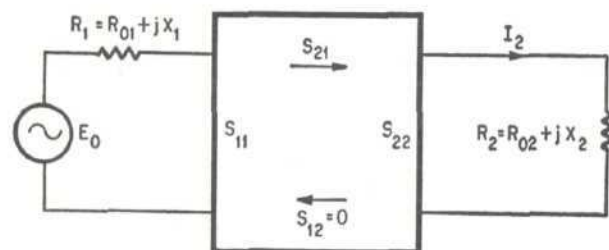

The two-port network is terminated at the ports by impedances containing resistance and reactance. Expressions for the transducer power gain can then be derived in terms of the scattering parameters.

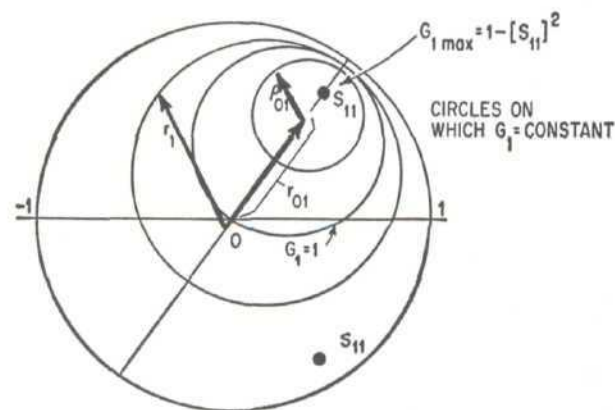

A graphical plot helps in design of an amplifier stage. Here the measured parameters s_{11} and s_{11}^* are plotted on a Smith chart. The upper point is s_{11}^* .

to s_{11}° , then the generator is matched to the load and the gain becomes maximum (G_{1max}). Constant-gain circles can be constructed, as shown, in 1- or 2-decibel increments or whatever is practical using equations 9 and 10.

If the source impedance R_1 or its reflection coefficient is plotted, the gain contribution G_1 is read directly from the gain circles. The same method is used to determine G_2 by plotting s_{22} , s_{22}° , constant-gain circles and r_2 .

Examples for the design procedure are given in greater detail in Transistor Parameter Measurements, Hewlett-Packard Application Note 77-1. The procedure is outlined in "Amplifier design with unilateral s parameters," beginning on page 82.

Measuring s parameters

S-parameter measurements of small-signal transistors require fairly sensitive measuring equipment. The input signal often cannot exceed 10 millivolts root mean square. On the other hand, wide frequency ranges are required as well as fast and easy operation. Recent advantages in measuring equipment have provided a fast and accurate measuring system. It is based on the use of a newly developed instrument, the H-P sampling vector voltmeter 8405A [see photo p. 81], and couplers.

The vector voltmeter covers a frequency range of 1 to 1,000 Mhz, a voltage measurement range of 100 microvolts full scale and a phase range of $\pm 180^\circ$ with 0.1° resolution. It is tuned automatically by means of a phase-locked loop.

Directional couplers are used to measure reflection coefficients and impedances. A directional coupler consists of a pair of parallel transmission lines that exhibit a magnetic and electric coupling between them. One, called the main line, is connected to the generator and load to be measured. Measurement is taken at the output of the other, called the auxiliary line. Both lines are built to have a well defined characteristic impedance; 50 ohms is usual. The voltage coupled into the auxiliary line consists of components proportional to the voltage and current in the main line. The coupling is arranged so that both components are equal in magnitude when the load impedance equals the characteristic impedance of the line.

Directional couplers using two auxiliary lines in reverse orientation are called dual-directional couplers. A feature of the unit is a movable reference plane; the point where the physical measurement is taken can be moved along the line connecting the coupler with the unknown load. A line stretcher is connected to the output of the first auxiliary line.

The reference plane is set closer to the transistor package than the minimum lead length used with the transistor. Additional lead length is then considered part of the matching networks. The influence of lead length is also measured by changing the location of the reference plane.

Measurement of s_{11} parameter is made when the instrument is switched to one of two positions. The quotient V_B/V_A equals the magnitude of s_{11} . Its

phase is read directly on the 8405A meter. When switched to the alternate position, the s_{21} parameter is read directly from the same ratio.

Accuracy and limitations

When measuring small-signal scattering parameters, a-c levels beyond which the device is considered linear must not be exceeded. In a grounded-emitter or grounded-base configuration, input voltage is limited to about 10 millivolts rms maximum (when measuring s_{11} and s_{21}). Much higher voltages can be applied when measuring s_{22} and s_{12} parameters. In uncertain cases linearity is checked by taking the same measurements at a sampling of several different levels.

The system shown is inherently broadband. Frequency is not necessarily limited by the published range of the dual directional couplers. The coupling factor K falls off inversely with frequency below the low-frequency limit of a coupler. The factor K does not appear in the result as long as it is the same for each auxiliary port. Since construction of couplers guarantees this to a high degree, measurements can be made at lower frequencies than are specified for the coupler.

The system's measurement accuracy depends on the accuracy of the vector voltmeter and the couplers. Although it is possible to short circuit the reference planes of the transistors at each frequency, it is not desirable for fast measurements. Hence, broadband tracking of all auxiliary arms of the couplers and tracking of both channels of the vector voltmeter are important. Tracking errors are within about 0.5 db of magnitude and $\pm 3^\circ$ of phase over wide frequency bands. Accuracy of measuring impedances expressed by s_{11} and s_{22} degrade for resistances and impedances having a high reactive component. This is because s_{11} or s_{22} are very close to unity. These cases are usually confined to lower frequencies.

Bibliography

- Charter, P.S., "Charts for Transmission-Line Measurements and Computations," Radio Corp. of America Review, Vol. III, No. 3, January, 1939, pp. 355-368.
- Smith, P.H., "An Improved Transmission Line Calculator," Electronics, January, 1944, pp. 130-325.
- Alsbet, D.A., "A Precise Sweep-Frequency Method of Vector Impedance Measurement," Proceedings of the IRE, November, 1951, pp. 1393-1400.
- Follingstad, H.G., "Complete Linear Characterization of Transistors from Low through Very High Frequencies," IRE Transactions on Instruments, March, 1957, pp. 49-63.
- General Radio Experimenter, "Type 1607-A Transfer-Function and Impedance Bridge," May, 1959, pp. 3-11. General Radio Experimenter, "Mounts for Transistor Measurements with the Transfer-Function Bridge," February-March, 1965, pp. 16-19.
- Mathis, H.F., "Extended Transmission-line Charts," Electronics, Sept. 23, 1960, pp. 76-78.
- Leed, D., and O. Kummer, "A Loss and Phase Set for Measuring Transistor Parameters and Two-Port Networks Between 5 and 250 Mc.," Bell System Technical Journal, May, 1961, pp. 841-884.
- Kurokawa, K., "Power Waves and the Scattering Matrix," Institute of Electronic and Electrical Engineers Transactions Microwave Theory and Techniques, March, 1965, pp. 194-202.
- Leed, D., "An Insertion Loss, Phase and Delay Measuring Set for Characterizing Transistors and Two-Port Networks between 0.25 and 4.2 Gc.," Bell System Technical Journal, March, 1966, pp. 340-397.
- Hewlett-Packard Journal, "The RF Vector Voltmeter," Vol. 17, No. 9, May, 1966, pp. 2-12.

SECTION III

S-PARAMETER TECHNIQUES FOR FASTER, MORE ACCURATE NETWORK DESIGN

Richard W. Anderson describes s parameters and flowgraphs and then relates them to more familiar concepts such as transducer power gain and voltage gain. He takes swept-frequency data obtained with a network analyzer and uses it to design amplifiers. He shows how to calculate the error caused by assuming the transistor is unilateral. Both narrow band and broad band amplifier designs are discussed. Stability criteria are also considered.

Two-Port Network Theory	3-1
S Parameters	3-2
Definition	3-2
Relation to Power Gains	3-3
Network Calculations with Scattering Parameters	3-3
Signal Flowgraphs	3-4
Nontouching Loop Rule	3-4
Transducer Power Gain	3-4
Power Absorbed by Load	3-4
Power Available from Source	3-4
Measurement of S Parameters	3-5
Narrowband Amplifier Design	3-6
Broadband Amplifier Design	3-7
Stability Considerations and the Design of Reflection Amplifiers and Oscillators	3-9
Useful Scattering Parameter Relationships	3-11

S-Parameter Techniques for Faster, More Accurate Network Design

LINEAR NETWORKS, OR NONLINEAR NETWORKS operating with signals sufficiently small to cause the networks to respond in a linear manner, can be completely characterized by parameters measured at the network terminals (ports) without regard to the contents of the networks. Once the parameters of a network have been determined, its behavior in any external environment can be predicted, again without regard to the specific contents of the network. The new microwave network analyzer described in the article beginning on p. 2 characterizes networks by measuring one kind of parameters, the scattering parameters, or s-parameters.

S-parameters are being used more and more in microwave design because they are easier to measure and work with at high frequencies than other kinds of parameters. They are conceptually simple, analytically convenient, and capable of providing a surprising degree of insight into a measurement or design problem. For these reasons, manufacturers of high-frequency transistors and other solid-state devices are finding it more meaningful to specify their products in terms of s-parameters than in any other way. How s-parameters can simplify microwave design problems, and how a designer can best take advantage of their abilities, are described in this article.

Two-Port Network Theory

Although a network may have any number of ports, network parameters can be explained most easily by considering a network with only two ports, an input port and an output port, like the network shown in Fig. 1. To characterize the performance of such a network, any of several parameter sets can be used, each of which has certain advantages.

Each parameter set is related to a set of four variables associated with the two-port model. Two of these variables represent the excitation of the network (independent variables), and the remaining two represent the response of the network to the excitation (dependent variables). If the network of Fig. 1 is excited by voltage sources V_1 and V_2 , the

network currents I_1 and I_2 will be related by the following equations (assuming the network behaves linearly):

$$I_1 = y_{11}V_1 + y_{12}V_2 \quad (1)$$

$$I_2 = y_{21}V_1 + y_{22}V_2 \quad (2)$$

In this case, with port voltages selected as independent variables and port currents taken as dependent variables, the relating parameters are called short-circuit admittance parameters, or y-parameters. In the absence of additional information, four measurements are required to determine the four parameters y_{11} , y_{21} , y_{12} , and y_{22} . Each measurement is made with one port of the network excited by a voltage source while the other port is short circuited. For example, y_{21} , the forward transadmittance, is the ratio of the current at port 2 to the voltage at port 1 with port 2 short circuited as shown in equation 3.

$$y_{21} = \left. \frac{I_2}{V_1} \right|_{V_2 = 0} \text{ (output short circuited)} \quad (3)$$

If other independent and dependent variables had been chosen, the network would have been described, as before, by two linear equations similar to equations 1 and 2, except that the variables and the parameters describing their relationships would be different. However, all parameter sets contain the same information about a network, and it is always possible to calculate any set in terms of any other set.

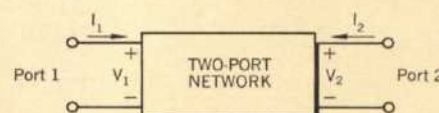

Fig. 1. General two-port network.

S-Parameters

The ease with which scattering parameters can be measured makes them especially well suited for describing transistors and other active devices. Measuring most other parameters calls for the input and output of the device to be successively opened and short circuited. This is difficult to do even at RF frequencies where lead inductance and capacitance make short and open circuits difficult to obtain. At higher frequencies these measurements typically require tuning stubs, separately adjusted at each measurement frequency, to reflect short or open circuit conditions to the device terminals. Not only is this inconvenient and tedious, but a tuning stub shunting the input or output may cause a transistor to oscillate, making the measurement difficult and invalid. S-parameters, on the other hand, are usually measured with the device imbedded between a 50Ω load and source, and there is very little chance for oscillations to occur.

Another important advantage of s-parameters stems from the fact that traveling waves, unlike terminal voltages and currents, do not vary in magnitude at points along a lossless transmission line. This means that scattering parameters can be measured on a device located at some distance from the measurement transducers, provided that the measuring device and the transducers are connected by low-loss transmission lines.

Generalized scattering parameters have been defined by K. Kurokawa.¹ These parameters describe the interrelationships of a new set of variables (a_i , b_i). The variables a_i and b_i are normalized complex voltage waves incident on and reflected from the i^{th} port of the network. They are defined in terms of the terminal voltage V_i , the terminal current I_i , and an arbitrary reference impedance Z_i , as follows

¹ K. Kurokawa, 'Power Waves and the Scattering Matrix,' IEEE Transactions on Microwave Theory and Techniques, Vol. MTT-13, No. 2, March, 1965.

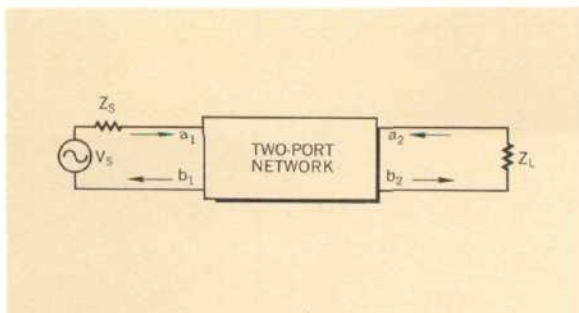

Fig. 2. Two-port network showing incident (a_1 , a_2) and reflected (b_1 , b_2) waves used in s-parameter definitions.

$$a_i = \frac{V_i + Z_i I_i}{2\sqrt{\text{Re } Z_i}} \quad (4)$$

$$b_i = \frac{V_i - Z_i^* I_i}{2\sqrt{\text{Re } Z_i}} \quad (5)$$

where the asterisk denotes the complex conjugate.

For most measurements and calculations it is convenient to assume that the reference impedance Z_i is positive and real. For the remainder of this article, then, all variables and parameters will be referenced to a single positive real impedance Z_0 .

The wave functions used to define s-parameters for a two-port network are shown in Fig. 2. The independent variables a_1 and a_2 are normalized incident voltages, as follows:

$$a_1 = \frac{V_1 + I_1 Z_0}{2\sqrt{Z_0}} = \frac{\text{voltage wave incident on port 1}}{\sqrt{Z_0}} = \frac{V_{1i}}{\sqrt{Z_0}} \quad (6)$$

$$a_2 = \frac{V_2 + I_2 Z_0}{2\sqrt{Z_0}} = \frac{\text{voltage wave incident on port 2}}{\sqrt{Z_0}} = \frac{V_{2i}}{\sqrt{Z_0}} \quad (7)$$

Dependent variables b_1 and b_2 are normalized reflected voltages:

$$b_1 = \frac{V_1 - I_1 Z_0}{2\sqrt{Z_0}} = \frac{\text{voltage wave reflected (or emanating) from port 1}}{\sqrt{Z_0}} = \frac{V_{r1}}{\sqrt{Z_0}} \quad (8)$$

$$b_2 = \frac{V_2 - I_2 Z_0}{2\sqrt{Z_0}} = \frac{\text{voltage wave reflected (or emanating) from port 2}}{\sqrt{Z_0}} = \frac{V_{r2}}{\sqrt{Z_0}} \quad (9)$$

The linear equations describing the two-port network are then:

$$b_1 = s_{11}a_1 + s_{12}a_2 \quad (10)$$

$$b_2 = s_{21}a_1 + s_{22}a_2 \quad (11)$$

The s-parameters s_{11} , s_{22} , s_{21} , and s_{12} are:

$$s_{11} = \left. \frac{b_1}{a_1} \right|_{a_2=0} = \text{Input reflection coefficient with the output port terminated by a matched load } (Z_L = Z_0 \text{ sets } a_2 = 0). \quad (12)$$

$$s_{22} = \left. \frac{b_2}{a_2} \right|_{a_1=0} = \text{Output reflection coefficient with the input terminated by a matched load } (Z_S = Z_0 \text{ and } V_S = 0). \quad (13)$$

$$s_{21} = \left. \frac{b_2}{a_1} \right|_{a_2 = 0} = \text{Forward transmission (insertion) gain with the output port terminated in a matched load.} \quad (14)$$

$$s_{12} = \left. \frac{b_1}{a_2} \right|_{a_1 = 0} = \text{Reverse transmission (insertion) gain with the input port terminated in a matched load.} \quad (15)$$

Notice that

$$s_{11} = \frac{b_1}{a_1} = \frac{\frac{V_1}{I_1} - Z_0}{\frac{V_1}{I_1} + Z_0} = \frac{Z_1 - Z_0}{Z_1 + Z_0} \quad (16)$$

$$\text{and} \quad Z_1 = Z_0 \frac{(1 + s_{11})}{(1 - s_{11})} \quad (17)$$

where $Z_1 = \frac{V_1}{I_1}$ is the input impedance at port 1.

This relationship between reflection coefficient and impedance is the basis of the Smith Chart transmission-line calculator. Consequently, the reflection coefficients s_{11} and s_{22} can be plotted on Smith charts, converted directly to impedance, and easily manipulated to determine matching networks for optimizing a circuit design.

The above equations show one of the important advantages of s-parameters, namely that they are simply gains and reflection coefficients, both familiar quantities to engineers. By comparison, some of the y-parameters described earlier in this article are not so familiar. For example, the y-parameter corresponding to insertion gain s_{21} is the 'forward transadmittance' y_{21} given by equation 3. Clearly, insertion gain gives by far the greater insight into the operation of the network.

Another advantage of s-parameters springs from the simple relationships between the variables a_1 , a_2 , b_1 , and b_2 , and various power waves:

$$|a_1|^2 = \text{Power incident on the input of the network.} \\ = \text{Power available from a source of impedance } Z_0.$$

$$|a_2|^2 = \text{Power incident on the output of the network.} \\ = \text{Power reflected from the load.}$$

$$|b_1|^2 = \text{Power reflected from the input port of the network.} \\ = \text{Power available from a } Z_0 \text{ source minus the power delivered to the input of the network.}$$

$$|b_2|^2 = \text{Power reflected or emanating from the output of the network.} \\ = \text{Power incident on the load.} \\ = \text{Power that would be delivered to a } Z_0 \text{ load.}$$

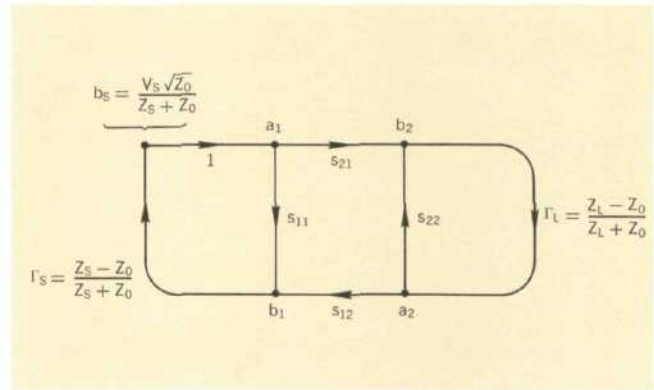

Fig. 3. Flow graph of network of Fig. 2.

Hence s-parameters are simply related to power gain and mismatch loss, quantities which are often of more interest than the corresponding voltage functions:

$$|s_{11}|^2 = \frac{\text{Power reflected from the network input}}{\text{Power incident on the network input}}$$

$$|s_{22}|^2 = \frac{\text{Power reflected from the network output}}{\text{Power incident on the network output}}$$

$$|s_{21}|^2 = \frac{\text{Power delivered to a } Z_0 \text{ load}}{\text{Power available from } Z_0 \text{ source}} \\ = \text{Transducer power gain with } Z_0 \text{ load and source}$$

$$|s_{12}|^2 = \text{Reverse transducer power gain with } Z_0 \text{ load and source.}$$

Network Calculations with Scattering Parameters

Scattering parameters turn out to be particularly convenient in many network calculations. This is especially true for power and power gain calculations. The transfer parameters s_{12} and s_{21} are a measure of the complex insertion gain, and the driving point parameters s_{11} and s_{22} are a measure of the input and output mismatch loss. As dimensionless expressions of gain and reflection, the parameters not only give a clear and meaningful physical interpretation of the network

performance but also form a natural set of parameters for use with signal flow graphs^{2,3}. Of course, it is not necessary to use signal flow graphs in order to use s-parameters, but flow graphs make s-parameter calculations extremely simple, and I recommend them very strongly. Flow graphs will be used in the examples that follow.

In a signal flow graph each port is represented by two nodes. Node a_n represents the wave coming into the device from another device at port n and node b_n represents the wave leaving the device at port n . The complex scattering coefficients are then represented as multipliers on branches connecting the nodes within the network and in adjacent networks. Fig. 3 is the flow graph representation of the system of Fig. 2.

Fig. 3 shows that if the load reflection coefficient Γ_L is zero ($Z_L = Z_0$) there is only one path connecting b_1 to a_1 (flow graph rules prohibit signal flow against the forward direction of a branch arrow). This confirms the definition of s_{11} :

$$s_{11} = \frac{b_1}{a_1} \Big|_{a_2 = \Gamma_L b_2 = 0}$$

The simplification of network analysis by flow graphs results from the application of the "non-touching loop rule." This rule applies a generalized formula to determine the transfer function between any two nodes within a complex system. The non-touching loop rule is explained in footnote 4.

² J. K. Hunton, 'Analysis of Microwave Measurement Techniques by Means of Signal Flow Graphs,' IRE Transactions on Microwave Theory and Techniques, Vol. MTT-8, No. 2, March, 1960.

³ N. Kuhn, 'Simplified Signal Flow Graph Analysis,' Microwave Journal, Vol. 6, No. 11, Nov., 1963.

⁴ The nontouching loop rule provides a simple method for writing the solution of any flow graph by inspection. The solution T (the ratio of the output variable to the input variable) is

$$T = \frac{\sum_k T_k \Delta_k}{\Delta}$$

where T_k = path gain of the k^{th} forward path

$$\Delta = 1 - (\text{sum of all individual loop gains}) + (\text{sum of the loop gain products of all possible combinations of two nontouching loops}) - (\text{sum of the loop gain products of all possible combinations of three nontouching loops}) + \dots$$

$$\Delta_k = \text{The value of } \Delta \text{ not touching the } k^{\text{th}} \text{ forward path.}$$

A path is a continuous succession of branches, and a forward path is a path connecting the input node to the output node, where no node is encountered more than once. Path gain is the product of all the branch multipliers along the path. A loop is a path which originates and terminates on the same node, no node being encountered more than once. Loop gain is the product of the branch multipliers around the loop.

For example, in Fig. 3 there is only one forward path from b_2 to b_1 and its gain is s_{21} . There are two paths from b_2 to b_1 ; their path gains are $s_{21}s_{12}\Gamma_L$ and s_{11} , respectively. There are three individual loops, only one combination of two nontouching loops, and no combinations of three or more nontouching loops; therefore, the value of Δ for this network is

$$\Delta = 1 - (s_{11}\Gamma_S + s_{21}s_{12}\Gamma_L\Gamma_S + s_{22}\Gamma_L) + (s_{11}s_{22}\Gamma_L\Gamma_S)$$

The transfer function from b_2 to b_1 is therefore

$$\frac{b_1}{b_2} = \frac{s_{21}}{\Delta}$$

Using scattering parameter flow-graphs and the non-touching loop rule, it is easy to calculate the transducer power gain with arbitrary load and source. In the following equations the load and source are described by their reflection coefficients Γ_L and Γ_S , respectively, referenced to the real characteristic impedance Z_0 .

Transducer power gain

$$G_T = \frac{\text{Power delivered to the load}}{\text{Power available from the source}} = \frac{P_L}{P_{avs}}$$

$$P_L = P(\text{incident on load}) - P(\text{reflected from load}) \\ = |b_2|^2 (1 - |\Gamma_L|^2)$$

$$P_{avs} = \frac{|b_s|^2}{(1 - |\Gamma_S|^2)}$$

$$G_T = \left| \frac{b_2}{b_s} \right|^2 (1 - |\Gamma_S|^2) (1 - |\Gamma_L|^2)$$

Using the non-touching loop rule,

$$\frac{b_2}{b_s} = \frac{s_{21}}{1 - s_{11}\Gamma_S - s_{22}\Gamma_L - s_{21}s_{12}\Gamma_L\Gamma_S + s_{11}\Gamma_S s_{22}\Gamma_L} \\ = \frac{s_{21}}{(1 - s_{11}\Gamma_S)(1 - s_{22}\Gamma_L) - s_{21}s_{12}\Gamma_L\Gamma_S} \\ G_T = \frac{|s_{21}|^2 (1 - |\Gamma_S|^2) (1 - |\Gamma_L|^2)}{|(1 - s_{11}\Gamma_S)(1 - s_{22}\Gamma_L) - s_{21}s_{12}\Gamma_L\Gamma_S|^2} \quad (18)$$

Two other parameters of interest are:

1) Input reflection coefficient with the output termination arbitrary and $Z_S = Z_0$.

$$s'_{11} = \frac{b_1}{a_1} = \frac{s_{11}(1 - s_{22}\Gamma_L) + s_{21}s_{12}\Gamma_L}{1 - s_{22}\Gamma_L} \\ = s_{11} + \frac{s_{21}s_{12}\Gamma_L}{1 - s_{22}\Gamma_L} \quad (19)$$

2) Voltage gain with arbitrary source and load impedances

$$A_V = \frac{V_2}{V_1} \quad V_1 = (a_1 + b_1) \sqrt{Z_0} = V_{11} + V_{r1} \\ V_2 = (a_2 + b_2) \sqrt{Z_0} = V_{12} + V_{r2} \\ a_2 = \Gamma_L b_2 \\ b_1 = s'_{11} a_1 \\ A_V = \frac{b_2(1 + \Gamma_L)}{a_1(1 + s'_{11})} = \frac{s_{21}(1 + \Gamma_L)}{(1 - s_{22}\Gamma_L)(1 + s'_{11})} \quad (20)$$

On p. 23 is a table of formulas for calculating many often-used network functions (power gains, driving point characteristics, etc.) in terms of scattering parameters. Also included in the table are conversion formulas between s-parameters and h-, y-, and z-parameters, which are other parameter sets used very often for specifying transistors at

Fig. 4. *S* parameters of 2N3478 transistor in common-emitter configuration, measured by *-hp-* Model 8410A Network Analyzer. (a) s_{11} . Outermost circle on Smith Chart overlay corresponds to $|s_{11}| = 1$. (b) s_{22} . Scale factor same as (a). (c) s_{12} . (d) s_{21} . (e) s_{21} with line stretcher adjusted to remove linear phase shift above 500 MHz.

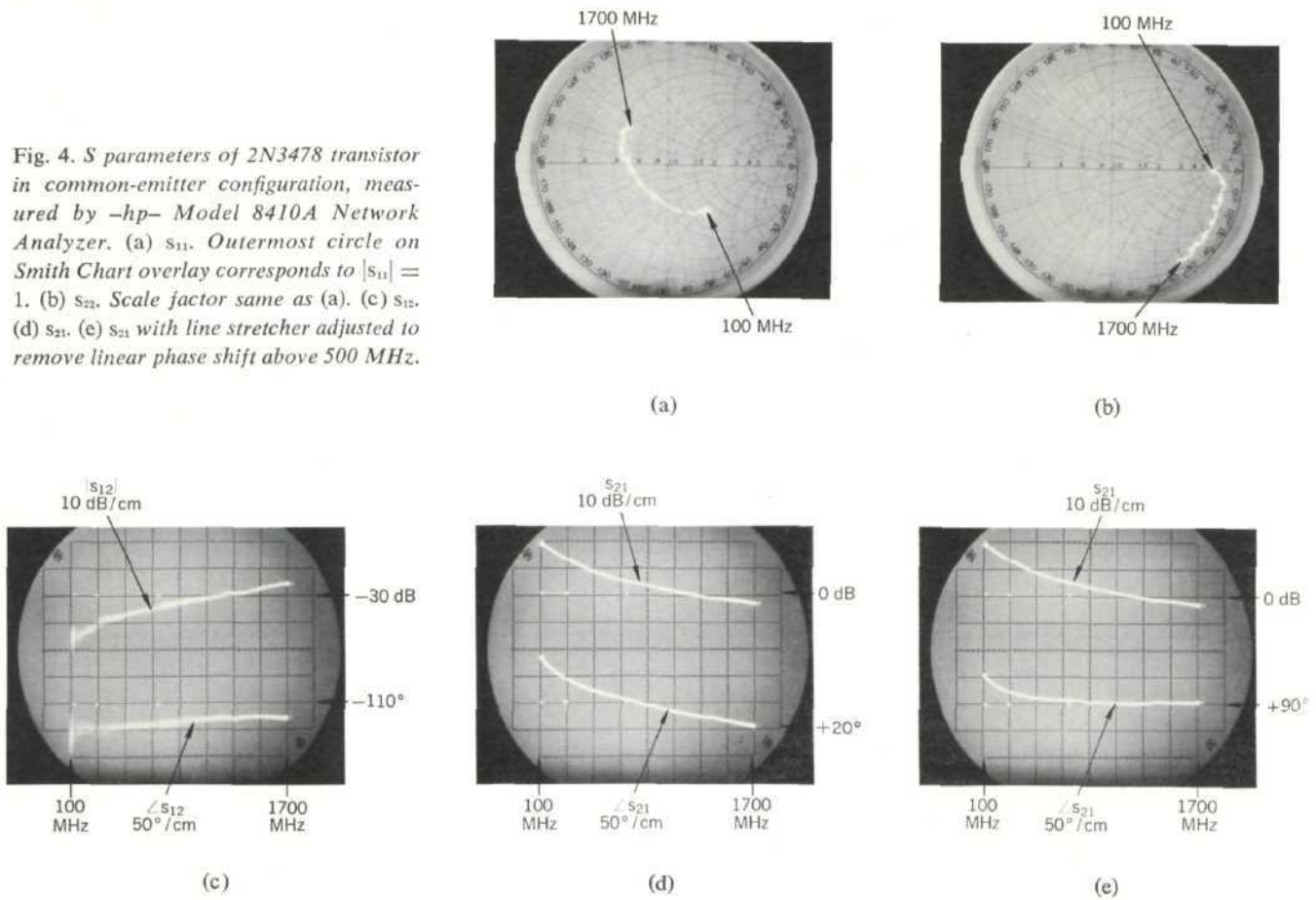

lower frequencies. Two important figures of merit used for comparing transistors, f_t and f_{max} , are also given, and their relationship to *s*-parameters is indicated.

Amplifier Design Using Scattering Parameters

The remainder of this article will show by several examples how *s*-parameters are used in the design of transistor amplifiers and oscillators. To keep the discussion from becoming bogged down in extraneous details, the emphasis in these examples will be on *s*-parameter design methods, and mathematical manipulations will be omitted wherever possible.

Measurement of S-Parameters

Most design problems will begin with a tentative selection of a device and the measurement of its *s*-parameters. Fig. 4 is a set of oscillograms containing complete *s*-parameter data for a 2N3478 transistor in the common-emitter configuration. These oscillograms are the results of swept-frequency measurements made with the new microwave network analyzer described elsewhere in this issue. They represent the actual *s*-parameters of this transistor between 100 MHz and 1700 MHz.

In Fig. 5, the magnitude of s_{21} from Fig. 4(d) is replotted on a logarithmic frequency scale, along with additional data on s_{21} below 100 MHz, measured with a vector voltmeter. The magnitude of s_{21} is essentially constant to 125 MHz, and then rolls off at a slope of 6 dB/octave. The phase angle

of s_{21} , as seen in Fig. 4(d), varies linearly with frequency above about 500 MHz. By adjusting a calibrated line stretcher in the network analyzer, a compensating linear phase shift was introduced, and the phase curve of Fig. 4(e) resulted. To go from the phase curve of Fig. 4(d) to that of Fig. 4(e) required 3.35 cm of line, equivalent to a pure time delay of 112 picoseconds.

After removal of the constant-delay, or linear-phase, component, the phase angle of s_{21} for this transistor [Fig. 4(e)] varies from 180° at dc to $+90^\circ$ at high frequencies, passing through $+135^\circ$ at 125 MHz, the -3 dB point of the magnitude curve. In other words, s_{21} behaves like a single pole in the frequency domain, and it is possible to write a closed expression for it. This expression is

$$s_{21} = \frac{-s_{210}e^{-j\omega T_0}}{1 + j\frac{\omega}{\omega_0}} \quad (21)$$

where

$$\begin{aligned} T_0 &= 112 \text{ ps} \\ \omega &= 2\pi f \\ \omega_0 &= 2\pi \times 125 \text{ MHz} \\ s_{210} &= 11.2 = 21 \text{ dB} \end{aligned}$$

The time delay $T_0 = 112$ ps is due primarily to the transit time of minority carriers (electrons) across the base of this npn transistor.

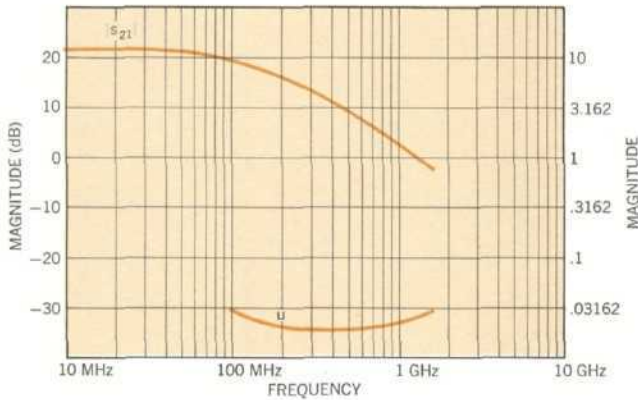

Fig. 5. Top curve: $|s_{21}|$ from Fig. 4 replotted on logarithmic frequency scale. Data below 100 MHz measured with *-hp-8405A Vector Voltmeter*. Bottom curve: unilateral figure of merit u , calculated from s parameters (see text).

Narrow-Band Amplifier Design

Suppose now that this 2N3478 transistor is to be used in a simple amplifier, operating between a 50Ω source and a 50Ω load, and optimized for power gain at 300 MHz by means of lossless input and output matching networks. Since reverse gain s_{12} for this transistor is quite small — 50 dB smaller than forward gain s_{21} , according to Fig. 4 — there is a possibility that it can be neglected. If this is so, the design problem will be much simpler, because setting s_{12} equal to zero will make the design equations much less complicated.

In determining how much error will be introduced by assuming $s_{12} = 0$, the first step is to calculate the unilateral figure of merit u , using the formula given in the table on p. 23, i.e.

$$u = \frac{|s_{11}s_{12}s_{21}s_{22}|}{|1 - |s_{11}|^2| |1 - |s_{22}|^2|} \quad (22)$$

A plot of u as a function of frequency, calculated from the measured parameters, appears in Fig. 5. Now if G_{Tu} is the transducer power gain with $s_{12} = 0$ and G_T is the actual transducer power gain, the maximum error introduced by using G_{Tu} instead of G_T is given by the following relationship:

$$\frac{1}{(1+u)^2} < \frac{G_T}{G_{Tu}} < \frac{1}{(1-u)^2} \quad (23)$$

From Fig. 5, the maximum value of u is about 0.03, so the maximum error in this case turns out to be about ± 0.25 dB at 100 MHz. This is small enough to justify the assumption that $s_{12} = 0$.

Incidentally, a small reverse gain, or feedback factor, s_{12} , is an important and desirable property for a transistor to have, for reasons other than that it simplifies amplifier de-

sign. A small feedback factor means that the input characteristics of the completed amplifier will be independent of the load, and the output will be independent of the source impedance. In most amplifiers, isolation of source and load is an important consideration.

Returning now to the amplifier design, the unilateral expression for transducer power gain, obtained either by setting $s_{12} = 0$ in equation 18 or by looking in the table on p. 23, is

$$G_{Tu} = \frac{|s_{21}|^2(1 - |\Gamma_S|^2)(1 - |\Gamma_L|^2)}{|1 - s_{11}\Gamma_S|^2 |1 - s_{22}\Gamma_L|^2} \quad (24)$$

When $|s_{11}|$ and $|s_{22}|$ are both less than one, as they are in this case, maximum G_{Tu} occurs for $\Gamma_S = s_{11}^*$ and $\Gamma_L = s_{22}^*$ (table, p. 23).

The next step in the design is to synthesize matching networks which will transform the 50Ω load and source impedances to the impedances corresponding to reflection coefficients of s_{11}^* and s_{22}^* , respectively. Since this is to be a single-frequency amplifier, the matching networks need not be complicated. Simple series-capacitor, shunt-inductor networks will not only do the job, but will also provide a handy means of biasing the transistor — via the inductor — and of isolating the dc bias from the load and source.

Values of L and C to be used in the matching networks are determined using the Smith Chart of Fig. 6. First, points corresponding to s_{11} , s_{11}^* , s_{22} , and s_{22}^* at 300 MHz are plotted. Each point represents the tip of a vector leading away from the center of the chart, its length equal to the magnitude of the reflection coefficient being plotted, and its angle equal to the phase of the coefficient. Next, a combination of constant-resistance and constant-conductance circles is found, leading from the center of the chart, representing 50Ω , to s_{11}^* and s_{22}^* . The circles on the Smith Chart are constant-resistance circles; increasing series capacitive reactance moves an impedance point counter-clockwise along these circles. In this case, the circle to be used for finding series C is the one passing through the center of the chart, as shown by the solid line in Fig. 6.

Increasing shunt inductive susceptance moves impedance points clockwise along constant-conductance circles. These circles are like the constant-resistance circles, but they are on another Smith Chart, this one being just the reverse of the one in Fig. 6. The constant-conductance circles for shunt L all pass through the leftmost point of the chart rather than the rightmost point. The circles to be used are those passing through s_{11}^* and s_{22}^* , as shown by the dashed lines in Fig. 6.

Once these circles have been located, the normalized values of L and C needed for the matching networks are calculated from readings taken from the reactance and susceptance scales of the Smith Charts. Each element's reactance or susceptance is the difference between the scale readings at the two end points of a circular arc. Which arc corresponds to which element is indicated in Fig. 6. The final network and the element values, normalized and unnormalized, are shown in Fig. 7.

Broadband Amplifier Design

Designing a broadband amplifier, that is, one which has nearly constant gain over a prescribed frequency range, is a matter of surrounding a transistor with external elements in order to compensate for the variation of forward gain $|s_{21}|$ with frequency. This can be done in either of two ways—first, negative feedback, or second, selective mismatching of the input and output circuitry. We will use the second method. When feedback is used, it is usually convenient to convert to y - or z -parameters (for shunt or series feedback respectively) using the conversion equations given in the table, p. 24, and a digital computer.

Equation 24 for the unilateral transducer power gain can be factored into three parts:

$$G_{TU} = G_0 G_1 G_2$$

where

$$G_0 = |s_{21}|^2$$

$$G_1 = \frac{1 - |\Gamma_s|^2}{|1 - s_{11}\Gamma_s|^2}$$

$$G_2 = \frac{1 - |\Gamma_L|^2}{|1 - s_{22}\Gamma_L|^2}$$

When a broadband amplifier is designed by selective mismatching, the gain contributions of G_1 and G_2 are varied to compensate for the variations of $G_0 = |s_{21}|^2$ with frequency.

Suppose that the 2N3478 transistor whose s -parameters are given in Fig. 4 is to be used in a broadband amplifier which has a constant gain of 10 dB over a frequency range of 300 MHz to 700 MHz. The amplifier is to be driven from a 50Ω source and is to drive a 50Ω load. According to Fig. 5,

$$\begin{aligned} |s_{21}|^2 &= 13 \text{ dB at } 300 \text{ MHz} \\ &= 10 \text{ dB at } 450 \text{ MHz} \\ &= 6 \text{ dB at } 700 \text{ MHz.} \end{aligned}$$

To realize an amplifier with a constant gain of 10 dB, source and load matching networks must be found which will decrease the gain by 3 dB at 300 MHz, leave the gain the same at 450 MHz, and increase the gain by 4 dB at 700 MHz.

Although in the general case both a source matching network and a load matching network would be designed, $G_{1\max}$ (i.e., G_1 for $\Gamma_s = s_{11}^*$) for this transistor is less than 1 dB over the frequencies of interest, which means there is little to be gained by matching the source. Consequently, for this example, only a load-matching network will be designed. Procedures for designing source-matching networks are identical to those used for designing load-matching networks.

The first step in the design is to plot s_{22}^* over the required frequency range on the Smith Chart, Fig. 8. Next, a set of constant-gain circles is drawn. Each circle is drawn for a single frequency; its center is on a line between the center of the Smith Chart and the point representing s_{22}^* at that frequency. The distance from the center of the Smith Chart to the center of the constant gain circle is given by (these equations also appear in the table, p. 23):

$$r_2 = \frac{g_2 |s_{22}|}{1 - |s_{22}|^2 (1 - g_2)}$$

where

$$g_2 = \frac{G_2}{G_{2\max}} = G_2 (1 - |s_{22}|^2).$$

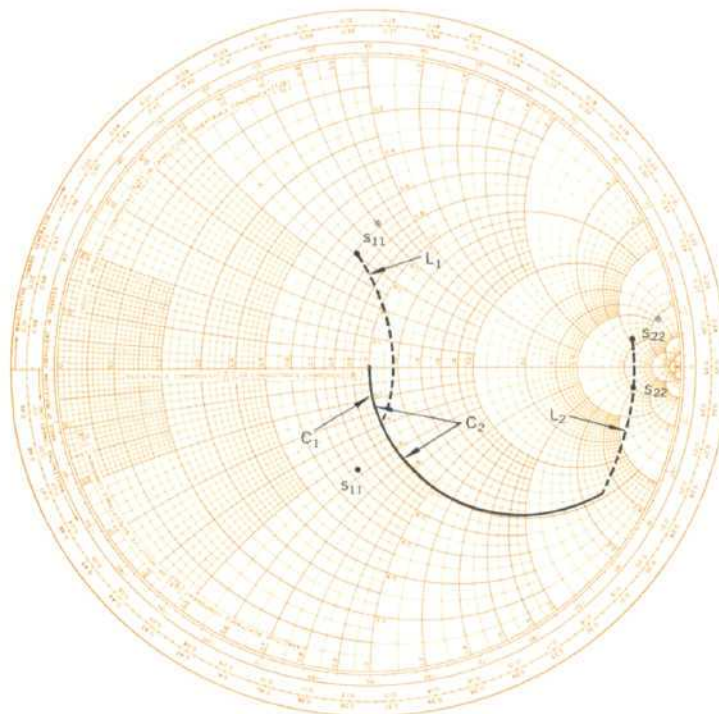

Fig. 6. Smith Chart for 300-MHz amplifier design example.

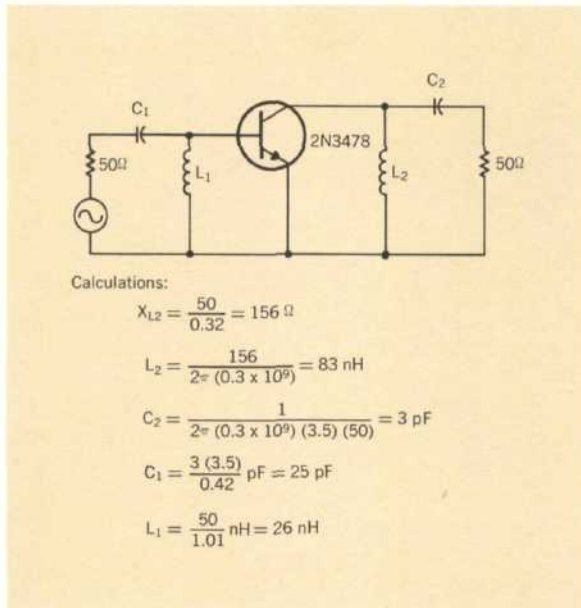

Fig. 7. 300-MHz amplifier with matching networks for maximum power gain.

The radius of the constant-gain circle is

$$\rho_2 = \frac{\sqrt{1 - g_2 (1 - |s_{22}|^2)}}{1 - |s_{22}|^2 (1 - g_2)}$$

For this example, three circles will be drawn, one for $G_2 = -3$ dB at 300 MHz, one for $G_2 = 0$ dB at 450 MHz, and one for $G_2 = +4$ dB at 700 MHz. Since $|s_{22}|$ for this transistor is constant at 0.85 over the frequency range [see Fig. 4(b)], $G_{2, \text{max}}$ for all three circles is $(0.278)^{-1}$, or 5.6 dB. The three constant-gain circles are indicated in Fig. 8.

The required matching network must transform the center of the Smith Chart, representing 50Ω , to some point on the -3 dB circle at 300 MHz, to some point on the 0 dB circle at 450 MHz, and to some point on the $+4$ dB circle at 700 MHz. There are undoubtedly many networks that will do this. One which is satisfactory is a combination of two inductors, one in shunt and one in series, as shown in Fig. 9.

Shunt and series elements move impedance points on the Smith Chart along constant-conductance and constant-resistance circles, as I explained in the narrow-band design example which preceded this broadband design example. The shunt inductance transforms the 50Ω load along a circle of constant conductance and varying (with frequency) inductive susceptance. The series inductor transforms the combination of the 50Ω load and the shunt inductance along circles of constant resistance and varying inductive reactance.

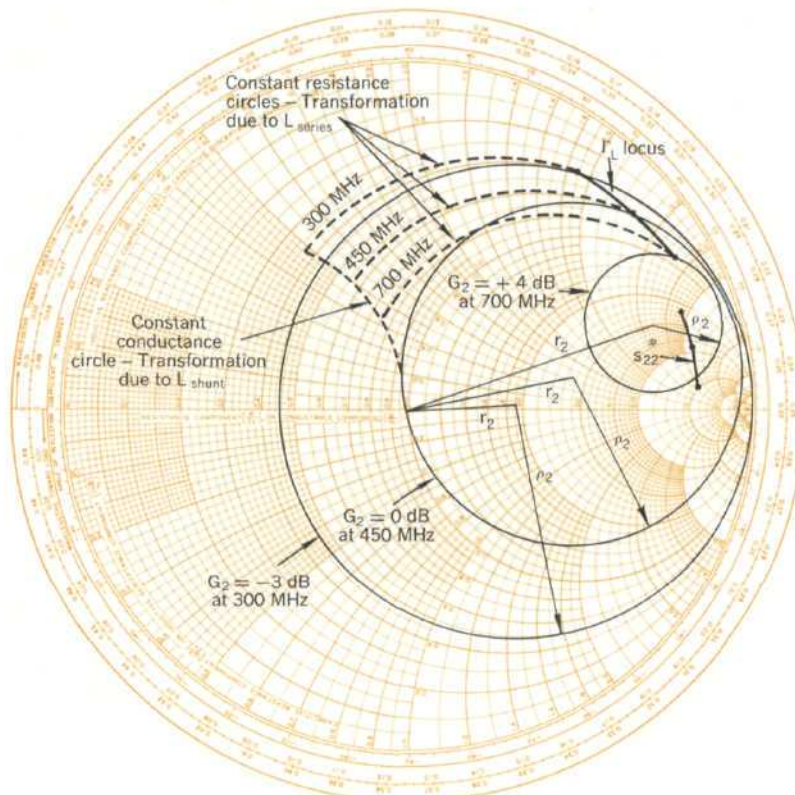

Fig. 8. Smith Chart for broadband amplifier design example.

Optimizing the values of shunt and series L is a cut-and-try process to adjust these elements so that

- the transformed load reflection terminates on the right gain circle at each frequency, and
- the susceptance component decreases with frequency and the reactance component increases with frequency. (This rule applies to inductors; capacitors would behave in the opposite way.)

Once appropriate constant-conductance and constant-resistance circles have been found, the reactances and susceptances of the elements can be read directly from the Smith Chart. Then the element values are calculated, the same as they were for the narrow-band design.

Fig. 10 is a schematic diagram of the completed broadband amplifier, with unnormalized element values.

Stability Considerations and the Design of Reflection Amplifiers and Oscillators

When the real part of the input impedance of a network is negative, the corresponding input reflection coefficient (equation 17) is greater than one, and the network can be used as the basis for two important types of circuits, reflection amplifiers and oscillators. A reflection amplifier (Fig. 11) can be realized with a circulator—a nonreciprocal three-port device—and a negative-resistance device. The circulator is used to separate the incident (input) wave from the larger wave reflected by the negative-resistance device. Theoretically, if the circulator is perfect and has a positive real characteristic impedance Z_0 , an amplifier with infinite gain can be built by selecting a negative-resistance device whose input impedance has a real part equal to $-Z_0$ and an imaginary part equal to zero (the imaginary part can be set equal to zero by tuning, if necessary).

Amplifiers, of course, are not supposed to oscillate, whether they are reflection amplifiers or some other kind. There is a convenient criterion based upon scattering parameters for determining whether a device is stable or potentially unstable with given source and load impedances. Referring again to the flow graph of Fig. 3, the ratio of the reflected voltage wave b_1 to the input voltage wave b_s is

$$\frac{b_1}{b_s} = \frac{s'_{11}}{1 - \Gamma_s s'_{11}}$$

where s'_{11} is the input reflection coefficient with $\Gamma_s = 0$ (that is, $Z_s = Z_0$) and an arbitrary load impedance Z_L , as defined in equation 19.

If at some frequency

$$\Gamma_s s'_{11} = 1 \quad (25)$$

the circuit is unstable and will oscillate at that frequency. On the other hand, if

$$|s'_{11}| < \left| \frac{1}{\Gamma_s} \right|$$

the device is unconditionally stable and will not oscillate, whatever the phase angle of Γ_s might be.

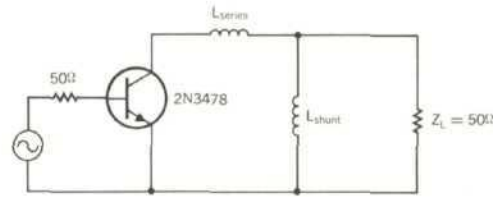
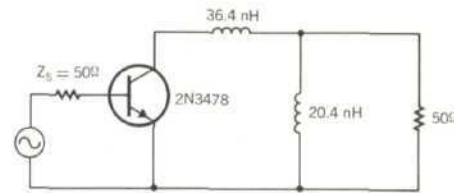

Fig. 9. Combination of shunt and series inductances is suitable matching network for broadband amplifier.



Inductance calculations:

$$\text{From 700 MHz data, } \frac{j\omega L_{\text{series}}}{Z_0} = j(3.64 - 0.44) = j3.2$$

$$L_{\text{series}} = \frac{(3.2)(50)}{2\pi(0.7)} \text{ nH} = 36.4 \text{ nH}$$

$$\text{From 300 MHz data, } \frac{Z_0}{j\omega L_{\text{shunt}}} = -j1.3$$

$$L_{\text{shunt}} = \frac{50}{(1.3)(2\pi)(0.3)} = 20.4 \text{ nH}$$

Fig. 10. Broadband amplifier with constant gain of 10 dB from 300 MHz to 700 MHz.

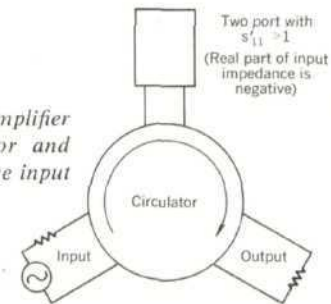

Fig. 11. Reflection amplifier consists of circulator and transistor with negative input resistance.

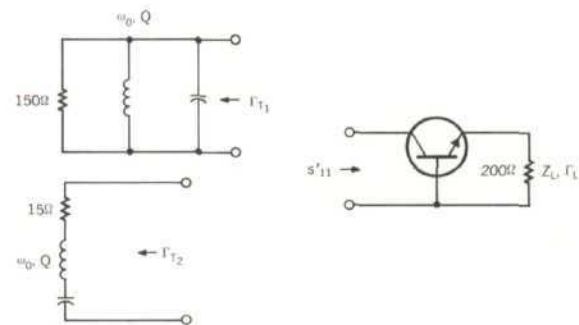

Fig. 12. Transistor oscillator is designed by choosing tank circuit such that $\Gamma_T s'_{11} = 1$.

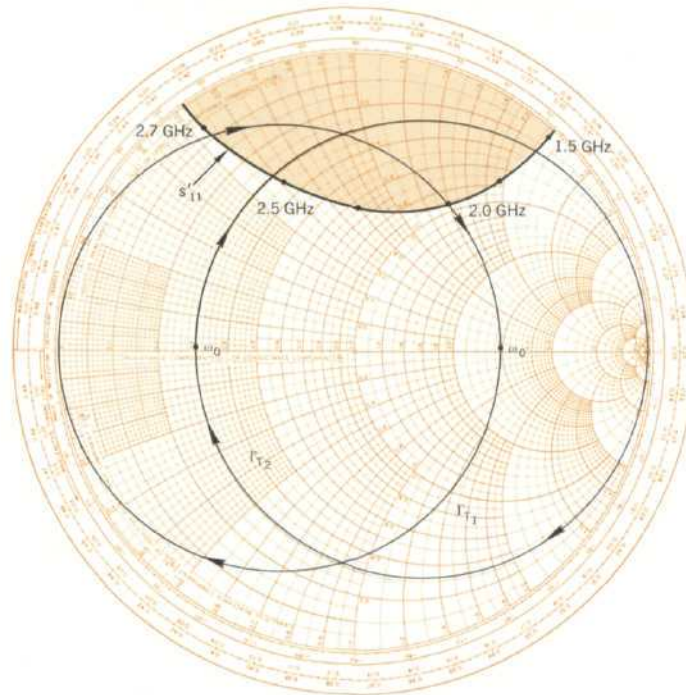

Fig. 13. Smith Chart for transistor oscillator design example.

As an example of how these principles of stability are applied in design problems, consider the transistor oscillator design illustrated in Fig. 12. In this case the input reflection coefficient s'_{11} is the reflection coefficient looking into the collector circuit, and the 'source' reflection coefficient Γ_S is one of the two tank-circuit reflection coefficients, Γ_{T1} or Γ_{T2} . From equation 19,

$$s'_{11} = s_{11} + \frac{s_{12} s_{21} \Gamma_L}{1 - s_{22} \Gamma_L}$$

To make the transistor oscillate, s'_{11} and Γ_S must be adjusted so that they satisfy equation 25. There are four steps in the design procedure:

- Measure the four scattering parameters of the transistor as functions of frequency.
- Choose a load reflection coefficient Γ_L , which makes s'_{11} greater than unity. In general, it may also take an external feedback element which increases $s_{12} s_{21}$ to make s'_{11} greater than one.
- Plot $1/s'_{11}$ on a Smith Chart. (If the new network analyzer is being used to measure the s-parameters of the transistor, $1/s'_{11}$ can be measured directly by reversing the reference and test channel connections between the reflection test unit and the harmonic frequency converter. The polar display with a Smith Chart overlay will then give the desired plot immediately.)
- Connect either the series or the parallel tank circuit to the collector circuit and tune it so that Γ_{T1} or Γ_{T2} is large enough to satisfy equation 25 (the tank circuit reflection coefficient plays the role of Γ_S in this equation).

Fig. 13 shows a Smith Chart plot of $1/s'_{11}$ for a high-frequency transistor in the common-base configuration. Load impedance Z_L is 200Ω , which means that Γ_L , referred to 50Ω is 0.6. Reflection coefficients Γ_{T1} and Γ_{T2} are also plotted as functions of the resonant frequencies of the two tank circuits. Oscillations occur when the locus of Γ_{T1} or Γ_{T2} passes through the shaded region. Thus this transistor would oscillate from 1.5 to 2.5 GHz with a series tuned circuit and from 2.0 to 2.7 GHz with a parallel tuned circuit.

—Richard W. Anderson

Additional Reading on S-Parameters

Besides the papers referenced in the footnotes of the article, the following articles and books contain information on s-parameter design procedures and flow graphs.

- F. Weinert, 'Scattering Parameters Speed Design of High-Frequency Transistor Circuits,' *Electronics*, Vol. 39, No. 18, Sept. 5, 1966.
- G. Fredricks, 'How to Use S-Parameters for Transistor Circuit Design,' *EEE*, Vol. 14, No. 12, Dec., 1966.
- D. C. Youla, 'On Scattering Matrices Normalized to Complex Port Numbers,' *Proc. IRE*, Vol. 49, No. 7, July, 1961.
- J. G. Linvill and J. F. Gibbons, 'Transistors and Active Circuits,' McGraw-Hill, 1961. (No s-parameters, but good treatment of Smith Chart design methods.)

Useful Scattering Parameter Relationships



$$b_1 = s_{11}a_1 + s_{12}a_2$$

$$b_2 = s_{21}a_1 + s_{22}a_2$$

Input reflection coefficient with arbitrary Z_L

$$s'_{11} = s_{11} + \frac{s_{12}s_{21}\Gamma_L}{1 - s_{22}\Gamma_L}$$

Output reflection coefficient with arbitrary Z_S

$$s'_{22} = s_{22} + \frac{s_{12}s_{21}\Gamma_S}{1 - s_{11}\Gamma_S}$$

Voltage gain with arbitrary Z_L and Z_S

$$A_V = \frac{V_2}{V_1} = \frac{s_{21}(1 + \Gamma_L)}{(1 - s_{22}\Gamma_L)(1 + s'_{11})}$$

Power Gain = $\frac{\text{Power delivered to load}}{\text{Power input to network}}$

$$G = \frac{|s_{21}|^2(1 - |\Gamma_L|^2)}{(1 - |s_{11}|^2) + |\Gamma_L|^2(|s_{22}|^2 - |D|^2) - 2 \operatorname{Re}(\Gamma_L N)}$$

Available Power Gain = $\frac{\text{Power available from network}}{\text{Power available from source}}$

$$G_A = \frac{|s_{21}|^2(1 - |\Gamma_S|^2)}{(1 - |s_{22}|^2) + |\Gamma_S|^2(|s_{11}|^2 - |D|^2) - 2 \operatorname{Re}(\Gamma_S M)}$$

Transducer Power Gain = $\frac{\text{Power delivered to load}}{\text{Power available from source}}$

$$G_T = \frac{|s_{21}|^2(1 - |\Gamma_S|^2)(1 - |\Gamma_L|^2)}{|(1 - s_{11}\Gamma_S)(1 - s_{22}\Gamma_L) - s_{12}s_{21}\Gamma_L\Gamma_S|^2}$$

Unilateral Transducer Power Gain ($s_{12} = 0$)

$$G_{Tu} = \frac{|s_{21}|^2(1 - |\Gamma_S|^2)(1 - |\Gamma_L|^2)}{|1 - s_{11}\Gamma_S|^2 |1 - s_{22}\Gamma_L|^2}$$

$$= G_0 G_1 G_2$$

$$G_0 = |s_{21}|^2$$

$$G_1 = \frac{1 - |\Gamma_S|^2}{|1 - s_{11}\Gamma_S|^2}$$

$$G_2 = \frac{1 - |\Gamma_L|^2}{|1 - s_{22}\Gamma_L|^2}$$

Maximum Unilateral Transducer Power Gain when $|s_{11}| < 1$ and $|s_{22}| < 1$

$$G_u = \frac{|s_{21}|^2}{|(1 - |s_{11}|^2)(1 - |s_{22}|^2)|}$$

$$= G_0 G_{1 \max} G_{2 \max}$$

$$G_{i \max} = \frac{1}{1 - |s_{ii}|^2} \quad i = 1, 2$$

This maximum attained for $\Gamma_S = s_{11}^*$ and $\Gamma_L = s_{22}^*$

Constant Gain Circles (Unilateral case: $s_{12} = 0$)

—center of constant gain circle is on line between center of Smith Chart and point representing s_{11}^*

—distance of center of circle from center of Smith Chart:

$$r_i = \frac{g_i |s_{ii}|}{1 - |s_{ii}|^2(1 - g_i)}$$

—radius of circle:

$$\rho_i = \frac{\sqrt{1 - g_i}(1 - |s_{ii}|^2)}{1 - |s_{ii}|^2(1 - g_i)}$$

where: $i = 1, 2$

$$\text{and } g_i = \frac{G_i}{G_{i \max}} = G_i(1 - |s_{ii}|^2)$$

Unilateral Figure of Merit

$$u = \frac{|s_{11}s_{22}s_{12}s_{21}|}{|(1 - |s_{11}|^2)(1 - |s_{22}|^2)|}$$

Error Limits on Unilateral Gain Calculation

$$\frac{1}{(1 + u^2)} < \frac{G_T}{G_{Tu}} < \frac{1}{(1 - u^2)}$$

HEWLETT-PACKARD JOURNAL

TECHNICAL INFORMATION FROM THE
LABORATORIES OF THE HEWLETT-PACKARD COMPANY

hp FEBRUARY 1967 Volume 18 • Number 6

PUBLISHED AT THE CORPORATE OFFICES
1501 PAGE MILL ROAD, PALO ALTO, CALIFORNIA 94304
Staff: F. J. BURKHARD, Editor; R. P. DOLAN, L. D. SHERGALIS
R. A. ERICKSON, Art Director

Conditions for Absolute Stability

No passive source or load will cause network to oscillate if a, b, and c are all satisfied.

- a. $|s_{11}| < 1, |s_{22}| < 1$
- b. $\left| \frac{|s_{12}s_{21}| - |M^*|}{|s_{11}|^2 - |D|^2} \right| > 1$
- c. $\left| \frac{|s_{12}s_{21}| - |N^*|}{|s_{22}|^2 - |D|^2} \right| > 1$

Condition that a two-port network can be simultaneously matched with a positive real source and load:

$K > 1$ or $C < 1$
 $C = \text{Linville C factor}$

Linville C Factor

$C = K^{-1}$

$$K = \frac{1 + |D|^2 - |s_{11}|^2 - |s_{22}|^2}{2 |s_{12}s_{21}|}$$

Source and Load for Simultaneous Match

$$\Gamma_{mS} = M^* \left[\frac{B_1 \pm \sqrt{B_1^2 - 4|M|^2}}{2|M|^2} \right]$$

$$\Gamma_{mL} = N^* \left[\frac{B_2 \pm \sqrt{B_2^2 - 4|N|^2}}{2|N|^2} \right]$$

Where $B_1 = 1 + |s_{11}|^2 - |s_{22}|^2 - |D|^2$
 $B_2 = 1 + |s_{22}|^2 - |s_{11}|^2 - |D|^2$

Maximum Available Power Gain

If $K > 1$,

$$G_{A \max} = \left| \frac{s_{21}}{s_{12}} (K \pm \sqrt{K^2 - 1}) \right|$$

 $K = C^{-1}$
 $C = \text{Linville C Factor}$

(Use minus sign when B_1 is positive, plus sign when B_1 is negative. For definition of B_1 see 'Source and Load for Simultaneous Match,' elsewhere in this table.)

$$D = s_{11}s_{22} - s_{12}s_{21}$$

$$M = s_{11} - D s_{22}^*$$

$$N = s_{22} - D s_{11}^*$$

s-parameters in terms of h-, y-, and z-parameters	h-, y-, and z-parameters in terms of s-parameters
$s_{11} = \frac{(z_{11} - 1)(z_{22} + 1) - z_{12}z_{21}}{(z_{11} + 1)(z_{22} + 1) - z_{12}z_{21}}$	$z_{11} = \frac{(1 + s_{11})(1 - s_{22}) + s_{12}s_{21}}{(1 - s_{11})(1 - s_{22}) - s_{12}s_{21}}$
$s_{12} = \frac{2z_{12}}{(z_{11} + 1)(z_{22} + 1) - z_{12}z_{21}}$	$z_{12} = \frac{2s_{12}}{(1 - s_{11})(1 - s_{22}) - s_{12}s_{21}}$
$s_{21} = \frac{2z_{21}}{(z_{11} + 1)(z_{22} + 1) - z_{12}z_{21}}$	$z_{21} = \frac{2s_{21}}{(1 - s_{11})(1 - s_{22}) - s_{12}s_{21}}$
$s_{22} = \frac{(z_{11} + 1)(z_{22} - 1) - z_{12}z_{21}}{(z_{11} + 1)(z_{22} + 1) - z_{12}z_{21}}$	$z_{22} = \frac{(1 + s_{22})(1 - s_{11}) + s_{12}s_{21}}{(1 - s_{11})(1 - s_{22}) - s_{12}s_{21}}$
$s_{11} = \frac{(1 - y_{11})(1 + y_{22}) + y_{12}y_{21}}{(1 + y_{11})(1 + y_{22}) - y_{12}y_{21}}$	$y_{11} = \frac{(1 + s_{22})(1 - s_{11}) + s_{12}s_{21}}{(1 + s_{11})(1 + s_{22}) - s_{12}s_{21}}$
$s_{12} = \frac{-2y_{12}}{(1 + y_{11})(1 + y_{22}) - y_{12}y_{21}}$	$y_{12} = \frac{-2s_{12}}{(1 + s_{11})(1 + s_{22}) - s_{12}s_{21}}$
$s_{21} = \frac{-2y_{21}}{(1 + y_{11})(1 + y_{22}) - y_{12}y_{21}}$	$y_{21} = \frac{-2s_{21}}{(1 + s_{11})(1 + s_{22}) - s_{12}s_{21}}$
$s_{22} = \frac{(1 + y_{11})(1 - y_{22}) + y_{12}y_{21}}{(1 + y_{11})(1 + y_{22}) - y_{12}y_{21}}$	$y_{22} = \frac{(1 + s_{11})(1 - s_{22}) + s_{12}s_{21}}{(1 + s_{22})(1 + s_{11}) - s_{12}s_{21}}$
$s_{11} = \frac{(h_{11} - 1)(h_{22} + 1) - h_{12}h_{21}}{(h_{11} + 1)(h_{22} + 1) - h_{12}h_{21}}$	$h_{11} = \frac{(1 + s_{11})(1 + s_{22}) - s_{12}s_{21}}{(1 - s_{11})(1 + s_{22}) + s_{12}s_{21}}$
$s_{12} = \frac{2h_{12}}{(h_{11} + 1)(h_{22} + 1) - h_{12}h_{21}}$	$h_{12} = \frac{2s_{12}}{(1 - s_{11})(1 + s_{22}) + s_{12}s_{21}}$
$s_{21} = \frac{-2h_{21}}{(h_{11} + 1)(h_{22} + 1) - h_{12}h_{21}}$	$h_{21} = \frac{-2s_{21}}{(1 - s_{11})(1 + s_{22}) + s_{12}s_{21}}$
$s_{22} = \frac{(1 + h_{11})(1 - h_{22}) + h_{12}h_{21}}{(h_{11} + 1)(h_{22} + 1) - h_{12}h_{21}}$	$h_{22} = \frac{(1 - s_{22})(1 - s_{11}) - s_{12}s_{21}}{(1 - s_{11})(1 + s_{22}) + s_{12}s_{21}}$

The h-, y-, and z-parameters listed above are all normalized to Z_0 . If h' , y' , and z' are the actual parameters, then

$z'_{11} = z_{11}Z_0$	$y'_{11} = \frac{y_{11}}{Z_0}$	$h'_{11} = h_{11}Z_0$
$z'_{12} = z_{12}Z_0$	$y'_{12} = \frac{y_{12}}{Z_0}$	$h'_{12} = h_{12}$
$z'_{21} = z_{21}Z_0$	$y'_{21} = \frac{y_{21}}{Z_0}$	$h'_{21} = h_{21}$
$z'_{22} = z_{22}Z_0$	$y'_{22} = \frac{y_{22}}{Z_0}$	$h'_{22} = \frac{h_{22}}{Z_0}$

Transistor Frequency Parameters

f_t = frequency at which $|h_{fe}| = 1$
 = $|h_{21}$ for common-emitter configuration = 1
 f_{max} = frequency at which $G_{A \max} = 1$

SECTION IV

COMBINE S PARAMETERS WITH TIME SHARING

This article describes how s parameters were used in conjunction with a small time-sharing computer for the design of thin-film amplifier circuits. Les Besser describes in clear detail how he approached the problem from both a circuit and a programming standpoint. He took advantage of the fact that one set of parameters can be used to calculate another set. The numerous transitions between s, y, z, and x parameters were readily done on the small computer. Finally he shows how his theoretical design utilizing s-parameter data agrees extremely well with the actual amplifier performance.

Introduction	4-1
Selection of Circuitry	4-3
Amplifier Specifications	4-3
Design Considerations.....	4-3
The Approach to the Problem	4-3
Combining Two Port Networks	4-4
Shunt Feedback	4-4
Series Feedback	4-4
Cascading Two Ports.....	4-4
Programming the Problem.....	4-5
Outline of the Computer Program.....	4-5
Program Explanation.....	4-6
Stability	4-7
Design Evaluation.....	4-7

Combine s parameters with time sharing and bring thin-film, high-frequency amplifier design closer to a science than an art.

High-frequency amplifier design traditionally has followed the route of an art rather than a science. The engineer would carry out approximate calculations and then make his amplifier circuit work by means of a tricky layout, shielding, grounding and so on.

The concept of the s parameters (see box) and the advent of computer time-sharing together are signaling an end to these trial and error techniques. And high time, too. Such techniques could not have helped approach, for example, the theoretical maximum performance of a transistor—a feat that required, in addition to time sharing and use of the s parameters, two other advances as well: thin-film hybrid circuits and lossless wideband matching networks. And even more specifically, s parameters and thin-film circuits have also been behind the designs of several wideband amplifiers for frequencies of from 10 kHz to 2 GHz, with 20 to 30 dB of gain. Each amplifier covers at least 4 to 5 octaves. In most cases, the first breadboard measurements were so close to the design values that only minor adjustments had to be made before turning the prototypes for production.

Why s parameters and thin-film circuits?

The conventional parameters— y , z and h —are hard to measure at frequencies above 100 MHz. This is because all of them require that open and short circuits be established and call for laborious and tedious measurements.

Then, commonly-used models of transistors do not truly represent the actual devices. Thus, when the inaccurate y , z , or h parameters are used in an inaccurate transistor model it is only natural to get inaccurate results.

S parameters, on the other hand, even in the GHz region, are measured easily and accurately by direct readout. Swept measurements of the s parameters can be made today with existing instruments (see photo) and the results easily observed on polar displays such as the familiar

Smith chart or any other suitable graph.

Mathematically, s parameters lend themselves nicely to matrix manipulations. A circuit of any complexity is built by adding and cascading two-port blocks. Since these blocks contain real elements that can be measured accurately, no approximations are used.

A designer cannot normally expect an amplifier above 500 MHz to give really accurate results with discrete components, because the physical dimensions of the components are approaching the order of magnitude of the electrical wavelengths. Thus, for 500 MHz or higher, microcircuits would be his natural choice.

However, for amplifiers below 500 MHz, too, microcircuits have definite advantages. The thin-film technique reduces size, parasitic reactances and long-term costs, and at the same time improves design accuracy, reliability, heat dissipation, and repeatability.

Accordingly, rather than utilize a conventional design routine, suppose we follow the outline given below in adapting the s -parameter approach and the thin-film circuits to be used:

1. *Use s parameters throughout.* All high-frequency measurements are done with s parameters, from taking the parameters of the active devices to evaluating the complete amplifier. Measurement errors can be reduced to as low as 2 to 3 per cent even in the GHz region. Magnitude and phase are both measurable.¹ Swept measurements and visual polar display of the s parameters are possible.

Some of the leading transistor manufacturers already are supplying s -parameter information for their products. Vector voltmeters, network analyzers, and other test equipment permit the designer to obtain the s parameters from 1 MHz up to 12.4 GHz both swiftly and accurately. A typical wideband system to measure transistor (discrete or chip form) s parameters can be calibrated into the GHz region in a few minutes, and the s parameters can be read directly without any additional tuning or adjustment (see photo).

2. *Work with parameter matrices.* Build up the circuits step by step by adding and cascading two-port blocks.² Keep converting the parameters³ (x , y , z and s) to the form that offers the

Les Besser, Project Supervisor, Hewlett-Packard Co., Palo Alto, Calif.

What are s parameters?

S parameters^{1,2} are reflection and transmission coefficients. Transmission coefficients are commonly called gain or attenuation; reflection coefficients are directly related to VSWR and impedance.

Conceptually, *s* parameters are like *h*, *y*, or *z* parameters insofar as they describe the inputs and outputs of a black box. But the inputs and outputs for *s* parameters are expressed in terms of power, and for *h*, *y*, and *z* parameters as voltages and currents. Also, *s* parameters are measured with all circuits terminated in an actual characteristic line impedance of the system, doing away with the open- and short-circuit measurements specified for *h*, *y* or *z* parameters.

The figure below, which uses the convention that *a* is a signal into a port and *b* a signal out of a port, explains *s* parameters.

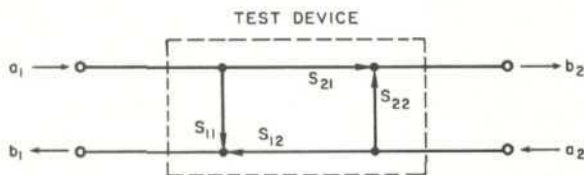

In this figure, *a* and *b* are the square roots of power; $(a_1)^2$ is the power incident at port 1, and $(b_2)^2$ is the power leaving port 2. The fraction of a_1 that is reflected at port 1 is s_{11} , and the transmitted part is s_{21} . Similarly, the fraction of a_2 that is reflected at port 2 is s_{22} , and s_{12} is transmitted in the reverse direction.

The signal b_1 leaving port 1 is the sum of the fraction of a_1 that was reflected at port 1 and what was transmitted from port 2.

The outputs related to the inputs are

$$b_1 = s_{11} a_1 + s_{12} a_2, \quad (1)$$

$$b_2 = s_{21} a_1 + s_{22} a_2. \quad (2)$$

When port 1 is driven by an RF source, a_2 is made zero by terminating the 50-Ω transmission line, coming out of port 2, in its characteristic impedance.

The setup for measuring s_{11} and s_{21} is this:

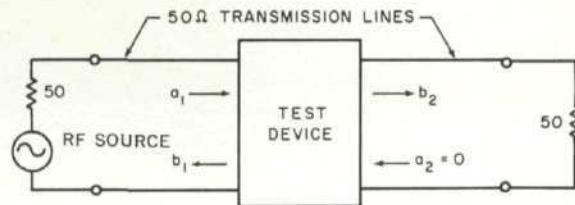

If $a_2 = 0$, then:

$$s_{11} = b_1/a_1, \quad s_{21} = b_2/a_1 \quad (3)$$

Similarly, the setup for measuring s_{12} and s_{22} is this:

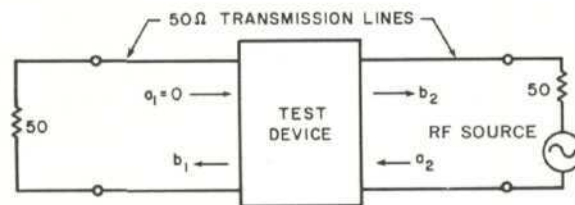

If $a_1 = 0$, then:

$$s_{12} = b_1/a_2, \quad s_{22} = b_2/a_2 \quad (4)$$

Another advantage of *s* parameters is that, being vector quantities, they contain both magnitude and phase information.

By definition, s_{11} and s_{22} are ratios of the reflected and incident powers, or exactly the same as the reflection coefficient, Γ , commonly used with the Smith chart. The input and output parameters of a two-port device can be presented on a polar display without any transformation (see photos in text) and the corresponding normalized impedances can be readily obtained on the same chart. Impedance transformation and matching can be done either graphically or analytically. Mismatch losses that occur between any port and a 50-Ω termination can be calculated. For example,

$$P_{\text{Mismatch}} = 10 \log_{10} (1 - |\Gamma|^2),$$

where P_M is the mismatch loss in dB at any given port having a reflection coefficient Γ . When the *s* parameters are known, s_{11} or s_{22} can be substituted for Γ .

The transducer power gain of the two-port network can be computed by

$$G_T = |s_{21}|^2 \quad (5)$$

or in dB

$$G_T = 10 \log_{10} (|s_{21}|^2) \quad (6)$$

simplest operation at every step. Since there are no approximations, the calculations will not introduce any additional error. This approach also eliminates the need for conventional transistor models, which not only do not truly represent the device, but require *h* parameters that can be accurately measured at frequencies above 100 MHz only with great difficulty.

3. Use on-line time sharing, and let the computer do all the work. With the help of a few simple "do-loops" the optimum values of the circuit elements can be readily determined. Time

sharing offers extraordinary flexibility. The designer need not wait until his program is returned from the computer center; and program changes can be done by teletypewriter and the results seen within seconds.

A completely automated network analyzer system was recently developed.⁴ Here a small computer controls all calibrations and measurements and also solves the circuit program. Its automatic calibration eliminates practically all uncertainties and human-factor errors to bring an unprecedented accuracy into microwave-circuit design. The maximum



A complete s-parameter test setup good for frequencies up to 12 GHz includes an HP 8410A/ 8411A Network Analyzer (\$4300) and an HP 8414A Polar Display (\$1100), both housed in the top frame. In the center is an HP 8745A S-Parameter Test Set (\$3000) and under it an HP 8690A Sweeper (\$1600). If you are willing to sacrifice the con-

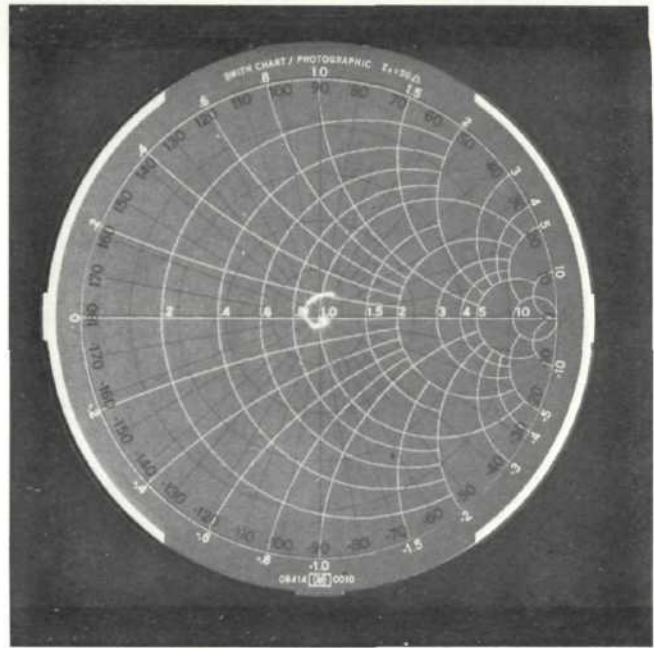

venience of polar display and swept measurement, you can get by with just the Vector Voltmeter (HP 8405, \$2750), top of the shelf to the left. It will work up to 1 GHz. A photo of a Smith chart overlay (white grid) of S_{22} over a 100 to 400 MHz range obtained by the author, Les Besser, is shown on the right.

magnitude of errors can be as low as 0.1%—and this is almost entirely due to the standard shorts and terminations that are used to calibrate the system.

Selecting the circuitry

The amplifier we are designing must meet the following specifications (all measurements are made in a 50- Ω system, i.e., 50- Ω load and a 50- Ω source):

- Forward gain at 10 MHz: 20 dB \pm 0.5 dB.
- Gain flatness 10 kHz — 400 MHz: \pm 0.5 dB.
- Reverse gain (isolation): $<$ -30 dB.
- Input and output VSWR: $<$ 1.5:1.

These specifications may be expressed in terms of the s parameters by using the following relationships for a two port network:

1. Input, output reflection parameters (s_{11} and s_{22}) are:

$$|s| = (\delta - 1) / (\delta + 1),$$

where δ is the VSWR of the port that is being specified while the other port is terminated in the characteristic line impedance, i.e., 50 Ω ; and

2. Forward and reverse gain parameters (s_{21} and s_{12}) are:

$$|s| = \log_{10}^{-1} (G/20),$$

where G is the network gain in dB, when both the driving source and the terminating load have the characteristic line impedance.

Thus the above specifications become, in terms of the s parameters:

$$\begin{aligned} |s_{11}| &< 0.2 \\ |s_{12}| &< 0.03 \\ |s_{21}| &= 10 \pm \begin{matrix} 0.60 \\ 0.55 \end{matrix} \\ |s_{22}| &< 0.2 \end{aligned}$$

The stated 20-dB wideband gain requires a voltage gain-bandwidth product of 4 GHz. This is impractical with a single stage, and may be impossible to achieve. An expensive transistor would be needed, and even with this transistor the specified isolation and stability could impose severe limitations. There are, however, several low-cost transistors (for example, HP-1, HP-2, 2N3570) on the market with the guaranteed f_T of 1.5 GHz. If mismatch losses are kept to a minimum value, two such transistors cascaded in a feedback circuit can provide 20-dB gain and meet the above gain-flatness specifications without requiring adjustment. Feedback, of course, reduces the circuit's sensitivity to component parameter variations and changes, and helps maintain flat-gain response through a wide range of frequencies. Of the various feedback arrangements the most stable consists of separate complex shunt and series feedbacks for each transistor (rather than over-all feedbacks around both). This approach also permits the designer to obtain the parameters of a single stage, and thus find a conjugate interstage match that assures maximum power transfer.

If the feedback circuit includes purely resistive elements, or if it includes reactive elements to reduce the effect of the feedback at the higher fre-

quencies, the bandwidth can be increased.

Combining two-port networks

It was mentioned earlier that the network parameter matrices should be continuously converted to the form that offers the simplest means for combining the various circuit elements. Besides the s parameters, three other parameter matrices are used (Fig. 1). The admittance Y and the impedance Z parameter matrices do not require an explanation, but the X -parameter matrix, which is used to cascade the two-port networks, does. Here is how it was derived:

The transmission parameters⁵, T , are commonly used to cascade two-port networks. In terms of the s parameters:

$$T = \begin{vmatrix} s_{21} - (s_{22} s_{11}/s_{12}) & s_{22}/s_{12} \\ -s_{11}/s_{12} & 1/s_{12} \end{vmatrix}$$

In the case of unilateral design ($s_{12} = 0$), the value of T would go to infinity. A more meaningful form called X matrix is obtained⁶ where s_{21} rather than s_{12} is in the denominator. This matrix, which has a finite value for all active devices, is defined as:

$$X = L(LT)^{-1},$$

where

$$L = \begin{vmatrix} 0 & 1 \\ 1 & 0 \end{vmatrix}$$

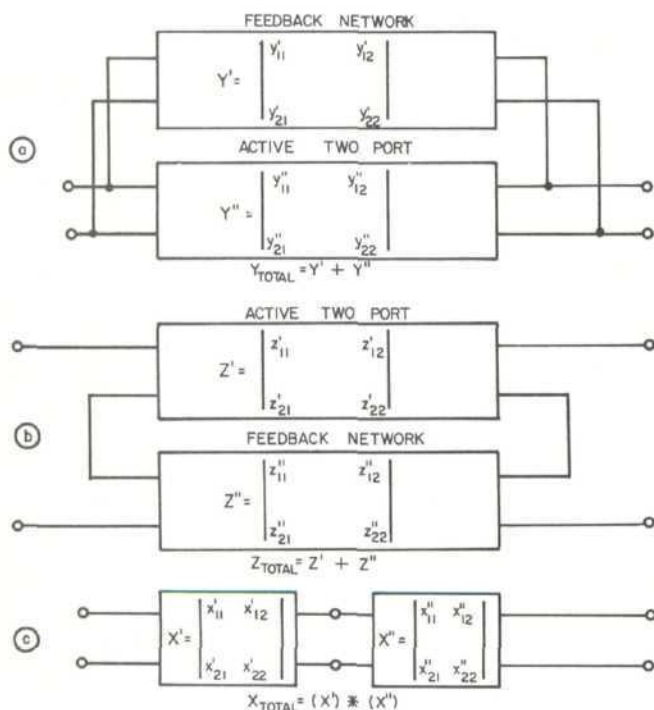

1. Feedback is added and two-port networks are cascaded by means of admittance (a), impedance (b) and modified transmission (c) parameters. See text for the derivation of the X -parameter matrix.

Set up the program

The computer program for this design was written for the GE time-share BASIC language through remote teletype outlets. It consists of a control section and several subroutines for the various conversions. The BASIC language handles matrices by simple (MAT READ, MAT PRINT, etc.) commands. However, at the present time it does not offer complex variable operation. A special subroutine therefore was developed in the following manner to enable the computer to operate with complex matrices:

It can be proved⁷ that any complex number can be represented by a 2×2 matrix for the duration of some mathematical operations, if, at the end, the matrix is "retransformed" in a comparable manner to the initial transformation. For example:

$$z_{11} = r_{11} + jx_{11} \implies \begin{vmatrix} r_{11} & x_{11} \\ -x_{11} & r_{11} \end{vmatrix} = Z_{11}$$

It can also be proved that the matrix operation will not change if all matrix elements are replaced by their equivalent matrices.

Now the real and imaginary parts of a complex 2×2 matrix form a 4×4 matrix. After the operations, this 4×4 matrix yields results in the original complex form

$$Z'_{11} = \begin{vmatrix} r'_{11} & x'_{11} \\ -x'_{11} & r'_{11} \end{vmatrix} \implies r'_{11} + jx'_{11} = z'_{11}$$

Since all calculations are done in matrix form, the passive network elements should be expressed in matrix form. The method is illustrated in Fig. 2, which deals with finding the equivalent Z matrix of a resistive "T." Here, in the matrix form, we have

$$Z = \begin{vmatrix} z_{11} & z_{12} \\ z_{21} & z_{22} \end{vmatrix} = \begin{vmatrix} (r_a + r_c) & r_c \\ r_c & (r_b + r_c) \end{vmatrix}$$

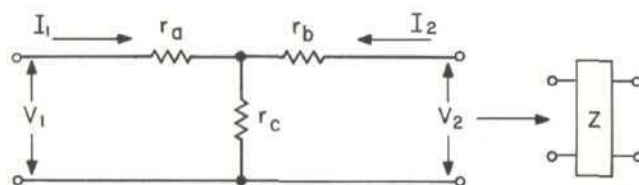

2. An equivalent Z matrix for a common resistive "T" is derived (in text) using the symbols defined above. All operations involve matrices; accordingly, the reader should familiarize himself with matrix algebra.

Step-by-step computerized design

We can now proceed with a description of the steps required to design an amplifier stage.

Note that since all the steps below are illustrated pictorially, the schematics sometimes will not change in converting matrices, say, S to Y .

1. Read in frequency.
2. Read in transistor s parameters in matrix form, S_{T1} .

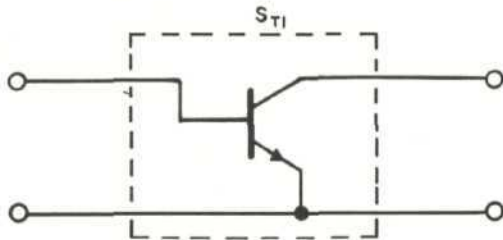

3. Convert device S matrix to Y matrix, $S_{T1} \rightarrow Y_{T1}$.
4. Set up Y matrix for complex shunt feedback element, Y_P .
5. Add shunt feedback, $Y_{T2} = Y_P + Y_{T1}$.

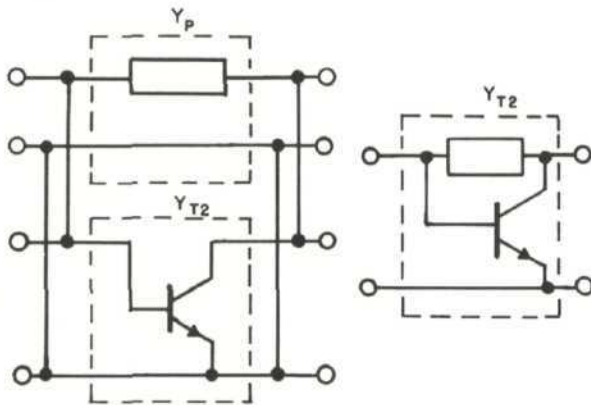

6. Convert Y matrix of device and shunt feedback to Z matrix, $Y_{T2} \rightarrow Z_{T1}$.
7. Set up Z matrix for complex emitter feedback element, Z_E .

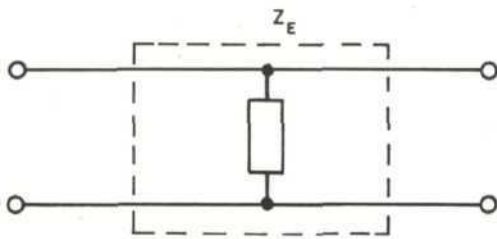

8. Add emitter feedback to device with shunt feedback, $Z_{T2} = Z_E + Z_{T1}$.

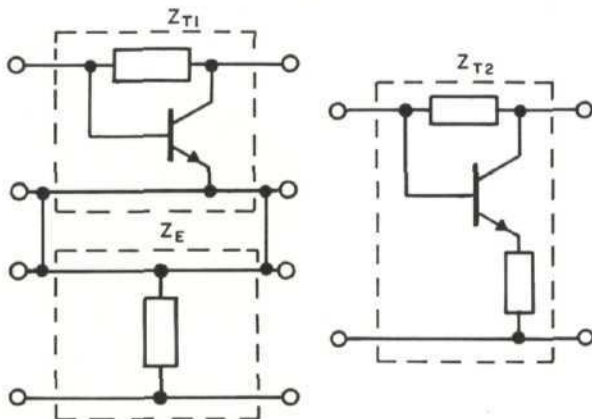

9. Convert Z matrix of device with feedbacks to X matrix, $Z_{T2} \rightarrow X_{T1}$.

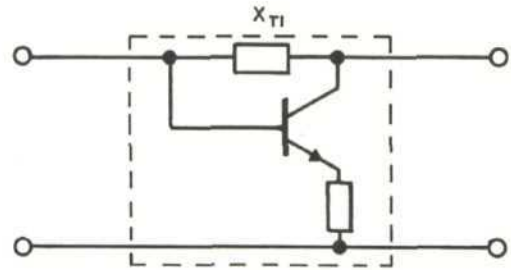

10. Set up X matrices for base and collector bias elements (may be complex), X_B, X_C .

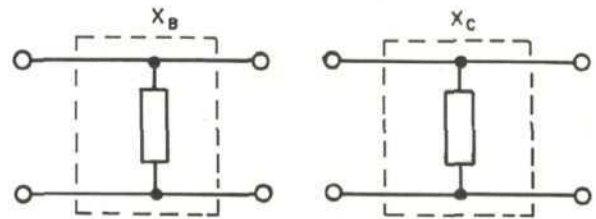

11. Multiply X matrices of bias elements by device and feedback matrices,

$$X_{T2} = (X_B) * (X_{T1})$$

$$X_{T3} = (X_{T2}) * (X_C)$$

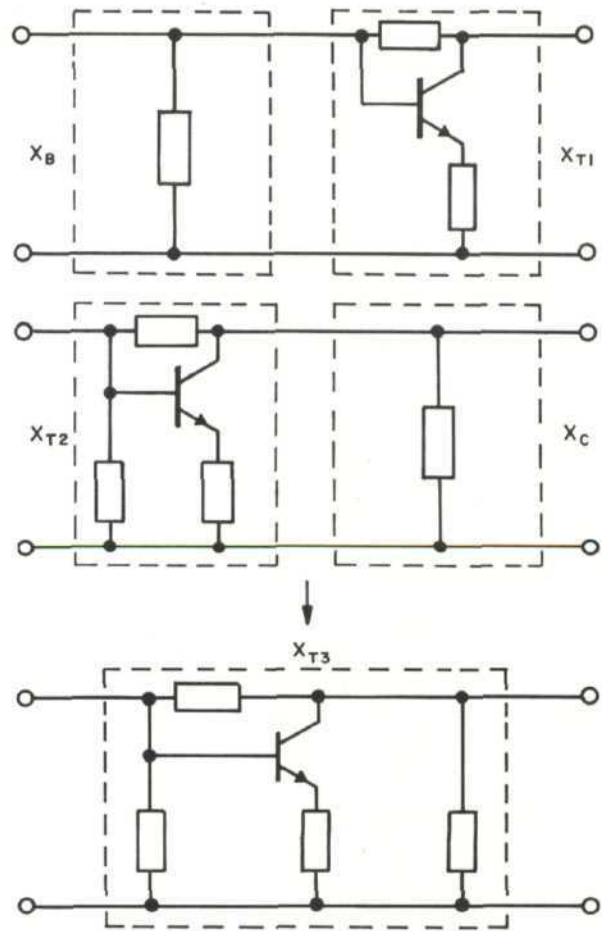

12. Set up X matrices for input and output matching elements (lumped or distributed), X_{M1} , X_{M2} .

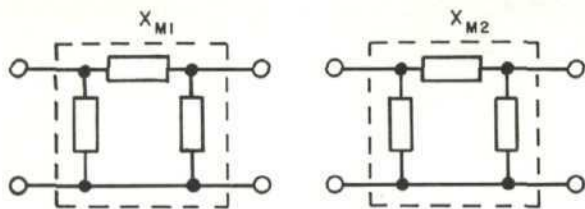

13. Multiply matching elements and device,

$$X_{T4} = (X_{M1}) * (X_{T3})$$

$$X_{T5} = (X_{T4}) * (X_{M2})$$

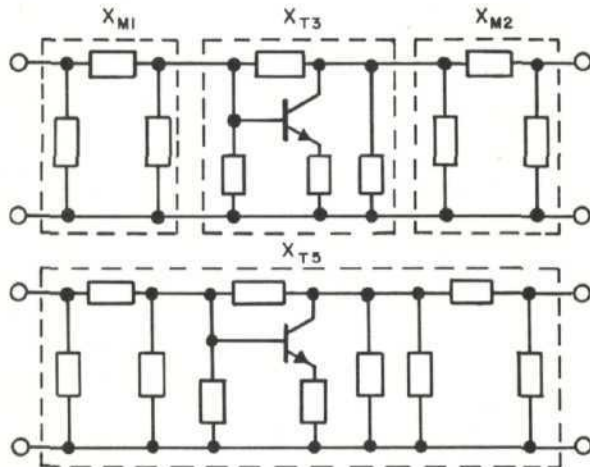

14. Convert over-all X matrix to S matrix, $X_{T5} \rightarrow S_{T2}$.

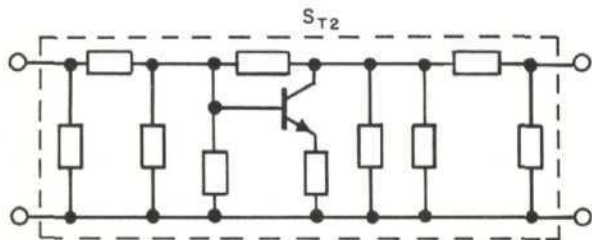

15. Print out:

- S parameters of amplifier.
- Maximum available gain.
- Transducer power gain (G_T).
- Circuit (mismatch) losses.
- Stability factor.
- Unilateral figure of merit, U .

(This outline should be followed for each stage of the amplifier. Afterward the stage should be optimized and its X matrices multiplied together to obtain the over-all parameters).

16. Go to next frequency (step 1).

17. End.

A sample printout for two cascaded stages operating at 100 MHz is shown below.

H P MICROW

GE TIME-SHARING SERVICE

ON AT 19:26 SF WED 05/22/68 TTY 13

USER NUMBER--
SYSTEM--BASIC
NEW OR OLD--OLD
OLD PROBLEM NAME--LB-AMP

READY.

RUN

LB-AMP 19:27 SF WED 05/22/68

F= 100 MHZ N= 2 STAGES

GT= 20.1109 DB
MISMATCH LOSSES
INPUT PM= 3.02588 E-2 DB
OUTPUT PM= 1.55601 E-2 DB
G MAX= 103.668 20.1567 DB
U= 1.15472 E-3
STABILITY FACTOR = 2.14316

OVERALL S MATRIX, S11, S12, S21, S22, (MAGN.+ ANGLE)

8.33249 E-2	-49.2713	2.28023 E-2	-69.5409
10.1282	-63.5409	5.98029 E-2	-64.777

Note that the maximum gain is given as 20.1567 dB, while the $G_T = 20.1109$ dB. The difference is due to the mismatch losses. The input mismatch loss, for instance, is printed out as 3.02588 E-2 dB. The E-2 notation stands for 10^{-2} . Subtracting the input and output mismatch losses from the maximum available gain results in the obtained G_T value.

Also note that the stability factor is well over one and that the s -parameter values are well within the specified limits.

Understand the program

The shunt and series feedback networks of the single stages should be determined first. With the help of two "do-loops" in steps 4 and 7 the feedback elements are varied and the trends of the resultant changes in s_{11} , s_{22} and the maximum available gain are printed out. The values of the feedback elements are selected to give flat response of maximum available gain, with an absolute value equal to the specified transducer gain, G_T , and the lowest possible set of values for $|s_{11}|$, $|s_{22}|$. A good flat response of maximum available gain within the frequency range of the amplifier indicates that the circuit will provide the required gain if and only if it is properly matched both at the input and the output.

It is advisable to keep the magnitudes of both s_{11} and s_{22} below 0.5 (the lower the better). Otherwise the wideband match will become rather difficult, requiring a ladder network of several sections.

After selecting the feedback networks the corresponding s_{11} and s_{22} should be plotted on a Smith chart and the matching networks deter-

mined.^{8,9} S_{11} of the first stage and s_{22} of the second stage are matched to have magnitudes smaller than 0.2, as specified earlier. S_{22} of the first stage is matched to the conjugate value of s_{11} of the second stage. Again, the "do-loops" will help to arrive at the optimum values.

The importance of this technique cannot be overemphasized. Using conventional design techniques, most engineers will accept far less satisfactory matches without much hesitation rather than face the difficulties involved in trial and error. For example, consider the case in which two stages are cascaded, each having a VSWR of 2.5:1 at the input and output (magnitudes of s_{11} and s_{22} equal to 0.43). The mismatch losses can total 3.5 dB—and yet in many instances they would still be acceptable.

In our own case, however, the s_{22} of the unmatched amplifier was 0.49 at 400 MHz, which would result in a 1.2-dB mismatch loss when the amplifier is terminated by a 50- Ω load. After the three-element matching network is placed into the output circuit, $|s_{22}|$ becomes less than 0.08 over the complete frequency range of the amplifier. The maximum value of the mismatch loss is reduced to 0.04 dB.

Once the matching networks are determined, the component values should be fed into step 12 and the over-all response of the amplifier checked. At this point the transducer gain G_T is to have a flat response. If the unilateral approach is not followed ($s_{12} \neq 0$), the output match will affect the input impedance and the input match may affect the output impedance. However, even here only minor changes of the component values will be needed, which the computer will do simultaneously. The circuit is ready to be built.

Stability and final measurements

Stability is of vital importance; the designer should be certain that the amplifier will be unconditionally stable. Although the Linvill stability factor,¹⁰ C , defines a necessary condition for stability, it alone does not guarantee absolute stability for all passive load and source impedances.

In terms of the s parameters, the general conditions for stability¹¹ require that

$$k = 1/C > 1$$

where

$$K = \frac{1 + |s_{11} s_{22} - s_{12} s_{21}|^2 - |s_{11}|^2 - |s_{22}|^2}{2 |s_{12}| |s_{21}|}$$

In addition, the quantity

$$1 + |s_{11}|^2 - |s_{22}|^2 - |s_{11} s_{22} - s_{12} s_{21}|^2$$

must be greater than zero.

Only when both the above conditions are fulfilled can the circuit be considered to be unconditionally stable for all possible combinations of source and load impedances. If the amplifier

Table. S parameters at 100 MHz.

Specified magnitudes	S_{11} < 0.2	S_{12} < 0.03	S_{21} (10 +0.6 -0.55)	S_{22} < 0.2
Design values	0.083 ∠-49°	0.023 ∠-70°	10.13 ∠-63°	0.060 ∠-64°
Measured values	0.110 ∠-52°	0.020 ∠-60°	10.36 ∠-54°	0.035 ∠-60°

shows tendencies toward instability, the gain-bandwidth product of the circuit may have to be reduced or the phase of the matching networks changed.

The efficiency and accuracy of the design are reflected in the close correlation between the computer-predicted and measured parameter values obtained on the first prototype (see table).

The thin-film process asserted itself through the unusual repeatability of the first five laboratory prototypes. The magnitudes of all s parameters were found to be within ± 2 per cent. ■

References:

1. "Network Analysis at Microwave Frequency," HP Application Note No. 92.
2. Franklin F. Kuo, *Network Analysis and Synthesis*, 2nd ed., John Wiley & Sons, New York, 1966.
3. Seshn. Balabanian, *Linear Network Analysis*, Wiley.
4. Richard A. Hackborn, "An Automatic Network Analyzer System," *Microwave Journal*, May 1968.
5. C. G. Montgomery, R. H. Dicke, E. M. Purcell, "Principles of Microwave Circuits," MIT Radiation Laboratory Series, Vol. 8, Boston Technical Publishers, Inc., Lexington, Mass., 1964.
6. George E. Bodway, Hewlett-Packard Internal Publication.
7. Luis Peregrino, Russ Riley, "A Method of Operating with Complex Matrices in the Time-Sharing Computer," Hewlett-Packard Internal Publication.
8. Gerald E. Martes, "Make Impedance Matching Easier," *Electronic Design*, July 5, 1966.
9. J. Linvill and J. Gibbons, *Transistors and Active Circuits*, McGraw-Hill, MC, New York, 1961.
10. *Ibid.*
11. George E. Bodway, "Two-Port Power Flow Analysis Using Generalized S Parameters," *Microwave Journal*, May 1967.
12. "S Parameter Test Set," *Hewlett-Packard Technical Data*, March 1967.

Test your retention

Here are questions based on the main points of this article. They are to help you see if you have overlooked any important ideas. You'll find the answers in the article.

1. What is the main advantage of s parameters over h , y , or z parameters?

2. Can you define each s parameter in terms of their physical significance?

3. Why is it desirable to have s_{12} as small as possible?

4. What is unconditional stability?

SECTION V

QUICK AMPLIFIER DESIGN WITH SCATTERING PARAMETERS

William H. Froehner's article shows how to design an amplifier from scattering parameter data. He shows the s parameters can be used to reliably predict the gain, bandwidth, and stability of a given design. Two design examples are included. One is the design of an amplifier for maximum gain at a single frequency from an unconditionally stable transistor. The second is the design of an amplifier for a given gain at a single frequency when the transistor is potentially unstable.

S Parameter Definitions	5-2
Amplifier Stability	5-4
K (Stability Factor)	5-4
Stability Circles	5-4
Constant Gain Circles	5-6
Designing a Transistor Amplifier for Maximum Gain at a Single Frequency	5-6
Matching the Output	5-8
Matching the Input	5-8
Designing a Transistor Amplifier for a Given Gain at a Single Frequency	5-10
Picking a Stable Load	5-10
Matching the Output	5-11
Matching the Input	5-11

• **Electronics**®

Quick amplifier design with scattering parameters

By William H. Froehner
Texas Instruments Incorporated, Dallas

Reprinted for **Hewlett Packard Company** from **Electronics**, October 16, 1967.

Copyright 1967 by McGraw-Hill Inc. 330 W. 42nd St., New York, N.Y. 10036

Quick amplifier design with scattering parameters

Smith chart and *s* parameters are combined in a fast, reliable method of designing stable transistor amplifiers that operate above 100 megahertz

By William H. Froehner

Texas Instruments Incorporated, Dallas

Bandwidth, gain, and stability are the most important parameters in any amplifier design. Designing for one without considering the other two can mean a mediocre amplifier instead of one with high performance. A reliable technique for predicting bandwidth, determining gain, and assuring stability uses scattering or *s* parameters.

Scattering parameters make it easy to characterize the high-frequency performance of transistors. As with *h*, *y*, or *z* parameter methods, no equivalent circuit is needed to represent the transistor device. A transistor is represented as a two-port network whose terminal behavior is defined by four *s* parameters, s_{11} , s_{12} , s_{21} , and s_{22} .

For designs that operate under 100 megahertz the problem of accurately representing the transistor is not acute, because transistor manufacturers provide relatively complete data in a form other than *s* parameters. However, at frequencies above 100 Mhz the performance data is frequently incomplete or in an inconvenient form. In addition, *h*, *y*, or

z parameters, ordinarily used in circuit design at lower frequencies, cannot be measured accurately. But *s* parameters may be measured directly up to a frequency of 12.4 gigahertz. Once the four *s* parameters are obtained, it is possible to convert them to *h*, *y*, or *z* terms with conventional tables.

Defining the terms

Because scattering parameters are based on reflection characteristics derived from power ratios they provide a convenient method for measuring circuit losses. Representing a network in terms of power instead of the conventional voltage-current description can help solve microwave-transmission problems where circuits can no longer be characterized using lumped R, L, and C elements.

When a network is described with power parameters, the power into the network is called incident, the power reflected back from the load is called reflected. A description of a typical two-port network based on the incident and reflected power is given by the scattering matrix. To understand the relationships, consider the typical two-port network, bottom of page 101, which is terminated at both ports by a pure resistance of value Z_0 , called the reference impedance. Incident and reflected waves for the two-port network are expressed by two sets of parameters (a_1, b_1) and (a_2, b_2) at terminals 1-1' and 2-2' respectively. They are

$$a_1 = \frac{1}{2} \left[\frac{V_1}{\sqrt{Z_0}} + \sqrt{Z_0} I_1 \right] = \text{input power to the load applied at port 1} \quad (1a)$$

$$b_1 = \frac{1}{2} \left[\frac{V_1}{\sqrt{Z_0}} - \sqrt{Z_0} I_1 \right] = \text{reflected power from the load as seen from port 1} \quad (1b)$$

Looking back

This is the second major article on scattering parameters to appear in *Electronics*. In the first, "Scattering parameters speed design of high-frequency transistor circuits," [Sept. 5, 1966, p. 78], F.K. Weinert described how to use the technique in a special case where the input impedance is matched to the load. This condition always results in an unconditionally stable amplifier. In practice, this ideal condition is not always possible.

In this article, author W. H. Froehner describes how to use the technique more generally—when the input impedance is not matched to the load and the scattering parameter s_{12} does not equal zero.

$$a_2 = \frac{1}{2} \left[\frac{V_2}{\sqrt{Z_0}} + \sqrt{Z_0} I_2 \right] = \text{input power to the load applied at port 2} \quad (1c)$$

$$b_2 = \frac{1}{2} \left[\frac{V_2}{\sqrt{Z_0}} - \sqrt{Z_0} I_2 \right] = \text{reflected power from the load as seen from port 2} \quad (1d)$$

Hence, the scattering parameters for the two-port network are given by

$$\begin{aligned} b_1 &= s_{11}a_1 + s_{12}a_2 \\ b_2 &= s_{21}a_1 + s_{22}a_2 \end{aligned} \quad (2)$$

Expressed as a matrix, equation 2 becomes

$$\begin{bmatrix} b_1 \\ b_2 \end{bmatrix} = \begin{bmatrix} s_{11} & s_{12} \\ s_{21} & s_{22} \end{bmatrix} \begin{bmatrix} a_1 \\ a_2 \end{bmatrix} \quad (3)$$

where the scattering matrix is

$$[s] = \begin{bmatrix} s_{11} & s_{12} \\ s_{21} & s_{22} \end{bmatrix} \quad (4)$$

Thus, the scattering parameters for the two-port network can be expressed as ratios of incident and reflected power waves.

$$s_{11} = \left. \frac{b_1}{a_1} \right|_{a_2=0} \quad s_{12} = \left. \frac{b_1}{a_2} \right|_{a_1=0} \quad (5)$$

$$s_{21} = \left. \frac{b_2}{a_1} \right|_{a_2=0} \quad s_{22} = \left. \frac{b_2}{a_2} \right|_{a_1=0}$$

The parameter s_{11} is called the input reflection coefficient; s_{21} is the forward transmission coefficient; s_{12} is the reverse transmission coefficient; and s_{22} is the output reflection coefficient.

By setting $a_2 = 0$, expressions for s_{11} and s_{21} can be found. To do this the load impedance Z_0 is set equal to the reference impedance R_{ML} . This conclusion is proven with the help of the terminating section of the two-port network shown above with the a_2 and b_2 parameters. The load resistor Z_0 is considered as a one-port network with a scattering parameter

$$s_2 = \frac{Z_0 - R_{ML}}{Z_0 + R_{ML}} \quad (6)$$

Hence a_2 and b_2 are related by

$$a_2 = s_2 b_2 \quad (7)$$

When the reference impedance R_{ML} is set equal to the load impedance Z_0 , then s_2 becomes

$$s_2 = \frac{Z_0 - Z_0}{Z_0 + Z_0} = 0 \quad (8)$$

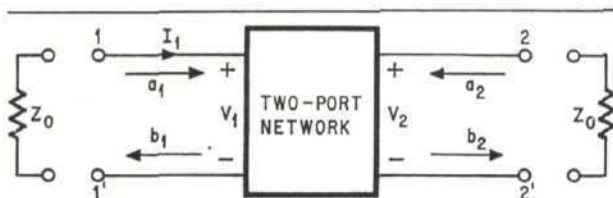

Defining the s parameters. Ratios of incident waves a_1 , a_2 and reflected power waves b_1 , b_2 for ports 1 and 2 define the four scattering parameters.

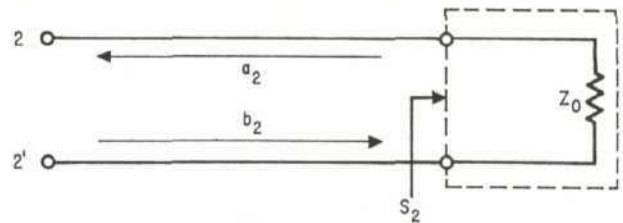

Impedance matching. By setting a_2 equal to zero the engineer can determine the s_{11} value. The condition $a_2 = 0$ implies that the reference impedance R_{MS} is set equal to the load impedance Z_0 .

so that $a_2 = 0$ under this condition. Likewise, when $a_1 = 0$, the reference impedance of port 1 is equal to the terminating impedance; $R_{MS} = Z_0$.

By defining the driving-point impedances at ports 1 and 2 as

$$Z_1 = \frac{V_1}{I_1}; \quad Z_2 = \frac{V_2}{I_2} \quad (9)$$

s_{11} and s_{22} can be written in terms of equation 9.

$$\begin{aligned} s_{11} &= \left. \frac{b_1}{a_1} \right|_{a_2=0} \\ &= \frac{\frac{1}{2}[(V_1/\sqrt{Z_0}) - \sqrt{Z_0} I_1]}{\frac{1}{2}[(V_1/\sqrt{Z_0}) + \sqrt{Z_0} I_1]} = \frac{Z_1 - Z_0}{Z_1 + Z_0} \end{aligned} \quad (10)$$

$$s_{22} = \frac{Z_2 - Z_0}{Z_2 + Z_0} \quad (11)$$

In the expression

$$s_{21} = \left. \frac{b_2}{a_1} \right|_{a_2=0}$$

The condition $a_2 = 0$ implies that the reference impedance R_{ML} is set equal to the load Z_0 . If a voltage source $2E_1$ is connected with a source impedance $R_{MS} = Z_0$, as seen on page 102, a_1 can be expressed as

$$a_1 = \frac{E_1}{\sqrt{Z_0}} \quad (12)$$

$$\text{Since } a_2 = 0, \text{ then } a_2 = 0 = \frac{1}{2} \left[\frac{V_2}{\sqrt{Z_0}} + \sqrt{Z_0} I_2 \right]$$

$$\text{from which } \frac{V_2}{\sqrt{Z_0}} = -\sqrt{Z_0} I_2$$

Consequently,

$$b_2 = \frac{1}{2} \left[\frac{V_2}{\sqrt{Z_0}} - \sqrt{Z_0} I_2 \right] = \frac{V_2}{\sqrt{Z_0}}$$

Hence,

$$s_{21} = \frac{V_2}{E_1} \quad (13)$$

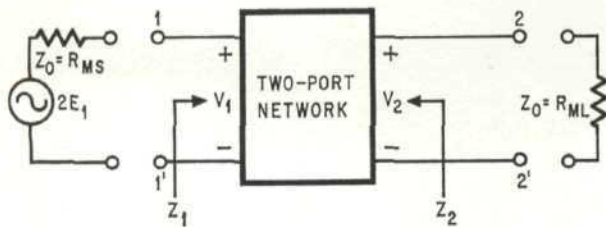

Finding s_{21} . By connecting a voltage source, $2E_1$, with the source impedance, Z_0 , parameter s_{21} can be evaluated.

Similarly when port 1 is terminated in $R_{MS} = Z_0$ and a voltage source equal to $2E_2$ having an impedance of Z_0 is connected to port 2

$$s_{12} = \frac{V_1}{E_2} \quad (14)$$

Both s_{12} and s_{21} are voltage-ratios and therefore have no dimensions. For a passive network, $s_{21} = s_{12}$. Parameters s_{11} and s_{22} are reflection coefficients and are also dimensionless.

Stabilizing an amplifier

Since the s parameters are based on reflection coefficients, they can be plotted directly on a Smith chart and easily manipulated to establish optimum gain with matching networks. To design an amplifier the engineer first plots the s -parameter values for the transistor on a Smith chart and then, using the plot, synthesizes matching impedances between a source and load impedance.

Stability or resistance to oscillation is most important in amplifier design and is determined from the s parameters and the synthesized source and load impedances. The oscillations are only possible if either the input or the output port, or both, have negative resistance. This occurs if s_{11} or s_{22} are greater than unity. However, even with negative resistances the amplifier might still be stable.

For a device to be unconditionally stable s_{11} and s_{22} must be smaller than unity and the transistor's inherent stability factor, K , must be greater than unity and positive. K is computed from

$$K = \frac{1 + |\Delta|^2 - |s_{11}|^2 - |s_{22}|^2}{2|s_{21}s_{12}|} \quad (15)$$

Plotting circles

Stability circles can be plotted directly on a Smith chart. These separate the output or input planes into stable and potentially unstable regions. A stability circle plotted on the output plane indicates the values of all loads that provide negative real input impedance, thereby causing the circuit to oscillate. A similar circle can be plotted on the input plane which indicates the values of all loads that provide negative real output impedance and again cause oscillation. A negative real impedance is defined as a reflection coefficient which has a magnitude that is greater than unity.

The regions of instability occur within the circles

whose centers and radii are expressed by

$$\begin{aligned} \text{center on the input plane} &= r_{s1} \\ &= \frac{C_1^*}{|s_{11}|^2 - |\Delta|^2} \quad (16) \end{aligned}$$

$$\begin{aligned} \text{radius on the input plane} &= R_{s1} \\ &= \frac{|s_{12}s_{21}|}{|s_{11}|^2 - |\Delta|^2} \quad (17) \end{aligned}$$

$$\begin{aligned} \text{center on the output plane} &= r_{s2} \\ &= \frac{C_2^*}{|s_{22}|^2 - |\Delta|^2} \quad (18) \end{aligned}$$

$$\begin{aligned} \text{radius on the output plane} &= R_{s2} \\ &= \frac{|s_{12}s_{21}|}{|s_{22}|^2 - |\Delta|^2} \quad (19) \end{aligned}$$

where

$$C_1 = s_{11} - \Delta s_{22}^* \quad (20)$$

$$C_2 = s_{22} - \Delta s_{11}^* \quad (21)$$

$$\Delta = s_{11}s_{22} - s_{12}s_{21} \quad (22)$$

In these equations the asterisk represents the complex conjugate value. Six examples of stable and potentially unstable regions plotted on the output plane are on the opposite page. In all cases the gray areas indicate the loads that make the circuit stable.

The first two drawings, A, and B, show the possible locations for stability, when the value of K is less than unity; C and D are for K greater than unity. When the stability circle does not enclose the origin of the Smith chart, its area provides negative real input impedance. But when the stability circle does enclose the origin, then the area bounded by the stability circle provides positive real input impedance.

Drawings E and F indicate the possible locations for stability when the value of K is greater than unity and positive. If the stability circle falls completely outside the unity circle, the area bounded by this circle provides negative real input impedance. But if the stability circle completely surrounds the unity circle then the area of the stability circle provides positive real input impedance.

When K is positive

The design of an amplifier where K is positive and greater than unity is relatively simple since these conditions indicate that the device is unconditionally stable under any load conditions. All the designer need do is compute the values of R_{MS} and R_{ML} that will simultaneously match both the input and output ports and give the maximum power gain of the device.

Reflection coefficient of the generator impedance required to conjugately match the input of the transistor = R_{MS}

$$= C_1^* \left[\frac{B_1 \pm \sqrt{B_1^2 - 4|C_1|^2}}{2|C_1|^2} \right] \quad (23)$$

Stability examples

(A) CONDITIONALLY STABLE $K < 1$

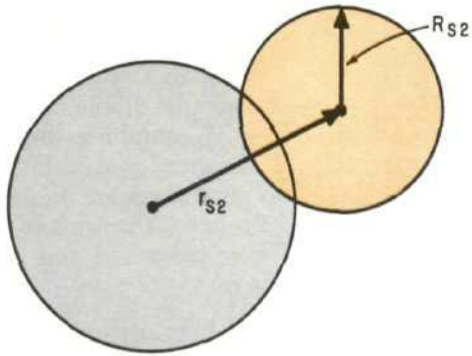

(B) CONDITIONALLY STABLE $K < 1$

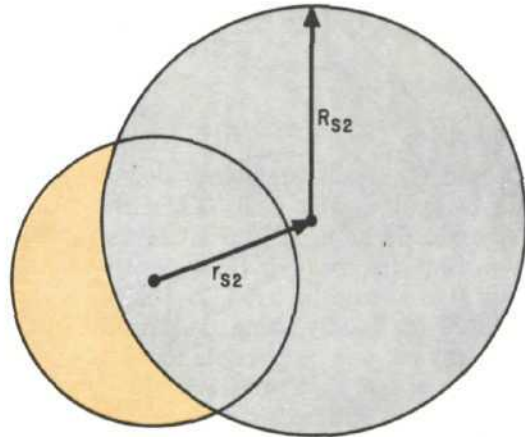

(C) CONDITIONALLY STABLE $K > 1$

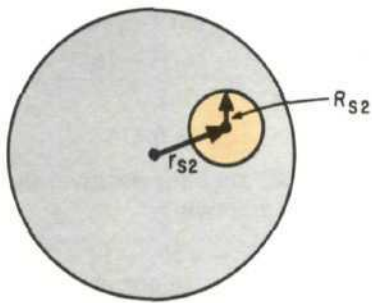

(D) CONDITIONALLY STABLE $K > 1$

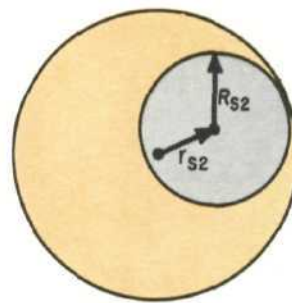

(E) UNCONDITIONALLY STABLE $K > 1$

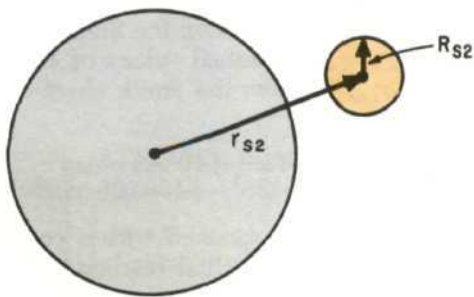

(F) UNCONDITIONALLY STABLE $K > 1$

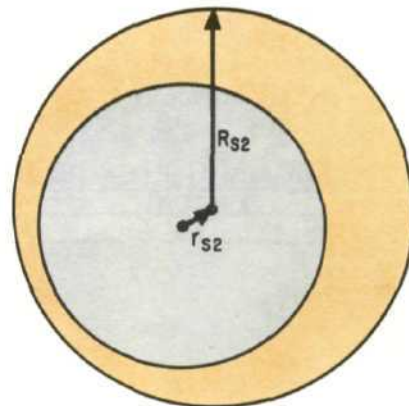

Controlling oscillation. Stability circles are superimposed on the output plane. Load impedances chosen from gray areas will not cause oscillation. Colored areas represent unstable loads.

where

$$B_1 = 1 + |s_{11}|^2 - |s_{22}|^2 - |\Delta|^2 \quad (24)$$

and

Reflection coefficient of that load impedance required to conjugately match the output of the transistor = R_{ML}

$$= C_2^* \left[\frac{B_2 \pm \sqrt{B_2^2 - 4|C_2|^2}}{2|C_2|^2} \right] \quad (25)$$

where

$$B_2 = 1 + |s_{22}|^2 - |s_{11}|^2 - |\Delta|^2 \quad (26)$$

and C_1 and C_2 are as previously defined.

If the computed value of B_1 is negative, then the plus sign should be used in front of the radical in equation 23. Conversely, if B_1 is positive, then the negative sign should be used. This also applies in equation 25 for B_2 . By using the appropriate sign only one answer will be possible in either equation and a value of less than unity will be computed.

The maximum power gain possible is found from the relationship

$$G_{MAX} = \left| \frac{s_{21}}{s_{12}} \right| |K| \quad K = \sqrt{K^2 - 1} \quad (27)$$

Once again the plus sign is used if B_1 is negative and the minus sign if B_1 is positive. This maximum power gain is obtained only if the device is loaded with R_{MS} and R_{ML} expressed as reflection coefficients. These values are plotted directly on a Smith chart that has been normalized to the reference impedance, ($Z_0 = 50$ ohms, in this case). The actual values of R_{MS} and R_{ML} are read from the Smith chart coordinates and multiplied by Z_0 . A lossless transforming network can then be placed between the transistor and the source and load terminations to obtain the maximum gain.

If a power gain other than G_{MAX} is desired, constant gain circles must be constructed. The solution for contours of constant gain is given by the equation of a circle whose center and radius are

$$\text{The center of the constant gain circle on the output plane} = r_{02} = \left[\frac{G}{1 + D_2 G} \right] C_2^* \quad (28)$$

The radius of the constant gain circle on the output plane = R_{02}

$$= \frac{(1 - 2K|s_{12}s_{21}|G + |s_{12}s_{21}|^2 G^2)^{1/2}}{1 + D_2 G} \quad (29)$$

where

$$D_2 = |s_{22}|^2 - |\Delta|^2 \quad (30)$$

$$G = \frac{G_p}{G_o} \quad (31)$$

$$G_o = |s_{21}|^2 \quad (32)$$

and $G_p =$ desired total amplifier gain (numeric)

After a load that falls on the desired constant gain circle has been selected, a generator impedance is selected to achieve the desired gain.

The value for the generator impedance that simultaneously matches the input load is given by

$$r_1 = \left[\frac{s_{11} - r_2 \Delta}{1 - r_2 s_{22}} \right]^* \quad (33)$$

where

$r_2 =$ the reflection coefficient of the load picked.

To prove stability

With the following example it can be demonstrated that when a positive K is greater than unity, the amplifier will always be stable.

Objective: Design an amplifier to operate at 750 Mhz with a maximum gain using a 2N3570 transistor. The bias conditions are $V_{CE} = 10$ volts and $I_C = 4$ milliamperes. Scattering parameters for this transistor were measured and found to be

$$s_{11} = 0.277 \angle -59.0^\circ$$

$$s_{12} = 0.078 \angle 93.0^\circ$$

$$s_{21} = 1.920 \angle 64.0^\circ$$

$$s_{22} = 0.848 \angle -31.0^\circ$$

Solution: Compute the values for the maximum gain, and the load impedances R_{MS} and R_{ML} .

$$\Delta = s_{11}s_{22} - s_{12}s_{21} = 0.324 \angle -64.8^\circ$$

$$C_1 = s_{11} - \Delta s_{22}^* = 0.120 \angle -135.4^\circ$$

$$B_1 = 1 + |s_{11}|^2 - |s_{22}|^2 - |\Delta|^2 = 0.253$$

$$C_2 = s_{22} - \Delta s_{11}^* = 0.768 \angle -33.8^\circ$$

$$B_2 = 1 + |s_{22}|^2 - |s_{11}|^2 - |\Delta|^2 = 1.537$$

$$K = \frac{1 + |\Delta|^2 - |s_{11}|^2 - |s_{22}|^2}{2|s_{12}s_{21}|} = 1.033$$

$$D_2 = |s_{22}|^2 - |\Delta|^2 = 0.614$$

Since B_1 and B_2 are both positive, the negative sign is used in the following:

$$G_{MAX} = \left| \frac{s_{21}}{s_{12}} \right| |K - \sqrt{K^2 - 1}| = 19.087 = 12.807 \text{ db}$$

$$R_{MS} = C_1^* \left[\frac{B_1 - \sqrt{B_1^2 - 4|C_1|^2}}{2|C_1|^2} \right] = 0.730 \angle 135.4^\circ$$

$$R_{ML} = C_2^* \left[\frac{B_2 - \sqrt{B_2^2 - 4|C_2|^2}}{2|C_2|^2} \right] = 0.951 \angle 33.8^\circ$$

R_{MS} and R_{ML} are plotted on the Smith chart on the opposite page. The actual values of R_{MS} and R_{ML} can now be read from the Smith chart coordinates as Z_s and Z_L .

$$R_{MS} = Z_s = 9.083 + j 19.903 \text{ ohms}$$

$$R_{ML} = Z_L = 14.686 + j 163.096 \text{ ohms}$$

These results were obtained with a computer and do not represent the actual reading of the coordinates on the Smith chart.

A lossless matching network can now be inserted between a 50-ohm generator and the transistor to provide a conjugate match for the input of the transistor. To conjugately match the output of the transistor a lossless matching network can be inserted between the transistor and a 50-ohm load. With the transistor's input and output conjugately

Strip-line design

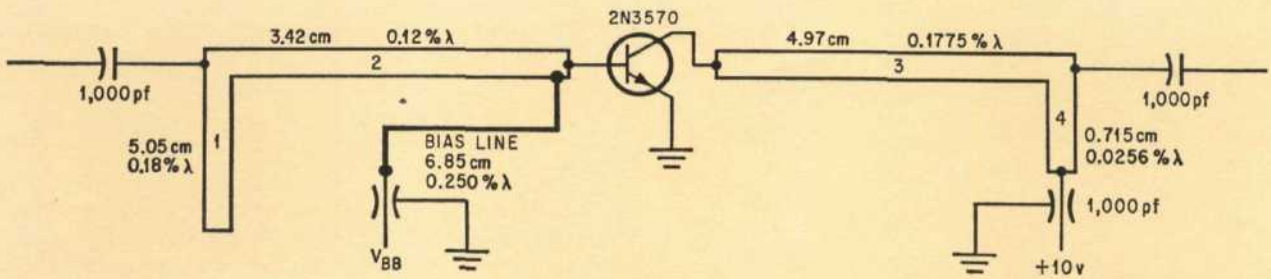
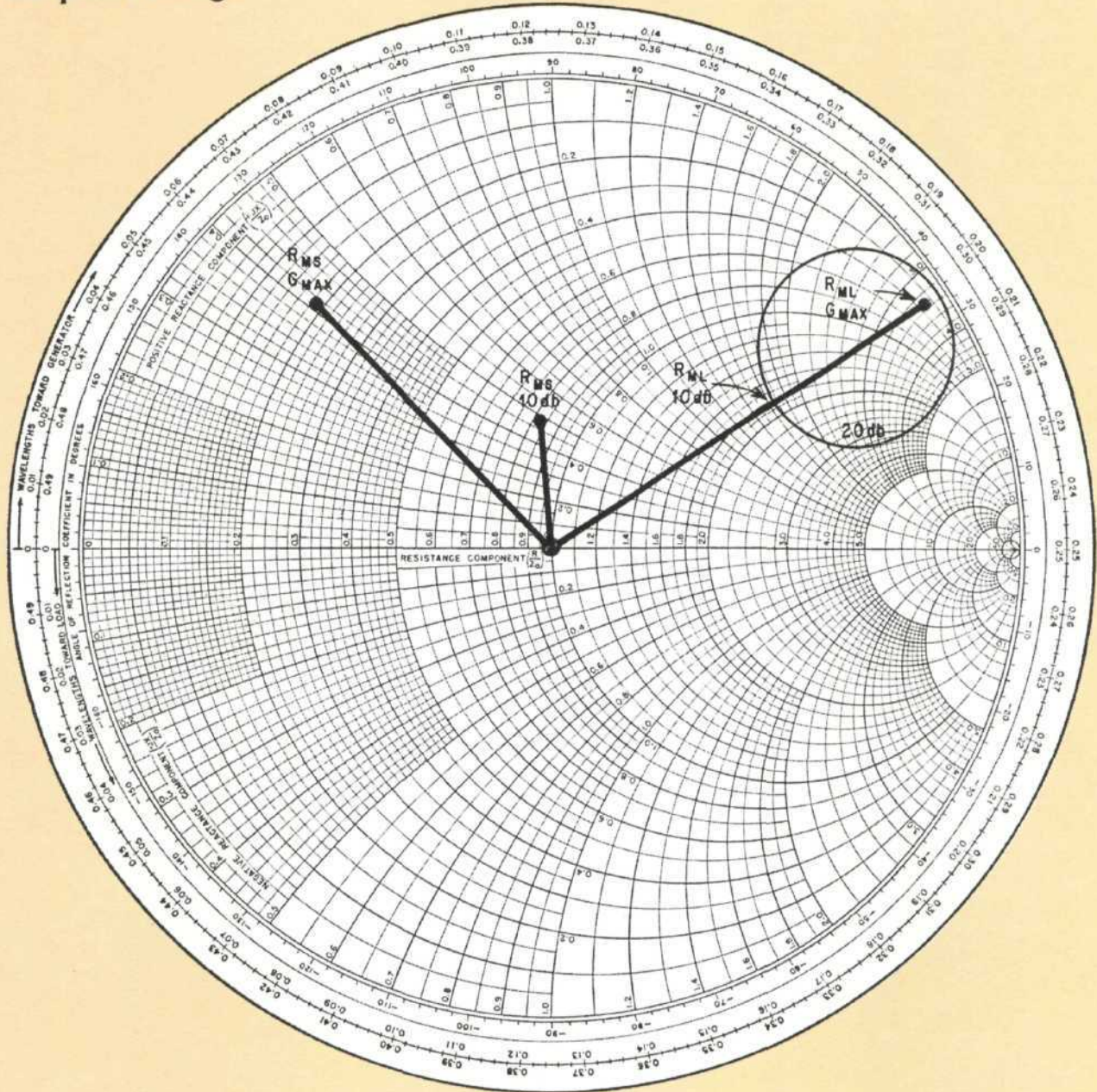

Design example. Graphical plot of a 75-MHz amplifier design using a 2N3570 transistor. Completed circuit uses strip lines to match the input and output to the transistor.

matched, a maximum power gain is achieved.

In this example Teflon transmission lines, using $\frac{1}{16}$ " Teflon Fiberglass p-c board, were chosen for matching the input and output. The values for the lines are determined as follows:

Output circuit

Step 1. Transform R_{ML} to $50 \pm jz$ ohms or $20 \pm jb$ mmhos using the relationship

$$jb = \pm \left[\frac{|R_{ML}|^2 (Y_o + G_L)^2 - (Y_o - G_L)^2}{1 - |R_{ML}|^2} \right]^{1/2}$$

where

jb = reactance of the parallel stub

Y_o = characteristic admittance of the transmission line

G_L = real part of load admittance

In this case Y_o and $G_L = 20$ mmhos. Hence,

$$jb = \pm \left[\frac{(0.951)^2 (20 + 20)^2 - (20 - 20)^2}{1 - (0.951)^2} \right]^{1/2}$$

$$= \pm 123.5 \text{ mmhos}$$

The negative sign was chosen for a shorted inductive stub to keep the over-all length below $\lambda/4$.

Step 2. Find the lengths for elements 3 and 4.

$$\tan \beta L = \frac{-Y_o}{jb} = \frac{20}{123.5} = 0.162$$

therefore,

$$\beta L = 9.2^\circ$$

but

$$\beta = \frac{2\pi}{\lambda}$$

and

$$\lambda = \frac{\text{velocity of light}}{\text{frequency}} = \frac{300 \times 10^6 \text{ meters/sec}}{750 \times 10^6 \text{ hz/sec}}$$

$$= 40 \text{ cm/hz}$$

Hence,

$$L = \frac{9.2^\circ}{360^\circ} \times 40 \text{ cm} = 1.02 \text{ cm}$$

For element 4

$$L_4 = (1.02)(0.7) = 0.715 \text{ cm}$$

where λ on Teflon Fiberglass $\frac{1}{16}$ " = $(0.7) (\lambda_{\text{free air}})$

For element 3

$$\Gamma = \left[\frac{Y_o - Y_L}{Y_o + Y_L} \right]$$

$$= \left[\frac{20 - (20 - j123.5)}{20 + (20 - j123.5)} \right] = 0.953 \angle 162^\circ$$

$$L_3 = \left[\frac{\theta_\Gamma - \theta_{R_{ML}}}{720^\circ} \right] \lambda (0.7)$$

$$= \left[\frac{162^\circ - 33.8^\circ}{720^\circ} \right] (40)(0.7) = 4.97 \text{ cm}$$

Input circuit

Step 1. Transform R_{MS} to $50 \pm jz$ ohms or $20 \pm jb$ mmhos using the relationship

$$jb = \pm \left[\frac{|R_{MS}|^2 (Y_o + G_s)^2 - (Y_o - G_s)^2}{1 - |R_{MS}|^2} \right]^{1/2}$$

where

G_s = real part of the source admittance which in this case is 20 mmhos. Hence,

$$jb = \pm \left[\frac{(0.730)^2 (20 + 20)^2 - (20 - 20)^2}{1 - (0.730)^2} \right]^{1/2}$$

$$= \pm 42.8 \text{ mmhos}$$

The positive sign was chosen for an open capacitive stub to keep its length below $\lambda/4$.

Step 2. Find the lengths of elements 1 and 2.

$$\cot \beta L = \frac{Y_o}{jb}$$

$$= \frac{20}{42.8} = 0.467$$

therefore,

$$\beta L = 65^\circ$$

and the length of element 1 is

$$L_1 = \left[\frac{65^\circ}{360^\circ} \right] (40)(0.7)$$

$$= 5.05 \text{ cm}$$

$$\Gamma = \left[\frac{Y_o - Y_s}{Y_o + Y_s} \right]$$

$$= \left[\frac{20 - (20 + j42.8)}{20 + (20 + j42.8)} \right]$$

$$= 0.730 \angle -137^\circ$$

Thus the length of element 2 is

$$L = \left[\frac{\theta_\Gamma - \theta_{R_{MS}}}{720^\circ} \right] \lambda$$

$$= \left[\frac{-137^\circ - 135.4^\circ}{720^\circ} \right] (40)$$

$$= - \frac{272.4}{720^\circ} \times 40$$

Since a positive angle is required, add 360° , then

$$L_2 = \frac{87.6^\circ}{720^\circ} (40)(0.7) = 3.42 \text{ cm}$$

The completed circuit is on page 105.

If a gain other than G_{MAX} had been desired, a constant gain circle would be required. For example, suppose a power gain of 10 db is desired. Thus,

$$G_p = 10 \text{ db}$$

and

$$G_o = |s_{21}|^2 = 3.686 = 5.666 \text{ db}$$

Discrete-component design

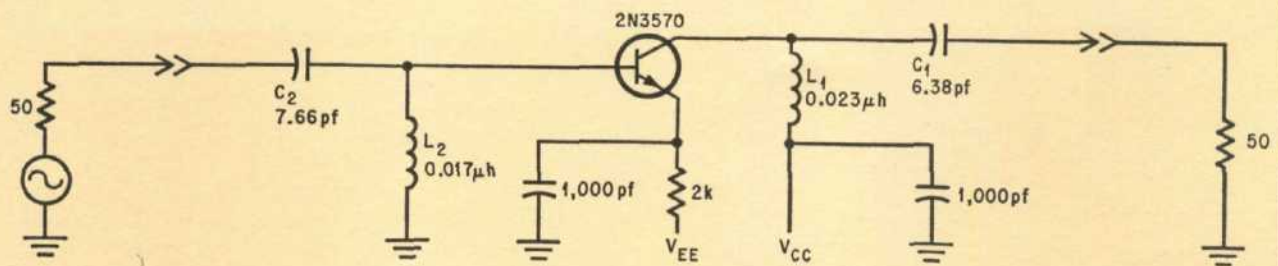
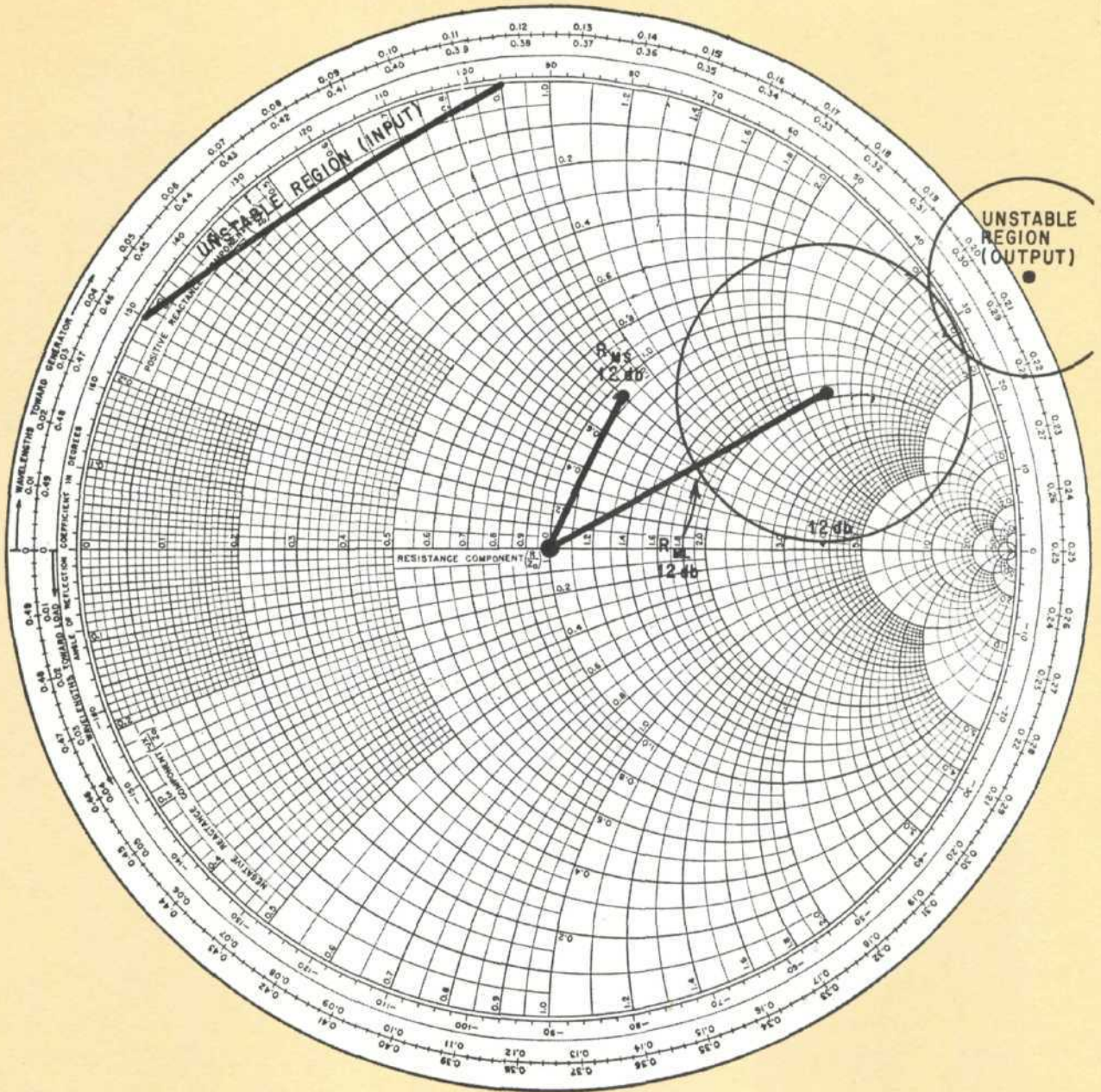

Design example. Graphical plot of a 500-MHz amplifier design using a 2N3570 transistor. Matching is achieved with discrete components whose values are determined from the Smith chart plot.

then

$$G = \frac{G_p}{G_o} = 2.713 = 4.334 \text{ db}$$

Now by computing the center

$$r_{o2} = \left[\frac{G}{1 + D_2 G} \right] C_2^* = 0.781 \angle 33.851^\circ$$

and radius

$$R_{o2} = \frac{(1 - 2K |s_{12}s_{21}| G + |s_{12}s_{21}|^2 G^2)^{1/2}}{1 + D_2 G} = 0.136$$

where

$$D_2 = |s_{22}|^2 - |\Delta|^2 = 0.614$$

a constant gain circle, which shows all loads for the output that yield a power gain of 10 db, can be constructed directly on the Smith chart on page 107. The R_{ML} picked in this example was $0.567 \angle 33.851^\circ$, and read off the Smith chart coordinates as $89.344 + j 83.177$ ohms. The source reflection coefficient required with this load is

$$R_{MS} = \left[\frac{s_{11} - R_{ML}\Delta}{1 - R_{ML}s_{22}} \right]^* = 0.276 \angle 93.329^\circ$$

Hence,

$$Z_s = 41.682 + j 24.859 \text{ ohms.}$$

Since K is greater than unity and B_1 is positive, unconditional stability is assured for all loads.

Alternate design

When the value of K is less than unity, a load must be chosen to assure stable operation of the amplifier. To accomplish this a stability circle is plotted on the Smith chart and examined to determine those loads that may cause oscillation. As long as a load is picked that does not fall in the area of the stability circle, stable operation is assured.

When K is less than unity, the gain of a potentially unstable device approaches infinity by definition. Therefore, equations 23, 25, and 27 cannot be used. Instead, a G_p must first be chosen and then the same procedure as used for $K > 1$ is followed.

The amplifier must be protected from oscillating by careful selection of the load impedance as demonstrated in this example.

Objective: Design an amplifier using a 2N3570 transistor that has a power gain of 12 db at 500 Mhz. The bias conditions are $V_{CE} = 10$ volts and $I_C = 4$ milliamperes. The s parameters are

$$\begin{aligned} s_{11} &= 0.385 \angle -55.0^\circ \\ s_{12} &= 0.045 \angle 90.0^\circ \\ s_{21} &= 2.700 \angle 78.0^\circ \\ s_{22} &= 0.890 \angle -26.5^\circ \end{aligned}$$

Solution: Compute the values of G , R_{MS} , and R_{ML} .

$$\begin{aligned} \Delta &= s_{11}s_{22} - s_{12}s_{21} = 0.402 \angle -65.040^\circ \\ C_1 &= s_{11} - \Delta s_{22}^* = 0.110 \angle -122.395^\circ \\ B_1 &= 1 + |s_{11}|^2 - |s_{22}|^2 - |\Delta|^2 = 0.195 \\ C_2 &= s_{22} - \Delta s_{11}^* = 0.743 \angle -29.881^\circ \end{aligned}$$

$$\begin{aligned} B_2 &= 1 + |s_{22}|^2 - |s_{11}|^2 - |\Delta|^2 = 1.483 \\ D_2 &= |s_{22}|^2 - |\Delta|^2 = 0.631 \end{aligned}$$

$$K = \frac{1 + |\Delta|^2 - |s_{11}|^2 - |s_{22}|^2}{2|s_{12}s_{21}|} = 0.909$$

$$G = \frac{G_o}{G_p} = 2.174 \text{ or } 3.373 \text{ db}$$

Since K is less than unity it is necessary to pick a load that does not cause oscillation. To accomplish this, first consider a stability circle on the output plane. This circle has a center at

$$r_{o2} = \frac{C_2^*}{|s_{22}|^2 - |\Delta|^2} = 1.178 \angle 29.881^\circ$$

and a radius of

$$R_{o2} = \frac{|s_{12}s_{21}|}{|s_{22}|^2 - |\Delta|^2} = 0.193$$

and is represented as the unstable region on the Smith chart on the previous page. As long as an output load is not picked that lies in the unstable region, stable operation is assured.

The constant gain circle that yields 12.0 db of power gain now has a center at

$$r_{o2} = \left[\frac{G}{1 + D_2 G} \right] C_2^* = 0.681 \angle 29.881^\circ$$

and a radius of

$$R_{o2} = \frac{(1 + 2K |s_{12}s_{21}| G + |s_{12}s_{21}|^2 G^2)^{1/2}}{1 + D_2 G} = 0.324$$

By constructing this constant gain circle, an output load is again chosen. The R_{ML} chosen on the circle had a reflection coefficient of $0.357 \angle 29.881^\circ$, and was read off the Smith chart coordinates as $85.866 + j 35.063$ ohms. The source reflection coefficient required for this load is

$$R_{MS} = \left[\frac{s_{11} - R_{ML}\Delta}{1 - R_{ML}s_{22}} \right]^* = 0.373 \angle 64.457^\circ$$

Thus,

$$Z_s = 52.654 + j 41.172 \text{ ohms}$$

Now a look at the stability circle plotted on the input plane is required to see if the value of R_{MS} assures stable operation. The circle on the input plane has a center at

$$r_{s1} = \frac{C_1^*}{|s_{11}|^2 - |\Delta|^2} = 8.372 \angle -57.605^\circ$$

and a radius of

$$R_{s1} = \frac{|s_{12}s_{21}|}{|s_{11}|^2 - |\Delta|^2} = 9.271$$

Only a portion of the input stability circle is shown due to its size. The shaded area is unstable.

Since R_{MS} does not fall inside this circle and R_{ML} does not fall inside the output circle stable operation is assured.

The complete circuit, bottom of page 107, was

constructed from this data. Values for the matching components were obtained using the following procedure.

Output circuit

Step 1. Transform R_{ML} to $50 \pm jz$ ohms or $20 \pm jb$ mmhos. Since individual components are used for matching it is necessary to convert R_{ML} to its parallel equivalent circuit by adding -180° to a positive angle, or $+180^\circ$ to a negative angle.

Therefore,

$$R_{ML_1} = 0.357 \angle -150.119^\circ$$

Using the formula

$$Y_L = \left[\frac{1 + R_{ML_1}}{1 - R_{ML_1}} \right] Y_0$$

where $Y_0 = 20$ mmhos

$$Y_L = 10 - j 4.08 \text{ mmhos}$$

Converting the Y_L admittance to an impedance yields $Z_L = 100 - j 245$ ohms.

Step 2. Compute the value for the capacitor from the relationship

$$X_c = \sqrt{(R_p - R_s)R_s}$$

where

$$R_p = \text{real part of } Z_L = 100$$

$$R_s = \text{load impedance} = 50$$

therefore,

$$X_c = \sqrt{2500} = 50$$

and

$$C_1 = \frac{1}{2\pi f X_c} = 6.38 \text{ pf}$$

Step 3. Compute L_1 from

$$X_{L_1} = \frac{R_s^2 + X_c^2}{X_c} = \frac{(50)^2 + (50)^2}{50} = 100$$

The total X_L is

$$X_{LT} = \frac{(X_{L_1})(X_L)}{(X_{L_1} + X_L)} = 71$$

where

$$X_L = 245 \text{ ohms} = \text{imaginary part of } Z_L$$

hence,

$$L_1 = \frac{X_{LT}}{2\pi f} = 0.023 \mu\text{h}$$

Input circuit

Step 1. Transform R_{MS} to $50 \pm jz$ ohms or $20 \pm jb$ mmhos. To do so convert R_{MS} to its parallel equivalent circuit by adding -180° to a positive angle, or $+180^\circ$ to a negative angle.

Therefore,

$$R_{MS_1} = 0.373 \angle -115.543^\circ$$

Using the formula

$$Y_s = \left[\frac{(1 + R_{MS})}{(1 - R_{MS})} \right] Y_0$$

where $Y_0 = 20$ mmhos

Compute Y_s . Thus,

$$Y_s = 11.8 - j 9.4 \text{ mmhos}$$

or

$$Z_s = 84.7 - j 106.4 \text{ ohms}$$

Step 2. Compute C_2

$$X_{C_2} = \sqrt{(R_p - R_s)R_s}$$

where

$$R_p = \text{real part of } Z_s = 84.7 \text{ ohms}$$

$$R_s = \text{source impedance} = 50 \text{ ohms}$$

Thus,

$$X_{C_2} = 41.6 \text{ ohms}$$

and

$$C_2 = \frac{1}{2\pi f X_c} = 7.66 \text{ pf}$$

Step 3. Compute L_2

$$X_{L_2} = \frac{R_s^2 + Y_c^2}{X_c} = \frac{(50)^2 + (41.6)^2}{41.6}$$

$$= 102 \text{ ohms}$$

$$X_{LT} = \frac{(X_{L_1})(X_L)}{(X_{L_1} + X_L)} = 52.2 \text{ ohms}$$

where

$$X_L = \text{imaginary part of } Z_s = 106.4 \text{ ohms}$$

hence

$$L_2 = \frac{X_{LT}}{2\pi f} = 0.017 \mu\text{h}$$

Bandwidth, the third important design factor, is dependent on the Q of the circuit. There are no magic formulas for accurately predicting bandwidth in all cases. Many LC combinations provide the same complex impedance at the center frequency but yield different Q 's and bandwidths.

If the inherent bandwidth, Q , of a transistor loaded with a particular LC combination yields a bandwidth that is greater than desired, adding LC elements narrows the bandwidth and keeps the gain constant. But if the inherent bandwidth is narrower than desired, a gain reduction or different LC combination changes the bandwidth.

The author



William H. Froehner, who started working at TI in 1964, designs high frequency measurement and test equipment. In the last 18 months he has been applying the scattering parameter technique to design high frequency amplifiers.

SECTION VI

TWO-PORT POWER FLOW ANALYSIS USING GENERALIZED SCATTERING PARAMETERS

Dr. George Bodway's article, first published as an internal HP report in April, 1966, was the first analytical treatment on the practical characterization of active semiconductor devices with s parameters.

Dr. Bodway shows the relation between generalized s parameters and those measured on a transmission line system with a real characteristic impedance. He then shows how these s parameters are related to power gain, available power gain, and transducer power gain. Stability and constant gain circles are derived from the s parameters. Bodway then shows, both mathematically and graphically, how stability and gain are considered in amplifier design.

Introduction	6-1
Generalized Scattering Parameters	6-1
Expression for Power Gain	6-2
Expression for Available Power Gain	6-2
Expression for Transducer Power Gain	6-2
Stability of a Two-Port Network	6-3
Stability Conditions	6-3
Stability Circle Defined	6-3
Conjugate Matched Two-Port	6-4
Relation to Stability	6-4
Power Flow	6-5
Unilateral Case	6-5
Unconditionally Stable Transistor	6-6
Constant Gain Circles	6-6
Potentially Unstable Transistor	6-6
Constant Gain Circles	6-6
Stable Regions	6-6
Error Due to Unilateral Assumption	6-6
Transducer Power, Power, and Available Power Gains for Matched Generator and Load.	6-7
Power Gain and Available Power Gain in the General Case	6-8

TECHNICAL SECTION

TWO PORT
POWER FLOW
ANALYSIS USING
GENERALIZED
SCATTERING
PARAMETERS

George E. Bodway
Hewlett-Packard
Palo Alto, California

INTRODUCTION

The difficulty of measuring the commonly accepted amplifier design parameters, such as the admittance or y parameters, increases rapidly as the frequency of interest is extended above 100 MHz. When the desired parameters must be referred either to a short or an open above 1000 MHz, a wideband measurement system becomes essentially impossible. A convenient way to overcome this problem is to refer the measurements to the characteristic impedance of a transmission line. A set of informative parameters which can readily be measured in terms of the traveling waves on a transmission line are the scattering or "s" parameters.

To illustrate the bandwidths possible, two measurement systems have been set up which measure the scattering parameters (amplitude and phase) without adjustments or calibrations of any kind (once the system is set up) over the frequency ranges 10 MHz to 3.0 GHz and 1.0 - 12.4 GHz.

There are then many advantages for having a design available in terms of the easily measured scattering parameters. One important advantage is that the matching networks are also measured in terms of scattering parameters, for reasons of simplicity at the lower frequencies, and at higher frequencies because of necessity. At microwave frequencies many of the passive elements in a design are open, shorted or coupled sections of transmission line which can be represented as a reflection coefficient on a Smith Chart. Thus, the process of design is readily served by a procedure involving reflection coefficients rather than impedance. Having measured both the active device and associated passive elements in terms of one set of parameters, much feeling for the importance of each measured parameter would be lost by converting all the parameters to another set and proceeding with the design from there. Another significant advantage is in the resulting simplicity of understanding and the intuitive insight one may thus gain from a design based on the generalized scattering parameters. Because of this, the design method is being used at frequencies far below the microwave region. The reason for this simplicity is that the parameters used for the design are inherently power flow parameters.

This paper attempts to formulate a theory which can be simply applied to the measured s parameters in order to synthesize a desired power transfer versus frequency for a linear two port. In addition to obtaining and display-

ing the three familiar forms of power flow, the power gain G , the available gain G_A and the transducer gain G_T versus the load and generator impedances, the potential stability, or instability as the case may be, is completely and simply specified graphically in terms of the measured quantities. A stability circle is defined for both the input and output planes (generator and load Smith Charts) which simply and completely defines the network both with respect to potential instability and with respect to the nature of constant power flow contours.

INTRODUCTION TO GENERALIZED
SCATTERING PARAMETERS

The power waves and generalized scattering matrix were defined very elegantly in a paper by K. Kurakawa.¹ These parameters were introduced previously by Penfield,^{2,3} and also by Youla⁴ for positive real reference impedances. These parameters will be presented here in a form consistent with the rest of the paper. It is possible that the usefulness of these parameters was not realized or used previously for transistor circuit design because of the slow, tedious job of measuring them accurately with a slotted line or a bridge.

The power waves are defined by Equations [1(a), (b)] and Fig. 1.

$$a_1 = \frac{V_1 + Z_1 I_1}{2 \sqrt{|\operatorname{Re} Z_1|}} \quad [1(a)]$$

$$b_1 = \frac{V_1 - Z_1^* I_1}{2 \sqrt{|\operatorname{Re} Z_1|}} \quad [1(b)]$$

Equation (1) defines a new set of variables a_1, b_1 , in terms of an old set, the terminal voltages and currents V_1 and I_1 . This change of variables accomplishes two things: for one, the a_1 and b_1 have units of (power)^{1/2} and a very precise meaning with respect to power flow; second, the relationship between the variables a_1, b_1 will now depend on the terminal impedances of the network.

The expression for the relation between the a_1 's and b_1 's is defined by

$$b_1 = s_{11} a_1 \quad (2)$$

where s_{11} is an element of the generalized scattering matrix and b_1 and a_1 are, respectively, the components of the reflected and incident power wave vectors.

If Z_1 is real and equal to the characteristic impedance of transmission lines connected to the ports of a network, then the definition of a_1, b_1 reduces to that of the forward and reverse traveling waves on the transmission lines and s reduces to the microwave scattering matrix. There-

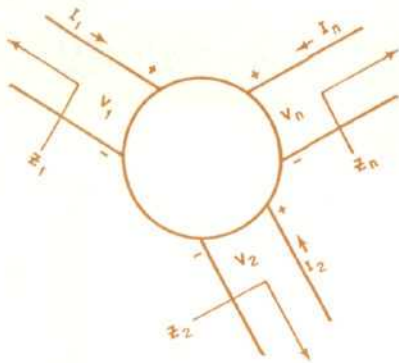

Fig. 1 — Representation of an n port network defining voltages, currents and reference impedances at each port.

fore the advantages of remote transmission line techniques can be used to measure the properties of the network and determine the generalized scattering matrix.

The physical meaning of the power waves a_i , b_i and the generalized parameters s_{ij} are demonstrated by the following equations (Fig. 2). The results follow from Equation (1) and circuit relations indicated by Fig. 2.

$$a_2 = 0 \quad (4)$$

$$\begin{aligned} |b_2|^2 &= |I_2|^2 |\text{Re } Z_2| \\ &= P_L \text{ for real part } Z_2 \text{ positive} \\ &= -P_L \text{ for real part } Z_2 \\ &\quad \text{negative} \end{aligned} \quad (5)$$

where P_L is the power delivered to the load.

$$\begin{aligned} |a_1|^2 &= \frac{|E_0|^2}{4|\text{Re } Z_1|} \\ &= P_a \text{ for real part } Z_1 \text{ positive} \\ &= P_e \text{ for real part } Z_1 \\ &\quad \text{negative} \end{aligned} \quad (6)$$

where P_a is equal to the power available from the generator and P_e is the exchangeable power of the generator,

and

$$|b_1|^2 = |a_1|^2 - \text{Re}(V_1 I_1^*) \quad (7)$$

Using the relations above for $|a_1|^2$ and $|b_1|^2$ the following significant and useful physical content of the generalized scattering parameters is evident. With the real part of Z_1 and Z_2 positive, the forward scattering parameter* $|s_{21}|^2$ is identically equal to the transducer power gain of the network.

$$\begin{aligned} |s_{21}|^2 &= \frac{|b_2|^2}{|a_1|^2} = \frac{P_L}{P_a} = G_T \\ &= \text{transducer power gain} \end{aligned} \quad (8)$$

* The word "generalized" will be deleted, but is to be understood throughout the remainder of the paper.

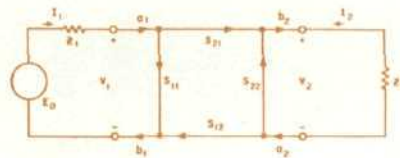

Fig. 2 — Two port model showing voltages, currents, load and generator impedances and power waves.

When either the load or generator impedance consists of negative real parts, appropriate negative signs must be used. In the remainder of this paper (unless stated otherwise) we will assume that the real parts of Z_1 and Z_2 are positive, in order to keep the repetitions in bounds. Nevertheless negative real loads and generator impedances come up quite often such as when cascading potentially unstable stages and are treated in the same way.

Similarly we have

$$|s_{11}|^2 = \frac{\text{Power reflected from the input of the network}}{\text{Power available from a generator at the input port}} \quad (9)$$

for the real part of Z_1 positive.

Placing the generator at the output port, we observe that

$$|s_{12}|^2 = \text{reverse transducer power gain} \quad (10)$$

and

$$|s_{22}|^2 = \frac{\text{Power reflected from the output of the device}}{\text{Power available from a generator at the output port}} \quad (11)$$

where

$$P_{\text{reflected}} = P_a - P_{\text{delivered to the network}} \quad (12)$$

To repeat, for "positive real" load and generator impedances, $|s_{21}|^2$ and $|s_{12}|^2$ are the forward and reverse transducer power gains, while $|s_{11}|^2$ and $|s_{22}|^2$ express the difference between power available from a generator and that which is delivered to the network normalized to the power available from the generator.

In addition to the transducer power gain $|s_{21}|^2$, there are two other useful measures of power flow for a two port network; these are given by

$$\begin{aligned} G &= \frac{\text{Power delivered to load}}{\text{Power into two port}} \\ &= \frac{|s_{21}|^2}{1 - |s_{11}|^2} \end{aligned} \quad (13)$$

$$G_A = \frac{\text{Power available at the output}}{\text{Power available from the generator}} = \frac{|s_{21}|^2}{1 - |s_{22}|^2} \quad (14)$$

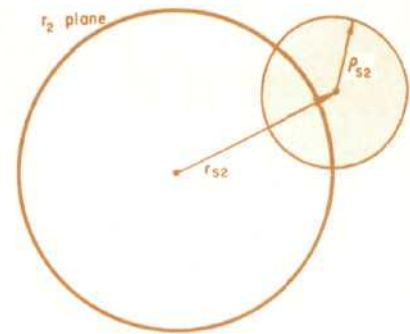

Fig. 3 — Circle defined by r_{s2} and ρ_{s2} divides r_2 plane into a stable and potentially unstable region of operation. If $|s_{11}| < 1$, the inside of the circle indicates those loads which provide negative real input impedance ($|s_{11}'| > 1$). The heavier weight circle defines the unit circle on the Smith Chart.

Because of the close relationship between power flow and the general-

ized scattering parameters we might expect that transistor amplifier design, which is intimately concerned with power flow, could be intuitively clear and straightforward in terms of these parameters.

The generalized scattering parameters are defined in terms of specific load and generator impedance. To make broadband measurements, the parameters are usually referred to 50 ohms. Then, to proceed with the design or to utilize the measured parameters, we must have an expression for the generalized scattering parameters in terms of the measured parameters and arbitrary generator and load impedances. The new scattering parameters for arbitrary load and generator are given by

$$s_{11}' = \frac{A_1^* [(1-r_2 s_{22})(s_{11}-r_1^*) + r_2 s_{12} s_{21}]}{A_1 [(1-r_1 s_{11})(1-r_2 s_{22}) - r_1 r_2 s_{12} s_{21}]} \quad (15)$$

$$s_{12}' = \frac{A_2^* s_{12} [1-|r_1|^2]}{A_1 [(1-r_1 s_{11})(1-r_2 s_{22}) - r_1 r_2 s_{12} s_{21}]} \quad (16)$$

$$s_{21}' = \frac{A_1^* s_{21} [1-|r_2|^2]}{A_2 [(1-r_1 s_{11})(1-r_2 s_{22}) - r_1 r_2 s_{12} s_{21}]} \quad (17)$$

$$s_{22}' = \frac{A_2^* [(1-r_1 s_{11})(s_{22}-r_2^*) + r_1 s_{12} s_{21}]}{A_2 [(1-r_1 s_{11})(1-r_2 s_{22}) - r_1 r_2 s_{12} s_{21}]} \quad (18)$$

where

$$A_1 = \frac{(1-r_1^*)}{|1-r_1|} (1-|r_1|^2)^{1/2} \quad (19)$$

and

$$r_1 = \frac{Z_1' - Z_1}{Z_1' + Z_1} \quad (20)$$

The three forms of power gain can now be expressed in terms of a given set of scattering parameters (s) and arbitrary load and generator impedances.*

$$G_T = |s_{21}'|^2 = \frac{|s_{21}|^2 (1-|r_1|^2) (1-|r_2|^2)}{|1-r_1 s_{11} - r_2 s_{22} - r_1 r_2 \Delta|^2} \quad (21)$$

$$G = \frac{|s_{21}'|^2}{(1-|s_{11}'|^2)} = \frac{|s_{21}|^2 (1-|r_2|^2)}{(1-|s_{11}|^2) + |r_2|^2 (|s_{22}|^2 - |\Delta|^2) - 2 \operatorname{Re}(r_2 C_2)} \quad (22)$$

$$G_A = \frac{|s_{21}'|^2}{(1-|s_{22}'|^2)} = \frac{|s_{21}|^2 (1-|r_1|^2)}{(1-|s_{22}|^2) + |r_1|^2 (|s_{11}|^2 - |\Delta|^2) - 2 \operatorname{Re}(r_1 C_1)} \quad (23)$$

where

$$\Delta = s_{11} s_{22} - s_{12} s_{21} \quad (24)$$

$$C_1 = s_{11} - \Delta s_{22}^* \quad (25)$$

$$C_2 = s_{22} - \Delta s_{11}^* \quad (26)$$

STABILITY OF TWO PORT NETWORK

An important consideration in designing transistor amplifiers is to insure that the circuit does not oscillate. A two port network can be classed as either being absolutely stable or potentially unstable, it is desirable to consider two types of loading and by this means two degrees of potential

instability; one in which the input and output impedances of the device are insured of having a positive real part and stability thereby guaranteed, and a second which allows the input and output impedance to have negative real parts, but only to the extent that the total circuitry is still stable.⁶

The question of stability must be investigated at all frequencies of course, but design for a specific gain or amplifier response versus frequency is usually required over some more restricted frequency range. If this

specific range is restricted to absolute stability, then the design is simplified considerably. However, this in turn severely restricts the potential usefulness of the device. The two alternative considerations, for potentially unstable frequency ranges, offer increased potential use for a given device. They also necessitate a corresponding increase in the complexity of the design. The information we desire concerning stability can then be summarized as follows. It is necessary to know over what frequency ranges the two port is potentially unstable; and in those frequency ranges where the device is

potentially unstable, we desire information about which loads and generator impedances provide stable operation. The answers to these questions are approached by considering Equations (15) and (18) with $r_1=0$ and r_2 as a variable.

Consideration of Equation (18) shows that if $|s_{22}| > 1$, then any passive r_2 still gives $|s_{22}'| > 1$ and the network is potentially unstable for all loads r_2 and the given r_1 . Stability with respect to the output port will be attained by insuring that the positive real part of r_2 is greater than the negative real part of the output impedance. For the condition $|s_{22}| < 1$, the magnitude of $|s_{22}'|$ is less than one for a passive r_2 .

Consideration of Equation (15) shows that the whole r_2 plane can be separated into two regions, one for which the input impedance is positive real and a second for which the input is negative real. The regions can be located by requiring $|s_{11}'|$ to be less than one. The solution for r_2 , separating the two regions, is given by the equation of a circle in the r_2 plane where the center and radius of the circle are

$$r_{s2} = \frac{C_2^*}{|s_{22}|^2 - |\Delta|^2} \quad (27)$$

$$\rho_{s2} = \left| \frac{s_{12} s_{21}}{|s_{22}|^2 - |\Delta|^2} \right| \quad (28)$$

respectively, and $C_2 = s_{22} - \Delta s_{11}^*$.

An example of the stable and potentially unstable regions is indicated in Fig. 3 where the shaded part or inside of the circle corresponds to those loads which provide a negative real input impedance.

The region of the r_2 plane which provides a positive real input impedance is obtained as follows: if the input impedance is positive real with $r_2=0$, and if the circle includes the origin, then the inside of the circle indicates a positive real input impedance; whereas if the circle excludes the origin, then the inside of the circle indicates a negative real input. If the input is negative real with $r_2=0$, then the converse is true.

In the same manner the load can be assumed fixed and the stability investigated as a function of r_1 . The same results are obtained with a corresponding stability circle defined by Equations (27) and (28) with twos replaced with ones.

* The generator r_1 and load r_2 are assumed positive real in Equations (21) through (23). For negative real loads or generators appropriate negative signs are required.

GEORGE E. BODWAY received a BS in 1960, an MS in 1964 and a PhD in Engineering Physics in 1967 from the University of California at Berkeley. He is presently Project Supervisor of the thin film microcircuit research, development and processing in the Microwave Division of Hewlett Packard. Before this position Dr. Bodway was a research engineer working with solid state microwave circuit design.



The circles defined by Equations (27), (28) and corresponding equation for the input plane (r_1) were obtained by setting $r_1=0$ and $r_2=0$ respectively. A simple intuitive argument can show that the circle in the r_2 plane is invariant to r_1 and the circle in the r_1 plane is invariant to changes in r_2 . In particular, if the input impedance is positive real, then the input reflection coefficient has a magnitude less than one; if the input impedance is negative real, the input reflection coefficient will have a magnitude greater than one; both statements are obviously independent of the generator impedance, as long as it is positive real. The converse is true if the generator impedance is negative real.

The condition for a two port to be absolutely stable can now be obtained. A two port network is absolutely stable if there exists no passive load or generator impedance which will cause the circuit to oscillate. This is equivalent to requiring the two stable regions to lie outside the unit circles in the r_1 and r_2 planes when the origins are stable. This is satisfied if

$$|\rho_{s1} - |r_{s1}|| > 1 \quad (29)$$

$$|\rho_{s2} - |r_{s2}|| > 1 \quad (30)$$

$$|s_{11}| < 1$$

and

$$|s_{22}| < 1$$

The stability circles would normally be superimposed on the generator (r_1) and load (r_2) planes, upon which the constant gain circles have already been constructed. The three different degrees of stability are then easily distinguished: first, if the two unstable regions lie outside the unit circles, the device is unconditionally stable; second, if the unstable regions lie inside the unit circles, but all load and generator impedances are chosen to lie outside these two regions, the network is assured of having positive real input and output impedances, and stability is assured. The third situation arises when r_1 or r_2 are allowed to be in one or both unstable regions. Then negative real input or output impedances exist, and it is necessary to make sure the positive real generator or load is sufficiently positive real to insure a stable system.

It is also appropriate to point out at this time that the section on stability can quite readily be used to design oscillators.

CONJUGATE MATCHED TWO PORT

The load and generator impedance which simultaneously conjugate match-

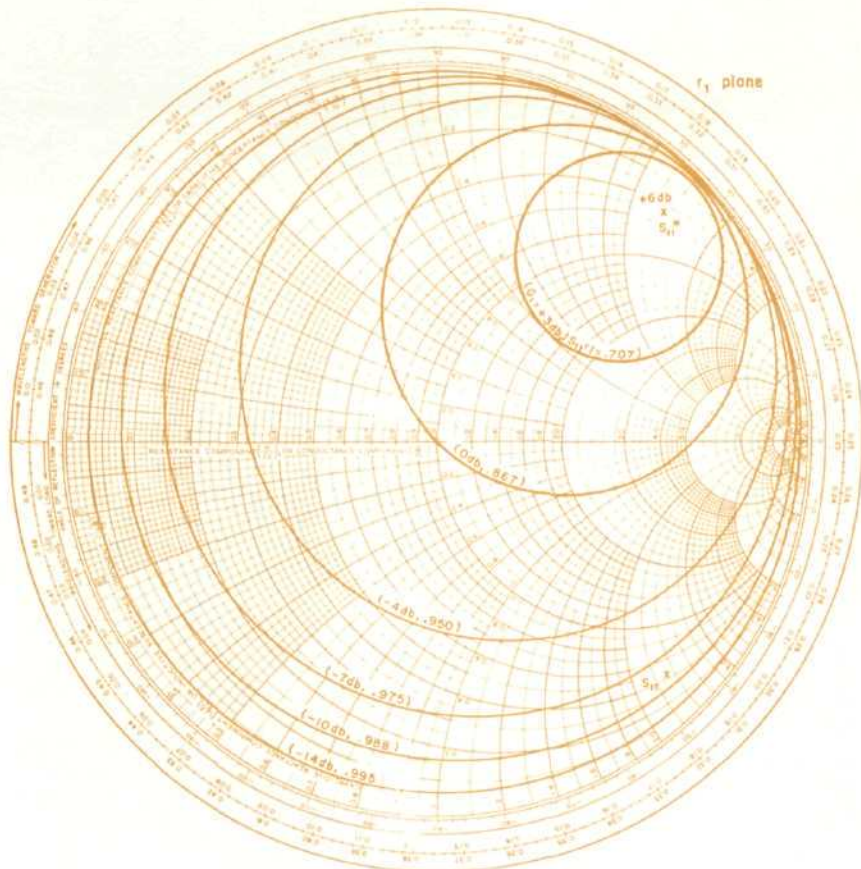

Fig. 4 — Contours of constant gain G_1 and constant $|s_{11}'|$ indicating gain and match obtained for various generators r_1 . $|s_{11}'|$ was taken as 0.867 at -45° .

es a two port can be expressed in terms of the s parameters by solving the pair of equations which result when $|s_{11}'|$ and $|s_{22}'|$ are both set equal to zero.*

The solution of this pair of equations for r_1 and r_2 provides the load and generator impedances (r_{m1} and r_{m2}) which will simultaneously match both the input and output ports.

$$r_{m1} = C_1 * \left[\frac{B_1 \pm \sqrt{B_1^2 - 4|C_1|^2}}{2|C_1|^2} \right] \quad (42)$$

$$r_{m2} = C_2 * \left[\frac{B_2 \pm \sqrt{B_2^2 - 4|C_2|^2}}{2|C_2|^2} \right] \quad (43)$$

where

$$B_1 = 1 + |s_{11}|^2 - |s_{22}|^2 - |\Delta|^2$$

$$C_1 = s_{11} - \Delta s_{22}^*$$

$$B_2 = 1 + |s_{22}|^2 - |s_{11}|^2 - |\Delta|^2$$

$$C_2 = s_{22} - \Delta s_{11}^*$$

Equations (42) and (43) give two solutions for r_{m1} and two for r_{m2} . Considering the i^{th} load if $\left| \frac{B_i}{2C_i} \right|$ is larger

than unity, then one solution will have a magnitude less than unity and the other will have a magnitude larger than unity. The r_{m1} which has a mag-

nitude less than one is obtained from Equations (42) and (43) using the plus sign for B_i negative and the minus sign for B_i positive. On the other hand if $\left| \frac{B_i}{2C_i} \right|$ is less than unity, then both solutions will have a magnitude equal to unity.

The condition $\left| \frac{B_i}{2C_i} \right| >$ can be expressed as

$$|K| > 1 \quad (44)$$

where

$$K = \frac{1 + |\Delta|^2 - |s_{11}|^2 - |s_{22}|^2}{2|s_{12}|s_{21}} \quad (45)$$

The two solutions for r_{m1} and the two for r_{m2} result in two pairs of solutions for a load and generator which simultaneously match the two port network.

The simultaneously matching pairs can be summarized as follows: for $|K| < 1$ both generator and load for each pair have a magnitude equal to one; for $|K| > 1$ and K positive then one solution has both r_{m1} and r_{m2} less

* The matched generator and load can also be obtained readily from $G_A'(r_{m1}) = 0$, and $G'(r_{m2}) = 0$.

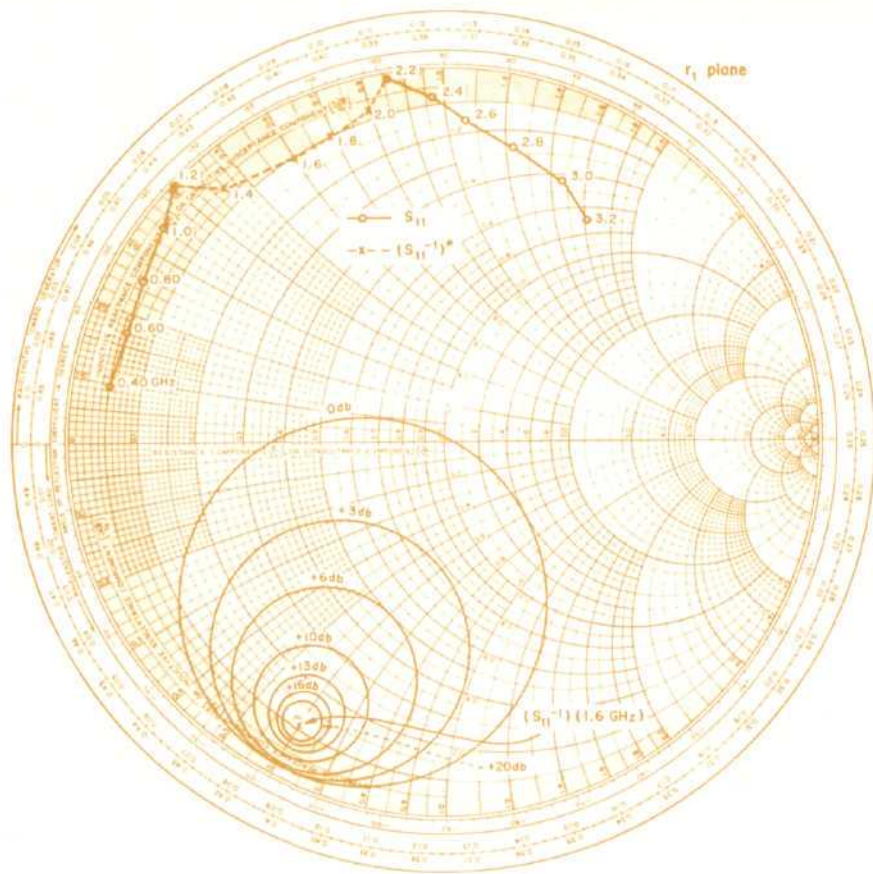

Fig. 5 — Plot of s_{11} vs. frequency for a transistor in common base showing frequency ranges over which the input is positive and negative real with 50Ω on the output. Where the curve is dashed, the real part is read off as negative. Any generator placed on the device which lies outside the shaded region provides a total positive resistance at all frequencies. The circles indicate contours of constant gain at 1.6 GHz.

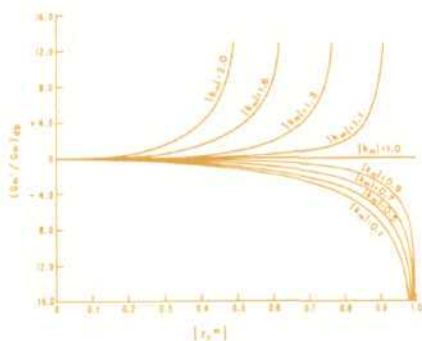

Fig. 6(a) — Set of curves giving the radii of constant power gain circles as a function of the load $|r_2^m|$ with $|k_m|$ as a parameter. This set of curves provides circles of positive power gain for $K > 1$.

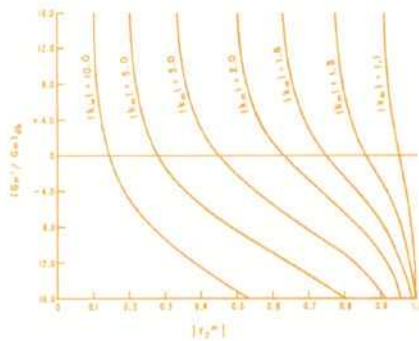

Fig. 6(b) — The curves shown for various values of $|K_m| > 1$ can be used to obtain constant power gain circles on the r_2^m plane. This graph gives the radii of stable power gain for the case $|K| > 1$ and K negative.

than one and the other solution has both greater than unity. For $|K| > 1$ and K negative then, both solutions consist of one $|r_1| > 1$ and the other $|r_1| < 1$.

The condition that a two port network can be simultaneously matched

with a positive real generator and load* is therefore given by

$$K > 1 \quad (46)$$

Equation (45) for K is invariant to changes in load and generator impedance, and is given in terms of the h

parameters by

$$K = \frac{2(\operatorname{Re}h_{11}) \operatorname{Re}(h_{22}) - \operatorname{Re}(h_{12}h_{21})}{|h_{12}h_{21}|} = k^r = C^{-1} \text{ (Linville factor)} \quad (47)$$

If $|K| > 1$ then

$$|s_{21}^m|^2 = \left| \frac{s_{21}}{s_{12}} \right| |(K \pm \sqrt{K^2 - 1})| \quad (48)$$

$$|s_{12}^m|^2 = \left| \frac{s_{12}}{s_{21}} \right| |(K \pm \sqrt{K^2 - 1})| \quad (49)$$

where the plus sign applies when B_1 is negative and the minus sign occurs when B_1 is positive.

The physical significance of K is stressed by repeating that $(C^{-1} = k = K) > 1$ is the condition that a two port can be simultaneously matched by a positive real generator and load. This is only a necessary condition for absolute stability. A necessary and sufficient condition for absolute stability is $K > 1$ and B_1 positive.

POWER FLOW

Unilateral Case

In this section the feedback term s_{12} is assumed to be sufficiently small in some sense so that we can set it equal to zero. The sense of being small is defined later in terms of a transducer power gain error which results when using the unilateral design.

For $s_{12} = 0$ we obtain the following equation for G_T

$$|s_{21}'|_u^2 = |s_{21}|^2 \frac{|1 - |r_1|^2|}{|1 - r_1 s_{11}|^2} \frac{|1 - |r_2|^2|}{|1 - r_2 s_{22}|^2} = G_0 G_1 G_2 \quad (31)$$

G_0 is the transducer power gain given by the original s_{21} parameters (for example the measured G_T). G_1 and G_2 are contributions to the transducer power gain due to changes in generator and loads respectively.

If $|s_{11}|$ and $|s_{22}|$ are less than one, then Equation (31) attains a finite maximum at $r_1 = s_{11}^*$ and $r_2 = s_{22}^*$ which is given by

$$|s_{21}'|_u^2 \max = \frac{|s_{21}|^2}{|1 - |s_{11}|^2| |1 - |s_{22}|^2|} = \text{M.A.G.} = G_u \quad (32)$$

Equation (32) can be expressed in

* The conditions under which a two port can be simultaneously matched were given previously in Reference 1.

terms of the h parameters. The equivalent expression is

$$|s_{21}'|_{u^2 \max} = \frac{|h_{21}|^2}{4 (\operatorname{Re} h_{11}) (\operatorname{Re} h_{22})} \quad (33)$$

In addition to Equation (32) for G_u , we also desire the gain for conditions other than that of conjugate match. The behavior of G_1 versus r_1 can be obtained by letting

$$G_1 = \frac{|1 - |r_1|^2|}{|1 - r_1 s_{11}|^2} = \text{constant} \quad (34)$$

and solving for r_1 . At this point it is convenient to break the discussion into two sections, Case 1, in which $|s_{11}| < 1$ and Case 2, in which $|s_{11}| > 1$.

Case 1

In this case the resulting expression for r_1 , the reflection coefficient of the generator impedance with respect to the complex conjugate of the reference impedance,* is an equation of a circle on a Smith Chart. The centers of the circles for different gains are located on a line through the origin and s_{11} .* The circle at $r_1 = s_{11}$ * of course reduces to a single point. The location of the center of the circle and the radius of the circle are given by r_{o1} and ρ_{o1} respectively. A circle of constant gain also corresponds to an input reflection coefficient s_{11}' of constant magnitude.

Defining a normalized gain

$$g_1 = \frac{G_1}{G_{1 \max}} = G_1 (1 - |s_{11}|^2) \quad (35)$$

the center and radius of each circle and the magnitude of the corresponding reflection coefficient $|s_{11}'|$ for a constant g_1 is given by

$$r_{o1} = \frac{g_1 |s_{11}|}{1 - |s_{11}|^2 (1 - g_1)} = \text{center} \quad (36)$$

$$\rho_{o1} = \frac{(1 - g_1)^{1/2} (1 - |s_{11}|^2)}{1 - |s_{11}|^2 (1 - g_1)} = \text{radius}$$

$$|s_{11}'| = (1 - g_1)^{1/2}$$

where $0 < g_1 = \frac{G_1}{G_{1 \max}} < 1$

Circles of constant g_1 are illustrated in Fig. 4. The circle which goes through the origin is always the zero decibel circle for G_1 . In other words, inside this circle $G_1 > 1$, and outside $G_1 < 1$.

Case 2

If values of $|s_{11}| > 1$ are encountered when measuring a transistor it is con-

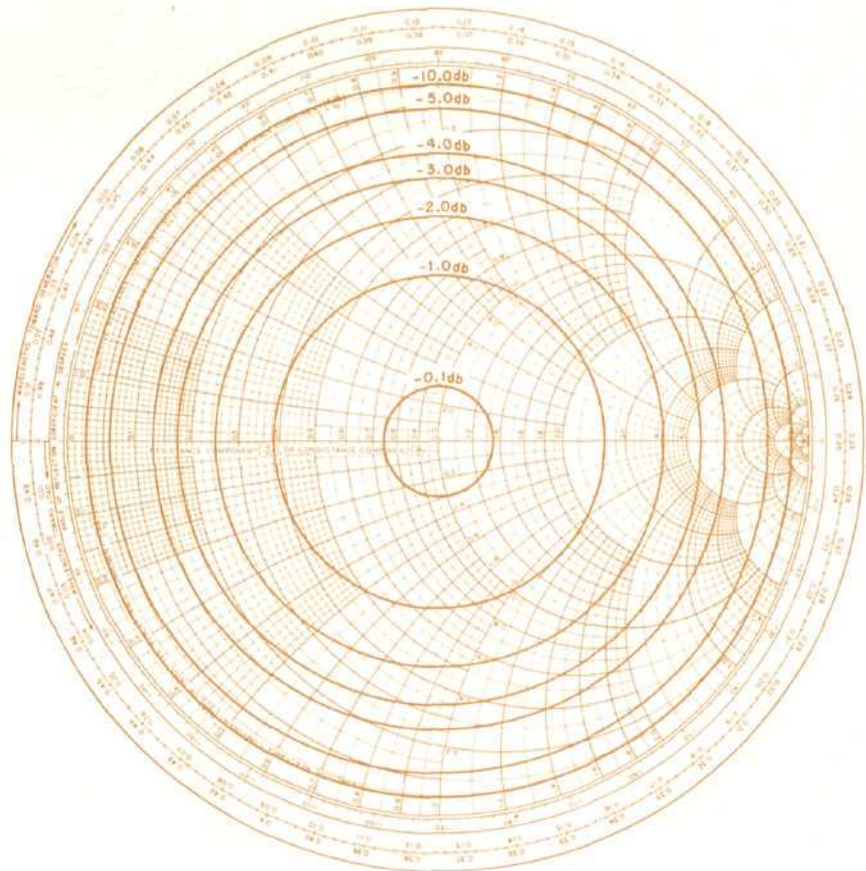

Fig. 7 — Return loss circles indicating constant gains G_{1m} or G_{2m} as a function of r_1^m or r_2^m respectively.

venient to place $(s_{11}^{-1})^*$ on a Smith Chart with a dotted line where $|s_{11}| > 1$, and s_{11} with a solid line for the ranges where $|s_{11}| < 1$. Where the dotted line occurs the resistance is now read off as negative resistance. In both cases the reactive part is read off as given on the Smith Chart. As we shall see this achieves two objectives. For one, it makes the curves for the device continuous on the inside of the Smith Chart; second, it makes the design for Case 2 correspond very closely to that of Case 1. A Smith Chart plot for $s_{11} > 1$ is given in Fig. 5 for a microwave transistor.

The contribution to the total transducer power gain provided by G_1 is again given by Equation (34).

The location and radii of constant gain circles, as well as the corresponding $|s_{11}'|$, are given again by Equation (36) except that now

$$-\infty < g < 0 \quad (37)$$

and the maximum gain $G_{1 \max}$ is now infinite at

$$r_1 = [(s_{11}^{-1})^*]^* = s_{11}^{-1} \quad (38)$$

As mentioned earlier, it is desirable to know in what sense s_{12} is small, or how adequate the unilateral design is. The actual transducer power gain

$|s_{21}'|_{\text{true}}^2$ is given by

$$|s_{21}'|_{\text{true}}^2 = |s_{21}'|_{u^2}^2 \frac{1}{|1 - x|^2} \quad (39)$$

where

$$x = \frac{r_1 r_2 s_{12} s_{21}}{(1 - r_1 s_{11})(1 - r_2 s_{22})}$$

The ratio of the true gain to the unilateral gain is bounded by

$$\frac{1}{|1 + |x||^2} < \frac{|s_{21}'|_{\text{true}}^2}{|s_{21}'|_{u^2}^2} < \frac{1}{|1 - |x||^2} \quad (40)$$

We can define a unilateral figure of merit u where

$$u = \frac{|s_{11}| |s_{22}| |s_{12} s_{21}|}{|1 - |s_{11}|^2| |1 - |s_{22}|^2|} \quad (41)$$

u has the following physical significance for $|s_{11}|$ and $|s_{22}|$ less than one. The ratio of the actual transducer power gain to the transducer power gain obtained by the unilateral design

* From now on r_i will simply be called the generator and the load. The actual load and generator impedance are given by Equation (20).

is bounded by $\frac{1}{|1-u|^2}$ and $\frac{1}{|1+u|^2}$

for any generator and load impedance which have a magnitude equal to or less than $|s_{11}|$ and $|s_{22}|$ respectively.

Transducer Power Gain, Power Gain and Available Power Gain Referred to Matched Generator and Load

If $|K|$ is greater than one, a particularly simple design procedure will evolve because the number of scattering parameters which occur in Equations (15) through (18) is reduced from four to two by definition. With matched load and generator impedances on the network, the matched scattering parameters s^m are given by $s_{11}^m = s_{22}^m = 0$ and

$$s_{12}^m = \frac{(A_2^m)^*}{A_1^m} \frac{s_{12} [1 - |r_{m1}|^2]}{[(1 - r_{m1} s_{11})(1 - r_{m2} s_{22}) - r_{m1} r_{m2} s_{12} s_{21}]} \quad (50)$$

$$s_{21}^m = \frac{(A_1^m)^*}{A_2^m} \frac{s_{21} [1 - |r_{m2}|^2]}{[(1 - r_{m1} s_{11})(1 - r_{m2} s_{22}) - r_{m1} r_{m2} s_{12} s_{21}]} \quad (51)$$

where r_{m1} and r_{m2} were given previously by Equations (42) and (43).

The scattering parameters s' can now be expressed as a function of arbitrary load and generator impedances r_1^m and r_2^m which are referred to the matched impedances r_{m1} and r_{m2} .

$$r_1^m = \frac{Z_1^m - Z_{m1}}{Z_1^m + Z_{m1}^*} \quad (52)$$

$$r_2^m = \frac{Z_2^m - Z_{m2}}{Z_2^m + Z_{m2}^*} \quad (53)$$

Z_{m1} is equal to the matched generator impedance, and Z_{m2} is the matched load impedance. On a Smith Chart Z_1^m is obtained from r_1^m by reading off the coordinates, multiplying by the real part of Z_{m1} , and adding the imaginary part of Z_{m1} , in particular.

$$Z_1^m = R_{m1}r + i(R_{m1}x + X_{m1}) \quad (54)$$

where r and x are the Smith Chart coordinates. The constant conductance and reactance coordinates of the Smith Chart are still preserved in Z_1^m .

The new s' parameters for arbitrary load and generator are now given by

$$s_{11}' = \frac{(A_1^m)^*}{A_1^m} \frac{[-(r_1^m)^* + r_2^m s_{12}^m s_{21}^m]}{(1 - r_1^m r_2^m s_{12}^m s_{21}^m)} \quad (55)$$

$$s_{12}' = \frac{(A_2^m)^*}{A_1^m} \frac{s_{12}^m (1 - |r_1^m|^2)}{(1 - r_1^m r_2^m s_{12}^m s_{21}^m)} \quad (56)$$

$$s_{21}' = \frac{(A_1^m)^*}{A_2^m} \frac{s_{21}^m (1 - |r_2^m|^2)}{(1 - r_1^m r_2^m s_{12}^m s_{21}^m)} \quad (57)$$

$$s_{22}' = \frac{(A_2^m)^*}{A_2^m} \frac{[-(r_2^m)^* + r_1^m s_{12}^m s_{21}^m]}{(1 - r_1^m r_2^m s_{12}^m s_{21}^m)} \quad (58)$$

where

$$A_1^m = \frac{[1 - (r_1^m)^*] (1 - |r_1^m|^2)^{1/2}}{|1 - r_1^m|}$$

$$A_2^m = \frac{[1 - (r_2^m)^*] (1 - |r_2^m|^2)^{1/2}}{|1 - r_2^m|}$$

The Linville design,^{8,9} with transducer gain a function of the load but keeping the input matched ($G_t = G$) for each value of the load, is obtained simply by requiring* that $s_{11}' = 0$. This is satisfied if

$$r_1^m = (r_2^m s_{12}^m s_{21}^m)^* \quad (59)$$

The new set of scattering parameters for the matched input is now

a function of only r_2^m , the load, and is given by

$$s_{11}^{im} = 0 \quad (60)$$

$$s_{12}^{im} = \frac{(A_2^m)^* s_{12}^m}{A_1^m} \quad (61)$$

$$s_{21}^{im} = \frac{(A_1^m)^* s_{21}^m (1 - |r_2^m|^2)}{A_2^m (1 - |r_2^m K_m|^2)} \quad (62)$$

$$s_{22}^{im} = \frac{(1 - r_2^m)}{[1 - (r_2^m)^*]} \left(\frac{1 - |K_m|^2}{1 - |r_2^m K_m|^2} \right) [-(r_2^m)^*] \quad (63)$$

where

$$|K_m| = |s_{12}^m s_{21}^m| = |K \pm \sqrt{K^2 - 1}| \quad (64)$$

The transducer power gain indicated by Equation (62) can be expressed as the product of two terms; one a constant, the matched gain, G_m , and the second, G_{im2} , a function of the load r_2^m .

If $K > 1$ and $|K_m| < 1$ (B_1 positive) the device is unconditionally

stable, and constant power gain circles for G_{im2} concentric with the origin can be constructed. Any circle other than the origin represents a gain which is less than the gain obtained under the simultaneous matched conditions. The radius of a circle for a given gain is

$$|r_2^m|^2 = \frac{1 - g_m}{1 - |K_m|^2 g_m} \quad (65)$$

where

$$g_m = \frac{G_{im2}}{G_m} \quad (66)$$

and $0 < g_m < 1$.

For $K > 1$ and $K_m > 1$ (B_1 negative), the device is potentially unstable and the transducer power gain under matched generator and load represents the minimum power gain obtainable under matched input conditions. Constant gain circles can again be constructed in the r_2^m plane. The circles are again concentric with the origin. The radius of the circle in this case is also given by Equation (65) but now g_m goes to infinity at

$$|r_2^m| = \frac{1}{|K_m|} \quad (67)$$

and the network is potentially unstable outside of this region.

For $|K| > 1$ but K negative, stable gain is obtained only for $|K_m| > 1$ (B_1 positive) and only for $|r_2^m| > \frac{1}{|K_m|}$.

The gain G_m' is a function only of the magnitude of r_2^m , the load, and it

is therefore possible to display $\frac{G_m'}{G_m}$ as

a function of $|r_2^m|$ with $|K_m|$ as a parameter. If on this plot the load coordinate (r_2^m) is physically equal to the radius of a standard Smith Chart, and the vertical scale is specified in decibels, then the constant gain circles for a given $|K_m|$ can be located on the r_2 plane [Fig. 6(a) $K > 1$, Fig. 6(b) $K < -1$].

With Equation (57) it is also possible now to display the transducer power gain for any load and any generator by means of two universal sets of curves. The transducer power gain Equation (57) can be expressed as the product of four terms.

* The available power gain G_A can be treated in a manner parallel to that which follows for G by setting $|s_{22}'| = 0$.

$$|s_{21}'| = G_m G_{1m} G_{2m} G_{12m} \quad (68)$$

G_m is the matched gain, G_{1m} is a function of only the generator r_1^m , G_{2m} is a function of only the load r_2^m , and G_{12m} is an interaction term between the generator and load.

$$G_m = |s_{21}^m|^2 = |K_m| \left| \frac{s_{21}}{s_{12}} \right| \quad (69)$$

$$G_{1m} = (1 - |r_1^m|^2) \quad (70)$$

$$G_{2m} = (1 - |r_2^m|^2) \quad (71)$$

$$G_{12m} = \frac{1}{|1 - r_1^m r_2^m K_m|^2} \quad (72)$$

Equations (70) and (71) simply represent constant return loss circles on the r_1^m and r_2^m planes and are therefore universal (Fig. 7). Constant gain circles represented by Equation (72) are given in Fig. 8 where the position from the origin is given by $f = r_1^m r_2^m K_m$.

For $|K| < 1$ the transducer power gain can still be given by the universal curves of Figs. 7 and 8. To accomplish this, the scattering parameters are normalized to $r_1 = s_{11}^*$ and $r_2 = s_{22}^*$. The transducer power gain is then given by the product of four terms similar to Equation (68). The vector f to be used in Fig. 8 is now the sum of three terms.

Constant power gain and available power gain circles are given in the next section for any value of $|K|$ including $|K| < 1$.

Power Gain and Available Power Gain in General Case

A constant power gain G and available power gain G_A , Equations (22) and (23), give the equation of a circle on the r_2 and r_1 planes respectively.

Equations (22) and (23) can be expressed as

$$G = |s_{21}|^2 g_2 \quad (73)$$

$$G_A = |s_{21}|^2 g_1 \quad (74)$$

where

$$g_2 = \frac{|1 - |r_2|^2|}{(1 - |s_{11}|^2) + |r_2|^2 (|s_{22}|^2 - |\Delta|^2) - 2 \operatorname{Re} r_2 C_2}$$

and g_1 is given simply by interchanging the indices 1 and 2. A discussion of one, g_2 in this instance, then suffices for both g_2 and g_1 .

The radius and location of a constant gain circle for g_2 is given by

$$\rho_g = \frac{(1 - 2K|s_{12}s_{21}|g_2 + |s_{12}s_{21}|^2 g_2^2)^{1/2}}{(1 + D_2 g_2)} \quad (75)$$

Fig. 9 — The six possible locations for the instability circle in the output plane. The shaded regions indicate the values of r_2 which provide a negative real input impedance for $|s_{11}| < 1$. Also indicated on the figures are the signs of the power gain in the various regions. The circles of equal size for all cases are the unit circles (inside the Smith chart) for r_2 ; outside of this circle r_2 is negative real and inside positive real.

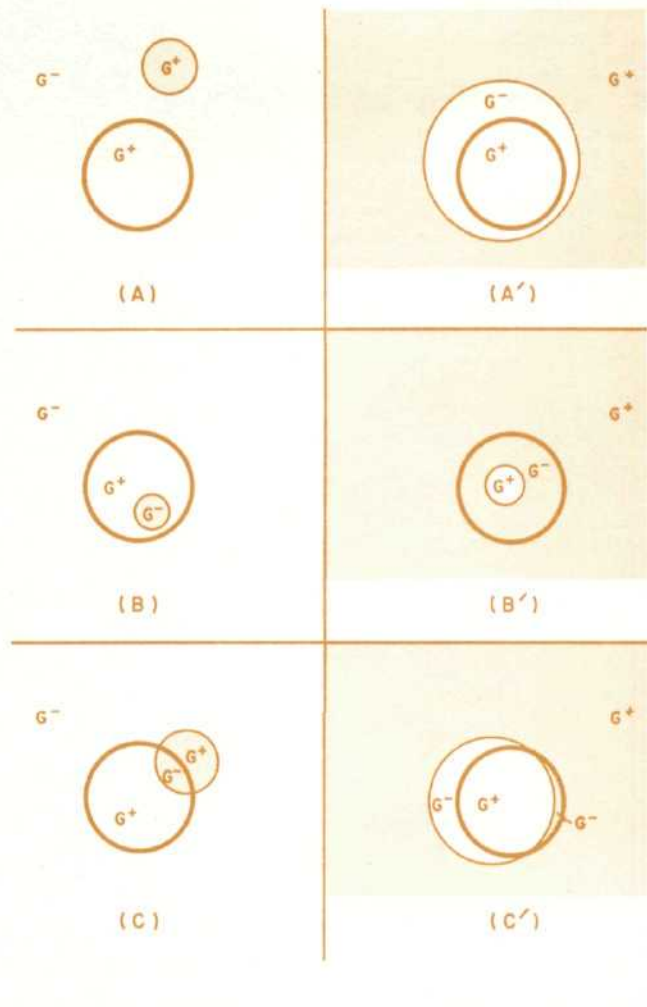

9(A) Input unconditionally stable; simultaneous matched load positive real. $|r_2^m| < 1$; $k > 1$; D_2 positive; $k_m < 1$.

9(B) Input potentially unstable; simultaneous matched loads positive real. $|r_{2m}| < 1$; $k > 1$; D_2 positive; $k_m > 1$.

9(C) Input potentially unstable. $|r_{2m}| = 1$; $|k| < 1$; D_2 positive.

9(A') Input unconditionally stable; simultaneous matched load positive real. $|r_2^m| < 1$; $k > 1$; D_2 negative; $k_m < 1$.

9(B') Input potentially unstable; simultaneous matched loads positive real. $|r_{2m}| < 1$; $k > 1$; D_2 negative; $k_m > 1$.

9(C') Input potentially unstable. $|r_{2m}| = 1$; $|k| < 1$; D_2 negative.

$$r_g = \left(\frac{g_2}{1 + D_2 g_2} \right) C_2^* \quad (76)$$

$$g_{20} = \frac{1}{|s_{12}s_{21}|} (K \pm \sqrt{K^2 - 1}) \quad (78)$$

respectively, where

$$D_2 = |s_{22}|^2 - |\Delta|^2 \quad (77)$$

For $g_2 = \infty$ the radius ρ_g and location r_g reduce to the stability circle in the r_2 plane.

The gain at which $\rho_g = 0$ is of interest and is given by

It is very informative at this time to give the six different possible locations for the stability circles, since their location indicates the general nature of the constant gain circles. Fig. 9 corresponds to an $|s_{11}| < 1$. If $|s_{11}| > 1$, then the shaded and unshaded regions simply change roles. The primed and unprimed cases are physically the same and just correspond to a positive or negative D_2 . The three pairs of cases correspond to these separate physical situations: In case A the device is unconditionally stable, the matched loads

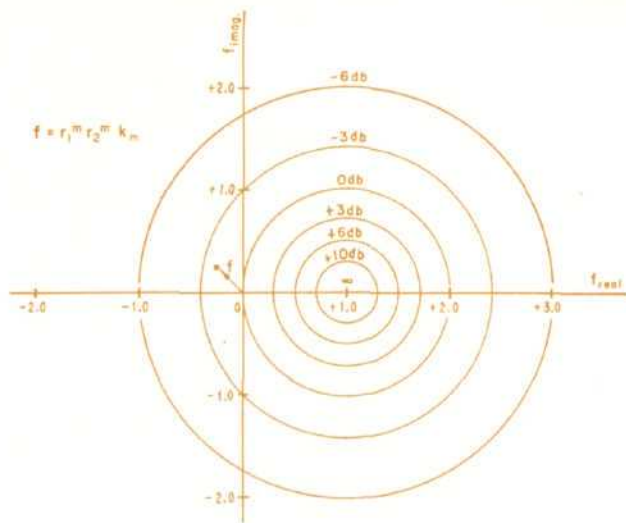

Fig. 8 — Constant gain circles giving contribution to total transducer panel gain due to interaction term G_{12m} as a function of the generator r_1^m , the load r_2^m and the device k_m .

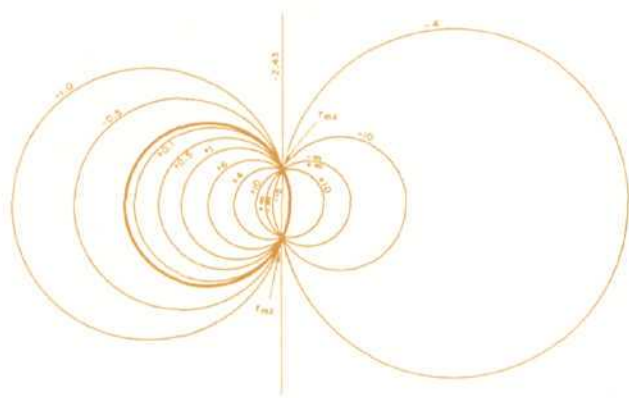

Fig. 10 — Constant gain circles (g_2) for a set of s parameters which satisfy case C of Fig. 9. Gain g_2 is given as a numerical ratio, not in dB. Circles are plotted on the r_2 plane. $s_{11} = 0.707 \angle 0^\circ$; $s_{22} = 0.707 \angle 0^\circ$; $s_{12} = 0.2 \angle 0^\circ$.

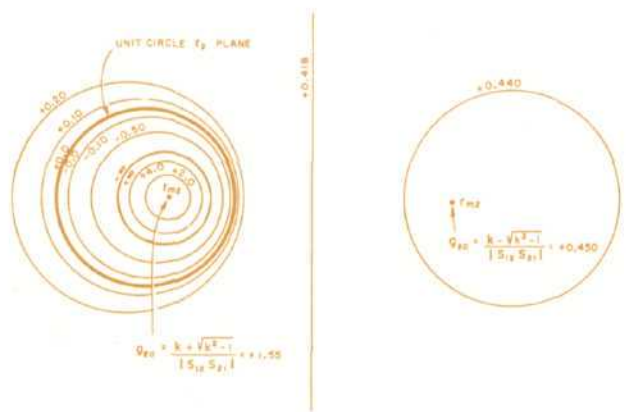

Fig. 11 — Constant gain circles for case B' of Fig. 9. The inside of the heavily lined circle provides positive real input impedance. $s_{11} = -0.707$; $s_{22} = 0.707$; $s_{12} = 1.2$; $r_{m2} = (3.53, 0.287)$.

are positive real and g_{20} is a maximum gain; for case B the loads are positive real but the device is potentially unstable and g_{20} is a minimum gain; the third case C corresponds to a potentially unstable device and also to the situation where the matched loads are pure imaginary and g_{20} is complex.

The sign of G is also given in Fig. 9 for the different regions. Equations (22) and (23) are valid for $|r_1| < 1$ and $|r_2| < 1$ only and it is necessary to return to the original definition to obtain the correct signs.

If $|K| > 1$ (case A, B) then constant power gain circles can be obtained from the previous section without having to calculate their radii and

location, but if $|K| < 1$ (case C) that procedure fails and it is necessary to use Equations (75) and (76).

An example of the constant gain circles for both case B' and C is given in Figs. 10 and 11.

As indicated previously, to realize ($G_t = G$), it is necessary to place the proper generator impedance on the input for each r_2 . The proper value is given by

$$r_1^* = \frac{s_{11} - r_2 \Delta}{1 - r_2 s_{22}} \quad (79)$$

CONCLUSION

It has been shown that a two port can be analyzed completely in terms of an

easily measured set of parameters, "the generalized scattering parameters." In the first section the generalized scattering parameters were presented and fundamental power flow relations developed. In the section on power flow, an analysis of power flow was given for the case when s_{12} is sufficiently small so that it can be neglected and the unilateral design is formulated. This leads to the case in which s_{12} is not assumed zero and general power flow relations are obtained and displayed in unique and very informative graphical form. Closely tied to power flow are questions of stability which are also thoroughly discussed.

The potential use of these parameters has only been touched on; some work that is under way deals with the set of equations similar to Equations (26) - (29) for a three port network. For example, a transistor which has Z_0 on all three leads can be defined by an easily measured (3 x 3) matrix. From these original 9 values all 12 s parameters for any two port configuration is given by a single equation using different sets of 4 of the original 9 matrix elements.

Possibly more important is the fact that the two port parameters for any configuration and a common lead feedback, are also then given by an equation of the same form but which includes the feedback impedance.

The practical use of the measurement system also seems unlimited.

ACKNOWLEDGMENT

The author wishes to express his appreciation to everyone who assisted in preparing and editing this manuscript. Particularly Sydney Neih, Ross Snyder and the late George Frederick for their technical assistance; also Roseanne Caldwell and Mee Chow among others for preparing the manuscript.

REFERENCES

1. Kurokawa, K., *IEEE Trans. - MTT*, March 1965, p. 194.
2. Penfield, P., Jr., "Noise in Negative Resistance Amplifiers," *IRE Trans. - CT*, Vol. CT-7, June 1960, pp. 166-170.
3. Penfield, P., Jr., "A Classification of Lossless Three Ports," *IRE Trans. - CT*, Vol. CT-9, September 1962, pp. 215-223.
4. Youla, D. C., "On Scattering Matrices Normalized to Complex Port Numbers," *Proc. IRE*, Vol. 49, July 1961, p. 122.
5. Hower, M. M., 1963 *ISSCC Digest of T.P.*, p. 90.
6. Stern, A. P., "Stability and Power Gain of Tuned Transistor Amplifiers," *Proc. IRE*, Vol. 45, March 1957, pp. 335-343.
7. Rollett, J. M., "Stability and Power Gain Invariants of Linear Two Ports," *IRE Trans. - CT*, Vol. CT-9, March 1962, pp. 29-32.
8. Linville, J. G. and L. G. Schimpf, *Bell Systems Tech. Journal*, Vol. 35, July 1956, p. 818.
9. Linville and Gibbons, "Transistors and Active Circuits," McGraw-Hill Book Co., Inc., New York, 1961.

SECTION VII

CIRCUIT DESIGN AND CHARACTERIZATION OF TRANSISTORS BY MEANS OF THREE-PORT SCATTERING PARAMETERS

This article defines the three-port parameters of a transistor with or without arbitrary terminations in the transistor leads. Dr. Bodway then relates the three-port parameters to the more familiar two-port parameters for common emitter, base, and collector. He next shows that all the two-port equations have a similar form and can be mapped into constant gain circles on a Smith Chart. The variation of two-port parameters, specifically for a common emitter configuration, is analyzed with respect to series or shunt feedback. Finally, he describes the equipment used to measure three parameters of transistor chips.

Introduction	7-1
Three-Port Scattering Parameters	7-1
Definition	7-1
For Arbitrary Termination of Transistor Leads	7-1
Obtaining Two-Port Parameters from Three- Port Parameters	7-3
Common Emitter	7-3
Common Base	7-3
Common Collector	7-3
Properties of the Two-Port Equations.....	7-3
Shunt Feedback	7-4
Application of Three-Port S Parameters	7-4
Common Emitter with Series Feedback.....	7-5
Common Emitter with Shunt Feedback	7-5
Three-Port Measurement System.....	7-5

CIRCUIT DESIGN AND CHARACTERIZATION OF TRANSISTORS BY MEANS OF THREE-PORT SCATTERING PARAMETERS

GEORGE E. BODWAY

Hewlett-Packard Co.
Palo Alto, California

microwave
Journal

Vol. 11, number 5

May 1968

INTRODUCTION

There are two requirements for the effective use of transistors, solid-state devices, and passive components. First, their characteristics must be precisely measured; second, a design capability must exist in terms of the measured quantities. Scattering (*s*) parameters satisfy these requirements from both a measurement and design point of view. They are particularly useful in the microwave frequency range.

Ordinarily, *s*-parameters of an active three-terminal device are determined by two-port measurements, connecting the common lead to ground. Unfortunately, the physical length between the device and the ground plane usually introduces a serious parasitic common-lead inductance, especially if the spacings are made large enough to obtain a very accurate 50-ohm system. The same reason that scattering parameters are measured at high frequencies (i.e. because accurate shorts and opens are difficult to achieve at these frequencies) necessitates measuring three-terminal parameters and thus, reducing considerably the errors due to this parasitic common-lead inductance.

Three-port admittance or impedance transistor parameters have been discussed before,¹ but they have never been as useful or as desirable as the three-terminal scattering parameters at microwave frequencies. When making three-port measurements, all three ports are terminated with 50 ohms. Bringing three 50-ohm transmission lines up to the device eliminates the common-lead inductance, ensures accurate reference planes, and results in a very stable measurement system. (Four-port measurements can be made in the same way for IC transistors where the substrate is the fourth terminal.) A 50-ohm termination also approximates the final circuit environment more closely at microwave frequencies than the open or short terminations required by *h*, *y*, or *z* parameters.

This paper discusses the theory of three-port scattering parameters and shows how previously complicated design procedures can be performed very simply in these terms. For example, all of the two-port parameters in any common configuration (CB, CE, CC) with any series feedback and any shunt feedback can be determined by using one single transformation and one matrix transformation. The two-port parameters with series feedback are related to the 9 measured quantities by 12 equations all identical in form, that is, the equations look alike. They only use different variables and consequently, only one equation has to be solved. Having only one equation to solve has been a tremendous help in tying a small desk top computer into the measurement system for instantaneous device characterizations and circuit design.

THREE-PORT SCATTERING PARAMETERS

Parameters for the three terminals of a transistor are shown schematically in Fig. 1, where the three terminals are all referred to a common ground. The incident and reflected power waves² can be represented by the three-port scattering matrix

$$\begin{bmatrix} b_1 \\ b_2 \\ b_3 \end{bmatrix} = \begin{bmatrix} s_{11} & s_{12} & s_{13} \\ s_{21} & s_{22} & s_{23} \\ s_{31} & s_{32} & s_{33} \end{bmatrix} \begin{bmatrix} a_1 \\ a_2 \\ a_3 \end{bmatrix} \quad (1)$$

where $|s_{ij}|^2$, $i \neq j$ represents the transducer power gain from port *j* to port *i*, and $|s_{ii}|^2$ represents the available generator power that is reflected from the device at the *i*th port.*

The measured parameters are referred to the characteristic impedance of the three transmission lines that terminate the device. To be of universal use, the parameters for arbitrary termination of the transistor leads are required as a function of these arbitrary terminations and the original measured parameters and arbitrary reference impedances. The expression for the new scattering parameters is given by

$$S' = A^{-1}(S - \Gamma^\dagger)(I - \Gamma S)^{-1}A^\dagger \quad (2)$$

where

$$A_i = \frac{(1 - r_i^*)}{|1 - r_i|} (1 - |r_i|^2)^{1/2} \text{ is the } ii^{\text{th}} \text{ element in a diagonal matrix.}$$

$$r_i = \frac{Z_i - Z_0}{Z_i + Z_0}$$

and

$$\Gamma_{ii} = r_i, \quad (3)$$

$A^\dagger, \Gamma^\dagger =$ transpose of the diagonal matrices *A*, Γ , respectively.

The nine new scattering parameters in terms of the original parameters and arbitrary reference impedances are given by

$$s'_{11} = \frac{A_1^*}{DA_1} \left\{ (s_{11} - r_1^*) \Delta_{23} + r_2 s_{12} s_{21} (1 - r_3 s_{33}) + r_2 r_3 [s_{23} s_{12} s_{31} + s_{21} s_{13} s_{32}] + r_3 s_{13} s_{31} (1 - r_2 s_{22}) \right\} \quad (4)$$

* For a detailed consideration of the physical interpretation of s_{ij} , see References 2, 3 and 4.

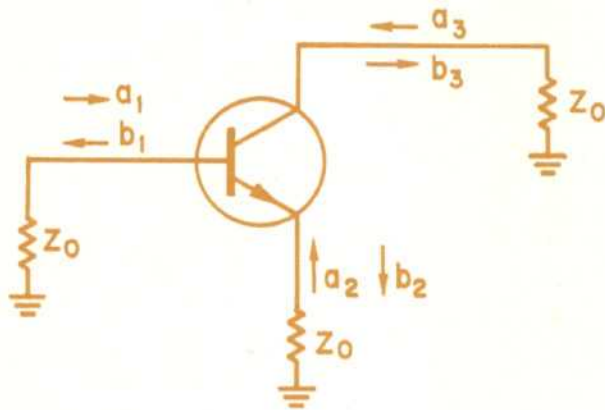

Fig. 1 — Incident and reflected waves (a, b respectively) for a transistor imbedded in a structure where all three leads are terminated by the characteristic impedance Z_0 of a transmission line.

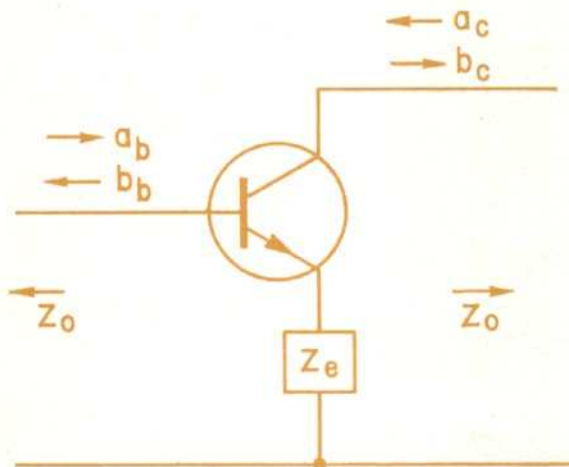

Fig. 2 — Incident and reflected waves for a transistor in common emitter configuration with an arbitrary impedance Z_e in the emitter lead.

$$s_{12}' = \frac{A_2^*}{DA_1} (1 - |r_1|^2) [s_{12}(1 - r_3 s_{33}) + r_3 s_{13} s_{32}] \quad (5)$$

where

$$D = 1 - r_1 s_{11} - r_2 s_{22} - r_3 s_{33} + r_1 r_2 (s_{11} s_{22} - s_{12} s_{21}) + r_2 r_3 (s_{22} s_{33} - s_{23} s_{32}) + r_1 r_3 (s_{11} s_{33} - s_{12} s_{21}) \quad (6)$$

$$\Delta_{23} = s_{22} s_{33} - s_{23} s_{32} \quad (7)$$

The other seven expressions are obtained by exchanging the indices on the above equations.

Although the set of equations represented by (4) and (5) can be used for computer analysis, it is unwieldy to manipulate and does not convey very much insight into what is taking place. A far more useful and rewarding approach has been to leave two of the ports terminated by Z_0 and allow the third port to be arbitrarily terminated. The two-port parameters are obtained in this manner by treating the common lead as arbitrarily terminated in a series impedance different than Z_0 . The maximum available gain, isolation, stability and other characteristics are simply related to the two-port parameters and thus, can be evaluated as a function of this series lead impedance.

To avoid any confusion with indices, an obvious convention has been adopted for labeling the three-port scattering parameters for a transistor:

$$s = \begin{bmatrix} s_{bb} & s_{be} & s_{bc} \\ s_{eb} & s_{ee} & s_{ec} \\ s_{cb} & s_{ce} & s_{cc} \end{bmatrix} \quad (8)$$

where, for example, s_{bb} is the driving point reflection coefficient of the base with the emitter and collector both terminated by Z_0 . Similarly, s_{cb} is the transducer power gain for the collector port when driving the base. s_{cb} is of particular significance for a device, being similar to h_{21} when using h -parameters and to s_{21} when considering two-port s -parameters. The frequency at which s_{cb} goes through 0 dB is defined as f_u and represents a minimum value for f_{max} . The other parameters have similar meanings.

The nine elements of matrix (8) are not all independent because we are considering a three-terminal device. In fact, there are only four independent parameters; if these are known, the others can be found, being related by the condition:

$$\sum_{j=1}^3 s_{1j} = \sum_{i=1}^3 s_{ij} = 1. \quad (9)$$

This relation follows from a similar relation for the y -parameters where

$$\sum_{i=1}^3 Y_{ij} = \sum_{j=1}^3 Y_{ij} = 0; \quad (10)$$

for example,

$$s_{cb} = 1 - s_{eb} - s_{bb}. \quad (11)$$

From Equation (4) it is now possible to obtain the expressions for the two-port parameters, with any feedback element as a common-lead impedance. See Fig. 2.

Obtaining Two-Port Parameters From Three-Port Information

The two-port parameters for the three possible configurations are given by three sets of Equations: (12a), (12b), and (12c).

Common Emitter

$$s_{fe} = s_{cb} + \frac{s_{ce}s_{eb}}{1 - s_{ee}} s_{1e} = s_{bb} + \frac{s_{be}s_{eb}}{1 - s_{ee}}$$

$$s_{re} = s_{bc} + \frac{s_{be}s_{ec}}{1 - s_{ee}} s_{2e} = s_{cc} + \frac{s_{ce}s_{ec}}{1 - s_{ee}}$$

(12a)

Common Base

$$s_{fb} = s_{ce} + \frac{s_{cb}s_{be}}{1 - s_{bb}} s_{1b} = s_{ee} + \frac{s_{eb}s_{be}}{1 - s_{bb}}$$

$$s_{rb} = s_{ee} + \frac{s_{eb}s_{bc}}{1 - s_{bb}} s_{2b} = s_{cc} + \frac{s_{cb}s_{bc}}{1 - s_{bb}}$$

(12b)

Common Collector

$$s_{fc} = s_{eb} + \frac{s_{ec}s_{eb}}{1 - s_{cc}} s_{2c} = s_{ee} + \frac{s_{ec}s_{ec}}{1 - s_{cc}}$$

$$s_{rc} = s_{be} + \frac{s_{bc}s_{ec}}{1 - s_{cc}} s_{1c} = s_{bb} + \frac{s_{bc}s_{eb}}{1 - s_{cc}}$$

(12c)

where

$$r_1 = \frac{Z_1 - Z_0}{Z_1 + Z_0^*}$$

If r_1 is replaced with -1 , this is the same as grounding the common lead; consequently the above series of equations give the normal two-port parameters.

Before discussing the properties of Equation (12) series, several interesting observations can be made. First, it has been recognized previously that the gain in the common emitter configuration can be increased by adding a capacitor in series with the emitter. It can be shown from typical data for s_{ee} that when Z_e is capacitive, $|(1/r_e) - s_{ee}|$ can be made a minimum, and s_{fe} attains a maximum value. The disadvantage is that the other parameters also increase; in fact, s_{1e} and s_{2e} (the input and output reflection coefficients in common emitter configuration) become greater than unity and the device is very unstable.

It can also be observed from typical data that an inductance in the common-base lead will usually cause $|(1/r_b) - s_{bb}|$ to diminish and the common-base gain to increase.

Another application of the equations is to find a common-lead impedance which will minimize the reverse transducer power gain. For example, the value of r_b which makes $s_{rb} = 0$ is given by Equation (13) and a similar expression holds for the other two configurations.

$$r_b = \frac{s_{ec}}{s_{ec}s_{bb} - s_{eb}s_{bc}} \quad (13)$$

If the magnitude of $r_b \leq 1$, then the element is passive and a neutralized device can be obtained.

We have touched briefly on some special applications of Equations (12). Because of the relative simplicity, a considerable amount of information can be obtained very quickly, particularly if the significance of the two-port parameters, with respect to desired circuit response, is kept in mind. The accuracy of the derived two-port parameters for a given accuracy in the original measured parameters can also be monitored easily.

Properties of Equation (12)

Equations (12a, b and c) are all of a single form which we can express as

$$s = a + \frac{b}{1 - r} \quad (14)$$

where a , b and c are related to the measured three-port parameters. Equation (14) is a complex equation relating the variables s and r ; it is a standard equation in complex variable theory. Manipulating Equation (14) shows that the relationship between r and s is a bilinear transformation:

$$s = \frac{a + r(b - ac)}{1 - rc} \quad (15)$$

There are two ways of looking at Equation (14) for s as a function of r . One is similar to that considered for the two-port transducer power gain. In this case, we can display circles of constant magnitude of s on the r plane. For s_{fe} , those are common emitter constant-gain circles as a function of the common-lead impedance instead of the load or generator. The radius and center of the constant-gain circles are given by (16) and (17) respectively:

$$\rho = \frac{1}{k^2} \sqrt{|f|^2 - g^2 k^2} \quad (16)$$

$$r_0 = \frac{f^*}{k^2} \quad (17)$$

where

$$g^2 = |s|^2 - |a|^2$$

$$f = c g^2 + a^* b$$

$$k^2 = |s|^2 |c|^2 - |b - ac|^2$$

The other way to handle Equation (14) is to map the r plane onto the s plane. It is well known that, for the bilinear transformation, circles on the r plane map into circles on the s plane. This is significant since it means that the Smith Chart for the r plane can be mapped onto the s plane, giving both the magnitude and phase of s for each complex value of r . Precision depends only on how many circles are mapped onto the s plane. This technique gives an exceedingly broad picture of what is going on.

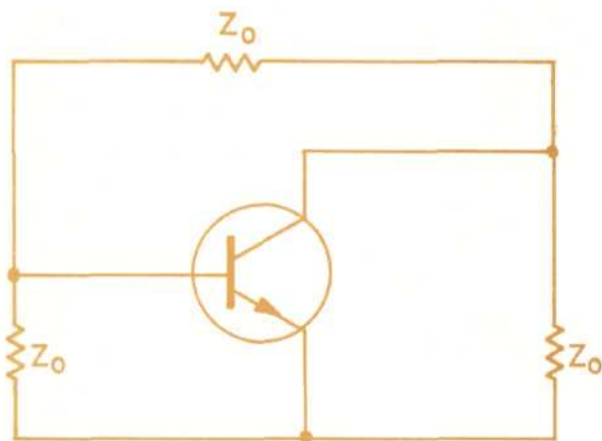

Fig. 3 — A three-terminal device imbedded in a network which can be used to readily evaluate the effects of shunt feedback.

SHUNT FEEDBACK

Not only can the effects of a common lead impedance be characterized by the set of Equation (12), but also shunt feedback can be handled in precisely the same way.

All three leads in the three-port measurement system are referred to a common ground through a characteristic impedance Z_0 . The parameters measured form the three-terminal scattering matrix. It is then possible to make a simple transformation to a new 3×3 scattering matrix where the ports are referred to one another (Fig. 3).

The two-port parameters with any shunt element in any configuration are then given by the same transformation as the series case [Equation (12)]. The series and shunt feedback transformation can be combined resulting in the analysis of very complicated circuits.

APPLICATIONS OF THREE-PORT SCATTERING PARAMETERS

An example of the use of the preceding three-port transformation will be described in order to demonstrate the capability and usefulness of the approach. The example chosen, because of its wide applications, will show how the two-port common emitter parameters at 1 and 2 GHz vary with either series or shunt feedback elements.

Fig. 4 is used as a reference for the mapping of circles from the r plane to circles in the s plane. For example, Point 1 is a short circuit and the values of the transformed parameters that occur at Point 1 are those that exist with a short as a series or shunt element.

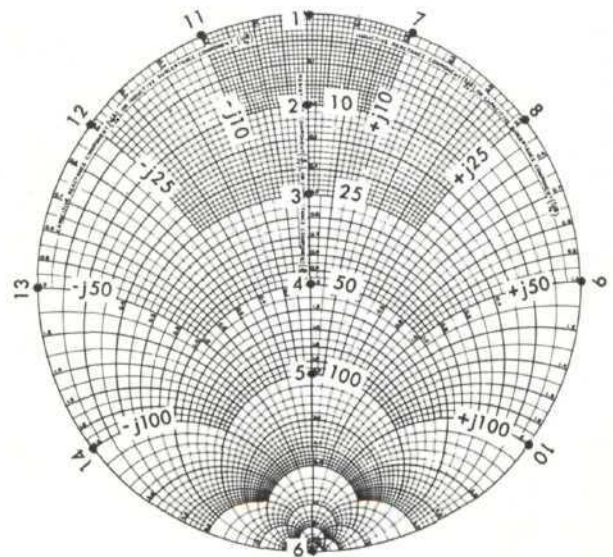

Fig. 4 — Points on the r plane (r defined by Equation 3) identified for location on the s plane for the series and shunt mapping. Note the circles which go through 1-6, 2-6, 3-6, 4-6 and 5-6 are constant r circles, while those through 7-6, 8-6, 9-6 and 10-6 are constant inductive reactance circles and the corresponding circles through 11-6, 12-6, 13-6 and 14-6 are capacitive reactance circles.

The graphs 5 through 8 display how the above theory can be applied to synthesizing the performance of transistor circuits. The example given is for a microwave small signal transistor with an f_t of about 4 GHz and an f_{max} of about 6 GHz. The transformation for 1 and 2 GHz for series feedback are given by Figs. 5 and 6 and for shunt feedback by Figs. 7 and 8.

Figs. 5 through 8 have a very general nature, in that, essentially all high frequency, small signal transistors behave similarly. Some of the information contained in Figs. 5 through 8 will be discussed in order to provide examples of the meaning and use of the graphs as well as to point out some of this general information.

Common Emitter Configuration With Series Feedback

Let us see what happens to s_{1E} or the input impedance as the common lead impedance varies (Figs. 5a and 6a). Point 1 represents a short circuit and the resulting input reflection coefficient is that of the grounded common emitter stage. As resistance is added in the emitter (moving from Points 1 through 6) s_{1E} moves essentially on a constant resistance line of a few ohms in the direction of increasing series capacitance. Similarly increasing inductance (Points 1, 6, 7, 8, 9, 10) results in essentially an increase in the real part of the input impedance; the reactance, being relatively constant.

In the case of s_{2E} (Figs. 5d and 6d) the effect is more complicated; the magnitude of s_{2E} increases with increasing L, R or C. With inductance or resistance in the emitter, the output impedance becomes more capacitive and, for values of R less than Point 4, the real part decreases while it increases for inductive loads.

The transducer power gain in a Z_o system $|s_{2E}|^2$ decreases for either a resistor or inductance in the common lead. The effect is less at higher frequencies for a given device; for example, a resistance indicated by Point 4 results in a gain which is the same at both 1 and 2 GHz. The very serious effect small inductances can have at high frequencies could be illustrated by evaluating the drop in gain if, for example, a 100 mil lead length were used with this chip. This would correspond to about 12.5 ohms of inductance, or just past Point 7 at 1 GHz (Fig. 5b), and 25 ohms on Point 8 at 2 GHz (Fig. 6b). The drop in gain is significant. The effect is, of course, much more serious as you move up in frequency to the 4-6 GHz range which is the present practical limit for useful transistor operation. A capacitive emitter impedance, in general, increases the transducer power gain, but also causes an increase in s_{11} and s_{22} resulting in instability. Notice also that there does not exist a positive real value of impedance which will neutralize the device at 1 or 2 GHz.

Common Emitter With Shunt Feedback

In this case Point 6 (Figs. 7 and 8) or an open circuit corresponds to the grounded emitter configuration. The values for the parameters obtained with an open shunt impedance (Point 6, Figs. 6 and 8) should, of course, be identical to that for a short circuit emitter series impedance (Point 1, Figs. 5 and 6).

The input impedance s_{1E} is relatively independent with either capacitive or resistive feedback (Figs. 7a and 8a). This is because of the low input impedance into the device. The value of s_{1E} is much more sensitive to inductive shunt feedback as indicated by moving from an open circuit Point 6 through Points 10, 9, 8, 7 and 1 corresponding to lower values of inductive impedance.

$|s_{21}|^2$, the transducer power gain, decreases with resistive or capacitive shunt feedback. For example, a collector base capacitance of 1.5 pf causes a drop in gain from Point 6, Figure 7b, to Point 14 and a drop to Point 13 in Fig. 8b. Also the effect of reducing the collector base capacitance, for example, by reducing the base pad size can be easily ascertained. As inductive shunt feedback is added, the gain increases to very large values until very small values of inductance are reached when the gain begins to drop approaching essentially zero with a short circuit.

The reverse gain s_{12} increases with any shunt feedback. It changes a relatively small amount for capacitive or resistive feedback, but changes more drastically for inductive feedback.

Point 5, (Figs. 7b and 8b, 100 ohms) gives a gain $|s_{21}|^2$ of about 5 dB at 1 and 2 GHz with about 15 to 10 ohms of input impedance with 45-60 ohms of output impedance and a low reverse feedback $|s_{12}| < 0.2$. More gain could be obtained over this frequency range by using inductive peaking in the shunt feedback.

The same gain, about 5 dB, can be obtained at both 1 and 2 GHz with about 50 ohms (Point 4) of series feedback (Figs. 5b and 6b).

In this case the input impedance is about 10 ohms but with about 60 ohms to 30 ohms of capacitive reactance (Figs. 5a and 6a). The output impedance is 10-20 ohms with 60-150 ohms of capacitive reactance. The reverse feedback goes from 0.2 to 0.4. Additional gain can be obtained with capacitive series peaking.

This technique has been exceptionally useful in obtaining a thorough understanding of the behavior of small signal devices in amplifier and oscillator circuits from low frequencies to the very highest frequencies at which transistors will presently operate. The technique has been used to advantage as an initial or rough synthesizing tool and also as a precise and general analysis technique for very complex circuits.

Although not illustrated, these transformations are particularly well suited for considering distributed impedances. For example, a transmission line terminated by a lumped element is represented on the r plane as a circle about the origin with frequency. This circle also maps onto the s planes as a circle.

Three-Port Measurement System

The three-port measurement system is just an extension of the two-port system, but what we will describe here in detail is the unique three-port broadband system for the measurement of unbonded transistor chips.

A schematic of the system is shown in Fig. 9 and photographs of the actual setup in Figs. 10, 11, 12, 13 and 14. The signal is directed incident on one port and measured reflected from this port and transmitted

out the other two ports. Next the second port is driven and then the third, resulting in the measurement of the 9 scattering parameters. The switching of the signal and measurement ports is controlled by electrical signals triggered either manually or by a computer. The signals are detected by a sampler and compared against a reference. The resulting output is displayed on a polar chart, oscilloscope, etc., or can be fed directly to a computer.

Transistor chips are presently being measured on a production basis for use on hybrid integrated circuits on this equipment. A chip can be measured from 0.1 to 12.4 GHz on this equipment. Almost any information about the device can be obtained; f_{max} , $|S_{21}|^2$, etc., or performance in an amplifier or oscillator. This information can also be obtained as a function of the dc bias conditions. The loading, testing, calculating, unloading and sorting can be done routinely in less than 2 minutes per device. The device is then ready to be bonded down on a microcircuit. It is assured not only that the device will work but that the circuit will perform as required with a very high yield even with many devices per circuit.

CONCLUSION

A practical and accurate technique for measuring unbonded transistor chips from 0.1 to 12.4 GHz has been described.

In order to accomplish this, a new set of parameters, the three-terminal scattering parameters for a transistor, are utilized. Not only can the conventional two-port parameters be obtained simply from the measured quantities, but also the paper shows how the effect of adding a series or shunt impedance to the device can be obtained mathematically by using a simple extension of the basic equation involved.

The data for a conventional microwave transistor is utilized for showing how a mapping technique can be applied which shows visibly at a single glance, at a

particular frequency, the effect of adding any series or shunt feedback element. The data and general effects shown are typical of any microwave small signal transistors and the many figures shown are therefore of general use for reference information.

The equipment used to accomplish the measurement of transistor chips is described including a description and pictures of the techniques used to make contact to the transistor chips.

In this paper and one previously published, the foundation has been laid for the precise measurements of transistor chips in terms of useful microwave parameters as well as describing powerful design tools particularly but not limited to the precise but simple design of microwave hybrid thin film circuitry. The utilization of this material in designing microwave circuits such as oscillators and amplifiers will be described in forthcoming articles.

ACKNOWLEDGMENT

The author wishes to express his appreciation to everyone who assisted in preparing and editing this manuscript. Particularly to Mee Chow for the considerable effort required in preparing the artwork, Joan McClung and Roseanne Caldwell for preparing the manuscript and to Larry Rayher for editing the paper.

REFERENCES

1. Linville and Gibbons, "Transistors and Active Circuits," McGraw-Hill Book Co., Inc., New York, 1961.
2. Bodway, George E., "Two-Port Power Flow Analysis of Linear Active Circuits Using the Generalized Scattering Parameters," Hewlett-Packard Internal Report, April 1966.
3. Bodway, George E., "Two-Port Power Flow Analysis Using Generalized Scattering Parameters," *the microwave journal*, Vol. 10, No. 6, May 1967.
4. Kurokawa, K., *IEEE Transactions - MTT*, March 1965, p. 194.



GEORGE E. BODWAY received a B.S. in 1960, an M.S. in 1964 and a Ph.D. in Engineering Physics in 1967 from the University of California at Berkeley. He is presently the Section Manager responsible for the Microcircuits and Solid State Program for the Microwave Division of the Hewlett-Packard Company.

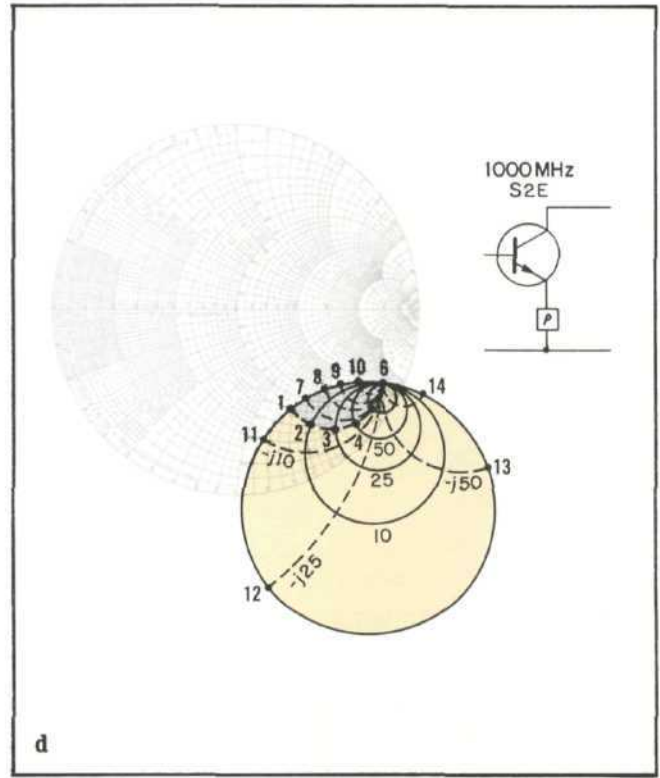
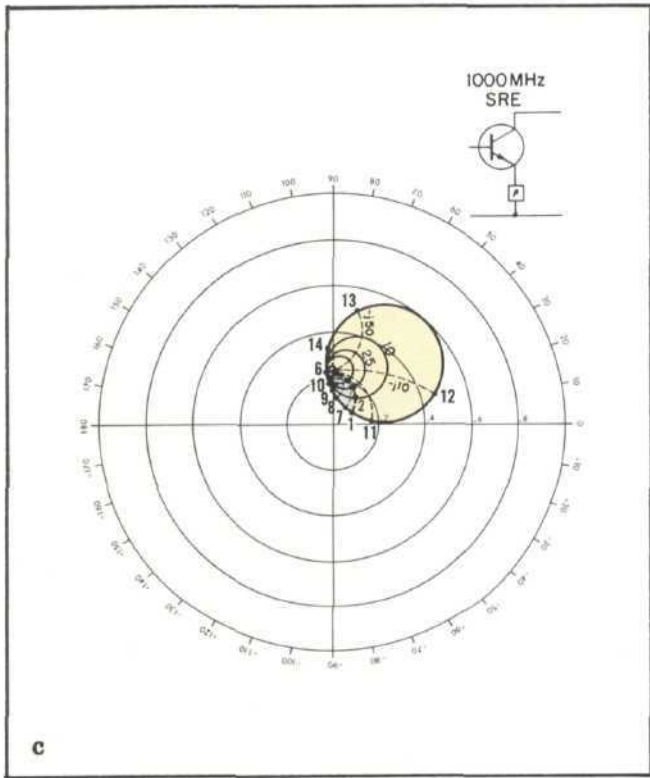
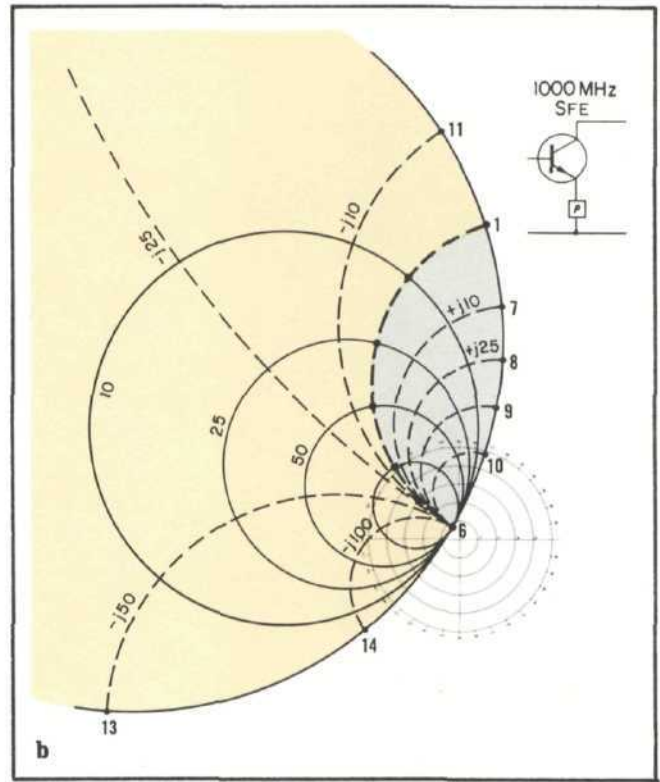
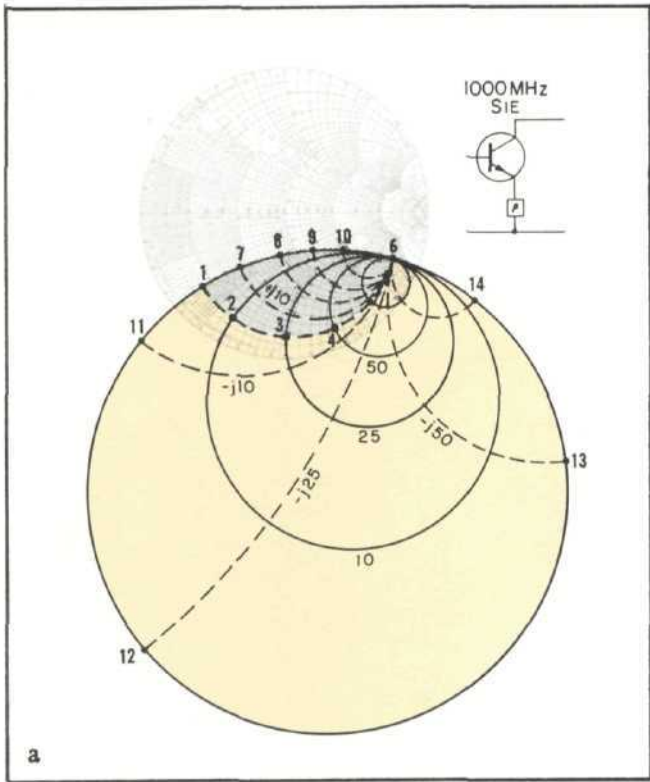

Figs. 5a, b, c and d – Common emitter series feedback impedance mapped onto the s-parameter planes at 1 GHz. The shaded regions correspond to inductive impedance while the colored areas are capacitive.

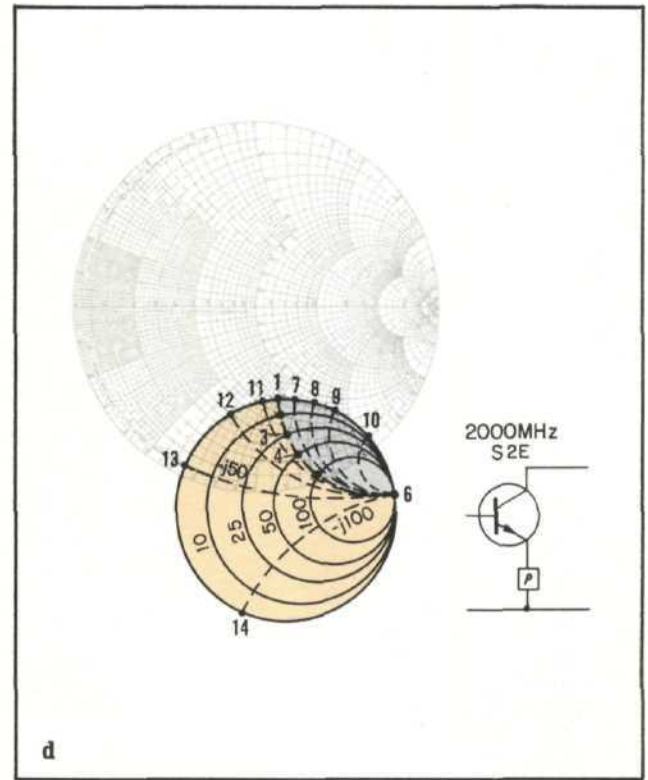
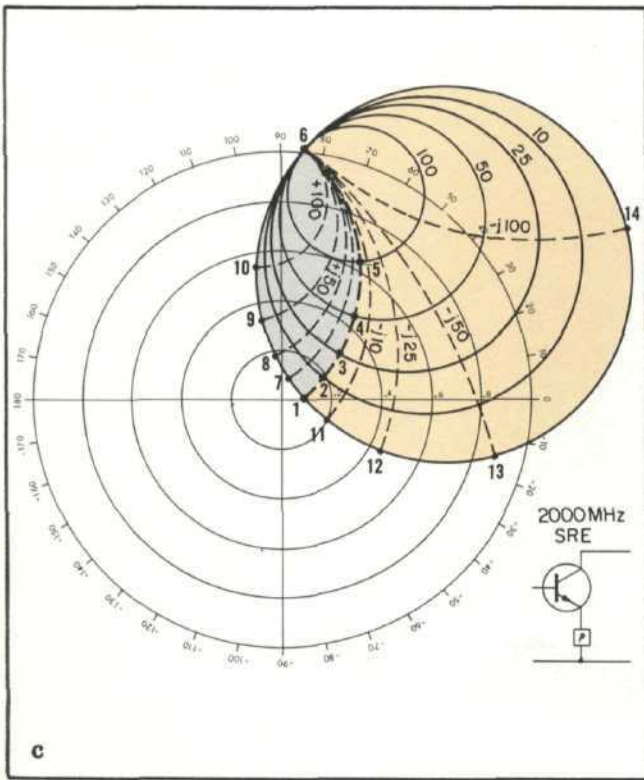
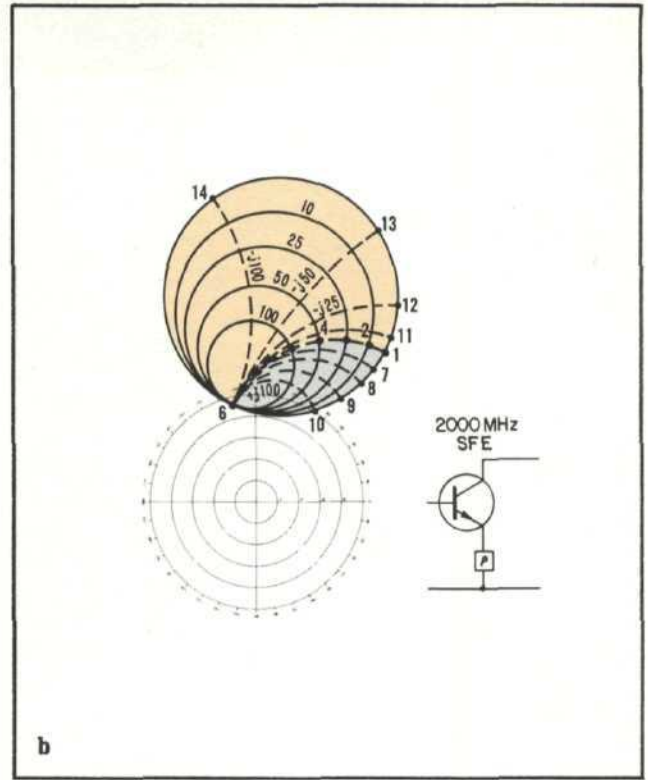
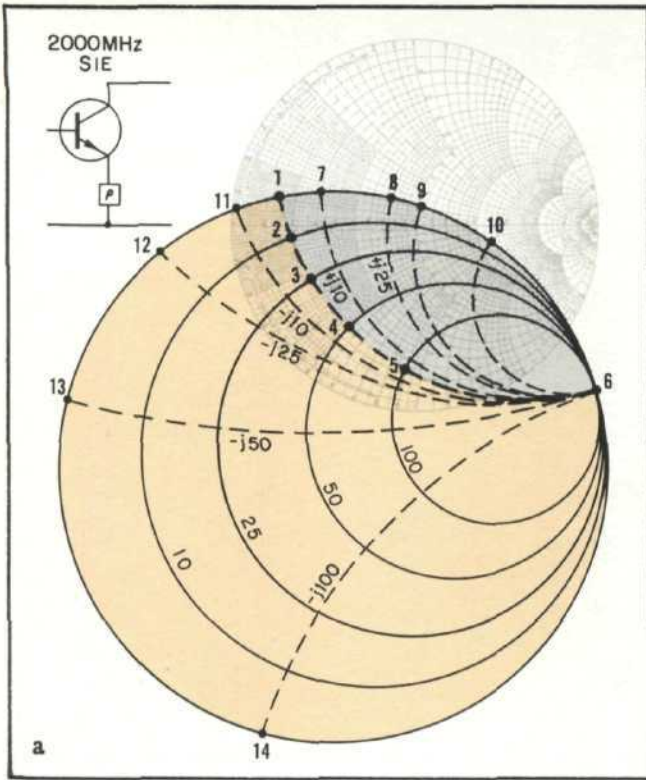

Figs. 6a, b, c and d – Common emitter series feedback impedance mapped onto the s-parameter planes at 2 GHz. The shaded regions correspond to inductive impedances while the colored areas are capacitive.

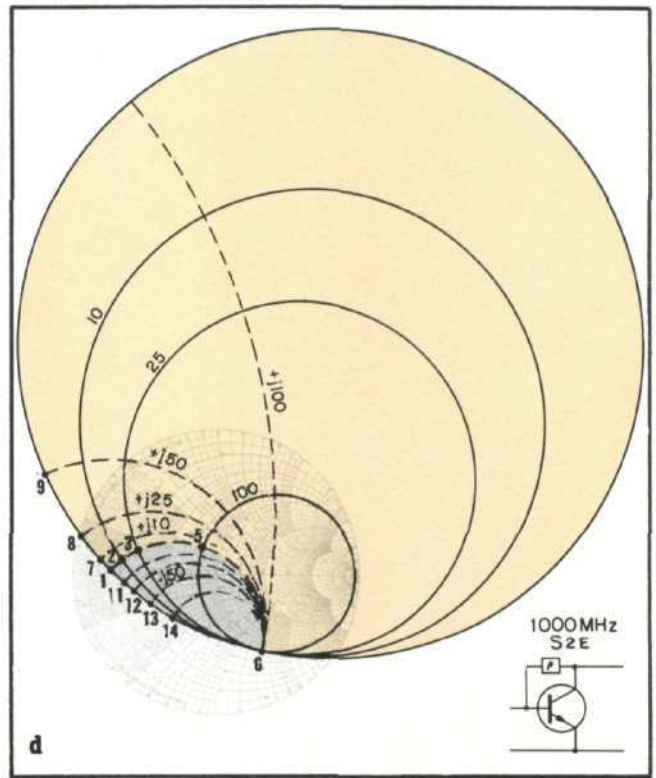
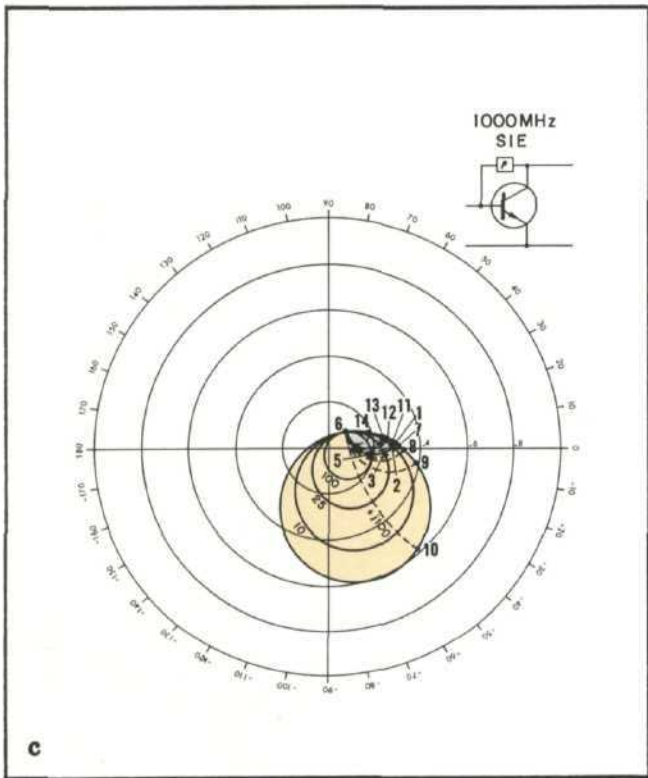
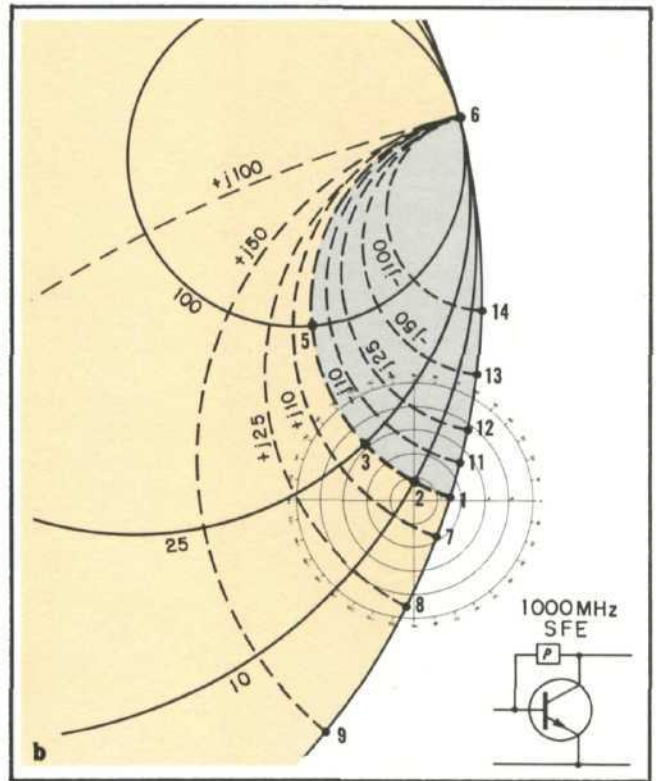
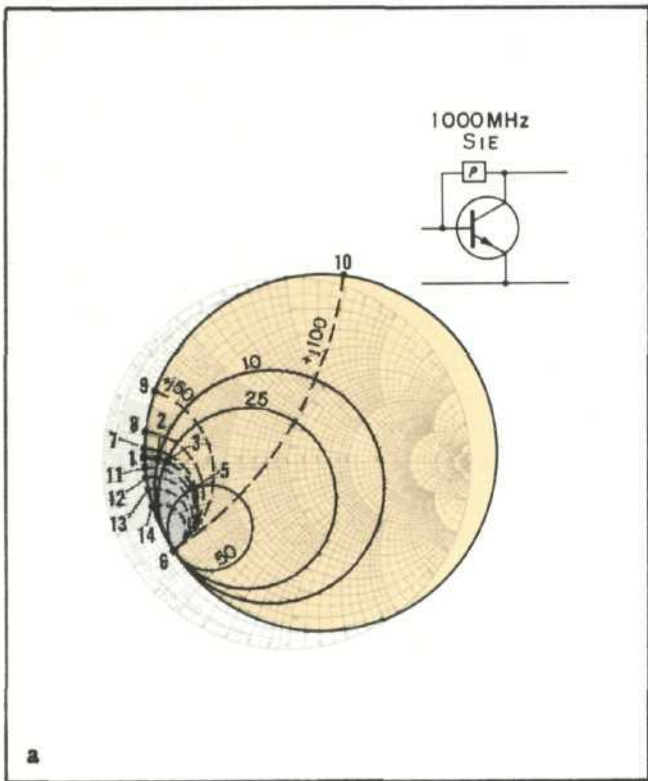

Figs. 7a, b, c and d – Common emitter shunt feedback impedance mapped onto the s-parameter planes at 1 GHz. The shaded regions correspond to inductive impedances while the colored areas are capacitive.

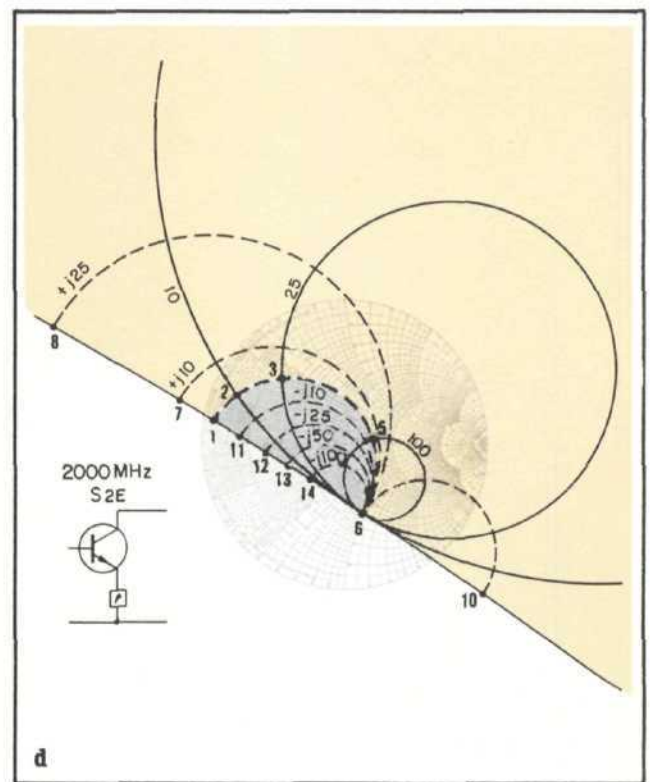
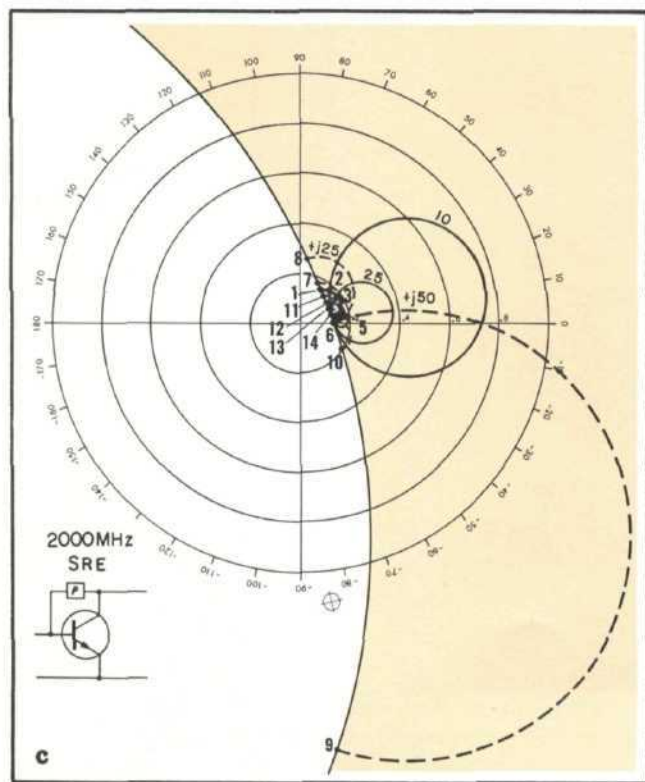
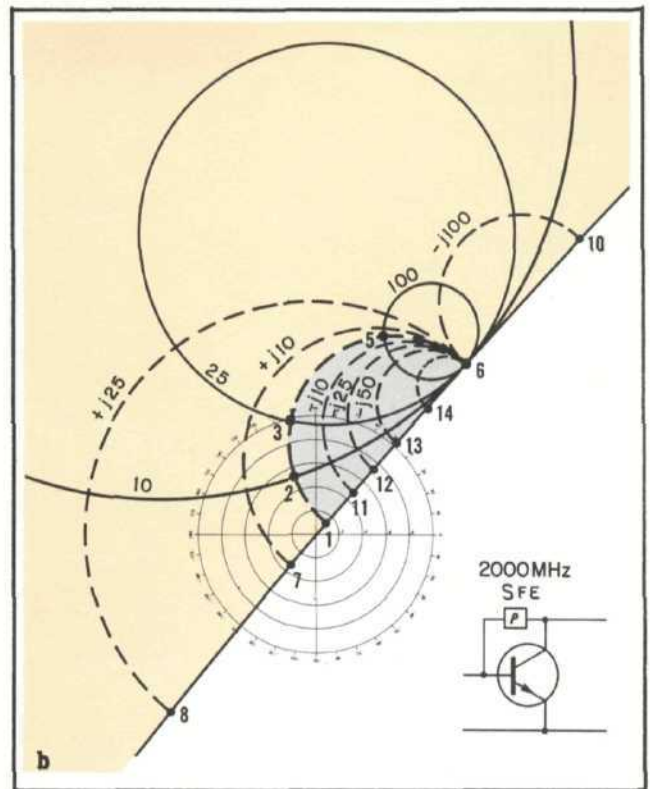
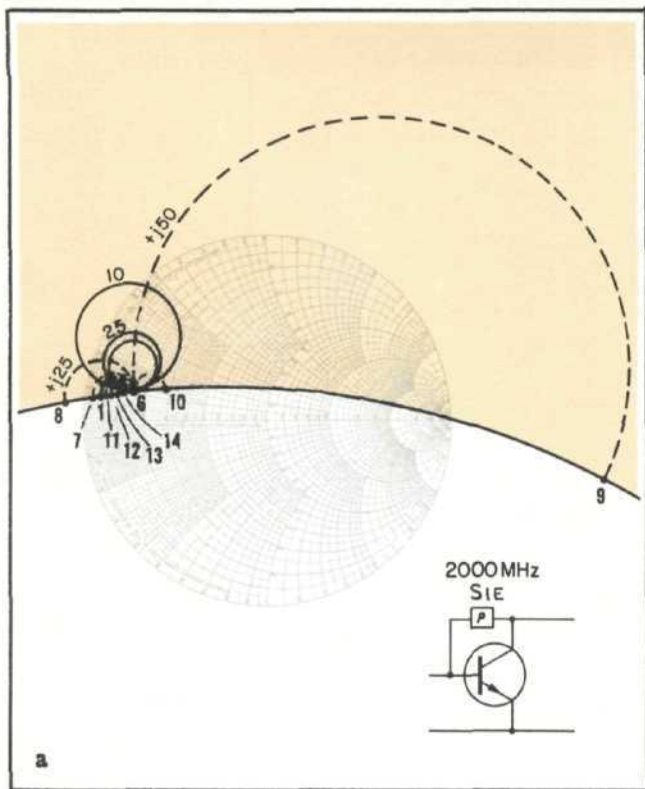

Figs. 8a, b, c and d – Common emitter shunt feedback impedance mapped onto the s-parameter planes at 2 GHz. The shaded regions correspond to inductive impedances while the colored areas are capacitive.

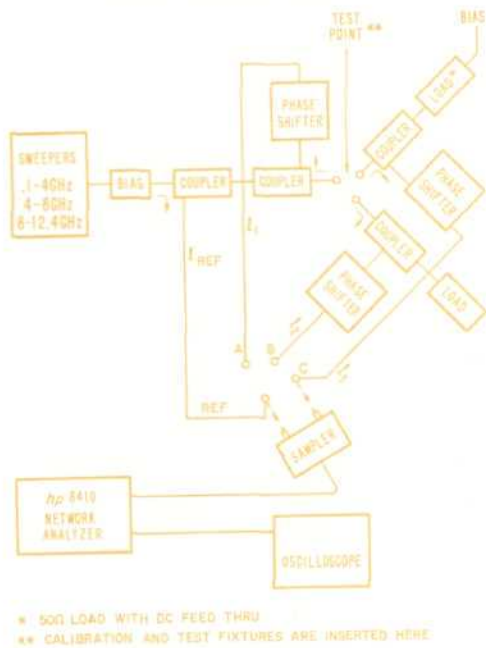

Fig. 9 — Schematic of the rf system used to make the three-port measurements.

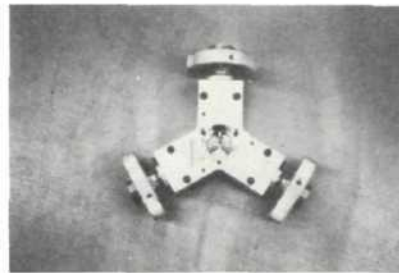

Fig. 12 — This is a close-up view of the fixture used for measuring chips with the cover removed for loading.



Fig. 10 — This is a photograph of the first system built to measure the three-port scattering parameters of transistor chips.



Fig. 13 — This is a close-up picture of the fixture. The three center conductors can be observed converging at the center.



Fig. 11 — This figure shows the system in more detail. Apparent in the photograph is one of the phase shifters, bottom, the sampler on the left, a microscope at the top, a positioner for making contact to the transistor, right, and the three signal ports terminating in the transistor chip fixture in the center.

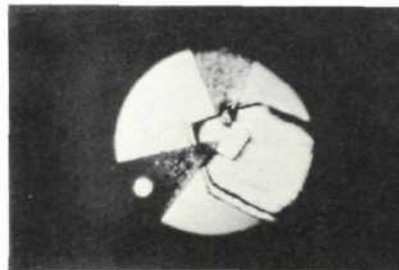

Fig. 14 — This photograph was taken through a microscope and shows one center conductor making contact to the collector (plated gold on the back of the chip) and the base and emitter contacts. This device has contact pads of about 1 mil on a side. Devices with pads 1/2 mil on a side are handled routinely.

APPENDIX

MEASURING S PARAMETERS

Today's interest in s parameters results from the ease with which these vector quantities are measured. One of the standard circuits for measuring s parameters of transistors consists of two dual directional couplers, two biasing tees, and a fixture to hold the transistors. The operation is quite straightforward.

Consider the circuit shown below.

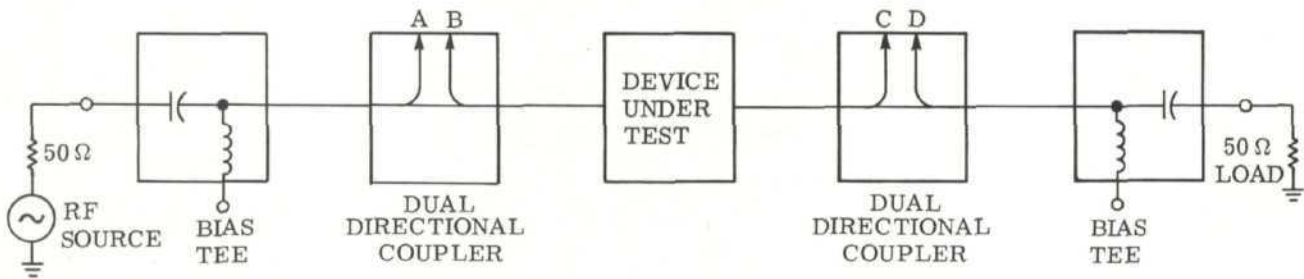

$$S_{11} = \frac{B}{A} \angle \phi_B - \phi_A$$

$$S_{21} = \frac{C}{A} \angle \phi_C - \phi_A$$

The RF source sends a signal down the 50Ω system toward the test device (transistor). The signal out of A is proportional to the signal incident on port 1 of the test device. The signal out of B is proportional to the signal reflected from port 1, and the signal at C is proportional to the signal transmitted through the test device and out of port 2. The 50Ω system on the port 2 side is terminated in the 50Ω load. As a result, the signal at D is zero because none of the signal out of port 2 is reflected back at the test device.

The ratio B/A is the magnitude of s_{11} , and the phase difference between B and A is the phase of s_{11} . Likewise, C and A determine s_{21} . Either the 8405A Vector Voltmeter or the 8410A Network Analyzer is used to detect these coupler outputs.

Similarly, the setup shown below measures s_{12} and s_{22} . The major difference between these two setups is that the 50Ω load and the RF source have been interchanged.

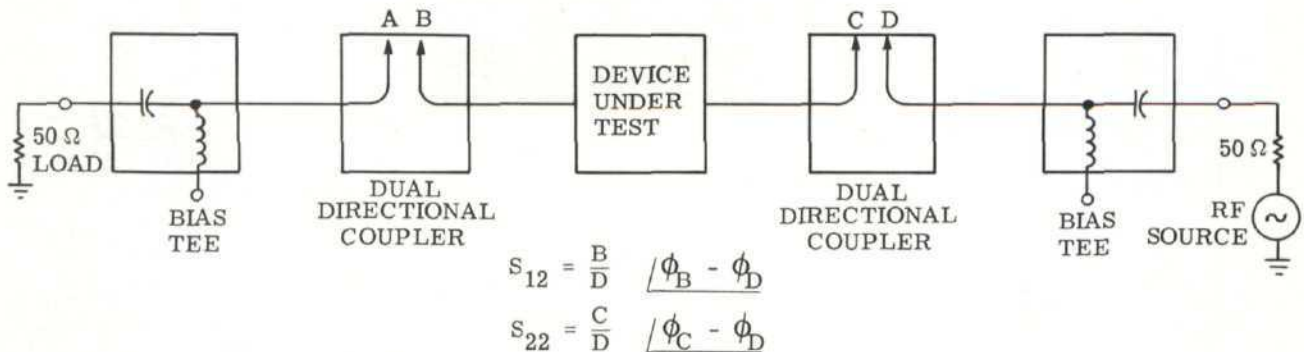

$$S_{12} = \frac{B}{D} \angle \phi_B - \phi_D$$

$$S_{22} = \frac{C}{D} \angle \phi_C - \phi_D$$

These circuits can be constructed from individual components or supplied in a single box. When the circuit is contained in a single box, the tedious job of connecting coax circuitry disappears, and s-parameter measurements can be made by pushing a button. This is the case with the HP 8745A S Parameter Test Set.

The figure below shows diagrams of two different s parameter systems.

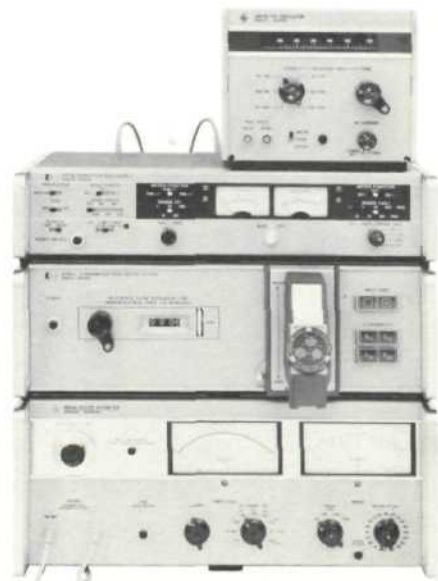
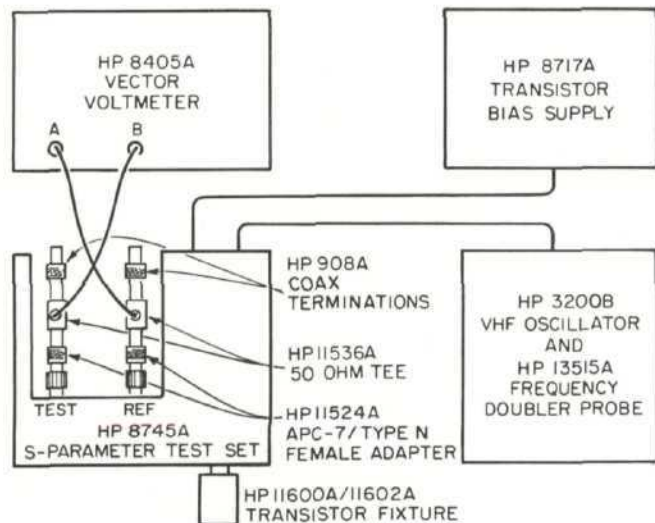
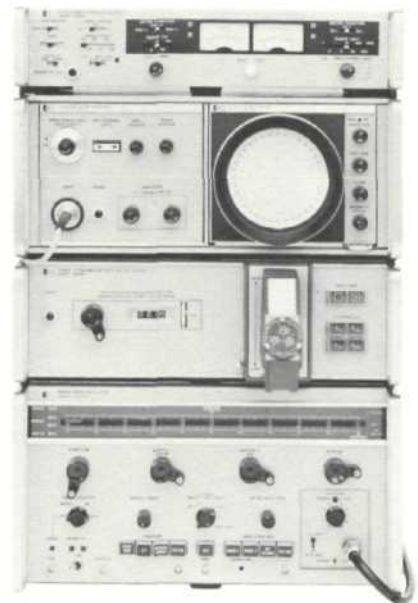
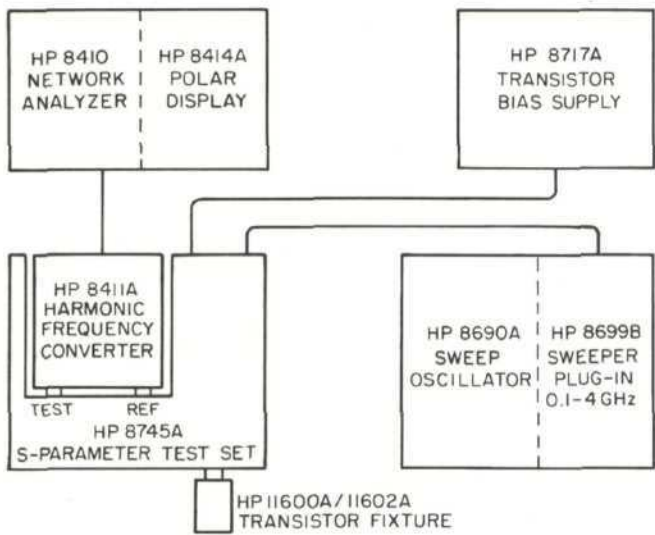

The first system makes swept-frequency measurements from 110 MHz to 2 GHz using an 8410A Network Analyzer. The minimum transistor drive signal required by this system is 22.5 mV.

The second system makes single-frequency measurements using the 8415A Vector Voltmeter. The vector

voltmeter is more sensitive than the network analyzer. The minimum transistor drive signal required by this system is 5 mV. This additional sensitivity will compensate for coupler rolloff in the s parameter test set below 100 MHz. As a result, this system can be used down to 14 MHz and still preserve the same transistor signal levels required by the network analyzer system at 110 MHz.

HEWLETT  PACKARD