

VON DUPRIN®

98/99™
Series

Exit devices



Introduction

Exit devices are a critical part of the fire and life safety egress system and will provide safe and reliable service when properly applied and maintained. Von Duprin designs and manufactures exit devices in accordance to ISO 9001 Quality Management System and meets or exceeds accepted U.S. domestic and International standards. All 98 and 99 Series exit devices are UL listed for panic hardware or fire hardware, and are certified to ANSI A156.3, 2008, Grade 1. Many models are also certified for Hurricane Resistant Applications. Consult your local Security & Safety consultant (SSC) or the Von Duprin factory for current listings.

It is intended that the information included in this publication, when properly used, will provide clear and reliable guidelines to the proper general selection and application. However, the scope of the information is necessarily limited.

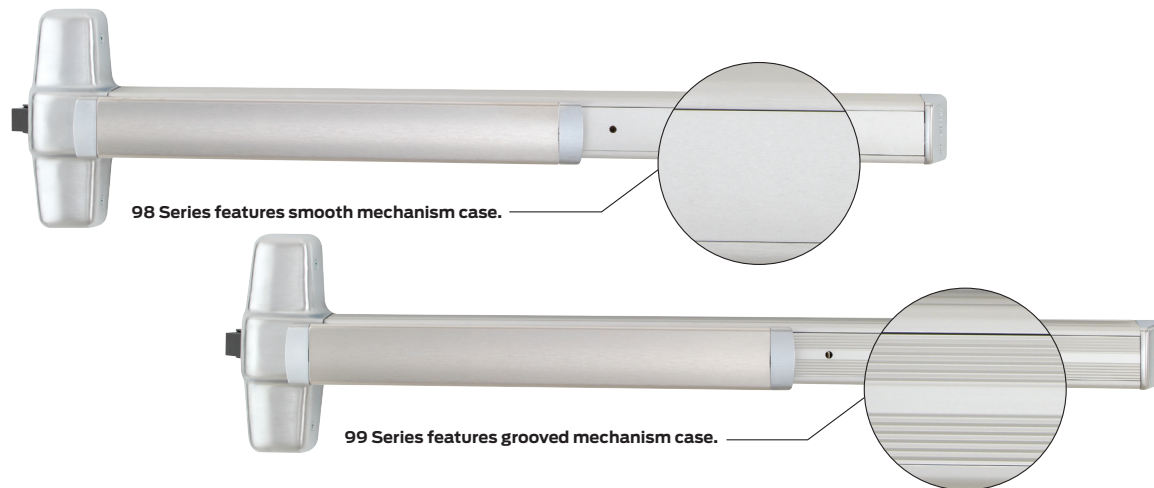

Von Duprin exit devices are available in two external surface styles, designated 98 and 99 Series.

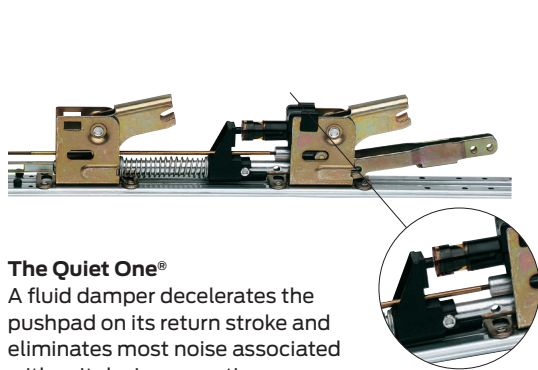

A fluid damper decelerates the pushpad on its return stroke and eliminates most noise associated with exit device operations. Furnished on all 98/99™ Series exit devices.

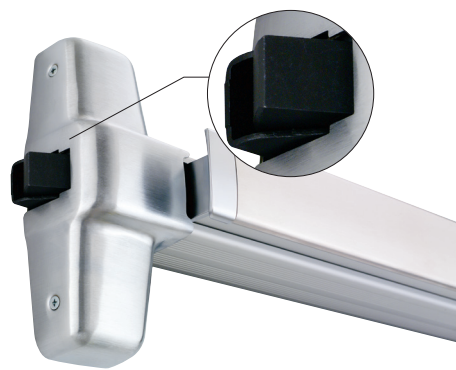

Deadlocking latchbolt provides security and improved performance at standard device cost.

VON DUPRIN
Administrative Offices
2720 Tobey Dr.
Indianapolis, IN 46219

Customer Service
877-671-7011
800-999-0328 - Fax

Technical Support
877-671-7011

Table of contents

Exit hardware

Rim devices

98/99	8
Trim	9

XP rim devices

XP98/99	12
Trim	13

Mortise lock devices

9875/9975	16
Trim	17

Surface mounted Vertical rod devices

9827/9927	20
Trim	21

Three-point latching devices

9857/9957	24
Trim	25

Concealed vertical rod devices

9847/9947	28
Trim	29
9848/9948	32
Trim	33

Concealed vertical cable devices

9849/9949	36
Trim	37

Wood door concealed vertical rod devices

9847WDC/9947WDC	40
Trim	41

Wood door concealed vertical cable devices

9849WDC/9949WDC	43
Trim	45

Wood door concealed vertical cable devices

9850WDC/9950WDC	48
Trim	49

Fire exit hardware

Rim devices

98-F/99-F	10
Trim	11

XP rim devices

XP98/99-F	14
Trim	15

Mortise lock devices

9875/9975	18
Trim	19

Surface mounted Vertical rod devices

9827-F/9927-F	22
Trim	23

Three-point latching devices

9857-F/9957-F	26
Trim	27

Concealed vertical rod devices

9847-F/9947-F	30
Trim	31
9848-F/9948-F	34
Trim	35

Concealed vertical cable devices

9849-F/9949-F	38
Trim	39

Wood door concealed vertical rod devices

9847WDC-F/9947WDC-F	42
Trim	43

Wood door concealed vertical cable devices

9849WDC-F/9949WDC-F	46
Trim	47

Wood door concealed vertical cable devices

9850WDC-F/9950WDC-F	50
Trim	51

THIS PRODUCT IS OBSOLETE it is replaced by the 98/9950 WDC.
See pages 48-51 for more information.

Options and accessories

Applications & trim operation	Single & double door applications Door handing Outside trim operation Lever styles
--	---

Trim options	Knob Thumbpiece Lever Electrified outside lever trim (E996L) Breakaway lever Thumbturn control Hospital pull Offset pull Vandal resistant pull AD-Series adaptable electronic trim
---------------------	---

Strike options	Strike/Stile information Strikes
Dogging options	Cylinder dogging Hex key dogging Less dogging Dogging keys Special center case dogging Double cylinder

Symbols

 Indicates fire rated application  Indicates ADA products

Electrical options	RX Request to exit LX Latchbolt monitoring SS Signal switch CX Chexit® ALK Alarm kit E Electric mortise lock device EL Electric latch retraction QEL Quiet electric latch retraction CON Allegion Connect
---------------------------	--

Electrical accessories	Power supplies Electric power transfer
-------------------------------	---

Mechanical options	XP98/99 rim exit device WS Surface vertical rod exit device Less bottom rod AX Accessible device Pullman latch Dummy push pad Braille, embossed, knurled and safety glow (Luminescent) touchpads
---------------------------	--

Pneumatic options	Pneumatic controlled exit devices Pneumatic power transfer
--------------------------	---

Device accessories	Glass bead kit Vertical rod and latch guard Cover plate kits Cylinders Mullions Sex bolts
---------------------------	--

Additional information	ANSI Function, grade & type UL fire labeling and opening size
-------------------------------	--

Finishes	Standard & special finishes
-----------------	-----------------------------

Nomenclature – how to order

		EL	99	27	-L	-16	-F	LBR	3'	US3	RHR
None	Standard										
SD	Special dogging R/VR - panic only										
CD	Cylinder dogging - panic only										
CX	Chexit										
E	Electric locking mortise/lever										
QEL	Quiet electric latch retraction										
EL	Electric latch retraction										
LX	Latch bolt monitoring										
RX	Request to exit										
RX2	Double request to exit										
SS	Signal switch										
AX	Accessible device										
PL	Pullman latch										
PN	Pneumatic latch retraction										
WS	Surface vertical rod exit device										
XP	Heavy protection - rim										
WS	Tornado & hurricane tested										
98	Series 98-smooth										
99	Series 99-grooved										
None	Rim device										
27	Surface mounted vertical rod device										
47	Concealed vertical rod device										
47WDC	Concealed vertical rod wood door device										
48	Concealed vertical rod device										
49	Concealed vertical cable device										
49WDC	Concealed vertical cable wood door device										
57	Three-point latch device										
75	Mortise lock device										
AD	AD Trim (to come from client)										
DT	Dummy trim										
EO	Exit only										
HL	Hospital pull trim										
K	Knob										
K-BE	Knob - blank escutcheon										
K-DT	Knob, rigid - dummy trim										
K-NL	Knob, rigid - night latch										
L	Lever (classroom)										
L-BE	Lever - blank escutcheon										
L-DT	Lever, rigid - dummy trim										
L-NL	Lever, rigid - night latch										
NL	Night latch										
NL-OP	Night latch cylinder assembly, optional pull										
TL	Turn lever										
TL-BE	Turn lever - blank escutcheon										
TP	Thumbpiece										
TP-BE	Thumbpiece - blank escutcheon										
XX	Lever style 06 standard Optional 01, 02, 03, 05, 07, 12 (Handed), 16 (Omega), 17, 18, Accent, Asti, Merano, St. Annes										
F	Fire exit device										
-2	Double cylinder (rim & mortise only)										
LBR	Less bottom rod										
LBL	Less bottom latch										
SG	Safety glow (luminescent) touchpad										
ALK	Alarm kit										
ALK-AR1	Auto-reset 1½ minute alarm kit										
ALK-AR3	Auto-reset 3 minute alarm kit										
ALK-AR6	Auto-reset 4½ minute alarm kit										
CON	Alligion Connect										
2'	2' Device (2' door size) 27, 47 or 49 only										
3'	3' Device (2' 4"- 3' door size)										
4'	4' Device (2' 10"- 4' door size)										
Finishes	US3, US4, US10, US26, US26D, US28, 313, 315 US32D – 98 ONLY -AM Antimicrobial (available US26D and US32D)										
-LHR	Left hand reverse										
-RHR	Right hand reverse										

Popular double door applications

Single door applications

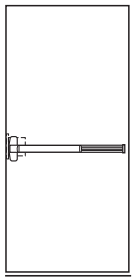

Single mortise lock device

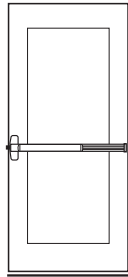

Single rim device

Double door applications

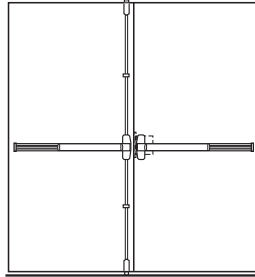

Mortise lock and surface mounted or concealed vertical cable/rod device combination—same direction

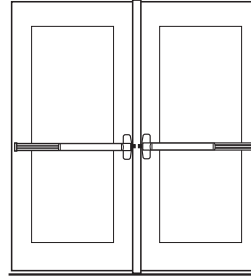

Two rim devices with mullion—same direction

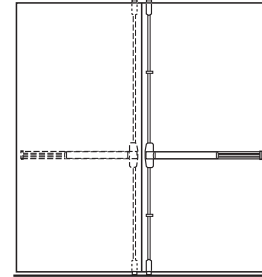

Two vertical rods—double egress

Door handing

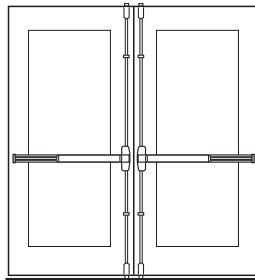
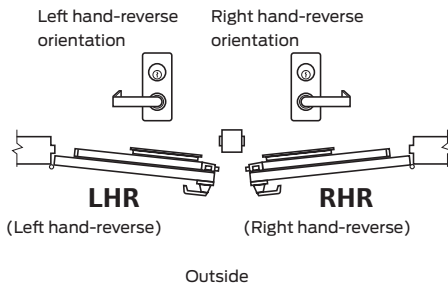

Two surface mounted vertical rod devices—same direction (do not use with overlapping astragal)

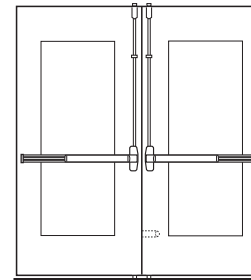

Two fire exit hardware vertical cables/rods with auxiliary fire latch—LBR option

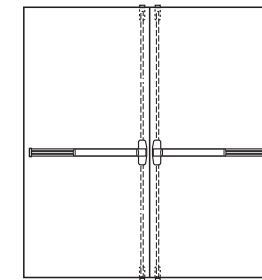

Two concealed vertical cables/rods

Outside trim operation

Trim operation lever or knob

Standard



Key locks and unlocks lever or knob, e.g., 996L (Classroom)

Night latch



Key retracts latch bolt. Lever or knob is rigid. Use NL suffix, e.g., 996LNL. (Storeroom)

Blank escutcheon



Lever or knob always active. Use BE suffix, e.g., 996L-BE. (Passage)

Dummy



Lever or knob rigid for pull operation. Use DT suffix, e.g., 996L-DT.

996L Breakaway™ lever



The 996L Breakaway trim has become the standard lever trim offering on the 98L/99L Series devices. The Breakaway design is especially effective in areas where vandalism to door hardware is a problem. The design intent is to discourage costly repairs from becoming necessary. The Breakaway feature is not available on the NL (night-latch) or DT (dummy trim) versions.

374T/376T Series thumbturn control



Standard operation, key locks and unlocks thumbturn. Optional operation, key unlocks thumbturn, re-locks when key is removed. This operation is created by changing the cylinder plate included with control. Use 1 1/4" mortise cylinder with a straight cam. Schlage cam reference L583-475. Use with a pull trim (990DT pictured).

Lever styles

Decorative levers



M51
Knurling available



M52
Knurling available



M53



M54



M55



M56



M57 **



M61
(Handed)



M62 **
(Handed)



M63
(Handed)



M81
Knurling available



M82



M83



M84



M85
(Handed)

** Available in Stainless Steel substrate ONLY.

Standard Levers



01



02
Knurling available



03*
Knurling available



05



06*
Default lever
Knurling available



07



12
(Handed)



16
(Omega)



17*
Knurling available



18



ACC
(Accent)
(Handed)



AST
(Asti)
(Handed)



MER
(Merano)
(Handed)



LAT*
Latitude



LON*
Longitude

*Available in Stainless Steel - specify SS when ordering

98/99 Rim exit device



The 299 Strike ships standard, optional strikes available

Hex key dogging comes standard on 98/99 Rim exit devices



98 and 99 Rim exit devices for all types of single and double doors with mullion, UL listed for panic exit hardware. Devices are ANSI A156.3 – 2014 Grade 1. The 98 device has a smooth mechanism case and the 99 device has a grooved case. The rim device is non-handed except when the following device options are used: SD (special dogging), -2 (double cylinder) or SS (signal switch). See Opposite page for available outside trim and device functions. Covers stock hollow metal doors with 86 or 161 cutouts on single doors (may cover cutouts on pairs – consult template).

Finishes – US3, US3A, US4, US4A, US10, US26, US26D, US26D-AM Antimicrobial, US28, 313, 315 & 643E. US15 and US32D available with 98 Series only.

Specifications

Device functions	Device ships EO/DT/NL. Field selectable. For TP, K or L remove NL drive screw from device.	
Device lengths	3'	2'4" to 3' (711mm to 914 mm) Door size
	4'	2'10" to 4' (864 mm to 1219 mm) Door size
Device centerline from finished floor	39 ¹³ / ₁₆ " (1011 mm) 39 ¹¹ / ₁₆ " (1008 mm) with mullion	
Center case dimensions	8" x 2 ³ / ₄ " x 2 ³ / ₈ " (203mm x 70mm x 60mm)	
Mechanism case dimensions	2 ¹ / ₄ " x 2 ¹ / ₄ " (57mm x 57mm)	
Projection	Pushbar neutral – 3 ¹³ / ₁₆ " (97 mm) Pushbar depressed – 3 ¹ / ₁₆ " (78 mm)	
Latch bolt	Deadlocking, ³ / ₄ " (19mm) throw	
Fasteners & sex bolts (SNB)	Includes screw pack for 1 ³ / ₄ " (44mm) and 2 ¹ / ₄ " (57mm) thick metal or wood doors. Optional 425 SNB available, see page 9 for quantities.	
Electric options	LX	Latchbolt monitor switch
	RX	Pushpad monitor switch
	RX2	Double pushpad monitor switch
	E	Electric locking & unlocking trim
	EL	Electric latch retraction
	QEL	Quiet electric latch retraction
	SS	Signal switch
	CX	Chexit delayed exit
	ALK	Alarm exit kit
	WP-RX	Waterproof request to exit
	CON	Allegion Connect
Mechanical options	-2	Double cylinder
	AX	Accessible device
	GBK	Glass bead kit
	PN	Pneumatic latch retraction
	XP	Extra protection
	SNB	Sex bolts
	SEC	Security screws
Dogging feature	Hex key dogging standard	
Dogging options	CD	Cylinder dogging
	SD	Special center case dogging
	LD	Less dogging
	DI	Dogging indicator
	CI	Cylinder dogging indicator
Strikes	299 – Dull black	

XP
Extra protection

- 90° latch-to-strike contact
- Force resistance of 2,000+ lbs.

CD
Cylinder dogging

- Replaces hex key dogging
- Requires 1 1/4" mortise cylinder with inverted cam

QEL
Quiet electric latch retraction

- Bolt retraction via switch
- Converts exit door to push-pull operation

RX
Pushpad monitor switch

- Signals use of an opening
- SPDT switch to monitor pushpad

CX
Chexit delayed exit

- Meets NFPA 101 requirements
- Self-contained controls, locking, alarm

AX
Accessible device

- UL certified to meet new 5 lb. maximum operating force requirement
- Exceeds ANSI/BHMA requirements

EL
Electric latch retraction

- Enables remote unlatching
- Alternative to manual dogging

ALK
Alarm exit kit

- Unauthorized opening triggers 85-decibel horn
- Set in armed or disarmed mode by key





PN
Pneumatic latch retraction





- For areas where electrical devices banned
- Special linkage for mechanical or pneumatic dogging

CON
Allegion Connectors

- Common connectors to connect various door hardware all the way to the power supply

Standard trim

	EO	DT	NL	NL-OP
				
Product description	98EO 99EO	98DT 99DT	98NL 99NL	98NL-OP 99NL-OP
Trim description	—	990DT	990NL-R/V	110NL-MD 110NL-WD
Escutcheon plate size	—	3" x 14 ¹³ / ₁₆ " x 3 ³ / ₃₂ " (76x360x2mm)	3" x 14 ¹³ / ₁₆ " x 3 ³ / ₃₂ " (76x360x2mm)	—
Pull center to center	—	5 ¹ / ₂ " (140mm)	5 ¹ / ₂ " (140mm)	—
Projection	—	2" (51mm)	2" (51mm)	—
ANSI function	01	02	03	03
Cylinder type	—	—	Rim	Rim
Handing	—	—	—	—
Optional trim	x990EO x996EO	x996K-DT x996L-DT x696DT x697DT	x996K-NL x996L-NL x696NL x697NL	
Optional #425 SNB quantity for device	6	2	2	6

	L	L-NL	L-BE	L-DT
				
Product description	98L 99L	98L-NL 99L-NL	98L-BE 99L-BE	98L-DT 99L-DT
Trim description	996L-R/V*	996L-NL-R/V	996L-BE-R/V*	996L-DT
Escutcheon plate size	2 ³ / ₄ " x 10 ³ / ₄ " x 2 ⁷ / ₃₂ " (70x273x21mm)	2 ³ / ₄ " x 10 ³ / ₄ " x 2 ⁷ / ₃₂ " (70x273x21mm)	2 ³ / ₄ " x 10 ³ / ₄ " x 2 ⁷ / ₃₂ " (70x273x21mm)	2 ³ / ₄ " x 10 ³ / ₄ " x 2 ⁷ / ₃₂ " (70x273x21mm)
Pull center to center	—	—	—	—
Projection	2 ⁷ / ₈ " (73mm)	2 ⁷ / ₈ " (73mm)	2 ⁷ / ₈ " (73mm)	2 ⁷ / ₈ " (73mm)
ANSI function	08	03	14	02
Cylinder type	Rim	Rim	—	—
Handing	Handed/Reversible	Handed/Reversible	Handed/Reversible	Handed/Reversible
Optional #425 SNB quantity for device	2	2	2	2

* Electrified lever operation available

Notes

98-F/99-F Rim exit device



98-F and 99-F Rim fire exit devices for all types of single doors up to 4' x 10' (1219mm x 3048mm) or 8' x 10' (2438mm x 3048mm) double doors with 9954 or 9854 mullion, UL listed for fire exit hardware. See page 76 for detailed information on UL listed fire exit hardware label and door opening size information. Devices are ANSI A156.3 – 2014 Grade 1. The 98-F device has a smooth mechanism case and the 99-F device has a grooved case. The rim device is non-handed except when the following device options are used: -2 (double cylinder) or SS (signal switch). See opposite page for available outside trim and device functions.

Finishes – US3, US3A, US4, US4A, US10, US26, US26D, US26D-AM Antimicrobial, US28, 313, 315 & 643E. US15 and US32D available with 98 Series only.



Specifications

Device functions	Device ships EO/DT/NL. Field selectable. For TP, K or L remove NL drive screw from device.	
Device lengths	3'	2'4" to 3' (711mm to 914 mm) Door size
	4'	2'10" to 4' (864 mm to 1219 mm) Door size
Device centerline from finished floor	39 ¹³ / ₁₆ " (1011 mm) 39 ¹¹ / ₁₆ " (1008 mm) with mullion	
Center case dimensions	8" x 2 ³ / ₄ " x 2 ³ / ₈ " (203mm x 70mm x 60mm)	
Mechanism case dimensions	2 ¹ / ₄ " x 2 ¹ / ₄ " (57mm x 57mm)	
Projection	Pushbar neutral – 3 ¹³ / ₁₆ " (97 mm) Pushbar depressed – 3 ¹ / ₁₆ " (78 mm)	
Latch bolt	Deadlocking, 3/4" (19mm) throw	
Fasteners & sex bolts (SNB)	Includes screw pack for 1 ³ / ₄ " (44mm) and 2 ¹ / ₄ " (57mm) thick metal or wood doors. Optional 425 SNB available for metal doors. 425 & 825 SNB required on wood doors without SLM blocking. See page 11 for quantities.	
Electric options	LX	Latchbolt monitor switch
	RX	Pushpad monitor switch
	RX2	Double pushpad monitor switch
	E	Electric locking & unlocking trim
	EL	Electric latch retraction
	QEL	Quiet electric latch retraction
	SS	Signal switch
	CX	Chexit delayed exit
	ALK	Alarm exit kit
	WP-RX	Waterproof request to exit
	CON	Allegion Connect
Mechanical options	-2	Double cylinder
	AX	Accessible device
	GBK	Glass bead kit
	PN	Pneumatic latch retraction
	XP	Extra protection
	SNB	Sex bolts
	SEC	Security screws
	SLM	Special Laminated Material Blocking
Dogging option	No mechanical dogging. EL and QEL option available	
Strikes	299F – Dull black, 499F with mullions	

XP
Extra protection

- 90° latch-to-strike contact
- Force resistance of 2,000+ lbs.

RX
Pushpad monitor switch

- Signals use of an opening
- SPDT switch to monitor pushpad

EL
Electric latch retraction

- Enables remote unlatching
- Alternative to manual dogging

ALK
Alarm exit kit

- Unauthorized opening triggers 85-decibel horn
- Set in armed or disarmed mode by key

QEL
Quiet electric latch retraction

- Bolt retraction via switch
- Converts exit door to push-pull operation

CX
Chexit delayed exit

- Meets NFPA 101 requirements
- Self-contained controls, alarm

AX
Accessible device

- UL certified to meet new 5 lb. maximum operating force requirement
- Exceeds ANSI/BHMA requirements

SG
Safety glow

- Shows exit door location in darkness or smoke
- Developed to meet MEA standards



PN
Pneumatic latch retraction





- For areas where electrical devices banned
- Special linkage for mechanical or pneumatic dogging

CON
Allegion Connectors

- Common connectors to connect various door hardware all the way to the power supply

Standard trim

	EO	DT 	NL 	NL-OP 
	No outside trim Exit only	Dummy trim Pull when dogged (not recommended for fire device)	Night latch Key retracts latchbolt	Night latch Key retracts latchbolt optional pull required
Product description	98EO-F 99EO-F	98DT-F 99DT-F	98NL-F 99NL-F	98NL-OP-F 99NL-OP-F
Trim description	—	990DT	990NL-R/V	110NL-MD 110NL-WD
Escutcheon plate size	—	3" x 14 ¹³ / ₁₆ " x 3 ³ / ₃₂ " (76x360x2mm)	3" x 14 ¹³ / ₁₆ " x 3 ³ / ₃₂ " (76x360x2mm)	—
Pull center to center	—	5 ¹ / ₂ " (140mm)	5 ¹ / ₂ " (140mm)	—
Projection	—	2" (51mm)	2" (51mm)	—
ANSI function	01	02	03	03
Cylinder type	—	—	Rim	Rim
Handing	—	—	—	—
Optional trim	x990EO x996EO	x996K-DT x996L-DT x696DT x697DT	x996K-NL x996L-NL x696NL x697NL	
#425 SNB optional - HMD req. WD w/o SLM pkg.	6	2	2	2
#825 SNB req. WD w/o SLM pkg.	2 (if using trim)	2	2	2
#425 SNB req. w/ 499F	2	2	2	2

	L 	L-NL 	L-BE 	L-DT 
	Lever Key locks & unlocks	Lever – night latch Key retracts latchbolt	Lever – blank escutcheon Always operable (no cylinder)	Lever dummy trim pull when dogged (not recommended for fire device)
Product description	98L-F 99L-F	98L-NL-F 99L-NL-F	98L-BE-F 99L-BE-F	98L-DT-F 99L-DT-F
Trim description	996L-R/V*	996L-NL-R/V	996L-BE-R/V*	996L-DT
Escutcheon plate size	2 ³ / ₄ " x 10 ³ / ₄ " x 2 ⁷ / ₃₂ " (70x273x21mm)	2 ³ / ₄ " x 10 ³ / ₄ " x 2 ⁷ / ₃₂ " (70x273x21mm)	2 ³ / ₄ " x 10 ³ / ₄ " x 2 ⁷ / ₃₂ " (70x273x21mm)	2 ³ / ₄ " x 10 ³ / ₄ " x 2 ⁷ / ₃₂ " (70x273x21mm)
Pull center to center	—	—	—	—
Projection	2 ⁷ / ₈ " (73mm)	2 ⁷ / ₈ " (73mm)	2 ⁷ / ₈ " (73mm)	2 ⁷ / ₈ " (73mm)
ANSI function	08	03	14	02
Cylinder type	Rim	Rim	—	—
Handing	Handed/Reversible	Handed/Reversible	Handed/Reversible	Handed/Reversible
#425 SNB optional - HMD req. WD w/o SLM pkg.	2	2	2	2
#825 SNB req. WD w/o SLM pkg.	2 (if using trim)	2	2	2
#425 SNB req. w/ 499F	2	2	2	2

* Electrified lever operation available

XP98/99 Rim exit device

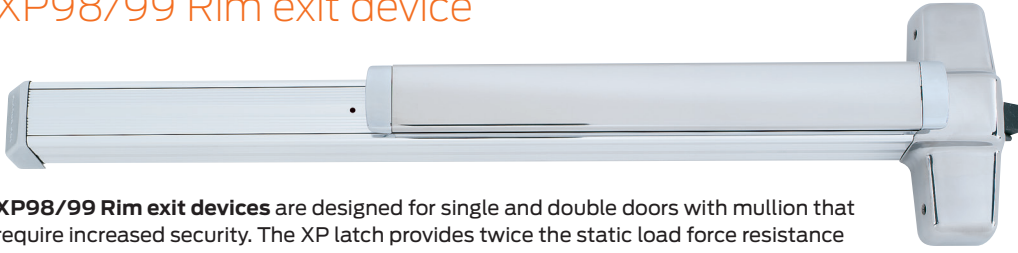

XP98/99 Rim exit devices are designed for single and double doors with mullion that require increased security. The XP latch provides twice the static load force resistance of standard exit devices. The “smart” latch changes shape when subjected to external forces. This design enables the exit door to withstand an external attack and remain secure. Additionally, the patented latch bolt design provides greater, longer-lasting latch bolt to strike contact which is not easily affected by the twisting motion of a weakened frame, resulting in an opening that will remain strong. Devices are ANSI A156.3 – 2014 Grade 1 and UL listed for panic exit hardware. The rim device is non-handed except when the following device options are used: SD (special dogging) or -2 (double cylinder). See Opposite page for available outside trim and device functions. Covers stock hollow metal doors with 86 or 161 cutouts on single doors (may cover cutouts on pairs – consult template).

Finishes – US3, US3A, US4, US4A, US10, US26, US26D, US26D-AM Antimicrobial, US28, 313, 315 & 643E. US15 and US32D available with 98 Series only.



The 909 Strike ships standard for single or double doors.



XP latch provides increased security with its two piece design.

Hex key dogging comes standard on 98/99 Rim exit devices



Specifications

Device functions	Device ships EO/DT/NL. Field selectable. For TP, K or L remove NL drive screw from device.	
Device lengths	3'	2'4" to 3' (711mm to 914 mm) Door size
	4'	2'10" to 4' (864 mm to 1219 mm) Door size
Device centerline from finished floor	39 ¹³ / ₁₆ " (1011 mm) 39 ¹¹ / ₁₆ " (1008 mm) with mullion	
Center case dimensions	8" x 2 ³ / ₄ " x 2 ³ / ₈ " (203mm x 70mm x 60mm)	
Mechanism case dimensions	2 ¹ / ₄ " x 2 ¹ / ₄ " (57mm x 57mm)	
Projection	Pushbar neutral – 3 ¹³ / ₁₆ " (97 mm) Pushbar depressed – 3 ¹ / ₁₆ " (78 mm)	
Latch bolt	Deadlocking, ³ / ₄ " (19mm) throw	
Fasteners & sex bolts (SNB)	Includes screw pack for 1 ³ / ₄ " (44mm) and 2 ¹ / ₄ " (57mm) thick metal or wood doors. Optional 425 SNB available, see page 13 for quantities.	
Electric options	LX-LC	Latchbolt monitor switch, low current
	RX	Pushpad monitor switch
	RX2	Double pushpad monitor switch
	E	Electric locking & unlocking trim
	EL	Electric latch retraction
	QEL	Quiet electric latch retraction
	CX	Chexit delayed exit
	ALK	Alarm exit kit
	WP-RX	Waterproof request to exit
	CON	Allegion Connect
Mechanical options	-2	Double cylinder (specify handing)
	AX	Accessible device
	GBK	Glass bead kit
	SNB	Sex bolts
	SEC	Security screws
Dogging feature	Hex key dogging standard	
Dogging options	CD	Cylinder dogging
	CDSI	Cylinder dogging with security indicator
	HDSI	Hex dogging with security indicator
	SD	Special center case dogging (specify handing)
	LD	Less dogging
	DI	Dogging indicator
	CI	Cylinder dogging indicator
Strikes	909 – Dull black	

XP
Extra protection

- 90° latch-to-strike contact
- Force resistance of 2,000+ lbs.

CD
Cylinder dogging

- Replaces hex key dogging
- Requires 1 1/4" mortise cylinder with inverted cam

QEL
Quiet electric latch retraction

- Bolt retraction via switch
- Converts exit door to push-pull operation

RX
Pushpad monitor switch

- Signals use of an opening
- SPDT switch to monitor pushpad

CX
Chexit delayed exit

- Meets NFPA 101 requirements
- Self-contained controls, locking, alarm

AX
Accessible device

- UL certified to meet new 5 lb. maximum operating force requirement
- Exceeds ANSI/BHMA requirements

EL
Electric latch retraction

- Enables remote unlatching
- Alternative to manual dogging





ALK
Alarm exit kit





- Unauthorized opening triggers 85-decibel horn
- Set in armed or disarmed mode by key

CON
Allegion Connectors

- Common connectors to connect various door hardware all the way to the power supply

Standard trim

	EO	DT	NL	NL-OP
				
Product description	XP98EO XP99EO	XP98DT XP99DT	XP98NL XP99NL	XP98NL-OP XP99NL-OP
Trim description	—	990DT	990NL-R/V	110NL-MD 110NL-WD
Escutcheon plate size	—	3" x 14 ¹³ / ₁₆ " x 3 ³ / ₃₂ " (76x360x2mm)	3" x 14 ¹³ / ₁₆ " x 3 ³ / ₃₂ " (76x360x2mm)	—
Pull center to center	—	5 ¹ / ₂ " (140mm)	5 ¹ / ₂ " (140mm)	—
Projection	—	2" (51mm)	2" (51mm)	—
ANSI function	01	02	03	03
Cylinder type	—	—	Rim	Rim
Handing	—	—	—	—
Optional trim	x990EO x996EO	x996K-DT x996L-DT x696DT x697DT	x996K-NL x996L-NL x696NL x697NL	
Optional #425 SNB quantity for device	6	2	2	6

	L	L-NL	L-BE	L-DT
				
Product description	XP98L XP99L	XP98L-NL XP99L-NL	XP98L-BE XP99L-BE	XP98L-DT XP99L-DT
Trim description	996L-R/V*	996L-NL-R/V	996L-BE-R/V*	996L-DT
Escutcheon plate size	2 ³ / ₄ " x 10 ³ / ₄ " x 2 ⁷ / ₃₂ " (70x273x21mm)	2 ³ / ₄ " x 10 ³ / ₄ " x 2 ⁷ / ₃₂ " (70x273x21mm)	2 ³ / ₄ " x 10 ³ / ₄ " x 2 ⁷ / ₃₂ " (70x273x21mm)	2 ³ / ₄ " x 10 ³ / ₄ " x 2 ⁷ / ₃₂ " (70x273x21mm)
Pull center to center	—	—	—	—
Projection	2 ⁷ / ₈ " (73mm)	2 ⁷ / ₈ " (73mm)	2 ⁷ / ₈ " (73mm)	2 ⁷ / ₈ " (73mm)
ANSI function	08	03	14	02
Cylinder type	Rim	Rim	—	—
Handing	Handed/Reversible	Handed/Reversible	Handed/Reversible	Handed/Reversible
Optional #425 SNB quantity for device	2	2	2	2

* Electrified lever operation available

Notes

XP98-F/99-F Rim exit device



XP98/99 Rim fire exit devices are designed for single (up to 4' x 10') and double doors (up to 8' x 10') with 9954-XP mullion that require increased security. The XP latch provides twice the static load force resistance of standard exit devices. The "smart" latch changes shape when subjected to external forces. This design enables the exit door to withstand an external attack and remain secure. Additionally, the patented latch bolt design provides greater, longer-lasting latch bolt to strike contact which is not easily affected by the twisting motion of a weakened frame, resulting in an opening that will remain strong. Devices are ANSI A156.3 – 2014 Grade 1 and UL listed for fire exit hardware. The rim device is non-handed except when the following device option is used: -2 (double cylinder). See Opposite page for available outside trim and device functions. Covers stock hollow metal doors with 86 or 161 cutouts on single doors (may cover cutouts on pairs – consult template).

Finishes – US3, US3A, US4, US4A, US10, US26, US26D, US26D-AM Antimicrobial, US28, 313, 315 & 643E. US15 and US32D available with 98 Series only.



XP latch provides increased security with its two piece design.



909 Strike for fire rated single doors



954 Strike for fire rated double doors and 9954XP mullion

Specifications

Device functions	Device ships EO/DT/NL. Field selectable. For TP, K or L remove NL drive screw from device.	
Device lengths	3'	2'4" to 3' (711mm to 914 mm) Door size
	4'	2'10" to 4' (864 mm to 1219 mm) Door size
Device centerline from finished floor	39 ¹³ / ₁₆ " (1011 mm) 39 ¹¹ / ₁₆ " (1008 mm) with mullion	
Center case dimensions	8" x 2 ³ / ₄ " x 2 ³ / ₈ " (203mm x 70mm x 60mm)	
Mechanism case dimensions	2 ¹ / ₄ " x 2 ¹ / ₄ " (57mm x 57mm)	
Projection	Pushbar neutral – 3 ¹³ / ₁₆ " (97 mm) Pushbar depressed – 3 ¹ / ₁₆ " (78 mm)	
Latch bolt	Deadlocking, 3/4" (19mm) throw	
Fasteners & sex bolts (SNB)	Includes screw pack for 1 ³ / ₄ " (44mm) and 2 ¹ / ₄ " (57mm) thick metal or wood doors. Optional 425 SNB available for metal doors. 425 & 825 SNB required on wood doors without SLM blocking. See page 15 for quantities.	
Electric options	LX-LC	Latchbolt monitor switch, low current
	RX	Pushpad monitor switch
	RX2	Double pushpad monitor switch
	E	Electric locking & unlocking trim
	EL	Electric latch retraction
	QEL	Quiet electric latch retraction
	CX	Chexit delayed exit
	ALK	Alarm exit kit
	WP-RX	Waterproof request to exit
	CON	Allegion Connect
Mechanical options	-2	Double cylinder (specify handing)
	AX	Accessible device
	GBK	Glass bead kit
	SNB	Sex bolts
	SEC	Security screws
	SLM	Special Laminated Material Blocking
Dogging option	No mechanical dogging. EL and QEL option available	
Strikes	909 – Dull black, fire rated single doors 954 – Dull black, fire rated double doors	

XP
Extra protection

- 90° latch-to-strike contact
- Force resistance of 2,000+ lbs.

RX
Pushpad monitor switch

- Signals use of an opening
- SPDT switch to monitor pushpad

EL
Electric latch retraction

- Enables remote unlatching
- Alternative to manual dogging

ALK
Alarm exit kit

- Unauthorized opening triggers 85-decibel horn
- Set in armed or disarmed mode by key

QEL
Quiet electric latch retraction

- Bolt retraction via switch
- Converts exit door to push-pull operation

CX
Chexit delayed exit

- Meets NFPA 101 requirements
- Self-contained controls, alarm

AX
Accessible device

- UL certified to meet new 5 lb. maximum operating force requirement
- Exceeds ANSI/BHMA requirements





SG
Safety glow



- Shows exit door location in darkness or smoke
- Developed to meet MEA standards

CON
Allegion Connectors

- Common connectors to connect various door hardware all the way to the power supply

Standard trim

	EO	DT	NL	NL-OP
				
Product description	XP98EO-F XP99EO-F	XP98DT-F XP99DT-F	XP98NL-F XP99NL-F	XP98NL-OP-F XP99NL-OP-F
Trim description	—	990DT	990NL-R/V	110NL-MD 110NL-WD
Escutcheon plate size	—	3" x 14 ¹³ / ₁₆ " x 3 ³ / ₃₂ " (76x360x2mm)	3" x 14 ¹³ / ₁₆ " x 3 ³ / ₃₂ " (76x360x2mm)	—
Pull center to center	—	5 ¹ / ₂ " (140mm)	5 ¹ / ₂ " (140mm)	—
Projection	—	2" (51mm)	2" (51mm)	—
ANSI function	01	02	03	03
Cylinder type	—	—	Rim	Rim
Handing	—	—	—	—
Optional trim	x990EO x996EO	x996K-DT x996L-DT x696DT x697DT	x996K-NL x996L-NL x696NL x697NL	
#425 SNB optional - HMD req. WD w/o SLM pkg.	2	2	2	2
#825 SNB req. WD w/o SLM pkg.	2 (if using trim)	2	2	2
#425 SNB req. w/ 954F	2	2	2	2

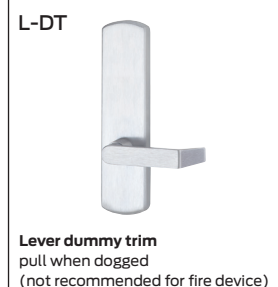
	L	L-NL	L-BE	L-DT
				
Product description	XP98L-F XP99L-F	XP98L-NL-F XP99L-NL-F	XP98L-BE-F XP99L-BE-F	XP98L-DT-F XP99L-DT-F
Trim description	996L-R/V*	996L-NL-R/V	996L-BE-R/V*	996L-DT
Escutcheon plate size	2 ³ / ₄ " x 10 ³ / ₄ " x 27 ³ / ₃₂ " (70x273x21mm)	2 ³ / ₄ " x 10 ³ / ₄ " x 27 ³ / ₃₂ " (70x273x21mm)	2 ³ / ₄ " x 10 ³ / ₄ " x 27 ³ / ₃₂ " (70x273x21mm)	2 ³ / ₄ " x 10 ³ / ₄ " x 27 ³ / ₃₂ " (70x273x21mm)
Pull center to center	—	—	—	—
Projection	2 ⁷ / ₈ " (73mm)	2 ⁷ / ₈ " (73mm)	2 ⁷ / ₈ " (73mm)	2 ⁷ / ₈ " (73mm)
ANSI function	08	03	14	02
Cylinder type	Rim	Rim	—	—
Handing	Handed/Reversible	Handed/Reversible	Handed/Reversible	Handed/Reversible
#425 SNB optional - HMD req. WD w/o SLM pkg.	2	2	2	2
#825 SNB req. WD w/o SLM pkg.	2 (if using trim)	2	2	2
#425 SNB req. w/ 954F	2	2	2	2

* Electrified lever operation available

9875/9975 Mortise lock device



9875/9975 Mortise lock device for all types of single or double doors, UL listed for Panic exit hardware. Devices are ANSI A156.3 – 2008 Grade 1. Fits stock hollow metal doors with 86 cutout and door stiles as narrow as 4 3/4" (121mm). The 9875 device has a smooth mechanism case and the 9975 device has a grooved case. The mortise lock device is non-handed except when the following device options are used: -2 (double cylinder) or SS (signal switch). See opposite page for available outside trim and device functions.

The 7500 Mortise lock is equipped with a 3/4" (19mm) anti-friction latch bolt which is field reversible without removing the lock from the door. It has a non-handed auxiliary bolt for deadlocking and a faceplate with an adjustable bevel.

Finishes – US3, US3A, US4, US4A, US10, US26, US26D, US26D-AM Antimicrobial, US28, 313, 315 & 643E. US15 and US32D available with 98 Series only.

Hex key dogging comes standard on 9875/9975 Mortise Lock Devices



Specifications

Device functions	Device ships EO/DT/NL. Field selectable. For TP, K or L remove NL drive screw from device.	
Device lengths	3' 4'	2'4" to 3' (711mm to 914 mm) Door size 2'10" to 4' (864 mm to 1219 mm) Door size
Device centerline from finished floor	39 13/16" (1011 mm) 39 11/16" (1008 mm) with mullion	
Center case dimensions	8" x 2 3/4" x 2 3/8" (203mm x 70mm x 60mm)	
Mechanism case dimensions	2 1/4" x 2 1/4" (57mm x 57mm)	
Projection	Pushbar neutral – 3 13/16" (97 mm) Pushbar depressed – 3 1/16" (78 mm)	
Fasteners & sex bolts (SNB)	Includes screw pack for 1 3/4" (44mm) and 2 1/4" (57mm) thick metal or wood doors. Optional 425 SNB available, see page 17 for quantities.	
Electric options	RX	Pushpad monitor switch
	RX2	Double pushpad monitor switch
	E	Electric locking & unlocking trim
	EL	Electric latch retraction
	QEL	Quiet electric latch retraction
	SS	Signal switch
	CX	Chexit delayed exit
	ALK	Alarm exit kit
	WP-RX	Waterproof request to exit
	CON	Allegion Connect
Mechanical options	-2	Double cylinder
	GBK	Glass bead kit
	PN	Pneumatic latch retraction
	SNB	Sex bolts
	SEC	Security screws
Dogging feature	Hex key dogging standard	
Dogging option	CD	Cylinder dogging
	SD	Special center case dogging
	LD	Less dogging
	DI	Dogging indicator
	CI	Cylinder dogging indicator
Strikes	575 – Dull Black	

QEL
Quiet electric latch retraction

- Bolt retraction via switch
- Converts exit door to push-pull operation

CD
Cylinder dogging

- Replaces hex key dogging
- Requires 1 1/4" mortise cylinder with inverted cam

CX
Chexit delayed exit

- Meets NFPA 101 requirements
- Self-contained controls, locking, alarm

RX
Pushpad monitor switch

- Signals use of an opening
- SPDT switch to monitor pushpad

EL
Electric latch retraction

- Enables remote unlatching
- Alternative to manual dogging

ALK
Alarm exit kit

- Unauthorized opening triggers 85-decibel horn
- Set in armed or disarmed mode by key

E (E7500)
Electric mortise lock device

- Remains latched while unlocked
- Remote electrical control

CON
Allegion Connectors

- Common connectors to connect various door hardware all the way to the power supply



PN
Pneumatic latch retraction





- For areas where electrical devices banned
- Special linkage for mechanical or pneumatic dogging

SS 7500
Signal switch

- Signals unauthorized use of an opening
- Switch makes latch bolt tamper-resistant

Standard trim

	EO	DT 	NL 	HL 
	No outside trim Exit only	Dummy trim Pull when dogged (not recommended for fire device)	Night latch Key retracts latchbolt	Hospital latch Key locks & unlocks
Product description	9875EO 9975EO	9875DT 9975DT	9875NL 9975NL	9875HL 9975HL
Trim description	—	990DT	990NL-M	HL6M
Escutcheon plate size	—	3" x 14 ³ / ₁₆ " x 3 ³ / ₃₂ " (76x360x2mm)	3" x 14 ³ / ₁₆ " x 3 ³ / ₃₂ " (76x360x2mm)	2 ⁹ / ₁₆ " x 5 ¹ / ₂ " x 2 ⁵ / ₈ " (65x140x67mm)
Pull center to center	—	5 ¹ / ₂ " (140mm)	5 ¹ / ₂ " (140mm)	—
Projection	—	2" (51mm)	2" (51mm)	2 ⁵ / ₈ " (67mm)
ANSI function	01	02	03	—
Cylinder type	—	—	1 ¹ / ₄ " Mortise	1 ¹ / ₄ " Mortise
Handing				
Optional trim	x990EO x996EO	x996K-DT x996L-DT) x696DT x697DT	x996K-NL x996L-NL x696NL x697NL	
Optional #425 SNB quantity for device	6	2	2	2

	L 	L-NL 	L-BE 	L-DT 
	Lever Key locks & unlocks	Lever – night latch Key retracts latchbolt	Lever – blank escutcheon Always operable (no cylinder)	Lever dummy trim pull when dogged
Product description	9875L 9975L	9875L-NL 9975L-NL	9875L-BE 9975L-BE	9875L-DT 9975L-DT
Trim description	996L-M*	996L-NL-M	996L-BE-M*	996L-DT
Escutcheon plate size	2 ³ / ₄ " x 10 ³ / ₄ " x 2 ⁷ / ₃₂ " (70x273x21mm)	2 ³ / ₄ " x 10 ³ / ₄ " x 2 ⁷ / ₃₂ " (70x273x21mm)	2 ³ / ₄ " x 10 ³ / ₄ " x 2 ⁷ / ₃₂ " (70x273x21mm)	2 ³ / ₄ " x 10 ³ / ₄ " x 2 ⁷ / ₃₂ " (70x273x21mm)
Pull center to center	—	—	—	—
Projection	2 ⁷ / ₈ " (73mm)	2 ⁷ / ₈ " (73mm)	2 ⁷ / ₈ " (73mm)	2 ⁷ / ₈ " (73mm)
ANSI function	08	03	14	02
Cylinder type	1 ¹ / ₄ " Mortise	1 ¹ / ₄ " Mortise	—	—
Handing	Handed/Reversible	Handed/Reversible	Handed/Reversible	Handed/Reversible
Optional #425 SNB quantity for device	2	2	2	2

* Electrified lever operation available

Notes

🔥 9875-F/9975-F Mortise lock fire exit device



9875-F/9975-F Fire exit mortise lock devices for all types of single doors up to 4' x 10' (1219mm x 3048mm) or 8' x 10' (2438mm x 3048mm) double doors installations, UL listed for fire exit hardware; See page 76 for detailed information on UL listed fire exit hardware label and door opening size information. Devices are ANSI A156.3 – 2008 Grade 1. Fits door stiles as narrow as 4 3/4" (121mm). The 9875-F device has a smooth mechanism case and the 9975-F device has a grooved case. The mortise lock device is non-handed except when the following device options are used: -2 (double cylinder) or SS (signal switch) devices. See opposite page for available outside trim and functions.

The 7500 Mortise lock is equipped with 3/4" (19mm) anti-friction latch bolt which is field reversible without removing the lock from the door. It has a non-handed auxiliary bolt for deadlocking and a faceplate with an adjustable bevel.

Finishes – US3, US3A, US4, US4A, US10, US26, US26D, US26D-AM Antimicrobial, US28, 313, 315 & 643E. US15 and US32D available with 98 Series only.

Specifications

Device functions	Device ships EO/DT/NL. Field selectable. For TP, K or L remove NL drive screw.	
Device lengths	3' 2'4' to 3' (711mm to 914 mm) Door size	4' 2'10" to 4' (864 mm to 1219 mm) Door size
Device centerline from finished floor	39 13/16" (1011 mm) 39 11/16" (1008 mm) with mullion	
Center case dimensions	8" x 2 3/4" x 2 3/8" (203mm x 70mm x 60mm)	
Mechanism case dimensions	2 1/4" x 2 1/4" (57mm x 57mm)	
Projection	Pushbar neutral – 3 13/16" (97 mm) Pushbar depressed – 3 1/16" (78 mm)	
Fasteners & sex bolts (SNB)	Includes screw pack for 1 3/4" (44mm) and 2 1/4" (57mm) thick metal or wood doors. Optional 425 SNB available for metal doors. 425 & 825 SNB required on wood doors without SLM blocking. See page 19 for quantities.	
Electric options	RX	Pushpad monitor switch
	RX2	Double pushpad monitor switch
	E	Electric locking & unlocking trim
	EL	Electric latch retraction
	QEL	Quiet electric latch retraction
	SS	Signal switch
	CX	Chexit delayed exit
	ALK	Alarm exit kit
	WP-RX	Waterproof request to exit
	CON	Allegion Connect
Mechanical options	-2	Double cylinder
	GBK	Glass bead kit
	PN	Pneumatic latch retraction
	SNB	Sex bolts
	SEC	Security screws
	SLM	Special Laminate Material Blocking
Dogging option	No Mechanical Dogging. EL and QEL option available	
Strikes	575 – Dull Black	

QEL
Quiet electric latch retraction

- Bolt retraction via switch
- Converts exit door to push-pull operation

RX
Pushpad monitor switch

- Signals use of an opening
- SPDT switch to monitor pushpad

CX
Chexit delayed exit

- Meets NFPA 101 requirements
- Self-contained controls, locking, alarm

ALK
Alarm exit kit

- Unauthorized opening triggers 85-decibel horn
- Set in armed or disarmed mode by key

EL
Electric latch retraction

- Enables remote unlatching
- Alternative to manual dogging

SG
Safety glow

- Shows exit door location in darkness or smoke
- Developed to meet MEA standards

E (E7500)
Electric mortise lock device

- Remains latched while unlocked
- Remote electrical control

SS 7500
Signal switch

- Signals unauthorized use of an opening
- Switch makes latch bolt tamper-resistant





PN
Pneumatic latch retraction



- For areas where electrical devices banned
- Special linkage for mechanical or pneumatic dogging

CON
Allegion Connectors

- Common connectors to connect various door hardware all the way to the power supply

Standard trim

	EO	DT	NL	HL
				
Product description	9875EO-F 9975EO-F	— —	9875NL-F 9975NL-F	9875HL-F 9975HL-F
Trim description	—	990DT	990NL-M	HL6M
Escutcheon plate size	—	3" x 14 ³ / ₁₆ " x 3 ³ / ₃₂ " (76x360x2mm)	3" x 14 ³ / ₁₆ " x 3 ³ / ₃₂ " (76x360x2mm)	2 ⁹ / ₁₆ " x 5 ¹ / ₂ " x 2 ⁵ / ₈ " (65x140x67mm)
Pull center to center	—	5 ¹ / ₂ " (140mm)	5 ¹ / ₂ " (140mm)	—
Projection	—	2" (51mm)	2" (51mm)	2 ⁵ / ₈ " (67mm)
ANSI function	01	02	03	—
Cylinder type	—	—	1 ¹ / ₄ " Mortise	1 ¹ / ₄ " Mortise
Handing				
Optional trim	x990EO x996EO	x996K-DT x996L-DT) x696DT x697DT	x996K-NL x996L-NL x696NL x697NL	
Optional #425 SNB quantity for device	6	2	2	2

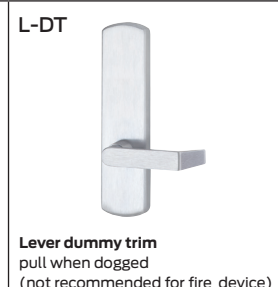
	L	L-NL	L-BE	L-DT
				
Product description	9875L-F 9975L-F	9875L-NL-F 9975L-NL-F	9875L-BE-F 9975L-BE-F	— —
Trim description	996L-M*	996L-NL-M	996L-BE-M*	996L-DT
Escutcheon plate size	2 ³ / ₄ " x 10 ³ / ₄ " x 2 ⁷ / ₃₂ " (70x273x21mm)	2 ³ / ₄ " x 10 ³ / ₄ " x 2 ⁷ / ₃₂ " (70x273x21mm)	2 ³ / ₄ " x 10 ³ / ₄ " x 2 ⁷ / ₃₂ " (70x273x21mm)	2 ³ / ₄ " x 10 ³ / ₄ " x 2 ⁷ / ₃₂ " (70x273x21mm)
Pull center to center	—	—	—	—
Projection	2 ⁷ / ₈ " (73mm)	2 ⁷ / ₈ " (73mm)	2 ⁷ / ₈ " (73mm)	2 ⁷ / ₈ " (73mm)
ANSI function	08	03	14	02
Cylinder type	1 ¹ / ₄ " Mortise	1 ¹ / ₄ " Mortise	—	—
Handing	Handed/Reversible	Handed/Reversible	Handed/Reversible	Handed/Reversible
Optional #425 SNB quantity for device	2	2	2	2

* Electrified lever operation available

Notes

9827/9927 Surface mounted vertical rod device



9827/9927 Surface mounted vertical rod device for all types of single or double doors, UL listed for panic exit hardware. Devices are ANSI A156.3 – 2008 (LBR option 2014) Grade 1. Covers stock hollow metal doors with 86 or 161 cutouts. The 9827 device has a smooth mechanism case and the 9927 device has a grooved case. The surface vertical rod device is non-handed except when the following device options are used: SD (special dogging), SS (signal switch) or WS (Tornado/Hurricane). See opposite page for available outside trim and functions. Vertical rod and latch guards are available to protect the bottom rod of the exit device from damage by impacts of carts or gurneys passing through doors.

Finishes – US3, US3A, US4, US4A, US10, US26, US26D, US26D-AM Antimicrobial, US28, 313, 315 & 643E. US15 and US32D available with 98 Series only.

Specifications

Device functions	Device ships EO/DT/NL. Field selectable. For TP, K or L remove NL drive screw from device.	
Device lengths	2'	2' (610 mm) Door size
	3'	2'4" to 3' (711mm to 914 mm) Door size
	4'	2'10" to 4' (864 mm to 1219 mm) Door size
Device centerline from finished floor	39 ⁵ / ₈ " (1006 mm)	
Center case dimensions	8" x 2 ³ / ₄ " x 2 ³ / ₈ " (203mm x 70mm x 60mm)	
Mechanism case dimensions	2 ¹ / ₄ " x 2 ¹ / ₄ " (57mm x 57mm)	
Projection	Pushbar neutral – 3 ¹³ / ₁₆ " (97 mm) Pushbar depressed – 3 ¹ / ₁₆ " (78 mm)	
Latch bolt	Deadlocking anti-friction top & bottom bolt, ⁵ / ₈ " (16mm) throw	
Door undercut	1/4" (7mm) recommended	
Top & bottom Latch case	4 ¹ / ₂ " x 2 ¹ / ₈ " x 1 ¹ / ₂ " (114mm x 54mm x 38mm)	
Vertical rods	1/2" square tubing, standard rods accommodate 7' (2134mm) doors. Top rod length: 34 ¹⁵ / ₁₆ " (887mm); Bottom rod length: 31 ¹ / ₂ " (794mm) Extension rods available in 1' (205mm) or 3' (914mm) for doors over 7'. One piece top rod is available for 8' (2438mm) and 10' (3048mm) doors.	
Fasteners & sex bolts (SNB)	Includes screw pack for 1 ³ / ₄ " (44mm) to 2 ¹ / ₄ " (57mm) thick metal or wood doors, and 325 SNB for top and bottom latch. Optional 425 SNB available.	
Electric options	LX	Latchbolt monitor switch
	RX	Pushpad monitor switch
	RX2	Double pushpad monitor switch
	EL	Electric latch retraction
	QEL	Quiet electric latch retraction
	SS	Signal switch
	CX	Chexit delayed exit
	ALK	Alarm exit kit
	PN	Pneumatic latch retraction
	WP-RX	Waterproof request to exit
Mechanical options	CON	Allegion Connect
	GBK	Glass bead kit
	PL	Pullman latch
	WS	Tornado and hurricane tested
	SNB	Sex bolts
	SEC	Security screws
	AX	Accessible device (LBR only)
Dogging feature Dogging option	Hex key dogging standard	
	CD	Cylinder dogging
	SD	Special center case dogging
	LD	Less dogging
	DI	Dogging indicator
	CI	Cylinder dogging indicator
Strikes	Top - 299 – Dull black, Bottom – 248L4 & 304L - Unfinished	

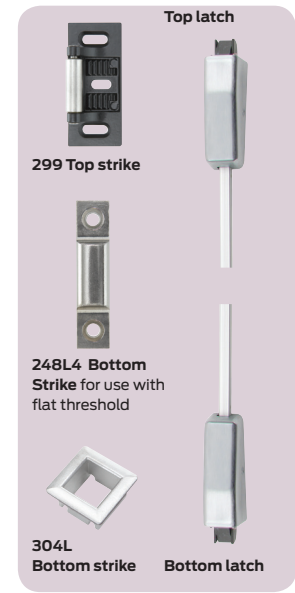

Hex key dogging comes standard on 9827/9927

WS
Windstorm

- Severe weather certified/tested
- FEMA and ICC compliant
- Tornado & hurricane tested

RX
Pushpad monitor switch

- Signals use of an opening
- SPDT switch to monitor pushpad

QEL
Quiet electric latch retraction

- Bolt retraction via switch
- Converts exit door to push-pull operation

CON
Allegion Connectors

- Common connectors to connect various door hardware all the way to the power supply

EL
Electric latch retraction

- Enables remote unlatching
- Alternative to manual dogging

ALK
Alarm exit kit

- Unauthorized opening triggers 85-decibel horn
- Set in armed or disarmed mode by key

E (E996L)
Electrified breakaway lever

- Electrified remote locking/unlocking
- Standard in fail safe condition

CX
Chexit delayed exit

- Meets NFPA 101 requirements
- Self-contained controls, locking, alarm







PN
Pneumatic latch retraction





- For areas where electrical devices banned
- Special linkage for mechanical or pneumatic dogging

SS
Signal switch

- Signals unauthorized use of an opening
- Switch makes latch bolt tamper-resistant

Standard trim

	EO  No outside trim Exit only	DT  Dummy trim Pull when dogged	NL  Night latch Key retracts latchbolt	NL-OP  Night latch Key retracts latchbolt optional pull required	TL  Thumbturn Key locks & unlocks (use with DT trim)	TL-BE  Thumbturn Blank escutcheon always operable (no cylinder) (use with DT trim)
Product description	9827EO 9927EO	9827DT 9927DT	9827NL 9927NL	9827NL-OP 9927NL-OP	9827TL 9927TL	9827TL-BE 9927TL-BE
Trim description	—	990DT	990NL-R/V	110NL-MD 110NL-WD	374T X 990DT	374T-BE X 990DT
Escutcheon plate size	—	3" x 14 ^{13/16} " x 3 ^{3/32} " (76x360x2mm)	3" x 14 ^{13/16} " x 3 ^{3/32} " (76x360x2mm)	—	1 ^{11/16} " x 7 ^{1/2} " x 7 ^{7/8} " (43x191x22mm)	1 ^{11/16} " x 7 ^{1/2} " x 7 ^{7/8} " (43x191x22mm)
Pull center to center	—	5 ^{1/2} " (140mm)	5 ^{1/2} " (140mm)	—	—	—
Projection	—	2" (51mm)	2" (51mm)	—	3 ^{1/4} " (83mm)	3 ^{1/4} " (83mm)
ANSI function	01	02	03	03	11 or 12	16
Cylinder type	—	—	Rim	Rim	1 ^{1/4} " Mortise	—
Handing	—	—	—	—	—	—
Optional trim	x990EO x996EO	x996K-DT x996L-DT x696DT x697DT	x996K-NL x996L-NL x696NL x697NL			
Optional #425 SNB quantity for device	6	2	2	6	2	2

	L  Lever Key locks & unlocks	L-NL  Lever – night latch Key retracts latchbolt	L-BE  Lever – blank escutcheon Always operable (no cylinder)	L-DT  Lever dummy trim pull when dogged
Product description	9827L 9927L	9827L-NL 9927L-NL	9827L-BE 9927L-BE	9827L-DT 9927L-DT
Trim description	996L-R/V*	996L-NL-R/V	996L-BE-R/V*	996L-DT
Escutcheon plate size	2 ^{3/4} " x 10 ^{3/4} " x 2 ^{7/32} " (70x273x21mm)	2 ^{3/4} " x 10 ^{3/4} " x 2 ^{7/32} " (70x273x21mm)	2 ^{3/4} " x 10 ^{3/4} " x 2 ^{7/32} " (70x273x21mm)	2 ^{3/4} " x 10 ^{3/4} " x 2 ^{7/32} " (70x273x21mm)
Pull center to center	—	—	—	—
Projection	2 ^{7/8} " (73mm)	2 ^{7/8} " (73mm)	2 ^{7/8} " (73mm)	2 ^{7/8} " (73mm)
ANSI function	08	03	14	02
Cylinder type	Rim	Rim	—	—
Handing	Handed/Reversible	Handed/Reversible	Handed/Reversible	Handed/Reversible
Optional #425 SNB quantity for device	2	2	2	2

* Electrified lever operation available

Notes

9827-F/9927-F Surface Mounted Vertical Rod Fire Device

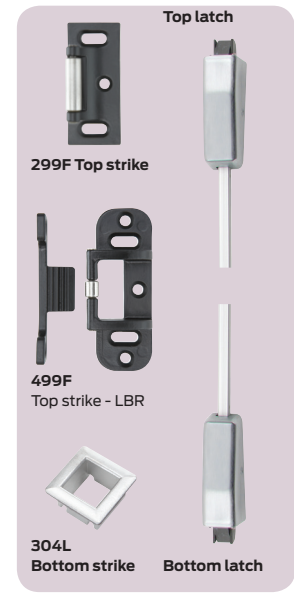

9827-F/9927-F Fire exit surface mounted vertical rod device pairs of doors up to 8' x 10' (2438mm x 3048mm), UL listed for fire exit hardware. See page 76 for detailed information on UL listed fire exit hardware label and door opening size information. Devices are ANSI A156.3 – 2008 (LBR option 2014) Grade 1. The 9827-F device has a smooth mechanism case and the 9927-F device has a grooved case. The surface vertical rod device is non-handed except when the following device options are used: SS (signal switch), and WS (Tornado/Hurricane). See opposite page for available outside trim and device functions. Vertical rod and latch guards are available to protect the bottom rod of the exit device from damage by impacts of carts or gurneys passing through doors. Rod and latch guards can be used on hollow metal or tin clad composite fire doors.

Finishes – US3, US4, US10, US26, US26D, US28 & 313. US15 and US32D available with 98 Series only.

Specifications

Device functions	Device ships EO/DT/NL. Field selectable. For TP, K or L remove NL drive screw from device.	
Device lengths	2'	2' (610 mm) Door size
	3'	2'4" to 3' (711mm to 914 mm) Door size
	4'	2'10" to 4' (864 mm to 1219 mm) Door size
Device centerline from finished floor	39 ⁵ / ₈ " (1006 mm)	
Center case dimensions	8" x 2 ³ / ₄ " x 2 ³ / ₈ " (203mm x 70mm x 60mm)	
Mechanism case dimensions	2 ¹ / ₄ " x 2 ¹ / ₄ " (57mm x 57mm)	
Projection	Pushbar neutral – 3 ¹³ / ₁₆ " (97 mm) Pushbar depressed – 3 ¹ / ₁₆ " (78 mm)	
Latch bolt	Deadlocking anti-friction top & bottom bolt, ⁵ / ₈ " (16mm) throw	
Door undercut	1 ¹ / ₄ " (7mm) recommended	
Top & bottom Latch case	4 ¹ / ₂ " x 2 ¹ / ₈ " x 1 ¹ / ₂ " (114mm x 54mm x 38mm)	
Vertical rods	1/2" square tubing, standard rods accommodate 7' (2134mm) doors. Top rod length: 34 ¹⁵ / ₁₆ " (887mm); Bottom rod length: 31 ¹ / ₂ " (794mm) Extension rods available in 1' (205mm) or 3' (914mm) for doors over 7'. One piece top rod is available for 8' (2438mm) and 10' (3048mm) doors.	
Fasteners & sex bolts (SNB)	Includes screw pack for 1 ³ / ₄ " (44mm) to 2 ¹ / ₄ " (57mm) thick metal or wood doors, and 325 SNB for top and bottom latch. Optional 425 SNB available.	
Electric options	LX	Latchbolt monitor switch
	RX	Pushpad monitor switch
	RX2	Double pushpad monitor switch
	E	Electric unlatching and locking trim
	EL	Electric latch retraction
	QEL	Quiet electric latch retraction
	SS	Signal switch
	CX	Chexit delayed exit
	ALK	Alarm exit kit
	WP-RX	Waterproof request to exit
CON	Allegion Connect	
Mechanical options	GBK	Glass bead kit
	PN	Pneumatic latch retraction
	LBR	Less bottom rod
	PL	Pullman latch
	WS	Tornado and hurricane tested
	SNB	Sex bolts
	SEC	Security screws
	SLM	Special laminate material blocking
AX	Accessible device (LBR only)	
Dogging option	No mechanical dogging. EL and QEL option available	
Strikes	Top – 299F (499F LBR) Dull black, Bottom – 304L - Unfinished	

WS
Windstorm

- Severe weather certified/tested
- FEMA and ICC compliant
- Tornado & hurricane tested

RX
Pushpad monitor switch

- Signals use of an opening
- SPDT switch to monitor pushpad

QEL
Quiet electric latch retraction

- Bolt retraction via switch
- Converts exit door to push-pull operation

ALK
Alarm exit kit

- Unauthorized opening triggers 85-decibel horn
- Set in armed or disarmed mode by key

EL
Electric latch retraction

- Enables remote unlatching
- Alternative to manual dogging

CX
Chexit delayed exit

- Meets NFPA 101 requirements
- Self-contained controls, locking, alarm

E (E996L)
Electrified breakaway lever

- Electrified remote locking/unlocking
- Standard in fail safe condition

LBR
Less bottom rod

- Available with UL Fire Label
- For pairs of vertical rod devices





PN
Pneumatic latch retraction





- For areas where electrical devices banned
- Special linkage for mechanical or pneumatic dogging

CON
Allegion Connectors

- Common connectors to connect various door hardware all the way to the power supply

Standard trim

	EO	DT 	NL 	NL-OP 	TL 	TL-BE 
	No outside trim Exit only	Dummy trim Pull when dogged (not recommended for fire device)	Night latch Key retracts latchbolt	Night latch Key retracts latchbolt optional pull required	Thumbturn Key locks & unlocks (use with DT trim)	Thumbturn Blank escutcheon always operable (no cylinder) (use with DT trim)
Product description	9827EO-F 9927EO-F	— —	9827NL-F 9927NL-F	9827NL-OP-F 9927NL-OP-F	9827TL-F 9927TL-F	9827TL-BE-F 9927TL-BE-F
Trim description	—	990DT	990NL-R/V	110NL-MD 110NL-WD	374T X 990DT	374T-BE X 990DT
Escutcheon plate size	—	3" x 14 ^{13/16"} x 3 ^{3/32"} (76x360x2mm)	3" x 14 ^{13/16"} x 3 ^{3/32"} (76x360x2mm)	—	1 ^{11/16"} x 7 ^{1/2"} x 7 ^{7/8"} (43x191x22mm)	1 ^{11/16"} x 7 ^{1/2"} x 7 ^{7/8"} (43x191x22mm)
Pull center to center	—	5 ^{1/2"} (140mm)	5 ^{1/2"} (140mm)	—	—	—
Projection	—	2" (51mm)	2" (51mm)	—	2" (51mm)	2" (51mm)
ANSI function	01	02	03	03	11 or 12	16
Cylinder type	—	—	Rim	Rim	1 ^{1/4"} Mortise	—
Handing	—	—	—	—	—	—
Optional trim	x990EO x996EO	x996K-DT x996L-DT x696DT x697DT	x996K-NL x996L-NL x696NL x697NL			
Optional #425 SNB quantity for device	6	2	2	6	2	2

	L 	L-NL 	L-BE 	L-DT 
	Lever Key locks & unlocks	Lever – night latch Key retracts latchbolt	Lever – blank escutcheon Always operable (no cylinder)	Lever dummy trim pull when dogged (not recommended for fire device)
Product description	9827L-F 9927L-F	9827L-NL-F 9927L-NL-F	9827L-BE-F 9927L-BE-F	— —
Trim description	996L-R/V*	996L-NL-R/V	996L-BE-R/V*	996L-DT
Escutcheon plate size	2 ^{3/4"} x 10 ^{3/4"} x 2 ^{7/32"} (70x273x21mm)	2 ^{3/4"} x 10 ^{3/4"} x 2 ^{7/32"} (70x273x21mm)	2 ^{3/4"} x 10 ^{3/4"} x 2 ^{7/32"} (70x273x21mm)	2 ^{3/4"} x 10 ^{3/4"} x 2 ^{7/32"} (70x273x21mm)
Pull center to center	—	—	—	—
Projection	2 ^{7/8"} (73mm)	2 ^{7/8"} (73mm)	2 ^{7/8"} (73mm)	2 ^{7/8"} (73mm)
ANSI function	08	03	14	02
Cylinder type	Rim	Rim	—	—
Handing	Handed/Reversible	Handed/Reversible	Handed/Reversible	Handed/Reversible
Optional #425 SNB quantity for device	2	2	2	2

* Electrified lever operation available

Notes

9857/9957 Three-point latching device



9857/9957 Three-point latching device for all types of single or double doors, UL listed for panic exit hardware. Devices are ANSI A156.3 – 2008 Grade 1. Covers stock hollow metal doors with 86 or 161 cutouts. The 9857 device has a smooth mechanism case and the 9957 device has a grooved case. The three-point latching device is non-handed except when the following device options are used: SD (special dogging), or SS (signal switch). See opposite page for available outside trim and functions. Vertical rod and latch guards are available to protect the bottom rod of the exit device from damage by impacts of carts or gurneys passing through doors.

Finishes – US3, US3A, US4, US4A, US10, US26, US26D, US26D-AM Antimicrobial, US28, 313, 315 & 643E. US15 and US32D available with 98 Series only.

Specifications

Device functions	Device ships EO/DT/NL. Field selectable. For TP, K or L remove NL drive screw from device.	
Device lengths	3' 2'4" to 3' (711mm to 914 mm) Door size	4' 2'10" to 4' (864 mm to 1219 mm) Door size
Device centerline from finished floor	39 ¹³ / ₁₆ " (1011 mm)	
Center case dimensions	8" x 2 ³ / ₄ " x 2 ³ / ₈ " (203mm x 70mm x 60mm)	
Mechanism case dimensions	2 ¹ / ₄ " x 2 ¹ / ₄ " (57mm x 57mm)	
Projection	Pushbar neutral – 3 ¹³ / ₁₆ " (97 mm) Pushbar depressed – 3 ¹ / ₈ " (78 mm)	
Latch bolt	Deadlocking anti-friction top & bottom bolt, ⁵ / ₈ " (16mm) throw Deadlocking rim bolt, ³ / ₄ " (19mm) throw	
Door undercut	¹ / ₄ " (7mm) recommended	
Top & bottom Latch case	4 ¹ / ₂ " x 2 ¹ / ₈ " x 1 ¹ / ₂ " (114mm x 54mm x 38mm)	
Vertical rods	¹ / ₂ " square tubing, standard rods accommodate 7' (2134mm) doors. Top rod length: 34 ¹⁵ / ₁₆ " (887mm); Bottom rod length: 31 ¹ / ₂ " (794mm) Extension rods available in 1' (205mm) or 3' (914mm) for doors over 7'. One piece top rod is available for 8' (2438mm) and 10' (3048mm) doors.	
Fasteners & sex bolts (SNB)	Includes screw pack for 1 ³ / ₄ " (44mm) to 2 ¹ / ₄ " (57mm) thick metal or wood doors, and 325 SNB for top and bottom latch. Optional 425 SNB available.	
Electric options	LX Latchbolt monitor switch	RX Pushpad monitor switch
	RX2 Double pushpad monitor switch	E Electric unlocking and locking trim
	EL Electric latch retraction	QEL Quiet electric latch retraction
	SS Signal switch	CX Chexit delayed exit
	ALK Alarm exit kit	WP-RX Waterproof request to exit
	CON Allegion Connect	
Mechanical options	GBK Glass bead kit	PN Pneumatic latch retraction
	PL Pullman latch	WS Tornado and hurricane tested
	SNB Sex bolts	SEC Security screws
Dogging feature	Hex key dogging standard	
Dogging option	CD Cylinder dogging	SD Special center case dogging
	LD Less dogging	DI Dogging indicator
	CI Cylinder dogging indicator	
Strikes	Top & middle – 299 - Dull black Bottom – 248L4 & 304L - Unfinished	

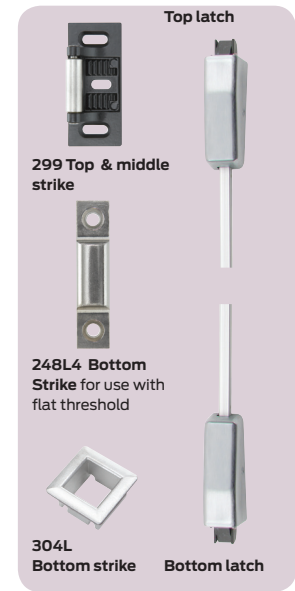

Hex key dogging comes standard on 9857/9957 Three-point latching devices

WS
Windstorm

- Severe weather certified/tested
- FEMA and ICC compliant
- Tornado & hurricane tested

CON
Allegion Connectors

- Common connectors to connect various door hardware all the way to the power supply

PN
Pneumatic latch retraction

- For areas where electrical devices banned
- Special linkage for mechanical or pneumatic dogging

ALK
Alarm exit kit

- Unauthorized opening triggers 85-decibel horn
- Set in armed or disarmed mode by key

EL
Electric latch retraction

- Enables remote unlatching
- Alternative to manual dogging

RX
Pushpad monitor switch

- Signals use of an opening
- SPDT switch to monitor pushpad

E (E996L)
Electrified breakaway lever

- Electrified remote locking/unlocking
- Standard in fail safe condition

LX
Latchbolt monitor switch

- Signals use of an opening
- SPDT switch to monitor latch bolt





QEL
Quiet electric latch retraction





- Bolt retraction via switch
- Converts exit door to push-pull operation

SS
Signal switch

- Signals unauthorized use of an opening
- Switch makes latch bolt tamper-resistant

Standard trim

	EO No outside trim Exit only	DT  Dummy trim Pull when dogged (not recommended for fire device)	NL  Night latch Key retracts latchbolt	NL-OP  Night latch Key retracts latchbolt optional pull required	TL  Thumbturn Key locks & unlocks (use with DT trim)	TL-BE  Thumbturn Blank escutcheon always operable (no cylinder) (use with DT trim)
Product description	9857EO 9957EO	9857DT 9957DT	9857NL 9957NL	9857NL-OP 9957NL-OP	9857TL 9957TL	9857TL-BE 9957TL-BE
Trim description	—	990DT	990NL-R/V	110NL-MD 110NL-WD	374T X 990DT	374T-BE X 990DT
Escutcheon plate size	—	3" x 14 ^{13/16} " x 3 ^{3/32} " (76x360x2mm)	3" x 14 ^{13/16} " x 3 ^{3/32} " (76x360x2mm)	—	2 ^{3/4} " x 10 ^{3/4} " x 27 ^{3/32} " (70x273x21mm)	2 ^{3/4} " x 10 ^{3/4} " x 27 ^{3/32} " (70x273x21mm)
Pull center to center	—	5 ^{1/2} " (140mm)	5 ^{1/2} " (140mm)	—	—	—
Projection	—	2" (51mm)	2" (51mm)	—	2" (51mm)	2" (51mm)
ANSI function	01	02	03	03	11 or 12	16
Cylinder type	—	—	Rim	Rim	1 ^{1/4} " Mortise	—
Handing	—	—	—	—	—	—
Optional trim	x990EO x996EO	x996K-DT x996L-DT x696DT x697DT	x996K-NL x996L-NL x696NL x697NL			
Optional #425 SNB quantity for device	6	2	2	6	2	2

	L  Lever Key locks & unlocks	L-NL  Lever – night latch Key retracts latchbolt	L-BE  Lever – blank escutcheon Always operable (no cylinder)	L-DT  Lever dummy trim pull when dogged
Product description	9857L 9957LF	9857L-NL 9957L-NL	9857L-BE 9957L-BE	— —
Trim description	996L-R/V*	996L-NL-R/V	996L-BE-R/V*	996L-DT
Escutcheon plate size	2 ^{3/4} " x 10 ^{3/4} " x 27 ^{3/32} " (70x273x21mm)	2 ^{3/4} " x 10 ^{3/4} " x 27 ^{3/32} " (70x273x21mm)	2 ^{3/4} " x 10 ^{3/4} " x 27 ^{3/32} " (70x273x21mm)	2 ^{3/4} " x 10 ^{3/4} " x 27 ^{3/32} " (70x273x21mm)
Pull center to center	—	—	—	—
Projection	2 ^{7/8} " (73mm)	2 ^{7/8} " (73mm)	2 ^{7/8} " (73mm)	2 ^{7/8} " (73mm)
ANSI function	08	03	14	02
Cylinder type	Rim	Rim	—	—
Handing	Handed/Reversible	Handed/Reversible	Handed/Reversible	Handed/Reversible
Optional #425 SNB quantity for device	2	2	2	2

* Electrified lever operation available

Notes

9857-F/9957-F Three-point latching fire exit device



9857-F/9957-F Fire exit three-point latching device for all types of single doors up to 4' x 8' (1219mm x 2438mm) or up to 8' x 8' (2438mm x 2438mm) double doors with 9954 or 9854 mullion, UL listed for fire exit hardware. See page 76 for detailed information on UL listed fire exit hardware label and door opening size information. Devices are ANSI A156.3 – 2008 Grade 1. The 9857-F device has a smooth mechanism case and the 9957-F device has a grooved case. The three-point latch device is non-handed except when the following device option is used: SS (signal switch). See opposite page for available outside trim and device functions. Vertical rod and latch guards are available to protect the bottom rod of the exit device from damage by impacts of carts or gurneys passing through doors.

Finishes – US3, US3A, US4, US4A, US10, US26, US26D, US26D-AM Antimicrobial, US28, 313, 315 & 643E. US15 and US32D available with 98 Series only.

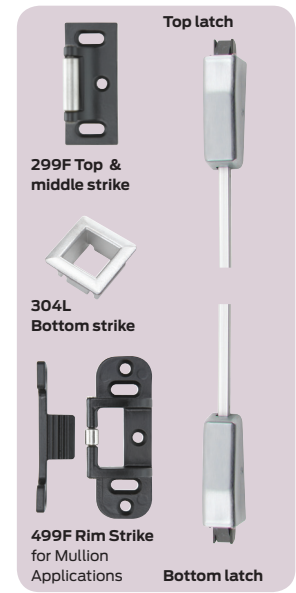

Specifications

Device functions	Device ships EO/DT/NL. Field selectable. For TP, K or L remove NL drive screw from device.
Device lengths	3' 2'4" to 3' (711mm to 914 mm) Door size 4' 2'10" to 4' (864 mm to 1219 mm) Door size
Device centerline from finished floor	39 ¹³ / ₁₆ " (1011 mm)
Center case dimensions	8" x 2 ³ / ₄ " x 2 ³ / ₈ " (203mm x 70mm x 60mm)
Mechanism case dimensions	2 ¹ / ₄ " x 2 ¹ / ₄ " (57mm x 57mm)
Projection	Pushbar neutral – 3 ¹³ / ₁₆ " (97 mm) Pushbar depressed – 3 ¹ / ₁₆ " (78 mm)
Latch bolt	Deadlocking anti-friction top & bottom bolt, ⁵ / ₈ " (16mm) throw Deadlocking rim bolt, ³ / ₄ " (19mm) throw
Door undercut	¹ / ₄ " (7mm) recommended
Top & bottom Latch case	4 ¹ / ₂ " x 2 ¹ / ₈ " x 1 ¹ / ₂ " (114mm x 54mm x 38mm)
Vertical rods	¹ / ₂ " square tubing, standard rods accommodate 7' (2134mm) doors. Top rod length: 34 ¹⁵ / ₁₆ " (887mm); Bottom rod length: 31 ¹ / ₂ " (794mm) Extension rods available in 1' (205mm) or 3' (914mm) for doors over 7'. One piece top rod is available for 8' (2438mm) and 10' (3048mm) doors.
Fasteners & sex bolts (SNB)	Includes screw pack for 1 ³ / ₄ " (44mm) and 2 ¹ / ₄ " (57mm) thick metal or wood doors, and 325 SNB for top and bottom latch. Optional 425 SNB available for metal doors. 425 SNB required on wood doors without SLM blocking.
Electric options	LX Latchbolt monitor switch RX Pushpad monitor switch RX2 Double pushpad monitor switch E Electric unlocking and locking trim EL Electric latch retraction QEL Quiet electric latch retraction SS Signal switch CX Chexit delayed exit ALK Alarm exit kit WP-RX Waterproof request to exit CON Allegion Connect
Mechanical options	GBK Glass bead kit PN Pneumatic latch retraction SNB Sex bolts SEC Security screws SLM Special laminate material blocking
Dogging option	No mechanical dogging. EL and QEL option available
Strikes	Top & middle – 299 - Dull black Bottom – 304L - Unfinished

PN
Pneumatic latch retraction
• For areas where electrical devices banned
• Special linkage for mechanical or pneumatic dogging

RG
Rod guard
• Protection from carts/gurneys
• Eases wheelchair access

EL
Electric latch retraction
• Enables remote unlatching
• Alternative to manual dogging

QEL
Quiet electric latch retraction
• Bolt retraction via switch
• Converts exit door to push-pull operation

E (E996L)
Electrified breakaway lever
• Electrified remote locking/unlocking
• Standard in fail safe condition

LX
Latchbolt monitor switch
• Signals use of an opening
• SPDT switch to monitor latch bolt





RX
Pushpad monitor switch
• Signals use of an opening
• SPDT switch to monitor pushpad





CX
Chexit delayed exit
• Meets NFPA 101 requirements
• Self-contained controls, locking, alarm

ALK
Alarm exit kit
• Unauthorized opening triggers 85-decibel horn
• Set in armed or disarmed mode by key

CON
Allegion Connectors
• Common connectors to connect various door hardware all the way to the power supply

Standard trim

	EO No outside trim Exit only	DT  Dummy trim Pull when dogged (not recommended for fire device)	NL  Night latch Key retracts latchbolt	NL-OP  Night latch Key retracts latchbolt optional pull required	TL  Thumbturn Key locks & unlocks (use with DT trim)	TL-BE  Thumbturn Blank escutcheon always operable (no cylinder) (use with DT trim)
Product description	9857EO-F 9957EO-F	9857DT-F 9957DT-F	9857NL-F 9957NL-F	9857NL-OP-F 9957NL-OP-F	9857TL-F 9957TL-F	9857TL-BE-F 9957TL-BE-F
Trim description	—	990DT	990NL-R/V	110NL-MD 110NL-WD	374T X 990DT	374T-BE X 990DT
Escutcheon plate size	—	3" x 14 ^{13/16} " x 3 ^{3/32} " (76x360x2mm)	3" x 14 ^{13/16} " x 3 ^{3/32} " (76x360x2mm)	—	2 ^{3/4} " x 10 ^{3/4} " x 27 ^{3/32} " (70x273x21mm)	2 ^{3/4} " x 10 ^{3/4} " x 27 ^{3/32} " (70x273x21mm)
Pull center to center	—	5 ^{1/2} " (140mm)	5 ^{1/2} " (140mm)	—	—	—
Projection	—	2" (51mm)	2" (51mm)	—	2" (51mm)	2" (51mm)
ANSI function	01	02	03	03	11 or 12	16
Cylinder type	—	—	Rim	Rim	1 ^{1/4} " Mortise	—
Handing	—	—	—	—	—	—
Optional trim	x990EO x996EO	x996K-DT x996L-DT x696DT x697DT	x996K-NL x996L-NL x696NL x697NL			
#425 SNB optional - HMD req. WD w/o SLM pkg.	6	2	2	6	2	2
#425 SNB req. w/ 499F	2	2	2	2		

	L  Lever Key locks & unlocks	L-NL  Lever – night latch Key retracts latchbolt	L-BE  Lever – blank escutcheon Always operable (no cylinder)	L-DT  Lever dummy trim pull when dogged
Product description	9857L-F 9957L-F	9857L-NL-F 9957L-NL-F	9857L-BE-F 9957L-BE-F	— —
Trim description	996L-R/V*	996L-NL-R/V	996L-BE-R/V*	996L-DT
Escutcheon plate size	2 ^{3/4} " x 10 ^{3/4} " x 27 ^{3/32} " (70x273x21mm)	2 ^{3/4} " x 10 ^{3/4} " x 27 ^{3/32} " (70x273x21mm)	2 ^{3/4} " x 10 ^{3/4} " x 27 ^{3/32} " (70x273x21mm)	2 ^{3/4} " x 10 ^{3/4} " x 27 ^{3/32} " (70x273x21mm)
Pull center to center	—	—	—	—
Projection	2 ^{7/8} " (73mm)	2 ^{7/8} " (73mm)	2 ^{7/8} " (73mm)	2 ^{7/8} " (73mm)
ANSI function	08	03	14	02
Cylinder type	Rim	Rim	—	—
Handing	Handed/Reversible	Handed/Reversible	Handed/Reversible	Handed/Reversible
#425 SNB optional - HMD req. WD w/o SLM pkg.	2	2	2	2
#425 SNB req. w/ 499F	2	2	2	2

* Electrified lever operation available

Notes

9847/9947 Concealed vertical rod device



9847/9947 Concealed vertical rod device for use on single or double metal doors, UL listed for panic exit hardware. Devices are ANSI A156.3 – 2008 Grade 1. The 9847 device has a smooth mechanism case and the 9947 device has a grooved case. The concealed vertical rod device is non-handed except when the following device options are used: SD (special dogging), or SS (signal switch). See opposite page for available outside trim and device functions.

Finishes – US3, US3A, US4, US4A, US10, US26, US26D, US26D-AM Antimicrobial, US28, 313, 315 & 643E. US15 and US32D available with 98 Series only.



Hex key dogging comes standard on 9847/9947 Concealed vertical rod devices

Specifications

Device functions	Device ships EO/DT/NL. Field selectable. For TP, K or L remove NL drive screw from device.	
Device lengths	2'	2' (610 mm) Door size
	3'	2'4" to 3' (711mm to 914 mm) Door size
	4'	2'10" to 4' (864 mm to 1219 mm) Door size
Device centerline from finished floor	39 ⁵ / ₈ " (1006 mm) Standard Adjustable from 35 ⁵ / ₈ " (905mm) to 49 ⁵ / ₈ " (1260mm)	
Center case dimensions	8" x 2 ³ / ₄ " x 2 ³ / ₈ " (203mm x 70mm x 60mm)	
Mechanism case dimensions	2 ¹ / ₄ " x 2 ¹ / ₄ " (57mm x 57mm)	
Projection	Pushbar neutral – 3 ¹³ / ₁₆ " (97 mm) Pushbar depressed – 3 ¹ / ₁₆ " (78 mm)	
Latch bolt	Deadlocking top & bottom bolt, ⁵ / ₈ " (16mm) throw	
Door undercut	1/4" (7mm) recommended	
Top & bottom Latch case	4 ¹ / ₂ " x 2 ¹ / ₈ " x 1 ¹ / ₂ " (114mm x 54mm x 38mm)	
Vertical rods	Round 2-piece adjustable rods – Top rod adjustable from 6'8" (2027mm) to 8'4" (2533mm). Bottom rod adjustable 35 ⁵ / ₈ " (905 mm) to 49 ⁵ / ₈ " (1260 mm). Extension rod kits available for doors over 8'4" (2533mm).	
Fasteners & sex bolts (SNB)	Includes screw pack for 1 ³ / ₄ " (44mm) to 2 ¹ / ₄ " (57mm) thick metal doors. Optional 425 SNB available.	
Electric options	LX	Latchbolt monitor switch
	RX	Pushpad monitor switch
	RX2	Double pushpad monitor switch
	E	Electric unlocking and locking trim
	EL	Electric latch retraction
	QEL	Quiet electric latch retraction
	SS	Signal switch
	CX	Chexit delayed exit
	ALK	Alarm exit kit
	WP-RX	Waterproof request to exit
	CON	Allegion Connect
Mechanical options	GBK	Glass bead kit
	PN	Pneumatic latch retraction
	LBR	Less bottom rod
	PL	Pullman latch
	SNB	Sex bolts
	SEC	Security screws
Dogging feature	Hex key dogging standard	
Dogging option	CD	Cylinder dogging
	SD	Special center case dogging
	LD	Less dogging
	DI	Dogging indicator
	CI	Cylinder dogging indicator
Strikes	Top – 338 - Unfinished, Bottom – 385A - Unfinished	

QEL
Quiet electric latch retraction

- Bolt retraction via switch
- Converts exit door to push-pull operation

RX
Pushpad monitor switch

- Signals use of an opening
- SPDT switch to monitor pushpad

CX
Chexit delayed exit

- Meets NFPA 101 requirements
- Self-contained controls, locking, alarm

CON
Allegion Connectors

- Common connectors to connect various door hardware all the way to the power supply

EL
Electric latch retraction

- Enables remote unlatching
- Alternative to manual dogging

ALK
Alarm exit kit

- Unauthorized opening triggers 85-decibel horn
- Set in armed or disarmed mode by key

E (E996L)
Electrified breakaway lever

- Electrified remote locking/unlocking
- Standard in fail safe condition

LX
Latchbolt monitor switch

- Signals use of an opening
- SPDT switch to monitor latch bolt





PN
Pneumatic latch retraction





- For areas where electrical devices banned
- Special linkage for mechanical or pneumatic dogging

DI
Dogging indicator

- Monitor dogging status without a control panel
- Red indicator light shows visibility to dogging from over 75 feet

Standard trim

	EO	DT 	NL 	NL-OP 	TL 	TL-BE 
	No outside trim Exit only	Dummy trim Pull when dogged (not recommended for fire device)	Night latch Key retracts latchbolt	Night latch Key retracts latchbolt optional pull required	Thumbturn Key locks & unlocks (use with DT trim)	Thumbturn Blank escutcheon always operable (no cylinder) (use with DT trim)
Product description	9847EO 9947EO	9847DT 9947DT	9847NL 9947NL	9847NL-OP 9947NL-OP	9847TL 9947TL	9847TL-BE 9947TL-BE
Trim description	—	990DT	990NL-R/V	110NL-MD	376T X 990DT	374T-BE X 990DT
Escutcheon plate size	—	3" x 14 ¹³ / ₁₆ " x 3 ³ / ₃₂ " (76x360x2mm)	3" x 14 ¹³ / ₁₆ " x 3 ³ / ₃₂ " (76x360x2mm)	—	2 ³ / ₄ " x 10 ³ / ₄ " x 27 ¹ / ₃₂ " (70x273x21mm)	2 ³ / ₄ " x 10 ³ / ₄ " x 27 ¹ / ₃₂ " (70x273x21mm)
Pull center to center	—	5 ¹ / ₂ " (140mm)	5 ¹ / ₂ " (140mm)	—	—	—
Projection	—	2" (51mm)	2" (51mm)	—	2" (51mm)	2" (51mm)
ANSI function	01	02	03	03	11 or 12	16
Cylinder type	—	—	Rim	Rim	1 ¹ / ₄ " Mortise	—
Handing	—	—	—	—	—	—
Optional trim	x990EO x996EO	x996K-DT x996L-DT x696DT x697DT	x996K-NL x996L-NL x696NL x697NL			
Optional #425 SNB quantity for device	6	2	2	6	2	2

	L 	L-NL 	L-BE 	L-DT 
	Lever Key locks & unlocks	Lever – night latch Key retracts latchbolt	Lever – blank escutcheon Always operable (no cylinder)	Lever dummy trim pull when dogged
Product description	9847L 9947LF	9847L-NL 9947L-NL	9847L-BE 9947L-BE	9847L-DT 9947L-DT
Trim description	996L-R/V*	996L-NL-R/V	996L-BE-R/V*	996L-DT
Escutcheon plate size	2 ³ / ₄ " x 10 ³ / ₄ " x 27 ¹ / ₃₂ " (70x273x21mm)	2 ³ / ₄ " x 10 ³ / ₄ " x 27 ¹ / ₃₂ " (70x273x21mm)	2 ³ / ₄ " x 10 ³ / ₄ " x 27 ¹ / ₃₂ " (70x273x21mm)	2 ³ / ₄ " x 10 ³ / ₄ " x 27 ¹ / ₃₂ " (70x273x21mm)
Pull center to center	—	—	—	—
Projection	2 ⁷ / ₈ " (73mm)	2 ⁷ / ₈ " (73mm)	2 ⁷ / ₈ " (73mm)	2 ⁷ / ₈ " (73mm)
ANSI function	08	03	14	02
Cylinder type	Rim	Rim	—	—
Handing	Handed/Reversible	Handed/Reversible	Handed/Reversible	Handed/Reversible
Optional #425 SNB quantity for device	2	2	2	2

* Electrified lever operation available

Notes

9847-F/9947-F Concealed vertical rod fire exit device

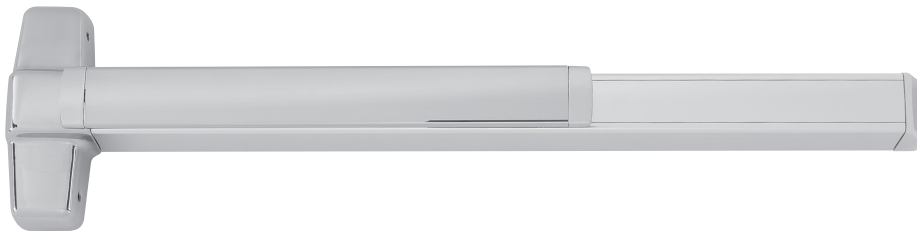

9847-F/9947-F Fire exit concealed vertical rod device for use on pairs of doors up to 8' x 10' (2438mm x 3048mm), UL listed for fire exit hardware. See page 76 for detailed information on UL listed fire exit hardware label and door opening size information. Devices are ANSI A156.3 – 2008 Grade 1. The 9847-F device has a smooth mechanism case and the 9947-F device has a grooved case. The concealed vertical rod device is non-handed except when the following device option is used: SS (signal switch) devices. See opposite page for available outside trim and functions.

Finishes – US3, US3A, US4, US4A, US10, US26, US26D, US26D-AM Antimicrobial, US28, 313, 315 & 643E. US15 and US32D available with 98 Series only.



Specifications

Device functions	Device ships EO/DT/NL. Field selectable. For TP, K or L remove NL drive screw from device.
Device lengths	2' 2' (610 mm) Door size 3' 2'4" to 3' (711mm to 914 mm) Door size 4' 2'10" to 4' (864 mm to 1219 mm) Door size
Device centerline from finished floor	39 ⁵ / ₈ " (1006 mm) Standard Adjustable from 35 ⁵ / ₈ " (905mm) to 49 ⁵ / ₈ " (1260mm)
Center case dimensions	8" x 2 ³ / ₄ " x 2 ³ / ₈ " (203mm x 70mm x 60mm)
Mechanism case dimensions	2 ¹ / ₄ " x 2 ¹ / ₄ " (57mm x 57mm)
Projection	Pushbar neutral – 3 ¹³ / ₁₆ " (97 mm) Pushbar depressed – 3 ¹ / ₁₆ " (78 mm)
Latch bolt	Deadlocking top & bottom bolt, ⁵ / ₈ " (16mm) throw
Door undercut	¹ / ₄ " (7mm) recommended
Top & bottom Latch case	3 ³ / ₄ " x 1 ¹ / ₂ " x 1" (95mm x 38mm x 25mm)
Vertical rods	Round 2-piece adjustable rods – Top rod adjustable from 6'8" (2027mm) to 8'4" (2533mm). Bottom rod adjustable 35 ⁵ / ₈ " (905 mm) to 49 ⁵ / ₈ " (1260 mm). Extension rod kits available for doors over 8'4" (2533mm).
Fasteners & sex bolts (SNB)	Includes screw pack for 1 ³ / ₄ " (44mm) to 2 ¹ / ₄ " (57mm) thick metal doors. Optional 425 SNB available.
Electric options	LX Latchbolt monitor switch RX Pushpad monitor switch RX2 Double pushpad monitor switch E Electric unlocking and locking trim EL Electric latch retraction QEL Quiet electric latch retraction SS Signal switch CX Chexit delayed exit ALK Alarm exit kit WP-RX Waterproof request to exit CON Allegion Connect
Mechanical options	LBR Less bottom rod PN Pneumatic latch retraction GBK Glass bead kit SNB Sex bolts SEC Security screws SLM Special laminate material blocking
Dogging option	No mechanical dogging. EL and QEL option available
Strikes	Top – 338 - Unfinished, Bottom – 385A - Unfinished

PN
Pneumatic latch retraction

- For areas where electrical devices banned
- Special linkage for mechanical or pneumatic dogging

EL
Electric latch retraction

- Enables remote unlatching
- Alternative to manual dogging

QEL
Quiet electric latch retraction

- Bolt retraction via switch
- Converts exit door to push-pull operation

E (E996L)
Electrified breakaway lever

- Electrified remote locking/unlocking
- Standard in fail safe condition

LX
Latchbolt monitor switch

- Signals use of an opening
- SPDT switch to monitor latch bolt

RX
Pushpad monitor switch

- Signals use of an opening
- SPDT switch to monitor pushpad

CX
Chexit delayed exit

- Meets NFPA 101 requirements
- Self-contained controls, locking, alarm

ALK
Alarm exit kit





- Unauthorized opening triggers 85-decibel horn
- Set in armed or disarmed mode by key





CON
Allegion Connectors

- Common connectors to connect various door hardware all the way to the power supply



Standard trim

	EO	DT 	NL 	NL-OP 	TL 	TL-BE 
	No outside trim Exit only	Dummy trim Pull when dogged (not recommended for fire device)	Night latch Key retracts latchbolt	Night latch Key retracts latchbolt optional pull required	Thumbturn Key locks & unlocks (use with DT trim)	Thumbturn Blank escutcheon always operable (no cylinder) (use with DT trim)
Product description	9847EO-F 9947EO-F	—	9847NL-F 9947NL-F	9847NL-OP-F 9947NL-OP-F	9847TL-F 9947TL-F	9847TL-BE-F 9947TL-BE-F
Trim description	—	990DT	990NL-R/V	110NL-MD	376T X 990DT	376T-BE X 990DT
Escutcheon plate size	—	3" x 14 ^{13/16} " x 3 ^{3/32} " (76x360x2mm)	3" x 14 ^{13/16} " x 3 ^{3/32} " (76x360x2mm)	—	2 ^{3/4} " x 10 ^{3/4} " x 27 ^{3/32} " (70x273x21mm)	2 ^{3/4} " x 10 ^{3/4} " x 27 ^{3/32} " (70x273x21mm)
Pull center to center	—	5 ^{1/2} " (140mm)	5 ^{1/2} " (140mm)	—	—	—
Projection	—	2" (51mm)	2" (51mm)	—	2" (51mm)	2" (51mm)
ANSI function	01	02	03	03	11 or 12	16
Cylinder type	—	—	Rim	Rim	1 ^{1/4} " Mortise	—
Handing	—	—	—	—	—	—
Optional trim	x990EO x996EO	x996K-DT x996L-DT x696DT x697DT	x996K-NL x996L-NL x696NL x697NL			
#425 SNB optional - HMD req. WD w/o SLM pkg.	6	2	2	6	2	2

	L 	L-NL 	L-BE 	L-DT 
	Lever Key locks & unlocks	Lever – night latch Key retracts latchbolt	Lever – blank escutcheon Always operable (no cylinder)	Lever dummy trim pull when dogged
Product description	9847L-F 9947L-F	9847L-NL-F 9947L-NL-F	9847L-BE-F 9947L-BE-F	— —
Trim description	996L-R/V*	996L-NL-R/V	996L-BE-R/V*	996L-DT
Escutcheon plate size	2 ^{3/4} " x 10 ^{3/4} " x 27 ^{3/32} " (70x273x21mm)	2 ^{3/4} " x 10 ^{3/4} " x 27 ^{3/32} " (70x273x21mm)	2 ^{3/4} " x 10 ^{3/4} " x 27 ^{3/32} " (70x273x21mm)	2 ^{3/4} " x 10 ^{3/4} " x 27 ^{3/32} " (70x273x21mm)
Pull center to center	—	—	—	—
Projection	2 ^{7/8} " (73mm)	2 ^{7/8} " (73mm)	2 ^{7/8} " (73mm)	2 ^{7/8} " (73mm)
ANSI function	08	03	14	02
Cylinder type	Rim	Rim	—	—
Handing	Handed/Reversible	Handed/Reversible	Handed/Reversible	Handed/Reversible
#425 SNB optional - HMD req. WD w/o SLM pkg.	2	2	2	2

* Electrified lever operation available

Notes

9848/9948 Concealed vertical rod device

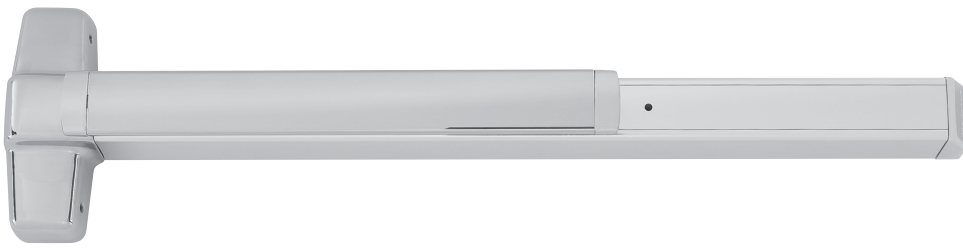

9848/9948 Concealed vertical rod device for use on single or double metal doors, UL listed for panic exit hardware. Covers stock hollow metal doors with 86 or 161 cutouts. Devices are ANSI A156.3 – 2008 Grade 1. The 9848 device has a smooth mechanism case and the 9948 device has a grooved case. The concealed vertical rod device is non-handed except when the following device options are used:SD (special dogging), or SS (signal switch). See opposite page for available outside trim and functions.

Finishes – US3, US3A, US4, US4A, US10, US26, US26D, US26D-AM Antimicrobial, US28, 313, 315 & 643E. US15 and US32D available with 98 Series only.



Hex key dogging comes standard on 9848/9948 Concealed vertical rod devices

Specifications

Device functions	Device ships EO/DT/NL. Field selectable. For TP, K or L remove NL drive screw from device.	
Device lengths	2'	2' (610 mm) Door size
	3'	2'4" to 3' (711mm to 914 mm) Door size
	4'	2'10" to 4' (864 mm to 1219 mm) Door size
Device centerline from finished floor	39 ⁵ / ₈ " (1006 mm) Standard Adjustable from 35 ⁵ / ₈ " (905mm) to 49 ⁵ / ₈ " (1260mm)	
Center case dimensions	8" x 2 ³ / ₄ " x 2 ³ / ₈ " (203mm x 70mm x 60mm)	
Mechanism case dimensions	2 ¹ / ₄ " x 2 ¹ / ₄ " (57mm x 57mm)	
Projection	Pushbar neutral – 3 ¹³ / ₁₆ " (97 mm) Pushbar depressed – 3 ¹ / ₈ " (78 mm)	
Latch bolt	Deadlocking top bolt, 3/4" (19mm) throw Deadlocking bottom bolt, 1 1/2" (38mm) throw	
Door undercut	3/4" (19mm) maximum, more than 1/4" minimum	
Top & bottom Latch case	4 1/4" x 1 1/2" x 1 1/8" (107mm x 38mm x 28mm)	
Vertical rods	Round 2-piece adjustable rods – Top rod adjustable from 6'8" (2027mm) to 8'4" (2533mm). Bottom rod adjustable 35 ⁵ / ₈ " (905 mm) to 49 ⁵ / ₈ " (1260 mm). Extension rod kits available for doors over 8'4" (2533mm).	
Fasteners & sex bolts (SNB)	Includes screw pack for 1 3/4" (44mm) to 2 1/4" (57mm) thick metal doors. Optional 425 SNB available.	
Electric options	LX	Latchbolt monitor switch
	RX	Pushpad monitor switch
	RX2	Double pushpad monitor switch
	E	Electric unlocking and locking trim
	EL	Electric latch retraction
	QEL	Quiet electric latch retraction
	SS	Signal switch
	CX	Chexit delayed exit
	ALK	Alarm exit kit
	WP-RX	Waterproof request to exit
	CON	Allegation Connect
Mechanical options	GBK	Glass bead kit
	PN	Pneumatic latch retraction
	SNB	Sex bolts
	SEC	Security screws
Dogging feature	Hex key dogging standard	
Dogging option	CD	Cylinder dogging
	SD	Special center case dogging
	LD	Less dogging
	DI	Dogging indicator
	CI	Cylinder dogging indicator
Strikes	Top – 338 - Unfinished, Bottom – 385A - Unfinished	

CX
Chexit delayed exit

- Meets NFPA 101 requirements
- Self-contained controls, locking, alarm

ALK
Alarm exit kit

- Unauthorized opening triggers 85-decibel horn
- Set in armed or disarmed mode by key

EL
Electric latch retraction

- Enables remote unlatching
- Alternative to manual dogging

SS
Signal switch

- Signals unauthorized use of an opening
- Switch makes latch bolt tamper-resistant

QEL
Quiet electric latch retraction

- Bolt retraction via switch
- Converts exit door to push-pull operation

LX
Latchbolt monitor switch

- Signals use of an opening
- SPDT switch to monitor latch bolt

E (E996L)
Electrified breakaway lever

- Electrified remote locking/unlocking
- Standard in fail safe condition

SG
Safety glow

- Shows exit door location in darkness or smoke
- Developed to meet MEA standards







PN
Pneumatic latch retraction



- For areas where electrical devices banned
- Special linkage for mechanical or pneumatic dogging

CON
Allegation Connectors

- Common connectors to connect various door hardware all the way to the power supply

Standard trim

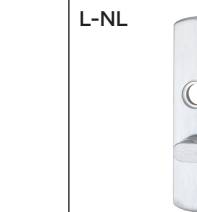
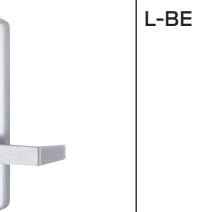
	EO  No outside trim Exit only	DT  Dummy trim Pull when dogged	NL  Night latch Key retracts latchbolt	NL-OP  Night latch Key retracts latchbolt optional pull required	TL  Thumbturn Key locks & unlocks (use with DT trim)	TL-BE  Thumbturn Blank escutcheon always operable (no cylinder) (use with DT trim)
Product description	9848EO 9948EO	9848DT 9948DT	9848NL 9948NL	9848NL-OP 9948NL-OP	9848TL 9948TL	9848TL-BE 9948TL-BE
Trim description	—	990DT	990NL-R/V	110NL-MD	376T X 990DT	376T-BE X 990DT
Escutcheon plate size	—	3" x 14 ^{13/16"} x 3 ^{3/32"} (76x360x2mm)	3" x 14 ^{13/16"} x 3 ^{3/32"} (76x360x2mm)	—	2 ^{3/4"} x 10 ^{3/4"} x 27 ^{3/32"} (70x273x21mm)	2 ^{3/4"} x 10 ^{3/4"} x 27 ^{3/32"} (70x273x21mm)
Pull center to center	—	5 ^{1/2"} (140mm)	5 ^{1/2"} (140mm)	—	—	—
Projection	—	2" (51mm)	2" (51mm)	—	3 ^{1/4"} (83mm)	3 ^{1/4"} (83mm)
ANSI function	01	02	03	03	11	—
Cylinder type	—	—	Rim	Rim	1 ^{1/4"} Mortise	—
Handing	—	—	—	—	—	—
Optional trim	x990EO x996EO	x996K-DT x996L-DT x696DT x697DT	x996K-NL x996L-NL x696NL x697NL			
Optional #425 SNB quantity for device	6	2	2	6	2	2

	L  Lever Key locks & unlocks	L-NL  Lever – night latch Key retracts latchbolt	L-BE  Lever – blank escutcheon Always operable (no cylinder)	L-DT  Lever dummy trim pull when dogged
Product description	9848L 9948LF	9848L-NL 9948L-NL	9848L-BE 9948L-BE	9848L-DT 9948L-DT
Trim description	996L-R/V*	996L-NL-R/V	996L-BE-R/V*	996L-DT
Escutcheon plate size	2 ^{3/4"} x 10 ^{3/4"} x 27 ^{3/32"} (70x273x21mm)	2 ^{3/4"} x 10 ^{3/4"} x 27 ^{3/32"} (70x273x21mm)	2 ^{3/4"} x 10 ^{3/4"} x 27 ^{3/32"} (70x273x21mm)	2 ^{3/4"} x 10 ^{3/4"} x 27 ^{3/32"} (70x273x21mm)
Pull center to center	—	—	—	—
Projection	2 ^{7/8"} (73mm)	2 ^{7/8"} (73mm)	2 ^{7/8"} (73mm)	2 ^{7/8"} (73mm)
ANSI function	08	03	14	02
Cylinder type	Rim	Rim	—	—
Handing	Handed/Reversible	Handed/Reversible	Handed/Reversible	Handed/Reversible
Optional #425 SNB quantity for device	2	2	2	2

* Electrified lever operation available

Notes

🔥 9848-F/9948-F Concealed vertical rod fire exit device

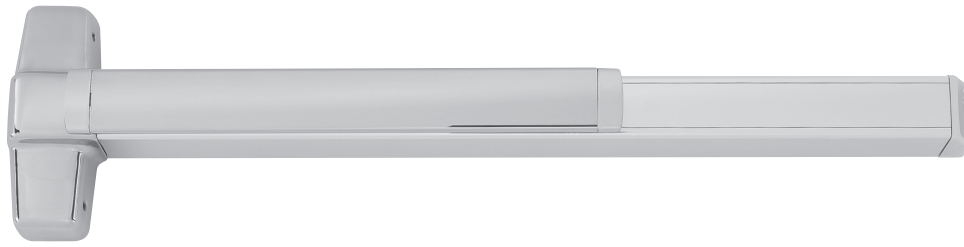

9848-F/9948-F Concealed vertical rod device for use on pairs of doors up to 8' x 10' (2438mm x 3048mm), UL listed for fire exit hardware. See page 76 for detailed information on UL listed fire exit hardware label and door opening size information. Devices are ANSI A156.3 – 2008 Grade 1. The 9848-F device has a smooth mechanism case and the 9948-F device has a grooved case. The concealed vertical rod device is non-handed except when the following device option is used: SS (signal switch). See opposite page for available outside trim and functions.

Finishes – US3, US3A, US4, US4A, US10, US26, US26D, US26D-AM Antimicrobial, US28, 313, 315 & 643E. US15 and US32D available with 98 Series only.

Specifications

Device functions	Device ships EO/DT/NL. Field selectable. For TP, K or L remove NL drive screw from device.	
Device lengths	2'	2' (610 mm) Door size
	3'	2'4" to 3' (711mm to 914 mm) Door size
	4'	2'10" to 4' (864 mm to 1219 mm) Door size
Device centerline from finished floor	39 ⁵ / ₈ " (1006 mm) Standard Adjustable from 35 ⁵ / ₈ " (905mm) to 49 ⁵ / ₈ " (1260mm)	
Center case dimensions	8" x 2 ³ / ₄ " x 2 ³ / ₈ " (203mm x 70mm x 60mm)	
Mechanism case dimensions	2 ¹ / ₄ " x 2 ¹ / ₄ " (57mm x 57mm)	
Projection	Pushbar neutral – 3 ¹³ / ₁₆ " (97 mm) Pushbar depressed – 3 ¹ / ₁₆ " (78 mm)	
Latch bolt	Deadlocking top bolt, 3/4" (19mm) throw Deadlocking bottom bolt, 1 ¹ / ₂ " (38mm) throw	
Door undercut	3/4" (19mm) maximum, more than 1/4" minimum	
Top & bottom Latch case	4 ¹ / ₄ " x 1 ¹ / ₂ " x 1 ¹ / ₈ " (107mm x 38mm x 28mm)	
Vertical rods	Round 2-piece adjustable rods – Top rod adjustable from 6'8" (2027mm) to 8'4" (2533mm). Bottom rod adjustable 35 ⁵ / ₈ " (905 mm) to 49 ⁵ / ₈ " (1260 mm). Extension rod kits available for doors over 8'4" (2533mm).	
Fasteners & sex bolts (SNB)	Includes screw pack for 1 ³ / ₄ " (44mm) to 2 ¹ / ₄ " (57mm) thick metal doors. Optional 425 SNB available.	
Electric options	LX	Latchbolt monitor switch
	RX	Pushpad monitor switch
	RX2	Double pushpad monitor switch
	E	Electric unlocking and locking trim
	EL	Electric latch retraction
	QEL	Quiet electric latch retraction
	SS	Signal switch
	CX	Chexit delayed exit
	ALK	Alarm exit kit
	WP-RX	Waterproof request to exit
	CON	Allegion Connect
Mechanical options	GBK	Glass bead kit
	PN	Pneumatic latch retraction
	SNB	Sex bolts
	SEC	Security screws
	SLM	Special laminate material blocking
Dogging option	No mechanical dogging. EL and QEL option available	
Strikes	Top – 338 - Unfinished, Bottom – 385A - Unfinished	

CX
Chexit delayed exit

- Meets NFPA 101 requirements
- Self-contained controls, locking, alarm

ALK
Alarm exit kit

- Unauthorized opening triggers 85-decibel horn
- Set in armed or disarmed mode by key

EL
Electric latch retraction

- Enables remote unlatching
- Alternative to manual dogging

SS
Signal switch

- Signals unauthorized use of an opening
- Switch makes latch bolt tamper-resistant

QEL
Quiet electric latch retraction

- Bolt retraction via switch
- Converts exit door to push-pull operation

LX
Latchbolt monitor switch

- Signals use of an opening
- SPDT switch to monitor latch bolt

E (E996L)
Electrified breakaway lever

- Electrified remote locking/unlocking
- Standard in fail safe condition

RX
Pushpad monitor switch

- Signals use of an opening
- SPDT switch to monitor pushpad

PN
Pneumatic latch retraction





- For areas where electrical devices banned
- Special linkage for mechanical or pneumatic dogging





CON
Allegion Connectors

- Common connectors to connect various door hardware all the way to the power supply



Standard trim

	EO No outside trim Exit only	DT  Dummy trim Pull when dogged (not recommended for fire device)	NL  Night latch Key retracts latchbolt	NL-OP  Night latch Key retracts latchbolt optional pull required	TL  Thumbturn Key locks & unlocks (use with DT trim)	TL-BE  Thumbturn Blank escutcheon always operable (no cylinder) (use with DT trim)
Product description	9848EO-F 9948EO-F	— —	9848NL-F 9948NL-F	9848NL-OP-F 9948NL-OP-F	9848TL-F 9948TL-F	9848TL-BE-F 9948TL-BE-F
Trim description	—	990DT	990NL-R/V	110NL-MD	376T X 990DT	376T-BE X 990DT
Escutcheon plate size	—	3" x 14 ^{13/16} " x 3 ^{3/32} " (76x360x2mm)	3" x 14 ^{13/16} " x 3 ^{3/32} " (76x360x2mm)	—	2 ^{3/4} " x 10 ^{3/4} " x 27 ^{3/32} " (70x273x21mm)	2 ^{3/4} " x 10 ^{3/4} " x 27 ^{3/32} " (70x273x21mm)
Pull center to center	—	5 ^{1/2} " (140mm)	5 ^{1/2} " (140mm)	—	—	—
Projection	—	2" (51mm)	2" (51mm)	—	3 ^{1/4} " (83mm)	3 ^{1/4} " (83mm)
ANSI function	01	02	03	03	11	—
Cylinder type	—	—	Rim	Rim	1 ^{1/4} " Mortise	—
Handing	—	—	—	—	—	—
Optional trim	x990EO x996EO	x996K-DT x996L-DT x696DT x697DT	x996K-NL x996L-NL x696NL x697NL			
#425 SNB optional - HMD req. WD w/o SLM pkg.	6	2	2	6	2	2

	L  Lever Key locks & unlocks	L-NL  Lever – night latch Key retracts latchbolt	L-BE  Lever – blank escutcheon Always operable (no cylinder)	L-DT  Lever dummy trim pull when dogged (not recommended for fire device)
Product description	9848L-F 9948L-F	9848L-NL-F 9948L-NL-F	9848L-BE-F 9948L-BE-F	— —
Trim description	996L-R/V*	996L-NL-R/V	996L-BE-R/V*	996L-DT
Escutcheon plate size	2 ^{3/4} " x 10 ^{3/4} " x 27 ^{3/32} " (70x273x21mm)	2 ^{3/4} " x 10 ^{3/4} " x 27 ^{3/32} " (70x273x21mm)	2 ^{3/4} " x 10 ^{3/4} " x 27 ^{3/32} " (70x273x21mm)	2 ^{3/4} " x 10 ^{3/4} " x 27 ^{3/32} " (70x273x21mm)
Pull center to center	—	—	—	—
Projection	2 ^{7/8} " (73mm)	2 ^{7/8} " (73mm)	2 ^{7/8} " (73mm)	2 ^{7/8} " (73mm)
ANSI function	08	03	14	02
Cylinder type	Rim	Rim	—	—
Handing	Handed/Reversible	Handed/Reversible	Handed/Reversible	Handed/Reversible
#425 SNB optional - HMD req. WD w/o SLM pkg.	2	2	2	2

* Electrified lever operation available

Notes

9849/9949 Concealed vertical cable device

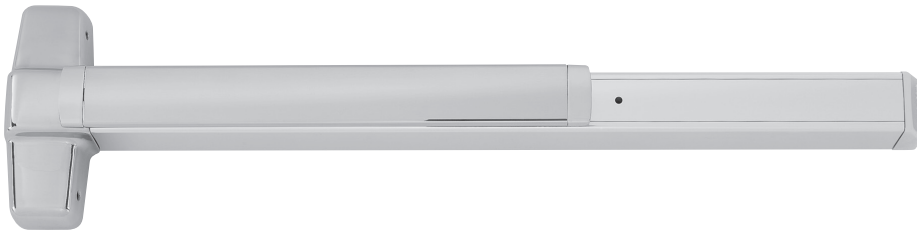

9849/9949 Concealed vertical cable device for use on single or double metal doors, UL listed for panic exit hardware. Devices are ANSI A156.3 – 2014 Grade 1. The 9849 device has a smooth mechanism case and the 9949 device has a grooved case. The concealed vertical cable device is non-handed except when the following device options are used: SD (special dogging), or SS (signal switch). See opposite page for available outside trim and device functions.

Finishes – US3, US3A, US4, US4A, US10, US26, US26D, US26D-AM Antimicrobial, US28, 313, 315 & 643E. US15 and US32D available with 98 Series only.

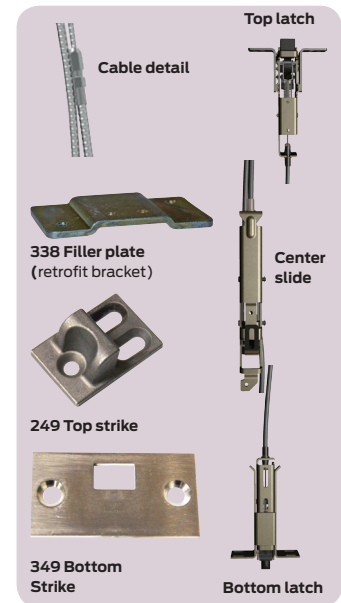

Hex key dogging comes standard on 9849/9949 concealed vertical cable devices

Specifications

Device functions	Device ships EO/DT/NL. Field selectable. For TP, K or L remove NL drive screw from device.
Device lengths	2' 2' (610 mm) Door size 3' 2'4" to 3' (711mm to 914 mm) Door size 4' 2'10" to 4' (864 mm to 1219 mm) Door size
Device centerline from finished floor	39 ⁵ / ₈ " (1006 mm)
Center case dimensions	8" x 2 ³ / ₄ " x 2 ³ / ₈ " (203mm x 70mm x 60mm)
Mechanism case dimensions	2 ¹ / ₄ " x 2 ¹ / ₄ " (57mm x 57mm)
Projection	Pushbar neutral – 3 ¹³ / ₁₆ " (97 mm) Pushbar depressed – 3 ¹ / ₁₆ " (78 mm)
Latch bolt	Deadlocking top & bottom bolt, 1/2" (13mm) throw
Door undercut	3/4" (19mm) maximum (24231516 spacer block kit needed for 3/4" undercut)
Top & bottom latch case	5 ¹³ / ₁₆ " x 1 ¹ / ₄ " x 1 ⁷ / ₁₆ " (147mm x 32mm x 37mm)
Vertical cable	7/32" (6mm) Diameter stainless steel cables
Fasteners & sex bolts (SNB)	Includes screw pack for 1 ³ / ₄ " (44mm) to 2 ¹ / ₄ " (57mm) thick metal doors. Optional 425 SNB available.
Electric options	ALK Alarm exit kit CX Chexit delayed exit E Electric unlocking and locking trim EL Electric latch retraction HD-EL Electric latch retraction w/ hex dogging QEL Quiet electric latch retraction *LX Latchbolt monitor switch RX2 Double pushpad monitor switch RX996L Trim monitor switch RX Pushpad monitor switch RXLC Pushpad monitor switch - low current SS Signal switch WP-RX Waterproof request to exit CON Allegion Connect
Mechanical options	GBK Glass bead kit LBL Less bottom latch AX Accessible device (LBL only) PN Pneumatic latch retraction SEC Security screws SG Safety glow SNB Sex bolts
Dogging feature Dogging option	Hex key dogging standard CD Cylinder dogging SD Special center case dogging LD Less dogging DI Dogging indicator CI Cylinder dogging indicator
Strikes	Top - 249 – Unfinished, Bottom – 349 - Unfinished

CX
Chexit delayed exit
 • Meets NFPA 101 requirements
 • Self-contained controls, locking, alarm

RX
Pushpad monitor switch
 • Signals use of an opening
 • SPDT switch to monitor pushpad alarm

EL
Electric latch retraction
 • Enables remote unlatching
 • Alternative to manual dogging

ALK
Alarm exit kit
 • Unauthorized opening triggers 85-decibel horn
 • Set in armed or disarmed mode by key

AX
Accessible device
 • UL certified to meet new 5 lb. maximum operating force requirement
 • Exceeds ANSI/BHMA requirements

CON
Allegion Connectors
 • Common connectors to connect various door hardware all the way to the power supply

PN
Pneumatic latch retraction
 • For areas where electrical devices banned
 • Special linkage for mechanical or pneumatic dogging





DI
Dogging indicator
 • Monitor dogging status without a control panel
 • Red indicator light shows visibility to dogging from over 75 feet





CD
Cylinder dogging
 • Replaces hex key dogging
 • Requires standard 1 1/4" mortise cylinder

QEL
Quiet electric latch retraction
 • Bolt retraction via switch
 • Converts exit door to push-pull operation

*For 98/9949 devices, LX switch monitors trim input or electric dogging of EL/QEL devices. LX switch does not monitor latchbolt condition.

Standard trim

	EO	DT	NL	NL-OP
	 No outside trim Exit only	 Dummy trim Pull when dogged	 Night latch Key retracts latchbolt	 Night latch Key retracts latchbolt optional pull required
Product description	9849EO 9949EO	9849DT 9949DT	9849NL 9949NL	9849NL-OP 9949NL-OP
Trim description	—	990DT	990NL-R/V	110NL-MD
Escutcheon plate size	—	3" x 14 ^{13/16"} x 3 ^{3/32"} (76x360x2mm)	3" x 14 ^{13/16"} x 3 ^{3/32"} (76x360x2mm)	—
Pull center to center	—	5 ^{1/2"} (140mm)	5 ^{1/2"} (140mm)	—
Projection	—	2" (51mm)	2" (51mm)	—
ANSI function	01	02	03	03
Cylinder type	—	—	Rim	Rim
Handing	—	—	—	—
Optional trim	x990EO x996EO	x996K-DT x996L-DT x696DT x697DT	x996K-NL x996L-NL x696NL x697NL	
Optional #425 SNB quantity for device	6	2	2	6

	L	L-NL	L-BE	L-DT
	 Lever Key locks & unlocks	 Lever – night latch Key retracts latchbolt	 Lever – blank escutcheon Always operable (no cylinder)	 Lever dummy trim pull when dogged
Product description	9849L 9949L	9849L-NL 9949L-NL	9849L-BE 9949L-BE	9849L-DT 9949L-DT
Trim description	996L-R/V*	996L-NL-R/V	996L-BE-R/V*	996L-DT
Escutcheon plate size	2 ^{3/4"} x 10 ^{3/4"} x 2 ^{7/32"} (70x273x21mm)	2 ^{3/4"} x 10 ^{3/4"} x 2 ^{7/32"} (70x273x21mm)	2 ^{3/4"} x 10 ^{3/4"} x 2 ^{7/32"} (70x273x21mm)	2 ^{3/4"} x 10 ^{3/4"} x 2 ^{7/32"} (70x273x21mm)
Pull center to center	—	—	—	—
Projection	2 ^{7/8"} (73mm)	2 ^{7/8"} (73mm)	2 ^{7/8"} (73mm)	2 ^{7/8"} (73mm)
ANSI function	08	03	14	02
Cylinder type	Rim	Rim	—	—
Handing	Handed/Reversible	Handed/Reversible	Handed/Reversible	Handed/Reversible
Optional #425 SNB quantity for device	2	2	2	2

* Electrified lever operation available

Nominal door opening height		Top cable part number	Bottom cable part number
72" - 82"	6'0" - 6'10"	47250398	47250403
*82" - 96"	*6'10" - 8'	47250175	47250178
>96" - 110"	>8'0" - 9' 2"	47250176	47250179
>110" - 120"	>9'2" - 10'	47250177	47250180

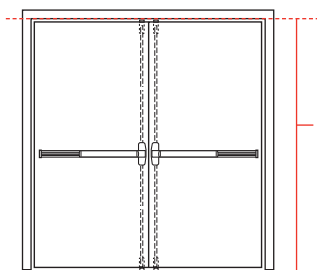

Door opening height is distance from bottom of frame header to finished floor.

See table on left for standard offering.

*Default door opening height. Specify door opening height if other than the default. For door heights less than 6'0" and greater than 10', contact our Customer Care department to discuss your specific application needs.

🔥 9849-F/9949-F Concealed vertical cable fire exit device



9849/9949 Concealed vertical cable device for use on single or double metal doors, UL listed for panic exit hardware. See page 76 for detailed information on UL listed fire exit hardware label and door opening size information. Devices are ANSI A156.3 – 2014 Grade 1. The 9849 device has a smooth mechanism case and the 9949 device has a grooved case. The concealed vertical cable device is non-handed except when the following device options are used: SD (special dogging), or SS (signal switch). See opposite page for available outside trim and device functions.

Finishes – US3, US3A, US4, US4A, US10, US26, US26D, US26D-AM Antimicrobial, US28, 313, 315 & 643E. US15 and US32D available with 98 Series only.



Specifications

Device functions	Device ships EO/DT/NL. Field selectable. For TP, K or L remove NL drive screw from device.	
Device lengths	2'	2' (610 mm) Door size
	3'	2'4" to 3' (711mm to 914 mm) Door size
	4'	2'10" to 4' (864 mm to 1219 mm) Door size
Device centerline from finished floor	39 ⁵ / ₈ " (1006 mm) Standard	
Center case dimensions	8" x 2 ³ / ₄ " x 2 ³ / ₈ " (203mm x 70mm x 60mm)	
Mechanism case dimensions	2 ¹ / ₄ " x 2 ¹ / ₄ " (57mm x 57mm)	
Projection	Pushbar neutral – 3 ¹³ / ₁₆ " (97 mm) Pushbar depressed – 3 ¹ / ₁₆ " (78 mm)	
Latch bolt	Deadlocking anti-friction top & bottom bolt, ⁵ / ₈ " (16mm) throw	
Door undercut	³ / ₄ " (19mm) maximum (24231516 spacer block kit needed for ³ / ₄ " undercut)	
Top & bottom Latch case	5 ¹³ / ₁₆ " x 1 ¹ / ₄ " x 1 ¹ / ₁₆ " (147mm x 32mm x 37mm)	
Vertical cable	7/ ₃₂ " (6mm) Diameter stainless steel cables	
Fasteners & sex bolts (SNB)	Includes screw pack for 1 ³ / ₄ " (44mm) to 2 ¹ / ₄ " (57mm) thick metal doors. Optional 425 SNB available.	
Electric options	ALK	Alarm exit kit
	CX	Chexit delayed exit
	E	Electric unlocking and locking trim
	EL	Electric latch retraction
	HD-EL	Electric latch retraction w/ hex dogging
	QEL	Quiet electric latch retraction
	*LX	Latchbolt monitor switch
	RX2	Double pushpad monitor switch
	RX996L	Trim monitor switch
	RX	Pushpad monitor switch
	RXLC	Pushpad monitor switch - low current
	SS	Signal switch
	WP-RX	Waterproof request to exit
	CON	Allegion Connect
Mechanical options	GBK	Glass bead kit
	LBL	Less bottom latch
	AX	Accessible device (LBL only)
	PN	Pneumatic latch retraction
	SEC	Security screws
	SG	Safety glow
	SNB	Sex bolts
Dogging option	No mechanical dogging. EL and QEL option available	
Strikes	Top – 249 - Unfinished, Bottom – 349 - Unfinished	

CX
Chexit delayed exit

- Meets NFPA 101 requirements
- Self-contained controls, locking, alarm

SS
Signal switch

- Signals unauthorized use of an opening
- Switch makes latch bolt tamper-resistant

EL
Electric latch retraction

- Enables remote unlatching
- Alternative to manual dogging

RX
Pushpad monitor switch

- Signals use of an opening
- SPDT switch to monitor pushpad

QEL
Quiet electric latch retraction

- Bolt retraction via switch
- Converts exit door to push-pull operation

E (E996L)
Electrified breakaway lever

- Electrified remote locking/unlocking
- Standard in fail safe condition

AX
Accessible device

- UL certified to meet new 5 lb. maximum operating force requirement
- Exceeds ANSI/BHMA requirements

CON
Allegion Connectors





- Common connectors to connect various door hardware all the way to the power supply



PN
Pneumatic latch retraction

- For areas where electrical devices banned
- Special linkage for mechanical or pneumatic dogging

*For 98/9949 devices, LX switch monitors trim input or electric dogging of EL/QEL devices. LX switch does not monitor latchbolt condition.

Standard trim

	EO	DT	NL	NL-OP
				
Product description	9849EO-F 9949EO-F	— —	9849NL-F 9949NL-F	9849NL-OP-F 9949NL-OP-F
Trim description	—	990DT	990NL-R/V	110NL-MD
Escutcheon plate size	—	3" x 14 ^{13/16} " x 3 ^{3/32} " (76x360x2mm)	3" x 14 ^{13/16} " x 3 ^{3/32} " (76x360x2mm)	—
Pull center to center	—	5 ^{1/2} " (140mm)	5 ^{1/2} " (140mm)	—
Projection	—	2" (51mm)	2" (51mm)	—
ANSI function	01	02	03	03
Cylinder type	—	—	Rim	Rim
Handing	—	—	—	—
Optional trim	x990EO x996EO	x996K-DT x996L-DT x696DT x697DT	x996K-NL x996L-NL x696NL x697NL	
Optional #425 SNB quantity for device	6	2	2	6

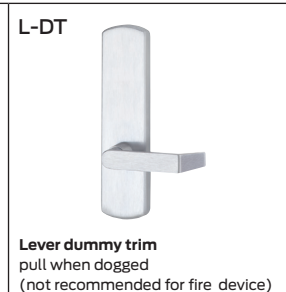
	L	L-NL	L-BE	L-DT
				
Product description	9849L-F 9949L-F	9849L-NL-F 9949L-NL-F	9849L-BE-F 9949L-BE-F	— —
Trim description	996L-R/V*	996L-NL-R/V	996L-BE-R/V*	996L-DT
Escutcheon plate size	2 ^{3/4} " x 10 ^{3/4} " x 27 ^{3/32} " (70x273x21mm)	2 ^{3/4} " x 10 ^{3/4} " x 27 ^{3/32} " (70x273x21mm)	2 ^{3/4} " x 10 ^{3/4} " x 27 ^{3/32} " (70x273x21mm)	2 ^{3/4} " x 10 ^{3/4} " x 27 ^{3/32} " (70x273x21mm)
Pull center to center	—	—	—	—
Projection	2 ^{7/8} " (73mm)	2 ^{7/8} " (73mm)	2 ^{7/8} " (73mm)	2 ^{7/8} " (73mm)
ANSI function	08	03	14	02
Cylinder type	Rim	Rim	—	—
Handing	Handed/Reversible	Handed/Reversible	Handed/Reversible	Handed/Reversible
Optional #425 SNB quantity for device	2	2	2	2

* Electrified lever operation available

Nominal door opening height		Top cable part number	Bottom cable part number
72" - 82"	6'0" - 6'10"	47250398	47250403
*82" - 96"	*6'10" - 8'	47250175	47250178
>96" - 110"	>8'0" - 9' 2"	47250176	47250179
>110" - 120"	>9'2" - 10'	47250177	47250180

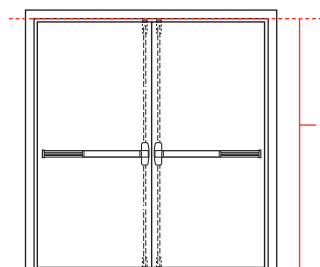

Door opening height is distance from bottom of frame header to finished floor.

See table on left for standard offering.

*Default door opening height. Specify door opening height if other than the default. For door heights less than 6'0" and greater than 10', contact our Customer Care department to discuss your specific application needs.

9847WDC/9947WDC Wood door concealed vertical rod device

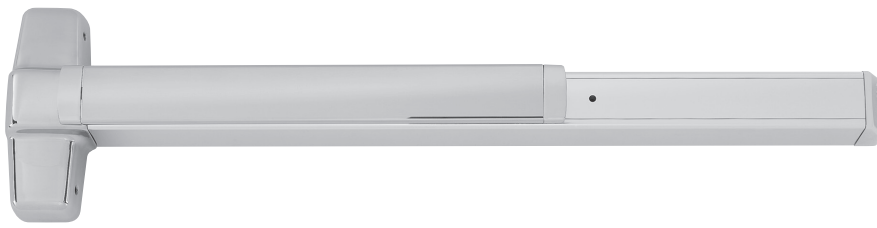

9847WDC/9947WDC Concealed vertical rod device for use on single or double wood doors, UL listed for panic exit hardware. Devices are ANSI A156.3 – 2008 Grade 1. The 9847WDC device has a smooth mechanism case and the 9947WDC device has a grooved case. The concealed vertical rod device is non-handed except when the following device options are used: SD (special dogging), or SS (signal switch). See opposite page for available outside trim and functions.

Scalp plate – Device is furnished standard with an 8" (203mm) long scalp plate for easy access to rods.

Note: Do not use on pair of doors with 9875/9975.

Finishes – US3, US4, US10, US26, US26D, US28 & 313. US15 and US32D available with 98 Series only.



Hex key dogging comes standard on 9847/9947 Wood door concealed vertical rod devices

Specifications

Device functions	Device ships EO/DT/NL. Field selectable. For TP, K or L remove NL drive screw from device.
Device lengths	2' 2' (610 mm) Door size 3' 2'4" to 3' (711mm to 914 mm) Door size 4' 2'10" to 4' (864 mm to 1219 mm) Door size
Device centerline from finished floor	39 ⁵ / ₈ " (1006 mm) Standard Adjustable from 35 ⁵ / ₈ " (905mm) to 49 ⁵ / ₈ " (1260mm)
Center case dimensions	8" x 2 ³ / ₄ " x 2 ³ / ₈ " (203mm x 70mm x 60mm)
Mechanism case dimensions	2 ¹ / ₄ " x 2 ¹ / ₄ " (57mm x 57mm)
Projection	Pushbar neutral – 3 ¹³ / ₁₆ " (97 mm) Pushbar depressed – 3 ¹ / ₈ " (78 mm)
Latch bolt	Deadlocking top bolt, ⁵ / ₈ " (16mm) throw
Door undercut	¹ / ₄ " (7mm) maximum
Top & bottom Latch case	3 ³ / ₄ " x 1 ¹ / ₂ " x 1" (95mm x 38mm x 25mm)
Vertical rods	Round 2-piece adjustable rods – Top rod adjustable from 6'8" (2027mm) to 8'4" (2533mm). Bottom rod adjustable 35 ⁵ / ₈ " (905 mm) to 49 ⁵ / ₈ " (1260 mm). Extension rod kits available for doors over 8'4" (2533mm).
Fasteners & sex bolts (SNB)	Includes screw pack for 1 ³ / ₄ " (44mm) to 2 ¹ / ₄ " (57mm) thick wood doors. 425 SNB required on wood doors without SLM blocking.
Electric options	LX Latchbolt monitor switch RX Pushpad monitor switch RX2 Double pushpad monitor switch E Electric unlocking and locking trim EL Electric latch retraction QEL Quiet electric latch retraction SS Signal switch CX Chexit delayed exit ALK Alarm exit kit WP-RX Waterproof request to exit CON Allegion Connect
Mechanical options	GBK Glass bead kit PN Pneumatic latch retraction PL Pullman latch LBR Less bottom rod SNB Sex bolts SEC Security screws
Dogging feature	Hex key dogging standard
Dogging option	CD Cylinder dogging LD Less dogging DI Dogging indicator CI Cylinder dogging indicator
Strikes	Top – 338 - Unfinished, Bottom – 385A - Unfinished

CX
Chexit delayed exit
• Meets NFPA 101 requirements
• Self-contained controls, locking, alarm

ALK
Alarm exit kit
• Unauthorized opening triggers 85-decibel horn
• Set in armed or disarmed mode by key

EL
Electric latch retraction
• Enables remote unlatching
• Alternative to manual dogging

PL
Pullman latch
• Not for use with Fire Exit Hardware

QEL
Quiet electric latch retraction
• Bolt retraction via switch
• Converts exit door to push-pull operation

LX
Latchbolt monitor switch
• Signals use of an opening
• SPDT switch to monitor latch bolt





E (E996L)
Electrified breakaway lever
• Electrified remote locking/unlocking
• Standard in fail safe condition



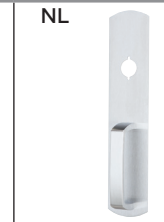

RX
Pushpad monitor switch
• Signals use of an opening
• SPDT switch to monitor pushpad

PN
Pneumatic latch retraction
• For areas where electrical devices banned
• Special linkage for mechanical or pneumatic dogging

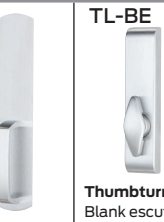
CON
Allegion Connectors
• Common connectors to connect various door hardware all the way to the power supply

Standard trim

	EO  No outside trim Exit only	DT  Dummy trim Pull when dogged	NL  Night latch Key retracts latchbolt	NL-OP  Night latch Key retracts latchbolt optional pull required	TL  Thumbturn Key locks & unlocks (use with DT trim)	TL-BE  Thumbturn Blank escutcheon always operable (no cylinder) (use with DT trim)
Product description	9847WDC-EO 9947WDC-EO	9847WDC-DT 9947WDC-DT	9847WDC-NL 9947WDC-NL	9847WDCNL-OP 9947WDCNL-OP	9847WDC-TL 9947WDC-TL	9847WDC-TL-BE 9947WDC-TL-BE
Trim description	—	990DT	990NL-R/V	110NL-WD	376TWDC x 990DT	376TWDC-BE x 990DT
Escutcheon plate size	—	3" x 14 ¹³ / ₁₆ " x 3 ³ / ₃₂ " (76x360x2mm)	3" x 14 ¹³ / ₁₆ " x 3 ³ / ₃₂ " (76x360x2mm)	—	2 ³ / ₄ " x 10 ³ / ₄ " x 27 ⁷ / ₃₂ " (70x273x21mm)	2 ³ / ₄ " x 10 ³ / ₄ " x 27 ⁷ / ₃₂ " (70x273x21mm)
Pull center to center	—	5 ¹ / ₂ " (140mm)	5 ¹ / ₂ " (140mm)	—	—	—
Projection	—	2" (51mm)	2" (51mm)	—	2" (51mm)	2" (51mm)
ANSI function	01	02	03	03	11 or 12	16
Cylinder type	—	—	Rim	Rim	1 ¹ / ₄ " Mortise	—
Handing	—	—	—	—	—	—
Optional trim	x990EO x996EO	x996K-DT x996L-DT x696DT x697DT	x996K-NL x996L-NL x696NL x697NL			
Optional #425 SNB quantity for device	6	2	2	6	2	2

	L  Lever Key locks & unlocks	L-NL  Lever – night latch Key retracts latchbolt	L-BE  Lever – blank escutcheon Always operable (no cylinder)	L-DT  Lever dummy trim pull when dogged
Product description	9847WDC-L 9947WDC-L	9847WDC-L-NL 9947WDC-L-NL	9847WDC-L-BE 9947WDC-L-BE	9847WDC-L-DT 9947WDC-L-DT
Trim description	996L-R/V*	996L-NL-R/V	996L-BE-R/V*	996L-DT
Escutcheon plate size	2 ³ / ₄ " x 10 ³ / ₄ " x 27 ⁷ / ₃₂ " (70x273x21mm)	2 ³ / ₄ " x 10 ³ / ₄ " x 27 ⁷ / ₃₂ " (70x273x21mm)	2 ³ / ₄ " x 10 ³ / ₄ " x 27 ⁷ / ₃₂ " (70x273x21mm)	2 ³ / ₄ " x 10 ³ / ₄ " x 27 ⁷ / ₃₂ " (70x273x21mm)
Pull center to center	—	—	—	—
Projection	2 ⁷ / ₈ " (73mm)	2 ⁷ / ₈ " (73mm)	2 ⁷ / ₈ " (73mm)	2 ⁷ / ₈ " (73mm)
ANSI function	08	03	14	02
Cylinder type	Rim	Rim	—	—
Handing	Handed/Reversible	Handed/Reversible	Handed/Reversible	Handed/Reversible
Optional #425 SNB quantity for device	2	2	2	2

* Electrified lever operation available

Notes

🔥 9847WDC-F/9947WDC-F Wood door concealed vertical rod fire device

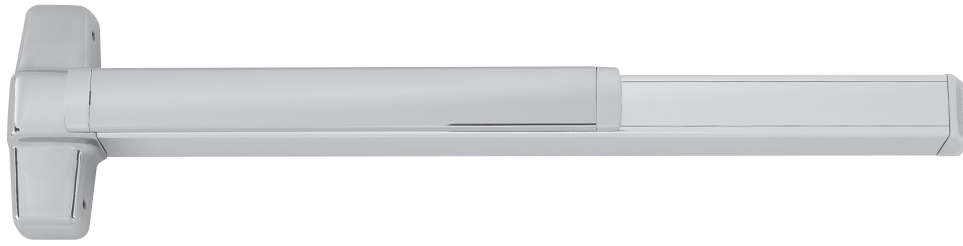

9847WDC-F/9947WDC-F Fire exit concealed vertical rod device for use on pairs of doors up to 8'0" x 9' 3" (2438mm x 2819mm) double wood doors, UL listed for fire exit hardware. See page 76 for detailed information on UL listed fire exit hardware label and door opening size information. Devices are ANSI A156.3 – 2008 Grade 1. The 9847WDC-F device has a smooth mechanism case and the 9947WDC-F device has a grooved case. The concealed vertical rod device is non-handed except when the following device options are used: SS (signal switch). See Opposite page for available outside trim and functions.

Scalp Plate – Device is furnished standard with an 8" (203mm) long scalp plate for easy access to rods. Note: Do not use on pair of doors with 9875-F/9975-F.

Finishes – US3, US4, US10, US26, US26D, US28 & 313. US15 and US32D available with 98 Series only.



Specifications

Device functions	Device ships EO/DT/NL. Field selectable. For TP, K or L remove NL drive screw from device.	
Device lengths	2'	2' (610 mm) Door size
	3'	2'4" to 3' (711mm to 914 mm) Door size
	4'	2'10" to 4' (864 mm to 1219 mm) Door size
Device centerline from finished floor	39 ⁵ / ₈ " (1006 mm) Standard	
Center case dimensions	8" x 2 ³ / ₄ " x 2 ³ / ₈ " (203mm x 70mm x 60mm)	
Mechanism case dimensions	2 ¹ / ₄ " x 2 ¹ / ₄ " (57mm x 57mm)	
Projection	Pushbar neutral – 3 ¹³ / ₁₆ " (97 mm) Pushbar depressed – 3 ¹ / ₁₆ " (78 mm)	
Latch bolt	Deadlocking top & bottom bolt, ⁵ / ₈ " (16mm) throw	
Door undercut	1/4" (7mm) maximum	
Top & bottom Latch case	3 ³ / ₄ " x 1 ¹ / ₂ " x 1" (95mm x 38mm x 25mm)	
Vertical rods	Round 2-piece adjustable rods – Top rod adjustable from 6'8" (2027mm) to 8'4" (2533mm). Bottom rod adjustable 35 ⁵ / ₈ " (905 mm) to 49 ⁵ / ₈ " (1260 mm). Extension rod kits available for doors over 8'4" (2533mm).	
Fasteners & sex bolts (SNB)	Includes screw pack for 1 ³ / ₄ " (44mm) to 2 ¹ / ₄ " (57mm) thick wood doors. 425 SNB required on wood doors without SLM blocking.	
Electric options	LX	Latchbolt monitor switch
	RX	Pushpad monitor switch
	RX2	Double pushpad monitor switch
	E	Electric unlocking and locking trim
	EL	Electric latch retraction
	QEL	Quiet electric latch retraction
	SS	Signal switch
	CX	Chexit delayed exit
	ALK	Alarm exit kit
	WP-RX	Waterproof request to exit
	CON	Allegion Connect
Mechanical options	GBK	Glass bead kit
	PN	Pneumatic latch retraction
	PL	Pullman latch
	LBR	Less bottom rod
	SNB	Sex bolts
	SEC	Security screws
Dogging option	No mechanical dogging. EL and QEL option available	
Strikes	Top – 338 - Unfinished, Bottom – 385A - Unfinished	

CX

Chexit delayed exit

- Meets NFPA 101 requirements
- Self-contained controls, locking, alarm

ALK

Alarm exit kit

- Unauthorized opening triggers 85-decibel horn
- Set in armed or disarmed mode by key

EL

Electric latch retraction

- Enables remote unlatching
- Alternative to manual dogging

LX

Latchbolt monitor switch

- Signals use of an opening
- SPDT switch to monitor latch bolt

QEL

Quiet electric latch retraction

- Bolt retraction via switch
- Converts exit door to push-pull operation

RX

Pushpad monitor switch

- Signals use of an opening
- SPDT switch to monitor pushpad

E (E996L)

Electrified breakaway lever

- Electrified remote locking/unlocking
- Standard in fail safe condition

CON

Allegion Connectors





- Common connectors to connect various door hardware all the way to the power supply





PN

Pneumatic latch retraction

- For areas where electrical devices banned
- Special linkage for mechanical or pneumatic dogging







Standard trim						
	EO	DT 	NL 	NL-OP 	TL 	TL-BE 
	No outside trim Exit only	Dummy trim Pull when dogged	Night latch Key retracts latchbolt	Night latch Key retracts latchbolt optional pull required	Thumbturn Key locks & unlocks (use with DT trim)	Thumbturn Blank escutcheon always operable (no cylinder) (use with DT trim)
Product description	9847WDC-EO-F 9947WDC-EO-F	9847WDC-DT-F 9947WDC-DT-F	9847WDC-NL-F 9947WDC-NL-F	9847WDCNL-OP-F 9947WDCNL-OP-F	9847WDC-TL-F 9947WDC-TL-F	9847WDC-TL-BE-F 9947WDC-TL-BE-F
Trim description	—	990DT	990NL-R/V	110NL-WD	376TWDC x 990DT	376TWDC-BE x 990DT
Escutcheon plate size	—	3" x 14 ^{13/16} " x 3 ^{3/32} " (76x360x2mm)	3" x 14 ^{13/16} " x 3 ^{3/32} " (76x360x2mm)	—	2 ^{3/4} " x 10 ^{3/4} " x 2 ^{7/32} " (70x273x21mm)	2 ^{3/4} " x 10 ^{3/4} " x 2 ^{7/32} " (70x273x21mm)
Pull center to center	—	5 ^{1/2} " (140mm)	5 ^{1/2} " (140mm)	—	—	—
Projection	—	2" (51mm)	2" (51mm)	—	2" (51mm)	2" (51mm)
ANSI function	01	02	03	03	11	—
Cylinder type	—	—	Rim	Rim	1 ^{1/4} " Mortise	—
Handing	—	—	—	—	—	—
Optional trim	x990EO x996EO	x996K-DT x996L-DT x996L-DT x696DT x697DT	x996K-NL x996L-NL x996L-NL x696NL x697NL			
#425 SNB optional - HMD req. WD w/o SLM pkg.	6	2	2	6	2	2

	L 	L-NL 	L-BE 	L-DT 
	Lever Key locks & unlocks	Lever – night latch Key retracts latchbolt	Lever – blank escutcheon Always operable (no cylinder)	Lever dummy trim pull when dogged
Product description	9847WDC-L-F 9947WDC-L-F	9847WDC-L-NL-F 9947WDC-L-NL-F	9847WDC-L-BE-F 9947WDC-L-BE-F	9847WDC-L-DT-F 9947WDC-L-DT-F
Trim description	996L-R/V*	996L-NL-R/V	996L-BE-R/V*	996L-DT
Escutcheon plate size	2 ^{3/4} " x 10 ^{3/4} " x 2 ^{7/32} " (70x273x21mm)	2 ^{3/4} " x 10 ^{3/4} " x 2 ^{7/32} " (70x273x21mm)	2 ^{3/4} " x 10 ^{3/4} " x 2 ^{7/32} " (70x273x21mm)	2 ^{3/4} " x 10 ^{3/4} " x 2 ^{7/32} " (70x273x21mm)
Pull center to center	—	—	—	—
Projection	2 ^{7/8} " (73mm)	2 ^{7/8} " (73mm)	2 ^{7/8} " (73mm)	2 ^{7/8} " (73mm)
ANSI function	08	03	14	02
Cylinder type	Rim	Rim	—	—
Handing	Handed/Reversible	Handed/Reversible	Handed/Reversible	Handed/Reversible
#425 SNB optional - HMD req. WD w/o SLM pkg.	2	2	2	2

* Electrified lever operation available





Notes

Standard trim

	EO	DT	NL	NL-OP
				
Trim description	9949WDC-EO	9949WDC-DT	9949WDC-NL	9949WDC-NL-OP
Escutcheon plate size	—	3" x 14 ⁷ / ₈ " x 7 ⁵ / ₁₆ "	3" x 14 ⁷ / ₈ " x 7 ⁵ / ₁₆ "	—
Pull center to center	—	5 ⁷ / ₈ " (140mm)	5 ⁷ / ₈ " (140mm)	—
Projection	—	2" (51mm)	2" (51mm)	—
ANSI function	01	02	03	03
Cylinder type	—	—	Rim	Rim
Handing	—	—	—	—
Optional trim	x990EO x996EO	x996K-DT x996L-DT x696DT x697DT	x996K-NL x996L-NL x696NL x697NL	
Optional #425 SNB quantity for device	6	2	2	6

THIS PRODUCT IS OBSOLETE
and has been replaced by the 98/9950 WDC.

See pages 48-51 for more information.

	L	L-NL	L-BE	L-DT
				
	Lever Key locks & unlocks	Lever – night latch Key retracts latchbolt	Lever – blank escutcheon Always operable (no cylinder)	Lever dummy trim pull when dogged
Product description	9849WDC-L 9949WDC-L	9849WDC-L-NL 9949WDC-L-NL	9849WDC-L-BE 9949WDC-L-BE	9849WDC-L-DT 9949WDC-L-DT
Trim description	996L-R/V*	996L-NL-R/V	996L-BE-R/V*	996L-DT
Escutcheon plate size	2 ³ / ₄ " x 10 ³ / ₄ " x 27 ⁵ / ₃₂ " (70x273x21mm)	2 ³ / ₄ " x 10 ³ / ₄ " x 27 ⁵ / ₃₂ " (70x273x21mm)	2 ³ / ₄ " x 10 ³ / ₄ " x 27 ⁵ / ₃₂ " (70x273x21mm)	2 ³ / ₄ " x 10 ³ / ₄ " x 27 ⁵ / ₃₂ " (70x273x21mm)
Pull center to center	—	—	—	—
Projection	2 ⁷ / ₈ " (73mm)	2 ⁷ / ₈ " (73mm)	2 ⁷ / ₈ " (73mm)	2 ⁷ / ₈ " (73mm)
ANSI function	08	03	14	02
Cylinder type	Rim	Rim	—	—
Handing	Handed/Reversible	Handed/Reversible	Handed/Reversible	Handed/Reversible
Optional #425 SNB quantity for device	2	2	2	2

* Electrified lever operation available

Standard door opening height	
Feet	Inches
6'8"	80"
7'	84"
8'	96"
9'	108"
10'	120"

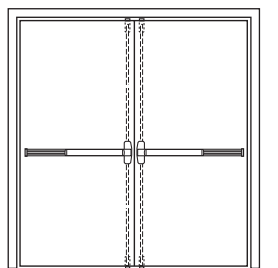

Door opening height
is measured from finished floor
to frame rabbet on door side.

See table on left for standard offering.

Note: Non-standard sizes available with extended lead time. Consult Customer Care for more information 1-877-671-7011.

9849WDC/9949WDC Wood door concealed vertical cable device



THIS PRODUCT IS OBSOLETE

and has been replaced by the 98/9950 WDC.

See pages 48-51 for more information.

Scalp Plate – Device is furnished standard with an 8" (203mm) long scalp plate for easy access to cables.

Note: Do not use on pair of doors with 9975 devices.

Finishes – US3, US3A, US4, US4A, US10, US26, US26D, US26D-AM Antimicrobial, US28, 313, 315 & 643E. US15 and US32D available with 98 Series only.

Specifications

Device functions	Device ships EO/DT/NL. Field selectable. For TP, K or L remove NL drive screw from device.
Device lengths	2' 2' (610 mm) Door size 3' 2'4" to 3' (711mm to 914 mm) Door size 4' 2'10" to 4' (864 mm to 1219 mm) Door size
Device centerline from finished floor	39 ⁵ / ₈ " (1006 mm) Standard
Center case dimensions	8" x 2 ³ / ₄ " x 2 ³ / ₈ " (203mm x 70mm x 60mm)
Mechanism case dimensions	2 ¹ / ₄ " x 2 ¹ / ₄ " (57mm x 57mm)
Projection	Pushbar neutral – 3 ¹³ / ₁₆ " (97 mm) Pushbar depressed – 3 ¹ / ₁₆ " (78 mm)
Latch bolt	Deadlocking top & bottom bolt, 1 ¹ / ₂ " (38mm) throw
Door undercut	³ / ₈ " undercut (10mm)
Top & bottom Latch case	5 ¹³ / ₁₆ " x 1 ¹ / ₄ " x 1 ⁷ / ₁₆ " (147mm x 32mm x 37mm)
Vertical cables	⁷ / ₃₂ " (6mm) Diameter stainless steel cables
Fasteners & sex bolts (SNB)	Includes screw pack for 1 ³ / ₄ " (44mm) to 2 ¹ / ₄ " (57mm) thick wood doors. 425 SNB required on wood doors without SLM blocking.
Electric options	ALK Alarm exit kit CX Chexit delayed exit E Electric unlocking and locking trim EL Electric latch retraction HD-EL Electric latch retraction w/ hex dogging QEL Quiet electric latch retraction *LX Latchbolt monitor switch RX2 Double pushpad monitor switch RX996L Trim monitor switch RX Pushpad monitor switch RXLC Pushpad monitor switch - low current SS Signal switch WP-RX Waterproof request to exit CON Allegion Connect
Mechanical options	GBK Glass bead kit LBL Less bottom latch PN Pneumatic latch retraction SEC Security screws SG Safety glow SNB Sex bolts SLM Special laminate material blocking
Dogging option	No mechanical dogging. EL and QEL option available
Strikes	Top – 249 - Unfinished, Bottom – 349 - Unfinished

CX
Chexit delayed exit
 • Meets NFPA 101 requirements
 • Self-contained controls, locking, alarm

ALK
Alarm exit kit
 • Unauthorized opening triggers 85-decibel horn
 • Set in armed or disarmed mode by key

EL
Electric latch retraction
 • Enables remote unlatching
 • Alternative to manual dogging

LX
Latchbolt monitor switch
 • Signals use of an opening
 • SPDT switch to monitor latch bolt

QEL
Quiet electric latch retraction
 • Bolt retraction via switch
 • Converts exit door to push-pull operation

RX
Pushpad monitor switch
 • Signals use of an opening
 • SPDT switch to monitor pushpad

E (E996L)
Electrified breakaway lever
 • Electrified remote locking/unlocking
 • Standard in fail safe condition





CON
Allegion Connectors
 • Common connectors to connect various door hardware all the way to the power supply





PN
Pneumatic latch retraction
 • For areas where electrical devices banned
 • Special linkage for mechanical or pneumatic dogging

*For 98/9949 devices, LX switch monitors trim input or electric dogging of EL/QEL devices. LX switch does not monitor latchbolt condition.

9849WDC-F/9949WDC-F Wood door concealed vertical cable fire device

Standard trim

	EO	DT	NL	NL-OP
				
		Dummy trim	Night latch	
<h1>THIS PRODUCT IS OBSOLETE</h1> <p>and has been replaced by the 98/9950 WDC.</p> <p>See pages 48-51 for more information.</p>				
Trim description	9849WDC-EO-F 9949WDC-EO-F	9849WDC-DT-F 9949WDC-DT-F	9849WDC-NL-F 9949WDC-NL-F	9849WDC-NL-OP-F 9949WDC-NL-OP-F
Escutcheon plate size	—	3" x 14 ⁷ / ₈ " x 7 ⁵ / ₈ "	3" x 14 ⁷ / ₈ " x 7 ⁵ / ₈ "	—
Pull center to center	—	5 ⁷ / ₈ " (140mm)	5 ⁷ / ₈ " (140mm)	—
Projection	—	2" (51mm)	2" (51mm)	—
ANSI function	01	02	03	03
Cylinder type	—	—	Rim	Rim
Handing	—	—	—	—
Optional trim	x990EO x996EO	x996K-DT x996L-DT x996L-DT x696DT x697DT	x996K-NL x996L-NL x996L-NL x696NL x697NL	
Optional #425 SNB quantity for device	6	2	2	6

	L	L-NL	L-BE	L-DT
				
	Lever	Lever – night latch	Lever – blank escutcheon	Lever dummy trim
	Key locks & unlocks	Key retracts latchbolt	Always operable (no cylinder)	pull when dogged (not recommended for fire device)
Product description	9849WDC-L-F 9949WDC-L-F	9849WDC-L-NL-F 9949WDC-L-NL-F	9849WDC-L-BE-F 9949WDC-L-BE-F	— —
Trim description	996L-R/V*	996L-NL-R/V	996L-BE-R/V*	996L-DT
Escutcheon plate size	2 ³ / ₄ " x 10 ³ / ₄ " x 2 ⁷ / ₃₂ " (70x273x21mm)	2 ³ / ₄ " x 10 ³ / ₄ " x 2 ⁷ / ₃₂ " (70x273x21mm)	2 ³ / ₄ " x 10 ³ / ₄ " x 2 ⁷ / ₃₂ " (70x273x21mm)	2 ³ / ₄ " x 10 ³ / ₄ " x 2 ⁷ / ₃₂ " (70x273x21mm)
Pull center to center	—	—	—	—
Projection	2 ⁷ / ₈ " (73mm)	2 ⁷ / ₈ " (73mm)	2 ⁷ / ₈ " (73mm)	2 ⁷ / ₈ " (73mm)
ANSI function	08	03	14	02
Cylinder type	Rim	Rim	—	—
Handing	Handed/Reversible	Handed/Reversible	Handed/Reversible	Handed/Reversible
Optional #425 SNB quantity for device	2	2	2	2

* Electrified lever operation available

Standard door opening height	
Feet	Inches
6'8"	80"
7'	84"
8'	96"
9'	108"
10'	120"

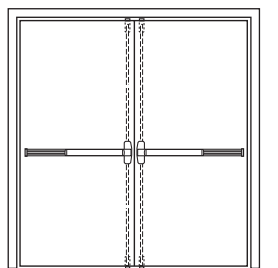

Door opening height
is measured from finished floor
to frame rabbet on door side.

See table on left for standard offering.

Note: Non-standard sizes available with extended lead time. Consult Customer Care for more information 1-877-671-7011.

9850WDC/9950WDC Wood door concealed vertical cable device



9850WDC/9950WDC Concealed vertical cable device for use on single or double wood doors, UL listed for panic exit hardware. Devices are ANSI A156.3 – 2008 Grade 1. The 9850WDC device has a smooth mechanism case and the 9950WDC device has a grooved case. The concealed vertical cable device is non-handed except when the following device options are used: SD (special dogging), or SS (signal switch). See Opposite page for available outside trim and functions.

Scalp Plate – Device is furnished standard with an 15" (381 mm) long scalp plate for easy access to cables.

Note: Do not use on pair of doors with 9975 devices.

Finishes – US3, US3A, US4, US4A, US10, US26, US26D, US26D-AM Antimicrobial, US28, 313, 315 & 643E. US15 and US32D available with 98 Series only.

Specifications

Device functions	Device ships EO/DT/NL. Field selectable. For TP, K or L remove NL drive screw from device.
Device lengths	2' 2' (610 mm) Door size 3' 2'4" to 3' (711mm to 914 mm) Door size 4' 2'10" to 4' (864 mm to 1219 mm) Door size
Device centerline from finished floor	39 ⁵ / ₈ " (1006 mm) Standard
Center case dimensions	8" x 2 ³ / ₄ " x 2 ³ / ₈ " (203mm x 70mm x 60mm)
Mechanism case dimensions	2 ¹ / ₄ " x 2 ¹ / ₄ " (57mm x 57mm)
Projection	Pushbar neutral – 3 ¹³ / ₁₆ " (97 mm) Pushbar depressed – 3 ¹ / ₁₆ " (78 mm)
Latch bolt	Deadlocking top & bottom bolt. 1 ¹ / ₂ " (38mm) throw
Door undercut	3 ³ / ₄ " (19mm) maximum
Top & bottom Latch case	5 ¹³ / ₁₆ " x 1 ¹ / ₄ " x 1 ⁷ / ₁₆ " (147mm x 32mm x 37mm)
Vertical cables	7 ⁷ / ₃₂ " (6mm) Diameter stainless steel cables
Fasteners & sex bolts (SNB)	Includes screw pack for 1 ³ / ₄ " (44mm) to 2 ¹ / ₄ " (57mm) thick wood doors.
Electric options	ALK Alarm exit kit CX Chexit delayed exit E Electric unlocking and locking trim EL Electric latch retraction HD-EL Electric latch retraction w/ hex dogging QEL Quiet electric latch retraction *LX Latchbolt monitor switch RX2 Double pushpad monitor switch RX996L Trim monitor switch RX Pushpad monitor switch RXLC Pushpad monitor switch - low current SS Signal switch WP-RX Waterproof request to exit CON Allegion Connect
Mechanical options	GBK Glass bead kit LBL Less bottom latch PN Pneumatic latch retraction SEC Security screws SG Safety glow SNB Sex bolts AX Accessible device (LBL only)
Dogging feature Dogging option	Hex key dogging standard CD Cylinder dogging SD Special center case dogging LD Less dogging DI Dogging indicator CI Cylinder dogging indicator
Strikes	Top - 249 – Unfinished, Bottom - 450 – Unfinished

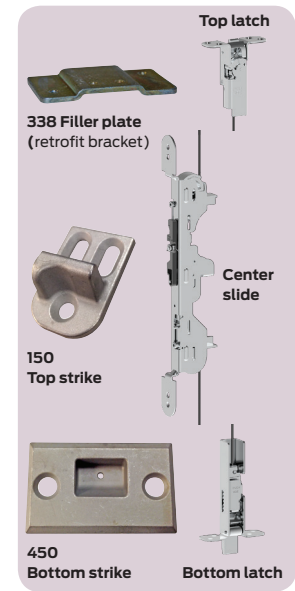

Hex key dogging comes standard on 9850/9950 Wood door concealed vertical cable devices

CX
Chexit delayed exit
• Meets NFPA 101 requirements
• Self-contained controls, locking, alarm

ALK
Alarm exit kit
• Unauthorized opening triggers 85-decibel horn
• Set in armed or disarmed mode by key

EL
Electric latch retraction
• Enables remote unlatching
• Alternative to manual dogging

RX
Pushpad monitor switch
• Signals use of an opening
• SPDT switch to monitor pushpad

QEL
Quiet electric latch retraction
• Bolt retraction via switch
• Converts exit door to push-pull operation

LX
Latchbolt monitor switch
• Signals use of an opening
• SPDT switch to monitor latch bolt



E (E996L)
Electrified breakaway lever
• Electrified remote locking/unlocking
• Standard in fail safe condition





CON
Allegion Connectors
• Common connectors to connect various door hardware all the way to the power supply

PN
Pneumatic latch retraction
• For areas where electrical devices banned
• Special linkage for mechanical or pneumatic dogging

*For 98/9950WDC devices, LX switch monitors trim input or electric dogging of EL/QEL devices. LX switch does not monitor latchbolt condition.

Standard trim

	EO No outside trim Exit only	DT  Dummy trim Pull when dogged	NL  Night latch Key retracts latchbolt	NL-OP  Night latch Key retracts latchbolt optional pull required
Product description	9850WDC-EO 9950WDC-EO	9850WDC-DT 9950WDC-DT	9850WDC-NL 9950WDC-NL	9850WDC-NL-OP 9950WDC-NL-OP
Trim description	—	990DT	990NL-R/V	110NL-WD
Escutcheon plate size	—	3" x 14 ^{13/16} " x 3 ^{3/32} " (76x360x2mm)	3" x 14 ^{13/16} " x 3 ^{3/32} " (76x360x2mm)	—
Pull center to center	—	5 1/2" (140mm)	5 1/2" (140mm)	—
Projection	—	2" (51mm)	2" (51mm)	—
ANSI function	01	02	03	03
Cylinder type	—	—	Rim	Rim
Handing	—	—	—	—
Optional trim	x990EO x996EO	x996K-DT x996L-DT x696DT x697DT	x996K-NL x996L-NL x696NL x697NL	
Optional #425 SNB quantity for device	6	2	2	6

	L  Lever Key locks & unlocks	L-NL  Lever – night latch Key retracts latchbolt	L-BE  Lever – blank escutcheon Always operable (no cylinder)	L-DT  Lever dummy trim pull when dogged
Product description	9850WDC-L 9950WDC-L	9850WDC-L-NL 9950WDC-L-NL	9850WDC-L-BE 9950WDC-L-BE	9850WDC-L-DT 9950WDC-L-DT
Trim description	996L-R/V*	996L-NL-R/V	996L-BE-R/V*	996L-DT
Escutcheon plate size	2 3/4" x 10 3/4" x 27/32" (70x273x21mm)	2 3/4" x 10 3/4" x 27/32" (70x273x21mm)	2 3/4" x 10 3/4" x 27/32" (70x273x21mm)	2 3/4" x 10 3/4" x 27/32" (70x273x21mm)
Pull center to center	—	—	—	—
Projection	2 7/8" (73mm)	2 7/8" (73mm)	2 7/8" (73mm)	2 7/8" (73mm)
ANSI function	08	03	14	02
Cylinder type	Rim	Rim	—	—
Handing	Handed/Reversible	Handed/Reversible	Handed/Reversible	Handed/Reversible
Optional #425 SNB quantity for device	2	2	2	2

* Electrified lever operation available

Standard door opening height	
Feet	Cable tolerance
6'8" - 7'	72" - 84"
7'1" - 8'	85" - 96"
8'1" - 9'	97" - 108"
9'1" - 10'	109" - 120"

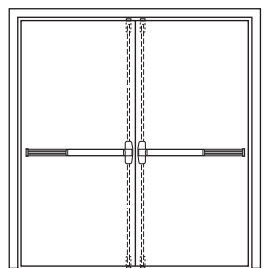

Door opening height
is measured from finished floor
to frame rabbet on door side.

See table on left for standard offering.

Note: Non-standard sizes available with extended lead time. Consult Customer Care for more information 1-877-671-7011.

9850WDC-F/9950WDC-F Wood door concealed vertical cable fire device

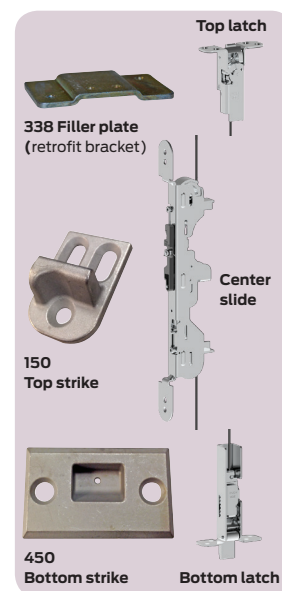
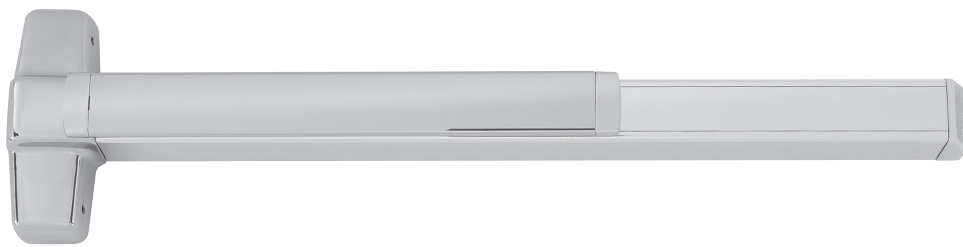

9850WDC-F/9950WDC-F Fire exit concealed vertical cable device for use on pairs of doors up to 8' x 9' 3" (2438mm x 2819mm) double wood doors, UL listed for fire exit hardware. See page 76 for detailed information on UL listed fire exit hardware label and door opening size information. Devices are ANSI A156.3 – 2008 Grade 1. The 9850WDC-F device has a smooth mechanism case and the 9950WDC-F device has a grooved case. The concealed vertical cable device is non-handed except when the following device options are used: SS (signal switch). See opposite page for available outside trim and functions.

Scalp Plate – Device is furnished standard with an 15" (381 mm) long scalp plate for easy access to cables.

Note: Do not use on pair of doors with 9975 devices.

Finishes – US3, US3A, US4, US4A, US10, US26, US26D, US26D-AM Antimicrobial, US28, 313, 315 & 643E. US15 and US32D available with 98 Series only.

Specifications

Device functions	Device ships EO/DT/NL. Field selectable. For TP, K or L remove NL drive screw from device.
Device lengths	2' 2' (610 mm) Door size 3' 2'4" to 3' (711mm to 914 mm) Door size 4' 2'10" to 4' (864 mm to 1219 mm) Door size
Device centerline from finished floor	39 ⁵ / ₈ " (1006 mm) Standard
Center case dimensions	8" x 2 ³ / ₄ " x 2 ³ / ₈ " (203mm x 70mm x 60mm)
Mechanism case dimensions	2 ¹ / ₄ " x 2 ¹ / ₄ " (57mm x 57mm)
Projection	Pushbar neutral – 3 ¹³ / ₁₆ " (97 mm) Pushbar depressed – 3 ¹ / ₁₆ " (78 mm)
Latch bolt	Deadlocking top & bottom bolt, 1 ¹ / ₂ " (38mm) throw
Door undercut	³ / ₄ " (19mm) maximum
Top & bottom Latch case	5 ¹³ / ₁₆ " x 1 ¹ / ₄ " x 1 ⁷ / ₁₆ " (147mm x 32mm x 37mm)
Vertical cables	⁷ / ₃₂ " (6mm) Diameter stainless steel cables
Fasteners & sex bolts (SNB)	Includes screw pack for 1 ³ / ₄ " (44mm) to 2 ¹ / ₄ " (57mm) thick wood doors.
Electric options	ALK Alarm exit kit CX Chexit delayed exit E Electric unlocking and locking trim EL Electric latch retraction HD-EL Electric latch retraction w/ hex dogging QEL Quiet electric latch retraction *LX Latchbolt monitor switch RX2 Double pushpad monitor switch RX996L Trim monitor switch RX Pushpad monitor switch RXLC Pushpad monitor switch - low current SS Signal switch WP-RX Waterproof request to exit CON Allegion Connect
Mechanical options	GBK Glass bead kit LBL Less bottom latch PN Pneumatic latch retraction SEC Security screws SG Safety glow SNB Sex bolts SLM Special laminate material blocking AX Accessible device (LBL only)
Dogging option	No mechanical dogging. EL and QEL option available
Strikes	Top – 249 - Unfinished, Bottom – 450 - Unfinished

CX
Chexit delayed exit
 • Meets NFPA 101 requirements
 • Self-contained controls, locking, alarm

ALK
Alarm exit kit
 • Unauthorized opening triggers 85-decibel horn
 • Set in armed or disarmed mode by key

EL
Electric latch retraction
 • Enables remote unlatching
 • Alternative to manual dogging

LX
Latchbolt monitor switch
 • Signals use of an opening
 • SPDT switch to monitor latch bolt

QEL
Quiet electric latch retraction
 • Bolt retraction via switch
 • Converts exit door to push-pull operation

RX
Pushpad monitor switch
 • Signals use of an opening
 • SPDT switch to monitor pushpad

E (E996L)
Electrified breakaway lever
 • Electrified remote locking/unlocking
 • Standard in fail safe condition





CON
Allegion Connectors
 • Common connectors to connect various door hardware all the way to the power supply





PN
Pneumatic latch retraction
 • For areas where electrical devices banned
 • Special linkage for mechanical or pneumatic dogging

*For 98/9950 devices, LX switch monitors trim input or electric dogging of EL/QEL devices. LX switch does not monitor latchbolt condition.



Standard trim

	EO	DT	NL	NL-OP
				
Product description	9850WDC-EO-F 9950WDC-EO-F	— —	9850WDC-NL-F 9950WDC-NL-F	9850WDC-NL-OP-F 9950WDC-NL-OP-F
Trim description	—	990DT	990NL-R/V	110NL-WD
Escutcheon plate size	—	3" x 14 ^{13/16} " x 3 ^{3/32} " (76x360x2mm)	3" x 14 ^{13/16} " x 3 ^{3/32} " (76x360x2mm)	—
Pull center to center	—	5 ^{1/2} " (140mm)	5 ^{1/2} " (140mm)	—
Projection	—	2" (51mm)	2" (51mm)	—
ANSI function	01	02	03	03
Cylinder type	—	—	Rim	Rim
Handing	—	—	—	—
Optional trim	x990EO x996EO	x996K-DT x996L-DT x996L-DT x696DT x697DT	x996K-NL x996L-NL x996L-NL x696NL x697NL	
Optional #425 SNB quantity for device	6	2	2	6

	L	L-NL	L-BE	L-DT
				
Product description	9850WDC-L-F 9950WDC-L-F	9850WDC-L-NL-F 9950WDC-L-NL-F	9850WDC-L-BE-F 9950WDC-L-BE-F	— —
Trim description	996L-R/V*	996L-NL-R/V	996L-BE-R/V*	996L-DT
Escutcheon plate size	2 ^{3/4} " x 10 ^{3/4} " x 27 ^{3/32} " (70x273x21mm)	2 ^{3/4} " x 10 ^{3/4} " x 27 ^{3/32} " (70x273x21mm)	2 ^{3/4} " x 10 ^{3/4} " x 27 ^{3/32} " (70x273x21mm)	2 ^{3/4} " x 10 ^{3/4} " x 27 ^{3/32} " (70x273x21mm)
Pull center to center	—	—	—	—
Projection	2 ^{7/8} " (73mm)	2 ^{7/8} " (73mm)	2 ^{7/8} " (73mm)	2 ^{7/8} " (73mm)
ANSI function	08	03	14	02
Cylinder type	Rim	Rim	—	—
Handing	Handed/Reversible	Handed/Reversible	Handed/Reversible	Handed/Reversible
Optional #425 SNB quantity for device	2	2	2	2

* Electrified lever operation available

Standard door opening height	
Feet	Cable tolerance
6'8" - 7'	72" - 84"
7'1" - 8'	85" - 96"
8'1" - 9'	97" - 108"
9'1" - 10'	109" - 120"

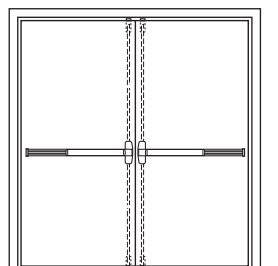









Door opening height
is measured from finished floor to frame rabbet on door side.

See table on left for standard offering.

Note: Non-standard sizes available with extended lead time. Consult Customer Care for more information 1-877-671-7011.





98/99 Optional trim

Knob, exit only and thumbpiece trim – 990 & 996K





	K	K-NL	K-BE	K-DT	EO	TP	TP-BE	EO
								
	Knob Key locks & unlocks	Knob – night latch Key retracts latchbolt	Knob – blank escutcheon Always operable (no cylinder)	Knob – dummy trim Pull when dogged	Exit only plate	Thumbpiece Key locks & unlocks	Thumbpiece blank escutcheon Always operable (no cylinder)	Exit only plate
Trim description	996K	996K-NL	996K-BE	996K-DT	996EO	990TP	990TP-BE	990EO
Escutcheon plate size	2 ³ / ₄ " x 10 ³ / ₄ " x 27 ³ / ₃₂ " (70x273x21mm)	2 ³ / ₄ " x 10 ³ / ₄ " x 27 ³ / ₃₂ " (70x273x21mm)	2 ³ / ₄ " x 10 ³ / ₄ " x 27 ³ / ₃₂ " (70x273x21mm)	2 ³ / ₄ " x 10 ³ / ₄ " x 27 ³ / ₃₂ " (70x273x21mm)	2 ³ / ₄ " x 10 ³ / ₄ " x 27 ³ / ₃₂ " (70x273x21mm)	3" x 14 ³ / ₁₆ " x 3 ³ / ₃₂ " (76x360x2mm)	3" x 14 ³ / ₁₆ " x 3 ³ / ₃₂ " (76x360x2mm)	3" x 14 ³ / ₁₆ " x 3 ³ / ₃₂ " (76x360x2mm)
Pull center to center	—	—	—	—	—	5 ¹ / ₂ " (140mm)	5 ¹ / ₂ " (140mm)	5 ¹ / ₂ " (140mm)
Projection	3 ¹ / ₄ " (83mm)	3 ¹ / ₄ " (83mm)	3 ¹ / ₄ " (83mm)	3 ¹ / ₄ " (83mm)	—	2" (51mm)	2" (51mm)	Z
ANSI function	08	09	14	02	01	05	14	14
Cylinder type								
Rim or vertical rod device	Rim	Rim	—	—	—	Rim	—	—
Mortise lock device	1 ¹ / ₄ " Mortise	1 ¹ / ₄ " Mortise			—	1 ¹ / ₄ " Mortise	—	—
Handing	—	—	—	—	—	—	—	—
#425 SNB optional-HMD req. WD w/o SLM pkg.	2	2	2	2	2	2	2	2
#825 SNB req. WD w/o SLM pkg F Rim device ONLY	2	2	2	2	2	2	2	2
#425 SNB req. w/499F	2	2	2	2	2	2	2	2

98/99 Optional trim

Optional trims – 696

	DT  Dummy trim Pull when dogged (not recommended for fire device)	NL  Night latch Key retracts latchbolt	TP  Thumbpiece Key locks & unlocks	TP-BE  Thumbpiece – blank escutcheon Always operable (no cylinder)
Trim description	696DT	696NL	696TP	696TP-BE
Escutcheon plate size	2 ³ / ₄ " x 10 ³ / ₄ " x 27 ³ / ₃₂ " (70x273x21mm)	2 ³ / ₄ " x 10 ³ / ₄ " x 27 ³ / ₃₂ " (70x273x21mm)	1 ⁵ / ₈ " x 13 ¹ / ₂ " x 3 ³ / ₁₆ " (41x343x5mm)	1 ⁵ / ₈ " x 13 ¹ / ₂ " x 3 ³ / ₁₆ " (41x343x5mm)
Pull center to center	5 ¹ / ₂ " (140mm)	5 ¹ / ₂ " (140mm)	5 ¹ / ₂ " (140mm)	5 ¹ / ₂ " (140mm)
Projection	2 ¹ / ₆ " (52mm)	2 ¹ / ₆ " (52mm)	2 ¹ / ₆ " (52mm)	2 ¹ / ₆ " (52mm)
ANSI function	02	03	05	15
Cylinder type				
Rim or vertical rod device	—	Rim	Rim	—
Mortise lock device	—	1 ¹ / ₄ " Mortise	1 ¹ / ₄ " Mortise	—
Handing	—	—	—	—
#425 SNB optional-HMD req. WD w/o SLM pkg.	2	2	2	2
#825 SNB req. WD w/o SLM pkg F Rim device ONLY	2	2	2	2
#425 SNB req. w/499F	2	2	2	2

Optional trims – 697

	DT  Dummy trim Pull when dogged (not recommended for fire device)	NL  Night latch Key retracts latchbolt	TP  Thumbpiece Key locks & unlocks (3/4" diameter pull) (19mm)	TP-BE  Thumbpiece – blank escutcheon Always operable (no cylinder) (3/4" diameter pull) (19mm)
Trim description	697DT	697NL	697TP	697TP-BE
Escutcheon plate size	2 ³ / ₄ " x 10 ³ / ₄ " x 27 ³ / ₃₂ " (70x273x21mm)	2 ³ / ₄ " x 10 ³ / ₄ " x 27 ³ / ₃₂ " (70x273x21mm)	1 ⁵ / ₈ " x 13 ¹ / ₂ " x 3 ³ / ₁₆ " (41x343x5mm)	2 ³ / ₄ " x 10 ³ / ₄ " x 27 ³ / ₃₂ " (70x273x21mm)
Pull center to center	5 ¹ / ₂ " (140mm)	5 ¹ / ₂ " (140mm)	5 ¹ / ₂ " (140mm)	5 ¹ / ₂ " (140mm)
Projection	3" (76mm)	3" (76mm)	3" (76mm)	3" (76mm)
ANSI function	02	03	05	15
Cylinder type				
Rim or vertical rod device	—	Rim	Rim	—
Mortise lock device	—	1 ¹ / ₄ " Mortise	1 ¹ / ₄ " Mortise	—
Handing	—	—	—	—
#425 SNB optional-HMD req. WD w/o SLM pkg.	2	2	2	2
#825 SNB req. WD w/o SLM pkg F Rim device ONLY	2	2	2	2
#425 SNB req. w/499F	2	2	2	2

98/99 Optional trim

HL6 Hospital pull



Von Duprin and Glynn-Johnson have collaborated on an exit device trim that answers the problem of accessibility and performance. Using the Von Duprin 98/9975 mortise lock exit device along with the Glynn-Johnson HL6 push/pull latch, Allegion has created an exit device with mortise lock durability that utilizes a fully ADA compliant Pull paddle trim. The 98/9975HL device is available in all standard architectural finishes. Consult the Glynn-Johnson catalog for complete product information.

392-7 Offset pull



The 392-7 Offset pull is $\frac{3}{4}$ " round stainless steel, with a 7" center to center which matches the 98/99 center case. Often used with a night latch operation. $3\frac{1}{2}$ " (89mm) offset with $1\frac{1}{2}$ " (38mm) clearance.

Vandal resistant trim: IVES VR910 & VR914 Series

VR910 grip coated in black plastisol for softer touch and resilience to temperature extremes. Grip designed for comfortable operation. VR914 grip in all stainless steel.

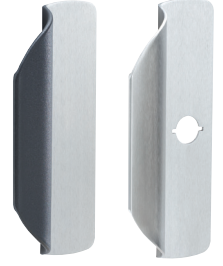

Features:

- Stainless steel construction, 11 gauge (0.120" thick)
- Finish: US32D, only
- Thru-bolts and rugged mounting screws for maximum fastening strength.
- Built-in lock protector prevents vandalism to mortise latchbolt (available on certain models).
- Extra-tough stainless steel cylinder collar prevents pipe wrench or similar tool from damaging cylinder. Tapered design prevents side impacts from transferring directly to cylinder. Collar spins freely.
- Furnished with mounting screws for door thicknesses of $1\frac{3}{4}$ " to $2\frac{1}{4}$ "

Model	For use with	Size
VR910DT & VR914DT	98/99 Rim or vertical rod device	5 $\frac{1}{2}$ " (133mm) w x 11" (279mm) h
VR910NL & VR914NL	98/99 Rim or vertical rod device	5 $\frac{1}{2}$ " (133mm) w x 11" (279mm) h
VR910M-DT & VR914M-DT	9875/9975 Mortise device	7 $\frac{1}{4}$ " (184mm) w x 11" (279mm) h
VR910M-NL & VR914M-NL Handing required	9875/9975 Mortise device	7 $\frac{1}{4}$ " (184mm) w x 11" (279mm) h

- Meets ANSI/BHMA 156.13, Trim security test and California State Accessibility Standards Title 24.
- $1\frac{1}{2}$ " (38mm) clearance from grip to door, total projection $1\frac{7}{8}$ " (48mm)
- Consult the IVES catalog for complete product information.

This page intentionally left blank



Schlage AD-Series

AD-Series adaptable electronic locks

The AD-Series was designed to be the right choice for today, and is ready to adapt to whatever the future holds.

There are a variety of options that allow you to select the AD-Series electronic lock that's right for you, and a wide selection of features that can be configured in the field to further customize each opening. When your needs change in the future, the innovative modular design of the AD-Series allows you to easily upgrade the credential reader or networking option, and adapt to emerging technologies using your existing chassis – all without taking the lock off the door. This means that you can be confident that your choice of the AD-Series is right for today, and that your investment will be protected into the future.



Credential reader options

AD-Series electronic locks are compatible with many different brands and technologies of credentials.



- Multi-technology (reads 125 kHz prox and 1 3.56 MHz smart)
- + KEYPAD



- Magnetic stripe (insertion)
- + KEYPAD



- Magnetic stripe (swipe)
- + KEYPAD



- Keypad

Communications options

Networked

In facilities where increased monitoring and control are needed, a networked solution is essential. The AD-Series networked options feature:

- Open architecture platform
- Acceptable reader technology
- Real-time monitoring

The AD-Series networked lock is available in either a wireless or hardwired configuration to fit your application needs.

- AD-300** Networked hardwired locks
- AD-301** Networked hardwired FIPS 201-1 compliant locks
- AD-400** Networked wireless locks
- AD-401** Networked wireless FIPS 201-1 compliant locks

Standalone

Standalone locks are a cost-effective solution for doors that do not require real-time monitoring. The AD-Series standalone solution provides:

- Upgradability
- Improved credential management
- Audit trail reports

Schlage offers two AD-Series standalone solutions to fit your environment:

- AD-200** Access rights are stored on the lock
- AD-250** Access rights are stored on the magnetic stripe credential

Chassis

- Cylindrical
- Mortise
- Mortise deadbolt
- Exit trim*

Locking functions

- Classroom/Storeroom
- Office
- Privacy
- Apartment

Lever styles



Sparta

Rhodes

Athens

Tubular

Warm Tone Finishes



605
Bright brass

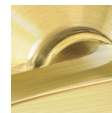

606
Satin brass



612
Satin bronze

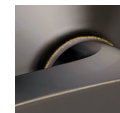

643e
Aged bronze

Cool Tone Finishes

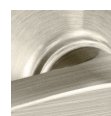

619
Satin nickel



625
Bright chrome

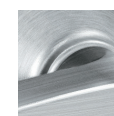

626
Satin chrome

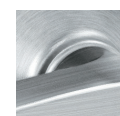

626AM
Satin chrome with antimicrobial

Certifications

- ANSI/BMHA A156.25
- ANSI/BHMA Grade 1
- UL 294 Listed
- UL 10C
- ADA
- FCC part 15
- RoHS
- FIPS 201-1 (AD-301 and AD-401)

Complete your system

Complete your AD-Series system with readers and credentials, biometric hand geometry readers, system components, HHD programming device and other wireless accessories.

*See AD-Series exit trim compatibility Datasheet for complete list of compatibility by manufacturer.

Schlage CO-Series

CO-Series electronic locks from Schlage

In the world of standalone electronic locks, nothing compares to the CO-Series from Schlage. And because CO-Series locks offer a wide variety of options, it's easy to find the right solution for any facility. For openings with a relatively small number of users, we recommend the CO-100. It's an offline keypad programmable lock. For larger applications try the CO-200 or CO-250. They're computer programmable locks that can provide audit trails. They also offer dual credential options (card+PIN) that provide an even greater level of security.



Compatible

The CO-Series was designed to easily integrate into your facility. It can work in conjunction with Schlage and Locknetics electronic locks and offers expanded cylinder, exit device, and credential compatibility.

Exit device compatibility*

	Rim	SVR	CVR/CVC	Mortise
Von Duprin 98/99 & 98/99 XP	✓	✓	✓	✓
Von Duprin 22/22F	✓	✓		
Falcon 25	✓			

*See AD-Series Exit trim compatibility datasheet for complete list of compatibility by manufacturer.

Cylinder compatibility

	Full size key-in-lever 6 pin	Full size key-in-lever 7 pin	FSIC 6 & 7 pin	SFIC 6 & 7 pin
Schlage	●		●	●
Falcon	▲	*		
Sargent® (10L + 11L full size)	▲		▲	▲
Corbin Russwin®			▲	▲
Yale® (includes Medeco 31*0100 FSIC)			▲	▲
Best®				▲

● = with cylinder or less cylinder options

▲ = less cylinder only

* = less cylinder, only with Sparta and Rhodes levers

Note: See price book for specific configurations

Credential compatibility

The CO-Series is compatible with many different brands and credential technologies.

For customers with an installed base of iButtons®, a combo proximity keyfob with iButton option is available to make an easy transition to proximity technology.

Class

CO-100

- Manually programmable • User rights stored on the lock
- Keypad only

CO-200 (shown)

- Computer or manually programmable
- User rights stored on the lock

CO-250

- Computer programmable • User rights stored on the card

Readers

- Keypad
- Magnetic stripe (swipe)
- Proximity
- Magnetic stripe plus keypad (swipe)
- Proximity plus keypad

Lever styles



Sparta

Rhodes

Athens

Tubular

Chassis

- Cylindrical
- Mortise
- Mortise deadbolt
- Exit Trim

Power

- 4 standard off the shelf (AA) batteries

Functions

- Classroom/storeroom
- Privacy
- Office

Warm tone finishes



605
Bright brass



606
Satin brass



612
Satin bronze

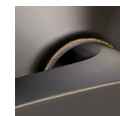

643e
Aged bronze

Cool tone finishes

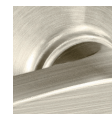

619
Satin nickel



625
Bright chrome

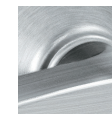

626
Satin chrome

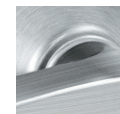

626AM
Satin chrome
with antimicrobial

Reliable

When it comes to securing your facility, you can't afford to take chances. CO-Series locks are tested to the highest quality and reliability standards in the industry, including:

- NSI/BHMA A156.25 & ANSI/BHMA Grade 1
- UL 294
- UL 10C
- ADA

98/99 Strike/Stile information

Device type	Standard single door	Optional single door			Optional double door		
	Strike	Strike	Trim/stile		Strike w/mullion*	Trim/Stile	
			990/996	696/697		990/996	696/697
98/99	299	1439 or 1410	3 ¹³ / ₁₆ " (97mm)	3 ¹³ / ₁₆ " (97mm)	299 x 5654	4 ⁷ / ₁₆ " (113mm)	4 ¹ / ₄ " (108mm)
						1408 x 5754	3 ¹³ / ₁₆ " (97mm)
		1606	4 ¹ / ₁₆ " (103mm)	3 ¹⁵ / ₁₆ " (100mm)	1606 x 1654	4 ³ / ₈ " (112mm)	4 ¹ / ₄ " (108mm)
XP 98/99	909	—	—	—	—	—	—
98-F/99-F	299F	—	—	—	499F x 9854 KR9954	—	—
XP98-F/XP99-F	909	—	—	—	—	—	—
9875 9975	575	—	—	—	576A-576B	4 ³ / ₈ " (121mm)	4 ³ / ₈ " (121mm)
9875-F 9975-F	575	—	—	—	576A-576B	4 ³ / ₈ " (121mm)	4 ³ / ₈ " (121mm)
9857 9957	299 (Top)	1439 or 1410	3 ¹³ / ₁₆ " (97mm)	3 ¹³ / ₁₆ " (97mm)	299 x 5654	4 ⁷ / ₁₆ " (113mm)	4 ¹ / ₄ " (108mm)
	299 (Middle)				1408 x 5754	3 ¹³ / ₁₆ " (97mm)	3 ¹³ / ₁₆ " (97mm)
	304L/248L-4 (Bottom)	1606	4 ¹ / ₁₆ " (103mm)	3 ¹⁵ / ₁₆ " (100mm)	1606 x 1654	4 ³ / ₈ " (112mm)	4 ¹ / ₄ " (108mm)
9857-F 9957-F	299F* (Top) 299F (Middle) 304L (Bottom)	—	—	—	—	—	—
	Strike	Optional strike			Application	Trim/Stile	
						990/996	696/697
9827 9927 Latch retraction	299 (Top) 304L/248L-4 (Bottom)	260U (Top) 385A (Bottom)			Single door	3 ¹¹ / ₁₆ " (94mm)	3 ⁵ / ₈ " (92mm)
PL9827/PL9927 Pullman latch	299 (Top) 304L/248L-4 (Bottom)				Two vertical rod devices	3 ¹¹ / ₁₆ " (94mm)	3 ⁵ / ₈ " (92mm)
9827-F 9927-F	299F* (Top) 304L (Bottom)	260U (Stainless) 385A (Bottom)			Vertical rod with Mortise lock device	4 ³ / ₈ " (121mm)	4 ³ / ₈ " (121mm)
9847 9947 9848 9948	338 (Top) 385A (Bottom)	304L (Bottom)			Two vertical rods	4 ¹ / ₄ " (108mm)	4 ¹ / ₈ " (105mm)
9847-F 9947-F 9848-F 9948-F	338 (Top) 385A (Bottom)	304L (Bottom)			Vertical rod with Mortise lock device	4 ³ / ₈ " (121mm)	4 ³ / ₈ " (121mm)
9847WDC 9947WDC	338 (Top) 385A (Bottom)	304L (Bottom)			Single door	4 ¹ / ₄ " (108mm)	4 ¹ / ₄ " (108mm)
					Two vertical rod devices	4 ¹ / ₄ " (108mm)	4 ¹ / ₄ " (108mm)
					Vertical rod with Mortise lock device	4 ³ / ₈ " (121mm)	4 ³ / ₈ " (121mm)
9847WDC-F 9947WDC-F	338 (Top) 385A (Bottom)	304L (Bottom)			Two vertical rod devices	4 ¹ / ₄ " (108mm)	4 ¹ / ₄ " (108mm)
9849 9949 9849 9949	249 (Top) 349 (Bottom)	—			Vertical cable with Mortise lock device	4 ³ / ₈ " (121mm)	4 ³ / ₈ " (121mm)
9849-F 9949-F 9849-F 9949-F	249 (Top) 349 (Bottom)	—			Two vertical cable	4 ¹ / ₄ " (108mm)	4 ¹ / ₈ " (105mm)
					Vertical cable with Mortise lock device	4 ³ / ₈ " (121mm)	4 ³ / ₈ " (121mm)
9850WDC 9950WDC	150 (Top) 450 (Bottom)	—			Single door	4 ¹ / ₄ " (108mm)	4 ¹ / ₄ " (108mm)
					Two vertical Cable devices	4 ¹ / ₄ " (108mm)	4 ¹ / ₄ " (108mm)
					Vertical cable with Mortise lock device	4 ³ / ₈ " (121mm)	4 ³ / ₈ " (121mm)
9850WDC-F 9950WDC-F	150 (Top) 450 (Bottom)	—			Two Vertical Cable Devices	4 ¹ / ₄ " (108mm)	4 ¹ / ₄ " (108mm)

*499F strike is the top strike for LBR applications.

98/99 Strike information

Strikes for rim devices

264 <p>Projection $\frac{9}{16}$" (14mm)</p>	299 <p>Projection $\frac{13}{16}$" (21mm)</p>	299F <p>Projection $\frac{13}{16}$" (21mm)</p>	499F <p>Projection $\frac{15}{16}$" (24mm)</p>	1408 <p>One per pair of doors</p>
1439-Blade stop <p>Projection $\frac{1}{2}$" (13mm)</p>	1410-Integral stop <p>Projection $\frac{1}{2}$" (13mm)</p>	1606 <p>Projection $\frac{3}{8}$" (10mm) Panic devices only</p>	1609 <p>- Requires coordinator - For panic exit application only, not fire rated</p>	

XP Strikes for rim devices

909 <p>Projection $\frac{13}{16}$" (21mm)</p>	954 <p>Projection $\frac{7}{8}$" (22mm) - For fire rated double door applications</p>
--	--

Strikes for vertical cable devices

249 - Top strike <p>Projection $\frac{9}{16}$" (14mm)</p>	349 - Bottom strike <p>Projection $\frac{1}{8}$" (3mm)</p>
--	---

Strikes for vertical rod devices

248L-4 <p>Projection $\frac{3}{8}$" (10mm)</p>	260U-Flush transom panic only 260U-F-Flush transom fire only <p>Projection $\frac{3}{8}$" (10mm)</p>	299 <p>Projection $\frac{13}{16}$" (21mm)</p>	299F <p>Projection $\frac{13}{16}$" (21mm)</p>	499F <p>Projection $\frac{15}{16}$" (24mm)</p>
304L <p>Projection $\frac{13}{16}$" (21mm)</p>	338 <p>Mortise $\frac{5}{8}$" (16mm)</p>	385A <p>Mortise $2\frac{1}{2}$" (64mm)</p>	283 <p>For use with WDC devices when used with wood frames</p>	

Strikes for mortise lock devices

575 <p>For use on $\frac{13}{4}$" (44mm) or $2\frac{1}{4}$" (57mm) Single door and $2\frac{1}{4}$" (57mm) double door with coordinator.</p>	575-2 <p>For use on $\frac{13}{4}$" (44mm) thick double door with coordinator and astragal.</p>	576A <p>Open back strike for $\frac{13}{4}$" (44mm) thick double doors without coordinator.</p>	576B <p>Open back strike for $2\frac{1}{4}$" (57mm) thick double doors without coordinator.</p>
--	--	--	--

- Not for use with astragals
- For use on wood doors, contact door manufacturer

- Acceptable for 90 minute pair of hollow metal doors

98/99 Dogging options

CDSI/HDSI dogging indicators



Indicator provides an at-a-glance verification of the status of the door from inside of the room. Visible "LOCKED" and "UNLOCKED" indicators show whether the device is undogged or dogged. This feature can be used with Hex key (HDSI) or Cylinder dogging (CDSI) options

on various device types – rim, mortise and vertical systems.

- Modular conversion kits allow you to quickly and easily upgrade your existing devices
- Available for 98/99 & 33A/35A Series panic devices

To order, specify:

- Use prefix, CDSI or HDSI, example CDSI99L

CD Cylinder dogging



Cylinder dogging is available on all 98/99™ Panic exit devices to replace the standard hex key dogging. Unit requires a standard 1 1/4" (32mm) mortise cylinder with an inverted straight cam. When ordering, reference Schlage cylinder 20-001, 1 1/4", XQ11-949. This provides the L583-477 cam inverted at the factory.

To order, specify:

- Use prefix, CD, example CD99L

CDK Cylinder dogging kit*

For field conversion, a cylinder dogging conversion kit is available.

To order, specify: 99CDK or 98CDK, specify finish.

*Cannot be added to fire exit hardware.



HDK Hex key dogging kit*

For field conversion, a hex key dogging conversion kit is available.

To order, specify: 99HDK or 98HDK, specify finish.

*Cannot be added to fire exit hardware.

LD Less dogging

Less dogging is available in all 98/99™ Panic exit devices to remove the dogging option.

To order, specify: Use prefix LD, example LD99L

Dog keys

Dog key (old style)

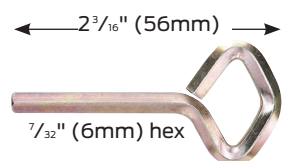

Dog key (standard)

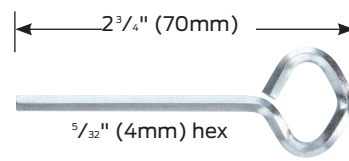

-2SI Double cylinder with security indicator



The Von Duprin Classroom Security Indicator provides an at-a-glance verification of the locked/unlocked status of the door from inside of the room. This option can be ordered as a new product or as a retrofit conversion kit to an existing 98/99 device. Indicator in Unlocked state presents a 1/2" x 1/2" metal flag (white background with black icon) at top of device head. Indicator in Locked state has no flag present.

To order, specify:

1. Suffix-2SI with device/trim number, example 99L-2SI.
 2. Handing required, LHR or RHR.
 3. *Specify keyed rim cylinder or thumbturn rim cylinder.
- * Rim cylinder (3216) sold separately. Rim cylinder with thumbturn available from Schlage (part #XB11-979).

Double cylinder



Double cylinder features an inside key cylinder which locks or unlocks the outside trim and an outside key cylinder which retracts the latch bolt only (Night latch function). Available on rim or mortise lock device.

Rim requires two rim type cylinders. Mortise device requires 1 rim cylinder and 1 mortise cylinder 1 1/4" with a straight cam. (Schlage cam reference L583-475.)

Available functions are thumbpiece, knob or lever.

To order, specify:

1. Suffix-2 with device/trim number, example 99TP-2.
2. Handing required, LHR or RHR.

SD Special center case dogging



Special cylinder dogging in the center case is available for Chexit, EL, QEL, ALK panic devices to allow for mechanical push/pull operation. With this option, the latchbolt is held retracted and pushbar is still operable. Specify handing—RHR or LHR.

SD requires 1 1/4" (32mm) mortise cylinder with an inverted straight cam. When ordering, reference Schlage cylinder 20-001, 1 1/4", XQ11-949. This provides the L583-477 cam inverted at the factory.

Note: Available on Rim and Vertical Rod Panic Exit Devices only.

To order, specify:

1. Prefix SD, example SD99L and Handing.
2. Not for 98/9975 Devices.

98/99 Electrical options

RX Request to exit

The RX (2xit) feature is used to signal the use of an opening. This device is equipped with one internal SPDT switch which monitors the pushpad.

The device can be connected to a security console, or may be used as a single door alarm when used with a horn and power supply.

The RX switch option should not be used to control a load, but as a signalling switch (0.5 amps. resistive maximum).

The RX switch is available in a low current (LC) switch. Most commonly used in computer operated monitoring systems.

To order, specify:

- Standard – use prefix RX, example RX99EO
- Low Current – use prefix RX-LC, example RX-LC98EO

RX2 Double request to exit

The RX2 feature uses two RX switches.

To order, specify:

- Standard – Use prefix RX2, example RX299EO

WP-RX Waterproof request to exit

LX Latchbolt monitoring



The LX feature is used to signal the use of an opening. This device is equipped with one internal SPDT switch which monitors the latch bolt.

The device can be connected to a security console, or may be used as a single door alarm when used with a horn and power supply.

The LX switch option should not be used to control a load, but as a signalling switch (0.5 amps. resistive maximum).

The LX switch is available in a low current (LC) switch. Most commonly used in computer operated monitoring systems.

To order, specify:

- Standard – Use prefix LX, example LX99EO
- Low Current – Use prefix LX-LC, example LX-LC98EO

Electrical rating for all switches:

- Standard – 2 Amp maximum @ 24VDC
- Low Current (LC) - below 50 Milliamps @ 24VDC

Note: All switches can be either factory or field installed



SS Signal switch

Monitors pushpad and latch bolt

The SS feature is used to signal the unauthorized use of an opening. This device is equipped with two internal SPDT switches. One switch monitors both the pushpad and the latch bolt assembly, making the latch bolt tamper resistant, for positive security. An additional SPDT switch is connected to the 1 1/4" (32mm) mortise cylinder with straight cam for alarm "bypass." (Schlage cam reference L583-475). The device can be connected to a security console, or may be used as a single door alarm when used with a horn and power supply.

Pushpad reads: "Emergency Exit ONLY – Push To Open And Sound Alarm." Pushpad is only available in US32D finish with red silk-screened lettering.

The SS mortise lock device is furnished with both the signal switch device and the SS7500 mortise lock. The SS7500 mortise lock has the versatility and advantages of the 7500 lock with the addition of signalling functions to monitor latch bolt operation and the trim locking function. The SS7500 mortise lock is supplied standard with the SS mortise lock device.

To order, specify:

1. Prefix SS, example SS99L.
2. Handing required, LHR or RHR.

Electrical ratings:

Up to 2.0 AMPS @ 24VDC

Popular SS application

Unauthorized use of this opening will activate the local horn. The key switch permits inhibiting this system for authorized entry.

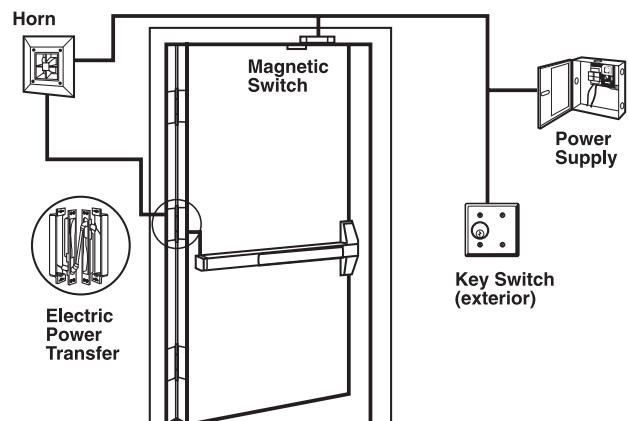

98/99 Chexit device

CX The Chexit® (with motor driven blocking actuator)*



The Von Duprin Chexit device is designed for controlled egress applications. It meets both life safety and security needs, as well as the requirements of NFPA 101 for "Special Locking Arrangement" and IBC "Special Egress-Control Devices". All control inputs, auxiliary locking, local alarm and remote signaling outputs are self-contained in the Chexit assembly. Numerous configurable options allow the device to be customized for the specific code or application requirements. The standard Chexit device sounds an alarm and keeps the door secured for 15 seconds following an exit attempt with immediate release upon fire.

The Chexit device includes a 6" x 20" decal for application on door.

"PUSH UNTIL ALARM SOUNDS.
DOOR CAN BE OPENED IN 15 SECONDS"

Chexit typical applications

Chexit single door with options – The Chexit is used as an access control device. The card reader allows access. Also shown in this application is an external horn and door position switch. The auxiliary horn is used for increased volume in remote locations. Using a door position switch gives added security to the opening in case the door is not reclosed.

With the Chexit disarmed, the opening functions as a normal exit device. If card readers are required on both sides of the door, the normally closed contacts of the readers should be wired in series.

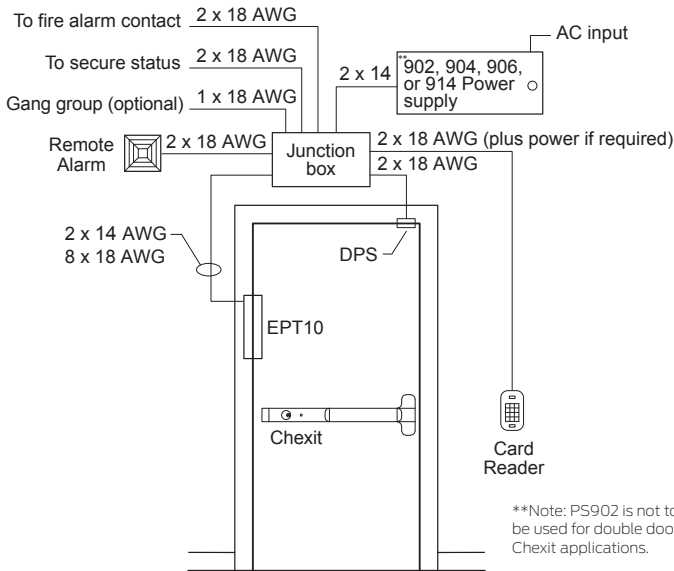

Figure 1. Riser Diagram, Single Door

Minimum door opening sizes for CX devices

Consult factory for other size requirements.

Device	3' (914mm) Length	4' (1219mm) Length
CX98/98-F/99/99-F	2'10 3/4" (883mm)	3'4 3/4" (1035mm)
CX-XP98/XP98-F/XP99/XP99-F	2'10 3/4" (883mm)	3'4 3/4" (1035mm)
CX9827/9827-F/9927/9927-F	2'10 1/4" (870mm)	3'4 1/4" (1022mm)
CX9847/9847-F/9947/9947-F	2'10 1/4" (870mm)	3'4 1/4" (1022mm)
CX9848/9848-F/9948/9948-F	2'10 1/4" (870mm)	3'4 1/4" (1022mm)
CX9849/9849-F/9949/9949-F	2'10 1/4" (870mm)	3'4 1/4" (1022mm)
CX9850/9850WDC-F/ 9950/9950WDC-F	2'10 1/4" (870mm)	3'4 1/4" (1022mm)
CX9857/9857-F/9957/9957-F	2'10 1/4" (870mm)	3'4 1/4" (1022mm)
CX9875/9875-F/9975/9975-F	2'10 1/4" (870mm)	3'4 1/4" (1022mm)

Specifications / Power supply requirements*

Input voltage – 24VDC

Input current inrush – 1.25A

Input current holding – 390mA

Alarm relay and Secure relay contact ratings – 24VDC, 1A

Fire alarm, Inhibit and Door position switch inputs require normally closed dry contacts.

Power supply information for CX devices with motor driven blocking actuator*.

Power supply	Maximum number of devices
PS902 (up to 2 amps)	1 Chexit device
PS904 (up to 4 amps)	3 Chexit devices
PS906 (up to 6 amps)	4 Chexit devices
PS914 (up to 4 amps)	4 Chexit devices

When powering multiple components, verify that the amperage requirements of all components combined does not exceed the power supply output rating, see table above for output ratings. Consult Installation Instructions for proper wire gauge and wire run requirements. Exceeding the recommended devices and/or not following Installation Instructions may void your warranty. Call Customer Care at 877-671-7011 or visit the Allegion website for more information - www.us.allegion.com.

How to order*

To order, specify:

1. Prefix product description number "CX".
Example: CX99L
2. Specify option (see options on page 60).
Example: CX-RCM or CD-CX
3. Door size other than 3' (914mm).
4. Door thickness other than 1 3/4" (45mm).
5. Finish.
6. Handing, LHR or RHR. Required with "CD" option.

*Note: Chexit devices built after August 24, 2015 are built using motor driven blocking actuators that have decreased power supply and operating requirements. The information listed in this catalog references the power supply and operating requirements that are needed for the new products with motor driven blocking actuators. For information on devices built previous to August 24, 2015, please contact Customer Care at 877-671-7011.

98/99 Chexit, RCM and DE5300 features

The Chexit, Remote Chexit Module (RCM) or DE5300 devices have several features and options available to fit your applications. See below for more information.

Inputs & Outputs

Fire Alarm Input

This input releases the door immediately upon a fire alarm allowing immediate egress. The Internal Alarm can be silenced during a fire input via an onboard switch setting.

Inhibit Input (Access Control)

This optional input is provided to allow authorized egress or entry when the device is Armed using an external card reader, Key Switch, etc. It also allows remote reset of the Chexit, RCM or DE5300 in an alarmed condition. The ability to reset alarms with the inhibit input can be disabled via an onboard switch setting.

Door Position Switch Input

An optional Door Position Switch (DPS) can provide door position status to Chexit, RCM or DE5300 for additional security, ensuring that the door is closed, and can cause alarm when the door is left or forced open.

Gang Bus

The Gang bus allows a Chexit, RCM or DE5300 device to signal other Chexit, RCM or DE5300 devices when it enters the Release Delay, allowing multiple doors to release at the same time in an emergency. Up to 8 devices may be connected to the Gang Bus.

Alarm Relay Contacts

The Alarm Relay contacts are provided as a means to control a Remote Alarm, such as a horn or lamp, or signal an external monitor. The contacts can be configured with a jumper as Normally Open or Normally Closed, and become active upon entering an alarmed condition.

Secure Relay Contacts

The Secure Relay contacts are provided as a means to signal an external monitor. The contacts can be configured as Normally Open or Normally Closed with a jumper, and become active when the DPS indicates the door is closed and the Push Pad is locked.

Delays

Release Delay

When the Push Pad is pushed and the Nuisance Delay expires, the Chexit, RCM or DE5300 enters the Release Delay with alarm. During the Release Delay, the Internal Alarm sounds, the Alarm Relay activates, and the Chexit/RCM keeps the Push Pad or DE5300 magnetic lock, locked for 15 seconds (less any time already elapsed during the Nuisance Delay). Once started, the Release Delay sequence will not stop and the devices will unlock.

Nuisance Delay

When a Chexit, RCM or DE5300 is located in a public area, it can be desirable to limit false releases when the Push Pad is accidentally pushed. The Nuisance Delay is the brief time a Push Pad can be accidentally pushed before the Release Delay sequence starts. If the Nuisance Time is set to 0 seconds the Chexit, RCM or DE5300 will enter Release Delay as soon as the Push Pad is pushed (when armed). Setting the Nuisance Time to 1, 2, or 3 seconds allows the Push Pad to be pressed for 1 to 3 seconds before the Chexit, RCM or DE5300 goes into Release Delay. If the Nuisance Audio and Nuisance Delay are both on, the Internal Alarm will pulse during the Nuisance Delay. The Alarm Relay does not activate during the Nuisance Delay. If the Push Pad is released before the Nuisance Delay expires, the Chexit, RCM or DE5300 will remain armed.

Rearm Delay

The Rearm Delay is the amount of time after the Key Switch or Inhibit Input is deactivated to when the device rearms. It is designed to give someone time to pass through the door before rearming occurs. The Rearm Time can be changed via the onboard switch settings from 0 and 28 seconds in 2 second increments. If the Rearm Time is set to 30 seconds and a DPS is used, if the door is opened and the Rearm Time expires, there will be no alarm. The Chexit, RCM or DE5300 will rearm after the door is closed. If the door never opens, the Chexit, RCM or DE5300 will rearm after 30 seconds. If not using a DPS, the Chexit, RCM or DE5300 will always rearm in 30 seconds.

DPS Delay

If the DPS detects that the door closed during the Rearm Delay, the Chexit, RCM or DE5300 ends the Rearm Delay and allows 2 seconds for the latch to clear the strike before rearming.

Interface

Key Switch

The Key Switch provides the means to Arm or Disarm/Reset the Chexit, RCM or DE5300. Turning the Key Switch clockwise initiates the Rearm Delay, and turning the Key Switch counter-clockwise Disarms/Resets the Chexit, RCM or DE5300. The Key Switch allows the key to be removed in either the Arm or the Disarm/Reset position.

Status Indicator

The red Status Indicator displays the status of the Chexit, RCM or DE5300. The Status Indicator flashes slow if the Chexit, RCM or DE5300 is armed, flashes fast in an alarmed mode, is off when inhibited and on solid during Rearm Delay.

Internal Alarm

The Internal Alarm sounds the status of the Chexit, RCM or DE5300. The Internal Alarm sounds continuously during and after a fire alarm or a Release Delay, pulses fast during the Nuisance Delay or a tamper and pulses slow during Disarmed Powerup mode.

Settings

Armed Powerup

When set to OFF, a power disruption and power return will put the Chexit, RCM or DE5300 in a disarmed, unlocked alarm mode.

Trim Fail Safe / Fail Secure (FS/FSE)

The trim input power can be set to FS (Fail Safe; locked when energized, unlocked when deenergized or during power failure) or FSE (Fail Secure; unlocked when energized, locked when deenergized or during power failure).

The trim must be bought or modified to physically function as FS or FSE. This on board setting only selects the trim input power.

98/99 Chexit options

RCM Remote Chexit Module — is designed to provide the concept of the Chexit delayed exit system for door sizes smaller than the standard Chexit device can accommodate. The Chexit module is installed in a control box and mounted in a remote location. Features and functions of the standard Chexit exit device are available on the Remote Chexit Module.



RCM Module

Minimum door opening sizes for RCM devices

Consult factory for other size requirements.

Device	3' (914mm) Length	4' (1219mm) Length
CX-RCM 98/98-F/99/99-F	2'5" (737mm)	2'11" (889mm)
CX-RCM XP98/XP98-F/XP99/XP99-F	2'5" (737mm)	2'11" (889mm)
CX-RCM 9827/9827-F/9927/9927-F	2'4 1/2" (724mm)	2'10 1/2" (876mm)
CX-RCM 9847/9847-F/9947/9947-F	2'4 1/2" (724mm)	2'10 1/2" (876mm)
CX-RCM 9848/9848-F/9948/9948-F	2'4 1/2" (724mm)	2'10 1/2" (876mm)
CX-RCM 9849/9849-F/9949/9949-F	2'4 1/2" (724mm)	2'10 1/2" (876mm)
CX-RCM 9850/9850WDC-F/ 9950/9950WDC-F	2'4 1/2" (724mm)	2'10 1/2" (876mm)
CX-RCM 9857/9857-F/9957/9957-F	2'4 1/2" (724mm)	2'10 1/2" (876mm)
CX-RCM 9875/9875-F/9975/9975-F	2'5 1/2" (743mm)	2'11 1/2" (902mm)

Specifications / Power supply requirements*

Size – 3.75" x 5.57" x 2.50"

Input voltage – 24VDC

Input current inrush – 1.25A

Input current holding – 390mA

Alarm relay and Secure relay contact ratings – 24VDC, 1A

Fire alarm, Inhibit and Door position switch inputs require normally closed dry contacts.

Cylinder dogging — Special center case cylinder dogging option is available to allow push/pull operation of the Chexit, when disarmed and used in a heavy traffic area. Prefix device with "CD" and specify handing.

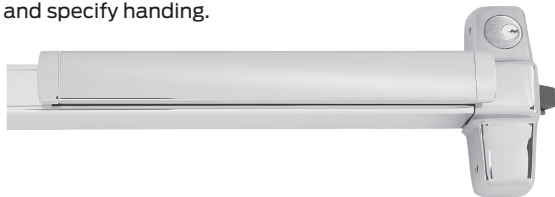

Cylinders — Cylinders are not furnished with the Chexit device and must be specified when ordering. Use 1 1/4" mortise cylinder with compression ring K510-406 with straight cam and orient cam as shown. Schlage cylinder 20-001-114 recommended for the device and the CD cylinder dogging option. See Schlage Pricebook for additional information.

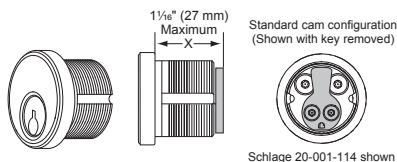

How to order*

See Chexit "How to order" on page 58.

*Note: RCM modules built after August 24, 2015 are built using motor driven blocking actuators that have decreased power supply and operating requirements. The information listed in this catalog references the power supply and operating requirements that are needed for the new products with motor driven blocking actuators. For information on devices built previous to August 24, 2015, please contact Customer Care at 877-671-7011.

DE5300 Delayed Egress System

DE5300 Delayed Egress System — is designed for controlled egress applications when used in conjunction with a magnetic lock. It meets both life safety and security needs, as well as the requirements of NFPA for "Special Locking Arrangement" and IBC "Special Egress-Control Devices". All control units, auxiliary locking, local alarm and remote signaling outputs are self-contained in the DE5300 assembly.



DE5300 Module

The DE5300 is commonly used on narrow stile doors where a standard or narrow stile Chexit is not practical. DE5300 Delayed Exit System uses a Chexit logic board and a Von Duprin RX-LC (low current request to exit) panic device to control a Schlage Electronics Direct Hold Magnetic Lock.

The Chexit module for the DE5300 is installed in a control box and mounted in the wall adjacent to the door. Features and functions of the standard Chexit exit device are available on the DE5300.

The DE5300 device includes a 6" x 20" decal for application on door.

"PUSH UNTIL ALARM SOUNDS.
DOOR CAN BE OPENED IN 15 SECONDS"

Cylinders — Cylinders are not furnished with the DE5300 and must be specified when ordering. Use 1 1/4" mortise cylinder with compression ring K510-406 with straight cam and orient cam as shown. Schlage cylinder 20-001-114 recommended for the device and the CD cylinder dogging option. See Schlage Pricebook for additional information.

Specifications / Power supply requirements

Size - 3.75" x 5.57" x 2.50"

Input voltage – 24VDC

Input current – 1A

Alarm relay and Secure relay contact ratings – 24VDC, 1A

Fire alarm, Inhibit and Door position switch inputs require normally closed dry contacts.

How to order

To order, specify:

- DE5300
- M420/P, M450/P, or M490/P magnetic lock (order direct from Schlage Electronics).
- RX-LC 22/33A/35A/98/99 device.
- PS900 Series
- EPT-2/10

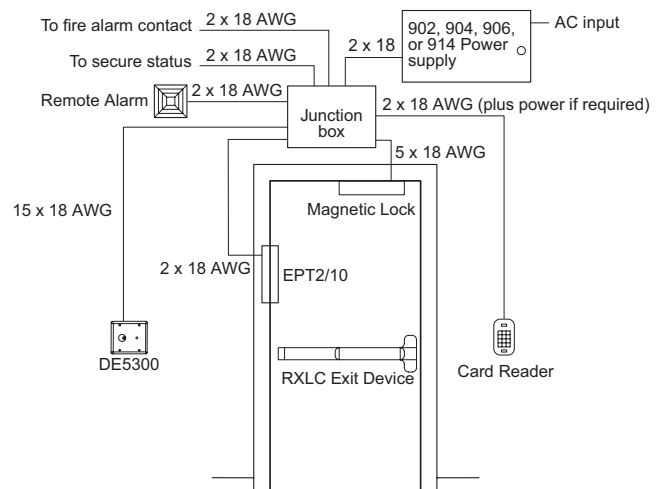

Figure 1. Riser Diagram, Single Door

98/99 Electrical options

ALK Alarm kit



ALK Alarm kit is a simple yet effective way to deter unauthorized use of an opening. While the exit device is still a means of egress, the ALK kit contains an internal horn. When the touch bar is depressed, the horn sounds to provide an audible means of signaling that the opening has been violated. The alarm kit can be armed or disarmed by key thus allowing the exit device to be set in an armed or disarmed mode. The horn is rated at 85 decibels.

For Hardware Applications

The assembly includes both a 24VDC Input and External Inhibit standard. The External Inhibit provides remote arming and dis-arming.

The key switch uses a standard 1 1/4" (32mm) mortise cylinder with a straight cam (Schlage 20-001, L583-475 cam). The unit operates on one standard 9-volt alkaline battery. When the battery is weak, the horn will emit an intermittent low battery alert signal.

Auto reset (AR) option is available with this kit. This kit allows the device to resume the alarm option after a preset time. Preset times can be field selected at 1.5, 3, or 4.5 minutes.

Alarm kits are available with a choice of two switch kits, RX or LX. RX monitors the touchpad and is furnished standard. LX optional latch bolt monitoring is recommended for use with surface vertical rod exit devices or when alarm needs to sound from both the exit device and trim side of the door. Specify ALK-LX.

Note: For latch bolt monitoring on a 98/9975 with ALK, specify a SS7500 lock. LX switch not available for 98/9975 devices.

The ALK is available in two styles, 99ALK, grooved cover and 98ALK, smooth cover.

The ALK includes a 6" x 20" decal for application on door "EMERGENCY EXIT ONLY. ALARM WILL SOUND." RSS push bar trim can be used instead of the door decal, specify RSS push bar trim when ordering the device.

When the ALK is used, standard dogging is removed. If cylinder dogging is required, there are two choices. Special center case dogging (SD) is available. Or, as an engineered special, the ALK can be moved to the hinge side of the device, and standard cylinder dogging (CD) can be added.

To Order, Specify:

1. Standard, 98 ALK
2. Special center case dogging, SD98 ALK
3. Cylinder Dogging, CD98 ALK

Minimum door opening sizes on ALK applications

Device	3' (914mm) Length	4' (1219mm) Length
98/98-F/99/99-F	2'10" (864mm)	3'4" (1016mm)
9875/9875-F/9975/9975-F	2'10" (864mm)	3'4" (1016mm)
9827/9827-F/9927/9927-F	2'10" (864mm)	3'4" (1016mm)
9857/9857-F/9957/9957-F	2'10" (864mm)	3'4" (1016mm)
9847/9847-F/9947/9947-F	2'9" (838mm)	3'3" (991mm)
9848/9848-F/9948/9948-F	2'9" (838mm)	3'3" (991mm)

Allegion Connect

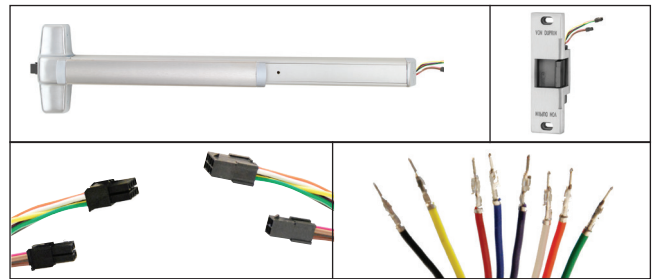

Allegion's cross-category Connect features common interconnect components to our electrified options. Allegion Connect is a quick and easy way to connect power sources; all the way from your power supply to locking device. There is no wire cutting; reducing installation and maintenance time ultimately cutting cost. After installation, Allegion's Connect continues to provide benefits throughout the lifetime of the opening by offering a service kit for repairs or modifications in the future.

Features and benefits

- Quick: common connections reducing installation time
- Perfect Connections: these factory installed connectors ensure the right wires match up every time
- Protective: the connectors protect the connection points throughout the installation process and lifetime of the opening
- Interchangeable: all Allegion Connect products utilize the same connectors
- Maintenance: you no longer need to cut away wire to disconnect Allegion products, also available is a service kit specifically for Connect products.

Harness length	Connectors on both ends	Connectors on one end, crimped pins on the other end
6 Inches	CON-6	CON-6P
12 Inches	CON-12	CON-12P
26 Inches	CON-26	CON-26P
32 Inches	CON-32	CON-32P
38 Inches	CON-38	CON-38P
44 Inches	CON-44	CON-44P
50 Inches	CON-50	CON-50P
192 Inches	CON-192	CON-192P

Power Supply Wire Harness = Connectors on one end, stripped leads on the other end, offering a direct connection to the power supply

6 Inches	CON-6W - wire extension to power supply
----------	---

Consult door manufacturer for harness length requirements.

Note: You will need to purchase a separate wiring harness to go from exit device to hinge/EPT and an additional harness to go from hinge/EPT to power supply or access control system. Harness part numbers with ordering information can be located in the Schlage, Von Duprin and Falcon pricebooks. A service kit is available for order in the Schlage, Von Duprin and Falcon pricebooks. Included in this kit are male end plugs, female end plugs and pins to customize harnesses to your application.

Note: Must be ordered with exit devices and locks

How to order

1. Specify CON for Connect electronic options
Example: EL-99-EO-CON (99 Series Electrified Latching exit only with Connect connectors)
2. Specify harness length: Consult door manufacturer for harness length
3. Specify Von Duprin EPT10-CON or Ives 7200 power transfer hinge

Wire run options

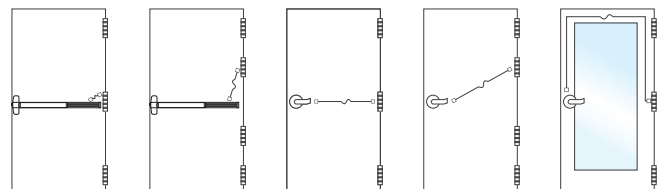

98/99 Electrical options

EL Electric latch retraction

The EL feature allows for the remote unlatching of exit devices. A control station operator can flip a switch to retract the latch bolt and immediately change an exit door to push-pull operation. A powerful, continuous duty solenoid retracts the latch bolt, either for momentary unlatching, or for extended periods of time. The EL feature is an alternative to manual dogging.

If manual hex-key dogging is required, specify HD-EL. If cylinder dogging is required, the standard cylinder dogging is not available, but special center case dogging is available, specify SD-EL. SD-EL is not available on the 9875 or 9975 devices.

EL devices are also useful with automatic door operators, and may be applied to fire-rated applications when under the control of an **automatic fire alarm system**.

UL approved for Class II circuit applications.

The EL option does not include the power transfer from door to frame, the power supply, or the control operator. Refer to EPT-2 power transfer and the PS914 power supply.

The PS914 with the 9002RS option card is the minimum option card required. Other option cards available for other functions, see PS914 power supply for additional information.

Solenoid specifications:

Continuous duty – 24 VDC
Current inrush – 16 Amps
Current holding – 0.3 Amps

Solenoid resistance:

-grn-yel 1.2 – 2.2 OHMS
-grn-org 100 – 150 OHMS

To order, specify:

Standard – use prefix EL, example EL99L. Hex Key dogging – Use prefix HD-EL, example HD-EL99L. Special center case dogging – Use prefix SD-EL, example SD-EL99L

Minimum door opening widths:

Application	Surf. vert.	Con. vert.	Mortise	Rim
Min. door opening	28 1/4"	28 1/4"	28 3/4"	29 1/4"

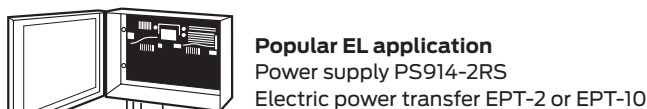

Popular EL application

Power supply PS914-2RS
Electric power transfer EPT-2 or EPT-10

Von Duprin exit device	EL Wire length (feet) ¹	Wire gauge (AWG)
EL 98/99 Rim	0-500	12
	0-300	14
	0-200	16
All other 98/99EL device types	0-250	12
	0-150	14
	0-100	16
Control Switch	0-1200	18

1. Wire lengths include an EPT, Door loop, electric hinge or pivot and are measured one way between the PS914/option board and the device.
2. Table is applicable to devices that have shipped after August 2012.

QEL electric latch retraction

The QEL feature allows for the remote unlatching of exit devices. A control station operator can flip a switch to retract the latch bolt and immediately change an exit door to push-pull operation. Different than the popular EL, the QEL quiet operation is achieved using an electric drive motor which retracts the latch bolt either momentary unlatching or for extended periods of time. This feature is an alternative to manual dogging.

If cylinder dogging is required, the standard cylinder dogging is not available, but special center case dogging is available, specify

SD-QEL. SD-QEL is not available on the 9875 or 9975 devices.

QEL devices are also useful with automatic door operators, and may be applied to fire-rated applications when under the control of an automatic fire alarm system.

UL approved for Class II circuit applications.

The QEL option does not include the power transfer from door to frame, the power supply, or the control operator. Refer to EPT-2 power transfer and the PS902 or 914 power supply.

The PS902/914 with the 2RS, 4RL or 4R board is the minimum required. Other option boards available for other functions, see PS902/914 power supply for additional information.

The QEL has a low inrush current, so it can be used with standard Schlage power supplies. Calculate the peak current draw of all devices in the system to determine the required amperage of the supply.

Schlage PS902	Schlage PS904	Schlage PS906
up to 2 amps	up to 4 amps	up to 6 amps

QEL Electrical load

Voltage	24VDC
Current	1.0 A Inrush (0.5 sec.) / 0.14 A Holding

The -2RS option board is designed to control two electric latch retraction devices and provide time delay between the firing of outputs is required. The power transfer is also sold separately.

To order, specify:

Standard – use prefix QEL, example QEL99L.
Special center case dogging – use prefix SD-QEL, example SD-QEL99L



Popular application

Power supply PS902-2RS
Electric power transfer EPT-2 or EPT-10

a*	Distance (one-way)	Wire gauge
	200'	18 AWG
	320'	16 AWG
	500'	14 AWG
	800'	12 AWG

b*	Wire selection	Switch wire size
	1200 ft. Max.	18 gauge standard

98/99 Electrical options

Power Supplies

Series PS902/914



Overview:

The PS900 Series is a consolidated line of power supplies and accessories that offer enhanced flexibility and functionality specific to the changing needs of the access control market. The PS900 Series can be used in a variety of applications to convert high voltage AC power into the low voltage DC outputs required by most access control devices. The PS900 Series protects devices downstream by providing Class 2*, filtered and regulated power. The full line is UL294 certified.

Note: PS906 can provide Class 2 rated outputs when used with 900-8P distribution board.

Features:

- Constant output rating at both 12 VDC and 24 VDC provides superior performance ; includes field selectable jumper
- Polarized connectors for option boards eliminate need for racks and side connectors
- Flat mounting of option boards provides easier access to terminal blocks for connection of electrified devices
- High voltage protective cover
- Battery back-up board auto-selects voltage
- Fire alarm relay can be configured to provide either switched or un-switched outputs from a power supply
- PS914 designed with high inrush current for powering electrified panic devices
- Universal 120-240 VAC input
- Low voltage DC, regulated and filtered
- Electronic power limiting foldback circuit for AC current overload protection
- Fused primary input
- AC status monitor- isolated SPDT contacts
- AC input and DC output LED status indicators
- Cover mounted AC input indication
- Hinged cover with lock down screws

Certifications:

- UL 294 certified—the standard for access control
- Class 2 rated*

* Except PS906, output rating exceeds Class 2 power limits

Once power is converted to low voltage DC, the PS900 Series offers a variety of distribution options, including basic fuse protection, simple relay, and advanced logic providing complex sequencing and timing functions.

* PS906 can provide Class 2 rated outputs when used with 900-8P distribution board.

	PS902	PS904	PS906	PS914
Number of connectors on power supply for the following:	2 amps	4 amps	6 amps	4 amps
Distribution boards	1	2	3	2
Battery back-up board	1	1	1	1

Note: One fire alarm board can be connected directly to the PS902. If a fire alarm board is desired for the PS904, PS906 or PS914 it can be connected to a distribution board.

Applications:

The PS900 Series of power supplies works with many electrified devices including Schlage electromagnetic locks, Schlage AD-Series hardwired locks, Schlage electrified mechanical locks, Von Duprin electrified strikes, Von Duprin exit devices, and many other brands.

Accessories:

The Schlage PS900 Series features seven option boards for use in a variety of applications. All Schlage PS900 Series power supplies option boards are UL 294 certified.

Option boards:

900-4R: 4 relay controlled output board to power multiple devices

900-4RL: 4 relay distribution board with logic is field configurable for time delay function, auto operator, security interlock

900-8F: Provides 8 individually fuse-protected outputs, giving the flexibility to power multiple devices and provide another layer of protection

900-FA: Emergency interface relay integrates with fire alarm and is used to cut power in case of emergency

900-BB: Battery backup

900-2RS: 2 relay EL/QEL panic device control board (PS914 - required for EL)

900-BBK: Battery backup kit includes two 7A/hr batteries and provides up to four hours of backup power when cycled every 5 minutes at full load

98/99 Electrical options

EPT Electrical power transfer PNT Pneumatic transfer

Electric Power Transfer provides a means of transferring electrical power from a door frame to the edge of a swinging door. The units are completely concealed when the door is in the closed position, and are ideal for installations involving abuse or heavy traffic.

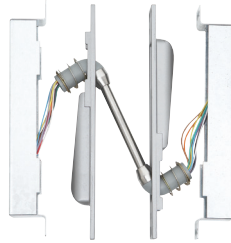

Two models are available; EPT-2, two 18 gauge wires and EPT-10, ten 24 gauge wires. The EPT-2 and EPT-10 are U/L listed as "miscellaneous door accessory".

UL Listed for use on fire doors.

Door applications:

Degree of opening	Hinge type	Door thickness
0-180	Up to 5" butt hinges	1 3/4"
0-180	Up to 3/4" offset pivots	1 3/4"
0-130	5 1/2" butt hinges	1 3/4"
0-110	6" butt hinges	1 3/4"
0-90	Swing clear hinges	1 3/4"

Finishes

SP28 (sprayed aluminum)

SP313 (sprayed duranodic).

Dimensions

Housing	Dimensions
	9" x 1 1/4" x 1 5/8" (229mm x 32mm x 38mm)
EPT-2	Two 18 gauge wires, Up to 2 AMPS @ 24VDC, with a 16 AMPS Maximum Surge
EPT-10	Ten 24 gauge wires, Up to 1 AMPS @ 24VDC, with a 16 AMPS Maximum Surge
PNT-1	5/32" Tubing

To order, specify:

1. EPT-2, EPT-10 or PNT-1.
2. Finish, SP28 or SP313.

E996L Electrified breakaway lever

E996L Electrified lever trim provides remote locking and unlocking. Furnished standard in fail safe (FS) condition, can be field converted to fail secure (FSE) where allowed. E996L is furnished standard with cylinder operation for nightlatch (NL) function, or with blank escutcheon (BE).



Specification:

Solenoid – continuous duty 24VDC
Solenoid draw – 0.22 amp.

To order, specify:

1. Use "E" prefix, example E996L. When ordering with the exit device specify trim series with prefix "E", example 9927L-BE 3' US26D E996.
2. Device type, R/V (rim/surface vertical rod/concealed vertical rod) or M (mortise).
3. RHR furnished standard if not specified, field reversible.
4. Lever style (06 lever furnished standard). Other levers, no extra charge.

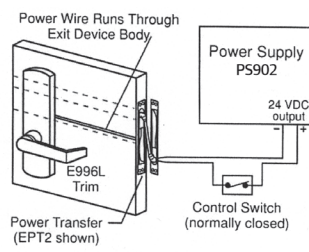

E Electric mortise lock device

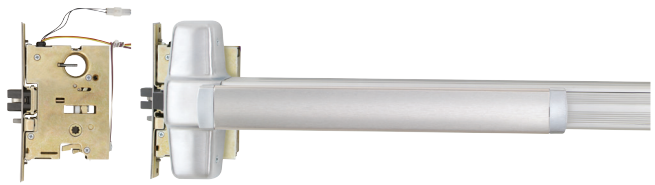

The electric mortise lock device has all the versatility and advantages of the standard mortise lock device, plus the advantage of being electrically controlled by a remote switching device, an access control system or an automatic fire alarm system. The device features the E7500 mortise lock. The E7500 controls the locking of the outside trim. When unlocked, the door remains latched, preserving the fire rating of the door and making it particularly useful where codes permit locking but require unlocking during a fire emergency. The outside trim cylinder retracts the latch bolt for mechanical override, night latch function. Only available with TP, K or L functions.

The E7500 lock contains a SPDT signal to monitor the outside trim condition (locked or unlocked) and a second SPDT signal switch to monitor the latch bolt.

Standard features:

- Field reversible handing
- 24 VDC continuous duty solenoid

Optional features:

- Fail safe (locked when energized, unlocked when de-energized or during power failure). Specify with suffix "FS."
- Fail secure (unlocked when energized, locked when de-energized or during power failure). Specify with suffix "FSE"
- 24 VAC (with SO option)
- 12 VDC
- 12 VAC (with SO option)

Note: Some Fire codes will require "Fail Safe" (FS) operation for stairwell doors. Be sure to specify the correct operation for your application.

Electrical specifications:

- Solenoid — .60 AMPS @ 12VDC
.30 AMPS @ 24VDC
- Each switch — Up to 2.0 AMPS @ 24VDC Maximum

The E option does not include the power transfer from door to frame, the power supply or the control operator. (Refer to EPT-10 and PS902 or PS914 power supply)

To order, specify:

1. Use prefix "E," example E9975.
2. FS or FSE
3. Voltage and current.

Electric mortise lock device

Adaptable for openings where continuous latching is required while the trim may be electrically locked or unlocked from a remote location—stairwells, exterior doors, etc.

Minimum system requirements:

- PS902
- EPT-10

98/99 Mechanical options

AX Accessible device

The AX device is a UL certified exit device designed to meet the progressive requirements of the California Building Code for accessible openings. This device meets the 5 lbs of operating force requirement called for in chapter 11B-309.4. The AX device also exceeds ANSI/BHMA requirements. Available devices include: AX98/99, AX98/99-F, AX98/9927LBR, AX98/9927-F LBR, AX98/9949LBL, AX98/9949-FLBL, AX98/9949-F LBLAFL, AX98/9950LBL, AX98/9950-FLBL. Additionally, all AX devices will be shipped with a new UL label clearly stating "Meets California building Code (2013) Sec. 11B-309.4" and an "AX" identifier label on device center case. See images below for reference.



XP Extra performance

For increased security the XP98/99 Rim exit device has a static load force resistance of more than 2,000 pounds, twice that of standard rim exit devices. The two-piece latch bolt forms a 90° latch-to-strike contact. The "smart" latch changes shape when subjected to external forces. This design enables the exit door to withstand an external attack and remain secure. Additionally, the patented latch bolt design provides a greater, longer-lasting latch bolt to strike contact which is not easily affected by the twisting motion of a weakened frame, resulting in an opening that will remain strong.

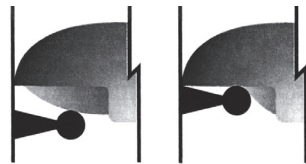

With a door loaded to 250 pounds, XP98/99 requires less than 40 pounds of pressure to open, 25% less than the safety code requires.

XP98/99 is available for panic or fire exit hardware applications. Dimensions, finishes and trim options are equal to the standard 98/99 series rim exit device.

Note: If an electric strike is required in your application, the use of a standard exit device is required.

The 909 strike is to be used for all applications. The exception occurs with the use of fire rated double door applications, in this instance the 954 strike is required.

WS Surface vertical rod one-point and three-point exit devices

WS Multi-point exit devices for tornado application devices WS98/9927 (one-point) and WS98/9957 (three-point) surface vertical rod exit devices are designed, tested and certified to comply with the Federal Emergency Management Agency's publication FEMA 361- Design and Construction Guidance for Community Safe Rooms.

UL Listing – panic hardware UL 305; and fire exit hardware UL 10C: WS98/9927:

3 hour pairs of doors double egress, 90 minutes swinging same direction, 8'0" x 8'0" BHMA Grade 1, ANSI A156.3-2001

WS98/9957:

3 hours single doors, 4'0" x 8'0" BHMA Grade 1, ANSI A156.3-2001

Windstorm ratings:

WS98/9927:

Miami-Dade County/FBC compliance to TAS 201, TAS 202, TAS 203; design load rating +150/-150 PSF (245 MPH wind zone); Enhanced Hurricane Protection (EHPA) ASTM E1996, ANSI/ICC 500 (245 MPH wind zone).

UL-FEMA 361 certified 8'0" x 8'0" pairs, swinging same direction and 4'0" x 8'0" single non-fire rated flush hollow metal. UL-ANSI/ICC 500 certified for F5 tornado applications.

WS98/9957:

UL-FEMA 361 certified 4'0" x 8'0" single flush hollow metal (fire-rated and panic). UL-ANSI/ICC 500 certified for F5 tornado applications.

These devices are listed with Steelcraft Paladin™ PW-Series doors for tornados, and Steelcraft H-Series doors hurricane applications.

To order, specify: WS prefix, example WS9927-F

LBR Less bottom rod, panic and fire rated

LBR option is available, using a spring loaded auxiliary latch bolt installed in the lower door edge. When exposed to heat the auxiliary latch bolt releases, keeping the doors in alignment and closed during a fire. UL listed 3 hours on hollow metal doors double egress, 90 minute swinging same direction, and 20 minutes wood doors (consult wood door manufacturer). Fits door stiles as narrow as 3 5/8".

LBR devices must be ordered in pairs or must be used in conjunction with an approved automatic or constant latching flush bolt.

PL Pullman latch

When PL is specified the standard latches are replaced with pullman style latches. Pullman latches are always extended and are most commonly used in conjunction with electric strikes and LBR-less bottom rod application. Not available with Fire rated devices.

Not recommended where security is of the utmost importance since latches do not deadlock.

98/99 Mechanical options

PN Pneumatic controlled exit devices



The PN feature provides remote latch bolt retraction in hazardous areas where electrically operated devices would not be permitted. The pneumatic solenoid will retract the latch bolt for momentary or prolonged periods. PN exit devices are particularly suited for use with automatic door operators. The PN feature is available on both Panic and fire exit hardware devices.

The PN feature includes a special actuating linkage that gives building owners the option of mechanically or pneumatically dogging the exit device. If manual hex-key dogging is required, specify HD-PN (Dogging the device, whether mechanically or pneumatically, makes the device function as a push/pull unit and reduces the wear on its moving parts.) If cylinder dogging is required, the standard cylinder dogging is not available, but special center case dogging is available, specify SD-PN. SD-PN is not available on the 9875 or 9975 devices.

When activated pneumatically, the latch bolt(s) of the exit device retract in $\frac{1}{2}$ to $1\frac{1}{2}$ seconds. This pneumatic operation uses air pressure ranging from 50 to 100 pounds per square inch.

This product will function only when it is part of a pneumatic system (air compressor, air lines, pneumatic system, etc.).

Contact LCN for correct control boxes.

To order, specify:

- Standard — Use prefix PN, example PN99NL
- Hex Key Dogging — Use prefix HD-PN, example HD-PN99NL
- Special Center Case Dogging (handing is required, specify RHR or LHR) — Use prefix SD-PN, example SD-PN99NL

PNT pneumatic transfer

Pneumatic controls

PNT-1 is available for pneumatic latch retraction exit devices. Appearance and dimensions are identical to EPT models.

RSS Red Silk Screen



Red silkscreen lettering on touchpad trim. - "Emergency Exit Only, Push To Open And Sound Alarm". This comes standard on RSS devices.

To order, specify: Suffix RSS, 9927L-RSS RHR

WH Weep holes

WH is available for all 98/99 Series exit devices. Weep holes are ideal for devices that are mounted to exterior doors that can be exposed to rain and other elements. Hole spacing on 3' and 4' devices are every 6" on center. A 3 foot device will have 5 holes, a 4 foot device will have 7 holes.

To order, specify: Suffix WH, 99EO-WH.

Dummy pushpad

The 330 dummy pushpad is designed as a companion unit for all 99 devices. The 350 dummy pushpad is a companion unit for all 98 devices. The pushpad is rigid or nonfunctioning. A push/pull operation can be accomplished by using 990DT, 996DT trim or any lves Pull.

The 330/350 can be equipped with a functional pushpad and will accommodate an RX or WP-RX switch. Specify RX-330. May also be equipped with the RX2, double RX switch. Specify RX2-330

To order, specify:

1. 330 or 350.
2. Size 3' or 4' (914mm or 1219mm)
3. Finish, US3, US4, US10, US26, US26D, US28, 313 & 315. US32D – 350 only.
4. Specify RX, WP-RX or RX-2 if desired.

SG Safety glow



Self-illuminating touchpad defines the location of the exit door in dark or smoke-filled area. The safety glow coating is a special powder coat finish that glows brightly during low or no light conditions. This coating was developed to meet MEA standards where luminescent exit door markings are required in commercial facilities. There are no batteries or electronics, the coating is charged when exposed to light.

To order, specify: Suffix SG, EL 9927L-SG

Braille, embossed and knurled touchpads



* Image shown is a special order.

Braille touchpad embossed with the standard message "CAUTION STAIRWELL" in braille and raised letters provides assistance to persons with impaired vision. Letters are $\frac{1}{2}$ " (13mm) high and braille is #2, raised height is $\frac{3}{32}$ " (2mm). Other messages are available on special order, limited to 20 characters per line.* **To order, specify:** Suffix BR, EL9927L-BR

Embossed touchpad is embossed with the word "PUSH".

To order, specify: Suffix EMB, EL9927L-EMB

Knurled touchpad is to provide warning to persons with impaired vision. **To order, specify:** Suffix PBKN, EL9927L-PBKN

Consult factory for availability.

98/99 Device options & accessories

RG-27 Vertical rod and latch guard



Rod guard

Series RG-27 Vertical rod and latch guards protect the bottom rods of exit devices from the damaging impacts of carts or gurneys passing through doors. (If bottom rods become damaged, the exit device will not function as intended and can jeopardize the ability to exit safely during an emergency.)

In addition to protecting the vertical rod, the guard provides a smooth, unobstructed surface so the door can be pushed open easily with the bumpers of a wheelchair. The latch guard portion is 10" high. The standard latch guard features a 45° ramp. The extended latch guard offers a continuous ramp in 3' or 4' widths.

All stainless steel construction in US32D finish. Latch guards can cover latches as large as 1 1/4"W x 10"H x 1 7/8" projection.

Latch guard



Extended latch guard

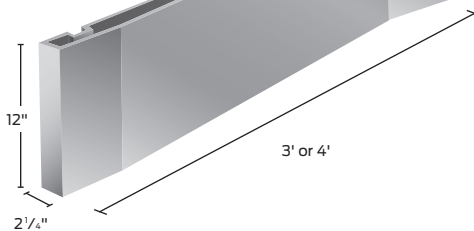

997 Cover plate kit

For 98/99 rim device, kit contains inside and outside plates for hinge stile cutouts, an inside plate for the lock stile, and necessary screws. Plates are designed to cover cutouts required by most existing exit device installations. Specify finish.

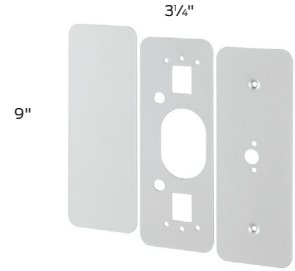

WDA Cover plate kit

For wood door applications, used to cover up door preparations for control, also prevents the control from boring into the wood door. Finished to match control.

#10WDA Cover plate kit for 370 series controls

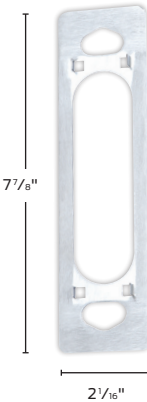

#33A-WDA Cover plate kit for 360 series controls



Models

- RGO Rod guard only (projection 1 3/16")
- RG-27 Rod and latch guard
- RG-27-3 3' (914mm) Rod guard and extended latch guard
- RG-27-4 4' (1219mm) Rod guard and extended latch guard
- LGO Latch guard only
- LGO-3 3' (914mm) Extended latch guard only
- LGO-4 4' (1219mm) Extended latch guard only

When using on wood fire doors, high density block is required.

To order, specify:

1. Model number.
2. Handing (except on RGO).
3. Door material if other than hollow metal.
4. Optional sex bolt mounting available.

GBK Glass bead kit

Glass bead conversion kits are available for all 98/99™ Series devices for use on doors with raised glass beads. Each kit consists of 1/4" (6mm) shim sets. GBK for surface vertical rod ships with 1/8" shims for rod guides.

To order, specify:

1. 99GBK
2. Device type (rim, mortise, surface vertical rod, concealed vertical rod)
3. Wood door, when used with concealed vertical Rod
4. When used with 330/350 Dummy pusher, order two hinge stile shims.

98/99 Device options & accessories

Cylinders

Cylinders are not furnished with device or trim and must be specified when ordering. Refer to trim pages for cylinder type.



Mortise — 3215 (Schlage 20-001, L583-475 cam)

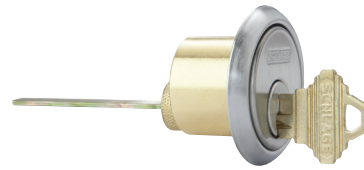
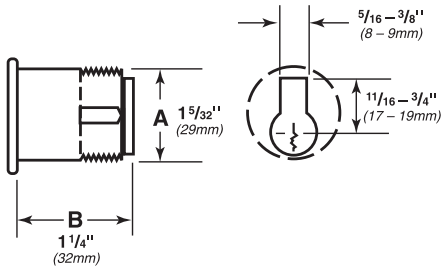

Rim — 3216 (Schlage 20-022 cam)

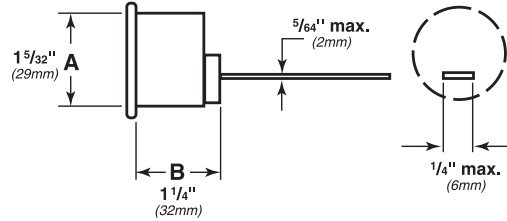

Dogged (inverted) cam

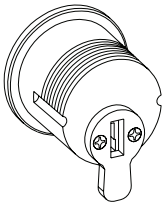

For cylinder dogging
or 360L

Undogged cam (standard operations)

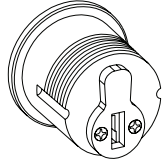

For standard trim functions
or 360L-NL

98/99 Device options & accessories

Mullions

Removable steel mullions provide single door performance in double door openings with rim devices. Mullions are easily removed by loosening bottom set screw and removing top fitting cover. The top mullion fitting is attached to the frame and is concealed by the fitting cover.

Steel mullions are 2" (51mm) wide and 3" (76mm) deep, with a wall thickness of 1/8" (3mm).

Mullions are shipped with mounting screws and prepared for strikes. Strikes are not included except where indicated.

Steel mullions are available in SP28 and SP313 finishes. Consult factory for other powder coat finish options.

KR – Keyed removable steel mullions make removal faster and easier by a single operation of the mortise cylinder. Once mullion is removed, large equipment or furniture can freely pass through the opening. The unit will self lock when re-installed, without the use of the cylinder key. Uses a 1 1/4" mortise cylinder with a straight cam (Schlage cam reference L583-475). Cylinders are sold separately. Prefix mullion model with "KR".

Removable aluminum mullions are 1 1/8" (27mm) wide on face closest to the door and 2 3/8" (60mm) at the widest point. The depth is 3 1/8" (79mm) with a wall thickness of 1/8" (3mm).

Aluminum mullions are available in US4, US10, US28, 313 and 315 finishes. Consult factory for other powder coat finish options. Aluminum mullions are not available keyed removable.

Stock hollow metal applications for devices mounted to cover ANSI 161 cutouts are higher than the standard mullion strike location. Consult the factory for special strike preparation or order a blank mullion. See below.

Blank mullions are furnished without strike preparation. They are used to mount devices at a strike height different from the standard mullion preparation.

To order, specify:

1. For keyed Removable option on steel mullions, prefix model number with "KR"
2. Model number
3. Height of opening
4. Finish
5. Handing if required
6. Centerline deviation (refer to device template for standard centerline)
7. Strikes, when required, should be ordered with device

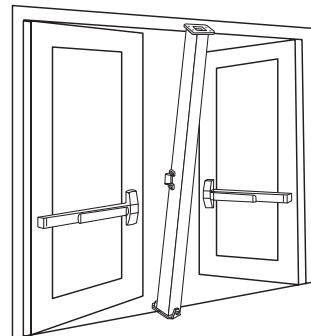

Removable mullions

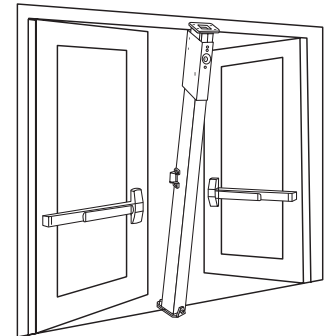

Keyed removable steel mullions

Steel mullions

1654 Prepared for two 1606 strikes. If 1606 strikes are not specified on the order, two per mullion will be added. Additional charges apply.

4954 Prepared for 264 or 299 strikes. For use with all Von Duprin Panic rim devices.



9954 Prepared for and must be used with two 268 strikes (88-F device), or two 499F (22-F, 98-F, 99F devices). UL fire labeled mullion for up to 3 hour opening using Von Duprin fire exit rim devices. This mullion is not easily removed due to special fittings.

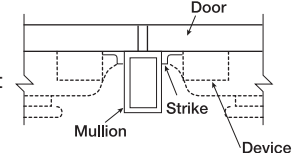

98-F and 99-F devices are rated up to 10'0" (3048 mm).

Note: If 268 or 499F strikes are not specified on the order, two per mullion will be added. Additional charges apply.

4754 Prepared for two 4263 monitor strikes.

4854 Prepared for one 299 and one 6111 electric strike. Indicate handing for electric strike.



9854 Prepared for one 268 or 499F strike and one 6111 electric strike. Indicate handing for electric strike. UL fire labelled mullion for up to 3 hour openings up to 8' x 8' (2438mm x 2438mm) using Von Duprin fire exit rim devices

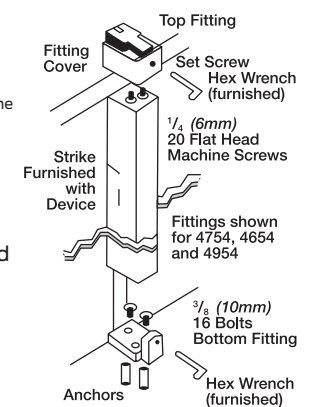

9954-XP Prepared for two 954 strikes, for XP device.

Aluminum mullions

5654 Prepared for two 299 strikes.

5654-XP Prepared for two 909 strikes, for XP device.

5754 Prepared for 1408 double strike.

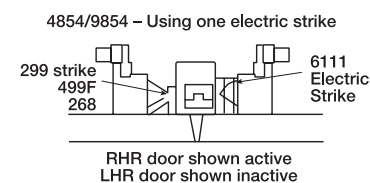

98/99 Device options & accessories

Sex bolts

Sex bolts when ordered with devices may be furnished with screw lengths different than shown in Column B.

Below, Column B indicates popular sizes. Sex Bolts ordered separately

are not furnished with screws. If screws are required refer to chart below and order screws by

description as a separate item. Other screw lengths may be used based on minimum and maximum allowable thread engagement, shown in column "C." Quantity required — refer to device section, quantities differ depending on outside trim.

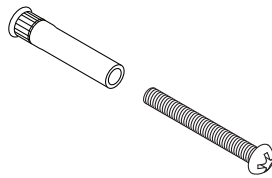

325 sex bolts used on surface Vertical Latches.

425 sex bolts are required for 98/99 Series fire rated devices when used on wood door applications. When wood doors are specified for these devices, sex bolts will be added to the device application unless SLM blocking package is specified.

825 sex bolts are required with 98-F/99-F rim devices on wood door applications using NL, TP, K and L outside trims. Two 825 sex bolts will be added to the device application unless SLM blocking package is specified.

To order, specify:

1. Model number
2. Quantity (2 per package)
3. Finish
4. Door thickness other than 1³/₄" (44mm)



325



425



825

Rim, mortise, surface and concealed vertical

Device type	Door thickness	Center case				C Thread engagement min. – max	Hinge case			C Thread engagement min. – max
		Sex bolt no.	A	B Screw	Sex bolt no.		A	B Screw		
98, 9827, 9827-F, 9875, 9875-F, 9847, 9847-F, 9847WDC, 9849, 9849-F 99, 9927, 9927-F, 9975, 9975-F, 9947, 9947-F, 9949, 9949F, 98/9950WDC, 98/9950WDC-F	1 ³ / ₄ " (44mm)	425	1 ⁹ / ₁₆ "	10-24 x 1" PPHMS	9 ³² / ₃₂ " – 1 ⁹ / ₁₆ "	425	1 ⁹ / ₁₆ "	10-24 x 1" PPHMS	9 ³² / ₃₂ " – 1 ⁹ / ₁₆ "	
	2 ¹ / ₄ " (57mm)	425	1 ⁹ / ₁₆ "	10-24 x 1 ¹ / ₂ " PPHMS	9 ³² / ₃₂ " – 1 ⁹ / ₁₆ "	425	1 ⁹ / ₁₆ "	10-24 x 1 ¹ / ₂ " PPHMS	9 ³² / ₃₂ " – 1 ⁹ / ₁₆ "	
98-F, 99-F*	1 ³ / ₄ " (44mm)	425	1 ⁹ / ₁₆ "	10-24 x 1" PPHMS	9 ³² / ₃₂ " – 1 ⁹ / ₁₆ "	425	1 ⁹ / ₁₆ "	10-24 x 3 ³ / ₄ " PPHMS	9 ⁹ / ₃₂ " – 1 ⁹ / ₁₆ "	
		825A*	1 ¹³ / ₁₆ "	10-24 x 3 ³ / ₄ " PPHMS						
	2 ¹ / ₄ " (57mm)	425	1 ⁹ / ₁₆ "	10-24 x 1 ¹ / ₂ " PPHMS	9 ³² / ₃₂ " – 1 ⁹ / ₁₆ "	425	1 ⁹ / ₁₆ "	10-24 x 1 ¹ / ₄ " PPHMS	9 ³² / ₃₂ " – 1 ⁹ / ₁₆ "	
		825B*	2 ⁵ / ₁₆ "	10-24 x 3 ³ / ₄ " PPHMS						

* For use with outside trims, see page 11 for details.

Surface vertical rod - latches only

Device type	Door thickness	Latch case		
		Sex bolt no.	A	B Screw
9827/9927/9827F, 9927F	1 ³ / ₄ " (44mm)	325	1 ⁹ / ₁₆ "	1/4 - 20 x 3 ³ / ₄ " FPHMS
	2 ¹ / ₄ " (57mm)	325	1 ⁹ / ₁₆ "	1/4 - 20 x 1 ¹ / ₄ " FPHMS

PPHMS – Pan phillips head machine screw

UFPHMS – Undercut flat phillips head machine screw

98/99 Function, grade, type options

ANSI Function, grade & type

Function	Grade 1, type 1	Grade 1, type 2	Grade 1, type 3	Grade 1, type 7	Grade 1, type 7	Grade 1, type 8	Grade 1, type 8	Grade 1, type 8	Grade 1, type 9
1	98EO & F 99EO & F	9827EO & F 9927EO & F	9875EO & F 9975EO & F	9847WDCEO & F 9947WDCEO & F	9850WDCEO & F 9950WDCEO & F	9847EO & F 9947EO & F	9848EO & F 9948EO & F	9849EO & F 9949EO & F	9857EO & F 9957EO & F
2	98DT 99DT	9827DT 9927DT	9875DT 9975DT	9847WDCDT 9947WDCDT	9850WDCDT 9950WDCDT	9847DT 9947DT	9848DT 9948DT	9849DT 9949DT	9857DT 9957DT
3	98NL & F 99NL & F	9827NL & F 9927NL & F	9875NL & F 9975NL & F	9847WDCNL & F 9947WDCNL & F	9850WDCNL & F 9950WDCNL & F	9847NL & F 9947NL & F	9848NL & F 9948NL & F	9849NL & F 9949NL & F	9857NL & F 9957NL & F
3	98K-NL & F 99K-NL & F	9827K-NL & F 9927K-NL & F	9875K-NL & F 9975K-NL & F	9847WDCK-NL & F 9947WDCK-NL & F	9850WDCK-NL & F 9950WDCK-NL & F	9847K-NL & F 9947K-NL & F	9848K-NL & F 9948K-NL & F	9849K-NL & F 9949K-NL & F	9857K-NL & F 9957K-NL & F
3	98L-NL & F 99L-NL & F	9827L-NL & F 9927L-NL & F	9875L-NL & F 9975L-NL & F	9847WDCL-NL & F 9947WDCL-NL & F	9850WDCL-NL & F 9950WDCL-NL & F	9847L-NL & F 9947L-NL & F	9848L-NL & F 9948L-NL & F	9849L-NL & F 9949L-NL & F	9857L-NL & F 9957L-NL & F
5	98TP & F 99TP & F	9827TP & F 9927TP & F	9875TP & F 9975TP & F	9847WDCTP & F 9947WDCTP & F	9850WDCTP & F 9950WDCTP & F	9847TP & F 9947TP & F	9848TP & F 9948TP & F	9849TP & F 9949TP & F	9857TP & F 9957TP & F
7	98TP-2 & F 99TP-2 & F		9875TP-2 & F 9975TP-2 & F						
8	98K & F 99K & F	9827K & F 9927K & F	9875K & F 9975K & F	9847WDCK & F 9947WDCK & F	9850WDCK & F 9950WDCK & F	9847K & F 9947K & F	9848K & F 9948K & F	9849K & F 9949K & F	9857K & F 9957K & F
8	98L & F 99L & F	9827L & F 9927L & F	9875L & F 9975L & F	9847WDCL & F 9947WDCL & F	9850WDCL & F 9950WDCL & F	9847L & F 9947L & F	9848L & F 9948L & F	9849L & F 9949L & F	9857L & F 9957L & F
10	98K-2 & F 99K-2 & F		9875K-2 & F 9975K-2 & F						
10	98L-2 & F 99L-2 & F		9875L-2 & F 9975L-2 & F						
11 12		9827TL & F 9927TL & F		9847WDC & F 9947WDC & F	9850WDC & F 9950WDC & F	9847TL & F 9947TL & F	9848 & F 9948 & F	9849 & F 9949 & F	9857TL & F 9957TL & F
14	98K-BE & F 99K-BE & F	9827K-BE & F 9927K-BE & F	9875K-BE & F 9975K-BE & F	9847WDCK-BE & F 9947WDCK-BE & F	9850WDCK-BE & F 9950WDCK-BE & F	9847K-BE & F 9947K-BE & F	9848K-BE & F 9948K-BE & F	9849K-BE & F 9949K-BE & F	9857K-BE & F 9957K-BE & F
14	98L-BE & F 99L-BE & F	9827L-BE & F 9927L-BE & F	9875L-BE & F 9975L-BE & F	9847WDCL-BE & F 9947WDCL-BE & F	9850WDCL-BE & F 9950WDCL-BE & F	9847L-BE & F 9947L-BE & F	9848L-BE & F 9948L-BE & F	9849L-BE & F 9949L-BE & F	9857L-BE & F 9957L-BE & F
16		9827TL-BE & F 9927TL-BE & F		9847WDC & F 9947WDC & F	9850WDC & F 9950WDC & F	9847TL-BE & F 9947TL-BE & F	9848 & F 9948 & F	9849 & F 9949 & F	9857TL-BE & F 9957TL-BE & F

Dimensions

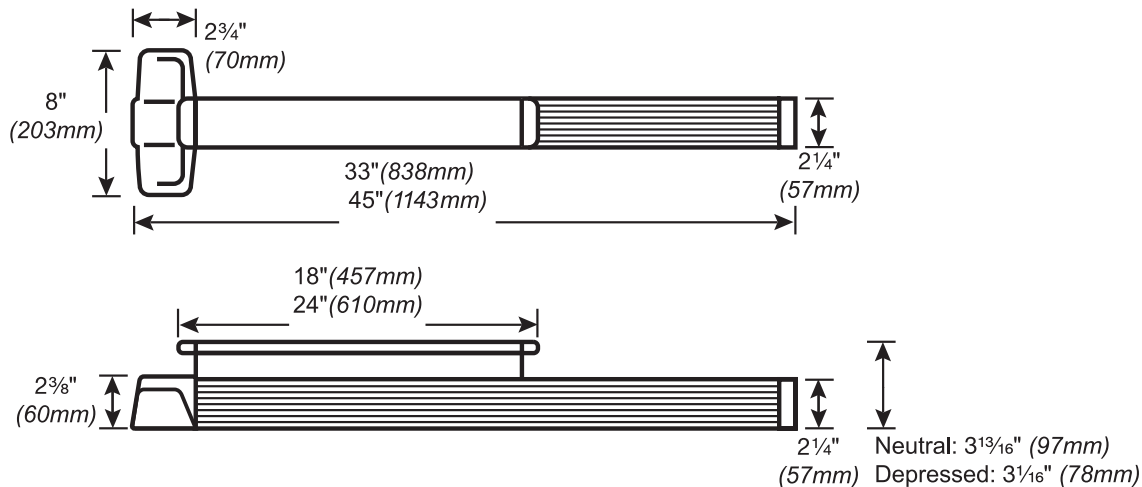

UL Listing for fire exit hardware

UL Listed fire exit hardware label and opening size

Exit device	Door material	Single door	Double door						
			With 9954 mullion	With 9854 mullion	With kr9954 mullion	With kr9854 mullion	V x v same direction	V x mortise same direction	V x v double egress
98-F 99-F	Metal	3 Hour 4' x 10'	3 Hour 8' x 10'	3 Hour 8' x 10'	3 Hour 8' x 8'	3 Hour 8' x 8'	—	—	—
9875-F 9975-F	Metal	3 Hour 4' x 10'	—	—	—	—	—	3 Hour 8' x 10'	—
9827-F 9927-F	Metal	—	—	—	—	—	90 Minute* 8' x 10'	3 Hour 8' x 10'	3 Hour 8' x 10'
9827LBR-F 9927LBR-F	Metal	—	—	—	—	—	90 Minute* 8' x 10'	—	3 Hour 8' x 10'
9857-F 9957-F	Metal	3 Hour 4' x 8'	3 Hour 8' x 8'	3 Hour 8' x 8'	3 Hour 8' x 8'	3 Hour 8' x 8'	—	—	—
9847-F 9947-F	Metal	—	—	—	—	—	90 Minute* 8' x 10'	3 Hour 8' x 10'	3 Hour 8' x 10'
9847LBR-F 9947LBR-F	Metal	—	—	—	—	—	90 Minute* 8' x 10'	—	3 Hour 8' x 10'
9848-F 9948-F	Metal	—	—	—	—	—	90 Minute* 8' x 10'	3 Hour 8' x 10'	3 Hour 8' x 10'
9849-F 9949-F	Metal	—	—	—	—	—	90 Minute* 8' x 10'	3 Hour 8' x 10'	3 Hour 8' x 10'
9849LBL-F 9949LBL-F	Metal	—	—	—	—	—	90 Minute* 8' x 10'	—	3 Hour 8' x 10'

* Currently, no door manufacturers offer a listing over 90 minutes with doors swinging same direction. Consult wood door manufacturers for current UL listings.

98/99 Finishes

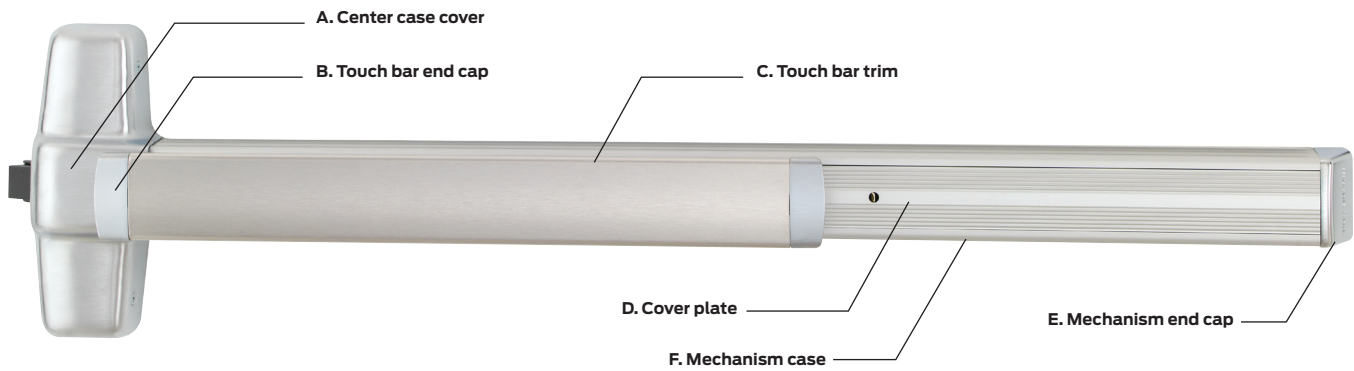

Finishes

Color	US number	BHMA number	A, B, E	C	D & F
Bright brass	US3	605	Bright brass	Bright brass US3, 605	Buffed anodized
Satin brass	US4	606	Bright brass	Satin brass US4, 606	Anodized
Satin bronze	US10	612	Plated	Satin bronze US10, 612	Anodized
Bright chrome	US26	625	Plated	Bright stainless steel US32, 629	Buffed anodized
Satin chrome	US26D	626	Plated	Satin stainless steel US32D, 630	Anodized
Satin stainless steel*	US32D	630	Stainless steel	Satin stainless steel US32D, 630	Anodized
Aluminum, anodized	US28	628	Powder coat	Satin stainless steel US32D, 630	Anodized
Duranodic dark bronze	313	710	Powder coat	Powder coat	Powder coat
Black	315	622	Powder coat	Powder coat	Powder coat
Aged bronze 643E	–	–	Relieved aged bronze	Relieved aged bronze	Aged bronze, no relief

Special Finishes

Color	US number	BHMA number	A, B, E	C	D & F
Satin bronze, oil-rubbed	US10B	613	Oil-rubbed, US10B	Oil-rubbed, US10B	Powder coat
Powder coat**	RAL #	–	Powder coat	Satin stainless steel US32D, 630 (unless specified to match device)	Powder coat
Bright bronze	US9	611	Plated	Bright bronze US9, 611	Buffed anodized
Satin nickel*	US15	619	Plated, clear powder	Satin stainless steel US32D	Anodized
Satin chrome (antimicrobial)	U26D-AM	626-AM	AM Clear over chrome	AM Clear over satin stainless steel US32D, 630	AM Clear over anodized
Satin stainless steel (antimicrobial)	US32D-AM	630-AM	AM Clear over stainless steel	AM Clear over Satin Stainless Steel US32D, 630	AM Clear over anodized

Touch bar trim options — Knurled
 Embossed “Push”
 Braille (Caution-Stairwell), satin stainless steel only
 RSS, US32D only, red silk screen lettered “EMERGENCY EXIT ONLY – PUSH TO OPEN AND SOUND ALARM.”

* US32D and US15—available on 98 Series only

** Other custom logo touchbar trim and RAL color combinations available - consult factory



98/99 Finishes

Finishes*

	Color	US number	BHMA number
	Chromium, polished	US26	625
	Anodized, aluminum	US28	628
	Chromium, dull	US26D	626
	Brass, polished	US3	605
	Brass, dull	US4	606

	Color	US number	BHMA number
	Bronze, dull	US10	612
	Satin nickel Available for 98 ONLY	US15	619
	Satin stainless steel	US32D	630
	Duranodic dark bronze	313	710
	Black, painted (not flat powder)	SPBLK	693
	Flat Black	US19/ 315	622/711
	Aged bronze	–	643e

Special finishes

	Color	US number	BHMA number
	Satin chrome, Antimicrobial	US26D-AM	626-AM
	Satin stainless steel, antimicrobial	US32D-AM	630-AM

Pushpad options — Knurled
 Embossed “Push”
 Braille (Caution-Stairwell), satin stainless steel only
 RSS – (Emergency Exit – Push to open and sound alarm) – Red Silkscreen lettering on US32D

* Note: Durable powder coated finishes available at specific special request. PLEASE CONTACT FACTORY.

About Allegion

Allegion (NYSE: ALLE) is a global pioneer in safety and security, with leading brands like CISA®, Interflex®, LCN®, Schlage®, SimonsVoss® and Von Duprin®. Focusing on security around the door and adjacent areas, Allegion produces a range of solutions for homes, businesses, schools and other institutions. Allegion is a \$2 billion company, with products sold in almost 130 countries.

For more, visit www.allegion.com

aptiQ ■ LCN ■ **SCHLAGE** ■ STEELCRAFT ■ VON DUPRIN