



HNM

MEDICAL SUPPLIES

HNM Medical SPO2 Sensors

HNM

MEDICAL

TABLE OF CONTENTS





SpO2 Sensor		
	Reusable SpO2 Sensor	1
	Disposable SpO2 Sensor	2
	SpO2 Sensor Extension Cable	3
	Pulse Oximeter SpO2 Sensor	4
Patient monitor ECG Cable and Lead Wires		
	One-Piece Series ECG Cable With Leads	5
	"One-LINE" Series ECG Lead Wires	6
	ECG Trunk Cable and Leads	7
	Disposable ECG Lead Wires	8
Electrocardiograph ECG Cable with Lead Wires		
	One-Piece Series EKG Cable With Leads	9
	EKG Multi-link Cable and Lead wires	10
	Electrodes	11
	Radiotransparent Leadwires (RTL)	12
Holter Recorder ECG Patient Cable and Lead Wires		
	Holter Recorder ECG Patient Cable and Lead Wires	13
Telemetry Monitor EKG cable and lead wires		
	Telemetry Monitor EKG cable and lead wires	14
Non-Invasive Blood Pressure(NIBP) Cuff & Tubes		
	Non-Invasive Blood Pressure(NIBP) Cuff & Tubes	15
IBP Cable and Pressure Transducers		
	IBP Cable and Pressure Transducers	16

TABLE OF CONTENTS

	ETCO2 Sensor Connector & Accessories Series	17	
	Medical Temperature Probes	18	
	Disposable non-invasive EEG sensor	19	
	EEG/EMG Leadwires with Electrodes	20	
	ESU pencil and Connecting Cable for electrosurgery	21	
	Grounding Pad	22	
	Pressure Infusion Bag	23	
	Instrument Connector and Socket	24	
	Raw Medical Cable and Wires	25	
	Defibrillator Multi-Link Cable and Leadwires	26	
	HyLink Series	27	
	Clinical evaluation for SpO2 Accuracy	28	
	29	

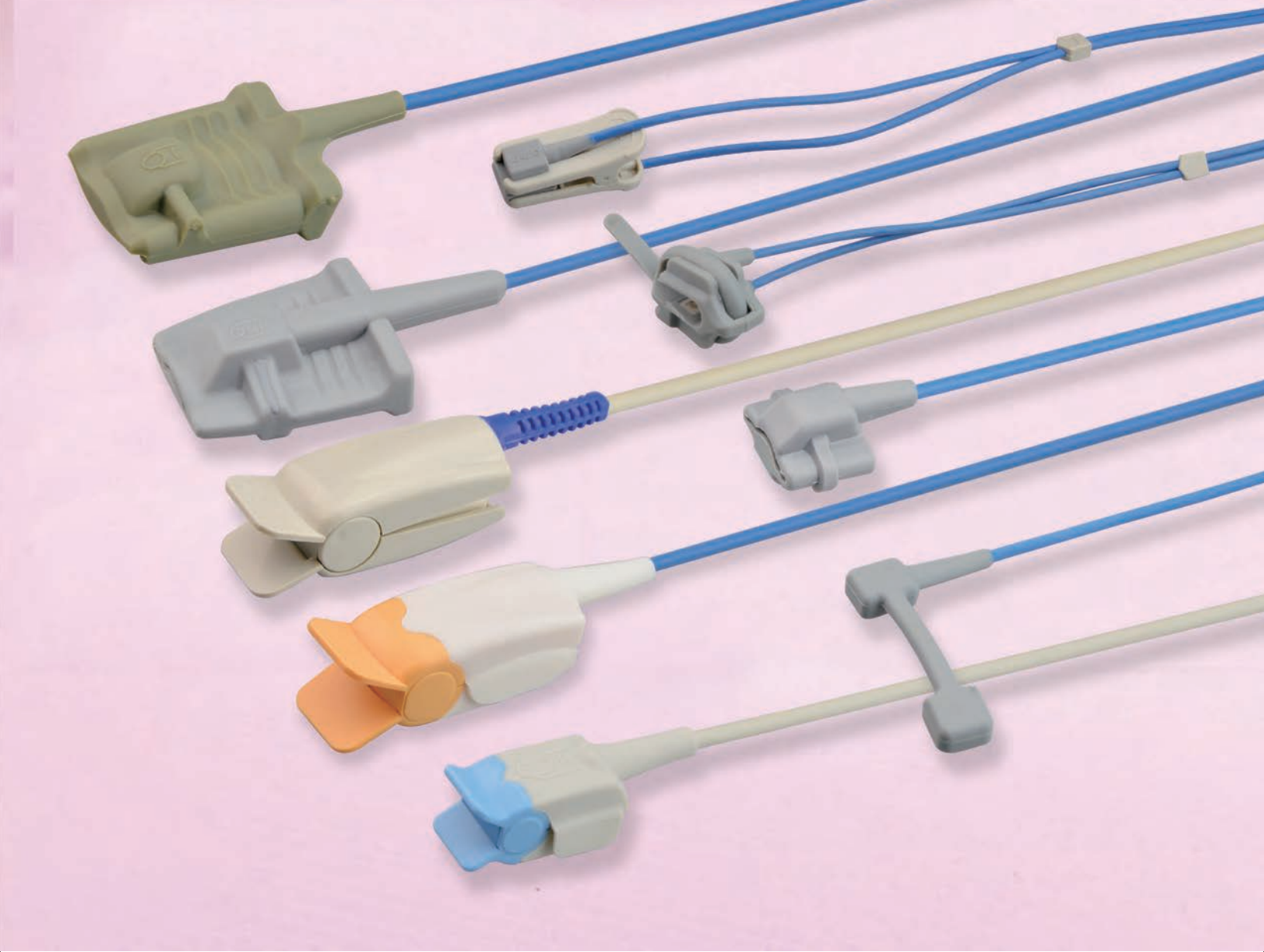

1

Reusable SpO2 Sensor



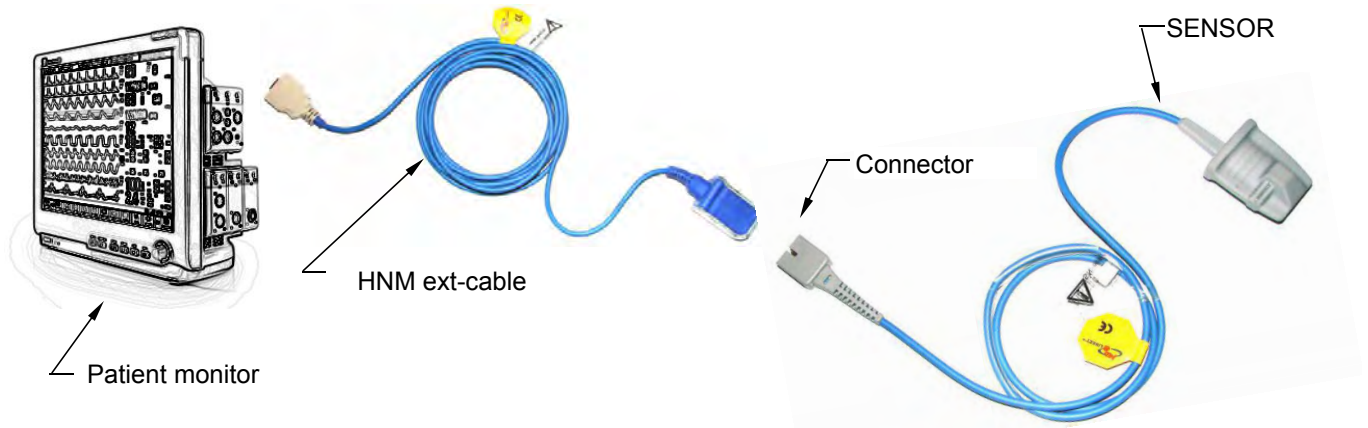

Connector type

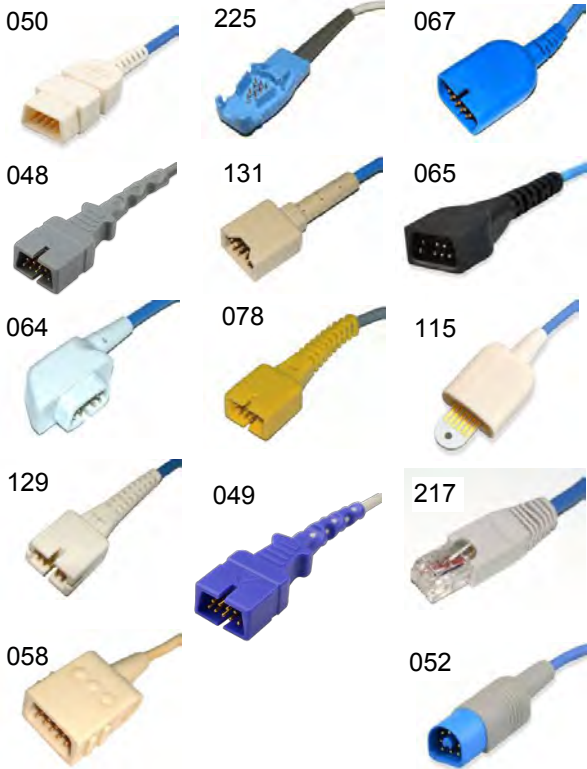

Type Disignation

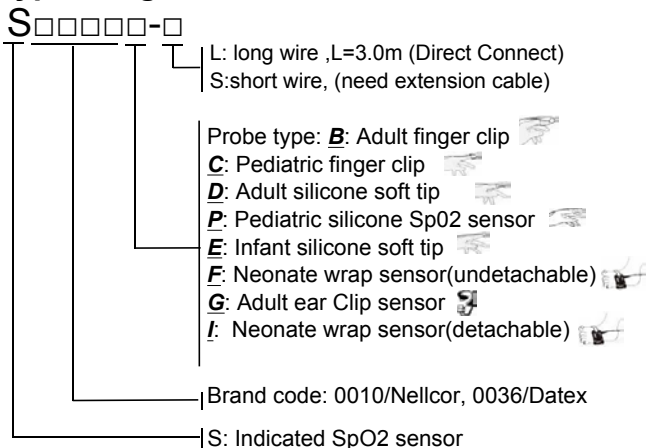

Sensor type

S0010A Series Adult finger clip SpO₂ sensor
Application: Adult>40kg
Application site: Index or other finger



S0022 Series Pediatric finger clip SpO₂ sensor
Application: Pediatric>10-40kg



S0012A Series Adult silicone SpO₂ sensor
Application: Adult>40kg
Application site: Index or other finger



Pediatric (medium size) silicone SpO₂ sensor
Application:for patients finger thickness 7~12 mm
 (Pediatric10-40kg)
Application site: Index or other finger



S0012A Series Infant silicone SpO₂ sensor
Application:Infant 4-15kg
Application site: Infant- great toe, thumb



S0011A Neonate silicone Wrap SpO₂ Sensor
Application:Neonate 1-4kg,
Pediatric 10-40kg; Infant 3-15kg
Application site: Adult,Pediatric-Index or other finger; Neonate-foot; Infant- great toe







S0011A Series Y type Multisite sensor
Application: Adult>40kg
Accessory: Neonate silicone Wrap

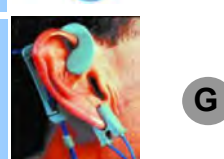



S0011A Series Adult ear Clip SpO₂ Sensor
Application: Adult>40kg
Application site: ear
Warning: only use for pulse oximeter which has autoconditioning power fuction.



Reusable SpO2 Sensor

Compatible Brand	Compatible Models No.	INSTRUMENT CONNECTOR	OEM P/N	HNM REF NO.	Description (Name, Length, Plug, Compatible)	Ext-cable	Price Code
Anke	ASC-553	074/467 		S0007B-L	Adult finger clip, 3M	/	C0
				S0007D-L	Adult silicone soft, 3M		D2
				S0007I-L	Neonate wrap sensor (detachable),3M		D2
	ASC-553 (*Oximax tech)	714/616 		S0003B-L	Adult finger clip, 3M	/	C0
				S0003D-L	Adult silicone soft, 3M		D2
				S0003I-L	Neonate wrap sensor (detachable),3M		D2
	ASC-553A	740/741 		S0145B-L	Adult finger clip, 3M	/	D0
				S0145D-L	Adult silicone soft, 3M		E5
				S0145I-L	Neonate wrap sensor (detachable),3M		E5
	ASC-553A	041 		S0064B-L	Adult finger clip, 3M	/	C0
				S0064C-L	Pediatric finger clip, 3M		C0
				S0064D-L	Adult silicone soft, 3M		D2
				S0064E-L	Infant silicone, 3M		D2
				S0064F-L	Neonate wrap sensor (und detachable), 3M		D2
			S0064G-L	Adult ear clip sensor, 3M	D2		
			S0064I-L	Neonate wrap sensor (detachable),3M	D2		
Artema/S&W	S&W Artema Patient monitor Diascope, 8000, Athena (*Non-Oximax) Compatible Original SL033057+DS100A	218 	SL033057 + DS100A	S0023B-L	Adult finger clip, 3M	/	D0
				S0023C-L	Pediatric finger clip, 3M		E5
				S0023D-L	Adult silicone soft, 3M		E5
				S0023E-L	Infant silicone, 3M		E5
				S0023F-L	Neonate wrap sensor, (und detachable), 3M		E5
				S0023G-L	Adult ear clip sensor, 3M		E0
				S0023I-L	Neonate wrap sensor (detachable),3M		E0
	370/048 	DS100A	S0010B-S	Adult finger clip, 0.915M	Need S0023OX-L	B5	
			S0010D-S	Adult silicone soft, 0.915M		C4	
		D-YS	S0010I-S	Neonate wrap sensor (detachable),0.915M		C4	
Artema/S&W	S&W Athena and Diascope, 8000			S0156B-L	Adult finger clip, 3M	/	D0
				S0156C-L	Pediatric finger clip, 3M		E5
				S0156D-L	Adult silicone soft, 3M		E5
				S0156E-L	Infant silicone, 3M		E5
				S0156F-L	Neonate wrap sensor (und detachable), 3M		E5
				S0156G-L	Adult ear clip sensor, 3M		E0
	370/048 	DS100A	S0010B-S	Adult finger clip, 0.915M	Need S0156NE-L	B5	
			S0010D-S	Adult silicone soft, 0.915M		C4	
		D-YS	S0010I-S	Neonate wrap sensor (detachable),0.915M		C4	
BRAINER	2000A/B/C/E (BCI tech)			S0058B-L	Adult finger clip, 3M	/	C0
				S0058C-L	Pediatric finger clip, 3M		C0
				S0058D-L	Adult silicone soft, 3M		D2
				S0058E-L	Infant silicone, 3M		D2
				S0058F-L	Neonate wrap sensor (und detachable), 3M		D2
				S0058G-L	Adult ear clip sensor, 3M		D2
				S0058I-L	Neonate wrap sensor (detachable),3M		D2

Reusable SpO2 Sensor

Compatible Brand	Compatible Models No.	INSTRUMENT CONNECTOR	OEM P/N	HNM REF NO.	Description (Name, Length, Plug, Compatible)	Ext-cable	Price Code	
BCI	3300, 3301, 3302, 3303, 3304, 3401 (*BCI)		3044	S0076B-S	Adult finger clip, 0.915M	Need S0076BC-L 	C2	
			3178	S0076C-S	Pediatric finger clip, 0.915M		C4	
			3044	S0076D-S	Adult silicone soft, 0.915M		C4	
				S0076P-S	Pediatric silicone, 0.915M		C4	
			3178	S0076E-S	Infant silicone, 0.915M		C4	
				S0076F-S	Neonate wrap sensor (undetachable), 0.915M		C4	
				S0076G-S	Adult ear clip sensor , 0.915M		C4	
				S0076I-S	Neonate wrap sensor (detachable),0.915M		C4	
BCI	BCI(Biochem International): 3401, 3304, 3303, 3302, 3301, 3300; Spacelabs Burdick: PRO2; Dräger: Dräger Oxipac 2000		3044	S0076B-L	 Adult finger clip, 3M		C0	
			3178	S0076C-L	 Pediatric finger clip, 3M		C0	
			3044	S0076D-L	 Adult silicone soft, 3M		D2	
				S0076P-L	 Pediatric silicone, 3M		D2	
				S0076F-L	 Neonate wrap sensor (undetachable), 3M		D2	
				S0076I-L	 Neonate wrap sensor (undetachable),3M		D2	
BCI	3300, 3301 6100, 9100 Advisor, Autocorr, MiniToor, Mini Torr plus (BCI*)				The same as S0076 series	Need S0111BC-L 	C4	
				S0111B-L	Adult finger clip, 3M		C0	
				S0111D-L	Adult silicone soft, 3M		D2	
				S0111E-L	Infant silicone, 3M		D2	
				S0111F-L	Neonate wrap sensor (undetachable), 3M	/	D2	
				S0111G-L	Adult ear clip sensor , 3M		D2	
				S0111I-L	Neonate wrap sensor (detachable),3M		D2	
Biosys	BPM200 BPM700 Guardian		DS100A	S0010B-S	Adult finger clip, 0.915M	Need S0010NE-L 	B5	
				S0010D-S	Adult silicone soft, 0.915M		C4	
			D-YS	S0010I-S	Neonate wrap sensor (detachable),0.915M		C4	
	BPM300			S0065B-L	Adult finger clip, 3M		C0	
				S0065C-L	Pediatric finger clip, 3M		C0	
				S0065D-L	Adult silicone soft, 3M		C3	
				S0065P-L	Adult silicone soft, 3M	/	D2	
				S0065E-L	Infant silicone, 3M		D2	
				S0065G-L	Adult ear clip sensor , 3M		D2	
				S0065I-L	Neonate wrap sensor (detachable),3M		D2	
	Biocare	BP-12B, BP-12C (Digital tech)			S0160B-L	Adult finger clip, 3M		C0
					S0160D-L	Adult silicone soft, 3M	/	D2
					S0160I-L	Neonate wrap sensor (detachable),3M		D2
		BM-9000, BM-9000S, FM-801, FM-801V (*Digital Tech)			S0425B-L	Adult finger clip, 3M		C0
				S0425D-L	Adult silicone soft, 3M	/	D2	
				S0425I-L	Neonate wrap sensor (detachable),3M		D2	
BM-9000				S0063B-L	Adult finger clip, 3M		C0	
				S0063D-L	Adult silicone soft, 3M	/	D2	
				S0063I-L	Neonate wrap sensor (detachable),3M		D2	













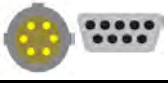

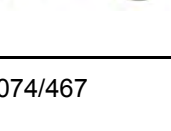

Reusable SpO2 Sensor

Compatible Brand	Compatible Models No.	INSTRUMENT CONNECTOR	OEM P/N	HNM REF NO.	Description (Name, Length, Plug, Compatible)	Ext-cable	Price Code
Baxter/ Simed	ASAT, S-50/100/100a		SL033057 + DS100A	S0023B-L	Adult finger clip, 3M	/	D0
				S0023D-L	Adult silicone soft, 3M		E5
				S0023I-L	Neonate wrap sensor (detachable),3M		E5
	Monarch/Explorer (Oxi Tech)		DS100A	S0026B-S	Adult finger clip, 0.915M	Need S0026OX-L 	C2
				S0026D-S	Adult silicone soft, 0.915M		D5
			D-YS	S0026I-S	Neonate wrap sensor (detachable),0.915M		D5
	Baxter:ASAT SiMED:S-50 SiMED:S-100 SiMED:S-100e			S0120B-L	Adult finger clip, 3M		C0
				S0120C-L	Pediatric finger clip, 3M		C0
				S0120D-L	Adult silicone soft, 3M		D2
				S0120E-L	Infant silicone, 3M		D2
				S0120F-L	Neonate wrap sensor (undetachable), 3M		D2
				S0120G-L	Adult ear clip sensor, 3M		D2
				S0120I-L	Neonate wrap sensor (detachable),3M		D2
	Bionet	370/048 	DS100A	S0010B-S	Adult finger clip, 0.915M	Need S0084BC-L 	B5
				S0010D-S	Adult silicone soft, 0.915M		C4
D-YS			S0010I-S	Neonate wrap sensor (detachable),0.915M	C4		
481/482 			S0084B-L	Adult finger clip, 3M	/	C0	
			S0084D-L	Adult silicone soft, 3M		C0	
			S0084E-L	Infant silicone, 3M		C0	
			S0084F-L	Neonate wrap sensor (undetachable), 3M		C0	
			S0084G-L	Adult ear clip sensor, 3M		C0	
			S0084G-S	Adult ear clip sensor,0.92M		C0	
BM3/BM5(New) 			S0121B-L	Adult finger clip, 3M	/	C0	
			S0121C-L	Pediatric finger clip, 3M		C0	
			S0121D-L	Adult silicone soft, 3M		D2	
			S0121E-L	Infant silicone, 3M		D2	
			S0121F-L	Neonate wrap sensor (undetachable), 3M		D2	
			S0121G-L	Adult ear clip sensor, 3M		D2	
	S0121I-L	Neonate wrap sensor (detachable),3M	D2				
Bruker (Odam)	668/062 		S0071B-L	Adult finger clip, 3M	/	C0	
			S0071C-L	Pediatric finger clip, 3M		C0	
			S0071D-L	Adult silicone soft, 3M		D2	
			S0071E-L	Infant silicone, 3M		D2	
			S0071F-L	Neonate wrap sensor (undetachable), 3M		D2	
			S0071G-L	Adult ear clip sensor, 3M		D2	
			S0071I-L	Neonate wrap sensor (detachable),3M		D2	
Bruker (Odam)	Bruker (Odam) all, as DC-3002, IH, M3, 		S0076B-S	Adult finger clip, 0.915M	Need S0071BC-L 	C2	
			S0076D-S	Adult silicone soft, 0.915M		C4	
			S0076I-S	Neonate wrap sensor (detachable),0.915M		C4	
BAOZHONG			S0041C-L	Pediatric finger clip, 3M		C0	
			S0041D-L	Adult silicone soft, 3M		D2	
			S0041E-L	Infant silicone, 3M		D2	
			S0041F-L	Neonate wrap sensor (undetachable), 3M		D2	
			S0041G-L	Adult ear clip sensor, 3M		D2	
			S0041I-L	Neonate wrap sensor (detachable), 3M		D2	

Reusable SpO2 Sensor

Compatible Brand	Compatible Models No.	INSTRUMENT CONNECTOR	OEM P/N	HNM REF NO.	Description (Name, Length, Plug, Compatible)	Ext-cable	Price Code
Biolight	M69, M66 (Old model)			S0101B-L	Adult finger clip, 3M	/	D0
				S0101C-L	Pediatric finger clip, 3M		D0
				S0101D-L	Adult silicone soft, 3M		E5
				S0101E-L	Infant silicone, 3M		E5
				S0101F-L	Neonate wrap sensor (undetachable), 3M		E5
				S0101G-L	Adult ear clip sensor, 3M		E5
		S0101I-L	Neonate wrap sensor (detachable),3M	E5			
	M6, M12, M69 (New model)	074/467 		S0029B-L	Adult finger clip, 3M	/	C0
				S0029C-L	Pediatric ear clip sensor,3M		C0
				S0029D-L	Adult silicone soft, 3M		D2
				S0029E-L	Infant silicone, 3M		D2
				S0029F-L	Neonate wrap sensor (undetachable), 3M		D2
			S0029I-L	Neonate wrap sensor (detachable),3M	C3		
Biolight	(*Oximax)			S0422B-L	Adult finger clip, 3M	/	C0
				S0422D-L	Adult silicone soft, 3M		D2
				S0422I-L	Neonate wrap sensor (detachable),3M		D2
Biolight	M700 (*Digital Tech)			S0404B-S	Adult finger clip, 0.915M	/	C8
				S0404D-S	Adult silicone soft, 0.915M		C0
				S0404I-S	Neonate wrap sensor (detachable),0.915M		C0
	M8000, M9000, M8000A M9000A, BTD-352A, new M69 (*Digital Tech)			S0160B-S	Adult finger clip, 0.915M	Need S0155DO-L 	C8
				S0160D-S	Adult silicone soft, 0.915M		C0
				S0160I-S	Neonate wrap sensor (detachable),0.915M		C0
				S0155B-L	Adult finger clip, 3M	/	C0
				S0155D-L	Adult silicone soft, 3M		D2
				S0155I-L	Neonate wrap sensor (detachable),3M		D2
	A6 (*Digital Tech)			S0165B-S	Adult finger clip, 0.915M	Need S0165DO-L 	C8
				S0165D-S	Adult silicone soft, 0.915M(2018)		C0
				S0165I-S	Neonate wrap sensor (detachable),0.915M		C0
				S0165B-L	Adult finger clip, 3M	/	C0
				S0165D-L	Adult silicone soft, 3M(2018)		D2
				S0165I-L	Neonate wrap sensor (detachable),3M (2018)		D2
	Biolight (Oxi Tech)			S0415B-L	Adult finger clip, 3M	/	C0
				S0415D-L	Adult silicone soft, 3M		D2
				S0415I-L	Neonate wrap sensor (detachable),3M		D2
M900, M7000, M9500 A8 Modular (*Digital Tech)			S0419B-L	Adult finger clip, 3M	/	C0	
			S0419D-L	Adult silicone soft, 3M		D2	
			S0419I-L	Neonate wrap sensor (detachable),3M		D2	
Charmcare	CX100 (OxiSmart) (Non-oximax)	370/048 	DS100A	S0010B-S	Adult finger clip, 0.915M	Need S0010NE-L 	B5
				S0010D-S	Adult silicone soft, 0.915M		C4
	D-YS	S0010I-S	Neonate wrap sensor (detachable),0.915M	C4			
Choice/MED	MMED6000DPM/M10, KD580(BCI tech)			S0169B-L	Adult finger clip, 3M	/	C2
				S0169D-L	Adult silicone soft, 3M		C3
				S0169I-L	Neonate wrap sensor (detachable),3M		C3
	MMED100H, MMED300A, MMED6000DP, (Digital tech)			S0403B-L	Adult finger clip, 3M	/	C0
				S0403D-L	Adult silicone soft, 3M		D2
				S0403I-L	Neonate wrap sensor (detachable),3M		D2













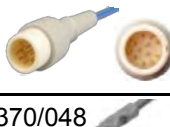

Reusable SpO2 Sensor

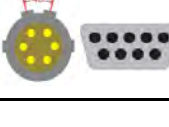
Compatible Brand	Compatible Models No.	INSTRUMENT CONNECTOR	OEM P/N	HNM REF NO.	Description (Name, Length, Plug, Compatible)	Ext-cable	Price Code	
Choice/MED	MMED3001		DS100A	S0010B-S	Adult finger clip, 0.915M	/	B5	
				S0010D-S	Adult silicone soft, 0.915M		C4	
			D-YS	S0010I-S	Neonate wrap sensor (detachable),0.915M		C4	
	MMED6000DPM/M10, KD580(BCI tech)			S0076B-S	Adult finger clip, 0.915M	Need 	C2	
				S0076D-S	Adult silicone soft, 0.915M		C4	
				S0076I-S	Neonate wrap sensor (detachable),0.915M		C4	
Choice/MED	Oximax module		DS100A	S0026B-S	Adult finger clip, 0.915M	Need 	C2	
				S0026D-S	Adult silicone soft, 0.915M		D5	
			D-YS	S0026I-S	Neonate wrap sensor (detachable),0.915M		D5	
				S0112B-L	Adult finger clip, 3M	/	D0	
				S0112C-L	Pediatric finger clip, 3M		D0	
				S0112D-L	Adult silicone soft, 3M		E5	
				S0112E-L	Infant silicone, 3M		F5	
				S0112F-L	Neonate wrap sensor (und detachable), 3M		F5	
				S0112G-L	Adult ear clip sensor, 3M		F5	
	Mmed 100H, Mmed 300A, Mmed 6000DP(Digital Tech)			S0402B-L	Adult finger clip, 3M	/	C0	
				S0402D-L	Adult silicone soft, 3M		D0	
				S0402I-L	Neonate wrap sensor (detachable),3M		D0	
	MMED6000DP(BCI TECH)			S0417B-L	Adult finger clip, 3M	/	C0	
				S0417D-L	Adult silicone soft, 3M		D2	
				S0417I-L	Neonate wrap sensor (detachable),3M		D2	
	Choice	Choice: MMED6000D/D;AnKe:553; Cheersails:CSM-2000;Goldway:UT4000A, UT4000C 4000B; WanDong;Jumbor:JB9101/9105/9107; TianRong; BaoZhong;HongRunDa:EM-6;BIOCARE: BM9000			S0007B-L	Adult finger clip, 3M	/	C0
					S0007C-L	Pediatric finger clip, 3M		C0
					S0007D-L	Adult silicone soft, 3M		D2
				S0007F-L	Neonate wrap sensor (und detachable), 3M	D2		
				S0007G-L	Adult ear clip sensor, 3M	D2		
				S0007I-L	Neonate wrap sensor (detachable),3M	D2		
CAS Medical	Oscillomate 9002, 9303, 9302S (Nonin)		8000AA	S0080B-S	Adult finger clip, 0.915M	Need 	C6	
				S0080D-S	Adult silicone soft, 0.915M		D2	
				S0080I-S	Neonate wrap sensor (detachable),0.915M		D2	
	740-750(M) (M Tech)		1863/LNCS DCI	S0204B-S	Adult finger clip, 0.915M	Need 	C9	
				S0204D-S	Adult silicone soft, 0.915M		C0	
			2258/LNCS Y1	S0204I-S	Neonate wrap sensor (detachable),0.915M		C0	
			LNOP DC-12	S0204B-L	Adult finger clip, 3M	/	C0	
				S0204D-L	Adult silicone soft, 3M		C0	
				S0204I-L	Neonate wrap sensor (detachable),3M		D0	
Contec	CMS60C/CW/D/DW, CMS60, PM50, PM60D, CSM5000, CMS5000C, CMS5100, CMS6000, CMS7000/8000/9000(*Digital Tech)			S0160B-S	Adult finger clip, 0.915M	Need 	C8	
				S0160D-S	Adult silicone soft, 0.915M		C0	
				S0160I-S	Neonate wrap sensor (detachable),0.915M		C0	
			S0424B-L	Adult finger clip, 3M	/	C2		
			S0424D-L	Adult silicone soft, 3M		C3		
			S0424I-L	Neonate wrap sensor (detachable),3M		C3		

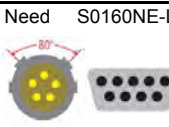
Reusable SpO2 Sensor

Compatible Brand	Compatible Models No.	INSTRUMENT CONNECTOR	OEM P/N	HNM REF NO.	Description (Name, Length, Plug, Compatible)	Ext-cable	Price Code	
Contec	CMS-7000			S0076B-S	Adult finger clip, 0.915M	Need S0155NE-L 	C2	
				S0076D-S	Adult silicone soft, 0.915M		C4	
				S0076I-S	Neonate wrap sensor (detachable),0.915M		C4	
	CreativePC9000, UP6000 ;TOB-MED: TOM MS-6-P ;EDAN:M9, M99A, M8, M8A, M8B, M3, M3B; BIOCARE: BM9000 Goldway; CONTEC; DHR960;	076/590			S0063B-L	Adult finger clip, 3M	/ 	C0
					S0063C-L	Pediatric finger clip, 3M		C0
					S0063D-L	Adult silicone soft, 3M		D2
					S0063F-L	Neonate wrap sensor (und detachable), 3M		D2
					S0063I-L	Neonate wrap sensor (detachable),3M		D2
Contec	Contec: CMS8000, CMS 60C *digital PD output directly DS. Biolight: M6, M69			S0155B-L	Adult finger clip Digital, 3M	/ 	C0	
				S0155C-L	Pediatric finger clip Digital, 3M		C0	
				S0155C-M	Pediatric finger clip Digital, 3M		C0	
				S0155D-S	Adult silicone soft Digital,0.915M		C0	
				S0155D-L	Adult silicone soft Digital, 3M		C0	
				S0155E-L	Infant silicone, Digital, 3M		C0	
				S0155F-L	Neonate wrap sensor (und detachable) Digital, 3M		C0	
				S0155G-L	Adult ear clip sensor Digital , 3M		C0	
				S0155I-S	Neonate wrap sensor (detachable) , Digital,1.0M		C0	
				S0155I-L	Neonate wrap sensor (detachable) , Digital , 3M		C0	
Colin	BP306, BP88, BP508 M570 (OxiSmart) (Non-oximax)		DS100A	S0010B-S	Adult finger clip, 0.915M	Need S0010NE-L 	B5	
				S0010D-S	Adult silicone soft, 0.915M		C4	
			D-YS	S0010I-S	Neonate wrap sensor (detachable),0.915M		C4	
			DS100A	S0010B-S	Adult finger clip, 0.915M		Need S0008CO-L (SCP-10) 	B5
	BP88S (OxiSmart) (Non-oximax)			S0010D-S	Adult silicone soft, 0.915M	C4		
			D-YS	S0010I-S	Neonate wrap sensor (detachable),0.915M	C4		
				S0001B-L	Adult finger clip, 3M	/ 	D0	
				S0001D-L	Adult silicone soft, 3M		E5	
	S0001I-L	Neonate wrap sensor (detachable),3M	E5					
Colin	BX 10NE (Oxi Tech)		DS100A	S0026B-S	Adult finger clip, 0.915M	Need S0117OX-L 	C2	
				S0026D-S	Adult silicone soft, 0.915M		D5	
			D-YS	S0026I-S	Neonate wrap sensor (detachable),0.915M		D5	
	BX 10MA (M Tech)		1863/LNCS DCI	S0204B-S	Adult finger clip, 0.915M	Need S0204CS-L 	C9	
				S0204D-S	Adult silicone soft, 0.915M		C0	
			2258/LNCS YI	S0204I-S	Neonate wrap sensor (detachable),0.915M		C0	
			LNOP/DC-12	S0204B-L	Adult finger clip, 3M	/ 	C0	
				S0204D-L	Adult silicone soft, 3M		C0	
	S0204I-L	Neonate wrap sensor (detachable),3M	D0					
Comen	C60 Neonatal Dedicated Monitor (M Tech)		2258/LNCS YI	S0204I-S	Neonate wrap sensor (detachable),0.915M	Need S0204CS-L 	C0	
				S0204I-L	Neonate wrap sensor (detachable),3M	/	D0	



















Reusable SpO2 Sensor

Compatible Brand	Compatible Models No.	INSTRUMENT CONNECTOR	OEM P/N	HNM REF NO.	Description (Name, Length, Plug, Compatible)	Ext-cable	Price Code				
Comen	STAR-1000			S0066B-L	Adult finger clip, 3M	/	C0				
				S0066C-L	Pediatric finger clip, 3M		C0				
				S0066P-L	Pediatric silicone, 3M		D2				
				S0066E-L	Infant silicone, 3M		D2				
				S0066F-L	Neonate wrap(undetachable), 3M		D2				
				S0066G-L	Adult ear clip sensor, 3M		D2				
	Star-8000A/8000B/ Star-8000C/8000D, Star-8000H Star-5000B/5000C, C50 (*Digital Tech)				S0066I-L		Neonate wrap(detachable),3M	D2			
					S0400B-L		Adult finger clip, 3M	C0			
					S0400D-L		Adult silicone soft, 3M	D2			
					S0400I-L		Neonate wrap sensor (detachable),3M	D2			
				Star-8000E				S0405B-L	Adult finger clip, 3M	C2	
								S0405D-L	Adult silicone soft, 3M	C3	
	S0405I-L	Neonate wrap (detachable),3M	C3								
Comen	C60, C80 (Oxi Tech) NC Series			S0411B-L	Adult finger clip, 3M	C0					
				S0411D-L	Adult silicone soft, 3M	D2					
				S0411I-L	Neonate wrap sensor (detachable),3M	D2					
Comen	COMEN C80			S0530B-L	Adult finger clip, 3M (2018)	D2					
				S0530D-L	Adult silicone soft, 3M (2018)	D2					
				S0530F-L	Neonate wrap sensor (undetectable), 3M (2018)	D2					
	COMEN C60			S0420B-L	Adult finger clip, 3M	D2					
				S0420D-L	Adult silicone soft, 3M	D2					
				S0420F-L	Neonate wrap sensor, 3M	D2					
Creative	UP-6000, PC-9000 (Non-Oximax)		DS100A	S0010B-S	Adult finger clip, 0.915M	Need 	B5				
				S0010D-S	Adult silicone soft, 0.915M		C4				
			D-YS	S0010I-S	Neonate wrap sensor (detachable),0.915M		C4				
	Creative: PC9000, UP6000 TOB-MED:TOM MS-6-P EDAN:M9, M99A, M8, M8A, M8B, M3, M3B Goldway, CONTEC, DHR960	076/590			S0063B-L	Adult silicone soft, 3M	C0				
					S0063C-L	Pediatric finger clip, 3M	C0				
					S0063D-L	Adult silicone soft, 3M	D2				
					S0063F-L	Neonate wrap sensor (undetectable), 3M	D2				
					S0063G-L	Adult finger clip,3M	D2				
					S0063I-L	Neonate wrap(detachable),3M	D2				
	UP-7000, UP-9000, PC-900, PC-900A, PC-900S PC-900SNPC-3000, PC-5000A/B, PC-9000B, PC-66A, PC-66B, PC-66V(Digital tech)	370/048			S0010B-S	Adult finger clip, 0.915M	Need 	B5			
					S0010D-S	Adult silicone soft, 0.915M		C4			
					S0010I-S	Neonate wrap sensor (detachable),0.915M		C4			
					S0160B-L	Adult finger clip, 3M	C0				
					S0160C-L	Pediatric finger clip Digital, 3M	C0				
					S0160D-L	Adult silicone soft, 3M	D2				
					S0160E-L	Infant silicone Digital, 3M	D2				
					S0160F-L	Neonate wrap sensor (undetectable) Digital, 3M	D2				
					S0160G-L	Adult ear clip Digital,3M	D2				
				S0160I-L	Neonate wrap(detachable),3M	D2					
Corpuls				08 / 16 (BCI Module)			3044	S0076B-S	Adult finger clip, 0.915M	NA	C2
								S0076D-S	Adult silicone soft, 0.915M		C4
		3043	S0076I-S			Neonate wrap(detachable),0.915M	C4				
	08 / 16(M) (OxiSmart) (Non-oximax)	370/048		DS100A	S0010B-S	Adult finger clip, 0.915M	Need 	B5			
					S0010D-S	Adult silicone soft, 0.915M		C4			
				D-YS	S0010I-S	Neonate wrap sensor (detachable),0.915M		C4			
08 /16(M) (M Tech)			1863/LN	S0204B-S	Adult finger clip, 0.915M	Need 	C9				
				S0204D-S	Adult silicone soft, 0.915M		C0				
		2258/ LN	S0204I-S	Neonate wrap sensor (detachable),0.915M	C0						















Reusable SpO2 Sensor

Compatible Brand	Compatible Models No.	INSTRUMENT CONNECTOR	OEM P/N	HNM REF NO.	Description (Name, Length, Plug, Compatible)	Ext-cable	Price Code			
Criticare (CSI)	510, 503, 504, 507, 507SD, 508, 581, 1100, 8100, Poet(602-3A), Scholar (CSI Tech) Mindray/:500A, 508, 509,		511-10L 934-10LN	S0100B-L	Adult finger clip, 3M	/	D0			
				S0100C-L	Pediatric finger clip, 3M		D0			
			975AD-10	S0100D-L	Adult silicone soft, 3M		E5			
				S0100F-L	Neonate wrap sensor (undetachable), 3M		E5			
				S0100G-L	Adult ear clip sensor, 3M		E5			
				S0100I-L	Neonate wrap sensor (detachable),3M		E5			
				S0044B-S	Adult finger clip, 0.915M		C0			
				S0044C-S	Pediatric finger clip, 0.915M		D2			
				S0044D-S	Adult silicone soft, 0.915M		D2			
				S0044P-S	Pediatric silicone, 0.915M		D2			
		S0044E-S	Infant silicone, 0.915M	D2						
		S0044F-S	Neonate wrap sensor (undetachable), 0.915M	D2						
		S0044G-S	Adult ear clip sensor, 0.915M	D2						
		S0044I-S	Neonate wrap sensor (detachable),0.915M	D2						
		511SD 934-10DN	S0044B-L	Adult finger clip, 3M	/	C0				
		S0044C-L	Pediatric finger clip, 3M	C0						
		S0044D-L	Adult silicone soft, 3M	D2						
		S0044P-L	Pediatric silicone, 3M	D2						
		S0044E-L	Infant silicone, 3M	D2						
		S0044F-L	Neonate wrap sensor (undetachable), 3M	D2						
	S0044G-L	Adult ear clip sensor, 3M	D2							
	S0044I-L	Neonate wrap sensor (detachable),3M	D2							
Digicare	Digimax5500 (BCI tech)		3044	S0076B-S	Adult finger clip, 0.915M	Need S0111BC-L	C2			
				S0076D-S	Adult silicone soft, 0.915M		C4			
			3043	S0076I-S	Neonate wrap sensor (detachable),0.915M		C4			
			041/471	S0111B-L	Adult finger clip, 3M		C0			
				S0111D-L	Adult silicone soft, 3M		D2			
		S0111I-L	Neonate wrap sensor (detachable),3M	D2						
				S0408B-L	Adult finger clip, 3M	/	D8			
				S0408D-L	Adult silicone soft, 3M		D0			
				S0408I-L	Neonate wrap sensor (detachable),3M		D0			
			Dolphin	Dolphin ONE Oximeters 2150, 2100 compatible for :2G00751. original factory code : 201 original factory code : 360 *digital PD output directly DS.			210	S0099B-S	Adult finger clip, 0.915M	Need S0099BC-L
							S0099C-S	Pediatric finger clip,0.6M (2009)	C0	
	S0099D-S	Adult silicone soft, 0.915M				D2				
	S0099G-S	Adult ear clip,0.6M (2006)				D2				
	S0099I-S	Neonate wrap sensor (detachable),0.915M				D2				
	S0099B-L	Adult finger clip, 3M	/		D8					
	S0099C-L	Pediatric finger clip,3M			D8					
	S0099D-L	Adult silicone soft, 3M			D0					
	S0099E-L	Infant silicone, 3M			D0					
	S0099F-L	Neonate wrap sensor (undetachable), 3M			D0					
	S0099I-L	Neonate wrap sensor (detachable),3M	D0							
Dima (Italia)	OxiSmart (Non-oximax)		DS100A	S0010B-S	Adult finger clip, 0.915M	Need S0010NE-L	B5			
				S0010D-S	Adult silicone soft, 0.915M		C4			
			D-YS	S0010I-S	Neonate wrap sensor (detachable),0.915M		C4			

Reusable SpO2 Sensor

Compatible Brand	Compatible Models No.	INSTRUMENT CONNECTOR	OEM P/N	HNM REF NO.	Description (Name, Length, Plug, Compatible)	Ext-cable	Price Code				
Dixtal	Full compatible with Novamatrix Sensors			S0406B-L	Adult finger clip, 3M	/	D8				
				S0406D-L	Adult silicone soft, 3M		D0				
				S0406I-L	Neonate wrap sensor (detachable),3M		D0				
Datascope	Accutor-Trio (OxiSmart) (Non-oximax)		DS100A	S0010B-S	Adult finger clip, 0.915M	Need S0010NE-L 	B5				
				S0010D-S	Adult silicone soft, 0.915M		C4				
			D-YS	S0010I-S	Neonate wrap sensor (detachable),0.915M		C4				
	Trio Nouvelle Generation (Oxi Tech)		DS100A	S0026B-S	Adult finger clip, 0.915M	Need S0117OX-L 	C2				
				S0026D-S	Adult silicone soft, 0.915M		D5				
			D-YS	S0026I-S	Neonate wrap sensor (detachable),0.915M		D5				
Datascope	Accusat, Accutor 3/4 sat Passport, Accutor plus (Datascope) Compatible for 0020-00-071-01		0600-00-0026-01	S0052B-S	Adult finger clip, 0.915M	Need S0052BC-L 	C0				
				S0052C-S	Pediatric finger clip, 0.915M		C0				
				S0052D-S	Adult silicone soft, 0.915M		D2				
				S0052P-S	Pediatric silicone, 0.915M		D2				
				S0052E-S	Infant silicone, 0.915M		D2				
				S0052F-S	Neonate wrap sensor (und detachable) , 0.915M		D2				
				S0052G-S	Adult ear clip sensor , 0.915M		D2				
				S0052I-S	Neonate wrap sensor (detachable),0.915M		D2				
			068/492				S0052B-L	Adult finger clip, 3M	/	C0	
							S0052D-L	Adult silicone soft, 3M		D2	
							S0052E-L	Infant silicone, 3M		D2	
							S0052F-L	Neonate wrap sensor (und detachable), 3M		D2	
							S0052I-L	Neonate wrap sensor (detachable),3M		D2	
					Accutor plus (M Tech)			1863/ LNCS DCI		S0204B-S	Adult finger clip, 0.915M
		S0204D-S				Adult silicone soft, 0.915M		D0			
	2258/ LNCS Y1	S0204I-S	Neonate wrap sensor (detachable),0.915M	D0							
	LNOP DC-12			S0204B-L		Adult finger clip, 3M		/	C0		
				S0204D-L		Adult silicone soft, 3M			C0		
				S0204I-L		Neonate wrap sensor (detachable),3M			D0		
	PassportII, Exper, T Passport XG, Accutor plus(OxiSmart)(Non-oximax)			DS100A	S0010B-S	Adult finger clip, 0.915M	Need S0001NE-L 	B5			
					S0010D-S	Adult silicone soft, 0.915M		C4			
D-YS				S0010I-S	Neonate wrap sensor (detachable),0.915M	C4					
Drager				Oxytrend (M Tech)		1863/ LNCS DCI		S0204B-S	Adult finger clip, 0.915M	Need S0204CS-L 	C9
								S0204D-S	Adult silicone soft, 0.915M		C0
2258/ LNCS Y1	S0204I-S	Neonate wrap sensor (detachable),0.915M	C0								
LNOP DC-12			S0204B-L			Adult finger clip, 3M	/	C0			
			S0204D-L			Adult silicone soft, 3M		C0			
			S0204I-L			Neonate wrap sensor (detachable),3M		D0			
Oxipac 2000 (BCI tech module)			3044			S0076B-S	Adult finger clip, 0.915M	/	C2		
				S0076D-S	Adult silicone soft, 0.915M	C4					
			3043	S0076I-S	Neonate wrap sensor (detachable),0.915M	C4					

Reusable SpO2 Sensor

Compatible Brand	Compatible Models No.	INSTRUMENT CONNECTOR	OEM P/N	HNM REF NO.	Description (Name, Length, Plug, Compatible)	Ext-cable	Price Code
Drager		740/741 		S0145B-L	Adult finger clip, 3M	/	D0
				S0145C-L	Pediatric finger clip, 3M		D0
				S0145D-L	Adult silicone soft, 3M		E5
				S0145E-L	Infant silicone, 3M		E5
				S0145F-L	Neonate wrap sensor (undetachable), 3M		E5
				S0145G-L	Adult ear clip sensor, 3M		E5
				S0145I-L	Neonate wrap sensor (detachable),3M		E5
	Vitalert 1000, Cicero (OxiSmart) (Non-oximax)	370/048 	DS100A	S0010B-S	Adult finger clip, 0.915M	Need S0119NE-L 	B5
				S0010D-S	Adult silicone soft, 0.915M		C4
			D-YS	S0010I-S	Neonate wrap sensor (detachable),0.915M	/	C4
			DS100A	S0010B-S	Adult finger clip, 0.915M		B5
				S0010D-S	Adult silicone soft, 0.915M		C4
			D-YS	S0010I-S	Neonate wrap sensor (detachable),0.915M		C4
	Narkomed-Oxysat 2 (OxiSmart) (Non-oximax)	370/048 	DS100A	S0010B-S	Adult finger clip, 0.915M	/	B5
			S0010D-S	Adult silicone soft, 0.915M	C4		
D-YS			S0010I-S	Neonate wrap sensor (detachable),0.915M	/	C4	
DS100A			S0010B-S	Adult finger clip, 0.915M		B5	
			S0010D-S	Adult silicone soft, 0.915M		C4	
D-YS			S0010I-S	Neonate wrap sensor (detachable),0.915M		C4	
Drager	Sirecust 700 Sirecust 630 Sirem SpO2 Module (OxiSmart) (Non-oximax)	370/048 	DS100A	S0010B-S	Adult finger clip, 0.915M	Need S0078NE-L 	B5
				S0010D-S	Adult silicone soft, 0.915M		C4
			D-YS	S0010I-S	Neonate wrap sensor (detachable),0.915M	C4	
		063/475 		S0078B-L	Adult finger clip, 3M	/	C0
				S0078C-L	Pediatric finger clip, 3M		C0
				S0078D-L	Adult silicone soft, 3M		D2
				S0078E-L	Infant silicone, 3M		D2
				S0078F-L	Neonate wrap sensor (undetachable), 3M		D2
				S0078G-L	Ear clip SpO2 sensor, 3M		D2
				S0078I-L	Neonate wrap sensor (detachable),3M		D2
	370/048 	DS100A	S0010B-S	Adult finger clip, 0.915M	Need S0072BC-L or S0072BC-S 	B5	
			S0010D-S	Adult silicone soft, 0.915M		C4	
		D-YS	S0010I-S	Neonate wrap sensor (detachable),0.915M	C4		
		390/437 		S0072B-L	Adult finger clip, 3M	/	D0
				S0072D-L	Adult silicone soft, 3M		E5
				S0072P-L	Pediatric silicone, 3M		E7
			S0072E-L	Infant silicone, 3M	E5		
			S0072F-L	Neonate wrap sensor (undetachable), 3M	E5		
			S0072G-L	Adult ear clip sensor, 3M	E5		
	613/684 		S0119B-L	Adult finger clip, 3M	/	G0	
			S0119C-L	Pediatric finger clip, 3M		G0	
			S0119D-L	Adult silicone soft, 3M		G0	
			S0119E-L	Infant silicone, 3M		G0	
			S0119F-L	Neonate wrap sensor (undetachable), 3M		G0	
			S0119G-L	Adult ear clip sensor, 3M		H0	
			S0119I-L	Neonate wrap sensor (detachable), 3M		H0	
			S0119I-L	Neonate wrap sensor (detachable), 3M		H0	
	Emtel	Fx2000 (OxiSmart) (Non-oximax)	370/048 	DS100A	S0010B-S	Adult finger clip, 0.915M	Need S0178CO-L 
				S0010D-S	Adult silicone soft, 0.915M	C4	
D-YS				S0010I-S	Neonate wrap sensor (detachable),0.915M	C4	
Fx2000 (Oxi Tech)				370/048 	DS100A	S0026B-S	Adult finger clip, 0.915M
			S0026D-S		Adult silicone soft, 0.915M	D5	
		D-YS	S0026I-S		Neonate wrap sensor (detachable),0.915M	D5	

Reusable SpO2 Sensor

Compatible Brand	Compatible Models No.	INSTRUMENT CONNECTOR	OEM P/N	HNM REF NO.	Description (Name, Length, Plug, Compatible)	Ext-cable	Price Code	
Edan	M9, M99A, M8, M8A, M8B, M3, M3B (Oxi Tech)		DS100A	S0026B-S	Adult finger clip, 0.915M	Need S0432OX-L 	C2	
				S0026D-S	Adult silicone soft, 0.915M		D5	
			D-YS	S0026I-S	Neonate wrap sensor (detachable),0.915M		D5	
Edan	EDAN Oximetry M3, M3A, M3B, M8, M8A, M8B M9, M9A, M50, M80 iM8, iM8A, iM8B iM9, iM9A, iM50, iM80 (Oxismart) (Non-Oximart)	370/048 	MS-109079	S0010B-S	Adult finger clip, 0.915M	Need S0040BC-L 	B5	
				S0010D-S	Adult silicone soft, 0.915M		C4	
			D-YS	S0010I-S	Neonate wrap sensor (detachable),0.915M		C4	
			MS3-109069	S0040B-L	Adult finger clip, 3M		/	C0
				S0040D-L	Adult silicone soft, 3M			D2
				S0040I-L	Neonate wrap sensor (detachable),3M			D2
	M3, M3B,M8,M8A,M8B M9,M9A,M50,M80 iM9,iM9A,iM50,iM80(Oxi-tech)			S0416B-L	Adult finger clip, 3M	/	C0	
				S0416D-L	Adult silicone soft, 3M		D2	
				S0416I-L	Neonate wrap sensor (detachable),3M		D2	
	(Digital Tech)			S0424B-L	Adult finger clip, 3M	/	C0	
				S0424D-L	Adult silicone soft, 3M		D2	
				S0424I-L	Neonate wrap sensor (detachable),3M		D2	
	H100B (OxiSmart) (Non-oximax)	370/048 	DS100A	S0010B-S	Adult finger clip, 0.915M	/	B5	
				S0010D-S	Adult silicone soft, 0.915M		C4	
	H100N (Oxi Tech)		DS100A	S0026B-S	Adult finger clip, 0.915M	/	C2	
			S0026D-S	Adult silicone soft, 0.915M	D5			
Fukuda	DS7100-DS7300 (Oxi Tech)		DS100A	S0026B-S	Adult finger clip, 0.915M	Need S0117OX-L 	C2	
				S0026D-S	Adult silicone soft, 0.915M		D5	
			D-YS	S0026I-S	Neonate wrap(detachable),0.915M		D5	
GMI	G2A Vital Signs Monitor G3D,G3A,G3C Patient monitor G3D,G3F,G3G Patient monitor G3H Patient monitor *digital PD output directly DS.			S0108B-L	Adult finger clip Digital, 3M		C0	
				S0108C-L	Pediatric finger clip Digital, 3M		C0	
				S0108D-L	Adult silicone soft Digital, 3M		D2	
				S0108E-L	Infant silicone Digital, 3M		D2	
				S0108F-L	Neonate wrap sensor (undetachable) Digital, 3M		D2	
				S0108G-L	Adult ear clip Digital, 3M		D2	
				S0108I-L	Neonate wrap sensor (detachable),Digital ,3M		D2	
Newtech	NT1, NT1A			S0108C-S	Pediatric finger clip		C0	
	NT2A/NT2C			S0410B-L	Adult finger clip, 3M	/	C6	
				S0410D-L	Adult silicone soft, 3M		C7	
				S0410I-L	Neonate wrap(detachable), 3M		C7	
	NT3A, NT3B, NT3E, NT3F			S0409B-L	Adult finger clip, 3M	/	D8	
				S0409D-L	Adult silicone soft, 3M		D0	
		S0409I-L	Neonate wrap sensor (detachable), 3M	D0				
	NT3A, NT3B, NT3E, NT3F, NT3B 60(Digital Tech)			S0402B-L	Adult finger clip, 3M	/	C0	
				S0402D-L	Adult silicone soft, 3M		D0	
				S0402I-L	Neonate wrap sensor (detachable), 3M		D0	













Reusable SpO2 Sensor

Compatible Brand	Compatible Models No.	INSTRUMENT CONNECTOR	OEM P/N	HNM REF NO.	Description (Name, Length, Plug, Compatible)	Ext-cable	Price Code	
GE Critikon	Dinamap 8700, 8710, 8720 Plus Critikon Dinamap Oxytrak			S0142B-S	Adult finger clip, 0.915M	Need CB-A400-1027A Temporarily unavailable	D5	
				S0142D-S	Adult silicone soft, 0.915M		D0	
				S0142I-S	Neonate wrap sensor (detachable),0.915M		D0	
	Dianmap 9700/9701 9702 PLUS, MPS ORTABLE, /COMPACT, (OxiSmart)(Non-oximax)	370/048		DS100A	S0010B-S	Adult finger clip, 0.915M	Need S0010NE-L (EC-8) 	B5
					S0010D-S	Adult silicone soft, 0.915M		C4
				D-YS	S0010I-S	Neonate wrap sensor (detachable),0.915M		C4
	Dianmap, ProSeries V1 Pro 1000 V2 (OxiSmart) (Non-oximax)			DS100A	S0010B-S	Adult finger clip, 0.915M	Need S0008CO-L (SCP-10) 	B5
					S0010D-S	Adult silicone soft, 0.915M		C4
				D-YS	S0010I-S	Neonate wrap sensor (detachable),0.915M		C4
	Dianmap, ProCare, ProSeries V2Pro1000 V3 (Oxi Tech)			DS100A	S0026B-S	Adult finger clip, 0.915M	Need S0117OX-L 	C2
					S0026D-S	Adult silicone soft, 0.915M		D5
				D-YS	S0026I-S	Neonate wrap sensor (detachable),0.915M		D5
	Dianmap 8700/8710/8720Pulse, Oxyshuttle11 et 2 Critikon Dinamap 8721, 9710, 9700, 8280	392/435			S0059B-L	Adult finger clip, 3M	/	D0
					S0059D-L	Adult silicone soft, 3M		E5
					S0059E-L	Infant silicone, 3M		E5
					S0059F-L	Neonate wrap sensor (undetachable), 3M		E5
					S0059I-L	Neonate wrap sensor (detachable),3M		E5
	Dianmap ProCare Series V2 Pro 1000 V3 (M Tech)		1863/LNCS DCI	S0204B-S	Adult finger clip, 0.915M	Need S0204CS-L 	C9	
				S0204D-S	Adult silicone soft, 0.915M		C0	
			2258/LNCS Y1	S0204I-S	Neonate wrap sensor (detachable),0.915M		C0	
		LNOP DC-12	S0204B-L	Adult finger clip, 3M	/	C0		
			S0204D-L	Adult silicone soft, 3M		C0		
			S0204I-L	Neonate wrap sensor (detachable),3M		D0		
GE Corometrics	188, 129, 129F, 128, 128F (OxiSmart) (Non-oximax)		DS100A	S0010B-S	Adult finger clip, 0.915M	Need S0010NE-L 	B5	
				S0010D-S	Adult silicone soft, 0.915M		C4	
			D-YS	S0010I-S	Neonate wrap sensor (detachable),0.915M		C4	
	120, 510, 511, 118, 556 (OxiSmart) (Non-oximax)			DS100A	S0010B-S	Adult finger clip, 0.915M	Need S0431NE-L 	B5
					S0010D-S	Adult silicone soft, 0.915M		C4
				D-YS	S0010I-S	Neonate wrap sensor (detachable),0.915M		C4
	128 129 (OxiSmart) (Non-oximax)			DS100A	S0010B-S	Adult finger clip, 0.915M	Need S0002NE-L 	B5
					S0010D-S	Adult silicone soft, 0.915M		C4
				D-YS	S0010I-S	Neonate wrap sensor (detachable),0.915M		C4
	SERIE 250 (OXI-tech)				S0002B-L	Adult finger clip, 3M	/	C0
					S0002D-L	Adult silicone soft, 3M		D2
					S0002I-L	Neonate wrap sensor (detachable),3M		D2
				DS100A	S0026B-S	Adult silicone soft, 0.915M	Need S0122OX-L 	C2
				S0026D-S	Adult silicone soft, 0.915M	D5		
D-YS	S0026I-S			Neonate wrap sensor (detachable),0.915M	D5			
				S0122B-L	Adult finger clip, 3M	/	E0	
				S0122D-L	Adult silicone soft, 3M		F5	
				S0122I-L	Neonate wrap sensor (detachable),3M		F5	













Reusable SpO2 Sensor

Compatible Brand	Compatible Models No.	INSTRUMENT CONNECTOR	OEM P/N	HNM REF NO.	Description (Name, Length, Plug, Compatible)	Ext-cable	Price Code
GE-Carescape	V100			603115514 (2018)	Adult finger clip; 0.915M	/	D2
GE	OXIMAX Module: GE B650 or B850	712/713 		S0205D-L	Adult silicone soft, 3M		E0
	GE-Dash 2500 (Oxi-tech)			S0444B-L	Adult finger clip, 3M		D0
GE Datex-Ohmeda	AS/3, CS/3, AS/5 (Built in M module) CH/S, CH/RSCG/2S, CARDIOCAPI-II Capnomac Ultima Light monitor, Satellite, Oscar (Datex tech)		OXY-F-DB	S0036B-S	Adult finger clip, 0.915M	Need S0036BC-L 	C0
				S0036C-S	Pediatric finger clip, 0.915M		D2
				S0036D-S	Adult silicone soft, 0.915M		D2
				S0036P-S	Pediatric silicone, 0.915M		D2
				S0036E-S	Infant silicone, 0.915M		D2
				S0036F-S	Neonate wrap sensor (undetachable), 0.915M		D2
				S0036G-S	Adult ear clip sensor, 0.915M		D2
		OXY-E-DB	S0036G-S	Adult ear clip sensor, 0.915M	D2		
		OXY-W-DB	S0036I-S	Neonate wrap sensor (undetachable), 0.915M	D2		
			OXY-F4-N	S0036B-L	Adult finger clip, 3M	C5	
				S0036C-L	Pediatric finger clip, 3M	C0	
				S0036D-L	Adult silicone soft, 3M	D2	
				S0036P-L	Pediatric silicone, 3M	D2	
				S0036E-L	Pediatric silicone, 3M	D2	
			S0036F-L	Neonate wrap sensor (undetachable), 3M	D2		
	OXY-E4-N		S0036G-L	Adult ear clip sensor, 3M	D2		
	OXY-W4-N		S0036I-L	Neonate wrap sensor (detachable), 3M	D2		
	3700, 3710, 3770, 3775, Biox3740, 3760, 3800, 3900, 3900P, 4700, 5250RGB, Cardiacap/5, S/5, AS/3 (built in Module N-XOSAT) CS/3 (Built in module M-OSAT) (Ohmeda)			OXY-F-UN	S0123B-S	Adult finger clip, 0.915M	C5
					S0123C-S	Pediatric finger clip, 0.915M	D0
				S0123D-S	Adult silicone soft, 0.915M	D0	
				S0123P-S	Pediatric silicone, 0.915M	D0	
				S0123E-S	Infant silicone, 0.915M	D0	
				S0123F-S	Neonate wrap sensor (undetachable), 0.915M	D0	
		OXY-E-UN		S0123G-S	Adult ear clip sensor, 0.915M	D0	
		OXY-W-UN	S0123I-S	Neonate wrap sensor (detachable), 0.915M	D0		
			OXY-F4-H	S0014B-L	Adult finger clip, 3M	C0	
				S0014C-L	Pediatric finger clip, 3M	C0	
				S0014D-L	Adult silicone soft, 3M	D2	
			S0014P-L	Pediatric silicone, 3M	D2		
			S0014E-L	Infant silicone, 3M	D2		
			S0014F-L	Neonate wrap sensor (undetachable), 3M	D2		
OXY-E4-H	S0014G-L		Adult ear clip sensor, 3M	D2			
OXY-W4-H	S0014I-L	Neonate wrap sensor (detachable), 3M	D2				
M-NSAT Module (AS/3, CS/3, S/5) (OxiSmart) (Non-oximax)		DS100A	S0010B-S	Adult finger clip, 0.915M	Need S0001NE-L (MC-10) 	B5	
			S0010D-S	Adult silicone soft, 0.915M	C4		
		D-YS	S0010I-S	Neonate wrap sensor (detachable), 0.915M	C4		
M-NSAT Module (i4) (Oxi Tech)		DS100A	S0026B-S	Adult finger clip, 0.915M	Need S0117OX-L (DOC-10) 	C2	
			S0026D-S	Adult silicone soft, 0.915M	D5		
		D-YS	S0026I-S	Neonate wrap sensor (detachable), 0.915M	D5		
Ohmeda Tuffsat (Ohmeda)		OXY-F1-H	S0014B-M	Adult finger clip, 1.5M	/	C0	
			S0014D-M	Adult silicone soft, 1.5M	C0		
Ohmeda TruSat Ohmeda TruSat TD (+Oxytip Technology)		See the above	See the above	See the above	Need S0127OH-L 	C0	













Reusable SpO2 Sensor

Compatible Brand	Compatible Models No.	INSTRUMENT CONNECTOR	OEM P/N	HNM REF NO.	Description (Name, Length, Plug, Compatible)	Ext-cable	Price Code		
GE Datex-Ohmeda	Ohmeda TruSat Ohmeda TruSat TD (+Oxytip Technology)		OXY-F4-MC	S0127B-L	Adult finger clip, 3M	/	E0		
				S0127C-L	Pediatric finger clip, 3M		E0		
				S0127D-L	Adult silicone soft, 3M		F5		
				S0127P-L	Pediatric silicone, 3M		F5		
				S0127E-L	Infant silicone, 3M		F5		
				S0127F-L	Neonate wrap sensor (undetachable), 3M		F5		
			OXY-E4-MC	S0127G-L	Adult ear clip sensor, 3M		F5		
			OXY-W4-MC	S0127I-L	Neonate wrap sensor (undetachable), 3M		F5		
GE Ohmeda OxyTip+	GE S/5 (i4 E series module built in)		See the above	See the above	See the above	/	Need S0128OH-L 	C0	
			S0128B-L	Adult finger clip, 3M	E0				
			S0128C-L	Pediatric finger clip, 3M	E0				
			S0128D-L	Adult silicone soft, 3M	F5				
			S0128P-L	Pediatric silicone, 3M	F5				
			S0128E-L	Infant silicone, 3M	F5				
			S0128F-L	Neonate wrap sensor (undetachable), 3M	F5				
			S0128G-L	Adult ear clip sensor, 3M	F5				
			S0128I-L	Neonate wrap sensor (detachable), 3M	F5				
	S0428B-S	Adult finger clip, 0.915M	C0						
	S0428P-S	Pediatric silicone, 0.915M	D2						
GE Hellige	Servomed 4.Generation SCP844,851,852;SCS 804;SMK151,153,154,155-1,156,157,SMK181,182,SMV,104T,107,111,168;SMS316;SMC108;SMV104,Servomed N4,Servocard,Serie Cardioserv,Vicom SM,SMU 511,611,612,630 SerieSMK-,200,SMK210,211,230,231,240,250,Pepita 203,R204,204R,205,Pepita 205R		620		S0006B-L	Adult finger clip, 3M	/	D5	
					S0006C-L	Pediatric finger clip, 3M		D0	
					S0006D-L	Adult silicone soft, 3M		E5	
					S0006E-L	Infant silicone, 3M		E0	
					S0006F-L	Neonate wrap sensor (undetachable), 3M		E0	
					S0006I-L	Neonate wrap sensor (detachable), 3M		E0	
	Cardioserv Eagle1000-3000 (OxiSmart) (Non-oximax)		370/048	DS100A	S0010B-S	Adult finger clip, 0.915M	/	Need S0006NE-L 	B5
					S0010D-S	Adult silicone soft, 0.915M		C4	
				D-YS	S0010I-S	Neonate wrap sensor (detachable),0.915M		C4	
	Cardioserv (Oxi Tech)			DS100A	S0026B-S	Adult finger clip, 0.915M	/	Need / Temporarily available	C2
					S0026D-S	Adult silicone soft, 0.915M		D5	
				D-YS	S0026I-S	Neonate wrap sensor (detachable),0.915M		D5	
	SMU, SMK, SMV (Ohmeda tech)			The same as S0014 series	See the above	See the above	/		
General	G1B (Digital Tech)			S0108B-S	Adult finger clip, 0.915M	/	D5		
				S0108D-S	Adult silicone soft, 0.915M		F5		
				S0108I-S	Neonate wrap sensor (detachable),0.915M		F5		
	G2A,G3A,G3C, G3D, G3F,G3G,G3H, G3L, G6A, G6A plus, G9L (Digital Tech)				S0108B-L	Adult finger clip, 3M	/	C0	
					S0108D-L	Adult silicone soft, 3M		D2	
					S0108I-L	Neonate wrap sensor (detachable),3M		D2	











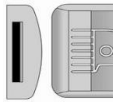



Reusable SpO2 Sensor

Compatible Brand	Compatible Models No.	INSTRUMENT CONNECTOR	OEM P/N	HNM REF NO.	Description (Name, Length, Plug, Compatible)	Ext-cable	Price Code		
GE Marquette	7000/7010, Tram 200/400/600/800 (Ohmeda Tech)		as S0014 series	See the above	See the above	/			
GE Marquette	Eagle 1000/3000/4000 Dash 2000/3000/4000 Solar 8000/8000M i/9500(Tram 451/451N /851/851N) CardioLab/Mac-Lab, Corometrics 120/2120 (Tram 451/451N) Responder3000(OxiSmart) (Non-oximax)		DS100A	S0010B-S	Adult finger clip, 0.915M	Need S0002NE-L 2006644-001	B5		
				S0010D-S	Adult silicone soft, 0.915M		C4		
			D-YS	S0010I-S	Neonate wrap sensor (detachable),0.915M		C4		
				S0002B-L	Adult finger clip, 3M	/	C0		
				S0002C-L	Pediatric finger clip, 3M		C0		
				S0002D-L	Adult silicone soft, 3M		D2		
				S0002P-L	Pediatric silicone, 3M		D2		
				S0002E-L	Infant silicone, 3M		D2		
				S0002F-L	Neonate wrap sensor (und detachable), 3M		D2		
				S0002G-L	Adult ear clip sensor, 3M		D2		
				S0002I-L	Neonate wrap sensor (detachable),3M		D2		
GE Marquette	Dash2500/Dash 3000/4000/5000 Solar 8000/8000M i/9500 (Tram 451N5/851N5) Corometrics 250 (GE-Oxi tech)		DS100A	S0026B-S	Adult finger clip, 0.915M	Need S0122OX-L 2021406-001	C2		
				S0026D-S	Adult silicone soft, 0.915M		D5		
			D-YS	S0026I-S	Neonate wrap sensor (detachable),0.915M		D5		
				S0122B-L	Adult finger clip, 3M	/	E0		
				S0122C-L	Pediatric finger clip, 3M		E0		
				S0122D-L	Adult silicone soft, 3M		F5		
				S0122P-L	Pediatric silicone, 3M		F5		
				S0122E-L	Infant silicone, 3M		F5		
				S0122F-L	Neonate wrap sensor (und detachable), 3M		F5		
				S0122G-L	Adult ear clip sensor, 3M		F5		
				S0122I-L	Neonate wrap sensor (detachable),3M		F5		
				Dash 3000, 4000, 5000 Solar 8000/8000M i/9500 (Tram 450.915M, 850.915M) Cardiolab/Mac-Lab (Tram 450.915M) Corometrics 259 (M tech)	1863/LNCS DCI	S0204B-S	Adult finger clip, 0.915M	Need S0025CS-L 2027263-002	C9
						S0204D-S	Adult silicone soft, 0.915M		C0
					2258/LNCS YI	S0204I-S	Neonate wrap sensor (detachable),0.915M		C0
		S0025B-L			Adult finger clip, 3M	/	D5		
		S0025C-L			Pediatric finger clip, 3M		D0		
		S0025D-L			Adult silicone soft, 3M		D0		
		S0025P-L			Pediatric silicone, 3M		D0		
		S0025E-L			Infant silicone, 3M		D0		
		S0025F-L	Neonate wrap sensor (und detachable), 3M		D0				
		S0025G-L	Adult ear clip sensor, 3M		D0				
	S0025I-L	Neonate wrap sensor (detachable),3M		D0					
Guoteng	PM300 (OxiSmart) (Non-oximax)		DS100A	S0010B-S	Adult finger clip, 0.915M	/	B5		
				S0010D-S	Adult silicone soft, 0.915M		C4		
	GT3000, GT5000, GT6000GT7000, GT9000, GT9002 PUAO: DPJ-300	543		as S0010 series	The same as S0010 series	The same as S0010 series	Need S0024NE-L		
					S0024B-L	Adult finger clip, 3M			C0
					S0024C-L	Pediatric finger clip, 3M		C0	
					S0024D-L	Adult silicone soft, 3M		D2	
					S0024E-L	Infant silicone, 3M		D2	
					S0024F-L	Neonate wrap sensor (und detachable), 3M		D2	
					S0024G-L	Adult ear clip sensor, 3M		D2	
					S0024I-L	Neonate wrap sensor (detachable),3M		D2	

Reusable SpO2 Sensor

Compatible Brand	Compatible Models No.	INSTRUMENT CONNECTOR	OEM P/N	HNM REF NO.	Description (Name, Length, Plug, Compatible)	Ext-cable	Price Code	
IVY	405A, 405D (OxiSmart) (Non-oximax)		DS100A	S0010B-S	Adult finger clip, 0.915M	Need/ Temporarily unavailable	B5	
				S0010D-S	Adult silicone soft, 0.915M		C4	
			D-YS	S0010I-S	Neonate wrap sensor (detachable),0.915M		C4	
	405P, 405T (OxiSmart) (Non-oximax)		DS100A	S0010B-S	Adult finger clip, 0.915M		Need S0010NE-L	B5
				S0010D-S	Pediatric silicone, 0.915M		C4	
			D-YS	S0010I-S	Neonate wrap sensor (detachable),0.915M		C4	
	Vital-Guard 450CN(M) (M Tech)		1863/LNCS DCI	S0204B-S	Adult finger clip, 0.915M		Need S0204CS-L	C9
				S0204D-S	Adult silicone soft, 0.915M		C0	
			2258/LNCS YI	S0204I-S	Neonate wrap sensor (detachable),0.915M		C0	
			LNOP DC-12	S0204B-L	Adult finger clip, 3M	/	C0	
			S0204D-L	Adult silicone soft, 3M	C0			
			S0204I-L	Neonate wrap sensor (detachable),3M	D0			
JOINSCIENCE	CD2000			S0093B-L	Adult finger clip, 3M		/	C2
				S0093D-L	Adult silicone soft, 3M	D2		
				S0093G-L	Adult ear clip sensor, 3M	D2		
				S0093I-L	Neonate wrap sensor (detachable),3M	D2		
			KEMP	KP-900C/900B				S0090B-L
	S0090D-L	Adult silicone soft, 3M				D2		
	S0090E-L	Infant silicone, 3M				D2		
	S0090F-L	Neonate wrap sensor (und detachable), 3M				D2		
	S0090G-L	Adult ear clip sensor, 3M				D2		
	S0090I-L	Neonate wrap sensor (detachable),3M				D2		
Kontron	Kontron:7138, 7840, 7845, Minimon7137, 7337		DS100A	S0010B-S	Adult finger clip, 0.915M	Need S0019NE-L 	B5	
				S0010D-S	Adult silicone soft, 0.915M		C4	
			D-YS	S0010I-S	Neonate wrap sensor (detachable),0.915M		C4	
			070	608010	S0019B-L		Adult finger clip, 3M	/
		S0019C-L		Pediatric finger clip, 3M	C0			
		S0019D-L		Adult silicone soft, 3M	D2			
		S0019E-L		Infant silicone, 3M	D2			
		S0019F-L		Neonate wrap sensor (und detachable), 3M	D2			
		S0019I-L		Neonate wrap sensor (detachable),3M	D2			
	Kontron	7150, 7850, Ivy 2000(M) (OxiSmart) (Non-oximax)		DS100A	S0010B-S	Adult finger clip, 0.915M	Need S0010NE-L 	B5
				S0010D-S	Adult silicone soft, 0.915M	C4		
D-YS				S0010I-S	Neonate wrap sensor (detachable),0.915M	C4		
			DS100A	S0010B-S	Adult finger clip, 0.915M	Need S0421NE-L 	B5	
				S0010D-S	Adult silicone soft, 0.915M		C4	
			D-YS	S0010I-S	Neonate wrap sensor (detachable),0.915M		C4	
KERNEL MEDICAL				S0057C-L	Pediatric finger clip, 3M	/	C0	
				S0057D-L	Adult silicone soft, 3M		D2	
				S0057E-L	Infant silicone, 3M		D2	
				S0057F-L	Neonate wrap sensor (und detachable), 3M		D2	
				S0057G-L	Adult ear clip sensor, 3M		D2	
				S0057I-L	Neonate wrap sensor (detachable), 3M		D2	
Lohmeier	Monitor M010 original sensor number 6051-0000-035		6051-0000-035	S0102B-L	Adult finger clip, 3M	/	E0	
				S0102D-L	Adult silicone soft, 3M		F5	
				S0102E-L	Infant silicone, 3M		F7	
				S0102G-L	Adult ear clip sensor, 3M		F9	
				S0102I-L	Neonate wrap sensor (detachable),3M		F5	













Reusable SpO2 Sensor

Compatible Brand	Compatible Models No.	INSTRUMENT CONNECTOR	OEM P/N	HNM REF NO.	Description (Name, Length, Plug, Compatible)	Ext-cable	Price Code	
Masmo Tech	Compatible model depending on the Ext-cable, E.g: Rad-8 Rad-5/Rad-5v SatShare			603115432	Adult sensor, (2018)	Need Depending on the instrument's SpO2 connector 	C0	
			1269/LNO P DCI	S0020B-S	Adult finger clip, 0.915M		C0	
			1276/LNO P DCIP	S0020C-S	Pediatric finger clip, 0.915M		C0	
				S0020D-S	Adult silicone soft, 0.915M		D2	
				S0020P-S	Pediatric silicone, 0.915M		D2	
				S0020E-S	Infant silicone, 0.915M		D2	
				S0020F-S	Neonate wrap,0.915M(undetachable)		D2	
			LNOP/TC-I	S0020G-S	Adult ear clip sensor , 0.915M		D2	
			1504/LNOP.YI	S0020I-S	Neonate wrap(detachable),0.915M		D2	
				LNCS/DCI	S0153B-S		Adult finger clip, 0.915M	Need Depending on the instrument's SpO2 connector 
		LNCS/DCIP	S0153C-S	Pediatric finger clip, 0.915M	C2			
			S0153D-S	Adult silicone soft, 0.915M	C3			
			S0153P-S	Pediatric silicone, 0.915M	C3			
			S0153E-S	Infant silicone, 0.915M	C3			
			S0153F-S	Neonate wrap(undetachable),0.915M	C3			
		LNCS TC-I	S0153G-S	Adult ear clip sensor , 0.915M	C3			
		LNCS YI	S0153I-S	Neonate wrap(detachable),0.915M	C3			
		403/434		LNOP DC12	S0020B-L	Adult finger clip, 3M	/	D0
				S0020C-L	Pediatric finger clip, 3M	E1		
				S0020D-L	Adult silicone soft, 3M	E5		
				S0020E-L	Infant silicone, 3M	E0		
				S0020F-L	Neonate wrap(undetachable), 3M	E0		
				S0020G-L	Adult ear clip sensor, 3M	E0		
				S0020I-L	Neonate wrap(detachable),3M	E5		
					S0442C-L	Pediatric finger clip, 3M		D0
		MASMO LNC-10 2056			S0442F-L	Neonate wrap (2018)	/	D0
				S0442I-L	Adult wrap sensor, 20P(2018)	D0		
				S0442B-S	Adult finger clip, 0.915M	C0		
	Rad-5, Rad-6, Rad-7, Rad-8, Rad-57			S0442C-S	Pediatric finger clip, (2018)	C0		
			S0442E-S	Infant silicone, DB9P (2018)	C0			
			S0442F-S	Neonate wrap, 0.915M	C0			
			S0442G-S	Adult ear clip sensor,0.915M(2018)	C0			
			S0442P-S	Pediatric silicone,(2018)	C0			
	S0010 Series sensor's adapter S0153NE-A, Its functions equivalent to S0204 series sensor		as S0010 series	The same as S0010 series	The same as S0010 series	Need S0153NE-A 		
				603165402	Adult sensor (2018)	Need S0540NE-S	D2	
MDE/Invivo (Masmo module)	Escort 1 Escort 300(OxiSmart) (Non-oximax)		DS100A	S0010B-S	Adult finger clip, 0.915M	Need Temporarily Unavailable	B5	
				S0010D-S	Adult silicone soft, 0.915M		C4	
			D-YS	S0010I-S	Neonate wrap(detachable),0.915M		C4	
	20300,20401,20403, Prism(OxiSmart) (Non-oximax)		DS100A	S0010B-S	Adult finger clip, 0.915M	Need S0010NE-L 	B5	
				S0010D-S	Adult silicone soft, 0.915M	C4		
			D-YS	S0010I-S	Neonate wrap(detachable),0.915M	C4		
	Millenia, Escort, (M) M10TM, M12TM, M8TM (M Tech)		1863/LNCS DCI	S0204B-S	Adult finger clip, 0.915M	Need S0204CS-L 	C9	
				S0204D-S	Adult silicone soft, 0.915M	C0		
			2258/LNCS YI	S0204I-S	Neonate wrap(detachable),0.915M	C0		
			LNOP DC-12	S0204B-L	Adult finger clip, 3M	/	C0	
			S0204D-L	Adult silicone soft, 3M	/	C0		
		S0204I-L	Neonate wrap(detachable),3M	/	D0			







Reusable SpO2 Sensor

Compatible Brand	Compatible Models No.	INSTRUMENT CONNECTOR	OEM P/N	HNM REF NO.	Description (Name, Length, Plug, Compatible)	Ext-cable	Price Code
MDE/Invivo (MASMO module)	4500, , Omni Track Omeg 1445Millennia (OxiSmart) (Non-oximax)			S0083B-L	Adult finger clip, 3M	/	D0
				S0083D-L	Adult silicone soft, 3M		E5
				S0083I-L	Neonate wrap sensor (detachable),3M		E5
	4500, M8, Omni Track Omeg 1445Millennia (M Tech)		1863/LNC S DCI	S0204B-S	Adult finger clip, 0.915M	Need S0094CS-L	C9
				S0204D-S	Adult silicone soft, 0.915M		C0
			2258/LNC S YI	S0204I-S	Neonate wrap sensor (detachable),0.915M		C0
				S0094B-L	Adult finger clip, 3M		D0
				S0094D-L	Adult silicone soft, 3M	E5	
				S0094P-L	Adult silicone soft, 3M	E7	
				S0094E-L	Infant silicone, 3M	E5	
				S0094F-L	Neonate wrap sensor (und detachable), 3M	E5	
		S0094G-L	Adult ear clip sensor , 3M	E5			
		S0094I-L	Neonate wrap sensor (detachable),3M	E5			
	Meditronic - Physio Control	Lifepack 12 (OxiSmart) (Non-oximax)		DS100A	S0010B-S	Adult finger clip, 0.915M	Need S0010NE-L
				S0010D-S	Adult silicone soft, 0.915M	C4	
D-YS				S0010I-S	Neonate wrap sensor (detachable),0.915M	C4	
Lifepack 12, 20(M) (M Tech)			1863/LNC S DCI	S0204B-S	Adult finger clip, 0.915M	Need S0204CS-L	C9
				S0204D-S	Adult silicone soft, 0.915M		C0
			2258/LNC S YI	S0204I-S	Neonate wrap sensor (detachable),0.915M		C0
				LNOP DC-12	S0204B-L	Adult finger clip, 3M	C0
				S0204D-L	Adult silicone soft, 3M	/	C0
				S0204I-L	Neonate wrap sensor (detachable),3M	D0	
MEK	MP-100, MP110, MP400, MP500, MP600, MP1000 (CSI Module)	078/056 		S0018B-L	Adult finger clip, 3M	/	C0
				S0018B-S	Adult finger clip,0.915M		
				S0018C-L	Pediatric finger clip, 3M		C0
				S0018D-L	Adult silicone soft, 3M		D2
				S0018E-L	Infant silicone, 3M		D2
				S0018F-L	Neonate wrap sensor (und detachable), 3M		D2
				S0018G-L	Adult ear clip sensor, 3M		D2
				S0018I-L	Neonate wrap sensor (detachable),3M		D2
	MP1000 (OxiSmart) (Non-oximax) (Nellcor Module)	370/048 	DS100A	S0010B-S	Adult finger clip, 0.915M	Need S0144NE-L	B5
				S0010D-S	Adult silicone soft, 0.915M		C4
			D-YS	S0010I-S	Neonate wrap sensor (detachable),0.915M		C4
				S0144B-L	Adult finger clip, 3M		D0
				S0144C-L	Pediatric finger clip, 3M		D0
				S0144D-L	Adult silicone soft, 3M		E5
				S0144P-L	Pediatric silicone, 3M		E7
	S0144E-L	Infant silicone, 3M	E5				
	S0144F-L	Neonate wrap sensor (und detachable), 3M	E5				
	S0144G-L	Adult ear clip sensor , 3M	E5				
	S0144I-L	Neonate wrap sensor (detachable),3M	E5				
MEK (CSI Module)	REF: MIS3AH_1 MEK ICS: MP1000NT TYPE: MEK (CSI Module)	212 	MIS3AH_1	S0115B-L	Adult finger clip, 3M	/	C0
				S0115C-L	Pediatric finger clip, 3M		C0
				S0115D-L	Adult silicone soft, 3M		D2
				S0115P-L	Pediatric silicone, 3M		D2
				S0115E-L	Infant silicone, 3M		D2
				S0115F-L	Neonate wrap sensor (und detachable), 3M		D2
				S0115G-L	Adult ear clip sensor, 3M		D2
				S0115I-L	Neonate wrap sensor (detachable), 3M		D2

Reusable SpO2 Sensor

Compatible Brand	Compatible Models No.	INSTRUMENT CONNECTOR	OEM P/N	HNM REF NO.	Description (Name, Length, Plug, Compatible)	Ext-cable	Price Code				
Mennen	Horizon2000			S0009B-L	Adult finger clip, 3M		J0				
				S0009C-L	Pediatric finger clip, 3M		J0				
				S0009D-L	Adult silicone soft, 3M		J0				
				S0009E-L	Infant silicone, 3M		J0				
				S0009F-L	Neonate wrap sensor (undetachable), 3M		J0				
				S0009G-L	Adult ear clip sensor, 3M		J0				
				S0009I-L	Neonate wrap sensor (detachable), 3M		J0				
	Envoy (OxiSmart) (Non-oximax)	370/048		DS100A	S0010B-S	Adult finger clip, 0.915M	Need S0103NE-L	B5			
					S0010D-S	Adult silicone soft, 0.915M		C4			
				D-YS	S0010I-S	Neonate wrap sensor (detachable),0.915M	Need Temporarily unavailable	C4			
				DS100A	S0010B-S	Adult finger clip, 0.915M		B5			
					S0010D-S	Adult silicone soft, 0.915M	C4				
				D-YS	S0010I-S	Neonate wrap sensor (detachable),0.915M	C4				
				Horizon 1100, 2000XL Mercury, MR1300 (OxiSmart) (Non-oximax)	370/048		DS100A	S0010B-S	Adult finger clip, 0.915M	Need S0009NE-L	B5
								S0010D-S	Adult silicone soft, 0.915M		C4
	D-YS	S0010I-S	Neonate wrap sensor (detachable),0.915M				C4				
	Horizon XL,Mercury 1200,MR1300 (OxiSmart) (Non-oximax)	370/048		DS100A	S0010B-S	Adult finger clip, 0.915M	Need S0009NE-L	B5			
					S0010D-S	Adult silicone soft, 0.915M		C4			
				D-YS	S0010I-S	Neonate wrap sensor (detachable),0.915M		C4			
	Horizon XL (Ohmeda)		OXY-F4-H	S0014B-L	Adult finger clip, 3M	/	C0				
				S0014D-L	Adult silicone soft, 3M		D2				
OXY-W4-H			S0014I-L	Neonate wrap sensor (detachable),3M	D2						
Horizon, Envoy, Vitalogik (M) (M Tech)		1863/LNC S DCI	S0204B-S	Adult finger clip, 0.915M	Need S0430CS-L	C9					
			S0204D-S	Adult silicone soft, 0.915M		C0					
		2258/LNC S YI	S0204I-S	Neonate wrap sensor (detachable),0.915M		C0					
MENNEN MEDICAL	584			S0103B-L	Adult finger clip, 3M		E0				
				S0103C-L	Pediatric finger clip, 3M		E0				
				S0103D-L	Adult silicone soft, 3M		F5				
				S0103E-L	Infant silicone, 3M		F5				
				S0103F-L	Neonate wrap sensor (undetachable), 3M		F5				
				S0103G-L	Adult ear clip sensor, 3M		F5				
				S0103I-L	Neonate wrap sensor (detachable), 3M		F5				
Medlab	NANOX 10 POX 10 Pearl 10 (BCI tech module)		3044	S0076B-S	Adult finger clip, 0.915M	Need S0111BC-L	C2				
				S0076D-S	Adult silicone soft, 0.915M		C4				
			3043	S0076I-S	Neonate wrap sensor sensor (detachable),0.915M		C4				
Mindray	509B, MEC-1000, MEC-1200, New PM6000, PM7000/8000/9000, VS 800, PM600, PM9000 Express (Mindray tech)	370/048	512D	S0010B-S	Adult finger clip, 0.915M	Need S0040NE-L 0010-20-42594	B5				
				S0010D-S	Adult silicone soft, 0.915M		C4				
				S0010I-S	Neonate wrap sensor (detachable),0.915M		C4				
	PM-5000, PM 6000 PM-8000 (Mindray tech)	370/048		512D	S0010B-S	Adult finger clip, 0.915M	Need S0045OX-L 0010-21-11957	B5			
					S0010D-S	Adult silicone soft, 0.915M		C4			
					S0010I-S	Neonate wrap sensor (detachable),0.915M		C4			
	PM-5000, PM 6000 PM-8000 (Mindray tech)	424/425			S0045B-L	Adult finger clip, 3M	/	D0			
					S0045C-L	Pediatric finger clip, 3M		D0			
					S0045D-L	Adult silicone soft, 3M		E5			
					S0045E-L	Infant silicone, 3M		E5			
				S0045F-L	Neonate wrap sensor (undetachable), 3M	E5					
				S0045G-L	Adult ear clip sensor, 3M	E5					
	S0045I-L	Neonate wrap sensor (detachable),3M	E5								





Reusable SpO2 Sensor

Compatible Brand	Compatible Models No.	INSTRUMENT CONNECTOR	OEM P/N	HNM REF NO.	Description (Name, Length, Plug, Compatible)	Ext-cable	Price Code	
Mindray	PM-6000 (M Tech) *Markets: China, CE, FDA *(MASMO module)		LNCS DCI	S0153B-S	Adult finger clip, 0.915M		C2	
				S0153D-S	Adult silicone soft, 0.915M		C3	
			LNCS YI	S0153I-S	Neonate wrap(detachable),0.915M		C3	
		412/425		S0012B-L	Adult finger clip, 3M	/	D0	
				S0012C-L	Pediatric finger clip, 3M		D0	
				S0012D-L	Adult silicone soft, 3M		D0	
				S0012E-L	Infant silicone, 3M		E5	
				S0012F-L	Neonate wrap(undetachable),3M		E5	
				S0012G-L	Adult ear clip sensor , 3M		E5	
				S0012I-L	Neonate wrap(detachable),3M		D0	
			S0012J-L	Neonate wrap(detachable),3M	D0			
	PM-9000, 9100, 9200, (PM-6201, 7000, 8000, M1K0, M2K0 before 2006) Marketing:CFDA, CE.FDA (M Tech) *Radel 2bit-40° plug (general) *(MASMO module)	241/569			S0013B-L	Adult finger clip, 3M	/	C0
					S0013C-L	Pediatric finger clip, 3M		C0
					S0013D-L	Adult silicone soft, 3M		D2
					S0013E-L	Infant silicone, 3M		D2
					S0013F-L	Neonate wrap sensor (undetachable), 3M		D2
					S0013G-L	Adult ear clip sensor , 3M		D2
					S0013I-L	Neonate wrap sensor (detachable),3M		D2
	New PM-6000 PM7000, 8000, 9000, PM-9000 Express VS 800 New PM6000(M tech)		LNCS DCI	S0153B-S	Adult finger clip, 0.915M		C2	
				S0153D-S	Adult silicone soft, 0.915M		C3	
	PM9000express (MASMO).PM8002,9201, (PM-6000,6201,7000,8000,9000,M1K0, M2K0 since 2006),T8 Marketing:SFDA,CE.FDA OEM No Express VS 800(M tech)		LNCS YI	S0153I-S	Neonate wrap sensor (detachable),0.915M	/	C3	
				S0116B-L	Adult finger clip, 3M		D5	
				S0116C-L	Pediatric finger clip, 3M		D5	
				S0116D-L	Adult silicone soft, 3M		D0	
				S0116E-L	Infant silicone, 3M		D8	
				S0116F-L	Neonate wrap sensor (undetachable), 3M		D8	
	PM-7000, PM-8000series, PM-9000series, VS-800 (Oxi tech)		DS100A	S0026B-S	Adult finger clip, 0.915M		C2	
				S0026D-S	Adult silicone soft, 0.915M		D5	
			D-YS	S0026I-S	Neonate wrap sensor (detachable),0.915M		D5	
	8002, 9201, PM7000(Since Jan. 2006) patient monitor of Nellcor module and 6pin plug (80° between 2bit) PM-8000series, PM-9000series, VS-800 (Oxi tech)			S0129B-L	Adult finger clip, 3M	/	D3	
			S0129C-L	Pediatric finger clip, 3M	D3			
			S0129D-L	Adult silicone soft, 3M	D5			
			S0129P-L	Pediatric silicone, 3M	D7			
			S0129E-L	Infant silicone, 3M	D8			
			S0129F-L	Neonate wrap(undetachable),3M	D8			
			S0129G-L	Adult ear clip sensor , 3M	E2			
			S0129I-L	Neonate wrap(detachable),3M	D5			
BeneView T5/T6/T8 iPM Series (Mindray tech)		512D	S0010B-S	Adult finger clip, 0.915M		B5		
			S0010D-S	Adult silicone soft, 0.915M		C4		
			S0010I-S	Neonate wrap sensor (detachable),0.915M		C4		
BeneView T5/T6/T8 iPM Series (Oxi tech)		DS100A	S0026B-S	Adult finger clip, 0.915M		C2		
			S0026D-S	Adult silicone soft, 0.915M		D5		
		D-YS	S0026I-S	Neonate wrap sensor (detachable),0.915M		D5		
Mindray	T8			S0126B-L	Adult finger clip (2017)	/	C0	
				S0125B-L	Adult finger clip (2018)		C0	
	T5			S0125D-L	Adult silicone soft	/	C0	
				S0125F-L	Neonate wrap sensor (2018)		C0	

















Reusable SpO2 Sensor

Compatible Brand	Compatible Models No.	INSTRUMENT CONNECTOR	OEM P/N	HNM REF NO.	Description (Name, Length, Plug, Compatible)	Ext-cable	Price Code			
Mindray	BeneView T5/T6/T8 iPM Series (M tech)		LNCS DCI	S0153B-S	Adult finger clip, 0.915M		C2			
				S0153D-S	Adult silicone soft, 0.915M		C3			
			LNCS YI	S0153I-S	Neonate wrap sensor (detachable),0.915M		C3			
	PM-50, PM-60 (Mindray tech)		512D	S0010B-S	Adult finger clip, 0.915M	/	B5			
				S0010D-S	Adult silicone soft, 0.915M		C4			
				S0010I-S	Neonate wrap sensor (detachable),0.915M		C4			
	503, 507, 508, 509, PM9000 (CSI tech)	429/430 		S0100B-S	Adult finger clip, 0.915M	/	C9			
				S0100D-L	Adult silicone soft, 3M		D2			
				S0100I-L	Neonate wrap sensor (detachable),3M		D2			
	500A, 509B, PM9000 (BCI tech) Goldway:Industrial, UT4000 *Markets: China			S0053B-L	Adult finger clip, 3M	/	D3			
				S0053C-L	Pediatric finger clip, 3M		D3			
				S0053D-L	Adult silicone soft, 3M		D5			
				S0053E-L	Infant silicone, 3M		D5			
	Mindray: PM9000 *(BCI module)	074/467 		S0007B-L	Adult finger clip, 3M	/	C0			
				S0007C-L	Pediatric finger clip, 3M		C0			
				S0007D-L	Adult silicone soft, 3M		D2			
				S0007F-L	Neonate wrap(und detachable),3M		D2			
				S0007G-L	Adult ear clip sensor, 3M		D2			
Mindray	509B, MEC-1000, MEC-1200 New PM6000 PM7000/8000/9000, VS 800, PM600 PM9000 Express (Mindray tech)			S0040B-L	Adult finger clip, 3M	/	C0			
				S0040C-L	Pediatric finger clip, 3M		C0			
				S0040D-L	Adult silicone soft, 3M		D2			
				S0040P-L	Pediatric silicone, 3M		D2			
				S0040E-L	Infant silicone, 3M		D2			
				S0040F-L	Neonate wrap sensor (und detachable),3M		D2			
				S0040G-L	Adult ear clip sensor, 3M		D2			
	MEC-509, 509+, 503, 507	451/452 		S0011B-L	Adult finger clip, 3M	/	D0			
				S0011C-L	Pediatric finger clip, 3M		D0			
				S0011D-L	Adult silicone soft, 3M		E5			
				S0011E-L	Infant silicone, 3M		E5			
				S0011F-L	Neonate wrap sensor (und detachable), 3M		E5			
MINDRAY (MASMO module)	VS800 *(MASMO module)		0010-20-42595		S0134B-L	Adult finger clip, 3M	D5			
					S0134C-L	Pediatric finger clip, 3M	D5			
					S0134D-L	Adult silicone soft, 3M	D8			
					S0134E-L	Infant silicone, 3M	D8			
					S0134F-L	Neonate wrap sensor (und detachable), 3M	D8			
					S0134G-L	Adult ear clip sensor, 3M	E2			
	DPM6 DPM7 M-Tech				S0199B-LU	Adult finger clip, 3M(2018)		C0		
			MEC, Sunmind	KP-9000, KP-930/930F			S0141B-L	Adult finger clip, 3M	/	C6
							S0141C-L	Pediatric finger clip, 3M	C6	
							S0141D-L	Adult silicone soft, 3M	C7	
	S0141E-L	Pediatric silicone, 3M				C7				
	S0141F-L	Neonate wrap(und detachable),3M				C7				
	S0141I-L	Neonate wrap sensor (detachable),3M	C7							

Reusable SpO2 Sensor

Compatible Brand	Compatible Models No.	INSTRUMENT CONNECTOR	OEM P/N	HNM REF NO.	Description (Name, Length, Plug, Compatible)	Ext-cable	Price Code			
MEC,sunmind	KP-9000, KP-930/930F		as S0010 series	The same as S0010 series	The same as S0010 series	Need S0141NE-L 				
			DS100A	S0010B-S	Adult finger clip, 0.915M	Need S0093NE-L 	B5			
M&B	CD2000 (OxiSmart) (Non-oximax)			S0010D-S	Adult silicone soft, 0.915M		C4			
			D-YS	S0010I-S	Neonate wrap(detachable),0.915M		C4			
				S0093B-L	Adult finger clip, 3M		/	C0		
M&B	MB526, MB526+, MB526T8 MB526T12, MB526+tw MB800, CD2000, CD2000+			S0093C-L	Pediatric finger clip, 3M	C0				
				S0093D-L	Adult silicone soft, 3M	D2				
				S0093E-L	Infant silicone, 3M	D2				
				S0093F-L	Neonate wrap(undetachable),3M	D2				
				S0093I-L	Neonate wrap(detachable),3M	D2				
				S0429B-S	Adult finger clip, 0.915M	/		C0		
			CD2000, CD2000+ (*Oxi tech)		S0429D-L			Adult silicone soft, 3M	D2	
					S0429I-L			Neonate wrap(detachable),3M	D2	
				Minolta (Konica)	PULSOX-300 PULSOX-300i				S0152B-S	Adult finger clip, 0.915M
							S0152D-S	Adult silicone soft, 0.915M	C3	
	S0152I-S	Neonate wrap(detachable),0.915M	C3							
Mediaid /Palco	M300/M305/340, M5305/M5340			S0079B-L	Adult finger clip, 3M	/	C0			
				S0079C-L	Pediatric finger clip, 3M		C0			
				S0079D-L	Adult silicone soft, 3M		D2			
				S0079P-L	Pediatric silicone, 3M		D2			
				S0079E-L	Infant silicone, 3M		D2			
				S0079F-L	Neonate wrap(undetachable) ,3M		D2			
				S0079G-L	Adult ear clip sensor , 3M		D2			
				S0079I-L	Neonate wrap(detachable),3M		D2			
	M30/40, M100, M130, M900, M960P, M6 Aster, M4 Nova, M1000			S0423B-L	Adult finger clip, 3M	/	D9			
				S0423C-L	Pediatric finger clip, 3M		E0			
				S0423D-L	Adult silicone soft, 3M		E0			
				S0423P-L	Pediatric silicone, 3M		E0			
				S0423E-L	Neonate silicone, 3M		E0			
				S0423F-L	Neonate wrap(undetachable),3M		E0			
				S0423G-L	Adult ear clip sensor , 3M		E0			
				S0423I-L	Neonate wrap(detachable),3M		E0			
HNM	COX801VB			S0445B-L	Adult finger clip,	/	C0			
				S0445F-L	Neonate wrap sensor (undetachable),		C0			
	6 Multi-com&site SpO2 Sensor & Extension Cable” and “5 Y type Multisite sensor”			S0136B-S	Adult finger clip,	/	B5			
				S0136C-S	Pediatric finger clip Digital,		C5			
Newtech	Pulse Oximer NT1A, NT1B, NT1D (Digital Tech)			S0108B-S	Adult finger clip, 0.915M	/	D5			
				S0108D-S	Adult silicone soft, 0.915M		F5			
				S0108I-S	Neonate wrap sensor (detachable),0.915M		F5			
	Patient monitor (Digital Tech)			S0108B-L	Adult finger clip, 3M	/	C0			
				S0108D-L	Adult silicone soft, 3M		D2			
				S0108I-L	Neonate wrap(detachable),3M		D2			
	NT3A, NT3B, NT3E, NT3F, NT3B60 GMI/:G3C (old version), Newtech/:G3C (old version)			S0113B-L	Adult finger clip, 3M	/	C6			
				S0113C-L	Pediatric finger clip, 3M		C0			
				S0113D-L	Adult silicone soft, 3M		D2			
				S0113E-L	Infant silicone, 3M		D2			
			S0113F-L	Neonate wrap(undetachable),3M	D2					
	S0113I-L	Neonate wrap(detachable),3M	D2							





Reusable SpO2 Sensor

Compatible Brand	Compatible Models No.	INSTRUMENT CONNECTOR	OEM P/N	HNM REF NO.	Description (Name, Length, Plug, Compatible)	Ext-cable	Price Code
Nellcor	All Nellcor & Nellcor equipped OEM monitors Include N-600x, Include GE Dash Series patient monitor (Oximax mould), as 1800, 2500, 3000. Include Spacelabs mCare 300 Vital Signs Monitor (Oximax mould), as 91220 series		DS-100A	S0132B-S	Adult finger clip, 0.915M		F0
				S0132C-S	Pediatric finger clip, 0.915M		F0
				S0132D-S	Adult silicone soft, 0.915M		F0
				S0132E-S	Infant silicone, 0.915M		F0
				S0132F-S	Neonate wrap sensor (undetachable), 0.915M		F0
				S0132G-S	Adult ear clip sensor, 0.915M		F0
				S0132I-S	Neonate wrap(detachable),0.915M		F0
			Nellcor	All Nellcor & Nellcor equipped OEM monitors		DEC8+ DS100A	S0026B-L
	S0026C-L	Pediatric finger clip, 3M					D0
	S0026D-L	Adult silicone soft, 3M					D0
	S0026E-L	Infant silicone, 3M					D0
	S0026F-L	Neonate wrap(undetachable),3M					D0
	S0026G-L	Adult ear clip sensor, 3M					D0
	S0026I-L	Neonate wrap(detachable),3M					D0
	S0026P-L	Pediatric silicone, 3M					D0
Nellcor	*OXI TECH N550, N595, N560		DOC10+ DS100A	S0117B-L	 Adult finger clip, 3M		E5
				S0117C-L	 Pediatric finger clip, 3M		E6
				S0117D-L	 Adult silicone soft, 3M		E0
				S0117P-L	 Pediatric silicone, 3M		E0
				S0117E-L	 Infant silicone, 3M		E0
				S0117F-L	 Neonate wrap sensor (undetachable), 3M		E0
				S0117G-L	 Adult ear clip sensor, 3M		F5
				S0117I-L	 Neonate wrap sensor, 3M		F5
				S0443B-L	 Adult finger clip, 3M		D0
			Nellcor-	NPB 40, NPB20, NPB75, NPB 180, NPB 185, NPB-190, NPB-195, NPB 3900, NPB 4000 (OxiSmart) (Non-oximax)		DS-100A	S0010B-S
OXI-P/I	S0010C-S	Pediatric finger clip, 0.915M					B0
	S0010D-S	Adult silicone soft, 0.915M					C4
	S0010P-S	Pediatric silicone, 0.915M					C4
	S0010E-S	Infant silicone, 0.915M					C4
OXI-A/N	S0010F-S	Neonate wrap sensor (undetachable), 0.915M					B0
D-YS-YSE	S0010G-S	Adult ear clip sensor, 0.915M					C4
D-YS	S0010I-S	Neonate wrap sensor (detachable),0.915M					C4
NPB3000-3100, Symphony, NPB-290, NPB-295, NPB-395 (OxiSmart) (Non-oximax)				S0010B-L	Adult finger clip, 3M		C0
				S0010C-L	Pediatric finger clip, 3M		C0
				S0010D-L	Adult silicone soft, 3M		D2
				S0010P-L	Pediatric silicone, 3M		D2
				S0010E-L	Infant silicone, 3M		D2
				S0010F-L	Neonate wrap(undetachable),3M		D2
	S0010G-L	Adult ear clip sensor, 3M		D2			
	S0010I-L	Neonate wrap(detachable),3M		D2			
as above	The same as above	The same as above			Need S0001NE-L		

Reusable SpO2 Sensor

Compatible Brand	Compatible Models No.	INSTRUMENT CONNECTOR	OEM P/N	HNM REF NO.	Description (Name, Length, Plug, Compatible)	Ext-cable	Price Code	
Nellcor-	N65 (Oxi tech)		DS-100A	S0026B-S	Adult finger clip, 0.915M	/	C2	
			OXI-P/I	S0026C-S	Pediatric finger clip, 0.915M		D5	
				S0026D-S	Adult silicone soft, 0.915M		D5	
				S0026P-S	Pediatric silicone, 0.915M		D0	
				S0026E-S	Infant silicone, 0.915M		D5	
			OXI-A/N	S0026F-S	Neonate wrap sensor (undetachable), 0.915M		C5	
			D-YS-YSE	S0026G-S	Adult ear clip sensor, 0.915M		D5	
			D-YS	S0026I-S	Neonate wrap sensor (detachable),0.915M		D5	
		503180262		multi-site SPO2 sensor ,1M	D5			
				S0433B-S	Adult finger clip, 0.915M		B5	
				S0433D-S	Adult silicone soft, 0.915M		C2	
				S0433F-S	Neonate wrap sensor (undetachable),0.915M		B0	
				S0433G-S	Adult ear clip sensor, 0.915M		C2	
				S0439B-S	Adult finger clip, 0.915M		B5	
as S0010 series	as S0010 series		The same as S0010 series					
Nellcor-Covidien-	NPB3000-3100, Symphony, NPB-290, NPB-295, NPB-395 (OxiSmart) (Non-oximax)			S0001B-L	Adult finger clip, 3M	/	D0	
				S0001C-L	Pediatric finger clip, 3M		D0	
				S0001D-L	Adult silicone soft, 3M		E5	
				S0001P-L	Pediatric silicone, 3M		E5	
				S0001E-L	Infant silicone, 3M		E5	
				S0001F-L	Neonate wrap sensor (undetachable), 3M		E5	
				S0001G-L	Adult ear clip sensor, 3M		E5	
				S0001I-L	Neonate wrap sensor (detachable),3M		E5	
	N550, N560, N595, N600, N751, N5500		as S0026 series	The same as above	The same as above		Need S0117OX-L	
	Neusoft	NSC series (Oxi tech)	714/616		as S0026 series		The same as above	The same as above
					S0003B-L	Adult finger clip, 3M	C0	
					S0003D-L	Adult silicone soft, 3M	D2	
		S0003I-L	Neonate wrap sensor (detachable),3M	D2				
		041			S0064B-L	Adult finger clip, 3M	C0	
					S0064D-L	Adult silicone soft, 3M	D2	
				S0064I-L	Neonate wrap sensor (detachable),3M	D2		
Novamatrix	512/513/710/715, MARS		8776-00	S0062B-S	Adult finger clip, 0.915M	/	C0	
				S0062C-S	Pediatric finger clip, 0.915M		D2	
				S0062D-S	Adult silicone soft, 0.915M		D2	
				S0062P-S	Pediatric silicone, 0.915M		D2	
				S0062E-S	Infant silicone, 0.915M		D2	
				S0062F-S	Neonate wrap sensor (undetachable), 0.915M		D2	
				S0062G-S	Adult ear clip sensor, 0.915M		D2	
				S0062I-S	Neonate wrap sensor (detachable),0.915M		D2	
	505, 510, 511, 515B/C, 520, 7000, 7100, Oxypleth			as above	The same as above		The same as above	Need S0062NE-L

















Reusable SpO2 Sensor

Compatible Brand	Compatible Models No.	INSTRUMENT CONNECTOR	OEM P/N	HNM REF NO.	Description (Name, Length, Plug, Compatible)	Ext-cable	Price Code	
Novamatrix	505, 510, 511, 515B/C, 520, 7000, 7100, Oxypleth			S0062B-L	Adult finger clip, 3M	/	C0	
				S0062C-L	Pediatric finger clip, 3M		C0	
				S0062D-L	Adult silicone soft, 3M		D2	
				S0062P-L	Pediatric silicone, 3M		D2	
				S0062E-L	Infant silicone, 3M		D2	
				S0062F-L	Neonate wrap sensor (undetachable), 3M		D2	
				S0062G-L	Adult ear clip sensor, 3M		D2	
				S0062I-L	Neonate wrap, 3M		D2	
				5547-32-10	S0143B-S	Adult finger clip, 0.915M	Need, Temporarily unavailable	D5
					S0143C-S	Pediatric finger clip, 0.915M		D0
					S0143D-S	Adult silicone soft, 0.915M		D0
					S0143P-S	Pediatric silicone, 0.915M		D0
					S0143E-S	Infant silicone, 0.915M		D0
					S0143F-S	Neonate wrap sensor (undetachable), 0.915M		D0
					S0143G-S	Adult ear clip sensor, 0.915M		D0
				S0143I-S	Neonate wrap, 0.915M	D0		
Nihon Kohden	BSM-1101/2101 /23101 7100, 7200, OLV-1100 ALife scope		TL-101S	S0069B-L	Adult finger clip, 3M	/	D5	
				S0069C-L	Pediatric finger clip, 3M		D5	
				S0069D-L	Adult silicone soft, 3M		E5	
				S0069P-L	Pediatric silicone, 3M		E5	
				S0069E-L	Infant silicone, 3M		E5	
				S0069F-L	Neonate wrap sensor (undetachable), 3M		E5	
				S0069G-L	Adult ear clip sensor, 3M		E5	
				S0069I-L	Neonate wrap sensor (detachable), 3M		E5	
Nihon Kohden	Lifescope S, BSS-9800 Lifescope M, BSM 9510 Lifescope P, BSM 4100 Life scope A, BSM 5100 Lifescope L, BSM 2350 Lifescope IBSM 2301K, 2303K		TL-201T	S0005B-S	Adult finger clip, 0.915M	Need S0005NI-L	C0	
				S0005C-S	Pediatric finger clip, 0.915M		D5	
				S0005D-S	Adult silicone soft, 0.915M		D5	
				S0005P-S	Pediatric silicone, 0.915M		D5	
				S0005E-S	Infant silicone, 0.915M		D5	
				S0005F-S	Neonate wrap sensor (undetachable), 0.915M		D5	
				S0005G-S	Adult ear clip sensor, 0.915M		D5	
			TL-220T	S0005I-S	Neonate wrap sensor (detachable), 0.915M		D5	
		OPV-1500, OPV-3100;		as S0005 series	The same as above	The same as above	Need S0159NI-L JL-302T	
				TL-201T	S0005B-L	Adult finger clip, 3M	/	D5
					S0005C-L	Pediatric finger clip, 3M		D6
					S0005D-L	Adult silicone soft, 3M		D0
					S0005P-L	Pediatric silicone, 3M		D0
					S0005E-L	Neonate silicone, 3M		D0
					S0005F-L	Neonate wrap sensor (undetachable), 3M		D0
	S0005G-L	Adult ear clip sensor, 3M	D0					
	S0005I-L	Neonate wrap sensor (detachable), 3M	D0					
Nonin	8500 2500 9840 Avant 4000, 9600, 9700 Avant 2120 PulseSense Model 7500, 7500FO (Nonin Tech)	065/419 	8000AA	S0080B-S	Adult finger clip, 0.915M	/	C6	
			8000AP	S0080C-S	Pediatric finger clip, 0.915M		C6	
			8000SL	S0080D-S	Adult silicone soft, 0.915M		D2	
				S0080P-L	Pediatric silicone, 1.2M		D2	
			8000SM	S0080P-S	Pediatric silicone, 0.915M		D2	
				S0080E-S	Infant silicone, 0.915M		D2	
				S0080F-S	Neonate wrap sensor (undetachable), 0.915M		D2	
			8000Q2	S0080G-S	Adult ear clip sensor, 0.915M		D2	
				S0080I-S	Neonate wrap sensor (detachable), 0.915M		D2	













Reusable SpO2 Sensor

Compatible Brand	Compatible Models No.	INSTRUMENT CONNECTOR	OEM P/N	HNM REF NO.	Description (Name, Length, Plug, Compatible)	Ext-cable	Price Code
Nonin	NONIN: 8500, 8600, 8700, 8800 NONIN: 2500		8000AA	S0080B-L	Adult finger clip, 3M	/	C0
			8000AP	S0080C-L	Pediatric finger clip, 3M		C0
			8000AA	S0080D-L	Adult silicone soft, 3M		D2
			8000AP	S0080E-L	Infant silicone, 3M		D2
				S0080F-L	Neonate wrap sensor (undetachable), 3M		D2
				S0080G-L	Adult ear clip sensor, 3M		D2
				S0080I-L	Neonate wrap sensor (detachable), 3M		D2
			as above	The same as above	The same as above		Need S0109NE-L
	8600 series, 8500, 8700, 8800, 9600, 9700;			S0109B-L	Adult finger clip, 3M	/	D0
				S0109D-L	Adult silicone soft, 3M		E5
				S0109E-L	Infant silicone, 3M		E5
				S0109F-L	Neonate wrap sensor (undetachable), 3M		E5
				S0109G-L	Adult ear clip sensor, 3M		E0
				S0109I-L	Neonate wrap sensor (detachable), 3M		E5
				The same as above	The same as above		Need S0080NE-L
	8604, 8604D;			S0106B-L	Adult finger clip, 3M	/	C9
				S0106C-L	Pediatric finger clip, 3M		D0
				S0106D-L	Adult silicone soft, 3M		E5
				S0106E-L	Infant silicone, 3M		E5
				S0106F-L	Neonate wrap sensor (undetachable), 3M		E5
				S0106G-L	Adult ear clip sensor, 3M		E5
				S0106I-L	Neonate wrap sensor (detachable), 3M		E5
	Avant 4000 Wearable Digital Pulse Oximetry			S0418D-S	Adult silicone soft, 0.3M	/	E5
				S0418E-S	Infant silicone, 0.3M		E5
NCC Medical	NTS3000 (OxiSmart) (Non-oximax)		DS100A	S0010B-S	Adult finger clip, 0.915M	Need S0192NE-L	B5
				S0010D-S	Adult silicone soft, 0.915M		C4
			D-YS	S0010I-S	Neonate wrap sensor (detachable), 0.915M		C4
PETAS	Horizon 1100, 2000XL Mercury, MR1300 (OxiSmart) (Non-oximax)		DS100A	S0010B-S	Adult finger clip, 0.915M	Need S0089BC-L	B5
				S0010D-S	Adult silicone soft, 0.915M		C4
			D-YS	S0010I-S	Neonate wrap Sensor (detachable), 0.915M		C4
PETAS				S0089B-L	Adult finger clip, 3M	/	C0
				S0089C-L	Pediatric finger clip, 3M		C0
				S0089D-L	Adult silicone soft, 3M		D2
				S0089E-L	Infant silicone, 3M		D2
				S0089F-L	Neonate wrap sensor (undetachable), 3M		D2
				S0089G-L	Adult ear clip sensor, 3M		D2
				S0089I-L	Neonate wrap sensor (detachable), 3M		D2
Puao Medical	DPJ-3000			S0024B-L	Adult finger clip, 3M	/	C0
				S0024D-L	Adult silicone soft, 3M		D2
				S0024I-L	Neonate wrap sensor (detachable), 3M		D2

Reusable SpO2 Sensor

Compatible Brand	Compatible Models No.	INSTRUMENT CONNECTOR	OEM P/N	HNM REF NO.	Description (Name, Length, Plug, Compatible)	Ext-cable	Price Code			
Philips/HP	C1, C3, M3, M4, VirDia, MP20, MP30, MP40/50/60/70/90, VM4, VM6, VM8		as S0015 series	The same as S0015 series	The same as S0015 series	Need S0015PH-L 				
	A1, A3		as S0010 series	The same as S0010 series	The same as S0010 series	Need S0026OX-L 				
	N550, N560, N595, N600, N751, N5500 MP20/30/40/50 PM60/70/90 VN4, VM6, VM8(Oxi tech)		as S0026 series	The same as S0026 series	The same as S0026 series	Need S0414OX-L				
	MP20/30/40/ PM50/60/70/90 VN4, VM6, VM8 (M Tech)		as S0204 series	The same as S0204 series	The same as S0204 series	Need S0197CS-L				
				S0197B-L	Adult finger clip, 3M (2018)	/	E5			
			S0197D-L	Adult silicone soft, 3M	E5					
		S0197I-L	Neonate wrap sensor (detachable),3m	E5						
Philips/HP	78352C, 78354C, 78834C, M1020A, M1025B, M1025A, M1350B, M1772A/B, M1732A/B, M2475B M3, M4, MP20, MP30, MP40, MP50, MP70, MP80, VM4, VM6, VM8		as S0010 series	The same as S0010 series	The same as S0010 series	Need S0015OX-L 				
		052/060 	M1196A	S0015B-S	Adult finger clip, 0.915M	Need S0015PH-L 	C0			
			M1196A	S0015C-S	Pediatric finger clip, 0.915M		D2			
			M1191A	S0015D-S	Adult silicone soft, 0.915M		D2			
				S0015M-S	Adult soft, 0.915M					
			M1192A	S0015P-S	Pediatric silicone, 0.915M		D2			
			M1195A	S0015E-S	Infant silicone, 0.915M		D2			
			M1193A	S0015F-S	Neonate wrap sensor (und detachable),0.915M		D2			
			M1194A	S0015G-S	Adult ear clip sensor, 0.915M		D2			
				S0015I-S	Neonate wrap sensor (detachable),0.915M		D2			
			M1191A	S0015B-L	Adult finger clip, 3M		C0			
			M1192A	S0015C-L	Pediatric finger clip, 3M		C0			
			M1191A	S0015D-L	Adult silicone soft, 3M		D2			
			M1192A	S0015E-L	Infant silicone, 3M		D2			
			M1193A	S0015F-L	Neonate wrap sensor (und detachable), 3M		D2			
			M1194A	S0015G-L	Adult ear clip sensor, 3M		D2			
				S0015I-L	Neonate wrap sensor (detachable) , 3M		D2			
			78352C, 78354C, 78834C, M1020A, M1025B, M1025A, M1350B, M1772A/B, M1732A/B, M2475B		as S0010 series		The same as S0010 series	The same as S0010 series	Need S0003OX-L 	
					as S0015 series		The same as S0015 series	The same as S0015 series	Need S0003PH-L 	
	714/616 				S0003B-L		Adult finger clip, 3M	/	C0	
				S0003C-L	Pediatric finger clip, 3M	C0				
				S0003D-L	Adult silicone soft, 3M	D2				
				S0003P-L	Pediatric silicone, 3M	D2				
		S0003E-L		Infant silicone, 3M	D2					
		S0003F-L		Neonate wrap sensor (und detachable),3M	D2					
		S0003G-L	Adult ear clip sensor, 3M	D2						
	S0003I-L	Neonate wrap sensor (detachable),3M	D2							









Reusable SpO2 Sensor

Compatible Brand	Compatible Models No.	INSTRUMENT CONNECTOR	OEM P/N	HNM REF NO.	Description (Name, Length, Plug, Compatible)	Ext-cable	Price Code	
Philips/HP	C1, C3, M3, M4, VirDia, MP20, MP30, MP40/50/60/70/90. VM4, VM6, VM8		as S0010 series	The same as S0010 series	The same as S0010 series	Need S0015OX-L 		
			as S0010 series	The same as S0010 series	The same as S0010 series	Need S0091BC-L 		
PaceTech /Generra			as S0010 series	The same as S0010 series	The same as S0010 series	/	C0	
							C0	
							D2	
							D2	
							D2	
							D2	
							D2	
	Pace Tech:All w/ black face (except Vitalmax 800 w/ Nellcor® SpO2), Generra: 710, 200, 300, 400, 810, 530; PACE TECH: Modell520 .		The same as S0010 series	The same as S0010 series	The same as S0010 series	The same as S0010 series	Need S0082BC-L 4510 	D0
								E5
								E5
								E5
								E5
								E0
								E5
PRIMEDIC			as S0010 series	The same as S0010 series	The same as S0010 series	/	D0	
							E5	
							E5	
							E5	
							E5	
							E0	
							E5	
	(OxiSmart) (Non-oximax)		as S0010 series	The same as S0010 series	The same as S0010 series	The same as S0010 series	Need S0140NE-L 	D0
								E5
								E5
								E5
								E5
								E0
								E5
RGB medical	(BCI tech module)		3044	S0076B-S	Adult finger clip, 0.915M	Need S0111BC-L 	C2	
				S0076D-S	Adult silicone soft, 0.915M		C4	
			3043	S0076I-S	Neonate wrap sensor (detachable),0.915M		C4	







Reusable SpO2 Sensor

Compatible Brand	Compatible Models No.	INSTRUMENT CONNECTOR	OEM P/N	HNM REF NO.	Description (Name, Length, Plug, Compatible)	Ext-cable	Price Code				
3F Medical	IRIS 300/IRIS 400 Phoebe PMS8300/8310 PhoebeProPMS8300/8310PMS8110A			S0111B-L	Adult finger clip, 3M	/	C0				
				S0111D-L	Adult silicone soft, 3M		D2				
				S0111I-L	Neonate wrap sensor (detachable),3M		D2				
CSI(RADO)	LANKE:LK-8600A CSI: RADO 4200 MAYTAG :MTK-2000 Shichuang:Prophet21 (BCI tech)			S0021B-L	Adult finger clip, 3M	/	C0				
				S0021C-L	Pediatric finger clip, 3M		C0				
				S0021D-L	Adult silicone soft, 3M		D2				
				S0021E-L	Infant silicone, 3M		D2				
				S0021G-L	Adult ear clip sensor, 3M		D2				
				S0021I-L	Neonate wrap sensor (detachable),3M		D2				
SAZGAN				S0161B-L	Adult finger clip, 3M	/	D0				
				S0161D-L	Adult silicone soft, 3M		E2				
				S0161I-L	Neonate wrap sensor (detachable),3M		E2				
Schiller ODAM/Bruker	CM8 SM783, 784, 785, TM910		as S0010 series	The same as S0010 series	The same as S0010 series	Need  S0028NE-L					
	CM8 SM783, 784, 785, TM910 Schiller Argus TM-7 (Nellocr module)	700/778 		S0028B-L	Adult finger clip, 3M	/	C0				
		S0028C-L	Pediatric finger clip, 3M	C0							
		S0028D-L	Adult silicone soft, 3M	D2							
Schiller ODAM /Bruker	CM8 SM783, 784, 785, TM910 Schiller Argus TM-7 (Nellocr module)			S0028E-L	Infant silicone, 3M	/	D2				
				S0028F-L	Neonate wrap sensor (und detachable), 3M		D2				
				S0028G-L	Adult ear clip sensor, 3M		D2				
				S0028I-L	Neonate wrap sensor (detachable),3M		D2				
	TM7, Argus LCM, (M Tech)			as S0204 series	The same as S0204 series	The same as S0204 series	/	Need  S0118CS-L			
								S0118B-L	Adult finger clip, 3M	C0	
								S0118C-L	Pediatric finger clip, 3M	C0	
								S0118D-L	Adult silicone soft, 3M	D2	
								S0118E-L	Infant silicone, 3M	D2	
			S0118I-L	Neonate wrap sensor (detachable),3M	D2						
	Propaq CS, Encore, Micropaq (New) (M) (M Tech)			as S0204 series	The same as S0204 series	The same as S0204 series	/	Need  S0204CS-L			
								LNOP DC-12	S0204B-L	Adult finger clip, 3M	C0
									S0204D-L	Adult silicone soft, 3M	C0
			S0204I-L	Neonate wrap sensor (detachable),3M	D0						
Schiller ODAM /Bruker	Propaq CS, Encore Series, Atlas (OxiSmart) (Non-oximax)		as S0010 series	The same as S0010 series	The same as S0010 series	Need  S0010NE-L					
	TM 910-Defgard 500(M) (OxiSmart) (Non-oximax)		as S0010 series	The same as S0010 series	The same as S0010 series	Need  S0071BC-L					
	Argus VCM (Oxi tech)		as S0026 series	The same as S0026 series	The same as S0026 series	Need  S0117OX-L					

Reusable SpO2 Sensor

Compatible Brand	Compatible Models No.	INSTRUMENT CONNECTOR	OEM P/N	HNM REF NO.	Description (Name, Length, Plug, Compatible)	Ext-cable	Price Code
Spacelabs	90419/01, 90651A/07, 90501, Ultraview 90496 (Novamatrix tech)			S0062B-L	Adult finger clip, 3M	/	C0
				S0062C-L	Pediatric finger clip, 3M		C0
				S0062D-L	Adult silicone soft, 3M		D2
				S0062P-L	Pediatric silicone, 3M		D2
				S0062E-L	Infant silicone, 3M		D2
				S0062F-L	Neonate wrap sensor (undetachable),3M		D2
				S0062G-L	Adult ear clip sensor, 3M		D2
				S0062I-L	Neonate wrap sensor (detachable),3M		D2
	90351-0/6, 90465, 90466, 90456, PC express (OxiSmart) (Non-oximax)		as S0010 series	The same as S0010 series	The same as S0010 series	Need  S0035NE-L	
				S0035B-L	Adult finger clip, 3M	/	C0
				S0035C-L	Pediatric silicone, 3M		C0
				S0035D-L	Adult silicone soft, 3M		D2
				S0035P-L	Pediatric silicone, 3M		D2
				S0035E-L	Infant silicone, 3M		D2
				S0035F-L	Neonate wrap sensor (undetachable),3M		D2
			S0035G-L	Adult ear clip sensor, 3M	D2		
	S0035I-L	Neonate wrap sensor (detachable),3M	D2				
Spacelabs	1050, 1600, 1700, 90369, 90469, 90496 Ultraview (OxiSmart) (Non-oximax)		as S0010 series	The same as S0010 series	The same as S0010 series	Need  S0004NE-L	
				S0004B-L	Adult finger clip, 3M	/	E5
				S0004C-L	Pediatric finger clip, 3M		E0
				S0004D-L	Adult silicone soft, 3M		E0
				S0004P-L	Pediatric silicone, 3M		E0
				S0004E-L	Infant silicone, 3M		E0
				S0004F-L	Neonate wrap sensor, (undetachable),3M		E0
				S0004G-L	Adult ear clip sensor, 3M		E0
		S0004I-L	Neonate wrap sensor (detachable),3M	E0			
	Ultraview (M tech)		as S0204 series	The same as S0204 series	The same as S0204 series	Need  S0004CS-L	
				S0412B-L	Adult finger clip, 3M	/	E5
				S0412D-L	Adult silicone soft, 3M		E5
				S0412I-L	Neonate wrap sensor (detachable),3M		E5
			Ultraview (Oxi tech)		as S0026 series	The same as S0026 series	The same as S0026 series
		S0203B-L			Adult finger clip, 3M	/	E5
	S0203D-L	Adult silicone soft, 3M			E5		
	S0203I-L	Neonate wrap sensor (detachable),3M		E5			
PRO2 (BCI tech module)		3044		S0076B-S	Adult finger clip, 0.915M	/	C2
				S0076D-S	Adult silicone soft, 0.915M		C4
		3043	S0076I-S	Neonate wrap sensor (detachable),0.915M	C4		

Reusable SpO2 Sensor

Compatible Brand	Compatible Models No.	INSTRUMENT CONNECTOR	OEM P/N	HNM REF NO.	Description (Name, Length, Plug, Compatible)	Ext-cable	Price Code	
SensorMedics	Oxyshuttle I , Oxyshuttle II,			S0142B-S	Adult finger clip, 0.915M	Need CB-A400-1003A Temporarily unavailable	D5	
				S0142D-S	Adult silicone soft, 0.915M		D0	
				S0142I-S	Neonate wrap sensor (detachable),0.915M		D0	
STRONG	Prophet21 (BCI tech)			S0021B-L	Adult finger clip, 3M	/	C0	
				S0021D-L	Adult silicone soft, 3M		D2	
				S0021I-L	Neonate wrap sensor (detachable),3M		D2	
TENKO	TK-1033			S0207B-L	Adult finger clip, 3M	/	C0	
Unicare	(Digital Tech)		U410-66D	S0400B-L	Adult finger clip, 3M	/	C0	
				S0400D-L	Adult silicone soft, 3M		D2	
				S0400I-L	Neonate wrap sensor (detachable),3M		D2	
URAY				S0407B-L	Adult finger clip, 3M	/	D8	
				S0407D-L	Adult silicone soft, 3M		D0	
				S0407I-L	Neonate wrap sensor (detachable),3M		D0	
WEGO	M3512 (OxiSmart) (Non-oximax)		as S0010 series	The same as S0010 series	The same as S0010 series	Need S0175NE-L		
Zoll	M series AED (M Tech)		as S0204 series	The same as S0204 series	The same as S0204 series	Need S0204CS-L		
			LNOP DC-12	S0204B-L	Adult finger clip, 3M	/	C0	
				S0204D-L	Adult silicone soft, 3M		C0	
			S0204I-L	Neonate wrap sensor (detachable),3M		D0		
Zondan	ZD9000			S0150B-L	Adult finger clip, 3M	/	C9	
				S0150C-L	Pediatric finger clip, 3M		C9	
				S0150D-L	Adult silicone soft, 3M		C0	
				S0150E-L	Infant silicone, 3M		C0	
				S0150F-L	Neonate wrap sensor (und detachable), 3M		C0	
				S0150I-L	Neonate wrap sensor (detachable),3M		C3	
Zondan	ZD120B ZD120D ZD120E (Digital Tech)			S0400B-L	Adult finger clip, 3M	/	C0	
				S0400D-L	Adult silicone soft, 3M		D2	
				S0400I-L	Neonate wrap sensor (detachable),3M		D2	
	Apollo N2, Apollo N4 Apollo N5(M tech optional) DS120C, ZD Series patient monitor				S0420B-L	Adult finger clip, 3M	/	C2
					S0420D-L	Adult silicone soft, 3M		C3
					S0420F-L	Neonate wrap sensor (und detachable), 3M		C2
					S0420I-L	Neonate wrap sensor (detachable),3M		C3
	ZD Series patient monitor (OxiSmart) (Non-oximax)			as S0010 series	The same as S0010 series	The same as S0010 series	Need S0150NE-L	
					S0150B-L	Adult finger clip, 3M	/	C9
				S0150D-L	Adult silicone soft, 3M	C0		
			S0150I-L	Neonate wrap sensor (detachable),3M		C3		

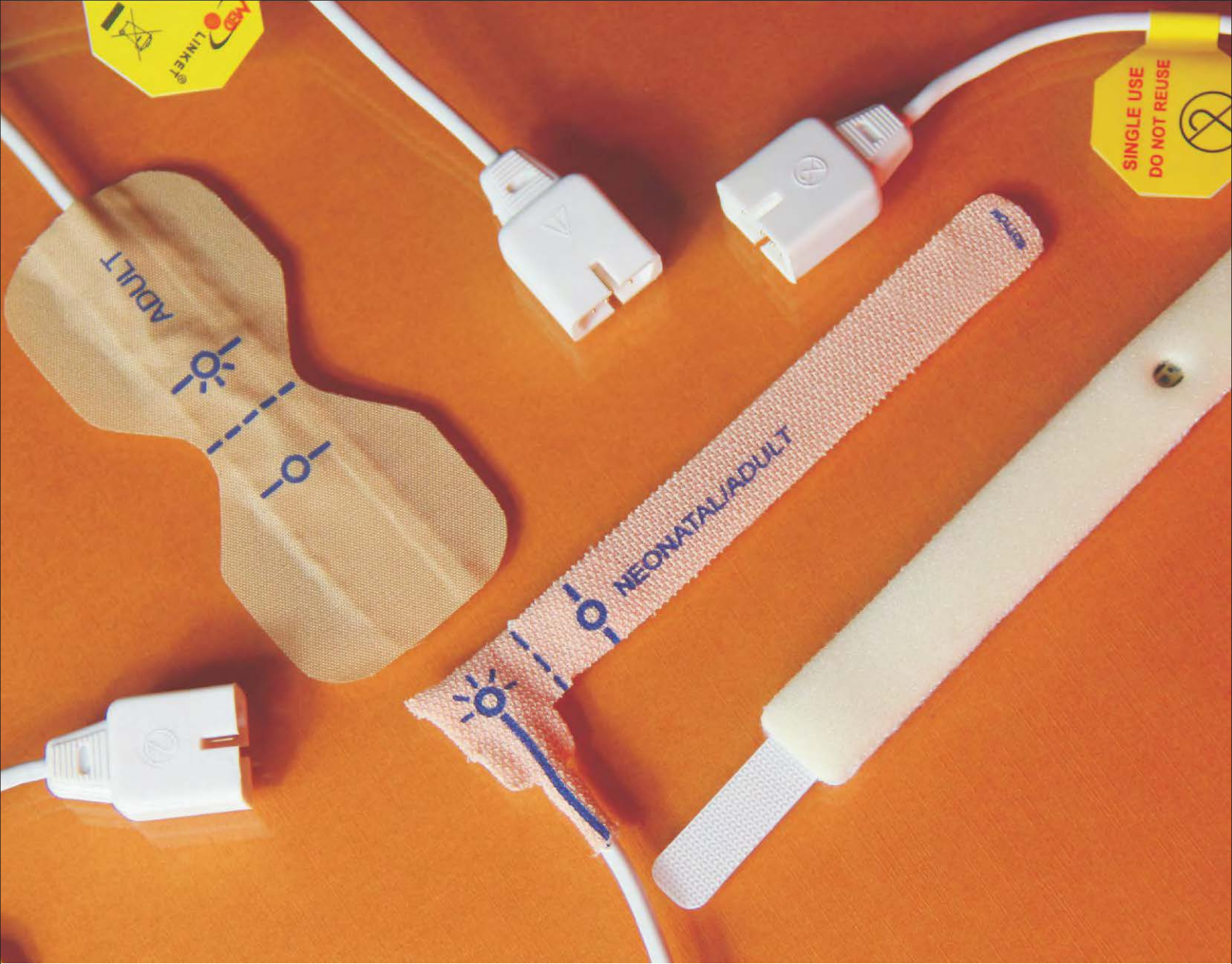

2

Disposable SpO2 Sensor

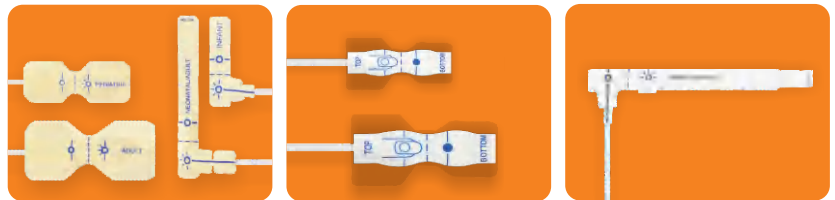

Disposable SpO2 Sensor (need ext-cable)

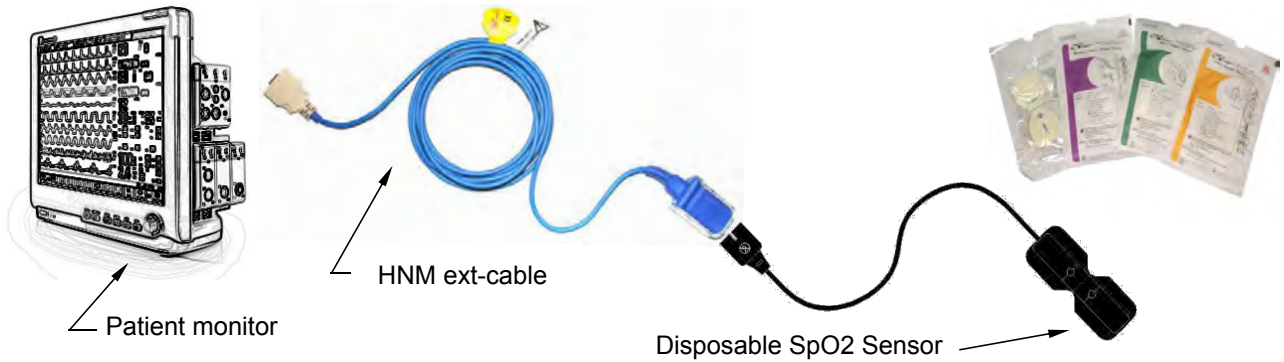

Connector type



Sensor type

Adult Disposable SpO2 Sensors

Application : Adult > 30kg,
Application site: Index or other finger

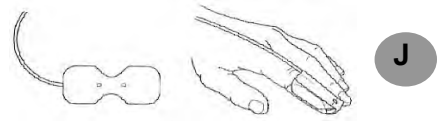

J

Pediatric Disposable SpO2 Sensor

Application: Pediatric: 10-50kg
Application site: Index or other finger



K

Infant Disposable SpO2 Sensors

Application: Infant 3~20kg
Application site: great toe



L

Neonatal Disposable SpO2 Sensors

Application: Neonatal <3 kg, Adult >40kg,
Application site: Neonatal foot, Adult Index or other finger

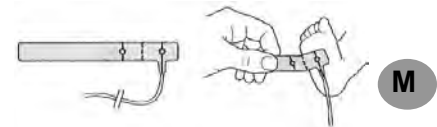

M

Comfort (foam) Disposable SpO2 Sensors

Application: Neonatal <3 kg, Adult >30kg,
Pediatric: 10-50kg, Infant 3~20kg
Application site: Neonatal foot, Adult Index or other finger, great toe
Soft biomedical comfortable foam material & Velcro fastener tape.



N

Medical grade application



Microfoam (standard)

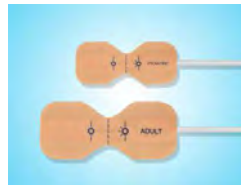

Medaplast-1
(All size)



Medaplast-2
(All size)

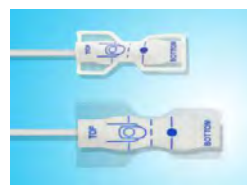

Transpore
(Adult & Pediatric only)



Comfort foam
(For Neonatal & Adult & Pediatric & Infant)

Type Disignation

S □ □ □ □ □ - □ □ □

vacant: English packing; C/Z: Chinese; U: USA; J: Economic type; S= Sterilization; e.g. S0005M-LPJ;

material: Vacant: Microfoam; P: Medaplast-1/Medaplast-2; T: Transpore; e.g. S0005J-SP;

Cable Length: L: Indicated L=0.9m, S: Indicated S=0.45m; e.g. S0005J-L;

Disposable Probe type: J: Adult; K: Pediatric; L: infant; M: Neonatal/Adult; N: For all people

Brand code: 0010/ Nellcor, 0036/ Datex;

S: Indicated SpO2 sensor.









Disposable SpO₂ Sensor (need ext-cable)

Compatible Models	INSTRUMENT CONNECTOR	OEM P/N	Applicable people	Microfoam	Medaplast-1	Medaplast-2	Transpore	Non-woven	EMITTER	
BCI										
BCI(Biochem International): 3401,3304,3303,3302,3301,3300; Spacelabs Burdick: PRO2; Dräger: Dräger Oxipac 2000	 24pcs/box		Adult	S0076J-L	S0076J-LP				660/905-2	
				S0076J-S	S0076J-SP				660/905-2	
				S0076J-SU					660/905-2	
				Pediatric	S0076K-L	S0076K-LP				660/905-2
					S0076K-S	S0076K-SP				660/905-2
					S0076K-SU					660/905-2
				Infant	S0076L-L		S0076L-LP			660/905-2
					S0076L-LU					660/905-2
				Neonatal/ Adult	S0076M-L		S0076M-LP		S0076N-L	660/905-2
					S0076M-LU					660/905-2
Biolight										
Biolight M8000			Neonatal/ Adult			S0183M-LPZ		S0183M-LP (2018)		
Biolight Q5			Neonatal					601411652 (2018)		
			Neonatal/ Adult	S0165N-LZ (2018)				S0165M-LPZ (2018)		
			Adult		S0195J-SPZ				T2/box	
			Neonatal/ Adult	S0195M-LZ		S0195M-LPZ		S0195N-LZ	T2/box	
								S0195N-SC		
CSI										
Alaris(IVAC):VitalCheck 4400,CSI:503DX,503S pot,504DX,506,506DX,507ELC2 ScholarIII,8100Poet Plus,Poet (602-3A) (Sensor + Cable),Scholar (Sensor + Cable)			Adult	S0044J-L	S0044J-LP			S0044J-ST	660/905-3	
		570SD		S0044J-S						
		571SD	Pediatric	S0044K-S						660/905-3
		572SD	Infant	S0044L-L						660/905-3
		573SD	Neonatal/ Adult	S0044M-L		S0044M-LP			S0044N-L	660/905-3
COMEN										
COMEN C70			Infant	901455422						
COMEN C30			Neonatal	801455422						
DATEX										
AS/3,CS/3,CH/S,CH/2S,CH-RS,CG/2S,Cardiacap I,Cardiacap II,Cardiacap 5,Capnomac Ultima,Light Monitor,M-Estpr,Oscar II,OSP-200,Satlite Trans,Satlite,Trans Plus,System 5,ULTS00,ULTSIO,ULT SVI,ULTSVO, original	 24pcs/box		Adult	S0036J-S	S0036J-SP			S0036J-ST	660/905-2	
					S0036J-SPC					
			Pediatric	S0036K-S						660/905-2
			Infant	S0036L-L		S0036L-LP				660/905-2
			Neonatal/ Adult	S0036M-L		S0036M-LP			S0036N-L	660/905-2
										S0036M-LC





Disposable SpO₂ Sensor (need ext-cable)

Compatible Models	INSTRUMENT CONNECTOR	OEM P/N	Applicable people	Microfoam	Medaplast-1	Medaplast-2	Transpore	Non-woven	EMITTER	
DATASCOPE										
Datascope:Accutorr 3/4 SAT, Accutorr Plus,Passport (Database SpO ₂),Compatible for 0020-00-071-01  24pcs/box	129		Adult	S0052J-S					660/940-3	
		0998-00-0076-04	Pediatric	S0052K-S						660/940-3
			Infant	S0052L-L						660/940-3
		0998-00-0074-04	Neonatal/Adult	S0052M-L					S0052N-L	660/940-3
DOLPHIN (OSI)										
Dolphin ONE Oximeters, *digital PD output directly DS. Copatible original : 360  24pcs/box	131		Adult	S0099J-S			S0099J-ST		660/905-2	
			Infant	S0099L-L						660/905-2
			Neonatal/Adult	S0099M-L	S0099M-LP				S0099N-LC	660/905-2
					S0099M-LPC			S0099N-LZ	660/905-2	
					S0099M-LPZ				660/905-2	
GMI,(General Meditech,Inc),Creative,Newtech										
G2A Vital Signs Monitor,G3D,G3A,G3C Patient monitor: G3D,G3F,G3G Patient monitor G3H Patient monitor,Creative: *digital PD output directly DS. PC-900, PC-900A, PC-900Color,PC-3000 Patient Monitor Newtech:NT2C 	110		Adult	S0108J-S	S0108J-SP				660/905-2	
				S0108J-SPZ					660/905-2	
			Pediatric	S0108K-S						660/905-2
			Neonatal/Adult	S0108M-L		S0108M-LP			S0108N-L	660/905-2
	S0108M-LZ			S0108M-LPZ			S0108N-LZ	660/905-2		
GE-Ohmeda										
GEB650 			Adult	S0190J-S	S0190J-SPZ			S0190J-ST	660/905/940-4	
			Infant	S0190L-L					660/905/940-4	
			Neonatal/Adult	S0190M-L		S0190M-LP			S0190N-L	660/905/940-4
				S0190M-LC		S0190M-LPZ			S0190N-LZ	660/905/940-4
Konica Minolta										
Pulsox-300, Pulsox-300i 	692		Neonatal/Adult	S0152M-L					660/905-2	
Mindray / Masimo										
PM-6800 (masimo module, 7pin socket) , T8 Patient monitor *Need adapter cable S0126CS-L compatible with Mindray patient monitor.  24pcs/box		0010-10-42630	Adult	S0153J-S	S0153J-LP				660/905-2	
					S0153J-LPZ				660/905-2	
					S0153J-SP				660/905-2	
					S0153J-SPZ				660/905-2	
		0010-10-42629	Pediatric	S0153K-S						660/905-2
		0010-10-42628	Infant	S0153L-L						660/905-2
		0010-10-42627	Neonatal/Adult	S0153M-L		S0153M-LP			S0153N-L	660/905-2
	S0153M-LJ			S0153M-LPZ		S0153N-LZ	660/905-2			
	S0153M-LZ				660/905-2					





Disposable SpO₂ Sensor (need ext-cable)

Compatible Models	INSTRUMENT CONNECTOR	OEM P/N	Applicable people	Microfoam	Medaplast-1	Medaplast-2	Transpore	Non-woven	EMITTER	
Masimo										
			Adult	S0020J-S	S0020J-SPZ					
			Pediatric	S0020K-S						
			Infant	S0020L-L						
			Neonatal/ Adult	S0020M-L			S0020M-LPJ S0020M-LPZ		S0020N-LZ	
			Neonatal/ Adult			S0217M-LPZ				
			Neonatal/ Adult			S0218M-LPZ				
	110 		Adult		S0219J-SPZ					
			Adult		601415402 (2018)					
			Adult		S0442J-SPZ					
			Pediatric		S0442K-SP (2017)					
			Neonatal/ Adult	S0442M-LZ			S0442M-SP S0442M-LP S0442M-LPZ		S0442N-LZ	
	370/048 		Adult	S0204J-S	S0204J-SPZ				T2/box	
			Infant				S0204L-LP		T2/box	
							S0204M-LPZ		S0204N-LZ	
HNM										
Compatible Brand and Models of equipment will be founded in "6 Multi-com&site SpO2 Sensor & Extension Cable" and "5 Y type Multisite sensor"			Adult	S0136J-L	S0136J-LPU					
				S0136J-LU						
				S0136J-S						
			Pediatric	S0136K-L						
				S0136K-S						
			Infant	S0136L-L						
			Neonatal/ Adult	S0136M-L	S0136M-LPU					S0136N-L
				S0136M-LU						S0136N-LU
Creative										
			Adult		S0160J-SPZ					
			Neonatal/ Adult	S0160M-LZ		S0160M-LPZ			S0160N-LZ	

Disposable SpO2 Sensor (need ext-cable)

Compatible Models	INSTRUMENT CONNECTOR	OEM P/N	Applicable people	Microfoam	Medaplast-1	Medaplast-2	Transpore	Non-woven	EMITTER		
NIHON KOHDEN											
Bedside Monitor: BSM-4101,4103, 4111,4113 Life scope P, BSM-5105,5135 Life scope A, BSM-2351,2353 Life scope L, BSM-2301,2303 Life scope I	 24pcs/box		Adult	S0005J-L	S0005J-SP		S0005J-ST		660/940-3		
		TL-251T		S0005J-S	S0005J-SPZ			660/940-3			
		TL-252T	Pediatric	S0005K-S						660/940-3	
		TL-252T	Infant	S0005L-L			S0005L-LP			660/940-3	
		TL-253T	Neonatal/ Adult	S0005M-L			S0005M-LP		S0005N-LZ	S0005N-L	660/940-3
				S0005M-LZ			S0005M-LPJ			660/940-3	
S0005M-S					S0005M-LPZ		660/940-3				
			Adult	S0096J-S	S0069J-SP						
			Pediatric	S0069K-S	S0069K-SP						
			Infant	S0069L-L							
			Neonatal/ Adult	S0069M-L			S0069M-LP				
NELLCOR											
Nellcor®:N100 (req. preamp cable),N180,N200 (req. preamp cable),N-20,NPB-40,NPB-75,NPB-290/5 ,N-390,N-395,N-3000,N-6000	 24pcs/box		Adult	S0010J-L	S0010J-LP		S0010J-ST		660/905-2		
				S0010J-LU	S0010J-LPU			660/905-2			
		D25		S0010J-S	S0010J-SP			S0010J-STU	660/905-2		
				S0010J-SJ	S0010J-SPC				660/905-2		
				S0010J-SU	S0010J-SPZ			660/905-2			
			Pediatric	S0010K-L	S0010K-SP		S0010K-ST		660/905-2		
		D20		S0010K-S	S0010K-SPC			660/905-2			
				S0010K-SJ	S0010K-SPZ			660/905-2			
				S0010K-SU				660/905-2			
			Infant	S0010L-L			S0010L-LP		660/905-2		
				S0010L-LJ			S0010L-LPZ		660/905-2		
				S0010L-LU				660/905-2			
			Neonatal/ Adult	N25	S0010M-L		S0010M-LP	S0010M-LT	S0010N-L	660/905-2	
				S0010M-LZ			S0010M-LPJ		S0010N-LU	660/905-2	
	S0010M-LJ				S0010M-LPU	660/905-2					
	S0010M-LU				S0010M-LPZ	S0010N-LZ	660/905-2				
	S0010M-S				S0010M-SP	660/905-2					
※NELLCOR OXI-TECH All Nellcor & Nellcor equipped OEM monitors not listed above	 24pcs/box		Adult	S0026J-LJ	S0026J-LPS		S0026J-ST		660/905-2		
		MAX-A		S0026J-S	S0026J-SP			660/905-2			
				S0026J-SJ	S0026J-SPS			S0026J-STZ	660/905-2		
				S0026J-SS					660/905-2		
				S0026J-SU	S0026J-SPZ				660/905-2		
			Pediatric	MAX-P	S0026K-S	S0026K-SP		S0026K-ST		660/905-2	
				S0026K-SJ	S0026K-SPS		660/905-2				
				S0026K-SS			660/905-2				
				S0026K-SU	S0026K-SPZ		660/905-2				
			Infant	MAX-I	S0026L-L		S0026L-LP			660/905-2	
				S0026L-LJ			S0026L-LPS		660/905-2		
				S0026L-LU			S0026L-LPZ		660/905-2		
			Neonatal/ Adult	MAX-N	S0026M-L		S0026M-LP		S0026N-L	660/905-2	
				S0026M-LJ			S0026M-LPJ		S0026N-LJ	660/905-2	
	S0026M-LU				S0026M-LPS		S0026N-LZ	660/905-2			
	S0026M-LZ				S0026M-LPZ		660/905-2				

Disposable SpO₂ Sensor (need ext-cable)

Compatible Models	INSTRUMENT CONNECTOR	OEM P/N	Applicable people	Microfoam	Medaplast-1	Medaplast-2	Transpore	Non-woven	EMITTER
NOVANMETRIX									
Novamatrix:505,510,511,515B/C,5207000,7100,Oxypleth; original match : 8776-00; Spacelabs:90351D/G,90465,90466,90467,90489,90651-07/08,90419-01,90651A-07,original match:8776-00			Adult	S0062J-S					660/940-3
			Pediatric	S0062K-S	S0062K-SP				660/940-3
			Infant	S0062L-L					660/940-3
			Neonatal/Adult	S0062M-L		S0062M-LP		S0062N-L	660/940-3
NONIN									
NONIN: 8500,8600,8700,8800			Adult	S0080J-LU	S0080J-LPC		S0080J-ST		660/905-2
		7000A		S0080J-S	S0080J-LPU			660/905-2	
				S0080J-SU	S0080J-SP			S0080J-STU	660/905-2
					S0080J-SPZ				660/905-2
			Pediatric	S0080K-L				660/905-2	
				S0080K-S	S0080K-SP		660/905-2		
				S0080K-SU			660/905-2		
			Infant	S0080L-L		S0080L-LP		660/905-2	
				S0080L-LU			660/905-2		
			Neonatal/Adult	S0080M-L		S0080M-LPU		S0080N-L	660/905-2
				S0080M-LU			S0080M-LPZ	S0080N-LU	660/905-2
				S0080M-LZ			S0080N-LZ	660/905-2	
OHMEDA									
(Need adapter cable S0014BC-L)Datex-Ohmeda:3740,3710,4700 OxiCap,5250RGM, Biox3760,Ohmeda3700,3770,3775,Rascal II, GE:7000Series,Corometrics511, TRAM A.R, TRAM Modular x00SL Series, as200SL,400SL,600SL,800A,800SL,Mennen:Horizon XL800 (Ohmeda SpO2)			Adult	S0014J-S	S0014J-SP				660/940-3
			Pediatric	S0014K-S	S0014K-SP				660/940-3
			Infant	S0014L-L					660/940-3
		24pcs/box	Neonatal/Adult	S0014M-L		S0014M-LP		S0014N-L	660/940-3
	S0014M-S			660/940-3					
Datex-Ohmeda:3740, 3710, only use for Ohmeda oximeter, EMITTER: 660/905/940-4		OXY-AP	Adult	S0123J-S	S0123J-SP				660/905/940
					S0123J-SPZ			660/905/940	
			Pediatric	S0123K-L					660/905/940
				S0123K-S		S0123K-ST	660/905/940		
			Infant	S0123L-L					660/905/940
			OXY-AF	Neonatal/Adult	S0123M-L		S0123M-LP		S0123N-L
	S0123M-LZ				660/905/940				
	S0123M-LU				S0123M-LPZ	S0123N-LZ		660/905/940	

Disposable SpO2 Sensor (need ext-cable)

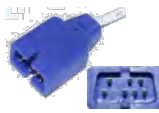
Compatible Models	INSTRUMENT CONNECTOR	OEM P/N	Applicable people	Microfoam	Medaplast-1	Medaplast-2	Transpore	Non-woven	price	
PHILIPS										
M3,M4,MP20,MP30,MP40,MP50,MP70,MP80,VM4,VM6,VM8	 052 24pcs/box		Adult	S0015J-S	S0015J-SP				660/905-2	
					S0015J-SPZ				660/905-2	
			Pediatric	S0015K-S						660/905-2
			Infant	S0015L-L						660/905-2
			Neonatal/Adult	S0015M-L		S0015M-LP		S0015N-L	660/905-2	
					S0015M-LPZ		S0015N-LZ	660/905-2		
DATEX-OHMEDA										
			Adult		S0194J-SPZ					
			Neonatal/Adult		S0194M-LZ		S0194M-LPZ		S0194N-LZ	

Clinical Test Result

Emitte: 660/905nm (OXI TECH)

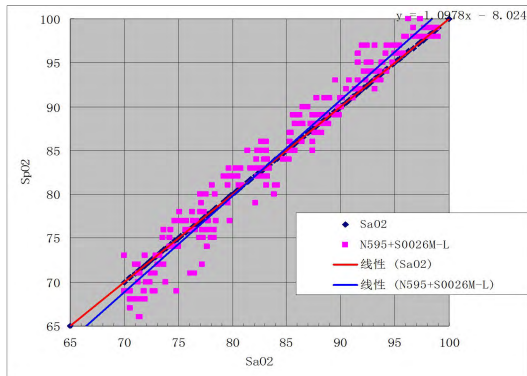

Item.	70--100.	90--100.	80--<90.	70--<80.	60--<70.
# pts	245	82	75	88	1
Bias	0.25	1.17	0.6	-0.89	-
A _{RMS}	2.12	1.74	1.86	2.6	-
Max diff	5	-	-	-	-
Min diff	-8.2	-	-	-	-

Emitte: 660/905nm

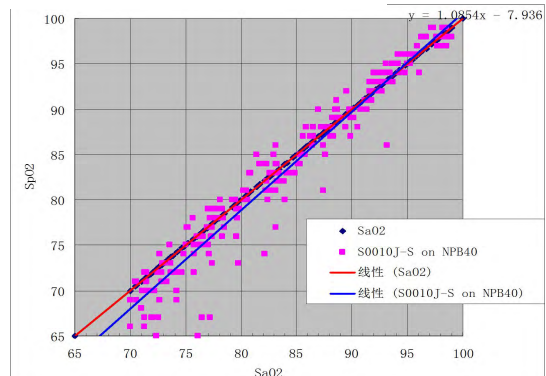

Item.	70--100.	90--100.	80--<90.	70--<80.	60--<70.
# pts	246	83	75	88	1
Bias	-0.7	0.04	-0.3	-1.74	-
A _{RMS}	2.38	1.32	2.04	3.26	-
Max diff	3.6	-	-	-	-
Min diff	-11.1	-	-	-	-

Emitte: 660/940/905nm

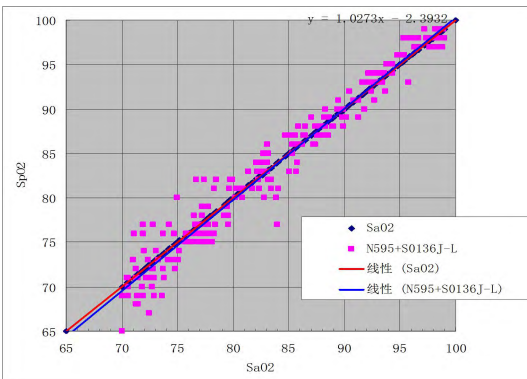

Item.	70--100.	90--100.	80--<90.	70--<80.	60--<70.
# pts	245	82	75	88	1
Bias	-0.08	0.17	0.11	-0.5	-
A _{RMS}	1.79	1.14	1.63	2.36	-
Max diff	5.3	-	-	-	-
Min diff	-7	-	-	-	-

Emitte: 660/905nm

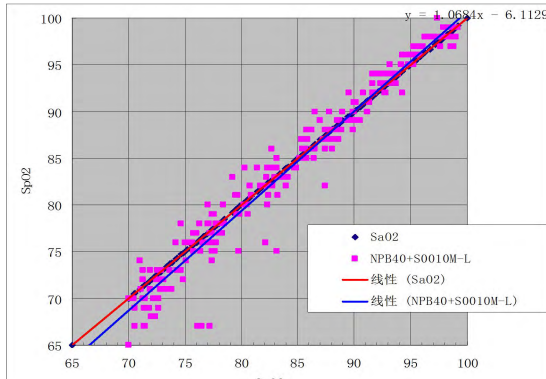

Item.	70--100.	90--100.	80--<90.	70--<80.	60--<70.
# pts	249	86	75	88	1
Bias	-0.3	0.37	-0.14	-1.11	-
A _{RMS}	2.03	1.09	1.89	2.72	-
Max diff	3.8	-	-	-	-
Min diff	-10.2	-	-	-	-

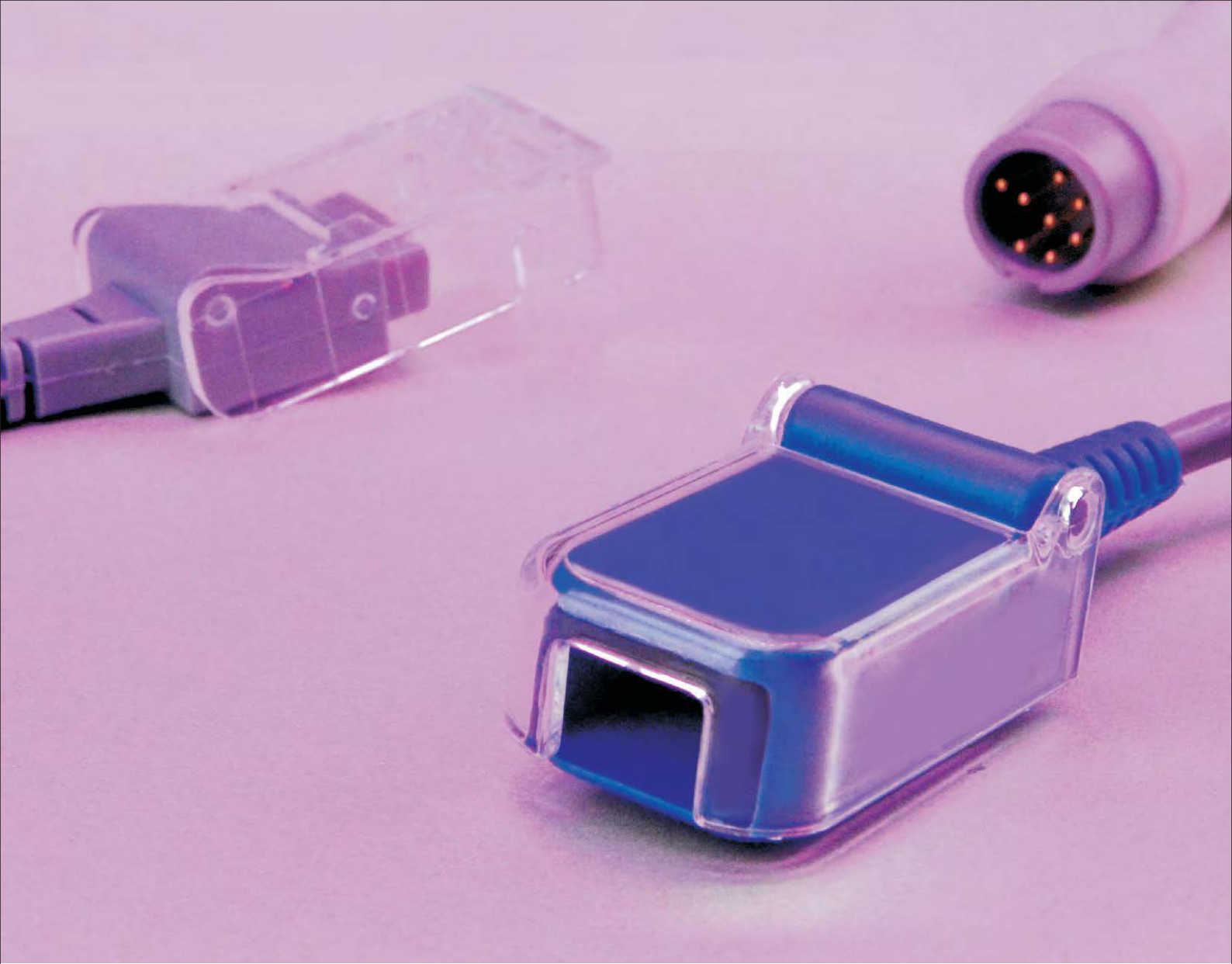

3

SpO2 Sensor Extension Cable



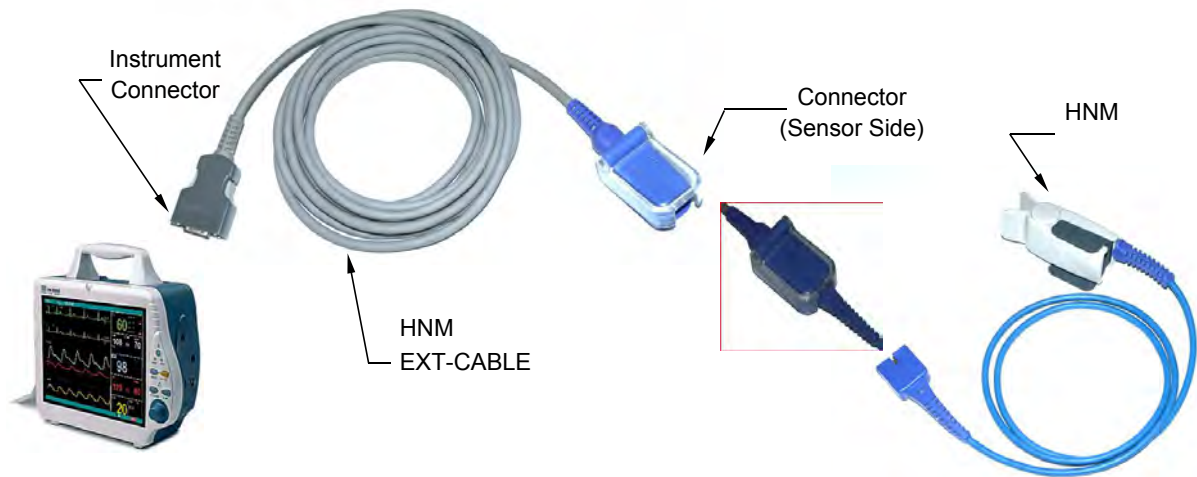

Instrument Connector

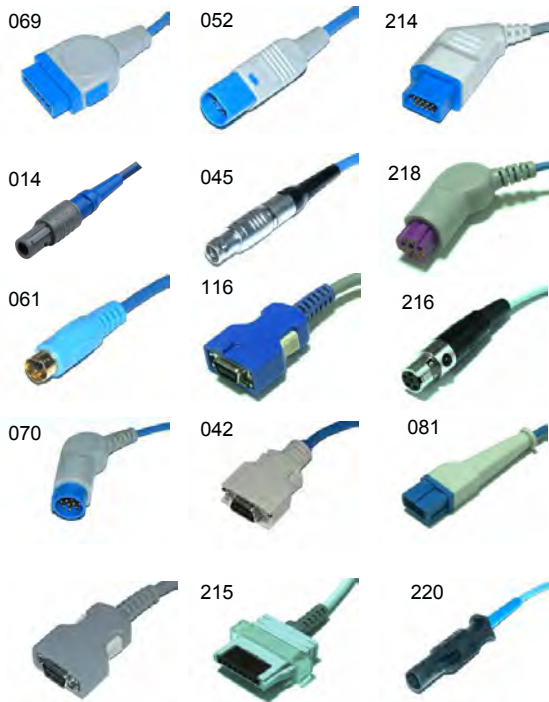

Connector(Sensor side)





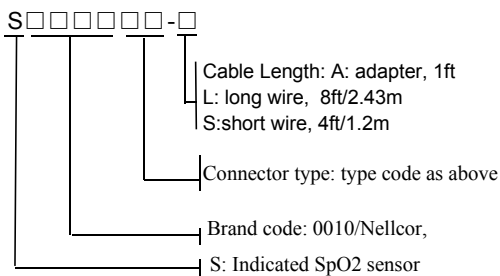

























Type Disignation



- The HNM product range will assist you by standardizing your EXT- Cable & Adapter cable selection while providing very durable products compatible with the many leading manufacturers of patient monitor systems.
- * Masimo SpO₂ Adapter cable refurbished or repair only.
- * The brands or registered trade mark listed in the files are belong to the respected owners of the properties.

SpO₂ Sensor Extension Cable

Compatible Brand	Compatible Models No.	OEM P/N	HNM REF NO.	Description (Name,Length,Plug,Compatible)	INSTRUMENT CONNECTOR	CONNECTOR (SENSOR SIDE)	Price Code
AnKe Choice: MMED6000D/D	AnKe:553; Biolight;BaoZhong; Cheersalls:CSM-2000; WanDong; Goldway:UT4000A UT4000C 4000B; Jumbor:JB9101/9105/9107; TianRong; QILan:M-III; HongRunDa:EM-6;JERRY:PM2000; JoyceTracker: BMD-50; Mindray:PM9000; Richer:RC9000;ShenMai:KP-900; Spurt:CP-1200; SHIPAI: KMI-1000; ZhongHengSheng:KD580;ZhongYua: HD-2000		S0007BC-L	Ext-Cable,8ft,Compatible Readel 1bt 5P>DB9F, fit for BCI probe	074 		B4
BCI	(Biochem International): 3401 ,3304,3303,3302,3301,3 300;		S0076BC-L	Ext-Cable,8ft,DB9M>DB9F, Suitable for BCI probe	389 		B4
	(Biochem International): 6100, 9100, Advisor, Autocorr, Mini Torr BCI (Biochem International), Mini Torr Plus;		S0111BC-L	Ext-Cable,8ft, Readel 1bit.7P>DB9F, Suitable for BCI probe	558 		B4
Bionet (Korea)	BM3,BM3 Plus;		S0121BC-L	Ext-Cable,8ft, AMP 6P>DB9F, Suitable for Bionet probe	725 		C5
	BM3Vet, BM31;		S0084BC-L	Ext-Cable,8ft, Readel 1bit.7P>DB9F, Suitable for Bionet probe	609 		B4
	BPM300		S0065NE-L	Ext-Cable,8ft, MD6M>DB9F,Suitable for Nellcor probe	061 		C0
Bruker (ODAM)	Bruker (Odam) all		S0071BC-L	Ext-Cable,8ft, Round12P>DB9F, Suitable for BCI probe	721 		C5
Biolight	Q5, A2 E EMS		S0515DO-L (2019)	Round 9p>DB9F, fit for HNM S0165 series.			B0
	M6,M12, M69(new version);		S0029BC-L	Ext-Cable,8ft,Compatible Readel 1bt 5P>DB9F, fit for BCI probe	408 		B4
	BLT: M66, M69(Old version);		S0101BC-L	Ext-Cable,8ft, Compatible Lemo 1bt 5P >DB9F, fit for BCI probe	044 		C5
	M8000;		S0155DO-L	Ext-Cable,8ft, Compatible Readel 1b 5P >DB9F, fit for HNM S0160 series.	074 		B2
	A6		S0165DO-S (2018)	Ext-Cable,4ft, Round 9p>DB9F,fit for HNM S0165M-L.	948 		C4
		S0165DO-L	Ext-Cable,8ft, Round 9p>DB9F,fit for HNM S0165M-L.			C4	
Biocare Jumbor	BM9000;		S0022BC-L	Ext-Cable,8ft, Compatible Readel 2bit.6P>DB9F, fit for BCI probe;	076 		B4

SpO₂ Sensor Extension Cable

Compatible Brand	Compatible Models No.	OEM P/N	HNM REF NO.	Description (Name,Length,Plug,Compatible)	INSTRUMENT CONNECTOR	CONNECTOR (SENSOR SIDE)	Price Code
Choice oximax module	NELLCOR OXIMAX module		S0112OX-L	Ext-Cable,8ft, MOQ 60PCS Compatible Readel 1bt 9P>DB9F, fit for Nellcor probe DS-100A and HNM S0026B-S;	444 	205 	C0
Creative	PC5000, PC9000.		S0160NE-L	Ext-Cable,8ft,Compatible Readel 2bit.5P>DB9F,fit for S0160 series.	898 	130 	B2
	UP-6000, PC-9000 (Non-Oximax)	DS100A D-YS	S0063BC-L	Exi-Cable,8ft, Compatible Readel 2bit.6P>DB9F, fit for BCI probe instead of S0047BC-L.	076 		B4
Contec	CMS-7000		S0155NE-L	Ext-Cable,8ft, Compatible Readel 1bt 5P>DB9F, fit for BCI probe.	408 		B4
	GSM9000		S0155DO-L	Ext-Cable,8ft, Compatible Readel 1bt 5P>DB9F, fit for S0160 series.			B2
COMEN	COMEN C80		S0437NE-L	Exi-Cable,9ft, Round 12PIN>DB9F, Suitable for Comen C80	059 	130 	C0
	COMEN C100A		S0546NE-L	Exi-Cable,8ft, Round 12PIN>DB9F, Suitable for Comen C100A			C0
	COMEN NC12		S0553NE-L (2019)	Exi-Cable,9ft, Round 12PIN>DB9F, Suitable for Comen NC12			C0
	COMEN C50		S0554NE-L (2019)	Exi-Cable,8ft, Round 12PIN>DB9F, Suitable for Comen C50			C0
Colin	Datascope:Accutorr Plus, Nellcor:NPB-290/5, N-390,N-395,N-3000 N-6000,NPB-290/5,N-390,N-395,N-3000,N-6000, Nihon Kohden:BSM-4104A, BSM-4114A, Colin BP88/306, Need S0008CO-L(Rev.C) to compatible with Pro1000(OXIMAX)	SCP-10	S0008CO-L	Ext-Cable,8ft, AMP14P>DB9F, Suitable for Nellcor probe, asS0010B-S,S0026B-S	116 	127 	D2
Corpuls	Corpuls 08/16, 08/16M;		S0138CO-L	Ext-Cable,8ft, Readel 2bit.6P>DB9F, Compatible for NELLCOR sensor and HNM S0010B-S	773 	480 	F0
			S0138CS-L	Ext-Cable,8ft, Readel 2bit.6P>DB9F, Suitable for Masimo CS Sensor and HNM S0153B-S		479 	F0
CSI	CSI (Criticare Systems International):506 Spot CSI ,507SD(Criticare Systems International):503 Spot;		S0044BC-L	Ext-Cable,8ft, DB9M>DB9F, Suitable for CSI probe	064 		B3
	CSI (Criticare Systems International):Scholar , Poet (602-3A), 1100 , 581, 508, 507, 507SD,504, 503, 501; Mindray 500A;		S0100BC-L	Ext-Cable,8ft, Lemo 1B.5>DB9F, Suitable for CSI probe instead of S0011NE-L	454 		D3
Datascope	Datascope:Accusat Datascope:Accutorr 3/4 SAT Datascope:Accutorr Plus (Datascope Sp02) Datascope:Passport (Database Sp02);	0012-00-0516-02	S0052BC-L	Ext-Cable,8ft, DIN8P>DB9F, Suitable for Datascope probe	722 		C5















SpO₂ Sensor Extension Cable

Compatible Brand	OEM MODELS NUMBER	OEM P/N	HNM REF NO.	Description (Name,Length,Plug,Compatible)	INSTRUMENT CONNECTOR	CONNECTOR (SENSOR SIDE)	Price Code
DATEX	Datex-Ohmeda:AS/3, CS/3, CH/S, CH/2S, CH-RS, CG/2S, Cardiocap I, Cardiocap II, Cardiocap 5, Capnomac Ultima, Light Monitor, M-Estpr, Oscar II, OSP-200, Satlite Trans, Satlite Trans Plus, ULTSVI, ULTSVO, ULTSIO, ULTS00;	OXY-C3	S0036BC-L	Ext-Cable,8ft, Round 10J>DB9F, Suitable for DATEX probe			C4
		OXY-SL3	S0036OH-L	Ext-Cable,8ft, Round 10J>8J, Suitable for DATEX probe		396 	D3
			S0036NE-L	Ext-Cable,8ft, Round 10J>DB9F, fit for HNM S0010 series		130 	C4
			S0529TS-L (2018)	Suitable for HNM S0190 series or Trusignal series			C0
Datex-Ohmeda	Suitable for Datex-Ohmeda:Ohmeda 3700, Ohmeda 3710, Ohmeda 3770, Ohmeda 3775, Biox 3740, Biox 3760, 3800 OxiCap, 4700 OxiCap, 5250RGM, Rascal II; GE Medical Systems:Corometrics 511; Mennen:Horizon XL (Ohmeda SpO2);		S0528TS-L (2018)	Suitable for HNM S0190 series or Trusignal series			C0
			S0014BC-L	Ext-Cable,8ft, Hyc7P>DB9F, Suitable for Ohmeda probe			C2
		OXY-OL3	S0014OH-L	Ext-Cable,8ft, Hyc7P>8J, Suitable for Ohmeda probe		396 	D3
Dolphin Medical (OSI)	Dolphin ONE Oximeters;	110	S0099BC-L	Ext-Cable,8ft, AMP 14P>DB9F, Suitable for Dolphin probe			C7
EDAN	EDAN: M9, WANDONG 万东: BYS-8000, MINDRAY 迈瑞: PM-8000 MEC1200;		S0040BC-L	Ext-Cable,8ft, Readel 2bit.6P>DB9F, Suitable for BCI probe			B4
	M9,M99A,M8,M8A, M8B, M3,M3B (Oxi Tech)		S0432OX-L	Exi-Cable,8ft, Round 6P>DB9F, Suitable for HNM S0026 series		205 	B0
Emtel	Emtel: (Fx2000)		S0178OX-L	Ext-Cable,8ft, 12p>DB9F, Compatible for NELLCOR sensor and S0010B-S.		205 	C5
			S0178CO-L	Ext-Cable,8ft, Round 12p>DB9F, Compatible for HNM S0010 series.	1442 		C5
GE-Ohmeda	Sensor solutions for GE Ohmeda TruSat™ pulse oximeter;	OXY-MC3	S0127OH-L	Interconnect cable,8ft DB9M>8J, Suitable for Ohmeda probe		352 	D9
GE Medical	GE-TruSignal		S0527TS-L (2018)	Interconnect cable,8ft DB9M>8J, Suitable for HNM S0190 series or Trusignal series			C0





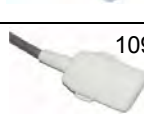



















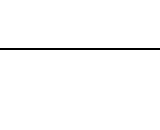

SpO₂ Sensor Extension Cable

Compatible Brand	Compatible Models No.	OEM P/N	HNM REF NO.	Description (Name,Length,Plug,Compatible)	INSTRUMENT CONNECTOR	CONNECTOR (SENSOR SIDE)	Price Code
GE Medical (Nellcor module)	Dash 2000/3000/4000 with Nellcor option, Dash 3000/4000/5000 with Ohmeda option, Solar 8000/8000M, i9500 with Tram Module 451/451N/851/851N, CardioLab®/Mac-Lab® with Tram Module 451/451N Corometrics® 120/2120 series Eagle 1000/3000/4000 Responder 3000 with Nellcor option;	2006644-001	S0002NE-L	Ext-Cable,8ft, Rectangle 11P>DB9F, Compatible for NELLCOR sensor and HNM S0010B-S	075 	130 	A0
GE Medical (Oxi-Tech Module)	Dash 3000/4000/5000 with Nellcor OxiMax option Solar 8000/8000M, i9500 with Tram module 451N5/851N5;	202140 6-001	S0122OX-L	Ext-Cable,8ft, Rectangle 11P>>DB9F, Suitable for DS-100A S0132B-S, and S0010B-S(Need S0026NE-A)	075 	205 	D9
GE Medical (Masimo Module)	Dash 3000/4000/5000 with Masimo option Solar 8000/8000M, i9500 with Tram Module 451M/851M CardioLab®/Mac-Lab® with Tram Module 451M Corometrics® 259;	201700 2-003	S0025MA-L※	Ext-Cable,8ft,Rectangle 11P>Masimo 6J, Suitable for Masimo LNOP probe	075 		D5
			S0025CS-L	Ext-Cable,8ft, Rectangle 11P>DB9F Suitable for Masimo CS Sensor and HNM S0153B-S	075 	479 	C0
			S0025CO-L	Ext-Cable,8ft, Rectangle 11P>DB9F, Compatible for NELLCOR sensor and HNM S0010B-S	069 		C7
GE-Ohmeda	S/5, i4 Modular Monitors with E-series modules Corometrics® 259 with TruSignal Ohmeda Technology;	OXY-ES3	S0128OH-L	Interconnect cable,8ft, Rectangle 11P>8J, Suitable for Ohmeda probe	379 	591 	D9
			S0194NE-L	Interconnect cable,8ft, Rectangle 11P>DB9F, fit for HNM S0194 Series.	955 	130 	D0
GE-MARQUETTE (Oximax Module)	GEMS Dash Series (Oximax Module)		S0122CO-L	Ext-Cable,8ft, Rectangle 11P>DB9F, Compatible for HNM S0026series.	069 	205 	D0
GE Medical	CARESCAPE* modular monitors and S/5, AS/3 and CS/3 modular monitors with E-(P)RESTN or E-PSM(P) modules. CARESCAPE V100 with TruSignal* option, Responder, B20 and B30 monitors.	TS-G3	S0190TS-L	Ext-Cable,8ft, Rectangle 11P>DB9F, Compatible for HNM S0190B-S series;			D2
GOLDWAY			S0061BC-L	Ext-Cable,8ft, Compatible Readel 2bt 7P>DB9F, fit for BCI probe.	041 		B5
	Goldway: UT4000A, UT4000C 4000B PACE TECH;		S0007BC-L	Ext-Cable,8ft, Compatible Readel 1bit.5p>DB9F, fit for BCI probe.	074 		B4
	UT4000A,UT4000B, UT4000F UT4000ACS(OxiSmart)(Non-oximax)	DS100A D-YS	S0007NE-L	Ext-Cable,8ft,Compatible Readel 1bt,5P>DB9P,fit for Nellcor probe			B4
	UT4000A, UT4000C, UT4000E, UT4000F, UT4000Apro, UT4000Fpro, UT6000A;		S0038BC-L	Ext-Cable,8ft, Lemo 1B.5>DB9F, fit for BCI probe	696 		C5

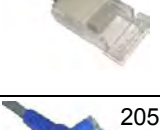
SpO₂ Sensor Extension Cable

Compatible Brand	Compatible Models No.	OEM P/N	HNM REF NO.	Description (Name,Length,Plug,Compatible)	INSTRUMENT CONNECTOR	CONNECTOR (SENSOR SIDE)	PRICE CODE
GE	GE Corometrics 120 510 511 118 556		S0431NE-L	Exi-Cable,8ft, 12P>DB9F, Suitable for HNM **		 130	D2
Guoteng	<u>GT9000</u>		S0024NE-L	Ext-Cable,8ft, Compatible Readel 1bt 6P>DB9F, fit for S0010 series.	543 	 130	B2
Hellige	Servomed 4.Generation SCP 844,851,852; SCS 804; SMK151,153,154,155-1,156,157,SMK181,182,SMV 104T,107,111,168;SMS316;SMC1 08; SMV104,Servomed N4, Servocard, Serie Cardioserv,Vicom SM,SMU 511,611,612,630 Serie SMK-200, SMK210,211,230.231.240,250,S MP 300,310,Pepita 201,202,202 R, .203,Pepita 203, R204,204R,205, Pepita 205R	3034435 8	S0006NE-L	Ext-Cable,8ft, Round 10P>DB9F, fit for Nellcor probe	077 	 130	C5
Huntleigh Healthcare			S0147NE-L	Ext-Cable,8ft, Readel 1bit.7P>DB9F, Suitable for BCI probe	041 	 130	C4
HongRunDa	EM-7		S0196NE-L	Exi-Cable,8ft, Readel 2bit.6P>DB9F, Suitable for HNM S0108 series			B4
Hexin ZongDan	<u>ZD Series patient monitor</u>		S0150NE-L	Ext-Cable,Length 8ft, Compatible Readel 1bt 6p>DB9F, Fit for S0010 series.	014 	 130	B2
INVIVO (Nellcor module)	4500,4500Plus,Millenia,Omeg a1445,Omni-TrakTVS,Sat Scout,original cable number 9383;		S0083NE-L	Ext-Cable,8ft, Lemo 1B.7p>DB9F, Suitable for Nellcor probe		 130	C4
INVIVO (Masimo module)	M8;	9217A	S0094MA-L※	Ext-Cable,8ft,Lemo 1B.7p>Masimo 6J,Suitable for Masimo LNOP probe	483 	 109	D0
			S0094CO-L	Ext-Cable,8ft, Lemo 1B.7p>DB9F, Compatible for NELLCOR sensor and MED-LINK S0010B-S			C7
	4500, ,Omni Track Omeg 1445Millennia (M Tech)	1863/LN CS DCI225 8/LNCS YI	S0094CS-L	Exi-Cable,8ft,Lemo 1B.7p>DB9F,Compatible for Masimo LNCS sensor and HNM S0153			C0
Kontron	Kontron:7840 Kontron:7845 Kontron:Kolormon Kontron:Micromon Kontron:Minimon 7137 Kontron:Supermon Kontron:Trakmon;		S0019NE-L	Ext-Cable,8ft, Round 12P>DB9F, Suitable for Nellcor probe	070 	 130	C2
			S0421NE-L	Exi-Cable,8ft, Readel 2bit.6P>DB9F, Suitable for HNM S0010 series			C2



















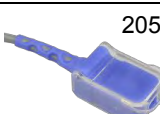

SpO₂ Sensor Extension Cable

Compatible Brand	Compatible Models No.	OEM P/N	HNM REF NO.	Description (Name,Length,Plug,Compatible)	INSTRUMENT CONNECTOR	CONNECTOR (SENSOR SIDE)	PRICE CODE
MINDRAY (Nellcor Module)	VS800、8002、9201、PM7000(Since Jan. 2006) patient monitor of Nellcor module and 6pin plug (80° between 2bit);	0010-20-42595(E)	S0129NE-L	Ext-Cable,8ft, Compatible Readel 2bit 6p (80°)>>DB9F, Suitable for Nellcor probe			B0
MMED6000D P/M10	MMED6000DPM/M10,KD580;		S0169NE-L	Ext-Cable, 8ft, Readel 1bit,6p>DB9F, Suitable for BCI Probe			B4
Masimo	Masimo all MDE:EscortII OPT30:Prism ,GE Marquette:,Pro1000,V300 , INVIVO:T8 , Schiller: , ZOLL: , Datascope: Trio,Passport2, Spectrum, (Must be Masimo Module);		S0020CO-L	Ext-Cable,8ft, Amp14P>DB9F, Compatible for NELLCOR sensor and HNM S0010B-S			C5
			S0020CS-L	Ext-Cable,8ft, Amp14P>DB9F, Suitable for Masimo CS Sensor and HNM S0153B-S			C0
			S0153NE-A	Adapter. DB9M>DB9F, Compatible for NELLCOR sensor and HNM S0010 Series			C0
	MASIMO LNC-10 2056		S0442CS-L	Exi-Cable,8ft, Rectangle 20P>DB9F, Suitable for HNM S0204 series			E0
	Compatible model depending on the Ext-cable, E.g: Rad-8 Rad-5/Rad-5v; SatShare		S0197MA-L	Exi-Cable,8ft, hemicycle 8p>Masimo 6J, suitable for Masimo LNOP probe			C0
MEK	MP-100, MP110, MP400, MP500,MP600,MP1000 (CSI Module);		S0018BC-L	Ext-Cable,8ft, DB9M>DB9F, Suitable for MEK probe			B5
	REF: MIS3AH_1 MEK ICS: MP1000NT TYPE: MEK (CSI Module);	MIS3AH_1	S0115BC-L	Ext-Cable,8ft, Round 8p>DB9F, Suitable for MEK probe			C7
	MP1000, (Nellcor Module);		S0144NE-L	Ext-Cable,8ft, Round 8p>DB9F, Suitable for Nellcor probe			C7
Mennen			S0103NE-L	Ext-Cable,8ft, Round 8p>DB9F, Suitable for Nellcor probe			C7
	Horizon2000;		S0009NE-L	Ext-Cable,8ft, Lemo 2b. 10P>DB9F, Suitable for Nellcor probe			F0
Mindray (CSI Module)	MEC-509,509+,503,507, OEM No.512A-30-06074;		S0011CS-L	Ext-Cable,8ft, Lemo 1B.5p>DB9F, Suitable for CSI probe			E0
Mindray (mindray module)	VS800(Mindray module), PM-7000,6201,8000,9000, Marketing:CFDA,CE,FDA; OEM No.0010-20-42594 MEC1200;	0010-20-42594	S0040NE-L	Ext-Cable,8ft, Redel 2bit-40° 6p>DB9F, Compatible for NELLCOR sensor and HNM S0010B-S, Mindray 512D,			A0



























SpO₂ Sensor Extension Cable

Compatible Brand	Compatible Models No.	OEM P/N	HNM REF NO.	Description (Name,Length,Plug,Compatible)	INSTRUMENT CONNECTOR	CONNECTOR (SENSOR SIDE)	PRICE CODE
Mindray (Masimo Module)	PM5000,PM6000,PM8100 Marketing:CFDA,CE. OEM No.0010-21-11957	0010-21-11957	S0045OX-L	Ext-Cable,8ft, Round 12p>DB9F, Compatible for NELLCOR sensor and HNM S0010B-S	 566	 205	B0
	PM-6800, (Mindray module) BeneView T5/T6/T8 (Mindray module) iPM Series (Mindray module) ;	0010-30-42737	S0125CO-L	Ext-Cable,8ft, Round 7p>DB9F, Compatible for NELLCOR sensor and HNM S0010B-S	 239	 205	C0
	PM9000express(.Masimo). PM80 02,9201,(PM- 6201,7000,8000,M1K0,M2K0 since 2006), Marketing:CFDA,CE.FDA ;	0010-30-42625	S0116CO-L	Ext-Cable,8ft, Radel 2bit- 60°6p,>>DB9F,Compatible for NELLCOR sensor and HNM S0010B-S	 241		B0
	New PM-6000 PM7000,8000,9000 PM-9000 Express VS 800,New PM6000(M tech)	0010-30-42625	S0116CO-L	Exi-Cable,8ft,Radel 2bit- 60°6p,>>DB9F,Compatible for NELLCOR sensor and HNM S0010B-S	 241		B0
	PM-9000,9100,9200,(PM- 6201,7000,8000,M1K0,M2K0 before 2006), Marketing:CFDA,CE.FDA	0010-30-42602	S0013CO-L	Ext-Cable,8ft,Compatible Readel 2bit 40° 6p>DB9F,Compatible for NELLCOR sensor and MED- LINK S0010B-S	 076		B0
	PM-9000,9100,9200,(PM- 6201,7000,8000, M1K0,M2K0 before 2006)(M Tech)	0010-30-42602	S0013CO-L	Exi-Cable,8ft,Compatible Readel 2bit 40° 6p>DB9F,Compatible for NELLCOR sensor and MED- LINK S0010B-S	 076		B0
	PM-6000 (masimo module, 12pin socket) Marketing:CFDA,CE.FDA OEM No.0010-30-12452;	0010-30-12452	S0012CO-L	Ext-Cable,8ft, Round 12p>DB9F, Compatible for NELLCOR sensor and HNM S0010B-S	 412		C7
	PM-6800 (masimo module, 7pin socket) , BeneView T5/T6/T8 (Masimo module) iPM Series (Masimo module) ;	0010-30-42738	S0126CO-L	Ext-Cable,8ft, Round 7p>DB9F, Suitable for NELLCOR probe., as S0010B-S	 772		C0
	PM-6800 (masimo module, 7pin socket) , BeneView T5/T6/T8 (Masimo module) iPM Series (Masimo module) ;	0010-30-42738	S0126CS-L	Ext-Cable,8ft, Round 7p>DB9F, Suitable for Masimo CS probe and HNM S0153B-S	 771	 480	C0
	MINDRAY T5,T8;	0010-20-42712	S0126OX-L	Nellcor OxiMax SpO2 Cable,8ft, Round 8p>DB9F,Suitable for Masimo CS probe and MED- LINK S0026B-S	 205		C0
	MINDRAY T3,T5,T8;		S0199CS-L	Exi-Cable,8ft, Round 8P>DB9F Suitable for HNM S0153 and S0201 series	 205		C0
	PM9000express, PM9000, 9100, 9200 (masimo module) Marketing:CFDA,CE.FDA;		S0013MA-L※	Ext-Cable,8ft, Compatible Readel 2bit 6p>Masimo 6J, Suitable for Masimo probe	 109		F5
	PM6000 (masimo module) Marketing:CFDA,CE.FDA OEM No.6200-30-11721;	6200-30-11721	S0012MA-L※	Ext-Cable,8ft, Round 12p>Masimo 6J, Suitable for Masimo probe	 505	 109	F5
	Mindray datascope passport V		S0204CS-L	Mindray 14P>>9P SpO2 2.43M, Fit for S0204Series.	 388		D9



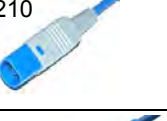























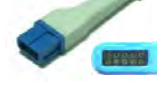

SpO₂ Sensor Extension Cable

Compatible Brand	OEM MODELS NUMBER	OEM P/N	HNM REF NO.	Description (Name,Length,Plug,Compatible)	INSTRUMENT CONNECTOR	CONNECTOR (SENSOR SIDE)	PRICE CODE	
M&B	M&B: CD2000		S0093NE-L	Ext-Cable,8ft, Hypertronics 6p>DB9F, Compatible for NELLCOR sensor or HNM S0010B-S.	 447	 130	C0	
Nellcor	Datascope:Accutorr Plus, Nellcor:NPB-290/5, N-390,N-395,N-3000 N-6000,NPB-290/5,N-390,N-395,N-3000,N-6000, Nihon Kohden:BSM-4104A, BSM-4114A, Colin BP88/306, Need S0008CO-L(Rev.C) to compatible with Pro1000(OXIMAX)	SCP-10	S0001NE-L	Ext-Cable,8ft, AMP 14P>DB9F, Suitable for Nellcor probe	 388	 130	B0	
Nellcor	Datascope:Expert,Passport, GE Medical:Corometrics 188/129,CritikonDinamap9700/9710/9720 Plus/Compact/MPS/Pro 300/Pro 400/Select, IvyBiomedical:405P,405T, M.D.E.:Escort II OPT30,Prism, Nellcor:N100,N200,N180,N-20,NPB-40,NPB-75, Nonin:8500,8604, Welch Allyn Protocol:Propaq 206-EL,Propaq 204-EL,Propaq 202-EL,Propaq 106EL;	EC-4	S0010NE-S	Ext-Cable,4ft, DB9M>DB9F, Suitable for Nellcor probe	 059	 130	A8	
		EC-8	S0010NE-L	Ext-Cable,8ft, DB9M>DB9F, Suitable for Nellcor probe			A8	
Nellcor (Oxi-tech)			S0026MD-A	Ext-Cable,Suitable for Nellcor oximax probe and HNM S0136 series	 496		B0	
	Nellcor:N550, N-595 GE:Dinamap PRO (w/Oxi), Schiller,Include N-600x, GE Dash Series patient monitor(Oximax mould), as 1800, 2500, 3000. CARESCAPE. Include Spacelabs mCare 300 Vital Signs Monitor(Oximax mould), as 91220 series;			S0026NE-A	OXI Adapter DB9M>DB9F, Suitable for Nellcor probe, Old Nellcor to OXIMA TECH OXIMETER	 496		C0
	All Nellcor & Nellcor equipped OEM monitors not listed above , Philips: Viridia A3;	DEC-4		S0026OX-S	Ext-Cable,4ft, DB9M>DB9F, Suitable for Nellcor oximax probe , as S0026B-S	 204	 238	B0
	All Nellcor & Nellcor equipped OEM monitors not listed above , Philips: Viridia A3;	DEC-8		S0026OX-L	Ext-Cable,8ft, DB9M>DB9F, Suitable for Nellcor oximax probe and HNM S0026B-S			B0
	Nellcor: N550,N560, N-595 GE: Dinamap PRO (w/Oxi) , Schiller;	DOC-10		S0117OX-L	Ext-Cable,8ft, AMP 14P>DB9F, Suitable for Nellcor probe and HNM S0026B-S	 116	 205	B0
Nihon Konden	Compatibilities : Be Compatible with Nihon Kohden OPV-1500 , OPV-3100;	JL-302T	S0159NI-L	Ext-Cable,8ft, 3M 20p>DB9F, Suitable for Nihon Konden probe TL-201T and Med-linket S0005 Series probe	 047	 090	E0	
			S0069NI-L	Ext-Cable,8ft, Round 10p>DB9F, Suitable for Nihon Konden probe and HNM S0005 Series probe;	 047		G0	
	Bedside Monitor: BSM-4101,4103,4111,4113 Life scope P,BSM-5105,5135 Life scope A,BSM-2351,2353 Life scope L,BSM-2301,2303 Life scope I	JL-900P		S0005NI-L	Ext-Cable,8ft, Rectangle 14p>DB9F, Suitable for Nihon Konden probe and S0005 Series probe	 214	 090	D5
	Bedside Monitor:Bsm-4104			S0005OX-L	Ext-Cable,8ft, Rectangle 14p>DB9F, Suitable for Nihon Konden probe and S0026 Series probe			

SpO₂ Sensor Extension Cable

Compatible Brand	Compatible Models No.	OEM P/N	HNM REF NO.	Description (Name,Length,Plug,Compatible)	INSTRUMENT CONNECTOR	CONNECTOR (SENSOR SIDE)	Price Code
Nonin	8604,8604D;		S0080NE-L	Ext-Cable,8ft, Lemo 1b 6p>DB9F, Suitable for Nonin probe	045 	130 	C5
	8600 series, 8500,8700,8800,9600,9700;		S0109NE-L	Ext-Cable,8ft, AMP 8p>DB9F, Suitable for Nonin probe	215 	130 	D0
Novamatrix	Novamatrix:505, 510,511,515B/C, 520, 7000, 7100, Oxypleth ; Spacelabs Medical:90351-D/G , 90465, , 90466, 90467, 90489, 90651-07/08 , 90419-01, 90651A-07;	8776-00	S0062NE-L	Ext-Cable,8ft, Hypertronics 7p>DB9F, fit for Novamatrix probe and HNM S0062B-S	071 	130 	C2
	Oxypleth (Extension Cable),7100 (Extension Cable),7000 (Extension Cable),520 (Extension Cable),515B/C (Extension Cable) ,505 (Extension Cable),500;		S0062HY-L	Ext-Cable,8ft, Hypertronics 7p>Hys 7J, fit for Novamatrix probe and HNM S0062B-L	775 	326 	D0
Pace Tech Generra	Pace Tech:All w/ black face (except Vitalmax 800 w/Nellcor® SpO2), Generra: 710, 200, 300, 400, 810, 530;	4510	S0082BC-L	Ext-Cable,8ft, Switchcraft 5J>DB9F, fit for BCI probe	216 		C5
			S0091BC-L	Ext-Cable,8ft, Compatible Readel 1bit 7p>DB9F, fit for BCI probe	041 		B4
Philips	Philips Medical:M2601A,M3000A,M3500B,M4735A;	M1943A	S0015OX-L	Ext-Cable,8ft, hemicycle 8p>DB9F, Compatible for NELLCOR sensor and MED-LINK S0010B-S	210 	205 	B8
	Philips Medical:M2601A,M3000A,M3500B,M4735A;	M1941A	S0015PH-L	Ext-Cable,8ft, hemicycle8P>hemicycle 8J, fit for Philips probe		080 	B8
	Philips Medical:78352C,78354C,78834C, M1020A,M1025B,M1205A,M1350 B,M1722A/B,M1732A/B,M2475B, Viridia A1, Viridia A3;	M1900B	S0003OX-L	Ext-Cable,8ft, Round 12p>DB9F, Compatible for NELLCOR sensor and HNM S0010B-S	128 	205 	B0
	Philips Medical:M2475B, M1732A/B, M1722A/B, M1020A, 78833C, 78833A, 78834A, 78352C, 78352A;	M1940A	S0003PH-L	Ext-Cable,8ft, Round 12P>hemicycle 8J, fit for Philips probe		207 	B8
	Philips MP,PM,VM;		S0414OX-L	Exi-Cable,8ft, hemicycle 8P>DB9F Suitable for HNM S0026 series	052/060 	205 	B0
Philips/HP	MP20/30/40/ PM50/60/70/90 VN4,VM6,VM8 (M Tech)	as S0024 series	S0197CS-L	Exi-Cable,8ft, hemicycle 8p>DB9F,Compatible for NELLCOR sensor and MED-LINK S0010B-S	210 		C0
PRIMEDIC			S0139NE-L	Ext-Cable,8ft, Compatible Redel 1Rib-7pin>DB9F,fit for Nellcor probe		130 	C2

SpO₂ Sensor Extension Cable

Compatible Brand	Compatible Models No.	OEM P/N	HNM REF NO.	Description (Name,Length,Plug,Compatible)	INSTRUMENT CONNECTOR	CONNECTOR (SENSOR SIDE)	Price Code
PRIMEDIC			S0140NE-L	Ext-Cable,8ft, Compatible Redel 2Rib-8pin>DB9F,fit for Nellcor probe			C2
PETAS			S0089BC-L	Ext-Cable,8ft, Readel 2Rib 40°-6P>DB9F, fit for Nellcor probe			B0
Schiller (Nellcor Module)	Schiller Argus TM-7;		S0028NE-L	Ext-Cable,8ft, Din7P>DB9F, fit for Nellcor probe			C2
Schiller (Masimo module)	Argus Pro, Argus LCM;		S0118MA-L※	Ext-Cable,8ft, Din7P>Masimo 6J, fit for Masimo probe			D0
Siemens Drager medical	Siemens medical SC 6002XL, SC7000, SC8000, SC9000XL;	3368433	S0072BC-S	Ext-Cable,4ft, round 7P>DB9F, fit for NELLCOR DS-100A orMED-LINK S0010 Series			B5
	Siemens medical SC 6002XL, SC7000, SC8000, SC9000XL;	3375834	S0072BC-L	Ext-Cable,8ft, round 7P>DB9F, fit for NELLCOR DS-100A o HNM S0010 Series			B5
	Drager medical: Vitalert 1000, Cicero;		S0119NE-L	Ext-Cable,8ft, Lemo 2b 8P>DB9F, Suitable for Nellcor probe			H0
	Siemens Medical:Sirecust 700 Siemens Medical:Sirecust 630 Siemens Medical:Sirem SpO2 Module ;		S0078NE-L	Ext-Cable,8ft, hemicycle10P>DB9F, fit for Nellcor probe			C5
Spacelabs	Spacelabs Medical:90351-0/6; 90465; 0466; 90489; 90651A-08; 90651-A; IM77,90308, PC Scout;	700-0020-0	S0035NE-L	Ext-Cable,8ft, Hypertronics 12p>DB9F, Suitable for Nellcor probe			C2
	Spacelabs Medical: 1050,1600,1700,90369,90469 ,90496 Ultraview;	700-0030-00	S0004NE-L	Ext-Cable,8ft, Compatible Rectangle 10P>DB9F, fit for Nellcor probe			C0
	Single Adapter Cable:90351-D/G; 90465,90466,90467,90489,90651-07/08;2nd Adapter Cable:90351-D/G,90465,90466,90467,90489, 90651-07/08;		S0035HY-L	Ext-Cable,8ft, Hypertronics 12p>Hypertronics 7J, fit for Novamatrix probe		 Code: HY	D0
	Spacelabs Medical: 1050, 1600, 1700, 90369, 90469, 91220-B, 904, 96, Ultraview and Ultraview SL with Oximax technology	700-0792-00	S0004OX-L	Ext-Cable, 8ft, Rectangle 10P>DB9F. Fit for MED-LINK S0026 Series Probes.			D2
	SpaceLab SpaceLab Xprezzon 91393		S0550MA-L (2018)	Ext-Cable, 8ft, Rectangle 10P>DB9F.fit for HNM 603115432 sensor			D5
	SpaceLab Xprezzon 91393		S0549OX-L (2018)	Compatible Rectangle 10P>DB9F			D5

SpO₂ Sensor Extension Cable

Compatible Brand	Compatible Models No.	OEM P/N	HNM REF NO.	Description (Name,Length,Plug,Compatible)	INSTRUMENT CONNECTOR	CONNECTOR (SENSOR SIDE)	PRICE CODE
Spacelabs	Ultraview (M tech)	as S0024 series	S0004CS-L	Exi-Cable,8ft,Compatible Rectangle 10P>DB9, fit for Masimo LNCS probe	081 		C0
S&W (Artema)	S&W Artema Patient monitor;	SL033057	S0023OX-L	Ext-Cable,8ft, Round 10J>DB9F, fit for Nellcor and S0010 Series SpO2 sensors	209 	205 	C5
S&W Athena and Diascope	S&W Athena and Diascope;		S0156NE-L	Ext-Cable,8ft, Round 10J>DB9F, fit for Nellcor and S0010 Series SpO2 sensors		130 	C5
Sunmind	Sunimind KP-930/930F		S0141NE-L	Ext-Cable,8ft, hemicycle 8p>DB9F, Compatible for NELLCOR sensor and MED-LINK S0010series	510 	130 	B8
Schiller (Masimo module)	TM7,Argus LCM, (M Tech)	as S0024 series	S0118CS-L	Ext-Cable,8ft,DIN7P>DB9,fit for Masimo LNCS probe	339 		D0
SIMED (Baxter)	Baxter:ASAT , SiMED:S-50 SiMED:S-100, SiMED:S-100e;	600015	S0120NE-L	Ext-Cable,8ft, Hypertronics 8p>DB9F, Compatible for NELLCOR sensor and S0010B-S	447 	130 	C0
3F	COMEN:STAR-1000; LANKE:LK-8600A; 3F: DIONA PMS-8100; CSI:RADO 4200; MAYTAG: MTK-2000;		S0021BC-L	Ext-Cable,8ft, Compatible Readell 1bt 6P>DB9F, fit for BCI probe	583 		B4
Neusoft	NSC series patient monitor;		S0003OX-L	Ext-Cable,8ft, Round 12p>DB9F, Compatible for NELLCOR sensor and HNM S0010B-S	128 	205 	B8
Shanghai	ShangHai NuoCheng: NTS3000		S0192NE-L	Ext-Cable,8ft, Lemo 6p>DB9F, fit for S0010 series.	1317 	130 	C6
	NTS-3000B		S0438NE-L	Exi-Cable,8ft, Round 6P>DB9F, Suitable for HNM S0010 series.			C6
Wego (Weigao Group)	<u>M3512</u>		S0175NE-L	Ext-Cable,8ft, Round 12p>DB9F, Fit for HNM S0010 series.	1077 	130 	B9
Winziss			S0537NE-L (2018)	2.43m. Fit for HNM S0010 series.			B0



4

Pulse Oximeter Sensor





Sensor type

S0162 Series Adult finger clip SpO2 sensor
Application: Adult>40kg
Application site: Index or other finger



S0162 Series Pediatric finger clip SpO2 sensor
Application: Pediatric>10-40kg
Application site: Index or other finger



S0162 Series Adult silicone SpO2 sensor
Application: Adult>40kg
Application site: Index or other finger



S0162 Series Infant silicone SpO2 sensor
Application: Infant 4-15kg
Application site: Infant- great toe, thumb



S0162 Series Neonate silicone Wrap SpO2 Sensor
Application: Neonate 1-4kg,
Pediatric 10-40kg; Infant 3-15kg
Application site: Adult, Pediatric-Index or other finger;
Neonate-foot; Infant- great toe



S0162 Series Adult ear Clip SpO2 Sensor
Application: Adult>40kg
Application site: ear
Warning: only use for pulse oximeter which has autoconditioning power function.



S0162 Series Y type Multisite sensor
Application: Adult>40kg
Accessory: Neonate silicone Wrap



Pediatric (medium size) silicone SpO2 sensor
Application: for patients finger thickness 7~12 mm
(Pediatric 10-40kg)
Application site: Index or other finger



Type Disignation

S□□□□□-□

L: long wire ,L=0.9m
S:short wire

Probe type:

- B: Adult finger clip
- C: Pediatric finger clip
- D: Adult silicone soft tip
- P: Pediatric silicone SpO2 sensor
- E: Infant silicone soft tip
- F: Neonate wrap sensor(undetachable)
- G: Adult ear Clip sensor
- I: Neonate wrap sensor(detachable)
- H: Animal tongue sensor
- R: Animal rectal sensor

Brand code: 0162/Medlinket

S: Indicated SpO2 sensor

Temperature Pulse Oximeter sensor

Reusable Pulse Oximeter sensor

Compatible Brand	Compatible Models No.	INSTRUMENT CONNECTOR	HNM REF NO.	Description (Name, Length)	PRICE CODE
HNM	AM-806,AM-807B,AM-807-C,AM-807B-C		S0162B-S	Adult finger clip ,0.28M	C0
			S0162C-S	Pediatric finger clip,0.28M	C0
			S0162D-S	Adult silicone soft, 0.28M	C0
			S0162P-S	Pediatric silicone, 0.28M	C0
			S0162E-S	Infant silicone, 0.28M	C0
			S0162F-S	Neonate wrap sensor(undetachable),1M	C0
			S0162G-S	Adult ear clip sensor , 0.28M	C0
			S0162I-S	Neonate wrap sensor (detachable),1M	C0
			S0162H-S	Animal tongue probe,1M	H1
			S0162R-S	Animal rectal probe,1M	M6

Disposable Pulse Oximeter sensor

Compatible Model	INSTRUMENT CONNECTOR	OEM P/N	Applicable people	Microfoam	Medaplast-2	Non-woven	EMITTER
HNM			Adult	S0162J-S			L0/box
			Pediatric	S0162K-S			L0/box
			Infant		S0162L-LP		L0/box
			Neonatal/ Adult		S0162M-LP	S0162N-L	L0/box

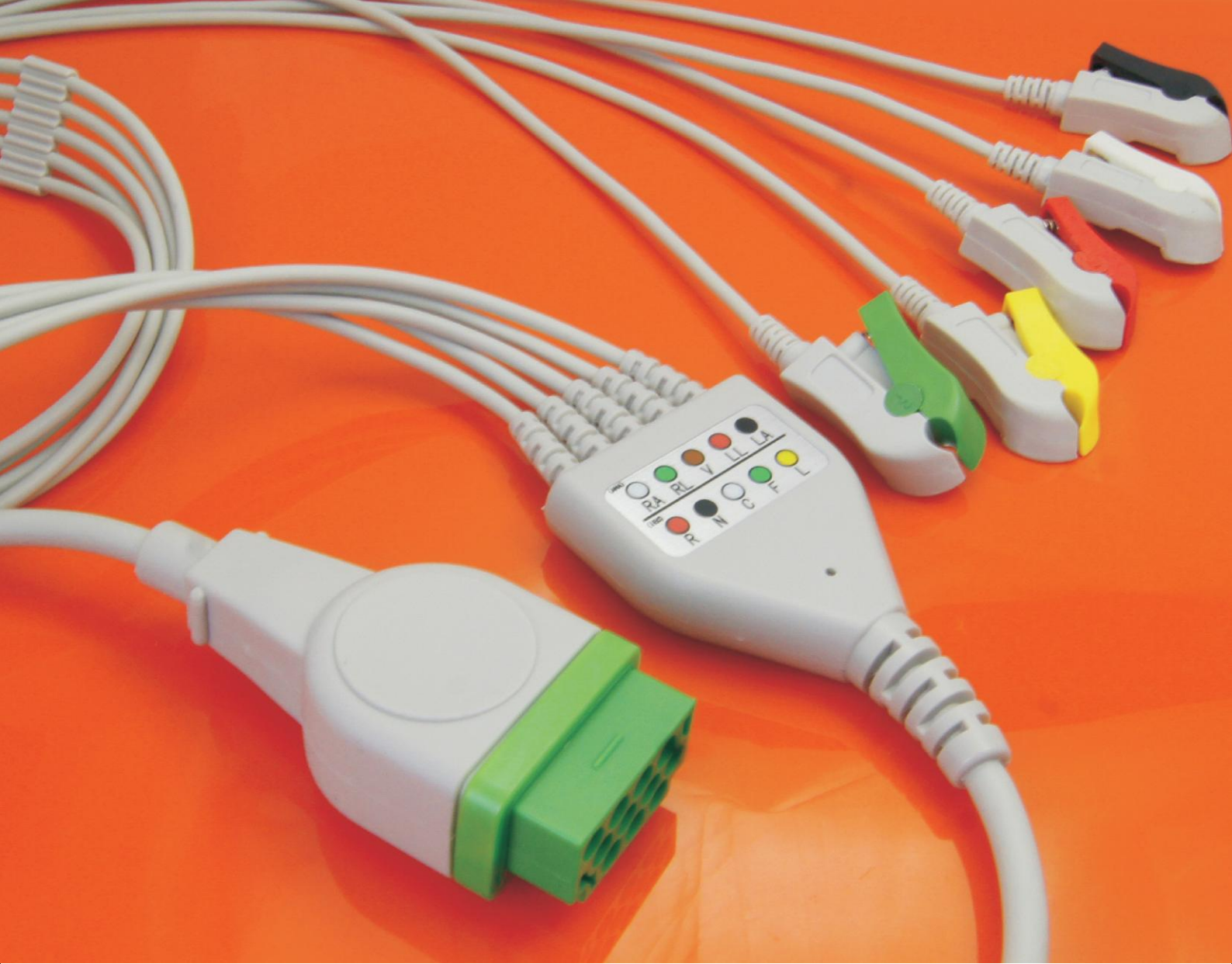

5

One-Piece Series ECG Cable with Lead Wires



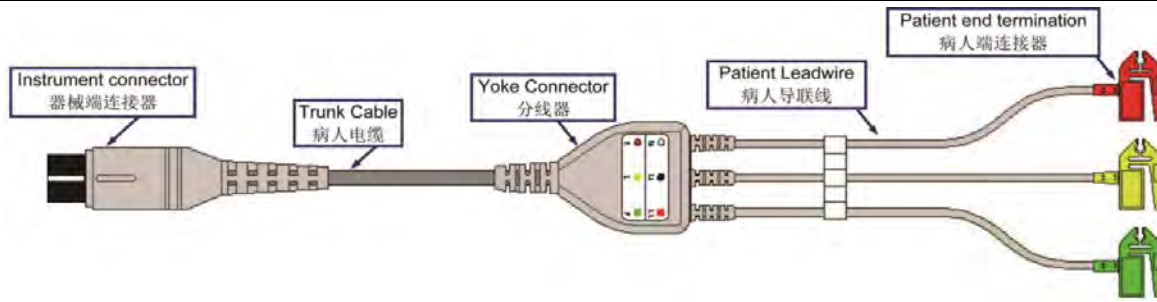

Connector type



Lead Position Marked

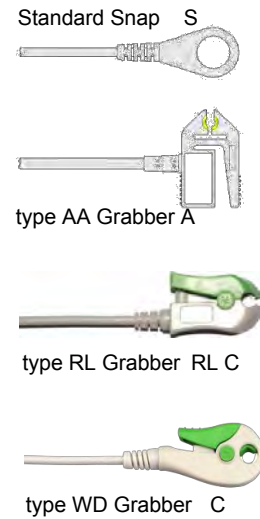
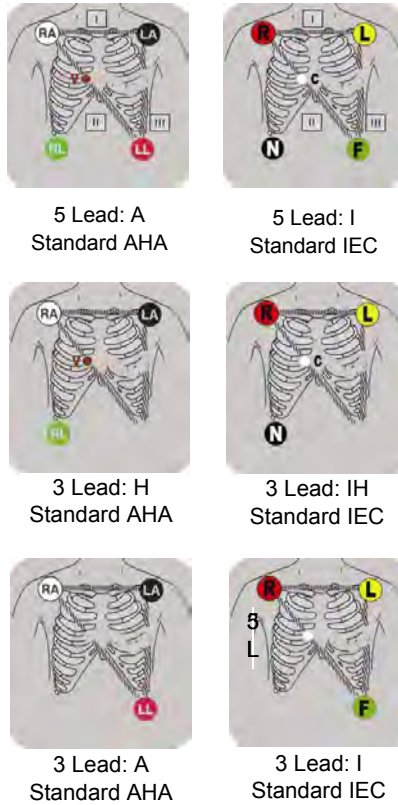

Type Disignation

E □ □ □ □ □ □ □

- 5A: 5Lead: A, Standard AHA
- 3H: 3Lead: H, Standard AHA
- 3A: 3Lead: A, Standard AHA
- 5I: 5Lead: I, Standard IEC
- 3IH: 3Lead: IH, Standard IEC
- 3I: 3Lead: I, Standard IEC
- Patient end termination: P: Assemble Clip, A: AA Clip, E: IEC mark Clip, F: Multifunctional Clip, M: Mini Clip, C: Clip(Grabber), S: Snap
- Brand code: as 041:Bionet, 040:Biosys
- Yoke type A: One-piece, B: Lifelinc, C:Din style, D: AA style, E: VS style
- E: ECG Cable with Leadwires

One-Piece Series ECG Cable With Leads

Compatible Brand	Compatible Models No.	INSTRUMENT CONNECTOR	HNM REF NO.	STANDARD	LEADS	PATIENT END TERMINAL	Material	Defibrillation withstand	PRICE CODE
AIR SHIELDS	<u>(AIR)</u> :HRRM-71-1/2,Porta-Fib I,II,III, System5(new),System6(Neonatal)		EA002S3A	AHA,	3LD:A,	SNAP,	TPU.		B5
			EA002C3A	AHA,	3LD:A,	CLIP,	TPU.		B6
			EA002S3I	IEC,	3LD:I,	SNAP,	TPU.		B5
ALT	<u>(ALT)</u> :800,800Plus,CX ATL Ultrasound CX200,CX400,Apogee,HDI 9/2000 Interspec Cardiology XL Mark IV,Mark VII ,Ultramark 4/5/7/9		EA002C3I	IEC,	3LD:I,	CLIP,	TPU.		B6
			EA002S5A	AHA,	5LD:A,	SNAP,	TPU.		B8
			EA002C5A	AHA,	5LD:A,	CLIP,	TPU.		B7
			EA002S5I	IEC,	5LD:I,	SNAP,	TPU.		B8
			EA002C5I	IEC,	5LD:I,	CLIP,	TPU.		B9
BCI	<u>(BCI)</u> :3101,3404,6100,6200, 9100,9200,Advisor ,Autocorr								
COLIN	<u>(COLIN)</u> :BP308, BP408, CBM3000	371	EA003S3A	AHA,	3LD:A,	SNAP,	TPU, 1KΩ		B8
CSI	<u>(CSI)</u> :504US,602-4USP,Poet2,Scholar		EA003C3A	AHA,	3LD:A,	CLIP,	TPU, 1KΩ		B9
			EA003S3I	IEC,	3LD:I,	SNAP,	TPU, 1KΩ		B8
GE MEDICAL	<u>(GMS)</u> :Corometrics 556 Critikon 8100T/Dinamap 8700/9700								
IVY	<u>(IVY)</u> :101 (before 1989),402, 700								
LSI	<u>(LSI)</u> :LS5 , 261		EA003C5A	AHA,	5LD:A,	CLIP,	TPU, 1KΩ		B0
			EA003C5I	IEC,	5LD:I,	CLIP,	TPU, 1KΩ		B0
MDE	<u>(MDE)</u> :Escort 100, 101,102,200, 300 Prism, 360SL, 450SL,521A PortaPak 80,PortaPak 90/1000		E0020A	AHA,	3LD:A,	SNAP,	PVC		A0
			E0020L	IEC,	3LD:A,	SNAP,	PVC		A0
PHYSIO-CONTROL	<u>(MPC)</u> : Lifepak 6 Life Pak 9. Life Pak 9B								
(MEDTRONIC)	VSM-1ESF (w/resistors)								
NELLCOR	<u>(NELLCOR)</u> :N-200/250 C-LOCK N-1000,NPB-3900,NPB-4000								
NIHON KOHDEN	<u>(NK)</u> :BSM-8301A/8302A/8500A/8502A OEC-6102A (s/n>20156)/7102A/8108A OEC-6105A (s/n>20226),TEC-7100A TEC-5200A(s/n>20421),TEC-7200A/7300A; <u>(PACE-TECH)</u> :Minipack 300 Minipack 3000/3100,MiniMax4000CL Vitalmax 800 Plus/2100/2200/4000/4100 Vitalmax/4000CL/4000 Modular/4100CL		EA020S3A	AHA,	3LD:A,	SNAP,	TPU.		B5
			EA020C3A	AHA,	3LD:A,	CLIP,	TPU.		B6
			EA020S3I	IEC,	3LD:I,	SNAP,	TPU.		B5
			EA020C3I	IEC,	3LD:I,	CLIP,	TPU.		B6
			EA020S5A	AHA,	5LD:A,	SNAP,	TPU.		B6
			EA020C5A	AHA,	5LD:A,	CLIP,	TPU.		B7
			EA020S5I	IEC,	5LD:I,	SNAP,	TPU.		B8
			EA020C5I	IEC,	5LD:I,	CLIP,	TPU.		B9
			EA021S3A	AHA,	3LD:A,	SNAP,	TPU, 1KΩ		B8
			EA021S3I	IEC,	3LD:I,	SNAP,	TPU, 1KΩ		B8
PHILIPS	<u>(PMS)</u> :M3921A A1,M3923A A1 M3925AA1,M3927AA3,M3928A3, M3929AA3		EA021C3I	IEC,	3LD:I,	CLIP,	TPU, 1KΩ		B9
			EA021S5A	AHA,	5LD:A,	SNAP,	TPU, 1KΩ		B9
PIONEER	<u>(PIONEER)</u> (American Optical):26125 33167, 5260 , 5330 , Pulsar 4								
PPG	<u>(PPG)</u> (Datamedix, Becton-Dickinson) Guardian 1001/N1001								
PPG	<u>(BURDICK)</u> :Medic3/4/5/4045Defib 500/600/900 Series (w/o respiration) 90300/90400/90600/90700 Series TEK-208/408/511/512/514/521 PC Bedside , PCMS		E0020J	AHA,	3LD:A,	SNAP,	PVC		A0
			E0020K	IEC,	3LD:A,	SNAP,	PVC		A0
			E0002J	AHA,	5LD:A,	SNAP,	PVC		B2
			E0002K	IEC,	5LD:A,	SNAP,	PVC		B2
			E0020W	IEC,	3LD:I,	CLIP,	PVC		A0
SPACELABS									
TEKTRONIX	<u>(Vitatek)</u> :4045Defib/208/400/500Series								
WELCH ALLYN	<u>(Protocol)</u> :Propaq100/200Series,Atlas Propaq Encore, Propaq CS,Ultra Smart								
ZOLL	<u>(ZOLL)</u> :D900, PD1200, PD1400								
GOLDWAY	UT4000A, UT4000A, UT4000Apro,UT6000A, UT4000B, UT4000C, UT4000F, UT6000F, UT4000Fpro, UT4800								
Bioligh									
Guoteng									

One-Piece Series ECG Cable With Leads

Compatible Brand	Compatible Models No.	INSTRUMENT CONNECTOR	HNM REF NO.	STANDARD	LEADS	PATIENT END TERMINAL	Material	Defibrillation withstand	PRICE CODE
BIONET	BM3		EA041S5A	AHA,	5LD:A,	SNAP,	TPU,	1KΩ	C1
			EA041S3A	AHA,	3LD:A,	SNAP,	TPU,	1KΩ	B9
			EA041C3A	AHA,	3LD:A,	CLIP,	TPU,	1KΩ	B0
			EA041C5I	IEC,	5LD:I,	CLIP,	TPU,	1KΩ	C2
			EA041S3I	IEC,	3LD:I,	SNAP,	TPU,	1KΩ	B9
	BPM-103		EA040S3A	AHA,	3LD:A,	SNAP,	TPU,	1KΩ	B9
			EA040S5I	IEC,	5LD:I,	SNAP,	TPU,	1KΩ	C1
			EA040S3I	IEC,	3LD:I,	SNAP,	TPU,	1KΩ	B9
	BRUKER	SM784, SM785 with 12-pin input connector		EA017C3IH	IEC,	3LD:IH,	CLIP,	TPU,	C4
	COLIN	BP88 / BP306		EA062S5A	AHA,	5LD:A,	SNAP,	TPU,	
EA062C5A				AHA,	5LD:A,	CLIP,	TPU,		D6
EA062S3A				AHA,	3LD:A,	SNAP,	TPU,		C0
EA062S5I				IEC,	5LD:I,	SNAP,	TPU,		D5
EA062S3I				IEC,	3LD:I,	SNAP,	TPU,		C0
BP88S			EA061S3A	AHA,	3LD:A,	SNAP,	TPU,		C0
			EA061S5I	IEC,	5LD:I,	SNAP,	TPU,		D2
			EA061C5I	IEC,	5LD:I,	CLIP,	TPU,		D3
			EA061S3I	IEC,	3LD:I,	SNAP,	TPU,		C0
			EA061C3I	IEC,	3LD:I,	CLIP,	TPU,		C0
Creative Spurt Biolight	Creative:PC9000S,PC9000,UP6000, Biolight: M12		EA046S5A	AHA,	5LD:A,	SNAP,	TPU,		C1
			EA046C5A	AHA,	5LD:A,	CLIP,	TPU,		C2
			EA046S3A	AHA,	3LD:A,	SNAP,	TPU,		B9
			EA046C3A	AHA,	3LD:A,	CLIP,	TPU,		B0
			EA046S5I	IEC,	5LD:I,	SNAP,	TPU,		C1
			EA046C5I	IEC,	5LD:I,	CLIP,	TPU,		C2
			EA046C3I	IEC,	3LD:I,	CLIP,	TPU,		B0
Corpuls	Corpuls 08/16, 0816M 		EA076C3IH	IEC,	4LD:IH,	CLIP,	TPU,	E0	
DATASCOPE	2000,2001,2002,2100,2200,3000, 3000A ,Ballon Pump, M/D3 w/lead select,M/D3A,M/D4, Passport,Passport IL,Passport XG, Passport XL,Passport 2, Passport 2LT,Spectrum System 90, System 90T , System 96, System 97		EA002S5A	AHA,	5LD:A,	SNAP,	TPU,		B8
			EA002C5A	AHA,	5LD:A,	CLIP,	TPU,	6P	B0
			EA002S3A	AHA,	3LD:A,	SNAP,	TPU,		B5
			EA002C3A	AHA,	3LD:A,	CLIP,	TPU,		B8
			EA002S5I	IEC,	5LD:I,	SNAP,	TPU,		B8
			EA002C5I	IEC,	5LD:I,	CLIP,	TPU,		B0
			EA002S3I	IEC,	3LD:I,	SNAP,	TPU,		B7
			EA002C3I	IEC,	3LD:I,	CLIP,	TPU,		B8

One-Piece Series ECG Cable With Leads

Compatible Brand	Compatible Models No.	INSTRUMENT CONNECTOR	HNM REF NO.	STANDARD	LEADS	PATIENT END TERMINAL	Material	Defibrillation withstand	PRICE CODE
DATEX	AS/3, CS/3, Cardiocap 1, Cardiocap 2 , Cardiocap 5 , Light Monitor , Satliteplus		EA010S5A	AHA,	5LD:A,	SNAP,	TPU,		C9
			EA010C5A	AHA,	5LD:A,	CLIP,	TPU,		C0
			EA010S3A	AHA,	3LD:A,	SNAP,	TPU,		C7
			EA010C3A	AHA,	3LD:A,	CLIP,	TPU,		C8
			EA010S5I	IEC,	5LD:I,	SNAP,	TPU,		C9
			EA010C5I	IEC,	5LD:I,	CLIP,	TPU,		C0
			EA010S3I	IEC,	3LD:I,	SNAP,	TPU,		C7
	EA010C3I	IEC,	3LD:I,	CLIP,	TPU,		C8		
	CS/3		EA091C3I (2018)	IEC,	3LD:I,	CLIP,	TPU,		D5
DRAGER SIEMENS	Drager UM1/3/3.1, RM1, PM8010, PM8014, Babyguard 8000, Cato, Babylog8000/8000 plus, PB8800 Serie 8000, Cicero, Parameterbox,	170 	EA057C3I	IEC,	3LD:I,	CLIP,	TPU,		E1
FUKUDA DENSHI	DATASCOPE:Expert FUKUDA DENSHI:DS5100E, DS5300W, DS5400,		EA068S3A	AHA,	3LD:A,	SNAP,	TPU, 1KΩ		D3
			EA068C3A	AHA,	3LD:A,	CLIP,	TPU, 1KΩ		D4
			EA068S5I	IEC,	5LD:I,	SNAP,	TPU, 1KΩ		D4
			EA068C5I	IEC,	5LD:I,	CLIP,	TPU, 1KΩ		D5
			EA068S3I	IEC,	3LD:I,	SNAP,	TPU, 1KΩ		D3
			EA068C3I	IEC,	3LD:I,	CLIP,	TPU, 1KΩ		D4
PETAS			EA064S3H	AHA,	3LD:H,	SNAP,	TPU,		C8
			EA064C3H	AHA,	3LD:H,	CLIP,	TPU,		C9
			EA064S3IH	IEC,	3LD:IH,	SNAP,	TPU,		C8
			EA064C3IH	IEC,	3LD:IH,	CLIP,	TPU,		C9
GE-MEDICAL Marquette	GEMS:Dash PRO 4000, Dash PRO 3000, Dash PRO 2000, Dash 1000, Eagle Systems, MAC-Lab, Solar 9500, Solar 8000. Solar 3000, Tram 100, Tram 200, Tram 300, Tram 400, Tram 500, Tram 600, Tram 800, Unity Systems	020/383 	EA007S5A	AHA,	5LD:A,	SNAP,	TPU,		C7
			EA007C5A	AHA,	5LD:A,	CLIP,	TPU,		C8
			EA007S3A	AHA,	3LD:A,	SNAP,	TPU,		C6
			EA007C3A	AHA,	3LD:A,	CLIP,	TPU,		C7
			EA007S5I	IEC,	5LD:I,	SNAP,	TPU,		C7
			EA007C5I	IEC,	5LD:I,	CLIP,	TPU,		C8
			EA007S3I	IEC,	3LD:I,	SNAP,	TPU,		C6
			EA007C3I	IEC,	3LD:I,	CLIP,	TPU,		C7
	PRO1000	377 	EA021S3A	AHA,	3LD:A,	SNAP,	TPU, 1KΩ		B7
			EA021C3I	IEC,	3LD:I,	CLIP,	TPU, 1KΩ		B9
GE-MEDICAL	GE MEDICAL SYSTEMS:2000, 2020, 2110, 2110N, 2120, 2210, 2230, 2230N, 2310, 2330, 2330N, 7000 Series, Tram AR		EA069S5A	AHA,	5LD:A,	SNAP,	TPU,		C9
			EA069C5A	AHA,	5LD:A,	CLIP,	TPU,		C0
			EA069S3A	AHA,	3LD:A,	SNAP,	TPU,		C7
			EA069C3A	AHA,	3LD:A,	CLIP,	TPU,		C8
			EA069S5I	IEC,	5LD:I,	SNAP,	TPU,		C9
			EA069C5I	IEC,	5LD:I,	CLIP,	TPU,		C0
			EA069S3I	IEC,	3LD:I,	SNAP,	TPU,		C7
			EA069C3I	IEC,	3LD:I,	CLIP,	TPU,		C8
HELLIGE	Hellige,Servomed 4 , Generation, SCP 851, SCP 852 , SCP 844, SCS 804,,CardioServ , VICOM-sm		EA011S5A	AHA,	5LD:A,	SNAP,	TPU,		D4
			EA011C5A	AHA,	5LD:A,	CLIP,	TPU,		D5
			EA011S3A	AHA,	3LD:A,	SNAP,	TPU,		C0
			EA011C3I	IEC,	3LD:I,	CLIP,	TPU,		C0
KONTRON	7000, 7135, 7135B, 7141, 7210 7250, 7251, K2000, KAAAT, Kolormon, Micromon, Minimon, Supermon , Vitalmon		EA031S5A	AHA,	5LD:A,	SNAP,	TPU,		C5
			EA031C5A	AHA,	5LD:A,	CLIP,	TPU,		C6
			EA031S5I	IEC,	5LD:I,	SNAP,	TPU,		C5
			EA031C5I	IEC,	5LD:I,	CLIP,	TPU,		C6
			EA031S3I	IEC,	3LD:I,	SNAP,	TPU,		C3
EA031C3I	IEC,	3LD:I,	CLIP,	TPU,		C4			









One-Piece Series ECG Cable With Leads

Compatible Brand	Compatible Models No.	INSTRUMENT CONNECTOR	HNM REF NO.	STANDARD	LEADS	PATIENT END TERMINAL	Material	Defibrillation withstand	PRICE CODE
KONTRON			EA032C3A	AHA,	3LD:A,	CLIP,	TPU,		C0
			EA032S3I	IEC,	3LD:I,	SNAP,	TPU,		C9
			EA032C3I	IEC,	3LD:I,	CLIP,	TPU,		C0
L&T (INDIA)	DLanet50 EA030S3H = EA030S3A		EA030S3H	AHA,	3LD:H,	SNAP,	TPU,	1KΩ	C5
			EA030C3H	AHA,	3LD:H,	CLIP,	TPU,	1KΩ	C6
			EA030S3IH	IEC,	3LD:IH,	SNAP,	TPU,	1KΩ	C5
			EA030C3IH	IEC,	3LD:IH,	CLIP,	TPU,	1KΩ	C6
MEK	MP1000,MP600,MP500		EA029S3A	AHA,	3LD:A,	SNAP,	TPU,		B7
			EA029C3A	AHA,	3LD:A,	CLIP,	TPU,		B8
			EA029C5I	IEC,	5LD:I,	CLIP,	TPU,		B0
			EA029S3I	IEC,	3LD:I,	SNAP,	TPU,		B7
	M160246 M360697		EA033S3A	AHA,	3LD:A,	SNAP,	TPU,		C3
			EA033C3A	AHA,	3LD:A,	CLIP,	TPU,		C4
			EA033C5I	IEC,	5LD:I,	CLIP,	TPU,		C5
			EA033C3I	IEC,	3LD:I,	CLIP,	TPU,		C4
M&B			EA072S3A	AHA,	3LD:A,	SNAP,	TPU,		C4
			EA072S5A	AHA,	5LD:A,	SNAP,	TPU,		C3
MENNEN	Horizon 250,3000,450, Microsolo,936 Series,425/101 Preamp,Cardio-Pak 2000,740, 741,742		EA059S3A	AHA,	3LD:A,	SNAP,	TPU,	1KΩ	C4
			EA059C3A	AHA,	3LD:A,	CLIP,	TPU,	1KΩ	C5
			EA059S3I	IEC,	3LD:I,	SNAP,	TPU,	1KΩ	C4
			EA059C3I	IEC,	3LD:I,	CLIP,	TPU,	1KΩ	C5
	(MENNEN):900,1100,1110, Horizon 2000,2100,2200,5200 Horizon 9000XL,MR1200,1270 Horizon 1280,1300,Horizon 1380		EA065S3A	AHA,	3LD:A,	SNAP,	TPU,		C0
			EA065C3A	AHA,	3LD:A,	CLIP,	TPU,		C0
			EA065S5I	IEC,	5LD:I,	SNAP,	TPU,		D5
			EA065C5I	IEC,	5LD:I,	CLIP,	TPU,		D5
			EA065C3I	IEC,	3LD:I,	CLIP,	TPU,		C0
MINDRAY	PM7000/8000/9000		EA085S3A	AHA,	3LD:A,	SNAP,	TPU,		B5
			EA085C3A	AHA,	3LD:A,	CLIP,	TPU,		B6
			EA085S3I	IEC,	3LD:I,	SNAP,	TPU,		B5
			EA085C3I	IEC,	3LD:I,	CLIP,	TPU,		B6
			EA085S5A	AHA,	5LD:A,	SNAP,	TPU,		B6
			EA085C5A	AHA,	5LD:A,	CLIP,	TPU,		B7
			EA085S5I	IEC,	5LD:I,	SNAP,	TPU,		B8
			EA085C5I	IEC,	5LD:I,	CLIP,	TPU,		B9
	MEC1000, MEC1200 with 6-pin input connector		EA020S3A	AHA,	3LD:A,	SNAP,	TPU,		B5
			EA020C3A	AHA,	3LD:A,	CLIP,	TPU,		B6
			EA020S3I	IEC,	3LD:I,	SNAP,	TPU,		B5
			EA020C3I	IEC,	3LD:I,	CLIP,	TPU,		B6
			EA020S5A	AHA,	5LD:A,	SNAP,	TPU,		B6
			EA020C5A	AHA,	5LD:A,	CLIP,	TPU,		B7
			EA020S5I	IEC,	5LD:I,	SNAP,	TPU,		B8
			EA020C5I	IEC,	5LD:I,	CLIP,	TPU,		B9
	BeneView (T5, T6, T8) iPM series 0010-30-42719 0010-30-42720		EA050S5A	AHA,	5LD:A,	SNAP,	TPU,		C9
			EA050S3A	AHA,	3LD:A,	SNAP,	TPU,		C7
EA050C3A			AHA,	3LD:A,	CLIP,	TPU,		C8	
EA050S5I			IEC,	5LD:I,	SNAP,	TPU,		C9	
EA050C5I			IEC,	5LD:I,	CLIP,	TPU,		C0	
EA050S3I			IEC,	3LD:I,	SNAP,	TPU,		C7	
PM5000/6000		EA060S5A	AHA,	5LD:A,	SNAP,	TPU,		C3	
		EA060S3A	AHA,	3LD:A,	SNAP,	TPU,		C3	
		EA060S5I	IEC,	5LD:I,	SNAP,	TPU,		C3	
		EA060S3I	IEC,	3LD:I,	SNAP,	TPU,		C3	
		EA060C3I	IEC,	3LD:I,	CLIP,	TPU,		C3	

One-Piece Series ECG Cable With Leads

Compatible Brand	Compatible Models No.	INSTRUMENT CONNECTOR	HNM REF NO.	STANDARD	LEADS	PATIENT END TERMINAL	Material	Defibrillation withstand	PRICE CODE
NEC	3M12		EA053S5A	AHA,	5LD:A,	SNAP,	TPU,		D4
			EA053C5A	AHA,	5LD:A,	CLIP,	TPU,		D5
			EA053S3A	AHA,	3LD:A,	SNAP,	TPU,		D3
			EA053S3I	IEC,	3LD:I,	SNAP,	TPU,		D3
	PB1916E		EA054C3A	AHA,	3LD:A,	CLIP,	TPU,		E0
			EA054S3I	IEC,	3LD:I,	SNAP,	TPU,		E9
NIHON KOHDEN	OEC-6102A (s/n<20156), OEC-6105A (s/n<20226), OEC-6120A/J/K BSM-7105K		EA037S3I	IEC,	3LD:I,	SNAP,	TPU,	1KΩ	C7
	EA037C3I		IEC,	3LD:I,	CLIP,	TPU,	1KΩ	C8	
	BSM-7102A,OMP-7201C, OMP-7203C, TEC-5200A (s/n<20421)		EA038S3I	IEC,	3LD:I,	SNAP,	TPU,		C0
			EA038C3I	IEC,	3LD:I,	CLIP,	TPU,		C0
	TEC-7621C		EA075C3A	AHA,	3LD:A,	CLIP,	TPU,	200KΩ	D5
	TEC-7621K, TEC-7631C		EA074C3I	IEC,	3LD:I,	CLIP,	TPU,	100KΩ	D5
PETAS	KMA160R,165R,260R,K-250,300...		EA063S3H	AHA,	3LD:H,	SNAP,	TPU,		B9
			EA063C3H	AHA,	3LD:H,	CLIP,	TPU,		B0
			EA063S3IH	IEC,	4LD:IH,	SNAP,	TPU,		B9
			EA063C3IH	IEC,	4LD:IH,	CLIP,	TPU,		B0
			EA063M3IH	IEC,	4LD:IH,	mini CLIP,	TPU,		B0
			EA063C5I	IEC,	5LD:IH,	CLIP,	TPU,		C2
			EA063S5I	IEC,	5LD:IH,	SNAP,	TPU,		C2
PHILIPS	43100A,43110A,43120A,78352C, 78354C,78834C,862474 C3, M1001A,M1002A,M1165A, M1166A,M1167A,M1175A,M1177A ,M1205A,M1264A,M1275A Transport, M1280A,M1722A/B,M1723A/B, M2475B,M2601A,M3000A,M3001A, M3046A M2/M3/M4,M4735A		EA023S5A	AHA,	5LD:A,	SNAP,	TPU,	1KΩ	C9
			EA023C5A	AHA,	5LD:A,	CLIP,	TPU,	1KΩ	C0
			EA023S3A	AHA,	3LD:A,	SNAP,	TPU,	1KΩ	C7
			EA023C3A	AHA,	3LD:A,	CLIP,	TPU,	1KΩ	C8
			EA023S5I	IEC,	5LD:I,	SNAP,	TPU,	1KΩ	C9
			EA023C5I	IEC,	5LD:I,	CLIP,	TPU,	1KΩ	C0
			EA023S3I	IEC,	3LD:I,	SNAP,	TPU,	1KΩ	C7
			EA023C3I	IEC,	3LD:I,	CLIP,	TPU,	1KΩ	C8
			EA023A3I	IEC, 3LD:I, (RL GRABBER) ,	TPU,	1KΩ	C8		
	43100A/43110A/43110M/43120A/MC Defib, 43200A Portable, M3500B,77000AC/77020A,77010AC Sonos/AC/AR,77025A,77030A,77035 A,77040A,78208A,78210A,78330A,78 331A,78332A,78333A,78341A,78342A ,78345A,78346A,78351T,78352A/C,78 353A/B,78354A,78532A/B,78534A/B/ C,78619A,7		EA035S5A	AHA,	5LD:A,	SNAP,	TPU,	1KΩ	D9
			EA035C5A	AHA,	5LD:A,	CLIP,	TPU,	1KΩ	D0
			EA035S3A	AHA,	3LD:A,	SNAP,	TPU,	1KΩ	D7
			EA035C3A	AHA,	3LD:A,	CLIP,	TPU,	1KΩ	D8
			EA035C6I	IEC,	6LD:I,	CLIP,	TPU,	1KΩ	D5
			EA035S5I	IEC,	5LD:I,	SNAP,	TPU,	1KΩ	D9
EA035C5I	IEC,	5LD:I,	CLIP,	TPU,	1KΩ	D0			
Primedic			EA077S3H	AHA,	3LD:H,	SNAP,	TPU,	10KΩ	I4
			EA077C3H	AHA,	3LD:H,	CLIP,	TPU,	10KΩ	I4
			EA077S3IH	IEC,	3LD:IH,	SNAP,	TPU,	10KΩ	I4
			EA077C3IH	IEC,	3LD:IH,	CLIP,	TPU,	10KΩ	I4
MEDTRONIC PHYSIO-CONTROL	Lifepak 12 , 120, Lifepak 20		EA066S5A	AHA,	5LD:A,	SNAP,	TPU,	10KΩ	D5
			EA066C5A	AHA,	5LD:A,	CLIP,	TPU,	10KΩ	D5
			EA066S3A	AHA,	3LD:H,	SNAP,	TPU,	10KΩ	C0
			EA066C3A	AHA,	3LD:H,	CLIP,	TPU,	10KΩ	C0
			EA066S5I	IEC,	5LD:I,	SNAP,	TPU,	10KΩ	D5
			EA066S3I	IEC,	3LD:IH,	SNAP,	TPU,	10KΩ	C0
			EA066C3I	IEC,	3LD:IH,	CLIP,	TPU,	10KΩ	C0

One-Piece Series ECG Cable With Leads

Compatible Brand	Compatible Models No.	INSTRUMENT CONNECTOR	HNM REF NO.	STANDARD	LEADS	PATIENT END TERMINAL	Material	Defibrillation withstand	PRICE CODE
MEDTRONIC PHYSIO-CONTROL	PHYSIO-CONTROL:Lifepak 2,3,33, Scope Monitor II; SIEMENS:Porta Pak 500PB, Porta Pak 500PM; SIMONSEN & WEELS(S&W):CB-600 Defib. DMS-600; SURVIVAL INSTRUMENTS:SafeGuard I, II UNIRAD:Series C Echo,VIGGO-SPECTRAMED (Gould):Ekoline 20A, 21, Smith-Kline 20A		EA067S3A	AHA,	3LD:H,	SNAP,	TPU,		B9
			EA067C3A	AHA,	3LD:H,	CLIP,	TPU,		B0
			EA067S3I	IEC,	3LD:IH,	SNAP,	TPU,		B9
			EA067C3I	IEC,	3LD:IH,	CLIP,	TPU,		B0
SAADAT			EA083S3I	IEC,	3LD:IH,	SNAP,	TPU,	1KΩ	D5
			EA083P3I	IEC,	3LD:IH,	SNAP,	TPU,	1KΩ	D5
S&W (Artema) Diascope	Diascope-NT, Athena Systems,		EA018S3A	AHA,	3LD:H,	SNAP,	TPU,		C0
			EA018C5I	IEC,	5LD:I,	CLIP,	TPU,		D0
			EA018S3I	IEC,	3LD:IH,	SNAP,	TPU,		C0
			EA018C3I	IEC,	3LD:IH,	CLIP,	TPU,		C0
SIEMENS	ECG Monitor, Polymed Modul,		EA052C5I	IEC,	5LD:I,	CLIP,	TPU,		B0
SCHILLER	SHILLER ARGUS LCM+		EA082C5I	IEC,	5LD:I,	CLIP,	TPU,	1KΩ	D0
SPACELABS	90496 Ultraview, 90369 Ultraview, 90367 Ultraview		EA009S5A	AHA,	5LD:A,	SNAP,	TPU,	1KΩ	C9
			EA009C5A	AHA,	5LD:A,	CLIP,	TPU,	1KΩ	C0
			EA009C3A	AHA,	3LD:A,	CLIP,	TPU,	1KΩ	C8
			EA009S5I	IEC,	5LD:I,	SNAP,	TPU,	1KΩ	C9
			EA009C5I	IEC,	5LD:I,	CLIP,	TPU,	1KΩ	C0
			EA009S3I	IEC,	3LD:I,	SNAP,	TPU,	1KΩ	C7
			EA009C3I	IEC,	3LD:I,	CLIP,	TPU,	1KΩ	C8
SPACELABS BURDICK	GE MEDICAL SYSTEMS:Corometrics 503,Corometrics 504,Corometrics 508; SIEMENS ELECTROMEDICAL SYSTEMS:806180A Nuclear Camera		EA036S3A	AHA,	3LD:H,	SNAP,	TPU,		B9
			EA036C3A	AHA,	3LD:H,	CLIP,	TPU,		B0
			EA036S3I	IEC,	3LD:IH,	SNAP,	TPU,		B9
			EA036C3I	IEC,	3LD:IH,	CLIP,	TPU,		B0
			ADVANCED MEDICAL RESEARCH (AMR):Model 3R; AEQUITRON MEDICAL:9101,9216 (Neonate),ATL ULTRASOUND:Ultramark 8,Ultramark 6,Mark VIII,Mark III,Mark II,600,400; BARD:500,500 GILSON; BECKMAN (Offner):Offner Dynograph (all),VSM-10C,RM-10 BIOCUM; INC:All models; B						
WELCH ALLYN	Propaq 100 Series, Propaq CS , Ultra Smart , Atlas Propaq 200 Series, Propaq Encore,		EA021S5A	AHA,	5LD:A,	SNAP,	TPU,	1KΩ	B9
			EA021S3A	AHA,	3LD:A,	SNAP,	TPU,	1KΩ	B7
			EA021S5I	IEC,	5LD:I,	SNAP,	TPU,	1KΩ	B9
			EA021C5I	IEC,	5LD:I,	CLIP,	TPU,	1KΩ	B0
			EA021S3I	IEC,	3LD:I,	SNAP,	TPU,	1KΩ	B7
			EA021C3I	IEC,	3LD:I,	CLIP,	TPU,	1KΩ	B8



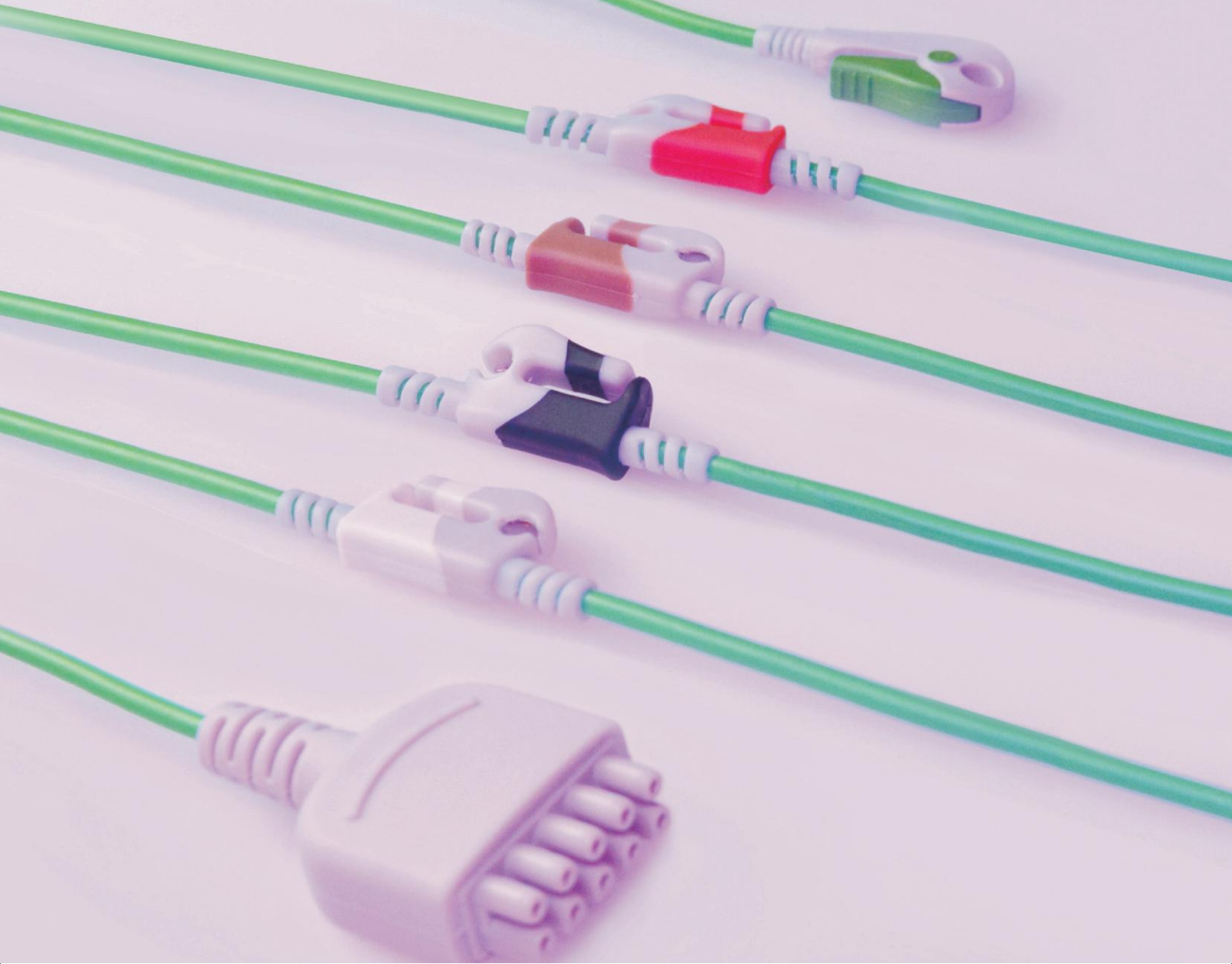

6

One-Line Series ECG Lead Wires



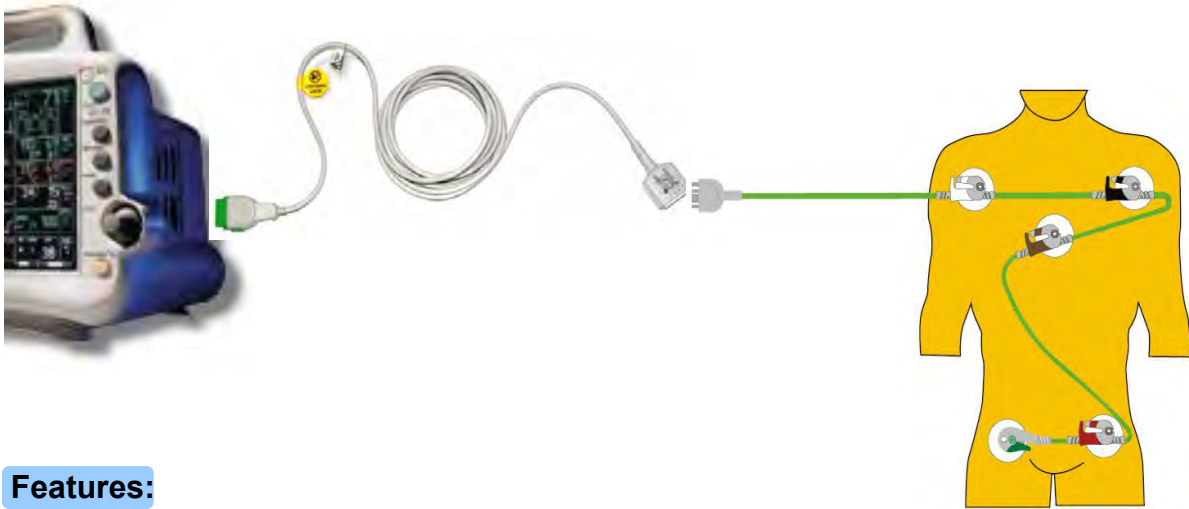

Features:

- Ideal for both adult and pediatric patients
- "One-LINE" is compatible with all Infinity patient monitors.
- Fast and easy to apply with clearly labeled,color-coded snaps
- More comfortable for patients,
- Flexible, durable and easy to clean
- "One-LINE" cable design with strategic electrode snap placement
- No need for separate leadwires; one piece design
- Cable can be cleaned or disinfected
- Lightweight wire can be used on a large cross section of patients
- Available in AHA and IEC color coding
- Latex-free

Type Disignation

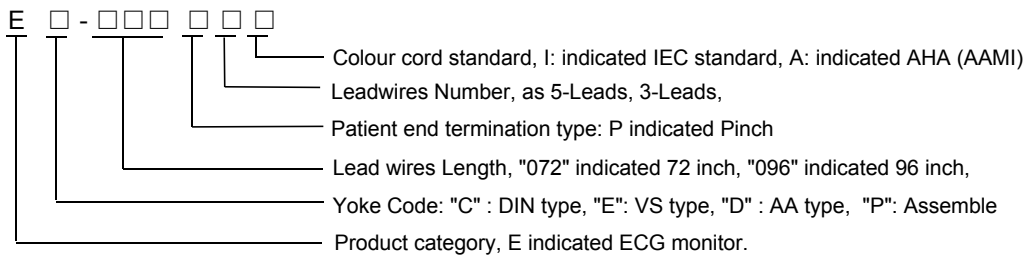

Exemple: EJ-096P5A indicated Compatible with Siemens Multicable, Length: 96 inch, 5-leads, AHA, Termination: pinch.

3-LD, AAMI, 72 inch



3-LD, IEC , 72 inch



5-LD, AAMI, 96 inch













5-LD, IEC , 96 inch



Declaration

All registered trademark and brand style mentioned in this information is always belonging to original made possessor. We only cite for machine compatibility use, no any other purpose exist. This is only for reference use; please do not take it as working guidance. Otherwise, we will not be responsible for any possible cost. This information has been carried out since 2010-Jan-15, we wouldn't further inform when revised and upgraded.

"One-LINE" Series ECG lead wires

Yoke type	Product Guide	Model No.	Description	Compatible Brand	Need Adapter	
DIN type, Code: C	 Price code: B0	EC-072P3A	Din 3LD, 72 inch, AAMI Leads	Datascope	EC002-3AI	
				Spacelabs	EC020-3AI	
		EC-072P3I	Din 3LD, 72 inch, IEC Leads	Biosys	EC040-3AI	
				Creative	EC046-3AI	
				MEK		
			Lohmeier	EC078-3AI		
	 Price code: D0	EC-096P5A	Din 5LD, 96 inch, AAMI Leads	Datascope	EC002-5AI	
				Spacelabs	EC020-5AI	
		EC-096P5I	Din 5LD, 96 inch, IEC Leads	Biosys	EC040-5AI	
				Creative	EC046-5AI	
			MEK	EC029-5AI		
		Lohmeier	EC078-5AI			
AAMI type, Code: D	 Price code: C0	ED-072P3A	AA-3LD, 72 inch, AAMI Leads	PHILIPS	ED023-3AI	
				PHILIPS	ED035-3AI	
				PHILIPS	ED036-3AI	
	 Price code: D0	ED-096P5A	AA-5LD, 96 inch, AAMI Leads	PHILIPS	ED023-5AI	
				PHILIPS	ED035-5AI	
				PHILIPS	ED036-5AI	
	VS type, Code: E	 Price code: D0	EE-072P3A	VS 3LD, 72 inch, AAMI Leads	Marquette	EE007-5AI
			EE-072P3I	VS 3LD, 72 inch, IEC Leads		
		 Price code: D0	EE-096P5A	VS 5LD, 96 inch, AAMI Leads	Marquette	EE007-5AI
				Hellige	EE011-5AI	
EE-096P5I			VS 5LD, 96 inch, IEC Leads			
Euro type, Code: J	 Price code: C0	EJ-072P3A	Euro-3LD, 72 inch, AAMI Leads	Siemens	EJ052-3AI	
				Mindray	EJ021-3AI	
				Mindray	EJ050-3AI	
		EJ-072P3I	Euro-3LD, 72 inch, IEC Leads	Mindray	EJ051-3AI	
	 Price code: D0	EJ-096P5A	Euro-5LD, 96 inch, AAMI Leads	Siemens	EJ052-5AI	
				Mindray	EJ021-5AI	
				Mindray	EJ050-5AI	
		EJ-096P5I	Euro-5LD, 96 inch, IEC Leads	Mindray	EJ051-5AI	
				Drager	EQ056-5AI	
				Fukuda	VJ032-EAI	
		Lohmeier	EJM079-5AI			
TRU-LINK type, Code: L	 Price code: B9	EL-072P3A	TRU-3LD, 72 inch, AAMI Leads	Spacelabs	EL009-5AI	
		EL-072P3I	TRU-3LD, 72 inch, IEC Leads			
	 Price code: C0	EL-096P5A	TRU-5LD, 96 inch, AAMI Leads	Spacelabs	EL009-5AI	
		EL-096P5I	TRU-5LD, 96 inch, IEC Leads			



7

ECG Trunk Cable and Leads for Patient Monitor



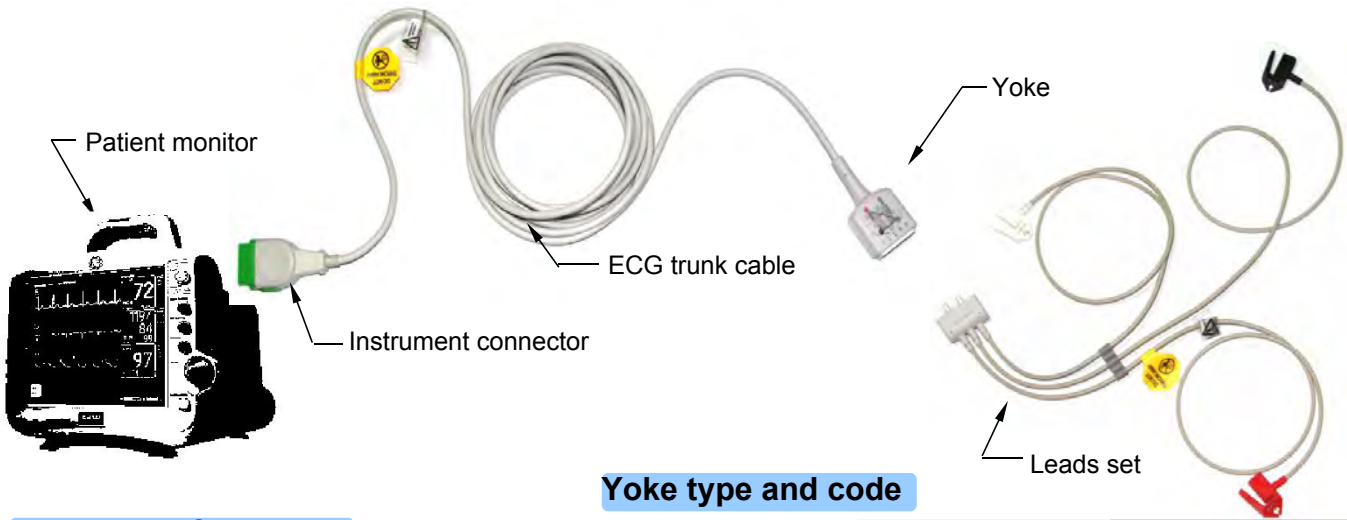

Instrument Connector



Yoke type and code

Din 3-Ld, Code: C	Din 5-Ld, Code: C	Colin,5-Ld,Code: M
Lifelinc(LL),3-Ld,Code: B	Lifelinc(LL),5-Ld,Code: B	TRU-link,5-Ld,Code: L
ASP,3-Ld,Code: H	ASP,5-Ld,Code: H	VS,5-Ld,Code: E
AAMI(AA),3-Ld,Code: D	AAMI(AA),5-Ld,Code: D	NK,5-Ld,Code: N
EURO,3-Ld,Code: J	EURO,5-Ld,Code: J	NK,6-Ld,Code: P
Conmed,3-Ld,Code: G	Conmed,5-Ld,Code: G	Multi-Link, 5Ld,
NEC,3-Ld,Code: K	NEC,5-Ld,Code: K	Lohmeier multi-link: JM
Multi-link,Code: R	Fukuda 16p,Code: Y	Philips M1668A yoke:
Din2.0 Pin: S ; 2.0Jack yoke: T ; LL1 type yoke: U ; NK Din2.0 jack: V GE SEER 10Ld: W ; GE MAX-1: F ; Philips Trim Yoke: X ;		

Type Disignation

E□□□□□□□

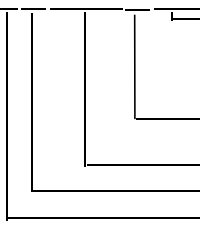

Color coding: **7A**: 7-Ld, AHA(AAMI); **10A**: 10-Ld,AHA; **7I**: 7-Ld,IEC; **10I**:10-Ld,IEC; **5A**:5-Ld, AHA(AAMI);**3H**:4-Ld,AHA; **3A**:3-Ld,AHA; **5I**: 5-Ld, IEC; **3IH**:4-Ld,IEC; **3I**:3-Ld,IEC; **5AI**:5-Ld, AHA/IEC; **3H/IH**:4-Ld, AHA/IEC,

Patient end termination type: **S**: snap; **C**: Clip (grabber),





























If the product is a cable, the lattice is useless, but use the "-" to express , as ED008-3A

Brand code, as 041 indicated Bionet; if the product is a leads, the lattice is indicated length, as 040 indicated 40 in.



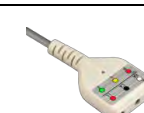











Yoke type: A: one-piece; B: Lifelinc, (LL); C: Din style; D: AA style; E: VS style, other sytle or details as above

E: Indicated patient minitor ECG cable and lead wires



























ECG Trunk Cable and Leads for Patient monitor

Compatible Brand	Compatible Models No.	OEM P/N	HNM REF NO.	Description (Name,Length,Plug,Compatible)	INSTRUMENT CONNECTOR	Yoke (Leads side)	PRICE CODE
Bionet	BM3;		EB041-3AI	3Ld Patient Cable,9ft AHA/IEC, Round 8pin>LL-3LD, 1KΩ resistance fit for LL style LeadWires	500 	107 	C2
	BIONET BM5/BM7		ED400-3A	3LD Patient Cable,L=2.7M 12pin>AA-3LD 1KΩ resistance fit for AA style Lead Wires		086 	D4
Biosys	BPM-103;		EC040-3AI	3Ld Patient Cable,9ft AHA/IEC, Readel 6pin>Din 3J, 1KΩ resistance fit for Din style LeadWires	014 	101 	C3
			EC040-5AI	5Ld Patient Cable,9ft AHA/IEC, Readel 6pin>Din 5J, 1KΩ resistance fit for Din style LeadWires	014 	102 	C4
Colin	BP88 / BP306;		EM062-5I	5Ld Patient Cable,9ft IEC, L type round 6pin>6J, no resistance fit for Colin LeadWires	013 	083 	D2
	BP88S;		EM061-5I	5Ld Patient Cable,9ft IEC, straight 6P>6J, no resistance fit for Colin LeadWires	025 	083 	E0
Creative Spurt Biolight	Creative: PC9000S,PC9000,UP6000, Biolight: M12 ;		EC046-3AI	3Ld Patient Cable,9ft AHA/IEC, Readel 6pin>Din 3J, 1KΩ resistance fit for Din style LeadWires	014 	101 	C3
			EC046-5AI	5Ld Patient Cable,9ft AHA/IEC, Readel 6pin>Din 5J, 1KΩ resistance fit for Din style LeadWires	014 	102 	C4
Conmed Style Normal	PHILIPS MEDICAL SYSTEMS: M3921A A1 Compact Monitor , M3923A A1 Compact Monitor, M3925A A1 Compact Monitor , M3927A A3 Compact Monitor , M3929A A3 Compact Monitor PIONEER (American Optical): 26125 , 33167, 5260 , 5330 , Pulsar 4;		EG020-3AI	Conmed 3Ld Patient Cable, Length: 9ft ; AHA/IEC, straight 6pin>Conmed 3LD, no resistance, fit for Conmed style LeadWires	004 	671 	C5
			EG020-5AI	Conmed 5Ld Patient Cable, Length: 9ft ; AHA/IEC, straight 6pin>Conmed 5LD, no resistance, fit for Conmed style LeadWires	004 	672 	C7
			EG021-3AI	Conmed 3Ld Patient Cable, Length: 9ft ; AHA/IEC, straight 6pin>Conmed 3LD, <u>1KΩ</u> resistance, fit for Conmed style LeadWires	003 	671 	C9
			EG021-5AI	Conmed 5Ld Patient Cable, Length: 9ft ;AHA/IEC, straight 6pin>Conmed 5LD, <u>1KΩ</u> resistance, fit for Conmed style LeadWires	003 	672 	C0
Comen	Comen C60		EC404-3AI	Din 3Ld Patient Cable, AHA/IEC , 12 pin> Din style 3 lead splitter,fit for Din style lead wire, 97 g			C0
Datascope	2000,2001,2002,2100,2200,3000,3000A ,Ballon Pump,M/D3 w/lead select,M/D3A,M/D4,Passport,Passport IL,Passport XG,Passport XL,Passport 2,Passport 2LT,Spectrum System 90, System 90T , System 96, System 97;		EC002-3AI	Din 3Ld Patient Cable,9ft AHA/IEC, straight 6pin>Din 3J,no resistance fit for Din style LeadWires	005 	101 	B9
			EC002-5AI	Din 5Ld Patient Cable,9ft AHA/IEC, straight 6pin>Din 5J, no resistance fit for Din style LeadWires	005 	102 	B0

ECG Trunk Cable and Leads for Patient monitor

Compatible Brand	Compatible Models No.	OEM P/N	HNM REF NO.	Description (Name,Length,Plug,Compatible)	INSTRUMENT CONNECTOR	Yoke (Leads side)	PRICE CODE
Din Style Normal Din	AIR SHIELDS (NARCO, Vickers): HRRM-71-1/2 , Porta-Fib I, II, III, System 5 (new), System 6 (Neonatal); ATL ULTRASOUND:800,800 Plus,Apogee, CX ATL LTRASOUND: CX200,CX400,HDI 9/2000, Interspec;	D-1340	EC020-3AI	Din 3Ld Patient Cable, 9ft AHA/IEC, straight 6pin>Din 3J, no resistance fit for Din style LeadWires	004 	101 	B9
		D-1540	EC020-5AI	Din 5Ld Patient Cable, 9ft AHA/IEC, straight 6pin>Din 5J, no resistance fit for Din style LeadWires	004 	102 	B0
			EC021-3AI	Din 3Ld Patient Cable,9ft AHA/IEC, straight 6pin>Din 3J, 1KΩ resistance fit for Din style LeadWires	003 	101 	C2
			EC021-5AI	Din 5Ld Patient Cable,9ft AHA/IEC, straight 6pin>Din 5J, 1KΩ resistance fit for Din style LeadWires	003 	102 	C5
Datex	AS/3, CS/3, S/5, Cardiocap 1, Cardiocap 2 , Cardiocap 5 , Light Monitor , Satliteplus ;		EB010-3AI	3Ld Patient Cable,9ft AHA/IEC, Round 10J>LL 3LD, no resistance fit for LL style LeadWires	023 	107 	C8
			EB010-5AI	5Ld Patient Cable,9ft AHA/IEC, Round 10J>LL 5LD, no resistance fit for LL style LeadWires	023 	105 	C0
Datex-Ohmeda	Datex-Ohmeda Patient monitor;		EH010-3AI	3Ld Patient Cable,9ft AHA/IEC, Round 10J>ASP 3LD, 4.7KΩ resistance fit for ASP style LeadWires	023 	183 	D1
			EH010-5AI	5Ld Patient Cable,9ft AHA/IEC, Round 10J>ASP 5LD, 4.7KΩ resistance fit for ASP style LeadWires	023 	221 	D2
DRAGER			EQ080-6AI	Multi-link Cable, AHA/IEC,			D0
Drager Siemens	Drager UM1/3/3.1, RM1, PM8010, PM8014, Babyguard 8000, Cato, Babylog8000/8000 plus, PB8800,Serie 8000, Cicero, Parameterbox;		EC057-3AI	SG 3Ld Patient Cable,9ft AHA/IEC, Round 10pin>Din 3J, no resistance fit for Din style LeadWires	170 	101 	D0
Drager Siemens	Multimed-Pot system fur serie SC 6000, SC 6002XL, SC 7000, SC 9000, Art. Nr.3368391 (8.2ft) Art. Nr. 5950196 (4.9ft) ;	3368391	EQ056-5AI	SC9000XL Multi-link Cable, 8.2ft AHA/IEC, 1KΩ resistance fit for Euro style LeadWires	178 	179 	M0
		5950196	EQ057-5AI	SC9000XL Multi-link Cable, 4.9ft AHA/IEC, 1KΩ resistance fit for Euro style LeadWires			M0
	Multimed-Pot system fur serie SC 6000, SC 6002XL, SC 7000, SC 9000,	MS20094	EQ091-6AI	Multi-link Cable, 8.2ft AHA/IEC, 1KΩ resistance	178 		O0

ECG Trunk Cable and Leads for Patient monitor

Compatible Brand	Compatible Models No.	OEM P/N	HNM REF NO.	Description (Name,Length,Plug,Compatible)	INSTRUMENT CONNECTOR	Yoke (Leads side)	PRICE CODE
Emtel	 EC092-3AI		EJ086-3AI	3Ld Patient Cable,9ft AHA/IEC, Kontron 12P>Euro3LD, fit for Euro style LeadWires;			D0
			EC086-3AI	Din 3Ld Patient Cable,9ft AHA/IEC, Kontron12Pin,1bit >Din 3 LD, no resistance fit for Din style LeadWires .			D0
			EC086-5AI	Din 5Ld Patient Cable,9ft AHA/IEC, Kontron 12Pin>Din 5 LD, no resistance fit for Din style LeadWires .	012 	102 	D0
			EC092-3AI	Din 3Ld Patient Cable,9ft AHA/IEC, Round 12Pin, 2bit. Orange>Din 3 LD, 1KΩ resistance , fit for Din style LeadWires .			D8
			EC094-3AI	Din 3Ld Patient Cable,9ft AHA/IEC, Round 12Pin, 1bit. Green>Din 3 LD, 1KΩ resistance, fit for Din style LeadWires .			D0
			EC095-3AI	Din 3Ld Patient Cable,9ft AHA/IEC, Round 12Pin, 1bit. Green>Din 3 LD, 20KΩ resistance, fit for Din style LeadWires .			D0
Fukuda Denshi	FUKUDA: 7100 patient monitor;		EJ032-5AI	5Ld Patient Cable,9ft AHA/IEC, Round 12P>Euro 5LD, fit for Euro style LeadWires;	963 	243 	D5
			EE032-5AI	5Ld Patient Cable,9ft AHA/IEC, Kontron12p>VS 5 LD,10KΩ resistance , fit for VS style LeadWires	963 	089 	D0
	DATASCOPE:Expert FUKUDA DENSHI:DS5100E, DS5300W, DS5400, DS7101/L, DS7141;		EY068-5AI	5Ld and 3Ld Patient Cable,9ft AHA/IEC, Round 12pin> 16 jack non- resistance fit for EY032S3I LeadWires	253 	373 	F2
GE-Hellige	Cardioserv Eagle 1000/3000;		EE011-5AI	5Ld Patient Cable,9ft AHA, (IEC) Round 10J>VS 5LD, 10KΩ resistance fit for VS style LeadWires	021 	089 	D6
	Hellige,Servomed 4 , Generation, SCP 851, SCP 852 , SCP 844, SCS 804,VICOM-sm;		EB011-5AI	5Ld Patient Cable,9ft AHA/IEC, Round 10P>LL 5LD, no resistance fit for LL style LeadWires	021 	105 	C0
	Hellige,Servomed 4 , Generation, SCP 851, SCP 852 , SCP 844, SCS 804,CardioServ , VICOM-sm;		EH011-3AI	3Ld Patient Cable,9ft AHA/IEC, Round 10J>ASP 3LD, 1KΩ resistance fit for ASP style LeadWires	021 	183 	D4
			EH011-5AI	5Ld Patient Cable,9ft AHA/IEC, Round 10J>ASP 5LD, 1KΩ resistance fit for ASP style LeadWires	021 	221 	D5

ECG Trunk Cable and Leads for Patient monitor

Compatible Brand	OEM MODELS NUMBER	OEM P/N	HNM REF NO.	Description (Name,Length,Plug,Compatible)	INSTRUMENT CONNECTOR	Yoke (Leads side)	PRICE CODE
GE-Medical Marquette	GEMS:Dash PRO 4000, Dash PRO 3000, Dash PRO 2000, Dash 1000, Eagle Systems, MAC-Lab, Solar 9500, Solar 8000, Solar 3000, Tram 100, Tram 200, Tram 300, Tram 400, Tram 500, Tram 600, Tram 800, Unity Systems;		EE007-5AI	5Ld Patient Cable,9ft AHA, (IEC) Round 10J>VS 5LD, no resistance fit for VS style LeadWires	020 	089 	C5
GE-medical Marquette	Pro1000;		EH021-3AI	3Ld Patient Cable,9ft AHA/IEC, Round 6pin>ASP 3LD, 1KΩ resistance fit for ASP style LeadWires	007 	183 	D4
			EH021-5AI	5Ld Patient Cable,9ft AHA/IEC, Round 6pin>ASP 5LD, 1KΩ resistance fit for ASP style LeadWires	007 	221 	D5
Goldway	Goldway: UT4000A,UT4000Apro,UT6000 A, UT4000B, UT4000C, UT4000F, UT6000F, UT4000Fpro, UT4800;		EB002-3AI	3Ld Patient Cable,9ft AHA/IEC, Round 6p>LL 3LD, no resistance fit for LL style LeadWires	005 	107 	B9
			EB002-5AI	5Ld Patient Cable,9ft AHA/IEC, Round 6p>LL 5LD, no resistance fit for LL style LeadWires	005 	105 	B0
GE	DASH 2000		EE007-6AI	6Ld Patient Cable,9ft AHA/IEC, Round 17p>TRU-LINK 6Ld, 1KΩ resistance fit for VS style leads.			C0
Huntleigh Healthcare	UK MONITOR;		EC047-3AI	Din 3Ld Patient Cable,9ft AHA/IEC, DB9M>Din 3J, no resistance fit for Din style LeadWires		101 	B0
Kontron	7000, 7135, 7135B, 7141, 7210, 7250, 7251, K2000, KAAT, Kolomon, Micromon, Minimon, Supermon , Vitalmon ;		EB031-5AI	5Ld Patient Cable,9ft AHA/IEC, Round 12P>LL 5LD, no resistance fit for LL style LeadWires	011 	105 	C5
Lifelinc (LL) Style Normal LL	LIFE SCIENCE INSTRUMENTS (LSI):LS5 , 261 MEDICAL DATA electronics (MDE):Escort 100, Escort 101, Escort 102 , Escort 200,Escort 300, Prism , 360SL, 450SL, 521A , PortaPak 80 , PortaPak 90 , PortaPak 1000;		EB020-3AI	LL 3Ld Patient Cable,9ft AHA/IEC, straight 6pin>LL 3LD, no resistance fit for LL style LeadWires	004 	107 	B9
			EB020-5AI	LL 5Ld Patient Cable,9ft AHA/IEC, straight 6pin>LL 5LD, no resistance fit for LL style LeadWires	004 	105 	B0
			EB021-3AI	LL 3Ld Patient Cable,9ft AHA/IEC, straight 6pin>LL 3LD, 1KΩ resistance fit for LL style LeadWires	003 	107 	C3
			EB021-5AI	LL 5Ld Patient Cable,9ft AHA/IEC, straight 6pin>LL 5LD, 1KΩ resistance , fit for LL style LeadWires	003 	105 	C5



















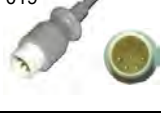







ECG Trunk Cable and Leads for Patient monitor

Compatible Brand	OEM MODELS NUMBER	OEM P/N	HNM REF NO.	Description (Name,Length,Plug,Compatible)	INSTRUMENT CONNECTOR	Yoke (Leads side)	PRICE CODE
Lohmeier			EC078-3AI	3Ld Patient Cable,9ft IEC/AAMI , 5pin+5Jack plug>Din-3LD non-resistance fit for Din1.5 style Leads	533 	101 	F0
	D-81241, original P/N.: 98.060.120/A;	98.060. 120/A	EJM079-5AI	5Ld Multi-Cable,9ft IEC/AAMI , 27pin plug>Euro 5Ld ECG+2*IBP+SpO2+2*Temp (discharge inside)			O0
MEK Korea	MP1000,MP600,MP500;		EC029-5AI	Din 5Ld Patient Cable,9ft AHA/IEC, DB9M>Din 5J, no resistance fit for Din style LeadWires	016 	102 	C1
MINDRAY	Mindray: PM7000/8000/9000; Creative: UT4000		EJ085-3AI	3Ld Patient Cable,9ft AHA/IEC, Round 6pin>Euro 3LD, 1KΩ resistance fit for Euro style LeadWires	007 	242 	C1
			EJ085-5AI	5Ld Patient Cable,9ft AHA/IEC, Round 6pin>Euro 5LD, 1KΩ resistance fit for Euro style LeadWires	007 	243 	C2
	PM-6000 after 2004;	0010-30- 12378	EJ021-3AI	3Ld Patient Cable,9ft AHA/IEC, Round 6pin>Euro 3LD, 1KΩ resistance fit for Euro style LeadWires	007 	242 	C1
		0010-30- 12257	EJ021-5AI	5Ld Patient Cable,9ft AHA/IEC, Round 6pin>Euro 5LD, 1KΩ resistance fit for Euro style LeadWires	007 	243 	C2
	PM-6800,PM-6000 after 2004 , with 12-pin green input connector BeneView (T5, T6, T8), iPM Series;	0010-30- 42724	EJ051-3AI	3Ld Patient Cable,9ft AHA/IEC, 12P>Euro 3LD, 1KΩ resistance /Inductance fit for Euro style LeadWires	577 	242 	D0
		0010-30- 42723	EJ051-5AI	5Ld Patient Cable,9ft AHA/IEC, straight, Round 12P>Euro 5LD, 1KΩ resistance /Inductance fit for Euro style LeadWires	222 	243 	E1
			EC050-3AI	3Ld Patient Cable,9ft AHA/IEC, Round 12pin> >Din 3J, Ω resistance, for Din style LeadWires	577 	201 	D0
	PM6000, with 12-pin green input connector,T8;	0010-30- 12379	EJ050-3AI	3Ld Patient Cable,9ft AHA/IEC, Type L Round 12P>Euro 3LD, 1KΩ resistance fit for Euro style LeadWires	222 	242 	C5
		0010-30- 12260	EJ050-5AI	5Ld Patient Cable,9ft AHA/IEC, Type L, Round 12P>Euro 5LD, 1KΩ resistance fit for Euro style LeadWires		243 	C6
	Mindray	 Datascope passport V, V12, V21	0012-00- 1745-01	ER090-3AI	3Ld Patient Cable,10.5ft IEC , 12pin>Mindray-3LD 1KΩ resistance fit for Mindray 3 Leadwires		
			ER090-5AI	5Ld Patient Cable,10.5ft IEC , 12pin>Mindray-5LD 1KΩ resistance fit for Mindray 5 Leadwires			E2

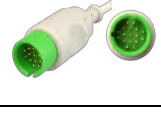
ECG Trunk Cable and Leads for Patient monitor

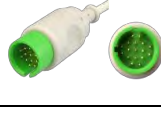
Compatible Brand	Compatible Models No.	OEM P/N	HNM REF NO.	Description (Name,Length,Plug,Compatible)	INSTRUMENT CONNECTOR	Yoke (Leads side)	PRICE CODE
Osypka	ICON hemodynamic monitor		EC419-4I	Din 4Ld Patient Cable,			G0
NEC	3M12;	47524	EK053-3I	3Ld Patient Cable,9ft AHA/IEC, Round 16p>NEC 3LD, no resistance fit for 47504 LeadWires	024 	096 	D5
		47525	EK053-5I	5Ld Patient Cable,9ft AHA/IEC, Round 16p>NEC 5LD, no resistance fit for 47505 LeadWires	024 	099 	D0
Nihon Kohden	OEC-6102A (s/n<20156), OEC-6105A (s/n<20226), OEC-6120A/J/K BSM-7105K;		EC037-3AI	3Ld Patient Cable,9ft AHA/IEC, Round 8p>Din 3LD, no resistance fit for Din style LeadWires	395 	101 	C0
		JC-005P	EN037-3I	3Ld Patient Cable,9ft IEC, Round 8p>NK 6J, no resistance fit for BR-019 LeadWires	395 	155 	D5
Nihon Kohden	BSM-7102A,OMP-7201C, OMP-7203C, TEC-5200A (s/n<20421);		EC038-3AI	3Ld Patient Cable,9ft AHA/IEC, Round 11p>Din 3LD, no resistance fit for Din style LeadWires	154 	101 	D5
			EN038-3I	3Ld Patient Cable,9ft IEC, Round 11p>NK 6J no resistance fit for BR-019 LeadWires	154 	155 	D5
	BSM-2301, BSM-2353, BSM-5100, Multi-parameter bedside monitors BSM-73;	JC-906P	EP055-6I	6Ld Patient Cable,9ft ,IEC, Rectangle 12p>NK 8J, no resistance fit for BR-903P, BR-906P	173 	174 	E5
	OPV-1500 Lifescope N BSM-73;	L060 JC-103T	EP080-3I	3Ld Patient Cable,9ft ,IEC, Rectangle 12p>NK 8J, no resistance fit for BR-903P, BR-906P		174 	E0
PHILIPS	78352C,7834C, 78834C, M1001A/B, M1002A/B, M1722A/B, M1723A/B, M2475B, M3000A, M3001A, M4735A, VM4/V24;	M1500A	ED023-3A	3Ld Patient Cable,9ft AHA, Round 12p>AA-3LD 1KΩ resistance fit for AA style LeadWires	018 	086 	C0
		M1510A	ED023-3I	3Ld Patient Cable,9ft IEC, Round 12p>AA-3LD 1KΩ resistance fit for AA style LeadWires	018 	086 	C0
	78352C,7834C, 78834C, M1001A/B, M1002A/B, M1722A/B, M1723A/B, M2475B, M3000A, M3001A, M4735A, VM4/V24;	M1520A	ED023-5A	5Ld Patient Cable,9ft AHA, Round 12p>AA-5LD 1KΩ resistance fit for AA style LeadWires	018 	085 	D4
		M1530A	ED023-5I	5Ld Patient Cable,9ft IEC, Round 12p>AA-5LD 1KΩ resistance fit for AA style LeadWires	018 	085 	D4
PHILIPS	M3000A, M3001A, M1001A/B,M1002A/B, 78352C,78354C;	M1669A	EDG073-3AI	3Ld Patient Cable,9ft IEC/AAMI, Round 12p>3-LD 1KΩ resistance fit for Philips LeadWires	519 		D9

ECG Trunk Cable and Leads for Patient monitor











Compatible Brand	OEM MODELS NUMBER	OEM P/N	HNM REF NO.	Description (Name,Length,Plug,Compatible)	INSTRUMENT CONNECTOR	Yoke (Leads side)	PRICE CODE
PHILIPS	M3000A, M3001A, M1001A/B, M1002A/B, 78352C, 78354C;	M1668A	EDG073-5AI	5Ld Patient Cable,9ft IEC/AAMI, Round 12p>5-LD 1KΩ resistance fit for Philips LeadWires	519 		E5
PHILIPS	Philips Instruments with 8-Pin Connector: 78208A,78210A,78330A, 78331A,78332A,78333A, 78341A,78342A,78345A, 78346A,78351T,78352A,78353A ,78354A,78532A/B,78534A/B/C, M1722A/B,M3500B;	M1600A	ED035-5A	5Ld Patient Cable,9ft AHA, Round 8p>AA-5LD 1KΩ resistance fit for AA style LeadWires	019 	085 	D4
		M1610A	ED035-5I	5Ld Patient Cable,9ft IEC, Round 8p>AA-5LD 1KΩ resistance fit for AA style LeadWires	019 		D4
PHILIPS	Philips Instruments with 8-Pin Connector: 77000AC,77020A/AC,77020AR, 77025A,77030A,77035A,77040A ,78208A,78210A,78330A,78331 A,78332A,78333A,78341A,7834 2A,78345A,78346A,78351T,783 52A,78353A/B,78354A,78532A/ B,78534A/B/C,M1722A/B,M1723 A/B,M2400A,M2406A,M2475B,	M1580A	ED035-3A	3Ld Patient Cable,9ft AHA, Round 8p>AA-3LD 1KΩ resistance fit for AA style LeadWires	019 	086 	C0
		M1590	ED035-3I	3Ld Patient Cable,9ft IEC, Round 8p>AA-3LD 1KΩ resistance fit for AA style LeadWires	019 	086 	C0
PHILIPS	78834C 78850A;	M1620A	ED036-3A	3Ld Patient Cable,9ft AHA, Round 5p>AA-3LD 1KΩ resistance fit for AA style LeadWires	236 	086 	C0
			ED036-3I	3Ld Patient Cable,9ft IEC, Round 5p>AA-3LD 1KΩ resistance fit for AA style LeadWires	236 	086 	C0
Siemens	Sirecust Series 400, 500, 600, Serie 700, 900, 1200, Sirecust 341/610/620/630/720/722, Sirecust 730/732/900/960/961/1260, Sirecust 1281/1801/400/-500, ECG Monitor, Polymed Modul, Modulbox Sirem;		EJ052-3AI	3Ld Patient Cable,9ft AHA/IEC, Round 10J>Euro 3LD, no resistance fit for Euro style LeadWires	017 	242 	C5
			EJ052-5AI	5Ld Patient Cable,9ft AHA/IEC, Round 10J>Euro 5LD, no resistance fit for Euro style LeadWires	017 	243 	C6
SPACELABS	90496 Ultraview, 90369 Ultraview,90367 Ultraview;	IEC:700-0008-07 AHA:700-0008-06	EL009-5AI	5Ld Patient Cable,9ft AHA/IEC, Round 17p>TRU-LINK 5Ld, 1KΩ resistance fit for TRU-LINK LeadWires	022 	091 	C9
			EE009-5AI	5Ld Patient Cable,9ft AHA/IEC, Round 17p>TRU-LINK 5Ld, 1KΩ resistance fit for VS style leads.	022 	089 	C9
			EJ009-3AI	3Ld Patient Cable,9ft AHA/IEC, Round 17p>Euro 3Ld, 1KΩ resistance fit for Euro style LeadWires.	022 	246 	C7
			EJ009-5AI	5Ld Patient Cable,9ft AHA/IEC, Round 17p>Euro 5Ld, 1KΩ resistance fit for EURO style leads.	022 	247 	C9

LEAD WIRES

Low profile, insert molded snap or pinch connectors offer patient comfort and secure attachment to snap electrodes. The snap termination's ergonomic, teardrop design reduces tangling at the patient end connector. Grabber and mini clip terminations have du

Compatible Brand	Product Guide	OEM P/N	HNM REF NO.	Description (Name,Length,Leads,)	Color coding / Leads	Patient end termination	PRICE CODE		
Bionet Datex Siemens GE-Hellige Kontron Goldway S&W (Artema)	suitable for all LL-Plug System , Yoke type: Lifelinc(LL),Code: B	 EB040C3A  EB040C5A	EB024S3A	LL lead wires,	AHA (AAMI)	Snap	B2		
			EB024C3I	24 in. (61 cm), 3-Ld	IEC	Grabber (Clip)	B3		
			EB024S5A	LL lead wires,	AHA (AAMI)	Snap	B5		
			EB024C5A	24 in. (61 cm), 5-Ld	AHA (AAMI)	Grabber (Clip)	B6		
			EB040S3A	LL lead wires,	AHA (AAMI)	Snap	B2		
			EB040C3A	LL lead wires,	AHA (AAMI)	Grabber (Clip)	B3		
			EB040S3I	40 in. (102 cm), 3-Ld	IEC	Snap	B2		
			EB040C3I		IEC	Grabber (Clip)	B3		
			EB040S5A		AHA (AAMI)	Snap	B5		
			EB040C5A	LL lead wires,	AHA (AAMI)	Grabber (Clip)	B6		
			EB040S5I	40 in. (102 cm), 5-Ld	IEC	Snap	B5		
			EB040C5I		IEC	Grabber (Clip)	B6		
Biosys Creative Datascope Nihon Kohden AIR SHIELDS (NARCO, Vickers) ATL ULTRASOUND	suitable for all Din-Plug System , Yoke type: Din style,Code: C	 EC040S3A  EC040N3A	EC018S3A	Din lead wires,	AHA (AAMI)	Snap	A6		
			EC018S3I	18 in. (45 cm), 3-Ld	IEC	Snap	A6		
			EC018S5A		AHA (AAMI)	Snap	A0		
			EC018C5A	Din lead wires,	AHA (AAMI)	Grabber (Clip)	B1		
			EC018C5I	18 in. (45 cm), 5-Ld	IEC	Grabber (Clip)	B1		
			EC024S3A	Din lead wires,	AHA (AAMI)	Snap	A6		
			EC024C3I	24 in. (61 cm), 3-Ld	IEC	Grabber (Clip)	A7		
			EC024S5A		AHA (AAMI)	Snap	A0		
			EC024C5A	Din lead wires,	AHA (AAMI)	Grabber (Clip)	B1		
			EC024S5I	24 in. (61 cm), 5-Ld	IEC	Snap	A0		
			EC024C5I		IEC	Grabber (Clip)	B1		
			EC040S3A		AHA (AAMI)	Snap	A6		
			EC040C3A	Din lead wires,	AHA (AAMI)	Grabber (Clip)	A7		
			EC040S3I	40 in. (102 cm), 3-Ld	IEC	Snap	A6		
			EC040C3I		IEC	Grabber (Clip)	A7		
			EC040S5A		AHA (AAMI)	Snap	A0		
			EC040C5A	Din lead wires,	AHA (AAMI)	Grabber (Clip)	B1		
EC040S5I	40 in. (102 cm), 5-Ld	IEC	Snap	A0					
EC040C5I		IEC	Grabber (Clip)	B1					
PHILIPS M3000A, M3001A, M1001A/B, M1002A/B, 78352C, 78354C		 M1673A  M1644A	M1673A	EDG040S3A	Multi-Link Ldwr, 3-Ld Set-Group, 40 in (102cm)	AHA (AAMI)	Snap	C5	
			M1674A	EDG040S3I		IEC	Snap	C5	
			M1671A	EDG040C3A		AHA (AAMI)	Grabber (Clip)	C5	
			M1672A	EDG040C3I		IEC	Grabber (AA Clip)	C5	
				EDG040M3I		IEC	Grabber (Mini)	C5	
			M1644A	EDG040S5A	Multi-Link Ldwr, 5-Ld Set-Group, LA,RA,V=40in(102cm); LL,RL=61in(155cm);	AHA (AAMI)	Snap	C0	
			M1645A	EDG040S5I		IEC	Snap	C0	
			M1968A	EDG040C5A		AHA (AAMI)	Grabber (Clip)	C0	
			M1971A	EDG040C5I		IEC	Grabber (Clip)	C0	
PHILIPS M1672A		 M1672A	M1672A	EDG040C3I-RL	Multi-Link Ldwr,3-Ld Set-Group,40 in(102cm)	IEC	Snap	C5	
				EDG040C3A-RL	Multi-Link Ldwr,3-Ld Set-Group,40 in(102cm)	AHA(AAMI)	Snap	C5	
			M1672A	EDG040C5I-RL	Multi-Link Ldwr,5-Ld Set-Group,LA, RA, V = 40in(102cm); LL, RL = 61in(155cm)	IEC	Snap	C0	
				EDG040C5A-RL	Multi-Link Ldwr,5-Ld Set-Group, LA,RA, V = 40in(102cm); LL,RL = 61in(155cm)	AHA(AAMI)	Snap	C0	
PHILIPS	suitable for all AA-Plug System , Yoke type: AA style,Code: D	 ED040C5A	M1605A	ED040S3A	AA lead wires, 40 in. (102 cm), 3-Ld	AHA (AAMI)	Snap	B8	
			M1603A	ED040N3A		AHA (AAMI)		C0	
				ED040C3A		AHA (AAMI)	Grabber (Clip)	B8	
			M1615A	ED040S3I		IEC	Snap	B8	
			M1613A	ED040C3I		IEC	Grabber (Clip)	B8	
			M1625A	ED040S5A	AA lead wires, 5-Ld LA,RA,V 40in(102cm); LL,RL 61in(155cm)	AHA (AAMI)	Snap	C5	
			M1623A	ED040C5A		AHA (AAMI)	Grabber (Clip)	C5	
			M1635A	ED040S5I		IEC	Snap	C5	
			M1633A	ED040C5I		IEC	Grabber (Clip)	C5	
			M1601A	ED040C3A-OR		AA lead wires, OR	AHA (AAMI)	Grabber (Clip)	C8
			M1611A	ED040C3I-OR		40 in. (102 cm), 3-Ld	IEC	Grabber (Clip)	C8
			M1626A	EDN040N3I	AA lead wires, 40 in. (102 cm), 3-Ld	IEC		C0	
			M1621A	ED040C5A-OR	AA lead wires, 5-Ld, OR	AHA (AAMI)	Grabber (Clip)	D6	
M1631A	ED040C5I-OR	LA,RA,V 40in(102cm); LL,RL 61in(155cm)	IEC	Grabber (Clip)	D6				

ECG Trunk Cable and Leads for Patient monitor

Compatible Brand	Productor Guide	OEM P/N	HNM REF NO.	Description (Name,Length,Leads,)	Color coding / Leads	Patient end termination	PRICE CODE		
GE--Marquette (Set –Group type Lead wires)  185	suitable for all Multi-link(VS)-Plug System , Yoke type: Multi-link(VS),Code: E  EE029C3A	E9008LF	EE029S3A-G	Multi-Link Ldwr Set – Group,, 29 in. (76 cm), 3-Ld	AHA (AAMI)	Snap	C1		
		E9003CL	EE029C3A-G		AHA (AAMI)	Grabber (Clip)	C2		
		E9003CN	EE029C3I-G		IEC	Grabber (Clip)	C2		
		E9003CG	EE029C6I-G (2017)	Multi-Link Ldwr Set – Group,, 29 in. (76 cm), 3-Ld	IEC	Grabber (Clip)	C0		
		E9008LG	EE051S3A-G	Multi-Link Ldwr Set – Group,, 51 in. (130 cm), 3-Ld	AHA (AAMI)	Snap	C1		
		E9003CM	EE051C3A-G		AHA (AAMI)	Grabber (Clip)	C2		
		E9003CP	EE051C3I-G		IEC	Grabber (Clip)	C2		
		GE--Marquette (Set –Group type Lead wires)  140	suitable for all Multi-link(VS)-Plug System , Yoke type: Multi-link(VS),Code: E  EE029S5A	E9008L	EE029S5A-G	Multi-Link Ldwr Set – Group,, 29 in. (76 cm), 5-Ld	AHA (AAMI)	Snap	C1
				E9003CE	EE029C5A-G		AHA (AAMI)	Grabber (Clip)	C2
				E9008LB	EE029S5I-G		IEC	Snap	C1
E9003CG	EE029C5I-G			IEC	Grabber (Clip)	C2			
E9003CF	EE051C5A-G			Multi-Link Ldwr Set – Group,, 51 in. (130 cm), 5-Ld	AHA (AAMI)	Grabber (Clip)	C2		
	EE051C5I-G				IEC	Grabber (Clip)	C2		
E9008LD	EE051S5A-GM			Multi-Link Ldwr SetGroup, 5-Ld , Mixed Length, RL,LL,V-51in.(130cm) ; RA,LA-29 in.(74cm)	AHA (AAMI)	Snap	C1		
E9003CJ	EE051C5A-GM			Multi-Link Ldwr SetGroup, 5-Ld , Mixed Length, N,F,C-51in. (130cm) , R,L-29 in.(74cm)	AHA (AAMI)	Grabber (Clip)	C2		
	EE051C5I-GM			Multi-Link Ldwr SetGroup, 5-Ld , Mixed Length, N,F,C-51in. (130cm) , R,L-29 in.(74cm)	IEC	Grabber (Clip)	C2		
GE-Medical Marquette (Set –Assembly type Lead wires)  140	suitable for all Multi-link(VS)-Plug System , Yoke type: Multi-link(VS),Code: E  EE051C5A-M			E9008KB	EE029S5A	Multi-Link Ldwr Set 29 in. (76 cm), 5-Ld	AHA (AAMI)	Snap	C1
		E9002ZW	EE029C5A	AHA (AAMI)	Grabber (Clip)		C2		
		E9008KD	EE029S5I	IEC	Snap		C1		
		E9002ZZ	EE029C5I	IEC	Grabber (Clip)		C2		
			EE029C6I	Multi-Link Ldwr Set 29 in. (76 cm), 5-Ld	IEC	Grabber (Clip)	C0		
		E9008KC	EE051S5A	Multi-Link Ldwr Set, 51 in. (130 cm), 5-Ld	AHA (AAMI)	Snap	C1		
		E9002ZY	EE051C5A		AHA (AAMI)	Grabber (Clip)	C2		
		E9008KE	EE051S5I		IEC	Snap	C1		
		E9003A	EE051C5I	IEC	Grabber (Clip)	C2			
		E9008KF	EE051S5A-M	Multi-Link Ldwr Set, 5-Ld , Mixed Length, RL,LL,V-51in.(130cm); RA,LA-29 in.(74cm)	AHA (AAMI)	Snap	C1		
		E9003AA	EE051C5A-M	Multi-Link Ldwr Set, 5-Ld , Mixed Length, N,F,C-51in.(130cm); RA,LA-29 in.(74cm)	AHA (AAMI)	Grabber (Clip)	C2		
			EE051S5I-M	Multi-Link Ldwr Set, 5-Ld , Mixed Length, N,F,C-51in.(130cm); RA,LA-29 in.(74cm)	IEC	Snap	C1		
		E9003AB	EE051C5I-M	Multi-Link Ldwr Set, 5-Ld , Mixed Length, N,F,C-51in.(130cm); RA,LA-29 in.(74cm)	IEC	Grabber (Clip)	C2		
Datex PHILIPS PIONEER PPG SPACELABS BURDICK TEKTRONIX (Vitatek) WELCH ALLYN  138	suitable for all Conmed-Plug System , Yoke type: Conmed,Code: G  EG040S5A		EG024C3I	Conmed lead wires, 24 in. (61 cm), 3-Ld	IEC	Grabber (Clip)	B4		
			EG024S5A	Conmed lead wires, 24 in. (61 cm), 5-Ld	AHA (AAMI)	Snap	C2		
			EG024C5A	Conmed lead wires, 24 in. (61 cm), 5-Ld	AHA (AAMI)	Grabber (Clip)	C3		
			EG024C5I	Conmed lead wires, 24 in. (61 cm), 5-Ld	IEC	Grabber (Clip)	C3		
			EG040S3A	Conmed lead wires, 40 in. (102 cm), 3-Ld	AHA (AAMI)	Snap	B3		
			EG040C3A	Conmed lead wires, 40 in. (102 cm), 3-Ld	AHA (AAMI)	Grabber (Clip)	B4		
			EG040S3I	Conmed lead wires, 40 in. (102 cm), 3-Ld	IEC	Snap	B3		
			EG040C3I	Conmed lead wires, 40 in. (102 cm), 3-Ld	IEC	Grabber (Clip)	B4		
			EG040S5A	Conmed lead wires, 40 in. (102 cm), 5-Ld	AHA (AAMI)	Snap	C2		
			EG040C5A	Conmed lead wires, 40 in. (102 cm), 5-Ld	AHA (AAMI)	Grabber (Clip)	C3		
Datex-Ohmeda GE-medical Pro1000  137	suitable for all ASP-Plug System , Yoke type: ASP, Code: H  EH024C3I  EH040A3A		EH024S3A	ASP lead wires, 24 in. (61 cm), 3-Ld	AHA (AAMI)	Snap	B8		
			EH024C3I	ASP lead wires, 24 in. (61 cm), 3-Ld	IEC	Grabber (Clip)	B8		
			EH024C5I	ASP lead wires, 24 in. (61 cm), 5-Ld	IEC	Grabber (Clip)	C7		
			EH040S3A	ASP lead wires, 40 in. (102 cm), 3-Ld	AHA (AAMI)	Snap	B8		
			EH040C3A	ASP lead wires, 40 in. (102 cm), 3-Ld	AHA (AAMI)	Grabber (Clip)	B8		
			EH040S3I	ASP lead wires, 40 in. (102 cm), 3-Ld	IEC	Snap	B8		
			EH040C3I	ASP lead wires, 40 in. (102 cm), 3-Ld	IEC	Grabber (Clip)	B8		
			EH040A3A	ASP lead wires, 40 in. (102 cm), 3-Ld	AHA (AAMI)	Grabber(AA type)	B8		
			EH040S5A	ASP lead wires, 40 in. (102 cm), 5-Ld	AHA (AAMI)	Snap	C7		
			EH040C5A	ASP lead wires, 40 in. (102 cm), 5-Ld	AHA (AAMI)	Grabber (Clip)	C7		
			EH040S5I	ASP lead wires, 40 in. (102 cm), 5-Ld	IEC	Snap	C7		
			EH040C5I	ASP lead wires, 40 in. (102 cm), 5-Ld	IEC	Grabber (Clip)	C7		

ECG Trunk Cable and Leads for Patient monitor





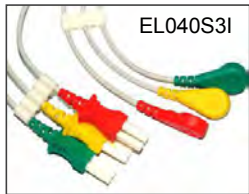

Compatible Brand	Product Guide	OEM P/N	HNM REF NO.	Description (Name,Length,Leads,)	Color coding / Leads	Patient end termination	PRICE CODE		
type LM Lead wires 494			EZ040S3A	LM lead wires, 40 in. (102 cm), 3-Ld	AHA (AAMI)	Snap	B8		
			EZ040C3A		AHA (AAMI)	Grabber (Clip)	B8		
			EZ040S3I		IEC	Snap	B8		
			EZ040C3I		IEC	Grabber (Clip)	B8		
			EZ040S5A	LM lead wires, 40 in. (102 cm), 5-Ld	AHA (AAMI)	Snap	C7		
			EZ040C5A		AHA (AAMI)	Grabber (Clip)	C7		
			EZ040S5I		IEC	Snap	C7		
			EZ040C5I		IEC	Grabber (Clip)	C7		
Mindray Siemens SPACELABS BURDICK Viggo-Spectramed (Statham) WESTINGHO USE			EJ024C3I	Euro style lead wires, 24 in. (61 cm), 3-Ld	IEC	Grabber (Clip)	B9		
				EJ024C5A	Euro style lead wires, 24 in. (61 cm), 5-Ld	AHA (AAMI)	Grabber (Clip)	C1	
				EJ024C5I	IEC	Grabber (Clip)	C1		
				EJ040S3A	Euro style lead wires, 40 in. (102 cm), 3-Ld	AHA (AAMI)	Snap	B8	
			EJ040C3A	AHA (AAMI)		Grabber (Clip)	B9		
			EJ040M3A	AHA (AAMI)		Mini Grabber (Clip)	D0		
			EJ040S3I	IEC		Snap	B8		
			EJ040C3I	IEC		Grabber (Clip)	B9		
				EJ040S5A		Euro style lead wires, 40 in. (102 cm), 5-Ld	AHA (AAMI)	Snap	C0
				EJ040C5A		AHA (AAMI)	Grabber (Clip)	C1	
				EJ040S5I		IEC	Snap	C0	
			EJ040C5I	IEC	Grabber (Clip)	C1			
Siemens			EQ040C3I	ECG leads, 40 in. (102cm), 3 leads	IEC	Grabber(clip)	C5		
			EQ040S3I		IEC	Snap	C5		
			EQ040C5I		IEC	Grabber(clip)	C0		
DRAGER			EQ040C6I	ECG leads, 40 in. (102cm), 6 leads	IEC	Grabber(clip)	C0		
NEC suitable for all NEC-Plug System , Yoke type: NEC style, Code: K			EK029S3I	47504 style lead wires, 29 in. (76 cm), 3-Ld	IEC	Snap	B1		
			EK029S5I	47505 style lead wires, 29 in. (76 cm), 5-Ld	IEC	Snap	B5		
		47505	EK029C5I	IEC	Grabber (Clip)	B6			
Colin suitable for all Colin-Plug System , Yoke type: Colin style, Code: M		CL-3601	EM040S3I	COLIN style lead wires, 40in. (102 cm), 3-Ld	IEC	Snap	B8		
			EM040C3I		IEC	Grabber (Clip)	B8		
			EM040S5I	COLIN style lead wires, 40in. (102 cm), 5-Ld	IEC	Snap	C5		
FUKUDA DENSHI			EY032S3I	One-piece lead wires,32 in. 80 cm, 3-Ld	IEC	Snap	C0		
			EY032S3A		AHA (AAMI)	Snap	C0		
		CMO-07CTP-5NA	EJ040C5I	Din lead wires, 40 in. (102 cm), 5-Ld	IEC	Grabber(clip)	C1		

ECG Trunk Cable and Leads for Patient monitor





Compatible Brand	Product Guide	OEM P/N	HNM REF NO.	Description (Name,Length,Leads,)	Color coding / Leads	Patient end termination	PRICE CODE
 <p>SPACELABS 166</p>	<p>suitable for all TRU-LINK Plug System , Yoke type: TRU-LINK style, Code: L</p>	700-0007-00	EL024S3A	TUR-LINK style lead wires, 24 in. (61 cm), 3-Ld	AHA (AAMI)	Snap	B5
		700-0007-04	EL024S4A	TUR-LINK style lead wires, 24 in. (61 cm), 4-Ld	AHA (AAMI)	Snap	B0
		700-0006-04	EL024C4A		AHA (AAMI)	Grabber (Clip)	C1
		700-0007-05	EL024S4I	TUR-LINK style lead wires, 24 in. (61 cm), 4-Ld	IEC	Snap	B0
		700-0006-05	EL024C4I		IEC	Grabber (Clip)	C1
		700-0007-08	EL024S5A	TUR-LINK style lead wires, 24 in. (61 cm), 5-Ld	AHA (AAMI)	Snap	C4
		700-0007-09	EL024S5I		IEC	Snap	C4
		700-0006-09	EL024C5I		IEC	Grabber (Clip)	C5
		700-0007-12	EL024S6A	TUR-LINK style lead wires, 24 in. (61 cm), 6-Ld	AHA (AAMI)	Snap	C9
		700-0006-12	EL024C6A		AHA (AAMI)	Grabber (Clip)	C0
		700-0007-13	EL024S6I		IEC	Snap	C9
		700-0006-13	EL024C6I		IEC	Grabber (Clip)	C0
		700-0007-16	EL024S10A	TUR-LINK style lead wires, 24 in. (61 cm), 10-Ld	AHA (AAMI)	Snap	E5
		700-0006-16	EL024C10A		AHA (AAMI)	Grabber (Clip)	E6
		700-0007-17	EL024S10I		IEC	Snap	E5
		700-0006-17	EL024C10I		IEC	Grabber (Clip)	E6
		700-0007-03	EL040S3I	TUR-LINK style lead wires, 40 in. (102 cm), 3-Ld	IEC	Snap	B5
		700-0006-03	EL040C3I		IEC	Grabber (Clip)	B6
		700-0007-06	EL040S4A	TUR-LINK style lead wires, 40 in. (102 cm), 4-Ld	AHA (AAMI)	Snap	B0
		700-0006-06	EL040C4A		AHA (AAMI)	Grabber (Clip)	C1
		700-0007-07	EL040S4I		IEC	Snap	B0
		700-0006-07	EL040C4I		IEC	Grabber (Clip)	C1
		700-0007-10	EL040S5A	TUR-LINK style lead wires, 40 in. (102 cm), 5-Ld	AHA (AAMI)	Snap	C4
		700-0006-10	EL040C5A		AHA (AAMI)	Grabber (Clip)	C5
		700-0007-11	EL040S5I		IEC	Snap	C4
		700-0006-11	EL040C5I	TUR-LINK style lead wires, 40 in. (102 cm), 6-Ld	IEC	Grabber (Clip)	C5
		700-0007-14	EL040S6A		AHA (AAMI)	Snap	C9
		700-0006-14	EL040C6A	TUR-LINK style lead wires, 40 in. (102 cm), 6-Ld	AHA (AAMI)	Grabber (Clip)	C0
		700-0007-15	EL040S6I		IEC	Snap	C9
		700-0006-15	EL040C6I		IEC	Grabber (Clip)	C0
		700-0007-18	EL040S10A	TUR-LINK style lead wires, 40in. (102 cm), 10-Ld	AHA (AAMI)	Snap	E5
		700-0006-18	EL040C10A		AHA (AAMI)	Grabber (Clip)	E6
700-0007-19	EL040S10I	IEC	Snap		E5		
700-0006-19	EL040C10I	IEC	Grabber (Clip)		E6		

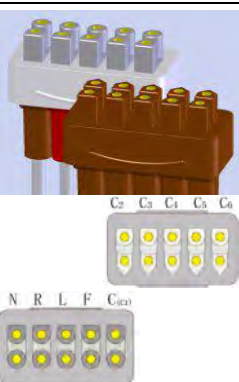



ECG Trunk Cable and Leads for Patient monitor



Compatible Brand	Product Guide	OEM P/N	HNM REF NO.	Description (Name,Length,Leads,)	Color coding / Leads	Patient end termination	PRICE CODE
Nihon Konden suitable for all NK-5LD Plug System , Yoke type: NK-5LD style, Code: <u>N</u>	 126	BR-019	EN032S3I	NK style lead wires, <u>32 in. 80 cm, 3-Ld</u>	IEC	Snap	B8
		BR-019P	EN032C3I		IEC	Grabber (Clip)	B8
	 125	BR-021P	EN032S5I	NK style lead wires, <u>32 in. 80 cm, 5-Ld</u>	IEC	Snap	C4
			EN032C5I		IEC	Grabber (Clip)	C5
Nihon Konden suitable for all NK-6LD Plug System , Yoke type: NK-6LD style, Code: <u>P</u> BSM-73	 171/433	BR-913P	EP035S3I	NK style lead wires, <u>35 in. 90 cm, 3-Ld</u>	IEC	Snap	B8
		BR-903P	EP035C3I		IEC	Grabber (Clip)	B8
			EP035S6I	NK style lead wires, <u>35 in. 90 cm, 6-Ld</u>	IEC	Snap	C7
		BR-906P	EP035C6I		IEC	Grabber (Clip)	C7
Nihon Konden suitable for all NK-5LD Plug System , Yoke type: NK-5LD style, Code: <u>R</u>	 124		HA004S3I	NK style lead wires, <u>32 in. 80 cm, 3-Ld</u>	IEC	Snap	B0
		BR-546S	HA004C3I		IEC	Grabber (Clip)	B0
	 123	BR-002P	EV032C3I	NK style lead wires, <u>32 in. 80 cm, 3-Ld</u>	IEC	Grabber (Clip)	B0
 122			EV032S5I		NK style lead wires, <u>32 in. 80 cm, 5-Ld</u>	IEC	Snap
	Mindray	Datascope passport V, V12, V21 	0012-00-1503-14	ER027C3I	Euro style lead wires, <u>28 in. 70 cm, 3-Ld</u>	IEC	Grabber (type RL)
			ER027C5I	Euro style lead wires, <u>28 in. 70 cm, 5-Ld</u>	IEC	Grabber (type RL)	C9
GE-Medica	 Holter Multi-Link Leadwire Sets -For GE SEER MC Holter Recorder For GE Eagle, Solar, Dash Monitors, Tram, MAC-Lab Cath Lab System, Datex-Ohmeda S/5 FM	416468-001	EW051S5A	Multi-Link Ldwr Set,5-Ld, Snap, V2-V6, <u>AHA</u> , 51 in. (130cm)	AHA (AAMI)	Snap	C5
		E9008KG					
		416468-002	EW051S5I	Multi-Link Ldwr Set, 5Ld, Snap, C2-C6, <u>IEC</u> , 51 in. (130cm)	IEC	Snap	C5
		E9008KH					
	EW051C5I	Multi-Link Ldwr Set, 5Ld, Grabber (Clip), C2-C6, <u>IEC</u> , 51 in. (130cm)	IEC	Grabber (Clip)	C6		

Compatible Philips New ECG Monitoring Cable and Lead System

Compatible Brand	Compatible Models No.	OEM P/N	HNM REF NO.	Description (Name,Length,Plug,Compatible)	INSTRUMENT CONNECTOR	Yoke (Leads side)	PRICE CODE
PHILIPS	M3000A, M3001A, M1001A/B,M1002A/B, 78352C,78354C	M1669A	EDG073-3AI	3Ld Patient Cable,9ft IEC/AAMI, Round 12p>3-LD 1KΩ resistance fit for Philips LeadWires	519 		D9
	M3000A, M3001A, M1001A/B,M1002A/B, 78352C,78354C	M1668A	EDG073-5AI	5Ld Patient Cable,9ft IEC/AAMI, Round 12p>5-LD 1KΩ resistance fit for Philips LeadWires	519 		E5



Compatible Brand	Product Guide	OEM P/N	HNM REF NO.	Description (Name,Length,Leads,)	Color coding / Leads	Patient end termination	PRICE CODE
PHILIPS Compatible M1668A 5-lead trunk cable. Use EDG073-3AI or EDG073-5AI Trunk cable.		M1673A	EDG040S3A	Multi-Link Ldwr, 3-Ld Set-Group, 40 in (102cm)	AHA (AAMI)	Snap	C5
		M1674A	EDG040S3I		IEC	Snap	C5
		M1671A	EDG040C3A		AHA (AAMI)	Grabber (Clip)	C5
		M1672A	EDG040C3I		IEC	Grabber (AA Clip)	C5
		M1644A	EDG040S5A	Multi-Link Ldwr, 5-Ld Set-Group, LA,RA,V=40in(102cm); LL,RL=61in(155cm);	AHA (AAMI)	Snap	C0
		M1645A	EDG040S5I		IEC	Snap	C0
		M1968A	EDG040C5A		AHA (AAMI)	Grabber (Clip)	C0
		M1971A	EDG040C5I		IEC	Grabber (Clip)	C0
GE MARQUETTE			EED051C3A-U	3-LD;51 inches;	IEC	Grabber (Clip)	A0

Compatible Brand	Compatible Models No.	OEM P/N	HNM REF NO.	Description (Name,Length,Plug,Compatible)	INSTRUMENT CONNECTOR	Yoke (Leads side)	PRICE CODE
PHILIPS	78352C, 78354C, 78834C Legacy HP Monitors,Modules M1001A/B,M1002A/B M3001A Opt. C12 or Opt. C18 IntelliVue Multi-Measurement Modules M3002A Opt. C12 MMS X2 M8102A Opt. C12 MP2 Monitor M8105A Opt. C12 MP5 Monitor M3535A/M3536A HeartStar;	M1949A	V DG023-AAI	10-lead ECG trunk cable with 12-pin ECG input connector. AAMI and IEC labels included. Length: 8.9' (2.7m)			E5





8

Dispoisable ECG Lead Wires



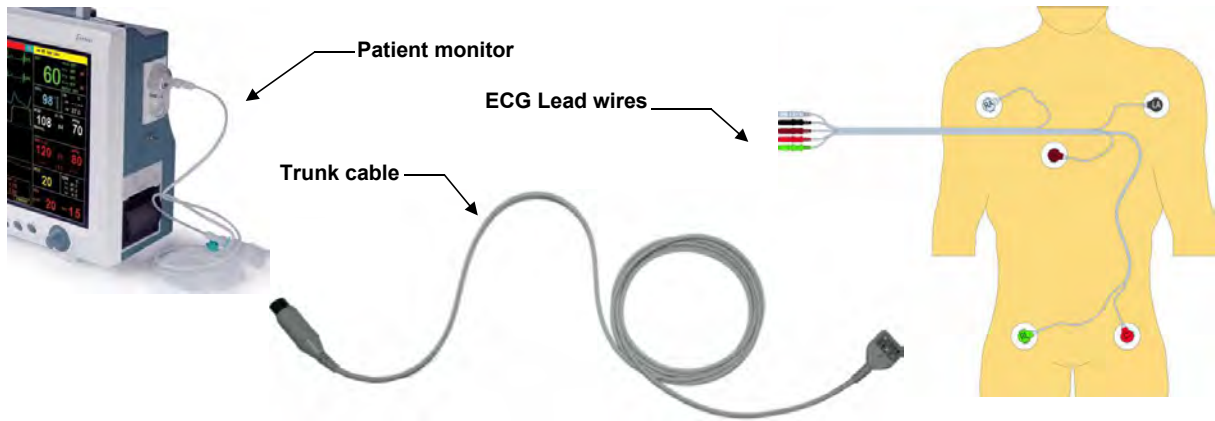





















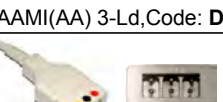

Trunk Cable

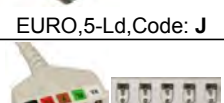

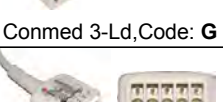
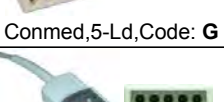

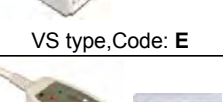
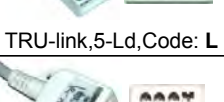









There are so many adapter that can assist the Lead wires to be applied to all monitors.

Disposable ECG Lead wires

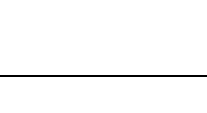
There are not only standard disposable ECG leads (see below picture), but also disposable ECG leads to match with all brands ECG cables directly.

 Din 3-Ld, Code: C	 Din 5-Ld, Code:	 package:24pcs/box	ECD040P3A J6/BOX
 Lifelinc(LL) 3-Ld,Code: B	 Lifelinc(LL),5-Ld,Code:	 package:24pcs/box	ECD040P3I J6/BOX
 ASP 3-Ld,Code: H	 ASP,5-Ld,Code: H	 package:24pcs/box	ECD040P5A N5/BOX
 AAMI(AA) 3-Ld,Code: D	 AAMI(AA),5-Ld,Code:	 package:24pcs/box	ECD040P5I N5/BOX
 EURO 3-Ld,Code: J	 EURO,5-Ld,Code: J	 package:24pcs/box	EJD040P3A L2/BOX
 Conmed 3-Ld,Code: G	 Conmed,5-Ld,Code: G	 package:24pcs/box	EDGD040P3I L2/BOX
 VS type,Code: E	 TRU-link,5-Ld,Code: L	 package:24pcs/box	EDD040P5A O8/BOX
 Philips ECG Yoke: DG	 NK,6-Ld,Code: P	 package:24pcs/box	EED040P5I O8/BOX

Disposable ECG Lead wires

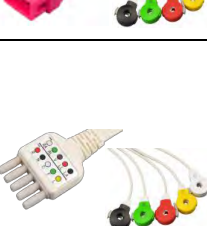
Compatible Brand	Compatible Models No.	OEM P/N	HNM REF NO.	Description	Product picture	PriceCode
PHILIPS			EDGD040P3A	3-LD; 40 inches; AAMI		A6
			EDGD040P3I	3-LD; 40 inches; IEC		A6
			EDGD040P5A	5-LD; 40 inches; AAMI		A8
			EDGD040P5I	5-LD; 40 inches; IEC		A8
GE			EED040P3A	3-LD;40 inches; AAMI		A6
			EED051P5I	5-LD;51 inches; IEC		A8
			EED051P3I	3-LD;51 inches; IEC		A6
SIEMENS			EJD040P3A	3-LD; 40 inches; AAMI		A5
			EJD040P3I	3-LD; 40 inches; IEC		A5
			EJD040P5A	5-LD; 40 inches; AAMI		A7
			EJD040P5I	5-LD; 40 inches; IEC		A7
Hailiyang Medical			ESD050P3A-C	3-LD; 50 inches; AAMI		B2
Covidien			END405P3I	3-LD; 40 inches; IEC		A8
			END405P5I	5-LD; 40 inches; IEC		A0
Compatible with all Din type connector			ECD040P3A	3-LD; 40 inches; AAMI		A5
			ECD040P3I	3-LD; 40 inches; IEC		A5
			ECD040P5A	5-LD; 40 inches; AAMI		A7
			ECD040P5I	5-LD; 40 inches; IEC		A7



9

One-Piece Series EKG Cable with Lead Wires



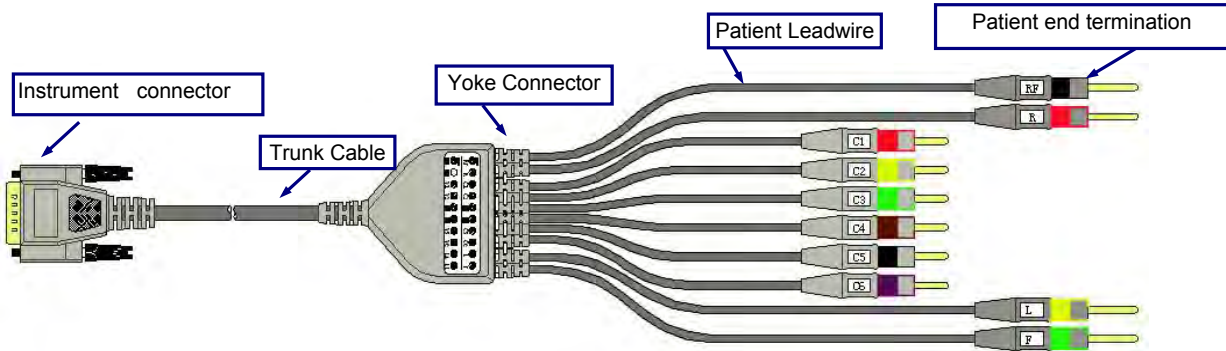

Connector type



Lead Position Marked

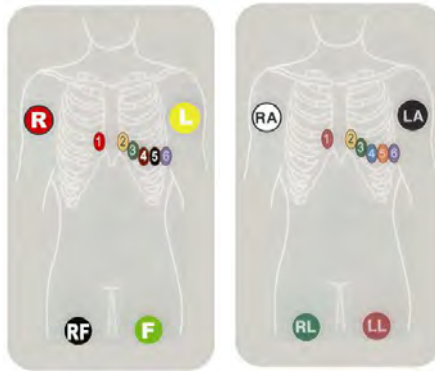

12 Lead: I
Standard IEC

12 Lead: A
Standard AHA

S: Standard Snap



C: Clip (type RL Grabber)



D: Din 3.0



B: Banana 4.0



Type Disignation

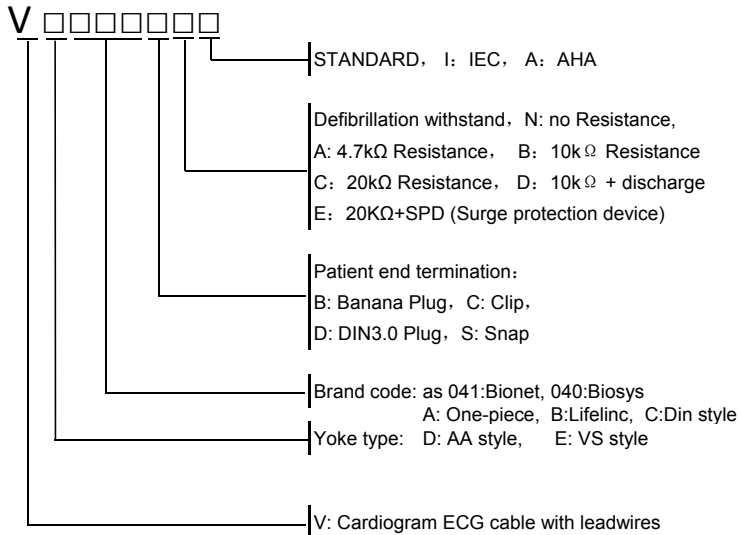

VA010DCI

VA002DNI

VA005BBI

VA016BAI







VA021BDI

VA024DNI









VA025CAI



One-Piece Series EKG Cable With Leads

Compatible Brand	Compatible Models No.	INSTRUMENT CONNECTOR	HNM REF NO.	STANDARD	Defibrillation withstand	PATIENT END TERMINAL	PRICE CODE			
Bosch Cambridge Custo-med DEGO Hellige Siemens Von Berg (hormann)	Bosch: 603 D, 603 ER, 603 S, 606 Cambridge: CM 6000, CM 6400 Custo-med: Custo-card DEGO: Cardiomed 3 Hellige: EK 36, EK41, EK43, EK53, EK56, EK403, EK413, EK512, EK512 E, EK512 P, Cardiosmart, CardioSys, Corna Siemens: Cardiostat1/3T/703/710/31/31S Cardina C, Cardirex 3T/4/6T/62, Cathcor, Megacard Elema A/B, R, R/E, Mingodoc, Mingocard 3/4/7, Mingograph 4/ 62/ 81 Mingograph 82 / 740, Mingolog 7, Mingophon 3/7/310/410/420/710/720, Miracard 1, Sirecard440/440S/460/460S/740 Siereg, Sirecard 803, Sirecust 701 Von Berg: Bioiset3500/3600/3700/6000/8000	291 	VA029CNA	AHA,	No Resistance,	Clip,	E2			
			VA029DNA	AHA,	No Resistance,	Din3.0,	E1			
			VA029BNA	AHA,	No Resistance,	Banana	E2			
			VA029SAA	AHA,	4.7kΩ Resistance,	Snap,	E3			
			VA029DAA	AHA,	4.7kΩ Resistance,	Din3.0	E3			
			VA029CNI	IEC,	No Resistance,	Clip,	E2			
			VA029DNI	IEC,	No Resistance,	Din3.0,	E1			
			VA029BNI	IEC,	No Resistance,	Banana	E2			
			VA029DAI	IEC,	4.7kΩ Resistance,	Din3.0	E3			
			VA029BAI	IEC,	4.7kΩ Resistance,	Banana	E4			
Hellige	Hellige: EK 51	036 	VA011CBA	AHA,	10 kΩ Resistance,	Clip	E4			
			VA011DBI	IEC,	10 kΩ Resistance,	Din3.0	E3			
Avionics(Del Mar) Custo-med Del mar Ergoline Esaote Biomedica Fidelity Innomed Kontron Reynolds Schiller Bionet	Avionics(Del Mar): 910 / 920 / 930 / 940 / 942 / 950 / 960 / 970 / 980 Custo-med: Custo-norm Del mar: 910,920,930,940,942,950, 960,970,980 Ergoline: Autoruler, Autoscript 6/12 Cardiette, EK 3003 / 3012, Ergoline Esaote Biomedica: EKG P120 Fidelity: LP 3000 Innomed: Heart Mirror (3-Kanal) Kontron: EKG P80 Reynolds: Cardiotrack 12 Schiller:AT3, AT5, AT6,AT10, AT60, AT104 PC, AT104, AT101 CS6, CS12,CS100, CS200 Trentina: All Excel-Types Von Berg: Bioiset 9000 Bionet:All models	036  Short Screw	VA021SNA	AHA,	No Resistance,	Snap,	E1			
			VA021BNA	AHA,	No Resistance,	Banana	E2			
			VA021BBA	AHA,	10 kΩ Resistance,	Banana	E4			
			VA021BDA	AHA,	10 kΩ+SPD,	Banana	F0			
			VA021CNI	IEC,	No Resistance,	Clip,	E2			
			VA021BNI	IEC,	No Resistance,	Banana	D5			
			VA021CBI	IEC,	10 kΩ Resistance,	Clip	E4			
			VA021DBI	IEC,	10 kΩ Resistance,	Din3.0	E3			
			VA057BBI	IEC,(2018)	4.7 kΩ Resistance,	Banana	E0			
			VA021BBI	IEC,	10 kΩ Resistance,	Banana	E4			
			VA021BBI							
			Schiller Esaote Biomedica	Schiller: AT-2 Plus, AT1, AT2, AT4, AT101, AT102 Esaote Biomedica: P80, P80Power, P80PowerSix	 9.5mm Long Screw	VA022SBA	AHA,	10 kΩ Resistance,	Snap,	E3
						VA022CBA	AHA,	10 kΩ Resistance,	Clip	E4
VA022DBA	AHA,	10 kΩ Resistance,				Din3.0	E3			
VA022BBA	AHA,	10 kΩ Resistance,				Banana	E4			
VA022SBI	IEC,	10 kΩ Resistance,				Snap,	E3			
VA022CBI	IEC,	10 kΩ Resistance,				Clip	E4			
VA022DBI	IEC,	10 kΩ Resistance,				Din3.0	E3			
VA022BBI	IEC,	10 kΩ Resistance,				Banana	E4			
Schiller	AT101,AT-2 Plus,AT1, AT2, AT4,AT102		9812284 1015	IEC,	No Resistance,	Din3.0,	E0			









One-Piece Series EKG Cable With Leads

Compatible Brand	Compatible Models No.	INSTRUMENT CONNECTOR	HNM REF NO.	STANDARD	Defibrillation withstand	PATIENT END TERMINAL	PRICE CODE
Bosch / dimeq Cambridge Cardioline/Remco Cardionics Hellige Honeywell/Philips: Polymed Schwarzer SECA	Bosch/dimeq: 501A,501NV,503,601 503B,503D,503NV,503V,506,506D, Cambridge: VS 6, SC 1000 Delta 1/3/300/360, E1/E1R /E3 Cardionics: all Models Hellige: Corina. EK 51 Honeywell/Philips: Polymed: Alpha 600 / 800 Schwarzer: VS 6 SECA: 3000	028 	VA004SAA	AHA,	4.7kΩ Resistance,	Snap,	C9
			VA004CAA	AHA,	4.7kΩ Resistance,	Clip	C0
			VA004DAA	AHA,	4.7kΩ Resistance,	Din3.0	C9
			VA004BAA	AHA,	4.7kΩ Resistance,	Banana	C0
			VA004SAI	IEC,	4.7kΩ Resistance,	Snap,	C9
Burdick Quinton ATRIA	BURDICK (QUINTON):Eclipse 4, Eclipse 400,Eclipse 8, Eclipse 800, Eclipse 850, Eclipse 850i, Eclipse Plus, Eclipse LE II BURDICK with serial number starting with 1067 or 92304 ATRIA: ATRIA PLUS, ATRIA3000	162 	VA005CBA	AHA,	10 kΩ Resistance,	Clip	E4
			VA005DBA	AHA,	10 kΩ Resistance,	Din3.0	E3
			VA005BBA	AHA,	10 kΩ Resistance,	Banana	E4
			VA005CBI	IEC,	10 kΩ Resistance,	Clip	E4
			VA005DBI	IEC,	10 kΩ Resistance,	Din3.0	E3
			VA005BBI	IEC,	10 kΩ Resistance,	Banana	E4
Burdick	EK-10 Burdick: Elite, Elite II, E-350, E550, E560, (1st Generation Eclipse LE/LEi, with serial number starting with 1051).	039 	VA002CNA	AHA,	No Resistance,	Clip,	C7
			VA002BNA	AHA,	No Resistance,	Banana	C7
			VA002SNI	IEC,	No Resistance,	Snap,	C6
			VA002CNI	IEC,	No Resistance,	Clip,	C7
			VA002DNI	IEC,	No Resistance,	Din3.0,	C6
	Burdick Quinton Eclipse 4, 8, 400, 800, 850, Plus and Elite II, ATRIA Plus Quinton. Burdick #007705, Stress cable with detachable leads 007706 Fukuda Denshi: Alpha 500 / 600, FCP 2201	028 	VA004SAA	AHA,	4.7kΩ Resistance,	Snap,	C9
			VA004CAA	AHA,	4.7kΩ Resistance,	Clip	C0
			VA004DAA	AHA,	4.7kΩ Resistance,	Din3.0	C9
			VA004BAA	AHA,	4.7kΩ Resistance,	Banana	C0
			VA004SAI	IEC,	4.7kΩ Resistance,	Snap,	C9
EDAN	SE-12 Express SE-3 SE-601A	038 	VA030SBA	AHA,	10 kΩ Resistance,	Snap,	C9
			VA030CBA	AHA,	10 kΩ Resistance,	Clip	C0
			VA030DBA	AHA,	10 kΩ Resistance,	Din3.0	C9
			VA030BBA	AHA,	10 kΩ Resistance,	Banana	C0
			VA030CBI	IEC,	10 kΩ Resistance,	Clip	C0
			VA030DBI	IEC,	10 kΩ Resistance,	Din3.0	C9
	VA030BBI	IEC,	10 kΩ Resistance,	Banana	C0		
SE-3		VA050BBA	AHA,	10kΩ Resistance,	Banana	C0	
Fukuda Denshi	Fukuda Denshi Autocardiner, Cardimax FX-2111 / FX-3010 / FX-4010, FCP-2155	034 	VA017BAA	AHA,	4.7kΩ Resistance,	Banana	C0
			VA017DAI	IEC,	4.7kΩ Resistance,	Din3.0	C9
			VA017BAI	IEC,	4.7kΩ Resistance,	Banana	C0
FUKUDA ME	KP-500	165 	VA024CNA	AHA,	No Resistance,	Clip,	E0
			VA024BNA	AHA,	No Resistance,	Banana	E0
			VA024SNI	IEC,	No Resistance,	Snap,	E9
			VA024CNI	IEC,	No Resistance,	Clip,	E0
			VA024DNI	IEC,	No Resistance,	Din3.0,	E9
	KP-500D		VA024SEA	AHA,	20kΩ+discharge,	Snap,	F5
			VA024CEA	AHA,	20kΩ+discharge,	Clip,	F6
			VA024DEA	AHA,	20kΩ+discharge,	Din3.0,	F5
			VA024SEI	IEC,	20kΩ+discharge,	Snap,	F5
			VA024CEI	IEC,	20kΩ+discharge,	Clip,	F6
VA024DEI	IEC,	20kΩ+discharge,	Din3.0,	F5			









One-Piece Series EKG Cable With Leads

Compatible Brand	Compatible Models No.	INSTRUMENT CONNECTOR	HNM REF NO.	STANDARD	Defibrillation withstand	PATIENT END TERMINAL	PRICE CODE
FUKUDA ME	FX-031		VA014SNA	AHA,	No Resistance,	Snap,	E9
			VA014CNA	AHA,	No Resistance,	Clip,	E0
			VA014SNI	IEC,	No Resistance,	Snap,	E9
			VA014CNI	IEC,	No Resistance,	Clip,	E0
			VA014DNI	IEC,	No Resistance,	Din3.0,	E9
	Fukuda M-E: Cardisuny alpha 1000, Cardisuny alpha 6600 A / 6600 AX		VA004SAA	AHA,	4.7kΩ Resistance,	Snap,	C9
			VA004CAA	AHA,	4.7kΩ Resistance,	Clip	C0
			VA004DAA	AHA,	4.7kΩ Resistance,	Din3.0	C9
			VA004BAA	AHA,	4.7kΩ Resistance,	Banana	C0
			VA004SAI	IEC,	4.7kΩ Resistance,	Snap,	C9
KANZ PC-104, Cardioline remco	Kanz: 103, 106 Cardioline/remco: delta 1,3,30,60 delta 1 plus, delta 3 plus, delta 60 plus		VA016CNA	AHA,	No Resistance,	Clip,	E3
			VA016DNA	AHA,	No Resistance,	Din3.0,	E2
			VA016BNA	AHA,	No Resistance,	Banana	E3
			VA016SAA	AHA,	4.7kΩ Resistance,	Snap,	E4
			VA016CAA	AHA,	4.7kΩ Resistance,	Clip	E5
			VA016SNI	IEC,	No Resistance,	Snap,	E2
			VA016DNI	IEC,	No Resistance,	Din3.0,	E2
			VA016BNI	IEC,	No Resistance,	Banana	D5
			VA016BAI	IEC,	4.7kΩ Resistance,	Banana	E5
Kanz PC-109	ECG 108/110/1203,1205		VA015SNA	AHA,	No Resistance,	Snap,	C9
			VA015CNA	AHA,	No Resistance,	Clip,	C0
			VA015BNA	AHA,	No Resistance,	Banana	C0
			VA015CNI	IEC,	No Resistance,	Clip,	C0
			VA015DNI	IEC,	No Resistance,	Din3.0,	C9
			VA015BNI	IEC,	No Resistance,	Banana	C0
Marquette (GEMS)	Hellige: MicroSmart, MAC 500 / 1100 MAC 1600 / 1200 / 1200 ST		VA008CBA	AHA,	10 kΩ Resistance,	Clip	C0
			VA008BBA	AHA,	10 kΩ Resistance,	Banana	C0
			VA008BBI	IEC,	10 kΩ Resistance,	Banana	C0
MEDICAL RESEARCH LABS (MRL)	MEDICAL RESEARCH LABS (MRL): Portable Intensive Care (PIC) System		VA012SBA	AHA,	10 kΩ Resistance,	Snap,	F5
			VA012CBA	AHA,	10 kΩ Resistance,	Clip	F6
			VA012DBA	AHA,	10 kΩ Resistance,	Din3.0	F5
			VA012BBA	AHA,	10 kΩ Resistance,	Banana	F6
			VA012SBI	IEC,	10 kΩ Resistance,	Snap,	F5
			VA012CBI	IEC,	10 kΩ Resistance,	Clip	F6
			VA012DBI	IEC,	10 kΩ Resistance,	Din3.0	F5
VA012BBI	IEC,	10 kΩ Resistance,	Banana	F6			
MEDTRONIC PHYSIO CONTROL	MEDTRONIC PHYSIO CONTROL: Lifepak 12		VA013SBA	AHA,	10 kΩ Resistance,	Snap,	F5
			VA013CBA	AHA,	10 kΩ Resistance,	Clip	F6
			VA013DBA	AHA,	10 kΩ Resistance,	Din3.0	F5
			VA013BBA	AHA,	10 kΩ Resistance,	Banana	F6
			VA013SBI	IEC,	10 kΩ Resistance,	Snap,	F5
			VA013DBI	IEC,	10 kΩ Resistance,	Din3.0	F5
Mindray	BeneView (12-Ld module) Oem p/n:0010-30-42721 (AAMI std.) Oem p/n:0010-30-42722 (IEC std.)		VA020SBA	AHA,	1 kΩ Resistance,	Snap,	D9
			VA020CBA	AHA,	1 kΩ Resistance,	Clip	D0
			VA020DBA	AHA,	1 kΩ Resistance,	Din3.0	D9
			VA020BBA	AHA,	1 kΩ Resistance,	Banana	D0
			VA020SBI	IEC,	1 kΩ Resistance,	Snap,	D9
			VA020CBI	IEC,	1 kΩ Resistance,	Clip	D0
			VA020DBI	IEC,	1 kΩ Resistance,	Din3.0	D9

One-Piece Series EKG Cable With Leads

Compatible Brand	Compatible Models No.	INSTRUMENT CONNECTOR	HNM REF NO.	STANDARD	Defibrillation withstand	PATIENT END TERMINAL	PRICE CODE			
MORTARA	MORTARA INSTRUMENT:ELI 100 MORTARA INSTRUMENT:ELI 50 MORTARA INSTRUMENT:ELI 200		VA025SAA	AHA,	4.7kΩ Resistance,	Snap,	E9			
			VA025BAA	AHA,	4.7kΩ Resistance,	Banana	E0			
			VA025SAI	IEC,	4.7kΩ Resistance,	Snap,	E9			
			VA025CAI	IEC,	4.7kΩ Resistance,	Clip	E0			
			VA025DAI	IEC,	4.7kΩ Resistance,	Din3.0	E9			
			VA025BAI	IEC,	4.7kΩ Resistance,	Banana	E0			
	Martara Surveyor		223	VA035SBI	IEC,	10 kΩ Resistance,	Snap,	F0		
NEC	YY-1063		VA003SBA	AHA,	10 kΩ Resistance,	Snap,	F9			
			VA003CBA	AHA,	10 kΩ Resistance,	Clip	F0			
			VA003DBA	AHA,	10 kΩ Resistance,	Din3.0	F9			
			VA003BBA	AHA,	10 kΩ Resistance,	Banana	F0			
			VA003SBI	IEC,	10 kΩ Resistance,	Snap,	F9			
			VA003CBI	IEC,	10 kΩ Resistance,	Clip	F0			
			VA003DBI	IEC,	10 kΩ Resistance,	Din3.0	F9			
			VA003BBI	IEC,	10 kΩ Resistance,	Banana	F0			
Nihon Kohden Biocare DongJiang	Nihon Kohden: ECG-9620/9010/9020 ECG-9022/9110/9130/9132/ ECG-8420(Except 9320) 1150/1250/1350/1550/9010 K BIOCARE: ECG-101/101G/300 ECG-300G,ECG-1200, ECG-9803. CMICS: ECG-11A, ECG-11B,ECG-11D ECG-32A, ECG-32A(II), ECG-120	 Long Screw	VA001SNA	AHA,	No Resistance,	Snap,	C3			
			VA001CNA	AHA,	No Resistance,	Clip,	C3			
			VA001DNA	AHA,	No Resistance,	Din3.0,	C2			
			VA001BNA	AHA,	No Resistance,	Banana	C3			
			VA001SNI	IEC,	No Resistance,	Snap,	B0			
			VA001CNI	IEC,	No Resistance,	Clip,	B0			
			VA001DNI	IEC,	No Resistance,	Din3.0,	B0			
			VA001BNI	IEC,	No Resistance,	Banana	B0			
			Nihon Kohden	BSM-2301,BSM-2353, BSM-5100, Supply Code No. K901 Article No.BJ-900P		VA036SNI	IEC,	No Resistance,	Snap,	F1
						VA036CNI	IEC,	No Resistance,	Clip,	F2
Nihon Kohden: Cardiofax6151/6353, Cardiofax EKG-8270/8350/8370/8420 8423/8450/8453/8820/8823/8830/9130 1150/1250/1350/1550/9010 K Cardiofax-Q		VA001CAA		AHA,	4.7kΩ Resistance,	Clip	C0			
		VA001DAA		AHA,	4.7kΩ Resistance,	Din3.0	C9			
		VA001BAA		AHA,	4.7kΩ Resistance,	Banana	C0			
		VA001SAI		IEC,	4.7kΩ Resistance,	Snap,	C9			
		VA001DAI		IEC,	4.7kΩ Resistance,	Din3.0	C9			
		VA001BAI		IEC,	4.7kΩ Resistance,	Banana	C0			
Cardiofax Q ECG-9110K Cardiofax Q ECG-9130K ECG-9130P, ECG-9620P special screw, imperial standard(SAE)	Note: partnumber with 001 is Long Screw, and with 009 is Short Screw;	VA009SNA		AHA,	No Resistance,	Snap,	C3			
		VA009BNA		AHA,	No Resistance,	Banana	C3			
		VA009DNI	IEC,	No Resistance,	Din3.0,	C2				
		VA009BNI	IEC,	No Resistance,	Banana	C3				
ECG-9320 ECG-9522P (Original part No.: BR-911D)		VA010SCA	AHA,	20 kΩ Resistance,	Snap,	J0				
		VA010CCA	AHA,	20 kΩ Resistance,	Clip	J0				
		VA010DCA	AHA,	20 kΩ Resistance,	Din3.0	J0				
		VA010BCA	AHA,	20 kΩ Resistance,	Banana	J0				
		VA010SCI	IEC,	20 kΩ Resistance,	Snap,	J0				
		VA010CCI	IEC,	20 kΩ Resistance,	Clip	J0				
		VA010DCI	IEC,	20 kΩ Resistance,	Din3.0	J0				
		VA010BCI	IEC,	20 kΩ Resistance,	Banana	J0				
PETAS		VA023SNA	AHA,	No Resistance,	Snap,	E9				
		VA023CNA	AHA,	No Resistance,	Clip,	E0				
		VA023DNA	AHA,	No Resistance,	Din3.0,	E9				
		VA023BNA	AHA,	No Resistance,	Banana	E0				
		VA023SNI	IEC,	No Resistance,	Snap,	E9				
		VA023CNI	IEC,	No Resistance,	Clip,	E0				
		VA023DNI	IEC,	No Resistance,	Din3.0,	E9				
		VA023BNI	IEC,	No Resistance,	Banana	E0				

One-Piece Series EKG Cable With Leads

Compatible Brand	Compatible Models No.	INSTRUMENT CONNECTOR	HNM REF NO.	STANDARD	Defibrillation withstand	PATIENT END TERMINAL	PRICE CODE
PHILIPS (HP)	PHILIPS MEDICAL SYSTEMS: M1770A PageWriter 200i , M1771A PageWriter 200 M1772A PageWriter 100	035 	VA018BCA	AHA,	20 kΩ Resistance,	Banana	C0
			VA018BCI	IEC,	20 kΩ Resistance,	Banana	C0
			VA018SCI	IEC,	20 kΩ Resistance,	Snap.	C0
Spacelabs	90496 Ultraview Module	022 	VA027SBA	AHA,	1 kΩ Resistance,	Snap,	F5
			VA027CBA	AHA,	1 kΩ Resistance,	Clip	F6
			VA027DBA	AHA,	1 kΩ Resistance,	Din3.0	F5
			VA027BBA	AHA,	1 kΩ Resistance,	Banana	F6
			VA027SBI	IEC,	1 kΩ Resistance,	Snap,	F5
			VA027CBI	IEC,	1 kΩ Resistance,	Clip	F6
			VA027DBI	IEC,	1 kΩ Resistance,	Din3.0	F5
			VA027BBI	IEC,	1 kΩ Resistance,	Banana	F6
Shanghai Konde ZhonLian JianYi	ShangHai Kohden: ECG-6511, 6151, 6551, 8110P/K, 6353, 6403, 6504 JIANYI: XD-106,XD-104B/D	028 	VA004SNA	AHA,	No Resistance,	Snap,	C3
			VA004CNA	AHA,	No Resistance,	Clip,	C3
			VA004DNA	AHA,	No Resistance,	Din3.0,	C2
			VA004BNA	AHA,	No Resistance,	Banana	C3
			VA004SNI	IEC,	No Resistance,	Snap,	C3
			VA004CNI	IEC,	No Resistance,	Clip,	C3
			VA004DNI	IEC,	No Resistance,	Din3.0,	C2
			VA004BNI	IEC,	No Resistance,	Banana	C3
Trentina:	All Excel-Types 	294 	VA031SNI	IEC,	No Resistance,	Snap,	F1
			VA031CNI	IEC,	No Resistance,	Clip,	F2
			VA031DNI	IEC,	No Resistance,	Din3.0,	F1
			VA031BNI	IEC,	No Resistance,	Banana	F2
PHILIPS (HP)	TC30 & TC50, TC70 	OEM P/N:989803151631 	VA051BNA	AHA,	No Resistance,	Banana	D0
			VA051BNI	IEC,	No Resistance,	Banana	D0
ZOLL		477 	VA034BBI	IEC,	10 kΩ Resistance,	Banana	F0
			VA034SBI	IEC,	10KΩ Resistance,	Snap	F0
			VA034SBA	AHA ,	10KΩ Resistance,	Snap	F0
			VA034CBI	IEC,	10KΩ Resistance,	Grabber	G1

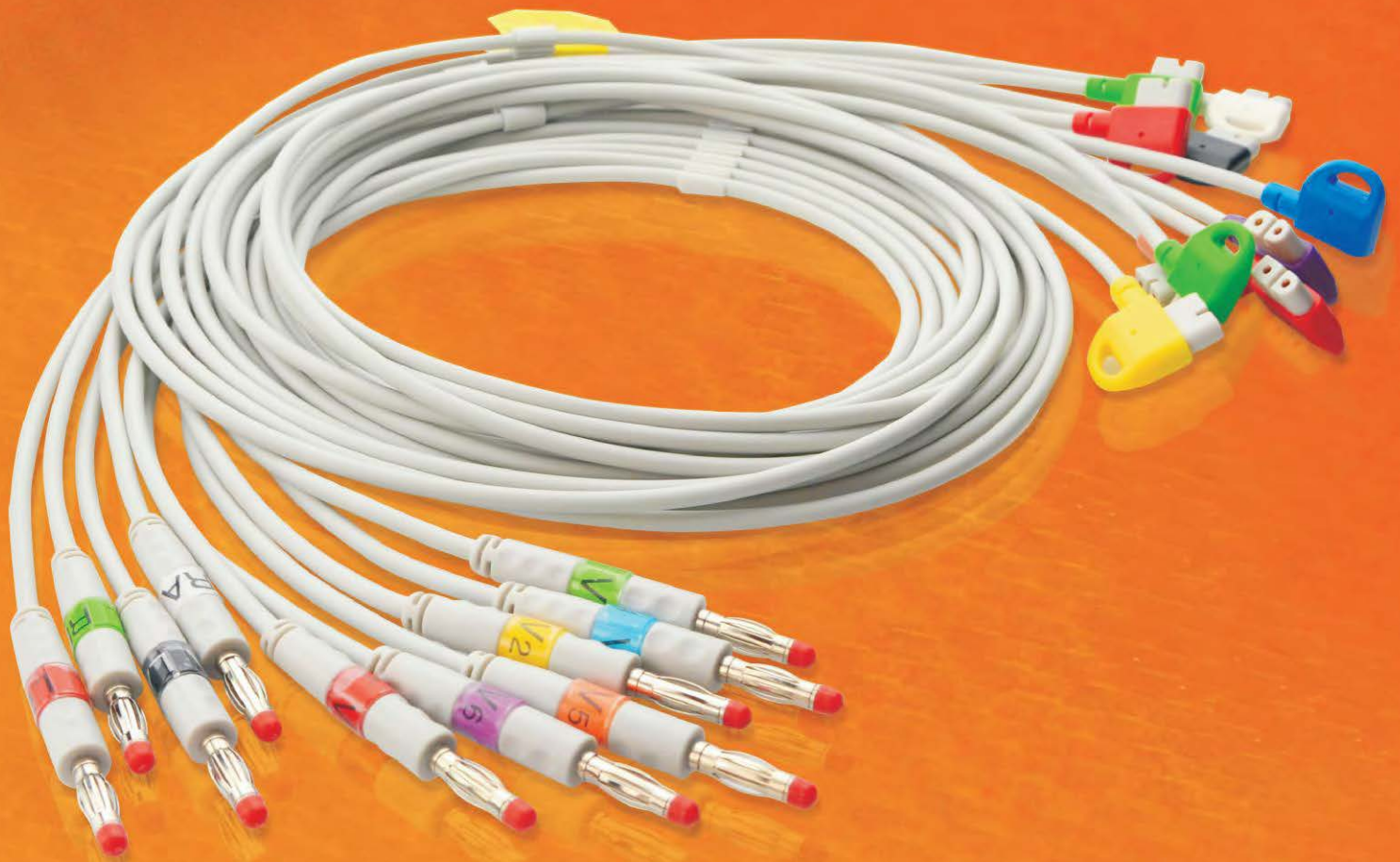



















10









EKG Multi-Link Cable and Lead Wires





EKG Multi-link Cable and Lead wires

Compatible Brand	Compatible Models No.	OEM P/N	HNM REF NO.	Description (Name,Length,Plug,Standard)	INSTRUMENT CONNECTOR	Yoke	PRICE CODE
Fukuda			VJ032-EAI	12-Lead ECG Trunk Cable, 12pin>>2p*10 Euro Yoke, L=2.2m, AAMI/IEC , 20kΩ Res.+discharge Fit Euro type leadwires			E0
	FUKUDA DENSHI Fukuda Denshi DYNASCOPE DS-8500 CIO-05CTP-10NU		VJ200-EAI	10LD EKG Trunk Cable, L=2.2m 15pin>>Euro 10LD Eoru Yoke, no resistance AHA/IEC,fit for Euro style Lead Wires as EJ040S5A and VJ040S5A			O0
Hellige GE-Marquette	MicroSmart, MAC 500 / 1100 / 1200 / 1200 ST	223 418 08	VE008-BAI	MAC1200 10Ld EKG Trunk Cable, L=2.2m, DB15M>VS 10L Yoke AAMI/IEC , 10kΩ Res.			C0
GE-Medical	For GE Eagle, Solar, Dash , Tram, MAC-Lab Cath Lab System, Datex-Ohmeda S/5 FM, Original P/N: (AAMI: E9002ZH, 416035-001) (IEC: E9002ZJ, 416035-002)		VE006-BAI	Multi-Link 12-Ld ECG cable L=2.2m, Rectangle 11p>VS 10L Yoke AAMI/IEC , 1kΩ Res.			D5
Avionics(Del Mar) Custo-med Del mar Ergoline Esaote Biomedica Fidelity Innomed Kontron Reynolds Schiller Trentina (Ellettronica) Von Berg Bionet Welch allyn,	Avionics(Del Mar) : 910/920/930 /940/942/950/960/970/980 , Custo-med : Custo-norm, Ergoline : Autoruler, Autoscript 6/12, Cardiette, EK 3003 / 3012, Ergoline; Esaote Biomedica : EKG P120, Fidelity : LP 3000, Innomed : Heart Mirror(3-Kanal), Kontron : EKG P80, Reynolds : Cardiotrack 12, Schiller : AT3, AT5, AT6,AT10, AT60, AT104 PC, AT104, CS6, CS12,CS100, CS200 Trentina : All Excel-Types, Von Berg: Bioset 9000		VE021-NAI	Schiller 10Ld EKG Trunk Cable,L=2.2m DB15M>VS 10L Yoke AAMI/IEC , no Res.			D3
Mindray	PM-7000/PM-9000Super/PM-9000Express (12 LEAD ECG MODULE) BeneView Oem p/n:0010-30-42721 (AAMI) Oem p/n:0010-30-42722 (IEC)	0010-30-42721	VE020-BAI	Mindray 10Ld EKG Trunk Cable,L=2.2m Round 12p>VS 10L Yoke AAMI/IEC , 1kΩ Res.			D5
Spacelabs	TRU-LINK Accessories for 90496 Module	700-0008-01	VE027-BAI	Spacelabs 10Ld EKG Trunk Cable,L=2.2m Round 17p>VS 10L Yoke AAMI/IEC , 1 kΩ Res.			D5
GEMS	MAC 5000 CAM14	201656 0-001	VF008-N	GE CAM 14 ext-cable, 50in. (130cm)			L0
			VF008-15	GE CAM 14 ext-cable, 15ft (450cm).			O0
Philips	XLI M1719A		V0018D	Philips DB9M Trunk Cable+ Philips DB9M Trunk Cable, 8.5ft (260cm),1pcs/pk			F0/pk



LEAD WIRES

Compatible Brand	Compatible Models No.	OEM P/N	HNM REF NO.	Description (Name,Length,Plug.)	Color coding Standard	Patient end termination	PRICE CODE
Hellige GE-Marquette  140	suitable for all MultiLink-Plug System 	384 018 16	VE008SNA	10-Ld Set patient leads, 4 x limb lead (130cm), 6 x chest leads (70cm), , no Resistance, VS-2P plug	AHA (AAMI)	Snap	C5
			VE008BNA		AHA (AAMI)	Banana	C5
			VE008SNI		IEC	Snap	C5
			VE008CNI		IEC	Grabber (Clip)	C0
			VE008BNI		IEC	Banana	C5
GE medical  136	For GE MAC PC, MAC 6, MAC 12, MAC 15, MAC VU, CASE 12, CASE 15, CASE 16, MAX-Personal, MAX-1, CENTRA Systems with AM4 or AM5 Acquisition Module 		VF008SNA	10-Ld Set patient leads, 4 x limb lead (130cm), 6 x chest leads (70cm), , no Resistance, L-2P plug	AHA (AAMI)	Snap	D5
			VF008CNA		AHA (AAMI)	Grabber (Clip)	D5
			VF008DNA		AHA (AAMI)	Din 3.0 plug	D5
			VF008SNI		IEC	Snap	D5
			VF008CNI		IEC	Grabber (Clip)	D5
CONMED JINJIANG  325	Cardio Beats Jinjiang Electronic Tech instrument: LEAD2000, GE electrophysiology machine 		VG019SNA	10-Ld Set patient leads, 4 x limb lead (130cm), 6 x chest leads (70cm), , no Resistance, 2P plug	AHA (AAMI)	Snap	D5
			VG019DNA		AHA (AAMI)	Din 3.0 plug	D5
			VG019CNI		IEC	Grabber (Clip)	D5
			VG019DNI		IEC	Din 3.0 plug	D5
			VG019BNI		IEC	Banana	D5
PHILIPS medical  552	Use with Philips Instrument M1700A M1701A M1702A; TRIM II, Trim 1, 2, 3 	M1713B	VX018BNA		AHA (AAMI)	Banana	D5
		9898031 29191	VX018BNI		IEC	Banana	D5

EKG Multi-link Cable and Lead wires

Compatible Brand	Compatible Models No.	OEM P/N	HNM REF NO.	Description (Name,Length,Plug,)	Color coding Standard	Patient end termination	PRICE CODE
Fukuda	 541		VJ040S5A	Euro style Lead wire Set, 5-Ld, 40in.(102), (V2, V3, V4, V5, V6)	AHA (AAMI)	Snap	C0
			VJ040S5I	Euro style Lead wire Set, 5-Ld, 40in.(102), _ (C2, C3, C4, C5, C6)	IEC	Snap	C0
			VJ040C5I	5Ld, L=100cm	IEC	Grabber (Clip)	C0
Mortara	Mortara 250C 		VT047BNI	10-Ld Set patient leads, 4 x limb lead (120cm), 6 x chest leads (80cm), no Resistance, 2P plug	IEC	Banana	D5
			VT047CNI	12-Ld Set Patient Leads, Grabber (Clip), IEC	IEC	Grabber (Clip)	D5
			VT047SNI	12-Ld Set Patient Leads, Snap, IEC	IEC	Snap	D5
PHILIPS Compatible M1663A or M1949A 10-lead trunk cable.		M1644A +M1602 A	VDG040SNA	5+5 Lead Sets, Length:1m, Lead mark: AAMI: (RL,LA,LL,RA,V) + (V2,V3,V4,V5,V6;) IEC: (N, L, F, R, C) + (C2,C3,C4,C5,C6;)	AHA (AAMI)	Snap	E5
		M1645A +M1604 A	VDG040SNI		IEC	Snap	E5
		M1968A +M1976 A	VDG040CNA		AHA (AAMI)	Grabber (Clip)	E5
		M1971A +M1978 A	VDG040CNI		IEC	Grabber (Clip)	E5

ADAPTER

Compatible Brand	Compatible Models No.	OEM P/N	HNM REF NO.	Description (Name,Length,Plug,)	Productor Guide	PRICE CODE
Hellige GE-Marquette	For GE MAC 1100/1200/1200ST, CardioSmart, CardioSys, MAC 5000, MAC 5000ST, CASE, CASE 8000 Systems with CAM 14 Acquisition Module or with Cable Accepting CAM 14 Leadwires	E9006PH	VE008A20	Leadwire,CAM/Universal, 20in.(51cm),6pcs/pk	 140 143	C4/pk
		E9006PJ	VE008A29	Leadwire,CAM/Universal, 29in.(74cm),6pcs/pk		C4/pk
		E9006PK	VE008A40	Leadwire,CAM/Universal, 40in.(102cm),6pcs/pk		C4/pk
		E9006PL	VE008A51	Leadwire,CAM/Universal, 51in.(130cm),4pcs/pk		C4/pk
		E9006P M	VE008A26	Leadwire,CAM/Universal, 26in.(66cm),6pcs/pk		C4/pk
		E9006PN	VE008A36	Leadwire,CAM/Universal, 36in.(90cm),6pcs/pk		C4/pk
Hellige GE-Marquette	For GE MAC PC, MAC 6, MAC 12, MAC 15, MAC VU, CASE 12, CASE 15, CASE 16, MAX-Personal,MAX-1, CENTRA Systems with AM4 or AM5 Acquisition Module	E9001ZT	VF008A24	Leadwire,AM4/Universal, 24 in.(60cm),6pcs/pk	 136 143	C4/pk
		E9001ZY	VF008A36	Leadwire,AM4/Universal, 36 in.(90cm),6pcs/pk		C4/pk
		E9001ZZ	VF008A42	Leadwire,AM4/Universal, 42 in.(107cm),6pcs/pk		C4/pk
		E9002A	VF008A52	Leadwire,AM4/Universal, 52 in.(132cm),4pcs/pk		C4/pk



11

ECG Electrodes



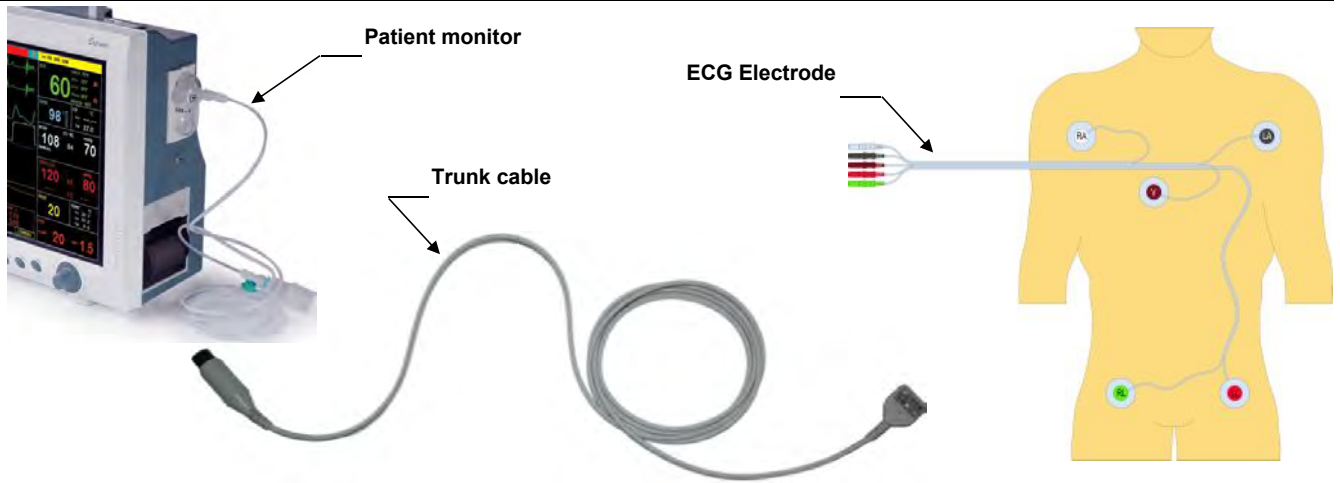

Trunk Cable

There are so many adapter that can assist the electrodes to be applied to all monitors.

Disposable ECG Electrode

There are not only standard disposable electrodes (see below picture), but also electrodes to match with all brands ECG cables directly.

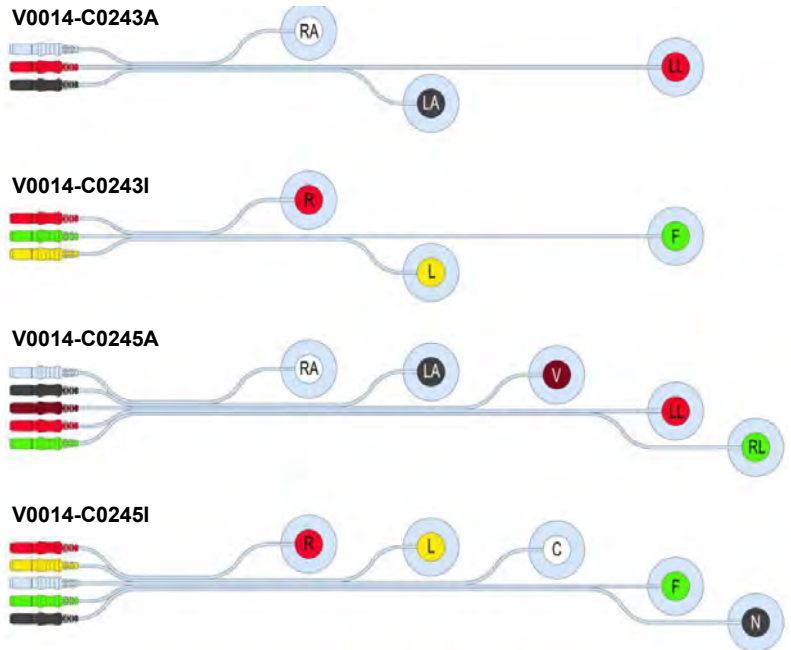

 Din 3-Ld, Code: C	 Lifelinc(LL),5-Ld,Code: B
 ASP,3-Ld,Code: H	 AAMI(AA),5-Ld,Code: D
 EURO,3-Ld,Code: J	 Conmed,5-Ld,Code: G
 VS,5-Ld,Code: E	 TRU-link,5-Ld,Code: L
 Philips ECG Yoke: DG	 NK,5-Ld,Code: N

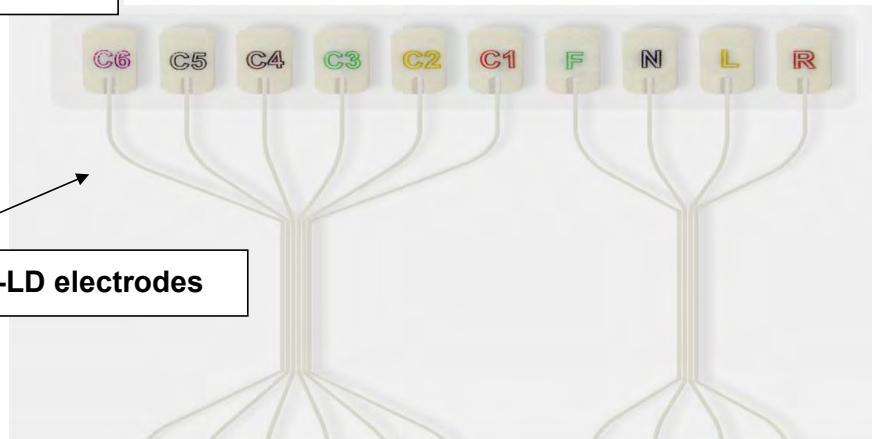

Neonates Disposable 10-LD electrodes







Disposable ECG Electrodes

Compatible Brand	HNM P/N.	Color code	LEADS	Description	Length	Packing	PRICE CODE
According to the yoke of trunk cable, use for E.C.G. monitoring Paediatric monitoring	V0014-C0243A	AAMI	3LD	Microfoam paster, Solid Gel, Preattached Leadwires, Copper wires,	610mm	1 set/bag; 25 set/box,	F5 / box
	V0014-C0243I	IEC	3LD		610mm		F5 / box
	V0014-C0245A	AAMI	5LD		610mm		J5 / box
	V0014-C0245I	IEC	5LD		610mm		J5 / box
Osypka ICON hemodynamic monitor	V0014A-C0234I	IEC	4LD		610mm	250pcs /box	A8 /PCS
According to the yoke of trunk cable, use for E.C.G. monitoring Paediatric monitoring	V0015-C0603A	AAMI	3LD	Microfoam paster, Solid Gel, Preattached Leadwires, Carbon wires for radiotransparent applications	1524mm	1 set/bag; 25 set/box	F0 / box
	V0015-C0603I	IEC	3LD		1524mm		F0 / box
	V0015-C0845A	AAMI	5LD		2133mm		J0 / box
	V0015-C0845I	IEC	5LD		2133mm		J0 / box
	V0015-C0243I	IEC	3LD	Carbon fiber conductive material,Radiotransparent	610mm	1 set/bag; 25 set/box,	F0/ box
Compatible Brand	Product Guide	OEM P/N	HNM REF NO.	Description	Price Code		
All Monitoring/ Telemetry/ Electrocardiograph instrument		GEMS OEM P/N: E9001BG	V0014C/P	Disposable Paediatric ECG Electrodes, Cloth Round, 40mm diameter, wet gel, snap electrode. Silver/silver chloride (Ag/AgCl) sensor, repositionable. – packaging (film/disc): 1000pcs	J0		
		GEMS P/N: E9007SG	V0014A	Disposable Adult ECG Electrodes, Cloth Round, 2"(50mm) diameter, wet gel, snap electrode. Silver/silver chloride (Ag/AgCl) sensor, repositionable. – packaging (film/disc): 1000pcs	J0		
			V0014D	Silver/silver chloride (Ag/AgCl) sensor, repositionable.	J0		







ECG Electrodes

Cardiography Reuseble ECG Electrodes



● Suction ECG electrodes

Compatible Brand	Productor Guide	OEM P/N	HNM REF NO.	Description	Price Code
All Resting ECG Recommended for Nihon Konden, GE, Philips		Nihon konden: H043	V0013AB	Adult suction electrode, – perfect fit for 3.0mm Din plug or 0.156-in.(4mm) banana plug – Latex-free, – Adult size replacement bulb for all 21mm diameter electrodes. Bulb diameter is 26mm. – Metal Electrodes: Nickel-plate. – 1 box = 6 bulbs	A0/box
			V0013A-P	Paediatric suction electrode, – perfect fit for 3.0mm Din plug leadwires – Latex-free, – Adult size replacement bulb for all 17mm diameter electrodes. Bulb diameter is 23mm. – Metal Electrodes: Nickel-plate. – 1 box = 6 bulbs	A0/box
All Resting ECG Recommended for Nihon Konden, GE, Philips			V0013B-P	Paediatric suction electrode, – perfect fit for 0.156-in.(4mm) banana plug leadwires – Latex-free – Adult size replacement bulb for all 17mm diameter electrodes. Bulb diameter is 23mm. – Metal Electrodes: Nickel-plate. – 1 box = 6 bulbs	A0/box
		HP OEM ON:40419A	V0013C-A	Adult suction Ag/AgCl electrode, – perfect fit for 3.0mm Din plug or 0.156-in.(4mm) banana plug or (4mm)Snap leadwires – Adult size replacement bulb for all 24mm diameter electrodes. Bulb volume is 5cc.(dia.27mm) – Metal Electrodes: Ag/AgCl. – 1 box = 6 bulbs	B5/box
All Resting ECG Recommended for GE-Marquette, Schiller, Mortala, Burdick, Philips	203				
		HP OEM ON:40422A	V0013C-P	Paediatric suction Ag/AgCl electrode, – perfect fit for 3.0mm Din plug or 0.156-in.(4mm) banana plug or (4mm)Snap leadwires – Adult size replacement bulb for all 17mm diameter electrodes. Bulb volume is 2cc. (dia.23mm) – Metal Electrodes: Ag/AgCl. – 1 box = 6 bulbs	B5/box

● Limb Clamp ECG Electrodes

all Resting ECG Recommended for Nihon Konden, Fukuda, NEC, Kenz, China		Nihon konden: H068K	V0012A	Limb clamp electrode, clothespin type – perfect fit for 3.0mm Din plug leads – Metal Electrodes: Nickel-plate. – 1 box = 4 electrodes – Color coding: IEC, red(R), yellow(L), black(RF), green(F)	A8/box
			V0012B-I	Limb clamp electrode, clothespin type perfect fit for 0.156-in.(4mm) banana plug leads – Metal Electrodes: Nickel-plate.. – 1 box = 4 electrodes – Color coding:IEC, red(R), yellow(L), black(RF), green(F)	A8/box
			V0012B	Limb clamp electrode, clothespin type – perfect fit for 0.156-in.(4mm) banana plug leadwires – Metal Electrodes: Nickel-plate. – 1 box = 4 electrodes – Color coding:AHA,white(RA), black(LA), green(RL), red(LL)	A8/box
all Resting ECG Recommended for GE-Marquette, Schiller, Bionet, Mortala, Burdick		HP OEM ON:40494E	V0012M-I	Adult Limb clamp Ag/AgCl electrode, clothespin type – perfect fit for 3.0mm Din plug or 0.156-in.(4mm) banana plug or (4mm)Snap leadwires – Metal Electrodes: Ag/AgCl. – 1 box = 4 electrodes – Color coding standard: IEC , red(R), yellow(L), black(RF), green(F)	B2/box
			V0012M-A	Adult Limb clamp Ag/AgCl electrode, clothespin type – perfect fit for 3.0mm Din plug or 0.156-in.(4mm) banana plug or (4mm)Snap leadwires – Metal Electrodes: Ag/AgCl. – 1 box = 4 electrodes – Color coding : AHA , white(RA),black(LA),green(RL),red(LL)	B3/box
all Resting ECG Recommended for GE-Marquette, Schiller, Bionet, Mortala, Burdick			V0012M-IP	Paediatric Limb clamp Ag/AgCl electrode, clothespin type – perfect fit for 3.0mm Din plug or 0.156-in.(4mm) banana plug or (4mm)Snap leadwires – Metal Electrodes: Ag/AgCl. – 1 box = 4 electrodes – Color coding standard: IEC , red(R), yellow(L), black(RF), green(F)	B2/box
			V0012M-AP	Paediatric Limb clamp Ag/AgCl electrode, clothespin type – perfect fit for 3.0mm Din plug or 0.156-in.(4mm) banana plug or (4mm)Snap leadwires – Metal Electrodes: Ag/AgCl. – 1 box = 4 electrodes – Color coding : AHA , white(RA),black(LA),green(RL),red(LL)	B3/box
			V0019M-I (2018)	Adult Limb clamp Ag/AgCl electrode; Color coding standard: IEC,black(RF), red(R), yellow(L), green(F); Metal shrapnel;	B2/box

● **Earth Cable**

Compatible Brand	Productor Guide	OEM P/N	HNM REF NO.	Description	PRICE CODE
All patient monitor and cardiographs with standard Earth terminal	144 		V0020A	Earth Cable, 6mm Jack >> Clip, – Length: 4000mm – Wires type: UL 1015 14AWG 105° 600V . – 1 bag = 1 pce – Color: yellow/green	A4
	037 		V0020B	Earth Terminal, 6mm diameter(perfect fit for 6mm jack of V0020A) – Length: 30mm – Metal terminal: Nickel-plate. – 1 bag = 1 pce	A1

● **ADAPTER**

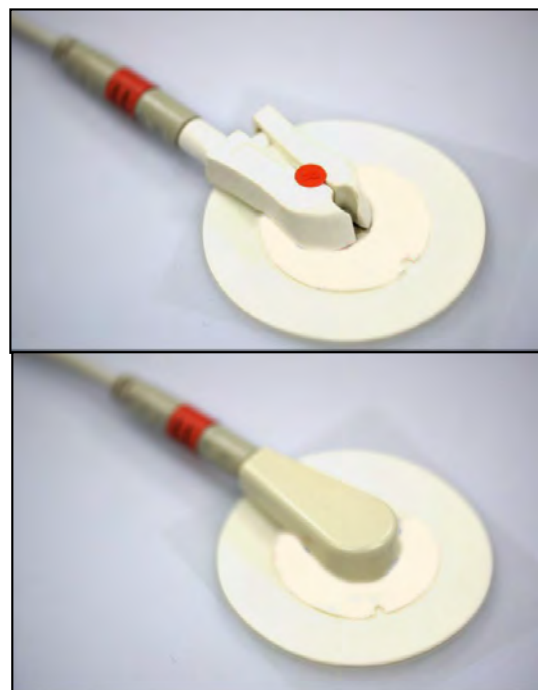

Moldel No.: V0010H
Name: Adapter,4mm with grabber end
Suitable for Snap ECG Electrode
Socket fit for 4.0mm Banana plug
Packaging: 10pcs/pk
Price code: B8/pk



Moldel No.: V0010G
Name: Adapter,4mm with Snap end
Suitable for Snap ECG Electrode
Socket fit for 4.0mm Banana plug
Packaging: 10pcs/pk
Price code: B8/pk



Moldel No.: V0010N
Name: Neonatal Electrode Adapter Cable
Suitable for 2.5mm ECG Electrode
Socket fit for 4.0mm Banana plug
Packaging: 10pcs/pk
Price code: FO/pk

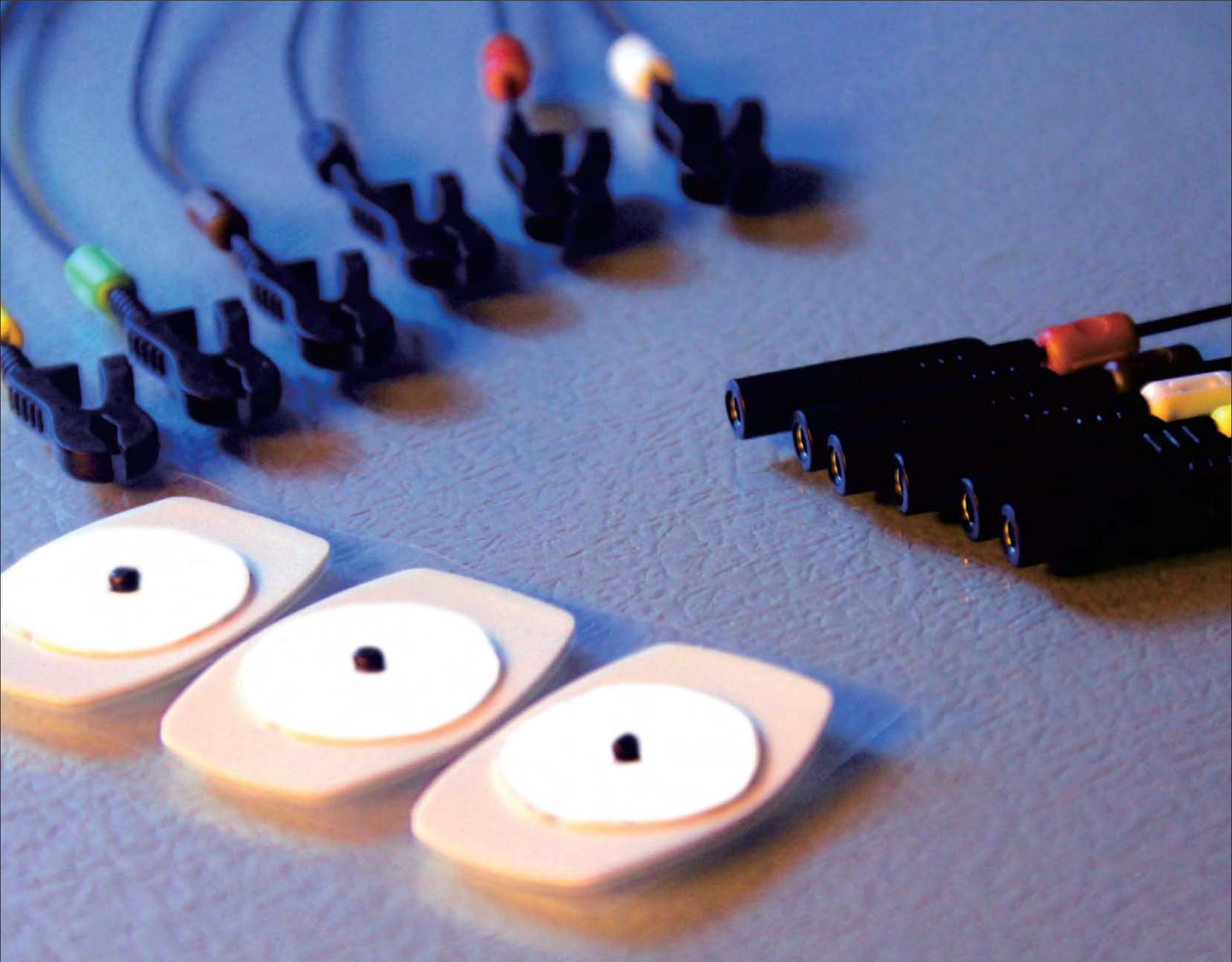

















12

Radiotransparent Lead Wires (RTL)



Radiotransparent Leadwires (RTL)

When used with Radiotransparent ECG electrodes, the Radiotransparent Leadwires offers a radiotransparent system resulting in an uninterrupted view of the chest during heart catheterizations, x-ray and thallium stress test studies.

Compatible Brand	Plug	Patient end termination	HNM REF NO.	Description (Name, Length, Patient end termination, Resistance,)	PRICE CODE
Neusoft Medical Systems Fit for 4.0mm banana plug , Yoke Code: <u>CC</u>			RT-CC036S-0	RTL, LL type plug, 36 inch, Snap, NO.Res.	C0
			RT-CC048S-0	RTL, LL type plug, 48 inch, Snap, NO.Res.	C0
			RT-CC060S-0	RTL, LL type plug, 60 inch, Snap, NO.Res.	C0
			RT-CC060S-147	RTL, LL type plug, 60 inch, Snap, 14.7kΩ.Res.	D0
Biosys Datascope IVY suitable for all Din-Plug System , Yoke: Din style, Code: C	707 	Snap 	RT-C048S-0	RTL, Din1.5 Jack type plug, 48 inch, Snap, NO.Res.	C0
			RT-C048C-0	RTL, Din1.5 Jack type plug, 48 inch, Clip, NO.Res.	C0
		Clip 	RT-C060S-0	RTL, Din1.5 Jack type plug, 60 inch, Snap, NO.Res.	C0
			RT-C072C-0	RTL, Din1.5 Jack type plug, 72 inch,Clip,NO.Res.	C0
		RT-C072C4A-0	RTL, Din1.5 Jack type plug, 72 inch,Clip,AAMI,4 Ld,NO.Res.	C0	
		RT-C072S-0	RTL, Din1.5 Jack type plug, 72 inch, Snap, NO.Res.	C0	
PHILIPS suitable for all AA-Plug System , Yoke: AA style, Code: D			RT-D036S-0	RTL, AAMI type plug, 36 inch, Snap, NO.Res.	C0
			RT-D048S-0	RTL, AAMI type plug, 48 inch, Snap, NO.Res.	C0
			RT-D060S-0	RTL, AAMI type plug, 60 inch, Snap, NO.Res.	C0
			RT-D072S-0	RTL, AAMI type plug, 72 inch, Snap, NO.Res.	C0
GE- Marquette suitable for all Multi-link(VS)-Plug System Yoke: Multi-link(VS), Code: E			RT-E036S-0	RTL, VS type plug, 36 inch, Snap, NO.Res.	C0
			RT-E048S-0	RTL, VS type plug, 48 inch, Snap, NO.Res.	C0
			RT-E060S-0	RTL, VS type plug, 60 inch, Snap, NO.Res.	C0
			RT-E072S-0	RTL, VS type plug, 72 inch, Snap, NO.Res.	C0
			RT-E060C-147	RTL, VS type plug, 60in.(152cm) Clip, NO.Res.	C0
			RT-E048C-0	RTL, VS type plug, 48 inch, Clip, NO.Res.	C0
Datex-Ohmeda suitable for all DB-Plug System Yoke: DB type, Code: <u>DB</u>	664 		RT-DB048S-0	RTL, LM type plug, 48 inch, Snap, NO.Res.	C0
			RT-DB060S-0	RTL, LM type plug, 60 inch, Snap, NO.Res.	C0
			RT-DB072S-0	RTL, LM type plug, 72 inch, Snap, NO.Res.	C0
CONMED suitable for all Conmed-Plug System Yoke: Conmed lock type 2pin, Code: GL	698 		RT-GL048S-0	RTL, Conmed lock type plug, 48 inch, Snap, NO.Res.	C0
			RT-GL048S-147	RTL, Conmed lock type plug, 48 inch, Snap, 14.7kΩ.Res.	D0
			RT-GL048C-0	RTL, Conmed lock type plug, 48 inch,Clip, NO.Res.	C0
			RT-GL060S-0	RTL, Conmed lock type plug, 60 inch, Snap, NO.Res.	C0
			RT-GL072S-0	RTL, Conmed lock type plug, 72 inch, Snap, NO.Res.	C0
Lead Bead Markers for Radiotranslucent Leadwires, Diameter range: 0.9mm~1.5mm			SL0373A	AAMI, 10pcs/pk, (RA,LA,RL,LL,V1,V2,V3,V4,V5,V6),Colour: White,Black,Green,Red,Red,Yellow,Green,Blue,Orange,Purple	A4/pk
			SL0373B	IEC, 10pcs/pk, (R,L,RF,F,C1,C2,C3,C4,C5,C6), Colour: Red,Yellow,Black,Green,Red,Yellow,Green,Brown,Black,Purple	A4/pk
			SL0373C	AAMI, 5pcs/pk, (Colour code: RA,LA,RL,LL,V), Colour: White,Black,Green,Red,Brown	A2/pk
			SL0373D	IEC, 5pcs/pk, (Colour code: R,L,RF,F,C), Colour: Red,Yellow,Black,Green,White)	A2/pk



13

Holter Recorder ECG Patient Cable and Lead Wires













Trunk Cables





The patient cable uses shielded, low noise cable to minimize tribo-electric noise and electrical interference. Flex reliefs at both the connector and cable yoke provide flexibility and reduce continuity breakage. Part numbers and lot numbers indicate equipment compatibility and product traceability. DIN cable yokes depict both AHA and IEC color coding for quick and easy lead attachment. All replaceable lead cables and lead wires have female "safety" sockets.

Compatible Brand	Compatible Models No.	OEM P/N	HNM REF NO.	Description (Name,Length,Plug,Compatible)	INSTRUMENT CONNECTOR	Yoke (Leads side)	Price Code
Biomedical Instruments (BI)/ Brentwood	Biomedical Instruments (BI): BI 9000 Brentwood : BH-3000		HC024-7A	Din 7-Ld Patient Cable, 3CH, 45 cm , AHA, FGG.0B 7pin>Din 7J, no resistance fit for Din style LeadWires		 103	D6
	BI 9800 compatible with BI9800 round connector only, not for new flat connector		HC024-10A	Din 10-Ld Patient Cable, 45 cm , AHA, Readel-14pin>Din 10J, no resistance fit for Din style LeadWires		 104	D5
Biox	Biox: CB-2300-A Biomedical Instruments (BI): BI9000TL		HC033-7A	Din 7-Ld Patient Cable, 3CH, 45 cm , AHA, Readel-14pin>Din 7J, no resistance fit for Din style LeadWires		 103	C5
Burdick	92512 Holter	43238	HC030-5A	Din 5-Ld Patient Cable, 2CH, 80 cm , AHA, PCB 7pin>Din 5J, no resistance fit for Din style LeadWires		 102	B0
	92513 Holter	175-1546-00	HC030-7A	Din 5-Ld Patient Cable, 3CH, 45 cm , AHA, PCB 7pin>Din 5J, no resistance fit for Din style LeadWires		 103	C5
Landcom			HC031-7A	Din 7-Ld Patient Cable, 3 CH, 45 cm , AHA, FGG.1B 7pin>Din 7J, no resistance fit for Din style LeadWires		 103	D6
			HC031-10A	Din 10-Ld Patient Cable, 45 cm , AHA, FGG.1B 10pin>Din 10J, no resistance fit for Din style LeadWires		 104	D0
Medilog	Medilog: FD5		HC051-7A	Din 7-Ld Patient Cable, 3CH, 45 cm , AHA, Readel-14pin>Din 7J, no resistance fit for Din style LeadWires		 103	C5
Ge-Marquette Rozinn GeTeMED	For GE Marquette: 8000, 8200, 8500, SEER Holter Recorder model: 151	E9002TE	HC006-7A	Snap-Lock Holter Cable, 3 CH, 45 cm , AHA, Snap-lock-7pin>Din 7J, no resistance fit for Din style LeadWires		 103	D7
GE-Marquette Rozinn	For GE SEER MC Holter Recorder	E9002TK	HC047-5A	Din 5-Ld Patient Cable, 2 CH, 80 cm , AHA, rectangle 12pin>Din 5J, no resistance, fit for Din style LeadWires		 102	D0
		E9002TL	HC047-7A	Din 7-Ld Patient Cable, 3 CH, 80 cm , AHA, rectangle 12pin>Din 7J, no resistance fit for Din style LeadWires		 103	D0
		E9002TP	HC047-10A	Din 10-Ld Patient Cable, 10-LD, 80 cm , AHA, rectangle 12pin>Din 10J, no resistance fit for Din style LeadWires		 104	E5

One-piece ECG patient cable with lead wires











Compatible Brand	Compatible Models No.	OEM P/N	HNM REF NO.	Description (Name,Length,Leads,)	Color coding / Leads	Patient end termination	Price Code
Biomedical Instruments (BI)	 BI9000TL		HA055S7A	One-piece holter ECG cable with leadwires, <u>7-Ld</u> Plug: Radel 14pin	AAMI	Snap	C0
Creative PC-80 Easy ECG Monitor			HA022S3A	3Ld lead wires, <u>40 in. (102 cm), 3-Ld</u> PLUG: stereo 2.5 plug	AHA	Snap	B5
	187 		HA023S3A	3Ld lead wires, <u>40 in. (102 cm), 3-Ld</u> PLUG: stereo 2.5 plug	AHA	Snap	B8
Fukuda	LX-5630 		HA057C4A	One-piece holter ECG cable with leadwires, <u>4-Ld</u> Plug: 6 pin	AAMI	Grabber	D0
Meigaoyi MGY-M1 Landcom Visual Stethoscope	529 		HA020S3I	3Ld lead wires, 40 in. (102 cm), 3-Ld PLUG: stereo 3.5 plug	IEC	Snap	B3
			HA020C3I		IEC	Din3.0	B4
Meigaoyi ECGLAB TDA3.0			HA046S5A	5-Ld lead wires, 40 in. (102 cm), 5-Ld PLUG: stereo 2.5+3.5 plug	AHA	Snap	B5
Mortara			HA035S10I	10-Ld lead wires, 40 in. (102 cm)	IEC	Snap	E5
GE-Marquette Rozinn			HA021S3A	3-Ld lead wires,40 in.	AHA	Snap	C5
GE-SEER Light		318 200859 4-001	HA053S5A	SEER Light Holter Patient Cable/Leadwires,5-Ld	AHA	Snap	E3
		200859 4-002	HA053S7A	SEER Light Holter Patient Cable/Leadwires,7-Ld	AHA	Snap	E5
		200859 4-004	HA053S7I	SEER Light Holter Patient Cable/Leadwires,7-Ld	IEC	Snap	E5
		200859 4-002	HA130S7A	SEER Light Holter Patient Cable/Leadwires,7-Ld	AHA	Snap	E5
M&B		EED029 P5A	HA132S5A-C	5-Ld lead wires	AHA	Snap	A0

Holter Recorder ECG Patient Cable and Leads



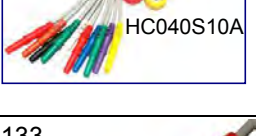

Compatible Brand	Compatible Models No.	OEM P/N	HNM REF NO.	Description (Name,Length,Leads,)	Color coding / Leads	Patient end termination	Price Code
MBELEC CD2000-1800			HA052S3A	3Ld lead wires, <u>40 in. (102 cm). 3-Ld</u> PLUG: 1.5mm*5pin	AHA	Snap	B8
PI	 233 232		HA048S4I	4-Ld lead wires, <u>40 in. (102 cm)</u> . PLUG: HRS-4P	IEC	Snap	D0
			HA048S6I	6-Ld lead wires, <u>40 in. (102 cm)</u> . PLUG: HRS-6P	IEC	Snap	D0
PHILIPS Digitrak Plus			HA056S5A	Telemetry monitoring leads <u>40 in. (102 cm)</u> .	AAMI	Snap	D0
			HA056S5I	Telemetry monitoring leads <u>40 in. (102 cm)</u> .	IEC	Snap	D0
Din 1.5 Style Normal	suitable for all Din-Plug System Yoke type: Din style,Code: <u>C</u> 		EC018S3A	Din lead wires, <u>18 in. (45 cm). 3-Ld</u>	AHA (AAMI)	Snap	A6
			EC018S3I		IEC	Snap	A6
			EC018S5A	Din lead wires, <u>18 in. (45 cm). 5-Ld</u>	AHA (AAMI)	Snap	A0
			EC018C5A		AHA (AAMI)	Grabber	B1
			EC018C5I		IEC	Grabber	B1
					HC127S7A	Din lead wires, <u>40 in. (100 cm). 7-Ld</u>	AHA (AAMI)

LEAD WIRES

Unshielded lead wires have the 1.5 mm (.060) DIN socket injection molded at one end and a snap, Grabber injection molded at the other. The snap termination's ergonomic, teardrop design reduces tangling at the patient end connector. Pinch and neo-pinch terminations have dual sided metal contacts to ensure the connection in flex-reliefs.

Compatible Brand	Compatible Models No.	OEM P/N	HNM REF NO.	Description (Name,Length,Leads,.)	Color coding / Leads	Patient end termination	Price Code	
Din 1.5 Style Normal	suitable for all Din-Plug System , Yoke type: Din style,Code: C  141		EC024S3A	Din lead wires, 24 in. (61 cm), 3-Ld	AHA (AAMI)	Snap	A6	
			EC024C3I		IEC	Grabber	A7	
			EC024S5A	Din lead wires, 24 in. (61 cm), 5-Ld	AHA (AAMI)	Snap	A0	
			EC024C5A		AHA (AAMI)	Grabber	B1	
			EC024S5I		IEC	Snap	A0	
			EC024C5I		IEC	Grabber	B1	
	 EC040C3A-RLA		EC040S3A	Din lead wires, 40 in. (102 cm), 3-Ld	AHA (AAMI)	Snap	A6	
			EC040C3A		AHA (AAMI)	Grabber	A7	
			EC040S3I		IEC	Snap	A6	
			EC040C3I		IEC	Grabber	A7	
	 EC040C5A-RLA		EC040S5A	Din lead wires, 40 in. (102 cm), 5-Ld	AHA (AAMI)	Snap	A0	
			EC040C5A		AHA (AAMI)	Grabber	B1	
			EC040S5I		IEC	Snap	A0	
			EC040C5I		IEC	Grabber	B1	
	 EC024S3A		EC040C5A-RL	Din lead wires, 40 in. (102 cm), 5-Ld	AHA (AAMI)	Grabber(RL Style)	A0	
			HC018S7A		AHA (AAMI)	Snap	B4	
		 EC024S5A		HC018C7A	Din lead wires, 18 in. (45 cm), 7-Ld	AHA (AAMI)	Grabber	B5
				HC018S7I		IEC	Snap	B4
				HC018C7I		IEC	Grabber	B5
				HC024S7A		AHA (AAMI)	Snap	B4
		 HC040S7A		HC024C7A	Din lead wires, 24 in. (61 cm), 7-Ld	AHA (AAMI)	Grabber	B5
				HC024S7I		IEC	Snap	B4
				HC024C7I		IEC	Grabber	B5
				HC040S7A		AHA (AAMI)	Snap	B4
			HC040C7A	Din lead wires, 40 in. (102 cm), 7-Ld		AHA (AAMI)	Grabber	B5
			HC040S7I			IEC	Snap	B4
	 HC040S10A		HC040C7I	Din lead wires, 40 in. (102 cm), 7-Ld	IEC	Grabber	B5	
			HC018S10A		AHA (AAMI)	Snap	B0	
		 HC040S10A		HC018C10A	Din lead wires, 18 in. (45 cm), 10-Ld	AHA (AAMI)	Grabber	C1
				HC018S10I		IEC	Snap	B0
				HC018C10I		IEC	Grabber	C1
				HC024S10A		AHA (AAMI)	Snap	B0
		 HC040S10A		HC024C10A	Din lead wires, 24 in. (61 cm), 10-Ld	AHA (AAMI)	Grabber	C1
				HC024C10I		IEC	Grabber	C1
				HC040S10A		AHA (AAMI)	Snap	B0
				HC040C10A		Din lead wires, 40 in. (102 cm), 10-Ld	AHA (AAMI)	Grabber
			HC040C10I	IEC			Grabber	C1
	CONTEC, MEIGAOYI		133  fit 1.35~1.6mm pin			HC040S7A-G	Din lead wires, 40 in. (102 cm), 7-Ld	AHA (AAMI)
				HC040S10A-G	Din lead wires, 40 in. (102 cm), 10-Ld	AHA (AAMI)	Snap	C1
	Din 2.0 Jack Style BIOMEDICAL SYSTEM: DH 073	132  φ2.0 mm Jack		HS024S7A	Din 2.0 lead wires, 24 in. (61 cm), 7-Ld	AHA (AAMI)	Snap	B4
			HS024C7A	AHA (AAMI)		Grabber	B5	
			HS040C7A		AHA (AAMI)	Grabber	B5	

Holter Recorder ECG Patient Cable and Leads

Compatible Brand	Compatible Models No.	OEM P/N	HNM REF NO.	Description (Name,Length,Leads,)	Color coding / Leads	Patient end termination	Price Code
Din 2.0 Plug Style ELA MEDICAL	suitable for all Din 2.0 Plug System , Yoke type: Din 2.0 plug style,Code: T 134 		HT040S3A	Din 2.0 plug lead wires, <u>40 in. (102 cm), 3-Ld</u>	AHA (AAMI)	Snap	A6
			HT040C3I		IEC	Grabber	A7
			HT040C5I	Din 2.0 plug lead wires, 40 in. (102 cm), 5-Ld	IEC	Grabber	B1
LL1 Plug Style MEDIALOG: FD4	suitable for all LL1-Plug System , Yoke type: Din style,Code: U 337   HU024S7A		HU018S3A	LL1 lead wires, <u>18 in. (45 cm), 3-Ld</u>	AHA (AAMI)	Snap	A9
			HU018C3A		AHA (AAMI)	Grabber	A0
			HU018S3I		IEC	Snap	A9
			HU018C3I	IEC	Grabber	A0	
			HU018S5A	LL1 lead wires, <u>18 in. (45 cm), 5-Ld</u>	AHA (AAMI)	Snap	B5
			HU018C5A		AHA (AAMI)	Grabber	B6
			HU018S5I		IEC	Snap	B5
			HU018C5I	IEC	Grabber	B6	
			HU024S3A	LL1 lead wires, <u>24 in. (61 cm), 3-Ld</u>	AHA (AAMI)	Snap	A9
			HU024C3A		AHA (AAMI)	Grabber	A0
			HU024S3I		IEC	Snap	A9
			HU024C3I	IEC	Grabber	A0	
			HU024S5A	LL1 lead wires, <u>24 in. (61 cm), 5-Ld</u>	AHA (AAMI)	Snap	B5
			HU024C5A		AHA (AAMI)	Grabber	B6
			HU024S5I		IEC	Snap	B5
			HU024C5I	IEC	Grabber	B6	
			HU040S3A	LL1 lead wires, <u>40 in. (102 cm), 3-Ld</u>	AHA (AAMI)	Snap	A9
			HU040C3A		AHA (AAMI)	Grabber	A0
			HU040S3I		IEC	Snap	A9
			HU040C3I	IEC	Grabber	A0	
			HU040S5A	LL1 lead wires, <u>40 in. (102 cm), 5-Ld</u>	AHA (AAMI)	Snap	B5
			HU040C5A		AHA (AAMI)	Grabber	B6
			HU040S5I		IEC	Snap	B5
			HU040C5I	IEC	Grabber	B6	
			HU018S7A	LL1 lead wires, <u>18 in. (45 cm), 7-Ld</u>	AHA (AAMI)	Snap	C1
			HU018C7A		AHA (AAMI)	Grabber	C2
			HU018S7I		IEC	Snap	C1
			HU018C7I	IEC	Grabber	C2	
			HU024C7A	LL1 lead wires, <u>24 in. (61 cm), 7-Ld</u>	AHA (AAMI)	Grabber	C2
			HU024S7I		IEC	Snap	C1
			HU024C7I		IEC	Grabber	C2
			HU040S7A	LL1 lead wires, <u>40 in. (102 cm), 7-Ld</u>	AHA (AAMI)	Snap	C1
			HU040C7A		AHA (AAMI)	Grabber	C2
	HU040S7I	IEC	Snap		C1		
	HU040C7I	IEC	Grabber	C2			
Compatible Brand	Productor Guide	OEM P/N	HNM REF NO.	Description (Name, Length,Plug)	Price Code		
All holter blood pressure monitor			Y001A1-A06 (2018)	Reusable Blood Pressure Cuffs,adult size, single-tube,Packaging: 1 piece/pk	C6		



14

Telemetry Monitor EKG Cable and Lead wires



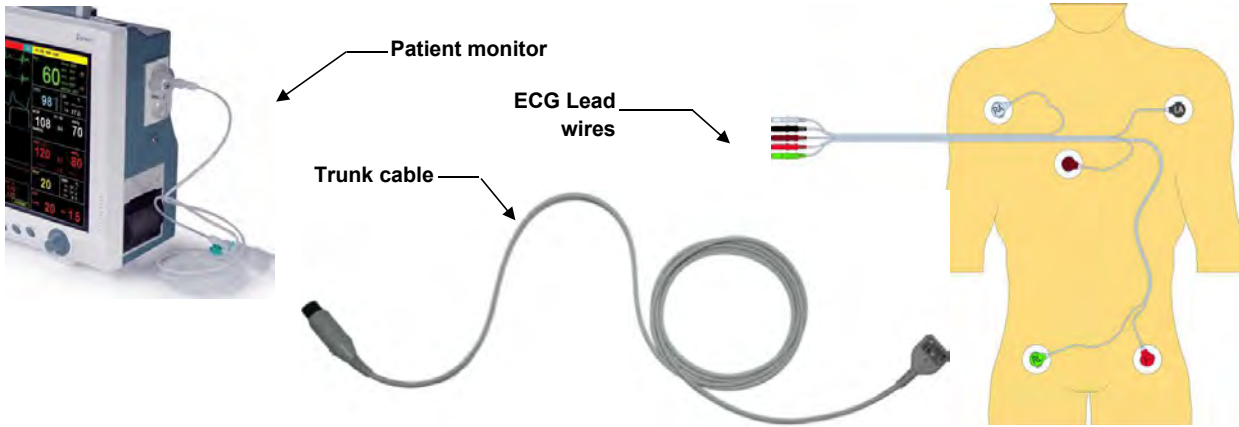

Instrument Connector

Yoke type

Patient end termination

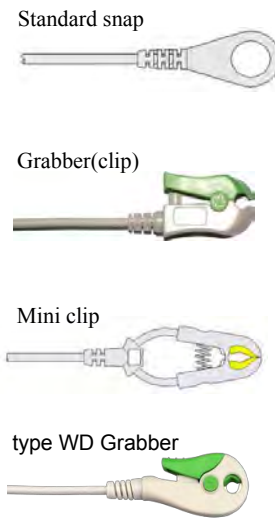
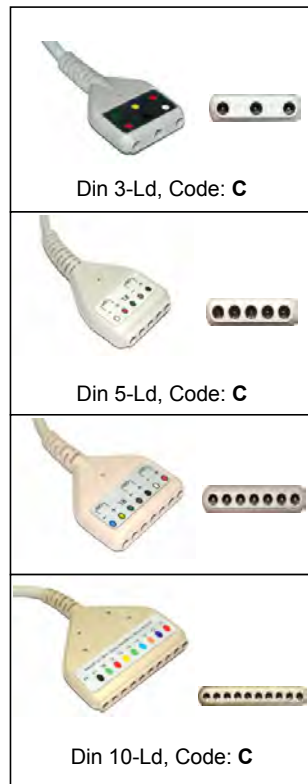

Type Disignation

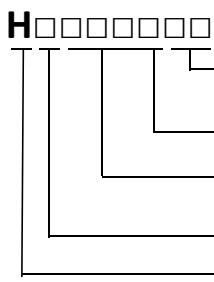

Color coding: **7A**: 7-Ld, AHA(AAMI); **10A**: 10-Ld,AHA; **7I**: 7-Ld,IEC; **10I**: 10-Ld,IEC;
5A: 5-Ld, AHA(AAMI); **3H**: 4-Ld,AHA; **3A**: 3-Ld,AHA; **5I**: 5-Ld, IEC; **3IH**: 4-Ld,IEC;
3I: 3-Ld,IEC; **5A/I**: 5-Ld, AHA/IEC; **3H/IH**: 4-Ld, AHA/IEC, **3A/I**: 3-Ld, AHA/IEC









Patient end termination type: **S**: snap; **C**: Clip (grabber),
 If the product is a cable, the lattice is useless, but use the "-" to express , as HC024-7A

Brand code, as 035 indicated Mortara; if the product is a leads the lattice is indicated length,

Yoke type: as **A**: one-piece; **B**: Lifelinc, (LL); **C**: Din style yoke, include 3-Ld, 5-Ld, 7-Ld,

H: Indicated Holter ECG cable and lead wires

Telemetry monitor ECG cable with lead wires

Compatible Brand	Compatible Models No.	OEM P/N	HNM REF NO.	Description (Name,Length,Leads,)	Color coding / Leads	Patient end termination	Price Code
Choice Telemetry Monitoring System MMED600RD-300E	 453		HA003S3I	3Ld lead wires, <u>40 in. (102 cm), 3-Ld</u> PLUG: READEL 6P	IEC	Snap	B5
			HA003C3I	3Ld lead wires, <u>40 in. (102 cm), 3-Ld</u> PLUG: READEL 5P	IEC	Grabber	B6
Creative PC-6000 Telemetry Monitoring	 114		HA037S3I	3Ld lead wires, <u>40 in. (102 cm), 3-Ld</u> PLUG: Din2.0*3pin	IEC	Snap	B2
			HA037C3I		IEC	Grabber	B3
MINDRAY TMS-6016 Telemetry monitoring system			HA052S5A	5Ld lead wires, <u>40 in. (102 cm), 5-Ld</u> PLUG: 1.5mm*5pin	AHA	Snap	B9
MINDRAY	Benevision Telemetr Transmitter TD60 		ER028C5I	Euro style lead wires, <u>28 in. 70 cm, 5-Ld</u>	IEC	Grabber (type RL)	A0
NEC	 098	YCE-205	HA001S3I	YCE205 lead wires, <u>30 in. (76 cm), 3-Ld</u>	IEC	Snap	B5
			HA001C3I		IEC	Grabber	B6
		47502	HA002S3I	47502 lead wires, <u>30 in. (76 cm), 3-Ld</u>	IEC	Snap	B5
NIHON KOHDEN		BR-546S	HA004S3I	3Ld lead wires, 40 in. (102 cm), 3-Ld PLUG: Din2.0*3pin	IEC	Snap	B0
			HA004C3I		IEC	Grabber	B0
PHILIPS	MX40 	989803 171811	ETD035C3A (2019)	3-LD; 2.00m*3	AHA	Grabber	B2
	MX40 	989803 171831	ETD035C5A-01 (2019)	5-LD; 2.00m*5	AHA	Grabber	B3
	MX40 	989803 171861	ETD035C6A-01 (2019)	6-LD; 2.00m*6	AHA	Grabber	B4
	MX Series 	989803 171831	EZD418C5A	5-LD; 40 inches;TPU	AHA	Grabber	A0



15

Non-Invasive Blood Pressure (NIBP) Cuff & Tubes



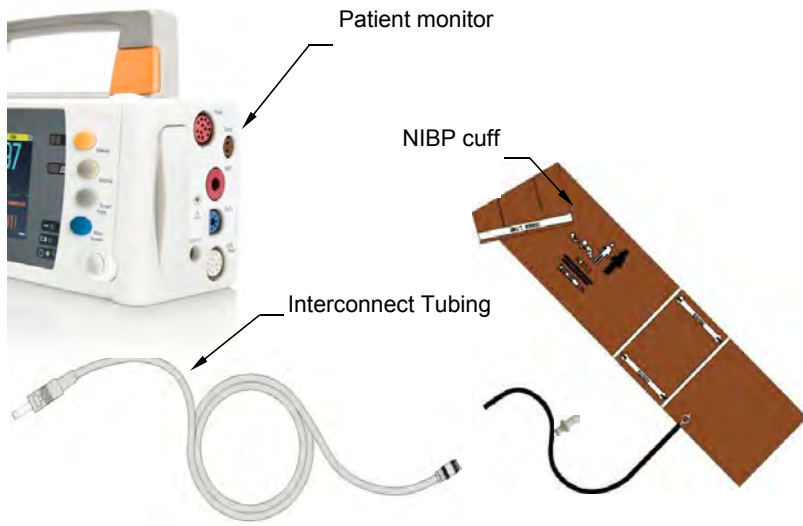

Comfort Reusable Cuffs Bladderless Reusable Neo Disposable Cuffs Disposable Cuffs



Instrument Connector



Patient Side Connector



Cuff Connector

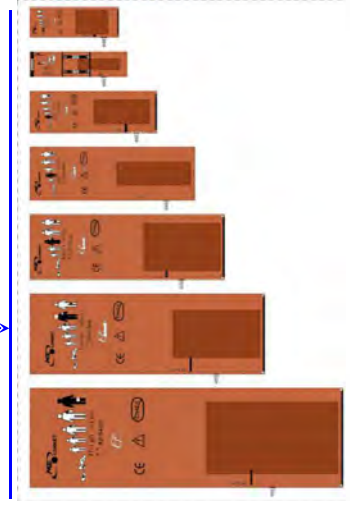

Reusable Blood Pressure Cuffs (Multi-Patient Comfort (Reusable) Cuffs - Latex Free)

Specifications

Blood Pressure Tubing (Air Hoses)

- Replacement tubing (air hose) for sphygmomanometers, wall manometers, aneroid gauges, and automated blood pressure monitoring systems;
- Available in Adult, Pediatric, and Neonatal styles;
- 8, 12, and 24-foot lengths permit positioning of the monitor in the room as needed;
- Durable tubing offers extended tubing life;
- Secure connection to blood pressure cuffs to prevent air leakage.

Reusable Blood Pressure Cuffs

- Gentle TPU, strong enough for repeated inflation;
- Reusable for multiple patient use;
- Convenient and easy to clean;
- Easy-to-use range markers and index line for proper size and placement;
- Extra hook and loop for added security;
- Variety of connection types to fit multiple monitoring systems;
- Latex-free, PVC-free;
- Excluding Connector.



Compatible Brand	Product Guide	OEM P/N	HNM REF NO.	Description (Name,Length,Plug)	PRICE CODE
Philips 78352A/C, 78354A/C,M1008A/B M1176A,M1350B,M3000A M3001A (with M1598B, M1599B, tubing) <u>Colin</u> , <u>Datascope</u> - Passport, Acutor; <u>Fukada Denshi</u> ; <u>Spacelabs</u> : all; <u>Older welch-Allyn</u> : Models-with locking luer-type connector, <u>Criticare</u> ; <u>Siemens</u> - with bayonet type connector; <u>Mindray</u> ; <u>Goldway</u> .	One-Tube "Monitor" 	M1576A	Y000T1	Reusable Blood Pressure Cuffs, <u>Thigh size</u> ,Single-tube, Bladder width=435*198mm, Limb cir.=42~54cm, Packaging: 1 piece/pk	A9
		M1575A	Y000L1	Reusable Blood Pressure Cuffs,Large Adult size,Single-tube, Bladder width=355*158mm, Limb cir.:34~43cm, Packaging: 1 piece/pk	A9
		M1574A	Y000A1	Reusable Blood Pressure Cuffs,adult size,Single-tube, Bladder width=280*125mm, Limb cir.=27~35cm, Packaging: 1 piece/pk	A6
		M1573A	Y000S1	Reusable Blood Pressure Cuffs,Small adult size, Single-tube, Bladder width=240*100mm, Limb cir.=20.5-28 cm, Packaging: 1 piece/pk	A6
		M1572A	Y000C1	Reusable Blood Pressure Cuffs, <u>Pediatric size</u> ,Single-tube, Bladder width=215*75mm, Limb cir.=14~21cm, Packaging: 1 piece/pk	A5
		M1571A	Y000I1	Reusable Blood Pressure Cuffs, <u>Infant size</u> ,Single-tube, Bladder width=150*50mm, Limb cir.=10~15cm, Packaging: 1 piece/pk	A5
		5082-81-3	Y000N1	Reusable Blood Pressure Cuffs, <u>Neonatal size</u> ,Single-tube, Bladder width=90*40mm, Limb cir.=6~11cm, Packaging: 1 piece/pk	A5
GE-Marquette, Datex-Ohmeda GE(Marquette) with male quick-connect type connector, Dinama plus, XL,SX/XP,8100 series, Each GE corometrics; Critikon ; Datex- Ohmeda -with one male and one female quick connect type connector; CAS; New Welch-Allyn vital signs models- with threaded type Critikon style connector	Two-Tube "Monitor" 	5082-88-4	Y000T2	Reusable Blood Pressure Cuffs, <u>Thigh size</u> , two-tube, Bladder width=435mm*198mm, Limb cir.=42~54cm, Packaging: 1 piece/pk	A9
		5082-87-4	Y000L2	Reusable Blood Pressure Cuffs,Large Adult size, two-tube, Bladder width= 355*158mm, Limb cir.:34~43cm, Packaging: 1 piece/pk	A9
		5082-86-4	Y000A2	Reusable Blood Pressure Cuffs,adult size, two-tube, Bladder width=280*125mm, Limb cir.=27~35cm, Packaging: 1 piece/pk	A6
		5082-85-4	Y000S2	Reusable Blood Pressure Cuffs,Small adult size, two-tube, Bladder width=240*100mm, Bladder length=9.4" (24cm), Limb cir.=20.5-28 cm	A6
		5082-84-4	Y000C2	Reusable Blood Pressure Cuffs, <u>Pediatric size</u> , two-tube, Bladder width=215*75mm, Limb cir.=14~21cm, Packaging: 1 piece/pk	A5
		5082-82-4	Y000I2	Reusable Blood Pressure Cuffs, <u>Infant size</u> , two-tube, Bladder width=150*50mm, Limb cir.=10~15cm, Packaging: 1 piece/pk	A5
			Y000N2	Reusable Blood Pressure Cuffs, <u>Neonatal size</u> ,two-tube, Bladder width=90*40mm, Packaging: 1 piece/pk	A5

Non-Invasive Blood Pressure(NIBP) Cuff & Tubes

Bladderless Reusable Blood Pressure Cuffs

Specifications

- Gentle Nylon+TPU, strong enough for repeated inflation
- Reusable for multiple patient use
- Convenient and easy to clean
- Easy-to-use range markers and index line for proper size and placement
- Extra hook and loop for added security
- Variety of connection types to fit multiple monitoring systems
- Latex-free,
- PVC-free
- Excluding Connector



Compatible Brand	Product Guide	OEM P/N	HNM REF NO.	Description (Name,Length,Plug)	Price Code
Philips 78352A/C, 78354A/C,M1008A/B M1176A,M1350B,M3000A M3001A (with M1598B, M1599B, tubing) <u>Colin</u> , <u>Datascope</u> - Passport, Acutor; <u>Fukada Denshi</u> ; <u>Spacelabs</u> ; all; <u>Older welch-Allyn</u> ; Models-with locking luer-type connector, <u>Criticare</u> ; <u>Siemens</u> - with bayonet type connector ; <u>Mindray</u> ; <u>Goldway</u> .	One-Tube "Monitor" 		Y000RLA1	Bladderless Reusable Blood Pressure Cuffs, Large Adult size, One-Tube, Arm width min/max [cm]=32~42cm, Packaging:1 piece/pk;	A6/pcs
			Y000RT1	Bladderless Reusable Blood Pressure Cuffs, High size,One-Tube, Arm width min/max [cm]=42~50cm, Packaging:1 piece/pk;	A9/pcs
			Y000RA1	Bladderless Reusable Blood Pressure Cuffs, Adult size, One-Tube, Arm width min/max [cm]=24~32cm, Packaging:1 piece/pk;	A6/pcs
			Y000RAL1	Bladderless Reusable Blood Pressure Cuffs, Adult long size, One-Tube, Arm width min/max [cm]=28~37cm, Packaging:1 piece/pk;	A6/pcs
			Y000RC1	Bladderless Reusable Blood Pressure Cuffs, Child size . One-Tube, Arm width min/max [cm]=15~22cm, Packaging:1 piece/pk;	A5/pcs
			Y000RSA1	Bladderless Reusable Blood Pressure Cuffs, Small Adult size, One-Tube, Arm width min/max [cm]=17~25cm, Packaging:1 piece/pk;	A5/pcs
GE-Marquette Datex- Ohmeda GE (Marquette) with male quick- connect type connector, Dinama plus, XL,SX/XP,8100 series, Each GE corometrics; Critikon; Datex-Ohmeda-with one male and one female quick connect type connector; CAS; New Welch-Allyn vital signs models- with threaded type Critikon style connector	Two-Tube "Monitor" 		Y000RLA2	Bladderless Reusable Blood Pressure Cuffs, Large Adult size, two-Tube, Arm width min/max [cm]=32~42cm, Packaging:1 piece/pk;	A6/pcs
			Y000RT2	Bladderless Reusable Blood Pressure Cuffs, High size,two-Tube, Arm width min/max [cm]=42~50cm, Packaging:1 piece/pk;	A9/pcs
			Y000RT2-A11 (2018)	Bladderless Reusable Blood Pressure Cuffs, Large Adult size, two-Tube, Leg width	A9/pcs
			Y000RA2	Bladderless Reusable Blood Pressure Cuffs, Adult size, two-Tube, Arm width min/max [cm]=24~32cm, Packaging:1pcs/pack,	A6/pcs
			Y000RAL2	Bladderless Reusable Blood Pressure Cuffs, Adult long size, two-Tube, Arm width min/max [cm]=28~37cm, Packaging:1pcs/pack,	A6/pcs
			Y000RC2	Bladderless Reusable Blood Pressure Cuffs, Child size, two-Tube, Arm width min/max [cm]=15~22cm, Packaging:1 piece/pk;	A5/pcs
			Y000RC2-A11 (2018)	Bladderless Reusable Blood Pressure Cuffs, Child size, two-Tube, Leg width	A5/pcs
			Y000RSA2-A 11 (2018)	Bladderless Reusable Blood Pressure Cuffs, Small Adult size, two-Tube, Leg width	A5/pcs
	Y000RSA2	Bladderless Reusable Blood Pressure Cuffs, Small Adult size, two-Tube, Arm width min/max [cm]=17~25cm, Packaging:1 piece/pk;	A5/pcs		

Disposable Blood Pressure Cuffs

Specifications

- Soft, absorbent material for maximum patient comfort
- Strong enough for repeated inflations
- Economical enough for single-patient use
- Color-coded by size for accuracy and added patient comfort
- Easy-to-use range size markers and index line for proper size and placement
- Sized to meet AHA, AAMI/ANSI/SP9 and EN1060 requirements
- Latex-free, PVC Free (Neo 1#-5#) , Including Plastic Connector



Compatible Brand	Product Guide	OEM P/N	HNM REF NO.	Description (Name,Length,Plug)	PRICE CODE		
For Philips (Hewlett Packard), Siemens, Datascope and Spacelabs Monitors; For Protocol Monitors ; For Colin, Spacelabs and Datascope Monitors		5082-101-1	Y000DSN1-1#	DISPOSABLE CUFFS NEONATES, Neo #1 , One-Tube, Arm width min/max [cm]=3~6cm, Packaging:24pcs/box,	E8/box		
		5082-102-1	Y000DSN1-2#	DISPOSABLE CUFFS NEONATES, Neo #2 , One-Tube, Arm width min/max [cm]=4~8cm, Packaging:24pcs/box,	E8/box		
		5082-103-1	Y000DSN1-3#	DISPOSABLE CUFFS NEONATES, Neo #3 , One-Tube, Arm width min/max [cm]=6~11cm, Packaging:24pcs/box,	E8/box		
		5082-104-1	Y000DSN1-4#	DISPOSABLE CUFFS NEONATES, Neo #4 , One-Tube, Arm width min/max [cm]=7~14cm, Packaging:24pcs/box,	E8/box		
		5082-105-1	Y000DSN1-5#	DISPOSABLE CUFFS NEONATES, Neo #5 , One-Tube, Arm width min/max [cm]=8~15cm, Packaging:24pcs/box,	E8/box		
		5082-94-3	Y000DC1	Disposable cuffs, Child size , One-Tube, Arm width min/max [cm]=15~22cm, Packaging:10pcs/box,	B0/box		
		5082-95-3	Y000DSA1	Disposable cuffs, Small Adult size , One-Tube, Arm width min/max [cm]=17~25cm, Packaging:10pcs/box,	B0/box		
		5082-96-3	Y000DA1	Disposable cuffs, Adult size , One-Tube, Arm width min/max [cm]=24~32cm, Packaging:10pcs/box,	B0/box		
		5082-96L-3	Y000DAL1	Disposable cuffs, Adult long size , One-Tube, Arm width min/max [cm]=28~37cm, Packaging:10pcs/box,	C0/box		
		5082-97-3	Y000DLA1	Disposable cuffs, Large Adult size , One-Tube, Arm width min/max [cm]=32~42cm, Packaging:10pcs/box,	D0/box		
		5082-98-3	Y000DT1	Disposable cuffs, Thigh size , One-Tube, Arm width min/max [cm]=42~50cm, Packaging:10pcs/box,	D0/box		
		Marquette, for GE Corometrics, DINAMAP and MDE Monitors, For GE Eagle, Dash, Tram, Solar, MAC-Lab Systems		5082-101-2	Y000DSN2-1#	DISPOSABLE CUFFS NEONATES, Neo #1 , two-Tube, Arm width min/max [cm]=3~6cm, Packaging:24pcs/box,	E8/box
				5082-102-2	Y000DSN2-2#	DISPOSABLE CUFFS NEONATES, Neo #2 , two-Tube, Arm width min/max [cm]=4~6cm, Packaging:24pcs/box,	E8/box
5082-103-2	Y000DSN2-3#			DISPOSABLE CUFFS NEONATES, Neo #3 , two-Tube, Arm width min/max [cm]=6~11cm, Packaging:24pcs/box,	E8/box		
5082-104-2	Y000DSN2-4#			DISPOSABLE CUFFS NEONATES, Neo #4 , two-Tube, Arm width min/max [cm]=7~14cm, Packaging:24pcs/box,	E8/box		
5082-105-2	Y000DSN2-5#			DISPOSABLE CUFFS NEONATES, Neo #5 , two-Tube, Arm width min/max [cm]=8~15cm, Packaging:24pcs/box,	E8/box		
5082-94-4	Y000DC2			Disposable cuffs, Child size , two-Tube, Arm width min/max [cm]=15~22cm, Packaging:10pcs/box,	B0/box		
5082-95-4	Y000DSA2			Disposable cuffs, Small Adult size , two-Tube, Arm width min/max [cm]=17~25cm, Packaging:10pcs/box,	B0/box		
	Y000DSA2-A11A12			sposable cuffs, Small Adult size , two-Tube, Arm width min/max [cm]=17~25cm, Packaging:10pcs/box,	C5/box		
5082-96-4	Y000DA2			Disposable cuffs, Adult size , two-Tube, Arm width min/max [cm]=24~32cm, Packaging:10pcs/box,	B0/box		
	Y000DA2-A11A12-C			Disposable cuffs, Adult size , two-Tube, Packaging:10pcs/box,	B0/box		
5082-96L-4	Y000DAL2			Disposable cuffs, Adult long size , two-Tube, Arm width min/max [cm]=28~37cm, Packaging:10pcs/box,	C0/box		
	Y000DAL2-A11A12			Disposable cuffs, Adult long size , two-Tube, Arm width min/max [cm]=28~37cm, Packaging:10pcs/box,	D5box		
5082-97-4	Y000DLA2			Disposable cuffs, Large Adult size , two-Tube, Arm width min/max [cm]=32~42cm, Packaging:10pcs/box,	D0/box		
5082-98-4	Y000DT2			Disposable cuffs, Thigh size , two-Tube, Arm width min/max [cm]=42~50cm, Packaging:10pcs/box,	D0/box		

Pressure Cuff Interconnect Tubing

Compatible Brand	Compatible Models No.	OEM P/N	HNM REF NO.	Description (Name,Length,Plug)	Instrument Connector	Yoke (cuff side)	PRICE CODE
Philips	Connects all sizes of Philips' reusable and disposable adult and pediatric NIBP cuffs to the monitor. Use with adult and pediatric cuffs only. CANNOT BE USED WITH NEONATAL CUFFS. Use with all Philips models except A1/A3	M1598B	YA25A06-05	Pressure Cuff Interconnect Tubing, Single tube, 5ft. 1.5M, 6.0 Air plug > Bayonet type, perfect fit for 5082-184 cuff connector	 347	 348	B8
		M1599B	YA25A06-10	Pressure Cuff Interconnect Tubing, Single tube, 10ft. 3.0M, 6.0 Air plug > Bayonet type, perfect fit for 5082-184 cuff connector	 347	 348	B8
			YA25A30-10	Pressure Cuff Interconnect Tubing, Single tube, 10ft(3m), A25>>A30, perfect fit for A02,A25,A26 tip cuff connector	 347	 B0	B0
Philips HP	MP Series Patient Monitor  New Product	M1597C	YA25A45-10	Pressure Cuff Interconnect Tubing, Single tube, 10ft(3m), A25>>A45, perfect fit for A41 tip cuff connector.	 347	 C5	C5
Philips Simens Mindray Spacelabs MEK,NPB , Contec	NIBP hose connects to 40401X, M45xx, M157x series pressure cuffs. Use with Philips Instrument: A1/A3, M3921A, M3923A, M3926A, M3927A, M3928A, M3929A Spacelabs: 90496 Module, Contec: CMS9000	M3918A Spacelabs P/N: 714-0018-00	YA06A06-10	Pressure Cuff Interconnect Tubing, Single tube, 10 ft 3.0 M, Bayonet type > Bayonet type perfect fit for 5082-184 cuff connector	 348	 348	B8
			YA06A06-10H	Pressure Cuff Interconnect Tubing, Single tube, 10ft(3m), A06>>A06, perfect fit for A04,A05 tip cuff connector.			B0
			YA06A06-12	Pressure Cuff Interconnect Tubing, Single tube, 12 ft 3.6 M, Bayonet type > Bayonet type perfect fit for 5082-184 cuff connector			B8
Goldway 3F Medical System			YA10A01-12	Blood Pressure Tubing (Air Hoses), single-tube, Adult-Pediatric, 12 ft., Screw Connector > Barbed to barbed connector.	 514	 B0	B0
Creative Neusoft Jeteem	Jeteem: BD6000		YA18A01-10	Pressure Cuff Interconnect Tubing, Single tube, 3.0M, Readle Air plug > Barbed to barbed connector.	 319	 B0	B0
Colin, Criticare, CSI Datascope, Nihon Kohden, Datascope			YA07A08-10	Pressure Cuff Interconnect Tubing, Single tube, 3.0M, Male Plastic Luer Lock > Female Plastic Luer Lock.	 B8	 B8	B8
Mindray			YA06A106-10	Pressure Cuff Interconnect Tubing, Single tube, 10ft(3m), A06>>A106	 B0	 B0	B0
Physiop-control	LIFEPAK 15		YA100A03-10	Pressure Cuff Interconnect Tubing, Single tube, 10ft(3m), A100>>A03, for sliding cuffs connector (A02,A25,A26).	 B0	 B0	B0
Fukuda	 New Product		YA47A48-06	Pressure Cuff Interconnect Tubing, Single tube, 6ft(1.8m), A47>>A48	 E9	 E9	E9
			YA48A48-12	Pressure Cuff Interconnect Tubing, Single tube, 12ft(3.6m), A48>>A48	 B5	 B5	B5

Pressure Cuff Interconnect Tubing

Compatible Brand	Compatible Models No.	OEM P/N	HNM REF NO.	Description (Name,Length,Plug)	Instrument Connector	Yoke (cuff side)	PRICE CODE	
GE Dinamap, Pro, MPS	DINAMAP, Pro, Compact, MPS Series		YA24A10-08	Pressure Cuff Interconnect Tubing, two- tube, Adult-Pediatric, 8ft (2.5m) , A24>>A10,perfect fit for A09 tip cuff connector.			C7	
		107365	YA24A10-12	Blood Pressure Tubing (Air Hoses), two- tube, Adult-Pediatric, 12 ft.,Gray Shroud to Screw Connector, Gray.	516	514	C8	
			YA24A109-12 (2018)	Blood Pressure Tubing (Air Hoses), two- tube, Adult-Pediatric, 12 ft.,Gray Shroud to Screw Connector, Gray.			C0	
		107366	YA24A10-24	Blood Pressure Tubing (Air Hoses), two- tube, Adult-Pediatric, 24 ft.,Gray Shroud to Screw Connecto.	516		Come with Metal Connector A34	C8
		107368	YA24A16-12	Blood Pressure Tubing (Air Hoses), two- tube, Neonatal, 12 ft., Gray Shroud to Female Slip Lue.	516		382	C0
		107363	YA24A12-12	Blood Pressure Tubing (Air Hoses), two- tube, Adult-Pediatric, 12 ft., Gray Shroud to Submin Connector, Gray.	516			C7
GE Marquette	Eagle 3000, Dash 2000/3000/4000,Tram 400/450/451, Tram 800. 850/851.Corometrics 120	9461-217	YA23A10-12	Blood Pressure Tubing (Air Hoses), two- tube, Adult-Pediatric, 12 ft.Gray, Rectangular Connector to Screw Connector,	381	514	C7	
		414873-001	YA23A12-12	Blood Pressure Tubing (Air Hoses), two- tube, fit for Adult-Pediatric, 12 ft.,Gray, Rectangular Connector (2 holes) to Submin Connector.	381		C7	
			YA40A12-12	Blood Pressure Tubing (Air Hoses), two- tube, fit for Adult-Pediatric, 12 ft (3.6M). A40》 A12, Gray, Rectangular Connector (3 holes) to Submin Connector, fit for A11			C7	
		414874-001	YA23A16-08	Blood Pressure Tubing (Air Hoses), two- tube, Neonatal, 8 ft., Rectangular Connector to Female Slip Luer.	381		C0	
GE medical Critikon, Kontron, Invivo	DINAMAP 1846, 8100, 9300 and Plus Series Monitors	88845	YA10A102-24	Blood Pressure Tubing (Air Hoses), two- tube, Adult-Pediatric, 24 ft., Screw Connector to Screw Connector.	514	514	C7	
		88845	YA10A12-08	Blood Pressure Tubing (Air Hoses), two- tube, Neonatal, 8 ft., Screw Connector to Female Slip Luer.			C7	

Non-Invasive Blood Pressure(NIBP) Cuff & Tubes

Compatible Brand	Compatible Models No.	OEM P/N	HNM REF NO.	Description (Name,Length,Plug)	Instrument Connector	Yoke (cuff side)	PRICE CODE
GE medical Corometrics GE Datex	Eagle 4000, Tram 100/200/250/300/350, Corometrics 120	9461-203	YA22A12-12	Blood Pressure Tubing (Air Hoses), two- tube, Adult-Pediatric, 12 ft., Screw Connector to Submin Connecto.			C7
		9461-214	YA22A10-12	Blood Pressure Tubing (Air Hoses), two- tube, Adult-Pediatric, 12 ft., Screw Connector to Screw Connector.			C7
		9461-205	YA22A16-08	Blood Pressure Tubing (Air Hoses), two- tube, Neonatal, 8 ft., Round Connector to Female Slip Luer.			C0
Nihon Kohden	Bedside Monitor: BSM-4101,4103,4111,4113 Life scope P,BSM-5105,5135 Life scope A,BSM-2351,2353 Life scope L,BSM-2301,2303 Life scope I		YA28A11-08	Blood Pressure Tubing (Air Hoses), two- tube, 8ft.(2.4m), A28>A11, Fit for A12.			C0
Siemens, Drager	Multimed-Pot system fur serie SC 6000, SC 6002XL, SC 7000, SC 9000, Art. Nr.3368391 (8.2ft) Art. Nr. 5950196 (4.9ft)		YA29A06-08	Blood Pressure Tubing (Air Hoses), single-tube, 8ft.(2.4m), 6.0 Air plug>A45, fit for A41.			B0
ZOLL	Compatible with Propaq ;Zoll X series monitors	8300-0002-01	YA12A116-12	Blood Pressure Tubing (Air Hoses),two-tube, 10ft(3.6m), A28>A11,			E0

Air Hose Connectors (Cuff side)

Air Hose Connectors

- Air hose connectors to convert your air hose to use blood pressure cuffs
- Variety of shapes and styles
- Economical way to standardize your blood pressure monitors throughout your facility.

Compatibility	Productor Guide	OEM P/N	HNM REF NO.	Description	Perfect fit for	PRICE CODE
All single tube of blood pressure monitors			HL0024B	Single Tubing, Gray . Inner diameter: 5/32 in. Out diameter: 8mm, Purchasing Unit: M - Material: Silicone	all Barbed diameter 5/32 in. air connector	A2
			HL0024E	Single Tubing, Black . Inner diameter: 5/32 in. Out diameter: 8mm, Purchasing Unit: M - Material: Silicone	all Barbed diameter 5/32 in. air connector	A2
		GE P/N:300959	SL0008A	Single Tubing, Gray , Φ6.0X3.0mm Purchasing Unit: M - Material: TPU	all Barbed diameter 5/32 in. air connector	A2
All two tube of blood pressure monitors			SL0008B	Two-Tubing, Gray, Inner diameter: 5/32 in. Out diameter: 3mm*2, Purchasing Unit: M - Material: TPU	all Barbed diameter 5/32 in. air connector	A5
Air Hose Connector		GE P/N:300670	A01	Barbed to Barbed, Plastic, Packaging: 10pcs/pk Fit for ID2.5mm - 4.0mm tube.	all Barbed diameter 5/32 in. air connector	A3/pk
L&T, Critikon, Datex (Neonatal)		Welch-allyn P/N:5082-176	A26	Barbed to Male Luer Slip type, Plastic, Packaging: 10pcs/pk , Fit for ID2.5mm tube.	Female Slip Luer (A03,A15,A16)	A3/pk
L&T, Critikon, Datex		GE P/N: 300667 Welch-allyn P/N: 5082-167	A25	5/32 in. ID Barbed to Male Slip Luer, Plastic, Packaging: 10pcs/pk Fit for ID4.0mm tube and OD4.0 tube.	Female Slip Luer (A03,A15,A16)	A3/pk

Non-Invasive Blood Pressure(NIBP) Cuff & Tubes

Compatibility	Product Guide	OEM P/N	HNM REF NO.	Description	Perfect fit for	PRICE CODE
L&T, Critikon, Datex		GE P/N: 300667 Welch-allyn P/N: 5082-167	A02	5/32 in. ID Barbed to Male Slip Luer, Metal, Packaging: 10pcs/pk Fit for ID4.0mm tube	Female Slip Luer (A03,A15,A16)	A8/pk
L&T, Critikon, Datex		GE P/N: 300669 Welch-allyn P/N: 5082-169	A03	5/32 in. ID Barbed to Female Slip Luer, Metal, Packaging: 10pcs/pk Fit for ID4.0mm tube	Male Slip Luer, (A02,A25,A26)	B6/pk
Regularly as the connector of air hose for neonate disposable BP cuffs		GE P/N: 300669 Welch-allyn P/N: 5082-169	A30	5/32 in. ID Barbed to Female Slip Luer, Metal, Packaging: 1piece/pk Fit for ID4.0mm tube	Male Slip Luer, (A02,A25,A26)	A2
Philips (HP), Siemens, Datascope and Colin		GE P/N: 330059 Welch-allyn P/N: 5082-184	A04	Male Bayonet to 5/32 in. ID Barbed, Metal, Packaging: 10pcs/pk Fit for ID4.0mm tube	Female Bayonet	A8/pk
		Welch-allyn P/N: 5082-184	A05	Male Bayonet to 5/32 in. ID Barbed, Plastic, Packaging: 10pcs/pk Fit for ID2.5mm - 4.0mm tube.	Female Bayonet	A5/pk
		GE P/N:330060	A06	5/32 in. ID Barbed to Female Bayonet, Metal, Packaging: 1piece/pk Fit for ID3.0mm - 4.0mm tube.	Male Bayonet	A4
Spacelabs, Datascope and Colin		GE P/N:300668 Welch-allyn P/N:5082-168	A07	(Plastic Luer Lock) Female Locking Luer to 5/32 in. ID Barbed, Plastic, Packaging: 10pcs/pk Fit for ID3.0mm - 4.0mm tube.	Male Locking Luer	A5/pk
		GE P/N:300665 Welch-allyn P/N:5082-165	A08	5/32 in. ID Barbed to Male Locking Luer (Plastic Luer Lock), Plastic, Packaging: 10pcs/pk Fit for ID2.5mm - 4.0mm tube.	Female Locking Luer	A5/pk
Spacelabs, Colin, Datascope		GE P/N:300668 Welch-allyn P/N:5082-168	A36	Female Metal Luer Lock Connetor; Fit for ID 3.00mm-4.00mm tube; Material: Metal; Packaging: 1 piece/pk;	Fit for A37	A6/ pcs
		GE P/N:300665 Welch-allyn P/N:5082-165	A37	Male Metal Luer Lock Connector; Fit for ID 2.50mm-4.00mm. Material: Metal; Packaging: 1 piece/pk;	Fit for A36	A6/ pcs
GE DINAMAP		GE P/N:300664 Welch-allyn P/N:5082-164	A09	Male Screw to 5/32 in. ID Barbed, Plastic, Packaging: 10pcs/pk Fit for ID2.5mm - 4.0mm tube.	Female Screw	A5/pk
		GE P/N:300619 Welch-allyn P/N:5082-161	A10	5/32 in. ID Barbed to Female Screw, Plastic, Packaging: 10pcs/pk Fit for ID2.5mm - 4.0mm tube.	Male Screw	A8/pk
GE DINAMAP		GE P/N:300664 Welch-allyn P/N:5082-164	A33	Male Metal Luer Lock Connector, L=22.6mm; Fit for ID 4.00mm tube (5/32in) ; Material: Nickel-plated brass; Packaging: 1 piece/pk;	Fit for A34	A2/ pcs
		GE P/N:300619 Welch-allyn P/N:5082-161	A34	Female Metal Luer Lock Connector, L=23.6mm, Fit for ID 4.00mm tube (5/32in) ; Material: Nickel-plated brass; Packaging: 1 piece/pk;	Fit for A33	A2/ pcs
GE, Marquette and Protocol		GE P/N:330064 Welch-allyn P/N:5082-182	A11	(Quick Disconnect Locking type) Female Submin to 5/32 in. ID Barbed, Plastic, Packaging: 10pcs/pk Fit for ID2.5mm - 4.0mm tube.	Male Submin	A8/pk

Non-Invasive Blood Pressure(NIBP) Cuff & Tubes

Compatibility	Productor Guide	OEM P/N	HNM REF NO.	Description	Perfect fit for	PRICE CODE
GE, Marquette, Datex-Ohmeda		GE P/N:330090	A12	(Quick Disconnect Locking type) Male Submin to 5/32 in. ID Barbed, Plastic, Packaging: 10pcs/pk Fit for ID2.5mm - 4.0mm tube.	Female Submin	A8/pk
GE Marquette one-tube systems		GE P/N:330057 Welch-allyn P/N:5082-181	A13	5/32 in. ID Barbed to Female Marquette locking type Connector, Plastic, Packaging: 1piece/pk Fit for ID2.5mm - 4.0mm tube.	male Marquette locking type Connector	A7
			A14	5/32 in. ID Barbed to male Marquette locking type Connector, Plastic, Packaging: 1piece/pk Fit for ID2.5mm - 4.0mm tube.	Female Marquette locking type Connector	A2
Welch Allyn		16-41-000	A38	Female Metal Luer Lock Connetor; L=20mm; Fit for ID 4.00mm tube (5/32in); Material: Nickel-plated brass; Packaging: 1 piece/pk;	Fit for A39	A6/ pcs
		16-40-000	A39	Male Metal Luer Lock Connetor; L=26.5mm, Fit for ID 4.00mm tube (5/32in); Material: Nickel-plated brass; Packaging: 1 piece/pk;	Fit for A38	A6/ pcs
ADAPTER			A15	5/32 in. ID Barbed X2 to Female Slip Luer., Plastic, Packaging: 10pcs/pk Fit for ID2.5mm - 4.0mm tube.	Marquette Neonatal cuff connector	B6/pk
			A21	5/32 in. ID Barbed X2 to 5/32 in. ID Barbed X2, Plastic, Packaging: 10pcs/pk Fit for ID2.5mm - 4.0mm tube.	5/32 in. ID Tube	B6/pk
			SL0424A	Y type tube adaptor, ID: 4.0mm, OD: 7.0mm	single tube to double tube style Interconnect Tubing	A2
GE Eagle 3000, Dash 2000/3000/4000, Tram 400/450/451, Tram 800/850/851, Coro			A16	5/32 in. ID Barbed to Female Slip Luer, Plastic, Packaging: 10pcs/pk Fit for ID2.5mm - 4.0mm tube.	Marquette Neonatal cuff connector	B6/pk
Readel			A17	5/32 in. ID Barbed to Readel air socket, Plastic, Packaging: 1piece/pk	Readel air plug	A3
			A18	5/32 in. ID Barbed to Readel air plug, Plastic, Packaging: 1piece/pk Fit for ID4.0mm tube.	Readel air socket,	A3
Philips			A19	Male Bayonet socket to 5/32 in. ID Barbed, Metal, L=29mm, Packaging: 1piece/pk Fit for ID4.0mm tube.	Female Bayonet	A2
			A20	Male Bayonet socket to 5/32 in. ID Barbed, Metal, L=38mm, Packaging: 1piece/pk Fit for ID4.0mm tube.	Female Bayonet	A2

Non-Invasive Blood Pressure(NIBP) Cuff & Tubes

Compatibility	Product Guide	OEM P/N	HNM REF NO.	Description	Perfect fit for	PRICE CODE
The connector of air hose for Reusable BP Cufs			A31	Female Metal Luer Lock Connector, L=22mm; Fit for ID 4.00mm tube (5/32in); Material: Nickel-plated brass; Packaging: 1 piece/pk;	Fit for A32	A2/ pcs
			A32	Male Metal Luer Lock Connector, L=27.3mm, Fit for ID 4.00mm tube (5/32in); Material: Nickel-plated brass; Packaging: 1 piece/pk	Fit for A31	A2/ pcs
GE Marquette		GE P/N:330057	A13	5/32 in. ID Barbed to Female Marquette locking type socket, Plastic, Packaging: 1piece/pk	male Marquette locking type Connector	A7
			A14	5/32 in. ID Barbed to male Marquette locking type Connector, Plastic, Packaging: 1piece/pk	Female Marquette locking type socket	A2
GE Eagle 4000, Tram 100/200/250/ 300/350, Corometrics 118			A22	5/32 in. ID Barbed*2 to Round Connector, Packaging: 1piece/pk	Perfect fit for two-tubes	A5
GE Eagle 3000, Dash 2000/3000/4000, Tram 400/450/451, Tram 800/850/851, Corometrics 120			A23	Rectangular Connector, Packaging: 1piece/pk	Perfect fit for two-tubes	A5
GE DINAMAP, Pro, Compact, MPS Series			A24	Gray Shroud Connector, Packaging: 1piece/pk	Perfect fit for two-tubes	A5
GE			A108 (2017)	ID Barbed, Plastic, White Two-Tubing connector	Perfect fit for two-tubes	A5
		212202296	A109 (2017)	ID Barbed, Plastic, black connector	Perfect fit for single-tube	A5
			A110 (2017)	ID Barbed, Plastic, Black Two-Tubing connector	Perfect fit for two-tubes	A5
Drager			A117 (2018)	Compatible with Drager Connector, Material: Nylon	Fit for A118	A5
			A118 (2018)	Compatible with Drager Connector, Material: Nylon	Fit for A117	A1

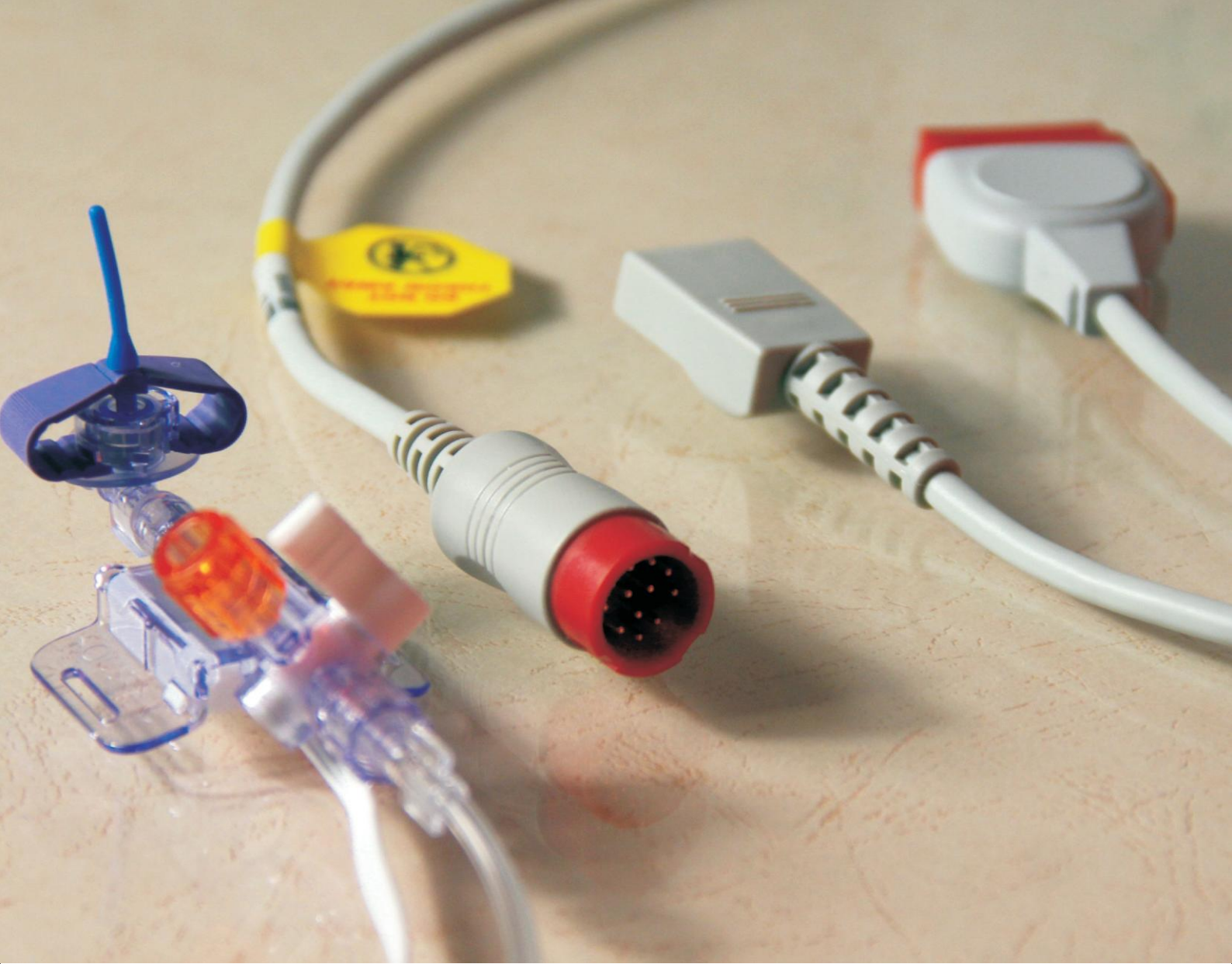

16

IBP Cable



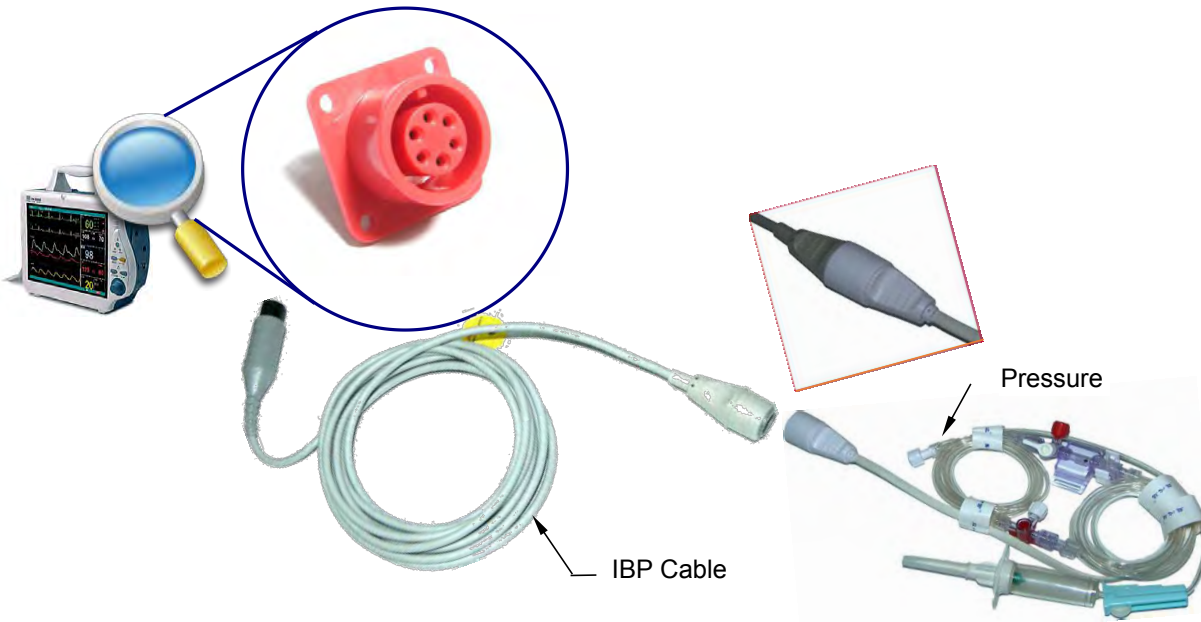

Instrument Connector



Yoke type

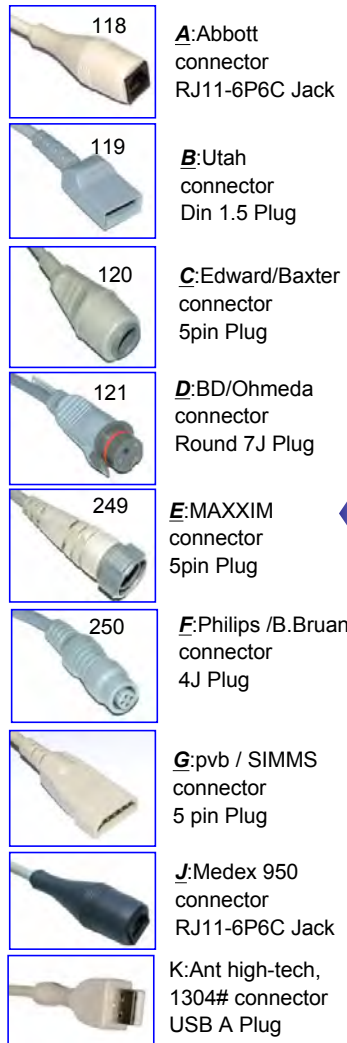



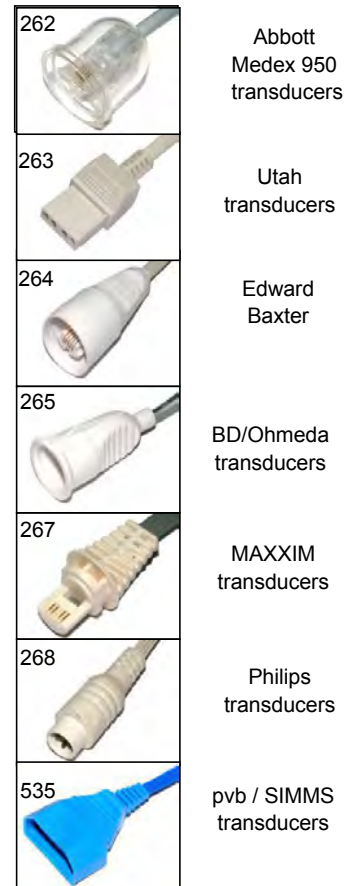



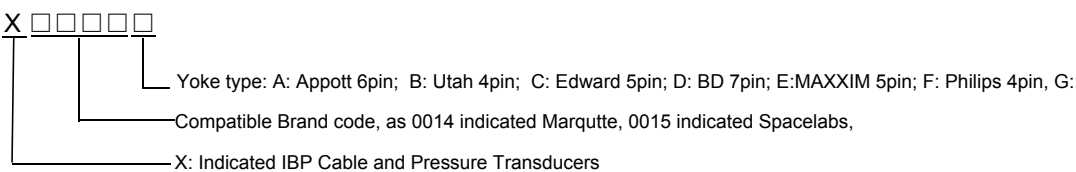



































transducers connector

























































Type Disignation





























































































IBP Cable and Pressure Transducers

Compatible Brand	Compatible Models No.	OEM P/N	HNM REF NO.	Description (Name,Length,Plug)	INSTRUMENT CONNECTOR	Yoke (transducers side)	PRICE CODE
Chenwei			X0017A	Abbott Transducer Adapter Cable, 12 ft. (3.6M), Readel 4pin>6p6c jack,	 251		B0
			X0017B	Utah Transducer Adapter Cable, 12 ft. (3.6M), Readel 4pin>Din 2.0 4pin	 251		B0
			X0017C	Edward Transducer Adapter Cable, 12 ft. (3.6M), Readel 4pin>5pin,	 251		B0
			X0017D	BD Transducer Adapter Cable, 12 ft. (3.6M), Readel 4pin>7p jack,	 251		C5
			X0017E	MAXXIM Transducer Adapter Cable, 12 ft (3.6M), Readel 4pin>5pin	 251		C5
			X0017F	Philips Transducer Adapter Cable, 12 ft. (3.6M), Readel 4pin>Round 4p	 251		B0
			X0017J	Medex Transducer Adapter Cable, 12 ft. (3.6M), Readel 4pin>6p6c jack,	 251		C5
Datex	 <p>X0030A</p>		X0030A	Abbott Transducer Adapter Cable, 12 ft. (3.6M), Round 10J>6p6c jack,	252 		B0
			X0030B	Utah Transducer Adapter Cable, 12 ft. (3.6M), Round 10J>Din 2.0 4pin	252 		B0
			X0030C	Edward Transducer Adapter Cable, 12 ft. (3.6M), Round 10J>5pin,	252 		B0
			X0030D	BD Transducer Adapter Cable, 12 ft. (3.6M), Round 10J>7p jack,	252 		C5
			X0030E	MAXXIM Transducer Adapter Cable, 12 ft. (3.6M), Round 10J>5pin	252 		C5
			X0030F	Philips Transducer Adapter Cable, 12 ft. (3.6M), Round 10J>Round 4p	252 		B0
			X0030J	Medex Transducer Adapter Cable, 12 ft. (3.6M), Round 10J>6p6c jack,	252 		E5
Fukuda	 <p>X0026B</p>		X0026A	Abbott Transducer Adapter Cable, 12 ft. (3.6M), Round 12pin>6p6c jack,	253 		B0
			X0026B	Utah Transducer Adapter Cable, 12 ft. (3.6M), Round 12pin>Din 2.0 4pin			B0
			X0026C	Edward Transducer Adapter Cable, 12 ft. (3.6M), Round 12pin>5pin,			B0
			X0026D	BD Transducer Adapter Cable, 12 ft. (3.6M), Round 12pin>7p jack,			C5
			X0026E	MAXXIM Transducer Adapter Cable, 12 ft(3.6M), Round 12pin>5pin			C5
			X0026F	Philips Transducer Adapter Cable, 12 ft. (3.6M), Round 12pin>Round 4p			B0
			X0026J	Medex Transducer Adapter Cable, 12 ft. (3.6M), Round 12pin>6p6c jack,			E5
	 <p>NEW PRODUCT Fukuda Denshi IBP Cable X0047 Series</p> <p>DESH 8000 Series</p>		X0047B	Utah Transducer Adapter Cable, 12 ft. (3.6M), Round 12pin>Din 2.0 4pin			F9
			X0047C	Edward Transducer Adapter Cable, 12 ft. (3.6M), Round 12pin>5pin,			F9
			X0047E	MAXXIM Transducer Adapter Cable, 12 ft(3.6M), Round 12pin>5pin			F9































IBP Cable and Pressure Transducers

Compatible Brand	Compatible Models No.	OEM P/N	HNM REF NO.	Description (Name,Length,Plug)	INSTRUMENT CONNECTOR	Yoke (transducers side)	PRICE CODE
GE-Marquette	GE Solar, Dash, Eagle, Tram  	700075-001	X0014A	Abbott Transducer Adapter Cable, 12 ft. (3.6M), Rectangle 11pin>6p6c jack,	413 		B0
		700078-001	X0014B	Utah Transducer Adapter Cable, 12 ft. (3.6M), Rectangle 11pin>Din2.0 4p	413 		B0
			X0014C2 (2018)	Edward Transducer Adapter Cable, 12 ft. (6.4M), Rectangle 11pin>5pin,			B0
		2021197-001	X0014C	Edward Transducer Adapter Cable, 12 ft. (3.6M), Rectangle 11pin>5pin,	413 		B0
		700077-001	X0014D	BD Transducer Adapter Cable, 12 ft. (3.6M), Rectangle 11pin>7p jack,	413 		C5
			X0014E	MAXXIM Transducer Adapter Cable, 12 ft. (3.6M), Rectangle 11pin>5pin	413 		C5
			X0014F	Philips Transducer Adapter Cable, 12 ft. (3.6M), Rectangle 11pin>Round 4p	413 		B0
			X0014G	Fit for PVB Transducer Adapter Cable, 12 ft.(3.6M), Rectangle 11pin>5p;	413 	 816	C0
			X0014J	Medex Transducer Adapter Cable, 12 ft. (3.6M), Rectangle 11pin>6p6c jack,	413 		C5
			X0014K	Fit for Ante PT-01 Adapter Cable, 12ft (3.6M) , Rectangle 11pin>4pin USB	413 	 1	B0
Lohmeier	M010  		X0019A	Abbott Transducer Adapter Cable, 12 ft. (3.6M), Rectangle 12p>6p6c jack,	079 		B0
			X0019B	Utah Transducer Adapter Cable, 12 ft. (3.6M), Rectangle 12p>Din 2.0 4pin	079 		B0
			X0019C	Edward Transducer Adapter Cable, 12 ft. (3.6M), Rectangle 12p>5pin,	079 		B0
			X0019D	BD Transducer Adapter Cable, 12 ft. (3.6M), Rectangle 12p>7p jack,	079 		C5
			X0019E	MAXXIM Transducer Adapter Cable, 12 ft(3.6M), Rectangle 12p>5pin	079 		C5
			X0019F	Philips Transducer Adapter Cable, 12 ft. (3.6M), Rectangle 12p>Round 4p	079 		B0
			X0019J	Medex Transducer Adapter Cable, 12 ft. (3.6M), Rectangle 12p>6p6c jack,	079 		E5
Mindray	PM6000,6800, T5, T8		X0016A	Abbott Transducer Adapter Cable, 12 ft. (3.6M), Round 12pin>6p6c jack,	030 		B0
			X0016B	Utah Transducer Adapter Cable, 12 ft. (3.6M), Round 12pin>Din 2.0 4pin	030 		B0
		0010-21-12179	X0016C	Edward Transducer Adapter Cable, 12 ft. (3.6M), Round 12pin>5pin,	030 		B0
		001C-30-70757	X0016D	BD Transducer Adapter Cable, 12 ft. (3.6M), Round 12pin>7p jack,	030 		C5
			X0016E	MAXXIM Transducer Adapter Cable, 12 ft (3.6M), Round 12pin>5pin	030 		C5
			X0016F	Philips Transducer Adapter Cable, 12 ft. (3.6M), Round 12pin>Round 4p	030 		B0
			X0016J	Medex Transducer Adapter Cable, 12 ft. (3.6M), Round 12pin>6p6c jack,	030 		C5
			X0016G	PVB Transducer Adapter Cable, 12 ft. (3.6M), Round 12pin>5pin.	030 		C0

Compatible Brand	Compatible Models No.	OEM P/N	HNM REF NO.	Description (Name,Length,Plug)	INSTRUMENT CONNECTOR	Yoke (transducers side)	PRICE CODE
Spacelabs Mindray Goldway	<p>Reusable and non-sterile. It may be gas sterilized. (Datex-Ohmeda TC-VTK.) For use with 690-0008-00, 690-0009-00, 690-0010-00, 690-0011-00, 690-0014-01, and 690-0015-01 transducers and all Spacelabs Medical monitoring systems. Use on 90496 also requires adapter cable 700-0028-00, sold separately. Mindray: PM7000, 8000,9000,6201.</p> 		X0015A	Abbott Transducer Adapter Cable, 12 ft. (3.6M), AMP 6pin>6p6c jack,	 377		B0
			X0015B	Utah Transducer Adapter Cable, 12 ft. (3.6M), AMP 6pin>Din 2.0 4pin	 377		B0
			X0015C	Edward Transducer Adapter Cable, 12 ft. (3.6M), AMP 6pin>5pin,	 377		B0
		690-0021-00	X0015D	BD Transducer Adapter Cable, 12 ft. (3.6M), AMP 6pin>7p jack,	 377		C5
			X0015E	MAXXIM Transducer Adapter Cable, 12 ft. (3.6M), AMP 6pin>6pin	 377		C5
			X0015F	Philips Transducer Adapter Cable, 12 ft. (3.6M), AMP 6pin>Round 4p	 377		B0
			X0015G	Fit for PVB Transducer Adapter Cable, 12ft (3.6M) Round 6Pin >5Pin	 377	 816	C5
			X0015J	Medex Transducer Adapter Cable, 12 ft. (3.6M), AMP 6pin>6p6c jack,	 377		C5
			X0015K	Fit for Ante PT-01 Adapter Cable, 12ft (3.6M) ,AMP 6Pin >USB A	 377	 1	B0
Philips	<p>M1567A, M1568A kits</p> 		X0018A	Abbott Transducer Adapter Cable, 12 ft. (3.6M), Round 12pin>6p6c jack,	519 		B0
			X0018B	Utah Transducer Adapter Cable, 12 ft. (3.6M), Round 12pin>Din 2.0 4pin	519 		B0
			X0018C	Edward Transducer Adapter Cable, 12 ft. (3.6M), Round 12pin>5pin,	519 		B0
			X0018D	BD Transducer Adapter Cable, 12 ft. (3.6M), Round 12pin>7p jack,	519 		C5
			X0018E	MAXXIM Transducer Adapter Cable, 12 ft. (3.6M), Round 12pin>5pin	519 		C5
		M1634A	X0018F	Philips Transducer Adapter Cable, 12 ft. (3.6M), Round 12pin>Round 4p	519 		B0
			X0018G	Fit for PVB Transducer Adapter Cable, 12ft (3.6M) Round 12Pin > 5pin	519 	 816	C0
			X0018J	Medex Transducer Adapter Cable, 12 ft. (3.6M), Round 12pin>6p6c jack,	519 		C5
			X0018K	Fit for Ante PT-01 Adapter Cable, 12ft (3.6M) ,Round 12Pin > 4pin USB	519 	 1	B0
Philips HP	Philips: V24 HP		X0039A	Abbott Transducer Adapter Cable, 12 ft. (3.6M), Round 12pin>6p6c jack,	519 		E5
			X0039J	Medex Transducer Adapter Cable, 12 ft. (3.6M), Round 12pin>6p6c jack,	519 		E5

Compatible Brand	Compatible Models No.	OEM P/N	HNM REF NO.	Description (Name,Length,Plug)	INSTRUMENT CONNECTOR	Yoke (transducers side)	PRICE CODE
Siemens	Siemens Medical:Sirecust 700, Sirecust 630		X0001A	Abbott Transducer Adapter Cable, 12 ft. (3.6M), Round 10P>6p6c jack,	257 		B0
			X0001B	Utah Transducer Adapter Cable, 12 ft. (3.6M), Round 10P>Din 2.0 4pin	257 		B0
			X0001C	Edward Transducer Adapter Cable, 12 ft. (3.6M), Round 10P>5pin,	257 		B0
			X0001D	BD Transducer Adapter Cable, 12 ft. (3.6M), Round 10P>7p jack,	257 		C5
			X0001E	MAXXIM Transducer Adapter Cable, 12 ft(3.6M), Round 10P>5pin	257 		C5
			X0001F	Philips Transducer Adapter Cable, 12 ft. (3.6M) Round 10P>Round 4p	257 		B0
			X0001J	Medex Transducer Adapter Cable, 12 ft. (3.6M), Round 10P>6p6c jack,	257 		C5
Siemens Drager	Siemens/Darger:SC6002XL,7000, SC8000,SC9000XL X0002A  		X0002A	Abbott Transducer Adapter Cable, 12 ft. (3.6M), Round 7pin>6p6c jack,	258 		B0
			X0002B	Utah Transducer Adapter Cable, 12 ft. (3.6M), Round 7pin>Din 2.0 4pin	258 		B0
			X0002C	Edward Transducer Adapter Cable, 12 ft. (3.6M), Round 7pin>5pin,	258 		B0
			X0002D	BD Transducer Adapter Cable, 12 ft. (3.6M), Round 7pin>7p jack,	258 		C5
			X0002E	MAXXIM Transducer Adapter Cable, 12 ft. (3.6M), Round 7pin>5pin	258 		C5
			X0002F	Philips Transducer Adapter Cable, 12 ft. (3.6M), Round 7pin>Round 4p	258 		B0
			X0002G (2018)	Fit for PVB Transducer Adapter Cable,12ft (3.6M) Round 7pin>5pin,	258 		816 C0
			X0002J	Medex Transducer Adapter Cable, 12 ft. (3.6M), Round 7pin>6p6c jack,	258 		C5
			X0002K	Fit for Ante PT-01 Adapter Cable,12ft (3.6M) , Round 7Pin > 4pin USB	258 		1304 B0
		Siemens	Siemens/Darge X0031D  		X0031A	Abbott Transducer Adapter Cable, 12 ft. (3.6M), DB15M>6p6c jack,	
	X0031B			Utah Transducer Adapter Cable, 12 ft. (3.6M), DB15M>Din 2.0 4pin			B0
	X0031C			Edward Transducer Adapter Cable, 12 ft. (3.6M), DB15M>5pin,			B0
	X0031D			BD Transducer Adapter Cable, 12 ft. (3.6M), DB15M>7p jack,			C5
	X0031E			MAXXIM Transducer Adapter Cable, 12 ft. (3.6M), DB15M>5pin			C5
	X0031F			Philips Transducer Adapter Cable, 12 ft. (3.6M), DB15M>Round 4p			B0
	X0031J			Medex Transducer Adapter Cable, 12 ft. (3.6M), DB15M>6p6c jack,			E5















IBP Cable and Pressure Transducers

Compatible Brand	Compatible Models No.	OEM P/N	HNM REF NO.	Description (Name,Length,Plug)	INSTRUMENT CONNECTOR	Yoke (transducers side)	PRICE CODE
Drager	<p>Drager PM8014 & PM8060</p>  <p>X0032B</p>		X0032A	Abbott Transducer Adapter Cable, 12 ft. (3.6M), Round 10pin>6p6c jack,	 749		B0
			X0032B	Utah Transducer Adapter Cable, 12 ft. (3.6M), Round 10pin>Din 2.0 4pin	 749		B0
			X0032C	Edward Transducer Adapter Cable, 12 ft. (3.6M), Round 10pin>5pin,	 749		B0
			X0032D	BD Transducer Adapter Cable, 12 ft. (3.6M), Round 10pin>7p jack,	 749		C5
			X0032E	MAXXIM Transducer Adapter Cable, 12 ft. (3.6M) Round 10pin>5pin	 749		C5
			X0032F	Philips Transducer Adapter Cable, 12 ft. (3.6M), Round 10pin>Round 4p	 749		B0
			X0032J	Medex Transducer Adapter Cable, 12 ft. (3.6M), Round 10pin>6p6c jack,	 749		E5
Choice:			X0033A	Abbott Transducer Adapter Cable, 12 ft. (3.6M), Redel 1-Rib 6p>6p6c jack,	 749		B0
			X0033B	Utah Transducer Adapter Cable, 12 ft. (3.6M), Redel 1-Rib 6p>Din 2.0 4P	 749		B0
			X0033C	Edward Transducer Adapter Cable, 12 ft. (3.6M), Redel 1-Rib 6p>5pin,	 749		B0
			X0033D	BD Transducer Adapter Cable, 12 ft. (3.6M), Redel 1-Rib 6p>7p jack,	 749		C5
			X0033E	MAXXIM Transducer Adapter Cable, 12 ft. (3.6M), Redel 1-Rib 6p>6pin	 749		C5
			X0033F	Philips Transducer Adapter Cable, 12 ft. (3.6M), Redel 1-Rib 6p>Round 4p	 749		B0
Spacelabs Medical	<p>Compatible: Spacelab Ultraview 90496 , 91496 .</p> 		X0038A	Abbott Transducer Adapter Cable, 12 ft. (3.6M), 10 pin>6p6c jack,	 816		B0
			X0038B	Utah Transducer Adapter Cable, 12 ft. (3.6M), 10 pin>Din 2.0 4P	 816		B0
			X0038C	Edward Transducer Adapter Cable, 12 ft. (3.6M), 10 pin>5pin,	 816		B0
			X0038D	BD Transducer Adapter Cable, 12 ft. (3.6M), 10 pin>7p jack,	 816		C5
			X0038E	MAXXIM Transducer Adapter Cable, 12 ft. (3.6M) 10 pin>6pin	 816		C5
			X0038F	Philips Transducer Adapter Cable, 12 ft. (3.6M), 10 pin>Round 4p	 816		B0
			X0038G	Fit for PVB Transducer Adapter Cable,12ft (3.6M) 10 pin> 5 pin,	 816		C0
			X0038J	Medex Transducer Adapter Cable, 12 ft. (3.6M), 10 pin>6p6c jack,	 816		E5
			X0038K	Fit for Ante PT-01 Adapter Cable,12ft (3.6M) , 10 pin> 4 pin USB,	 816		B0













IBP Cable and Pressure Transducers

Compatible Brand	Compatible Models No.	OEM P/N	HNM REF NO.	Description (Name,Length,Plug)	INSTRUMENT CONNECTOR	Yoke (transducers side)	PRICE CODE
Nihon Konden	 <p>X0028D</p>		X0028A	Abbott Transducer Adapter Cable, 12 ft. (3.6M), Rectangle 14pin>6p6c jack,	256 		E5
			X0028B	Utah Transducer Adapter Cable, 12 ft. (3.6M), Rectangle 14pin>4pin	256 		E5
			X0028C	Edward Transducer Adapter Cable, 12 ft. (3.6M), Rectangle 14pin>5pin,	256 		E5
			X0028D	BD Transducer Adapter Cable, 12 ft. (3.6M), Rectangle 14pin>7p jack,	256 		E5
			X0028G	Fit for PVB Transducer Adapter Cable,12ft (3.6M) Rectangle 14pin>5p	256 	 816	E5
			X0028K	Fit for Ante PT-01 Adapter Cable,12ft (3.6M) , Rectangle 14pin>4P USB	256 	 1304	E5
			X0045D	BDTransducer Adapter Cable, 12 ft. (3.6M), AMP 5pin > 7p jack,			C0
MEK (KOREA)	 <p>X0027C</p> 		X0027A	Appott Transducer Adapter Cable, 12 ft. (3.6M), AMP 6pin 30°>6p6c jack,			B0
			X0027B	Utah Transducer Adapter Cable, 12 ft. (3.6M), AMP 6pin 30°>Din 2.0 4pin			B0
			X0027C	Edward Transducer Adapter Cable, 12 ft. (3.6M), AMP 6pin 30°>6pin,			B0
		690-0021-00	X0027D	BD Transducer Adapter Cable, 12 ft. (3.6M), AMP 6pin 30°>7p jack,			C5
			X0027E	MAXXIM Transducer Adapter Cable, 12 ft. (3.6M), AMP 6pin 30°>6pin			C5
			X0027F	Philips Transducer Adapter Cable, 12 ft. (3.6M), AMP 6pin 30°>Round 4p			B0
			X0027G	Fit for PVB Transducer Adapter Cable,12ft (3.6M) AMP 6pin 30°>5 pin,		 816	C0
			X0027J	Medex Transducer Adapter Cable, 12 ft. (3.6M), AMP 6pin 30°>6p6c jack,			E5
			X0027K	Fit for Ante PT-01 Adapter Cable,12ft (3.6M) , AMP 6pin 30°> 4 pin USB,		 1304	B0
DATASCOPE	<p>Datascope System 80, 82, 83, 84, 90, 90T, 95, 98, 97 IABP, 850, 870, P2, P3, 2000, 2000A., 2001, 2001A, 2002, 2002A, 22001, 3000, Passport</p>		X0041A	Appott Transducer Adapter Cable, 12 ft. (3.6M), AMP 6pin 30°>6p6c jack,			B0
			X0041B	Utah Transducer Adapter Cable, 12 ft. (3.6M), AMP 6pin 30°>Din 2.0 4pin			B0
			X0041C	Edward Transducer Adapter Cable, 12 ft. (3.6M), AMP 6pin 30°>6pin,			B0
			X0041D	BD Transducer Adapter Cable, 12 ft. (3.6M), AMP 6pin 30°>7p jack,			C5
			X0041E	MAXXIM Transducer Adapter Cable, 12 ft. (3.6M) AMP 6pin 30°>6pin			C5
			X0041F	Philips Transducer Adapter Cable, 12 ft. (3.6M), AMP 6pin 30°>Round 4p			C5
			X0041G	Fit for PVB Transducer Adapter Cable,12ft (3.6M) AMP 6pin 30° >5p		 816	C0
			X0041K	Fit for Ante PT-01 Adapter Cable,12ft (3.6M) , AMP 6pin 30°>4P USB		 1304	B0









ADAPTER (Exchange pressure transducers type)

Compatible Brand	Compatible Models No.	OEM P/N	HNM REF NO.	Description (Name,Length,Function)	Plug	Yoke (transducers side)	PRICE CODE
BD	Compatible: All monitors that accept BD plugs 		X0034A	Pressure transducers Adapter, BD to Abbott			B0
			X0034B	Pressure transducers Adapter, BD to Utah			B0
			X0034J	Pressure transducers Adapter, BD to Medex			C0
pvb	Compatible: All monitors that accept pvb plugs		X0035A	Pressure transducers Adapter, pvb to Abbott			B0
			X0035B	Pressure transducers Adapter, pvb to Utah			C5
Philips	Compatible: All monitors that accept Philips plugs		X0036A	Pressure transducers Adapter, Philips to Abbott			C5
			X0036B	Pressure transducers Adapter, Philips to Utah			B0

ADAPTER CABLE

Compatible Brand	Compatible Models No.	OEM P/N	HNM REF NO.	Description (Name,Length,Plug)	INSTRUMENT CONNECTOR	Yoke (transducers side)	PRICE CODE
Mennen			X0025A	Adapter cable, pressure transducer interface cable, 35 cm, Round 8p>AMP 6J	015 	270 	E5
		800-030-270	X0003A	Adapter cable, pressure transducer interface cable, 35 cm, Round 10p>2* 6J	260 	2 	F5
Siemens		13646	X0004A	Adapter cable, pressure transducer interface cable, 35 cm, Rec16p> 2*Rou 10p	261 	2 	G0
Spacelabs Medical	For use with the 90496 and 690-0021-00.	700-0028-00	X0024A	Adapter cable, pressure transducer interface cable, 122 cm/4 ft	082 	2 	F0
GE-Marquette	GE Solar, Dash, Eagle, Tram 		X0014H	Adapter cable, pressure transducer interface cable, Durable cable for extended cable life	413 	2 	F0

DISPOSABLE PRESSURE TRANSDUCER

Compatible Brand	Product Guide	Transducer Connector	HNM REF NO.	Description	PRICE CODE
Abbott		262 	X0020A	Pressure transducer kit for patientmount application, single-use Connector: RJ11-6P6C (No.: 262) Requires IBP adapter cable.	C2
UTAH		263 	X0020B	Pressure transducer kit for patientmount application, single-use Connector: 1.58 Jack x 4pin (No.: 263) Requires IBP adapter cable.	C2
Edwards Baxter		264 	X0020C	Pressure transducer kit for patientmount application, single-use Connector: 5pin (No.: 264) Requires IBP adapter cable.	C2
BD / Ohmeda		265 	X0020D	Pressure transducer kit for patientmount application, single-use Connector: Round 7pin (No.: 265) Requires IBP adapter cable.	C2
MAXXIM		267 	X0020E	Pressure transducer kit for patientmount application, single-use Connector: 5pin (No.: 267) Requires IBP adapter cable.	C2
Philips B.Bruan		268 	X0020F	Pressure transducer kit for patientmount application, single-use Connector: 1.0 x 4pin (No.: 268) Requires IBP adapter cable.	C2
pvb / SIMMS			X0020G	Pressure transducer kit for patientmount application, single-use Connector: 1.5 Jack x 5pin Requires IBP adapter cable.	C2



17

ETCO2 Sensor



Product Introduction:

The self-developed BA series ETCO₂ Sensor with high integration level is designed on the basis of the dual waveband, non-dispersive infrared technology combined with the latest microprocessor and digital signal processing technique. The proven concentration algorithm is used to draw real-time curve of CO₂ and deduct the parameters, such as ETCO₂, inCO₂ and RR. The sampling flow rate of BA series CO₂ Sensor can be set to a minimum of 50ml/min and could be setup according to different patient groups, such as babies, children and adults. The standard RS232 or TTL communication interface of the system can be quickly integrated into the monitor or other medical systems involved with the need to monitor the CO₂.

WinLand has nearly 20 years of experience in the production, research and development of infrared breath analyzer. The BA series sensor is the ideal choice for your demand of breath monitoring device with its stability, reliability, flexibility and accessibility.



Product Features:

- ★ Simple operation;plug and play
- ★ Long-term stability; dual waveband, non-dispersive infrared technology
- ★ Long operating life; infrared blackbody light source with MEMS technology
- ★ Accurate results; with built-in compensation algorithm for temperature, atmospheric pressure and balance gas
- ★ Free of calibration; patented calibration algorithm; calibration-free operation
- ★ With a minimum sampling flow rate of 50ml/min
- ★ Comprehensive solutions for OEM and ODM of CO₂ sensor







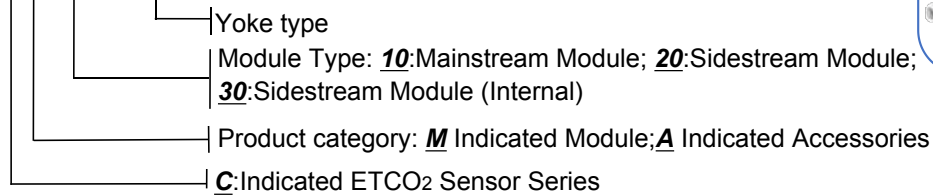





Type Designation











C □ □ □ - □ □ □







ETCO₂ Mainstream Module

Compatible Brand	Part No.	Description	Ref Picture	Connector Picture	Remarks	Price Code
Respironics	CM10-001	Respironics ETCO ₂ Mainstream			8pin, DP	Z0+D0
(Masimo) Phase In (ISA AX+)	CM10-002	Phase In ETCO ₂ Mainstream			DB9pin	Z0+D0
Zoll	CM10-003	ZOLL ETCO ₂ Mainstream			8pin, SP	Z0+D0
Philips	CM10-004	Philips ETCO ₂ Mainstream			8pin	Z0+D0
Mindray	CM10-005	Mindray ETCO ₂ Mainstream			8pin	Z0+D0



ETCO₂ Sidestream Module (External)

Compatible Brand	Part No.	Description	Ref Picture	Connector Picture	Remarks	Price Code
Respironics	CM20-001	Respironics External Sidestream			8pin, DP	Z0+D0
(Masimo) Phase In	CM20-002	Phase In External Sidestream			DB,9pin	Z0+D0
Zoll	CM20-003	Zoll External Sidestream			8pin, SP	Z0+D0
Philips	CM20-004	Philips External Sidestream			8pin	Z0+D0
Mindray	CM20-005	Philips External Sidestream			8pin	Z0+D0









ETCO₂ Sidestream Module (Internal)

Compatible Brand	Part No.	Description	Ref Picture	Connector Picture	Remarks	Price Code
Respironics /Phase In /CPT	CM30-001	Internal Sidestream			5pin	Z0+D0
	CM30-002	Internal Sidestream			16pin	Z0+D0

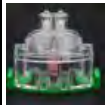
Disposable ETCO₂ Sidestream Module (Internal)

Part No.	Description	Ref Picture	Price Code	Part No.	Description	Ref Picture	Remarks	Price Code
CA10-001	Airway Adapter for adult		A7	CA10-002	Airway Adapter for Pediatric		Disposable	A7

ETCO₂ External Sidestream Module Accessories



Part No.	Description	Ref Picture	Remarks	Price Code	Part No.	Description	Ref Picture	Remarks	Price Code
CA20-001	Nasal Sampling Line for Adult		Disposable 2m	A5	CA20-007	T-Extension tube		Disposable	A7
CA20-002	Nasal Sampling Line for Pediatric		Disposable 3m	A5	CA20-008	Dehydration bottle		Disposable	C2
CA20-003	Water Filter		Disposable	A2	CA20-004	Sampling tube for CO ₂		Disposable	A3
CA20-004	Extension tube		Disposable	A5	CA20-014	Sidestream sampling tube		Disposable	B8
CA20-005	One L-fitting Connector		Disposable	A2	CA20-015	Sidestream sampling tube with oxygen absorption		Disposable	B0

Respiratory Mechanics

Type Disignation

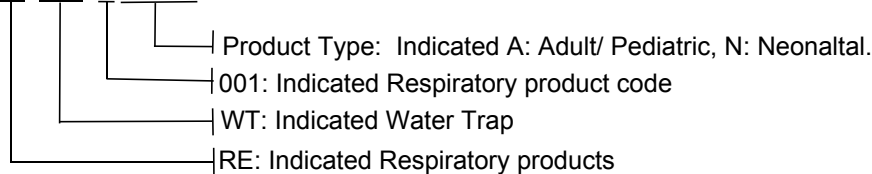
RE-□□□□□



Compatible Brand	Compatible Models No.	OEM P/N	HNM REF No.	Description (Name, Length, Packages)	Product Guide	PRICE CODE
Mindray	PM-9000 series, PM-7000, PM-6000 series, BeneView	9200-10-10530	RE-WT001A	Water Trap- Adult/Pediatric, 57mm;		A6
		9200-10-10574	RE-WT001N	Water Trap- Neonate, 47mm;		A6

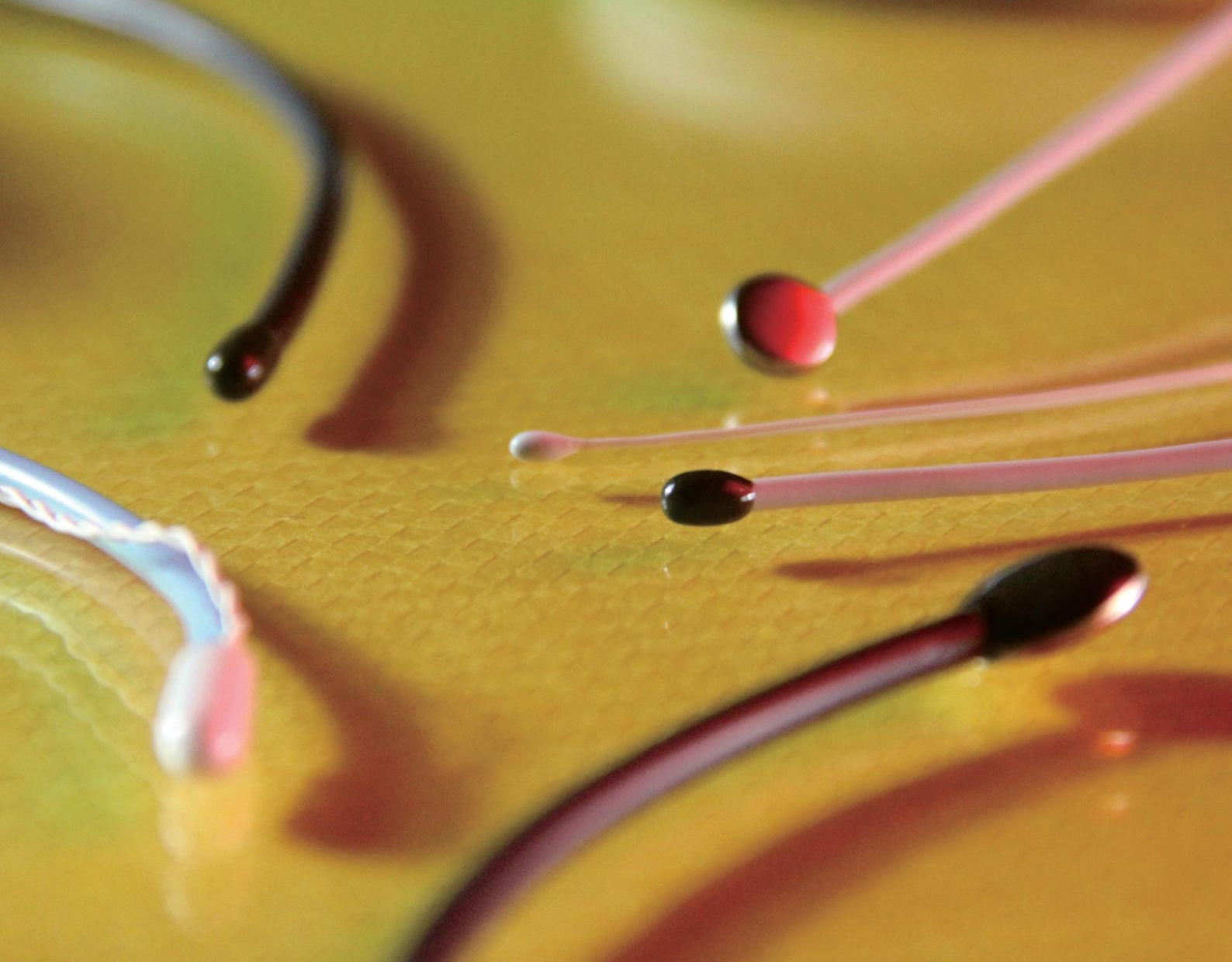

18

Medical Temperature Probes

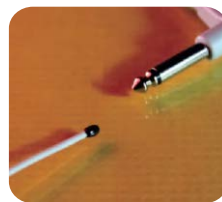
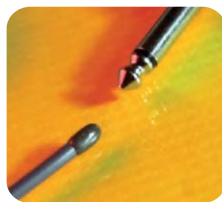
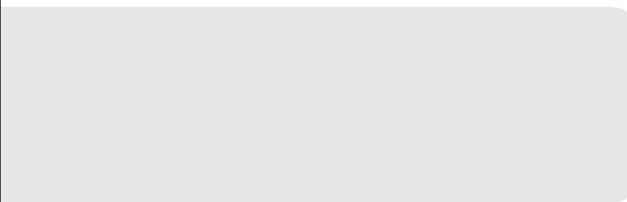

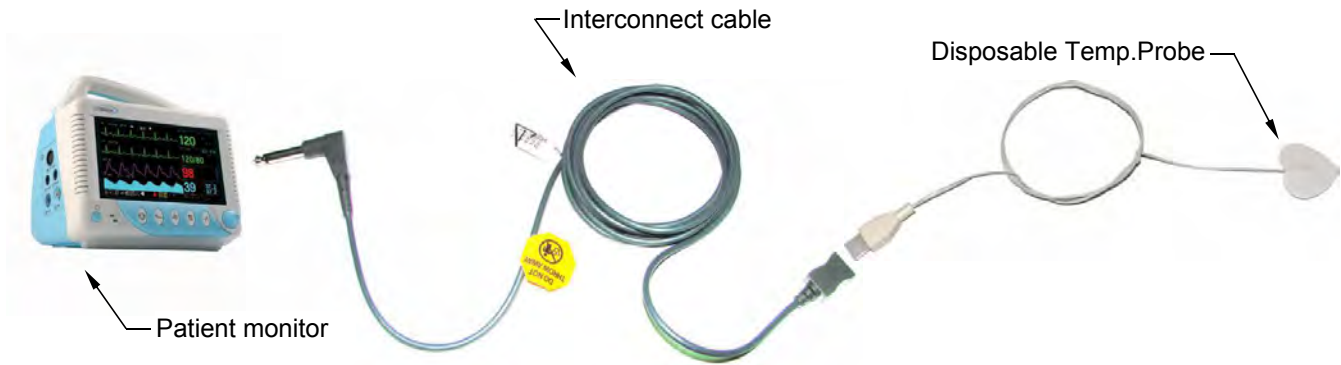

Instrument Connector



Yoke type



Disposable temp. probe connector



Probe type and Code

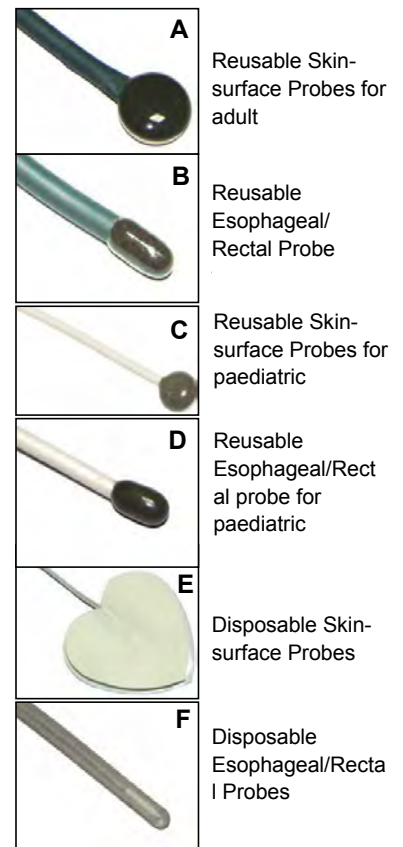

Specifications

Temperature Range: 0 to 50°C

Accuracy: ±0.1°C from 25 to 45°C







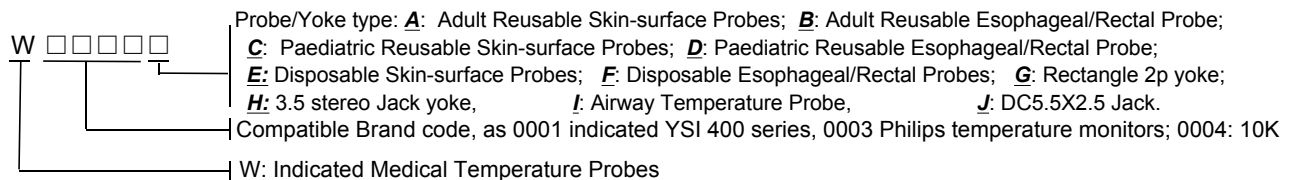







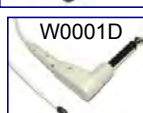

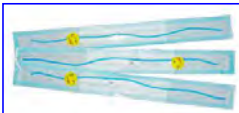





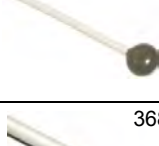

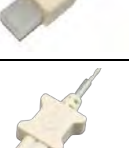



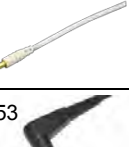
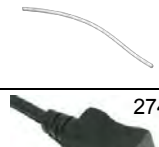

© Today's quality patient care requires body temperature monitor to be an integral part of any physiological measurements in the OR, ICU, CCU, or ER. HNM offers a full line of reusable, sterilizable, temperature probes to measure body temperature on your critical patients.

© Available in Rectal/Esophageal and Skin Surface Styles





























Type Disignation

























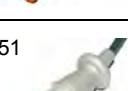



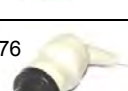

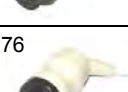

Medical Temperature Probes

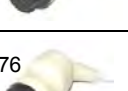
Compatible Brand	Compatible Models No.	OEM P/N	HNM REF NO.	Description (Name,Length,Probes,Plug)	Instrument Connector or Probe connector	Yoke (probe side) or Probe type	Price Code		
YSLSeries	Nihon Kohden	409A	W0103E (2018)	Adult Reusable Skin-surface Probe, 10ft. (3.0 m), 25°C@2.25KΩ, Ø6.3 mono plug>>Ø12mm disk	053 	365 	A9		
YSI 400 Series • Reusable temperature probes with Single Thermistors • Available in Rectal/Esophageal	Philips A3 series monitor Instrument: M3926A, M3927A, M3928A, M3929A; Marquette 7000/7010,GE Eagle, Solar, Tram, Tramscope, MAC-Lab Systems  W0001A  W0001B  W0001C  W0001D  W0001E  W0001F  W0102F  W0001G	409B	W0001A	Adult Reusable Skin-surface Probe, 10ft. (3.0 m), 25°C@2.25KΩ, Ø6.3 mono plug>>Ø12mm disk		365 	A9		
		401	W0001B	Adult Reusable Esophageal/Rectal Probe, 10ft. (3.0 m), 25°C@2.25KΩ, Ø6.3 mono plug>>Ø4.7mm tip	053 	367 	A9		
		427	W0001C	paediatric Reusable Skin-surface Probe, 10ft. (3.0 m), 25°C@2.25KΩ, Ø6.3 mono plug>>Ø8.0mm disk	053 	366 	A0		
		402	W0001D	paediatric Reusable Esophageal/Rectal Probe, 10ft. (3.0 m), 25°C@2.25KΩ, Ø6.3 mono plug>>Ø3.0mm tip	053 	368 	A0		
		4499	W0001E	Disposable Skin-surface Probe, 0.8 m, 25°C@2.25KΩ, Rectangle 2pin>>Adhesive Pad Package:24pcs/pk	117 		L0/pk		
			W0100F	Adult Esophageal/Rectal Probe, 0.7 m, 25°C@2.25KΩ, Rectangle 2pin>>Ø3.0mm tip Package:24pcs/pk			A3		
		4491	W0001F	Adult Esophageal/Rectal Probe, 0.7 m, 25°C@2.25KΩ, Rectangle 2pin>>Ø3.0mm tip Package:24pcs/pk	117 		L0/pk		
		21090A	W0102F	Disposable Adult esophageal/Rectal Probe, 0.7 m, 3.4mmmono plug>>Ø3.0mm tip Package:24pcs/pk			A3		
		E9004ZS	W0001G	Temp. probe Interconnect Cable, 8 ft. (2.4M) , Ø6.3 mono plug >> Rectangle 2pin, for use with Disposable Probes	053 	274 	A6		
		441A	W0001I	Airway Temperature Probe, 10 ft. (3.0M) ,25°C@2.25KΩ, Ø2.5 mono plug >> Type L probe, 7.6 mm diameter tapered manifold fitting	219 	311 	B0		
		Drager	Infant Incubator/Radiant Warmer The reflective insulator serves as a barrier against ambient and radiant heat while allowing the most accurate sensing of the skin temperature.		W0020C	Reusable Skin-surface Probe, 0.8 m, 25°C@2.25KΩ, 2pin plug>>Ø8.0mm disk Package:1pcs/pk		366 	B0
					W0020E	Disposable Skin-surface Probe, 0.8 m, 25°C@2.25KΩ, 2pin plug>>Adhesive Pad Package:24pcs/pk		BZ0109D Disposable probe pad price code: A2 /12pcs 	L0/pk
			C2000		W0095E	Disposable Temperature Probe			A3
15K Series			W0011B	Adult Reusable Esophageal/Rectal Probe, 10ft. (3.0m),25°C@15KΩ, Ø6.3 mono>>Ø4.7mm tip	053	367	A9		

Medical Temperature Probes































Compatible Brand	Compatible Models No.	OEM P/N	HNM REF NO.	Description (Name,Length,Probes,Plug)	Instrument Connector or Probe connector	Yoke (probe side) or Probe type	PRICE CODE
10K Series • Reusable temperature probes with Single Thermistors • Available in Rectal/Esophageal	Suitable for China OEM patient monitor: Tianrong :TR900D/E; Anke :ASC553A3, ASC553; Comon : star 8000A/B/C, star 5000,5000B/C		W0004A	Adult Reusable Skin-surface Probe, 10ft. (3.0 m), 25°C@10KΩ, Ø6.3 mono plug>>Ø12mm disk	053 	3 	A8
			W0004B	Adult Reusable Esophageal/Rectal Probe, 10ft. (3.0 m), 25°C@10KΩ, Ø6.3 mono plug>>Ø4.7mm tip	053 	3 	A8
			W0004C	paediatric Reusable Skin-surface Probe, 10ft. (3.0 m), 25°C@10KΩ, Ø6.3 mono plug>>Ø8.0mm disk	053 	3 	A0
			W0004D	paediatric Reusable Esophageal/Rectal Probe, 10ft. (3.0 m), 25°C@10KΩ, Ø6.3 mono plug>>Ø3.0mm tip	053 	3 	A0
			W0004E	Disposable Skin-surface Probe, 0.8 m, 25°C@10KΩ, Rectangle 2pin>>Adhesive Pad Package:24pcs/pk	117 		L0 /pk
			W0004F	Adult Esophageal/Rectal Probe, 0.8 m, 25°C@10KΩ, Rectangle 2pin>>Ø4.0mm tip Package:24pcs/pk	117 		L0 /pk
			E9004ZS	Temp. probe Interconnect Cable, 8 ft. (2.4M) , Ø6.3 mono plug >> Rectangle 2pin, for use with Disposable Probes	053 	2 	A6
			W0001G				
Creative Shenzhen	Creative patient monitor: PC-1000,5000,9000,UP-6000,		W0005A	Adult Reusable Skin-surface Probe, 10ft. (3.0 m), 25°C@10KΩ, Readell 2p>>Ø12mm disk	273 	3 	B5
			W0005B	Adult Reusable Esophageal/Rectal Probe, 10ft. (3.0 m), 25°C@10KΩ, Readell 2p>>Ø4.7mm tip	273 	367 	B5
18B20 series	Probes: DALLAS 18B20		W0006A	Adult Reusable Skin-surface Probe, 10ft. (3.0 m), 18B20, Ø6.3 stereo plug>>Ø12mm disk	054 	365 	B0
			W0006B	Adult Reusable Esophageal/Rectal Probe, 10ft. (3.0 m), 18B20, Ø6.3 stereo plug>>Ø6.0mm tip	054 	367 	B0

Compatible Brand	Compatible Models No.	OEM P/N	HNM REF NO.	Description (Name,Length,Probes,Plug)	Instrument Connector or Probe connector	Yoke (probe side) or Probe type	PRICE CODE
Ohmeda			W0021C	paediatric Reusable Skin-surface Probe, 10ft. (3.0 m), 25°C@10KΩ, Ø3.5 stereo plug>>Ø8.0mm disk			B0
Philips • Reusable temperature probes with Single Thermistors • Available in Rectal/Esophageal	All Philips temperature monitors that accept two-prong plugs  W0003A	21078A	W0003A	Adult Reusable Skin-surface Probe, 10ft. (3.0 m), 25°C@2.25KΩ, 2pin plug>>Ø12mm disk	051 	365 	B5
		21075A	W0003B	Adult Reusable Esophageal/Rectal Probe, 10ft. (3.0 m), 25°C@2.25KΩ, 2 pin plug>>Ø4.7mm tip	051 	367 	B5
		21076A	W0003D	paediatric Reusable Esophageal/Rectal Probe, 10ft. (3.0 m), 25°C@2.25KΩ, 2pin plug>>Ø8.0mm disk	051 	368 	B7
		21091A	W0003E	Disposable Skin-surface Probe, 0.8 m, 25°C@2.25KΩ, 3.5 mono plug>>Adhesive Pad Package:24pcs/pk	369 		L0/pk
		21090A	W0003F	Adult Esophageal/Rectal Probe, 0.8 m, 25°C@2.25KΩ, 3.5 mono plug>>Ø4.0mm tip Package:24pcs/pk	369 		L0/pk
			W0003G	Temp. probe Interconnect Cable, 8 ft. (2.4M) , 2 pin plug >> Rectangle 2pin, for use with Disposable Probes	051 	274 	B3
		21082A	W0003H	Temp. probe Interconnect Cable, 8 ft. (2.4M) , 2pin plug >> Ø3.5 Stereo jack, for use with Disposable Probes	051 	275 	B3
S&W Artema • Reusable temperature probes with Single Thermistors • Available in Rectal/Esophageal	DIASCOPE G2		W0007A	Adult Reusable Skin-surface Probe, 10ft. (3.0 m), 25°C@2.25KΩ, Round 10J>>Ø12mm disk	276 	365 	B5
			W0007B	Adult Reusable Esophageal/Rectal Probe, 10ft(3.0 m), 25°C@2.25KΩ, Round 10J>>Ø4.7mm tip	276 	367 	B5
			W0007C	paediatric Reusable Skin-surface Probe, 10ft. (3.0 m), 25°C@2.25KΩ, Round 10J>>Ø8.0mm disk	276 	366 	B7
			W0007D	paediatric Reusable Esophageal/Rectal Probe, 10ft(3.0 m), 25°C@2.25KΩ, Round 10J>>Ø3.0mm tip	276 	368 	B7
			W0007G	Temp. probe Interconnect Cable, 8 ft. (2.4M) , Round 10J>> Rectangle 2pin, for use with Disposable Probes	276 	274 	B5
GE-MARQUETTE	Compatible with GE Healthcare Marquette PDM Module and Procure B40	2021701-001	W0015G (2018)	Temp probe adapter , 9ft, Flat 11 pin>>Rectangle 2pin, for use with disposable temperature probe.			A0
GE Eagle Tram, Solar Monitors,MAC-Lab Cath Lab System	• Capability to select 400 or 700 Series directly on the cable • Cables can accommodate two temperature probes simultaneously • Latex-free	402015-004 E9004Z M	W0015A	Dual Temperature Cable, 8 in., Accepts YSI 400 or 700 Series Probes			E5































Medical Temperature Probes

Compatible Brand	Compatible Models No.	OEM P/N	HNM REF NO.	Description (Name,Length,Probes,Plug)	Instrument Connector or Probe connector	Yoke (probe side) or Probe type	PRICE CODE
GE Ohmeda Giraffe • Reusable temperature probes with Single Thermistors	GE Ohmeda Giraffe		W0026C	paediatric Reusable Skin-surface Probe, 10ft (3.0 m), Round 2p>>Ø8.0mmdisk			C1
			W0026E	Disposable Skin surface Probe			A5
Siemens •Reusable temperature probes with Single Thermistors • Available in Rectal/Esophageal	Siemens medical SC 6002XL, SC7000, SC8000, SC9000XL		W0008A	Adult Reusable Skin-surface Probe, 10ft. (3.0 m), 25°C@2.25KΩ, Round 7p>>Ø12mm disk	266 	365 	B5
			W0008B	Adult Reusable Esophageal/Rectal Probe, 10ft. (3.0m),25°C@2.25KΩ, Round 7p>>Ø4.7mm tip	266 	367 	B5
			W0008C	paediatric Reusable Skin-surface Probe, 10ft. (3.0 m), 25°C@2.25KΩ, Round 7p>>Ø8.0mm disk	266 	366 	B7
			W0008D	paediatric Reusable Esophageal/Rectal Probe, 10ft. (3.0m), 25°C@2.25KΩ, Round 7p>>Ø3.0mm tip	266 	368 	B7
			W0008G	Temp. probe Interconnect Cable, 8 ft. (2.4M) , 7p >> Rectangle 2pin, fit for disposable probes	266 	274 	B5
Specelabs Medical	Spacelab : New modules 90651-08, 90496, Ultraview		W0022A	Adult Reusable Skin-surface Probe, 10ft. (3.0 m), 10pin>>Ø12mm disk		365 	B0
			W0022B	Adult Reusable Esophageal/Rectal Probe, 10ft. (3.0m), 10pin>>Ø4.7mm tip		367 	B0
			W0022G	Adult Reusable Skin-surface Probe, 10ft (3.0 m), 10pin>> Rectangle 2pin ,fit for W0001E and W0001F			B5
25°C@2.016KΩ O.S.7929	O.S.7929	Ref.:092059.600	W0009A	Adult Reusable Skin-surface Probe, 10ft. (3.0 m), 25°C@2.016KΩ, Din3p>>Ø12mm disk	235 	365 	B0
			W0009B	Adult Reusable Esophageal/Rectal Probe, 10ft. (3.0m),25°C @2.016KΩ, Din3p>>Ø4.7mm tip	235 	367 	B0
Temp Sensor Cut Air Shields 25°C@6.867KΩ C-100	C-100 		W0010A	Adult Reusable Skin-surface Probe, 10ft. (3.0 m), 25°C@6.867KΩ, Din3p>>Ø12mm disk	462 	365 	B0
			W0010B	Adult Reusable Esophageal/Rectal Probe, 10ft. (3.0m),25°C@6.867KΩ, Din3p>>Ø4.7mm tip	462 	367 	B0
Air Shields Versalet	C2000		W0045K	Temp. probe Interconnect Cable, 2.2 ft. (0.67M) , MD5M >> ladder-shaped 4pin, fit for Drager temp. probes 4S and 4L			B5
			W0045C	Pediatric Skin-surface probe Length: 1.2M Resistance: 25°C 9/9KΩ		366 	C5
		MU12520	W0045E	Disposable Skin-surface Probe,1.2M, 25°C@2.25KΩ, Package:24pcs/box			V3 /box

Medical Temperature Probes

Compatible Brand	Compatible Models No.	OEM P/N	HNM REF NO.	Description (Name,Length,Probes,Plug)	Instrument Connector or Probe connector	Yoke (probe side) or Probe type	PRICE CODE
Mindray YSI 400 Series • Reusable temperature probes with Single Thermistors • Available in Rectal/Esophageal	PM6800 Series 	0011-30-37393	W0013A	Adult Reusable Skin-surface Probe, 10ft. (3.0 m), 25°C@2.25KΩ, 2pin plug>>Ø12mm disk	277 	365 	B0
		0011-30-37392	W0013B	Adult Reusable Esophageal/Rectal Probe, 10ft. (3.0 m), 25°C@2.25KΩ, 2pin plug>>Ø4.7mm tip	277 	367 	B0
		0011-30-37395	W0013C	paediatric Reusable Skin-surface Probe, 10ft. (3.0 m), 25°C@2.25KΩ, 2pin plug>>Ø8.0mm disk	277 	366 	C1
		0011-30-37394	W0013D	paediatric Reusable Esophageal/Rectal Probe, 10ft. (3.0 m), 25°C@2.25KΩ, 2pin plug>>Ø3.0mm tip	277 	368 	C1
		0011-30-37391	W0013E	Disposable Skin-surface Probe, 0.8 m, 25°C@2.25KΩ, DC5.5x2.5 plug>>Adhesive Pad Package:24pcs/pk	278 		L0 /pk
		0011-30-3790439	W0013F	Adult Esophageal/Rectal Probe, 0.8 m, 25°C@2.25KΩ, DC5.5x2.5 plug>>Ø4.0mm tip Package:24pcs/pk	278 		L0 /pk
		0011-30-90438	W0013J	Temp. probe Interconnect Cable, 8 ft. (2.4M) , 2pin plug >> DC5.5x2.5Jack, for use with Disposable Probes	277 	279 	B5
			W0013G	Temp. probe Interconnect Cable, 8 ft. (2.4M) , 2pin plug >> Rectangle 2pin, for use with Disposable Probes	277 	274 	B5
	Mindray all module, except PM6800 Series  	0011-30-90434	W0001A	Adult Reusable Skin-surface Probe, 10ft. (3.0 m), 25°C@2.25KΩ, Ø6.3 mono plug>>Ø12mm disk	053 	365 	A9
		0011-30-90432	W0001B	Adult Reusable Esophageal/Rectal Probe, 10ft. (3.0 m), 25°C@2.25KΩ, Ø6.3 mono plug>>Ø4.7mm tip	053 	367 	A9
		0011-30-90435	W0001C	paediatric Reusable Skin-surface Probe, 10ft. (3.0 m), 25°C@2.25KΩ, Ø6.3 mono plug>>Ø8.0mm disk	053 	366 	A0
		0011-30-90433	W0001D	paediatric Reusable Esophageal/Rectal Probe, 10ft. (3.0 m), 25°C@2.25KΩ, Ø6.3 mono plug>>Ø3.0mm tip	053 	368 	A0
		0011-30-90436	W0014J	Temp. probe Interconnect Cable, 8 ft. (2.4M) , Ø6.3 mono plug >> DC5.5x2.5Jack, for use with Disposable Probes	053 	279 	B5

Medical Temperature Probes

Compatible Brand	Compatible Models No.	OEM P/N	HNM REF NO.	Description (Name,Length,Probes,Plug)	Instrument Connector or Probe connector	Yoke (probe side) or Probe type	PRICE CODE
Philips YSI400 Series • Reusable temperature probes with Single Thermistors			W0025A	Adult Reusable Skin-surface Probe, 10ft (3.0 m), Ø6.3 mono plug>>Ø12disk			A9
			W0025B	Adult Reusable Esophageal/Rectal Probe, 10ft (3.0 m), Ø6.3mono plug>>Ø4.7mm tip			A9
			W0025C	paediatric Reusable Skin-surface Probe, 10ft (3.0 m), Ø6.3mono plug>>Ø8.0mm disk			A0
			W0025D	paediatric Reusable Esophageal/Rectal Probe, 10ft (3.0 m), Ø6.3mono plug>>Ø3.0mm tip			A0
YSI-4499 • Reusable temperature probes with Single Thermistors			W0028E	Disposable Skin-surface Probe, 24pcs/box			L0
YSI 400 • Reusable temperature probes with Single Thermistors 25°C@2.25KΩ			W0029A	Adult Reusable Skin-surface Probe, 10ft (3.0 m), Ø6.3mono plug>>Ø12 disk			A9
			W0029C	Adult Reusable Skin-surface Probe, 10ft (3.0 m), Ø6.3mono plug>>Ø8.0mm disk			A0
		8001644	W0099F	Disposable esophagea l/ Rectal probe; 2.5 ft (0.75m) 25°C@2.25KΩ,			A3
Comen	Comen C60		W0092A	Adult skin-surface Probe, 10ft (3.0 m), 2pin plug >> Rectangle 2pin ,57 g			B3
			W0092B	Adult esophagea l/ Rectal Probe, 10ft (3.0 m), 2pin plug >> Rectangle 2pin, 57.1g			B3
			W0092C	Paediatric Reusable Skin-surface Probe, 10ft (3.0 m), 2pin plug >> Rectangle 2pin, 29.5 g			B3
			W0092D	Paediatric Esophageal/Rectal Probe, 10ft (3.0 m), 2pin plug >> Rectangle 2pin, 31.3 g			B3
HNM	AM807/808		W0024A	Veterinary Resuable Skin-Surface Probe			A0
	AM807/808		W0024B	Veterinary Resuable Esophageal/Rectal Probe			A0
	AM807/808		W0024E-D	Veterinary Disposable Esophageal/Rectal Probe			A0

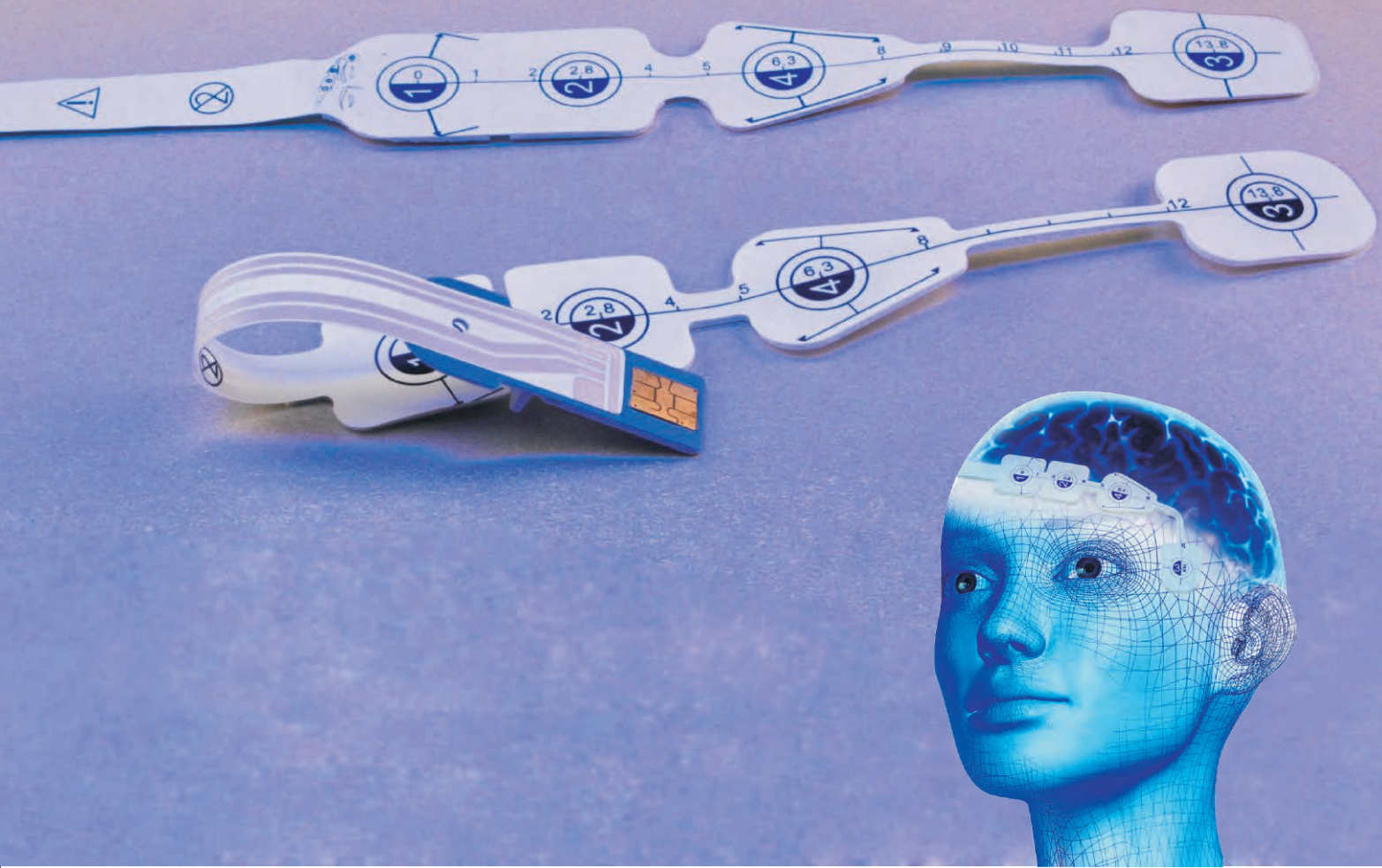





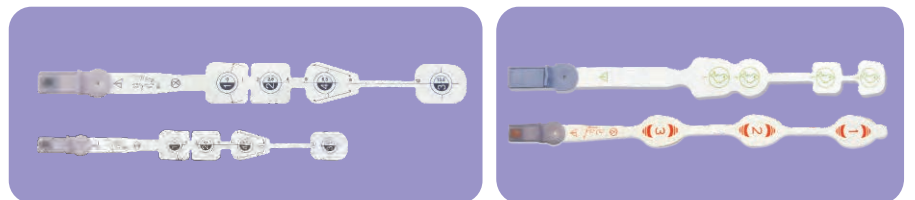

19

Disposable non-invasive EEG sensor





Patient Cables or Non-invasive Sensors

HNM Ref No.	Description	Guid	Price Code
B00501 (2018)	Adapt to BIS module EEG cable,		M0
B0051A (2019)	Compatible GE B20 EEG lead wires		K0
B0052A (2018)	Mindary T5 EEG lead wires		N0
B-BIS-4A	Suitable for BIS module, adult		B6
B-BIS-4P	Suitable for BIS module, Child		B8
9903030901	Disposable EEG Non-Invasive sensor; Suitable for EIS module		B6



20

EEG/EMG Lead Wires With Electrodes

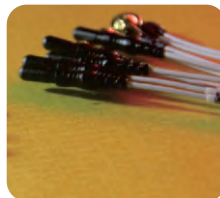



Instrument Connector

Patient end termination or Electrodes

143

134

112



T



P



N

Socket

HNM Ref No.	Description	Price Code
CT0254 Series	Din1.0mm double socket, Diffent colour can be choosed: CT0254A(Black), CT0254D(Orange),CT0254C(Blue),CT0254B(Yellow)	A2
CT0068 Series See page 18-3	Din1.5mm single socket, (Diffent colour can be choosed: Black,Brown,Red, Orange, Yellow,Green,Blue,Purple,Grey,White)	A1
CT0111 Series See page 18-3	Din1.5mm single straight socket, (Diffent colour can be choosed: Black,Brown,Red, Orange, Yellow,Green,Blue,Purple,Grey,White)	A1

EEG Lead wires with Electrodes

HNM Ref No.	Description,Name,Connector, Color,Length	Instrument side	Patient side	Price Code
B143-T-BLA-60	Tooth type grabber EEG cord, 143>T, Black, L=60" (1.5 m) 5pcs/bag	143		A0/bag
B143-T-RED-60	Tooth type grabber EEG cord, 143>T, RED, L=60" (1.5 m)			A2
B143-T-GRN-60	Tooth type grabber EEG cord, 143>T, Green, L=60" (1.5 m)		322	A2
B143-P-BLA-30	Cup Electrode EEG cord, 143>P, Black, L=30" (1.5 m)			A0/bag
B143-P-BLA-60	Cup Electrode EEG cord, 143>P, Black, L=60" (1.5 m) 5pcs/bag	143		A0/bag
B143-P-RED-60	Cup Electrode EEG cord, 143>P, Red, L=60" (1.5 m) 5pcs/bag			A0/bag
B143-P-GRN-30	Cup Electrode EEG cord, 143>P, Green, L=30" (1.5 m)			A0/bag
B143-P-GRN-60	Cup Electrode EEG cord, 143>P, Green, L=60" (1.5 m) 5pcs/bag		345	A0/bag
B143-P-10-48	EEG LEAD 10-WIRESET(48IN), KRYPTONITE	143		D6
B143-P-10-72	EEG LEAD 10-WIRESET(72IN), KRYPTONITE			E2
B143-P-10-96	EEG LEAD 10-WIRESET(96IN), KRYPTONITE			E8
B143-P-10-120	EEG LEAD 10-WIRESET(120IN), KRYPTONITE			F4
B143-DP-10-60	Disposable EEG electrodes, Preattached Leadwires,Copper wires, 10 lead-Wire Set , L=60"(1.5m)			E2
B708-P-BLA-45	Compatible Biomedical Instruments EEG lead wires, 12-Lead, Radiotransparent Leadwires, Cup electrode.		345 P	K0
CT0086A	EEG Electrode, Matal: Cu/AgCl ,10pcs/pk			E0
SL0760A	Disposable EEG Cup Electrodes, 9.2 mm diam, AgCl, 20pcs/pack;			A2/pk

EMG Lead wires with Electrodes

HNM Ref No.	Description,Name,Connector, Color,Length	Instrument side	Patient side	Price Code
B143-N-BLA-60	Needle electrode EMG cord, 143>N, Black, L=60" (1.5 m) 5pcs/bag	143	346 N	A0/bag
B143-N-WHE-60	Needle Electrode EEG cord, 143>N, WHE, L=60" (1.5 m)			A2
B143-N-PUR-60	Needle Electrode EEG cord, 143>N, PUR, L=60" (1.5 m)			A2
B143-N-BLU-60	Needle Electrode EEG cord, 143>N, BLU, L=60" (1.5 m)			A2
B143-N-YEL-60	Needle Electrode EEG cord, 143>N, YEL, L=60" (1.5 m)			A2
B143-N-BRO-60	Needle Electrode EEG cord, 143>N, BRO, L=60" (1.5 m)			A2
B143-N-ORA-60	Needle Electrode EEG cord, 143>N, ORA, L=60" (1.5 m)			A2
B143-N-RED	Disposable Twisted Pair Needle Electrode L=1.5M, 20pack/box	143	346 N	F0/box
B143-N-PUR	Disposable Twisted Pair Needle Electrode L=2.5M,20pack/box			F0/box
B143-N-BLU	Disposable Twisted Pair Needle Electrode L=1.5M,20pack/box			F0/box
B143-N-YEL	Disposable Twisted Pair Needle Electrode L=1.5M,20pack/box			F0/box
B143-N-BRO	Disposable Twisted Pair Needle Electrode L=1.5M,20pack/box			F0/box
B143-N-ORA	Disposable Twisted Pair Needle Electrode L=1.5M,20pack/box			F0/box

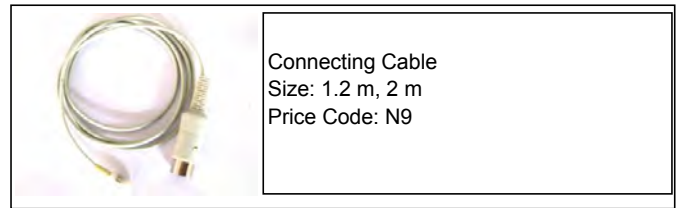
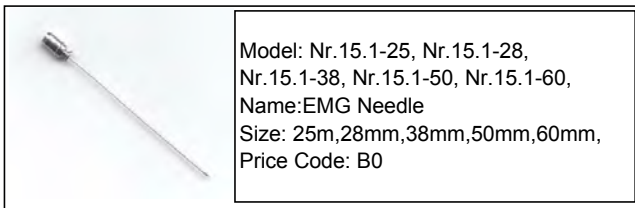

Lead Bead Markers

Compatible Brand	Plug	HNM REF NO.	Description (Name, Length, Patient end termination, Resistance,)	PRICE CODE
Lead Bead Markers Diameter range: 0.9mm~1.5mm		SL0373A	AAMI, 10pcs/pk, (RA,LA,RL,LL,V1,V2,V3,V4,V5,V6), Colour: White,Black,Green,Red,Red,Yellow,Green,Blue,Orange,Purple	A4/pk
		SL0373B	IEC, 10pcs/pk, (R,L,RF,F,C1,C2,C3,C4,C5,C6), Colour: Red,Yellow,Black,Green,Red,Yellow,Green,Brown,Black,Purple	A4/pk
		SL0373C	AAMI, 5pcs/pk, (Colour code: RA,LA,RL,LL,V), Colour: White,Black,Green,Red,Brown	A2/pk
		SL0373D	IEC, 5pcs/pk, (Colour code: R,L,RF,F,C), Colour: Red,Yellow,Black,Green,White)	A2/pk

OEM & ODM Service

- HNM Co is capable to offer sockets, signal cables, patient lead wires, electrode materials, processing technology, molds and products' technical standards for ECG, EEG and EMG. Welcome OEM business.
- Meanwhile, HNM has very experienced biomedical science engineers, electrical engineers, structural engineers to provide you ODM solution.

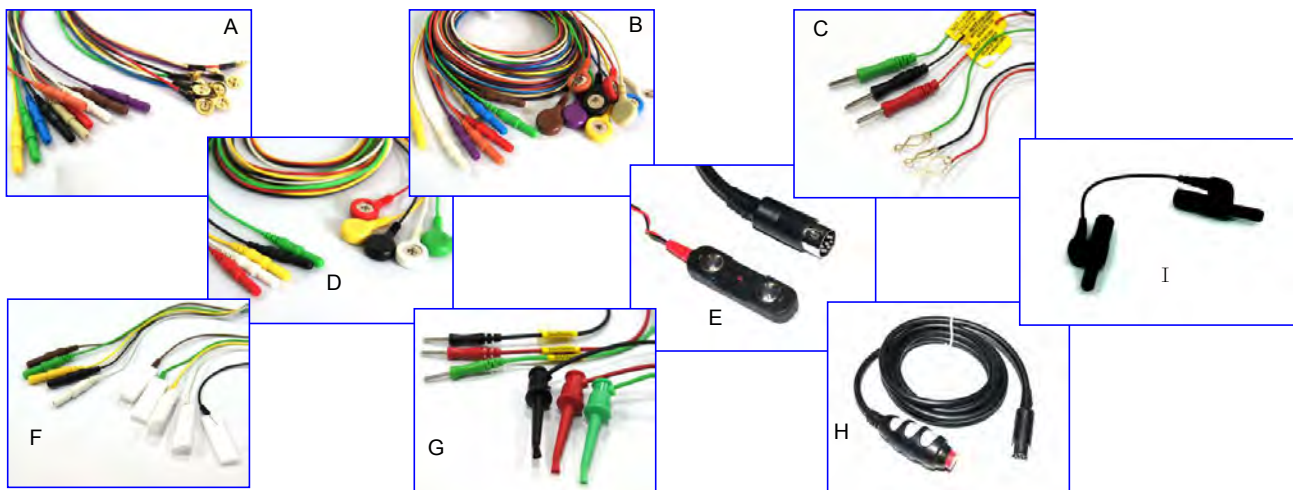

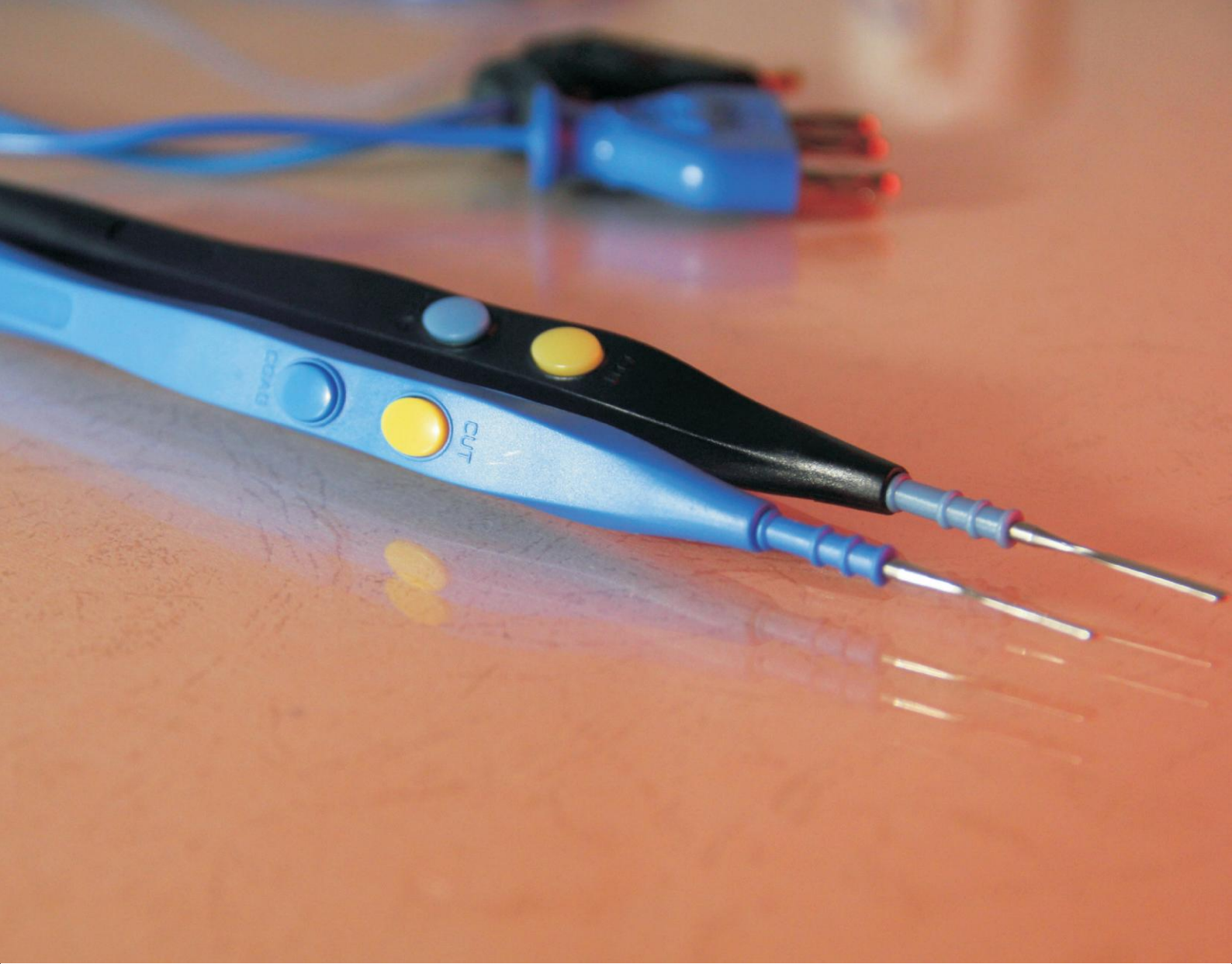

21

ESU Pencil and Connecting Cable for Electrosurgery



Our company can provide customers with a variety of standard and custom high-frequency surgical instrument cables and electrodes (Disposable and Reuseble)

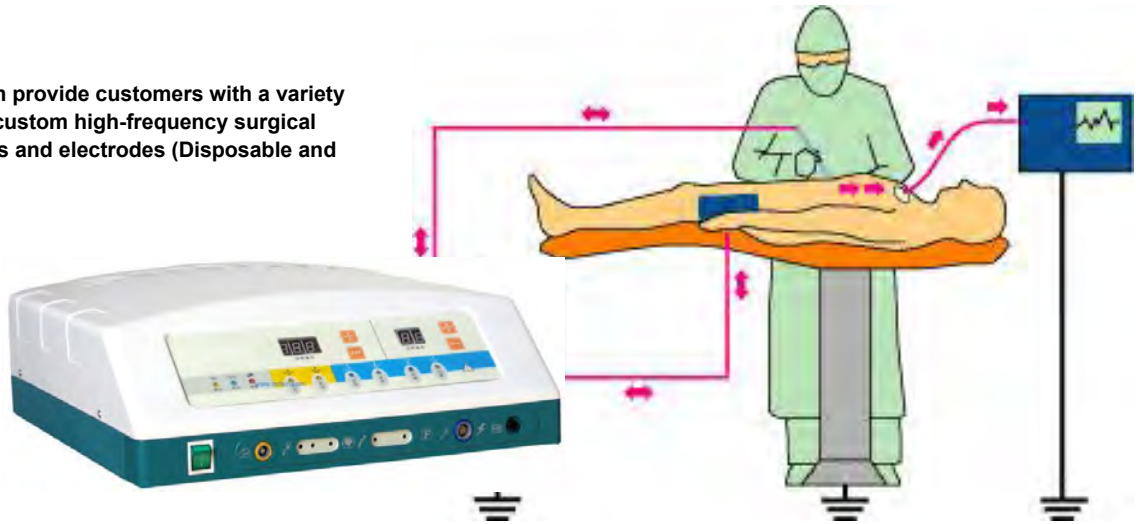

Instrument

Active Electrode

P351-148-13 Connecting cable for electrosurgery (Endoscope) MOQ 180PCS



P296-315-10 Bipolar Electrode Cable(US)



P296-297-10 Bipolar Electrode Cable(EURO)



P283-284-10 Bipolar Electrode Cable(EURO)



P285-286-09 Disposable Electrosurgical pencil



P876-877-10 Reusable Foot Control Electrosurgical pencil



P053-281-13 Patient Return Plate Cable



P281-903-13 Patient Return Plate Cable

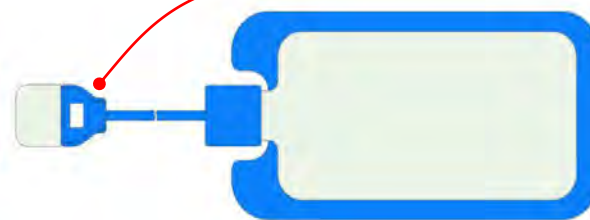

P913-288-03 Disposable ESU Patient Plate-Bipolar

P281-280-13 Patient Return Plate Cable

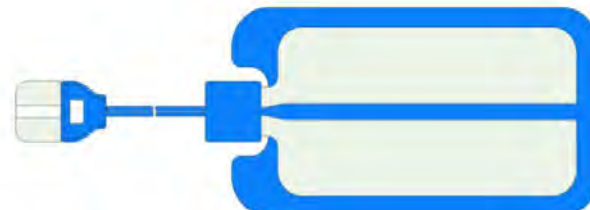

Preset 1m cables to avoid the plug stress patients, add adhesion flexibility, reduce the pollution which Reusable return cables impacted Operation Area, Jacket can prevent dropping and the liquid splash spilled.

Type Disignation

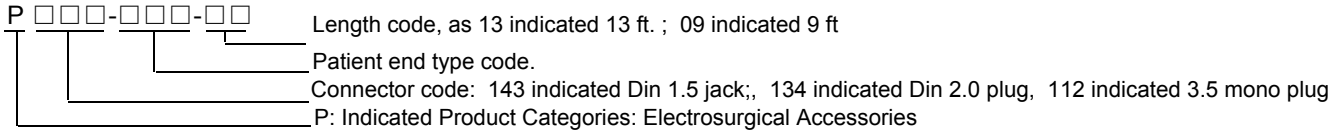

Patient Return Plate Cable and Grounding Pad



280

Model No: P281-280-13
Description: Patient Return Plate Cable, L=13 ft.(4 m)
Connector: 2.35 Jack to Plate-Bipolar Connector
Price Code: A5



280

Model No: P053-281-13
Description: Patient Return Plate Cable, L=13 ft.(4 m)
Connector: 6.3 Mono Plug to Plate-Bipolar Connector
Price Code: A5



282

Model No: P053-296-10
Description: Patient Return Plate Cable, L=10 ft.(3 m)
Connector: 6.35 Mono Plug to Banana plug
Price Code: A5



281

Model No: P281-296-13
Description: Patient Return Plate Cable, L=13 ft.(4 m)
Connector: 2.35 Jack to Banana plug
Price Code: A5

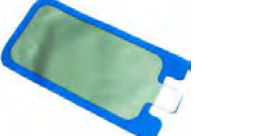

287

Model No: 287
Description: Disposable Electro-surgical Patient Plate-Monopolar, Size: 200x105mm
Price Code: A2



288

Model No: 288
Description: Disposable Electro-surgical Patient Plate-Bipolar, Size: 200x105mm
Price Code: A2

Electrosurgical Pencil



285

Model No: P285-286-09
Name: Disposable Electro-surgical pencil
Description: Standard Blade Length=40mm; Length of wire: 9 ft (2.8m);
Package way:200pcs/box;
Price Code: A3



285

Model No: P285-286-09-R
Name: Reusable Electro-surgical pencil
Description: Standard Blade Length=40mm; Length of wire: 9 ft (2.8m);
Package way:1 piece/bag;
Price Code: A0



286

Model No: P876-877-10
Name: Reusable Foot Control Electro-surgical pencil
Description:Standard Blade Length=40mm; Length of wire: 9 ft (2.8m);
Package way:1 piece/bag;
Price Code: A0



We can supply our customer with common active electrode and customize special active electrode according to their requirements.

Connecting cable for electrosurgery



284

Model No: P283-284-10
Name: Bipolar Electrode Cable
Description: L=10 ft.(3 m)
2*Banana Plug to Euro style con.
Fit Euro style bipolar forceps
Package way: 1 piece/bag;
Price Code: A5



148

Model No: P351-148-13
Name: Connecting cable for electrosurgery (Endoscope)
Original No.: 20192-117
Description: L=13 ft, Connector type: 7.9 mono plug to 3.0 Jack.
Price Code: A6



297

Model No: P296-297-10
Name: Bipolar Electrode Cable
Description: Length: 10 ft.(3 m)
2*Banana Plug to US style con.
Fit Euro style bipolar forceps



315

Model No: P296-315-10
Name: Bipolar Electrode Cable
Description: Length: 10 ft.(3 m)
2*Banana Plug to US style con.
Fit US style bipolar forceps

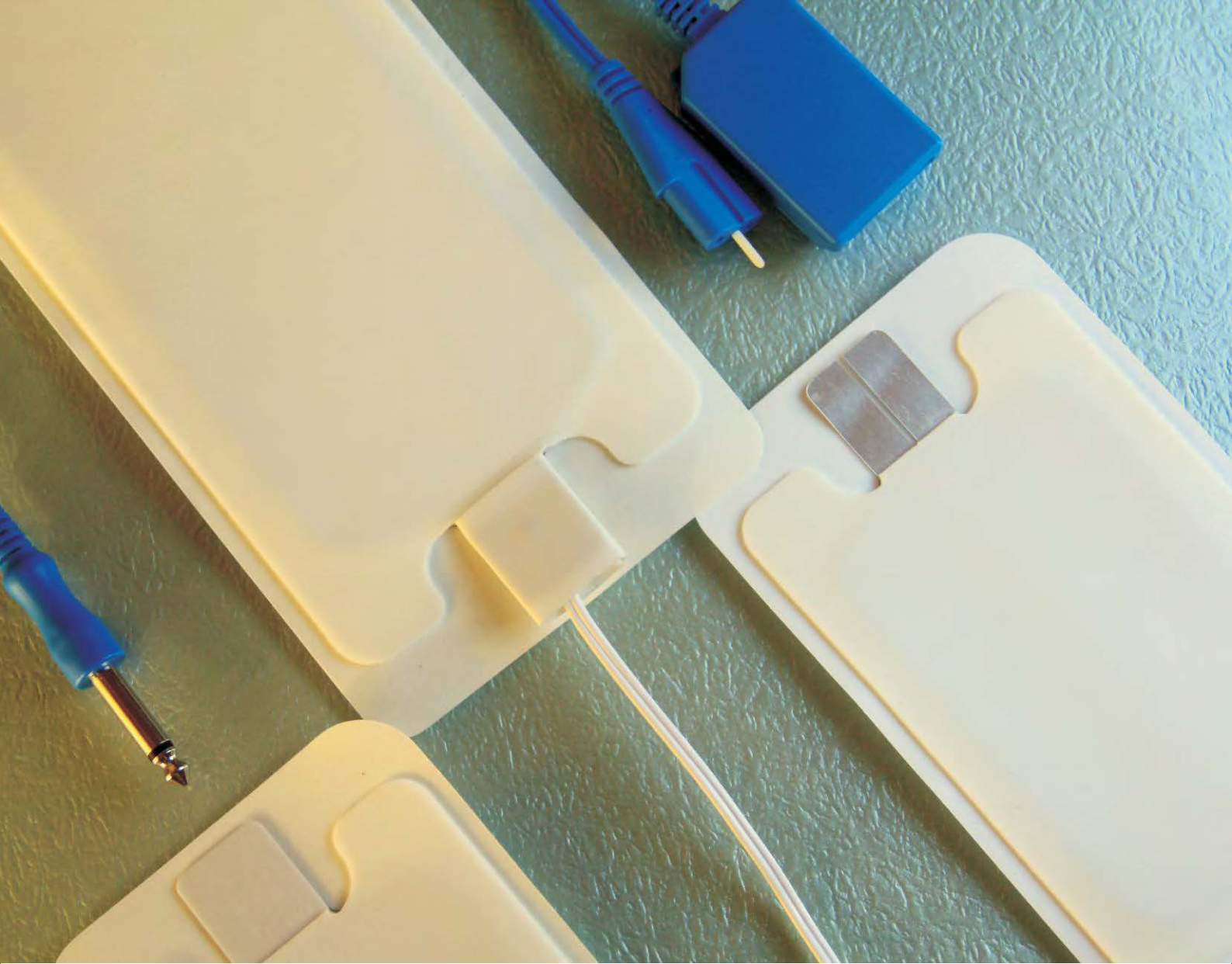

22

Grounding Pad

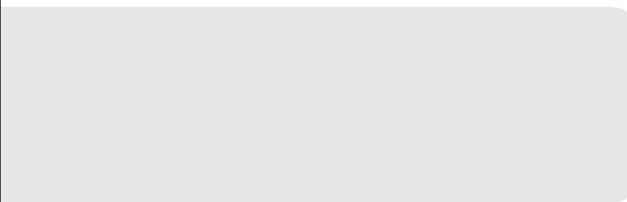



Grounding Pad

Features:

High performance mounting to skin.High safty

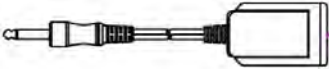
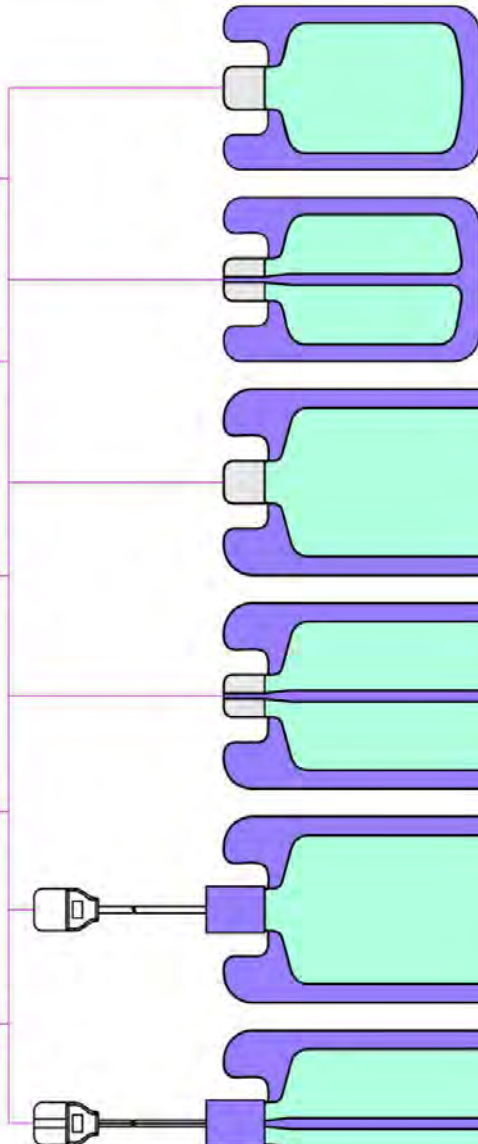
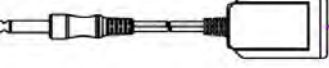
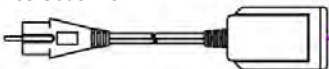
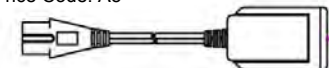
Optional: Adult application, Pediatric application, Bipolar plate, Monopolar, Single wire and double wires.

<p>Part No.: P676-280-13 Description.: Grounding Pad cable, 5.3 Audio plug connector Price code: A5</p> 		<p>Part No.: 287-P Description.: Grounding Pad . Pediatric, Monopolar. Package: 1pcs/bag, 50bags/box, 8boxes/Carton Price Code: A1/pcs</p>
<p>Part No.: P053-281-13 Description.: Grounding Pad cable, 4M length. 6.3 Audio plug connector Price Code: A5</p> 		<p>Part No.: 288-P Description.: Grounding Pad . Pediatric, Bipolar plate. Package: 1pcs/bag, 50bags/box, 8boxes/Carton Price Code: A1/pcs</p>
<p>Part No.: P281-280-13 Description.: Grounding Pad cable, 4M length, "8" shape connector(2*Φ2.35 femal contacts with a single pin) Price Code: A5</p> 		<p>Part No.: 287 Description.: Grounding Pad. Adult, Monopolar. Package: 1pcs/bag, 50bags/box, 8boxes/Carton Price Code: A1/pcs</p>
<p>Part No.: P677-280-13 Description.: Grounding Pad cable, "8" shape connector(2*Φ2.35 femal contacts without a single pin) Price Code: A5</p> 		<p>Part No.: 288 Description.: Grounding Pad. Adult, Bipolar plate. Package: 1pcs/bag, 50bags/box, 8boxes/Carton Price Code: A1/pcs</p>
<p>Part No.: P678-280-13 Description.: Grounding Pad cable, "8" shape connector(2*Φ2.35 femal contacts with a single pin) Price Code: A5</p> 		<p>Part No.: P913-287-03 Description.: Grounding Pad. Adult, Monopolar. With 1M cable. Package: 1pcs/bag, 50bags/box, 4boxes/Carton Price Code: H5/box</p>
 <p>Connectors can be customized</p>		<p>Part No.: P913-288-03 Description.: Grounding Pad. Adult, Bipolar plate. With 1M cable. Package: 1pcs/bag, 50bags/box, 4boxes/Carton Price Code: H5/box</p>
		<p>Part No.: P281-288-09 Description.: Grounding Pad. Adult, Bipolar plate. With 2.8M cable. Package: 1pcs/bag, 50bags/box, 4boxes/Carton Price Code: A2/pcs</p>
		<p>Part No.: P053-288-09 Description.: Grounding Pad. Adult, Bipolar plate. With 2.8M cable. Package: 1pcs/bag, 50bags/box, 4boxes/Carton Price Code: A2/pcs</p>



23

Pressure Infusion Bag



Part No: Y000P05;
 500ml pressure infusion bag, with pressure indicator;
Material: White Nylon, waterproof;
 Used for blood transfusion and liquid transfusion;
Package: 24pcs/; 2Boxes/Carton;
Price code: B1/pcs.



Part No: Y000R05;
 500ml pressure infusion bag, with pressure indicator;
Material: navy blue nylon, waterproof;
 Used for blood transfusion and liquid transfusion;
Package: 1 piece/Bag; 12 pieces/Box;
Price code: E6/piece.



Part No: Y000P10
 1000ml pressure infusion bag, with pressure indicator;
Material: White Nylon, waterproof;
 Used for blood transfusion and liquid transfusion;
Package: 24pcs/; 2Boxes/Carton;
Price code: B3/pcs.



Part No: Y000R10;
 1000ml pressure infusion bag, with pressure indicator;
Material: navy blue nylon, waterproof;
 Used for blood transfusion and liquid transfusion;
Package: 1 piece/Bag; 12 pieces/Box;
Price code: E0/piece.



Part No: Y000P30;
 3000ml pressure infusion bag, with pressure indicator;
Material: White Nylon, waterproof;
 Used for blood transfusion and liquid transfusion;
Package: 24pcs/; 2Boxes/Carton;
Price code: B7/pcs.



Part No: Y000R30;
 3000ml pressure infusion bag, with pressure indicator;
Material: navy blue nylon, waterproof;
 Used for blood transfusion and liquid transfusion;
Package: 1 piece/Bag; 12 pieces/Box;
Price code: F5/piece.



24

Instrument Connector and Socket













Electrocardiograph

<p>CT0056B FUKUDA EKG Price: B0</p>  <p>Lock type DB15M, Gray, Plastic Fit Cable Diameter: Φ6.0</p>	<p>CT0056A FUKUDA EKG Price: B0</p>  <p>Lock type DB15M, Gray, Plastic Fit Cable Diameter: Φ6.0</p>	<p>CT0057M Mortala EKG Price: B0</p>  <p>Lock type DB15M, Gray, Plastic Fit Cable Diameter: Φ6.0</p>	<p>CT0076A Siemens EKG Price: B0</p>  <p>Lock type DB15M, Gray, Plastic Fit Cable Diameter: Φ6.0</p>	<p>CT0036A Siemens EKG Price: A0</p>  <p>Screw type DB15M, Gray, Metal Fit Cable Diameter: Φ6.0</p>
<p>CT0050A PETAS EKG Price: B0</p>  <p>Screw type Round 12pin, Black, Metal, Fit Cable Diameter: Φ6.0</p>	<p>CT0112A RMS EKG Price: A0</p>  <p>Screw type DB25M, Gray, Plastic Fit Cable Diameter: Φ6.0</p>	<p>CT0058Q Mortala EKG Price: B0</p>  <p>Round 12pin, yellow, Plastic Fit Cable Diameter: Φ6.0</p>	<p>CT0071A Medtronic EKG Price: B0</p>  <p>Round 12pin, Green, Plastic Fit Cable Diameter: Φ6.0</p>	

Patient monitor Connector for ECG

<p>CT0038A General ECG Price: B2</p>  <p>AMP Round 6pin, Black, Plastic Fit Cable Diameter: Φ5.0</p>	<p>CT0057A Philips ECG Price: B2</p>  <p>Round 12pin, White, Plastic, Fit Cable Diameter: Φ5.0</p>	<p>CT0057B Kontron ECG Price: B2</p>  <p>Round 12pin, Green, Plastic Fit Cable Diameter: Φ5.0</p>	<p>CT0057C Datex ECG Price: B2</p>  <p>Locking type round 10J, Blue, Plastic, Fit Cable Diameter: Φ5.0</p>	<p>CT0057D NihonKonden ECG Price: B2</p>  <p>Round 8pin, Black, Plastic Fit Cable Diameter: Φ5.0</p>
<p>CT0057E Drager ECG Price: B2</p>  <p>Round 10pin, White, Plastic, Fit Cable Diameter: Φ5.0</p>	<p>CT0057F Bionet ECG Price: B2</p>  <p>Locking type 8pin, Red, Plastic Fit Cable Diameter: Φ5.0</p>	<p>CT0057G GEMS ECG Price: B2</p>  <p>AMP Round 5pin, Black, Plastic Fit Cable Diameter: Φ5.0</p>	<p>CT0057H Mennen ECG Price: B2</p>  <p>Round 10pin, White, Plastic Fit Cable Diameter: Φ5.0</p>	<p>CT0057I NK TEC-7621C ECG Price: B2</p>  <p>Round 11pin, Black, Plastic Fit Cable Diameter: Φ5.0</p>
<p>CT0057J PETAS ECG Price: B0</p>  <p>Screw type Din-5pin, Black, Metal, Fit Cable Diameter: Φ5.0</p>	<p>CT0057K PETAS ECG Price: A5</p>  <p>Stereo 6.3 Plug, black, Plastic Fit Cable Diameter: Φ5.0</p>	<p>CT0002A Criticare ECG Price: A5</p>  <p>PAG 1Rib 6-pin, Green, Plastic Fit Cable Diameter: Φ5.0</p>	<p>CT0014C Novamatrix ECG Price: B2</p>  <p>Locking type 7pin, Black, Plastic Fit Cable Diameter: Φ5.0</p>	<p>CT0057K NK TEC-7621K ECG Price: B2</p>  <p>Round 11pin, Black, Plastic Fit Cable Diameter: Φ5.0</p>
<p>CT0077A GEMS ECG Price: B2</p>  <p>Lock 6pin, Black, Plastic Fit Cable Diameter: Φ5.0</p>	<p>CT0090A GEMS ECG Price: B2</p>  <p>Rectangle 11pin, Green, Plastic Fit Cable Diameter: Φ5.0</p>	<p>CT0113A MEK ECG Price: A5</p>  <p>Mini din 8pin, Black, Plastic Fit Cable Diameter: Φ5.0</p>	<p>CT0057Q Artema ECG Price: B2</p>  <p>Locking type round 10J, Blue, Plastic, Fit Cable Diameter: Φ5.0</p>	<p>CT0101A Lohmeier ECG Price: B2</p>  <p>Round 5pin+5Jack, White, Plastic Fit Cable Diameter: Φ5.0</p>

Patient monitor Connector for IBP

<p>CT0044 Chenwie IBP Price: A5</p>  <p>PAG 1Rib-5pin, Red, Plastic Fit Cable Diameter: Φ5.0</p>	<p>CT0105A Choice IBP Price: A5</p>  <p>PAG 1Rib-6pin, Red, Plastic Fit Cable Diameter: Φ5.0</p>	<p>CT0085C Marquette IBP Price: B2</p>  <p>Rectangle 11pin, Red, Plastic Fit Cable Diameter: Φ5.0</p>	<p>CT0078A Philips IBP Price: B2</p>  <p>Round 12pin, Red, Plastic Fit Cable Diameter: Φ5.0</p>	<p>CT0102A Philips IBP Price: B2</p>  <p>Round 10pin, White, Plastic, Fit Cable Diameter: Φ5.0</p>
<p>CT0103A Spacelabs IBP Price: B2</p>  <p>AMP Round 6pin, Black, Plastic Fit Cable Diameter: Φ5.0</p>	<p>CT0058L Datex IBP Price: B2</p>  <p>Locking type round 10J, White, Plastic, Fit Cable Diameter: Φ5.0</p>	<p>CT0100A Mennen IBP Price: B2</p>  <p>Locking type 8pin, Red, Plastic Fit Cable Diameter: Φ5.0</p>	<p>CT0076B Siemens IBP Price: B0</p>  <p>Lock type DB15M, Gray, Plastic Fit Cable Diameter: Φ5.0</p>	<p>CT0104A BD IBP Price: A5</p>  <p>Round 7pin, White, Plastic Fit Cable Diameter: Φ5.0</p>





Patient monitor Connector for SpO2 and Holter

<p>CT0001A Mindray SpO2 Price: A5</p>  <p>PAG 1Rib 5-pin, Blue, Plastic Fit Cable Diameter: Φ4.0</p>	<p>CT0106A CSI RADO SpO2 Price: A5</p>  <p>PAG 1Rib 6-pin, Blue, Plastic Fit Cable Diameter: Φ4.0</p>	<p>CT0009A BCI SpO2 Price: A5</p>  <p>PAG 1Rib 7-pin, Blue, Plastic Fit Cable Diameter: Φ4.0</p>	<p>CT0003A Mindray SpO2 Price: A5</p>  <p>PAA 2Rib 40° 6-pin, Blue, Plastic Fit Cable Diameter: Φ4.0</p>	<p>CT0008A Goldway SpO2 Price: A5</p>  <p>PAA 2Rib 40° 7-pin, Blue, Plastic Fit Cable Diameter: Φ4.0</p>
<p>CT0017 (Original) Medilog Holter Price: B1</p>  <p>PAG 1Rib 14-pin, Blue, Plastic Fit Cable Diameter: Φ5.0</p>	<p>CT0011D Brentwood Holter Price: B1</p>  <p>FGG 0B 7-pin, Grey, metal Fit Cable Diameter: Φ5.0</p>	<p>CT0099A Brentwood Holter Price: B2</p>  <p>FGG 0B 10-pin, Grey, metal Fit Cable Diameter: Φ5.0</p>	<p>CT0018B Mennen SpO2 Price: C2</p>  <p>FGG 2B 10-pin, Blue, metal Fit Cable Diameter: Φ4.0</p>	<p>CT0043A (Original) Drager SpO2 Price: F0</p>  <p>FGY 2B 8-pin, White, Plastic Fit Cable Diameter: Φ4.0</p>
<p>CT0010A CSI SpO2 Price: B1</p>  <p>FGG 1B 5-pin, Blue, metal Fit Cable Diameter: Φ4.0</p>	<p>CT0010C NONIN SpO2 Price: B1</p>  <p>FGG 1B 6-pin, Blue, metal Fit Cable Diameter: Φ4.0</p>	<p>CT0011A INVIVO SpO2 Price: B1</p>  <p>FGG 1B 7-pin, Blue, metal Fit Cable Diameter: Φ4.0</p>	<p>CT0018 Landcom Holter Price: B1</p>  <p>FGG 1B 10-pin, Blue, metal Fit Cable Diameter: Φ4.0</p>	<p>CT0034D Schiller SpO2 Price: A5</p>  <p>Din 7-pin, Black, Plastic Fit Cable Diameter: Φ4.0</p>
<p>CT0014A Novamatrix SpO2 Price: B2</p>  <p>Hye 7-pin, Black, Plastic Fit Cable Diameter: Φ4.0</p>	<p>CT0013A Simed SpO2 Price: B2</p>  <p>Hye 9-pin, Black, Plastic Fit Cable Diameter: Φ4.0</p>	<p>CT0015A Spacelabs SpO2 Price: B2</p>  <p>Hye 9-pin, Black, Plastic Fit Cable Diameter: Φ4.0</p>	<p>CT0058A Bruker SpO2 Price: B2</p>  <p>Round 12-pin, Blue, Plastic Fit Cable Diameter: Φ4.0</p>	<p>CT0034A Datascope SpO2 Price: A5</p>  <p>Din 8-pin, Black, Plastic Fit Cable Diameter: Φ4.0</p>
<p>CT0058B Datex SpO2 Price: B2</p>  <p>Round 10J, White, Plastic Fit Cable Diameter: Φ4.0</p>	<p>CT0058E Philips SpO2 Price: B2</p>  <p>Round 12-pin, Blue, Plastic Fit Cable Diameter: Φ4.0</p>	<p>CT0058F Nihon Konden SpO2 Price: B2</p>  <p>Round 10-pin, Blue, Plastic Fit Cable Diameter: Φ4.0</p>	<p>CT0058C S&W SpO2 Price: B2</p>  <p>Round 10J, Purple, Plastic Fit Cable Diameter: Φ4.0</p>	<p>CT0058M Siemens SpO2 Price: B2</p>  <p>Round 6pin, Black, Plastic Fit Cable Diameter: Φ4.0</p>
<p>CT0058N Bionet SpO2 Price: B2</p>  <p>Round 6pin 30°, Black, Plastic Fit Cable Diameter: Φ4.0</p>	<p>CT0058D Palco SpO2 Price: A5</p>  <p>RJ11 6P6C, Gray, Plastic Fit Cable Diameter: Φ4.0</p>	<p>CT0058H Mennen SpO2 Price: B2</p>  <p>Round 8-pin, Blue, Plastic Fit Cable Diameter: Φ4.0</p>	<p>CT0035A Pace Tech SpO2 Price: B2</p>  <p>Karon 5J, Black, Metal Fit Cable Diameter: Φ4.0</p>	<p>CT0020A Masmo SpO2 Price: A5</p>  <p>HD14-pin, Gray, Plastic Fit Cable Diameter: Φ4.0</p>
<p>CT0020C Nellcor SpO2 Price: B2</p>  <p>HD14-pin, 1 bit Gray, Plastic Fit Cable Diameter: Φ5.0</p>	<p>CT0020D Nellcor SpO2 Price: B2</p>  <p>HD14-pin, 1 bit, Blue, Plastic Fit Cable Diameter: Φ5.0</p>	<p>CT0058I Ohmeda SpO2 Price: B2</p>  <p>Locking 8P, Blue, Plastic Fit Cable Diameter: Φ4.0</p>	<p>CT0058J Ohmeda SpO2 Price: B2</p>  <p>Locking 8J, Blue, Plastic Fit Cable Diameter: Φ4.0</p>	<p>CT0058K Masmo SpO2 Price: B2</p>  <p>Quick Lock 6-pin, White, Plastic Fit Cable Diameter: Φ4.0</p>
<p>CT0058R Masmo SpO2 Price: B2</p>  <p>Quick Lock 6J, White, Plastic Fit Cable Diameter: Φ4.0</p>	<p>CT0107A Nellcor SpO2 Price: A5</p>  <p>DB9pin Male, Gray, Plastic Fit Cable Diameter: Φ4.0</p>	<p>CT0085B GEMS-Dash Price: B2</p>  <p>Rectangle 11pin, Blue, Plastic Fit Cable Diameter: Φ4.0</p>	<p>CT0085A GEMS-Masmo Price: B2</p>  <p>MOQ:30PCS Rectangle 11pin, Blue, Plastic Fit Cable Diameter: Φ4.0</p>	<p>CT0003E (Original) Mindray SpO2 Price: A9</p>  <p>PAB 2Rib 60° 6-pin, White, Plastic Fit Cable Diameter: Φ4.0</p>
<p>CT0092A (Original) Mindray SpO2 Price: A9</p>  <p>PAC 2Rib 80° 6-pin, White, Plastic Fit Cable Diameter: Φ4.0</p>	<p>CT0003F Choice SpO2 Price: B1</p>  <p>PAG 1Rib 9-pin, Blue, Plastic Fit Cable Diameter: Φ4.0</p>	<p>CT0062A Price: A5</p>  <p>CT0062B Price: A5</p>  <p>M12 1Rib 2-pin, Black, Metal Fit Cable Diameter: Φ5.0</p>	<p>CT0065A Price: A5</p>  <p>CT0065B Price: A5</p>  <p>M12 1Rib 8-pin, Black, Metal Fit Cable Diameter: Φ5.0</p>	

Patient Monitor Socket

 <p>E0001B Mindray ECG Price: F0/box 20pcs/box</p> <p>Round 6-pin socket, Black, Plastic, Flange: 30X30cm</p>	 <p>E0001G Mindray ECG Price: F0/box 20pcs/box</p> <p>Round 6-pin socket, Black, Plastic, Flange: 23.5X23.5cm</p>	 <p>E0001D Mindray IBP Price: F0/box 20pcs/box</p> <p>AMP Round 6-pin socket, Red, Plastic, Flange: 30X30cm</p>	 <p>E0001F Mindray IBP Price: F0/box 20pcs/box</p> <p>AMP Round 6-pin socket, Red, Plastic, Flange: 23.5X23.5cm</p>	 <p>E0001O GEMS ECG Price: F0/box 20pcs/box</p> <p>AMP Round 5-pin socket, Grey, Plastic, Flange: 30X30cm</p>
 <p>E0001P Siemens SpO2 Price: F0/box 20pcs/box</p> <p>AMP Round 6-pin socket, Grey, Plastic, Flange: 30X30cm</p>	 <p>CT0108A Mindray ECG Price: A6</p> <p>Round 12-pin socket, Green, Plastic, Flange: 30X30cm</p>	 <p>CT0109A Mindray SpO2 Price: A6</p> <p>Round 12-pin socket, Blue, Plastic, Flange: 30X30cm</p>	 <p>CT0110A Mindray IBP Price: A6</p> <p>Round 12-pin socket, Red, Plastic, Flange: 30X30cm</p>	 <p>CT0001B Mindray SpO2 Price: A5</p> <p>PKG 1-bit 5Jack Socket, Blue, Plastic</p>
 <p>CT0002B CSI RADO SpO2 Price: A5</p> <p>PKG 1-bit 6Jack Socket, Blue, Plastic</p>	 <p>CT0009B BCI SpO2 Price: A5</p> <p>PKG 1-bit 7Jack Socket, Blue, Plastic</p>	 <p>CT0003G Choice SpO2 Price: B1</p> <p>PKG 1-bit 9Jack Socket, Blue, Plastic</p>	 <p>CT0017B Medilog Holter Price: B1</p> <p>PKG 1-bit 14Jack Socket, Grey, Plastic</p>	 <p>CT0044B Chenwie IBP Price: A5</p> <p>PKG 1-bit 4Jack Socket, Grey, Plastic</p>
 <p>CT0003B Mindray SpO2 Price: A5</p> <p>PKA 2Rib 40° 6-pin, Socket Blue, Plastic</p>	 <p>CT0008B Goldway SpO2 Price: A5</p> <p>PKA 2Rib 60° 7-pin, Socket Blue, Plastic</p>	 <p>CT0011C Brentwood Holter Price: B1</p> <p>EGG 0B 7Jack, socket, metal</p>	 <p>CT0099B Brentwood Holter Price: B1</p> <p>EGG 0B, 10Jack, socket, metal</p>	 <p>CT0010D CSI SpO2 Price: B1</p> <p>EGG 1B, 5Jack, socket,</p>
 <p>CT0010E NONIN SpO2 Price: B1</p> <p>EGG 1B, 6Jack, socket, metal</p>	 <p>CT0011E INVIVO SpO2 Price: B1</p> <p>EGG 1B, 7Jack, socket, metal</p>	 <p>CT0081A Landcom Holter Price: B1</p> <p>EGG 1B, 10Jack, socket, metal</p>	 <p>CT0068A YSI 400 TEMP Price: A1</p> <p>6.3 mm Stereo socket Black, Plastic</p>	
<p>Din1.5mm single socket, (Diffent colour can be choosed: Black,Brown, Red,Orange, Yellow,Green,Blue,Purple,Grey, White), Price Code: A1</p>				
				
<p>Din1.5mm single straight socket, (Diffent colour can be choosed: Black,Brown, Red,Orange, Yellow,Green,Blue,Purple,Grey, White), Price Code: A1</p>				
				

Junction box (assembly)

 <p>CT0375A Price Code: A3</p> <p>Junction box, Grey 5.0mm to 2.6mm * 2</p>	 <p>CT0376A Price Code: A4</p> <p>Junction box, Grey 5.0mm to 2.6mm * 3</p>	 <p>CT0377A Price Code: A4</p> <p>Junction box, Grey 5.0mm to 2.6mm * 4</p>	 <p>CT0378A Price Code: A4</p> <p>Junction box, Grey 5.0mm to 2.6mm * 5</p>	 <p>CT0379A Price: A5</p> <p>Junction box, Grey 6.0mm to 3.25mm * 10</p>
---	---	---	--	--

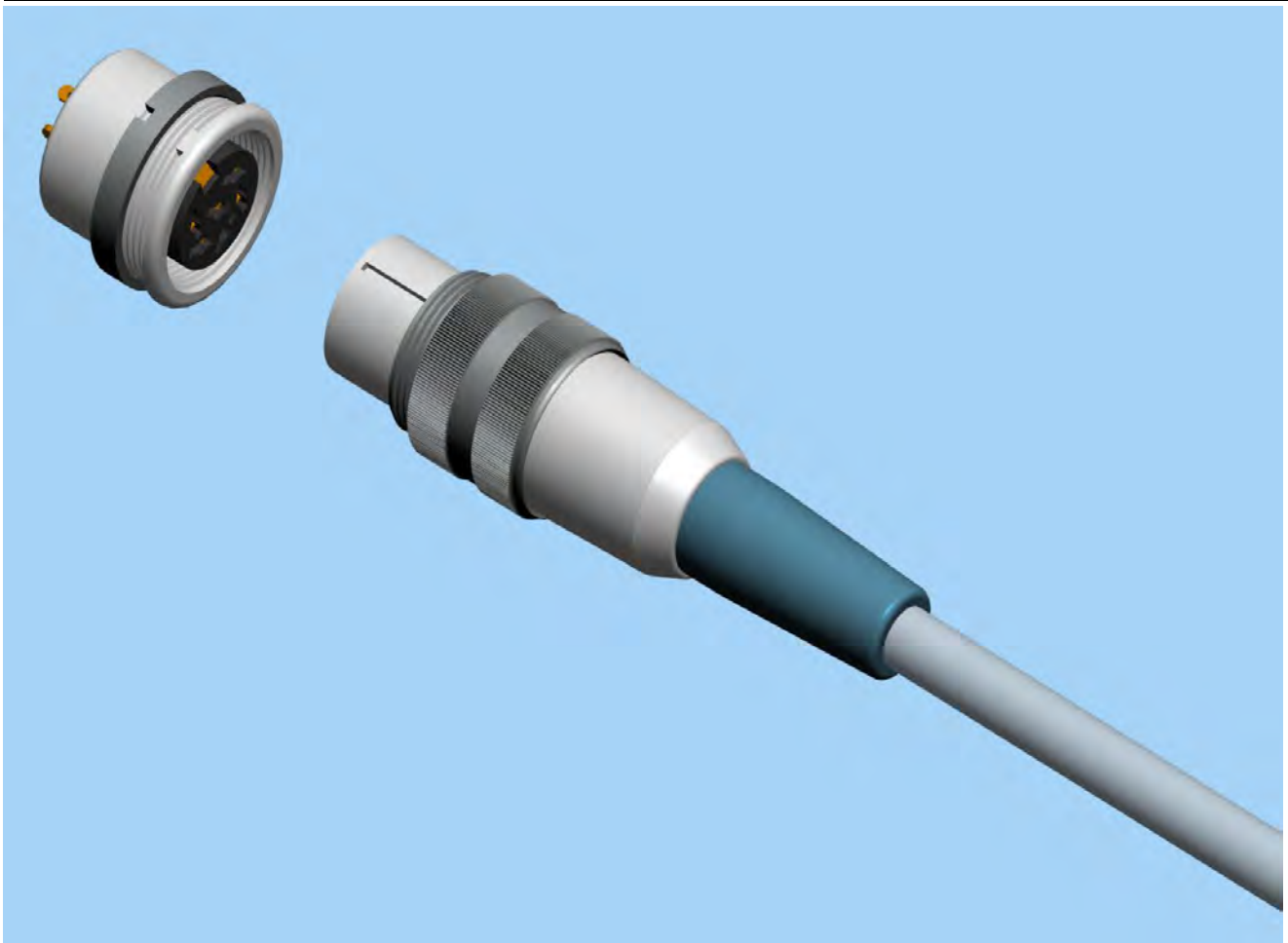

Product Specification.

1) Application illustration

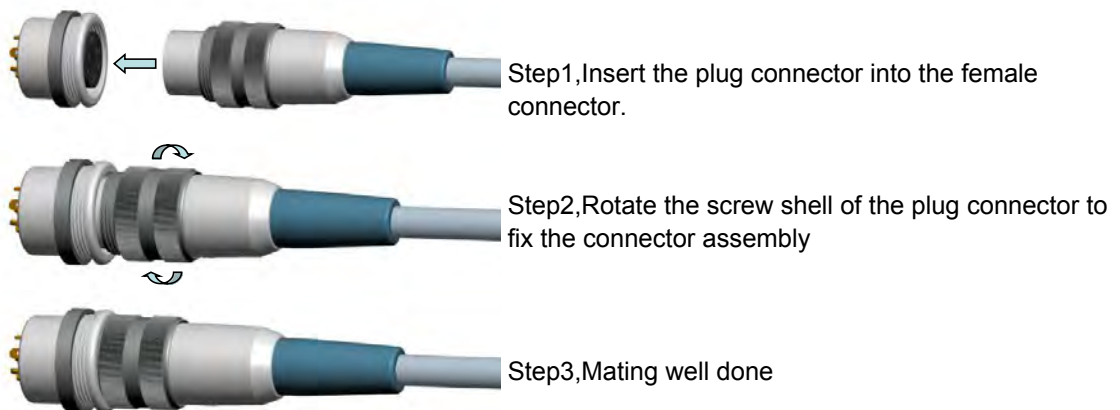

2) Key features

- 1) Various of position types suitable for different contact interface. Standard type 3-8 positions. Small size.
- 2) Contact resistance 30mohms per contact. Rated current 2A Max. Insulation resistance 50M ohms.
- 3) No electrical circuit on outer shell to meet electrical safety requirement.
- 4) Screw lock functional features, robust lock design.
- 5) Standard strain relief feature is suitable for raw cable outer diameter 4mm, 5mm and 6mm.
- 6) Color defined by customer

Socket fixing panel outline

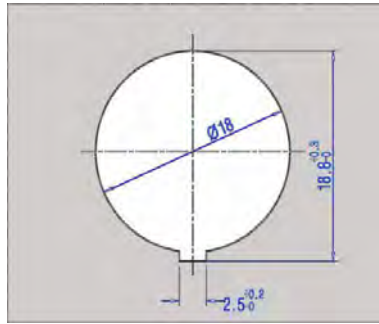

Plus Spec.

Ref NO.	CT0141A	CT0142A MOQ:750pcs	CT0143A	CT0144A	CT0145A
Plus	3P DIN Plus	4P DIN Plus	5P 180° DIN Plus	5P 240° DIN Plus	5P 360° DIN Plus
Figure	 B6/10pcs	 B6/10pcs	 B6/10pcs	 B6/10pcs	 B6/10pcs
Ref NO.	CT0146A	CT0147A	CT0148A	CT0149A	customization
Plus	6P DIN Plus	7P 270° DIN Plus	8P 270° DIN Plus	8P 262° DIN Plus	customization
Figure	 B6/10pcs	 B6/10pcs	 B6/10pcs	 B6/10pcs	customization

Socket Spec.

Ref NO.	CT0150A	CT0151A MOQ:700pcs	CT0152A	CT0153A	CT0154A
Socket	3P DIN Socket	4P DIN Socket	5P 180° DIN Socket	5P 240° DIN Socket	5P 360° DIN Socket
Figure	 B7/10pcs	 B7/10pcs	 B7/10pcs	 B7/10pcs	 B7/10pcs
Ref NO.	CT0155A	CT0156A	CT0157A	CT0158A	customization
Socket	6P DIN Socket	7P 270° DIN Socket	8P 270° DIN Socket	8P 262° DIN Socket	customization
Figure	 B7/30pcs	 B7/30pcs	 B7/30pcs	 B7/30pcs	customization

Product Facts

- Superior Data Transmission.
- Shielding, Anlistatig, Low noise.
- Tough high flexing cycle.
- Superior aging performance and enduring. - Latex-free
- Jacket material can be medical grade PVC, TPR or TPU.
- Biocompatibility: All patient contact materials are latex free and have been tested according to ISO 10993-5, ISO 10993-10.



DX0047A SpO2 sensor raw cable

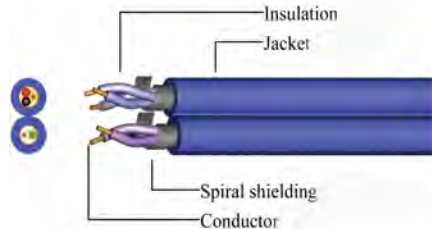

DX0027A SpO2 sensor raw cable

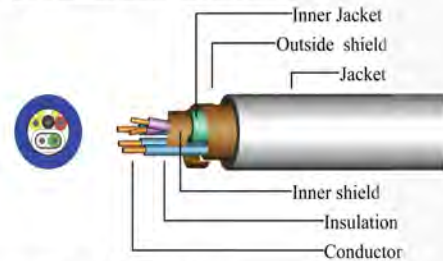

DX0022A EKG raw cable

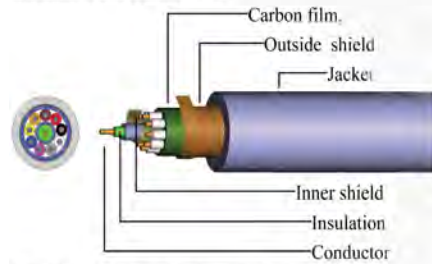

DX0009A ECG raw cable

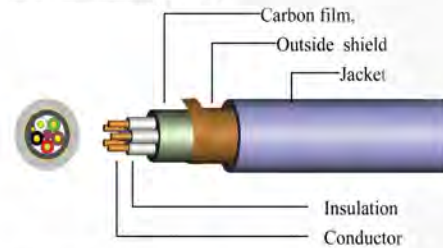

DX0109A Spiral shield leadwire

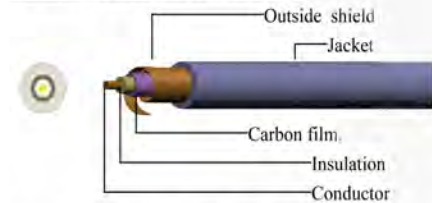

DX0012 Unshield lead wire

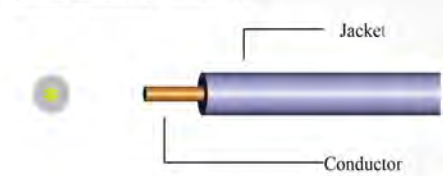

DX0281A Dibrillation cable

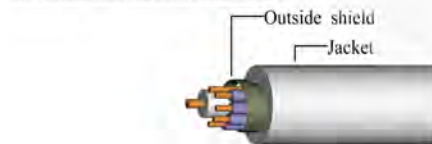

DX0271A Special medical cable

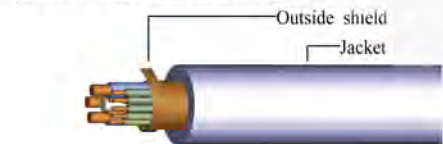

Model No.	No. of conductor	Conductor		Insulation		Inner shield		Inner Jacket		Outside shield		Jacket			Application / Price code
		Sectional Area (mm ²)	Construction (No./mm)	Nom. Thick (mm)	Nom. Diam. (mm)	type	Construction (No./mm)	Nom. Thick. (mm)	Nom. Diam. (mm)	type	Construction (No./mm)	Nom. Thick. (mm)	Nom. Diam. (mm)	Material	
DX0047A	5	0.05	25/0.05	0.15	0.65	Spiral	48/0.08TC	/	/	/	/	0.45	2.5X5.	TPU	SpO2 / A3
DX0027A	5	0.05	25/0.05	0.15	0.65	Spiral	43/0.08TC	0.2	1.8	Spiral	80/0.08TC	0.6	4.0	TPU	SpO2 / A4
DX0069A	5	0.06	12/0.08	0.15	0.6	Spiral	40/0.08TC	0.15	1.65	Spiral	75/0.08TC	0.4	3.3	PVC	SpO2 / A1
DX0012A	1	/	7/0.23Tinse	/	/	/	/	/	/	/	/	0.65	2.0	TPU	EEG / A2
DX0110A	1	0.08	41/0.05	0.25	0.9	/	/	/	/	Spiral	40/0.08TC	0.35	2.0	TPU	HOLTER
DX0109A	1	0.14	28/0.08	0.35	1.2	/	/	/	/	Spiral	60/0.08TC	0.4	2.6	TPU	ECG / A1
DX0023A	1	0.2	41/0.08	0.3	1.2	/	/	/	/	Spiral	60/0.08TC	0.7	3.3	TPU	EKG / A2
DX0009A	5	0.15	19/0.10	0.25	1	/	/	/	/	Spiral	90/0.10TC	0.65	5.0	TPU	ECG / A1
DX0022A	10	0.095	19/0.08	0.2	0.8	Spiral	50/0.08TC	/	/	Spiral	90/0.10TC	1.1	6.0	PVC	EKG / A3
DX0120A	4	0.22	28/0.10	0.3	1.2	/	/	/	/	Spiral	80/0.10TC	0.9	5.0	PVC	IBP / A2
DX0016A	2	0.095	19/0.08	0.2	0.8	/	/	/	/	/	/	0.95	3.5	PVC	Temp / A1
DX0113A	2	0.75	68/0.10	/	/	/	/	/	/	/	/	1	3.0X6.	PVC	ESU / A3
DX0132A	3	0.15	19/0.10	0.25	1	/	/	/	/	/	/	0.4	3.0	PVC	ESU / A1
DX0281A	5	0.15	19/0.10	0.25	1	/	/	/	/	/	/	1.2	6.5	TPU	Defib. / A0
DX0271A	10	0.095	19/0.08	0.2	0.8	/	/	/	/	Braid	C	1	7	Silicone	Special / A0



Type Disignation

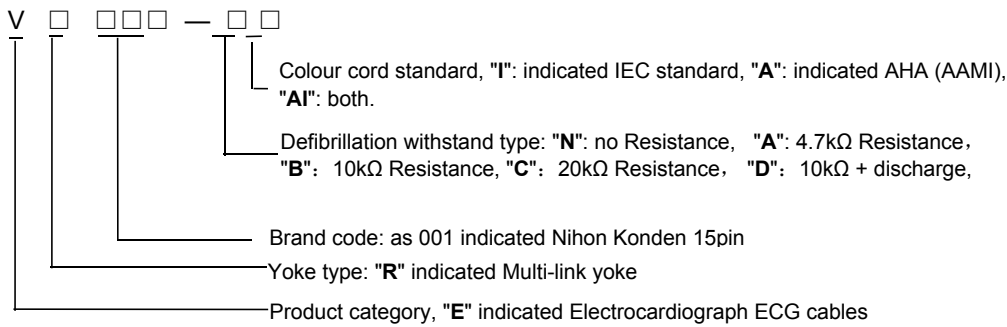

Example: **VR001-NAI** indicated Use with NihonKonden EKG, 10-Lds, AHA and IEC Colour code.

Defibrillator Multi-Link Cable

Compatible Brand	Compatible Models No.	OEM P/N	HNM REF NO.	Description (Name,Length,Plug,Standard)	INSTRUMENT CONNECTOR	Yoke	PRICE CODE
MEDTRONIC PHYSIO CONTRO	Medtronic Physio Control: Lifepak 12		VR013-BAI	12-Lead ECG Trunk Cable, 12pin>>LL4+7pin Yoke, L=2.0m, AAMI/IEC, 10kΩ Res. Fit LL 4LD leadwires and VR024S6A, VR024S6I			F0

Defibrillator Multi-Link Lead set

Compatibility	Compatible Models No.	OEM P/N	HNM REF NO.	Description (Name,Length,Plug,Standard)	Diagram	PRICE CODE
Defibrillator Multi-Link Cable	Medtronic Physio Control: Lifepak 12, Zoll medical: R Series Monitor Defibrillators		VR024S6A	AAMI 6-Ld ECG leadwires, 7pin>>6*Snap, L=1.15m,		C0
			VR024S6I	IEC 6-Ld ECG leadwires, 7pin>>6*Snap, L=1.15m,		C0
Defibrillator Multi-Link Cable	Medtronic Physio Control: Lifepak 12, Zoll medical: R Series Monitor Defibrillators		VB051S4A	AAMI 4-LD ECG leadwires, LL 2pin >> 4*Snap, L=1.0m,		B5
			VB051S4I	IEC 4-LD ECG leadwires, LL 2pin >> 4*Snap, L=1.0m,		B5

HyLink Series



HyLink SpO2 Sensor

Compatible Brand	Compatible Models No.	INSTRUMENT CONNECTOR	HNM REF NO.	SENSOR TYPE	PRICE CODE
Philips	M3,M4,MP20,MP30,MP40,MP50,MP70,MP80,VM4,VM6,VM8		98011603021	Adult finger clip	D6
			98011611021	Adult silicone soft	D8
			98011623021	Neonate wrap(undetachable)	D8
NELLCOR (OXI)	All Nellcor & Nellcor equipped OEM monitors not listed above		98011003012	Adult finger clip	D6
			98011011012	Adult silicone soft	D8
			98011023012	Neonate wrap(undetachable)	D8



HyLink ECG Cable

Compatible Brand	INSTRUMENT CONNECTOR	HNM REF NO.	SENSOR TYPE	PRICE CODE
Philips		98111021022	clip,3LD,IEC (1.0M)	C0
		98111022022	clip,3LD,AHA (1.0M)	C0
		98111023022	clip,5LD,IEC, (0.75M/1.0M)	D6
		98111024022	clip,5LD,AHA, (0.75M/1.0M)	D6
		98111021021	clip,3LD,IEC (0.58M/1.0M)	C2
		98111022021	clip,3LD,AHA (0.58M/1.0M)	C2
		98111023021	clip,5LD,IEC (0.56M/1.0M)	C0
		98111024021	clip,5LD,AHA (0.56M/1.0M)	C0

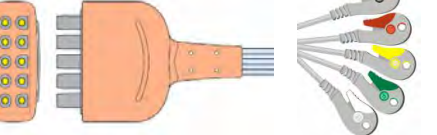
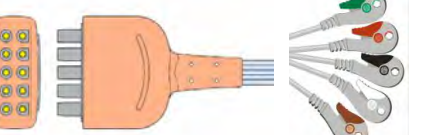
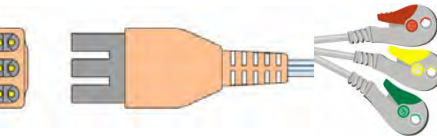
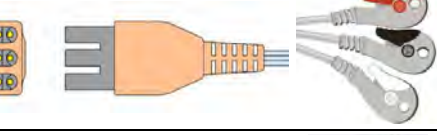
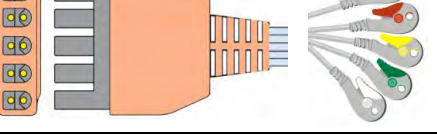
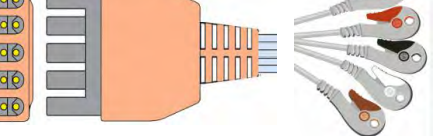
Hylink ECG Cable

Compatible Brand	INSTRUMENT CONNECTOR	HNM REF NO.	SENSOR TYPE	PRICE CODE
GE MEDICAL		98111021031	clip,3LD,IEC (0.75M/1M Injecting plug)	C2
		98111022031	clip,3LD,AHA (0.75M/1M Injecting plug)	C2
		98111023031	clip,5LD,IEC (0.75M/1M Injecting plug)	C6
		98111024031	clip,5LD,AHA (0.75M/1M Injecting plug)	C6
SIEMENS/Dräger/Fukuda		98111021041	clip,3LD,IEC 1M	C2
		98111022041	clip,3LD,AHA 1M	C2
		98111023041	clip,5LD,IEC 1M	C0
		98111024041	clip,5LD,AHA 1M	C0

HyLink EKG Cable

Compatible Brand	INSTRUMENT CONNECTOR	HNM REF NO.	SENSOR TYPE	PRICE CODE
SCHILLER		98122841015	EKG Cable, 12LD,IEC,rectangle, 15 pin, Ø4.0	F4
		98122842015	EKG Cable, 12LD,AHA, rectangle, 15 pin, Ø4.0	F4
		98122831015	EKG Lead wire, 12LD,IEC, Grabber	F4
		98122832015	EKG Lead wire, 12LD,AHA, Grabber	F4

HyLink Non-Invasive Blood Pressure (NIBP)Cuff

Compatible Brand	Productor Guide	HNM REF NO.	Description (Name,Length,Plug)	PRICE CODE
<p>One-Tube "Monitor"</p> 		98210303004	Reusable , Neonatal size,One-tube,with pocket, Limb cir.=6~11cm, Packaging: 1 piece/pk	A6
		98210305004	Reusable, Infant size, One-tube,with pocket, Limb cir.=10~15cm, Packaging: 1 piece/pk	A6
		98210306004	Reusable,Pediatric size, One-tube,with pocket, Limb cir.=14~21cm, Packaging: 1 piece/pk	A6
		98210307004	Reusable,Small adult size, One-tube,with pocket,Limb cir.=20.5-28 cm, Packaging: 1 piece/pk	A7
		98210308004	Reusable, adult size,One-tube,with pocket, Limb cir.=27~35cm,Packaging: 1 piece/pk	A7
		98210310004	Reusable ,Large Adult size, One-tube,with pocket,Limb cir.=34~43cm,Packaging: 1 piece/pk	B1
		98210311004	Reusable, Thigh size,One-tube,with pocket, Limb cir.=42~54cm, Packaging: 1 piece/pk	B1
<p>Two-Tube "Monitor"</p> 		98212303004	Reusable, Neonatal size, two-tube, with pocket, Limb cir.=6~11cm Packaging: 1 piece/pk	A6
		98212305004	Reusable, Infant size, two-tube, with pocket, Limb cir.=10~15cm, Packaging: 1 piece/pk	A6
		98212306004	Reusable, Pediatric size, two-tube,with pocket, Limb cir.=14~21cm, Packaging: 1 piece/pk	A6
		98212307004	Reusable, Small adult size, two-tube,with pocket, Limb cir.=20.5-28 cm, Packaging: 1 piece/pk	A7
		98212308004	Reusable, adult size,two-tube,with pocket,Limb cir.=27~35cm,Packaging: 1 piece/pk	A7
		98212310004	Reusable, Large Adult size, two-tube,with pocket,Limb cir.=34~43cm,Packaging: 1 piece/pk	B1
		98212310004-A04	Reusable, Large Adult size, two-tube,with pocket,Packaging: 1 piece/pk	B1
98212311004	Reusable,Thigh size,two-tube,with pocket,Limb cir.=42~54cm, Packaging: 1 piece/pk	B1		
<p>One-Tube "Monitor"</p> 		98220306004	Reusable ,Pediatric size, One-tube,without pocket,Limb cir.=15~22cm, Packaging: 1 piece/pk	A6
		98220307004	Reusable ,Small adult size, One-tube,without pocket,Limb cir.=17-25cm, Packaging: 1 piece/pk	A6
		98220308004	Reusable ,adult size,One-tube,without pocket,Limb cir.=24~32cm,Packaging: 1 piece/pk	A7
		98220309004	Reusable ,Adult long size, One-Tube,without pocket,Limb cir.=28-37cm, Packaging: 1 piece/pk	A7
		98220310004	Reusable ,Large Adult size, One-Tube,without pocket,Limb cir.=32-42cm, Packaging: 1 piece/pk	A7
		98220311004	Reusable ,Thigh size,One-Tube,without pocket,Limb cir.=42-50cm, Packaging: 1 piece/pk	B1
<p>Two-Tube "Monitor"</p> 		98222306004	Reusable ,Pediatric size, Two-tube,without pocket,Limb cir.=15~22cm, Packaging: 1 piece/pk	A6
		98222307004	Reusable ,Small adult size, Two-tube,without pocket,Limb cir.=17-25cm, Packaging: 1 piece/pk	A6
		98222308004	Reusable ,adult size,Two-tube,without pocket,Limb cir.=24~32cm,Packaging: 1 piece/pk	A7
		98222309004	Reusable ,Adult long size, Two-Tube,without pocket,Limb cir.=28-37cm, Packaging: 1 piece/pk	A7
		98222310004	Reusable ,Large Adult size, Two-Tube,without pocket,Limb cir.=32-42cm, Packaging: 1 piece/pk	A7
		98222311004	Reusable ,Thigh size,Two-Tube,without pocket,Limb cir.=42-50cm, Packaging: 1 piece/pk	B1

HyLink Non-Invasive Blood Pressure (NIBP)Cuff

Compatible Brand	Productor Guide	HNM REF NO.	Description (Name,Length,Plug)	PRICE CODE
<p>One-Tube "Monitor"</p> 		98230301026	Disposable cuffs, 1#Neonatal, One-Tube, Limb cir.=3~6cm, Packaging: 24pcs/box,	F0
		98230302026	Disposable cuffs, 2#Neonatal, One-Tube, Limb cir.=4~8cm, Packaging: 24pcs/box,	F0
		98230303026	Disposable cuffs, 3#Neonatal, One-Tube, Limb cir.=6~11cm, Packaging: 24pcs/box,	F0
		98230304026	Disposable cuffs, 4#Neonatal, One-Tube, Limb cir.=7~14cm, Packaging: 24pcs/box,	F0
		98230305026	Disposable cuffs, 5#Neonatal, One-Tube, Limb cir.=8~15cm, Packaging: 24pcs/box,	F0
<p>Two-Tube "Monitor"</p> 		98232301026	Disposable cuffs, 1#Neonatal, Two-Tube, Limb cir.=3~6cm, Packaging: 24pcs/box	F0
		98232302026	Disposable cuffs, 2#Neonatal, Two-Tube, Limb cir.=4~8cm, Packaging: 24pcs/box	F0
		98232303026	Disposable cuffs, 3#Neonatal, Two-Tube, Limb cir.=6~11cm, Packaging: 24pcs/box	F0
		98232304026	Disposable cuffs, 4#Neonatal, Two-Tube, Limb cir.=7~14cm, Packaging: 24pcs/box	F0
		98232305026	Disposable cuffs, 5#Neonatal, Two-Tube, Limb cir.=8~15cm, Packaging: 24pcs/box	F0



HNM
MEDICAL

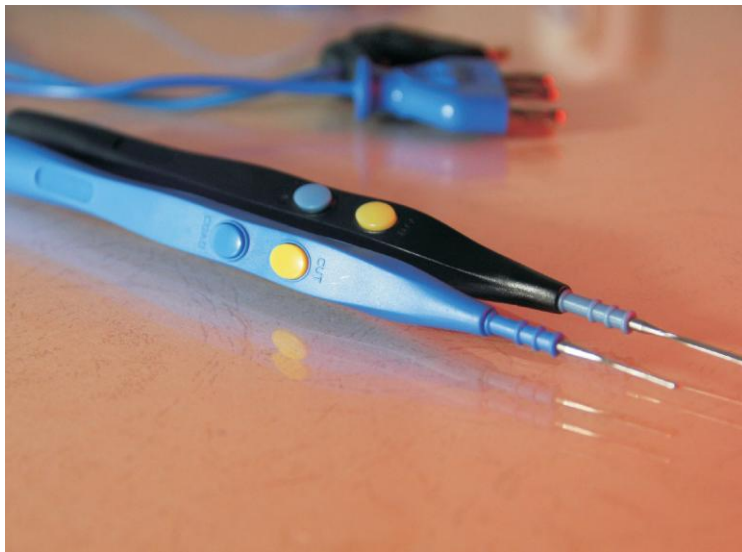
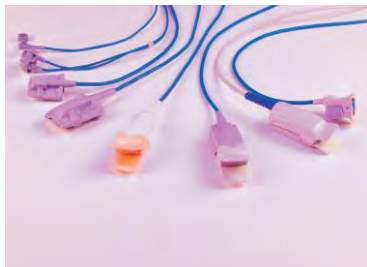

20855 NE 16th Avenue, Miami 33179



1.866.291.8498



sales@hnmmedical.com