



INSTALLATION MANUAL

Read this manual thoroughly prior to the installation.

Installation must be done by a professional.

Store this manual together with the Instruction Manual in a safe place.

This product fits only the following vehicle.

Should the model of your vehicle not comply with the application of this product, contact the seller at your earliest convenience.

PRODUCT NAME	GT2 SUPERCHARGER SYSTEM
PURPOSE	AUTOMOBILE PARTS
PART No.	12001-AT013
MANUAL NUMBER	E04215-T59131-00 Ver.3-3.03
VEHICLE	•TOYOTA GR86 (3BA-ZN8) •SUBARU BRZ (3BA-ZD8)
ENGINE	FA24
MODEL YEAR	•TOYOTA GR86 (3BA-ZN8) 2021/10~ •SUBARU BRZ (3BA-ZD8) 2021/08~

※This application was confirmed by May, 2023

REVISION OF MANUAL

Rev. No.	Date	Detail
3-3.01	2022/10	1 st Edition
3-3.02	2022/12	2 nd Edition
3-3.03	2023/05	3 rd Edition

Published in May 2023 by HKS Co, Ltd. (Unauthorized reproduction is strictly prohibited.)

REMARKS							
<ul style="list-style-type: none"> ▪ HKS will not be responsible for any and all damages to the vehicle's engine or other supplemental devices through the use of this product. ○ This kit (12001-AT013) includes the HKS GT2 Supercharger System Complete Kit Base warranty (hereinafter referred to as "Base Warranty"). ○ Please be sure to use this product in combination with the items specified below. <ul style="list-style-type: none"> ▪ If you use items other than the required items specified below, the Base Warranty will be void. ▪ The engine may be damaged if you use items other than those specified below. 							
<table border="1" style="width: 100%;"> <thead> <tr> <th colspan="2">Required Items for HKS GT2 Supercharger System Complete Kit</th> </tr> </thead> <tbody> <tr> <td style="width: 30%;">Spark Plug</td> <td>HKS Super Fire Racing M45HL, M50HL, or Factory Spark Plug</td> </tr> <tr> <td>Engine Oil</td> <td>HKS Engine Oil Series (Viscosity must be higher than 40)</td> </tr> </tbody> </table>		Required Items for HKS GT2 Supercharger System Complete Kit		Spark Plug	HKS Super Fire Racing M45HL, M50HL, or Factory Spark Plug	Engine Oil	HKS Engine Oil Series (Viscosity must be higher than 40)
Required Items for HKS GT2 Supercharger System Complete Kit							
Spark Plug	HKS Super Fire Racing M45HL, M50HL, or Factory Spark Plug						
Engine Oil	HKS Engine Oil Series (Viscosity must be higher than 40)						
<ul style="list-style-type: none"> ○ Base Warranty shall not apply if this product is used under the following conditions. 							
<table border="1" style="width: 100%;"> <thead> <tr> <th>Conditions/Usage That Voids Warranty</th> </tr> </thead> <tbody> <tr> <td> <ul style="list-style-type: none"> ▪ The maximum RPM limit is changed by replacing the supercharger pulley. ▪ The maximum RPM limit is changed by modifying the ECU data. ▪ Pulleys that are relating to belt layout, such as crank pulley, are changed to non-factory parts. </td> </tr> </tbody> </table>		Conditions/Usage That Voids Warranty	<ul style="list-style-type: none"> ▪ The maximum RPM limit is changed by replacing the supercharger pulley. ▪ The maximum RPM limit is changed by modifying the ECU data. ▪ Pulleys that are relating to belt layout, such as crank pulley, are changed to non-factory parts. 				
Conditions/Usage That Voids Warranty							
<ul style="list-style-type: none"> ▪ The maximum RPM limit is changed by replacing the supercharger pulley. ▪ The maximum RPM limit is changed by modifying the ECU data. ▪ Pulleys that are relating to belt layout, such as crank pulley, are changed to non-factory parts. 							
<ul style="list-style-type: none"> ○ Modifications of the Radiator Support, Alternator Bracket, etc. are required.(See table below) ○ Use ThreeBond TB1324 or similar anaerobic sealant. ○ Use Rivets to attach the Air Cleaner Inlet. ○ Maintenances of the Belts, Traction Fluid etc. is required. Refer to the instruction manual for more details. 							

○Parts that need modification

Part Names	Modification Details	Material	Remarks
Alternator Bracket	Partial cut off	Aluminum	
A/C Condenser Bracket	Partial cut off	Steel	
Front Bumper Reinforcement	Hole Drilling, Partial cut off	Steel	
Air Cleaner Case	Removal of Resonator, Hole drilling	Resin	
Air Cleaner Inlet	Hole Drilling, Partial cut off	Resin	
Radiator Support	Partial cut off	Steel	
Oil Level Gauge	Partial cut off	Steel	
Washer Tank	Hole enlargement	Resin	
Front Bumper Energy Absorber	Partial cut off		
Headlamp	Partial cut off	Resin	

NOTE

▪ Internal component parts of the GT2 Supercharger are precision parts. They could be damaged if any foreign objects get into the Traction Fluid. Make sure not to contaminate the hose or tank with foreign objects while working on the Traction Fluid Piping.

INDEX

NOTICE/ATTENTION	2
PARTS LIST	3
1. REMOVAL OF FACTORY PARTS	6
2. MODIFICATION OF FACTORY PARTS	9
3. INSTALLATION OF INTERCOOLER AND TRACTION FLUID COOLER	15
4. INSTALLATION OF GT2 SUPERCHARGER	22
5. INSTALLATION OF TRACTION FLUID PIPING	28
6. INSTALLATION OF SUCTION PIPE	34
7. INSTALLATION OF INTERCOOLER PIPING	37
8. INSTALLATION OF BLOW-OFF VALVE	40
9. REINSTALLATION OF FACTORY PARTS	42
10. CONFIRMATION AFTER INSTALLATION & FILLING TRACTION FLUID	44
11. 1 ST MONTH INSPECTION	46
12. MAINTENANCE	47
13. TROUBLESHOOTING	48
14. IF BELT BREAKS	48

NOTICE

Thank you for purchasing HKS GT2 SUPERCHARGER SYSTEM. This manual has been prepared assuming that you have a professional knowledge on how to use tools and equipment that are necessary to safely perform service operations on your vehicle. It is also assumed that you are familiar with typical automotive systems and basic service and repair procedures. Do not attempt to carry out the operations shown in this manual unless these assumptions are correct. Always have access to a factory service manual. To avoid injury, follow the safety precautions contained in the factory service manual.

ATTENTION

- This manual states the things you need to be aware of in order to install this product safely, and lists precautions to be taken to avoid any possible damages and/or accidents.
- This product is an automobile part. Do not use for any other purposes.
- HKS will not be responsible for any damage caused by incorrect installation and/or use, or use after modification and/or dismantling of this product.
- This product was designed for installation on a specific factory vehicle.
- The specifications of this product are subject to change without notice.
- The instructions are subject to change without notice. Make sure to refer to the most recent instructions.

SAFETY PRECAUTIONS

The following precautions for use of this product are to prevent possible accidents and/or injuries and for proper use.



WARNING Indicates risk of serious injury and/or possible death.



CAUTION Indicates risk of serious injury and/or possible property damage (i.e. vehicle damage from use of this product.).

PARTS LIST

No.1

No.	Part Name	QT	Description
1	GT2 Supercharger	1	GT2-7040L
2	Supercharger Bracket No.1	1	
3	Supercharger Bracket No.2	1	
4	Supercharger Bracket No.3	1	
5	V-ribbed Belt	1	6PK2070
6	Intercooler	1	
7	Suction Pipe	1	
8	Restrictor	1	ID39mm
9	Suction Pipe Gasket	1	
10	Intercooler Inlet Pipe	1	
11	Intercooler Outlet Pipe No.1	1	
12	Intercooler Outlet Pipe No.2	1	
13	Blow-off Valve	1	includes 2 cap bolts M6 L=45
14	Blow-off Valve Gasket	1	
15	Traction Fluid	1	
16	Traction Fluid Tank	1	
17	Traction Fluid Filter	1	
18	Traction Fluid Cooler	1	
19	Blow-by Gas Pipe Bracket	1	
20	Intercooler Bracket No.1	1	
21	Intercooler Bracket No.2	1	
22	Intercooler Bracket No.3	1	
23	Intercooler Inlet Pipe Bracket	1	
24	Traction Fluid Filter Bracket	1	
25	Traction Fluid Tank Bracket	1	
26	Traction Fluid Cooler Bracket No.1	1	
27	Traction Fluid Cooler Bracket No.2	1	
28	Air Cleaner Bracket No.1	1	
29	Air Cleaner Bracket No.2	1	
30	Air Cleaner Inlet Duct Bracket	1	
31	Air Cleaner Lid	1	
32	Silicone Hose ID60 L70	3	
33	Silicone Hose ID55 L43	1	
34	Silicone Hose ID50-ID60	1	
35	Silicone Hose ID61-ID79	1	
36	Silicone Hose ID74-ID79	1	
37	Silicone Hose ID22-ID25	1	
38	Traction Fluid Hose ID10	1	L1000

PARTS LIST

No.2

No.	Part Name	QT	Description
39	Traction Fluid Hose ID8	1	L2200
40	Hose ID16	1	L60
41	Hose ID4	1	L1000
42	Corrugated Tube ID15	1	L2400
43	Corrugated Tube ID10	3	L70
44	Oil Level Gauge Clamp	1	
45	Blow-by Gas Pipe	1	
46	T-fitting OD16-OD4-OD16	1	
47	Spacer(OD20×ID8×L13)	1	
48	Spacer(OD25×ID10×L15)	7	
49	Spacer(OD25×ID10×L11.8)	1	
50	Spacer(OD20×ID10×L25.4)	1	
51	Spacer(OD12.6×ID8×L18.4)	3	
52	Spacer(OD15×ID6×L35.5)	1	
53	Spacer(OD22×ID8×L51.5)	1	
54	Spacer(OD16×ID8×L82.4)	1	
55	Spacer(OD20×ID10×L6)	1	
56	Spacer(OD18×ID6×L5)	1	
57	Spacer(OD20×ID6×L10)	1	
58	Spacer(OD16×ID8×L35.5)	1	
59	Spacer(OD20×ID10×L 5.5)	1	
60	Insulator Rubber	1	
61	Hose Band #52	1	
62	Hose Band #48	2	
63	Hose Band #40	9	
64	Hose Band #36	3	
65	Hose Clamp ID29.5	1	No Mark
66	Hose Clamp ID26.0	1	Mark 260
67	Hose Clamp ID23.0	3	Mark 230
68	Hose Clamp ID15.5	5	Mark 155
69	Hose Clamp ID13.0	4	Mark 130
70	Hose Clamp ID6.8	2	Mark 68
71	Cap Bolt M10 L70	1	
72	Cap Bolt M10 L60	1	
73	Cap Bolt M8 L130	1	
74	Cap Bolt M8 L115	1	
75	Cap Bolt M8 L90	1	
76	Cap Bolt M8 L60	1	

PARTS LIST

No.3

No.	Part Name	QT	Description
77	Cap Bolt M8 L55	1	
78	Cap Bolt M8 L40	1	
79	Cap Bolt M8 L35	1	
80	Cap Bolt M8 L20	3	
81	Cap Bolt M6 L55	1	
82	Cap Bolt M6 L18	4	
83	Low Head Cap Bolt M8 L35	2	
84	Dish Bolt M8 L35	1	
85	Dish Bolt M8 L30	2	
86	Button Bolt M10 L20	1	
87	Hexagon Bolt M8 L35	6	
88	Hexagon Bolt M8 L20	4	
89	Hexagon Bolt M6 L25	1	
90	Hexagon Bolt M6 L15	1	
91	Flange Bolt M8 L20	2	
92	Flange Bolt M6 L25	2	
93	Flange Bolt M6 L20	2	
94	Flange Bolt M6 L18	2	
95	Flange Bolt M6 L15	1	
96	Stud Bolt M6 8-7-8	1	
97	Flat Washer M8	19	
98	Flat Washer M6 Large Diameter	8	
99	Flange Nut M10	1	
100	Flange Nut M8	1	
101	Flange Nut M6	5	
102	Hexagon Nut M8	3	
103	Hexagon Nut M6	2	
104	Rivet	2	
105	Tie Wrap (M)	16	
106	Tie Wrap (S)	9	
107	Installation Manual	1	The Book
108	Instruction Manual	1	

1. REMOVAL OF FACTORY PARTS

Refer to this installation manual and the factory service manual to remove the factory parts.

- (1) Disconnect the negative terminal from the Battery.
- (2) Unplug the wiring connectors of the ① Side Turn Signal Lamps on both left and right sides.
- (3) Remove ② Front Bumper. (The removed Bumper will be reinstalled later).

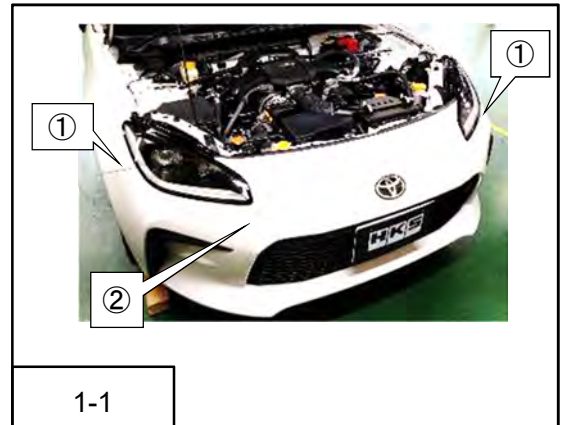

- (4) Remove ③ Right Air Duct located in ② Front Bumper.

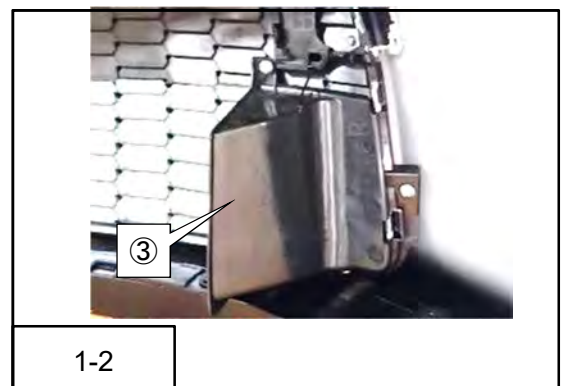

- (5) Remove ④ Front Bumper Energy Absorber. (The removed Absorber will be modified and reinstalled later)
- (6) Remove ⑤ Air Cleaner Inlet. (The removed Air Cleaner Inlet will be modified and reinstalled later)
- (7) Remove ⑥ Radiator Cover Plate.
- (8) Remove ⑦ Front Bumper Corner Bracket from both left and right sides. (The removed Bracket will be reinstalled later)
- (9) Remove ⑧ Right Headlamp. (The removed Headlamp will be modified and installed later)

- (10) Remove ⑨ Washer Tank. (The removed Washer Tank will be modified and installed later)

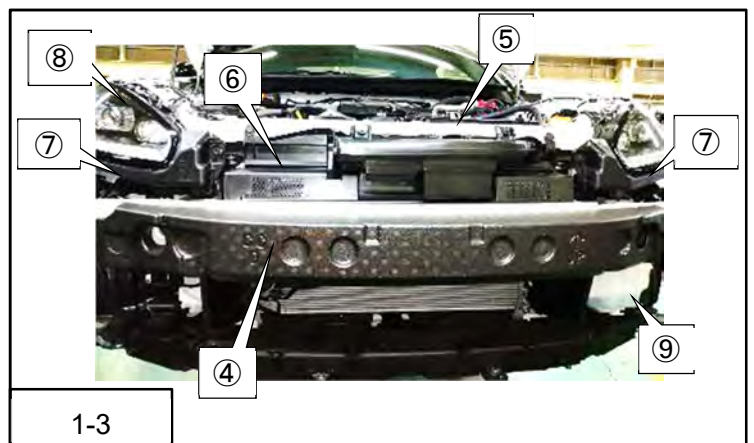

(11) Remove ⑩ Horn from Front Bumper Reinforcement.
(The removed Horn will be reinstalled later)

(12) Remove ⑪ Outside Air Temperature Sensor from the A/C Condenser Bracket. (The removed Sensor will be modified and reinstalled later)

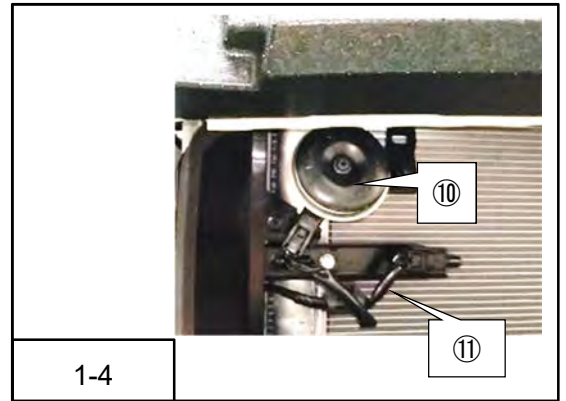

(13) Remove ⑫ Front Bumper Reinforcement. (The removed Front Bumper Reinforcement will be modified and reinstalled later)

(14) Remove the ⑬ Radiator Guide from both left and right sides.

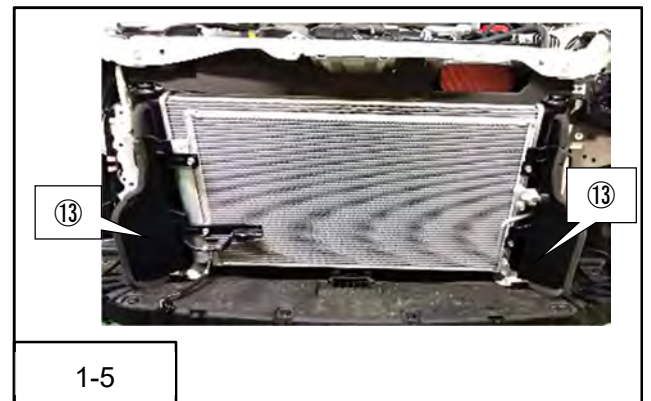

(15) Remove ⑭ Air Cleaner Case. (The removed Air Cleaner Case will be modified and reinstalled later)

(16) Remove ⑮ Belt Cover. (The removed Cover on the A/C Compressor side will be reinstalled later)

(17) Hold the Tensioner Pulley with a tool and rotate the Tensioner to the right to lower the tension, then remove ⑯ Belt.

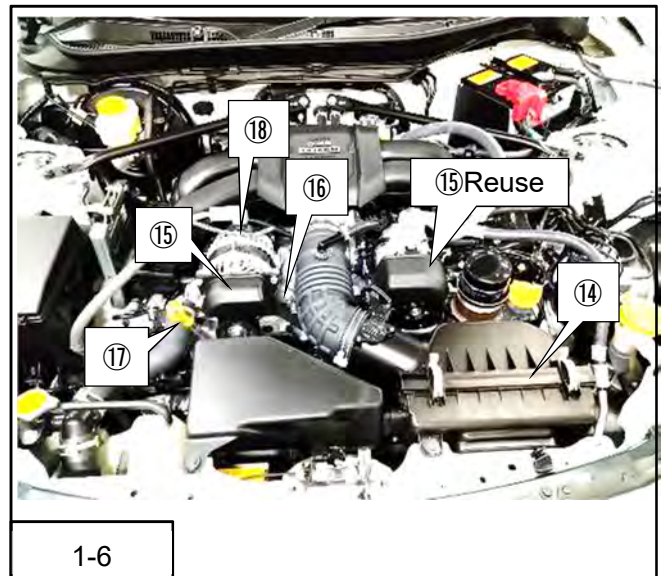

(18) Remove ⑰ Oil Level Gauge. (The removed Oil Level Gauge will be modified and reinstalled later)

(19) Remove ⑱ Alternator. (The removed Alternator will be reinstalled later)

(20) Remove ⑱ Idler Pulley.

(21) Remove ⑳ Auto Tensioner. (The removed Auto Tensioner will be reinstalled later)

(22) Remove ㉑ Alternator Bracket. (The removed Alternator Bracket will be modified and reinstalled later)

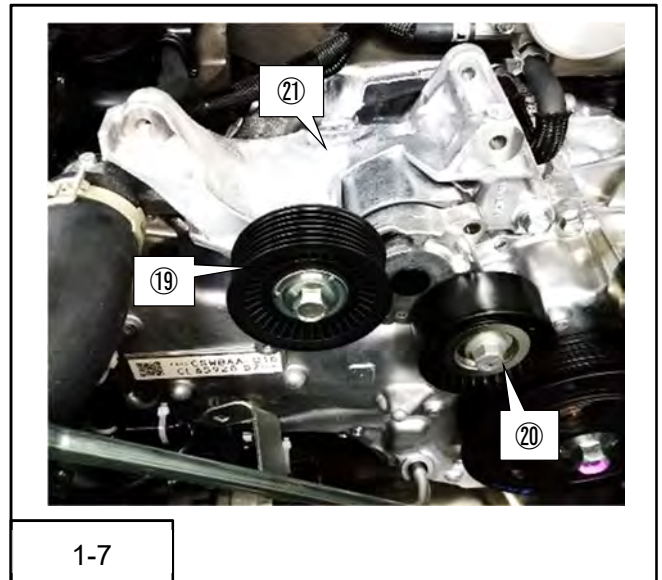

(23) Remove ㉒ Hood Lock from the Radiator Support. (The removed Hood Lock will be reinstalled later)

(24) Remove ㉓ Radiator Support. (The removed Radiator Support will be modified and reinstalled later)

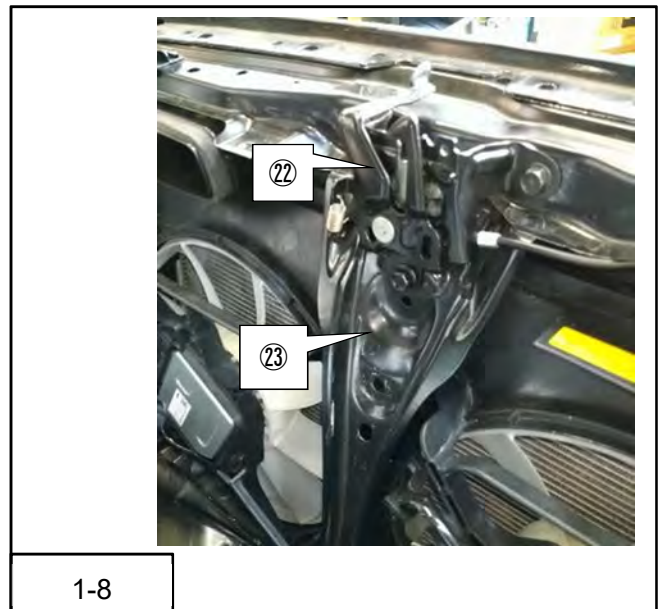

2. MODIFICATION OF FACTORY PARTS

(1) Remove A/C Condenser Bracket on right side on the vehicle. Cut off portion of the A/C Condenser Bracket along the dotted line shown in the diagram on the right.

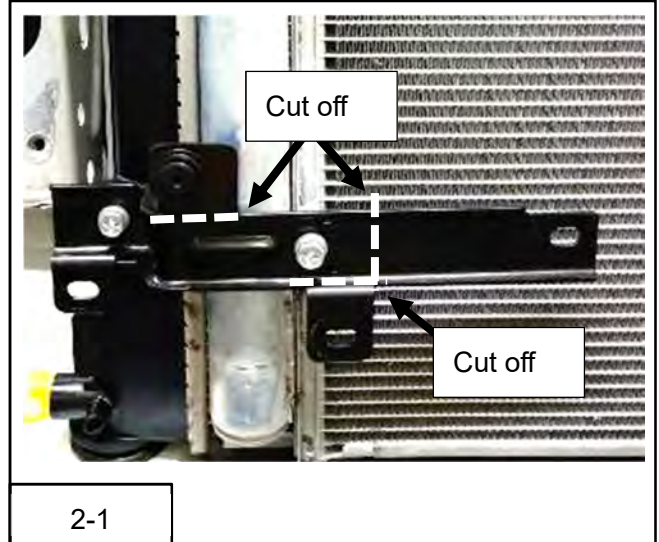

(2) Reinstall the A/C Condenser Bracket modified at 2.(1) to the original position.

(3) Drill an 8mm hole in ⑫the Front Bumper Reinforcement in the position indicated in 2-2 below.

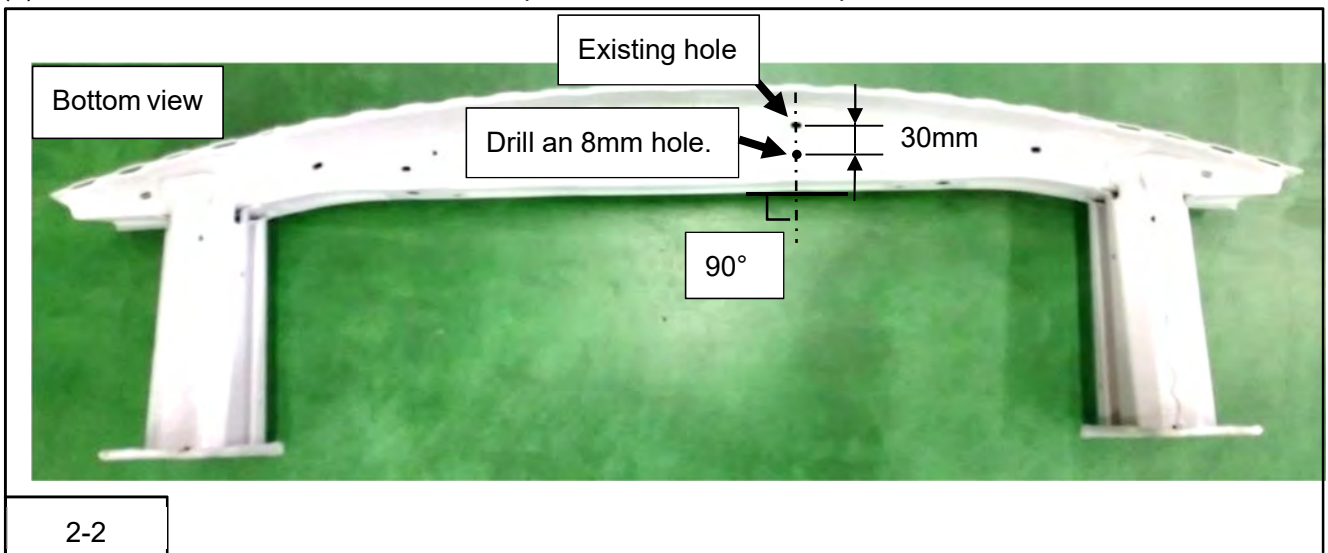

(4) Cut off the shaded area of ⑫the Front Bumper Reinforcement shown in 2-3 below.

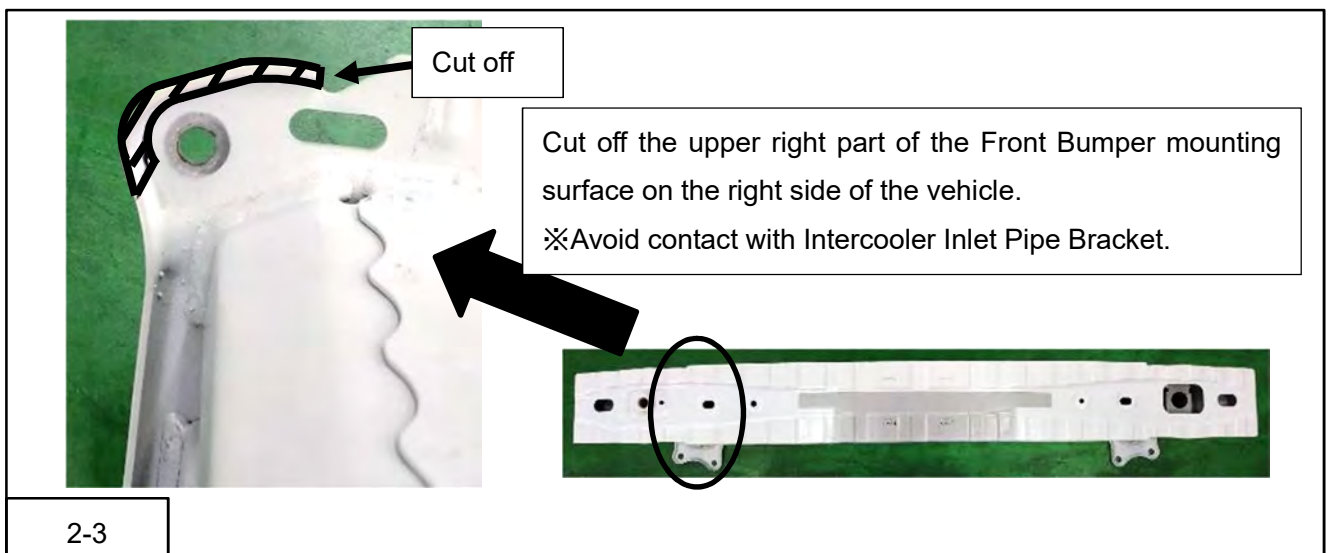

※BRZ also cuts off part of ⑫the Front Bumper Reinforcement shown in 2-4 below.

Front view

↑Upper

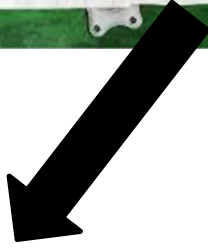

※Dimensional value is symmetrical

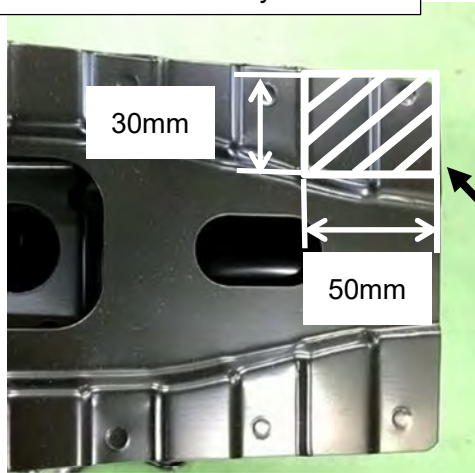

Cut off
※ Avoid contact with Front Bumper

NOTE

◇ Cut off the back side so that it is not sharp.

Cut off



2-4

(5) Cut off part of the ③Radiator Support removed at 1. (24).(3 parts)

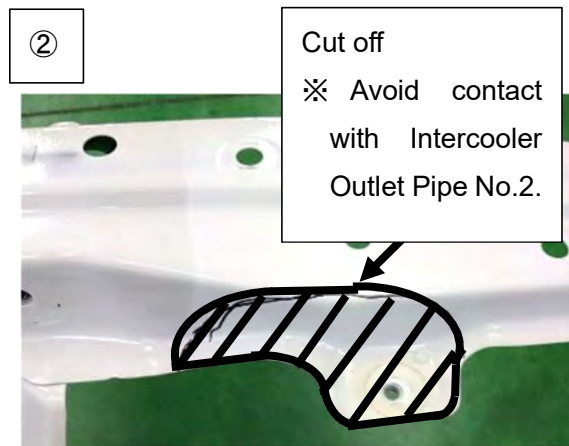
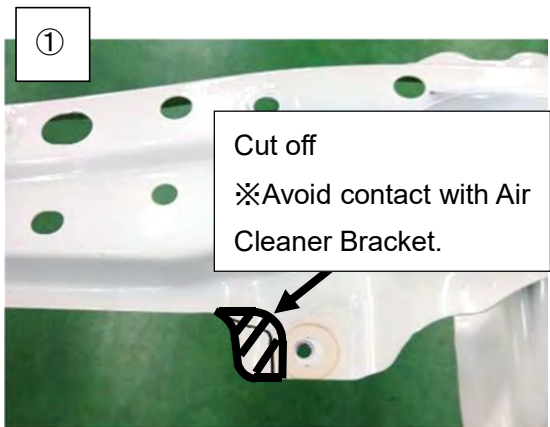
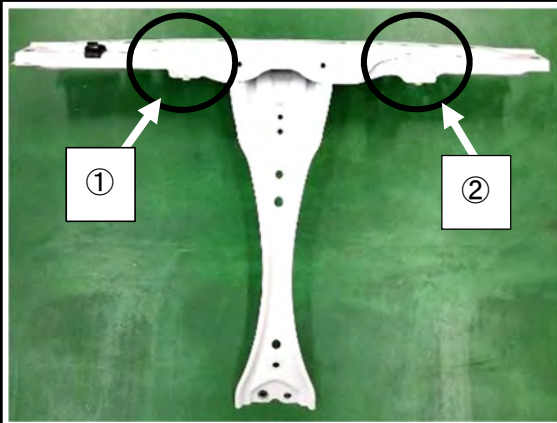

2-5

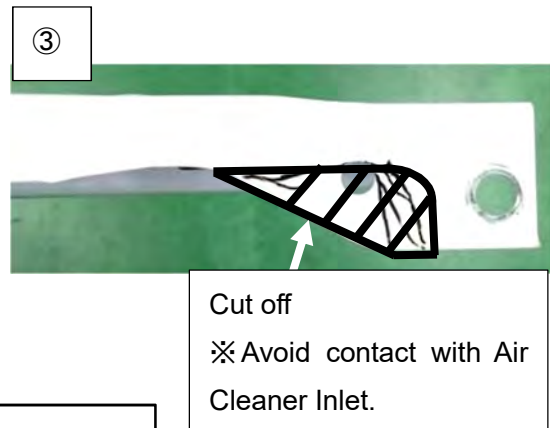

2-6

- (6) Cut off the ②①Alternator Bracket removed at 1. (22) at the dotted line.

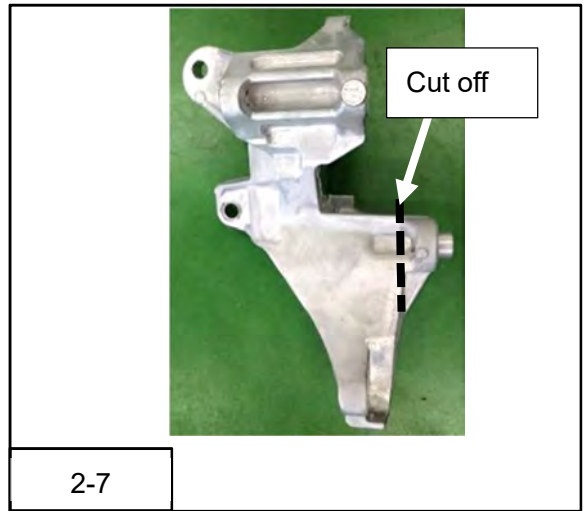

- (7) Remove the Resonator from the ⑭Air Cleaner Case removed at 1.(15).

NOTE

- ✧ Remove the 2 rivets using a drill.

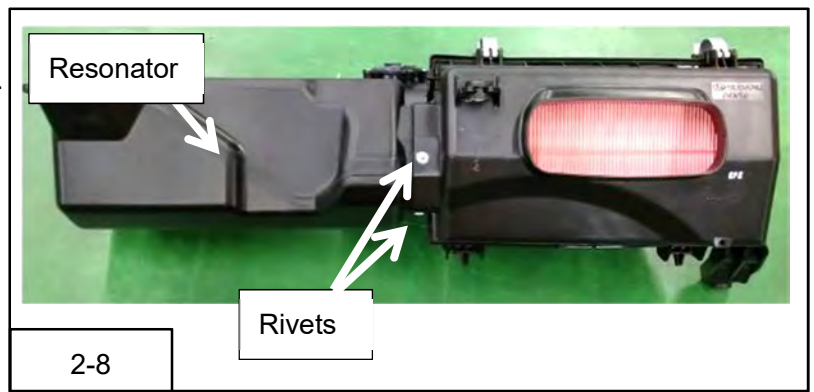

- (8) Drill a 4mm hole in ⑭Air Cleaner Case in the position indicated in 2-8 below.

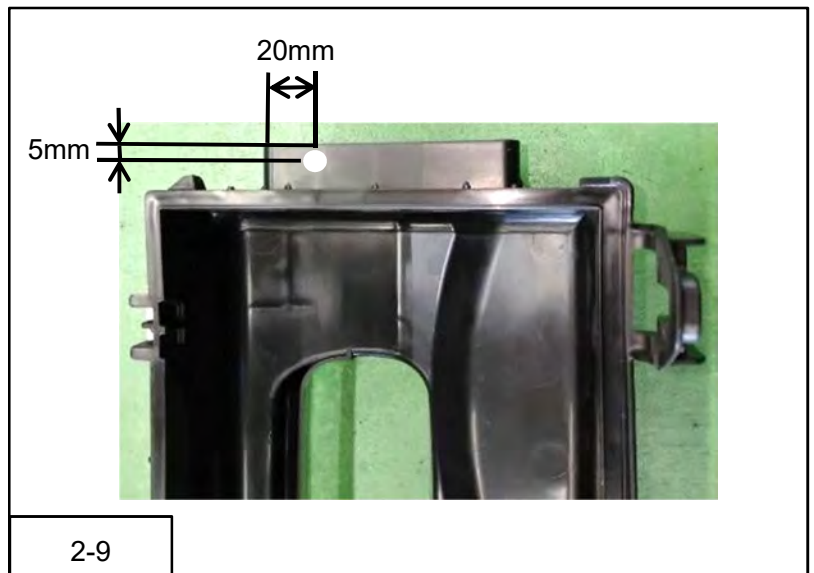

(9) Cut off the ⑤Air Cleaner Inlet removed at 1. (6) at the dotted line.

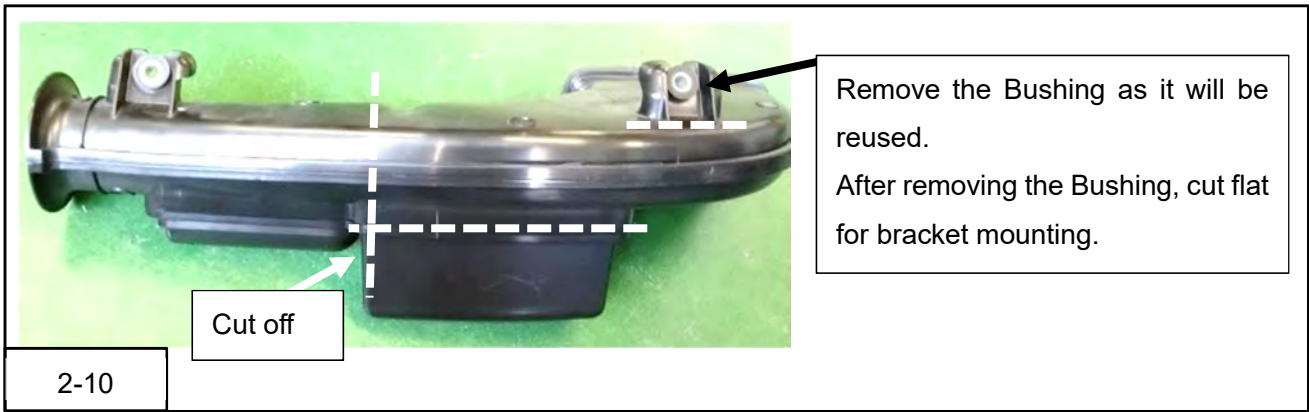

(10) Enlarge the mounting hole of the ⑨Washer Tank removed at 1. (10).

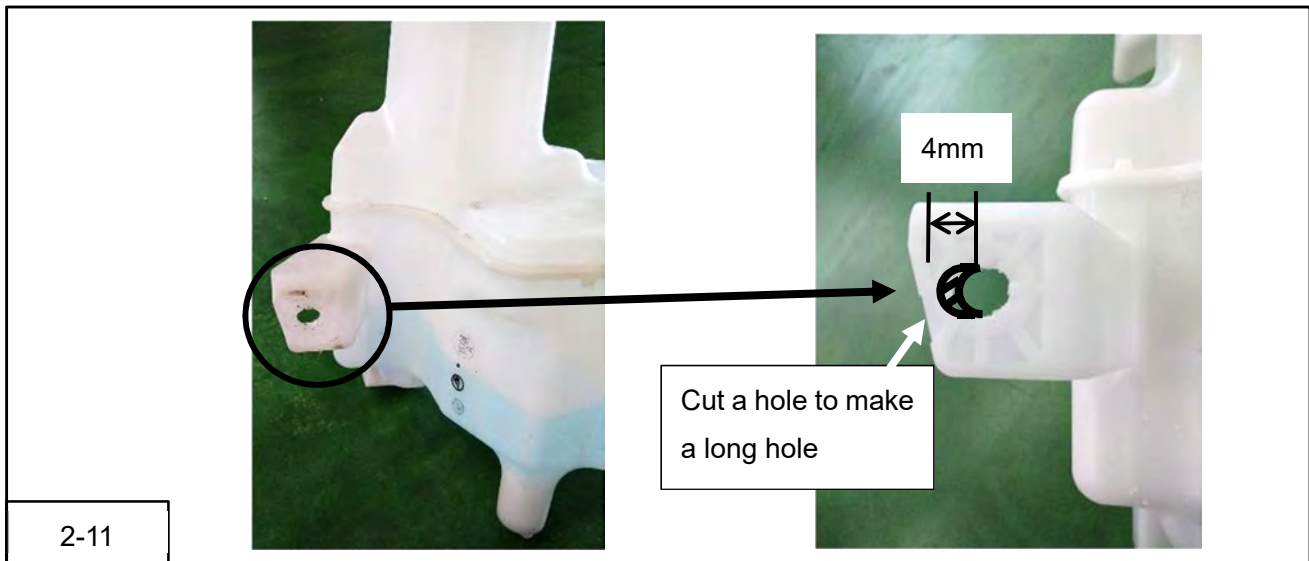

(11) Cut off ⑰Oil Level Gauge Bracket at the dotted line.

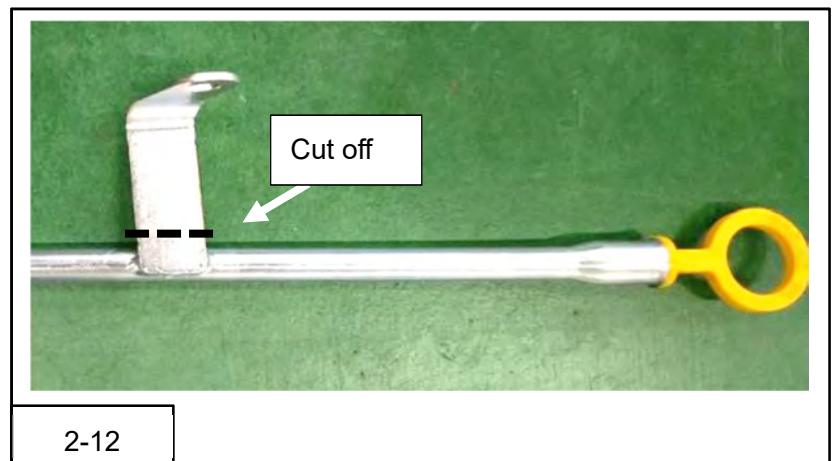

(12) Cut off the wiring connector fixing points(2points) of the ⑨Right Headlamp removed at 1. (9).

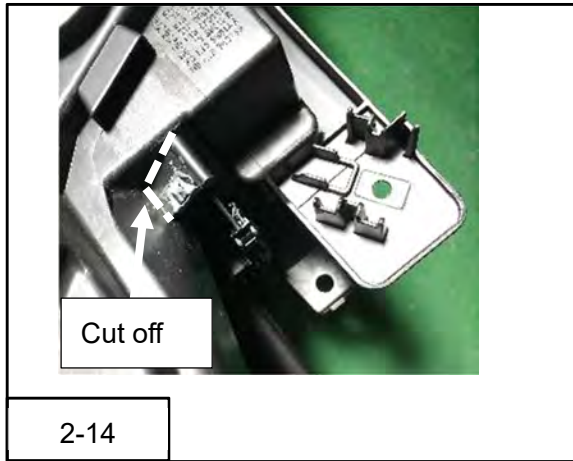
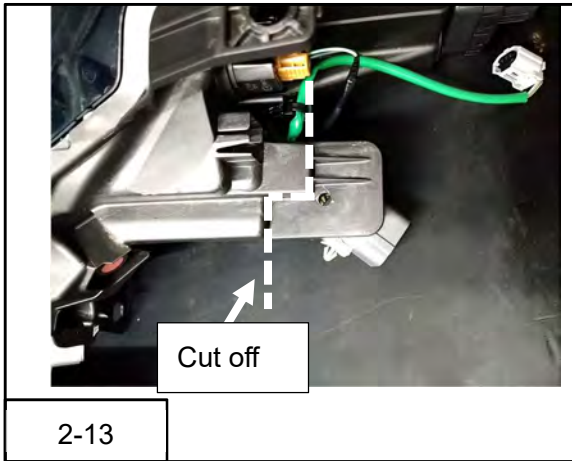

(13) Cut off the ④Front Bumper Energy Absorber removed at 1.(5) at the dotted line.

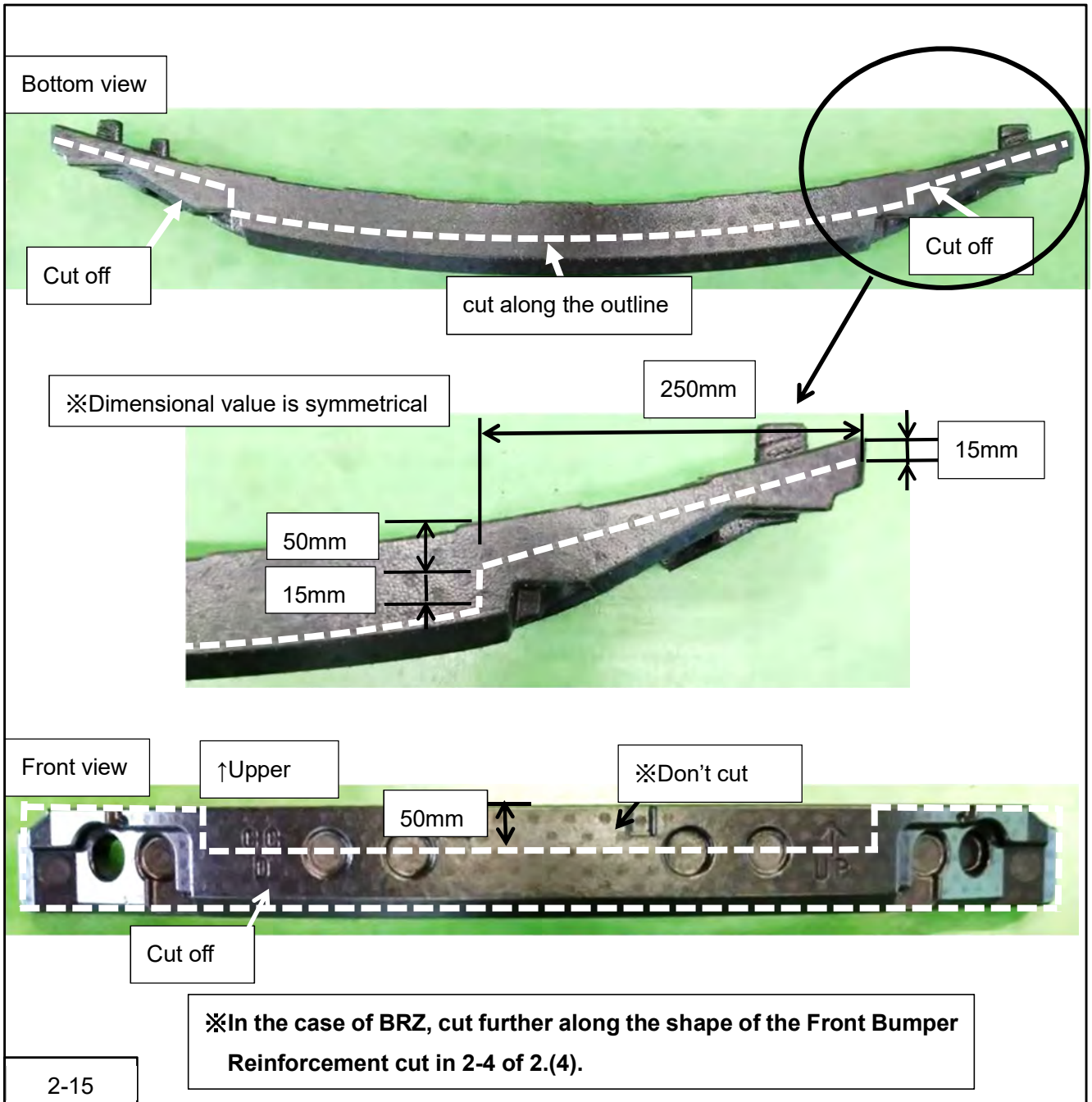

3.INSTALLATION OF INTERCOOLER AND TRACTION FLUID COOLER

PARTS LIST

The parts list number shown in the table on the right corresponds to the number of the parts list on page 3-5.

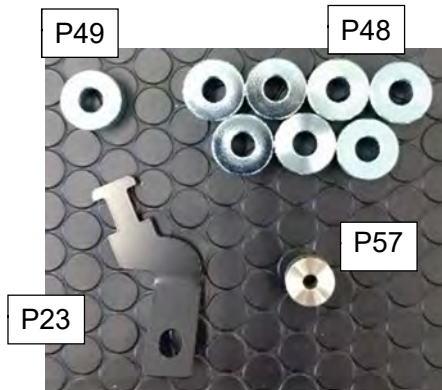
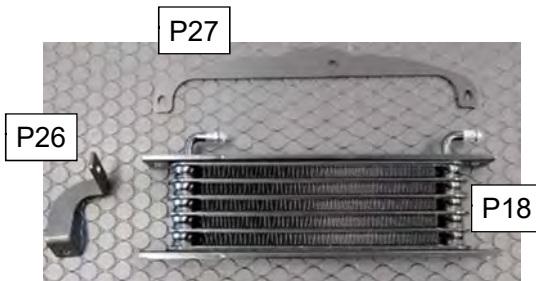
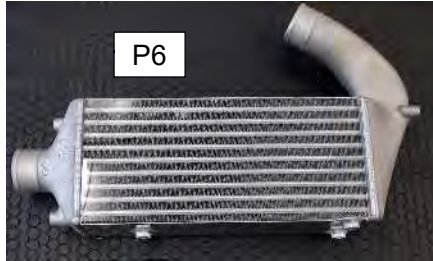

No.	Part Name	QT
P6	Intercooler	1
P18	Traction Fluid Cooler	1
P20	Intercooler Bracket No.1	1
P21	Intercooler Bracket No.2	1
P22	Intercooler Bracket No.3	1
P23	Intercooler Inlet Pipe Bracket	1
P26	Traction Fluid Cooler Bracket No.1	1
P27	Traction Fluid Cooler Bracket No.2	1
P39	Traction Fluid Hose ID8	1
P42	Corrugated Tube ID15	1
P43	Corrugated Tube ID10	2
P47	Spacer (OD20×ID8×L13)	1
P48	Spacer (OD25×ID10×L15)	7
P49	Spacer (OD25×ID10×L11.8)	1
P57	Spacer (OD20×ID6×L10)	1
P69	Hose Clamp ID13.0	2
P78	Cap Bolt M8 L40	1
P80	Cap Bolt M8 L20	3
P82	Cap Bolt M6 L18	4
P83	Low Head Cap Bolt M8 L35	2
P87	Hexagon Bolt M8 L35	6
P88	Hexagon Bolt M8 L20	4
P89	Hexagon Bolt M6 L25	1
P90	Hexagon Bolt M6 L15	1
P97	Flat Washer M8	19
P98	Flat Washer M6 Large Diameter	8
P100	Flange Nut M8	1
P101	Flange Nut M6	3
P102	Hexagon Nut M8	3
P103	Hexagon Nut M6	2
P105	Tie Wrap (M)	4
P106	Tie Wrap (S)	4

(1) Install the Intercooler and Traction Fluid Cooler in the ⑫Front Bumper Reinforcement modified at 2. (3)(4).

- P6 Intercooler ×1
- P18 Traction Fluid Cooler ×1
- P20 Intercooler Bracket No.1 ×1
- P21 Intercooler Bracket No.2 ×1
- P22 Intercooler Bracket No.3 ×1
- P26 Traction Fluid Cooler Bracket No.1 ×1
- P27 Traction Fluid Cooler Bracket No.2 ×1
- P47 Spacer(OD20×ID8×L13) ×1
- P78 Cap Bolt M8 L40 ×1
- P80 Cap Bolt M8 L20 ×3
- P82 Cap Bolt M6 L18 ×4
- P88 Hexagon Bolt M8 L20 ×4
- P97 Flat Washer M8 ×11
- P98 Flat Washer M6 Large Diameter ×5
- P100 Flange Nut M8 ×1
- P101 Flange Nut M6 ×3
- P102 Hexagon Nut M8 ×3
- P103 Hexagon Nut M6 ×1

NOTE

✧ For easier installation, use a magnet hand or something similar when passing the bolt through the inside of the Front Bumper Reinforcement.

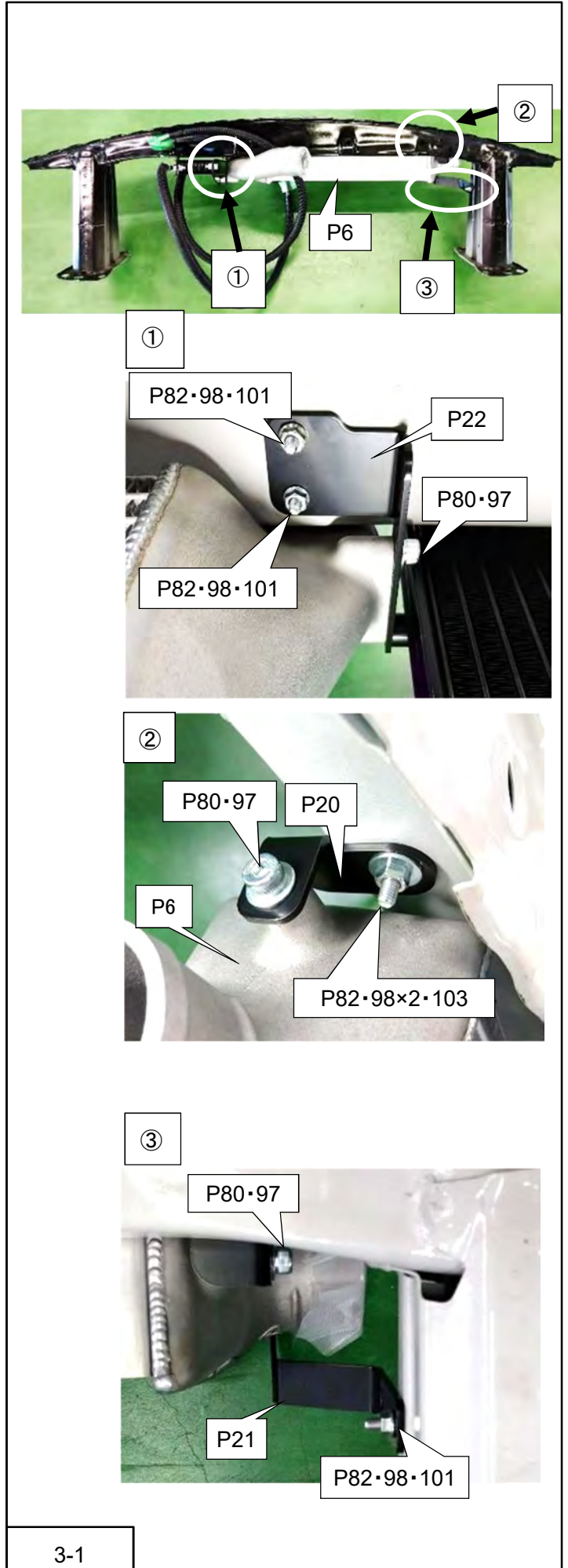

3-1

NOTE

- ◇ Install the Traction Fluid Cooler Bracket on the inner surface of the Traction Fluid Cooler.

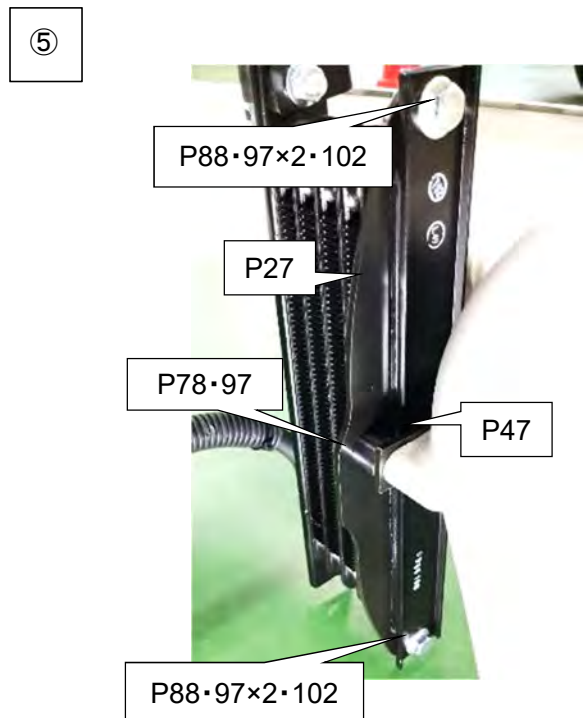
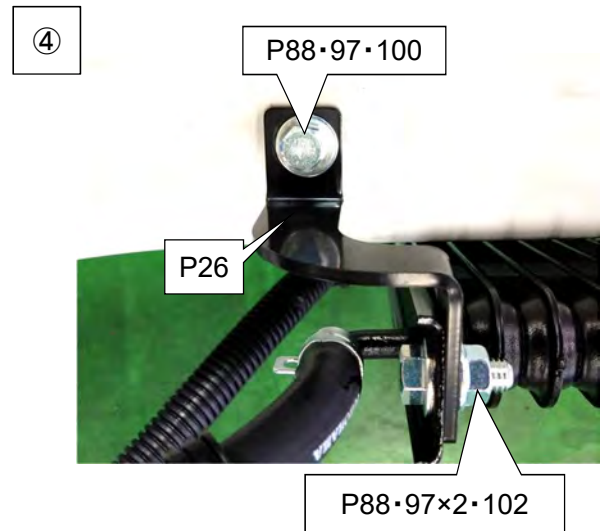
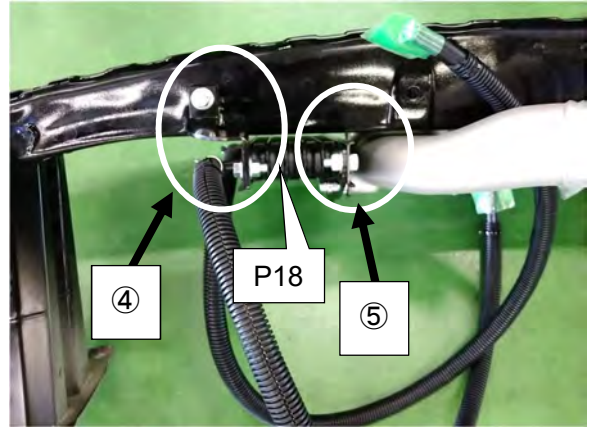

3-2

(2) Cut the Traction Fluid Hose ID8 into ①1,050mm and ②880mm.

•P39 Traction Fluid Hose ID8 ×1

(3) Cut the Corrugated Tube ID15 into ①150mm, ②410mm, ③980mm and ④810mm.

•P42 Corrugated Tube ID15 ×1

(4) Connect the Traction Fluid Hose ID8 ① cut at 3.(2) to the nipple located on the bottom of the Traction Fluid Cooler. Connect the Traction Fluid Hose ID8 ② cut at 3.(2) to the nipple located on the top of the Traction Fluid Cooler.

•P69 Hose Clamp ID13.0 ×2

(5) Install the Corrugated Tube ID15 ③ and ④ cut at 3.(3) around the Traction Fluid Hose ID8 ① and ②. Secure both ends of the Corrugated Tube with Tie Wraps.

•P105 Tie Wrap (M) ×4

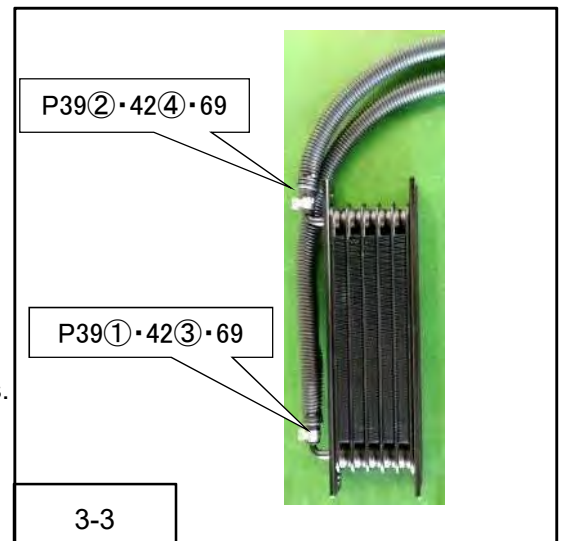

(6) Install the Corrugated Tube around the Airbag Sensor wiring on both left and right sides.

•P43 Corrugated Tube ID10 ×2

•P106 Tie Wrap (S) ×4

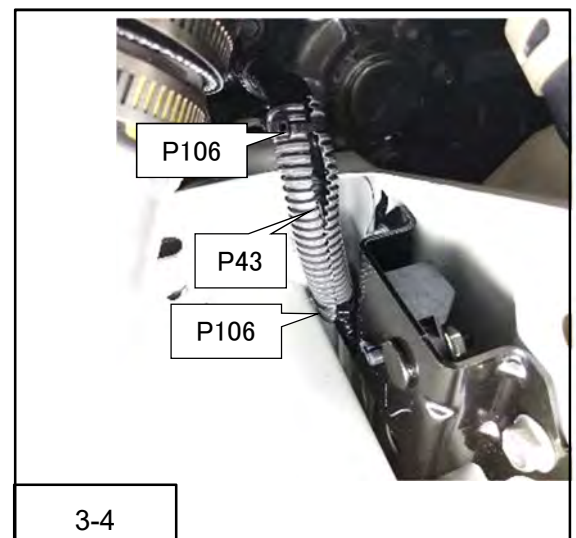

(7) Install the ⑫ Front Bumper Reinforcement with the Intercooler and the Traction Fluid Cooler on the vehicle. Place the Spacer (OD25×ID10×L11.8) between the Intercooler Inlet Pipe Bracket and the vehicle.

Low Head Cap Bolt M8 L35 are used for the lower left on the left side of the vehicle and the upper right on the right side of the vehicle.

- P23 Intercooler Inlet Pipe Bracket ×1
- P48 Spacer(OD25×ID10×L15) ×7
- P49 Spacer(OD25×ID10×L11.8) ×1
- P83 Low Head Cap Bolt M8 L35 ×2
- P87 Hexagon Bolt M8 L35 ×6
- P97 Flat Washer M8 ×8

Tightening Torque : N·m (kgf·m)

T=32 (3.26) (Low Head Cap Bolt, Hexagon Bolt)

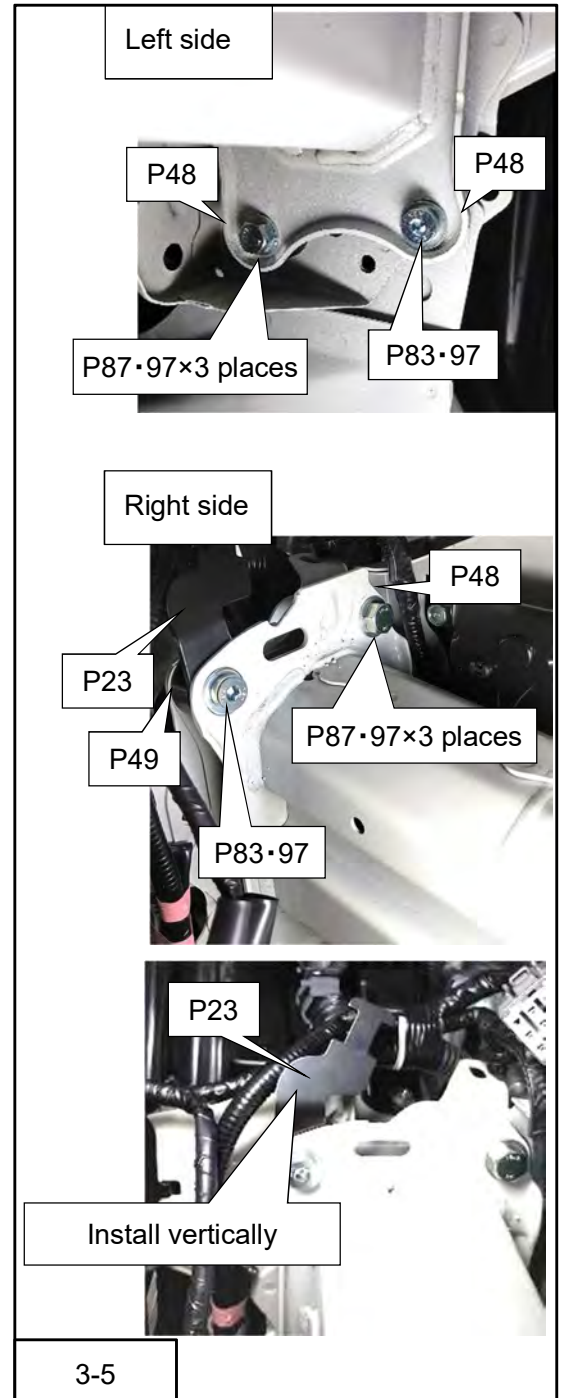

(8) Degrease the threads of the Hexagon Bolt and apply the ThreeBond TB1324 thinly then mount the ⑭ Washer Tank modified at 2. (10).

- P57 Spacer(OD20×ID6×L10) ×1
- P89 Hexagon Bolt M6 L25 ×1
- P90 Hexagon Bolt M6 L15 ×1
- P98 Flat Washer M6 Large Diameter ×2

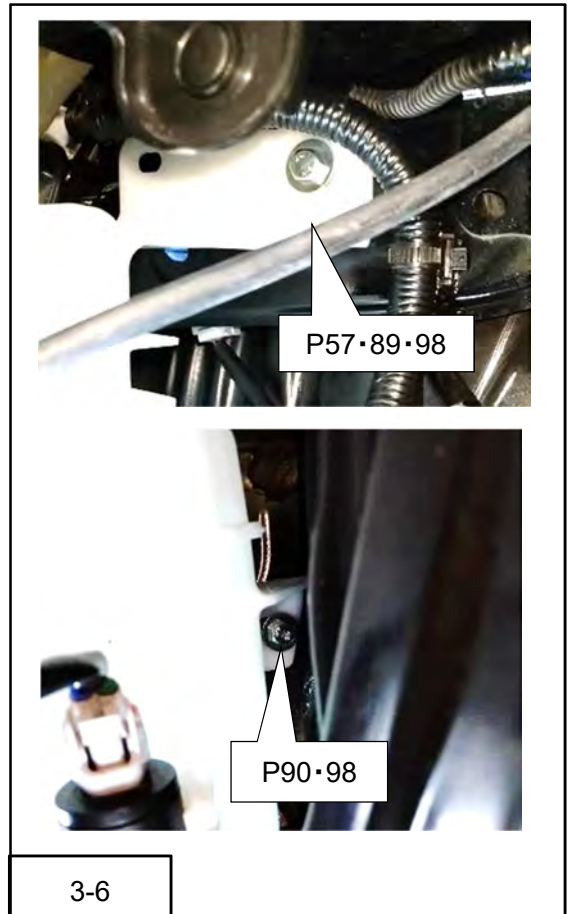

(9) Install the ⑩Horn removed at 1. (11) on the vehicle using the genuine unused hole located under the Front Bumper Reinforcement mounting surface on the right side of the vehicle.

- P98 Flat Washer M6 Large Diameter ×1
- P103 Hexagon Nut M6 ×1

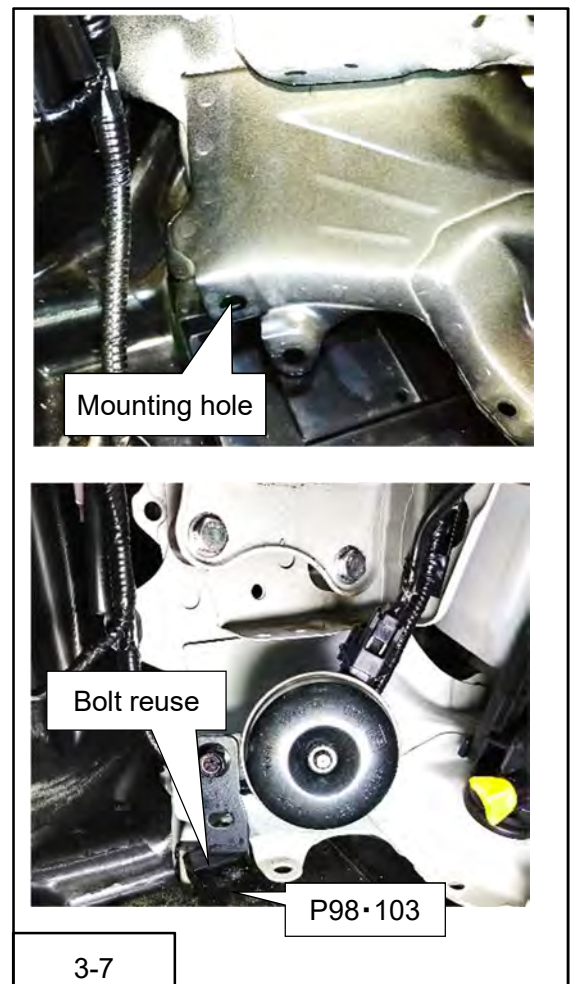

(10) Install the ⑪Outside Air Temperature Sensor removed at 1.(12) on the Intercooler Bracket. No.2.

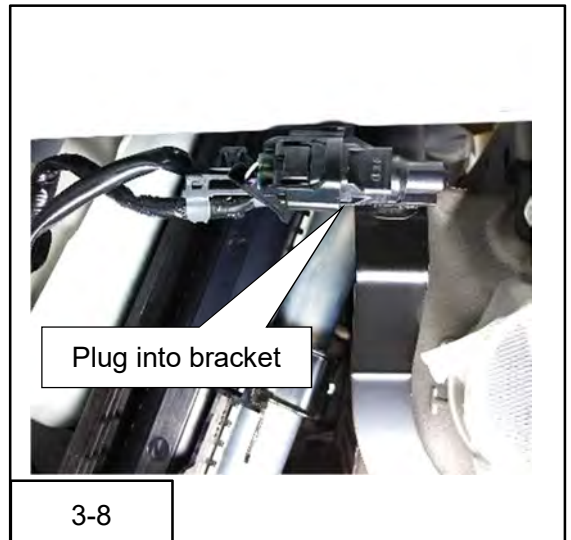

(11) Loosen the fixing bolt of the Wiper Relay. Use the upper hole on the bracket to move the Wiper Relay downward and re-tighten the bolt.

NOTE

- ✧ Bend the claws of the bracket to be securely attached.

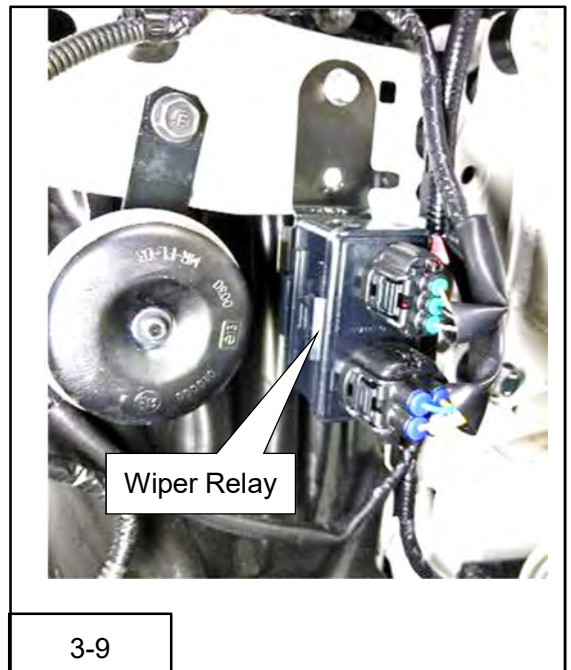

4. INSTALLATION OF GT2 SUPERCHARGER

PARTS LIST

No.	Part Name	QT
P1	GT2 Supercharger	1
P2	Supercharger Bracket No.1	1
P3	Supercharger Bracket No.2	1
P4	Supercharger Bracket No.3	1
P5	V-ribbed Belt	1
P50	Spacer(OD20×ID10×L25.4)	1
P51	Spacer(OD12.6×ID8×L18.4)	3
P52	Spacer(OD15×ID6×L35.5)	1
P53	Spacer(OD22×ID8×L51.5)	1
P54	Spacer(OD16×ID8×L82.4)	1
P58	Spacer(OD16×ID8×L35.5)	1
P59	Spacer(OD20×ID10×L35.5)	1
P71	Cap Bolt M10 L70	1
P72	Cap Bolt M10 L60	1
P73	Cap Bolt M8 L130	1
P74	Cap Bolt M8 L115	1
P75	Cap Bolt M8 L90	1
P76	Cap Bolt M8 L60	1
P77	Cap Bolt M8 L55	1
P79	Cap Bolt M8 L35	1
P81	Cap Bolt M6 L55	1
P84	Dish Bolt M8 L35	1
P85	Dish Bolt M8 L30	2
P94	Flange Bolt M6 L18	1

(1) Install the ㉑Alternator Bracket modified at 2.(6) to the vehicle, and install the ㉒Auto Tensioner.

(2) For maintenance purpose, mark two positions on the Auto Tensioner as shown in the diagram 4-1 using an oil-based marking pen or a similar pen.

NOTE

- ✧ Mark the reference point on the Alternator. The scale must be marked on the movable side on the Auto Tensioner.
- ✧ The diagram on the right shows when Auto Tensioner is fully stroked to the stopper.

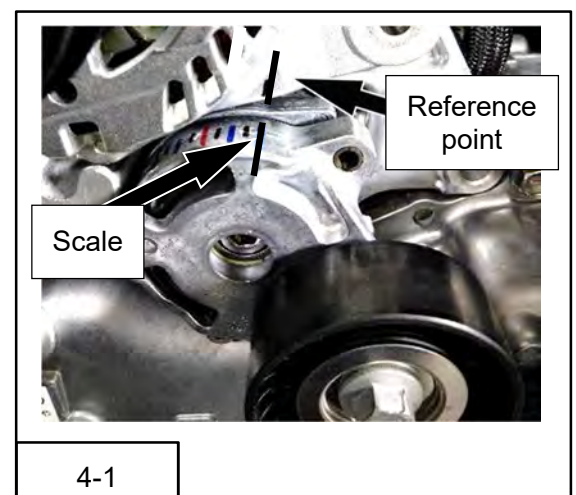

- (3) Rotate Auto Tensioner Pulley to the right until it hits the stopper. Mark where the Pulley aligns with the reference point marked in (2).

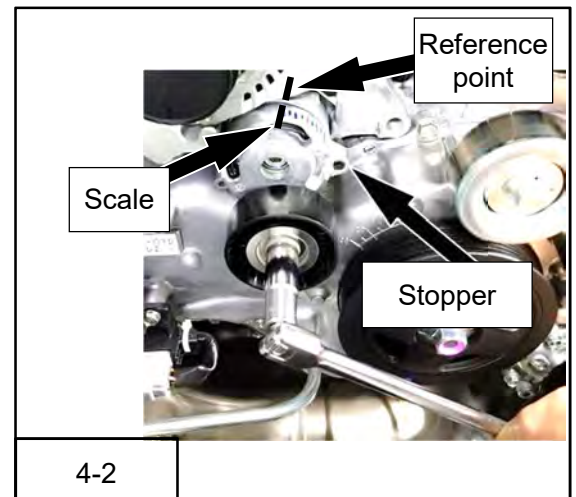

- (4) Remove the ⑳Auto Tensioner from the ㉑Alternator Bracket.

- (5) Equally divide and mark the area between the mark made in (2) and (3) into 8 parts as shown in 4-3.

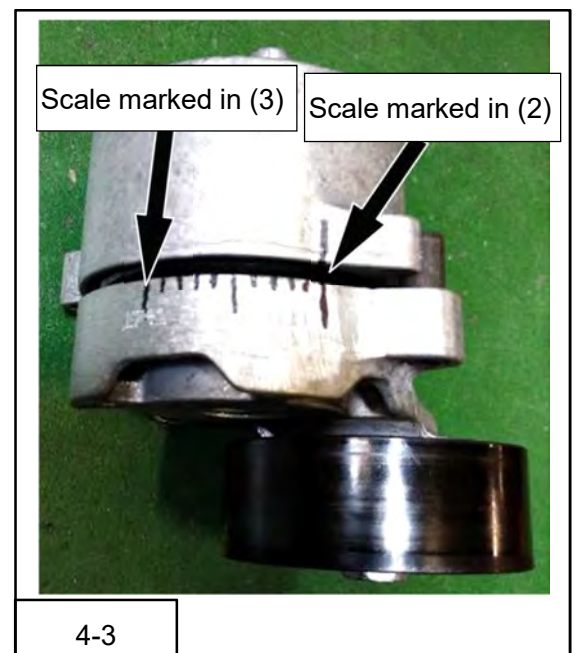

- (6) Reinstall ⑳Auto Tensioner onto the ㉑Alternator Bracket.

- (7) Remove one of the M10 bolts that secure the ㉑ Alternator Bracket.

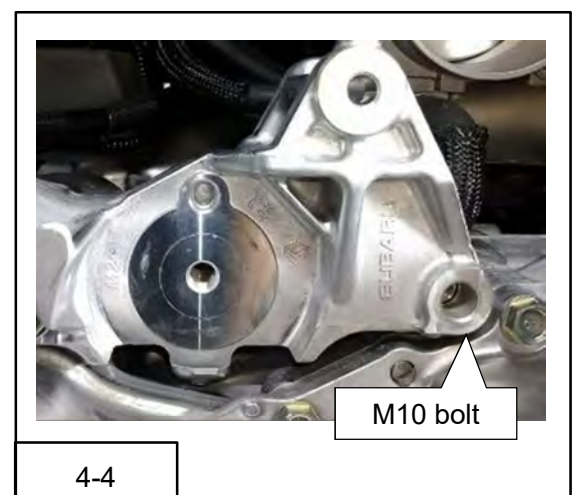

- (8) Remove one of the M8 bolts that secures the Timing Chain Belt Cover.

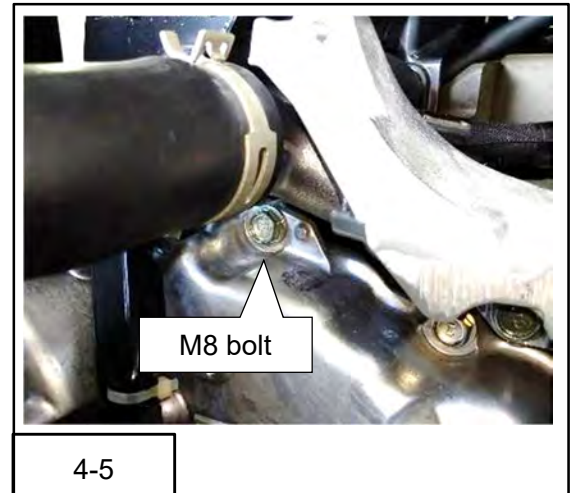

- (9) Temporary insert the Flange Bolt M6 L18 into the 7mm hole of the Supercharger Bracket No.3.

- P4 Supercharger Bracket No.3 ×1
- P94 Flange Bolt M6 L18 ×1

NOTE

- ✧ The Flange Bolt M6 L18 cannot be installed after Supercharger Bracket No.3 is installed to the Supercharger Bracket No.1.

- (10) Mount the Supercharger Bracket No.3 on the Supercharger Bracket No.1. Temporarily insert the Spacer (OD12.6×ID8×L18.4) and the Cap Bolt M8 L60 to the 9mm hole for bracket positioning.

- P2 Supercharger Bracket No.1 ×1
- P51 Spacer(OD12.6×ID8×L18.4) ×3
- P76 Cap Bolt M8 L60 ×1
- P79 Cap Bolt M8 L35 ×1
- P84 Dish Bolt M8 L35 ×1

NOTE

- ✧ The Cap Bolt M8 L60 will be used for GT2 Supercharger installation later.

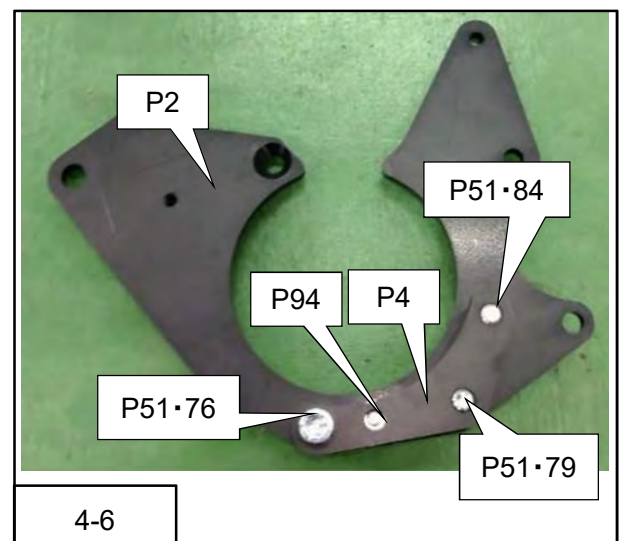

(11) Temporary insert the Flange Bolt M8 L90 into the 9mm hole of the Supercharger Bracket No.1.

- P75 Cap Bolt M8 L90 ×1

NOTE

- ✧ The Cap Bolt M8 L90 cannot be installed after GT2 Supercharger is installed.

(12) Install the GT2 Supercharger on the Supercharger Bracket No.1.

- P1 GT2 Supercharger ×1
- P85 Dish Bolt M8 L30 ×2

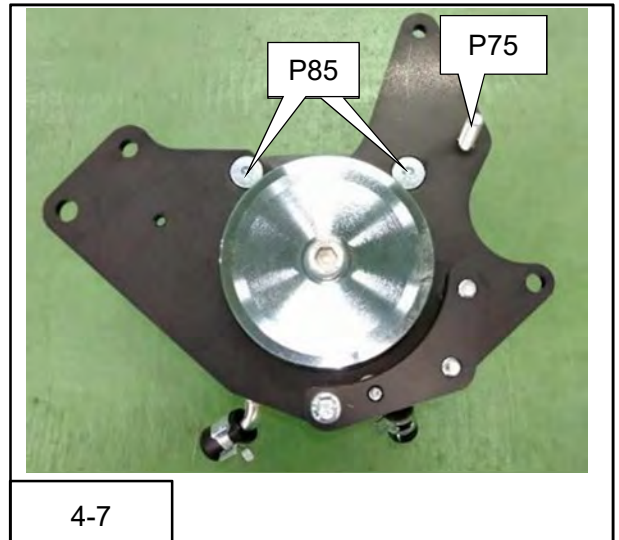

(13) Temporary install the ⑱Alternator removed at 1.(19) on the ㉑Alternator Bracket.

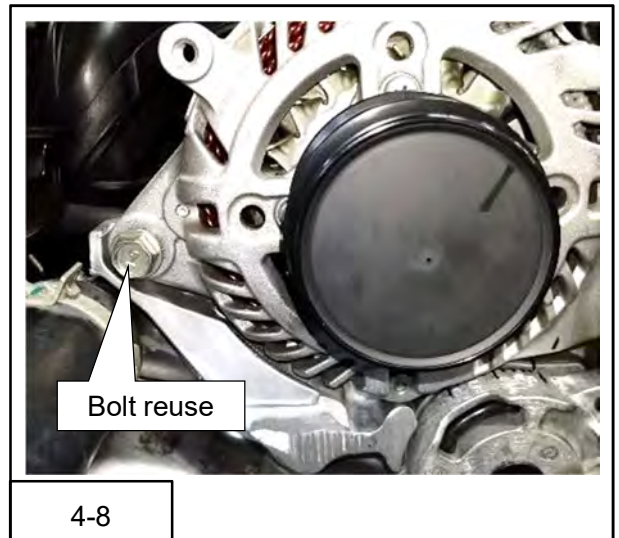

(14) Install the Supercharger Bracket No.2 onto the engine. Remove the bolt temporarily installed at (13) after installation.

- P3 Supercharger Bracket No.2 ×1
- P50 Spacer(OD20×ID10×L 25.4) ×1
- P71 Cap Bolt M10 L70 ×1
- P73 Cap Bolt M8 L130 ×1

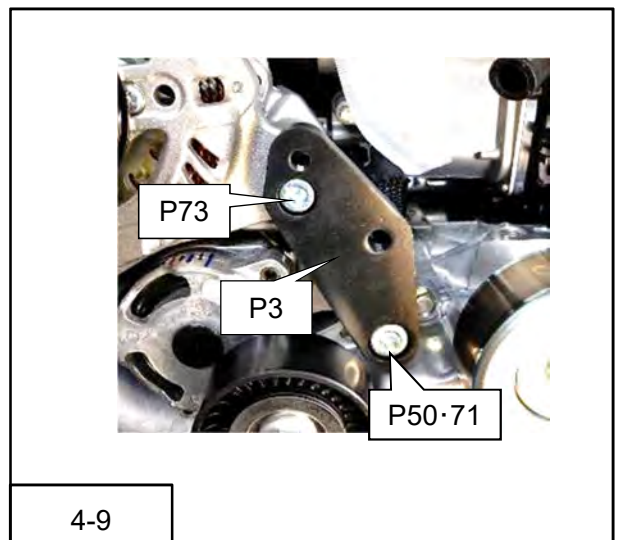

(15) Wrap the V-ribbed Belt around the pulley of the GT2 Supercharger and temporarily install the Supercharger Bracket and the V-ribbed Belt onto the engine.

Since the V-ribbed Belt should be installed after the Supercharger Bracket is securely tightened, temporarily install the V-ribbed belt onto a pulley other than the *7 Idler Pulley.

- P5 V-ribbed Belt ×1
- P52 Spacer(OD15×ID6×L35.5) ×1
- P53 Spacer(OD22×ID8×L51.5) ×1
- P54 Spacer(OD16×ID8×L82.4) ×1
- P74 Cap Bolt M8 L115 ×1
- P75 Cap Bolt M8 L90 ×1
- P81 Cap Bolt M6 L55 ×1

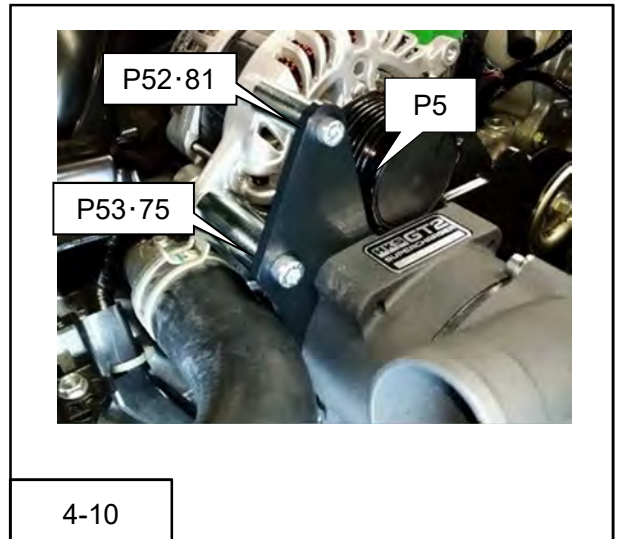

4-10

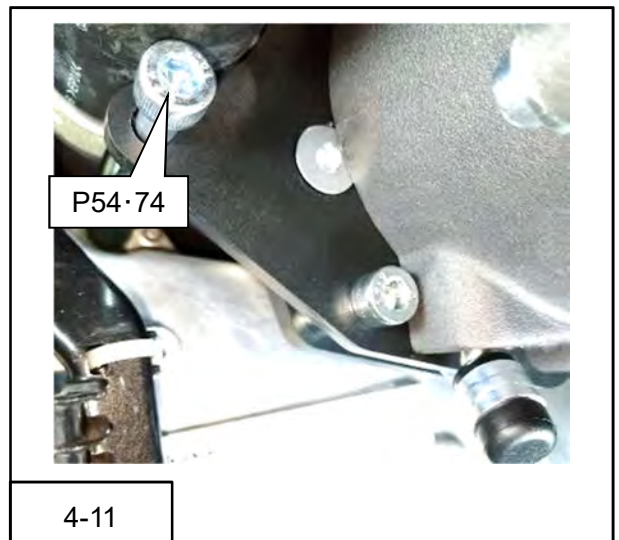

4-11

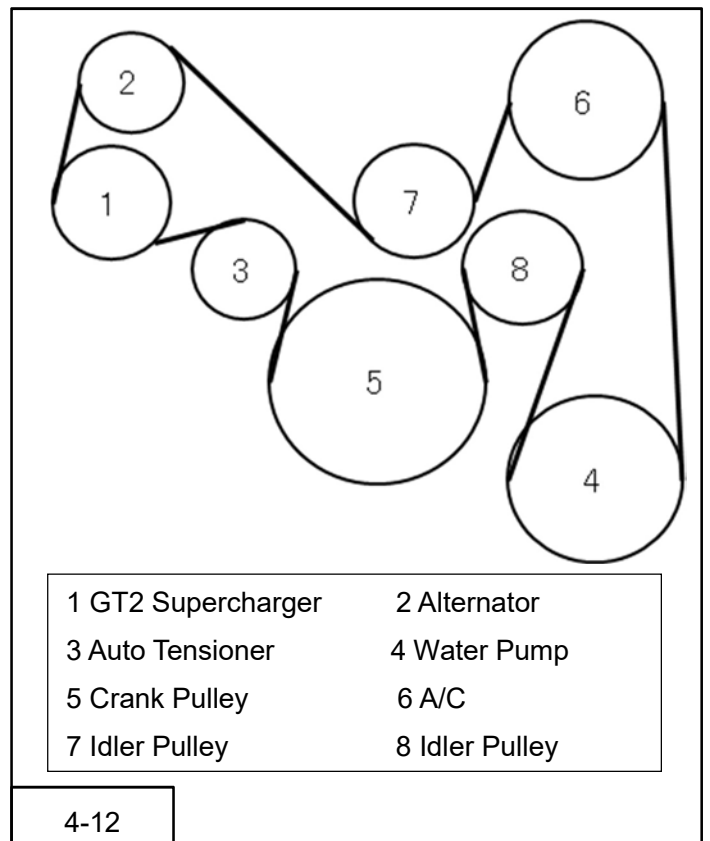

4-12

(16) Temporarily install the Supercharger Bracket No.1 and the Supercharger Bracket No.2.

- P58 Spacer(OD16×ID8×L35.5) ×1
- P59 Spacer(OD20×ID10×L35.5) ×1
- P72 Cap Bolt M10 L60 ×1
- P77 Cap Bolt M8 L55 ×1

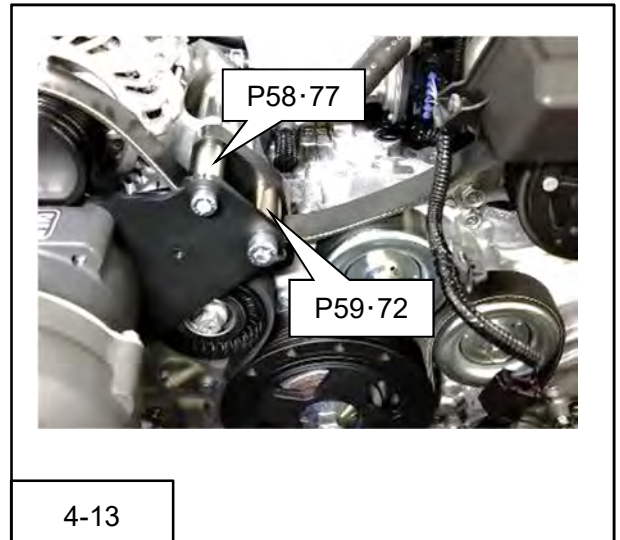

4-13

(17) Temporarily install the Supercharger Bracket No.3 onto the engine using the Flange Bolt M6 L18 that were temporarily installed at 4. (9).

- P94 Flange Bolt M6 L18 ×1

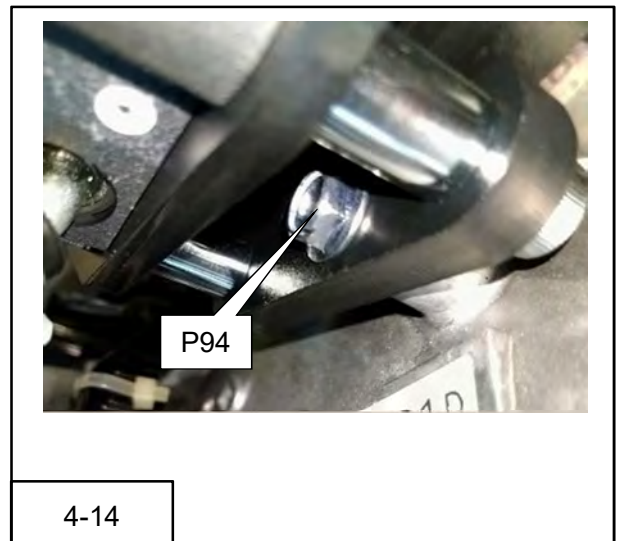

4-14

(18) Make sure the V-ribbed Belt is not caught in the Supercharger Bracket or engine. Tighten each bolt little by little.



CAUTION

- Do not tighten the cap bolt at once. Tighten them in several times. Improper installation of the bracket may cause misalignment resulting in damage of the belt.
- Tighten the bolts while confirming that the V-ribbed Belt is not caught in the engine or any other part of a vehicle. If neglected, it may cause damage to the belt.

(19) Install the V-ribbed Belt that was temporarily installed at 4.(15) onto the *7 Idler Pulley, then securely Install the V-ribbed Belt onto the engine.

(20) Visually check if the V-ribbed Belt is properly installed. Also, rotate the Crank Pulley clockwise, and verify direction the movements.

5. INSTALLATION OF TRACTION FLUID PIPING

PARTS LIST

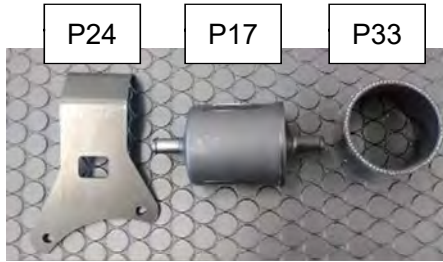

No.	Part Name	QT
P15	Traction Fluid	1
P16	Traction Fluid Tank	1
P17	Traction Fluid Filter	1
P24	Traction Fluid Filter Bracket	1
P25	Traction Fluid Tank Bracket	1
P33	Silicone Hose ID55 L43	1
P38	Traction Fluid Hose ID10	1
P44	Oil Level Gauge Clamp	1
P55	Spacer(OD20×ID10×L6)	1
P64	Hose Band #36	1
P68	Hose Clamp ID15.5	4
P69	Hose Clamp ID13.0	2
P86	Button Bolt M10 L20	1
P91	Flange Bolt M8 L20	2
P99	Flange Nut M10	1
P105	Tie Wrap (M)	9

NOTE

- ◇ **GT2 Supercharger unit is a precision part. If any foreign objects get mixed in the Traction Fluid, the supercharger may be damaged. Make sure the hoses and/or fitting ends are fully covered to prevent foreign objects from getting inside the hoses, the tank and/or the cooler.**
- ◇ **Refer to the 5-1 below for connecting the Traction Fluid Tank, Cooler, and Supercharger. Make sure to connect all parts properly.**

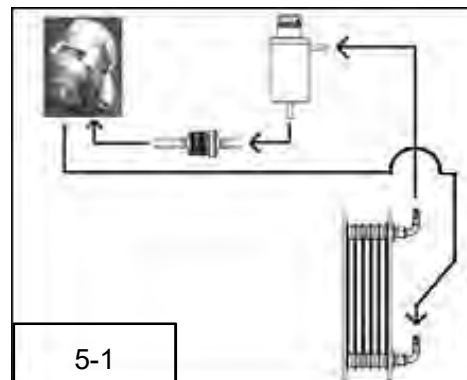

(1) Cut the Traction Fluid Hose ID10 into ①220mm and ②490mm.

•P38 Traction Fluid Hose ID10 ×1

(2) Connect the Silicone Hose ID55 L43 to the Traction Fluid Filter.

- P17 Traction Fluid Filter ×1
- P33 Silicone Hose ID55 L43 ×1

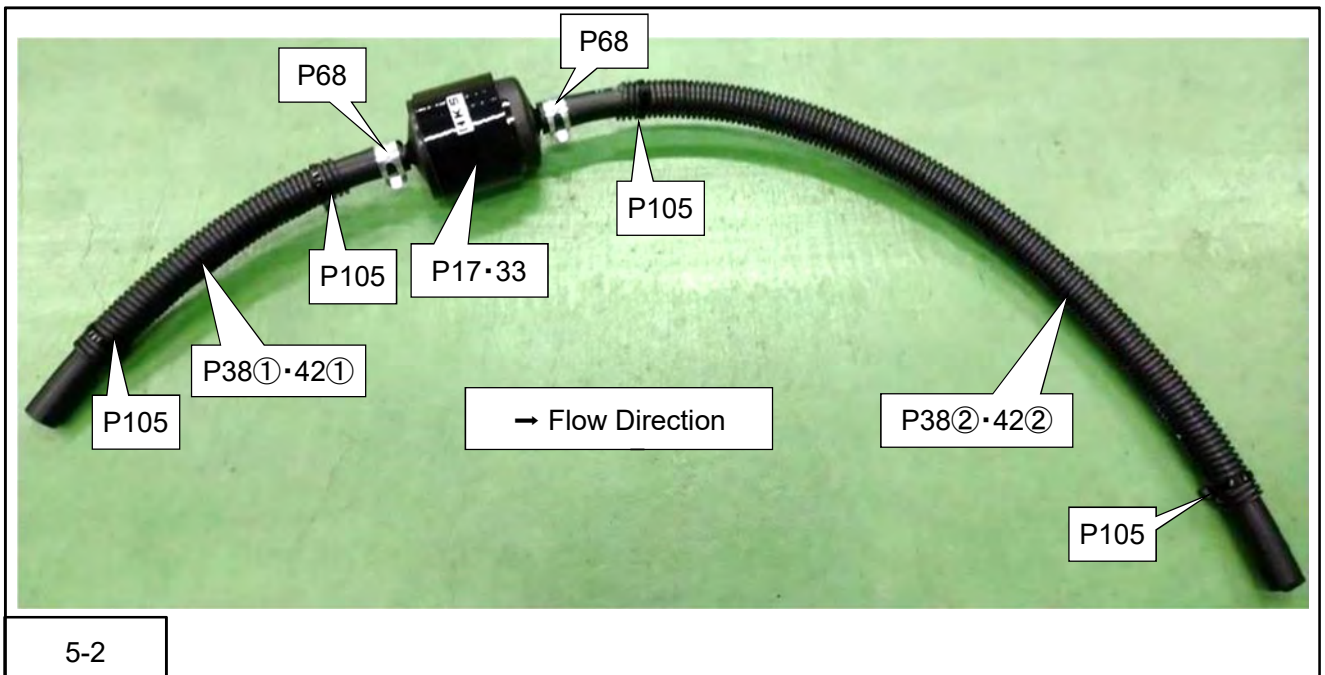

(3) Connect the Traction Fluid Hose ID10 ① and ② modified at 5.(1) to the Traction Fluid Filter.

- P68 Hose Clamp ID15.5 ×2

NOTE

- ✧ Make sure to install the Traction Fluid Filter in the correct direction. The arrow on the filter indicates the flow direction.

(4) Put the Corrugated Tube ID15 ① and ② modified at 3.(3) around the Traction Fluid Hose ID10 ① and ②.

- P105 Tie Wrap (M) ×4

(5) Remove 2 of M6 bolts that are securing the compressor housing of the GT2 Supercharger and Install the Traction Fluid Filter Bracket.

- P24 Traction Fluid Filter Bracket ×1

NOTE

- ✧ Do not use the large diameter washer that secured the compressor housing.

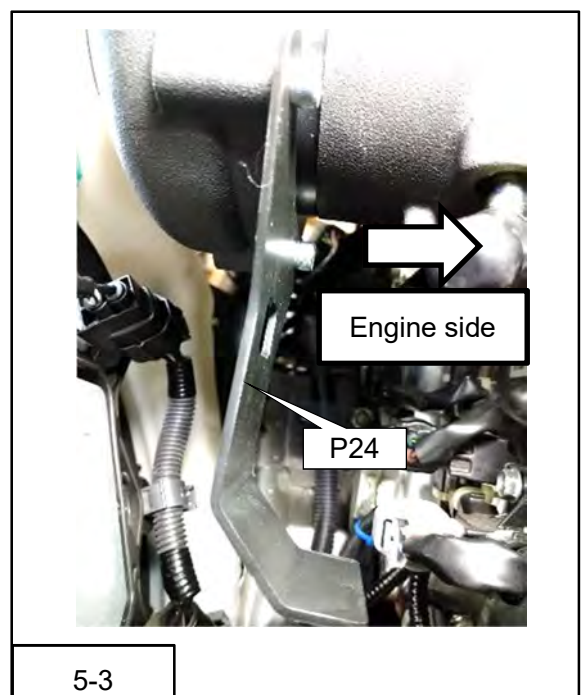

- (6) Pass the Traction Fluid Hose ID8 ① through from the side of the A/C Condenser to the engine room.
 •P105 Tie Wrap (M) ×1

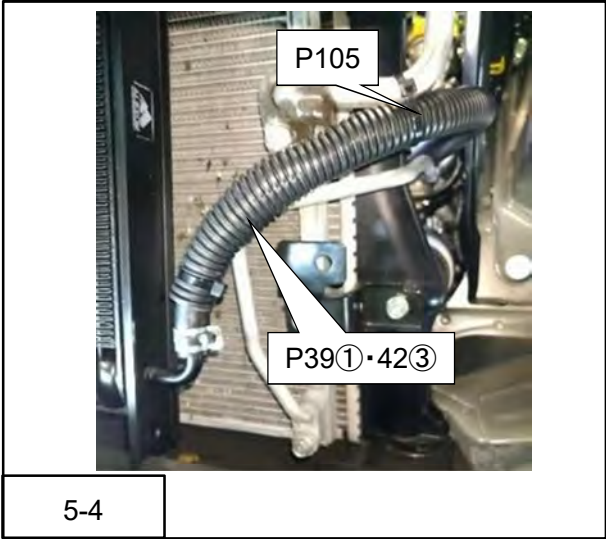

- (7) Connect the Traction Fluid Hose ID8 ① to the GT2 Supercharger.
 •P69 Hose Clamp ID13.0 ×1
- (8) Install the Traction Fluid Filter on the Traction Fluid Filter Bracket.
 •P64 Hose Band #36 ×1

- (9) Install the Traction Fluid Hose ID10 ② to the GT2 Supercharger.
 •P68 Hose Clamp ID15.5 ×1

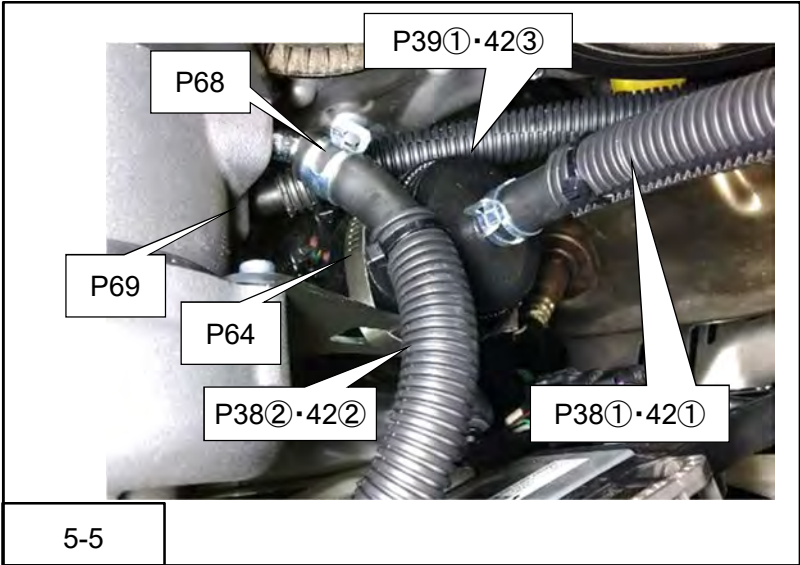

- (10) Install the Traction Fluid Tank on the Traction Fluid Tank Bracket.
 •P16 Traction Fluid Tank ×1
 •P25 Traction Fluid Tank Bracket ×1
 •P91 Flange Bolt M8 L20 ×2

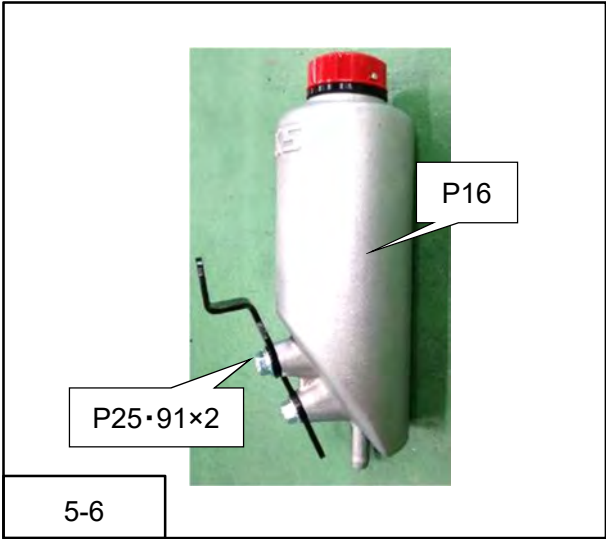

(11) Install the Traction Fluid Tank Bracket on the ⑬Radiator Support modified at 2.(5).

- P55 Spacer(OD20×ID10×L 6) ×1
- P86 Button Bolt M10 L20 ×1
- P99 Flange Nut M10 ×1

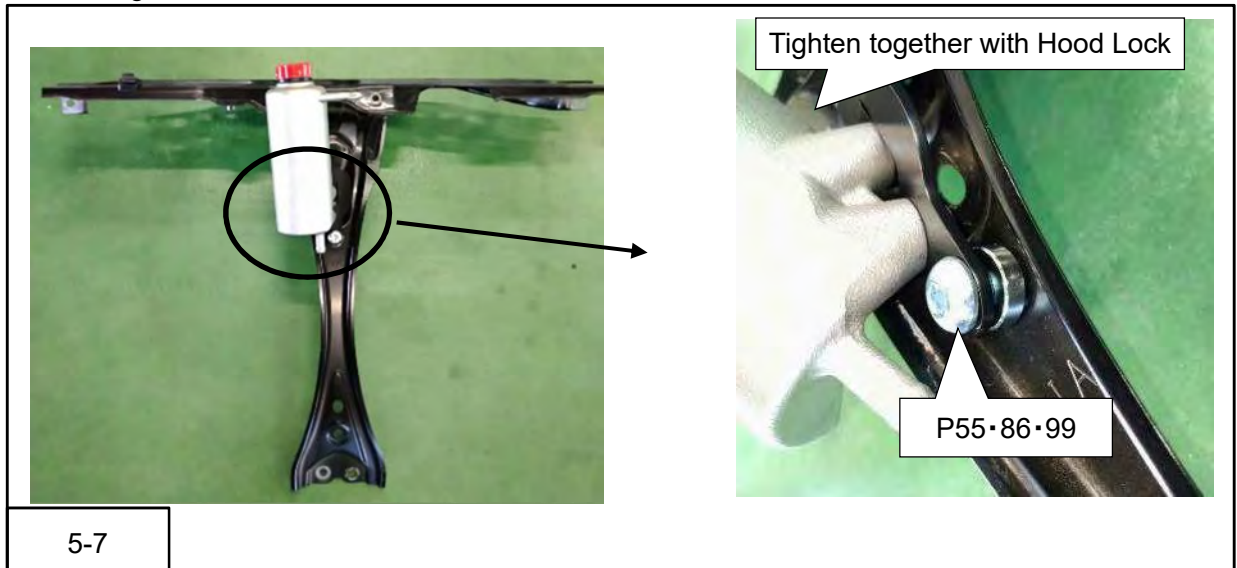

(12) Install the ⑬Radiator Support to the vehicle.

(13) Install the ⑫Hood Lock to the vehicle.

(14) Route the Traction Fluid Hose ID8 ② through the Radiator Support as shown in 5-8. Connect the Traction Fluid Hose ID8 ② to the nipple on the upper side of the Traction Fluid Tank.

- P69 Hose Clamp ID13.0 ×1

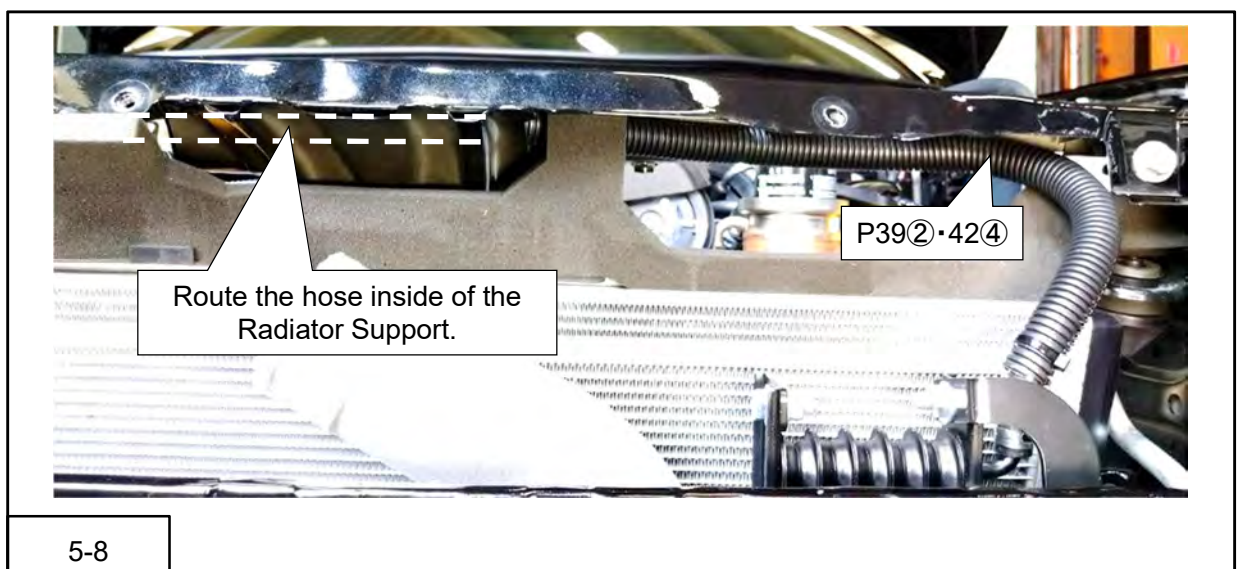

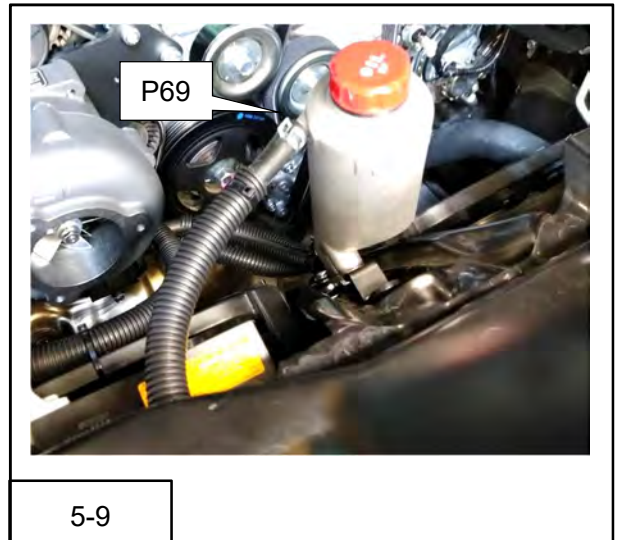

5-9

(15) Install the Traction Fluid Hose ID10 ① to the nipple located on the bottom side of the Traction Fluid Tank.

- P68 Hose Clamp ID15.5 ×1

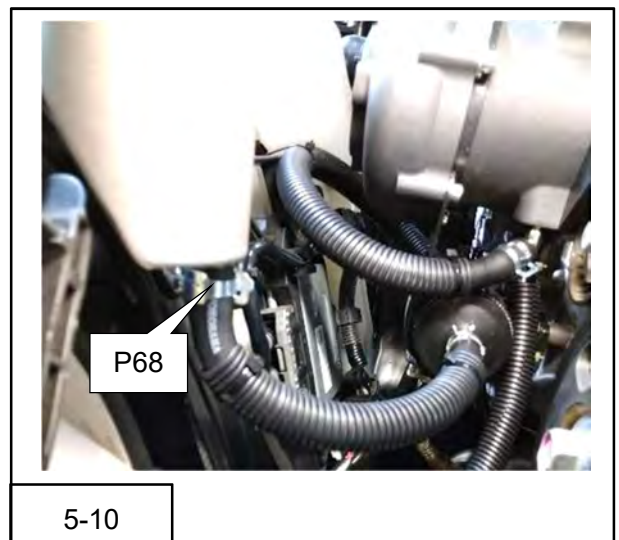

5-10

(16) Install ⑰Oil Level Gauge modified at 2.(11) on the Supercharger Bracket No.1 and engine reusing genuine bolt.

- P44 Oil Level Gauge Clamp ×1

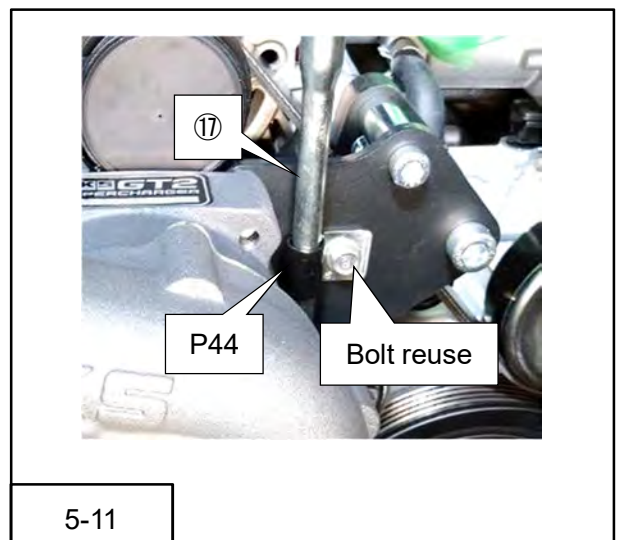

5-11

(17) Secure the Traction Fluid Hose ID10 ② and ID8 ① to the Radiator Fan Shroud using the provided Tie Wraps (M).

•P105 Tie Wrap (M) ×3

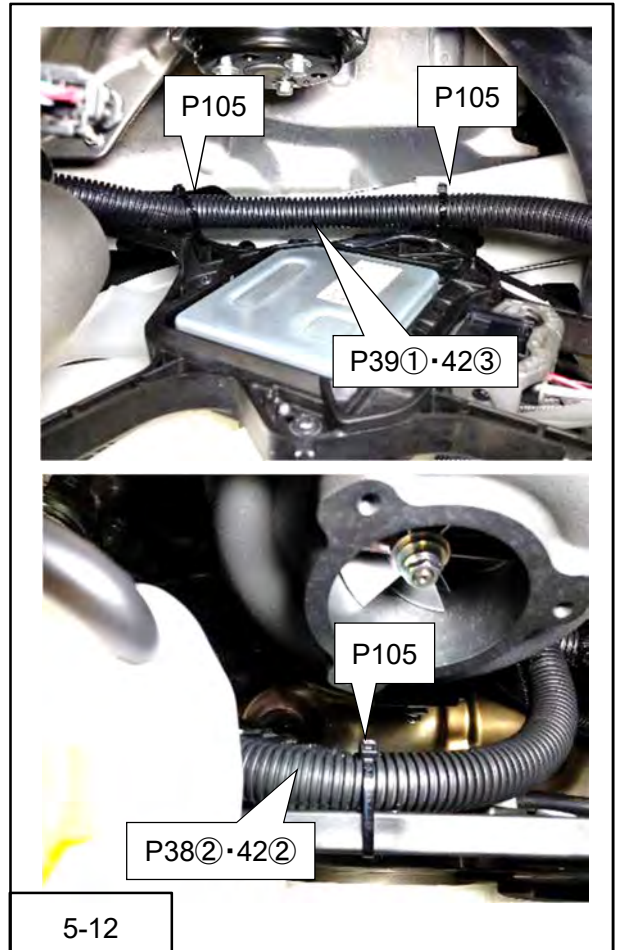

(18) Secure the Traction Fluid Hose ID10 ① and ID8 ① with Tie Wraps (M).

•P105 Tie Wrap (M) ×1

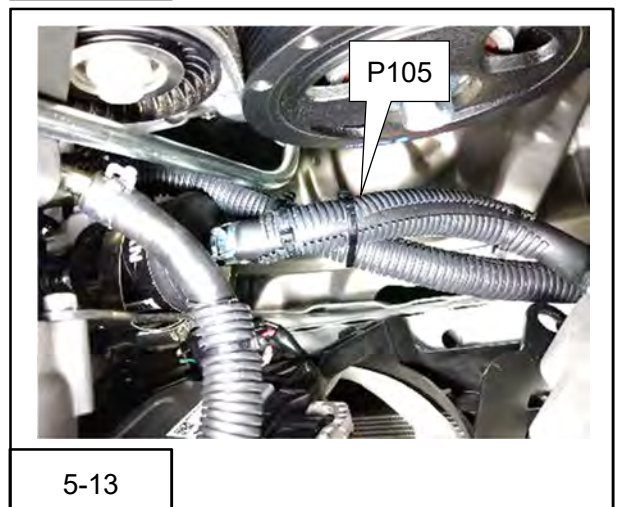

(19) Make sure there are no foreign objects in the Traction Fluid Tank. Add the Traction Fluid up to the dotted line in the diagram. Close the cap properly and securely.

•P15 Traction Fluid ×1

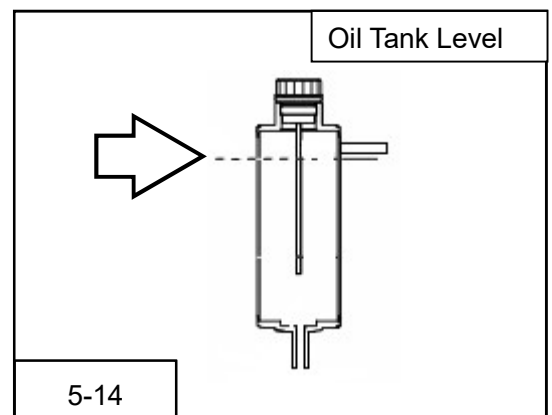

6. INSTALLATION OF SUCTION PIPE

PARTS LIST

No.	Part Name	QT
P7	Suction Pipe	1
P8	Restrictor	1
P9	Suction Pipe Gasket	1
P19	Blow-by Gas Pipe Bracket	1
P28	Air Cleaner Bracket No.1	1
P29	Air Cleaner Bracket No.2	1
P31	Air Cleaner Lid	1
P35	Silicone Hose ID61-ID79	1
P45	Blow-by Gas Pipe	1
P56	Spacer(OD18×ID6×L5)	1
P61	Hose Band #52	1
P63	Hose Band #40	2
P68	Hose Clamp ID15.5	1
P92	Flange Bolt M6 L25	2
P93	Flange Bolt M6 L20	2
P94	Flange Bolt M6 L18	1
P95	Flange Bolt M6 L15	1
P96	Stud Bolt M6 8-7-8	1
P101	Flange Nut M6	2
P105	Tie Wrap (M)	1
P106	Tie Wrap (S)	3

- (1) Put the Stud Bolt M6 8-7-8 on the GT2 Supercharger.

•P96 Stud Bolt M6 8-7-8 ×1

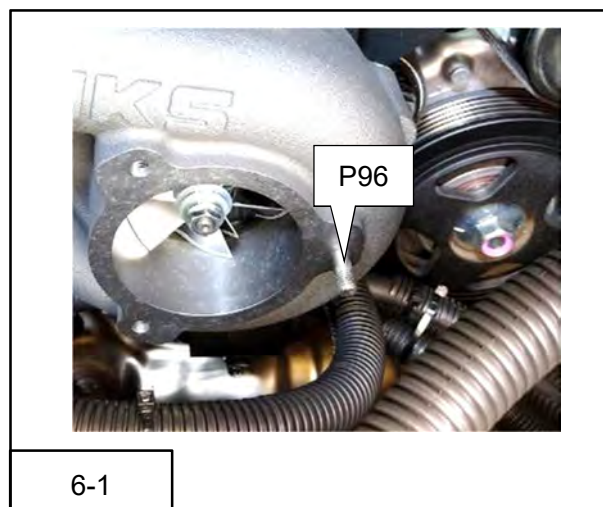

(2) Connect the Suction Pipe to the GT2 Supercharger.

- P7 Suction Pipe ×1
- P9 Suction Pipe Gasket ×1
- P93 Flange Bolt M6 L20 ×2
- P101 Flange Nut M6 ×1

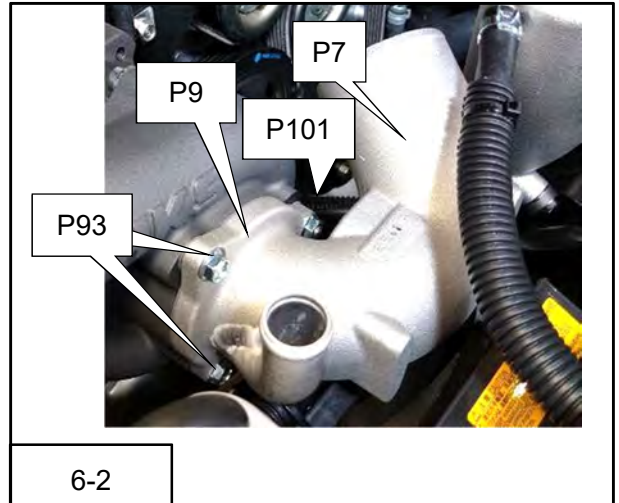

(3) Put the Air Cleaner Lid on the ⑭ Air Cleaner Case modified at 2.(8).

- P31 Air Cleaner Lid ×1
- P106 Tie Wrap (S) ×3

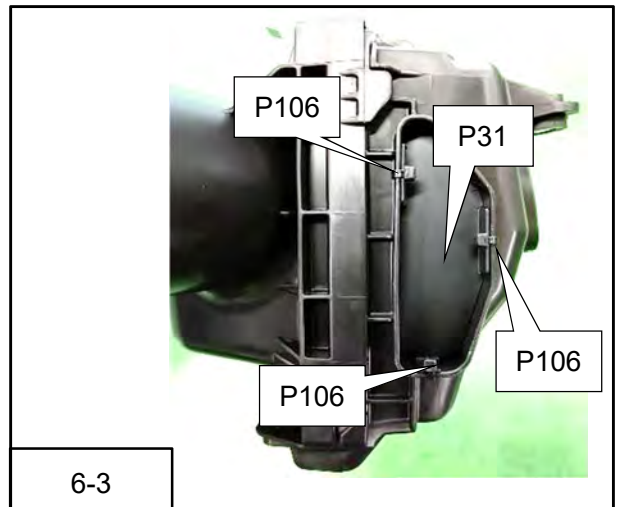

(4) Replace the OEM Air Cleaner Bracket with the Air Cleaner Bracket No.2, then install the Air Cleaner Case in the vehicle. To secure the Air Cleaner Case, reuse the OEM Bolt.

- P28 Air Cleaner Bracket No.1 ×1
- P29 Air Cleaner Bracket No.2 ×1
- P56 Spacer (OD18×ID6×L5) ×1
- P94 Flange Bolt M6 L18 ×1
- P95 Flange Bolt M6 L15 ×1
- P101 Flange Nut M6 ×1

NOTE

- ◇ Insert the Spacer (OD18×ID6×L5) between the Air Cleaner Bracket No.1 and the vehicle body.

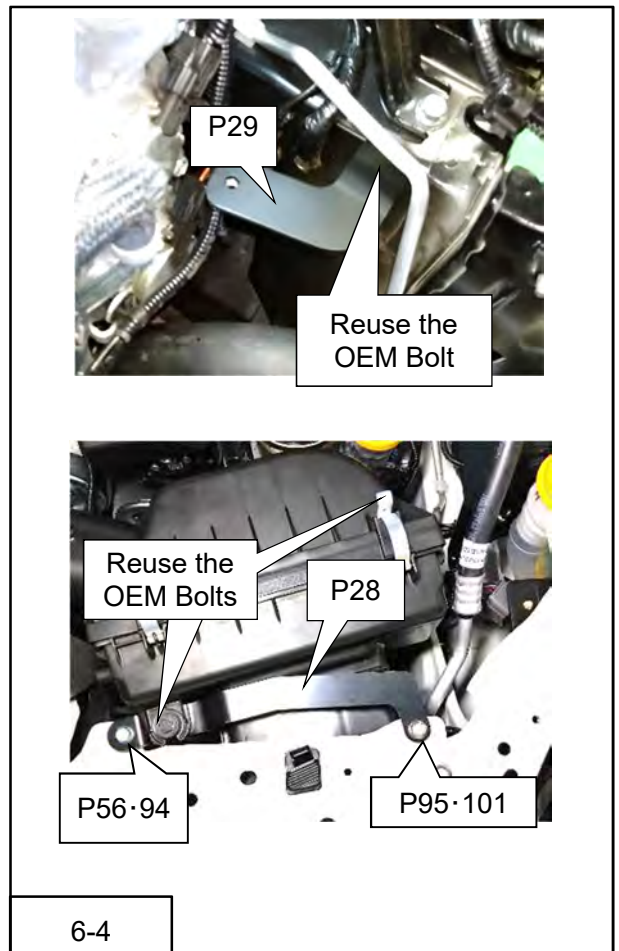

- (5) Lightly insert the Restrictor on the Suction Pipe side and connect the Silicone Hose ID61-ID79 to the Suction Pipe. Once the Restrictor reaches to the Suction Pipe, put the Hose Bands. One of the Hose Bands #40 should be used at the position of the Restrictor.

- P8 Restrictor ×1
- P35 Silicone Hose ID61-ID79 ×1
- P61 Hose Band #52 ×1
- P63 Hose Band #40 ×2

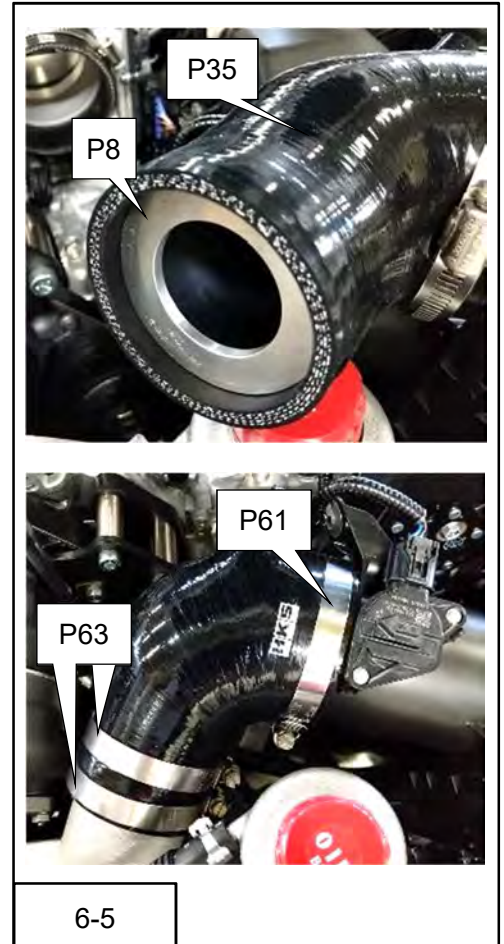

6-5

- (6) Attach the Blow-by Gas Pipe Bracket together with the Belt Cover removed in 1.(16). Make sure to place the Belt Cover on the Blow-by Gas Pipe Bracket.

- P19 Blow-by Gas Pipe Bracket ×1
- P92 Flange Bolt M6 L25 ×2

- (7) Connect the Blow-by Gas Pipe to the Silicone Hose ID61-ID79 and Blow-by Hose. The Blow-by Gas Pipe should be inserted by at least 50mm into the Blow-by Hose.

- P45 Blow-by Gas Pipe ×1
- P68 Hose Clamp ID15.5 ×1

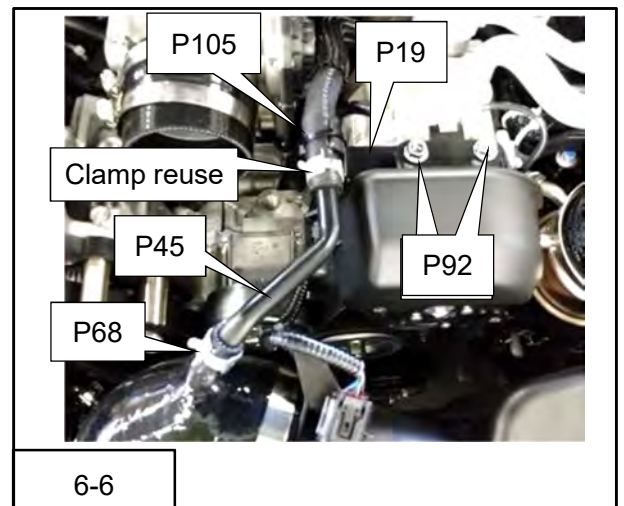

6-6

- (8) Secure the Blow-by Gas Pipe to Blow-by Gas Pipe Bracket with Tie Wrap (M).

- P105 Tie Wrap (M) ×1

NOTE

- ✧ Use the Tie Wrap (M) to secure the part where the Blow-by Gas Pipe is inserted into the Blow-by Hose.

- (9) Connect the wiring connector of the Air Flow Sensor.

7. INSTALLATION OF INTERCOOLER PIPING

PARTS LIST

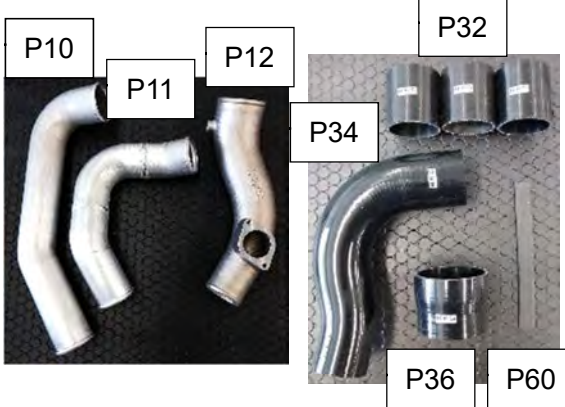
	No.	Part Name	QT
	P10	Intercooler Inlet Pipe	1
P11	Intercooler Outlet Pipe No.1	1	
P12	Intercooler Outlet Pipe No.2	1	
P32	Silicone Hose ID60 L70	3	
P34	Silicone Hose ID50-ID60	1	
P36	Silicone Hose ID74-ID79	1	
P60	Insulator Rubber	1	
P62	Hose Band #48	2	
P63	Hose Band #40	7	
P64	Hose Band #36	2	

- (1) Temporarily connect the Intercooler Inlet Pipe to the Intercooler.

- P10 Intercooler Inlet Pipe ×1
- P32 Silicone Hose ID60 L70 ×1
- P63 Hose Band #40 ×2

- (2) Mark position where the Intercooler Inlet Pipe will be put on the Intercooler Inlet Pipe Bracket, then remove it from the Intercooler.

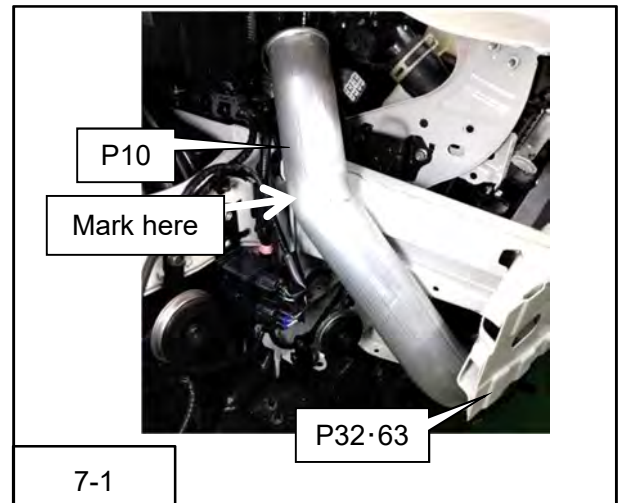

- (3) Install the Insulator Rubber on the Intercooler Inlet Pipe.

- P60 Insulator Rubber ×1

NOTE

- ◇ Taping down the Insulator Rubber would be helpful.



- (4) Connect the Intercooler Inlet Pipe to the Intercooler, and securely put it on the Intercooler Inlet Pipe Bracket using the provided Hose Band #36.
- P64 Hose Band #36 ×1

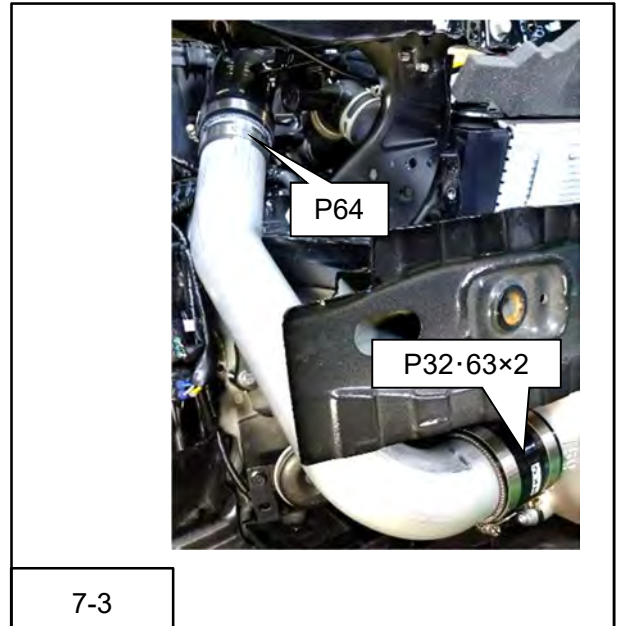

7-3

- (5) Connect the Silicone Hose ID50-ID60 to the GT2 Supercharger and to the Intercooler Inlet Pipe.
- P34 Silicone Hose ID50-ID60 ×1
 - P63 Hose Band #40 ×1
 - P64 Hose Band #36 ×1

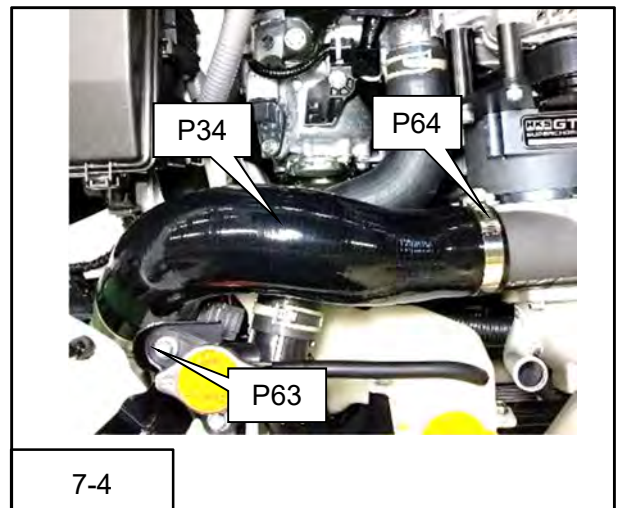

7-4

- (6) Cut the sponge, using tools like scissors, to insert the Intercooler Outlet Pipe No.1.

NOTE

- ✧ Although the Intercooler Outlet Pipe No.1 is OD60, it would be easier if the sponge is cut by 70-80mm.

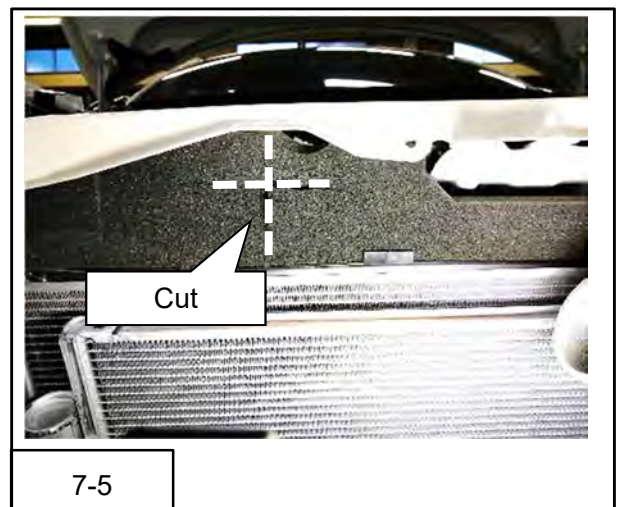

7-5

(7) Connect the Intercooler Outlet Pipe No.1 and No.2 to the Intercooler and the Throttle.

- P11 Intercooler Outlet Pipe No.1 ×1
- P12 Intercooler Outlet Pipe No.2 ×1
- P32 Silicone Hose ID60 L70 ×2
- P36 Silicone Hose ID74-ID79 ×1
- P62 Hose Band #48 ×2
- P63 Hose Band #40 ×4

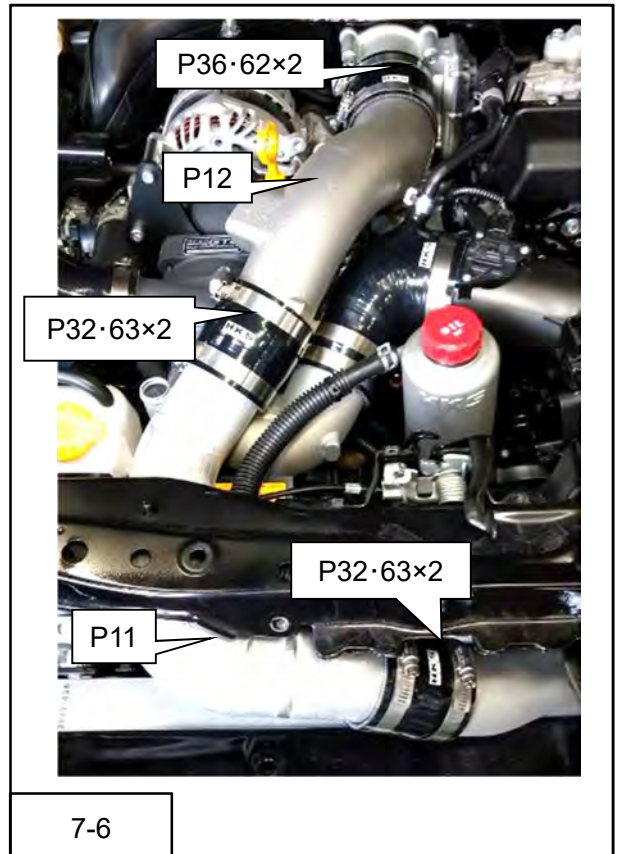

8. INSTALLATION OF BLOW-OFF VALVE

PARTS LIST

No.	Part Name	QT
P13	Blow-off Valve (includes 2 cap bolts M6 L=45)	1
P14	Blow-off Valve Gasket	1
P37	Silicone Hose ID22-ID25	1
P40	Hose ID16	1
P41	Hose ID4	1
P46	T-fitting OD16-OD4-OD16	1
P65	Hose Clamp ID29.5	1
P66	Hose Clamp ID26.0	1
P67	Hose Clamp ID23.0	3
P70	Hose Clamp ID6.8	2
P105	Tie Wrap (M)	2



P13



P14

P37

- (1) Install the Blow-off Valve to the Intercooler Outlet Pipe No.2.

- P13 Blow-off Valve ×1
- P14 Blow-off Valve Gasket ×1



Caution

- Be sure to install the blow-off valve with the two bolts provided. If other bolts are used, the blow-off valve cannot be installed correctly and may cause air leakage or damage to the blow-off valve.

- (2) Connect the Silicone Hose ID22-ID25 to the Blow-off Valve and the Suction Pipe.

- P37 Silicone Hose ID22-ID25 ×1
- P65 Hose Clamp ID29.5 ×1
- P66 Hose Clamp ID26.0 ×1

NOTE

- ◇ Connect the ID25 side to the Suction Pipe.

- (3) Cut the Hose ID4 into 650mm.

- P41 Hose ID4×1

- (4) Remove the Engine Cover.

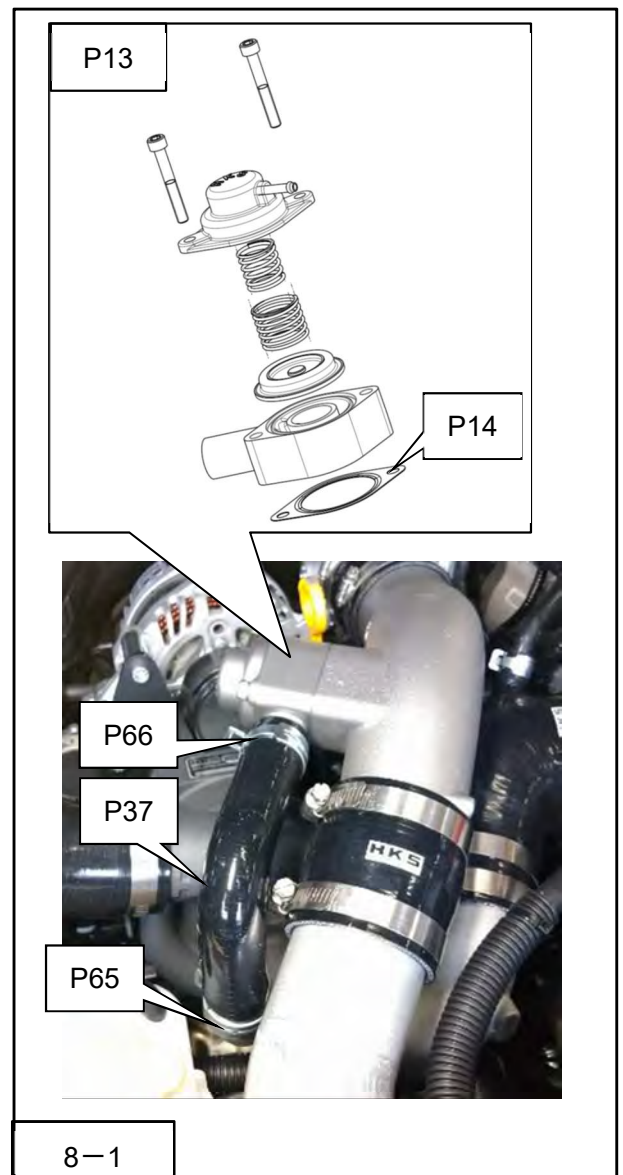

P13

P14

P66

P37

P65

- (5) Remove the Engine Cover Bracket first, then remove the Blow-by Hose.

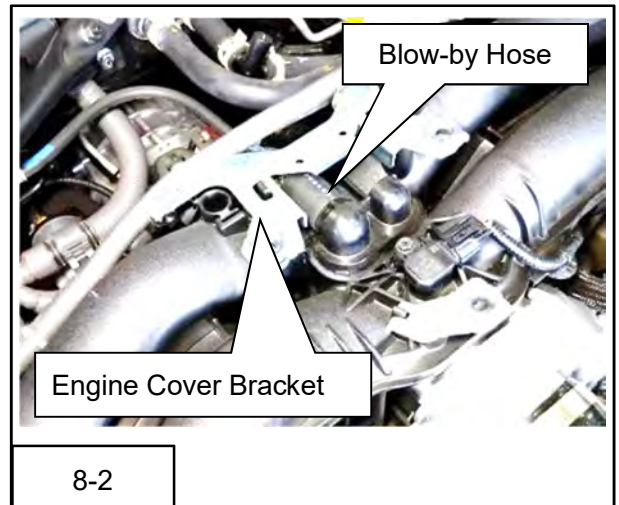

- (6) Connect the Hose ID4 cut at 8.(3), Blow-by Hose removed at 8.(5), and Hose ID16 to the T-fitting OD16-OD4-OD16.

- P40 Hose ID16 ×1
- P46 T-fitting OD16-OD4-OD16 ×1
- P67 Hose Clamp ID23.0 ×2
- P70 Hose Clamp ID6.8 ×1

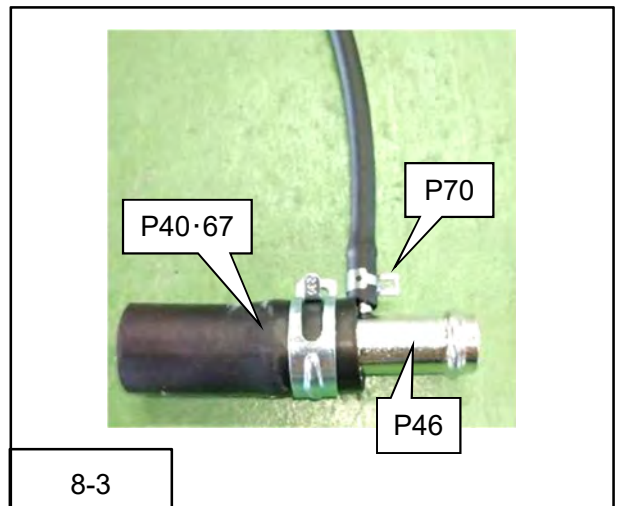

- (7) Connect the Hose ID16 to the Intake Manifold.

- P67 Hose Clamp ID23.0 ×1

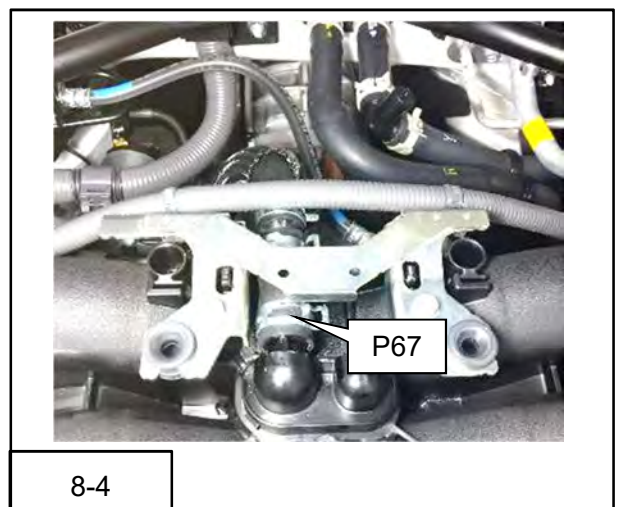

- (8) Connect the Hose ID4 to the Blow-off Valve.
 •P70 Hose Clamp ID6.8 ×1

NOTE

- ◇ Make sure to pass the Hose ID4 under the Intake Manifold.

- (9) Secure the Hose ID4 onto the Alternator.
 •P105 Tie Wrap (M) ×2

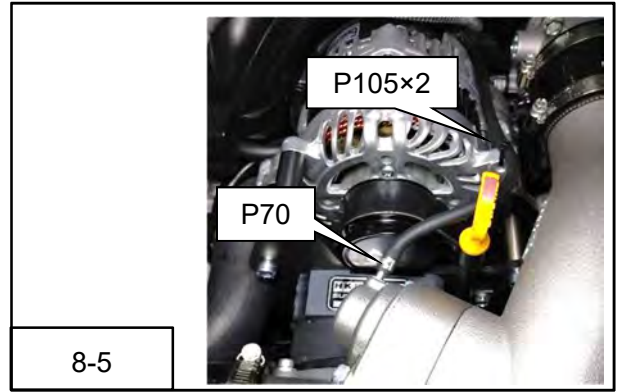

- (10) Mount the Engine Cover Bracket onto the Engine and put the Engine Cover.

- (11) Shift the sponge of the Hood Support Rod to the position shown in 8-6.

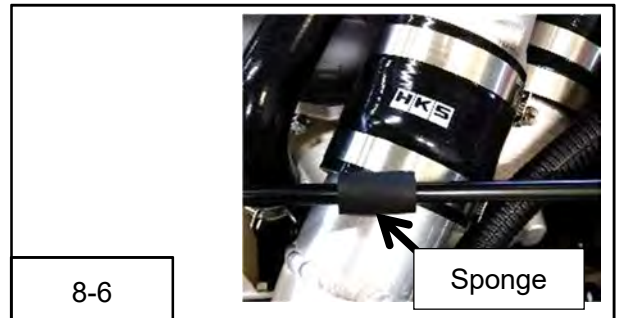

9. REINSTALLATION OF FACTORY PARTS

PARTS LIST

	No.	Part Name	QT
	P30	Air Cleaner Inlet Duct Bracket	1
	P43	Corrugated Tube ID10	1
	P104	Rivet	2
	P106	Tie Wrap (S)	2

- (1) Bundle the wiring for ⑧Right Headlamp modified at 2.(12) as shown in the picture on the left below, then cover them with the Corrugated Tube ID10.

- P43 Corrugated Tube ID10 ×1
 •P106 Tie Wrap (S) ×2

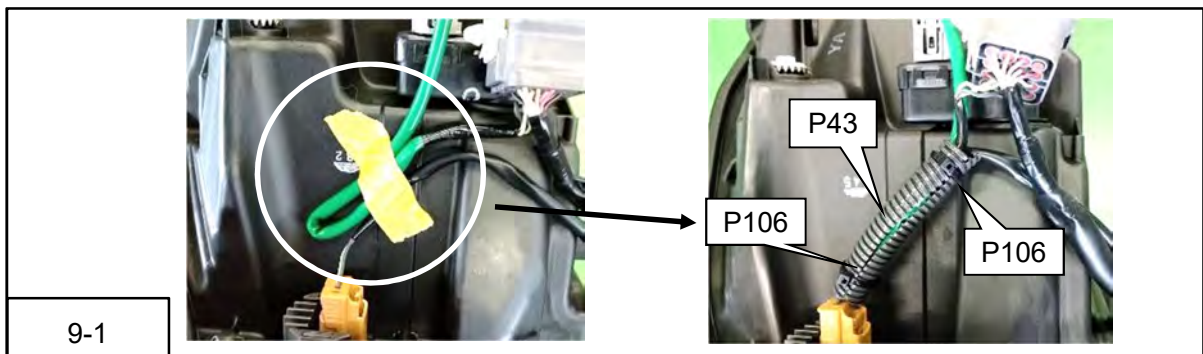

- (2) Reinstall ⑧Right Headlamp modified at 2.(12) on vehicle.

- (3) Reinstall both the left and right ⑦Front Bumper Corner Bracket removed at 1.(8).

(4) Temporarily connect the ⑤Air Cleaner Inlet modified at 2.(9), drill a D5 hole in the position indicated in 9-2 below, referring to the $\phi 5$ hole position of the bracket. Then reinstall the ⑤Air Cleaner Inlet using OEM Bolt and the provided Rivets.

•P30 Air Cleaner Inlet Duct Bracket $\times 1$

•P104 Rivet $\times 2$

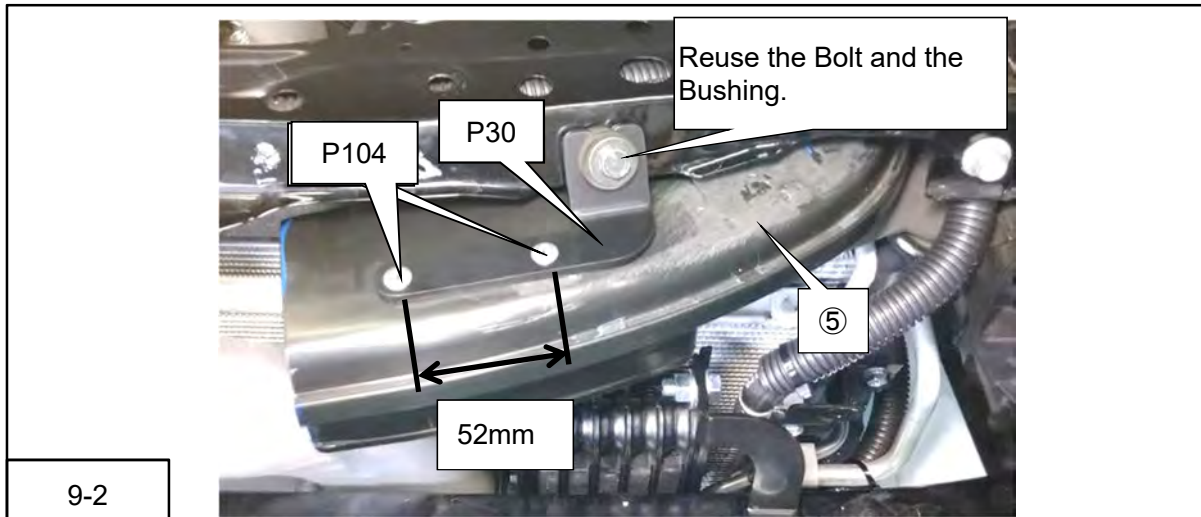

(5) Install the ④Front Bumper Energy Absorber modified at 2.(13).

(6) Install the ②Front Bumper.

(7) Connect the wiring connectors of ①Side Turn Signal Lamps on both left and right sides.

(8) Connect the negative terminal to the Battery.

10. CONFIRMATION AFTER INSTALLATION & FILLING TRACTION FLUID

Make sure to follow the instructions below after installation of the product.

(1) Check the followings before starting the engine:

	Items to confirm	Check
1	The Traction Fluid Piping is done correctly.	
2	No installed parts are getting in contact with each other.	
3	Make sure the harness is not pinched at any point.	
4	Make sure the belt is properly aligned with the grooves of the pulley.	
5	The Traction Fluid in the tank reaches to the bottom part of the return pipe.	
6	All the pipes and hoses are installed correctly.	
7	No hoses are kinked or excessively bent.	
8	The hose band is secured properly.	
9	All the bolts and nuts are securely tightened.	
10	All the installed parts are secured properly.	
11	The Cable Terminal is securely connected to the negative terminal of the Battery.	
12	The engine oil reaches between H-L of the level gauge.	

(2) Prepare Traction Fluid in a beaker or small container, open the oil cap and start the engine.

(3) Immediately after starting the engine, perform the following:

- a) Check if the Fluid Level in the Traction Fluid Tank starts to lower and the Traction Fluid returns into the Traction Fluid Tank.
- b) To prevent the Traction Fluid from running out, add the Traction Fluid prepared in the container. When adding the Traction Fluid, make sure it will not be spilled over from the tank.
 ※Right after the engine is started, “jingling” noise will come from the GT2 Supercharger during warm-up. This is normal and it will stop in 2-3 minutes after the Traction Fluid gets warm.

(4) Check the followings after the engine is warmed up.:

NOTE

- ◇ Do not raise the engine RPM while the engine is warming up; let it idle.

	Items to confirm	Check
1	The Traction Fluid is returning to the Traction Fluid Tank.	
2	No leakage of the Traction Fluid, Cooling Water, and/or Air from any parts.	
3	Make sure there is no excessive stress on any harnesses or hoses.	
4	Make sure the installed parts do not come in contact with any other parts.	

- (5) Once all the above listed items are checked and no issue is confirmed, keep the engine rpm at 2000rpm for 10 seconds, then immediately stop the engine and check if the Traction Fluid remains at the marked level of the level gauge (see 10-1). If it is below or above the marked level, adjust the quantity of the Traction Fluid accordingly.

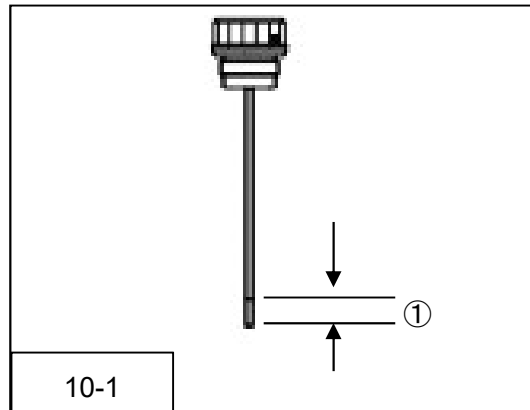

※Store the remaining traction fluid in the container in which it came, tightly sealing with the cap.

Since the Traction Fluid is made up of special components, if stored in other containers, the components may change, or the container may be damaged.

- (6) Close the cap of oil tank cap back on.

The installation process is now complete..

※If the engine is turned off after driving, while the engine room is in high temperature, the belt may make squeaking noise. This is caused by the factory Auto Tensioner's adjustment function; this is normal.

11. 1ST MONTH INSPECTION

○ Within 40 days of installation, it is recommended to consult your installer/retailer for the following 1st month inspection:

Entry Method	No Issue	<input checked="" type="checkbox"/>	Replace	×	Adjust	A	Tighten	T
--------------	----------	-------------------------------------	---------	---	--------	---	---------	---

	Inspection Item	
1	<u>Inspection of the GT2 Supercharger Unit</u>	
	<div style="border: 1px solid black; padding: 5px; margin: 5px auto; width: fit-content;">  WARNING </div> <ul style="list-style-type: none"> • When checking operation of the unit, avoid touching any moving belts, even clothing. • Touching these moving belts can lead to severe injury and damage. 	
	Compare the current operating sound against initial installation, check for increased sound levels or unusual noises.	<input type="checkbox"/>
	Compare the sound of the air cleaner against initial installation, check for increased intake sound levels or unusual noises.	<input type="checkbox"/>
	Check Traction Fluid level for unusually high Traction Fluid consumption. (Fluid level surface is not touching the Fluid level gauge)	<input type="checkbox"/>
2	<u>Inspection of the Traction Fluid Piping</u>	
	Check for Traction Fluid leaking from the piping, loose hose clamps.	<input type="checkbox"/>
	Locations:	
	• Connection point to the GT2 Supercharger.	<input type="checkbox"/>
	• Connection point to the Traction Fluid Cooler.	<input type="checkbox"/>
	• Connection point to the Traction Fluid Tank.	<input type="checkbox"/>
	• Connection point to the Traction Fluid Filter.	<input type="checkbox"/>
Signs of damage due to rubbing of the Traction Fluid Hose to other parts.	<input type="checkbox"/>	
Cracks or breaks in the Traction Fluid Hose.	<input type="checkbox"/>	
If the Traction Fluid filled to the marking level on the Fluid level gauge.	<input type="checkbox"/>	
3	<u>Belt Inspection</u>	
	Check if belt's tension is within the Auto-tensioner's adjusting range.	<input type="checkbox"/>
	Cracks or breaks in the belts.	<input type="checkbox"/>
4	<u>Bolt Tightening</u>	
	Check if GT2 Supercharger mounting bolt is tightened.	<input type="checkbox"/>
5	<u>Other</u>	
	Check all mounted parts for interference with other parts.	<input type="checkbox"/>
	Locations:	
	• Belt and surrounding parts.	<input type="checkbox"/>
	• Piping and surrounding parts.	<input type="checkbox"/>
• Blow-off Valve Hose and surrounding parts.	<input type="checkbox"/>	
	Check if hose bands are properly tightened.	<input type="checkbox"/>
	Check if engine oil level is between H-L.	<input type="checkbox"/>

12. MAINTENANCE

○The Traction Fluid is exclusively for our GT2 Supercharger. Never use any Traction Fluid other than those specified by us. Using non-designated Traction Fluid, Engine Oil, Transmission Oil, or any other oils may damage the internal parts of the GT2 Supercharger.



CAUTION

- Periodically check Traction Fluid levels prior to driving the vehicle. If the oil level is too low, add Traction Fluid as necessary.

○Use the part number below to order additional Traction Fluid:

PRODUCT NAME	PART No.
GT S/C TRACTION FLUID I	12002-AK029

※If the GT2 Supercharger System is used in an area minus 20°C, use the following Traction Fluid(Sold separately):

PRODUCT NAME	PART No.
GT S/C TRACTION FLUID II	12002-AK030

○Replace the Traction Fluid Filter after 5 years or 70,000 km after installation of the HKS GT2 Supercharger. Use the part number below to order the Traction Fluid Filter:

PRODUCT NAME	PART No.
Traction Fluid Filter	12002-AK015

○The V-ribbed Belt is a “wear and tear” part. Check if there are no cracks, fissures, or chippings at the inspection before driving.

Replace it if any cracks, fissures, or chippings are found. Never use any V-ribbed Belt other than the specified one. Using non-designated belts may cause noise from the V-ribbed Belt when starting the engine and/or at idle.

Use the part number below to order the V-ribbed Belt:

PRODUCT NAME	PART No.
V-ribbed belt 6PK2070	G13572-T59020-00

※The belt length is different from the factory belt.

○Check the Bellofram of the Blow-off Valve every 6 months. Bellofram are “wear and tear” items. Replace if any cracks or tears were found.

Use the part number below to order the Bellofram:

PRODUCT NAME	PART No.
Bellofram	12002-AK040

13. TROUBLESHOOTING

○ If this product does not operate properly, check all wiring and connections referring to the following before contacting your dealer.

Symptoms	Cause	Checking Items • Measures
<ul style="list-style-type: none"> ● Belt squeals when engine starts. 	—	<ul style="list-style-type: none"> ● It is normal. Engine squeals a few times when it's started.
<ul style="list-style-type: none"> ● Belt squeals for a few seconds when engine starts. ● Engine output feels weak. ● At wide open throttle the boost starts to decrease at a certain RPM while engine RPM is increasing. 	Low belt tension.	<ul style="list-style-type: none"> ● If the belt tension does not reach the required spec, replace with a new belt. ● Replace the auto-tensioner with a new belt after 50,000km.
<ul style="list-style-type: none"> ● Engine output feels weak. ● At wide open throttle the boost starts to decrease at a certain RPM while engine RPM is increasing. 	Air filter worn out.	<ul style="list-style-type: none"> ● Replace the filter element depending on dirt buildup. ● If Factory Filter was used for more than 10,000km, replace the filter element. (Replace the element even it's used less than 10,000km depending on the filter condition.)
<ul style="list-style-type: none"> ● Belt squeals when revving engine at high RPM. 	This symptom does not always show malfunction.	<ul style="list-style-type: none"> ● If the boost pressure does not drop at a certain engine RPM while driving, it is normal. ● Usually engine RPM increases rapidly at revving; the belt may be more slippery. Especially with a cold engine, belt tension is low and slippery.
<ul style="list-style-type: none"> ● Drivability becomes unstable while driving. 	Inadequate piping.	<ul style="list-style-type: none"> ● Inspect the piping for air leaks. ● Inspect the Bellofram of the Blow-off Valve.

14. IF THE BELT BREAKS

- Park the vehicle in a safe place to check if the car is still drivable. Check for any damage caused by the torn belt such as oil leak, coolant leak, damaged harness, and etc.
- Do not drive the vehicle if the belt is damaged since the water pump is operated by the belt.
- Move the vehicle to a safe place and replace the belt with a brand new one. Repair any problems that may have caused the belt to break.



HKS Co., Ltd.

7181 Kitayama, Fujinomiya, Shizuoka 418-0192, Japan

<https://www.hks-power.co.jp/>