

Automotive Products

Perfect Cable Solutions

HellermannTyton

Contents

Welcome!

Our automotive catalogue is in your hands. HellermannTyton is one of the world's leading suppliers of cable management solutions. Our products are used for fastening, fixing, identification and protecting cables and their connecting components.

In this catalogue you will find our core product range for the automotive industry. It encompasses numerous standardised products and solutions, specially customised and optimised for the needs of the automotive industry. It includes cable ties, heat shrinkable tubing, braided sleeving and identification systems, together with the relevant application tooling. In addition to the "classic" cable tie, HellermannTyton also develops and produces many fastening systems, specifically created for the sophisticated demands of the automotive industry. This is why this catalogue not only presents our currently available products, but also explains how we can develop innovative products and how we can work for you.

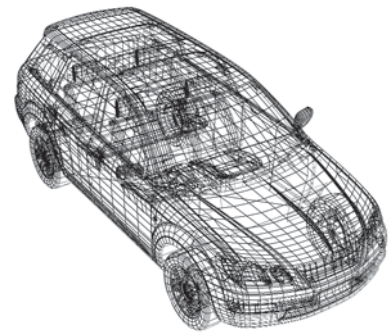

Your Automotive Team

The-cable-tie-that-started-it-all.

This is a cable tie. One of a total of 60 000 HellermannTyton products for fastening, fixing, identification and protecting cables and wiring in the automotive industry. Cable ties exist in practically innumerable variations. Their lengths range between 83 and 1060 millimetres, available in a variety of colours. Some can be released and are re-useable. Some have serrations on the outside, others on the inside. There are some that don't have any serrations at all or can be tied in a double loop. It is easy to take the cable tie for granted but at HellermannTyton we are dedicated to ensuring that our cable ties are fully tried, tested and optimised. All HellermannTyton products, which you see in this catalogue, started at this point – even the most complex fastening solutions.

This page shows an example of a cable tie with the type description: T50ROS

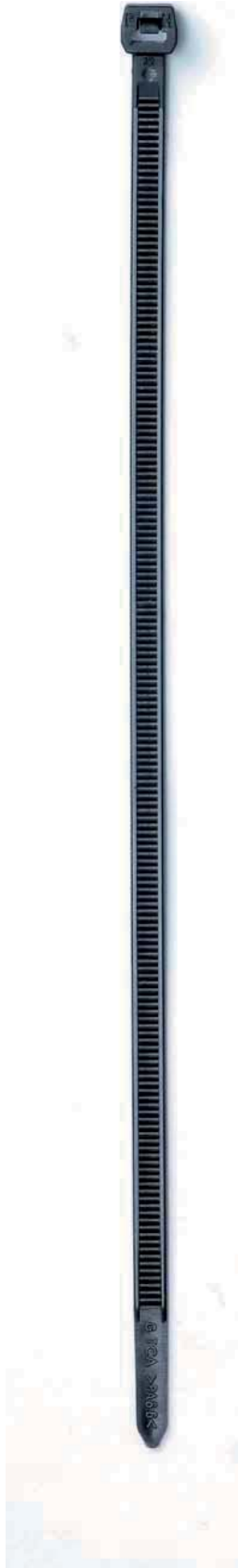



The-cable-fastener-specifically-developed-for-the-automotive-industry.

Final car door assembly: this one-piece push mount tie is the result of three decades of experience. Its arrowhead design ensures that the cable tie can be easily fitted without additional tools. In combination with a black foam rubber seal the plastic disc protects against the ingress of water. No wonder that these fixing ties can be found inside about every third car door produced in the world. In contrast to most of our other cable ties, they are green, so that workers can immediately spot a rare case where the black seal is missing. However, this almost never happens, as both parts are securely laser-welded to each other.

The green cable tie shown on this page has the type description:
T50SOSSFT6.5 16-2MD



One-piece-fixing-ties-for-manual-mounting-in-drilled-holes-or-on-weld-studs-or-on-edges.

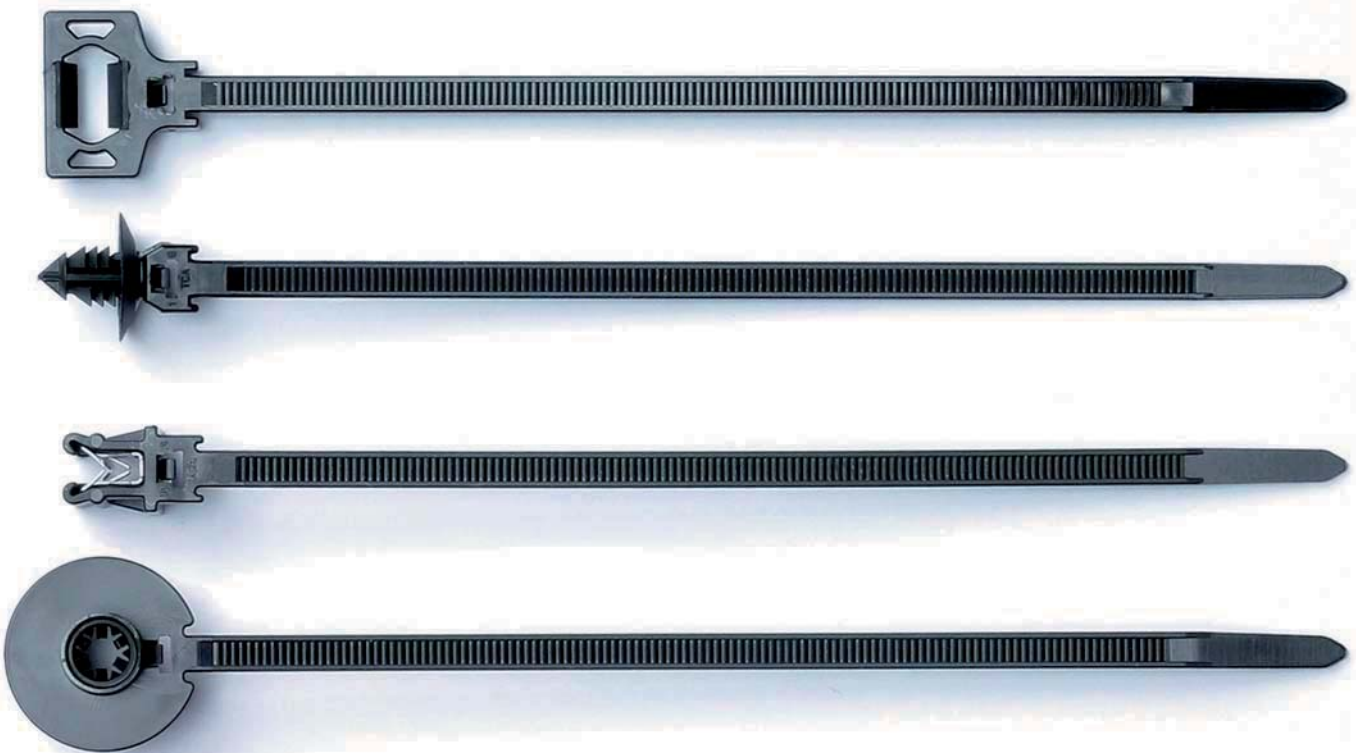

HellermannTyton standard fixing ties cover 90 % of main circuit applications in a car. These products have been proving their success for many years. Not least due to the fact that they are continually optimised. Each cable tie is a specialist in its own field: For attaching two cable ties to one weld stud. For applications, which require a particularly high tensile strength, for example in the production of heavy-duty vehicles. For quick and easy mounting on edges without drilled holes or studs. The elements with the "soft push" mechanism can be easily mounted by hand and without the aid of any tools.

As examples for many standard one-piece fixing ties this page shows cable ties with the type descriptions: T50SOSWSP5E, T50SOSFT6E1, T50SOSEC 12E and T50SOSSBH5E



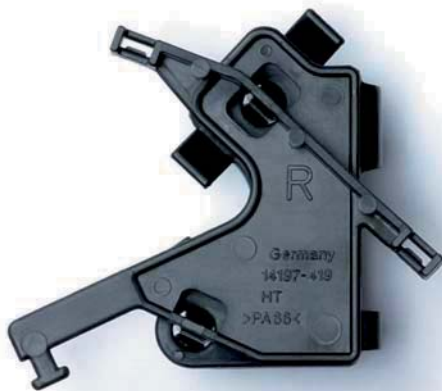

The double-clip that holds three tubes for the brake and antilock brake sensor and CDC on just two point-fastening points on the rear axle.

An innovative solution, which combines two clips in one. The rear suspension construction requires a fastening element for which there are only two fastening points available and with which the lines for the brake, antilock brake sensor and CDC can be accurately routed. The result of our development is our double clip. Its arrowhead enables fast and easy mounting. The brake tube is easily assembled with a simple push. This kind of development is always accompanied by a team including a developer, a new parts project manager and key account manager – from the idea to serial production.



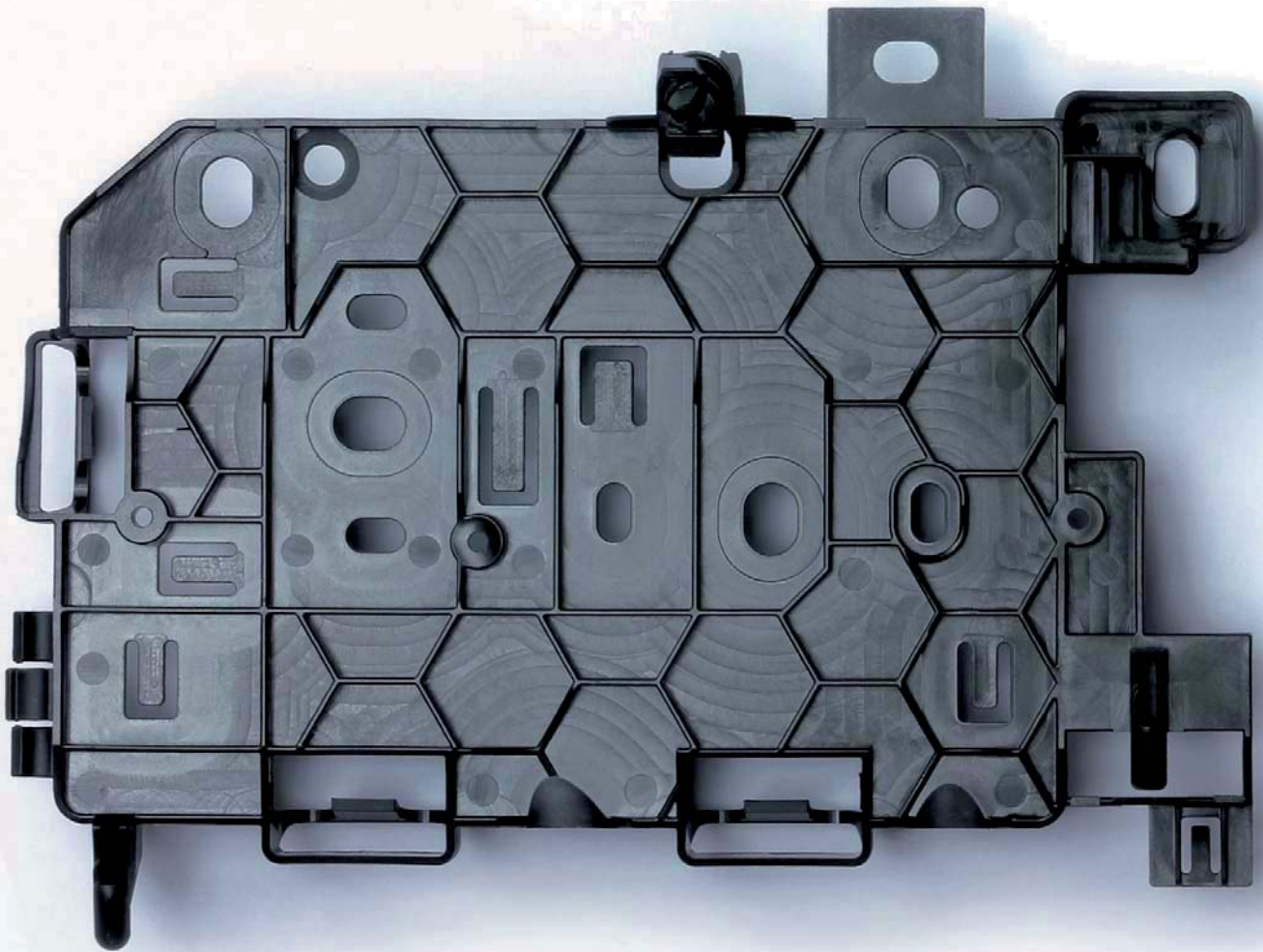

The-system-for-fastening-the-seat-adjustment-controlling-devices-and-lumbar-support-as-well-as-seat-heating-with-an-integrated-clip-bracket-and-cable-guide.

The unit for operating the numerous options of comfortable seat adjustment needs to be accommodated in a very small space. This bracket replaces the conventional metal construction for the operating unit under the seat. The innovative combination of design and

material made the development of this product possible. Its outstanding quality lies in the fact that the connector clip is also integrated in this bracket and therefore additional clips become superfluous. No question that this saves weight as well as costs.



Granules-for-the-fastening-system-of-tomorrow.



We develop tailor-made products in direct collaboration with our customers – working with an international network of experienced specialists. The newest CAD- and Rapid-Prototyping-Systems and our expert knowledge flow together in our in-house mould and product development. Experienced engineers and the latest development tools guarantee you the superior quality of our products. Only this way we can provide innovative solutions to meet the most specific needs.

We look forward to developing a product for you!



The three-points-to-start-the-thinking-process.

What is it that makes a fastening solution perfect? It's the added value that takes you and your company a step further. It can be the optimisation of a tiny detail that makes a profitable difference.

It can also be an idea for the development of a brand new product. We generally work according to three methods to get the most out of our product solutions for our customers.

1

Optimisation of existing products.

We understand the optimisation of our products as a completely independent re-engineering commitment. This means we constantly scrutinize the properties and possible applications of our complete product portfolios. In close dialogue with our customers, as only extensive market and competitive analysis keeps us up-to-date with our customers' requirements and demands. Direct collaboration with automotive manufacturers and suppliers allows us to constantly adapt and refine existing products according to contemporary manufacturing trends.

This consistent and continual development of our products allows HellermannTyton to be your reliable partner, today and in future.

2

Development of market-leading all-purpose products.

When integrated with care and consideration, plastic products are perfect substitutes for many complex fastening systems – especially multipart constructions manufactured from various materials. In this they offer prerequisites for concepts that effectively reduce costs and increase productivity in all stages of the manufacturing process. From the production process, to the functionality of the actual application through to recycling, which in most cases only involves a product made from only one engineering polymer, such as polyamide.

This is why we constantly invest in research and development. We are always aiming to set new global standards. Our success has proven us right: today we have over 60.000 products in our portfolio, which serve as international benchmarks.

3

Individual customer product developments.

HellermannTyton develops sophisticated engineering for complex and individual fastening solutions for a particular vehicle, series or platform in the automotive industry.

Innovative fastening solutions to meet your specific requirement profile.

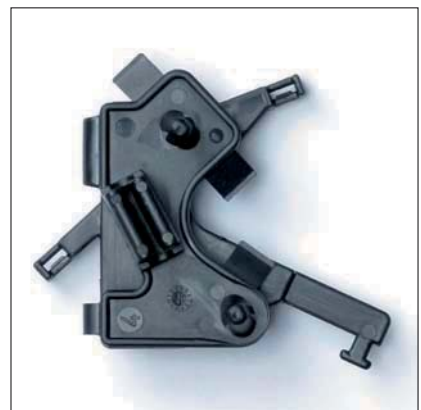



	Page
1.1 Technical Information	12
Materials specification	21
1.2 Cable ties inside serrated	
<i>T-Series</i>	23
for temperatures up to +105 °C, heat stabilised	24
for outdoor use (UV-resistant)	26
for higher impact resistance, Scan Black	27
for temperatures up to +150 °C	27
Cable ties for hose and gaiter	28
Cable ties for parallel routing	29
1.3 Cable ties outside serrated	
for thin walled bundles	30
for high temperature application up to +240 °C	31
with 90° angled head	32
1.4 Cable ties without serration	
locked by glass fibre pin	33
1.5 Cable ties for direct fixation	
for single holes (Chassis Tie)	35
1.6 Stainless steel cable ties	
Properties of steel 304/316	36
<i>Stainless steel cable ties</i>	
with ball-lock	37
with ball-lock, for double bundling	39
with ball-lock and coating	40

	Page
with fold locking	41
with raster locking	42
Protective channel	43
1.7 Fixing ties	
User guide for fixing ties	44
<i>Fixing ties</i>	
• with arrowhead, 1-piece	52
with disk	46
with disk, sealed	47
with disk in the strap	48
with wings	49
with wings in the strap	51
• with arrowhead, 2-piece	
with disk	53
with disk, for high temperature applications	55
• with fir tree, 1-piece	
with disk	56
with disk, releasable	57
• with fir tree, 2-piece	
with disk	58
with disk, for oval holes	59
• for weld studs, 1-piece	60
for measurement adjustments	62
for heavy duty applications	63, 66
with softpush, in the strap	64
releasable, flexible strap	65



Cable ties and fixings

1

	Page		Page
• for weld studs, 2-piece	67	for wires, self locking	94
with disk (for isolation material)	68	for edges	96
for parallel routing	69	• for corrugated tubing	
EdgeClip-Family	70	with arrowhead	97
EdgeClip Family, 1-piece	71	with fir tree	98
EdgeClip Family, 2-piece	72	for weld studs, with distance retainer	99
Fixing ties		Snapper hose clips	100
for edges, twistable	74	1.10 Plugs and cover plugs	
for holes	75	Plugs	102
with pipe clip	76	Cover plugs and open plugs	103
with wire clip	76	1.11 Connector clips	
with pipe clip, twistable 360°	77	for round holes	104
for heavy duty applications, scewable	79	for oval holes	106
for parallel routing	80	for edges	108
1.8 Bundling clips		1.12 Cable tie mounts	
with arrowhead	81	Information and instructions for self adhesive mounts	109
for measurement adjustments	82	Fixing elements with special adhesive	110
with arrowhead, with distance retainer	83	Paste adhesive mounts	111
with fir tree	84	for heavy duty applications	112
with fir tree, with distance retainer	86	for heavy duty applications, for parallel routing	113
for weld studs, with distance retainer	87	Coupler, twistable	114
flat, for weld studs, with distance retainer	88	Distance retainer with fir tree	114
for edges	89	Distance retainer for BHT-ties	115
for connectors	90		
1.9 Fixing elements for tubes and harnesses			
with arrowhead	91		
for tubes and wires	92		
for tubes and wires, connectable	93		

Properties of polyamide PA66

Polyamides are among the most important thermoplastic synthetic materials.

Thermoplastics can be reshaped by heating as often as required without undergoing chemical decomposition or other negative changes. This makes polyamide ideal for processing via injection moulding into high-quality products. About 90% of cable ties and fixings from **HellermannTyton** are made from this material. Polyamide is also known under the brand name of Nylon®, which was introduced by the Dupont company.

The inner structure of polyamide displays a partial order of polymer chains, i.e. polyamides are partially crystalline. Due to the tighter packing of the individual molecular chains polyamide only has limited transparency to light. The plastic is therefore described as translucent.

The molecular chains of PA66 are made from two base units:

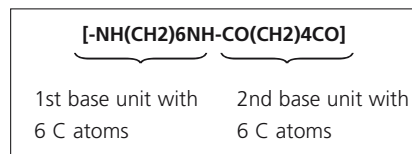

Each base unit contains 6 carbon atoms (C). Hence the name PA66.

The polyamide PA66 has many properties which are highly advantageous for **HellermannTyton** cable ties and fixings, such as:

- High strength, rigidity and hardness
- High dimensional stability, even under the effect of heat
- High abrasion resistance

A wide-ranging selection of polyamides and additives allows for an optimum adaptation of the properties of the finished product to suit the respective requirements.

The following PA66 variants are used for **HellermannTyton** products:

- Polyamide 6.6 standard (PA66) for temperature conditions of up to +85°C
- Polyamide 6.6 heat-stabilised (PA66HS) for temperature conditions of up to +105°C
- Polyamide 6.6 UV-stabilised (PA66W) for exterior use
- Polyamide 6.6 heat-stabilised and UV-stabilised (PA66HSW) for exterior use up to +105°C
- Polyamide 6.6 impact-resistant (PA66HIR) for high elasticity requirements
- Polyamide 6.6 impact-resistant and heat-stabilised (PA66HIRHS) for high elasticity requirements and temperatures up to +105°C
- Polyamide 6.6 V0 for high standards of fire protection.

Water content in polyamide

Polyamide is a hygroscopic material - this means that it absorbs and releases water. The mechanical properties are significantly affected by the water content – especially flexibility and minimum tensile strength. In a standard atmosphere of 23°C and 50% relative humidity, the degree of water saturation of polyamide is around 2.5%. For optimal processing of cable ties it is therefore important that the polyamide has a water content of approximately 2.5% in a state of equilibrium.

The quality and functionality of the products are thus affected by the water content, therefore the correct storage of our products is crucial. Please read our separate instructions on storage.

Since humidity is so critical to the quality of the tie, the question arises: What happens if the tie is installed and the water content in the tie alters?

The water content determines the flexibility and strength of a tie. At a water content of approximately 2.5% the tie has the ideal flexibility for installation. When the strap is being threaded through the head of the tie, the pawl must be flexible enough to “see-saw” over the serration of the strap without breaking. On the other hand, there must also be adequate material rigidity for the serrations of the pawl to engage with the serrations of the strap during the tying process so that a 'positive locking' action is achieved. After achieving the positive locking action the

tie is in a static condition. Changes in the mechanical properties of the tie as a function of water content are insignificant during this status.

 **For more details on the materials, see page 21.**

Properties of UV-stabilised polyamide (PA66W)

The question constantly arises as to whether a black cable tie is suitable for use outside. This is dependant on the application of the tie, but in general the following statements can be made:

A black cable tie made of polyamide 6.6 standard (PA66) is only coloured black with a low proportion of carbon black. This is not sufficient to protect the material from damage caused by UV-radiation in the long term.

Products made from UV-stabilised polyamide PA66W are produced in accordance with ASTM standard D6779 with a higher carbon black percentage of approx. 2%. So they resist UV-radiation in the European area for a considerably longer period than standard PA66.

This is clearly illustrated by the comparison of the two images on the right:

After 500 hours of UV- radiation exposure

Polyamide 6.6 standard (PA66) dyed black:



The joint has been damaged throughout by UV-radiation.

Polyamide 6.6 UV-stabilised (PA66W) with approx. 2% carbon black:

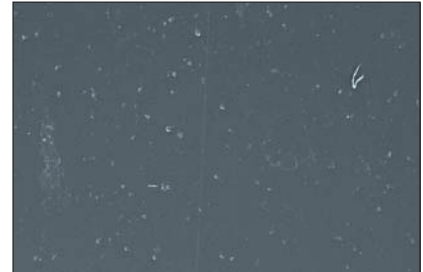

The joint has only been altered at isolated points by the UV-radiation.

For outdoor use, therefore, we recommend our range of products made from UV-stabilised polyamide (PA66W).

A simple practical test: "the hammer test"

You can quickly determine whether or not a cable tie is UV stabilised. Strike with a hammer the tail of the strap on the tie. Hold up this flattened end to the light. Cable ties with a carbon black content of about 2% allow no light through and look black throughout. Standard black ties, however, are transparent on the flattened end.

Properties of polyamide PA12

Apart from PA66, there are polyamides which are less hygroscopic. These include PA12, which has a molecular chain made of a base unit with 12 carbon atoms:

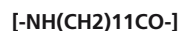

PA12 has the following advantages over PA66:

- Less hygroscopic - saturation at 23°C and 50% relative humidity is approximately 1%.
- Better impact performance.
- Good weather resistance, even without a special additive.

These three properties make PA12 ideal for use outdoors, in particularly when requirements may include impact resistance.

The water absorption of PA12 is not only less than that of PA66 but also slower. This is the requirement where the mechanical properties need to remain relatively unaffected by changing environmental conditions.

Properties of polyamide PA46

Polyamide PA66, despite the use of additives, is not suitable for long-term use in temperatures of +105°C. Due to considerably better heat resistance, polyamide PA46 is more suitable for temperatures of up to and exceeding 150°C (depending on the length of time of operation).

The molecular chain of PA46 is composed of two base units:

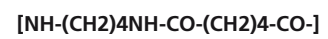

1st base unit with 4 C atoms	2nd base unit with 6 C atoms
---------------------------------	---------------------------------

Advantages of PA46 over PA66:

- Greater rigidity, even at higher temperatures.
- Higher operating temperature ranges of up to +150°C (5,000 hours).
- Greater form stability at higher temperatures.
- Excellent chemical resistance.



Properties of Polyetheretherketone PEEK

PEEK, a linear aromatic polymer is semi-crystalline and is widely regarded as the highest performance thermoplastic material currently available. A summary of key physical properties is as follows:

High temperature performance

- Melting temperature of 343 °C (649 °F).
- Continuous Use Temperature of 240 °C (464 °F) (UL 746B).

Wear resistance

- Outstanding wear resistance over wide ranges of pressure, velocity, temperature and counter facial roughness.

Chemical resistance

- Excellent resistance to a wide range of chemical environments, even at elevated temperatures.
- The only common environment that dissolves it is concentrated sulfuric acid.

Fire, smoke and toxicity

- Highly stable and requires no flame-retardant additives to achieve a V-0 rating at 1.45 mm thickness.
- The composition and inherent purity of the material results in extremely low smoke and toxic gas emission in fire situations.

Hydrolysis resistance

- PEEK is not attacked by water or pressurized steam.
- Components that are constructed from these materials retain a high level of mechanical properties when continuously conditioned in water at elevated temperatures and pressures.

Purity

- PEEK materials are inherently pure with exceptionally low levels of ionic extractables.
- Excellent out gassing characteristics.

This makes PEEK the right choice for any high performance application in any industry with a clearly outstanding continuous use temperature of 260 °C.

Radiation Resistance

- Excellent Radiation Resistance due to the energetically stable chemical structure of PEEK.

Properties of Ethylenetrafluoroethylene (E/TFE)

E/TFE can be best described as a rugged thermoplastic with an outstanding balance of properties.

Mechanically, it is tough, has medium stiffness, impact and abrasion resistance.

Summary of key properties:

- No load continuous use temperature of 150 °C.
- Weather resistant
- Inert to most solvents and chemicals
- Hydrolytically stable
- Substantially better resistance to radiation than other plastic materials.

E/TFE can perform successfully in applications where other materials are lacking in mechanical toughness, broad thermal capability, ability to meet severe environmental conditions.

General linguistic usage for cable ties made from raw material E/TFE is Tefzel®-Tie. In addition to Tefzel® from DuPont HellermannTyton is also using equivalent E/TFE raw material from other suppliers. Tefzel® is a registered trademark of DuPont.

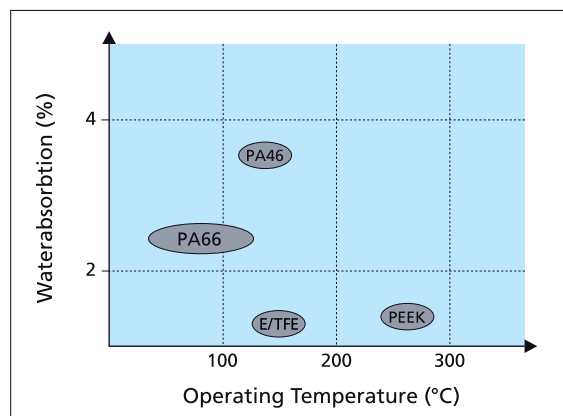

What does Flammability UL94 mean?

UL is the shortcut for Underwriters Laboratories. This is an independent organisation in the United States to control and certificate product safety.

Beside a lot of product standards UL also specified the flammability test UL94 for plastic materials. UL94 is a material burning test done on defined specimen of the raw material but not a test on final products.

UL94 differs between a horizontal burning test UL94 HB (picture 1) and a vertical burning test UL94 V (picture 2).

For the vertical test UL94 V there are three flame ratings defined: UL94 V0, UL94 V1 and UL94 V2.

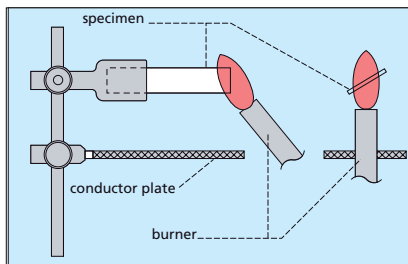

UL94 HB:

horizontal burning test

Test criteria:

- burning rate of specimen in mm/min.

Classification:

- according to HB

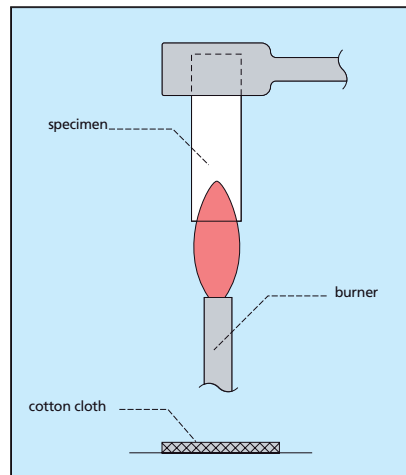

UL94 V:

Vertical burning test

Test criteria:

- afterflame time of specimen
- drip of flaming particles

Classification:

- according to V0, V1 or V2

In all these burning tests an open flame is applied for a certain time to the specimen. As the burning behaviour also depends on the thickness of the material it is important to classify the material not only according to HB, V0, V1 or V2 but also to mention the thickness of specimen.

Following table is a summary of test procedures and requirements of the above four UL94 classification.

Classification	Horizontal Test UL94		Vertical Test UL94		
	HB	HB	V0	V1	V2
Number of specimen	3	3	5	5	5
Thickness of specimen	< 3 mm	3 to 13 mm	up to max. 13 mm		
1st flame application	30 sec.	30 sec.	10 sec.	10 sec.	10 sec.
2nd flame application	-	-	10 sec.	10 sec.	10 sec.
Burning rate	max. 75 mm/min	max. 40 mm/min	-	-	-
Afterflame time after 1st flame application for each individual specimen	-	-	max. 10 sec.	max. 30 sec.	max. 30 sec.
Afterflame time after 2nd flame application for each individual specimen	-	-	max. 30 sec.	max. 60 sec.	max. 60 sec.
Total afterflame time for all 5 specimen after 1st and 2nd flame application	-	-	max. 50 sec.	max. 250 sec.	max. 250 sec.
Afterflame or afterglow of any specimen up to its end allowed	yes	yes	no	no	no
Cotton indicator ignited by flaming particles or drips allowed	-	-	no	no	yes

Flammability behaviour on the following product pages are always related to the raw material burning rate according to UL94.

Most commonly used raw materials for cable ties and fixing elements are Polyamide 6.6 standard, Polyamide 6.6 weather resistant and Polyamide 6.6 heat stabilised. These materials normally fulfill UL94 V2 requirement.

Chemical resistances of various plastics

+ = resistant
o = partly resistant
- = not resistant

These values are only rough guides. They should be regarded as a material specification and are no substitute for a suitability test. Please see our technical datasheets for further details.

Medium	Conc. [%]	Temp. [°C]	PA66	PA46	PA12	POM	PP	TPU	E/TFE (Tefzel®)	PEEK
Acetaldehyde, liquid	100	23	+	-		+	o	-	+	+
Acetone	100	23	+	+	+	+	+	-	+	+
Allyl chloride	100	23					+	-		
Formic acid	98	23	-		-	-	+	-	+	o
Aniline	100	23	+	o	o	o	+	-	+	+
Aromatic compounds						+	-		+	+
Benzaldehyde	any	23	+	o		+	+	-	+	+
Benzine/Benzol mix		23	+	+	+	+	o	o	+	+
Benzol	100	23	+		+	o	o	-	+	+
Bromine		23		-	-		-	-		
Chlorine, gaseous	100	23					-	o	+	
Chlorine, liquefied	100	23		-			-			
Chlorobenzene	100	23			-	o	+			
Chloroform	100	23		-	-	-	o			
Chromic acid	10	20	o	-		o	+		+	+
Chromic acid	20	23	-	-		-	+		+	+
Chromic acid	50	20	-	-		-	+		+	
CFC							o			
Cyclohexane	100	23	+			+	+	+	+	+
Cyclohexanone	100	23	+			+	+		+	+
Decahydronaphthlene	100	23	+			+	o		+	+
Diethyl ether	100	23	+			+	o		+	+
Di-isopropyl ether	100	23					o			
Dimethyl formamide	100	23	+	+		+	+		+	+
Diethyl phthalate		23	+	+		+	+	-	+	+
Ethanonic acid	10	20	-	o	o	+	+		+	
Ethanonic acid	25	20	-			o	+		+	
Ethanonic acid	50	20	-			o	+		+	
Ethanonic acid	100	23	-	-		o	+		+	
Ethyl acetate	tech. pure	23		+	+	o	o			+
Freon		23					+			+
Heptane	100	23	+	+	+	+	+		+	+
Potass. Permanganate	<= 6	23	-	-	-	+	+		+	+
Ketone			+	+		+	+		+	+
Methylethylketone	100	23	+	+		o	+	-	+	+
Methyisobutylketone	100	23	+			+	+		+	+
Engine oil	100	23			+	+	+			+
Nitrobenzene	100	23	+	o		+	+	-	+	+
Ordinary petrol		23		+		+	+			+
Paraffin oil		23	+	+	+	+	+		+	+
Perchloroethylene		23	+		+	+	o	-	+	+
Petroleum		23	+	+	+	+	+		+	+
Phenol	approx. 70	23	-	-	-	-	+	-	+	
Nitric acid	10	20	-		-	-	+	-	+	+
Nitric acid	50	23	-		-	-	-	-	+	-
Carbon bisulphide	100	23	+	-	+	+	-	-	+	+
Sulphuric acid	10	20	-		o	-	+	+	+	o
Sulphuric acid	50	20	-			-	+	+	+	-
Sulphuric acid	96	23	-	-		-	-	+	+	-
Silicon oil		23	+	+	+	+	+	+	+	+
Salad oil		23		o			+			+
Carbon tetrachloride	100	23	+	+	o	+	o	-	+	+
Toluol	100	23	+		+	+	o	-	+	+
Trichlorethylene	100	23	+	o	o	o	o	-	+	+
Water, cold			+		+	+				+
Water, hot							+			+
Hydrogen peroxide	10	20	o			+	+		+	
Hydrogen peroxide	30	23	-	-		+	+	+	+	
Xylene	100	23	+	+	+	+	o	-	+	+

Tefzel® is a registered trademark of DuPont.

General linguistic usage for cable ties made from raw material E/TFE is Tefzel®-Tie. In addition to Tefzel® from DuPont HellermannTyton is also using equivalent E/TFE raw material from other suppliers.

Introduction to the main locking technologies used for cable ties

HellermannTyton offers a wide range of cable ties for use in different applications. By constantly refining our products and satisfying the ever-changing demands of the market, various locking technologies have been developed. Below you will find a brief overview of three most common locking technologies and their characteristics.

Cable ties with plastic pawls

This technology is used in 90% of all polyamide (PA) cable ties supplied by HellermannTyton. In order to cover a variety of applications, there are different variants of this system, for example: releasable versions, in-line versions, open head versions. These are one-piece cable ties, that is the pawl is moulded as an integral part of the cable tie, thereby building in inherent strengths.

Locking technology

Positive locking is achieved by engaging the pawl with the strap serrations. This allows the cable tie to perform to the published minimum tensile strength, that is the loading that the cable tie can hold under application (see page 0000).

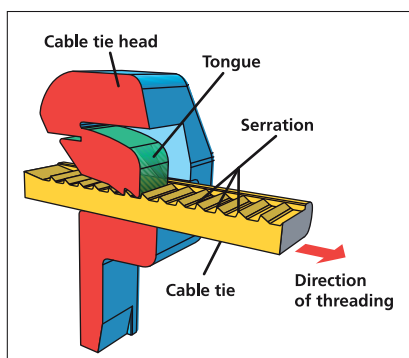

KR series cable ties

This cable tie is distinguished by its smooth strap and unique locking mechanism. With the KR series the chamfered head achieves an especially firm fit around the bundled material.

Locking technology

This patented lock technology takes advantage of the excellent deformation properties of polyamide (PA). Here, the glass fibre-reinforced (GRP) locking pin (yellow) is forced into the strap by the use of an application tool - either the KR6/8 or KR8PNSE (see page 0000). The strap is deformed into the head of the tie by the application of the pin, thereby locking the cable tie in position and allowing for the bundling heavy loads.

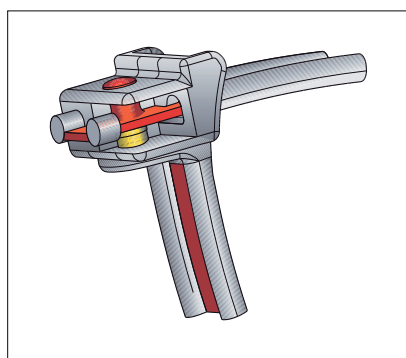
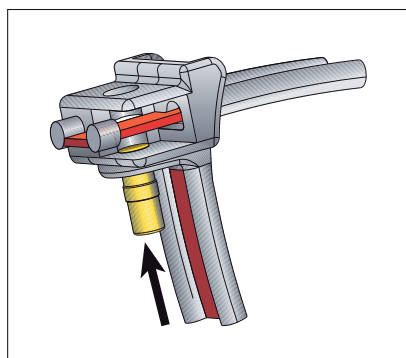

MBT series of cable ties

Made of stainless steel grades 304 or 316, the MBT range of cable ties have no serrations on the strap and are threaded parallel through the head, gliding under a metal ball-bearing locking mechanism. By using the MK9SST application tool the cable tie is tensioned and the strap cut to a flush finish.

Locking technology

The strap is locked into the head by means of the small ball-bearing. The ball locks into the small end of the wedged shaped housing, forming a positive locking with the strap.

This cable tie is not suitable for rigid objects. Retraction of the ball-bearing (see drawing) is required into the small end of the wedged shaped housing to allow for a positive locking of the strap and also to make a flush cut of the end of the strap. Retraction, therefore, cannot take place with the bundling of inflexible materials. To bundle rigid objects LFPC channel should be laid as buffer between strap and bundled material to compensate for this retraction. This locking technology allows for minimum tensile strengths of up to 5400 Newton.

1. Initial position

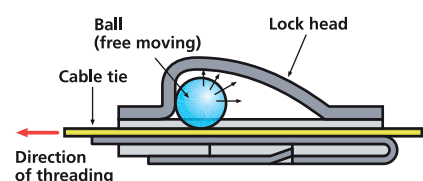

2. Ball locks cable tie by wedging.

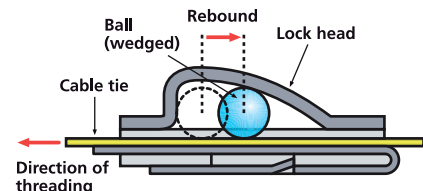

Determination of minimum tensile strength

The minimum tensile strength is a critical selection criterion for cable ties. It expresses how much loading a cable tie can bear. This minimum tensile strength is determined in

accordance with the Military Specification and Standards of the USA. Test conditions being laid down precisely in MIL-S-23190E:

- Conditioning of the test pieces

- Construction of the test apparatus
- Application of the tie on a split test probe
- Test speed

The test procedure to determine minimum tensile strength

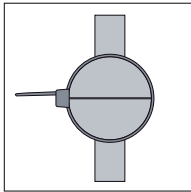

The cable tie is fixed onto a split mandril test probe with the suitable cable tie application tool.

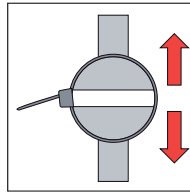

The mandril is opened at a defined speed.

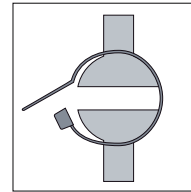

The loading at which the cable tie fails is determined. This value is stated in Newtons (N) and is recorded through a computer programme reading the tests. This programme produces graphs as outlined below.

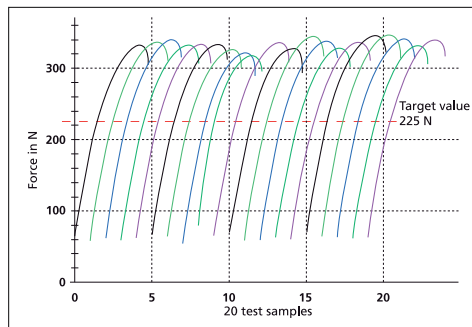

Typical measurement protocol of a T50R made of PA66 with a minimum tensile strength of 225 N.

Explanation of minimum tensile strengths

What does a minimum tensile strength of 225 N (50LBS) mean?

To explain what this value means, the mass with which the tie can be loaded is calculated. The unit of measurement of the mass is stated in kg. To do so, the unit Newton (N) is shown in the following way:

$$[N] = [kg \cdot m/s^2]$$

The formula for calculating the mass is:

$$\text{Mass} = \frac{\text{minimum tensile strength}}{\text{acceleration due to gravity}}$$

The acceleration due to gravity is 9.81 m/s²:

$$\text{Mass} = \frac{\text{minimum tensile strength}}{[kg \cdot m/s^2] / 9.81 [m/s^2]}$$

At a minimum tensile strength of 225 N (50LBS) the mass is:

$$\text{Mass} = 225 [kg \cdot m/s^2] / 9.81 [m/s^2]$$

The units m/s² cancel each other out, leaving the unit [kg] for the mass. Thus:

$$\text{Mass} = 225/9.81 \text{ kg} = 22.9 \text{ kg}$$

Therefore, a T50R cable tie with a minimum tensile strength of 225 N (50LBS) can be loaded with 22.9 kg.

Conversely, with the required loading capacity the minimum tensile strength can be calculated by a mass:

$$\text{Min. tensile strength} = \text{mass} \cdot 9.81 [m/s^2]$$

If the tie is to be loaded with, for example, 53 kg this produces:

$$\text{Minimum tensile strength} = [53 \text{ kg}] \cdot 9.81 [m/s^2] = 520 \text{ N}$$

In order to withstand a load of 53 kg, the tie must therefore have a minimum tensile strength of 520 N. In this case, select our T120R with a minimum tensile strength of 535 N (120LBS).



$$225 \text{ N} / 9.81 = 22.9 \text{ kg}$$



$$53 \text{ kg} \cdot 9.81 = 520 \text{ N}$$

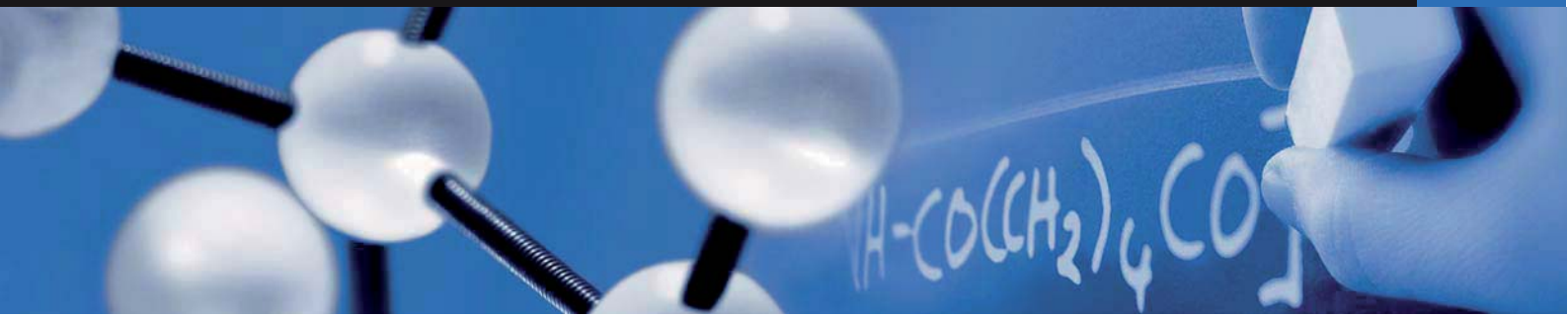

Optimum storage conditions for cable ties made of polyamide (PA)

HellermannTyton cable ties, fastenings and fixings are manufactured from high-quality polyamide (PA). This industrial synthetic material is mainly processed using injection moulding, but can also be extruded.

Polyamide is a hygroscopic material. This means that the material absorbs and loses moisture. For optimum handling of cable ties it is important that the material is in a condition of equilibrium with a water content of approximately 2.5%.

The packaging used by **HellermannTyton** ensures that the water content in the material remains constant. Therefore, it is important to store the products in their original packaging to preserve the quality of the ties.

Always store ties in the sealed plastic bag made of polyethylene!

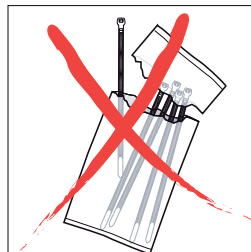

Once opened you should use the ties as quickly as possible.

Do not expose the product to direct sunlight

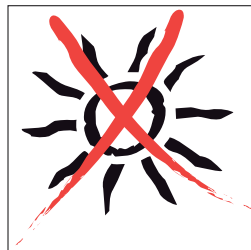

Do not store the product in sunlight; for example, on the windowsill.

Store the product away from direct sources of heat

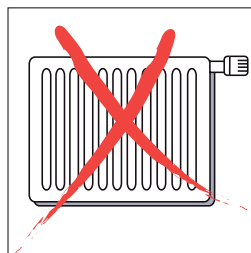

Avoid contact with heat: for example, do not place on the radiators.

The ideal storage conditions are those of the central European standard climate:

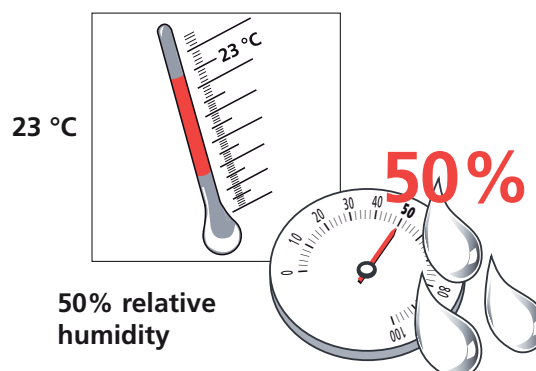

HellermannTyton cable ties conform to DIN EN 50146 standard

HellermannTyton are a supplier of high-quality solutions for the routing, organising and securing of cables, hoses and pipes. The level of quality has been inspected by the VDE (Verband der Elektrotechnik, Elektronik, Informationstechnik e.V) [German Association for Electrical, Electronic and Information Technologies].

Cable ties from the inside-serrated T-Series and the outside-serrated OS-Series have been tested in accordance to the cable tie standard DIN EN 50146 (VDE 0604 PART 201):2000-12; EN 50146:1999-08. The result of this independent testing is complete compliance:



These cable ties therefore qualify to bear the VDE symbol.

In addition to cable ties made of the standard material polyamide 6.6 (PA66), ties made from heat-stabilised (PA66H) and UV-stabilised polyamide 6.6 (PA66W) have been successfully tested and approved.

HellermannTyton is the only manufacturer to offer cable ties with inside and outside serration with DIN approval. So all current applications in the field of electrical installation are covered.

The standard includes the following tests:

- Test of minimum installation temperature
- Test of minimum application temperature
- Minimum tensile strength
(in the standard this is described as the looping test)
- Load test and heat ageing test
- Temperature cycle test
- Contribution to spread of fire
- Corrosion resistance

The following HellermannTyton cable ties have been tested and certified:

T-Series inside-serrated cable ties

(see page 67-73) in the qualities:

Polyamide 6.6 (all colours) 38 types x 11 colours	=	418 cable ties
Polyamide 6.6 heat-stabilised (all colours) 38 types x 11 colours	=	418 cable ties
Polyamide 6.6 UV-stabilised (black) 38 types in black	=	38 cable ties

Total number of cable ties in T-Series to DIN standard 874 cable ties

OS-series outside-serrated cable ties

(see page 83-84)

Polyamide 6.6 heat-stabilised (all colours) 7 types x 11 colours	=	77 cable ties
Total number of cable ties in OS series to DIN standard	=	77 cable ties

Total number of HellermannTyton cable ties to DIN standard 951 cable ties

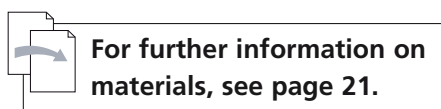

For further information on materials, see page 21.

Material specifications				
Material	Operating Temperature	Colour	Flammability	Material Properties*
Ethylene-Tetrafluorethylene - E/TFE (Tefzel®)	-80 °C to +150 °C, continuous	Blue (BU)	UL94 V0	<ul style="list-style-type: none"> • Resistance to radioactivity • UV- resistant, not moisture sensitive • Good chemical resistance to: acids, bases, oxidizing agents
Polyamide 6.6 high impact modified (PA66HIR)	-40 °C to +80 °C, intermittent +105 °C (for 500 h)	Black (BK)	UL94 HB	<ul style="list-style-type: none"> • Limited brittleness sensitivity • Good at low temperature
Polyamide 6.6 high impact modified, heatstabilised (PA66HIRHS)	-40 °C to +105 °C	Black (BK)	UL94 HB	<ul style="list-style-type: none"> • Limited brittleness sensitivity • Good at low temperature • Modified elevated max. temperature
Polyacetal (POM)	-40 °C to +90 °C, intermittent +110 °C (for 500 h)	Natural (NA)	UL94 HB	<ul style="list-style-type: none"> • Limited brittleness sensitivity • Flexible at low temperature • Not moisture sensitive • Robust on impacts

Material specifications, Halogen Free				
Material	Operating Temperature	Colour	Flammability	Material Properties*
Polyamide 11 (PA11)	-40 °C to +85 °C, intermittent +105 °C (for 500 h)	Black (BK)	UL94 HB	<ul style="list-style-type: none"> • Bio-plastic which is derived from vegetable oil • Extreme temperature stability • Good chemical resistance • Strong impact resistance at low temperatures • Very low moisture absorption • Weathering resistance
Polyamide 12 (PA12)	-40 °C to +85 °C, intermittent +105 °C (for 500 h)	Black (BK)	UL94 HB	<ul style="list-style-type: none"> • Good chemical resistance to: acids, bases, oxidizing agents • UV- resistant
Polyamide 6.6 (PA66)	-40 °C to +85 °C, intermittent +105 °C (for 500 h)	Natural (NA), Black (BK)**	UL94 V2	<ul style="list-style-type: none"> • High yield strength
Polyamide 6.6, heat stabilised (PA66HS)	-40 °C to +105 °C, intermittent +145 °C (for 500 h)	Natural (NA), Black (BK)**	UL94 V2	<ul style="list-style-type: none"> • High yield strength • Modified elevated max. temperature
Polyamide 6.6 UV-resistant (PA66W)	-40 °C to +85 °C, intermittent +105 °C (for 500 h)	Black (BK)	UL94 V2	<ul style="list-style-type: none"> • High yield strength, UV-resistant
Polypropylene (PP)	-40 °C to +85 °C, intermittent +105 °C (for 500 h)	Natural (NA), Black (BK)**	UL94 HB	<ul style="list-style-type: none"> • Good chemical resistance to: organic acids • Floats in water, moderate yield strength
Thermoplastic Polyurethane (TPU)	-40 °C to +85 °C	Black (BK)	UL94 HB	<ul style="list-style-type: none"> • High elastic, UV-resistant • Good chemical resistance to: acids, bases, oxidizing agents
Polyamide 6.6, Glassfibre reinforced (PA66GF13%)	-40 °C to +105 °C	Black (BK)	UL94 HB	<ul style="list-style-type: none"> • Good resistance to lubricants, vehical fuel, salt water and a lot of solvents
Polyamide 6.6 with metal particles (PA66MP)	-40 °C to +85 °C, intermittent +105 °C (for 500 h)	Blue (BU)	UL94 HB	<ul style="list-style-type: none"> • High yield strength

Tefzel® is a registered trademark of DuPont.

* These details are only rough guide values. They should be regarded as a material specification and are no substitute for a suitability test. Please see our datasheets for further details.

** Other colours on request.

Material specifications, Limited Fire Hazard



Material	Operating Temperature	Colour	Flammability	Material Properties*
Polyamide 4.6 (PA46)	-40 °C to +150 °C for 5000 h, (+195 °C for 500 h)	Natural (NA), Grey (GY)**	UL94 V2	<ul style="list-style-type: none"> Resistant to high temperatures Very moisture sensitive, low smoke sensitive
Polyamide 6.6 V0 (PA66V0)	-40 °C to +85 °C	White (WH)	UL94 V0	<ul style="list-style-type: none"> High yield strength, low smoke emissions
Polyamide 6.6 V0 High Oxygen Index (PA66V0-HOI)	-40 °C to +85 °C, intermittent +105 °C (for 500 h)	White (WH)	UL94 V0	<ul style="list-style-type: none"> High yield strength, low smoke emissions
Polyolefin (PO)	-40 °C to +90 °C	Black (BK)	UL94 V0	<ul style="list-style-type: none"> Low smoke emissions
Polyetheretherketone (PEEK)	-55 °C to +240 °C	Beige (BGE)	UL94 V0	<ul style="list-style-type: none"> Resistance to radioactivity UV- resistant Good chemical resistance to: acids, bases, oxidizing agents Not moisture sensitive
Stainless Steel Type SS304, Type SS316	-80 °C to +538 °C	Metal (ML)	–	<ul style="list-style-type: none"> Corrosion resistant Antimagnetic

* These details are only rough guide values. They should be regarded as a material specification and are no substitute for a suitability test. Please see our datasheets for further details.

** Other colours on request.

Cable Ties inside serrated

• T-Series

For the routing, bundling and securing of cables, pipes and hoses.

Features and Benefits



- Available in a wide range of material and sizes
- Made from 100% high quality plastic, allows for good recycling
- Inside serration for a strong hold onto bundles.
- Easy application either manually or with a processing tool
- Simply to insert due to bent tail



**Material specification
please see page 21.**

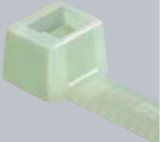

T-Series for bundling and securing of cables for a wide range of applications, available in various colours and materials.

	Material	Page Number
	Polyamide 6.6, heat stabilised (PA66HS) Polyamide 6.6 UV-resistant (PA66W) Polyamide 6.6 high impact modified, scan black (PA66HIR(S))	25 26 27
	Polyamide 6.6, heat stabilised (PA66HS)	24
	Polyamide 4.6 (PA46)	27

Tefzel® is a registered trademark of DuPont.

General linguistic usage for cable ties made from raw material E/TFE is Tefzel®-Tie. In addition to Tefzel® from DuPont HellermannTyton is also using equivalent E/TFE raw material from other suppliers.



Please note! Not all products listed on this page may have this approval. For product specific approvals please refer to the Appendix.

Cable Ties for temperatures up to + 105°C (heat stabilised)

- T-Series in PA66HS natural

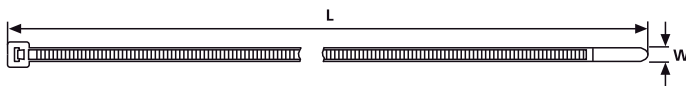

T18S – T150XXL

 **Material specification please see page 21.**



Article-No.	Type	Length (L)	Width (W)	Bundle Ø max.	Min. Tensile Strength (N)	Material	Colour	Application Tool
Polyamide 6.6. Heat Stabilised								
111-01959	T18R	100	2.5	22.0	80	PA66HS	Natural (NA)	1–3, 5
111-02359	T18I	145	2.5	35.0	80	PA66HS	Natural (NA)	1–3, 5
111-02159	T18L	205	2.5	55.0	80	PA66HS	Natural (NA)	1–3, 5
111-03259	T30R	150	3.5	35.0	135	PA66HS	Natural (NA)	1–3, 5
111-03459	T30L	198	3.5	50.0	135	PA66HS	Natural (NA)	1–3, 5
111-03569	T30LL	290	3.5	80.0	135	PA66HS	Natural (NA)	1–3, 5
111-03859	T40R	175	4.0	40.0	180	PA66HS	Natural (NA)	1–5
111-05859	T50S	150	4.6	35.0	225	PA66HS	Natural (NA)	1–10
111-04882	T50R	200	4.6	50.0	225	PA66HS	Natural (NA)	1–10
111-05259	T50I	300	4.6	85.0	225	PA66HS	Natural (NA)	1–10
111-05436	T50L	390	4.6	110	225	PA66HS	Natural (NA)	1–10
111-05059	T80R	210	4.7	55.0	355	PA66HS	Natural (NA)	1–10
111-08259	T80I	300	4.7	85.0	355	PA66HS	Natural (NA)	1–10
111-05459	T80L	390	4.7	110	355	PA66HS	Natural (NA)	1–10
111-12824	T120S	225	7.6	55.0	535	PA66HS	Natural (NA)	6–10
111-12249	T120I	300	7.6	80.0	535	PA66HS	Natural (NA)	6–10
111-12059	T120R(E)	387	7.6	100	535	PA66HS	Natural (NA)	6–10
111-12719	T120XM	600	7.6	175	535	PA66HS	Natural (NA)	6–10
111-12449	T120L	760	7.6	225	535	PA66HS	Natural (NA)	6–10
111-15069	T150R(H)	365	7.6	100	670	PA66HS	Natural (NA)	6–10

All dimensions in mm. Subject to technical changes.



Please note! Not all products listed on this page may have this approval. For product specific approvals please refer to the Appendix.

Cable Ties for temperatures up to + 105°C (heat stabilised)

• T-Series in PA66HS black

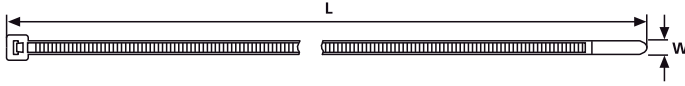

T18S – T150XXL

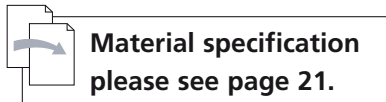

Material specification
please see page 21.



Article-No.	Type	Length (L)	Width (W)	Bundle Ø max.	Min. Tensile Strength (N)	Material	Colour	Application Tool
Polyamide 6.6. Heat Stabilised								
111-01950	T18R	100	2.5	22.0	80	PA66HS	Black (BK)	1–3, 5
111-02358	T18I	145	2.5	35.0	80	PA66HS	Black (BK)	1–3, 5
111-02049	T18L	205	2.5	55.0	80	PA66HS	Black (BK)	1–3, 5
111-03050	T30R	150	3.5	35.0	135	PA66HS	Black (BK)	1–3, 5
111-03450	T30L	198	3.5	50.0	135	PA66HS	Black (BK)	1–3, 5
111-03660	T30LL	290	3.5	80.0	135	PA66HS	Black (BK)	1–3, 5
111-03970	T40R	175	4.0	40.0	180	PA66HS	Black (BK)	1–5
111-05850	T50S	150	4.6	35.0	225	PA66HS	Black (BK)	1–10
111-04950	T50R	200	4.6	50.0	225	PA66HS	Black (BK)	1–10
117-05250	T50I	300	4.6	85.0	225	PA66HS	Black (BK)	1–10
111-05450	T50L	390	4.6	110	225	PA66HS	Black (BK)	1–10
117-08070	T80R	210	4.7	55.0	355	PA66HS	Black (BK)	1–10
111-08250	T80I	300	4.7	85.0	355	PA66HS	Black (BK)	1–10
111-00388	T80L	390	4.7	110	355	PA66HS	Black (BK)	1–10
111-12850	T120S	225	7.6	55.0	535	PA66HS	Black (BK)	6–10
111-12240	T120I	300	7.6	80.0	535	PA66HS	Black (BK)	6–10
111-12050	T120R(E)	387	7.6	100	535	PA66HS	Black (BK)	6–10
111-00153	T120M	460	7.6	125	535	PA66HS	Black (BK)	6–10
111-12700	T120XM	600	7.6	175	535	PA66HS	Black (BK)	6–10
111-12440	T120L	760	7.6	225	535	PA66HS	Black (BK)	6–10
111-15050	T150R(H)	365	7.6	100	670	PA66HS	Black (BK)	6–10
111-15609	T150M	525	8.9	150	780	PA66HS	Black (BK)	6–9
111-15410	T150L	820	8.8	245	780	PA66HS	Black (BK)	6–9
111-15510	T150XL	1095	8.9	330	780	PA66HS	Black (BK)	6–9

All dimensions in mm. Subject to technical changes.



Please note! Not all products listed on this page may have this approval. For product specific approvals please refer to the Appendix.

Cable Ties for outdoor use (UV-resistant)

• T-Series in PA66W black

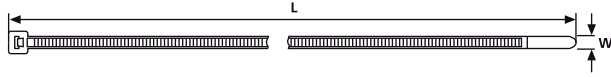

T18S – T150XXL



T250-Series

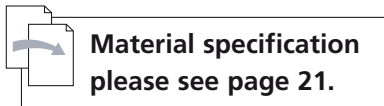

**Material specification
please see page 21.**

Article-No.	Type	Length (L)	Width (W)	Bundle Ø max.	Min. Tensile Strength (N)	Material	Colour	Application Tool
Polyamide 6.6. UV Stabilised								
111-01960	T18R	100	2.5	22	80	PA66W	Black (BK)	1–3, 5
111-02360	T18I	145	2.5	35.0	80	PA66W	Black (BK)	1–3, 5
111-02160	T18L	205	2.5	55	80	PA66W	Black (BK)	1–3, 5
111-02660	T25LL	330	2.8	95.0	110	PA66W	Black (BK)	1–3, 5
111-03260	T30R	150	3.5	35	135	PA66W	Black (BK)	1–3, 5
111-03460	T30L	198	3.5	50	135	PA66W	Black (BK)	1–3, 5
111-03570	T30LL	290	3.5	80.0	135	PA66W	Black (BK)	1–3, 5
111-03860	T40R	175	4.0	40.0	180	PA66W	Black (BK)	1–5
111-05860	T50S	150	4.6	35.0	225	PA66W	Black (BK)	1–10
111-04889	T50R	200	4.6	50.0	225	PA66W	Black (BK)	1–10
111-06206	T50M	245	4.6	65.0	225	PA66W	Black (BK)	1–10
111-05260	T50I	300	4.6	85.0	225	PA66W	Black (BK)	1–10
111-05440	T50L	390	4.6	110	225	PA66W	Black (BK)	1–10
111-06000	T50LL	445	4.6	130	225	PA66W	Black (BK)	1–10
111-05060	T80R	210	4.7	55	355	PA66W	Black (BK)	1–10
111-08290	T80I	300	4.7	85	355	PA66W	Black (BK)	1–10
111-05460	T80L	390	4.7	110	355	PA66W	Black (BK)	1–10
111-12830	T120S	225	7.6	55.0	535	PA66W	Black (BK)	6–10
111-12230	T120I	300	7.6	80.0	535	PA66W	Black (BK)	6–10
111-12060	T120R(E)	387	7.6	100	535	PA66W	Black (BK)	6–10
111-12660	T120M	460	7.6	125	535	PA66W	Black (BK)	6–10
111-12430	T120L	760	7.6	225	535	PA66W	Black (BK)	6–10
111-14860	T150R(H)	365	7.6	100	670	PA66W	Black (BK)	6–10
111-15660	T150M	525	8.9	150	780	PA66W	Black (BK)	6–9
111-15460	T150L	820	8.8	245	780	PA66W	Black (BK)	6–9
111-15502	T150XL	1095	8.9	330	780	PA66UV	Black (BK)	6–9
111-15305	T150XLL	1325	8.9	405	780	PA66W	Black (BK)	6–9
111-25100	T250X	370	12.5	100	1115	PA66W	Black (BK)	7–9
111-24805	T250R	520	12.5	145	1115	PA66HIRHSUV	Black (BK)	7–9

All dimensions in mm. Subject to technical changes.



Please note! Not all products listed on this page may have this approval. For product specific approvals please refer to the Appendix.

Cable Ties for higher impact resistant Polyamide 6.6 ScanBlack

• T-Series in PA66HIR(S)

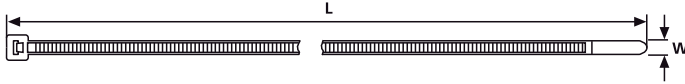

T18S – T150XXL



Article-No.	Type	Length (L)	Width (W)	Bundle Ø max.	Min. Tensile Strength (N)	Material	Colour	Application Tool
Polyamide 6.6 high impact modified, scan black (PA66HIR(S))								
111-04890	T50R	200	4.6	50.0	225	PA66HIR(S)	Black (BK)	1–10
111-00222	T50I	300	4.6	85.0	225	PA66HIR(S)	Black (BK)	1–10
111-05441	T50L	390	4.6	110	225	PA66HIR(S)	Black (BK)	1–10
111-12203	T120I	300	7.6	80.0	535	PA66HIR(S)	Black (BK)	6–10
111-00168	T120R(E)	387	7.6	100	535	PA66HIR(S)	Black (BK)	6–10
111-12402	T120L	760	7.6	225	535	PA66HIR(S)	Black (BK)	6–10

All dimensions in mm. Subject to technical changes.

Cable Ties for temperatures up to + 150°C in Polyamide 4.6

• T-Series in PA46

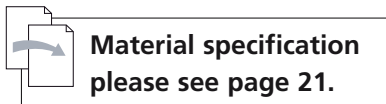

Material specification
please see page 21.



Article-No.	Type	Length (L)	Width (W)	Bundle Ø max.	Min. Tensile Strength (N)	Material	Colour	Application Tool
Polyamide 4.6								
114-01879	T18R	100	2.5	22.0	80	PA46	Natural (NA)	1–3, 5
114-03079	T30R	150	3.5	35.0	135	PA46	Natural (NA)	1–3, 5
111-00264	T30R	150	3.5	35.0	135	PA46	Grey (GY)	1–3, 5
111-00525	T50R	200	4.6	50.0	225	PA46	Natural (NA)	1–10
111-00824	T50R	200	4.6	50.0	225	PA46	Grey (GY)	1–10
111-05220	T50I	300	4.6	85.0	225	PA46	Natural (NA)	1–10
111-00526	T50L	390	4.6	110	225	PA46	Natural (NA)	1–10
114-12179	T120R(E)	387	7.6	100	535	PA46	Natural (NA)	6–10

All dimensions in mm. Subject to technical changes.



Please note! Not all products listed on this page may have this approval. For product specific approvals please refer to the Appendix.

Cable Ties for hose and gaiter

- CTT-Series up to 265 N loop tensile strength
- HT-Series up to 535 N loop tensile strength

Designed to secure pipes, hoses and gaiters, where low pressures are being secured. These ties can be used in many industries, including: automotive, white goods manufacturers and construction.

Features and Benefits

- Curved design of head offers a good fit to the bundle
- Inside serration for a positive hold onto bundles.
- Easy application either manually or with a processing tool



CTT ties installed on flexible gaiters.



Material specification
please see page 21.

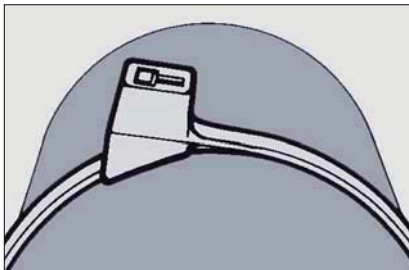

For secure fixing of round and solid shapes.



CTT Hose Ties

Article-No.	Type	Length (L)	Width (W)	Bundle Ø max.	Min. Tensile Strength (N)	Material	Colour	Application Tool
112-51919	CTT20R	100	2.5	13.0	90	PA66	Natural (NA)	1-3, 5
112-51960	CTT20R	100	2.5	13.0	90	PA66HS	Black (BK)	1-3, 5
112-56019	CTT60R	205	4.7	45.0	265	PA66	Natural (NA)	1-10
112-56060	CTT60R	205	4.7	45.0	265	PA66HS	Black (BK)	1-10
112-00100	HT120R	340	7.6	90.0	535	PA66HS	Black (BK)	6-10

All dimensions in mm. Subject to technical changes.



Please note! Not all products listed on this page may have this approval. For product specific approvals please refer to the Appendix.

Cable Ties for parallel routing

• DH-Series

Ideal for running two cables in parallel, but separated. These ties can be used for installation of a second cable run without the need for additional cable ties.

Features and Benefits

- Cable tie designed with a double head
- For parallel routing of two bundles with only one cable tie
- Bundles can be of different diameter
- Easy application either manually or with a processing tool



Parallel routing of two cable bundles using DH-Series. The double head creates an inside and an outside serrated loop.

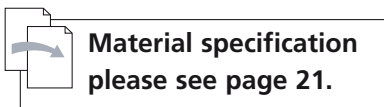

Material specification
please see page 21.

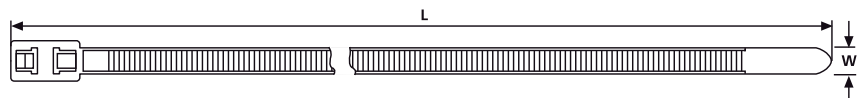

DH Series

Article-No.	Type	Length (L)	Width (W)	Ø per loop max.	Min. Tensile Strength (N)	Min. Tensile Strength (N) 2nd loop	Material	Colour	Application Tool
117-05002	T50RDH	210	4.7	19	225	180	PA66	Natural (NA)	1-10
117-05000	T50RDH	210	4.7	19	225	180	PA66	Black (BK)	1-10
117-05060	T50RDH	210	4.7	19	225	180	PA66W	Black (BK)	1-10
117-05050	T50RDH	210	4.7	19	225	180	PA66HS	Black (BK)	1-10
117-05168	T50RDH	210	4.7	19	225	180	PA46	Grey (GY)	1-10
117-05303	T50IDH	305	4.7	38.1	225	180	PA66	Natural (NA)	1-10
117-05360	T50IDH	305	4.7	38	225	180	PA66W	Black (BK)	1-10
117-05350	T50IDH	305	4.7	38	225	180	PA66HS	Black (BK)	1-10
117-05461	T50LDH	395	4.7	50.8	225	180	PA66	Natural (NA)	1-10
117-00008	T50LDH	395	4.7	50	225	180	PA66HS	Black (BK)	1-10

All dimensions in mm. Subject to technical changes.



Please note! Not all products listed on this page may have this approval.
For product specific approvals please refer to the Appendix.

Cable Ties for thin-walled bundles

• OS-Series

Designed originally for the automotive market these ties are now being used in many areas where thin-walled or soft insulation wires and cable are being installed, e.g. railways, aircraft, data cable installations, electronics.

Features and Benefits

- Outside serrated cable tie with smooth surface to the bundle
- Tie follows the contours of the cable bundle perfect
- Takes up less space due to curved head
- Easy insertion and high tensile strength
- For higher temperature or Limited Fire Hazard demand: Material PA46 or PA66V0
- Easy application either manually or with a processing tool

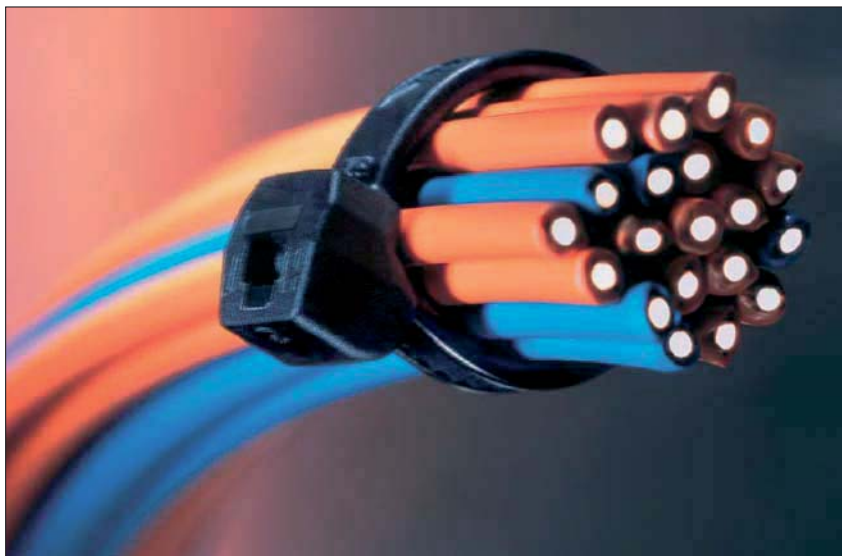

The contoured head needs less installation space, provides low insertion force and offers high strength.

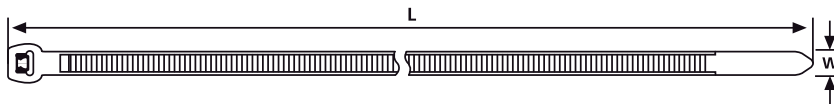

**Material specification
please see page 21.**



The new head design of the OS Series

Article-No.	Type	Length (L)	Width (W)	Bundle Ø min.	Bundle Ø max.	Min. Tensile Strength (N)	Material	Colour	Application Tool
Polyamide 6.6. Heat Stabilised									
118-00035	T18ROS	100	2.5	1.6	20.0	80	PA66HS	Natural (NA)	1-3, 5
118-04701	T18ROS	100	2.5	1.6	20.0	80	PA66HS	Black (BK)	1-3, 5
118-00064	T30ROS	148	3.4	1.6	35.0	135	PA66HS	Natural (NA)	1-3, 5
118-04800	T30ROS	145	3.4	1.6	35.0	135	PA66HS	Black (BK)	1-3, 5
118-00044	T30LOS	200	3.4	1.6	50.0	135	PA66HS	Natural (NA)	1-3, 5
118-04900	T30LOS	200	3.4	1.6	50.0	135	PA66HS	Black (BK)	1-3, 5
118-05859	T50SOS	150	4.6	1.6	35.0	225	PA66HS	Natural (NA)	1-5
118-05850	T50SOS	150	4.6	1.6	35.0	225	PA66HS	Black (BK)	1-5
118-05059	T50ROS	200	4.6	1.6	50.0	225	PA66HS	Natural (NA)	1-5
118-05040	T50ROS	200	4.6	1.6	50.0	225	PA66HS	Black (BK)	1-5
118-00055	T50MOS	245	4.6	1.6	66.0	225	PA66HS	Natural (NA)	1-5
118-00018	T50MOS	245	4.6	1.6	66.0	225	PA66HS	Black (BK)	1-5
118-05900	T50LOS	384	4.6	1.6	110	225	PA66HS	Black (BK)	1-5
118-00067	T120ROS	385	7.6	5.0	105	535	PA66HS	Natural (NA)	6-10
118-00066	T120ROS	385	7.6	5.0	105	535	PA66HS	Black (BK)	6-10
Polyamide 6.6 V0-HOI									
118-00079	T18ROS	100	2.5	1.6	20.0	80	PA66V0-HOI	White (WH)	1-3, 5
118-00080	T30LOS	200	3.4	1.6	50.0	135	PA66V0-HOI	White (WH)	1-3, 5
118-00081	T50MOS	245	4.6	1.6	66.0	225	PA66V0-HOI	White (WH)	1-5
118-00082	T120ROS	385	7.6	5.0	105	535	PA66V0-HOI	White (WH)	6-10
Polyamide 4.6									
118-05078	T50ROS	200	4.6	1.6	50.0	225	PA46	Grey (GY)	1-5

All dimensions in mm. Subject to technical changes.

Other materials available on request.

Cable Ties for high temperature application up to +240°C

• PEEK Ties

PEEK Ties have been designed for the use in hazardous environment.

Its suitability for high temperature applications makes it useful for the drilling industry, railway, offshore or automotive industry.

The excellent chemical and radiation resistance is predestined for applications in medical engineering, chemical industry and power stations.

With regards to aerospace industry PEEK ties are suitable due to their good ratio weight to tensile strength.

Because of this combination of different properties PEEK ties can replace metal solutions.



The contoured head takes up less space, gives a low insertion force and offers high strength.

Features and Benefits

- For high temperature application from -55° C up to +240° C
- Outside serrated cable tie with smooth surface to the bundle
- Close-fitting to the cable bundle due to the deepening head shape
- Easy insertion combined with high tensile strength
- Takes up less space due to curved head
- Conjuncts performance of a metal tie with the ease of use of a polyamide cable tie.
- Easy application either manually or with a processing tool

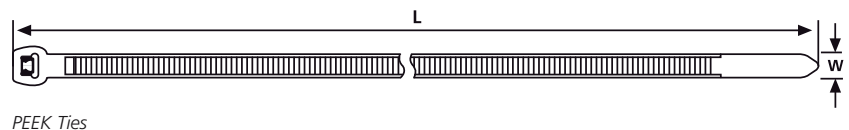
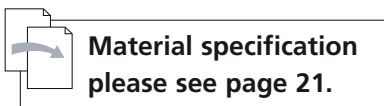

Article-No.	Type	Length (L)	Width (W)	Bundle Ø min.	Bundle Ø max.	Min. Tensile Strength (N)	Material	Colour	Application Tool
118-00032	Outside serrated PT2A	145	3.4	4.0	35.0	230	PEEK	Beige (BGE)	MK7, MK7P
111-01235	Inside Serrated PT220	220	4.7	8.0	56	380	PEEK	Beige (BGE)	MK7, MK7P, MK9, MK9P

All dimensions in mm. Subject to technical changes.



Please note! Not all products listed on this page may have this approval. For product specific approvals please refer to the Appendix.

Cable tie with 90° angled head

• V-Series

The outside serrated V-Series are perfectly suitable with its low profile head for applications with restricted space like camera and alarm systems and Automation systems (Remote I/O Systems)

If bundles have to be fed through a grommet or ductwork the V-Series is due to its lentiform head and rounded design a practical solution.

Features and Benefits

- Outside serrated cable tie with smooth surface to the bundle
- Lentiform, 90° angled head
- Rounded head design minimizes risk to damage insulation especially of parallel routed bundles
- Head takes up less height above the bundle
- close-fitting to the the cable bundle
- Easy insertion and high tensile strength
- Easy application either manually or with a processing tool

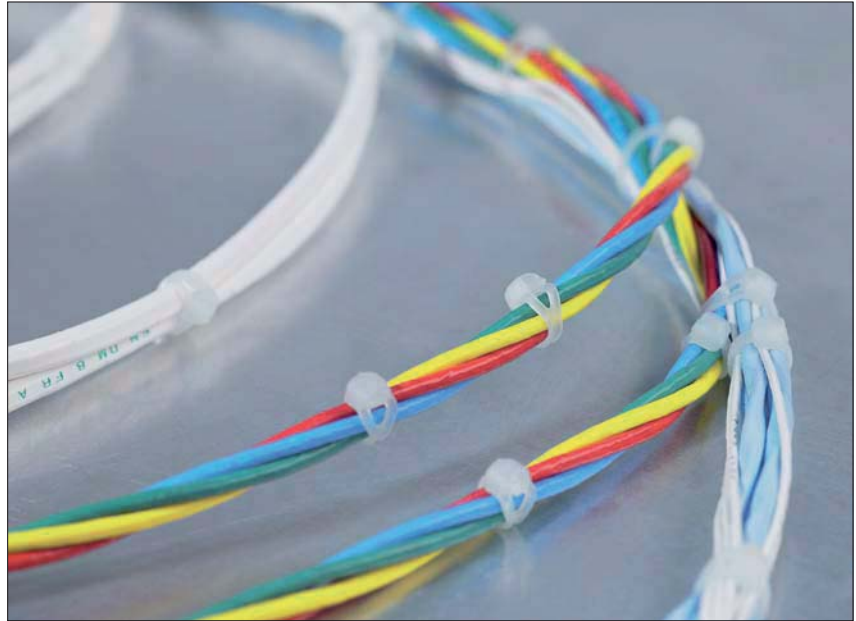

V-Series is perfect for parallel bundles.

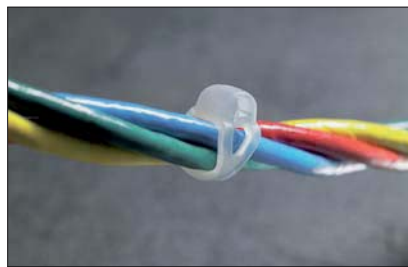

V-Series - less height above the bundle.



Outside serration means no damage of insulation.

 **Material specification please see page 21.**

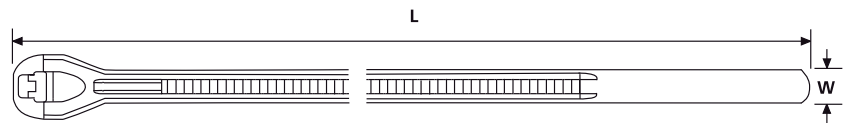

V-Series

Article-No.	Type	Length (L)	Width (W)	Bundle Ø max.	Min. Tensile Strength (N)	Material	Colour	Application Tool
118-00074	V100R	102.5	2.45	20	100	PA66HS	Natural (NA)	1-3, 5
118-00089	V150R	150	3.3	35	150	PA66HS	Natural (NA)	1-3, 5
118-00109	V100R	102.5	2.45	20	100	PA46	Grey (GY)	1-3, 5
118-00107	V150R	150	3.3	35	150	PA46	Grey (GY)	1-3, 5

All dimensions in mm. Subject to technical changes.

Cable Tie locked by glass fibre pin

• KR-Series

In addition to offering a secure method of bundling cables the design of the KR ties make them ideal for use as a method of securing bellows on steering racks, water hoses and vacuum lines.

Material PA 12 is less hygroscopic and therefore constant in dimension and performance.

Features and Benefits

- Patented cable tie system consisting of:
- Smooth strap which is locked into place with a glass-fibre reinforced pin
- For assembly a special KR-tool is needed
- Very secure and vibration resistant fixing
- KR-ties up to 426 mm are made as one piece
- KR-ties 500 mm and longer have a ultrasonic welded head
- Endless strap (50 m on reel) and separate heads KR8C5 for bundle diameters larger than 470 mm

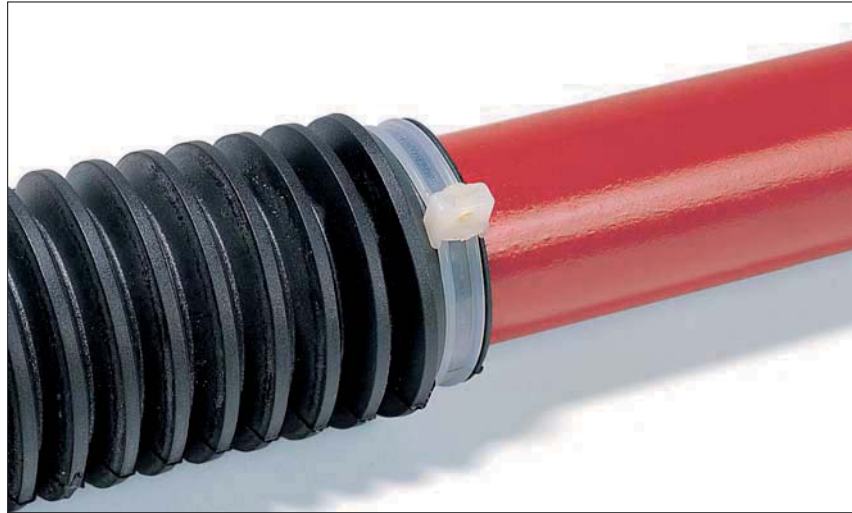

The KR8/33 has been repeatedly proven in High Vibration applications.

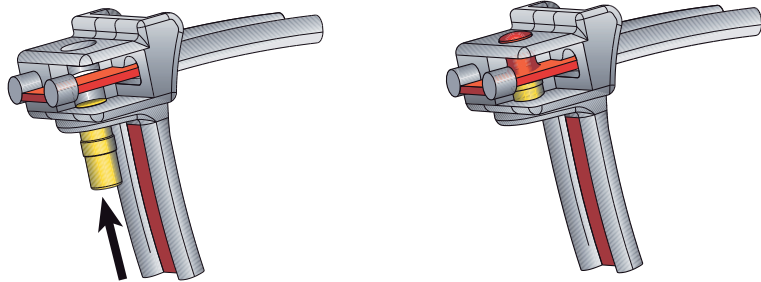

The unlocked head of a KR-tie.

The cable tie (red) is locked into place with the pin.

Material specification please see page 21.

Article-No.	Type	Length (L)	Width (W)	Bundle Ø max.	Min. Tensile Strength (N)	Material	Colour	Application Tool
KR6								
121-63519	KR6/35	356	6.0	93.0	490	PA66	Natural (NA)	KR6/8
121-63555	KR6/35	356	6.0	93.0	490	PA66HS	Natural (NA)	KR6/8
121-63560	KR6/35	356	6.0	93.0	490	PA66W	Black (BK)	KR6/8
KR8-one piece								
121-82119	KR8/21	210	8.0	47.0	785	PA66	Natural (NA)	KR6/8, KR8PNSE
121-82155	KR8/21	210	8.0	47.0	785	PA66HS	Natural (NA)	KR6/8, KR8PNSE
121-82160	KR8/21	210	8.0	47.0	785	PA66W	Black (BK)	KR6/8, KR8PNSE
121-83319	KR8/33	337	8.0	86.0	785	PA66	Natural (NA)	KR6/8, KR8PNSE
121-83355	KR8/33	337	8.0	86.0	785	PA66HS	Natural (NA)	KR6/8, KR8PNSE
121-83360	KR8/33	337	8.0	86.0	785	PA66W	Black (BK)	KR6/8, KR8PNSE
121-83380	KR8/33	337	8.0	86.0	390	PA12	Black (BK)	KR6/8, KR8PNSE
121-83378	KR8/33	337	8.0	86.0	785	PA46	Grey (GY)	KR6/8, KR8PNSE
121-74359	KR8/43	426	8.0	105	785	PA66HS	Natural (NA)	KR6/8, KR8PNSE
121-74360	KR8/43	426	8.0	105	785	PA66HS	Black (BK)	KR6/8, KR8PNSE

All dimensions in mm. Subject to technical changes.



Please note! Not all products listed on this page may have this approval. For product specific approvals please refer to the Appendix.

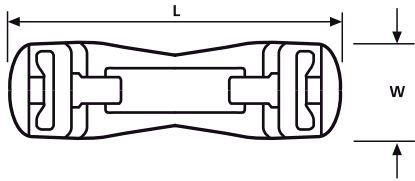

Double-head KR8C5



KR Series is available in different sizes

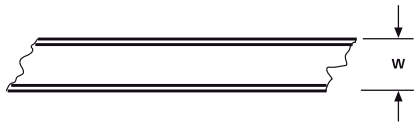

Cable ties KR8S1

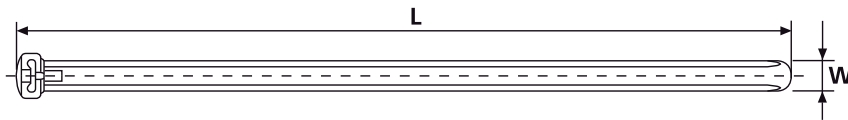

Cable ties KR-Series

 **Material specification
please see page 21.**

Article-No.	Type	Length (L)	Width (W)	Bundle Ø max.	Min. Tensile Strength (N)	Material	Colour	Application Tool
KR8-ultrasonic welded								
121-05019	KR8/50	500	8.0	152	785	PA66	Natural (NA)	KR6/8, KR8PNSE
121-05051	KR8/50	500	8.0	152	720	PA66HS	Natural (NA)	KR6/8, KR8PNSE
121-05060	KR8/50	500	8.0	152	785	PA66W	Black (BK)	KR6/8, KR8PNSE
121-06019	KR8/60	600	8.0	184	785	PA66	Natural (NA)	KR6/8, KR8PNSE
121-06060	KR8/60	600	8.0	184	785	PA66W	Black (BK)	KR6/8, KR8PNSE
121-07019	KR8/70	700	8.0	216	785	PA66	Natural (NA)	KR6/8, KR8PNSE
121-07060	KR8/70	700	8.0	216	785	PA66W	Black (BK)	KR6/8, KR8PNSE
121-08019	KR8/80	800	8.0	248	785	PA66	Natural (NA)	KR6/8, KR8PNSE
121-08060	KR8/80	800	8.0	248	785	PA66W	Black (BK)	KR6/8, KR8PNSE
121-10019	KR8/100	1000	8.0	300	785	PA66	Natural (NA)	KR6/8, KR8PNSE
121-10060	KR8/100	1000	8.0	300	785	PA66W	Black (BK)	KR6/8, KR8PNSE
121-11051	KR8/110	1100	8.0	344	720	PA66HS	Natural (NA)	KR6/8, KR8PNSE
121-11060	KR8/110	1100	8.0	344	785	PA66W	Black (BK)	KR6/8, KR8PNSE
121-12019	KR8/120	1200	8.0	375	785	PA66	Natural (NA)	KR6/8, KR8PNSE
121-15019	KR8/150	1500	8.0	471	785	PA66	Natural (NA)	KR6/8, KR8PNSE
KR8C5								
121-58560	KR8/C5	38.0	11.7	–	–	PA66W	Black (BK)	KR6/8
121-58551	KR8/C5	38.0	11.7	–	–	PA66HS	Natural (NA)	KR6/8
KR8S1								
121-98160	KR8/S1	50.0	8.0	–	785	PA66W	Black (BK)	KR6/8
121-98151	KR8/S1	50.0	8.0	–	720	PA66HS	Natural (NA)	KR6/8

All dimensions in mm. Subject to technical changes.

Cable Ties for single hole application (Chassis Tie)

Using a single hole these 'chassis ties' are widely used in the automotive, truck and heavy equipment markets. Ideal for applications which have access to both sides of the hole - for example truck frames.

Features and Benefits

- Both sides serrated cable tie
- BHT-Series with round head for larger bearing area
- BHT375 for centered position
- CT- and DE-Series with small squared head for restricted space areas
- Tensioning with application tool



BHT375 - used for mounting cables via a single hole.

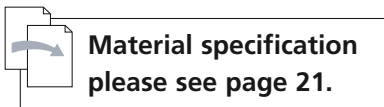

Material specification
please see page 21.

Article-No.	Type	Length (L)	Width (W)	Bundle Ø max.	Min. Tensile Strength (N)	Material	Colour	Application Tool
With centering, round head								
150-37595	BHT375	375	7.6	100	700	PA66HS	Black (BK)	6-10
Without centering, round head								
150-47595	BHT375M	375	7.6	100	700	PA66HS	Black (BK)	6-10
Without centering, square head								
132-37540	CT375	375	7.6	100	700	PA66HS	Black (BK)	6-10
132-00200	DE863220	300	6.0	80.0	135	PA66HS	Black (BK)	6-10

All dimensions in mm. Subject to technical changes.

Properties of 304/316 steel (similar to V2A/V4A steel)



Stainless Steel Cable Ties can be used at temperatures up to 538° C.

Stainless steel cable ties				
Material	Chem. material properties*	Operating Temperature	Flammability	
Stainless Steel (SS304)	<ul style="list-style-type: none"> Corrosion resistant Weather resistant Outstanding chemical resistance Antimagnetic 	-80 °C to +538 °C	non-burning	
Stainless Steel (SS316)	<ul style="list-style-type: none"> Salt spray resistant Corrosion resistant Weather resistant Outstanding chemical resistance Antimagnetic 	-80 °C to +538 °C	non-burning	
Material	Chem. material properties*	Operating Temperature Tie	Flammability Coating	Operating Temperature Coating
Stainless Steel (SS316), Polyester (SP)	<ul style="list-style-type: none"> Salt spray resistant Corrosion resistant Weather resistant Outstanding chemical resistance Antimagnetic 	-80 °C to +538 °C	halogen free	-50 °C to +150 °C, continuous



*These details are only rough guide values. They should be regarded as a material specification and are no substitute for a suitability test. Please see our datasheets for further details.

Cable Ties with Ball-Lock

• MBT-Series

The MBT range of stainless steel cable ties can be used in the most arduous of conditions or where the additional security, strength and fire resistance of a metal fixing is required. Used in all industries from Mass Transit and Ship building to automotive high temperature application.

Features and Benefits

- Cable ties MBT, made from stainless steel
- Patented non-releasable locking feature
- Corrosion resistant
- Weather resistant
- Outstanding chemical resistance
- Antimagnetic
- High temperatur resistant
- Non-burning

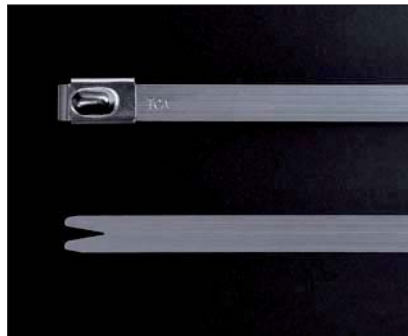

MBT_SS, MBT_HS.



MBT_XHS.

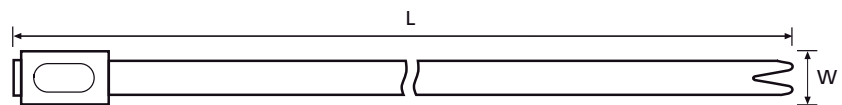

MBT_SS, MBT_HS.

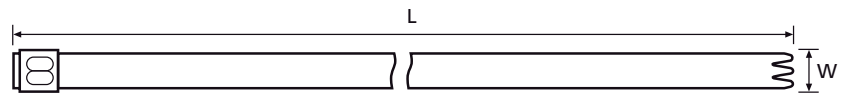

MBT_XHS.

 **Material specification
please see page 36.**

Article-No.	Type	Length (L)	Width (W)	Bundle Ø max.	Min. Tensile Strength (N)	Material	Application Tool
Material Typ SS304							
111-93058	MBT5SS	127	4.6	25	900	SS304	MK9SST, KST-STG200
111-93088	MBT8SS	201	4.6	50	900	SS304	MK9SST, KST-STG200
111-93148	MBT14SS	362	4.6	102	900	SS304	MK9SST, KST-STG200
111-93208	MBT20SS	521	4.6	152	900	SS304	MK9SST, KST-STG200
111-93278	MBT27SS	681	4.6	203	900	SS304	MK9SST, KST-STG200
111-93338	MBT33SS	838	4.6	254	900	SS304	MK9SST, KST-STG200
111-94088	MBT8HS	201	7.9	50	2000	SS304	MK9SST, KST-STG200
111-94148	MBT14HS	362	7.9	102	2000	SS304	MK9SST, KST-STG200
111-94208	MBT20HS	521	7.9	152	2000	SS304	MK9SST, KST-STG200
111-94278	MBT27HS	681	7.9	203	2000	SS304	MK9SST, KST-STG200
111-94338	MBT33HS	838	7.9	254	2000	SS304	MK9SST, KST-STG200
111-95148	MBT14XHS	362	12.3	102	2700	SS304	MK9SST, KST-STG200
111-95208	MBT20XHS	521	12.3	152	2700	SS304	MK9SST, KST-STG200
111-95278	MBT27XHS	681	12.3	203	2700	SS304	MK9SST, KST-STG200
111-95338	MBT33XHS	838	12.3	254	2700	SS304	MK9SST, KST-STG200

All dimensions in mm. Subject to technical changes.



Please note! Not all products listed on this page may have this approval.

For product specific approvals please refer to the Appendix.

Cable Ties with Ball-Lock

• MBT-Series

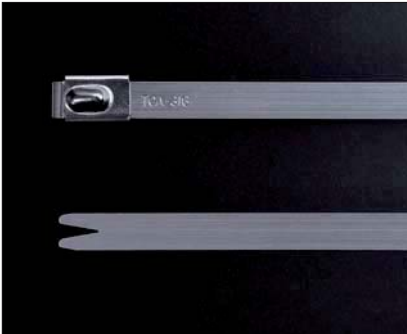

MBT_S, MBT_H.



MBT_XH.

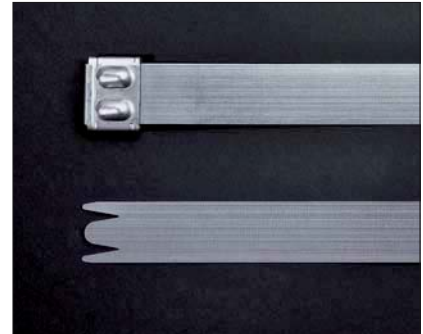

MBT_UH.

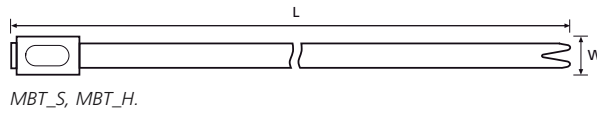

MBT_S, MBT_H.

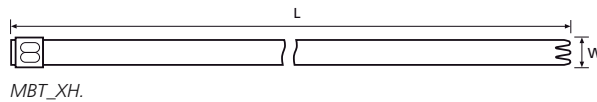

MBT_XH.

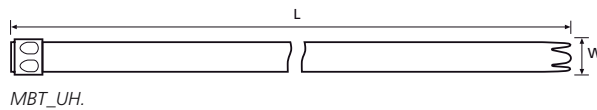

MBT_UH.

 **Material specification please see page 36.**

Article-No.	Type	Length (L)	Width (W)	Bundle Ø max.	Min. Tensile Strength (N)	Material	Application Tool
Material Typ SS316							
111-93059	MBT5S	127	4.6	25	900	SS316	MK9SST, KST-STG200
111-93089	MBT8S	201	4.6	50	900	SS316	MK9SST, KST-STG200
111-93149	MBT14S	362	4.6	102	900	SS316	MK9SST, KST-STG200
111-93209	MBT20S	521	4.6	152	900	SS316	MK9SST, KST-STG200
111-93279	MBT27S	681	4.6	203	900	SS316	MK9SST, KST-STG200
111-93339	MBT33S	838	4.6	254	900	SS316	MK9SST, KST-STG200
111-94089	MBT8H	201	7.9	50	2000	SS316	MK9SST, KST-STG200
111-94149	MBT14H	362	7.9	102	2000	SS316	MK9SST, KST-STG200
111-94209	MBT20H	521	7.9	152	2000	SS316	MK9SST, KST-STG200
111-94279	MBT27H	681	7.9	203	2000	SS316	MK9SST, KST-STG200
111-94339	MBT33H	838	7.9	254	2000	SS316	MK9SST, KST-STG200
111-95149	MBT14XH	362	12.3	102	2700	SS316	MK9SST, KST-STG200
111-95209	MBT20XH	521	12.3	152	2700	SS316	MK9SST, KST-STG200
111-95279	MBT27XH	681	12.3	203	2700	SS316	MK9SST, KST-STG200
111-95339	MBT33XH	838	12.3	254	2700	SS316	MK9SST, KST-STG200
111-01301	MBT14UH	362	16.0	102	4100	SS316	on request
111-01302	MBT20UH	521	16.0	152	4100	SS316	on request
111-01303	MBT27UH	681	16.0	203	4100	SS316	on request
111-01304	MBT33UH	838	16.0	254	4100	SS316	on request
111-01305	MBT43UH	1092	16.0	330	4100	SS316	on request
111-01306	MBT49UH	1245	16.0	380	4100	SS316	on request

All dimensions in mm. Subject to technical changes.



Please note! Not all products listed on this page may have this approval. For product specific approvals please refer to the Appendix.

Double Band Cable Ties with Ball-Lock

• MBTXHD- / MBTUHD-Series

Metal ties are predestinated for all areas with requirements for high holding force, reliability and fire resistance. The double band ties of the MBT-series are used in applications where a fixing requires an extraordinary high tensile strength. This may be required on oil platform as well as in shipbuilding, mining and railway industry.

Features and Benefits

- MBT ties made from stainless steel SS304 or SS316
- Can be wrapped around the bundle twice
- For improved tensile strength to withstand enormous applied loads
- Patented non-releasable locking feature with two balls
- Corrosion resistant
- Weather resistant
- Outstanding chemical resistance
- Antimagnetic
- High temperatur resistant
- Non-burning



MBT_XHD Double Band.

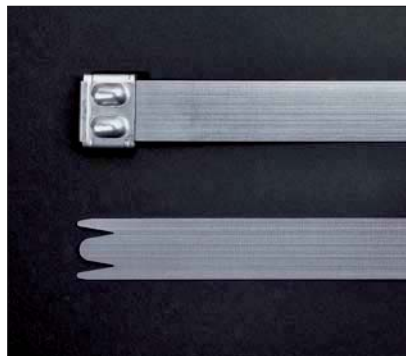

MBT_UHD Double Band.

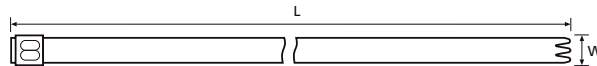

MBT_XHD.

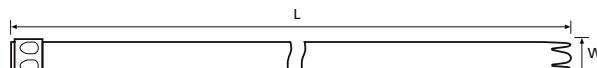

MBT_UHD.



**Material specification
please see page 36.**

Article-No.	Type	Length (L)	Width (W)	Bundle Ø max.	Min. Tensile Strength (N)	Material	Application Tool
111-01307	MBT27XHD	681	12.3	100	3600	SS316	MK9SST, KST-STG200
111-01308	MBT33XHD	838	12.3	120	3600	SS316	MK9SST, KST-STG200
111-01309	MBT43XHD	1092	12.3	160	3600	SS316	MK9SST, KST-STG200
111-01310	MBT49XHD	1245	12.3	180	3600	SS316	MK9SST, KST-STG200
111-01311	MBT60XHD	1524	12.3	230	3600	SS316	MK9SST, KST-STG200
111-01312	MBT27UHD	681	16.0	100	5400	SS316	on request
111-01313	MBT33UHD	838	16.0	120	5400	SS316	on request
111-01314	MBT43UHD	1092	16.0	160	5400	SS316	on request
111-01315	MBT49UHD	1245	16.0	180	5400	SS316	on request
111-01316	MBT60UHD	1524	16.0	230	5400	SS316	on request

All dimensions in mm. Subject to technical changes.



Please note! Not all products listed on this page may have this approval. For product specific approvals please refer to the Appendix.

Cable Ties with Ball-Lock and Coating

• MBT-FC-Series

Metal ties are predestinated for all areas with requirements for high holding force, reliability and fire resistance. Stainless Steel cable ties with polyester coating provide a comfortable installation, especially when using at low temperatures. These products are chosen when high tensile strength is demanded and contact corrosion has to be avoided.

Features and Benefits

- MBT cable ties, Stainless steel SS316, fully polyester coated
- Improved installation comfort especially when used at low temperatures
- Strong tensile strength combined with the protection of plastic coating for sensitive harnesses
- Avoids contact corrosion



MBT_SFC, MBT_HFC.

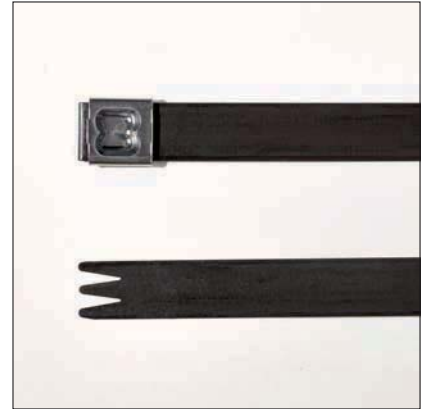

MBT_XHFC.

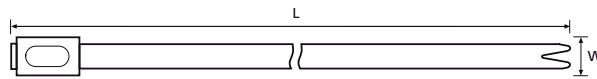

MBT_SFC, MBT_HFC.

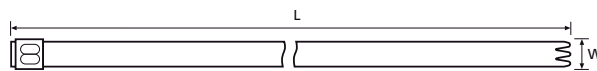

MBT_XHFC.

 **Material specification please see page 36.**

Article-No.	Type	Length (L)	Width (W)	Bundle Ø max.	Min. Tensile Strength (N)	Material	Application Tool
MBT fully coated							
111-00288	MBT5SFC	127	4.6	25	540	SS316, SP	MK9SST, KST-STG200
111-00289	MBT8SFC	201	4.6	50	540	SS316, SP	MK9SST, KST-STG200
111-00290	MBT14SFC	362	4.6	102	540	SS316, SP	MK9SST, KST-STG200
111-00291	MBT20SFC	521	4.6	152	540	SS316, SP	MK9SST, KST-STG200
111-00292	MBT27SFC	681	4.6	203	540	SS316, SP	MK9SST, KST-STG200
111-00293	MBT33SFC	838	4.6	254	540	SS316, SP	MK9SST, KST-STG200
111-00294	MBT8HFC	201	7.9	50	1020	SS316, SP	MK9SST, KST-STG200
111-00295	MBT14HFC	362	7.9	102	1020	SS316, SP	MK9SST, KST-STG200
111-00296	MBT20HFC	521	7.9	152	1020	SS316, SP	MK9SST, KST-STG200
111-00297	MBT27HFC	681	7.9	203	1020	SS316, SP	MK9SST, KST-STG200
111-00298	MBT33HFC	838	7.9	254	1020	SS316, SP	MK9SST, KST-STG200
111-00299	MBT14XHFC	362	12.3	102	1620	SS316, SP	MK9SST, KST-STG200
111-00300	MBT20XHFC	521	12.3	152	1620	SS316, SP	MK9SST, KST-STG200
111-00301	MBT27XHFC	681	12.3	203	1620	SS316, SP	MK9SST, KST-STG200
111-00302	MBT33XHFC	838	12.3	254	1620	SS316, SP	MK9SST, KST-STG200

All dimensions in mm. Subject to technical changes.



Please note! Not all products listed on this page may have this approval. For product specific approvals please refer to the Appendix.

Cable Ties with Fold Locking

- **MLT-Series**
- **MLT-C**

Metal ties are predestinated for all areas with requirements for high holding force, reliability and fire resistance. The MLT range of stainless steel cable ties can be used in all industries from Mass Transit, Ship building, oil rigs, mining, and chemical to theatres and exhibition halls.

Features and Benefits

- MLT metal cable ties, Stainless steel SS316
- Simple and effective locking mechanism
- Feed the strap through the locking head and tension it
- Bend the strap and crimp the buckle for closing
- Locking can be opened
- To avoid contact corrosion the MLT-Series are also available with polyester coating

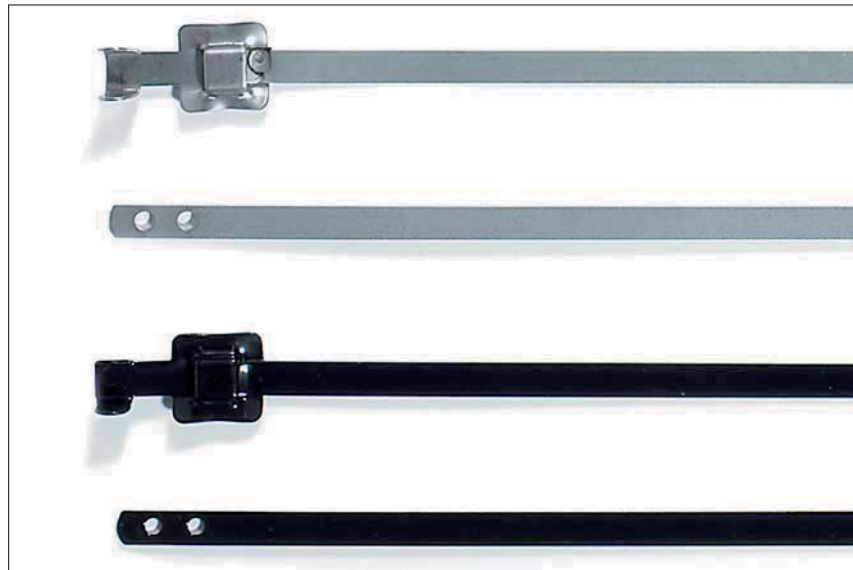

These Metal ties are available with and without coating.

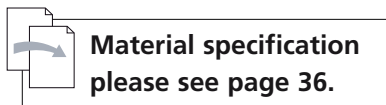
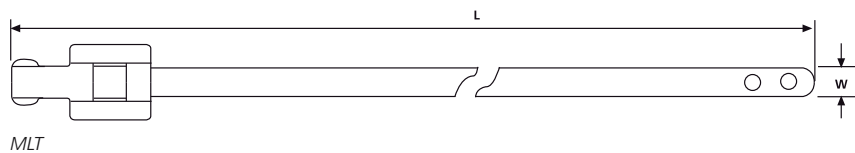

**Material specification
please see page 36.**

Article-No.	Type	Length (L)	Width (W)	Bundle Ø max.	Min. Tensile Strength (N)	Material	Application Tool
MLT Uncoated							
111-94080	MLT8SS5	230	5.0	60	420	SS316	MTT4
111-94120	MLT12SS5	330	5.0	90	420	SS316	MTT4
111-94161	MLT16SS5	430	5.0	120	420	SS316	MTT4
111-91400	MLT24SS5	630	5.0	180	420	SS316	MTT4
111-95080	MLT8SS10	230	10.0	60	850	SS316	MTT4
111-95120	MLT12SS10	330	10.0	90	850	SS316	MTT4
111-91300	MLT16SS10	430	10.0	120	850	SS316	MTT4
111-95241	MLT24SS10	630	10.0	180	850	SS316	MTT4
MLT-C Coated							
111-91000	MLT8SSC5	230	5.26	60	420	SS316, SP	MTT4
111-91121	MLT12SSC5	330	5.26	90	420	SS316, SP	MTT4
111-91161	MLT16SSC5	430	5.26	120	420	SS316, SP	MTT4
111-91180	MLT24SSC5	630	5.26	180	420	SS316, SP	MTT4
111-91001	MLT8SSC10	230	10.26	60	850	SS316, SP	MTT4
111-91123	MLT12SSC10	330	10.26	90	850	SS316, SP	MTT4
111-91163	MLT16SSC10	430	10.26	120	850	SS316, SP	MTT4
111-91181	MLT24SSC10	630	10.26	180	850	SS316, SP	MTT4

All dimensions in mm. Subject to technical changes.



Please note! Not all products listed on this page may have this approval.

For product specific approvals please refer to the Appendix.

Cable Ties with Raster Locking

- MAT-Series
- MAT-C

The MAT range of stainless steel cable ties can be used when durability and fire resistance is required. i.e.g. MassTransit or light and radio technology. The 12mm wide MAT ties offer a broad contact area and are therefore suitable for more damageable bundles.

Features and Benefits

- MAT metal cable ties, Stainless steel SS316
- Similar in design to conventional 'plastic' cable ties
- Locking mechanism works on a ratchet system
- To avoid contact corrosion the MLT-Series are also available with polyester coating



Stainless Steel Cable Ties can be used at temperatures up to 538° C.

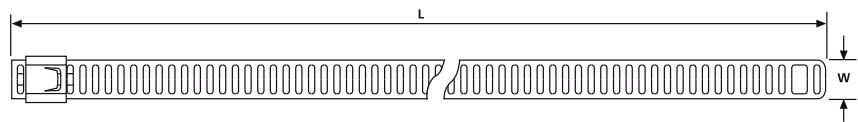

MAT

 **Material specification please see page 36.**

Article-No.	Type	Length (L)	Width (W)	Bundle Ø max.	Min. Tensile Strength (N)	Material	Application Tool
MAT Uncoated							
111-92080	MAT8SS7	230	7.0	60	445	SS316	MK9SST, KST-STG200
111-92120	MAT12SS7	330	7.0	90	445	SS316	MK9SST, KST-STG200
111-92160	MAT16SS7	430	7.0	120	445	SS316	MK9SST, KST-STG200
111-92240	MAT24SS7	630	7.0	180	445	SS316	MK9SST, KST-STG200
111-93080	MAT8SS12	230	12.0	60	445	SS316	MK9SST, KST-STG200
111-93120	MAT12SS12	330	12.0	90	445	SS316	MK9SST, KST-STG200
111-93160	MAT16SS12	430	12.0	120	445	SS316	MK9SST, KST-STG200
111-93240	MAT24SS12	630	12.0	180	445	SS316	MK9SST, KST-STG200
MAT-C Coated							
111-92004	MAT8SSC7	230	7.0	60	445	SS316, SP	MK9SST, KST-STG200
111-96120	MAT12SSC7	330	7.0	90	445	SS316, SP	MK9SST, KST-STG200
111-92162	MAT16SSC7	430	7.0	120	445	SS316, SP	MK9SST, KST-STG200
111-92200	MAT24SSC7	630	7.0	180	445	SS316, SP	MK9SST, KST-STG200
111-92002	MAT8SSC12	230	12.0	60	445	SS316, SP	MK9SST, KST-STG200
111-92122	MAT12SSC12	330	12.0	90	445	SS316, SP	MK9SST, KST-STG200
111-92163	MAT16SSC12	430	12.0	120	445	SS316, SP	MK9SST, KST-STG200
111-92201	MAT24SSC12	630	12.0	180	445	SS316, SP	MK9SST, KST-STG200

All dimensions in mm. Subject to technical changes.



Please note! Not all products listed on this page may have this approval. For product specific approvals please refer to the Appendix.

Protective Channel for Stainless Steel Ties

• LFPC

When used in conjunction with the MBT range of stainless steel cable ties this channel gives the cable protection against chafing, vibration and shock.

Features and Benefits

- LFPC channel, manufactured from Polyolefin
- Works with MBT-Series
- Smooth surface protects bundel against chafing due to vibrations
- Halogenfree
- Flame retardant



Cable tie MBTXH with LFPC Protective Channel.

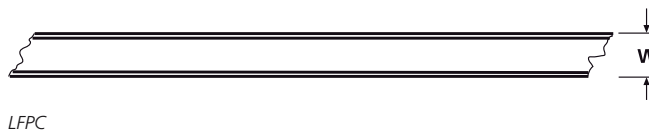

LFPC



**Material specification
please see page 21.**

Article-No.	Type	For Ties	Width (W)
111-93000	LFPC70	MBTS	7.0
111-94000	LFPC103	MBTH	10.3
111-95000	LFPC150	MBTXH	15.0
111-00257	LFPC83	MBTH	8.3
111-00253	LFPC129	MBTXH	12.9
111-00254	LFPC132	MBTXH	13.2
111-00255	LFPC163	AMT, MBTUH	16.3

All dimensions in mm. Subject to technical changes.

The fire protection properties of the material relate to the test performed on defined test samples. This is a test under laboratory conditions and not directly transferable to the product made from this material.

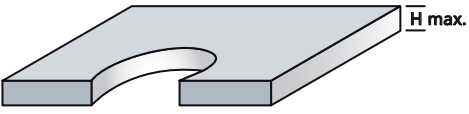
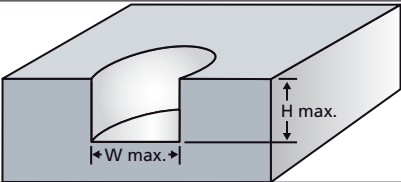
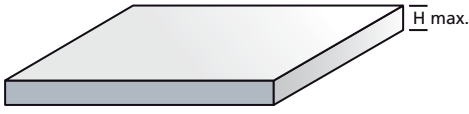
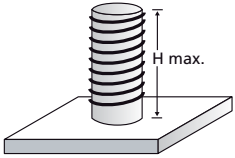
Application	Arrowhead	Fir Tree Mount	Rivet Wall Plug	Screw Mount	EdgeClip	Weld Stud Mount
	●	●		●		
		●	●	●		
					●	
						●



Arrowhead

This fixing tie is based on an arrowhead offering high extraction forces. The arrowhead is securely in place when a click can be heard and felt by the user.



Arrowhead with disc

The disc minimises the ingress of dust, dirt and water. Furthermore a safe fixation inside the drill hole is assured that withstands pressure from various directions.



Arrowhead with supporting legs

Arrowhead fixings with supporting legs offer good and stable fixation in drilled holes. The supporting legs generate additional pressure to assure a firm and secure fixing while taking up any variation in panel thickness. These ties are also suitable in high vibration applications.



Arrowhead without supporting legs

The arrowhead design assures good fixation while utilising lowest possible space.



Fir Tree Mount

Fir Tree Mounts can be pushed into pre-punched holes easily in panels or threaded, blind holes based on the low insertion forces. The design is ideally suited for a wide range of sheet thicknesses. The disc on top of the fir tree covers the hole and minimises the ingress of dust, dirt and water.



Weld Stud Mount

Various of the HellermannTyton weld stud mounts can easily be attached by hand ("soft push") the design offers very low insertion forces that require no tools.

The mounts can be removed by twisting to the left.

SB9 and SB14 are based on "hard push" technology and require a hammer to be applied.



Weld Stud Fixings with lateral adjustment

The special oval shape of these mounts provides a 5-6 mm lateral adjustment to cater for any misalignment of the stud or incorrect positioning of ties on the cables. The bundle can therefore be moved when mounted.



EdgeClip

The EdgeClips are specifically designed to bundle and guide cable and wires on edges. Cost intensive drill holes for fixing are no longer required. EdgeClips are easily mounted by hand, the integrated metal clamp, securely keeping the clips on the edge.



EdgeClip twistable

Ideally suited for fixations where bundles need to be flexibly guided. These EdgeClips are available with facilities for 90° or 360° rotation.



EdgeClip without metal clamp

These EdgeClips are easily attached. The holding tap snaps into the drill hole securely.



Cable & Hose Attachment

Excellent solution for subsequent attachment of pipes and wires to installed tubes.

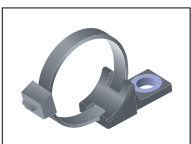

Heavy Duty Application

These sturdy fixing ties can withstand vibrations. They are easy to apply and give a secure alignment to the bundle. There will be High tightening torque through metal bushing.



Two Piece Fixing Ties with Clip Coupler

The Coupler is an article to connect two cable ties maximum for parallel bundling of tubes, harnesses or cables. Its design enables the cable ties to rotate up to 90° and allows flexible installations.

1-Piece Fixing Ties with Arrowhead, with Disc

With a diverse range of fixing possibilities (from 4.4mm to 8.0mm hole diameters and 0.5mm to 8.0mm panel thickness) this range of fixing ties is ideal for use in many different industries, including automotive, aerospace and panel building.

Features and Benefits

- Easy to install without the need for a tool
- Arrowhead simply locks into place
- Disc adjusts tie for pressures from various directions and minimises access of dust, dirt and water
- Cable tie head always situated in a defined position
- KSFT-types with specially rounded arrowhead minimise the assembly height



The flexible 'disc' adjusts to take up variations in panel thickness - ensuring a firm fixing at all times.

 **Material specification please see page 21.**



Special design without a gap between head and bundle; T50MD7.

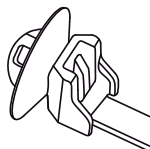

T50SOSKSFT65E

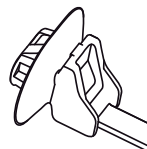

T50SOSKSFT62x122PT07-13

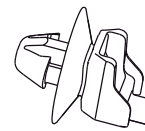

T50SOSSFT6.5E

Article-No.	Type	Length (L)	Width (W)	Bundle Ø max.	Min. Tensile strength for ties (N)	Disc Ø	Hole Ø	Panel Thickness min.	Panel Thickness max.	Material	Colour
1-Piece Fixing Ties with Arrowhead, with Disc for round holes											
126-00075	T50SOSKSFT5.4E	156.0	4.6	35.0	225	16.0	5.2 - 5.6	0.7	1.3	PA66HS	Black (BK)
126-02300	T50SST5	170.0	4.6	31.0	225	16.2	6.1 - 6.5	0.7	1.5	PA66	Natural (NA)
150-15395	T50SST5	170.0	4.6	31.0	225	16.2	6.1 - 6.5	0.7	1.5	PA66HS	Black (BK)
126-00017	T50SST5	170.0	4.6	31.0	225	16.2	6.1 - 6.5	0.7	1.5	PA66HS	Black (BK)
111-85850	T50MD7	225.0	5.0	59.0	225	16.0	6.8 - 7.2	1.2	2.0	PA66HS	Black (BK)
126-03102	T50SOSSFT6.5E	160.0	4.6	35.0	225	16.0	6.3 - 6.7	1.9	2.5	PA66HS	Black (BK)
126-00081	T50SOSKSFT65E	156.0	4.6	35.0	180	16.0	6.3 - 6.7	0.7	1.3	PA66HS	Black (BK)
126-00086	T50SOSSFT6.5S2-E	157.0	4.6	35.0	225	16.0	6.3 - 6.7	1.7	2.3	PA66HS	Black (BK)
111-85350	T50SD6	160.0	5.0	31.0	180	18.0	6.3 - 7.5	0.6	1.8	PA66HS	Black (BK)

1-Piece Fixing Ties with Arrowhead, with Disc, releasable

111-85480	RT50SD6	160.0	5.0	31.0	180	18.0	6.3 - 7.5	0.6	1.8	PA66HS	Black (BK)
-----------	---------	-------	-----	------	-----	------	-----------	-----	-----	--------	------------

1-Piece Fixing Ties with Arrowhead, with Disc for oval holes

126-00015	T50SDOP	160.0	5.0	30.0	225	22.0	6.2 x 12.2	0.7	2.0	PA66HS	Black (BK)
126-00119	T50SOSAH7X12U	166.5	5.1	50.0	225	15.2 x 20.2	7.0 x 12.0	0.6	3.6	PA66HS	Black (BK)
126-00120	T50ROSAH7x12U	216.5	5.1	50.0	225	15.2 x 20.2	7.0 x 12.0	0.6	3.6	PA66HS	Black (BK)
126-00141	T50SOSKSFT62x122PT0.7-1.3	153.5	4.6	35.0	225	16.0 x 21.0	6.2 - 12.2	0.7	1.3	PA66HS	Black (BK)
126-00143	T50SOSKSFT62x122PT0.7-1.3 90°	158.0	4.6	35.0	225	16.0 x 21.0	6.2 - 12.2	0.7	1.3	PA66HS	Black (BK)
126-00142	T50SOSKSFT62x122PT1.7-2.3	159.0	4.6	35.0	225	16.0 x 21.0	6.2 x 12.2	1.7	2.3	PA66HS	Black (BK)
126-00144	T50SOSKSFT62x122PT1.7-2.3 90°	159.0	4.6	35.0	225	16.0 x 21.0	6.2 x 12.2	1.5	2.3	PA66HS	Black (BK)

All dimensions in mm. Subject to technical changes.

1-Piece Fixing Ties with Arrowhead, with Disc, sealed

The parts are mainly used in the automotive industry, e.g. for door harnesses.

Features and Benefits

- Easy to assemble without the need for a tool
- Arrowhead simply locks into place
- Disc adjusts the tie for pressures from various directions
- Cable tie head always situated in defined position
- Cellular rubber seal minimises access of dust, dirt and water
- T50SOSSFT6,5E-MD with lasered seal and T60SOSSFT6,5E-MD made from PA6.6 HS are tested acc. IEC60529 and fulfill IP67



The additional seal protects against the ingress of moisture.

 **Material specification please see page 21.**

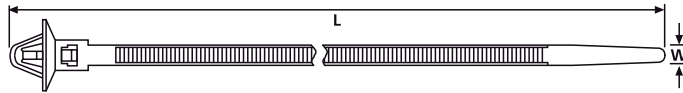

One piece fixing tie with arrowhead and disc, standard design.

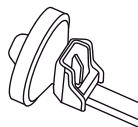

T50SOSSFT6.5E-MDL

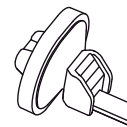

T60SOSSFT65x130E-MD

Article-No.	Type	Length (L)	Width (W)	Bundle Ø max.	Min. Tensile strength for ties (N)	Disc Ø	Hole Ø	Panel Thickness min.	Panel Thickness max.	Material	Colour
Fixing Ties, sealed, round holes											
126-03100	T50SOSSFT6.5E-MDL	160.0	4.6	35.0	225	16.0	6.3 - 6.7	0.6	1.8	PA66HS	Green (GN)
156-00264	T50SOSSFT6.5E-MDL	160.0	4.6	35.0	225	16.0	6.3 - 6.7	0.6	1.8	PA66HS	Black (BK)
156-00271	T50SOSSFT6.5-E-MDL	160.0	4.6	35.0	225	16.0	6.3 - 6.7	0.6	1.8	PA66HS	Natural (NA)
156-00379	T50XCROSSFT6.5EMDL	200.0	4.6	45.0	200	16.0	6.25 - 6.75	1.2	2.1	PA66HS	Black (BK)
126-00065	T50SOSSFT65MSMD	163.0	4.6	35.0	180	16.0	6.25 - 6.75	0.7	1.6	PA66HS	Natural (NA)

Fixing Ties, sealed, oval holes

126-00079	T60SOSSFT70x120-E-MD	157.5	5.5	30.0	300	16.0 x 22.0	7.0 x 12.0	0.7	2.0	PA66HS	Black (BK)
-----------	----------------------	-------	-----	------	-----	-------------	------------	-----	-----	--------	------------

All dimensions in mm. Subject to technical changes.

1-Piece Fixing Ties with Arrow-head, with Disc in the strap

These fixing ties are ideal for use in many different industries, including automotive, aerospace and panel building.

Features and Benefits

- Easy to assemble without the need for a tool
- Arrowhead simply locks into place
- Disc adjusts tie for pressures from various directions and minimises access of dust, dirt and water
- Cable tie head always situated in defined position
- Bundle runs directly across fixing point
- Simple assembly due to tab at the end of the head



The 'tab' on the head of the tie makes it easy to locate and lift the head for assembly.

 **Material specification please see page 21.**

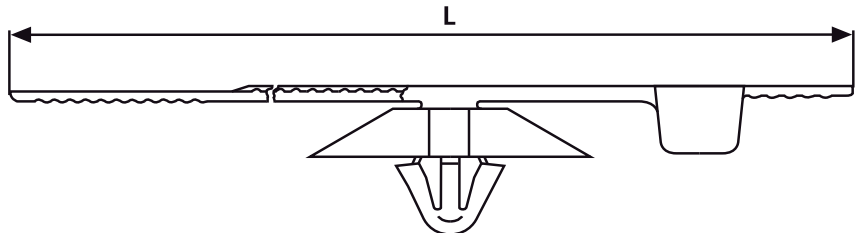

T80RSFT

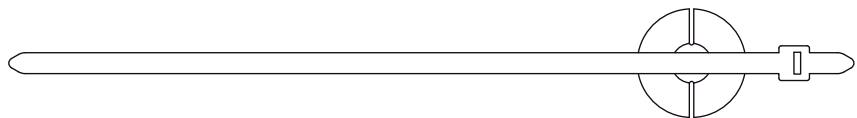

T80RSFT with flexible disc

Article-No.	Type	Length (L)	Width (W)	Bundle Ø max.	Min. Tensile strength for ties (N)	Disc Ø	Hole Ø	Panel Thickness min.	Panel Thickness max.	Material	Colour	Application Tool
150-15493	T80RSFT	190	4.6	45.0	355	24.4	5.7 - 6.3	1.0	3.5	PA66	Black (BK)	1-3, 5
150-15498	T80RSFT	190	4.6	45.0	355	24.4	5.7 - 6.3	1.0	3.5	PA46	Grey (GY)	1-3, 5

All dimensions in mm. Subject to technical changes.

1-Piece Fixing Ties with Arrowhead, with Wings

For the bundling and fixing of cable harnesses, pipes and hoses in the automotive, aerospace, white goods industries and panel building.

Features and Benefits

- Easy to assemble without the need for a tool
- Cable tie head always situated in defined position
- Arrowhead simply locks into place
- Supporting legs provide a secure and firm fixing in areas where space is limited
- Variations for round and oval holes are available
- "Ladder style" types are very flexible

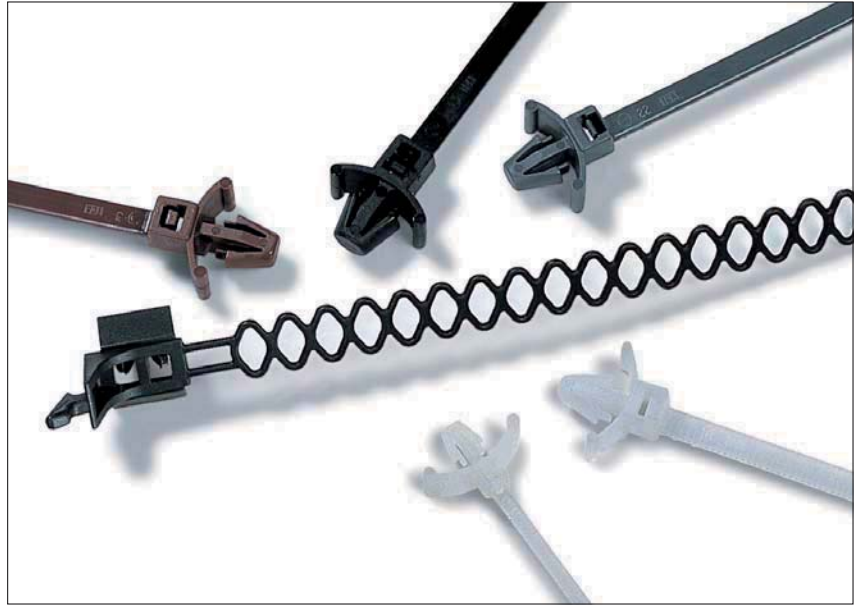

A wide range of arrowhead fixing ties which are suitable for different panel thicknesses and hole diameters.

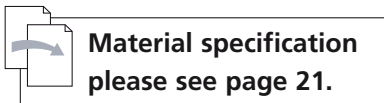

Material specification
please see page 21.

1-Piece Fixing Ties with Arrowhead, with Wings, releasable

Article-No.	Type	Length (L)	Width (W)	Bundle Ø max.	Min. Tensile strength for ties (N)	Hole Ø	Panel Thickness min.	Panel Thickness max.	Material	Colour
115-07010	RT50RSF	215	4.6	50.0	225	7.8 - 8.2	0.80	2.50	PA66	Black (BK)
115-06960	RT50SFK	225	5.0	50.0	225	6.4 - 7.0	0.8	3.0	PA66	Black (BK)
150-26100	FBS100	115	10.0	27.0	-	6.3 - 6.7	0.7	3.9	PA66	Black (BK)
150-26180	FBS185	200	10.0	53.0	-	6.3 - 6.7	0.7	3.9	PA66	Black (BK)

All dimensions in mm. Subject to technical changes.

1-Piece Fixing Ties with Arrowhead, with Wings

Article-No.	Type	Length (L)	Width (W)	Bundle Ø max.	Min. Tensile strength for ties (N)	Hole Ø	Panel Thickness min.	Panel Thickness max.	Material	Colour
111-85519	T18RSF	100	2.5	16.0	80	4.6 - 4.8	1.0	3.0	PA66	Natural (NA)
111-85560	T18RSF	100	2.5	16.0	80	4.6 - 4.8	1.0	3.0	PA66W	Black (BK)

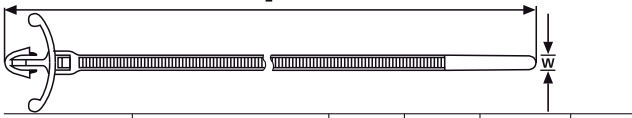

111-85739	T50SSF	160	4.6	35.0	225	6.0 - 6.6	0.7	3.0	PA66	Natural (NA)
126-01104	T50SSF	160	4.6	25.0	225	6.0 - 6.6	0.7	3.0	PA66HS	Natural (NA)
126-00032	T50SSF	160	4.6	35.0	225	6.0 - 6.6	0.7	3.0	PA66HS	Black (BK)
111-85729	T50RSF	200	4.6	45.0	225	6.0 - 6.6	1.0	3.0	PA66	Natural (NA)

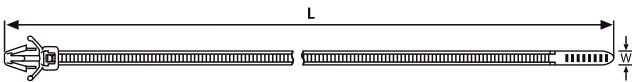

111-85339	T50SSL5	135	4.6	27.0	225	6.1 - 6.5	0.8	2.7	PA66	Natural (NA)
126-02204	T50SSL5	135	4.6	27.0	225	6.1 - 6.5	0.8	2.7	PA66HS	Black (BK)
111-85395	T50SSL5	135	4.6	27.0	225	6.1 - 6.5	0.8	2.7	PA46	Grey (GY)
126-00005	T50SL5	165	4.6	34.0	225	6.1 - 6.3	0.8	2.7	PA66HIRHS	Black (BK)
111-85369	T50SL5	165	4.6	34.0	225	6.1 - 6.3	0.8	2.7	PA66	Natural (NA)
126-00001	T50SL5	165	4.6	34.0	225	6.1 - 6.3	0.8	2.7	PA66HS	Black (BK)
111-85460	T50SL6	165	4.6	34.0	225	6.3 - 7.5	0.5	2.5	PA66	Black (BK)
111-85479	T50SL7	165	4.6	34.0	225	6.9 - 7.1	0.8	2.5	PA66	Natural (NA)

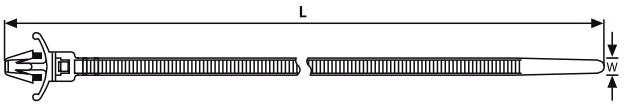

155-41102	T50SAH	160	4.6	25.0	225	6.3	0.7	3.0	PA66HS	Natural (NA)
-----------	--------	-----	-----	------	-----	-----	-----	-----	--------	--------------

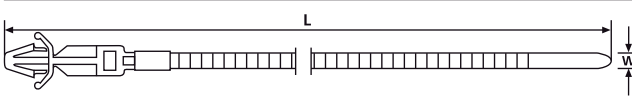

All dimensions in mm. Subject to technical changes.

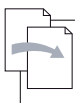

Material specification
please see page 21.

1-Piece Fixing Ties with Arrowhead, with Wings, for Oval Holes

Article-No.	Type	Length (L)	Width (W)	Bundle Ø max.	Min. Tensile strength for ties (N)	Hole Ø	Panel Thickness min.	Panel Thickness max.	Material	Colour
150-48396	T80RFT6X12	228	4.6	45.0	225	6.3 x 12.3	0.6	3.0	PA66	Black (BK)
150-48397	T80RFT6X12	228	4.6	45.0	225	6.3 x 12.3	0.6	3.0	PA46	Grey (GY)

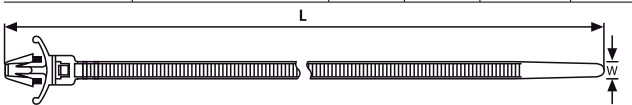

All dimensions in mm. Subject to technical changes.

1-Piece Fixing Ties with Arrow-head, with Wings in the strap

- **T80RSF6.5F**
- **T80RSF6.5FW with rib for convoluted tubes**

This range of fixing ties is ideal for use in many different industries, including automotive, aerospace and panel building. The T80RSF6.5FW feature a detent that fits securely into the profile of the tubing which assists from preventing lateral movement and slipping of the tubing.



Designed to secure battery cables the T80RSF6.5F offers a simple and secure fixing.

Features and Benefits

- Easy to assemble without the need for a tool
- Arrowhead simply locks into place
- Supporting legs provide a secure and firm fixing in areas where space is limited
- Bundle runs central across fixing point
- Cable tie head always situated in defined position
- For parallel routing of two bundles

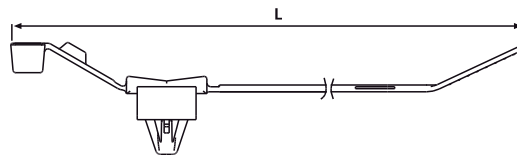

T80RSF6.5FW

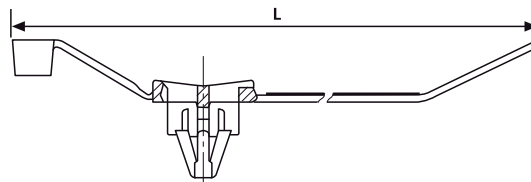

T80RSF6.5F



Material specification
please see page 21.

Article-No.	Type	Length (L)	Width (W)	Bundle Ø max.	Min. Tensile strength for ties (N)	Hole Ø	Panel Thickness min.	Panel Thickness max.	Material	Colour
126-02600	T80RSF6.5F	209	4.6	45.0	300	6.3 - 6.5	0.6	3.0	PA66HS	Black (BK)
150-39395	T80RSF6.5F	209	4.6	45.0	300	6.3 - 6.5	0.6	3.0	PA46	Grey (GY)
150-39385	T80RSF6.5FW	209	4.6	45.0	300	6.3 - 6.5	0.6	3.0	PA66HS	Black (BK)

All dimensions in mm. Subject to technical changes.

1-Piece Fixing Ties with Arrowhead

The arrowhead designs allows these fixing ties to be used in areas with limited space.

Features and Benefits

- Easy to assemble without the need for a tool
- Fixing tie with arrowhead without legs
- Arrowhead simply locks into place
- Cable tie head always situated in defined position



The arrowhead designs allows these ties to be used in areas with limited space.

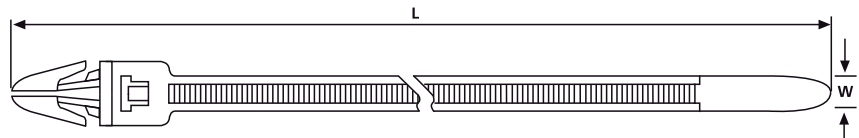

T30RSF(U)

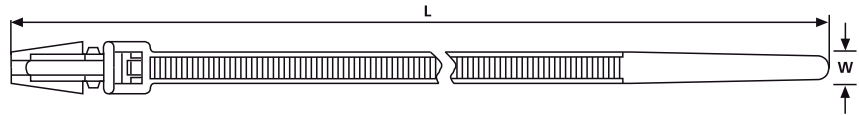

T50RSF(E)

 **Material specification please see page 21.**

Article-No.	Type	Length (L)	Width (W)	Bundle Ø max.	Min. Tensile strength for ties (N)	Hole Ø	Panel Thickness min.	Panel Thickness max.	Material	Colour
111-85603	T30RSF(U)	161	3.6	31.0	135	4.8 - 5.6	0.9	2.4	PA66	Natural (NA)
111-85610	T30RSF(U)	161	3.6	31.0	135	4.8 - 5.6	0.9	2.4	PA66HS	Black (BK)
111-85799	T50RSF(E)	210	4.6	50.0	225	6.2 - 6.4	2.9	3.0	PA66	Natural (NA)
126-01001	T50RSF(E)	210	4.6	50.0	225	6.2 - 6.4	2.9	3.0	PA66	Black (BK)

All dimensions in mm. Subject to technical changes.



Please note! Not all products listed on this page may have this approval. For product specific approvals please refer to the Appendix.

2-Piece Fixing Ties with Arrowhead, with Disc

Primarily designed for fixing cable harnesses in the automotive industry, their simplicity and ease of use has resulted in these parts being used in other industries, for example: aviation, switch-gear manufacturers, white goods manufacturers.

Features and Benefits

- Pre-assembled 2-piece fixing tie with arrowhead foot part
- Cable tie head can be moved after bundling
- Easy to assemble without the need for a tool
- Arrowhead simply locks into place
- Disc adjusts tie for pressure from various directions and minimises access of dust, dirt and water



Being a two piece assembly allows the tie head to be located in the most convenient position.

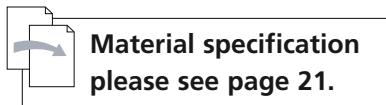

Material specification
please see page 21.



2-Pieces Fixing Ties with Arrowhead, with Disc, sealed

Article-No.	Type	Length (L)	Width (W)	Bundle Ø max.	Min. Tensile strength for ties (N)	Disc Ø	Hole Ø	Panel Thickness min.	Panel Thickness max.	Material Cable Tie	Material Foot Part
150-37799	T50ROSSFT6.5 16-3MD	200	4.6	45.0	225	16.0	6.3 - 6.7	2.5	3.5	PA66HS	PA66HIRHS
150-93100	T50ROSSFT6.5ZD 16-2	200	4.6	45.0	225	16.0	6.3 - 6.7	0.7	2.0	PA66HS	PA66HIRHS
155-42002	T50ROSSFT6.5-16-2-BK	200	4.6	45.0	225	16.0	6.3 - 6.7	0.7	1.2	PA66HS	PA66HIRHS

All dimensions in mm. Subject to technical changes.



2-Pieces Fixing Ties with Arrowhead, for Oval Holes

Article-No.	Type	Length (L)	Width (W)	Bundle Ø max.	Min. Tensile strength for ties (N)	Hole Ø	Panel Thickness min.	Panel Thickness max.	Material Cable Tie	Material Foot Part
156-00446	T50RFT62x122HR	200	4.6	45.0	225	6.3 x 12.2	0.6	3.0	PA46	PA46
150-37591	T50RFT6OVAL	200	4.6	45.0	225	6.3 x 12.2	0.6	3.0	PA66HS	PA66HIR

All dimensions in mm. Subject to technical changes.

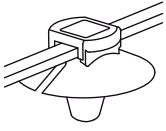

T50SSFT6.5

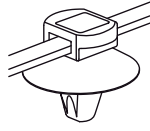

T50RSFT6.5D18

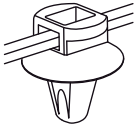

SFT6.5 16-3

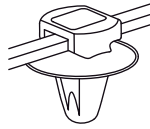

SFT6.5 16-2

Other dimensions are available on request.

2-Piece Fixing Ties with Arrowhead, with Disc

Article-No.	Type	Length (L)	Width (W)	Bundle Ø max.	Min. Tensile strength for ties (N)	Disc Ø	Hole Ø	Panel Thickness min.	Panel Thickness max.	Material Cable Tie	Material Foot Part
150-13593	T50SSFT6.5	150	4.6	31.0	225	22.4	6.3 - 6.7	0.7	2.0	PA66HS	PA66HS
150-13591	T50RSFT6.5	200	4.6	45.0	225	22.4	6.3 - 6.7	0.7	2.0	PA66HS	PA66HS
117-05160	T50RDHSFT6.5	210	4.7	45.0	225	22.4	6.3 - 6.7	0.7	2.0	PA66HS	PA66HS
150-13596	T80ISFT6.5	300	4.6	81.0	355	22.4	6.3 - 6.7	0.7	2.0	PA66HS	PA66HS
150-37691	T50RSFT6.5D18	200	4.6	45.0	225	18.0	6.5 - 6.8	0.4	1.6	PA66HS	PA66HIRHS
150-37791	T50ROS-SFT6.5 16-3	200	4.6	45.0	225	16.0	6.3 - 6.7	2.5	3.5	PA66HS	PA66HIRHS
150-37792	T50RSFT6.5 16-3	200	4.6	45.0	225	16.0	6.3 - 6.7	2.5	3.5	PA66HS	PA66HIRHS
150-93130	T50SOSSFT65162OD	150	4.6	35.0	225	16.0	6.3 - 6.7	1.5	2.2	PA66HS	PA66HIRHS

All dimensions in mm. Subject to technical changes.

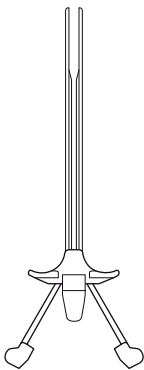

Being a two piece assembly allows the tie head to be located in the most convenient position.

Material specification please see page 21.

2-Pieces Fixing Ties with Arrowhead, for parallel routing

Article-No.	Type	Length (L)	Width (W)	Bundle Ø max.	Min. Tensile strength for ties (N)	Hole Ø	Panel Thickness min.	Panel Thickness max.	Material Cable Tie	Material Foot Part
156-00133	T50SOSDSFT6.5	150	4.6	35.0	225	6.3 - 6.7	0.7	1.5	PA66HS	PA66HIRHS

All dimensions in mm. Subject to technical changes.

2-Pieces Fixing Ties with Arrowhead, with Disc for high temperature applications

- **T50ROSP1SFT6.5** for panel thickness 0.7 - 1.3 mm
- **T50ROSP2SFT6.5** for panel thickness 1.7 - 2.3 mm

The Fixing-Ties with P1SFT6,5 and P2SFT6,5 are ideal when the requirements for temperature or chemical resistance are very high. They are used for cable harnesses in the automotive industry.

Features and Benefits

- Pre-assembled 2-piece fixing tie with arrowhead foot part
- Cable tie head can be moved after bundling
- Easy to assemble without the need for a tool
- Arrowhead simply locks into place
- Disc adjusts tie for pressure from various directions and minimises access of dust, dirt and water

Features material PEEK:

- -55 °C to 240 °C operating temperature
- Excellent resistance against chemicals and gamma radiation

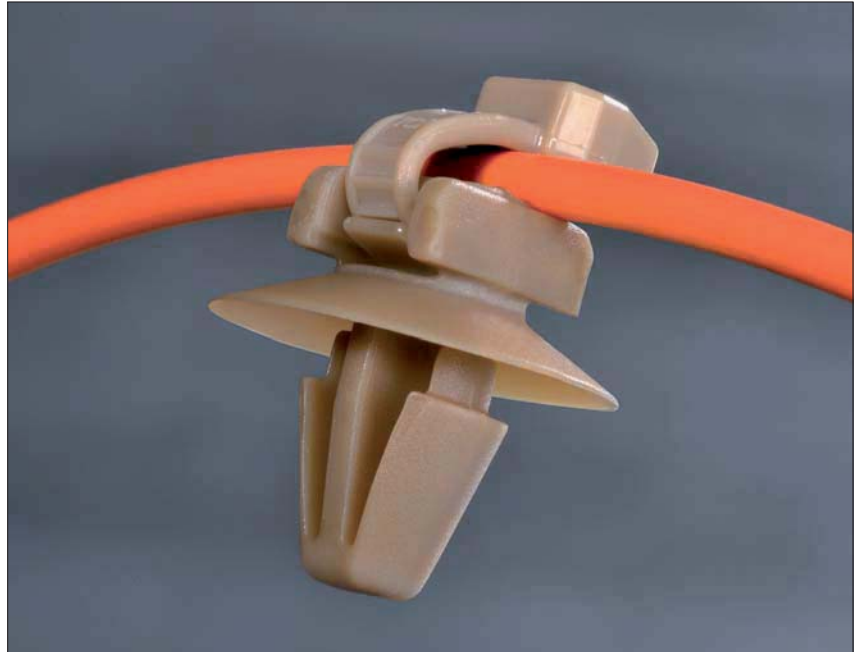

Peek FixingTies can be used for small diameters from 1.0 mm.

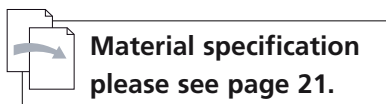

Material specification please see page 21.

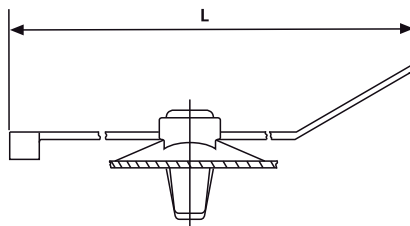

Article-No.	Type	Length (L)	Width (W)	Bundle Ø max.	Min. Tensile strength for ties (N)	Hole Ø	Panel Thickness min.	Panel Thickness max.
156-00455	T50ROSP1SFT65	200	4.6	45.0	225	6.3 - 6.7	0.7	1.3
156-00456	T50ROSP2SFT65	200	4.6	45.0	225	6.3 - 6.7	1.7	2.3

All dimensions in mm. Subject to technical changes.

Material Cable Tie	Material Foot Part	Colour Cable Tie	Colour Foot Part
PA46	PEEK	Grey (GY)	Beige (BGE)
PA46	PEEK	Grey (GY)	Beige (BGE)

All dimensions in mm. Subject to technical changes.



Please note! Not all products listed on this page may have this approval. For product specific approvals please refer to the Appendix.

1-Piece Fixing Ties with Fir Tree, with Disc

Primarily designed for fixing cable harnesses in the automotive industry their simplicity, and ease of use, has seen these parts used in everything from aircraft, to switch-gear, to washing machines.

Features and Benefits

- Cable tie head always situated in defined position
- Easy to assemble without the need for a tool
- Disc adjusts tie for pressure from various directions and minimises access of dust, dirt and water
- Fir tree foot part can be used for a variety of panel thicknesses
- Suitable for use within threaded holes
- DOP versions for oval holes feature anti-twist protection



T50SOSFT6LGE

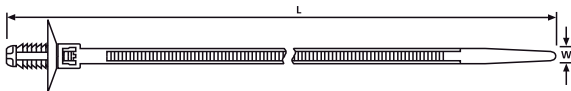

One piece fixing tie with fir tree mount, standard design.

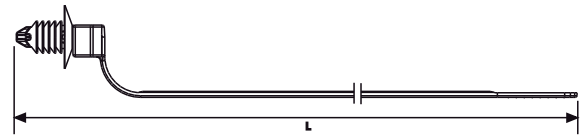

Special design without a gap between head and bundle; FT220DP7.

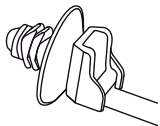

T50SOSFT6E2

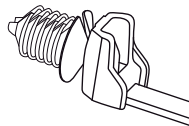

T50SOSFT6D10E

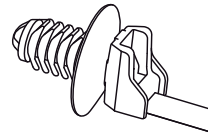

T50SOSFT6LGE

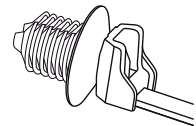

T50SOSFT8E



**Material specification
please see page 21.**

Article-No.	Type	Length (L)	Width (W)	Bundle Ø max.	Min. Tensile strength for ties (N)	Disc Ø	Hole Ø	Panel Thickness min.	Panel Thickness max.	Material	Colour
150-55610	T18RDP5	110.0	2.5	20.0	80	13.0	4.9 - 5.1	3.0	4.0	PA66	Black (BK)
157-00033	T50SOSFT6E1	160.0	4.7	35.0	150	16.0	6.3 - 7.0	0.7	3.0	PA66HS	Black (BK)
157-00085	T50SOSFT6-E2	160.0	4.6	35.0	180	16.0	6.3 - 7.0	0.6	4.2	PA66HS	Black (BK)
157-00045	T50SOSFT6D10E	163.0	4.6	32.0	225	10.0	5.8 - 6.2	0.8	5.5	PA66	Black (BK)
157-00028	T50SOSFT6D10E	163.0	4.6	32.0	225	10.0	5.8 - 6.2	0.8	5.5	PA46	Grey (GY)
157-00042	T50SOSFT6LGE	165.0	4.6	35.0	180	16.0	6.3 - 7.0	0.7	7.0	PA66HS	Black (BK)
150-01700	FT220DP7	230.0	4.7	40.0	225	16.0	6.8 - 7.2	0.8	5.0	PA66	Black (BK)
157-00072	T50SOSFT8E	163.0	4.6	35.0	225	16.0	8.0 - 8.5	0.6	6.0	PA66HS	Black (BK)
157-00115	T50SOSFT8E	163.0	4.6	35.0	225	16.0	8.0 - 8.5	0.6	6.0	PA46	Grey (GY)

All dimensions in mm. Subject to technical changes.

1-Piece Fixing Ties with Fir Tree, with Disc, releasable

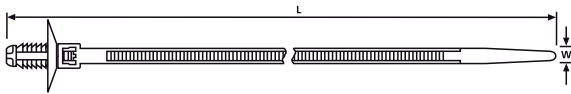

One piece fixing tie with fir tree mount, standard design.

Article-No.	Type	Length (L)	Width (W)	Bundle Ø max.	Min. Tensile strength for ties (N)	Disc Ø	Hole Ø	Panel Thickness min.	Panel Thickness max.	Material	Colour
150-55500	REL30SDP6	170.0	5.0	31.0	135	22.0	6.3 - 7.0	3.0	7.0	PA66	Black (BK)

All dimensions in mm. Subject to technical changes.

 **Material specification please see page 21.**

1-Piece Fixing Ties with Fir Tree, with Disc, for Oval Holes

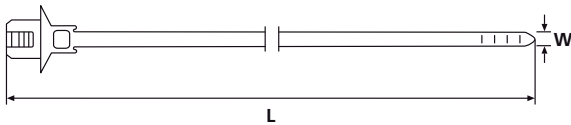

T50SOS2DOP

Article-No.	Type	Length (L)	Width (W)	Bundle Ø max.	Min. Tensile strength for ties (N)	Disc Ø	Hole Ø	Panel Thickness min.	Panel Thickness max.	Material	Colour
157-00014	T50SOS2DOP	165.0	4.6	35.0	225	16.0x21.0	6.2 x 12.2	0.6	6.0	PA66HIRHS	Black (BK)
157-00069	T50SOS2DOP	165.0	4.6	35.0	225	16.0x21.0	6.2 x 12.2	0.6	6.0	PA46	Grey (GY)
157-00016	T50SOS3DOP65130E	165.0	4.6	35.0	180	16.0x21.0	6.5 x 13.0	0.7	5.0	PA66HIRHS	Black (BK)
157-00053	T50SOSFT7X12U	165.0	5.1	35.0	225	15.2x20.2	7.0 x 12.0	0.6	4.0	PA66HS	Black (BK)
157-00054	T50ROSFT7X12U	216.0	5.1	50.0	225	15.2x20.2	7.0 x 12.0	0.6	4.0	PA66HS	Black (BK)

All dimensions in mm. Subject to technical changes.

2-Pieces Fixing Ties with Fir Tree, with Disc

Primarily designed for fixing cable harnesses in the automotive industry their simplicity and ease of use, has resulted in these parts being used in many industries, for example: aviation, switch gear and white goods.

Features and Benefits

- Pre-assembled 2-piece fixing tie with fir tree foot part
- Cable tie head can be moved after bundling
- Easy to assemble without the need for a tool
- Disc adjusts tie for pressure from various directions and minimises access of dust, dirt and water
- Fir tree foot part can be used for a variety of panel thicknesses
- Suitable for use within threaded holes
- DOP versions for oval holes feature anti-twist protection



These Fir-Tree fixings can also be used in threaded, blind holes.

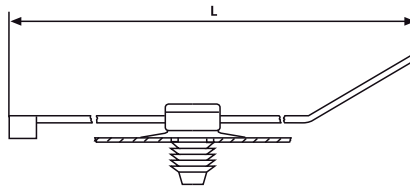

One piece fixing tie with fir tree mount

Other combinations between cable tie and foot part available on request.

Material specification please see page 21.

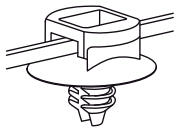

T30RFT5

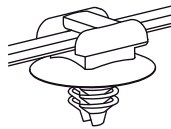

T50SOSFT5SD

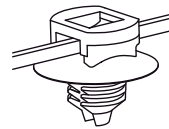

T18RFT6

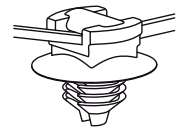

T30RFT6SD

Article-No.	Type	Length (L)	Width (W)	Bundle Ø max.	Min. Tensile strength for ties (N)	Disc Ø	Hole Ø	Panel Thickness min.	Panel Thickness max.	Colour	Material Cable Tie	Material Foot Part
150-55850	T30RFT5	150	3.6	34.0	135	16.0	4.5 - 5.0	0.7	3.0	Black (BK)	PA66HS	PA66HIRHS
150-55948	T30RFT5	150	3.6	34.0	135	16.0	4.5 - 5.0	0.7	3.0	Natural (NA), Grey (GY)	PA46	PA46
156-00025	T50RFT5	200	4.6	45.0	225	16.0	4.5 - 5.0	0.7	3.0	Black (BK)	PA66HS	PA66HIRHS
156-06200	T50SOSFT5	150	4.6	31.0	225	16.0	4.5 - 5.0	0.7	3.0	Black (BK)	PA66HS	PA66HIRHS
156-00432	T50SOSFT5SD	150	4.6	35.0	225	16.0	4.5 - 5.0	0.7	3.0	Black (BK)	PA66HS	PA66HIRHS
150-09110	T18RFT6	100	2.5	20.0	80	16.0	6.4 - 7.1	0.75	3.0	Black (BK)	PA66	PA66
150-77950	T30RFT6	150	3.6	34.0	135	16.0	6.4 - 7.1	0.75	3.0	Black (BK)	PA66HS	PA66HIRHS
150-77941	T50RFT6	200	4.6	45.0	225	16.0	6.4 - 7.1	0.75	3.0	Black (BK)	PA66HS	PA66
150-77938	T50RFT6	200	4.6	45.0	225	16.0	6.4 - 7.1	0.75	3.0	Grey (GY)	PA46	PA46
150-77934	T80LFT6	390	4.6	108.0	355	16.0	6.4 - 7.1	0.75	3.0	Black (BK)	PA66HS	PA66HIRHS
156-00076	T50ROSFT6	200	4.6	45.0	225	16.0	6.4 - 7.1	0.75	3.0	Black (BK)	PA66HS	PA66HIRHS
150-77936	T50RDHFT6	210	4.7	19.0	225	16.0	6.4 - 7.1	0.75	3.0	Black (BK)	PA66HS	PA66HIRHS
150-52690	T30RFT6SD	148.0	3.6	35.0	135	16.0	6.4 - 7.1	0.75	3.0	Black (BK)	PA66HS	PA66HIRHS
156-05902	T50ROSFT6SD	200	4.6	45.0	225	16.0	6.4 - 7.1	0.75	3.0	Black (BK)	PA66HS	PA66HIR
156-00085	T50ROSFT6SD	200	4.6	45.0	225	16.0	6.4 - 7.1	0.75	3.0	Grey (GY)	PA46	PA46

All dimensions in mm. Subject to technical changes.

2-Pieces Fixing Ties with Fir Tree, with Disc

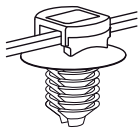

T30RFT6LG

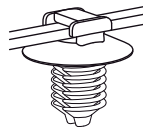

T50SFT6LG1SD

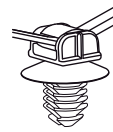

T50RFT6LGSDEX

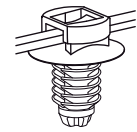

T50IFT7

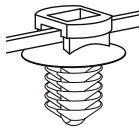

T50RFT8

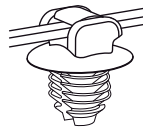

T50RFT8GSD

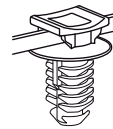

T120IFT9

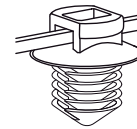

T50RFT10

Article-No.	Type	Length (L)	Width (W)	Bundle Ø max.	Disc Ø	Min. Tensile strength for ties (N)	Hole Ø	Panel Thickness min.	Panel Thickness max.	Colour	Material Cable Tie	Material Foot Part
150-31090	T30RFT6LG	150	3.6	35.0	16.0	135	6.4 - 7.1	0.75	6.0	Black (BK)	PA66HS	PA66HIRHS
150-31091	T50RFT6LG	200	4.6	44.0	16.0	225	6.4 - 7.1	0.75	6.0	Black (BK)	PA66HS	PA66HIRHS
150-31096	T80IFT6LG	300	4.6	81.0	16.0	355	6.4 - 7.1	0.75	6.0	Black (BK)	PA66HS	PA66HIRHS
156-00154	T50SFT6LG1SD	160	4.6	30.0	16.0	225	6.5 - 7.0	0.6	6.0	Black (BK)	PA66HS	PA66HIRHS
156-00399	T50RFT6LGS-D-HEX	200	4.6	45.0	16.0	225	6.25 - 6.75	0.7	5.0	Black (BK)	PA66HS	PA66HIRHS
111-85871	T50RFT7	200	4.6	44.0	16.0	225	6.5 - 7.0	0.8	7.0	Black (BK)	PA66HS	PA66HS
150-00700	T50IFT7	300	4.6	81.0	16.0	225	6.5 - 7.0	0.8	7.0	Black (BK)	PA66HS	PA66HS
111-85880	T50RFT8	200	4.6	45.0	16.0	225	7.7 - 8.0	0.8	6.0	Black (BK)	PA66HS	PA66HS
156-00104	T40RFT8GSD	180	4.0	40.0	16.0	180	8.0 - 8.5	1.5	4.0	Black (BK)	PA66HS	PA66HIRHS
133-00034	T50RFT8GSD	200	4.6	45.0	16.0	225	8.0 - 8.5	1.5	4.0	Black (BK)	PA66HS	PA66HIRHS
156-00235	T50RFT8GSD	200	4.6	45.0	16.0	225	8.0 - 8.5	1.5	4.0	Grey (GY)	PA46	PA46
156-00200	T120IFT9	300	7.6	75.0	20.0	535	9.0 - 10.6	5.0	11.0	Black (BK)	PA66HIR(S)	PA66HIR(S)
111-85810	T50RFT10	200	4.6	45.0	18.0	225	9.7 - 10.0	0.8	5.0	Black (BK)	PA66HS	PA66HS
156-00120	T50ROSFT10	200	4.6	45.0	18.0	225	9.7 - 10.0	0.8	5.0	Black (BK)	PA66HS	PA66HIRHS

All dimensions in mm. Subject to technical changes.

2-Pieces Fixing Ties with Fir Tree, with Disc, for Oval Holes

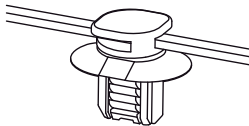

T50ROS1DOP



Material specification
please see page 21.

Article-No.	Type	Length (L)	Width (W)	Bundle Ø max.	Disc Ø	Min. Tensile strength for ties (N)	Hole Ø	Panel Thickness min.	Panel Thickness max.	Colour	Material Cable Tie	Material Foot Part
156-05908	T50ROSFT62x122	200	4.6	45.0	12.0 x 21.0	225	6.2 x 12.2	0.6	6.0	Black (BK)	PA66HS	PA66HIRHS

All dimensions in mm. Subject to technical changes.

1-Piece Fixing Ties for Weld Studs

- **T50SOSSBH5E** with plate to fix isolation material
- Cable tie head always situated in defined position
- Easy to assemble without the need for a tool
- Can retain insulation materials while fixing a cable bundle

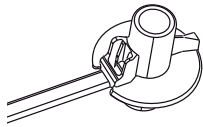

T50SOSSBH5E



The new head design offers additional fixing of soft materials.

Article-No.	Type	Length (L)	Width (W)	Bundle Ø max.	Min. Tensile strength for ties (N)	Stud Ø	Material	Colour
155-05701	T50SOSSBH5E	165	4.6	35.0	225	5.0	PA66HS	Black (BK)

All dimensions in mm. Subject to technical changes.



Material specification please see page 21.

- **T50SSBS50TE** for cable routing above the stud
- Cable tie head always situated in defined position
- Easy to assemble without the need for a tool
- Bundle runs directly above weld stud with defined stand-off from the panel

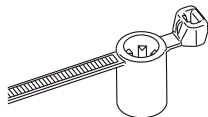

T50SSBS50TE



The T50SSBS50TE allows very precise routing of cable bundles.

Article-No.	Type	Length (L)	Width (W)	Bundle Ø max.	Min. Tensile strength for ties (N)	Stud Ø	Material	Colour
155-30602	T50SSBS50TE*	160	4.6	35.0	200	5.0	PA66HS	Black (BK)
157-00083	T50SSBS60T-E*	160.0	4.6	35.0	200	6.0	PA66HS	Black (BK)

All dimensions in mm. Subject to technical changes.

* Since the bundled cables lie directly above or on the weld stud, care must be taken to ensure that the length of the weld stud does not exceed the height of the sheath. To avoid damage, we recommend a maximum weld stud length of 16.5 mm.

1-Piece Fixing Ties for Weld Studs

- Cable tie head always situated in defined position
- Easy to install without the need for a tool
- Bundles are routed very close to stud

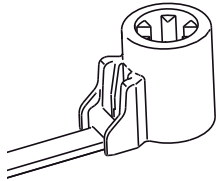

T50SOSSB55E

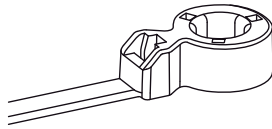

T50SOSSBD-M8

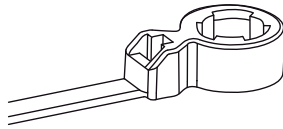

T50SOSSBD-M10

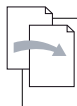

**Material specification
please see page 21.**

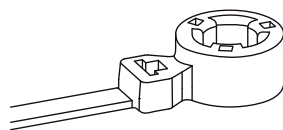

T50SOSSBU-M8

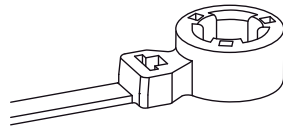

T50SOSSBU-M10



This outside serrated cable tie with weld stud mounting keeps the cables close to the fixing stud.



T50SOSSBD-M8



T50SOSSBD-M is made for bundles that run below the stud.

Article-No.	Type	Length (L)	Width (W)	Bundle Ø max.	Min. Tensile strength for ties (N)	Stud Ø	Mounting Screw Type	Material	Colour
155-12300	T50SOSSB55E	160.0	4.6	35.0	225	5.0	–	PA66HS	Black (BK)
157-00039	T50SOSSBD-M8	175.0	5.7	30.0	150	–	M8	PA66HSW	Black (BK)
157-00066	T50SOSSBU-M8	175.0	5.7	30.0	150	–	M8	PA66HSW	Grey (GY)
157-00040	T50SOSSBD-M10	175.0	5.7	30.0	150	–	M10	PA66HSW	Black (BK)
157-00067	T50SOSSBU-M10	175.0	5.7	30.0	150	–	M10	PA66HSW	Grey (GY)

All dimensions in mm. Subject to technical changes.

1-Piece Fixing Ties for Weld, moveable

• WSP-Serie

- Cable tie head always situated in defined position
- Easy to install without the need for a tool
- Provides a 5 – 6 mm lateral adjustment possibility
- Very low profile, stackable design
- For bundles which need to be routed in different directions

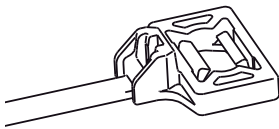

T50SOSWSP5E-2

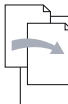

**Material specification
please see page 21.**



T50SOSWSP5E, parallel installation using two fixing ties.

• T50SOSSB5-High-E-C-CC for 5 and 6 mm studs

• T50SOSSB6HE for 6 mm studs

- Cable tie head always situated in defined position
- Easy to install without the need for a tool
- Provides a 5 – 6 mm lateral adjustment possibility



T50SOSSB5-High-E-C-CC

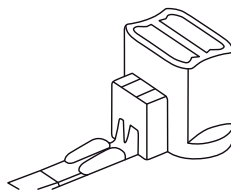

T50SOSSB5-High-E-C-CC

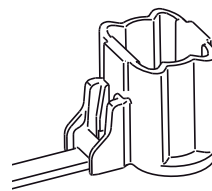

T50SOSSB6HE

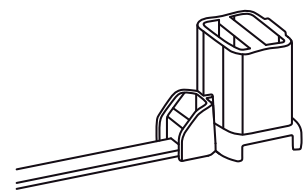

T60ROSSBH6HEC

Article-No.	Type	Length (L)	Width (W)	Bundle Ø max.	Min. Tensile strength for ties (N)	Stud Ø	Material	Colour
157-00037	T50SOSSB5-High-E-C-CC	167.0	5.0	35.0	225	5.0, 6.0	PA66HS	Black (BK)
155-46302	T50SOSSB6HE	160.0	4.6	35.0	170	6.0	PA66HS	Black (BK)
157-00101	T60ROSSBH6HEC	227.4	5.5	55.0	300	6.0	PA66HS	Black (BK)
133-00391	T50SOSWSP5E-2	163.0	4.6	35.0	200	5.0	PA66HS	Black (BK)

All dimensions in mm. Subject to technical changes.

1-Piece Fixing Ties for Weld Studs

- LFC-Series for routing close to the stud

Features and Benefits

- 1-piece fixing tie for 5 mm studs
- Cable tie head always situated in defined position
- Easy to install without the need for a tool
- Bundle runs very close next to stud
- Closed stud retainer protects the bundle against damage
- Contact surface allows secure bundling with tensioning tool



LFC165-2 for bundle diameters up to 35.0 mm

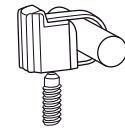

LFC165-2 can be put on by hand.

Article-No.	Type	Length (L)	Width (W)	Bundle Ø max.	Stud Ø	Min. Tensile strength for ties (N)	Material	Colour
157-00047	LFC165-2	165	4.7	35.0	5.0	150	PA66HS	Black (BK)
155-34202	LFC165(PSA)	165	4.7	35.0	5.0	90	PA66HS	Black (BK)
131-60070	LFC155	163	4.7	26.0	5.0	160	PA66	Black (BK)

All dimensions in mm. Subject to technical changes.



Material specification please see page 21.

1-Piece Fixing Ties for Weld Studs, for Heavy Duty Applications

- WS-Series for 6.35 mm threaded studs
- WSI380 for 9.525 mm threaded studs

Wide strap stud-mounted cable ties are primarily designed for use in the automotive or truck industry.

Features and Benefits

- Very flexible strap and minimum pinching of soft hoses and convoluted tubing
- Low profile head for compact bundling
- Clamping rails to increase grip on round bundles
- Flexible hinge



The wide strap stud mount cable tie minimizes pinching on soft bundles.

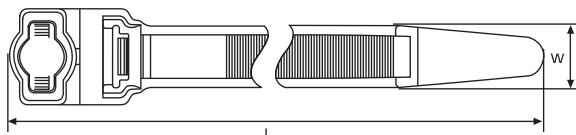

Wide Strap Heavy Duty Stud Mount Cable Ties

Article-No.	Type	Length (L)	Width (W)	Bundle Ø max.	Stud Ø	Min. Tensile strength for ties (N)	Material	Colour
157-00400	WSS250	246.4	12.7	57.1	6.35	534	PA66HIRHS	Black (BK)
157-00401	WSI250	322.6	12.7	82.5	6.35	534	PA66HIRHS	Black (BK)
157-00402	WSR250	398.8	12.7	104.8	6.35	534	PA66HIRHS	Black (BK)
157-00404	WSI380	322.6	12.7	82.5	9.525	534	PA66HIRHS	Black (BK)

All dimensions in mm. Subject to technical changes.

1-Piece Fixing Ties for Weld Studs (Softpush) in the strap

Features and Benefits

- For 5mm studs or 5mm ISO threaded studs
- "Soft-push" versions for easy assembly, without tool
- "Hard-push" versions for special firm fit need to be hammered onto the stud
- Releasable types: RT50RS5 and SB



With the RT50RS5 and the SB14/172 you can mount pipes or cables to a weldstud.

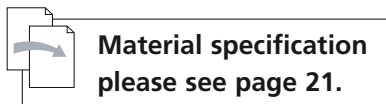

Material specification please see page 21.



Simple fixing to a weld stud or 5mm ISO bolt.

Article-No.	Type	Length (L)	Width (W)	Height (H2)	Bundle Ø max.	Min. Tensile strength for ties (N)	Material	Colour
1-Piece Fixing Ties for Weld Studs (Softpush) in the strap								
111-07110	T50RS5	190	4.6	14.5	40.0	225	PA66	Black (BK)
1-Piece Fixing Ties for Weld Studs (Softpush) in the strap, releasable								
115-07110	RT50RS5	190	4.6	14.5	40.0	225	PA66	Black (BK)
150-10901	SBS9/230	230	5.0	10.0	60.0	245	PA66	Black (BK)
1-Piece Fixing Ties for Weld Studs (Hardpush) in the strap, releasable								
150-10900	SB9/230	230	5.0	10.0	60.0	245	PA66	Black (BK)
150-10690	SB14/172	172	5.0	15.5	40.0	245	PA66	Black (BK)
150-11400	SB14/230	230	5.0	15.5	60.0	245	PA66	Black (BK)

All dimensions in mm. Subject to technical changes.

1-Piece Fixing Ties for Weld Studs, releasable, with flexible strap

Features and Benefits

- Releasable
- FBB-types for 5mm studs or 5mm ISO threaded studs
- SBR8S for M8 threaded studs
- "Soft-push" versions for easy assembly, without tool
- "Hard-push" versions for special firm fit need to be hammered onto the stud
- The versions FBB_M have a little recess for eventually welding burrs on the substructure

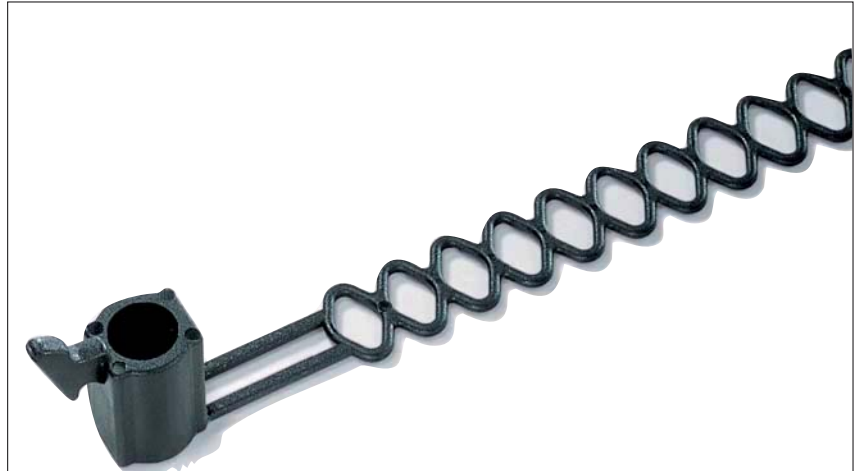

FBB one-piece fixing ties for weld studs, can be easily removed by unscrewing in an anti-clockwise direction.



Material specification
please see page 21.

Article-No.	Type	Length (L)	Width (W)	Bundle Ø max.	Min. Tensile strength for ties (N)	Material	Colour
-------------	------	------------	-----------	---------------	------------------------------------	----------	--------

1-Piece Fixing Ties for Weld Studs (Softpush), releasable, with flexible strap

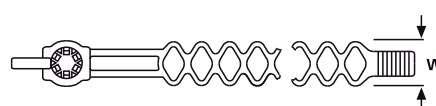

150-28140	FBB140	145	10.0	38.0	–	PA66	Black (BK)
150-29100	FBB100M	110	10.0	23.0	–	PA66	Black (BK)
150-29140	FBB140M	145	10.0	38.0	–	PA66	Black (BK)
150-29180	FBB185M	200	10.0	50.0	–	PA66	Black (BK)

1-Piece Fixing Ties for Weld Studs (Hardpush) , releasable

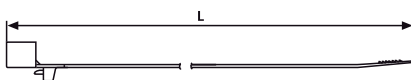

131-60060	SBR5	220	6.0	40.0	300	PA66HS	Black (BK)
131-60058	SBR8S	215	6.0	40.0	300	PA46	Grey (GY)

All dimensions in mm. Subject to technical changes.

1-Piece Fixing Ties for Weld Studs, for Heavy Duty Applications, for parallel routing

Primarily designed for use in the automotive industry, these parts can be used in a wide variety of applications where weld studs ISO bolts are used and cables need to be bundled and secured.

Features and Benefits

- For parallel routing of cables, wires and hoses
- Minimum pinching of soft hoses and convoluted tubing
- Easy to install without the need for a tool
- DCT9 and DCT11 are releasable
- SDCTR312 for defined standoff to substructure



Standoff Mounting Dual Clamp Ties.

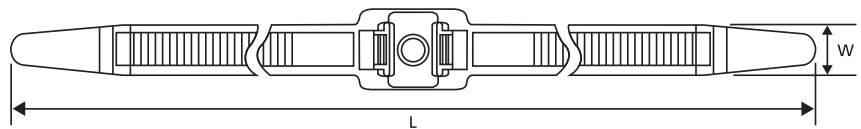

Dual Clamp Ties

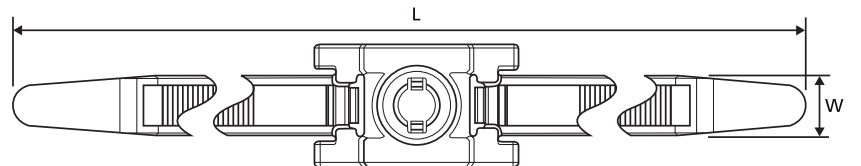

Standoff Mounting Dual Clamp Ties

 **Material specification please see page 21.**

Article-No.	Type	Length (L)	Width (W)	Bundle Ø max.	Min. Tensile strength for ties (N)	Stud Ø	Material	Colour
115-00034	DCT9	330.0	12.7	33.0	670	6.35	PA66HIR	Black (BK)
115-00033	DCT11	489.0	12.7	58.0	670	6.35	PA66HIR	Black (BK)
117-00012	SDCTR312	511.0	12.7	58.0	445	8.0	PA66HIRHSW	Black (BK)

All dimensions in mm. Subject to technical changes.

2-Piece Fixing Ties for Weld Studs

Series SBH5 and SBH5SD are used mainly in the automotive industry. The SD variant is for the smallest bundle diameters, from 1.0 mm. Series SB5 and SBS5 are suitable for bundling and fastening cable looms and pipes in switch cabinet construction and automotive and construction machine industry.

Features and Benefits

- Pre-assembled 2-piece fixing tie with stud retainer
- Cable tie head can be moved after bundling
- Easy to install without the need for a tool
- SB5-types for 5mm studs or 5mm ISO threaded studs
- Types with discs can retain insulation materials while fixing a cable bundle
- Oval shape can be adjusted in a lateral position
- GBS8C for 8 mm retainer enables parallel routing





Cable ties illustrating the variety of application methods for weld stud fixing.





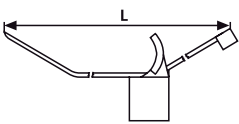

**Material specification
please see page 21.**

2-Piece Fixing Ties for Weld Studs, moveable

Article-No.	Type	Length (L)	Width (W)	Bundle Ø max.	Min. Tensile strength for ties (N)	Material Cable Tie	Material Foot Part	Application Tool
								
				SB5		SB5CSD		
150-10140	T30RSB5	150	3.5	31.0	135	PA66HS	POM	1-3, 5
150-10144	T50SSB5	150	4.6	31.0	225	PA6HS	PA66HS	1-5
150-10141	T50RSB5	200	4.6	45.0	225	PA66HS	POM	1-5
156-00084	T50RSB5	200	4.6	45.0	225	PA46	PA46	1-5
156-00080	T50SOSSB5	150	4.6	31.0	225	PA66HS	POM	1-5
150-10149	T50ROSSB5	200	4.6	45.0	225	PA66HS	POM	1-5
156-00083	T50RSB5CSD	200	4.6	45.0	225	PA66HS	PA66HS	1-5
156-05906	T50ROSSB5CSD	200	4.6	45.0	225	PA66HS	PA66HS	1-5

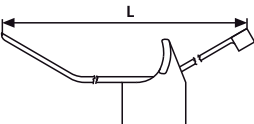
All dimensions in mm. Subject to technical changes.

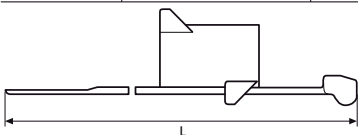



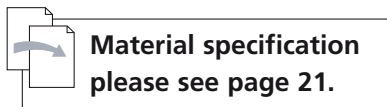

2-Piece Fixing Ties for Weld Studs

Article-No.	Type	Length (L)	Width (W)	Bundle Ø max.	Min. Tensile strength for ties (N)	Material Cable Tie	Material Foot Part	Application Tool
  SB55								
150-21290	T30RSB55	150	3.5	31.0	135	PA66HS	PA66HS	1-3, 5
150-21293	T50SSB55	150	4.6	31.0	225	PA66HS	PA66HS	1-5
150-21291	T50RSB55	200	4.6	45.0	225	PA66HS	PA66HS	1-5
150-21297	T80ISB55	300	4.6	81.0	355	PA66HS	PA66HS	1-5
156-00079	T50SOSSB55	150	4.6	31.0	225	PA66HS	PA66	1-5
150-21299	T50ROSSB55	200	4.6	45.0	225	PA66HS	PA66HS	1-5
  T50ROSGBS8C-B								
156-00251	T50ROSGBS8CA	200	4.6	45.0	225	PA66HS	PA66HIRHS	1-5
156-00252	T50ROSGBS8CB	200	4.6	45.0	225	PA66HS	PA66HIRHS	1-5
156-00116	T50ROSGBS8CC	200	4.6	45.0	225	PA66HS	PA66HIRHS	1-5

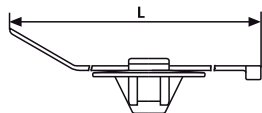
All dimensions in mm. Subject to technical changes.

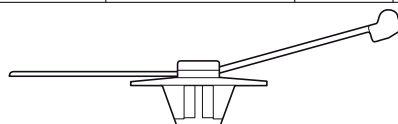

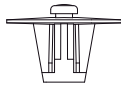
2-Piece Fixing Ties for Weld Studs, with disk

Article-No.	Type	Length (L)	Width (W)	Bundle Ø max.	Min. Tensile strength for ties (N)	Disc Ø	Material Cable Tie	Material Foot Part	Application Tool
  SBH5									
150-16941	T30RSBH5	150	3.5	31.0	135	30.0	PA66HS	PA66HS	1-3, 5
150-16943	T50RSBH5	200	4.6	45.0	225	30.0	PA66HS	PA66HS	1-5
150-16945	T80ISBH5	300	4.6	81.0	355	30.0	PA66HS	PA66HS	1-5
    SBH5SD SBH6SD SBH5SD-14									
150-92904	T50RSBH5-SD	200	4.6	45.0	225	30.0	PA66HS	PA66HS	1-5
150-92905	T80ISBH5SD	300	4.6	78.0	355	30.0	PA66HS	PA66HS	1-5
156-05905	T50ROSSBH5SD	200	4.6	45.0	225	30.0	PA66HS	PA66HS	1-5
150-77591	T50R-SBH5SD-14	200	4.6	45.0	222	30.0	PA66HS	PA66HS	1-5
156-00819	T50RSBH6SD	200	4.6	45.0	225	30.0	PA66HS	PA66HS	1-5

All dimensions in mm. Subject to technical changes.

2-Piece Fixing Ties for Weld Studs, for parallel routing

Many applications require cables to be run parallel to each other but separated to avoid abrasion. The double mounting base, when used with two cable ties allow this to be achieved simply and quickly.

Features and Benefits

- Pre-assembled 2-piece fixing tie with stud retainer
- For parallel routing of cables, hoses or harnesses
- Cable tie head can be moved after bundling
- Easy to install without the need for a tool
- For 5 mm studs or 5 mm ISO threaded studs



Parallel fixation of two cables.

Other dimensions available on request.

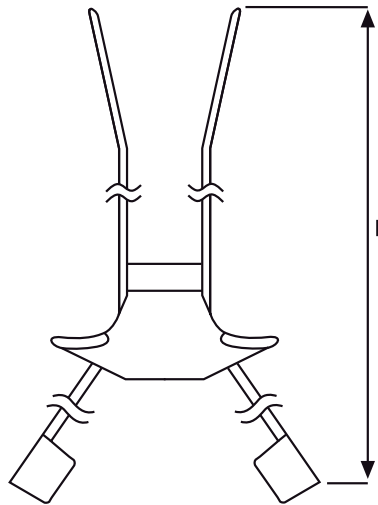

T50SDSBS5, T50ROSDBS5

Material specification please see page 21.

Article-No.	Type	Length (L)	Width (W)	Bundle Ø max.	Min. Tensile strength for ties (N)	Stud Ø	Material Cable Tie	Material Foot Part	Colour	Application Tool
150-56193	T50SDSBS5	150	4.6	31.0	225	5.0	PA66HS	PA66HIRHS	Black (BK)	1-5
150-56199	T50ROSDBS5	200	4.6	45.0	225	5.0	PA66HS	PA66HIRHS	Black (BK)	1-5

All dimensions in mm. Subject to technical changes.

1-Piece Fixing Ties for Edges EdgeClip-Family

These cable ties and Edge Clip assemblies are ideal for use where holes are not acceptable or where due to temperature problems adhesives will fail. These assemblies are widely used for fixing and bundling cables, pipes and hoses within the automotive industry, harness making, panel building and electrical industry.

Features and Benefits

- Easy assembly, just clip on per hand
- For edges of 1 – 3 mm or 3 – 6 mm
- Integrated metal clamp holds clip firmly in place
- Clamp consists of double tempered steel spring
- Ideal for applications where holes or adhesives are not suitable



T50ROSEC10 fitted onto a plastic panel to hold a door harness.

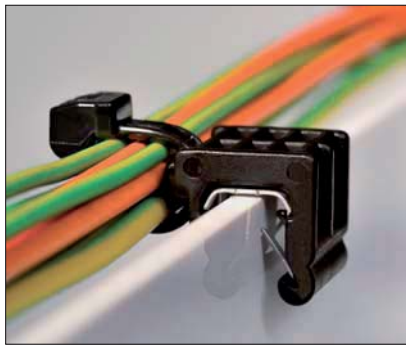

T50ROSEC23 - the cable bundle runs parallel with the edge.



1-Piece-Fixing Tie T50SOSEC12 can be pushed easily on edges.

The silver-grey clamp, the heart of our EdgeClips, consists of double-tempered spring steel in accordance with DIN EN 10132-4 C75S. The spring steel gives the clamp both the necessary rigidity to provide high pull-off forces and also sufficient flexibility for various possible applications. The double coating is applied initially with a zinc plate system followed by inorganic surface sealing. Naturally, no chromium (VI) is used in this process. The clamp therefore complies with the current EU Directive

200/53/EC on end of life vehicles and the prohibition on heavy metals. The refined spring-steel clamp also fulfils the requirements for resistance to salt spray stipulated in DIN EN ISO 9227 NSS (min. 840 h without corrosion of base metal) and DIN EN ISO 6270-Z-CH (min. 720 h without corrosion of base material). This solution has therefore been approved by many OEMs for exposed installation locations, e.g. in engine compartments and the running-gear area.

1-Piece Fixing Ties for Edges

• EdgeClip-Family

Features and Benefits

- Cable tie head always situated in defined position
- Suitable for minimum bundle diameters of 1 mm
- Outside serrated tie prevents bundle from being damaged
- For edges of 1 – 3 mm

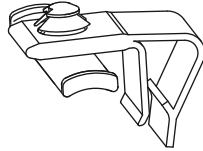

EdgeClips are also available on request for panel thickness from 4 - 7mm.

Article-No.	Type	Length (L)	Width (W)	Bundle Ø max.	Min. Tensile strength for ties (N)	Material Cable Tie	Material Foot Part	Application Tool	Drawing
148-00200	T50SOSEC12E	160.0	4.6	35.0	180	PA66HS	PA66HS	1-5	
126-00000	T50SOSEC13E	160.0	4.6	35.0	180	PA66HS	PA66HS	1-5	
126-00036	T50SOSEC34E	155.0	4.6	35.0	180	PA66HS	PA66HS	1-5	
133-00059	T40XEC5SP-E	85.0	4.0	15.0	178	PA66HS	PA66HS	1-5	

All dimensions in mm. Subject to technical changes.

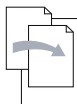

Material specification please see page 21.

2-Piece Fixing Ties for Edges, 1,0 - 3,0 mm

• EdgeClip-Family

Features and Benefits

- Pre-assembled 2-piece fixing tie with EdgeClip
- Cable tie head can be moved after bundling
- EC9, EC10, EC21 and EC22 are for minimum bundle diameters of 1 mm
- For edges of 1 – 3 mm



Material specification
please see page 21.

Article-No.	Type	Length (L)	Width (W)	Bundle Ø max.	Min. Tensile strength for ties (N)	Material Cable Tie	Material Foot Part	Application Tool	Drawing
150-76090	T30REC4A	150	3.5	32.0	135	PA66HS	PA66HIRHS	1–3, 5	
150-76091	T50REC4A	200	4.6	45.0	225	PA66HS	PA66HIRHS	1–10	
150-76093	T50SOSEC4A	150	4.6	35.0	225	PA66HS	PA66HIRHS	1–5	
150-76099	T50ROSEC4A	200	4.6	45.0	225	PA66HS	PA66HIRHS	1–5	
156-00570	T50ROSEC4A-W	200	4.6	45.0	225	PA66UV	PA66UV	1–5	
150-76080	T30REC4B	150	3.5	32.0	135	PA66HS	PA66HIRHS	1–3, 5	
156-00109	T50SOSEC4B	150	4.6	35.0	225	PA66HS	PA66HIRHS	1–5	
150-76079	T50ROSEC4B	200	4.6	45.0	225	PA66HS	PA66HIRHS	1–5	
156-00003	T30REC5A	150	3.6	33.0	135	PA66HS	PA66HIRHS	1–3, 5	
150-40593	T50SOSEC5A	150	4.6	35.0	225	PA66HS	PA66HIRHS	1–5	
150-40591	T50ROSEC5A	200	4.6	45.0	225	PA66HS	PA66HIRHS	1–5	
150-40582	T50REC5B	200	4.6	45.0	225	PA66HS	PA66HIRHS	1–10	
150-40583	T50SOSEC5B	150	4.6	31.0	225	PA66HS	PA66HIRHS	1–5	
150-40581	T50ROSEC5B	200	4.6	45.0	225	PA66HS	PA66HIRHS	1–5	
155-37104	T18REC9SD	100	2.5	20.0	80	PA66HS	PA66HIRHS	1–5	
156-00019	T50SOSEC9SD	150	4.6	31.0	225	PA66HS	PA66HIRHS	1–5	
156-05903	T50ROSEC9	200	4.6	45.0	225	PA66HS	PA66HIRHS	1–5	
155-38304	T18REC10SD	100	2.5	20.0	80	PA66HS	PA66HIRHS	1–3, 5	
156-00015	T50SOSEC10	150	4.6	31.0	225	PA66HS	PA66HIRHS	1–5	
156-05904	T50ROSEC10	200	4.6	45.0	225	PA66HS	PA66HIRHS	1–5	
156-00017	T50SOSEC21	150	4.6	35.0	225	PA66HS	PA66HIRHS	1–5	
156-00010	T50ROSEC21	200	4.6	45.0	225	PA66HS	PA66HIRHS	1–5	
156-00576	T50ROSEC22	200	4.6	45.0	225	PA66UV	PA66HIRHS	1–10	
156-00011	T50ROSEC22	200	4.6	45.0	225	PA66HS	PA66HIRHS	1–5	



All dimensions in mm. Subject to technical changes.

2-Piece Fixing Ties for Edges, 3,0 - 6,0 mm

• EdgeClip-Family

Features and Benefits

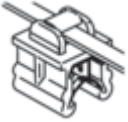
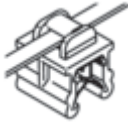
- Pre-assembled 2-piece fixing tie with EdgeClip
- Cable tie head can be moved after bundling
- For minimum bundle diameters of 1 mm
- For edges of 3 – 6 mm

Article-No.	Type	Length (L)	Width (W)	Bundle Ø max.	Min. Tensile strength for ties (N)	Material Cable Tie	Material Foot Part	Application Tool	Drawing
156-04600	T18ROSEC19	100.0	2.5	20.0	80	PA66HS	PA66HIRHS	1–3, 5	
156-04601	T50SOSEC19	150.0	4.6	31.0	225	PA66HS	PA66HIRHS	1–5	
156-04602	T50ROSEC19	200.0	4.6	45.0	225	PA66HS	PA66HIRHS	1–5	
156-00016	T50SOSEC20	150.0	4.6	35.0	225	PA66HS	PA66HIRHS	1–5	
156-00020	T50ROSEC20	200.0	4.6	45.0	225	PA66HS	PA66HIRHS	1–5	
156-00006	T50ROSEC23	200.0	4.6	45.0	225	PA66HS	PA66HIRHS	1–5	
156-00007	T50ROSEC24	200.0	4.6	45.0	225	PA66HS	PA66HIRHS	1–5	

All dimensions in mm. Subject to technical changes.

Other combinations between cable tie and foot part available on request.

Material specification please see page 21.

2-Piece Fixing Ties for Edges, twistable

Features and Benefits

- Pre-assembled 2-piece fixing tie with EdgeClip
- Easy to assemble by hand
- Cable tie head can be moved after bundling
- For edges of 1 – 2.5 mm or 1 – 3 mm
- Can be rotated to the desired position during mounting



**Material specification
please see page 21.**

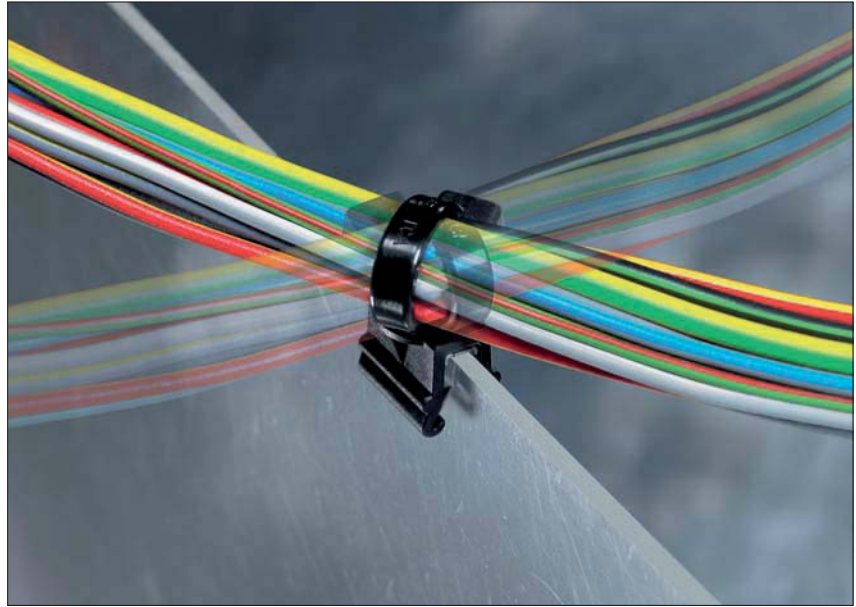

EdgeClip CBTO50R, rotatable 90°.

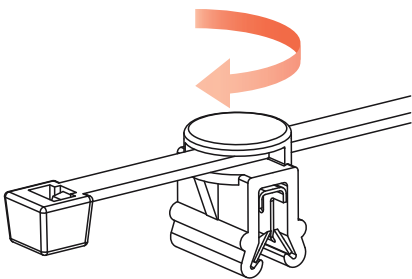

CBT50R - the bundle can run above an edge.

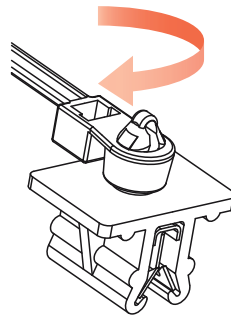

EdgeClip CBT30MR, rotatable 360°

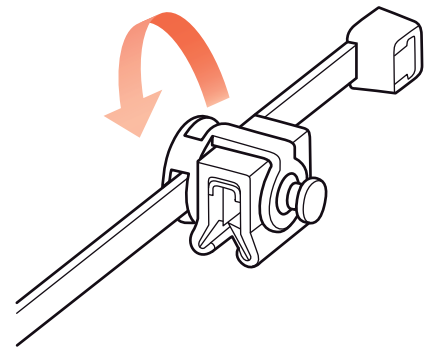

CBTO50RSTUD5

Article-No.	Type	Length (L)	Width (W)	Bundle Ø max.	Min. Tensile strength for ties (N)	Material Cable Tie	Material Foot Part	Panel Thickness max.	Application Tool
156-00049	CBT30MR	160	3.5	32.0	135	PA66HS	POM	2.5	1–3, 5
156-01601	CBTO50R	200	4.6	47.0	225	PA66HS	PA66HIRHS	3.0	1–3, 5
156-00380	CBTO50RSTUD5	200	4.6	50.0	225	PA66HS	PA66HIRHS	3.0	1–3, 5

All dimensions in mm. Subject to technical changes.

2-Piece Fixing Ties for Edges, for Holes

Ideal for use on 2.5 mm edges, the tie's reduced installation height makes it ideal for use wherever space is at a premium.

Features and Benefits

- Pre-assembled 2-piece fixing tie with EdgeClip
- Easy to assemble by hand
- Cable tie head can be moved after bundling
- For edges of 2.5 mm
- Secure fixing of the EdgeClip into drill hole
- Ideal for use wherever space is at its premium



The holding tab increases the tensile strength additionally.

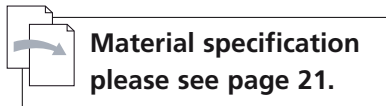

Material specification
please see page 21.

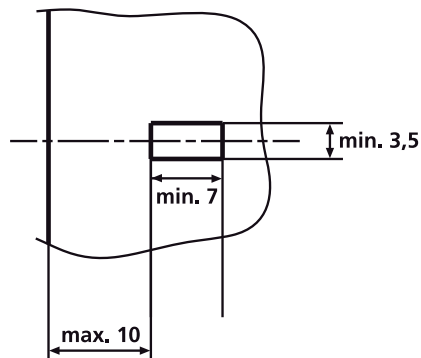

Position of the drill hole for the holding tab

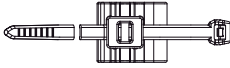
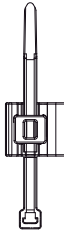
Article-No.	Type	Length (L)	Width (W)	Bundle Ø max.	Min. Tensile strength for ties (N)	Material Cable Tie	Material Foot Part	Application Tool	Drawing
150-45299	T50ROS-EC2,5	200.0	4.6	45.0	225	PA66HS	PA66HIRHS	1-5	
150-45292	T50REC2.5B	200.0	4.6	45.0	225	PA66HS	PA66HIRHS	1-10	

All dimensions in mm. Subject to technical changes.

1-Piece Fixing Tie with Pipe Clip

Features and Benefits

- Easily locks onto a cable, tube or hose (D = 4.5 – 5.2 mm)
- Cable tie head always in defined position
- Suitable for post-installation of bundles

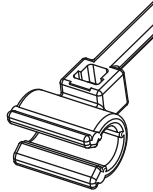

Brake cable fixing

Material specification please see page 21.

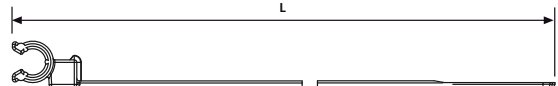

Brake cable fixing

Article-No.	Type	Length (L)	Width (W)	Bundle Ø max.	Min. Tensile Strength (N)	Attach to Ø	Material	Colour
148-00100	Bracket brake line	154.0	3.6	35.0	133	5.1	PA66HS	Natural (NA)
148-00101	Bracket brake line	154.0	3.6	35.0	133	5,1	PA46	Grey (GY)

All dimensions in mm. Subject to technical changes.

One Piece Fixing Ties with Wire Clip

Features and Benefits

- Cable tie head always in defined position
- Easy to close by simply pressing the cover
- Firm sit as a variation of sizes for different wires is available
- Suitable for post-installation of bundles

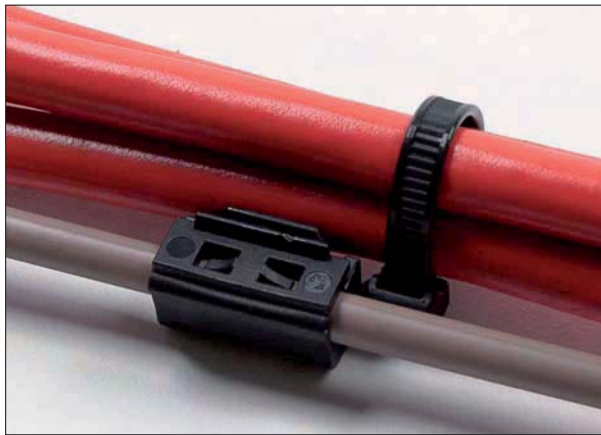

T50SOSWA - the easy way for parallel guidance of cables next to a wire.

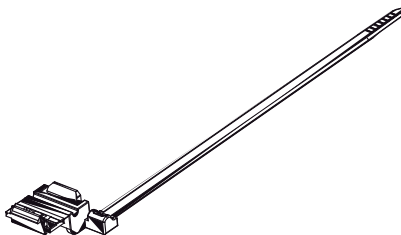

T50SOSWA-types

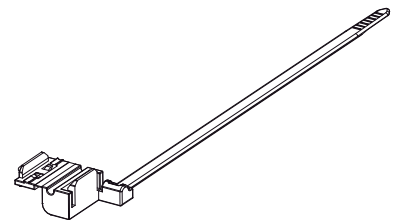

T50SOSWB-types

Article-No.	Type	Length (L)	Width (W)	Bundle Ø max.	Min. Tensile strength for ties (N)	Attach to Ø	Material	Colour
148-00089	T50SOSWA1.8E	150.0	4.6	35.0	225	1.8	PA66HS	Black (BK)
148-00088	T50SOSWA2.0E	150.0	4.6	35.0	225	2.0	PA66HS	Black (BK)
148-00095	T50SOSWA3.4E	150.0	4.6	35.0	225	3.4	PA66HS	Black (BK)
148-00092	T50SOSWA4.3E	150.0	4.6	35.0	225	4.3	PA66HS	Black (BK)
148-00090	T50SOSWB1.8E	150.0	4.6	35.0	225	1.8	PA66HS	Black (BK)
148-00093	T50SOSWB2.0E	150.0	4.6	35.0	225	2.0	PA66HS	Black (BK)
148-00096	T50SOSWB3.4E	150.0	4.6	35.0	225	3.4	PA66HS	Black (BK)
148-00091	T50SOSWB4.3E	150.0	4.6	35.0	225	4.3	PA66HS	Black (BK)

All dimensions in mm. Subject to technical changes.

2-Piece Fixing Ties with Pipe Clip, twistable 360°

Features and Benefits

- Simply clip on a wire or hose
- Fixing clip offers full 360° rotation
- Routed cable can move in any direction in relation to the fixing point
- Inside serrated cable tie
- Ideally used in the Automotive Industry

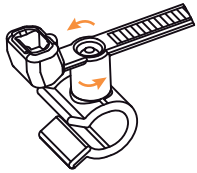

T50SVC65.

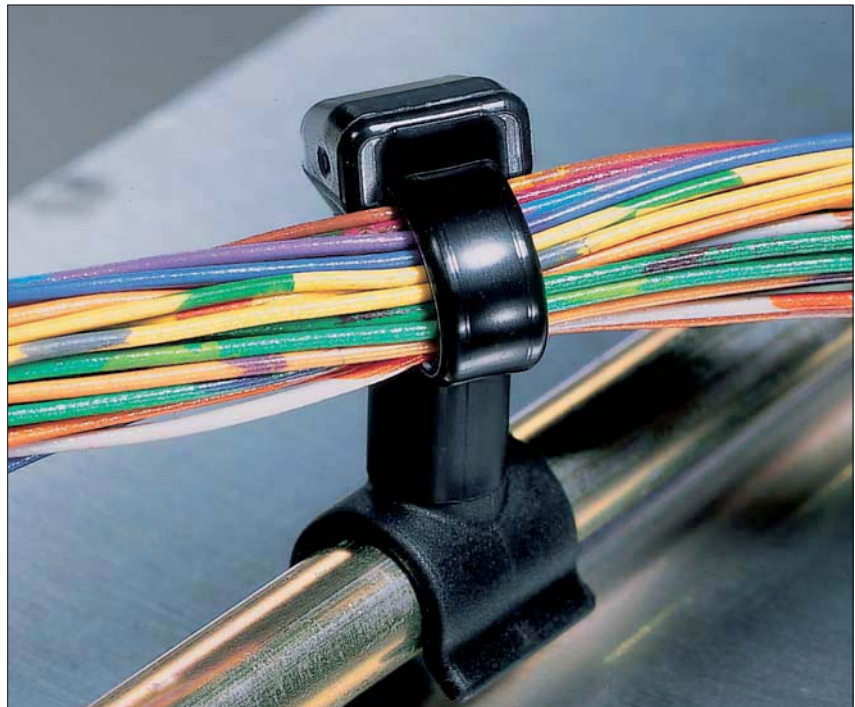

T50SVC5 rotates in any direction.

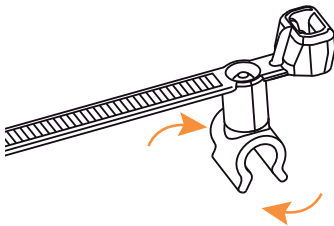

T50SVC5, T50SVC4

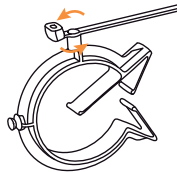

T50SVCOC39-45

Material specification
please see page 21.

Article-No.	Type	Length (L)	Width (W)	Bundle Ø max.	Min. Tensile strength for ties (N)	Attach to Ø	Material	Colour
156-00791	T50SVC3.5	155	4.7	35.0	225	3.45 - 3.55	PA66HS, PA66HIRHS	Black (BK)
156-00318	T50SVC45	155	4.7	35.0	225	3.8 - 4.2	PA66HS, PP	Black (BK), Natural (NA)
156-00447	T50SVC4	155	4.7	35.0	225	3.8 - 4.2	PA66HS, PA66HIRHS	Black (BK)
155-31202	T50SVC5	155	4.7	35.0	225	4.5 - 5.2	PA66HS	Black (BK)
156-00155	T50SVC65	155	4.7	35.0	225	6.5 - 8.0	PA66HS, PA66HIRHS	Black (BK)
156-00134	T50SVCOC10-14	155	4.7	35.0	225	10.0 - 14.0	PA66HS, PA66HIRHS	Black (BK)
156-00135	T50SVCOC15-18	155	4.7	35.0	225	15.0 - 18.0	PA66HS, PA66HIRHS	Black (BK)
156-00136	T50SVCOC19-245	155	4.7	35.0	225	19.0 - 24.5	PA66HS, PA66HIRHS	Black (BK)
156-00272	T50SVCOC25-31	155	4.7	35.0	225	25.0 - 31.0	PA66HS, PA66HIRHS	Black (BK)
156-00273	T50SVCOC31-39	155	4.7	35.0	225	31.0 - 39.0	PA66HS, PA66HIRHS	Black (BK)
156-00137	T50SVCOC39-45	155	4.7	35.0	225	39.0 - 45.0	PA66HS, PA66HIRHS	Black (BK)
156-00128	T50SMVCOC1014	210	4.7	50.0	225	10.0 - 14.0	PA66HS, PA66HIRHS	Black (BK)
156-00129	T50SMVCOC15-18SET	210	4.7	50.0	225	15.0 - 18.0	PA66HS, PA66HIRHS	Black (BK)
156-00130	T50SMVCOC19245	210	4.7	50.0	225	19.0 - 24.5	PA66HS, PA66HIRHS	Black (BK)
156-00577	T50SMVCOC19245	210	4.7	50.0	225	19.0 - 24.5	PA46	Grey (GY)
156-00303	T50SMVCOC25-31	210	4.7	50.0	225	25.0 - 31.0	PA66HS, PA66HIRHS	Black (BK)
156-00304	T50SMVCOC31-39	210	4.7	50.0	225	31.0 - 39.0	PA66HS, PA66HIRHS	Black (BK)
156-00131	T50SMVCOC39-45SET	210	4.7	50.0	225	39.0 - 45.0	PA66HS, PA66HIRHS	Black (BK)

All dimensions in mm. Subject to technical changes.

2-Piece Fixing Ties with Pipe Clip

Features and Benefits

- For post-installation of additional cables for preassembled cable looms
- Variety of twist angles and even different loop directions provide flexibility for cable routing
- For OC1 and 2A additional cable tie dimensions are available
- CBTO-series for cable ties up to 5 mm



EdgeClip CBTO50R, verdrehbar um 90°.

Other dimensions available on request.

Material specification please see page 21.

Article-No.	Type	Length (L)	Width (W)	Bundle Ø max.	Attach to Ø	Colour	Material	Drawing
156-00012	T30ROC1A	150	3.6	31.0	4.0 - 10.0	Black (BK)	PA66HS, PA66HIRHS	
156-00036	T50ROC1A	200	4.6	45.0	4.0 - 10.0	Black (BK)	PA66HS, PA66HIRHS	
156-00505	T30ROC1B	150	3.6	31.0	4.0 - 10.0	Black (BK)	PA66HS, PA66HIRHS	
156-00306	T50ROC1B	200	4.6	45.0	4.0 - 10.0	Black (BK)	PA66HS, PA66HIRHS	
156-00013	T30ROC2A	150	3.6	31.0	6.5 - 7.5	Black (BK)	PA66HS, PA66HIRHS	
156-00014	T30ROC2A	150	3.6	31.0	6.5 - 7.5	Grey (GY)	PA46	
156-00470	T30ROC2B	150	3.6	31.0	6.5 - 7.5	Black (BK)	PA66HS, PA66HIRHS	

2-Piece Fixing Ties with Pipe, twistable 90°

156-00416	T50ROC10-14CBTO-SD-SET	200	4.6	45.0	10.0 - 14.0	Black (BK)	PA66HS, PA66HIRHS	
156-00419	T50ROC15-18CBTO-SD-SET	200	4.6	45.0	15.0 - 18.0	Black (BK)	PA66HS, PA66HIRHS	
156-00422	T50ROC19-24.5CBTO-SD-SET	200	4.6	45.0	19.0 - 24.5	Black (BK)	PA66HS, PA66HIRHS	

All dimensions in mm. Subject to technical changes.

2-Piece Fixing Ties for Heavy Duty Applications, for Screws

Used in the Automotive and Truck Industry for harness fixing in the engine body, these parts offer solutions in many other industrial applications with difficult environment.

Features and Benefits

- Pre-assembled 2-piece fixing tie
- Cable tie head can be moved after bundling
- Secure alignment to the bundle due to H-design
- A suitable alternative for metal clamps
- Withstands vibrations and displacement forces
- High tightening torque through metal bushing



These HDM can be assembled on either screw or stud



Material specification
please see page 21.

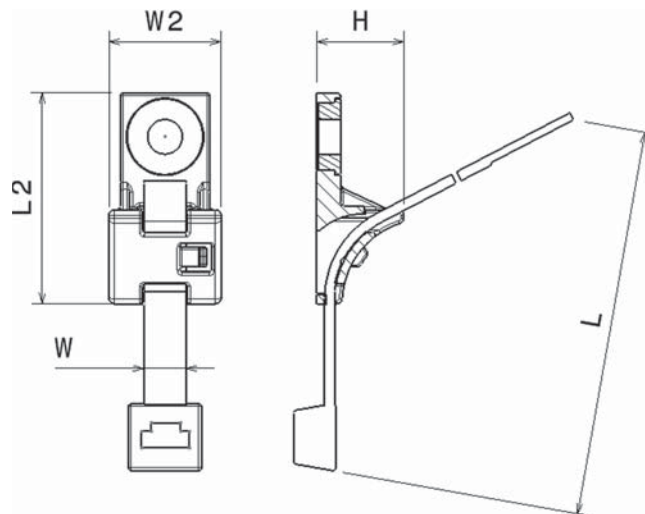

HDM with cable tie (L = length of the tie's flat")

Article-No.	Type	Length (L)	Length (L2)	Width (W)	Width (W2)	Height (H)	Bundle Ø max.	Mounting Screw Type	Material	Colour
HDM6-Series for M6-Screws										
156-00406	T120RHDM6	380.0	38.0	7.6	20.0	15.5	100	M6	PA66HIRHS	Black (BK)
156-00407	T120RHDM6	380.0	38.0	7.6	20.0	15.5	100	M6	PA46	Grey (GY)
HDM8-Series for M8-Screws										
156-00408	T120RHDM8	380.0	38.0	7.6	20.0	15.5	100	M8	PA66HIRHS	Black (BK)
156-00409	T120RHDM8	380.0	38.0	7.6	20.0	15.5	100	M8	PA46	Grey (GY)

All dimensions in mm. Subject to technical changes.

2-Piece Fixing Ties for parallel separation

Features and Benefits

- Pre-assembled 2-piece fixing tie with coupler
- Cable tie head can be moved after bundling
- Easy addition of cables after assembly
- For parallel routing of bundles that can be twisted 90° even after setting



T120RCoupler can be used for parallel routing of two cable ties.



The second tie can be used for post-installations.

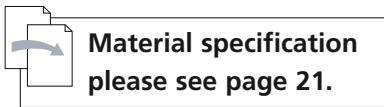

**Material specification
please see page 21.**



T120RCoupler with two ties

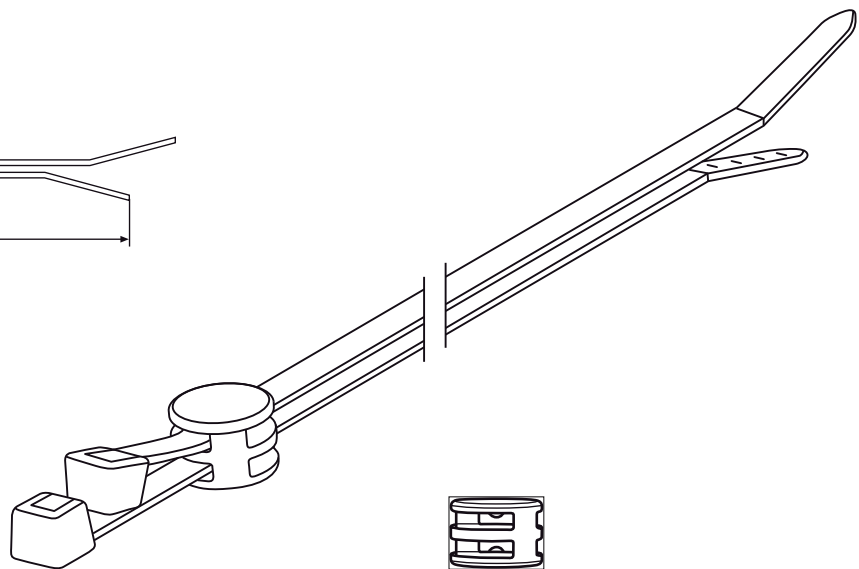

T120RCoupler

Fixing Element - Coupler

Article-No.	Type	Length (L)	Width (W)	Bundle Ø max.	Min. Tensile strength for ties (N)	Material Cable Tie	Material Foot Part	Colour
156-00276	T50RCOUPLER	200	4.6	50.0	225	PA66HIR(S)	PA66HIRHS	Black (BK)
156-00382	T50RCOUPLER	200	4.6	50.0	225	PA46	PA46	Grey (GY)
156-00550	T120RSINGLECOUPLER	380	7.6	100.0	535	PA66HIR(S)	PA66HIRHS	Black (BK)

All dimensions in mm. Subject to technical changes.

Bundling Clips with/without Arrowhead

Features and Benefits

- Easy to install without the need for a tool
- Cable tie head always situated in defined position
- Arrowhead simply locks into place
- Disc adjusts tie for pressure from various directions and minimises access of dust, dirt and water
- ATS fixing elements can be tied automatically with the ATS3080 tool
- Variants with pipe clips allow the addition of cables after installation



L to R: BundlingClip with OmegaClip, BundlingClip with foam, BundlingClip LRJ1.

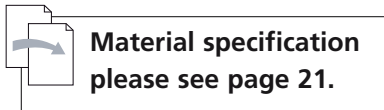

Material specification
please see page 21.

Article-No.	Type	Length (L)	Fixing Hole Ø (FH)	Panel Thickness min.	Panel Thickness max.	Colour	Material	Drawing
Bundling Clips with/without Arrowhead								
151-00431	BCSFT6.5 16-3	55.0	6.3 - 6.7	2.3	3.5	Black (BK)	PA66HIRHS	
102-69066	ATSBCSFT6.5	39.0	6.3 - 6.7	2.3	3.3	Black (BK)	PA66HIRHS	
102-69067	ATSBCSFT6,5S	39.0	6.3 - 6.7	0.7	1.3	Black (BK)	PA66HIRHS	
102-69068	ATSBC2KSFT6,5	39.0	6.3 - 6.7	0.7	1.3	Black (BK)	PA66HIRHS	
151-08101	LRJ1	55.0	6.2 - 6.7	0.7	2.0	Black (BK)	PA6	
Bundling Clips with Arrowhead, sealed								
155-11601	BCSFT6.5 16-3MD	55.0	6.3 - 6.7	1.5	3.0	Black (BK)	PA66HIRHS	
102-69065	ATSBCSFT6.5-MD	39.0	6.3 - 7.0	0.6	5.1	Black (BK)	PA66HIRHS	
Bundling Clips with Arrowhead								
133-00067	Halter SFT6.5	60.0	6.3 - 6.7	0.6	1.5	Black (BK)	PA66HIRHS	
151-00447	OCTC1*	60.0	–	–	–	Black (BK)	PA66HIRHS	

All dimensions in mm. Subject to technical changes.

*without arrowhead

Bundling Clips, moveable

An easy means of routing and securing cable sets in various parts of cars.

Features and Benefits



- Easy to install without the need for a tool
- Rubber seal stops dirt and water gaining access
- Horizontal length tolerance compensation
- Ideal if holes do not fit registration or bundles need to be routed round corners



The CHA2 with fir tree base and length tolerance compensation for precise cable routing even in difficult conditions.

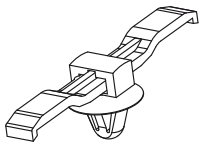

Material specification
please see page 21.

Article-No.	Type	Length (L)	Width (W)	Fixing Hole Ø (FH)	Panel Thickness min.	Panel Thickness max.	Colour	Material	Drawing
CHA1 with arrowhead									
150-08110	CHA1	54.0	6.0	6.3 - 7.0	0.5	1.2	Black (BK)	PA66HS	
TCSFT6.5CHAMD with arrowhead, sealed									
151-00153	TCSFT6.5CHAMD	54.0	6.0	6.5 - 6.7	0.6	1.8	Black (BK)	PA66HS	
CHA2 with fir tree									
151-02901	CHA2	54.0	6.0	6.5 - 7.0	0.8	2.0	Black (BK)	PA66	

All dimensions in mm. Subject to technical changes.

Bundling Clips with Arrowhead for Distance Routing

Features and Benefits

- Easy to install without the need for a tool
- Arrowhead simply locks into place
- Disc adjusts tie for pressure from various directions and minimises access of dust, dirt and water
- Versions for oval holes feature anti-twist protection

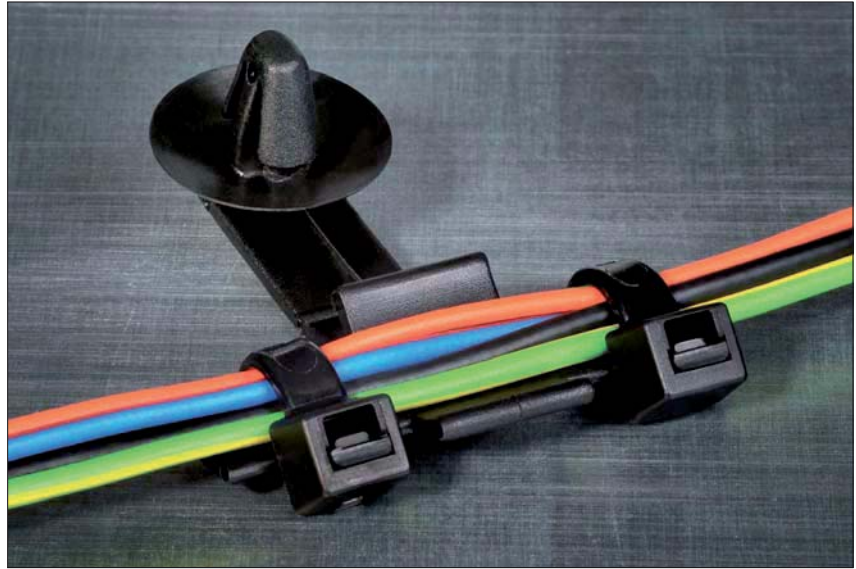

StandOff Clips allow cable looms to be routed at a set distance from the punched holes.

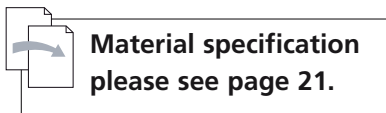

Material specification
please see page 21.

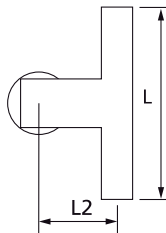

Article-No.	Type	Length (L)	Length (L2)	Fixing Hole Ø (FH)	Panel Thickness min.	Panel Thickness max.	Colour	Material	Drawing
150-45397	STAND OFF CLIP	40.0	31.0	6.5 - 6.8	0.4	1.6	Black (BK)	PA66HIRHS	
150-45398	STAND OFF CLIP	40.0	31.0	6.5 - 6.8	0.4	1.6	Grey (GY)	PA46	
155-01600	STAND-OFF-CLIP-2	40.0	25.0	6.5 - 6.8	0.4	1.6	Black (BK)	PA66HIRHS	
151-00077	CH20D6	50.0	20.0	6.5	0.8	1.6	Black (BK)	PA66HS	
151-02600	CH20D7	50.0	20.0	7.0	0.8	1.6	Black (BK)	PA66	

All dimensions in mm. Subject to technical changes.

Bundling Clips with Fir Tree

Widespread use in cable harness production; a quick and easy means of fixing cables and lines securely in various parts of cars.

Features and Benefits

- Easy to install without the need for a tool
- One fir tree foot part can be used for a variety of panel thicknesses
- Suitable for use within threaded holes
- Holding tabs prevent the tie slipping sideways
- Versions for oval holes feature anti-twist protection



BundlingClips with fir tree bases for a variety of applications with a wide range of metal thicknesses and drill holes.



Article-No.	Type	Length (L)	Fixing Hole Ø (FH)	Panel Thickness min.	Panel Thickness max.	Colour	Material	Drawing
151-00028	TC3FT6S	37.0	6.5 - 7.0	0.75	1.5	Black (BK)	PA66HIRHS	
150-95500	TC5FT6S	37.0	6.5 - 7.0	0.75	1.5	Black (BK)	PA66HIRHS	
151-00215	TC4FT6LG	37.0	6.3 - 7.0	0.6	5.1	Black (BK)	PA66HIRHS	
151-00467	TC4FT6LG-A	37.0	6.3 - 7.0	0.6	5.1	Natural (NA)	PA66HIRHS	
155-30802	TC2FT6LG	55.0	6.3 - 7.0	0.6	5.1	Black (BK)	PA66HIRHS	
151-00020	TC2FT6LG	55.0	6.3 - 7.0	0.6	5.1	Natural (NA)	PA66HIRHS	
151-00662	BCFT6XL56	56.0	6.3 - 7.0	0.7	9.0	Black (BK)	PA66HIRHS	
102-67065	ATSBCFT6LG	39.0	6.3 - 7.0	0.6	5.1	Black (BK)	PA66HIRHS	
151-00790	BCOWFT6M	27.3	6.5 - 7.0	0.6	3.5	Black (BK)	PA66HIRHS	
151-00904	BCOWFT5	24.9	4.9 - 5.1	2.9	3.10	Black (BK)	PA66HIRHS	
155-39002	TCDSFT6-HEX	40.0	6.35	0.8	4.5	Black (BK)	PA66HIRHS	

All dimensions in mm. Subject to technical changes.

Bundling Clips with Fir Tree

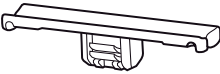
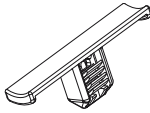
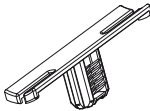

Material specification
please see page 21.

Article-No.	Type	Length (L)	Fixing Hole Ø (FH)	Panel Thickness min.	Panel Thickness max.	Colour	Material	Drawing
Bundling Clips with Fir Tree, for Oval Holes								
151-00759	BCFT63x100S	40.0	6.5 x 10.2	0.6	2.5	Black (BK)	PA66HIRHS	
155-16301	WICKELCLIP-VDS	40.0	6.3 x 9.0	0.6	2.5	Black (BK)	PA66HIRHS	
151-00605	TCOP62x122	55.0	6.2 x 12.2	0.6	6.0	Black (BK)	PA66HIRHS	
151-00029	TCOP70x120	55.0	7.0 x 12.0	0.6	6.0	Black (BK)	PA66HIRHS	

All dimensions in mm. Subject to technical changes.

Bundling Clips with Fir Tree, for Distance Routing

Originally designed for the Automotive industry these clips offer simple and easy methods of securing cables or pipes, they have many applications within a wide range of industries.

Features and Benefits

- Easy to install without the need for a tool
- One fir tree foot part can be used for a variety of panel thicknesses
- Suitable for use within threaded holes
- Disc covers the hole to prevent dirt and water gaining access
- Bundle runs in a set distance to the hole



COW Clip used as tape-on clip.

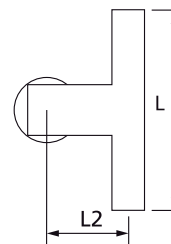

**Material specification
please see page 21.**

Article-No.	Type	Length (L)	Length (L2)	Fixing Hole Ø (FH)	Panel Thickness min.	Panel Thickness max.	Colour	Material	Drawing
151-03100	COW20DP7	42.0	20.0	6.3 - 7.0	0.8	4.5	Brown (BN)	PA66HS	
151-03200	COW30DP7	42.0	30.0	6.3 - 7.0	0.8	4.5	Black (BK)	PA66	
155-19001	SOC3-FT6-LG.	12.0	30.0	6.4 - 7.1	0.75	6.0	Black (BK)	PA66HIRHS	
151-00629	SOC7FT6	56.0	31.0	6.35 - 7.0	0.7	5.7	Black (BK)	PA66HIRHS	
155-30902	SOC4 M.FT6	55.0	20.0	6.5 - 7.0	0.7	5.1	Black (BK)	PA66HIRHS	
151-00074	SOC5FT6LG	55.0	13.0	6.5 - 7.0	0.7	5.1	Black (BK)	PA66HIRHS	
151-00023	SOC6	55.0	22.0	6.3 - 7.0	0.8	3.5	Black (BK)	PA66HIRHS	
151-00665	SOC8FT6LG	40.0	30.0	6.5 - 7.0	0.7	5.75	Black (BK)	PA66HIRHS	
151-00282	SOC10405	55.0	20.0	6.3 - 6.7	0.7	3.5	Black (BK)	PA66HIRHS	

All dimensions in mm. Subject to technical changes.

Bundling Clips for Weld Studs, movable

Features and Benefits

- Easy assembly, without tool
- Horizontal length tolerance compensation up to 4 mm
- BCUWS5-D5-25: for coarse thread studs
- If connector retainer is a request: TCSB5CYCC
- If post-installation of cables is a need: Bundling clip SB5
- For defined distance of bundles to surface: BCOS variants



TCSB5CYCC: Tapebar, Stud Retainer and ConnectorClip in just one article.

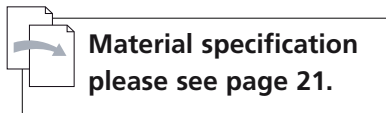

Article-No.	Type	Length (L)	Stud Ø	Colour	Material	Drawing
Bundling Clips for Weld Studs, movable						
151-26101	TC-SB5C	55.0	5.0	Black (BK)	PA66HS	
151-00851	BCUWS5-D5-25	50.0	5.0	Black (BK)	PA66HIRHS	
151-00484	TCSB5CYCC	55.0	5.0	Black (BK)	PA66HIRHS	
155-23701	WICKELCLIP-SB5	60.0	5.0	Black (BK)	POM	
Bundling Clips for Weld Studs						
151-00664	BCOS5	59.0	5.0	Black (BK)	PA66HIRHS	
151-00281	TCOS10305	59.0	6.0	Black (BK)	PA66HIRHS	

All dimensions in mm. Subject to technical changes.

Bundling Clips for Weld Studs, movable

The BC series is proving very popular in the automotive industry as a means of installing cable sets easily in various areas of the vehicle.

Features and Benefits

- Very flat bundling clip for 5mm weld stud
- Horizontal length tolerance compensation
- Suitable for cables of reduced weight and diameter



The slim line BS series is particularly compact and flexible.

 **Material specification please see page 21.**

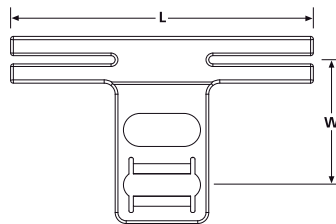

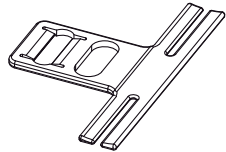
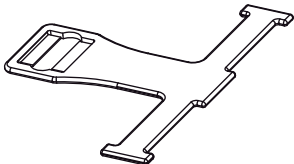
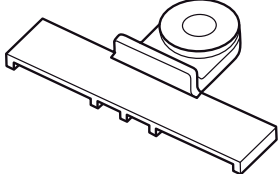
Article-No.	Type	Length (L)	Width (W)	Stud Ø	Colour	Material	Drawing
BC2212 for distance routing 12.0 and 22.0 mm							
151-00017	BC2212	55.0	22.0	5	Black (BK)	PA66HIRHS	
BC30 for distance 30.0 mm							
151-00016	BC30	55.0	30.0	5	Black (BK)	PA66HIRHS	
Bundling Clips for Screws							
156-00390	BC-SCR6	60.0	20.0	6.5	Black (BK)	PA66GF60, PA66HIRHS	

All dimensions in mm. Subject to technical changes.

Bundling Clips for Edges

• EdgeClip-Family

Edge Clips are used in the automotive industries and electrical industries and when it is impossible to drill holes or no other fixing points are available.

Features and Benefits

- Easy assembly, just shuffle manually
- Designed for edges of 1 - 3 resp. 1,5 - 4,5 mm
- Integrated metal clamp holds clip firmly in place
- Clamp consists of double tempered steel spring
- ATS fixing elements can be tied automatically with tools ATS3080 and AT2000



Cables and leads can be fastened with a cable tie or adhesive tape to the bars of the mounting element.

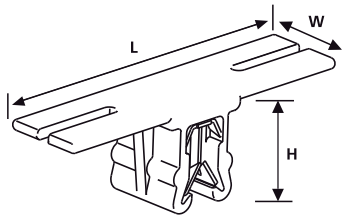

EC15

Material specification please see page 21.

Article-No.	Type	Length (L)	Width (W)	Height (H)	Panel Thickness min.	Panel Thickness max.	Material	Drawing
151-03404	EC14	40.0	10.0	12.4	1.0	3.0	PA66HIRHS	
151-03401	EC15	40.0	10.0	12.4	1.0	3.0	PA66HIRHS	
151-03402	EC16	40.0	10.0	13.0	1.0	3.0	PA66HIRHS	
151-03403	EC17	46.5	10.0	13.0	1.0	3.0	PA66HIRHS	
151-00819	EC17	46.5	10.0	13.0	1.0	3.0	PA46	
102-68355	ATSBCEC35	39.0	9.0	13.2	1.5	4.0	PA66HIRHS	
102-68365	ATSBCEC36	39.0	9.0	16.0	1.5	4.0	PA66HIRHS	
102-68375	ATSBCEC37	39.0	9.0	14.2	1.5	4.0	PA66HIRHS	

Bundling Clips for Edges, 1,0 - 3,0 mm, for Distance Routing

151-00022	EC30	50.0	9.0	13.5	1.0	3.0	PA66HIRHS	
-----------	------	------	-----	------	-----	-----	-----------	--

All dimensions in mm. Subject to technical changes.

Bundling Clips for Connectors

The ConnectorClips used here have been designed for cables and cable sets used in the automotive industry.

Features and Benefits

- Bundles are guided above connector plug
- Secure fixing of connector
- For horizontal length tolerance compensation up to 5 mm: CONNECTOR CLIP



**Material specification
please see page 21.**

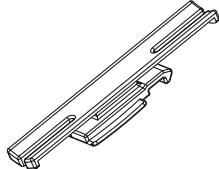
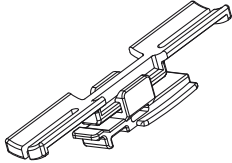

ConnectorClips designed for cables and cable sets used in the automotive industry.

Article-No.	Type	Length (L)	Colour	Material	Drawing
Bundling Clips for Connectors					
155-31102	YAZ-CONN-TAPE-CLIP	55.0	Black (BK)	PA66HS	
Bundling Clips for Connectors, movable					
150-41397	CONNECTOR CLIP	55.0	Black (BK)	PA66HIRHS	

All dimensions in mm. Subject to technical changes.

Fixing Elements with Arrowhead

Features and Benefits



- Fixing part with rounded arrowhead to minimise assembly height
- Ideal for applications where space is limited
- Bundle diameter is defined
- Suitable for post-installation of bundles



The very low Arrowhead is specially designed for narrow installation spaces.



The OmegaClip KSFT6,5OC7-9 can be used repeatedly and flexibly to bundle cables, pipes or hoses.

Article-No.	Type	Height (H)	Attach to Ø	Fixing Hole Ø (FH)	Panel Thickness min.	Panel Thickness max.	Material	Colour	Drawing
151-00673	KSFT6.5OC1-3	14.4	1.0 - 3.0	6.3 - 6.7	2.3	2.7	PA66HIRHS	Black (BK)	
151-00674	KSFT6,5 OC 7-9	21.6	7.0 - 9.0	6.3 - 6.7	2.3	2.7	PA66HIRHS	Black (BK)	

All dimensions in mm. Subject to technical changes.

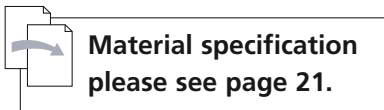

Fixing Elements with Fir Tree

Features and Benefits

- Easy to install without the need for a tool
- Disc covers the hole to prevent dirt and water gaining access
- Bundle diameter is defined
- Suitable for post-installation of bundles

Article-No.	Type	Height (H)	Attach to Ø	Fixing Hole Ø (FH)	Panel Thickness min.	Panel Thickness max.	Material	Colour	Drawing
151-00680	HC48FT6	20.8	4.3 - 5.2	6.5 - 7.0	0.7	2.8	PA66HIRHS	Black (BK)	

All dimensions in mm. Subject to technical changes.

Fixing Elements for Tubes and Harnesses

- PC-Series with Arrowhead
- PC-Series with Firtree

Pipe clips offering a simple and time saving fixing method for hoses and pipes even when a cable tie can't be used.

Features and Benefits

- Fixing elements with fir tree or arrow head
- Simply clip on a wire or hose
- Clips to be attached into bore hole
- Bundels can be released at any time



For quick and simple routing of tubes and harnesses.

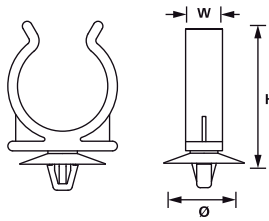

PC-Clip with Arrowhead

Article-No.	Type	Width (W)	Height (H)	Height (H2)	Disc Ø	Bundle Ø max.	Fixing Hole Ø (FH)	Panel Thickness min.	Panel Thickness max.	Material	Colour	Drawing
151-14700	PC35LAH	8.0	10.5	5.0	–	3.5	4.7	0.8	2.0	PA66	Black (BK)	
151-14300	PC23	10.0	36.0	6.5	22.0	24.0	6.3	0.6	1.6	PA66	Black (BK)	
151-00119	PC5DP7S	8.0	9.5	8.1	16.0	5.0	7.0	0.8	3.0	PA66	Black (BK)	
151-14801	PC5DP7L	–	9.5	12.6	16.0	5.0	7.0	0.8	7.0	PA46	Black (BK)	

All dimensions in mm. Subject to technical changes.



Material specification
please see page 21.

Fixing Elements for Tubes and Harnesses, interconnectable

• IPC-Series

Originally designed for the automotive industry they are finding a wide and time saving variety of applications in all industries where the use of a cable tie is not suitable.

Features and Benefits

- Fixing elements with fir tree or arrow head
- Simply clip on a wire or hose
- Clips to be attached into bore hole
- Bundels can be released at any time



Simple and secure installation of pipes or hoses to panels.

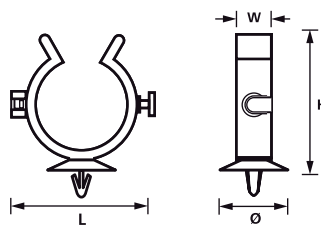

IPC Clip with arrowhead

IPC-Series can be combined with IAHC-Series on page 95. Please contact us!

Material specification please see page 21.

Article-No.	Type	Height (H)	Width (W)	Disc Ø	Bundle Ø max.	Fixing Hole Ø (FH)	Panel Thickness max.	Material	Colour
Connectable Arrowhead									
151-00096	IPC10AH	18.4	10.0	22.0	12.5	6.3	1.6	PA66	Black (BK)
151-14130	IPC13AH	21.0	10.0	22.0	13.5	6.3	1.6	PA66	Black (BK)
151-14500	IPC15AH	23.0	10.0	22.0	14.7	6.3	1.6	PA66	Black (BK)
151-14601	IPC23AH	34.0	10.0	22.0	25.0	6.3	1.6	PA66	Black (BK)
Connectable									
151-00870	IPC5P	9.8	10.0	–	6.0	–	–	PA66	Black (BK)
151-14400	IPC10P	15.0	10.0	–	12.5	–	–	PA66HIR	Black (BK)
151-14132	IPC13P	17.4	10.0	–	13.5	–	–	PA66	Black (BK)
151-14502	IPC15P	19.5	10.0	–	14.7	–	–	PA66HIR	Black (BK)
151-14603	IPC23P	30.5	10.0	–	25.0	–	–	PA66	Black (BK)

All dimensions in mm. Subject to technical changes.

Fixing Elements for Tubes and Harnesses with Automatic Locking Feature

• AHC-Serie

Offering a simple and secure method of attaching cables to panels. Originally designed for the automotive industry they are finding a wide variety of applications in all industries using sheet metal panels.

Features and Benefits

- Push and click closure for fixation of wires
- Clip is clicked into a specific hole
- AHC_SS und AHC_SB can be pushed onto a 5mm stud



Automatic Harness Clip open.



Automatic Harness Clip closed.



**Material specification
please see page 21.**

Article-No.	Type	Length (L)	Length (L2)	Width (W)	Disc Ø	Bundle Ø max.	Fixing Hole Ø (FH)	Panel Thickness min.	Panel Thickness max.	Material	Drawing
151-00366	AHC1AH	25.0	7.0	10.0	20.0	13.0	6.2 - 6.7	0.50	2.00	PA66HIRHS	
151-00367	AHC2AH	29.5	7.0	10.0	20.0	20.0	6.2 - 6.7	0.50	2.00	PA66HIRHS	
151-00374	AHC4AH	58.0	7.5	13.5	24.0	36.0	6.2 - 6.7	0.70	3.00	PA66HIR	
151-00208	AHC2BH	29.0	7.0	10.0	20.0	20.0	6.2 x 12.2	0.7	3.0	PA66HIRHS	
151-00370	AHC3BHR	40.0	7.0	10.0	24.0	28.0	6.2 x 12.2	0.7	3.0	PA66HIRHS	
151-00371	AHC3CHR	40.0	7.0	10.0	24.0	28.0	6.2 x 12.2	0.7	3.0	PA6HIR	
151-00368	AHC2SS	29.0	-	10.0	-	20.0	-	-	-	PA66HIRHS	
151-00373	AHC3SB	41.0	-	10.0	27.0	28.0	-	-	-	PA66HIRHS	
151-00181	AHC3DH	66.0	-	10.0	-	28.0	6.2 x 12.2	0.50	2.00	PA66HIRHS	
151-00928	AHC3EH2	44.2	5.2	11.0	24.0	28.0	6.2 x 12.2	1.80	4.80	PA66HIRHS	

All dimensions in mm. Subject to technical changes.

Fixing Elements for Tubes and Harnesses with Automatic Locking Feature

• IAHC-Series

Offering a simple and secure method of attaching cables to panels. Originally designed for the automotive industry they are finding a wide variety of applications in all industries using sheet metal panels.

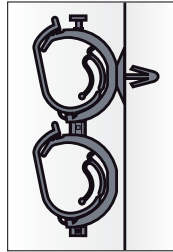

IAHC elements can be connected.

Material specification please see page 21.

Features and Benefits

- Push and click closure
- Coupling elements of the IAHC variants allow parts to interconnect
- Clip is clicked into a specific hole
- IAHC_T can only be connected with another (!)AHC element

Article-No.	Type	Length (L)	Length (L2)	Width (W)	Disc Ø	Bundle Ø max.	Fixing Hole Ø (FH)	Panel Thickness min.	Panel Thickness max.	Material	Drawing
151-00223	IAHC1T	23.0	–	10.0	–	13.0	–	–	–	PA66HIRHS	
151-00199	IAHC2T	30.0	–	10.0	–	20.0	–	–	PA66HIRHS		
151-00213	IAHC3T	40.0	–	10.0	–	28.0	–	–	PA66HIRHS		
151-00207	IAHC4T	47.0	–	13.5	–	36.0	–	–	PA66HIRHS		
151-00195	IAHC5T	57.0	–	13.5	–	45.0	–	–	PA66HIRHS		
151-00378	IAHC3AH	40.0	7.5	13.5	24.0	28.0	6.2 - 6.7	0.7	2.7	PA66HIRHS	
151-00382	IAHC4AH	48.0	7.0	13.5	24.0	36.0	6.2 - 6.7	0.7	3.0	PA66HIRHS	
151-00384	IAHC5BH	57.0	7.0	13.5	24.0	45.0	6.2 x 12.2	0.7	3.0	PA66HIRHS	
151-00381	IAHC3CH	40.0	7.0	13.5	24.0	28.0	6.2 x 12.2	0.7	3.0	PA66HIRHS	
151-00383	IAHC4CH	47.0	7.0	13.5	24.0	36.0	6.2 x 12.2	0.7	3.0	PA66HIRHS	
151-00787	IAHC5FH	61.5	4.1	13.5	24.0	45.0	6.2 x 12.2	1.5	3.0	PA66HIRHS	
151-00489	IAHC3EH	44.5	4.8	13.5	24.0	28.0	6.2 x 12.2	1.5	3.1	PA66HIRHS	

All dimensions in mm. Subject to technical changes.

Fixing Elements for Tubes and Harnesses, for Edges

• EdgeClip-Family

Features and Benefits

- Releasable fixing elements with EdgeCpip
- Low-vibration routing of bigger bundle diameters
- Clips to be pushed onto an edge
- To be closed single handed, a snap can be felt
- Bundels can be released at any time
- EC27: fixing element enables usage of smaller bundle diameter
- EC41: for parallel guidance of two bundles



EdgeClip cable and tube clips are suitable for the low-vibration routing of cables and tubes with larger bundle diameters.

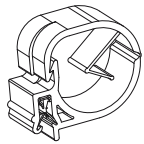
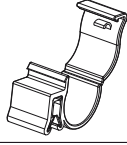
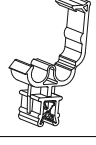
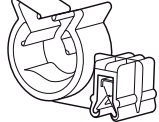

Material specification
please see page 21.

Article-No.	Type	Panel Thickness min.	Panel Thickness max.	Bundle Ø max.	Colour	Material	Drawing
151-00161	EC27	1.0	3.0	15.0 - 22.0 mm	Black (BK)	PA66HIRHS	
151-00174	EC39	1.0	3.0	15.3 - 15.9 mm	Black (BK)	PA6HIR	
151-00234	EC41	3.0	6.0	2 x 8.0 mm	Black (BK)	PA66HIR	
151-00610	HCEC3.0SP-C	1.0	3.0	12.0 - 15.0 mm	Black (BK)	PA66HIRHS	

All dimensions in mm. Subject to technical changes.

Fixing Elements for Corrugated Tubing, with Arrowhead

These clamps are used for example in the automotive industry, in the production of cable harnesses and in the electrical industry. Their quick and easy mounting is the reason for their universal success wherever corrugated tubing and pipes have to be fixed quickly and securely.

Features and Benefits

- Clamps for corrugated tubing for a variety of nominal diameters
- Arrowhead simply locks into place
- Tube is guided accurately by clicking
- Axial slipping is prevented by the inside profile of the clamp
- Type RCCD for oval holes 6.2 x 12.2 mm
- OCTCSFT6,5 clamp for corrugated tubes for nom. diameter of 55-80 mm.
- CTC-L profile clamp can also be fastened to a metal edge



Simple and secure installation of pipes or hoses to panels.

 **Material specification please see page 21.**

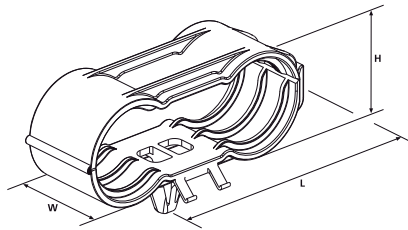

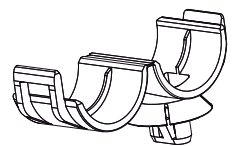
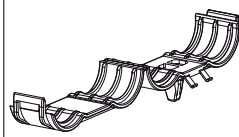
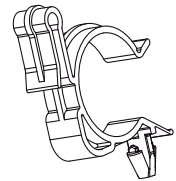
Article-No.	Type	Length (L)	Width (W)	Height (H)	Fixing Hole Ø (FH)	Panel Thickness min.	Panel Thickness max.	Colour	Material	Drawing
150-92300	RCC D21*	31.0	22.0	30.0	6.2 x 12.2	0.7	2.5	Black (BK)	PA66HIRHS	
155-04000	RCC D24*	33.0	22.0	33.0	6.2 x 12.2	0.7	2.5	Black (BK)	PA66HIRHS	
151-00598	RCC D28*	37.0	22.0	37.0	6.75 x 13.25	0.7	3.0	Black (BK)	PA66HIRHS	
151-00021	OCTCSFT6.5	64.0	20.0	24.5	6.3 - 6.6	1.0	2.5	Black (BK)	PA66HIRHS	
151-00026	CTCLPROFILE	49.7	12.0	47.0	7.8 - 8.2	2.3	2.7	Black (BK)	PA66HIRHS	

All dimensions in mm. Subject to technical changes.

* for oval hole

Fixing Elements for Corrugated Tubing, with Fir Tree

• CTC-Series

CTC clamps are used for example in the automobile, harness making, electrical industry and wherever corrugated tubing has to be quickly and firmly fixed.

Features and Benefits

- CTC clamps for a variety of nominal diameters
- Fir tree foot part can be used for a variety of panel thicknesses
- Suitable for use within threaded holes
- Tube is guided accurately by clicking
- Axial slipping is prevented by the inside profile of the clamp



The tubing is clicked into the CTC clamp and is held firmly.

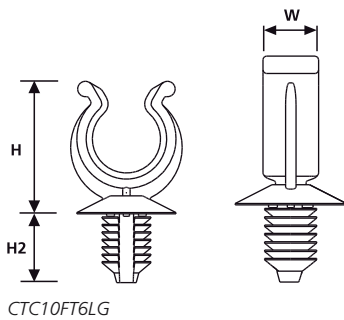

Material specification
please see page 21.

Article-No.	Type	Width (W)	Height (H)	Height (H2)	Nominal Ø	Disc Ø	Fixing Hole Ø (FH)	Panel Thickness min.	Panel Thickness max.	Material
151-14314	CTC4.5FT6LG	10.0	16.1	11.1	4.5	16.0	6.5 - 7.0	0.75	6.0	PA66HIRHS
151-14313	CTC7.5FT6LG	8.0	18.6	11.1	7.5	16.0	6.5 - 7.0	0.75	6.0	PA66HIRHS
155-31602	CTC7.5FT9	8.0	19.9	12.2	7.5	23.0	8.7 - 9.0	3.0	5.0	PA66HIRHS
151-00794	CTC8.5FT6	8.0	18.6	11.1	8.5	16.0	6.5 - 7.0	0.75	3.0	PA66HIRHS
151-14311	CTC10FT6	8.0	21.4	7.5	10.0	16.0	6.5 - 7.0	0.75	3.0	PA66HIRHS
151-00018	CTC10FT6LG	8.0	21.4	11.1	10.0	16.0	6.5 - 7.0	0.75	6.0	PA66HIRHS
155-17801	CTC10FT9	8.0	22.7	12.2	10.0	23.0	8.7 - 9.0	3.0	5.0	PA66HIRHS
151-14312	CTC13FT6	8.0	25.2	7.5	13.0	16.0	6.5 - 7.0	0.75	3.0	PA66HIRHS
151-00019	CTC13FT6LG	8.0	25.2	11.1	13.0	16.0	6.5 - 7.0	0.75	6.0	PA66HIRHS
151-00783	CTCFT6	11.0	18.5	9.3	15.0	-	6.3 - 6.7	0.7	4.5	PA66HIRHS
155-25201	CTC22FT9	8.0	37.7	12.2	22.0	23.0	8.7 - 9.0	3.0	5.0	PA66HIRHS

All dimensions in mm. Subject to technical changes.

Fixing Elements for Corrugated Tubing, for Weld Studs

• CTC-Series

These holders are used for example in the automotive industry, in the production of cable harnesses and in the electrical industry. Their quick and easy mounting is the reason for their universal success wherever corrugated tubing and pipes have to be fixed quickly and securely.

Features and Benefits

- Fixing elements for corrugated tubing for nominal diameters from 4.5-17mm
- For M6 weld studs
- Soft-Push mechanic for simple assembly, without tool
- Tube is guided accurately by clicking
- Axial slipping is prevented by the inside profile of the clamp
- Clamp can be unscrewed and removed from the weld stud



The tubing is clicked into the CTC clamp and is held firmly.

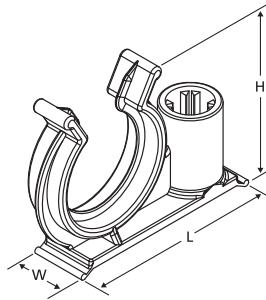

Material specification please see page 21.

Article-No.	Type	Length (L)	Width (W)	Height (H)	Nominal Ø	Colour	Material	Drawing
151-00700	CTC4.5SBS6	28.6	11.0	18.7	4.5	Black (BK)	PA66HIRHS	
151-00701	CTC7.5SBS6	31.8	11.0	19.4	7.5	Black (BK)	PA66HIRHS	
151-00702	CTC10SBS6	35.3	11.0	22.2	10.0	Black (BK)	PA66HIRHS	
151-00703	CTC13SBS6	37.0	11.0	26.5	13.0	Black (BK)	PA66HIRHS	
151-00010	CTC17SBS6	44.6	11.0	33.2	17.0	Black (BK)	PA66HIRHS	

All dimensions in mm. Subject to technical changes.

Snapper Hose Clips for Tubes and Harnesses

• SNP-Series

SNP range may replace metal hose clamps. Snapper can be used in markets as diverse as automotive, agriculture, white goods, venting systems, pumps and hydraulic systems to medical engineering.

Features and Benefits

- Releasable and reusable plastic hose clamps
- Self-locking
- Releasable by giving a lateral movement to the 'head'
- Installation by hand possible
- Installation with processing tool for a secure tensioning
- For higher operating temperatures: Glass Filled PA66



SNP - Snapper Hose Clips range.

Application Tool	Registration Numbers
ASNP2-22	1
ASNP24-70	2
MSNP1-70	3

For detailed information on Application Tools please refer to page 140.

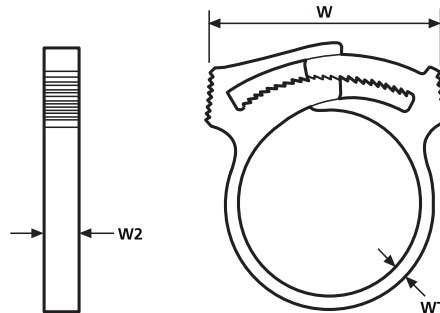

SNP - Snapper Hose Clips range

Snapper Hose Clips for Tubes and Harnesses

- SNP-Series

SNP Snapper are also available on request in material PA66HS and PA46.

Material specification please see page 21.

Article-No.	Type	Bundle Ø min.	Bundle Ø max.	Width (W) min.	Width (W) max.	Width (W2)	Wall (WT)	Material	Colour	Application Tool
192-10010	SNP1	6.0	6.8	8.4	11.7	3.8	1.0	PA66GF13	Black (BK)	3
190-00029	SNP1.25	7.1	7.7	10.4	12.4	3.8	1.1	PA66GF13	Black (BK)	3
193-00150	SNP1.5	7.8	9.2	13.0	17.0	3.7	1.4	PA66GF15	Black (BK)	3
192-10020	SNP2	9.3	10.5	12.2	17.6	5.9	1.7	PA66GF13	Black (BK)	1, 3
192-10040	SNP4	10.4	11.7	13.3	19.2	5.8	1.7	PA66GF13	Black (BK)	1, 3
192-10060	SNP6	11.7	13.3	14.7	21.6	5.9	1.7	PA66GF13	Black (BK)	1, 3
192-10070	SNP7	11.4	13.7	18.4	28.5	5.9	1.7	PA66GF13	Black (BK)	1, 3
192-10080	SNP8	13.1	15.0	16.7	24.9	5.7	1.7	PA66GF13	Black (BK)	1, 3
192-10100	SNP10	14.5	16.6	17.6	26.9	5.9	1.8	PA66GF13	Black (BK)	1, 3
190-00254	SNP12A	15.9	18.2	20.7	29.8	5.9	1.8	PA66GF13	Black (BK)	1, 3
190-00300	SNP14A	18.5	21.0	20.9	30.1	5.9	1.8	PA66GF13	Black (BK)	1, 3
192-10160	SNP16	19.1	21.7	19.9	30.8	5.8	1.5	PA66GF13	Black (BK)	1, 3
190-00258	SNP18A	20.0	23.1	24.3	36.0	6.1	1.8	PA66GF13	Black (BK)	1, 3
190-00090	SNP19	22.3	25.3	23.0	36.2	5.9	1.8	PA66GF13	Black (BK)	1, 3
192-10220	SNP22	23.7	27.4	23.9	37.7	6.0	1.8	PA66GF13	Black (BK)	1, 3
192-10240	SNP24	25.8	29.2	25.5	39.4	7.4	1.7	PA66GF13	Black (BK)	2, 3
190-00127	SNP28	28.8	33.2	25.9	41.8	7.3	1.7	PA66GF13	Black (BK)	2, 3
192-10320	SNP32	31.2	35.8	27.3	44.4	7.3	1.8	PA66GF13	Black (BK)	2, 3
192-10360	SNP36	37.8	44.0	32.4	53.8	7.3	1.7	PA66GF13	Black (BK)	2, 3
192-10380	SNP38	41.0	48.1	35.6	57.5	7.3	1.8	PA66GF13	Black (BK)	2, 3
191-00005	SNP42N	44.5	52.2	35.1	59.1	9.1	1.7	PA66GF13	Black (BK)	2, 3
192-10500	SNP50	52.2	58.6	36.5	60.4	7.3	1.7	PA66GF13	Black (BK)	2, 3
190-00022	SNP1	6.0	6.5	8.1	11.5	3.8	1.0	POM	White (WH)	3
191-10029	SNP2(E)	8.7	10.0	17.0	21.0	6.0	1.5	POM	Natural (NA)	1, 3
191-10039	SNP3(E)	10.0	11.4	19.0	25.0	6.0	1.8	POM	Natural (NA)	1, 3
191-10049	SNP4(E)	10.8	12.3	19.0	23.0	6.0	1.8	POM	Natural (NA)	1, 3
191-10069	SNP6(E)	12.0	13.7	19.0	24.0	6.0	1.8	POM	Natural (NA)	1, 3
191-10089	SNP8(E)	13.7	15.3	19.0	24.0	6.0	1.8	POM	Natural (NA)	1, 3
191-10109	SNP10(E)	15.0	16.8	19.0	24.0	6.0	1.8	POM	Natural (NA)	1, 3
191-10129	SNP12(E)	16.8	18.4	19.0	24.0	6.0	1.8	POM	Natural (NA)	1, 3
191-10149	SNP14(E)	18.1	19.9	19.0	24.0	6.0	1.8	POM	Natural (NA)	1, 3
191-10169	SNP16(E)	19.9	21.7	19.0	24.0	6.0	1.9	POM	Natural (NA)	1, 3
191-10189	SNP18(E)	21.4	23.0	16.0	22.0	6.0	1.9	POM	Natural (NA)	1, 3
191-10209	SNP20(E)	22.7	24.7	20.0	26.0	6.0	1.8	POM	Natural (NA)	1, 3
191-10229	SNP22(E)	25.3	27.3	20.0	26.0	6.0	1.6	POM	Natural (NA)	1, 3
191-10249	SNP24(E)	26.5	28.6	26.5	39.4	7.4	2.5	POM	Natural (NA)	2, 3
191-10329	SNP32(E)	30.3	33.1	27.0	34.0	7.5	2.0	POM	Natural (NA)	2, 3
191-10349	SNP34(E)	32.5	35.1	27.0	34.0	7.5	2.0	POM	Natural (NA)	2, 3
191-10369	SNP36(E)	34.8	37.1	27.0	34.0	7.5	2.0	POM	Natural (NA)	2, 3
191-10389	SNP38(E)	36.7	38.9	27.0	34.0	7.5	2.0	POM	Natural (NA)	2, 3
191-10429	SNP42(E)	41.0	44.2	32.0	45.0	7.5	2.0	POM	Natural (NA)	2, 3
191-10469	SNP46(E)	44.6	47.6	32.0	45.0	7.5	2.0	POM	Natural (NA)	2, 3
191-10509	SNP50(E)	48.8	52.0	32.0	45.0	7.5	2.0	POM	Natural (NA)	2, 3
191-10549	SNP54(E)	52.3	55.7	32.0	45.0	7.5	2.0	POM	Natural (NA)	2, 3
191-10589	SNP58(E)	56.7	59.2	31.0	39.0	7.5	2.0	POM	Natural (NA)	2, 3
191-10629	SNP62(E)	61.1	63.5	31.0	39.0	7.5	2.0	POM	Natural (NA)	2, 3

All dimensions in mm. Subject to technical changes.

Blind Plugs

Products were developed especially for the automotive industry. Application in trunks, doors, wheel housing and dash panels. Parts are even used for optical reasons.





Features and Benefits

- Easy assembly without the need of a tool
- Disc of the part covers the hole and minimises ingress of dust, dirt and water
- Standard geometry for example fir tree or arrowhead

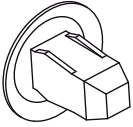
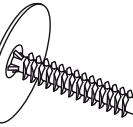
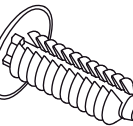
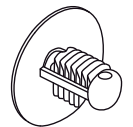

Blindplugs are available in different shapes and material.

 **Material specification please see page 21.**

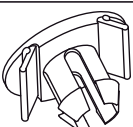
Article-No.	Type	Fixing Hole Ø (FH)	Panel Thickness min.	Panel Thickness max.	Colour	Material	Drawing
151-00333	TRIM PLUG 5	5.0	–	4.0	Natural (NA)	PA66HIR	
151-00419	PLUG5 WITH OPENING	5.05 - 5.25	4.8	5.2	Black (BK)	PA66HIRHS	
151-00415	PLUG SQ8x8	7.6 - 8.0	1.0	3.0	Black (BK)	PA66HIR	
151-00399	PLUG5.5	5.0 - 5.5	2.5	26.0	Black (BK)	PA6HIR	
151-00401	PLUG5.5	5.0 - 5.5	2.5	26.0	Grey (GY)	PA6HIR	
241-00001	PLUGFT6XL	6.5 - 7.0	0.7	18.0	Grey (GY)	PA66HIR	
241-00002	PLUGFT6XL	6.5 - 7.0	0.7	18.0	Black (BK)	PA66HIR	
151-00428	PLUGFT6XL	6.5 - 7.0	0.7	18.0	Brown (BN)	PA46	
151-00414	PLUGFT7	7.05 - 7.25	2.5	8.0	Black (BK)	PA6HIR	
151-00426	PLUG10	10.2	2.0	12.0	Black (BK)	PE	
151-00488	PLUG10	10.2	2.0	12.0	Grey (GY)	PE	
151-00360	PLUG11	11.0	6.0	8.0	Black (BK)	POM	
151-00485	PLUG11	11.0	4.0	6.0	Natural (NA)	PA66HIRHS	

All dimensions in mm. Subject to technical changes.

Cover Plugs and Open Plugs

Products were developed especially for the automotive industry. Application in trunks, doors, wheel housing and dash panels particularly where holes have to be covered and tubes must be guided securely. Parts are even used for optical reasons

Features and Benefits

- Easy assembly without the need of a tool
- Protection of ingress of dust, dirt and water are offered by cover plugs.
- Open plugs cover and secure the edges of drilled holes



Cover Plugs are protecting and securing boreholes.

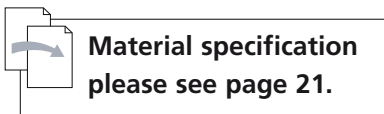

**Material specification
please see page 21.**

• Cover Plugs

Article-No.	Type	Fixing Hole Ø (FH)	Panel Thickness min.	Panel Thickness max.	Colour	Material	Drawing
151-00343	Cover Plug 20	19.5	–	3.0	Black (BK)	PP, EPDM	
151-00424	Cover Plug 32	32.0	–	2.5	Black (BK)	EPDM	
151-00342	Cover Plug 20x50	20.0 x 50.0	–	2.5	Black (BK)	PP, EPDM	

All dimensions in mm. Subject to technical changes.

• Open Plugs

Article-No.	Type	Fixing Hole Ø (FH)	Panel Thickness min.	Panel Thickness max.	Colour	Material	Drawing
151-00394	OPEN PLUG 34.6x112	34.6 x 112.0	5.0	8.0	Black (BK)	PA66HIR	
151-00391	Open Plug 42x84	42.0 x 84.0	5.0	8.0	Black (BK)	PA6HIR	
151-00392	Open Plug 55x70	55.0 x 70.0	5.0	8.0	Black (BK)	PP	

All dimensions in mm. Subject to technical changes.

Connector Clips for round holes

Features and Benefits

- Connector easily installed by simply pushing into place
- Connection can be released non-destructive
- One fir tree foot part can be used for a variety of panel thicknesses
- Arrowhead simply locks into place
- Disc covers the hole to prevent dirt and water gaining access
- For twist protection in round holes: Variants with additional stick



ConnectorClips are available for many different connector types and fixing varieties.



**Material specification
please see page 21.**

Article-No.	Type	Fixing Hole Ø (FH)	Panel Thickness min.	Panel Thickness max.	Colour	Material	Drawing
155-38102	YCC-FT6-S	6.5 - 7.0	0.75	1.5	Black (BK)	PA66HIRHS	
151-00606	YCCFT6S-2	6.5 - 7.0	0.75	1.5	Black (BK)	PA66HIRHS	
155-32602	FT6LG.M.St.Aufn.II	6.5 - 7.0	0.75	5.0	Black (BK)	PA66HIRHS	
155-18901	FT6LG.M.STECKERAUFN.	6.4 - 7.1	0.75	6.0	Black (BK)	PA66HIRHS	
155-43702	FT6S-Y-CONN-TS	6.5 - 7.0	0.8	1.5	Black (BK)	PA66HIRHS	
155-30702	FT6LG.YAZ.Connect.TS	6.3 - 7.0	0.7	5.1	Black (BK)	PA66HIRHS	
151-00235	Big YCC TS	6.4 - 7.1	0.7	5.1	Black (BK)	PA66HIRHS	
151-00459	FT6LG.JAE.CONNECT.TS	6.5 - 7.0	0.7	5.1	Black (BK)	PA66HIRHS	

All dimensions in mm. Subject to technical changes.

Connector Clips for round holes

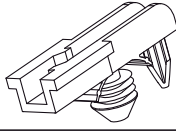
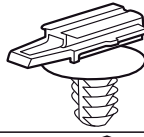
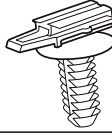
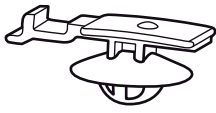
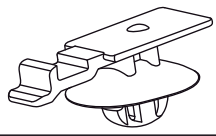
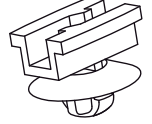
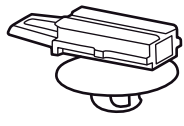
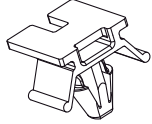
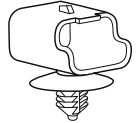
Article-No.	Type	Fixing Hole Ø (FH)	Panel Thickness min.	Panel Thickness max.	Colour	Material	Drawing
155-36002	STECKERHALTER SITZ	6.7 - 7.0	0.6	3.0	Black (BK)	PA66HIRHS	
151-00785	CCFT6LG	6.0 - 6.7	0.7	4.0	Black (BK)	PA66HIRHS	
151-00786	CCFT6XLG	6.0 - 6.7	0.7	11.0	Black (BK)	PA66HIRHS	
151-00675	YCCKSFT6.5	6.3 - 6.7	0.7	1.3	Black (BK)	PA66HIRHS	
151-00792	YCCKSFT6.5-PT1.7-2.3	6.3 - 6.7	1.7	2.3	Black (BK)	PA66HIRHS	
151-00840	CC-PAEKSFT6.5PT1.7-2.3	6.3 - 6.7	1.7	2.3	Black (BK)	PA66HIRHS	
151-00775	CCSFT6.5	6.3 - 6.7	1.7	2.3	Black (BK)	PA66HIRHS	
150-54498	BIG CONNECTOR CLIP	6.3 - 6.7	0.7	2.7	Black (BK)	PA66HIRHS	
151-00216	CP2FT6	6.5	0.7	5.0	Black (BK)	PA66HIRHS	
151-00163	CP3FT6	6.5	0.7	5.0	Black (BK)	PA66HIRHS	
151-00162	CP6FT6	6.5	0.7	5.0	Black (BK)	PA6HIR	

All dimensions in mm. Subject to technical changes.

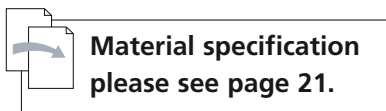

Connector Clips for oval holes

Features and Benefits

- Connector easily installed by simply pushing into place
- Connection can be released non-destructive
- Easy assembly, just shuffle manually
- Oval connectors offer twist protection



**Material specification
please see page 21.**

For a secure fixation simply push the connector by hand on our ConnectorClip YCCFT62x122.

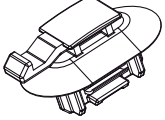
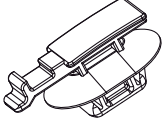
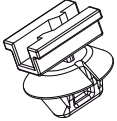
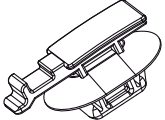
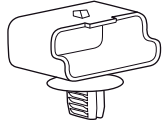
Article-No.	Type	Fixing Hole Ø (FH)	Panel Thickness min.	Panel Thickness max.	Colour	Material	Drawing
151-00704	YCCFT82x185	8.5 x 18.5	1.5	4.5	Black (BK)	PA66HIRHS	
151-00180	YCCFT62x122	6.2 x 12.2	0.6	6.0	Black (BK)	PA66HIRHS	
151-00194	CCSFT7x12	7.0 x 12.0	0.8	2.0	Black (BK)	PA66HIRHS	
151-00222	CCSFT7x12	7.0 x 12.0	0.8	2.0	Grey (GY)	PA66HIRHS	
151-00595	CCSFT7x12	7.0 x 12.0	0.8	2.0	Blue (BU)	PA66HIRHS	
151-00513	YCCSFT62x122	6.2 x 12.2	0.6	1.0	Black (BK)	PA66HIRHS	
151-00465	CP21DOP	6.2 x 12.2	0.6	5.0	Black (BK)	PA66HIRHS	
151-00214	CP31DOP	6.2 x 12.2	0.6	5.0	Black (BK)	PA66HIRHS	
151-00466	CP61DOP	6.2 x 12.2	0.6	5.0	Black (BK)	PA6HIR	

All dimensions in mm. Subject to technical changes.

Connector Clips for oval holes

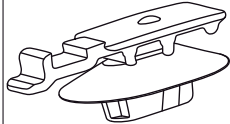
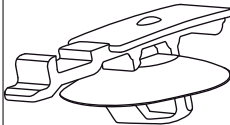
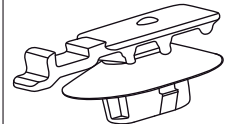
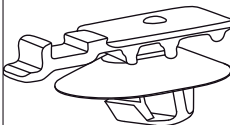
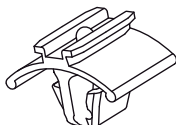
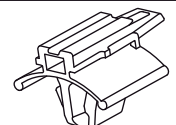
Article-No.	Type	Fixing Hole Ø (FH)	Panel Thickness min.	Panel Thickness max.	Colour	Material	Drawing
151-00835	YCCKSFT62x122PT0.7-1.3	6.2 x 12.2	0.7	1.3	Black (BK)	PA66HS	
151-00833	YCCKSFT62x122PT0.7-1.3 90°	6.2 x 12.2	0.7	1.3	Black (BK)	PA66HS	
151-00836	YCCKSFT62x122PT1.7-2.3	6.2 x 12.2	1.7	2.3	Black (BK)	PA66HS	
151-00834	YCCKSFT62x122PT1.7-2.3 90°	6.2 x 12.2	1.7	2.3	Black (BK)	PA66HS	
151-00620	CCIISFT6.5x13	6.5 x 13.0	0.7	3.0	Black (BK)	PA66HIRHS	
133-00392	Steckerhalter IV SFT 65x130	6.5 x 13.0	0.7	1.5	Black (BK)	PA66HIRHS	

All dimensions in mm. Subject to technical changes.



**Material specification
please see page 21.**

Connector Clips for Edges

• EdgeClip-Family





Features and Benefits

- Connectors are mounted simply by pushing them into retainer
- Connector can be removed without damage

- Fastened to an edge, the EdgeClip ensures snug fit almost all types of connector

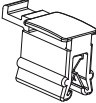
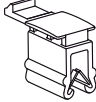
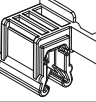
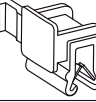
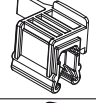

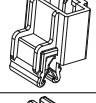
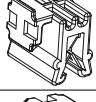
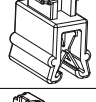
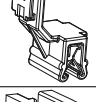
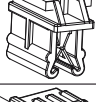
**Material specification
please see page 21.**

Article-No.	Type	Panel Thickness min.	Panel Thickness max.	Material	Drawing
151-00464	EC6mod	1.0	3.0	PA66HIRHS	
150-92600	CONNECTOR-CLIP EC6	1.0	3.0	PA66HIRHS	
151-00429	EC42	1.5	4.0	PA66HIRHS	
155-40602	EC11	1.0	3.0	PA66HIRHS	
151-00430	EC43	1.5	4.0	PA66HIRHS	
151-00611	CCEC3.0TP	1.0	3.0	PA66HIRHS	
151-00499	ECC1CPT	3.0	6.0	PA66HIRHS	
133-00075	Edge-Clip25	1.0	3.0	PA66HIRHS	
151-00460	EC45	1.0	3.0	PA66HIRHS	
151-00472	EC JAE CC	1.0	3.0	PA66HIRHS	
151-00173	EC32	1.0	3.0	PA66HIRHS	
151-00151	EC28	1.0	3.0	PA66HIRHS	
151-00192	EC33	1.0	3.0	PA66HIRHS	



All dimensions in mm. Subject to technical changes.



Information and installation instructions for self-adhesive mounting bases

HellermannTyton uses two different types of adhesives for self-adhesive bases: acrylate and synthetic rubber. These differ in the operating temperature range and the 'pull off' force of the adhesive. Synthetic rubber has an excellent initial grip, allowing for almost immediate use. Acrylate adhesive has

less initial grip, so there is a need to wait for a few hours before use, but has a higher 'pull off' force than synthetic rubber. This enables a permanent fixing lasting months or even years. To use these adhesives the surface must be dry, and free of dust, oil, oxides, parting agents and other impurities.

For this the use of isopropane/water (50/50) is recommended. After cleaning allow the surface to dry completely. Peel off the protective backing on the self-adhesive base, ensuring the adhesive is not touched. Apply the part to the surface and press down firmly for several seconds.

Acrylate	
Base material	PE foam or PU foam
Temperature range	at least up to +105 °C
 	

Synthetic rubber	
Base	PE foam
Temperature range	at least -40°C to +60°C
 	

1. Instructions for use



The surface must be dry, free from dust, oil, oxides, parting agents and other impurities. The surface to be glued should be cleaned using a clean cloth and isopropanol / water (50/50). When using other appropriate cleaning agents, ensure that they do not attack the surface nor leave any residues.



After cleaning allow the surface to air-dry completely.

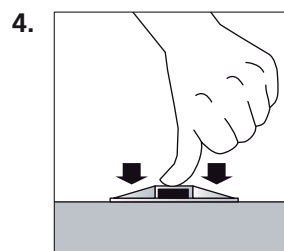

Press down firmly on the base with the thumbs for several seconds.

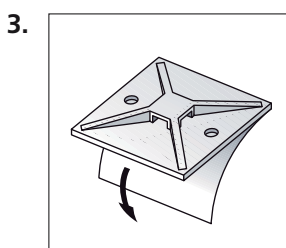

Peel off protective backing and ensure the adhesive area is not touched.

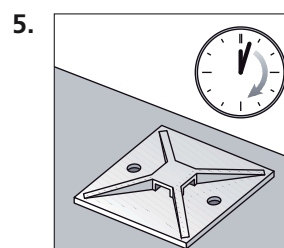

Depending on the type of adhesive, wait for several minutes (synthetic rubber) or hours (acrylate) so that the adhesive can bond completely with the surface.

We will be happy to send you on request an up-to-date technical datasheet for whichever adhesive you are using.

Fixing Parts with Special Adhesive

• SolidTack-Series

SolidTack mounts offering an innovative fixing solution especially for low energy surfaces like PP, PE or if drilling a hole is not possible. Suitable for a wide range of in- and outdoor applications on varnished or plastic or metal surfaces in many areas i.eg. electrical cabinet, railway, aerospace, automotive and agriculture machinery.

Features and Benefits

- MB mounts with homogeneous system of acrylic adhesive
- Very good initial adhesion, increases with time
- High cohesive strength combined with good weathering resistance
- Innovative fixing solution for low energy surfaces like PP, PE or painted/varnished surfaces
- Protection foil with finger lift for easy peel off



SolidTack products work on varnished and powder coated surfaces.



Material specification
please see page 21.

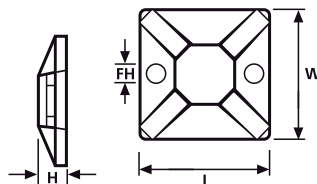

Cable Tie Mounts MB3, MB4, MB5

Adhesive	mod. Acrylate
Adhesive Operating Temperature	-40 °C to +90 °C

Article-No.	Type	Length (L)	Width (W)	Height (H)	Fixing Hole Ø (FH)	Strap Width max. (G)	Material	Colour
151-00432	MB3APT	19.0	19.0	3.8	3.1	4.1	PA66	Black (BK)
151-00514	MB3APT	19.0	19.0	3.8	3.1	4.1	PA66	Natural (NA)
151-00433	MB4APT	28.0	28.0	4.7	4.0	5.4	PA66	Black (BK)
151-00587	MB4APT	28.0	28.0	4.7	4.0	5.4	PA66	Natural (NA)
151-00434	MB5APT	38.0	38.0	6.4	4.7	10.0	PA66	Black (BK)

All dimensions in mm. Subject to technical changes.

Paste Adhesive Mount

• **PMB5**

PMB5 pasty mount offers a fixing solution wherever screw fixing is not allowed. Due to a larger diameter the mount can even be installed onto uneven surfaces. PMB5 pasty mount is used in the railway industry as well as in the renewable energy industry. Further applications are in the ship building industry, in the electrical industry and the production of switching cabinets.

Features and Benefits

- PMB5 paste adhesive mount for fixings with paste/liquid adhesive.
- Mount geometry offers a good form closure with cured adhesive
- Can even be installed onto uneven surfaces due to large diameter
- Can also be applied in combination with hot-melt adhesive, as mount is made of heat resistant PA66



PMB5 mount with paste adhesive.

 **Material specification please see page 21.**

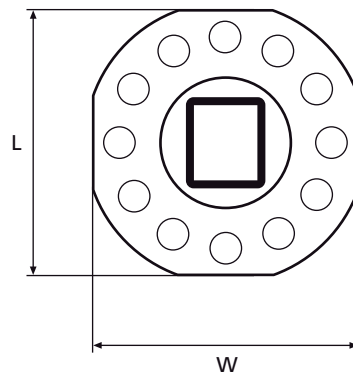

PMB5

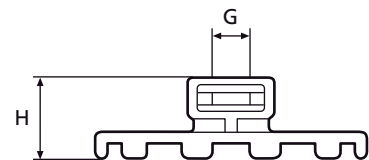

Article-No.	Type	Length (L)	Width (W)	Height (H)	Strap Width max. (G)	Material	Colour
151-00498	PMB5	36.0	36.0	10.7	4.8	PA66HS	Black (BK)

All dimensions in mm. Subject to technical changes.

Harness Clip for Heavy Duty Applications, for Screws or Studs

Primarily designed for use in the automotive/truck industry, these parts can be used in a wide variety of industries and applications where bundles need mounting.

Features and Benefits

- Secure alignment to the bundle due to H-design
- Pre-fixing of clip with integrated nose
- For cable ties up to 12.7 mm wide
- High tightening torque through metal bushing (Variants "For high strength" and "Double holder")
- Easy maintenance of bundle by simply changing the cable tie



U.S. Patent Number 5,820,083



Material specification please see page 21.

• Standard Torque Mounts

Article-No.	Type	Length (L)	Width (W)	Height (H)	Fixing Hole Ø (FH)	Strap Width max. (G)	Material	Colour
151-00134	HDM19	36.3	19.3	16.7	4.7	12.7	PA66HIR	Black (BK)
151-00437	HDM25	36.3	19.3	16.7	6.3	12.7	PA66HIR	Black (BK)
151-00439	HDM312	36.3	19.3	16.7	7.8	12.7	PA66HIR	Black (BK)

All dimensions in mm. Subject to technical changes.

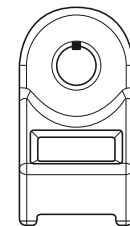

Standard Torque Mounts

• Medium Torque Mounts

Article-No.	Type	Length (L)	Width (W)	Fixing Hole Ø (FH)	Strap Width max. (G)	Material	Colour
151-00442	HDM401	46.0	24.0	9.5	12.7	PA66HIR	Black (BK)
151-07100	HDM321	46.0	24.0	8.0	12.7	PA66HSW	Black (BK)
151-07500	HDM501	46	24.0	12.7	12.7	PA66HIRHS	Black (BK)

All dimensions in mm. Subject to technical changes.

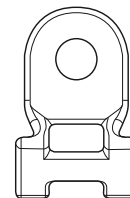

Medium Torque Mounts

• High Torque Mounts

Article-No.	Type	Length (L)	Width (W)	Fixing Hole Ø (FH)	Strap Width max. (G)	Material	Colour
151-07000	HDM320	47.0	25.0	8.0	12.7	PA66HIR	Black (BK)
151-07200	HDM400	47.0	25.0	9.5	12.7	PA66HIRHS	Black (BK)
151-07400	HDM500	47.0	25.0	12.7	12.7	PA66HIRHS	Black (BK)

All dimensions in mm. Subject to technical changes.

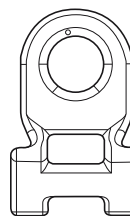

High Torque Mounts

• High Torque Double Mounts

Article-No.	Type	Width (W)	Fixing Hole Ø (FH)	Strap Width max. (G)	Material	Colour
151-00756	HDM375BDM4W	34.5	9.5	12.7	PA66HIRHS	Black (BK)

All dimensions in mm. Subject to technical changes.



High Torque Double Mounts

Harness Clip for Heavy Duty Applications. for Screws or Studs, for parallel separation

- S2HM25 with hexagonal retention feature
- S2CM25 with a socket counter bore

This heavy duty harness clip helps to fix and secure cable and wires in railway, truck and agriculture vehicle construction as well as in ship building.

Features and Benefits

- For parallel routing of bundles
- Secure alignment to the bundle due to H-design
- Cable tie head can be moved after bundling
- For cable ties up to 12.7 mm wide
- Easy maintenance of bundle by simply changing the cable tie



This saddle mount is installed between two bundles to separate them and prevent chafing and wear.



Material specification please see page 21.

Article-No.	Type	Length (L)	Width (W)	Height (H)	Fixing Hole Ø (FH)	Bundle Ø max. (each side)	Material	Colour
151-29403	S2HM25	45	30.0	23.0	6.0	89.0	PA66HIRHS	Black (BK)
151-29400	S2CM25	45	30.0	23.0	6.0	89.0	PA66HIRHS	Grey (GY)

All dimensions in mm. Subject to technical changes.

- SAOM82 with Turnstop
- SAM83 with a socket counter bore

This heavy duty harness clip helps to fix and secure cable and wires in railway, truck and agriculture vehicle construction as well as in ship building.

Features and Benefits

- Guides bundles securely above sharp edges
- For bolts or screws of D = 8 mm
- Cable tie head can be moved after bundling
- Secure alignment to the bundle due to H-design
- For cable ties up to 12.7 mm wide



Axial oval mounts stand off bundles from frame rails and cross members to prevent them from rubbing and chafing.

Article-No.	Type	Length (L)	Width (W)	Height (H)	Stud Ø	Material	Colour
151-29701	SAOM82	34	26.0	35.0	8.0	PA66HIRHS	Black (BK)
151-29600	SAM83	34	26.0	35.0	8.0	PA66HIRHS	Grey (GY)

All dimensions in mm. Subject to technical changes.

Fixing elements for Parallel Routing, twistable

These fixing element for parallel routing can be used where bundles need separation from each other combined with the necessary functionality to support moving harnesses.

Features and Benefits

- For parallel routing of bundles that can be twisted 360° even after setting
- Secure alignment to the bundle due to H-design
- Cable tie head can be moved after bundling
- For cable ties up to 12.7 mm wide
- For post-installation of bundles



The spacers can be easily rotated by hand, allowing the bundles to be crossed and rotated at any angle.

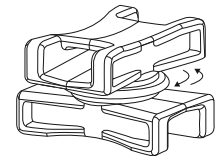

swivels

Article-No.	Type	Length (L)	Width (W)	Height (H)	Bundle Ø min.	Bundle Ø max.	Min. Extraction Force (N)	Material	Colour
151-06500	DSWS4	23.6	20.3	18.0	6.0	76.0	445	PA66HS, POM	Black (BK)
151-06502	DSWS5	40.6	25.4	23.6	16.0	152.0	1112	PA66HS	Black (BK)

All dimensions in mm. Subject to technical changes.

Fixing Elements with Fir Tree, for Distance Routing

• S3STM50

With its heavy duty fixing ability this product offers excellent performance for the truck, ship and construction vehicle industries.

Features and Benefits

- For parallel routing of four bundles
- Secure alignment to the bundle due to H-design
- For cable ties up to 12.7 mm wide
- Pre-fixing of tie with integrated nose

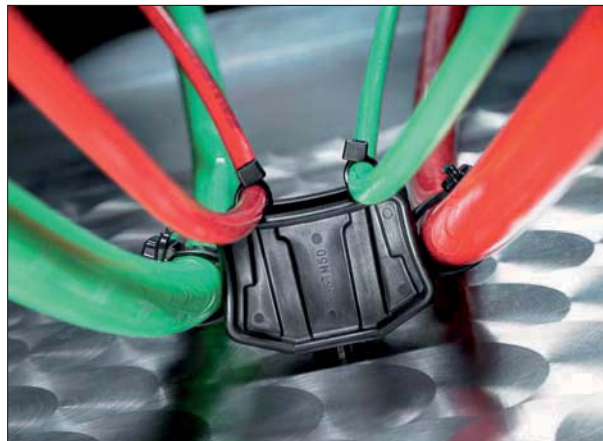

The mount can secure up to 4 separate bundles, providing parallel spacing between the frame rail and adjacent bundles.

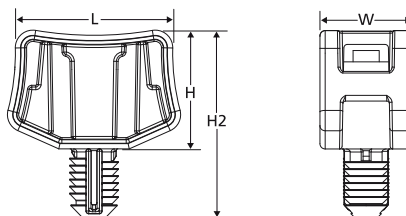

Fir Tree Saddle Mounts

 **Material specification please see page 21.**

Article-No.	Type	Length (L)	Width (W)	Height (H)	Height (H2)	Fixing Hole Ø (FH)	Panel Thickness min.	Panel Thickness max.	Bundle Ø max.	Material	Colour
151-29500	S3STM50	50.0	22.0	35.0	55.0	12.7	1.90	13.00	127.0	PA66HIRHS	Black (BK)

All dimensions in mm. Subject to technical changes.

Fixing Elements for BHT-Ties for Distance Routing

• MSBT120

With its heavy duty fixing ability this product offers excellent performance for the truck, ship and construction vehicle industries.

Features and Benefits

- For parallel routing of three bundles
- Retainer is fixed in the hole with BHT-tie
- Socket centres retainer in the hole and can protect tie from sharp edges



Saddle Mount MSBT120.

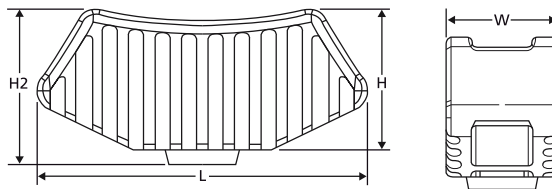

MSBT120

Article-No.	Type	Length (L)	Width (W)	Height (H)	Height (H2)	Fixing Hole Ø (FH)		Panel Thickness min.	Bundle Ø max.		Material	Colour
						min.	max.		(side)	(center)		
151-29301	MSBT120	48.3	16.5	20.6	22.2	11.2	20.8	4.10	25.4	152.4	PA66HIRHS	Black (BK)

All dimensions in mm. Subject to technical changes.

• CGS1 for Convoluted Tubes

This heavy duty fixing element can be used to guide tubes in a defined distance to the substructure.

Features and Benefits

- Tubes are fixed a defined distance from the substructure
- Defined diameter for the wire entry
- Retainer is fixed in the hole with BHT-tie



This product perfectly secures convoluted tubings up to 26 mm diameter.

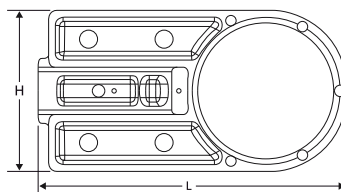

Cable Guide Standoff

 **Material specification please see page 21.**

Article-No.	Type	Length (L)	Width (W)	Height (H)	Bundle Ø max.	Material	Colour
151-00006	CGS1	56.6	25.4	30.5	26.0	PA66HIRHSW	Black (BK)

All dimensions in mm. Subject to technical changes.





Application tools 2

	Page
2.1 Automatic cable tying system	
Autotool System 3080 for diameter up to 80 mm	118
Autotool 2000 for diameter up to 20 mm	121
2.2 Application tools for cable ties	
Overview application tools for cable ties	125
Flowchart for optimum tool selection	126
Application tools	
Manual processing tool, cable ties up to 4,8 mm	127
Manual processing tool, cable ties up to 9 mm	128
Manual processing tool, cable ties up to 13,5 mm	129
Pneumatic processing tool, cable ties up to 4,8 mm	130
Pneumatic processing tool, cable ties up to 13,5 mm	132
Processing tools KR-Series	133
Manual processing tool for stainless steel ties	134
Manual cutting tool CUTties	135
How to use a processing tool (Example MK7)	136

	Page
2.3 Application tools for other products	
Electrical hot air tool	137
Gas powered hot air tool	138
Tree pronged plier for sleeves and grommets	139
Snapper tool	140
Hot cutting tool	141

Autotool System 3080

- **Waste-free bindings for diameters up to 80mm**

The ATS3080 is an electrical bundling system from HellermannTyton. In about one second you get absolutely waste free bindings. The outside serrated strap and closures are each supplied on "endless reels". The ATS3080 is an outstanding innovation in bundling systems!

High quality standards in the production industry are requiring fully automatic, precise bundling. Only the automation of bindings allows efficient manufacturing of high quantities in a consistent workflow. A challenge which HellermannTyton solved successfully with the development of the ATS3080.

The ATS3080 can be used with an overhead dispenser, a bench mount system or integrated into a fully automated production line. This makes the tool flexible for different applications, especially in the Automotive and the white or brown goods industry, or even for packaging. It is a high-capacity tool with a very short cycle time (0.8 - 1.3 sec., depending on diameter of jaws).



For the stationary installation – the bench mount kit.

Article-No.	Type
102-00000	ATS3080 complete
102-00010	Power Pack
102-00040	Bench Mount Kit Flexible
102-00041	Horizontal Bench Mount Kit
102-00042	Bench Mount Kit for Automation
102-00043	Bench Mount Kit fixed
102-00050	Overhead Dispenser
102-00052	Overhead Dispenser Lowering

Subject to technical changes.

Power Supply	Electrical
Cycle Time	max. 1.3 sec.
Weight (kg)	1.9
Application	Stationary or mobile

Power Supply unit	Input: 230/115 VAC, 50/60 Hz, Output: 48 VDC, max. 50 W
Bench mount kit	Tool- and tiereelstand including footpedal
Overhead Suspender	Overhead dispenser and tiereelstand including balancer



ATS3080 with overhead dispenser for mobile applications.

The ATS 3080 is innovative for its strap and closures. The two-piece consumable consists of strap and closures, is waste-free and guarantees optimised material utilisation. You do not lose any time cleaning or opening any waste boxes. The bundle diameter is detected mechanically. This allows a flush cut off of the bindings and together with the plain inner surface of the strap prevents damage to wire insulation. The material is available in reels of 500m strap and reels of 5000 piece closures.



Closures and strap for ATS3080.

Another advantage of the ATS3080 is the three different jaw diameters which can be changed very quickly: 30mm, 50mm and 80mm are available. If your application needs ties from very small up to 80mm, you use the 80 s. If your max. is 45mm you choose the 50 s and save time. You don't have to adjust anything.



Three jaws optimise the cycle time for the different bundling diameters.

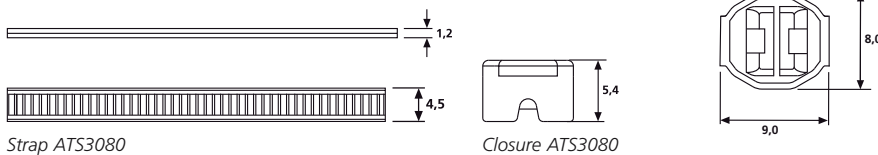

Strap ATS3080

Closure ATS3080

Article-No.	Type	Type	Min. Tensile Strength (N)	Material	Colour	Pack Cont.
102-66109	102-66109	Strap Natural ATS3080	220	PA66HIRHSUV	Natural (NA)	500 m
102-66110	Strap ATS3080	Strap Black ATS3080	220	PA66HIRHSUV	Black (BK)	500 m
102-66209	102-66209	Closures Natural ATS3080	220	PA66HSUV	Natural (NA)	5000 pcs.
102-66210	102-66210	Closures Black ATS3080	220	PA66HSUV	Black (BK)	5000 pcs.

Subject to technical changes.

By assembling the ATS3080 into different devices the tool can be customised for various customer applications. For example, with the horizontal bench mount kit plastic bags can be closed in seconds. Also, because of the unique closing mechanism the plastic tie closing the bag can serve as a tamper evident seal and is compatible material for recycling.

For products with special requirements of cable tying e.g. a binding at an exact position, as shown on the picture with the medical hoses, the HellermannTyton development department can design and supply special jigs for the ATS3080.

HellermannTyton developed an innovative solution for harnesses in the Automotive industry. With the ATS3080 it is now possible to fasten fixings, also known as foot parts, at the same time as the automatic binding. This simplifies the final assembly of harnesses, because the pre-assembled harness can be fixed directly to the metal edge or into a hole! This means that you can now produce a complex harness completely automatically.

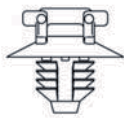

Fir Tree ATS FT6

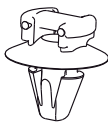

Arrow Head ATS SFT6,5

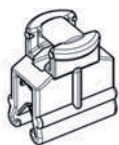

Fixing Clip ATS EC35

**For your assembly
line situation we offer
individual solutions.**



Exact positioning of cable ties.



Close plastic bags.



Fix clips automatically.

Autotool 2000

- Automatic bundling up to 20mm diameter

Features and Benefits

Autotool 2000 is an electronically operated automatic cable tying system which has been design to speed up the binding process. Consistency and quality in the process of bundling, threading and cutting is achieved at the touch of a button.

The HellermannTyton Autotool 2000 is very easy to use. The tool has a binding speed of 0,8 seconds per cycle. The tool handles both bands of 50 or reels of 3500 cable ties. The ties can bundle up to a diameter of 20 mm. Once fitted, the tie will have a flush cut off. The adjustable binding force and the electronic fault diagnosis system ensures that optimum results are achieved.



Autotool 2000.



Packaging application with the bench mount kit.



Bench mount kit, bandoleer reel, Autotool 2000 and power pack.

The reliability, ergonomics, simple handling and flexibility makes the HellermannTyton Autotool 2000 ideal for the diverse applications where high quantities are required, e.g. in cable assemblies for automotive, electronics, TV and domestic appliances, packaging of bags and the bundling of parts together. The system suits both the high volume use of ties or where flexible production practices are necessary. Overall the Autotool 2000 gives full, flexible and cost effective utilization of labour and maximises efficiency.

With the bench mount kit or the overhead dispenser the Autotool 2000 can be used stationary or mobile, depending on the customer's application.

Another opportunity is the integration of AT2000 into a fully automated production line. To do this you would need the control box, which is the interface between AT2000 and your production line.

For your assembly line situation we offer individual solutions.



Overhead suspender, reel with ties and Autotool 2000.



Harness application.

Power Supply	Electrical, with Power Pack
Cycle Time	0.8 s
Weight (kg)	1.2
Application	Stationary, mobile or included in a fully automated production line.
Tension Force	Continuously adjustable

Article-No.	Description	Description
120-00000	Autotool 2000	Automatic bundling up to 20mm diameter
120-00010	Power Pack	Electrical: - 230/115 VAC Mains Output: - 25 VDC 50 W
120-00040	Bench Mount Kit	Bench mounting kit with foot pedal operation
120-00050	Overhead Suspender	Overhead suspension unit with spring balance
120-00060	Control Box	For Automation, interface for your production line
120-00080	HH20	Bundle Ø max. 20 mm, standoffs are used as spacer for an optimal bundling, Bundle height 45-25 mm

Subject to technical changes.

Cable ties for Autotool 2000

The cable ties for the Autotool 2000 are made entirely of plastic, making them easy to recycle. The inside-serrated cable ties ensure a secure hold on the bundle, up to a diameter of 20 mm. Once fitted, the tie will have a flush cut-off. The cable ties are available in natural and black.

The tool handles both bands of 50 or reels of 3500 cable ties.



Cableties for AT2000.

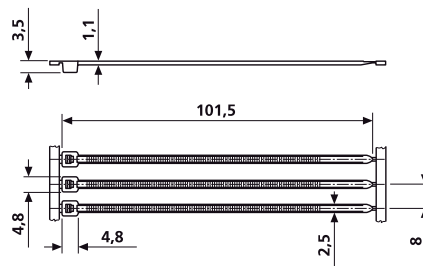

Bandoleer T18RA.

Article-No.	Type	Length (L)	Width (W)	Bundle Ø max.	Min. Tensile Strength (N)	Colour	Material
120-40019	T18RA50	100	2.5	20.0	80	Natural (NA)	PA66HS
120-50009	T18RA3500 HS	100	2.5	20.0	80	Natural (NA)	PA66HS
120-40020	T18RA50	100	2.5	20.0	80	Black (BK)	PA66HSUV
120-50010	T18RA3500	100	2.5	20.0	80	Black (BK)	PA66HSUV
120-46009	T18RA3500	100	2.5	20.0	80	Natural (NA)	PA46

All dimensions in mm. Subject to technical changes.

Bundling Clips

On Automotive harnesses many "tape clips" are used for harness mount points. These are mostly manually installed with tape. HellermannTyton have now created a new and much faster solution to install the now called "bundling clips".

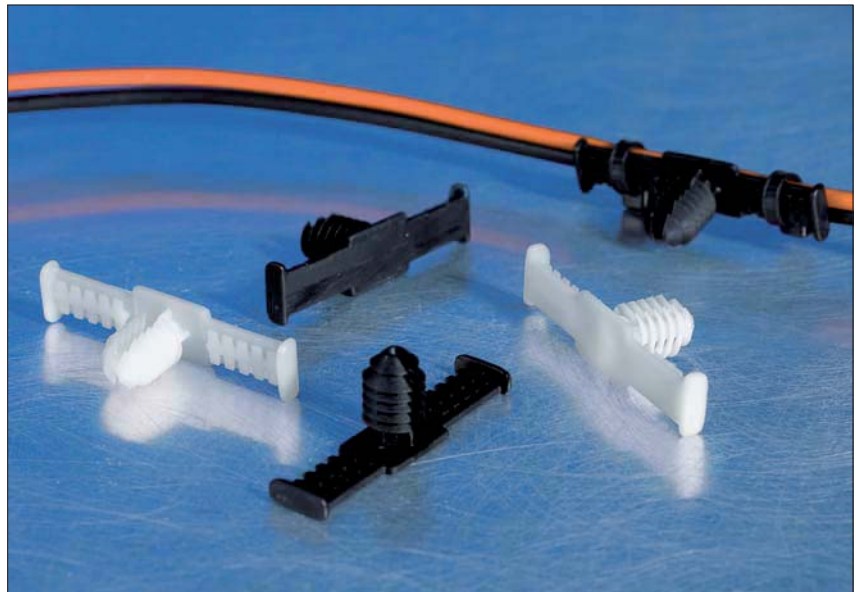

Bundling Clip ATS BC FT6LG.

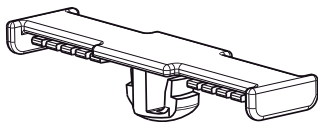

Bundling Clip ATSBCSFT6,5.

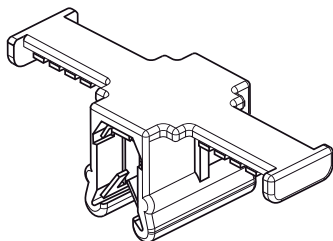

BundlingClip ATSBCEC35.

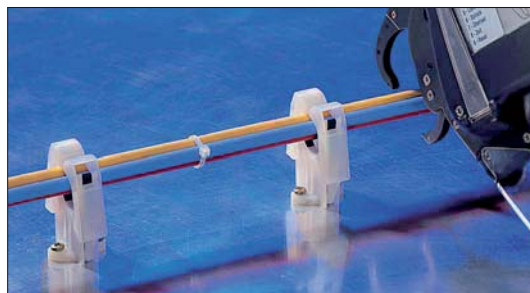

Harness board accessory HH20.

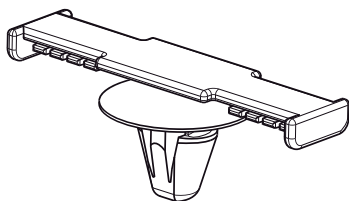

BundlingClip ATSBCKSFT6,5.

Article-No.	Type	Panel Thickness min.	Panel Thickness max.	Fixing Hole Ø (FH)	Colour	Material
102-67065	ATSBCFT6LG	0.6	5.1	6.3 - 7.0	Black (BK)	PA66HIRHS
102-69065	ATSBCSFT6.5-MD	0.6	5.1	6.3 - 7.0	Black (BK)	PA66HIRHS
102-69066	ATSBCSFT6.5	2.3	3.3	6.3 - 6.7	Black (BK)	PA66HIRHS
102-69067	ATSBCSFT6,5S	0.7	1.3	6.3 - 6.7	Black (BK)	PA66HIRHS
102-68355	ATSBCEC35	1.5	4.0	–	Black (BK)	PA66HIRHS

All dimensions in mm. Subject to technical changes.

Manual Processing Tools for Cable Ties

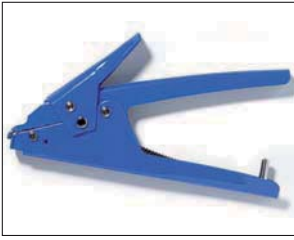

MK10-SB



MK20, MK21

MK3SP
see page 127.MK7
see page 127.MK7HT
see page 128.MK6
see page 128.MK9
see page 129.MK9HT
see page 129.

Pneumatic Tensioning Tools for Cable Ties

MK3PNSP2
see page 130.MK7P
see page 131.MK9P
see page 132.

Processing Tools for Cable Ties KR-Series

KR6/8
see page 133.KR8PNSE
see page 133.

Processing Tools for Metal Ties

MK9SST
see page 134.MTT4
see page 134.KST-STG200.
see page 134.

Application Tool	Registration Numbers
MK3SP	1
MK3PNSP2, MK7P	2
MK7	3
MK7HT	4
MK20	5
MK6	6
MK9P	7
MK9	8
MK9HT	9
MK21	10

For detailed information on Application Tools please refer to page 127.

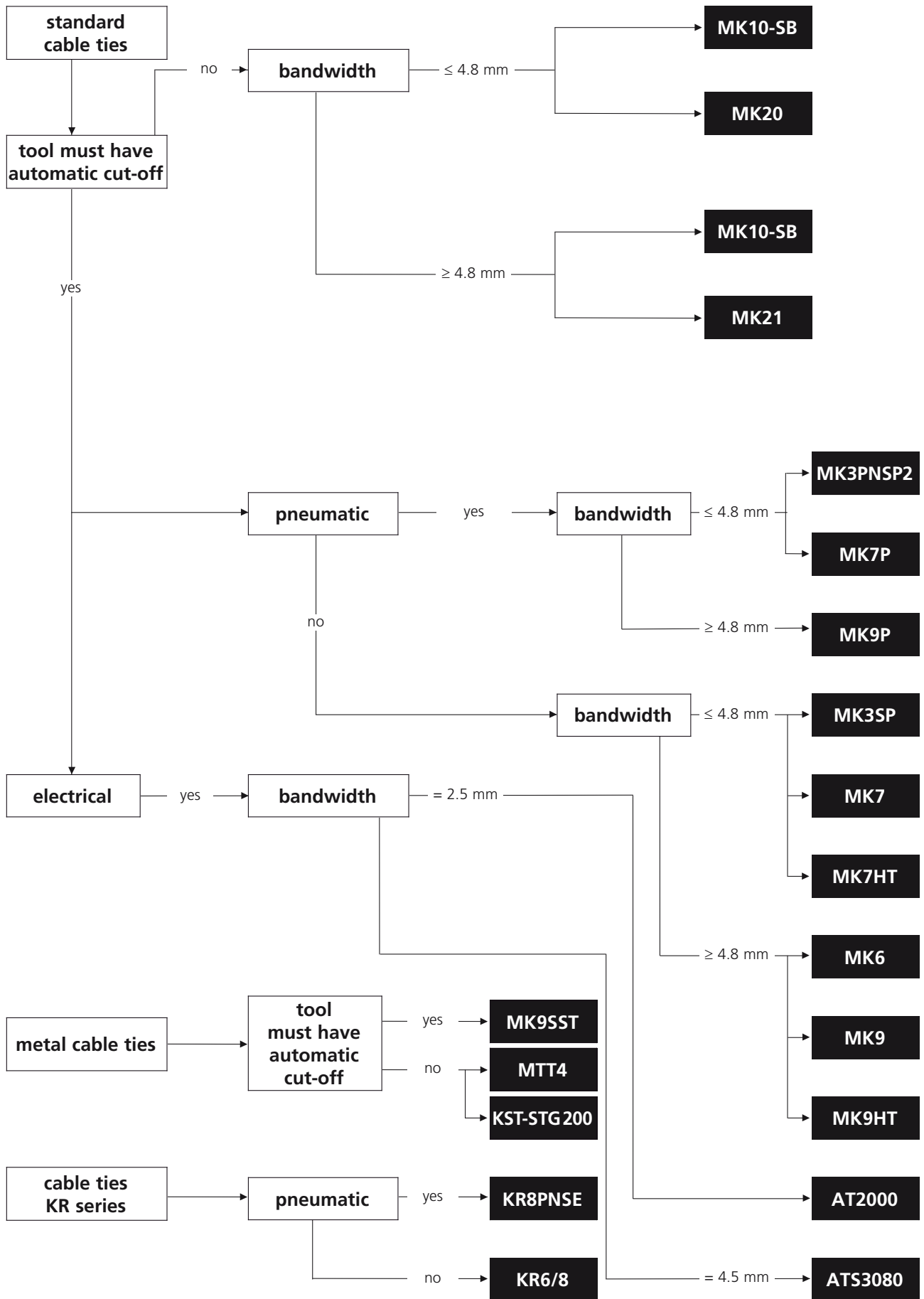

Manual Processing Tool Metal Housing

- **MK3SP up to 4.8 mm strap width**

This tough metal tool MK3SP for plastic cable ties is used by harness makers for automotive industry and white goods as well as in the aerospace, railway and medical industry. An other range of application is the entire electrical installation i.e.g. in buildings or production plants.

Features and Benefits

- Tough metal tool for HellermannTyton plastic cable ties up to 4,8 mm width
- For consistent tensioning and automatically plane cutting of cable ties
- Infinitely adjustable tension force
- Reliable and low maintenance



MK3SP.

Manual Processing Tool Plastic Housing

- **MK7 up to 4.8 mm strap width**

The MK7 tension tool is used by harness makers. Based on the US Military Specification (MIL) and the German Military Specification (VG) MK7 is also used to apply cable ties in all military vehicles and aircrafts. An other range of application is the entire electrical installation i.e.g. in buildings or production plants.

Features and Benefits

- Light glass-fibre-reinforced housing
- Ergonomic design
- For ties up to 4,8 mm width
- Consistent tensioning and automatically plane cut of
- Infinitely adjustable tension force combined with three-step quick adjustment
- MIL and VG approved



MK7.

Article-No.	Type	Strap Width max. (G)	Strap Thickness max.	Weight (kg)
110-03500	MK3SP	4.8	1.5	0.33
110-03524	Replacement Blade	–	–	0.01
110-07500	MK7	4.8	1.5	0.29
110-07511	Replacement Blade	–	–	0.01

All dimensions in mm. Subject to technical changes.



Please note! Not all products listed on this page may have this approval. For product specific approvals please refer to the Appendix.

Manual Processing Tool Plastic Housing

- **MK7HT up to 4.8 mm strap width**

MK7HT application tool is mainly used to apply cable ties in harness making industries.

Features and Benefits

- Light glass-fibre-reinforced housing
- Ergonomic design
- For cable ties up to 4.8 mm width
- MK7 HighTension-Version with higher tension force than MK7
- Consistent tensioning and automatically flush cutting
- Infinitely adjustable tension force combined with three-step quick adjustment



MK7HT.

Manual Processing Tool Metal Housing

- **MK6 up to 9 mm strap width**

This tough metal tool MK3SP for plastic cable ties is used by harness makers for automotive industry and white goods as well as in the aerospace, railway and medical industry. An other range of application is the entire electrical installation i.e. in buildings or production plants.

Features and Benefits

- Tough metal tool
- For cable ties up to 9 mm width
- For consistent tensioning and automatically flush cutting
- Infinitely adjustable tension force
- Reliable and low maintenance



MK6.

Article-No.	Type	Strap Width max. (G)	Strap Thickness max.	Weight (kg)
110-07000	MK7HT	4.8	1.5	0.29
110-07511	Replacement Blade	–	–	0.01
110-06000	MK6	9.0	2.0	0.52
110-06026	Replacement Blade	–	–	0.01

All dimensions in mm. Subject to technical changes.

Manual Processing Tool Plastic Housing

• MK9 up to 13.5 mm strap width

MK9 tool is used to apply bigger cable ties as they are used in trucks and busses. MIL and VG certification allows the use of MK9 for military vehicle and aviation construction.

Features and Benefits

- Glass-fibre-reinforced housing
- Ergonomic design
- For HellermannTyton plastic cable ties up to 13,5 mm width
- Consistent tensioning and automatically cutting of cable ties
- Infinitely adjustable tension force combined with three-step quick adjustment
- Plane cut of the strap at cable tie head
- MIL and VG approved



MK9.

Manual Processing Tool Plastic Housing

• MK9HT up to 13.5 mm strap width

The MK9HT boasts especially high tensioning forces. Ideally when a very firm sit of bigger cable ties are required like in truck and bus construction.

Features and Benefits

- Glass-fibre-reinforced housing
- Ergonomic design
- For cable ties up to 13,5 mm width
- MK9 HighTension-Version with higher tension force than MK9
- Consistent tensioning and automatically flush cutting
- Infinitely adjustable tension force combined with two-step quick adjustment



MK9HT.

Article-No.	Type	Strap Width max. (G)	Strap Thickness max.	Weight (kg)
110-09500	MK9	13.5	2.0	0.385
110-09000	MK9HT	13.5	2.0	0.385
110-09511	Replacement Blade	–	–	0.01

All dimensions in mm. Subject to technical changes.



Please note! Not all products listed on this page may have this approval. For product specific approvals please refer to the Appendix.

Pneumatic Tensioning Tool Metal Housing

- **MK3PNSP2 up to 4.8 mm strap width**

Powered by compressed air at a pressure of up to 6 bars, the MK3PNSP2 is most beneficial in mass production environments, whether on the assembly line or in cable fabrication.

Features and Benefits

- Pneumatic tensioning tool
- Tough metal housing
- For cable ties up to 4,8 mm width
- For consistent tensioning and automatically flush cutting
- Infinitely adjustable tension force
- High application speed
- Reliable and low maintenance



MK3PNSP2

Air Supply	non oiled / oiled
Air Pressure (min.)	3
Air Pressure (max.)	6
Hose Internal Diameter	4.0 mm
L x H x W	approx. 225 x 140 x 40 mm

Article-No.	Type	Strap Width max. (G)	Strap Thickness max.	Weight (kg)
110-03400	MK3PNSP2	4.8	1.5	0.56
110-30002	Air hose, complete	–	–	0.35
110-30101	Replacement Blade	–	–	0.01

All dimensions in mm. Subject to technical changes.



Pneumatic Tensioning Tool Plastic Housing

• MK7P up to 4.8 mm strap width

The MK7P pneumatic bundling tool sets a new benchmark for the rational application of ties in the industrial production process. Improved compressed air supply moves the tensioning piston faster than in comparable tools.

Features and Benefits

- Pneumatic tensioning tool
- Light glass-fibre-reinforced housing
- For cable ties up to 4,8 mm width
- For consistent tensioning and automatically flush cutting
- Infinitely adjustable tension force
- High application speed



MK7P



The easy to use quick-set-knob.

Air Supply	non oiled / oiled
Air Pressure (min.)	3
Air Pressure (max.)	6
Hose Internal Diameter	4.0 mm
L x H x W	220 x 170 x 40 mm

Article-No.	Type	Strap Width max. (G)	Strap Thickness max.	Weight (kg)
110-07100	MK7P	4.8	1.5	0.43
110-30002	Compressed-air hose	–	–	0.35
110-07111	Replacement Blade	–	–	0.01
110-07200	Lock cap tensioning knob	–	–	0.011

All dimensions in mm. Subject to technical changes.



Pneumatic Tensioning Tool Plastic Housing

- MK9P up to 13.5 mm strap width

The MK9 P is constructed with heavy duty parts to ensure optimum performance. It is ideally designed to apply heavy-duty ties like they are used in vehicle construction like trucks, busses and railways.

Features and Benefits

- Pneumatic tensioning tool
- Glass-fibre-reinforced housing
- For cable ties up to 13.5 mm width
- For consistent tensioning and automatically flush cutting
- Infinitely adjustable tension force
- High application speed
- Holding ring for a balancer
- Optional with lower or upper air attachment



MK9P



MK9P is also available with upper air attachment.

Air Supply	non oiled / oiled
Air Pressure (min.)	3
Air Pressure (max.)	6
Hose Internal Diameter	4.0 mm
L x H x W	approx. 280 x 200 x 55 mm

Article-No.	Type	Strap Width max. (G)	Strap Thickness max.	Weight (kg)	Air att. Position
110-09100	MK9P	13.5	2.5	0.91	lower air connection
110-09110	MK9P	13.5	2.5	0.91	top air connection
110-30002	Compressed-air hose	–	–	0.35	–
110-07200	Lock cap tensioning knob	–	–	0.011	–
110-09111	Replacement Blade	–	–	0.01	–

All dimensions in mm. Subject to technical changes.



Manual Tensioning Tool for KR-Series

• KR6/8

Application tool KR6/8 crimps the glass-fibre-reinforced locking pin of the KR seal and leads to plastic deformation of the tie ends. This produces a very proof permanent connection.

Features and Benefits

- Tough metal tool
- For applying KR-cable ties only
- For tensioning, fixing and cutting KR-cable ties
- Simply change the front plate to apply two different strap widths: 6 mm and 8mm



KR6/8.

Article-No.	Type	For Ties	Strap Width max. (G)	Weight (kg)
121-00680	KR6/8	KR6, KR8	8.0	0.52
122-68019	Replacement Blade	KR6, KR8	–	0.01

All dimensions in mm. Subject to technical changes.

Pneumatic Tensioning Tool for KR-Series

• KR8PNSE

Application tool KR8PNSE crimps the glass-fibre-reinforced locking pin of the KR seal and leads to plastic deformation of the tie ends. This produces a very proof permanent connection.

Features and Benefits

- Tough metal tool
- Pneumatic
- For applying KR-cable ties only
- For tensioning, fixing and automatically cutting KR-cable ties
- Tensioning force can be adapted in reliance on air pressure
- Holding ring for a balancer



KR8PNSE.

Air Supply	non oiled / oiled
Air Pressure (min.)	3
Air Pressure (max.)	4
Hose Internal Diameter	6.0 mm
L x H x W	approx. 320 x 210 x 50mm

Article-No.	Type	For Ties	Strap Width max. (G)	Weight (kg)
121-00889	KR8PNSE	KR8	8.0	1.56
122-80032	Replacement Blade	–	–	0.3

All dimensions in mm. Subject to technical changes.



Manual Processing Tool for Metal Ties MBT- and MAT-Series

- MK9SST up to 13 mm strap width

Features and Benefits

- Glass-fibre-reinforced housing
- Ergonomic design
- Consistent tensioning and automatically cutting of metal ties MBT/MAT-series
- Infinitely adjustable tension force combined with two-step quick adjustment



MK9SST.

- KST-STG200 up to 12.3 mm strap width

Features and Benefits

- Tough metal tool
- Operator controlled tensioning
- Cut off by pulling the hand lever



KST-STG200.

Manual Processing Tool for Metal Ties MLT-Series

- MTT4 up to 12 mm strap width

Features and Benefits

- Tough metal tool
- Simple ratchet operation, easy to use
- Operator controlled tensioning and cutting facility



MTT4.

Article-No.	Type	Strap Width max. (G)	Strap Thickness max.	Weight (kg)
110-95000	MK9SST	13.0	0.25	0.6
110-95011	Replacement Blade	–	–	0.01
110-09950	KST-STG200	12.3	0.3	0.561
110-04000	MTT4	12.0	0.7	0.78

All dimensions in mm. Subject to technical changes.

Manual Cutting tool for plastic ties

• CUTties

The CUTties is a cutting tool for plastic ties, which ensures the cut of the strap while preserving wires and harnesses from being damaged in the process.

Its use is recommended in many applications for which wires and harnesses have a high value added, in particular for railway and aviation industries.

Features and Benefits

- Cutting tool for plastic ties
- Tie can be cut off at any part of the strap
- Ensures the cable isolation from being damaged
- Light-weighting aluminium housing, ergonomic designed
- Single-handed operation
- Three tools for cable tie width from 2.3 to 4.8 mm
- Coloured push rods allows their identification



The CUTties is a precise cutting tool for plastic ties.



Bring the tool perpendicular on the tie...



... apply a light pressure...



... press on the push rod by maintaining the pressure on the tool...



... release the push rod and remove the tool, the tie is cut.

Article-No.	Type	For Cable Tie Width	Colour
110-05000	CUTties-1	2.3 - 2.8	Blue (BU), Yellow (YE)
110-05001	CUTties-3	3.3 - 3.8	Blue (BU), Green (GN)
110-05002	CUTties-5	4.0 - 4.8	Blue (BU), Red (RD)

All dimensions in mm. Subject to technical changes.

How to use a cable tie tool (using an MK7 as an example)

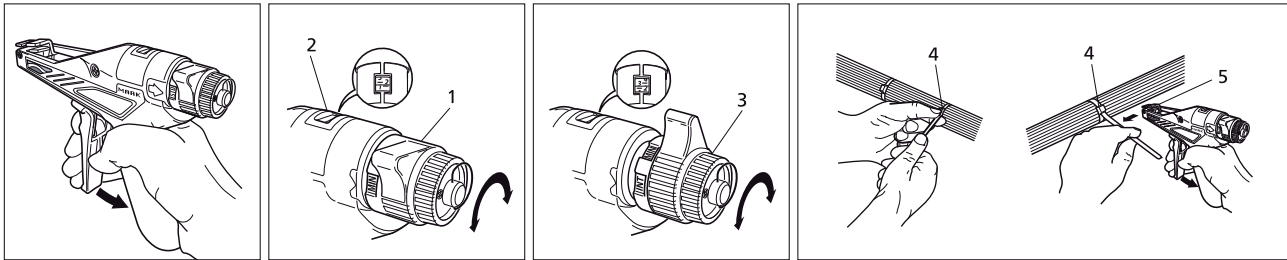

1. Rough adjustment (1) depending on cable tie, and set according to details in the user instructions. Value is displayed in the viewing window (2).
2. Use fine adjustment (3), if necessary, to set the desired value.
3. Lay cable tie around the bundle and guide strap end through the cable tie head (4). Tighten tie firmly enough that one stroke of the tool is enough to tension and cut off.
4. Push the tool with the open side of the tool head (5) over the free strip end and guide in the direction of the bundle until the tool head butts on the tie head (4).
5. Pull manual lever through one or more times to the stop. Once the pre-selected tension is reached, the free tie end is automatically cut off flush with the tie head.

Tool testing - Determination of tensions

To date, no generally applicable test method has been established on the market. The companies within the HellermannTyton group work with the HT50 test device from MAV Prüftechnik (Berlin) to determine the tensile forces of the tools and to guarantee the quality of the tools.

It is more difficult to test cable tie tools than would appear at first glance. It is of supreme importance to comply with a standardised test procedure and consistent test conditions. This means e.g. the size and thus the cross-section of the cable ties, but also the water content of the tie. A test using different ties and/or different conditioning can easily lead to different values.

In general, the speed of cut-off, the position of the tool with respect to the cable tie, the condition of the wearing parts in the tool and the state of the cable tie play a fundamental role in the determination of tensile forces.

Therefore we must point out that any values we provide must only ever be regarded as guide values for your information. The values cannot be transferred into practice "one for one".

In our user instructions, we specify an adjustment range for each type of cable tie. If tension values must be documented or comply with a specification, we recommend that you adjust them with the aid of the MAV device. Also, as a guideline, half the minimum holding strength of the cable tie should be used as tensile force.

The minimum tensile strength (also referred to as minimum unlocking strength) is the least force which the cable tie can withstand before it tears or stretches (see also determination of minimum tensile strength on page 18). This strength is determined using a threaded tie, hence the following formula should be used for guidance as to the correct tensile force of the tool:

$$\frac{\text{Min. tensile strength}}{2} = \text{rec. tensile force}$$

Example:

$$T50R = \frac{225 \text{ N min. tensile strength}}{2}$$

$$\frac{225 \text{ N}}{2} = 112,5 \text{ N rec. tensile force according to formula}$$

Electrical Hot Air Tool

• H5002 - handy tool

Features and Benefits

- Lightweight and compact hot air tool
- Enables comfortable, fatigue-free work
- Temperature electronically controlled from 100- 600 °C, cold air step of 50 °C
- Air-flow regulation adjusted in two stages (300 l/min and 500 l/min)



H5002 - The light, convenient hot-air tool.

• H5004 - for professional use

Features and Benefits

- Professional hot air gun
- Temperature electronically controlled
- Air flow regulation
- Equipped with LED temperature indication enabling precise temperature adjustment



H5004 - for professional use.



Accessories suitable for both H5002 and H5004.

Article-No.	Type	Air Flow l/min	Temp. °C	Standby Temp.°C	Wattage	Operational Voltage	Weight (kg)
391-50200	H 5002	300-500	+100 °C to +600 °C	50	2000	230 V AC ~ / 230-240 V	0.9
391-50400	H5004	500	+50 °C to +650 °C	50	2300	230 - 240V, 50Hz	1.13
391-50500	Z3 Reflector	–	–	–	–	–	0.05
391-50600	Z4 Wide Slot Nozzle	–	–	–	–	–	0.05

Subject to technical changes.



Gas powered Hot Air Tool

• E4500

The E4500 hot-air gun is suitable for shrinking all types of heat shrink products including tubing, shapes and cable repair sleeves. It can also be used for the bending and shaping of PVC pipes, soft soldering of copper pipes, sealing, defrosting, heating and paint stripping.

Features and Benefits

- Cordless hot air gun
- With protective spring, two nozzles and a gas cartridge
- Does not need any power supply
- Allows precise working in any position even in restricted spaces
- Can be operated on its stand for hands free use
- Weight of tool: 760g
- Gas cartridge Type P445, 110ml/60 g
- Operating time: approx. 1.5 hours
- New 3-component gas mixture providing higher pressure, especially useful at low (< 0 °C) outdoor temperatures
- Piezo ignition
- Valve controlled temperature setting



E4500 the cordless hot air gun, ideal for service jobs.



Practical hot air gun kit E4500 with accessories.



Gas cartridge P445.

Article-No.	Type	Description
391-90002	E4500	Hot air gun with protective spring incl. gas cartridge, reflector nozzle Z2 and flat nozzle Z3
391-90101	P445	P445 Refill Gas Cartridge (Methyl Acetylene Propadiene, Butane, Propane)
391-90300	Z2	Deflector Nozzle
391-90001	Z3	Reduction Nozzle

Subject to technical changes.

Three-Pronged Pliers for Sleeves and Grommets

• NA

Features and Benefits

- To easy affix sleeves of every type onto cables
- Sleeve simply slide onto the pronges
- Push plier and pull over cabel
- Close plier, sleeve is placed easily



Fast, secure application with the NA three-pronged pliers.

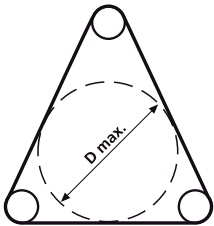

Three-prong pliers;
D = max. application diameter

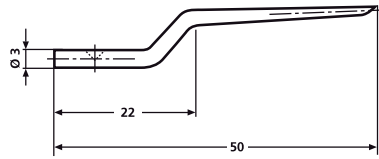

Replacement prong NA0/1

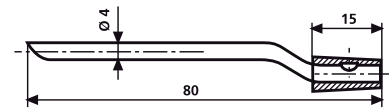

Replacement prong NA4/5

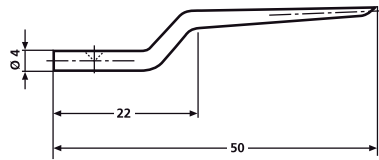

Replacement prong NA1K/3

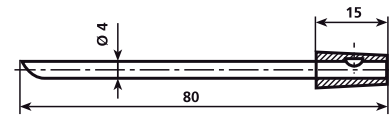

Replacement prong NA8/10

Article-No.	Type	Bundle Ø min.	Bundle Ø max.	Ø D max.	Max. length of marker
621-10001	NA0/1	1.25	1.75	10.5	28.0
621-60001	Replacement prongs for NA-0/1	1.25	1.75	–	28.0
621-10103	NA1K/3	2.50	5.00	11.0	28.0
621-60103	Replacement prongs for NA1K/3	2.50	5.00	–	28.0
621-10405	NA4/5	7.50	10.00	15.5	50.0
621-60405	Replacement prongs for NA4/5	7.50	10.00	–	50.0
621-10810	NA8/10	12.00	17.00	25.5	60.0
621-60810	Replacement prongs for NA8/10	12.00	17.00	–	60.0

All dimensions in mm. Subject to technical changes.

Snapper Tools

Features and Benefits

- For efficient fixing of the snapper hose clips
- MSNP tool: handy for installation on site
- ASNP tool: suitable for series production
- Retaining screw limits the draw-in area prevents overstretching of the snapper



Snapper Application Tools MSNP1-70 and ASNP24-70.



Snapper Application Tool ASNP2-22.

Article-No.	Type	Application	Weight (kg)	Material	Colour
191-02220	ASNP2-22	SNP-Series 2 up to 22	0.20	Metal, Plastic	Blue (BU)
191-24700	ASNP24-70	SNP-Series 24 up to 70	0.25	Metal, Plastic	Red (RD)
191-01700	MSNP1-70	SNP-Series 1 up to 70	0.18	Plastic, Metal	Yellow (YE)

Subject to technical changes.

Pneumatic Tools for Snapper are available on request. Contact us!

Hot cutting tool

- **HSG0**

The HSG0 hand tool is used to cut braided sleeving cleanly and without fraying.

Features and Benefits

- Light and sturdy
- Heats up quickly with the press of button and cuts in seconds
- The yarn melts and fuses together
- No fraying of the sleeving



The HSG0 hot cutting tool prevents the braided sleeving from fraying.

Article-No.	Type	Weight (kg)	Colour
170-99001	HSG0	1.15	Blue (BU)

Subject to technical changes.





Protection 3

	Page
3.1 Heat shrinkable tubing	
Heat shrink tubing selection guide	144
Application overview heat shrinkable tubing	146
The right heat shrink tube	147
Heat shrinkable tubing	
TCN20, 2:1, fast shrinkable, self-extinguishing	148
TCN20, 3:1, fast shrinkable, self-extinguishing	149
TL27, 2:1, fast shrinkable, halogenfree	150
TF21, 2:1, coloured	151
TF24, 2:1, transparent	154
TF31, 3:1, coloured	155
TF34, 3:1, transparent	157
EPS, 3:1, 4:1, adhesive lined	158
Viton®-E, 2:1, Fluorelastomer	159
TK20, 2:1, PVDF	160
TK29, 2:1, PVDF	161
TFE2, 2:1, 4:1, PTFE	162
TR27, 2:1, flame retardant	164

	Page
3.2 Braided sleeving	
Braided sleeving Helagaine	
HEGP	165
HEGPX, expansion rate: 3:1	166
HEGPV0, UL94V0 classification	167
HEGPV0X, expansion rate: 3:1, UL94V0 classification	168
HEGPA66, for abrasion resistance	169
HEGSAS, for noise reduction	170
HEGEMIP, EMI protection	171
HEGEMIPV0, EMI protection, UL94V0 classification	172
HEGPL, light weight	173
Fabric tubing	
HELAHOOK, re-sealable	174
Twist-In, self-closing	175

Use our flow chart to find the correct heat shrink tubing for your particular application.

Begin your search in the flow chart at the START point. You will be guided through Charts 1 to 4 to the target according to your heat shrink tubing requirements. Using the "yes/no" and "either/or" decisions, you will be able to select the correct heat shrinkable tubing with ease.

Of course, you can always call us whenever you wish on our usual telephone numbers.

Diagram 1

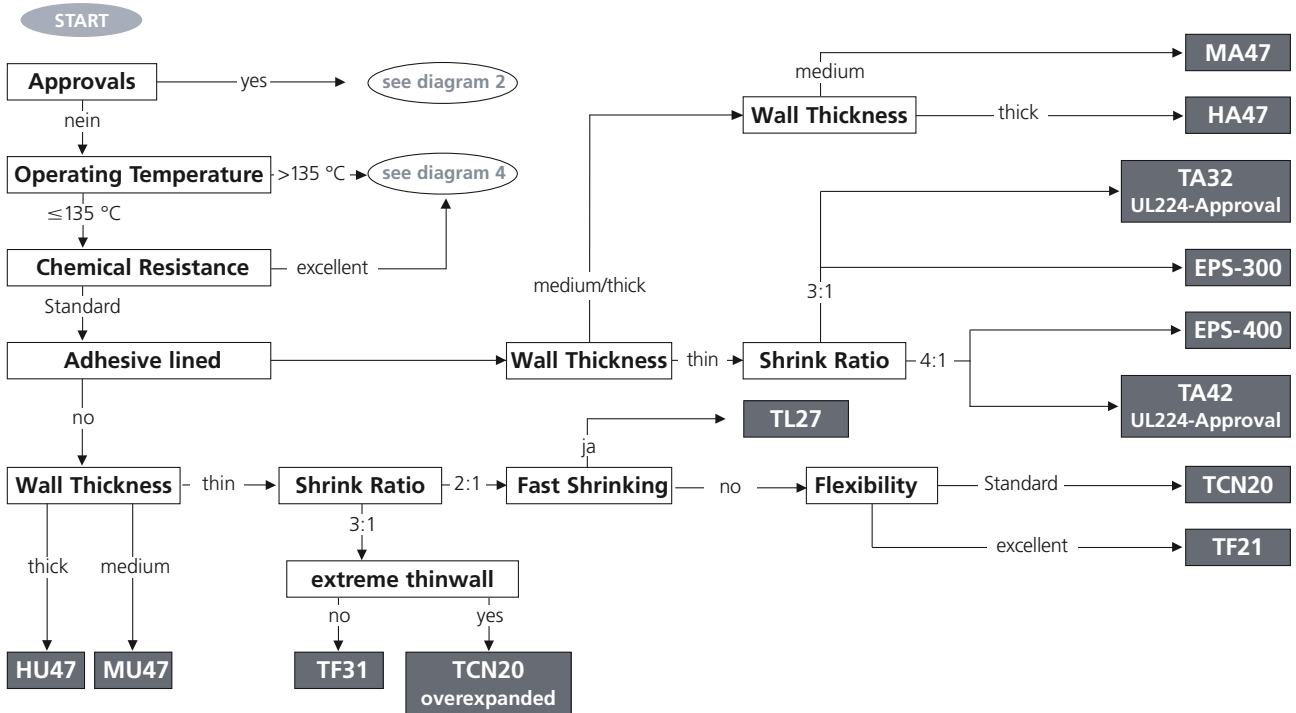
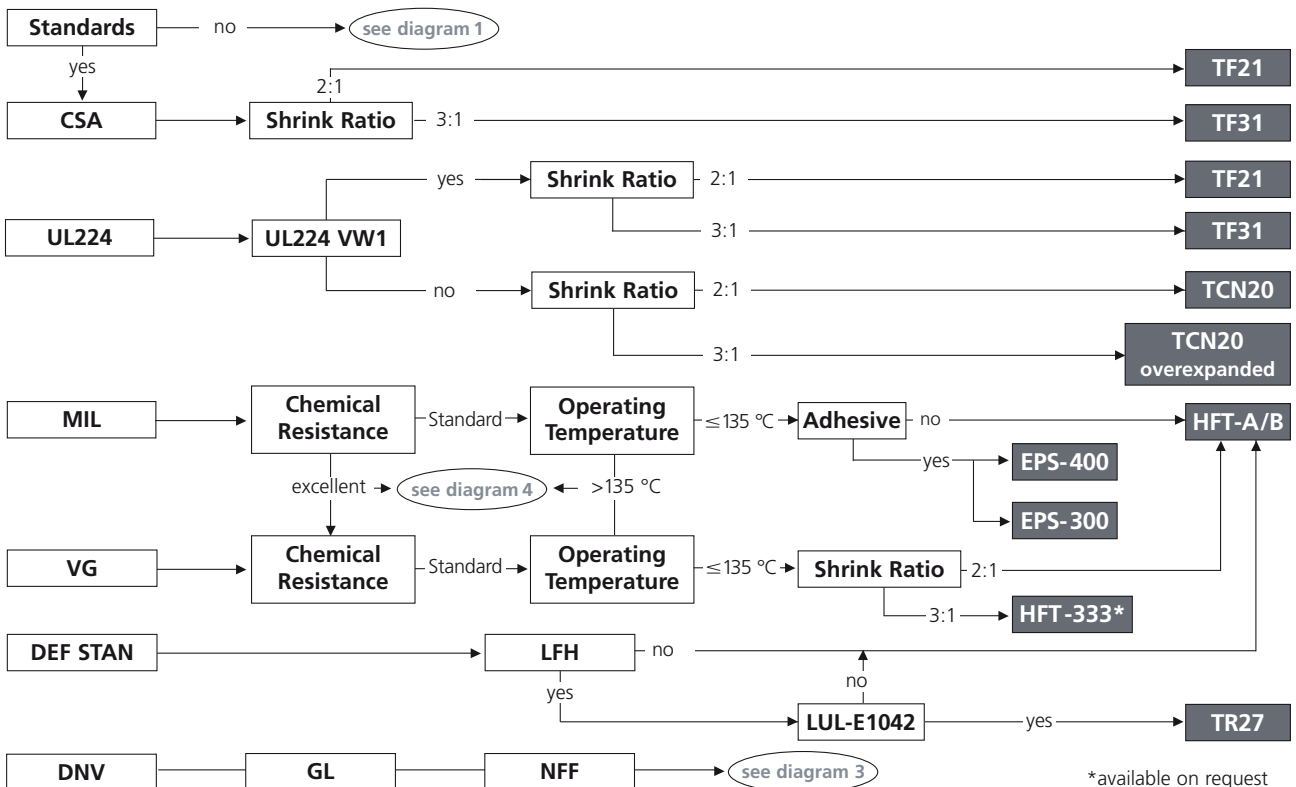

Diagram 2



*available on request

Diagram 3

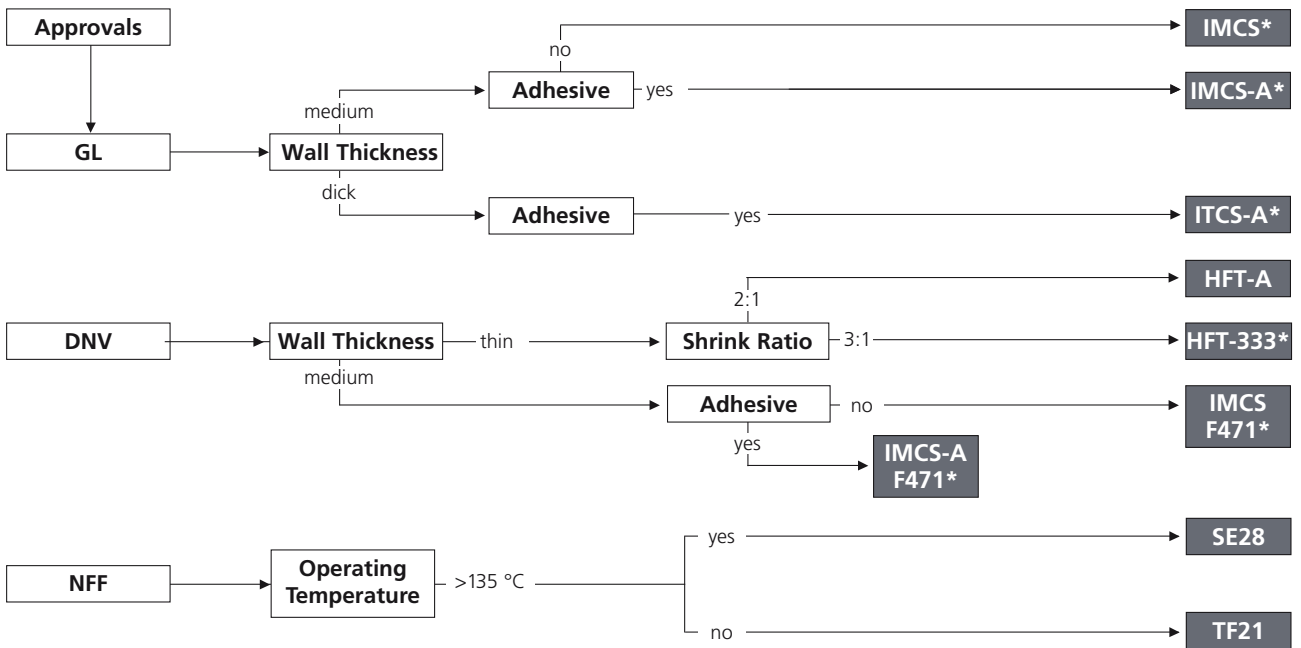
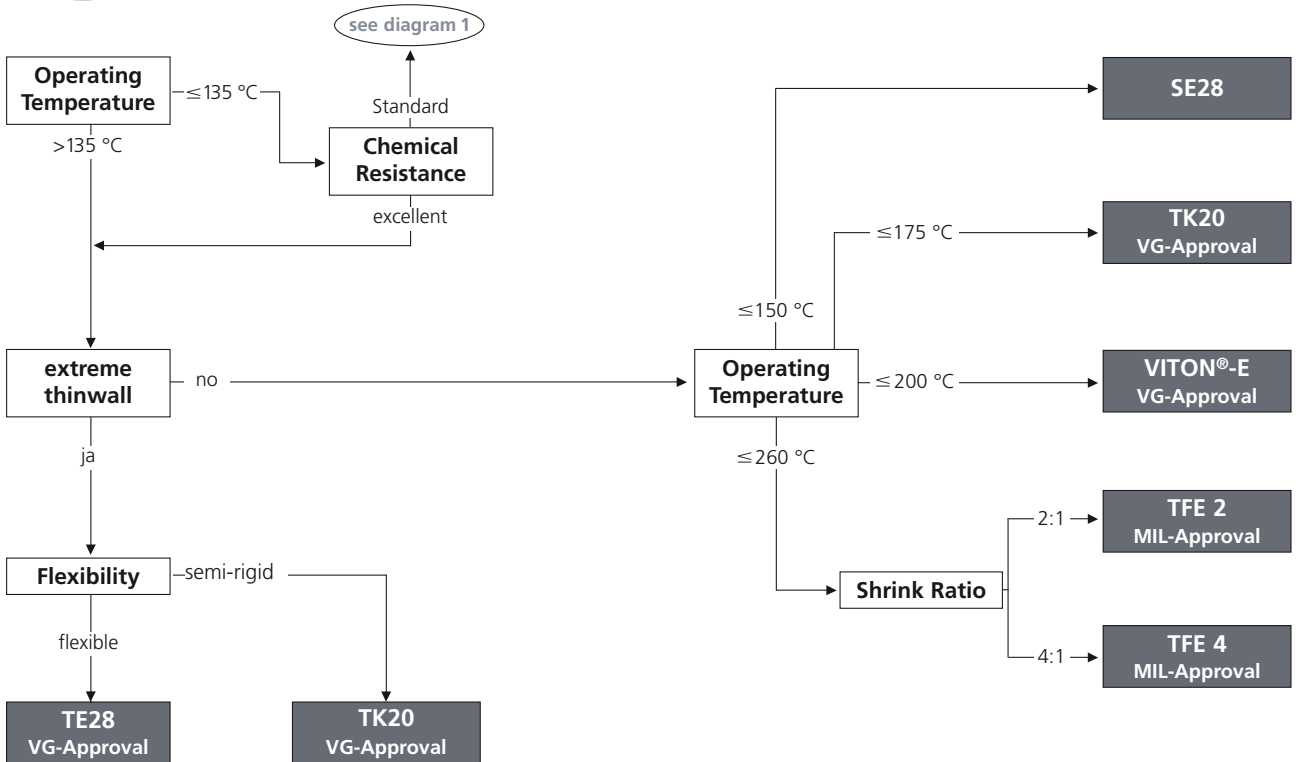

Diagram 4



*available on request

VITON® is a registered trademark of DuPont.



Overview of applications for Heat Shrink Tubing

When selecting the correct heat shrink tubing size, it is important to bear in mind the 80:20 rule. The heat shrink tubing must shrink by at least 20% and not more than 80% of its complete shrinkage capacity to achieve the right result. In our overview of applications you will find the best heat shrink tube for every cable diameter. The 80:20 rule has of course been taken into account in the table.

Heat Shrinkable Tubing with a shrink ratio of 2:1

HIS-Pack; LVR; TF21; TL27; HFT-A; HFT-B;
VITON-E®; TFE-2; TR27; TCN20; TF24; SE28;
TE28

Shrink ratio 2:1		
Size mm		Cable/Wire diameter
1,2/0,6		0,7 mm
		1,1 mm
		1,4 mm
3,2/1,6	2,4/1,2	1,9 mm
		2,2 mm
		2,9 mm
6,4/3,2	4,8/2,4	3,8 mm
		4,3 mm
		5,7 mm
12,7/6,4	9,5/4,7	5,8 mm
		7,7 mm
		8,6 mm
25,4/12,7	19,1/9,5	11,4 mm
		15,2 mm
		17,2 mm
50,8/25,4	38,1/19,1	22,9 mm
		30,5 mm
		34,3 mm
101,6/50,8	76,2/38,1	45,7 mm
		61,0 mm
		68,6 mm
		91,4 mm

Heat Shrinkable Tubing with a shrink ratio of 3:1

With the optimal shrinkage ratio of 3:1, you can cover a wide range of applications with just a few sizes. This leads to reduced stock expenditure and requires less space. 3:1 heat shrink tubes: HIS-3; HIS-A; TREDUX; TF34; TF31; EPS-300; TA32; TCN20 overexpanded; HIS-3 BAG; ShrinKits 3z1

Shrink ratio 3:1		
Size mm		Cable/Wire diameter
1,5/0,5		0,7 mm
		1,3 mm
	3/1	1,4 mm
		2,6 mm
6/2		2,8 mm
		5,2 mm
		5,6 mm
		8,4 mm
18/6	12/4	10,4 mm
		11,2 mm
	24/8	15,6 mm
		18,4 mm
40/13		20,8 mm
		34,6 mm

Conversion from imperial to metric

Zoll	1/32"	3/64"	1/16"	5/64"	3/32"	1/8"	3/16"	1/4"	3/8"
mm	0,8	1,2	1,6	2,0	2,4	3,2	4,8	6,4	9,5
Zoll	1/2"	5/8"	3/4"	1"	1 1/4"	1 1/2"	2"	3"	4"
mm	12,7	15,9	19,1	25,4	31,8	38,1	50,8	76,2	101,6

VITON® is a registered trademark of DuPont.

The right Heat Shrink Tube

The **80:20 rule** means that a heat shrink tube should shrink by a **maximum of 80%** and a **minimum of 20%**.

For example:

A cable with a diameter of 5 mm is to be wrapped in heat shrinkable tubing. In theory both sizes 6/2 and 12/4 would be suitable, since the required diameter of 5 mm lies within the shrink range of both tube sizes.

Size 6/2

Maximal shrink (100%)

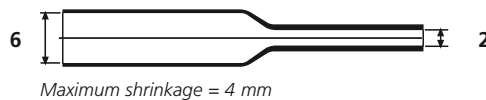

Optimum Shrinkage max. (80%)



Optimum shrink min. (20%)

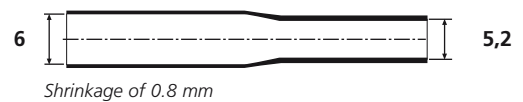

Size 6/2 has a range of application of between 2.8 mm and 5.2 mm and is therefore suitable for the cable diameter of 5 mm.

Size 12/4

Maximum shrink (100%)

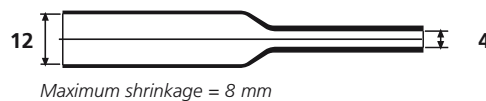

Optimum shrink max. (80%)

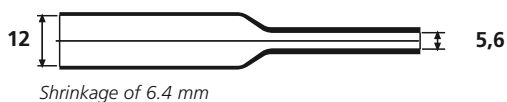

Optimum shrink min. (20%)

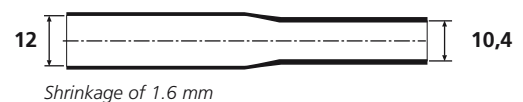

The smallest application diameter of size 12/4 is 5.6 mm. This size is therefore unsuitable for a cable diameter of 5 mm.

Calculator tool for Heat Shrink Tubing

The calculator tool for Heat Shrink Tubing is a selection guide for shrink tubing sizes based on the object to be covered. Fill in your specification and the calculator presents the right tubing size according to the 80:20 rule.

Find more information under <http://www.hellermannntyton.co.uk/heatshrink-calculator/>

The calculator tool also checks if the Heat shrink tubing you have choosed is suitable for your application.

For example you can find the Heat shrink tubing with the Product Search on the HellermannTyton website.

Low-Heat Shrinkable Tubing 2:1

• TCN20 - self extinguishing

TCN20 is suitable for a wide range of applications like electrical insulations, mechanical protection, cable bundling, et cetera.

Features and Benefits

- Thin walled general purpose polyolefin tubing TCN20
- Shrink ratio 2:1
- Flame-retardant
- Fast shrinkable
- Low shrink temperature
- Good mechanical strength
- Resistance to common fluids and solvents



Heat shrink tubing TCN20.



TCN20

Material	Polyolefin, cross-linked (POX)
Colour	Black (BK)
Shrink Ratio	2:1
Longitudinal change after	+/- 5%
Min. Shrink Temperature	+100 °C
Operating Temperature	-55 °C to +125 °C
Dielectric Strength	20 kV/mm according to IEC 243
Flammability	self-extinguishing
Specification	UL224 125 °C 600V VW-1



Article-No.	Type	Supplied Ø D min.	Recov. Ø d max.	Wall (WT) nom.	Reel Length (m)
300-73010	TCN20-1.2/0.6	1.2	0.6	0.30	300
300-73020	TCN20-1.6/0.8	1.6	0.8	0.35	300
300-73030	TCN20-2.4/1.2	2.4	1.2	0.45	300
300-73040	TCN20-3.2/1.6	3.2	1.6	0.45	300
300-73050	TCN20-4.8/2.4	4.8	2.4	0.50	300
300-73060	TCN20-6.4/3.2	6.4	3.2	0.55	300
300-73070	TCN20-9.5/4.8	9.5	4.8	0.55	100
300-73080	TCN20-12.7/6.4	12.7	6.4	0.65	100
300-73090	TCN20-19.1/9.5	19.1	9.5	0.80	60
300-73100	TCN20-25.4/12.7	25.4	12.7	0.90	60
300-73110	TCN20-38.1/19.1	38.1	19.1	1.02	30
300-73120	TCN20-50.8/25.4	50.8	25.4	1.15	30

All dimensions in mm. Subject to technical changes.



Please note! Not all products listed on this page may have this approval. For product specific approvals please refer to the Appendix.

Low-Heat Shrinkable Tubing 3:1

• TCN20 overexpanded - self extinguishing

Mechanical, electrical and corrosion protection applications for parts with high diameter variances. This fast shrinking tubing makes it suitable for high volume production.

Features and Benefits

- Thin walled overexpanded polyolefin tubing TCN20X
- Shrink ratio 3:1
- Flame-retardant
- Extremely fast shrinkable
- Low shrink temperature
- Good mechanical strength
- Resistance to common fluids and solvents



Battery cables safely insulated with TCN20 overexpanded shrinkable tubing



Due to its thin wall TCN20 overexpanded is suitable for insulation of antennas.

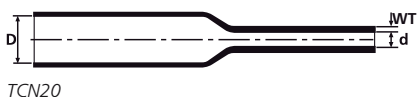

Material	Polyolefin, cross-linked (POX)
Colour	Black (BK)
Shrink Ratio	3:1
Longitudinal change after shrinkage	+/- 5%
Min. Shrink Temperature	+100 °C
Operating Temperature	-55 °C to +125 °C
Dielectric Strength	20 kV/mm
Flammability	self-extinguishing
Specification	UL224



Article-No.	Type	Supplied Ø D min.	Recov. Ø d max.	Wall (WT) nom.	Reel Length (m)
300-73130	TCN20-2.4/0.8	2.4	0.8	0.50	300
300-73140	TCN20-3.2/1.2	3.2	1.2	0.50	300
300-73150	TCN20-4.8/1.6	4.8	1.6	0.50	300
300-73160	TCN20-6.6/2.4	6.6	2.4	0.55	300
300-73170	TCN20-9.5/3.2	9.5	3.2	0.65	100
300-73180	TCN20-12.7/4.8	12.7	4.8	0.75	100
300-73190	TCN20-19.0/6.4	19.0	6.4	0.75	60
300-73200	TCN20-25.4/9.5	25.4	9.5	0.79	60
300-73210	TCN20-38.0/12.7	38.0	12.7	0.95	30

All dimensions in mm. Subject to technical changes.



Please note! Not all products listed on this page may have this approval. For product specific approvals please refer to the Appendix.

Low-Heat Shrinkable Tubing 2:1

• TL27 - halogen free

Its low shrink temperature offers very quick recovery. Application fields include covering of heat sensitive parts, mechanical protection and cosmetic covering.

Features and Benefits

- Thin walled and light weighting polyolefin tubing TL27
- Shrink ratio 2:1
- Halogenfree
- Very flexible
- Extremely fast shrinkable
- Very low shrink temperature

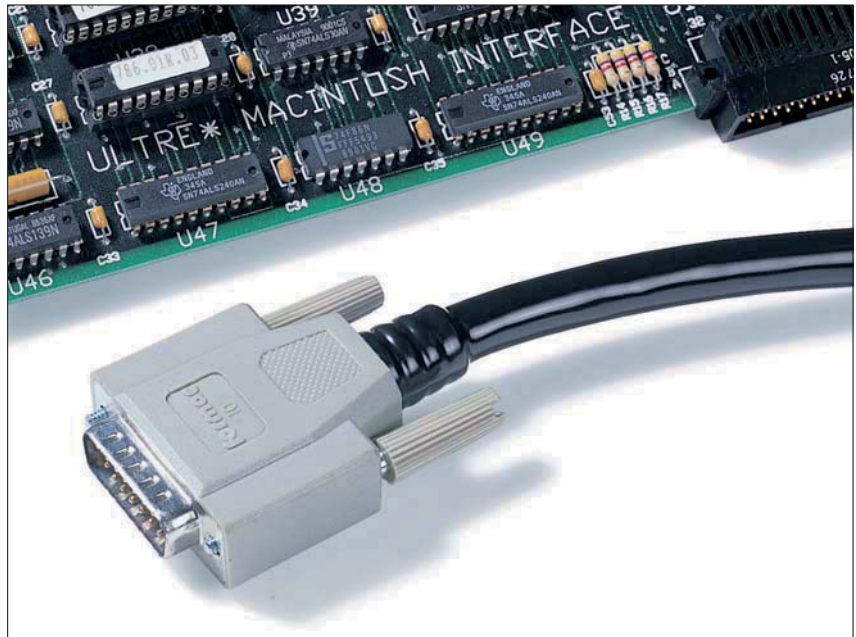

TL27 – a very flexible tubing for automotive applications.



Material	Polyolefin, cross-linked (POX)
Colour	Black (BK)
Shrink Ratio	2:1
Operating Temperature	-55 °C to +135 °C
Min. Shrink Temperature	+90 °C
Flammability	FMVSS 302
Longitudinal change after shrinkage	+5%/-15%



Article-No.	Type	Supplied Ø D min.	Recov. Ø d max.	Wall (WT) nom.	Reel Length (m)
302-20120	TL27-1.2/0.6	1.2	0.6	0.31	500
302-20160	TL27-1.6/0.8	1.6	0.8	0.33	500
302-30240	TL27-2.4/1.2	2.4	1.2	0.36	300
302-30320	TL27-3.2/1.6	3.2	1.6	0.39	300
302-30480	TL27-4.8/2.4	4.8	2.4	0.42	150
302-30640	TL27-6.4/3.2	6.4	3.2	0.45	100
302-30950	TL27-9.5/4.8	9.5	4.8	0.48	100
302-21270	TL27-12.7/6.4	12.7	6.4	0.52	100
302-31900	TL27-19.1/9.5	19.1	9.5	0.58	100
302-32540	TL27-25.4/12.7	25.4	12.7	0.67	100
302-23810	TL27-38.1/19.1	38.1	19.1	0.76	100
302-25080	TL27-50.8/25.4	50.8	25.4	0.85	100

All dimensions in mm. Subject to technical changes.

Heat Shrinkable Tubing 2:1 flexible and coloured

• TF21

TF21 is due to its versatility suitable for a wide range of applications like electrical insulations, mechanical protection and marking.

Features and Benefits

- Thin walled, flexible polyolefin tubing TF21
- Shrink ratio 2:1
- Extremely fast shrinkable
- Very low shrink temperature
- Very good mechanical strength and strain relief
- Resistance to common fluids and solvents
- Meets and exceeds lots of industrial standards
- Big variety of different colours and sizes
- Printable

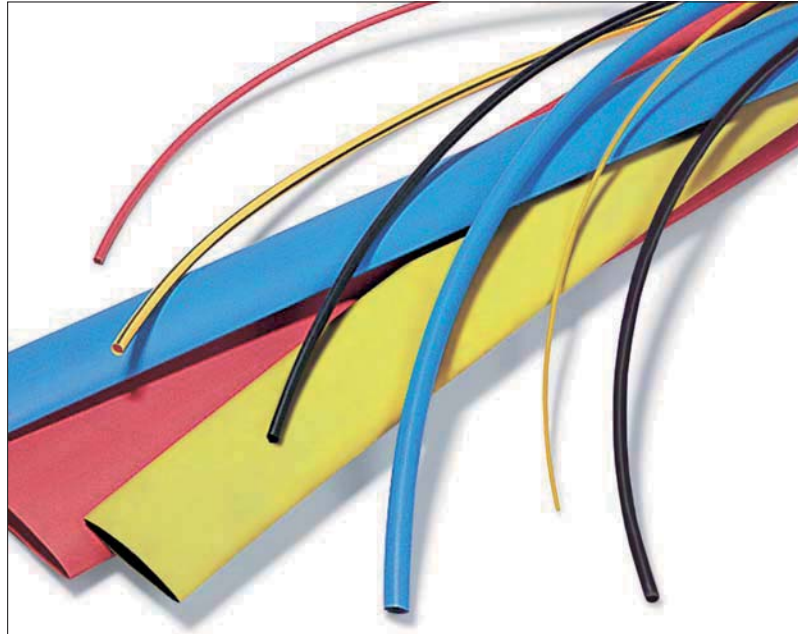

TF21 – available in a wide range of colours and sizes.



TF21

Material	Polyolefin, cross-linked (POX)
Shrink Ratio	2:1
Operating Temperature	-55 °C to +135 °C
Min. Shrink Temperature	+90 °C
Flammability	ASTM D876
Longitudinal change after shrinkage	+/- 5%
Dielectric Strength Specification	37 kV/mm UL224 125 °C 600V VW-1, CSA, SAE - AMS - DTL-23053/5 Class 1, NF F 00-608, JAR/FAR 25.853



Please note! Not all products listed on this page may have this approval. For product specific approvals please refer to the Appendix.

Heat Shrinkable Tubing 2:1 flexible and coloured

• TF21

Article-No.	Type	Supplied \varnothing D min.	Recov. \varnothing d max.	Wall (WT)	Colour	Reel Length (m)
309-10120	TF21-1.2/0.6	1.2	0.6	0.41	Black (BK)	300
309-20129	TF21-1.2/0.6	1.2	0.6	0.41	White (WH)	100
309-20122	TF21-1.2/0.6	1.2	0.6	0.41	Red (RD)	100
309-20124	TF21-1.2/0.6	1.2	0.6	0.41	Yellow (YE)	100
309-20126	TF21-1.2/0.6	1.2	0.6	0.41	Blue (BU)	100
309-10160	TF21-1.6/0.8	1.6	0.8	0.43	Black (BK)	300
309-20169	TF21-1.6/0.8	1.6	0.8	0.43	White (WH)	100
309-20162	TF21-1.6/0.8	1.6	0.8	0.43	Red (RD)	100
309-20164	TF21-1.6/0.8	1.6	0.8	0.43	Yellow (YE)	100
309-20166	TF21-1.6/0.8	1.6	0.8	0.43	Blue (BU)	100
309-10240	TF21-2.4/1.2	2.4	1.2	0.51	Black (BK)	300
309-20249	TF21-2.4/1.2	2.4	1.2	0.51	White (WH)	100
309-20242	TF21-2.4/1.2	2.4	1.2	0.51	Red (RD)	100
309-20244	TF21-2.4/1.2	2.4	1.2	0.51	Yellow (YE)	100
309-20246	TF21-2.4/1.2	2.4	1.2	0.51	Blue (BU)	100
309-40247	TF21-2.4/1.2	2.4	1.2	0.51	Green-Yellow (GNYE)	100
309-10320	TF21-3.2/1.6	3.2	1.6	0.51	Black (BK)	300
309-20329	TF21-3.2/1.6	3.2	1.6	0.51	White (WH)	100
309-20322	TF21-3.2/1.6	3.2	1.6	0.51	Red (RD)	100
309-20324	TF21-3.2/1.6	3.2	1.6	0.51	Yellow (YE)	100
309-20326	TF21-3.2/1.6	3.2	1.6	0.51	Blue (BU)	100
309-40327	TF21-3.2/1.6	3.2	1.6	0.51	Green-Yellow (GNYE)	100
309-10480	TF21-4.8/2.4	4.8	2.4	0.51	Black (BK)	300
309-50489	TF21-4.8/2.4	4.8	2.4	0.51	White (WH)	60
309-50482	TF21-4.8/2.4	4.8	2.4	0.51	Red (RD)	60
309-50484	TF21-4.8/2.4	4.8	2.4	0.51	Yellow (YE)	60
309-50486	TF21-4.8/2.4	4.8	2.4	0.51	Blue (BU)	60
309-50487	TF21-4.8/2.4	4.8	2.4	0.51	Green-Yellow (GNYE)	60
309-10640	TF21-6.4/3.2	6.4	3.2	0.64	Black (BK)	300
309-50649	TF21-6.4/3.2	6.4	3.2	0.64	White (WH)	60
309-50642	TF21-6.4/3.2	6.4	3.2	0.64	Red (RD)	60
309-50644	TF21-6.4/3.2	6.4	3.2	0.64	Yellow (YE)	60
309-50646	TF21-6.4/3.2	6.4	3.2	0.64	Blue (BU)	60
309-50647	TF21-6.4/3.2	6.4	3.2	0.64	Green-Yellow (GNYE)	60
309-10950	TF21-9.5/4.8	9.5	4.8	0.64	Black (BK)	150
309-20959	TF21-9.5/4.8	9.5	4.8	0.64	White (WH)	50
309-20952	TF21-9.5/4.8	9.5	4.8	0.64	Red (RD)	50
309-20954	TF21-9.5/4.8	9.5	4.8	0.64	Yellow (YE)	50
309-20956	TF21-9.5/4.8	9.5	4.8	0.64	Blue (BU)	50
309-50957	TF21-9.5/4.8	9.5	4.8	0.64	Green-Yellow (GNYE)	50

All dimensions in mm. Subject to technical changes.



TF21

Heat Shrinkable Tubing 2:1 flexible and coloured

• TF21

Article-No.	Type	Supplied Ø D min.	Recov. Ø d max.	Wall (WT)	Colour	Reel Length (m)
309-11270	TF21-12.7/6.4	12.7	6.4	0.64	Black (BK)	100
309-21279	TF21-12.7/6.4	12.7	6.4	0.64	White (WH)	50
309-21272	TF21-12.7/6.4	12.7	6.4	0.64	Red (RD)	50
309-21274	TF21-12.7/6.4	12.7	6.4	0.64	Yellow (YE)	50
309-21276	TF21-12.7/6.4	12.7	6.4	0.64	Blue (BU)	50
309-41277	TF21-12.7/6.4	12.7	6.4	0.64	Green-Yellow (GNYE)	50
309-11900	TF21-19.0/9.5	19.1	9.5	0.76	Black (BK)	50
309-11909	TF21-19.0/9.5	19.1	9.5	0.76	White (WH)	50
309-11902	TF21-19.0/9.5	19.1	9.5	0.76	Red (RD)	50
309-11904	TF21-19.0/9.5	19.1	9.5	0.76	Yellow (YE)	50
309-11906	TF21-19.0/9.5	19.1	9.5	0.76	Blue (BU)	50
309-11907	TF21-19.0/9.5	19.1	9.5	0.76	Green-Yellow (GNYE)	50
309-12540	TF21-25.4/12.7	25.4	12.7	0.89	Black (BK)	50
309-12549	TF21-25.4/12.7	25.4	12.7	0.89	White (WH)	50
309-12542	TF21-25.4/12.7	25.4	12.7	0.89	Red (RD)	50
309-12544	TF21-25.4/12.7	25.4	12.7	0.89	Yellow (YE)	50
309-12546	TF21-25.4/12.7	25.4	12.7	0.89	Blue (BU)	50
309-12547	TF21-25.4/12.7	25.4	12.7	0.89	Green-Yellow (GNYE)	50
309-13810	TF21-38.0/19.0	38.1	19.1	1.02	Black (BK)	60
309-13819	TF21-38.0/19.0	38.1	19.1	1.02	White (WH)	60
309-13812	TF21-38.0/19.0	38.1	19.1	1.02	Red (RD)	60
309-13814	TF21-38.0/19.0	38.1	19.1	1.02	Yellow (YE)	60
309-13816	TF21-38.0/19.0	38.1	19.1	1.02	Blue (BU)	60
309-13817	TF21-38.0/19.0	38.1	19.1	1.02	Green-Yellow (GNYE)	60
309-15080	TF21-50.8/25.4	50.8	25.4	1.14	Black (BK)	60
309-15089	TF21-50.8/25.4	50.8	25.4	1.14	White (WH)	60
309-15082	TF21-50.8/25.4	50.8	25.4	1.14	Red (RD)	60
309-15084	TF21-50.8/25.4	50.8	25.4	1.14	Yellow (YE)	60
309-15086	TF21-50.8/25.4	50.8	25.4	1.14	Blue (BU)	60
309-15087	TF21-50.8/25.4	50.8	25.4	1.14	Green-Yellow (GNYE)	60
309-17600	TF21-76.0/38.0	76.2	38.1	1.27	Black (BK)	30
309-17609	TF21-76.0/38.0	76.2	38.1	1.27	White (WH)	30
309-17602	TF21-76.0/38.0	76.2	38.1	1.27	Red (RD)	30
309-17604	TF21-76.0/38.0	76.2	38.1	1.27	Yellow (YE)	30
309-17606	TF21-76.0/38.0	76.2	38.1	1.27	Blue (BU)	30
309-11020	TF21-101.6/50.8	101.6	50.8	1.40	Black (BK)	15
309-11029	TF21-101.6/50.8	101.6	50.8	1.40	White (WH)	15
309-11022	TF21-101.6/50.8	101.6	50.8	1.40	Red (RD)	15
309-11024	TF21-101.6/50.8	101.6	50.8	1.40	Yellow (YE)	15
309-11026	TF21-101.6/50.8	101.6	50.8	1.40	Blue (BU)	15

All dimensions in mm. Subject to technical changes.



TF21

Cut lengths available on request. Please contact us!

Heat Shrinkable Tubing 2:1 flexible and transparent

• TF24

Features and Benefits

- Transparent, flexible polyolefin tubing TF24
- Protects identification marking perfect
- Shrink ratio 2:1
- Halogenfree
- Good mechanical and chemical resistance
- VG-approval and additional industrial approvals



TF24 – ideal to protect cable markers.



TF24

Cut lengths available on request. Please contact us!

Material	Polyolefin, cross-linked (POX)
Shrink Ratio	2:1
Operating Temperature	-55 °C to +135 °C
Min. Shrink Temperature	+110 °C
Longitudinal change after shrinkage	+/-5% max.
Dielectric Strength	46 kV/mm
Specification	VG 95343, SAE - AMS - DTL-23053/5 Class 2, DEF STAN 59-97 Type 2B



Article-No.	Type	Designation as per VG-Norm	Wall (WT) nom.	Supplied Ø D min.	Recov. Ø d max.	Colour	Reel Length (m)
309-40123	TF24-1.2/0.6	VG95343T05B001M	0.41	1.2	0.6	Transparent (CL)	100
309-40163	TF24-1.6/0.8	VG95343T05B002M	0.43	1.6	0.8	Transparent (CL)	100
309-40243	TF24-2.4/1.2	VG95343T05B003M	1.51	2.4	1.2	Transparent (CL)	100
309-40323	TF24-3.2/1.6	VG95343T05B004M	0.51	3.2	1.6	Transparent (CL)	100
309-50483	TF24-4.8/2.4	VG95343T05B005M	0.51	4.8	2.4	Transparent (CL)	60
309-50643	TF24-6.4/3.2	VG95343T05B006M	0.64	6.4	3.2	Transparent (CL)	60
309-40953	TF24-9.5/4.8	VG95343T05B007M	0.64	9.5	4.8	Transparent (CL)	50
309-41273	TF24-12.7/6.4	VG95343T05B008M	0.64	12.7	6.4	Transparent (CL)	50
309-31903	TF24-19.1/9.5	VG95343T05B009M	0.76	19.1	9.5	Transparent (CL)	50
309-32543	TF24-25.4/12.7	VG95343T05B010M	0.89	25.4	25.4	Transparent (CL)	50
309-33813	TF24-38.1/19.1	VG95343T05B011M	1.02	38.1	19.1	Transparent (CL)	60
309-35083	TF24-50.8/25.4	VG95343T05B012M	1.14	50.8	25.4	Transparent (CL)	60
309-37603	TF24-76.2/38.1	VG95343T05B013M	1.27	76.2	38.1	Transparent (CL)	30
309-31023	TF24-101.6/50.8	VG95343T05B014M	1.40	101.6	50.8	Transparent (CL)	15

All dimensions in mm. Subject to technical changes.



Please note! Not all products listed on this page may have this approval. For product specific approvals please refer to the Appendix.

Heat Shrinkable Tubing 3:1 flexible and coloured

• TF31

If higher fire protection is a requirement heat shrinkable tubing TF31 is a good choice. It is used for protection insulation and identification wires, cables and light duty harnesses.

Features and Benefits

- Thin walled, flexible polyolefin tubing TF31
- Shrink ratio 3:1
- Flame-retardant
- Fast shrinkable
- Low shrink temperature
- Good mechanical strength and chemical resistance
- Resistance to common fluids and solvents

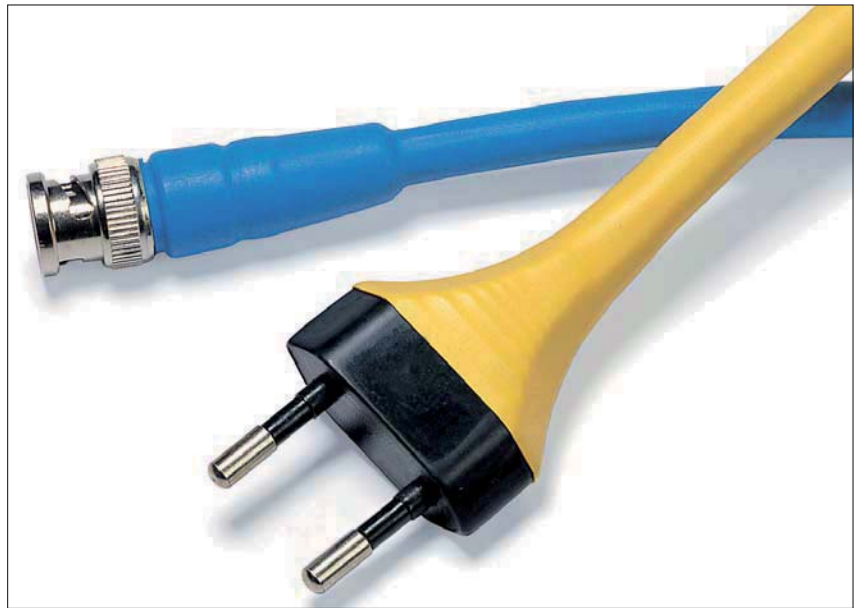

TF31 with 3:1 shrink ratio allowing for a wider range of application.



TF31

Cut lengths available on request. Please contact us!

Detailed Information about Heatguns please refer to page 137.

Material	Polyolefin, cross-linked (POX)
Shrink Ratio	3:1
Operating Temperature	-55 °C to +135 °C
Min. Shrink Temperature	+90 °C
Flammability	ASTM D876
Longitudinal change after shrinkage	+5%/-15%
Dielectric Strength Specification	37 kV/mm UL224 125 °C 600V VW-1, CSA



Article-No.	Type	Supplied Ø D min.	Recov. Ø d max.	Wall (WT)	Colour	Reel Length (m)
333-20150	TF31-1.5/0.5	1.5	0.5	0.50	Black (BK)	300
333-40300	TF31-3/1	3.0	1.0	0.60	Black (BK)	150
333-40600	TF31-6/2	6.0	2.0	0.70	Black (BK)	150
333-20900	TF31-9/3	9.0	3.0	0.80	Black (BK)	150
333-21200	TF31-12/4	12.0	4.0	0.85	Black (BK)	100
333-41800	TF31-18/6	18.0	6.0	1.00	Black (BK)	60
333-42400	TF31-24/8	24.0	8.0	1.20	Black (BK)	60
333-24000	TF31-40/13	40.0	13.0	1.25	Black (BK)	60

All dimensions in mm. Subject to technical changes.



Please note! Not all products listed on this page may have this approval. For product specific approvals please refer to the Appendix.

Heat Shrinkable Tubing 3:1 flexible and coloured

Article-No.	Type	Supplied Ø D min.	Recov. Ø d max.	Wall (WT)	Colour	Reel Length (m)
333-30150	TF31-1.5/0.5	1.5	0.5	0.50	Black (BK)	30
333-30156	TF31-1.5/0.5	1.5	0.5	0.50	Blue (BU)	30
333-30155	TF31-1.5/0.5	1.5	0.5	0.50	Green (GN)	30
333-30157	TF31-1.5/0.5	1.5	0.5	0.50	Green-Yellow (GNYE)	30
333-30152	TF31-1.5/0.5	1.5	0.5	0.50	Red (RD)	30
333-30159	TF31-1.5/0.5	1.5	0.5	0.50	White (WH)	30
333-30154	TF31-1.5/0.5	1.5	0.5	0.50	Yellow (YE)	30
333-30306	TF31-3/1	3.0	1.0	0.60	Blue (BU)	30
333-30300	TF31-3/1	3.0	1.0	0.60	Black (BK)	30
333-30305	TF31-3/1	3.0	1.0	0.60	Green (GN)	30
333-30307	TF31-3/1	3.0	1.0	0.60	Green-Yellow (GNYE)	30
333-30302	TF31-3/1	3.0	1.0	0.60	Red (RD)	30
333-30309	TF31-3/1	3.0	1.0	0.60	White (WH)	30
333-30304	TF31-3/1	3.0	1.0	0.60	Yellow (YE)	30
333-30606	TF31-6/2	6.0	2.0	0.70	Blue (BU)	30
333-30600	TF31-6/2	6.0	2.0	0.70	Black (BK)	30
333-30605	TF31-6/2	6.0	2.0	0.70	Green (GN)	30
333-30607	TF31-6/2	6.0	2.0	0.70	Green-Yellow (GNYE)	30
333-30602	TF31-6/2	6.0	2.0	0.70	Red (RD)	30
333-30609	TF31-6/2	6.0	2.0	0.70	White (WH)	30
333-30604	TF31-6/2	6.0	2.0	0.70	Yellow (YE)	30
333-30906	TF31-9/3	9.0	3.0	0.80	Blue (BU)	30
333-30900	TF31-9/3	9.0	3.0	0.80	Black (BK)	30
333-30905	TF31-9/3	9.0	3.0	0.80	Green (GN)	30
333-30907	TF31-9/3	9.0	3.0	0.80	Green-Yellow (GNYE)	30
333-30902	TF31-9/3	9.0	3.0	0.80	Red (RD)	30
333-30909	TF31-9/3	9.0	3.0	0.80	White (WH)	30
333-30904	TF31-9/3	9.0	3.0	0.80	Yellow (YE)	30
333-31206	TF31-12/4	12.0	4.0	0.85	Blue (BU)	30
333-31200	TF31-12/4	12.0	4.0	0.85	Black (BK)	30
333-31205	TF31-12/4	12.0	4.0	0.85	Green (GN)	30
333-31207	TF31-12/4	12.0	4.0	0.85	Green-Yellow (GNYE)	30
333-31202	TF31-12/4	12.0	4.0	0.85	Red (RD)	30
333-31209	TF31-12/4	12.0	4.0	0.85	White (WH)	30
333-31204	TF31-12/4	12.0	4.0	0.85	Yellow (YE)	30
333-31806	TF31-18/6	18.0	6.0	1.00	Blue (BU)	30
333-31800	TF31-18/6	18.0	6.0	1.00	Black (BK)	30
333-31805	TF31-18/6	18.0	6.0	1.00	Green (GN)	30
333-31807	TF31-18/6	18.0	6.0	1.00	Green-Yellow (GNYE)	30
333-31802	TF31-18/6	18.0	6.0	1.00	Red (RD)	30
333-31809	TF31-18/6	18.0	6.0	1.00	White (WH)	30
333-31804	TF31-18/6	18.0	6.0	1.00	Yellow (YE)	30
333-32406	TF31-24/8	24.0	8.0	1.20	Blue (BU)	30
333-32400	TF31-24/8	24.0	8.0	1.20	Black (BK)	30
333-32405	TF31-24/8	24.0	8.0	1.20	Green (GN)	30
333-32407	TF31-24/8	24.0	8.0	1.20	Green-Yellow (GNYE)	30
333-32402	TF31-24/8	24.0	8.0	1.20	Red (RD)	30
333-32409	TF31-24/8	24.0	8.0	1.20	White (WH)	30
333-32404	TF31-24/8	24.0	8.0	1.20	Yellow (YE)	30
333-34006	TF31-40/13	40.0	13.0	1.25	Blue (BU)	30
333-34000	TF31-40/13	40.0	13.0	1.25	Black (BK)	30
333-34005	TF31-40/13	40.0	13.0	1.25	Green (GN)	30
333-34002	TF31-40/13	40.0	13.0	1.25	Red (RD)	30
333-34009	TF31-40/13	40.0	13.0	1.25	White (WH)	30
333-34004	TF31-40/13	40.0	13.0	1.25	Yellow (YE)	30

Alle Maße in mm. Technische Änderungen vorbehalten.

Heat Shrinkable Tubing 3:1 flexible and transparent

• TF34

Features and Benefits

- Transparent, highly flexible polyolefin tubing TF34
- Protects identification marking perfect
- Shrink ratio 3:1
- Halogenfree
- Good mechanical and chemical resistance



TF34 transparent tubing with 3:1 shrink ratio allowing for a wider range of application.



TF34

! Cut lengths available on request. Please contact us!

Material	Polyolefin, cross-linked (POX)
Colour	Transparent (CL)
Shrink Ratio	3:1
Operating Temperature	-55 °C to +135 °C
Min. Shrink Temperature	+110 °C
Longitudinal change after shrinkage	-5% max.
Dielectric Strength	46 kV/mm



Article-No.	Type	Supplied Ø D min.	Recov. Ø d max.	Wall (WT) nom.	Reel Length (m)
333-30153	TF34-1.5/0.5	1.5	0.5	0.50	30
333-30303	TF34-3/1	3.0	1.0	0.50	30
333-30603	TF34-6/2	6.0	2.0	0.70	30
333-30903	TF34-9/3	9.0	3.0	0.80	30
333-31203	TF34-12/4	12.0	4.0	0.85	30
333-31803	TF34-18/6	18.0	6.0	1.00	30
333-32403	TF34-24/8	24.0	8.0	1.20	30
333-34003	TF34-40/13	40.0	13.0	1.25	30

All dimensions in mm. Subject to technical changes.

Heat Shrinkable Tubing adhesive lined

- EPS-300 3:1
- EPS-400 4:1

Heatshrinkable tubing EPS seals and protects a wide variety of electrical applications like back end connector sealing, connector-to-cable transitions and splices.

Features and Benefits

- Flexible, thin walled polyolefin tubing EPS
- With coextruded hot melt adhesive inner wall
- Shrink ratio 3:1 and 4:1
- Protects against moisture
- Provides an environmental sealing of complex parts



EPS offers high shrink ratios and protection against humidity.



EPS-300, EPS-400

Cut lengths available on request. Please contact us!

Material	Polyolefin, cross-linked (POX)
Colour	Black (BK)
Shrink Ratio	3:1, 4:1
Longitudinal change after shrinkage	-10% max.
Min. Shrink Temperature	+120 °C
Operating Temperature	-55 °C to +110 °C
Softening Point Adhesive	+90 °C
Dielectric Strength	15 kV/mm according to IEC 684 P2
Flammability	ASTM D2671 (outer layer only)
Specification	SAE - AMS - DTL-23053/4 (EPS400)



Article-No.	Type	Supplied Ø D min.	Recov. Ø d max.	Wall (WT) nom.	Reel Length (m)
EPS-300					
340-03010	EPS-300-3/1	3.0	1.0	1.00	400
340-06020	EPS-300-6/2	6.0	2.0	1.00	300
340-09030	EPS-300-9/3	9.0	3.0	1.40	150
340-12040	EPS-300-12/4	12.0	4.0	1.80	100
340-19060	EPS-300-19/6	19.0	6.0	2.20	50
340-24080	EPS-300-24/8	24.0	8.0	2.50	25
340-40130	EPS-300-40/13	40.0	13.0	2.50	25
EPS-400					
341-04010	EPS-400-4/1	4.0	1.0	1.00	300
341-08020	EPS-400-8/2	8.0	2.0	1.00	150
341-12030	EPS-400-12/3	12.0	3.0	1.40	100
341-16040	EPS-400-16/4	16.0	4.0	1.80	100
341-24060	EPS-400-24/6	24.0	6.0	2.20	50
341-32080	EPS-400-32/8	32.0	8.0	2.50	25

All dimensions in mm. Subject to technical changes.



Please note! Not all products listed on this page may have this approval. For product specific approvals please refer to the Appendix.

Heat Shrinkable Tubing 2:1 - Fluororubber

• Viton®-E

Viton®-E is used for reliable protection against aggressive chemicals in high temperature environments like engine compartments and turbines. It is also used when protective tubings are required to remain flexible at low temperatures.

Features and Benefits

- High resistant fluoroelastomeric heat shrink tubing Viton®-E
- Shrink ratio 2:1
- For high temperature applications
- Very low shrink temperature
- Flexible even at very low temperatures
- Very good electrical, chemical and mechanical features
- Resistance to fuels and lubricants
- Approved to VG 95343/5E



Viton®-E for flexibility and protection against aggressive chemicals.



Viton®-E

Cut lengths available on request. Please contact us!

Detailed Information about Heatguns please refer to page 137.

Material	Fluoropolymer cross-linked (FPMX)
Colour	Black (BK)
Shrink Ratio	2:1
Longitudinal change after shrinkage	-10% max.
Min. Shrink Temperature	+175 °C
Operating Temperature	-55 °C to +220 °C
Insulation Class	C (VDE 0530)
Dielectric Strength	15 kV/mm
Flammability	VG 95343
Specification	VG 95343



Article-No.	Type	Designation as per VG-Norm	Supplied Ø D min.	Recov. Ø d max.	Wall (WT) nom.	Reel Length (m)
330-00320	VITON®-E-3.2/1.6	VG 95343 T 05 E 001 A	3.2	1.6	0.70	50
330-00480	VITON®-E-4.8/2.4	VG 95343 T 05 E 002 A	4.8	2.4	0.80	50
330-00640	VITON®-E-6.4/3.2	VG 95343 T 05 E 003 A	6.4	3.2	0.90	50
330-00950	VITON®-E-9.5/4.8	VG 95343 T 05 E 004 A	9.5	4.8	1.00	50
330-01270	VITON®-E-12.7/6.4	VG 95343 T 05 E 005 A	12.7	6.4	1.20	25
330-01900	VITON®-E-19.0/9.5	VG 95343 T 05 E 006 A	19.0	9.5	1.40	25
330-02540	VITON®-E-25.4/12.7	VG 95343 T 05 E 007 A	25.4	12.7	1.80	25
330-03810	VITON®-E-38.0/19.0	VG 95343 T 05 E 008 A	38.0	19.0	2.40	15
330-05080	VITON®-E-50.8/25.4	VG 95343 T 05 E 009 A	50.8	25.4	2.80	15

All dimensions in mm. Subject to technical changes.

Viton® is a registered trademark of DuPont.



Please note! Not all products listed on this page may have this approval. For product specific approvals please refer to the Appendix.

Heat Shrinkable Tubing 2:1 - PVDF

• TK20

Typical applications of this translucent tubing are where high-temperature performance is required. Also very suitable for applications that ask for visual inspection of covered components, or if low friction surface is needed. TK20 is also used as oil stop for energy cables.

This thin walled, translucent heat shrink tubing is often used for chemical applications.

Features and Benefits

- Transparent, semi-rigid heat shrinkable Tubing TK20
- Thin walled and tough
- Shrink ratio 2:1
- Self extinguishing
- For higher temperature applications
- Very good mechanical strength and chemical resistance
- Meets lots of industrial standards
- Cutted length: 1,20 m



TK20, TK29



This thin walled, translucent heat shrink tubing is often used for chemical applications.

Material	Polyvinylidene fluoride (PVDF)
Colour	Transparent (CL)
Shrink Ratio	2:1
Operating Temperature	-55 °C to +175 °C
Min. Shrink Temperature	+175 °C
Flammability	UL224 VW-1
Longitudinal change after shrinkage	+/-10% max
Dielectric Strength	≥ 30 kV/mm min. according to ASTM D2171
Specification	SAE - AMS - DTL-23053/8, UL224 150 °C 600V VW-1, VG 95343



Article-No.	Type	Designation as per VG-Norm	Supplied Ø D min.	Recov. Ø d max.	Wall (WT) nom.	Length (L) (m)
311-00129	TK20-1.2/0.6	VG95343T05F001M	1.2	0.6	0.25	1.20
311-00169	TK20-1.6/0.8	VG95343T05F002M	1.6	0.8	0.25	1.20
311-00249	TK20-2.4/1.2	VG95343T05F003M	2.4	1.2	0.25	1.20
311-00329	TK20-3.2/1.6	VG95343T05F004M	3.2	1.6	0.25	1.20
311-00489	TK20-4.8/2.4	VG95343T05F005M	4.8	2.4	0.25	1.20
311-00649	TK20-6.4/3.2	VG95343T05F006M	6.4	3.2	0.30	1.20
311-00959	TK20-9.5/4.8	VG95343T05F007M	9.5	4.8	0.30	1.20
311-01279	TK20-12.7/6.4	VG95343T05F008M	12.7	6.4	0.30	1.20
311-01909	TK20-19.1/9.5	VG95343T05F009M	19.1	9.5	0.43	1.20
311-02549	TK20-25.4/12.7	VG95343T05F010M	25.4	12.7	0.48	1.20
311-03819	TK20-38.1/19.1	–	38.1	19.1	0.51	1.20
311-05089	TK20-50.8/25.4	–	50.8	25.4	0.51	1.20

All dimensions in mm. Subject to technical changes.



Please note! Not all products listed on this page may have this approval.

For product specific approvals please refer to the Appendix.

Heat Shrinkable Tubing 2:1 - PVDF

• TK29

Typical applications of this translucent tubing are where high-temperature performance is required. Also very suitable for applications that ask for visual inspection of covered components, or if low friction surface is needed. TK29 is also used as oil stop for energy cables.

This thin walled, translucent heat shrink tubing is often used for chemical applications.

Features and Benefits

- Transparent, semi-rigid heat shrinkable Tubing TK29
- Thin walled and tough
- Shrink ratio 2:1
- Self extinguishing
- For higher temperature applications
- Very good mechanical strength and chemical resistance
- Meets lots of industrial standards
- Delivery on reel

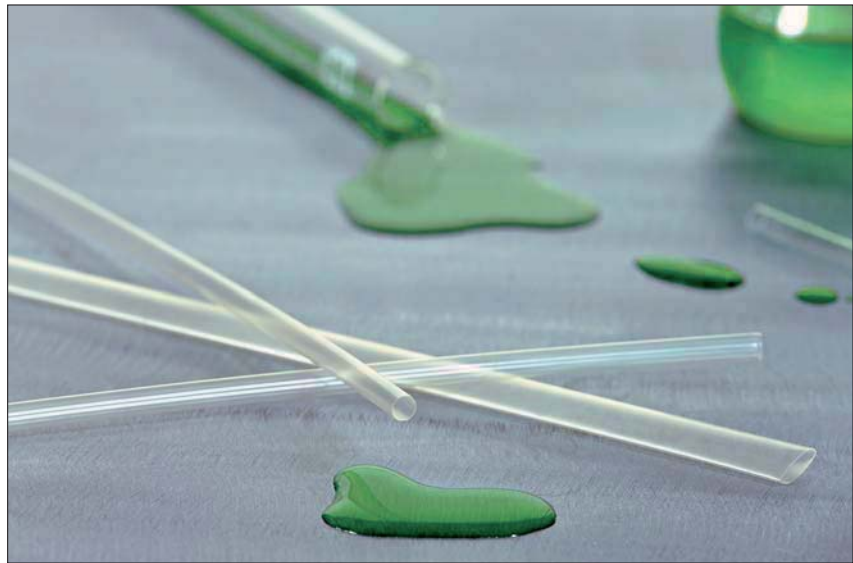

This thin walled, translucent heat shrink tubing is often used for chemical applications.



TK20, TK29

Material	Polyvinylidene fluoride (PVDF)
Colour	Transparent (CL)
Shrink Ratio	2:1
Operating Temperature	-55 °C to +175 °C
Min. Shrink Temperature	+150 °C
Flammability	UL224 VW-1
Longitudinal change after shrinkage	+/-10% max
Dielectric Strength	≥ 30 kV/mm min. according to ASTM D2171
Specification	MIL-DTL-23053, UL224 VW-1



Article-No.	Type	Supplied Ø D min.	Recov. Ø d max.	Wall (WT) nom.	Length (L) (m)
311-90129	TK29-1.2/0.6	1.2	1.2	0.25	300
311-90169	TK29-1.6/0.8	1.6	0.8	0.25	300
311-90249	TK29-2.4/1.2	2.4	1.2	0.25	150
311-90329	TK29-3.2/1.6	3.2	1.6	0.25	150
311-90489	TK29-4.8/2.4	4.8	2.4	0.25	60
311-90649	TK29-6.4/3.2	6.4	3.2	0.30	60
311-90959	TK29-9.5/4.8	9.5	4.8	0.30	60
311-91279	TK29-12.7/6.4	12.7	6.4	0.30	60
311-91909	TK29-19.1/9.5	19.1	9.5	0.43	60
311-92549	TK29-25.4/12.7	25.4	12.7	0.48	60
311-93819	TK29-38.1/19.1	38.1	19.1	0.51	60
311-95089	TK29-50.8/25.4	50.8	25.4	0.51	60

All dimensions in mm. Subject to technical changes.



Please note! Not all products listed on this page may have this approval. For product specific approvals please refer to the Appendix.

Heat Shrinkable Tubing - PTFE

- TFE2 2:1
- TFE4 4:1

TFE is ideal for high temperature applications, when resistance to aggressive fluids is required or a very thin walled tubing is needed, for example in pH-measuring instruments. TFE tubing is also used to reduce movement due to friction, covering cylinders for example.

Features and Benefits

- Transparent, non-burning heat shrinkable Tubing TFE
- Very thin walled and tough
- Shrink ratio 2:1 and 4:1
- For operating temperatures up to +260° C
- Very good mechanical strength
- High chemical resistance

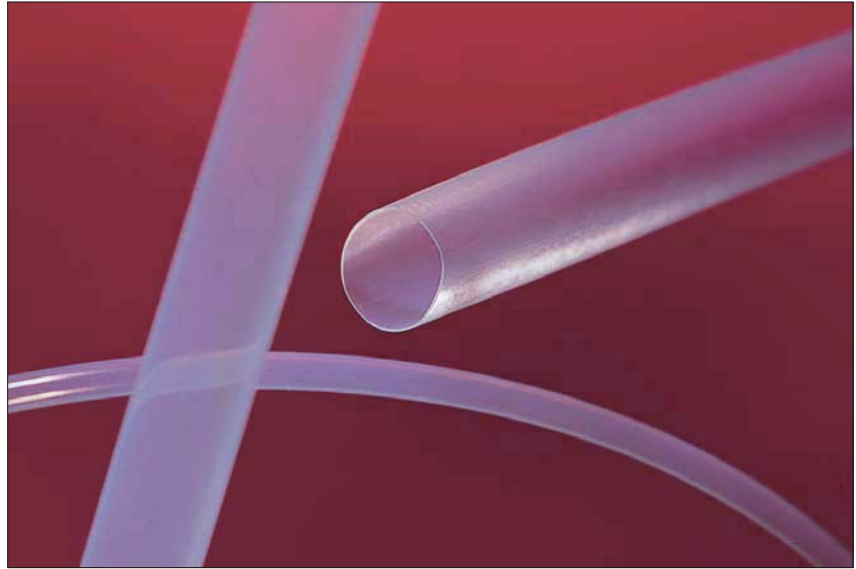

TFE is available in either 2:1 or 4:1 shrink ratios.



TFE2, TFE4

Material	Polytetrafluoroethylene (PTFE)
Colour	Transparent (CL)
Shrink Ratio	2:1, 4:1
Operating Temperature	-70 °C to +260 °C
Min. Shrink Temperature	+330 °C
Flammability	non-burning
Longitudinal change after shrinkage	-20% max.
Dielectric Strength	40 kV/mm according to DIN 53481

Cut lengths available on request. Please contact us!



Heat Shrinkable Tubing - PTFE

- TFE2 2:1
- TFE4 4:1

Article-No.	Type	Wire Size (AWG)	Supplied Ø D min.	Recov. Ø d max.	Wall (WT) nom.	Length (L) (m)
TFE2						
336-00079	TFE2-30	30	0.86	0.38	0.23	1.22
336-00099	TFE2-28	28	0.96	0.46	0.23	1.22
336-00109	TFE2-26	26	1.17	0.56	0.23	1.22
336-00139	TFE2-24	24	1.27	0.69	0.25	1.22
336-00149	TFE2-22	22	1.39	0.82	0.25	1.22
336-00159	TFE2-20	20	1.52	0.99	0.30	1.22
336-00199	TFE2-18	18	1.93	1.25	0.30	1.22
336-00249	TFE2-16	16	2.36	1.55	0.30	1.22
336-00319	TFE2-14	14	3.05	1.83	0.30	1.22
336-00399	TFE2-12	12	3.81	2.26	0.30	1.22
336-00489	TFE2-10	10	4.85	2.85	0.30	1.22
336-00619	TFE2-8	8	6.10	3.58	0.38	1.22
336-00779	TFE2-6	6	7.67	4.52	0.38	1.22
336-00949	TFE2-4	4	9.40	5.69	0.38	1.22
336-01109	TFE2-2	2	10.92	7.06	0.38	1.22
336-01209	TFE2-0	0	11.94	8.81	0.38	1.22
TFE4						
		Size/Inch				
339-00209	TFE4-5/64	5/64	1.98	0.64	0.22	1.22
339-00329	TFE4-1/8	1/8	3.17	0.94	0.25	1.22
339-00340	TFE4-3/16	3/16	4.75	1.27	0.30	1.22
339-00649	TFE4-1/4	1/4	6.35	1.60	0.30	1.22
339-00959	TFE4-3/8	3/8	9.52	2.44	0.30	1.22
339-01279	TFE4-1/2	1/2	12.7	3.66	0.38	1.22
339-01599	TFE4-5/8	5/8	15.87	4.52	0.38	1.22
339-01909	TFE4-3/4	3/4	19.05	5.69	0.38	1.22
339-02549	TFE4-1	1	25.4	7.06	0.38	1.22
339-03189	TFE4-1 1/4	1 1/4	31.75	8.82	0.38	1.22

All dimensions in mm. Subject to technical changes.

Heat Shrinkable Tubing 2:1 - Flame retardant

• TR27

TR27 is used in applications where toxic emissions during a fire must be kept low, e.g. for heavily populated buildings or high security areas like tunnels, hospitals, schools, theatres, mass transit vehicles and computer centres.

Features and Benefits

- Thin walled, flexible polyolefin tubing TR27
- Shrink ratio 2:1
- Halogenfree
- Self-extinguishing
- Excellent flame-retardant properties
- Meets lots of industrial standards
- Optional available with adhesive or as thick walled version SR27



TR27 is ideal for safety sensitive areas.

Detailed Information about Heatguns please refer to page 106.

Material	Polyolefin, cross-linked (POX)
Colour	Black (BK)
Shrink Ratio	2:1
Operating Temperature	-40 °C to +105 °C
Min. Shrink Temperature	+115 °C
Flammability	Limited Fire Hazard, halogen free, low generation of toxic gases and corrosive acid, low smoke generation
Longitudinal change after shrinkage	+5%/-10% max.
Dielectric Strength	15 kV/mm according to IEC 684 P2
Specification	DEF STAN 59-97 Type 8, LUL Engineering Standard E1042:A6, CEN TS 45545-2: HL3



Article-No.	Type	Supplied Ø D min.	Recov. Ø d max.	Wall (WT) nom.	Reel Length (m)
315-50320	TR27-3.2/1.6	3.2	1.6	0.51	150.0
315-50480	TR27-4.8/2.4	4.8	2.4	0.51	60.0
315-50640	TR27-6.4/3.2	6.4	3.2	0.64	60.0
315-50950	TR27-9.5/4.8	9.5	4.8	0.64	60.0
315-51270	TR27-12.7/6.4	12.7	6.4	0.64	60.0
315-51900	TR27-19.1/9.5	19.1	9.5	0.76	60.0
315-52540	TR27-25.4/12.7	25.4	12.7	0.89	60.0
315-53810	TR27-38.1/19.1	38.1	19.1	1.02	60.0
315-55100	TR27-50.8/25.4	50.8	25.4	1.14	60.0

All dimensions in mm. Subject to technical changes.



DEF STAN

Please note! Not all products listed on this page may have this approval. For product specific approvals please refer to the Appendix.

Standard polyester braided sleeving

• Helagaine HEGP

Helagaine HEGP braided sleeving is used in the automotive industry, in machine building, in panel building and in electrical appliances to provide abrasion protection. Its open structure prevents pockets of high temperature. HEGP fulfils the requirements of DIN5510-2 and is therefore also optimal for railway applications.



Helagaine HEGP braided sleeving

Features and Benefits

- Made from sturdy polyester
- Highly flexible
- High abrasion resistance
- Eases application by expanding when compressed
- High surface coverage (approx. 81%)
- 13 sizes for diameters from 1 - 66 mm for an optimal fit

Material	Polyester (PET)
Colour	Black (BK)
Operating Temperature	-50 °C to +150 °C, intermittent +220 °C
Melting Point	+250 °C
Flammability	UL94 V2, FMVSS 302
Specification	DIN 5510-2



Article-No.	Type	Bundle Ø min.	Bundle Ø max.	Reel Length (m)
HEGP				
170-10300	HEGP03	1	5	200
170-10400	HEGP04	2	7	200
170-10500	HEGP05	3	9	200
170-10600	HEGP06	4	11	100
170-10800	HEGP08	5	12	100
170-11000	HEGP10	7	15	100
170-11200	HEGP12	8	17	100
170-11500	HEGP15	10	20	100
170-12000	HEGP20	14	26	50
170-12500	HEGP25	18	34	50
170-13000	HEGP30	20	40	50
170-14000	HEGP40	30	50	50
170-15000	HEGP50	40	66	50

All dimensions in mm. Subject to technical changes.

Colour grey available on request.

Cuts in any lengths.

 **To prevent fraying, the sleeve can be cut with the hot cutting tool HSG0, see page 141.**

Standard polyester braided sleeving, expansion rate: 3:1

• Helagain HEGPX

Helagain HEGPX is used whenever a higher expansion ratio is required. HEGPX is particularly suitable for use in the automotive and railway industry and in electrical appliances.

Features and Benefits

- Made from sturdy polyester
- Expansion ratio of 3:1
- Easier application over irregular shapes
- Highly flexible
- High abrasion resistance
- 7 sizes for diameters from 3 - 70 mm for an optimal fit

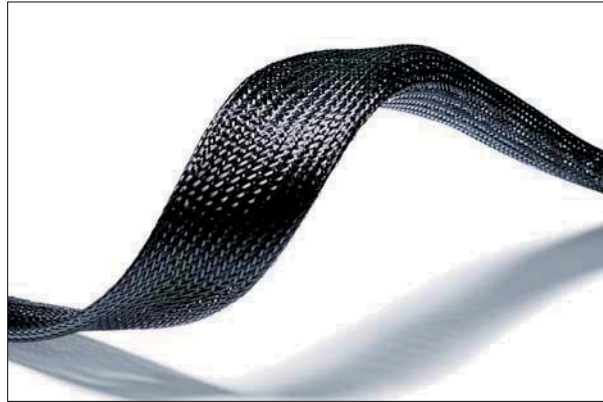

Helagain HEGPX braided sleeving

Material	Polyester (PET)
Colour	Black (BK)
Operating Temperature	-50 °C to +150 °C, intermittent +220 °C
Melting Point	+250 °C
Flammability	UL94 V2, FMVSS 302
Specification	DIN 5510-2



To prevent fraying, the sleeve can be cut with the hot cutting tool HSG0, see page 141.

Article-No.	Type	Bundle Ø min.	Bundle Ø max.	Reel Length (m)
170-00060	HEGPX06	3	10	200
170-00090	HEGPX09	5	16	100
170-00120	HEGPX12	6	19	100
170-00200	HEGPX20	13	32	100
170-00300	HEGPX30	19	45	50
170-00400	HEGPX40	32	70	50

All dimensions in mm. Subject to technical changes.

Colour grey available on request.

Cuts in any lengths.



Please note! Not all products listed on this page may have this approval. For product specific approvals please refer to the Appendix.

Polyester braided sleeving, UL94V0 classification

• Helagain HEGPV0

HEGPV0 braided sleeveings are used wherever fire protection is important such as in railway vehicles, machine tools, robotics and automatic equipment. HEGPAV0 fulfill the requirements of DIN5510-2 and NFF-16 101.

Features and Benefits

- Made from sturdy polyester
- Self-extinguishing according to UL94 V0 for enhance fire protection
- Keeps out moisture and dirt
- Resistant to chemicals and acids
- High surface coverage



Helagain HEGPV0 braided sleeving



To prevent fraying, the sleeve can be cut with the hot cutting tool HSG0, see page 141.

Material	Polyester (PBT)
Colour	Black with White Identification Yarn (BKIDWH)
Operating Temperature	-50 °C to +150 °C, intermittent +200 °C
Melting Point	+225 °C
Flammability	UL94 V0, FMVSS 302
Specification	NF F 16-101, DIN 5510-2



Article-No.	Type	Bundle Ø min.	Bundle Ø max.	Reel Length (m)
170-30400	HEGPV004	3	7	100
170-30600	HEGPV006	5	11	100
170-30800	HEGPV008	7	13	100
170-31200	HEGPV012	11	17	50
170-31500	HEGPV015	13	20	50
170-32000	HEGPV020	18	25	50
170-33000	HEGPV030	27	40	50
170-34000	HEGPV040	35	50	50
170-35000	HEGPV050	40	60	50

All dimensions in mm. Subject to technical changes.

Colour grey available on request.

Cuts in any lengths.

Polyester braided sleeving, expansion rate: 3:1, UL94V0 classification

• Helagaine HEGPVOX

Helagaine HEGPVOX braided sleeving is especially suitable wherever fire protection and higher expansion ratio are important. Helagaine HEGPVOX offers superior cable protection for railway vehicle construction, machine tools, robotics and automatic equipment.

Features and Benefits

- Helagaine HEGPVOX braided sleeving made from polyester
- Self-extinguishing according to UL94 V0 for enhanced fire protection
- Easier application over irregular shapes due to expansion ratio of 3:1
- Good abrasion protection
- Keeps out moisture and dirt
- Resistant to acids

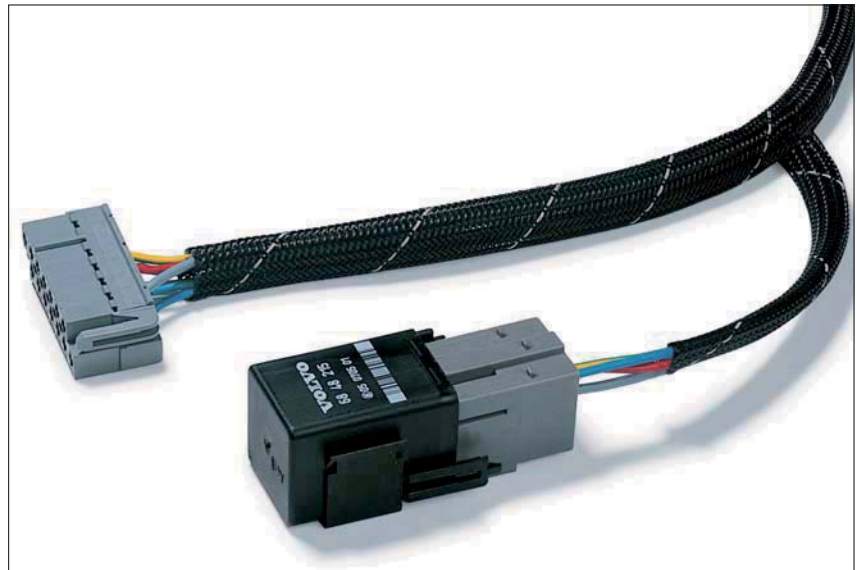

Helagaine flame-retardant UL94 V0 braided sleeving.

 **To prevent fraying, the sleeve can be cut with the hot cutting tool HSG0, see page 141.**

Material	Polyester (PBT)
Colour	Black with White Identification Yarn (BKIDWH)
Operating Temperature	-70 °C to +150 °C
Melting Point	+225 °C
Flammability	UL94 V0, FMVSS 302
Specification	UL, NF F 16-101, DIN 5510-2



Article-No.	Type	Bundle Ø min.	Bundle Ø max.	Reel Length (m)
170-50030	HEGPVOX03	2	6	200
170-50060	HEGPVOX06	3	10	200
170-50090	HEGPVOX09	5	16	100
170-50120	HEGPVOX12	6	19	100
170-50200	HEGPVOX20	12	32	100
170-50300	HEGPVOX30	19	45	50
170-50400	HEGPVOX40	32	70	50
170-50500	HEGPVOX50	38	76	50

All dimensions in mm. Subject to technical changes.

Colour grey available on request.

Cuts in any lengths.



Please note! Not all products listed on this page may have this approval. For product specific approvals please refer to the Appendix.

Polyamide braided sleeving for excellent abrasion resistance

- Helagain HEGPA66

Helagain HEGPA66 is particularly suitable for vehicle manufacturing as well as plant construction.

Features and Benefits

- Made from heavy-duty polyamide yarn
- Eases application by expanding when compressed
- High surface covering
- Excellent abrasion resistance



Helagain HEGPA66 braided sleeving are made from Polyamid 6.6 and offer excellent abrasion resistance.

 **To prevent fraying, the sleeve can be cut with the hot cutting tool HSG0, see page 141.**

Material	Polyamide 6.6 (PA66)
Colour	Black (BK)
Operating Temperature	-60 °C to +150 °C, intermittent +200 °C
Melting Point	+255 °C
Flammability	UL94 V2, FMVSS 302
Specification	DIN 5510-2, NF F 16-101



Article-No.	Type	Bundle Ø min.	Bundle Ø max.	Reel Length (m)
170-40400	HEGPA6604	3	6	200
170-40600	HEGPA6606	4	8	100
170-40800	HEGPA6608	5	10	100
170-41000	HEGPA6610	7	12	100
170-41200	HEGPA6612	8	14	100
170-41600	HEGPA6616	12	18	50
170-42000	HEGPA6620	15	23	50
170-42500	HEGPA6625	18	28	50
170-43000	HEGPA6630	25	32	50
170-44000	HEGPA6640	30	44	50
170-45000	HEGPA6650	40	55	50
170-46000	HEGPA6660	50	65	50

All dimensions in mm. Subject to technical changes.

Colour grey available on request.

Cuts in any lengths.

Polyester braided sleeving for reduction of vibration noise

• Helagain HEGSAS

Helagain HEGSAS braided sleeving is used primarily in the automotive sector and wherever vibration noise must be reduced. Helagain HEGSAS can be supplied in pre-cut lengths on request

Features and Benefits

- Made of sturdy polyester
- Superior noise reduction
- Easier application over irregular shapes due to expansion ratio of 3:1
- High surface coverage
- Excellent abrasion resistance



With its special yarn structure, Helagain HEGSAS is very effective in reducing vibration noise.



To prevent fraying, the sleeve can be cut with the hot cutting tool HSG0, see page 141.

Material	Polyester (PET)
Colour	Black (BK)
Operating Temperature	-50 °C to +150 °C, intermittent +200 °C
Flammability	FMVSS 302



Article-No.	Type	Bundle Ø min.	Bundle Ø max.	Reel Length (m)
170-60401	HEGSAS04	2	8	200
170-60600	HEGSAS06	4	11	200
170-60900	HEGSAS09	6	16	100
170-61200	HEGSAS12	8	20	100
170-61500	HEGSAS15	10	24	50
170-62000	HEGSAS20	13	30	50
170-63000	HEGSAS30	20	40	25
170-64000	HEGSAS40	30	50	25

All dimensions in mm. Subject to technical changes.

Colour grey available on request.

Cuts in any lengths.

Braided sleeving for electromagnetic protection

• Helagaine HEGEMIP

Helagaine HEGEMIP braided sleeving is used for highly sensitive electronics, such as electrical appliances and machines, radio equipment, military engineering and automobiles.

Features and Benefits

- Excellent electromagnetic protection
- Extremely flexible, expandable and easy to apply
- Superior abrasion protection
- No kinks or tears, even when bending the sleeve 90°
- Particularly suitable for applications with restricted space or requiring movement
- Fulfils the requirements of international EMI norm (10KHz to 1GHz)

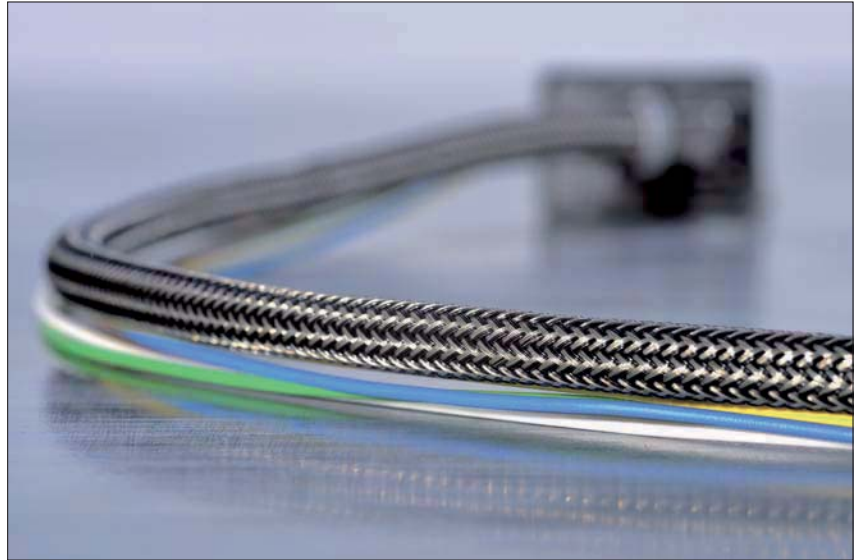

HEGEMIP braided sleeving: reliable protection from electromagnetic radiation.

Material	Polyester (halogen free), Tin-plated copper (TNCU)
Colour	Tin-coloured and Black (TCBK)
Operating Temperature	-40 °C to +175 °C, intermittent +200 °C
Flammability	UL94 V2, FMVSS 302
EMI requirements	10 KHz to 1 GHz according to CISPR25 (DIN VDE 0879-2)



Article-No.	Type	Ø D	Bundle Ø min.	Bundle Ø max.	Reel Length (m)	Weight (g/m)
173-00400	HEGEMIP04	4	4	6.5	100	21.5
173-00600	HEGEMIP06	6	5	10	100	28.5
173-00800	HEGEMIP08	8	8	11.5	100	26.5
173-01000	HEGEMIP10	10	8	13	50	43.5
173-01200	HEGEMIP12	12	10	15	50	48.0
173-01400	HEGEMIP14	14	12	18	100	58.0
173-01600	HEGEMIP16	16	14	20	100	72.5
173-01800	HEGEMIP18	18	16	22	50	78.6
173-02000	HEGEMIP20	20	18	25	50	100.0

All dimensions in mm. Subject to technical changes.

Cuts in any lengths.

Braided sleeving for electromagnetic protection, UL94V0 classification

• Helagaine HEGEMIPV0

Helagaine HEGEMIPV0 braided sleeving is used for protection of highly sensitive electronics in industries, wherever fire protection is important, such as mass transit, aerospace and military industry.

Features and Benefits

- Excellent electromagnetic protection
- Extremely flexible, expandable and easy to apply
- Self-extinguishing according to UL94 V0
- Superior abrasion protection
- No kinks or tears, even when bending the sleeve 90°
- Particularly suitable for applications with restricted space or requiring movement
- Fulfils the requirements of international EMI norm (10 KHz to 1 GHz)



HEGEMIPV0 braided sleeving: EMI protection for enhanced flame protection.

Material	Polyester (PBT), Tin-plated copper (TNCU)
Colour	Tin-coloured and Black (TCBK)
Operating Temperature	-40 °C to +175 °C, intermittent +200 °C
Flammability	UL94 V0, FMVSS 302
EMI requirements	10 KHz to 1 GHz according to CISPR25 (DIN VDE 0879-2)



Article-No.	Type	Ø D	Bundle Ø min.	Bundle Ø max.	Reel Length (m)	Weight (g/m)
173-60400	HEGEMIPV004	4	4	6.5	100	–
173-60600	HEGEMIPV006	6	5	10	100	28.5
173-60800	HEGEMIPV008	8	8	11.5	100	26.5
173-61000	HEGEMIPV010	10	8	13	50	43.5
173-61200	HEGEMIPV012	12	10	15	50	48.0
173-61400	HEGEMIPV014	14	12	18	100	58.0
173-61600	HEGEMIPV016	16	14	20	100	72.5
173-61800	HEGEMIPV018	18	16	22	50	78.6
173-62000	HEGEMIPV020	20	18	25	50	100.0

All dimensions in mm. Subject to technical changes.

Cuts in any lengths.

Light weight standard polyester braided sleeving

• Helagain HEGPL

Helagain HEGPL is used primarily in automobile interiors, motor compartments, car bodies and underfloors.

Features and Benefits

- Made from sturdy polyester
- Expansion ratio of 3:1
- Easier application over irregular shapes
- Highly flexible
- High abrasion resistance

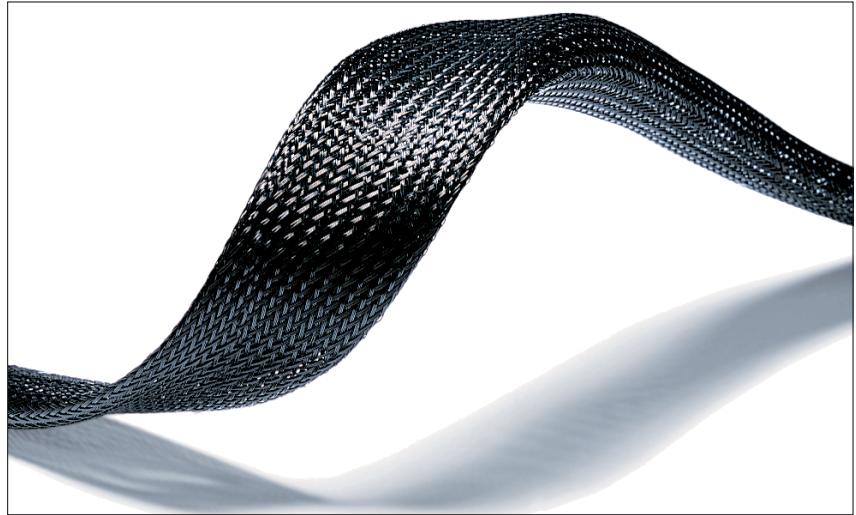

Helagain HEGPL Braided Sleeving



To prevent fraying, the sleeve can be cut with the hot cutting tool HSG0, see page 141.

Material	Polyester (PET)
Colour	Black (BK)
Operating Temperature	-50 °C to +150 °C, intermittent +220 °C
Melting Point	+250 °C
Flammability	UL94 V2, FMVSS 302, Type B



Article-No.	Type	Bundle Ø min.	Bundle Ø max.	Reel Length (m)
170-80503	HEGPL03	3	8	1000
170-80506	HEGPL06	5	12	400
170-80512	HEGPL12	8	21	300
170-80520	HEGPL20	12	30	300
170-80530	HEGPL30	18	55	200
170-80540	HEGPL40	24	66	150
170-80550	HEGPL50	30	82	150

All dimensions in mm. Subject to technical changes.

Colour grey available on request.

Cuts in any lengths.

Re-sealable protective sleeving for post-termination cable organisation

• HELAHOOK

HELAHOOK is used in industrial machines, electrical appliances, shipbuilding, railway vehicles and in the aerospace industry. HELAHOOK is also employed in automobiles or commercial vehicles. It is the ideal solution for post-termination cable organisation and wherever repeated use is a necessity.

Features and Benefits

- Re-sealable cable protection made from polyester
- Very elastic, fits snugly around the cables
- Hook and loop sealing system can be used for retro-fitting
- Abrasion resistant



HELAHOOK protective sleeving allows for retrospective fitting and repeated use.

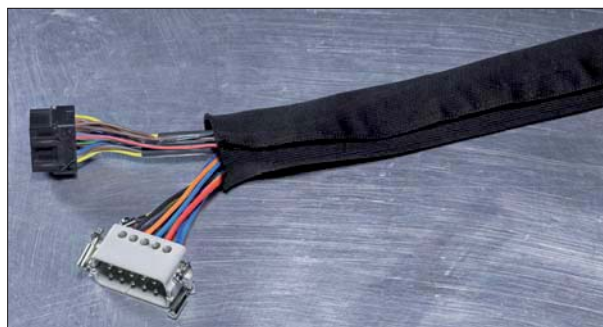

HELAHOOK provides excellent abrasion resistance.

Material	Polyester (PET)
Colour	Black (BK)
Operating Temperature	-50 °C to +150 °C, continuous
Flammability	UL94 V2, FMVSS 302
Specification	NF F 16-101



Article-No.	Type	Bundle Ø min.	Bundle Ø max.	Reel Length (m)
170-05100	HELAHOOK10	3	15	25
170-05150	HELAHOOK15	10	20	25
170-05200	HELAHOOK20	15	30	25
170-05250	HELAHOOK25	20	40	25
170-05300	HELAHOOK30	25	50	25

All dimensions in mm. Subject to technical changes.

Cuts in any lengths are available on request.

Polyester self-closing sleeving

• Helagain Twist-In

Helagain Twist-In has many applications in engineering, electronics and electrical installations.

Features and Benefits

- Self-closing sleeve made from polyester
- Ideal for retro-fitting
- Very easy, quick installation and removal
- Quick and easy access to bundle for inspection, maintenance and assembly
- Small range of sizes covers a wide range of applications



Helagain Twist-In gives easy access to cables and wires for inspection, maintenance and assembly.

 To prevent fraying, the sleeve can be cut with the hot cutting tool HSG0, see page 141.

Material	Polyester (PET)
Colour	Black (BK)
Operating Temperature	-70 °C to +125 °C
Melting Point	+255 °C
Flammability	FMVSS 302, self-extinguishing



Article-No.	Type	Material	Bundle Ø min.	Bundle Ø max.	Weight (g/m)	Reel Length (m)
170-01000	Twist-In 05	PET	4	5	10.25	150
170-01001	Twist-In 08	PET	5	8	13.30	100
170-01002	Twist-In 13	PET	10	13	21.20	50
170-01004	Twist-In 19	PET	16	19	28.70	25
170-01005	Twist-In 25	PET	19	25	42.20	25
170-01006	Twist-In 29	PET	25	29	44.00	15
170-01007	Twist-In 32	PET	29	32	48.10	15
170-01008	Twist-In 38	PET	32	38	58.00	15

All dimensions in mm. Subject to technical changes.



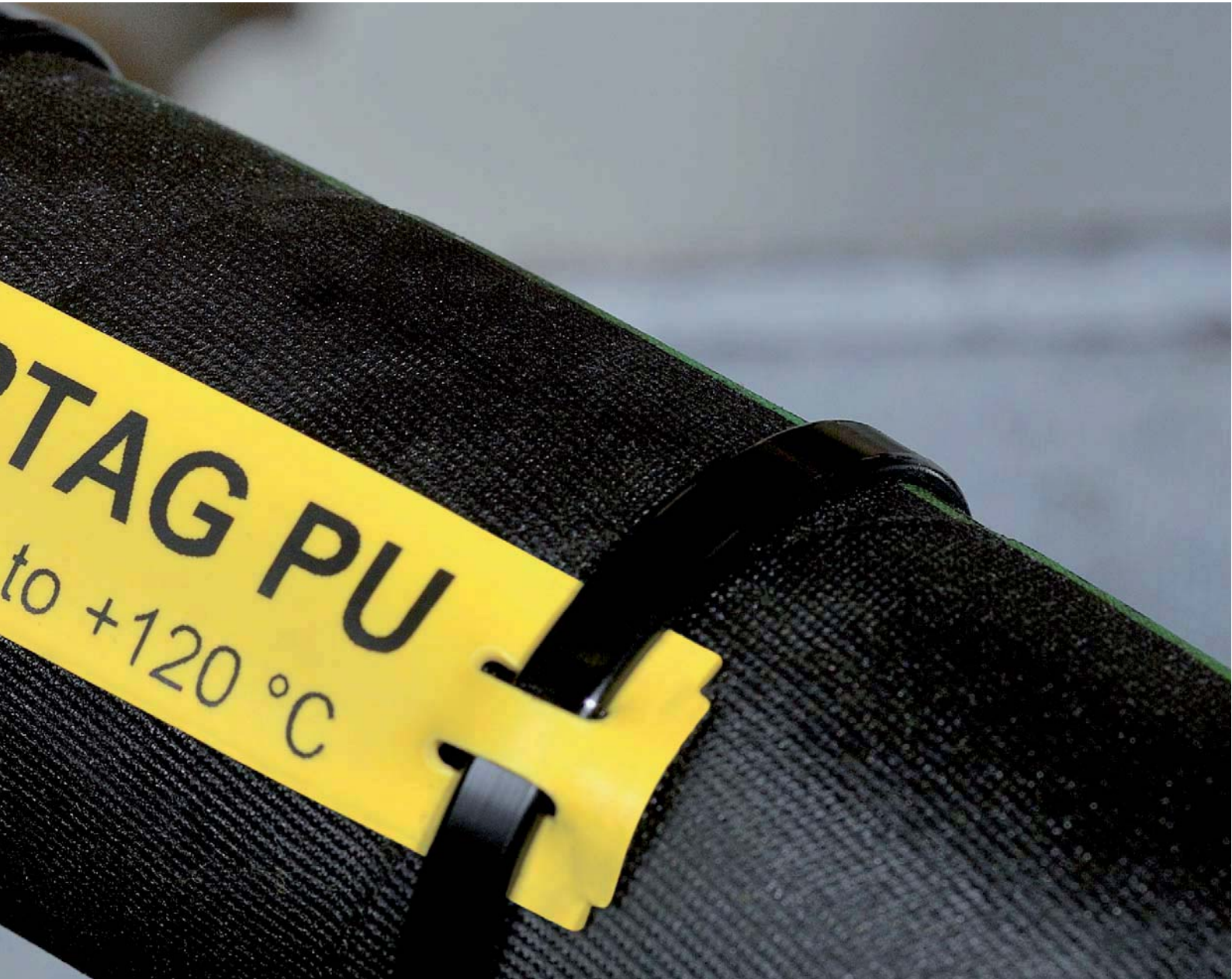

Identification 4

	Page
4.1 Technical Information	178
4.2 Wire and cable markers	
Shrinkable tubing, 3:1, UL-listed	185
Identification tags, continuous, for high temperature	187
Self-laminating labels	188
ABR-Markers, pre-printed	189
Identification ties and plates	192
Labels for identification ties and plates	193
4.3 Industrial Identification	
Type label identification	195
Asset label identification	196

	Page
4.4. Security labeling	
Tamper evident security labeling	197
Tamper evident security labeling, 2 parts	198
4.5 Printers and software	
Thermal transfer printer	199
Thermal printer ribbons	201
Accessories, thermal transfer printer	202
Labelling software	203

Use our flowchart to find the right label or identification material.

Select the object to be identified (flat or curved surface) and its surface quality (smooth or rough). Depending on what you require from our identification systems, you will be guided through the flowchart to the end. Please note that we have highlighted the respective printer technology (thermal transfer, matrix or laser printer, etc.) in colour.

figure 1

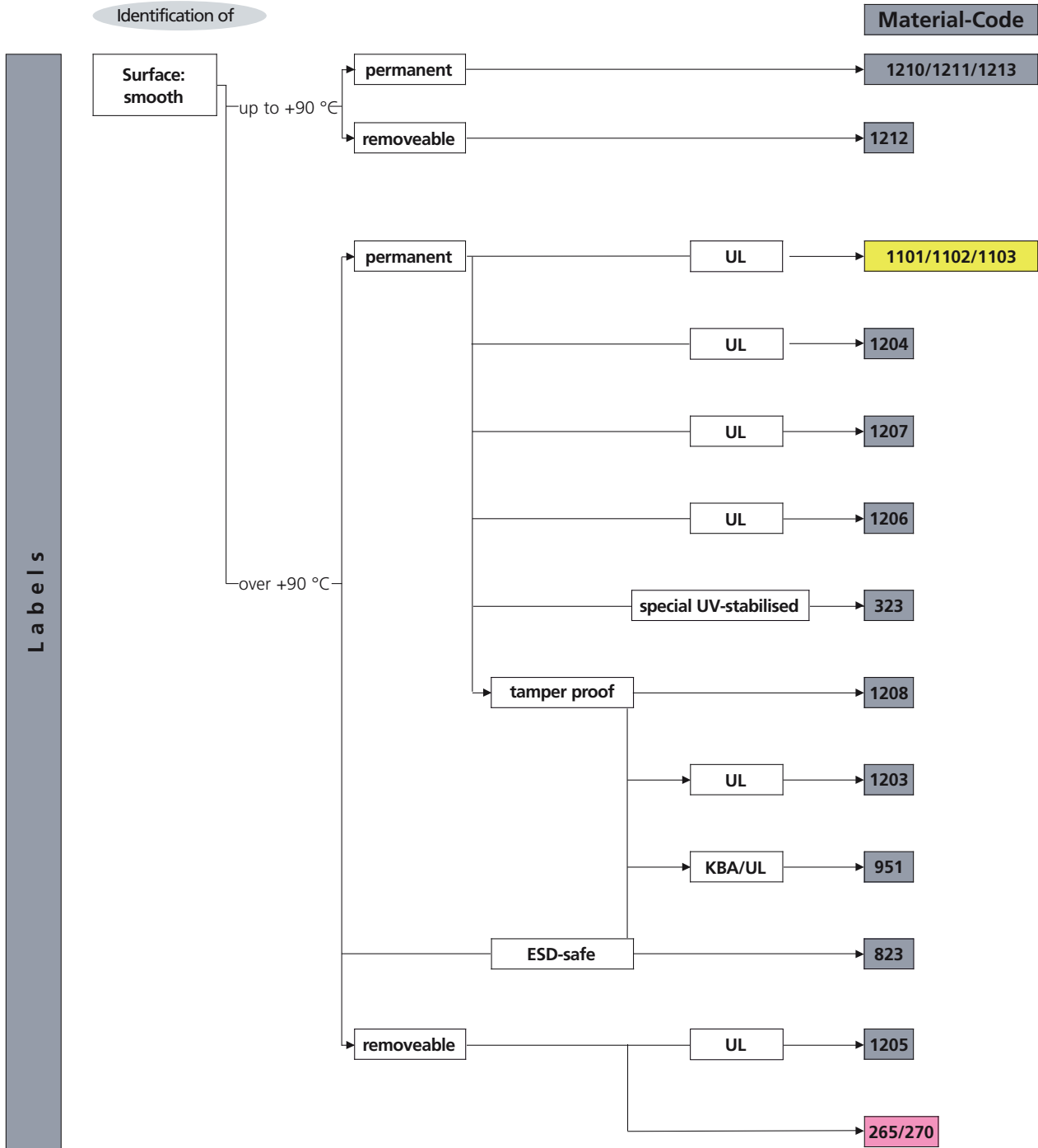

When selecting the material, the general rule is that a higher quality material can of course be used for lower requirements (e.g. a material for operating temperatures of over +90 °C can also be used for temperatures below +90 °C). And you can, of course, always ring us on our usual telephone numbers.

figure 2

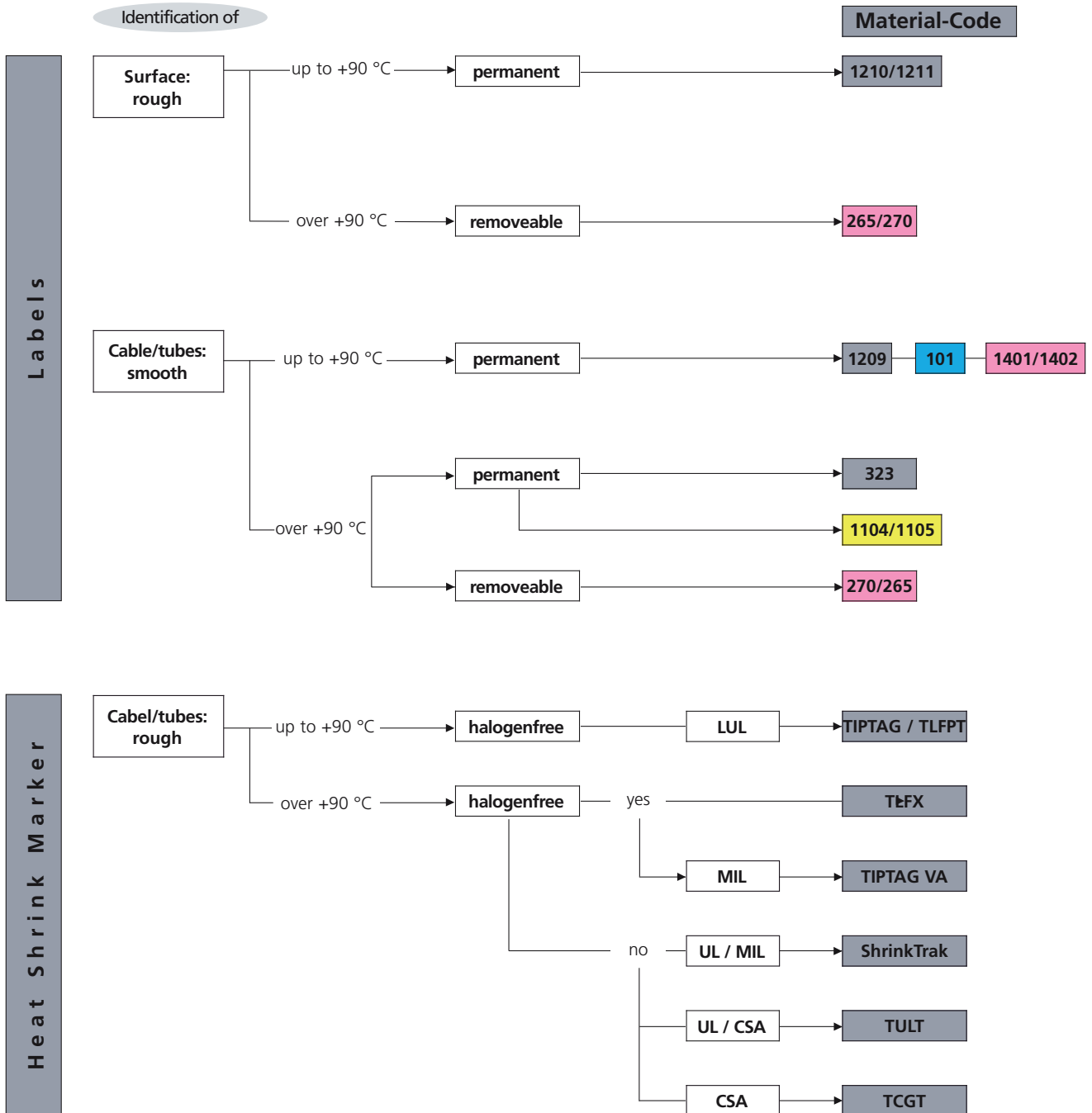

Labelling material for:

- TT printer
- Matrix printer
- Laser printer
- Handwritten identification

Approvals:

- 1) UL: Underwriter Laboratories
- 2) KBA: German Motor Transport Authority
- 3) MIL: Military Specification (USA)
- 4) LUL: London Underground RSE STD 013 (Großbritannien)
- 5) CSA: Canadian Standards Authority

Bonding properties of labels

The great variety of ways and places where labels can be used requires a broad range of combinations of different materials and adhesives. In the following text, a glimpse into the basic properties and differences between label adhesives will be provided.

To enable you to make the right choice for your particular application quickly and efficiently, we have set out the most important selection criteria diagrammatically in our flowchart.

Adhesion: powers of attraction between two materials

Adhesion can be described, in principle, as the ability of the adhesive to form a bond with the surface of the surface of the material (substrate). The influencing factors for optimum bonding of the label are the quality of the surface of the material and the creep ability of the adhesive. The crucial factor is the proportion of the surface which is actually to be wetted by the adhesive.

Adhesive basis

HellermannTyton currently uses acrylate and synthetic rubber as adhesive bases. Acrylate adhesives belong to the family of thermoplastic resins and at normal temperatures they provide high and lasting adhesion.

When considering the final bonding of acrylate adhesives, however, it must be noted that the relatively high final bonding is only attained after a certain curing period. This is especially true of labelling materials which may be used for rating plates.

So, for example, the adhesive for material types 1203 or 951 must harden for at least 48 hours on the surface without loading.

Initial and final bonding

In principle there are two different bonding conditions for labels: The initial bonding which occurs immediately after the label and surface are brought together and the final bonding which represents the permanent bonding status between label and surface following the application, pressing on and curing of the adhesive. The bonding of labels is measured in a defined test process (FINATFTM) and stated in N/mm. The initial bonding (or tack) describes the

Most surfaces appear – from a microscopic point of view – like a mountain range with peaks and valleys; i.e. the effective surface is much bigger than that seen by the naked eye. No matter how smooth and flat a substrate may appear to be, there is always some roughness. The more thinly the adhesive flows into the valleys, the more bonding points it can form and the better the adhesive will bond to the surface. A thicker layer of adhesive does allow these uneven

Only after this period does the safety measure become apparent; when an attempt is made to pull off the rating plate (check-board traces remain on the type 1203 and 951 materials).

Synthetic rubber-based adhesives, unlike acrylate-based adhesives, are distinguished by their high initial bonding. But this adhesive technology does not achieve a final bonding comparable to acrylate adhesives (see graph). Special mixtures of synthetic rubber are used in labelling technology, for example for removable labels, e.g. HellermannTyton material type 265 and 270.

bonding ability of the label after it has been applied to the surface, without being pressed down. The final bonding of labels is ultimately affected by the combined factors of material quality, adhesive basis, curing time, pressure applied and surface tension.

areas to be filled in better, but a thicker coat of adhesive has negative effects when labels are processed by machine (e.g. leakage of the adhesive or limited storage life).

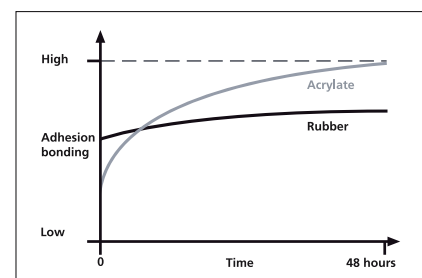
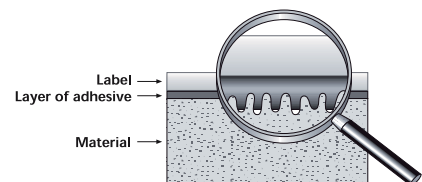

Effect of surface energy on bonding properties

The surface energy (also known as surface tension) is an important factor in the selection of the right adhesive. Because of their chemical formulation, all surfaces have their own polarity and surface tension. The cause of surface tensions is the tendency of liquids to reduce their surface as far as possible, thus to form drops. When a surface which is to be marked (substrate) is wetted with an adhesive, in addition to the adhesive formulation and the surface quality (material, roughness, dampness etc.) the surface energy is also a decisive factor in the maximum attainable bonding force of the adhesive.

As a basic rule, it can be noted that the surface energy of the adhesive must be less than the surface energy of the material to be bonded (substrate). The adhesive should completely wet the substrate and not form any drops.

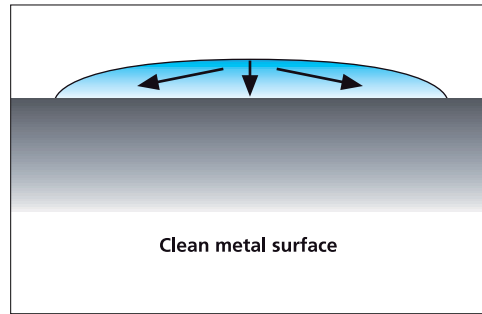

Flat drops

- High surface energy
- Good wetting
- Good bonding properties

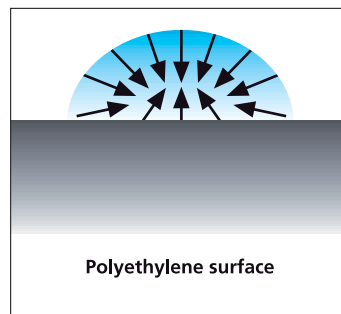

Rounded drops

- Low surface energy
- Poor wetting
- Weak bonding properties

The material combination is the decisive factor

An acrylate-based adhesive is polar and therefore has a relatively high surface energy. Acrylate-based adhesives achieve optimum final bonding on polar substrates (e.g. glass or metals) with a high surface energy.

More critical is the application of labels using acrylate-based adhesives on materials with low surface energy (apolar substrates) such as, for example, silicon, polyethylene and polypropylene. The surface tensions of an acrylate-based adhesive can be reduced for particular applications by the addition of specific additives. However, this step brings with it some drawbacks, for example, a free-flowing adhesive and thus a limited life and storage ability of the labels.

The lower bonding force of low-energy surfaces must therefore be taken into account of when considering the end use.

Surface energies of different materials

Material	Surface energy [mN/m]*
Polytetrafluorethylene (PTFE)	18
Silicon (Si)	24
Polyvinyl fluoride (PVF)	25
Natural rubber (CR)	25
Polypropylene (PP)	29
Polyethylene (PE)	35
Polymethyl methacrylate, Acryl (PMMA)	36
Epoxy (EP)	36
Polyoxymethylene, Acetal (POM)	36
Polystyrene (PS)	38
Polyvinyl chloride (PVC)	39
Vinylidene chloride (VC)	40
Polyester (PET)	41
Polyimide (PI)	41
Polyarylsulfone (PAS)	41
Phenolic resin	42
Polyurethane (PUR)	43
Polyamide 6 (PA 6)	43
Polycarbonate (PC)	46
Lead (Pb)	450
Aluminium (Al)	840
Copper (Cu)	1100
Chromium (Cr)	2400
Iron (Fe)	2550

For optimum marking using acrylate-based adhesive labels, HellermannTyton uses an improved adhesive formulation, which is coordinated to the most common materials in industry. In most cases it is possible to guarantee very good application of these labels. In borderline cases, a modified adhesive formulation may be necessary.

Talk to us, we'll be delighted to advise you.

*The values stated are non-binding reference values and for guidance purposes only.



Instructions for using cable markers with protective laminate

Cable markers with protective laminate (also known as cable laminators) have a white or coloured label field which can be written on either manually using a marker pen (see RiteOn and Helasign) or using a matrix, laser or thermal transfer printer (see Helatag). Depending on the design for the respective type of printing, the title block has a special surface finish to achieve the optimum fixation of the printing ink.

This results in long-lasting, clear, sharp writing with text, graphics or barcode. A special feature is that the HellermannTyton protective laminate comes with rounded corners. This achieves greater final adhesion of the protective laminate and counteracts any undesirable removal of the label, especially with cables of small diameter and in heavy-duty applications.

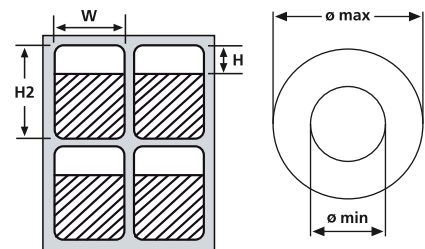

Helatag self-laminating labels.

When calculating the minimum and maximum diameters, the following formula has been used:

$$\text{Diameter} = \frac{\text{Length of laminate}}{\pi}$$

Pi (π) is the constant 3.14.

Minimum diameter:

o save time, when wrapping the cable with the cable laminator, a limit of max. 2 windings has been set. The protective laminate length is calculated from: Height H2 – height H.

By applying the “diameter” formula this produces the approx. minimum diameter:

$$\text{Diameter min.} = \frac{H2 - H}{2 * \pi}$$

Example: TAG136LA4

(H = 19,05 mm; H2 = 67,70 mm):

$$\text{Diameter min.} = \frac{67,7 - 19,05}{2 * 3,14}$$

Minimum Diameter:

In this case the minimum requirement is complete coverage of the label field with the protective laminate with a single winding. The length of the protective laminate is again obtained from the formula: H2 – H.

By applying the “diameter” formula this produces the approx. maximum diameter, which also corresponds to double the minimum diameter:

$$\text{Diameter max.} = \frac{H2 - H}{\pi} = 2 * \text{Durchmesser min.}$$

Example: TAG136LA4

(H = 19,05 mm; H2 = 67,70 mm):

$$\text{Diameter max.} = \frac{67,7 - 19,05}{3,14} = 2 * \text{Diameter min.}$$

Diameter max. = (67,7 - 19,05) / 3,14 = 2 * Diameter min.

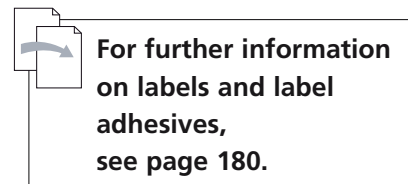

**For further information
on labels and label
adhesives,
see page 180.**

Interesting facts about thermal transfer films (colour ribbons)

The thermal transfer ribbon is perhaps the most important consumable that is used in this printing system - using the right ribbon for a particular application is extremely important.

Not every transfer ribbon is equally suited to any purpose. Depending on the printing requirements (e.g. smudge- or scratchproof) to be met, what type of labels (paper or plastic) will be used, an appropriate thermal transfer ribbon must be used.

Another important consideration for the thermal transfer ribbon is the electrostatic charging which can arise during the printing process. Some transfer ribbons become statically charged during the printing process, which can damage an ESD-sensitive printer head in the long run.

To clarify: The thermal transfer printer head is in physical contact with the back of the thermal transfer ribbon and consists solely of electronic, voltage-sensitive elements, which are known as dots.

These can become damaged when the thermal transfer ribbon causes discharges, which usually results in dot drop-outs. At points where the print head is damaged, no more colour is transferred. This leaves gaps on the label.

Thermal transfer films usually consist of three layers:

- A polyester strip as supporting material
- A protective, gliding backing layer on one side
- A colour layer on the other side.

The colour remains solid at room temperature, but liquefies under the effect of heat. To manufacture the colour ribbons, the polyester ribbon is coated with a special backing and then the respective coloured ink is applied. Print characteristics and bonding ability on various materials depend mainly on the chemical composition of this colour ink.

The main distinguishing feature of thermal transfer ribbons is the so-called quality of the coating. There are three basic types of thermal transfer ribbons:

Wax-based films – economical and versatile

Economical wax-based thermal transfer films are most frequently used in logistics applications. Due to the softness of the coloured ink, they produce good printing results at standard print temperatures even at high print speeds. Wax based films are almost exclusively suited to simple or coated papers. Resistance to solvents, heat and general abrasion and scratch-resistance is only average.

Wax-resin based films – good synthesis

With this quality of a wax-resin mixture, the good print characteristics of the wax are essentially retained, but the resin content increases mechanical strength. The print image produced has high resistance to heat, solvents, abrasion and scratching and high print quality, e.g. for barcodes. These colour ribbons are suitable for use on synthetic materials. They can be used for most applications at standard print temperatures.

Resin-based films – for very heavy-duty purposes

The colour layer at this quality level is based entirely on synthetic resins, developed for industrial applications and extreme conditions. Resin-based colour ribbons guarantee maximum readability, even on the most difficult materials (e.g. barcodes). Depending on the backing material, medium to high print temperatures and slow print speeds are necessary when using these thermal transfer films. In return, a print image is obtained which stands out for its high resistance to abrasion and scratching and great solvent and heat resistance.



Interesting facts about thermal transfer printing

Although thermal transfer printing is still a relatively new technology, because it is so versatile, it promises a high rate of growth. Thermal transfer printing plays a central role, especially in the field of printing variable data, single-proofs and even for small series. This is largely due to the fact that thermal transfer printing is a non-impact printing (NIP) process. Unlike traditional printing processes, such as offset-printing, a NIP printing process does not require a fixed printing block and can therefore print out different data with consistent quality from print to print.

Due to the increasing spread and importance of one and two-dimensional barcodes in goods inventory systems, logistics and in the field of component identification, the market potential of thermal transfer printing is growing all the time. The same is also true of incremental serial numbers, inventory designations, entrance tickets, rating plates, wine labels and many more.

Good print quality, high print speeds and the option of printing almost all backing materials permanently – these are the critical

advantages of thermal transfer printing. It's good readability, resistance and abrasion resistance allow thermal transfer printing to be put to use in applications where the print results from laser, inkjet or dot matrix printers are not satisfactory.

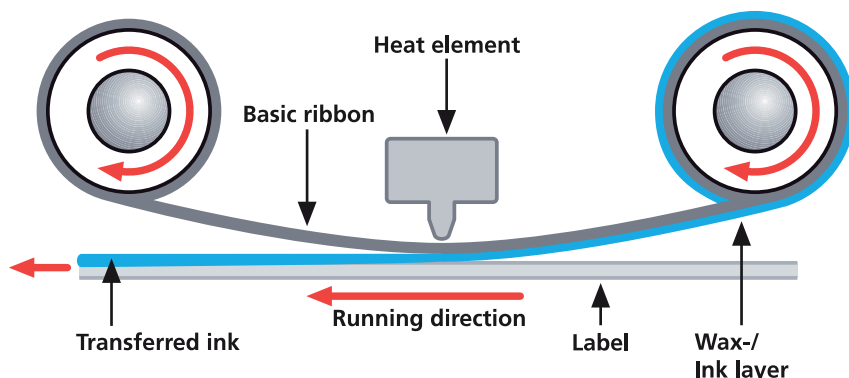

Heated dots strike a special colour ribbon, the thermal transfer film, which transfers liquefied colour ink at exactly that point onto the backing material (labels, tubes, rating plates). Our modern printers use what is known as "thin film technology", in which the very brief liquid phase of the ink produces faster print speeds and better and more precise images than with the "thick film technology" formerly used.

Moreover, the linear orientation of the labels or of the heatshrink tubing makes it possible to print on demand. The printing is then carried out as required. This is especially useful in the production of rating plates in series production.

In thermal transfer printing, the print image is defined by the three components: printer, label material and thermal transfer film (colour ribbon).

The advantages at a glance:

- High print quality with a resolution of 8-12 dots/mm (12 dots/mm corresponds to approx. 300 dpi)
- Barcode printing in excellent quality, hence good optical readability
- High print speeds of between 50 mm/sec and 200 mm/sec
- Individual graphics capability

- Problem-free and rapid realisation of self-designed drafts
- Quiet and service-friendly printers
- Prints are UV-fast and permanent, with high definition and contrast and good resistance to mechanical and chemical influences.

Shrinkable tubing 3:1, continuous, thermal transfer

- TULT, UL listed

Features and Benefits

- Heat shrinkable tubing TULT - UL listed
- Shrink ratio 3:1
- Good mechanical strength and resistance to organic solvents and chemicals
- Unmeltable
- Self-extinguishing
- Highly flexible
- Delivery in convenient storage boxes
- Fulfils UL224 VW-1 und CSA requirements



Thermal Transfer Printer

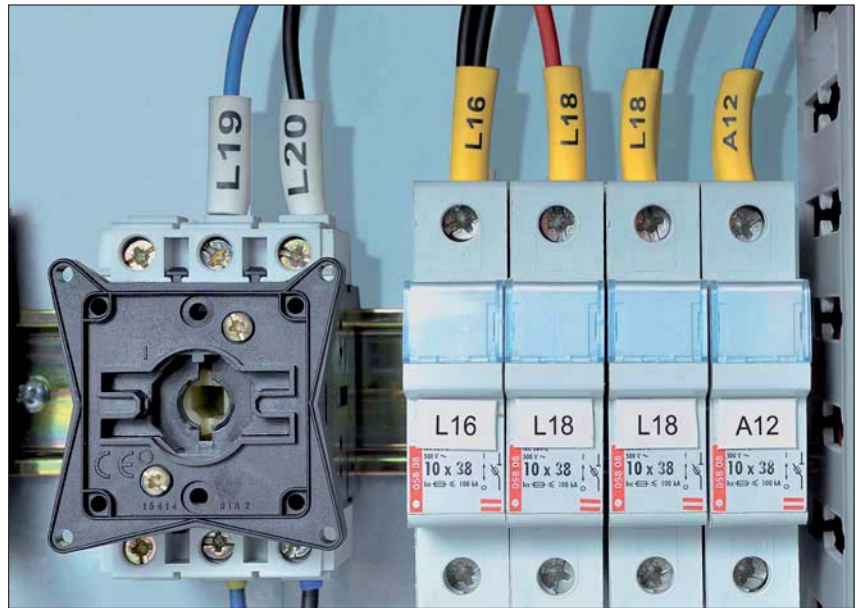

TULT – 5 colours of UL printable tube to cover a wide range of diameters

Certifications please see Appendix.

Material	Polyolefin, cross-linked (POX)
Colour	White (WH), Yellow (YE), Red (RD), Blue (BU), Black (BK)
Shrink Ratio	3:1
Longitudinal change after shrinkage	-15% max.
Min. Shrink Temperature	+90 °C
Dielectric Strength	37 kV/mm according to ASTM D 876
Operating Temperature	-55 °C to +135 °C
Recommended Ribbon Type	TTRC+, TTDTHOUT, TTRW, TT822OUT8
Specification	UL224 VW-1, CSA

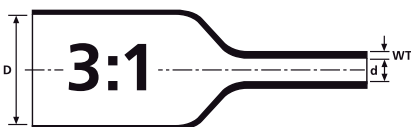

Type	Supplied Ø D min.	Recov. Ø d max.	Wall (WT)
TULT3-1	3.0	1.0	0.60
TULT4.8-1.6	4.8	1.6	0.65
TULT6-2	6.0	2.0	0.70
TULT9-3	9.0	3.0	0.80
TULT12-4	12.0	4.0	0.85
TULT18-6	18.0	6.0	1.00
TULT24-8	24.0	8.0	1.20
TULT39-13	39.0	13.0	1.25

All dimensions in mm. Subject to technical changes.



Please note! Not all products listed on this page may have this approval. For product specific approvals please refer to the Appendix.

Shrinkable tubing 3:1, continuous, thermal transfer

- TULT, UL listed

Article-No.	Type	Colour	Supplied Ø D min.	Recov. Ø d max.	Wall (WT)	Pack Cont.
553-40309	TULT3-1WH	White (WH)	3.0	1.0	0.60	22 m x 8
553-40304	TULT3-1YE	Yellow (YE)	3.0	1.0	0.60	22 m x 8
553-40302	TULT3-1RD	Red (RD)	3.0	1.0	0.60	22 m x 8
553-40306	TULT3-1BU	Blue (BU)	3.0	1.0	0.60	22 m x 8
553-40300	TULT3-1BK	Black (BK)	3.0	1.0	0.60	22 m x 8
553-40489	TULT4.8-1.6WH	White (WH)	4.8	1.6	0.65	22 m x 5
553-40484	TULT4.8-1.6YE	Yellow (YE)	4.8	1.6	0.65	22 m x 5
553-40482	TULT4.8-1.6RD	Red (RD)	4.8	1.6	0.65	22 m x 5
553-40486	TULT4.8-1.6BU	Blue (BU)	4.8	1.6	0.65	22 m x 5
553-40480	TULT4.8-1.6BK	Black (BK)	4.8	1.6	0.65	22 m x 5
553-40609	TULT6-2WH	White (WH)	6.0	2.0	0.70	22 m x 5
553-40604	TULT6-2YE	Yellow (YE)	6.0	2.0	0.70	22 m x 5
553-40602	TULT6-2RD	Red (RD)	6.0	2.0	0.70	22 m x 5
553-40606	TULT6-2BU	Blue (BU)	6.0	2.0	0.70	22 m x 5
553-40600	TULT6-2BK	Black (BK)	6.0	2.0	0.70	22 m x 5
553-40909	TULT9-3WH	White (WH)	9.0	3.0	0.80	18 m x 4
553-40904	TULT9-3YE	Yellow (YE)	9.0	3.0	0.80	18 m x 4
553-40902	TULT9-3RD	Red (RD)	9.0	3.0	0.80	18 m x 4
553-40906	TULT9-3BU	Blue (BU)	9.0	3.0	0.80	18 m x 4
553-40900	TULT9-3BK	Black (BK)	9.0	3.0	0.80	18 m x 4
553-41209	TULT12-4WH	White (WH)	12.0	4.0	0.85	18 m x 3
553-41204	TULT12-4YE	Yellow (YE)	12.0	4.0	0.85	18 m x 3
553-41202	TULT12-4RD	Red (RD)	12.0	4.0	0.85	18 m x 3
553-41206	TULT12-4BU	Blue (BU)	12.0	4.0	0.85	18 m x 3
553-41200	TULT12-4BK	Black (BK)	12.0	4.0	0.85	18 m x 3
553-41809	TULT18-6WH	White (WH)	18.0	6.0	1.00	13 m x 2
553-41804	TULT18-6YE	Yellow (YE)	18.0	6.0	1.00	13 m x 2
553-41802	TULT18-6RD	Red (RD)	18.0	6.0	1.00	13 m x 2
553-41806	TULT18-6BU	Blue (BU)	18.0	6.0	1.00	13 m x 2
553-41800	TULT18-6BK	Black (BK)	18.0	6.0	1.00	13 m x 2
553-42409	TULT24-8WH	White (WH)	24.0	8.0	1.20	13 m x 2
553-42404	TULT24-8YE	Yellow (YE)	24.0	8.0	1.20	13 m x 2
553-42402	TULT24-8RD	Red (RD)	24.0	8.0	1.20	13 m x 2
553-42406	TULT24-8BU	Blue (BU)	24.0	8.0	1.20	13 m x 2
553-42400	TULT24-8BK	Black (BK)	24.0	8.0	1.20	13 m x 2
553-43909	TULT39-13WH	White (WH)	39.0	13.0	1.25	10 m
553-43904	TULT39-13YE	Yellow (YE)	39.0	13.0	1.25	10 m
553-43902	TULT39-13RD	Red (RD)	39.0	13.0	1.25	10 m
553-43906	TULT39-13BU	Blue (BU)	39.0	13.0	1.25	10 m
553-43900	TULT39-13BK	Black (BK)	39.0	13.0	1.25	10 m

All dimensions in mm. Subject to technical changes.



Thermal Transfer Printer

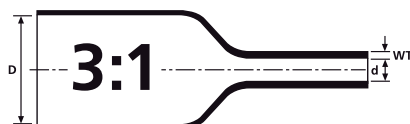

Identification tags for cable bundle, continuous, thermal transfer

- **TIPTAG PU for high temperature**

Features and Benefits

- Identification tags TIPTAG, Polyurethane
- Very tough and flexible material
- For bigger cable bundles and wires
- For cable ties up to 4.7 mm width
- Delivery on reel, perforated
- Flame retardant
- Weather resistant
- Abrasion resistant
- Good resistance to chemicals



Thermal Transfer Printer



The printed mark has a tattoo-like permanency.

Material	Polyurethane (PUR)
Flammability	self-extinguishing
Operating Temperature	-65 °C to +120 °C, intermittent +150 °C
Recommended Ribbon Type	TTRC+, TTDTHOUT

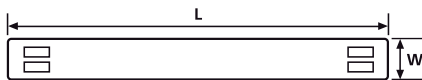

Article-No.	Type	Colour	Length (L)	Width (W)	Quantity per reel
556-25010	TTAGPU15X100YE	Yellow (YE)	100	15	125
556-25006	TTAGPU15X100WH	White (WH)	100	15	125
556-25011	TTAGPU15X65YE	Yellow (YE)	65	15	190
556-25007	TTAGPU15X65WH	White (WH)	65	15	190
556-25020	TTAGPU11X100YE	Yellow (YE)	100	11	125
556-25021	TTAGPU11X100WH	White (WH)	100	11	125
556-25019	TTAGPU11X65YE	Yellow (YE)	65	11	190
556-25012	TTAGPU11X65WH	White (WH)	65	11	190

All dimensions in mm. Subject to technical changes.

Self-laminating labels, thermal transfer

- **Material 323 (White-clear/ yellow-clear) high temperature**

Self-laminating labels are made for identification applications in outside environments like industry and defence technology.

Features and Benefits

- Self-laminating labels for thermal transfer printing of polyvinyl fluorid
- Abrasion resistant
- UV- and weather resistant
- For durable outdoor applications
- Good resistance against chemicals
- Laminating foil ensures optimal protection against environmental influences

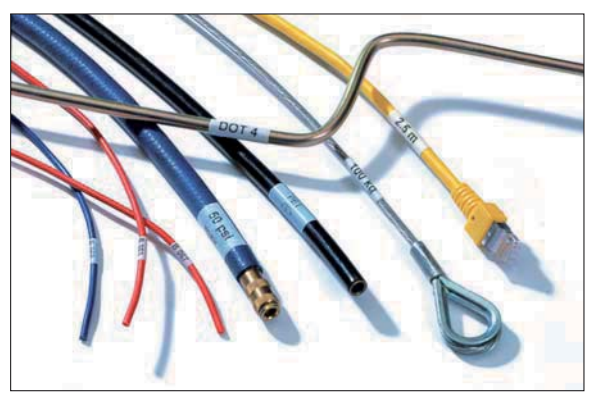

Easy marking of flexible, semi-rigid and rigid cables and wires.

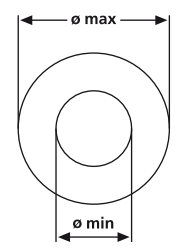
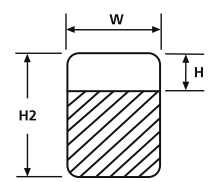

Thermal Transfer Printer

Material	Type 323, Polyvinylfluoride, white/yellow-transparent (WH/YE-CL)
Operating Temperature	-40 °C to +140 °C, intermittent +160 °C
Curing Temperature	from +10 °C
Recommended Ribbon Type	TT932DOUT
Adhesive	Acrylic
Thickness of Foil (µm)	25
chem. material properties	excellent resistance against water, UV radiation, weather influence and solvents based on petroleum



Article-No.	Type	Colour	Bundle Ø min.	Bundle Ø max.	Width (W)	Height (H)	Height (H2)	Width of Liner (WL)	Labels per Row	Pack Cont.
596-51320	TAG51TD3-323-WHCL	White (WH), Transparent (CL)	1.35	3.0	25.40	8.80	19.05	85.0	3	5000
596-26320	TAG26TD6-323-WHCL	White (WH), Transparent (CL)	1.5	3.0	12.70	9.52	19.05	85.0	6	10000
596-36320	TAG36TD7-323-WHCL	White (WH), Transparent (CL)	2.0	4.7	12.70	9.00	23.80	95.0	7	10000
596-02320	TAG2TD6-323-WHCL	White (WH), Transparent (CL)	3.5	7.6	12.70	12.70	36.50	82.0	6	5000
596-22320	TAG22TD3-323-WHCL	White (WH), Transparent (CL)	3.5	7.6	25.40	12.70	36.50	82.0	3	2500
596-24320	TAG24TD1-323-WHCL	White (WH), Transparent (CL)	3.5	7.6	50.80	12.70	36.50	55.0	1	1000
596-23320	TAG23TD5-323-WHCL	White (WH), Transparent (CL)	4.5	10.0	19.05	12.70	44.50	101.6	5	5000
596-25320	TAG25TD3-323-WHCL	White (WH), Transparent (CL)	4.5	10.0	25.40	12.70	44.50	82.0	3	2500
596-09320	TAG9TD3-323-WHCL	White (WH), Transparent (CL)	5.5	12.1	25.40	19.05	57.10	82.0	3	2500
596-10320	TAG10TD2-323-WHCL	White (WH), Transparent (CL)	5.5	12.1	49.53	19.05	57.10	101.6	2	1000
596-01320	TAG1TD2-323-WHCL	White (WH), Transparent (CL)	8.5	18.2	48.20	19.05	79.20	101.6	2	1000
596-03320	TAG3TD3-323-WHCL	White (WH), Transparent (CL)	10.0	22.2	25.40	25.40	95.25	82.0	3	1000
596-06320	TAG6TD1-323-WHCL	White (WH), Transparent (CL)	10.0	22.2	50.80	25.40	95.25	55.0	1	500
596-10732	TAG107TD3-323-WHCL	White (WH), Transparent (CL)	12.0	37.5	25.40	31.75	149.86	82.0	3	1000
596-38320	TAG38TD3-323-WHCL	White (WH), Transparent (CL)	20.8	47.5	25.40	38.10	187.20	82.0	3	1000
596-07320	TAG07TD1-323-WHCL	White (WH), Transparent (CL)	20.8	47.5	50.80	25.40	187.20	55.0	1	250
596-03322	TAG3TD3-323 YECL	Yellow (YE), Transparent (CL)	10.0	22.2	25.40	25.40	95.25	82.0	3	1000

All dimensions in mm. Subject to technical changes.

Pre-printed Cable Markers

• **ABR-Markers**

Ideally suited for the automotive industry for the identification coding of ignition cables. The embossed mark ensures clear legibility even in areas where dust and debris is found.

Features and Benefits

- Semi-severed markers made from chloroprene
- Highly elastic (up to 400%)
- Fits tightly onto bundles
- Embossed characters give excellent visibility even in dirty areas
- On request we offer already served markers
- Recommended applicator tool: Series NA or VA



Highly flexible, legible, and easy to apply.

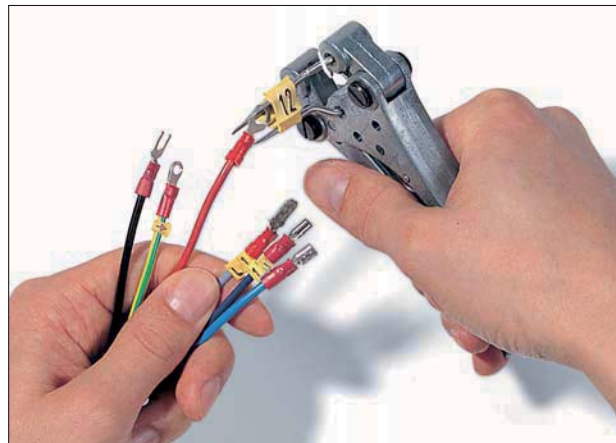
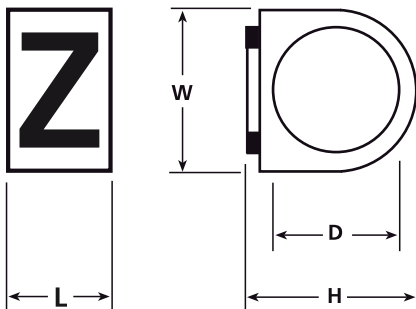

The sleeve applicator tool allows markers to be fitted after crimping.

For detailed information on Application Tools please refer to page 140.

Material	Chloroprene (CR)
Colour	Yellow (YE)
Operating Temperature	-25 °C to +90 °C, intermittent +100 °C
Shore Hardness A	Elastomer 31 +/- 5% Shore A
Flammability	UL94 HB and FMVSS-302



Type	Ø D max.	Ø D	Width (W)	Height (H)	Length (L)	Application Tool	Pack Cont.
ABR.1	3.50	1.75	4.00	4.50	3.0	NA-0/1	500
ABR.2	6.00	3.0	5.00	5.50	4.0	NA-1K/3, VA2,5/5	500
ABR.3	9.00	5.0	8.00	8.50	5.0	NA-1K/3, VA2,5/5	500
ABR.4	13.00	7.5	10.00	10.50	6.0	NA-4/5, VA2,5/5	200
ABR.5	17.00	10.0	13.00	13.50	8.0	NA-4/5	100

All dimensions in mm. Subject to technical changes.

Pre-printed Cable Markers

• ABR-Markers

	Article-No.	Type
A	501-01014	ABR.1-A
B	501-01024	ABR.1-B
C	501-01034	ABR.1-C
D	501-01044	ABR.1-D
E	501-01054	ABR.1-E
F	501-01064	ABR.1-F
G	501-01074	ABR.1-G
H	501-01084	ABR.1-H
I	501-01094	ABR.1-I
J	501-01104	ABR.1-J
K	501-01114	ABR.1-K
L	501-01124	ABR.1-L
M	501-01134	ABR.1-M
N	501-01144	ABR.1-N
O	501-01154	ABR.1-O
P	501-01164	ABR.1-P
Q	501-01174	ABR.1-Q
R	501-01184	ABR.1-R
S	501-01194	ABR.1-S
T	501-01204	ABR.1-T
U	501-01214	ABR.1-U
V	501-01224	ABR.1-V
W	501-01234	ABR.1-W
X	501-01244	ABR.1-X
Y	501-01254	ABR.1-Y
Z	501-01264	ABR.1-Z
+	501-01274	ABR.1-+
-	501-01284	ABR.1--
0	501-01604	ABR.1-0
1	501-01614	ABR.1-1
2	501-01624	ABR.1-2
3	501-01634	ABR.1-3
4	501-01644	ABR.1-4
5	501-01654	ABR.1-5
6	501-01664	ABR.1-6
7	501-01674	ABR.1-7
8	501-01684	ABR.1-8
9	501-01694	ABR.1-9

	Article-No.	Type
A	501-02014	ABR.2-A
B	501-02024	ABR.2-B
C	501-02034	ABR.2-C
D	501-02044	ABR.2-D
E	501-02054	ABR.2-E
F	501-02064	ABR.2-F
G	501-02074	ABR.2-G
H	501-02084	ABR.2-H
I	501-02094	ABR.2-I
J	501-02104	ABR.2-J
K	501-02114	ABR.2-K
L	501-02124	ABR.2-L
M	501-02134	ABR.2-M
N	501-02144	ABR.2-N
O	501-02154	ABR.2-O
P	501-02164	ABR.2-P
Q	501-02174	ABR.2-Q
R	501-02184	ABR.2-R
S	501-02194	ABR.2-S
T	501-02204	ABR.2-T
U	501-02214	ABR.2-U
V	501-02224	ABR.2-V
W	501-02234	ABR.2-W
X	501-02244	ABR.2-X
Y	501-02254	ABR.2-Y
Z	501-02264	ABR.2-Z
+	501-02274	ABR.2-+
-	501-02284	ABR.2--
0	501-02604	ABR.2-0
1	501-02614	ABR.2-1
2	501-02624	ABR.2-2
3	501-02634	ABR.2-3
4	501-02644	ABR.2-4
5	501-02654	ABR.2-5
6	501-02664	ABR.2-6
7	501-02674	ABR.2-7
8	501-02684	ABR.2-8
9	501-02694	ABR.2-9

	Article-No.	Type
A	501-03014	ABR.3-A
B	501-03024	ABR.3-B
C	501-03034	ABR.3-C
D	501-03044	ABR.3-D
E	501-03054	ABR.3-E
F	501-03064	ABR.3-F
G	501-03074	ABR.3-G
H	501-03084	ABR.3-H
I	501-03094	ABR.3-I
J	501-03104	ABR.3-J
K	501-03114	ABR.3-K
L	501-03124	ABR.3-L
M	501-03134	ABR.3-M
N	501-03144	ABR.3-N
O	501-03154	ABR.3-O
P	501-03164	ABR.3-P
Q	501-03174	ABR.3-Q
R	501-03184	ABR.3-R
S	501-03194	ABR.3-S
T	501-03204	ABR.3-T
U	501-03214	ABR.3-U
V	501-03224	ABR.3-V
W	501-03234	ABR.3-W
X	501-03244	ABR.3-X
Y	501-03254	ABR.3-Y
Z	501-03264	ABR.3-Z
+	501-03274	ABR.3-+
-	501-03284	ABR.3--
0	501-03604	ABR.3-0
1	501-03614	ABR.3-1
2	501-03624	ABR.3-2
3	501-03634	ABR.3-3
4	501-03644	ABR.3-4
5	501-03654	ABR.3-5
6	501-03664	ABR.3-6
7	501-03674	ABR.3-7
8	501-03684	ABR.3-8
9	501-03694	ABR.3-9

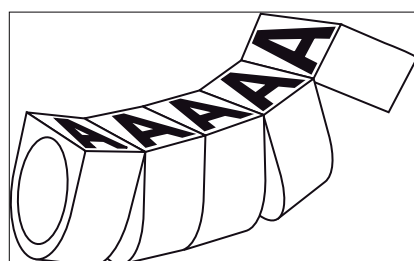

Special characters
available on request.

Pre-printed Cable Markers

• ABR-Markers

	Article-No.	Type
A	501-04014	ABR.4-A
B	501-04024	ABR.4-B
C	501-04034	ABR.4-C
D	501-04044	ABR.4-D
E	501-04054	ABR.4-E
F	501-04064	ABR.4-F
G	501-04074	ABR.4-G
H	501-04084	ABR.4-H
I	501-04094	ABR.4-I
J	501-04104	ABR.4-J
K	501-04114	ABR.4-K
L	501-04124	ABR.4-L
M	501-04134	ABR.4-M
N	501-04144	ABR.4-N
O	501-04154	ABR.4-O
P	501-04164	ABR.4-P
Q	501-04174	ABR.4-Q
R	501-04184	ABR.4-R
S	501-04194	ABR.4-S
T	501-04204	ABR.4-T
U	501-04214	ABR.4-U
V	501-04224	ABR.4-V
W	501-04234	ABR.4-W
X	501-04244	ABR.4-X
Y	501-04254	ABR.4-Y
Z	501-04264	ABR.4-Z
+	501-04274	ABR.4-+
-	501-04284	ABR.4--
0	501-04604	ABR.4-0
1	501-04614	ABR.4-1
2	501-04624	ABR.4-2
3	501-04634	ABR.4-3
4	501-04644	ABR.4-4
5	501-04654	ABR.4-5
6	501-04664	ABR.4-6
7	501-04674	ABR.4-7
8	501-04684	ABR.4-8
9	501-04694	ABR.4-9

	Article-No.	Type
A	501-05014	ABR.5-A
B	501-05024	ABR.5-B
C	501-05034	ABR.5-C
D	501-05044	ABR.5-D
E	501-05054	ABR.5-E
F	501-05064	ABR.5-F
G	501-05074	ABR.5-G
H	501-05084	ABR.5-H
I	501-05094	ABR.5-I
J	501-05104	ABR.5-J
K	501-05114	ABR.5-K
L	501-05124	ABR.5-L
M	501-05134	ABR.5-M
N	501-05144	ABR.5-N
O	501-05154	ABR.5-O
P	501-05164	ABR.5-P
Q	501-05174	ABR.5-Q
R	501-05184	ABR.5-R
S	501-05194	ABR.5-S
T	501-05204	ABR.5-T
U	501-05214	ABR.5-U
V	501-05224	ABR.5-V
W	501-05234	ABR.5-W
X	501-05244	ABR.5-X
Y	501-05254	ABR.5-Y
Z	501-05264	ABR.5-Z
+	501-05274	ABR.5-+
-	501-05284	ABR.5--
0	501-05604	ABR.5-0
1	501-05614	ABR.5-1
2	501-05624	ABR.5-2
3	501-05634	ABR.5-3
4	501-05644	ABR.5-4
5	501-05654	ABR.5-5
6	501-05664	ABR.5-6
7	501-05674	ABR.5-7
8	501-05684	ABR.5-8
9	501-05694	ABR.5-9

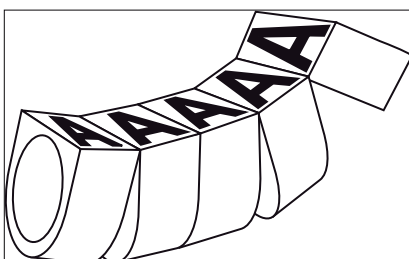

Special characters
available on request.

Identification ties and plates for marking cable bundles

• IT Ties

One of the major benefits is the ability to both secure and identify cable bundles at different times.

Features and Benefits

- Identification ties made of Polyamide 6.6
- For simple identification and securing of cable bundles in one step
- Can be marked either on-site or after bundling (Pen T82)
- In addition a large selection of labels are available



One operation with two user benefits.

Material	Polyamide 6.6 (PA66)
Colour	Natural (NA), Black (BK), Various (DIV)
Operating Temperature	-40 °C to +85 °C, intermittent +105 °C (for 500 h)
Flammability	UL94 V2



Certifications please see Appendix.

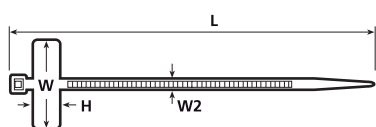

IT18R

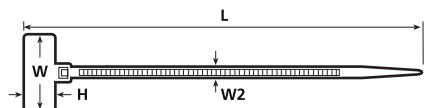

IT18FL

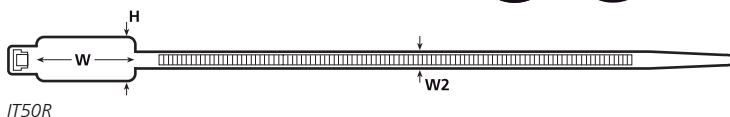

IT50R

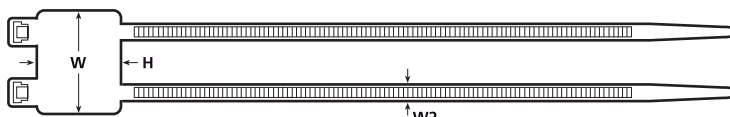

IT50RD

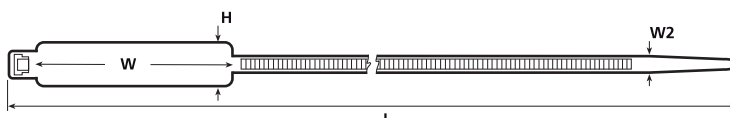

IT50L

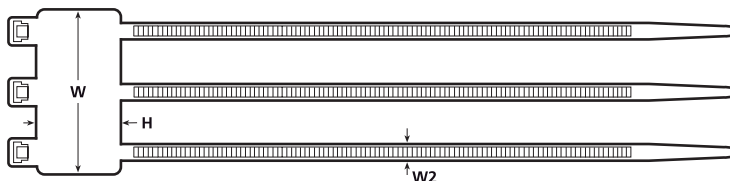

IT50RT

Article-No.	Type	Colour	Bundle Ø min.	Bundle Ø max.	Width (W)	Height (H)	Length (L)	Width (W2)	Min. Tensile Strength (N)	Pack Cont.	Recommended Labels
111-81821	IT18R	Natural (NA)	6.00	22.00	25.00	8.00	100.0	2.30	80	100	TAG23-06TD1
111-81919	IT18FL	Natural (NA)	1.50	19.00	20.50	9.00	110.0	2.50	80	100	TAG18-07TD1
111-85019	IT50R	Natural (NA)	9.50	44.50	28.00	12.90	203.0	4.60	225	100	TAG23-10TD1
111-85219	IT50RD	Natural (NA)	10.00	44.00	29.00	26.30	205.0	4.70	225	50	TAG26-21TD1
111-85119	IT50RT	Natural (NA)	10.00	44.00	46.00	26.30	205.0	4.70	225	50	TAG43-21TD1
111-85319	IT50L	Natural (NA)	10.00	100.00	56.00	12.80	390.0	4.70	225	100	TAG52-10TD1

All dimensions in mm. Subject to technical changes.

Please note! Not all products listed on this page may have this approval. For product specific approvals please refer to the Appendix.

Adhesive labels for plates and tags, thermal transfer

• **Material 1210 (White)**

These labels are especially used for cable and wire identification in computer and electronic business.

For problem-free printing, we recommend Tagprint Pro software, TT4000+ and TT420+ printers.

Features and Benefits

- Marking labels made of vinyl, white gloss
- Very flexible material
- Specially tailored to the sizes of IT marking ties and IMP tag range
- Suitable for permanent marking of components and devices on different surfaces
- Sticks even on rounded surfaces

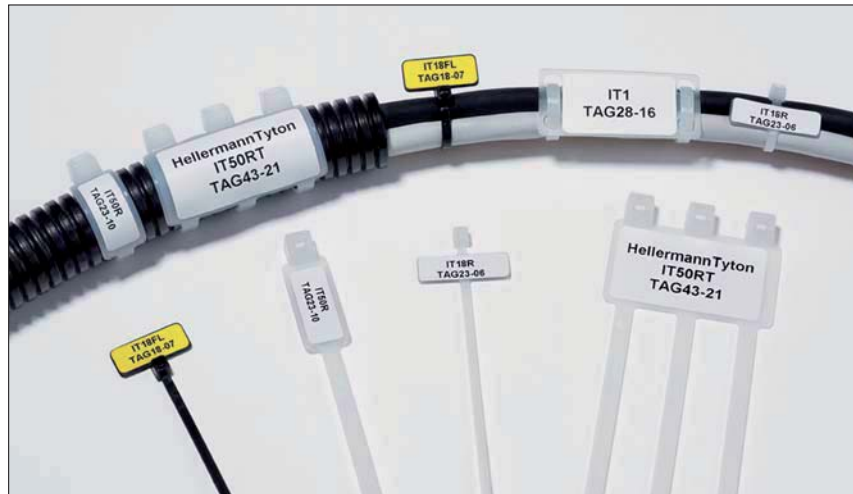

Identification ties and tags.



Thermal Transfer Printer

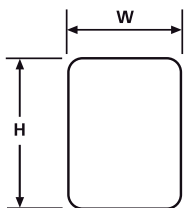

Material	Type 1210, Vinyl (PVC), white gloss (WH)
Operating Temperature	-20 °C to +80 °C
Curing Temperature	from +5 °C
Adhesive	Acrylic
Recommended Ribbon Type	TT822OUT
Thickness of Foil (µm)	83
chem. material properties	Resistant to water, alcohol, most oils, greases, fuel, aliphatic solvents, weak acids, salts and alkalis.



Article-No.	Type	Colour	Width (W)	Height (H)	Width of Liner (WL)	For Size	Labels per Row	Pack Cont.
Thermal Transfer - Plain Labels, Material 1210								
596-12126	TAG18-07TD1-1210-WH	White (WH)	18.00	7.00	24.0	IT18FL	1	5000
596-12127	TAG18-16TD1-1210-WH	White (WH)	18.00	16.00	24.0	IMP1.5	1	2500
596-12128	TAG23-06TD1-1210-WH	White (WH)	23.00	6.00	30.0	IT18R	1	5000
596-12129	TAG23-10TD1-1210-WH	White (WH)	23.00	10.00	30.0	IT50R	1	5000
596-12130	TAG26-21TD2-1210-WH	White (WH)	26.00	21.00	57.0	IT50RD	2	2500
596-12131	TAG28-16TD1-1210-WH	White (WH)	28.00	16.00	34.0	IT1, IMP2	1	2500
596-12132	TAG43-16TD1-1210-WH	White (WH)	43.00	16.00	50.0	IMP2.5	1	2500
596-12133	TAG43-21TD1-1210-WH	White (WH)	43.00	21.00	50.0	IT50RT	1	2500
596-12134	TAG43-41TD1-1210-WH	White (WH)	43.00	41.00	50.0	IMP2.5W1.75	1	1000
596-12135	TAG52-10TD1-1210-WH	White (WH)	52.00	10.00	58.0	IT50L	1	5000
596-12136	TAG68-16TD1-1210-WH	White (WH)	68.00	16.00	74.0	IMP3.5, QT7016R	1	2500

All dimensions in mm. Subject to technical changes.

Adhesive labels for plates and tags, thermal transfer

• Material 1211 (Yellow)

Features and Benefits

- Marking labels made of vinyl, yellow gloss
- Very flexible material
- Specially tailored to the sizes of IT marking ties and IMP tag range
- Suitable for permanent marking of components and devices on different surfaces
- Sticks even on rounded surfaces



Identification ties and tags.



Thermal Transfer Printer

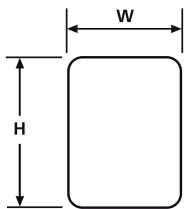

Material	Type 1211, Vinyl (PVC), yellow gloss (YE)
Operating Temperature	-20 °C to +80 °C
Curing Temperature	from +5 °C
Recommended Ribbon Type	TT822OUT
Adhesive	Acrylic
Thickness of Foil (µm)	83
chem. material properties	Resistant to water, alcohol, most oils, greases, fuel, aliphatic solvents, weak acids, salts and alkalis.



Article-No.	Type	Colour	Width (W)	Height (H)	Width of Liner (WL)	For Size	Labels per Row	Pack Cont.
596-12110	TAG18-07TD1-1211-YE	Yellow gloss (GSYE)	18.00	7.00	24.0	IT18FL	1	5000
596-12111	TAG18-16TD1-1211-YE	Yellow gloss (GSYE)	18.00	16.00	24.0	IMP1.5	1	2500
596-12112	TAG23-06TD1-1211-YE	Yellow gloss (GSYE)	23.00	6.00	30.0	IT18R	1	5000
596-12113	TAG23-10TD1-1211-YE	Yellow gloss (GSYE)	23.00	10.00	30.0	IT50R	1	5000
596-12114	TAG26-21TD2-1211-YE	Yellow gloss (GSYE)	26.00	21.00	57.0	IT50RD	2	2500
596-12115	TAG28-16TD1-1211-YE	Yellow gloss (GSYE)	28.00	16.00	34.0	IT1, IMP2	1	2500
596-12116	TAG43-16TD1-1211-YE	Yellow gloss (GSYE)	43.00	16.00	50.0	IMP2.5	1	2500
596-12117	TAG43-21TD1-1211-YE	Yellow gloss (GSYE)	43.00	21.00	50.0	IT50RT	1	2500
596-12118	TAG43-41TD1-1211-YE	Yellow gloss (GSYE)	43.00	41.00	50.0	IMP2.5W1.75	1	1000
596-12119	TAG52-10TD1-1211-YE	Yellow gloss (GSYE)	52.00	10.00	58.0	IT50L	1	5000
596-61211	TAG68-16TD1-1211-YE	Yellow gloss (GSYE)	68.00	16.00	74.0	IMP3.5, QT7016R	1	2500

All dimensions in mm. Subject to technical changes.

Type label identification, thermal transfer

Material 1204 (Silver)

Scratch-resistant type plates for the industry. The adhesive is also suitable for critical surfaces like plastic and varnish.

Features and Benefits

- Marking labels made of Polyester, silver matt
- Replacement for aluminium plates
- For even and smooth surfaces
- Also for difficult surfaces like plastics and varnish
- Operating temperature up to +150 °C
- Many different sizes are available



Thermal Transfer Printer



Professional type plate on a heating unit.

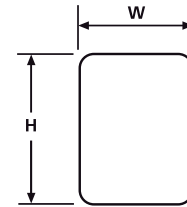

Material	Type 1204, Polyester (PET), silver matt (SR)
Operating Temperature	-40 °C to +150 °C, intermittent +200 °C
Curing Temperature	from +0 °C
Recommended Ribbon Type	TT822OUT
Adhesive	Acrylic
Thickness of Foil (µm)	55
chem. material properties	Excellent resistance to water, alcohol, most oils, greases, fuel, aliphatic solvents, weak acids, salts and alkalis.



Article-No.	Type	Colour	Width (W)	Height (H)	Width of Liner (WL)	Labels per Row	Pack Cont.
596-12071	TAG71TD6-1204	Silver (SR)	12.70	11.10	101.60	6	15000
596-12043	TAG13TD4-1204	Silver (SR)	19.05	6.35	101.60	4	10000
596-12046	TAG16TD3-1204	Silver (SR)	22.86	6.35	80.00	3	10000
596-34120	TAG34TD3-1204	Silver (SR)	25.40	9.53	85.09	3	75000
596-12045	TAG15TD3-1204	Silver (SR)	25.40	12.70	85.09	3	7500
596-31120	TAG31TD3-1204	Silver (SR)	25.40	19.05	85.09	3	5000
596-12042	TAGR2TD1-1204	Silver (SR)	30.00	endless	30.00	1	37,5 m
596-12035	TAG35TD3-1204	Silver (SR)	31.75	9.53	101.60	3	7500
596-12047	TAG17TD2-1204	Silver (SR)	38.10	6.35	85.09	2	5000
596-27120	TAG27TD2-1204	Silver (SR)	38.10	19.05	85.09	2	5000
596-12067	TAG67TD2-1204	Silver (SR)	38.10	31.75	85.10	2	1000
596-12069	TAG69TD2-1204	Silver (SR)	40.64	22.86	89.00	2	2500
596-12077	TAG77TD1-1204	Silver (SR)	50.80	22.86	55.00	1	2000
596-73124	TAG73TD1-1204	Silver (SR)	50.80	25.40	55.00	1	2000
596-12066	TAG66TD1-1204	Silver (SR)	50.80	36.50	56.80	1	1000
596-12068	TAG68TD1-1204	Silver (SR)	63.50	25.40	69.00	1	2000
596-12063	TAG63TD1-1204	Silver (SR)	63.50	38.10	70.00	1	1000
596-12076	TAG76TD1-1204	Silver (SR)	63.50	50.80	70.00	1	500
596-12072	TAG72TD1-1204	Silver (SR)	69.85	31.75	76.00	1	1000
596-12065	TAG65TD1-1204	Silver (SR)	76.20	36.50	82.00	1	1000
596-12062	TAG62TD1-1204	Silver (SR)	76.20	50.80	82.00	1	500
596-12064	TAG64TD1-1204	Silver (SR)	88.90	36.50	95.00	1	1000
596-71204	TAG97TD1-1204	Silver (SR)	101.60	74.00	106.00	1	500
596-21204	TAG02TD1-1204	Silver (SR)	104.00	12.00	104.00	1	5000
596-12078	TAG78TD1-1204	Silver (SR)	104.00	140.00	105.00	1	500
596-31204	TAGR3TD1-1204	Silver (SR)	104.00	endless	108.00	1	75.0 m

All dimensions in mm. Subject to technical changes.

Asset identification label, thermal transfer

• Material 1206 (White)

Glossy white polyester label suited for the generation of asset tracking labels. The white colour guarantees a suitable contrast for all barcode scanners to read printed barcodes.

Features and Benefits

- Marking labels made of Polyester, white gloss
- For even and smooth surfaces
- Also for difficult surfaces like plastic and varnish
- Operating temperature up to +150 °C
- Many different sizes available



Thermal Transfer Printer



HELATAG label for a permanent asset identification.

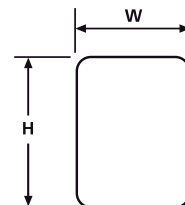

Material	Type 1206, Polyester (PET), white (WH)
Operating Temperature	-40 °C to +150 °C, intermittent +200 °C
Curing Temperature	from +0 °C
Recommended Ribbon Type	TT822OUT
Adhesive	Acrylic
Thickness of Foil (µm)	50
chem. material properties	Excellent resistance to water, alcohol, most oils, greases, fuel, aliphatic solvents, weak acids, salts and alkalis.



Article-No.	Type	Colour	Width (W)	Height (H)	Width of Liner (WL)	Labels per Row	Pack Cont.
596-12671	TAG71TD6-1206	White gloss (GSWH)	12.70	11.10	101.60	6	15000
596-12061	TAG13TD4-1206	White gloss (GSWH)	19.05	6.35	101.60	4	10000
596-12616	TAG16TD3-1206	White gloss (GSWH)	22.86	6.35	80.00	3	10000
596-12661	TAG61TD3-1206	White gloss (GSWH)	25.40	4.75	89.00	3	10000
596-01120	TAG01TD3-1206	White gloss (GSWH)	25.40	6.35	89.00	3	7500
596-12634	TAG34TD3-1206	White gloss (GSWH)	25.40	9.53	85.09	3	7500
596-12615	TAG15TD3-1206	White gloss (GSWH)	25.40	12.70	85.09	3	7500
596-12631	TAG31TD3-1206	White gloss (GSWH)	25.40	19.05	85.09	3	5000
596-12635	TAG35TD3-1206	White gloss (GSWH)	31.75	9.53	101.60	3	7500
596-12617	TAG17TD2-1206	White gloss (GSWH)	38.10	6.35	85.09	2	5000
596-12627	TAG27TD2-1206	White gloss (GSWH)	38.10	19.05	85.09	2	2500
596-12667	TAG67TD2-1206	White gloss (GSWH)	38.10	31.75	85.10	2	2500
596-12669	TAG69TD2-1206	White gloss (GSWH)	40.64	22.86	89.00	2	2500
596-71206	TAG77TD1-1206	White gloss (GSWH)	50.80	22.86	55.00	1	2000
596-12673	TAG73TD1-1206	White gloss (GSWH)	50.80	25.40	55.00	1	2000
596-12666	TAG66TD1-1206	White gloss (GSWH)	50.80	36.50	56.80	1	1000
596-12668	TAG68TD1-1206	White gloss (GSWH)	63.50	25.40	69.00	1	2000
596-12663	TAG63TD1-1206	White gloss (GSWH)	63.50	38.10	70.00	1	1000
596-61206	TAG76TD1-1206	White gloss (GSWH)	63.50	50.80	70.00	1	500
596-41206	TAG4TD1-1206	White gloss (GSWH)	65.00	20.00	70.00	1	2500
596-12672	TAG72TD1-1206	White gloss (GSWH)	69.85	31.75	76.00	1	1000
596-12665	TAG65TD1-1206	White gloss (GSWH)	76.20	36.50	82.00	1	1000
596-12662	TAG62TD1-1206	White gloss (GSWH)	76.20	50.80	82.00	1	500
596-12664	TAG64TD1-1206	White gloss (GSWH)	88.90	36.50	95.00	1	1000

All dimensions in mm. Subject to technical changes.

Tamper evident security labelling, thermal transfer

• **Material 1208 (White), fragmenting**

In nearly all areas, but especially suitable for cable and wire identification in computer and electronic businesses. For problem-free printing, we recommend our software Tagprint PRO.

Features and Benefits

- Marking labels made of acrylate foil, white, tamper proof
- Material will fragment when it is removed
- Construction has a weakness built in that will immediately indicate if anyone has been tampering with the label
- Adhesive must harden before tampering attempt
- Securely and unambiguously marking of assets



A secure way of identifying ...



... if an asset label has been tampered with.



Thermal Transfer Printer

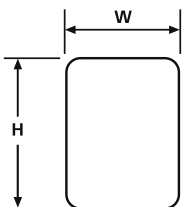

Material	Type 1208, Acrylate foil (AC), white (WH), tamper proof
Operating Temperature	-40 °C to +150 °C
Curing Temperature	from +4 °C
Recommended Ribbon Type	TT822OUT
Adhesive	Acrylic
Thickness of Foil (µm)	56
chem. material properties	Resistant to oils, water and solvents



Article-No.	Type	Colour	Width (W)	Height (H)	Width of Liner (WL)	Labels per Row	Pack Cont.
596-20871	TAG71TD6-1208-WH	White (WH)	12.70	11.10	101.60	6	15000
596-12083	TAG34TD3-1208-WH	White (WH)	25.40	9.53	85.09	3	7500
596-12080	TAG15TD3-1208-WH	White (WH)	25.40	12.70	85.09	3	7500
596-12084	TAG31TD3-1208-WH	White (WH)	25.40	19.05	85.09	3	5000
596-12085	TAG35TD3-1208-WH	White (WH)	31.75	9.53	101.60	3	7500
596-12081	TAG17TD2-1208-WH	White (WH)	38.10	6.35	85.09	2	5000
596-12082	TAG27TD2-1208-WH	White (WH)	38.10	19.05	85.09	2	2500
596-12087	TAG67TD2-1208-WH	White (WH)	38.10	31.75	85.10	2	2500
596-12089	TAG69TD2-1208-WH	White (WH)	40.64	22.86	89.00	2	2500
596-71208	TAG77TD1-1208-WH	White (WH)	50.80	22.86	55.00	1	2000
596-31208	TAG73TD1-1208-WH	White (WH)	50.80	25.40	55.00	1	2000
596-12086	TAG66TD1-1208-WH	White (WH)	50.80	36.50	56.80	1	1000
596-12088	TAG68TD1-1208-WH	White (WH)	63.50	25.40	69.00	1	2000
596-20872	TAG72TD1-1208-WH	White (WH)	69.85	31.75	76.00	1	1000

All dimensions in mm. Subject to technical changes.

Tamper evident security labelling, thermal transfer

• **Material 951 (Silver), 2 parts**

Marking label especially for applications in the automotive area for lasting, non-transferable and tamperproof application of type plates. Recommended for use on flat surfaces on the vehicle chassis. The transparent protective laminate, which overlaps by a few millimetres, guarantees high resistance and is simple and safe to apply by hand.

Features and Benefits

- Marking labels made of polyester, silver with protective laminate, tamper evident
- 2-part label, delivered on reel together with the protective label
- Tamper evident, when pulled off a checkered pattern will be visible as evident
- High durability in outside use
- Meets requirements of the KBA (Kraftfahrtbundesamt [Federal Motor Transport Authority]).
- Particularly suitable as type label for vehicles

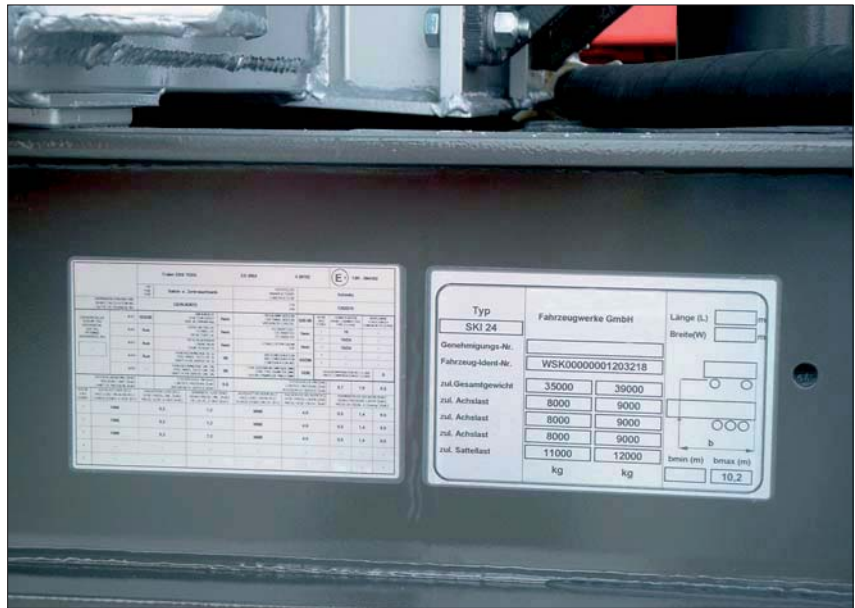

Type plate of an HGV trailer with protective laminate.

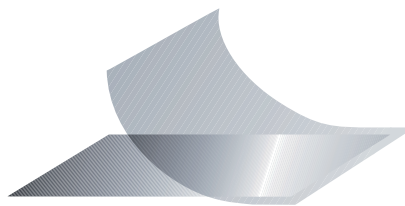

The printed silver type plate (Mat. 951A) is protected by the transparent laminate (Mat 951B).



Thermal Transfer Printer

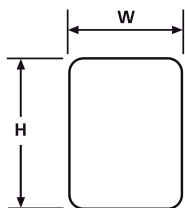

Material	Type 951, Polyester, silver (SR) and Polyester, transparent (CL)
Adhesive	Acrylic
Application	For automotive and electric industries for tamper proof applications. Particularly suitable as type label according to norms of German Kraftfahrtbundesamt (KBA).
Recommended Ribbon Type	TT822OUT
Operating Temperature	-40 °C to +150 °C
Curing Temperature	from +0 °C



Article-No.	Type	Colour	Width (W)	Height (H)	Width of Liner (WL)	Labels per Row	Pack Cont.
596-44951	TAG25.4-12.7TD1-951 SET	Silver (SR)	25.40	12.70	31.50	1	1000
596-43951	TAG50.8-25.4TD1-951 SET	Silver (SR)	50.80	25.40	56.80	1	1000
596-42951	TAG63.5-50.8TD1-951 SET	Silver (SR)	63.50	50.80	69.50	1	500
596-41951	TAG101-74TD1-951 SET	Silver (SR)	101.60	74.00	107.00	1	250
596-40951	TAG101-160TD1-951 SET	Silver (SR)	101.60	160.00	105.80	1	250

All dimensions in mm. Subject to technical changes.

Thermal transfer printer

- **TT4000+**

Features and Benefits

- Thermal transfer printer, premium class, for medium and high printing volumes
- Print head resolution: 300 dpi
- Very high print accuracy, consistency, speed, and power
- Perfect use for printing high definition graphics such as 2D barcodes, standard bar codes, numbers and text
- Print speeds up to 125mm per second (5" per second)
- Materials to print on: adhesive labels, thermo plastics such as heatshrink and TIPTAG markers

Accessories (optional)

- Perforator P4000
- Cutter S4000
- Tagprint Pro 2.0



For problem-free printing we recommend Tagprint Pro, page 203.



TT4000+ series printer.

Thermal Transfer Printers TT4000+ 300dpi, and TT420+	
Print Method	Thermal Transfer
Print Head Type	300 dpi, flat type
Print Speed	30, 40, 50, 75, 100, 125 mm/s
Max. Print Width	105.6 mm
Maximum Print Length	1000 mm
Printer Interfaces	Serial RS 232 C, USB 2.0, Ethernet 10/100 Base T, LPD, DHCP, FTP, SMTP, SNMP, NTP
Supported Barcodes, Printer	Standard, 2D
L x H x W	446 mm x 274 mm x 242 mm
Printer Memory	8 MB RAM
Weight (kg)	9 kg

Recommended Media	
Supported Consumables	Shrinkable Wire Markers Ladder Style – ShrinkTrak, TULT DS, TLFX DS; Continous shrinkable tubing – TULT, TCGT, TLFX
	Cable Bundle Tags Ladder Style – TIPTAG VA; Continous Tags – TIPTAG
	All Self-laminating Wire Markers Adhesive Labels – Helatag 320, 322, 323, 1209
	Complete Asset Labeling range Adhesive Labels – Helatag 271, 321, 917, 951, 823, 1203, 1204, 1205, 1206, 1207, 1208, 1210, 1211, 1212, 1213, 1216

Article-No.	Type
556-04000	TT4000+ 300dpi
556-04024	P4000 Perforator
556-04025	S4000 Cutter

Subject to technical changes.

Thermal transfer printer

• TT420+ Entry Level Printer

The thermal transfer technology is ideally suited for precise printing results of bar codes or graphical icons

Features and Benefits

- Thermal transfer printer, for low and medium printing volumes
- Lightweighting, solid housing, very easy to transport
- Print head resolution: 300 dpi
- Perfect use for printing standard bar codes, numbers and text
- Materials to print on: adhesive labels and ladder style pre-cut 3:1 heatshrink markers (ShrinkTrak) and TIPTAG markers



Thermal transfer printer (TT420+).

Thermal Transfer Printer TT420+

Print Method	Thermal Transfer
Print Head Type	300 dpi, flat type
Print Speed	up to 127 mm/sec.
Max. Print Width	106 mm
Maximum Print Length	1016 mm
Printer Interfaces	Serial- Parallel port, USB
Supported Barcodes, Printer	Standard and 2D
L x H x W	314 mm (L) x 188 (H) x 213 (W)
Printer Memory	8 MB RAM
Weight (kg)	2.8 kg

Recommended Media

Supported Consumables	<p>Shrinkable Wire Markers Ladder Style – ShrinkTrak; Continuous shrinkable tubing – TULT, TCGT, TLFX</p> <p>Cable Bundle Tags Ladder Style – TIPTAG VA; Continuous Tags – TIPTAG</p> <p>All Self-laminating Wire Markers Adhesive Labels – Helatag 320, 322, 323, 1209</p> <p>Complete Asset Labeling range Adhesive Labels – Helatag 271, 321, 917, 951, 823, 1203, 1204, 1205, 1206, 1207, 1208, 1210, 1211, 1212, 1213, 1216</p>
------------------------------	--

The thermal transfer technology is ideally suited for precise printing results of bar codes or graphical icons

Article-No.	Type
556-00420	TT420+

Thermal Printer Ribbons for adhesive labels

Features and Benefits

- Thermal transfer ribbons for highest quality and performance of printed markers
- The ribbons are specifically designed to maximise print performance for the recommended material (see below)



Ribbons for printing on labels.

Certifications please see Appendix.

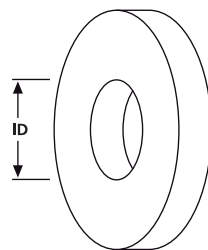

ID: The standard inside core diameter is 25.4 mm. Other sizes are available on request.

Article-No.	Type	Recommended Material	Colour	Dimensions of Spool	
				Width (W)	Length (L)
556-00111	TT822OUT 60MM	TIPTAG VA/823/951/1203/1204/1205/1206/1207/1208/1209/1210/1211/1212/1213	Black (BK)	60	300 m
556-00101	TT822OUT 110MM	TIPTAG VA/823/951/1203/1204/1205/1206/1207/1208/1209/1210/1211/1212/1213	Black (BK)	110	300 m
556-00117	TT932DOUT 85MM	320/322/323/1209	Black (BK)	85	300
556-00118	TT932DOUT 102MM	320/322/323/1209	Black (BK)	102	300
556-00139	TTDTHOUT 40MM	TIPTAG/TIPTAG PU/ShrinkTrak/TULT/TCGT/TLFX	Black (BK)	40	300
556-00140	TTDTHOUT 60MM	TIPTAG/TIPTAG PU/ShrinkTrak/TULT/TCGT/TLFX	Black (BK)	60	300
556-00114	TTRC+ 30MM	TIPTAG PU/ShrinkTrak/TULT/TCGT/TLFX	Black (BK)	30	300
556-00115	TTRC+ 60MM	TIPTAG PU/ShrinkTrak/TULT/TCGT/TLFX	Black (BK)	60	300
556-00125	TTRW 30MM	Black ShrinkTrak/TULT/TCGT	White (WH)	30	300
556-00137	TTRW 60MM	Black ShrinkTrak/TULT/TCGT	White (WH)	60	300

All dimensions in mm. Subject to technical changes.

Other ribbon qualities and colours on inquiry.

Thermal transfer printer accessories

• S4000 Cutter

Features and Benefits

- To cut printed tubing and continuous label material at a desired length
- The cutter automatically initialises each time the printer is powered on
- The cutter tray ensures the cut pieces are collected in one place
- The plug and play cutter is simply attached with one Allen screw



Cutter S4000 for both TT4000+ and TrakMark DS.



Perforator P4000 for both TT4000+ and TrakMark DS.

• P4000 Perforator

Features and Benefits

- To perforate printed tubing and continuous label material at a desired length
- Perforation depth can be adjusted to different thicknesses of the material
- Very useful accessory if tubings are printed with serial numbers
- Plug and play perforator is simply attached with one Allen screw



Article-No.	Type
556-04025	S4000 Cutter
556-04024	P4000 Perforator
556-03011	Cutter Tray for S4000

Labelling Software

• Tagprint Pro

Features and Benefits

Tagprint Pro label creation and printing software is powerful, multi-functional and extremely easy to use.

Used to provide solutions for industrial identification, Tagprint Pro speeds production and offers many options for a wide variety of labelling requirements.

“What You See Is What You Get” (WYSIWYG) label creation, bar coding, serialization, label sets, wire lists, graphics and text choices are just some capabilities of Tagprint Pro software.

Tagprint Pro's functionality and simplicity of use makes it a market leading label creation software package and the ideal program for your printing needs.

Tagprint Pro can be utilized with HellermannTyton's wide array of label options including laser, ink jet, dot matrix and thermal transfer printable labels.



Tagprint Pro Label Creation Software.

New Features for Version 2.0

- Alphanumeric sequences
- Print to multiple printers at one time
- “Print later” feature allows user to save jobs in queue and print all at one time
- Print faster
- Connect or import directly from other databases including Excel, Access, text files
- More bar code types
- Inverse, flip, and mirror image options for graphic images
- Multi-lingual
- Print log available
- Manually adjust font size to 1/10 of a point
- Customize height and width of characters
- Customize line spacing
- Compatible with all Tagprint Pro version 1.0 files
- And much more!

System Requirements

- IBM compatible PC
- Microsoft Windows 98SE, ME, NT 4.0, 2000, XP, Vista, Windows 7
- 128 MB of RAM (recommended)
- 60 MB of available hard-disk space

Article-No.	Type	Media	Pack Cont.
556-00049	TAGPRINTPRO Version 2.0 – Full	CD-ROM	1





Appendix 5

	Page
5.1 Abreviation table for material and colours	206
5.2 Degrees of protection (IP) according to DIN EN IEC 60529	207
5.3 HellermannTyton product standards	208
5.4 Numerical index	214
5.5 Alphanumerical index	219
5.6 General terms of conditons of sales	229

Abreviation table for material and colours

Abbreviation*	Material
ABS	Acrylonitrile Butadiene Styrene
ALU	Aluminium
AR	Acryl
CN	Cotton
CR	Chloroprene
EPDM	Ethylen-Propylen-Dien-Terpolymer-Rubber
FPM	Fluoroelastomer (Viton)
HIR	Polyamide 6.6 high impact modified
HIRHS	Polyamide 6.6 high impact modified, heat stabilised
HL	Halar
HS	Polyamide 6.6 heat stabilised
HSW	Polyamide 6.6, heat stabilised and UV resistant on request
HV	Helvin
IIR	Butyl rubber
PA	Polyamide
PA11	Polyamide 11
PA12	Polyamide 12
PA46	Polyamide 4.6
PA6/PA66	Polyamide 6.6
PA66MP	Polyamide 6.6 with metal particles
PAP	Paper
PC	Polycarbonate
PE	Polyethylene
PEEK	PolyEtherEtherKetone
PEN	Polyethylenaphtalat
PET	Polyester
POX	Polyolefin, cross-linked
PI	Polyimide
PK	Polyketone
PO	Polyolefin
POA	Elastomer modified
POM	Polyacetal
PP	Polypropylene
PPESB	Polyphenylenether, Polysterene
PPMOD	Polypropylene, modified
PPO	Noryl
PS	Polystyrene
PTFE	Polytetrafluoroethylene (Teflon)
PUR	Polyurethane
PVC	Polyvinylchloride
PVDF	Polyvinylidene fluoride
SI	Silicone
SP	Saturised Polyester
SS	Stainless Steel
ST	Steel
TPE	Thermoplastisc Elastomer
TPU	Thermoplastic Polyurethane
TZ	Ethylenterafluorineethylene (Tefzel)
VO	Polyamide 6.6 Flamability according to UL94V0
W	Polyamide 6.6 UV resistant

*according to EN ISO 1043 Part 1 and ISO 1629

Abbreviation*	Colour
BK	Black
BN	Brown
BU	Blue
GD	Gold
GN	Green
GNYE	Green-Yellow
GY	Grey
OG	Orange
PK	Pink
RD	Red
SR	Silver
VT	Violet
WH	White

*according to DIN IEC 757

Abbreviation*	Colour
CL	Transparent
NA	Natural
YE	Yellow
BE	Beige
XX	Special colour
BV	Zinc-plated Metal
GC	Brass chromated
WC	White Chromated

*according to HellermannTyton

Degrees of protection (IP) according to DIN EN IEC 60529

Definition of the degrees of protection according to DIN EN IEC 60529

The levels of protection are indicated by a code made up of two constant letters IP and two characteristic numbers for the degree of protection, e.g. IP54.

Example:

Code IP65

First index: — Protection against contact and ingress of foreign objects.













Second index: — Protection against liquids.

Degree of protection against access and foreign bodies			Degrees of protection for water		
First Index	Designation	Scope of protection	Second Index	Designation	Scope of protection
0	Non-protected	No special protection for persons against direct contact with live or moving parts. No protection of the equipment against ingress of solid foreign objects.	0	Non-protected	No special protection.
1	Protection against large foreign bodies	Protection against accidental contact of large areas with live and internal moving parts, e.g. back of hand, but not protection against deliberate access to the parts. Protection against ingress of solid foreign objects with a diameter greater than 50 mm.	1	Protection against vertically dripping water	Water dripping vertically must cause no damage.
2	Protection against medium-sized foreign bodies	Protection against contact between the finger and live or internal moving parts. Protection against ingress of solid foreign objects with a diameter greater than 12.5 mm.	2	Protection against dripping water (tilted)	Water dripping at an angle of 15° to the vertical from any direction must cause no damage.
3	Protection against small foreign bodies	Protection against contact between live or internal moving parts and tools, wires and the like with a thickness greater than 2.5 mm. Protection against ingress of solid foreign objects with a diameter greater than 2.5 mm.	3	Protection against spraying water	Water dripping at an angle of 60° to the vertical from any direction must cause no damage.
4	Protection against granular foreign objects	Protection against contact between live or internal moving parts and tools, wires and the like with a thickness greater than 1 mm. Protection against ingress of solid foreign objects with a diameter greater than 1 mm.	4	Protection against splashing water	Water that splashes against the equipment from any direction must cause no damage.
5	Protection against dust deposits	Complete protection against contact with live or internal moving parts, protection against hazardous dust deposits. The ingress of dust is not completely prevented, but dust may not penetrate in such quantities as to impair the function.	5	Protection against water jets	A water jet from a nozzle that is directed against the equipment from any direction must cause no damage.
6	Protection against dust entry	Complete protection against contact with live or internal moving parts. Protection against the ingress of dust.	6	Protection against flooding	Water must not penetrate the equipment in hazardous quantities in cases of temporary flooding, e.g. due to heavy seas.
			7	Protection during temporary immersion	Water must not penetrate the equipment in hazardous quantities if the equipment is immersed in water under the specified conditions of pressure and time (1m for 30 min.).
			8	Protection during continuous immersion	Water must not penetrate the equipment in hazardous quantities if the equipment is immersed in water (at least 2 bar for 2 h for HelaGuard IP68 non-metallic fittings and 5 bar for 5 h for HelaGuard IP68 metallic fittings.)
			9k	Protection against high pressure/steam jet cleaning	Highly pressurised water directed at the enclosure from any direction must cause no damage.

Standards Overview

CSA	Canadian Standards Association	Canada	
cUL	Canadian Underwriters Laboratories	Canada	
BV	Bureau Veritas	France	
DEF STAN	Defence Standard	Great Britain	
DNV	Det Norske Veritas	Norway	
E.D.F.	Electricité de France	France	
NF F	Norme Française Ferroviaire	France	
GL	Germanischer Lloyd	Germany	
LUL	London Underground Tested	Great Britain	
MIL	Military Specification	USA	
SAE - AMS	Society of Automotive Engineers - Aerospace Material Specifications	International	
EN IEC 61386	Elektroinstallationsrohrsysteme	International	
LR	Lloyd's Register	Great Britain	

Standards Overview

UL, UL224	Underwriters Laboratories (Yellow Card)	USA	
UR	Underwriters Laboratories Recognized Component	USA	
VDE	Verband der Elektrotechnik Elektronik Informationstechnik e.V.	Germany	
VG	Verteidigungsgerätenorm der Bundeswehr	Germany	
FIMKO	Soumalainen testaus- ja sertifiointiyritys	Finland	
DEMKO	Danske Elektriske Materialkontrol	Denmark	
NEMKO	Norges Elektriske Materiellkontroll	Norway	
SEMKO	Sveriges Elektriska Materielkontrol	Sweden	
KEMA KEUR	KEMA Quality B.V	The Netherlands	
cULus	Underwriters Laboratories	Canada, USA	
CEBEC	Comité Electrotechnique Belgic	Belgium	
ENEC	European Norms Electrical Certification	Europe	
DIN	Deutsches Institut für Normung	Germany	
PAN	Panvia Aircraft GmbH	Germany	

Standards for HellermannTyton Cable Ties

Type	Length	Width	UL/ UR	GL	BV	DNV	VG 95387 T04 PA66HS-Natur	VG 95387 T04 PA66W-Black	VG 95387 T04 PA66-Natural	SAE AS23190 (MIL MS 3367)	DIN EN 50146
T18S	83	2,3	● ¹	● ²		● ³			A106A	MS 3367-4 ²	● ⁴
T18R	100	2,5	● ¹	● ²	● ²	● ³	A201L	A106B	A106A	MS 3367-4 ²	● ⁴
T18RA	100	2,5	● ¹							MS 3367-4 ²	
T18ROS	100	2,5									● ⁴
T18I	140	2,5	● ¹		● ²	● ³					● ⁴
T18L	200	2,5	● ¹		● ²	● ³					● ⁴
T25L	240	2,8	● ¹	● ²	● ²						● ⁴
T25LL	330	2,8	● ¹	● ²	● ²						● ⁴
T30R	150	3,5	● ¹	● ²	● ²	● ³	A208L	A107B	A107A	MS 3367-5 ²	● ⁴
T30ROS	145	3,4									● ⁴
T30L	190	3,5	● ¹	● ²	● ²	● ³		A107B	A107A		● ⁴
T30LOS	200	3,4									● ⁴
T30LL	285	3,5	● ¹	● ²	● ²	● ³					● ⁴
T30LR	260	3,3			● ²						● ⁴
T40S	145	3,5									● ⁴
T40R	175	4,0	● ¹	● ²	● ²						● ⁴
T40I	290	4,0	● ¹								● ⁴
T40L	365	4,0	● ¹								● ⁴
T50S	150	4,6	● ¹	● ²	● ²	● ³					● ⁴
T50SOS	150	4,6									● ⁴
T50R	200	4,6	● ¹	● ²	● ²	● ³	A202L	A108B	A108A	MS 3367-1 ¹	● ⁴
T50ROS	200	4,6									● ⁴
T50RDH	200	4,6	● ¹		● ²						
T50MOS	245	4,6									● ⁴
T50I	300	4,6	● ¹	● ²	● ²	● ³	A203L	A109B	A109A	MS 3367-7 ²	● ⁴
T50IDH	300	4,6	● ¹								
T50L	390	4,6	● ¹	● ²	● ²	● ³	A205L	A110B	A110A	MS 3367-2 ¹	● ⁴
T50LOS	384	4,6									● ⁴
T50LDH	390	4,6	● ¹								
T50LL	445	4,6			● ²	● ³					● ⁴
T80R	210	4,7	● ¹	● ²	● ²		A202L				● ⁴
T80I	300	4,7	● ¹	● ²	● ²						
T80L	390	4,7	● ¹	● ²	● ²		A205L				
T120S	225	7,6	● ¹	● ²	● ²	● ³					● ⁴
T120I	300	7,6	● ¹		● ²						● ⁴
T120R	380	7,6	● ¹	● ²	● ²	● ³		A111B	A111A	MS 3367-3 ²	● ⁴
T120M	460	7,6		● ²	● ²	● ³					● ⁴
T120XM	600	7,6			● ²						● ⁴
T120L	760	7,6	● ¹		● ²	● ³		A112B	A112A	MS 3367-6 ²	● ⁴
T150R	365	7,6	● ¹	● ²	● ²		A204L				● ⁴
T150M	530	8,9	● ¹	● ²	● ²						● ⁴
T150L	820	8,9	● ¹	● ²	● ²						● ⁴
T150LL	925	8,9	● ¹		● ²						● ⁴
T150XL	1095	8,9	● ¹		● ²						● ⁴
T150XLL	1325	8,9	● ¹		● ²						● ⁴
T250S	225	12,5	● ¹		● ²						
T250R	520	12,5	● ¹		● ²						
T250M	565	12,5	● ¹		● ²						
T250I	725	12,5	● ¹		● ²						
T250L	880	12,5	● ¹		● ²						
T250XL	1030	12,5	● ¹								
T255S	225	12,5	● ¹								
T255R	520	12,5	● ¹								
T255M	565	12,5	● ¹								
LK2	120	4,8		● ²	● ²						
LK2A	270	4,6	● ¹	● ²	● ²	● ³					
LK5	535	13,2	● ¹	● ²							

Type	Length	Width	UL/UR	GL	BV	VG 95387 T04 PA66W-Black	VG 95387 T04 PA66-Natural	E.D.F.
PE180	180	9,0		● ²	● ²			HN-33-S-62/97
RPE275	275	9,0						HN-33-S-62/97
RPE350	350	9,0						HN-33-S-62/97
PE530	535	9,0			● ²			HN-33-S-62/97
LPH175	175	9,0			● ²			
LPH275	100	2,5			● ²			
LPH350	100	2,5			● ²			
CTT20R	100	2,5	● ¹					
CTT60R	205	4,7	● ¹					
LRT230	230	7,6			● ³			
RLT120	340	7,6		● ²	● ²			
RLT150	770	8,9		● ²	● ²			
REL100	100	6,5	● ¹					
REL140	140	7,5	● ¹					
REL250	250	7,5	● ¹					
RT40R	217	3,9	● ¹					
RELK2R	200	4,6			● ²			
RELK2M	250	4,6			● ²			
RELK2I	300	4,6			● ²			
RELK2L	350	4,6			● ²			
RT50R	140	8,6	● ¹					
RT50S	165	4,6	● ¹					
RT250S	230	12,5	● ¹		● ²			
RT250R	516	12,5	● ¹		● ²			
RT250M	570	12,5	● ¹		● ²			
RT250I	729	12,5	● ¹					
RT250L	878	12,5	● ¹					
RT250XL	1025	12,5	● ¹					
T18MR	110	2,3	● ¹			B001B	B001A	
IT18R	102	2,3	● ¹					
IT18FL	111	2,3	● ¹					
T30MR	160	3,5	● ¹			B002B	B002A	
T30RSF	165	3,5	● ¹					
IT50RT	203	4,7	● ¹					
IT50L	381	4,7	● ¹					
T50ML	400	4,6	● ¹					
T50MR	215	4,6	● ¹			B004B	B004A	
T50MS	160	4,6	● ¹					
IT50R	203	4,7	● ¹					
T50RSF	216	4,6	● ¹					
T120MR	400	7,6	● ¹			B005B	B005A	
KR6/18	180	6,0		● ²				
KR6/35	350	6,0		● ²				
KR8/21	210	8,0		● ²				
KR8/33	330	8,0		● ²				

¹ Polyamide 6.6 (PA66), Polyamid 6.6 UV Resistant (W) black

² Polyamide 6.6 (PA66) natural, Polyamid 6.6 UV Resistant (W) black

³ Polyamide 6.6 (PA66) natural, Polyamide 6.6 Heat stabilised (HS) natural, Polyamide 6.6 UV Resistant (W) black

⁴ Polyamide 6.6 (PA66), Polyamid 6.6 Heat stabilised (HS) all colours and Polyamide UV Resistant (W)

Subject to changes.

HellermannTyton UL-File Nr.:

E 64 13 9

E 64 96 2

E 64 96 3

E 65 34 4

E 85 31 9

E 19 38 18

HellermannTyton product standards

Type	Length	Width	GL	BV	DNV	DEF STAN
MAT8SS7	230	7.0	● ⁷	● ⁷		
MAT12SS7	330	7.0	● ⁷	● ⁷		
MAT16SS7	430	7.0	● ⁷	● ⁷		
MAT24SS7	630	7.0	● ⁷	● ⁷		
MAT8SS12	230	12.0	● ⁷	● ⁷		
MAT12SS12	330	12.0	● ⁷	● ⁷		
MAT16SS12	430	12.0	● ⁷	● ⁷		
MAT24SS12	630	12.0	● ⁷	● ⁷		
MAT8SSC7	230	7.0	● ⁶			
MAT12SSC7	330	7.0	● ⁶			
MAT16SSC7	430	7.0	● ⁶			
MAT24SSC7	630	7.0	● ⁶			
MAT8SSC12	230	12.0	● ⁶			
MAT12SSC12	330	12.0	● ⁶			
MAT16SSC12	430	12.0	● ⁶			
MAT24SSC12	630	12.0	● ⁶			
MBT5S	127	4.6	● ⁷	● ⁷	● ⁷	
MBT8S	201	4.6	● ⁷	● ⁷	● ⁷	
MBT14S	362	4.6	● ⁷	● ⁷	● ⁷	
MBT20S	521	4.6	● ⁷	● ⁷	● ⁷	
MBT27S	681	4.6	● ⁷	● ⁷	● ⁷	
MBT33S	838	4.6	● ⁷	● ⁷	● ⁷	
MBT8H	201	7.9	● ⁷	● ⁷	● ⁷	
MBT14H	362	7.9	● ⁷	● ⁷	● ⁷	
MBT20H	521	7.9	● ⁷	● ⁷	● ⁷	
MBT27H	681	7.9	● ⁷	● ⁷	● ⁷	
MBT33H	838	7.9	● ⁷	● ⁷	● ⁷	
MBT14XH	362	12.3	● ⁷	● ⁷		
MBT20XH	521	12.3	● ⁷	● ⁷		
MBT27XH	681	12.3	● ⁷	● ⁷		
MBT33XH	838	12.3	● ⁷	● ⁷		
MLT8SS5	230	5.0		● ⁷		
MLT12SS5	330	5.0		● ⁷		
MLT16SS5	430	5.0		● ⁷		
MLT24SS5	630	5.0		● ⁷		
MLT8SS10	230	10.0		● ⁷		
MLT12SS10	330	10.0		● ⁷		
MLT16SS10	430	10.0		● ⁷		
MLT24SS10	630	10.0		● ⁷		
Protective Channel LFPC70	–	7.0				61-12/31
Protective Channel LFPC103	–	10.3				61-12/31
Protective Channel LFPC150	–	15.0				61-12/31

⁶ Stainless Steel Type 316 coated

⁷ Stainless Steel Type 316 uncoated

Subject to changes.

HellermannTyton UL-File Nr.:

E 14 35 29 E 19 80 23
E 19 80 24 E 20 40 71

Standards for HellermannTyton Heat Shrinkable Tubing

Type	UL224 AFT	UL224 VW1	CSA	MIL/SAE - AMS	VG 95343 T05	DEF STAN	LUL	NF F 00-608
TF21		●	●					●
TF31		●	●					
TF24				DTL-23053/5	●	●		
TCN20	●							
Viton®-E					●			
EPS-400				DTL-23053/4				
EPS-300				DTL-23053/4				
TK20		●		DTL-23053/8	●			
TK29		●						
TFE2								
TFE4								
TR27						59-97/3	E1042:A6	

Standards for HellermannTyton Cable Protection

Type	UR	FMVSS 302	UL94	NF F 16-101	DIN 5510-2	DIN VDE 0879-2
Helagaine HEGP		●	V2		●	
Helagaine HEGPX	●	●	V2		●	
Helagaine HEGPV0		●	V0	●	●	
Helagaine HEGPV0X	●	●	V0	●	●	
Helagaine HEGPA66		●	V2	●	●	
Helagaine HEGEMIP		●	V2			●
Helagaine HEGEMIPV0		●	V0			●
Helagaine HEGPL		●	V2			
HELAHOOK		●	V2	●		

Standards for HellermannTyton Identification Systems

Type	UL/UR	CSA	LUL
IT Ties	●		
Helatag Thermotransfer, Material 951	●		
Helatag Thermotransfer, Material 1204	●		
Helatag Thermotransfer, Material 1206	●		
TULT	●	●	
TIPTAG			RSE STD 013

Standards for HellermannTyton Application Tooling

Type	MIL	VG
MK7 Application Tool for Cable Ties	MS 90387-1	VG 95387-105
MK9 Application Tool for Cable Ties	MS 90387-2	VG 95387-105

Type 061-20186 - EC45

Type	Article-No.	Page	Type	Article-No.	Page	Type	Article-No.	Page	Type	Article-No.	Page
061-20186	122-68019	133	ABR.2-Z	501-02264	190	ABR.5-2	501-05624	191	CC-PAEK5FT6.5PT1.7-2.3	151-00840	105
061-20815	110-06026	128	ABR.3-+	501-03274	190	ABR.5-3	501-05634	191	CCEC3.0TP	151-00611	108
061-21077	122-80032	133	ABR.3--	501-03284	190	ABR.5-4	501-05644	191	CCFT6LG	151-00785	105
064-00101	110-30101	130	ABR.3-0	501-03604	190	ABR.5-5	501-05654	191	CCFT6XLG	151-00786	105
069-00221	110-09511	129	ABR.3-1	501-03614	190	ABR.5-6	501-05664	191	CCISFT6.5x13	151-00620	107
069-05114	110-95011	134	ABR.3-2	501-03624	190	ABR.5-7	501-05674	191	CCSFT6.5	151-00775	105
ABR.1-+	501-01274	190	ABR.3-3	501-03634	190	ABR.5-8	501-05684	191	CCSFT7x12	151-00194	106
ABR.1--	501-01284	190	ABR.3-4	501-03644	190	ABR.5-9	501-05694	191	CCSFT7x12	151-00595	106
ABR.1-0	501-01604	190	ABR.3-5	501-03654	190	ABR.5-A	501-05014	191	CCSFT7x12	151-00222	106
ABR.1-1	501-01614	190	ABR.3-6	501-03664	190	ABR.5-B	501-05024	191	CGS1	151-00006	115
ABR.1-2	501-01624	190	ABR.3-7	501-03674	190	ABR.5-C	501-05034	191	CH20D6	151-00077	83
ABR.1-3	501-01634	190	ABR.3-8	501-03684	190	ABR.5-D	501-05044	191	CH20D7	151-02600	83
ABR.1-4	501-01644	190	ABR.3-9	501-03694	190	ABR.5-E	501-05054	191	CHA1	150-08110	82
ABR.1-5	501-01654	190	ABR.3-A	501-03014	190	ABR.5-F	501-05064	191	CHA2	151-02901	82
ABR.1-6	501-01664	190	ABR.3-B	501-03024	190	ABR.5-G	501-05074	191	CONNECTOR CLIP	150-41397	90
ABR.1-7	501-01674	190	ABR.3-C	501-03034	190	ABR.5-H	501-05084	191	CONNECTOR-CLIP EC6	150-92600	108
ABR.1-8	501-01684	190	ABR.3-D	501-03044	190	ABR.5-I	501-05094	191	COW20DP7	151-03100	86
ABR.1-9	501-01694	190	ABR.3-E	501-03054	190	ABR.5-J	501-05104	191	COW30DP7	151-03200	86
ABR.1-A	501-01014	190	ABR.3-F	501-03064	190	ABR.5-K	501-05114	191	CP2FT6	151-00216	105
ABR.1-B	501-01024	190	ABR.3-G	501-03074	190	ABR.5-L	501-05124	191	CP3FT6	151-00163	105
ABR.1-C	501-01034	190	ABR.3-H	501-03084	190	ABR.5-M	501-05134	191	CP6FT6	151-00162	105
ABR.1-D	501-01044	190	ABR.3-I	501-03094	190	ABR.5-N	501-05144	191	CP21DOP	151-00465	106
ABR.1-E	501-01054	190	ABR.3-J	501-03104	190	ABR.5-O	501-05154	191	CP31DOP	151-00214	106
ABR.1-F	501-01064	190	ABR.3-K	501-03114	190	ABR.5-P	501-05164	191	CP61DOP	151-00466	106
ABR.1-G	501-01074	190	ABR.3-L	501-03124	190	ABR.5-Q	501-05174	191	CT375	132-37540	35
ABR.1-H	501-01084	190	ABR.3-M	501-03134	190	ABR.5-R	501-05184	191	CTC4.5FT6LG	151-14314	98
ABR.1-I	501-01094	190	ABR.3-N	501-03144	190	ABR.5-S	501-05194	191	CTC4.5SB56	151-00700	99
ABR.1-J	501-01104	190	ABR.3-O	501-03154	190	ABR.5-T	501-05204	191	CTC7.5FT6LG	151-14313	98
ABR.1-K	501-01114	190	ABR.3-P	501-03164	190	ABR.5-U	501-05214	191	CTC7.5FT9	155-31602	98
ABR.1-L	501-01124	190	ABR.3-Q	501-03174	190	ABR.5-V	501-05224	191	CTC7.5SB56	151-00701	99
ABR.1-M	501-01134	190	ABR.3-R	501-03184	190	ABR.5-W	501-05234	191	CTC8.5FT6	151-00794	98
ABR.1-N	501-01144	190	ABR.3-S	501-03194	190	ABR.5-X	501-05244	191	CTC10FT6	151-14311	98
ABR.1-O	501-01154	190	ABR.3-T	501-03204	190	ABR.5-Y	501-05254	191	CTC10FT6LG	151-00018	98
ABR.1-P	501-01164	190	ABR.3-U	501-03214	190	ABR.5-Z	501-05264	191	CTC10FT9	155-17801	98
ABR.1-Q	501-01174	190	ABR.3-V	501-03224	190	AHC1AH	151-00366	94	CTC10SB56	151-00702	99
ABR.1-R	501-01184	190	ABR.3-W	501-03234	190	AHC2AH	151-00367	94	CTC13FT6	151-14312	98
ABR.1-S	501-01194	190	ABR.3-X	501-03244	190	AHC2BH	151-00208	94	CTC13FT6LG	151-00019	98
ABR.1-T	501-01204	190	ABR.3-Y	501-03254	190	AHC2SS	151-00368	94	CTC13SB56	151-00703	99
ABR.1-U	501-01214	190	ABR.3-Z	501-03264	190	AHC3BHR	151-00370	94	CTC17SB56	151-00010	99
ABR.1-V	501-01224	190	ABR.4+	501-04274	191	AHC3CHR	151-00371	94	CTC22FT9	155-25201	98
ABR.1-W	501-01234	190	ABR.4--	501-04284	191	AHC3DH	151-00181	94	CTCFT6	151-00783	98
ABR.1-X	501-01244	190	ABR.4-0	501-04604	191	AHC3EH2	151-00928	94	CTCLPROFILE	151-00026	97
ABR.1-Y	501-01254	190	ABR.4-1	501-04614	191	AHC3S5B	151-00373	94	CIT20R	112-51919	28
ABR.1-Z	501-01264	190	ABR.4-2	501-04624	191	AHC4AH	151-00374	94	CIT20R	112-51960	28
ABR.2+	501-02274	190	ABR.4-3	501-04634	191	ASN2-22	191-02220	140	CIT60R	112-56060	28
ABR.2--	501-02284	190	ABR.4-4	501-04644	191	ASN24-70	191-24700	140	CIT60R	112-56019	28
ABR.2-0	501-02604	190	ABR.4-5	501-04654	191	ATSB2CKSFT6,5	102-69068	81	CUTTER TRAY FOR S4000	556-03011	202
ABR.2-1	501-02614	190	ABR.4-6	501-04664	191	ATSBCEC35	102-68355	89, 124	CUTties-1	110-05000	135
ABR.2-2	501-02624	190	ABR.4-7	501-04674	191	ATSBCEC36	102-68365	89	CUTties-3	110-05001	135
ABR.2-3	501-02634	190	ABR.4-8	501-04684	191	ATSBCEC37	102-68375	89	CUTties-5	110-05002	135
ABR.2-4	501-02644	190	ABR.4-9	501-04694	191	ATSBCTF6LG	102-67065	84, 124	Closures Black ATS3080	102-66210	119
ABR.2-5	501-02654	190	ABR.4-A	501-04014	191	ATSBCTF6,5S	102-69067	81, 124	Closures Natural ATS3080	102-66209	119
ABR.2-6	501-02664	190	ABR.4-B	501-04024	191	ATSBCTF6.5	102-69066	81, 124	Compressed-air hose	110-30002	130
ABR.2-7	501-02674	190	ABR.4-C	501-04034	191	ATSBCTF6.5-MD	102-69065	81, 124	Control Box	120-00060	122
ABR.2-8	501-02684	190	ABR.4-D	501-04044	191	Autotool 2000	120-00000	122	Cover Plug 20	151-00343	103
ABR.2-9	501-02694	190	ABR.4-E	501-04054	191	Autotool System 3080	102-00000	118	Cover Plug 20x50	151-00342	103
ABR.2-A	501-02014	190	ABR.4-F	501-04064	191	BC-SCR6	156-00390	88	Cover Plug 32	151-00424	103
ABR.2-B	501-02024	190	ABR.4-G	501-04074	191	BC30	151-00016	88	DCT9	115-00034	66
ABR.2-C	501-02034	190	ABR.4-H	501-04084	191	BC2212	151-00017	88	DCT11	115-00033	66
ABR.2-D	501-02044	190	ABR.4-I	501-04094	191	BCFT6XL56	151-00662	84	DE863220	132-00200	35
ABR.2-E	501-02054	190	ABR.4-J	501-04104	191	BCFT63x100S	151-00759	85	DSWS4	151-06500	114
ABR.2-F	501-02064	190	ABR.4-K	501-04114	191	BCOSS	151-00664	87	DSWS5	151-06502	114
ABR.2-G	501-02074	190	ABR.4-L	501-04124	191	BCOWFT5	151-00904	84	E4500	391-90002	138
ABR.2-H	501-02084	190	ABR.4-M	501-04134	191	BCOWFT6M	151-00790	84	EC JAE CC	151-00472	108
ABR.2-I	501-02094	190	ABR.4-N	501-04144	191	BCTF6.5 16-3	151-00431	81	EC6mod	151-00464	108
ABR.2-J	501-02104	190	ABR.4-O	501-04154	191	BCTF6.5 16-3MD	155-11601	81	EC11	155-40602	108
ABR.2-K	501-02114	190	ABR.4-P	501-04164	191	BCUW55-D5-25	151-00851	87	EC14	151-03404	89
ABR.2-L	501-02124	190	ABR.4-Q	501-04174	191	BHT375	150-37595	35	EC15	151-03401	89
ABR.2-M	501-02134	190	ABR.4-R	501-04184	191	BHT375M	150-47595	35	EC16	151-03402	89
ABR.2-N	501-02144	190	ABR.4-S	501-04194	191	BIG CONNECTOR CLIP	150-54498	105	EC17	151-00819	89
ABR.2-O	501-02154	190	ABR.4-T	501-04204	191	Bench Mount Kit	120-00040	122	EC17	151-03403	89
ABR.2-P	501-02164	190	ABR.4-U	501-04214	191	Bench Mount Kit Flexible	102-00040	118	EC27	151-00161	96
ABR.2-Q	501-02174	190	ABR.4-V	501-04224	191	Bench Mount Kit for Automation	102-00042	118	EC28	151-00151	108
ABR.2-R	501-02184	190	ABR.4-W	501-04234	191	Bench mount kit fixed	102-00043	118	EC30	151-00022	89
ABR.2-S	501-02194	190	ABR.4-X	501-04244	191	Big YCC TS	151-00235	104	EC32	151-00173	108
ABR.2-T	501-02204	190	ABR.4-Y	501-04254	191	Bracket brake line	148-00100	76	EC33	151-00192	108
ABR.2-U	501-02214	190	ABR.4-Z	501-04264	191	Bracket brake line	148-00101	76	EC39	151-00174	96
ABR.2-V	501-02224	190	ABR.5+	501-05274	191	CBT30MR	156-00049	74	EC41	151-00234	96
ABR.2-W	501-02234	190	ABR.5--	501-05284	191	CBTO50R	156-01601	74	EC42	151-00429	108
ABR.2-X	501-02244	190	ABR.5-0	501-05604	191	CBTOS50RSTUD5	156-00380	74	EC43	151-00430	108
ABR.2-Y	501-02254	190	ABR.5-1	501-05614	191				EC45	151-00460	108

Type ECC1CPT - NA01PRONG

Type	Article-No.	Page	Type	Article-No.	Page	Type	Article-No.	Page	Type	Article-No.	Page
ECC1CPT	151-00499	108	HEGPA6640	170-44000	169	KR6/35	121-63519	33	MBT145S	111-93148	37
EPS-300-3/1	340-03010	158	HEGPA6650	170-45000	169	KR8/21	121-82160	33	MBT14UH	111-01301	38
EPS-300-6/2	340-06020	158	HEGPA6660	170-46000	169	KR8/21	121-82119	33	MBT14XH	111-95149	38
EPS-300-9/3	340-09030	158	HEGPL03	170-80503	173	KR8/21	121-82155	33	MBT14XHFC	111-00299	40
EPS-300-12/4	340-12040	158	HEGPL06	170-80506	173	KR8/33	121-83319	33	MBT14XHS	111-95148	37
EPS-300-19/6	340-19060	158	HEGPL12	170-80512	173	KR8/33	121-83360	33	MBT20H	111-94209	38
EPS-300-24/8	340-24080	158	HEGPL20	170-80520	173	KR8/33	121-83355	33	MBT20HFC	111-00296	40
EPS-300-40/13	340-40130	158	HEGPL30	170-80530	173	KR8/33	121-83378	33	MBT20HS	111-94208	37
EPS-400-4/1	341-04010	158	HEGPL40	170-80540	173	KR8/33	121-83380	33	MBT20S	111-93209	38
EPS-400-8/2	341-08020	158	HEGPL50	170-80550	173	KR8/43	121-74360	33	MBT20SFC	111-00291	40
EPS-400-12/3	341-12030	158	HEGPO03	170-50030	168	KR8/43	121-74359	33	MBT20SH	111-93208	37
EPS-400-16/4	341-16040	158	HEGPO06	170-50060	168	KR8/50	121-05019	34	MBT20SH	111-01302	38
EPS-400-24/6	341-24060	158	HEGPO09	170-50090	168	KR8/50	121-05051	34	MBT20XH	111-95209	38
EPS-400-32/8	341-32080	158	HEGPOX12	170-50120	168	KR8/50	121-05060	34	MBT20XHFC	111-00300	40
Edge-Clip25	133-00075	108	HEGPOX20	170-50200	168	KR8/60	121-06060	34	MBT20XHS	111-95208	37
FBB100M	150-29100	65	HEGPOX30	170-50300	168	KR8/60	121-06019	34	MBT27H	111-94279	38
FBB140	150-28140	65	HEGPOX40	170-50400	168	KR8/70	121-07019	34	MBT27HFC	111-00297	40
FBB140M	150-29140	65	HEGPOX50	170-50500	168	KR8/70	121-07060	34	MBT27HS	111-94278	37
FBB185M	150-29180	65	HEGPO04	170-30400	167	KR8/80	121-08019	34	MBT27S	111-93279	38
FBS100	150-26100	49	HEGPO06	170-30600	167	KR8/80	121-08060	34	MBT27SFC	111-00292	40
FBS185	150-26180	49	HEGPO08	170-30800	167	KR8/100	121-10019	34	MBT27SS	111-93278	37
FT6LG.JAE.CONNECT.TS	151-00459	104	HEGPO12	170-31200	167	KR8/100	121-10060	34	MBT27UH	111-01303	38
FT6LG.M.STECKERAUFN.	155-18901	104	HEGPO15	170-31500	167	KR8/110	121-11060	34	MBT27UHD	111-01312	39
FT6LG.M.St.Aufn.II	155-32602	104	HEGPO20	170-32000	167	KR8/110	121-11051	34	MBT27XH	111-95279	38
FT6LG.YAZ.Connect.TS	155-30702	104	HEGPO30	170-33000	167	KR8/120	121-12019	34	MBT27XHFC	111-01307	39
FT65-Y-C.ONN-TS	155-43702	104	HEGPO40	170-34000	167	KR8/150	121-15019	34	MBT27XHFC	111-00301	40
FT220DP7	150-01700	56	HEGPO50	170-35000	167	KR8/C5	121-58560	34	MBT27XHS	111-95278	37
H5002	391-50200	137	HEGPO06	170-00600	166	KR8/C5	121-58551	34	MBT33H	111-94339	38
H5004	391-50400	137	HEGPO09	170-00900	166	KR8/S1	121-98151	34	MBT33HFC	111-00298	40
HC48FT6	151-00680	91	HEGPIX12	170-00120	166	KR8/S1	121-98160	34	MBT33HS	111-94338	37
HCCEC3.OSP-C	151-00610	96	HEGPIX20	170-00200	166	KR8PNSE	121-00889	133	MBT33S	111-93339	38
HDM19	151-00134	112	HEGPIX30	170-00300	166	KSF16.5 OC 7-9	151-00674	91	MBT33SFC	111-00293	40
HDM25	151-00437	112	HEGPIX40	170-00400	166	KSF16.5OC1-3	151-00673	91	MBT33SS	111-93338	37
HDM312	151-00439	112	HEGSA504	170-60401	170	KST-STG200	110-09950	134	MBT33UH	111-01304	38
HDM320	151-07000	112	HEGSA506	170-60600	170	LFC155	131-60070	63	MBT33UHD	111-01313	39
HDM321	151-07100	112	HEGSA509	170-60900	170	LFC165(PSA)	155-34202	63	MBT33XH	111-95339	38
HDM375BDM4W	151-00756	112	HEGSA512	170-61200	170	LFC165-2	157-00047	63	MBT33XHFC	111-01308	39
HDM400	151-07200	112	HEGSA515	170-61500	170	LFC70	111-93000	43	MBT33XHFC	111-00302	40
HDM401	151-00442	112	HEGSA520	170-62000	170	LFC83	111-00257	43	MBT33XHS	111-95338	37
HDM500	151-07400	112	HEGSA530	170-63000	170	LFC103	111-94000	43	MBT43UH	111-01305	38
HDM501	151-07500	112	HEGSA540	170-64000	170	LFC129	111-00253	43	MBT43UHD	111-01314	39
HEGEMIP04	173-00400	171	HELAHOOK10	170-05100	174	LFC132	111-00254	43	MBT43XH	111-01309	39
HEGEMIP06	173-00600	171	HELAHOOK15	170-05150	174	LFC150	111-95000	43	MBT49UH	111-01306	38
HEGEMIP08	173-00800	171	HELAHOOK20	170-05200	174	LFC163	111-00255	43	MBT49UHD	111-01315	39
HEGEMIP10	173-01000	171	HELAHOOK25	170-05250	174	LRJ1	151-08101	81	MBT49XHD	111-01310	39
HEGEMIP12	173-01200	171	HELAHOOK30	170-05300	174	Lock cap tensioning knob	110-07200	131	MBT60UH	111-01316	39
HEGEMIP14	173-01400	171	HH20	120-00080	122	MAT8SS7	111-92080	42	MBT60XHD	111-01311	39
HEGEMIP16	173-01600	171	HSG0	170-99001	141	MAT8SS12	111-93080	42	MK3PNSP2	110-03400	130
HEGEMIP18	173-01800	171	HT120R	112-00100	28	MAT8SSC7	111-92004	42	MK3SP	110-03500	127
HEGEMIP20	173-02000	171	Halter SFT6.5	133-00067	81	MAT8SSC12	111-92002	42	MK6	110-06000	128
HEGEMIPV004	173-60400	172	Horizontal Bench Mount Kit	102-00041	118	MAT12SS7	111-92120	42	MK7	110-07500	127
HEGEMIPV006	173-60600	172	IAHC1T	151-00223	95	MAT12SS12	111-93120	42	MK7HT	110-07000	128
HEGEMIPV008	173-60800	172	IAHC2T	151-00199	95	MAT12SSC7	111-96120	42	MK7P	110-07100	131
HEGEMIPV010	173-61000	172	IAHC3AH	151-00378	95	MAT12SSC12	111-92122	42	MK9	110-09500	129
HEGEMIPV012	173-61200	172	IAHC3CH	151-00381	95	MAT16SS7	111-92160	42	MK9HT	110-09000	129
HEGEMIPV014	173-61400	172	IAHC3EH	151-00489	95	MAT16SS12	111-93160	42	MK9P	110-09110	132
HEGEMIPV016	173-61600	172	IAHC3T	151-00213	95	MAT16SSC7	111-92162	42	MK9P	110-09100	132
HEGEMIPV018	173-61800	172	IAHC4AH	151-00382	95	MAT16SSC12	111-92163	42	MK9SST	110-95000	134
HEGEMIPV020	173-62000	172	IAHC4CH	151-00383	95	MAT24SS7	111-92240	42	MLT8SS5	111-94080	41
HEGP03	170-10300	165	IAHC4T	151-00207	95	MAT24SS12	111-93240	42	MLT8SS10	111-95080	41
HEGP04	170-10400	165	IAHC5BH	151-00384	95	MAT24SSC7	111-92200	42	MLT8SSC5	111-91000	41
HEGP05	170-10500	165	IAHC5FH	151-00787	95	MAT24SSC12	111-92201	42	MLT8SSC10	111-91001	41
HEGP06	170-10600	165	IAHC5T	151-00195	95	MB3APT	151-00514	110	MLT12SS5	111-94120	41
HEGP08	170-10800	165	IPC5P	151-00870	93	MB3APT	151-00432	110	MLT12SS10	111-95120	41
HEGP10	170-11000	165	IPC10AH	151-00096	93	MB4APT	151-00587	110	MLT12SSC5	111-91121	41
HEGP12	170-11200	165	IPC10P	151-14400	93	MB4APT	151-00433	110	MLT12SSC10	111-91123	41
HEGP15	170-11500	165	IPC13AH	151-14130	93	MB5APT	151-00434	110	MLT16SS5	111-94161	41
HEGP20	170-12000	165	IPC13P	151-14132	93	MBT5S	111-93059	38	MLT16SS10	111-91300	41
HEGP25	170-12500	165	IPC15AH	151-14500	93	MBT5SFC	111-00288	40	MLT16SSC5	111-91161	41
HEGP30	170-13000	165	IPC15P	151-14502	93	MBT5SS	111-93058	37	MLT16SSC10	111-91163	41
HEGP40	170-14000	165	IPC23AH	151-14601	93	MBT8H	111-94089	38	MLT24SS5	111-91400	41
HEGP50	170-15000	165	IPC23P	151-14603	93	MBT8HFC	111-00294	40	MLT24SS10	111-95241	41
HEGPA6604	170-40400	169	IT18FL	111-81919	192	MBT8HS	111-94088	37	MLT24SSC5	111-91180	41
HEGPA6606	170-40600	169	IT18R	111-81821	192	MBT8S	111-93089	38	MLT24SSC10	111-91181	41
HEGPA6608	170-40800	169	ITS0L	111-85319	192	MBT8SFC	111-00289	40	MSBT120	151-29301	115
HEGPA6610	170-41000	169	ITS0R	111-85019	192	MBT8SS	111-93088	37	MSNP1-70	191-01700	140
HEGPA6612	170-41200	169	ITS0RD	111-85219	192	MBT14H	111-94149	38	MTT4	110-04000	134
HEGPA6616	170-41600	169	ITS0RT	111-85119	192	MBT14HFC	111-00295	40	NA01	621-10001	139
HEGPA6620	170-42000	169	KR6/8	121-00680	133	MBT14HS	111-94148	37	NA1K3	621-10103	139
HEGPA6625	170-42500	169	KR6/35	121-63555	33	MBT14S	111-93149	38	NA1K3PRONG	621-60103	139
HEGPA6630	170-43000	169	KR6/35	121-63560	33	MBT14SFC	111-00290	40	NA01PRONG	621-60001	139

Type NA45 - T50SOSAH7X12U

Type	Article-No.	Page	Type	Article-No.	Page	Type	Article-No.	Page	Type	Article-No.	Page
NA45	621-10405	139	SNP16(E)	191-10169	101	T30RECSA	156-00003	72	T50ROC19-24.5CBTO-SD-SET	156-00422	78
NA45PRONG	621-60405	139	SNP18(E)	191-10189	101	T30RFT5	150-55850	58	T50ROS	118-05040	30
NA810	621-10810	139	SNP18A	190-00258	101	T30RFT5	150-55948	58	T50ROS	118-05059	30
NA810PRONG	621-60810	139	SNP19	190-00090	101	T30RFT6	150-77950	58	T50ROS	118-05078	30
OCTC1	151-00447	81	SNP20(E)	191-10209	101	T30RFT6LG	150-31090	59	T50ROS-EC2,5	150-45299	75
OCTCSFT6.5	151-00021	97	SNP22	192-10220	101	T30RFT6SD	150-52690	58	T50ROS-SFT6.5 16-3	150-37791	54
OPEN PLUG 34.6x112	151-00394	103	SNP22(E)	191-10229	101	T30ROC1A	156-00012	78	T50ROSAH7X12U	126-00120	46
Open Plug 42x84	151-00391	103	SNP24	192-10240	101	T30ROC1B	156-00505	78	T50ROSDBS5	150-56199	69
Open Plug 55x70	151-00392	103	SNP24(E)	191-10249	101	T30ROC2A	156-00013	78	T50ROSEC4A	150-76099	72
Overhead Dispenser	102-00050	118	SNP28	190-00127	101	T30ROC2A	156-00014	78	T50ROSEC4A-W	156-00570	72
Overhead Dispenser Lowering	102-00052	118	SNP32	192-10320	101	T30ROC2B	156-00470	78	T50ROSEC4B	150-76079	72
Overhead Suspender	120-00050	122	SNP32(E)	191-10329	101	T30ROS	118-00064	30	T50ROSEC5A	150-40591	72
P445	391-90101	138	SNP34(E)	191-10349	101	T30ROS	118-04800	30	T50ROSEC5B	150-40581	72
P4000 Perforator	556-04024199, 202		SNP36	192-10360	101	T30RSB5	150-10140	67	T50ROSEC9	156-05903	72
PC5DP7L	151-14801	92	SNP36(E)	191-10369	101	T30RSB5H5	150-16941	68	T50ROSEC10	156-05904	72
PC5DP7S	151-00119	92	SNP38	192-10380	101	T30RSB5S	150-21290	68	T50ROSEC19	156-04602	73
PC23	151-14300	92	SNP38(E)	191-10389	101	T30RSF(U)	111-85603	52	T50ROSEC20	156-00020	73
PC35LAH	151-14700	92	SNP42(E)	191-10429	101	T30RSF(U)	111-85610	52	T50ROSEC21	156-00010	72
PLUG 5Q8x8	151-00415	102	SNP42N	191-00005	101	T40R	111-03970	25	T50ROSEC22	156-00011	72
PLUGS WITH OPENING	151-00419	102	SNP46(E)	191-10469	101	T40R	111-03859	24	T50ROSEC23	156-00576	72
PLUG5.5	151-00399	102	SNP50	192-10500	101	T40R	111-03860	26	T50ROSEC23	156-00006	73
PLUG5.5	151-00401	102	SNP50(E)	191-10509	101	T40RFT8GSD	156-00104	59	T50ROSEC24	156-00007	73
PLUG10	151-00426	102	SNP54(E)	191-10549	101	T40XEC55P-E	133-00059	71	T50ROSF6	156-00076	58
PLUG10	151-00488	102	SNP58(E)	191-10589	101	T50I	117-05250	25	T50ROSF6SD	156-00085	58
PLUG11	151-00360	102	SNP62(E)	191-10629	101	T50I	111-05259	24	T50ROSF6SD	156-05902	58
PLUG11	151-00485	102	SOC3-FT6-LG.	155-19001	86	T50I	111-05220	27	T50ROSF7X12U	157-00054	57
PLUGFT6XL	241-00002	102	SOC4 M.FT6	155-30902	86	T50I	111-05260	26	T50ROSF10	156-00120	59
PLUGFT6XL	151-00428	102	SOC5FT6LG	151-00074	86	T50I	111-00222	27	T50ROSF10	156-00120	59
PLUGFT6XL	241-00001	102	SOC6	151-00023	86	T50IDH	117-05303	29	T50ROSF10	156-00120	59
PLUGFT7	151-00414	102	SOC7FT6	151-00629	86	T50IDH	117-05360	29	T50ROSF10	156-00120	59
PMB5	102-00498	111	SOC8FT6LG	151-00665	86	T50IDH	117-05350	29	T50ROSF10	156-00120	59
PT2A	118-00032	31	SOC10405	151-00282	86	T50IFT7	150-00700	59	T50ROSF10	156-00120	59
PT220	111-01235	31	STAND OFF CLIP	150-45398	83	T50L	111-00526	27	T50ROSF10	156-00120	59
Power Pack	102-00010	118	STAND OFF CLIP	150-45397	83	T50L	111-05450	25	T50ROSF10	156-00120	59
Power Pack	120-00010	122	STAND-OFF-CLIP-2	155-01600	83	T50L	111-05440	27	T50ROSF10	156-00120	59
RCC D21	150-92300	97	STECKERHALTER SITZ	155-36002	105	T50L	111-05436	24	T50ROSF10	156-00120	59
RCC D24	155-04000	97	Steckerhalter IV SFT 65x130	133-00392	107	T50L	111-05441	27	T50ROSF10	156-00120	59
RCC D28	151-00598	97	Strap Black ATS3080	102-66110	119	T50LDH	117-05461	29	T50ROSF10	156-00120	59
REL30SDP6	150-55500	57	Strap Natural ATS3080	102-66109	119	T50LDH	117-00008	29	T50ROSF10	156-00120	59
RT50RS5	115-07110	64	T18I	111-02359	24	T50LL	111-06000	26	T50ROSF10	156-00120	59
RT50RS6	115-07010	49	T18I	111-02360	26	T50LOS	118-05900	30	T50ROSF10	156-00120	59
RT50SD6	111-85480	46	T18I	111-02358	25	T50M	111-06206	26	T50ROSF10	156-00120	59
RT50SFK	115-06960	49	T18L	111-02159	24	T50M	111-06206	26	T50ROSF10	156-00120	59
Replacement Blade	110-07111	131	T18L	111-02049	25	T50M	111-06206	26	T50ROSF10	156-00120	59
Replacement Blade	110-07511	127	T18L	111-02160	26	T50M	111-06206	26	T50ROSF10	156-00120	59
Replacement Blade	110-09111	132	T18R	111-01950	25	T50M	111-06206	26	T50ROSF10	156-00120	59
Replacement Blade	110-03524	127	T18R	111-01959	24	T50M	111-06206	26	T50ROSF10	156-00120	59
S2CM25	151-29400	113	T18R	111-01960	26	T50M	111-06206	26	T50ROSF10	156-00120	59
S2HM25	151-29403	113	T18R	114-01879	27	T50R	111-04950	25	T50ROSF10	156-00120	59
S3STM50	151-29500	114	T18R	114-01879	27	T50R	111-00525	27	T50ROSF10	156-00120	59
S4000 Cutter	556-04025199, 202		T18RA50	120-40020	123	T50R	111-00824	27	T50ROSF10	156-00120	59
SAM83	151-29600	113	T18RA50	120-40019	123	T50R	111-04889	26	T50ROSF10	156-00120	59
SAOM82	151-29701	113	T18RA3500	120-50010	123	T50R	111-04890	27	T50ROSF10	156-00120	59
SB9/230	150-10900	64	T18RA3500	120-46009	123	T50R	150-77591	68	T50ROSF10	156-00120	59
SB14/172	150-10690	64	T18RA3500 HS	120-50009	123	T50R	156-00382	80	T50ROSF10	156-00120	59
SB14/230	150-11400	64	T18RDP5	150-55610	56	T50R	156-00276	80	T50ROSF10	156-00120	59
SBRS	131-60060	65	T18REC9SD	155-37104	72	T50R	117-05168	29	T50ROSF10	156-00120	59
SBR85	131-60058	65	T18REC10SD	155-38304	72	T50RDH	117-05000	29	T50ROSF10	156-00120	59
SBS9/230	150-10901	64	T18RFT6	150-09110	58	T50RDH	117-05002	29	T50ROSF10	156-00120	59
SDCTR312	117-00012	66	T18ROS	118-04701	30	T50RDH	117-05050	29	T50ROSF10	156-00120	59
SNP1	192-10010	101	T18ROS	118-00035	30	T50RDH	117-05060	29	T50ROSF10	156-00120	59
SNP1	190-00022	101	T18ROS	118-00079	30	T50RDH	150-77936	58	T50ROSF10	156-00120	59
SNP1.5	193-00150	101	T18ROSEC19	156-04600	73	T50RDH	117-05160	54	T50ROSF10	156-00120	59
SNP1.25	190-00029	101	T18RSF	111-85560	50	T50RDH	150-77936	58	T50ROSF10	156-00120	59
SNP2	192-10020	101	T18RSF	111-85519	50	T50RDH	117-05160	54	T50ROSF10	156-00120	59
SNP2(E)	191-10029	101	T25LL	111-02660	26	T50RDH	150-45292	75	T50ROSF10	156-00120	59
SNP3(E)	191-10039	101	T30L	111-03460	26	T50RDH	150-76091	72	T50ROSF10	156-00120	59
SNP4	192-10040	101	T30L	111-03459	24	T50RDH	150-40582	72	T50ROSF10	156-00120	59
SNP4(E)	191-10049	101	T30L	111-03450	25	T50RDH	156-00025	58	T50ROSF10	156-00120	59
SNP6	192-10060	101	T30L	111-03570	26	T50RDH	150-77938	58	T50ROSF10	156-00120	59
SNP6(E)	191-10069	101	T30L	111-03569	24	T50RDH	150-77941	58	T50ROSF10	156-00120	59
SNP7	192-10070	101	T30LL	111-03660	25	T50RDH	150-31091	59	T50ROSF10	156-00120	59
SNP8	192-10080	101	T30LL	111-03570	26	T50RDH	156-00399	59	T50ROSF10	156-00120	59
SNP8(E)	191-10089	101	T30LL	111-03569	24	T50RDH	150-37591	53	T50ROSF10	156-00120	59
SNP10	192-10100	101	T30LOS	118-00044	30	T50RDH	111-85871	59	T50ROSF10	156-00120	59
SNP10(E)	191-10109	101	T30LOS	118-00080	30	T50RDH	111-85880	59	T50ROSF10	156-00120	59
SNP12(E)	191-10129	101	T30LOS	118-04900	30	T50RDH	156-00235	59	T50ROSF10	156-00120	59
SNP12A	190-00254	101	T30R	111-00264	27	T50RDH	133-00034	59	T50ROSF10	156-00120	59
SNP14(E)	191-10149	101	T30R	111-03259	24	T50RDH	111-85810	59	T50ROSF10	156-00120	59
SNP14A	190-00300	101	T30R	111-03050	25	T50RDH	156-00446	53	T50ROSF10	156-00120	59
SNP16	192-10160	101	T30R	111-03260	26	T50RDH	150-31091	59	T50ROSF10	156-00120	59
			T30R	114-03079	27	T50RDH	156-00399	59	T50ROSF10	156-00120	59
			T30REC4A	150-76090	72	T50RDH	150-77591	68	T50ROSF10	156-00120	59
			T30REC4B	150-76080	72	T50RDH	156-00416	78	T50ROSF10	156-00120	59
						T50RDH	156-00419	78	T50ROSF10	156-00120	59

Alphanumerical Index

Type TF21-9.5/4.8 - Z4 Wide Slot Nozzle

Type	Article-No.	Page	Type	Article-No.	Page	Type	Article-No.	Page	Type	Article-No.	Page
TF21-9.5/4.8	309-10950	152	TF31-6/2	333-30602	156	TK20-9.5/4.8	311-00959	160	TULT12-4BK	553-41200	186
TF21-9.5/4.8	309-20952	152	TF31-6/2	333-30600	156	TK20-12.7/6.4	311-01279	160	TULT12-4BU	553-41206	186
TF21-9.5/4.8	309-20959	152	TF31-9/3	333-30906	156	TK20-19.1/9.5	311-01909	160	TULT12-4RD	553-41202	186
TF21-9.5/4.8	309-20954	152	TF31-9/3	333-30905	156	TK20-25.4/12.7	311-02549	160	TULT12-4WH	553-41209	186
TF21-9.5/4.8	309-20956	152	TF31-9/3	333-30904	156	TK20-38.1/19.1	311-03819	160	TULT12-4YE	553-41204	186
TF21-12.7/6.4	309-11270	153	TF31-9/3	333-30909	156	TK20-50.8/25.4	311-05089	160	TULT18-6BK	553-41800	186
TF21-12.7/6.4	309-21274	153	TF31-9/3	333-30902	156	TK29-1.2/0.6	311-90129	161	TULT18-6BU	553-41806	186
TF21-12.7/6.4	309-21272	153	TF31-9/3	333-30900	156	TK29-1.6/0.8	311-90169	161	TULT18-6RD	553-41802	186
TF21-12.7/6.4	309-41277	153	TF31-9/3	333-20900	155	TK29-2.4/1.2	311-90249	161	TULT18-6WH	553-41809	186
TF21-12.7/6.4	309-21279	153	TF31-9/3	333-30907	156	TK29-3.2/1.6	311-90329	161	TULT18-6YE	553-41804	186
TF21-12.7/6.4	309-21276	153	TF31-12/4	333-31200	156	TK29-4.8/2.4	311-90489	161	TULT24-8BK	553-42400	186
TF21-19.0/9.5	309-11909	153	TF31-12/4	333-31207	156	TK29-6.4/3.2	311-90649	161	TULT24-8BU	553-42406	186
TF21-19.0/9.5	309-11907	153	TF31-12/4	333-31206	156	TK29-9.5/4.8	311-90959	161	TULT24-8RD	553-42402	186
TF21-19.0/9.5	309-11906	153	TF31-12/4	333-31205	156	TK29-12.7/6.4	311-91279	161	TULT24-8WH	553-42409	186
TF21-19.0/9.5	309-11904	153	TF31-12/4	333-31204	156	TK29-19.1/9.5	311-91909	161	TULT24-8YE	553-42404	186
TF21-19.0/9.5	309-11900	153	TF31-12/4	333-31209	156	TK29-25.4/12.7	311-92549	161	TULT39-13BK	553-43900	186
TF21-19.0/9.5	309-11902	153	TF31-12/4	333-31202	156	TK29-38.1/19.1	311-93819	161	TULT39-13BU	553-43906	186
TF21-25.4/12.7	309-12549	153	TF31-12/4	333-21200	155	TK29-50.8/25.4	311-95089	161	TULT39-13RD	553-43902	186
TF21-25.4/12.7	309-12546	153	TF31-18/6	333-41800	155	TL27-1.2/0.6	302-20120	150	TULT39-13WH	553-43909	186
TF21-25.4/12.7	309-12544	153	TF31-18/6	333-31800	156	TL27-1.6/0.8	302-20160	150	TULT39-13YE	553-43904	186
TF21-25.4/12.7	309-12542	153	TF31-18/6	333-31802	156	TL27-2.4/1.2	302-30240	150	Twist-In 05	170-01000	175
TF21-25.4/12.7	309-12540	153	TF31-18/6	333-31804	156	TL27-3.2/1.6	302-30320	150	Twist-In 08	170-01001	175
TF21-25.4/12.7	309-12547	153	TF31-18/6	333-31805	156	TL27-4.8/2.4	302-30480	150	Twist-In 13	170-01002	175
TF21-38.0/19.0	309-13814	153	TF31-18/6	333-31806	156	TL27-6.4/3.2	302-30640	150	Twist-In 19	170-01004	175
TF21-38.0/19.0	309-13819	153	TF31-18/6	333-31807	156	TL27-9.5/4.8	302-30950	150	Twist-In 25	170-01005	175
TF21-38.0/19.0	309-13812	153	TF31-18/6	333-31809	156	TL27-12.7/6.4	302-21270	150	Twist-In 29	170-01006	175
TF21-38.0/19.0	309-13810	153	TF31-24/8	333-32407	156	TL27-19.1/9.5	302-31900	150	Twist-In 32	170-01007	175
TF21-38.0/19.0	309-13816	153	TF31-18/6	333-32406	156	TL27-25.4/12.7	302-32540	150	Twist-In 38	170-01008	175
TF21-38.0/19.0	309-13817	153	TF31-24/8	333-32400	156	TL27-38.1/19.1	302-23810	150	V100R	118-00074	32
TF21-50.8/25.4	309-15086	153	TF31-24/8	333-42400	155	TL27-50.8/25.4	302-25080	150	V100R	118-00109	32
TF21-50.8/25.4	309-15082	153	TF31-24/8	333-32402	156	TR27-3.2/1.6	315-50320	164	V150R	118-00089	32
TF21-50.8/25.4	309-15080	153	TF31-24/8	333-32404	156	TR27-4.8/2.4	315-50480	164	V150R	118-00107	32
TF21-50.8/25.4	309-15084	153	TF31-24/8	333-32405	156	TR27-6.4/3.2	315-50640	164	VITON®-E-3.2/1.6	330-00320	159
TF21-50.8/25.4	309-15087	153	TF31-24/8	333-32409	156	TR27-9.5/4.8	315-50950	164	VITON®-E-4.8/2.4	330-00480	159
TF21-50.8/25.4	309-15089	153	TF31-40/13	333-34000	155	TR27-12.7/6.4	315-51270	164	VITON®-E-6.4/3.2	330-00640	159
TF21-76.0/38.0	309-17600	153	TF31-40/13	333-34002	156	TR27-19.1/9.5	315-51900	164	VITON®-E-9.5/4.8	330-00950	159
TF21-76.0/38.0	309-17602	153	TF31-40/13	333-34004	156	TR27-25.4/12.7	315-52540	164	VITON®-E-12.7/6.4	330-01270	159
TF21-76.0/38.0	309-17604	153	TF31-40/13	333-34009	156	TR27-38.1/19.1	315-53810	164	VITON®-E-19.0/9.5	330-01900	159
TF21-76.0/38.0	309-17606	153	TF31-40/13	333-34006	156	TR27-50.8/25.4	315-55100	164	VITON®-E-25.4/12.7	330-02540	159
TF21-76.0/38.0	309-17609	153	TF31-40/13	333-34005	156	TRIM PLUG 5	151-00333	102	VITON®-E-38.0/19.0	330-03810	159
TF21-101.6/50.8	309-11020	153	TF31-40/13	333-34000	156	TT420+	556-00420	200	VITON®-E-50.8/25.4	330-05080	159
TF21-101.6/50.8	309-11022	153	TF34-1.5/0.5	333-30153	157	TT822OUT 60MM	556-00111	201	WICKELCLIP-SB5	155-23701	87
TF21-101.6/50.8	309-11024	153	TF34-3/1	333-30303	157	TT822OUT 110MM	556-00101	201	WICKELCLIP-VDS	155-16301	85
TF21-101.6/50.8	309-11026	153	TF34-6/2	333-30603	157	TT896DOUT 85MM	556-00119	201	WSI250	157-00401	63
TF21-101.6/50.8	309-11029	153	TF34-9/3	333-30903	157	TT896DOUT 102MM	556-00120	201	WSI380	157-00404	63
TF24-1.2/0.6	309-40123	154	TF34-12/4	333-31203	157	TT932DOUT 30MM	556-00124	201	WSR250	157-00402	63
TF24-1.6/0.8	309-40163	154	TF34-18/6	333-31803	157	TT932DOUT 85MM	556-00117	201	WSS250	157-00400	63
TF24-2.4/1.2	309-40243	154	TF34-24/8	333-32403	157	TT932DOUT 102MM	556-00118	201	YAZ-CONN-TAPE-CLIP	155-31102	90
TF24-3.2/1.6	309-40323	154	TF34-40/13	333-34003	157	TT940DOUT 85MM	556-00121	201	YCC-FT6-5	155-38102	104
TF24-4.8/2.4	309-50483	154	TFE2-0	336-01209	163	TT940DOUT 102MM	556-00122	201	YCCFT6S-2	151-00606	104
TF24-6.4/3.2	309-50643	154	TFE2-2	336-01109	163	TT4000+ 300dpi	556-04000	199	YCCFT62x122	151-00180	106
TF24-9.5/4.8	309-40953	154	TFE2-4	336-00949	163	TTAGPU11X65WH	556-25012	187	YCCFT82x185	151-00704	106
TF24-12.7/6.4	309-41273	154	TFE2-6	336-00779	163	TTAGPU11X65YE	556-25019	187	YCCKSFT6.5	151-00675	105
TF24-19.1/9.5	309-31903	154	TFE2-8	336-00619	163	TTAGPU11X100WH	556-25021	187	YCCKSFT6.5-PT1.7-2.3	151-00792	105
TF24-25.4/12.7	309-32543	154	TFE2-10	336-00489	163	TTAGPU11X100YE	556-25020	187	YCCKSFT62x122PT0.7-1.3	151-00835	107
TF24-38.1/19.1	309-33813	154	TFE2-12	336-00399	163	TTAGPU15X65WH	556-25007	187	YCCKSFT62x122PT0.7-1.3 90°	151-00833	107
TF24-50.8/25.4	309-35083	154	TFE2-14	336-00319	163	TTAGPU15X65YE	556-25011	187	YCCKSFT62x122PT1.7-2.3	151-00836	107
TF24-76.2/38.1	309-37603	154	TFE2-16	336-00249	163	TTAGPU15X100WH	556-25006	187	YCCKSFT62x122PT1.7-2.3 90°	151-00834	107
TF24-101.6/50.8	309-31023	154	TFE2-18	336-00199	163	TTAGPU15X100YE	556-25010	187	YCCSFT62122	151-00513	106
TF31-1.5/0.5	333-30156	156	TFE2-20	336-00159	163	TTDTHOUT 60MM	556-00140	201	Z2 Deflector Nozzle	391-90300	138
TF31-1.5/0.5	333-30155	156	TFE2-22	336-00149	163	TTDTHOUT 100MM	556-00141	201	Z3 Reduction Nozzle	391-90001	138
TF31-1.5/0.5	333-30154	156	TFE2-24	336-00139	163	TULT3-1BK	553-40300	186	Z3 Reflector	391-50500	137
TF31-1.5/0.5	333-30152	156	TFE2-26	336-00109	163	TULT3-1BU	553-40306	186	Z4 Wide Slot Nozzle	391-50600	137
TF31-1.5/0.5	333-30150	156	TFE2-28	336-00099	163	TULT3-1RD	553-40302	186			
TF31-1.5/0.5	333-20150	155	TFE2-30	336-00079	163	TULT3-1WH	553-40309	186			
TF31-1.5/0.5	333-30159	156	TFE4-1	339-02549	163	TULT3-1YE	553-40304	186			
TF31-1.5/0.5	333-30157	156	TFE4-1 1/4	339-03189	163	TULT4.8-1.6BK	553-40480	186			
TF31-3/1	333-30307	156	TFE4-1/2	339-01279	163	TULT4.8-1.6BU	553-40486	186			
TF31-3/1	333-40300	155	TFE4-1/4	339-00649	163	TULT4.8-1.6RD	553-40482	186			
TF31-3/1	333-30309	156	TFE4-1/8	339-00329	163	TULT4.8-1.6WH	553-40489	186			
TF31-3/1	333-30306	156	TFE4-3/4	339-01909	163	TULT4.8-1.6YE	553-40484	186			
TF31-3/1	333-30305	156	TFE4-3/8	339-00959	163	TULT6-2BK	553-40600	186			
TF31-3/1	333-30304	156	TFE4-3/16	339-00340	163	TULT6-2BU	553-40606	186			
TF31-3/1	333-30302	156	TFE4-5/8	339-01599	163	TULT6-2RD	553-40602	186			
TF31-3/1	333-30300	156	TFE4-5/64	339-00209	163	TULT6-2WH	553-40609	186			
TF31-6/2	333-40600	155	TK20-1.2/0.6	311-00129	160	TULT6-2YE	553-40604	186			
TF31-6/2	333-30609	156	TK20-1.6/0.8	311-00169	160	TULT9-3BK	553-40900	186			
TF31-6/2	333-30607	156	TK20-2.4/1.2	311-00249	160	TULT9-3BU	553-40906	186			
TF31-6/2	333-30606	156	TK20-3.2/1.6	311-00329	160	TULT9-3RD	553-40902	186			
TF31-6/2	333-30605	156	TK20-4.8/2.4	311-00489	160	TULT9-3WH	553-40909	186			
TF31-6/2	333-30604	156	TK20-6.4/3.2	311-00649	160	TULT9-3YE	553-40904	186			

Article-No. 102-00000 - 118-00080

Article-No.	Type	Page	Article-No.	Type	Page	Article-No.	Type	Page	Article-No.	Type	Page
102-00000	Autotool System 3080	118	111-01235	PT220	31	111-12449	T120L	24	111-93160	MAT16SS12	42
102-00010	Power Pack	118	111-01301	MBT14UH	38	111-12660	T120M	26	111-93208	MBT20SS	37
102-00040	Bench Mount Kit Flexible	118	111-01302	MBT20UH	38	111-12700	T120XM	25	111-93209	MBT20S	38
102-00041	Horizontal Bench Mount Kit	118	111-01303	MBT27UH	38	111-12719	T120XM	24	111-93240	MAT24SS12	42
102-00042	Bench Mount Kit for Automation	118	111-01304	MBT33UH	38	111-12824	T120S	24	111-93278	MBT27SS	37
102-00043	Bench mount kit fixed	118	111-01305	MBT43UH	38	111-12830	T120S	26	111-93279	MBT27S	38
102-00050	Overhead Dispenser	118	111-01306	MBT49UH	38	111-12850	T120S	25	111-93338	MBT33SS	37
102-00052	Overhead Dispenser Lowering	118	111-01307	MBT27XHD	39	111-14860	T150R(H)	26	111-93339	MBT33S	38
102-66109	Strap Natural ATS3080	119	111-01308	MBT33XHD	39	111-15050	T150R(H)	25	111-94000	LFPC103	43
102-66110	Strap Black ATS3080	119	111-01309	MBT43XHD	39	111-15069	T150R(H)	24	111-94080	MLT8SS5	41
102-66209	Closures Natural ATS3080	119	111-01310	MBT49XHD	39	111-15305	T150XLL	26	111-94088	MBT8HS	37
102-66210	Closures Black ATS3080	119	111-01311	MBT60XHD	39	111-15410	T150L	25	111-94089	MBT8H	38
102-67065	ATSBCFT6LG	124	111-01312	MBT27UHD	39	111-15460	T150L	26	111-94120	MLT12SS5	41
102-68355	ATSBCCEC35	124	111-01313	MBT33UHD	39	111-15502	T150XL	26	111-94148	MBT14HS	37
102-68365	ATSBCCEC36	89	111-01314	MBT43UHD	39	111-15510	T150XL	25	111-94149	MBT14H	38
102-68375	ATSBCCEC37	89	111-01315	MBT49UHD	39	111-15609	T150M	25	111-94161	MLT16SS5	41
102-69065	ATSBCSFT6.5-MD	124	111-01316	MBT60UHD	39	111-15660	T150M	26	111-94208	MBT20HS	37
102-69066	ATSBCSFT6.5	124	111-01950	T18R	25	111-24805	T250R	26	111-94209	MBT20H	38
102-69067	ATSBCSFT6.5S	124	111-01959	T18R	24	111-25100	T250X	26	111-94278	MBT27HS	37
102-69068	ATSBC2KSFT6.5	81	111-01960	T18R	26	111-81821	IT18R	192	111-94279	MBT27H	38
110-03400	MK3PNSP2	130	111-02049	T18L	25	111-81919	IT18FL	192	111-94338	MBT33HS	37
110-03500	MK3SP	127	111-02159	T18L	24	111-85019	IT50R	192	111-94339	MBT33H	38
110-03524	Replacement Blade	127	111-02160	T18L	26	111-85119	IT50RT	192	111-95000	LFPC150	43
110-04000	MTT4	134	111-02358	T18I	25	111-85219	IT50RD	192	111-95080	MLT8SS10	41
110-05000	CUTies-1	135	111-02359	T18I	24	111-85319	IT50L	192	111-95120	MLT12SS10	41
110-05001	CUTies-3	135	111-02360	T18I	26	111-85339	T50SSL5	50	111-95148	MBT14XHS	37
110-05002	CUTies-5	135	111-02660	T25LL	26	111-85350	T50SD6	46	111-95149	MBT14XH	38
110-06000	MK6	128	111-03050	T30R	25	111-85369	T50SL5	50	111-95208	MBT20XHS	37
110-06026	061-20815	128	111-03259	T30R	24	111-85395	T50SSL5	50	111-95209	MBT20XH	38
110-07000	MK7HT	128	111-03260	T30R	26	111-85460	T50SL6	50	111-95241	MLT24SS10	41
110-07100	MK7P	131	111-03450	T30L	25	111-85479	T50SL7	50	111-95278	MBT27XHS	37
110-07111	Replacement Blade	131	111-03459	T30L	24	111-85480	RT50SD6	46	111-95279	MBT27XH	38
110-07200	Lock cap tensioning knob	131	111-03460	T30L	26	111-85519	T18RSF	50	111-95338	MBT33XHS	37
110-07500	MK7	127	111-03569	T30LL	24	111-85560	T18RSF	50	111-95339	MBT33XH	38
110-07511	Replacement Blade	127	111-03570	T30LL	26	111-85603	T30RSF(U)	52	111-96120	MAT12SSC7	42
110-09000	MK9HT	129	111-03660	T30LL	25	111-85610	T30RSF(U)	52	112-00100	HT120R	28
110-09100	MK9P	132	111-03859	T40R	24	111-85729	T50RSFM	50	112-51919	CTT20R	28
110-09110	MK9P	132	111-03860	T40R	26	111-85739	T50RSFM	50	112-51960	CTT20R	28
110-09111	Replacement Blade	132	111-03970	T40R	25	111-85799	T50RSF(E)	52	112-56019	CTT60R	28
110-09500	MK9	129	111-04882	T50R	24	111-85810	T50RFT10	59	112-56060	CTT60R	28
110-09511	069-00221	129	111-04889	T50R	26	111-85850	T50MD7	46	114-01879	T18R	27
110-09950	K5F-STG200	134	111-04890	T50R	27	111-85871	T50RFT7	59	114-03079	T30R	27
110-30002	Compressed-air hose	130	111-04950	T50R	25	111-85880	T50RFT8	59	114-12179	T120R(E)	27
110-30101	064-00101	130	111-05059	T80R	24	111-91000	MLT8SSC5	41	115-00033	DCT11	66
110-95000	MK9SST	134	111-05060	T80R	26	111-91001	MLT8SSC10	41	115-00034	DCT9	66
110-95011	069-05114	134	111-05220	T50I	27	111-91121	MLT12SSC5	41	115-06960	RT50SFK	49
111-00153	T120M	25	111-05259	T50I	24	111-91123	MLT12SSC10	41	115-07010	RT50RSF	49
111-00168	T120R(E)	27	111-05260	T50I	26	111-91161	MLT16SSC5	41	115-07110	RT50RS5	64
111-00222	T50I	27	111-05436	T50L	24	111-91163	MLT16SSC10	41	117-00008	T50LDH	29
111-00253	LFPC129	43	111-05440	T50L	26	111-91180	MLT24SSC5	41	117-00012	SDCTR312	66
111-00254	LFPC132	43	111-05441	T50L	27	111-91181	MLT24SSC10	41	117-05000	T50RDH	29
111-00255	LFPC163	43	111-05450	T50L	25	111-91300	MLT16SS10	41	117-05002	T50RDH	29
111-00257	LFPC83	43	111-05459	T80L	24	111-91400	MLT24SS5	41	117-05050	T50RDH	29
111-00264	T30R	27	111-05460	T80L	26	111-92002	MAT8SSC12	42	117-05060	T50RDH	29
111-00288	MBT5SFC	40	111-05850	T50S	25	111-92004	MAT8SSC7	42	117-05160	T50RDHSFT6.5	54
111-00289	MBT8SFC	40	111-05859	T50S	24	111-92080	MAT8SS7	42	117-05168	T50RDH	29
111-00290	MBT14SFC	40	111-05860	T50S	26	111-92120	MAT12SS7	42	117-05250	T50I	25
111-00291	MBT20SFC	40	111-06000	T50LL	26	111-92122	MAT12SSC12	42	117-05303	T50IDH	29
111-00292	MBT27SFC	40	111-06206	T50M	26	111-92160	MAT16SS7	42	117-05350	T50IDH	29
111-00293	MBT33SFC	40	111-07110	T50RS5	64	111-92162	MAT16SSC7	42	117-05360	T50IDH	29
111-00294	MBT8HFC	40	111-08250	T80I	25	111-92163	MAT16SSC12	42	117-05461	T50LDH	29
111-00295	MBT14HFC	40	111-08259	T80I	24	111-92200	MAT24SSC7	42	117-08070	T80R	25
111-00296	MBT20HFC	40	111-08290	T80I	26	111-92201	MAT24SSC12	42	118-00018	T50MOS	30
111-00297	MBT27HFC	40	111-12050	T120R(E)	25	111-92240	MAT24SS7	42	118-00032	PT2A	31
111-00298	MBT33HFC	40	111-12059	T120R(E)	24	111-93000	LFPC70	43	118-00035	T18ROS	30
111-00299	MBT14XHFC	40	111-12060	T120R(E)	26	111-93058	MBT5SS	37	118-00044	T30LOS	30
111-00300	MBT20XHFC	40	111-12203	T120I	27	111-93059	MBT5S	38	118-00055	T50MOS	30
111-00301	MBT27XHFC	40	111-12230	T120I	26	111-93080	MAT8SS12	42	118-00064	T30ROS	30
111-00302	MBT33XHFC	40	111-12240	T120I	25	111-93088	MBT8SS	37	118-00066	T120ROS	30
111-00388	T80L	25	111-12249	T120I	24	111-93089	MBT8S	38	118-00067	T120ROS	30
111-00525	T50R	27	111-12402	T120L	27	111-93120	MAT12SS12	42	118-00074	V100R	32
111-00526	T50L	27	111-12430	T120L	26	111-93148	MBT14SS	37	118-00079	T18ROS	30
111-00824	T50R	27	111-12440	T120L	25	111-93149	MBT14S	38	118-00080	T30LOS	30

Article-No. 118-00081 - 151-00610

Article-No.	Type	Page	Article-No.	Type	Page	Article-No.	Type	Page	Article-No.	Type	Page
118-00081	T50MOS	30	126-00119	T50SOSAH7X12U	46	150-37791	T50ROS-SFT6.5 16-3	54	151-00194	CCSFT7x12	106
118-00082	T120ROS	30	126-00120	T50ROS AH7x12U	46	150-37792	T50RSFT6.5 16-3	54	151-00195	IAHC5T	95
118-00089	V150R	32	126-00141	T50SOSKSF62x122PT0.7-1.3	46	150-37799	T50ROSSFT6.5 16-3MD	53	151-00199	IAHC2T	95
118-00107	V150R	32	126-00142	T50SOSKSF62x122PT1.7-2.3	46	150-39385	T80RSF6.5FW	51	151-00207	IAHC4T	95
118-00109	V100R	32	126-00143	T50SOSKSF62x122PT0.7-1.3 90°	46	150-39395	T80RSF6.5F	51	151-00208	AHC2BH	94
118-04701	T18ROS	30	126-00144	T50SOSKSF62x122PT1.7-2.3 90°	46	150-40581	T50ROSEC5B	72	151-00213	IAHC3T	95
118-04800	T30ROS	30	126-01001	T50RSF(E)	52	150-40582	T50REC5B	72	151-00214	CP31DOP	106
118-04900	T30LOS	30	126-01104	T50SSFM	50	150-40583	T50SOSEC5B	72	151-00215	TC4FT6LG	84
118-05040	T50ROS	30	126-02204	T50SSL5	50	150-40591	T50ROSEC5A	72	151-00216	CP2FT6	105
118-05059	T50ROS	30	126-02300	T50SST5	46	150-40593	T50SOSEC5A	72	151-00222	CCSFT7x12	106
118-05078	T50ROS	30	126-02600	T80RSF6.5F	51	150-41397	CONNECTOR CLIP	90	151-00223	IAHC1T	95
118-05850	T50SOS	30	126-03100	T50SOSSFT6.5E-MDL	47	150-45292	T50REC2.5B	75	151-00224	EC41	96
118-05859	T50SOS	30	126-03102	T50SOSSFT6.5E	46	150-45299	T50ROS-EC2,5	75	151-00235	Big YCC T5	104
118-05900	T50LOS	30	131-60058	SBR85	65	150-45397	STAND OFF CLIP	83	151-00281	TCOS10305	87
120-00000	Autotool 2000	122	131-60060	SBR5	65	150-45398	STAND OFF CLIP	83	151-00282	SOC10405	86
120-00010	Power Pack	122	131-60070	LFC155	63	150-47595	BHT375M	35	151-00331	TRIM PLUG 5	102
120-00040	Bench Mount Kit	122	132-00200	DE863220	35	150-48396	T80RFT6x12	50	151-00342	Cover Plug 20x50	103
120-00050	Overhead Suspender	122	132-37540	CT375	35	150-48397	T80RFT6x12	50	151-00343	Cover Plug 20	103
120-00060	Control Box	122	133-00034	T50RFT8GSD	59	150-52690	T30RFT6SD	58	151-00360	PLUG11	102
120-00080	HH20	122	133-00059	T40XEC5SP-E	71	150-54498	BIG CONNECTOR CLIP	105	151-00366	AHC1AH	94
120-40019	T18RA50	123	133-00067	Halter SFT6.5	81	150-55500	REL30SDP6	57	151-00367	AHC2AH	94
120-40020	T18RA50	123	133-00075	Edge-Clip25	108	150-55610	T18RDP5	56	151-00368	AHC2SS	94
120-46009	T18RA3500	123	133-00391	T50SOSWSP5E-2	62	150-55850	T30RFT5	58	151-00370	AHC3BHR	94
120-50009	T18RA3500 HS	123	133-00392	Steckerhalter IV SFT 65x130	107	150-55948	T30RFT5	58	151-00371	AHC3CHR	94
120-50010	T18RA3500	123	148-00088	T50SOSWA2.0E	76	150-56193	T50SDSBS5	69	151-00373	AHC3SB	94
121-00680	KR6/8	133	148-00089	T50SOSWA1.8E	76	150-56199	T50ROSDBS5	69	151-00374	AHC4AH	94
121-00889	KR8PNSE	133	148-00090	T50SOSWB1.8E	76	150-76079	T50ROSEC4B	72	151-00378	IAHC3AH	95
121-05019	KR8/50	34	148-00091	T50SOSWB4.3E	76	150-76080	T30REC4B	72	151-00401	IAHC3CH	95
121-05051	KR8/50	34	148-00092	T50SOSWA4.3E	76	150-76090	T30REC4A	72	151-00382	IAHC4AH	95
121-05060	KR8/50	34	148-00093	T50SOSWB2.0E	76	150-76091	T50REC4A	72	151-00383	IAHC4CH	95
121-06019	KR8/60	34	148-00095	T50SOSWA3.4E	76	150-76093	T50SOSEC4A	72	151-00384	IAHC5BH	95
121-06060	KR8/60	34	148-00096	T50SOSWB3.4E	76	150-76099	T50ROSEC4A	72	151-00391	Open Plug 42x84	103
121-07019	KR8/70	34	148-00100	Bracket brake line	76	150-77591	T50R-SBH5SD-14	68	151-00392	Open Plug 55x70	103
121-07060	KR8/70	34	148-00101	Bracket brake line	76	150-77934	T80LFT6	58	151-00394	OPEN PLUG 34.6x112	103
121-08019	KR8/80	34	148-00200	T50SOSEC12E	71	150-77936	T50RDHFT6	58	151-00399	PLUG5.5	102
121-08060	KR8/80	34	150-00700	T50IFT7	59	150-77938	T50RFT6	58	151-00401	PLUG5.5	102
121-10019	KR8/100	34	150-01700	FT220DP7	56	150-77941	T50RFT6	58	151-00414	PLUGFT7	102
121-10060	KR8/100	34	150-08110	CHA1	82	150-77950	T30RFT6	58	151-00415	PLUG SQ8x8	102
121-11051	KR8/110	34	150-09110	T18RFT6	58	150-92300	RCC D21	97	151-00419	PLUG5 WITH OPENING	102
121-11060	KR8/110	34	150-10140	T30RSB5	67	150-92600	CONNECTOR-CLIP EC6	108	151-00424	Cover Plug 32	103
121-12019	KR8/120	34	150-10141	T50RSB5	67	150-92904	T50RSBH5-SD	68	151-00426	PLUG10	102
121-15019	KR8/150	34	150-10144	T50SB5	67	150-92905	T80SBH5SD	68	151-00428	PLUGFT6XL	102
121-58551	KR8/CS	34	150-10149	T50ROSSB5	67	150-93100	T50ROSSFT6.5ZD 16-2	53	151-00429	EC42	108
121-58560	KR8/CS	34	150-10690	SB14/172	64	150-93130	T50SOSSFT6.51620D	54	151-00430	EC43	108
121-63519	KR6/35	33	150-10900	SB9/230	64	150-95500	TC5FT6S	84	151-00431	BCSFT6.5 16-3	81
121-63555	KR6/35	33	150-10901	SB59/230	64	151-00006	CG51	115	151-00432	MB3APT	110
121-63560	KR6/35	33	150-11400	SB14/230	64	151-00010	CTC175BS6	99	151-00433	MB4APT	110
121-74359	KR8/43	33	150-13591	T50RSFT6.5	54	151-00016	BC30	88	151-00434	MB5APT	110
121-74360	KR8/43	33	150-13593	T50SSFT6.5	54	151-00017	BC2212	88	151-00437	HDM25	112
121-82119	KR8/21	33	150-13596	T80ISFT6.5	54	151-00018	CTC10FT6LG	98	151-00439	HDM312	112
121-82155	KR8/21	33	150-15395	T50SST5	46	151-00019	CTC13FT6LG	98	151-00442	HDM401	112
121-82160	KR8/21	33	150-15493	T80RSFT	48	151-00020	TC2FT6LG	84	151-00447	OCTC1	81
121-83319	KR8/33	33	150-15498	T80RSFT	48	151-00021	OCTCSFT6.5	97	151-00459	FT6LG.JAE.CONNECT.TS	104
121-83355	KR8/33	33	150-16941	T30RSBH5	68	151-00022	EC30	89	151-00460	EC45	108
121-83360	KR8/33	33	150-16943	T50RSBH5	68	151-00023	SOC6	86	151-00464	EC6mod	108
121-83378	KR8/33	33	150-16945	T80ISBH5	68	151-00026	CTCLPROFILE	97	151-00465	CP21DOP	106
121-83380	KR8/33	33	150-21290	T30RSB55	68	151-00028	TC3FT6S	84	151-00466	CP61DOP	106
121-98151	KR8/S1	34	150-21291	T50RSB55	68	151-00029	TCOP70x120	86	151-00467	TC4FT6LG-A	84
121-98160	KR8/S1	34	150-21293	T50SSB55	68	151-00074	SOC5FT6LG	85	151-00472	EC JAE CC	108
122-68019	061-20186	133	150-21297	T80ISB55	68	151-00077	CH20D6	83	151-00484	TC5B5CYCC	87
122-80032	061-21077	133	150-21299	T50ROSSB55	68	151-00096	IPC10AH	93	151-00485	PLUG11	102
126-00000	T50SOSEC13E	71	150-26100	FBS100	49	151-00119	PC5DP7S	92	151-00488	PLUG10	102
126-00001	T50SL5	50	150-26180	FBS185	49	151-00134	HDM19	112	151-00489	IAHC3EH	95
126-00005	T50SL5	50	150-28140	FBB140	65	151-00151	EC28	108	151-00498	PMB5	111
126-00015	T50SDOP	46	150-29100	FBB100M	65	151-00153	TC5FT6.5SCHAMD	82	151-00499	EC11CPT	108
126-00017	T50SST5	46	150-29140	FBB140M	65	151-00161	EC27	96	151-00513	YCCSFT62122	106
126-00032	T50SSFM	50	150-29180	FBB185M	65	151-00162	CP6FT6	105	151-00514	MB3APT	110
126-00036	T50SOSEC34E	71	150-31090	T30RFT6LG	59	151-00163	CP3FT6	105	151-00587	MB4APT	110
126-00065	T50SOSSFT65MSMD	47	150-31091	T50RFT6LG	59	151-00173	EC32	108	151-00595	CCSFT7x12	106
126-00075	T50SOSKSF5.4E	46	150-31096	T80IFT6LG	59	151-00174	EC39	96	151-00598	RCC D28	97
126-00079	T60SOSSFT70x120-E-MD	47	150-37591	T50RFT6GOVAL	53	151-00180	YCCFT62x122	106	151-00605	TCOP62x122	85
126-00081	T50SOSKSF65E	46	150-37595	BHT375	35	151-00181	AHC3DH	94	151-00606	YCCFT65-2	104
126-00086	T50SOSSFT6.552-E	46	150-37691	T50RSFT6.5D18	54	151-00192	EC33	108	151-00610	HCEC3.05P-C	96

Article-No. 151-00611 - 173-00800

Article-No.	Type	Page	Article-No.	Type	Page	Article-No.	Type	Page	Article-No.	Type	Page
151-00611	CCEC3.0TP	108	155-04000	RCC D24	97	156-00273	T50SVCOC31-39	77	170-01001	Twist-In 08	175
151-00620	CCISFT6.5x13	107	155-05701	T50SOSSBH5E	60	156-00276	T50RCOUPLER	80	170-01002	Twist-In 13	175
151-00629	SOC7FT6	86	155-11601	BCSFT6.5 16-3MD	81	156-00303	T50SMVCOC25-31	77	170-01004	Twist-In 19	175
151-00662	BCFT6XL56	84	155-12300	T50SOSSB55E	61	156-00304	T50SMVCOC31-39	77	170-01005	Twist-In 25	175
151-00664	BCOSS	87	155-16301	WICKELCLIP-VDS	85	156-00306	T50ROC1B	78	170-01006	Twist-In 29	175
151-00665	SOC8FT6LG	86	155-17801	CTC10FT9	98	156-00318	T50SVC45	77	170-01007	Twist-In 32	175
151-00673	KSFT6.SOC1-3	91	155-18901	FT6LG.M.STECKERAUFN.	104	156-00379	T50XROSSFT6.5EMDL	47	170-01008	Twist-In 38	175
151-00674	KSFT6.5 OC 7-9	91	155-19001	SOC3-FT6-LG.	86	156-00380	CBTOSORSTUD5	74	170-05100	HELAAHOOK10	174
151-00675	YCCKSFT6.5	105	155-23701	WICKELCLIP-SB5	87	156-00382	T50RCOUPLER	80	170-05150	HELAAHOOK15	174
151-00680	HC48FT6	91	155-25201	CTC22FT9	98	156-00390	BC-SCR6	88	170-05200	HELAAHOOK20	174
151-00700	CTC4.5SB56	99	155-30602	T50SSB50TE	90	156-00399	T50RFT6LGS-D-HX	59	170-05250	HELAAHOOK25	174
151-00701	CTC7.5SB56	99	155-30702	FT6LG.YAZ.Connect.TS	104	156-00406	T120RHDM6	79	170-05300	HELAAHOOK30	174
151-00702	CTC10SB56	99	155-30802	TC2FT6LG	84	156-00407	T120RHDM6	79	170-10300	HEGP03	165
151-00703	CTC13SB56	99	155-30902	SOC4 M.FT6	86	156-00408	T120RHDM8	79	170-10400	HEGP04	165
151-00704	YCCFT82x185	106	155-31102	YAZ-CONN-TAPE-CLIP	90	156-00409	T120RHDM8	79	170-10500	HEGP05	165
151-00750	HDM501	112	155-31202	T50SVC5	77	156-00416	T50ROC10-14CBTO-SD-SET	78	170-10600	HEGP06	165
151-00756	HDM375BDM4W	112	155-31602	CTC7.5FT9	98	156-00419	T50ROC15-18CBTO-SD-SET	78	170-10800	HEGP08	165
151-00759	BCFT63x100S	85	155-32602	FT6LG.M.St.Aufn.II	104	156-00422	T50ROC19-24.5CBTO-SD-SET	78	170-11000	HEGP10	165
151-00775	CCSFT6.5	105	155-34202	LFC165(P5A)	63	156-00432	T50SOSFT5SD	58	170-11200	HEGP12	165
151-00783	CTCF16	98	155-36002	STECKERHALTER SITZ	105	156-00446	T50RFT62x122HR	53	170-11500	HEGP15	165
151-00785	CCFT6LG	105	155-37104	T18REC9SD	72	156-00447	T50SVC4	77	170-12000	HEGP20	165
151-00786	CCFT6XLG	105	155-38102	YCC-FT6-S	104	156-00455	T50ROS15FT65	55	170-12500	HEGP25	165
151-00787	IAHC5FH	95	155-38304	T18REC10SD	72	156-00456	T50ROS2P2FT65	55	170-13000	HEGP30	165
151-00790	BCOWFT6M	84	155-39002	TCDSFT6-HEX	84	156-00470	T3OROC2B	78	170-14000	HEGP40	165
151-00792	YCCKSFT6.5.PT1.7-2.3	105	155-40602	EC11	108	156-00505	T3OROC1B	78	170-15000	HEGP50	165
151-00794	CTC8.5FT6	98	155-41102	T50SAH	50	156-00550	T12ORSINGLECOUPLER	80	170-30400	HEGPV004	167
151-00819	EC17	89	155-42002	T50ROSSFT6.5-16-2-BK	53	156-00570	T50ROSEC4A-W	72	170-30600	HEGPV006	167
151-00833	YCCKSFT62x122PT0.7-1.3 90°	107	155-43702	FT65-Y-CONN-TS	104	156-00576	T50ROSEC22	72	170-30800	HEGPV008	167
151-00834	YCCKSFT62x122PT1.7-2.3 90°	107	155-46302	T50SOSSB6HE	62	156-00577	T50SMVCOC19245	77	170-31200	HEGPV012	167
151-00835	YCCKSFT62x122PT0.7-1.3	107	156-00003	T3OREC5A	72	156-00791	T50SVC3.5	77	170-31500	HEGPV015	167
151-00836	YCCKSFT62x122PT1.7-2.3	107	156-00006	T50ROSEC23	73	156-00819	T50SRBH6SD	74	170-32000	HEGPV020	167
151-00840	CC-PAEK5FT6.5PT1.7-2.3	105	156-00007	T50ROSEC24	73	156-01601	CBTOSOR	68	170-33000	HEGPV030	167
151-00851	BCUW55-05-25	87	156-00010	T50ROSEC21	72	156-04600	T18ROSEC19	73	170-34000	HEGPV040	167
151-00870	IPC5P	93	156-00011	T50ROSEC22	72	156-04601	T50SOSEC19	73	170-35000	HEGPV050	167
151-00904	BCOWFT5	84	156-00012	T3OROC1A	78	156-04602	T50ROSEC19	73	170-40400	HEGPA6604	169
151-00928	AHC3EH2	94	156-00013	T3OROC2A	78	156-05902	T50ROSFT6SD	58	170-40600	HEGPA6606	169
151-02600	CH20D7	83	156-00014	T3OROC2A	78	156-05903	T50ROSEC9	72	170-40800	HEGPA6608	169
151-02901	CHA2	82	156-00015	T50SOSEC10	72	156-05904	T50ROSEC10	72	170-41000	HEGPA6610	169
151-03100	COW20DP7	86	156-00016	T50SOSEC20	73	156-05905	T50ROSSBH5SD	67	170-41200	HEGPA6612	169
151-03200	COW30DP7	86	156-00017	T50SOSEC21	72	156-05906	T50ROSSB5CSD	68	170-41600	HEGPA6616	169
151-03401	EC15	89	156-00019	T50SOSEC9SD	72	156-05908	T50ROSFT62x122	59	170-42000	HEGPA6620	169
151-03402	EC16	89	156-00020	T50ROSEC20	73	156-06200	T50SOSFT5	58	170-42500	HEGPA6625	169
151-03403	EC17	89	156-00025	T5ORFT5	57	157-00014	T50SOS2DOP	57	170-43000	HEGPA6630	169
151-03404	EC14	89	156-00036	T5OROC1A	78	157-00016	T50SOS3DOP65130E	57	170-44000	HEGPA6640	169
151-06500	DSWS4	114	156-00049	CBT30MR	74	157-00028	T50SOSFT6D10E	56	170-45000	HEGPA6650	169
151-06502	DSWS5	114	156-00076	T5OROSFT6	58	157-00033	T50SOSFT6E1	56	170-46000	HEGPA6660	169
151-07000	HDM320	112	156-00079	T50SOSSB55	68	157-00037	T50SOSSB55-High-E-C-CC	62	170-50030	HEGPV0X03	168
151-07100	HDM321	112	156-00080	T50SOSSB5	67	157-00039	T50SOSSBD-M8	61	170-50060	HEGPV0X06	168
151-07200	HDM400	112	156-00083	T5ORSB5CSD	67	157-00040	T50SOSSBD-M10	61	170-50090	HEGPV0X09	168
151-07400	HDM500	112	156-00084	T5ORSB5	67	157-00042	T50SOSFT6LGE	56	170-50120	HEGPV0X12	168
151-08101	LRJ1	81	156-00085	T5OROSFT6SD	58	157-00045	T50SOSFT6D10E	56	170-50200	HEGPV0X20	168
151-14130	IPC13AH	93	156-00104	T4ORFT8GSD	59	157-00047	LFC165-2	63	170-50300	HEGPV0X30	168
151-14132	IPC13P	93	156-00109	T50SOSEC4B	72	157-00053	T50SOSFT7X12U	57	170-50400	HEGPV0X40	168
151-14300	PC23	92	156-00116	T5OROSGBS8CC	68	157-00054	T50ROSFT7X12U	57	170-50500	HEGPV0X50	168
151-14311	CTC10FT6	98	156-00120	T5OROSFT10	59	157-00066	T50SOSSBU-M8	61	170-60401	HEGSA504	170
151-14312	CTC13FT6	98	156-00128	T50SMVCOC1014	77	157-00067	T50SOSSBU-M10	61	170-60600	HEGSA506	170
151-14313	CTC7.5FT6LG	98	156-00129	T50SMVCOC15-18SET	77	157-00069	T50SOS2DOP	57	170-60900	HEGSA509	170
151-14314	CTC4.5FT6LG	98	156-00130	T50SMVCOC19245	77	157-00072	T50SOSFT8E	56	170-61200	HEGSA512	170
151-14400	IPC10P	93	156-00131	T50SMVCOC39-45SET	77	157-00083	T50SSB5GOT-E	60	170-61500	HEGSA515	170
151-14500	IPC15AH	93	156-00133	T50SOSDSFT6.5	54	157-00085	T50SOSFT6-E2	56	170-62000	HEGSA520	170
151-14502	IPC15P	93	156-00134	T50SVCOC10-14	77	157-00101	T60ROSSBH6HEC	62	170-63000	HEGSA530	170
151-14601	IPC23AH	93	156-00135	T50SVCOC15-18	77	157-00115	T50SOSFT8E	56	170-64000	HEGSA540	170
151-14603	IPC23P	93	156-00136	T50SVCOC19-245	77	157-00400	WSS250	63	170-80503	HEGPL03	173
151-14700	PC35LAH	92	156-00137	T50SVCOC39-45	77	157-00401	WSI250	63	170-80506	HEGPL06	173
151-14801	PC5DP7L	92	156-00154	T50SFT6LGS1SD	59	157-00402	WSR250	63	170-80512	HEGPL12	173
151-26101	TC-SB5C	87	156-00155	T50SVC65	77	157-00404	WSI380	63	170-80520	HEGPL20	173
151-29301	MSBT120	115	156-00200	T120FT9	59	170-00060	HEGPX06	166	170-80530	HEGPL30	173
151-29400	S2CM25	113	156-00235	T5ORFT8GSD	59	170-00090	HEGPX09	166	170-80540	HEGPL40	173
151-29403	S2HM25	113	156-00251	T5OROSGBS8CA	68	170-00120	HEGPX12	166	170-80550	HEGPL50	173
151-29500	S3STM50	114	156-00252	T5OROSGBS8CB	68	170-00200	HEGPX20	166	170-99001	HSG0	141
151-29600	SAMB3	113	156-00264	T50SOSSFT6.5-E-MDL	47	170-00300	HEGPX30	166	173-00400	HEGEMIP04	171
151-29701	SAOM82	113	156-00271	T50SOSSFT6.5-E-MDL	47	170-00400	HEGPX40	166	173-00600	HEGEMIP06	171
155-01600	STAND-OFF-CLIP-2	83	156-00272	T50SVCOC25-31	77	170-01000	Twist-In 05	175	173-00800	HEGEMIP08	171

Article-No. 173-01000 - 333-32405

Article-No.	Type	Page	Article-No.	Type	Page	Article-No.	Type	Page	Article-No.	Type	Page
173-01000	HEGEMIP10	171	300-73080	TCN20-12.7/6.4	148	309-20164	TF21-1.6/0.8	152	315-50640	TR27-6.4/3.2	164
173-01200	HEGEMIP12	171	300-73090	TCN20-19.1/9.5	148	309-20166	TF21-1.6/0.8	152	315-50950	TR27-9.5/4.8	164
173-01400	HEGEMIP14	171	300-73100	TCN20-25.4/12.7	148	309-20169	TF21-1.6/0.8	152	315-51270	TR27-12.7/6.4	164
173-01600	HEGEMIP16	171	300-73110	TCN20-38.1/19.1	148	309-20242	TF21-2.4/1.2	152	315-51900	TR27-19.1/9.5	164
173-01800	HEGEMIP18	171	300-73120	TCN20-50.8/25.4	148	309-20244	TF21-2.4/1.2	152	315-52540	TR27-25.4/12.7	164
173-02000	HEGEMIP20	171	300-73130	TCN20-2.4/0.8	149	309-20246	TF21-2.4/1.2	152	315-53810	TR27-38.1/19.1	164
173-60400	HEGEMIPV004	172	300-73140	TCN20-3.2/1.2	149	309-20249	TF21-2.4/1.2	152	315-55100	TR27-50.8/25.4	164
173-60600	HEGEMIPV006	172	300-73150	TCN20-4.8/1.6	149	309-20322	TF21-3.2/1.6	152	330-00320	VITON®-E-3.2/1.6	159
173-60800	HEGEMIPV008	172	300-73160	TCN20-6.6/2.4	149	309-20324	TF21-3.2/1.6	152	330-00480	VITON®-E-4.8/2.4	159
173-61000	HEGEMIPV010	172	300-73170	TCN20-9.5/3.2	149	309-20326	TF21-3.2/1.6	152	330-00640	VITON®-E-6.4/3.2	159
173-61200	HEGEMIPV012	172	300-73180	TCN20-12.7/4.8	149	309-20329	TF21-3.2/1.6	152	330-00950	VITON®-E-9.5/4.8	159
173-61400	HEGEMIPV014	172	300-73190	TCN20-19.0/6.4	149	309-20952	TF21-9.5/4.8	152	330-01270	VITON®-E-12.7/6.4	159
173-61600	HEGEMIPV016	172	300-73200	TCN20-25.4/9.5	149	309-20954	TF21-9.5/4.8	152	330-01900	VITON®-E-19.0/9.5	159
173-61800	HEGEMIPV018	172	300-73210	TCN20-38.0/12.7	149	309-20956	TF21-9.5/4.8	152	330-02540	VITON®-E-25.4/12.7	159
173-62000	HEGEMIPV020	172	302-20120	TL27-1.2/0.6	150	309-20959	TF21-9.5/4.8	152	330-03810	VITON®-E-38.0/19.0	159
190-00022	SNP1	101	302-20160	TL27-1.6/0.8	150	309-21272	TF21-12.7/6.4	153	330-05080	VITON®-E-50.8/25.4	159
190-00029	SNP1.25	101	302-21270	TL27-12.7/6.4	150	309-21274	TF21-12.7/6.4	153	333-20150	TF31-1.5/0.5	155
190-00090	SNP19	101	302-23810	TL27-38.1/19.1	150	309-21276	TF21-12.7/6.4	153	333-20900	TF31-9/3	155
190-00127	SNP28	101	302-25080	TL27-50.8/25.4	150	309-21279	TF21-12.7/6.4	153	333-21200	TF31-12/4	155
190-00254	SNP12A	101	302-30240	TL27-2.4/1.2	150	309-31023	TF24-101.6/50.8	154	333-24000	TF31-40/13	155
190-00258	SNP18A	101	302-30320	TL27-3.2/1.6	150	309-31903	TF24-19.1/9.5	154	333-30150	TF31-1.5/0.5	156
190-00300	SNP14A	101	302-30480	TL27-4.8/2.4	150	309-32543	TF24-25.4/12.7	154	333-30152	TF31-1.5/0.5	156
191-00005	SNP42N	101	302-30640	TL27-6.4/3.2	150	309-33813	TF24-38.1/19.1	154	333-30153	TF34-1.5/0.5	157
191-01700	MSN1-70	140	302-30950	TL27-9.5/4.8	150	309-35083	TF24-50.8/25.4	154	333-30154	TF31-1.5/0.5	156
191-02220	ASNP2-22	140	302-31900	TL27-19.1/9.5	150	309-37603	TF24-76.2/38.1	154	333-30155	TF31-1.5/0.5	156
191-10029	SNP2(E)	101	302-32540	TL27-25.4/12.7	150	309-40123	TF24-1.2/0.6	154	333-30156	TF31-1.5/0.5	156
191-10039	SNP3(E)	101	309-10120	TF21-1.2/0.6	152	309-40163	TF24-1.6/0.8	154	333-30157	TF31-1.5/0.5	156
191-10049	SNP4(E)	101	309-10160	TF21-1.6/0.8	152	309-40243	TF24-2.4/1.2	154	333-30159	TF31-1.5/0.5	156
191-10069	SNP6(E)	101	309-10240	TF21-2.4/1.2	152	309-40247	TF21-2.4/1.2	152	333-30300	TF31-3/1	156
191-10089	SNP8(E)	101	309-10320	TF21-3.2/1.6	152	309-40323	TF24-3.2/1.6	154	333-30302	TF31-3/1	156
191-10109	SNP10(E)	101	309-10480	TF21-4.8/2.4	152	309-40327	TF21-3.2/1.6	152	333-30303	TF34-3/1	157
191-10129	SNP12(E)	101	309-10640	TF21-6.4/3.2	152	309-40953	TF24-9.5/4.8	154	333-30304	TF31-3/1	156
191-10149	SNP14(E)	101	309-10950	TF21-9.5/4.8	152	309-41273	TF24-12.7/6.4	154	333-30305	TF31-3/1	156
191-10169	SNP16(E)	101	309-11020	TF21-10.6/50.8	153	309-41277	TF21-12.7/6.4	153	333-30306	TF31-3/1	156
191-10189	SNP18(E)	101	309-11022	TF21-10.6/50.8	153	309-50482	TF21-4.8/2.4	152	333-30307	TF31-3/1	156
191-10209	SNP20(E)	101	309-11024	TF21-10.6/50.8	153	309-50483	TF24-4.8/2.4	154	333-30309	TF31-3/1	156
191-10229	SNP22(E)	101	309-11026	TF21-10.6/50.8	153	309-50484	TF21-4.8/2.4	152	333-30600	TF31-6/2	156
191-10249	SNP24(E)	101	309-11029	TF21-10.6/50.8	153	309-50486	TF21-4.8/2.4	152	333-30602	TF31-6/2	156
191-10329	SNP32(E)	101	309-11270	TF21-12.7/6.4	153	309-50487	TF21-4.8/2.4	152	333-30603	TF34-6/2	157
191-10349	SNP34(E)	101	309-11900	TF21-19.0/9.5	153	309-50489	TF21-4.8/2.4	152	333-30604	TF31-6/2	156
191-10369	SNP36(E)	101	309-11902	TF21-19.0/9.5	153	309-50642	TF21-6.4/3.2	152	333-30605	TF31-6/2	156
191-10389	SNP38(E)	101	309-11904	TF21-19.0/9.5	153	309-50643	TF24-6.4/3.2	154	333-30606	TF31-6/2	156
191-10429	SNP42(E)	101	309-11906	TF21-19.0/9.5	153	309-50644	TF21-6.4/3.2	152	333-30607	TF31-6/2	156
191-10469	SNP46(E)	101	309-11907	TF21-19.0/9.5	153	309-50646	TF21-6.4/3.2	152	333-30609	TF31-6/2	156
191-10509	SNP50(E)	101	309-11909	TF21-19.0/9.5	153	309-50647	TF21-6.4/3.2	152	333-30900	TF31-9/3	156
191-10549	SNP54(E)	101	309-12540	TF21-25.4/12.7	153	309-50649	TF21-6.4/3.2	152	333-30902	TF31-9/3	156
191-10589	SNP58(E)	101	309-12542	TF21-25.4/12.7	153	309-50957	TF21-9.5/4.8	152	333-30903	TF34-9/3	157
191-10629	SNP62(E)	101	309-12544	TF21-25.4/12.7	153	311-00129	TK20-1.2/0.6	160	333-30904	TF31-9/3	156
191-24700	ASNP24-70	140	309-12546	TF21-25.4/12.7	153	311-00169	TK20-1.6/0.8	160	333-30905	TF31-9/3	156
192-10010	SNP1	101	309-12547	TF21-25.4/12.7	153	311-00249	TK20-2.4/1.2	160	333-30906	TF31-9/3	156
192-10020	SNP2	101	309-12549	TF21-25.4/12.7	153	311-00329	TK20-3.2/1.6	160	333-30907	TF31-9/3	156
192-10040	SNP4	101	309-13810	TF21-38.0/19.0	153	311-00489	TK20-4.8/2.4	160	333-30909	TF31-9/3	156
192-10060	SNP6	101	309-13812	TF21-38.0/19.0	153	311-00649	TK20-6.4/3.2	160	333-31200	TF31-12/4	156
192-10070	SNP7	101	309-13814	TF21-38.0/19.0	153	311-00959	TK20-9.5/4.8	160	333-31202	TF31-12/4	156
192-10080	SNP8	101	309-13816	TF21-38.0/19.0	153	311-01279	TK20-12.7/6.4	160	333-31203	TF34-12/4	157
192-10100	SNP10	101	309-13817	TF21-38.0/19.0	153	311-01909	TK20-19.1/9.5	160	333-31204	TF31-12/4	156
192-10160	SNP16	101	309-13819	TF21-38.0/19.0	153	311-02549	TK20-25.4/12.7	160	333-31205	TF31-12/4	156
192-10220	SNP22	101	309-15080	TF21-50.8/25.4	153	311-03819	TK20-38.1/19.1	160	333-31206	TF31-12/4	156
192-10240	SNP24	101	309-15082	TF21-50.8/25.4	153	311-05089	TK20-50.8/25.4	160	333-31207	TF31-12/4	156
192-10320	SNP32	101	309-15084	TF21-50.8/25.4	153	311-90129	TK29-1.2/0.6	161	333-31209	TF31-12/4	156
192-10360	SNP36	101	309-15086	TF21-50.8/25.4	153	311-90169	TK29-1.6/0.8	161	333-31800	TF31-18/6	156
192-10380	SNP38	101	309-15087	TF21-50.8/25.4	153	311-90249	TK29-2.4/1.2	161	333-31802	TF31-18/6	156
192-10500	SNP50	101	309-15089	TF21-50.8/25.4	153	311-90329	TK29-3.2/1.6	161	333-31803	TF34-18/6	157
193-00150	SNP1.5	101	309-17600	TF21-76.0/38.0	153	311-90489	TK29-4.8/2.4	161	333-31804	TF31-18/6	156
241-00001	PLUGFT6XL	102	309-17602	TF21-76.0/38.0	153	311-90649	TK29-6.4/3.2	161	333-31805	TF31-18/6	156
241-00002	PLUGFT6XL	102	309-17604	TF21-76.0/38.0	153	311-90959	TK29-9.5/4.8	161	333-31806	TF31-18/6	156
300-73010	TCN20-1.2/0.6	148	309-17606	TF21-76.0/38.0	153	311-91279	TK29-12.7/6.4	161	333-31807	TF31-18/6	156
300-73020	TCN20-1.6/0.8	148	309-17609	TF21-76.0/38.0	153	311-91909	TK29-19.1/9.5	161	333-31809	TF31-18/6	156
300-73030	TCN20-2.4/1.2	148	309-20122	TF21-1.2/0.6	152	311-92549	TK29-25.4/12.7	161	333-32400	TF31-24/8	156
300-73040	TCN20-3.2/1.6	148	309-20124	TF21-1.2/0.6	152	311-93819	TK29-38.1/19.1	161	333-32402	TF31-24/8	156
300-73050	TCN20-4.8/2.4	148	309-20126	TF21-1.2/0.6	152	311-95089	TK29-50.8/25.4	161	333-32403	TF34-24/8	157
300-73060	TCN20-6.4/3.2	148	309-20129	TF21-1.2/0.6	152	315-50320	TR27-3.2/1.6	164	333-32404	TF31-24/8	156
300-73070	TCN20-9.5/4.8	148	309-20162	TF21-1.6/0.8	152	315-50480	TR27-4.8/2.4	164	333-32405	TF31-24/8	156

Article-No. 333-32406 - 556-00101

Article-No.	Type	Page	Article-No.	Type	Page	Article-No.	Type	Page	Article-No.	Type	Page
333-32406	TF31-24/8	156	501-01134	ABR.1-M	190	501-03104	ABR.3-J	190	501-05074	ABR.5-G	191
333-32407	TF31-24/8	156	501-01144	ABR.1-N	190	501-03114	ABR.3-K	190	501-05084	ABR.5-H	191
333-32409	TF31-24/8	156	501-01154	ABR.1-O	190	501-03124	ABR.3-L	190	501-05094	ABR.5-I	191
333-34000	TF31-40/13	156	501-01164	ABR.1-P	190	501-03134	ABR.3-M	190	501-05104	ABR.5-J	191
333-34002	TF31-40/13	156	501-01174	ABR.1-Q	190	501-03144	ABR.3-N	190	501-05114	ABR.5-K	191
333-34003	TF34-40/13	157	501-01184	ABR.1-R	190	501-03154	ABR.3-O	190	501-05124	ABR.5-L	191
333-34004	TF31-40/13	156	501-01194	ABR.1-S	190	501-03164	ABR.3-P	190	501-05134	ABR.5-M	191
333-34005	TF31-40/13	156	501-01204	ABR.1-T	190	501-03174	ABR.3-Q	190	501-05144	ABR.5-N	191
333-34006	TF31-40/13	156	501-01214	ABR.1-U	190	501-03184	ABR.3-R	190	501-05154	ABR.5-O	191
333-34009	TF31-40/13	156	501-01224	ABR.1-V	190	501-03194	ABR.3-S	190	501-05164	ABR.5-P	191
333-40300	TF31-3/1	155	501-01234	ABR.1-W	190	501-03204	ABR.3-T	190	501-05174	ABR.5-Q	191
333-40600	TF31-6/2	155	501-01244	ABR.1-X	190	501-03214	ABR.3-U	190	501-05184	ABR.5-R	191
333-41800	TF31-18/6	155	501-01254	ABR.1-Y	190	501-03224	ABR.3-V	190	501-05194	ABR.5-S	191
333-42400	TF31-24/8	155	501-01264	ABR.1-Z	190	501-03234	ABR.3-W	190	501-05204	ABR.5-T	191
336-00079	TFE2-30	163	501-01274	ABR.1+	190	501-03244	ABR.3-X	190	501-05214	ABR.5-U	191
336-00099	TFE2-28	163	501-01284	ABR.1--	190	501-03254	ABR.3-Y	190	501-05224	ABR.5-V	191
336-00109	TFE2-26	163	501-01604	ABR.1-0	190	501-03264	ABR.3-Z	190	501-05234	ABR.5-W	191
336-00139	TFE2-24	163	501-01614	ABR.1-1	190	501-03274	ABR.3+	190	501-05244	ABR.5-X	191
336-00149	TFE2-22	163	501-01624	ABR.1-2	190	501-03284	ABR.3--	190	501-05254	ABR.5-Y	191
336-00159	TFE2-20	163	501-01634	ABR.1-3	190	501-03604	ABR.3-0	190	501-05264	ABR.5-Z	191
336-00199	TFE2-18	163	501-01644	ABR.1-4	190	501-03614	ABR.3-1	190	501-05274	ABR.5+	191
336-00249	TFE2-16	163	501-01654	ABR.1-5	190	501-03624	ABR.3-2	190	501-05284	ABR.5--	191
336-00319	TFE2-14	163	501-01664	ABR.1-6	190	501-03634	ABR.3-3	190	501-05604	ABR.5-0	191
336-00399	TFE2-12	163	501-01674	ABR.1-7	190	501-03644	ABR.3-4	190	501-05614	ABR.5-1	191
336-00489	TFE2-10	163	501-01684	ABR.1-8	190	501-03654	ABR.3-5	190	501-05624	ABR.5-2	191
336-00619	TFE2-8	163	501-01694	ABR.1-9	190	501-03664	ABR.3-6	190	501-05634	ABR.5-3	191
336-00779	TFE2-6	163	501-02014	ABR.2-A	190	501-03674	ABR.3-7	190	501-05644	ABR.5-4	191
336-00949	TFE2-4	163	501-02024	ABR.2-B	190	501-03684	ABR.3-8	190	501-05654	ABR.5-5	191
336-01109	TFE2-2	163	501-02034	ABR.2-C	190	501-03694	ABR.3-9	190	501-05664	ABR.5-6	191
336-01209	TFE2-0	163	501-02044	ABR.2-D	190	501-04014	ABR.4-A	191	501-05674	ABR.5-7	191
339-00209	TFE4-5/64	163	501-02054	ABR.2-E	190	501-04024	ABR.4-B	191	501-05684	ABR.5-8	191
339-00329	TFE4-1/8	163	501-02064	ABR.2-F	190	501-04034	ABR.4-C	191	501-05694	ABR.5-9	191
339-00340	TFE4-3/16	163	501-02074	ABR.2-G	190	501-04044	ABR.4-D	191	553-40300	TULT3-1BK	186
339-00649	TFE4-1/4	163	501-02084	ABR.2-H	190	501-04054	ABR.4-E	191	553-40302	TULT3-1RD	186
339-00959	TFE4-3/8	163	501-02094	ABR.2-I	190	501-04064	ABR.4-F	191	553-40304	TULT3-1YE	186
339-01279	TFE4-1/2	163	501-02104	ABR.2-J	190	501-04074	ABR.4-G	191	553-40306	TULT3-1BU	186
339-01599	TFE4-5/8	163	501-02114	ABR.2-K	190	501-04084	ABR.4-H	191	553-40309	TULT3-1WH	186
339-01909	TFE4-3/4	163	501-02124	ABR.2-L	190	501-04094	ABR.4-I	191	553-40480	TULT4.8-1.6BK	186
339-02549	TFE4-1	163	501-02134	ABR.2-M	190	501-04104	ABR.4-J	191	553-40482	TULT4.8-1.6RD	186
339-03189	TFE4-1 1/4	163	501-02144	ABR.2-N	190	501-04114	ABR.4-K	191	553-40484	TULT4.8-1.6YE	186
340-03010	EPS-300-3/1	158	501-02154	ABR.2-O	190	501-04124	ABR.4-L	191	553-40486	TULT4.8-1.6BU	186
340-06020	EPS-300-6/2	158	501-02164	ABR.2-P	190	501-04134	ABR.4-M	191	553-40489	TULT4.8-1.6VH	186
340-09030	EPS-300-9/3	158	501-02174	ABR.2-Q	190	501-04144	ABR.4-N	191	553-40600	TULT6-2BK	186
340-12040	EPS-300-12/4	158	501-02184	ABR.2-R	190	501-04154	ABR.4-O	191	553-40602	TULT6-2RD	186
340-19060	EPS-300-19/6	158	501-02194	ABR.2-S	190	501-04164	ABR.4-P	191	553-40604	TULT6-2YE	186
340-24080	EPS-300-24/8	158	501-02204	ABR.2-T	190	501-04174	ABR.4-Q	191	553-40606	TULT6-2BU	186
340-40130	EPS-300-40/13	158	501-02214	ABR.2-U	190	501-04184	ABR.4-R	191	553-40609	TULT6-2WH	186
341-04010	EPS-400-4/1	158	501-02224	ABR.2-V	190	501-04194	ABR.4-S	191	553-40900	TULT9-3BK	186
341-08020	EPS-400-8/2	158	501-02234	ABR.2-W	190	501-04204	ABR.4-T	191	553-40902	TULT9-3RD	186
341-12030	EPS-400-12/3	158	501-02244	ABR.2-X	190	501-04214	ABR.4-U	191	553-40904	TULT9-3YE	186
341-16040	EPS-400-16/4	158	501-02254	ABR.2-Y	190	501-04224	ABR.4-V	191	553-40906	TULT9-3BU	186
341-24060	EPS-400-24/6	158	501-02264	ABR.2-Z	190	501-04234	ABR.4-W	191	553-40909	TULT9-3WH	186
341-32080	EPS-400-32/8	158	501-02274	ABR.2+	190	501-04244	ABR.4-X	191	553-41200	TULT12-4BK	186
391-50200	H5002	137	501-02284	ABR.2--	190	501-04254	ABR.4-Y	191	553-41202	TULT12-4RD	186
391-50400	H5004	137	501-02604	ABR.2-0	190	501-04264	ABR.4-Z	191	553-41204	TULT12-4YE	186
391-50500	Z3 Reflector	137	501-02614	ABR.2-1	190	501-04274	ABR.4+	191	553-41206	TULT12-4BU	186
391-50600	Z4 Wide Slot Nozzle	137	501-02624	ABR.2-2	190	501-04284	ABR.4--	191	553-41209	TULT12-4VH	186
391-90001	Z3 Reduction Nozzle	138	501-02634	ABR.2-3	190	501-04604	ABR.4-0	191	553-41800	TULT18-6BK	186
391-90002	E4500	138	501-02644	ABR.2-4	190	501-04614	ABR.4-1	191	553-41802	TULT18-6RD	186
391-90101	P445	138	501-02654	ABR.2-5	190	501-04624	ABR.4-2	191	553-41804	TULT18-6YE	186
391-90300	Z2 Deflector Nozzle	138	501-02664	ABR.2-6	190	501-04634	ABR.4-3	191	553-41806	TULT18-6BU	186
501-01014	ABR.1-A	190	501-02674	ABR.2-7	190	501-04644	ABR.4-4	191	553-41809	TULT18-6VH	186
501-01024	ABR.1-B	190	501-02684	ABR.2-8	190	501-04654	ABR.4-5	191	553-42400	TULT24-8BK	186
501-01034	ABR.1-C	190	501-02694	ABR.2-9	190	501-04664	ABR.4-6	191	553-42402	TULT24-8RD	186
501-01044	ABR.1-D	190	501-03014	ABR.3-A	190	501-04674	ABR.4-7	191	553-42404	TULT24-8YE	186
501-01054	ABR.1-E	190	501-03024	ABR.3-B	190	501-04684	ABR.4-8	191	553-42406	TULT24-8BU	186
501-01064	ABR.1-F	190	501-03034	ABR.3-C	190	501-04694	ABR.4-9	191	553-42409	TULT24-8VH	186
501-01074	ABR.1-G	190	501-03044	ABR.3-D	190	501-05014	ABR.5-A	191	553-43900	TULT39-13BK	186
501-01084	ABR.1-H	190	501-03054	ABR.3-E	190	501-05024	ABR.5-B	191	553-43902	TULT39-13RD	186
501-01094	ABR.1-I	190	501-03064	ABR.3-F	190	501-05034	ABR.5-C	191	553-43904	TULT39-13YE	186
501-01104	ABR.1-J	190	501-03074	ABR.3-G	190	501-05044	ABR.5-D	191	553-43906	TULT39-13BU	186
501-01114	ABR.1-K	190	501-03084	ABR.3-H	190	501-05054	ABR.5-E	191	553-43909	TULT39-13VH	186
501-01124	ABR.1-L	190	501-03094	ABR.3-I	190	501-05064	ABR.5-F	191	556-00101	TR822OUT 110MM	201

Article-No. 556-00111 - 621-60810

Article-No.	Type	Page	Article-No.	Type	Page
556-00111	TT822OUT 60MM	201	596-12126	TAG18-07TD1-1210-WH	193
556-00117	TT932DOOUT 85MM	201	596-12127	TAG18-16TD1-1210-WH	193
556-00118	TT932DOOUT 102MM	201	596-12128	TAG23-06TD1-1210-WH	193
556-00119	TT896DOOUT 85MM	201	596-12129	TAG23-10TD1-1210-WH	193
556-00120	TT896DOOUT 102MM	201	596-12130	TAG26-21TD2-1210-WH	193
556-00121	TT940DOOUT 85MM	201	596-12131	TAG28-16TD1-1210-WH	193
556-00122	TT940DOOUT 102MM	201	596-12132	TAG43-16TD1-1210-WH	193
556-00124	TT932DOOUT 30MM	201	596-12133	TAG43-21TD1-1210-WH	193
556-00140	TTDTHOUT 60MM	201	596-12134	TAG43-41TD1-1210-WH	193
556-00141	TTDTHOUT 100MM	201	596-12135	TAG52-10TD1-1210-WH	193
556-00420	TT420+	200	596-12136	TAG68-16TD1-1210-WH	193
556-03011	CUTTER TRAY FOR S4000	202	596-12615	TAG15TD3-1206	196
556-04000	TT4000+ 300dpi	199	596-12616	TAG16TD3-1206	196
556-04024	P4000 Perforator	199, 202	596-12617	TAG17TD2-1206	196
556-04025	S4000 Cutter	199, 202	596-12627	TAG27TD2-1206	196
556-25006	TTAGPU15X100WH	187	596-12631	TAG31TD3-1206	196
556-25007	TTAGPU15X65WH	187	596-12634	TAG34TD3-1206	196
556-25010	TTAGPU15X100YE	187	596-12635	TAG35TD3-1206	196
556-25011	TTAGPU15X65YE	187	596-12661	TAG61TD3-1206	196
556-25012	TTAGPU11X65WH	187	596-12662	TAG62TD1-1206	196
556-25019	TTAGPU11X65YE	187	596-12663	TAG63TD1-1206	196
556-25020	TTAGPU11X100YE	187	596-12664	TAG64TD1-1206	196
556-25021	TTAGPU11X100WH	187	596-12665	TAG65TD1-1206	196
596-01120	TAG01TD3-1206	196	596-12666	TAG66TD1-1206	196
596-01320	TAG1TD2-320-WHCL	188	596-12667	TAG67TD2-1206	196
596-02320	TAG2TD6-320-WHCL	188	596-12668	TAG68TD1-1206	196
596-03320	TAG3TD3-320-WHCL	188	596-12669	TAG69TD2-1206	196
596-03322	TAG3TD3-322 YECL	188	596-12671	TAG71TD6-1206	196
596-06320	TAG6TD1-320-WHCL	188	596-12672	TAG72TD1-1206	196
596-07320	TAG07TD1-320-WHCL	188	596-12673	TAG73TD1-1206	196
596-09320	TAG9TD3-320-WHCL	188	596-20871	TAG71TD6-1208-WH	197
596-10320	TAG10TD2-320-WHCL	188	596-20872	TAG72TD1-1208-WH	197
596-10732	TAG107TD3-320-WHCL	188	596-21204	TAG02TD1-1204	195
596-12035	TAG35TD3-1204	195	596-22320	TAG22TD3-320-WHCL	188
596-12042	TAGR2TD1-1204	195	596-23320	TAG23TD5-320-WHCL	188
596-12043	TAG13TD4-1204	195	596-24320	TAG24TD1-320-WHCL	188
596-12045	TAG15TD3-1204	195	596-25320	TAG25TD3-320-WHCL	188
596-12046	TAG16TD3-1204	195	596-26320	TAG26TD6-320-WHCL	188
596-12047	TAG17TD2-1204	195	596-27120	TAG27TD2-1204	195
596-12061	TAG13TD4-1206	196	596-31120	TAG31TD3-1204	195
596-12062	TAG62TD1-1204	195	596-31204	TAGR3TD1-1204	195
596-12063	TAG63TD1-1204	195	596-31208	TAG73TD1-1208-WH	197
596-12064	TAG64TD1-1204	195	596-34120	TAG34TD3-1204	195
596-12065	TAG65TD1-1204	195	596-36320	TAG36TD7-320-WHCL	188
596-12066	TAG66TD1-1204	195	596-38320	TAG38TD3-320-WHCL	188
596-12067	TAG67TD2-1204	195	596-40951	TAG101-160TD1-951 SET	198
596-12068	TAG68TD1-1204	195	596-41206	TAG4TD1-1206	196
596-12069	TAG69TD2-1204	195	596-41951	TAG101-74TD1-951 SET	198
596-12071	TAG71TD6-1204	195	596-42951	TAG63.5-50.8TD1-951 SET	198
596-12072	TAG72TD1-1204	195	596-43951	TAG50.8-25.4TD1-951 SET	198
596-12076	TAG76TD1-1204	195	596-44951	TAG25.4-12.7TD1-951 SET	198
596-12077	TAG77TD1-1204	195	596-51320	TAG51TD3-320-WHCL	188
596-12078	TAG78TD1-1204	195	596-61206	TAG76TD1-1206	196
596-12080	TAG15TD3-1208-WH	197	596-61211	TAG68-16TD1-1211-YE	194
596-12081	TAG17TD2-1208-WH	197	596-71204	TAG97TD1-1204	195
596-12082	TAG27TD2-1208-WH	197	596-71206	TAG77TD1-1206	196
596-12083	TAG34TD3-1208-WH	197	596-71208	TAG77TD1-1208-WH	197
596-12084	TAG31TD3-1208-WH	197	596-73124	TAG73TD1-1204	195
596-12085	TAG35TD3-1208-WH	197	621-10001	NA01	139
596-12086	TAG66TD1-1208-WH	197	621-10103	NA1K3	139
596-12087	TAG67TD2-1208-WH	197	621-10405	NA45	139
596-12088	TAG68TD1-1208-WH	197	621-10810	NA810	139
596-12089	TAG69TD2-1208-WH	197	621-60001	NA01PRONG	139
596-12110	TAG18-07TD1-1211-YE	194	621-60103	NA1K3PRONG	139
596-12111	TAG18-16TD1-1211-YE	194	621-60405	NA45PRONG	139
596-12112	TAG23-06TD1-1211-YE	194	621-60810	NA810PRONG	139
596-12113	TAG23-10TD1-1211-YE	194			
596-12114	TAG26-21TD2-1211-YE	194			
596-12115	TAG28-16TD1-1211-YE	194			
596-12116	TAG43-16TD1-1211-YE	194			
596-12117	TAG43-21TD1-1211-YE	194			
596-12118	TAG43-41TD1-1211-YE	194			
596-12119	TAG52-10TD1-1211-YE	194			

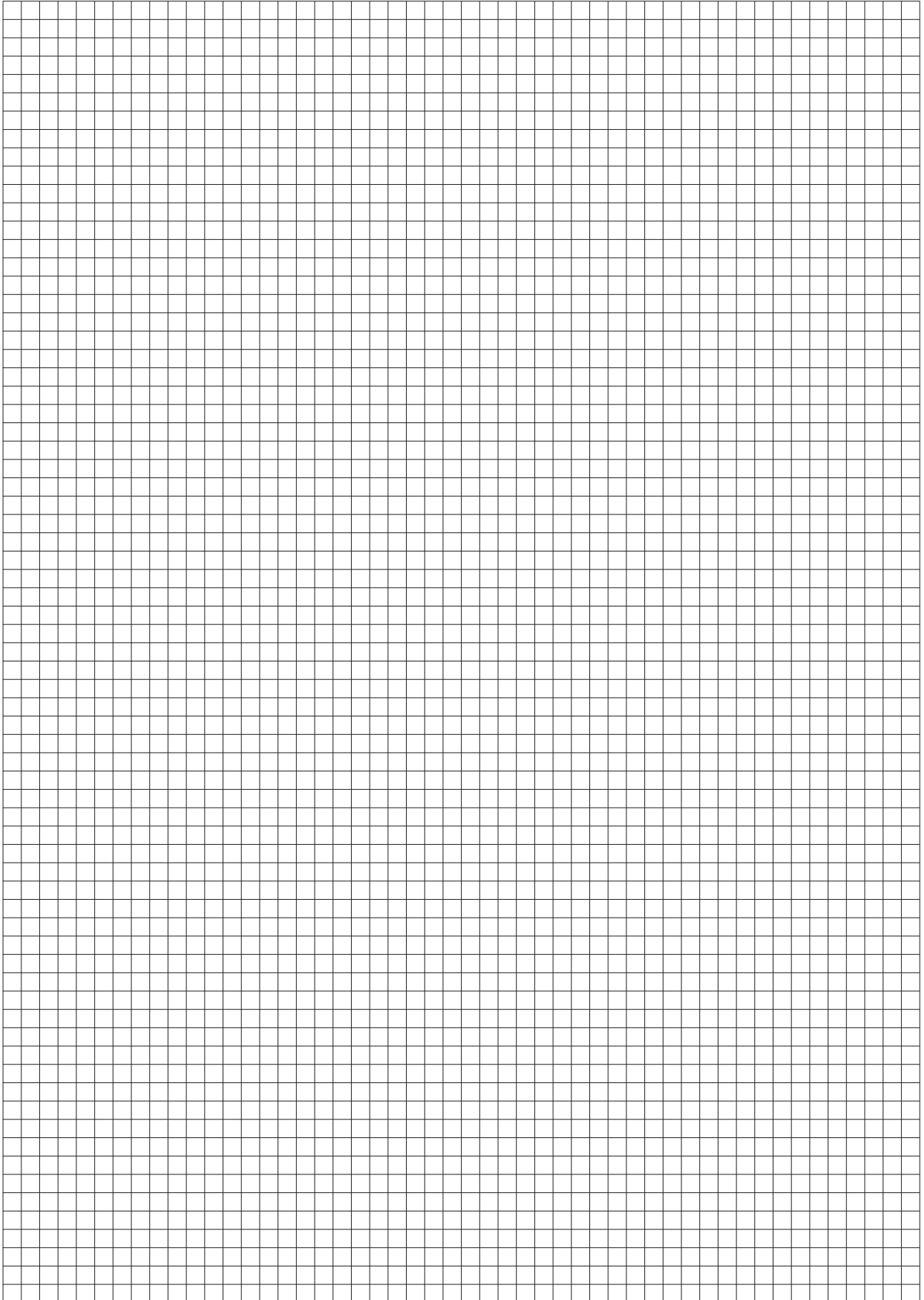

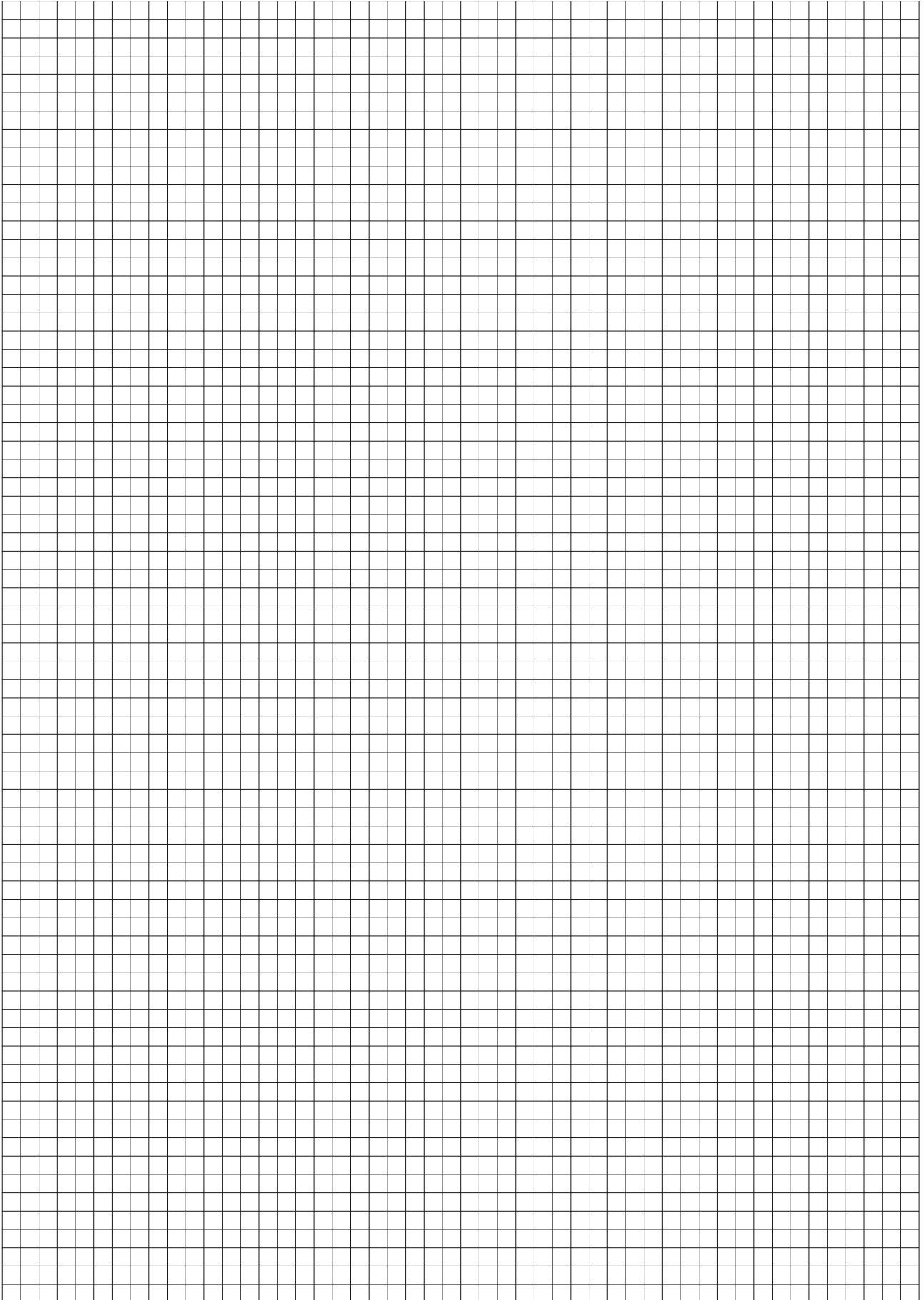

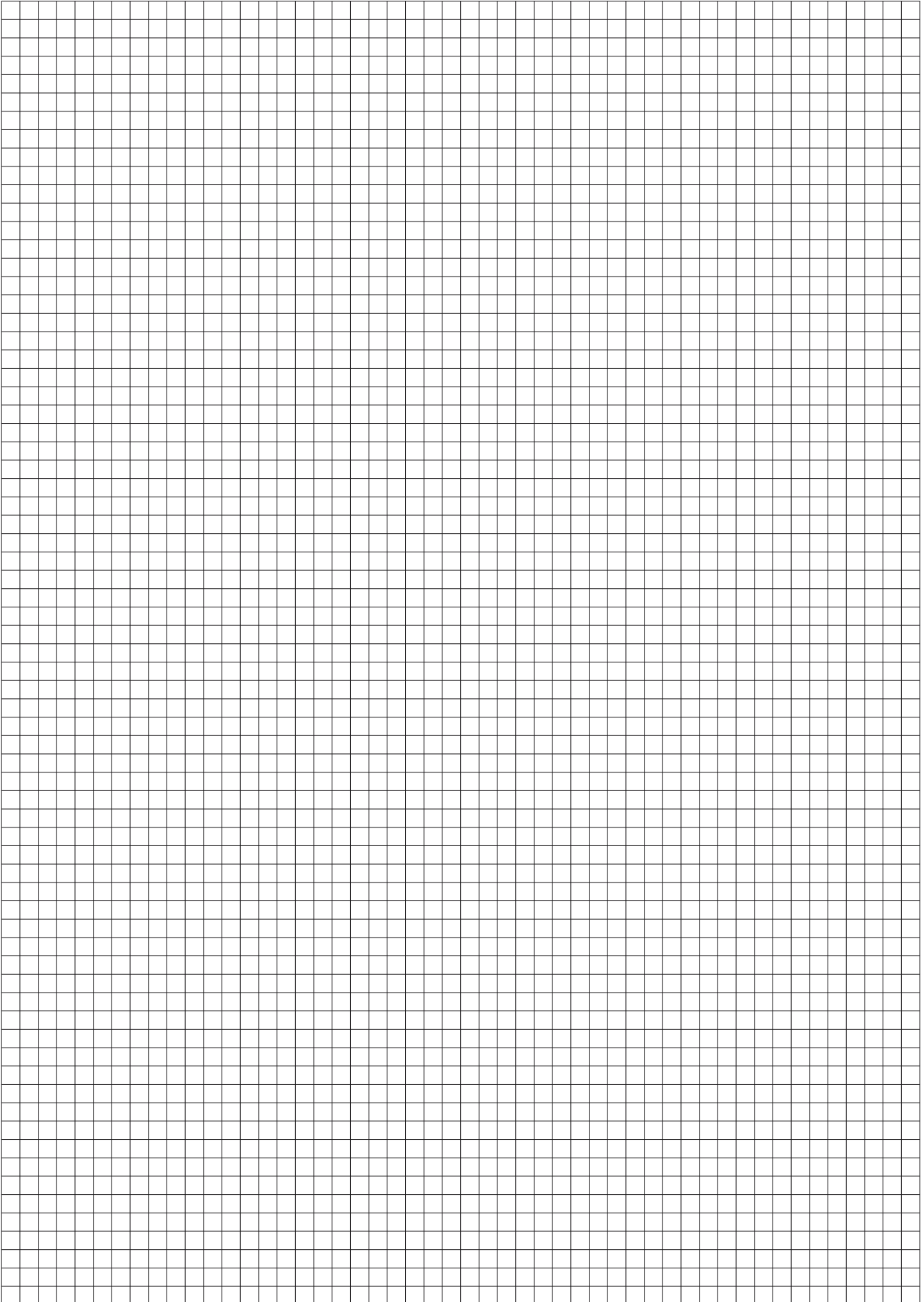

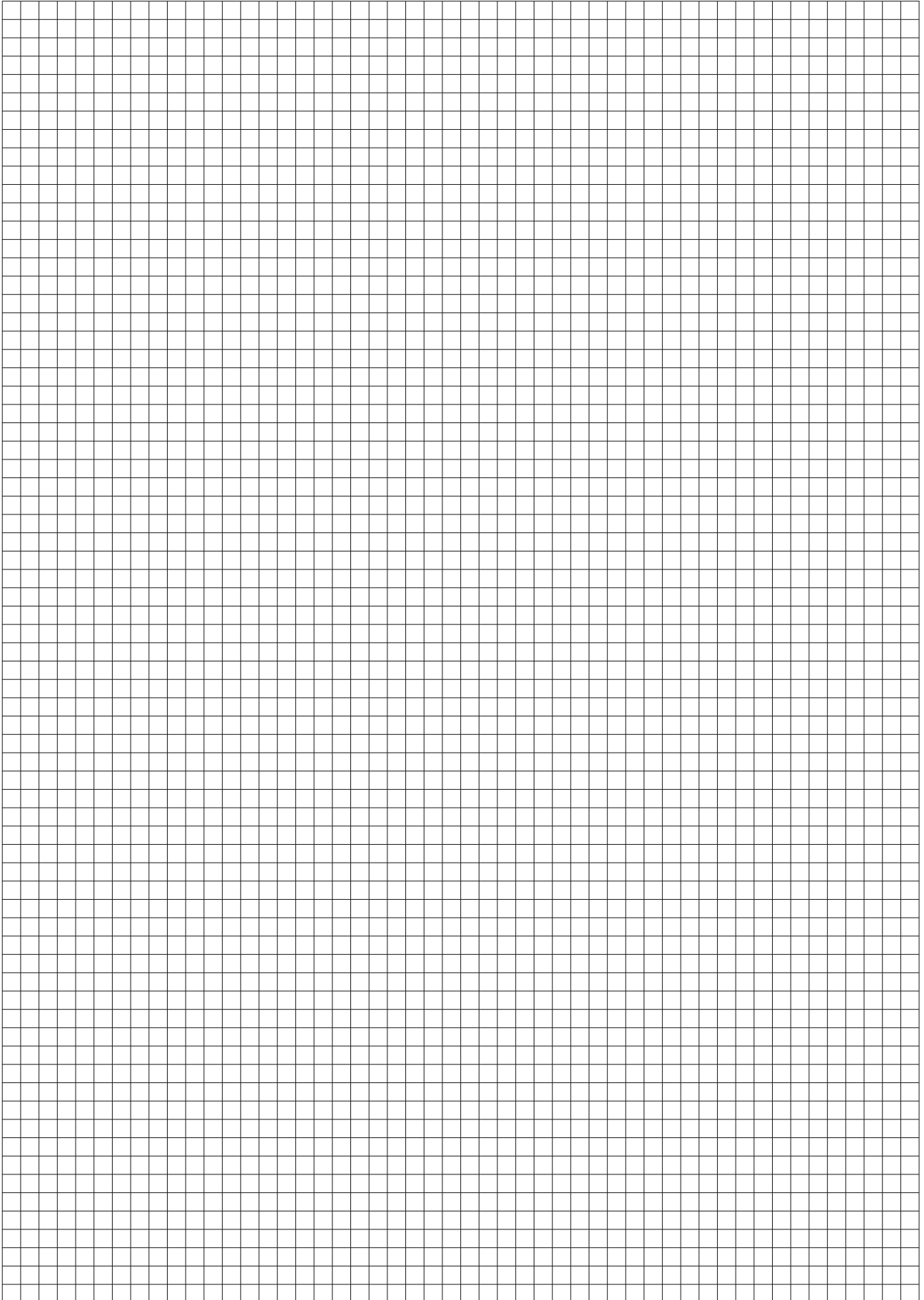

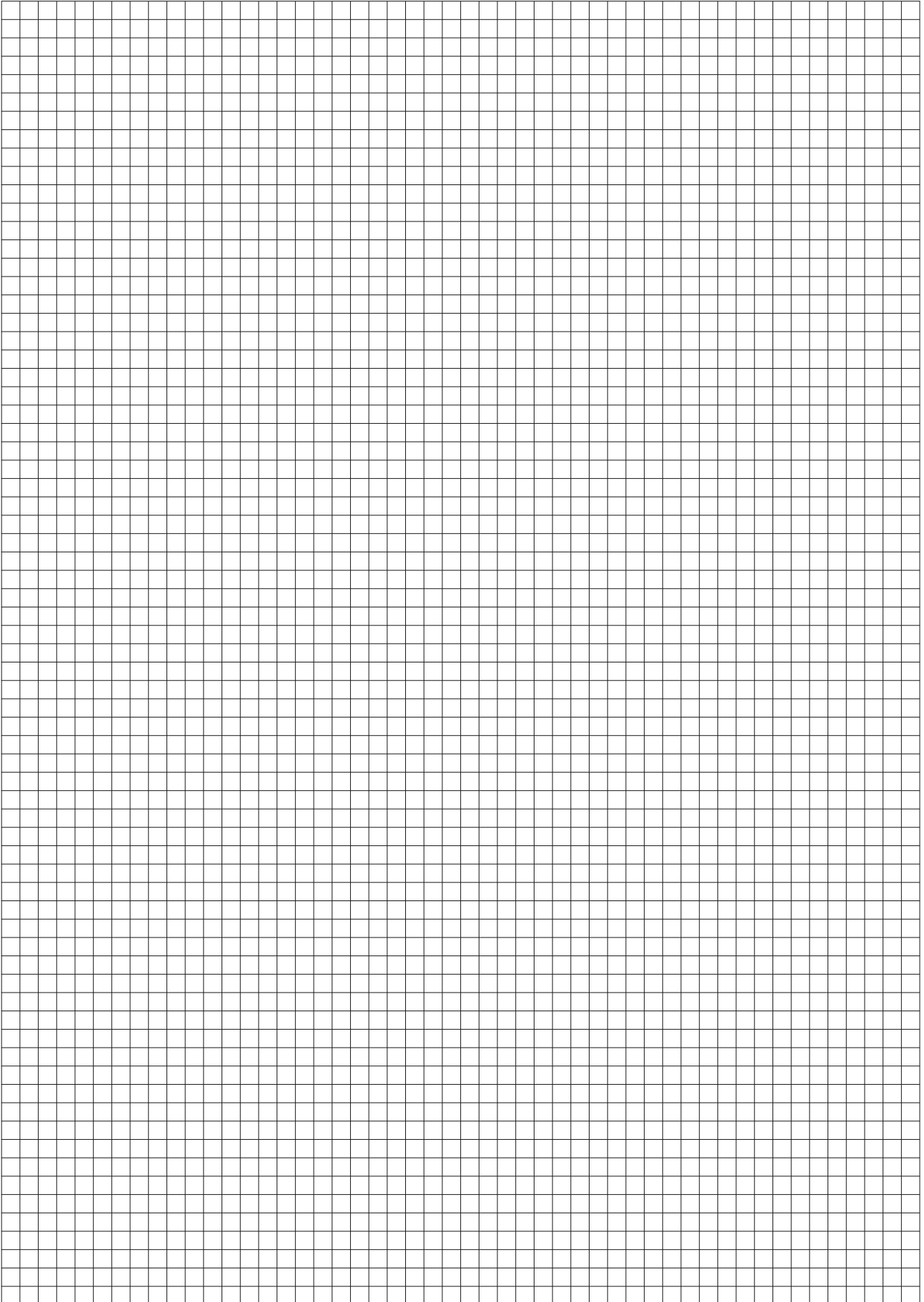

1. General

1.1 The following General Terms of Sale and Supply ("GTSS") apply to all current and future supplies and other services including any consultancy services and information of HellermannTyton Holdings GmbH and branches ("the Company"). This will also apply even if the Company does not refer the Buyer to them again in subsequent transactions. The Buyer's terms and conditions shall not form part of a contract even if the Company does not expressly raise objections. Rather these GTSS shall apply exclusively.

1.2 Quotations by the Company are made without obligation. A duty to supply will not exist until the Company issues a written Company confirmation of order.

1.3 All agreements that are made between the Company and the Buyer shall be put in writing in the contract.

1.4 In case of doubt Incoterms 2000 shall prevail for the interpretation of trade terms.

1.5 The Buyer may only assign to third parties claims against the Company arising from this contract with the prior express consent of the Company.

1.6 Where individual provisions of these General Terms of Sale and Supply are or become ineffective, this shall not affect the validity of the rest of the provisions. The invalid provision shall be replaced by such existing provision as is common practice in the trade for this event and, where there is no permissible one that is common practice in the trade, the corresponding statutory provision.

2. Prices and payment conditions

2.1 Unless otherwise agreed in writing, prices are understood, ex works or ex Company warehouse exclusive of packaging. Value Added Tax at the current statutory rate will apply. For minimum orders under 150 Euros (net less Turnover Tax) the Company will charge a minimum order surcharge of 25 Euros (net) per order.

2.2 All invoices – subject to any divergent written agreement in individual cases – are payable within thirty days of date of invoice.

2.3 Payments must be made free of charge, in the agreed currency and with provision of the account number, exclusively to the Company's accounts shown in the invoice. They must be made on the date due free of charge and without any deduction. Completion for payments of all types is the date on which the Company has unrestricted access to the payment.

2.4 The Company is not obliged to accept bills of exchange or cheques. If permitted they will only be accepted subject to possible discounting against payment of all charges. The Company is not obliged to submit bills of exchange or cheques on time or to lodge protests.

2.5 In the event of payment default by the Buyer, default interest of 8 (eight) percentage points p.a. over the current basic interest rate according to § 247 BGB [German Civil Code] shall be chargeable. The claiming of further loss caused by default is reserved.

2.6 Rights of set-off or retention shall be available to the Buyer only if his counterclaims are legally established, unchallenged or recognised by the Company. This restriction shall not apply to the § 320 BGB right of retention.

2.7 In the event of a petition to commence insolvency proceedings against the Buyer's assets, if the Buyer has initiated out-of-court proceedings to settle the debt or has stopped payments, or if the Company is aware of other circumstances which substantially reduce the credit-worthiness of the Buyer and appears to threaten fulfilment by the

Buyer of the counter-performance, the Company is entitled to seek security by advance payment or bank guarantee (at the Buyer's choice) for outstanding supplies by fixing a period of at least one week and to delay supply until the security is made. The Company is further entitled after the fruitless expiry of a reasonable period of grace to withdraw from this contract or to demand compensation for non-fulfilment of contract. In this case the Company may also withdraw the authority to resell together with the authorisation to collect under 5.3 and 5.5 and the right to handle and process, combine and mix goods already supplied under 5.2 and 5.3 and also to demand the return of the goods supplied.

3. Supply and acceptance

3.1 The Company's duty to supply is conditional on it receiving delivery that is complete, correct and on time in as far as the Company obtains the goods as complete or as components of the goods from a subcontractor. This does not apply if the Company is responsible for nondelivery or delay.

3.2 The Buyer shall bear the risk and cost of shipment of the goods ex works/ex warehouse as well as the cost of any transport insurance. This will also apply if shipment is by a carrier chosen by the Company.

3.3 The risk passes to the Buyer with the start of loading the goods onto the vehicle - even in the case of carriage-paid deliveries.

3.4 Should the goods be ready to be shipped and dispatch or assignment of space and/or acceptance is delayed on grounds beyond the Company's control, the risk passes to the Buyer upon receipt by the Buyer of notification of readiness to ship.

3.5 The Buyer may not return part shipments of a reasonable size and must pay for these immediately upon receipt of the part shipment. Objection to a part shipment does not entitle to a refusal of further supplies under the same or other contract. The Company reserves the right to over or under supply by 10% of the quantity ordered in the case of special orders. The actual quantity supplied will be invoiced in each case.

3.6 The Buyer will also be in default of acceptance if the supply is only offered by the Company in writing. Section 294 BGB is therefore contracted out. The other legal conditions for delay in acceptance are not affected.

3.7 The Buyer must promptly accept goods notified as ready for shipment under the terms of the contract. Otherwise the Company is entitled either to ship the goods at the risk and cost of the Buyer or place the goods in store and to invoice after a period of grace of one week has elapsed, as the Company chooses. The same will apply if the goods have not been retrieved in full or in part within the period agreed for retrieval.

3.8 If the Buyer falls more than one month behind in fulfilling the obligations resulting from the above arrangements the Company can, notwithstanding rights that extend further, demand from the Buyer a contract penalty of 5 (five) percent of the invoice value in place of fulfilment of contract, and sell the goods stored elsewhere. The contractual penalty must be calculated against the compensation the Buyer would have to pay if the situation arose. The Buyer must repay any quantity discount granted on earlier deliveries.

3.9 The Buyer must also notify the Company promptly of any damage in transit but no later than one week from receipt of the goods even if the Company is not responsible for shipping.

4. Delivery periods and deadlines

4.1 A condition of the due fulfilment of contractual obligations is observance of delivery periods and deadlines. Delivery periods start with the date of the Company's confirmation of order but not before clarification of all details for execution of the order and receipt of all materials required for execution of the order and of other details to be supplied by the Buyer and the receipt of any payment agreed.

The delivery period will also be considered to have been met if the goods leave the works or warehouse at the time agreed or notification of readiness to ship has been sent to the Buyer but the goods have not been shipped on time for reasons for which the Company is not responsible. The above arrangements will apply to the delivery deadlines respectively.

4.2 Even when there is agreement on the definition of time for performance according to the calendar or a time is calculable according to the calendar after a preceding event, default will not apply until a reminder is received by the Company.

4.3 Unpredictable events outside the control of the Company such as war, risk of war, unrest, the use of violence by third parties against persons or property, intervention involving sovereignty including currency and commercial policy measures, employment disputes at the Company or its suppliers or shipping companies, interruptions to the transport links provided, fire, shortages of raw materials, shortage of energy and other non-fault operating problems at the company or its suppliers will extend fixed delivery periods and deadlines by the duration of the obstruction. This will also apply to the extent the Company is already behind with deliveries or to the extent that the foregoing obstructions to delivery were already present before conclusion of the contract but the Company was not aware of them. The Company will advise the Buyer immediately of obstructions of the type mentioned above.

4.4 If delivery delays caused by the above last longer than two months both parties will be entitled to withdraw from the contract. The Buyer may only withdraw if the Company, at the former's request, fails to state within a week whether it wishes to withdraw or make delivery within a reasonable period. The same right to withdraw arises independent of the above period, if completion of the contract has become unreasonable for one of the parties taking account of the delay.

5. Reservation of ownership

5.1 All goods delivered shall remain the property of the Company (reserved goods) until complete and final fulfilment (i.e. only after final release from any joint liability for bills of exchange or cheques) of all claims arising from the business connection for whatever legal reason. The same shall also apply in respect of any future or conditional claims arising from contracts entered into concurrently or later within the context of the business connection. Reserved ownership shall serve to secure Company claims arising from a competitive relationship where there is a current account.

5.2 Treatment and processing of reserved goods occur for the Company as manufacturer within the meaning of Section 950 BGB without placing an obligation on the latter. The treated/processed goods shall apply as reserved goods to secure Company claims within the meaning of 5.1. In the event of treatment/processing, linking or mixing of the reserved goods by the Buyer with other goods not belonging to the Company, the Company shall have joint ownership of the new item in the ratio of the invoice value of the reserved goods to the

invoice value of the other goods used. If Company ownership of the reserved goods expires by linking, mixing or treatment/processing of the reserved goods the Buyer will transfer the title held by him in the new part or item to the extent of the invoice value of the reserved goods and will hold it for the Company free-of-charge with the care of a diligent businessman. The joint title rights accruing will also apply as reserved goods as security for Company claims within the meaning of No. (5.1).

5.3 The Buyer may only sell the reserved goods in the normal course of his business and only on his normal terms of business provided that concurrently the claims under the resale pass to the Company as per 5.4 to 5.6. The Buyer is not entitled to other dispositions [disposals] of the reserved goods, in particular to a pledge or transfer by way of security. The above authorisation will expire in the event of the Buyer's default of payment. The authorisation may also be cancelled by the Company in the cases listed in 2.7, by a breach of the foregoing obligations and in the case of non-payment of an invoice when due. In these cases the Buyer is also prohibited from treating and processing the reserved goods and linking or mixing it with other goods.

5.4 The demands and other claims including the Buyer's collateral rights arising from the resale of the reserved goods are now, i.e. with the agreement of these GTSS, assigned to the Company, who hereby accepts the assignment. They will serve to secure the Company's claims to the same extent as the reserved goods. If the reserved goods are sold by the Buyer with other goods not supplied by the Company, the claim arising from the resale is assigned in the ratio of the invoice value of the reserved goods to the invoice value of the other goods. When goods are sold to which the Company has joint title under 5.2, the Company shall be assigned a part corresponding to its share under the joint title.

5.5 As long as the resale authority has not been cancelled, the Buyer meets his payment obligations towards the Company and is not in breach of any other fundamental contractual duties (cf. 7.2 in this connection), the Buyer is entitled to collect any claims from resale. The Buyer is not entitled to assign or pledge any claims to third parties – including the sale of any claims to factoring banks. The Buyer shall notify the Company immediately of any detriment to its rights through third parties by delivering any documents required for intervention. Any intervention costs incurred shall be borne by the Buyer.

5.6 After cancellation of the resale authority and/or the authorisation to collect the Buyer shall, at the Company's request, undertake to supply information on the status of the reserved goods and assigned claims and to inform his purchaser of the assignment to the Company (in as far as the Company does not do this itself) and to give the Company the information and documents necessary for collection. The Company may, if the Buyer is more than two weeks in arrears with his payment obligations to the Company, demand the return of the reserved goods and collect the demands and other claims assigned to the Company. Furthermore, the Company may use the reserved goods to satisfy its claims as soon as the Company has withdrawn from the contract or the conditions for a claim for compensation on the grounds of non-fulfilment have arisen. The right of the Buyer to possess the reserved goods expires under the foregoing conditions. In said cases the Company will be entitled to enter the Buyer's property and retrieve the reserved goods after giving notice in advance and arranging a time.

5.7 If the collectible value of the existing securities exceed the secured claims by a total of 10 (ten)

percent the Company, at the Buyer's request, will undertake to release securities to that extent as the Company elects.

6. Nature of the goods and warranty

6.1 To the extent that the Company places test pieces or sample at the disposal of the Buyer or receives them from the Buyer, or quotes analyses, DIN provisions, other domestic or foreign quality standards or gives other details on the quality of the goods these shall merely serve to specify in more detail the works the Company is to provide. No guarantee of quality is linked thereto.

6.2 In particular, the Company does not undertake to check whether the goods meet or are suitable for the specific purpose intended by the Buyer.

6.3 The Buyer must inspect the goods delivered without delay with the care it considers reasonable and (if necessary by way of a test process) check the quality of the goods supplied and raise a claim for any identifiable defects without delay but no later than 7 (seven) days of receipt of the goods in writing (as far as possible and reasonable enclosing samples) quoting the invoice, manufacture and shipping number. Hidden defects must be similarly notified immediately they are discovered.

Otherwise the goods will be deemed approved without reservation. Any further obligations of the Buyer under Section 377 HGB [German Commercial Code] will not be affected.

6.4 No claims for defects will apply if the Buyer fails to grant third party rights of recourse, processes defective goods without prior quality control or supplies goods claimed as defective to third parties without giving the Company the opportunity to check the claimed defects. The same will apply to inappropriate or improper use of the goods, faulty assembly or commissioning by the Buyer or third parties, improper modifications to the goods supplied, natural wear and tear and faulty or careless handling.

6.5 And if claims for defects or complaints are justified, the Company undertakes at its choice either to repair or remedy the defect or supply a replacement. In the event of repair, the Buyer shall pay the extra costs that are due to the goods delivered being taken to a place other than the place of performance.

6.6 Should the repair chosen by the Company repeatedly be unsuccessful; should it be unreasonable to expect such of the Buyer; should it be refused by the Company or be delayed beyond a reasonable period on grounds within the Company's control, the Buyer may – notwithstanding any claims for damages – withdraw from the contract or reduce the purchase price.

6.7 Warranty claims for the goods expire within one year after passing of the risk. This shall not apply where the law prescribes longer time limits pursuant to § 438, sub-section 1, No. 2 BGB (Building Works and Items for Building Works), § 479 sub-section 1 BGB (Recourse Claim) and § 634 a sub-section 1 No. 2 BGB (Structural Defects) or where the Company is liable for malice aforethought.

6.8 Further, claims for damages are limited under No. (7).

7. Limitation of claims for damages and reimbursement of expenses

7.1 The Buyer's claims for damages and reimbursement of expenses against the Company or the Company's employees, representatives and agents, on whatever legal grounds, are precluded, unless the aforementioned are held liable for malice aforethought, gross negligence, guarantee given, risk of

sourcing accepted, harm to life, body, health or fundamental contractual duties. This shall also apply to any claims for damages arising from incorrect supplier declarations. This ruling does not shift the burden of proof to the Buyer.

7.2 The Buyer's claims for damages and reimbursement of expenses against the Company or the Company's employees, representatives and agents, for breach of fundamental contractual duties are limited to the contractually typical, foreseeable harm, unless held liable for malice aforethought, gross negligence, guarantee given, risk of sourcing accepted or harm to life, body or health.

Fundamental contractual duties will be deemed to mean such duties as, when violated, threaten the purpose of the contract, e.g. in cases of substantial delay, considerable infringement of cooperation, notification or confidentiality obligations or in the case of considerable violation of obligations that may determine the success or failure of the contract. This arrangement does not shift the burden of proof to the Buyer.

7.3 Contractual claims for damages and reimbursement of expenses against the Company or its employees, representatives and agents, on whatever legal grounds, shall expire after one year at the latest. The special arrangement for warranty claims for the goods in No. (6.7) is not affected.

7.4 Where the Company is liable imperatively under the Product Liability Act of 15 December 1989 for damage to property or personal injury caused by a product's defects, the provisions of the Product Liability Act shall prevail. The foregoing rules shall still apply for an internal settlement under § 5 sentence 2 of the Product Liability Act.

8. Intellectual Property Rights and Data Protection

8.1 The Company reserves the copyright in drawings and other design materials. These may not be made accessible to third parties. Where the Company manufactures goods to the Buyer's drawings, samples or other details and infringes third-party intellectual property rights thereby, the Buyer shall indemnify the Company against all linked claims.

8.2 The Company is entitled to adapt and store within the meaning of the Federal Data Protection Act such data about the Buyer as is received in connection with the business association – even when such originates from third parties.

9. Place of performance, jurisdiction and applicable law.

9.1 Tornesch shall be the place of performance for delivery and payment.

9.2 Elmshorn shall be the forum for any legal disputes arising from or about the existence and validity of this contract including those arising from cheques or bills of exchange – insofar as the Buyer is a trader or a public corporation or a statutory undertaking. However, the Company may sue the Buyer at any other jurisdiction that is given under the Code of Civil Procedure.

9.3 The contractual relationship shall be governed by the law of the Federal Republic of Germany. The provisions of the UN Treaty on International Trade (CISG) are excluded.

Version: December 2007



When ever you need us...
you will find your local contact here:

Europe

HellermannTyton GmbH – Austria
Obachgasse 6
1221 Vienna
Tel: +43 (0) 1 259 99 55 - 0
Fax: +43 (0) 1 259 99 11
E-Mail: office@HellermannTyton.at
www.HellermannTyton.at

HellermannTyton B.V. – Belgium
E-Mail: info@HellermannTyton.be
www.HellermannTyton.be

HellermannTyton – Czech Republic
E-Mail: office.cz@HellermannTyton.at
www.HellermannTyton.cz

HellermannTyton Denmark
Baldersbuen 15D 1. TV
2640 Hedehusene
Tel: +45 702 371 20
Fax: +45 702 371 21
E-Mail: htdk@HellermannTyton.dk
www.HellermannTyton.dk

HellermannTyton Oy – Finland
Sähkötie 8
01510 Vantaa
Tel: +358 9 8700 450
Fax: +358 9 8700 4520
E-Mail: myynti@HellermannTyton.fi
www.HellermannTyton.fi

HellermannTyton S.A.S. – France
2 rue des Hêtres, B.P. 130
78196 Trappes Cedex
Tel: +33 1 30 13 80 00
Fax: +33 1 30 13 80 60
E-Mail: info@HellermannTyton.fr
www.HellermannTyton.fr

HellermannTyton GmbH – Germany
Großer Moorweg 45
25436 Tornesch
Tel: +49 4122 701-0
Fax: +49 4122 701-400
E-Mail: info@HellermannTyton.de
www.HellermannTyton.de

HellermannTyton KFT – Hungary
Kisfaludy u. 13
1044 Budapest
Tel: +36 1 369 4151
Fax: +36 1 369 4151
E-Mail: office@HellermannTyton.hu
www.HellermannTyton.hu

HellermannTyton S.r.l. – Italy
Via Praimbole 9 Bis
35010 Limena (PD)
Tel: +39 049 767 870
Fax: +39 049 767 985
E-Mail: info@HellermannTyton.it
www.HellermannTyton.it

HellermannTyton Ltd – Ireland
Unit 77 Cherry Orchard
Industrial Estate
Ballyfermot, Dublin 10
Tel: +353 1 626 8267
Fax: +353 1 626 8022
E-Mail: sales@HellermannTyton.ie
www.HellermannTyton.co.uk

HellermannTyton B.V. – Netherlands
Vanadiumweg 11-C
3812 PX Amersfoort
Tel: +31 33 460 06 90
Fax: +31 33 460 06 99
E-Mail: info@HellermannTyton.nl
www.HellermannTyton.nl

HellermannTyton AS – Norway
PO Box 240 Alnabru
0614 Oslo
Tel: +47 23 17 47 00
Fax: +47 22 97 09 70
E-Mail: firmapost@HellermannTyton.no
www.HellermannTyton.no

HellermannTyton – Poland
E-Mail: info@HellermannTyton.pl
www.HellermannTyton.pl

OOO HellermannTyton – Russia
St. Petersburg
E-Mail: info@HellermannTyton.ru
www.HellermannTyton.ru

HellermannTyton – Slovenia
Branch Office Ljubljana
Trubarjeva 79
1101 Ljubljana
Tel: +386 1 433 70 56
Fax: +386 1 433 63 21
E-Mail: sales@HellermannTyton.si
www.HellermannTyton.si

HellermannTyton España s.l. – Spain/Portugal
Avda. de la Industria nº 37, 2º 2º
28.108 Alcobendas, Madrid
Tel: +34 91 661 2835
Fax: +34 91 661 2368
E-Mail: HellermannTyton@HellermannTyton.es
www.HellermannTyton.es

HellermannTyton AB – Sweden
Datavägen 5, PO Box 569
17526 Järfälla
Tel: +46 8 580 890 00
Fax: +46 8 580 890 01
E-Mail: support@HellermannTyton.se
www.HellermannTyton.se

HellermannTyton Ltd – UK
Manufacturing Site
Pennycross Close, Plymouth
Devon PL2 3NX
Tel: +44 1752 701 261
Fax: +44 1752 790 058
E-Mail: info@HellermannTyton.co.uk
www.HellermannTyton.co.uk

HellermannTyton Ltd – UK
Manufacturing Site
Sharston Green Business Park
1 Robeson Way
Altrincham Road, Wythenshawe
Manchester M22 4TY
Tel: +44 161 945 4181
Fax: +44 161 945 3708
E-Mail: info@HellermannTyton.co.uk
www.HellermannTyton.co.uk

HellermannTyton Ltd – UK
Main Contact for Customer Service
Wharf Approach
Aldridge, Walsall, West Midlands
WS9 8BX
Tel: +44 1922 458 151
Fax: +44 1922 743 237
E-Mail: info@HellermannTyton.co.uk
www.HellermannTyton.co.uk

HellermannTyton Data Ltd – UK
43-45 Salthouse Road
Cornwell Business Park Brackmills
Northampton NN4 7EX
Tel: +44 1604 707 420
Fax: +44 1604 705 454
E-Mail: hns@htdata.co.uk
www.htdata.co.uk

North America

HellermannTyton – Canada
Tel: +1 905 726 1221
Fax: +1 905 726 8538
E-Mail: sales@HellermannTyton.ca
www.HellermannTyton.ca

HellermannTyton – Mexico
Tel: +52 333 133 9880
Fax: +52 333 133 9861
E-Mail: info@HellermannTyton.com.mx
www.HellermannTyton.com

HellermannTyton – USA
Tel: +1 414 355 1130
Fax: +1 414 355 7341
E-Mail: corp@htamericas.com
www.HellermannTyton.com

South America

HellermannTyton – Argentina
Tel: +54 11 4754 5400
Fax: +54 11 4752 0374
E-Mail: ventas@HellermannTyton.com.ar
www.HellermannTyton.com.ar

HellermannTyton – Brazil
Tel: +55 11 4815 9000
Fax: +55 11 4815 9030
E-Mail: vendas@HellermannTyton.com.br
www.HellermannTyton.com.br

Asia-Pacific

HellermannTyton – Australia
Tel: +61 2 9525 2133
Fax: +61 2 9526 2495
E-Mail: cservice@HellermannTyton.com.au
www.HellermannTyton.com.au

HellermannTyton – China
Tel: +86 510 528 2536
Fax: +86 510 528 0112
E-Mail: cservice@HellermannTyton.com.cn
www.HellermannTyton.com.cn

HellermannTyton – Hong Kong
Tel: +852 2832 9090
Fax: +852 2832 9381
E-Mail: cservice@HellermannTyton.com.hk
www.HellermannTyton.com.sg

HellermannTyton – India
Tel: +91 11-2620 9230/6661 9230
Fax: +91 11-2620 9330/6661 9330
E-Mail: cservice@HellermannTyton.co.in
www.HellermannTyton.co.in

HellermannTyton – Japan
Tel: +81 3 5790 3111
Fax: +81 3 5790 3112
E-Mail: cservice@HellermannTyton.co.jp
www.HellermannTyton.co.jp

HellermannTyton – Korea
Tel: +82 2 2614 0157
Fax: +82 2 2614 0284
E-Mail: cservice@HellermannTyton.co.kr
www.HellermannTyton.co.kr

HellermannTyton – Philippines
Tel: +63 2 752 6551
Fax: +63 2 752 6553
E-Mail: cservice@HellermannTyton.com.ph
www.HellermannTyton.com.ph

HellermannTyton – Singapore
Tel: +65 6 852 8585
Fax: +65 6 756 6798
E-Mail: cservice@HellermannTyton.sg
www.HellermannTyton.com.sg

HellermannTyton – Thailand
Tel: +66 2 237 6702
Fax: +66 2 266 8664
E-Mail: cservice@HellermannTyton.com.th
www.HellermannTyton.com.sg

Africa

HellermannTyton – South Africa
Tel: +27 11 879 6680
Fax: +27 11 879 6601
E-Mail: sales.jhb@HellermannTyton.co.za
www.HellermannTyton.co.za

Give us a call! Here are your contacts for enquiries and orders

For all product information please visit our website www.HellermannTyton.com

Automotive Sales Department

Telephone: +49 4122 / 701-180

E-Mail: vidautomobil@HellermannTyton.de

Project Management New Parts

Telephone: +49 4122 / 701-181

E-Mail: ntpm@HellermannTyton.de

**Project Management
Automatic Tool Systems**

Telephone: +49 4122 / 701-445

E-Mail: autotool@HellermannTyton.de

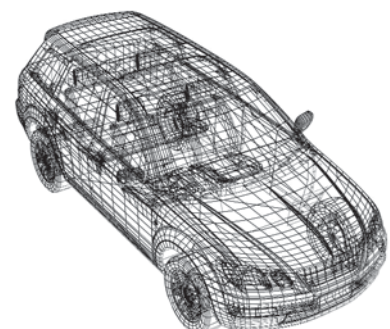

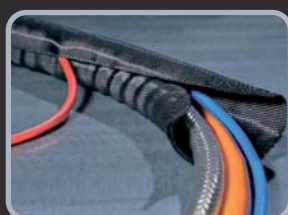
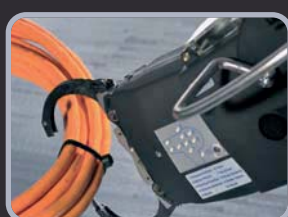

HellermannTyton

HellermannTyton GmbH
Großer Moorweg 45
25436 Tornesch
Tel: +49 (0)4122/701-1
Fax: +49 (0)4122/701-400
E-Mail: info@HellermannTyton.de
Internet: www.HellermannTyton.de