



HAMILTON-C1

Operator's Manual

REF 161001, 1610010

Software version 2.2.x

624326/05 | 2020-04-20

Valid for devices with SN 6000 or higher

CE 0197

HAMILTON
MEDICAL
Intelligent Ventilation since 1983

HAMILTON-C1 Operator's Manual

© 2020 Hamilton Medical AG. All rights reserved. Printed in Switzerland. No part of this publication may be reproduced or stored in a database or retrieval system, nor transmitted, in any form or by any means, electronic, mechanical, by photocopying, recording, or otherwise, without the prior written permission of Hamilton Medical.

This manual may be revised or replaced by Hamilton Medical at any time and without notice. Ensure that you have the most current applicable version of this manual; if in doubt, contact Hamilton Medical AG Marketing Department. While the information set forth is believed to be accurate, it is not a substitute for the exercise of professional judgment.

Nothing in this manual shall limit or restrict in any way Hamilton Medical's right to revise or otherwise change or modify the equipment (including its software) described herein, without notice. In the absence of an express, written agreement to the contrary, Hamilton Medical has no obligation to furnish any such revisions, changes, or modifications to the owner or user of the equipment (including software) described herein.

The equipment must be operated and serviced by trained professionals only. Hamilton Medical's sole responsibility with respect to the equipment and its use is as stated in the Limited Warranty provided in this manual.

Product and company names mentioned herein may be the trademarks of their respective owners

Hamilton Medical will make available on request circuit diagrams, component parts lists, descriptions, calibration instructions, or other information that will assist the user's authorized trained personnel to repair those parts of the equipment deemed by Hamilton Medical to be repairable.

Manufacturer

Hamilton Medical AG
Via Crusch 8
CH-7402 Bonaduz
Switzerland
Phone: (+41) 58 610 10 20
Fax: (+41) 58 610 00 20
info@hamilton-medical.com
www.hamilton-medical.com

HAMILTON-C1 software information

The software version for the HAMILTON-C1 is visible in the **System -> Info** window. The software version should match the version on the title page of this manual. See Section 3.3.1 for details.

Definitions

WARNING

A **WARNING** alerts the user to the possibility of injury, death, or other serious adverse reactions associated with the use or misuse of the device. It also describes potential serious adverse reactions and safety hazards.

CAUTION

A **CAUTION** alerts the user to the possibility of a problem with the device associated with its use or misuse, such as device malfunction, device failure, damage to the device, or damage to other property. It also alerts against unsafe practices. This includes the special care necessary for the safe and effective use of the device.

NOTE:

A **NOTE** emphasizes information of particular importance.

Button and tab names are shown in a **bold** font.

**NIV/
NIV-ST**

Applies only when NIV/NIV-ST option is installed

CO2

Applies only when the CO2 sensor option is installed

SpO2

Applies only when the SpO2 sensor option is installed

**DuoPAP/
APRV**

Applies only when DuoPAP/APRV option is installed



Applies only when Trend/Loops option is installed



Applies only when the Neonatal option is installed.

Intended use

The HAMILTON-C1 ventilator is intended to provide positive pressure ventilatory support to adults and pediatrics, and optionally infants and neonates.

Intended areas of use:

- In the intensive care ward, intermediate care ward, emergency ward, long term acute care hospital or in the recovery room
- During transfer of ventilated patients within the hospital

The HAMILTON-C1 ventilator is a medical device intended for use by qualified, trained personnel under the direction of a physician and within the limits of its stated technical specifications.

CAUTION

(USA only): Federal law restricts this device to sale by or on the order of a physician.

General cautions and notes

WARNING

Modifications to the device are not permitted.

General operation notes

- The use of this equipment is restricted to one patient at a time.
- Additional information about installing the medical equipment, as well as additional technical information, is provided in the *Service Manual*.
- If there is visible damage to any part of the ventilator, do not use the device. Technical service is required.
- The intended patient population ranges from neonatal patients with 0.2 kg to 30 kg body weight to pediatric patients with 30 cm height (3 kg ideal body weight) up to adults up to 250 cm height (139 kg ideal body weight). The minimum tidal volume delivered shall be equal to or greater than 20 ml for adults/pediatrics, 2 ml for neonates.
- The displays shown in this manual may not exactly match what you see on your own ventilator.
- Familiarize yourself with this operator's manual before using the ventilator on a patient.
- Do not simultaneously touch conductive components (for example, the USB port) or conductive parts of the ventilator enclosure and the patient.
- Displayed information that is ghosted is not active and may not be selected.
- Dashes displayed in place of monitored data indicate that valid values are not yet available or do not apply.
- If a ventilator control does not respond when selected by touch or by the turn of a dial, the control is not active in this particular instance or the function is not implemented.

-
- The HAMILTON-C1 handle allows you to easily reposition the ventilator; for example, to move the ventilator from the trolley to the CT scanner table.

Monitoring and alarms

- The HAMILTON-C1 is not intended to be a comprehensive vital sign monitor for patients on life-support equipment. Patients on life-support equipment should be appropriately monitored by qualified medical personnel and suitable monitoring devices. The use of an alarm monitoring system does not give absolute assurance of warning for every type of issue that may arise with the ventilator. Alarm messages may not exactly pinpoint a problem; the exercise of clinical judgment is necessary.
- An alternative means of ventilation must be available whenever the ventilator is in use. If a fault is detected in the ventilator or its life-support functions are in doubt, disconnect the HAMILTON-C1 from the patient and immediately start ventilation with such a device (for example, a resuscitation bag), using PEEP and/or increased oxygen concentration when appropriate. The ventilator must be removed from clinical use and serviced by a Hamilton Medical authorized service engineer.
- It is recommended that additional independent monitoring devices be used during mechanical ventilation. The operator of the ventilator must still maintain full responsibility for proper ventilation and patient safety in all situations.
- Do not silence the audible alarm when leaving the patient unattended.
- Do not use the exhaust port of the expiratory valve for spirometry. Due to the HAMILTON-C1's base flow, the exhaust gas output is larger than the patient's actual exhaled volume.
- Do not put a vessel filled with a liquid on the ventilator. If a liquid enters the product, a fire and/or electric shock may occur.

Fire and other hazards

- To reduce the risk of fire or explosion, do not place the ventilator in a combustible or explosive environment (for example, around flammable anaesthetics or other ignition sources) or insufficiently ventilated areas. Do not use it with any equipment contaminated with oil or grease. Highly compressed oxygen together with flammable sources could lead to spontaneous explosions.
- To minimize the risk of fire, do not use high-pressure gas hoses that are worn or contaminated with combustible materials like grease or oil.
- The HAMILTON-C1 can be used in an oxygen-enriched environment. To reduce the risk of fire, use only breathing circuits intended for use in oxygen-enriched environments. Do not use antistatic or electrically conductive tubing.
- In case of fire, immediately secure the patient's ventilatory needs, switch off the ventilator, and disconnect it from its gas and electrical sources.
- Do not use if primary power source cables are damaged.
- To ensure that toxic constituents are not entrained into the breathing gas ventilate the patient with 100% O₂.

Service and testing

- To ensure proper servicing and to prevent possible physical injury, only Hamilton Medical authorized service personnel should attempt to service the ventilator.
- To reduce the risk of electrical shock, disconnect electrical power from the ventilator before servicing. Be aware that battery power remains even after the mains is disconnected. Be aware that if the power switch is off, some parts still carry high voltage.
- Do not attempt service procedures other than those specified in the service manual.
- Use replacement parts supplied by Hamilton Medical only.

-
- Any attempt to modify the ventilator hardware or software without the express written approval of Hamilton Medical automatically voids all warranties and liabilities.
 - The preventive maintenance program requires a general service every 5000 hours or yearly, whichever comes first.
 - To ensure the ventilator's safe operation, always run the preoperational check before using the ventilator on a patient. If the ventilator fails any tests, remove it from clinical use immediately. Do not use the ventilator until necessary repairs are completed and all tests have passed.
 - The manufacturer can only be responsible for the safety, reliability, and performance of the ventilator if all of the following requirements are met:
 - Appropriately trained personnel carry out assembly operations, extensions, readjustments, modifications, maintenance, or repairs.
 - The electrical installation of the relevant room complies with the appropriate requirements.
 - The ventilator system is used in accordance with the operator's manual.

Electromagnetic susceptibility

WARNING

MR UNSAFE. Keep away from magnetic resonance imaging (MRI) equipment. The HAMILTON-C1 poses unacceptable risks to the patient, medical staff, or other persons within the MR environment.

The HAMILTON-C1 complies with the IEC 60601-1-2 EMC (Electromagnetic Compatibility) Collateral Standard. It is intended for use in the electromagnetic environment described in Tables A-17 through A-19.

General standards and approvals

NOTE:

Where standards are mentioned, the HAMILTON-C1 complies with the versions listed in Table 1.

Table 1. Standards and approvals, valid versions

IEC 60601-1:2005/A1:2012
ANSI/AAMI ES60601-1:2005/(R)2012
CAN/CSA-C22.2 No. 60601-1:14
IEC 60601-1-2:2007
ISO 80601-2-12:2011 + Cor.:2011
ISO 80601-2-55:2011
IEC 61000-3-2:2005
IEC 61000-3-3:2008
IEC 61000-4-2:2008
IEC 61000-4-3:2006+A1:2007+A2:2010
IEC 61000-4-4:2004
IEC 61000-4-5:2005
IEC 61000-4-6:2003+A1:2004+A2:2006
IEC 61000-4-8:2009
IEC 61000-4-11:2004
EN ISO 5359:2008 + A1: 2011
EN ISO 13485:2012/AC:2012
IEC 60950-1:2013
ISO 15883-1:2006+A1:2014
ISO 15883-2:2006

Table 1. Standards and approvals, valid versions

ISO 15883-3: 2006
ISO 15883-4:2008
ISO 11607-1: 2006 + AMD1:2014
EN ISO 9001:2008
EN ISO 5356-1:2004
ISO 4135:2001

For further Information see Section A.12.

Units of measure

NOTE:

In this manual pressure is indicated in cmH₂O and length in cm.

On the HAMILTON-C1 pressures are indicated in cmH₂O, mbar, or hPa. Hectopascals (hPa) are used by some institutions instead. Since 1 mbar equals 1 hPa, which equals 1.016 cmH₂O, the units may be used interchangeably. Length is indicated in cm or inch.

Disposal

All parts removed from the device must be considered contaminated and pose infection risk. Dispose of all parts removed from the device according to your institution's protocol. Follow all local, state, and federal regulations with respect to environmental protection, especially when disposing of the electronic device or parts of it (for example oxygen cell, batteries).

Year of manufacture

The year of manufacture is shown on the serial number label on the HAMILTON-C1 ventilation unit.

Table of Contents

Preface	5
HAMILTON-C1 software information	7
Definitions	7
Intended use	8
General cautions and notes	9
Electromagnetic susceptibility	12
General standards and approvals	13
Units of measure	14
Disposal	14
Year of manufacture	14
Chapter 1 General information	1-1
1.1 Introduction	1-2
1.2 Functional description	1-6
1.2.1 System overview	1-6
1.2.2 Gas supply and delivery	1-7
1.2.3 Gas monitoring with the flow sensor	1-8
1.3 Physical description	1-9
1.3.1 Breathing circuits and accessories	1-9
1.3.2 Ventilator unit	1-12
1.3.3 Main display	1-19
1.4 Symbols used on device labels and packaging	1-21
Chapter 2 Preparing for ventilation	2-1
2.1 Introduction	2-3
2.2 Installing the humidifier	2-4
2.3 Installing the patient breathing circuit	2-5
2.3.1 Installing the bacteria filter or HMEF/HME	2-7
2.3.2 Installing the expiratory valve	2-8
2.3.3 Selecting the breathing circuit	2-9
2.3.4 Assembling the patient breathing circuit	2-10
2.3.5 Positioning the breathing circuit	2-14
2.4 Installing the pneumatic nebulizer	2-15
2.5 Setting up CO2 monitoring	2-16
2.5.1 CO2 mainstream measurement	2-18
2.5.2 CO2 sidestream measurement	2-21

- 2.6 Installing the Aeroneb Pro nebulizer 2-23
- 2.7 Using an expiratory filter 2-24
- 2.8 Connecting to a power source 2-25
 - 2.8.1 Connecting to AC power 2-25
- 2.9 About the battery 2-25
- 2.10 Connecting the oxygen supply 2-28
 - 2.10.1 Using a low-pressure oxygen supply 2-30
 - 2.10.2 Connecting the oxygen supply to the ventilator . . . 2-31
 - 2.10.3 Selecting the oxygen source type 2-31
- 2.11 Working with the trolley 2-33
 - 2.11.1 Installing the patient tubing support arm 2-34
 - 2.11.2 Preparing the trolley for intrahospital transport . . . 2-34
- 2.12 Connecting to an external patient monitor or other device. 2-35
- 2.13 Turning on the ventilator 2-36
- 2.14 Turning off the ventilator 2-37
- 2.15 Display navigation guidelines 2-37

Chapter 3 Tests, calibrations and utilities 3-1

- 3.1 Introduction 3-2
- 3.2 Running the preoperational check 3-3
- 3.3 System functions 3-5
 - 3.3.1 Info: Viewing device-specific information 3-6
 - 3.3.2 Tests & calib: Running calibrations and the tightness test 3-6
 - 3.3.3 Sensors on/off: Enabling/disabling O2, CO2, and SpO2 monitoring 3-16
 - 3.3.4 Setting day and night display brightness 3-17
 - 3.3.5 Setting date and time 3-19
- 3.4 Utilities. 3-20
 - 3.4.1 Data transfer: Copying event log data to a USB memory device 3-20
- 3.5 Alarm tests. 3-21
 - 3.5.1 High pressure 3-22
 - 3.5.2 Low minute volume 3-22
 - 3.5.3 Low oxygen alarm. 3-22
 - 3.5.4 Disconnection on patient side 3-23
 - 3.5.5 Loss of external power 3-23

3.5.6	Exhalation obstructed	3-23
3.5.7	Apnea	3-24
Chapter 4	Ventilator settings	4-1
4.1	Introduction	4-2
4.2	Patient grouping	4-3
4.3	Quick setup settings	4-3
4.4	Patient setup	4-4
4.5	Modes window: Setting the ventilation mode	4-7
4.6	Specifying mode settings.	4-8
4.6.1	Changing parameter settings.	4-9
4.6.2	Changing parameter settings with mode change	4-11
4.6.3	About apnea backup ventilation	4-11
4.6.4	Table of control parameter settings	4-13
4.7	Working with alarms.	4-19
4.7.1	Setting alarm limits	4-19
4.7.2	Adjusting alarm volume (loudness).	4-22
4.7.3	Buffer: Viewing alarm information.	4-23
4.7.4	Table of alarm limit settings	4-23
Chapter 5	Neonatal ventilation.	5-1
5.1	Introduction	5-2
5.2	Setting up for neonatal ventilation	5-3
5.2.1	Installing the neonatal expiratory valve.	5-3
5.2.2	Setting the patient group and weight	5-5
5.2.3	Selecting the ventilation mode.	5-6
5.2.4	Setting up the breathing circuit	5-9
5.2.5	Performing tests and calibrations	5-17
5.2.6	Performing the preoperational check	5-25
5.3	Ventilation modes for neonates.	5-27
5.3.1	About the nCPAP mode.	5-28
5.3.2	About the nCPAP-PC mode	5-30
5.4	Parameters for neonatal ventilation	5-33
5.4.1	Weight	5-34
5.4.2	TI max	5-34
5.4.3	P-ramp.	5-34
5.4.4	Flow and Insp Flow	5-35
5.5	Alarms for neonatal ventilation	5-36

5.5.1	Flow alarm	5-36
5.5.2	Volume-related alarms, Vt and ExpMinVol	5-37
5.6	O2 enrichment for neonates	5-37
Chapter 6	Monitoring ventilation	6-1
6.1	Introduction	6-2
6.2	Viewing numeric patient data	6-3
6.2.1	About the main monitoring parameters (MMP)	6-4
6.2.2	Viewing patient data in the Monitoring window	6-5
6.3	Waveforms and graphs	6-6
6.3.1	Selecting a graphical view of patient data	6-6
6.4	About graphic types	6-8
6.4.1	Waveforms	6-8
6.4.2	Dynamic Lung	6-11
6.4.3	Vent Status	6-11
6.4.4	ASV Graph	6-11
6.5	Trends	6-11
6.5.1	Displaying trends	6-13
6.6	Loops	6-14
6.6.1	Displaying loops	6-14
6.6.2	Storing loops	6-15
6.7	Table of monitored parameters	6-16
6.8	Freeze and cursor measurement	6-24
Chapter 7	Intelligent panels	7-1
7.1	Dynamic Lung panel	7-2
7.1.1	Displaying the Dynamic Lung	7-3
7.1.2	Tidal volume (Vt)	7-3
7.1.3	Compliance (Cstat)	7-4
7.1.4	Patient triggering: Muscle	7-4
7.1.5	Resistance (Rinsp): Bronchial tree	7-5
7.2	Vent Status panel	7-6
7.2.1	Displaying the Vent Status panel	7-8
7.3	ASV Graph panel	7-9
7.3.1	Displaying the ASV Graph	7-9
Chapter 8	Responding to alarms	8-1
8.1	Introduction	8-2
8.2	Responding to an alarm	8-6

8.3	Alarm buffer	8-7
8.4	About the event log	8-9
8.5	Alarm troubleshooting table	8-10
Chapter 9	Special functions	9-1
9.1	Introduction	9-2
9.2	Standby	9-3
9.3	Alarm silence	9-6
9.4	O2 enrichment	9-7
9.5	Suctioning tool	9-8
9.6	Manual breath/inspiratory hold	9-9
9.7	Nebulizer	9-10
9.8	Print screen	9-11
9.9	Screen Lock/unlock	9-12
9.10	Day/Night	9-13
Chapter 10	Maintenance	10-1
10.1	Introduction	10-2
10.2	Cleaning, disinfection, and sterilization	10-2
10.2.1	General guidelines for cleaning	10-4
10.2.2	General guidelines for disinfection	10-6
10.2.3	General guidelines for reprocessing	10-9
10.3	Preventive maintenance	10-13
10.3.1	Servicing the air intake and fan filters	10-15
10.3.2	Working with the battery	10-17
10.3.3	Replacing the oxygen cell	10-17
10.4	Storage	10-18
10.5	Repacking and shipping	10-18
10.6	Reprocessing the autoclavable expiratory valve	10-19
10.6.1	Expiratory valve reprocessing overview	10-20
10.6.2	Preparing and reprocessing the expiratory valve after use 10-21	
10.6.3	Cleaning and disinfecting the expiratory valve	10-21
10.6.4	Visual test	10-25
10.6.5	Packaging	10-25
10.6.6	Sterilization	10-25
10.6.7	Testing before use	10-26
10.6.8	Expiratory valve life span	10-26

10.6.9 Autoclaved and packaged expiratory valve: life span and storage conditions 10-26

10.6.10 Disposal 10-26

Appendix A Specifications. A-1

A.1 Physical characteristics A-2

A.2 Environmental requirements. A-3

A.3 Pneumatic specifications A-4

A.4 Electrical specifications A-5

A.5 Control settings A-6

A.6 Monitored parameters A-12

A.7 Alarms A-18

A.8 Configuration specifications A-20

A.9 Ventilator breathing system specifications A-22

A.10 Technical performance data A-23

 A.10.1 Accuracy testing A-25

 A.10.2 Essential performance A-26

A.11 Pulse oximeter sensor data A-27

A.12 Standards and approvals A-28

A.13 EMC declarations (IEC 60601-1-2) A-29

A.14 Warranty A-34

A.15 Miscellaneous A-36

A.16 Adjustable alarm setting resolution A-36

Appendix B Modes of ventilation B-1

B.1 Introduction B-2

B.2 The biphasic concept B-5

B.3 Mandatory modes B-8

 B.3.1 (S)CMV+ mode (APVcmv) B-8

 B.3.2 PCV+ mode B-10

B.4 Spontaneous modes (SPONT and NIV) B-12

B.5 SIMV modes. B-16

 B.5.1 SIMV+ mode (APVsimv) B-17

 B.5.2 PSIMV+ mode B-19

 B.5.3 NIV-ST mode. B-23

B.6 DuoPAP (Duo positive airway pressure) mode. B-26

 B.6.1 The many faces of DuoPAP B-27

 B.6.2 Pressure support in DuoPAP breaths B-27

B.6.3	Synchronization	B-28
B.6.4	DuoPAP controls	B-29
B.7	APRV (airway pressure release ventilation) mode	B-30
B.7.1	Initialization of APRV	B-31
B.7.2	Sustained high-pressure recruitment maneuvers.	B-32
B.7.3	APRV controls	B-32
B.8	Safety mode and ambient state.	B-34

Appendix C ASV, adaptive support ventilation C-1

C.1	Introduction	C-2
C.2	ASV use in clinical practice	C-3
C.3	Detailed functional description of ASV	C-15
C.3.1	Normal minute ventilation	C-15
C.3.2	Targeted minute ventilation	C-16
C.3.3	Lung-protective rules strategy	C-17
C.3.4	Optimal breath pattern	C-20
C.3.5	Dynamic adjustment of lung protection	C-24
C.3.6	Dynamic adjustment of optimal breath pattern	C-24
C.4	Minimum work of breathing (Otis' equation).	C-26
C.5	ASV technical data	C-28
C.6	ASV startup.	C-30
C.7	References	C-31

Appendix D NIV, noninvasive ventilation. D-1

D.1	Introduction	D-2
D.2	Benefits of noninvasive ventilation.	D-4
D.3	Required conditions for use.	D-4
D.4	Contraindications	D-5
D.5	Potential adverse reactions	D-5
D.6	Selecting a patient interface	D-6
D.7	Control settings	D-7
D.8	Alarms	D-8
D.9	Monitored parameters	D-8
D.10	Additional notes about using noninvasive ventilation.	D-9
D.11	References	D-11

Appendix E CO2 sensor option: Volumetric capnography E-1

E.1	Introduction	E-2
-----	------------------------	-----

E.2	CO2 elimination ($V'CO_2$)	E-2
E.3	End-tidal CO2 (PetCO2 and FetCO2)	E-4
E.4	Airway dead space (VDaw)	E-4
E.5	Alveolar minute ventilation ($V'alv$)	E-5
E.6	Capnogram shape	E-6
E.7	Formulas	E-8
E.8	References	E-9
Appendix F Pneumatic diagram		F-1
Appendix G Parts and accessories		G-1
Appendix H Communications interface		H-1
H.1	Introduction	H-2
H.2	About the protocols	H-3
H.3	Using the COM1 communication interface	H-4
H.3.1	Connecting to a patient monitor	H-4
H.3.2	Connecting to a PDMS or computer	H-6
H.3.3	COM1 connector pin assignments	H-8
H.4	Using the Nurse call (6-pin) communication interface	H-8
H.4.1	Sending alarm signals to a remote device	H-9
H.4.2	Sending inspiratory:expiratory (I:E) timing signals	H-9
H.4.3	Nurse 6-pin connector pin assignments	H-10
Appendix I Configuration		I-1
I.1	Introduction	I-2
I.2	Entering Configuration mode	I-2
I.3	Configuring general settings	I-3
I.3.1	Language: Selecting the default language	I-3
I.3.2	Selecting the default units of measure	I-4
I.3.3	Enabling the communication interface	I-5
I.3.4	Setting the minimum alarm loudness	I-6
I.4	Setting breath timing and mode naming options	I-7
I.4.1	Setting breath timing options for PCV+ and (S)CMV+ modes I-7	
I.4.2	Choosing the mode naming convention	I-8
I.5	Configuring default MMP display	I-8
I.6	Setup window (quick setup configuration)	I-9
I.6.1	Configuring individual setup settings	I-9

1.6.2	Selecting a default quick setup.	I-15
1.7	Configuring pulse oximeter sensor settings	I-16
1.8	Copying configuration settings	I-16
1.9	Configuring software and hardware options	I-17
1.9.1	Reviewing installed options	I-17
1.9.2	Adding software options	I-17
1.9.3	Enabling hardware options	I-19
1.9.4	Removing options	I-20

Appendix J Pulse oximetry J-1

J.1	Introduction	J-3
J.2	SpO2 monitoring with Masimo SET	J-7
J.2.1	Pulse oximetry components	J-7
J.3	Working with pulse oximetry data	J-8
J.3.1	Enabling SpO2 monitoring	J-8
J.3.2	Monitored parameters and settings	J-9
J.4	Viewing pulse oximetry data	J-10
J.4.1	Viewing data in the Monitoring window	J-11
J.4.2	Viewing SpO2 data on the main display	J-12
J.4.3	Dynamic Lung panel with SpO2	J-13
J.4.4	Displaying the plethysmogram	J-15
J.4.5	Displaying trends	J-16
J.5	Working with alarms	J-17
J.5.1	Setting alarm limits	J-17
J.5.2	SpO2 alarm delay	J-18
J.5.3	Pulse-oximetry-related alarms and settings	J-18
J.6	Connecting the pulse oximetry system	J-22
J.6.1	Connecting the components	J-25
J.6.2	Verifying sensor measurements	J-27
J.6.3	Disconnecting the SpO2 adapter	J-28
J.6.4	Connecting the adapter for transport	J-29
J.7	Configuring and enabling the pulse oximeter	J-30
J.7.1	Enabling the hardware	J-30
J.7.2	Selecting SpO2 sensor data options	J-31
J.8	Troubleshooting	J-35

J.9 Cleaning and maintenance. J-37

 J.9.1 Cleaning the adapter and sensor. J-38

 J.9.2 Replacing the adapter, cables, or sensor J-38

 J.9.3 Disposing of the adapter, cables, and sensor. J-38

J.10 About the SpO2/FiO2 ratio. J-39

Glossary Glossary-1

Index Index-1

**Addendum to the Operator’s Manual,
software version 2.2.x Addendum-1**

1 General information

1.1	Introduction	1-2
1.2	Functional description	1-6
1.2.1	System overview	1-6
1.2.2	Gas supply and delivery	1-7
1.2.3	Gas monitoring with the flow sensor	1-8
1.3	Physical description	1-9
1.3.1	Breathing circuits and accessories	1-9
1.3.2	Ventilator unit	1-12
1.3.3	Main display	1-19
1.4	Symbols used on device labels and packaging	1-21

1.1 Introduction



The HAMILTON-C1 ventilator is intended to provide positive pressure ventilatory support to adults and pediatrics, and optionally infants and neonates.

Ventilation modes. This full-functioned intensive care ventilator offers a complete range of ventilation modes:

Table 1-1. Ventilation modes

Volume modes (adaptive pressure)	
<i>Delivered by an adaptive volume controller, these modes combine the attributes of pressure-controlled with volume-targeted ventilation.</i>	
(S)CMV+/APVcmv	Synchronized controlled mandatory ventilation
SIMV+/APVsimv	Synchronized intermittent mandatory ventilation
Pressure modes	
<i>Conventional pressure-controlled ventilation.</i>	
PCV+	Pressure-controlled ventilation
PSIMV+	Pressure-controlled synchronized intermittent ventilation
SPONT	Spontaneous pressure-supported ventilation
<i>Related forms of pressure ventilation designed to support spontaneous breathing on two alternating levels of CPAP. Available as an option.</i>	
DuoPAP	Dual positive airway pressure
APRV	Airway pressure release ventilation
Intelligent Ventilation	
<i>Guarantees that the patient receives the selected minute ventilation with the optimal breath pattern (lowest pressure and volume, optimal rate to minimize work of breathing, and intrinsic PEEP).</i>	
ASV®	Adaptive support ventilation Not available for neonatal patients.

Table 1-1. Ventilation modes (continued)

Noninvasive	
<i>Pressure support ventilation through a mask or other noninvasive interface. Available as options.</i>	
NIV	Noninvasive ventilation. Leak compensated with IntelliTrig in order to secure perfect patient–ventilator synchronization.
NIV-ST	Spontaneous/timed noninvasive ventilation. Leak compensated with IntelliTrig in order to secure perfect patient–ventilator synchronization.
nCPAP 	Nasal continuous positive airway pressure through a nasal interface (mask or prongs) for infants and neonates. This mode provides controlled airway pressure, without any breaths.
nCPAP-PC 	Nasal continuous positive airway pressure - pressure control through a nasal interface (mask or prongs) for infants and neonates. Provides pressure-controlled mandatory breaths, triggered by the ventilator.

Patient-triggered breaths are flow triggered.

Monitoring. The HAMILTON-C1 offers a variety of monitoring capabilities. It displays monitored parameters as numbers. You can also see this data graphically, as a combination of real-time waveforms (curves), loops, trends, and special Intelligent Panels.

These Intelligent Panels include the Dynamic Lung, which shows the lung’s activity, and the Vent Status, which indicates the patient’s level of ventilator dependency.

The HAMILTON-C1's monitored data is based on pressure and flow measurements collected by the Hamilton Medical proximal flow sensor¹, between the Y-piece and the patient, and on FiO2 measurements by the integrated oxygen monitor.

Alarms. The HAMILTON-C1's operator-adjustable and non-adjustable alarms help ensure your patient's safety.

User interface. The ventilator's ergonomic design, including an 8.4-in color touchscreen, press-and-turn dial, and keys, lets you easily access the ventilator settings and monitored parameters.

Customizability. You can customize the HAMILTON-C1 so that it starts up with institution-defined settings.

Power. The HAMILTON-C1 uses AC power as its primary source. If the primary power source fails, the ventilator automatically switches to backup battery.

Mounting variations for the HAMILTON-C1 include a standard trolley and a shelf mount. The trolley has space for one oxygen cylinder.

Nebulization function. The nebulization function lets your HAMILTON-C1 power a pneumatic nebulizer connected to the nebulizer outlet. Pneumatic nebulization is disabled during neonatal ventilation.

Options²

The following options are available for the HAMILTON-C1:

Table 1-2. Options

Option	Description
<i>Some options require additional hardware. Options are enabled in Configuration mode.</i>	
Adult/pediatric support	Ventilation of adult and pediatric patients.
Neonatal support	Ventilation of infants and neonates starting from a tidal volume of 2 ml.
nCPAP and nCPAP-PC ventilation modes	See Table 1-1.

1. In the neonatal nCPAP and nCPAP-PC modes, a pressure line is used instead of a flow sensor.
2. Not all options are available in all markets

Table 1-2. Options *(continued)*

Option	Description
<i>Some options require additional hardware. Options are enabled in Configuration mode.</i>	
DuoPAP and APRV ventilation modes	See Table 1-1.
NIV and NIV-ST ventilation modes	See Table 1-1.
CO2 sensor	Continuously monitors airway carbon dioxide and reports EtCO2 and inhaled/exhaled CO2 for display and alarm purposes.
SpO2 sensor	Continuously monitors the oxygen saturation of the blood.
Loops and trends	View 1-, 6-, 12-, 24-, or 72-h trends for monitored parameters. ¹ Display a dynamic loop for a variety of parameter combinations, including pressure-volume, pressure-flow, and flow-volume.
Communication interface	Provides a COM1 port for connection to a remote monitor, patient data management system (PDMS), or other computer system.
Nurse call	With the nurse call interface, the ventilator relays alarms and alarm messages to the nurse call system.

1. 72-h trends not available in all markets.

1.2 Functional description

The following paragraphs describe the operation of the HAMILTON-C1 ventilator hardware.

1.2.1 System overview

The HAMILTON-C1 is an electronically controlled pneumatic ventilation system with an integrated air compressing system. It runs on AC with battery backup to protect against power failure or unstable power and to facilitate intra-hospital transport. The HAMILTON-C1's pneumatics deliver gas, and its electrical systems control pneumatics, monitor alarms, and distribute power.

The user provides inputs to the HAMILTON-C1 microprocessor system through a touch screen, keys, and a press-and-turn knob. These inputs become instructions for the HAMILTON-C1's pneumatics to deliver a precisely controlled gas mixture to the patient. The HAMILTON-C1 receives inputs from the proximal flow sensor and other sensors within the ventilator. Based on this monitored data, the HAMILTON-C1 adjusts gas delivery to the patient. Monitored data is also displayed by the graphic user interface.

The HAMILTON-C1's microprocessor system controls gas delivery and monitors the patient. The gas delivery and monitoring functions are cross-checked by an alarm controller. This cross-checking helps prevent simultaneous failure of these two main functions and minimizes the possible hazards of software failure.

A comprehensive system of visual and audible alarms helps ensure the patient's safety. Clinical alarms can indicate an abnormal physiological condition. Technical alarms, triggered by the ventilator's self-tests including ongoing background checks, can indicate a hardware or software failure. In the case of some technical alarms, a special safety mode ensures basic minute ventilation while giving the user time for corrective actions.

When a condition is critical enough to possibly compromise safe ventilation, the HAMILTON-C1 is placed into the ambient state. The inspiratory channel and expiratory valves are opened, letting the patient inspire room air through the inspiratory channel and exhale through the expiratory valve.

The HAMILTON-C1 has several means to ensure that safe patient or respiratory pressures are maintained. The maximum working pressure is ensured by the high pressure alarm limit. If the set high pressure limit is reached, the ventilator cycles into exhalation. The ventilator pressure cannot exceed 60 cmH₂O.

1.2.2 Gas supply and delivery

The HAMILTON-C1 uses room air and low- or high-pressure oxygen (Figure 1-1). The use of medical oxygen is mandatory. Air enters through a fresh gas intake port and is compressed together with the oxygen by the blower. Oxygen enters through a high¹- or low²-pressure inlet.

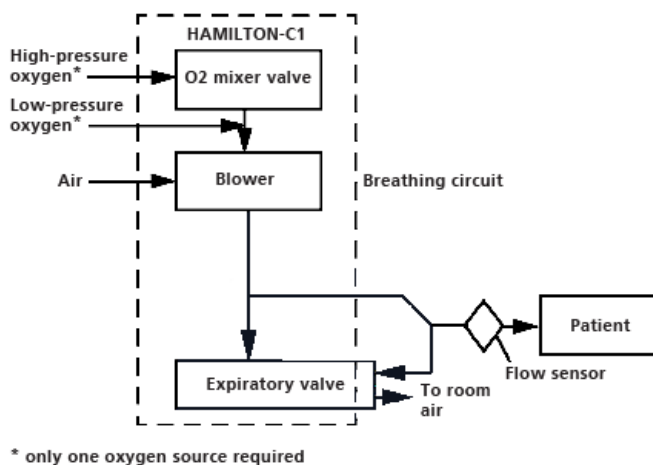

Figure 1-1. Gas delivery in the HAMILTON-C1

1. High-pressure oxygen: Maximum allowed pressure, 600kPa
2. Low-pressure oxygen: Maximum allowed pressure, 600kPa / maximum allowed flow, 15 l/min

Within the ventilator, the gas enters the HAMILTON-C1's pneumatic system. If high-pressure oxygen is supplied, a mixer valve provides for the operator-set concentration. If low-pressure oxygen is supplied, the delivered oxygen concentration is determined by the flow of the source oxygen.

Gas is supplied to the patient via the blower. The microprocessor controls the size of the speed of the blower and the length of time it is running to meet the user settings.

The HAMILTON-C1 delivers gas to the patient through the inspiratory limb breathing circuit parts, which includes one or more of the following: an inspiratory filter, flex tubes, the humidification system, water traps, the Y-piece, and the flow sensor. An internal pneumatic nebulizer supplies the nebulizer flow.

Gas exhaled by the patient passes through the expiratory limb breathing circuit parts, including flex tubes, flow sensor, the Y-piece, a water trap, and an expiratory valve cover and membrane. Gas is vented through the expiratory valve cover such that no exhaled gas comes into contact with any internal components of the HAMILTON-C1. Measurements taken at the flow sensor are used in the pressure, flow, and volume measurements.

An oxygen cell (sensor) monitors the oxygen concentration of the gas to be delivered to the patient. This galvanic cell generates a voltage proportional to the partial pressure of oxygen in the delivered gas. This oxygen measurement is compensated for changes in pressure.

The operations of the blower and expiratory valve are coordinated to maintain system pressure levels.

1.2.3 Gas monitoring with the flow sensor

The HAMILTON-C1 accurately measures flow, volume, and pressure in the patient's airway with the Hamilton Medical flow sensor. This proximal flow sensor lets the HAMILTON-C1 sense even weak patient breathing efforts. Between its highly sensitive flow trigger and fast response time, the HAMILTON-C1 helps minimize the patient's work of breathing.

The flow sensor contains a thin, diamond-shaped membrane within the outer housing and has a pressure port on either side. The membrane allows bidirectional flow through its variable orifice (Figure 1-2).

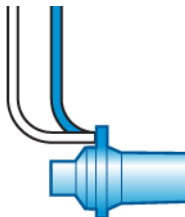

Figure 1-2. Flow sensor (adult/pediatric)

The area of the orifice changes depending on the flow rate. It opens progressively as the flow increases, creating a pressure drop across the orifice. The pressure difference is measured by a high-precision differential pressure sensor inside the ventilator. The pressure difference varies with flow (relationship determined during flow sensor calibration), so the patient's flow is determined from the pressure drop. The HAMILTON-C1 calculates volume from the flow measurements.

The flow sensor is highly accurate even in the presence of secretions, moisture, and nebulized medications. The HAMILTON-C1 flushes the sensing tubes with mixed gases (rinse flow) to prevent blockage.

1.3 Physical description

1.3.1 Breathing circuits and accessories

WARNING

To ensure proper ventilation operation, use only parts and accessories specified in Appendix G and in the product catalog, or that are specified as being compatible with this ventilator.

NOTE:

Pressure and volume measurement accuracy may be affected by using a breathing circuit with high resistance. Accuracy was tested with Hamilton Medical devices using the breathing circuits PN 281592 for neonates, and PN 260086 for adults and pediatrics.

Figure 1-3 shows the HAMILTON-C1 with its breathing circuit and accessories. Contact your Hamilton Medical representative for details on breathing circuits and accessories supplied by Hamilton Medical.

See Appendix G of this manual and the product catalog for information on compatible breathing circuits and accessories.

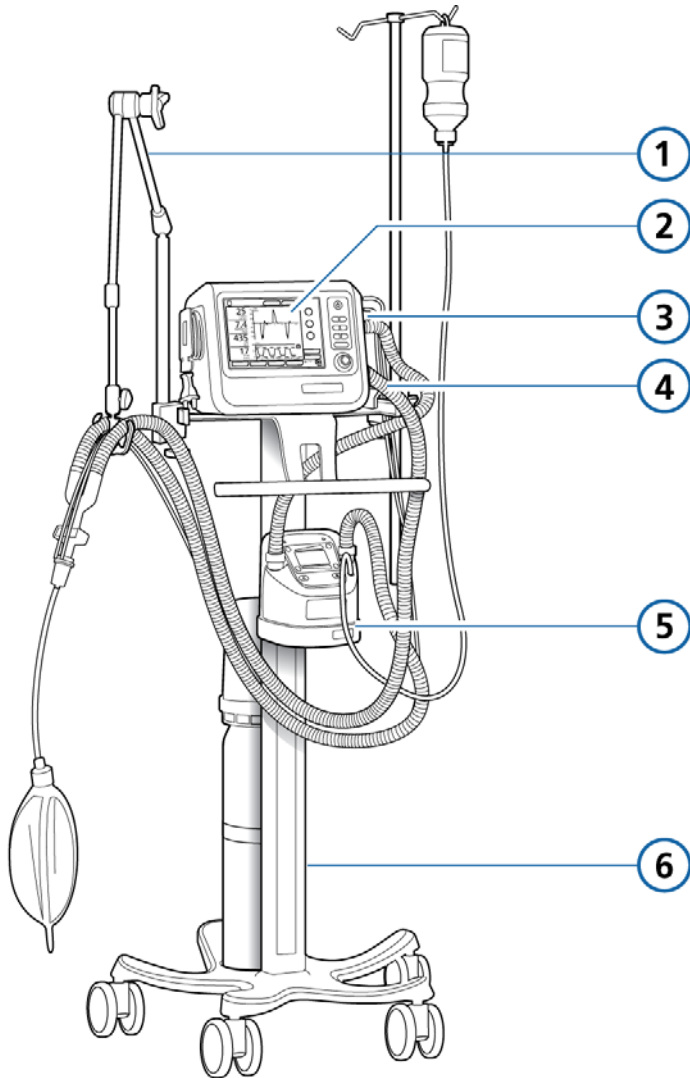

Figure 1-3. HAMILTON-C1 with accessories

- | | | | |
|---|-------------------------------|---|-------------------|
| 1 | Support arm | 4 | Breathing circuit |
| 2 | Display and controls | 5 | Humidifier |
| 3 | Breathing circuit connections | 6 | Trolley |

1.3.2 Ventilator unit

Figures 1-4 through 1-7 show the controls, indicators, and other important parts of the ventilator unit.

When a selected function is active, the indicator light next to the key is lit.

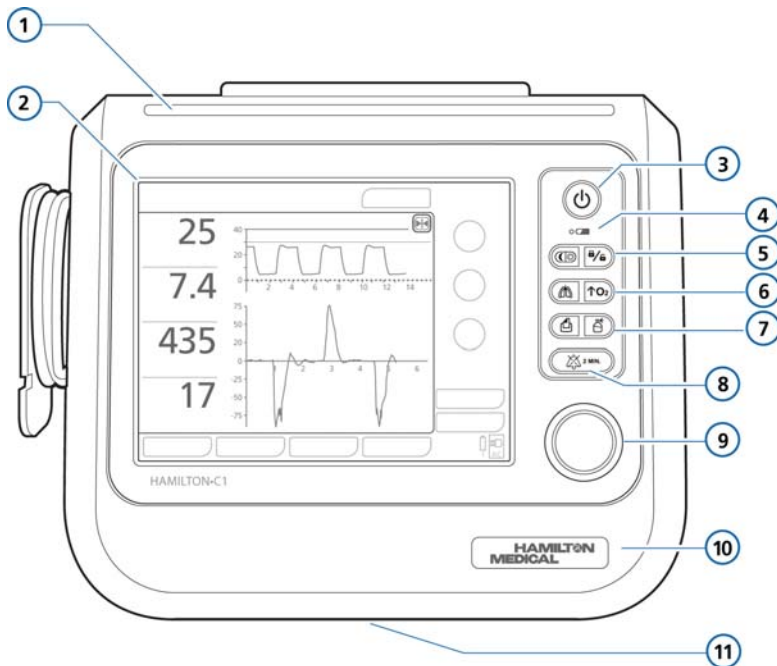











Figure 1-4. Front view

Item	Description
1	Alarm lamp. Entire lamp lights when an alarm is active (red = high-priority alarm, yellow = medium- or low-priority alarm). In addition, a red LED in the middle is continuously lit when alarm silence is active. This red LED flashes when an alarm silence is inactive but an alarm is active.
2	Touch screen. Provides access to measurements and controls.

Item	Description
<p data-bbox="236 213 250 234">3</p> 	<p data-bbox="357 213 967 268">Power/standby key. Powers the ventilator on and off and accesses standby. See Section 9.2.</p> <ul data-bbox="357 280 986 459" style="list-style-type: none"> <li data-bbox="357 280 900 304">• To turn on the ventilator, press the key for ~ 0.3 s. <li data-bbox="357 317 981 371">• To put the ventilator into standby, press and quickly release the key, then touch Activate Standby on the display. <li data-bbox="357 384 986 459">• To turn off ventilator power, press the key quickly to access standby window, then press the key again for > 3 s; or, if there is a technical fault, press and hold the key for > 10 s.
<p data-bbox="236 478 250 499">4</p> 	<p data-bbox="357 478 986 619">Battery charge indicator. Lit to show the battery is fully charged, even if the ventilator is switched off. Flashes to show the battery is charging, even if the ventilator is turned off. Dark to show the battery is not being charged (over temperature) or a primary power source is missing.</p>
<p data-bbox="236 635 250 655">5</p> 	<p data-bbox="357 635 981 743">Day/Night key. Switches between the Day and Night display brightness settings specified in the System window. When the Night setting is active, the green indicator is lit. See Section 9.10.</p>
<p data-bbox="236 761 250 782">5</p> 	<p data-bbox="357 761 975 842">Screen lock/unlock key. Prevents inadvertent change of settings. When screen lock is active, the green indicator is lit. See Section 9.9.</p>
<p data-bbox="236 877 250 898">6</p> 	<p data-bbox="357 877 981 986">Manual breath/inspiratory hold key. Triggers a mandatory breath when pressed and released during exhalation. Triggers an inspiratory hold when held down during any breath phase. When active, the green indicator is lit. See Section 9.6.</p>
<p data-bbox="236 1005 250 1026">6</p> 	<p data-bbox="357 1005 972 1059">O2 enrichment key. When active, the green indicator is lit. See Section 9.4.</p> <p data-bbox="357 1072 986 1181">Adults/Pediatric: Delivers 100% oxygen for 2 min. The actually applied oxygen concentration is displayed on the oxygen control (green). Push the key a second time or manually change the oxygen concentration (FiO2) to end enrichment.</p> <p data-bbox="357 1193 981 1327">Neonatal: Delivers 125% of the last oxygen setting for 2 min. The backlit color changes to green and the currently applied oxygen concentration is displayed on the oxygen control. Push the key a second time or manually change the oxygen concentration (FiO2) to end enrichment.</p>

Item	Description
<p data-bbox="199 213 213 234">7</p> 	<p data-bbox="320 213 945 320">Print screen key. Save a JPG file of the used current ventilator screen to a USB memory drive. The green indicator is lit while the device saves the image to the USB memory drive. See Section 9.8.</p>
<p data-bbox="199 341 213 362">7</p> 	<p data-bbox="320 341 945 480">Nebulizer on/off key. Activates pneumatic nebulizer, during the inspiration phase if high-pressure oxygen is connected. Nebulization stops automatically after 30 min. Turn it off earlier by pressing the key again. When active, the green indicator is lit. For details, see Section 9.7.</p>
<p data-bbox="199 497 213 518">8</p> 	<p data-bbox="320 497 945 636">Alarm silence key. Silences the main ventilator audible alarm for 2 min. Press the key a second time to cancel the alarm silence. The red indicator next to the key flashes when an alarm is active but not muted. It is continuously lit while alarm silence is active. See Section 9.3.</p>
<p data-bbox="199 654 213 675">9</p>	<p data-bbox="320 654 945 732">Press-and-turn (P&T) knob. Used to select and adjust ventilator settings. A green ring around the knob is lit when the ventilator is turned on.</p>
<p data-bbox="193 753 219 774">10</p>	<p data-bbox="320 753 900 805">Front cover and battery. The backup battery is located inside the front cover.</p>
<p data-bbox="193 825 219 845">11</p>	<p data-bbox="320 825 882 884"><i>Underside of ventilator:</i> Expiratory valve bleed port. Do not obstruct.</p>

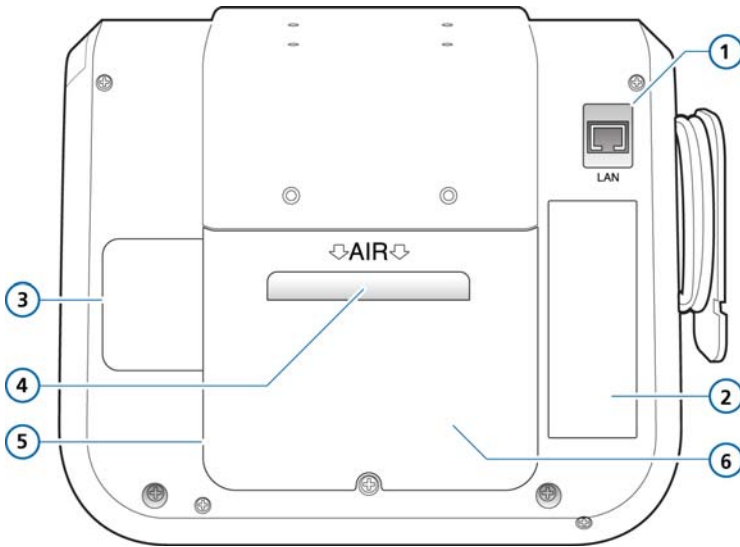

Figure 1-5. Rear view

Item	Description
1	RJ-45 Ethernet connector For internal use only.
2	Label with device-specific information
3	O2 cell
4	Air intake and dust filter Do not obstruct
5	Rear cover To exchange the HEPA filter or O2 cell, remove the rear cover.
6	HEPA filter (under the plastic cover)

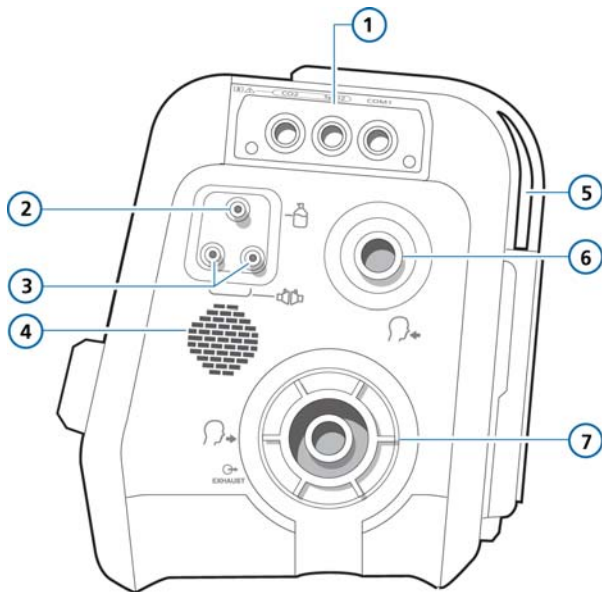







Figure 1-6. Side view, with breathing circuit connections

Item	Description
1	Communication board (optional)
 2	Pneumatic nebulizer output connector Port for pneumatic nebulizer. For details, see Section 9.7.
 3	Hamilton Medical flow sensor ports
4	Loudspeaker
5	Cooling air vent Do not obstruct
 6	To patient port To connect the inspiratory filter and the inspiratory limb of the breathing circuit.

Item	Description
<p data-bbox="228 213 244 236">7</p>   <p data-bbox="194 386 275 402">EXHAUST</p>	<p data-bbox="338 213 857 268">From patient port with expiratory valve cover and membrane</p> <p data-bbox="338 277 969 306">To connect the expiratory limb of the patient breathing circuit</p>

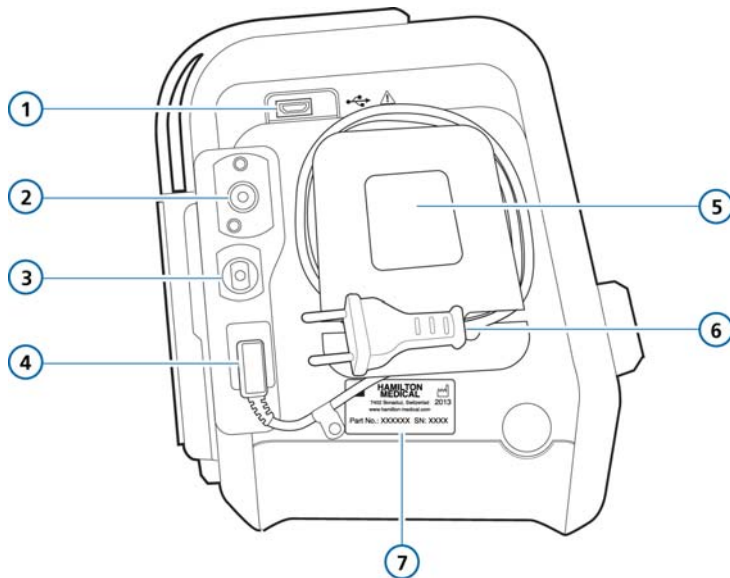



Figure 1-7. Side view, with gas connections

Item	Description
<p>1</p> 	<p>USB connector. Used by passive memory devices only, for software update, event log export, configuration setting export and import, and print screen.</p> <hr/> <p>WARNING</p> <p>Not for use as a wireless plug-in connection (that is, dongles). No wireless connections are to be made using the USB port.</p> <hr/>
2	High-pressure oxygen DISS or NIST inlet fitting
3	Low-pressure oxygen connector
4	AC power receptacle
5	<p>Cooling air intake and dust filter</p> <p>Do not obstruct</p>
6	AC power cord with retaining clip

Item	Description
7	Serial number label

1.3.3 Main display

Directly access all the windows for mode, controls, alarms, and monitoring from the main display during normal ventilation. Figure 1-8 shows the default display.

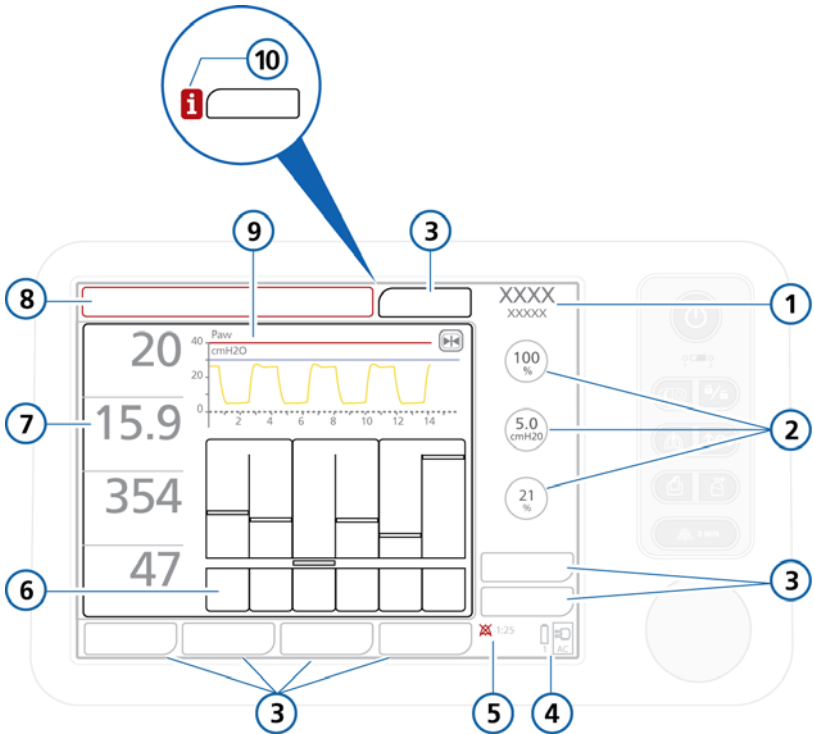













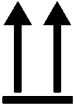







Figure 1-8. Default (basic) display







Item	Description
1	Active mode and patient group





Item	Description
2	Main controls. The most important controls. Touch the Controls button (3) to display all controls for the selected mode.
3	Window buttons (tabs). Open the associated windows.
4	Input power. Shows all available power sources. The framed symbol indicates the current source (AC = mains, 1 = battery). The green part of the battery symbol shows the level of battery charge, while the red shows the level of discharge.
5	Alarm silence indicator and countdown. Shows whether alarm silence has been activated, and displays the remaining silence time.
6	Graphic display. Shows user-selectable waveform or an Intelli-Panel graphic (Dynamic Lung, ASV graph, Vent Status).
7	Main monitoring parameters (MMP). You can view other numeric parameters from the monitored parameter windows. If the patient's condition becomes critical, the color of the numeric parameters either changes to red for a high priority alarm or to yellow for a medium priority alarm.
8	Message bar. Displays color-coded alarm messages. If an alarm is active, view the alarm buffer by touching the message bar.
9	<p>Pressure/time waveform. Always displayed.</p> <ul style="list-style-type: none"> • The waveform shows the patient's breath cycles. • The (red) line across the top is the maximum pressure, corresponding to the Pmax alarm limit. • The (blue) line indicates the pressure limit value, set to the maximum pressure – 10 cmH2O. • The pink triangles indicate the patient is triggering a breath. • The Freeze button freezes the graphic so you can scroll through the points and examine them in more detail.
10	Alarm indicator (i-icon). Indicates that there is information about alarms in the alarm buffer. View the alarm buffer by touching the icon.

1.4 Symbols used on device labels and packaging

Symbol	Definition
	Power/standby key
	Manufacturer
	Date of manufacture
	Type B applied part (classification of medical electrical equipment, type B, as specified by IEC 60601-1)
	Type BF applied part (classification of medical electrical equipment, type BF, as specified by IEC 60601-1)
	Consult operator's manual. Refer to the operator's manual for complete information. This label on the device points the user to the operator's manual for complete information. In the operator's manual, this symbol cross-references the label.
	Symbol for "Caution". Applied parts not protected against defibrillation.
CE 0197	CE Marking of Conformity, seal of approval guaranteeing that the device is in conformance with the Council Directive 93/42/EEC concerning medical devices
	Indicates the degree of protection against electric shock according to IEC 60601-1. Class II devices have double or reinforced insulation, as they have no provision for protective grounding.
	The TÜV NRTL mark with the indicators "C" and "US" means that the product complies with Canadian requirements and the requirements of US authorities for safety.

Symbol	Definition
	Dispose according to Council Directive 2002/96/EC or WEEE (Waste Electrical and Electronic Equipment)
	Serial number
	This way up at transport and storage
	Fragile, handle with care at transport and storage
	Keep dry at transport and storage
	Temperature limitations at transport and storage
	Humidity limitations at transport and storage
	Atmospheric pressure limitations at transport and storage
	Stacking limitations at transport and storage
	Recyclable materials
	Mass

Symbol	Definition
IP21	Protected against dripping water and solid particles larger than 12.5 mm.
	HAMILTON-C1 poses unacceptable risks to the patient, medical staff, or other persons within the MR environment.
	<p>Autoclavable.</p> <p>Autoclavable parts can be used inside an autoclave (for example, a steam autoclave) without damage. These parts withstand temperatures up to approximately 134°C. The correct way to reprocess autoclavable parts is described in the <i>Reprocessing Guide</i> provided by the manufacturer.</p> <p>Parts that Hamilton Medical terms as <i>autoclavable</i> can undergo autoclaving with steam sterilization without damage.</p>
	<p>Reusable.</p> <p>A reusable part is a medical device or part of a medical device that can be reused if it undergoes some sort of reprocessing between use on different patients. The correct way to reprocess reusable parts is described in the <i>Reprocessing Guide</i> provided by the manufacturer.</p> <p>Parts that Hamilton Medical terms as <i>reusable</i> cannot be autoclaved with steam sterilization.</p>
	Single use
	Applicable to neonatal patient group
	Applicable to pediatric patient group

Symbol	Definition
	Applicable to adult patient group
	Applicable to neonatal/pediatric patient groups
	Applicable to pediatric/adult patient groups
	Applicable to all patient groups

2 Preparing for ventilation

2.1	Introduction	2-3
2.2	Installing the humidifier	2-4
2.3	Installing the patient breathing circuit	2-5
2.3.1	Installing the bacteria filter or HMEF/HME	2-7
2.3.2	Installing the expiratory valve	2-8
2.3.3	Selecting the breathing circuit	2-9
2.3.4	Assembling the patient breathing circuit	2-10
2.3.5	Positioning the breathing circuit	2-14
2.4	Installing the pneumatic nebulizer	2-15
2.5	Setting up CO ₂ monitoring	2-16
2.5.1	CO ₂ mainstream measurement	2-18
2.5.2	CO ₂ sidestream measurement	2-21
2.6	Installing the Aeroneb Pro nebulizer	2-23
2.7	Using an expiratory filter	2-24
2.8	Connecting to a power source	2-25
2.8.1	Connecting to AC power	2-25
2.9	About the battery	2-25
2.10	Connecting the oxygen supply	2-28
2.10.1	Using a low-pressure oxygen supply	2-30
2.10.2	Connecting the oxygen supply to the ventilator	2-31
2.10.3	Selecting the oxygen source type	2-31
2.11	Working with the trolley	2-33
2.11.1	Installing the patient tubing support arm	2-34
2.11.2	Preparing the trolley for intrahospital transport	2-34

2.12	Connecting to an external patient monitor or other device	2-35
2.13	Turning on the ventilator	2-36
2.14	Turning off the ventilator	2-37
2.15	Display navigation guidelines	2-37

2.1 Introduction

WARNING

- Additional equipment connected to medical electrical equipment must comply with the respective IEC or ISO standards (for example, IEC 60950 for data processing equipment). Furthermore, all configurations shall comply with the requirements for medical electrical systems (see IEC 60601-1, clause 16).

Anybody connecting additional equipment to medical electrical equipment configures a medical system and is, therefore, responsible that the system complies with the requirements for medical electrical systems. Note that local laws take priority over the above-specified requirements. If you have questions about how to proceed, consult your Hamilton Medical representative or technical service department.

- In case of ventilator failure, the lack of immediate access to appropriate alternative means of ventilation can result in patient death.
- The ventilator must not be used in a hyperbaric chamber.
- Before beginning ventilation, ensure the O2 cell is installed. See Section 10.3.3.
- Adding attachments or other components or subassemblies to the HAMILTON-C1 can change the pressure gradient across the HAMILTON-C1; these changes to the HAMILTON-C1 can adversely affect the ventilator performance.
- To prevent back pressure and possible patient injury, do not attach any parts not expressly recommended by Hamilton Medical to the expiration port of the expiratory valve housing (for example, spirometers, tubes, or other devices).
- To prevent increased emissions, decreased immunity, or interrupted operation of the ventilator or any accessories, use only accessories or cables that are expressly stated in this manual.

- To prevent interrupted operation of the ventilator due to electromagnetic interference, avoid using it adjacent to or stacking other devices on it. If adjacent or stacked use is necessary, verify the ventilator's normal operation in the configuration in which it will be used.
 - For important safety information about using the HAMILTON-C1 trolley, see Section 2.11.
-

CAUTION

- Before using the ventilator for the first time, we recommend that you clean its exterior and sterilize its components as described in Chapter 10.
 - To electrically isolate the ventilator circuits from all poles of the primary power supply simultaneously, disconnect the power plug.
 - To prevent possible patient injury, do not block the holes at the back and the side (cooling fan) of the ventilator. These holes are vents for the fresh air intake and the cooling fan.
-

2.2 Installing the humidifier

WARNING

- To prevent possible patient injury and possible water damage to the ventilator, make sure the humidifier is set to appropriate temperature and humidification settings.
 - To prevent possible patient injury and equipment damage, do not turn the humidifier on until the gas flow has started and is regulated. Starting the heater or leaving it on without gas flow for prolonged periods may result in heat build-up, causing hot air to be delivered to the patient. Circuit tubing may melt under these conditions. Turn the heater power switch off before stopping gas flow.
-

CAUTION

Regularly check the water traps and the breathing circuit hoses for water accumulation. Empty as required.

Install a humidifier to the HAMILTON-C1 using the slide bracket on the trolley column. Prepare the humidifier as described in the manufacturer's operation manual.

2.3 Installing the patient breathing circuit

WARNING

- **To minimize the risk of bacterial contamination or physical damage, handle bacteria filters with care.**
 - **Make sure a HEPA filter is installed.**
 - **To prevent patient or ventilator contamination, always use a bacteria filter or HMEF/HME between the patient and the inspiratory port.**
 - **To reduce the risk of fire, use only breathing circuits intended for use in oxygen-enriched environments. Do not use antistatic or electrically conductive tubing.**
 - **Only use approved CE-labeled consumables as accessories.**
-

NOTE:

- Any bacteria filter, HMEF/HME, or additional accessories in the expiratory limb may substantially increase flow resistance and impair ventilation.
- To ensure that all breathing circuit connections are leak-tight, perform the tightness test every time you install a circuit or change a circuit part.
- Do not combine the neonatal CO2 airway adapter and the adult flow sensor. Artifacts during the measurement are possible.

- For optimal ventilator operation, use Hamilton Medical breathing circuits or other circuits that meet the specifications given in Appendix A. When altering the Hamilton Medical breathing circuit configurations (for example, when adding components), make sure not to exceed these inspiratory and expiratory resistance values of the ventilator breathing system, as required by ISO 80601-2-12.
- Pressure and volume measurement accuracy may be affected by using a breathing circuit with high resistance. Accuracy was tested with Hamilton Medical devices using the breathing circuits PN 281592 for neonates, and PN 260086 for adults and pediatrics.

Connecting the adult/pediatric breathing circuit comprises the following steps. For neonatal ventilation, see Chapter 5.

		See
1.	Install the bacteria filter or HMEF/HME	Section 2.3.1 on page 2-7
2.	Install the expiratory valve	Section 2.3.2 on page 2-8
3.	Select the appropriate breathing circuit and components	Section 2.3.3 on page 2-9
4.	Assemble the breathing circuit	Section 2.3.4 on page 2-10
5.	Adjust position of the breathing circuit	Section 2.3.5 on page 2-14
6.	Perform any required tests (tightness test and calibrations) and the preoperational check	Chapter 3

2.3.1 Installing the bacteria filter or HMEF/HME

To prevent patient or ventilator contamination, be sure to install a bacteria (inspiratory) filter or HMEF/HME between the patient and the inspiratory port.



For neonatal patients, use an infant HMEF/HME.

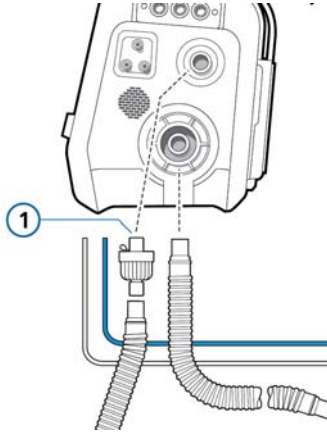

Figure 2-1. Installing a bacteria filter (1)

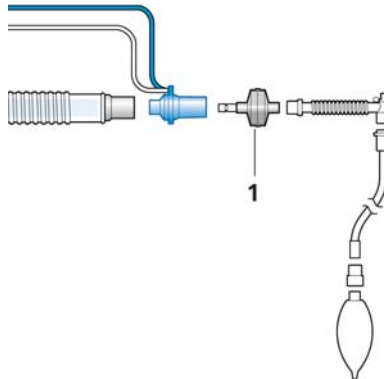

Figure 2-2. Installing an HMEF/HME (1)

2.3.2 Installing the expiratory valve

NOTE:

Ensure you select the correct expiratory valve (adult/pediatric or neonatal) for your patient. If the expiratory valve type does not match the selected patient group on the ventilator, the **Wrong expiratory valve** alarm is generated. See Table 8-2.

For neonatal ventilation, see Chapter 5.

1. Holding the expiratory valve housing (Figure 2-3), seat the silicone membrane onto the housing.
The metal plate must face up and be visible.
2. Position the housing and twist clockwise until it locks into place.

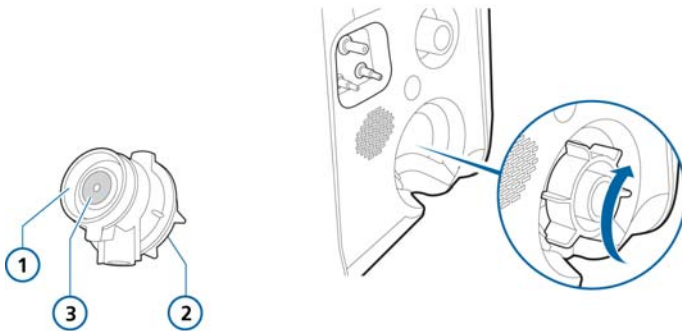

Figure 2-3. Installing the expiratory valve

- | | | | |
|---|---------------------------|---|-----------------------------------|
| 1 | Expiratory valve membrane | 3 | Metal plate facing the ventilator |
| 2 | Expiratory valve housing | | |
-

2.3.3 Selecting the breathing circuit

Select the correct breathing circuit parts for your patient from Tables 2-1 and 2-2 (when applicable).

For neonatal ventilation, see Chapter 5.

Table 2-1. Adult/pediatric breathing circuit parts

Patient group	Patient height (cm)	IBW (kg)	Tracheal tube ID (mm)	Breathing circuit tube ID (mm)	Flow sensor	CO2 airway adapter
Pediatric	30 to 150 (11 to 59 in)	3 to 42	3 to 7	15	Pediatric/adult	Pediatric/adult
Adult	> 130 (51 in)	> 30	≥ 5	22	Pediatric/adult	Pediatric/adult

CO2

Table 2-2. Tracheal tubes and CO2

Tracheal tube ID (mm)	CO2 airway adapter
≥ 4	Adult/pediatric

2.3.4 Assembling the patient breathing circuit

Assembling the adult/pediatric breathing circuit comprises the following steps:

		See
1.	Connect the circuit	Figures 2-4 through 2-5 on page 2-11
2.	Install the flow sensor	Section 2.3.4.2 on page 2-14

2.3.4.1 Connecting the breathing circuit

Figures 2-4 through 2-5 show typical adult/pediatric breathing circuits. For neonatal ventilation, see Chapter 5.

For ordering information, contact your Hamilton Medical representative. Follow the specific guidelines for the different parts.

Connect the components as appropriate for your patient.

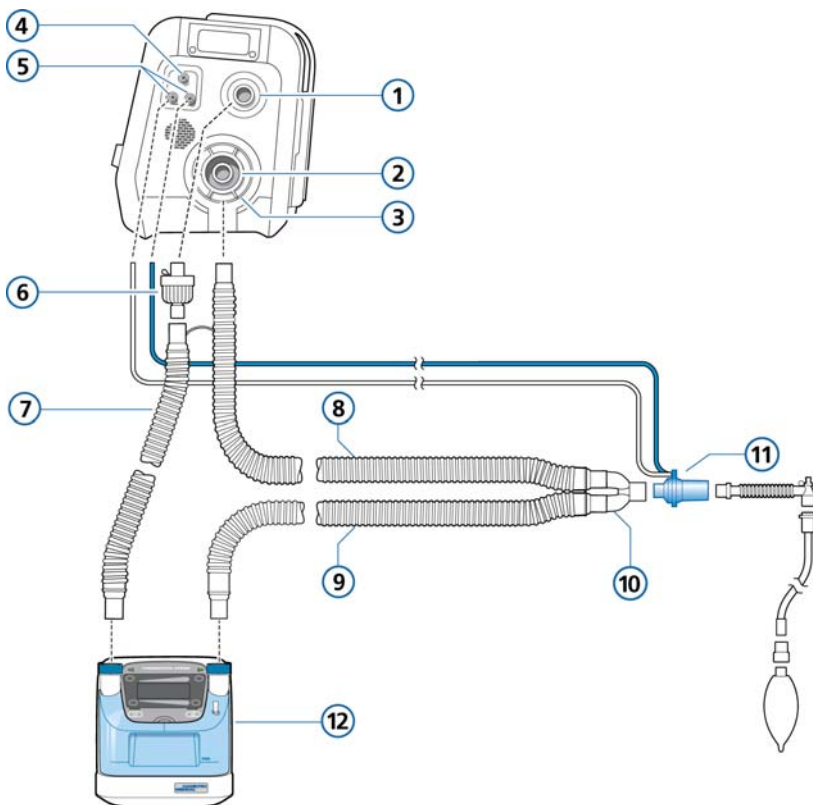

Figure 2-4. Dual-limb breathing circuit with humidifier (adult/pediatric)

- | | | | |
|---|--------------------------------------|----|--|
| 1 | To patient | 7 | Inspiratory limb |
| 2 | From patient | 8 | Expiratory limb |
| 3 | Expiratory valve with membrane cover | 9 | Inspiratory limb (with integrated heater wire) |
| 4 | Nebulizer outlet | 10 | Y-piece (integrated with breathing circuit) |
| 5 | Flow sensor connectors | 11 | Flow sensor |
| 6 | Bacteria filter | 12 | Humidifier |

In some cases, an elbow adapter may be useful between the inspiratory filter and the inspiratory limb.

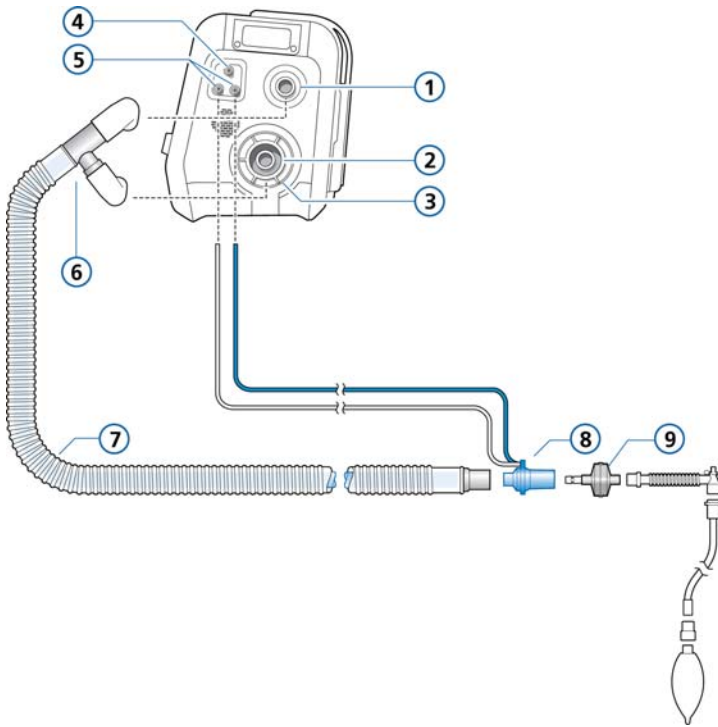

Figure 2-5. Coaxial breathing circuit with HMEF/HME (adult/pediatric)

- | | | | |
|---|--------------------------------------|---|--------------------------------------|
| 1 | To patient | 6 | Limb connector |
| 2 | From patient | 7 | Co-axial inspiratory/expiratory limb |
| 3 | Expiratory valve with membrane cover | 8 | Flow sensor |
| 4 | Nebulizer outlet | 9 | HMEF/HME |
| 5 | Flow sensor connectors | | |

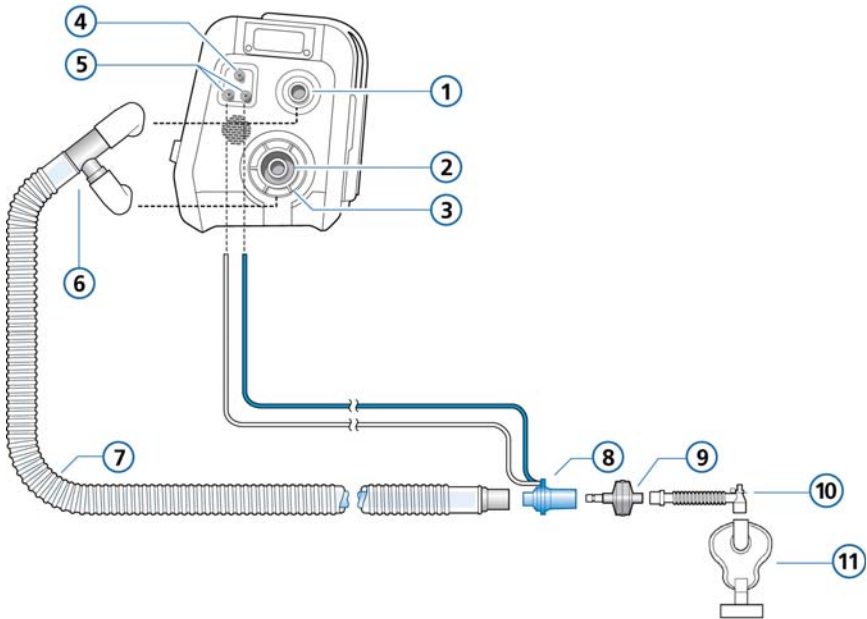

Figure 2-6. Coaxial breathing circuit for use with mask (adult/pediatric)

1	To patient	7	Co-axial inspiratory/expiratory limb
2	From patient	8	Flow sensor
3	Expiratory valve with membrane cover	9	HMEF/HME
4	Nebulizer outlet	10	Adapter
5	Flow sensor connectors	11	Mask (nonvented)
6	Limb connector		

2.3.4.2 Installing the flow sensor

NOTE:

To prevent inaccurate flow sensor readings, make sure the flow sensor is correctly installed:

- The flow sensor tubes must not be kinked.
 - The flow sensor tubes must be secured with the included clamp (does not affect HAMILTON-C1 breathing circuits).
 - For neonatal ventilation, see Chapter 5.
-

1. Insert a flow sensor between the Y-piece of the breathing circuit and the patient connection.
2. Connect the blue and clear tubes to the flow sensor connectors on the ventilator.

The blue tube goes to the blue connector. The colorless tube goes to the white connector.

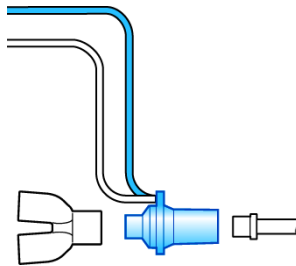

Figure 2-7. Installing the flow sensor

2.3.5 Positioning the breathing circuit

After assembly, position the breathing circuit so that the hoses will not be pushed, pulled, or kinked as a result of a patient's movement, nebulization, or other procedures.

The next step is to perform all required tests, calibrations, and the preoperational check. See Chapter 3.

2.4 Installing the pneumatic nebulizer

WARNING

- **Do not use an expiratory filter or HME in the patient's breathing circuit during nebulization. Nebulization can cause an expiratory side filter to clog, substantially increasing flow resistance and impairing ventilation.**
 - **Connect the nebulizer in the inspiratory limb per your institution's policy and procedures. Connecting the nebulizer between the flow sensor and the endotracheal tube increases dead space and causes incorrect volume measurements.**
 - **To prevent the expiratory valve from sticking due to nebulized medications, use only medications approved for nebulization and regularly check and clean or replace the expiratory valve membrane.**
 - **Be aware that nebulization affects delivered oxygen concentration.**
-
-

NOTE:

Pneumatic nebulization is disabled during neonatal ventilation.

The nebulization feature provides a stable driving pressure to power a pneumatic nebulizer connected to the nebulizer outlet, optimally specified for a flow of approximately 8 l/min.

Connect the nebulizer and accessories as shown in Figure 2-8. See Appendix G for information about compatible nebulizers.

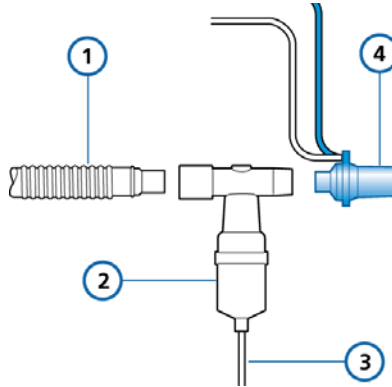

Figure 2-8. Installing a pneumatic nebulizer

- | | | | |
|---|-----------------------------------|---|-------------|
| 1 | Breathing circuit (coaxial shown) | 3 | Tube |
| 2 | Nebulizer | 4 | Flow sensor |

2.5 Setting up CO₂ monitoring

CO₂

WARNING

- Always ensure the integrity of the patient breathing circuit after insertion of the airway adapter by verifying a proper CO₂ waveform (capnogram) on the ventilator display.
- If the capnogram appears abnormal, inspect the CO₂ airway adapter and replace if needed.
- Monitor the capnogram for higher-than-expected CO₂ levels during ventilation. These can be caused by sensor or patient problems.
- Use the correct adapter. In adult patients small geometrics may induce low tidal volumes and intrinsic PEEP. In neonatal patients large geometrics impede effective CO₂ removal.
- Do not use the CO₂ sensor if it appears to have been damaged or if it fails to operate properly. Refer servicing to Hamilton Medical authorized personnel.

-
- To reduce the risk of explosion, do not place the CO₂ sensor in a combustible or explosive environment (for example, around flammable anesthetics or other ignition sources).
 - Do not use the CO₂ sensor when it is wet or has exterior condensation.
 - To prevent increased PaCO₂ do not use an adult sensor adapter for neonates as it will increase dead space.
-

CAUTION

- Position airway adapters with windows in a vertical, *not* a horizontal, position. This helps keep patient secretions from pooling on the windows.
 - To prevent premature failure of the CO₂ sensor, Hamilton Medical recommends that you remove it from the circuit whenever an aerosolized medication is delivered. This is due to the increased viscosity of the medication, which may contaminate the airway adapter window.
 - All devices are not protected against reanimation with a defibrillator.
 - Avoid permanent direct contact of the CO₂ sensor with the body.
 - Nebulization may influence the CO₂ measurements.
 - Disconnect the CO₂ sensor before using a defibrillator on the patient.
-

CO₂ monitoring is used for various applications in order to gain information such as the assessment of the patient's airway integrity or the proper endotracheal tube placement.

The HAMILTON-C1 offers two monitoring options:

- Mainstream CO₂ measurement
- Sidestream CO₂ measurement

Whether mainstream or sidestream CO₂ is used to monitor end-tidal CO₂ depends on the clinical setting. A volumetric capnogram as described in Appendix E is only possible with a mainstream CO₂ sensor.

2.5.1 CO2 mainstream measurement

WARNING

In NIV and neonatal ventilation with uncuffed tubes, leaks may influence the volumetric capnogram and the measured numerical monitoring parameters.

The optional mainstream CO₂ sensor is a solid-state infrared sensor, which is attached to an airway adapter that connects to an endotracheal (ET) tube or other airway and measures bases flowing through these breathing circuit components.

The sensor generates infrared light and beams it through the airway adapter or sample cell to a detector on the opposite side. CO₂ from the patient, flowing through the mainstream airway adapter or aspirated into the sample cell, absorbs some of this infrared energy. The HAMILTON-C1 determines the CO₂ concentration in the breathing gases by measuring the amount of light absorbed by gases flowing through the airway or sample cell.

The HAMILTON-C1 can display measurements derived from the CO₂ sensor as numeric values, waveforms, trends, and loops. The waveform is a valuable clinical tool that can be used to assess patient airway integrity and proper endotracheal (ET) tube placement.

The CO₂ sensor can be easily transferred from one HAMILTON-C1 ventilator to another, even “on the fly”, during ventilation.

2.5.1.1 Connecting the CO2 mainstream sensor

NOTE:

You must use the included adapter to connect the mainstream CO2 sensor to an infant flow sensor to avoid increasing dead space.

To set up CO2 monitoring

1. Plug the sensor cable into the CO2 module connector on the ventilator (Figure 1-6), observing the orientation of the indexing guides on the connector body. The cable should snap into place.
2. Attach the airway adapter to the CO2 sensor:
 - a. Verify that the adapter windows are clean and dry. Clean or replace the adapter if necessary.
 - b. Align the arrow on the bottom of the adapter with the arrow on the bottom of the sensor.
 - c. Press the sensor and the adapter together until they click.

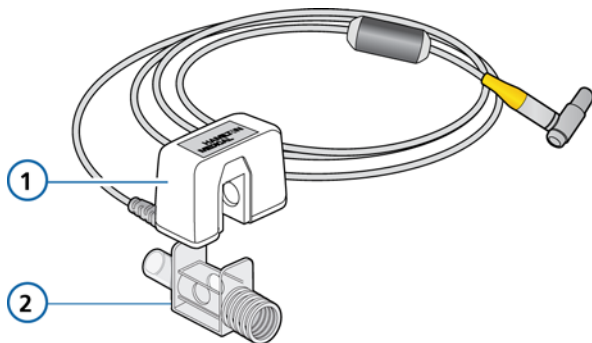

Figure 2-9. Attaching the CO2 sensor to the airway adapter

1 CO2 sensor **2** Airway adapter

3. Connect the sensor/airway adapter to the patient circuit as follows (Figure 2-10):

- a. Place the sensor/airway adapter assembly at the proximal end of the airway circuit as shown.

Do *not* place the airway adapter between the ET tube and the elbow, as this may allow patient secretions to accumulate in the adapter.

- b. Position the airway adapter with its windows in a vertical, not a horizontal, position.

This helps keep patient secretions from pooling on the windows. If pooling does occur, the airway adapter may be removed from the circuit, rinsed with water and reinserted into the circuit. To prevent moisture from draining into the airway adapter, do *not* place the airway adapter in a gravity-dependent position.

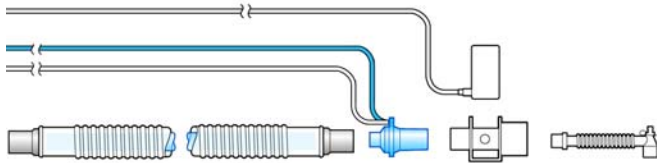

Figure 2-10. Connecting the CO2 sensor/airway adapter to the patient circuit

4. Check that connections have been made correctly by verifying the presence of a proper CO2 waveform (capnogram) on the HAMILTON-C1 display. Monitor the capnogram for higher-than-expected CO2 levels. If CO2 levels are higher than expected, verify patient condition first. If you determine that the patient's condition is not contributing, calibrate the sensor.
5. To secure the sensor cable safely out of the way, attach sensor cable holding clips to the airway tubing, then connect the sensor cable to the clips. The sensor cable should face away from the patient.

The next step is to calibrate the sensor. See page 3-14.

To remove the sensor cable, pull back on the connector sheath and disengage from connector.

2.5.2 CO₂ sidestream measurement

NOTE:

- Neither humidity (noncondensing) nor cyclical pressures (up to 10 kPa) have any effect on the stated accuracy of the device.
 - The device performs as stated both when connected to AC power or when running on battery power.
-

The optional sidestream CO₂ sensor samples gases using a sampling adapter placed into the breathing circuit proximal to the patient. The gas passes through sampling tube to the sample cell. The sampling tube is water permeable in order to minimize cross interference effects and collision broadening.

The sampling cell measures the gas components using infrared spectroscopy at a wavelength of 4260 nm. The measured values can be displayed by the HAMILTON-C1 as real-time waveform, loops, and trends and as numeric values.

2.5.2.1 Connecting the CO₂ sidestream sensor

WARNING

- **Leakages in the breathing or sampling system may cause the displayed etCO₂ values to be significantly underreported (too low).**
 - **Always connect all components securely and check for leaks according to standard clinical procedures. Displacement of the nasal or combined nasal-oral cannulas can cause lower-than-actual etCO₂ readings.**
-

CAUTION

- **DO NOT use with patients that cannot tolerate the removal of 50 ml ±10 ml/min from their total minute volume. In adaptive modes (such as ASV, APVcmv, and APVsimv), the removal is fully compensated.**
- **Always use the correct CO2 adapter. In adult patients, smaller geometrics induce low tidal volumes and intrinsic PEEP. In neonatal patients, large geometrics detain effective CO2 removal.**

To set up CO2 sidestream monitoring

1. Plug the LoFlow™ sidestream CO2 module cable into the CO2 option board connector (yellow), observing the orientation of the indexing guides on the connector body. The cable snaps into place. See Figure 2-11.
2. Plug the sample cell into the CO2 module as shown in Figure 2-11. The connector “clicks” into place.

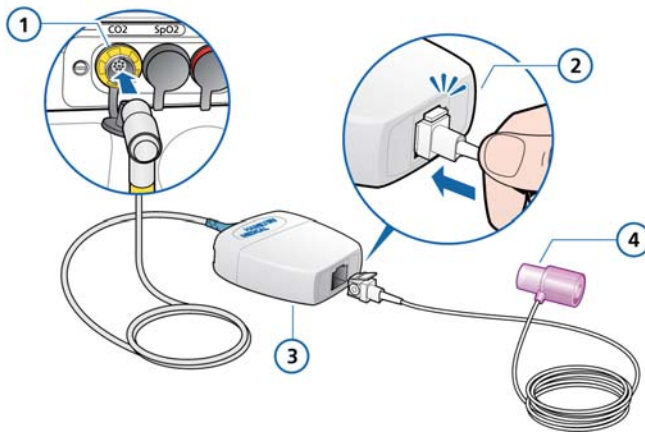

Figure 2-11. Inserting the sample cell into the CO2 module

- | | | | |
|---|-------------------------------|---|------------------------------|
| 1 | CO2 connection on ventilator | 3 | LoFlow sidestream CO2 module |
| 2 | Sample cell clicks into place | 4 | Airway adapter |

-
3. Inserting the sample cell into the receptacle automatically starts the sampling pump. Removal of the sample cell turns the sample pump off.
 4. Before attaching the airway adapter, the CO₂ sensor needs to be calibrated. See page 3-14.
 5. Attach the airway adapter between the flow sensor and ET tube.

The sampling line should face away from the patient.

6. To secure the sampling line safely out of the way, attach the sensor cable holding clips to the airway tubing, then connect the sampling line to the clips.

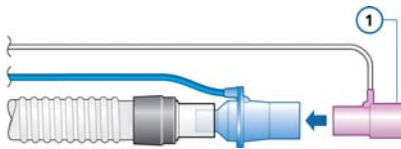

Figure 2-12. Attaching the CO₂ sensor (1) to the airway

To remove the sampling kit sample cell from the receptacle, press down on the locking tab and pull the sample cell out of the receptacle.

2.6 Installing the Aeroneb Pro nebulizer

NOTE:

Connect only approved piezo nebulizers to the HAMILTON-C1 ventilator.

The Aerogen Aeroneb Pro nebulizer system is available as an option for the HAMILTON-C1. Attach it to the mounting bracket. Consult the operating instructions supplied with the nebulizer for further installation and operating information.

2.7 Using an expiratory filter

CAUTION

- **The use of an expiratory filter can lead to a significant increase in expiratory circuit resistance. Excessive expiratory circuit resistance can compromise ventilation and increase patient work of breathing or AutoPEEP or both.**
 - **Nebulization of drugs can cause an occlusion and increased resistance of the filter.**
-

NOTE:

Monitored parameters for increased expiratory resistance are not specific to the breathing circuit and may indicate increased patient airway resistance and/or increased resistance of the artificial airway (if used). Always check the patient and confirm adequate ventilation.

An expiratory filter is not required on the HAMILTON-C1, but you may use one according to your institution's protocol. An expiratory filter is not required, because the expiratory valve design prevents internal ventilator components from contact with the patient's exhaled gas.

If you do use an expiratory filter, place it on the patient side of the expiratory valve cover. Remove any expiratory filter or HMEF/HME during nebulization. Monitor closely for increased expiratory circuit resistance. An **Exhalation obstructed** alarm may also indicate excessive expiratory circuit resistance. If the **Exhalation obstructed** alarm occurs repeatedly, remove the expiratory filter immediately. If you otherwise suspect increased expiratory circuit resistance, remove the expiratory filter or install a new filter to eliminate it as a potential cause.

2.8 Connecting to a power source

NOTE:

- To prevent unintentional disconnection of the power cord, make sure it is well seated into the ventilator socket and secured with the power cord retaining clip.
 - Install the ventilator in a location where the primary power can be easily disconnected.
 - The HAMILTON-C1 does not require protective earth grounding, because it is a class II device, as classified according to IEC 60601-1.
-

2.8.1 Connecting to AC power

Connect the HAMILTON-C1 to an outlet that supplies AC power between 100 and 240 V AC, 50/60 Hz.

Always check the reliability of the AC outlet. When connected to AC power, the AC symbol in the bottom right-hand corner of the screen shows a frame around it.

2.9 About the battery

WARNING

- **The battery will not charge if the ambient temperature is above 43°C.**
 - **Be aware that ventilation stops if the internal battery is fully discharged and no external supply is available.**
 - **Periodically check or replace the battery.**
-

NOTE:

- The use of one battery is mandatory. The battery is used as internal backup battery.
- HAMILTON MEDICAL recommends that the ventilator's battery be fully charged before you ventilate a patient. Regularly monitor the battery charge level to ensure an adequate power supply

- The device generates alarms to alert you to low battery capacity. For details, see the Battery low alarm description on page 8-11.
 - The battery depletion rate may vary according to the age of the battery, ventilation mode, temperature, settings, etc.
-

A backup battery protects the ventilator from low power or failure of the primary power source. When the primary power source fails, the ventilator automatically switches to operation on backup battery with no interruption in ventilation. An alarm sounds to signal the switchover.

Silence the alarm to confirm notification of the power system change; this resets the alarm.

It also has a capacitor-driven backup buzzer that sounds continuously for at least 2 min when battery power is completely lost.

The battery powers the ventilator until the primary power source is again adequate or until the battery is depleted.

Hamilton Medical provides a high-capacity¹ battery that provides a longer charge. When installed, the text **High-Cap** appears next to the battery capacity information in the System -> Info window.

The ventilator charges the battery whenever the ventilator is connected to the primary power supply (AC), with or without the ventilator being turned on. The battery charge indicator lights show that the battery is being charged.

1. Hamilton Medical Li-Ion batteries, revision 4 and later

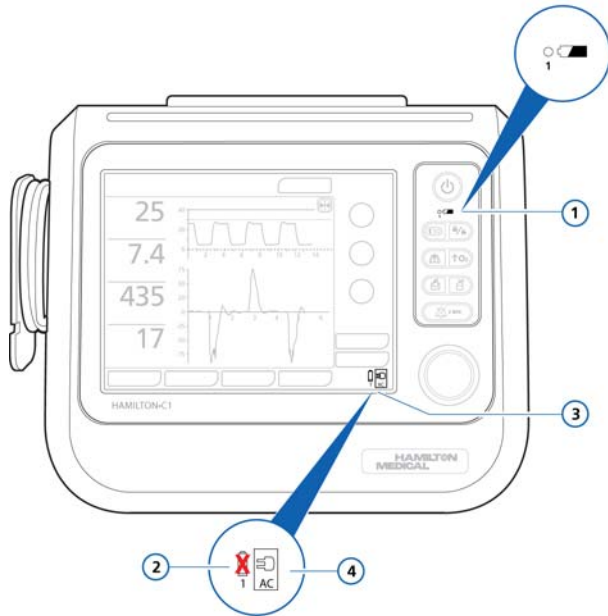

Figure 2-13. Power source symbols and battery charge indicator

- | | |
|---|--|
| <p>1 Battery charge indicator</p> <p>2 Crossed-out battery means standard battery not available</p> | <p>3 AC power symbol</p> <p>4 Frame indicates current power source</p> |
|---|--|

The power source symbols in the bottom right-hand corner of the screen show the available power sources. A frame around a symbol indicates the current ventilator power source. Green indicates the level of battery charge.

Check the battery charge level before putting the ventilator on a patient and before unplugging the ventilator for transport or other purposes.

The charge level is indicated as follows:

- A green symbol indicates a fully charged battery.
- An orange and green symbol indicates a partially charged battery.

- If the battery symbol is crossed out, the battery is discharged or defective.

If a battery is not fully charged, recharge it by connecting the ventilator to the primary power source for a minimum of 4 hours, until the battery charge level is 80% to 100%. Alternatively, the battery can also be charged with the external charger.

Chapter 10 describes how to charge the battery.

2.10 Connecting the oxygen supply

WARNING

- It is **NOT** permitted to use the equipment with flammable gases or anaesthetic agents. Danger of fire!
 - It is **NOT** permitted to use the ventilator with helium or mixtures of helium.
 - An O₂ cell must be installed.
-

CAUTION

- Always check the status of the oxygen cylinders or other supply before using the ventilator during intrahospital transport.
 - Make sure oxygen cylinders are equipped with pressure-reducing valves.
 - To minimize the risk of fire, do not use high-pressure gas hoses that are worn or contaminated with combustible materials like grease or oil.
-

NOTE:

- To prevent damage to the ventilator, connect only clean, dry medical-grade oxygen.
- Before starting ventilation, make sure the appropriate oxygen source, either high-pressure oxygen (HPO mode) or low-pressure oxygen (LPO mode), was selected when configuring the ventilator.

Set the source type in the Utilities window (in Standby mode). See Section 2.10.3.

Oxygen for the HAMILTON-C1 can come from a high- or low-pressure source.

- High-pressure oxygen, provided by a central gas supply or a gas cylinder, is supplied through DISS or NIST male gas fittings. With the optional cylinder holder, you can mount oxygen cylinders to the trolley. If you use gases from cylinders, secure the cylinders to the trolley with the accompanying straps.

Pressure	2.8 – 6 bar / 280 to 600 kPa / 41 – 87 psi
----------	---

- Low-pressure oxygen is provided by a concentrator or liquid cylinder.

Flow	≤ 15 l/min
Pressure	≤ 6 bar / 600 kPa / 87 psi

For important safety information related to the use of low-pressure oxygen, see Section 2.10.1.

The selected setting is active until manually changed or the ventilator is restarted.

2.10.1 Using a low-pressure oxygen supply

CAUTION

- To reduce the risk of fire:
 - DO NOT use a low-pressure oxygen source that delivers a flow greater than 15 l/min.
 - Ensure adequate ventilation at the rear of the ventilator.
 - Switch off the oxygen source when the ventilator is not in a ventilating mode.
- To prevent possible patient injury when the ventilator is sourced from an oxygen concentrator, never operate the concentrator with a humidifier. Any humidifier system supplied with the concentrator must be drained or removed before using the ventilator.
- The ventilator's Oxygen control is not active when low-pressure oxygen is used. It is the operator's responsibility to control the oxygen setting.
- To prevent possible patient injury, use low-pressure oxygen only in cases where the low-pressure source can provide an adequate level of oxygenation.
- To prevent possible patient injury, ensure that an emergency backup oxygen supply (for example, a cylinder) is available in case the low-pressure oxygen source fails.
- To calibrate the O₂ cell, disconnect all O₂ supplies. Calibration is done at 21%.
- To protect the oxygen control system, do not supply both high- and low-pressure oxygen to the ventilator simultaneously.

Using the low-pressure oxygen supply involves two steps:

- Connecting the supply to the ventilator (Section 2.10.2)
- Selecting the source type on the ventilator (Section 2.10.3)

2.10.2 Connecting the oxygen supply to the ventilator

NOTE:

Only use low-pressure hoses that comply with EN ISO 5359 to connect the device to the oxygen supply.

To connect the oxygen supply to the ventilator

Connect the oxygen hose to the HAMILTON-C1's high-pressure or low-pressure oxygen inlet fitting. See Section 2.10.3.

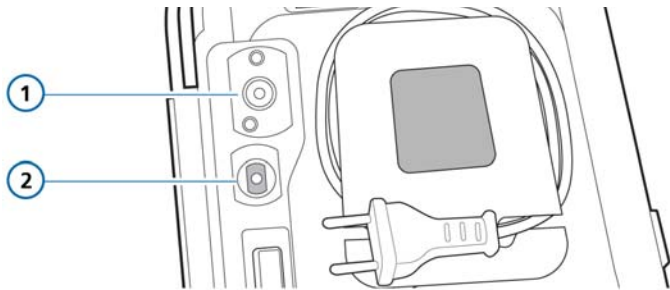

Figure 2-14. Oxygen inlet fittings

- | | |
|---|--|
| 1 Oxygen high-pressure inlet fitting | 2 Oxygen low-pressure inlet fitting (for safety information, see Section 2.10.1 on page 2-30) |
|---|--|
-

2.10.3 Selecting the oxygen source type

Before starting ventilation, be sure to select the appropriate oxygen source. By default, the ventilator is set to high-pressure oxygen (HPO).

You set the source in Standby mode.

To select the oxygen source

1. In Standby mode, touch the **Utilities** button.
By default, the Gas source window is displayed.

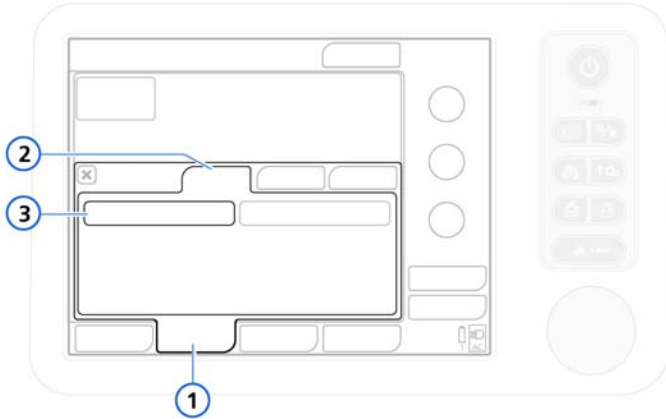

Figure 2-15. Gas source window

1	Utilities	3	HPO/LPO
2	Gas source		

2. Touch the appropriate button for the desired oxygen source.
 - Select **HPO** for high-pressure oxygen (the default)
 - Select **LPO** for low-pressure oxygen (see Section 2.10.1)The ventilator always resets to HPO mode when restarted.
3. Close the Utilities window.

2.11 Working with the trolley

WARNING

- To prevent possible personal injury and equipment damage, make sure the ventilator is properly secured to the trolley.
 - To prevent possible tipping of the trolley and equipment damage:
 - Lock the trolley's wheels when parking the ventilator.
 - Take care when crossing thresholds.
 - Table 2-3 below describes the warning labels provided with the HAMILTON-C1 trolley.
-

Table 2-3. HAMILTON-C1 trolley warning labels



Make sure the wheel brakes are unlocked when moving the trolley.



Do not lean on the trolley.



Do not park the trolley on an incline greater than 5 degrees.

2.11.1 Installing the patient tubing support arm

WARNING

To prevent possible patient injury due to accidental extubation, check the support arm joints and secure as necessary.

Install the patient tubing support arm on either side of the HAMILTON-C1 trolley.

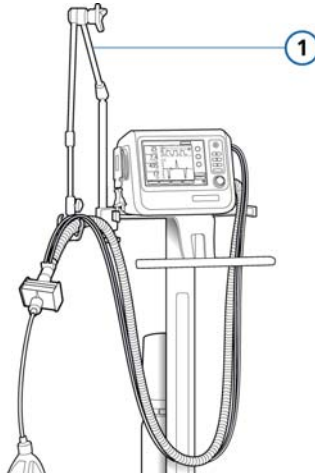

Figure 2-16. Patient tubing support arm (1)

2.11.2 Preparing the trolley for intrahospital transport

WARNING

- Only the components listed in this section are approved for intrahospital transport.
- Use of additional items, such as patient tubing support arm or humidifier, can result in the trolley tipping over.
- Ventilator must be attached to the trolley using the locking bolt. Ensure the device is securely attached before use.

NOTE:

The following requirements apply only to transport using ventilators mounted on a HAMILTON-C1 trolley. They do not apply to other mounting solutions.

If using a HAMILTON-C1 trolley, the ventilator and its components, as well as the trolley, **must be** configured and positioned as follows during transport within the hospital:

- The ventilator must be securely mounted on the trolley
- The O2 cylinder must be securely attached to the trolley
- *Only* the following components are allowed to be connected during transport:
 - Breathing circuit
 - Flow sensor (or pressure line)
 - CO2 sensor (mainstream or sidestream)
 - SpO2 sensor
 - O2 cylinder

2.12 Connecting to an external patient monitor or other device

WARNING

All devices connected to the HAMILTON-C1 must be for medical use and meet the requirements of standard IEC 60950.

You can connect your ventilator to a patient monitor, a Patient Data Monitoring System (PDMS), or a computer via the COM1 port. For details on the communication interface, see Appendix H.

2.13 Turning on the ventilator

CAUTION

To ensure the ventilator's safe operation, always run the preoperational check before using the ventilator on a patient. If the ventilator fails any tests, remove it from clinical use immediately. Do not use the ventilator until necessary repairs are completed and all tests have passed.

NOTE:

If the HAMILTON-C1 is new, be sure it has been properly configured for default language, alarms, and other important settings (see Appendix I).

To turn on the ventilator

1. Press the ventilator power key. The ventilator runs a self-test.
After a short time, the patient setup window is displayed.

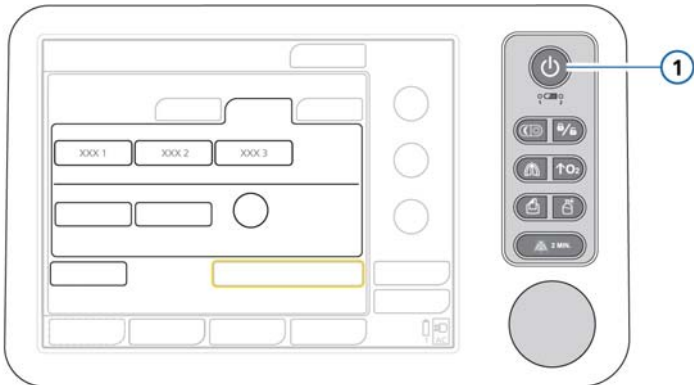

Figure 2-17. Power/Standby key (1)

2. Set up the ventilator as described in Chapter 4.
3. Run the preoperational check (Section 3.2).

2.14 Turning off the ventilator

NOTE:

The ventilator remains connected to power when the power is turned off. This permits the battery to charge. To completely disconnect the ventilator from power, unplug it from the primary power outlet.

To turn off the HAMILTON-C1, press and quickly release the power key to access standby, then press the key again for > 3 seconds; or, if there is a technical fault, press and hold the key for > 10 seconds.

2.15 Display navigation guidelines

Use the touch screen and the press-and-turn (P&T) knob to access the HAMILTON-C1 ventilation parameters and monitored data. You typically use a select - activate or select - activate - adjust - activate procedure.

To open a window, touch the window tab to select and activate it; or turn the P&T knob to select the window tab (it is framed in yellow) and then press the knob to activate your selection.



Selected



Activated



To close a window, touch the window tab or the X in the upper left-hand corner to select and activate it; or turn the P&T knob to select the X (it is framed in yellow) and then press the knob to activate your selection.

To adjust a control, touch the control to select and activate it; or turn the P&T knob to select the control (it is framed in yellow) and then press the knob to activate your selection. The activated control turns orange. Turn the knob to increment or decrement the value. Press the knob or touch the control to confirm the adjustment and deactivate.



Selected



Activated

To scroll through a list using the scroll bar or arrows, touch the scroll bar to select and activate it; or turn the P&T knob to select the scroll bar (it is framed in yellow) and then press it to activate your selection. Your selection turns orange when activated. Now turn the knob to scroll through the log. Touch the scroll bar or press the knob to deactivate.

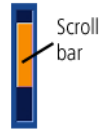

3 Tests, calibrations and utilities

3.1	Introduction	3-2
3.2	Running the preoperational check	3-3
3.3	System functions	3-5
3.3.1	Info: Viewing device-specific information	3-6
3.3.2	Tests & calib: Running calibrations and the tightness test	3-6
3.3.3	Sensors on/off: Enabling/disabling O2, CO2, and SpO2 monitoring	3-16
3.3.4	Setting day and night display brightness	3-17
3.3.5	Setting date and time	3-19
3.4	Utilities	3-20
3.4.1	Data transfer: Copying event log data to a USB memory device	3-20
3.5	Alarm tests	3-21
3.5.1	High pressure	3-22
3.5.2	Low minute volume	3-22
3.5.3	Low oxygen alarm	3-22
3.5.4	Disconnection on patient side	3-23
3.5.5	Loss of external power	3-23
3.5.6	Exhalation obstructed	3-23
3.5.7	Apnea	3-24

3.1 Introduction

NOTE:

The device provides automatic barometric pressure compensation.

The tests and calibrations described in this section help verify the safety and reliability of the HAMILTON-C1. Perform the HAMILTON-C1's tests and calibrations as described in Table 3-1. If a test fails, troubleshoot the ventilator as indicated or have the ventilator serviced. Make sure the tests pass before you return the ventilator to clinical use.

Table 3-1. When to perform tests and calibrations

When to perform	Test or calibration
<p>Before placing a new patient on the ventilator</p> <hr/> <p>CAUTION</p> <p>To ensure the ventilator's safe operation, always run the full preoperational check before using the ventilator on a patient. If the ventilator fails any tests, remove it from clinical use immediately. Do not use the ventilator until necessary repairs are completed and all tests have passed.</p> <hr/>	<p>Preoperational check</p>
<p>After installing a new or decontaminated breathing circuit or component (including a flow sensor or pressure-monitoring line)</p>	<p>Tightness test, flow sensor calibration, and circuit calibration for nCPAP and nCPAP-PC</p>
<p>After installing a new oxygen cell or when a related alarm occurs</p>	<p>Oxygen cell calibration</p>

Table 3-1. When to perform tests and calibrations *(continued)*

When to perform	Test or calibration
<p>Required after installing a new, previously unused CO₂ sensor or when a related alarm occurs; recommended after switching between different airway adapter types</p> <hr/> <p>NOTE:</p> <p>All calibration data is saved in the sensor head. Therefore, when a previously used sensor is reconnected, you need not recalibrate the sensor unless you have changed the adapter type.</p> <hr/>	<p>CO₂ sensor/adapter calibration (mainstream/sidestream)</p>
<p>As desired</p>	<p>Alarm tests</p>

3.2 Running the preoperational check

CAUTION

To prevent possible patient injury, disconnect the patient from the ventilator before running this test. Make sure another source of ventilatory support is available.

When to perform: Before placing a new patient on the ventilator.

Required materials: Use the setup below appropriate to your patient type. To ensure that the ventilator also functions according to specifications on your patient, we recommend that your test circuit be equivalent to the circuit used for ventilation.

For details on running the preoperational check for neonatal ventilation, see Chapter 5.

Table 3-2. Breathing circuit setup

Adult/pediatric patients	<ul style="list-style-type: none"> • Breathing circuit, 22 mm ID with 22F connectors • Flow sensor, pediatric/adult • Demonstration lung, 2 l, with adult ET tube between flow sensor and lung (PN 151815 or equivalent)
--------------------------	---

Procedure:

Do or observe...	Verify...	Notes
1. Connect ventilator to AC power and oxygen supply. Assemble the patient breathing circuit.	Breathing circuit is assembled correctly.	See Section 2.3.4.
2. Turn on power.	During the self test the red and yellow alarm lamp is flashed on in sequence and the buzzer sounds. After the self-test is passed the alarm lamp flashes red again.	The buzzer sounds only briefly.
3. Make sure the ventilator is in standby, and select Preop check from the Patient setup window.		
4. Open System -> Tests & calib window (Figure 3-2). Select and run the tightness test, then the flow sensor calibration. Follow all prompts.	These tests and calibrations pass.	For details on running these tests and calibrations, refer to Section 3.3.2.

Do or observe...	Verify...	Notes
5. If necessary, run O2 cell calibration. Close window.	This calibration passes.	See Section 3.3.2.3.
6. Generate an alarm (for example, by disconnecting primary power).	Corresponding alarm message in message bar (for example, Loss of external power).	During standby, patient alarms are suppressed.
7. Resolve the alarm situation (for example, reconnect mains power).	Alarm is reset.	

Corrective action: If the ventilator does not pass the preoperational check, have it serviced.

3.3 System functions

You can run tests and calibrations, view device-specific information, and perform other ventilator system functions from the System window.

3.3.1 Info: Viewing device-specific information

Open the System -> Info window to view device-specific information including serial number, model, operating hours, hours since startup, time to service, battery capacity, software version, and installed options.

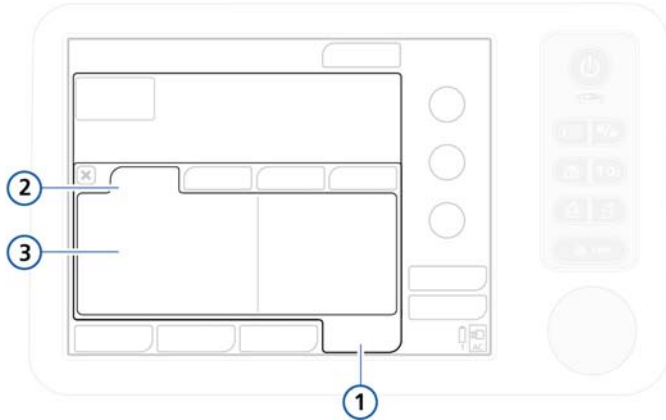

Figure 3-1. Info window

- | | | | |
|---|--------|---|----------------|
| 1 | System | 3 | System details |
| 2 | Info | | |

3.3.2 Tests & calib: Running calibrations and the tightness test

NOTE:

- To enable or disable O₂, CO₂, and SpO₂ monitoring, see Section 3.3.3.
 - The audible alarm is silenced during the calibration functions and for 30 s thereafter.
-

The following tests and calibrations are provided, depending on your device and selected ventilation mode:

	See
Tightness test	page 3-8
Flow sensor calibration	page 3-9 and Chapter 5 (neonatal)
 In nCPAP and nCPAP-PC modes, flow sensor calibration is replaced by circuit calibration	Chapter 5
O2 cell calibration, if needed	page 3-12
CO2 sensor calibration, when enabled	page 3-14

Open the System -> Tests & calib window to access the tests and calibrations.

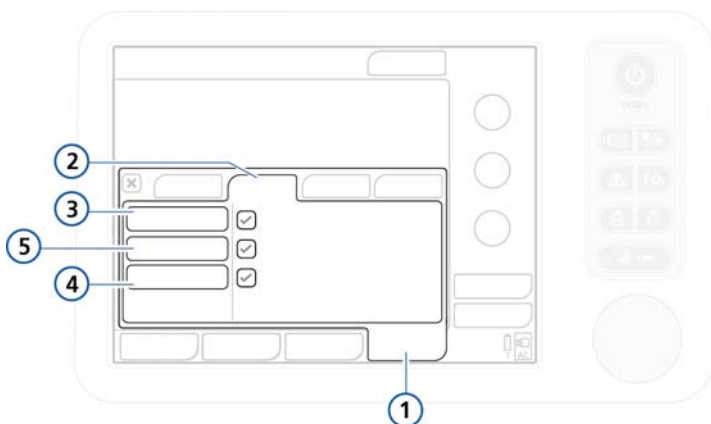



Figure 3-2. Tests & calib window

- | | | | |
|----------|---------------|---|--|
| 1 | System | 5 | Depends on selected mode. |
| 2 | Tests & calib |  | <i>In the neonatal nCPAP-PC and nCPAP modes: Circuit</i> |
| 3 | Tightness | | <i>In all other modes: Flow sensor</i> |
| 4 | O2 cell | | |

3.3.2.1 Tightness test

NOTE:

- Make sure another source of ventilatory support is available during this test. The patient must be disconnected from the ventilator during the test.
 - To cancel the tightness test while it is in progress, select **Tightness** again.
-

Description: This test checks for leakage in the patient breathing circuit. The ventilator is pressurized to 45 cmH₂O. The circuit is considered tight if this pressure can be maintained.

Procedure:

1. Set the ventilator up as for normal ventilation, complete with the breathing circuit.
2. Activate **Tightness test** from the Tests & calib window (Figure 3-2).
The text **Disconnect patient** is now displayed.
3. Disconnect the breathing circuit at the patient side of the flow sensor. Do not block the open end of the flow sensor.
The text **Tighten patient system** is now displayed.
4. Block the opening (wearing a sterilized glove is recommended).
The text **Connect patient** is now displayed.
5. Connect the patient.
6. When the test is complete, verify that there is a green check mark in the **Tightness** checkbox.

In case of test failure

If the test fails, a red X is displayed in the **Tightness** checkbox. Perform the following checks, repeating the tightness test after each one, until the test is successful:

- Check the breathing circuit for a disconnection between the ventilator and the flow sensor, or for other large leaks (for example, breathing circuit, humidifier).
- Check that the expiratory valve is correctly installed.
- Replace the breathing circuit, flow sensor, and expiratory valve.

If the problem still persists, have the ventilator serviced.

3.3.2.2 Flow sensor calibration

NOTE:

- Make sure another source of ventilatory support is available during this calibration. The patient must be disconnected from the ventilator during the test.
- To cancel the flow sensor calibration while it is in progress, select **Flow Sensor** again.
- Circuit resistance compensation is measured during calibration.
- If you are using a LiteCircuit, block the opening of the whisper valve with your finger.
- If there is a mismatch between the active patient profile and the flow sensor type you are using, the calibration fails. Ensure you are using the correct flow sensor for the patient.
- Noninvasive neonatal ventilation does not use a flow sensor. For details about neonatal ventilation, tests, and calibration, see Chapter 5.



Description: This calibration checks and resets the calibration points specific to the flow sensor in use.

Choose the appropriate process for the patient type:

- Adult/pediatric
- Neonate/infant. For details, see Chapter 5.



To calibrate an adult/pediatric flow sensor

1. Set the ventilator up as for normal ventilation, complete with breathing circuit and flow sensor.
2. Activate **Flow Sensor** from the Tests & calib window (Figure 3-2).

If you have not already disconnected the patient, the message line displays **Disconnect patient**.

3. Disconnect the patient now.

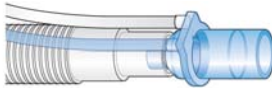

4. Follow the instructions displayed in the message line, attaching the adapter when needed and turning the flow sensor around as indicated.

If using the disposable flow sensor PN 281637, the additional adapter for calibration must be attached.

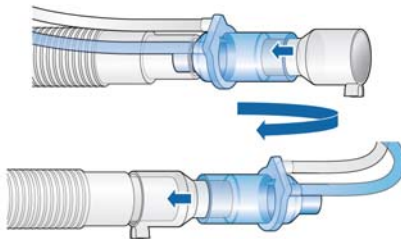

5. Follow the instructions displayed in the message line, turning the flow sensor back to its starting position when indicated.
6. When calibration is complete, verify that there is a green check mark in the **Flow Sensor** checkbox.

-
7. When successful, touch the **Start ventilation** button in the Standby window, and connect the patient, as indicated.

In case of calibration failure

If the calibration fails, a red X is displayed in the **Flow Sensor** checkbox.

Perform the following checks, repeating the calibration after each one, until calibration is successful:

- Check the breathing circuit for a disconnection between the ventilator and the flow sensor, or for other large leaks (for example, breathing circuit, humidifier).
- Check that the correct flow sensor is connected, and that the flow sensor and expiratory valve/membrane are properly seated.
- If the calibration fails again, replace the flow sensor.
- If the calibration still fails, replace the expiratory valve/membrane.

If the problem persists, have the ventilator serviced.

3.3.2.3 Oxygen cell calibration

NOTE:

- The oxygen cell calibration requires that the ventilator's oxygen monitoring be enabled. To check for an oxygen cell, see Section 10.3.3. To determine whether oxygen monitoring is enabled, check the System -> Sensors on/off window and ensure the **O2 cell** check box is selected.
 - If using the low-pressure-mode, disconnect all O2 supplies during calibration. After reconnecting, the oxygen concentration is set to 21%.
 - The O2 cell requires approximately 30 minutes warm-up time to reach stable values. O2 monitoring during this time period may be more variable. We recommend performing the calibration after the O2 cell is warmed up.
-

Description: During the 2-min calibration of the oxygen cell, the ventilator sets the oxygen concentration as shown in Table 3-1. The device tests the cell and resets the calibration points specific to the cell in use.

Table 3-1. Oxygen concentrations during O2 cell calibration

Standby or active ventilation	Gas source/ connection status	Oxygen (FiO2) setting	Oxygen concentration used during calibration
Recommended settings for calibration at 100% oxygen			
Standby	HPO/ connected	> 21%	100%
Active ventilation	HPO/ connected	> 21%	100%
Settings for calibration at 21% oxygen			
Standby	HPO/ disconnected	any	21%
Standby	HPO/ connected	21%	21%

Table 3-1. Oxygen concentrations during O2 cell calibration

Standby or active ventilation	Gas source/ connection status	Oxygen (FiO2) setting	Oxygen concentration used during calibration
Standby	LPO/ disconnected	any	21%
Active ventilation	HPO/ connected	21%	21%
Active ventilation	LPO/ disconnected	any	21%

We recommend calibrating the O2 cell using 100% oxygen to improve the stability of measurements at higher oxygen concentrations during use. To this end, use the information in Table 3-1 to choose the associated settings and connections for calibration.

Procedure:

1. *Recommended.* To calibrate at 100% oxygen, adjust the settings on the ventilator as needed (Table 3-1).
2. In the Tests & calib window, select **O2 cell**.
3. When calibration is complete, verify that there is a green check mark in the **O2 cell** checkbox.

In case of calibration failure

If the calibration fails, a red X is displayed in the **O2 cell** checkbox.

Perform the following checks, repeating the calibration after each one, until calibration is successful:

- Ensure O2 cell is connected and a Hamilton Medical O2 cell is used (PN 396200).
- If the second calibration attempt fails, replace the O2 cell.

If the problem persists, have the ventilator serviced.

3.3.2.4 CO2 sensor/adapter zero calibration

CAUTION

- **Always calibrate the CO2 sensor with the airway attached.**
 - **Be sure *NOT* to cover both ends of the airway adapter with your fingers.**
-

NOTE:

- Wait at least 20 s – and for best results, 2 min – to perform the CO2 sensor/adapter calibration after removing the adapter from the patient's airway. This time allows any CO2 remaining in the adapter to dissipate.
 - If you close the Tests & calib window when the calibration has failed, the HAMILTON-C1 starts or continues ventilating, but continues to display **CO2 sensor calibration needed**. This may result in inaccurate monitoring.
-

Description: The CO2 sensor/adapter zero calibration compensates for the optical differences between airway adapters and for sensor drift.

Procedure:

1. Before you begin, ensure:
 - The CO2 hardware option is installed and activated
 - CO2 monitoring is enabled (System -> Sensors on/off)
2. Disconnect the CO2 sensor from the breathing circuit.
3. Attach the CO2 adapter to the sensor.

Figure 3-3 shows the mainstream sensor/adapter. Figure 3-4 shows the sidestream sensor/adapter.

Place the sensor/adapter away from all sources of CO2 (including the patient's and your own exhaled breath) and the exhaust port of the expiratory valve.

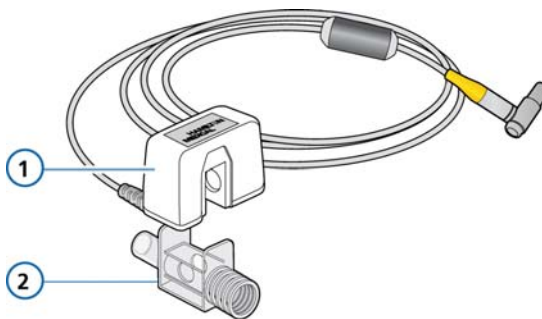

Figure 3-3. Attaching CO2 sensor to the airway adapter

- | | | | |
|---|------------|---|----------------|
| 1 | CO2 sensor | 2 | Airway adapter |
|---|------------|---|----------------|

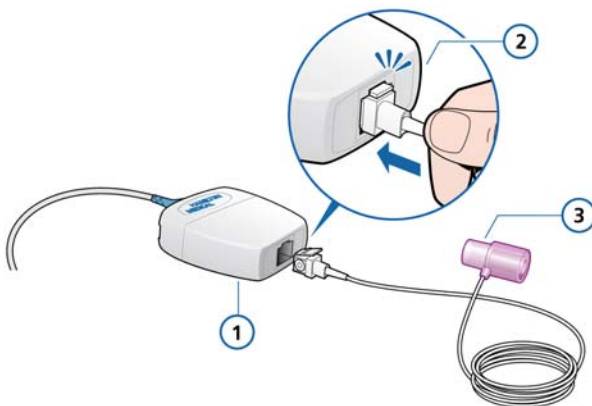

Figure 3-4. Connect sidestream sensor to CO2 module

- | | | | |
|---|-------------------------------|---|----------------|
| 1 | LoFlow™ sidestream CO2 module | 3 | Airway adapter |
| 2 | Sample cell clicks into place | | |

Connect the adapter cable to the CO2 connection on the ventilator.

4. Ensure CO2 monitoring is enabled (System -> Sensors on/off).

Once enabled, the sensor requires approximately 90 seconds to warm up.

5. Touch System -> Tests & calib window, and then select **CO2**.
Sensor calibration takes place.
Do not move the sensor during calibration.
6. Verify that there is a green check mark in the **CO2** checkbox.

In case of calibration failure

If the calibration fails, a red X is displayed in the **CO2** checkbox.

Perform the following checks, repeating the calibration after each one, until calibration is successful:

- Check airway adapter and clean if necessary.
- Re-calibrate the sensor, making sure there is no source of CO2 near the airway adapter.
- Connect a new airway adapter.
- Install a new CO2 sensor.

If the problem persists, have the ventilator serviced.

3.3.3 Sensors on/off: Enabling/disabling O2, CO2, and SpO2 monitoring

CAUTION

The HAMILTON-C1's oxygen monitoring function can be disabled. Ensure that an alternative means of oxygen monitoring is always available and enabled.

NOTE:

To enable the optional CO2 and SpO2 monitoring, you must first enable the associated hardware option in configuration.

1. Open the System -> Sensors on/off window.
2. Select the appropriate check boxes (O2, CO2, SpO2) to enable/disable the monitoring functions, as desired.
O2 cell monitoring is enabled by default.

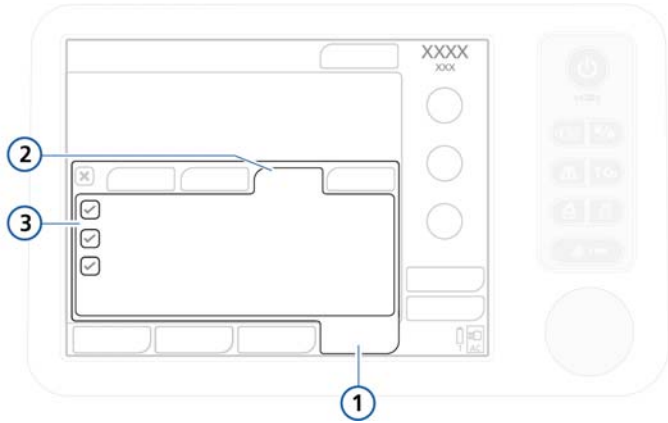

Figure 3-5. Sensor on/off window

- | | | | |
|---|----------------|---|----------------|
| 1 | System | 3 | Sensor options |
| 2 | Sensors on/off | | |

3.3.4 Setting day and night display brightness

NOTE:

- The day and night controls are in the System -> Settings window.
- The **Day/Night** key lets you quickly switch between the default day and night settings. See Section 9.10.

Use these settings to set the brightness of the display for use during the day and night.

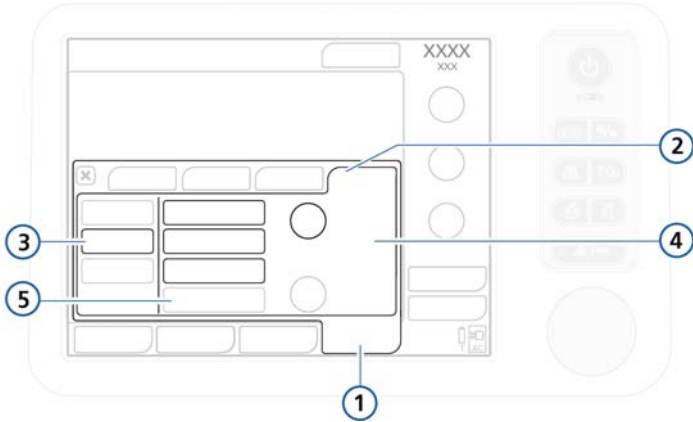

Figure 3-6. Day & Night window

- | | |
|---|--|
| <p>1 System</p> <p>2 Settings</p> | <p>3 Day & Night button</p> <p>4 Day, Night, Brightness settings</p> |
|---|--|

To set the display brightness

1. Open the System -> Settings window.
2. To select Day mode with a bright display, touch the **Day** button.
 To select Night mode with a dimmer display, touch the **Night** button. When Night is selected, the green indicator next to the **Day/Night** key is lit.
 The mode you select remains in effect when the device is restarted.
3. Adjust the brightness of the display in each mode using the **Brightness** control. The setting you choose becomes the new default for that mode.

Setting	Brightness range	Default
Day	10% to 100%	80%
Night	10% to 100%	40%

-
- To have the device control the brightness based on ambient light, select the **Automatic** button.

The device senses the available light and dynamically adjusts the display brightness.

You can quickly switch the display brightness between the Day and Night settings by pressing the **Day/Night** key¹ on the ventilator. For details, see Section 9.10.

3.3.5 Setting date and time

NOTE:

- The date and time controls are in the System -> Settings window.
 - Make sure the date and time are set correctly so that event log entries have accurate time and date stamps.
-

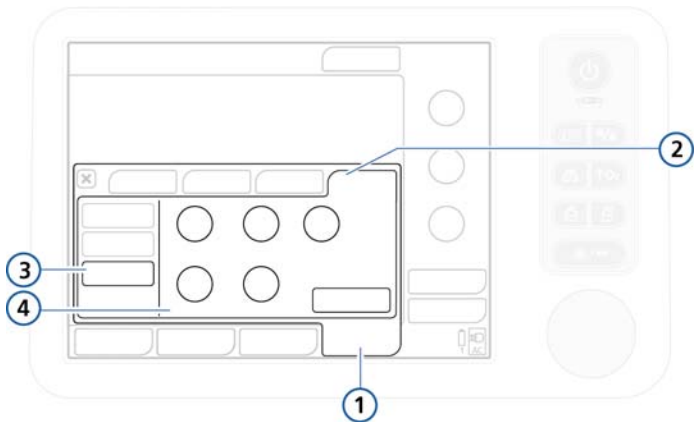

Figure 3-7. Date & Time settings

- | | | | |
|----------|----------|----------|--------------------------------------|
| 1 | System | 3 | Date & Time |
| 2 | Settings | 4 | Date and time settings, Apply button |
-

1. Not available in all markets.

To set the date and time

1. Open the System -> Settings window.
2. Touch **Date & Time** and adjust the day and time.
3. Touch the **Apply** button to save the changes.

3.4 Utilities

The Utilities window provides access to the following functions:

- Selecting the gas source (HPO or LPO).
For details, see Section 2.10 on page 2-28.
- Accessing the Configuration window
For details, see Appendix I.
- Transferring event log data to a USB memory device

3.4.1 Data transfer: Copying event log data to a USB memory device

NOTE:

- Touch the HAMILTON-C1 before using the USB port.
 - The USB connector is intended for passive memory devices only.
 - If you remove the memory device before the files are successfully transferred, you must reinitialize the USB port by powering the ventilator off and on again.
 - The USB device must be USB 1.1 compatible.
 - A jpg file can be stored to the USB using the Print screen key.
-

You can save the event and service logs to a USB memory device. The device must have a FAT or FAT32 format and it must not have an operating system or a security system installed.

To save the logs

1. Place the ventilator into standby and insert a memory device into the USB connector.
2. Open the Utilities -> Data transfer window (Figures 3-8), and select **Export logs**.
3. Remove the memory device when File transfer successful is displayed.

A folder named "C1_sn<Serial Number>" is created on the USB stick containing all event log and service log files.

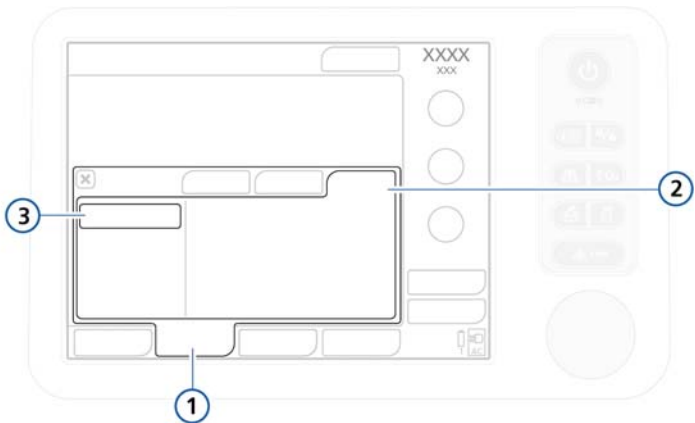

Figure 3-8. Data transfer window 1

- | | | | |
|---|---------------|---|-------------|
| 1 | Utilities | 3 | Export logs |
| 2 | Data transfer | | |

3.5 Alarm tests

The HAMILTON-C1 performs a self-check during start-up and continuously during operation. This self-check verifies the alarm functionality. You may also want to run alarm tests, which demonstrate the alarms' operation.

Before performing the alarm tests, set the HAMILTON-C1 up as for normal ventilation, complete with breathing circuit and 2 l demonstration lung assembly with ET tube.

3.5.1 High pressure

1. Make sure a 2 l demonstration lung assembly is connected to the ventilator.
2. Put the ventilator into the PCV+ mode.
3. Set the Pressure alarm limit to 15 cmH₂O above the measured P_{peak}.
4. Squeeze the demonstration lung hard during inspiration.
5. Verify that the **High pressure** alarm is activated, the ventilator cycles into exhalation, and pressure falls to the PEEP/CPAP level.

3.5.2 Low minute volume

1. Let the ventilator deliver 10 breaths with no alarms.
2. Adjust the minimum ExpMinVol alarm limit so it is higher than the measured value.
3. Verify that the **Low minute volume** alarm is activated.

3.5.3 Low oxygen alarm

1. Set the Oxygen control to 50%.
2. Wait for 2 min.
3. Disconnect the oxygen supply.
4. Verify the following:
 - The Oxygen concentration displayed in the monitoring window decreases.
 - The **Low oxygen** alarm activates.
5. Wait 30 s or until the oxygen concentration falls below 40%.
6. Reconnect the oxygen supply.
7. Verify that the Low oxygen alarm resets. The Low oxygen alarm should reset when the measured oxygen exceeds 45%.

3.5.4 Disconnection on patient side

1. Disconnect the demonstration lung.
2. Verify that the Disconnection on patient side alarm is activated.
3. Reconnect the demonstration lung.
4. Verify that the alarm resets and that the ventilator automatically resumes ventilation.

3.5.5 Loss of external power

1. With the ventilator connected to AC power, turn it on.
2. Disconnect the power cord.
3. Verify that the Loss of external power alarm is activated and that the ventilator is powered by its backup battery.
4. Reconnect the ventilator to AC power.
5. Verify that the alarm resets and that the ventilator is again powered by AC.

3.5.6 Exhalation obstructed

1. Block the expiratory valve exhaust port.
2. Observe the pressure rise.
3. Verify that the Exhalation obstructed alarm is activated.

3.5.7 Apnea

1. Put the ventilator into SPONT mode. Make sure apnea backup ventilation is disabled.
2. Wait for the set apnea time.
3. Verify that the Apnea alarm is activated.
4. Squeeze the demonstration lung.
5. Verify that the Apnea alarm resets.

4 Ventilator settings

4.1	Introduction	4-2
4.2	Patient grouping	4-3
4.3	Quick setup settings	4-3
4.4	Patient setup	4-4
4.5	Modes window: Setting the ventilation mode	4-7
4.6	Specifying mode settings	4-8
4.6.1	Changing parameter settings	4-9
4.6.2	Changing parameter settings with mode change	4-11
4.6.3	About apnea backup ventilation	4-11
4.6.4	Table of control parameter settings	4-13
4.7	Working with alarms	4-19
4.7.1	Setting alarm limits	4-19
4.7.2	Adjusting alarm volume (loudness)	4-22
4.7.3	Buffer: Viewing alarm information	4-23
4.7.4	Table of alarm limit settings	4-23

4.1 Introduction

CAUTION

- **To prevent possible patient injury, make sure the ventilator is set up for the appropriate patient group with the appropriate breathing circuit parts as described in Chapter 2.**
- ***To ensure the ventilator's safe operation, always run the required tests and calibrations before using the ventilator on a patient.***
- **To ensure the ventilator's safe operation, always run the preoperational check before using the ventilator on a patient. If the ventilator fails any tests, remove it from clinical use immediately. Do not use the ventilator until necessary repairs are completed and all tests have passed.**
- **It is the clinician's responsibility to ensure that all ventilator settings are appropriate, even when "automatic" features such as ASV or standard settings are used.**

This section explains how to set up the HAMILTON-C1 for ventilation on an individual patient. Prepare the ventilator as instructed in Chapter 2.



When ventilating neonatal patients, see also Chapter 5.

You must be familiar with using the touch screen and using the Press-and-turn knob to select, activate, and confirm parameters. For details, see Section 2.15.

4.2 Patient grouping

The HAMILTON-C1 facilitates the ventilation of your patient by providing two patient groups, neonatal and adult/pediatric.

Table 4-1. Patient grouping

	Neonatal	Adult/pediatric
Patient group	Weight: 0.2 to 30 kg	Gender: M, F Height: 30 to 250 cm IBW: 3 to 139 kg
Specialities	nCPAP, nCPAP-PC	ASV, Dynamic Lung, Ventilation status

4.3 Quick setup settings

The HAMILTON-C1 has three different Quick setup buttons per patient group.(Figure 4-1). Mode, mode controls settings, alarm settings, ventilation status settings and Vt/IBW or Vt/kg (neonatal) can be stored in each Quick setup.

To configure the Quick setup settings, see Section I.6.

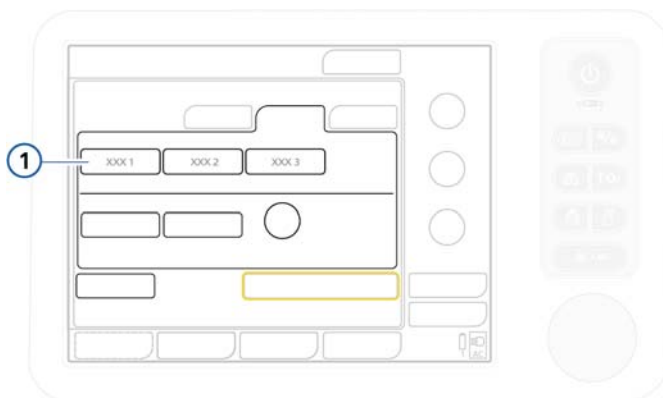

Figure 4-1. Quick setup buttons (1) in Standby window

4.4 Patient setup

WARNING

- **Ensure you choose the correct patient group: adult/ pediatric or neonatal, and choose the correct gender, if appropriate. Correct selections prevent possible hyper- or hypoventilation.**
- **For adult and pediatric patient groups, specifying a substantially incorrect height will generate incorrect IBW input, and will lead to a deviation of rate setting. Carefully check the value you specified in the Standby window.**

NOTE:

- When setting up for a new patient, the settings you see are the system default settings for mode, control, and the alarm settings.
If you selected **Last patient**, the settings you see are the last active ventilator parameters in use.
- You can configure default settings for each patient group (mode and controls). See the Configuration chapter.
- If an inadvertent setting is made but has not yet been confirmed, it will automatically be canceled after 30 seconds. Alternatively, the setting window closes after 3 min, again canceling your settings.
- If you select the Neonatal patient group, **Neonatal** appears on the screen.



After you initiate ventilation, the patient setup window is displayed (Figure 4-2), with default settings selected. Select, adjust, and activate the desired items.

Make sure the ventilator is configured with the appropriate breathing circuit parts, as described in Section 2.3. See also Chapter 5 for additional details about ventilating neonatal patients.

To start ventilation

1. If you have not already done so, select the **Preop check** button and perform the required tests.
2. Select the desired patient group:
 - **Adult/Ped.** For adult and pediatric patients (Figure 4-2). See Table 4-1 for age and weight ranges.
 - **Neonatal.** For neonatal patients (Figure 4-3). See Table 4-1 for age and weight ranges.
 - **Last patient.** Re-use the last active ventilator parameters in use.



The selected patient group (**Adult/Ped.** or **Neonatal**) appears under the Mode name, in the top right corner of the display.

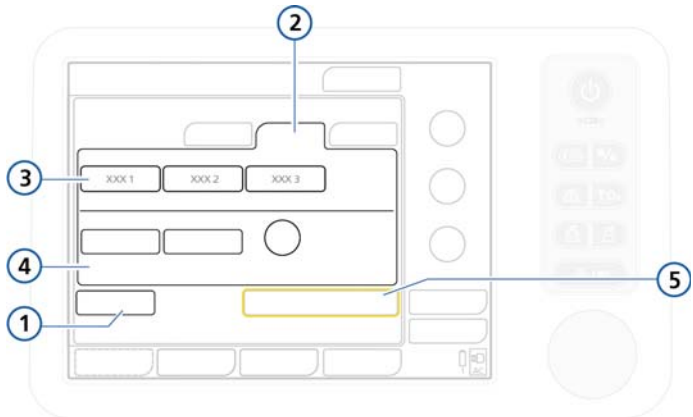

Figure 4-2. Patient setup/Standby window (adult/pediatric)

- | | | | |
|---|-------------------------|---|-------------------------|
| 1 | Preop check | 4 | Gender, Height, and IBW |
| 2 | Adult/Ped patient group | 5 | Start ventilation |
| 3 | Quick setup buttons | | |

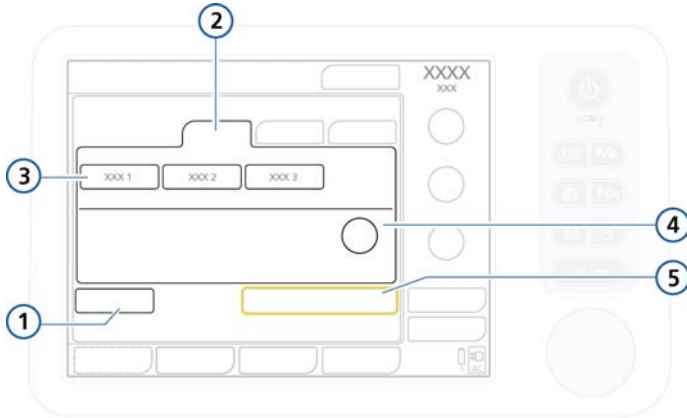

Figure 4-3. Patient setup/Standby window (neonatal)

- | | | | |
|----------|------------------------|----------|-------------------|
| 1 | Preop check | 4 | Weight |
| 2 | Neonatal patient group | 5 | Start ventilation |
| 3 | Quick setup buttons | | |

3. Adjust settings as follows:

- For adult and pediatric patients, select the **Gender** and specify the patient height (**Pat. height**).
The ideal body weight (**IBW**) is automatically calculated and displayed¹.
- For neonatal patients, adjust the **Weight** setting.
The system uses body weight; it does not calculate the **IBW**.

4. To start ventilating the patient, select **Start ventilation**.

1. The IBW, based on Pennsylvania Medical Center (adults) and Traub SL. Am J Hosp Pharm 1980 (pediatric patients), is calculated as follows:
 IBW: Ideal Body Weight [kg] BH: Body Height [cm]
 BH ≤ 70 cm IBW = 0.125 x BH – 0.75 70 < BH ≤ 128
 IBW = 0.0037 x BH – 0.4018 x BH + 18.62 BH ≥ 129
 Male IBW = 0.9079 x BH – 88.022, Female IBW = 0.9049 x BH – 92.006

4.5 Modes window: Setting the ventilation mode

NOTE:



- For details on modes, see:
 - Chapter 5 for the neonatal-only modes, nCPAP and nCPAP-PC
 - Appendix C (adaptive support ventilation, ASV)
 - Appendix D (noninvasive ventilation)
 - Appendix B (for all other modes)
 - ASV mode is not supported for neonatal patients.
-

The active ventilation mode is displayed at the top right-hand corner of the display.

When first starting to ventilate a patient, a default mode is pre-selected. You can change it, if needed, as described next.

For details about modes and their controls, see Section 4.6 on page 4-8.

To change the mode

1. Open the Modes window. See Figure 4-4.
2. Select the mode to change to.
3. Touch **Confirm** to select the mode and display the control settings for the selected mode.
The Controls window opens.
4. Review and, if needed, adjust the control settings (Section 4.6.2) and touch **Confirm** in the Controls window to enable the new mode.

The newly selected mode is not active *until* you select **Confirm** in the Controls window. If you do not touch **Confirm**, the currently active mode remains in place.

Note that the **Confirm** button is only displayed when changing modes.

If the control settings are not confirmed, the window automatically closes after a period of time. The new mode selection will not be valid, and the previous settings remain in effect.

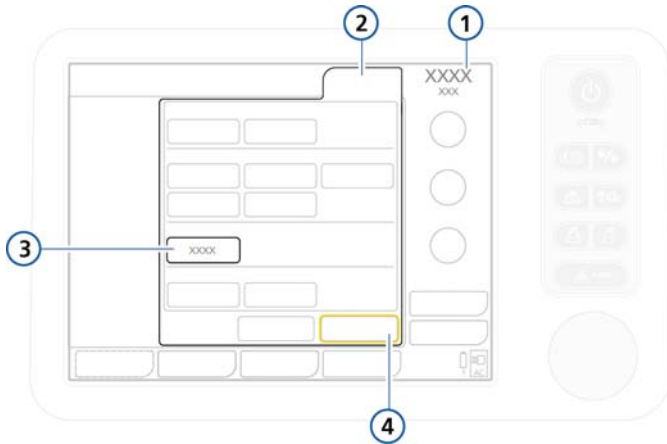

Figure 4-4. Changing the mode, Modes window

1	Active mode	3	New mode to apply
2	Modes	4	Confirm

4.6 Specifying mode settings

NOTE:



- In addition to control settings, the Basic window displays breath timing parameters determined from timing control settings; see Figure 4-5.
- For noninvasive ventilation modes (NIV, NIV-ST), see Appendix D.
- For neonatal modes (including nCPAP, nCPAP-PC), see Chapter 5.
- The alarm **Flow sensor calibration needed** may appear when changing to and from nCPAP modes.

You set controls on three Controls windows: Basic, More, Apnea.

You enable the Sigh function through the More window. You can set apnea backup through the Apnea window.

For additional information about control parameters, see:

- Table 4-2 defines the control parameter settings.
- Table A-5 describes control parameter ranges and default settings, including accuracy.
- Table A-6 lists control settings applicable to the different ventilation modes.

4.6.1 Changing parameter settings

NOTE:

You can adjust PEEP/CPAP, Oxygen, and an additional control setting (depending on active mode) from the main display without opening the Controls window.

The Controls window provides access to the parameter settings used by the active mode.

To change the parameter settings for the active mode:

1. Open the **Controls** -> **Basic** window (Figure 4-5).
2. Select a parameter and adjust the value. The change takes effect immediately. Repeat for any other desired parameters.
3. Open the **Controls** -> **More** window (Figure 4-6), and select and adjust parameters as desired.
4. If applicable, open the **Controls** -> **Apnea** window (Figure 4-7). Select or deselect **Backup** as desired.

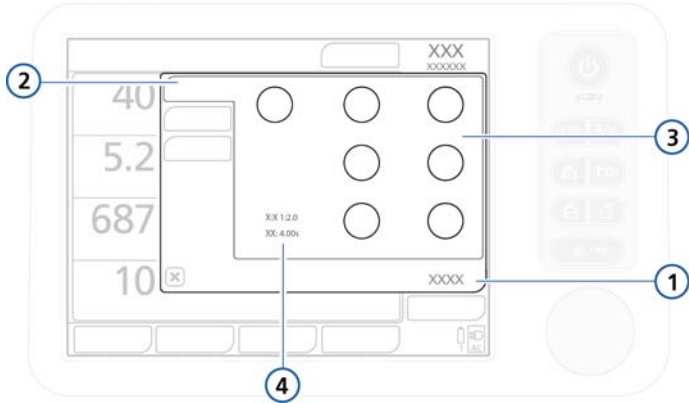

Figure 4-5. Basic settings, Controls window

- | | |
|---|--|
| <p>1 Controls</p> <p>2 Basic</p> <p>3 Control settings corresponding to the mode</p> | <p>4 Timing parameters, determined from the timing settings (if control breaths are permitted in selected mode):</p> <ul style="list-style-type: none"> • I:E: Ratio of inspiratory time; applies mandatory breaths • TE: Duration of expiratory phase, TI: Duration of inspiratory phase |
|---|--|

When in the process of changing modes, Confirm and Cancel buttons are also displayed.

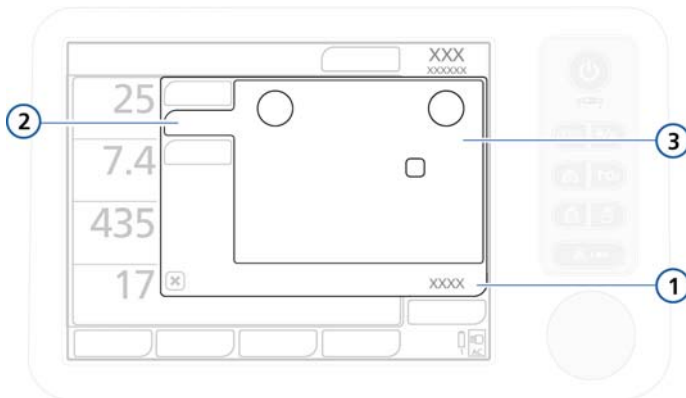

Figure 4-6. More settings, Controls window

- | | |
|---|--|
| <p>1 Controls</p> <p>2 More</p> | <p>3 Control settings corresponding to the mode</p> |
|---|--|

4.6.2 Changing parameter settings with mode change

After you select a different mode, the **Basic** window automatically opens (Figure 4-7) showing the new mode name and parameter settings. Review and confirm these proposed settings or the mode change will not be accepted.

To review and confirm the control settings:

1. Select a parameter and adjust the value. The change takes effect as soon as you confirm the mode change. Repeat for any other desired parameters.
2. Open the **Controls** -> **More** window (Figure 4-6), and select and adjust parameters as desired.
3. If applicable, open the **Controls** -> **Apnea** window (Figure 4-7).

Select or deselect **Backup** as desired. For details, see Section 4.6.3.

Adjust parameters as desired. For details, see Section 4.6.4.

4.6.3 About apnea backup ventilation

CAUTION

Hamilton Medical recommends that apnea backup ventilation be enabled whenever a mode that allows spontaneous breathing is selected. For safety reasons, apnea backup is enabled by default.

The HAMILTON-C1 provides apnea backup ventilation, a mechanism that minimizes possible patient injury due to apnea or cessation of respiration. Apnea can occur in all modes except (S)CMV+, PCV+, ASV, PSIMV+, NIV-ST, and nCPAP-PC.

When the ventilator is in such a mode and no inspiratory efforts are detected or control breaths are delivered during an operator-set interval, it assumes that apnea is present. If apnea backup ventilation is enabled, ventilation continues.

When apnea backup ventilation is enabled. Apnea backup provides ventilation after the apnea time passes with no breath attempts detected. (You set the **Apnea time** in the **Alarms** window.) When this occurs, the ventilator automatically and immediately switches into apnea backup ventilation. It annunciates a low-priority alarm, displays Apnea ventilation, and provides ventilation at the following settings:

If the original support mode is...	the ventilator enters this backup mode...
SIMV+/APVsimv	SIMV+/APVsimv
SPONT	SIMV+
DuoPAP/APRV	SIMV+
NIV	PCV+

The control setting for the apnea backup mode depends on the ideal body weight (or weight for neonates) of the patient. The default values can be overwritten by disabling the **Automatic** button.

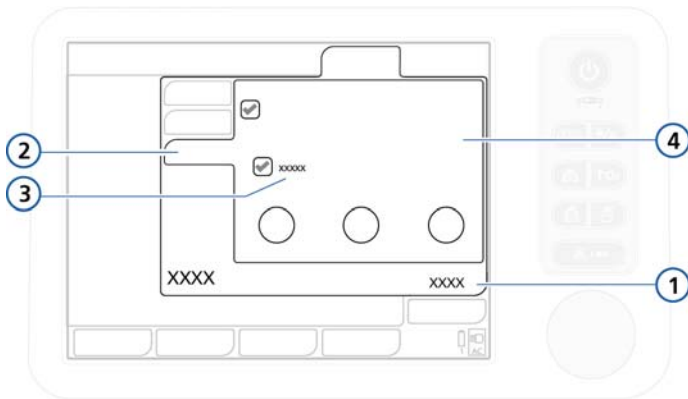

Figure 4-7. Apnea window, Automatic button

- | | | | |
|----------|----------|----------|--|
| 1 | Controls | 3 | Automatic check box |
| 2 | Apnea | 4 | Control settings corresponding to the mode |

If the patient triggers two consecutive breaths, the ventilator reverts to ventilation in the original support mode and at the original settings, and it displays Apnea ventilation ended.

Once apnea backup ventilation is enabled or disabled, it retains this status in all applicable modes. Apnea backup ventilation requires no clinician intervention, although you can freely change the mode during apnea backup ventilation, either switching to a new mode or accepting the backup mode as the new mode.

When apnea backup ventilation is disabled, the high-priority Apnea alarm is annunciated when apnea occurs.

4.6.4 Table of control parameter settings

The following table briefly describes each of the ventilator control parameters.

Table A-5 in Appendix A provides the control parameter ranges and default settings, including accuracy.

Table 4-2. Control parameters

Parameter	Definition
<i>For additional details, including parameter ranges and accuracy, see Table A-5 on page A-6.</i>	
Apnea backup	A function that provides ventilation after the adjustable apnea time passes without breath attempts. If "Automatic" is enabled, control parameters are calculated based on the patient's IBW.
ETS	Expiratory trigger sensitivity. The percent of peak inspiratory flow at which the ventilator cycles from inspiration to exhalation. Increasing the ETS setting results in a shorter inspiratory time, which may be beneficial in patients with obstructive lung disease. The ETS setting lets you match the inspiratory time of pressure-supported breaths to the patient's neural timing. Applies to spontaneous breaths.

Table 4-2. Control parameters (continued)

Parameter	Definition
Flow trigger	<p>The patient's inspiratory flow that triggers the ventilator to deliver a breath.</p> <p>Changing the setting during the inspiratory phase affects the next breath. During the expiratory phase, affects the breath after the next breath.</p> <p>Applies to all breaths except nCPAP-PC.</p>
	<p>CAUTION</p> <p>If auto-triggering occurs, first check the patient, breathing circuit, and other settings as possible causes before decreasing the trigger sensitivity.</p> <hr/> <p>NOTE:</p> <p>If the flow trigger is set higher than the patient is able to meet, a breath cannot be triggered. Reset the flow trigger to an achievable value, and deliver a manual breath to activate the new setting.</p>
Gender	Sex of patient. Used to compute ideal body weight (IBW) for adults and pediatrics.

Table 4-2. Control parameters *(continued)*

Parameter	Definition
I:E	Ratio of inspiratory time to expiratory time. Applies to mandatory breaths.
%MinVol	Percentage of minute volume to be delivered in ASV mode. The ventilator uses the %MinVol, Pat. height, and Gender settings to calculate the target minute ventilation. Typical %MinVol might be as follows: <ul style="list-style-type: none">• Normal patient, 100% (100 ml/min/kg body weight for adults and 300 ml/min/kg body weight for pediatric patients)• COPD patient, 90%• ARDS patient, 120%• Other patients, 110%• Add 20% per degree of body temperature > 38.5°C (101.3°F) Add 5% per 500 m (1640 ft) above sea level
Oxygen	Oxygen concentration to be delivered. Applies to all breaths. Not active when low-pressure oxygen is used.
Pasvlimit	The maximum pressure to apply in ASV mode. For the ASV controller to function correctly, Pasvlimit must be at least 15 cmH ₂ O above PEEP/CPAP. Changing Pasvlimit or the Pressure alarm limit automatically changes the other: The Pressure alarm limit is always 10 cmH ₂ O greater than Pasvlimit.
Pat. height	Patient height. It determines the ideal body weight (IBW), which is used in calculations for ASV and startup settings for adult and pediatric patients.
Pcontrol	The pressure (additional to PEEP/CPAP) to apply during the inspiratory phase in PCV+ and nCPAP-PC mode.
PEEP/CPAP	Positive end expiratory pressure and continuous positive airway pressure, baseline pressures applied during the expiratory phase. Applies to all breaths.

Table 4-2. Control parameters (continued)

Parameter	Definition
<i>For additional details, including parameter ranges and accuracy, see Table A-5 on page A-6.</i>	
P high	The high pressure setting in APRV and DuoPAP modes. Absolute pressure, including PEEP.
Pinsp	Pressure (additional to PEEP/CPAP) to apply during the inspiratory phase. Applies in PSIMV+ IntelliSync and NIV-ST.
P low	The low pressure setting in APRV.
P-ramp	<p>Pressure ramp. Time required for inspiratory pressure to rise to the set (target) pressure.</p> <p>The P-ramp setting lets you fine-tune the initial flow output during a pressure-controlled or pressure-supported breath to match the ventilator flow to the patient's demand.</p> <p>Short P ramp settings (0 to 50 ms) provide higher initial flow rates and result in faster attainment of the target pressure. This may benefit patients with elevated respiratory drive.</p> <p>Lower P-ramp values have been correlated with reduced work of breathing in certain patients.</p> <p>Setting the P-ramp too low, especially in combination with a small ET tube (high resistance), may result in a noticeable pressure overshoot during the early stage of inspiration and a Pressure limitation alarm.</p> <p>Setting the P-ramp too high may prevent the ventilator from attaining the set inspiratory pressure. A square (rectangular) pressure profile is the goal.</p> <p>Applies to all breaths except nCPAP.</p> <hr/> <p>NOTE:</p> <p>To prevent possible pressure overshoot in pediatric applications, it is recommended that P-ramp be set to at least 75 ms.</p> <hr/>

Table 4-2. Control parameters *(continued)*

Parameter	Definition
<i>For additional details, including parameter ranges and accuracy, see Table A-5 on page A-6.</i>	
Psupport	<p>Pressure support for spontaneous breaths in SPONT, NIV, and SIMV+ modes. It is the pressure (additional to PEEP/CPAP) to apply during the inspiratory phase.</p> <p>Pressure support helps the patient counteract the flow resistance of the breathing circuit and endotracheal tube. It compensates for the decreasing tidal volume and rising respiratory rate of a spontaneously breathing patient.</p>
Rate	Respiratory frequency or number of breaths per minute.
Sigh	<p>Breaths delivered at a regular interval (every 50 breaths) at a pressure up to 10 cmH₂O higher than non-sigh breaths, as allowed by the Pressure alarm limit.</p> <p>During sigh breaths, the Pressure and Vt alarm limits remain in effect to help protect the patient from excessive pressures and volumes.</p> <p>Not available for neonatal patients, or DuoPAP or APRV modes.</p>
T high	Length of time at the higher pressure level, P high, in DuoPAP and APRV modes.
TI	<p>Inspiratory time, the time to deliver the required gas (time to reach the operator-set Vt or Pcontrol value). Used with Rate to set the breath cycle time.</p> <p>In PCV+ and (S)CMV+ modes, TI can be controlled by rate and TI or by the I:E ratio; you set the desired method in Configuration. All other modes are controlled by rate and TI.</p>
TI max	Maximum inspiratory time for flow-cycled breaths in NIV, NIV-ST, SPONT in neonatal modes.
T low	Length of time at the lower pressure level, P low, in APRV mode.
Vt	Tidal volume delivered during inspiration in (S)CMV+ and SIMV+ modes.

Table 4-2. Control parameters *(continued)*

Parameter	Definition
<i>For additional details, including parameter ranges and accuracy, see Table A-5 on page A-6.</i>	
VT/kg	Tidal volume per weight.
Weight 	Actual body weight. Used only with neonates.

4.7 Working with alarms

WARNING

Be sure to set the auditory alarm volume above the ambient sound level. Failure to do so can prevent you from hearing and recognizing alarm conditions.

Use the Alarms window to:

- Set alarm limits (Section 4.7.1)
- Adjust the alarm volume (Section 4.7.2)
- View active alarms (Section 4.7.3)

Details about device alarms are provided as follows:

- Table 4-3 describes each of the adjustable alarms
- Table 8-2 in Chapter 8 provides troubleshooting details
- Table A-9 in Appendix A provides ranges and accuracy information

4.7.1 Setting alarm limits

CAUTION

To prevent possible patient injury, make sure the alarm limits are appropriately set before you place the patient on the ventilator.

NOTE:

- If the ventilator is in the (S)CMV+, or SIMV+ mode, be sure the Pressure alarm is appropriately set. This alarm provides a safety pressure limit for the device to appropriately adjust the inspiratory pressure necessary to achieve the target tidal volume.

The maximum available inspiratory pressure is 10 cmH₂O below the Pressure limit, indicated by a blue line on the pressure waveform display.

Set Pressure to a safe value (e.g., 45 cmH₂O, which limits the pressure target to a maximum of 35 cmH₂O). If Pressure is set too low, there may not be enough margin for the device to adjust its inspiratory pressure in order to deliver the target tidal volume.

- Selecting **Auto** automatically sets all alarm limits around the current monitoring parameter values, except for the V_t and Apnea alarm limits. The V_t alarm limits remain unchanged, and must be set manually to the desired level.
- 
- The **Auto** button is disabled during neonatal ventilation.
 - After power has been interrupted for up to 120 seconds, the device stores the last settings, including any specified alarm limits. Upon reconnection with the power supply, the device resumes ventilation with these stored settings. Should the power failure exceed 120 seconds, the settings are still stored but the device starts in standby upon reconnection with the power supply.
-

You can access the Alarms window and change alarm settings at any time, without affecting ventilation.

The device offers two alarm-setting options:

- Manually set individual alarm limits.
- Use the **Auto** alarm function.

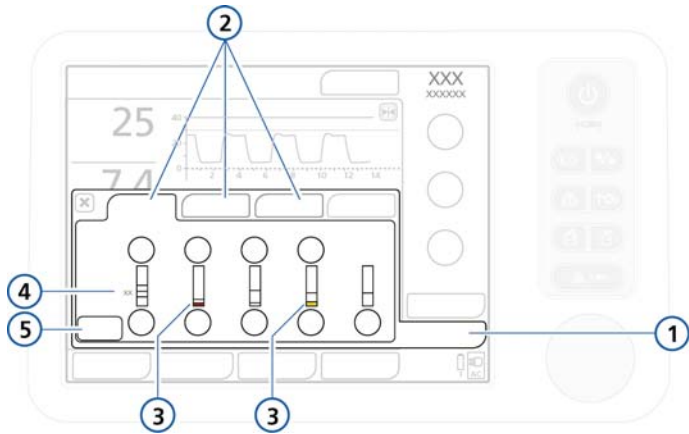

Figure 4-8. Limits window

- | | | | |
|---|---|---|-------------------------|
| 1 | Alarms | 4 | Current monitored value |
| 2 | Limits 1, 2, 3 | 5 | Auto button |
| 3 | Red or yellow bar (depending on alarm priority: high, medium, or low) indicates the monitored value is out of range | | |

To review and adjust alarms

1. Touch the **Alarms** button.
The Limits 1 window is displayed (Figure 4-8).
2. To set an alarm individually, select the alarm control and adjust the value. Repeat for any other alarm.
Additional alarm settings are available in the Limits 2, and if used, Limits 3 windows.
3. To set alarm limits automatically, select the **Auto** button in the Limits 1 window.
Selecting **Auto** automatically sets all alarm limits around the current monitoring parameter values, except for the Vt and apnea alarm limits. The Vt alarm limits remain unchanged, and must be set manually to the desired level.
4. Close the window.

4.7.2 Adjusting alarm volume (loudness)

WARNING

Be sure to set the auditory alarm volume above the ambient sound level. Failure to do so can prevent you from hearing and recognizing alarm conditions.

NOTE:

- The alarm volume cannot be set lower than the minimum alarm loudness specified for the device in Configuration (Section 1.3.4).
- If the alarm volume was set to < 5 before the ventilator was turned off, it will be reset to 5 when the ventilator is turned back on.

However, if the minimum loudness setting is configured and is set to a value greater than 5, the higher value is set.

- If you decrease the alarm volume during the night shift, do not forget to return it to its daytime setting.
- The alarm volume control is on the **Settings** tab.

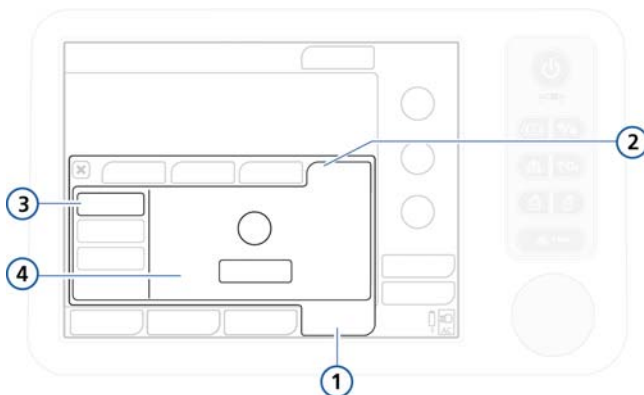

Figure 4-9. Alarm volume (loudness) control

1	System	3	Loudness button
2	Settings	4	Loudness dial and Test button

To adjust the alarm volume

1. Open the System -> Settings window.
2. Activate and adjust the **Loudness** dial, as needed.
3. Touch **Test** to check the volume.
Ensure the volume level is above the ambient sound level.
4. Repeat the process as required, and close the window.

4.7.3 Buffer: Viewing alarm information

See Chapter 8 for a description of the alarm buffer.

4.7.4 Table of alarm limit settings

The following table briefly describes each of the adjustable ventilator alarms. Table A-9 in Appendix A provides the adjustable alarm ranges and default settings, including accuracy.

Table 4-3. Adjustable alarms

Alarm	Definition
<i>For additional details, including alarm ranges and accuracy, see Table A-9 on page A-18.</i>	
Apnea time	The maximum time allowed from the beginning of one inspiration to the beginning of the next inspiration. If the patient does not trigger a breath during this time, an alarm is announced. Apnea backup ventilation will begin, if enabled. Not applicable to nCPAP or nCPAP-PC.
ExpMinVol (low and high)	Low and high expiratory minute volume. If either limit is reached, a high-priority alarm is announced. Not applicable to nCPAP or nCPAP-PC.
Flow 	Only active in nCPAP and nCPAP-PC modes. The High Flow alarm sounds when the limit is reached.
fTotal (low and high)	Low and high monitored total breath rate (fTotal), including both spontaneous and mandatory breaths. If either limit is reached, a medium-priority alarm is announced. Not applicable to nCPAP or nCPAP-PC.

Table 4-3. Adjustable alarms (continued)

Alarm	Definition
<i>For additional details, including alarm ranges and accuracy, see Table A-9 on page A-18.</i>	
Oxygen (low and high)	<p>Low and high monitored oxygen concentration (Oxygen). If either limit is reached, a high-priority alarm is annunciated.</p> <p>Applies only when low-pressure oxygen is used.</p>
PetCO ₂ (low and high)	<p>Low and high monitored PetCO₂. If either limit is reached, a medium-priority alarm sounds.</p>
Pressure (low and high)	<p>Low and high monitored pressure at the patient airway (P_{peak}). If pressure (high) is reached or pressure (low) is not reached, a high-priority alarm sounds.</p> <p>In addition, when pressure (high) reaches Pressure minus 10 cmH₂O, pressure is limited: no further pressure is applied. If pressure (high) is reached, the ventilator immediately stops gas flow to the patient and opens the expiratory valve to reduce pressure to the PEEP/CPAP level. The ventilator is designed to limit patient airway pressure to 60 cmH₂O, but if pressure climbs to 75 cmH₂O, the ambient valve opens, releasing pressure to the ambient level.</p> <p>An exception is sigh breaths, when the ventilator may apply inspiratory pressure 3 cmH₂O below the Pressure alarm limit.</p>
V _t (low and high)	<p>Low and high expiratory tidal volume, for two consecutive breaths. If either limit is reached, a medium-priority alarm sounds.</p> <p>When the delivered V_t is > 1.5 times the set V_t high alarm, the Inspiratory volume limitation alarm is generated.</p> <p>In this case, the device aborts the breath and reduces the pressure to PEEP level.</p> <p>The APV controls reduce the pressure for the next breath by 3 cmH₂O.</p> <p>Not applicable to nCPAP or nCPAP-PC.</p>

5 Neonatal ventilation

5.1	Introduction	5-2
5.2	Setting up for neonatal ventilation	5-3
5.2.1	Installing the neonatal expiratory valve	5-3
5.2.2	Setting the patient group and weight	5-5
5.2.3	Selecting the ventilation mode	5-6
5.2.4	Setting up the breathing circuit	5-9
5.2.5	Performing tests and calibrations	5-17
5.2.6	Performing the preoperational check	5-25
5.3	Ventilation modes for neonates	5-27
5.3.1	About the nCPAP mode	5-28
5.3.2	About the nCPAP-PC mode	5-30
5.4	Parameters for neonatal ventilation	5-33
5.4.1	Weight	5-34
5.4.2	TI max	5-34
5.4.3	P-ramp	5-34
5.4.4	Flow and Insp Flow	5-35
5.5	Alarms for neonatal ventilation	5-36
5.5.1	Flow alarm	5-36
5.5.2	Volume-related alarms, Vt and ExpMinVol	5-37
5.6	O2 enrichment for neonates	5-37

5.1 Introduction



WARNING

- **To prevent possible patient injury, make sure the ventilator is set up correctly for the neonatal patient. The ventilator must have the appropriate breathing circuit parts and neonatal flow sensor or neonatal pressure line (nCPAP/nCPAP-PC modes).**
 - **Make sure you perform all tests and calibrations before using the ventilator.**
-

CAUTION

To prevent increased PaCO₂ do not use an adult airway adapter for neonates as it will increase dead space.

NOTE:

- When changing from an Adult/Pediatric to a Neonatal patient group or vice versa, you must calibrate the flow sensor or circuit (pressure line), and perform the tightness test.
 - When changing from nCPAP/nCPAP-PC to another mode or vice versa, you must calibrate the flow sensor or circuit (pressure line).
 - After connecting a new or decontaminated breathing circuit or component, perform a tightness test, and calibrate the flow sensor or circuit (pressure line, for nCPAP/nCPAP-PC modes).
 - Pneumatic nebulization is disabled during neonatal ventilation.
-

While the process for ventilating neonates is very similar to that for other patients, neonatal ventilation presents some unique challenges and requirements. This chapter provides a comprehensive overview of these requirements and special conditions.

5.2 Setting up for neonatal ventilation

Setting up for neonatal ventilation comprises the following steps:

		See
1.	Install the neonatal expiratory valve.	Section 5.2.1 on page 5-3
2.	On the ventilator, select the patient group and specify weight.	Section 5.2.2 on page 5-5
3.	Select the ventilation mode.	Section 5.2.3 on page 5-6
4.	Set up the breathing circuit.	Section 5.2.4 on page 5-9
5.	Perform any required tests (tightness test and calibrations) and the preoperational check.	Section 5.2.5 on page 5-17

5.2.1 Installing the neonatal expiratory valve

CAUTION

Make sure the correct type of expiratory valve for your patient is installed:

- **Ensure the Neonatal patient group is selected on the ventilator when using the neonatal expiratory valve. It cannot be used with the Adult/Ped patient group.**
 - **You must use a neonatal expiratory valve for neonates.**
-

NOTE:

Ensure you select the correct expiratory valve (adult/pediatric or neonatal) for your patient. If the expiratory valve type does not match the selected patient group on the ventilator, the **Wrong expiratory valve alarm** is generated. For details, see the Alarm troubleshooting table in Section 8.5.

Table 5-2 shows both neonatal and adult/pediatric expiratory valves, highlighting the differences.

Table 5-1. Neonatal and adult/pediatric expiratory valves

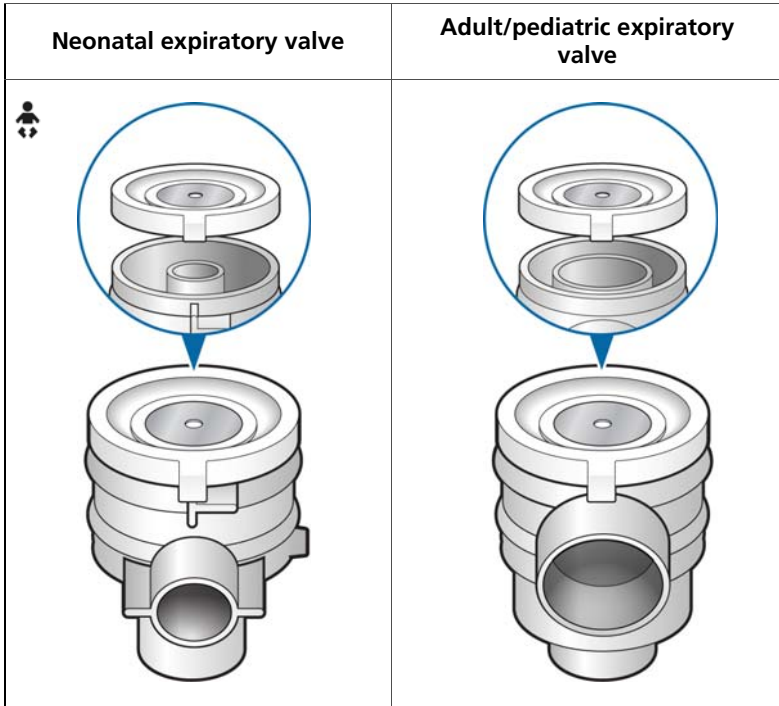

To install the neonatal expiratory valve

1. Holding the expiratory valve housing (Figure 5-1), seat the silicone membrane onto the housing.
The metal plate must face up and be visible.
2. Position the housing and twist clockwise until it locks into place.

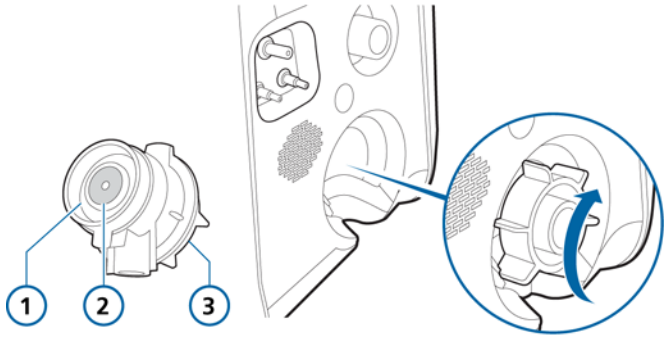

Figure 5-1. Installing the neonatal expiratory valve

- | | | | |
|---|-------------------------------|---|--------------------------|
| 1 | Expiratory valve membrane | 3 | Expiratory valve housing |
| 2 | Metal plate toward ventilator | | |

5.2.2 Setting the patient group and weight

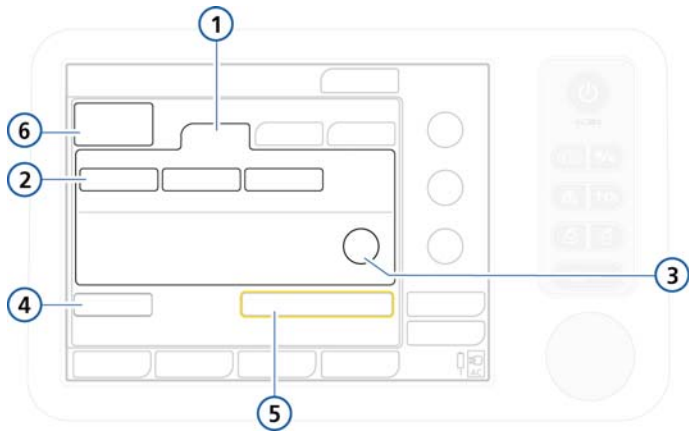

Figure 5-2. Neonatal patient group (in Standby window)

- | | | | |
|---|---------------------|---|-------------------------|
| 1 | Neonatal | 4 | Preop check |
| 2 | Quick setup buttons | 5 | Start Ventilation |
| 3 | Weight | 6 | Elapsed time in standby |

To select the patient group

1. In the Standby window, touch the **Neonatal** tab. See Figure 5-2.
2. Touch the appropriate Quick setup button, if applicable.
In Figure 5-2, they are labeled **Neonatal 1**, **Neonatal 2**, and **Neonatal 3**. (The button names can be changed during configuration.) These settings are defined in configuration (Section I.6). Quick setups allow you to specify default options, including the ventilation mode to use.
3. Touch the **Weight** control and set the patient's body weight.

Setting the weight properly is critical for ensuring that the tidal volume and minute volume alarms are correctly set.

By default, the weight is set to 2 kg.

You can now select the ventilation mode, if the desired mode is not already selected.

Once you start ventilation, the selected patient group is displayed below the active mode. See item 1 in Figure 5-4.

5.2.3 Selecting the ventilation mode

NOTE:

- You can only select nCPAP/ nCPAP-PC or change from nCPAP/ nCPAP-PC to another mode when in Standby.
 - When changing from nCPAP/nCPAP-PC to another mode or vice versa, you must calibrate the circuit (for the pressure line) or flow sensor.
-

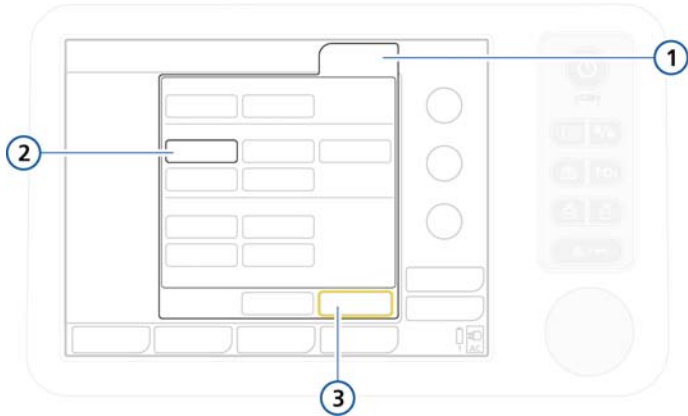

Figure 5-3. Neonatal modes

- | | | | |
|----------|---------------|----------|-----------------|
| 1 | Modes | 3 | Confirm, Cancel |
| 2 | Selected mode | | |
-

To select the ventilation mode

1. Touch the **Modes** button at the top of the display.
The Modes window appears (Figure 5-3).
2. Touch the desired mode.
The Controls window for the selected mode appears.

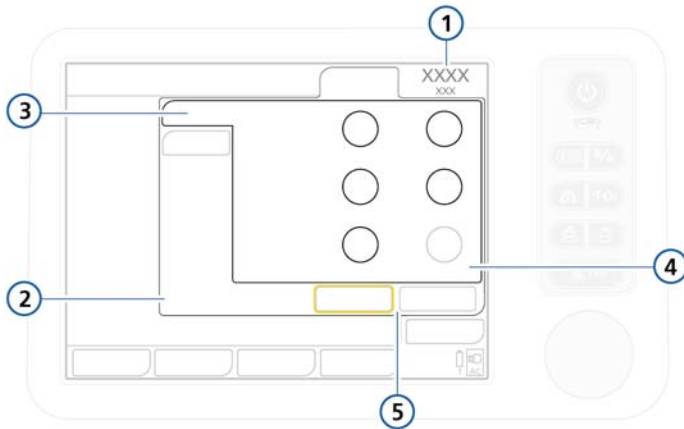

Figure 5-4. Controls window

- | | |
|--|---|
| <p>1 Active mode and selected patient group</p> <p>2 Newly selected mode</p> <p>3 Basic</p> | <p>4 Mode controls</p> <p>5 Confirm, Cancel</p> |
|--|---|

3. Set the desired parameter values in the various tabs (Basic, More, Apnea) as appropriate and available, and touch **Confirm**.

The next step depends on your mode selection.

- If changing from nCPAP/nCPAP-PC to another mode or vice versa, the System -> Tests & calib window appears. Proceed to step 4.
- If changing between any other modes, set the desired alarm limits. Proceed to step 5.

4. Perform the flow sensor or circuit (nCPAP, nCPAP-PC modes) calibration.
5. Touch the **Alarms** button and set the appropriate alarm limits in the Limits windows (Figure 4-8).

The device is ready for the appropriate preoperational checks and calibrations, if not already performed. You can then start ventilation.

5.2.4 Setting up the breathing circuit

Setting up a neonatal breathing circuit comprises the following steps:

		See
1.	Selecting the components	Section 5.2.4.1 on page 5-9
2.	Connecting the breathing circuit	Section 5.2.4.2 on page 5-10
3.	Installing the flow sensor	Section 5.2.4.3 on page 5-15
4.	Connecting the pressure line (nCPAP and nCPAP-PC modes)	Section 5.2.4.4 on page 5-16
5.	Positioning the circuit	Section 5.2.4.5 on page 5-17

5.2.4.1 Components for neonatal ventilation

CAUTION

- **To determine appropriate tidal and minute volumes for neonatal patients, you must consider (anatomic) dead space. Artificial airways (Y-piece, flow sensor, ET tube, CO2 airway adapter, etc.) may increase the dead space.**
 - **Always use the correct CO2 adapter. In adult patients, smaller geometrics induce low tidal volumes and intrinsic PEEP. In neonatal patients, large geometrics detain effective CO2 removal.**
 - **A heating wire may noticeably increase the inspiratory resistance of the neonatal breathing circuit.**
-

NOTE:

An infant flow sensor is required with breathing circuits used for all ventilation modes except nCPAP and nCPAP-PC.

When using the nCPAP or nCPAP-PC modes, remove the flow sensor and use the pressure-monitoring line with the breathing circuit. See Section 5.2.4.4.

Select the correct breathing circuit parts for your patient from Table 5-1.

Table 5-2. Neonatal breathing circuit part specifications

Patient group	Weight (kg)	Tracheal tube ID (mm)	Breathing circuit tube ID (mm)	Flow sensor ¹	CO2 airway adapter
Neonatal	≤ 30	< 4	10	Infant	Infant

1. Not required for noninvasive nCPAP or nCPAP-PC neonatal modes; a pressure-monitoring line is used instead.

CO2

Table 5-3. Neonatal tracheal tube and CO2

Tracheal tube ID (mm)	CO2 airway adapter
< 4	Neonatal

5.2.4.2 Connecting the neonatal breathing circuit

Figures 5-5 and 5-6 show typical breathing circuits using a humidifier or an HME, applicable to most ventilation modes. Figure 5-7 and 5-8 show typical breathing circuits for use with the nCPAP or nCPAP-PC modes.

For ordering information, contact your Hamilton Medical representative. Follow the specific guidelines for the different parts.

Connect the components as appropriate for your patient.

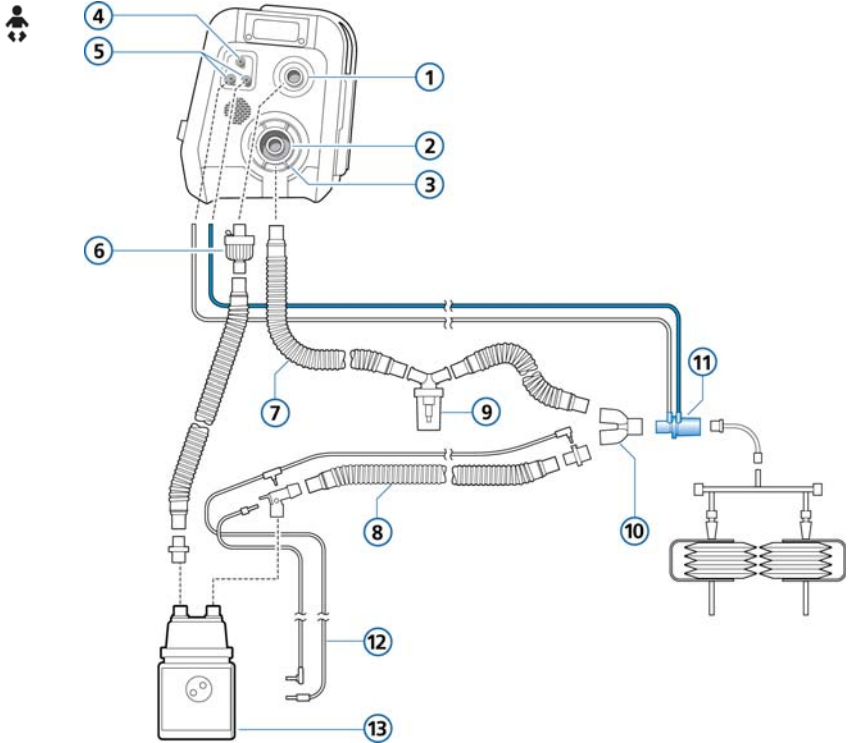

Figure 5-5. Dual-limb breathing circuit with humidifier (neonatal)

- | | | | |
|---|--------------------------------------|----|------------------|
| 1 | To patient | 8 | Inspiratory limb |
| 2 | From patient | 9 | Water trap |
| 3 | Expiratory valve with membrane cover | 10 | Y-piece |
| 4 | Nebulizer outlet | 11 | Flow sensor |
| 5 | Flow sensor connectors | 12 | Heater wire |
| 6 | Inspiratory filter | 13 | Humidifier |
| 7 | Expiratory limb | | |

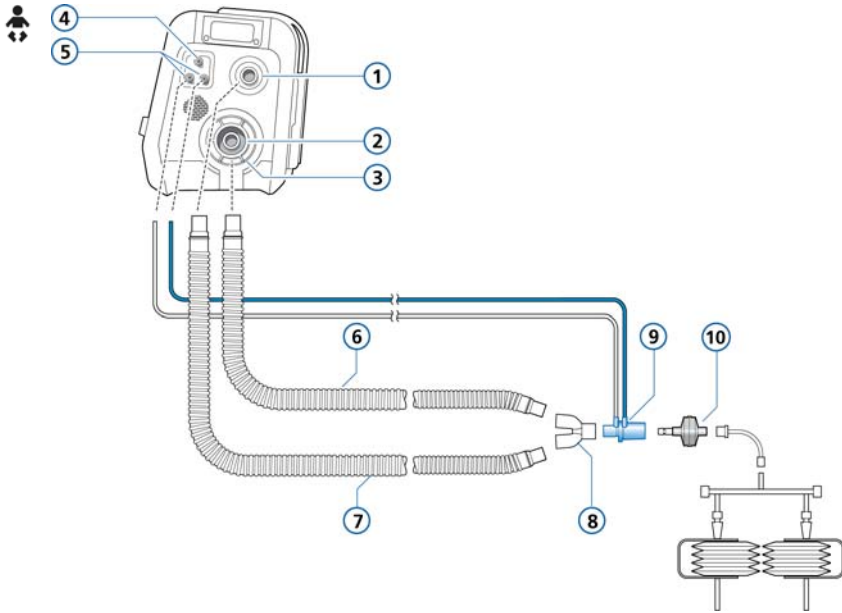

Figure 5-6. Dual-limb breathing circuit with HMEF/HME (neonatal)

1	To patient	6	Expiratory limb
2	From patient	7	Inspiratory limb
3	Expiratory valve with membrane cover	8	Y-piece
4	Nebulizer outlet	9	Flow sensor
5	Flow sensor connectors	10	HMEF/HME (infant)

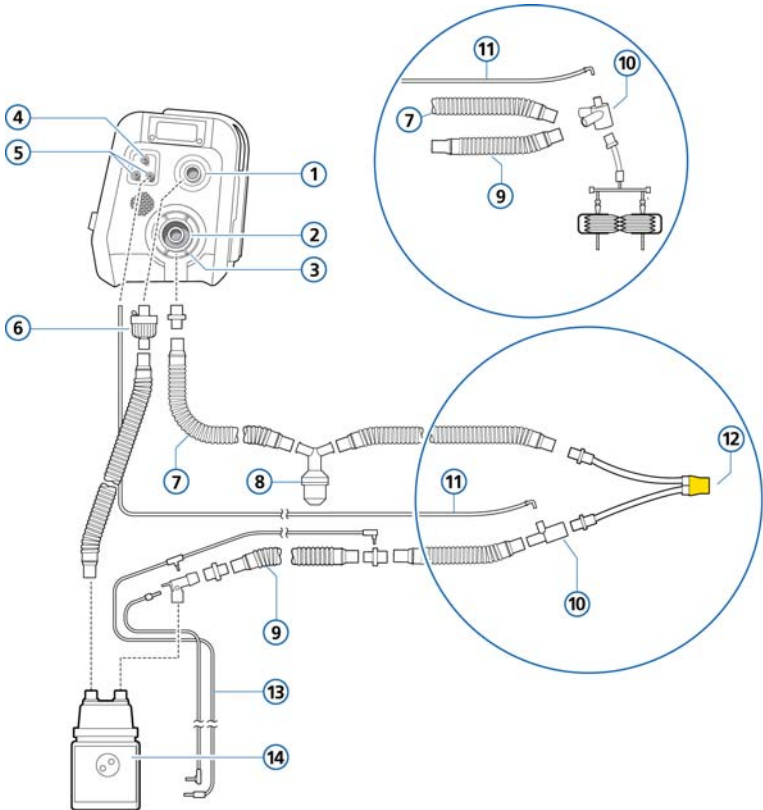

Figure 5-7. Breathing circuit with pressure line and humidifier, for nCPAP and nCPAP-PC modes, with Y- or T-piece (neonatal)

- | | | | |
|---|---|----|--|
| 1 | To patient | 8 | Water trap |
| 2 | From patient | 9 | Inspiratory limb |
| 3 | Expiratory valve with membrane cover | 10 | T-piece with pressure line or Y-piece with pressure line |
| 4 | Nebulizer outlet | 11 | Pressure-monitoring line |
| 5 | Pressure-monitoring line connector (blue) | 12 | Patient interface (mask or nasal prongs) |
| 6 | Inspiratory filter | 13 | Heater wire |
| 7 | Expiratory limb | 14 | Humidifier |

Note that this circuit does not use a flow sensor. It uses a pressure-monitoring line.

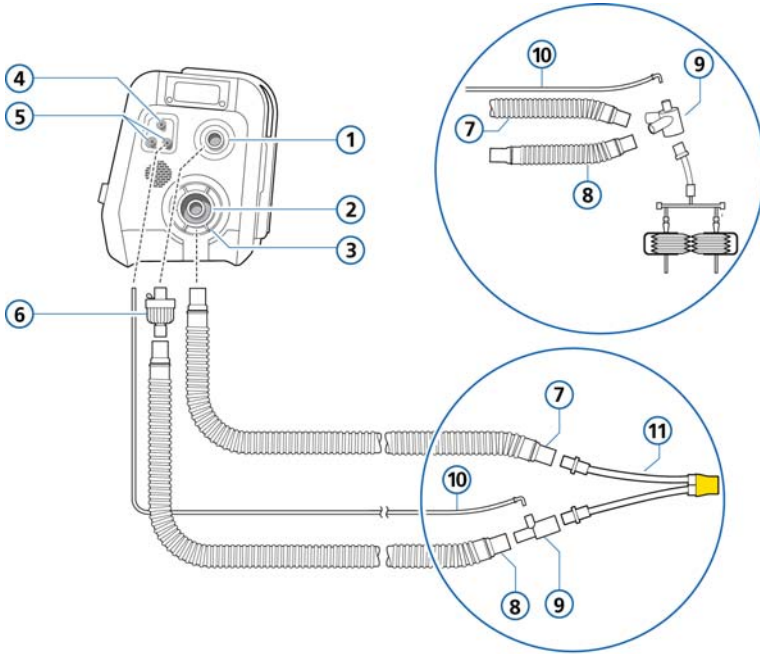

Figure 5-8. Breathing circuit with pressure line, for nCPAP and nCPAP-PC modes, with Y- or T-piece (neonatal)

- | | | | |
|---|---|----|--|
| 1 | To patient | 7 | Expiratory limb |
| 2 | From patient | 8 | Inspiratory limb |
| 3 | Expiratory valve with membrane cover | 9 | T-piece with pressure line or Y-piece with pressure line |
| 4 | Nebulizer outlet | 10 | Pressure-monitoring line |
| 5 | Pressure-monitoring line connector (blue) | 11 | Patient interface (mask or nasal prongs) |
| 6 | Inspiratory filter | | |

Note that this circuit does not use a flow sensor. It uses a pressure-monitoring line.

5.2.4.3 Installing the flow sensor

NOTE:

- To prevent inaccurate flow sensor readings, make sure the flow sensor is correctly installed:
 - The flow sensor tubes must not be kinked.
 - The flow sensor tubes must be secured with the included clamp.
 - When using the nCPAP or nCPAP-PC modes, remove the flow sensor and use the pressure-monitoring line with the breathing circuit. See Section 5.2.4.4.
-

Use a Hamilton Medical infant flow sensor to ventilate your neonatal patient. Do not use an adult flow sensor. The neonatal flow sensor has a dead space of < 1.3 ml.

To install the infant flow sensor

1. Insert a flow sensor between the Y-piece of the breathing circuit and the patient connection (Figure 5-9).
2. Connect the blue and clear tubes to the flow sensor connectors on the ventilator.

The blue tube goes to the blue connector. The clear tube goes to the white connector.

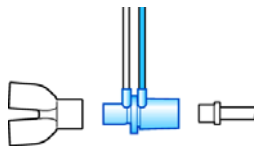

Figure 5-9. Installing the infant flow sensor

3. Calibrate the flow sensor. See Section 5.2.5.2.

5.2.4.4 Connecting the pressure line (nCPAP modes)

Use the pressure-monitoring line with the breathing circuit when using the nCPAP or nCPAP-PC modes. Do not use a flow sensor.

The pressure is measured by a built-in T-piece adapter in the inspiratory line, close to the patient, or (if available) over the optional pressure measuring connection at the Y-piece of the breathing circuit.

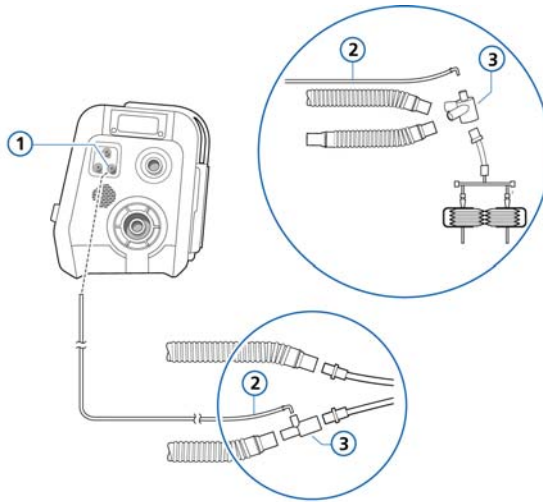

Figure 5-10. Connecting the pressure-monitoring line

- | | |
|--|--|
| <p>1 Pressure-monitoring line connector (blue)</p> <p>2 Pressure-monitoring line</p> | <p>3 T-piece with pressure line or Y-piece with pressure line</p> |
|--|--|

To connect the pressure line

1. Using an adapter, connect the pressure-monitoring line to the small inlet at the top of the T- or Y-piece, whichever is used. See Figure 5-10.
2. Connect the pressure-monitoring line to the blue flow sensor connector on the ventilator.
3. Calibrate the breathing circuit. See Section 5.2.5.3.

5.2.4.5 Positioning the breathing circuit

After assembly, position the breathing circuit so that the hoses will not be pushed, pulled, or kinked as a result of a patient's movement, nebulization, or other procedures.

5.2.5 Performing tests and calibrations

Be sure to perform a tightness test, and flow sensor or breathing circuit calibration, in addition to the preoperational checks. See Chapter 3 for details, as well as additional tests and procedures, for example, O₂ cell and CO₂ sensor calibration.

This section describes the following basic tests and calibrations required for neonatal ventilation:

		See
1.	Perform the tightness test	Section 5.2.5.1 on page 5-18
2.	Calibrate the infant flow sensor	Section 5.2.5.2 on page 5-20
	Calibrate the neonatal breathing circuit (nCPAP or nCPAP-PC modes only)	Section 5.2.5.3 on page 5-23
3.	Perform the preoperational check	Section 5.2.6 on page 5-25

5.2.5.1 Performing the tightness test

NOTE:

- Make sure another source of ventilatory support is available during this test. The patient must be disconnected from the ventilator for the duration of the test.
 - To cancel the tightness test while it is in progress, select **Tightness** again.
 - Perform this test after installing a new or decontaminated breathing circuit or component (including a flow sensor or pressure line).
-

Description: This test checks for leakage in the patient breathing circuit.

Procedure:

Figure 5-11. Tests & calib window, Tightness test

- | | | | |
|---|---------------|---|-----------|
| 1 | System | 3 | Tightness |
| 2 | Tests & calib | | |
-

To perform the tightness test

1. Set the ventilator up as for normal ventilation, complete with the breathing circuit.
2. In the System -> Tests & calib window, select **Tightness**. See Figure 5-11.

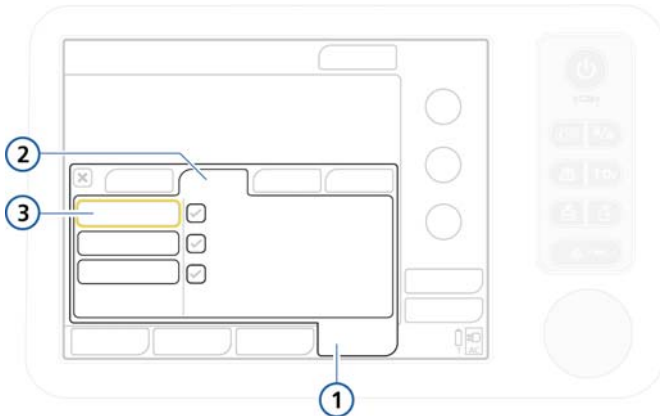
The text **Disconnect patient** is now displayed.

3. Disconnect the breathing circuit at the patient side of the flow sensor. Do not block the open end of the flow sensor.

The text **Tighten patient system** is now displayed.

4. Block the opening (wearing a sterilized glove is recommended).

The text **Connect patient** is now displayed.

5. Connect the patient.
6. When the test is complete, verify that there is a green check mark in the **Tightness** checkbox.

In case of test failure

If the test fails, a red X is displayed in the **Tightness** checkbox.

Perform the following checks, repeating the tightness test after each one, until the test is successful:

- Check the breathing circuit for a disconnection between the ventilator and the flow sensor or pressure-monitoring line (nCPAP, nCPAP-PC modes), or for other large leaks (for example, breathing circuit, humidifier).
- Check that the expiratory valve is correctly installed.
- Replace the breathing circuit, and flow sensor or pressure-monitoring line (nCPAP, nCPAP-PC modes), and expiratory valve.

If the problem still persists, have the ventilator serviced.

5.2.5.2 Calibrating the infant flow sensor

NOTE:

An infant flow sensor is required with breathing circuits used for all ventilation modes except nCPAP and nCPAP-PC.

Calibrate the flow sensor after connecting a new flow sensor or whenever the **Flow sensor calibration needed** alarm is generated.

During calibration, when the ventilator detects a mismatch between the set patient group and the flow sensor, the calibration fails.

Procedure:

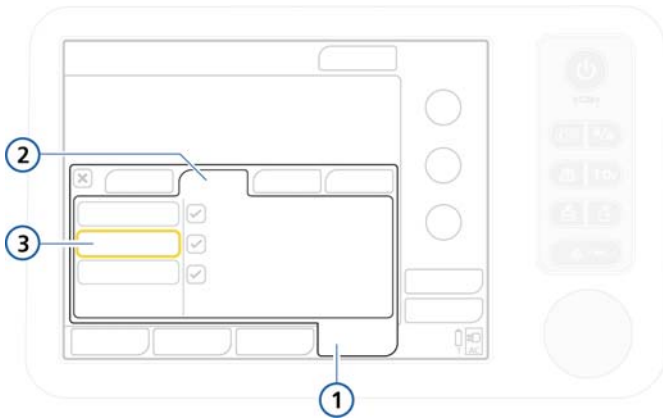
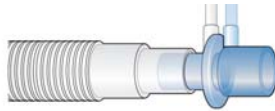

Figure 5-12. Tests & calib window, Flow sensor calibration

- | | |
|-----------------|---------------|
| 1 System | 3 Flow sensor |
| 2 Tests & calib | |

To calibrate the infant flow sensor

1. Set the ventilator up as for normal ventilation, complete with breathing circuit and expiratory membrane and cover.
2. Make sure that the Neonatal patient group is selected, an infant flow sensor and neonatal expiratory valve are installed, and the calibration adapter is available.
3. In the System -> Tests & calib window, select **Flow Sensor**.
If you have not already disconnected the patient, the text **Disconnect patient** is displayed.
4. Disconnect the patient now.



5. Follow the instructions displayed in the message line, attaching the adapter and turning the flow sensor around as indicated.

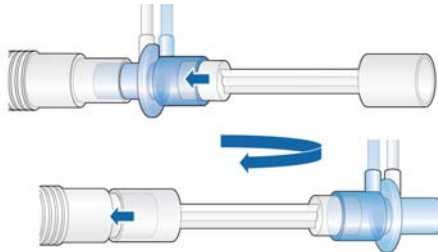

6. When prompted to turn the flow sensor again, turn the flow sensor back to its starting position, and remove the calibration adapter.
7. When calibration is complete, verify that there is a green check mark in the **Flow Sensor** checkbox.
8. If the calibration is successful, connect the patient, and touch the **Start ventilation** button in the Standby window to start ventilation.

In case of calibration failure

If the calibration fails, a red X is displayed in the **Flow Sensor** checkbox.

Perform the following checks, repeating the calibration after each one, until calibration is successful:

- Check the breathing circuit for a disconnection between the ventilator and the flow sensor, or for other large leaks (for example, breathing circuit, humidifier).
- Check that the correct flow sensor is connected, and that the flow sensor and expiratory valve/membrane are properly seated.
- If the calibration fails again, replace the flow sensor.
- If the calibration still fails, replace the expiratory valve/membrane.

If the problem persists, have the ventilator serviced.

5.2.5.3 Calibrating the neonatal breathing circuit (nCPAP and nCPAP-PC modes)

NOTE:

- We strongly recommend calibrating the breathing circuit before starting to ventilate the patient using either the nCPAP or nCPAP-PC mode.
 - Make sure another source of ventilatory support is available when precalibration is not possible. The patient must be disconnected from the ventilator for the duration of the calibration.
-

The nCPAP and nCPAP-PC modes use a pressure-monitoring line in the breathing circuit to measure the inspiratory pressure. Do not use a flow sensor.

This calibration ensures that the breathing circuit resistance compensation is accurate.

Procedure:

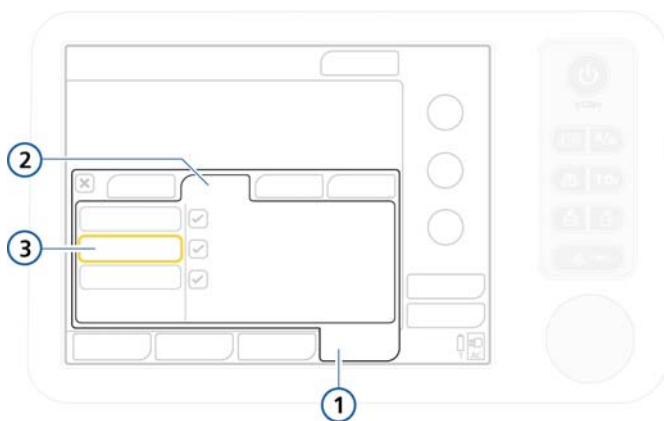

Figure 5-13. Tests & calib window, Circuit calibration

- | | | | |
|---|---------------|---|---------|
| 1 | System | 3 | Circuit |
| 2 | Tests & calib | | |
-

To calibrate the circuit with the pressure-monitoring line

1. In the System -> Tests & calib window, select **Circuit**.
If you have not already disconnected the patient, the text **Disconnect patient** is displayed.
2. Disconnect patient as follows:
 - If using a Y-piece, disconnect the breathing circuit from the patient.
 - If using a T-piece, disconnect the interface from the patient.
3. Follow the instructions displayed in the message line.
4. When calibration is complete, verify that there is a green check mark in the **Circuit** checkbox.
5. If calibration is successful, touch the **Start ventilation** button in the Standby window, and connect the patient, as indicated.

In case of calibration failure

If the calibration fails, a red X is displayed in the **Circuit** checkbox.

Perform the following checks, repeating the calibration after each one, until calibration is successful:

- Check the breathing circuit for a disconnection between the ventilator and the pressure-monitoring line, or for other large leaks (for example, breathing circuit, humidifier).
- Check that the pressure-monitoring line and expiratory valve/membrane are properly seated.
- If the calibration fails, replace the pressure-monitoring line.
- If the calibration still fails, replace the breathing circuit and expiratory valve/membrane.

If the problem persists, have the ventilator serviced.

5.2.6 Performing the preoperational check

CAUTION

- To ensure the ventilator's safe operation, always run the full preoperational check before using the ventilator on a patient. If the ventilator fails any tests, remove it from clinical use immediately. Do not use the ventilator until necessary repairs are completed and all tests have passed.
- To prevent possible patient injury, disconnect the patient from the ventilator before running this test. Make sure another source of ventilatory support is available.

When to perform: Before placing a new patient on the ventilator.

Required materials: To ensure that the ventilator also functions according to specifications on your patient, we recommend that your test circuit be equivalent to the circuit used for ventilation.

Breathing circuit	Neonatal, 10 mm ID with 10F connectors
Flow sensor	Infant, for all modes except nCPAP and nCPAP-PC
Pressure-monitoring line	Neonatal, 1.4, 2.1, or 3.1 m length For nCPAP and nCPAP-PC modes (no flow sensor)
Test lung	Neonatal, with neonatal ET tube between flow sensor and lung model (an IngMar neonatal lung model is recommended)

Procedure:

Do or observe...	Verify...
1. Connect ventilator to AC power and oxygen supply. Assemble the patient breathing circuit.	Breathing circuit is assembled correctly. See Section 5.2.4 on page 5-9.
2. Turn on power.	When ventilator is turned on, buzzer sounds briefly and the red alarm lamp flashes. After the self-test is passed, the alarm lamp flashes red again.
3. Make sure the ventilator is in standby, and select Preop check in the Patient setup/Standby window.	
4. Open System -> Tests & calib window (Figure 3-2). Select and run the tightness test, then the flow sensor or circuit calibration. Follow all prompts.	These tests pass.
5. If necessary, run O2 cell . Close window.	These tests pass. For details, see Chapter 3.
6. Generate an alarm (for example, by disconnecting primary power).	Corresponding alarm message in message bar (for example, Loss of external power). Note that in standby, patient alarms are suppressed.
7. Resolve the alarm situation (for example, reconnect primary power).	Alarm is reset.

Corrective action: If the ventilator does not pass the preoperational check, have it serviced.

5.3 Ventilation modes for neonates

CAUTION

Auto triggering is harmful and can occur easily with sensitive trigger settings due to gas leaks around the ET tubes.

NOTE:

Because neonatal ET tubes normally do not have a cuff, leakage can be significant; that is, the inspiratory tidal volume (VTI) can be much greater than the measured expiratory tidal volume (VTE).

Check the VLeak parameter in the Monitoring window from time to time; the leak may not be predictable.

The neonatal modes available in the HAMILTON-C1 are either pressure controlled or adaptive (pressure regulated and volume targeted) modes.

The following modes are supported for neonates (Figure 5-3)

PCV+	PSIMV+	(S)CMV+/ APVcmv	SIMV+/ APVsimv	SPONT
DuoPAP	APRV	NIV	NIV-ST	
nCPAP	nCPAP-PC			

For details about:

- Neonatal-only nCPAP modes, see Sections 5.3.1 and 5.3.2
- All other modes, see Appendix B

5.3.1 About the nCPAP mode

NOTE:

Apnea backup, trigger detection, disconnection detection, and volume measurements are not available in nCPAP mode.

The nCPAP (nasal Continuous Positive Airway Pressure) mode applies CPAP over a nasal interface (mask or prongs). Leaks are compensated due to the set High Flow limit.

The following parameters are used in the nCPAP mode:

- PEEP/CPAP
- Oxygen

The following monitoring parameters are used in the nCPAP mode:

- Insp Flow
- Flow

For details about these parameters, see Section 5.4.4.

When a manual breath is applied, the pressure changes to PEEP + 5 cmH₂O for a period of 0.4 seconds, or so long as the button is pressed, to a maximum of 15 s. When the manual breath is completed, the pressure returns to the set CPAP level.

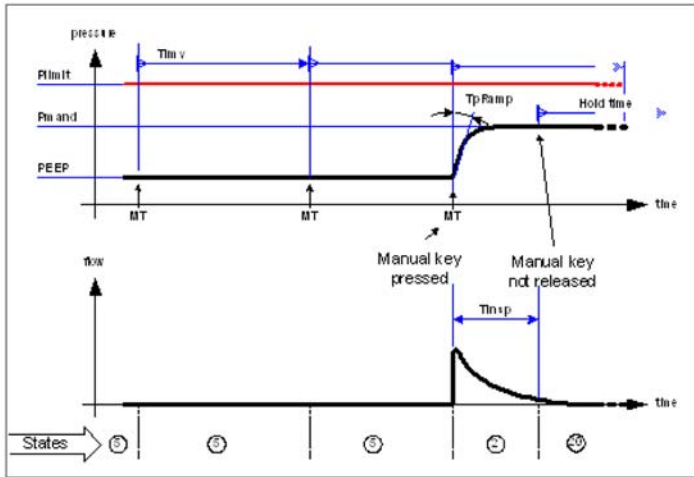

Figure 5-14. nCPAP breathing pattern

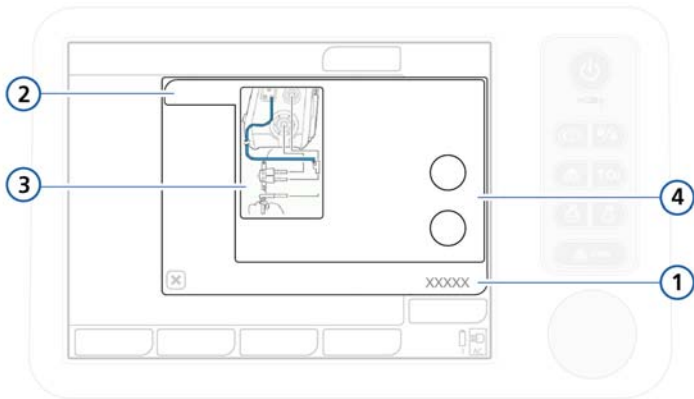

Figure 5-15. nCPAP mode basic controls

- | | | | |
|----------|----------|----------|-----------------------------|
| 1 | Controls | 3 | nCPAP connection diagram |
| 2 | Basic | 4 | Mode controls: PEEP, Oxygen |

For parameter details, see Table A-5 (Appendix A) for ranges, default settings, and accuracy of measurements applicable to neonatal patients.

5.3.2 About the nCPAP-PC mode

NOTE:

Apnea backup, trigger detection, disconnection detection, and volume measurements are not available in nCPAP-PC mode.

The nCPAP-PC (nasal Continuous Positive Airway Pressure - Pressure Control) mode delivers, in addition to the set CPAP, intermittent, time-cycled, and pressure-controlled breaths. This results in a biphasic breathing pattern.

The patient can also breathe freely at both pressure levels. The inspiratory flow follows the respiratory effort of the patient on both pressure levels. Leaks are compensated due to the set High Flow limit.

The following parameters are used in the nCPAP-PC mode:

- Rate
- P-ramp
- Pcontrol
- PEEP/CPAP
- TI
- Oxygen

The following monitoring parameters are used in the nCPAP mode:

- Insp Flow
- Flow

For details about these parameters, see Section 5.4.4.

When a manual breath is applied, the pressure changes to the Pcontrol setting for the length of time set by the TI (inspiratory time) or so long as the button is pressed, to a maximum of 15 s. When the manual breath is completed, the pressure returns to the set CPAP level.

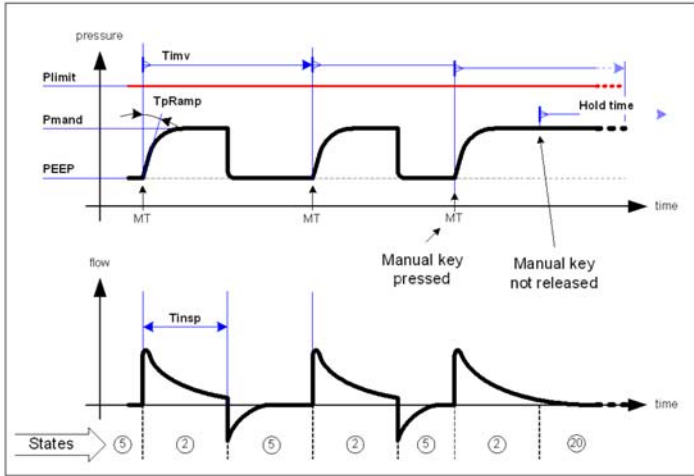

Figure 5-16. nCPAP-PC breathing pattern

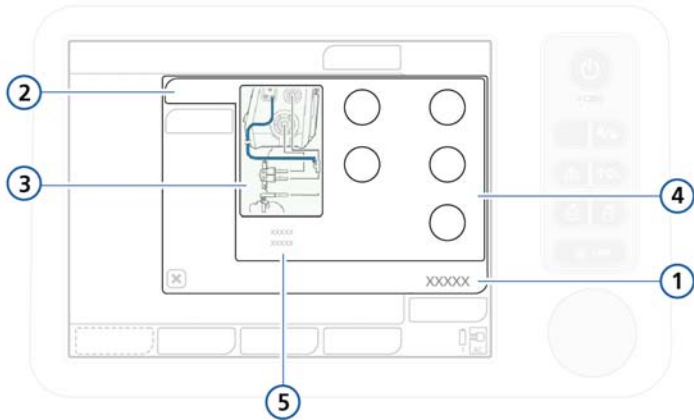

Figure 5-17. nCPAP-PC mode basic controls

- | | |
|---|--|
| <ul style="list-style-type: none"> 1 Controls 2 Basic 3 nCPAP connection diagram | <ul style="list-style-type: none"> 4 Mode controls: Rate, Pcontrol, TI, PEEP, Oxygen 5 I:E, TE |
|---|--|

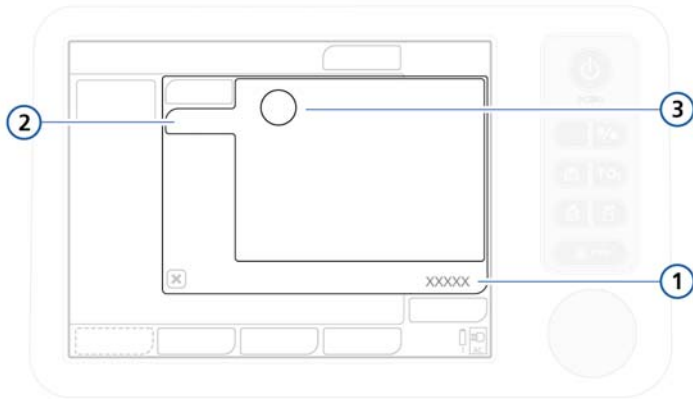

Figure 5-18. nCPAP-PC mode parameters, more controls

- | | | | |
|----------|----------|----------|-----------------------|
| 1 | Controls | 3 | Mode controls: P-ramp |
| 2 | More | | |
-

For parameter details, see Table A-5 (Appendix A) for ranges, default settings, and accuracy of measurements applicable to neonatal patients.

5.4 Parameters for neonatal ventilation

WARNING

- **Prolonged exposure to high oxygen concentrations may cause irreversible blindness and pulmonary fibrosis in preterm neonates.**
 - **High rate settings, or very short TI or TE may cause incomplete inspiration or expiration.**
-

NOTE:

- Pneumatic nebulization is disabled in neonatal ventilation. If needed, use the Aerogen nebulizer in neonatal ventilation.
 - The ventilator generates a continuous and constant base flow from the inspiratory outlet to the expiratory outlet during the later part of exhalation. The base flow is set to a fixed 4 l/min for neonatal patients.
-

Some of the ventilation parameters require special consideration when setting up the ventilator for a neonatal patient.

This section briefly describes the following parameters:

- Weight
- P-ramp
- ETS
- Flow (monitoring parameter)
- TI max

For additional information on these and all other parameters, see:

- Table 4-2 (Chapter 4) for definitions of the ventilator control parameters
- Tables A-5 and A-7 for parameter ranges, default settings, and accuracy of measurements applicable to neonatal patients

5.4.1 Weight

For neonates, the ventilator uses actual body weight. Be sure to set the correct patient weight on the Patient setup screen before starting ventilation. See Section 5.2.1 on page 5-3.

Setting the **Weight** parameter correctly is very important in neonatal ventilation, as tidal volume and minute volume alarm limits are set based on patient weight.

By default, neonatal weight is set to 2 kg.

For parameter details, see Table A-5, Control settings, ranges and accuracy.

5.4.2 TI max

The **TI max** (maximum inspiratory time) parameter is set for spontaneous breaths in NIV and NIV-ST modes.

For all patient groups, the switchover from inspiration to exhalation in spontaneous breaths is normally controlled by the ETS (expiratory trigger sensitivity). If gas leakage is significant, however, the set ETS may never be reached. The **TI max** setting provides a backup so inspiration can be terminated. The ventilator switches over to exhalation when the set **TI max** is reached.

For parameter details, see Table A-5, Control settings, ranges and accuracy.

5.4.3 P-ramp

P-ramp is the pressure ramp, the time required for inspiratory pressure to rise to the set (target) pressure.

Note that **P-ramp** time cannot exceed one-third of the inspiratory time (TI). In the following modes, the maximum setting is 200 ms: SPONT, NIV, NIV-ST, nCPAP, nCPAP-PC.

By default, **P-ramp** is set to 50 ms for neonates.

If a neonatal patient has stiff lungs (for example, RDS), be careful when using a short **P-ramp** (pressure rise time). A very short **P-ramp** in this case may cause pressure overshoot.

For parameter details, see Table A-5, Control settings, ranges and accuracy.

5.4.4 Flow and Insp Flow

NOTE:

- Flow is only active in nCPAP and nCPAP-PC modes.
 - A trend graph cannot be generated using the Flow parameter.
-

The Flow and Insp Flow parameters monitor average and peak flow, respectively, in nCPAP and nCPAP-PC modes, as described below.

Table 5-4. Flow parameters in nCPAP and nCPAP-PC

	nCPAP mode	nCPAP-PC mode
Flow (l/min)	Average flow, updated every second. Displayed in the Monitoring window.	Average flow during expiration, updated each breath. Displayed in the Monitoring window.
Insp Flow (l/min)	Peak flow during patient inspiration, measured every second. Insp flow is a main monitoring parameter (MMP) and is always displayed.	Peak flow during inspiration, measured every breath. Insp flow is a main monitoring parameter (MMP) and is always displayed.

Flow is affected by the setting of the Flow alarm (Section 5.5.1).

5.5 Alarms for neonatal ventilation

The following alarms require special consideration for a neonatal patient:

- Adjustable alarms:
 - Flow
 - Volume-related alarms, Vt and ExpMinVol
- Nonadjustable alarms (see Table 8-2):
 - Obstruction

For additional information about alarms and settings, see Tables 8-2 and A-9.

5.5.1 Flow alarm

CAUTION

Be sure to set the Flow alarm limit to an appropriate level above the current monitored peak flow to avoid potential gastric overinflation, and to be able to detect leaks and disconnection of the patient interface.

NOTE:

Only active in nCPAP and nCPAP-PC modes.

The primary purpose of the medium-priority Flow alarm is to help detect disconnection of the patient interface by monitoring the inspiratory flow (Insp Flow parameter).

When the flow exceeds the set limit, in addition to generating the High Flow alarm, the system reduces the delivered flow, and, as a result, the delivered pressure may be reduced.

To minimize the incidence of this alarm, observe the Insp Flow values, and then set the limit to a value above the average Insp Flow reading + known minimum leakage.

If the alarm sounds, check the patient interface and breathing circuit for disconnection or excessive leakage, and check the ventilator settings and alarm limits.

The alarm is adjustable from 8 to 30 l/min. By default, the flow limit is set to 15 l/min.

For additional details, see Table A-9.

5.5.2 Volume-related alarms, Vt and ExpMinVol

Note that the following adjustable alarms use patient weight to set the initial alarm limits:

- Tidal volume, high and low (VT)
- Minute volume, high and low (ExpMinVol)

Be sure to set the correct patient weight on the Patient setup screen in standby before starting ventilation. See Section 5.2.1.

5.6 O2 enrichment for neonates

WARNING

Prolonged exposure to high oxygen concentrations may cause irreversible blindness and pulmonary fibrosis in preterm neonates.

NOTE:

In nCPAP and nCPAP-PC modes, starting O2 enrichment or changing the Oxygen setting sets the flow to 10 l/min for 60 seconds. The flow then returns to its previous setting.

During the O2 enrichment maneuver the applied oxygen concentration is increased by 25% of the last oxygen setting (for example, if the last oxygen setting is 40%, resulting oxygen concentration during O2 enrichment maneuver is 50%).

The currently applied oxygen concentration is displayed on the **Oxygen** control. Oxygen enrichment continues for 2 min unless you terminate it by pressing the O2 enrichment key again or manually activating and confirming the **Oxygen** control.

6 Monitoring ventilation

6.1	Introduction	6-2
6.2	Viewing numeric patient data	6-3
6.2.1	About the main monitoring parameters (MMP)	6-4
6.2.2	Viewing patient data in the Monitoring window	6-5
6.3	Waveforms and graphs	6-6
6.3.1	Selecting a graphical view of patient data	6-6
6.4	About graphic types	6-8
6.4.1	Waveforms	6-8
6.4.2	Dynamic Lung	6-11
6.4.3	Vent Status	6-11
6.4.4	ASV Graph	6-11
6.5	Trends	6-11
6.5.1	Displaying trends	6-13
6.6	Loops	6-14
6.6.1	Displaying loops	6-14
6.6.2	Storing loops	6-15
6.7	Table of monitored parameters	6-16
6.8	Freeze and cursor measurement	6-24

6.1 Introduction

CAUTION

- **To ensure that oxygen monitoring is always fully functional, replace an exhausted or missing oxygen cell as soon as possible or use an external monitor that complies with ISO 80601-2-55.**
 - **The HAMILTON-C1's oxygen monitoring function can be disabled. Ensure that an alternative means of oxygen monitoring is always available and enabled.**
 - **In case of a problem developing with the ventilator's built-in monitoring and in order to maintain an adequate level of patient monitoring at all times, it is recommended that additional independent monitoring devices be used. The operator of the ventilator must still maintain full responsibility for proper ventilation and patient safety in all situations.**
-

During ventilation, you can view patient data on the HAMILTON-C1 screen (Figure 6-1). You can configure the screen layout with different waveforms, loops or trends, or with Intelligent Panel graphics to suit your institution's needs. Access the Monitoring window at any time without affecting breath delivery.

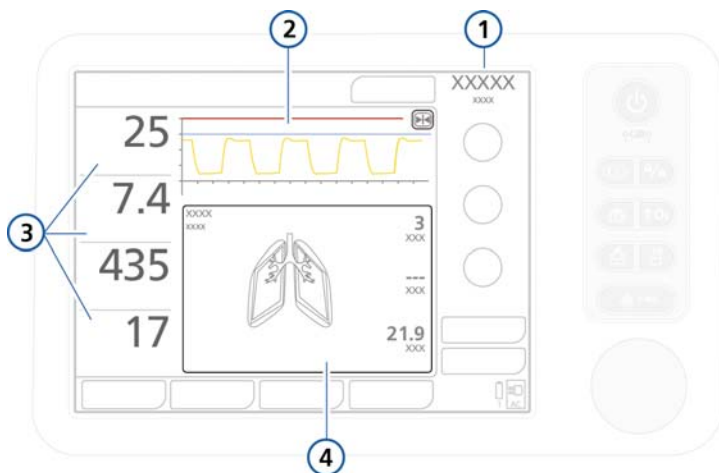

Figure 6-1. Main display

- | | |
|---|---|
| 1 Current mode | 3 Main monitoring parameters (MMP) (Section 6.2.1) |
| 2 Pressure/time graph, nonconfigurable (Section 6.3) | 4 Graphic display, configurable (Section 6.3.1) |

6.2 Viewing numeric patient data

Numeric patient data is readily available in the following locations:

- The main display prominently shows the four main monitoring parameters (MMPs). See Section 6.2.1.
- The Monitoring window provides access to all of the parameter data, including CO₂ and SpO₂ values, when enabled. See Section 6.2.2.

6.2.1 About the main monitoring parameters (MMP)

The MMPs are the four numerical monitoring parameters shown on the left side of the display. Every displayed parameter has three critical elements: the current value, name, and unit of the monitoring parameter.

The factory default MMPs are peak pressure, expiratory minute volume, tidal volume, and total respiratory rate. The MMPs that are displayed, as well as their sequence on the display, can be changed in configuration (Section I.5). Any of the monitored parameters can be displayed as an MMP. As a result, since the display is configurable, MMPs may differ between individual ventilators.

MMPs are normally displayed in white. It may also be shown in yellow or red if it is directly related to an active alarm, such as Pressure high or Tidal volume low. The color of the MMP corresponds to the alarm priority (Chapter 8). After the alarm resets, the affected MMP returns to white.

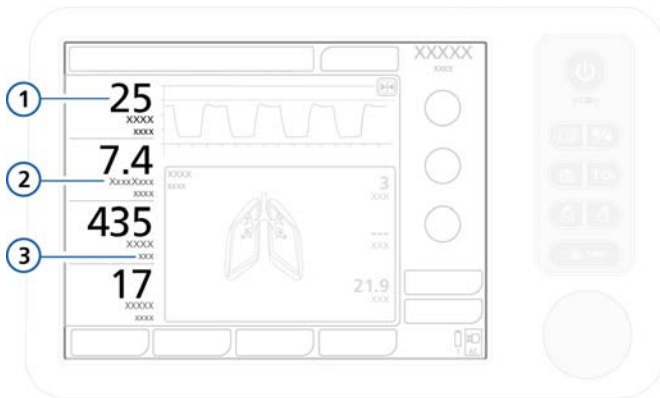

Figure 6-2. MMP components

- | | | | |
|---|--|---|--------------------------------------|
| 1 | MMP value | 3 | Unit of measure (for example, l/min) |
| 2 | Name of parameter (for example, ExpMinVol) | | |

6.2.2 Viewing patient data in the Monitoring window

The Monitoring window provides access to all of the parameter data, including CO₂ and SpO₂ values, when enabled.

Figure 6-3 shows the monitored parameters in window 1. Additional parameters are displayed in windows 2 and 3.

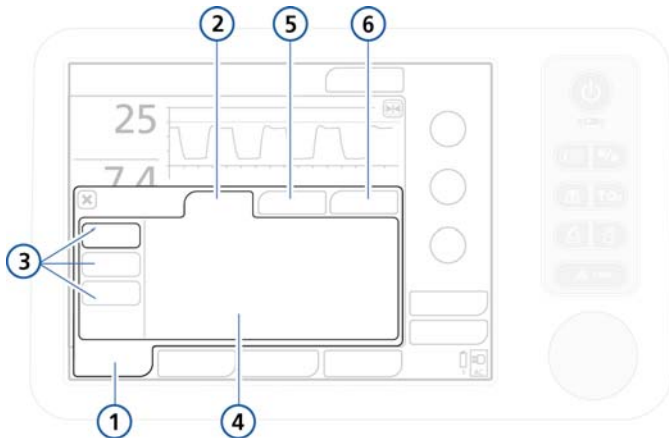

Figure 6-3. General monitoring window 1

1	Monitoring	4	Parameter values
2	General	5	CO ₂ (if installed and enabled)
3	1, 2, 3 buttons	6	SpO ₂ (if installed and enabled)

1. Touch the **Monitoring** button.
The contents of the General window are displayed.
2. In the General window, touch the **1**, **2**, or **3** button to view the parameter values in that window.
Each window displays a different set of parameters.
The **CO₂** and **SpO₂** tabs, when available, provide access to the related parameter values.

6.3 Waveforms and graphs

The HAMILTON-C1 offers two primary graphic areas on the display.

- The pressure/time waveform. This graph is always displayed and is not configurable. See item 4 in Figure 6-1.
- The following graphic views of the patient data: trends, loops, graphics (Intelligent panels), and waveforms. Table 6-1 shows the options for each graphic type.

Table 6-1. Graphics options

Graphic type	Options
Trends	1-, 6-, 12-, 24-, or 72-h ¹ trend data for a selected parameter
Loops	<ul style="list-style-type: none"> • Pressure/volume • Pressure/flow • Flow/volume • Volume/PCO2 • Volume/FCO2
Graphics	<ul style="list-style-type: none"> • Dynamic Lung • Vent Status • ASV Graph
Waveforms	<ul style="list-style-type: none"> • Flow • Volume • Off • PCO2 • FCO2

1. 72-h trends not available in all markets.

Detailed information about the Intelligent Panels is provided in Chapter 7.

6.3.1 Selecting a graphical view of patient data

To select a graphic to display

1. Touch anywhere in the graphic area of the display to open the graphics window. See **(1)** in Figure 6-4.

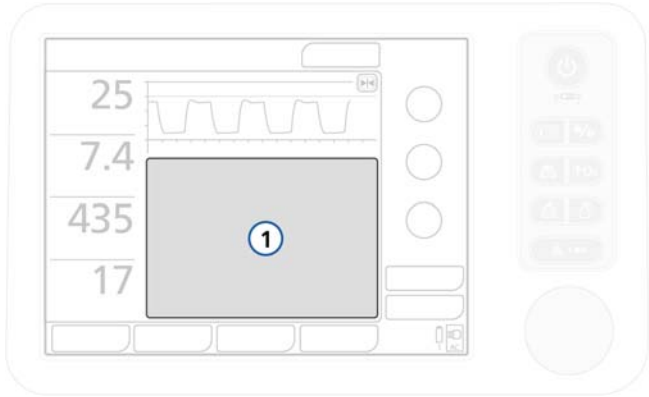

Figure 6-4. Display the graphics window (1)

2. The window displays four tabs, each of which offers different views of the data. By default, the Trends window is displayed.

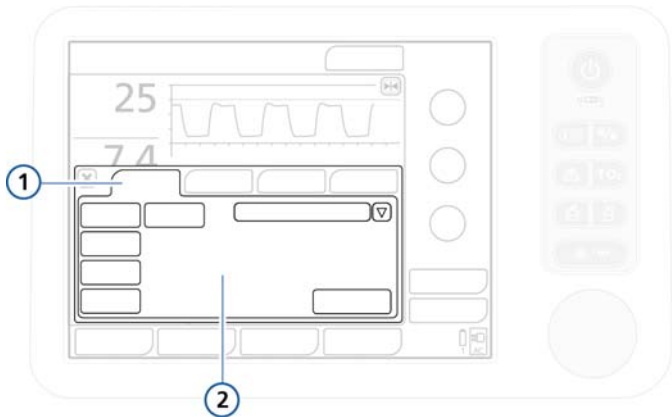

Figure 6-5. Graphics window

- | | |
|---|--|
| <ol style="list-style-type: none"> 1 Trends, Loops, Graphics, Waveforms tabs | <ol style="list-style-type: none"> 2 Settings for each view |
|---|--|

3. Touch the appropriate tab to access the desired options. See Table 6-1.

Details on these options are provided in this chapter, Chapter 7, and in Appendix C (ASV).

6.4 About graphic types

The following sections describe the different graphical display options available:

	See
Waveforms	Section 6.4.1
Trends	Section 6.5.1
Loops	Section 6.6.1
Intelligent panels (Dynamic Lung, Vent Status, ASV Graph)	Chapter 7

For details on accessing the graphics window, see Section 6.3.1.

6.4.1 Waveforms

NOTE:

The ventilator uses an autoscaling function, so the values displayed for individual waveforms may differ, based on the range of values to be displayed. For example, the flow scale may vary between one flow/time waveform to another.

The ventilator plots pressure, volume, and flow against time. A blue pressure limitation line shows the maximum “safe” pressure, which is 10 cmH₂O below the set high Pressure alarm limit. The Pressure limit is shown as a red line.

The pressure/time graph is always present. You can choose to display a second waveform, as well. For details, see 6.4.1.1.

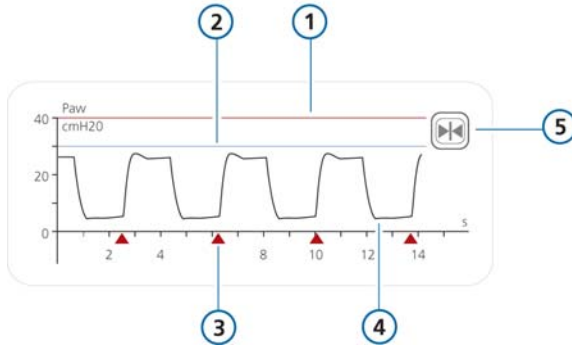

Figure 6-6. Pressure/time graph

- | | | | |
|----------|---|----------|--------------------------------|
| 1 | Pressure high alarm limit | 4 | Airway pressure (Paw) waveform |
| 2 | Pressure limitation: <i>Pressure high alarm limit -10 cmH2O</i> | 5 | Freeze button |
| 3 | Patient trigger indicator | | |

When the ventilator is in the (S)CMV+/APVcmv, or SIMV+/APV-simv mode, it uses the Pressure limit as a safety boundary for its inspiratory pressure adjustment. The ventilator does not apply inspiratory pressures higher than this pressure limitation value. An exception is sigh breaths, when the ventilator may apply inspiratory pressures 3 cmH2O below the Pressure alarm limit.

6.4.1.1 Displaying additional waveforms

To display an additional waveform

1. Touch the graphic area of the display to access the graphics window. See Section 6.3.1.
2. Touch the **Waveforms** tab.

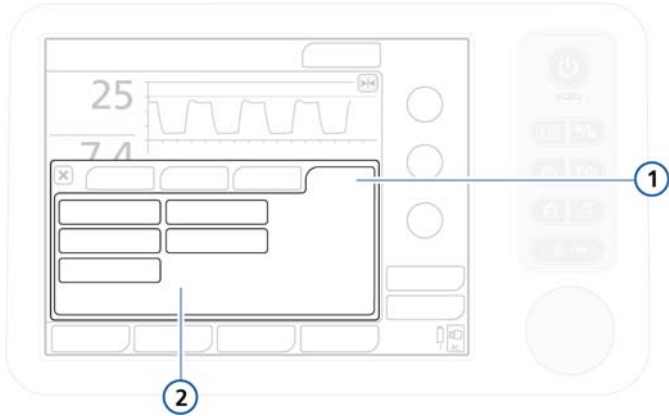

Figure 6-7. Waveforms tab, graphics window

- 1** Waveforms **2** Waveform options

3. Select the value to plot (pressure, volume, or flow, or CO₂ options (PCO₂, FCO₂) against time.
 4. Touch the **X** to close the window.
- The selected waveform is displayed.

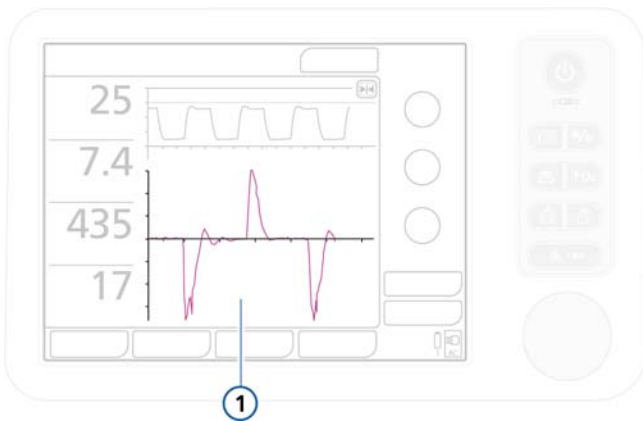

Figure 6-8. Waveform display (1)

6.4.2 Dynamic Lung

The Dynamic Lung panel visualizes tidal volume, lung compliance, patient triggering, and resistance in real-time.

For details about the panel and how to display it, see Chapter 7.

6.4.3 Vent Status

The Vent Status panel visualizes parameters related to oxygenation, CO2 elimination, and patient activity, and indicates the patient's level of ventilator dependence and when discontinuing ventilation should be considered.

For details about the panel and how to display it, see Chapter 7.

6.4.4 ASV Graph

Available in ASV mode, the ASV graph shows how the adaptive lung controller moves toward its targets. The graph shows both the target and real-time patient data for tidal volume, frequency, pressure, and minute ventilation.

For details about the panel and how to display it, see Chapter 7 and Appendix C.

6.5 Trends

NOTE:

- 72-h trends not available in all markets.
 - The neonatal Flow parameter cannot be selected for a trend graph.
-

You can view monitored parameters as 1-, 6-, 12-, 24-, or 72-h trends. Trend data includes all data for the selected parameter since you switched on the ventilator for the past 1, 6, 12, 24, or 72 hours.

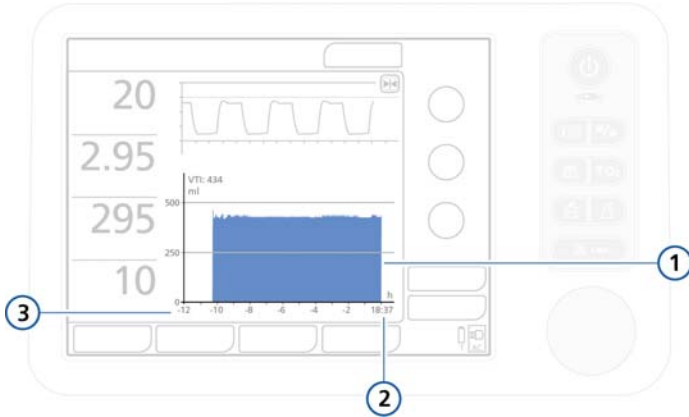

Figure 6-9. Trend display

- | | |
|-----------------------|---|
| 1 Trend graph | 3 Elapsed time relative to present |
| 2 Current time | |

From the time you turn on the HAMILTON-C1, the ventilator continually stores the monitored parameters in its memory, so you have access to any of this data, even after standby. If the HAMILTON-C1 is turned off, the data of the last patient is available in memory when ventilator is turned on again.

The freeze and cursor measurement function (Section 6.8) can also be used to examine points on trend waveforms. When trends are frozen, the time axis shows elapsed time relative to the present and the corresponding value of the monitored parameter.

All monitoring parameters can be trended. The following parameters are trended in combination:

- Ppeak/PEEP
- fTotal/fControl
- MVSPONT/ExpMinVol
- Vtalv/VTE

6.5.1 Displaying trends

To display trends

1. Touch the graphic area of the display to access the graphics window. See Section 6.3.1.
2. Touch the **Trends** tab.

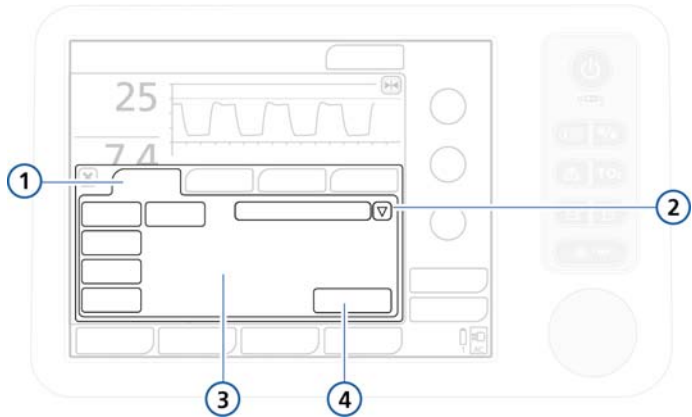

Figure 6-10. Trends tab

1	Trends	3	Trend time
2	Parameter list	4	Confirm button

3. Select the parameter to review:
 - a. Touch the arrow next to the Parameter list, and turn the P&T knob to scroll through the list.
 - b. Press the knob to select an entry.
 4. Select the desired trend time button.
 5. Touch the **Confirm** button.
 6. Touch the **X** to close the window.
- The selected trend information is displayed.

6.6 Loops

The HAMILTON-C1 can display a dynamic loop based on the following parameter combinations, depending on the options installed.

- Pressure/volume
- Flow/volume
- Pressure/flow
- Volume/FCO₂
- Volume/PCO₂

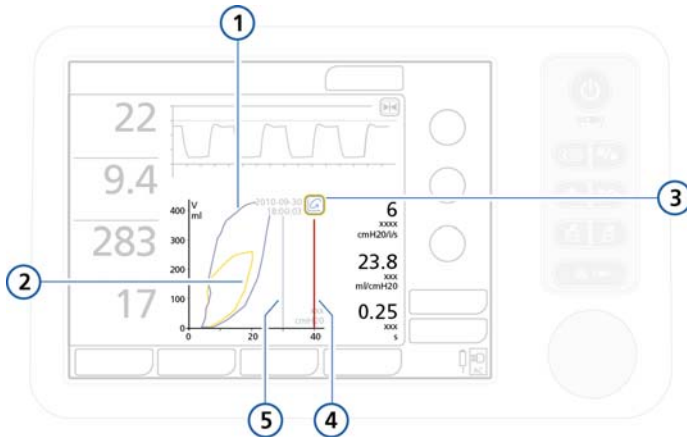

Figure 6-11. Loop display

- | | | | |
|---|-------------------------------|---|--|
| 1 | Curve in the past (reference) | 4 | Pressure high alarm limit |
| 2 | Current curve | 5 | Pressure limitation: <i>Pressure high alarm limit -10 cmH₂O</i> |
| 3 | Loop reference button | | |

6.6.1 Displaying loops

To display loops

1. Touch the graphic area of the display to access the graphics window. See Section 6.3.1.
2. Touch the **Loops** tab.

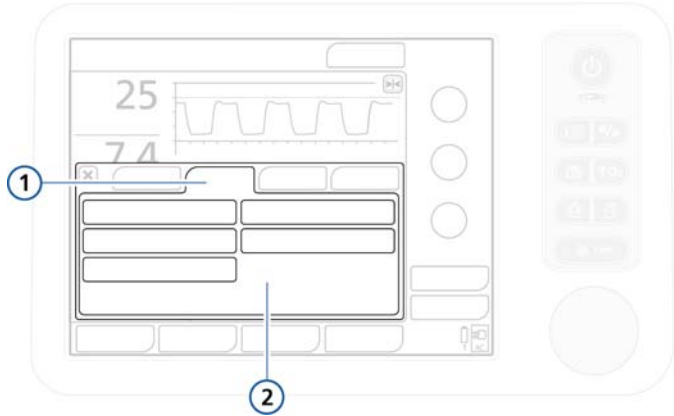

Figure 6-12. Loops tab

-
- | | | | |
|----------|-------|----------|-------------------------------|
| 1 | Loops | 2 | Parameter combination options |
|----------|-------|----------|-------------------------------|
-

3. Touch the button for the parameter combination to display.
 4. Touch the **X** to close the window.
- The selected combination is displayed (Figure 6-11).

6.6.2 Storing loops

To store a new loop

In the Loop display (Figure 6-11), touch the **Loop reference** button (Figure 6-11) to store the loop curve with the current date and time. The past and current characteristics are shown.

If the parameter combination is changed and the **Loop reference** button is pressed again, the present curve is stored. The one before is lost.

6.7 Table of monitored parameters

NOTE:

The HAMILTON-C1 automatically measures inspiratory resistance (R_{insp}), compliance (C_{stat}), and AutoPEEP breath by breath, during mandatory and spontaneous breaths in all modes, without interruption in ventilation.

To obtain these measurements, the HAMILTON-C1 uses a statistical technique called the Least Squares Fitting (LSF) method. This method is applied on a breath-by-breath basis, without the need for special inspiratory flow patterns and occlusion maneuvers, provided that the patient is relaxed or nearly relaxed.

Actively breathing patients can create artifacts or noise, which can affect the accuracy of these measurements, however. The more active the patient, the less accurate the measurements. To minimize patient participation during these measurements, you may want to increase P_{support} by 10 cmH₂O. After completion, return this control to its former setting.

Table 6-2 is an alphabetical list of the HAMILTON-C1's monitored parameters. These parameters are displayed in the individual parameter windows 1, 2, and 3 (Figure 6-3). The display of monitored parameters is updated every breath.

Table A-7 in Appendix A provides the parameter ranges and accuracy.

Table 6-2. Monitored parameters

Parameter (unit)	Definition
AutoPEEP (cmH2O)	<p>The difference between the set PEEP and the calculated total PEEP within the lungs. AutoPEEP is the abnormal pressure generated by air “trapped” in the alveoli due to inadequate lung emptying. Ideally, it should be zero. AutoPEEP is calculated using the LSF method applied to the entire breath.</p> <p>When AutoPEEP is present, volutrauma or barotrauma might develop. In active patients, AutoPEEP may present an extra workload to the patient.</p> <p>AutoPEEP or air trapping may result from an expiratory phase that is too short, which may be observed under these conditions:</p> <ul style="list-style-type: none">• Delivered tidal volume too large• Expiratory time too short or respiratory rate too high• Circuit impedance too high or expiratory airway obstruction• Peak expiratory flow too low
Cstat (ml/cmH2O)	<p>Static compliance of the respiratory system, including lung and chest wall compliances. It is calculated using the LSF method. Cstat can help diagnose changes in elastic characteristics of the patient’s lungs. Also displayed in the Dynamic Lung panel.</p> <hr/> <p>NOTE:</p> <p>Actively breathing patients can create artifact or noise, which can affect the accuracy of these measurements, however. To minimize patient participation during these measurements, you may want to increase P_{support} by 10 cmH2O. After completion, return this control to its former setting.</p> <hr/>
Exp Flow (l/min)	Peak expiratory flow.

Table 6-2. Monitored parameters *(continued)*

Parameter (unit)	Definition
ExpMinVol (l/min) MinVol NIV	Expiratory minute volume. The moving average of the monitored expiratory volume per minute over the last 8 breaths. ExpMinVol changes to MinVol NIV in noninvasive modes. MinVol NIV is an adjusted parameter taking into account the leakage.
fControl (b/min)	Mandatory breath frequency. The moving average of machine-delivered breaths per minute over the last 8 total breaths.
Flow (l/min)	<p>Only active in the nCPAP and nCPAP-PC modes.</p> <p>Displays the current flow as follows:</p> <ul style="list-style-type: none"> • In nCPAP mode, this value is the average flow, updated every second. • In nCPAP-PC mode, this value is the average flow during expiration, updated every breath. <p>Flow can be configured as a main monitoring parameter (MMP).</p> <p>Flow is affected by the setting of the Flow alarm. See Chapter 5.</p>
fSpont (b/min)	<p>Spontaneous breath frequency. The moving average of spontaneous breaths per minute over the last 8 total breaths.</p> <p>An increased fSpont may indicate that the patient is compensating for a low compliance. This may indicate ventilatory fatigue due to imposed work of breathing.</p>
fTotal (b/min)	<p>Total breathing frequency. The moving average of the patient's total breathing frequency over the last 8 breaths, including both mandatory and spontaneous breaths. When the patient triggers or the user initiates a breath, fTotal may be higher than the Rate setting.</p> <hr/> <p>NOTE:</p> <p>Respiratory rate monitoring on the HAMILTON-C1 requires breath delivery followed by detection of expiratory flow at the proximal flow sensor.</p> <hr/>

Table 6-2. Monitored parameters (continued)

Parameter (unit)	Definition
I:E	Inspiratory:expiratory ratio. Ratio of the patient's inspiratory time to expiratory time for every breath cycle. This includes both mandatory and spontaneous breaths. I:E may differ from the set I:E ratio if the patient breathes spontaneously.
Insp Flow (l/min)	Peak inspiratory flow, spontaneous or mandatory, measured every breath.
MVSpont/ MVSpont NIV (l/min)	Spontaneous expiratory minute volume. The moving average of the monitored expiratory volume per minute for spontaneous breaths, over the last 8 mandatory and spontaneous breaths. In noninvasive ventilation modes, MVSpont is replaced by MVSpont NIV. MV Spont NIV is an adjusted parameter taking into account the leakage.
Oxygen (%)	Oxygen concentration of the delivered gas. It is measured by the oxygen cell in the inspiratory pneumatics. This parameter is not displayed if the oxygen cell is not installed, is defective, or is not a genuine Hamilton Medical part; or if oxygen monitoring is disabled.
P0.1 (cmH2O)	<hr/> <p>NOTE: Due to changes in pneumatic impedance, P0.1 values may vary with different settings of the Trigger function.</p> <hr/> <p>Airway occlusion pressure. The maximum slope of the airway pressure drop during the first 100 ms when the airway is occluded. P0.1 indicates the patient's respiratory drive and efforts. It applies to patient-triggered breaths only.</p> <p>A P0.1 value of -3 cmH2O indicates a strong inspiratory effort, and a value of -5 cmH2O, an excessive effort, possibly because the patient is "air hungry" (peak inspiratory flow or total ventilatory support is inadequate) or has an excessive drive.</p> <p>If P0.1 is below -3 cmH2O:</p> <ul style="list-style-type: none"> • Increase pressure or volume settings (depending on mode) • Increase %MinVol if in manual mode • Shorten P-ramp time

Table 6-2. Monitored parameters *(continued)*

Parameter (unit)	Definition
PEEP/CPAP (cmH ₂ O)	<p>Monitored PEEP (positive end expiratory pressure)/CPAP (continuous positive airway pressure). The airway pressure at the end of exhalation.</p> <p>Measured PEEP/CPAP may differ slightly from set PEEP/CPAP, especially in actively breathing patients.</p>
P _{insp} (cmH ₂ O)	<p>Inspiratory pressure, the automatically calculated target pressure (additional to PEEP/CPAP) applied during the inspiratory phase. Available in the Vent Status panel.</p> <p>P_{insp} is:</p> <p>(S)CMV+, SIMV+: Automatically calculated target pressure (PCV+): Pcontrol setting PSIMV+, NIV-ST: P_{insp} setting SPONT, NIV: P_{support} setting APRV, DuoPAP: P_{high} setting</p>
P _{mean} (cmH ₂ O)	<p>Mean airway pressure. The absolute pressure, averaged over the breath cycle.</p> <p>P_{mean} is an important indicator of the possible impact of applied positive pressure on hemodynamics and surrounding organs.</p>
P _{peak} (cmH ₂ O)	<p>Peak airway pressure. The highest pressure during the previous breath cycle. It is influenced by airway resistance and compliance. It may differ noticeably from alveolar pressure if airway flow is high.</p>
P _{plateau} (cmH ₂ O)	<p>Plateau or end-inspiratory pressure. The pressure measured at the end of inspiration when flow is or is close to zero.</p> <p>P_{plateau} is displayed for mandatory and time-cycled breaths.</p> <p>P_{plateau} is a rough representation of alveolar pressure.</p>

Table 6-2. Monitored parameters (continued)

Parameter (unit)	Definition										
PTP (cmH ₂ O*s)	<p>Inspiratory pressure time product. The measured pressure drop required to trigger the breath multiplied by the time interval until the PEEP/CPAP level is reached at the beginning of inspiration.</p> <p>The PTP indicates work by the patient to trigger the breath. The work depends on</p> <ul style="list-style-type: none"> • The intensity of the patient’s effort • The trigger sensitivity • The volume and resistance of the breathing circuit <p>PTP is valid for patient-initiated breaths only.</p> <p>The PTP does not indicate total patient work. But it is a good indicators of how well the ventilator is adapted to the patient.</p> <p>If PTP values increase...</p> <ul style="list-style-type: none"> • Check and remove water in tubes • Increase trigger sensitivity 										
RCexp (s)	<p>Expiratory time constant. The rate at which the lungs empty, as follows:</p> <table data-bbox="364 885 655 1061"> <thead> <tr> <th><i>Actual TE</i></th> <th><i>% emptying</i></th> </tr> </thead> <tbody> <tr> <td>1 x RCexp</td> <td>63%</td> </tr> <tr> <td>2 x RCexp</td> <td>86.5%</td> </tr> <tr> <td>3 x RCexp</td> <td>95%</td> </tr> <tr> <td>4 x RCexp</td> <td>98%</td> </tr> </tbody> </table> <p>RCexp is calculated as the ratio between VTE and flow at 75% of the VTE.</p> <p>In adults, an RCexp value above 1.2 s indicates airway obstruction, and a value below 0.5 s indicates a severe restrictive disease.</p> <p>Use RCexp to set optimal TE (Goal: TE ≥ 3 x RCexp):</p> <ul style="list-style-type: none"> • In passive patients: Adjust rate and I:E. • In active patients: Increase Psupport and/or ETS to achieve a longer TE. <p>These actions may reduce the incidence of AutoPEEP.</p>	<i>Actual TE</i>	<i>% emptying</i>	1 x RCexp	63%	2 x RCexp	86.5%	3 x RCexp	95%	4 x RCexp	98%
<i>Actual TE</i>	<i>% emptying</i>										
1 x RCexp	63%										
2 x RCexp	86.5%										
3 x RCexp	95%										
4 x RCexp	98%										

Table 6-2. Monitored parameters (continued)

Parameter (unit)	Definition
Rinsp (cmH ₂ O/(l/s))	<p>Resistance to inspiratory flow caused by the endotracheal tube and the patient's airways, during inspiration. It is calculated using the LSF method applied to the inspiratory phase. Also displayed in the Dynamic Lung panel.</p> <hr/> <p>NOTE: Actively breathing patients can create artifact or noise, which can affect the accuracy of these measurements, however. To minimize patient participation during these measurements, you may want to increase P_{supp} by 10 cmH₂O. After completion, return this control to its former setting.</p> <hr/>
TE (s)	<p>Expiratory time. In mandatory breaths, TE is measured from the start of exhalation until the set time has elapsed for the switchover to inspiration. In spontaneous breaths, TE is measured from the start of exhalation, as dictated by the ETS setting, until the patient triggers the next inspiration. TE may differ from the set expiratory time if the patient breathes spontaneously.</p>
TI (s)	<p>Inspiratory time. In mandatory breaths, TI is measured from the start of breath delivery until the set time has elapsed for the switchover to exhalation. In spontaneous breaths, TI is measured from the patient trigger until the flow falls to the ETS setting, for the switchover to exhalation. TI may differ from the set inspiratory time if the patient breathes spontaneously.</p>

Table 6-2. Monitored parameters *(continued)*

Parameter (unit)	Definition
VLeak(%) MVLeak (l/min)	<p>Due to the leakage at the patient interface, displayed exhaled volumes in the noninvasive modes can be substantially smaller than the delivered volumes. The flow sensor measures the delivered volume and the exhaled tidal volume; the ventilator displays the difference as VLeak in %, and as MVLeak in l/min, averaged over the past 8 breaths.</p> <p>VLeak/MVLeak can indicate leaks on the patient side of the flow sensor (endotracheal tube, chest tube, mask). They do not include leakage between the ventilator and flow sensor.</p> <p>Use VLeak and MVLeak to assess the fit of the mask or other noninvasive patient interface.</p> <p>Not applicable in nCPAP, nCPAP-PC modes.</p>
VTE VTE NIV (ml)	<p>Expiratory tidal volume. The volume exhaled by the patient. It is determined from the Flow Sensor measurement, so it does not show any volume added due to compression or lost due to leaks in the breathing circuit. If there is a gas leak at patient side, the displayed VTE may be less than the tidal volume the patient actually receives. In non invasive ventilation modes, VTE is replaced by VTE NIV. VTE NIV is an adjusted parameter taking into account the leakage</p>
VTEspont (ml)	<p>Spontaneous expiratory tidal volume. The volume exhaled by the patient. If there is a gas leak at patient side, the displayed VTEspont may be less than the tidal volume the patient actually receives. Only displayed for spontaneous breaths.</p>
VTI (ml)	<p>Inspiratory tidal volume. The volume delivered to the patient. It is determined from the flow sensor measurement. If there is a gas leak at the patient side, the displayed VTI may be larger than the displayed VTE.</p>

6.8 Freeze and cursor measurement

This function lets you freeze the display of a graphic for up to 30 s.

The freeze function is particularly useful when you perform a breath hold maneuver. The screen automatically freezes following a successful inspiratory maneuver.

To freeze the graphic



1. In the pressure/time waveform, touch the **Freeze** button in the right upper corner (item 5 in Figure 6-6). The graphic is frozen for 30 s.
2. To analyze the curves, turn the Press-and-turn knob.
3. Unfreeze by pressing the **Freeze** button again or by pressing the Press-and-turn knob.

7 Intelligent panels

7.1	Dynamic Lung panel	7-2
7.1.1	Displaying the Dynamic Lung	7-3
7.1.2	Tidal volume (Vt)	7-3
7.1.3	Compliance (Cstat)	7-4
7.1.4	Patient triggering: Muscle	7-4
7.1.5	Resistance (Rinsp): Bronchial tree	7-5
7.2	Vent Status panel	7-6
7.2.1	Displaying the Vent Status panel	7-8
7.3	ASV Graph panel	7-9
7.3.1	Displaying the ASV Graph	7-9

You can lay out the ventilator screen to display any of the three types of Intelligent Panel, which are described in this chapter.

7.1 Dynamic Lung panel

NOTE:

The Dynamic Lung panel is not available for neonates.

The Dynamic Lung panel visualizes tidal volume, lung compliance, patient triggering, and resistance in real-time. The lungs expand and contract in synchrony with actual breaths. Numeric values for resistance (R_{insp}) and compliance (C_{stat}) are displayed. In addition, the shape of the lungs and the bronchial tree are also related to the compliance and resistance values. If all values are in a normal range, the panel is framed in green.

If the SpO₂ option is installed and enabled, the panel also shows SpO₂ and pulse rate. For details, see the Pulse oximetry appendix.

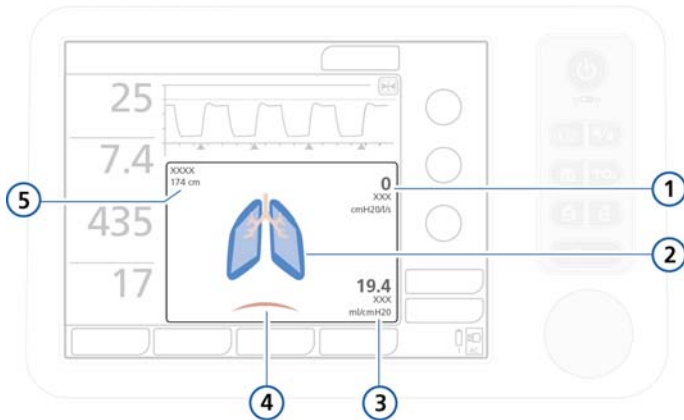

Figure 7-1. Dynamic Lung panel

- | | | | |
|---|---|---|-----------------------------|
| 1 | Resistance of the lung (R _{insp}) | 4 | Patient trigger (diaphragm) |
| 2 | “Normal” lungs (reference) | 5 | Gender and IBW |
| 3 | Compliance of the lung (C _{stat}) | | |

7.1.1 Displaying the Dynamic Lung

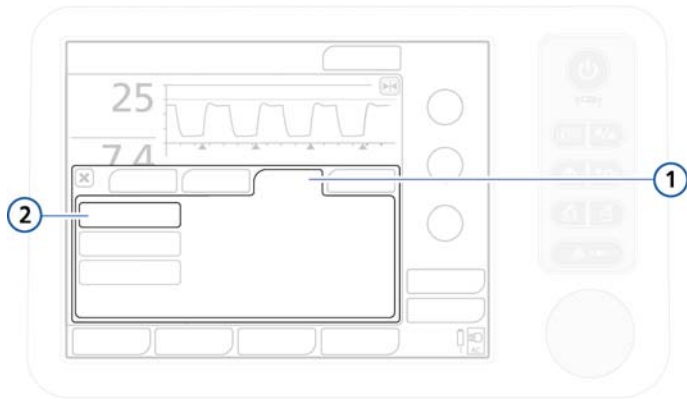

Figure 7-2. Graphics tab, Dynamic Lung

1 Graphics **2** Dynamic Lung

To display the Dynamic Lung

1. Touch the graphic area at the bottom half of the display to access the graphics-selection window. See Figure 6-4.
2. Touch the **Graphics** tab.
3. Touch the **Dynamic Lung** button.
4. Touch the **X** to close the window.

The Dynamic Lung is displayed. See Figure 7-1.

7.1.2 Tidal volume (Vt)

The Dynamic Lung expands and contracts to show tidal volume (Vt) in real-time. It moves in synchrony with actual breaths, based on the proximal flow sensor signal. The lung size shown is relative to “normal” size for the patient’s height (IBW), based on a “normal” value of 10 ml/kg.

A disconnection alarm is visualized by a deflated lung. An Exhalation obstructed alarm is visualized by an inflated lung.

7.1.3 Compliance (Cstat)

The Dynamic Lung shows compliance (Cstat) breath by breath relative to “normal” values for the patient’s height. As the figure shows, the shape of the lungs changes with compliance. The numeric value is also displayed. The lung in the middle shows “normal” compliance.



Figure 7-3. Compliance shown by the Dynamic Lung

- 1 Low compliance
- 2 Normal compliance
- 3 High compliance

7.1.4 Patient triggering: Muscle

The muscle in the Dynamic Lung shows patient triggering.

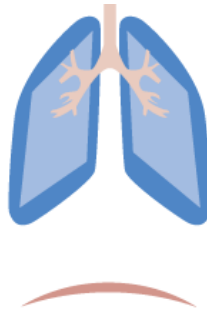

Figure 7-4. Patient triggering shown by the Dynamic Lung muscle

7.1.5 Resistance (R_{insp}): Bronchial tree

The bronchial tree in the Dynamic Lung shows resistance (R_{insp}) breath by breath relative to “normal” values for the patient’s height. The numeric value is also displayed. The gray portion of the image shows the relative degree of resistance: the leftmost tree shows normal resistance.

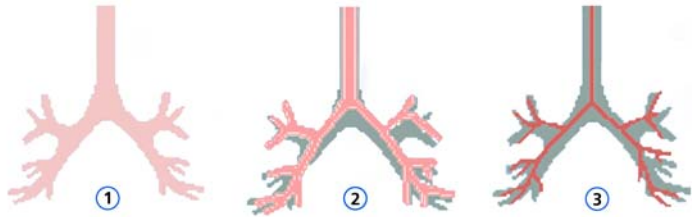

Figure 7-5. R_{insp} shown by the bronchial tree of the Dynamic Lung

- | | |
|------------------------------|-------------------|
| 1 Normal resistance | 3 High resistance |
| 2 Moderately high resistance | |

Table 7-1. Dynamic Lung normal values

Parameter	Definition of normal value
Tidal volume (V _t)	10 ml/kg IBW (calculated from Pat. height)
Compliance (C _{stat})	For Pat. height between 30 and 135 cm (11 and 53 in): $0.000395 * \text{Pat. height}^{2.38}$ For Pat. height > 135 cm (53 in): $-0.0028 * \text{Pat. height}^2 + 1.3493 * \text{Pat. height} - 84.268$
Resistance (R _{insp})	For Pat. height ≤ 210 cm (83 in): $(1.993 - 0.0092 * \text{Pat. height}) * 10.2 + 5$ For Pat. height > 210 cm (83 in): $0.5 + 5$

7.2 Vent Status panel

The Vent Status panel (Figure 7-6) displays six parameters related to the patient's ventilator dependence, including oxygenation, CO₂ elimination, and patient activity.

A floating indicator (floater) moving up and down within the column shows the value for a given parameter. When the indicator is in the light blue (weaning) zone, a timer starts, showing how long that value has been in the weaning zone. When all values are in the weaning zone, the Vent Status panel is framed in green, indicating that weaning should be considered. The panel is updated breath by breath.

Table 7-2 describes the parameters shown in the Vent Status panel. You can configure the weaning zone ranges in configuration. To set these values, see Section I.6.1, step 9.

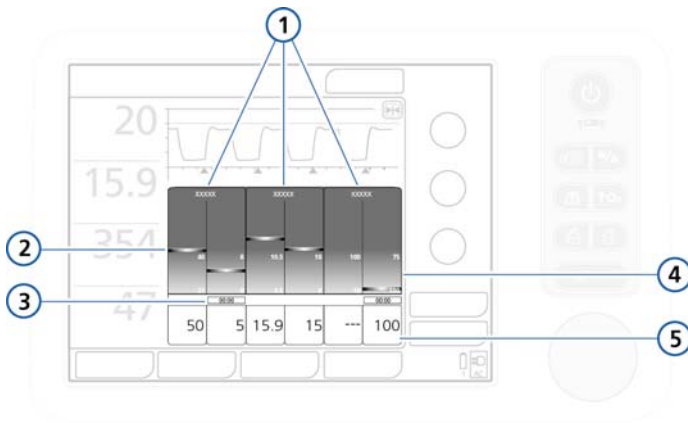

Figure 7-6. Vent Status panel

- | | |
|---|--|
| <p>1 Group title</p> <p>2 Monitored value, graphic (floater)</p> <p>3 Elapsed time value has been in weaning zone</p> | <p>4 Light blue weaning zone with user-configurable limits</p> <p>5 Monitored value, numeric</p> |
|---|--|

The following table describes the Vent Status parameters. For parameter ranges and details, see the tables in Appendix A.

Table 7-2. Vent Status parameters

Parameter (unit)	Definition
<i>For additional details, including ranges and accuracy, see Table A-5 on page A-6.</i>	
Oxygen (%)	Oxygen setting.
PEEP (cmH ₂ O)	PEEP/CPAP setting.
MinVol (l/min)	Normal minute ventilation (defined in Appendix C).
Pinsp (cmH ₂ O)	Inspiratory pressure, the target pressure (additional to PEEP/CPAP) applied during the inspiratory phase.
RSB (1/(l*min)) ¹	<p>Rapid shallow breathing index. The total breathing frequency (fTotal) divided by the exhaled tidal volume (VTE).</p> <p>Because a patient with dyspnea typically takes faster, shallower breaths than a non-dyspnoeic patient, RSB is high in the dyspnoeic patient and low in the non-dyspnoeic patient.</p> <p>RSB is often used clinically as an indicator to judge whether a ventilated patient is ready for weaning.</p> <p>RSB has significance for spontaneously breathing patients only and is shown only if 80% of the last 25 breaths are spontaneous.</p>
%fSpont (%)	Spontaneous breath percentage. The moving average of the percentage of spontaneous breaths over the last 8 total breaths.

1. Weaning zone defaults are based on a normal of <100/(l*min) for adult patients.

7.2.1 Displaying the Vent Status panel

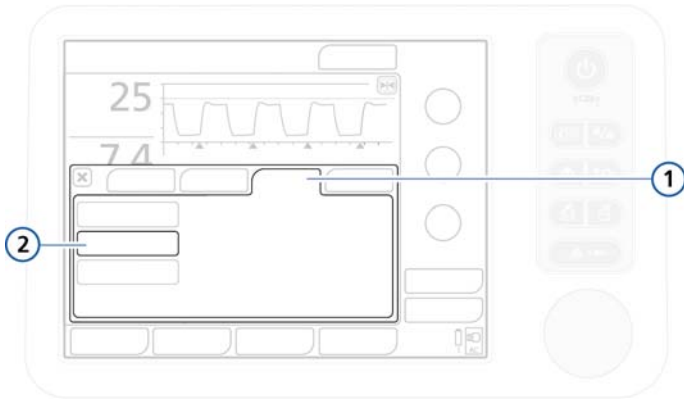

Figure 7-7. Graphics tab, Vent Status

1 Graphics **2** Vent Status

To display the Vent Status panel

1. Touch the graphic area of the display to access the graphics-selection window. See Figure 6-4.
 2. Touch the **Graphics** tab.
 3. Touch the **Vent Status** button.
 4. Touch the **X** to close the window.
- The Vent Status panel is displayed (Figure 7-6).

7.3 ASV Graph panel

Available in ASV mode, the ASV Graph shows how the adaptive lung controller moves toward its targets. The graph shows both the target and real-time patient data for tidal volume, frequency, pressure, and minute ventilation.

For details about the graph, see Figure C-5 in the ASV appendix.

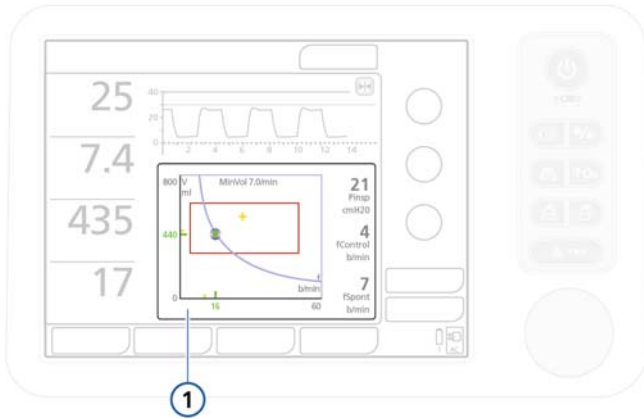

Figure 7-8. ASV target graphics window (1)

7.3.1 Displaying the ASV Graph

To display the ASV graph

1. Touch the graphic area of the display to access the graphics window. See Section 6.3.1.
2. Touch the **Graphics** tab. See Figure 7-9.

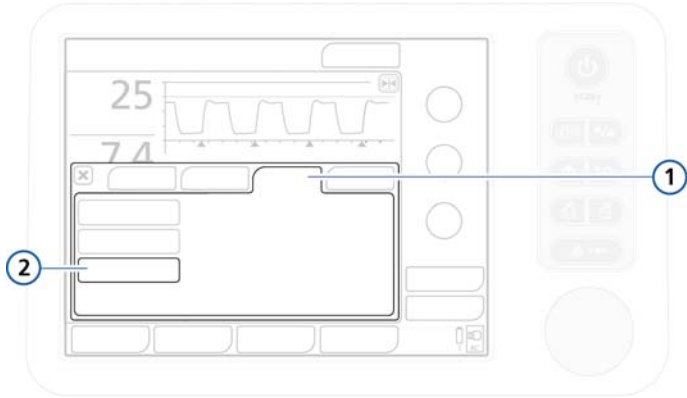

Figure 7-9. Graphics tab

- 1** Graphics **2** ASV Graph

3. Touch the **ASV Graph** button.
4. Touch the **X** to close the window.
The ASV target graphic is displayed (Figure 7-8).

8 Responding to alarms

8.1	Introduction	8-2
8.2	Responding to an alarm	8-6
8.3	Alarm buffer	8-7
8.4	About the event log	8-9
8.5	Alarm troubleshooting table	8-10

8.1 Introduction

The HAMILTON-C1 alarms notify the operator of problems. These alarms can be categorized as:

- High priority
- Medium priority
- Low priority

Additionally there are other alarm conditions associated with technical fault alarms and operator messages.

The main monitoring parameters (MMP) change their colors when a corresponding alarm activates. The color reflects the priority of the alarm.

Table 8-1 shows the audio and visual characteristics of these types of alarm and tells you how to respond. Figure 8-1 shows the ventilator's visual alarm indications. You can view active alarms in the active alarm buffer (Figure 8-4). Information about the alarm is also stored in an event log (Section 8.4).

When an alarm condition is serious enough to possibly compromise safe ventilation, the device defaults to the ambient state (Appendix B). The inspiratory valve closes, and the ambient and expiratory valves are opened, letting the patient breathe room air unassisted.

For details on setting alarm limits, see Section 4.7.

Table 8-1. Alarm indications in HAMILTON-C1

Alarm type	Message bar¹	Alarm lamp	Audio	Action required
High-priority alarm	Red, with alarm message	Red, flashing	A sequence of 5 beeps, repeated until the alarm is reset. If the audible alarm is not silenced during the first minute, the continuous-tone buzzer also sounds.	The patient's safety is compromised. The problem needs immediate attention.
Medium-priority alarm	Yellow, with alarm message	Yellow, flashing	A sequence of 3 beeps, repeated periodically. If the audible alarm is not silenced during the first minute, the continuous-tone buzzer also sounds.	The patient needs prompt attention.
Low-priority alarm	Yellow, with alarm message	Yellow, solid	Two sequences of beeps. This is not repeated.	Operator awareness is required.
Technical fault	Red, with the text, Safetyventilation:xxxx xx or Technicalfault:xxxxxx	Red, flashing	Same as for high-priority alarm, if technically possible. At a minimum, a continuous buzzer tone. The buzzer cannot be silenced.	The ventilator enters the safety mode, or, if it cannot safely ventilate, the ambient state. Provide alternative ventilation. Turn off the ventilator. Have the ventilator serviced.
Technical event	Depends on severity of the event. Can be low, medium, or high.	Same as the associated alarm level (as described above)	Same as the associated alarm level (as described above).	A technical alarm cannot typically be corrected by the operator. Ventilation continues. Have the ventilator serviced.

1. If more than one alarm is active, the associated alarm messages alternate in the message bar.

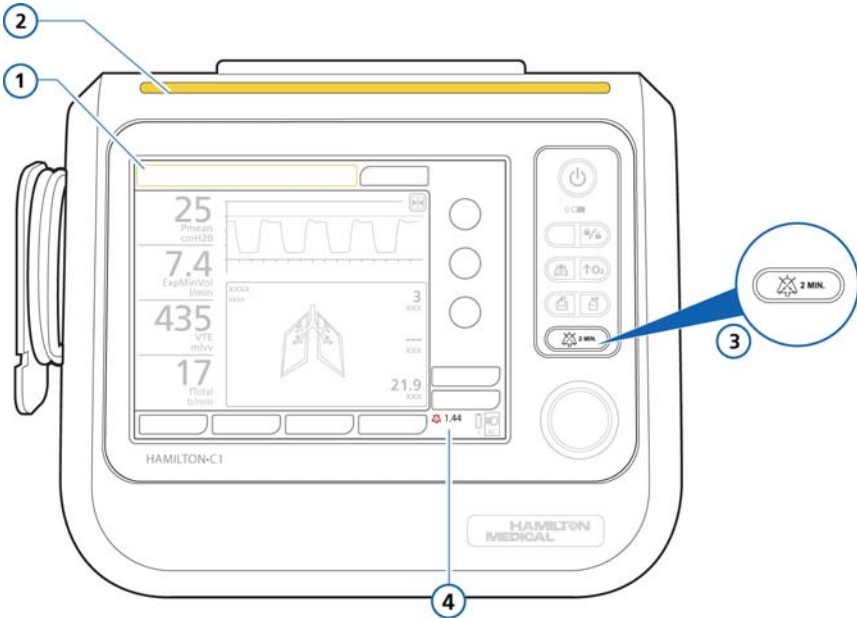

Figure 8-1. Visual alarm indications

- | | | | |
|----------|-------------|----------|---------------------------------------|
| 1 | Message bar | 3 | Alarm silence key |
| 2 | Alarm lamp | 4 | Alarm silence indicator and countdown |

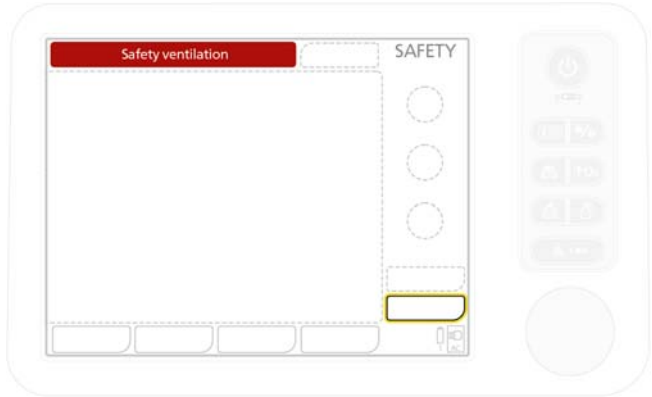

Figure 8-2. Safety ventilation

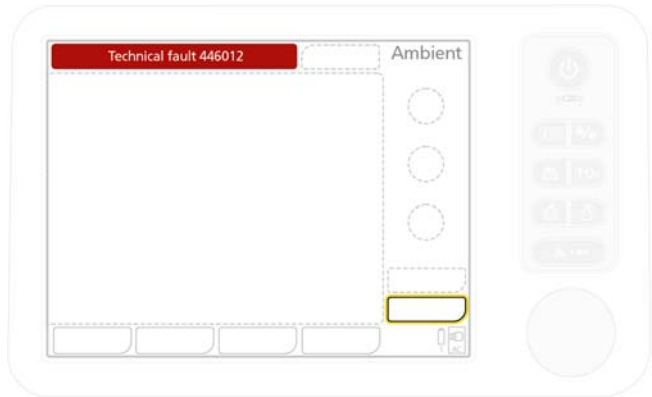

Figure 8-3. Ambient state

For details about Safety mode and the Ambient state, see Appendix B.

8.2 Responding to an alarm

WARNING

- To prevent possible patient injury when alarms are active, check the patient for adequate ventilation. Identify and remove the cause of the alarms. Readjust the alarm limits only when they are inappropriately set for the current conditions.
 - To prevent possible patient injury arising from any issues with the device, Hamilton Medical recommends that you immediately remove any ventilator with a technical fault from use, record the technical fault code, and have the ventilator serviced.
-

CAUTION

Setting alarm limits to extreme values can render the alarm system useless.

NOTE:

- Be aware that an alarm may result from either a clinical condition or an equipment problem.
 - Be aware that one alarm condition can induce multiple alarms. Normally only one or two indicate the root cause of the alarm; the rest are resultant. Your search for the causes of the alarm condition should be assisted by, but not limited to, the alarm messages displayed.
-

To respond to an alarm

1. Approach the patient immediately. Secure sufficient and effective ventilation for the patient. You may silence the alarm if possible.
2. Correct the alarm condition from the alarm messages, referring to Table 8-2. For low-, medium-, and high-priority alarms, when the alarm triggering condition is corrected, the ventilator automatically resets the alarm. For a technical fault alarm, switch off ventilator power first; then correct the problem.

8.3 Alarm buffer

The alarm buffer shows up to six alarm messages:

- If there are currently active alarms, the alarm buffer shows the most recent active alarms (Figure 8-4). The associated alarm messages also alternate in the message bar. Active alarms are in boxes with rounded corners.
- If no alarms are active, the alarm buffer shows the most recent inactive alarms (Figure 8-5). Inactive alarms are in boxes with square corners.

To view alarms

Open the Alarms -> Buffer window by doing one of the following:

- Touch the message bar in the upper left-hand corner
- Touch the inactive alarm indicator (the i-icon) (Figure 8-5)

The most recent alarm is at the top of the list.

To clear the alarm messages for all inactive alarms, touch the **Reset** button (Figure 8-5). Closing the buffer does not erase its contents.

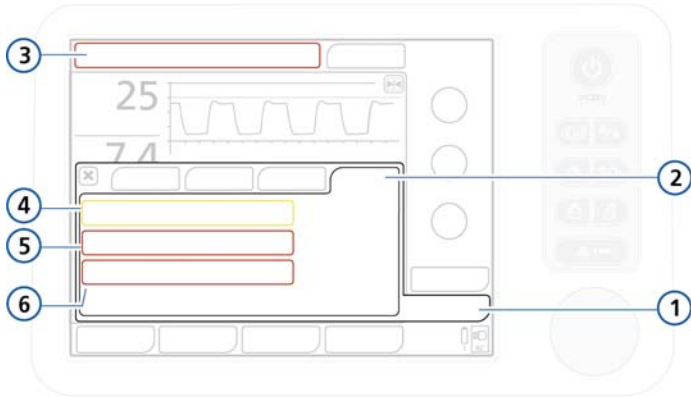

Figure 8-4. Alarm buffer with active alarms

- | | |
|--------------------------|--|
| 1 Alarms | 4 Low- or medium priority alarm (yellow) |
| 2 Buffer | 5 High priority alarm (red) |
| 3 Currently active alarm | 6 Round corners |

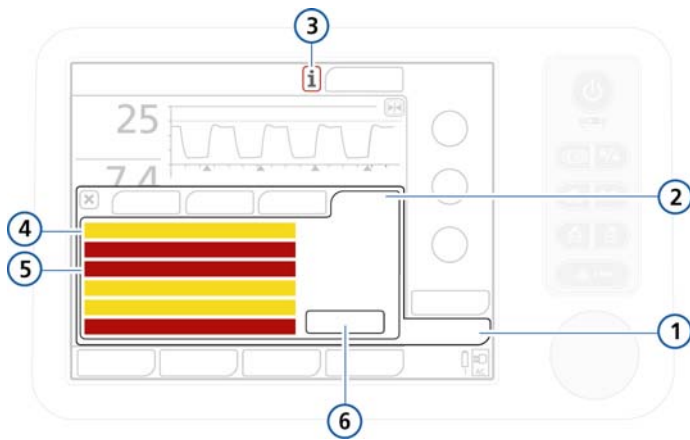

Figure 8-5. Alarm buffer with inactive alarms

- | | |
|---------------------------|--|
| 1 Alarms | 4 Inactive low- or medium-priority alarm (yellow square box) |
| 2 Buffer | 5 Inactive high-priority alarm (red square box) |
| 3 i-icon: Inactive alarms | 6 Reset button |

8.4 About the event log

Once the ventilator is turned on, several event logs collect data about clinically relevant ventilator activities, including alarms, setting changes, calibrations, maneuvers, and special functions. The date, time, and a unique identification reference (ID) for event classification is included. Alarms are shown in color, depending on priority level (yellow for low or medium, red for high). Note that a more extensive log including technical and configuration information is available to service engineers.

When setting up a new patient:

- Data is appended to the existing event log when you select the **Last patient** tab.
- The event log is cleared and starts anew when you select a different patient group tab (**Adult/Ped.** or **Neonatal**).

Event log data persists after shutting off the ventilator or in the event of a power loss. A maximum of 1000 events is stored. When a log buffer is full, new events overwrite the oldest log entries.

View the event log in the Events window.

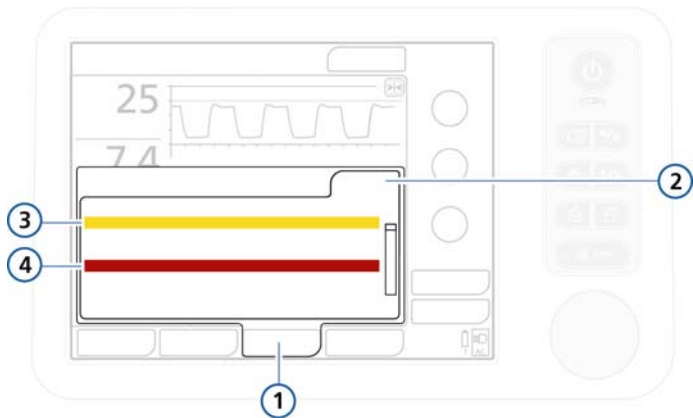

Figure 8-6. Events window

- | | | | |
|----------|--------|----------|--|
| 1 | Events | 3 | Low- or medium-priority alarm (yellow) |
| 2 | All | 4 | High-priority alarm (red) |

8.5 Alarm troubleshooting table

Table 8-2 is an alphabetical list of the alarm messages displayed by the HAMILTON-C1, along with their definitions and suggested corrective actions.

These corrective actions are sequenced to correct the most probable issue or to present the most efficient corrective action first. The proposed actions, however, may not always correct the particular problem.

If your issue is not resolved after performing the recommended tasks, contact your Hamilton Medical authorized service personnel.

Table 8-2. Alarms and other messages

Alarm	Definition	Action needed
Apnea	<i>High priority.</i> No patient trigger within the operator-set apnea time in SPONT, SIMV+, or NIV modes. Apnea backup is off.	Check the patient. Consider switching to a mandatory mode or increasing the mandatory rate.
Apnea ventilation	<i>Low priority.</i> Apnea backup ventilation has started. No breath delivered for the operator-set apnea time. Apnea backup is on.	The ventilator is in the corresponding backup mode. Check the control settings for the backup mode.
Apnea ventilation ended	<i>Low priority.</i> Backup mode was reset, and HAMILTON-C1 is again ventilating in its original support (pre-apnea) mode.	No action required.
ASV: Cannot meet the target	<i>Low priority.</i> The operator-set %MinVol cannot be delivered, possibly because of setting conflicts.	Check the Pasv limit setting in the Controls window.
Battery 1: calibration required	<i>Low priority.</i> The battery requires calibration. You may continue to use the battery.	Calibrate the battery.

Table 8-2. Alarms and other messages (continued)

Alarm	Definition	Action needed
Battery communication error	<i>High priority.</i> Battery data is not available. Ventilation continues.	Make sure the battery connectors are intact and the battery is installed correctly. If the problem persists, replace the battery. If the problem still persists, have the ventilator serviced.
Battery defective	<i>High priority.</i> Battery defective.	Replace battery.
Battery low	The low battery alarm has different levels of priority, depending on how much charge is left, and which power supply is in use. Note that at 20% battery charge, the ventilator can generally continue operation for up to approx 10 min, depending on battery and operating conditions. <i>High priority.</i> The ventilator is running on battery power, and the total battery charge is below 20%. <i>Medium priority.</i> The ventilator is running on battery power, and the total battery charge is below 25%. <i>Low priority.</i> The ventilator is running on AC power, and the total battery charge is below 20%.	Connect the ventilator to its primary power source. Install charged battery.
Battery power loss	<i>High priority.</i> No battery is present.	Insert a battery.

Table 8-2. Alarms and other messages (continued)

Alarm	Definition	Action needed
Battery 1: replacement required	<i>Low priority.</i> Battery capacity is insufficient for reliable operation and must be replaced immediately.	Replace the battery. For details about battery maintenance, see Section 10.3.2. For specifications, see Section A.4.
	<hr/> <p>NOTE: Battery life indications are approximate. The actual battery life depends on ventilator settings, battery age, and level of battery charge. To ensure maximum battery life, maintain a full charge and minimize the number of complete discharges.</p> <hr/>	
Battery 1: temperature high	<i>High priority.</i> The battery temperature is higher than expected.	Remove the ventilator from the sun or other heat source. Install a new battery.
Battery 1: Wrong battery	<i>Low priority.</i> The battery in use is not a HAMILTON-C1 Li-Ion battery.	Change the battery. Use a HAMILTON-C1 Li-Ion battery.
Battery totally discharged	<i>High priority.</i> The battery charge level is below 5%. The ventilator switches to the ambient state.	Connect the device to the primary power supply and recharge the battery. Provide alternative ventilation. Have the ventilator serviced.
Blower fault	<i>High priority.</i> A blower malfunction was detected. A technical alarm cannot typically be corrected by the operator. The ventilator switches to the ambient state.	Provide alternative ventilation. Have the ventilator serviced.
Blower service required	<i>Low priority.</i> Blower has reached the end of its lifespan.	Have the ventilator serviced
Buzzer defective	<i>High priority.</i> A buzzer malfunction was detected. A technical alarm cannot typically be corrected by the operator. Ventilation continues.	Restart device. If the problem persists, have the ventilator serviced.

Table 8-2. Alarms and other messages (continued)

Alarm	Definition	Action needed
Check CO ₂ airway adapter	<p><i>Low priority.</i> One of the following may have occurred:</p> <p>The airway adapter was disassembled from the CO₂ sensor</p> <p>There is an optical blockage on the windows of the adapter</p> <p>The adapter type was changed, but the sensor/adapter calibration was not performed</p>	<p>Clean the airway adapter and dry thoroughly, then reattach it.</p> <p>If the problem persists or the adapter type was changed, calibrate the CO₂ sensor/adapter.</p>
Check CO ₂ sampling line	<p><i>Low priority.</i> Sampling line of CO₂ sidestream sensor kinked or disconnected.</p>	<p>Check the sampling line.</p>
Check flow sensor	<p><i>High priority.</i> Flow sensor measurements are out of expected range. The ventilator switches over to PCV+ mode and displays ventilator pressure (Pvent) instead of Paw. The ventilator automatically returns to its previous mode when the measurements are within the expected range.</p>	<p>Check the flow sensor and the sensing tubes.</p> <p>Try to calibrate the flow sensor.</p> <p>Install a new flow sensor.</p>
Check flow sensor tubing	<p><i>High priority.</i> The flow sensor sensing lines are disconnected or occluded. The ventilator switches over to PCV+ mode and displays ventilator pressure (Pvent) instead of Paw. The ventilator automatically returns to its previous mode when the measurements are within the expected range.</p>	<p>Check the flow sensor and the sensing lines.</p> <p>Try to calibrate the flow sensor.</p> <p>Install a new flow sensor.</p>
Check settings	<p><i>Low priority.</i> A change to a control or alarm setting was not saved.</p>	<p>Check settings.</p>
Circuit calibration needed	<p><i>Medium priority, Low after silence.</i> The ventilator does not have correct calibration data.</p> <p>Applies only in nCPAP and nCPAP-PC modes.</p>	<p>Calibrate the circuit (Section 5.2.5.3)</p>

Table 8-2. Alarms and other messages (continued)

Alarm	Definition	Action needed
CO2 calibration needed	<i>Low priority.</i> A previous sensor calibration failed.	<p>Perform the following checks, repeating the calibration after each one, until calibration is successful:</p> <ul style="list-style-type: none"> • Check airway adapter and clean if necessary. • Re-calibrate the sensor, making sure there is no source of CO2 near the airway adapter. • Connect a new airway adapter. • Install a new CO2 sensor. <p>If the problem persists, have the ventilator serviced.</p>
CO2 sensor disconnected	<i>Low priority.</i> The CO2 module is installed, but there is no signal from the CO2 sensor. CO2 monitoring is enabled.	<p>Make sure a CO2 sensor is installed.</p> <p>Check CO2 sensor connections (CO2 sensor cable to module, CO2 module to ventilator).</p> <p>Have the ventilator serviced.</p>
CO2 sensor defective	<i>Low priority.</i> CO2 sensor signal indicates a hardware error; or a third-party sensor is installed.	<p>Disconnect the sensor from the CO2 module. Wait a few seconds, and reconnect.</p> <p>Recalibrate the sensor. Ensure the sensor is attached to the airway adapter during calibration.</p> <p>Install a new CO2 sensor. Make sure the sensor is a genuine Hamilton Medical part.</p>
CO2 sensor over temperature	<i>Low priority.</i> Temperature at CO2 sensor too high.	<p>Remove the sensor from the airway, and disconnect the sensor from the CO2 module. Reconnect.</p> <p>Verify that system is running within the specified environmental conditions. Check for excessive airway temperature (e.g., caused by defective humidifier, heater wire, or probe).</p>

Table 8-2. Alarms and other messages (continued)

Alarm	Definition	Action needed
CO2 sensor warmup	<i>Low priority.</i> CO2 operating temperature not yet reached or unstable.	Wait for sensor to warm up
Device temperature high	<i>High priority.</i> The internal temperature of the ventilator is higher than expected.	Remove the ventilator from the sun or other heat source. Check the cooling fan filter and fan. Have the ventilator serviced.
Disconnection on patient side	<i>High priority.</i> VTE < 1/8 delivered VTI, and delivered VTI > 50 ml. Does not apply in nCPAP modes.	Check the patient. Check the breathing circuit for a disconnection between the patient and the flow sensor, or for other large leaks (for example, ET tube, bronchopleural fistula).
Disconnection on ventilator side	<i>High priority.</i> VTI measured at the airway < 1/2 delivered VTI, and delivered VTI > 50 ml. Does not apply in nCPAP modes.	Check the breathing circuit for a disconnection between the ventilator and the flow sensor or for other large leaks (for example, breathing circuit, humidifier). Reconnect and calibrate the flow sensor.
Exhalation obstructed	<i>High priority.</i> End-expiratory pressure is too high End-expiratory flow is too low Note that you must use an inspiratory filter to prevent contamination. The ventilator may be contaminated if no inspiratory filter is used.	Check the patient. Check the expiratory limb for occlusion. Check the expiratory valve membrane and cover. Check the flow sensor tubes for occlusion. Adjust breath timing controls to increase the expiratory time. Have the ventilator serviced.
External flow sensor failed	<i>High priority.</i> The external flow sensor doesn't work properly.	Check flow sensor tubes. Change the flow sensor.

Table 8-2. Alarms and other messages (continued)

Alarm	Definition	Action needed
Fan failure	<i>Medium priority.</i> There is a problem with the cooling fan.	Disconnect the ventilator from the patient. Have the ventilator serviced.
CAUTION A fan failure could result in oxygen enrichment inside the ventilator and present a subsequent fire hazard.		
Flow sensor calibration needed	<i>High priority.</i> The ventilator does not have correct calibration data or automatic recalibration of the flow sensor is impossible.	Calibrate the flow sensor.
Functional key not operational	<i>Medium priority.</i> Function key defective.	Have the ventilator serviced.
High Flow	<i>Medium priority, Low after silence.</i> Flow has reached the set limit. Only active in nCPAP and nCPAP-PC modes.	Check the patient interface and breathing circuit for disconnection or excessive leakage. Check ventilator settings and alarm limits.
High frequency	<i>Medium priority.</i> The measured $f_{Total} >$ the set alarm limit.	Check the patient for adequate ventilation (VTE). Check the alarm limits. If the ventilator is in ASV, refer to Appendix C.
High minute volume	<i>High priority.</i> The measured ExpMinVol $>$ the set alarm limit.	Check the patient. Check and adjust the ventilator settings, including alarms.
High oxygen	<i>High priority.</i> With LPO selected: The measured oxygen is $>$ the set high Oxygen alarm limit. With HPO selected: The measured oxygen is $>$ 5% over the Oxygen control setting.	Calibrate the oxygen cell. Install a new oxygen cell.

Table 8-2. Alarms and other messages (continued)

Alarm	Definition	Action needed
High PEEP	<p><i>Medium priority.</i> Monitored PEEP > (set PEEP + 5) for two consecutive breaths.</p> <p><i>For DuoPAP and APRV only:</i></p> <ul style="list-style-type: none"> Alarm applies to both Phigh and Plow settings. The alarm sounds when the monitored Phigh > (set Phigh + 5) or monitored Plow > (set Plow +5) for two consecutive breaths. If Tlow is set to < 3 s, the High PEEP alarm is disabled for Plow settings. This reduces the incidence of false positive alarms. 	<p>Check the patient.</p> <p>Check and adjust the ventilator settings, including alarms.</p>
High pressure	<p><i>High priority.</i> Measured inspiratory pressure > the set Pressure alarm limit (also referred to as Pmax).</p> <p>The ventilator immediately stops the blower to stop gas flow to the patient and opens the expiratory valve to reduce pressure to the PEEP/CPAP level. The ventilator attempts to limit patient airway pressure to 60 cmH₂O, but if pressure climbs to 75 cmH₂O, the ventilator enters the ambient state.</p>	<p>Check the patient.</p> <p>Adjust the Pressure alarm limit.</p> <p>Check the breathing circuit and flow sensor tubes for kinks and occlusions.</p> <p>Provide alternative ventilation once the ventilator enters the ambient state.</p>
High pressure during sigh	<p><i>High priority.</i> A sigh cannot be fully delivered because excessive inspiratory pressure (Pressure - 3 cmH₂O) would be required. The sigh is partially delivered.</p>	<p>Check the patient.</p> <p>Check the breathing circuit.</p> <p>Adjust the Pressure alarm limit.</p> <p>Consider disabling the sigh function.</p>
Inspiratory volume limitation	<p><i>Medium priority.</i> The delivered Vt is > 1.5 times the set Vt high alarm limit. Pressure is reduced to PEEP level.</p> <p>The APV controls reduce the pressure for the next breath by 3 cmH₂O.</p> <p>Disabled in noninvasive modes.</p>	<p>Reduce the Psupport setting.</p> <p>Adjust the Vt high alarm limit.</p>

Table 8-2. Alarms and other messages (continued)

Alarm	Definition	Action needed
IRV	<i>Low priority.</i> The set I:E ratio is above 1:1, leading to inverse ratio ventilation. Does not apply in APRV.	Check the timing control settings.
Invalid option board	<i>Low priority.</i> Installed option board is invalid.	Have the ventilator serviced.
Loss of external power	<i>Low priority.</i> The HAMILTON-C1 is running on battery power due to loss of its primary power source.	Silence the alarm. Check integrity of connection to primary power source. Check battery status. If you have spare batteries, prepare to swap if necessary. Prepare for possible power loss. Obtain alternative ventilation.
Loss of PEEP	<i>Medium priority.</i> Pressure during exhalation < (set PEEP/CPAP – 3 cmH ₂ O) for more than 10 s.	Check the patient. Check the breathing circuit for leaks. Replace the breathing circuit, if necessary.
Loudspeaker defective	<i>High priority.</i> A loudspeaker malfunction was detected. A technical alarm cannot typically be corrected by the operator. Ventilation continues.	Have the ventilator serviced.
Low frequency	<i>Medium priority.</i> Measured f _{Total} < the set alarm limit.	Check the patient. Adjust the low f _{Total} alarm limit. If the ventilator is in ASV, check the %MinVol and Pat. height settings. Consider suctioning, check for a kinked ET tube, or consider the possibility of acute asthma.

Table 8-2. Alarms and other messages (continued)

Alarm	Definition	Action needed
Low minute volume	<i>High priority.</i> Measured ExpMinVol < the set alarm limit.	<p>Check the patient.</p> <p>Check the breathing circuit.</p> <p>Check and adjust the ventilator settings, including alarms.</p> <p>If the ventilator is in ASV, check the %MinVol and Pat. height settings.</p> <p>Consider suctioning, check for a kinked ET tube, or consider the possibility of acute asthma.</p>
Low oxygen	<i>High priority.</i> Measured oxygen is < the set alarm limit (low-pressure oxygen) or the operator-set oxygen -5% (high-pressure oxygen).	<p>Check the patient.</p> <p>Check the oxygen supply. Provide an alternative source of oxygen, if necessary.</p> <p>Calibrate the oxygen cell.</p> <p>Install a new oxygen cell.</p>
Low pressure	<i>High priority.</i> Set pressure during inspiration not reached.	<p>Check the patient.</p> <p>Check the breathing circuit for a disconnection between the patient and the flow sensor, or for other large leaks (for example, ET tube, bronchopleural fistula).</p>
O2 cell calibration needed	<i>Low priority.</i> Oxygen cell calibration data is not within expected range, or cell is new and requires calibration.	Calibrate the oxygen cell.
O2 cell defective	<i>Low priority.</i> The oxygen cell is depleted.	Install a new oxygen cell.
<p>CAUTION</p> <p>To ensure that oxygen monitoring is always fully functional, replace an exhausted or missing oxygen cell as soon as possible or use an external monitor that complies with ISO 80601-2-55.</p>		

Table 8-2. Alarms and other messages (continued)

Alarm	Definition	Action needed
O2 cell missing	<i>Low priority.</i> There is no signal from the oxygen cell.	Install an oxygen cell or use an external monitor, according to ISO 80601-2-55.
<p style="text-align: center;">CAUTION</p> <p style="text-align: center;">To ensure that oxygen monitoring is always fully functional, replace an exhausted or missing oxygen cell as soon as possible or use an external monitor that complies with ISO 80601-2-55.</p> <hr/> <p>NOTE:</p> <p>To prevent leakage within the ventilator, make sure an oxygen cell is installed at all times, even if you use an external monitor or disable oxygen monitoring.</p>		
O2 cell not system-compatible	<i>Low priority.</i> The incorrect type of oxygen cell is installed.	Ensure O2 cell is connected and a Hamilton Medical O2 cell is used (PN 396200).
Obstruction	<i>High priority.</i> End-expiratory pressure > (set PEEP/CPAP + 5) or Flow < 1 l/min Only active in nCPAP and nCPAP-PC modes.	<p>Check the patient.</p> <p>Check the expiratory limb for occlusion.</p> <p>Check the expiratory valve membrane and cover.</p> <p>Check the pressure-monitoring lines for occlusion.</p> <p>Adjust breath timing controls to increase the expiratory time.</p> <p>Have the ventilator serviced.</p>
Options not found	<i>High priority.</i> Options were not found during startup.	<p>Restart device.</p> <p>If the problem persists, have the ventilator serviced.</p>
Oxygen supply failed	<i>High priority.</i> Oxygen source flow lower than expected.	<p>Check the patient.</p> <p>Check the oxygen supply. Provide an alternative source of oxygen, if necessary.</p>

Table 8-2. Alarms and other messages (continued)

Alarm	Definition	Action needed
Performance limited by high altitude	<i>Medium priority, Low after silence.</i> The airway pressure cannot be reached at the current altitude. As long as the device remains above the altitude limit, the pressure cannot be reached, and the alarm is active.	Check the patient. Provide alternative ventilation if needed.
PetCO2 high	<i>Medium priority.</i> PetCO2 > the set alarm limit.	Check the patient. Check and adjust the ventilator settings, including alarms.
PetCO2 low	<i>Medium priority.</i> PetCO2 < the set alarm limit.	Check the patient. Check and adjust the ventilator settings, including alarms.
Pressure limit has changed	<i>Low priority.</i> Applies in ASV. The Pasvlimit was changed. When this setting is changed, the device automatically adjusts the high Pressure alarm limit to 10 cmH2O above the specified Pasvlimit setting.	Make sure the pressure limit is high enough so that sufficient pressure can be applied for adequate breath delivery.
Pressure limitation	<i>Medium priority, Low after silence.</i> Inspiratory pressure, including PEEP/CPAP, is 10 cmH2O below Pressure. The ventilator limits applied pressure, so the target pressure or volume may not be achieved.	Check the patient for adequate ventilation. Check ventilator settings and alarm limits.
Pressure not released	<i>High priority.</i> Airway pressure has exceeded the Pressure limit, and the pressure was not released via the expiratory valve after 5 s. The ventilator enters the ambient state.	Provide alternative ventilation. Check expiratory valve and breathing circuit. Have the ventilator serviced.
Preventive maintenance required	<i>Low priority.</i> According to its operating hours, the ventilator requires preventive maintenance.	Have the ventilator serviced.
Real time clock failure	<i>Medium priority.</i> Date and time not set.	Set date and time.

Table 8-2. Alarms and other messages (continued)

Alarm	Definition	Action needed
Replace HEPA filter	<i>Low priority.</i> The air inlet HEPA filter shows increased resistance.	Replace the HEPA filter.
Replace O2 cell	<i>High priority.</i> Communication error, O2 cell defective	Replace O2 cell.
Safety ventilation: xxxxxx	<i>Technical fault.</i> A hardware or software issue was detected. The ventilator switches to the safety mode.	Provide alternative ventilation. Have the ventilator serviced.
<div style="background-color: black; color: white; padding: 5px; display: inline-block;">CAUTION</div> To prevent possible patient injury arising from issues with the device, Hamilton Medical recommends that you immediately remove any ventilator with a technical fault from use, record the code, and have the ventilator serviced.		
Self test failed	<i>High priority.</i> The self test failed during startup. The Start ventilation button is ghosted. Note that if this error occurs when the device is restarting from a complete power loss, the device enters the ambient state.	Restart device. If the problem persists, have the ventilator serviced. If the device enters the ambient state, provide alternative ventilation and have the ventilator serviced.
SpO2 alarms	See the Pulse oximetry appendix.	
Suctioning maneuver	<i>Low priority.</i> Ventilation suppression is active, and ventilator settings are being maintained, although the ventilator is not delivering breaths.	Resume ventilation when desired by first reconnecting the patient.
Technical error: xxxxxx	<i>Low, medium, or high priority.</i> A hardware or software issue was detected. A technical alarm cannot typically be corrected by the operator. Ventilation continues.	Have the ventilator serviced.

Table 8-2. Alarms and other messages (continued)

Alarm	Definition	Action needed
Technical event: xxxxxx	<i>Low, medium, or high priority.</i> A hardware or software issue was detected. A technical alarm cannot typically be corrected by the operator. Ventilation continues.	Have the ventilator serviced.
Technical fault: xxxxxx	<i>Technical fault.</i> A hardware or software issue was detected. The ventilator switches to the ambient state.	Provide alternative ventilation. Have the ventilator serviced.
<p style="text-align: center;">CAUTION</p> <p style="text-align: center;">To prevent possible patient injury arising from issues with the device, Hamilton Medical recommends that you immediately remove any ventilator with a technical fault from use, record the code, and have the ventilator serviced.</p>		
Technical state failed	<i>High priority.</i> Technical state failed during startup.	Have the ventilator serviced.
Touch not functional	<i>Low priority.</i> Touch screen defective.	Have the ventilator serviced.
Turn Flow Sensor	<i>Medium priority.</i> The flow sensor connections are reversed. Ventilation continues, but the ventilator corrects for the reversed signal.	Reverse the ends of the flow sensor. The blue sensing line is close to the patient and must be attached to the blue connector. The colorless sensing line is close to the ventilator and must be attached to the white connector.
Unknown part number	<i>High priority.</i> Part number of a part in the ventilator is unknown.	Have the ventilator serviced.
Ventilation canceled	<i>Technical fault.</i> A hardware or software issue was detected. The ventilator switches to the ambient state.	Provide alternative ventilation. Have the ventilator serviced.

Table 8-2. Alarms and other messages (continued)

Alarm	Definition	Action needed
Ventilator outlet temperature high	<i>High priority.</i> Measured inhalation temperature is too high.	Check whether the room temperature exceeds the ventilator's operating temperature limit. Have the ventilator serviced if temperature cannot be reduced.
Vt high	<i>Medium priority.</i> Measured VTE > the set limit for 2 consecutive breaths. If the delivered tidal volume is greater than 1.5 times the Vt high limit ($Vt > 1.5 * Vt \text{ high limit}$), the Inspiratory volume limitation alarm is generated.	Reduce P _{support} . Check and adjust the ventilator settings, including alarm limits.
Vt low	<i>Medium priority.</i> Measured VTE is below the set limit for 2 consecutive breaths.	Check the patient. Check and adjust the ventilator settings, including alarm limits. Check for leaks and disconnects. If the ventilator is in ASV, consider suctioning, check for a kinked ET tube, or consider the possibility of acute asthma.

Table 8-2. Alarms and other messages (continued)

Alarm	Definition	Action needed
<p>Wrong expiratory valve</p>	<p><i>Medium priority, Low after silence.</i> The type of expiratory valve installed does not match the selected patient group (Adult/Ped or Neonatal).</p> <p>In addition to the alarm message, after attempting to start ventilation, the device displays a dialog box describing the risks of proceeding with the wrong valve.</p> <p>Note that:</p> <ul style="list-style-type: none">• The use of an adult expiratory valve with a neonatal patient may affect ventilation performance and can cause pressure oscillation.• The use of a neonatal expiratory valve with an adult or pediatric patient may affect ventilation performance and can cause increased expiratory resistance and work of breathing. <p>The alarm is recorded in the Events log and remains in the alarm buffer.</p>	<p>Install the appropriate expiratory valve.</p> <p>To start ventilating the patient, you must confirm that you are aware of the issue by selecting either Accept or Decline in the dialog box.</p> <ul style="list-style-type: none">• By selecting Accept, you accept the risks associated with using the wrong valve for the selected patient. Ventilation starts after touching Accept. This option is only to be used in emergency cases, where the appropriate expiratory valve for the patient group is not available and mechanical ventilation must be delivered.• By selecting Decline, the dialog box closes and you remain in standby. <p>The selection you make (Accept or Decline) is recorded with the alarm in the Events log.</p>
<p>Wrong flow sensor</p>	<p><i>High priority.</i> The type of flow sensor connected does not match the selected patient group (Adult/Ped or Neonatal).</p>	<p>Connect the appropriate flow sensor.</p> <p>Calibrate again.</p>

9 Special functions

9.1	Introduction	9-2
9.2	Standby	9-3
9.3	Alarm silence	9-6
9.4	O2 enrichment	9-7
9.5	Suctioning tool	9-8
9.6	Manual breath/inspiratory hold	9-9
9.7	Nebulizer	9-10
9.8	Print screen	9-11
9.9	Screen Lock/unlock	9-12
9.10	Day/Night	9-13

9.1 Introduction

Keys on the front of the ventilator provide access to important functions, including entering Standby mode and silencing an alarm.

When a selected function is active, the indicator light next to the key is lit.

This chapter describes all of the functions in detail.

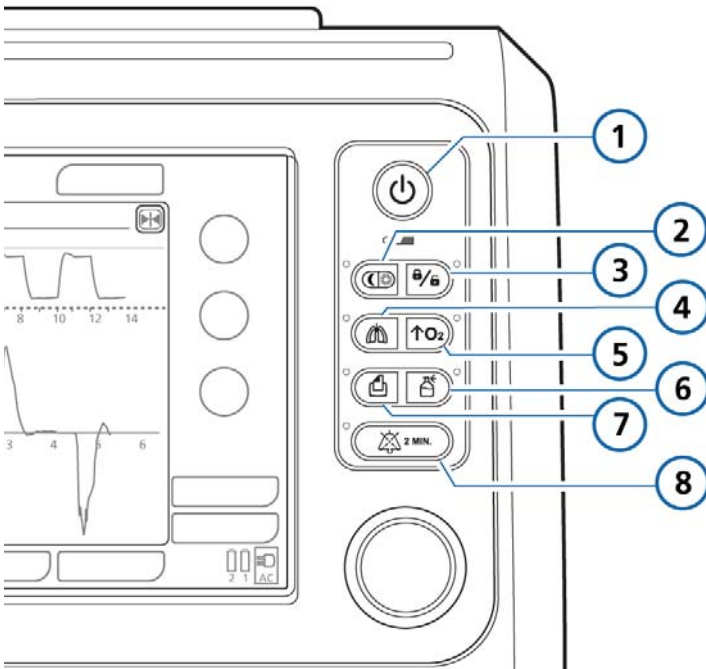

Figure 9-1. Special function keys

- | | | | |
|----------|-----------------------------------|----------|--------------------------|
| 1 | Power/Standby | 5 | O2 enrichment/suctioning |
| 2 | Day/Night | 6 | Nebulizer on/off |
| 3 | Screen lock/unlock | 7 | Print screen |
| 4 | Manual breathing/inspiratory hold | 8 | Alarm silence |

9.2 Standby

WARNING

- **To prevent possible patient injury due to lack of ventilatory support, secure alternative ventilation for the patient before entering the standby mode. You must confirm that no patient is attached before entering standby.**
 - **To prevent possible patient injury or damage to breathing circuit from overheated gas after reconnection from standby, turn off the humidifier when entering the standby mode.**
-

NOTE:

- To keep the battery fully charged, make sure the ventilator is connected to AC power while in Standby mode.
 - When in standby, the ventilator does not automatically resume ventilation when the patient is reconnected. You must manually restart ventilation.
 - Patient alarms are suppressed during standby.
 - Acoustical patient alarms are suppressed for 1 minute after starting ventilation from standby.
-

Standby is a waiting mode that lets you maintain ventilator settings while the ventilator is not performing any ventilatory functions.

To put the ventilator into standby



1. Press and quickly release the **Power/Standby** key while the ventilator is powered on.

The Activate standby window opens.

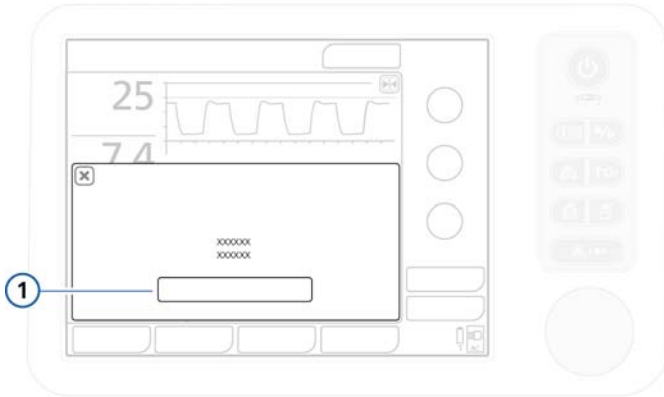

Figure 9-2. Activate Standby (1) window

2. Touch **Activate standby**.

The Standby window opens. See Figure 9-3.

During standby, the window shows the elapsed time since standby was started.

To start ventilation (end standby)

Do either of the following:

- In the Standby window, touch the **Start Ventilation** button.
- Press and quickly release the **Power/Standby** key.



Ventilation resumes with the previous settings.

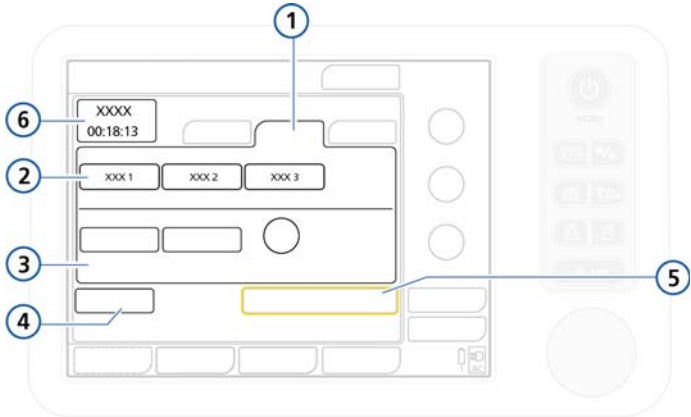

Figure 9-3. Standby window (adult/pediatric shown)

- | | | | |
|----------|-------------------------|----------|-------------------------|
| 1 | Adult/Ped patient group | 4 | Preop check |
| 2 | Quick setup buttons | 5 | Start Ventilation |
| 3 | Gender, Height, and IBW | 6 | Elapsed time in standby |

For the Neonatal Standby window, see Figure 5-2 in Chapter 5.

9.3 Alarm silence

NOTE:

The High pressure alarm cannot be silenced.

For details on ventilator alarms, see Chapter 8.

To silence an alarm

Press the **Alarm silence** key.

The audible ventilator alarm is muted for 2 min. Pressing the key a second time cancels the alarm silence.

The red indicator light next to the key flashes when an alarm is active but not muted. It is continuously lit while the alarm silence is active.

The display also indicates alarm silence is engaged (Figure 8-1):



- A countdown timer on the main display shows the remaining time for the silence.
- The red alarm silence icon is lit.

When the silence expires and the issue has not yet been resolved, the alarm sounds again.

9.4 O2 enrichment

NOTE:

- Oxygen alarms are suppressed while the O2 enrichment function is active.
 - O2 enrichment is not available in low pressure oxygen mode.
-

Oxygen enrichment is useful for pre- or post-oxygenation before/after tracheal suctioning or for other clinical applications.

In the adult patient group, the O2 enrichment function delivers 100% oxygen for 2 minutes.

In the neonatal patient group, the applied oxygen concentration during the enrichment maneuver is increased by 25% of the last oxygen setting (e.g., if the last oxygen setting = 40%, the resulting oxygen concentration during O2 enrichment maneuver will be 50%).

When active, the green indicator next to the key is lit.

To start oxygen enrichment



- ▶ Press the **O2 enrichment** key.

After a short time, which is required for the oxygen concentration to rise, the HAMILTON-C1 starts delivering 100% oxygen (adult and pediatric) or the current oxygen setting increased by 25% of the setting (infant/neonate). Afterward, the HAMILTON-C1 resets the concentration to the previous operator-set value.

The currently applied oxygen concentration is displayed on the **Oxygen** control (green).

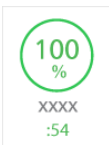

To stop O2 enrichment manually

Press the key again or touch the **Oxygen** control, which shows the currently set value, and adjust it as needed.

The HAMILTON-C1 resumes ventilation at the set oxygen concentration.

9.5 Suctioning tool

NOTE:



- The suctioning tool is inactive during NIV and NIV-ST modes.
 - The pre- and post oxygenation is displayed with green O2 control and timer (max. 120 seconds)
 - The suctioning tool is not available with low pressure oxygen supply.
 - Suctioning may affect measured values.
-

The suctioning maneuver is intended to withdraw an excess of tracheal and/or bronchial secretions in the patient's airways while protecting the user from possible contamination, as well as ensuring the patient's safety during the suctioning maneuver.

When active, the green indicator next to the key is lit.

To perform the suctioning maneuver



1. Press the **O2 enrichment** key for pre-oxygenation.
2. Disconnect the patient.
Disconnecting the patient halts ventilation so that no gases are blown through the tubes. For 60 seconds all alarms are suppressed.
3. Use a suctioning tool (not included) to suction all secretions out of the patient's airways.
4. Reconnect the patient to the ventilator.
Post-oxygenation starts and for another 60 seconds all acoustic alarms are suppressed. The alarm message and lamp are still active.

To prematurely terminate the pre- and/or post oxygenation maneuver, press the **O2 enrichment** key again.

9.6 Manual breath/inspiratory hold

This function lets you deliver a manually triggered breath or perform an inspiratory hold maneuver.

When active, the green indicator next to the key is lit.

To deliver a manual breath only



- ▶ Press and release the **Manual breath** key (Figure 9-1) during exhalation.

In nCPAP mode, you can deliver a manual breath at any time.

Do not press the key quickly and repeatedly. The manual breath uses the mandatory breath settings (standard or operator set).

If you try to initiate a manual breath during the early stage of inspiration or the early stage of exhalation, the breath will not be delivered. This does not apply in nCPAP mode.

To perform an inspiratory hold

- ▶ Hold down the **Manual breath** key during any breath phase.

If the ventilator is in exhalation, it delivers a mandatory breath, then performs a hold maneuver until the key is released, up to 15 seconds in addition to the set inspiratory time.

If the ventilator is in inspiration, it performs a hold maneuver at the end of inspiration, lasting until the key is released, for up to 15 additional seconds.

9.7 Nebulizer

CAUTION

- **Do not use an expiratory filter or HMEF/HME in the patient's breathing circuit during nebulization. Nebulization can cause an expiratory side filter to clog, substantially increasing flow resistance and impairing ventilation.**
- **To prevent the expiratory valve from sticking due to nebulized medications, use only medications approved for nebulization and regularly check and clean the expiratory valve.**

NOTE:



- The pneumatic nebulizer is inactive when low pressure oxygen (LPO) is used.
- Delivered ventilation is compensated for the contribution of the internal nebulizer so that the expected volume and pressure are delivered.
- Pneumatic nebulization is disabled during neonatal ventilation.

The HAMILTON-C1's pneumatic nebulization function powers a standard inline nebulizer for delivery of prescribed medications in the ventilator circuit. When nebulization is active, the nebulizer flow is synchronized with the inspiratory phase of each breath for 30 min. Nebulization can be activated in all modes of ventilation.

When active, the green indicator next to the key is lit.

To start nebulization



- ▶ Press the **Nebulizer** key.

To stop nebulization

- ▶ Press the Nebulizer key again.

For effective nebulization, use a pneumatic nebulizer jar (see Appendix G). Section 2.4 briefly describes how to install the nebulizer.

9.8 Print screen

NOTE:

Touch the HAMILTON-C1 before using the USB port.

The print screen function saves a JPG file of the current ventilator screen to a USB memory drive.

To create a screen shot

1. Insert a USB memory drive into the USB port.



2. Press the **Print screen** key while the desired display is shown.

The device saves the image to the memory drive. The green indicator next to the key is lit while the device saves the image.

The filename takes this format:

screenshot_yyyymmdd_hhmmss.jpg

where:

yyyy is the year

mm is the month

dd is the date

hh is the hour (in 24-hour format)

mm is the minute

ss is the second

9.9 Screen Lock/unlock

The Screen Lock/unlock function prevents inadvertent touch screen and device entries. When touching the locked screen, an acoustic BEEP sounds and a **Screen lock active** message is displayed.

When active, the green indicator next to the key is lit.

When screen lock is active, some device controls remain available, while others are disabled, as follows:

- | | |
|-----------------|---|
| Active | <ul style="list-style-type: none">• Alarm silence key• Manual breath key• O2 enrichment key• Day/Night key• Nebulizer key |
| Inactive | <ul style="list-style-type: none">• Touch screen• Power/Standby key• Print screen key• P&T knob |

To lock or unlock the screen



- Press the **Screen Lock/unlock** key.

9.10 Day/Night

The **Day/Night** key¹ allows you to quickly switch between the display Day and Night settings. The device uses the brightness settings specified in the System window (Section 3.3.4).

When the Night setting is active, the green indicator next to the key is lit.

To change the display brightness to the pre-set Day or Night setting



► Press the **Day/Night** key.

The device changes the display brightness as follows.

Table 9-1. Day/Night key actions

The current brightness setting (in System window) is ...	When Day/Night key is pressed, the device switches to the default setting for ...
Day	Night When the Night setting is active, the green light next to the Day/Night key is lit.
Night	Day
Automatic	Night When the device is restarted, it resets the display brightness to the Day setting.

1. Not available in Japan.

10 Maintenance

10.1	Introduction	10-2
10.2	Cleaning, disinfection, and sterilization	10-2
	10.2.1 General guidelines for cleaning	10-4
	10.2.2 General guidelines for disinfection	10-6
	10.2.3 General guidelines for reprocessing	10-9
10.3	Preventive maintenance	10-13
	10.3.1 Servicing the air intake and fan filters	10-15
	10.3.2 Working with the battery	10-17
	10.3.3 Replacing the oxygen cell	10-17
10.4	Storage	10-18
10.5	Repacking and shipping	10-18
10.6	Reprocessing the autoclavable expiratory valve	10-19

10.1 Introduction

WARNING

No modification of this equipment is allowed. Servicing must be performed by Hamilton Medical-authorized personnel using the instructions provided in the Service Manual.

You must comply with these maintenance procedures to ensure the safety and reliability of the HAMILTON-C1. All the procedures in this manual are to be performed by the operator. For additional maintenance requirements, contact your Hamilton Medical service representative.

10.2 Cleaning, disinfection, and sterilization

WARNING

- **Always disconnect the device from electrical power before cleaning and disinfection to reduce the risk of electric shock.**
- **DO NOT reuse single-use bacteria filters, flow sensors, and other accessories. They must be discarded after use. Follow your hospital procedures for disposal.**
- **Reusing, disassembling, cleaning, disinfecting, or sterilizing a single-use part may compromise its functionality and system performance, leading to a possible operator or patient hazard.**
- **Performance is not guaranteed if an item labeled as single-use is reused.**
- **Reuse of a single-use product voids the warranty.**
- **Always use caution when handling bacteria filters to minimize the risk of bacterial contamination or physical damage. Dispose of used filters immediately after use. Follow your hospital procedures for disposal.**

-
- To prevent patient exposure to sterilizing agents and to prevent premature deterioration of parts, sterilize parts using the techniques recommended in this section only.
-

CAUTION

- **DO NOT attempt to sterilize the interior components of the ventilator. DO NOT attempt to sterilize the entire device with ETO gas.**
- **Exposure to sterilizing agents may reduce the useful life of certain parts. Using more than one sterilization technique on a single part may damage a part.**
- **Intrusion of fluids, or immersing parts in fluids, will damage the device.**
- **Do not pour fluids onto the device surfaces.**
- **Do not use abrasives materials (for example, steel wool or silver polish) on surfaces.**
- **You can use bleaching agents according to the manufacturer's recommendations and the instructions provided in the *Compatibility of cleaning / disinfectant agents with HAMILTON MEDICAL ventilators* statement.**
- **Incorrect concentrations or residence times of sterilization agents may lead to bacterial resistance.**

NOTE:

- Because sanitation practices vary among institutions, Hamilton Medical cannot specify specific practices that will meet all needs or be responsible for the effectiveness of these practices.
 - This manual only provides general guidelines for cleaning, disinfecting, and sterilizing. It is the operator's responsibility to ensure the validity and effectiveness of the actual methods used.
 - For specific information on cleaning, disinfecting, and sterilizing autoclavable (reusable) accessories and components, refer to the appropriate *Reprocessing Guide* and *Instructions for Use* provided with each part.
-

The following sections provide general recommendations for cleaning, disinfecting, and sterilizing parts. Table 10-4 provides an overview of how to reprocess each part. For parts not supplied by Hamilton Medical, comply with the manufacturers' recommendations.

DO NOT attempt decontamination procedures unless specified by Hamilton Medical or the original manufacturer.

If you have any questions about the use of a particular cleaning or disinfection agent, contact the manufacturer of the agent.

If you are unsure how to clean and decontaminate a given part, contact your hospital hygiene administrator. This is especially important to avoid the spread of Hepatitis and HIV.

Ensure you follow your hospital infection control procedures, as well as all local, state, and federal regulations.

After cleaning and decontaminating parts, perform any required tests and calibrations described in Chapter 3.

The following sections provide a general overview of how to clean and disinfect ventilator-related parts. Additional information for each part is included in Table 10-3.

10.2.1 General guidelines for cleaning

CAUTION

- **To prevent damage to the ventilator and components, DO NOT clean with hard brushes, pointed instruments, or rough materials.**
- **Cleaning and disinfection agent residues can cause blemishes or fine cracks, especially on parts exposed to elevated temperatures during sterilization.**
- **Incorrect concentrations or residence times of sterilization agents may lead to bacterial resistance.**
- **Use of a rinse agent reduces the lifespan of the product.**

Additional information for cleaning each part is included in Table 10-3.

To clean the device parts

1. Disassemble parts. Breathing circuits must be disassembled completely.
2. Wash parts in warm water and soap or an appropriate mild detergent solution.

The following table shows supported cleaning agents. When available, refer to the documentation provided with the part for details about supported cleaning agents.

Table 10-1. Supported cleaning agents

Cleaning Agent	Description
Surfactant	Alconox®
Ammonia based	Solution of < 3% ammonia Glass cleaner
Alcohol based	Solution of 70% isopropanol Solution of 70% ethanol Glass cleaner

3. Rinse parts thoroughly with clean, warm water.
4. Air dry.
5. Inspect all parts, and replace if damaged.
6. If you will sterilize or disinfect the part, continue with the appropriate sterilization/disinfection procedure as described in the product documentation.

If you will not sterilize or disinfect the part, reassemble and reinstall (if needed), and perform any required tests.

10.2.2 General guidelines for disinfection

CAUTION

Table 10-4 lists the materials used for HAMILTON-C1 parts. To prevent premature deterioration of parts, make sure the disinfecting chemical is compatible with the part material. Check the manufacturer's recommendations.

Additional information for disinfecting each part is included in Table 10-3.

To disinfect the device parts

1. Clean, but DO NOT re-assemble.
2. Disinfect with an appropriate mild bactericidal chemical solution.

Acceptable chemicals include:

- Schülke & Mayr Lysetola AF and Gigasepta FF
- Henkel-Ecolab Incidura
- Sekusepta PLUS
- CIDEX

These agents have been tested according to the manufacturers' guidelines. Other brand names with similar active ingredients may also be suitable.

The following table, Table 10-2, shows appropriate alcohol and aldehyde concentrations, if preferred.

Table 10-2. Additional disinfection agents

Disinfection Agent	Description
Alcohol	Solution of $\leq 70\%$ ethanol Solution of $\leq 70\%$ 1- and 2-Propanol solution
Aldehyde	Solution of $\leq 3.6\%$ glutaraldehyde

3. Reassemble and reinstall parts, and perform any required tests before reuse.

The following table summarizes the cleaning and disinfection guidelines for each major system component.

Table 10-3. Cleaning and disinfection methods for parts

Part (material)	How to clean and disinfect	Remarks
<p>Ventilator exterior, including housing, basket, tray, gas supply hoses, power cord, modules</p> <p>(Does not apply to touch screen.)</p>	<p>Wipe with an appropriate bactericidal agent after each patient use.</p> <p>Be particularly careful with infectious patients, and follow your hospital infection control procedures.</p>	<p>Use any of the following options. Dampen a lint-free cloth with any of the following.</p> <p>For examples and concentrations, see Tables 10-1 and 10-2.</p> <ul style="list-style-type: none"> • Warm water (maximum 40°C (104°F)) and soap. • A dilute and nonacid agent • A surfactant • A cleaning agent in a base of ammonia or alcohol <p>Do not use strong solvents, such as acetone or Trichlorethylene.</p> <p>DO NOT clean the ventilator interior. This can damage internal parts.</p> <p>Be sure to only clean around the connection ports, not inside them.</p>
<p>Touch screen</p>	<p>Wipe the screen with a damp soft cloth, using either of the following:</p> <ul style="list-style-type: none"> • An antibacterial cleaning agent • Cleaning agents recommended by your hospital 	<p>Lock the screen before cleaning. See Section 9.9.</p> <p>Handle the touch screen with care.</p> <p>DO NOT use any vinegar-based solutions.</p> <p>Avoid using gritty cloths.</p> <p>Do not pour fluids onto the screen during cleaning.</p>

Table 10-3. Cleaning and disinfection methods for parts *(continued)*

Part (material)	How to clean and disinfect	Remarks
CO2 sensor	<p>Clean and disinfect the outside by wiping with a cloth dampened with any of the following agents.</p> <p>For examples and concentrations, see Table 10-3.</p> <ul style="list-style-type: none"> • 70% isopropyl alcohol • 10% aqueous solution of sodium hypochloride (bleach) • Disinfectant spray cleaner • Ammonia-based solution • Mild soap <p>Wipe down with a clean water-dampened cloth to rinse, and dry before use.</p> <p>Make sure the sensor windows are clean and dry before reuse.</p>	<p>Always disconnect the CO2 sensor before cleaning. DO NOT immerse or attempt to sterilize the sensor.</p> <p>Before reusing the sensor, ensure the windows are dry and residue free, and that the sensor has not been damaged during handling or by the cleaning process.</p> <p>Replace if damaged or if excessive secretions are observed.</p>
<div style="background-color: black; color: white; padding: 5px; display: inline-block;">WARNING</div> <p>Reusing, disassembling, cleaning, disinfecting, or sterilizing the single-use CO2 airway adapter can compromise its functionality and system performance, leading to a possible user or patient hazard. Performance is not guaranteed if an item labeled as single-use is reused.</p>		
Humidifier and chamber Temperature probe Other accessories	Comply with the manufacturer's guidelines	
Aeroneb control module Control module cable AC/DC adapters	<p>Wipe clean with a damp cloth.</p> <p>Check for exposed wiring, damaged connectors, or other defects and replace if any are visible.</p>	DO NOT autoclave.

Table 10-3. Cleaning and disinfection methods for parts *(continued)*

Part (material)	How to clean and disinfect	Remarks
Aeroneb mounting brackets	Wipe clean with a damp cloth and mild liquid detergent and antibacterial cleaning agent.	DO NOT use abrasive or sharp tools.

10.2.3 General guidelines for reprocessing

Reprocessing (decontamination) may include one or more of the following processes:

- Chemical disinfection
- ETO sterilization
- Steam autoclaving

Table 10-4 provides additional information for reprocessing individual parts.

For details about reprocessing the autoclavable expiratory valve, see Section 10.6.

To reprocess the device parts

1. Clean/disinfect.
2. Reassemble.
3. Inspect.
4. Autoclave.
5. Perform any required tests.

The following table provides additional information for reprocessing (decontaminating) individual parts.

Table 10-4. Reprocessing methods for parts

Part (material)	Reprocessing recommendations	Remarks
<p><i>For specific information on cleaning, disinfecting, and sterilizing autoclavable (reusable) accessories and components, refer to the appropriate Reprocessing Guide and Instructions for Use provided with each part.</i></p>		
Breathing tubes, reusable, autoclavable (silicone rubber)	Steam autoclave, chemically disinfect, or ETO sterilize	<p>Roll tubes into large coils. DO NOT twist, kink, or cross tubes when sterilizing them. The tubing lumen must not have vapor or moisture before wrapping for autoclaving.</p> <p>Avoid exposing silicone rubber breathing tubes to grease, oil, silicone-based lubricants, organic solvents (benzene, ether, ketone, and chlorinated hydrocarbons), acids, concentrated alkaline cleaning products, and phenols and derivatives.</p>
Mask, reusable, autoclavable (silicone rubber)	Steam autoclave, chemically disinfect, or ETO sterilize	<p>Avoid exposing silicone rubber masks to grease, oil, silicone-based lubricants, organic solvents (benzene, ether, ketone, and chlorinated hydrocarbons), acids, concentrated alkaline cleaning products, and phenols and derivatives.</p> <p>Deflate air cushion before steam autoclaving to prevent possibility of explosion.</p>
Flow sensor, reusable, autoclavable	Steam autoclave, chemically disinfect, or ETO sterilize	DO NOT use hard brushes, pointed instruments, or rough materials. These can damage the flow sensor's membrane.

Table 10-4. Reprocessing methods for parts *(continued)*

Part (material)	Reprocessing recommendations	Remarks
<p><i>For specific information on cleaning, disinfecting, and sterilizing autoclavable (reusable) accessories and components, refer to the appropriate Reprocessing Guide and Instructions for Use provided with each part.</i></p>		
Inspiratory filter, reusable autoclavable	Steam autoclave	After reprocessing, always inspect the filter media for cracks or foreign matter; replace if necessary.
Nebulizer jar, reusable (polysulfone)	Steam autoclave or chemically disinfect	
Expiratory valve cover (polysulfone) Expiratory valve membrane Y-piece Water traps Adapters Connectors (polysulfone) Temperature probe housing (polysulfone and silicone rubber)	Steam autoclave, chemically disinfect, or ETO sterilize For details about reprocessing the autoclavable expiratory valve, see Section 10.6.	DO NOT autoclave if medications containing chlorinated or aromatic hydrocarbons are used. Solutions such as Medizyme, Pyroneg, Control 3, Solution 2, and CIDEX [®] have been tested according to the manufacturers' guidelines. Other brand names with similar active ingredients may also be suitable.

Table 10-4. Reprocessing methods for parts (continued)

Part (material)	Reprocessing recommendations	Remarks
CO2 sensor airway adapter, reusable (polyetherimide), aluminum, black oxide finish, Al2O3-sapphire)	Chemically disinfect, then steam autoclave (adult adapters only) at 121°C (250°F) for 20 min, unwrapped.	<p>Acceptable chemical disinfectants include:</p> <ul style="list-style-type: none"> • 70% isopropyl alcohol • 10% aqueous solution of sodium hypochlorite (bleach) • 2% glutaraldehyde solution such as CIDEX or Steris System 1® (refer to the disinfectant manufacturer's instructions for use) • Ammonia <p>Rinse with sterile water and dry.</p> <p>With proper care and if not otherwise damaged, adapters can be disinfected/sterilized according to the stated validated methods at least 100 times.</p> <p>Before reusing the adapter, make sure the windows are dry and residue free, and that the adapter has not been damaged during handling or by the cleaning/sterilizing process.</p> <p>Replace if damaged or if excessive secretions are observed.</p>
Aeroneb adapter	Autoclave wrapped parts using steam sterilization pre-vacuum cycle, a minimum of 134°C (270°F – 275°F) for 20 minutes with drying cycle (sometimes referred to as a "Prion cycle").	DO NOT reassemble parts prior to autoclaving.

10.3 Preventive maintenance

NOTE:

- Dispose of all parts removed from the device according to your institution's protocols. Comply with all local, state, and federal regulations with respect to environmental protection, especially when disposing of the electronic device or parts of it (for example, oxygen cell, battery).
 - Any attempt to modify the ventilator hardware or software without the express written approval of Hamilton Medical automatically voids all warranties and liabilities.
 - Hamilton Medical recommends that you document all maintenance procedures.
 - It is not allowed to perform service or maintenance on the device while a patient is connected.
-

Perform preventive maintenance on your HAMILTON-C1 according to the schedule shown in Table 10-5. You can view the hours of ventilator operation in the System -> Info window. The following subsections provide details for some of these preventive maintenance procedures.

Table 10-5. Preventive maintenance schedule

Interval	Part/accessory	Procedure
Between patients and according to hospital policy	Breathing circuit (including mask, inspiratory filter, flow sensor, nebulizer jar, expiratory valve cover and membrane)	Replace with sterilized or new single-patient use parts. Run the tightness test and the appropriate calibration (Chapter 3).
	Entire ventilator	Run the preoperational checks (Section 3.2).
Every 2 days or according to hospital policy	Breathing circuit	Empty any water from breathing tubes or water traps. Inspect parts for damage. Replace as necessary.

Table 10-5. Preventive maintenance schedule (continued)

Interval	Part/accessory	Procedure
Every month (or more often, if required)	<p style="text-align: center;">WARNING</p> <p style="text-align: center;">To reduce the risk of patient cross-contamination through the fan filter, always perform maintenance at the prescribed interval.</p>	
	Fan filter (rear panel)	Check for dust and lint. If needed, clean or replace.
Every 6 months	Battery	Recharge battery by plugging the ventilator into a primary power source for at least 4 hours.
Yearly or every 5000 hours, whichever comes first, or as necessary	Oxygen cell	Replace if depleted.
	<p style="text-align: center;">NOTE:</p> <p style="text-align: center;">Oxygen cell life specifications are approximate. The actual cell life depends on operating environment. Operation at higher temperatures or higher oxygen concentrations shortens cell life.</p>	
	Air intake HEPA filter	Replace.
	Ventilator	Perform service-related preventive maintenance. ¹
	CO2 sensor	If the CO2 option is installed, have a CO2 accuracy check performed
Dynamic lifetime surveillance Typically 8 years	Blower	Replace if indicated ¹

1. Must be performed by Hamilton Medical authorized service personnel according to instructions in the *Service Manual*.

10.3.1 Servicing the air intake and fan filters

To service the air intake and fan filters

1. Remove the fan filter.

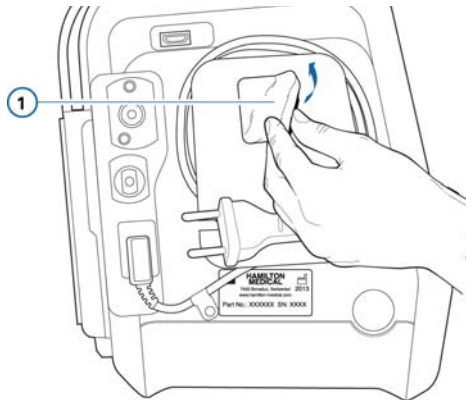

Figure 10-1. Removing the fan filter (1)

2. Remove the air intake dust filter.

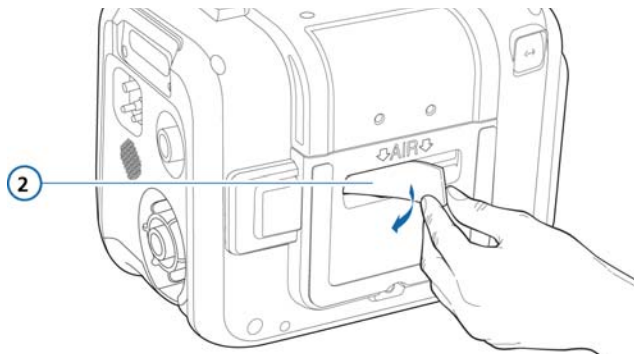

Figure 10-2. Removing the air intake filter (1)

3. Remove the filter cover.

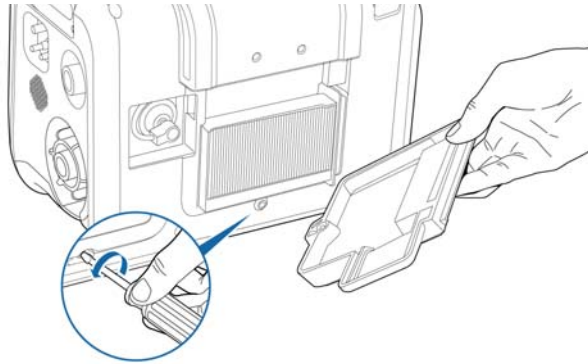

Figure 10-3. Removing the cover

4. Pull up the retaining clip and pull out the HEPA filter.

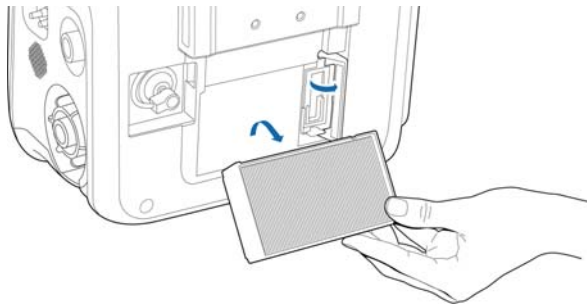

Figure 10-4. Removing the HEPA filter

5. Install a new HEPA filter as required.
6. Install a new fan filter (Figure 10-1) or wash the existing filter in a mild soap solution, rinse, dry and reinstall.
7. Install a new air intake dust filter (Figure 10-2) or wash the existing filter in a mild soap solution, rinse, dry, and reinstall.
8. Reattach the filter cover.

10.3.2 Working with the battery

The HAMILTON-C1 has a fixed, internal backup battery. For details on batteries, see Section 2.9. For specifications and charge time, see Section A.4. The battery is charged with connected AC power.

10.3.3 Replacing the oxygen cell

NOTE:

- Replace the oxygen cell with genuine Hamilton Medical parts only; otherwise, oxygen measurement will not function.
 - To prevent leakage within the ventilator, make sure an oxygen cell is installed at all times, even if you use an external monitor or disable oxygen monitoring.
 - To prevent a permanent alarm use special Hamilton Medical oxygen cells only.
-

To replace the oxygen cell, remove the cover, then disconnect and remove the cell (Figure 10-5). Install and reconnect the new cell; then replace the cover.

Run the oxygen cell calibration (see Chapter 3).

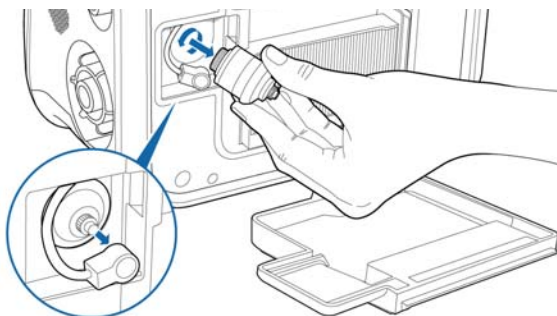

Figure 10-5. Replacing the oxygen cell

10.4 Storage

To maintain the battery charge and to prolong the life of the battery, keep the ventilator connected to its primary power source. Have the battery recharged every 6 months, depending on storage conditions (see specifications in Appendix A).

10.5 Repacking and shipping

CAUTION

Inform Hamilton Medical if you are shipping a contaminated (nonsterilized and nondisinfected) device for service.

If you must ship the ventilator, use the original packing materials. If these materials are not available, contact your Hamilton Medical representative for replacement materials.

10.6 Reprocessing the autoclavable expiratory valve

This recommendation is valid for the following products from the Hamilton Medical accessories and consumables program.

The autoclavable expiratory valve consists of the following materials.

Expiratory set, reusable PN	HAMILTON-C1	Materials
161175 (adult / pediatric)	Body	PC
161188 (neonatal)	Locking ring	PA12
	Membrane	Silicon rubber
	Cap on membrane	Stainless steel

All materials used are heat resistant up to 140°C (284°F).

WARNING

- **Clean, disinfect, and sterilize the expiratory valve directly after use.**
 - **Hamilton Medical cannot be held responsible for the correct functioning of expiratory valves that are not reprocessed and used according to these instructions.**
 - **Ensure that only processes that have been specifically validated for the product or device are used, and that the validated parameters are used with every cycle.**
 - **A used expiratory valve must be handled as a contaminated item. Follow all local, state, and federal regulations with respect to environmental protection when disposing of used expiratory valves.**
 - **Follow hospital infection control procedures, as well as local laws and regulations. This applies in particular to the various regulations regarding an effective deactivation of prions.**
-

CAUTION

- The autoclavable expiratory valve has a limited life span. The expiratory valve may be damaged due to the use of hard brushes, scouring agents, or by the exertion of too much force.
- The use of rinse aids will reduce the life span of the expiratory valve, as it can lead to early failure and cracks in the plastic expiratory valve body.
- The expiratory valve must not be autoclaved if medication containing aromatic or chlorinated hydrocarbons has been applied via a nebulizer. Discard the valve.

Make sure that the reprocessing does not damage the steel ring and the membrane.

The steel ring is there to reinforce the membrane and to improve tightness. Make sure the ring does not get bent out of shape.

10.6.1 Expiratory valve reprocessing overview

The expiratory valve must be cleaned, disinfected, and sterilized before every use.

Reprocessing comprises the following steps:

1. Cleaning and disinfecting the valves.
2. Visually inspecting the valves after disinfection.
3. Packaging the valves.
4. Sterilizing the packaged valves.

These steps are described in this section, both for mechanical and manual reprocessing of the valves.

After each reprocessing cycle, the expiratory valve housing must be inspected for damage. If any changes are visible, the valve must be discarded. Perform a tightness test after each reprocessing cycle. If the test fails, it may be repeated once. The expiratory valve must be replaced if the tightness test fails the second time.

The expiratory valve has a limited life span. If reprocessing expiratory valves manually, take care that no damage is caused by the use of hard brushes, scouring agents, or by the exertion of too much force.

Rinse aids will cause premature damage and reduce product life span, and should not be used. Hamilton Medical does not guarantee the expiratory valve's life span if rinse aids are used.

10.6.2 Preparing and reprocessing the expiratory valve after use

The expiratory valve must be handled in accordance with all local, state, and federal regulations. Reprocess the expiratory valve immediately after use. The reprocessing cycle comprises cleaning, disinfection, and sterilization.

Remove macroscopic impurities of the expiratory valve by rinsing or wiping. You can add an aldehyde-free disinfection agent to the rinse water. You must not use any hard tools or hard brushes to remove resilient impurities.

Prior to sterilization, the expiratory valve must be cleaned and disinfected.

10.6.3 Cleaning and disinfecting the expiratory valve

The expiratory valve can be disinfected mechanically or manually.

NOTE:

Since mechanical disinfection is more effective and consistent, manual cleaning and disinfection is only permitted when no mechanical process is available.

Follow the chemical concentrations and soak times as stated in the corresponding manufacturer's instructions for use. Only use freshly made solutions. The disinfection solution must not foam.

Use only sterile water or water with a low microorganism count for all cleaning steps. Make sure that the particulate matter concentration in the water is low.

When selecting the cleaning and disinfection agent, consider whether the agents in question are suitable for the expiratory valve. Make sure the disinfection agents' effects are proven and the chemicals are compatible with the materials of the expiratory valve. In addition, instructions for cleaning with the selected agents must be available.

When in doubt contact the manufacturer of the disinfection or cleaning agent.

10.6.3.1 Mechanically cleaning and disinfecting the expiratory valve

The expiratory valves must be reprocessed in such a manner that hygienic and safe reuse can be assured. Cleaning / disinfection should only be carried out in a cleaning and disinfection device that complies with ISO 15883 and has been proven to be effective. Place the expiratory valve in such a manner that it is easy to clean and the effectiveness of cleaning and disinfection is not impaired.

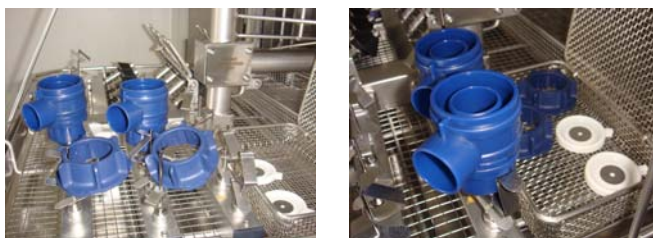

To ensure safe cleaning, the expiratory valve must be connected to the corresponding receptors. The expiratory valve must not disconnect from the receptor during reprocessing.

Expiratory valves that disconnect during reprocessing must be processed again. After the cleaning process is complete, check that the expiratory valve is completely dry and undamaged. Damaged expiratory valves must be discarded.

The following program parameters must be met for successful mechanical cleaning:

Pre-rinse:	one cycle using cold water for 1 min
-------------------	--------------------------------------

Cleaning:	one cycle at 55°C (131°F) for 5 min
Optional neutralization:	one cycle using cold water for 1 min
Rinsing:	one cycle using cold water for 1 min
Thermic disinfection:	one cycle at 83°C (181.4°F) for 10 min
Drying:	100°C (212°F) for 10 min and 95°C (203°F) for 30 min

10.6.3.2 Recommended equipment for mechanical reprocessing

CAUTION

Using a rinse aid will cause premature damage and reduce product life span.

Hamilton Medical recommends the DES-VAR-TD-Anaesthesia program, among others in the Miele PG8536 disinfecter, together with the E436/3 injector tray.

Suitable cleaning agents:

Manufacturer	Product	Concentration
Dr. Weigert	Neodisher Mediclean forte®	1.00%

Suitable neutralizer:

Manufacturer	Product	Concentration
Dr. Weigert	Neodisher Z®	0.10%

10.6.3.3 Manually cleaning the expiratory valve

1. Disassemble the expiratory valve.
2. Submerge the expiratory valve in the cleaning solution (for example, Neodisher Mediclean forte®) and let it soak for the time defined by the manufacturer of the disinfection or

cleaning agent. Make sure that all parts of the expiratory valve are fully submerged in the solution.

3. Rinse all parts at the beginning and the end of the soak time with the cleaning agent at least five times.
4. Remove matter and larger exterior impurities by carefully scrubbing the expiratory valve with a soft brush or soft towel.
5. Rinse the expiratory valve at least five times intensively, or according to the validated cleaning plan, in freshly distilled or deionized water.
6. Repeat the cleaning process if the last cleaning solution was not clear or there are still visible impurities on the expiratory valve.

10.6.3.4 Manually disinfecting the expiratory valve

1. Disassemble the expiratory valve and submerge it in the disinfection solution, and let it soak for the time defined by the manufacturer of the disinfection agent (for example, CIDEX[®] OPA). Make sure that all parts of the expiratory valve are fully submerged in the solution.
2. Rinse the expiratory valve at the beginning and at the end of the soak time with the disinfection solution at least five times, or in accordance with the validated disinfection plan.
3. Rinse the expiratory valve in freshly distilled or deionized water at least five times intensively, or according to the validated cleaning plan.
4. Repeat the cleaning process if the last cleaning solution was not clear or there are still visible impurities on the expiratory valve.
5. Dry the expiratory valve with filtered, oil-free compressed air.
6. Immediately package the expiratory valve using appropriate packaging.

10.6.4 Visual test

After each cleaning and disinfection cycle, the expiratory valve must be macroscopically clean, that is, free of visible residual matter and other impurities. If it is not, the entire cleaning and disinfection process must be repeated.

Visually check for external damage, such as cracks, broken or deformed parts, or discoloration.

10.6.5 Packaging

Make sure that the expiratory valves are not moist during packaging.

The packaging must conform to ISO 11607 and be suitable for vapor sterilization (heat resistance up to 141.0°C (285.8°F)) and be sufficiently permeable to vapor.

Only use packaging suitable for sterilization.

10.6.6 Sterilization

Sterilize the expiratory valve after cleaning and disinfection before use. Use one of the following methods:

- 134.0°C (273.2°F) with or without prevacuum, with an exposure time of a minimum of 3 min and a maximum of 18 min
- 121.0°C (249.8°F) with or without prevacuum, with an exposure time of a minimum of 30 min

Place the expiratory valve parts horizontally into the sterilizer; do not stack them. Note that Hamilton Medical is not responsible for the efficacy of any sterilization method, including but not limited to hot-air, ethylene oxide, formaldehyde, radiation, and low-temperature plasma sterilization.

10.6.7 Testing before use

WARNING

Defective expiratory valves or expiratory valves that fail the tightness test must not be used.

Carry out a visual check and a tightness test as described in the ventilator's operator's manual. Replace defective expiratory valves.

10.6.8 Expiratory valve life span

The expiratory valve can be cleaned, disinfected, and autoclaved at least 40 times. As long as the expiratory valve passes the tightness test during the preoperational check, the expiratory valve can be used. Tests and calibrations have to be carried out as specified in the ventilator's operator's manual. It is the user's responsibility to validate the processes used if the reprocessing procedures used differ from those in this guide.

10.6.9 Autoclaved and packaged expiratory valve: life span and storage conditions

The life span of an autoclaved and packaged expiratory valve depends on how long the packaging can keep the expiratory valve sterile. Follow the packaging manufacturer's specifications. At a minimum, the expiratory valve must be autoclaved every two years. Storage is subject to the same guidelines as the Hamilton Medical ventilator, as specified in the ventilator's operator's manual.

10.6.10 Disposal

A used expiratory valve must be handled as a contaminated item. Follow all local, state, and federal regulations with respect to environmental protection when disposing of used expiratory valves.

A**Specifications**

A.1	Physical characteristics	A-2
A.2	Environmental requirements	A-3
A.3	Pneumatic specifications	A-4
A.4	Electrical specifications	A-5
A.5	Control settings	A-6
A.6	Monitored parameters	A-12
A.7	Alarms	A-18
A.8	Configuration specifications	A-20
A.9	Ventilator breathing system specifications	A-22
A.10	Technical performance data	A-23
	A.10.1 Accuracy testing	A-25
	A.10.2 Essential performance	A-26
A.11	Pulse oximeter sensor data	A-27
A.12	Standards and approvals	A-28
A.13	EMC declarations (IEC 60601-1-2)	A-29
A.14	Warranty	A-34
A.15	Miscellaneous	A-36
A.16	Adjustable alarm setting resolution	A-36

A.1 Physical characteristics

Table A-1. Physical characteristics

Weight	4.9 kg (10.8 lb) 15.8 kg (35 lb) with trolley The trolley can accommodate a maximum safe working load of 44 kg (97.003 lb). ¹
Dimensions	See Figure A-1

1. The maximum safe working load applies to a stationary properly load-balanced trolley.

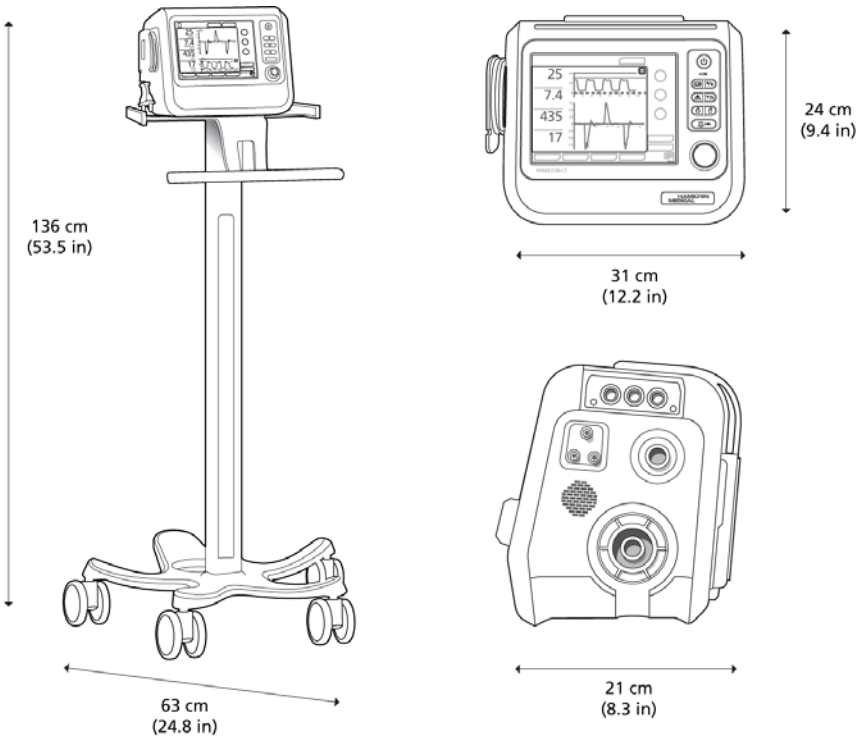

Figure A-1. HAMILTON-C1 dimensions

A.2 Environmental requirements

CAUTION

Ambient temperature < 0°C: The oxygen concentration that is displayed may be inaccurate. Disable O2 monitoring. Ensure that an alternative means of oxygen monitoring is always available and enabled.

Table A-2. Environmental requirements

Temperature	Operating: 5°C to 40°C (41°F to 104°F) Storage: -20°C to 60°C (-4°F to 140°F), in original packaging -15°C to 60°C (5°F to 140°F) otherwise
Altitude	-650 to 4000 m (-2132 to 13,120 ft) above sea level
Atmospheric pressure	Operating and storage: 600 to 1100 hPa
Relative humidity	Operating/storage: 10% to 95%, noncondensing
Water protection	IP21

A.3 Pneumatic specifications

Table A-3. Pneumatic specifications

High-pressure oxygen inlet	<p>Pressure: 2.8 to 6 bar / 280 to 600 kPa / 41 to 87 psi</p> <p>Flow: Maximum of 200 l/min</p> <p>Connector: DISS (CGA 1240) or NIST</p>
Low-pressure oxygen inlet	<p>Peak pressure: \leq 6 bar / 600 kPa / 87 psi</p> <p>Flow: \leq 15 l/min</p> <p>Connector: Quick-coupling system, compatible with Colder Products Company® (CPC) PMC Series</p>
Air supply	Integrated blower
Gas mixing system	<p>Delivered flow:</p> <ul style="list-style-type: none"> • 260 l/min \pm10% against ambient pressure (at sea level) • 120 l/min at 30 cmH2O • 0 to 200 l/min with 100% O2 • Flow limitation in neonatal modes: 40 l/min • Flow accuracy (for calibrated flow sensor) Adult/Ped: \pm10% or \pm300 ml/min (whichever is greater) Neonatal: \pm2 ml/s or \pm10% (whichever is greater) <p>Delivered pressure:</p> <p>Adult: 0 to 60 cmH2O</p> <p>Neonatal: 0 to 45 cmH2O</p>
Inspiratory outlet (To patient port)	Connector: ISO 15 mm female/22 mm male conical
Expiratory outlet (From patient port)	Connector (on expiratory valve): ISO 15 mm female/22 mm male conical

A.4 Electrical specifications

Table A-4. Electrical specifications

Input power	100 to 240 V AC -15%/+10%, 50/60 Hz
Power consumption	50 VA typical, 150 VA maximum
Battery	<p>NOTE:</p> <p>Battery life indications are approximate. The actual battery life depends on ventilator settings, battery age, and level of battery charge. To ensure maximum battery life, maintain a full charge and minimize the number of complete discharges.</p> <hr/> <p>Hamilton Medical provides a high-capacity¹ battery. Electrical specifications: 6.7 Ah, 72 Wh, 50 W typical, 150 W maximum</p> <p>Type: Lithium-ion, supplied by Hamilton Medical only</p> <p>Operating time:</p> <p>Operating times are measured with one fully charged battery, the blower in use, without option board, and with the following settings: Mode = PCV+, Rate = 10 b/min, Pcontrol = 10 cmH₂O, I:E = 1:4, PEEP = 5 cmH₂O, Flow trigger = 5 l/min, FiO₂ = 40%.</p> <p>Approximate operating times under these conditions are as follows:</p> <ul style="list-style-type: none"> • One battery, display brightness = 80%: 4 h • One battery, display brightness = 20%: 4.5 h <p>This operating time applies to new, fully charged Li-ion batteries not exposed to extreme temperatures. The actual operating time depends on battery age and on how the battery is used and recharged.</p> <p>Recharge time: While ventilator is connected to primary power, approximately 3.25 h to fully recharge one battery.</p> <hr/> <p>Storage: -20°C to 50°C, ≤ 95% relative humidity. Storage place should be free from vibration, dust, direct sunlight, moisture, and corrosive gases, and with a recommended temperature range < 21°C. Extended exposure to temperatures above 45°C could degrade battery performance and life.</p>

1. PN 369108, revision 4 and later

A.5 Control settings

NOTE:

- Some modes are available as options, and may not be available in all countries or on all devices.
- Some default settings are configurable.
- The following parameters are based on ideal body weight (IBW): Vt, Rate, Thigh, Tlow, and TI
- The following parameters are set based on body weight (neonatal): Vt, Rate, Tlow, Thigh, TI, and TI max



Table A-5 provides the control parameter ranges, default settings, and accuracy of measurements.

Table A-5. Control settings, ranges and accuracy



Parameter or Setting (units)	Range		Default settings		Accuracy ¹
	Adult/Ped	Neonatal 	Adult/Ped	Neonatal 	
Apnea backup	On, Off	On, Off	On	On	
ETS ² (%)	5 to 80	5 to 80	25 <i>In noninvasive modes:</i> 35	25 <i>In noninvasive modes:</i> 35	
Flow trigger ³ (l/min)	(S)CMV+, PCV+: 1 to 20, Off <i>Other modes:</i> 1 to 20	(S)CMV+, PCV+: 0.1 to 5.0, Off <i>Other modes:</i> 0.1 to 5.0	5	0.5	±10%
Height <i>See Pat. height</i>					
I:E ¹¹	1:9 to 4:1	1:9 to 4:1	1:4	1:3	
%MinVol ⁴ (%)	25 to 350	--	100	--	

Table A-5. Control settings, ranges and accuracy



Parameter or Setting (units)	Range		Default settings		Accuracy ¹
	Adult/Ped	Neonatal 	Adult/Ped	Neonatal 	
Mode	(S)CMV+, PCV+, SIMV+, PSIMV+, SPONT, ASV, NIV, NIV-ST, DuoPAP, APRV	(S)CMV+, PCV+, SIMV+, PSIMV+, SPONT, nCPAP-PC, nCPAP, NIV, NIV-ST, DuoPAP, APRV	ASV	PSIMV+	
Oxygen (%)	21 to 100	21 to 100	50	40	± (volume fraction of 2.5% + 2.5% gas level)
Pasvlimit ⁴ (cmH ₂ O)	5 to 60	--	30	--	
Pat. height					
(cm)	30 to 250	--	174	--	
(in)	12 to 98		70		
Pcontrol ⁵ (cmH ₂ O)	5 to 60	<i>nCPAP-PC:</i> 0 to 45 <i>Other modes:</i> 3 to 45	15	15	±5% or ±1 cmH ₂ O, whichever is greater <i>Neo:</i> ±5% or ±0.5 cmH ₂ O, whichever is greater
PEEP/CPAP (cmH ₂ O)	0 to 35	3 to 25	5	5	±5% or ±1 cmH ₂ O, whichever is greater <i>Neo:</i> ±5% or ±0.5 cmH ₂ O, whichever is greater

Table A-5. Control settings, ranges and accuracy



Parameter or Setting (units)	Range		Default settings		Accuracy ¹
	Adult/Ped	Neonatal 	Adult/Ped	Neonatal 	
P _{insp} ⁶ (cmH ₂ O)	3 to 60	3 to 45	15	15	±5% or ±1 cmH ₂ O, whichever is greater Neo: ±5% or ±0.5 cmH ₂ O, whichever is greater
P high (cmH ₂ O) <i>in DuoPAP</i>	0 to 60 <i>absolute pressure</i>	3 to 45 <i>absolute pressure</i>	20	--	±5% or ±1 cmH ₂ O, whichever is greater Neo: ±5% or ±0.5 cmH ₂ O, whichever is greater
P high (cmH ₂ O) <i>in APRV</i>	0 to 60 <i>absolute pressure</i>	0 to 45 <i>absolute pressure</i>	20 <i>startup setting = PEEP+15</i>	20	±5% or ±1 cmH ₂ O, whichever is greater Neo: ±5% or ±0.5 cmH ₂ O, whichever is greater
P low (cmH ₂ O) <i>in APRV</i>	0 to 35	0 to 25	5	5	±5% or ±1 cmH ₂ O, whichever is greater Neo: ±5% or ±0.5 cmH ₂ O, whichever is greater

Table A-5. Control settings, ranges and accuracy





Parameter or Setting (units)	Range		Default settings		Accuracy ¹
	Adult/Ped	Neonatal 	Adult/Ped	Neonatal 	
P-ramp ⁷ (ms)	0 to 2000 <i>ASV, NIV, NIV-ST, SPONT:</i> max = 200	0 to 600 <i>NIV, NIV-ST, SPONT, nCPAP-PC:</i> max = 200	100	50	±10 ms
Psupport ⁸ (cmH ₂ O)	0 to 60	0 to 45	15	15	±5% or ±1 cmH ₂ O, whichever is greater <i>Neo:</i> ±5% or ±0.5 cmH ₂ O, whichever is greater
Rate ¹³ (b/min)	<i>(S)CMV+, PCV+:</i> 4 to 80 <i>PSIMV+, NIV-ST:</i> 5 to 80 <i>Other modes:</i> 1 to 80	<i>(S)CMV+, PCV+, PSIMV+, NIV-ST:</i> 15 to 80 <i>PSIMV (non-Intellisync):</i> 5 to 80 <i>nCPAP-PC:</i> 10 to 80 <i>Other modes:</i> 1 to 80	<i>3.0 to 5.8 IBW:</i> 38 <i>5.9 to 8.0 IBW:</i> 32 <i>8.1 to 20.0 IBW:</i> 25 <i>20.1 to 29.9 IBW:</i> 19 <i>30 to 39 IBW:</i> 17 <i>40 to 59 IBW:</i> 15 <i>60 to 200 IBW:</i> 12	<i>0.2 to 1.25 kg:</i> 60 <i>1.26 to 3.0 kg:</i> 45 <i>3.1 to 5.9 kg:</i> 35 <i>6.0 to 8.9 kg:</i> 30 <i>9.0 to 20.5 kg:</i> 25 <i>21 to 30 kg:</i> 20	±1 b/min
Sex	Male, Female	not shown	Male		
Sigh ⁹	On, Off		Off		
T high ¹³ (s) <i>in DuoPAP</i>	0.1 to 40	0.1 to 40	Based on rate (IBW) and I:E = 1:4	Based on rate (Weight) and I:E = 1:3	±0.01
T high ¹³ (s) <i>in APRV</i>	0.1 to 40	0.1 to 40	Based on IBW	Based on Weight	±0.01

Table A-5. Control settings, ranges and accuracy

Parameter or Setting (units)	Range		Default settings		Accuracy ¹
	Adult/Ped	Neonatal 	Adult/Ped	Neonatal 	
TI ^{10,11,13} (s)	0.1 to 12	0.1 to 12	Based on rate (IBW) and I:E = 1:4	Based on rate (Weight) and I:E = 1:3	±0.01
TI max ¹² (s)	1 to 3	0.25 to 3.0	1.5	1.0 s ≤ 10 kg 1.5 s > 10 kg	± 0.1
T low (s) <i>in APRV</i>	0.2 to 40	0.2 to 40	Based on IBW	Based on Weight	± 0.01
Vt ¹³ (ml)	20 to 2000	2 to 300	560	10 <i>based on 2 kg body weight</i>	Adult: ±10% or ±10 ml, whichever is greater Neo: ±10% or ±2 ml, whichever is greater
VT/kg ¹⁴ (ml/kg)	--	5 to 12	8	5	
Weight ¹⁵ (kg)	--	0.2 to 30.0	--	2.0	

1. The stated accuracy includes the tolerance interval for each measurement. See Section A.10.1 for details.
2. Expiratory trigger sensitivity, in % of inspiratory peak flow.
3. Flow trigger is leak compensated.
4. In ASV mode only.
5. Control pressure, added to PEEP/CPAP.
6. Inspiratory pressure, added to PEEP/CPAP.
7. P-ramp is limited by 1/3 of TI time. Adjustment of TI time can override Pramp setting.
8. Pressure support, added to PEEP/CPAP.
9. Sigh is disabled in DuoPAP, APRV, and for neonates.
10. Inspiratory time; used with Rate to set the breath cycle time.
11. In PCV+ and (S)CMV+ modes, mandatory breath timing can be controlled by using a combination of inspiratory time (TI) and rate, or by the I:E ratio; set the method in Configuration. All other modes are controlled by using a combination of inspiratory time (TI) and rate.
12. Maximum inspiratory time for spontaneous breaths during noninvasive ventilation.
13. Startup setting derived from body weight setting (neonates), IBW (adults/pediatrics).
14. Set in configuration.
15. Actual body weight, used for neonates only. For adults and pediatrics, ideal body weight (IBW) is calculated instead.

Table A-6. Controls active in HAMILTON-C1 ventilation modes

Mode type	Closed-loop	Mandatory		SIMV				DuoPAP/APRV		Pressure support		Neonatal	
		PCV+	(S)CMV+	PSIMV+ Intellisync	PSIMV+	SIMV+	NIV-ST	DuoPAP	APRV	SPONT	NIV	nCPAP	nCPAP- PC
Mode	ASV												
Timing	--	Rate						Flow	--				Rate
	--	I:E	TI				Thigh		--				TI
Mandatory breaths	--	Pcontrol	Vt	Pcontrol	Vt	Pinsp	Phigh		--				Pcontrol
	--			Psupport			Psupport	--	Psupport				
Spontaneous breaths	ETS	--	ETS					--	ETS				
	--						Tlmax	--	--	Tlmax			
Baseline pressure	PEEP/C/PAP								Flow	PEEP/C/PAP		PEEP/ CPAP	PEEP/ CPAP
General	Flowtrigger												
	P-ramp												
	Oxygen												
	Gender												
	Patient height												
ASV-specific	%MinVol	--											
	Pas/limit	--											

A.6 Monitored parameters

Table A-7 provides the monitored parameter ranges, default settings, and accuracy of measurements.

Table A-8 lists the ranges of the real-time curves and loops. Pressure, flow, and volume measurements are based on readings from the flow sensor, and are expressed in BTPS (body temperature and pressure saturated).

You can show all monitored parameters as 1-, 6-, 12-, 24-, or 72-h trends¹.

For SpO2 parameter information, see the Pulse oximetry appendix.

Table A-7. Monitored parameters, ranges, and accuracy

Parameter (units)	Range		Accuracy ¹
	Adult/Ped	Neonatal 	
Pressure			
PEEP/CPAP (cmH2O)	0 to 80	0 to 80	± (2% of full scale reading + 4% of actual reading)
Pinsp ² (cmH2O)	0 to 80	--	± (2% of full scale reading + 4% of actual reading)
Pmean (cmH2O)	0 to 80	0 to 80	± (2% of full scale reading + 4% of actual reading)
Ppeak (cmH2O)	0 to 80	0 to 80	± (2% of full scale reading + 4% of actual reading)
Pplateau (cmH2O)	0 to 80	0 to 80	± (2% of full scale reading + 4% of actual reading)
AutoPEEP ³ (cmH2O)	0 to 80	0 to 80	

1. 72-h trends not available in all markets.

Table A-7. Monitored parameters, ranges, and accuracy (continued)

Parameter (units)	Range		Accuracy ¹
	Adult/Ped	Neonatal 	
Flow			
Insp flow, peak (l/min)	0 to 260	0 to 260	<i>Adult:</i> ±10% or 20 ml/s, whichever is greater <i>Neo:</i> ±10% or 2 ml/s, whichever is greater
Exp flow, peak (l/min)	0 to 260	0 to 260	<i>Adult:</i> ±10% or 20 ml/s, whichever is greater <i>Neo:</i> ±10% or 2 ml/s, whichever is greater
Flow ^{4,5} (l/min)	--	0 to 30	±10% or 20 ml/s, whichever is greater
Volume			
ExpMinVol ^{3,6} or MinVol NIV ^{3,7} (l/min)	0 to 99.9	0 to 99.9	±10% or ±0.3 l/min, whichever is greater
MVSpont ^{3,6} or MVSpont NIV ^{3,7} (l/min)	0 to 99.9	0 to 99.9	±10% or ±0.3 l/min, whichever is greater
VTE ^{3,6} or VTE NIV ^{3,7} (ml)	0 to 9000	0 to 9000	<i>Adult:</i> ±10% or ±10 ml, whichever is greater <i>Neo:</i> ±10% or ±2 ml, whichever is greater
VTI ³ (ml)	0 to 9000	0 to 9000	<i>Adult:</i> ±10% or ±10 ml, whichever is greater <i>Neo:</i> ±10% or ±2 ml, whichever is greater
VLeak ³ (%)	0 to 100	0 to 100	±10% (for leak vol- umes between 100 and 2000 ml)
MVLeak ³ (l/min)	0 to 99.9	0 to 99.9	±10% or ±0.3 l/min, whichever is greater

Table A-7. Monitored parameters, ranges, and accuracy (continued)



Parameter (units)	Range		Accuracy ¹
	Adult/Ped	Neonatal 	
Time			
I:E	9.9:1 to 1:99	9.9:1 to 1:99	--
fControl (b/min)	0 to 999	0 to 999	±1
fSpont ³ (b/min)	0 to 999	0 to 999	±1
fTotal (b/min)	0 to 999	0 to 999	±1
TI (s)	0 to 60	0 to 60	±100 ms
TE (s)	0 to 60	0 to 60	±100 ms
Other calculated and displayed parameters			
Cstat ³ (ml/cmH2O)	0 to 200	0 to 200	--
IBW ⁸ (kg)	3 to 139 default: 70	--	--
P0.1 ³ (cmH2O)	-99 to 0	-99 to 0	--
PTP ³ (cmH2O * s)	0 to 100	0 to 100	--
RCexp ³ (s)	0.0 to 99.9	0.0 to 99.9	--
Rinsp ³ (cmH2O / l/s)	0 to 999	0 to 999	--
Trigger	No or Yes	No or Yes	
VTEspont ³ (ml)	0 to 9000	0 to 9000	±10% or ±10 ml, whichever is greater
Weight ⁸ (kg)	--	0.2 to 30 kg	
Oxygen			
Oxygen ⁹ (%)	18 to 105	18 to 105	± (volume fraction of 2.5% + 2.5% of actual reading)
O2 consumption ^{10, 11} (l/min)	0 to 99.9	0 to 99.9	±10% or ±0.3 l/min, whichever is greater,

Table A-7. Monitored parameters, ranges, and accuracy (continued)

Parameter (units)	Range		Accuracy ¹
	Adult/Ped	Neonatal 	
CO₂¹²			
FetCO ₂ (%)	0 to 20	0 to 20	CO ₂ (BTPS): 0 to 40 mmHg (0 to 5.3 kPa): ±2 mmHg (0.3 kPa) 41 to 70 mmHg (5.4 to 9.3 kPa): ±5% 71 to 100 mmHg (9.4 to 13.3 kPa): ±8% 101 to 150 mmHg (13.4 to 20.0 kPa): ±10%
PetCO ₂ (mmHg)	0 to 150	0 to 150	
(kPa)	0 to 20	0 to 20	
slopeCO ₂ ^{3,13} (%CO ₂ / l)	0 to 9.99	0 to 9.99	--
V _t alv ^{3,13} (ml)	0 to 9999	0 to 9999	--
V' alv ^{3,13} (l/min)	0 to 20	0 to 20	--
V'CO ₂ ^{3,13} (ml/min)	0 to 9999	0 to 9999	--
VDaw ^{3,13} (ml)	0 to 999	0 to 999	--
VDaw/VTE ^{3,13} (%)	0 to 100	0 to 100	--
VeCO ₂ ^{3,13} (ml)	0 to 999	0 to 999	--
ViCO ₂ ^{3,13} (ml)	0 to 999	0 to 999	--

SpO₂ See the Pulse Oximetry appendix.

1. The stated accuracy includes the tolerance interval for each measurement, except for measurements displayed from external sensors (CO₂ and SpO₂). See Section A.10.1 for details.
2. Target inspiratory pressure in ASV mode.
3. Not applicable to nCPAP and nCPAP-PC modes.
4. Only applicable to nCPAP and nCPAP-PC modes.
5. A trend graph cannot be generated using the Flow parameter.
6. Used only with invasive modes.
7. The NIV parameter is used with noninvasive modes.
8. IBW is calculated using height and sex, and is used for adult and pediatric patients. Actual body weight is used for neonates.
9. A high setting of 105 is not available in all markets; in these cases, the high limit is 103.
10. Displayed after first 2.5 min of ventilation; not applicable for LPO.
11. Requires activation; contact your Hamilton Medical representative. When activated, the O₂ consumption parameter is displayed in the System > Info window.
12. Only available if the CO₂ option board is installed and the CO₂ sensor is enabled.
13. For mainstream CO₂ only.

Table A-8. Real-time waveforms and loops



Parameter	Range		Scale
	Adult/Ped	Neonatal 	
Real-time waveforms			
<i>All waveforms show Time on the x-axis. For adults/pediatrics, the time scale is 15 s; for neonates, 6 s.</i>			
Volume ^{1,2} (V) (ml) / time (s)	0 to 3200	0 to 300	0 to 5, 0 to 10, 0 to 25, 0 to 50 (default Neo), 0 to 100, 0 to 200, 0 to 400, 0 to 800 (default Adult), 0 to 1600, 0 to 3200
Flow ^{1,2} (l/min) / time (s)	-300 to 300	-30 to 30	±2.5, ±5, ±10 (default Neo), ±15, ±25, ±45, ±75 (default Adult), ±150, ±300
Airway pressure (Paw) (cmH2O) / time (s)	-10 to 80	-10 to 80	10/20, -10/40 (default), -10/80
FCO2 ³ (%) / time (s)	0 to 10	0 to 10	0 to 6, 0 to 10
PCO2 ³ / time (s) (mmHg)	0 to 100	0 to 100	0 to 60, 0 to 100
	(kPa)	0 to 14	0 to 8, 0 to 14
ASV graphs			
ASV target graphics: Tidal volume (Vt) (ml) / time (s)	0 to 3200	--	0 to 5, 0 to 10, 0 to 25, 0 to 50, 0 to 100, 0 to 200, 0 to 400, 0 to 800 (default), 0 to 1600, 0 to 3200
ASV target graphics: Tidal volume (Vt) (ml) / rate (l/min)	0 to 60	--	0 to 60
Loops¹			
Pressure/Volume <i>x-axis: ml</i> <i>y-axis: cmH2O</i>	x: 0 to 3200	x: 0 to 300	
	y: -10 to 80	y: -10 to 80	
Volume/Flow <i>x-axis: ml</i> <i>y-axis: l/min</i>	x: 0 to 3200	x: 0 to 300	
	y: -300 to 300	y: -30 to 30	

Table A-8. Real-time waveforms and loops (continued)

Parameter	Range		Scale
	Adult/Ped	Neonatal 	
Pressure/Flow <i>x-axis: l/min</i> <i>y-axis: cmH2O</i>	x: -300 to 300	x: -30 to 30	
	y: -10 to 80	y: -10 to 80	
Volume/PCO2 <i>x-axis: ml</i> <i>y-axis: mmHg</i>	x: 0 to 3200	--	
	y: 0 to 100	--	
Volume/FCO2 <i>x-axis: ml</i> <i>y-axis: %</i>	x: 0 to 3200	--	
	y: 0 to 10	--	

1. Not applicable to nCPAP and nCPAP-PC modes.
2. Scaled automatically. Not leak compensated.
3. Available with CO2 option.

A.7 Alarms

Table A-9 provides details about the adjustable alarms, including priority, upper and lower limit range, and default settings. For additional details about alarms, see Chapter 4 and Chapter 8.

Table A-9. Adjustable alarm ranges





Alarm (units)	Priority	Range		Default setting	
		Adult/Ped	Neonatal 	Adult/Ped	Neonatal 
Apnea time ⁹ (s)	<i>Adult:</i> High <i>Neonatal:</i> Medium	15 to 60	5 to 60	20 ¹	15 ¹
ExpMinVol, low ^{2,9} (l/min)	High	<i>in NIV, NIV-ST:</i> OFF, 0.1 to 50 <i>other modes:</i> 0.1 to 50	OFF, 0.01 to 10	4 <i>0.6 * Rate * Vt</i>	0.27 <i>0.6 * Rate * Vt</i>
ExpMinVol, high ^{2,9} (l/min)	High	<i>in NIV, NIV-ST:</i> OFF, 0.1 to 50 <i>other modes:</i> 0.1 to 50	OFF, 0.03 to 10	10 <i>1.5 * Rate * Vt</i>	0.67 <i>1.5 * Rate * Vt</i>
Flow ³ (l/min)	Medium; Low after silence	--	8 to 30	--	15
fTotal, low ⁹ (b/min)	Medium	0 to 99	0 to 200	0	0
fTotal, high ⁹ (b/min)	Medium	0 to 99	2 to 210	40	70
Oxygen, low ^{4,5} (%)	High	18 to 97	18 to 97	45	45
Oxygen, high ^{4,5} (%)	High	18 to 105 ⁶	18 to 105 ⁶	55	55
PetCO2, low (mmHg) (kPa)	Medium	Off, 0 to 100 Off, 0 to 13.2	Off, 0 to 100 Off, 0 to 13.2	30 4	30 4

Table A-9. Adjustable alarm ranges (continued)

Alarm (units)	Priority	Range		Default setting	
		Adult/Ped	Neonatal 	Adult/Ped	Neonatal 
PetCO ₂ , high (mmHg) (kPa)	Medium	1 to 100 1 to 13.2	1 to 100 1 to 13.2	60 8	60 8
Pressure, high (P _{max}) (cmH ₂ O)	High	15 to 70	<i>nCPAP, nCPAP-PC:</i> 10 to 55 <i>APRV:</i> 15 to 55 <i>other modes:</i> 18 to 55	40	40 <i>nCPAP:</i> 15 <i>nCPAP-PC:</i> Pcontrol+PEEP+5
Pressure, low (cmH ₂ O)	High	4 to 60	<i>nCPAP, nCPAP-PC:</i> 2 to 55 <i>other modes:</i> 4 to 55	PEEP	PEEP <i>nCPAP:</i> 3 <i>nCPAP-PC:</i> PEEP at startup
Pressure limitation (cmH ₂ O)	Medium; Low after silence	5 to 60	<i>nCPAP, nCPAP-PC:</i> P _{max} <i>APRV:</i> 5 to 45 <i>other modes:</i> 8 to 45	P _{max} - 10	P _{max} - 10
SpO ₂	See the Pulse oximetry appendix.				
V _t , low ^{7,9} (ml)	Medium	OFF ⁸ , 10 to 3000	OFF ⁸ , 0.1 to 300	280 $0.5 * V_t$	5 $0.5 * V_t$
V _t , high ^{7,9} (ml)	Medium	OFF ⁸ , 10 to 3000	OFF ⁸ , 0.1 to 300	850 $1.5 * V_t$	15 $1.5 * V_t$

1. The default setting is configurable.

2. Startup setting derived from body weight setting (neonates), IBW (adults/pediatrics).

3. Only active in nCPAP and nCPAP-PC modes.

4. Active only when O₂ monitoring (O₂ sensor) is enabled.

5. Oxygen alarm limits are adjustable only when using a low-pressure oxygen (LPO) supply. With HPO, the high and low oxygen alarm limits are automatically set in relation to the current oxygen setting as follows: O₂ setting + 5 (Oxygen high limit) and O₂ setting - 5 (Oxygen low limit). For example, if the Oxygen setting is 70%, the Oxygen high limit is set to 75 and the low limit is set to 65. Note that when switching from HPO to LPO, the oxygen alarm limits in force with HPO remain in place after the change.

6. A high setting of 105 is not available in all markets; in these cases, the high limit is 103.

7. In ASV mode, this alarm only applies for spontaneous breaths.

8. OFF available in NIV, NIV-ST, and neonatal modes (other than nCPAP/nCPAP-PC).

9. Not applicable to nCPAP and nCPAP-PC modes.

A.8 Configuration specifications

The following table lists the parameters and settings that can be specified in the Configuration windows. For details, see Appendix I.

Table A-10. Configuration specifications

Parameter	Configuration range	Default setting
General		
Language	English, Chinese, Croatian, Czech, Danish, Dutch, Finnish, French, German, Greek, Hungarian, Indonesian, Italian, Japanese, Korean, Norwegian, Polish, Portuguese, Romanian, Russian, Serbian, Slovak, Spanish, Swedish, Turkish	English
Units	Pressure: hPa, mbar, cmH2O CO2: mmHg, torr, kPa Length: cm, inch	cmH2O mmHg cm
More	RS232 protocol: Hamilton, Galileo compatible, Hamilton P2, Open VUELink, DrägerTestProtocol, Block Protocol	Galileo
Modes		
Philosophy	PCV+ / SIMV+: I:E, TI Mode label: (S)CMV+ / SIMV+, APVcmv / APVsimv	I:E (S)CMV+ / SIMV+
Graphics		
MMP ¹	MMP 1 to 4: Pmean, PEEP/CPAP, Ppeak, ExpMinVol, VTI, VTE, VLeak, fTotal, fSpont, Oxygen, Cstat, Rinsp, I:E, TI, TE, MVSpont, AutoPEEP, P0.1, PTP, RCexp, Pplateau, VTEspont	Ppeak ² , ExpMinVol, VTE, fTotal
Settings	For all mode, control, and alarm settings, see the appropriate tables in this appendix.	
Setups	The settings shown in this table apply to the default adult setups. You can also specify default neonatal settings.	

Table A-10. Configuration specifications *(continued)*

Parameter	Configuration range	Default setting
Mode Ctrl		
	Vt/IBW: 6 to 12 ml/kg	Adult: 8 ml/kg Neonatal: 5 ml/kg
Vent Status		
Oxygen ³ (%)	22 to 80	40
PEEP ⁴ (cmH ₂ O)	1 to 20	8
Pinsp (cmH ₂ O)	1 to 50	10
%MinVol high (%)	100 to 250	150
%MinVol low (%)	25 to 99	50
RSB <i>high</i> (l/l*min)	50 to 150	100
RSB <i>low</i> (l/l*min)	0 to 49	10
%fSpont ⁵ (%)	0 to 99	75

1. Additional parameters available when the Neonatal, CO2, and/or SpO2 options are installed.
2. The default setting is configurable.
3. The low Oxygen setting is always 21%.
4. The low PEEP setting is always 0 cmH2O.
5. The high %fSpont setting is always 100%.

A.9 Ventilator breathing system specifications

Table A-11 lists specifications for the HAMILTON-C1 ventilator breathing system.

Table A-11. Ventilator breathing system specifications

Parameter	Specification
Resistance ¹	<p>Dual limb circuit, adult, with humidifier: (19 mm ID, flow of 60 l/min): Inspiratory limb: < 6 cmH₂O/60 l/min Expiratory limb: < 6 cmH₂O/60 l/min</p> <p>Coaxial circuit, adult, no humidifier: (flow of 60l/min): Inspiratory limb: < 2.05 cmH₂O/60 l/min Expiratory limb: < 2.3 cmH₂O/60 l/min</p> <p>Dual limb circuit, neonatal, with humidifier: (10 mm ID, flow of 5 l/min): Inspiratory limb: < 6 cmH₂O/5 l/min Expiratory limb: < 6 cmH₂O/5 l/min</p>
Compliance ¹	<p>Dual limb circuit, adult, with humidifier: Approximately 2 ml/cmH₂O</p> <p>Coaxial circuit, adult, no humidifier: Approximately 0.64 ml/cmH₂O</p> <p>Dual limb circuit, neonatal, with humidifier: Approximately 1.0 ml/cmH₂O</p>
Volume ¹	<p>Adult circuit (19 mm ID): Approximately 2.4 l Adult flow sensor: 9 ml (single-use) or 11 ml (reusable)</p> <p>Neonatal circuit (10 mm ID): Approximately 0.9 l Infant flow sensor: Approximately 1.3 ml</p>
Bacteria filter	<p>Particle size: Captures particles of 0.3 mm (micron) with > 99.99% efficiency Resistance: < 2 cmH₂O at 60 l/min</p>
Flow sensor dead space	<p>Adult: Single use, < 9 ml; Reusable, < 11 ml Neonatal: < 1.3 ml</p>

1. The inspiratory limb includes ambient valve, flow sensor, inspiratory filter, inspiratory tubes, and humidifier. It does not include the heating wire. The expiratory limb includes expiratory tubes, water trap, expiratory valve, and flow sensor.

A.10 Technical performance data

Table A-12 lists technical performance data for the ventilator.

Table A-12. Technical performance data

Description	Specification
Patient ideal body weight (IBW, determined from Pat. height setting)	3 to 139 kg (6.6 to 306 lb) ¹
 Weight (used for neonatal patients)	0.2 to 30 kg (0.44 to 66 lb)
Inspiratory pressure	0 to 60 cmH ₂ O
Maximum limited pressure	60 cmH ₂ O
Maximum working pressure	Adults/ped: 0 to 60 cmH ₂ O (a combination of PEEP/CPAP and P _{insp}). Ensured through pressure limiting. Neonatal: Limitation depending on frequency, to a maximum of 45 cmH ₂ O at frequency of 80
Maximum inspiratory flow	260 l/min (120 l/min with 100% O ₂)
Tidal volume/target tidal volume	Adults/ped: 20 to 2000 ml Neonatal: 2 to 300 ml
Minute volume capability	Up to 60 l/min
Inspiratory time (spontaneous breaths)	0.2 to 3 s
Minimum expiratory time	20% of cycle time; 0.2 to 0.8 s
Automatic expiratory base flow	Adults/ped: fixed at 3 l/min Neonatal: fixed at 4 l/min
Means of inspiratory triggering	Flow (flow trigger control setting)
Oxygen mixer accuracy	± (volume fraction of 2.5% + 2.5% of actual reading)

Table A-12. Technical performance data (continued)

Description	Specification
Measuring devices	<p>Continuous oxygen measurement</p> <p>Measurement: Delivered oxygen concentration, range: 18% to 105%</p> <p>Response time: < 45 s to reach 90% of final oxygen concentration</p> <p>Initialization time (time from turning device on until operating performance): < 40 s</p> <p>Drift: ≤ 2.5% at 60% Oxygen over 6 h</p> <hr/> <p>CO2 measurement</p> <p>Measurements: See Table A-9</p> <p>Rise time: < 60 ms</p> <p>Initialization time: Capnogram displayed in < 15 s at an ambient temperature of 25°C, full specifications within 2 min</p> <p>Sampling frequency: 100 Hz</p> <p>CO2 calculation method: BTPS</p> <p>CO2 stability:</p> <p>Short-term drift: ≤ 0.8 mmHg (0.10 kPa) over 4 h</p> <p>Long-term drift: Accuracy specification maintained over 120 h</p> <p>CO2 noise (rms): ≤ 0.25 mmHg (0.03 kPa) at 7.5% CO2</p>
Tests and special functions	<p>Tightness test, flow sensor/circuit/O2 cell/CO2 sensor calibration, O2 enrichment, manual breath, inspiratory hold maneuver, nebulization (30 min, 8 l/min), leak compensation, communication interface, compensation of breathing circuit resistance and compliance.</p>
Display device	<p>Display of settings, alarms, and monitored data:</p> <p>Type: TFT color</p> <p>Size: 640 x 480 pixels, 8.4 in (134 mm) diagonal</p>

Table A-12. Technical performance data *(continued)*

Description	Specification
Brightness setting for display	The range is 10% to 100% brightness. By default, Day is set to 80%; Night is set to 40%.
Alarm volume (Loudness ²)	The range is 1 to 10. The default for adults is 5, for neonates, 3.
Sound power level ³	51 dB(A) \pm 3 dB(A)
Sound pressure level ³	43 dB(A) \pm 3 dB(A)

1. Actual patient weight can be much greater (e.g., 300 kg or 661 lb)

2. Volume at 1 m distance from ventilator. A setting of 1 = 60 dB(A), 5 = 70 dB(A), and 10 = 83dB(A), with accuracy of \pm 3 dB(A).

3. Per ISO 80601-2-12

A.10.1 Accuracy testing

The ventilator's parameter and measurement accuracy is tested using an IMT FlowAnalyser™. The tolerance intervals for the data generated by the FlowAnalyser are as specified below, and are included in the accuracy information provided in this manual.

Table A-13. Tolerance intervals for accuracy testing

Parameter type	Tolerance interval of measurement
Volume	\leq 50 ml: \pm 1% > 50 ml: \pm 1.75%
Pressure	\pm 0.75% or \pm 0.1 cmH ₂ O (mbar), whichever is greater
Flow	\pm 1.75% or \pm 0.5 l/min, whichever is greater
O ₂	\pm 1%

Test equipment intended to test a pulse oximeter probe's or a pulse oximeter monitor's function cannot be used to assess their accuracy.

A.10.2 Essential performance

Table A-14. Essential performance

Component	Requirement
Gas supply failure	Gas supply failure must be detected and the operator informed.
Oxygen level alarm condition	If O ₂ is higher or lower than the set alarm limits, this must be detected and the operator informed through an alarm.
CO ₂ level alarm condition ¹	If CO ₂ is higher or lower than the set alarm limits, this must be detected and the operator informed through an alarm.
SpO ₂ level alarm condition ¹	If SpO ₂ is higher or lower than the set alarm limits, this must be detected and the operator informed through an alarm.
Pressure	The airway pressure must be monitored. If it is higher or lower than the set alarm limits, this must be detected and the operator informed through an alarm.
Volume	The applied and expired volumes must be monitored. If they are higher or lower than the set alarm limits, this must be detected and the operator informed through an alarm.
Electrical supply failure	An electrical supply failure must be detected and the operator informed.
Internal electrical power source nears depletion	The remaining battery capacity must be monitored and qualitatively indicated. At last 5 min prior to depletion, an alarm must be issued.

1. If option is installed.

A.11 Pulse oximeter sensor data

The following sensor data is displayed in the Monitoring > SpO2 window.

Table A-15. Radiant power specifications for Masimo SpO2 sensors

Radiant power of light, LNOP, LNCS/M-LNCS sensors, at 50 mA, pulsed

≤ 15 mW

Table A-16. Nominal wavelength specifications for SpO2 sensors

	LED	Wavelength
LNOP, LNCS sensors	Red	660 nm
	Infrared	905 nm
LNOP tip clip (LNOP TC-1) and LNCS/M-LNCS tip clip (LNCS/M-LNCS TC-1)	Red	653 nm
	Infrared	880 nm
LNOP transreflectance (LNOP ZF-1) forehead and LNCS/M-LNCS transreflectance (LNCS/-LNCS TF-1)	Red	660 nm
	Infrared	880 nm

A.12 Standards and approvals

NOTE:

Where standards are mentioned, the HAMILTON-C1 complies with the versions listed in Table 1 on page 13.

The HAMILTON-C1 was developed in accordance with pertinent international standards.

The ventilator is manufactured within an EN ISO 13485 and EN ISO 9001, Council Directive 93/42/EEC, Annex II, Article 1 certified quality management system.

The ventilator meets the Essential Requirements of Council Directive 93/42/EEC, Annex I.

The ventilator meets relevant parts of, among others, the following standards:

- **IEC 60601-1:** Medical electrical equipment, Part 1: General requirements for basic safety and essential performance. The device classification is: Class II, Type B applied part (ventilator breathing system, VBS), type BF applied part (CO₂ sensor including CO₂ module connector; SpO₂ sensor including adapter), continuous operation
- **IEC 60601-1-2:** Medical electrical equipment - Part 1-2: General requirements for basic safety and essential performance - Collateral standard: Electromagnetic compatibility - Requirements and tests
- **ISO 80601-2-12:** Medical electrical equipment - Part 2-12: Particular requirements for the basic safety and essential performance of critical care ventilators
- **CAN/CSA-C22.2 No. 60601-1:** Lung ventilators - Part 1: Particular requirements for critical care ventilators
- **ANSI/AAMI ES 60601-1:** Medical electrical equipment: General requirements for safety
- **EN ISO 5356-1:** Anaesthetic and respiratory equipment - Conical connectors - Part 1: Cones and sockets
- **EN ISO 5359:** Low-pressure hose assemblies for use with medical gases.

- **ISO 80601-2-55:** Medical electrical equipment - Part 2-55. Particular requirements for the basic safety and essential performance of respiratory gas monitors

A.13 EMC declarations (IEC 60601-1-2)

The HAMILTON-C1 ventilator is intended for use in the electromagnetic environment specified in Tables A-17 and A-18. The customer or the user of the HAMILTON-C1 ventilator should ensure that it is used in such an environment.

NOTE:

- U_T is the AC mains voltage prior to application of the test level.
 - At 80 MHz and 800 MHz, the higher frequency range applies.
 - These guidelines may not apply in all situations. Electromagnetic propagation is affected by absorption and reflection from structures, objects, and people.
-

Table A-17. Guidance and manufacturer's declaration – electromagnetic emissions (IEC 60601-1-2)

Emissions test	Compliance	Electromagnetic environment guidance
RF emissions CISPR 11	Group 1	The HAMILTON-C1 ventilator uses RF energy only for its internal function. Therefore, its RF emissions are very low and are not likely to cause any interference in nearby electronic equipment.
RF emissions CISPR 11, conducted	Class A	The HAMILTON-C1 ventilator is suitable for use in all establishments other than domestic and those directly connected to the public low-voltage power supply network that supplies buildings for domestic purposes.
RF emissions CISPR 11, radiated	Class A	
Harmonic emissions IEC 61000-3-2	Class A	
Voltage fluctuations/ flicker emissions IEC 61000-3-3	Complies	

Table A-18. Guidance and manufacturer's declaration – electromagnetic immunity (IEC 60601-1-2)

Immunity test	IEC 60601 test level	Compliance level	Electromagnetic environment guidance
Electrostatic discharge (ESD) IEC 61000-4-2	±6 kV contact ±8 kV air	±6 kV contact ±8 kV air	Floors should be wood, concrete, or ceramic tile. If floors are covered with synthetic material, the relative humidity should be at least 30%.
Electrical fast transient/burst IEC 61000-4-4	±2 kV for power supply lines ±1 kV for input/output lines	±2 kV for power supply lines ±1 kV for input/output lines	Mains power quality should be that of a typical commercial or hospital environment.
Surge IEC 61000-4-5	±1 kV line(s) to line(s) ±2 kV line(s) to earth	±1 kV line(s) to line(s) ±2 kV (line(s) to earth	Mains power quality should be that of a typical commercial or hospital environment.
Voltage dips, short interruptions, and voltage variations on power supply input lines IEC 61000-4-11	< 5% U_T (>95% dip in U_T) for 0.5 cycle 40% U_T (60% dip in U_T) for 5 cycles 70% U_T (30% dip in U_T) for 25 cycles <5% U_T (>95% dip in U_T) for 5 s	<5% U_T (>95% dip in U_T) for 0.5 cycle 40% U_T (60% dip in U_T) for 5 cycles 70% U_T (30% dip in U_T) for 25 cycles <5% U_T (>95% dip in U_T) for 5 s	Mains power quality should be that of a typical commercial or hospital environment. If the user of the HAMILTON-C1 ventilator requires continued operation during power mains interruptions, it is recommended that the HAMILTON-C1 ventilator be powered from an uninterruptible power supply or battery.

**Table A-18. Guidance and manufacturer's declaration –
electromagnetic immunity (IEC 60601-1-2) (continued)**

Immunity test	IEC 60601 test level	Compliance level	Electromagnetic environment guidance
Power frequency (50/60 Hz) magnetic field IEC 61000-4-8	3 A/m	3 A/m	The power frequency magnetic field should be at levels characteristic of a typical location in a typical commercial or hospital environment.
Conducted RF IEC 61000-4-6	3 Vrms 150 kHz to 80 MHz outside ISM bands ¹ 10 Vrms 150 kHz to 80 MHz in ISM bands ¹	10 V 10 V	Portable and mobile RF communications equipment should be used no closer to any part of the HAMILTON-C1 ventilator, including cables, than the recommended separation distance calculated from the equation applicable to the frequency of the transmitter. Recommended separation distance: $d = 0.35\sqrt{P}$ $d = 1.2\sqrt{P}$

Table A-18. Guidance and manufacturer's declaration – electromagnetic immunity (IEC 60601-1-2) (continued)

Immunity test	IEC 60601 test level	Compliance level	Electromagnetic environment guidance
Radiated RF IEC 61000-4-3	10 V/m 80 MHz to 2.5 GHz	10 V/m	80 MHz to 800 MHz $d = 1.2 \cdot \sqrt{P}$ 800 MHz to 2.5 GHz $d = 2.3 \cdot \sqrt{P}$ where P is the maximum output power rating of the transmitter in watts (W) according to the transmitter manufacturer and <i>d</i> is the recommended separation distance in meters (m). ² Field strengths from fixed RF transmitters, as determined by an electromagnetic site survey ³ , should be less than the compliance level in each frequency range ⁴ . Interference may occur in the vicinity of equipment marked with the symbol 

1. The ISM (industrial, scientific and medical) bands between 150 kHz and 80 MHz are 6.765 MHz to 6.795 MHz; 13.553 MHz to 13.567 MHz; 26.957 MHz to 27.283 MHz; and 40.66 MHz to 40.70 MHz.
2. The compliance levels in the ISM frequency bands between 150 kHz and 80 MHz and in the frequency range 80 MHz to 2.5 GHz are intended to decrease the likelihood that mobile/portable communications equipment could cause interference if it is inadvertently brought into patient areas. For this reason, an additional factor of 10/3 has been incorporated into the formulas used in calculating the recommended separation distance for transmitters in these frequency ranges.
3. Field strengths from fixed transmitters, such as base stations for radio (cellular/cordless) telephones and land mobile radios, amateur radio, AM and FM radio broadcast and TV broadcast cannot be predicted theoretically with accuracy. To assess the electromagnetic environment due to fixed RF transmitters, an electromagnetic site survey should be considered. If the measured field strength in the location in which the HAMILTON-C1 ventilator is used exceeds the applicable RF compliance level above, the HAMILTON-C1 ventilator should be observed to verify normal operation. If abnormal performance is observed, additional measures may be necessary, such as re-orienting or relocating the HAMILTON-C1 ventilator.
4. Over the frequency range 150 kHz to 80 MHz, field strengths should be less than 10 V/m.

The HAMILTON-C1 is intended for use in an electromagnetic environment in which radiated RF disturbances are controlled. The customer or the user of the ventilator can help prevent electromagnetic interference by maintaining a minimum distance between portable and mobile RF communications equipment (transmitters) and the ventilator as recommended in Table A-19, according to the maximum output power of the communications equipment.

Table A-19. Recommended separation distances between portable and mobile RF communications equipment and the HAMILTON-C1 ventilator

Rated maximum output power of transmitter (W)	Separation distance according to frequency of transmitter (m)			
	150 kHz to 80 MHz outside ISM bands $d = 0.35\sqrt{P}$	150 kHz to 80 MHz in ISM bands $d = 1.2\sqrt{P}$	80 MHz to 800 MHz $d = 1.2\sqrt{P}$	800 MHz to 2.5 GHz $d = 2.3\sqrt{P}$
0.01	0.035	0.12	0.12	0.23
0.1	0.11	0.38	0.38	0.73
1	0.35	1.2	1.2	2.3
10	1.1	3.8	3.8	7.3
100	3.5	12	12	23

NOTES:

- These guidelines may not apply in all situations. Electromagnetic propagation is affected by absorption and reflection from structures, objects, and people.
- For transmitters rated at a maximum output power not listed above, the recommended separation distance d in meters (m) can be determined using the equation applicable to the frequency of the transmitter, where P is the maximum output power rating of the transmitter in watts (W) according to the transmitter manufacturer.
- At 80 MHz and 800 MHz, the separation distance for the higher frequency range applies.
- The ISM (industrial, scientific and medical) bands between 150 kHz and 80 MHz are 6.765 MHz to 6.795 MHz; 13.553 MHz to 13.567 MHz; 26.957 MHz to 27.283 MHz; and 40.66 MHz to 40.70 MHz.
- An additional factor of 10/3 has been incorporated into the formulas used in calculating the recommended separation distance for transmitters in the ISM frequency bands between 150 kHz and 80 MHz and in the frequency range 80 MHz to 2.5 GHz to decrease the likelihood that mobile/portable communications equipment could cause interference if it is inadvertently brought into patient areas.

A.14 Warranty

LIMITED WARRANTY

THE WARRANTY DESCRIBED IN THIS AGREEMENT IS IN LIEU OF ANY AND ALL OTHER WARRANTIES, EXPRESS OR IMPLIED, INCLUDING IMPLIED WARRANTIES OF MERCHANTABILITY AND FITNESS FOR A PARTICULAR PURPOSE. HOWEVER, IMPLIED WARRANTIES ARE NOT DISCLAIMED DURING THE PERIOD OF THIS LIMITED WARRANTY.

Hamilton Medical guarantees its products to be shipped free from defects in material and workmanship. The warranty does not include disposable items. Disposable items and consumable products are considered to be of single use or of limited use only and must be replaced regularly as required for proper operation of the product following the operator's manual.

Hamilton Medical and the manufacturer shall have no obligations nor liabilities in connection with the product other than what is specified herein, including without limitation, obligations and/or liabilities for alleged negligence, or for strict liability. In no event shall the company be liable for incidental or consequential damages, either direct or contingent.

This Limited Warranty shall be void and not apply:

1. If the product has not been installed and connected by an authorized local representative of Hamilton Medical in accordance with the instructions furnished by Hamilton Medical and by a Hamilton Medical representative;
2. If replacements and/or repairs have not been performed by authorized or properly trained personnel.
3. If no evidence is present that the occurrence of damage/repair happened within the certified warranty period.
4. If the serial number has been altered, effaced or removed and there is no bill of sale or evidence to verify the product's purchase date.

-
5. If the defects arise from misuse, negligence, or accidents or from repair, adjustment, modification or replacement made outside Hamilton Medical's factories or other than an authorized service center or authorized service representative.
 6. If the product has been modified, or in any nature altered without prior written authorization from Hamilton Medical.
 7. If yearly maintenance is not performed.
 8. If the product is or has been used in any way that is not specified under "Intended Use" (see "General cautions and notes").
 9. If the product has been used by anyone, but properly trained personnel under the supervision of a physician.

Replacements and/or repairs furnished under this Limited Warranty do not carry a new warranty, but carry only the unexpired portion of the original Limited Warranty. The warranty of repaired and/or replaced components does not exceed the Limited Warranty of the device.

To obtain service under this Limited Warranty, claimant must promptly notify the country's sales partner of Hamilton Medical regarding the nature of the problem, serial number and the date of purchase of the Product.

Except as stated above, Hamilton Medical shall not be liable for any damages, claims or liabilities including, but not limited to, personal bodily injury, or incidental, consequential, or special damages. Nor will Hamilton Medical be liable for any damages, claims or liabilities including, but not limited to, personal bodily injury, or incidental, consequential, or special damages resulting from misuse of the device or failure to comply with any of the provisions made in this manual.

A.15 Miscellaneous

The general terms and conditions of Hamilton Medical shall be applicable. This agreement shall be governed by and construed in accordance with the laws of Switzerland and may be enforced by either party under the jurisdiction of the court of Chur, Switzerland.

A.16 Adjustable alarm setting resolution

Table A-20 provides the setting resolutions for the adjustable alarms. For additional alarm specifications, see Table A-9.

Table A-20. Adjustable alarm setting resolution

Alarm (units)	Resolution
Apnea time (s)	<i>Adult:</i> 5 s <i>Neonatal:</i> 1 < 15 s 5 ≥ 15
ExpMinVol, low (l/min)	<i>Adult:</i> 0.1 < 1 l/min 0.5 ≥ 1 1 ≥ 10 <i>Neo:</i> 0.01 < 1 0.1 ≥ 1
ExpMinVol, high (l/min)	<i>Adult:</i> 0.1 < 1 l/min 0.5 ≥ 1 1 ≥ 10 <i>Neo:</i> 0.01 < 1 0.1 ≥ 1
Flow (high) (l/min)	1
fTotal, low (b/min)	1
fTotal, high (b/min)	1

Table A-20. Adjustable alarm setting resolution

Alarm (units)	Resolution
Oxygen, low (%)	1
Oxygen, high (%)	1
PetCO ₂ , low (mmHg)	1
(kPa)	0.1
PetCO ₂ , high (mmHg)	1
(kPa)	0.1
Pressure, high (Pmax) (cmH ₂ O)	1
Pressure, low (cmH ₂ O)	1
Pressure limitation (cmH ₂ O)	1
SpO ₂ alarms	
Vt, low (ml)	<i>Adult:</i> OFF 5 < 100 ml 10 ≥ 100 and < 500 50 ≥ 500 <i>Neo:</i> OFF 0.1 < 10 1 ≥ 10 and < 100 5 ≥ 100
Vt, high (ml)	<i>Adult:</i> OFF 5 < 100 ml 10 ≥ 100 and < 500 50 ≥ 500 <i>Neo:</i> OFF 0.1 < 10 1 ≥ 10 and < 100 5 ≥ 100

B Modes of ventilation

B.1	Introduction	B-2
B.2	The biphasic concept	B-5
B.3	Mandatory modes	B-8
B.3.1	(S)CMV+ mode (APVcmv)	B-8
B.3.2	PCV+ mode	B-10
B.4	Spontaneous modes (SPONT and NIV)	B-12
B.5	SIMV modes	B-16
B.5.1	SIMV+ mode (APVsimv)	B-17
B.5.2	PSIMV+ mode	B-19
B.5.3	NIV-ST mode	B-23
B.6	DuoPAP (Duo positive airway pressure) mode	B-26
B.6.1	The many faces of DuoPAP	B-27
B.6.2	Pressure support in DuoPAP breaths	B-27
B.6.3	Synchronization	B-28
B.6.4	DuoPAP controls	B-29
B.7	APRV (airway pressure release ventilation) mode	B-30
B.7.1	Initialization of APRV	B-31
B.7.2	Sustained high-pressure recruitment maneuvers	B-32
B.7.3	APRV controls	B-32
B.8	Safety mode and ambient state	B-34

B.1 Introduction

NOTE:

- For details about the neonatal-only nCPAP and nCPAP-PC modes, see Chapter 5.
 - Some modes use different parameters for the Neonatal patient group. When present, these differences are shown.
 - The Sigh setting is only for adult/pediatric patients. It does not apply to neonatal patients.
-

This section discusses the principles of operation for the HAMILTON-C1 ventilation modes. It lays the groundwork by describing the biphasic concept, which is at the heart of the device's pneumatic design and which is vital to understanding how the HAMILTON-C1 ventilates in all modes.

The HAMILTON-C1 has a full range of ventilation modes that provide full and partial ventilatory support. Table B-1 classifies these modes according to a scheme developed by Branson et al¹. The table classifies modes based on primary breath type and characteristics of mandatory breaths in that mode. Table A-6 lists the controls active in all modes.

Volume modes in the HAMILTON-C1 are delivered by an adaptive volume controller. Combining the advantages of pressure-controlled ventilation with volume-targeted ventilation, the adaptive volume controller ensures that the target tidal volume is delivered but without undue application of pressure, even when lung characteristics change. The operation of the adaptive volume controller is described as part of the (S)CMV+ mode description, Section B.3.1.

1. Branson RD, Hess DR, Chatburn RL. Respiratory Care Equipment. Philadelphia: Lippincott Williams & Wilkins Publishers, 1999;359-93.

The HAMILTON-C1 modes have these general characteristics:

- **Mandatory breaths.** See Table B-1 for information on mandatory breaths as they apply to the various modes. Not listed in the table are operator-initiated mandatory (manual) breaths, which are pressure controlled and time cycled. Mandatory breaths have a decelerating flow waveform.
- **Spontaneous breaths.** Spontaneous breathing is allowed in all modes at any time. Additionally, in PSIMV+, SPONT, SIMV+, NIV, NIV-ST, and DuoPAP, spontaneous breaths are pressure supported and time cycled if the users set flow trigger threshold is passed. In the modes (S)CMV+ and PCV+, a spontaneous effort of the patient activating the flow trigger, results in a pressure controlled and time cycled breath.
- **Triggering.** Breaths can be patient (flow) triggered in all modes except nCPAP and nCPAP-PC, based on an operator-set flow sensitivity. All modes permit operator-initiated manual breaths.
- **Pressure.** A positive baseline pressure (PEEP/CPAP) may be set for all breaths in all modes.
- **Pressure rise time.** An operator-set pressure ramp (P-ramp) defines the time required for inspiratory pressure to rise to the set (target) pressure.
- **FiO2.** FiO2 can be set in all modes except when oxygen is provided by a low-pressure supply.

Table B-1. Classification of HAMILTON-C1 ventilation modes

Mode name	Breathing pattern ¹	Mandatory breaths			
		Control type ²	Trigger ³	Limit ⁴	Cycle ⁵
PCV+	PC-CMV	Setpoint	F, T	P	T
	Operational logic: Every breath is pressure controlled and mandatory.				
PSIMV+	PC-IMV	Setpoint	F, T	P	T, F
	Operational logic: Mandatory breaths are pressure controlled.				
SPONT	PC-CSV	Setpoint	F	P	F
	Operational logic: Every breath is spontaneous.				
(S)CMV+ (APVcmv)	PC-CMV	Adaptive	F, T	V, P	T
	Operational logic: Every breath is volume targeted and mandatory.				

Table B-1. Classification of HAMILTON-C1 ventilation modes (continued)

Mode name	Breathing pattern ¹	Mandatory breaths			
		Control type ²	Trigger ³	Limit ⁴	Cycle ⁵
SIMV+ (APV-simv)	PC-IMV	Adaptive	F, T	V, P	T
	Operational logic: Mandatory breaths are volume targeted.				
NIV	PC-CSV	Setpoint	F	P	F
	Operational logic: Every breath is spontaneous. Leakage is compensated for.				
NIV-ST	PC-IMV	Setpoint	F, T	P	T, F
	Operational logic: Mandatory breaths are pressure controlled. Leakage is compensated for.				
DuoPAP	PC-IMV	Setpoint	F, T	P	F, T
	Operational logic: Mandatory breaths are pressure controlled. Leakage is compensated for.				
APRV	PC-APRV	Setpoint	T	P	T
	Operational logic: Mandatory breaths are pressure controlled. Leakage is compensated for.				
nCPAP	PC-IMV	---	---	Pressure	Time
nCPAP-PC	PC-IMV	Set-point or adaptive	Time	Pressure	Time

1. A designator that combines the primary control variable (PC = pressure control) for the mandatory breaths (or in CSV, for the spontaneous breaths) with the breath sequence (CMV = continuous mandatory ventilation – all breaths are mandatory, IMV = intermittent mandatory ventilation – spontaneous breaths between mandatory breaths, CSV = continuous spontaneous ventilation – all breaths are spontaneous). The control variable is the independent variable that the ventilator manipulates to cause inspiration.
2. The way pressure and volume are controlled within or between breaths. Setpoint means the ventilator output automatically matches a constant, unvarying, operator preset input value (like the production of a constant inspiratory pressure or tidal volume from breath to breath). Optimum is a control scheme that uses automatic adjustment of setpoints to optimize other variables as respiratory mechanics change. Adaptive control means one setpoint (e.g., the pressure limit) of the ventilator is automatically adjusted over several breaths to maintain another setpoint (e.g., the target tidal volume) as the mechanics of the respiratory system change.
3. A trigger variable starts inspiration.
4. A limit variable can reach and maintain a preset level before inspiration ends but it does not end inspiration.
5. A cycle variable is a measured parameter used to end inspiration.

B.2 The biphasic concept

It is widely accepted that early spontaneous breathing is beneficial for many ventilated patients, provided the device lets the patient inspire and exhale whenever the respiratory muscles contract and relax. In other words, the ventilator needs to be in synchrony with the patient's muscle contractions, regardless of how the ventilator's controls are set.

Accordingly, the HAMILTON-C1's pneumatics were designed to permit the patient's free spontaneous breathing. The ventilator never forces the patient into a preset breathing pattern but always yields to spontaneous breathing. This is achieved through a special valve control system independent of any trigger mechanism. This concept is called "biphasic," because gas can flow into and out of the patient at any time. The biphasic concept applies in all HAMILTON-C1 ventilation modes.

Implementation of the biphasic concept improves patient breathing comfort¹, as spontaneous breathing is encouraged², less sedation is required even with prolonged inspiratory phases³, and there is a free delivery of flow to the patient at any time. The decelerating inspiratory waveform improves gas distribution, oxygenation, and lowers peak pressures^{2,3,4,5,6}.

Figures B-1 through B-3 illustrate this concept. Figure B-1 shows a passive patient ventilated by pressure-controlled ventilation. Gas flows into the patient when pressure rises and gas flows out of the patient when inspiratory pressure falls.

-
1. 1996 Mar;153(3):1025-33
 2. Kuhlen R, Putensen C, Editorial: Maintaining spontaneous breathing efforts during mechanical ventilatory support, *Int Care Med* 1999;25:1203-5
 3. Sydow M, Burchardi H, Ephraim E, Zielmann S, Crozier TA, Long-term effects of two different ventilatory modes on oxygenation in acute lung injury. Comparison of airway pressure release ventilation and volume-controlled inverse ratio ventilation. *Am J Respir Crit Care Med* 1994 Jun;149(6):1550-6
 4. Al-Saady N, Bennett ED, Decelerating inspiratory flow waveform improves lung mechanics and gas exchange in patients on intermittent positive pressure ventilation. *Int Care Med* 1985;11(2):68-75
 5. Tharatt R St, Allen RP, Albertson TE, Pressure controlled inverse ratio ventilation in severe adult respiratory failure, *Chest* 1988 Oct;94(4):755-62
 6. Davis K Jr, Branson RD, Campbell RS, Porembka DT, Comparison of volume and pressure control ventilation: is flow waveform the difference? *J Trauma* 1996 Nov;41(5):808-14

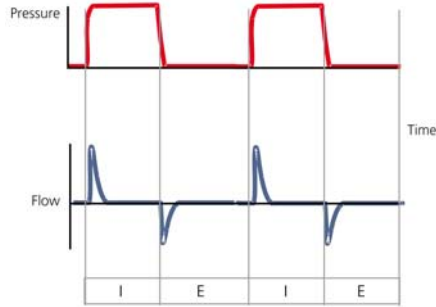

Figure B-1. Conventional pressure-controlled ventilation in a passive patient. Flow to patient during inspiration (I); flow from patient during expiration (E) only.

Figure B-2 shows a partially active patient during conventional pressure-controlled ventilation when the trigger is disabled. If respiratory activity is present during the machine-determined inspiratory phase, gas flows only into the patient. Gas flow out of the patient is impossible due to the closed expiratory valve (see Flow curve).

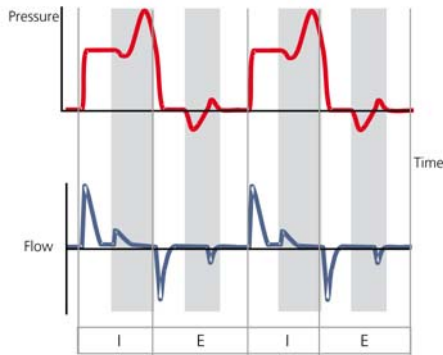

Figure B-2. Conventional pressure-controlled ventilation in an active patient when the trigger is off. Pressure increases when the patient tries to exhale (E) and pressure decreases when the patient tries to inspire (I), as valves are closed.

During the machine-determined expiratory phase, gas flows only out of the patient. Gas flow to the patient is impossible due to the closed check valve (see Flow curve).

Figure B-3 shows a partially active patient in the HAMILTON-C1's biphasic PCV+ mode. Note that inspiration and exhalation are possible at any time, thereby offering the best synchronization possible between patient and machine. PCV+ acts like an artificial atmosphere to the patient: the machine varies the airway pressure to guarantee a minimal ventilation and the patient contributes whatever they can.

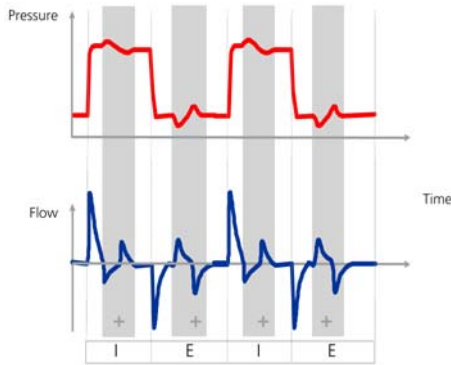

Figure B-3. Biphasic PCV+ in an active patient when trigger is off. The patient can freely inspire and exhale during any phase of ventilation (+).

B.3 Mandatory modes

The mandatory ventilation modes, (S)CMV+ (or APVcmv) and PCV+, deliver time-cycled mandatory breaths.

B.3.1 (S)CMV+ mode (APVcmv)

The (S)CMV+ (synchronized controlled mandatory ventilation) mode provides volume-targeted mandatory breaths using an adaptive volume controller. The adaptive volume controller delivers the set target volume (Vt) at the lowest possible pressure, depending on lung conditions.

The control settings active in the (S)CMV+ mode are shown in Figures B-4 and B-5.

- The tidal volume (Vt) setting defines the delivered volume.
- The Rate and I:E control settings determine the breath timing.

Breaths can be triggered by the ventilator, the patient, or by the ventilator operator.

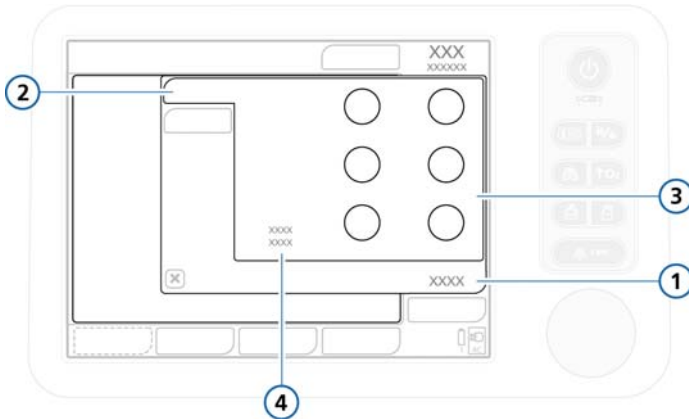

Figure B-4. (S)CMV+ Basic controls

1	Controls	3	Mode controls: Rate, Vt, I:E, PEEP, Flow trigger, Oxygen
2	Basic	4	TI, TE

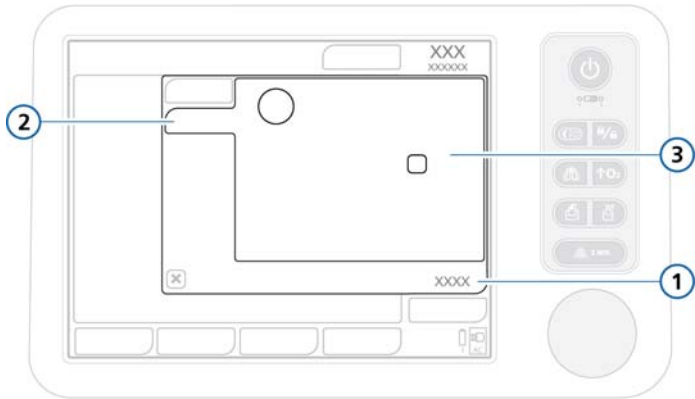



Figure B-5. (S)CMV+ More controls

- | | |
|---|--|
| <p>1 Controls</p> <p>2 More</p> | <p>3 Mode controls: P-ramp, Sigh*</p> <p> *The Sigh setting is <i>only</i> for adult/pediatric patients, not neonates.</p> |
|---|--|

The adaptive volume controller works by comparing the user-set tidal volume with the average of delivered and exhaled tidal volumes. The controller in turn adjusts the inspiratory pressure that will be applied during the next breath in order to obtain the target volume. The inspiratory pressure is adjusted in steps, to a maximum of 2 cmH₂O per breath. The controller adjusts the total inspiratory pressure applied (including PEEP) so it is between (PEEP + 3 cmH₂O) and (Pressure - 10 cmH₂O), to a maximum of 60 cmH₂O (Figure B-6).

The ventilator recalculates the minimal inspiratory pressure needed to achieve the target volume as lung characteristics change. This continuous reassessment of the patient's dynamic lung status helps guarantee the required ventilation while preventing hypoventilation or barotrauma.

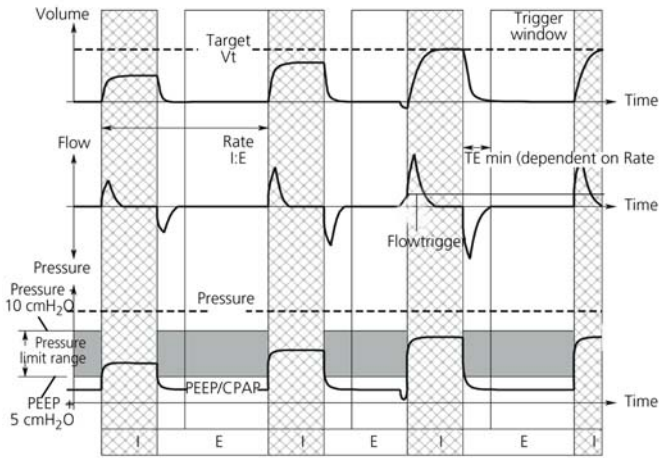

Figure B-6. Breath delivery by the adaptive volume controller

B.3.2 PCV+ mode

The PCV+ (pressure-controlled ventilation) mode provides pressure-controlled mandatory breaths. The mode's biphasic nature allows free breathing at both the PEEP and the Pcontrol pressure levels.

The control settings active in the PCV+ mode are shown in Figures B-7 and B-8.

- The pressure control (Pcontrol) setting defines the applied pressure.
- The Rate and I:E control settings determine the breath timing.

Breaths can be triggered by the ventilator, the patient, or by the ventilator operator.

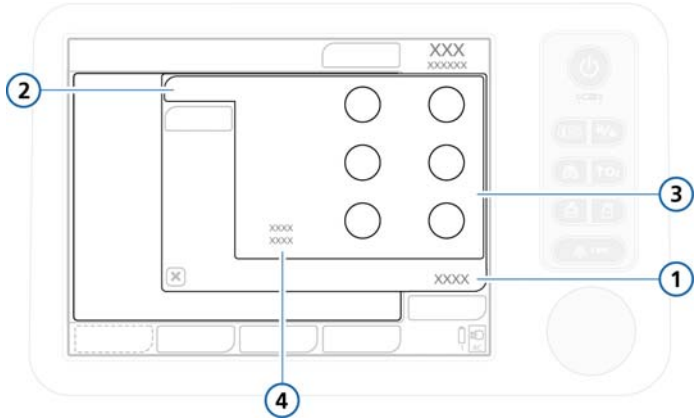

Figure B-7. PCV+ Basic controls

- | | |
|--|---|
| <p>1 Controls</p> <p>2 Basic</p> | <p>3 Mode controls: Rate, Pcontrol, I:E ratio, PEEP, Flow trigger, Oxygen</p> <p>4 TI, TE</p> |
|--|---|

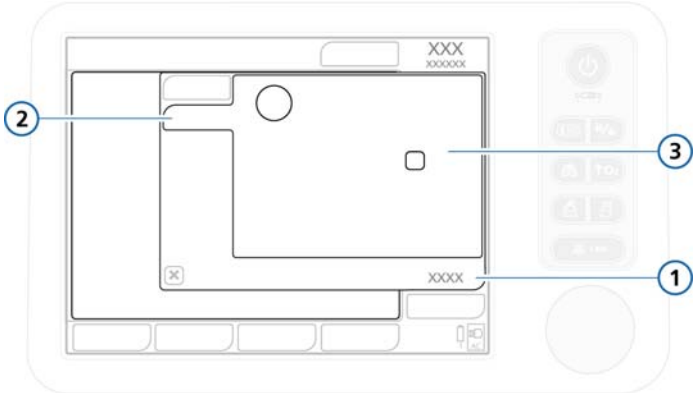



Figure B-8. PCV+ More controls

- | | |
|---|--|
| <p>1 Controls</p> <p>2 More</p> | <p>3 Mode controls: P-ramp, Sigh*</p> <p> *The Sigh setting is <i>only</i> for adult/pediatric patients, not neonates.</p> |
|---|--|

B.4 Spontaneous modes (SPONT and NIV)

The spontaneous or pressure support modes, SPONT and NIV (noninvasive ventilation), deliver spontaneous breaths and user-initiated manual (mandatory) breaths. SPONT is designed for an intubated patient, while NIV is designed for use with a mask or other noninvasive patient interface. See Appendix D for clinical application information on the noninvasive modes. In SPONT and NIV, the ventilator functions as a demand flow system. The patient’s spontaneous breathing efforts can also be supported with the set pressure support. When pressure support is set to zero, the ventilator functions like a conventional CPAP system.

The control settings active in the SPONT mode are shown in Figures B-9 through B-12. The control settings active in the NIV mode are shown in Figures B-13 through B-15.

- The pressure support (Psupport) setting defines the applied pressure.
- The patient determines the breath timing.

Breaths can be triggered by the patient or by the ventilator operator.

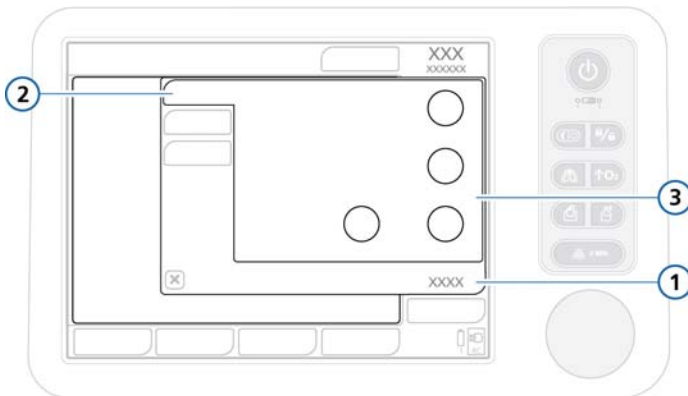

Figure B-9. SPONT Basic controls

- | | |
|--|---|
| <p>1 Controls</p> <p>2 Basic</p> | <p>3 Mode controls: Psupport, PEEP, Flow trigger, Oxygen</p> |
|--|---|

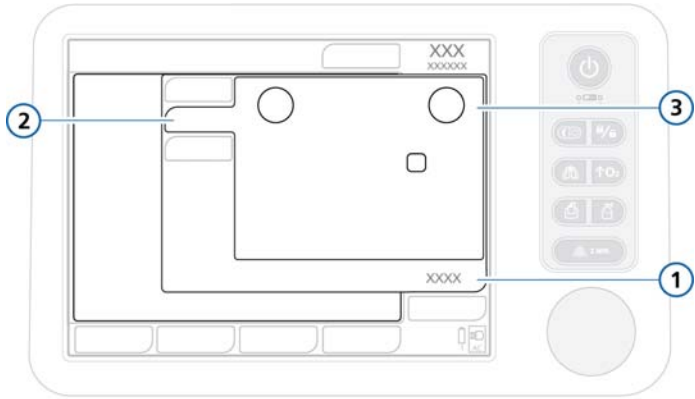

Figure B-10. SPONT More controls (adult/pediatric)

- | | |
|-------------------|--|
| 1 Controls | 3 Mode controls: P-ramp,
ETS, Sigh |
| 2 More | |

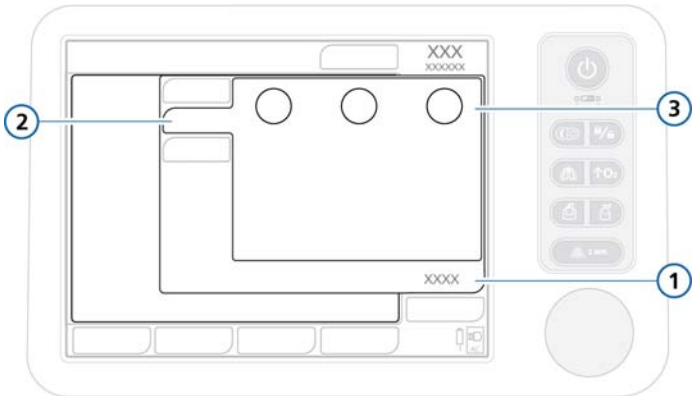

Figure B-11. SPONT More controls (neonatal)

- | | |
|-------------------|--|
| 1 Controls | 3 Mode controls: P-ramp,
TI max, ETS |
| 2 More | |

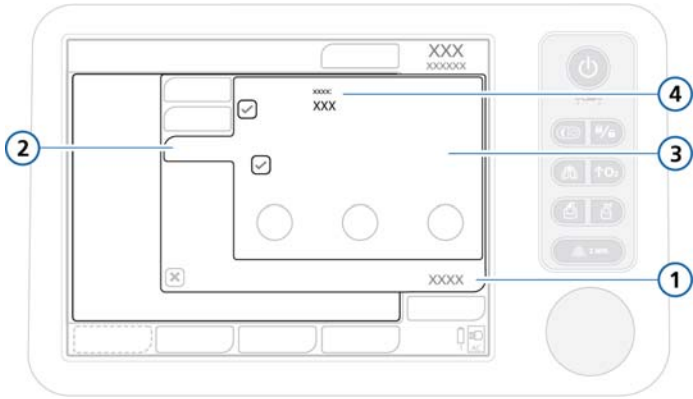

Figure B-12. SPONT Apnea controls

- | | | | |
|---|----------|---|----------------------------------|
| 1 | Controls | 3 | Mode controls: Backup, Automatic |
| 2 | Apnea | 4 | Backup mode |

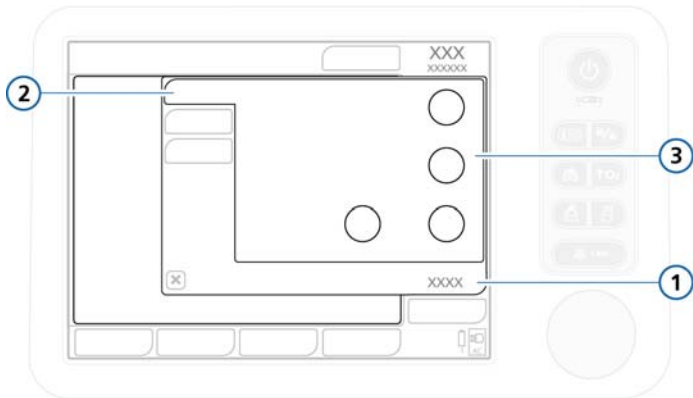

Figure B-13. NIV Basic controls

- | | | | |
|---|----------|---|---|
| 1 | Controls | 3 | Mode controls: Psupport, PEEP, Flow trigger, Oxygen |
| 2 | Basic | | |

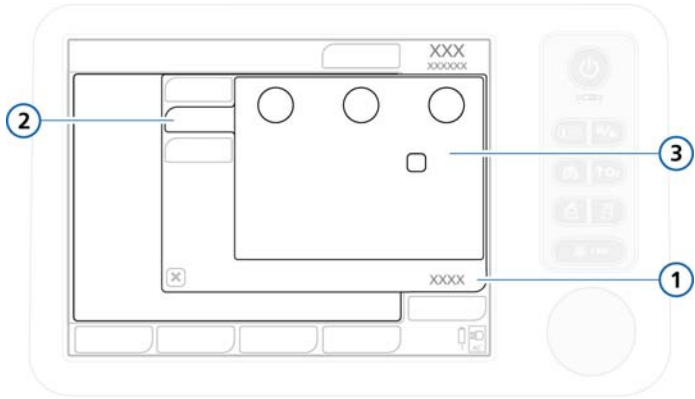



Figure B-14. NIV More controls

- | | |
|---|---|
| <p>1 Controls</p> <p>2 More</p> | <p>3 Mode controls: P-ramp, TI max, ETS, Sigh*</p> <p> *The Sigh setting is <i>only</i> for adult/pediatric patients, not neonates.</p> |
|---|---|

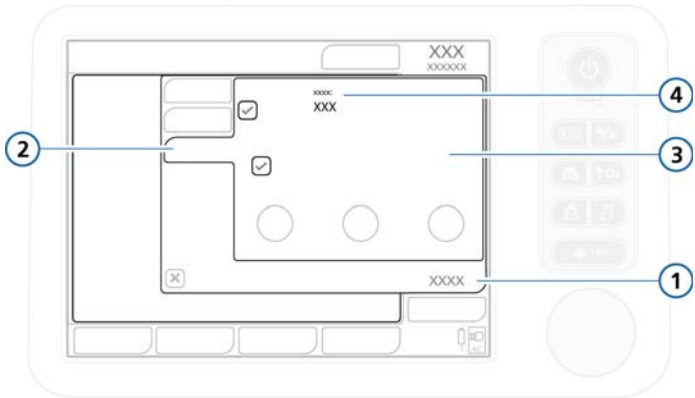

Figure B-15. NIV Apnea controls

- | | |
|--|--|
| <p>1 Controls</p> <p>2 Apnea</p> | <p>3 Mode controls: Backup, Automatic</p> <p>4 Backup mode</p> |
|--|--|

B.5 SIMV modes

The SIMV (synchronized intermittent mandatory ventilation) modes, SIMV+ (APVsimv), PSIMV+, and NIV-ST, guarantee breath delivery at the operator-set rate. Both mandatory and spontaneous breaths may be delivered in the SIMV modes. Because the SIMV modes are mixed modes with attributes of both a mandatory and a spontaneous pressure support mode, you set the parameters specific to the applicable mandatory mode and to the spontaneous mode.

Each SIMV breath interval includes mandatory time (T_{mand}) and spontaneous time (T_{spont}) portions (Figure B-16). During T_{mand} , the ventilator waits for the patient to trigger a breath. When the patient triggers a breath, the ventilator immediately delivers a mandatory breath. If the patient does not trigger a breath, the ventilator automatically delivers a mandatory breath at the end of T_{mand} . After the mandatory breath is delivered, the patient is free to take any number of spontaneous breaths for the remainder of the SIMV breath interval.

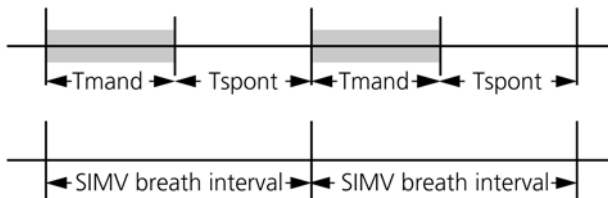

Figure B-16. Breath delivery in SIMV modes

B.5.1 SIMV+ mode (APVsimv)

The SIMV+ mode combines attributes of the (S)CMV+ and SPONT modes, delivering volume-targeted, time-cycled mandatory breaths and pressure-supported, flow-cycled spontaneous breaths. As with the (S)CMV+ mode, the SIMV+ mode ensures that the set target volume is delivered during the mandatory breaths.

Each SIMV+ breath interval, t_{imv} has a trigger window, $t_{trigger}$, during which the ventilator waits for a patient trigger (Figure B-17). If the patient triggers a breath during this time, the ventilator immediately delivers a mandatory breath with the target volume. If the patient does not trigger a breath, then the ventilator automatically delivers a mandatory breath at the end of $t_{trigger}$. After the mandatory breath is delivered, the patient can take any number of spontaneous breaths for the remainder of t_{imv} .

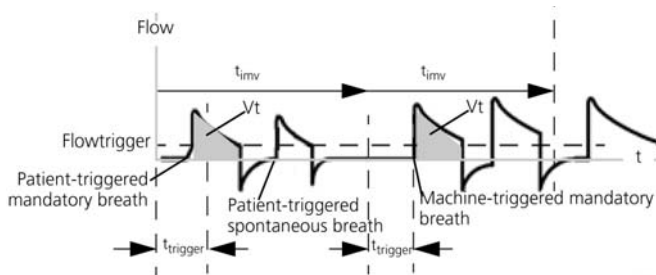

Figure B-17. Breath timing in SIMV+

The control settings active in the SIMV+ mode are shown in Figures B-18 through B-20. The SIMV+ mode requires that you set the parameters needed for both mandatory and spontaneous breath types.

- As for (S)CMV+ breaths, the tidal volume (V_t) setting defines the delivered volume of mandatory breaths.
- The Rate and TI control settings define the breath timing.
- For spontaneous breaths, the expiratory trigger sensitivity (ETS) setting defines the percentage of peak flow that cycles the ventilator into exhalation.

Breaths can be triggered by the ventilator, the patient, or by the ventilator operator.

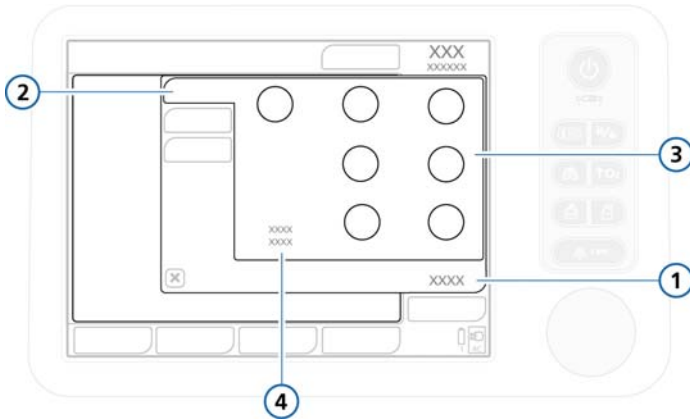

Figure B-18. SIMV+ (APVsimv) Basic controls

- | | |
|----------------------------------|---|
| <p>1 Controls</p> <p>2 Basic</p> | <p>3 Mode controls: Psupport, Rate, Vt, TI, PEEP, Flow trigger, Oxygen</p> <p>4 I:E, TE</p> |
|----------------------------------|---|

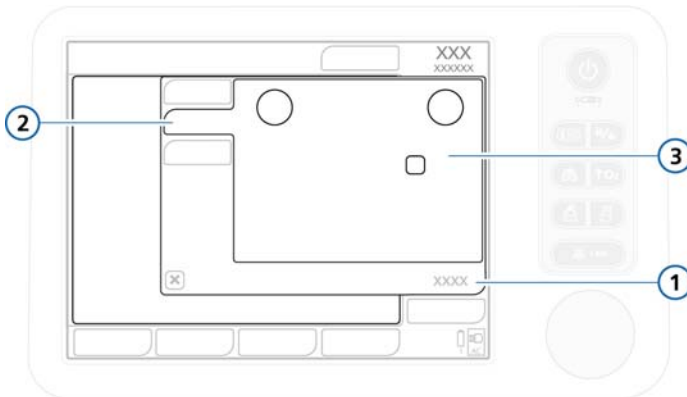

Figure B-19. SIMV+ (APVsimv) More controls

- | | |
|---------------------------------|---|
| <p>1 Controls</p> <p>2 More</p> | <p>3 Mode controls: P-ramp, ETS, Sigh*</p> <p>*The Sigh setting is <i>only</i> for adult/ pediatric patients, not neonates.</p> |
|---------------------------------|---|

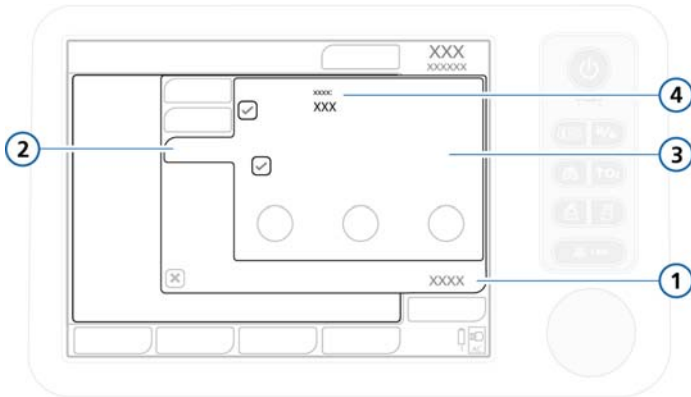

Figure B-20. SIMV+ (APVsimv) Apnea controls

- | | | | |
|----------|----------|----------|----------------------------------|
| 1 | Controls | 3 | Mode controls: Backup, Automatic |
| 2 | Apnea | 4 | Backup mode |

B.5.2 PSIMV+ mode

Two PSIMV+ modes are available: PSIMV+ and PSIMV+ with IntelliSync. See Sections B.5.2.1 and B.5.2.2, respectively.

IntelliSync is an additional setting to apply the same pressures for spontaneous and controlled breaths. It allows patients to breath spontaneously when they are able to maintain the operator-set guaranteed rate.

B.5.2.1 PSIMV+ mode

In the PSIMV+ mode, the mandatory breaths are PCV+ breaths (Section B.3.2). These can be alternated with SPONT breaths.

The PSIMV+ mode does not guarantee the delivery of an adequate tidal volume at all times. When using this mode, carefully monitor changes in the patient's status.

Each PSIMV+ breath interval, t_{imv} , has a trigger window, $t_{trigger}$, during which the ventilator waits for the patient to trigger a breath (Figure B-21). If the patient triggers a breath during this time, the ventilator immediately delivers a mandatory breath with the target volume. If the patient does not trigger a breath, the ventilator automatically delivers a mandatory breath at the end of $t_{trigger}$. After the mandatory breath is delivered, the patient can take any number of spontaneous breaths for the remainder of t_{imv} .

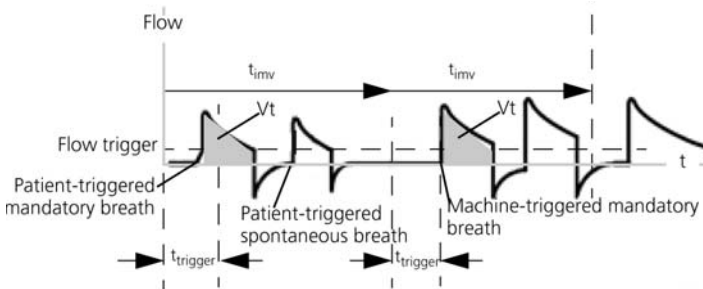

Figure B-21. Breath timing in PSIMV+

The control settings active in the PSIMV+ mode are shown in Figures B-22 and B-23. The SIMV+ mode requires that you set the parameters needed for both mandatory and spontaneous breath types.

- Similar to (S)CMV+ breaths, the tidal volume (V_t) setting defines the delivered volume of mandatory breaths.
- The **Rate** and **TI** control settings define the breath timing.
- For spontaneous breaths, the expiratory trigger sensitivity (ETS) setting defines the percentage of peak flow that cycles the ventilator into exhalation.

Breaths can either be triggered by the ventilator, the patient, or by the ventilator operator.

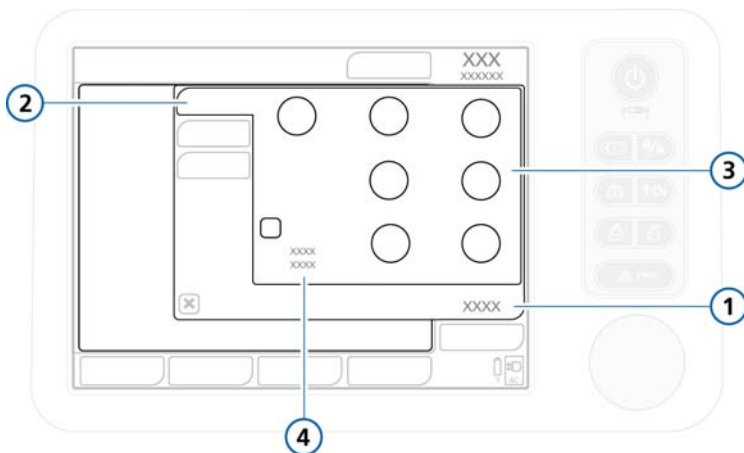

Figure B-22. PSIMV+ Basic controls

- | | |
|--|---|
| <p>1 Controls</p> <p>2 Basic</p> | <p>3 Mode controls: Rate, Pinsp, TI, PEEP, Flow trigger, Oxygen</p> <p>4 I:E, TE, IntelliSync</p> |
|--|---|

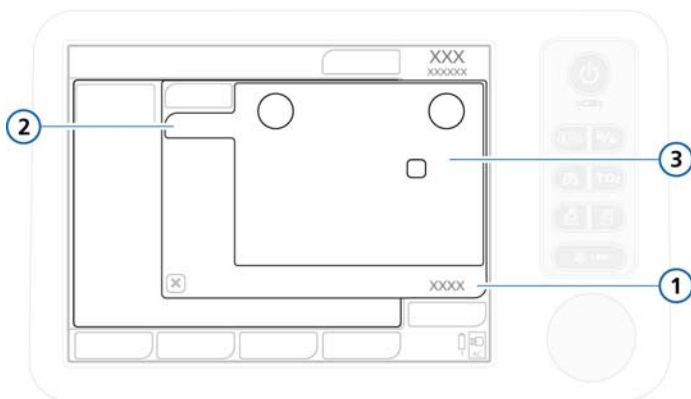



Figure B-23. PSIMV+ More controls

- | | |
|---|---|
| <p>1 Controls</p> <p>2 More</p> | <p>3 Mode controls: P-ramp, ETS, Sigh*</p> <p> *The Sigh setting is <i>only</i> for adult/pediatric patients, not neonates.</p> |
|---|---|

B.5.2.2 PSIMV+ IntelliSync

The PSIMV+ IntelliSync (pressure-controlled SIMV) delivers pressure-controlled, time-cycled mandatory breaths and pressure-supported, flow-cycled spontaneous breaths. PSIMV+ combines attributes of the PCV+ and SPONT modes and like SPONT, it is designed for an intubated patient.

As with the PCV+ mode, PSIMV+ IntelliSync delivers a preset pressure, but does not guarantee a fixed tidal volume, especially during changes in respiratory system compliance, airway resistance, AutoPEEP, or the patient's respiratory activity.

If the patient triggers a breath during the breath interval t_{mv} , the ventilator immediately delivers a spontaneous breath (Figure B-24). If the patient does not trigger an inspiration during this time, the ventilator initiates a mandatory breath at the end of t_{mv} .

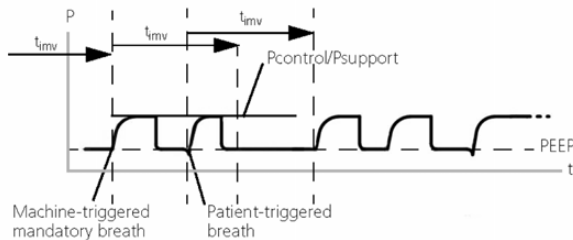

Figure B-24. Breath timing in PSIMV+ IntelliSync

The control settings active in the PSIMV+ IntelliSync mode are shown in Figures B-25 and B-23 (the controls in the More window are the same as for PSIMV+ without IntelliSync). This mode requires that you set the parameters needed for both mandatory and spontaneous breath types.

- The inspiratory pressure (P_{insp}) setting defines the applied pressure for both mandatory and spontaneous breaths.
- The Rate and TI (inspiratory time) control settings define the breath timing.
- For spontaneous breaths, the expiratory trigger sensitivity (ETS) setting defines the percentage of peak flow that cycles the ventilator into exhalation.

Breaths can either be triggered by the ventilator, the patient, or by the ventilator operator.

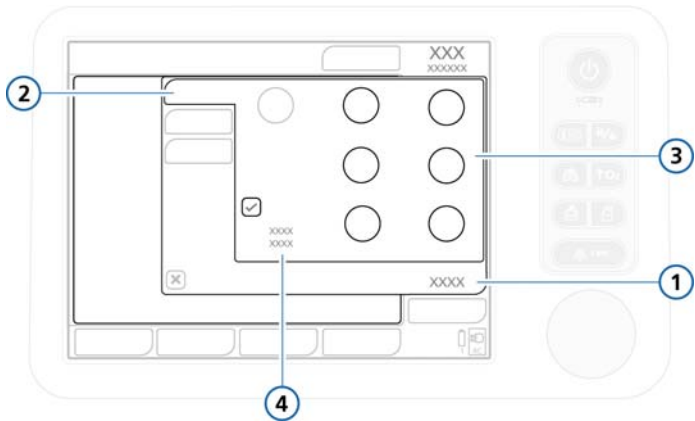

Figure B-25. PSIMV+ IntelliSync basic controls

- | | |
|-------------------|---|
| 1 Controls | 3 Mode controls: Rate, P _{insp} , T _I , PEEP, Flow trigger, Oxygen |
| 2 Basic | 4 I:E, T _E , IntelliSync |

See Figure B-23 for the P-ramp, ETS, and Sigh controls in the Controls > More window.

B.5.3 NIV-ST mode

NIV-ST (spontaneous/timed noninvasive ventilation) mode delivers pressure-controlled, time-cycled mandatory breaths and pressure-supported, flow-cycled spontaneous breaths. It combines attributes of the PCV+ and NIV modes. NIV-ST, like NIV, is designed for use with a mask or other noninvasive patient interface. See Appendix D for clinical application information on the noninvasive modes.

As with the PCV+ mode, NIV-ST both delivers a preset pressure, but does not guarantee a fixed tidal volume, especially during changes in respiratory system compliance, airway resistance, AutoPEEP, or the patient's respiratory activity.

If the patient triggers a breath during the breath interval t_{imv} , the ventilator immediately delivers a spontaneous breath (Figure B-26). If the patient does not trigger an inspiration during this time, the ventilator initiates a mandatory breath at the end of t_{imv} .

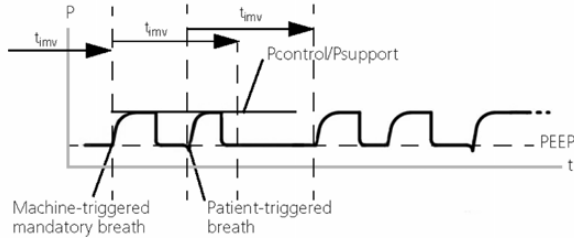

Figure B-26. Breath timing in NIV-ST

The control settings active in the NIV-ST mode are shown in Figures B-27 and B-28. You must set the parameters needed for both mandatory and spontaneous breath types.

- The inspiratory pressure (P_{insp}) setting defines the applied pressure for both mandatory and spontaneous breaths.
- The Rate and TI (inspiratory time) control settings define the breath timing.
- For spontaneous breaths, the expiratory trigger sensitivity (ETS) setting defines the percentage of peak flow that cycles the HAMILTON-C1 into exhalation.

Breaths can be triggered by the ventilator, the patient, or by the ventilator operator.

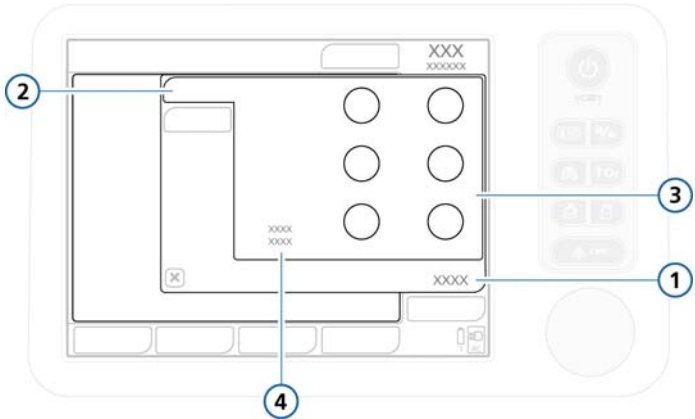

Figure B-27. NIV-ST Basic controls

- | | |
|--|--|
| <p>1 Controls</p> <p>2 Basic</p> | <p>3 Mode controls: Rate, P_{insp}, T_I, PEEP, Flow trigger, Oxygen</p> <p>4 I:E, TE</p> |
|--|--|

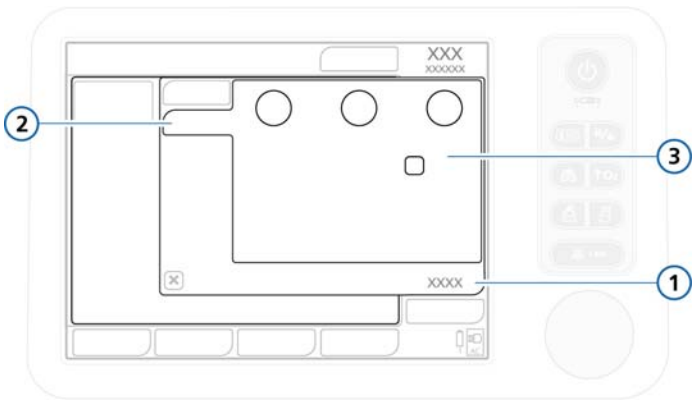



Figure B-28. NIV-ST More controls

- | | |
|---|--|
| <p>1 Controls</p> <p>2 More</p> | <p>3 Mode controls: P-ramp, T_I max, ETS, Sigh*</p> <p> *The Sigh setting is <i>only</i> for adult/pediatric patients, not neonates.</p> |
|---|--|

B.6 DuoPAP (Duo positive airway pressure) mode

DuoPAP is a related form of pressure ventilation designed to support spontaneous breathing on two alternating levels of CPAP. In these mode, the ventilator switches automatically and regularly between two operator-selected levels of positive airway pressure or CPAP. The patient may breathe freely at either level. In DuoPAP pressure support can be added to these spontaneous breaths. Cycling between the levels is triggered by DuoPAP timing settings or by patient effort. Pressure/time curve for this mode is shown in Figure B-29.

The control settings active in the DuoPAP mode are shown in Figures B-31 through B-33.

In DuoPAP (Figure B-29), the switchover between the two levels is defined by pressure settings P_{high} and PEEP/CPAP and time settings T_{high} and Rate. Like PEEP/CPAP, P_{high} is relative to atmospheric pressure.

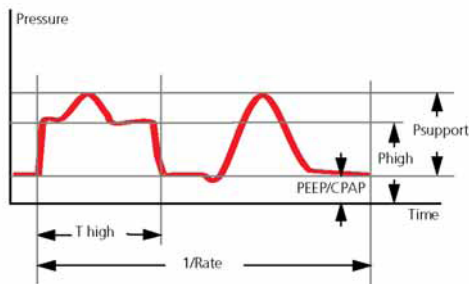

Figure B-29. DuoPAP pressure curve

B.6.1 The many faces of DuoPAP

With different patients and with different combinations of control settings, DuoPAP can be made to resemble a variety of conventional ventilation modes.

At conventional settings and in the absence of spontaneous breathing, DuoPAP resembles PCV+. As you decrease the rate, keeping **Thigh** short relative to the time at the lower pressure level, the modes look more like PSIMV+, with spontaneous breaths following mandatory breaths. If **Thigh** is almost set to breath cycle time with just enough time at the low level to allow full or near-full exhalation, these mode looks like APRV. By setting PEEP/CPAP and **Phigh** equal to one another and adjusting other parameters, the mode can be made to resemble SPONT.

B.6.2 Pressure support in DuoPAP breaths

Pressure support can be set to assist spontaneous breaths in DuoPAP, whether they occur at the PEEP/CPAP or **Phigh** level. Psupport is set relative to PEEP/CPAP, the target pressure becomes PEEP/CPAP. That means that spontaneous breaths at the **Phigh** level are supported only when this target pressure is greater than **Phigh**. Figure B-30 (a) shows the situation where breaths at both the PEEP and **Phigh** level are pressure-supported. Figure B-30 (b) shows the situation where only breaths at the PEEP/CPAP level are pressure-supported.

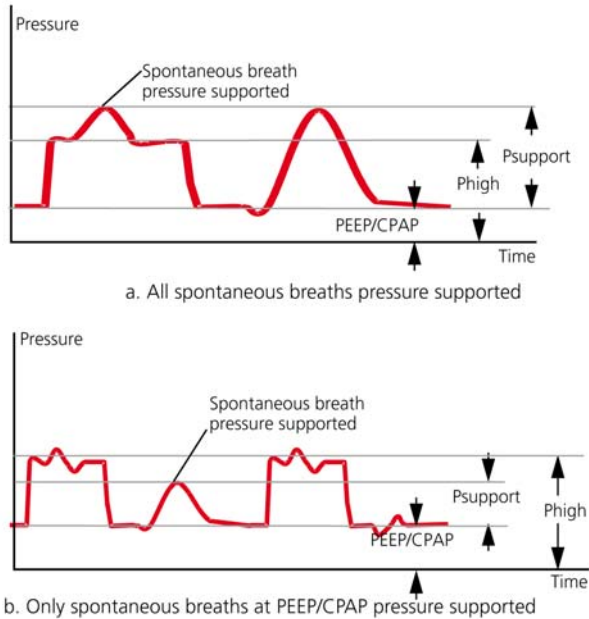

Figure B-30. Pressure support in DuoPAP

B.6.3 Synchronization

To adapt easily to the patient's spontaneous breathing pattern, the change-over from low to high pressure level and vice versa are synchronized with the patient's spontaneous breathing.

The frequency of the change-over is kept constant, even with patient synchronization, by defining a trigger time window with a fixed time constant.

B.6.4 DuoPAP controls

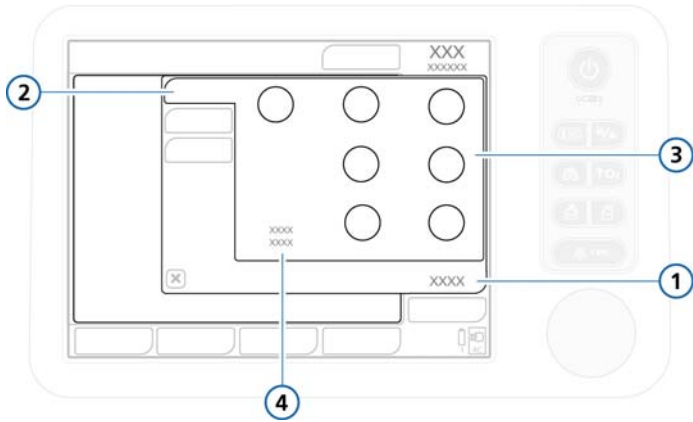

Figure B-31. DuoPAP Basic controls

- | | | | |
|---|----------|---|---|
| 1 | Controls | 3 | Mode controls: Psupport, Rate, P high, T high, PEEP, Flow trigger, Oxygen |
| 2 | Basic | 4 | I:E, T low |

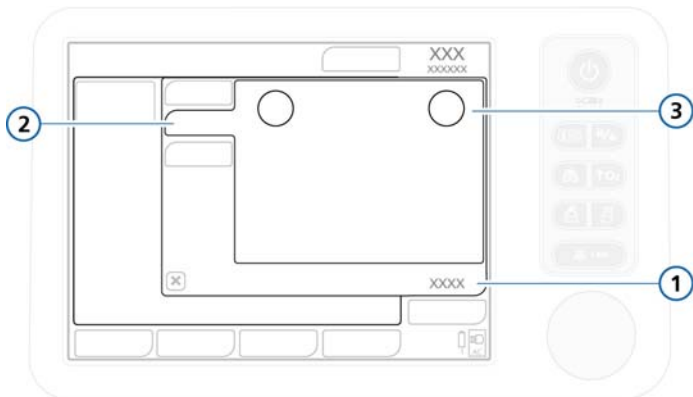

Figure B-32. DuoPAP More controls

- | | | | |
|---|----------|---|----------------------------|
| 1 | Controls | 3 | Mode controls: P-ramp, ETS |
| 2 | More | | |

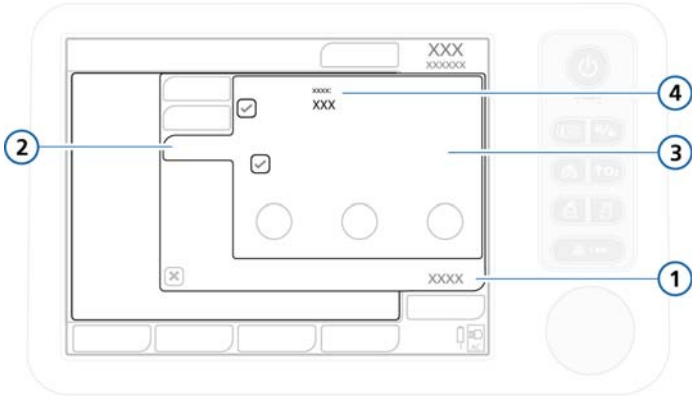

Figure B-33. DuoPAP Apnea controls

- | | |
|-------------------|---|
| 1 Controls | 3 Mode controls: Backup, Automatic |
| 2 Apnea | 4 Backup mode |

B.7 APRV (airway pressure release ventilation) mode

APRV produces alveolar ventilation as an adjunct to CPAP. Set airway pressure P_{high} is transiently released to a lower level P_{low} , after which it is quickly restored to reinflate the lungs. For a patient who has no spontaneous breathing efforts, APRV is similar to pressure-controlled inverse ratio ventilation.

APRV allows spontaneous breathing at any time during the respiratory cycle.

Tidal volume (V_t) for APRV breath depends on lung compliance, respiratory resistance, the magnitude and duration of the pressure release and the magnitude of the patient's spontaneous breathing efforts.

Figure B-34 shows the breath timing and pressure settings in APRV.

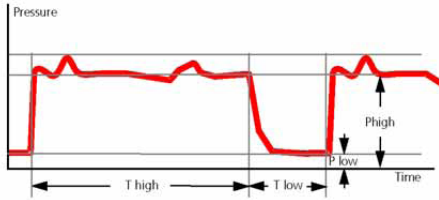

Figure B-34. APRV breath timing

B.7.1 Initialization of APRV

NOTE:

When applying long Thigh phases without patient activity, you may adjust the apnea time alarm setting to avoid switching to apnea backup ventilation.

When switching to APRV the first time, timing and pressure settings proposed are based on Table B-2. Settings for Phigh, Thigh, and Tlow will be stored when switching back to another mode, but recalled when returning to APRV again.

The initialization occurs as shown or last set value in APRV.

Table B-2. Control parameters for initialization of APRV¹

IBW (kg)	Phigh / Plow (cmH20)	Thigh (s)	Tlow (s)
0.2 to 3	20 / 5	1.4	0.
3 to 5	20 / 5	1.7	0.3
6 to 8	20 / 5	2.1	0.3
9 to 20	20 / 5	2.6	0.4
21 to 39	20 / 5	3.5	0.5
40 to 59	20 / 5	4.4	0.6
60 to 89	20 / 5	5.4	0.6
90 to 99	23 / 5	5.4	0.6
≥ 100	25 / 5	5.4	0.6

1. When switching to APRV a second time (repeatedly) the former settings are kept.

B.7.2 Sustained high-pressure recruitment maneuvers

One approach to lung recruitment has been that of sustained high-pressure recruitment maneuvers. APRV can be set to apply elevated pressures for up to 40 seconds.

B.7.3 APRV controls

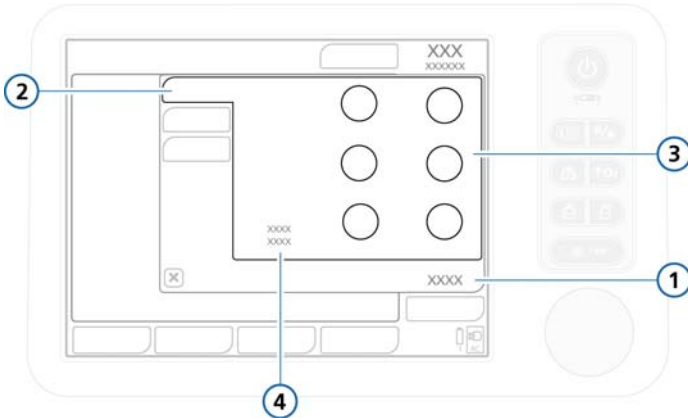

Figure B-35. APRV Basic controls

- | | |
|--|---|
| <p>1 Controls</p> <p>2 Basic</p> | <p>3 Mode controls: T high, P high, T low, P low, Flow trigger, Oxygen</p> <p>4 I:E, Rate</p> |
|--|---|

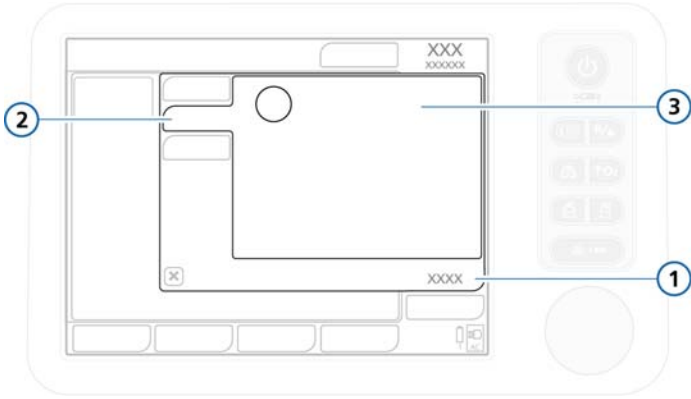

Figure B-36. APRV More controls

- | | |
|-------------------|--------------------------------|
| 1 Controls | 3 Mode controls: P-ramp |
| 2 More | |

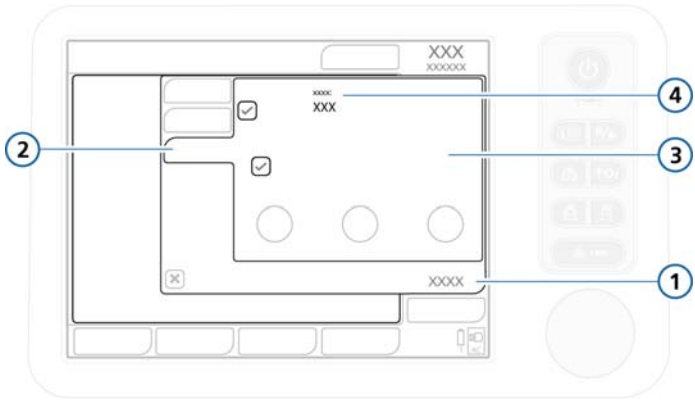

Figure B-37. APRV Apnea controls

- | | |
|-------------------|--|
| 1 Controls | 3 Mode controls:
Backup, Automatic |
| 2 Apnea | 4 Backup mode |

B.8 Safety mode and ambient state

In the event of certain technical failures, the ventilator switches to SAFETY mode. This gives you time to arrange for corrective actions, including organizing a replacement ventilator.

The blower runs constantly to create inspiratory pressure (P_{insp}) (Table B-3). The expiratory valve switches system pressure levels between PEEP and inspiratory pressure. Patient sensing is nonfunctional during safety ventilation. You must switch off ventilator power to exit safety ventilation.

If the technical fault alarm is serious enough to possibly compromise safe ventilation, the ventilator enters the ambient state. The inspiratory channel and expiratory valves are opened, letting the patient breathe room air unassisted. You must switch off ventilator power to exit the ambient state.

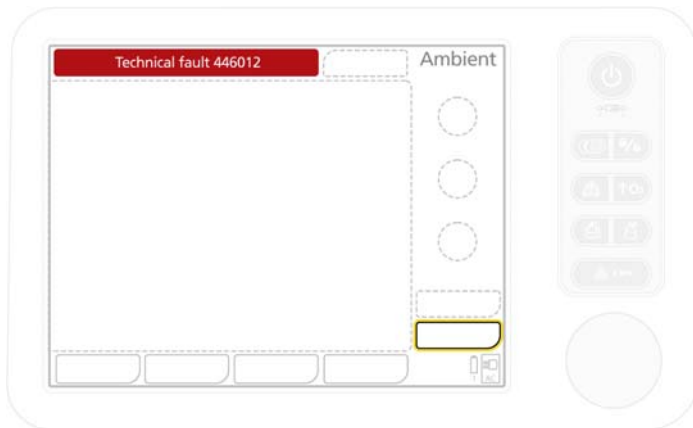

Figure B-38. Ambient state

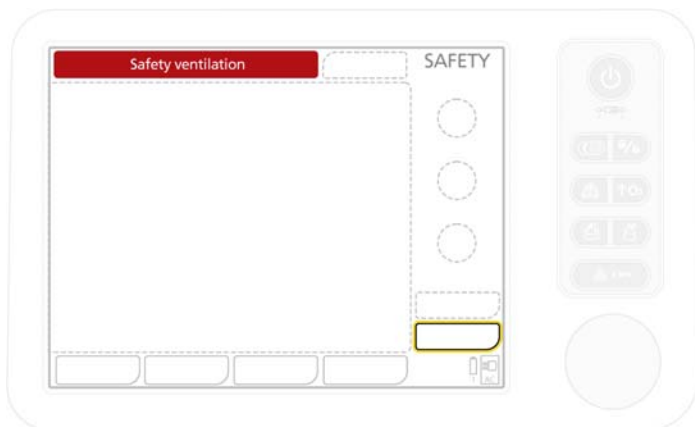

Figure B-39. Safety mode

Table B-3. Safety mode settings

IBW (kg)	P_{insp} (cmH₂O)	Rate (b/min)	I:E	PEEP¹	O₂
< 3	15	< 35	1:3		> 21%
3 to 5	15	30	1:4		> 21%
6 to 8	15	25	1:4		> 21%
9 to 20	15	20	1:4		> 21%
21 to 29	15	15	1:4		> 21%
30 to 39	15	14	1:4		> 21%
40 to 59	15	12	1:4		> 21%
60 to 89	15	10	1:4		> 21%
90 to 99	18	10	1:4		> 21%
≥ 100	20	10	1:4		> 21%

1. Set PEEP plus circuit resistance (+ 5 cmH₂O).

C ASV, adaptive support ventilation

C.1	Introduction	C-2
C.2	ASV use in clinical practice	C-3
C.3	Detailed functional description of ASV	C-15
C.3.1	Normal minute ventilation	C-15
C.3.2	Targeted minute ventilation	C-16
C.3.3	Lung-protective rules strategy	C-17
C.3.4	Optimal breath pattern	C-20
C.3.5	Dynamic adjustment of lung protection	C-24
C.3.6	Dynamic adjustment of optimal breath pattern	C-24
C.4	Minimum work of breathing (Otis' equation)	C-26
C.5	ASV technical data	C-28
C.6	ASV startup	C-30
C.7	References	C-31

C.1 Introduction

WARNING

This appendix describes ASV as it is implemented in the HAMILTON-C1. It does not replace the clinical judgment of a physician and is not to be used for clinical decision making.

NOTE:

ASV is not supported in neonatal ventilation.

In 1977, Hewlett et al. introduced mandatory minute volume (MMV). “The basic concept is that the system is supplied with a metered, preselected minute volume of fresh gas, from which the patient breathes as much as he is able, the remainder being delivered to him via a ventilator. Thus the patient is obliged to breathe, one way or the other, a Mandatory Minute Volume MMV” (Hewlett 1977).

Since then, many ventilators have included versions of MMV under different names. However, all commercially available MMV algorithms have clear limitations, which lead to certain risks for the patient (Quan 1990). These include rapid shallow breathing, inadvertent PEEP creation, excessive dead space ventilation, and inadvertent wrong operator settings due to very complicated use.

Adaptive Support Ventilation (ASV) was designed to minimize those risks and limitations. ASV maintains an operator-preset, minimum minute ventilation independent of the patient’s activity. The target breathing pattern (tidal volume and rate) is calculated using Otis’ equation, based on the assumption that if the optimal breath pattern results in the least work of breathing, it also results in the least amount of ventilator-applied inspiratory pressure when the patient is passive. Inspiratory pressure and machine rate are then adjusted to meet the targets. A lung protection strategy ensures ASV’s safety.

In contrast to MMV, ASV attempts to guide the patient using a favorable breathing pattern and avoids potentially detrimental patterns like rapid shallow breathing, excessive dead space ventilation, breath stacking (inadvertent PEEP), and excessively large breaths.

Contrary to some opinions, ASV does not eliminate the need for a physician or clinician. However, ASV alleviates the need for tedious tasks and laborious readjustments of the ventilator; thus, it is a modern tool for the clinician. As such, ASV does not make clinical decisions. ASV executes a general command from the clinician and the clinician can modify it. This command can be summarized, where the modifiable parts are in bold:

Maintain a **present minimum minute ventilation**,

- take spontaneous breathing into account,
- prevent tachypnea,
- prevent AutoPEEP,
- prevent excessive dead space ventilation,
- fully ventilate in apnea or low respiratory drive,
- give control to the patient if breathing activity is okay, and
- all this without exceeding a plateau pressure of 10 cmH₂O below the **upper pressure limit**.

This appendix explains in practical terms how to use ASV at the patient's bedside and provides a detailed functional description. Since Otis' equation (Otis 1950) is the cornerstone of the optimal-breath pattern calculation, this equation is included and described. A table of detailed technical specifications and pertinent references is also given.

C.2 ASV use in clinical practice

ASV does not require a special sequence of actions. It is used in much the same way as are conventional modes of ventilation. Figure C-1 summarizes how to use ASV, while the subsequent sections explain it in detail. Figures C-2 and C-3 show the control settings active in the ASV mode.

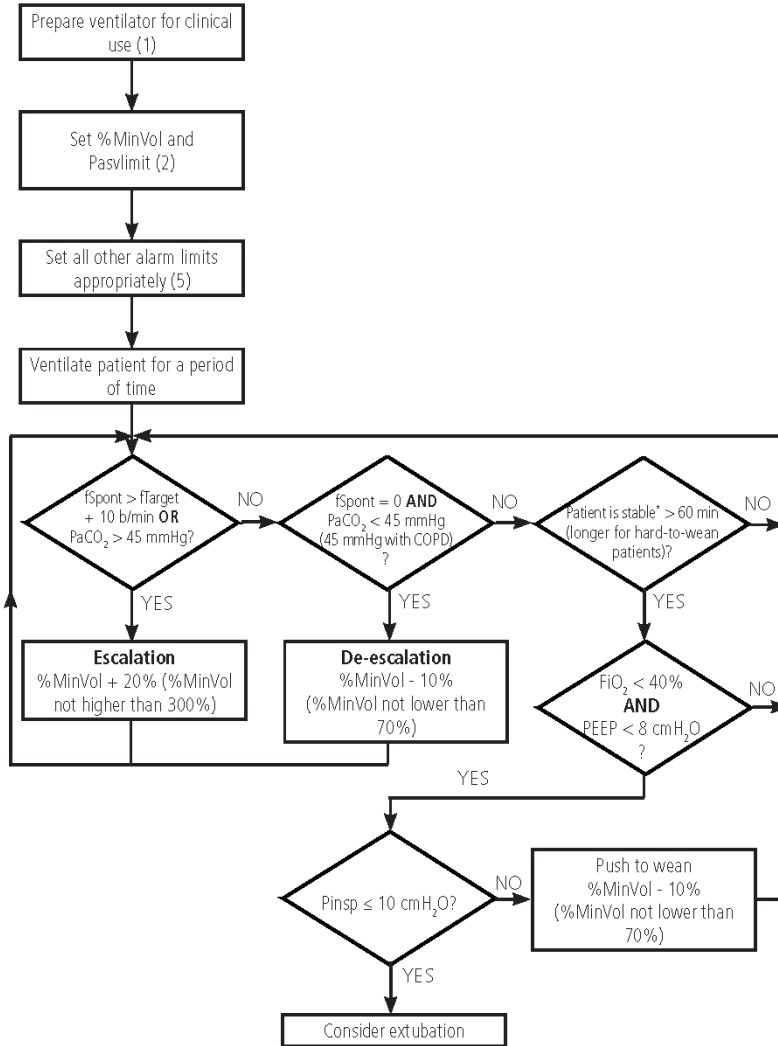

* Stable means $f_{Control} = 0$ b/min AND $PaCO_2 \leq 45$ mmHg (50 mmHg with COPD)

Figure C-1. Clinical use of ASV

The numbers in parentheses are step numbers, which are explained in the next sections.

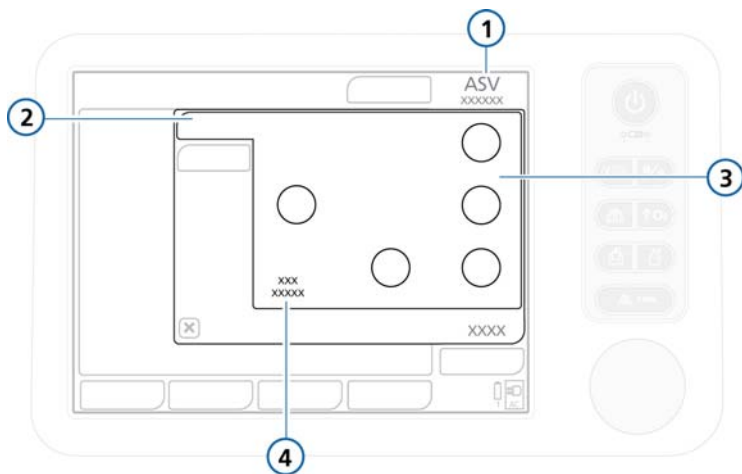

Figure C-2. ASV Basic controls

- | | |
|-------------------|---|
| 1 ASV mode | 3 Mode controls: Pat. height, %MinVol, Pasvlimit, PEEP, Flow trigger, Oxygen |
| 2 Basic | 4 IBW, target %MinVol |

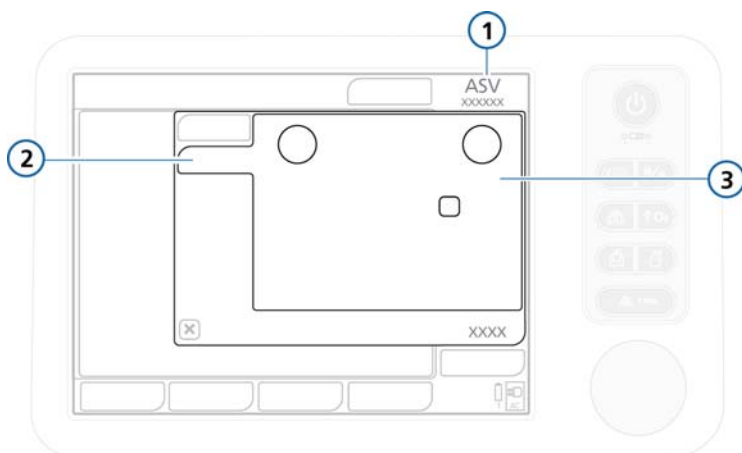

Figure C-3. ASV More controls

- | | |
|-------------------|---|
| 1 ASV mode | 3 Mode controls: P-ramp, ETS, Sigh |
| 2 More | |

Step 1: Before connecting the patient to the HAMILTON-C1

It is important to prepare the HAMILTON-C1 for clinical use according to Chapter 2. This includes, but is not limited to, performing the preoperational procedures and testing indicated.

Step 2: Preparing the HAMILTON-C1 for ASV before ventilation

NOTE:

The high limit must be at least 25 cmH₂O above PEEP/CPAP.

ASV requires that you set the following basic parameters:

Pressure	High Pressure alarm limit, in cmH ₂ O
Patient height	Patient height, in cm or inches
Gender	Sex of patient
%MinVol	Desired minute ventilation, in % of normal values

It is suggested you do the following before connecting the patient to the ventilator:

1. Remove the demonstration lung, when a demonstration lung is used, and silence the alarm.
2. Set the high Pressure alarm limit to an appropriate value (e.g., 45 cmH₂O or 50 cmH₂O for COPD patients).

The maximum inspiratory pressure delivered in ASV (P_{asv}) will be **10 cmH₂O below the preset high pressure limit**, indicated by a blue band on the pressure curve display.

The maximum inspiratory pressure for ASV can be also set using the P_{asv} control in the Controls window. Changing the P_{asv} value will also change high Pressure limit.

3. Activate ASV in the Modes window and then **Confirm** the mode change. The Controls window automatically opens.

-
4. Specify the following control settings:
 - **Patient height**
 - **Gender**
 - **%MinVol.** A logical starting point is a %MinVol that will result in the same minute volume as a previous mode, if applicable. The %MinVol for a normal patient might be 100%; for a COPD patient, 90%; for an ARDS patient, 120%; and for other patients, 110%. Add 20% if body temperature > 38.5°C (101.3°F) and 5% per 500 m (1640 ft) above sea level.
 - **Trigger.** Suggested settings are a Flowtrigger of 2 l/min; or you can leave the previous patient trigger method and sensitivity, if applicable.
 - **ETS.** A suggested setting is 25% (40% for a COPD patient); or you can leave this unchanged, if applicable.
 - **Other settings.** Set PEEP/CPAP and Oxygen values according to clinical requirements. You can leave the P-ramp setting at its standard value unless clinical judgment calls for adjustment. To set it, see Chapter 4.
 5. **Confirm** the settings.
 6. Connect the patient to the ventilator if applicable. This will initiate three test breaths.

Step 3: Compensation for changes in apparatus dead space

NOTE:

Changes in alveolar dead space due to ventilation/perfusion mismatch must be compensated via the %MinVol control.

The HAMILTON-C1 calculates the (anatomical or “series”) dead space based on the IBW calculated from the patient height input. Dead space is calculated as 2.2 ml per kg (1 ml per lb). This dead space is a nominal value that is valid, on average, for intubated patients whose endotracheal tube is connected to the Y-piece of the ventilator by a standard catheter mount. If this dead space is altered by an artificial airway configuration such as the use of a heat and moisture exchanging filter (HMEF) or nonstandard tubing, modify the Patient height setting accordingly to take into account the added or removed dead space.

Consider the following when compensating dead space:

- A shorter-than-standard endotracheal or tracheostomy tube probably does not require compensation.
- Different sizes of endotracheal tube probably do not require compensation.
- A much longer-than-normal catheter mount may require compensation.
- A bacterial filter or an HMEF may require compensation. The volume of these devices, for an adult, is on average 50 to 60 ml, but may be as high as 95 ml (Mallinckrodt Hygroster). For an HMEF, a simple rule of thumb is to add 10% to the IBW (by adjusting the Patient height control).

Step 4: Adjusting ventilation: Maintaining adequate ventilation

WARNING

It is inappropriate to adjust the IBW (through the Patient height control) to change minute volume. Always use the %MinVol control to adjust minute volume.

Once ASV is started, the HAMILTON-C1 calculates an optimal breath pattern and associated target values for tidal volume and rate according to the rules in ASV, then adjusts the inspiratory pressure (P_{insp}) and machine rate (f_{Control}) to achieve the targets.

Once the calculated targets are reached, the result of the ventilation needs to be assessed. All HAMILTON-C1 monitored parameters can be used for this purpose. However, to assess respiratory acid-base status, it is recommended that arterial blood gases be measured and minute ventilation be adjusted accordingly. Table C-1 provides examples of how to adjust the %MinVol setting.

Table C-1. Blood gas and patient conditions and possible adjustments for ASV

Condition	%MinVol change	Remarks
Normal arterial blood gases	None	--
High PaCO ₂	Increase %MinVol	Pay attention to inspiratory pressures
Low PaCO ₂	Decrease %MinVol	Pay attention to mean pressures and oxygenation status
High respiratory drive	Consider increase in %MinVol	Consider sedation, analgesia, or other treatments

Table C-1. Blood gas and patient conditions and possible adjustments for ASV *(continued)*

Condition	%MinVol change	Remarks
Low O ₂ saturation	None	Consider increase in PEEP/CPAP and/or Oxygen

Step 5: Alarm settings review and special ASV alarms

To monitor the breathing pattern, you must review the alarm settings periodically and set them according to clinically acceptable values. As described below, ASV changes the breathing pattern according to the respiratory system mechanics and within the boundaries resulting from the operator's settings for ASV. However, you can closely monitor ASV's actions through the alarm system, since the alarm settings work totally independently of ASV.

It is possible to select a %MinVol that is incompatible with the lung-protective rules that govern ASV (for a detailed description, see Section C.3.3). For example, you might want a high ventilation for a COPD patient in spite of severe pulmonary obstruction. In such a case, ASV tries to achieve the maximum possible ventilation and alarms that ASV: Cannot meet target. Such a case is shown in Figure C-4, where a high ventilation (300% at 70 kg) was set by the operator for a patient with severely obstructed lungs ($R_{aw} = 40 \text{ cmH}_2\text{O}/(\text{l/s})$).

The high ventilation moves the minimum minute volume curve to the right while the obstructive disease causes the safety limit of rate to shift to the left. These two effects cause the minute volume curve to lie outside the safety limits as determined by the lung-protective rules strategy (see functional description below). ASV thus chooses the safest point closest to the user-set minute volume.

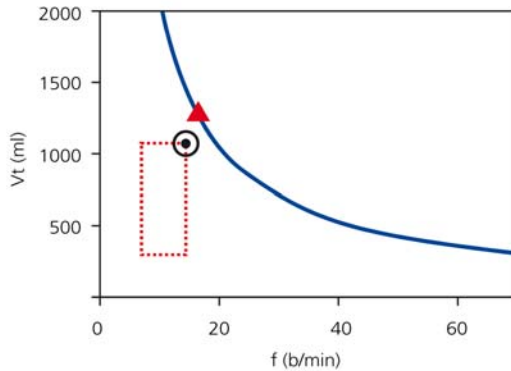

Figure C-4. Hypothetical example of high %MinVol setting incompatible with the lung-protective rules strategy.

The open circle denotes the actual target, the closed triangle (never shown on the ventilator) denotes the (energetically) optimal target according to Otis' equation. The HAMILTON-C1 will alarm and inform the user that the ASV target cannot be achieved.

Step 6: Monitoring ASV

ASV interacts with the patient continuously. Whenever the patient's respiratory mechanics change, ASV adapts to this change. Whenever the patient's breathing activity changes, ASV adapts. To let you view the current status, the HAMILTON-C1 provides the ASV target graphics (ASV Graph) window (Figure C-5).

To monitor progress over time, it is recommended that you plot trends for P_{insp} , f_{Total} , and f_{Spont} . Interpret these trends, together with the %MinVol setting. Tables C-2 through C-4 provide interpretation of typical ventilatory patterns.

For details on displaying the ASV Graph, see Section 7.3.

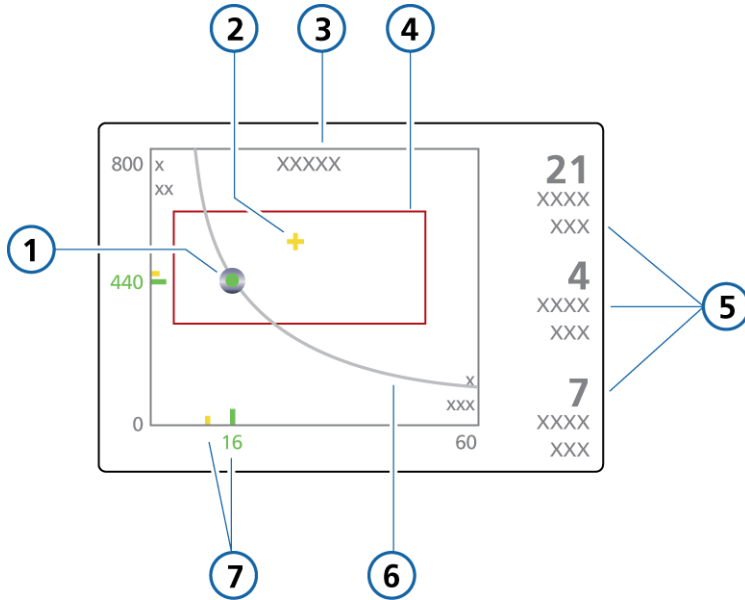

Figure C-5. ASV target graphics window

- | | |
|---|--|
| <p>1 Current measured point, formed by intersection of measured tidal volume (V_t, on the y-axis) and rate (f, on the x-axis)</p> <p>2 Target point, formed by intersection of target tidal volume and target rate</p> <p>3 Numerical value of target minute volume</p> <p>4 Safety frame in which target point may move.</p> | <p>5 f_{Spont} = spontaneous breath rate, $f_{Control}$ = machine rate, P_{insp} = inspiratory pressure set by ventilator</p> <p>6 Minute volume curve</p> <p>7 Numerical value of the current measured point (in green) and relative position of the target value (in yellow)</p> |
|---|--|

Table C-2. Interpretation of breathing pattern at 100% MinVol setting

Pinsp	fControl	fSpont	Interpretation
> 10	> 10	0	Fully controlled, mechanical ventilation. To start weaning, consider reducing %MinVol.
> 10	0	Acceptable	Supported spontaneous breathing. Consider reducing %MinVol.
< 8	0	Acceptable	Unsupported breathing. Consider extubation.
> 10	0	High	Dyspnea. Consider increasing %MinVol and other clinical treatments. Check for autotriggering.

Table C-3. Interpretation of breathing pattern at much higher than 100% MinVol setting

Pinsp	fControl	fSpont	Interpretation
> 10	> 10	0	Fully controlled mechanical ventilation. Check arterial blood gases. To start weaning, consider reducing %MinVol.
> 10	0	Acceptable	Supported spontaneous breathing. Check reason for increased ventilation requirement. Consider reducing %MinVol.
< 8	0	Acceptable	Unsupported breathing. Check reason for increased ventilation requirement. Consider reducing %MinVol and extubation.
> 10	0	High	Dyspnea. Check reason for increased ventilation requirement. Consider other mode of ventilation and clinical treatment. Check for autotriggering.

Table C-4. Interpretation of breathing pattern at much lower than 100% MinVol setting

Pinsp	fControl	fSpont	Interpretation
>10	> 10	0	Danger of hypoventilation. Check arterial blood gases and consider increasing %MinVol.
>10	0	Acceptable	Enforced weaning pattern. Monitor arterial blood gases and patient respiratory effort. Consider decreasing or increasing %MinVol accordingly.
<8	0	Acceptable	Unsupported breathing. Consider extubation.
>10	0	High	Dyspnea. Consider increasing %MinVol and other clinical treatments. Check for autotriggering.

Step 7: Weaning

Weaning patients from the ventilator is a clinical task that requires tremendous experience and involves more than just ventilation issues. This appendix does not intend to provide clinical information other than that needed to operate the ventilator with ASV.

ASV always allows patients to take spontaneous breaths. Episodes of spontaneous breathing can occur and are supported by ASV even within a period of fully controlled ventilation. In other words, weaning can start with ASV so early that it may go unrecognized clinically. It is therefore important to monitor the spontaneous efforts of the patient over time.

The weaning progress can be monitored in the trends display when inspiratory pressure (Pinsp), total rate (fTotal), and spontaneous rate (fSpont) are plotted. If the patient tolerates minimum respiratory support after a period of time with

$$Pinsp < 8 \text{ cmH}_2\text{O} \quad fControl = 0$$

weaning can be considered achieved, if at a minimum, fSpont is acceptable, ExpMinVol is acceptable.

What is "acceptable" must be defined by the clinician.

It may be necessary to reduce the %MinVol setting to 70% or even lower to “motivate” the patient to resume spontaneous breathing. If a patient can sustain minutes or even hours with a low %MinVol setting, it does not mean that weaning is complete. In fact, the %MinVol setting must always be interpreted in conjunction with the level of P_{insp} needed to achieve the set minute ventilation. Only if P_{insp} and fControl are at their minimal values can weaning be assumed to be complete.

C.3 Detailed functional description of ASV

C.3.1 Normal minute ventilation

ASV defines normal minute ventilation according to the graph in Figure C-6.

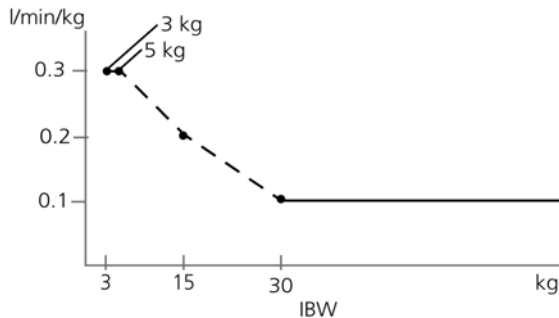

Figure C-6. Normal minute ventilation as a function of ideal body weight (IBW)

For adult patients, minute ventilation is calculated as $0.1 \text{ l/kg} \times \text{IBW}$ (solid line). For pediatric patients, the value indicated by the dotted line is used. Minute ventilation for a 15 kg patient thus is calculated as

$$0.2 \text{ l/kg} \times 15 \text{ kg} = 3 \text{ l/min}$$

For example, for an IBW of 70 kg, normal minute ventilation corresponds to 7 l/min.

C.3.2 Targeted minute ventilation

When you chose ASV, you must select an appropriate minute ventilation for the patient. Minute ventilation is set with the %MinVol control, which, together with the Patient height control, determines the total minute ventilation in liters per minute.

A %MinVol setting of 100% corresponds to a normal minute ventilation, as discussed above. A setting less than 100% or higher than 100% corresponds to a minute ventilation lower or higher than normal.

From the %MinVol, the target minute ventilation (in l/min) is calculated as:

$$\text{Bodyweight (in kg)} \times \text{NormMinVent (in l/kg/min)} \times (\% \text{MinVol}/100)$$

where NormMinVent is the normal minute ventilation from Figure C-6.

For example, with a %MinVol = 100 and an IBW = 70 kg, a target MinVol of 7 l/min is calculated. This target can be achieved with a number of combinations of tidal volume (Vt) and respiratory rate (f). This is shown in Figure C-7, where all possible combinations of Vt and f lie on the bold line, the target minute volume curve.

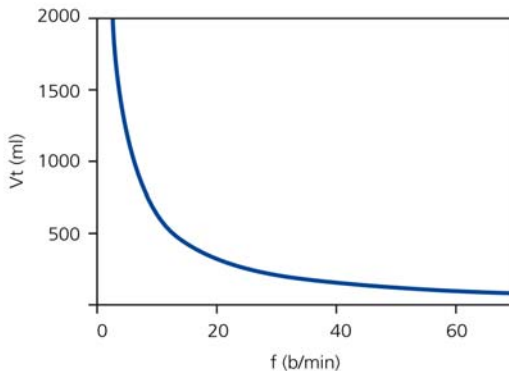

Figure C-7. MinVol = 7 l/min

All possible combinations of Vt and f that result in a minute ventilation of 7 l/min lie on the bold line.

C.3.3 Lung-protective rules strategy

Not all combinations of V_t and f shown in Figure C-7 are safe for the patient. The high tidal volumes will over distend the lungs and the small tidal volumes cannot produce alveolar ventilation at all. Another risk lies in inadequate respiratory rates. High rates can lead to dynamic hyperinflation or breath stacking, and thus inadvertent PEEP. Low rates can lead to hypoventilation and apnea. Therefore, it is necessary to limit the number of possible combinations of V_t and f . When limits are imposed on the possible combinations of V_t and f , then ASV uses a double strategy:

- The operator input for ASV determines the absolute boundaries.
- Internal calculations based on patient measurements further narrow the limits to counteract possible operator errors and to follow changes of respiratory system mechanics.

The effect of the strategy is shown in Figure C-8 and explained in the subsequent sections.

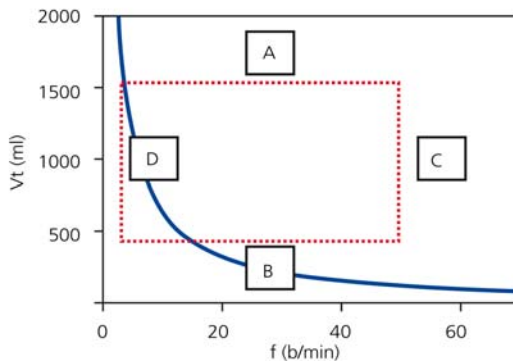

Figure C-8. Lung-protective rules strategy to avoid high tidal volumes and pressures (A), low alveolar ventilation (B), dynamic hyperinflation or breath stacking (C), and apnea (D)

A: High tidal volume limit

WARNING

Check Vt high setting to make sure the target minute ventilation can be reached in passive patients.

The tidal volume applied by ASV is limited (see A in Figure C-8) by three operator settings: high Pressure alarm limit, Vt high alarm limit, and Patient height.

The operator must set the high Pressure limit before connecting a patient to the ventilator. It was recommended by a group of physicians (Slutsky 1994) that the plateau pressure not exceed 35 cmH₂O. To achieve this with ASV, the high Pressure limit must be set to 45 cmH₂O. The maximum pressure to be applied in the ASV mode is 10 cmH₂O below the high Pressure limit.

For example, a normal 70 kg normal (post-operative) patient would have a compliance of about 50 ml/cmH₂O. A high Pressure limit of 45 cmH₂O will result in a maximum applied pressure of 35 cmH₂O. With a PEEP level of 5 cmH₂O, the effective pressure swing will be 30 cmH₂O. This in turn leads to an effective Vt of equal to, or less than 1500 ml. If the patient's lungs stiffen, to a compliance of 30 ml/cmH₂O, the maximum tidal volume becomes 900 ml.

If the operator sets the Pressure limit to a very high pressure, say 60 cmH₂O, the target volume is limited by the second criterion: 22 x IBW. For the 70 kg sample patient, a maximum target volume of 1540 ml results.

Additionally the target volume is limited to 1.5 * VT high limit, and pressure support actually is limited in a way that the inspired volume does not exceed Vt high limit in mechanical breaths for more than a few breaths.

B: Low tidal volume limit

To determine the minimum target V_t in ASV (see B in Figure C-8) use the IBW calculated from the Patient height, which corresponds to 4.4 ml/kg. In this example for a 70 kg patient, the minimum target V_t is 308 ml.

The operator must use caution with low tidal volumes to avoid insufficient alveolar ventilation. The determining parameter for alveolar ventilation is dead space (V_{Daw}). Tidal volume value must always be greater than the V_{Daw} value. It is widely accepted that a first approximation of dead space can be obtained by the following simple equation (Radford 1954):

The lower limit for tidal volume is based on this equation and calculated to be at least twice the dead space. Or, the minimum V_t is $4.4 \times \text{IBW}$.

$$V_{Daw} = 2.2 * \text{IBW} \quad (1)$$

C: High rate limit

You derive the maximum rate (see C in Figure C-8) from the operator-set %MinVol and the calculated IBW, which is calculated from the operator-set Patient height. The equation used to calculate the maximum rate is:

$$f_{\max} = \text{target MinVol} / \text{minimum } V_t \quad (2)$$

For example, the 70 kg patient described above will have a maximum rate of 22 b/min, when %MinVol is set to 100%.

However, as an example, if you choose an excessively high %MinVol of 350%, the maximum rate becomes 77 b/min. To protect the patient against such high rates, ASV employs a further safety mechanism, which takes into account the patient's ability to exhale.

A measure of the ability to exhale is the expiratory time constant (RC_{exp}) (Marini 1989, Brunner 1995). To achieve a nearly complete exhalation to the equilibrium point of the respiratory system (90% of the maximum potential volume change), an expiratory time of at least $2 \times RC_{\text{exp}}$ is theoretically required.

For this reason, ASV calculates the maximum rate based on the principle of giving a minimum inspiratory time equal to $1 \times RC_{exp}$ and a minimum expiratory time equal to $2 \times RC_{exp}$, which results in these equations:

$$\begin{aligned} f_{max} &= 60 / (3 \times RC_{exp}) = 20 / RC_{exp} \\ f_{max} &\leq 60 \text{ b/min} \end{aligned} \quad (3)$$

For example, the 70 kg patient with a respiratory system compliance of 50 ml/cmH₂O (equal to 0.05 l/cmH₂O), an airway resistance including endotracheal tube of 5 cmH₂O/l/s, and a resistance of the expiratory hose and valve of another 5 cmH₂O/l/s, would have an RC_{exp} of

$$0.05 \text{ l/cmH}_2\text{O} \times (5+5) \text{ cmH}_2\text{O/l/s} = 0.5 \text{ s}$$

and thus a maximum rate of 40 b/min. Since this value is higher than the one calculated above, the lower of the two values is in effect, that is, 22 b/min.

This limit applies to the respiratory rate of the ventilator only, *not* to the respiratory rate of the patient.

D. Low rate limit

The lowest target rate (see D in Figure C-8) is fixed at 5 b/min. This low rate in turn limits the maximum tidal volume to 1400 ml in the example of the 70 kg patient above, when %MinVol is set to 100%.

C.3.4 Optimal breath pattern

Although the lung-protective rules strategy limits possible combinations of V_t and f , ASV prescribes an explicit target combination. Using the example in Figure C-8, this shows considerable room for selection within the dotted rectangle. The selection process is an exclusive feature of ASV. The device works on the assumption the optimal breath pattern is identical to the one a totally unsupported patient will choose naturally (assuming the patient is capable of maintaining the pattern).

It is common knowledge that the choice of breathing pattern is governed by either work of breathing, or the force needed to maintain a pattern. ASV uses the original equation by Otis (Otis 1950) and calculates the optimal rate based on operator entries of %MinVol and the IBW (based on the Patient height setting) as well as on the measurement of RCexp (see Section C.4).

For example, with the 70 kg patient, a setting of 100 %MinVol, and a measured RCexp of 0.5 s, the optimal rate is 15 b/min according to Otis' equation.

Once the optimal rate is determined, the target Vt is calculated as:

$$V_t = \text{target MinVol} / \text{optimal rate} \quad (4)$$

In the example of the 70 kg patient, the target Vt becomes 467 ml (see Section C.4 for details).

Figure C-9 shows the position of the target breathing pattern as well as the safety limits imposed by the lung-protective rules strategy.

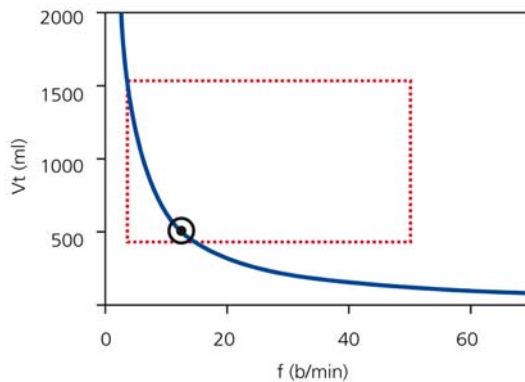

Figure C-9. Anatomy of the ASV target graphics window

The rectangle shows the safety limits; the circle shows the target breath pattern.

C.3.4.1 Initial breaths: How ASV starts

How does the operator make this determination: how to achieve the target values in a given patient if it is not known whether or not the patient can breathe spontaneously? For this purpose, ASV uses a synchronized intermittent mandatory pressure ventilation mode.

Each breath triggered by the patient is pressure-supported and flow-cycled, or, the transition to exhalation is made based on flow. In contrast, if the patient does not trigger the breath, the delivery of the breath is pressure-preset and time-cycled.

The operator-set controls (manual):

- PEEP/CPAP
- Oxygen
- P-ramp
- ETS
- Trigger type and sensitivity

This list of controls is adjusted automatically by ASV, and cannot be adjusted by the operator:

- SIMV rate: to change total respiratory rate
- Inspiratory pressure level: to change inspiratory volume
- Inspiratory time: to allow gas flow into the lungs
- Startup breath pattern

To safely start ASV, the operator inputs the Patient height setting, which is used to calculate the IBW.

Three initial test breaths are delivered. The resulting rate and tidal volume are measured and compared with the target values. ASV then responds to the differences between the actual and target V_t as well as the actual and target rates.

C.3.4.2 Approaching the target

Figure C-10 shows a possible scenario after the three initial test breaths. The actual breath pattern, which is plotted as the patient symbol, shows clear deviation from the target. The task of ASV is now to move the patient symbol as close to the circle as possible.

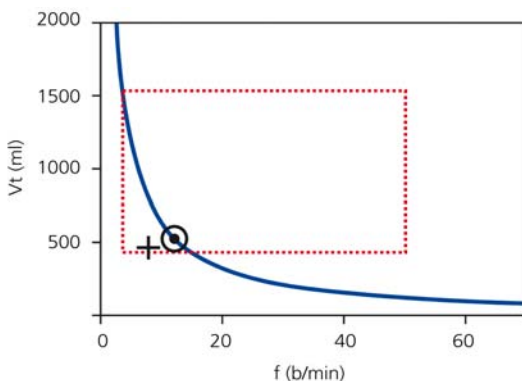

Figure C-10. Example of a situation after the three initial breaths

The patient symbol marks the actual measured values for V_t and rate.

To achieve the target, use this strategy:

- If actual $V_t <$ target V_t , the inspiratory pressure is increased.
- If actual $V_t >$ target V_t , the inspiratory pressure is decreased.
- If actual $V_t =$ target V_t , the inspiratory pressure is left unchanged.
- If actual rate $<$ target rate, the SIMV rate is increased.
- If actual rate $>$ target rate, the SIMV rate is decreased.
- If actual rate $=$ target rate, the SIMV rate is left unchanged.

As a result, the patient symbol in Figure C-10 moves toward the circle. The actual V_t is calculated as the average of inspiratory and expiratory volumes of the last 5 breaths. This definition compensates in parts for leaks in the breathing circuit, including the endotracheal tube.

C.3.5 Dynamic adjustment of lung protection

The operator preset values are not changed by ASV, and the corresponding safety limits remain as defined above. However, if the respiratory system mechanics change, the safety limits change accordingly and as defined in Section C.3.3. The safety limits are updated on a breath-by-breath basis.

For example, if the lungs stiffen, the high V_t limit is lowered proportionally, and the high Rate limit is increased according to Equation 5.

This dynamic adjustment ensures that ASV applies a safe breathing pattern at all times. In graphical terms, the dotted rectangle changes as shown in Figure C-11.

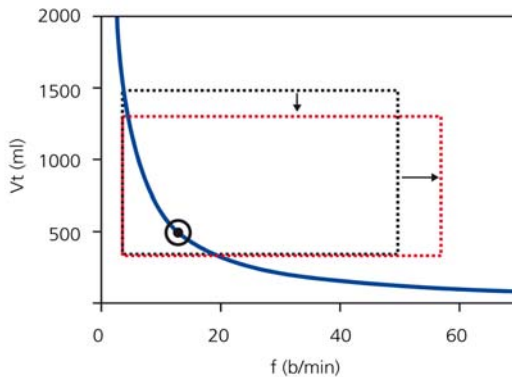

Figure C-11. Lung-protective limits are changed dynamically and according to the respiratory system mechanics. However, the limits derived from the operator input are never violated.

C.3.6 Dynamic adjustment of optimal breath pattern

After calculated, the optimal breath pattern is revised with each breath according to the measurements of RC_{exp} . Apply Otis' equation and a new target breathing pattern is calculated. The targets do not change under steady-state conditions. However, if the patient's respiratory system mechanics change, the target values also change.

In this example: the bronchi of our normal 70 kg sample patient (being ventilated at 15 b/min and with a V_t of 467 ml) constrict due to asthma, and the expiratory resistance increases to values higher than 5 cmH₂O/l/s. For this reason, more time is needed during exhalation for the lungs to reach the end-expiratory equilibrium position. In technical terms, the RC_{exp} has increased and this increase requires a longer expiratory time.

For a given minute ventilation, this calls for an increase in V_t and a decrease in rate (longer expiratory time). Otis' equation yields new targets:

$$f = 11 \text{ b/min and } V_t = 636 \text{ ml}$$

Figure C-12 shows the change. Notice also that the increase in resistance results in a decrease in the volume/pressure ratio (V/P). The changes in RC_{exp} and dynamic compliance affect the safety limits accordingly and with each breath (see Section C.3.5).

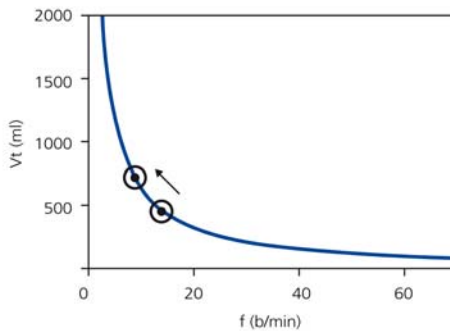

Figure C-12. Changes of target values in broncho-constriction

For clarity, the safety limits are omitted. For clinical examples, see Belliato 2000.

C.4 Minimum work of breathing (Otis' equation)

Otis' basic question was: how do mammals choose their breathing pattern and on what parameters does it depend (Otis 1950)? The same question was investigated years before by Rohrer and a very similar result was obtained (Rohrer 1925). The hypothesis was that the breath pattern with the least work of breathing (WOB) is chosen by mammals. Figure C-13 shows the relationship between rate and WOB graphically, for resistive load, elastic load, and total load to breathing.

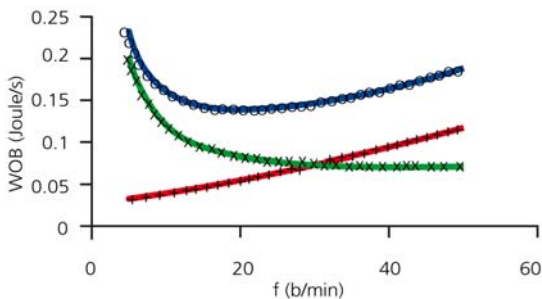

Figure C-13. Three different relationships between rate and WOB are plotted for a hypothetical lung: (+) purely resistive load causes WOB to rise with rate, (x) purely elastic load creates highest load at low rates, (o) the total lung shows a clear minimum which can be calculated according to the equation below.

The following equation was found to represent the rate where WOB is minimum:

$$f = (1 + 2a \cdot RCe \cdot (\text{MinVol} - f \cdot Vd) / (Vd))^{-0.5} - 1/a \cdot RCe$$

where a is a factor that depends on the flow waveform. For sinusoidal flows, a is $2\pi^2/60$.

The corresponding tidal volume is calculated as:

$$Vt = \text{MinVol}/f$$

Example: A 70 kg male patient with normal lungs ($R_{total} = 5 \text{ cmH}_2\text{O/l/s}$, expiratory resistance hose and valve = $5 \text{ cmH}_2\text{O/l/s}$, $C_{rs} = 50 \text{ ml/cmH}_2\text{O}$) may have a measured RC_{exp} of 0.5 s , an estimated V_{Daw} of 154 ml , and an operator-set $\%MinVol$ of 100% . With these values, the target $MinVol$ becomes

$$MinVol = 100\% \times 70 \text{ kg} \times 0.1 \text{ l/min/kg} = 7 \text{ l/min}$$

Next, Otis' equation is applied with the following parameters:

$$MinVol = 7 \text{ l/min}$$

$$V_{Daw} = 154 \text{ ml}$$

$$RC_{exp} = 0.5 \text{ s}$$

$$a = 2\pi^2/60$$

$$f = 10 \text{ b/min (this is always used as a starting value)}$$

The result is a new rate $f(1)$

$$f(1) = 15 \text{ b/min}$$

This rate is again inserted into Otis' equation, the calculation is performed again, and the next estimate for rate $f(2)$ is obtained. This procedure is repeated until the difference between subsequent results for rate (f) becomes lower than 0.5 b/min . In the present example, one iteration step is sufficient, i.e.,

$$f_{target} = 15 \text{ b/min}$$

Finally, the target tidal volume is obtained by dividing $MinVol$ by f :

$$V_{target} = 7000 \text{ ml/min} / 15 \text{ b/min} = 467 \text{ ml}$$

C.5 ASV technical data

Table C-5 lists technical data related to ASV. *Underlined> parameters are operator-set in the ASV mode.*

Table C-5. ASV technical data

ASV-related operator settings	
%MinVol	25% to 350%
Patient height	Adults: 130 to 250 cm / 50 to 100 in Pediatric: 30 to 150 cm / 12 to 60 in
Internal calculations	
IBW	In kg, calculated based on Patient height and Gender
MinVol (target)	In l/min, target minute volume is calculated as: $IBW \text{ (in kg)} \times \text{NormMinVent (in l/kg/min)} \times \%MinVol/100$ where NormMinVent is the normal minute ventilation from Figure C-6.
fTotal	In b/min, calculated on the basis of Otis' equation
VDaw	2.2 ml/kg IBW
Vt (target)	MinVol/ f(target)
ASV monitor	
Target values (numerical)	MinVol, Vt, fTotal
Current achieved values (numerical)	MinVol, Vt, fTotal, $Vt = (VTI+VTE)/2$
Status of patient (numerical)	fSpont, fControl, PInsp
Graphics display (curve)	f versus Vt, target value, actual value, safety boundaries

Table C-5. ASV technical data

Alarms	
All HAMILTON-C1 alarms are functional except apnea alarms	See Chapter 8
Special	ASV: Check hi press limit, ASV: Cannot meet target
Performance specifications	
Response time (90% of steady state)	< 1 min (typical)
Overshoot/undershoot	< 20%
Maximum pressure change per breath	2 cmH2O
Lung-protective rules	
Maximum Vt	Limited to 1.5 x Vthigh. Depends on high Pressure alarm limit and volume/pressure ratio (V/P) always < 22 x IBW
Minimum Vt	4.4 x IBW
Maximum machine rate	Depends on RCexp, but always < 60 b/min
Minimum target rate	5 to 15 b/min
Maximum P _{insp}	High Pressure alarm limit - 10 cmH2O - PEEP
Minimum P _{insp}	5 cmH2O above PEEP/CPAP
Minimum inspiratory time (T _I)	0.5 s or RCexp, whichever is longer
Maximum inspiratory time (T _I)	2 s
Minimum expiratory time (T _e)	2 x RCexp
Maximum expiratory time (T _e)	12 s
I:E range	1:4 to 1:1

C.6 ASV startup

When ASV is started, the device delivers 3 (three) test breaths in the synchronized intermittent mandatory pressure ventilation mode. The device automatically selects the values for SIMV rate, inspiratory time (TI), and inspiratory pressure (P_{insp}) based on the calculated IBW, which is determined from the operator-set Patient height and Gender settings, and according to information described in Tables C-6 and C-7.

Table C-6. Initial breath pattern for Adult settings

IBW (kg)	P_{insp} (cmH₂O)	TI (s)	SIMV rate (b/min)	Minimum target rate (b/min)
30 to 39	15	1	14	7
40 to 59	15	1	12	6
60 to 89	15	1	10	5
90 to 99	18	1.5	10	5
> 100	20	1.5	10	5

Table C-7. Initial breath pattern for Pediatric settings

IBW (kg)	P_{insp} (cmH₂O)	TI (s)	SIMV rate (b/min)	Minimum target rate (b/min)
3 to 5	15	0.4	30	15
6 to 8	15	0.6	25	12
9 to 11	15	0.6	20	10
12 to 14	15	0.7	20	10
15 to 20	15	0.8	20	10
21 to 23	15	0.9	15	7
24 to 29	15	1	15	7

C.7 References

- **Hewlett AM, Platt AS, Terry VG.** Mandatory minute volume. A new concept in weaning from mechanical ventilation. *Anaesthesia* 1977, 32:163-9.
- **Radford EP jr.** Ventilation standards for use in artificial respiration. *N Engl J Med* 1954, 251:877-83.
- **Otis AB, Fenn AWO, Rahn H.** Mechanics of breathing in man. *J Appl Physiol* 1950, 2:592-607.
- **Marini JJ, Crooke PS, Truwit JD.** Determinants and limits of pressure-preset ventilation: a mathematical model of pressure control. *J Appl Physiol* 1989, 67:1081-92.
- **Slutsky AS.** Consensus conference on mechanical ventilation- January 28-30, 1993 at Northbrook, Illinois, USA. *Int Care Med* 1994, 20:64-79.
- **Lourens MS, Van den Berg BV, Aerts JGJ, Verbraak AFM, Hoogsteden HC, Bogtaard JM.** Expiratory time constants in mechanically ventilated patients with and without COPD. *Int Care Med* 2000, 26:1612-18.
- **Quan SF, Parides GC, Knoper ST.** Mandatory Minute Volume (MMV) Ventilation: An Overview. *Resp Care* 1990, 35:898-905.
- **Belliato M, Maggio M, Neri S, Via G, Fusilli N, Olivei M, Lotti G, Braschi A.** Evaluation of the adaptive support ventilation (ASV) mode in paralyzed patients. *Intensive Care Med* 2000, 26, Suppl. 3:S327.
- **...more** and updated references on www.hamilton-medical.com

D NIV, noninvasive ventilation

D.1	Introduction	D-2
D.2	Benefits of noninvasive ventilation	D-4
D.3	Required conditions for use	D-4
D.4	Contraindications	D-5
D.5	Potential adverse reactions	D-5
D.6	Selecting a patient interface	D-6
D.7	Control settings	D-7
D.8	Alarms	D-8
D.9	Monitored parameters	D-8
D.10	Additional notes about using noninvasive ventilation	D-9
D.11	References	D-11

D.1 Introduction

NOTE:

- Noninvasive ventilation in critically ill patients should only be used by properly trained and experienced personnel.
 - As a precaution, you must be prepared to intubate the patient and start invasive ventilation at any time while noninvasive ventilation is in use.
 - The use of a mask can increase dead space. Always comply with the mask manufacturer's instructions when using noninvasive ventilation.
 - If you are using the neonatal noninvasive modes, nCPAP and nCPAP-PC, see Chapter 5.
-

The noninvasive ventilation mode (NIV) and the spontaneous/timed noninvasive ventilation mode (NIV-ST) are implementations of noninvasive positive pressure ventilation (NPPV). NPPV can use as its patient interface a mask, mouthpiece, or helmet-type interface, rather than an invasive conduit such as an endotracheal tube.

Used for years in home care and subacute care settings, NPPV can also benefit intensive care ventilation patients by decreasing the need for intubation and promoting early extubation. Benefits such as reduced mortality (COPD patients), reduced ventilation time (COPD and ARF patients), and reduced complication rates (of ventilator-associated pneumonias) have been clearly demonstrated^{1,2}.

-
1. Mehta S et al. Noninvasive ventilation. *Am J Respir Crit Care Med* 2001 Feb;163(2):540-77.
 2. Hess DR. The evidence for noninvasive positive-pressure ventilation in the care of patients in acute respiratory failure: a systematic review of the literature. *Respiratory Care* 2004 Jul;49(7):810-25.

Intended for actively breathing patients, noninvasive ventilation is provided through a nonvented or nonported mask interface. Because this open breathing circuit permits air to leak around the mask or through the mouth, the ventilator achieves and maintains the prescribed pressure by adjusting the inspiratory flow. If the leak is large, the ventilator's inspiratory flow can be large—up to 260 l/min—thus compensating at least in part for most leaks. The NIV modes were also designed to minimize nuisance leak-related alarms.

NIV is an adaptation of the SPONT mode, while NIV-ST is an adaptation of the PSIMV+ mode. The primary difference between SPONT and NIV or PSIMV+ and NIV-ST is that SPONT and PSIMV+ are designed for an intubated patient, while the NIV modes are designed for use with a mask or other noninvasive patient interface. See Appendix A for technical details about the ventilator's noninvasive modes.

D.2 Benefits of noninvasive ventilation

Noninvasive ventilation offers these short-term benefits^{1,2}:

- Relieves respiratory symptoms
- Optimizes patient comfort
- Reduces work of breathing
- Improves or stabilizes gas exchange
- Improves patient-ventilator synchrony
- Minimizes risks associated with aspiration, intubation, injury to the mucus membranes and teeth, and circulatory reactions

Noninvasive ventilation offers these long-term benefits:

- Improves sleep duration and quality
- Maximizes quality of life
- Enhances functional status
- Prolongs survival

D.3 Required conditions for use

CAUTION

- **To prevent possible patient injury, DO NOT use noninvasive ventilation on patients with no or irregular spontaneous breaths. Noninvasive ventilation was intended to provide supplemental ventilatory support to patients with regular spontaneous breaths.**
 - **To prevent possible patient injury, DO NOT attempt to use noninvasive ventilation on intubated patients.**
-

1. Mehta S et al. Noninvasive ventilation. Am J Respir Crit Care Med 2001 Feb;163(2):540-77.
2. Hess DR. The evidence for noninvasive positive-pressure ventilation in the care of patients in acute respiratory failure: a systematic review of the literature. Respiratory Care 2004 Jul;49(7):810-25.

Ensure these requirements are met to use noninvasive ventilation:

- The clinician's instructions must be strictly followed.
- The patient must not be intubated.
- The patient must be able to trigger the ventilator and must have regular spontaneous breaths.
- The patient must be conscious.
- The patient must be able to maintain an adequate airway.
- The patient must be monitored by external monitors.
- Intubation must be possible at any time.
- The mask should fit face structures well.

D.4 Contraindications

- Intolerance of interface
- Inability to trigger breath
- Facial or brain injury
- Recent upper airway or esophageal surgery
- Hemodynamic instability
- Gastric distension
- Inability to protect airway

D.5 Potential adverse reactions

- Skin breakdown from interface (pressures sores)
- Aspiration
- Conjunctivitis
- Gastric insufflation
- Claustrophobic reaction
- Potential hemodynamic instability

D.6 Selecting a patient interface

CAUTION

Make sure to follow the instructions for use of the manufacturer when using any noninvasive patient interface. Incorrectly used masks can cause skin irritations.

The quality and performance of the patient interface largely determine the effectiveness of noninvasive ventilation.

The following types of interfaces are supported:

- Face (oronasal) mask that covers the mouth and nose
- Nasal mask that covers the nose only
- Mouthpiece
- Helmet

In general, an interface used with the noninvasive modes must meet these requirements:

- It must be of the nonvented/nonported design
- Gas leakage should be controllable at low mask application pressures
- The material in contact with the face should be soft, biocompatible, and nonallergenic
- It should be easy to install and remove
- It should remain properly positioned when the patient moves their head

If you try using a nasal mask, but there is significant gas leakage through the open mouth, switch to a face mask.

D.7 Control settings

WARNING

The exhaled volume from the patient can differ from the measured exhaled volume due to leaks around the mask.

CAUTION

- **When ventilating with a mask, avoid high airway pressures. High pressures may cause gastric distension.**
 - **Peak pressures exceeding 33 cmH₂O may increase the risk of aspiration due to gastric insufflation¹. When ventilating with such pressures, consider using an invasive mode.**
-

When a significant leak occurs, the inspiratory flow can never fall below ETS, thus not allowing the ventilator to cycle into exhalation and resulting in endless inspiration. For this reason, the TI max setting was added, providing an alternative way to cycle into exhalation. When inspiration lasts longer than TI max, the ventilator cycles into exhalation.

When the ventilator cycles are based on ETS setting rather than TI max, it is the most comfortable for the patient. Ensure the TI max setting is sufficiently long to give ETS the chance to cycle the ventilator. Adjusting the TI max setting increases or decreases the allowable inspiratory time. Increasing ETS above the default 25% allows the ventilator to cycle to terminate inspiration at a higher flow, to accommodate larger leaks.

Other controls require special attention. Carefully observe the patient/ventilator interaction. The leakage in this mode reduces the actual applied PEEP/CPAP and give rise to autotriggering. Adjust P_{support} or P_{insp} to obtain appropriate tidal volumes. Adjust PEEP/CPAP further, considering oxygenation and AutoPEEP.

1. Bach JR, Alba AS, Saporito LR. Intermittent positive pressure ventilation via the mouth as an alternative to tracheostomy for 257 ventilator users. Chest 1993;103:174-182.

D.8 Alarms

NOTE:

The **Inspiratory volume limitation** alarm is inactive in noninvasive modes.

Due to the changing and unpredictable amount of leakage, volume alarms are less meaningful in noninvasive than in other modes. Alarms are based on the returned expiratory gas volume measured at the flow sensor; this value can be significantly lower than the delivered tidal volume, because the delivered tidal volume is the sum of the displayed VTE and the leakage volume. To avoid nuisance volume alarms, set the low Vt and ExpMinVol alarms to a low level.

Because the noninvasive modes are pressure modes, however, do pay attention to the pressure-related alarms. If the defined PEEP and inspiratory pressure can be maintained, the ventilator is compensating the gas leak sufficiently.

D.9 Monitored parameters

NOTE:

- Due to the changing and unpredictable amount of leakage, these numeric monitoring parameters cannot be used for reliable analysis of patient conditions: **ExpMinVol**, **RCexp**, **Rinsp**, **Insp Flow**, **AutoPEEP**, and **Cstat**. Continuous monitoring of the clinical parameters and patient comfort is of critical importance.
 - The parameters **VTE NIV**, **MinVol NIV**, **MVSpont NIV**, and **MVLeak** are leak compensated, and are used in noninvasive modes. These parameters are estimations and may not reflect exact values.
-

Due to the leakage at the patient interface, displayed exhaled volumes in the noninvasive modes can be substantially smaller than the delivered volumes. The flow sensor measures the delivered volume and the exhaled tidal volume; the ventilator displays the difference as **VLeak** in %, and as **MVLeak** in l/min. Use **VLeak** and **MVLeak** to assess the fit of the mask or other noninvasive patient interface.

While a leak at the patient interface influences the tidal volume measurement, leaks in the breathing circuit itself do not influence the tidal volume measurement.

Besides all the other clinical parameters, **TI**, **Ppeak**, **PEEP/CPAP**, **I:E**, **fTotal**, **Pmean**, and **fSpont** can be used to assess the patient's ventilatory status.

D.10 Additional notes about using noninvasive ventilation

NOTE:

If the mask fit cannot be improved, select an alternative treatment method.

Due to some unique characteristics of noninvasive ventilation, consider the following points when using it. Consistent with best practices, monitor the patient closely to evaluate the adequacy of the prescribed therapy.

IntelliTrig (intelligent trigger) function. With its IntelliTrig function, the ventilator can automatically adapt to changing breath patterns and system leaks to achieve optimum synchronization between patient and device.

To synchronize, IntelliTrig compensates any leaks and resistances between the ventilator and the patient, and with each breath it measures the leakage at the patient interface (mask). With this information IntelliTrig adapts the trigger mechanism so leakage and the changing breath pattern do not influence the operator-set trigger sensitivity (flow trigger).

Maintaining PEEP and preventing autotriggering. Significant leakage can be present in noninvasive ventilation, which can serve to reduce the actual applied PEEP/CPAP and give rise to autotriggering. If you cannot reach the set PEEP/CPAP, check the mask fit.

The ventilator maintains PEEP with the expiratory valve in combination with a compensating base flow delivered by the check valve through the breathing circuit.

The **Loss of PEEP** alarm alerts you to uncompensated leaks (that is, when the measured PEEP/CPAP is 3 cmH₂O lower than the set PEEP/CPAP).

Inspect mask fit and position. For noninvasive ventilation to function as intended, the mask must fit well and remain in place. It is desirable to maintain a good seal and minimize leakage.

Inspect the mask position regularly and adjust as necessary. If the mask slides away from the mouth and nose (patient disconnection), reinstall and secure it. React promptly and appropriately to any alarms.

The ventilator's Leak parameter provides one indicator of mask fit. To check the proper fit of the mask verify that the patient can trigger and flow-cycle inspiration and by verify that:

$$P_{\text{peak}} = (\text{PEEP/CPAP} + P_{\text{support/Pinsp}}) \pm 3 \text{ cmH}_2\text{O}$$

CO₂ rebreathing in noninvasive ventilation. CO₂ rebreathing per breath can increase in noninvasive ventilation. Typically this is not critical, because there is also generally significant leakage in noninvasive ventilation. CO₂ rebreathing can occur because there is not the usual dead space reduction from an endotracheal tube or tracheostomy. And because the mask or other noninvasive interface creates additional dead space. Consider this additional dead space when prescribing a specific type of noninvasive patient interface. Despite the use of a noninvasive interface, the dead space ventilation per minute can decrease when the therapy results in an increase in tidal volume and decrease in respiratory rate.

D.11 References

- **Hess DR.** The evidence for noninvasive positive-pressure ventilation in the care of patients in acute respiratory failure: a systematic review of the literature. *Respir Care* 2004 Jul;49(7):810-25.
- **Mehta S et al.** Noninvasive ventilation. *Am J Respir Crit Care Med* 2001 Feb;163(2):540-77.
- **Arroliga AC.** Noninvasive positive pressure ventilation in acute respiratory failure: does it improve outcome? *Cleveland Clin J Med.* 2001 Aug;68(8):677-80.
- **Hill NS.** Noninvasive ventilation in chronic obstructive pulmonary disease. *Clin Chest Med.* 2000 Dec;21(4):783-97.
- **AARC.** Consensus statement: Noninvasive positive pressure ventilation. *Respir Care* 1997;42(4):365-9.
- **Evans TW et al.** Noninvasive positive pressure ventilation in acute respiratory failure: Report of an international consensus conference in intensive care medicine, Paris, France, 13 - 14 April 2000. *Reanimation* 2001;10:112-25.

E CO₂ sensor option: Volumetric capnography

E.1	Introduction	E-2
E.2	CO ₂ elimination ($V'CO_2$)	E-2
E.3	End-tidal CO ₂ (PetCO ₂ and FetCO ₂)	E-4
E.4	Airway dead space (VDaw)	E-4
E.5	Alveolar minute ventilation ($V'alv$)	E-5
E.6	Capnogram shape	E-6
E.7	Formulas	E-8
E.8	References	E-9

E.1 Introduction

The ventilator uses volumetric capnography as the method to assess the quality and quantity of ventilation.

The device is able to provide volumetric capnography measurements such as:

- The **CO2 elimination ($V'CO_2$)** measurement permits assessment of metabolic rate (for example, it is high with sepsis, tetanus, and so on) and treatment progress.
- The **end-tidal CO2 ($P_{et}CO_2$ and $F_{et}CO_2$)** measurements permit assessment of arterial CO2 (Notice that they are inaccurate in pulmonary embolism.).
- The **airway dead space (VD_{aw})** and alveolar minute ventilation (V'_{alv}) measurements permit assessment of actual alveolar ventilation (as opposed to minute ventilation).
- The **capnogram shape (slopeCO2)** permits assessment of COPD, asthma, and inefficient ventilation.
- The **physiological dead space fraction (VD/V_t)** permits assessment of risk (Nuckton 2002).

E.2 CO2 elimination ($V'CO_2$)

To convert a time-based capnogram into a volumetric capnogram, CO2 must be combined with flow. Figure E-3 shows the volume of CO2 exhaled in one breath, combining a typical $F_{et}CO_2$ versus time curve (Figure E-1) with the flow curve (Figure E-2) for a mechanically ventilated patient.

The area under the expiratory curve (B) minus the area under the inspiratory curve (A) is the net transfer of CO2 out of the lungs per breath, or VCO_2 .

CO2 elimination ($V'CO_2$) is obtained by adding VCO_2 over several breaths and dividing the sum by the total time in minutes (Noe 1963). Steady-state conditions are essential to interpret the $V'CO_2$ values (Brandi 1999). $V'CO_2$ thus represents CO2 elimination but not necessarily CO2 production. Normal values for $V'CO_2$ can be found in the reference literature or in Table E-1.

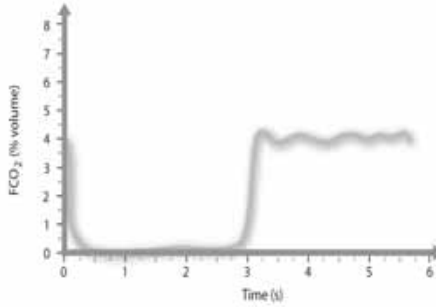

Figure E-1. Typical capnogram of patient on pressure-controlled ventilation, showing fractional concentration of CO₂ plotted against time.¹

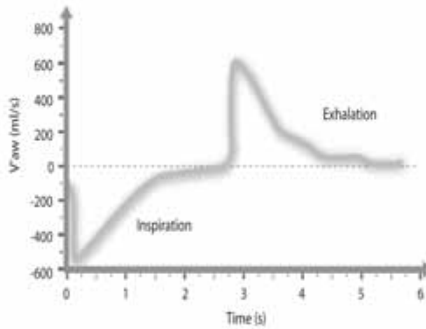

Figure E-2. Typical spirogram of a patient on pressure-controlled ventilation (same breath as shown in Figure E-1).²

1. Inspiration starts at time 0; exhalation, at approximately 2.75 sec. Notice that inspiratory gas initially contains CO₂ (rebreathing) that is washed out of the Y-piece.
2. The flow into the patient (inspiration) is negative, while the flow out of the patient (exhalation) is positive. The expiratory flow curve is an exponential decay curve. Notice that in spontaneously breathing subjects, the flow curves may be of different shapes.

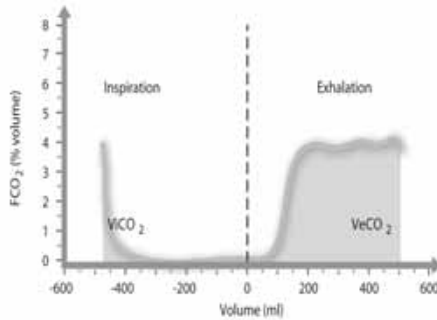

Figure E-3. Combination of capnogram and spirogram (fractional end-tidal CO₂ concentration plotted against volume)¹

E.3 End-tidal CO₂ (PetCO₂ and FetCO₂)

The maximum value of CO₂ measured during exhalation is normally considered the end-tidal CO₂ value, and is either given as a partial pressure (PetCO₂), or as a fractional concentration of CO₂ in dry gas (FetCO₂).

Normal values for PetCO₂ and FetCO₂ can be found in the literature or in Table E-1.

E.4 Airway dead space (VDaw)

NOTE:

The airway dead space (VDaw) is in approximation to the anatomical dead space.

1. ViCO₂ is the volume of inspired CO₂, while VeCO₂ is the volume of exhaled CO₂. The net elimination of CO₂ is VeCO₂ - ViCO₂. ViCO₂, which is a negative volume indicating rebreathed CO₂, is normally omitted.

Airway dead space measurement using a volumetric capnogram gives an effective, in-vivo measure of volume lost in the conducting airways. By dividing the capnogram into phases¹ (Figure E-4), V_{Daw} can be calculated as the smallest measurable dead space, essentially the volume exhaled up until phase II. The calculation, described in literature (Wolff 1989 and Aström 2000), consists of a number of computational steps, which take the slope of the alveolar plateau into account.

Normal values for V_{Daw} can be found in the literature or in Table E-1.

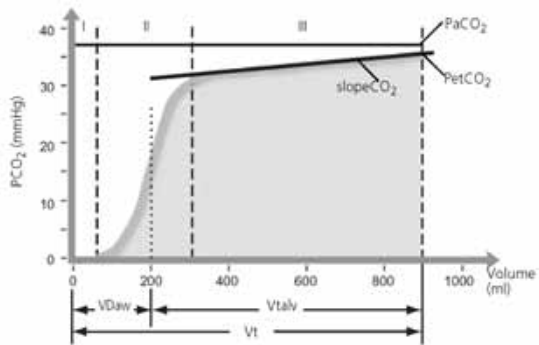

Figure E-4. Interpretation of volumetric capnogram.²

E.5 Alveolar minute ventilation (V'_{alv})

Minute ventilation includes not only ventilation of the lungs, but also ventilation that is wasted in the airways. Thus, high minute ventilation does not conclusively indicate the actual alveolar reach. For example, a tidal volume of 100 ml at 80 b/min yields the same minute ventilation as a tidal volume of 500 ml at 16 b/min, yet it has no real benefit to the patient since only dead space ventilation occurs. Alveolar ventilation is defined as

1. In an early detailed description (Folkow 1955), the capnogram can be thought of as being divided into phases: phase I (no CO₂ present), phase II (rapid rise in CO₂), and phase III (alveolar plateau).
2. Phase I: pure airway dead space, from point of measurement of CO₂ toward the lungs. Phase II: weighted average of alveolar gas from different lung spaces, at the sensor location; measurement is V_{Daw} . Phase III: alveolar plateau; measurement is slopeCO₂ together with end-tidal CO₂, P_{etCO_2} , or F_{etCO_2} .

$$V'_{alv} = \text{MinVol} - V'_{Daw}$$

where

$$\text{MinVol} = f \cdot V_t$$

and

$$V'_{Daw} = f \cdot V_{Daw}$$

or

$$V'_{alv} = f \cdot (V_t - V_{Daw})$$

Therefore, V'_{alv} is the pertinent parameter to measure ventilation.

Not all gas that enters the alveoli participates in gas exchange. Some gas ends up in non- or under-perfused lung spaces. To measure the efficiency of alveolar ventilation, PaCO_2 must be determined from an arterial blood gas sample. The ratio of mixed to ideal alveolar partial pressure is a measure of alveolar efficiency (Severinghaus 1957).

Normal values for V'_{alv} can be found in the literature or in Table E-1.

E.6 Capnogram shape

The slope of the alveolar plateau (slopeCO_2) is a characteristic of the volumetric capnogram shape. This slope is measured in the geometric center of the curve, which is defined as the middle two quarters lying between V_{Daw} and the end of exhalation (Wolff 1989, Aström 2000). A steep slope is seen in COPD patients, while a flat plateau is seen in postoperative patients. A steep slope in normal patients may indicate a technical problem.

Normal values for slopeCO_2 can be found in the literature or in Table E-1.

Table E-1. Examples of “normal” or expected values in mechanically ventilated patients¹

Description	Unit ²	Normal	Reference
VDaw	ml BTPS	2.2 ml/kg IBW	Radford 1954
slopeCO2	%CO2/l	31324*Vt-1.535	Aström 2000
V'CO2 ³	ml/min STPD	2.6 to 2.9 ml/min/kg	Weissmann 1986, Wolff 1986
FetCO2 ⁴	%	5.1 to 6.1%	Wolff 1986
V'alv	mmHg (kPa)	36 mmHg (4.8 kPa)	Kiiski, Takala 1994
VD/Vt	ml/min BTPS	52 to 70 ml/min/kg actual body weight	⁵
VD/Vtbohr	--	Normal: 0.36 to 0.42 High: > 0.63 ±0.1	Kiiski, Takala 1994, Wolff 1986, Nuckton 2002 ⁶

1. These values are for illustration purposes and do not replace physician-directed treatment.
2. Bulk gas volumes such as minute ventilation and tidal volumes are usually measured in BTPS. Specific gas volumes are expressed in STPD. Conversion factors can be found in physics textbooks.
3. $V'CO_2 = V'alv * FetCO_2$
4. $FetCO_2 = PetCO_2/(Pb-PH_2O)$
5. $V'alv = V'CO_2/FetCO_2$ STPD
Lower value of normal range: $V'alv = 2.6/0.061 = 43*ml*kg/min*STPD = 52*ml*kg/min*BTPS$
Upper value of normal range: $V'alv = 2.9/0.051 = 57*ml*kg/min*STPD = 70*ml*kg/min*BTPS$
6. VD/Vtbohr is equivalent to VD/Vt if PetCO2 is identical to PaCO2. In normal lungs, this is the case. In diseased lungs, however, PetCO2 and PaCO2 are not identical. The classic example is pulmonary embolism.

E.7 Formulas

Alveolar tidal ventilation (Vtalv)

$$V_{talv} = V_t - V_{Daw}$$

Alveolar minute ventilation (V'alv)

$$V'_{alv} = f \cdot V_{talv}$$

Volume of CO2 eliminated in one breath (VCO2)

$$VCO_2 = V_{eCO_2} - V_{iCO_2}$$

Fractional concentration of CO2 in exhaled gas (FeCO2)

$$F_{eCO_2} = V'_{CO_2} / \text{MinVol}$$

Partial pressure of CO2 in exhaled gas (PeCO2)

$$P_{eCO_2} = F_{eCO_2} \cdot (P_b - P_{H_2O})$$

Bohr dead space fraction (VDbohr/Vt)

(Note: Vt in this formula needs to be in ml STPD)

$$V_{Dbohr} / V_t = 1 - (V_{eCO_2} / (V_t \cdot F_{eCO_2}))$$

Physiological dead space fraction (VD/Vt)

$$V_D / V_t = 1 - ((V_{eCO_2} / V_t) / (p_{aCO_2} / (P_b - P_{H_2O})))$$

E.8 References

- **Astrom E, Niklason L, Drefeldt B, Bajc M, Jonson B.** Partitioning of dead space – a method and reference values in the awake human. *Eur Respir J.* 2000 Oct; 16(4):659-664.
- **Brandi LS, Bertolini R, Santini L, Cavani S.** Effects of ventilator resetting on indirect calorimetry measurement in the critically ill surgical patient. *Crit Care Med.* 1999 Mar; 27(3):531-539.
- **Kiiski R, Takala J, Eissa NT.** Measurement of alveolar ventilation and changes in deadspace by indirect calorimetry during mechanical ventilation: a laboratory and clinical validation. *Crit Care Med.* 1991 Oct; 19(10):1303-1309.
- **Noe FE.** Computer analysis of curves from an infrared CO₂ analyzer and screen-type airflow meter. *J Appl Physiol* 1963; 18:149-157.
- **Nuckton TJ, Alonso JA, Kallet RH, Daniel BM, Pittet JF, Eisner MD, Matthay MA.** Pulmonary dead-space fraction as a risk factor for death in the acute respiratory distress syndrome. *N Engl J Med.* 2002 Apr 25; 346(17):1281-1286.
- **Radford EP.** Ventilation standards for use in artificial respiration. *N Engl J Med* 1954; 251:877-883.
- **Severinghaus JW, Stupfel M.** Alveolar dead space as an index of distribution of blood flow in pulmonary capillaries. *J Appl Physiol* 1957; 10:335-348.
- **Weissman C, Kemper M, Elwyn DH, Askanazi J, Hyman AI, Kinney JM.** The energy expenditure of the mechanically ventilated critically ill patient. An analysis. *Chest.* 1986 Feb; 89(2):254-259.
- **Wolff G, Brunner JX, Weibel W, et al.** Anatomical and series dead space volume: concept and measurement in clinical practice. *Appl Cardiopul Pathophysiol* 1989; 2:299-307.
- **Wolff G, Brunner JX, Grädel E.** Gas exchange during mechanical ventilation and spontaneous breathing. Intermittent mandatory ventilation after open heart surgery. *Chest.* 1986 Jul; 90(1):11-17

F Pneumatic diagram

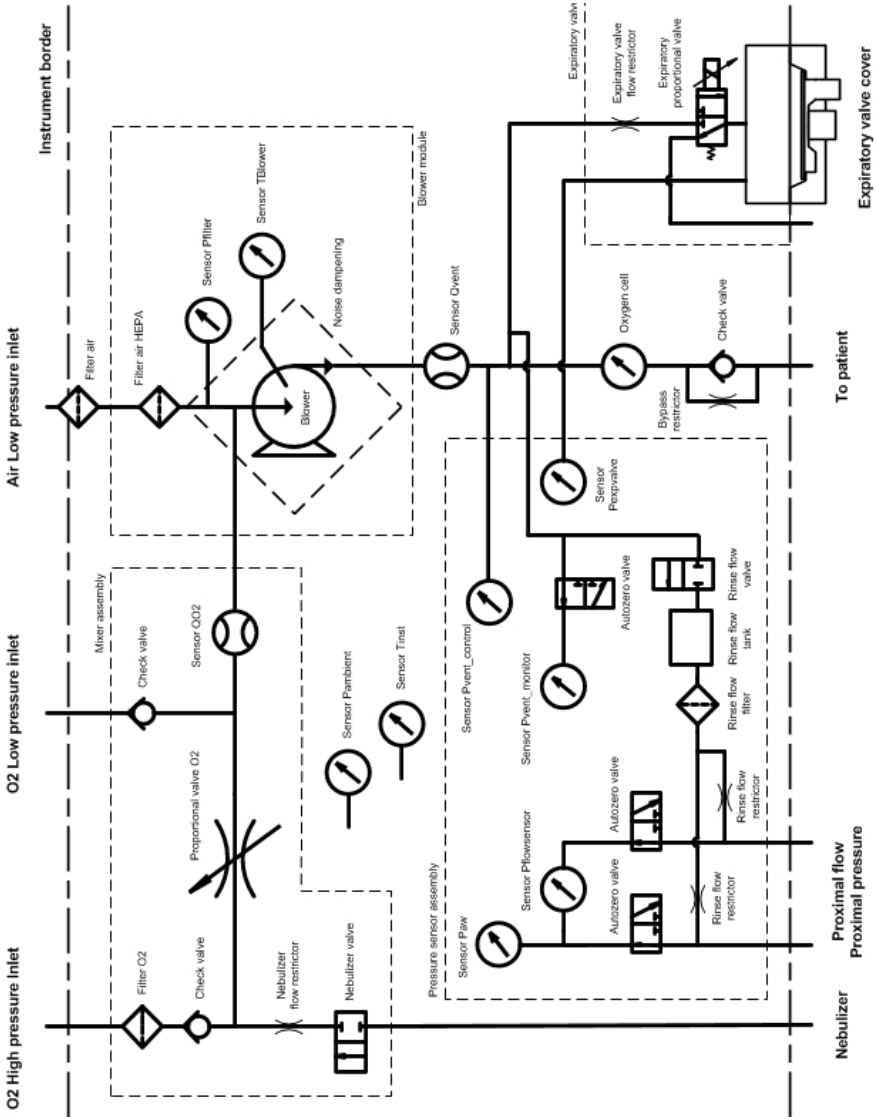

Figure F-1. Pneumatic diagram

G Parts and accessories

This appendix lists the parts available for the HAMILTON-C1 ventilator.

WARNING

To ensure proper ventilation operation, use only parts and accessories specified in this appendix and in the product catalog, or that are specified as being compatible with this ventilator.

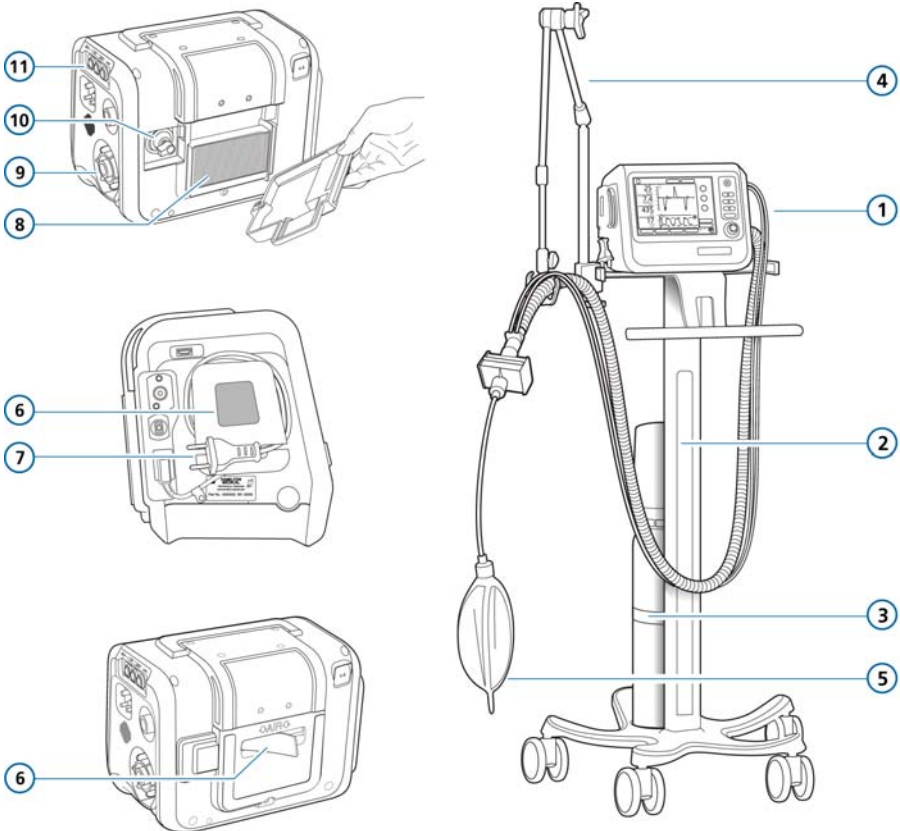

Figure G-1. Ventilator parts and accessories

NOTE:

- Note that not all parts are available in all markets.
- For additional parts and accessories, see the product catalog or contact your Hamilton Medical representative.

Table G-1. Ventilator parts and accessories

Item no. (Fig. G-1)	Description	PN
1	HAMILTON-H900 breathing set, pediatric/adult, single-use, with water chamber, temperature probe, and all in-one connector	
	Breathing set BC8022, dual limb, pre-assembled, box of 15	260161
	Breathing set, adult, reusable, MR850, without humidifier kit, with C1/T1/MR1 expiratory valve set	
	Breathing set A0-C1, without water trap	260153
	Breathing set GM A0-C1, without water trap	260154
	Breathing set, pediatric, reusable, MR850, without humidifier kit, with C1/T1/MR1 expiratory valve set	
	Breathing set P1-C1, single water trap	260159
	Breathing set, pediatric, reusable, HMEF, without humidifier kit, with C1/T1/MR1 expiratory valve set	
	Breathing set P0-C1, without water trap	260157
	Breathing set GM P0-C1, without water trap	260158
	Breathing set, adult, single-use, MR850, without expiratory valve set	
	Breathing set RT200, without water trap, box of 10	260039
	Breathing set, infant, single-use, MR850, without expiratory valve set	
	Breathing set RT225, single water trap, box of 10	281592

Table G-1. Ventilator parts and accessories *(continued)*

Item no. (Fig. G-1)	Description	PN
1	Breathing set, infant, reusable, MR850, without humidifier kit, with C1/T1/MR1 expiratory valve set	
	Breathing set I1, single water trap	260193
	Breathing set GM I1, single water trap	260194
	Breathing set, pediatric/adult, single use, without expiratory valve set	
	Breathing set, coaxial, length 1.8 m, box of 20	260086
	Breathing set, coaxial, incl. flow sensor and elbow adapters, length 1.8 m, box of 20	260087
	Breathing set, coaxial, incl. flow sensor and elbow adapters, length 2.4 m, box of 20	260094
	Breathing set, coaxial, incl. flow sensor and elbow adapters, length 3.0 m, box of 10	260145
	Breathing set, coaxial, incl. flow sensor and elbow adapters, length 4.8 m, box of 8	260144
	Breathing set, pediatric/adult, single use, with expiratory valve set	
	Breathing set, coaxial, incl. flow sensor and elbow adapters, length 1.8 m, box of 20	260128
	Breathing set, coaxial, incl. flow sensor and elbow adapters, length 2.4 m, box of 20	260127
	Breathing set, coaxial, incl. flow sensor and elbow adapters, length 3.0 m, box of 10	260167
	Breathing set, coaxial, incl. flow sensor and elbow adapters, length 4.8 m, box of 8	260168

Table G-1. Ventilator parts and accessories *(continued)*

Item no. (Fig. G-1)	Description	PN
1	Breathing set, neonatal, single-use, without expiratory valve set	
	Breathing set, dual limb, incl. flow sensor, pressure line, Y-piece, and elbow adapters, length 1.5 m, box of 20	260180
	Breathing set, dual limb, incl. flow sensor, pressure line, Y-piece, and elbow adapters, length 3.0 m, box of 10	260182
	Flow sensors	
	Flow sensor, pediatric/adult, single patient use, 1.88 m, box of 10	281637
	Flow sensor, pediatric/adult, reusable, 1.88 m, box of 10	155362
	Flow sensor, pediatric/adult, autoclavable, 1.88 m, box of 1	950185
	Flow sensor, infant/neonatal, single patient use, 1.6 m, box of 10	260177
	Flow sensor, infant/neonatal, single patient use, 1.88 m, box of 10	155500
	Flow sensor, infant/neonatal, single patient use, 3.1 m, box of 10	260179
not shown	Flow sensor calibration adapter, pediatric/adult, single patient use, box of 10	279937
	Flow sensor calibration adapter, infant/neonatal, single patient use, box of 10	279964

Table G-1. Ventilator parts and accessories *(continued)*

Item no. (Fig. G-1)	Description	PN
not shown	Pressure-monitoring line (for nCPAP, nCPAP-PC modes)	
	Pressure line for nCPAP and nCPAP-PC, infant/neonatal, single patient use, 1.6 m, box of 10	260174
	Pressure line for nCPAP and nCPAP-PC, infant/neonatal, single patient use, 3.1 m, box of 10	260176
	Luerlock Adapter Kit for nCPAP/nCPAP-PC with breathing set RT225 and similar, single-use, box of 50	282438
not shown	CO2 mainstream measurement	
	HAMILTON CAPNOSTAT-5™ CO2 sensor	282157
	CO2 adult airway adapter single patient use, box of 10	281719
	CO2 adult airway adapter reusable, box of 1	281721
	CO2 neonatal airway adapter, single patient use, box of 10	281722
	CO2 neonatal airway adapter, reusable, box of 1	281722
	15 mm male/female adapter for infant flow sensor, single patient use, box of 25	281803
not shown	CO2 sidestream measurement	
	HAMILTON LoFlow™ sidestream CO2 sensor	281928
	CO2 sidestream adult/pediatric airway adapter single patient use, box of 10	281929
	CO2 sidestream adult/pediatric airway adapter with dehumidification, single patient use, box of 10	281931
	CO2 sidestream neonatal airway adapter with dehumidification, single patient use, box of 10	281932

Table G-1. Ventilator parts and accessories (continued)

Item no. (Fig. G-1)	Description	PN
not shown	Humidifier	
	HAMILTON-H900 <i>For details, see the HAMILTON-H900 Product Catalog</i>	624686
	Fisher & Paykel <i>For details, see the Humidifier and Breathing Set catalog</i>	689292
Trolley		
2	Trolley (incl. humidifier support)	161150
3	Cylinder holder	161152
4	Support arm, quick positioning, basic	281671
5 Demonstration lung		
IntelliLung, maximum 1 liter		281869
Demonstration lung assembly with endotracheal tube, adult, 2 liter, with 15 mm male x 22 mm male connector		151815
Demonstration lung, neonatal, 15 mm <i>A passive lung simulator with two independent compartments for simulating infant and neonatal patients.</i>		R53353
Filter		
6	Filter set <i>Includes 5 sets. Each set includes 2 air intake dust filters and 1 fan filter.</i>	161275
8	Filter, air intake (HEPA)	161236

Table G-1. Ventilator parts and accessories *(continued)*

Item no. (Fig. G-1)	Description	PN
not shown	Patient filter	
	HMEF, adult	279963
	HMEF, neonatal	279960
	Inspiratory bacteria filter	279204
7	Power cord	
	Power cord with US plug, 2-pin	355198
	Power cord with British angled-plug	355199
	Power cord with continental European plug, 2-pin	355200
	Power cord with Chinese plug, 2-pin	355308
9	Expiratory valve	
	Expiratory valve set, pediatric/adult, autoclavable, incl. cover and membrane, box of 1	161175
	Expiratory valve set, neonatal, autoclavable, incl. cover and membrane, box of 1	161188
	Expiratory valve membrane, autoclavable, box of 5	161390
	Expiratory valve set, adult/pediatric, single patient use, box of 10	161186
10	Oxygen cell	396200

Table G-1. Ventilator parts and accessories (continued)

Item no. (Fig. G-1)	Description	PN
11	Communication	
	Communication boards - CO ₂ , Nurse Call, RS-232	161520
	Communication boards - Nurse Call	161521
	Communication boards - CO ₂ , SpO ₂ , RS-232	161636
	Cable to COM1 (260 mm)	161545
	Cable to COM1 (500 mm)	161650
	Cable, Nurse Call	160166
not shown	Battery	
	Li-Ion battery	369108
	Battery charger/calibrator	369104
not shown	High-pressure oxygen connector	
	DISS – diameter index safety standard	160470
	NIST – no interchangeable screw thread	160471
not shown	Gas-supply hoses and parts	
	Coupling insert 4.8 mm ID for low pressure O ₂ inlet	279913
not shown	SpO₂ sensors	
	Masimo SET SpO ₂ pulse oximeter <i>See the Masimo SET Accessories & Consumables catalog</i>	689484
	Masimo Rainbow SET (SW option) <i>Available only in the USA. See the Masimo Rainbow SET Accessories & Consumables catalog</i>	689485

Table G-1. Ventilator parts and accessories (continued)

Item no. (Fig. G-1)	Description	PN
not shown	Masks and accessories <i>See the Hamilton Medical Accessories catalog</i>	689304
	nCPAP starter kit	282330
	NIV mask starter kit	282013
	Nebulizer and accessories <i>See the Hamilton Medical Accessories catalog</i>	689304
	Adapters <i>See the Hamilton Medical Accessories catalog</i>	689304
	Tools and test equipment <i>See the Hamilton Medical Accessories catalog</i>	689304
	Language kit	
	English	161020
	German	161021
	Spanish	161022
	French	161023
	Italian	161024
	Language kit	
	Chinese	161027
	Russian	161026
	Portuguese	161028

Table G-1. Ventilator parts and accessories *(continued)*

Item no. (Fig. G-1)	Description	PN
	Extended warranty	
	Extended warranty of 1 year	700403
	Extended warranty of 2 years	700404
	Extended warranty of 3 years	700405

H

Communications interface

H.1	Introduction	H-2
H.2	About the protocols	H-3
H.3	Using the COM1 communication interface	H-4
H.3.1	Connecting to a patient monitor	H-4
H.3.2	Connecting to a PDMS or computer	H-6
H.3.3	COM1 connector pin assignments	H-8
H.4	Using the Nurse call (6-pin) communication interface	H-8
H.4.1	Sending alarm signals to a remote device	H-9
H.4.2	Sending inspiratory:expiratory (I:E) timing signals	H-9
H.4.3	Nurse 6-pin connector pin assignments	H-10

H.1 Introduction

NOTE:

- Additional equipment connected to medical electrical equipment must comply with the respective IEC or ISO standards (for example, IEC 60950 for data processing equipment). Furthermore, all configurations shall comply with the requirements for medical electrical systems (see IEC 60601-1, clause 16).

Anybody connecting additional equipment to medical electrical equipment configures a medical system and is, therefore, responsible that the system complies with the requirements for medical electrical systems. Note that local laws take priority over the above-specified requirements. If you have questions about how to proceed, consult your Hamilton Medical representative or technical service department.

- The option board includes EMI-protective covers for the connector ports. When a port is not in use, make sure the cover is in place, sealing the port.
- The delay time between the start of an alarm condition and the signal leaving the interface's input/output port is typically 500 ms. The time it takes for the message to appear on the connected monitor display depends on specific the patient monitor.

The communications interface provides the following data transfer options, depending on what is configured:

Using the	The ventilator can ...
COM1 connector on the option board	Send monitored data, ventilator settings, and alarms to a patient monitor, a patient data management system (PDMS), or other computer system. See Section H.3.
Nurse Call connector on the option board	Send alarm signals to a nurse call device. For details, see Section H.4.

H.2 About the protocols

The interface uses three general protocol types, described here briefly. For more detailed information and specifications, contact your Hamilton Medical representative.

Table H-1. Protocol overview

	Philips VueLink Open	Polling protocol (legacy)	Block protocol (new)
Transmission frequency	Continuous	Polling	Continuous
Transmission speed	<ul style="list-style-type: none"> • 19200 baud • 8 data bits, 1 stop bit • Parity: none • Handshake: none 	<ul style="list-style-type: none"> • 9600 baud • 7 data bits, 2 stop bits • Parity: EVEN • Handshake: XON/XANY 	<ul style="list-style-type: none"> • 38400 baud • 8 data bits, 1 stop bit • Parity: none • Handshake: none
Waveforms	6 waveforms, sent 2 at a time	4 waveforms Resolution: <ul style="list-style-type: none"> • Flow at 2.5 ml/s • Volume at 2.5 ml 	8 high-resolution waveforms Resolution: <ul style="list-style-type: none"> • Flow at 0.1 ml/s • Volume at 0.1 ml
Transmittable data Settings, measurements, waveforms, alarms, modes, device info	Subset	Subset	All
Available protocols in ventilator configuration (<i>Configuration > General > More</i>) See Tables H-2, H-3, and H-4	Philips Open VueLink <i>Philips-specific standard protocol for transmitting data, offers preconfigured data mapping</i>	<ul style="list-style-type: none"> • Galileo compatible (simulates a Galileo ventilator) • Hamilton P2 (standard polling protocol) • Hamilton (backward compatibility) • DrägerTestProtocol (for Dräger MIB II converter with Infinity monitoring) 	Block Protocol
Additional information			Two modes: wave (waveform data only) and mixed (default, support for sending waveform and/or parameter data)

H.3 Using the COM1 communication interface

Using the COM1 connector on the option board, you can connect to

- Patient monitors (Section H.3.1)
- Patient data management system (PDMS) or other computer system (Section H.3.2)

H.3.1 Connecting to a patient monitor

CAUTION

To prevent possible patient injury when using a patient monitor, check the patient and the ventilator whenever the monitor reports a ventilator alarm. It is possible that detailed information about the alarm may not be displayed on the monitor.

NOTE:

- As part of configuring the communications interface, outgoing data from the ventilator (parameters and labels, alarms and messages) is mapped to specific display and behavior characteristics on connected patient monitors. As a result of the specified mapping:
 - Your monitor may not recognize and report all modes and parameters (for example, ASV mode, peak pressure monitoring parameter). In addition, the alarm message on the monitor may differ from the message displayed on the ventilator. In such cases, we recommend that you read the data directly from the HAMILTON-C1 display.
 - Silencing the HAMILTON-C1's audible alarm **may not** automatically silence the audible alarm of a connected patient monitor.
-

Using the COM1 connector on the option board, the ventilator can send monitored data, ventilator settings, and alarms to a patient monitor.

Communication comprises two primary components:

- Hardware connection

This connection requires the components shown in Figure H-1, as well as specific interface hardware ordered directly from the patient monitor manufacturer (Table H-2).

- Data mapping

For more detailed information and specifications, contact your Hamilton Medical representative.

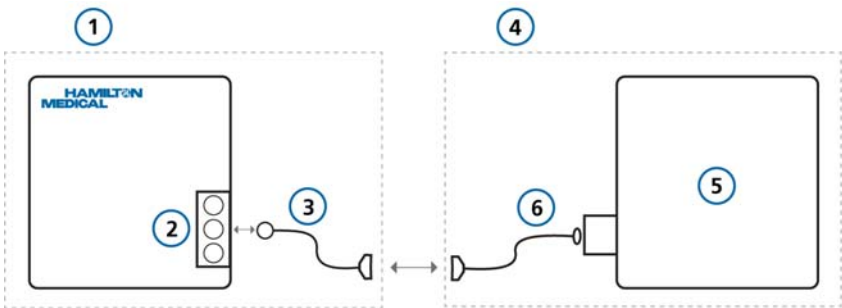

Figure H-1. Connection to a patient monitor

1 Components available from Hamilton Medical	4 Third-party components
2 Ventilator and option board with COM1 port	5 Patient monitor
3 COM1 cable (PN 161573)	6 Interface to monitor

Table H-2. Supported patient monitor manufacturers and associated protocols

Manufacturer	Product name	Protocol <i>Select this protocol in the device Configuration > General > More window</i>
Philips	IntelliVue (VueLink)	Open VueLink
	IntelliVue (IntelliBridge)	
Spacelabs Medical	Ultraview	GALILEO compatible
Nihon Kohden	BSM-9101K (v12-06 or later)	Hamilton
	BSM-6000K (v02-10 or later)	
Dräger	Infinity	DrägerTestProtocol
Mindray	Beneview	Hamilton / Hamilton P2

H.3.2 Connecting to a PDMS or computer

Using the COM1 connector on the option board, the ventilator can send monitored data, ventilator settings, and alarms to a patient data management system (PDMS) at a hospital, or to another computer system.

Access to the data can be useful for data management and clinical studies. Data from the ventilator can be analyzed using a variety of software tools, and can also be made part of a patient’s electronic health record (EHR).

In addition, you can use the HAMILTON MEDICAL DataLogger software for research purposes. For details, contact your Hamilton Medical representative.

This connection requires the hardware shown in Figure H-2.

Table H-3 lists supported PDMS manufacturers and the associated protocol to use.

In some cases, additional middleware solutions may be required to interface to the desired system; see Table H-4.

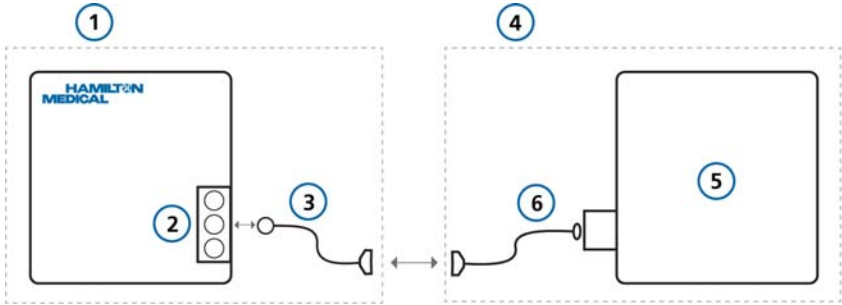

Figure H-2. Connection to a PDMS or computer

- | | |
|--|---|
| <p>1 Components available from HAMILTON MEDICAL</p> <p>2 Ventilator and Option board with COM1 port</p> <p>3 COM1 cable (PN 161573)</p> | <p>4 Third-party components</p> <p>5 PDMS or computer</p> <p>6 Interface to system</p> |
|--|---|

Table H-3. Supported PDMS manufacturers and associated protocols

Manufacturer	Product name	Protocol <i>Select this protocol in the device Configuration > General > More window</i>
GE Healthcare	Centricity™ Critical Care	GALILEO compatible
iMDsoft	MetaVision	Hamilton
Dräger	Integrated Care Manager (ICM)	GALILEO compatible / Hamilton P2
Cerner	BMDI Device Interface	Hamilton P2
LOWTeq	LOWTeq-PDMS intensive care	GALILEO compatible / Hamilton P2
B-Simple	B-ICU Care	Hamilton P2

Table H-4. Supported middleware and associated protocols

Manufacturer	Product name	Protocol name/ Protocol type <i>Select this protocol in the device Configuration > General > More window</i>
Capsule Technologie	DataCaptor	Hamilton P2
Bridge-Tech	Device Connectivity Solution (DCS)	Hamilton / Hamilton P2

H.3.3 COM1 connector pin assignments

For details on the COM1 cable, connector, and pin assignments, see the *Cable to COM1 User Note (PN 624442)*.

H.4 Using the Nurse call (6-pin) communication interface

CAUTION

The maximum allowable voltage and current between the relay contacts are 0.2 A, 48 V.

The 6-pin connector on the option board is labeled *Nurse*.

Using the Nurse connector on the option board, the ventilator can send the following signals to a nurse call device or other device in a different location:

- Alarm signals (Section H.4.1)
- I:E timing signals (Section H.4.2)

The ability to send alarm signals to an external device is referred to as *remote alarm* or *nurse call* capability.

H.4.1 Sending alarm signals to a remote device

WARNING

Before using the remote alarm function, check that alarms are being properly transmitted to the remote device.

CAUTION

If the remote alarm function is used in an isolation ward, regularly check that alarms are being properly transmitted to the remote device.

The remote alarm (nurse call) capability allows alarms to be displayed and heard at locations other than the ventilator. This function is useful, for example, when the ventilator is in an isolation room, and the alarm signals must be transmitted to a different location.

The ventilator Alarm Silence key silences the audible portions of the alarms at both the ventilator and the remote device.

The remote alarm capability is based on relays inside the ventilator. This application requires the 6-pin Nurse Call cable (PN 160166) and final assembly of the cable at your site. For details about the cable, connectors, and pin assignments, see the *Nurse Call Cable Setup Guide (PN 624344)*.

H.4.2 Sending inspiratory:expiratory (I:E) timing signals

Using the 6-pin Nurse connector on the option board, the ventilator can send I:E timing signals to an external device.

This application requires the hardware shown in Figure H-3.

The I:E timing capability is based on a relay inside the ventilator. For details, see the *Nurse Call Cable Setup Guide (PN 624344)*.

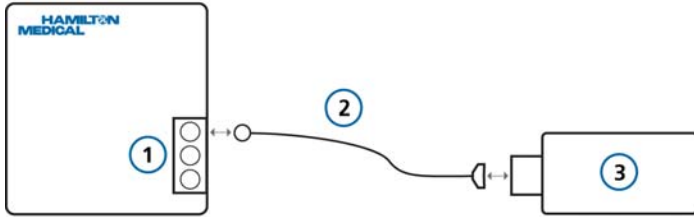

Figure H-3. Connection to external device using 6-pin Nurse connector

- | | |
|--|-------------------|
| 1 Ventilator and option board with Nurse call port | 3 External device |
| 2 Nurse call cable (PN 160166) | |
-

H.4.3 Nurse 6-pin connector pin assignments

For details on the Nurse call cable, connector, and pin assignments, see the *Nurse Call Cable Setup Guide (PN 624344)*.



Configuration

I.1	Introduction	I-2
I.2	Entering Configuration mode	I-2
I.3	Configuring general settings	I-3
I.3.1	Language: Selecting the default language	I-3
I.3.2	Selecting the default units of measure	I-4
I.3.3	Enabling the communication interface	I-5
I.3.4	Setting the minimum alarm loudness	I-6
I.4	Setting breath timing and mode naming options	I-7
I.4.1	Setting breath timing options for PCV+ and (S)CMV+ modes	I-7
I.4.2	Choosing the mode naming convention	I-8
I.5	Configuring default MMP display	I-8
I.6	Setup window (quick setup configuration)	I-9
I.6.1	Configuring individual setup settings	I-9
I.6.2	Selecting a default quick setup	I-15
I.7	Configuring pulse oximeter sensor settings	I-16
I.8	Copying configuration settings	I-16
I.9	Configuring software and hardware options	I-17
I.9.1	Reviewing installed options	I-17
I.9.2	Adding software options	I-17
I.9.3	Enabling hardware options	I-19
I.9.4	Removing options	I-20

I.1 Introduction

During configuration, you set up the ventilator with a default language, main monitoring parameter display, startup settings for a new patient, and unit of measure for pressure, among other settings.

I.2 Entering Configuration mode

You can access configuration mode when the ventilator is in Standby. Access requires a configuration code; contact your administrator.

To access configuration mode

1. Touch the **Utilities** button at the bottom of the screen, and then touch the **Configuration** tab.

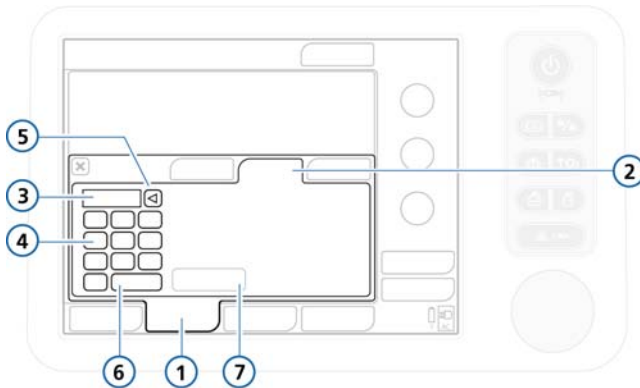

Figure I-1. Accessing configuration

- | | |
|---------------------------|------------------------|
| 1 Utilities | 5 Delete |
| 2 Configuration | 6 Enter |
| 3 Text field to type code | 7 Configuration button |
| 4 Keypad | |

2. Touch the text field and, using the keys on the onscreen keypad, type the configuration code; then touch **Enter**.
The Configuration button is enabled.

3. Touch the **Configuration** button.

The Configuration window appears, displaying the Language tab.

You can now define settings and add options.

I.3 Configuring general settings

You can configure some general default settings for the ventilator, including language, units of measure, and communication interface to use

I.3.1 Language: Selecting the default language

Open the **General** -> **Language** window and select the desired language for screen display.

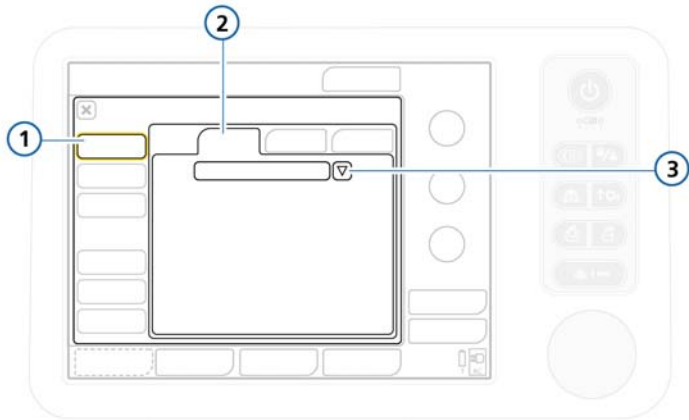

Figure I-2. Language configuration window

- | | | | |
|---|-----------|---|---------------|
| 1 | General | 3 | Language list |
| 2 | Languages | | |

I.3.2 Selecting the default units of measure

Open the **General** -> **Units** window and select the unit of measure for pressure, length and CO2 display.

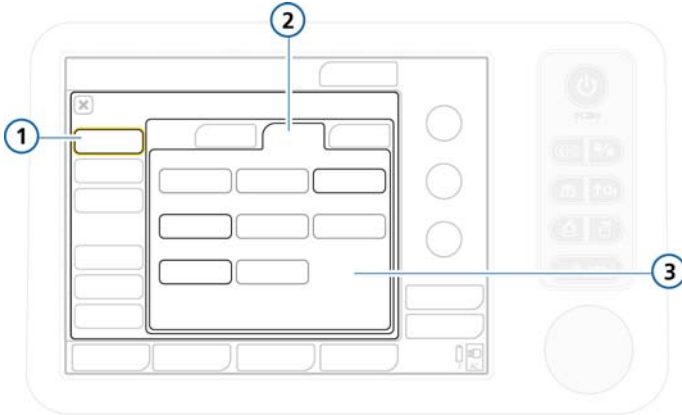

Figure I-3. Units configuration

- | | | | |
|---|---------|---|-----------------------------|
| 1 | General | 3 | Pressure, CO2, Length units |
| 2 | Units | | |

I.3.3 Enabling the communication interface

Open the **General** -> **More** window (Figure I-4).

Enable the desired **Communication interface**, if any, as desired.
For details, see Appendix H.

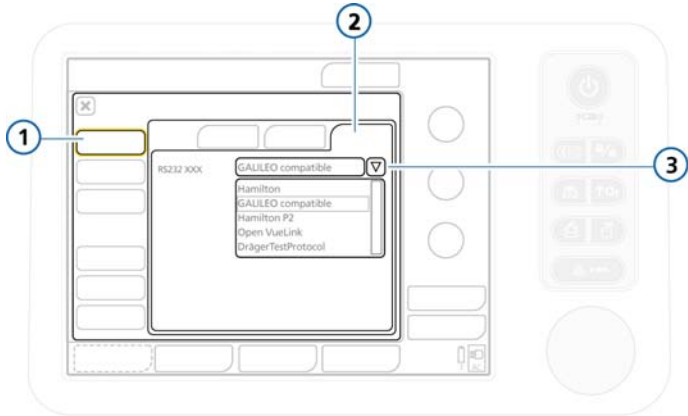

Figure I-4. Communication interface configuration

- | | | | |
|---|---------|---|----------------------|
| 1 | General | 3 | Available interfaces |
| 2 | More | | |
-

I.3.4 Setting the minimum alarm loudness

You can set a minimum alarm volume (loudness) setting for the device. Once set, the device operator cannot set the alarm volume below the value set here in Configuration.

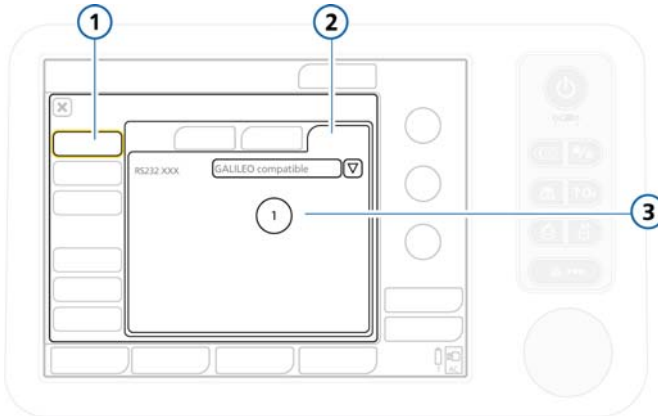

Figure I-5. Minimum loudness configuration

- | | |
|------------------|------------------------|
| 1 General | 3 Min. loudness |
| 2 More | |

To set the minimum alarm volume

1. Open the General -> More window (Figure I-5).
2. Touch the **Min. Loudness** button and choose minimum alarm volume to allow on the device. By default, set to 1.
3. Continue setting configuration options or exit Configuration mode.

The setting is applied to the device. Note that if the new minimum is greater than the currently set alarm volume, the alarm volume is reset to the new minimum level.

To verify the setting, check the **Loudness** value in the System -> Settings window.

I.4 Setting breath timing and mode naming options

You can choose which mandatory breath timing philosophy to use for PCV+ and SCMV+ modes (I:E or TI), and the naming convention to use for volume controlled pressure adaptive modes.

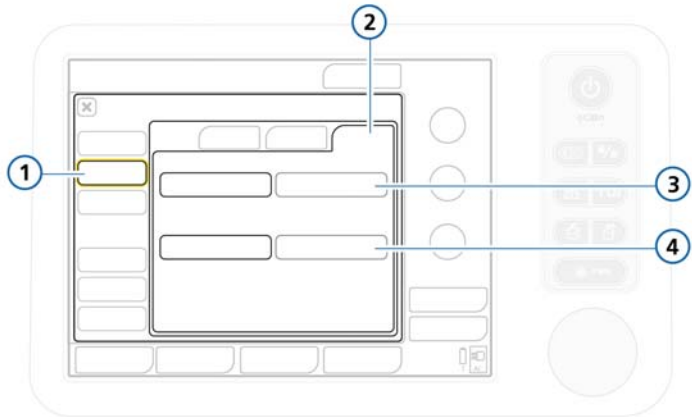

Figure I-6. Setting breath timing and labeling options

- | | | | |
|---|------------|---|-----------------------|
| 1 | Modes | 3 | Breath timing options |
| 2 | Philosophy | 4 | Mode naming options |

I.4.1 Setting breath timing options for PCV+ and (S)CMV+ modes

The ventilator controls mandatory breath timing using a combination of inspiratory time (TI) and rate. For two modes, PCV+ and (S)CMV+, you can set the ventilator to use the inspiratory:expiratory (I:E) ratio to control breath timing instead.

To change breath timing for PCV+/(S)CMV+ modes

In the Modes window, select either **I:E** (the default) or **TI** for the desired timing option. See Figure I-6.

I.4.2 Choosing the mode naming convention

You can select the naming convention used for adaptive (pressure regulated and volume targeted) modes.

To select the mode naming convention

Select either **(S)CMV+/SIMV+** (the default) or **APVcmv/APVsimv**.

I.5 Configuring default MMP display

You can define a default set of main monitoring parameters (MMPs) to display on the ventilator.

Open the **Graphics -> MMP** window (Figure I-7). Select the desired parameter to be displayed in that position on the screen. Repeat for the remaining parameters.

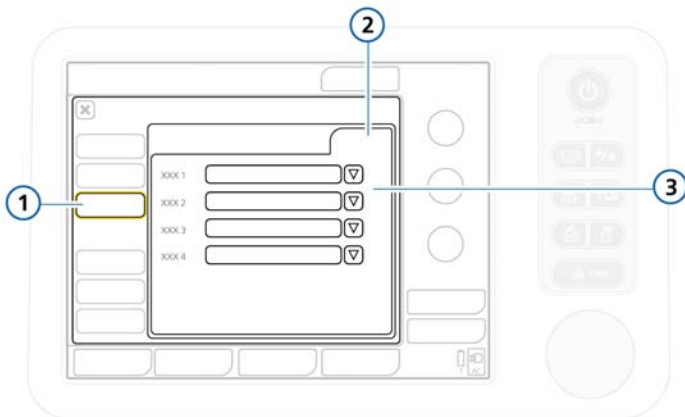

Figure I-7. MMP configuration

- | | |
|--|--|
| <p>1 Graphics</p> <p>2 MMP</p> | <p>3 Parameter list for MMP 1 through MMP 4</p> |
|--|--|

I.6 Setup window (quick setup configuration)

A *Quick setup* refers to a group of settings you define, including patient characteristics (group and weight), mode selection and control settings, alarm limit settings, and weaning zone limits, that is automatically applied when the setup is selected in the Standby window.

You can configure up to three Quick setups, and can specify a setup to be selected by default when the ventilator is turned on (Section I.6.2).

I.6.1 Configuring individual setup settings

To configure a Quick setup

1. In Standby mode, configure the ventilator with the parameters you will save as a Quick setup. Select:
 - Patient group and gender/height (adult/pediatric) or weight (neonatal)
 - Ventilation mode
 - Mode control settings
 - Alarm limits
2. Enter Configuration mode (Section I.2).
3. In the Configuration window, touch **Setups**, and then touch the button (1, 2, or 3, or your custom-defined labels) for the setup to configure.

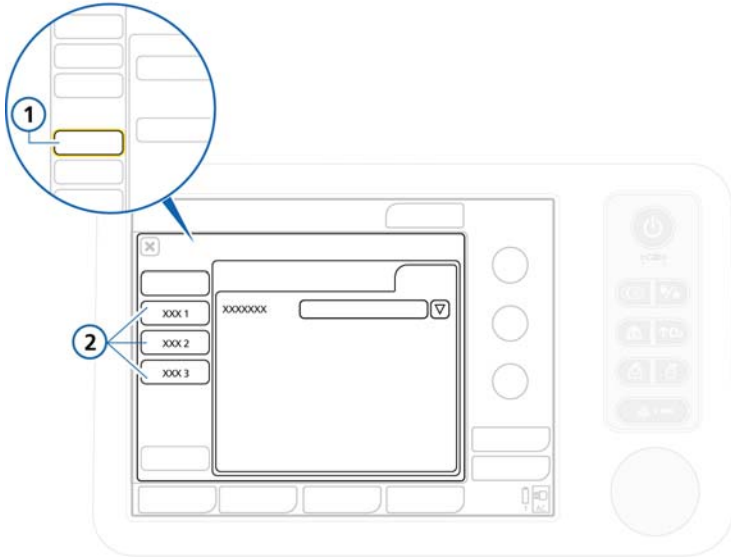

Figure I-8. Accessing setup configuration

- | | |
|--|-------------------------------------|
| <p>1 Setups button in main Configuration window</p> | <p>2 Quick setup buttons</p> |
|--|-------------------------------------|

The General setup configuration window is displayed (Figure I-9). Note that the buttons in the left panel now change to provide access to the setup options.

4. Touch **Rename setup** to give the setup a meaningful name. You must define a name, as it is used as the Quick setup button label in Standby, as well as in this configuration window.
5. Select the configuration settings to apply to this setup by touching the appropriate button (Figure I-9):
 - To apply the ventilator settings you selected in step 1, touch **Use current settings**.
 - To apply factory settings, touch **Use factory settings**.

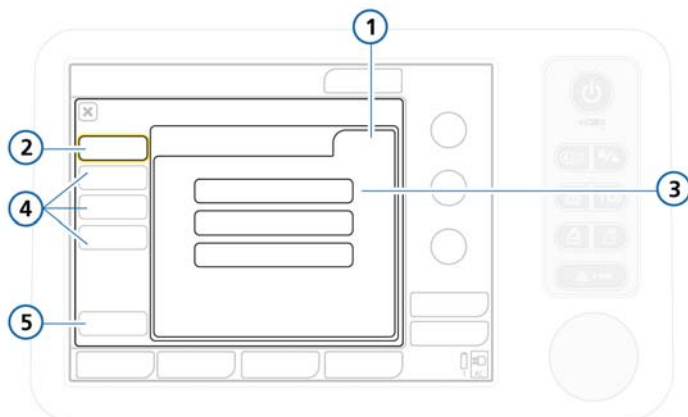

Figure I-9. Setup configuration window

1,2	General	4	Mode Ctrls, Alarms, Vent Status buttons
3	Rename setup, Use current settings, Use factory settings buttons	5	Back (return to main Configuration window)

6. Touch **Mode Ctrls -> Controls** to review patient parameter settings. Note that the following parameters are not displayed, as they are based on weight:

- The following parameters are set based on ideal body weight (IBW): Vt, Rate, Thigh, Tlow, and TI.
- The following parameters are set based on body weight (neonatal): Vt, Rate, Tlow, Thigh, TI, and TI max.



7. Touch **Vt/IBW** (or **Vt/Weight** for neonatal) to set the tidal volume per IBW or weight (neonatal). See Figures I-10 and I-11.

The ventilator uses the **Vt/IBW** or **Vt/Weight** (neonatal) setting in calculations for the following:

- To set the initial delivered Vt in volume-controlled modes
- To set the initial high and low alarm limits for Vt and ExpMinVol

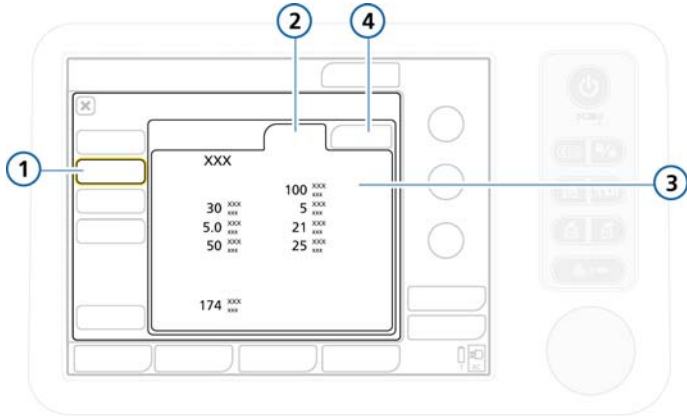

Figure I-10. Mode controls configuration

- | | | | |
|---|-----------|---|-------------------------------------|
| 1 | Mode Ctrl | 3 | Mode and patient parameter settings |
| 2 | Controls | 4 | Vt/IBW or Vt/Weight (neonatal) |

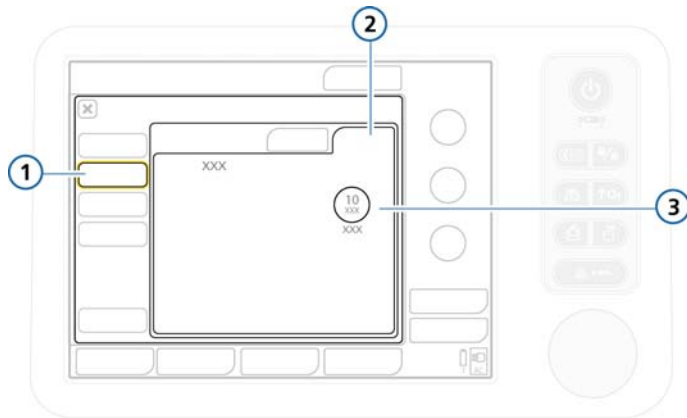

Figure I-11. Mode controls configuration, Vt/IBW

- | | | | |
|---|--------------------------------|---|---|
| 1 | Mode Ctrl | 3 | Mode and Vt/IBW or Vt/Weight (neonatal) |
| 2 | Vt/IBW or Vt/Weight (neonatal) | | |

-
8. Review the alarm settings in the **Alarms** window.

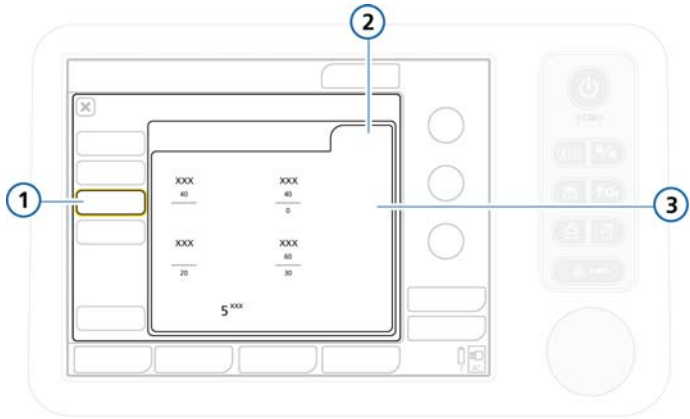

Figure I-12. Reviewing alarm settings

1, 2 Alarms **3** Alarm settings

9. In **Vent status**, set patient parameters manually.
The **Vent Status** window (Figure I-13) configures the weaning zone ranges of the Vent Status intelligent panel (Figure I-14) according to your institution's protocol.

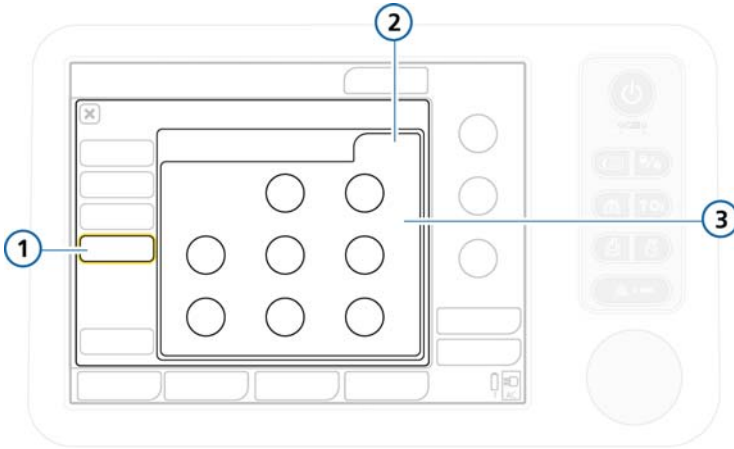

Figure I-13. Vent Status configuration

- | | |
|--------------------------------|--|
| <p>1, 2 Vent Status</p> | <p>3 Parameter weaning-zone settings: Oxygen, PEEP, %MinVol, P_{insp}, RSB, %fsport</p> |
|--------------------------------|--|

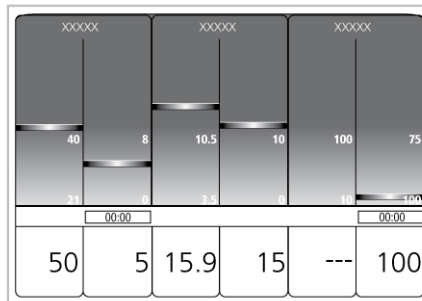

Figure I-14. Vent Status intelligent panel

10. Touch the **Back** button to return to the Default setup window.

The next time the configured settings will be used by default.

I.6.2 Selecting a default quick setup

A default setup comprises a group of settings that are automatically loaded when turning on the ventilator.

After you have configured one or more quick setups, select the default to use.

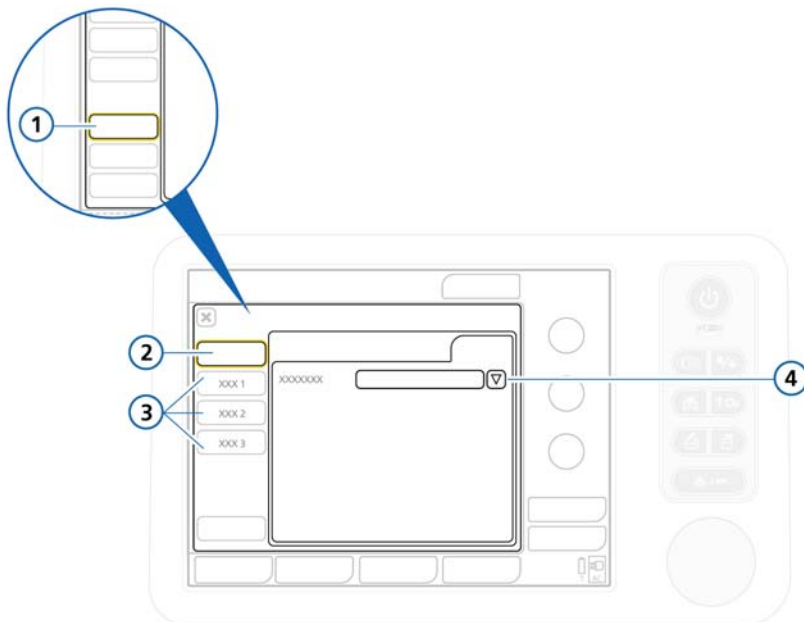

Figure I-15. Default setup configuration

- | | | | |
|---|--|---|------------------------------|
| 1 | Setups button in main Configuration window | 3 | Quick setup 1 through 3 |
| 2 | Default setup | 4 | Default setup selection list |

To select a default quick setup

1. In the Setups window (Figure I.6.1), open the **Default setup** window.
2. Select the setup to use from the list.

I.7 Configuring pulse oximeter sensor settings

If you have the SpO2 option and are using a pulse oximeter, the **Sensors** button is displayed in the Configuration window. The Sensors window provides access to the pulse oximeter data acquisition settings.

For details on configuring this option, see the Pulse oximetry appendix.

I.8 Copying configuration settings

Touch **Import** or **Export** to transfer configuration data with a USB memory stick.

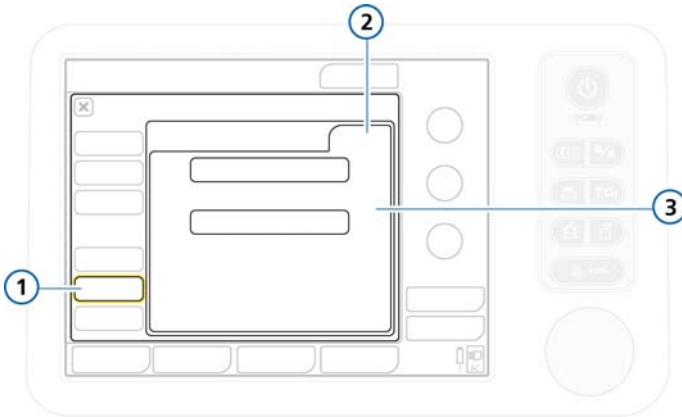

Figure I-16. Transfer window

1,2 Transfer **3** Import, Export

I.9 Configuring software and hardware options

Before use, you must enable any hardware (CO₂, SpO₂) options, and add and enable software options.

I.9.1 Reviewing installed options

To view installed options

1. In the Configuration window, touch the **Options** button.
2. Touch the desired tab: **SW options** for software, or **HW options** for hardware. See Figure I-17.

I.9.2 Adding software options

The following software options are added using license keys¹:

-
- Neonatal
 - NeoNIV (nCPAP)
 - NIV/NIV-ST
 - DuoPAP/APRV
 - Trends/Loops
-

Trial versions of software options may be available. Trial options expire and are automatically deactivated after 30 days.

Have available all required keys before proceeding.

To add a software option

1. In Configuration window, touch the **Options** button.
2. In the Options window, touch the **SW options** tab.

1. This list might not be comprehensive. Refer to your order and product catalog for details.

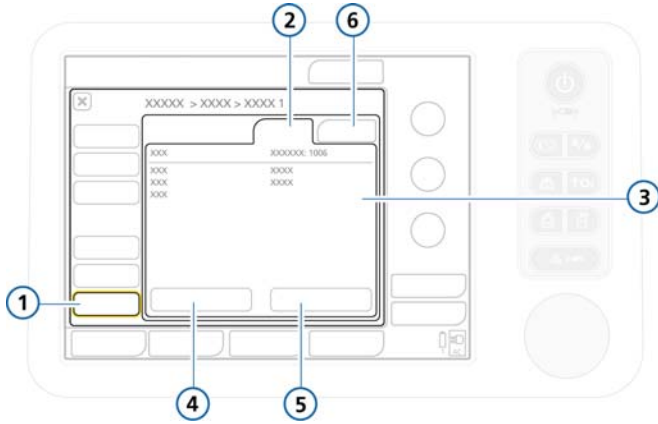

Figure I-17. SW options tab

- | | |
|---------------------|-----------------|
| 1 Options | 4 Add options |
| 2 SW options | 5 Clear options |
| 3 Installed options | 6 HW options |

3. Touch the **Add options** button.

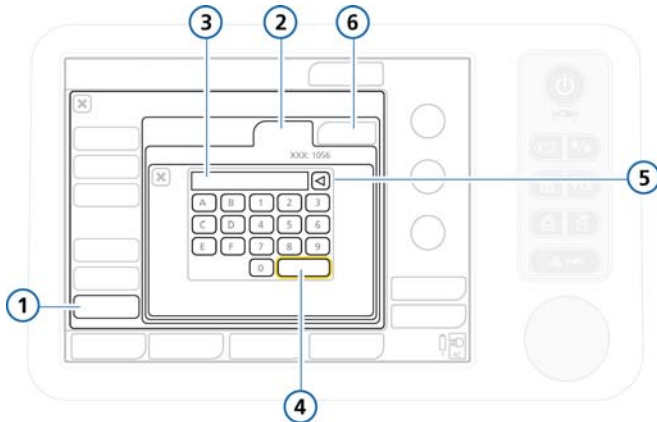

Figure I-18. Add options window

- | | |
|----------------------------------|--------------|
| 1 Options | 4 Enter |
| 2 SW options | 5 Delete |
| 3 Text field to type license key | 6 HW options |

4. Type the activation code exactly as provided into the field and touch **Enter**.

If the message *Option code invalid* appears, re-enter the code. The message *Option valid* indicates the code is correct and the option has been added.

5. Repeat until all desired software options are added.
6. Touch the **X** to close the window.
7. Restart the ventilator to enable the options.

Upon turning on the ventilator, the added options are available for use.

I.9.3 Enabling hardware options

Option board-related functions (CO₂, SpO₂) are enabled at two levels:

- The hardware itself must be enabled in configuration to make the functionality available to the user. This section describes this procedure.
- Sensors that plug into the hardware are individually enabled by the user, as needed, in the System window. See Section 3.3.3.

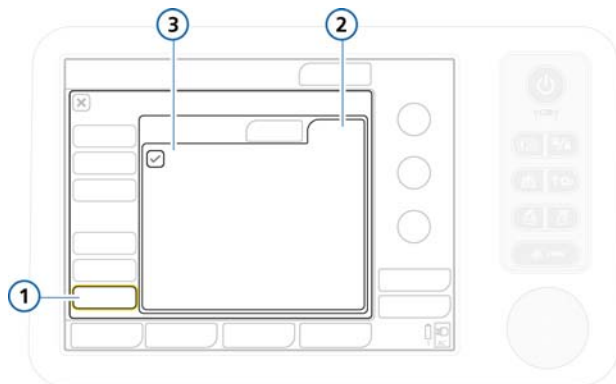

Figure I-19. Hardware options

- | | | | |
|---|------------|---|-------------------|
| 1 | Options | 3 | Available options |
| 2 | HW options | | |

To enable hardware options in configuration

1. Touch **Options**.
2. In the Options window, touch the **HW options** tab.
See Figure I-19.

The window lists installed hardware that requires activation.

3. Select the check box for options to enable.

Upon exiting configuration, the enabled hardware is available for use.

I.9.4 Removing options

NOTE:

- The **Clear options** function removes *all* non-trial options. You cannot remove just one or a few. If that is your goal, clear the options and re-add those that are needed.
- The patient groups on the ventilator, Adult/Ped and Neonatal, are both treated as options. Clearing options also removes these patient groups and the associated ventilation modes.

Before the ventilator can be used on a patient, the required patient groups (and associated modes) must be re-added. Follow the steps to add options (Section I.9.2) and add the necessary patient groups. The associated ventilation modes are also added.

- Options are removed after restarting the ventilator.
-

To remove software options

You can remove all non-trial software options from the ventilator.

1. In the SW options window, touch **Clear options**.

You are prompted to confirm deletion of all non-trial options, including the Adult/Ped and/or Neonatal patient groups. See Note above.

-
2. Touch **Clear options** to remove the options.
Touch **Cancel** to leave the options installed.
 3. Restart the ventilator.
Once you restart the ventilator, all options (including patient groups) listed in the window are cleared.
 4. To re-add the patient groups and any other desired options, re-enter Configuration mode.
 5. Add the required patient groups and any desired options, as appropriate. See Section I.9.2.

I.9.4.1 Disabling hardware options

In the HW options window, clear the check boxes for the hardware to disable. See Section I.9.3.

J**Pulse oximetry**

J.1	Introduction	J-3
J.2	SpO2 monitoring with Masimo SET	J-7
J.2.1	Pulse oximetry components	J-7
J.3	Working with pulse oximetry data	J-8
J.3.1	Enabling SpO2 monitoring	J-8
J.3.2	Monitored parameters and settings	J-9
J.4	Viewing pulse oximetry data	J-10
J.4.1	Viewing data in the Monitoring window	J-11
J.4.2	Viewing SpO2 data on the main display	J-12
J.4.3	Dynamic Lung panel with SpO2	J-13
J.4.4	Displaying the plethysmogram	J-15
J.4.5	Displaying trends	J-16
J.5	Working with alarms	J-17
J.5.1	Setting alarm limits	J-17
J.5.2	SpO2 alarm delay	J-18
J.5.3	Pulse-oximetry-related alarms and settings	J-18
J.6	Connecting the pulse oximetry system	J-22
J.6.1	Connecting the components	J-25
J.6.2	Verifying sensor measurements	J-27
J.6.3	Disconnecting the SpO2 adapter	J-28
J.6.4	Connecting the adapter for transport	J-29
J.7	Configuring and enabling the pulse oximeter	J-30
J.7.1	Enabling the hardware	J-30
J.7.2	Selecting SpO2 sensor data options	J-31
J.8	Troubleshooting	J-35
J.9	Cleaning and maintenance	J-37

J.9.1	Cleaning the adapter and sensor	J-38
J.9.2	Replacing the adapter, cables, or sensor	J-38
J.9.3	Disposing of the adapter, cables, and sensor	J-38
J.10	About the SpO₂/FiO₂ ratio	J-39

J.1 Introduction

This appendix is designed to be added to your ventilator *Operator's Manual* folder, and refers to information provided in the *Operator's Manual*.

The Masimo SET[®] pulse oximeter (also referred to as a *pulse CO-oximeter*) comprises a sensor (also referred to as a *probe*), cables, and adapter.

WARNING

- **A pulse CO-oximeter should be considered an early warning device. As a trend towards patient hypoxemia is indicated, blood samples should be analyzed by laboratory instruments to completely understand the patient's condition.**
- **Verify the compatibility of the adapter, sensor, and cables before use. Use of incompatible components can result in patient injury.**
- **SpO₂ is empirically calibrated to functional arterial oxygen saturation in healthy adult volunteers with normal levels of carboxyhaemoglobin (COHb) and methaemoglobin (MetHb). A pulse oximeter can not measure elevated levels of COHb or MetHb. Increases in either COHb or MetHb will affect the accuracy of the SpO₂ measurement.**

- **For increased COHb: COHb levels above normal tend to increase the level of SpO₂. The level of increase is approximately equal to the amount of COHb that is present.**

Note that high levels of COHb may occur with a seemingly normal SpO₂. When elevated levels of COHb are suspected, laboratory analysis (CO-oximetry) of a blood sample should be performed.

- **For increased MetHb: The SpO₂ may be decreased by levels of MetHb of up to approximately 10% to 15%. At higher levels of MetHb, the SpO₂ may tend to read in the low to mid 80s. When elevated levels of MetHb are suspected, laboratory analysis (CO-oximetry) of a blood sample should be performed.**

- To ensure patient electrical isolation, connect only to other equipment with electrically isolated circuits.
- Do not use the pulse CO-oximeter during magnetic resonance imaging (MRI) scanning. Induced current could potentially cause burns. The pulse CO-oximeter may affect the MRI image, and the MRI unit may affect the accuracy of the oximetry measurements.
- The pulsations from intra-aortic balloon support can be additive to the pulse rate on the oximeter pulse rate display. Verify patient's pulse rate against the ECG heart rate.
- Elevated levels of total Bilirubin may lead to inaccurate SpO₂ measurements.
- Loss of pulse signal can occur when
 - The sensor is too tight
 - The patient has hypotension, severe vasoconstriction, severe anemia, or hypothermia
 - There is arterial occlusion proximal to the sensor
 - The patient is in cardiac arrest or is in shock
- In case of anemia and blood loss, the SpO₂ sensor is unable to detect tissue hypoxia.
- SpO₂ measurement can be incorrect if
 - The patient's carboxyhaemoglobin or methaemoglobin increases abnormally
 - Dye is injected into the blood
 - An electrosurgical unit is used
 - During CPR
 - Measuring at a site with venous pulse
 - There is body movement
 - The pulse wave is small (insufficient peripheral circulation)
- Severe anemia may cause erroneous SpO₂ readings.
- Skin pigmentation can affect the SpO₂ value. Verify SpO₂ by checking the plethysmographic waveform and the quality index of the measured SpO₂ value.
- SpO₂ measurement in case of patients with carbon monoxide poisoning can be incorrect.

-
- **Interfering substances:** Dyes, or any substance containing dyes, that change usual blood pigmentation may cause erroneous readings.
 - When there is abnormally high methaemoglobin and carboxyhaemoglobin, the SpO₂ reading is incorrect.
 - Pulse rate measurement is based on the optical detection of a peripheral flow pulse and therefore may not detect certain arrhythmias. The pulse CO-oximeter should not be used as a replacement or substitute for ECG-based arrhythmia analysis.
 - With very low perfusion at the monitored site, the readings may read lower than core arterial oxygen saturation.
 - Venous pulsations may cause erroneous low readings (for example, tricuspid valve regurgitation).
 - The pulse CO-oximeter is NOT intended for use as an apnea monitor.
 - Incorrect measurements can also be caused by
 - Excessive patient movement
 - Incorrect application or use of the pulse oximetry components

CAUTION

- If using pulse CO-oximetry during full body irradiation, keep the sensor out of the irradiation field. If the sensor is exposed to the irradiation, the reading might be inaccurate or the unit might read zero for the duration of the active irradiation period.
- Verify SpO₂ periodically by observing the plethysmographic wave form and the quality index (QI-SpO₂) of the measured SpO₂ value.
- Verify SpO₂ periodically by comparing measured SpO₂ against patients' SaO₂ with an ABG (Arterial Blood Gas) measurement.
- All devices are NOT protected against the effect of the discharge of a cardiac defibrillator.
- Detach the SpO₂ sensor before defibrillation.

- **Under normal conditions, this probe is almost unaffected by light. However, when measuring under strong light (surgical light, sunlight), cover the probe with a blanket or cloth. Otherwise, measurement accuracy is affected.**

NOTE:

- U.S. Federal law restricts this device to sale by or on the order of a physician.
 - Only use components specified by Hamilton Medical.
 - Use only Masimo sensors for SpO₂ measurements.
 - DO NOT use or store outside of specified environmental conditions.
 - Read all of the safety information before using the sensor. Before use, carefully read the sensor's *Directions for use*.
 - Equipment used to test pulse oximeter components (probe, adapter) cannot be used to assess their measurement accuracy.
 - Only qualified personnel may operate the pulse oximeter. Read this manual, safety information, accessory directions for use, and specifications before use.
-

This appendix includes several descriptions, warnings and specifications for the Masimo adapter and sensors.

Not all of the information is included here. For detailed information, see the Masimo Starter Kit documentation, sensor inserts, and the manufacturer's *Directions for use*. Be sure to also read the safety information for the ventilator, provided in the device *Operator's Manual*.

Additional information may also be available at the manufacturers' website: <http://www.masimo.com>. For information on Masimo patents, see www.masimo.com/patents.htm.

Note that possession or purchase of this device does not convey any express or implied license to use the device with unauthorized sensors or cables which would, alone or in combination with this device, fall within the scope of one or more of the patents relating to this device.

J.2 SpO2 monitoring with Masimo SET

The Masimo SET[®] pulse oximeter comprises a sensor, cables, and adapter.

The sensor takes a reading every second to provide accurate, reliable data for SpO₂, heart rate (pulse), and perfusion index, together with a signal quality indicator. Working with the adapter, the sensor sends this information to the ventilator.

The values of these parameters are integrated into the ventilator's display, support trend graphics and a plethysmogram, and are subject to applicable alarms, all of which are controlled at the ventilator.

J.2.1 Pulse oximetry components

Support for pulse oximetry is available with installation of the SpO₂-enabled option board (PN 161636).

Figure J-1 shows the system components (the option board is not shown).

For connection and setup information, see Section J.6.

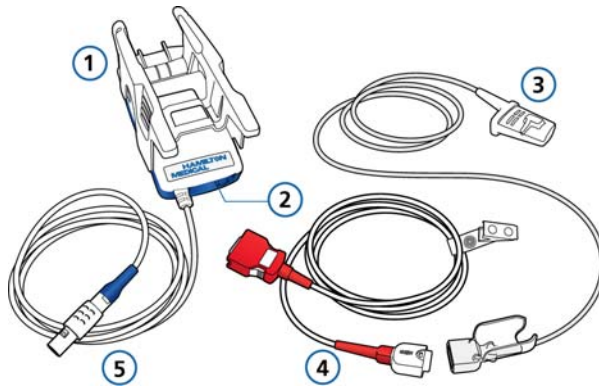

Figure J-1. Masimo SET pulse oximeter components

- | | | | |
|---|---|---|--|
| 1 | Adapter, which contains the oximeter hardware | 4 | Patient cable (connects to adapter and sensor) |
| 2 | Cable connection ports | 5 | Adapter cable (connects the adapter to SpO ₂ connector on ventilator) |
| 3 | Sensor and cable | | |

Not shown: The SpO₂ option board must be installed on the ventilator.

J.3 Working with pulse oximetry data

Sensor data is fully integrated with the ventilator monitoring system.

J.3.1 Enabling SpO2 monitoring

Once the option board is installed and configured, you can enable or disable SpO2 monitoring as needed.

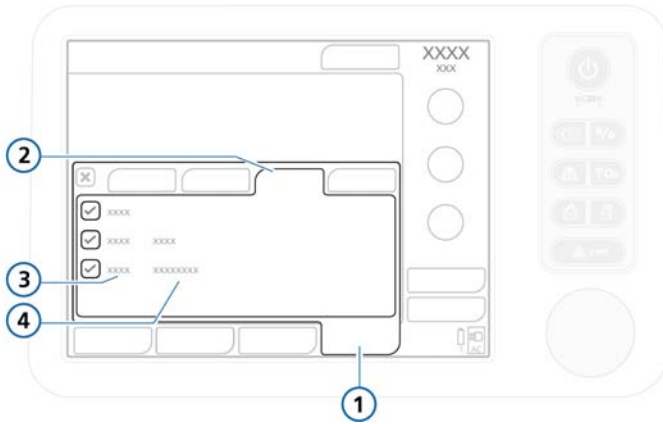

Figure J-2. Enabling SpO2 monitoring

1	System	3	Spo2
2	Info	4	Sensor status

To enable SpO2 monitoring

1. Open the System > Sensors on/off window.
2. Select the SpO2 check box, and then close the window.

The status text active appears next to the check box, as long as the adapter is connected to the ventilator.

If the status area is empty, the adapter is not connected.

Once enabled, pulse oximetry data is displayed in the Monitoring > SpO2 window. If a related parameter is configured as a main monitoring parameter (MMP), it is also shown on the main display. See Section J.4.

J.3.2 Monitored parameters and settings

The following sensor data is displayed in the Monitoring > SpO2 window.

Table J-3. SpO2 parameters and settings

Setting	Description	Display Range
Masimo SET parameters		
SpO2 (%)	Arterial oxygen saturation in blood	0 to 100
SpO2/FiO2 (%)	Calculated approximation of PaO2/FiO2, when SpO2 is 94% or lower ¹ . Calculated as: $100 * \text{SpO2} / \text{Oxygen}$ For details about this calculation, see Section J.10.	0 to 500
Pulse rate (bpm)	Heart rate	0 to 240
Perfusion index (%)	Pulse strength	0 to 20

Accuracy

See footnotes 2, 3, 4, 5, 6, 7.

Refer to the Masimo sensor documentation for information about sensor accuracy.

SpO2, no motion	60%–80%: $\pm 3\%$ adults/pediatrics/infants 70%–100%: $\pm 2\%$ adults/pediatrics/infants; $\pm 3\%$ neonates
SpO2, motion	70%–100%: $\pm 3\%$, adults/pediatrics/infants/ neonates
SpO2, low perfusion	70%–100%: $\pm 2\%$, adults/pediatrics/infants/ neonates
Pulse rate, no motion	25–240 bpm: ± 3 bpm, adults/pediatrics/infants/ neonates
Pulse rate, motion	25–240 bpm: ± 5 bpm, adults/pediatrics/infants/ neonates
Pulse rate, low perfusion	25–240 bpm: ± 5 bpm, adults/pediatrics/infants/ neonates

1. When SpO₂ exceeds 94%, the SpO₂/FiO₂ ratio is not calculated; the display shows dashes (---).
2. SpO₂ accuracy was determined by testing on healthy adult volunteers in the range of 60-100% SpO₂, against a laboratory CO-oximeter. SpO₂ accuracy was determined on 16 neonatal NICU patients ranging in age from 7 - 135 days old and weighing between 0.5 - 4.25 kg. Seventy-nine (79) data samples were collected over a range of 70 - 100% SaO₂ with a resultant accuracy of 2.9% SpO₂.
3. The Masimo sensors have been validated for no-motion accuracy in human blood studies on healthy adult male and female volunteers with light to dark skin pigmentation in induced hypoxia studies in the range of 70-100% SpO₂ against a laboratory CO-oximeter and ECG monitor. This variation equals plus or minus one standard deviation, which encompasses 68% of the population.
4. The Masimo sensors have been validated for motion accuracy in human blood studies on healthy adult male and female volunteers with light to dark skin pigmentation in induced hypoxia studies in the range of 70-100% SpO₂ against a laboratory CO-oximeter and ECG monitor. This variation equals plus or minus one standard deviation, which encompasses 68% of the population.
5. The Masimo SET technology has been validated for low-perfusion accuracy in bench-top testing against a Biotek Index 2 simulator and Masimo's simulator with signal strengths of greater than 0.02% and transmission of greater than 5% for saturations ranging from 70 to 100%. This variation equals plus or minus one standard deviation, which encompasses 68% of the population.
6. The Masimo sensors have been validated for pulse-rate accuracy for the range of 25-240 bpm in bench-top testing against a Biotek Index 2 simulator. This variation equals plus or minus one standard deviation, which encompasses 68% of the population.
7. The following substances may interfere with pulse CO-oximetry measurements:
Severe anemia may cause erroneous SpO₂ measurements.
Dyes or any substance containing dyes that change usual blood pigmentation may cause erroneous readings.
Elevated levels of total bilirubin may lead to inaccurate SpO₂ measurements.

J.4 Viewing pulse oximetry data

NOTE:

When a parameter shows dashes or no value, it is not used in any calculations.

Pulse oximeter sensor data is measured and updated every second.

This data is readily available as follows:

- In the Monitoring window (Section J.4.1)
- On the main display (Section J.4.2)
- In the Dynamic Lung panel (Section J.4.3)
- In a plethysmogram (Section J.4.4)
- As a trend graph (Section J.4.5)

J.4.1 Viewing data in the Monitoring window

The Monitoring > SpO2 window provides access to the pulse oximetry data.

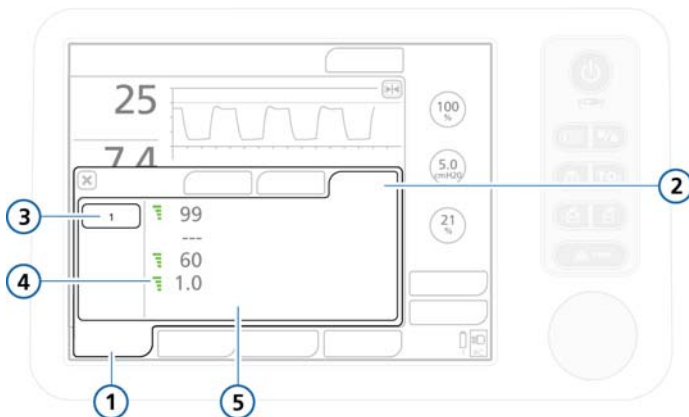

Figure J-3. Pulse oximetry data, Monitoring window

- | | | | |
|----------|-----------------|----------|----------------------------|
| 1 | Monitoring | 4 | Quality index |
| 2 | SpO2 | 5 | Monitored parameter values |
| 3 | 1 (SpO2 values) | | |

The quality index shows the sensor's evaluation of the signal quality. A low quality index indicates a poor signal due to interference from excessive motion or other cause.

Table J-4. Quality index





Quality indicator	Confidence value
4 grey bars, no data 	OFF (no information)
1 red bar, poor quality 	The data from the sensor is not usable or the parameter measurements is still initializing.

Table J-4. Quality index *(continued)*

Quality indicator	Confidence value
2 orange bars, medium quality 	The data from the sensor is acceptable for most uses. An alarm may be active that could affect how accurately this parameter is currently measured.
3 green bars, good quality 	The data from the sensor is reliable.
4 green bars, best quality 	The data from the sensor is highly stable and reliable.

J.4.2 Viewing SpO2 data on the main display

As with other parameters, any of the monitored pulse oximetry parameters can be configured to be displayed as a main monitoring parameter (MMP), as shown in Figure J-4. For configuration details, see Appendix I.

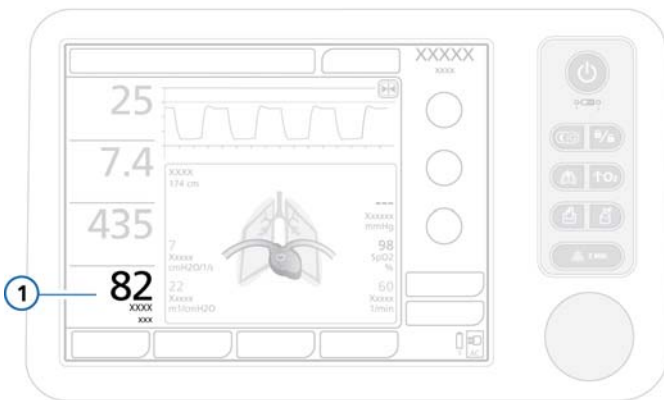

Figure J-4. Pulse rate as MMP (1)

The SpO2 parameter is a special case.

When SpO2 monitoring is enabled (in the System > Sensors on/off window), the SpO2 low alarm limit and measured SpO2 value are always displayed, below the MMP list, as shown in Figure J-5.

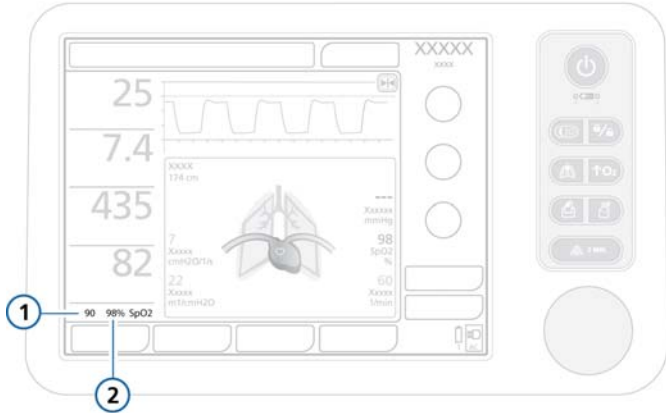

Figure J-5. SpO2 data in main display

- 1 SpO2 low alarm limit 2 Measured SpO2 value

J.4.3 Dynamic Lung panel with SpO2

When the SpO2 option is enabled, the Dynamic Lung panel is expanded to show the circulation of blood through the heart, superimposed on the breathing of the lungs.

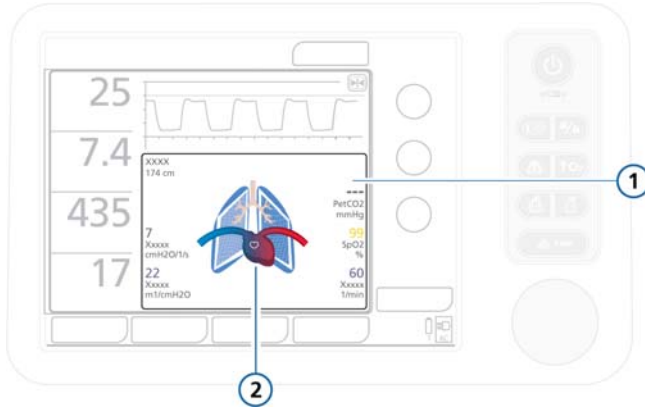





Figure J-6. Dynamic Lung panel with SpO2 data

- 1** Dynamic Lung panel **2** SpO2 and pulse indicators
 Displayed parameters: Rinsp, Cstat, PetCO2, SpO2, Pulse

The heart and pulse display varies as shown below.

Note that if the large heart is *not* displayed, the SpO2 option is disabled or not installed.

Table J-5. SpO2 and pulse indicators

	The small white heart pulsates in time with the patient's heart beat. SpO2 is being measured.
	No pulse detected. SpO2 is being measured.
	SpO2 option is enabled, but the SpO2 sensor is disabled. SpO2 and pulse are not being measured.

J.4.4 Displaying the plethysmogram

A plethysmogram is a waveform that represents the pulsating blood volume; it is delivered by the pulse oximeter.

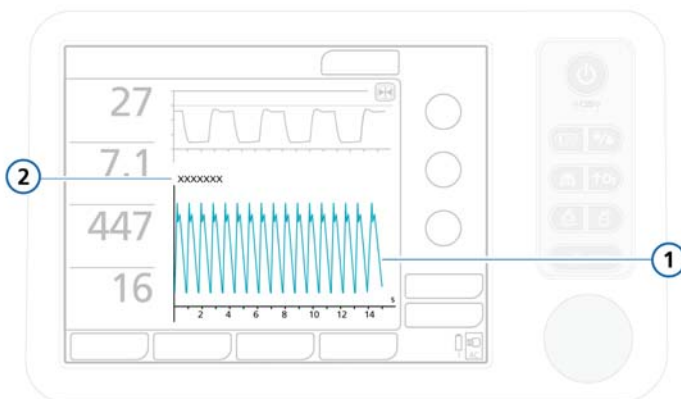

Figure J-7. Plethysmogram waveform (adult)

1 Plethysmogram waveform **2** Sensitivity setting

The time scale for adult waveforms is 15 seconds; for neonatal patients, it is 6 seconds.

The upper left corner of the graph shows the currently selected sensor sensitivity setting, if it is set to **Maximum** or **APOD**. The area is left blank when the setting is **Normal**. For details about each option, see Table J-8 on page J-33.

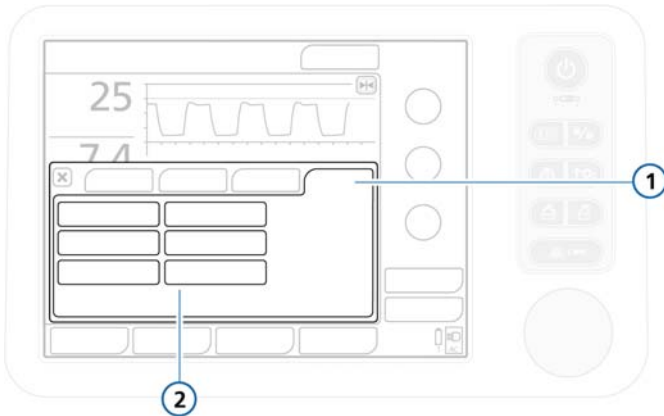

Figure J-8. Selecting the plethysmogram

- 1 Waveforms 2 Plethysmogram

To display the plethysmogram

1. Touch the graphic area of the display to access the graphics-selection window. See Chapter 6.
2. Touch the **Waveforms** tab, and then touch the **Plethysmogram** button.
3. Touch the **X** to close the window.

The plethysmogram appears on the ventilator main display (Figure J-7).

J.4.5 Displaying trends

You can view trend data for the pulse oximetry-related parameters.

For details on generating trend graphs, see Chapter 6.

You can view trend data for the following SpO₂-related data:

- SpO₂
- SpO₂/FiO₂
- Pulse
- PI
- QI-SpO₂ (quality index)

J.5 Working with alarms

You can specify alarm limits for several pulse oximetry parameters. In addition, default ranges can be defined in configuration.

For the list of alarms, see Section J.5.3.

J.5.1 Setting alarm limits

Use the Alarms Limits 2 windows to set the acceptable value ranges for each parameter.

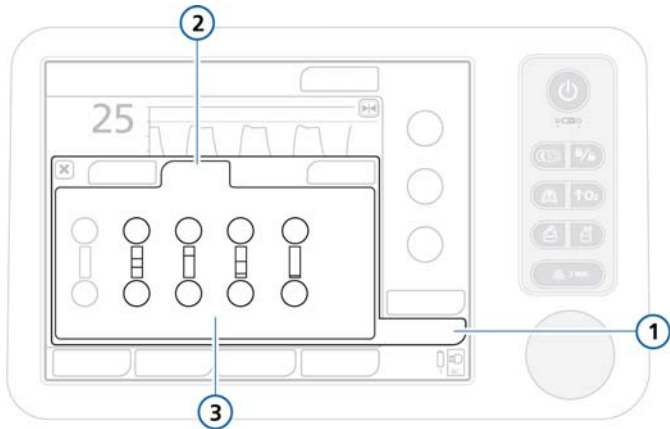

Figure J-9. Pulse oximetry alarms

- | | | | |
|----------|----------|----------|------------------------|
| 1 | Alarms | 3 | SpO2, Pulse, PI alarms |
| 2 | Limits 2 | | |

The SpO2 high and low alarm limits are a special case:

- When SpO2 monitoring is enabled (in the System > Sensors on/off window), the SpO2 low alarm limit and measured SpO2 value are always displayed below the MMP list, as shown in Figure J-5 (Section J.4.2).
- You can set a short alarm delay (Section J.5.2)

For details on how to set and work with alarms, see Chapter 8.

J.5.2 SpO₂ alarm delay

Oxygen saturation levels can be relatively variable but the changes are transient, and as such, do not generally require clinical intervention. These changes can exceed the limits set for high or low SpO₂ for brief periods of time, which can generate frequent alarms.

To reduce the number of alarms that are not actionable (*nuisance* alarms), a short delay of up to 15 seconds can be configured after an SpO₂ low or SpO₂ high alarm condition occurs before the system displays the message and sounds the alarm.



The alarm delay is set in configuration.

J.5.3 Pulse-oximetry-related alarms and settings

Table J-6 lists the pulse-oximetry-related adjustable alarms, ranges, default settings, and resolution.

Table J-7 lists the pulse-oximetry-related alarms alphabetically and provides alarm priority, the messages displayed by the ventilator, and potential corrective actions. The proposed actions, however, may not always correct the particular problem.

Table J-6. Adjustable alarm ranges, default settings, resolution

Alarm (units)	Range		Default setting		Resolution
	Adult/Ped	Neonatal 	Adult/Ped	Neonatal 	
Pulse low (1/min)	30–230, in increments of 5		50	100	5
Pulse high (1/min)	35–235, in increments of 5		140	180	5
SpO2 low (%)	70–99, in increments of 1		90	90	1
	<i>When SpO2 monitoring is enabled (in the System > Sensors on/off window), the SpO2 low alarm limit and measured SpO2 value are always displayed below the MMP list, as shown in Figure J-5 (Section J.4.2).</i>				
SpO2 high (%)	71–100 / OFF, in increments of 1		99	95	1
PI (perfusion index) low (%)	OFF / 0.03–18.00		OFF	OFF	0.01 < 1% 0.10 ≥ 1
PI (perfusion index) high (%)	0.04–19.00 / OFF		OFF	OFF	0.01 < 1% 0.10 ≥ 1

The alarms in the following table are listed alphabetically. The text may differ slightly from that on the display.

Table J-7. SpO2 alarms, priority, and corrective action

Alarm	Priority and definition	Action needed
<i>In all cases, the low alarm limit must be set lower than the high alarm limit.</i>		
Hardware, connection, and sensor placement messages		
Adapter missing (SpO2)	<i>Medium priority.</i> Adapter is disconnected from ventilator.	<ul style="list-style-type: none"> • Connect an adapter. • Replace adapter.
Light interference (SpO2)	<i>Medium priority.</i> Light interference with sensor.	<ul style="list-style-type: none"> • Cover sensor with blanket or change attachment site on patient. • In Configuration > Sensors, ensure the line frequency is correctly set. • Replace sensor.
Low perfusion index (SpO2)	<i>Medium priority.</i> The signal is insufficient.	Move the sensor to a better perfused site.

Table J-7. SpO2 alarms, priority, and corrective action *(continued)*

Alarm	Priority and definition	Action needed
<i>In all cases, the low alarm limit must be set lower than the high alarm limit.</i>		
Probe missing (SpO2)	<p><i>Medium priority.</i></p> <ul style="list-style-type: none"> • Sensor is disconnected from adapter. • Cable defective. 	<ul style="list-style-type: none"> • Connect sensor to adapter. • Replace adapter, patient cable, and/or sensor.
Patient disconnected (SpO2)	<p><i>Medium priority.</i></p> <ul style="list-style-type: none"> • Sensor is disconnected from patient or not properly attached to patient. • Sensor malfunction. 	<ul style="list-style-type: none"> • Check whether sensor is attached properly to patient. • Replace sensor.
Sensor error (SpO2)	<p><i>Medium priority.</i></p> <ul style="list-style-type: none"> • Hardware problem with sensor • Incompatible sensor • Sensor expired 	Replace adapter, patient cable, and/or sensor.
Measurements out of range messages		
High PI	<p><i>Medium priority.</i></p> <p>The peripheral perfusion measured by the sensor exceeds the set limit.</p>	<ul style="list-style-type: none"> • Observe the patient. • Verify ventilator settings, including alarm settings.
Low PI	<p><i>Medium priority.</i></p> <p>The peripheral perfusion measured by the sensor is below the set limit.</p>	Move the sensor to a better perfused site.
High pulse	<p><i>Medium priority.</i></p> <p>The pulse rate measured by the sensor exceeds the set limit.</p>	<ul style="list-style-type: none"> • Observe the patient. • Verify ventilator settings, including alarm settings.
Low pulse	<p><i>Medium priority.</i></p> <p>The pulse rate measured by the sensor is below the set limit.</p>	<ul style="list-style-type: none"> • Observe the patient. • Verify ventilator settings, including alarm settings.
High SpO2	<p><i>Low priority.</i></p> <p>Measured SpO2 value exceeds the set limit.</p>	<ul style="list-style-type: none"> • Observe the patient. • Verify ventilator settings, including alarm settings.

Table J-7. SpO2 alarms, priority, and corrective action *(continued)*

Alarm	Priority and definition	Action needed
<i>In all cases, the low alarm limit must be set lower than the high alarm limit.</i>		
Low SpO2	<p>The low SpO2 alarm has two levels of priority, depending on how much below the limit the measured value is.</p> <p><i>Medium priority.</i></p> <p>Measured SpO2 meets all of these conditions:</p> <ul style="list-style-type: none"> • Below the limit • Above 85% • Above (limit - 2% of limit) 	<ul style="list-style-type: none"> • Observe the patient. • Verify ventilator settings, including alarm settings.
	<p><i>High priority.</i></p> <p>Measured SpO2 is either:</p> <ul style="list-style-type: none"> • Lower than (limit - 2% of limit) even if above 85% • Below 85% 	<ul style="list-style-type: none"> • Observe the patient. • Verify ventilator settings, including alarm settings.

J.6 Connecting the pulse oximetry system

WARNING

- Never use the SpO₂ adapter in the presence of any flammable anesthetic gas or high concentration oxygen atmosphere or nitrous oxide. Failure to comply with this warning can cause explosion or fire.
- Never use the SpO₂ adapter in a hyperbaric oxygen chamber. Failure to comply with this warning can cause explosion or fire.
- If the SpO₂ adapter is used with SpO₂ sensors other than those specified, the patient and operator can receive an electric shock and the SpO₂ adapter can become hot.
- If a sensor or cable is damaged in any way, discontinue use immediately. Do not use a sensor or patient cable with exposed optical or electrical components.
- Avoid permanent contact of the SpO₂ adapter and the body.
- Do not diagnose patients based solely on the data from the pulse oximeter. Overall judgment must be made by a physician who understands the limitations and characteristics of the pulse oximeter and can read the biomedical signals acquired by other instruments.
- Use disposable sensors only once. They cannot be sterilized and can cause cross infection.
- To avoid cross contamination, only use Masimo single-use sensors on the same patient.
- Tissue damage can occur due to incorrect placement of sensor.
- If the attachment site is unclean, clean the attachment site before attaching the sensor. If there is nail polish on the attachment site, remove the polish. Otherwise, the amount of transmitted light decreases, and the measured value can be incorrect or measurement may be unable to be performed.

-
- Do not pull or bend the sensor cable, and do not let caster feet run over the sensor cable. Failure to follow these cautions may cause cable discontinuity, short circuit, skin burn on the patient and incorrect measurement data. Replace any broken sensor with a new one.
 - Tissue damage can be caused by incorrect application or use of a sensor, for example by wrapping the sensor too tightly. Inspect the sensor site as directed in the sensor's *Directions for use* to ensure skin integrity and correct positioning and adhesion of the sensor.
 - Misapplied sensors or sensors that become partially dislodged may cause either over or under reading of actual arterial oxygen saturation.
 - Keep the patient away from the cable as much as possible. If the cable coils around the patient by their body movement, the patient can get injured. If this happens, remove the cable promptly.
 - The sensor cable must face away from the patient. Safely secure the sensor cable out of the way, to do so, attach the sensor cable holding clips to the airway tubing, and then connect the sensor cable to the clips.
 - High intensity extreme lights (including pulsating strobe lights) directed on the sensor may not allow the pulse CO-oximeter to obtain readings.
 - Inaccurate measurements or loss of pulse signal may be caused by placement of a sensor on an extremity with a blood pressure cuff, arterial catheter, or intravascular line.
 - Avoid placing the sensor on any extremity with an arterial catheter or blood pressure cuff.
 - Always remove the sensor from the patient and completely disconnect the patient from the patient cable before bathing the patient.
 - Regularly change the measurement site of the sensors according to the skin of the patient. Take extreme care with the following patients: patient with fever, patient with peripheral circulation insufficiency, neonate or low-birth-weight infant with delicate skin

- The site must be checked at least every four (4) hours to ensure adequate adhesion, circulation, skin integrity and correct optical alignment. If the circulatory condition or skin integrity has deteriorated, the sensor should be applied to a different site.
- Do not use tape to secure the sensor to the site; this can restrict blood flow and cause inaccurate readings. Use of additional tape can cause skin damage or damage the sensor.
- Turning or twisting the sensor cable can permanently damage the sensor.
- If the sensor is wrapped too tightly or supplemental tape is used, venous congestion/pulsations may occur causing erroneous readings.
- Sensors wrapped too tightly may cause erroneously low readings or cause pressure injuries.
- Venous congestion may cause under-reading of actual arterial oxygen saturation. Therefore, assure proper venous outflow from monitored site. The sensor should not be below heart level (for example, sensor on hand of a patient in bed with arm dangling to the floor).

CAUTION

- Exercise caution when applying a sensor to a site with compromised skin integrity. Applying tape or pressure to such a site may reduce circulation and/or cause further skin deterioration.
 - Redness or skin irritation may appear on the attachment site. Take extreme care of patients with weak skin. In case of redness or skin irritation, change the attachment site or stop using the sensor.
 - Circulation distal to the sensor site should be checked routinely.
 - Do not modify or alter the sensor in any way. Alterations or modification may affect performance and/or accuracy.
-

Before you begin, ensure that:

- The SpO2 option board is already installed
- You have all of the components (Figure J-1)

For the system to be operational, you must also:

- Connect all of the components (Section J.6.1)
- Enable the option board (Section J.7.1)
- Configure sensor data settings (Section J.7.2)

J.6.1 Connecting the components

Connecting the components comprises the following steps:

- Attach the adapter to a rail (Figure J-10)
- Connect the cables (Figure J-11)
- Attach the sensor to the patient (not shown)

Attaching the adapter to a rail

Attach the adapter to a rail as shown. Ensure the adapter handle clicks into place in steps 2 and 3, and is securely attached.

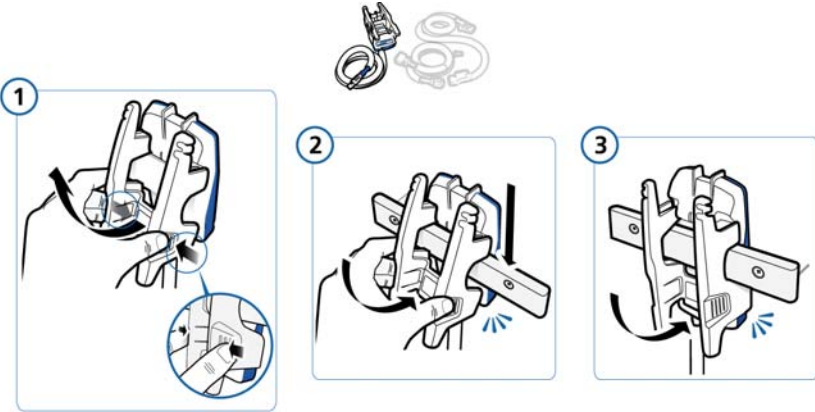

Figure J-10. Attaching the adapter to a rail

Connecting the cables

Connect the ventilator, patient, and sensor cables as shown.

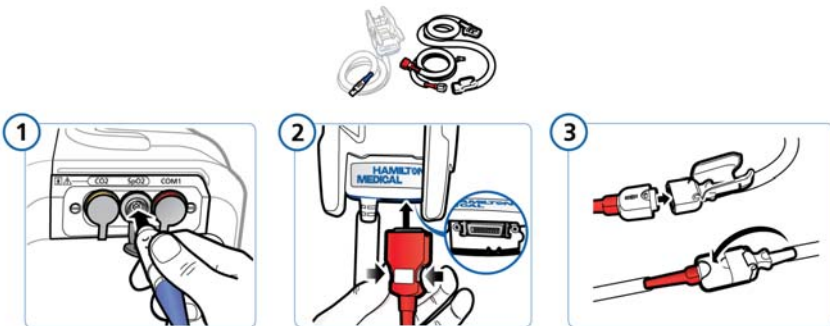

Figure J-11. Connecting the cables

J.6.2 Verifying sensor measurements

Measurements recorded by the pulse oximeter are displayed in the Monitoring > SpO2 window.

To verify that measurements are being recorded

- ▶ On the ventilator, touch the **Monitoring** button, and then touch the **SpO2** tab (Figure J-3 on page J-11).

The SpO2 value is displayed approximately 10 seconds after placing the sensor.

If the device does not detect a pulse for 30 seconds, the ventilator generates a **Patient disconnected** alarm.

If you do not see any oximeter-related measurements, ensure that the SpO2 sensor is enabled in the System > Sensor on/off window. See Section J.3.1.

J.6.3 Disconnecting the SpO2 adapter

Disconnect the SpO2 sensor, cables, and, if needed, remove the adapter from the rail, as shown in Figures J-12 and J-13.

For details on connecting the components, see Section J.6.1.

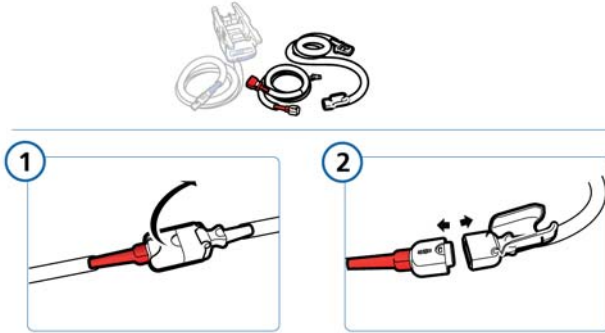

Figure J-12. Disconnecting the SpO2 sensor

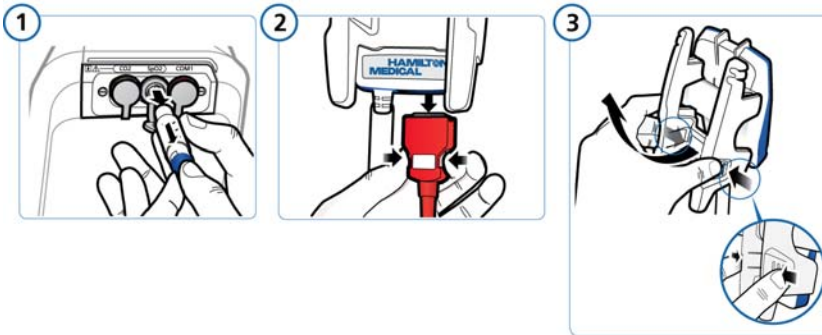

Figure J-13. Disconnecting the adapter

J.6.4 Connecting the adapter for transport

The SpO2 adapter is provided with a transport case for use when a rail is not available. The case completely encloses and protects the adapter, while leaving the bottom free for the cables.

To connect the adapter for transport

1. Detach the SpO2 adapter rail-mount handle top piece from the base by squeezing the sides together and pulling out and up, then unhooking it from the base.
2. Place the SpO2 adapter into the transport case and fasten the straps tightly. The case fits snugly around the adapter.
3. Place the adapter over the breathing circuit near the connections to the ventilator, with the cable connections at the bottom, and wrap the Velcro fastener around one of the breathing limbs. Tighten the strap, being careful not to exert pressure on the breathing limb.

The adapter should now be securely attached to the limb, above the breathing circuit sleeve.

4. Connect the ventilator cable and the patient cable to the bottom of the adapter.
5. Connect the ventilator cable to the SpO2 connector on the option board.
6. Attach the patient cable to the SpO2 sensor.

J.7 Configuring and enabling the pulse oximeter

Initial setup of the pulse oximeter comprises the following steps, each of which is described in the listed section.

	See
1. Initial configuration. Only needed when first setting up the system.	
A. Enable the option board	Section J.7.1
B. Select sensor data options	Section J.7.2
2. Specify alarm limits	Section J.5
3. Enable SpO2 monitoring on the ventilator	Section J.3.1

J.7.1 Enabling the hardware

Before you begin, ensure the SpO2 option board is installed. The board must be enabled on the ventilator.

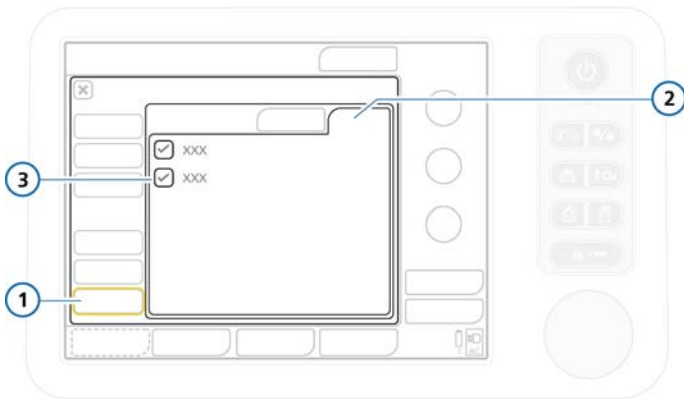

Figure J-14. Enabling the SpO2 option board

- | | | | |
|---|------------|---|------|
| 1 | Options | 3 | SpO2 |
| 2 | HW options | | |

To enable the SpO2 option board

1. Open the Configuration window and touch the **Options** button, and then touch the **HW options** tab (Figure J-14).
2. Ensure the SpO2 check box is selected.

Once the option board is enabled, the **Sensors** button appears on the left side of the main Configuration window.

J.7.1.1 Reviewing configured options

Once enabled, sensor configuration data is displayed in the Configuration > Sensors > Upgrade window.

The window shows version number and Masimo sensor codes. For details on the codes, see the ventilator *Service Manual*.

Note that if the window shows only dashes (--) for all the data, an adapter is not connected.

J.7.2 Selecting SpO2 sensor data options

NOTE:

- Be sure to enable the SpO2 option board first (Section J.7.1). The Configuration > Sensors window is only available when the hardware is enabled.
 - For upgrade details, see the ventilator *Service Manual*.
-

When first setting up pulse oximetry on the ventilator, you select the desired sensor data settings in the Configuration > Sensors window.

Typically, these settings are set once and do not need to be regularly updated. However, it is possible to modify some of the settings even during ventilation, if necessary. Others can only be modified in standby. See Table J-8 for details.

These settings are persistent, with one exception. Once you change a setting, the new selection is in force until manually changed.

The exception is the **Maximum** sensitivity mode setting.

When **Maximum** is selected, this setting remains in effect until a new patient session begins, as long as the new patient is *not* set up using the *Last patient* ventilator settings.

To illustrate

Figure J-15 shows how the Sensitivity mode might change depending on the selected patient group, when the Sensitivity mode is already set to **Maximum**, and a new patient is now being configured in the Patient Setup/Standby window.

If the **Last patient** setup (1) is used, the Sensitivity mode setting stays at **Maximum**.

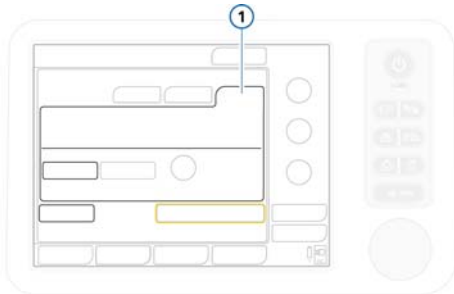

If the **Neonatal** or **Adult/Ped** patient group (1) is selected, the Sensitivity mode setting is reset to the default, **Normal**.

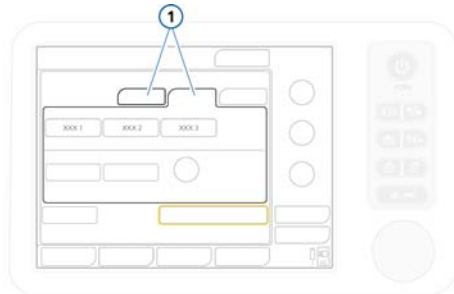

Figure J-15. Sensitivity mode setting

To configure sensor data options

1. Open the Configuration window, and touch the **Sensors** button (Figure J-16).
2. In the Settings window, specify the desired settings (Table J-8), as appropriate.
3. When done, touch **Back** to return to the main Configuration window.

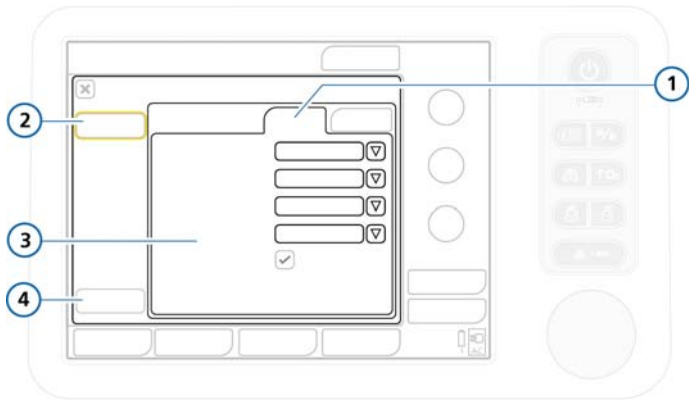

Figure J-16. Sensor data settings

- | | | | |
|---|----------|---|----------------------|
| 1 | Settings | 3 | Sensor data settings |
| 2 | SpO2 | 4 | Back |

Table J-8. SpO2 sensor data settings

Parameter	Description	Settings (default)
SpO2 alarm delay	Specifies the length of time that the measured SpO2 value must be outside the set alarm limits before the system generates the alarm. For details, see Section J.5.2. Can be changed during ventilation.	In seconds. 0 5 (default) 10 15

Table J-8. SpO2 sensor data settings (continued)

Parameter	Description	Settings (default)
SpO2 averaging time	<p>Defines how many SpO2 readings will be used to calculate the final value to display.</p> <p>A higher averaging time provides a more accurate value, but takes longer.</p> <p>Can be changed during ventilation.</p>	<p>In seconds.</p> <p>2</p> <p>4</p> <p>8 (default)</p> <p>10</p> <p>12</p> <p>14</p> <p>16</p>
Sensitivity mode	<p>Specifies the sensor sensitivity, which can be tailored to different patient conditions.</p> <p>Options are:</p> <p>Maximum. Recommended for patients with low perfusion, for use during procedures, or in high acuity settings where there is frequent clinician/patient contact.</p> <p>Normal. Appropriate for most patients, provides an optimal combination of measurement sensitivity and responsiveness to a detached sensor.</p> <p>APOD (adaptive probe off detection). Protects against incorrect pulse rate and SpO2 readings due to a detached sensor. Not appropriate for patients with low perfusion.</p> <p>Can be changed during ventilation.</p>	<p>Maximum. For patients with low perfusion.</p> <p>Normal (default).</p> <p>APOD. For cases where it is likely that the sensor (probe) may be dislodged.</p>
Line frequency	<p>Power line frequency.</p> <p>Can only be changed in Standby mode.</p>	<p>50 Hz</p> <p>60 Hz (default)</p>
FastSat	<p>Provides quick SpO2 sampling and display. May show more changes in rate, as it is not an averaged value.</p> <p>Can be changed during ventilation.</p>	<p>On</p> <p>Off (default)</p>

J.8 Troubleshooting

Alarm messages appear in the message bar, as with other ventilator alarms. The Configuration > Sensors > Upgrade window shows detailed sensor information.

For troubleshooting ideas and details, see Table J-9.

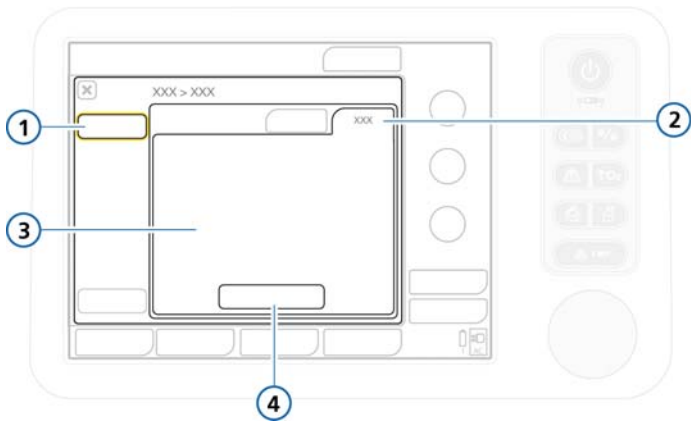

Figure J-17. Sensor information

1	SpO2	3	Sensor information
2	Upgrade	4	Upgrade button (Service only)

The following tables describe how to address some potential pulse oximeter issues. It also includes a description of the Masimo-generated sensor codes. Be sure to also check the information provided in Table J-7, “SpO2 alarms, priority, and corrective action” on page J-19.

Table J-9. Troubleshooting issues

Message or Issue	Details	Action
No SpO2 tab or disabled SpO2 tab in Monitoring window	SpO2 monitoring is not enabled.	Ensure the SpO2 check box is selected in the System -> Sensors on/off window.
	A different option board is installed.	In the System Info window, ensure that the Option board entry supports SpO2. If it does not, a different option board is installed.
No pulse oximetry data is displayed in the Monitoring -> SpO2 window.	<ul style="list-style-type: none"> • A component is damaged: for example, pins may be bent in the connector head. • An unsupported sensor is connected. 	Replace adapter, patient cable, or sensor, as appropriate.
The Monitoring -> SpO2 window shows values as dashes	A component is disconnected.	<ul style="list-style-type: none"> • Check the connection from the adapter to the ventilator. • Check the patient cable connection to the adapter. • Check the connection between the sensor and the patient cable.
No pulse oximetry data in Configuration -> Sensors -> Upgrade window	No adapter is connected.	Connect an adapter.

J.9 Cleaning and maintenance

WARNING

- If a sensor or cable is damaged in any way, discontinue use immediately. Do not use a sensor or patient cable with exposed optical or electrical components.
 - Do not soak or immerse the sensor or cables in any liquid solution. The sensor and connectors are not waterproof.
 - Unless otherwise specified, do not sterilize sensors or patient cables by irradiation, steam, autoclave, or ethylene oxide. See the cleaning instructions in the Directions for use for the Masimo reusable sensors.
 - Do not attempt to reprocess, recondition, or recycle any Masimo sensors or patient cables as these processes may damage the electrical components, potentially leading to harm.
 - Before maintenance or cleaning, disconnect the SpO2 adapter from the device. Failure to comply with this instruction can result in electrical shock and SpO2 problems or both.
-

CAUTION

- Do not modify or alter the adapter or sensor in any way. Alterations or modification may affect performance and/or accuracy.
 - Do not disinfect and sterilize the SpO2 adapter. Doing so will damage the adapter.
 - Do not immerse the SpO2 adapter in any chemical solution or water. If the adapter is immersed, wipe off liquid with a dry cloth and thoroughly dry the adapter.
 - After cleaning and before use, wipe liquid off with a dry cloth and thoroughly dry the adapter.
-

This section provides cleaning, replacement, and disposal recommendations.

J.9.1 Cleaning the adapter and sensor

NOTE:

Before proceeding, review the safety information at the beginning of this section.

To clean the adapter

Periodically clean the SpO₂ adapter by wiping it with a soft cloth moistened with ethanol (15°C (59°F), 76.9% to 81.4% by volume).

To clean a reusable sensor

1. Remove the sensor from the patient.
2. Disconnect the sensor and the patient cable from the adapter.
3. Wipe the components with a soft cloth moistened with a 70% isopropyl solution.
4. Allow to air dry before reuse.

J.9.2 Replacing the adapter, cables, or sensor

When an SpO₂ adapter, cable, or sensor is broken, cracked, or visibly damaged, immediately stop using it and replace it with a new one.

J.9.3 Disposing of the adapter, cables, and sensor

Follow your local laws for disposing of the SpO₂ adapter, cables, and sensor. For detailed information, contact your Hamilton Medical representative.

J.10 About the SpO₂/FiO₂ ratio

For the diagnosis of ARDS and ALI, the PaO₂/FiO₂ ratio index is used, where PaO₂ is the partial pressure of oxygen in the arterial blood measured by arterial blood gas test, and FiO₂ is the fraction of inspired oxygen (Oxygen control) set on the ventilator. PaO₂/FiO₂ is used as a measure of blood hypoxia.

The SpO₂/FiO₂ ratio (%) is an approximation of the PaO₂/FiO₂ ratio, which, in contrast to PaO₂/FiO₂, can be calculated non-invasively and continuously.

As an example, adult SpO₂/FiO₂ ratios of 235 and 315, and child ratios of 201 and 263 correspond to PaO₂/FiO₂ ratios of 200 and 300¹, respectively.

Therefore, SpO₂/FiO₂ ratio is a useful monitoring value for bedside assessment of a patient's oxygenation status, and can be helpful relative to ALI and ARDS diagnosis and status follow up of these patients.

The ventilator calculates and displays the SpO₂/FiO₂ ratio when the measured SpO₂ is 94% or lower.

When SpO₂ exceeds 94%, the SpO₂/FiO₂ ratio is not calculated; the display shows dashes (---). This is because at these higher oxygen saturation levels, the correlation between SpO₂ and PaO₂ is poor (the oxygen-haemoglobin curve flattens out), so SpO₂/FiO₂ is no longer a good approximation of PaO₂/FiO₂. See Figure J-18.

1. References:

Rice TW, Wheeler AP, Bernard GR, Hayden DL, Schoenfeld DA, Ware LB. Comparison on the SpO₂/FiO₂ ratio and the PaO₂/FiO₂ ratio in patients with acute lung injury or ARDS. *Chest*. 2007 Aug;132(2):410-7. Epub 2007 Jun 15.

Khemani RG, Patel NR, Bart RD 3rd, Newth CJ. Comparison of the pulse oximetric saturation/fraction of inspired oxygen ratio and the PaO₂/fraction of inspired oxygenation in children. *Chest*. 2009 Mar;135(3):662-8. Epub 2008 Nov 24.

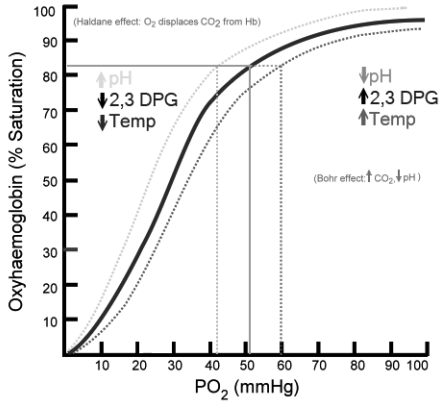

Figure J-18. Oxygen-haemoglobin dissociation curve

Glossary

A	Ampere, a unit of current.
AC	Alternating current.
alarm buffer	Contains information on the four most recent alarm occurrences.
alarm lamp	Lamp atop the ventilator that lights in a color corresponding to the active alarm.
alarm silence key	Silences alarm sound for 2 min.
ambient state	An emergency state, in which the ventilator opens the inspiratory channel and expiratory valve. This lets the patient breathe room air unassisted by the ventilator.
apnea	Cessation of breathing.
Apnea time	The maximum time allowed without a breath trigger, an alarm setting.
APRV	Airway Pressure Release Ventilation.
ASV target graphics panel	ASV graphical data representation, an Intelligent Panel.
ASV monitored data window	ASV numeric patient data, an Intelligent Panel.
ATP	Ambient temperature and pressure.
ATPD	Ambient temperature and pressure, dry.
AutoPEEP	Unintended positive end-expiratory pressure, a monitored parameter.
Backup	Apnea backup ventilation.
backup buzzer	The buzzer designed to sound for at least 2 min as a backup to the alarm speaker.
base flow	A continuous and constant gas flow from the inspiratory outlet to the expiratory outlet.

b/min	Breaths per minute.
breathing circuit	Includes the inspiratory-expiratory tubing, humidifier, filters, and water traps.
bronchial tree	A part of the Dynamic Lung that shows resistance.
BTPS	Body temperature, barometric pressure at sea level, saturated with water vapor.
C	Compliance.
CE	A certification mark that indicates compliance with the Medical Device Directive, 93/42/EEC.
cm	Centimeter, a unit of length.
cmH2O	Centimeters of water, a unit of pressure. 1 cmH2O is approximately equal to 1 mbar, which equals 1 hPa.
CMV	Controlled mandatory ventilation.
COPD	Chronic obstructive pulmonary disease.
CPAP	Continuous positive airway pressure.
CSA	Canadian Standards Association.
Cstat	Static compliance, a monitored parameter.
DC	Direct current
dB(A)	Decibel, a unit of acoustic power.
DISS	Diameter index safety standard, a standard for high-pressure gas inlet fittings.
DuoPAP	Duo Positive Airway Pressure.
Dynamic Lung	An Intelligent Panel that graphically represents tidal volume, lung compliance, patient triggering, and resistance in real time.
E	Exhalation.
EMC	Electromagnetic compatibility.
EMI	Electromagnetic interference.

EN	European Norm, a European standard.
ET	Endotracheal.
ETO	Ethylene oxide.
ETS	Expiratory trigger sensitivity, a control setting.
event log	A record of clinically relevant ventilator occurrences, including alarms, setting changes, calibrations, maneuvers, and special functions since the ventilator was powered on.
Exp Flow	Peak expiratory flow, a monitored parameter.
ExpMinVol	Expiratory minute volume, a monitored parameter and alarm setting. In the Vent Status panel, ExpMinVol is the percentage of normal minute ventilation, based on IBW.
f	Respiratory rate.
fControl	Mandatory breath frequency, a monitored parameter. It is displayed in monitored data window.
FiO ₂	Fraction of inspired oxygen.
Flow (parameter)	In the neonatal nCPAP and nCPAP-PC modes, monitored parameter that measures and displays the current flow. The upper limit is controlled by the Flow alarm.
Flow trigger	The patient's inspiratory effort that causes the ventilator to deliver a breath, a control setting.
fSpont	Spontaneous breathing frequency, a monitored parameter.
fTotal	Total breathing frequency, a monitored parameter and alarm setting.
ft	Foot, a unit of length.
Gender	Sex of patient, a control setting.
HEPA	High efficiency particle air filter.
HME, HMEF	Heat and moisture exchanger (artificial nose), heat and moisture exchanging filter

hPa	Hectopascal, a unit of pressure. 1 hPa is equal to 1 mbar, which is approximately equal to 1 cmH ₂ O.
HPO	High-pressure oxygen.
Hz	Hertz, or cycles per second, a unit of frequency.
I	Inspiration.
IBW	Ideal body weight.
ICU	Intensive care unit.
ID	Inner diameter.
IEC	International Electrotechnical Commission.
I:E	Inspiratory:expiratory ratio, a setting, timing parameter, and monitored parameter. Ratio of inspiratory time to expiratory time.
in	Inch, a unit of length.
Insp Flow	Peak inspiratory flow, a monitored parameter.
inspiratory hold	A respiratory maneuver in which gas is retained in the patient's airways, often for X-raying purposes.
Intelligent Panel	A type of graphic display on the ventilator. The Intelligent Panels include the Dynamic Lung, Vent Status, ASV target graphics panel, and ASV monitored data window panels.
IntelliSync	Applies same pressures for spontaneous and controlled breaths. Allows the patient to breath spontaneous if he is able to keep the user set guaranteed rate.
IntelliTrig	Intelligent trigger, a feature that ensures that the set trigger sensitivity can trigger a breath independent from leakage and breath pattern.
IRV	Inverse ratio ventilation
ISO	International Organization for Standardization, a world-wide federation of national standards bodies.
kg	Kilogram, a unit of mass.
kPa	Kilopascal, a unit of pressure.

l	Liter, a unit of volume.
l/min	Liters per minute, a unit of flow.
lb	Pound, a unit of weight.
Loops	Special graphic type.
Loudness	Sets the volume for the audible ventilator alarms.
LPO	Low-pressure oxygen.
LSF	Least squares fitting, a mathematical procedure for finding the best fitting curve to a given set of points by minimizing the sum of the squares of the offsets of the points from the curve.
m	Meter, a unit of length.
mandatory breath	A breath for which either the timing or size is controlled by the ventilator. That is, the machine triggers and/or cycles the breath.
manual breath	A user-triggered mandatory breath started by pressing the manual breath key.
%MinVol	Percentage of minute ventilation, a control setting in ASV mode.
MinVol	Minute volume, a calculated and monitored parameter used in ASV mode. Based on the operator-set %MinVol, the ventilator calculates the target MinVol in l/min, then measures and displays it in the ASV target graphics panel.
ml	Milliliter, a unit of volume.
ms	Millisecond, a unit of time.
MVLeak	Total minute volume leakage. MVLeak shows VLeak * frequency (breath rate).
MVSpont	Spontaneous expiratory minute volume, a monitored parameter.
nCPAP	Neonatal-only ventilation mode that applies CPAP over a nasal interface (mask or prongs).

nCPAP-PC	Neonatal-only ventilation mode that delivers, in addition to the set CPAP, intermittent, time-cycled, and pressure-controlled breaths.
NIST	Noninterchangeable screw thread, a standard for high-pressure gas inlet fittings.
NIV	Noninvasive ventilation, a ventilation mode.
NIV-ST	Spontaneous/timed noninvasive ventilation, a ventilation mode.
NPPV	Noninvasive positive pressure ventilation.
O ₂	Oxygen.
Oxygen	Oxygen concentration of the delivered gas, a control setting, monitored parameter, and, in LPO mode, an alarm setting.
P&T knob	Press-and-turn knob. Used to navigate the display, select list items, activate controls and set values.
Pasvlimit	Maximum pressure to be applied in ASV, a control setting.
Pat. height	A control setting. It is used to compute the patient's ideal body weight (IBW) in calculations for ASV and start-up settings.
Paw	Airway pressure.
Pcontrol	Pressure control, a control setting in PCV+ mode. Pressure (additional to PEEP/CPAP) to be applied during the inspiratory phase.
PCV+	Pressure controlled ventilation
PDMS	Patient data management system
PEEP/CPAP	PEEP (positive end-expiratory pressure) and CPAP (continuous positive airway pressure), a control setting and monitored parameter. PEEP and CPAP are constant pressures applied during both the inspiratory and expiratory phases.
Phigh	High pressure in APRV and DuoPAP mode

Pinsp	Inspiratory pressure, the target pressure (additional to PEEP/CPAP) to be applied during the inspiratory phase. It is operator-set in the PSIMV+ and NIV-ST and a displayed parameter in the Vent Status panel and the ASV target graphics panel.
Plethysmogram	The waveform that visualizes the pulsating blood volume; it is delivered by the pulse oximeter.
Plow	Low pressure in APRV mode
Pmax	High pressure alarm limit
Press-and-turn knob	Also called <i>P&T knob</i> . Used to navigate the display, select list items, activate controls and set values.
Pressure	Maximum pressure allowed in the patient breathing circuit, an alarm setting.
Pmean	Mean airway pressure, a monitored parameter.
PN	Part number.
Ppeak	Peak airway pressure, a monitored parameter.
Pplateau	Plateau or end-inspiratory pressure. The pressure measured at the end of inspiration when flow is or is close to zero.
P-ramp	Pressure ramp, a control setting. The time required for the inspiratory pressure to rise to the set (target) pressure.
Press-and-Turn (P&T) navigation knob	Used to navigate through the display, as well as activate controls and select values. Also called the <i>P&T knob</i> .
pressure control	Maintenance of a consistent transrespiratory pressure waveform despite changing respiratory system mechanics.
psi	Pounds per square inch, a unit of pressure.
PSIMV+	Pressure-controlled synchronized intermittent mandatory ventilation mode.

Psupport	Pressure support, a control setting valid during spontaneous breaths in SPONT, SIMV+, and NIV modes. Psupport is pressure (additional to PEEP/CPAP) to be applied during the inspiratory phase.
Rate	Breath frequency or number of breaths per minute, a control setting.
RCexp	Expiratory time constant, a monitored parameter.
Rinsp	Inspiratory flow resistance, a monitored parameter.
RSB	Rapid shallow breathing index.
s	Second, a unit of time.
safety mode	An emergency state that ensures a basic minute ventilation while giving the user time for corrective actions in case of some technical fault alarms. The default inspiratory pressure is maintained, the expiratory valve opens as needed to switch system pressure levels between PEEP and inspiratory pressure, and patient sensing is non-functional.
(S)CMV+	Synchronized controlled mandatory ventilation mode.
sigh	Breaths delivered to deliberately increase tidal volume at a regular interval. If enabled, a sigh breath is delivered every 50 breaths with an additional 10 cmH ₂ O.
SIMV+	Synchronized intermittent mandatory ventilation mode.
SpO ₂	Oxygen saturation
SPONT	Spontaneous (pressure support) mode of ventilation.
spontaneous breath	A breath for which both the timing and size are controlled by the patient. That is, the patient both triggers and cycles the breath.
standby	The ventilator is in a waiting state, during which time there is no breath delivery.
STPD	Standard temperature and pressure, dry. Defined as dry gas at 0°C (32°F) at 758 mmHg (101 kPa) pressure at sea level.
TE	Expiratory time, a monitored parameter.

technical fault	A type of alarm, resulting because HAMILTON-C1's ability to ventilate safely is questionable.
TF	Technical fault.
Thigh	Maximum time in APRV and DuoPAP mode
TI	Inspiratory time, a control setting and monitored parameter.
TI max	Maximum inspiratory time, a control setting in NIV and NIV-ST modes.
timv	SIMV breath interval.
ttrigger	Trigger window in SIMV modes.
Tlow	Minimum time in APRV mode
Trends	Special graphic type.
V	Volt, a unit of electric potential or volume.
VA	Volt-ampere, a unit of electric power.
VDaw	Airway dead space.
ventilator breathing system (VBS)	A breathing system bounded by the low-pressure gas input port(s), the gas intake port(s), and the patient connection port, together with the fresh-gas inlet and exhaust port(s), if fresh-gas inlet or exhaust ports are provided, as described in ISO 4135:2001.
Vent Status panel	An Intelligent Panel that visualizes six parameters related to the patient's ventilator dependency, including oxygenation and patient activity.
VLBW	Very Low Birth Weight
VLeak	Leakage percent, a monitored parameter.
Vt	Tidal volume, a control setting, an alarm setting and a monitored parameter in the Vent Status panel.
VTE	Expiratory tidal volume, a monitored parameter. It is the integral of all negative flow measurements during exhalation.
VTI	Inpiratory tidal volume, a monitored parameter.

Index

A

Accessories

- about 1-9
- list of G-1

Aeroneb Pro nebulizer 2-23

Airway pressure, mean. *See* Pmean

Alarm silence key 9-6

Alarms

- Alarm silence key, description 9-6
- buffer, viewing 8-7
- lamp on top of ventilator, about 1-12
- list of 8-10
- loudness, adjusting 4-22
- priorities, ranges, and default settings A-18
- responding to 8-22
- sending to remote device (nurse call) H-9
- setting limits 4-19
- silencing 9-6
- SpO2 related J-17
- tests to ensure proper functioning 3-21
- troubleshooting 8-10
- viewing active and inactive 8-7
- visual and audible indications 8-3
- volume (loudness), adjusting 4-22
- volume (loudness), setting minimum I-6
- with ASV, setting C-10

Alarms, adjustable

- Apnea time 4-23, A-18, A-36
- ExpMinVol 4-23, A-18, A-36
- Flow 4-23
- Flow (nCPAP modes) A-18
- Flow (nCPAP, nCPAP-PC) A-36
- fTotal 4-23, A-18, A-36
- Oxygen 4-24, A-18, A-37
- PetCO2 4-24, A-18, A-37
- Pressure 4-24, A-19, A-37
- Pressure limitation A-19, A-37
- SpO2 related J-17, J-18
- Vt 4-24, A-19, A-37

Alarms, SpO2

- Adapter missing J-19
- delay for SpO2 alarm, setting J-18
- Light interference J-19
- limits, setting J-17

Alarms, SpO2

- Low perfusion index J-19
- Patient disconnected J-20
- PI high J-20
- PI low J-20
- PI (perfusion index) high J-19
- PI (perfusion index) low J-19
- Probe missing J-20
- Pulse high J-19
- Pulse low J-19
- Pulse rate high J-20
- Pulse rate low J-20
- ranges and defaults J-19
- ranges, defaults J-18
- Sensor error J-20
- setting J-17
- SpO2 high J-19
- SpO2 low J-19
- SpO2 too high J-20
- SpO2 too low J-21
- troubleshooting J-19
- See also* SpO2 pulse oximetry alarms

Ambient state, about B-34

Apnea alarms

- Apnea 8-10
- Apnea time 4-23, A-36
- Apnea ventilation 8-10
- Apnea ventilation ended 8-10
- troubleshooting 8-10

Apnea backup ventilation

- Apnea backup, definition 4-13
- description 4-11
- enabling/disabling 4-11
- ranges, accuracy A-6

APOD sensitivity mode (SpO2), about J-34

APRV mode A-11, B-3, B-30

- controls in A-11, B-32
- high-pressure recruitment maneuvers B-32
- initialization B-31

APVcmv mode A-11, B-3, B-8

- controls in A-11, B-8, B-9
- selecting naming convention for I-8

APVsimv mode A-11, B-3, B-16, B-17

- controls in A-11, B-18, B-19
- selecting naming convention for I-8

- ASV Graph (target graphics window)
 - about 6-6, 7-9, C-11
 - displaying 7-9
 - illustrated C-12
 - ranges, scale A-16
- ASV mode A-11
 - about C-2, C-15
 - alarms C-10
 - ASV Graph, illustrated C-12
 - breathing patterns C-13
 - Cannot meet the target alarm 8-10
 - clinical workflow chart C-4
 - controls in A-11, C-5
 - dead space compensation C-8
 - monitoring requirements C-9, C-11
 - preparing for use C-6
 - weaning C-14
 - See *also* ASV Graph
- AutoPEEP
 - definition 6-17
 - ranges and accuracy A-12
- B**
- Backup ventilation. See Apnea backup ventilation
- Bacteria filter, connecting 2-7
- Base flow
 - adults/pediatrics A-23
 - neonates 5-33, A-23
 - specifications A-23
- Batteries
 - specifications A-5
- Battery
 - about 2-25
 - charging 10-18
 - power symbols on device 2-27
 - specifications A-5
 - storing 10-18
- Battery alarms
 - Battery calibration required 8-10
 - Battery communication error 8-11
 - Battery low 8-11
 - Battery power loss 8-11
 - Battery replacement required 8-12
 - Battery temperature high 8-12
 - Battery totally discharged 8-12
 - Loss of external power 8-18
 - Wrong battery 8-12
- Biphasic ventilation, about B-5
- Blower fault alarm 8-12
- Breath timing options, selecting for PCV+ and (S)CMV+ modes I-7
- Breathing circuits
 - adult/ped, coaxial with HMEF/HME 2-12
 - adult/ped, coaxial with mask 2-13
 - adult/ped, dual limb with humidifier 2-11
 - bacteria filter, connecting 2-7
 - by patient group (adult/ped) 2-9
 - by patient group (neo) 5-10
 - components (adult/ped) 2-9
 - components (neo) 5-9
 - connecting (adult/ped) 2-5, 2-10
 - connecting (neo) 5-10
 - HMEF/HME, connecting 2-7
 - maintenance, replacement 10-13
 - neonatal, dual limb with HMEF/HME 5-12
 - neonatal, dual limb with humidifier 5-11
 - neonatal, nCPAP/nCPAP-PC modes 5-14
 - neonatal, nCPAP/nCPAP-PC modes, with humidifier 5-13
 - neonatal, setting up 5-9
 - positioning 2-14
 - pressure-monitoring line (nCPAP modes), connecting 5-16
 - specifications A-22
- Buzzer defective alarm 8-12
- C**
- Calibrating
 - circuit (neo) 5-23
 - CO₂ sensor 3-14
 - flow sensor (adult/ped) 3-9
 - flow sensor (neo) 5-20
 - O₂ cell 3-12
 - when to perform calibrations 3-2
- Cannot meet the target (ASV) alarm 8-10
- Check flow sensor alarm 8-13
- Check flow sensor tubing alarm 8-13
- Check settings alarm 8-13
- Circuit calibration needed alarm 8-13
- Circuits. See Breathing circuits
- Cleaning
 - device and components, guidelines for 10-4, 10-7

- Cleaning
 - supported cleaning agents 10-5
- CO2 alarms
 - Check CO2 sensor airway adapter 8-13
 - Check CO2 sensor sampling line 8-13
 - CO2 sensor calibration needed 8-14
 - CO2 sensor defect 8-14
 - CO2 sensor disconnected 8-14
 - CO2 sensor over temperature 8-14
 - PetCO2 high 8-21
 - PetCO2 low 8-21
- CO2 measurement
 - CO2 sensor, calibrating 3-14
 - enabling/disabling 3-16
 - mainstream 2-18, 2-19, 3-15
 - setting up 2-16
 - sidestream 2-21, 3-15
- CO2 sensors. *See* CO2 measurement
- COM1 connector, using to send data H-4
- Communications interface
 - about H-2
 - COM1, about H-4
 - connecting to computer, PDMS H-6
 - connecting to patient monitor H-4
 - nurse call connector, about H-8
 - protocols about H-3
 - sending data and alarms to remote device H-8
- Compliance. *See* Cstat
- Configuration
 - accessing Configuration mode I-2
 - alarm volume (loudness), setting minimum I-6
 - breath timing options for PCV+/(S)CMV+, selecting I-7
 - communications interface, enabling I-5
 - copying configuration to other ventilators (via USB) I-16
 - default settings I-15
 - initial/default ventilator settings, configuring I-15
 - language, selecting I-3
 - MMPs, selecting which to display I-8
 - naming convention for APV modes, selecting I-8
 - pulse oximetry options, reviewing J-31
 - quick setup settings, configuring I-9
 - quick setup settings, selecting default I-15
- Configuration
 - specifications A-20
 - SpO2 alarm delay J-18, J-33
 - SpO2 option, enabling/disabling J-30
 - SpO2 sensor data options, setting J-31, J-33
 - units of measure, setting I-4
 - weaning zone ranges, configuring I-14
 - See also* Software options
- Connecting to other devices, about H-2
- Control settings
 - accuracy of measurements A-6
 - adjusting 4-9
 - definitions 4-13
 - list of 4-13, A-6
 - ranges and defaults A-6
 - See also* name of setting/parameter
- Cstat (compliance)
 - definition 6-17
 - in Dynamic Lung panel 7-4
 - normal values in Dynamic Lung panel 7-5
 - ranges, accuracy A-14
- Curves. *See* Waveforms
- D**
- Date and time
 - real time clock failure alarm 8-21
 - setting 3-19
- Day and night display brightness
 - Day/Night key 9-13
 - setting 3-17
- Device temperature high alarm 8-15
- Disconnection alarms
 - Disconnection on patient side 8-15
 - Disconnection on ventilator side 8-15
- Disinfection
 - device and components, guidelines for 10-6, 10-7
 - supported disinfection agents 10-6
- Display, locking the touch screen 9-12
- DuoPAP mode A-11, B-3, B-26
 - adjusting to mimic other modes B-27
 - controls in A-11, B-29
 - pressure support in B-27
 - synchronization B-28
- Dynamic Lung panel
 - about 7-2
 - compliance (Cstat), about 7-4

Dynamic Lung panel
 displaying 7-3
 illustrated 7-2
 normal values 7-5
 patient triggering, illustrated 7-4
 resistance (Rinsp), about 7-5
 SpO₂/pulse rate, display of J-13
 tidal volume (Vt), about 7-3

E

End-expiratory pause pressure. See Pplateau
Environmental specifications A-3
ETS (expiratory trigger sensitivity)
 definition 4-13, 5-34
 ranges, accuracy A-6
Event log
 about 8-9
 copying to USB device 3-20
Exhalation obstructed alarm 8-15
Exp flow (peak expiratory flow)
 definition 6-17
 ranges, accuracy A-13
Expiratory filter, using 2-24
Expiratory flow. See Exp flow
Expiratory minute volume. See ExpMinVol
Expiratory tidal volume. See VTE
Expiratory time constant. See RCexp
Expiratory time. See TE
Expiratory trigger sensitivity. See ETS
Expiratory valves
 adult/ped and neonatal, compared 5-4
 installing (adult/ped) 2-8
 installing (neo) 5-3
 maintenance and replacement 10-13
 reprocessing autoclavable 10-19
 Wrong expiratory valve alarm 8-25
ExpMinVol alarms
 definition 4-23
 ranges and defaults A-36
 ranges, defaults A-18
ExpMinVol/MinVol NIV (expiratory minute volume)
 definition 6-18
 ranges, accuracy A-13
External flow sensor failed alarm 8-15

F

Fan failure alarm 8-16
fControl (mandatory breath rate)
 definition 6-18
 ranges, accuracy A-14
FetCO₂ (endtidal CO₂)
 definition E-4
 ranges, accuracy A-15
Filters
 air intake (dust and HEPA), cleaning and replacing 10-15
 expiratory, using 2-24
 fan, cleaning and replacing 10-15
 inspiratory, particle size and efficiency A-22
 maintenance, replacement 10-14
Flow alarm
 definition 4-23, 5-36
 Flow high and low alarms, definition 8-16
 range and default A-36
 range and defaults A-18
Flow (nCPAP modes)
 definition 5-35, 6-18
 ranges, accuracy A-13
Flow sensor calibration required alarm 8-16
Flow sensors
 about 1-8
 calibrating (adult/ped) 3-9
 calibrating (neo) 5-20
 connecting (adult/ped) 2-14
 connecting (neo) 5-15
 maintenance and replacement 10-13
Flow trigger
 definition 4-14
 ranges, accuracy A-6
Frequency high and low alarms
 definition 8-16, 8-18
 ranges, defaults A-18
Frequency (respiratory frequency)
 mandatory breath. See fControl
 spontaneous breath. See fSpont
 total breath. See fTotal
 See also Rate
%fSpont
 (Vent Status) definition 7-7
 (Vent Status) range, default A-21

fSpont (spontaneous breath frequency)
definition 6-18
ranges, accuracy A-14

fTotal (total respiratory rate)
alarms 4-23, A-36
high and low alarms, ranges and
defaults A-18
monitored parameter, about 6-18
ranges, accuracy A-14

Function tests. See Preoperational check 3-2

G

Gas supply
Gas source window, about 2-32
overview of 1-7
source type (HPO, LPO), selecting 2-31
specifications A-4
See also Oxygen supply

Gender setting, definition 4-14

Graphical views of data
displaying 6-6
selecting 6-6
types of 6-8

Graphical views of data, types of
ASV Graph 6-11
Dynamic Lung 6-11
loops 6-14
Trends 6-11
Vent Status 6-11
waveform, pressure-time 6-9
waveforms 6-8

H

Hardware options, enabling/disabling 1-19

High flow alarm 8-16

High frequency alarm 8-16

High minute volume alarm 8-16

High oxygen alarm 8-16

High PEEP alarm 8-17

High pressure alarm 4-24, 8-17

High pressure during sigh alarm 8-17

High tidal volume alarm 8-24

HMEF/HME, connecting 2-7

Humidifiers
connecting 2-4
supported G-6

I

IBW
calculation of 4-6, 4-14, 4-15
definition 4-6
range, accuracy 4-3, A-14

I:E (inspiratory:expiratory ratio)
definition 4-15, 6-19
ranges, accuracy A-6, A-14
selecting as timing option for PCV+ and
(S)CMV+ modes 1-7
timing signals, sending to remote device
H-9

Insp flow (peak inspiratory flow)
definition 5-35, 6-19
ranges, accuracy A-13

Inspiratory flow resistance. See Rinsp

Inspiratory hold
performing 9-9
See also Manual breath

Inspiratory pressure. See Pinsp

Inspiratory tidal volume. See VTI

Inspiratory time. See TI

Inspiratory volume limitation alarm 8-17

Installation, first-time, notes for 2-4

Intelligent Panels 7-2
ASV Graph 7-9, C-12
Dynamic Lung 7-2
Vent Status 7-6

IntelliTrig (intelligent trigger), about D-9

Interface (communications) connector (RJ-45), location of 1-15

Intrinsic PEEP. See AutoPEEP

IRV alarm 8-18

K

Keypad on front of ventilator, about 9-2

Keys on front panel 1-12
Alarm silence 9-6
Day/Night 9-13
Manual breath 9-9
Nebulizer 9-10
O2 enrichment 9-7
Power/Standby 9-3
Print screen 9-11
Screen Lock/unlock 9-12

L

- LAN connector, location of 1-15
- Language, selecting (configuration) 1-3
- Leakage. *See* VLeak/MVLeak
- Loops
 - about 6-14
 - displaying 6-14
 - ranges and scales used A-16
 - storing 6-15
- Loss of external power alarm 8-18
- Loss of PEEP alarm 8-18
- Loudness for alarms
 - setting 4-22
 - setting minimum for 1-6
 - specifications A-25
- Loudspeaker defective alarm 8-18
- Low frequency alarm 8-18
- Low minute volume alarm 8-19
- Low oxygen alarm 8-19
- Low PetCO₂ alarm 8-21
- Low pressure alarm 4-24, 8-19
- Low tidal volume alarm 8-24

M

- Main monitoring parameters (MMP)
 - about 1-20, 6-4
 - configuring which to display 1-8
 - location on display 1-20, 6-4
 - viewing 6-4
 - with SpO₂ monitoring J-12
- Maintenance
 - cleaning agents, supported 10-5
 - cleaning guidelines 10-4
 - cleaning, disinfection, sterilization overview 10-2
 - disinfection agents, supported 10-6
 - disinfection guidelines 10-6
 - expiratory valves, reprocessing autoclavable 10-19
 - filters 10-15
 - preventive, schedule for 10-13
 - reprocessing components, guidelines for 10-9
- Mandatory breath rate. *See* fControl
- Mandatory ventilation modes, about B-8
- Manual breath
 - delivering 9-9
 - Manual breath key 1-13, 9-9

- Masks, noninvasive
 - maintenance and replacement 10-13
 - using in noninvasive ventilation D-6
- Maximum inspiratory time. *See* TI max
- Maximum pressure alarm. *See* Pressure
- Maximum sensitivity mode (SpO₂)
 - about J-32, J-34
- Mean airway pressure. *See* Pmean
- Minute volume high and low alarms
 - definition 8-16, 8-19
 - ranges, defaults A-18
- Minute volume setting. *See* %MinVol
- %MinVol (% minute volume)
 - definition 4-15
 - ranges, accuracy A-6
 - (Vent Status) definition 7-7
 - (Vent Status) ranges and defaults A-21

MMPs

- about 6-4
 - viewing 6-4
 - See* Main monitoring parameters
- Modes, ventilation. *See* Ventilation modes

Monitored parameters

- accuracy of measurements A-12
- default settings A-12
- definitions 6-17
- list of (definitions) 6-16
- pulse oximeter related J-9
- ranges A-12
- viewing 6-3
- See also* name of specific parameter

Monitoring windows, viewing 6-3

MVLeak/VLeak (leakage)

- definition 6-23
- ranges, accuracy A-13

MVSpont/MVSpont NIV (spontaneous minute volume)

- definition 6-19
- ranges, accuracy A-13

N

- nasal CPAP. *See* nCPAP
- nCPAP mode A-11, B-3
 - controls in A-11
 - Flow alarm 8-16, A-13
- nCPAP mode (neo) 5-28
- nCPAP-PC mode A-11, B-3
 - controls in A-11
 - Flow alarm 5-36, 8-16, A-13

nCPAP-PC mode (neo) 5-30
Nebulizer
 Aeroneb Pro, installing 2-23
 connecting 2-15
 maintenance and replacement 10-13
 Nebulizer key, about 1-14, 9-10
 starting/stopping 9-10
Neonatal ventilation 5-2
 adjustable alarms in 5-36
 calibrations, performing 5-17
 components for 5-9
 expiratory valve, connecting 5-3
 flow sensor, calibrating 5-20
 modes available for 5-27
 patient group and weight, setting 5-5
 preoperational checks, performing 5-17, 5-25
 pressure line, connecting 5-16
 setting up for 5-3
 ventilation mode, selecting 5-6
 See also Ventilation modes, Breathing circuits
NIV mode A-11, B-3, B-12, B-14
 controls in A-11
NIV-ST mode A-11, B-3, B-16, B-23
 controls in A-11
Noninvasive ventilation
 adverse reactions D-5
 alarms D-8
 CO₂ rebreathing, about D-10
 contraindications D-5
 control settings in D-7
 important notes about D-9
 mask fit, checking D-10
 monitored parameters D-8
 patient interface, selecting D-6
 PEEP, maintaining, and preventing autotriggering D-10
 required conditions for use D-4
Normal sensitivity mode (SpO₂), about J-34
Numeric patient data, viewing 6-3
Nurse call connector
 about H-8
 sending data and alarms to remote device H-8

O

O₂ cell
 calibrating 3-12
 replacing 10-17
O₂ cell alarms
 O₂ cell calibration needed 8-19
 O₂ cell defective 8-19
 O₂ cell missing 8-20
 O₂ cell not system compatible 8-20
O₂ consumption, ranges and accuracy A-14
O₂ enrichment
 about (adult/ped) 9-7
 about (neo) 5-37
 O₂ enrichment key 9-7
 starting/stopping 9-7
Obstruction alarm 8-20
Operating hours, versions, options, and versions, viewing 3-6
Options not found alarm 8-20
Oxygen 9-7
 definition 4-15, 6-19
 ranges, accuracy A-7, A-14 (Vent Status) definition 7-7 (Vent Status) range and default A-21
Oxygen high and low alarms
 definition 4-24, 8-16, 8-19
Oxygen monitoring, enabling/disabling 3-16
Oxygen supply
 connecting to ventilator 2-31
 high pressure (HPO), about 2-29
 low pressure (LPO), about 2-29
 source type (HPO, LPO), selecting 2-31
Oxygen supply failed alarm 8-20
Oxygen-related alarms
 ranges and defaults A-18, A-37

P

P high
 (APRV) ranges, accuracy A-8
 definition 4-16
 (DuoPAP) ranges, accuracy A-8
P low
 definition 4-16
 ranges, accuracy A-8
P0.1 (airway occlusion pressure)
 definition 6-19
 ranges, accuracy A-14

- Parameters
 - control settings, list of 4-13, A-6
 - monitored, list of 6-16, A-12
 - pulse oximeter related, list of J-9
 - See *also* individual parameter entries
- Passlimit (ASV pressure limit)
 - definition 4-15
 - ranges, accuracy A-7
- Pat. height (patient height)
 - definition 4-15
 - ranges, accuracy A-7
- Patient groups 4-3
 - about 4-3, 4-4
 - selecting 4-4, 5-5
- Patient monitor, connecting to H-4
- Pause (end-expiratory) pressure. See Pplateau
- PC, connecting to H-6
- Pcontrol (pressure control)
 - definition 4-15
 - ranges, accuracy A-7
- PCV+ mode A-11, B-3, B-10
 - controls in A-11
- PDMS, connecting to H-6
- Peak expiratory flow. See Exp flow
- Peak inspiratory flow. See Insp flow
- Peak proximal airway pressure. See Ppeak
- PEEP/CPAP
 - definition 4-15, 6-20
 - ranges, accuracy A-7, A-12
 - (Vent Status) definition 7-7
 - (Vent Status) range and default A-21
- Performance limited by high altitude alarm 8-21
- Perfusion index (PI)
 - definition and range J-9
 - viewing data J-10
- PetCO₂ (endtidal CO₂)
 - definition E-4
 - display in Dynamic Lung J-13
 - ranges, accuracy A-15
- PetCO₂ high and low alarms
 - definition 4-24
 - ranges, defaults A-18
- Piezo nebulizer, use of 2-23
- Pinsp (inspiratory pressure)
 - definition 6-20
 - ranges, accuracy A-8, A-12
 - (Vent Status) definition 7-7
- Pinsp (inspiratory pressure)
 - (Vent Status) range and default A-21
- Plateau pressure. See Pplateau
- Plethysmogram with SpO₂, displaying J-15
- Pmean (mean airway pressure)
 - definition 6-20
 - ranges, accuracy A-12
- Pneumatic diagram F-1
- Power source
 - about 2-25
 - battery, about 2-25
 - connecting to 2-25
 - power symbols on device 2-27
 - specifications A-5
- Power/standby key 9-3
- Ppeak (peak proximal airway pressure)
 - definition 6-20
 - ranges, accuracy A-12
- Pplateau (plateau pressure)
 - definition 6-20
 - ranges, accuracy A-12
- P-ramp (pressure ramp)
 - definition 4-16, 5-34
 - ranges, accuracy A-9
- Preoperational checks
 - performing (adult/ped) 3-3
 - performing (neo) 5-25
- Press-and-turn (P&T) navigation knob, about 1-14, 2-37
- Pressure control. See Pcontrol
- Pressure high and low alarms
 - definition 8-17, 8-19
- Pressure limit has changed alarm 8-21
- Pressure limitation alarm 8-21
- Pressure not released alarm 8-21
- Pressure ramp. See P-ramp
- Pressure support setting. See Psupport
- Pressure-related alarms
 - High and low alarm ranges and defaults A-19, A-37
 - Pressure limitation alarm ranges and defaults A-37
- Preventive maintenance required alarm 8-21
- Preventive maintenance. See Maintenance
- Print screen key 9-11
- Protocols, communication with other devices H-3
- PSIMV+ IntelliSync mode B-22

PSIMV+ mode A-11, B-3, B-16, B-19
controls in A-11

Psupport (pressure support)
definition 4-17
ranges, accuracy A-9

P&T navigation knob, about 1-14, 2-37

PTP (inspiratory pressure time product)
definition 6-21
ranges, accuracy A-14

Pulse oximetry. *See* SpO2 pulse oximetry

Pulse rate
definition and range J-9
display in Dynamic Lung J-13, J-14
viewing data J-10

Q

Quality index
definition J-11
viewing J-11

Quick setup settings
configuring I-9
default, selecting I-15
using to select basic ventilation options
4-3

R

Rate (respiratory frequency)
definition 4-17
mandatory breath. *See* fControl
ranges, accuracy A-9
spontaneous breath. *See* fSpont
total respiratory. *See* fTotal

Rate-related alarms
High frequency 8-16
Low frequency 8-18

RCexp (expiratory time constant)
definition 6-21
ranges, accuracy A-14

Real time clock failure alarm 8-21

Replace HEPA filter alarm 8-22

Reprocessing components
guidelines for 10-9
See also Maintenance

Resistance, inspiratory flow. *See* Rinsp

Rinsp (inspiratory flow resistance)
definition 6-22
display in Dynamic Lung panel 7-5
normal values in Dynamic Lung panel
7-5

Rinsp (inspiratory flow resistance)
ranges, accuracy A-14

RSB (rapid shallow breathing index)
(Vent Status) definition 7-7
(Vent Status) ranges and defaults A-21

S

Safety mode B-34

Safety ventilation alarm 8-22

(S)CMV+ mode A-11, B-3, B-8
controls in A-11, B-8, B-9
selecting naming convention for I-8

Screen Lock/unlock key 9-12

Screenshots, capturing. *See* Print screen key

Self test failed alarm 8-22

Sensitivity mode (SpO2) J-31
APOD, about J-34
Maximum, about J-32, J-34
Normal, about J-34
options J-34

Sensors, enabling/disabling 3-16

Setup, ventilator 2-38

Sidestream CO2 sensor
about 2-21
connecting 2-21
See also CO2 measurement

Sigh
default A-9
definition 4-17
setting 4-9

Silencing alarms 9-6

SIMV+ mode A-11, B-3, B-16, B-17
controls in A-11, B-18, B-19
selecting naming convention for I-8

SIMV (synchronized intermittent mandatory)
modes, about B-16

slopeCO2
definition E-6
ranges, accuracy A-15

Software options
adding I-17
removing I-20
reviewing installed I-17

Specifications
accuracy testing A-25
alarms, settings and ranges, adjustable
A-18
breathing system A-22
configuration A-20

Specifications

- electrical A-5
- EMC declarations A-29
- environmental requirements A-3
- essential performance A-26
- gas mixing system A-4
- pneumatic A-4
- standards and approvals A-28
- technical performance data A-23
- ventilator dimensions A-2

SpO2 low alarm J-13, J-17

SpO2 (oxygen saturation)

- displayed as MMP J-13, J-17
- indicators in Dynamic Lung, definition J-13
- viewing data J-10

SpO2 pulse oximetry

- attaching adapter to rail J-26
- cleaning components J-37
- components J-7
- connecting components J-22, J-25
- connecting the cables J-26
- disconnecting components J-28
- display in Dynamic Lung panel J-13
- disposal of components J-38
- enabling/disabling hardware (configuration) J-30
- enabling/disabling sensor J-8
- overview J-7
- parameters and settings J-9
- plethysmogram, displaying J-15
- quality index, definition J-11
- replacing components J-38
- reviewing configured options (configuration) J-31
- sensor data options, configuring (configuration) J-31
- SpO2 and pulse indicators in Dynamic Lung J-13
- trends for SpO2 parameters, viewing J-16
- troubleshooting issues J-35
- verifying measurements J-27
- viewing data J-10
- viewing SpO2 as MMP J-12
- viewing SpO2 data on main display J-12
- See *also* SpO2 pulse oximetry alarms and Alarms, SpO2

SpO2 pulse oximetry alarms J-17

- list of J-18
- ranges and defaults J-19
- ranges, defaults J-18
- See *also* individual alarms
- setting J-17
- SpO2 alarm delay J-18, J-33
- SpO2 low alarm, MMP display J-13, J-17
- troubleshooting J-19
- See *also* Alarms, SpO2

SpO2 pulse oximetry parameters, list of J-9

SpO2/FiO2 ratio

- about J-39
- definition and range J-9
- viewing data J-10

SPONT mode A-11, B-3, B-12

- controls in A-11

Spontaneous breath frequency. See fSpont
Spontaneous minute volume. See MVSpont, MVSpont NIV

Spontaneous ventilation modes. See SPONT, NIV

Standby

- about 9-3
- Adult/ped Standby window 9-5
- ending (start ventilation) 9-4
- entering and exiting 9-3
- Neonatal Standby window 5-5
- putting ventilator into 9-3

Starting ventilation 9-4

Storage requirements 10-18

Suctioning

- maneuver, performing 9-8
- performing 9-8
- use of O2 enrichment key 9-8

Symbols, definitions 1-21

Synchronized controlled mandatory ventilation mode. See (S)CMV+ (APVcmv)

Synchronized intermittent mandatory ventilation modes. See SIMV+ (APVsimv), PSIMV+, NIV-ST

T

T high

- (APRV) ranges, accuracy A-9
- definition 4-17
- (DuoPAP) ranges, accuracy A-9

- T low
 - definition 4-17
 - ranges, accuracy A-10
- TE (expiratory time)
 - definition 6-22
 - ranges, accuracy A-14
- Technical event alarm 8-22, 8-23
- Technical fault alarm 8-23, B-34
- Tests
 - alarm tests 3-21
 - calibrating components 3-6
 - preoperational checks, performing (adult/ped) 3-3
 - preoperational checks, performing (neo) 5-25
 - tightness test (adult/ped) 3-8
 - tightness test (neo) 5-18
 - when to perform 3-2
- TI (inspiratory time)
 - definition 6-22
 - ranges, accuracy A-10, A-14
 - selecting as breath timing option for PCV+ and (S)CMV+ modes I-7
- TI max (maximum inspiratory time)
 - definition 4-17, 5-34
 - ranges, accuracy A-10
- Tidal volume setting or alarm. *See* Vt
- Tightness test
 - performing (adult/ped) 3-8
 - performing (neo) 5-18
 - when to perform 3-5, 5-18
- Time and date, setting 3-19
- Time constant, expiratory. *See* RCexp
- Time, expiratory. *See* TE
- Time, inspiratory. *See* TI
- Total respiratory rate. *See* fTotal
- Touch screen, disabling (locking) 9-12
- Trends
 - about 6-11
 - displaying 6-13
 - for SpO2 parameters, viewing J-16
- Trigger, ranges and accuracy A-14
- Trolley
 - patient support arm 2-34
 - preparing for intrahospital transport 2-34
 - use guidelines 2-33
- Troubleshooting alarms, what to do 8-10
- Turn the Flow Sensor alarm 8-23
- Turning ventilator on/off 2-36, 2-37
- U**
 - Ultrasonic nebulizer. *See* AeroNeb Pro ultrasonic nebulizer system
 - Units of measure, setting I-4
 - USB device
 - copying configuration settings using I-16
 - copying Event log using 3-20
 - USB port, location 1-18
- V**
 - V'alv, ranges and accuracy A-15
 - V'CO2 (CO2 elimination)
 - about E-2
 - ranges, accuracy A-15
 - VDaw, ranges and accuracy A-15
 - VDaw/VTE, ranges and accuracy A-15
 - VeCO2, ranges and accuracy A-15
 - Vent Status panel 7-6
 - about 7-6
 - displaying 7-8
 - list of parameters in 7-7
 - weaning zone ranges, configuring I-14
 - Ventilation modes
 - about B-2
 - characteristics of B-3
 - controls active in A-11
 - controls, setting 4-8
 - default selection A-7
 - naming convention for adaptive modes, selecting I-8
 - neonatal modes, selecting 5-6
 - selecting 4-7, 4-8
 - supported A-7
 - See also* Ventilation modes, list of and Modes, ventilation
 - Ventilation modes, list of
 - Ambient state B-34
 - APRV B-30
 - DuoPAP B-26
 - mandatory ((S)CMV+, PCV+) B-8
 - nCPAP (neo) 5-28
 - nCPAP-PC (neo) 5-30
 - NIV B-12, B-14
 - NIV-ST B-23
 - PCV+ B-10
 - PSIMV+ B-19

- Ventilation modes, list of
 - PSIMV+ IntelliSync B-22
 - Safety B-34
 - (S)CMV+ (APVcmv) B-8
 - SIMV+ (APVsimv) B-17
 - SPONT B-12
 - spontaneous modes (SPONT, NIV) B-12
 - spontaneous (SPONT, NIV) B-12
 - Standby 9-3
 - synchronized intermittent mandatory ventilation, about B-16
 - Ventilator
 - components, illustrated 1-9
 - date and time, setting 3-19
 - display, locking the touch screen 9-12
 - entering and exiting standby 9-3
 - shipping 10-18
 - starting ventilation 9-4
 - turning on/off 2-36, 2-37
 - viewing operating hours, options, and versions 3-6
 - Ventilator keys (front panel)
 - about 9-2
 - Alarm silence 9-6
 - Day/Night 9-13
 - Manual breath 9-9
 - Nebulizer 9-10
 - O2 enrichment 9-7
 - Power/standby 9-3
 - Print screen 9-11
 - Screen Lock/unlock 9-12
 - Ventilator outlet temperature high alarm 8-24
 - ViCO2, ranges and accuracy A-15
 - VLeak/MVLeak (leakage)
 - definition 6-23
 - ranges, accuracy A-13
 - Volume
 - expiratory minute volume. *See* ExpMinVol
 - expiratory tidal volume. *See* VTE
 - inspiratory tidal volume. *See* VTI
 - leakage. *See* VLeak and MVLeak
 - spontaneous minute volume. *See* MVSpont, MVSpont NIV
 - tidal volume. *See* Vt
 - Volume (loudness) for alarms
 - setting 4-22
 - setting minimum I-6
 - Volume (loudness) for alarms
 - specifications A-25
 - Volume-related alarms
 - ExpMinVol high A-18
 - ExpMinVol low A-18
 - High minute volume 8-16
 - Low minute volume 8-19
 - Vt high 8-24, A-19, A-37
 - Vt low 4-24, 8-24, A-19, A-37
 - Vt (tidal volume)
 - definition 4-17
 - normal values in Dynamic Lung panel 7-5
 - ranges, accuracy A-10
 - Vtalv, ranges and accuracy A-15
 - VTEspont (spontaneous expiratory tidal volume)
 - definition 6-23
 - ranges, accuracy A-14
 - VTE/VTE NIV (expiratory tidal volume)
 - definition 6-23
 - ranges, accuracy A-13
 - VTI (inspiratory tidal volume)
 - definition 6-23
 - ranges, accuracy A-13
 - VT/kg
 - definition 4-18
 - ranges, accuracy A-10
- ## W
- Warranty A-34
 - Waveforms
 - about 6-8
 - displaying 6-9
 - pressure-time waveform, illustrated 6-9
 - ranges and scales used A-16
 - types of 6-6
 - Weaning zone ranges (Vent Status), configuring I-14
 - Weaning, with ASV mode C-14
 - Weight
 - definition 4-18, 5-34
 - ranges, accuracy A-10, A-14
 - Wrong battery alarm 8-12
 - Wrong expiratory valve alarm 8-25
 - Wrong flow sensor alarm 8-25

Addendum to HAMILTON-C1/T1/MR1 Operator's Manuals

REF 161001, 161006,
161010, 161009,
1610010, 1610060,
1610100, 1610090

Software version 2.2.x
2020-04-20

624983/05
English

Add this addendum to the front of your HAMILTON-C1, HAMILTON-T1, and/or HAMILTON-MR1 Operator's Manual.

The HAMILTON-C1/T1/MR1 software version 2.2.x introduces some important enhancements and updates to the device software.

The changes are described in this addendum, which serves as an adjunct to your existing documentation, listed below, depending on the serial number of your device(s).

Table 1 HAMILTON-C1

Language	HAMILTON-C1 SN < 6000	
	Operator's Manual	Operator's Manual Addendum
English	624326/01	624731/00
German	624327/01	
Spanish	624328/00	
French	624329/00	
Portuguese	624333/00	
Italian	<i>provided by Hamilton Medical partner</i>	
Japanese		
Chinese	624331/00	
Russian	624332/00	

Table 2 HAMILTON-T1

Language	HAMILTON-T1 SN < 3000	
	Operator's Manual	Operator's Manual Addendum
English	624369/02	624730/01
German	624370/00	
Spanish	624371/00	
French	624372/00	
Portuguese	624373/00	
Italian	<i>provided by Hamilton Medical partner</i>	
Japanese		
Chinese	624374/00	
Russian	624375/00	

Table 3 HAMILTON-MR1

Language	HAMILTON-MR1 SN < 2000	
	Operator's Manual	Operator's Manual Addendum
English	624495/00	624760/01 624815/00
German	624496/00	
Spanish	624497/00	
French	624498/00	
Portuguese	624499/00	
Italian	<i>provided by Hamilton Medical partner</i>	
Japanese		
Chinese	624500/00	
Russian	624501/00	

What's new in software version 2.2.x

The following features and options have been added or updated in version 2.2.x.

NOTICE

- Neonatal options only apply to HAMILTON-C1 devices with serial number ≥ 6000 , HAMILTON-T1 devices with serial number ≥ 3000 , and HAMILTON-MR1 devices with serial number ≥ 2000 .
- Pulse oximetry options only apply to HAMILTON-C1 devices with serial number ≥ 6000 , and HAMILTON-T1 devices with serial number ≥ 3000 .

Table 4 Updates by device

Feature/Option	See ...
High flow oxygen therapy mode	Section 1
Compatibility with speaking valves	Section 2
ASV-related changes	Section 3
Use of adult/pediatric flow sensor with neonatal/pediatric breathing circuits	Section 4
User interface (display) and software changes	Section 5
Ventilator alarms and settings updates	Section 6
Graphics-related changes	Section 7
Pulse-oximetry-related changes	Section 8
Control and monitoring-parameter-related changes	Section 9
Safety information updates	Section 10
New parts and accessories	Section 11
Alarm volume (loudness) changes	Section 12
<i>HAMILTON-MR1 only.</i> HAMILTON-MR1 transport kit	Section 13
Corrections/additions to manuals	Section 14

1 High flow oxygen therapy (HiFlowO2 mode)

HiFlowO2¹ is an optional therapy in which a continuous flow of heated and humidified air and oxygen is delivered to the patient. An operating humidifier is required.

High flow oxygen therapy is indicated for patients who are able to inhale and exhale spontaneously.

The user sets the oxygen and flow rate.² It is also important to control the temperature and humidity of the gas delivered to the patient.

Depending on the circuit and interface resistance, higher pressures may be required to deliver the set flow. Pressure is measured inside the ventilator. If pressure exceeds the high pressure limit of 50 cmH₂O, the gas flow stops immediately and pressure is released.

Flow resumes after 8 seconds (Adult/Ped) or 4 seconds (Neonatal) at the set flow rate.

This respiratory support is usually delivered through a nasal cannula, with the flow exceeding the patient's peak inspiratory flow to provide inspired oxygen of up to 100%, while allowing the patient to talk, drink, or eat during the therapy.

High flow oxygen therapy can be delivered using single or double limb breathing circuits, using a high-flow nasal cannula or a tracheal adapter/tracheal mask to enable the patient to exhale.

For details on using the therapy, see Section 1.1.

Figure 1 High flow oxygen therapy: Breathing pattern and controls

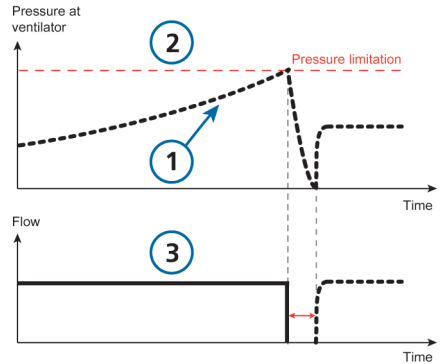

- | | |
|-----------------------|--------------------|
| 1 Pressure | 3 Flow |
| 2 Pressure limitation | Oxygen (not shown) |

1.1 Working with high flow oxygen therapy

⚠ WARNING

- Do not use high flow oxygen therapy with a nasal mask, facial mask, a helmet with a dual limb breathing circuit, or any interface that increases patient dead space volume. Ensure the interface allows the patient to exhale.
- The ventilator is a high-flow device that can operate at a flow setting greater than 80 l/min and with a high oxygen concentration. Ensure the ventilator's gas pipeline system does not exceed the pipeline design flow capacity. If the system exceeds the flow capacity, it can interfere with the operation of other equipment using the same gas source.
- Always use active humidification during high flow oxygen therapy.

1. Optional, not available in all markets.

2. In some markets, Flow is limited to 50 l/min.

CAUTION

- Expiration over the expiratory valve is not possible when using high flow oxygen therapy.
- Use only interfaces intended for high flow oxygen therapy that allow the patient to exhale, such as a nonocclusive high-flow nasal cannula, tracheal adapter, or tracheal mask.
- Do not use high flow oxygen therapy with a closed breathing circuit, an endotracheal tube, or directly connected to a tracheal cannula as it may expose the patient to risk and excess pressure. Ensure the interface allows the patient to exhale.

NOTICE

- The SpO₂ trend graph and plethysmogram are only available when the SpO₂ option is enabled.
- The SpO₂ option is *not* available for the HAMILTON-MR1.

High flow oxygen therapy is indicated for adult, pediatric, and neonatal patients.

1.1.1 Connecting the patient

Figure 2 shows a typical adult/pediatric breathing circuit set.

- ▶ Connect the components as appropriate for your patient.

Figure 2 High flow oxygen therapy breathing circuit set

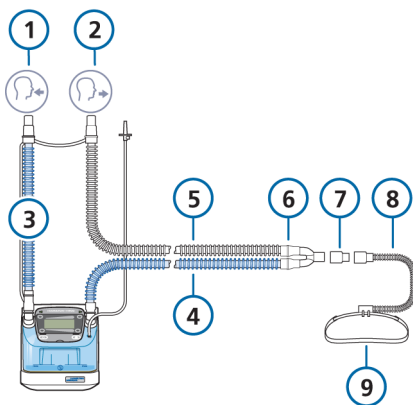

- | | |
|---|---|
| 1 To patient | 6 Y-piece (integrated with breathing circuit) |
| 2 From patient | 7 Adapter |
| 3 Inspiratory limb (blue) to humidifier | 8 Nasal cannula |
| 4 Heated inspiratory limb (blue) with temperature sensor to patient | 9 Attachment strap |
| 5 Expiratory limb (white) | |

After assembly, position the breathing circuit so that the hoses will not be pushed, pulled, or kinked as a result of patient movement, transport, or other activities, including scanner bed operation and nebulization.

1.1.2 Delivering high flow oxygen therapy

Note that you must be in Standby to change the mode.

1. Set up the patient with an appropriate breathing circuit. Figure 2 shows a noninvasive circuit set.
2. Place the ventilator in Standby and open the Modes window.
3. Touch the **HiFlowO2** button and touch **Confirm**.

The Controls > Basic window opens.

Be sure to carefully read the safety information displayed in the window:



Use only interfaces intended for high flow O2.

The use of unsuitable interfaces poses a risk to the patient.

Active humidification is mandatory.

4. Set the desired values for Oxygen and Flow, then touch **Confirm**.
You can change these settings any-time.
The Standby window is displayed, showing the **Start therapy** button.
5. Perform the preoperational checks as described in your ventilator *Operator's Manual*.
6. In the Standby window, touch **Start therapy** to begin the high flow oxygen therapy.

The main display changes to show the following safety information about high flow oxygen therapy, and a Control flow/Oxygen trend graph (Figure 3).



Hi Flow O2 therapy

No apnea detection!

No disconnection detection!

For details on selecting the graph to display, see Section 1.2.

Figure 3 High flow oxygen therapy display, Flow/Oxygen Trend view

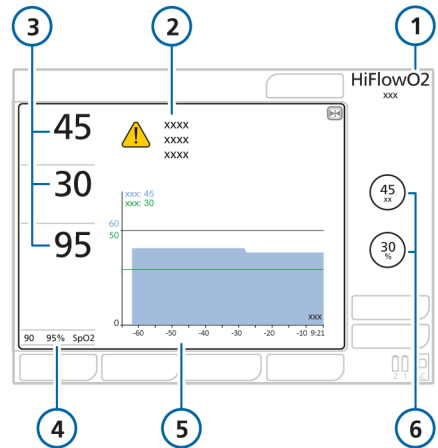

- | | |
|---|--|
| 1 HiFlowO2 mode active | 4 SpO2 low alarm limit, current value ^a |
| 2 Safety information | 5 Selectable graph (Flow/Oxygen trend shown) |
| 3 MMPs: Control Flow, Oxygen, SpO2 ^a | 6 Flow and Oxygen controls |

a. When the SpO2 option is enabled. The SpO2 option is *not* available for the HAMILTON-MR1.

1.2 Changing the high flow oxygen therapy display

Any of the following graphs can be displayed when delivering high flow oxygen therapy:

- Flow/Oxygen trend, the default (Figure 3)
- SpO2/Oxygen trend¹
- Plethysmogram (Figure 4)¹

You can also disable graphs altogether. Other elements of the display are not adjustable.

To change the display in HiFlowO2 mode

1. Touch the graph.

The graphics selection window appears.
2. For the Trends graph (Figure 3):
 - a. Touch the **Trends** tab.
 - b. Select the desired trend option and touch **Confirm**.
3. For the plethysmogram (Figure 4):
 - a. Touch the **Waveforms** tab.
 - b. Touch the **Plethysmogram** button.

The window closes and the selected graph is displayed.

Figure 4 High flow oxygen therapy display, Plethysmogram view (1)

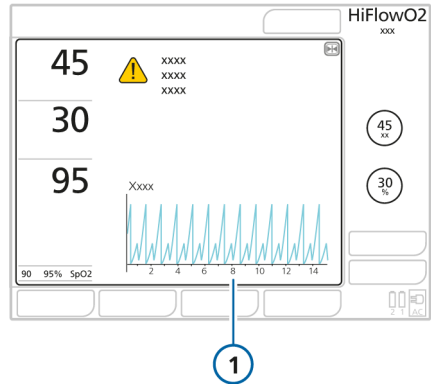

To disable graphs

1. In the graphics selection window, touch the **Waveforms** tab.
2. Touch the **Off** button.

The window closes; the graph area is empty.

1.3 Alarms in HiFlowO2 mode

The following alarm is specific to the HiFlowO2 mode.

Table 1 HiFlowO2-mode-specific alarms

Alarms	Description
Check patient interface	The pressure has reached the limit of 50 cmH2O.
<i>High priority</i>	The flow stops while the device releases pressure. After a set time (8 seconds Adult/Ped , 4 seconds Neonatal), the flow restarts.

1. When the SpO2 option is enabled. The SpO2 option is *not* available for the HAMILTON-MR1.

When using LPO, or HPO with the **Set oxygen alarm limits manually** option selected (Section 6.1.1), you can adjust the high/low **Oxygen** limits in the **Alarms > Limits 2** window.¹

1.4 Parameters monitored in HiFlowO2 mode

When high flow oxygen therapy is in progress, the following parameters are monitored²:

- Oxygen
- PEEP/CPAP
- Control Flow (in trend and as MMP)
- SpO2 related (when enabled)

The specifications for the **Control Flow** parameter are provided in Section 9.1. Specifications for the other parameters are provided in your ventilator *Operator's Manual*.

1.5 Functions unavailable in HiFlowO2 mode

The following functions are deactivated when HiFlowO2 mode is selected:

- Inspiratory hold
- Manual breath
- Suctioning tool
- Pneumatic nebulizer

Note that you must be in Standby to change the mode.

1. In HiFlowO2 mode, the **Alarms > Limits 1** tab is not displayed.
2. If flow sensor or pressure line is connected. With high flow oxygen therapy, PEEP/CPAP indicates the pressure at the patient interface.

2 Compatibility with speaking valves

A speaking valve allows certain tracheostomized adult and pediatric patients to communicate verbally, in addition to numerous other clinical benefits.

2.1 Compatible modes

Speaking valve compatibility is an option available for **Adult/Ped** invasive ventilation when using any of the following modes: **PCV+**, **PSIMV+**, and **SPONT**.

2.2 Setting up the patient

Set up the patient in the following order:

Table 2 Patient setup with speaking valve

To ...	See ...
Connect speaking valve	
Select a compatible mode.	Section 2.1
Activate speaking valve compatibility.	Section 2.3
Deflate the tracheostomy cuff.	
Connect the speaking valve to the breathing circuit set and patient.	Section 2.4
Review control settings and alarm limits.	Sections 2.6, 2.7
Start ventilation Touch the Start ventilation button.	--
Remove speaking valve	
Remove speaking valve.	
Deactivate speaking valve compatibility.	Section 2.5
Inflate tracheostomy cuff.	

Table 2 Patient setup with speaking valve

To ...	See ...
Review control settings and alarm limits.	Sections 2.6, 2.7

2.3 Activating speaking valve compatibility

CAUTION

- Do not leave the patient unattended when speaking valve compatibility is activated and a speaking valve is connected to the patient.
- When compatibility is activated:
 - Apnea backup ventilation is disabled.
When compatibility is turned off, apnea backup ventilation returns to its previous setting.
 - Some alarm limits are changed and some alarms are disabled. For details, see Table 3.
 - Some changes apply to monitoring parameters. For details, see Section 2.7.

NOTICE

If PEEP > 0, auto-triggering can occur while using a speaking valve.

By default, speaking valve compatibility is deactivated (OFF).

Figure 5 SpeakValve window

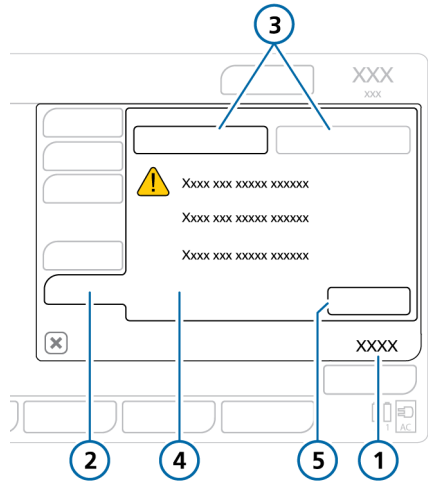

- | | |
|-----------------------------------|--------------------------------|
| 1 Controls | 4 Important safety information |
| 2 SpeakValve | 5 Apply |
| 3 SpeakValve ON
SpeakValve OFF | |

To activate the use of a speaking valve with the ventilator

1. Open the Controls window.
2. Touch the **SpeakValve** tab.
Be sure to carefully read the safety information displayed in the window.
3. Be sure to do the following:
 - a. Deflate the tracheostomy cuff.
 - b. Connect a speaking valve.
4. To activate compatibility, touch the **SpeakValve ON** button, then touch **Apply**.
Consider setting PEEP to 0 while compatibility is activated.

As long as compatibility is activated, the message **SpeakValve ON** is displayed and the following safety messages are shown in the SpeakValve window:



The tracheostomy cuff must be completely deflated prior to connecting a speaking valve.

Disconnection alarms and the Inspiratory limitation alarm are disabled. The Vt alarms are based on VTI. The ExpMinVol alarm limits are set to OFF.

Apnea backup ventilation is disabled.

2.4 Connecting a speaking valve to the breathing circuit set

Connect the speaking valve between the flow sensor and the patient interface.

Pay careful attention to any safety information and requirements for cuff deflation.

For connection details, refer to the speaking valve manufacturer's *Instructions for use*.

2.5 Deactivating speaking valve compatibility

In some cases, compatibility is automatically deactivated. See Section 2.5.1.

To deactivate speaking valve compatibility

1. Touch the **SpeakValve OFF** button, then touch **Apply**.
2. Be sure to do the following:
 - a. Remove the speaking valve.
 - b. Inflate the cuff.

When compatibility is deactivated (OFF), the following safety messages are shown in the SpeakValve window:



Remove the speaking valve, deactivate speaking valve compatibility, and inflate the tracheostomy cuff.

All alarms are enabled. The Vt alarms are based on VTE.

Apnea backup ventilation is enabled.

Upon deactivation, alarms and monitoring parameters return to their previous operation. The ExpMinVol alarm limits are reset based on the patient's IBW. See Sections 2.7 and 2.8.

2.5.1 Mode changes that automatically turn off compatibility

The following actions *automatically deactivate* speaking valve compatibility:

- Entering Standby
 - You must manually reactivate compatibility when restarting ventilation, if desired.
- Selecting a mode that does not support use of a speaking valve (see list in Section 2.1).
- Entering Safety or Ambient mode

Note that upon automatic deactivation, the message **SpeakValve OFF** is displayed in the ventilator message bar¹. See Table 3.

1. Except in Safety or Ambient mode.

2.6 Control setting-related changes

In PSIMV+ and SPONT modes, the control setting **TI max** is now available in the Controls > More window when speaking valve compatibility is activated (ON).

When speaking valve compatibility is deactivated (OFF), **TI max** is unavailable in these modes.

2.7 Alarm-related changes

The alarms listed in Table 2 are related to speaking valve compatibility.

Table 3 Speaking-valve-related alarm conditions

Alarm	Status
SpeakValve ON	
SpeakValve ON <i>Low priority</i>	Always displayed as long as compatibility is activated.
Vt low <i>High priority when SpeakValve is ON</i>	This alarm can indicate that the cuff is still inflated. Based on delivered volume instead of exhaled volume; alarm is generated when VTI is below the limit.
Check patient interface <i>High priority</i>	Generated when the Vt low or Low pressure alarm is active. Check patient interface for: <ul style="list-style-type: none"> • Disconnection • Whether cuff is fully deflated • Upper airway occlusion • Speaking valve is operating properly

Table 3 Speaking-valve-related alarm conditions

Alarm	Status
ExpMinVol low ExpMinVol high	Automatically set to OFF.
Disconnection ventilator side Disconnection patient side	Suppressed. If the low pressure limit is appropriately set, when a disconnection occurs, a Low pressure alarm is generated.
Inspiratory volume limitation	Suppressed.
SpeakValve OFF (after being enabled)	
Volume related	Upon deactivation, all volume-related alarm limits are reset based on the patient's IBW .
SpeakValve OFF <i>Low priority</i>	Displayed when compatibility has been automatically deactivated. Confirm the change in status by pressing the Audio pause key.
ExpMinVol low and high	Reset based on the patient's IBW .

2.8 Parameters monitored when compatibility is activated

When speaking valve compatibility is activated, the following changes related to monitoring parameters apply.

- The following monitoring parameter values are invalid when compatibility is activated and only show dashes (---):

AutoPEEP	PTP
Cstat	RCexp
Exp Flow	Rinsp
ExpMinVol	VLeak
MVLeak	VTE
P0.1	VTESpont
Pmean	Vt/IBW
Pplateau	

- If VTE is set as a main monitoring parameter (MMP), VTI is displayed instead.

Upon deactivation of compatibility, VTE is again displayed.

If *both* VTI and VTE are selected as MMPs, when compatibility is activated the VTE MMP is invalid and shows dashes (---).

- Apnea backup ventilation is disabled when compatibility is activated. Once deactivated, apnea backup ventilation returns to its previous setting.

3 ASV-related changes

ASV 1.1¹ is now the default setting for ASV mode. The previous version of ASV is also available on the device, in Configuration.

To select the ASV version

- In the Configuration > Modes > General > Philosophy window, select either **ASV 1.1** (default) or **ASV**.

3.1 Differences between ASV and ASV 1.1

ASV 1.1 extends the use of ASV with the following additional features and changes:

- Increased target rate and reduced tidal volumes for the majority of patients compared to standard ASV.
- VT_{max} is limited to 15 ml/kg in cases of high time constants and high minute volumes.

1. Not available in all markets.

4 Use of adult/pediatric flow sensor with neonatal/pediatric breathing circuits

NOTICE

- Only use a neonatal/pediatric breathing circuit with an adult/pediatric flow sensor when the patient IBW is 20 kg or below; otherwise, flow sensor calibration may fail.
- For breathing circuit specifications, see Table 4.

With small pediatric patients whose IBW is below 20 kg, using an adult/ped breathing circuit can generate too much dead space, resulting in ineffective ventilation.

For these patients, consider using a neonatal/pediatric breathing circuit with an adult/pediatric flow sensor instead, that meets the specifications in Tables 4 and 18.

Table 4 Breathing circuit component specifications

Parameter/component	Specifications
Patient group	Adult/Ped
Patient height (cm)	30 to 112
IBW (kg)	3 to 20
Breathing circuit tube ID (mm)	12 to 15
Flow sensor	Adult/pediatric
CO2 airway adapter	Adult/pediatric

To use an adult/pediatric flow sensor with a neonatal/pediatric breathing circuit

1. Verify that the Adult/Ped patient group is selected.
2. Verify that the patient IBW is below 20 kg.
3. Set up the ventilator for adult/pediatric ventilation, but connect a neonatal/pediatric breathing circuit.
4. Perform the tightness test, calibrate the flow sensor, and perform other pre-operational checks as described in your ventilator's *Operator's Manual*.
5. Connect the patient.
6. Start ventilation.

5 User-interface (display) and software changes

Table 5 Summary of user-interface changes

For details about ...	See ...
Sensor window changes	Section 5.1
Tools window changes	Section 5.2
Patient window changes	Section 5.3
Configuration changes	Section 5.4
IntelliSync label change	Section 5.5
O2 sensor calibration	Section 5.6

5.1 About the System > Sensors window

The Sensors on/off window has been renamed Sensors and offers two buttons: **On/Off** for sensor selection and **SpO2¹** for SpO2 sensor settings (see Section 8).

To enable sensor monitoring

1. Open the System > Sensors window and touch the **On/Off** button.
2. Select the appropriate checkboxes (O2 sensor, CO2, SpO2) to enable/disable the monitoring functions, as desired.

The ventilator always enables O2 monitoring (O2 sensor checkbox is selected) upon restart.

Figure 6 Sensors > On/Off window

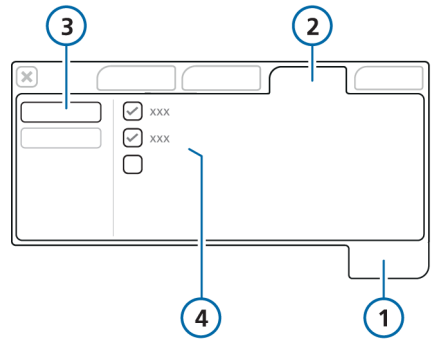

- | | |
|-----------|---|
| 1 System | 3 On/Off |
| 2 Sensors | 4 Sensor options (O2 sensor, CO2 ¹ , SpO2 ¹) |

5.2 About the Tools window

The **Utilities** button has been renamed **Tools**. The following options are available in the Tools window: Gas source, Set Oxygen alarm limits manually, Export logs, and Configuration.

1. If the option is installed.

5.3 About the Patient window

The Patient window provides access to patient settings during ventilation and to the ventilation timer (Section 5.3.2).

5.3.1 Adjusting patient settings during ventilation

NOTICE

If patient data is changed during active ventilation, **ONLY** the following settings are automatically updated by the device:

- Apnea backup settings (if backup is set to **Automatic**)
- Startup values for **Safety mode**
- Other control settings and alarm limits are *not* updated

After setting up a new patient and starting ventilation, you can adjust the sex and patient height (**Adult/Ped**), or weight (**Neonatal**) in the Controls > Patient window.¹

Adjusting adult/pediatric data changes the calculated IBW.

Figure 7 Patient window

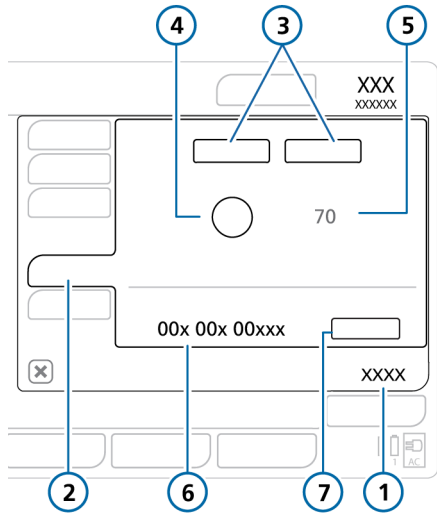

- | | | | |
|---|---------------------------------------|---|----------------------------|
| 1 | Controls | 5 | Calculated IBW (Adult/Ped) |
| 2 | Patient | 6 | Ventilation time |
| 3 | Sex (Adult/Ped) | 7 | Reset |
| 4 | Height (Adult/Ped), Weight (Neonatal) | | |

To access the Patient window

- ▶ Touch the **Controls** button, then the **Patient** tab.

1. In some markets, the **Patient** tab is only available when ventilating in ASV mode.

5.3.2 About the ventilation timer

The Controls > Patient window displays a timer that shows how long the patient has been ventilated^{1,2}.

The timer records time as follows:

- The timer starts when you start ventilation.
- When you enter Standby, the timer pauses. It picks up again from the last value when you exit Standby and return to active ventilation.
- When you set up a new patient in the Standby window and start ventilation, the timer resets to 0.
- When you select **Last Patient** in the Standby window, the timer continues from the last total time recorded.
- When you touch the **Reset** button, the timer resets to 0.

When the timer is reset, an entry is made to the Event log recording the time of the reset, as well as how long the ventilator had been running prior to the reset.

To reset the timer to 0

1. Open the Controls > Patient window.
2. Touch the **Reset** button.
The timer starts again at 00d 00h 00min.

5.4 Configuration changes

The Configuration > General > More window now shows the following message when you change the communication protocol:

Please wait 10 seconds and restart the device after changing the protocol.

The Configuration window now shows all installed options in a single window. Use the scroll bar if needed.

5.5 IntelliSync label change

The label *IntelliSync* in the Controls window (when available) has been renamed *PSync*.

5.6 O2 sensor calibration

CAUTION

When using an oxygen supply < 99% (HPO) or low pressure oxygen (LPO), calibrate the O2 sensor at 21%. This information is displayed in the Calibration window.

When calibrating the O2 sensor at 21% or when using LPO, be sure to disconnect the oxygen supply before calibration.

For details, see your ventilator *Operator's Manual*.

1. Not available in all markets.

2. The ventilation timer does not record time during High flow oxygen therapy.

6 Ventilator alarms and settings updates

Table 6 Summary of updates to ventilator alarms and settings

For details about ...	See ...
HiFlowO2 alarm	Section 1.3
Speaking valve alarms	Section 2.7
Oxygen alarm changes	Section 6.1
Battery alarm changes	Section 6.2
Vt low alarm limit ^a	Section 6.3
IBW/Weight in alarm limits	Section 6.3
Reset button in alarms	Section 6.3

a. Not available in all markets.

6.1 Changes to oxygen supply and setting the Oxygen alarm limits

The following changes have been made to oxygen supply settings and setting the Oxygen alarm limits when using a high-pressure oxygen (HPO) gas source:

- The selected gas source setting (HPO or LPO) is active until manually changed, regardless of whether the device is restarted.
- When using high-pressure oxygen (HPO gas source), you can choose whether to:
 - Set the Oxygen high/low alarms manually¹ using the **Set Oxygen alarm limits manually** checkbox.

- Have the device automatically set the **Oxygen** alarm limits to the *current setting ± 5%*, the same as in software version 2.1.x. This is the default setting.

- The setting (manual or auto) is active until manually changed, regardless of whether the device is restarted.
- When using low-pressure oxygen (LPO)², the alarm limits are always set manually.

6.1.1 Setting the Oxygen alarm limits when using HPO

Figure 8 Setting Oxygen alarm limit options with HPO³

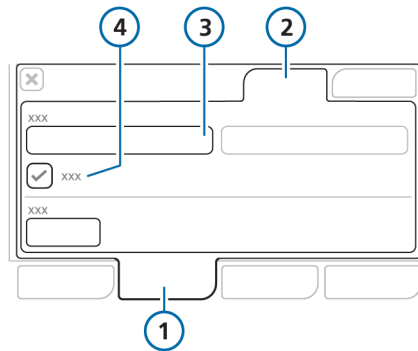

- | | |
|-------------|---|
| 1 Tools | 3 Gas source: HPO |
| 2 Utilities | 4 Set Oxygen alarm limits manually checkbox selected |

1. Not available in all markets.

2. Not available on HAMILTON-MR1.

3. Not available in all markets.

To enable manual adjustment of Oxygen alarm limits in HPO mode

1. In the Tools > Utilities window, select **HPO** as the gas source.
2. To set the Oxygen alarm limits, touch the **Set Oxygen alarm limits manually** checkbox.

When selected, the Oxygen alarm control is enabled in the Alarms > Limits 2 window.

3. To have the limits set automatically, ensure the checkbox is clear.

See your ventilator *Operator's Manual* for details about the Oxygen alarm limits.

6.2 Battery alarm changes

The following changes have been made to the battery alarms.

6.2.1 Battery low alarm update

The Battery low alarm limits are now calculated values and depend on battery age and condition. The alarm priority levels are defined as follows.

Table 7 Battery low alarm priority levels

Battery Low alarm	Definition
High priority	The ventilator is running on battery power, and the battery charge is critically low. You have a minimum of 5 minutes operating time left. If the high-priority Battery low alarm occurs when starting up the ventilator, you may have less than 5 minutes of operating time remaining.
Medium priority	The ventilator is running on battery power and the battery charge is low.

Table 7 Battery low alarm priority levels

Battery Low alarm	Definition
Low priority	The ventilator is running on primary power and the battery charge is low.

6.2.2 Battery troubleshooting update

Added disposal guidelines related to battery replacement. This change applies to the Alarm Troubleshooting table in the *Operator's Manual*.

Table 8 Alarm troubleshooting update

Alarm message	Definition/Action needed
Battery 1, 2: replacement required	<p><i>Low priority.</i> Battery condition is inadequate for reliable operation and must be replaced immediately.</p> <p>Action needed</p> <ul style="list-style-type: none"> • Replace the battery. • Consider sending the removed battery to your technical service representative. They can evaluate whether the battery can be recalibrated for reuse. <p>Follow all local, state, and federal regulations with respect to environmental protection when disposing of the battery.</p> <p>For details about battery maintenance, see your ventilator <i>Operator's Manual</i>.</p>

6.3 Alarm-related updates and corrections

The following updates have been made.

- The **Vt low** alarm limit can now be set to **OFF**¹ for all patient groups.
- When changing from a mode in which alarm limits can be set to **OFF** to a mode in which they cannot, the affected alarm limits are set based on the patient's **IBW (Adult/Ped)** or **weight (Neonatal)** in the new mode.
- The **Reset** button in the Alarms > Buffer window has moved to the bottom of the window.

The following table provides troubleshooting updates for alarms.

Table 9 Alarm troubleshooting update

Alarm message	Definition/Action needed
External flow sensor failed	<p>High priority. The external flow sensor does not work properly.</p> <p>Upon sensing a flow sensor failure, the device automatically switches to PCV+ mode and uses internal sensors only.</p> <p>Once the issue is corrected, the device returns to the original ventilation mode.</p> <p>Action needed</p> <ul style="list-style-type: none"> • Check the flow sensor tubing • Replace the flow sensor and perform calibration <p>For details about the flow sensor and calibration, see your ventilator <i>Operator's Manual</i>.</p>

Table 9 Alarm troubleshooting update

Alarm message	Definition/Action needed
Release valve defective	<p>The release valve is not operating properly.</p> <p>Action needed</p> <p>Have the ventilator serviced.</p>

The following table provides corrections for adjustable alarm ranges for the **Neonatal** patient group.

Table 10 Adjustable alarm corrections for Neonatal patient group

Alarm	Correction
Apnea time (s)	<p>Cannot be set to OFF.</p> <p>The default apnea time for neonatal patients has been changed to 5 seconds.</p>
Pressure high (Pmax) (cmH2O)	<p><i>nCPAP, nCPAP-PC:</i> 10 to 55</p> <p><i>APRV:</i> 15 to 55</p> <p><i>other modes:</i> 18 to 55</p>
Pressure, low (cmH2O)	<p><i>nCPAP, nCPAP-PC:</i> 2 to 55</p> <p><i>other modes:</i> 4 to 55</p>
Pressure limitation (cmH2O)	<p><i>nCPAP, nCPAP-PC:</i> Pmax</p> <p><i>APRV:</i> 5 to 45</p> <p><i>other modes:</i> 8 to 45</p>

1. Not available in all markets.

7 Graphics-related changes

The following updates have been made.

- PetCO₂ and FetCO₂ values are shown next to the associated CO₂ waveform, when displayed.
- The axes on the Volume Flow loop have been swapped. Volume is now on the x-axis, flow is on the y-axis.
- Adjusting the timescale of waveforms (Section 7.1).

7.1 Adjusting the time scale of a waveform

NOTICE

Changing the scale of one waveform affects *all* waveforms displayed in the current layout.

Scale refers to the displayed values of the time axis of a waveform.

The x-axis represents time, while the y-axis can represent a variety of parameters such as tidal volume, pressure, flow and so on. You can change the scale of any waveform.

A scale value refers to the length of the x-axis. For example, a scale value of 12 means that the x-axis displays the waveform from 0 to 12 seconds.

The following scaling options, in seconds, are available:

- Adult/Ped: 6, 12, 18, 24, 30
- Neonatal: 3, 6, 12, 18, 24

Figure 9 Waveforms window

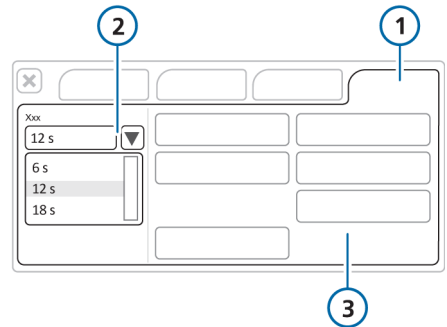

- 1 Waveforms 3 Waveform options
2 Time scale selection

To change the time scale

1. Touch the waveform to adjust.
The Waveforms window opens.
2. Touch the **Time scale** arrow button (2), and select the desired time scale from the list.
3. Touch the waveform value (3) to plot against time.
Once the selection is made, the window closes and the selected waveform is displayed.

For additional details about graphics, see your ventilator *Operator's Manual*.

8 Pulse-oximetry-related changes

The following changes have been made to SpO2 pulse oximetry:

- Added support for Nihon Kohden SpO2 sensors, including related ventilator settings.
- Masimo SpO2 sensors and cables offer a specified operation time period. Integration with the expiration information has been added.
- A new parameter, PVI, for Masimo SET sensors is now supported.
- Support for Masimo rainbow SET has been added.¹

For details, see the *Pulse Oximetry Instructions for Use*.

All documentation related to pulse oximetry is now provided in a separate document, the *HAMILTON-C1/T1 Pulse oximetry Instructions for use*.

Remove the *Pulse oximetry* appendix from your ventilator *Operator's Manual* and replace it with the new *Instructions for use*.

9 Control- and monitoring-parameter-related changes

Table 11 Alarm troubleshooting update

For details about ...	See ...
Parameters measuring tidal volume by IBW for adult/pediatric patients, and tidal volume by body weight for neonates have been added.	Table 13
For HiFlowO2 mode, addition of Flow parameter (labeled Control Flow for monitored value).	Tables 12, 13, and Section 1.4
Added two monitoring parameters, Vt/IBW (Adult/Ped) and Vt/Weight (Neonatal).	Section 8.1

1. Not available in all markets.

9.1 Parameter specifications

Tables 13 and 12 provide new and updated parameter specifications for monitoring and control parameters.

Table 12 Control parameters, definition, range, and accuracy

Parameter (unit)	Definition	Range	Default	Accuracy	Resolution
Flow (l/min)	<i>HiFlowO2 mode only.</i> Set the flow of gas to the patient.	<i>Adult/Ped:</i> 2 to 80 <i>Neo:</i> 2 to 12	<i>Adult/Ped:</i> 15 <i>Neo:</i> 2	±10% or ± 1 l/min, whichever is greater	1
TI max (s)	When speaking valve compatibility is activated (ON), the control setting TI max is available in PSIMV+ and SPONT modes, in the Controls > More window. For ranges, defaults, and other data, see your ventilator <i>Operator's Manual</i> .				

Table 13 Monitored parameters, definition, range, and resolution

Parameter (unit)	Definition	Range	Resolution
Control Flow (l/min)	<i>HiFlowO2 mode only.</i> The set flow of gas to the patient.	<i>Adult/Ped:</i> 2 to 80 <i>Neo:</i> 2 to 12	1
Vt/IBW (ml/kg)	Tidal volume is calculated according to ideal body weight (IBW) for adult/pediatric patients	<i>Adult/Ped:</i> 2 to 20	0.1
Vt/Weight (ml/kg)	Tidal volume is calculated according to patient weight for neonatal patients	<i>Neo:</i> 2 to 20	0.1

10 Safety message updates

Safety messages have been updated in the following areas:

- Noninvasive modes
- SpO2 pulse oximetry
- Battery
- Device-specific additions

Noninvasive ventilation safety

The following safety messages for contraindications working with noninvasive modes have been updated as follows:

WARNING

Do not place an HMEF between the flow sensor and the patient as doing so limits the ventilator's ability to identify disconnection at the patient, including displacement of a mask or nasal interface.

CAUTION

If you place an additional component, such as an HMEF, between the flow sensor and the patient, the additional resistance limits the ventilator's ability to identify disconnection at the patient.

To correctly identify a patient disconnection, be sure to appropriately set the lower limit of the Pressure alarm, as well as the Volume alarms limits, and carefully monitor the patient's SpO2 and PetCO2 values, if available.

Working with pulse oximeter (SpO2) safety

The following notice has been updated:

NOTICE

It is recommended that additional independent monitoring devices, including pulse oximeters measuring SpO2, be used during mechanical ventilation. The operator of the ventilator must still maintain full responsibility for the proper ventilation and patient safety in all situations.

Battery safety

The following caution applies to battery use:

CAUTION

Do not remove Battery 2 if the charge level of Battery 1 is below 20%.

Device-specific safety

The following warning applies to HAMILTON-C1 and HAMILTON-T1 use:

WARNING

Correct function of the device may be impaired by the operation of high-frequency surgical equipment, micro-waves, shortwaves, or strong magnetic fields in close proximity.

The following warning applies to HAMILTON-MR1 use:

WARNING

Correct function of the device may be impaired by the operation of high-frequency surgical equipment, micro-waves, or shortwaves in close proximity.

11 Parts and accessories

Table 14 Parts and accessories

Description	PN
For high flow oxygen therapy	
Adult/pediatric nasal cannula	
Size S (4 mm)	282495
Size M (5 mm)	282496
Size L (6 mm)	282497
Adult/pediatric nasal high flow cannula	
Size 1 (2.4 mm)	282521
Size 2 (4.2 mm)	282522
Size 3 (6.5 mm)	282523
Size 4 (10.0 mm)	282524
Neonatal oxygen nasal cannula	
Size 0	282510
Size 0.5	282511
Size 1	282512
Nasal cannula adapter	
Adapter, 22F/22F, box of 30	282509
Adapter, 10M/15M, box of 30	282519
Other	
HAMILTON-MR1 Transport kit	161140

12 Alarm volume changes

The alarm volume (loudness) levels have changed.¹

The information below updates Table A-12 in the ventilator *Operator's Manual* with the new volume levels.

Table 15 Alarm volume (loudness) levels^a

Setting	Sound level
1	62 dB(A) ±3 dB(A)
5	76 dB(A) ± 3 dB(A)
10	85 dB(A) ± 3 dB(A)

a. Measured according to IEC 60601-1-8, complying with type 1 instruments specified in IEC 61672-1.

13 Mounting-related changes for the HAMILTON-MR1

A Transport kit (PN 161140) for the HAMILTON-MR1 ventilator is available. The kit comprises:

- Universal Mount handle
- Mounting plate assembly, to attach the ventilator to the trolley or to a shelf

For details, see the *HAMILTON-MR1 Transport Kit User Guide* (PN 624939) and *Installation Guide* (PN 624991).

1. In some markets the alternative alarm volume (loudness) level may vary.

14 Corrections and updates to manuals

The following sections provide corrections to your software version 2.1.x ventilator *Operator's Manual*.

14.1 Minimum work of breathing calculation (Otis' equation)

The presentation of the formula for work of breathing (in Appendix C) has been corrected:

$$f = \frac{\sqrt{1 + 4\pi^2 RC_{rs} \frac{V'a}{Vd}} - 1}{2\pi^2 RC_{rs}}$$

where a is a factor that depends on the flow waveform. For sinusoidal flows, $a = 2\pi^2/60$.

$$f_p = \left(\frac{V'a}{Vd}\right)^{1/3} (2\pi RC)^{-2/3}$$

14.2 Breathing circuit set components

Note the following updates to the breathing circuit component tables.

These specifications supersede those provided:

- In *HAMILTON-C1/T1 Operator's Manuals*, Tables 2-1, 2-2, 5-2, and 5-3.
- In *HAMILTON-MR1 Operator's Manual*, Tables 2-1 and 6-1.

Table 16 Breathing circuit component specifications, Adult/Ped patient group

Patient data/ Component	Adult	Pediatric
Patient height (cm)	> 130	30 to 150
IBW (kg)	> 30	3 to 48
Tracheal tube ID (mm)	≥ 4	3 to 7
Breathing circuit tube ID (mm) ^a	15 to 22	10 to 22
Flow sensor	Adult/Ped	Adult/Ped
CO2 airway adapter	Adult/Ped ^b	Adult/Ped ^b

- When using coaxial breathing sets, follow the manufacturer's recommendations for each patient group.
- When tracheal tube ID > 4 mm.

Table 17 Breathing circuit component specifications, Neonatal patient group

Parameter/component	Specifications
Patient group	Neonatal
Weight (kg)	0.2 to 30
Tracheal tube ID (mm)	≤ 4
Breathing circuit tube ID (mm)	10 to 12
Flow sensor	Neonatal
CO2 airway adapter	Neonatal

14.3 Ventilator breathing system specifications

The breathing circuits used with the HAMILTON-C1/T1/MR1 ventilators must fulfil the following resistance and compliance specifications.

For detailed breathing circuit specifications, refer to the individual *Instructions for use* provided with the breathing circuits.

These specifications supersede those provided in Table A-11 of the ventilator *Operator's Manual*.

Table 18 General breathing circuit set specifications

Breathing circuit	Specifications by patient group
Resistance according to ISO 5367: 2014	Adult/Ped (15–22 mm ID) ≤ 0.06 cmH ₂ O/l/min at 30 l/min
	Adult/Ped (12–15 mm ID) ≤ 0.12 cmH ₂ O/l/min at 15 l/min
	Neonatal (9–12 mm ID) ≤ 0.12 cmH ₂ O/l/min at 15 l/min
Compliance according to ISO 5367: 2014	Adult/Ped (15–22 mm ID) ≤ 4.0 ml/cmH ₂ O at 60 cmH ₂ O ± 3 cmH ₂ O
	Adult/Ped (12–15 mm ID) ≤ 4.0 ml/cmH ₂ O at 60 cmH ₂ O ± 3 cmH ₂ O
	Neonatal (9–12 mm ID) ≤ 1.5 ml/cmH ₂ O at 60 cmH ₂ O ± 3 cmH ₂ O

14.4 CO₂ sensor/adapter calibration updates

HAMILTON-C1/T1 only. In Section 3.3.2.4, the Caution is missing a word; see correction below.

⚠ CAUTION

Always calibrate the CO₂ sensor with the airway adapter attached.

Important notes for successful calibration

During calibration:

- When the ventilator is connected to AC power, do *not* hold the sensor/adapter in your hand during calibration.
- Place the sensor/adapter away from all sources of CO₂ (including the patient's and your own exhaled breath) and the exhaust port of the expiratory valve.

14.5 Freeze and cursor measurement

The description of freeze and cursor measurement in Section 6.8 of the ventilator *Operator's Manual* has been updated as follows:

- This function lets you freeze the display of the graphic for up to 30 seconds.

14.6 Symbols used on device labels and packaging

Symbol	Definition
	Medical device

14.7 Alarm indications

The Medium priority description in Table 8-1 of the ventilator *Operator's Manual* has been corrected as follows:

Table 19 Alarm audio indicators

Alarm type	Audio
Medium priority	A sequence of 3 beeps, repeated periodically.

14.8 Corrections to specifications

The following sections provide corrections to specifications and details provided for alarms, waveforms, TeslaSpy (HAMILTON-MR1 only), and monitoring and control parameters.

14.8.1 Corrections to real-time waveforms and loops

Table 20 Corrected specifications for real-time waveforms and loops

Parameter	Range
Real-time waveforms	
Pressure (cmH ₂ O) / time (s)	-10 to 80 Scale -10 to 20, -10 to 40 (default), -10 to 80
Volume (ml) / time (s)	0 to 3200 Scale 0 to 5, 0 to 10, 0 to 25, 0 to 50 (Neonatal default), 0 to 100, 0 to 200, 0 to 400, 0 to 800 (Adult/Ped default), 0 to 1600, 0 to 3200

Table 20 Corrected specifications for real-time waveforms and loops

Parameter	Range
Flow (l/min) /time (s)	-300 to 300 Scale ±2.5, ±5, ±10 (Neonatal default), ±15, ±25, ±45, ±75 (Adult/Ped default), ±150, ±300
Loops	
Pressure/Volume x-axis: cmH ₂ O y-axis: ml	-10 to 80 0 to 3200
Volume/Flow x-axis: ml y-axis: l/min	0 to 3200 -300 to 300

14.8.2 Addition to TeslaSpy specifications (HAMILTON-MR1 only)

Table 21 HAMILTON-MR1 TeslaSpy alarm loudness

Parameter	Specification
TeslaSpy alarm loudness (dB(A))	75 ±3

14.8.3 Corrections to parameter information

CAUTION

The minimum inspiratory pressure ($P_{peak} - PEEP$) in APVsimv and APVcmv modes is 5 cmH₂O. Be aware that a low set tidal volume with high lung compliance may lead to unexpectedly high tidal volumes.

Table 22 Parameter accuracy corrections for Neonatal patient group

Parameter	Accuracy
Insp Flow, peak	Neo: $\pm 10\%$ or 2 ml/s, whichever is greater
Exp Flow, peak	

Tables 23 and 24 provide corrected information related to monitoring and control parameter value ranges.

Table 23 Corrections to monitored parameters, definition, range, and accuracy

Parameter (unit)	Definition	Range	Accuracy
Cstat (ml/cmH2O)	Static compliance of the respiratory system, including lung and chest wall compliances. It is calculated using the LSF method.	<i>Adult/Ped:</i> 0 to 300 <i>Neo:</i> 0 to 300	--
P0.1 (cmH2O)	Airway occlusion pressure. The maximum slope of the airway pressure drop during the first 100 ms when the airway is occluded.	<i>Adult/Ped:</i> -99 to 0 <i>Neo:</i> -99 to 0	--
Oxygen (%)	Oxygen concentration of the delivered gas.	<i>Adult/Ped:</i> 18 to 105 <i>Neo:</i> 18 to 105	± (volume fraction of 2.5% + 2.5% gas level)
Oxygen consumption (l/min)	Current oxygen consumption rate.	<i>Adult/Ped:</i> 0 to 300 <i>Neo:</i> 0 to 300	±10% or ±0.3 l/min, whichever is greater

Table 24 Corrections to control parameters, definition, range, and accuracy

Parameter (unit)	Definition	Range	Default	Accuracy	Resolution
Oxygen (%)	Oxygen concentration to be delivered. Applies to all breaths.	21 to 100	<i>Adult/Ped:</i> 50 <i>Neo:</i> 40	± (volume fraction of 2.5% + 2.5% gas level) ^a	1
Pasvlimit (cmH2O)	<i>Adult/Ped only:</i> The maximum pressure to apply in ASV mode.	<i>Adult/Ped:</i> 5 to 60 <i>Neo:</i> N/A	<i>Adult/Ped:</i> 30 <i>Neo:</i> N/A	±5% or ±1 cmH2O, whichever is greater	1
P high (cmH2O) <i>in DuoPAP</i>	High pressure (absolute pressure) in APRV and DuoPAP mode	<i>Adult/Ped:</i> 0 to 60 <i>Neo:</i> 3 to 45	<i>Adult/Ped:</i> 20 <i>Neo:</i> 20	±5% or ±1 cmH2O, whichever is greater	1 0.5
P high (cmH2O) <i>in APRV</i>	High pressure (absolute pressure) in APRV and DuoPAP mode	<i>Adult/Ped:</i> 0 to 60 <i>Neo:</i> 0 to 45	<i>Adult/Ped:</i> 20 <i>Neo:</i> 20	±5% or ±1 cmH2O, whichever is greater	1 0.5

Table 24 Corrections to control parameters, definition, range, and accuracy

Parameter (unit)	Definition	Range	Default	Accuracy	Resolution
Rate (b/min)	Respiratory frequency	<i>Adult/Ped:</i> 1 to 80	<i>Adult/Ped, IBW based on patient height.</i>	±1	1
		<i>APVcmv, PCV+: 4 to 80 PSIMV+, NIV-ST: 5 to 80</i>	<i>3.0 to 5.9 cm: 38 6.0 to 8.0 cm: 32 8.1 to 20.0 cm: 25 20.1 to 29.9 cm: 19 30 to 39 cm: 17 40 to 59 cm: 15 60 to 139 cm: 12</i>		
		<i>Neonatal: 1 to 80</i>	<i>Neonatal based on patient weight.</i>	±1	1
		<i>APVcmv, PCV+, PSIMV+ Psync, NIV-ST, APV-simv+ Apnea Backup: 15 to 80 nCPAP-PC: 10 to 80 PSIMV+: 5 to 80</i>	<i>0.2 to 1.25 kg: 60 1.26 to 3.0 kg: 45 3.1 to 5.9 kg: 35 6.0 to 8.9 kg: 30 9.0 to 20.5 kg: 25 21 to 30 kg: 20</i>		
Vt (ml)	Tidal volume, a control setting, an alarm setting and a monitored parameter in the Vent Status panel.	<i>Adult/Ped:</i> 20 to 2000	<i>Adult/Ped: 560 Based on IBW</i>	<i>Adult/Ped: ±10% or ±10 ml, whichever is greater</i>	5 (< 100) 10 (≥ 100 and < 1000) 50 (≥ 1000)
		<i>Neo: 2 to 300</i>	<i>Neo: 10 Based on body weight</i>	<i>Neo: ±10% or ±2 ml, whichever is greater</i>	0.1 (< 10) 1 (≥ 10 and < 100) 10 (≥ 100)

The accuracy of Pcontrol, PEEP/CPAP, Pinsp, P low, and Psupport has changed as follows:

Neo: ±5% or ±1 cmH2O, whichever is greater

- a. When using oxygen < 99%, accuracy is reduced based on the concentration of the oxygen source.



More information and free software simulation:

www.hamilton-c1.com



HAMILTON MEDICAL

Intelligent Ventilation since 1983



Hamilton Medical AG

Via Crusch 8, 7402 Bonaduz, Switzerland

+41 (0)58 610 10 20

info@hamilton-medical.com

www.hamilton-medical.com



medin Innovations GmbH

Adam-Geisler-Strasse 1

DE – 82140 Olching