

## PRECISIONMix<sup>®</sup> II System

308916L

ENG

**For proportional mixing of plural component coatings. For professional use only.**

Patent No. 5,368,059

Patent No. 6,554,204



### Important Safety instructions

Read all warnings and instructions in this manual.  
Save these instructions.  
See page 2 [Table of Contents](#).



Conforms to ANSI/UL  
standard 2279  
Class 1 Zone 0  
AExia II A T4

110474  
Certified to CAN/CSA  
22.2 No. E79–11



EExia II A T3  
ITS03ATEX21383



# Table of Contents

<b>Warnings</b> .....	1-1	<b>Power-up Checklist</b> .....	3-32
<b>Overview</b> .....	2-1	Checking Flow Control I/P Transducers .....	3-34
Using this Manual .....	2-3	Testing Flow Control External 4-20 mA Input Signal .....	3-35
Related Publications .....	2-4	<b>Pressure Test and Solvent Flush Procedure</b> .....	3-36
How the PrecisionMix Works .....	2-6	Test Color Valve Operation .....	3-36
Functional Diagrams .....	2-7	Pressure Test the Resin (A) Side .....	3-36
Flow Control Overview .....	2-8	Pressure Test the Catalyst (B) Side .....	3-36
Flow Control Features .....	2-8	Pressure Test the Solvent Lines .....	3-36
System Requirements .....	2-8	<b>Operation</b> .....	4-1
General Operation Sequence .....	2-8	Pressure Relief Procedure .....	4-3
One Gun Flow Control Using Component A and B Flow Meters .....	2-9	Operator Controls and Indicators .....	4-4
One Gun Flow Control Using a Flow Meter in the Mixed Material Line .....	2-10	Operator Station .....	4-4
Two Gun Flow Control .....	2-11	User Interface .....	4-6
Flow Control Components .....	2-12	Operating Checklist .....	4-7
Flow Control Parameters .....	2-13	Mode Switch .....	4-7
Using Recipes/Color Change .....	2-14	Purging the Ratio Check Valves .....	4-8
No Color Change .....	2-14	Purging the PrecisionMix II System .....	4-10
Integrated Color Change .....	2-14	Starting Production .....	4-12
Integrated Color Change with Queue .....	2-15	Stopping Production .....	4-14
Color Change Sequences .....	2-16	Flow Control Operation .....	4-15
Changing from One Color Change Sequence to Another .....	2-17	Integrated Color Change .....	4-16
Actual Valve Times .....	2-18	Multiple Gun Flush Box Operation .....	4-16
<b>Installation</b> .....	3-1	Printer Reports .....	4-17
Typical Installation .....	3-3	Run Mode Report .....	4-17
Non-intrinsically Safe .....	3-4	Recipe Report .....	4-18
Intrinsically Safe .....	3-5	System Setup (Configuration) Report .....	4-18
Robo-Mix .....	3-6	Job Totals Report .....	4-19
Fluid Supply Requirements .....	3-7	Batch Totals Report .....	4-19
Mounting Components .....	3-8	Grand Totals Report .....	4-20
For Wall Mounting .....	3-8	Alarm Report .....	4-20
Stand Mounting Kit 241501 .....	3-10	<b>Screen Map</b> .....	5-1
System Installation .....	3-12	<b>Run Monitor</b> .....	6-1
Install the Controller and User Interface .....	3-12	Home Screen .....	6-3
Power Requirements .....	3-13	Target/Actual .....	6-3
Install the Fluid Panel with Fluid Meters .....	3-14	Flow Rate .....	6-4
Install the Air Control Kit .....	3-15	Potlife Timer .....	6-4
Install the Operator Station .....	3-15	Flow Rate Setpoint .....	6-5
Install the Color/Catalyst Change Valves and Solenoids .....	3-16	Enter New Setpoint .....	6-5
Install the Gun Flush Box and Solenoid Box .....	3-18	Recipe Select .....	6-5
Install the Optional Flow Control .....	3-23	Alarm History .....	6-6
Fluid Connections .....	3-23	Integrated Color Change with Queue .....	6-7
Pressure Test and Solvent Flush the System .....	3-23	Modify Queue Screen .....	6-8
Component Electrical Connections .....	3-24	<b>Totalizers</b> .....	7-1
Controller Terminal Block .....	3-29	Home Screen .....	7-3
Ground the System .....	3-30	Select Recipe and Totalizer Screen .....	7-3
Check the Resistance .....	3-31	Job Totals .....	7-4
		Batch Totals .....	7-4
		Grand Totals .....	7-5

# Table of Contents

<b>System Configuration</b> .....	<b>8-1</b>	A Component Solvent Timer Value .....	8-24
Home Screen .....	8-3	B Component Dump Timer Value .....	8-25
Password Screen .....	8-3	B Component Solvent Timer Value .....	8-25
Menu Screen .....	8-4	Gun 1 Trigger Start/Duration Times .....	8-26
Language .....	8-5	Gun 2 Trigger Start/Duration Times .....	8-26
Station Number .....	8-5	Special 1-6 Trigger Start/Duration Times .....	8-27
Display Units of Measurement .....	8-6	PrecisionMix II Remote Interface .....	8-28
Recipes .....	8-6	Pressure Test and Solvent Flush the System .....	8-28
Potlife Timer .....	8-7	PrecisionMix II Remote Applications .....	8-28
Flow Rate Limits .....	8-7	Integrated Color Change .....	8-29
Solvent Meter .....	8-8	Non-integrated Color Change .....	8-30
Purge Sequence: Valves .....	8-8	Digital Inputs .....	8-31
Purge Sequence: Purge Alarms .....	8-9	Digital Outputs .....	8-33
Mixed Load Volumes .....	8-10	<b>Recipe Setup</b> .....	<b>9-1</b>
Guns Setup .....	8-10	Home Screen .....	9-3
Mix/Purge .....	8-11	Password Screen .....	9-3
Flow Control .....	8-11	Recipe Selection .....	9-4
Integrator Volume .....	8-12	Setup Menu with Integrated Color Change On and Flow Control On .....	9-5
Integrated Color Change .....	8-12	Setup Menu with Integrated Color Change and Flow Control Off .....	9-5
Password Selection .....	8-12	Mix Ratio and Tolerance .....	9-6
Time and Date Set .....	8-13	Color Change Sequence .....	9-7
Run Screen Monitor .....	8-13	Purge Sequence .....	9-8
Display Setup .....	8-14	System Alarms with Flow Control On and Hand Gun Selected .....	9-9
Print Setup .....	8-14	System Alarms with Flow Control On and Automatic Gun Selected .....	9-10
Air Flow Switch .....	8-15	System Alarms with Flow Control Off .....	9-10
Flow Control Setup .....	8-16	Meter Calibration Tests .....	9-11
Home Screen .....	8-16	Component A Flow Meter Calibration .....	9-12
Password Screen .....	8-16	Component B Flow Meter Calibration .....	9-13
Menu Screen .....	8-16	Mixed Material Calibration Screen .....	9-13
Flow Control Options .....	8-17	Solvent Flow Meter Calibration .....	9-14
Flow Control Menu .....	8-17	Gun 1 Meter Calibration .....	9-14
Source of Flow Control Data .....	8-18	Gun 2 Meter Calibration .....	9-14
Flow Control Scaling .....	8-18	Setup Flow Control .....	9-15
Flow Control Force Output .....	8-19	Gain Factor Graphs .....	9-16
Flow Control Delay Time .....	8-19	Flow Meter Calibration Procedure .....	9-17
Flow Control Meter Location .....	8-20	Selection 1, 2, or 4: Calibrating the Meters Individually .....	9-17
Integrated Color Change Setup .....	8-21	Selection 5 or 6: Calibrating Gun 1 or Gun 2 Meters .....	9-19
Home Screen .....	8-21	Selection 3: Mixed Material Calibration .....	9-20
Password Screen .....	8-21		
Menu Screen .....	8-21		
Color Change Mode Screen .....	8-22		
Color Change Sequence .....	8-22		
Color Change Graph Screen .....	8-23		
Purge and Mix Timer Values .....	8-23		
A Component Dump Timer Value .....	8-24		

# Table of Contents

<b>Troubleshooting</b> .....	<b>10-1</b>	<b>Parts</b> .....	<b>12-1</b>
Revision Numbers .....	10-3	Controller with User Interface .....	12-3
Troubleshooting Reference .....	10-4	Part No. 241184 .....	12-3
Alarm Troubleshooting .....	10-7	Part No. 241183 .....	12-3
To Clear the Alarm and Restart the System ..	10-7	Controller .....	12-4
Ratio Low or Ratio High .....	10-8	Part No. 240834 .....	12-4
Dose Time A or Dose Time B .....	10-9	Flow Control .....	12-6
Overdose A or Overdose B .....	10-9	Part No. 241382 .....	12-6
Flow Rate Alarms for a System without		Part No. 241383 .....	12-6
Flow Control .....	10-10	Part No. 242028 .....	12-6
Flow Too Low .....	10-10	Fluid Panel .....	12-8
Flow Too High .....	10-10	Part No. 241384 .....	12-8
Flow Rate Alarms for a System with		Part No. 241385 .....	12-8
Flow Control .....	10-10	Part No. 241390 .....	12-9
Gun #1 High/Low Flow .....	10-10	Fluid Panel Module .....	12-10
Gun #2 High/Low Flow .....	10-10	Part No. 241585 .....	12-10
Pot Life Exceeded .....	10-10	Part No. 949909 .....	12-12
Purge/Load Interlock Not Ready .....	10-11	Bare Robotic Module .....	12-14
Invalid Recipe .....	10-11	Part No. 949679 .....	12-14
I/O Change .....	10-11	Part No. 692068 .....	12-14
Purge Not Completed .....	10-11	Solenoid Module .....	12-16
Purge Time Out .....	10-11	Part No. 552184 .....	12-16
Display Battery Low .....	10-12	Part No. 552186 .....	12-16
Control Battery Low .....	10-12	Fluid Meters .....	12-17
Memory Failure .....	10-12	Part No. 241391 .....	12-17
Communications Error .....	10-12	Part No. 241392 .....	12-17
Invalid Guns From Input/Output Alarm	10-12	Air Supply Station .....	12-18
Air Flow Switch Alarm .....	10-12	Part No. 570122 .....	12-18
Defaults Loaded .....	10-12	Operator Station .....	12-19
Software Revision Alarm .....	10-12	Part No. 240835 .....	12-19
Configuration Module Alarm .....	10-12	Part No. 240877 .....	12-20
External Alarms .....	10-12	Low Pressure Color Change Module .....	12-21
Valve C Alarm .....	10-12	Part No. 241386 .....	12-21
Warnings .....	10-13	Part No. 241387 .....	12-22
Job Total Rollover .....	10-13	Part No. 241386 .....	12-23
Batch Total Rollover .....	10-13	Part No. 241387 .....	12-23
Grand Total Rollover .....	10-13	Part No. 241388 .....	12-24
Calibrate A Meter .....	10-13	Part No. 241388 .....	12-25
Calibrate B Meter .....	10-13	High Pressure Color Change Module .....	12-26
Solenoid Box Troubleshooting .....	10-14	Part No. 241499 .....	12-26
Gun Flush Box Troubleshooting .....	10-16	Part No. 241500 .....	12-27
Operator Station with Color Change		Part No. 241499 .....	12-28
Troubleshooting .....	10-16	Part No. 241500 .....	12-28
		Part No. 907347 .....	12-29
		Color Change Valve Assemblies .....	12-30
<b>Service</b> .....	<b>11-1</b>	Low Pressure Color Change Valves .....	12-30
Replacing the User Interface Battery .....	11-3	High Pressure Color Change Valves .....	12-30
Replacing the Controller Battery .....	11-4	Valve Bracket Changing Procedure .....	12-30
Replacing Isolation Barrier Fuses .....	11-5		
Replacing the User Interface .....	11-5		
Replacing the Power Supply .....	11-6		
Changing the Power Supply Voltage .....	11-6		
Replacing Power Supply Fuses .....	11-6		
Servicing the Operator Station .....	11-7		
Replacing Control Modules .....	11-8		
Replacing Control Submodules .....	11-9		

# Table of Contents

Gun Flush Box .....	12-32	Part No. 514037 Printer Paper .....	12-39
Part No. 241389 .....	12-32	Manual Dump Valve Kits .....	12-40
Part No. 241394 .....	12-32	2K Fluid Outlet Valves .....	12-40
Gun Flush Solenoid Box .....	12-33	Part No. 513052 Air Flow Switch .....	12-40
Part No. 115125 .....	12-33	Part No. 241962 Hydro-Softfeel Material Application Kit .....	12-40
Gun Holders for Gun Flush Box .....	12-34	Cable Network PC AMR .....	12-40
Cable Chart .....	12-35	Catalyst Supply Modules .....	12-40
Run Screen Monitor Accessory .....	12-36		
Part No. 240907 .....	12-36	<b>Utilities Software .....</b>	<b>13-1</b>
Remote User Interface .....	12-36	Utilities Overview .....	13-3
Part No. 240874 .....	12-36	Connection Error .....	13-3
Communication Ports .....	12-37	Mode Switch .....	13-3
Part No. 241379 .....	12-37	Backup PrecisionMix II .....	13-4
Part No. 241378 .....	12-37	Restore PrecisionMix II .....	13-7
Software Utilities Kit .....	12-37	Update the Operating System .....	13-9
Part No. 241841 .....	12-37	Update PrecisionMix II Program .....	13-11
Stand Mount .....	12-38	Connecting Utilities .....	13-12
Part No. 241501 .....	12-38	Update User Interface Program .....	13-13
Audio/Visual Alarm Indicator .....	12-38	Reset PrecisionMix II Password .....	13-15
Part No. 241380 .....	12-38	Set PrecisionMix II Date and Time .....	13-16
Accessories .....	12-39	Open Graco Web Site .....	13-17
Part No. 241647 Catalyst Change Kit ..	12-39	Edit Language .....	13-17
Part No. 195048 Paint Shield .....	12-39		
Part No. 195049 Paint Shield .....	12-39	<b>Technical Data .....</b>	<b>14-1</b>
Meter Kits .....	12-39	<b>Graco Standard Warranty .....</b>	<b>14-6</b>
Intrinsically Safe Meter Kits .....	12-39	<b>Graco Information .....</b>	<b>14-6</b>
Part No. 241263 Printer Kit .....	12-39		
Printer Power Supply .....	12-39		



# 1

## Warnings





# WARNING



## FIRE, EXPLOSION, AND ELECTRIC SHOCK HAZARD

Improper grounding, poor air ventilation, open flames, or sparks can cause a hazardous condition and result in fire or explosion and serious injury.

- The PrecisionMix Controller must only be installed and serviced by a qualified electrician.
- The PrecisionMix Controller is for use only in non-hazardous locations. The maximum applied relay voltage shall not exceed +24 volts. Do not operate the controller in hazardous locations, as defined in Article 500 of the National Electrical Code (USA).
- Ground the equipment and the object being sprayed. See **Ground the System** on page 3–30.
- Do not install non-intrinsically safe equipment in a hazardous area.
- Provide fresh air ventilation to avoid the buildup of flammable vapors from solvent or the fluid being sprayed.
- Extinguish all the open flames or pilot lights in the spray area.
- Keep the spray area free of debris, including solvent, rags, and gasoline.
- Do not turn on or off any light switch in the spray area while operating or if fumes are present.
- Do not smoke in the spray area.
- Do not operate a gasoline engine in the spray area.
- If there is any static sparking while using the equipment, **stop spraying immediately**. Identify and correct the problem.
- Keep liquids away from the electrical components.
- Disconnect electrical power at the main switch before servicing the equipment.
- The battery inside the PrecisionMix Controller may explode if mishandled. Do not recharge or disassemble the battery. Do not expose the battery to fire or heat. The battery is intended for use at normal temperatures, where high temperature cycles are not expected to exceed 212° F (100° C).



## TOXIC FLUID HAZARD

Hazardous fluids or toxic fumes can cause serious injury or death if splashed in the eyes or on the skin, swallowed, or inhaled.

- Know the specific hazards of the fluid you are using. Read the fluid manufacturer's warnings.
- Store hazardous fluid in an approved container. Dispose of hazardous fluid according to all local, state and national guidelines.
- Wear the appropriate protective clothing, gloves, eyewear, and respirator.

# WARNING



## SKIN INJECTION HAZARD

Spray from the gun, hose leaks, or ruptured components can inject fluid into your body and cause extremely serious injury, including the need for amputation. Splashing fluid in the eyes or on the skin can also cause serious injury.

- Fluid injected into the skin might look like just a cut, but it is a serious injury. **Get immediate surgical treatment.**
- Do not point the spray gun at anyone or at any part of the body.
- Do not put hand or fingers over the spray tip.
- Do not stop or deflect fluid leaks with your hand, body, glove, or rag.
- Follow the **Pressure Relief Procedure** on page 4–3 whenever you: are instructed to relieve pressure; stop spraying; clean, check, or service the equipment; or install or clean the spray tip.
- Tighten all the fluid connections before operating the equipment.
- Check the hoses, tubes, and couplings daily. Replace worn, damaged, or loose parts immediately. Permanently coupled hoses cannot be repaired; replace the entire hose.



INSTRUCTIONS



## EQUIPMENT MISUSE HAZARD

Equipment misuse can cause the equipment to rupture, malfunction, or start unexpectedly and result in serious injury.

- This equipment is for professional use only.
- Read all instruction manuals, tags, and labels before operating the equipment.
- Use the equipment only for its intended purpose. If you are uncertain about usage, call your Graco distributor.
- Do not alter or modify this equipment. Use only genuine Graco parts and accessories.
- Check the equipment daily. Repair or replace worn or damaged parts immediately.
- Do not exceed the maximum working pressure of the lowest rated system component. See the instruction manuals of the individual PrecisionMix components for their maximum working pressures.
- Route the hoses away from the traffic areas, sharp edges, moving parts, and hot surfaces. Do not expose Graco hoses to temperatures above 180°F (82°C) or below -40°F (-40°C).
- Do not use the hoses to pull the equipment.
- Do not move pressurized equipment.
- Use fluids or solvents that are compatible with the equipment wetted parts. See the **Technical Data** section of all the equipment manuals. Read the fluid and solvent manufacturer's warnings.
- Comply with all applicable local, state and national fire, electrical and other safety regulations.

# 2

## Overview



# Using this Manual

## Warning Symbol



This symbol alerts you to the possibility of serious injury or death if you do not follow the instructions.

## Caution Symbol



This symbol alerts you to the possibility of damage to or destruction of equipment if you do not follow the instructions.



## Special Note Symbol

This symbol precedes information that should be taken special note of.



## Screen Navigation Symbol

This symbol precedes information that tells you how to enter information and navigate through the User Interface screens.

Text that appears in grey on the screens in these instructions indicates lines that may or may not appear on your display, depending on previous selections that have been made.

Text that appears in a grey box indicates a selection that is being recommended or explained in that section of the instructions.

## Manual Overview

The information is organized in the following way:

1. **Warnings:** Read this section for important safety information.
2. **Overview:** This section provides information on the instruction manuals and on PrecisionMix II Component ID and function.
3. **Installation:** This section provides information on installing a configured PrecisionMix II system. After installation is complete, a startup checklist is provided to verify the system is installed correctly and ready to begin production. Portions of the checklist will guide you to other procedures, such as purging the system and configuring the software, to prepare the system for production.
4. **Operation:** The Pressure Relief Procedure and miscellaneous operation procedures are in this section.
5. **Screen Map:** The screen map shows the general layout of all the User Interface screens and provides the page number to go to for more detailed information on each screen.
6. **Run Monitor:** This section covers the use of the Run Monitor screens.
7. **Totalizer:** This section covers the use of the Totalizer screens.
8. **System Configuration:** This section covers how to use the System Configuration screens. These screens are used to configure how the system will operate. Integrated color change and flow control are part of the system configuration.
9. **Recipe Setup:** This section covers how to use the Recipe Setup screens to setup recipes.
10. **Troubleshooting:** This section provides information on troubleshooting alarm conditions and some system problems.
11. **Parts:** This section includes parts drawings and lists for components of the PrecisionMix II system.

# Related Publications

Form No.	Description
308288	Fluid Manifold Manual
308778	G3000 Meter Manual
307731	LP Color Change Valve Assy. Manual
307941	LP Color Change Valve Manual
308977	HP Color Change Valve Assy. Manual
308291	HP Color Change Valve Manual

Form No.	Description
309227	Gun Flush Box Manual
308818	Printer Manual
308292	Fluid Pressure Regulator
309001	System Electrical Schematic
309231	System Configurator Schematic
309234	Coriolis Meter Manual



# How the PrecisionMix Works

## Usage

The standard Graco PrecisionMix II can blend most two-component epoxy or polyurethane paints. The PrecisionMix is not for use with “quick-setting” paints (those with a pot life of less than 15 minutes). For information on handling quick-setting paints or abrasive fluids, contact your Graco distributor.

## Fluid Supply

The system can be set up to mix components supplied from pressure tanks or feed pumps. The materials can be transferred from their original containers or from a central paint recirculating line.

The standard PrecisionMix II is designed to operate an air spray or air-assisted system with a capacity of up to 4000 cc/min.

## Operating Cycle

To begin operation, the spray gun operator enters the desired ratio and other parameters through the User Interface and energizes the electronic controller’s mix input. From that point on, normal operation of the PrecisionMix II is controlled by the operation of the spray gun.

When the gun is triggered, the controller sends signals to the solenoid enclosure to activate the solenoid valves. The solenoid valves activate the manifold’s Component A and B valves.

The two components are introduced into the integrator chamber one at a time, through separate fluid lines, check valves, and flow meters. Their entry into the chamber is controlled by a dispense valve for each component. The flow meters monitor the exact fluid volumes being dispensed and send electrical pulses to the controller. The controller monitors these pulses and signals the solenoids to turn the dispense valves on or off accordingly (based on the target volumes calculated by the controller).

The components are pre-mixed in the integrator, then given a homogeneous blending as they pass through a static mixer tube. Output from the mixer tube to the spray gun may be controlled by a fluid pressure regulator.

The two components continue to be alternately fed into the integrator as long as the gun is triggered. After the trigger is released, if the gun is not triggered again within four minutes, the system will go to an idle mode, which closes off the mix manifold. When the gun is triggered again, the system will continue the process where it left off. Operation can be stopped at any time by energizing the standby input or shutting off the main power switch.

Other inputs and outputs are provided to control the purging process, signal an alarm, and interface with the operator.

### The following is a typical ratio cycle:

- First, the Component A (resin) dispense valve opens, and the fluid begins to flow into the integrator chamber. When the correct quantity has been dispensed (based on the calculated target value), the component A dispense valve closes. See Fig. 2.1.
- Next, the Component B (catalyst) dispense valve opens. The fluid begins to flow into the integrator chamber and is lined up proportionately with the previously-dispensed Component A dose. The B dispense valve closes when the target volume for Component B has been reached. See Fig. 2.2.
- The process repeats itself as long as the spray gun is triggered.
- If the operator stops spraying, the PrecisionMix II continues where it left off when the operator resumes spraying.

### Adaptive Overrun Correction

The actual volume of fluid dispensed each cycle can vary slightly from the calculated target. However, the controller monitors this variance and continuously makes adjustments to keep the ratio of Component B to the Component A and user specified tolerance.



### Functional Diagram – Component A (Resin) Dispense

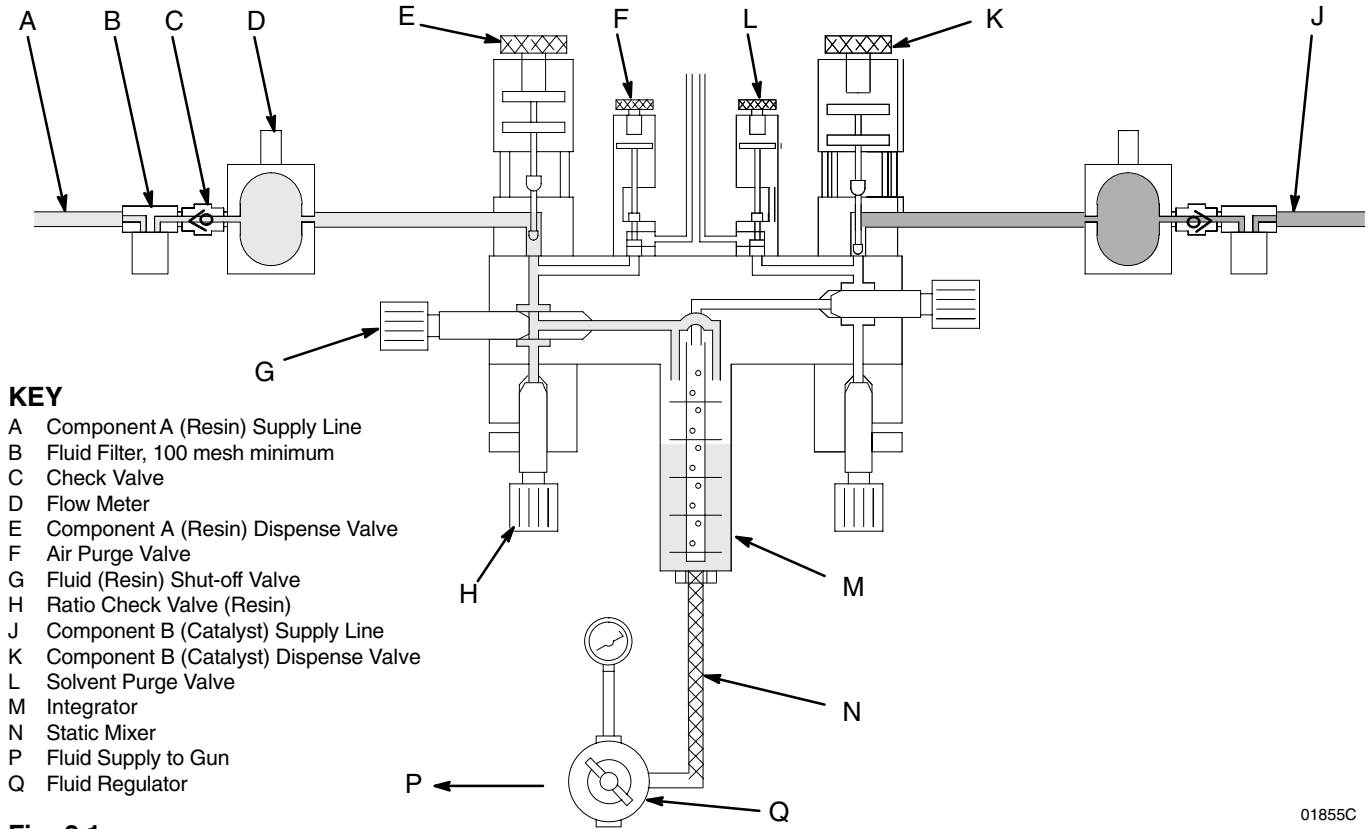

Fig. 2.1

01855C

### Functional Diagram – Component B (Catalyst) Dispense

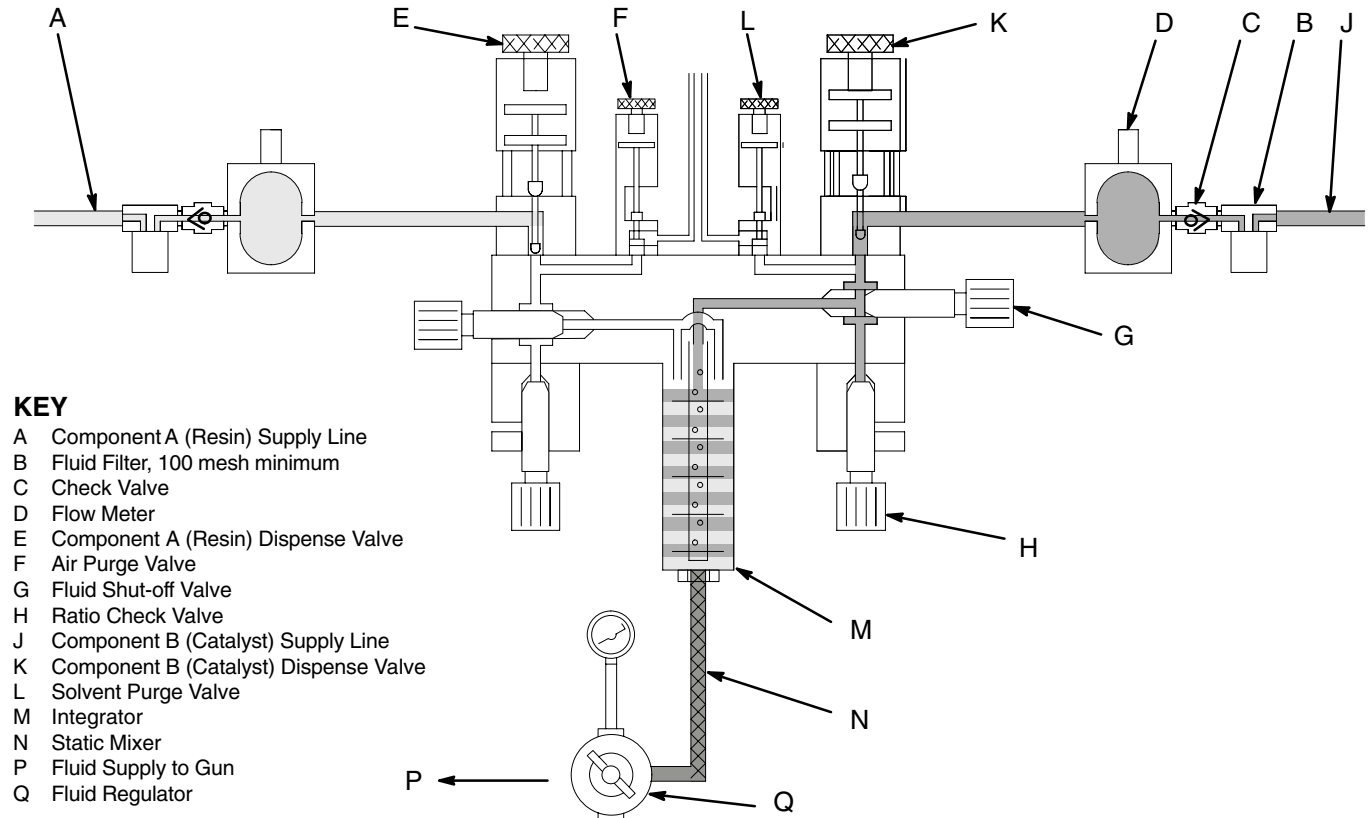

Fig. 2.2

01855C

# Flow Control Overview

Flow Control is used to limit the flow of material to the air spray gun to help avoid sags and runs in the finish due to coatings being applied too thick or quickly and to assure adequate coverage. Flow control can be configured for use with a manual or automatic air spray gun. Refer to **Flow Control Setup**, page 8–16.

The flow control module uses flow meters, fluid regulator, current to pressure (I/P) transducer, and the PrecisionMix II controller to adjust and maintain the flow of material to the air spray gun.



Flow control is an optional feature of the PrecisionMix II system. Your system must be configured with flow control hardware and software in order to use flow control. Detailed information on using flow control is in other sections of this manual.

Flow control is NOT for use with air-assisted or airless spray guns.

## Flow Control Features

- Ability to control one or two manual or automatic air spray guns
- Programmable maximum flow setpoint
- Programmable lower flow control start value for manual gun
- Delayed activation of flow control after the gun is triggered
- Manual flow rate reset function, which can be initiated from the in-booth Flow Control Station
- An indicator light on the Flow Control Station to show when the flow rate is resetting for manual gun operation.

## System Requirements

The fluid feed system must have adequate volume and pressure to supply the air spray gun(s). The Component A and B fluid supply pressures need to be balanced. The fluid feed hose, gun nozzle and needle size and travel must be sized and adjusted properly to keep the flow control operating at its maximum efficiency.

## General Operation Sequence

1. When the controller is first turned on, a pre-configured pilot air pressure is applied to the fluid regulator.
2. When the air spray gun is triggered, the controller waits for the set delay time to elapse before it starts monitoring the flow and making any necessary adjustments. The delay time is user selectable (typically 1–2 seconds) and helps assure the fluid is moving at a normal rate before flow rate adjustments occur.
3. When the fluid moves through the fluid lines, the flow meter monitors the flow and sends meter pulses to the controller. These pulses are converted into flow measurements and checked against the set values in the controller.
4. If the fluid flow falls outside the set values, the controller sends a signal to adjust the fluid regulator to correct the flow. The flow is raised or lowered by the pilot air pressure from the current to pressure (I/P) transducer. The greater the pilot air pressure to the fluid regulator, the higher the fluid pressure and the greater the fluid flow.
5. When the air spray gun is turned off, the flow control holds the pilot air pressure value and does not attempt to adjust fluid flow until the gun is triggered again.
6. When the gun is triggered, the process of controlling the fluid flow continues.

# Flow Control Overview

## One Gun Flow Control Using Component A and B Flow Meters

Fig. 2.3 shows a one gun system that is using the component A and B flow meters on the fluid panel to monitor the flow rate.

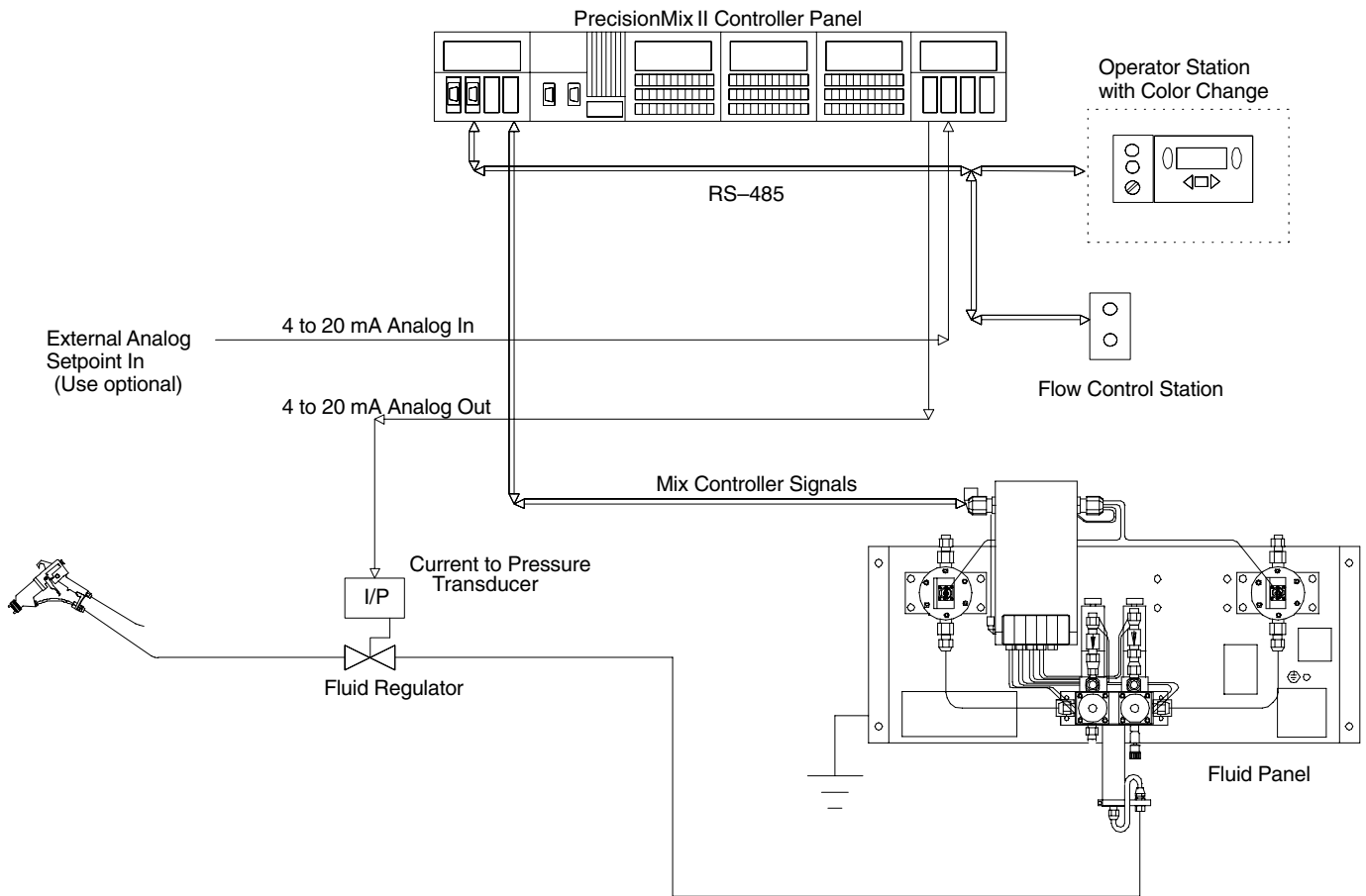

9015A

**Fig. 2.3** Typical Installation of One Gun Flow Control Using Component A and B Flow Meters

# Flow Control Overview

## One Gun Flow Control Using a Flow Meter in the Mixed Material Line

Fig. 2.4 shows a one gun system that is using a flow meter, installed in the mixed material line, to monitor fluid flow to the gun. Using a flow meter in the mixed material line, rather than monitoring fluid flow with the component A and B flow meters, provides a faster response to changes in the flow rate setpoint.

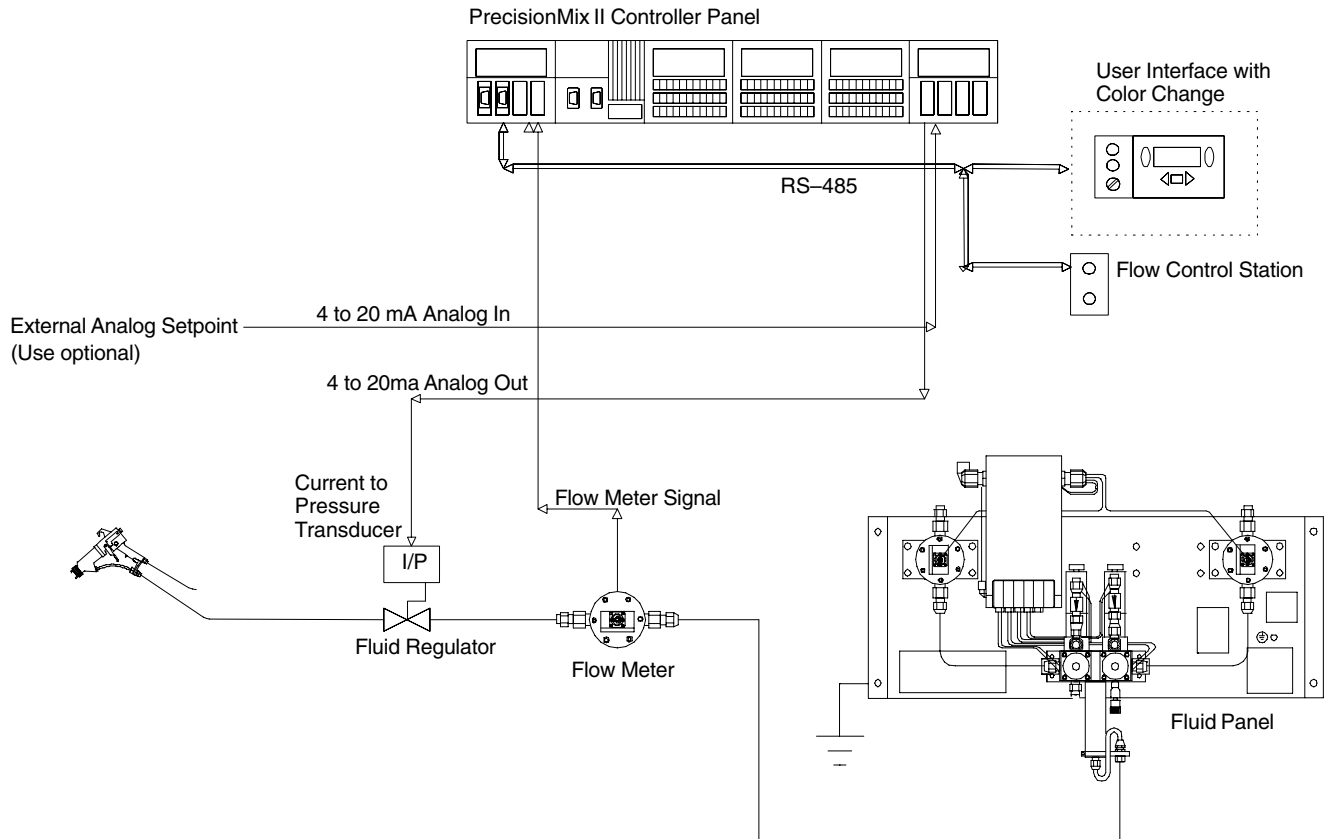

9014A

**Fig. 2.4** Typical Installation of One Gun Flow Control Using a Flow Meter in the Mixed Material Line

# Flow Control Overview

## Two Gun Flow Control

Fig. 2.5 shows a two gun system. The operation of the two gun flow control is similar to the one gun flow control that uses a flow meter in the mixed material line (page 2–10). The difference is that two flow meters, one on each gun supply line, are added to the system to monitor flow for each gun and two different sets of flow control values can be maintained.

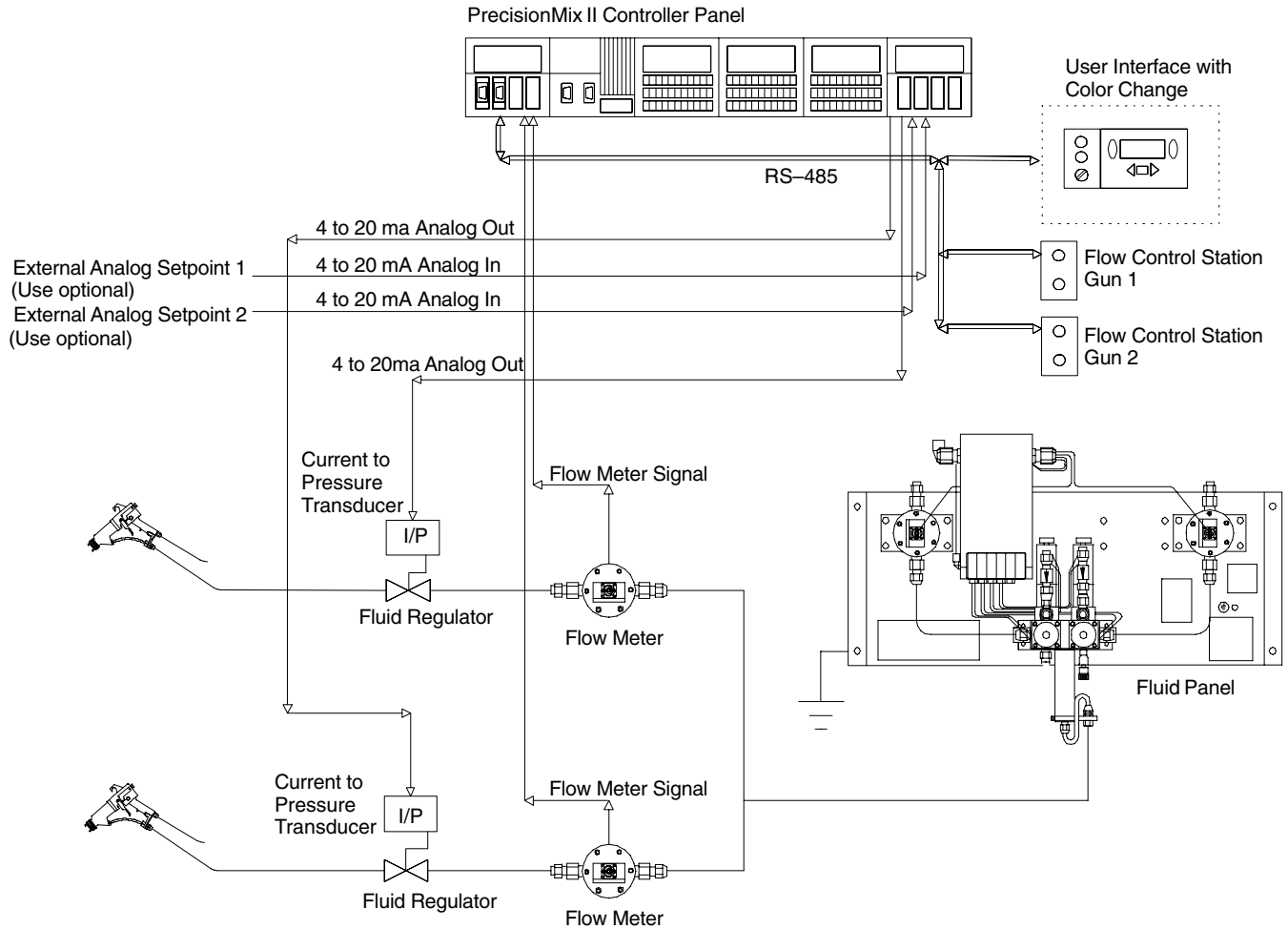

9014A

Fig. 2.5 Typical Installation of Two Gun Flow Control

# Flow Control Overview

## Flow Control Components

(Refer to Fig. 2.3, 2.4, or 2.5)

### Flow Meter

Digital pulses are sent by the flow meters to the controller to provide fluid flow rate information.

### Fluid Regulator

The flow control regulates the fluid flow to a pre-programmed flow rate by adjusting the fluid regulator. The fluid regulator uses a pneumatic pilot pressure from a current to pressure (I/P) transducer to open and close the regulator needle.

### Current to Pressure (I/P) Transducer

An adjustable pneumatic signal is required for the controller to regulate the fluid flow. The current to pressure transducer provides this signal. The controller outputs an analog current signal that varies from 4 milli-amperes to 20 milli-amperes and the transducer changes the milli-amp signal to a 1–100 psi (7–700 kPa, 0.1–7 bar) pneumatic signal. The pneumatic pressure signal is applied to a fluid pressure regulator, which controls the output fluid pressure to the air spray gun.

### PrecisionMix II Controller

The controller can be configured to control and display the fluid control information, including setpoint, actual flow, milli-amp output values to the I/P transducer, system parameter, and I/O conditions. The controller will indicate when the system is operating within flow control tolerance and when it is not.

## Flow Control Station

The Flow Control Station consists of a Flow Control Reset/Warning light and Flow Control Reset button, which are used with manual air spray guns to manually initiate flow control reset.

### Flow Control Reset Button

Pressing the reset button will cause the flow control system to calibrate the flow rate to the current setpoint.

### Flow Control Reset/Warning Light

The controller activates the Reset/Warning light when the flow control system is resetting flow rate (solid light) or when a flow control alarm condition occurs (flashing light—flow rate is outside the set tolerance).

### Flow Rate Alarms

Wait for the system to automatically calibrate the flow rate or manually reset the flow rate by pressing the reset button.

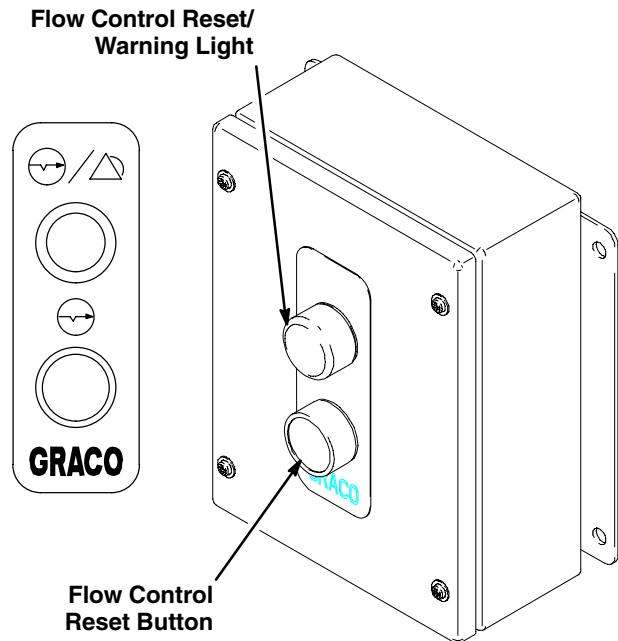

Fig. 2.6 **Flow Control Station**

9003A

# Flow Control Overview

## Flow Control Parameters (Refer to Fig. 2.7)

The following flow control parameters are entered from either the User Interface or from digital input:

- **Setpoint Source** – Specifies the source of the flow limit value as User Interface, network or analog input (refer to page 8–18).
- **Analog Scaling** – If analog is the source of input, the scaling for analog input must be set. The setting is used to calculate the relationship between the flow rate and a 4–20 mA input signal (refer to page 8–18).
- **Flow Rate Setpoint** – Sets the value for the desired flow rate. Flow control monitors and calibrates flow rate based on this value and the other parameters (refer to page 9–9 or 9–15).
- **Delay Time** – Sets the time that flow control waits after the gun is triggered before starting to monitor the flow rate. This allows time for the fluid to quickly reach the setpoint and avoid unnecessary alarms or corrections (refer to page 8–19).
- **Flow Control Low Limit** – This value is only used with manual guns and is always entered from the User Interface (refer to page 9–9). The flow control stops making adjustment if the flow rate falls below the difference of setpoint and the “Low Limit” volume. The warning alarm output will be on when the actual flow rate falls out of this tolerance for 5 seconds. This helps the system allow for periodic partial triggering (feathering) of a hand gun without adjusting the flow rate.

If the setpoint is changed, the low limit will change accordingly.

**Example** – If the setpoint is 500 cc/min. and the low limit is 100 cc/min.:

- The flow control will stop making adjustments when the flow rate falls below 400 cc/min.
- Changing the setpoint to 300 cc/min. will change the low limit value to 200 cc/min.

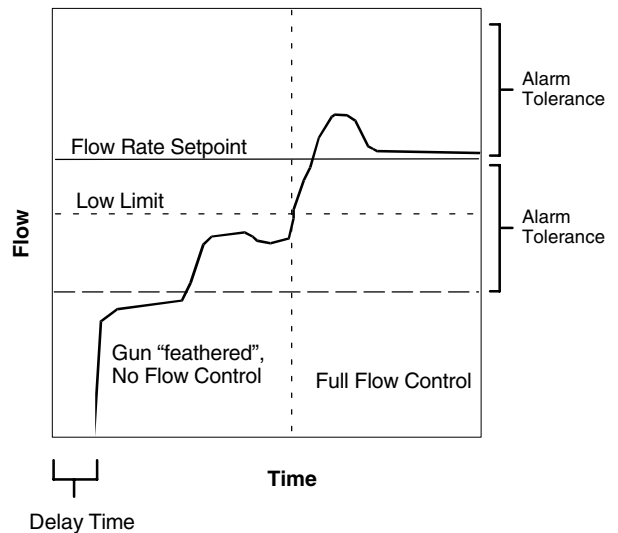

**Fig. 2.7** NOTE: Graph shown for hand gun flow control.

# Using Recipes/Color Change

There are three modes of operation relating to the changing of recipes: No Color Change, Integrated Color Change, and Integrated Color Change with Queue. Refer to page 8–22. The controller logic decides whether or not to allow a chosen recipe change to occur. The criteria for allowing a recipe change are as follows:



1. The new recipe must contain valid data for the desired ratio, flow meter K-factors, tolerance, and pot life times.
2. An active alarm must not exist in the system.
3. An Integrated Color Change can not already be in progress.
4. The recipe number must not be greater than the number of recipes configured to run on the system.
5. The input device used to change the recipe value must be configured as the recipe input device (User Interface, Network, I/O, or Operator Station).
6. When “No Color Change” is selected, the operator switch on the Operator Station must be in the Standby  position.

## No Color Change

The system will boot up for the first time with color change turned off. In this mode, color changes are performed manually. The recipe number is changed through the User Interface, Network, I/O, or Operator Station. The operator must manually dump and purge the old material from the system and then load the new material into the system.

## Integrated Color Change

The Integrated Color Change mode of operation automatically performs the tasks necessary to execute a color change. This is a time-based mode that is configurable by the user. Refer to page 8–21. The timing of the color change is configured in one of four color change sequences. The color change sequences contain start times and timer duration for the devices that are controlled during a color change. Each recipe is then assigned one of the four color change sequences for its operation.

A color change may be performed with the operator switch in the Mix  or Standby  position. If the operator switch is in the Mix  position, the system will be ready for immediate spraying after a color change. The green light on the Operator Station will blink while a color change is in operation. The green light indicates that the system is busy and is not ready for spraying.

## Mix/Load Volumes

If mix/load volumes are configured for the system, the fill portion of the color change may continue after the color change has timed out. This feature may be used in conjunction with a gun flush box to make sure that the desired volume of material is loaded into the system. The system keeps track of the volume that is mixed during the fill portion of the color change. If the mix/load volume is not reached, then the system will continue to fill until the volume is reached (the operator switch needs to be in the Mix  position for this to occur automatically). Setting the mix/load volume to zero will disable the mix/load volume feature.

## Recipe Zero

Recipe zero is considered the “Purge Down” recipe. The purpose of this recipe is to allow the user to purge out the material lines and the mixed material lines without loading a new color. A typical use for recipe zero is at the end of a shift. The operator performs a color change to recipe zero and the lines are cleaned out to prevent hardening of catalyzed material between shifts. Multiple Purge Downs may also be performed if the lines are not sufficiently clean. Another Purge

Down is triggered by pressing the Enter  key on the Operator Station or by setting the color change bit on the I/O high.

**NOTE:** Recipe 0 has a unique Purge Sequence 0 to allow for end of shift or production shutdown. If you are using a solvent meter, any additional solvent used in the recipe 0 purge cycle will not be included in the solvent totals. It is important to configure Purge Sequence 0 to flush all materials clean in one purge cycle, to maintain accurate solvent use records.

*Continued on the next page.*



# Using Recipes/Color Change

## Integrated Color Change – continued

The devices that are controlled by the Integrated Color Change Sequences are as follows.

**Purge Valves:** The Integrated Color Change Sequence typically starts by purging out the old mixed material. The purge can be further defined by setting the total purge time, the purge time for the first cycle, the purge time for the last cycle, and the individual purge times for the three possible purge valves. The beginning of the purge can be delayed to allow time for the gun triggers to activate. Refer to page 8–23.

**Mix Valves:** The sequence fills the hoses with the new mixed material after the system has finished purging. The target mix parameters are calculated after the purge is completed, before the mix begins. The user defines the mix (fill) time duration for the Color Change Sequence. Refer to page 8–23.

**Dump Valves:** The dump valves open immediately when the Color Change Sequence begins. The user then configures how long these valves stay open. The purpose of these valves is to allow the unmixed A and B component materials to dump from the system before entering the mix manifold. Refer to page 8–24 and 8–25.

**Solvent Valves:** The Solvent valves open immediately when the Color Change Sequence begins. The user then configures how long these valves stay open. The purpose of these valves is to push the unmixed A and B component materials through the dump valves and clean the hoses for the next material. Refer to page 8–24 and 8–25.

**Gun Triggers 1–2:** The gun triggers are electrical outputs that can be configured to turn on and off up to two times. These outputs are typically wired to the spray guns triggers to allow automatic purging and filling. Refer to page 8–26.

**Special Outputs 1–6:** The special outputs are optional outputs that the user can configure for their particular application. Each of these valves can be turned on and off up to four times during a color change sequence. Refer to page 8–27.

Specials 1, 2, 3, and 4 are pneumatic outputs, while Specials 5 and 6 are electrical outputs.

## Integrated Color Change with Queue

The Integrated Color Change with Queue mode of operation runs in a similar fashion to the standard Integrated Color Change mode. The difference between the two modes is that the Queue parameters override the normal color change parameters during the color change. Five data sets can be set up in a queue and sent to the controller individually. Refer to page 6–7. A queue data set consists of the following four parameters.

1. **Sequence Number** – The number for the color change sequence that will be used for the new color.
2. **Recipe Number** – The recipe number that will be used for the new color.
3. **A Color Valve (Resin)** – The number corresponding to the A side color valve chosen for the new color.
4. **B Color Valve (Catalyst)** – The number corresponding to the B side color valve chosen for the new color.

A Queue Color Change is triggered by pressing the Enter key on the Operator Station or by setting the Color Change Bit on the I/O of the controller. The data set values on the top of the queue will be used for the Color Change. When color change is complete, the top level of the queue is erased and all of the other data sets move up one level on the queue.

# Using Recipes/Color Change

## Color Change Sequences

There are four color change sequences that can be set up to control how a color change will operate. These sequences can be viewed on the User Interface in a graphical fashion. A typical color change sequence looks as follows.

### Color Change Graph Screen

1. PURGE MIX**	
2. A DUMP	
3. A SOLV	
4. B DUMP	
5. B SOLV	
6. GUN1 TG	
7. GUN2 TG	
8. SPEC 1	
9. SPEC 2	
10. SPEC 3	
11. SPEC 4	
12. SPEC 5	
13. SPEC 6	
0 Sec	40.0
Color Chg Seq 1. Enter Function (1-13)	01

### Sequence 1:

Purge time = 20 Seconds

Mix time = 20 seconds

A Dump time = 7 seconds

A Solvent time = 5 seconds

Special 1 on time = 0 seconds

Special 1 time = 40 seconds

Total Sequence Time = 40 seconds

This sequence is a 40 second long operation.

**NOTE:** When using automatic spray guns or gun flush boxes, you must specify trigger times for each gun. The screen shown above reflects the use of manually triggered spray guns.

The color change sequence begins by closing all of the color change valves. Then the dump valve for the A component side (resin) will immediately open, as well as the solvent valve on the color stack. This will allow solvent to flow into the fluid lines, through the flow meter, and out through the dump valve.

The color change solvent valve stays open for 5 seconds, then it closes and the new color valve, associated with the new recipe, will open. The dump valve remains open for two seconds after the new color valve is opened, to allow the new color to fill the fluid line and flush out the remaining solvent. The dump valve is open for a total of 7 seconds.

In parallel with the dumping and filling of the fluid lines, a purge is occurring through the mix manifold and mixed material lines. The purge always starts at the beginning of a color change sequence. The above sequence triggers Special 1 for the entire sequence. Special 1 output can be used for functions such as fluid regulator override, which aid in the flushing process by allowing the purge to flush solvent through the mix manifold and mixed material lines and out through the gun. After 20 seconds, the purge is complete.

The system then begins to mix new material. The system mixes for 20 seconds until the mix manifold and the mixed material lines are full of new material.

# Using Recipes/Color Change

## Changing from One Color Change Sequence to Another

It is possible to perform a color change from a recipe associated with one color change sequence to a recipe that is associated with another color change sequence. In this case the system automatically uses the old sequence for dumping and purging and the new sequence for loading and mixing. This type of color change is useful in applications where one material tends to purge and load more quickly than another.

When switching from one sequence to another, there are two transition points that determine which sequence is being used at a given time. The first transition point occurs when the solvent valve for the color change stack closes. The second transition point is when the purge is complete. The table at right lists the outputs associated with the transition points.

Transition Point	Output
Color Stack Solvent A Closes	Dump Valve A
Color Stack Solvent B Closes	Dump Valve B
Purge Ends	Mix
	Gun 1 Trigger
	Gun 2 Trigger
	Special 1
	Special 2
	Special 3
	Special 4
	Special 5
	Special 6

An example of a color change from one sequence to another is as follows.

### Sequence 1:

Purge time = 20 Seconds  
 Mix time = 20 seconds  
 A Dump time = 7 seconds  
 A Solvent time = 5 seconds  
 Special 1 on time = 0 seconds  
 Special 1 time = 40 seconds  
 Total Sequence Time = 40 seconds

### Sequence 2:

Purge time = 40 Seconds  
 Mix time = 40 seconds  
 A Dump time = 13 seconds  
 A Solvent time = 10 seconds  
 Special 2 on time = 0 seconds  
 Special 2 time = 40 seconds  
 Total Sequence Time = 80 seconds

### Color Change Graph Screen

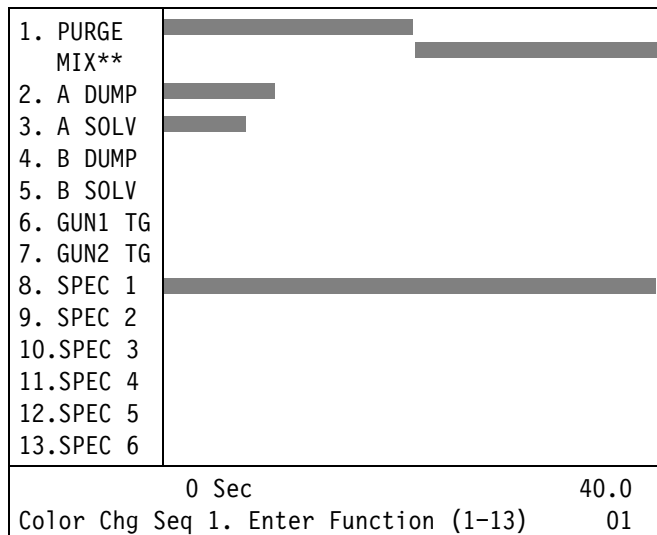

### Color Change Graph Screen

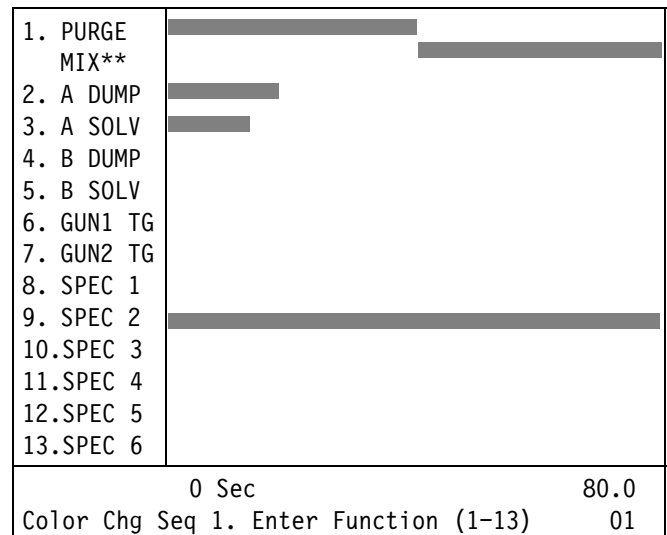

*Continued on the next page.*

# Using Recipes/Color Change

## Changing from One Color Change Sequence to Another – continued

### Actual valve times:

Purge time = 20 seconds

Mix time = 40 seconds

A Dump time = 8 seconds

A Solvent time = 5 seconds

Special 1 on time = 0 seconds

Special 1 time = 20 seconds

Special 2 on time = 20 seconds

Special 2 time = 40 seconds

Total Sequence Time = 60 seconds

## Actual Valve Times

1. PURGE	████████████████████
MIX**	██
2. A DUMP	██████████
3. A SOLV	██████
4. B DUMP	
5. B SOLV	
6. GUN1 TG	
7. GUN2 TG	
8. SPEC 1	████████████████████
9. SPEC 2	██
10. SPEC 3	
11. SPEC 4	
12. SPEC 5	
13. SPEC 6	

# **3**

## **Installation**



# Typical Installation

## WARNING



### FIRE, EXPLOSION, AND ELECTRIC SHOCK HAZARD

Installing and servicing this equipment requires access to parts which could cause an electric shock or other serious injury if the work is not performed properly.



- Do not install or service this equipment or perform any of the following installation and adjustment procedures unless you are trained and qualified.
- Comply with all applicable local, state, and national fire, electrical, and other safety regulations.

## WARNING



### FLAMMABLE OR TOXIC VAPOR HAZARD

Provide fresh air ventilation to avoid the buildup of flammable or toxic vapors. Do not operate the spray gun unless ventilation fans are operating. Follow all national, state, and local codes regarding air exhaust velocity requirements.



### NOTE:

- Reference numbers and letters in parentheses in this manual's text refer to the numbers and letters in the illustrations.
- Be sure all accessories are adequately sized and pressure-rated to meet the system's requirements.
- The Typical Installations shown in Figs. 3.1, 3.2, and 3.3 are only a guideline for selecting and installing system components and accessories, and is not an actual system design. Contact your Graco distributor for assistance.

### KEY FOR FIG. 3.1, 3.2, AND 3.3

**NOTE:** The typical installation drawings (Fig. 3.1, 3.2, and 3.3) show all possible system options. Your system may not include all these options.

A Alarm	G Solenoid Box for gun flush box, 1 & 2 guns	P Solenoid Box for fluid panel
B Controller	H Gun Flush Box	Q Operator Station
C Solenoid Bank for color change, 8 or 16 valves	J Flow Control	R Operator Station with color change
D Solenoid Bank for catalyst change, 8 valves	K Fluid Regulator, air operated	S Flow Control Station
E Air Regulators	L Atomizing Air Shutoff Valve, air piloted	T User Interface (also available as a remote interface, see page 3-12)
F Transducer	M Color/Resin Change Valves	U Catalyst Change Valve
	N Fluid Panel	

# Typical Installation

NON-INTRINSICALLY SAFE

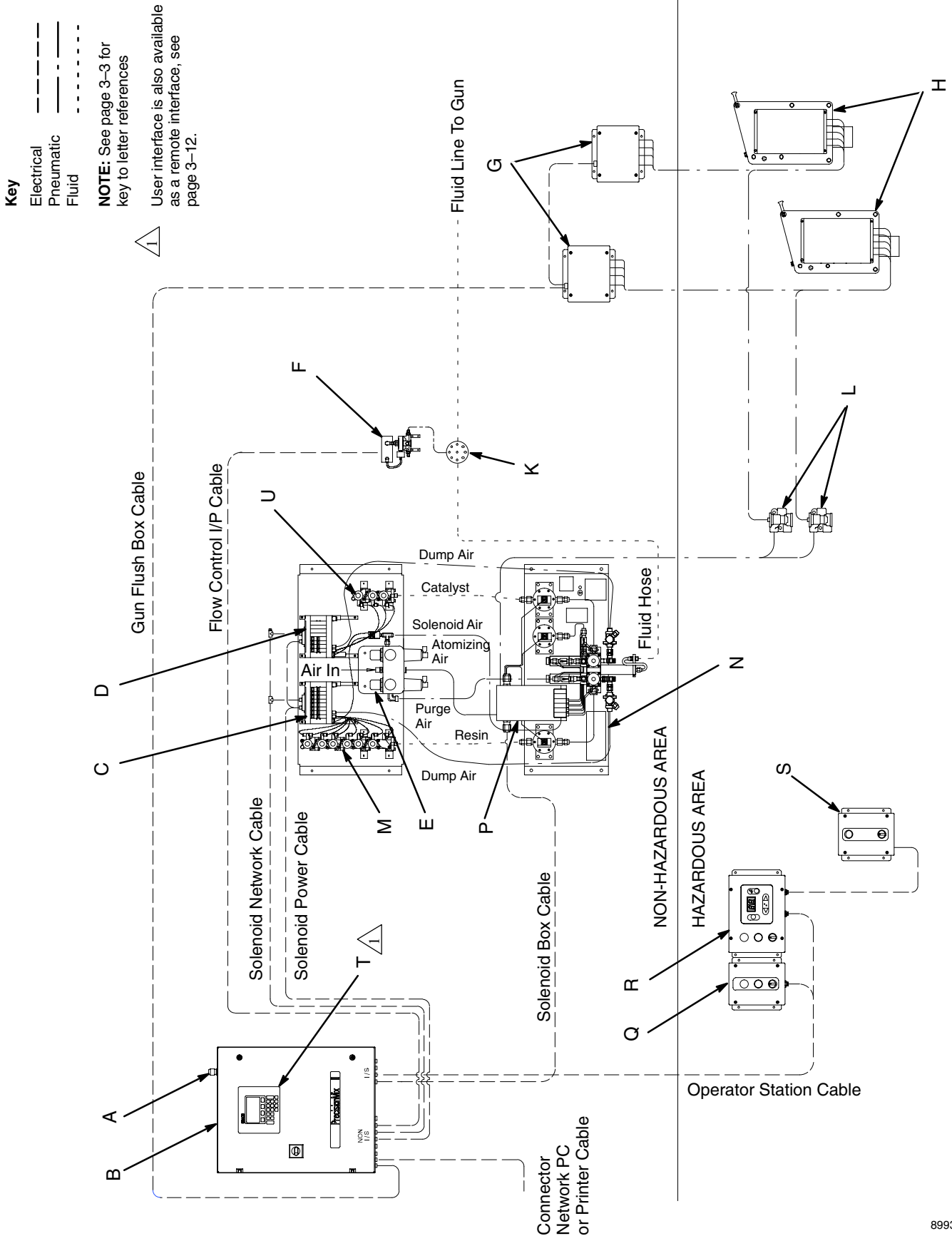

Fig. 3.1



# Typical Installation

INTRINSICALLY SAFE

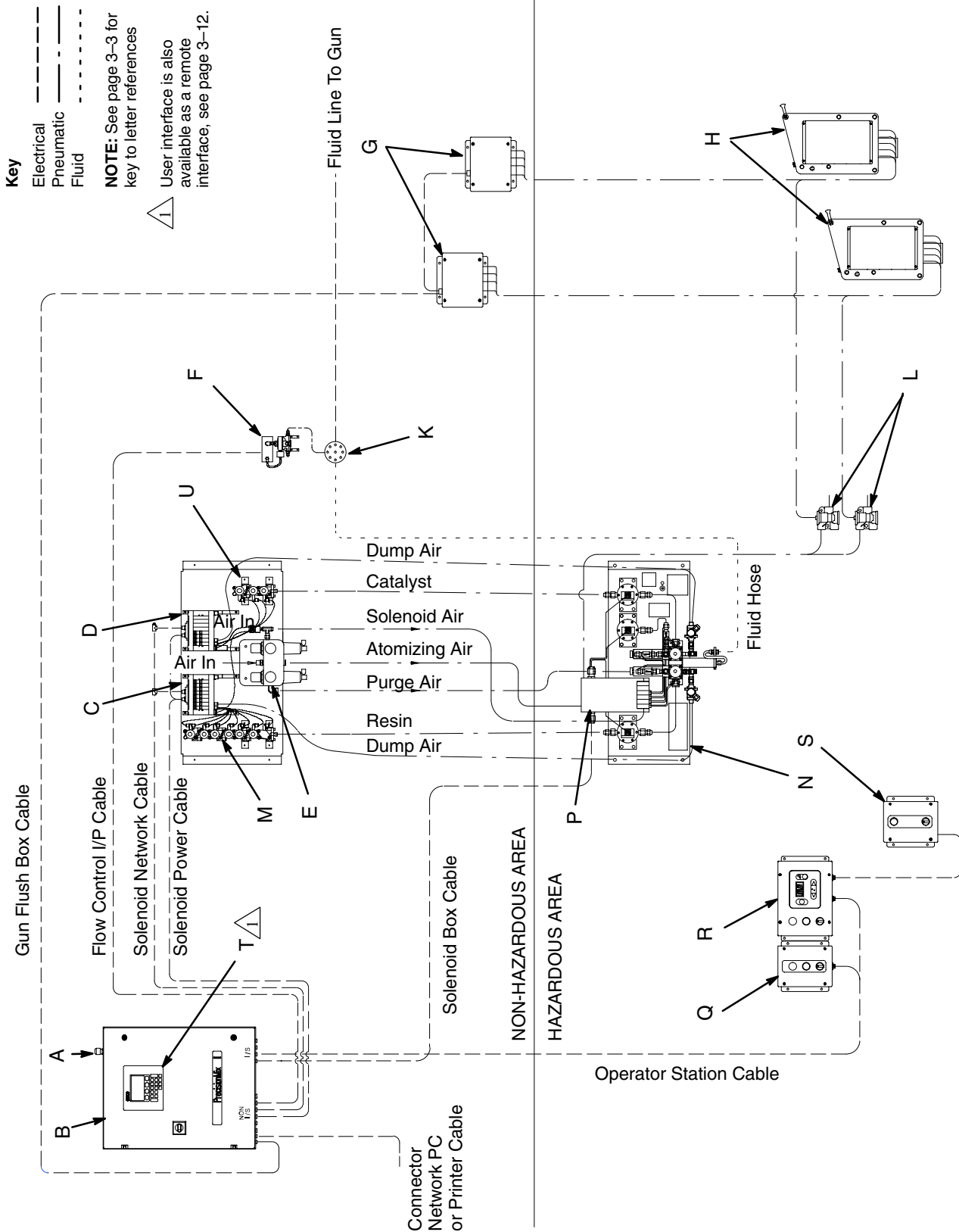
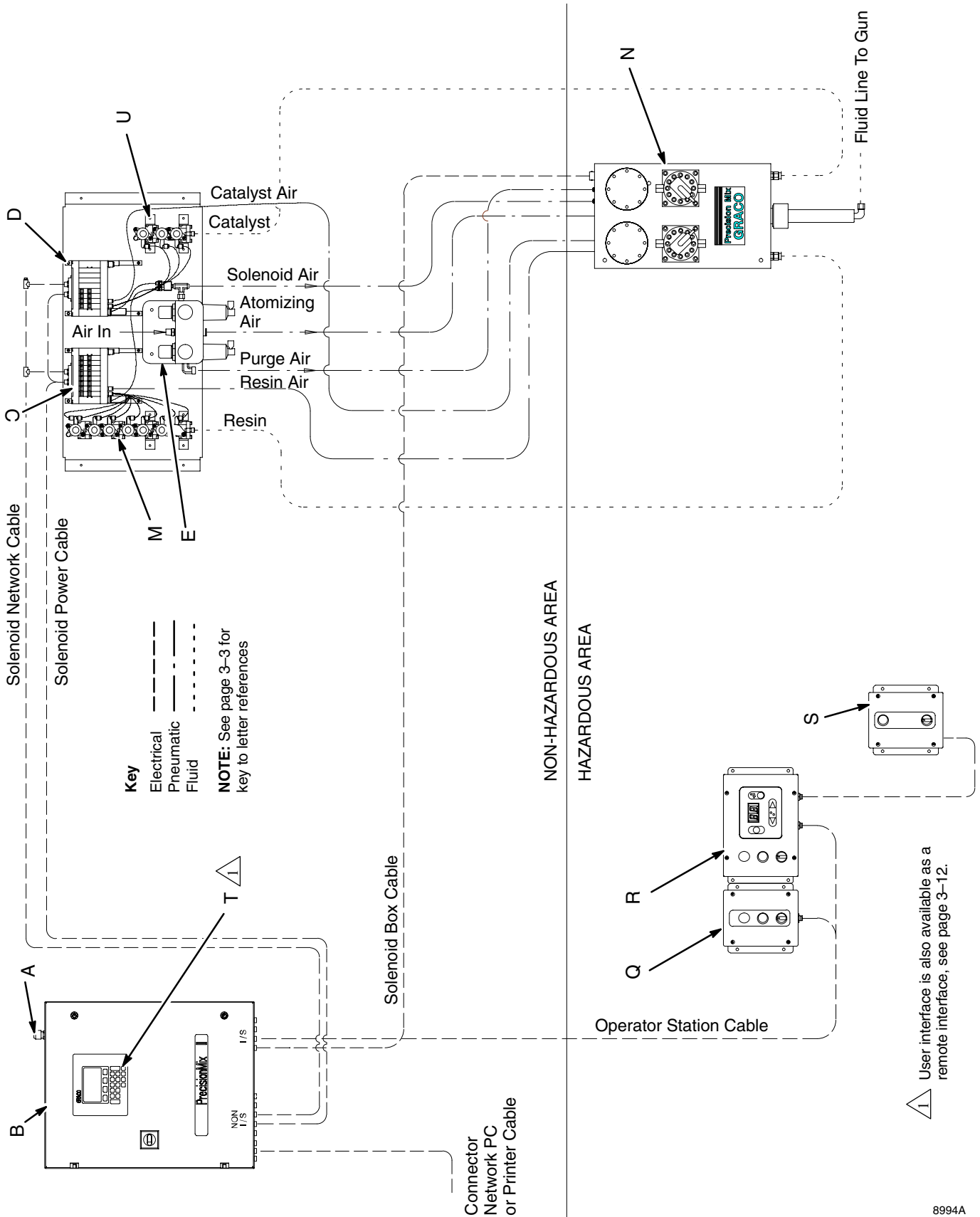

Fig. 3.2

8998A

# Typical Installation

## ROBO-MIX



⚠ User interface is also available as a remote interface, see page 3-12.

8994A

Fig. 3.3

# Fluid Supply Requirements

Common fluid supplies include pressure tanks, circulating lines, and pail or drum pumps. The fluid supply should be capable of supplying enough pressure to deliver a flow rate 1.5 times the maximum desired flow rate.

If the Flow Control system is installed, it is very important to balance the fluid pressures of the Component A and B fluid supplies to be within 2 psi (14 kPa, 0.1 bar) of each other at the fluid outlet.

The fluid supply must be free of pressure spikes, which are commonly caused by a pump stroke changeover. If necessary, install pressure regulators on the fluid inlets to the PrecisionMix II to reduce the fluid supply pressure. Contact your Graco distributor for information on fluid pressure regulators.

## **Circulating Lines**

For maintenance and safety, you must install a ball valve between each supply line and the PrecisionMix II.

# Mounting Components

The controller, color change panel, and fluid panel can be wall mounted or installed on Part No. 241501 Stand Mounting Kit. If the Stand Mounting Kit was ordered with the system, the parts were mounted to the stand at Graco. The Gun Flush Box can be wall, stand, or drum mounted in the spray booth.

## NOTE:

- Refer to Fig. 3.1, 3.2, or 3.3 for non-hazardous versus hazardous location equipment requirements.
- Refer to Fig. 3.4 through 3.7 for dimensions and mounting hole layouts.

## For Wall Mounting

Mount the components to a wall, as follows:

1. Ensure that the wall and mounting hardware are strong enough to support the weight of the equipment, fluid, hoses, and stress caused during operation.
2. Mark the mounting holes on the wall at a convenient height for the operator, using the equipment as a template.
  - **Color Change Panel:** In order to use the standard supplied fluid hose, the color change panel must be mounted within 12 in. (305 mm) of the fluid panel. Contact your Graco distributor for other available fluid hoses.
  - **Operator Station or Flow Control Station:** Mount the station(s) inside the spray booth, at a convenient location for the operator to access and use.

### Operator Station (without integrated color change)

Depth: 3.25 in.  
(83 mm)

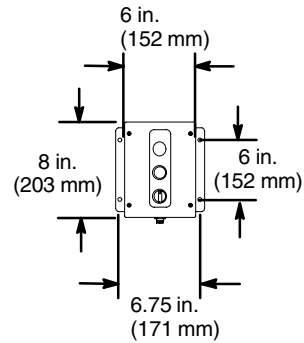

### Operator Station (with integrated color change)

Depth: 3 in.  
(76 mm)

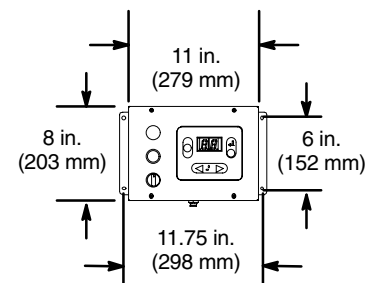

### Flow Control Station

Depth: 3.25 in.  
(83 mm)

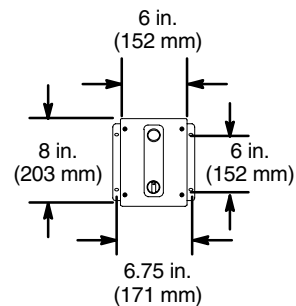

9042A

Fig. 3.4

Continued on the next page.

# Mounting Components

## For Wall Mounting – continued

- Remote User Interface or Run Screen Monitor**: If a remote User Interface and/or a Run Screen Monitor are used, mount them at a convenient location for the operator to view and use.
- Gun Flush Box**: Install the gun flush box in the spray booth. Locate it as far away from the spray or application point as possible to help avoid getting over-spray on it.
- Gun Flush Solenoid Box**: Install the gun flush solenoid box in the non-hazardous area, within 25 ft. (7.6 m) of the gun flush box. 100 ft. (30.5 m) of cable is provided, which connects the solenoid box with the controller.

- Drill the mounting holes in the wall and install anchors as needed.
- Bolt the equipment securely to the wall.

### Controller

Depth: 9 in. (229 mm)

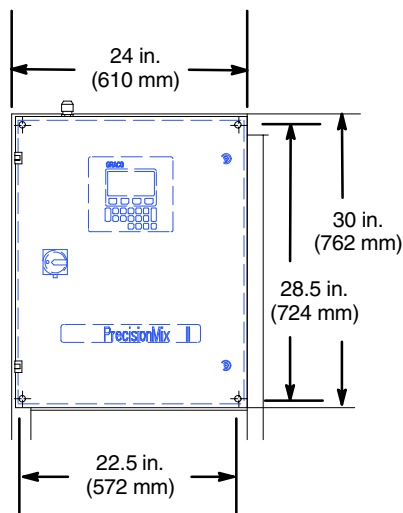
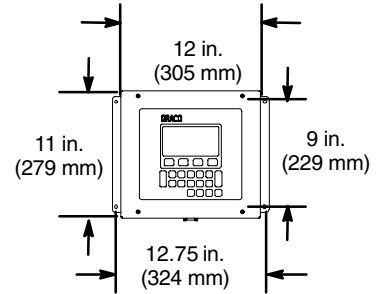

Fig. 3.5

### Remote User Interface

Depth: 3.75 in. (95 mm)



### Run Screen Monitor

Depth: 3 in. (76 mm)

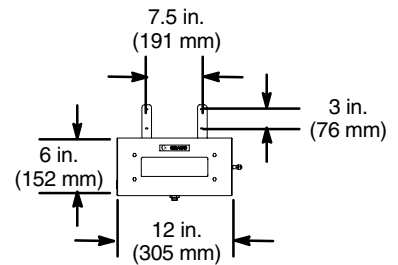

### Gun Flush Box

Depth: 9 in. (229 mm)

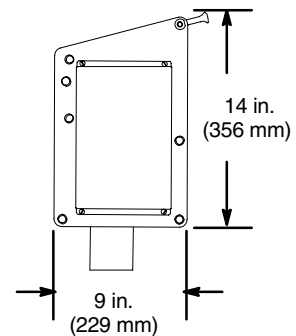

### Gun Flush Solenoid Box

Depth: 3.25 in. (83 mm)

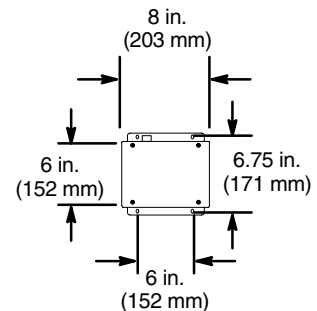

Fig. 3.6

9042A

# Mounting Components

## Stand Mounting Kit 241501

1. Select the desired location for the mounting stand. Be sure to leave sufficient space around the equipment for operator access, routing of hoses and cabling, and ventilation.
2. Drill holes in the floor, using the mounting stand base as a template, and install anchors as needed.
3. Secure the mounting stand to the floor.

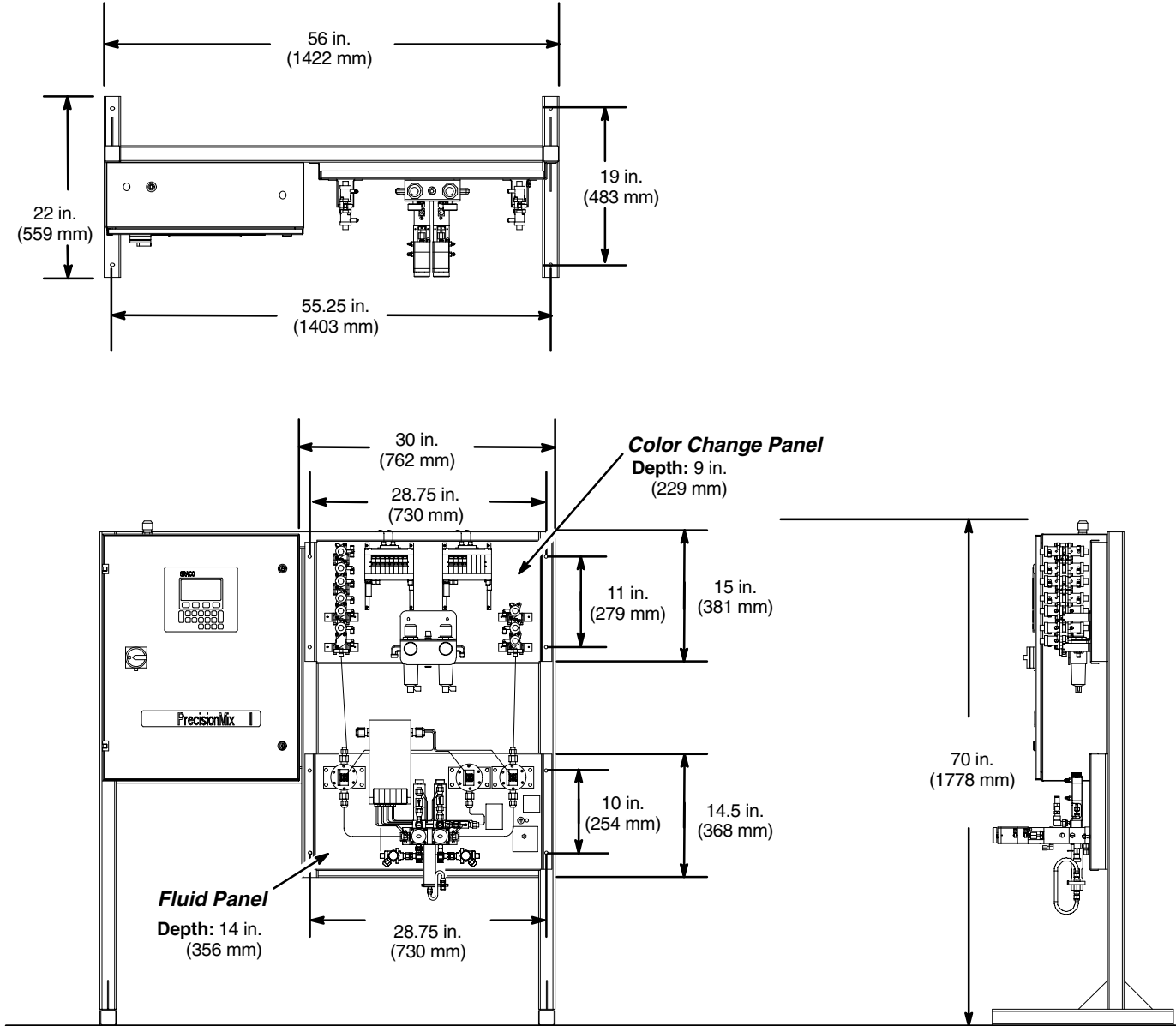

8999A

**Fig. 3.7** Dimensions and Mounting Holes



# System Installation

## NOTE:

- All options ordered on configured systems are electrically tested at the factory and shipped connected from Graco.
- It is recommended that all cables routed in the spray booth and high traffic areas be enclosed in conduit to prevent damage from paint, solvent, and traffic.
- Refer to the **Electrical Connection** table and diagram, page 3–29 for wiring connections.

## Install the Controller and User Interface (Code A)

The controller is available with a panel mount user interface or a remote user interface.

1. If you are using a remote user interface (T), Part No. 194372 standard cable (C1) is provided to connect the remote interface (T) to the controller (B). The 9-pin D-SUB cable is 50 ft. (15.2 m) long. See Fig. 3.8.

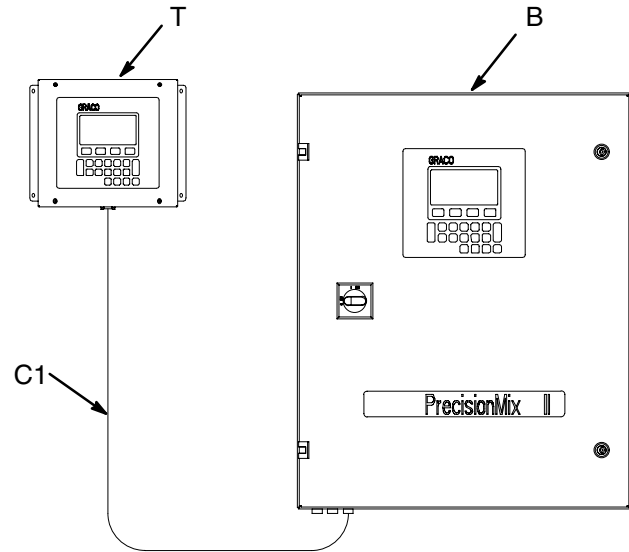

8992A

**Fig. 3.8**

2. Provide power to the controller, using conduit to protect the wiring.
3. Ground the controller to a true earth ground. See **Grounding the System** on page 3–30.



# System Installation

## Power Requirements

The Precision Mix II control is designed to operate with 120 Vac or 220 Vac input power. See Fig. 3.9 for the wiring connections.

It is possible for voltage brown out conditions to cause the Precision Mix II control to go into a memory failure mode. If the power being supplied to the system is not free of excessive dips an uninterruptable power supply (UPS) or a power conditioner will need to be supplied. The Precision Mix II control is already equipped with a surge suppressor, adding one will not be necessary. The basic requirements for purchasing a UPS or power conditioner are as follows:

1. Purchase one rated for the desired input voltage (120 Vac or 220 Vac).
2. Purchase one with a minimum output current of 125 Watts.
3. Purchase one that is rated for industrial use and the maximum temperature conditions of the installation site.

**NOTE:** It is not recommended to mount either a UPS or power conditioner inside the Precision Mix II control.

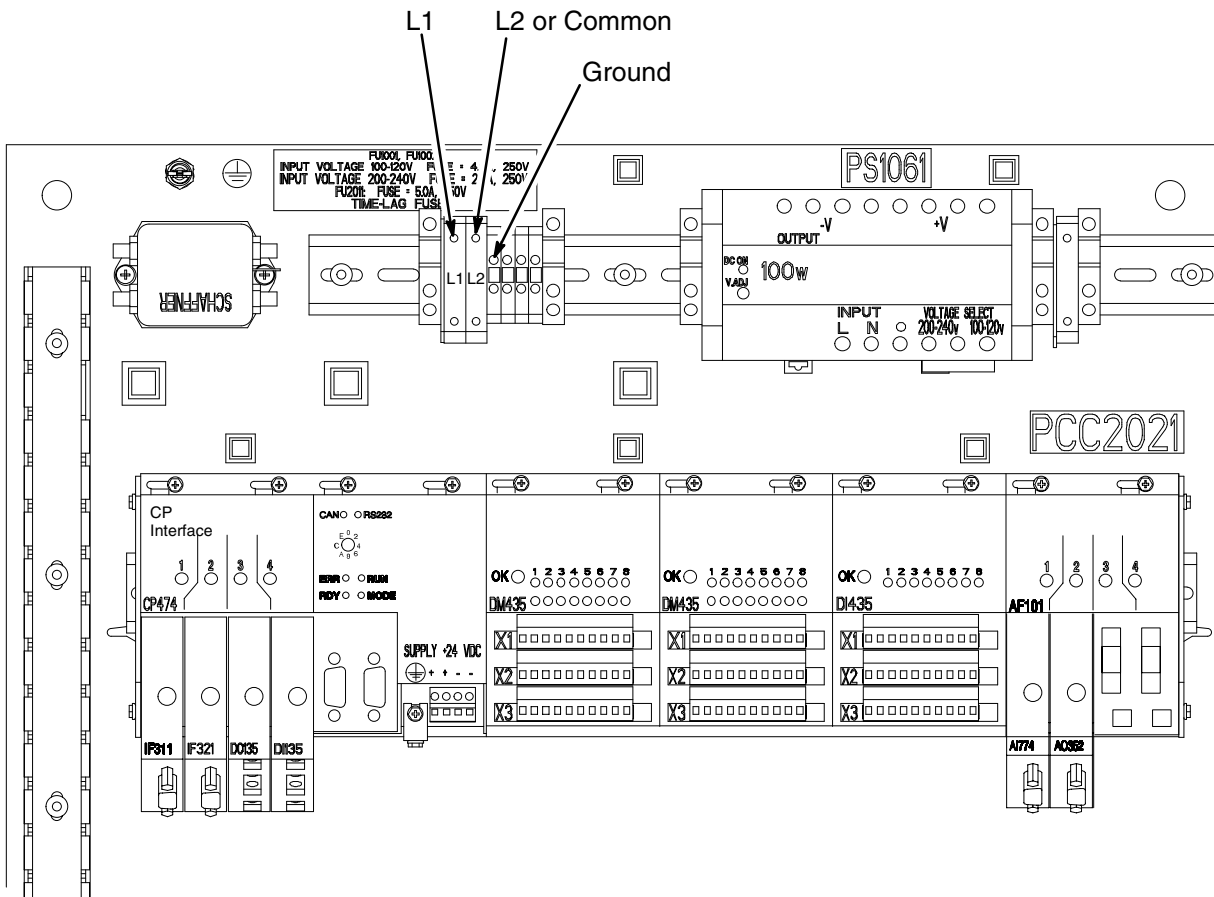

Fig. 3.9

# System Installation

## Install the Fluid Panel (Code E) with Fluid Meters (Code F)

A non-intrinsically safe fluid panel (Code E-1) is available for installing in a non-hazardous area. Refer to the typical installation drawing on page 3-4.

**⚠ WARNING**

**FIRE AND EXPLOSION HAZARD**  
The controller must be configured with the proper barriers for it to be used with a fluid panel installed in a hazardous area. A non-intrinsically safe system must be installed as shown in Fig. 3.1, page 3-4.

An intrinsically safe fluid panel (Code E-2) is available for installing in a hazardous area. Refer to the typical installation drawing on page 3-4.

### NOTE:

- The selected fluid meters ( $S^1$ ,  $S^2$ ,  $S^3$ ) are installed on the fluid panel at the factory.
  - See page 10-15 for a pneumatic schematic of the fluid panel.
1. 50 ft. (15.2 m) of cable (C6) is supplied, connecting the fluid panel solenoid box (P) and the PrecisionMix II controller (B). See Fig. 3.10.

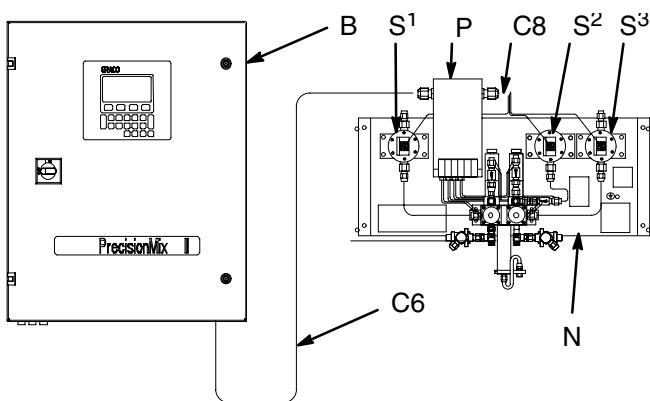

Fig. 3.10

2. In certain situations, the cable (C6) may need to be disconnected and reconnected to route the cable as desired. If this is necessary follow the steps below and refer to the **Electrical Connection** table and diagram, page 3-29.

### Non-intrinsically Safe Fluid Panel Cable Wiring

- a. Connect the cable wires to the terminals in the controller.
- b. Connect the cable wires to the terminal blocks in the solenoid box.

### Intrinsically Safe Fluid Panel Cable Wiring

- a. Connect the cable wires to the barriers in the controller.
  - b. Connect the cable wires to the terminal blocks in the solenoid box.
  - c. All wires must be connected to the terminal blocks and barriers. All shields must be connected to the ground terminal of the appropriate barrier.
3. A cable is factory connected between the solenoid box and meters to the meters. Bring the free end of the cables into the solenoid box and connect the wires to the terminal blocks.
  4. Ground the fluid panel to the same true earth ground used for the controller. See **Grounding the System** on page 3-30.

# System Installation

## Install the Air Control Kit

If you have ordered the color change, the air control kit is installed at the factory. Refer to **Install the Optional Color Change Panel**, page 3–16.

1. 25 ft. (7.6 m) of air line is provided with the air control kit (E). See Fig. 3.11.
2. Connect a minimum 1/2 in. (13 mm) main air supply line to the air inlet.

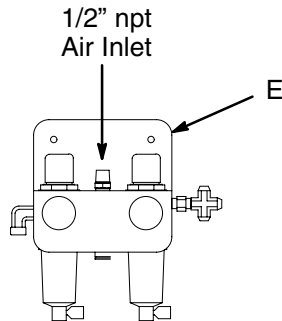

Fig. 3.11

## Install the Operator Station (Code J)

There are two types of operator station: with integrated color change (R) and without integrated color change (Q).

Be sure the supplied cable (C5) can reach the PrecisionMix II controller (B). 100 ft. (30.5 m) of cable is supplied, pre-connected to the operator station. The cable is pre-stripped and has ferrules assembled. See Fig. 3.12.

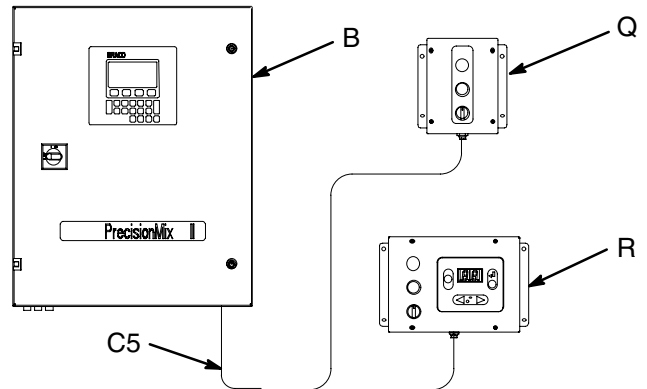

Fig. 3.12

**NOTE:** It is recommended that the cable be enclosed in conduit to prevent damage from paint, solvent, and traffic inside the spray booth. Cut the cable to the length needed, or coil the excess neatly in an out-of-the-way location where it will not be damaged.

# System Installation

## Install the Color/Catalyst Change Valves and Solenoids (Code K and L)

If color/catalyst change valves are ordered, the valves along with the necessary solenoid valves and the air control kit will be factory installed on the color change panel (C). Fig 3.13 shows both color and catalyst valves and their solenoids mounted on the panel.

1. See Fig. 3.13 and 3.14. All fluid and pneumatic connections are factory completed. The air lines may be shortened if desired.

2. Power (P) and network (N) cables, connecting the color change panel with the controller (B), are installed at the factory. The cables are 50 ft. (15.2 m) long. They may be shortened at the controller end only.
3. Ground the color change panel to the same true earth ground used for the controller and the fluid panel. See **Grounding the System** on page 3–30.

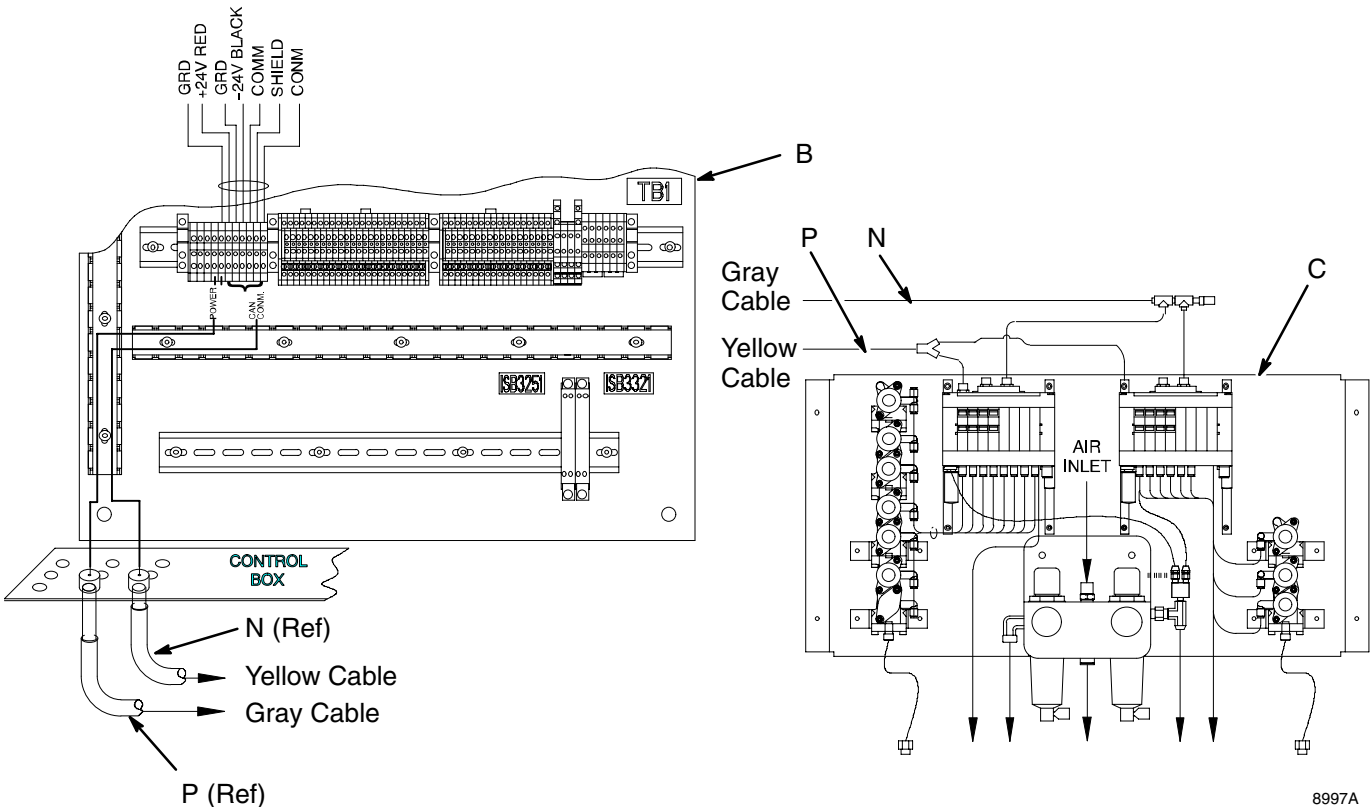

8997A

Fig. 3.13 Electrical Connections

Color Change Cable Connections Network Cable (Gray Cable)		
Wire Color	Termnal No.	Function
Blue	2041	CPU Data
Shield	2051	CPU Data
White	2061	CPU Data
Red	2021	+24 VDC
Black	1082	Common

Power Cable for Solenoids (Yellow Cable)		
Wire Color	Termnal No.	Function
White and Brown *	2041	+24 VDC
ShieldBlue	2051	Common

\* Brown wire is for new or replacement solenoid banks.

# System Installation

## Install the Color/Catalyst Change Valves and Solenoids (Code K and L) – continued

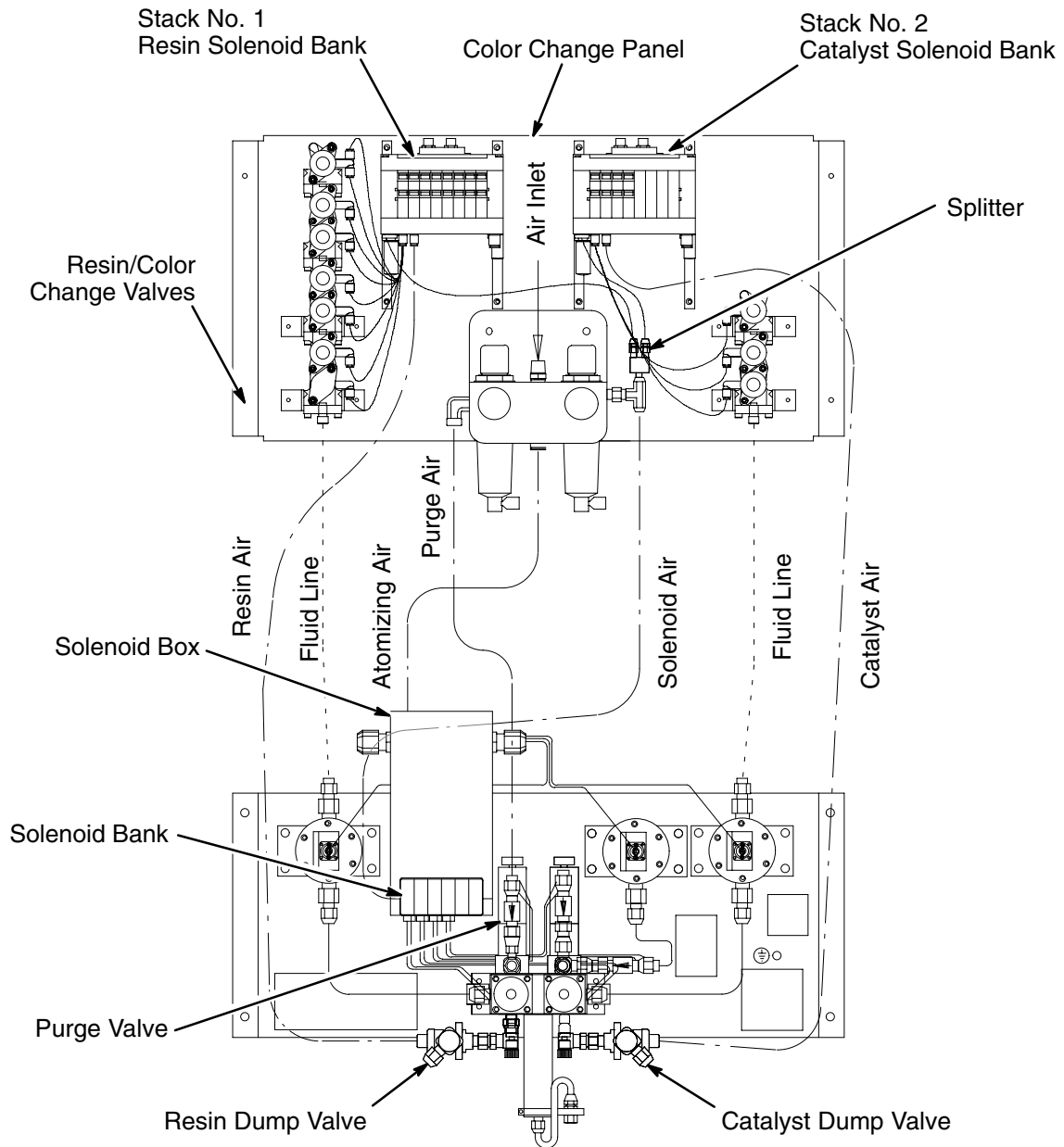

8993A

**Fig. 3.14 Air and Fluid Connections**

# System Installation

## Install the Gun Flush Box and Solenoid Box (Code M, N and P)

### NOTE:

- See Gun Flush Box Manual 309227 for gun flush box adjustment and parts information.
  - See page 10–16 for a pneumatic schematic of the gun flush box.
1. See Fig. 3.18. Install the gun flush box (H) in the spray booth. Locate the Gun Flush Box as far away from the spray or application point as possible to help avoid getting over-spray on it.
  2. Install the gun flush solenoid box (G) in the non-hazardous area, within 25 ft. (7.6 m) of the gun flush box. 100 ft. (30.5 m) of cable (C9) is provided, connecting the solenoid box with the controller (B).
  3. Connect two feet (0.6 m) of straight pipe or tubing (T) between the Gun Flush Box fluid outlet (O) and an enclosed waste container (W). See Fig. 3.15.

4. Electrically interlock the Gun Flush Box air supply with the ventilators to prevent the box from operating when ventilating fans are not operating. Check and follow all National, State, and Local codes regarding air exhaust velocity requirements.

**⚠ WARNING**

**TOXIC FLUID HAZARD**

To reduce the risk of splashing, a minimum of two feet (0.6 m) of straight pipe or tubing must be connected between the Gun Flush Box and an enclosed waste container for the solvent.

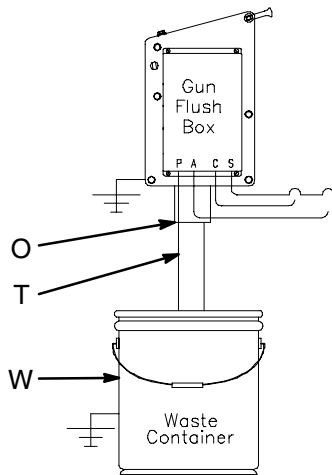

Fig. 3.15

**⚠ WARNING**

**TOXIC OR FLAMMABLE FUMES HAZARD**

To avoid hazardous concentrations of flammable or toxic fumes, install the Gun Flush Box in a properly ventilated spray booth. Never operate the Gun Flush Box unless ventilation fans are operating.

5. Use a clean, dry air supply; filtered to 10 microns. Connect a minimum 3/8 in. (10 mm) air supply line to the gun flush box solenoid box (G).
6. Install an atomizing air shutoff valve (L) in the spray gun air supply line. See Fig. 3.18 or 3.19.
7. Connect an air line (A3) between the valve (L) and the air flow switch (D).

*Continued on the next page.*

# System Installation

## Install the Gun Flush Box and Solenoid Box (Code M, N and P) – continued

8. Connect another air line (A1) from the atomizing air shutoff valve (L) to port **S** on the gun flush box. See Fig. 3.16.
9. Connect 5/32" (4 mm) OD air tubes (A2) between the gun flush solenoid box (G) ports and the gun flush box (H) ports. Refer to the table below and Fig. 3.16 for connection ports.

### Gun Flush Box Air Tube Connections

Solenoid Box		Gun Flush Box	
Ports	Description	Ports	Description
C	Solenoid Output	C	Gun trigger cylinder air (activates gun trigger)
A	Pressure Switch	A	Return air for the gun in the box signal
P	Air Supply	P	Supply air in
*		S	Safety interlock (locks out the atomizing air)
E	Solenoid Exhaust – no connections required		No connections required

- \* Connect to the atomizing air shutoff valve (L). See Figs. 3.18 and 3.19.

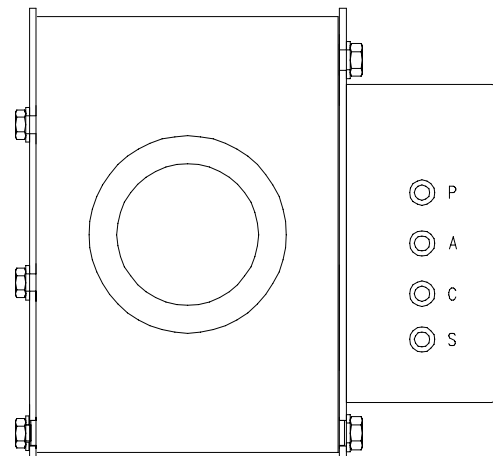

**Fig. 3.16** Gun Flush Box Bottom View

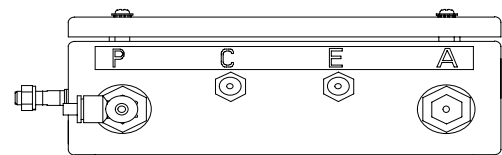

T10469

**Fig. 3.17** Solenoid Box Bottom View

# System Installation

Install the Gun Flush Box and Solenoid Box (Code M, N and P) – continued

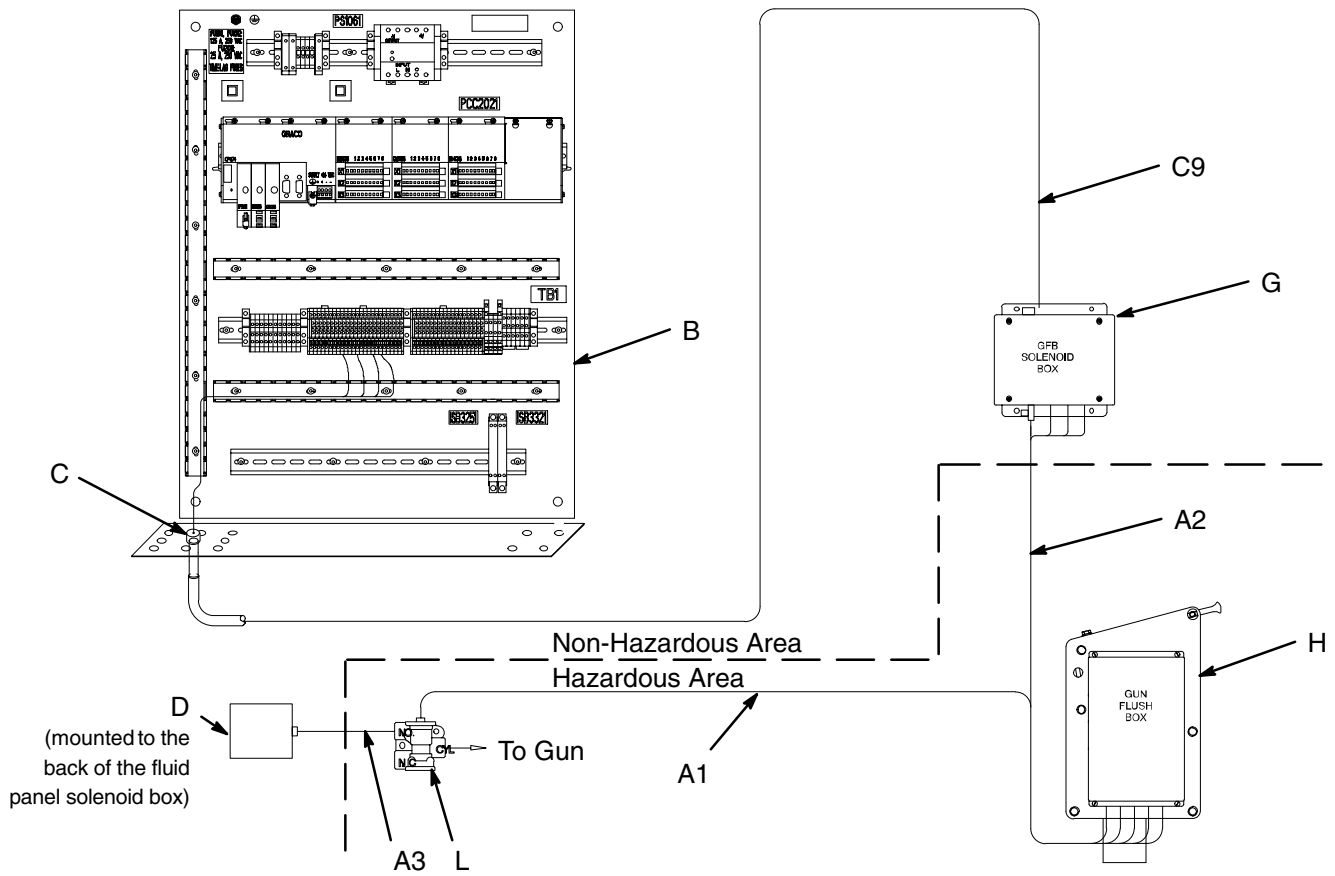

**Fig. 3.18 One Gun Flush Box Installation**

8990A



# System Installation

## Install the Gun Flush Box and Solenoid Box (Code M, N and P) – continued

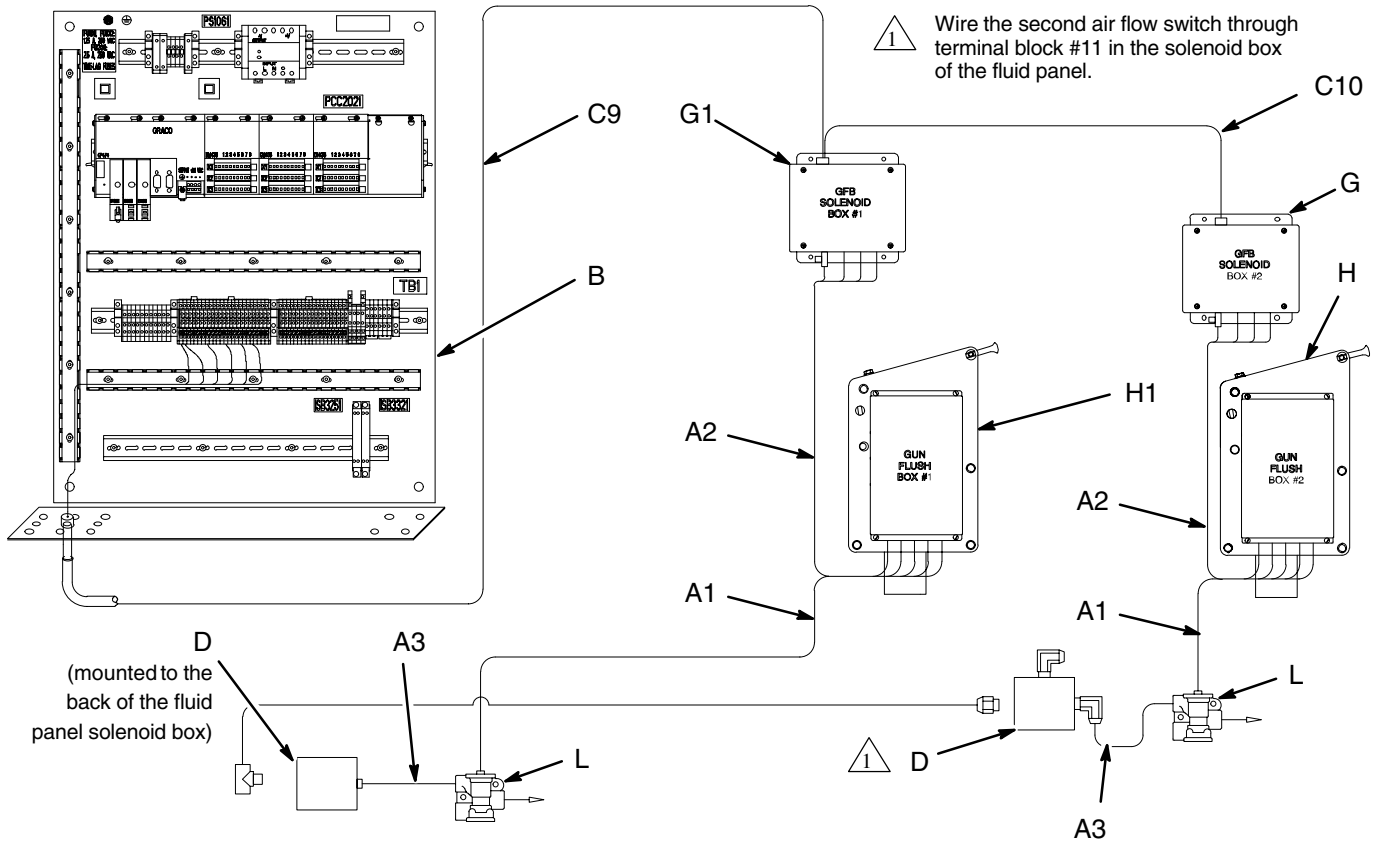

Fig. 3.19 Two Gun Flush Box Installation

8990A

# System Installation

Install the Gun Flush Box and Solenoid Box (Code M, N and P) – continued

## Electrical Connections & Wiring Schematic

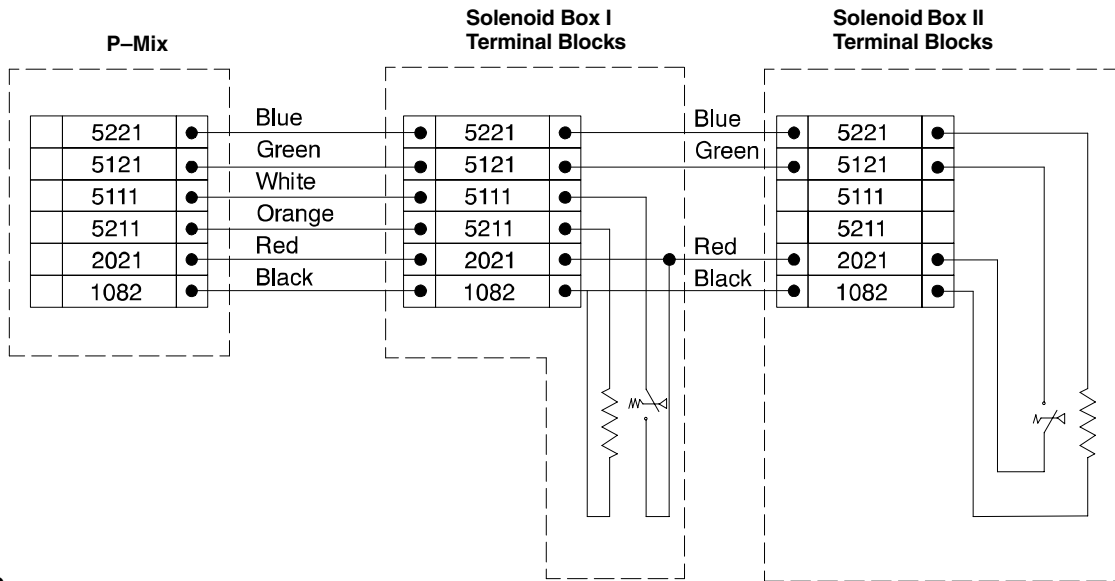

Fig. 3.20

T10471

# System Installation

## Install the Optional Flow Control

**NOTE:** Refer to the system electrical schematic, Manual 309001, included with the system.

1. See Fig. 3.21. Install the fluid regulator (K) in the spray booth, on the fluid supply line to the spray gun. Locate the fluid regulator as close to the spray gun as possible.
2. Install the I/P transducer (F) in the non-hazardous area, but as close to the fluid regulator as possible. Mount the transducer on a vibration free surface. 100 ft. (30.5 m) of cable (C12) is supplied, connecting the I/P transducer to the controller.
3. Connect a minimum 3/8 in. (10 mm) air supply line to the I/P transducer (F).
4. The I/P transducer supply air must be a maximum of 100 psi (0.7 MPa, 7 bar), free of oil or water, and filtered to a minimum of 40 micron.

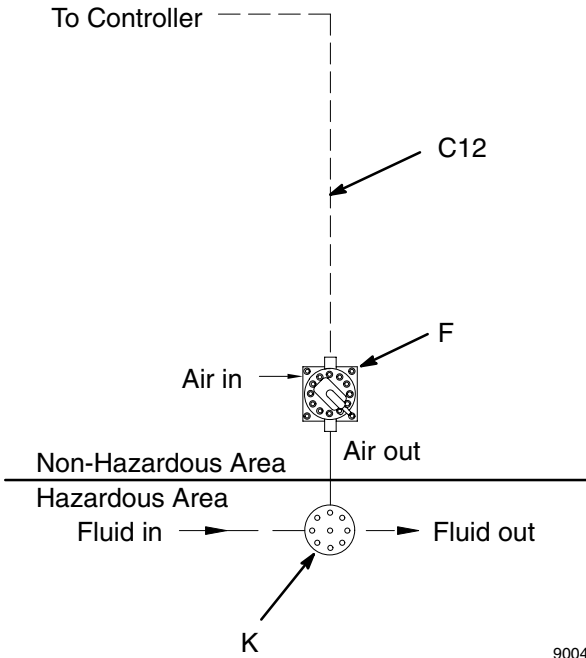

9004A

Fig. 3.21

## Fluid Connections

See Figs. 3.1, 3.2, and 3.3.

1. Connect the solvent supply line to the solvent inlet on the fluid panel. If your system has color change, make solvent connections to the color change stack and the catalyst change stack.
2. Connect the resin supply line and catalyst supply line to their respective inputs on the fluid panel. The fluid supplies must have consistent, non-fluctuating pressure through the full flow rate range.
3. Connect a fluid hose between the spray gun and the mixer outlet.
4. Connect an atomizing air hose from the air flow switch to the spray gun.

## Pressure Test and Solvent Flush the System

Before operating the system, perform the **Pressure Test and Solvent Flush** procedures on page 3–36. See system assembly drawings on electrical schematic 309001 for more specific details.

# Component Electrical Connections

Terminal Strip No. in Main Controller	Accessory/Option Name	Cable Part No.	Wire Color	Function	Barriers Uncontrolled Side	Barriers Controlled Side	Accessory Terminal No.
	<b>Color Change</b>						Festo Solenoid Stack
2041	Festo solenoid bank	115153	Blue	Can Low			
2051	Network communication		Shield	Shield			Can network port
2061			White	Can High			Pin connector port
2021			Red	24 VDC			
1082			Black	Ground			
4081	Not listed						
2021	Festo solenoid bank	115150	White/Brown	24 VDC			Power supply
1082	Power supply		Blue	Ground			Pin connector port
	<b>Graphic User Interface</b>						
None	Pre-wired with connectors	194400					Pre-wired connectors
	<b>Printer Port</b>						
None	Pre-wired with connectors	See printer option					Pre-wired connectors
	<b>PC Network Interface</b>						
3101			Blue/White	Network B			All other P-Mix II systems on the network
3081			White/Blue	Network A			
3091			Shield	Ground			
	<b>Run Screen Monitor</b>						
3131		194481	Green	Network A			Network A
3151			White	Network B			Network B
2021			Red	24 VDC			24 VDC
1082			Black	Ground			Ground
1082			Shield	Signal protection			
	<b>Operator Station</b>						
				Barrier No. 3321 (factory wired)			
3131		194477	Green	Network A	1	3	A
3151			White	Network B	2	4	B
Ground			Shield/drain	Ground		PA/gnd	Shield/drain
				Barrier No. 3251 (factory wired)			
2021			Red	24 VDC	1	3	+24 VDC
1082			Black	Common	2	4	Com
Ground			Shield/drain	Ground		PA/gnd	Shield/drain

# Component Electrical Connections

Terminal Strip No. in Main Controller	Accessory/Option Name	Cable Part No.	Wire Color	Function	Barriers Uncontrolled Side	Barriers Controlled Side	Accessory Terminal No.
	<b>Solenoids</b>						
4021	Resin		Brown	Signal	1	3	4021
1082			Black	Common	2	4	1082
1082			Drain	Shield		PA/gnd	Shield
4061	Catalyst		Blue	Signal	1	3	4061
1082			Black	Common	2	4	1082
1082			Drain	Shield		PA/gnd	Shield
5171	Solvent A		Green	Signal	1	3	4081
1082			Black	Common	2	4	1082
1082			Drain	Shield		PA/gnd	Shield
5181	Solvent B		White	Signal	1	3	5171
1082			Black	Common	2	4	1082
1082			Drain	Shield		PA/gnd	Shield
5191	Solvent C		N/A	Signal	1	3	5181
1082			N/A	Common	2	4	1082
1082			Drain	Shield		PA/gnd	Shield
	<b>Meters</b>						
4251	Meter A		White/Red	Signal	2	4	4251
1082			Black	Ground		PA/gnd	1082
2021			Red	24 VDC	1	3	2021
1082			Drain	Shield/drain		PA/gnd	Shield
4271	Meter B		Blue/Red	Signal	2	4	4271
1082			Black	Ground		PA/gnd	1082
2021			Orange	24 VDC	1	3	2021
1082			Drain	Shield/drain		PA/gnd	Shield
4291	Meter Solvent/Gun 2		Brown/Red	Signal	2	4	4291
1082			Black	Ground		PA/gnd	1082
2021			Yellow	24 VDC	1	3	2021
1082			Drain	Shield/drain		PA/gnd	1082
4311	Meter Gun 1		N/A	Signal	2	4	4311
1082			N/A	Ground		PA/gnd	1082
2021			N/A	24 VDC	1	3	2021
1082			Drain	Shield/drain		PA/gnd	Shield

# Component Electrical Connections

Terminal Strip No. in Main Controller	Accessory/Option Name	Cable Part No.	Wire Color	Function	Barriers Uncontrolled Side	Barriers Controlled Side	Accessory Terminal No.
	<b>Air Flow Switch</b>						
5051	Gun 1 Trigger		Orange	Signal	2	4	5051
2021			Black	24 VDC	1	3	2021
1082			Drain	Shield			1000
5061	Gun 2 Trigger		Orange	Signal	2	4	5061
2021			Black	24 VDC	1	3	2021
1082			Drain	Shield	GND	GND	1000
	<b>Alarm</b>						
6171		From Alarm	Gray	Ratio alarm			Gray wire
6201			Orange	Potlife alarm			Orange wire
1082			Yellow	Ground			Yellow wire
	<b>Gun Flush Box</b>						
5111		065338	White	Gun flush box interlock gun 1			5111 input +24 VDC
5121			Green	Gun flush box interlock gun 2			5121 input +24 VDC
5221			Blue	Gun trigger gun flush box 2/auto dump			5221 output +24 VDC
5211			Orange	Gun trigger gun flush box 1/auto dump			5211 output +24 VDC
2021			Red	24 VDC			2021
1082			Black	Common			1082
	<b>Flow Control</b>						
8041			Red	Analog + input gun #1 remote 0–20 Ma			Field Source
8051			Black	Analog – input gun #1 remote 0–20 Ma			Field Source
1082			Shield	Signal Protection			Field Source
1082			Shield	Signal Protection			Field Source
8071			White	Analog + input gun #2 remote 0–20 Ma			Field Source
8081			Green	Analog – input gun #2 remote 0–20 Ma			Field Source

# Component Electrical Connections

Terminal Strip No. in Main Controller	Accessory/Option Name	Cable Part No.	Wire Color	Function	Barriers Uncontrolled Side	Barriers Controlled Side	Accessory Terminal No.
	<b>Flow Control (cont.)</b>						
2021			Red	24 VDC power to I/P gun #1			6
8281			White	4–20 Ma signal I/P gun #1			4
8291			Green	I/P common gun #1			1
1082			Black	I/P common gun #1			2
1082			Shield	Signal protection			Case
1082			Shield	Signal protection			Case
2021			Red	24 VDC power to I/P gun #2			6
8331			White	4–20 Ma signal I/P gun #2			4
	<b>Field Wiring Terminals for Additional Interface Capabilities</b>						
8341			Green	I/P common gun #2			1
1082			Black	I/P ground gun #2			2
7121				Security bypass			Input +24 VDC discrete
7111				Spare			Input +24 VDC discrete
7101	External process controller			Recipe bit 5			Input +24 VDC discrete
7091	External process controller			Recipe bit 4			Input +24 VDC discrete
7081	External process controller			Recipe bit 3			Input +24 VDC discrete
7071	External process controller			Recipe bit 2			Input +24 VDC discrete
7061	External process controller			Recipe bit 1			Input +24 VDC discrete
7051	External process controller			Recipe bit 0			Input +24 VDC discrete
6101				Spare			
6121				Gun #2 Selected from I/O (GFB)			
6111				Gun #1 Selected from I/O (GFB)			

# Component Electrical Connections

Terminal Strip No. in Main Controller	Accessory/Option Name	Cable Part No.	Wire Color	Function	Barriers Uncontrolled Side	Barriers Controlled Side	Accessory Terminal No.
	<b>Field Wiring Terminals for Additional Interface Capabilities (continued)</b>						
6091	External process controller			Flow control override			Input +24 VDC discrete
6081	External process controller			Gun 2 flow rate control reset			Input +24 VDC discrete
6071	External process controller			Gun 1 flow rate control reset			Input +24 VDC discrete
6061	External process controller			Mix			Input +24 VDC discrete
6051	External process controller			Purge			Input +24 VDC discrete
5051	External solenoid			Gun 1 trigger			Input +24 VDC
5061	External solenoid			Gun 2 trigger			Input +24 VDC
5071	Remote alarm			External alarm			Input +24 VDC
5081	External process controller			Abort reset			Input +24 VDC discrete
5091	External process controller			Color change			Input +24 VDC discrete
5101	External process controller			Print report			Input +24 VDC discrete
6241				Spare			
6231	Remote alarm			Purge not complete alarm			Output +24 VDC
6221				Spare			
6211	Remote alarm			Potlife alarm gun 2			Output +24 VDC
6201	Remote alarm			Potlife alarm gun 1			Output +24 VDC
6191	Remote alarm			Flow alarm: high flow/gun 2			Output +24 VDC
6181	Remote alarm			Flow alarm: low flow/gun 1			Output +24 VDC
6171	Remote alarm			Ratio alarm			Output +24 VDC
5241				Special			Output +24 VDC
5231				Special			Output +24 VDC
5201	External process controller			Purge/mix load			Input +24 VDC discrete



# Controller Terminal Block

## ⚠ CAUTION

If power and grounding connections are not done properly, the equipment will be damaged and the warranty will be voided.

Refer to Fig. 3.22.

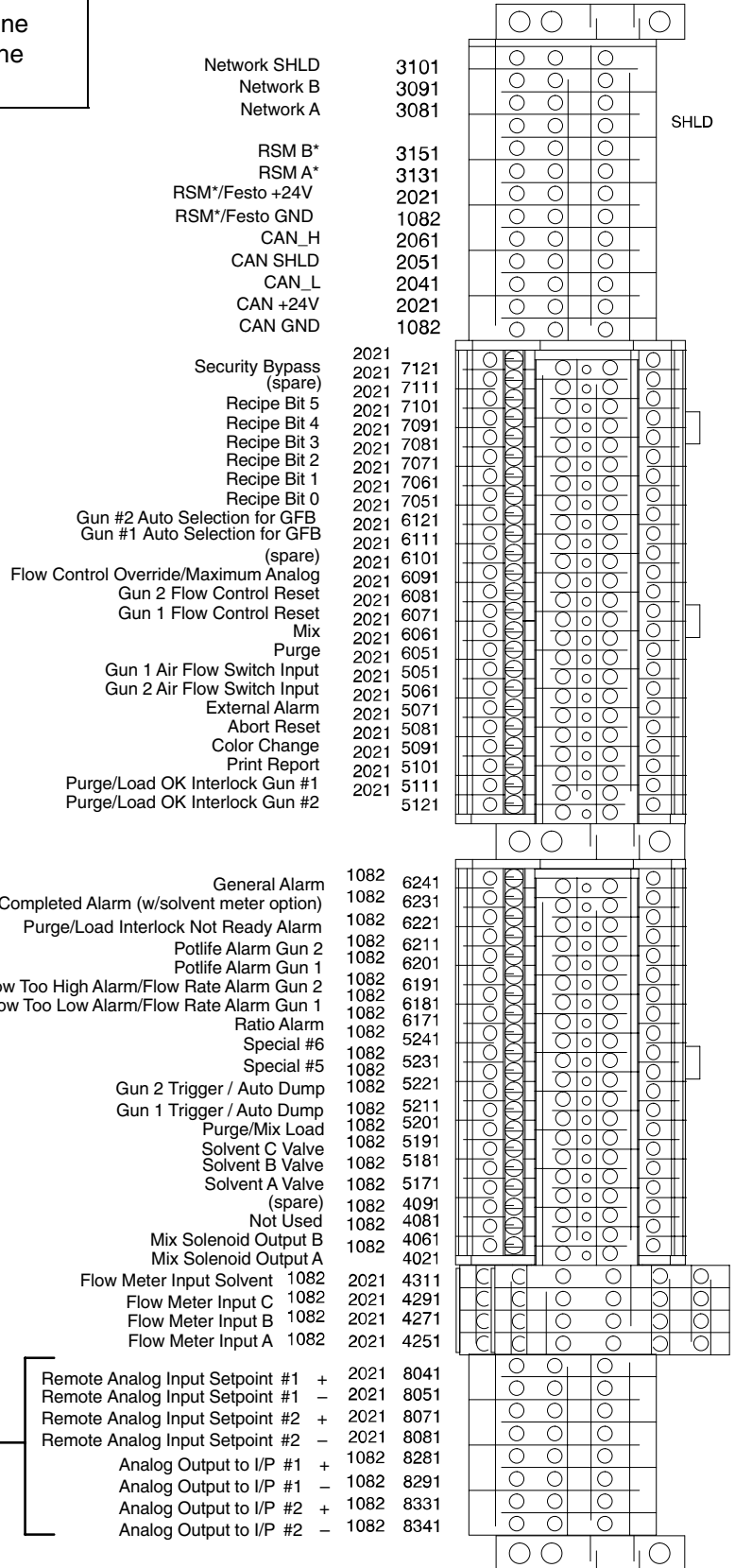

\* RSM = Run screen monitor

**NOTE:** All signals labeled 1082 are GND.  
All signals labeled 2021 are +24V.

Optional Terminal Blocks for Flow Control

Fig. 3.22

T10240

# Ground the System

See Fig. 3.23.

**⚠ WARNING**

**FIRE, EXPLOSION, AND ELECTRIC SHOCK HAZARD**  
To reduce the risk of fire, explosion, or electric shock:

- The PrecisionMix II system must be electrically connected to a true earth ground; the ground in the electrical system is not sufficient.
- All wires used for grounding must be 10 gauge minimum.
- A qualified electrician must complete all grounding and wiring connections and check the resistance as instructed on page 3–31.
- Refer to your local code for the requirements for a “true earth ground” in your area.
- Also read and follow the warnings on page 1–3.

Ground the PrecisionMix II system as instructed here and in the individual component manuals. A ground wire and clamp, part no. 222011, is available from Graco. Grounding instructions are continued on page 3–31.

## Controller

Connect the controller’s green-yellow ground terminal block to the NEMA enclosure’s grounding lug. Connect a ground wire from the enclosure to a true earth ground. The controller enclosure and the manifold mounting surface must be connected to the same true earth ground point.

## PrecisionMix II Manifold

The mounting surface for the PrecisionMix II manifold must be electrically connected to the same true earth ground point as the controller enclosure. Different ground points may cause current to flow through the meter cables, causing incorrect signals.

## Color Change Panel

The mounting surface for the color change valves and solenoids must be electrically connected to the same true earth ground point as the controller enclosure. Different ground points may cause current to flow through the meter cables, causing incorrect signals.

## Operator Station

Ground the operator station to a true earth ground.

## Flow Control Station

Ground the flow control stations to a true earth ground.

## Gun Flush Boxes

Ground the gun flush boxes to a true earth ground.

## Gun Flush Solenoid Boxes

Ground the gun flush solenoid boxes to a true earth ground, or mount them on a grounded surface.

## Flow Meters

Connect the meter cables as instructed in the manual for your flow meter. Failure to properly connect the grounded conductor and shield may cause incorrect signals.

## Feed Pumps or Pressure Pots

Use a ground wire and clamp to electrically connect the pumps or pots to a true earth ground. See your separate pump or pressure pot manual.

## Air and Fluid Hoses:

Use grounded hoses only.

## Spray Gun

Follow the spray gun manufacturer’s grounding instructions.

## Fluid Supply Container

Ground the container according to your local code.

## Object Being Sprayed

Ground the object according to your local code.

## All Solvent Pails Used When Purging

Ground the solvent pails according to your local code. Use only metal pails, which are conductive, placed on a grounded surface. Do not place the pail on a nonconductive surface, such as paper or cardboard, which interrupts the grounding continuity.

## Maintain Grounding Continuity When Purging Or Relieving Pressure

Follow the instructions in your separate gun manual for safely grounding your gun while purging.

# Ground the System

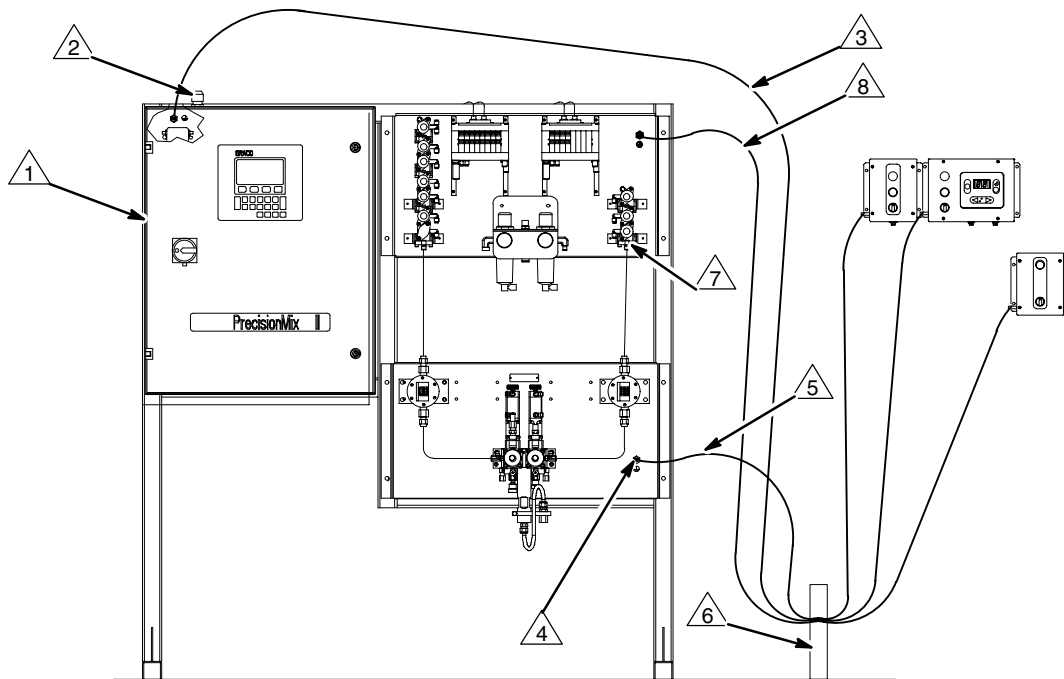

## KEY









- |  |   |
|--|---|
| <ul style="list-style-type: none"> <li> Controller</li> <li> Controller's Ground Lug</li> <li> Controller Enclosure Ground Wire; must be connected to same true earth ground [6] as the fluid panel is connected to .</li> <li> Ground Wire connection point for the fluid panel ground wire.</li> <li> Fluid Panel Ground Wire; must be connected to same true earth ground [6] as the controller is connected to.</li> </ul> | <ul style="list-style-type: none"> <li> True Earth Ground; check your local code for requirements.</li> <li> Ground Wire connection point for the color change panel ground wire.</li> <li> Color Change Panel Ground Wire; must be connected to same true earth ground [6] as the controller and fluid panel are connected to.</li> </ul> |
|--|---|

Fig. 3.23

9060A

# Check the Resistance

**⚠ WARNING**



**FIRE, EXPLOSION, AND ELECTRIC SHOCK HAZARD**

To reduce the risk of fire, explosion, or electric shock the resistance between the PrecisionMix II components and true earth ground must be less than 1 ohm.

Have a qualified electrician check the resistance between each PrecisionMix II component and the true earth ground. The resistance must be less than 1 ohm. If the resistance is greater than 1 ohm, a different ground site may be required. Do not operate the system until the problem is corrected.

# Power-up Checklist

✓	<b>Power-up Steps</b>
	<b>PrecisionMix II System</b>
	<b><i>Make sure the Operator Station switch is in STANDBY before turning on the system.</i></b>
	1. Ensure that the jumper position on the 24 VDC power supply is in the correct position for the main supply voltage.
	2. Ensure that the fuses are the correct value for the main supply voltage.
	3. Turn on the main power switch.
	4. Check that the DC ON LED on the power supply is lit. See Fig. 3.24.
	5. Check that LEDs 1, 2, 3, and 4 on the controller interface module are lit. See Fig. 3.24.
	6. Check that the RUN LEDs on the controller are lit, the ERR (error) LED is not lit, and the RS232 LED is blinking. See Fig. 3.24.
	7. Check that the OK LEDs on all the I/O modules are lit. See Fig. 3.24.
	8. Check that the User Interface has powered up and is displaying the initial Run Monitor screen. See page 6–3.
	9. Check that all the lights on the Operator Station, including the alarm light, illuminate for about 1 second during power-up. If the Operator Station includes integrated color change, make sure that the color change display does not remain at "E2". See page 4–4.
	10. Ensure that the Run Screen Monitor (if installed) has powered up and is displaying data on its screen.
	<b>Optional Flow Control</b>
	11. Check that the LEDs 1 and 2 on the analog interface module are lit. See Fig. 3.24.
	12. Check the I/P transducers as instructed on page 3–34.
	13. If flow rate setpoint is controlled from analog input, test the external 4–20 mA input signal as instructed on page 3–35.

# Power-up Checklist

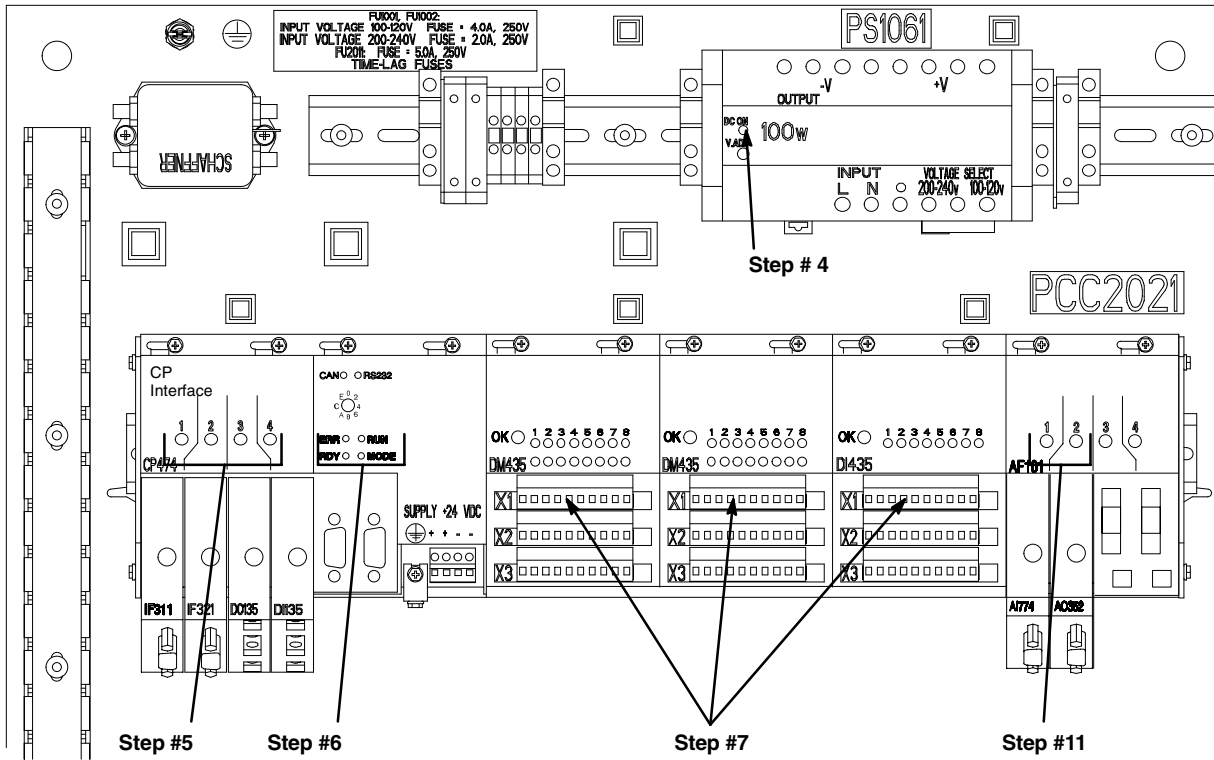

Fig. 3.24

# Power-up Checklist

## Checking Flow Control I/P Transducers

**NOTE:** Only follow this procedure if a Flow Control system is installed.

1. Turn on the main power on the PrecisionMix II controller.
2. Turn off the air supply to the I/P transducers.

### **WARNING**

The next test will use free-flowing air from the I/P transducer. Make sure the area is safe for this test.

3. Remove the air line from the I/P transducer outlets. Turn on the air supply to the I/P transducer.
4. Go to the System Configuration Menu screen.

### System Configuration Menu

SYSTEM CONFIGURATION	Station: 00
MENU	
1.LANGUAGE	11.MIX/PURGE
2.STATION NUMBER	12.FLOW CONTROL
3.DISPLAY UNITS	13.INTEGRATOR VOLUME
4.RECIPES	14.COLOR CHANGE
5.POTLIFE TIMER	15.PASSWORD CHANGE
6.FLOW RATE LIMITS	16.TIME AND DATE
7.SOLVENT METER	17.RUN SCREEN DISPLAY
8.PURGE SEQUENCE	18.DISPLAY SETUP
9.MIXED LOAD VOL.	19.PRINT SETUP
10.GUNS SETUP	20.AIR FLOW SWITCH
Select a menu item and press enter: > 1	

5. Type number 12, for FLOW CONTROL, then .

### C12: Flow Control

SYSTEM CONFIGURATION	Station: 1
FLOW CONTROL OPTIONS	
Select Flow Control Options:	
1. OFF	
2. Hand Gun Operation	
3. Automatic Gun Operation	
> 2	
Press Enter to Accept Data and Edit the Flow Control Options.	

6. Type the number for the desired flow control option then .

## Flow Control Menu (FCMenu)

SYSTEM CONFIGURATION	Station: 1
FLOW CONTROL: MENU	
Select Flow Control Options to Edit:	
1. Source of Flow Control Data	
2. Analog Input Scaling Range	
3. Force Analog Output	
4. Delay Time to Start Flow Control	
5. Flow Meter Location	
> 3	

7. Type number 3 for Force Analog Output then .

### FC1: Flow Control Force Output

SYSTEM CONFIGURATION	Station: 1
FLOW CONTROL:FORCE OUTPUT	
Select On to Begin Forcing the Outputs:	
> OFF	
Enter a New Output Percentage to Force the Flow Regulator:	
Gun 1 = 000 %	
Gun 2 = 000 %	

8. Select ON and enter 100% to force the fluid regulator open. Maximum air pressure should flow from the I/P transducer. Enter 0% to close the Fluid regulator. There should be no air flow from the I/P transducer.
9. Re-install the I/P transducer air lines.

# Power-up Checklist

## Testing Flow Control External 4–20 mA Input Signal

**NOTE:** Only follow this procedure if a Flow Control system is installed.

1. Select to display the Flow Rate Setpoint screen (fourth screen) on the User Interface.

### Flow Rate Setpoint

RUN MONITOR 00/00/00	Recipe #: 1	Station: 1 00:00
Gun #1 Flow Rate	Setpoint: Actual: Analog out: Setpoint in:	0000 cc/min 0000 cc/min 00.0 mA 00.0 mA
Gun #2 Flow Rate	Setpoint: Actual: Analog out: Setpoint in:	0000 cc/min 0000 cc/min 00.0 mA 00.0 mA

Press Enter for a new Setpoint

2. Vary the 4–20 mA signal and note the Setpoint in value changes on the screen.

For a maximum flow rate setpoint of 2000 cc/min., the scaling will be as follows:

- 20 mA signal = 2000 cc/min. "Actual" display on screen
- 10 mA signal = 1000 cc/min. "Actual" display on screen
- 4 mA signal = 0 cc/min. "Actual" display on screen

# Pressure Test and Solvent Flush Procedure

## WARNING

### COMPONENT RUPTURE HAZARD



Do not exceed the maximum working pressure of the lowest rated system component. See the instruction manuals of the individual PrecisionMix II components for their maximum working pressures.

## WARNING

### SKIN INJECTION HAZARD



Spray from the gun, hose leaks, or ruptured components can inject fluid into your body and cause extremely serious injury, including the need for amputation. Splashing fluid in the eyes or on the skin can also cause serious injury.

- Do not stop or deflect fluid leaks with your hand, body, glove, or rag.
- Wear the appropriate protective clothing, gloves, eyewear, and respirator.
- Make sure all fluid lines are properly connected before performing the pressure test or solvent flush procedures.

**NOTE:** Perform all of the following steps before operating the PrecisionMix II.

## Test Color Valve Operation

1. Complete all steps of the System Installation procedure.
2. Turn on main power and perform all power-up checks. Refer to page 3–32.
3. Turn on the air supply. Manually activate each solenoid valve on the color change panel and observe the associated color change valve or dump valve to verify that the valves are operating properly.
4. Turn on the solvent supply to the flush valves and the resin (component A) and catalyst (component B) material supply. Repair any leaks.

## Pressure Test the Resin (A) Side

**NOTE:** On systems with color change, perform steps 1 through 6. On systems without color change, begin with step 4.

### With Color Change

1. Supply solvent pressure to the solvent flush port of the color stack.
2. Manually actuate the solvent solenoid valve (#1) on the resin side of the color change panel. Repair any solvent leaks.
3. Manually actuate the resin dump solenoid valve (#2) on the color change panel. Flush solvent through the color stack, meter, and resin dump valve until the solvent is clean and free of air. Repair any leaks. Continue with step 4.

### Without Color Change

4. Manually actuate the resin solenoid valve (#2) in the solenoid box on the fluid panel. Repair any leaks.
5. Trigger the spray gun into a grounded metal pail until the solvent dispensed from the gun is clean and free of air.
6. Open the ratio check valves and flush with solvent until clean.

## Pressure Test the Catalyst (B) Side

**NOTE:** On the catalyst side, follow the same procedure used on the resin side.

## Pressure Test the Solvent Lines

1. Manually actuate the solvent solenoid valve (#1) on the resin side of the color change panel. Repair any solvent leaks.
2. Trigger the spray gun into a grounded metal pail until the solvent dispensed from the gun is clean and free of air.



**4**

# **Operation**



# Pressure Relief Procedure

## **WARNING**

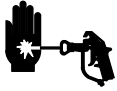



### **SKIN INJECTION HAZARD**

The system pressure must be manually relieved to prevent the system from starting or spraying accidentally. Fluid under high pressure can be injected through the skin and cause serious injury. To reduce the risk of an injury from injection, splashing fluid, or moving parts, follow the **Pressure Relief Procedure** whenever you:

- are instructed to relieve the pressure,
- stop spraying,
- check or service any of the system equipment,
- install or clean the spray tip.

1. Set the operator switch to STANDBY .

2. Relieve fluid and air pressure at the component and solvent feed pumps or pressure pots, as explained in their separate instruction manuals.
3. Set the operator switch to MIX .
4. If using an electrostatic gun, make sure the electrostatic power is turned off.
5. Hold a metal part of the spray gun firmly to the side of a grounded metal pail, and trigger the gun to relieve fluid pressure.
6. Set the operator switch to STANDBY .

Stop production at any time by setting the operator switch to STANDBY. If your stop time will not exceed the pot life of Component A or B, no additional action is needed, except to relieve the system pressure. If your stop time will exceed the pot life, you must purge the mixing system.

# Operator Controls and Indicators

There are two controller configurations:

- Controller with panel mounted User Interface
- Controller with remote User Interface

Both configurations have an Operator Station.

## Operator Station (See Fig. 4.1 and 4.2)

The Operator Station consists of an operator switch, print button, and alarm light. The station may also have an optional Color Change Control.

**NOTE:** The operator switch and the color change control portion of the Operator Station are enabled or disabled during system configuration. See Recipe Source selection, on page 8–6 and Mix/Purge Input source selection, on page 8–11 for more information.

### Operator Switch

There are three operator switch input settings: mix, standby, and purge.

**MIX** 

Setting the operator switch to mix starts the normal operation (mixing and dispensing) of the system.

**STANDBY** 

Setting the operator switch to standby stops the system.

**PURGE** 

Setting the operator switch to purge causes the system to cycle between the air and solvent purge solenoid outputs to operate the air and solvent purge valves. Purge will not initiate until two seconds after the operator switch has been moved to the purge position. This cycling can be either a function of time or of volume if flow meters are connected to measure volume.

**Print Button** 

Pressing the print button will output a run report and reset the job totals.



**Alarm Light** 

The controller activates the alarm light when the PrecisionMix II has stopped operating because of an alarm condition. The type of alarm will display on the user interface.

## Clearing Alarms

 When clearing alarms, do not leave the operator switch in the PURGE position for more than 2 seconds or the system will purge.

All alarms, except the Pot Life Alarm, can be cleared by moving the operator switch momentarily to PURGE

 , then back to STANDBY .

To start spraying again, turn the switch back to MIX .

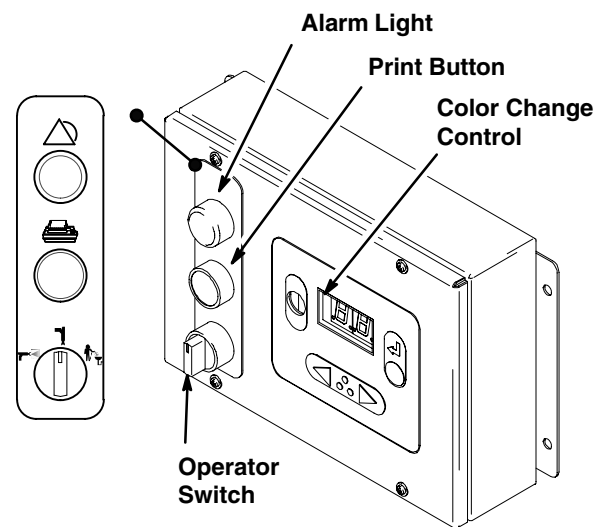

**Operator Station**

*with Color Change Control*

**Fig. 4.1**

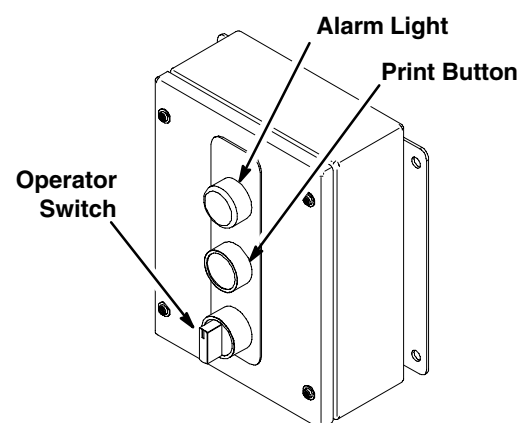



**Operator Station**



*without Color Change Control*

**Fig. 4.2**

# Operator Controls and Indicators

## Color Change Control

The current working recipe can be modified using the arrow keys   and the enter key  on the Operator Station.

Key	Function
 Increase Arrow	Press to increase the recipe value by one increment each time the key is pressed.
 Decrease Arrow	Press to decrease the recipe value by one increment each time the key is pressed.
 Return	Press to send the new recipe information to the controller. The enter key also triggers a color change if one of the Integrated Color Change modes is selected.

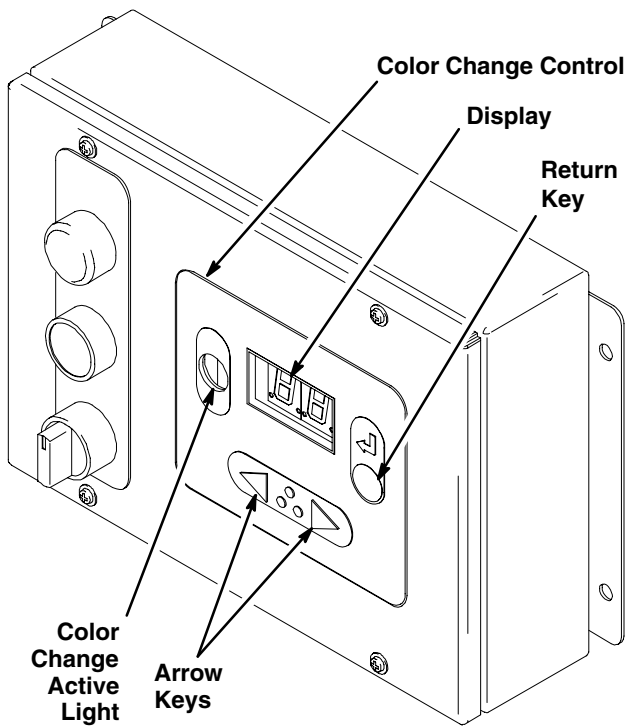

**Operator Station**

**Fig. 4.3** *with Color Change Control*

When a new recipe is selected using the arrow keys, two blinking periods  appear on the display, indicating the new recipe information has been input, but the enter key has not been pressed. The user has 5 seconds to press the enter key and accept the new recipe before the display returns to the old recipe.

The function of the Color Change Control key entries is dependent on which color change mode has been selected; see the table below. See page 8–21 for instructions on selecting the color change mode.

Color Change Mode	Function of Key Entries
<b>No Color Change:</b>	A new recipe may be selected immediately by changing the recipe value with the arrow keys and pressing the enter key.
<b>Integrated Color Change On:</b>	Selecting a new recipe with the arrow keys and pressing the enter key will start an integrated color change. The green “Color Change Active” light on the Operator Station will blink until the color change is finished.
<b>Integrated Color Change On With Queue:</b>	Pressing the enter key will trigger the next integrated color change from the queue. The arrow keys are not active in this mode. The green “Color Change Active” light on the Operator Station will blink until the color change is finished.

# Operator Controls and Indicators

## User Interface

The User Interface is a small terminal with a 16 x 40 character display and a keyboard for entering setup parameters. The User Interface is available mounted in

the controller door or as a remote station that can be mounted as desired. See page 3–13. The operation of the interface remains the same for both versions.

### NAVIGATIONAL KEYS



**HOME Key:** Press to go to the HOME screen. See page 6–3.



**PRINTER Key:** Press to print pre-defined report.

### Screen Navigation Keys

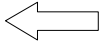

**PREVIOUS Key:** Press to view the previous screen.

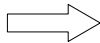

**NEXT Key:** Press to view the next screen.



**CANCEL Key:** When in a configuration or setup mode, press X to cancel a change that was entered and revert back to the previous data. When in run mode, press X to reset the totalizers.



**ENTER Key:** Press to enter numerical data or to enter data and move to the next field on screens with multiple fields.



### Selection Toggle Keys

**INCREASE Key:** Press to toggle up through the selections for a data field.



**DECREASE Key:** Press to toggle down through the selections for a data field.

### Data Field Navigation Keys



**DOWN Key:** Press to move down a line of data fields.



**UP Key:** Press to move up a line of data fields.

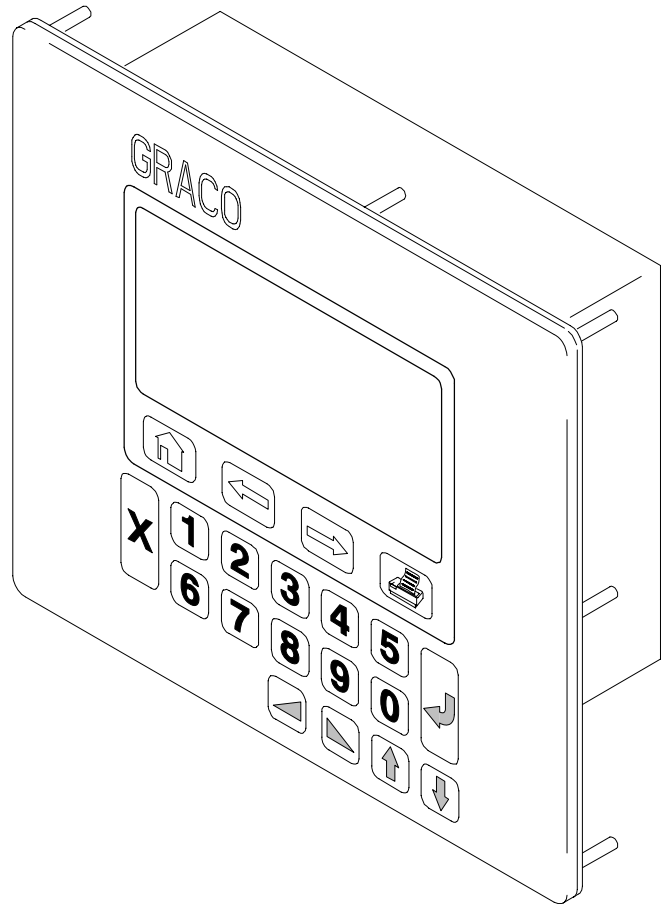

Fig. 4.4

### NOTE:

- If a number for an option is entered that is not available, the User Interface will beep to indicate an error. If the screen is exited while the error is present, the screen will automatically return to the previous existing number that was entered.
- Some configuration choices will affect what is available for choices on related screens.
- When an entry is accepted by the system, the value will be highlighted.

# Operation

## Operating Checklist

Check the following list daily, before starting to operate the system, to help ensure safe, efficient operation.

- \_\_\_ 1. All operators are properly trained to safely operate the system.
- \_\_\_ 2. If using electrostatics, all operators are properly trained to safely operate an electrostatic spray system. Operators must always turn off the electrostatics (P) before placing the spray gun in the Gun Flush Box.
- \_\_\_ 3. The system is thoroughly grounded and the operator and all persons entering the spray area are properly grounded. See **Grounding**, page 3–30.
- \_\_\_ 4. The air lines are all connected to the Gun Flush Box.
- \_\_\_ 5. The ventilation fans are operating properly.
- \_\_\_ 6. All the debris, including flammable liquids, rags, and non-essential equipment, is removed from the spray area.
- \_\_\_ 7. All flammable liquids in the spray booth are in approved, grounded containers.
- \_\_\_ 8. All electrically conductive objects in the spray area, including paint containers; Gun Flush Box; and wash cans, are electrically grounded and the floor of the spray area is electrically conductive and grounded.



The PrecisionMix II was tested with lightweight oil. To prevent contamination of your fluids, thoroughly purge the system with solvent as instructed in **Purging the PrecisionMix II System**, page 4–11. Leave the solvent in the system.

## Mode Switch (See Fig. 4.5)

Make sure the mode switch is set to 1 before beginning normal operation of the system. The possible mode switch settings are as follows:

Switch Position	Used For
A	Controller download
B	Disable printer
f	Diagnostics ( <i>do not use in normal operation</i> )
0	Operating system download
1	Default setting for normal operation

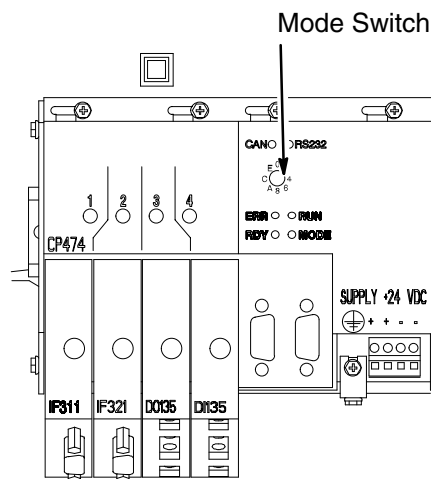



Fig. 4.5

# Operation

## Purging the Ratio Check Valves

 This procedure is not used with the Robo-Mix system.

### WARNING



#### PRESSURIZED EQUIPMENT HAZARD

To avoid splashing fluid in the eyes when purging the ratio check valves:

- Wear eye protection.
- Only open the ratio check valves enough to allow fluid to flow at a rate of 100 to 200 cc per minute.

### WARNING

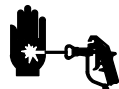

#### SKIN INJECTION HAZARD

To reduce the risk of a serious injury from injection or splashing fluid, follow the **Pressure Relief Procedure** on page 4-3 whenever you are instructed to relieve the pressure.

### CAUTION

The fluid shut-off valves and ratio check valves are retained in their housings by mechanical stops that prevent accidental removal of the valve stem while the manifold is pressurized. Do not use a tool to open or close the valve stems. If manual force cannot turn the valve stems, the system pressure must be relieved and the valve properly disassembled and cleaned to remove the resistance.

**NOTE:** Refer to Fig. 2.1 and Fig. 2.2, page 2-7, to understand the fluid paths that occur during this procedure, which involves the manual manipulation of the fluid shut-off valves and ratio check valves.

1. Relieve the system pressure.
2. Close both Component A and B fluid shut-off valves. See Fig. 4.6.
3. Place a container under the Component B ratio check valve dispense tube.
4. Turn on the solvent supply.
5. Open the Component B ratio check valve one-half to one full turn.

#### KEY

- |   |                      |   |                         |
|---|----------------------|---|-------------------------|
| A | Dispense Valve Knobs | C | Fluid Shut-off Knobs    |
| B | Purge Valve Knobs    | D | Ratio Check Valve Knobs |

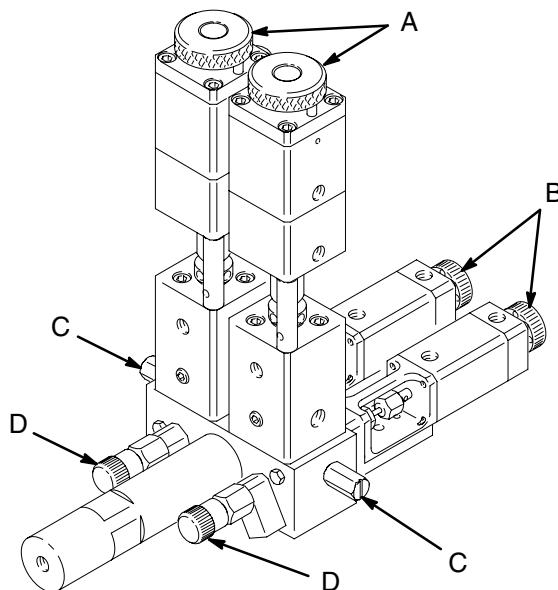

01909C

Fig. 4.6



# Operation

## Purging the Ratio Check Valves

– continued

6. Press the manual override button (H) on the solvent solenoid valve, which is inside the PrecisionMix II solenoid enclosure. Refer to Fig. 4.7.

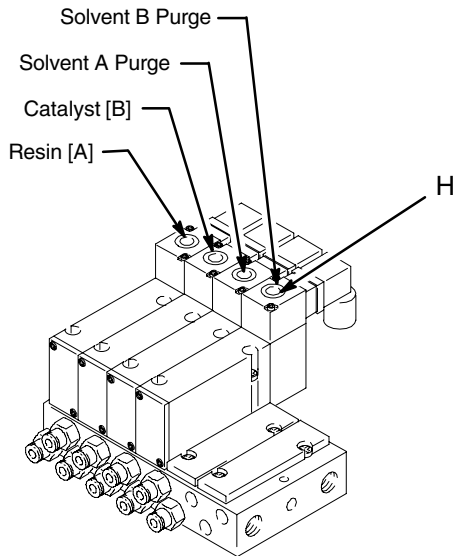

Fig. 4.7

01906

7. Purge until clean solvent flows from the Component B ratio check valve, then close the valve.
8. Open the Component B fluid shut-off valve.
9. Trigger the spray device while pressing the manual override button (H) on the solvent solenoid valve until clean solvent flows from the gun.
10. Fully open the Component A fluid shut-off valve, and open the Component A ratio check valve one-half to one full turn.
11. Press the manual override button (H) on the solvent solenoid valve.
12. Purge the Component A ratio check valve until clean solvent flows from the check valve, then close the valve.
13. At this point, both Component A and B ratio check valves should be closed and both fluid shut-off valves should be fully open.
14. Purge the system as instructed on page 4–10 if you are not loading paint into the system to start production. If you are starting production, follow the procedure on page 4–12.

# Operation

## Purging the PrecisionMix II System

### WARNING



#### FIRE AND EXPLOSION HAZARD

To reduce the risk of fire, explosion and serious injury when purging the PrecisionMix II:



- Be sure the entire system and flushing pails are properly grounded.
- Follow the instructions in your separate gun manual for safely grounding your gun while purging.

### WARNING



#### SKIN INJECTION HAZARD

To reduce the risk of a serious injury from injection or splashing fluid:

- Follow the **Pressure Relief Procedure** on page 4–3 whenever you are instructed to relieve the pressure.
- If you are using a high pressure gun\*, remove the spray tip before purging. Relieve pressure before removing the spray tip.
- Wear protective eyewear.
- Use the lowest possible fluid pressure when purging.

Purge the system during initial startup, at the end of each workday, and before any break longer than the pot life of the fluid.

Solvent purges the right-hand (Component B/catalyst) side of the mixing block and the inner tube of the integrator. Air purges the left-hand (Component A/resin) side of the mixing block and the outer tube of the integrator.

**NOTE:** Solvent may be used to purge both sides of the mixing block, but this will result in longer purge sequences and high solvent usage. Call your Graco distributor before choosing this option.

### Recipe Zero

If you are using integrated color change, you can use Recipe 0 to also purge the color change stack. Refer to page 9–4.

Recipe zero is considered the “Purge Down” recipe. The purpose of this recipe is to allow the user to purge out the material lines and the mixed material lines without loading a new color.

A typical use for recipe zero is at the end of a shift. The operator performs a color change to recipe zero and the lines are cleaned out to prevent hardening of catalyzed material between shifts.

Multiple Purge Downs may also be performed if the lines are not sufficiently clean. Another Purge Down is triggered by pressing the Enter key on the Operator Station or by setting the the color change bit on the I/O high.

# Operation

## Purging the PrecisionMix II System

– continued





### Standard System Purge Procedure

1. Relieve the system pressure.
2. If you are using a high pressure gun\*, remove the spray tip before purging. Clean the tip separately.
3. If cleaning an electrostatic gun, turn off the electrostatics.

**⚠ WARNING**



**FIRE AND EXPLOSION HAZARD**  
**For Electrostatic Guns:** To reduce the risk of fire, explosion, or electric shock, always turn off the electrostatics on an electrostatic gun before purging or before placing the gun in the Gun Flush Box.

4. Set the fluid pressure regulator at a pressure sufficient to thoroughly flush the system in a reasonable amount of time, but low enough to avoid splashing fluid and an injection injury. In general, a setting of 100 psi (7 bar) is sufficient for flushing.
5. Open the fluid pressure regulator.
6. Set the operator switch to Standby .
7. Trigger the spray gun or place the gun in the gun flush box, and set the operator switch to Purge . The purge sequence will automatically cycle. Hold the gun trigger open until the purge sequence is complete. See page 8–8 for the setup of the purge sequence.
8. If the system requires further purging, set the operator switch to Standby  and back to Purge  for another sequence.

**NOTE:** If necessary, adjust the purge sequence so that only one sequence is required.

9. Release the gun trigger when the pressure is relieved, and set the operator switch back to Standby .
10. Adjust the fluid pressure regulator back to the normal working pressure.

### Emergency Purging Procedure

**⚠ WARNING**



**SKIN INJECTION HAZARD**  
To reduce the risk of a serious injury, follow the **Pressure Relief Procedure** on page 4–3 whenever you:

- are instructed to relieve the pressure,
- stop spraying,
- check or service any of the system equipment,
- install or clean the spray tip.

If the electrical power is interrupted, the system can be purged by using the following procedure:

1. Relieve the system pressure.
2. If you are using a high pressure gun\*, remove the spray tip before purging. Clean the tip separately.

**NOTE:** The Gun Flush Box will be inoperable if the electrical power is off.

3. Trigger the spray gun, and press the manual override button for air on the manifold solenoid valves for five seconds. See Fig. 4.7, page 4–9.
4. Press the solenoid manual override button for solvent and hold it until the system is thoroughly purged.
5. Repeat the purge if necessary until the valves are clean.
6. Relieve the system pressure.

\* A gun is considered *high pressure* when its maximum working pressure is 900 psi [62 bar] or greater. *Airless* spray guns and *air-assisted* spray guns are high pressure guns. *Air spray* guns are low pressure guns.

# Operation

## Starting Production

### WARNING



#### SKIN INJECTION HAZARD

To reduce the risk of a serious injury, follow the **Pressure Relief Procedure** on page 4–3 whenever you:

- are instructed to relieve the pressure,
- stop spraying,
- check or service any of the system equipment,
- install or clean the spray tip.

**NOTE:** When you first start up the system after it has been shut down for a period of time, the relays, solenoids, and valves for Components A and B will cycle rapidly until system pressure is built back up. This is normal.

1. Check that the supply tanks for the Component A, Component B, and solvent are filled.
2. Make sure the operator switch is set to Standby .
3. Check that all the fluid valves are turned on and the fluid pressure to the PrecisionMix II is properly set.
4. Check that the air pressure to the PrecisionMix II solenoid enclosure is properly set. Most applications require about 80 psi (5.5 bar) pressure. To operate properly, do not go below 75 psi (5.2 bar) or exceed 95 psi (6.6 bar) pressure.

5. Check that the PrecisionMix II fluid shut-off knobs, dispense valve knobs, and purge valve knobs are set as follows (see Fig. 4.6, page 4–8):
  - Fluid Shut-off Knobs: fully open
  - Dispense Valve Knobs: three “clicks” open from fully closed setting
  - Purge Valve Knobs: two turns open from fully closed setting
6. Turn on the PrecisionMix II main power switch. The User Interface will display the first Run screen.

RUN MONITOR	Recipe: 1	Station: 1	
00/00/00		00:00	
<hr/>			
MIX RATIO (A:B)	Desired =	2.00 : 1	
	Actual =	2.00 : 1	
<hr/>			
		Target	Actual
COMPONENT A		32.0	32.0 cc
VOLUMES B		16.0	16.0 cc
<hr/>			
JOB TOTALS	TOTAL A + B =	000000	cc
	COMPONENT A =	000000	cc
	COMPONENT B =	000000	cc
	SOLVENT =	000000	cc

7. Check if the desired recipe/ratio is correct. Check that the totalizer and target volumes are satisfactory.



**Recipe 0 is not a valid selection.**

See page 6–5 to select a recipe with the User Interface. See page 4–5 to make recipe changes with the Color Change Control. See section 9 to setup recipes.



*Continued on the next page.*

# Operation

## Starting Production – continued

8. Remove any air from the fluid lines of the system:

- Shut off the air to the gun by closing the air regulator or shut-off valve for the gun atomizing air.
- Hold a metal part of the spray gun firmly to the side of a grounded metal pail and trigger the gun.
- Set the operator switch to Mix .
- If the flow meters overrun because of air in the system, and alarm will occur and operation will stop. Move the operator switch momentarily to

 Purge , then back to Standby  to clear the alarm and continue operation.

 When clearing alarms, do not leave the operator switch in the Purge position for more than 2 seconds or the system will purge.

- Set the operator switch to Mix  to spray.

9. Adjust the flow rate.

*If a flow control system is installed, see page 4–15 for flow control setup instructions.*

*For a system without flow control:*

- If the fluid output is too low, increase the regulated fluid pressure. If the fluid output is too high, adjust the fluid pressure regulator. For fine adjustment, close the dispense valves further.

## CAUTION

Do not use the first 4 to 5 oz. (120 to 150 ml) of material from the system, as it may not be thoroughly mixed due to alarms while loading material into the system.

- Check the air pressure regulators on the fluid supply tanks. The fluid flow rate at the spray gun should be the same regardless of whether the Component A or B dispense valves are open. The pressure adjustments of each component will vary with each components viscosity. In general, start with the same feed pressures for Component A and B.
- Check or reset the air regulator in the atomizing air line.

10. Operation of the PrecisionMix II is controlled by the operation of the spray gun. When the gun is triggered and the Operator Station switch is set to Mix , the dispense valves cycle and allow Components A and B to enter the mix manifold and be mixed and dispensed to the gun.

### NOTES:

- If required, switch on the supply tank agitators briefly whenever the fluid needs stirring. Over-agitating can cause air entrainment.
- Periodically check the fluid level of Component A, Component B, and solvent in the fluid supply tanks.

## CAUTION

Never allow the fluid supply tanks to empty completely while the PrecisionMix II is operating. Fill them periodically, as needed. Failure to fill the tanks when they are low may cause the metering ratios to be incorrect without an alarm occurring.

# Operation

## Stopping Production

### **WARNING**

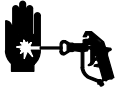

#### **SKIN INJECTION HAZARD**

To reduce the risk of a serious injury, follow the **Pressure Relief Procedure** on page 4-3 whenever you:

- are instructed to relieve the pressure,
- stop spraying,
- check or service any of the system equipment,
- install or clean the spray tip.

### **WARNING**



#### **FIRE AND EXPLOSION HAZARD**

**For Electrostatic Guns:** To reduce the risk of fire, explosion, or electric shock, always turn off the electrostatics on an electrostatic gun before purging or before placing the gun in the Gun Flush Box.

Stop production at any time by setting the operator

switch to Standby . If Gun Flush Boxes are installed on the system, always place the gun inside its box when the gun is not being used.

If your stop time will not exceed the pot life of Component A or B, no additional action is needed, except to relieve the system pressure. If your stop time will exceed the pot life, you must purge the mixing system. See **Purging the PrecisionMix II System**, page 4-10.

# Operation

## Flow Control Operation

### Initial Setup:

1. See page 8–16 for flow control setup.
2. See page 8–19 to set the “Delay Time” to 9.9 seconds.
3. See page 9–15 to set the “Gain Factor.” For fluid regulator P/N 83035X, set the gain to 250.
4. See page 6–5 to enter the flow rate setpoint. If Analog Inputs is selected, set the desired flow rate setpoint from the robot or other source.
5. While monitoring the Flow Rate Setpoint screen (page 6–5), trigger the gun (airflow switch) until flow rate is close to the setpoint. Release the gun trigger.
6. Trigger the gun on for another 30 seconds. Make sure the flow rate is still close to the setpoint. Repeat step 5, if necessary.
7. While the gun trigger is off, change the setpoint to a different value.
8. While monitoring the flow rate screen, trigger the gun on for 10 seconds.
  - a. Setpoint change from a small value (300 cc/min.) to a larger value (500 cc/min.):
    - If the flow rate during the first 10 seconds is below the new setpoint, increase the Gain Factor by 50.
    - If the flow rate during the first 10 seconds is above the new setpoint, decrease the Gain Factor by 50.
  - b. Setpoint change from a large value (600 cc/min.) to a smaller value (400 cc/min.):
    - If the flow rate during the first 10 seconds is below the new setpoint, increase the Gain Factor by 50.
    - If the flow rate during the first 10 seconds is above the new setpoint, decrease the Gain Factor by 50.
9. Repeat steps 6–8 until an optimum Gain Factor is achieved.
10. Change the Delay Time to an appropriate value. too short of a delay time will create inaccurate initial flow rate reading after the gun is triggered.

## Flow Control Tips

- Always keep a balanced fluid inlet pressure between component A, component B, and component C. This will prevent the fluid pressure regulator from opening or closing every time the PrecisionMix system switched from A valve to B valve to C valve. Do this by adding a manual fluid regulator for each of the fluid supply inlet. Also, try to adjust the dispense valve opening. Refer to the Plural Component Mix Manifold manual 308288.
- Keep the gun trigger on as long as possible during spraying. This will give the PrecisionMix system more time to adjust the fluid regulator to get to the flow rate setpoint. If the gun delay time is set at 1.0 second, and the gun trigger is on for 2.0 seconds, then the PrecisionMix system has only one second to do any flow control.
- Add an inline flow meter with high-resolution pulse output in the mixed material stream. Note that any flow meter installed in the mixed material stream may experience a flushing/clearing problem.

# Operation

## Integrated Color Change

### **WARNING**

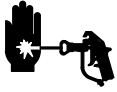

#### **SKIN INJECTION HAZARD**

To reduce the risk of a serious injury, follow the **Pressure Relief Procedure** on page 4–3 whenever you:

- are instructed to relieve the pressure,
- stop spraying,
- check or service any of the system equipment,
- install or clean the spray tip.



1. If using an electrostatic gun, turn off the electrostatics.

### **WARNING**



#### **FIRE AND EXPLOSION HAZARD**

**For Electrostatic Guns:** To reduce the risk of fire, explosion, or electric shock, always turn off the electrostatics on an electrostatic gun before placing the gun in the Gun Flush Box.

2. Place the gun in the Gun Flush Box and close the door.
3. Set the Operator Station switch to Standby  or Mix .
4. Select the new Recipe.
5. When the color change indicator light stops flashing or the color change popup screen stops displaying on the User Interface, the color change is complete.
6. When ready to spray, remove the gun from the Gun Flush Box and close its door.

**NOTE:** The Gun Flush Box door must be closed for the atomizing air valve to open.

7. Set the Operator Station switch Mix  to start spraying.

**NOTE:** The first three PrecisionMix II alarms will be reset by the Gun Flush Box controller to prevent nuisance alarms during flushing and loading.

## Multiple Gun Flush Box Operation

### **NOTE:**

- Guns will be loaded and purged in sequential order. The sequence depends on which guns are in their box at the start of a fill cycle.
- During the automatic purge cycle, only guns with mixed material loaded will be purged.
- Automatic purge will not start until all guns with loaded material are in their box. Operators should put the guns in their box with the door closed whenever they finish spraying.
- If a gun or guns are being taken out of the line for service (by valve shutoff or other means), one of the following things must occur to prevent the gun flush box controller from trying to fill these guns during the mix/fill mode.
  - Leave the gun in the box, but leave the door partially open or
  - Take the gun out of the box completely.
  - Purge the gun(s) before taking them out of the line for service.



# Printer Reports

The PrecisionMix II can output reports to a printer that is connected to the controller. The report will show the PrecisionMix II information available at the time the report was printed.

In order to send reports to a printer, the printer option had to be selected during system configuration. You can also choose to automatically generate a run report when a color change is initiated. Refer to **System Configuration**, page 8–14.

## Print Setup Screen

SYSTEM CONFIGURATION	Station: 1
<b>PRINT SETUP</b>	
Select the reporting type:	
1. Network (Printer Disabled)	
2. Printer Enabled	
> 2	
Select whether or not a Color Change will automatically generate a run report.	
1. No	
2. Yes	
> 2	

To output the report you desire, you need to be at the mode of operation for the desired report when you

press the print  key on the User Interface. See the description of the following individual reports for more information. The printer will print reports that are similar to the reports shown, only they will show the values on your system.

Pressing the print button on the Operator Station will always print the Run Mode Report. See Fig. 4.8.

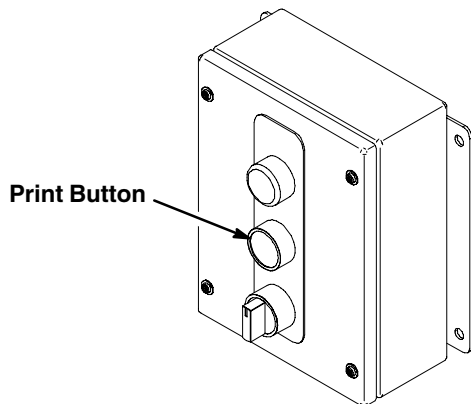

**Fig. 4.8** *Operator Station without Color Change Control*

## Run Mode Report

To print the Run Mode Report with the User Interface, you must be at one of the run mode screens, then

press the print  key. Pressing the print button on the Operator Station will always print the Run Mode Report.

The Run Mode Report will list the information that can be accessed on the Run Mode screens. The values will show what the PrecisionMix II is producing at the time the report was printed.

The printer will print a report that is similar to the report below. An alarm report will print each time a run report is requested. The alarm history is then cleared.

## Run Report

```

GRACO PMIX II RUN REPORT
Station 1      0/00/00      00:00
Active Recipe 2
Target Volume A = 32.0 cc
Target Volume B = 16.0 cc
Desired Ratio AB = 02.00 : 1
Current Ratio AB = 02.00 : 1
Gun 1 Flow Rate Setpoint = 0016 oz/m
Job Total A = 000000130.8 oz
Job Total B = 000000131.5 oz
Job Total A+B = 000000262.3 oz
** Job totals were reset **
Batch Total A = 000000003.8 L
Batch Total B = 000000003.8 L
Batch Total A+B = 000000007.7 L
Batch Total Dump A+B = 000000000.0 L
** End Run Report

GRACO PMIX II ALARM REPORT
Station 1      0/00/00      00:00
1.            00/00      00:00
I/O ALARM
2.            00/00      00:00
I/O ALARM
3.            00/00      00:00
INVALID RECIPE                                00006
4.            00/00      00:00
PURGE/LOAD INTERLOCK
5.            00/00      00:00
PURGE/LOAD INTERLOCK
6.            00/00      00:00
PURGE/LOAD INTERLOCK
7.            00/00      00:00
PURGE/LOAD INTERLOCK
8.            00/00      00:00
MEMORY FAILURE
** Alarms cleared **
** End Alarms Report
    
```

# Printer Reports

## Recipe Report

To print the Recipe Report with the User Interface, you must be at the Recipe Setup Menu screen (refer to page 9–4), then press the print  key.

### Recipe Setup Menu Screen

SETUP MENU	Recipe: 1	Station: 1
1. MIX RATIO		
2. COLOR CHANGE SEQUENCE		
3. SYSTEM ALARMS		
4. FLOW METER VALUES		
5. FLOW CONTROL		
Select a menu item and press enter: > 1		

The Recipe Report will list the setup information for the recipe selected for setup (in the screen above, this would be recipe 1). The printer will print a report that is similar to the report below.

### Recipe Report

GRACO PMIX II RECIPE REPORT		
Station 1	0/00/00	00:00
Recipe 1		
Ratio A:B = 2.00 : 1		
Mix Ratio Tolerance = 5%		
First Purge Dispense Time = 30 sec		
Purge A Dispense Time = 2.0 sec		
Purge B Dispense Time = 2.0 sec		
Last Purge Dispense Time = 3.0 sec		
Total Purge Sequence Cycles = 5		
Gun 1 Potlife Time = 30 min		
Gun 1 Potlife Reset Vol. = 250 cc		
Comp A Flow Meter Value = 0.123 cc/P		
Comp B Flow Meter Value = 0.124 cc/P		
** End Recipe Report		

## System Setup (Configuration) Report

To print the System Setup Report with the User Interface, you must be at the System Configuration Menu screen (refer to page 8–3), then press the print  key.

### System Configuration Menu Screen

SYSTEM CONFIGURATION MENU	Station: 00
1. LANGUAGE	11. MIX/PURGE
2. STATION NUMBER	12. FLOW CONTROL
3. DISPLAY UNITS	13. INTEGRATOR VOLUME
4. RECIPES	14. COLOR CHANGE
5. POTLIFE TIMER	15. PASSWORD CHANGE
6. FLOW RATE LIMITS	16. TIME AND DATE
7. SOLVENT METER	17. RUN SCREEN DISPLAY
8. PURGE SEQUENCE	18. DISPLAY SETUP
9. MIXED LOAD VOL.	19. PRINT SETUP
10. GUNS SETUP	20. AIR FLOW SWITCH
Select a menu item and press enter: > 1	

The System Setup Report will list the system configuration information. The printer will print a report that is similar to the report below.

### System Setup Report

GRACO PMIX II SYSTEM SETUP REPORT		
Station 1	0/00/00	00:00
PCC App Software Rev. = 3.01		
Display units -- cc & L		
Total Recipes In Use = 63		
Recipe Selection -- digital I/O		
Potlife Alarm -- stops system, dump off		
Flow Rate Alarms -- off		
Solvent Meter -- off		
Meter 4 -- off		
Number of Purge Valves = 2		
Purge B Method -- time		
First Purge Valve -- A		
Last Purge Valve -- off		
Component A Dump -- off		
Gun 1 Mix Load Volume = 00000 cc		
Number of Guns -- Gun 1		
Mix / Purge Control Source -- booth control		
Flow Control Setpoint -- off		
Integrator Volume = 50		
Integrated Color Change -- off		
Auto Print on Color Change -- off		
** End System Setup Report		

# Printer Reports

## Job Totals Report

To print the Job Totals Report with the User Interface, you must be at the Job Totals screen (refer to page 7-3), then press the print  key.

### Job Totals Screen

```
TOTALIZERS 2  Recipe: 1          Station: 1
  

          JOB TOTALS
  

COMP. A + B = 004792 cc
COMPONENT A = 003232 cc
COMPONENT B = 001560 cc
      SOLVENT = 000000 cc
  

Press "X" key to clear totals
Press Print key to print
```

The Job Totals Report will list the Job Totals screen information at the time the report was printed.

The printer will print a report that is similar to the report below.

### Job Totals Report

```
GRACO PMIX II JOB TOTALS REPORT
Station 1      0/00/00          00:00
Recipe Number 1
Job Total A = 003232 cc
Job Total B = 001560 cc
Job Total A+B = 004792 cc
Job Total Solvent = 000000 cc
** Job totals were reset **
** End Job Totals Report
```

## Batch Totals Report

To print the Batch Totals Report with the User Interface, you must be at the Batch Totals screen (refer to page 7-3), then press the print  key.

### Batch Totals Screen

```
TOTALIZERS 3  Recipe: 1          Station: 1
  

          BATCH TOTALS
  

COMP. A + B = 3173.0 liter
COMPONENT A = 2129.0 liter
COMPONENT B = 1044.0 liter
      A + B DUMP = 0000.0 liter
      SOLVENT = 0000.0 liter
  

Press "X" key to clear totals
Press Print key to print
```

The Batch Totals Report will list the Batch Totals screen information at the time the report was printed.

The printer will print a report that is similar to the report below.

### Batch Totals Report

```
GRACO PMIX II BATCH TOTALS REPORT
Station 1      0/00/00          00:00
Recipe Number 1
Batch Total A = 2129.0 L
Batch Total B = 1044.0 L
Batch Total A+B = 3173.0 L
Batch Total Dump A+B = 0000.0 L
Batch Total Solvent = 0000.0 L
** End Batch Totals Report
```

# Printer Reports

## Grand Totals Report

To print the Grand Totals Report with the User Interface, you must be at the Grand Totals screen (refer to page 7-3), then press the print  key.

### Grand Totals Screen

```
TOTALIZERS 4  Recipe: 00          Station: 00

          GRAND TOTALS

COMP. A + B = 31730 liter
COMPONENT A = 21290 liter
COMPONENT B = 10440 liter
A + B DUMP = 000000 liter
  SOLVENT = 000000 liter

Press Print key to print
```

The Grand Totals Report will list the Grand Totals screen information at the time the report was printed.

The printer will print a report that is similar to the report below.

### Grand Totals Report

```
GRACO PMIX II GRAND TOTALS REPORT
Station 1      0/00/00          00:00
Recipe Number 1
Grand Total A = 21290 L
Grand Total B = 10440 L
Grand Total A+B = 31730 L
Grand Total Dump A+B = 00000 L
Grand Total Solvent = 00000 L
** End Grand Totals Report
```

## Alarm Report

To print the Alarm Report with the User Interface, you must be at the Alarm History screen (refer to page 6-6), then press the print  key.

### Alarm History Screen

RUN MONITOR		Recipe : 1	Station: 1	
00/00/00			00:00	
<u>ALARM HISTORY</u>				
Description	Value	Time	Date	
1 A DOSE TIME		23:33	02/22	
2 RATIO HIGH AB	00102	04:24	02/22	
3 RATIO HIGH AB	00.97	04:24	02/22	
4 B OVERDOSE	01449	03:28	02/22	
5 A OVERDOSE	036.7	03:26	02/22	
6 B OVERDOSE	05552	03:26	02/22	
7 A OVERDOSE	02630	03:23	02/22	
8 EXTERNAL		03:22	02/22	
9 A OVERDOSE	037.3	03:22	02/22	
10 B OVERDOSE	09917	03:22	02/22	

The Alarm Report will list the Alarm History screen information at the time the report was printed.

The printer will print a report that is similar to the report below.

### Alarm Report

```
GRACO PMIX II 3K ALARM REPORT
Station 1      0/00/00          00:00

1.    02/22    23:33
B DOSE TIME

2.    02/22    04:24
RATIO HIGH AB          00102

3.    02/22    04:24
RATIO HIGH AB          00.97

4.    02/22    03:28
A OVERDOSE            01449

5.    02/22    03:26
A OVERDOSE            036.7

6.    02/22    03:26
B OVERDOSE            05552

7.    02/22    03:23
A OVERDOSE            02630

8.    02/22    03:22
EXTERNAL

9.    02/22    03:22
A OVERDOSE            037.3

10.   02/22    03:22
B OVERDOSE            09917

** Alarms cleared **
** End Alarm Report **
```

**5**

# Screen Map



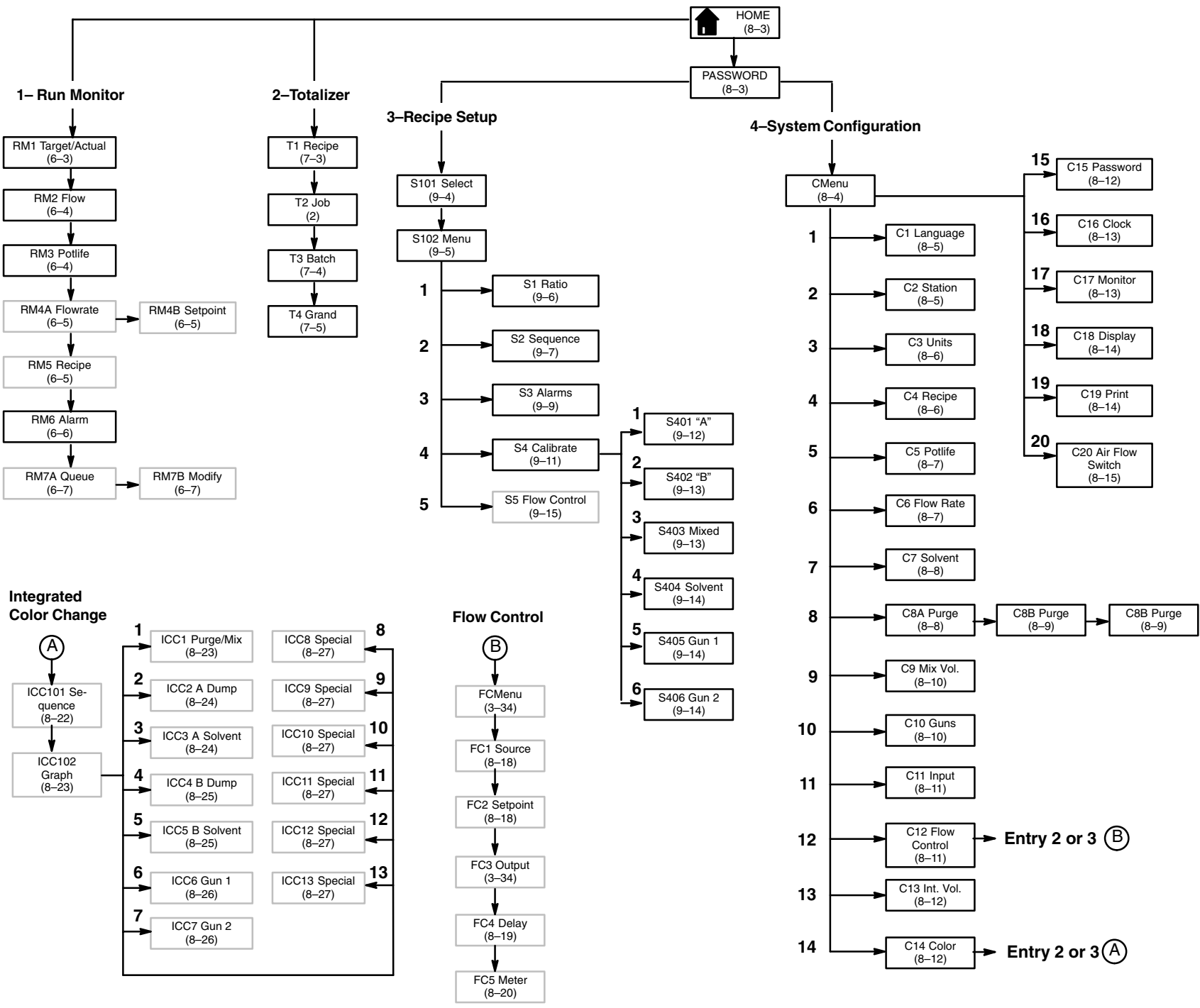





# 6

## Run Monitor



# Run Monitor

## Screens

## Information



### Home Screen



```

Graco PrecisionMix II (R)
Version X.XX

HOME SCREEN          Station: 1
1. RUN MONITOR
2. TOTALIZERS
3. RECIPE SETUP
4. SYSTEM CONFIGURATION

Select a menu item and press enter: > 1
    
```

 Type in , then .

Press the next screen  or previous screen  arrow key to move forward or backward to the desired Run Monitor screen.

Press the HOME key  to return to the HOME screen.

This is the HOME screen where you choose which system function to enter.

- RUN MONITOR (#1) has the normal operating screens.
- TOTALIZERS (#2) has the screens with information on material usage on the selected recipe.
- RECIPE SETUP (#3) screens allow you to setup “recipes” (ratio programs) for a variety of fluids.
- SYSTEM CONFIGURATION (#4) screens allow you to setup the controller to operate according to your system requirements.

Selecting #1 on the Home Screen will bring up the first Run Monitor screen (RM1 – Target/Actual). The run monitor screens allow you to monitor the status of the system. The readings will be displayed in either cubic centimeters (cc), liters (l), ounces (oz), and/or gallons (gal), depending on how the system has been configured.

### RM1 Target/Actual

```

RUN MONITOR  Recipe: 1      Station: 1
00/00/00                                00:00

MIX RATIO (A:B)  Desired = 00.00 : 1
                  Actual  = 00.00 : 1

COMPONENT VOLUMES  Target  Actual
                   A       00.0  00.0 cc
                   B       00.0  00.0 cc

JOB TOTALS        TOTAL A + B = 000000 cc
                  COMPONENT A = 000000 cc
                  COMPONENT B = 000000 cc
                  SOLVENT    = 000000 cc
    
```

#### Mix Ratios

Desired Ratio is the ratio entered during recipe setup.

Current Ratio is a ratio the system actually dispensed on the last cycle.

#### Component Volumes

Target (left hand column) is the desired volumes of Component A and Component B that the controller will request.

Actual (right hand column) shows the quantities of Component A and Component B as they are being dispensed.

 Component Volumes are always measured in cubic centimeters.

#### Job Totals

Displays total volume for the current job of Component A + B, Component A, Component B, and Solvent (if a solvent valve is installed and configured). The job totals can be changed to read in ounces during system configuration. See page 8–6.

# Run Monitor

## Screens

## Information

### RM2 Flow Rate

RUN MONITOR 00/00/00	Recipe: 1	Station: 1 00:00
<u>FLOWRATE</u>		
ACTUAL FLOW	=	000000 cc/min
COMPONENT A	=	000000 cc/min
COMPONENT B	=	000000 cc/min

Flow rate is a real time display of how much flow is going through the system. It updates every two seconds and is a weighted average of the previous flow rate displays. The readings are taken by the Component A and B fluid meters. The flow rate display can be altered in the setup program to read in ounces per minute. See page 8-6.

### RM3 Potlife Timer

RUN MONITOR 00/00/00	Recipe: 1	Station: 1 00:00
Gun 1 Potlife Timer	Time Remaining:	000 min
Gun 2 Potlife Timer	Time Remaining:	000 min
System Idle Time Remaining: 00 min		

#### Potlife Time Remaining

Potlife time remaining displays the time remaining before a potlife alarm will occur. The timer does not start until the controller detects mixed material is in the lines.

#### System Idle Time Remaining

System Idle Time uses a 4 minute clock that counts down the time that the spray device is not in use. After 4 minutes of not triggering the spray device, the mix manifold closes and the screen changes to the System Idle screen. When the spray device is triggered with the operator switch set to mix, the PrecisionMix will start again where it left off.



The potlife timer values will appear for the quantity of gun(s) that were selected during system configuration.



# Run Monitor

## Screens

## Information

### RM4A Flow Rate Setpoint

RUN MONITOR	Recipe: 1	Station: 1
00/00/00		00:00
Gun #1	Setpoint:	0000 cc/min
Flow	Actual:	0000 cc/min
Rate	Analog out:	00.0 mA
	Setpoint in:	00.0 mA
Gun #2	Setpoint:	0000 cc/min
Flow	Actual:	0000 cc/min
Rate	Analog out:	00.0 mA
	Setpoint in:	00.0 mA
Press Enter for a new Setpoint		

 If a new setpoint is desired and the user interface is the source of flow control data, press  to go to the next screen.



### RM4B Enter New Setpoint

RUN MONITOR	Recipe: 1	Station: 1
00/00/00		00:00
Enter new Setpoint for Gun 1:		
> 0000 cc/min		
Enter new Setpoint for Gun 2:		
> 0000 cc/min		

 Type the new setpoint for the gun(s), then .

### RM5 Recipe Select

RUN MONITOR	Recipe: 1	Station: 1
00/00/00		00:00
<u>RECIPE SELECT</u>		
New Recipe for Operation (1-63):		
> 00		

 Type the new recipe number, then .

Flow control can only be used with the proper hardware installation. The Flow Rate Setpoint screen only appears if flow control is turned on. It shows the flow control Setpoint and the Actual flow rate.

The mA reading for Analog out and Setpoint in is converted to a pneumatic signal, which is applied to a fluid pressure regulator to open the regulator a certain amount.

 The setpoint can be changed by the operator if the user interface was set as the source of flow control data during system configuration. See page 8–18. If this option is not available, "Press Enter for a new Setpoint" will not appear at the bottom of the screen.

The Enter New Setpoint screen only appears if the user interface was set as the source of flow control data during system configuration. See page 8–18. Use this screen to enter the new Setpoint for the gun(s).

 Setpoint changes made at this screen will not be stored in the recipe data.

This screen only appears if the User Interface was selected as the input for changing recipes. The recipe screen will display the current recipe running.

# Run Monitor

## Screens

## Information

### RM6 Alarm History

RUN MONITOR	Recipe : 1	Station: 1	
00/00/00		00:00	
<u>ALARM HISTORY</u>			
<u>Description</u>	<u>Value</u>	<u>Time</u>	<u>Date</u>
1 POTLIFE #1		5:15	9/28
2 RATIO HIGH	1.35	3:15	9/27

The alarm history screen displays the last 10 alarms that have occurred. See the alarm descriptions on page 10-7. The most recent alarm will appear at the top of the screen.

This screen does not ever completely clear. There is a maximum of 10 alarm lines that can display. If there are 10 lines and a new alarm occurs, alarm #10 will be cleared and all alarms will shift down one location.

# Run Monitor

## Screens

## Information

### RM7A Integrated Color Change with Queue

RUN MONITOR		Recipe: 1	Station: 1	
00/00/00		00:00		
INTEGRATED COLOR CHANGE WITH QUEUE				
	A-comp	B-comp	Recipe	Sequence
1.	00	00	00	00
2.	00	00	00	00
3.	00	00	00	00
4.	00	00	00	00
5.	00	00	00	00
Press Enter Key to edit Queue.				



If you want to edit one of the queues, press



to go to the Modify Queue screen.



Zero is not a valid entry for A-comp, B-comp, or Sequence. If zero is entered for any of these parameters, color change will not occur.

This screen only appears if Integrated Color Change with Queue is turned on. Integrated color change with queue is generally used with an automated system where there is a set job sequence to be performed.

The queue parameters override the normal color change parameters during the color change.

#### Queue Data Sets

Five data sets for color change can be set up in a queue and sent to the controller individually. A queue data set consists of the following four parameters:







- **A-comp:** The A side (resin) color valve number chosen for the new color. Entering 0 will allow the color to be selected from the A-comp associated with the recipe selected. Entering 1–12 will cause the color selection to override the recipe color parameter and load the specific selection made here.
- **B-comp:** The B side (catalyst) color valve number chosen for the new color. Entering 0 will allow the color to be selected from the B-comp associated with the recipe selected. Entering 1–3 will cause the color selection to override the recipe color parameter and load the specific selection made here.
- **Recipe Number** – The recipe number that will be used with the new color. If the recipe 0 is selected the system will flush out the old color and not load a new color. The recipe selection determines mix ratio, ratio tolerance, flow control parameters, potlife time and volume, meter calibrate, and K-Factor to be used. The A-comp, B-comp and sequence will also be selected by recipe if their specific values are 0.
- **Sequence Number** – The color change sequence number that will be used for the new color. The color change sequence number will be used for the new color. Entering 0 will allow the sequence to be selected by recipe parameter. 1–4 will override the recipe and select the specific component.

The data set values in the first line (1) of the queue will be used for the color change. Following the color change, the top data set of the queue is erased and the other data sets move up one level on the queue.

# Run Monitor

## RM7B Modify Queue Screen

RUN MONITOR	Recipe: 1	Station: 1		
00/00/00		00:00		
Enter Queue to modify (1-5): 1				
Modify Selected Queue				
A-comp	B-comp	Recipe	Sequence	
(0-12)	(0-3)	(0-63)	(0-4)	
1.	00	0	00	0
Press Up/Down Arrows to change fields				
Press Left Arrow to view Queue Display				

 Type the number for the queue you want to modify, then . Enter the changes desired, using the   to change fields. Press  to view the Queue Display (RM7A). Press  to go to the next screen.

This screen is used to make modifications to the existing queue.

 If zero is selected for the recipe, a “purge down” will occur. The system will flush out the old color and will not load a new color. Valid number entries still must be made for A-comp, B-comp, and Sequence.

### Activating a Queue Color Change

A Queue Color Change can be activated by pressing

 on the Operator Station or setting the Color Change Bit on the I/O of the controller.



# 7

## Totalizers



# Totalizers

## Screens

## Information

### Home Screen

```
Graco PrecisionMix II (R)
Version X.XX

HOME SCREEN Station: 1
1. RUN MONITOR
2. TOTALIZERS
3. RECIPE SETUP
4. SYSTEM CONFIGURATION

Select a menu item and press enter: > 2
```



Type in , then .

Press the next screen  or previous screen  arrow key to move forward or backward to the desired Totalizers screen.

Press the HOME key  to return to the HOME screen.

Selecting #2 on the Home Screen will bring up the first Totalizers screen (T1 – Select Recipe and Totalizer Screen). The totalizers screens allow you to monitor the amount of fluid that has gone through the individual meters in the system for a particular recipe.

The readings will be displayed in either cubic centimeters (cc), liters (l), ounces (oz), and/or gallons (gal), depending on how the system has been configured and which screen is being viewed.

### T1 Select Recipe and Totalizer Screen

```
TOTALIZERS 1 Recipe: 1 Station: 1

RECIPE SELECT

Enter New Recipe for Totalizers (1-63):
> 1

Choose the Totalizer Screen:
1. Job Totals Screen
2. Batch Totals Screen
3. Grand Totals Screen
> 1
```



Type the number for the desired recipe, then . Choose the Totalizer screen you want to view, then .

Use this screen to select the recipe you want to check for fluid usage. Then select whether to view the job, batch or grand total.

# Totalizers

## Screens

## Information



### T2 Job Totals

```
TOTALIZERS 2  Recipe: 1  Station: 1

      JOB TOTALS

COMP. A + B = 000000 cc
COMPONENT A = 000000 cc
COMPONENT B = 000000 cc
  SOLVENT = 000000 cc

Press "X" key to clear totals
Press Print key to print
```

 Press  to clear totals. Press  to print the job totals.



### T3 Batch Totals

```
TOTALIZERS 3  Recipe: 1  Station: 1

      BATCH TOTALS

COMP. A + B = 00000.0 liter
COMPONENT A = 00000.0 liter
COMPONENT B = 00000.0 liter
  A + B DUMP = 00000.0 liter
  SOLVENT = 00000.0 liter

Press "X" key to clear totals
Press Print key to print
```

 Press  to clear totals. Press  to print the batch totals.

The Job Totalizers are resettable. They keep a running total in cubic centimeters or ounces of the fluid dispensed until the totals are cleared by pressing the cancel  key.

#### Solvent

SOLVENT will only appear if the system was configured to use a solvent valve. The solvent totalizer totalizes all the fluid that passes through the solvent flow meter. To use the solvent totalizer, you must have a flow meter on the PrecisionMix solvent inlet.

The Batch Totalizers are resettable. They keep a running total in liters or gallons of the fluid dispensed until the totals are cleared by pressing the cancel  key.

#### Solvent

*See the Solvent information above.*

#### **A + B Dump**

The A + B Dump totalizer will totalize all the fluid that passes through the resin and catalyst flow meters in the dump mode.

# Totalizers

## Screens

## Information

### T4 Grand Totals

```
TOTALIZERS 4  Recipe: 00          Station: 00

      GRAND TOTALS

COMP. A + B = 000000 liter
COMPONENT A = 000000 liter
COMPONENT B = 000000 liter
A + B DUMP = 000000 liter
  SOLVENT = 000000 liter

Press Print key to print
```

The Grand Totalizers are not resettable. They keep a running total in liters or gallons of the fluid dispensed.



#### **Solvent**

*See the Solvent information on previous page.*

#### **A + B Dump**

*See the A + B Dump information on previous page.*



Press  to print the grand totals.



# 8

## System Configuration





# System Configuration

## Screens

## Information

### Home Screen

```
Graco PrecisionMix II (R)
Version X.XX

HOME SCREEN _____ Station: 00
1. RUN MONITOR
2. TOTALIZERS
3. RECIPE SETUP
4. SYSTEM CONFIGURATION
Select a menu item and press enter: > 4
```

 Press key , then .

### Password Screen

```
TYPE IN THE PASSWORD AND PRESS ENTER

> xxxx
```

 Type the password, then .

Selecting #4 on the Home Screen will bring up the Password Screen, if a password is required, or the System Configuration Menu screen if no password is required. The System Configuration screens allow you to setup the controller to operate according to your system requirements.

This is the PASSWORD screen where you enter the password to access the RECIPE SETUP and SYSTEM CONFIGURATION functions.

 If the password was set to 0 (zero), the Password screen will not appear.

# System Configuration

## Screens



## Information

### Menu Screen (CMENU)

SYSTEM CONFIGURATION MENU	Station: 00
1.LANGUAGE	11.MIX/PURGE
2.STATION NUMBER	12.FLOW CONTROL
3.DISPLAY UNITS	13.INTEGRATOR VOLUME
4.RECIPES	14.COLOR CHANGE
5.POTLIFE TIMER	15.PASSWORD CHANGE
6.FLOW RATE LIMITS	16.TIME AND DATE
7.SOLVENT METER	17.RUN SCREEN DISPLAY
8.PURGE SEQUENCE	18.DISPLAY SETUP
9.MIXED LOAD VOL.	19.PRINT SETUP
10.GUNS SETUP	20.AIR FLOW SWITCH
Select a menu item and press enter: > 1	

 Type the desired menu item, then .

This is the SYSTEM CONFIGURATION MENU screen where you can access the system configuration parameters.

- Any selections made during configuration are globally applied to all recipes.
- When an entry is accepted by the system, the value will be highlighted.
- For initial setup, start with menu item 1, LANGUAGE, and go through all the System Configuration screens, providing the necessary information to configure the control.
- Text that appears in grey on the screens in these instructions indicate lines that may or may not appear on your display, depending on previous selections that have been made.
- Text that appears in a grey box indicates a selection that is being recommended or explained in that section of the instructions.
- Use the next screen key  to go to the next configuration screen. Pressing the previous screen key  will bring the display back to the configuration menu screen, where a number can be entered to go to a specific configuration screen.



# System Configuration

## Screens

## Information

### C1: Language



```
SYSTEM CONFIGURATION          Station: 0
LANGUAGE SELECTION
-----
Select the desired language:
1. English
2. Francais
3. Deutsch
4. Espanol
5. Japanese
6. Other
> 1
```

 Type the number for the desired language, then . Next screen .

### C2: Station Number

```
SYSTEM CONFIGURATION          Station: 0
STATION NUMBER
-----
Enter Station number (1-32):
> 1

Note: The system must be powered down
and powered back up again for the
new station number to take effect.
```

 Type the station number for the controller, then . Next screen .

Select the language you want the screens to display. Your choices are English, French, German, Spanish, Japanese or other.

 In order to use selection #6, "Other", the user interface must be programmed with the language utility.

 **IMPORTANT! When switching from one language to another you must cycle power. Power down the PrecisionMix II and restart. The new language will be displayed.**

The Station Number screen is used to set an identification (ID) number for the PrecisionMix controller. The ID number will print out on the run and setup reports. The station number is needed when multiple PrecisionMix controls are connected to a network. Station #1 is the default.

 **IMPORTANT! When using station numbers for network addresses, the control must be powered down and back up again for a new number to be activated.**



# System Configuration

## Screens

## Information

### C3: Display Units of Measurement





```
SYSTEM CONFIGURATION          Station: 1
DISPLAY UNITS
-----
Select Display Units:
1. cc and liter
2. oz and liter
3. oz and gallon
4. cc and gallon
> 1
```

 Type the number for the desired display units, then . Next screen .

### C4: Recipes

```
SYSTEM CONFIGURATION          Station: 1
RECIPES: TOTAL/SELECTION/PROGRAMMING
-----
Enter Recipes to use (1-63):
> 31
          RECIPE_SOURCE
1. User Interface
2. Network
3. I/O
4. Remote Operator Station

Enter a Recipe Source (1-4):
> 4
```

 Type the number of recipes to use, then . Type the number for the desired recipe source, then . Next screen .

Select the units of measurement you want the screens to display.

 The TARGET/ACTUAL display will not show ounces on the Run Monitor #1 screen. The display is fixed for cubic centimeters. See page 6-3.

### Recipes to Use

The number entered for the "Recipes to use" sets the total number of recipes that are available for configuration. If a user selects a recipe number larger than the total recipe number entered here, an Invalid Recipe alarm will occur.

 The Utilities Software will back up the number of recipes that are set for use during configuration. For faster backups and restores, set the number of recipes as low as possible.

### Recipe Source

The "Recipe Source" field allows you to select whether different recipes will be set by the User Interface, Network, I/O or the Remote Operator Station. Recipe selections cannot be made from multiple locations.



# System Configuration

## Screens

## Information

### C5: Potlife Timer

SYSTEM CONFIGURATION	Station: 1
POTLIFE: TIMERS/ALARM/DUMP	
Select Potlife Alarm to:	
1. Potlife Timer Off	
2. Alarm Stops System, Auto Dump Off	
3. Alarm Continue, Auto Dump Off	
4. Alarm Stops System, Auto Dump On	
> 1	

 Type the number for the desired potlife timer alarm response, then . Next screen .

You can turn the potlife timer off or activate it and choose one of the three possible system responses to the alarm.



 The system must have a dump valve or gun flush box installed to use selection #4. A separate output Gun Trigger 1 Auto/Dump Terminal Block #5211 or #5221, based on the number of the gun selected, is provided to actuate the dump valve. An automatic (auto) dump will turn on the dump valve and the purge sequence two minutes after a pot life alarm occurs. Use this feature to protect the fluid components from having mixed fluid in them older than the specified pot life.

If #4 is selected and an alarm occurs, you have two minutes to clear the alarm before the automatic dump is activated. To clear the alarm, turn the operator control to purge, then spray enough\* material to clear the alarm.

\* You must spray a larger volume of material than the Potlife Timer Reset volume, set in Recipe Setup. Refer to page 9–9.

### C6: Flow Rate Limits

SYSTEM CONFIGURATION	Station: 1
FLOW RATE: LIMITS/ALARM	
Select Flow Rate Alarms to:	
1. Off	
2. Flow Limit Stops System	
3. Flow Limit Continues	
> 1	

 Type the number for the desired flow rate alarm response, then . Next screen .

You can turn the flow rate alarm off or activate it and choose one of the three possible system responses to the alarm. The Flow Rate alarm occurs when the flow rate exceeds the minimum and maximum flow rate limits set during Recipe Setup.

When a flow limit alarm occurs, the alarm output goes on (for an auditory/visual alarm) and the alarm message displays on the user interface. When the flow rate is again within the limits set, the alarm output will turn off and the display will return to the Run Monitor screen.

 After an Auto dump occurs you may turn the switch to purge until the alarm light goes off. You may go to mix or standby without a second purge cycle occurring. Purge will not occur until 2 seconds after the light goes off.



# System Configuration

## Screens

## Information

### C7: Solvent Meter

SYSTEM CONFIGURATION	Station: 1
<u>SOLVENT METER</u>	
Select Solvent Meter to be:	
1. Off	
2. On	
> 1	

 Type the number to turn the solvent meter on or off, then . Next screen .





You can turn the input to the solvent meter off or on. Select #1 if a solvent meter is not installed in the system. Select #2 if a solvent meter is installed in the system.

 The solvent meter will be disabled if both the Flow Control and Gun 2 options are selected.

- If #1 is selected, a purge must be done by time. Purge method is set with the Purge Sequence screen (C8A). Solvent meter information will not appear on totalizer screens, run monitor screens, and purge and color change screens.
- If #2 is selected, a solvent meter must be installed in the system. This selection will cause solvent meter information to appear in the totalizer screens, run monitor screens, and purge and color change screens, where applicable. Purge by volume is enabled.

### C8A: Purge Sequence: Valves

SYSTEM CONFIGURATION	Station: 1
<u>PURGE SEQUENCE:VALVES</u>	
Select Total Number of Purge Valves:	
1. 1 Purge Valve	
2. 2 Purge Valves	
3. 3 Purge Valves	
> 3	
Select the Purge Method	
1. Purge Based on Time	
2. Purge Based on Volume.	
-PRESS NEXT FOR MORE PURGE PARAMETERS-	

 Type the number for the total number of purge valves in your systems, then . Type the number for the desired purge method, as applicable for your system, then . Next screen .

Set the total number of purge valves and the purge method.

#### Total Number of Purge Valves

- Select #1, 1 Purge Valve, if you want solvent purge alone and have only one purge valve.
- Select #2 if you want alternating solvent and air purge and have two purge valves. This is the default selection as it is most commonly used for purging.
- Selection #3 requires a hardware modification to the system. Contact your Graco distributor for further information.

#### Purge Method

- The purge method portion will only appear if the solvent meter was turned on in the Solvent Meter screen (previous) and "No Color Change" is selected when configuring screen C14 – Integrated Color Change (page 8–12). Time is the only possible purge method when Integrated Color Change is activated.
- Purge Valves A and C can only be purged by time as they are used for air and solvent.
- Purge Valve B can be purged by either time or volume.





# System Configuration

## Screens

## Information

### C8B: Purge Sequence: Valves

SYSTEM CONFIGURATION	Station: 1
PURGE SEQUENCE:VALVES	
Select First Purge Valve to be:	
1. Purge Valve A	
2. Purge Valve B	
3. Purge Valve C	
> 1	
Select Last Purge Valve to be:	
1. Purge Valve A	
2. Purge Valve B	
3. Purge Valve C	
> 2	
-PRESS NEXT OR PREV FOR MORE PURGE PARAMETERS-	





 Type the number for the first purge valve, then . Type the number for last purge valve, then . Press  to go to the previous purge sequence configuration screen. Press  to go to the next purge sequence configuration screen.

Select the valve you want the purge sequence to start and end with. Typically start with Purge Valve A and end with Purge Valve B.

- If 1 Purge Valve was selected in the previous purge sequence screen, only Purge Valve B will appear as a choice.
- If 2 Purge Valves was selected in the previous purge sequence screen, Purge Valves A and B will appear as choices.
- If 3 Purge Valves was selected in the previous purge sequence screen, Purge Valves A, B, and C will appear as choices.

### C8C: Purge Sequence: Purge Alarms

SYSTEM CONFIGURATION	Station: 1
PURGE SEQUENCE:PURGE ALARMS	
Enter the Minimum Purge Volume:	
> 0000 cc	
Enter the Maximum Purge Time:	
> 000.0 sec	
NOTE: The above parameters are used with the solvent meter for purge related alarms.	
-PRESS PREV FOR MORE PURGE PARAMETERS-	

 Type the number for the minimum purge volume, then . Type the number for maximum purge time, then . Press  to go to the previous purge sequence configuration screen. Press  to go to the next configuration screen.

This screen only appears if the solvent meter was turned on in the Solvent Meter Screen (screen C7). The values help determine when purge alarms will occur.

#### Minimum Purge Volume

This setting is important when purge is set by time, which is true when integrated color change is turned on. If the minimum purge volume of solvent does not flow through the solvent valve during the allotted purge time, a "Purge Not Completed" alarm will occur.

#### Maximum Purge Time

This setting is important when purge is set by volume. If the set volume of solvent does not flow through the solvent valve by the time the maximum purge time has elapsed, a "Purge Time Out" alarm will occur. This alarm could indicate a meter or solvent supply problem.

# System Configuration

## Screens



## Information



### C9: Mixed Load Volumes

```

SYSTEM CONFIGURATION                               Station: 1
MIXED LOAD VOLUMES
-----
Enter Gun1 Mixed Load Volume
> 0000 cc

Enter Gun2 Mixed Load Volume
> 0000 cc
    
```



 Type in the required Mixed Load Volume for gun 1, then .



If prompted, type in the required Mixed Load Volume for gun 2, then . Next screen .

### C10: Guns Setup

```

SYSTEM CONFIGURATION                               Station: 1
GUNS SETUP
-----
Turn Gun Flush Boxes On or Off:
1. Gun Flush Boxes Off
2. Gun Flush Boxes On
> _
Select Locations for Guns Being Used:
1. Gun 1
2. Gun 2
3. Gun 1 and Gun 2
4. Guns selected from I/O.
5. Guns selected automatically.
    
```

 Type the number for the gun locations, then .

Type the number to turn the gun flush boxes on or off, then . Next screen .

Select the gun(s) according to the guns being used with flow control, potlife timers, and flow alarms. The default selection is #1, "Gun 1".

The Mixed Load Volume is the amount of material needed to evacuate the solvent from the hose and gun.

- If color change is off, the load volume activates after a complete purge and will then turn on the gun trigger output for the volume entered.
- If integrated color change is on which purges by time, the color change time will extend as needed to reach the volume entered. This only applies when the the operation switch on the control booth is in the mix mode.
- If the value is set to zero, the mixed load volume feature is turned off. The default setting is zero. Turning off the gun flush boxes on screen C10 will also disable the mixed load volume.

- Turn gun flush boxes On if they are present, or Off if they are not present.
- Your selection affects a number of screen displays pertaining to the potlife timer, purge/load interlock and flow control.
- Select #4 if the guns are selected using the I/O on the controller. This option is used with a 3 position switch to select the active gun.
- In Selection #5 the number of guns selected is automatically based on the "gun in box" signals and the air flow switch signals. No additional hardware is needed for this option. This option may not be as reliable as selection #4 for safety critical operations.

### I/O Gun Selection Table

6111	6121	Guns Enabled
0	+ 24 VDC	Gun 2
+ 24 VDC	0	Gun 1
0	0	Gun 1 and Gun 2
+ 24 VDC	+ 24 VDC	Gun 1 and Gun 2



# System Configuration

## Screens

The features related to the gun flush boxes are the potlife autodump, the mixed load volume, and the purge/load interlock alarm.



## Information

Turning the gun flush boxes on or off will enable or disable the features related to the gun flush boxes and the purge/load interlock. The system will assume that the number of gun flush boxes is the same as the number of guns selected previously on this screen. The default setting is "Gun Flush Boxes On".

### C11: Mix/Purge

SYSTEM CONFIGURATION	Station: 1
<u>MIX/PURGE</u>	
Select Mix/Purge Input:	
1. Remote Operator Station	
2. Digital Inputs	
3. Network	
> 1	

Select whether to have mix/purge input come from the Remote Operator Station or from digital inputs.



 Type the number for the desired Mix/Purge input source, then .  
Next screen .

### C12: Flow Control

SYSTEM CONFIGURATION	Station: 1
<u>FLOW CONTROL OPTIONS</u>	
Select Flow Control Options:	
1. Off	
2. Hand Gun Operation	
3. Automatic Gun Operation	
> 2	
Press Enter to Accept Data and Edit the Flow Control Options.	

Flow control is used to assure that the same amount of fluid consistently sprays out of the gun at all times for a better finish. The flow control is set according to the fluid viscosity and finish requirements. The Precision-Mix II controller reads the flow from the flow meters and adjusts the fluid regulator as needed.

- Select #1, OFF, if flow control hardware is not installed on the system. Flow control cannot be used without the proper hardware. Refer to the Installation section.
- If flow control is installed, select #2 or #3, depending on whether you are using a hand gun or an automatic gun. Pressing Enter  key will take you to the next Flow Control screen. Follow the **Flow Control Setup** procedure on page 8–18 to complete the flow control setup.

 Type the number for the desired flow control option, then .



# System Configuration

## Screens

## Information



### C13: Integrator Volume

SYSTEM CONFIGURATION	Station: 1
<u>INTEGRATOR VOLUME</u>	
Select an Integrator Volume:	
1. 25 cc	
2. 50 cc	
3. 75 cc	
4. 100 cc	
> 2	

 Type the number for the integrator volume, then . Next screen .



### C14: Integrated Color Change

SYSTEM CONFIGURATION	Station: 1
<u>INTEG. COLOR CHANGE</u>	
Select Integrated Color Change Mode:	
1. No Color Change	
2. Integrated Color Change	
3. Integrated Color Change with Queue	
> 2	
Press Enter to Accept Data and Edit the Integrated Color Change Sequences.	

 Type the number for the desired integrated color change mode, then . Read the text at right.

### C15: Password Selection

SYSTEM CONFIGURATION	Station: 1
<u>PASSWORD CHANGE</u>	
Enter new password (0-9999):	
> 0000	

 Type a 1 to 4 digit password between 0-9999, then .

Select the total volume to dispense for each component A and component B cycle.

A typical setting is 50 cc. A setting greater than 50 cc requires a hardware change.

Select whether to operate with no color change, with integrated color change, or with integrated color change with queue.

- If "No Color Change" is selected, color changes must be done manually and no further color change setup is required. Press the next screen key  to go to the next configuration screen.
- If selection #1 or #2 is chosen, follow the **Integrated Color Change Setup** procedure on page 8-12 to complete the color change setup.

Use this screen to set a password for access to system configuration, recipe setup, and flow control setpoint changes screens.

 If the password is set to zero, the password requirement is de-activated.

# System Configuration



## Screens

## Information

### C16: Time and Date Set

SYSTEM CONFIGURATION	Station: 1
TIME AND DATE SET	
Enter year:	> 00
Enter month:	> 00
Enter day:	> 00
Enter hour:	> 00
Enter minutes:	> 00
Enter seconds:	> 00
Select Day, Month, Year display format	
1. MM/DD/YY	
2. DD/MM/YY	
> 1	

Use this screen to set time and date information. A date display format of month/day/year (MM/DD/YY) or day/month/year (DD/MM/YY) is available.

 Type the time and date information. Press  after each entry.

Type the number for the desired date display format. Next screen .



### C17: Run Screen Monitor

SYSTEM CONFIGURATION	Station: 1
RUN SCREEN MONITOR	
Configure the Run Screen Monitor Display	
1. No Run Screen Monitor	
2. Target/Actual Screen	
3. Flow Screen	
4. Volume Screen	
5. Idle Time Screen	
6. Flow Rate/Setpoint for Gun 1 Screen	
7. Flow Rate/Setpoint for Gun 2 Screen	
> 2	

Select what type of information you want to display on the run screen monitor. Selection #2, "Target/Actual Screen", is the default.

 Selection #1 "No Run Screen Monitor" is used when a run screen monitor is not installed on the system.

If the system has a run screen monitor, one of the selections #2 to #7 must be entered or the screen will be blank.

 Type the number for the desired screen to display on the Run Screen Monitor, then . Next screen .



# System Configuration

## Screens

## Information





### C18: Display Setup

SYSTEM CONFIGURATION	Station: 1
<u>DISPLAY SETUP</u>	
The Display battery is not low.	
Enter Display brightness (10-132):	
> 000	
Enter Display Contrast (30-70):	
> 000	
Select Display to be:	
1. Non Inverted	
2. Inverted	
> 1	

 Type the number for the desired display brightness and contrast. Press  after each entry. Type the number to select a non-inverted or inverted screen. Next screen .

### C19: Print Setup

SYSTEM CONFIGURATION	Station: 1
<u>PRINT SETUP</u>	
Select the reporting type:	
1. Network (Printer Disabled)	
2. Printer Enabled	
> 2	
Select whether or not a Color Change will automatically generate a run report.	
1. No	
2. Yes	
> 2	

 Type the number for the desired reporting tool, then . Move down to the next data field . Type in the number to select whether to automatically generate a run report or not after a color change, then . Next screen .

Use this screen to set the User Interface display brightness and contrast and select a non-inverted (the default selection) or inverted display.

Larger numbers increase the brightness and contrast.

 This screen also notifies you if the User Interface battery is running low. If the battery is low, replace it immediately. Batteries should be replaced every one to two years as part of routine maintenance. See page 11-3.

Select whether to send the report to a networked computer or to a printer connected to the controller. Then select whether or not an integrated color change will automatically generate a run report.

- Install printer part no. 113774 if a printer is desired. See page 12-39.



# System Configuration

## Screens



## Information

### C20: Air Flow Switch

SYSTEM CONFIGURATION	Station: 1
AIR FLOW SWITCH	
Select the Time Delay before the Air Flow Switch Alarm will become Active (10–60 sec): > 10	
Select the type of gun to be used with the system: 1. Air Spray 2. Airless Spray > 1	

 Type the number of seconds desired, then .

Type the number for the type of gun to be used, then .

Press the next screen arrow key  to return to the Configuration Menu or press the HOME key  to return to the HOME screen.

The Air Flow Switch alarm will occur if component A or B is not dispensed, after the gun is triggered, within the set time delay period. 10 seconds is the default setting.

This alarm is important to ensuring the operator does not spray pure resin or pure catalyst onto a part, due to a meter or cable failure. See Air Flow Switch Alarm on page 10–9.

### CAUTION

To avoid ruining the finish on parts, only increase the time delay past 10 seconds if necessary and use the smallest increase possible.

Most applications will select #1 "Air Spray", which uses the standard air flow switch or a gun trigger signal from a robot.

Selection #2 "Airless Spray" does not use the air flow switch, so there is no signal that the gun is triggered. An inline switch must be installed in the fluid line to provide a signal when there is fluid flow in the system. See your Graco distributor to order.

When "Airless Spray" is selected, the mix valves do not close when the system is in idle mode. Instead, the booth control alarm light flashes and a system idle pop-up screen appears on the user interface. The system will exit idle mode when the inline switch signals flow through the system.

### CAUTION

#### IMPORTANT

The accuracy of the PrecisionMix II relies on a signal that the gun is being triggered. Failure to use a gun trigger signal will cause unpredictable performance which can result in off-ratio spraying and ruined finish on parts.

The gun trigger signal can be from an air flow switch, an external gun trigger signal, or an inline switch if "Airless Spray" is selected.

# Flow Control Setup

## Screens

### Home Screen

```
Graco PrecisionMix II (R)
Version X.XX

HOME SCREEN                      Station: 00
1. RUN MONITOR
2. TOTALIZERS
3. RECIPE SETUP
4. SYSTEM CONFIGURATION
Select a menu item and press enter: > 4
```

 Press key , then .

### Password Screen

```
TYPE IN THE PASSWORD AND PRESS ENTER

> 0000
```

 If requested, type the password, then .

- This password screen only appears if the password is changed from the factory default of "0" (zero).

### Menu Screen (CMENU)

```
SYSTEM CONFIGURATION              Station: 1
MENU
1.LANGUAGE                        11.MIX/PURGE
2.STATION NUMBER                  12.FLOW CONTROL
3.DISPLAY UNITS                   13.INTEGRATOR VOLUME
4.RECIPES                          14.COLOR CHANGE
5.POTLIFE TIMER                   15.PASSWORD CHANGE
6.FLOW RATE LIMITS                16.TIME AND DATE
7.SOLVENT METER                   17.RUN SCREEN DISPLAY
8.PURGE SEQUENCE                  18.DISPLAY SETUP
9.MIXED LOAD VOL.                 19.PRINT SETUP
10.GUNS SETUP                      20.AIR FLOW SWITCH
Select a menu item and press enter:> 12
```

 Type 12, for FLOW CONTROL, then .

# Flow Control Setup



## Screens

## Information

### C12: Flow Control Options



```
SYSTEM CONFIGURATION          Station: 1
FLOW CONTROL OPTIONS
-----
Select Flow Control Options:
1. OFF
2. Hand Gun Operation
3. Automatic Gun Operation
> 2

Press Enter to Accept Data and Edit
the Flow Control Options.
```

 Type the number for the desired flow control option, then .

### Flow Control Menu (FCMenu)

```
SYSTEM CONFIGURATION          Station: 1
FLOW CONTROL: MENU
-----
Select Flow Control Options to Edit:
1. Source of Flow Control Data
2. Analog Input Scaling Range
3. Force Analog Output
4. Delay Time to Start Flow Control
5. Flow Meter Location
> 1
```

 Type the number for the flow control option you want to edit, then .

- Select #1, OFF, if flow control hardware is not installed on the system. Flow control cannot be used without the proper hardware. Refer to the Installation section.
- If flow control is installed, select #2 or #3, depending on whether you are using a hand gun or an automatic gun.

This is the FLOW CONTROL MENU screen where you select the flow control option you want to edit.

Item 5, Flow Meter Location, will only appear if “Gun 1” was selected for Guns Setup. See page 8–10.





# Flow Control Setup

## Screens

## Information



### FC1: Source of Flow Control Data

SYSTEM CONFIGURATION	Station: 1
FLOW CONTROL: SETPOINT/RESET	
Select Flow Control Setpoint:	
1. User Interface	
2. Network	
3. Analog Inputs	
> 2	
Select Source of Loop Reset Signal:	
1. Remote Station	
2. Digital Inputs	
> 1	

-  Type the number for the desired source of flow control data, then .
- Move down to next data field .
- Type the number, then . Next screen .

### FC2: Flow Control Scaling

SYSTEM CONFIGURATION	Station: 1
FLOW CONTROL: SCALING	
Enter Maximum Flow Rate Setpoint Corresponding to a 20 mA Input Signal:	
> 1000 cc/min	

-  Type in the Maximum Flow Rate Setpoint, then . Next screen .

Select the source for flow rate setpoint input.

#### Flow Control and Setpoint

- Selecting #1 will set the User Interface as the source of input.
- Selecting #2 will set a network computer as the source of input.
- Selecting #3 will set an analog signal as the source of input.

#### Loop Reset Signal

- Selecting #1 will set the Flow Control Remote Station as the source of a flow control reset signal.
- Selecting #2 will set digital input as the source of a flow control reset signal.

The Analog Input Scaling Range screen enables you to scale the flow rate setpoint to a 4–20 mA input signal. The controller calculates the relationship between the cc/min. entry and 20 mA.

**Example:** Value of 1000 cc/min. is entered.

4 mA = 0 cc/min.

12 mA = 500 cc/min.

20 mA = 1000 cc/min.



# Flow Control Setup

## Screens





## Information

### FC3: Flow Control Force Output

```
SYSTEM CONFIGURATION                      Station: 1
FLOW CONTROL:FORCE OUTPUT
-----
Select On to Begin Forcing the Outputs:
> OFF

Enter a New Output Percentage to Force
the Flow Regulator:



Gun 1 = 000 %
Gun 2 = 000 %
```

 Select to turn the outputs ON or OFF, then . Move down to next data field . Type in the output percentage number for the gun(s). Press  after each entry. Next screen .

### FC4: Flow Control Delay Time

```
SYSTEM CONFIGURATION                      Station: 1
FLOW CONTROL:DELAY TIME
-----
Enter the Delay Time to Start the
Flow Control Loop:

Gun 1 = 1.0 Sec
Gun 2 = 1.0 Sec
```

 Type in the delay time for the gun(s). Press  after each entry. Next screen .

The Force Analog Output screen can be used for troubleshooting. It enables you to manipulate the mA output to force the regulator open or closed.

 The "Force Output" option is disabled (turned to OFF) when the screen is left.

The Delay Time to Start Flow Control enables you to set the amount of time to delay the start of flow control monitoring after the gun is triggered.

 Set to allow enough time for the fluid to flow steadily to avoid unnecessary alarm.

# Flow Control Setup



## Screens

## Information

### FC5: Flow Control Meter Location

SYSTEM CONFIGURATION	Station: 1
FLOW CONTROL:METER LOCATION	
Select the Flow Meter Location:	
1. Use Component A and B Flow Meters	
2. Use Meter in Mixed Material Stream	
> 1	

- Select #1 if the component A and B flow meters are being used to monitor fluid flow. Refer to page 2–9.
- Selecting #2 if a fluid meter is installed in the mixed material line to monitor fluid flow. Refer to page 2–10 or 2–11.

 Select the flow meter location, then . Next screen .

# Integrated Color Change Setup

## Screens

## Information

### Home Screen

```
Graco PrecisionMix II (R)
Version X.XX



HOME SCREEN _____ Station: 00
1. RUN MONITOR
2. TOTALIZERS
3. RECIPE SETUP
4. SYSTEM CONFIGURATION
Select a menu item and press enter: > 4
```

 Press key **4**, then .

### Password Screen

```
TYPE IN THE PASSWORD AND PRESS ENTER

> 0000
```

 If requested, type the password, then .

### Menu Screen (CMENU)

```
SYSTEM CONFIGURATION _____ Station: 1
MENU
1.LANGUAGE          11.MIX/PURGE
2.STATION NUMBER   12.FLOW CONTROL
3.DISPLAY UNITS    13.INTEGRATOR VOLUME
4.RECIPES          14.COLOR CHANGE
5.POTLIFE TIMER    15.PASSWORD CHANGE
6.FLOW RATE LIMITS 16.TIME AND DATE
7.SOLVENT METER    17.RUN SCREEN DISPLAY
8.PURGE SEQUENCE   18.DISPLAY SETUP
9.MIXED LOAD VOL.  19.PRINT SETUP
10.GUNS SETUP      20.AIR FLOW SWITCH

Select a menu item and press enter:> 14
```

 Type 14, for COLOR CHANGE, then .

# Integrated Color Change Setup



## Screens

## Information

### C14 Color Change Mode Screen



```
SYSTEM CONFIGURATION                      Station: 1
INTEG. COLOR CHANGE
-----
Select Integrated Color Change Mode:
1. No Color Change
2. Integrated Color Change
3. Integrated Color Change with Queue
> 2

Press Enter to Accept Data and Edit
the Integrated Color Change Sequences.
```

 Type the number for the desired color change option, then .

### ICC101: Color Change Sequence

```
SYSTEM CONFIGURATION                      Station: 1
INTEG. COLOR CHANGE
-----
Enter Color Change Sequence:
> 1
NOTE: Sequence 0 (zero) is used for the end
of day purge only. (Recipe 0 only.)
```

 Type the number (0–4) desired to define the Color Change Sequence, then .

 Set to allow enough time for the fluid to flow steadily to avoid unnecessary alarm. Sequence 0 (zero) is only used with Recipe 0 (zero) for end of the day flush. Sequence 0 (zero) will not allow a mix time value to be loaded.

Select "Integrated Color Change" or "Integrated Color Change With Queue".

With "Integrated Color Change", the tasks necessary to execute a color change are done automatically whenever a new recipe is selected. The color change sequence is a time-based mode of operation that can be configured by the user.

The color change sequence is setup the same way with "Integrated Color Change with Queue" selected as it is with "Integrated Color Change".

The difference between the two modes is that the Queue parameters, which are setup in the RUN MONITOR mode, override the normal color change parameters during the color change.

There are five possible color change sequences that can be configured. The color change sequences contain start times and timer durations for the devices that are controlled during a color change.

After the color change sequences are setup, each recipe is assigned one of the four sequences during recipe setup. The color change sequence is used to purge the lines and load the new material when the recipe is selected.

# Integrated Color Change Setup

## Screens

## Information

### ICC102: Color Change Graph Screen

1. PURGE MIX**	
2. A DUMP	
3. A SOLV	
4. B DUMP	
5. B SOLV	
6. GUN1 TG	
7. GUN2 TG	
8. SPEC 1	
9. SPEC 2	
10. SPEC 3	
11. SPEC 4	
12. SPEC 5	
13. SPEC 6	
0 Sec <span style="float: right;">40.0</span>	
Color Chg Seq 1. Enter Function (1-13) <span style="float: right;">01</span>	

Type the number for the function desired, then .

The functions will appear in the Color Change Graph in the order that they were previously entered. The graph takes time to update so wait for the update before going onto the next screen.

Start color change setup by defining function 1, PURGE/MIX.

See page 2–14 for examples of the effect of entering various data for the color change sequence parameters.

### ICC1: Purge and Mix Timer Values

SYSTEM CONFIGURATION	Station: 1
INTEG. COLOR CHANGE	Color Chng Seq: 1
<u>Purge and Mix Timer Values</u>	
Enter Purge start time:	> 2.0 sec
Enter Purge duration time:	> 20.0 sec
Enter Mix duration time:	> 20.0 sec
First Purge Valve is	<u>Valve A</u>
Enter First Purge time:	> 3.0 sec
Enter A Purge time:	> 2.0 sec
Enter B Purge time:	> 2.0 cc
Last Purge Valve is	<u>Valve B</u>
Enter Last Purge time:	> 3.0 sec
Total Sequence time is	<u>42.0</u> sec

Type the number of seconds/volume to run the selected function. Press after each entry. Press to return to the **Color Change Sequence Graph** screen to view your input if desired or go to the next screen .

#### Purge Values

A typical integrated color change sequence starts by purging out the old mixed material.

The purge is further defined by setting:

- purge start time,
- total purge time,
- purge time for the first cycle,
- purge time for the last cycle,
- and individual purge times for the three possible purge valves.

#### Mix Values

The integrated color change sequence fills the hoses with the new mixed material after the system has finished purging. The duration of the mix (fill) time for the color change sequence must be defined during color change setup.





# Integrated Color Change Setup

## Screens

## Information





### ICC2: A Component Dump Timer Value

SYSTEM CONFIGURATION	Station: 1
<u>INTEG. COLOR CHANGE</u>	Color Chng Seq: 3
<u>A Component Dump Timer Value</u>	
Total Sequence time is	40.0 Sec
Enter A Component Dump duration time.	
> 7.0 Sec	
Duration time must not be larger than the total Sequence time.	

 Type the number of seconds to run the A Component Dump, then .  
Press  to return to the **Color Change Sequence Graph** screen to view your input if desired or go to the next screen .

### ICC3: A Component Solvent Timer Value

SYSTEM CONFIGURATION	Station: 1
<u>INTEG. COLOR CHANGE</u>	Color Chng Seq: 3
<u>A Component Solvent Timer Value</u>	
Total Sequence time is	40.0 Sec
Enter A Component Solvent duration time.	
> 5.0 Sec	
Duration time must not be larger than the total Sequence time.	

 Type the number of seconds to run the A Component Solvent, then .  
Press  to return to the **Color Change Sequence Graph** screen to view your input if desired or go to the next screen .

### Total Sequence Time

The total sequence time is automatically set by the addition of the purge start time, the purge duration time, and the mix duration time. In order to change Total Sequence Time, the purge and/or mix time must be changed in the previous screen.

### A Component Dump Timer Value

The first dump valve opens as soon as the integrated color change sequence begins. The time length the dump valve stays open must be defined during color change setup. The dump valve allows the unmixed A component materials to be dumped from the system before entering the mix manifold.

 The A Component Dump time must not be greater than the total purge time. If a larger number is entered, the valve will close automatically when the purge duration time is finished.

### A Component Solvent Timer Value

The color change solvent valve opens as soon as the color change sequence begins. The time length the solvent valve stays open must be defined during color change setup. The solvent valve pushes the unmixed A Component through the dump valve and cleans the A material inlet for the next material being used.

 The Component A Solvent purge time must not be greater than the total purge time. If a larger number is entered, the valve will close automatically when the purge duration time is finished.





# Integrated Color Change Setup

## Screens

## Information





### ICC4: B Component Dump Timer Value

SYSTEM CONFIGURATION	Station: 1
INTEG. COLOR CHANGE	Color Chng Seq: 3
<u>B Component Dump Timer Value</u>	
Total Sequence time is	40.0 Sec
Enter B Component Dump duration time.	
> 0.0 Sec	
Duration time must not be larger than the total Sequence time.	

-  Type the number of seconds to run the B Component Dump, then .
- Press  to return to the **Color Change Sequence Graph** screen to view your input if desired or go to the next screen .

### ICC5: B Component Solvent Timer Value

SYSTEM CONFIGURATION	Station: 1
INTEG. COLOR CHANGE	Color Chng Seq: 3
<u>B Component Solvent Timer Value</u>	
Total Sequence time is	40.0 Sec
Enter B Component Solvent duration time.	
> 0.0 Sec	
Duration time must not be larger than the total Sequence time.	

-  Type the number of seconds to run the B Component Solvent, then .
- Press  to return to the **Color Change Sequence Graph** screen to view your input if desired or go to the next screen .

### B Component Dump Timer Value

The time length the dump valve stays open must be defined during color change setup. The dump valve allows the unmixed B component materials to be dumped from the system before entering the mix manifold.

-  The B Component Dump time must not be greater than the total purge time. If a larger number is entered, the valve will close automatically when the purge duration time is finished.

### B Component Solvent Timer Value

The time length the catalyst solvent valve stays open must be defined during color change setup. The solvent valve pushes the unmixed B Component through the dump valve and cleans the B material inlet for the next material being used.

-  The Component B Solvent purge time must not be greater than the total purge time. If a larger number is entered, the valve will close automatically when the purge duration time is finished.

# Integrated Color Change Setup

## Screens

## Information



### ICC6: Gun 1 Trigger Start/Duration Times

SYSTEM CONFIGURATION	Station: 1
<u>INTEG. COLOR CHANGE</u>	<u>Color Chng Seq: 3</u>
<u>GUN 1 TRIGGER START/DURATION TIMES</u>	
	<u>Start</u> <u>Duration</u>
Gun 1 1st Trigger:	0.0 Sec                      0.0 Sec
Gun 1 2nd Trigger:	0.0 Sec                      0.0 Sec



Type the desired time entry for each field.

Press  after each entry.

Press  to return to the **Color Change Sequence Graph** screen to view your input if desired or go to the next screen .



### ICC7: Gun 2 Trigger Start/Duration Times

SYSTEM CONFIGURATION	Station: 1
<u>INTEG. COLOR CHANGE</u>	<u>Color Chng Seq: 3</u>
<u>GUN 2 TRIGGER START/DURATION TIMES</u>	
	<u>Start</u> <u>Duration</u>
Gun 2 1st Trigger:	0.0 Sec                      0.0 Sec
Gun 2 2nd Trigger:	0.0 Sec                      0.0 Sec



Type the desired time entry for each field.

Press  after each entry.

Press  to return to the **Color Change Sequence Graph** screen to view your input if desired or go to the next screen .

### Gun Triggers 1–2

The gun triggers are electrical outputs that can be configured to turn on and off up to two times. These outputs are typically wired to the gun triggers on the Gun Flush Boxes or the operator's gun control.



# Integrated Color Change Setup

## Screens

## Information

### ICC8-13: Special 1-6 Trigger Start/Duration Times

SETUP	Station: 1
INTEG. COLOR CHANGE	Color Chng Seq: 3
<u>SPECIAL 1 TRIGGER START/DURATION TIMES</u>	
	<u>Start</u> <u>Duration</u>
Special 1 1st Trg:	00.0 Sec    00.0 Sec
Special 1 2nd Trg:	00.0 Sec    00.0 Sec
Special 1 3rd Trg:	00.0 Sec    00.0 Sec
Special 1 4th Trg:	00.0 Sec    00.0 Sec
Enter Special 1 description:	
> SPEC 1	

#### Special Triggers 1-6

The special triggers are optional outputs that the user can configure for their particular application. Each of the six outputs can turn valves on and off up to four times during a color change sequence.



The description for the special outputs can be customized for a particular application. See the instructions at left.



 Specials 1, 2, 3, and 4 are pneumatic outputs, while Specials 5 and 6 are electrical outputs.





Type the desired time entry for each field.

Press  after each entry.

Use the   keys to move up or down the data fields.

Use the   keys to toggle through the available characters for the special outputs descriptions.

Press  to return to the **Color Change Sequence Graph** screen to view your input if desired or go to the next screen .

# PrecisionMix II Remote Interface

## Pressure Test and Solvent Flush the System

Before operating the system, perform the **Pressure Test and Solvent Flush** procedures on page 3–36. See system assembly drawings on electrical schematic 309001 for more specific details.

## PrecisionMix II Remote Applications

The PrecisionMix II software has been designed to work in remote applications. These types of applications use I/O to communicate with the system instead of the standard operator stations and user interfaces.

### I/O Timing

The I/O system on the PrecisionMix II unit need 200 ms to process and I/O change. For this reason, it is a good idea to space out sequential commands to the system by at least 200 ms. An example of this would be if the robot wanted the system to go from purge to mix. The best way to program this transition would be turn off the purge signal, wait 200 ms and then turn on the mix signal. This will prevent the situation where the PrecisionMix II sees a mix and purge signal simultaneously.

### Automatic Gun Selection from I/O

Use Gun Enabled Inputs 6111 (for Gun 1) and 6121 (for Gun 2) for gun use identification.

Gun Input 6111	Gun Input 6121	Gun Selected
+ 24 VDC	0	Gun 1
0	+ 24 VDC	Gun 2
0	0	Guns 1 and 2
+ 24 VDC	+ 24 VDC	Guns 1 and 2

To remove an active gun, the PrecisionMix II must complete a purge cycle or a color change to recipe 0. The second gun may be added at any time during operation.

## Integrated vs. Non-Integrated Color Changes

The integrated color change feature simplifies the amount of robot programming needed to perform a color change. The reason for this is that the color change is performed automatically. The timing issues related to this automatic color change are handled internally by the PrecisionMix II controller. The robot program needs to select the new recipe and then set the color change bit (wire #5091) high for at least 200 ms. The system will then automatically color change to the new recipe. The mix input (wire #6061) can remain high throughout the color change as long as the new recipe is not recipe 0. If the mix signal is high in recipe 0, an Invalid Recipe Alarm will occur (recipe 0 is not a valid recipe for mixing).

**NOTE:** Some applications will not be able to take advantage of the Integrated Color Change feature.

The following two examples show how a color change would be programmed for a 1 gun flow control system, with a gun flush box, for a recipe change from recipe 1 to 2. The color change has a five second purge.

The digital inputs are shaded dark and the outputs are shaded gray. Also note, that some tasks that typically take place during a color change are not shown in the following examples for clarity. These tasks include opening dump valves, opening solvent valves, and changing color valves. All of these tasks are handled automatically when using the Integrated Color Change feature.

# PrecisionMix II Remote Interface

## Integrated Color Change

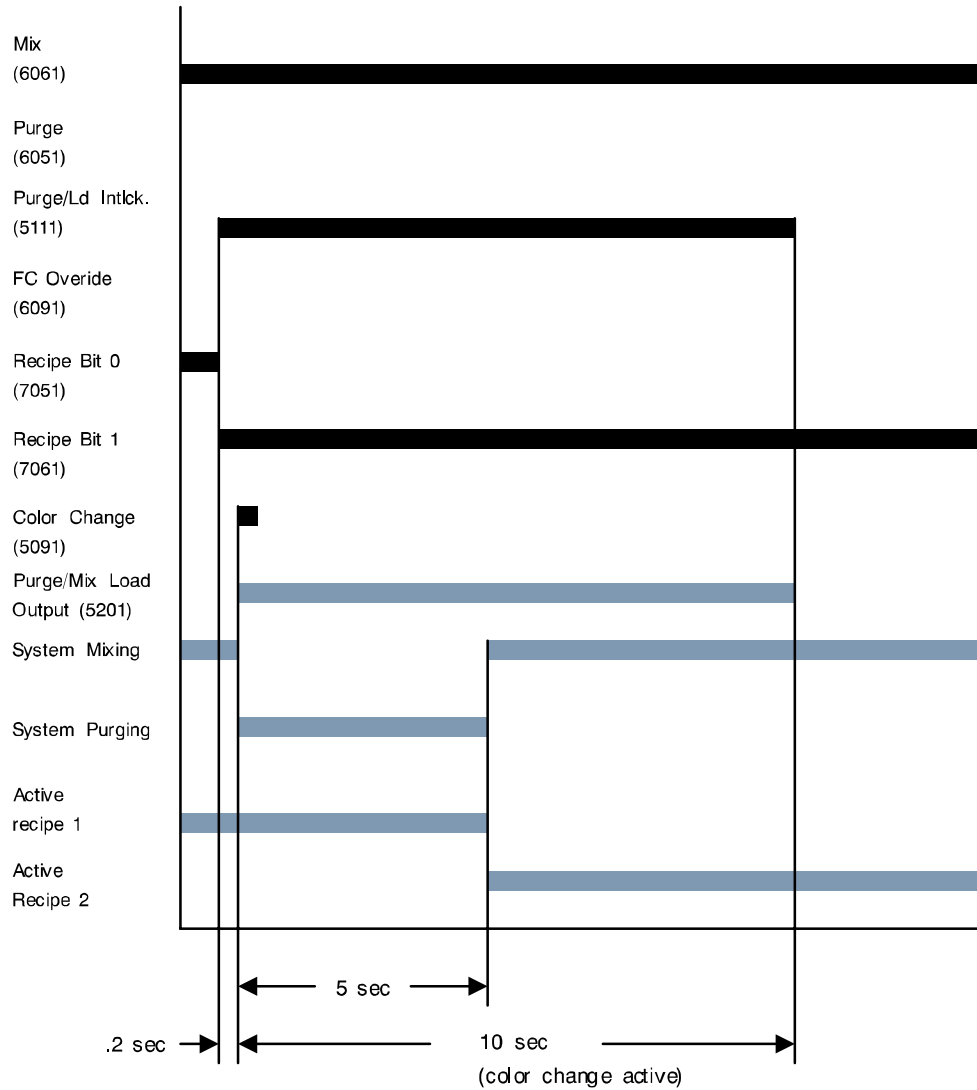
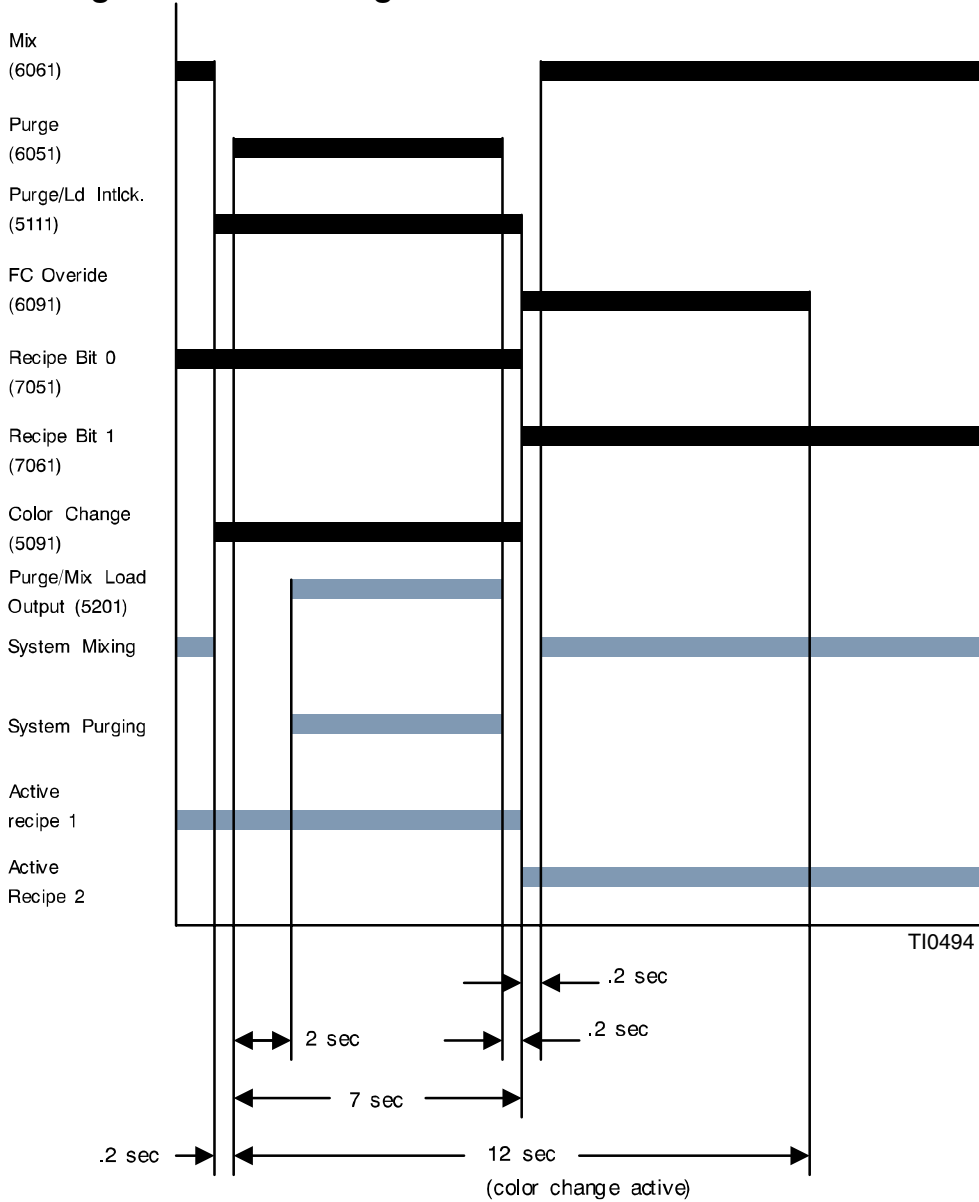

Fig. 8.1

T10494

# PrecisionMix II Remote Interface

## Non-Integrated Color Change



**Fig. 8.2**

**Note:** When purging through the I/O, there is a 2 second delay after the purge signal goes high before the purge actually begins. this delay allows time for resetting alarms or for relieving pressure in the system before the purge begins.

# PrecisionMix II Remote Interface

Digital Inputs			
Terminal Block	Description	Non-Integrated Color Change Function	Integrated Color Change Function
5051	Gun Trigger 1	The Gun 1 Trigger input signals the PrecisionMix II that spraying with the first gun is being attempted. This input is typically wired to an air flow switch that signals when atomization air is being sent to the gun. This input may also be wired to a gun trigger signal from a robot to indicate that material is being sprayed.	Same as Non-Integrated Color Change.
5061	Gun Trigger 2	The Gun 2 Trigger input signals the PrecisionMix II that spraying with the second gun is being attempted. This input is typically wired to an air flow switch that signals when atomization air is being sent to the gun. This input may also be wired to a gun trigger signal from a robot to indicate that material is being sprayed.	Same as Non-Integrated Color Change.
5071	External Alarm	The External Alarm input allows an external device to shut down the PrecisionMix II system. If any operation is taking place on the system, it will stop and the system will go into standby. The alarm will be displayed on the User Interface and on the Run Screen Monitor. It will also be logged to the alarm history.	Same as Non-Integrated Color Change.
5081	Abort Reset	The Abort Reset input will reset any active alarms in the system. This input has the same function as moving the operator switch from the standby to purge position to reset alarms. Alarms such as the Potlife alarm and Purge Not Complete Alarm will still require a full purge to be reset.	Same as Non-Integrated Color Change.
5091	Color Change	The Color Change input indicates that a manual color change is taking place. When this input is high, all totals are accumulated under the "A + B Dump" category. Setting the color change input high also prevents getting Overdose Alarms during the dump of the A or B component.	The Color Change input will trigger an integrated color change if it is kept high for more than 0.2 seconds. The color change will only occur if a new, valid recipe has been selected by the recipe input bits. This input will also trigger a Queue color change when the system is set on the Integrated Color Change with Queue mode.
5101	Print Report	The Print Report input will trigger the system to print a run report. Printing a report will also trigger clearing of the job totalizers.	Same as Non-Integrated Color Change.
5111	Purge/Load Interlock #1	The Purge/Load Interlock #1 input is a safety interlock and is required to be high before purging or loading with gun #1 is allowed. This feature is typically used in conjunction with Gun Flush Boxes and can be disabled by turning off the Gun Flush Boxes on the configuration screens of the User Interface.	The Purge/Load Interlock #1 input must also be set high before an Integrated Color Change is allowed. This safety interlock will still prevent purging or loading manually and can be disabled through the configuration screens.
5121	Purge/Load Interlock #2	The Purge/Load Interlock #2 input is a safety interlock and is required to be high before purging or loading with gun #2 is allowed. This feature is typically used in conjunction with Gun Flush boxes and can be disabled by turning off the Gun Flush Boxes on the configuration screens of the User Interface.	The Purge/Load Interlock #2 must also be set high before an Integrated Color Change is allowed. This safety interlock will still prevent purging or loading manually and can be disabled through the configuration screen.

# PrecisionMix II Remote Interface

Digital Inputs			
Terminal Block	Description	Non-Integrated Color Change Function	Integrated Color Change Function
6051	Purge	The Purge input is used to trigger a purge of the system. The purge will be initiated after a 2 second delay. Turning this input on and then off again will also reset all active alarms.	Same as Non-Integrated Color Change.
6061	Mix	The Mix input is used to set the system into the mix mode.	The mix signal can remain high when an Integrated Color Change is triggered. The system will then perform the Integrated Color Change and immediately go back into the mix mode. If this is attempted when color changing to recipe 0, an Invalid Recipe alarm will occur because recipe 0 is not a valid recipe for mixing.
6071	Gun 1 Flow Control Reset	The Gun 1 Flow Control Reset input is used with hand gun flow control operations. This signal will trigger the system to try to maintain its setpoint if the current flow rate is below the low limit setpoint. This signal is not used for automatic gun flow control applications.	Same as Non-Integrated Color Change.
6081	Gun 2 Flow Control Reset	The Gun 2 Flow Control Reset input is used with hand gun flow control operations. This signal will trigger the system to try to maintain its setpoint if the current flow rate is below the low limit setpoint. This signal is not used for automatic gun flow control applications.	Same as Non-Integrated Color Change.
6091	Flow Control Override/ Maximum Analog	The Flow Control/Maximum Analog Override input is used when the system is being filled. This input will cause the flow control fluid regulator to open so the system can be quickly filled. This input is not needed if the mixed load volume fill feature is used.	The Flow Control/Maximum Analog Override input does not need to be used during an Integrated Color Change. The system will automatically open the fluid regulator for purging and filling. This input will still be needed, however, if a manual fill is attempted while in the integrated color change mode.
6111	Gun 1 Enabled	This input is used to enable spray gun #1 use. Potlife tracking and GFB operation by remote input.	Same as Non-Integrated Color Change
6121	Gun 2 Enabled	This input is used to enable spray gun #2 use. GFB operation by remote select switch.	Same as Non-Integrated Color Change
7051-7101	Recipe Bits (6 bits – 63 recipes)	The Recipe Bit inputs are a binary representation of the desired recipe for the PrecisionMix II. When these bits are changed the system will immediately change to the new recipe. Example: Recipe 1 = Bit 0 high. Recipe 3 = Bit 0,1 high. Recipe 7 = Bit 0, 1,2 high.	The Recipe Bit inputs work in conjunction with the Color Change Input (5091) for Integrated Color Change. The system will automatically color change to a new recipe if the Recipe Bits are changed and then the Color Change bit is set high.
7121	Password	The Password input is used to override the system password set by the User Interface. If the system password is forgotten or mistyped, this input allows the user to temporarily bypass the security system.	Same as Non-Integrated Color Change.

# PrecisionMix II Remote Interface

Digital Outputs			
Terminal Block	Description	Non-Integrated Color Change Function	Integrated Color Change Function
5171	Solvent A Valve	The Solvent A Valve output opens the solvent valve for purging. This valve is typically used with air.	Same as Non-Integrated Color Change.
5181	Solvent B Valve	The Solvent B Valve output opens the solvent valve for purging. The valve is typically used with solvent.	Same as Non-Integrated Color Change.
5191	Solvent C Valve	The Solvent C Valve output opens the solvent valve for purging. The valve is typically reserved for special applications.	Same as Non-Integrated Color Change.
5201	Purge/Mix Load	The Purge/Mix Load output indicates that the system is purging or loading. This output will be high during a purge or a fill using the mix load volume.	The Purge/Mix Load output will be high during an Integrated Color Change. It will also be high if the system is being manually purged or filled.
5211	Gun 1 Trigger On	The Gun 1 Trigger On output is used as an input to a Gun Flush Box to automatically trigger the gun. This output will turn on automatically (if gun flush boxes are enabled) for purging and loading.	The Gun 1 Trigger output may be turned on or off via the programmable color change sequences. It will also turn on if the system is being manually purged or filled.
5221	Gun 2 Trigger On	The Gun 2 Trigger On output is used as an input to a Gun Flush Box to automatically trigger the gun. This output will turn on automatically (if gun flush boxes are enabled) for purging and loading.	The Gun 2 Trigger output may be turned on or off via the programmable color change sequences. It will also turn on if the system is being manually purged or filled.
5231	Special 5	This output is not used for Non-Integrated Color Change.	The Special 5 output may be turned on or off via the programmable color change sequences.
5241	Special 6	This output is not used for Non-Integrated Color Change.	The Special 6 output may be turned on or off via the programmable color change sequences.
6171	Ratio Alarm	Ratio Low, Ratio High, A Overdose, B Overdose, A Dose Time, B Dose Time.	Same as Non-Integrated Color Change.
6181	Flow Rate Alarm Gun 1	Flow Control Off: Low Flow Flow Control On: Gun 1 High Flow, Gun 1 Low Flow	Same as Non-Integrated Color Change.
6191	Flow Rate Alarm Gun 2	Flow Control Off: High Flow Flow Control On: Gun 2 High Flow, Gun 2 Low Flow	Same as Non-Integrated Color Change.
6201	Potlife Alarm Gun 1	Potlife Alarm for Gun #1.	Same as Non-Integrated Color Change.
6211	Potlife Alarm Gun 2	Potlife Alarm for Gun #2.	Same as Non-Integrated Color Change.
6221	Purge/Load Interlock Alarm	Purge/Load Interlock, I/O Alarm, Invalid Recipe.	Same as Non-Integrated Color Change.
6231	Purge Not Complete Alarm	Purge Time Out, Purge Not Complete	Same as Non-Integrated Color Change.
6241	General Alarm	All System Alarms: This includes all alarms included for outputs 1-7, plus Memory Failure, Control Battery Low, and Display Battery Low.	Same as Non-Integrated Color Change.





# 9

## Recipe Setup



# Recipe Setup

## Screens

## Information

### Home Screen

```
Graco PrecisionMix II (R)
Version X.XX

HOME SCREEN _____ Station: 00
1. RUN MONITOR
2. TOTALIZERS
3. RECIPE SETUP
4. SYSTEM CONFIGURATION
Select a menu item and press enter: > 3
```

 Press key  then .

### Password Screen

```
TYPE IN THE PASSWORD AND PRESS ENTER

> 0000
```

 Type the password then .

- RECIPE SETUP (#3) screens allow you to setup “recipes” (ratio programs) for a variety of fluids.

- This password screen only appears if the password is changed from the factory default of “0” zero.
- After the password is entered the system remains unlocked for 5 minutes allowing the user to navigate all screens without further password prompting.

# Recipe Setup

## Screens

### S101: Recipe Selection

```
SETUP          Recipe: 0          Station: 1
RECIPE SELECTION
-----
Enter Recipe to be edited (1-63):
> 1
```

 Type the recipe number then .

## Information

Enter a number between 0–63 to assign to the recipe being configured. Keep a record of the recipes you have entered. The number of recipes available are set during system configuration. Refer to page 8–6.

 Recipe 0 is the global recipe. Any changes made to recipe 0 will be copied to all the recipes. If Recipe 0 is entered, the following warning screen will appear.

```
SETUP          Recipe: 0          Station: 1
RECIPE SELECTION
-----
You have selected Recipe Zero. Any changes
made to a recipe parameter will change that
particular parameter in all recipes.

Select YES to Edit Recipe zero or NO to return
to the previous screen.
> YES

Press Enter to Continue.
```

# Recipe Setup

## S102: Setup Menu with Integrated Color Change On (with or without Queue) and Flow Control On

```
SETUP          Recipe: 1          Station: 1
MENU
-----
1. MIX RATIO
2. COLOR CHANGE SEQUENCE
3. SYSTEM ALARMS
4. FLOW METER VALUES
5. FLOW CONTROL

Select a menu item and press enter:
> 1
```

Recipes allow you to store ratio programs for various materials or job requirements.



After setup, the recipes are selected for use on an outside source, such as the User Interface. The source was determined during system configuration. Refer to page 8–6.

- If integrated color change is on, selection #2 will be COLOR CHANGE SEQUENCE.
- If Integrated color change is off, selection #2 will be PURGE SEQUENCE.
- If flow control is on, selection #5, FLOW CONTROL, will display.

## S102 Setup Menu with Integrated Color Change and Flow Control Off

```
SETUP          Recipe: 1          Station: 1
MENU
-----
1. MIX RATIO
2. PURGE SEQUENCE
3. SYSTEM ALARMS
4. FLOW METER VALUES

Select a menu item and press enter: > 1
```

 Type the number for the desired menu item then .





# Recipe Setup

## Screens

## Information

### S1 Mix Ratio and Tolerance

SETUP	Recipe: 1	Station: 1
MIX RATIO		
Enter Ratio (A:B):		
> 1.00 : 1		
Enter Tolerance:		
> 5 %		

 Type the ratio for the recipe then . Type the tolerance percentage then . Next screen .

#### Mix Ratio

Enter the volumetric mix ratio of component A to component B. The mix ratio can be set from 0.6:1 to 30:1.

 Depending on your application, other mix ratios may be possible. Contact your Graco Authorized distributor for other capabilities.

The value of Component B is set at 1 and cannot be adjusted. If your B value does not equal one, you must convert the ratio.

*Example:* If a 3:2 ratio is desired, you would convert the ratio to 1.5:1.

 A setting of 0.0:1 represents a one component dispense. The component A valve will remain open. The Component B valve will not open.

#### Tolerance

Select the tolerance of the ratio entered above. If this tolerance is exceeded, the PrecisionMix Controller will generate a ratio alarm and the system will shut down. The value can be set down to 1% minimum.

*Example:* If the mix ratio is 2:1 and the tolerance is 5%, when the PrecisionMix checks the ratio on each cycle, if the ratio is within 2.1:1 or 1.9:1, the system will continue to operate. If the ratio is not within those values, the system will generate a Ratio Alarm and shut down.

# Recipe Setup

## Screens

## Information

*If Integrated Color Change is On (with or without Queue)*

### S2 Color Change Sequence

SETUP	Recipe: 1	Station: 1
COLOR CHANGE SEQUENCE		
Enter Flush/Fill Sequence Number (1-4):		
> 1		
Enter (Resin) A valve (1-12):		
> 1		
Enter (Catalyst) B valve (1-3):		
> 1		

#### Flush/Fill Sequence Number (1-4)

The flush/fill sequences were set up during system configuration. Refer to the Integrated Color Change Sequence screen on page 8-22.

#### A Color Valve (1-12)

Select the color valve to open for the Component A material desired.

#### B Color Valve (1-3)

Select the color valve to open for the Component B material desired.



Type the desired number entry for each field.

Press  after each entry.

Next screen .



The choices available for dispensing Component A and B materials depends on the number of color valves installed in your system and the assignment of valves to materials.

# Recipe Setup

## Screens

## Information

### If Integrated Color Change is Off

#### S2 Purge Sequence

SETUP	Recipe: 1	Station: 1
PURGE SEQUENCE		
The First Purge valve is Valve X		
Enter First Purge time: > 000.0 seconds		
Enter A Purge time: > 000.0 seconds		
Enter B Purge time: > 000.0 seconds		
Enter C Purge time: > 000.0 seconds		
The Last Purge valve is Valve X		
Enter Last Purge time: > 000.0 seconds		
Enter Total # of Purge Cycles: >		



Type the desired number entry for each field.

Press  after each entry.

Next screen .

#### Purge Time

If the Integrated Color Change is turned off, the purge sequence needs to be setup manually for each recipe, using the PURGE SEQUENCE screen.

Which purge valves appear for setup depends on the number of valves selected during system configuration. Refer to the Purge Sequence screen on page 8–8.

The purge sequence activates the purge valves chosen, usually one for Component A and one for Component B, alternating on and off, according to the time set here. The value you enter for A PURGE time determines how long the Component A purge valve is open for its dispense cycle during the purge sequence, with the exception of the first and last purge, which have their own values.

#### Total # of Purge Cycles

Select how many times the purge sequence shifts between Component A purge and Component B purge

when the Operator Station switch is set to Purge .



During a purge cycle, a message will appear on the operator Interface indicating the remaining time or volume for the purge sequence.





# Recipe Setup

## Screens

## Information

### S3 System Alarms with *Flow Control On* and *Hand Gun Selected*

```
SETUP          Recipe: 1          Station: 1
SYSTEM ALARMS
Enter Gun 1 Potlife Time Limit:
> 000 minutes
Enter Gun 1 Potlife Timer Reset:
> 0000 cc
Enter Gun 2 Potlife Time Limit:
> 000 minutes
Enter Gun 2 Potlife Timer Reset:
> 0000 cc
Enter Flow Rate Alarm Tolerance
> 0000 %
Enter Low Limit Below Flow Rate Setpoint
> 0000 cc/min
```

 Type the desired number entry for each field.  
Press  after each entry.  
Next screen .

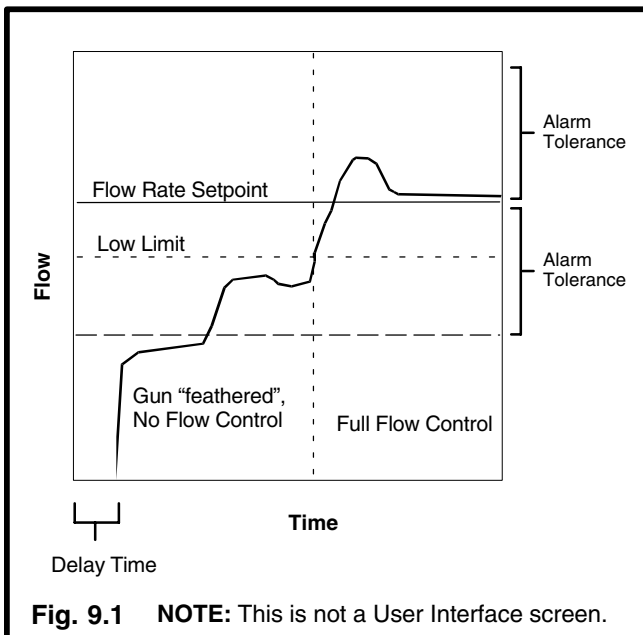

#### Gun Potlife Time Limit

Sets the maximum time allowed for mixed fluid to be in the system before tripping a pot life alarm. The timer starts when catalyst is introduced into the integrator. Follow the material recommendation when setting a value.

 The pot life timer is reset either by a purge or by the passage of a specified amount of fluid.

The guns that appear for potlife time limit and timer reset depends on the guns selected during system configuration. Refer to page 8–10.

#### Gun Potlife Timer Reset

Sets the volume of fluid that needs to be dispensed before the pot life timer resets. Enter a value that represents the volume of mixed fluid that is in the integrator, hoses, and guns.

#### Flow Rate Alarm Tolerance (Refer to Fig. 9.1)

Sets the alarm tolerance percentage in relation to the flow rate setpoint. The tolerance percentage should be outside of the low limit setpoint. The flow rate alarm output will be on when the actual flow rate falls out of this tolerance for three seconds. The alarm output will be off when the actual flow rate falls within this tolerance.

- For the gun 1 flow rate alarm, output #2 of module #2 will be on.
- For the gun 2 flow rate alarm, output #3 of module #2 will be on.

#### Low Limit Below Flow Rate Setpoint

This setting helps the system allow for periodic partial triggering of a hand gun without adjusting the flow rate. See page 9–9 for a detailed information on Flow Control Low Limit.

# Recipe Setup

## Screens

## Information

### S3 System Alarms with *Flow Control On* and *Automatic Gun Selected*

SETUP	Recipe: 1	Station: 1
SYSTEM ALARMS		
Enter Gun 1 Potlife Time Limit: > 000 minutes		
Enter Gun 1 Potlife Timer Reset: > 0000 cc		
Enter Gun 2 Potlife Time Limit: > 000 minutes		
Enter Gun 2 Potlife Timer Reset: > 0000 cc		
Enter Flow Rate Alarm Tolerance > 0000 %		

#### Gun Potlife Time Limit

See previous screen information.

#### Gun Potlife Time Limit

See previous screen information.

#### Gun Potlife Timer Reset

See previous screen information.

#### Flow Rate Alarm Tolerance

The flow rate alarm output will be on when the actual flow rate falls out of this tolerance for three consecutive seconds.

- For the gun 1 flow rate alarm, output #2 of module #2 will be on.
- For the gun 2 flow rate alarm, output #3 of module #2 will be on.

### S3 System Alarms with *Flow Control Off*

SETUP	Recipe: 1	Station: 1
SYSTEM ALARMS		
Enter Gun 1 Potlife Time Limit: > 000 minutes		
Enter Gun 1 Potlife Timer Reset: > 0000 cc		
Enter Gun 2 Potlife Time Limit: > 000 minutes		
Enter Gun 2 Potlife Timer Reset: > 0000 cc		
Enter Minimum Flow Rate Limit > 0000 cc/min		
Enter Maximum Flow Rate Limit > 0000 cc/min		



Type the desired number entry for each field.

Press  after each entry.

Next screen .

#### Gun Potlife Time Limit

See previous screen information.

#### Gun Potlife Timer Reset

See previous screen information.

#### Minimum Flow Rate Limit

Sets the minimum flow rate allowed for the recipe. The flow rate alarm output #2 of module #2 will be on when the actual flow rate drops below the flow rate limit for three seconds.

#### Maximum Flow Rate Limit

Sets the maximum flow rate allowed for the recipe. The flow rate alarm output #3 of module #2 will be on when the actual flow rate exceeds the flow rate limit for three seconds.

# Recipe Setup

## Screens

## Information

### S4 Meter Calibration Tests

```
SETUP          Recipe: 1          Station: 1
METER CALIBRATION TESTS
-----
1. COMPONENT A FLOW METER CALIBRATION
2. COMPONENT B FLOW METER CALIBRATION
3. MIXED MATERIAL CALIBRATION
4. SOLVENT FLOW METER CALIBRATION
5. GUN 1 METER CALIBRATION
6. GUN 2 METER CALIBRATION

Select a menu item and press enter:
> 1
```



Type the desired calibration option number then  to start the calibration routine.

The Meter Calibration Tests screen is used to select which flow meter to calibrate individually or to do a mixed material calibration.

- Selection 4, "Solvent Flow Meter Calibration", will only appear if a solvent meter was selected during system configuration.
- Selection 5, "Mixed Material Meter 1 Calibration", will only appear if a fluid meter in the mixed material stream was selected during meter location configuration (page 8–20) for a Gun 1/Gun 1 and 2 selection (page 8–10).
- Selection 6, "Mixed Material Meter 2 Calibration", will only appear for a Gun 2/Gun 1 and 2 selection (page 8–10).

# Recipe Setup

## Screens

## Information

### S401 Component A Flow Meter Calibration

```
SETUP          Recipe: 1          Station: 1
COMPONENT A FLOW METER CALIBRATION
Enter Component A Meter K-Factor:
> 0.124 cc/pulse

Press Enter to begin calibration:
> STOP

          Calibration Volume is    0 cc

Enter new Calibration Volume:
>    0 cc

-OPERATOR SWITCH MUST BE IN STANDBY-
```

 For the greatest metering accuracy, always calibrate meters at flow rates  $\leq$  the typical system operating flow rates.

#### Selection 1, 2, and 4

(Selection 1 shown at left, Selections 2–6 on the following pages)

The existing Flow Meter K-factor will appear in the first field. A new K-factor can be entered in this field.

Using the part number on the meter identification tag, verify that the K-factors for the meters are set correctly by comparing the values displayed on the screen to the K-factors in the **Meter K-factor Table** below.

The flow meter size must be entered in cubic centimeters per electrical pulse. The number you enter must be a 3 digit decimal.

The meters can be calibrated by dispensing material to a calibrated container and entering the amount dispensed. The system will automatically calculate the proper cc/pulse K-factor and enter it into the system.

 Follow the procedure on page 9–17 to calibrate each meter.

#### METER K-FACTOR REFERENCE TABLE

Meter Part No.	Model No.	K-factor (cc/pulse)
239716	G3000	0.119
235587	PPM 3050	0.114
235588	PPM 3100	0.229
235592	PPM3550	0.588
551634	Water borne	0.910
116161	Piston meter	0.1052

# Recipe Setup

## Screens

## Information

### S402 Component B Flow Meter Calibration

```
SETUP          Recipe: 1          Station: 1
COMPONENT B FLOW METER CALIBRATION
-----
Enter Component B Meter K-Factor:
> 0.123 cc/pulse

Press Enter to begin calibration
> STOP

          Calibration Volume is    0 cc

Enter new Calibration Volume:
>    0 cc

          -OPERATOR SWITCH MUST BE IN STANDBY-
```

#### Selection 2

See the description on page 9–12.

### S403 Mixed Material Calibration Screen

```
SETUP          Recipe: 1          Station: 1
MIXED MATERIAL CALIBRATION
-----
          Desired Mix Ratio is 1.00 : 1

K-Factor A = 0.124    K-Factor B = 0.123

          Enter Cycles for Calibration:    0

Press Enter to begin calibration:
> STOP

          Target    Actual    New
A Volume (cc)      0         0         0
B Volume (cc)      0         0         0

          -OPERATOR SWITCH MUST BE IN STANDBY-
```

#### Selection 3

This screen is used to do a mixed material calibration, which can be the most accurate method of calibrating the component A and B meters.

Using the part number on the meter identification tag, verify that the K-factors for the meters are set correctly by comparing the values displayed on the screen to the K-factors in the **Meter K-factor Table** on page 9–12. The meter K-factors are entered in the screens for Component A and B Flow Meter Calibration, refer to pages 9–12 and 9–13.

The flow meter size must be entered in cubic centimeters per electrical pulse. The number you enter must be a 3 digit decimal.

The meters can be calibrated by operating the system for a selected number of cycles, dispensing material to a calibrated container, and entering the amount dispensed. The system will automatically calculate the proper cc/pulse K-factor and enter it into the system.



Follow the calibration procedure on page 9–20.

# Recipe Setup

## Screens

## Information

### S404 Solvent Flow Meter Calibration

```
SETUP          Recipe: 1          Station: 1
SOLVENT FLOW METER CALIBRATION
-----
Enter Solvent Meter K-Factor:
> 0.000 cc/pulse

Press Enter to begin calibration
> STOP

          Calibration Volume is    0 cc

Enter new Calibration Volume:
>    0 cc

          -OPERATOR SWITCH MUST BE IN STANDBY-
```

#### Selection 4

See the description on page 9–12.

### S405 Gun 1 Meter Calibration

```
SETUP          Recipe: 1          Station: 1
GUN 1 METER CALIBRATION
-----
Enter Gun 1 Meter K-Factor:
> 0.119 cc/pulse

Press Enter to begin calibration
> STOP

          Calibration Volume is    0 cc

Enter new Calibration Volume:
>    0 cc

          -OPERATOR SWITCH MUST BE IN MIX-
```

#### Selection 5

See the description on page 9–12.

### S406 Gun 2 Meter Calibration

```
SETUP          Recipe: 1          Station: 1
GUN 2 METER CALIBRATION
-----
Enter Gun 2 Meter K-Factor:
> 0.119 cc/pulse

Press Enter to begin calibration
> STOP

          Calibration Volume is    0 cc

Enter new Calibration Volume:
>    0 cc

          -OPERATOR SWITCH MUST BE IN MIX-
```

#### Selection 6

See the description on page 9–12.

# Recipe Setup

## Screens

## Information

### S5: Setup Flow Control

SETUP	Recipe: 1	Station: 1
<u>FLOW CONTROL</u>		
Enter the Purge Override Setpoint:		
> 000 %		
Enter the Fill Override Setpoint:		
> 000 %		
Enter the Gun 1 Gain Factor (1-1000):		
> 000		
Enter the Gun 1 Flow Setpoint:		
> 000 cc/min		
Enter the Gun 2 Gain Factor (1-1000):		
> 000		
Enter the Gun 2 Flow Setpoint:		
> 000 cc/min		



Type the desired number entry for each field.

Press  after each entry.

Next screen .

#### Purge Override Setpoint

Sets the percentage to open the fluid regulator during a purge cycle. Generally use a setting of 100% to allow maximum fluid flow.

#### Fill Override Setpoint

Sets the percentage to open the fluid regulator during a fill cycle. Generally use a setting of 100% to allow maximum fluid flow.

#### Gain Factor

The gain factor setting affects the rate at which the system will adjust to a change in flow rate. Start with a setting of 500 and adjust as needed. See page 9–16 for graphic examples of three different settings.

#### Flow Setpoint

The flow setpoint should be set according to the recipe requirements. The setpoint for the recipe is loaded when a recipe change is made.



The Gun 1 and/or Gun 2 "Gain Factor" and "Flow Setpoint" selections only appear if Gun 1 and/or Gun 2 are selected (page 8–10).

The flow rate setpoint can be overridden by the operator on a Run Monitor screen or by an analog input.

**Robotic Users:** The flow control system was designed to maintain consistent flow rates in a changing environment. However, it does not jump from one setpoint to another without small reaction time delays. If a part is being painted that requires changes of coating thickness in specific areas, increasing or decreasing the robot arm speed through these areas will provide better results than manipulating flow control settings.

# Recipe Setup

## Gain Factor Graphs

The following examples of gain factors are based on switching between a setpoint of 200 cc/min. to 400 cc/min. and back to 200 cc/min. A preferred gain factor will change your setpoint quickly without jumping too far above or below the new setpoint.

### Gain = 1

Slower setpoint transition but less overshooting of the new setpoint.

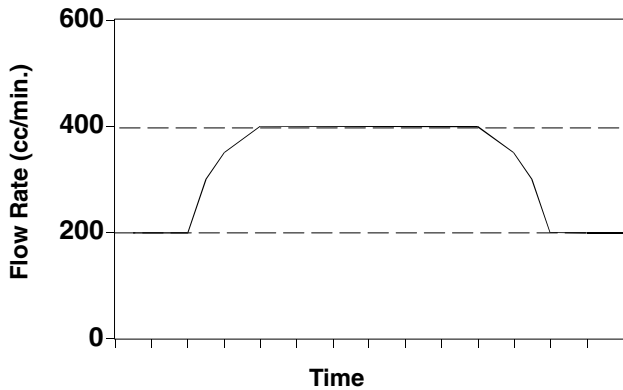

### Gain = 1000

Faster setpoint transition but greater overshooting of the new setpoint.

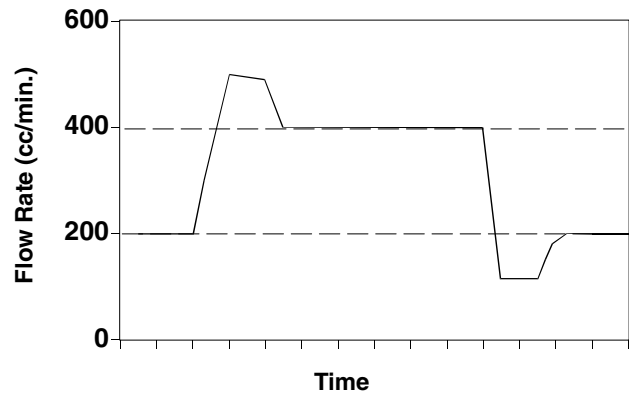

### Gain = 500

Fast setpoint transition with less overshooting of the new setpoint.

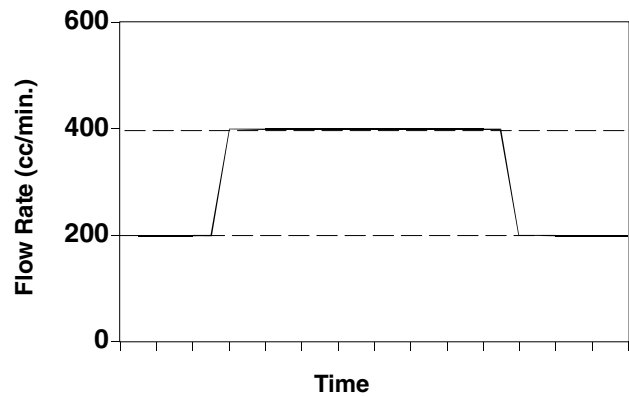





# Flow Meter Calibration Procedure

## Selection 1, 2, or 4: Calibrating the Meters Individually

**NOTE:** Take a large sample (1000 cc or more) of a fluid that is a known accurate weight per gallon so that any error in measuring the sample is spread out.

 **WARNING**





**PRESSURIZED EQUIPMENT HAZARD**  
To avoid splashing fluid in the eyes when calibrating the meters:

- Wear eye protection.
- Only open the ratio check valves enough to allow fluid to flow at a rate of 100 to 200 cc per minute.

 **CAUTION**

The fluid shut-off valves and ratio check valves are retained in their housings by mechanical stops that prevent accidental removal of the valve stem while the manifold is pressurized. Do not use a tool to open or close the valve stems. If manual force cannot turn the valve stems, the system pressure must be relieved and the valve properly disassembled and cleaned to remove the resistance.

1. Make sure the operator switch is set at Standby .

 **CAUTION**

Both the Component A and Component B fluid shut-off valves must be closed if you choose to do a calibration test. Selecting enter on the calibration menus will automatically open the dispense valve for the meter being tested.

2. Enter selection 1, 2, or 4 for the flow meter you want to calibrate.

Recipe: 1      Station: 1

SETUP  
METER CALIBRATION TESTS

---

1. COMPONENT A FLOW METER CALIBRATION
2. COMPONENT B FLOW METER CALIBRATION
3. MIXED MATERIAL CALIBRATION
4. SOLVENT FLOW METER CALIBRATION

Select a menu item and press enter:  
> 1

3. Close both the Component A and Component B fluid shut-off valves and ratio check valves.
4. Place a waste container under the ratio check valve tube for the meter being tested.
5. Press Enter  to begin calibration.

Recipe: 1      Station: 1

SETUP  
COMPONENT A FLOW METER CALIBRATION

---

Enter Component A Meter K-Factor:  
> 0.124 cc/pulse

Press Enter to begin calibration:  
> STOP

Calibration Volume is    0 cc

Enter new Calibration Volume:  
>    0 cc

-OPERATOR SWITCH MUST BE IN STANDBY-

6. Open the Component A ratio check valve and dispense about 50 cc to clear the tube of any air. Close the ratio check valve.
7. Press the Previous  key to stop the calibration. Enter selection 1 to calibrate component A again.

*Continued on the next page.*



# Flow Meter Calibration Procedure

## Selection 1, 2, or 4: Calibrating the Meters Individually – continued

8. Place a graduated beaker under the ratio check valve tube.
9. To avoid splashing, slowly open the ratio check valve. Allow a large sample (1000 cc or more) of the fluid to flow into the container.
10. Close the ratio check valve when a sufficient sample is dispensed.

 To abort calibration, you can select STOP.

11. The screen will display the volume of fluid the PrecisionMix II determined was dispensed in the Calibration Volume field, based on the previously entered calibration factor.
12. If the actual volume dispensed into the container is different, type in the amount actually dispensed in the new Calibration Volume field and press Enter .

**NOTE:** New values can be typed in or the toggle keys can be used to increase  or decrease  values.

13. The new Meter K-Factor will appear in the top field on the screen.



```
SETUP          Recipe: 1          Station: 1
COMPONENT A FLOW METER CALIBRATION
Enter Component A Meter K-Factor:
> 0.124 cc/pulse

Press Enter to begin calibration:
> STOP

          Calibration Volume is      0 cc

Enter new Calibration Volume:
> 0 cc

-OPERATOR SWITCH MUST BE IN STANDBY-
```

14. Go to  the next screen and repeat the process for the Component B Flow Meter.
15. If using a Solvent Flow Meter, go to  the next screen and calibrate that meter.
16. When you are done calibrating meters,
  - a. Flush the ratio check valves.
  - b. Open the manifold shut-off valves.
  - c. Return to the Run Monitor screens to begin production.

# Flow Meter Calibration Procedure

## Selection 5 or 6: Calibrating Gun 1 or Gun 2 Meters

**NOTE:** Take a large sample (1000 cc or more) of a fluid that is a known accurate weight per gallon so that any error in measuring the sample is spread out.

**⚠ WARNING**

**PRESSURIZED EQUIPMENT HAZARD**  
To avoid splashing fluid in the eyes when calibrating the meters, wear eye protection.



1. Load the fluid hose and gun with mixed material and leave the operator switch in Mix .

**⚠ CAUTION**

Both the Component A and Component B fluid shut-off valves must be closed if you choose to do a calibration test. Selecting enter on the calibration menus will automatically open the dispense valve for the meter being tested.

2. Enter selection 5 or 6, for the flow meter you want to calibrate.

```
SETUP          Recipe: 1          Station: 1
METER CALIBRATION TESTS
1. COMPONENT A FLOW METER CALIBRATION
2. COMPONENT B FLOW METER CALIBRATION
3. MIXED MATERIAL CALIBRATION
4. SOLVENT FLOW METER CALIBRATION
5. GUN 1 METER CALIBRATION
6. GUN 2 METER CALIBRATION

Select a menu item and press enter:
> 5
```

3. Move the cursor to > STOP, and press Enter  to begin calibration.

```
SETUP          Recipe: 1          Station: 1
MIXED MATERIAL METER 1 CALIBRATION
Enter Gun 1 Meter K-Factor:
> 0.124 cc/pulse



Press Enter to begin calibration:
> STOP

          Calibration Volume is      0 cc

Enter new Calibration Volume:
> 0 cc

-OPERATOR SWITCH MUST BE IN MIX-
```

4. To avoid splashing, make sure the spray gun in the meter fluid line has its atomizing air turned off. Use the gun to dispense a large sample (1000 cc or more) of the fluid into a calibrated container.
5. The screen will display the volume of fluid the PrecisionMix II determined was dispensed in the Calibration Volume field, based on the previously entered calibration factor.
6. If the actual volume dispensed into the container is different, type in the amount actually dispensed in the new Calibration Volume field and press Enter .

**NOTE:** New values can be typed in or the toggle keys can be used to increase  or decrease  values.

7. The new Meter K-Factor will appear in the top field on the screen.

# Flow Meter Calibration Procedure

**NOTE:** Take a large sample (1000 cc or more) of a fluid that is a known accurate weight per gallon so that any error in measuring the sample is spread out.

 **WARNING**



**PRESSURIZED EQUIPMENT HAZARD**  
To avoid splashing fluid in the eyes when calibrating the meters:

- Wear eye protection.
- Only open the ratio check valves enough to allow fluid to flow at a rate of 100 to 200 cc per minute.

 **CAUTION**

The fluid shut-off valves and ratio check valves are retained in their housings by mechanical stops that prevent accidental removal of the valve stem while the manifold is pressurized. Do not use a tool to open or close the valve stems. If manual force cannot turn the valve stems, the system pressure must be relieved and the valve properly disassembled and cleaned to remove the resistance.

## Selection 3: Mixed Material Calibration

Another method for calibrating the meters is to select menu item 3, MIXED MATERIAL CALIBRATION.

**NOTE:** A valid A and B Flow Meter K-factor must be entered into the system before beginning the Mixed Material Calibration.

SETUP                      Recipe #: 1                      Station: 1  
**METER CALIBRATION TESTS**

---

1. COMPONENT A FLOW METER CALIBRATION  
 2. COMPONENT B FLOW METER CALIBRATION  
 3. MIXED MATERIAL CALIBRATION

Select a menu item and press enter: > 3

1. Make sure the operator switch is set at Standby .

 **CAUTION**

Both the Component A and Component B fluid shut-off valves must be closed if you choose to do a calibration test. Selecting enter on the calibration menu will automatically open the dispense valve for the meter being tested.

2. Close both the Component A and Component B fluid shut-off valves and ratio check valves.
3. Make sure two separate beakers and ratio dispense tubes are in place for Component A and B.
4. Select menu item 4, MIXED MATERIAL CALIBRATION. When the MIXED MATERIAL CALIBRATION screen displays, it will show the mix ratio for the current recipe.

### Mixed Material Calibration Screen

SETUP                      Recipe #: 1                      Station: 1  
**MIXED MATERIAL CALIBRATION**

---

Desired Mix Ratio is 1.00 : 1  
 Enter Cycles for Calibration: 00000  
 Select enter to begin calibration: STOP

Component A Flow Meter Calibration  
 K-Factor = 0.124 cc/pulse  
 Volume is 0000 cc  
 Enter new Component A Volume: 0000 cc

Component B Flow Meter Calibration  
 K-Factor = 0.123 cc/pulse  
 Volume is 0000 cc  
 Enter new Component B Volume: 0000 cc

5. Type in the number of cycles you want to dispense for calibration. One cycle equals a complete dispense of component A and B doses.
6. Select  enter to begin calibration.

*Continued on the next page.*

# Flow Meter Calibration Procedure

## Selection 3: Mixed Material Calibration – continued



7. To avoid splashing, slowly open the component A ratio check valve by turning the knob out. After one shot of component A has dispensed, slowly open the component B ratio check valve.

The PrecisionMix II will run and dispense the number of doses selected of component A and B into the separate beakers.

8. Close both of the ratio check valves after the sample is dispensed.

 To abort calibration, you can select STOP.

9. The screen will display the volume of fluid the PrecisionMix II determined was dispensed in the Calibration Volume fields for A and B Flow Meters, based on the previously entered calibration factor.
10. If the actual volumes dispensed into the containers are different, type in the amount actually dispensed in the new Calibration Volume fields for Component A and B and press the ENTER key .

**NOTE:** New values can be typed in or the toggle keys can be used to increase  or decrease  values.

11. When you are done calibrating meters,
  - a. Flush the ratio check valves.
  - b. Open the manifold shut-off valves.
  - c. Return to the Run Monitor screens to begin production.



# 10

## Troubleshooting





# Revision Numbers

RUN MONITOR	Recipe: 1	Station: 1
00/00/0000		00:00
2K	No Color Change	
Controller Revision: 0.00		
User Interface Revision: 0.00		
Remote Operator Station Revision: 0.00		
Run Screen Monitor Revision: 0.00		
Dongle Revision: 0.00		
Flow Control 1 Revision: 0.00		
Flow Control 2 Revision: 0.00		
Unit ID: 0		
ModBus Receive Command = 0000		

This screen displays the revision numbers for all electronic devices connected to the PrecisionMix II system. For any device that is not connected, or has a fault, the revision will be 0.00. The ModBus Receive Command value will increment every time the PrecisionMix II system communicates with the computer that has the Graco's Advance Material Reporting software running.

1. Press the HOME key on the User Interface.
2. Hold down the INCREASE and UP keys simultaneously for three seconds.
3. This screen will display on the User Interface.
4. Press the HOME key to exit this screen.

# Troubleshooting Reference

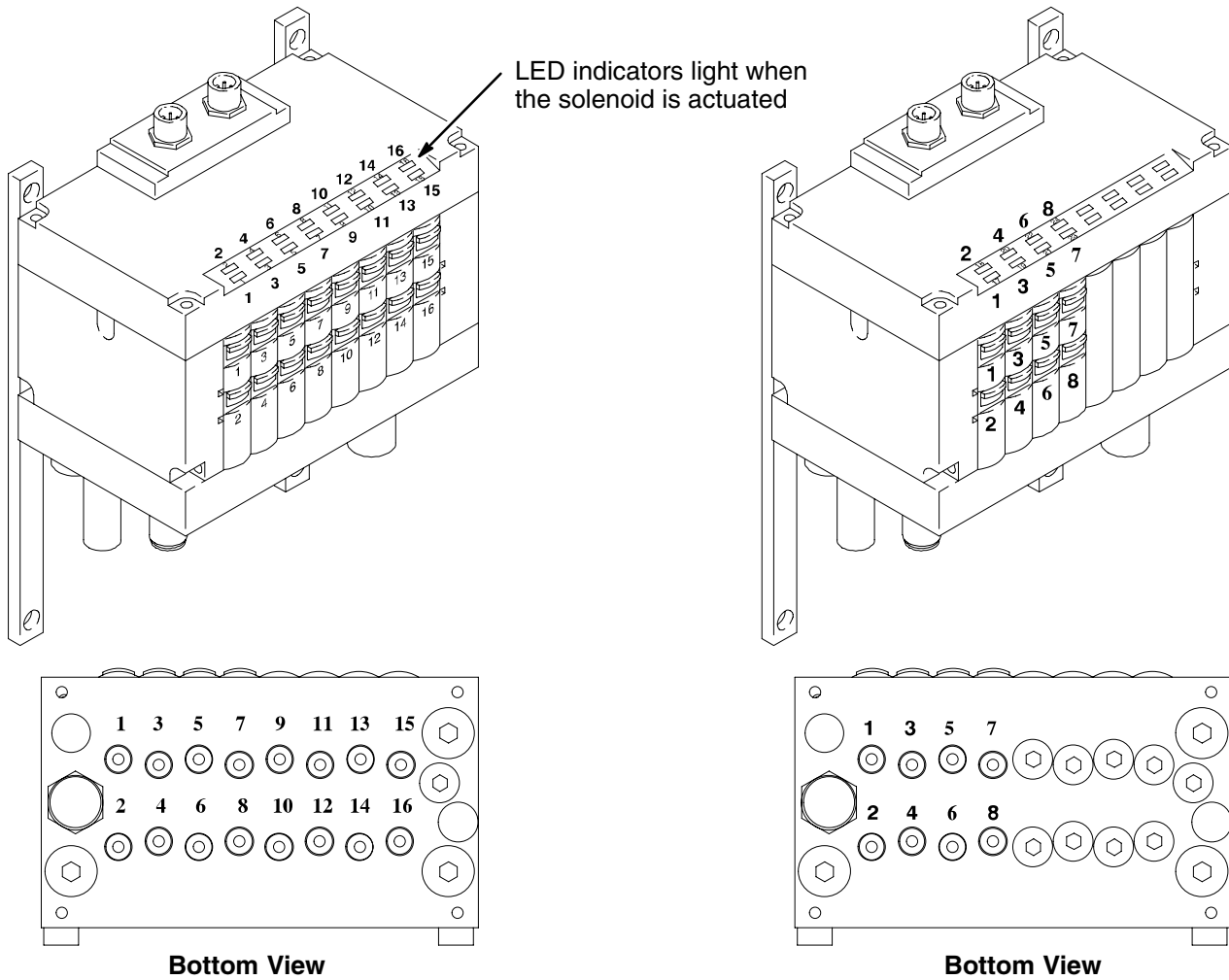
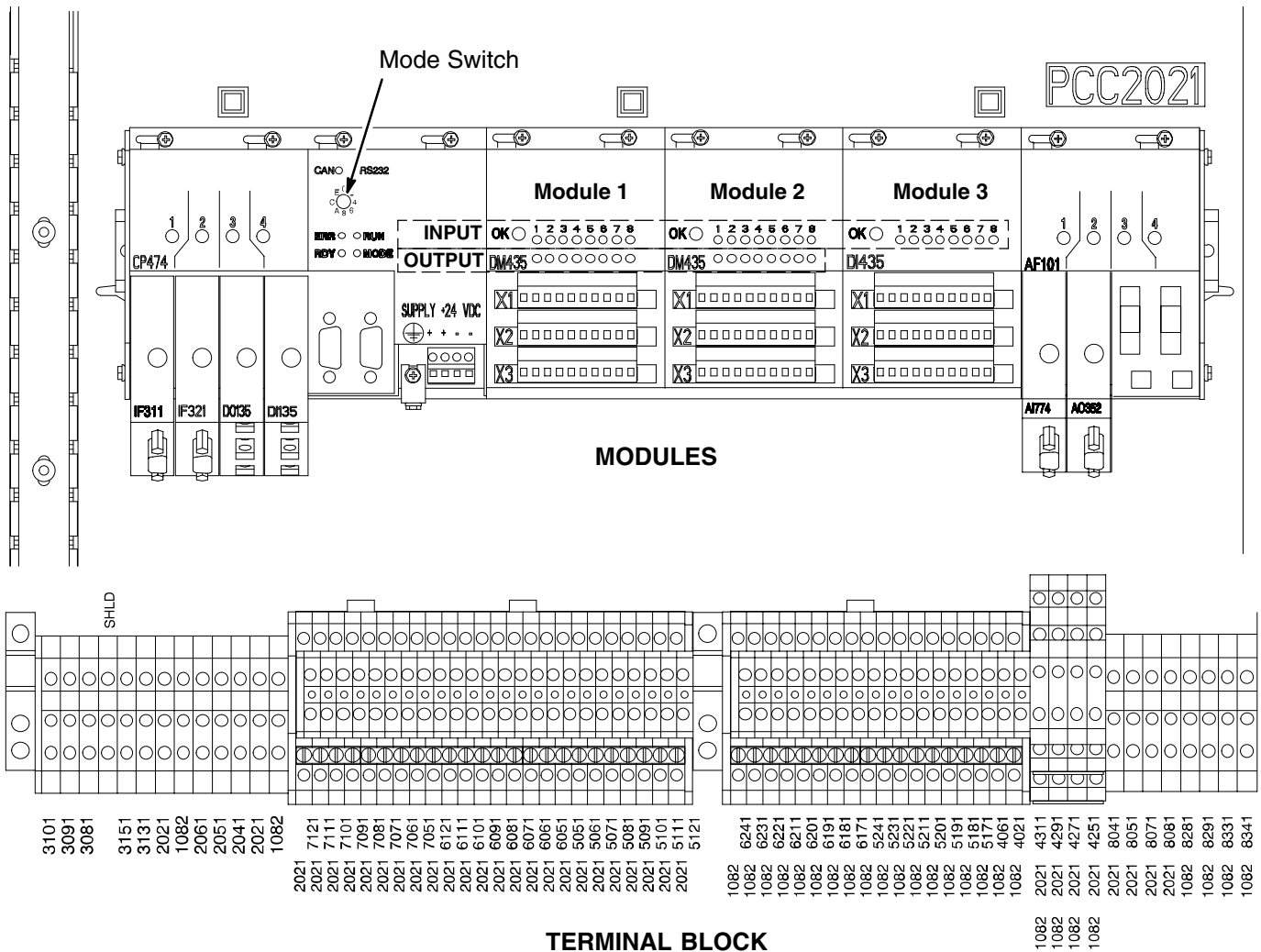

Fig. 10.1 COLOR CHANGE VALVE SOLENOIDS

Rack #1, Solenoid Bank #1	
LED No.	Function
1	Component A Solvent
2	Component A Dump
3	Color #1
4	Color #2
5	Color #3
6	Color #4
7	Special #1
8	Special #2
Rack #1, Solenoid Bank #2	
LED No.	Function
9	Special #3
10	Special #4
11	Color #5

12	Color #6
13	Color #7
14	Color #8
15	Color #9
16	Color #10
Rack #2, Solenoid Bank #1	
LED No.	Function
1	Color #11
2	Color #12
3	Component B Solvent
4	Component B Dump
5	Catalyst #1
6	Catalyst #2
7	Catalyst #3
8	Spare

# Troubleshooting Reference



**Fig. 10.2 CONTROLLER**

Module 1 Inputs		
LED No.	Function	Terminal Block No.
1	Gun 1 Trigger (Air Flow Switch)	5051
2	Gun 2 Trigger (Air Flow Switch)	5061
3	External Alarm	5071
4	Abort Reset	5081
5	Color Change	5091
6	Print Report	5101
7	Purge/Load Interlock #1	5111
8	Purge/Load Interlock #2	5121

Module 1 Outputs		
LED No.	Function	Terminal Block No.
1	Solvent A Valve	5171
2	Solvent B Valve	5181
3	Solvent C Valve	5191
4	Purge/Mix Load	5201
5	Gun 1 Trigger On/Auto Dump	5211
6	Gun 2 Trigger On/Auto Dump	5221
7	Special 5	5231
8	Special 6	5241

*Continued on the next page.*

# Troubleshooting Reference

Module 2 Inputs		
LED No.	Function	Terminal Block No.
1	Purge	6051
2	Mix	6061
3	Gun 1 Flow Control Reset Start	6071
4	Gun 2 Flow Control Reset Start	6081
5	Flow Control Override/Maximum Analog	6091
6	Spare	6101
7	Gun 1 Selected from I/O (GFB)	6111
8	Gun 2 Selected from I/O (GFB)	6121
Module 2 Outputs		
LED No.	Function	Terminal Block No.
1	Ratio Low, Ratio High, A Overdose, B Overdose, A Dose Time, B Dose Time	6171
2	<i>Flow Control Off:</i> Low Flow <i>Flow Control On:</i> Gun 1 High Flow, Gun 1 Low Flow	6181
3	<i>Flow Control Off:</i> High Flow <i>Flow Control On:</i> Gun 2 High Flow, Gun 2 Low Flow	6191
4	Potlife #1	6201
5	Potlife #2	6211
6	Purge/Load Interlock, I/O Alarm, Invalid Recipe	6221
7	Purge Time Out, Purge Not Completed	6231
8	<i>All System Alarms:</i> This includes all alarms included for outputs 1–7, plus Memory Failure, Control Battery Low, and Display Battery Low	6241

Module 3 Inputs		
LED No.	Function	Terminal Block No.
1	Recipe Bit 0	7051
2	Recipe Bit 1	7061
3	Recipe Bit 2	7071
4	Recipe Bit 3	7081
5	Recipe Bit 4	7091
6	Recipe Bit 5	7101
7	Spare	7111
8	Password	7121

# Alarm Troubleshooting

## **WARNING**



### **SKIN INJECTION HAZARD**

To reduce the risk of a serious injury, follow the **Pressure Relief Procedure** on page 4–3 before checking or servicing the equipment.

## **CAUTION**

Do not use the fluid in the line that was dispensed off ratio as it may not cure properly.

## Alarms



If the machine stops due to an alarm condition, the associated alarm output will be active. The alarm outputs are described below and on the following pages. In addition, the alarm light on the Operator Station turns on and a relevant message is displayed on the User Interface alarm screen.

Output number #8 on module #2 will be high when any of the alarms occur.

 See page 10–5 for the location of the Controller modules inputs and outputs.

## To Clear the Alarm and Restart the System

All alarms, except the Pot Life Alarm, can be cleared by moving the operator switch momentarily to PURGE

 , then back to STANDBY .

 When clearing alarms, do not leave the operator switch in the PURGE position for more than 2 seconds or the system will purge.

To start spraying again, turn the switch back to MIX .

# Alarm Troubleshooting

## Ratio Low or Ratio High

*Alarm output will be on Output #1 of Module #2*

Ratio alarms occur when the PrecisionMix II has dispensed a cycle where the amount of resin compared to the amount of catalyst does not meet the tolerances that have been programmed for the system.

### **Ratio Low XX.XX**

The PrecisionMix II has dispensed a cycle (A + B) at a mix ratio less than the ratio target plus the tolerance.

### **Ratio High XX.XX**

The PrecisionMix II has dispensed a cycle (A + B) at a mix ratio higher than the ratio target plus the tolerance.

### **Common Causes for a Ratio Low or High Alarm**

- The flow rate is too high
- Highly unbalanced pressures from the fluid supply system or fluid pressure spikes
- Slow actuation of the resin or catalyst valves
- Purge sequence left air in the mixed material line

### Checking the Flow Rate

If the alarm occurs while starting up the system after purging, the flow rate was probably too high.

Restrict the gun needle travel to slow down the initial fluid delivery rate until the fluid hoses are loaded with material.

### Checking for Unbalanced Pressures

If the alarm occurred after you have been spraying for some time, the pressures from the fluid supplies could be unbalanced.

1. Check the catalyst and resin pressures.
2. *If the pressures are not about equal*, adjust both fluid supply pressures with the fluid regulators, until the pressures are about the same.
3. *If the pressures are already about equal*, verify that the resin and catalyst valves are operating properly.

### Checking the Actuation of the Valves

Manually operate the valves by pressing the buttons on the solenoids. The valves should snap open and shut quickly.

If the valves move slowly, it could be caused by:

- air pressure to the valve actuators is too low,
- an interruption in the valve actuating air caused by dirt or water in the air,
- there is something restricting the solenoid or tubing,
- the packings on the dispense valves are too tight, or
- a dispense valve knob is turned out too far. The knob should be turned in until you feel the detents engaging. You may want to put a piece of tape on the knobs after they are properly set to discourage anyone from changing the setting. The recommended setting is three “clicks” open from fully closed.

### Air in the Mixed Material Line

To correct:

- change the purge sequence
- completely fill the lines with solvent, during last purge function.

# Alarm Troubleshooting

## Dose Time A or Dose Time B

When the PrecisionMix II is in the MIX mode and the air flow switch is closed, which indicates that the gun is being triggered, the PrecisionMix II is programmed to expect that the resin or catalyst will dispense at least ten flow meter pulses every 10–60 seconds. The 10–60 second time period can be set by the customer. Refer to page 8–15. The Dose Time alarm will occur if one of the components is not dispensed within the set time period.

### **Dose Time A**

The PrecisionMix II has not completed a dose of Component A (resin) within a set time period.

### **Dose Time B**

The PrecisionMix II has not completed a dose of Component B (catalyst) within a set time period.

### **Common Causes for a Dose Time Alarm**

- The system is in the MIX mode and the gun is only partially triggered, allowing air but no fluid to pass through the gun
- The fluid flow rate becomes too low
- The meter or cable fails
- The dispense (dose) times are set too low

If a meter or cable fails, resin or catalyst will flow to the gun without the flow being read through the meter pulses. The PrecisionMix II could keep the dispense valve open indefinitely because the computer will never see the target value being reached. This condition could cause the operator to spray pure resin or pure catalyst onto a part.

To prevent this from happening, the computer will only allow the Component A or B valve to remain open for the duration of the dose time. The alarm will alert the user if the dose time is exceeded.

## Checking for a Meter or Cable Failure

Manually open the catalyst or resin dispense valve and trigger the gun into a grounded waste container. The counts should increase in the first Run screen on the User Interface.

**NOTE:** This test will probably cause an Overdose alarm.

## Overdose A or Overdose B

An Overdose alarm occurs if the fluid continues to dispense on the one side of the manifold after the valves have opened on the other side of the manifold.

### **Overdose A**

The PrecisionMix II has continued dispensing fluid on the Component A (resin) side after the valve has shifted to the Component B (catalyst) side. An alarm will occur when the actual dose size reaches 20 cc higher than the target value for Component A.

### **Overdose B**

The PrecisionMix II has continued dispensing fluid on the Component B (catalyst) side after the valve has shifted to the Component A (resin) side. An alarm will occur when the actual dose size reaches 10 cc higher than the target value for Component B.

### **Common causes for an Overdose Alarm are:**

- Valve(s) packings or needle/seat are leaking
- Ratio check valve is leaking
- Flow meter fluctuations caused by pressure pulsations,
- Slow actuation of the resin or catalyst valves,
- Last purge solvent fill did not remove air from the mixed material lines, causing excessive flow rate during mixed material load process.

*Continued on the next page.*

# Alarm Troubleshooting

## Overdose A or Overdose B (continued)

### Checking for Pressure Pulsations

1. Close all the manifold valves.
2. Turn on the circulating pumps and all the booth equipment (such as fans and conveyors).
3. Check to see if the PrecisionMix II is reading any fluid flow.
4. If the PrecisionMix II shows there is fluid flow and there are no leaks from the gun or any other packings or fittings, the meters are probably being affected by pressure pulsations.
5. Close the fluid shut-off valve between the fluid supply system and the meter. The flow indication should stop.
6. If necessary, install pressure regulators or a surge tank on the fluid inlets to the PrecisionMix II to reduce the fluid supply pressure. Contact your Graco distributor for information on fluid pressure regulators.

### Checking the Actuation of the Valves

See page 10–8.

## **Flow Rate Alarms for a System without Flow Control**

### **Flow Too Low**

*Alarm output will be on Output #2 of Module #2.*

The PrecisionMix II is dispensing a lower fluid flow rate than pre-selected in the Recipe Setup screens.

#### **Common Causes for a Flow Too Low Alarm**

- Low fluid pressures from the fluid supply system
- The buildup of cured paint in the fluid components downstream of the PrecisionMix II
- The dispense valve knobs are turned too far in

### **Flow Too High**

*Alarm output will be on Output #3 of Module #2.*

The PrecisionMix II is dispensing a higher fluid flow rate than pre-selected in the Recipe Setup screens.

## **Flow Rate Alarms for a System with Flow Control**

### **Gun #1 High/Low Flow**

*High/Low flow alarm output will be on Output #2 of Module #2.*

### **Gun #2 High/Low Flow**

*High/Low flow alarm output will be on Output #3 of Module #2.*

The Gun #1 and Gun #2 alarms will occur when the fluid flow rate out of the gun goes above or below the alarm tolerance setting for three seconds.

**Example:** If a gun flow rate setpoint of 500 cc/minute and a tolerance of 10% was entered, the Gun High Flow alarm would occur if the actual flow rate was more than 550 cc/minute for three full seconds. A Gun Low Flow alarm would occur if the actual flow rate was less than 450 cc/minute for three full seconds.

### **Pot Life Exceeded**

*Alarm output for Gun #1 will be on Output #4 of Module #2.*

*Alarm output for Gun #2 will be on Output #5 of Module #2.*

This alarm will occur if the mixed material is in the lines for a longer period of time than the pot life time value that was entered during setup.

*For example:* If a pot life value of 30 minutes and a volume of 600 cc was entered, the Pot Life Exceeded alarm would occur if over a 30 minute period, 600 cc of fluid was not dispensed.

The alarm becomes inactive if the system has been purged and no new material has been mixed since that purge.

#### To Remove the Alarm

You have two minutes to move fresh mixed material out to the gun. If this cannot be done, AUTO DUMP will activate if that feature has been selected. Otherwise, a full purge cycle will be required to clear the alarm.





# Alarm Troubleshooting

## Purge/Load Interlock Not Ready

*Alarm output will be on Output #6 of Module #2.*

This alarm occurs when a purge, color change, or mixed load sequence is attempted without satisfying the purge/load interlocks. The purge/load interlocks are digital inputs to the Controller that indicate it is safe to perform a purge or color change. The interlocks typically are signals from the Gun Flush Boxes, but they can also be customized for a particular application. The number of interlocks depends on the number of guns set up in the system configuration.

**NOTE:** A PURGE  sequence is set from the Operator Switch. See page 4–4. A MIXED LOAD sequence is set by entering a value for the mixed load volume for Gun #1 and/or Gun #2 and by setting the operator switch to MIX . Refer to **System Configuration**, beginning on page 8–8 for more information on the settings.

## Invalid Recipe

*Alarm output will be on Output #6 of Module #2.*



This alarm occurs when the user tries to access a recipe that has not been configured or has not been configured properly. In order for a recipe to be configured properly, K-factors must be set for both flow meters and a valid recipe must be input from the recipe setup screens.

### Common Causes of an Invalid Recipe Alarm

- The recipe number is greater than the number of recipes configured to run on the system.
- Recipe 0 was selected for mixing.
- The flow meter K-factors are set to zero.
- Values for the desired ratio, K-factors, and pot life timers have not been input for the recipe.

## I/O Change

*Alarm output will be on Output #6 of Module #2.*

When this alarm occurs, the recipe number has been changed while the Operator Switch is in the MIX  position and Integrated Color Change On is not selected. The alarm will also occur if the system is turned on with the Operator Switch in the MIX  position.

## Purge Not Completed

This alarm only occurs when a solvent meter is present and configured in the system. The alarm works along with a purge by time (color change purge) to indicate that the preset minimum purge volume has not been reached during the purge time. Refer to page 8–9. The alarm will not clear until the purge volume is reached or the system is powered down and back up.

## Purge Time Out

This alarm only occurs when a solvent meter is present and configured in the system. The alarm works along with a purge by volume to indicate that the set volume of solvent has not flowed through the solvent valve by the time the maximum purge time has elapsed. Refer to page 8–9. This alarm could indicate a meter or solvent supply problem. The alarm will not clear until the purge volume is reached or the system is powered down and back up.

# Alarm Troubleshooting

## ALARMS

### Display Battery Low

This alarm indicates that the User Interface's lithium battery is low and it could lose its memory if the problem is not corrected. **Do not** power down the system if this alarm occurs. Follow the instructions for changing the battery on page 11–3.

### Control Battery Low

This alarm indicates that the Controller's lithium battery is low and the Controller could lose its memory if the problem is not corrected. **Do not** power down the system if this alarm occurs. Follow the instructions for changing the battery on page 11–4.

### Memory Failure

This alarm indicates that memory has been lost in the system. If memory is lost, all recipe and configuration data are gone and factory default settings are reloaded. Memory failure is most likely caused by a low or faulty Controller battery. Follow the instructions for changing the battery on page 11–4. Restore the memory with the PrecisionMix II Maintenance Utilities software, provided with the system.

### Communications Error

A communications error occurs when the User Interface is not communicating with the Controller. This is usually due to a loose wire or a poor connection at the back of the User Interface. If a communications error occurs, check for loose wires or a loose cable. If that does not correct the problem, turn the power to the system off and then back on again to re-initialize communications.

### Invalid Guns From Input/Output Alarm

The selection of spray guns that idle on active gun prior to purge activate alarm. Guns can be added at any time while spraying by selecting both guns from gun #1 and gun #2 selection but changing from gun #1 to gun #2 or both to gun#1 and gun #2 will generate this alarm.

### Air Flow Switch Alarm

This alarm is associated with the gun flush boxes option only. The alarm is generated when the system is in the purge mode and the air flow switch signal is active preventing atomization of the solvent.

### Defaults Loaded

This alarm is generated when all the factory default configuration and recipe values are loaded. This alarm will always be active when the system is shipped from Graco.

### Software Revision Alarm

This alarm is generated when the user interface software revision is different than the Precision Mix II controller software revision. If this alarm is generated, finish upgrading the software using the utility kit.

### Configuration Module Alarm

This alarm is generated when the meter interface module fails or is removed.

### External Alarms

Generated from Input/Output Alarm input.

### Valve C Alarm

This alarm is generated when there is a mix-match of software revisions between the User Interface and PrecisionMix II controller. Reprogram either the User Interface or the controller to fix this problem.

# Warning Troubleshooting

## WARNINGS

Warnings are different from alarms in that they do not turn on the Operator Station alarm light, appear as a popup message on the User Interface, or cause a Controller action (such as shutting off the system). Warnings will appear on the Alarm History screen (refer to page 6–6).

### Job Total Rollover

The Job Total Rollover warning indicates that the job totals have been reset to zero, which will occur when the totals exceed 9,999,999 cc (337,838 ounces). The job totals will start over at zero.

### Batch Total Rollover

The Batch Total Rollover warning indicates that the batch totals have been reset to zero, which will occur when the totals exceed 99,999.9 liters (26,420.1 gallons). The batch totals will start over at zero.

### Grand Total Rollover

The Grand Total Rollover warning indicates that the grand totals have been reset to zero, which will occur when the totals exceed 380,000 liters (100,396 gallons). The grand totals will start over at zero.

### Calibrate A Meter

A meter calibration reminder occurs each 100 calendar days.

### Calibrate B Meter

A meter calibration reminder occurs each 100 calendar days.

# Solenoid Box Troubleshooting

The troubleshooting chart below will help you locate and solve a problem with the fluid panel solenoid box.

**⚠ WARNING**



**FIRE, EXPLOSION, AND ELECTRIC SHOCK HAZARD**

Troubleshooting and servicing this equipment requires access to parts that may cause electric shock or other serious injury if the work is not performed properly. All wiring and electrical troubleshooting must be done by a qualified electrician.

Relieve air pressure to the solenoid box and turn off the main power source before checking or servicing the solenoid box.

**⚠ CAUTION**

To avoid contaminating, losing, or damaging parts, remove the equipment from the worksite for service or repair. The service or repair area must be clean.

## Electrical Failure

If there is an electrical failure, push the solenoid manual button (K) on the Solvent B Purge valve while triggering the gun to reset the system. See Fig. 10.3.

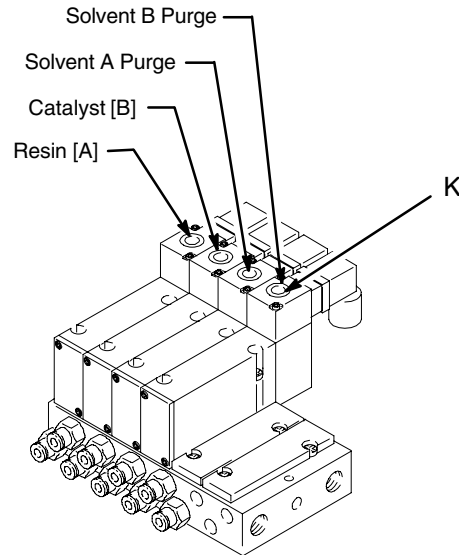

Fig. 10.3

PROBLEM	CHECK	CAUSE	SOLUTION
Catalyst, Resin, and/or Solvent Purge Valve(s) are not turning on or off correctly.	Visually inspect air and electrical lines for kinks, abrasions, severed lines, or loose connections. The corresponding solenoid LED should come on when the solenoid is actuated (refer to Fig. 10.3).	Air or electrical lines damaged or connections are loose.	Correct the air or electrical line problem.
	Check the voltage level to the solenoid. Pull the solenoid connector and check the voltage between the pins. If the voltage is 24 Vdc, the solenoid is damaged. If there is no voltage, check the cable connections.	Damaged solenoid or cable is damaged or not properly connected.	Replace the solenoid or correct the electrical line problem.
	Visually inspect air regulator gauges for proper pressure setting.	Air regulator pressure set too high or too low.	Adjust the air regulator. 60 psi (410 kPa, 4.1 bar) is the minimum setting, 80 psi (550 kPa, 5.5 bar) is commonly used. Do not exceed 100 psi (0.7 MPa, 7 bar).

*Continued on the next page.*

# Solenoid Box Troubleshooting

PROBLEM	CHECK	CAUSE	SOLUTION
Catalyst, Resin, and/or Solvent Purge Valve(s) are not turning on or off correctly (continued).	Remove the air hose from the solenoid box output for the non-functioning valve. Air should be coming out the solenoid box fitting when that valve is actuated.	Solenoid failure.	<p>Make sure there is sufficient air being supplied to the solenoid box.</p> <p>Check that air pressure to solenoids does not exceed 100 psi (0.7 MPa, 7 bar).</p> <p>Solenoid is clogged; be sure to filter the air supply with a 10 micron filter.</p> <p>Solenoid is damaged; replace it.</p>

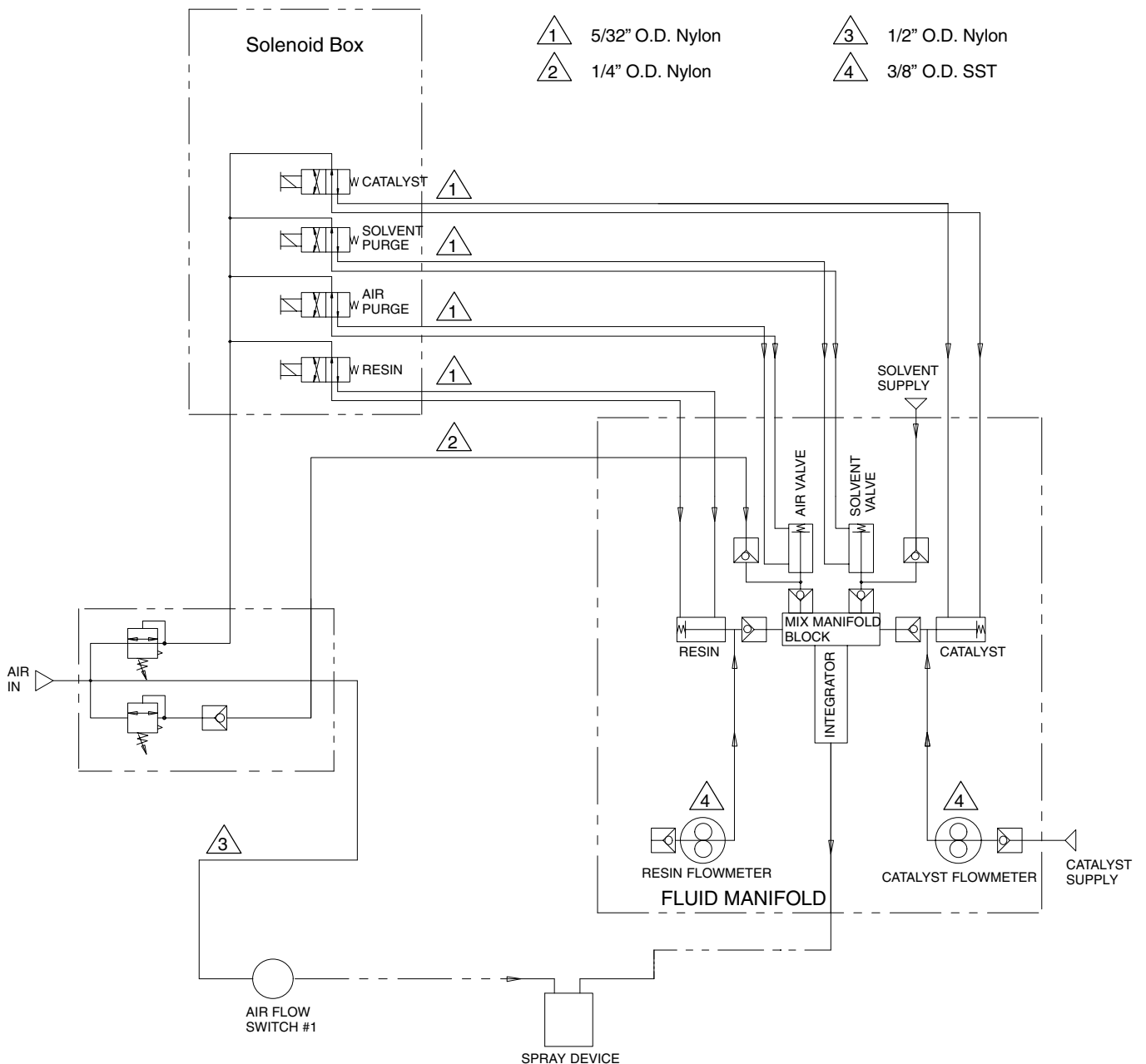

Fig. 10.4  
308916

PrecisionMix II Fluid Panel Pneumatic Schematic

# Gun Flush Box Troubleshooting

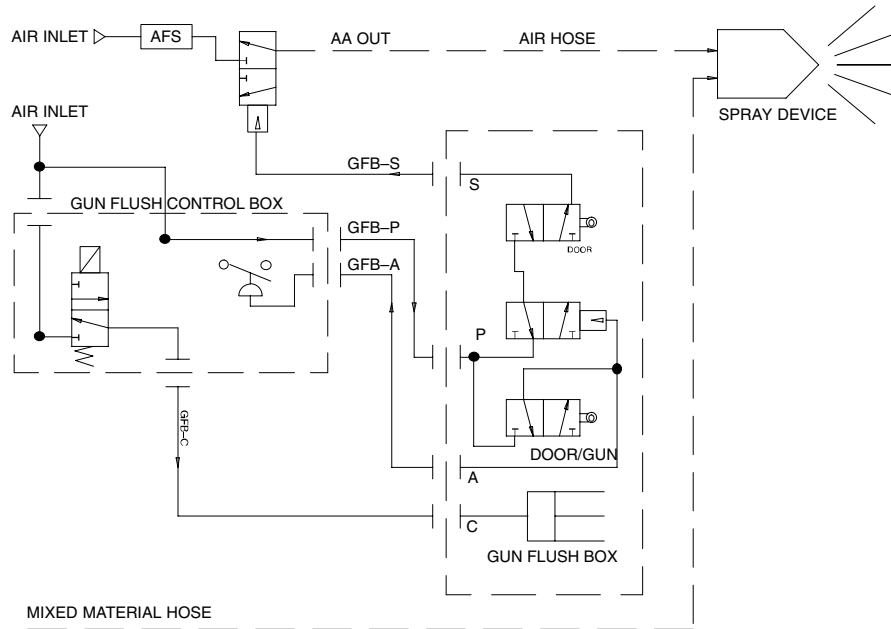

Fig. 10.5 Gun Flush Box Pneumatic Schematic

## Operator Station with Color Change Troubleshooting

PROBLEM	CAUSE	SOLUTION
Nothing displayed	Power is off.	Turn on power to the PrecisionMix II.
	Faulty cable.	Check or replace cable.
	Circuit board failure.	Replace circuit board.
Error code- E2	321 module failure.	Replace module with part no. 114783.
	Faulty cable.	Check or replace cable.

**11**

# **Service**





# Service

## Replacing the User Interface Battery

The User Interface is supplied with a lithium battery, which maintains the internal memory. The battery should be replaced every one to two years. The Display Setup screen indicates if the battery is getting low. See page 8–14.

### ⚠ CAUTION

If the battery fails or is not installed correctly, the User Interface setup memory could be lost. A copy of this setup is on the PrecisionMix II Maintenance Utilities software, which is on a CD, included with the system. Always keep this CD available so if a problem occurs, the information can be reloaded.

## Changing the Battery

### ⚠ WARNING



#### ELECTRIC SHOCK HAZARD

Only qualified electricians should perform this procedure. To avoid losing the User Interface setup memory, the power must be on while the battery is changed. **Do not touch the circuit board while the power is on as this could cause electric shock.**

### ⚠ WARNING

#### FIRE, EXPLOSION, AND BURN HAZARD

To avoid explosion or burns, the battery must not be exposed to fire or its contents allowed to come in contact with skin. Dispose of the old battery according to your local waste regulations.

1. Leave the power on to the system to avoid losing the User Interface setup memory.
2. Disconnect the power (A) and communications (B) connectors from the back of the User Interface. See Fig. 11.1.
3. Remove the four screws (C) from the back cover of the User Interface.

4. Remove the back cover carefully, to avoid damaging the circuit board.
5. Reconnect the power supply connector (A). Read the previous **WARNING, ELECTRIC SHOCK HAZARD**, before proceeding.
6. Carefully remove the battery from its holder on the main circuit board, without touching the circuit board with a tool or hand. Install the new battery (part no. 115563) in the holder.
7. Disconnect the power connector (A).
8. Carefully put the back cover in place and secure it with the screws (C).
9. Reconnect the power (A) and communications (B) connectors.
10. If the User Interface displays an error message, such as "Invalid Database", the memory was lost. Restore the User Interface program with the PrecisionMix II Maintenance Utilities software, provided with the system.

**NOTE:** Write down the date the battery was replaced for future maintenance reference.

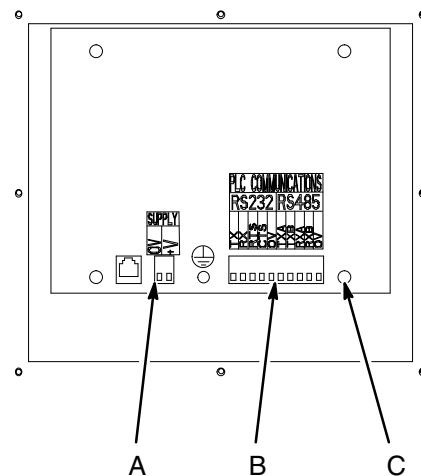

Fig. 11.1

# Service

## Replacing the Controller Battery

The Controller is supplied with a lithium battery, which maintains the internal memory during power outages. It is recommended that the battery be replaced every one to two years to prevent memory loss. The system has an alarm, "Control Battery Low", to indicate when the battery is getting low. See page 10–12.

### CAUTION

If the battery fails or is not installed correctly, the Controller memory could be lost. Backup the PrecisionMix II configuration, using the Graco PrecisionMix II Maintenance Utilities software, periodically and before changing the Controller battery. Then if a problem occurs, the information can be reloaded. This software is on a CD, included with the system.

## Changing the Battery

1. Back up the PrecisionMix II configuration, using the Graco PrecisionMix II Maintenance Utilities software.
2. Turn off the power before disconnecting the cables to avoid damaging the system.

### WARNING



#### ELECTRIC SHOCK HAZARD

Only qualified electricians should perform this procedure. To avoid losing the Controller memory, the power must be on while the battery is changed. **Do not touch the circuit board while the power is on as this could cause electric shock.**

3. To have access to the battery door, disconnect the cables from the Controller communications ports, CAN (H) and RS232 (J). See Fig. 11.2.
4. Turn the power back on.
5. Remove the battery door (K). Pull lightly on the battery ribbon until the battery pops out of the slot.
6. Install the new battery (part no. 114836) into the battery slot, with the ribbon underneath the battery. Install the battery door (K).
7. Turn off the power before connecting the cables.
8. Reconnect the communication cables.
9. Turn the power back on again. If a "Memory Failure" alarm occurs, the system memory was lost. Restore the memory with the PrecisionMix II Maintenance Utilities software, provided with the system.

**NOTE:** Write down the date the battery was replaced for future maintenance reference.

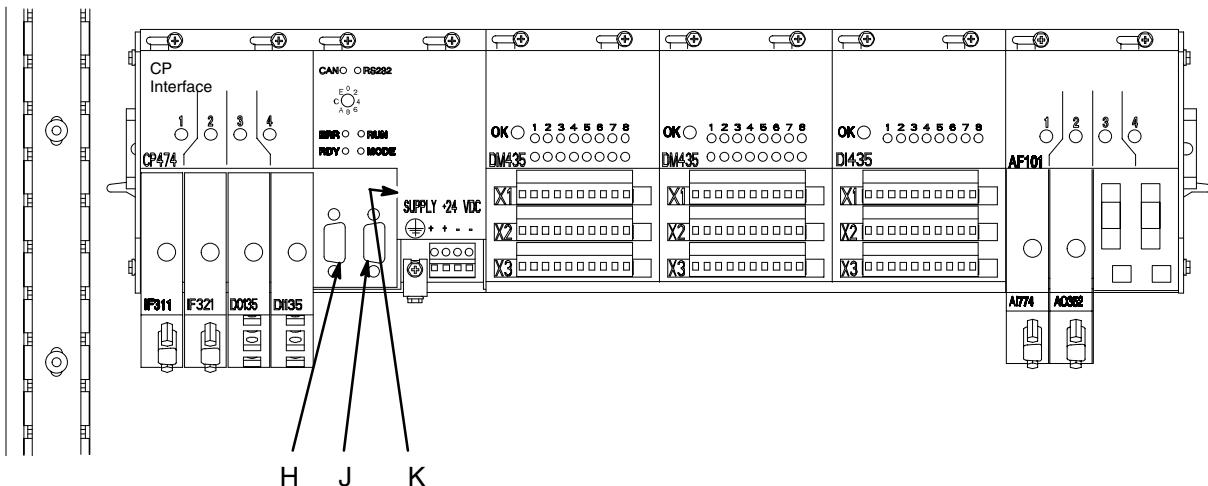

Fig. 11.2

# Service

## Replacing Isolation Barrier Fuses

1. Turn the PrecisionMix II power switch (D) to off. See Fig. 11.3.
2. Open the controller door (E).
3. Remove the barrier cover (F) for the fuse being replaced. See Fig. 11.4.
4. Place a screw driver in the barrier slot and gently pry out the fuse.
5. Install a new fuse (part no. 115429) and re-install the barrier cover (F).

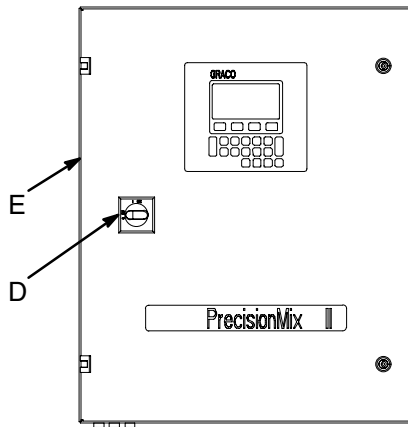

Fig. 11.3

## Replacing the User Interface

1. Turn the PrecisionMix II power switch (D) to off. See Fig. 11.3.
2. Disconnect the power (A) and communications (B) connectors from the back of the User Interface. See Fig. 11.5.
3. Remove the 8 screws (G), and remove the User Interface.
4. Install the new User Interface and secure it with the 8 screws (G).
5. Reconnect the power (A) and communications (B) connectors.

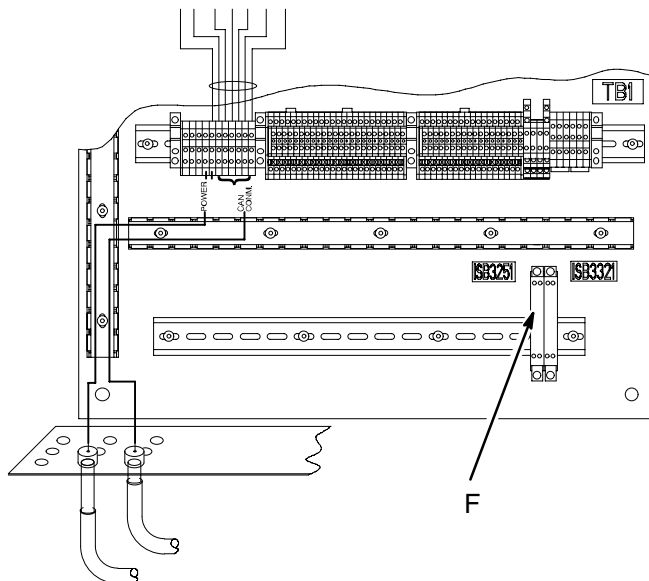

Fig. 11.4

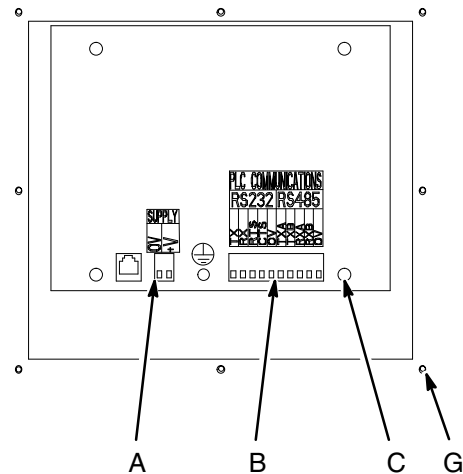



Fig. 11.5

# Service

## Replacing the Power Supply

1. Turn the PrecisionMix II power switch (D) to off. See Fig. 11.3.
2. Turn off the main power to the PrecisionMix II controller.
3. Open the controller door.
4. Disconnect the 6 wires from the power supply.
5. Pull down the clips (C), holding the power supply in place. Remove the power supply from the din rail.
6. Install the new power supply and push up the clips.
7. Locate the power supply jumper (J). See Fig. 11.6.
8. Make sure the jumper (J) is installed for the correct voltage (100–120 or 200–240 Vac). The voltage setting is visible on the front of the jumper.
9. Reconnect the 6 wires to the power supply.

 To change the power supply voltage, rotate the jumper 180° and reinsert it in the terminals.

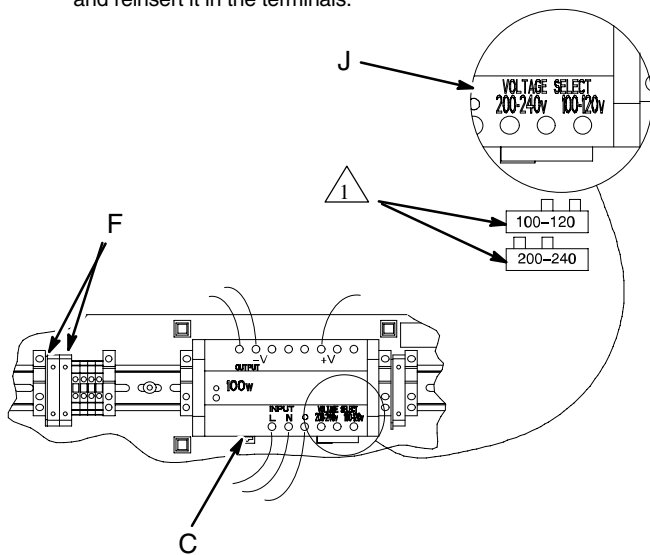

Fig. 11.6

8992A

## Changing the Power Supply Voltage

To change the power supply voltage from 100–120 Vac to 200–240 Vac or the reverse, follow this procedure.

1. Turn the PrecisionMix II power switch (D) to off. See Fig. 11.3.
2. Turn off the main power to the PrecisionMix II controller.
3. Open the controller door.
4. Loosen the terminal screws and remove the jumper (J). See Fig. 11.6.
5. Rotate the jumper 180° and reinsert it in the terminals. Tighten the terminal screws.
6. Change to the proper power supply fuses as instructed below.

## Replacing Power Supply Fuses

1. Turn the PrecisionMix II power switch (D) to off. See Fig. 11.3.
2. Turn off the main power to the PrecisionMix II controller.
3. Open the controller door.
4. Remove the two fuses from the fuse holders (F). See Fig. 11.6. Install the two new fuses.
  - If the power supply is 100–120 Vac, use Part No. 114835 4 Amp. Fuses.
  - If the power supply is 200–240 Vac, use Part No. 114788 2 Amp. Fuses.

# Service

## Servicing the Operator Station

1. Turn the PrecisionMix II power switch (D) to off. See Fig. 11.3.
2. While holding the operator station cover (B), remove the 4 screws (A). See Fig. 11.7. Open the cover, which will still be connected by one or two cables.

### To replace the station cover:

3. Disconnect the cable from the P3 circuit board connector. See Fig. 11.8. Disconnect the flow control cable from the P4 connector if it is installed.
4. Remove the cover.
5. Connect the cable to P3 circuit board connector on the new cover. Connect the flow control cable to the P4 connector if flow control is installed.
6. Install the cover on the box, and secure it with the 4 screws (A).

### To replace the circuit board:

3. Disconnect the cable from the P2 circuit board connector. See Fig. 11.8. Disconnect the membrane switch from the P1 connector if servicing an operator station with color change.
4. Remove the 4 screws (C) from the circuit board.
5. Remove the circuit board (D).

6. If servicing an operator station with color change, make sure the P1 slot of the new circuit board aligns with the membrane switch. Secure the new circuit board to the cover with the 4 screws (C).
7. Connect the cable to the P2 circuit board connector. Connect the membrane switch to the P1 connector if servicing an operator station with color change.

### To replace the membrane on operator station with color change:

3. Disconnect the membrane switch from the P1 connector. See Fig. 11.8.
4. Peel off the membrane (E) from the cover. See Fig. 11.7. Slide the membrane switch through the P1 slot to remove the membrane.
5. Slide the membrane switch through the P1 slot and install the new membrane on the cover. Connect the membrane switch to the P1 connector.

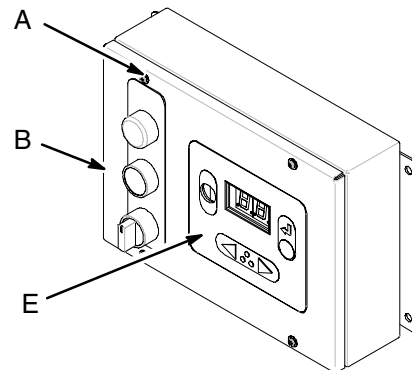

Operator Station with Color Change

Fig. 11.7

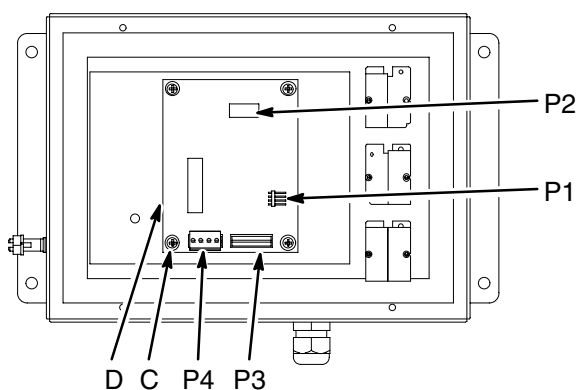

Operator Station with Color Change

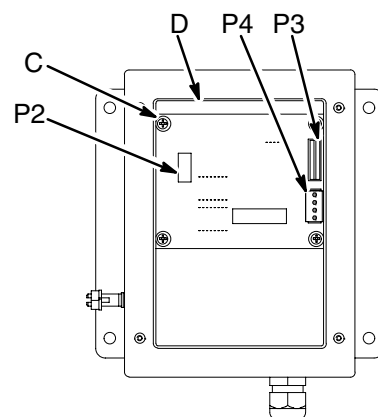

Operator Station for One Color

Fig. 11.8

# Service

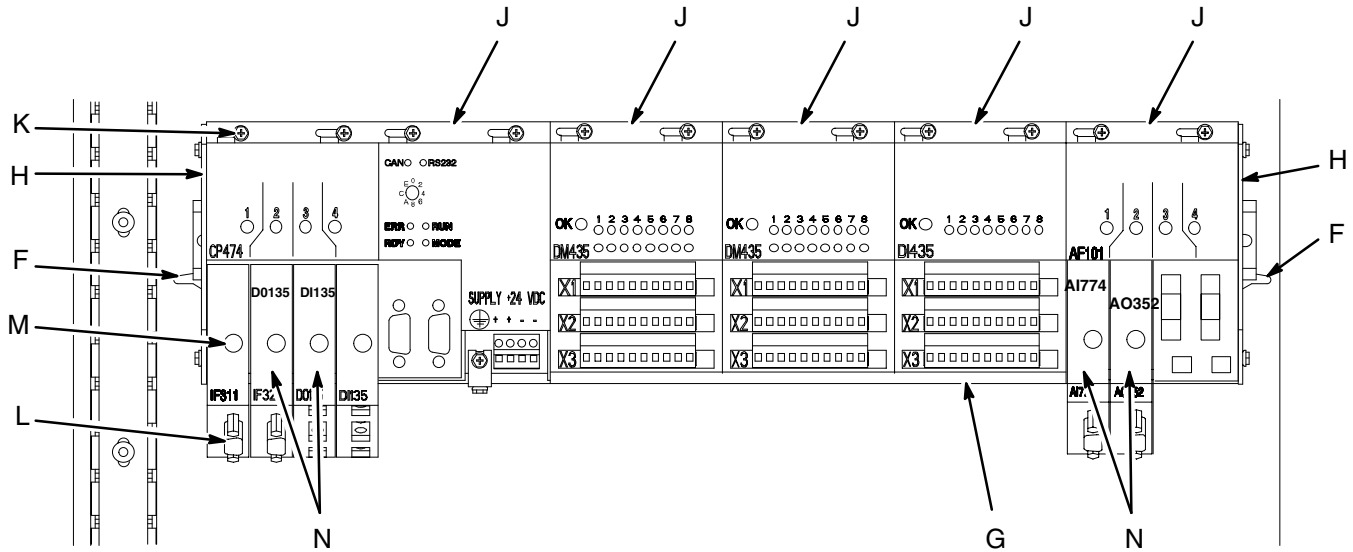

Fig. 11.9

## Replacing Control Modules

1. Turn the PrecisionMix II power switch (D) to off. See Fig. 11.3.
2. Turn off the main power to the PrecisionMix II controller.
3. Open the controller door.
4. Unlatch (F) the control modules mounting plate (G). See Fig. 11.9.
5. Tip the mounting plate down to unscrew the end plate (H) that is nearest the module being replaced.
6. Latch the mounting plate back in place in the controller.
7. Remove the screws (K) from the modules (J) between the removed end plate and the module being replaced.
8. Slide the module(s) away from the module being replaced to unplug that module from the others.
9. Remove the module. Install the new module and push the other modules against it.
10. Install the end plate (H) to tighten the modules together. Then secure the modules with the screws (K).

# Service

## Replacing Control Submodules

1. Turn the PrecisionMix II power switch (D) to off. See Fig. 11.3.
2. Turn off the main power to the PrecisionMix II controller.
3. Open the controller door.

### To replace COMM submodules

4. Unplug the cable from the submodule connector (L). See Fig. 11.9.
5. Remove the screw (M), then remove the submodule (L).
6. Install the new submodule and secure it with the screw.
7. Plug the cable into the connector (L).

### To replace input/output submodules

8. Remove the screw (M), then remove the submodule (N).
9. Disconnect the wire harness connector from the submodule.
10. Connect the wire harness to the new submodule as shown in the figure for the submodule being replaced.
11. Install the submodule back into its slot and secure it with the screw (M).

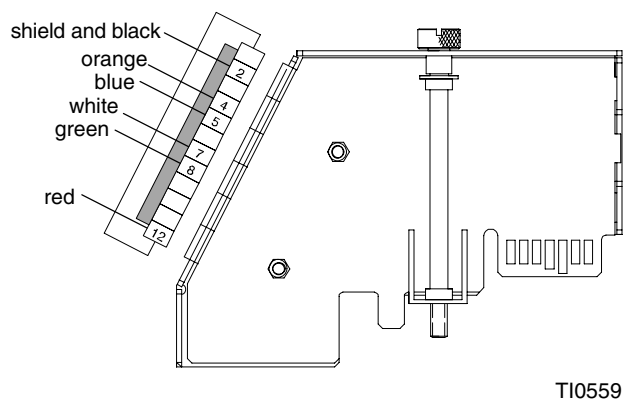

T10559

**Fig. 11.10** Digital Input Submodule–114782

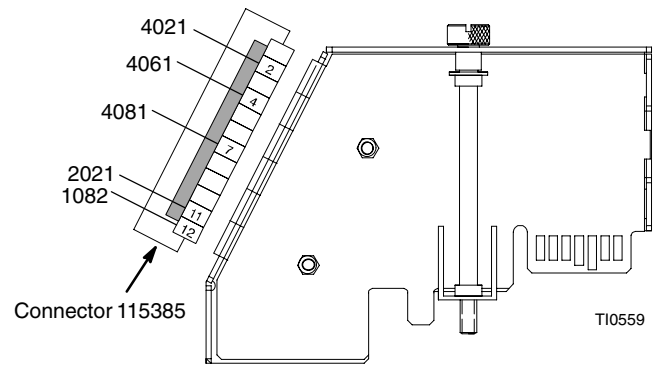

T10559

**Fig. 11.11** Digital Output Submodule–114781

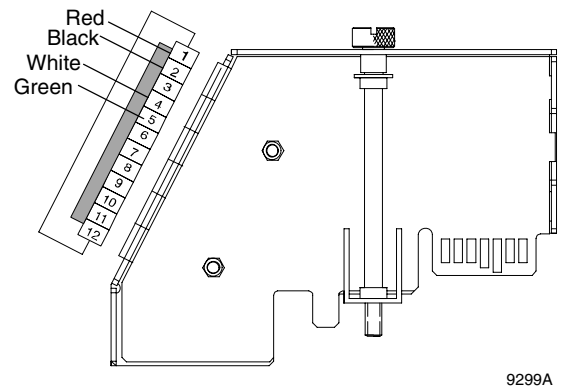

9299A

**Fig. 11.12** Analog Input Submodule–A1774

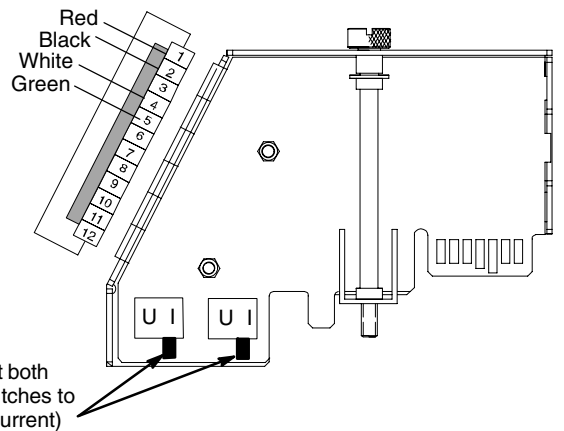

Set both switches to I (current)

**Fig. 11.13** Analog Output Submodule–AO352





**12**

# Parts



# Parts

## Controller with User Interface

### Part No. 241184 Controller with Panel Mounted User Interface (Shown)

Ref. No.	Part No.	Description	Qty.
2	240834	CONTROLLER, See page 12-4 for service parts	1
3	514030	CONNECTOR	1
4	104227	NUT, lock, conduit	1
5	108788	WASHER, flat	4
6	105329	NUT, hex	4
7	111750	WASHER, plain	2
8	108050	WASHER, lock, spring	2
9	105468	SCREW, cap, hex head	2
10	114785	HINGE, bolt-on	2
11	194334	WIRE HARNESS, user panel	1
14	114784	LATCH, door, 1/4 turn	2
15*	114786	SWITCH, disconnect	1
17	241261	KIT, user interface, Includes item 17a	1
17a	115563	BATTERY, user interface (not shown)	1
18	110911	NUT, hex	4
19	111307	WASHER, lock, external, 5 mm	2
20	194337	WIRE, grounding, door	1
24	194988	WIRE, grounding, panel	1
31	114887	KEY (not shown)	1

### Part No. 241183 Controller with Remote User Interface

Ref. No.	Part No.	Description	Qty.
2	240834	CONTROLLER, See page 12-4 for service parts	1
3	514030	CONNECTOR	1
4	104227	NUT, lock, conduit	1
5	108788	WASHER, flat	4
6	105329	NUT, hex	4
7	111750	WASHER, plain	2
8	108050	WASHER, lock, spring	2
9	105468	SCREW, cap, hex head	2
10	114785	HINGE, bolt-on	2
11	194335	WIRE HARNESS, user panel	1
14	114784	LATCH, door, 1/4 turn	2
15*	114786	SWITCH, disconnect	1
17	240874	KIT, remote user interface, See page 12-36 for service parts	1
18	110911	NUT, hex	4
19	111307	WASHER, lock, external, 5 mm	2
20	194337	WIRE, grounding, door	1
24	194988	WIRE, grounding, panel	1
31	114887	KEY (not shown)	1

\* Keep these spare parts on hand to reduce down time.

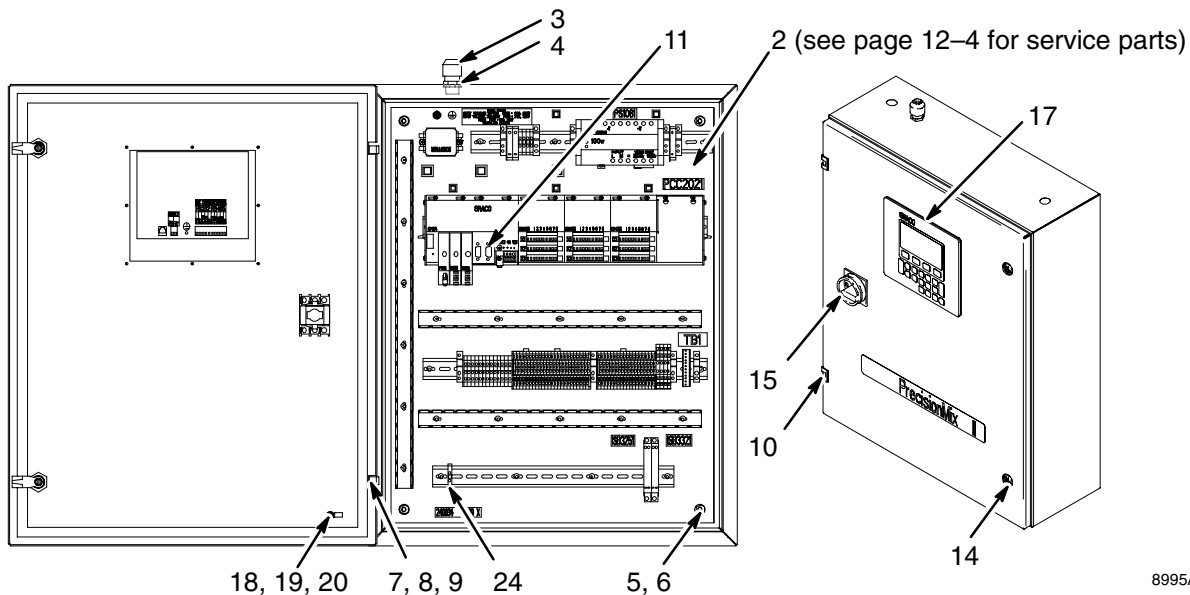

8995A

# Parts

## Controller

### Part No. 240834 Controller

Ref. No.	Part No.	Description	Qty.	Ref. No.	Part No.	Description	Qty.
109	104029	GROUND CLAMP	1	126*	115142	FUSE, time lag, 5 Amp	1
110	111307	WASHER, lock, M5	1	127	114895	BARRIER, intrinsic safety	1
111	110911	NUT, hex, M5	1	128	114896	BARRIER, intrinsic safety	1
112	112446	END BRACKET, universal	8	129	114892	INSERTION BRIDGE, 2 position	3
113*	114837	POWER SUPPLY, +24 V, 100 watts	1	130	115307	CONNECTOR, plug	1
114	112443	GROUND TERMINAL BLOCK	5	131	114894	FIXED BRIDGE BAR	5
115	112444	TERMINAL BLOCK	13	132	114929	CONNECTOR, plug	9
116	112445	END COVER	1	133	114899	CONNECTOR, shorting bar	1
117	514556	FUSE HOLDER	3	134	114900	CONNECTOR, shorting bar	1
118	514771	END COVER, fuse holder	2	145	194332	WIRING HARNESS, remote I/O	1
119	114774	CONTROL MODULE, 6 slot includes items 119a-119h	1	146	194333	WIRING HARNESS, booth control	1
119a	114775	● RACK, module	1	151	194336	WIRE, ground, panel	1
119b*	114776	● PROCESSOR	1	155*	115306	FILTER, power line	1
119c*	114777	● MODULE	2	156	105335	SCREW, pan hd, M4 x 10	2
119d*	114778	● MODULE	1	157	110918	WASHER, flat, M4	2
119e	114779	● BLANK	1	158	110919	WASHER, lock, M4	2
119f*	114783	● INTERFACE	1	159*	115429	FUSE, barrier (for items 127 and 128)	2
119g*	114782	● INPUT/OUTPUT	1	160	114836	BATTERY (not shown)	1
119h*	114781	● INPUT	1	161	241639	METER INTERFACE MODULE with color change	1
120	114839	TERMINAL BLOCK	4		241640	METER INTERFACE MODULE without color change	1
122	114884	SPACER PLATE	2				
123	114885	TERMINAL BLOCK, mini	42				
124	114886	END COVER	2				
125*	114835	FUSE, time lag, 4 Amp (120V only)	2				
	114788	FUSE, time lag, 2 Amp (240V only)	2				

\* Keep these spare parts on hand to reduce down time.

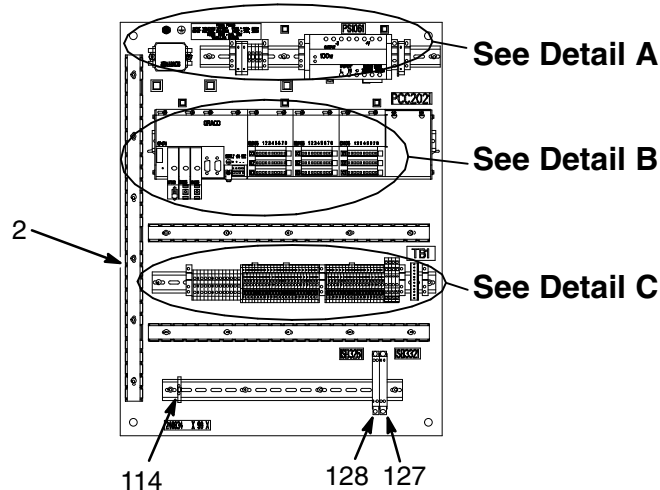

# Parts

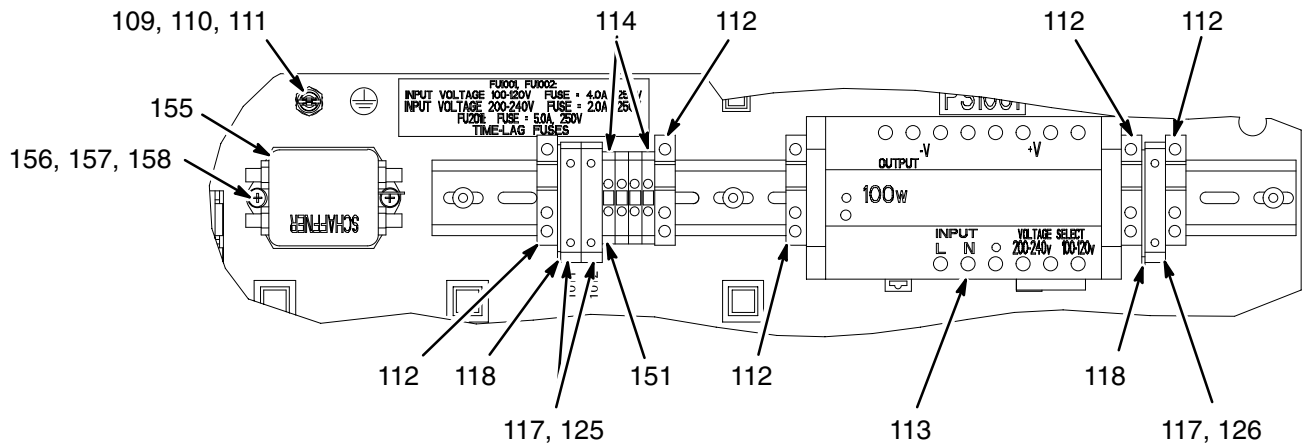

**Detail A**

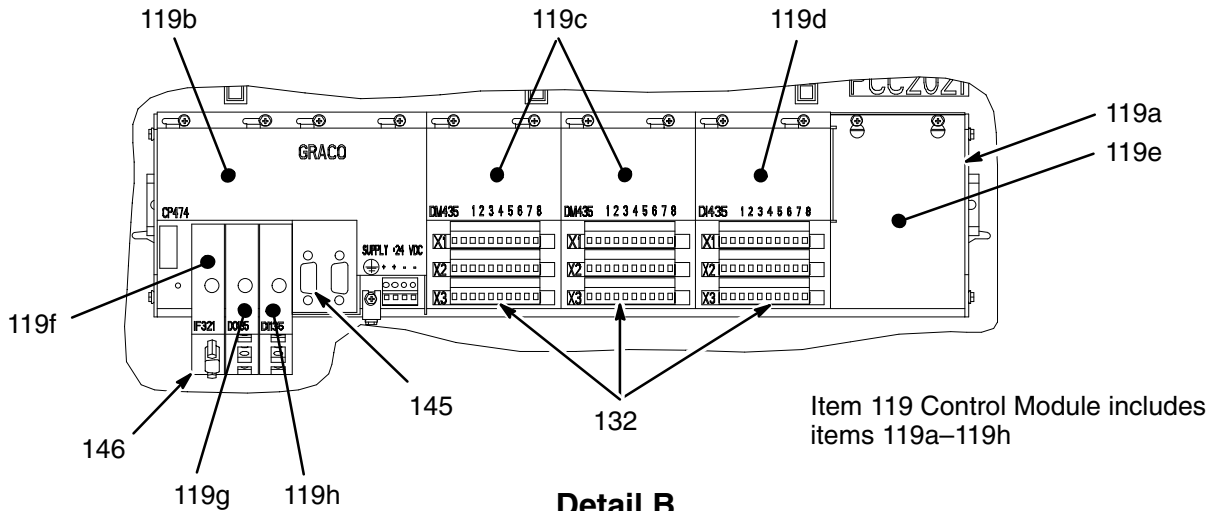

**Detail B**

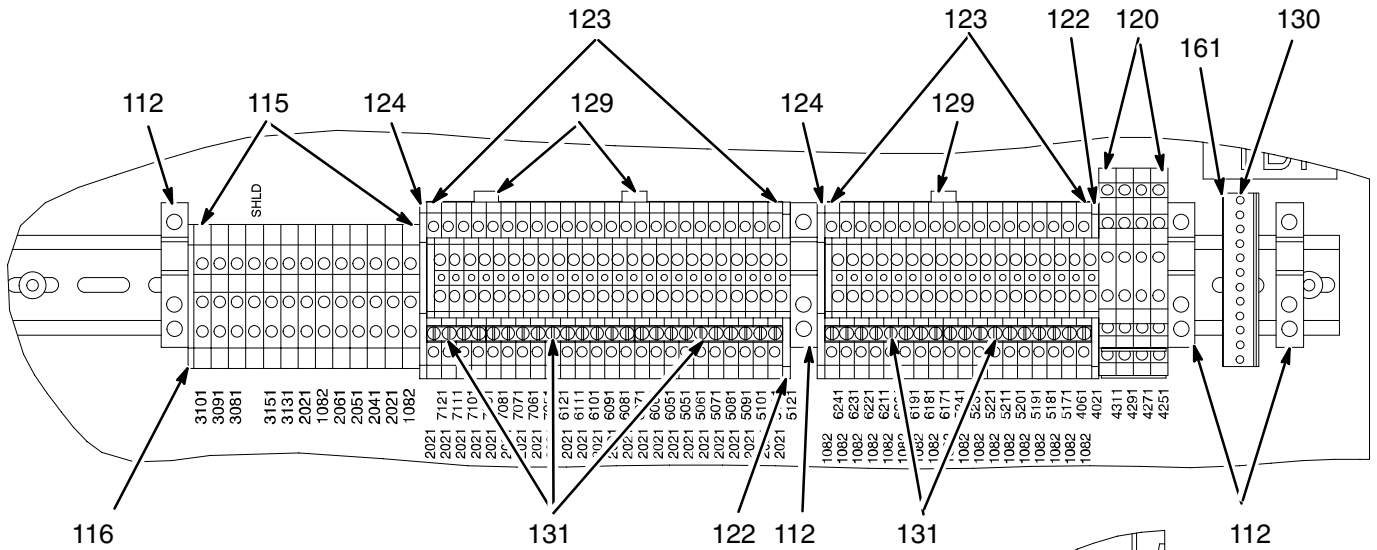

**Detail C**

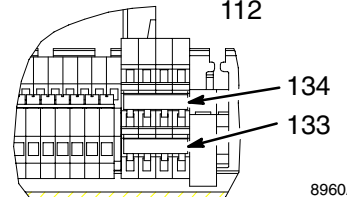

# Parts

## Flow Control

### Part No. 241382

#### One Gun Flow Control

### Part No. 241383

#### Two Gun Flow Control (Shown)

Ref. No.	Part No.	Description	Qty.	
			241382	241383
1	241467	FLOW CONTROL, Includes items 1a–1n	1	2
1a	194561	● LABEL	1	1
1b*	115112	● LIGHT, indicator, green	1	1
1c*	115113	● BASE, green light	1	1
1d*	114933	● SWITCH, push button	1	1
1e	114931	● BASE, switch	1	1
1f*	241185	● CIRCUIT BOARD KIT	1	1
1g	114993	● SCREW, machine, M4 x 0.7 x 8	8	8
1h	194560	● WIRE HARNESS, 2 switch	1	1
1j	115033	● CONNECTOR, plug, 5.08 mm	1	1
1k	110874	● WASHER, flat	2	2
1m	104029	● CLAMP, grounding	1	1
1n	115322	● LOCKWASHER	4	4
2	194559	CABLE, flow control	1	1
3	115127	CONNECTOR, plug, 5.08 mm, 5 position (not shown)	1	2
4*	115109	INTERFACE, analog	1	1
5*	115110	INPUT, analog	1	1
6*	115111	OUTPUT, analog	1	1
7	194702	WIRE HARNESS, analog	2	2
8*	551576	TRANSDUCER	1	2
9	513652	CABLE	**	***
10	104165	FITTING, tube	2	4
11*	830352	REGULATOR, fluid, quick flush	1	2
12	597151	FITTING, elbow (not shown)	1	2
13	590332	TUBING, 1/4" OD	†	**
14*	239716	METER, 6–3000 1/4" npt	none	2
15	948926	CABLE ASSEMBLY 100 ft	none	2
17	115130	JUMPER CONNECTOR (not shown)	none	1
18	194477	CABLE, 100 ft. (30.5 m)	none	1
21	114885	MINI TERMINAL BLOCK, MBKKB 2.5 (not shown)	8	8
22	114884	PLATE, spacer (not shown)	1	1
23	114886	COVER, end, terminal (not shown)	1	1
24	114894	FIXED BRIDGE BAR	2	2

\* Keep these spare parts on hand to reduce down time.

\*\* Order 100 ft. (30.5 m) minimum.

\*\*\* Order 200 ft. (61 m) minimum.

† Order 50 ft. (15.25 m) minimum.

# Parts

## Flow Control

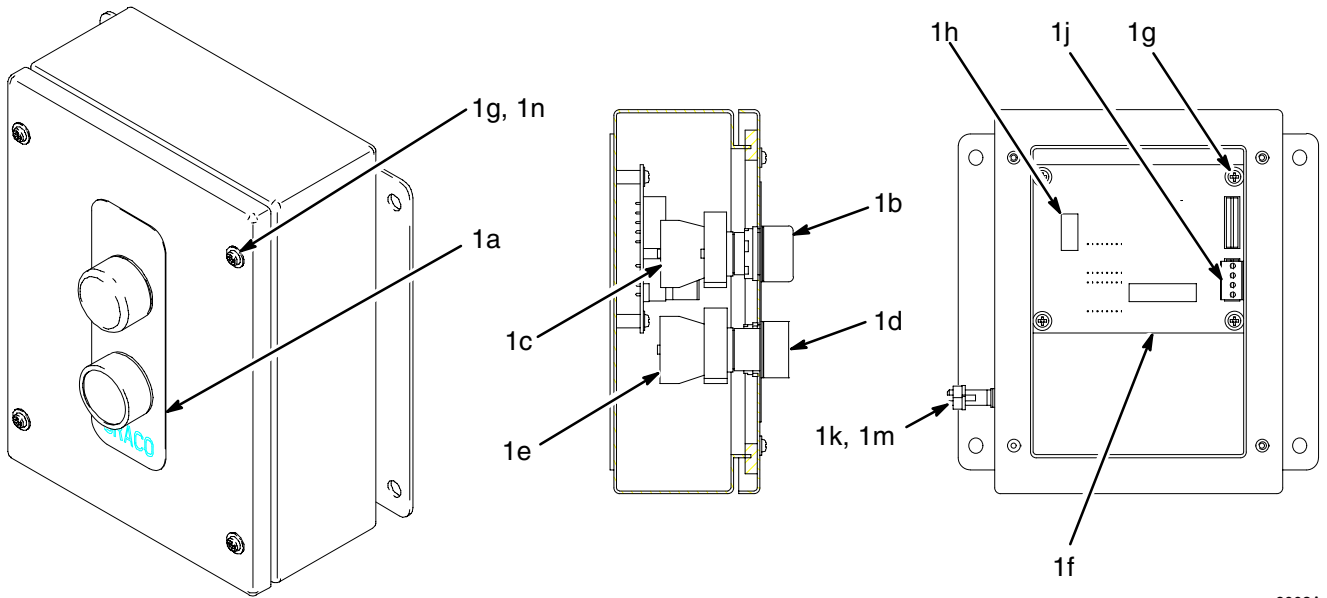

9003A

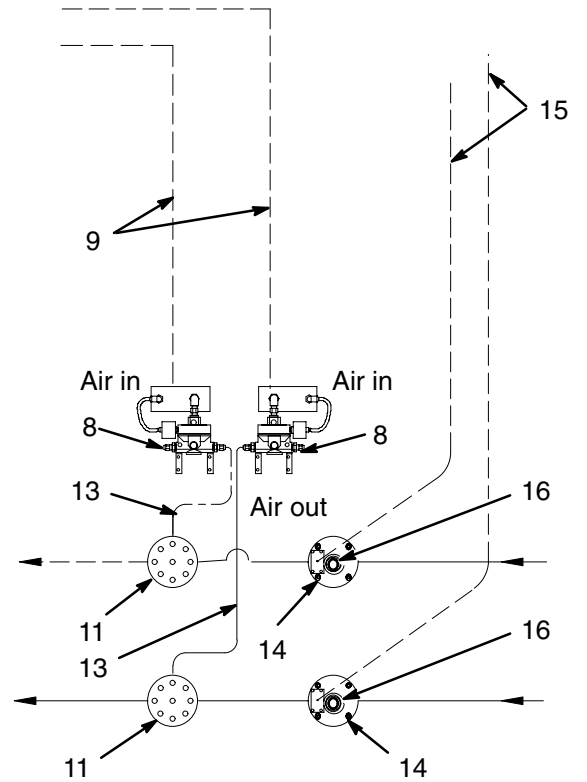
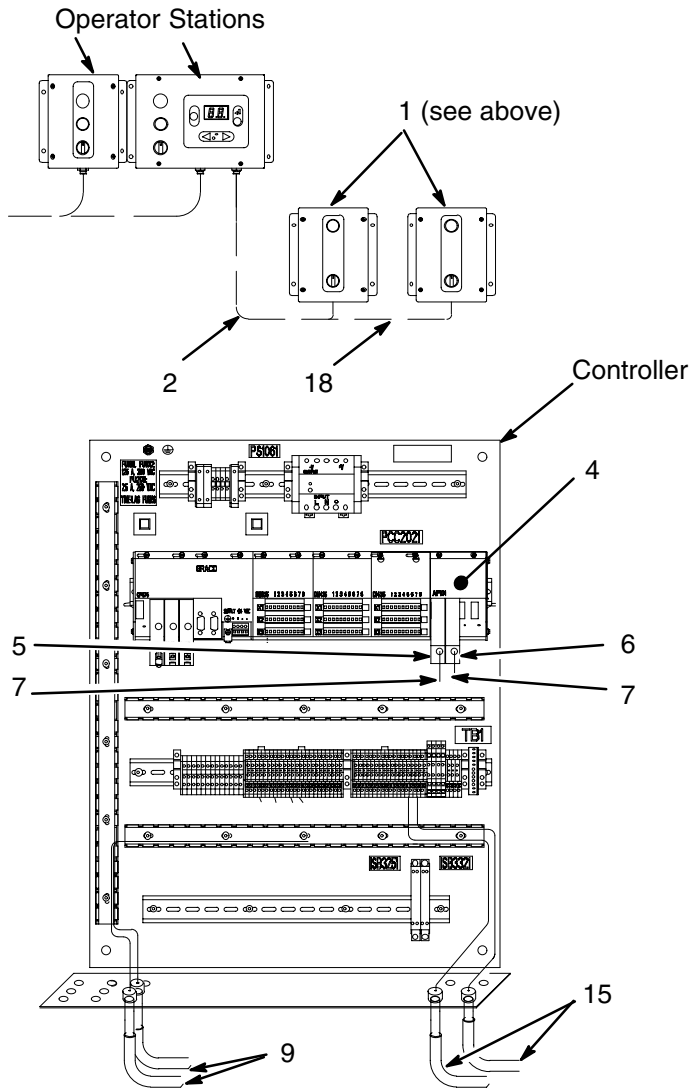

# Parts

## Fluid Panel

### Part No. 241384 Wall Fluid Panel, Non-intrinsically Safe

Ref. No.	Part No.	Description	Qty.
1	241585	FLUID PANEL MODULE, See page 12–10 for service parts	1
2*	552186	SOLENOID MODULE, Non-intrinsically safe, See page 12–16 for parts	1
3	570122	AIR SUPPLY STATION, See page 12–18 for parts	1
6	551986	CABLE, 12 pair, individually shielded, 24 AWG	†
7	061134	HOSE, nylon, 200 psi (1.4 MPa, 14 bar) maximum working pressure (not shown)	**
8	590332	TUBING (not shown)	**
12	114421	GRIP, cable, strain relief	1

\* Keep these spare parts on hand to reduce down time.

\*\* Order 25 ft. (7.6 m) minimum.

† Order 50 ft. (15.25 m) minimum.

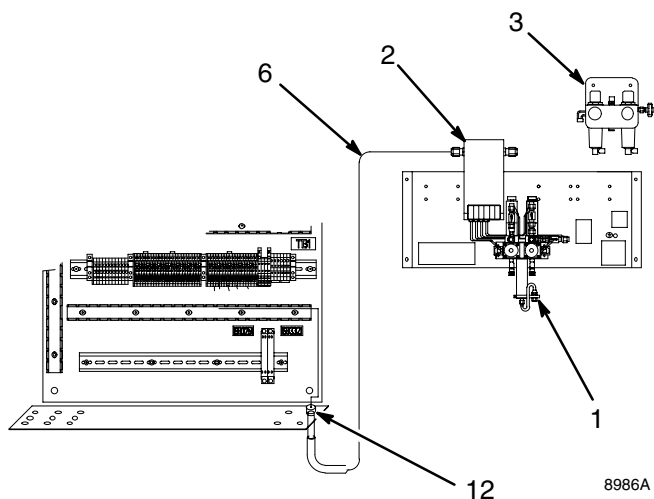

### Part No. 241385 Wall Fluid Panel, Intrinsically Safe

Ref. No.	Part No.	Description	Qty.
1	241585	FLUID PANEL MODULE, See page 12–10 for service parts	1
2*	552184	SOLENOID MODULE, IS, See page 12–16 for parts	1
3	570122	AIR SUPPLY STATION, See page 12–18 for parts	1
4	111985	BARRIER, IS (for barrier slots 1, 2, and 7)	3
5	514895	BARRIER, IS (for barrier slots 3, 4, 5, and 6)	4
6	551986	CABLE, 12 pair, individually shielded, 24 AWG	†
7	061134	HOSE, nylon, 200 psi (1.4 MPa, 14 bar) maximum working pressure (not shown)	**
8	590332	TUBING (not shown)	**
9▲	195012	LABEL, warning, IS (not shown)	5
10	065145	WIRE, copper (not shown)	**
12	114421	GRIP, cable, strain relief	1
13*	115429	FUSE, barrier (for items 127 and 128, see page 12–4)	2

\* Keep these spare parts on hand to reduce down time.

\*\* Order 25 ft. (7.6 m) minimum.

† Order 50 ft. (15.25 m) minimum.

▲ Replacement labels, tags and cards are available at no cost.

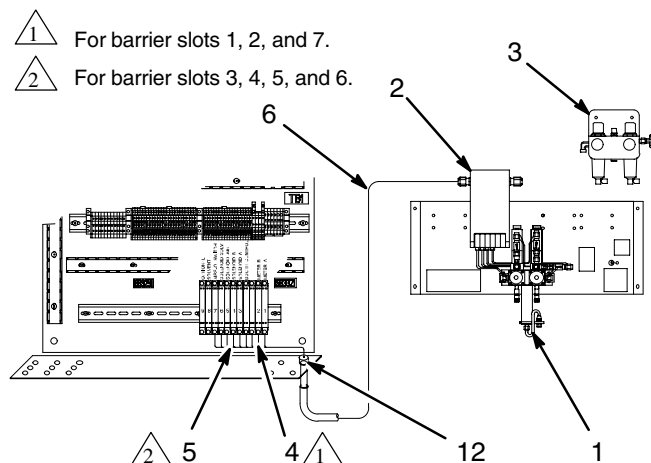



# Parts

## Part No. 241390 Robomix Fluid Panel, Intrinsically Safe

Ref. No.	Part No.	Description	Qty.
1	949909	FLUID PANEL MODULE, robomix, See page 12–12 for service parts	1
2	241963	CABLE, solenoid box	1
3	111985	BARRIER, IS (for barrier slots 1, 2, and 7)	2
4	514895	BARRIER, IS (for barrier slots 3, 4, 5, and 6)	4
5	949678	MODULE, ratio check, Includes items 5a–5d	1
5a	513063	● TUBE, 1/8 O.D., nylon	4
5b	551277	● VALVE, needle, 1/8 npt x 1/8 tube	2
5c	625936	● NUT	1
5d	626118	● MANIFOLD, tube integrator	1
6*	195579	DUMP VALVE KIT	1
7*	949122	FLEXIBLE MIXER KIT, Includes items 7a–7c	1
7a*	510198	● ELEMENT, mixer	6
7b	513972	● NUT, ferrule, 3/8" tube	2
7c	513980	● FERRULE, back, 3/8"	2
7d	513988	● FERRULE, front, 3/8"	2
7e	597350	● TUBE, PTFE	†
8	065145	WIRE, copper (not shown)	**
11	195012	LABEL, warning, IS (not shown)	5
12	114421	GRIP, cable, strain relief	1
13*	115429	FUSE, barrier (for items 127 and 128, see page 12–4)	2

\* Keep these spare parts on hand to reduce down time.

\*\* Order 25 ft. (7.6 m) minimum.

† 18 in. (457.2 mm) minimum.

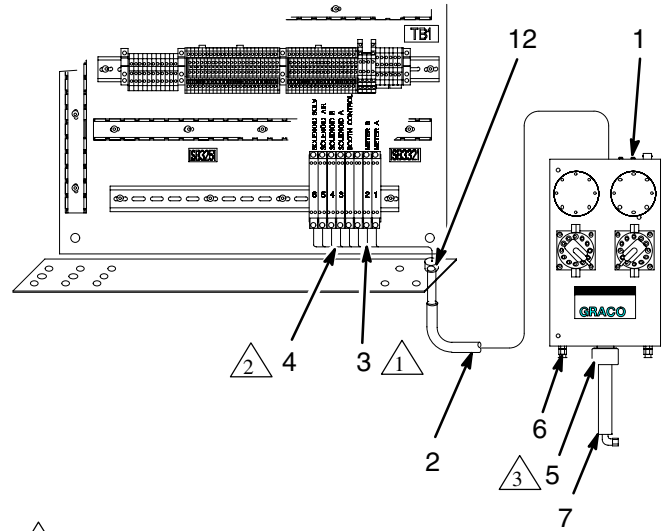

For barrier slots 1, 2, and 7.



For barrier slots 3, 4, 5, and 6.



Remove the integrator manifold and install item 5 for doing the ratio check.

8986A

# Parts

## Fluid Panel Module

### Part No. 241585

### Fluid Panel Module

Ref. No.	Part No.	Description	Qty.	Ref. No.	Part No.	Description	Qty.
101	236931	MANIFOLD, fluid, See manual 308288 for service parts	1	121	513035	SCREW, cap, socket head, M6 x 1 x 20 mm	4
102	598095	TUBE, nylon, 5/32 OD (not shown)	†	127	114151	ELBOW, swivel, 1/8 (m)	8
107	551390	BEAKER, 1000 ml graduated (not shown)	2	130	115222	FITTING, adapter; 3/8 in. OD tube x 1/8 bsp	2
108	552137	VALVE, check, 1/4 npt	2	131	115223	ELBOW, 3/8 OD tube x 1/4 npt(f)	2
110	513697	ADAPTER, 3/8" tube x 1/4 bspt/iso(m)	1	132	114172	PLUG, pipe	2
111	513816	ELBOW, 1/4 tube x 1/8 bspt/iso(m)	4	134▲	194741	WARNING LABEL	1
113	625129	BRACKET, static mixer	1	137	104029	GROUND CLAMP	1
114*	625634	STATIC MIXER	1	138	513505	WASHER, #10	1
115	513817	BULKHEAD, 3/8" tube x 1/4 npt(f)	1	140	590332	TUBE, polyethylene, 5/32" ID x 1/4" OD (not shown)	**
116	504235	CONNECTOR, 1/4" tube x 1/4 (f)	1	142▲	626413	CAUTION LABEL, coil	1
118	100058	SCREW, cap, hex head, 1/4 x 1.5"	1	143▲	551713	GROUND LABEL, symbol	1
119	624709	PLATE, manifold mounting	1				
120	100644	SCREW, 1/4 x 3/4"	4				

\* Keep these spare parts on hand to reduce down time.

\*\* Order 25 ft. (7.6 m) minimum.

† Order 15 ft. (4.6 m) minimum.

▲ Replacement labels, tags and cards are available at no cost.

# Parts

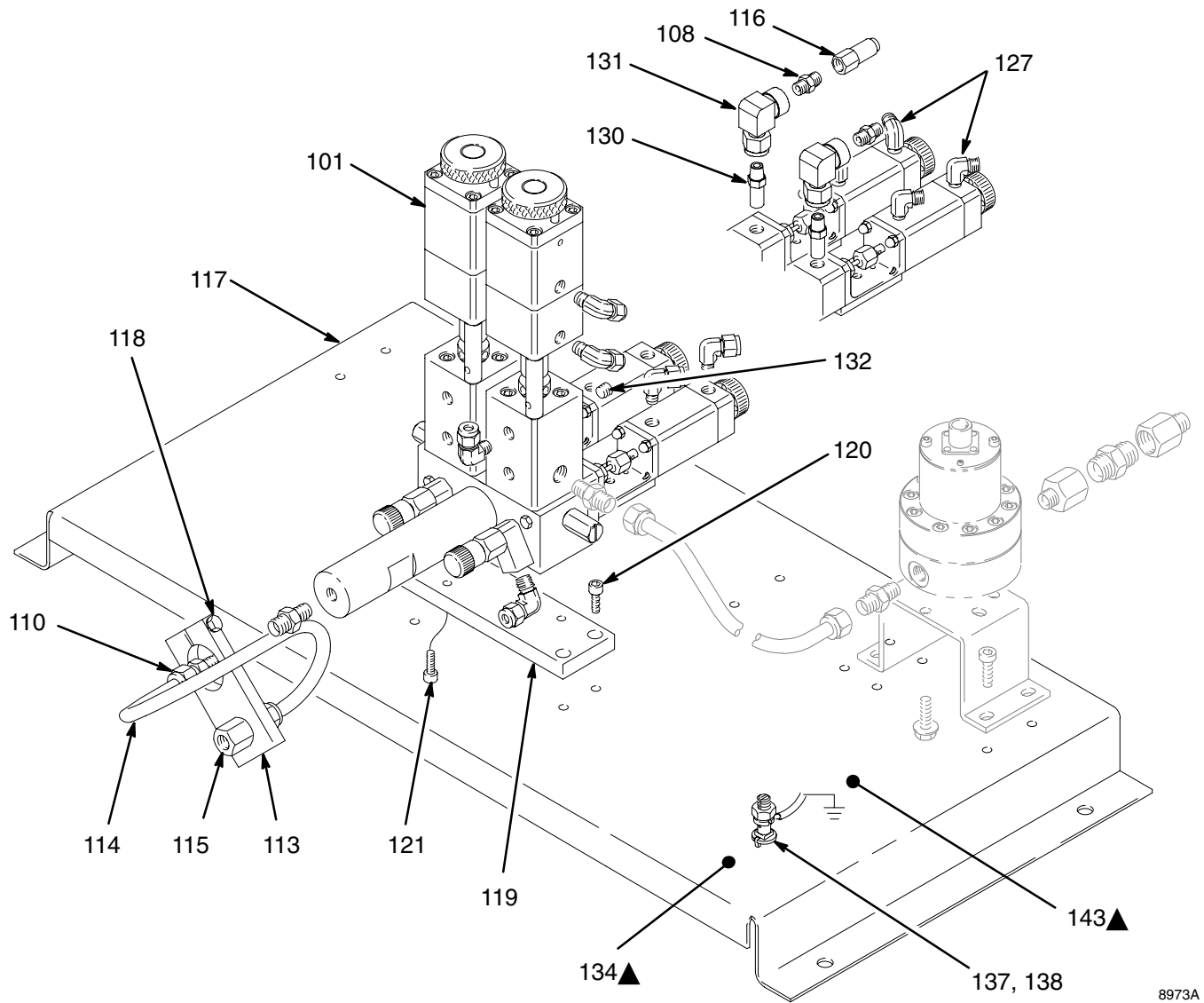

8973A

# Parts

## Fluid Panel Module

**Part No. 949909**

**Robomix Fluid Panel Module, Intrinsically Safe, without Flow Control**

Ref. No.	Part No.	Description	Qty.	Ref. No.	Part No.	Description	Qty.
101	552183	PLATE, blanking	1	127	597350	TUBE, PTFE, 1/4 ID	**
102	551787	SCREW, machine, cap, 10–32 x 5	10	128	598095	TUBE, nylon, 5/32 OD	†
103	104029	CLAMP, ground	1	129	C19404	FITTING, tube	8
104	598251	BULKHEAD, 1/4 tube	2	130	551179	PLUG, nylon, 9/16"	2
105	108382	O-RING	4	131	514023	SCREW, 4–40 x 0.5	4
106	114230	MANIFOLD, solenoid	1	132	514024	NUT, 4–40	4
108*	552180	VALVE, solenoid	4	133	626357	PLATE, meter mounting	2
110*	501684	CHECK VALVE, 3/8 npt(m)	2	134	625945	CABINET, manifold	1
111*	501867	CHECK VALVE, 1/4 npt	2	135	625946	COVER, cabinet	1
112	504235	CONNECTOR, 1/4 TUBE x 1/4	4	136*	949122	MIXER KIT, flexible	1
113	510223	ELBOW	2	137	241799	CABLE	2
114	166866	ELBOW, 1/4 (m x f)	2	138	949679	MANIFOLD, bare	1
115	512351	ADAPTER, 1/4 npt(m) x 3/8 npt(f)	2	139▲	186531	WARNING LABEL	1
116	551640	SCREW, cap, socket head, M6 x 1 x 10 mm	4	140▲	513310	INSTRUCTION LABEL	1
117	513843	CONNECTOR, 3/8 tube x 3/8 npt(f)	2	141▲	513312	WARNING LABEL	1
118	513308	CONNECTOR, 1/4 npt(m) x 3/8 tube	1	143	551787	SCREW, cap, 10–32 x 5	8
119	513505	WASHER, #10	1				
120	513817	BULKHEAD, 3/8 tube x 1/4 npt(f)	3				
121	101885	SCREW, 1/4–20 x 1.75"	2				
122	551216	CONNECTOR, plug	1				
123	551250	SCREW, thumb, 1/4–20 x 1/2"	4				
124	590332	TUBE, polyethylene, 5/32" ID x 1/4" OD	‡				
125	513798	SCREW, 1/4–20 x 3/8"	8				
126	597151	ELBOW, 1/8 npt(m) x 1/4" tube	1				

\* *Keep these spare parts on hand to reduce down time.*

\*\* *Order 5 ft. (1.53 m) minimum.*

† *Order 30 ft. (9.15 m) minimum.*

‡ *Order 35 ft. (10.7 m) minimum.*

▲ *Replacement labels, tags and cards are available at no cost.*

*Ratio Check/Calibration Kit 949678 shipped with each Robomix System. Use the kit for meter calibration and ratio checking.*

# Parts

## Fluid Panel Module

Part No. 949909

Robomix Fluid Panel Module, Intrinsically Safe

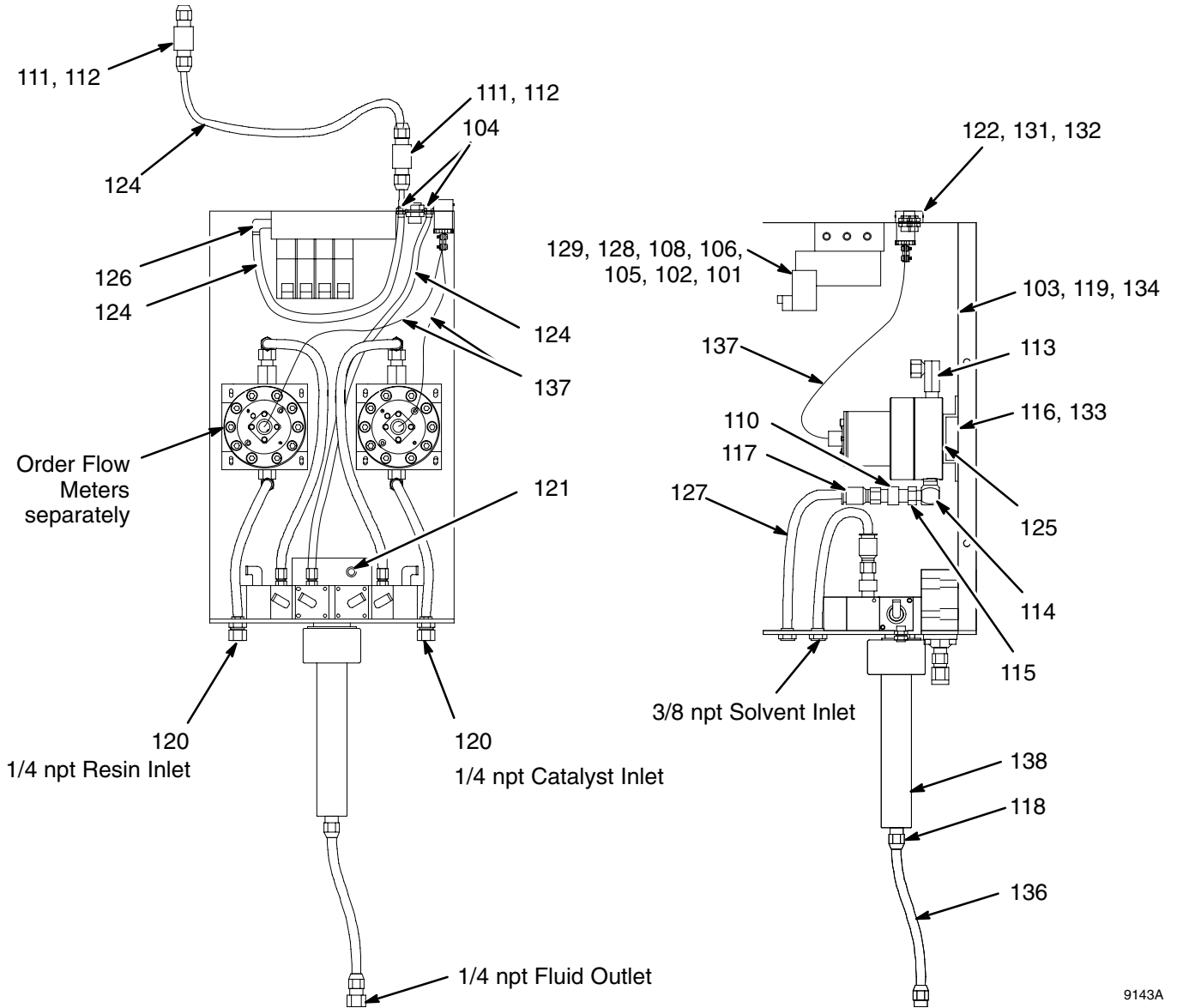

9143A

# Parts

## Bare Robotic Manifold

### Part No. 949679

Ref. No.	Part No.	Description	Qty.	Ref. No.	Part No.	Description	Qty.
201	625935	P-MIX ROBOT MANIFOLD	1	209	514929	DOWEL PIN	2
202	625942	MOUNTING PLATE	1	210	514932	O-RING	2
203	692068	SURFACE MOUNT VALVE, see parts below	4	211	625941	INT. B COMP P-MIX ROBOT MANIFOLD TUBE	1
204	690191	O-RING	4	212	111260	SET SCREW, cup point	1
205	552137	CHECK VALVE	2	213	514931	O-RING	1
206	504235	FEMALE CONNECTOR tube fitting	1	214	625940	MANIFOLD TUBE	1
207	504164	COUPLING, pipe	1	215	513308	CONNECTOR fitting	4
208	101885	SCREW, cap, socket hd	2	216	625936	NUT	1
				217	101970	PLUG, pipe; sst	4

## Surface Mount Valve

### Part No. 692068

Ref. No.	Part No.	Description	Qty.	Ref. No.	Part No.	Description	Qty.
				203g	166080	O-RING; buna-N	1
				203h	514210	SCREW, cap, socket hd; 10-32 x 1/2 in.; sst	1
203a	102598	SCREW, cap, socket hd; 10-32 x 1/2 in.	2	203j	514211	SCREW, cap, socket hd; 10-32 x 1 in.	1
203b	103255	O-RING; buna-N	1	203k	690038	DIAPHRAGM	1
203c	104282	O-RING; buna-N	1	203m	690250	RETAINER, seal	1
203d	514930	SCREW, cap, socket hd; 10-32 x 2-1/2 in.	2	203n	690251	CAP, air cylinder	1
203e	109193	ELBOW; 5/32 in. OD tube x 10-32(m); see page 12-15	2	203p	690252	PISTON	1
203f	110004	PACKING, u-cup; UHMWPE	1	203r	690253	SHAFT, shutoff	1
				203s	690254	HOUSING, fluid; sst	1
				203t	625939	HOUSING, air cylinder	1

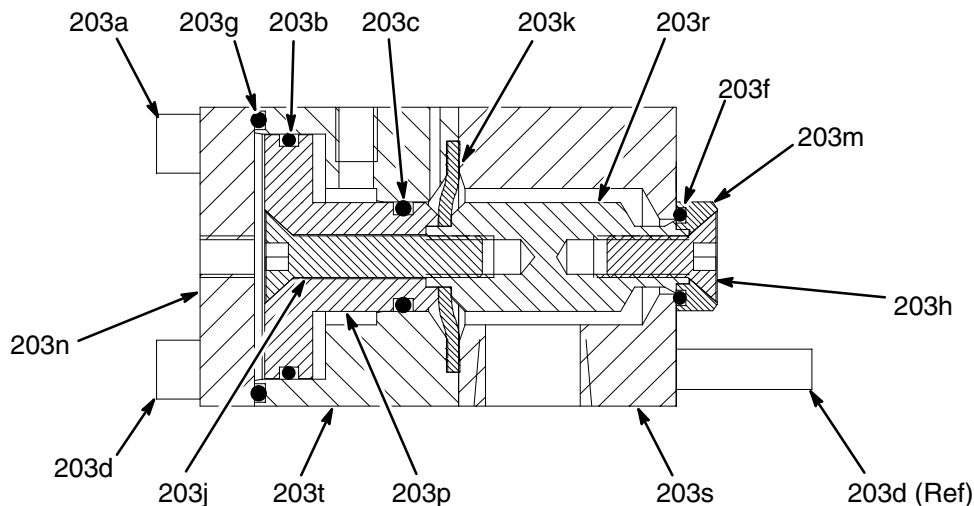

TI0802A

# Parts

## Bare Robotic Manifold

Part No. 949679

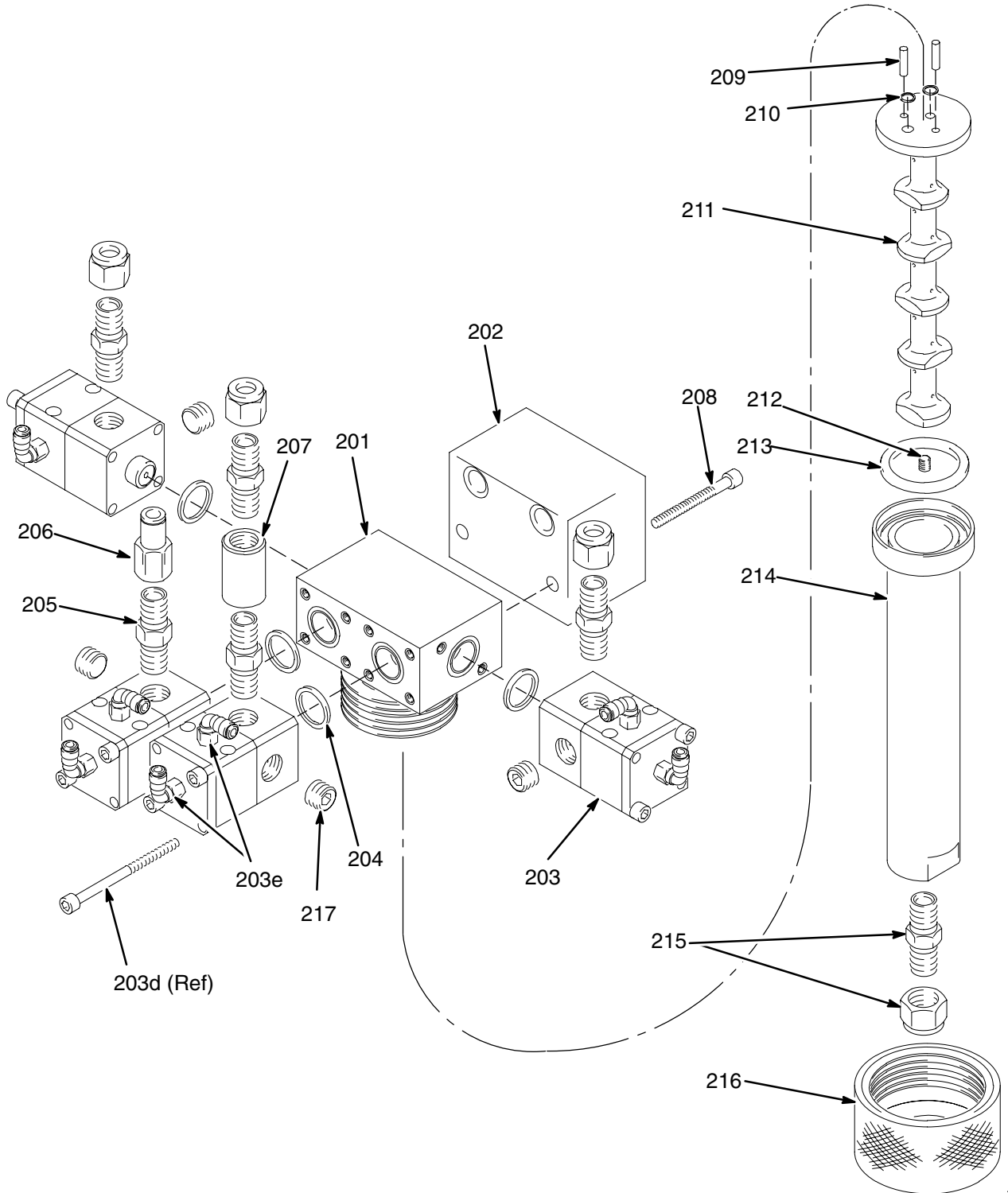

T1003

# Parts

## Solenoid Module

**Part No. 552184**  
**Solenoid Module, Intrinsically Safe**

**Part No. 552186**  
**Solenoid Module, Non-intrinsically Safe**

Ref. No.	Part No.	Description	Qty.
103	114230	MANIFOLD, solenoid	1
104	112698	ELBOW, 1/8 npt(m) x 1/4" O.D. tube	1
105	114263	CONNECTOR, 5/32 tube	8
110	114421	CONNECTOR, strain relief, 0.170-0.470	2
111	104227	NUT, conduit, 1/2"	2
112*	514768	FLOW SWITCH, 1 cfm piston, 1/4" port	1
113	114128	ELBOW, swivel	1
114*	115321	MUFFLER	2

Ref. No.	Part No.	Description	Qty.
102*	552180	VALVE, solenoid, intrinsically safe, P/N 552184 only	4
	115320	VALVE, solenoid, non-intrinsically safe, P/N 552186 only	4

\* Keep these spare parts on hand to reduce down time.

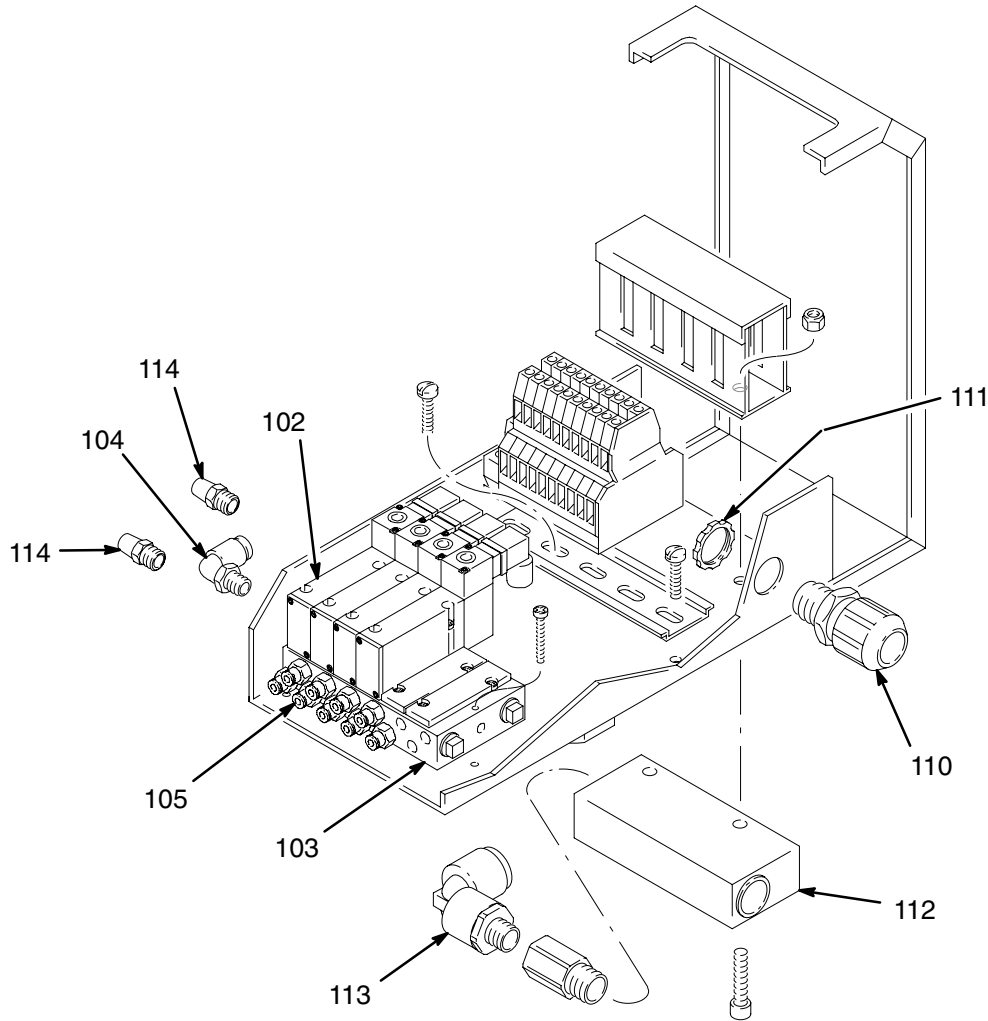

8977B



# Parts

## Fluid Meters

### Part No. 241391 G3000™ Meter Kit

Ref. No.	Part No.	Description	Qty.
1*	239716	G3000 METER, See manual 308778 for service parts	1
2	626204	PLATE, mounting	1
3	551903	SCREW, cap, socket head	4
4	114182	SCREW, machine, hex flange head	2
5	513697	FITTING, adapter, 3/8 tube x 1/4	1
6	513308	FITTING, connector	1
7	115060	TUBE, fluid	1
8*	501684	VALVE, check	1
9	512351	ADAPTER, pipe increase	2
10*	241799	CABLE ASSEMBLY (not shown)	1
11	195283	SHIELD	1

\* Keep these spare parts on hand to reduce down time.

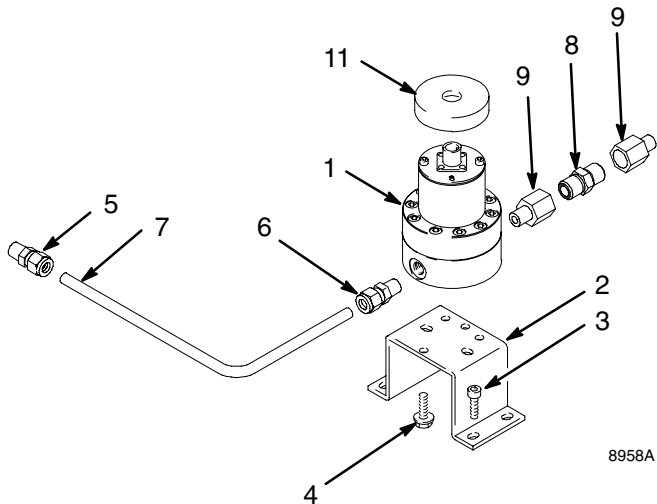

### Part No. 241392 G3000™ Solvent Meter Kit

Ref. No.	Part No.	Description	Qty.
1*	239716	G3000 METER, See manual 308778 for service parts	1
2	626204	PLATE, mounting	1
3	551903	SCREW, cap, socket head	4
4	114182	SCREW, machine, hex flange head	2
5	114120	FITTING, adapter, male	1
6	114119	FITTING, elbow, union	1
7	115061	TUBE, fluid	1
8	513308	FITTING, connector	1
10*	241799	CABLE ASSEMBLY (not shown)	1
11	195283	SHIELD	1
12*	552137	VALVE, check (part of 241585 Fluid Panel)	1

\* Keep these spare parts on hand to reduce down time.

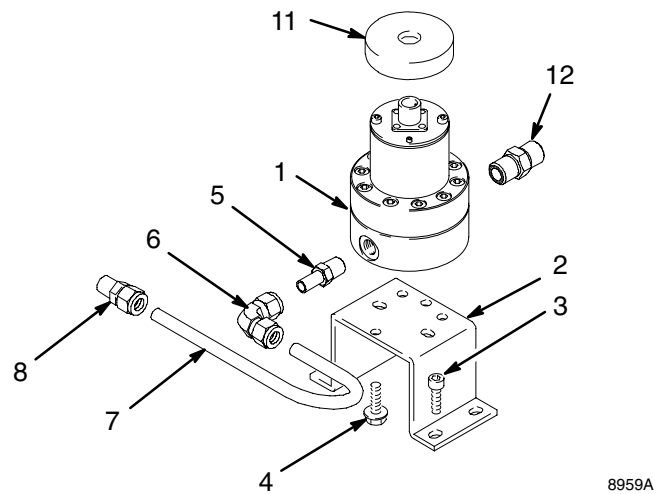

# Parts

## Air Supply Station

### Part No. 570122 Air Supply Station

Ref. No.	Part No.	Description	Qty.
101	551980	AIR REGULATOR ASSEMBLY	1
102	551974	WALL BRACKET	1
103*	552137	CHECK VALVE, 1/4 npt(m)	1
104	504235	CONNECTOR, 1/4" OD tube x 1/4 npt(f)	1

\* Keep these spare parts on hand to reduce down time.

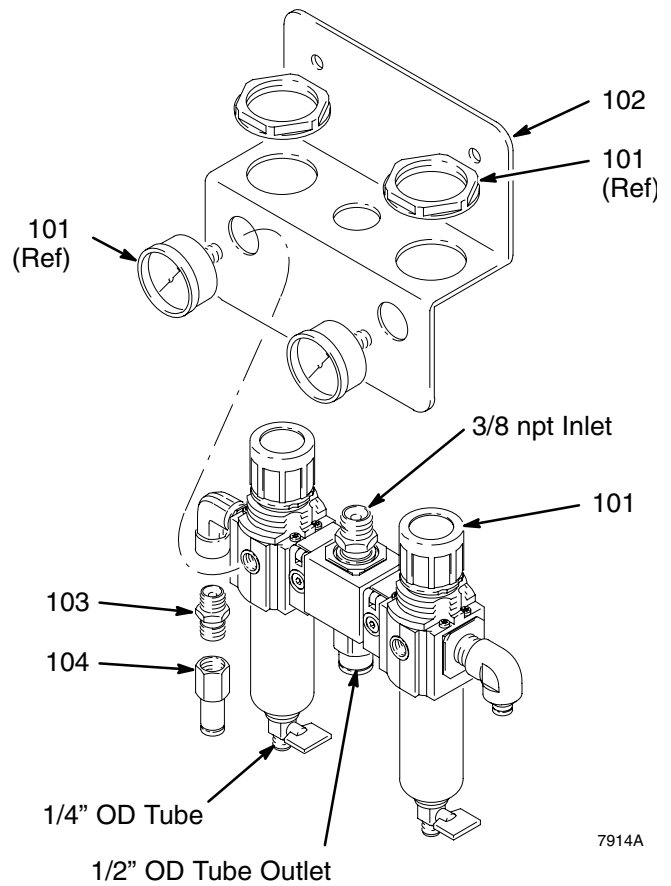

# Parts

## Operator Station

### Part No. 240835

### Operator Station for One Color

Ref. No.	Part No.	Description	Qty.	Ref. No.	Part No.	Description	Qty.
3	193733	LABEL	1	15	194477	CABLE, operator station, 100 ft. (30.5 m)	1
4*	114760	LIGHT, indicator	1	15a	194478	CABLE, operator station, 200 ft. (61 m), optional	1
5*	114761	BASE, light	1	18	110874	WASHER	2
6*	114933	SWITCH, push button	1	19	104029	GROUND STUD	1
7*	114931	BASE, switch	2	21	115322	WASHER	4
8*	114932	CONTACT, switch	1	22	241640**	INTERFACE, meter (not shown), <b>not included with 240835; order separately</b>	1
9*	114762	SWITCH, 3 position selector	1				
10*	241185	KIT, monitor circuit board	1				
11	114993	SCREW, machine, pan washer head, M4 x 0.7 x 8	8				
12	194480	HARNESS, wire, 3 switch	1				
13	115033	CONNECTOR, plug, 5.08 mm	1				

\* Keep these spare parts on hand to reduce down time.  
 \*\* Located on terminal strip in the Precision Mix II control box..

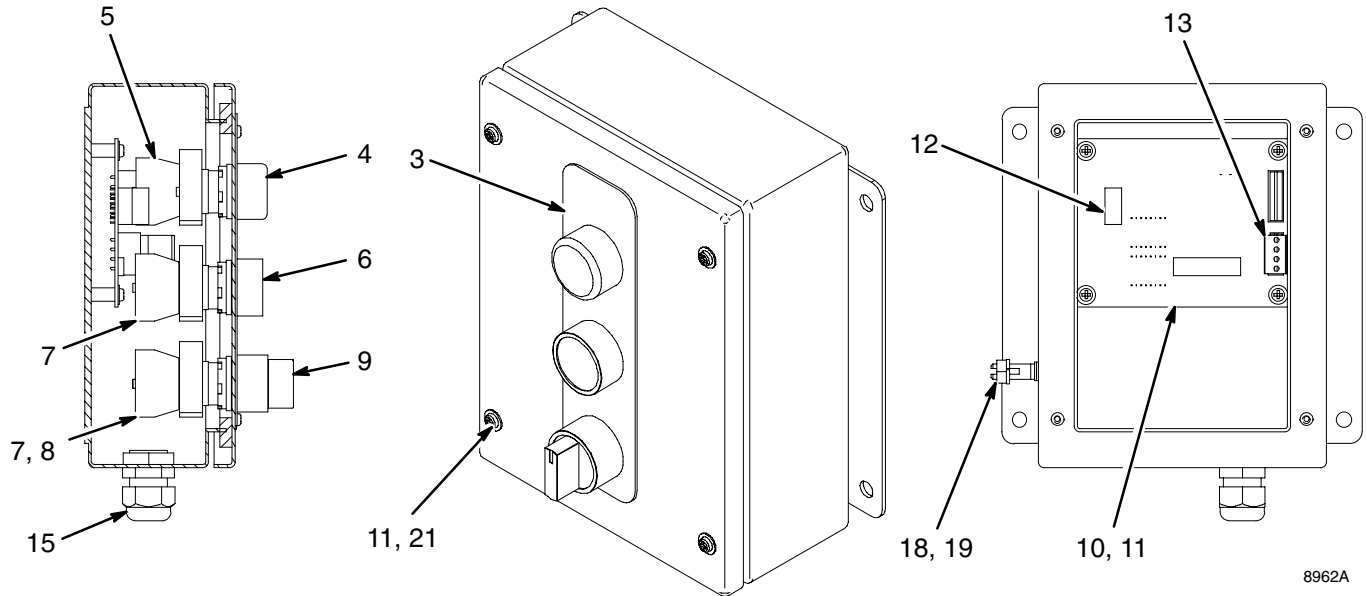

8962A

# Parts

## Part No. 240877

### Operator Station with Color Change

Ref. No.	Part No.	Description	Qty.	Ref. No.	Part No.	Description	Qty.
3	193733	LABEL	1	15	194477	CABLE, operator station, 100 ft. (30.5 m) (not shown)	1
4*	114760	LIGHT, indicator	1	15a	194478	CABLE, operator station, 200 ft. (61 m), optional	1
5*	114761	BASE, light	1	16	114620	MEMBRANE	1
6*	114933	SWITCH, push button	1	18	110874	WASHER	2
7*	114931	BASE, switch	2	19	104029	GROUND STUD	1
8*	114932	CONTACT, switch	1	21	115322	WASHER	4
9*	114762	SWITCH, 3 position selector	1	22	241639**	INTERFACE, meter (not shown) <b>not included with 240877; order separately</b>	1
10*	241381	KIT, monitor circuit board	1				
11	114993	SCREW, machine, pan washer head, M4 x 0.7 x 8	8				
12	194480	HARNESS, wire, 3 switch	1				
13	115033	CONNECTOR, plug, 5.08 mm	1				

\* Keep these spare parts on hand to reduce down time.

\*\* Located in the Precision Mix II control box 241639 interface is required to utilize integrated color change software..

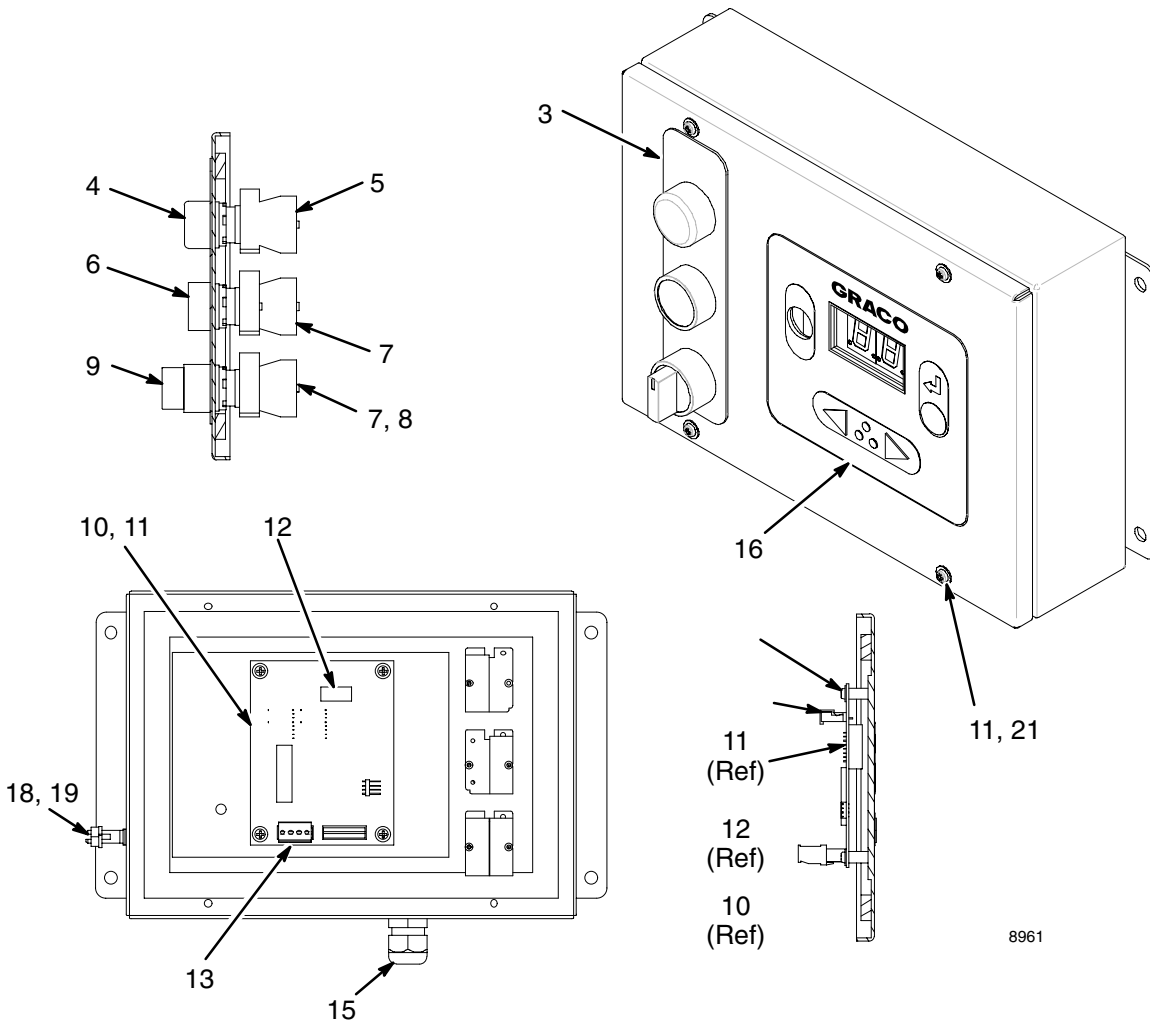

8961

# Parts

## Low Pressure Color Change Module

### Part No. 241386

### 2-4 Color, Low Pressure Module

Includes items 1-15

**NOTE:** Refer to page 12-23 for the parts drawing.

Ref. No.	Part No.	Description	Qty.	Ref. No.	Part No.	Description	Qty.
1	241586	MANIFOLD ASSEMBLY, pneumatic valve, Includes items 1a-1t	1	4	115155	CABLE, devicenet, extension	1
1a	115196	● PLATE, bottom	1	5*	115156	CONNECTOR, tee, device net	1
1b	115197	● PLATE, end, le ft.	1	6*	115157	CONNECTOR, terminating, resistor	1
1c	115198	● PLATE, end, right	1	8	194905	BRACKET, color change, <i>241386 only</i>	4
1d*	115199	● CARTRIDGE, solenoid valve	4	9	205324	HOSE, fluid, PTFE, 1/4" x 12", <i>241386 only</i> (not shown)	1
1e	115200	● PLATE, blanking	4	11	598095	TUBING, air, 5/32" OD	**
1f*	115201	● INTERFACE MODULE	1	12	948944	VALVE, dump, low pressure, Includes items 12a-12d	1
1g	195450	● BRACKET, mounting, Festo	1	12a	502820	● FITTING, elbow, street, 1/8	1
1h*	115325	● MUFFLER, plastic	1	12b	513842	● FITTING, elbow, male, 3/8" tube x 1/8" npt	1
1j*	115326	● MUFFLER, plastic	1	12c	513949	● CONNECTOR, swivel, 1/4 npsf x 1/8 nptm	1
1k	114263	● FITTING, tube	8	12d*	907438	● VALVE, trigger, See manual 307941 for service parts	1
1m*	115202	● GASKET	1	13	599246	FITTING, tee, tube, 1/4 tube x 1/4 npt	1
1n*	115203	● GASKET	1	14	114158	FITTING, adapter, Y, 1/4 tube	1
1p*	115204	● GASKET	16	15	114109	ELBOW, 1/4 tube x 1/4 npt	1
1q	115205	● SCREW	4				
1r	115206	● SCREW	4				
1s	115207	● SCREW	3				
1t	115208	● SCREW	4				
2	115150	CABLE, power, solenoid, 50 ft. (16 m)	1				
2a	115151	CABLE, power, solenoid, 165 ft. (50 m), optional	1				
3	115153	CABLE, devicenet, single ended	1				
3a	115154	CABLE, devicenet, single ended, 165 ft. (50 m), optional	1				

\* *Keep these spare parts on hand to reduce down time.*

\*\* *Order 50 ft. (15.25 m) minimum.*

# Parts

## Low Pressure Color Change Module

### Part No. 241387

### 5–10 Color, Low Pressure Module

Includes items 1–15

Ref. No.	Part No.	Description	Qty.	Ref. No.	Part No.	Description	Qty.
1	241587	MANIFOLD ASSEMBLY, pneumatic valve, Includes items 1a–1t	1	6*	115157	CONNECTOR, terminating, resistor	1
1a	115196	● PLATE, bottom	1	8	194905	BRACKET, color change, <i>241387 only</i>	4
1b	115197	● PLATE, end, le ft.	1	9	205324	HOSE, fluid, PTFE, 1/4" x 12", <i>241387 only</i>	1
1c	115198	● PLATE, end, right	1			(not shown)	
1d*	115199	● CARTRIDGE, solenoid valve	8	11	598095	TUBING, air, 5/32" OD	**
1f*	115201	● INTERFACE MODULE	1	12	948944	VALVE, dump, low pressure, Includes items 12a–12d	1
1g	195450	● BRACKET, mounting, Festo	1	12a	502820	● FITTING, elbow, street, 1/8	1
1h*	115325	● MUFFLER, plastic	1	12b	513842	● FITTING, elbow, male, 3/8" tube x 1/8" npt	1
1j*	115326	● MUFFLER, plastic	1	12c	513949	● CONNECTOR, swivel, 1/4 npsf x 1/8 nptm	1
1k	114263	● FITTING, tube	16	12d*	907438	● VALVE, trigger, See manual 307941 for service parts	1
1m*	115202	● GASKET	1	13	599246	FITTING, tee, tube, 1/4 tube x 1/4 npt	1
1n*	115203	● GASKET	1	14	114158	FITTING, adapter, Y, 1/4 tube	1
1p*	115204	● GASKET	16	15	114109	ELBOW, 1/4 tube x 1/4 npt	1
1q	115205	● SCREW	4				
1r	115206	● SCREW	4				
1s	115207	● SCREW	3				
1t	115208	● SCREW	4				
2	115150	CABLE, power, solenoid	1				
3	115153	CABLE, devicenet, single ended	1				
4	115155	CABLE, devicenet, extension	1				
5*	115156	CONNECTOR, tee, device-net	1				

\* *Keep these spare parts on hand to reduce down time.*

\*\* *Order 50 ft. (15.25 m) minimum.*

# Parts

## Low Pressure Color Change Module

Part No. 241386, 2-4 Color

Part No. 241387, 5-10 Color (Shown)

Detail of dipswitch settings on solenoid stack under cover shown

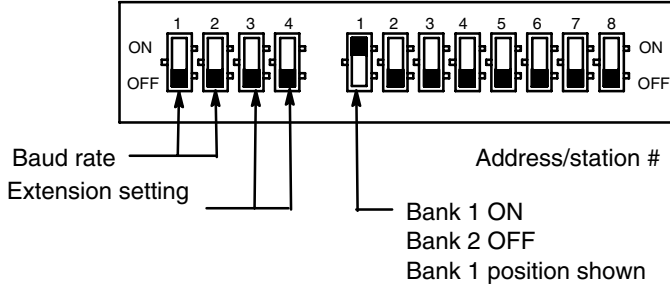

Dump Valve Location

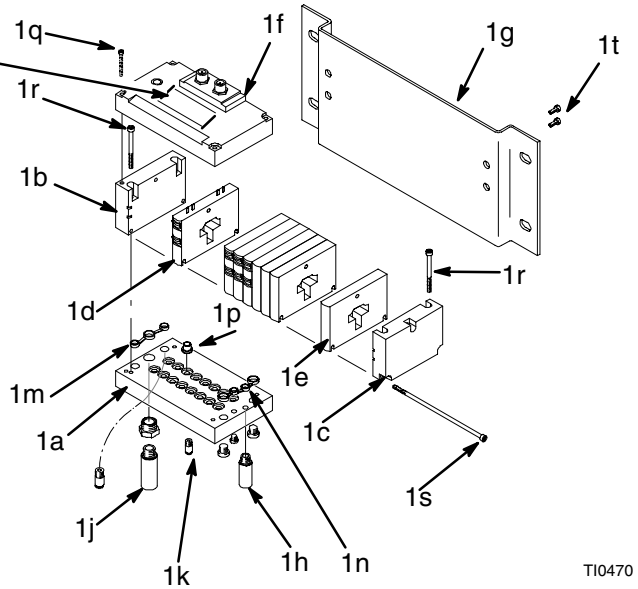
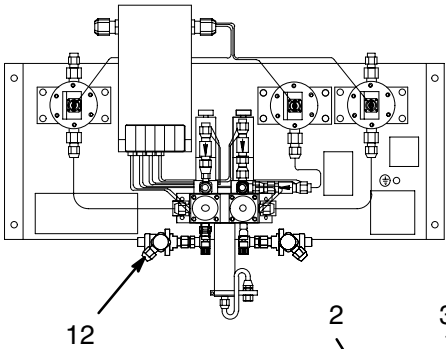

T10470

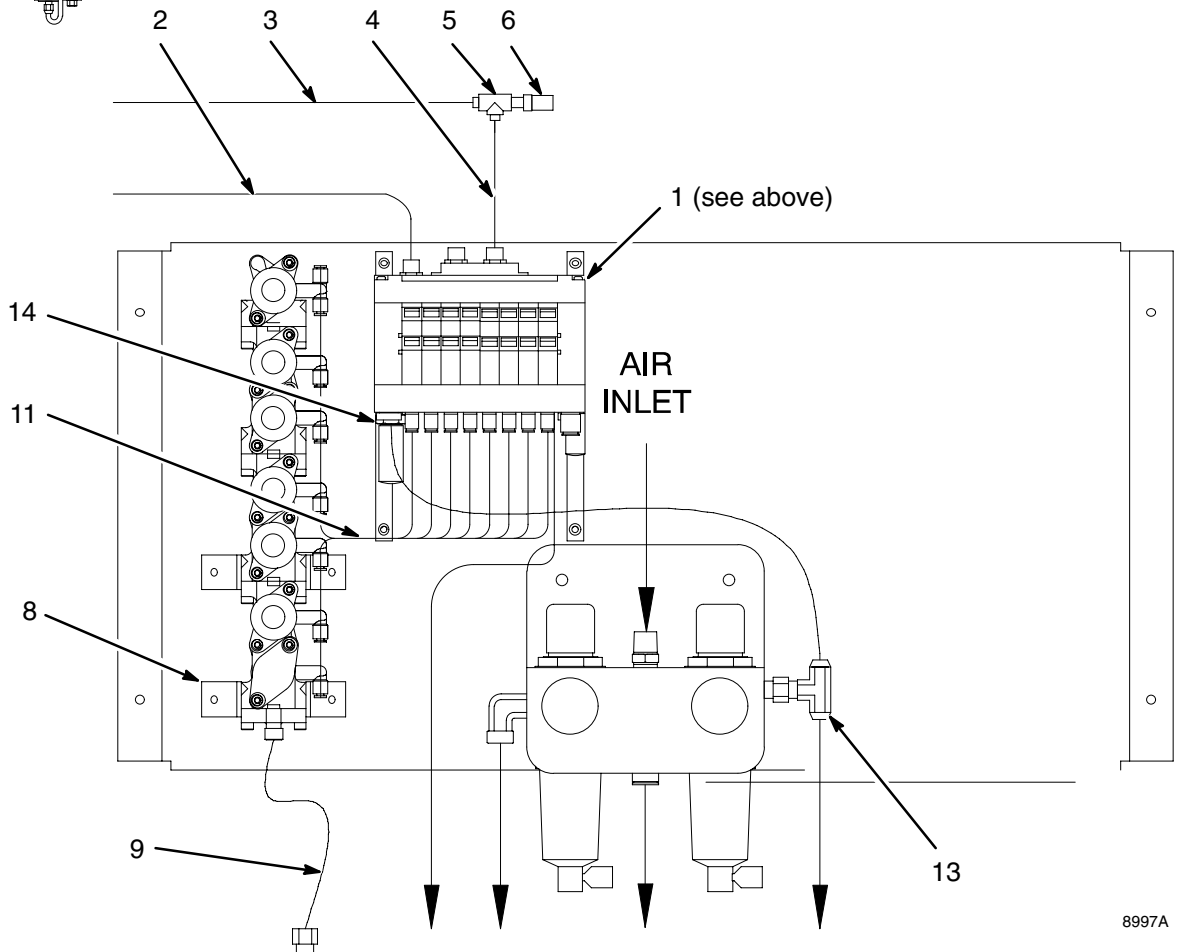

8997A

# Parts

## Low Pressure Color Change Module

### Part No. 241388

### 11–12 Color, Low Pressure Module

Includes items 1–17

Ref. No.	Part No.	Description	Qty.	Ref. No.	Part No.	Description	Qty.
1	241387	MODULE, color change, <i>241388 only</i> , See page 12–22 for parts	1	2p*	115204	● GASKET	16
2	241586	MANIFOLD ASSEMBLY, pneumatic valve, Includes items 2a–2t	1	2q	115205	● SCREW	4
2a	115196	● PLATE, bottom	1	2r	115206	● SCREW	4
2b	115197	● PLATE, end, le ft.	1	2s	115207	● SCREW	3
2c	115198	● PLATE, end, right	1	2t	115208	● SCREW	4
2d*	115199	● CARTRIDGE, solenoid valve	4	3	115155	CABLE, devicenet, extension	1
2e	115200	● PLATE, blanking	4	4*	115156	CONNECTOR, tee, devicenet	1
2f*	115201	● INTERFACE MODULE	1	5*	115152	CABLE, power, junction, 2 branch	1
2g	195450	● BRACKET, mounting, Festo	1	8	114109	FITTING, elbow, male swivel, 1/4 npt	1
2h*	115325	● MUFFLER, plastic	1	9	598095	TUBING, air, 5/32" OD	**
2j*	115326	● MUFFLER, plastic	1	11	114158	FITTING, adapter, Y, 1/4 tube	1
2k	114263	● FITTING, tube	16	16	115263	SCREW, socket head cap, M4 x 12, <i>241388 only</i>	4
2m*	115202	● GASKET	1	17	111637	WASHER, lock, M5, <i>241388 only</i>	4
2n*	115203	● GASKET	1				

\* Keep these spare parts on hand to reduce down time.

\*\* Order 50 ft. (15.25 m) minimum.



# Parts

## Low Pressure Color Change Module

Part No. 241388, 11-12 Color (shown)

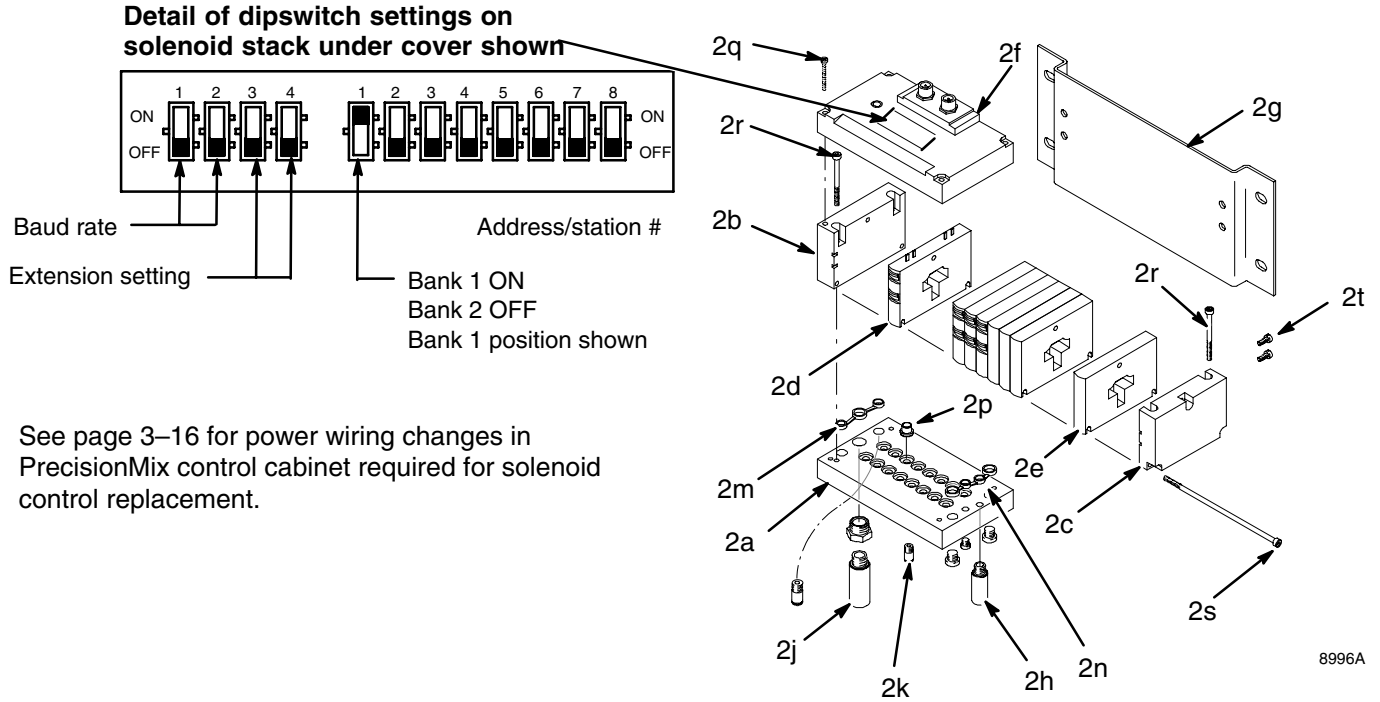

8996A

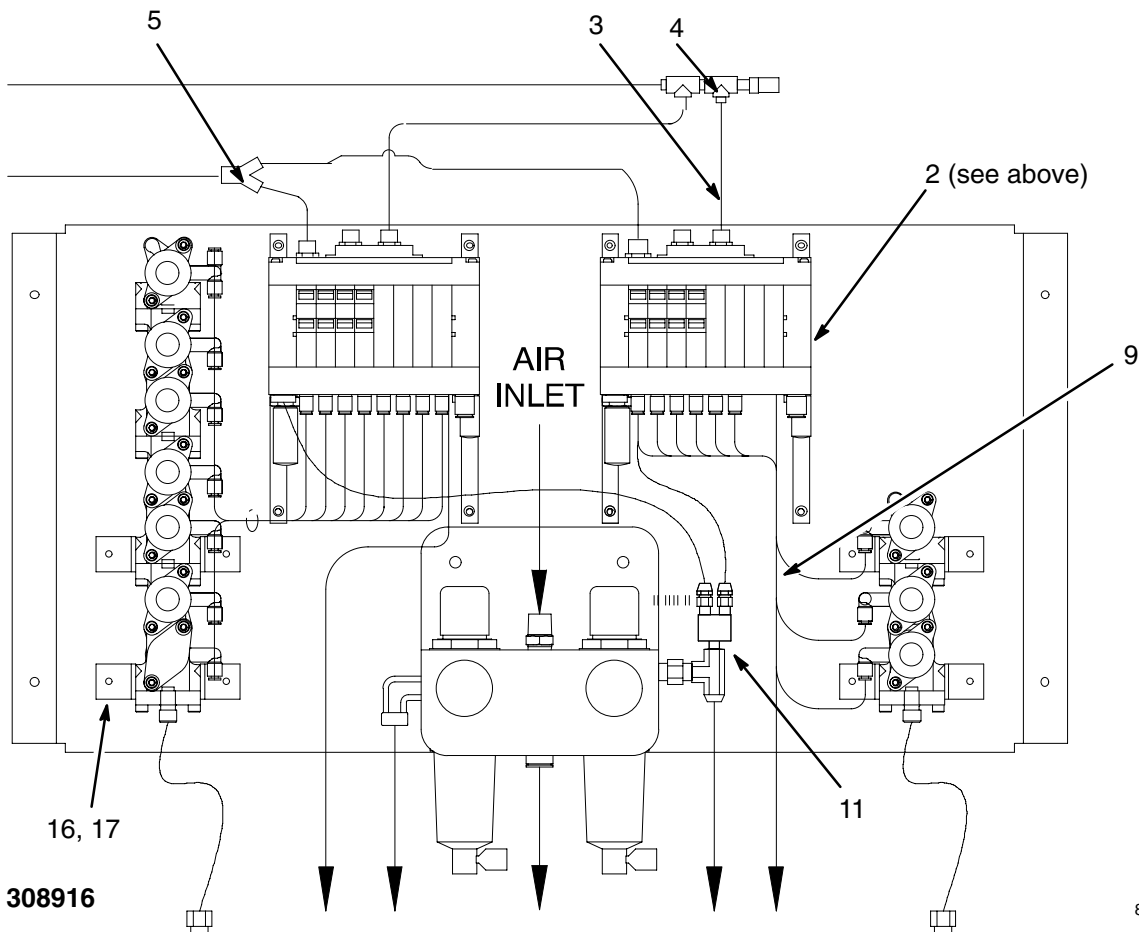

308916

8997A

12-25

# Parts

## High Pressure Color Change Module

### Part No. 241499

### 2-4 Color, High Pressure Module

Ref. No.	Part No.	Description	Qty.	Ref. No.	Part No.	Description	Qty.
1	241586	MANIFOLD ASSEMBLY, pneumatic valve, Includes items 1a-1t	1	5*	115156	CONNECTOR, tee, device-net	1
1a	115196	● PLATE, bottom	1	6*	115157	CONNECTOR, terminating, resistor	1
1b	115197	● PLATE, end, le ft.	1	8	194906	BRACKET, color change	2
1c	115198	● PLATE, end, right	1	9	205324	HOSE, fluid, PTFE, 1/4" x 12"	1
1d*	115199	● CARTRIDGE, solenoid valve	4	11	598095	TUBING, air, 5/32" OD	**
1e	115200	● PLATE, blanking	4	12	947994	VALVE, dump, high pressure, Includes items 12a-12c	1
1f*	115201	● INTERFACE MODULE	1	12a*	832503	● VALVE, color change, see manual 308291 for service parts	1
1g	195450	● BRACKET, mounting, Festo	1	12b*	947993	● SEAT, dump valve	1
1h*	115325	● MUFFLER, plastic	1	12c	108176	● ELBOW, swivel, 90°	1
1j*	115326	● MUFFLER, plastic	1	13	599246	FITTING, tee, tube, 1/4 tube x 1/4 npt	1
1k	114263	● FITTING, tube	16	14	114158	FITTING, adapter, Y, 1/4 tube	1
1m*	115202	● GASKET	1	15	114109	ELBOW, 1/4 tube x 1/4 npt	1
1n*	115203	● GASKET	1	18	514185	FITTING, 3/8 tube x 1/8 npt (not shown)	2
1p*	115204	● GASKET	16	19	546001	TUBING, 3/8" OD (not shown)	1
1q	115205	● SCREW	4				
1r	115206	● SCREW	4				
1s	115207	● SCREW	3				
1t	115208	● SCREW	4				
2	115150	CABLE, power, solenoid	1				
3	115153	CABLE, devicenet, single ended	1				
4	115155	CABLE, devicenet, extension	1				

\* Keep these spare parts on hand to reduce down time.

\*\* Order 50 ft. (15.25 m) minimum.

# Parts

## High Pressure Color Change Module

### Part No. 241500

### 5–10 Color, High Pressure Module

Ref. No.	Part No.	Description	Qty.	Ref. No.	Part No.	Description	Qty.
1	241587	MANIFOLD ASSEMBLY, pneumatic valve, Includes items 1a–1t	1	6*	115157	CONNECTOR, terminating, resistor	1
1a	115196	● PLATE, bottom	1	8	194906	BRACKET, color change	2
1b	115197	● PLATE, end, le ft.	1	9	205324	HOSE, fluid, PTFE, 1/4" x 12"	1
1c	115198	● PLATE, end, right	1	11	598095	TUBING, air, 5/32" OD	**
1d*	115199	● CARTRIDGE, solenoid valve	16	12	947994	VALVE, dump, high pressure, Includes items 12a–12c	2
1f*	115201	● INTERFACE MODULE	2	12a*	832503	● VALVE, color change, see manual 308291 for service parts	1
1g	195450	● BRACKET, mounting, Festo	1	12b*	947993	● SEAT, dump valve	1
1h*	115325	● MUFFLER, plastic	1	12c	108176	● ELBOW, swivel, 90°	1
1j*	115326	● MUFFLER, plastic	1	13	599246	FITTING, tee, tube, 1/4 tube x 1/4 npt	1
1k	114263	● FITTING, tube	16	14	114158	FITTING, adapter, Y, 1/4 tube	1
1m*	115202	● GASKET	1	15	114109	ELBOW, 1/4 tube x 1/4 npt	1
1n*	115203	● GASKET	1	18	514185	FITTING, 3/8 tube x 1/8 npt (not shown)	2
1p*	115204	● GASKET	16	19	546001	TUBING, 3/8" OD (not shown)	1
1q	115205	● SCREW	4				
1r	115206	● SCREW	4				
1s	115207	● SCREW	3				
1t	115208	● SCREW	4				
2	115150	CABLE, power, solenoid	1				
3	115153	CABLE, devicenet, single ended	1				
4	115155	CABLE, devicenet, extension	1				
5*	115156	CONNECTOR, tee, device-net	1				

\* Keep these spare parts on hand to reduce down time.

\*\* Order 50 ft. (15.25 m) minimum.

# Parts

## High Pressure Color Change Module

Part No. 241499, 2-4 Color

Part No. 241500, 5-10 Color (Shown)

### Dump Valve Location

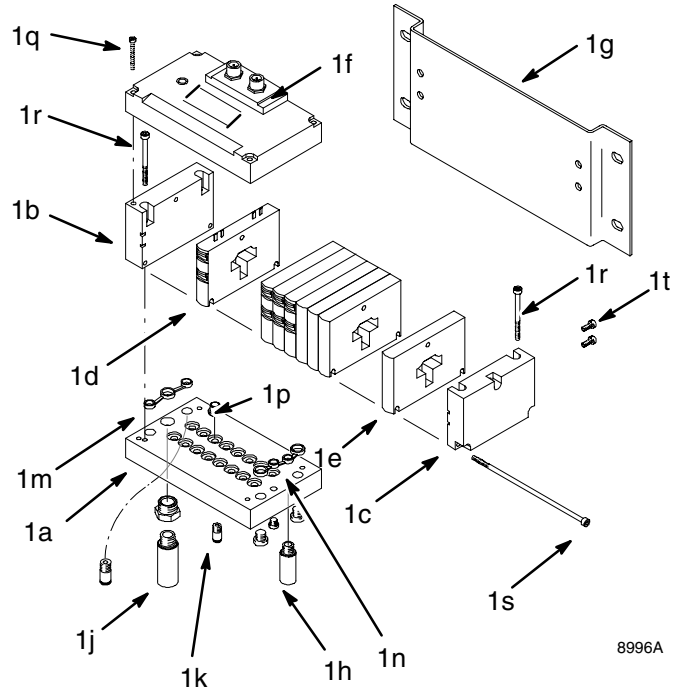
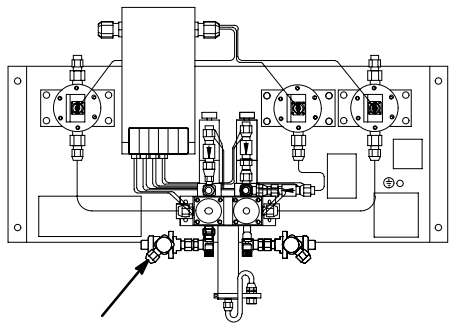

8996A

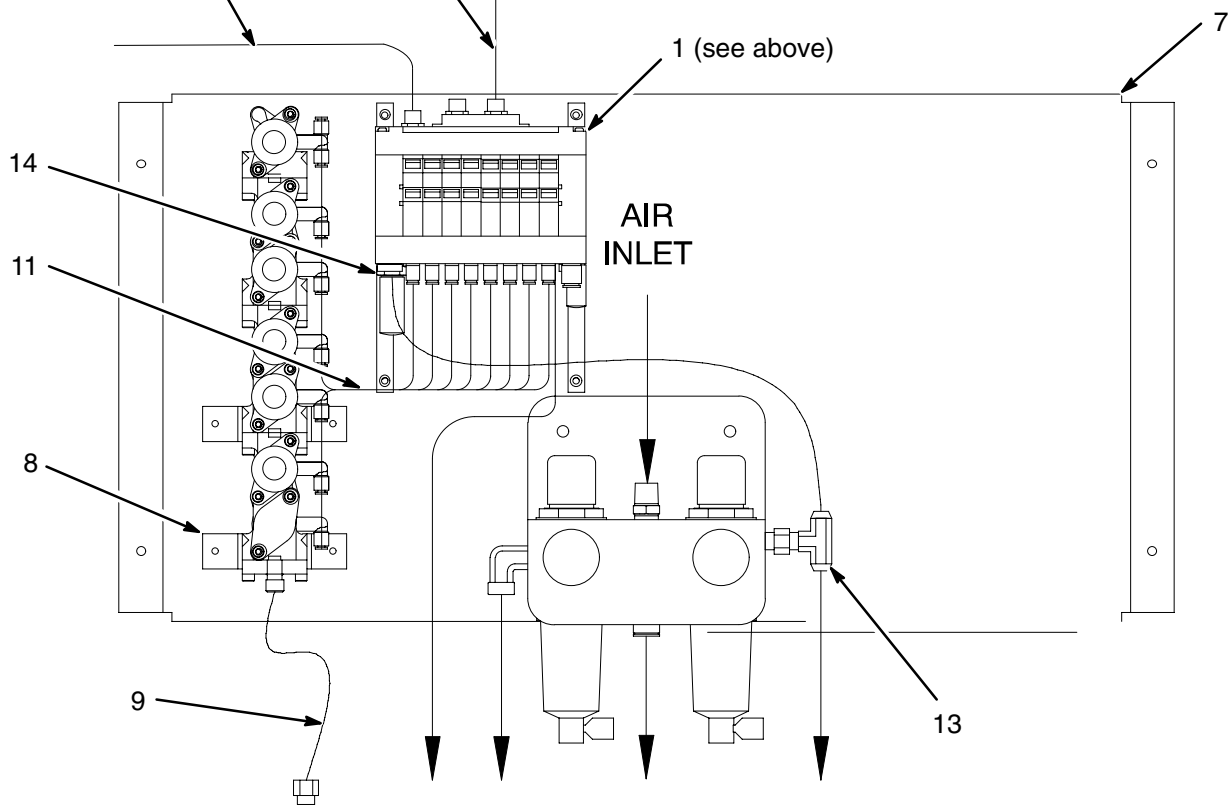

8997A

# Parts

## High Pressure Color Change Module

### Part No. 907347

*Includes 8 valves, one for solvent and seven for color*

Ref. No.	Part No.	Description	Qty.
1	832503	BARE VALVE	*
2	832904	MANIFOLD, center, 4 valve	*
3	833108	MANIFOLD, end, 4 valve	*
4	832905	MANIFOLD, end 2 valve	*
5	833107	BLOCK, outlet	*
6	552000	O-RING	*
7	100643	SCREW	*
8	510947	ROD	*
9	102040	NUT, lock; 1/4-20	*
10	194905	BRACKET, mounting	2
11	103195	SCREW, cap (not shown)	

 Part of color valve (item 1)

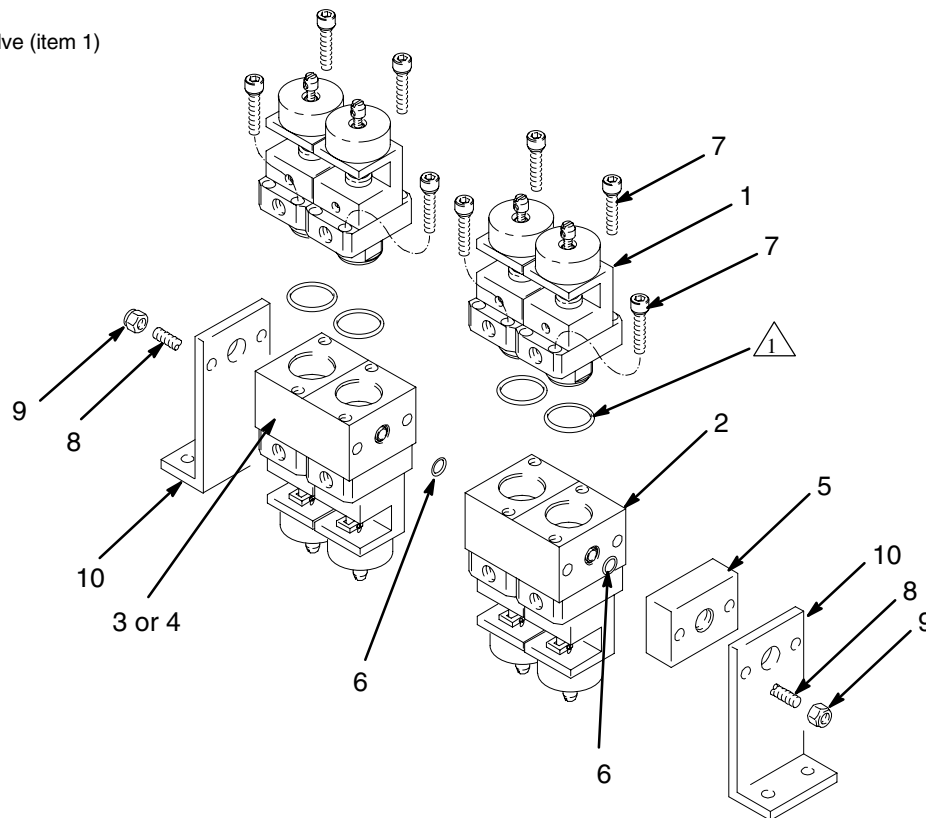

8882B

# Parts

## Color Change Valve Assemblies

### Low Pressure Color Change Valves

See Manual 307731 to order parts.

Part No.	No. of Colors	No. of Valves	Catalyst or Resin
949796	2	3	catalyst or resin
220020	4	5	catalyst or resin
220022	6	7	resin
220024	8	9	resin
220026	10	11	resin
220028	12	13	resin

### High Pressure Color Change Valves

See Manual 308977 to order parts.

Part No.	No. of Colors	No. of Valves	Catalyst or Resin
907345	3	4	resin
907346	5	6	resin
907347	7	8	resin
907348	9	10	resin
907349	11	12	resin

### Valve Bracket Change Procedure

1. Install a nut (9) on each of the rods (8). Slide the bracket (10) and outlet block (5) onto the rods. See the parts drawing on page 12–29.
2. Place an o-ring (6) on the front of the first center manifold (2), and slide it onto the rods up to the outlet block.
3. Place an o-ring (6) between each of the center manifolds (2). Slide the center manifolds onto the rods.
4. Place an o-ring (6) on the open end of the last center manifold. Slide the end manifold (3 or 4) onto the rods.
5. Slide a bracket (10) onto the rods and secure with the nuts (9).
6. Install the valves (1) on the manifolds with two screws (7).

**NOTE:** Each center manifold (2) can hold up to four valves (two on each side). One end manifold (3) can hold four valves, the other end manifold (4) can hold two valves.

**NOTE:** One of the last two color changer valves on the end manifold is used for solvent flush.

7. Connect a 4 mm (5/32 in.) OD tube to each piston air inlet fitting (B) by pushing the tube into the special quick disconnect of the fitting.

**NOTE:** The air inlet fitting (B) is a 90° elbow. An optional straight air inlet fitting is available; see **Accessories** to order.

8. See the parts drawing on page 12–29. Install a suitable adapter (A) in the 1/8 npt fluid inlet of each valve. Apply thread sealant to the adapter and torque to 2.3 N•m (20 in-lb). Connect the paint supply hose to the adapter (A).

# Parts

## Valve Bracket Change Procedure – continued

9. Connect the paint hoses from the gun to the outlet block (5). The threads on the outlet block are 1/4-18.6 compound thread, which fits both 1/4-18 npsm or 1/4-19 BSP female connectors.
10. If you are recirculating the paint, remove the recirculating plug (C) from the valve and connect the recirculating line to the 1/8 npt(f) port, using a suitable adapter. Use sealant on the adapter and torque to 2.3 N•m (20 in-lb).

# Service

## **WARNING**

To reduce the risk of serious bodily injury, including splashing in the eyes or on the skin, injury from moving parts or electric shock, always follow the **Pressure Relief Procedure** and read and follow the warnings given in your pump and spraying device instruction manuals.

See Instruction Manual 308291 for the color valve repair procedure.

# Parts

## Gun Flush Box

### Part No. 241389 Gun Flush Box, one gun

Ref. No.	Part No.	Description	Qty.
1	244105	GUN FLUSH BOX, See manual 309227 for parts	1
2	570123	KIT, wall mount	1
3	570132	KIT, atomizing air shutoff	1
4	115125	MODULE, solenoid box, See page 12-33 for parts	1
5	065338	CABLE, 6 conductor, 22 AWG	*
6	598095	TUBING, nylon, 5/32"	**
7	514030	GRIP, cable, strain relief	1

\* Order 100 ft. (31 m) minimum.

\*\* Order 250 ft. (76 m) minimum.

### Part No. 241394 Gun Flush Box, two gun (Shown)

Ref. No.	Part No.	Description	Qty.
1	244105	GUN FLUSH BOX, See manual 309227 for parts	2
2	570123	KIT, wall mount	2
3	570132	KIT, atomizing air shutoff	2
4	115125	MODULE, solenoid box, See page 12-33 for parts	2
5	065338	CABLE, 6 conductor, 22 AWG	*
6	598095	TUBING, nylon, 5/32"	**
7	514030	GRIP, cable, strain relief	1
9	514768	SWITCH, air flow	1
10	598728	FITTING, elbow, 1/2 tube x 1/4 npt	3
11	598739	FITTING, tee, 1/2 tube x 1/4 npt	1

\* Order 200 ft. (61 m) minimum.

\*\* Order 500 ft. (153 m) minimum.

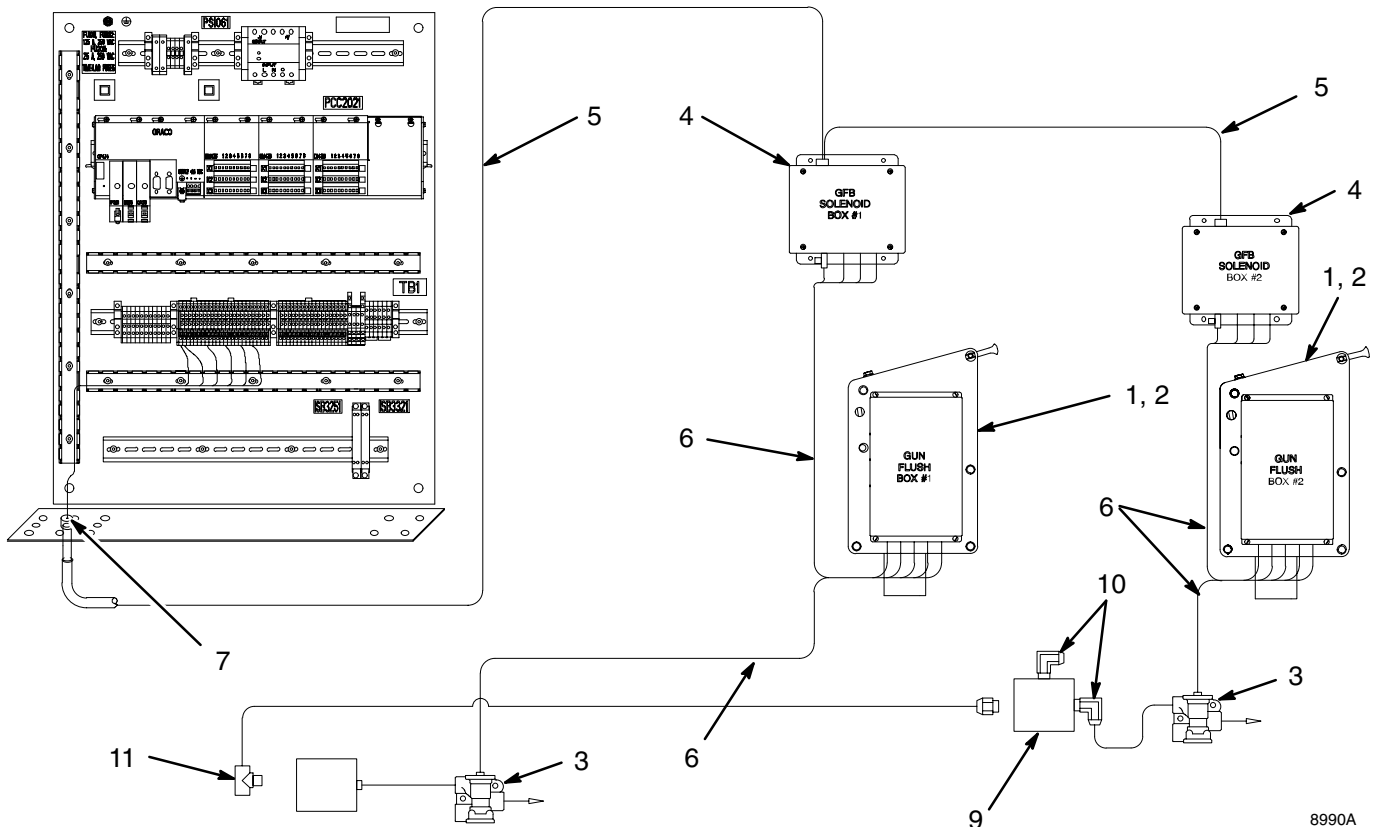

8990A



# Parts

## Gun Flush Solenoid Box

Part No. 115125

Gun Flush Solenoid Box Module

Ref. No.	Part No.	Description	Qty.	Ref. No.	Part No.	Description	Qty.
1	104641	FITTING, bulkhead	2	16	598252	FITTING, pneumatic, tube	1
2	100030	BUSHING	1	19	169797	ADAPTER	1
3*	513937	SWITCH, pressure	1	20	112446	BLOCK, clamp, end	2
5	598251	FITTING, bulkhead, tube	2	22	112444	BLOCK, terminal, 2-conductor	2
6	598140	FITTING, elbow	2	23	112445	COVER, end, terminal	1
7*	551870	SOLENOID, 24 VDC, 3-way	1	26	502723	TEE, male run	1
9	112442	BLOCK, terminal	4	27	514228	FITTING, reducer	1
10	114993	SCREW, machine	6	31	110874	WASHER, flat	2
13	114421	BUSHING, strain relief	1	32	104029	STUD, grounding	1
14	104227	NUT, lock, conduit	1	34	115322	LOCKWASHER, 4 mm	4
15	598095	TUBE, 4 mm OD, 2 ft. (0.6 m)	1				

\* Keep these spare parts on hand to reduce down time.

See pages 3-17, 3-21 and 3-22 for wiring tables, solenoid boxes, and airflow switches.

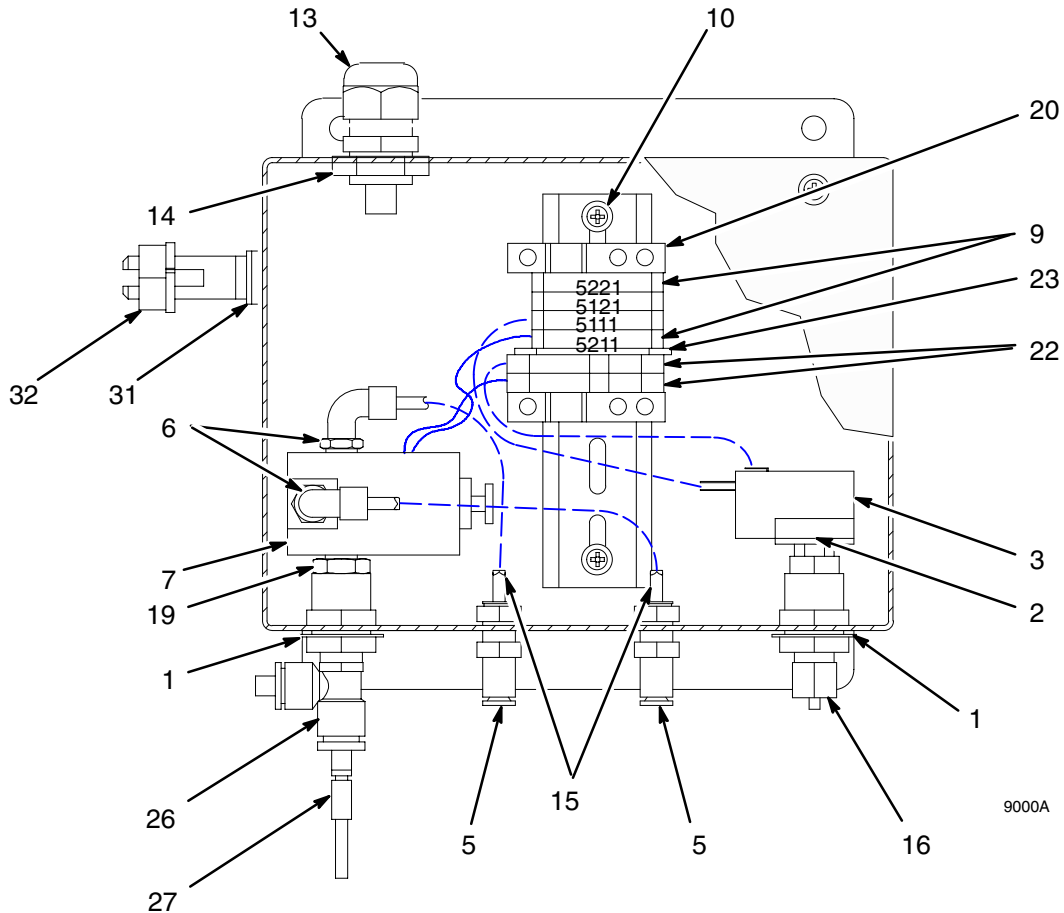

# Parts

## Gun Holders for Gun Flush Box

**For Part No. 570046 Gun Flush Box, with ball tip sensors.**

See manual 684019 for installation instructions.

Part No.	Description
570296*	Graco Delta Spray™ Gun
626518	Graco AA Gun with RAC Tip
626540	Graco AA 200 HS Gun
626508	Graco Manual PRO™ Gun 3500/4500

Part No.	Description
626571	Devilbiss JGA/MSA**
626499	Binks HVLP**
570098	Binks 2001**

\* Part No. 570296 includes the gun holder and the guide, both are necessary to use the gun flush box with the Delta Spray Gun.

\*\* Brand names or marks are used for identification purposes and are trademarks of their respective owners.

### Part No. 244169 Gun Holder Mounting Kit

Allows mounting of new gun holders in the Part No. 570046 Gun Flush Box.

### Part No. 244373 Gun Switch/Yoke Conversion Kit

Converts Part No. 570046 Gun Flush Box to new style upper gun switch/yoke assembly.

## Gun Holders for Gun Flush Box

**For Part No. 244105 Gun Flush Box, with roller actuator sensors.**

See manual 309227 for installation instructions.

Part No.	Description
198405	Graco PRO™ Xs3 and PRO™ Xs4
196768	Graco PRO™ Guns 3500, 4500 and HC

196767	Devilbiss JGA/MSA Guns
196770	Graco Alpha Gun
196771	Graco Alpha Plus Gun
196769	Graco Delta Spray™ Gun

# Parts

## Cable Chart

Cable Part No.	Description	From	To	Length
065338	CABLE, gun flush box #1	Controller	Gun Flush Solenoid Box #1	100 ft. (30.5 m)
065338	CABLE, gun flush box #2	Gun Flush Solenoid Box #1	Gun Flush Solenoid Box #2	100 ft. (30.5 m)
114990	CABLE, printer (optional)	Controller	Printer	25 ft. (7.6 m)
115150	CABLE, power	Controller	Color Change Panel Solenoid Bank	50 ft. (16 m)
115151	CABLE, power (optional)	Controller	Color Change Panel Solenoid Bank	165 ft. (50 m)
115153	CABLE, network	Controller	115156 Connector Tee	50 ft. (16 m)
115154	CABLE, network (optional)	Controller	115156 Connector Tee	165 ft. (50 m)
115155	CABLE, drop, network	115156 Connector Tee	Color Change Panel Solenoid Bank	1 ft. (0.3 m)
115770		Controller	Controller/P.C.	1000 (300.5 m)
194400	CABLE, remote user interface	Controller	Remote User Interface	40 ft. (12 m)
194477	CABLE, flow control #2	Flow Control #2	Flow Control #1	100 ft. (30.5 m)
194477	CABLE, operator station	Operator Station	Controller	100 ft. (30.5 m)
194478	CABLE, operator station (optional)	Operator Station	Controller	200 ft. (61 m)
194481	CABLE, run screen monitor	Controller	Run Screen Monitor	100 ft. (30.5 m)
194482	CABLE, run screen monitor (optional)	Controller	Run Screen Monitor	200 ft. (61 m)
194559	CABLE, flow control #1	Flow Control #1	Operator Station	10 ft. (3.05 m)
241799	CABLE, meter	Fluid Panel Solenoid Box	Resin, Catalyst, or Solvent Meter	3 ft. (1 m)
241799	CABLE, flow data sensor	Controller	Flow Data Sensor	3 ft. (1 m)
241963	CABLE, Robomix	Controller	Robomix Solenoid Box	50 ft. (15.2 m)
513652	CABLE, I/P transducer	Controller	I/P Transducer	100 ft. (30.5 m)
513652	CABLE, I/P transducer (optional)	Controller	I/P Transducer	200 ft. (61 m)
515769	CABLE, Network	Controller	Controller/P.C.	500 ft. (152.5 m)
551986	CABLE, 12 pair, individually shielded, 24 AWG	Controller	Fluid Panel Solenoid Box	50 ft. (15.2 m)

# Parts

## Run Screen Monitor Accessory

Part No. 240907

### Run Screen Monitor Kit

Ref. No.	Part No.	Description	Qty.
1	194531	HARNESS, wire	1
2*	240876	KIT, repair, circuit board	1
3	114993	SCREW, machine	12
4	115033	CONNECTOR, plug	1
5*	241264	KIT, repair, display	1
6	115034	CABLE, display board (not shown)	1
7	194481	CABLE, 100 ft. (30.5 m) (not shown)	1
	194482	CABLE, 200 ft. (61 m), optional (not shown)	1
8	114421	BUSHING, strain relief	2
9	115322	LOCKWASHER, 4 mm	4
10	110874	WASHER, flat	2
11	104029	STUD, grounding	1

\* Keep these spare parts on hand to reduce down time.

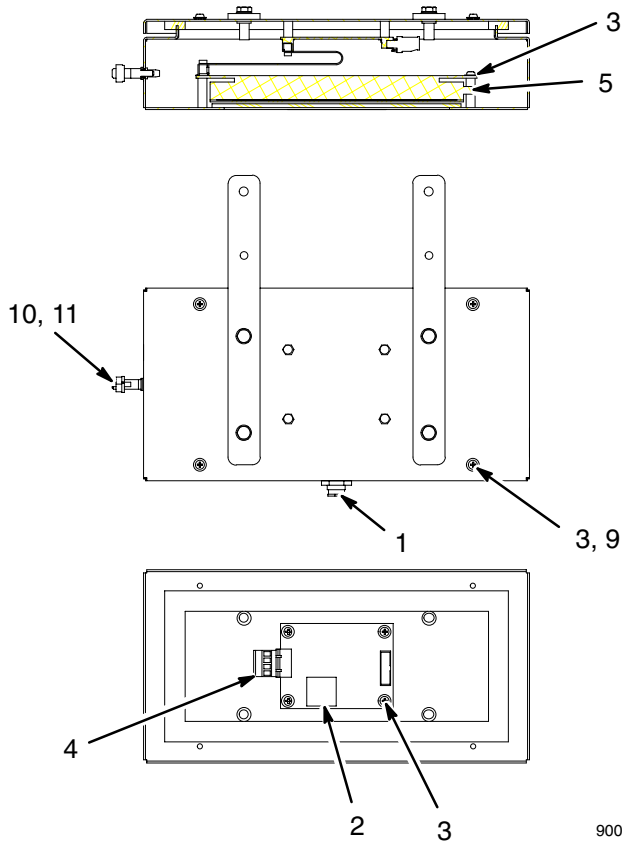

9002A

## Remote User Interface

Part No. 240874

### Remote User Interface Kit

Ref. No.	Part No.	Description	Qty.
1*	241261	KIT, user interface	1
2	194396	HARNESS, wire	1
3	111682	KIT, screwlock, female	1
4	114993	SCREW, machine	4
5	194400	CABLE, interface (not shown)	1
6	110874	WASHER, flat	2
7	104029	STUD, grounding	1
8	115322	LOCKWASHER, 4 mm	4
9*	195049	SHIELD, paint, package (not shown)	1
10	115563	BATTERY (not shown)	1

\* Keep these spare parts on hand to reduce down time.

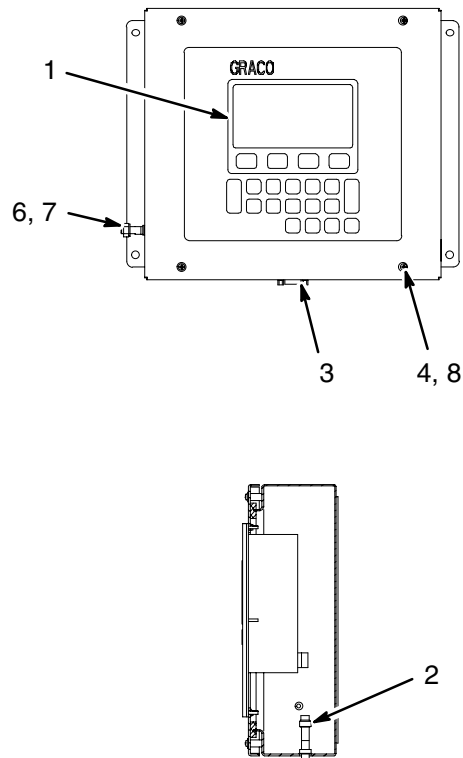

9045A

# Parts

## Communication Ports

### Part No. 241379 Network/PC Port Accessory Kit

Ref. No.	Part No.	Description	Qty.
1*	114783	MODULE, interface, RS485	1
2	194544	WIRE HARNESS, network PC	1
3	111987	CONNECTOR, strain relief	1
4*	195013	MODULE, converter, RS232/RS485 (not shown)	1
5	195638	POWER SUPPLY, desktop, 12 VDC (not shown)	1
6	514001	CORD, power	1

\* Keep these spare parts on hand to reduce down time.

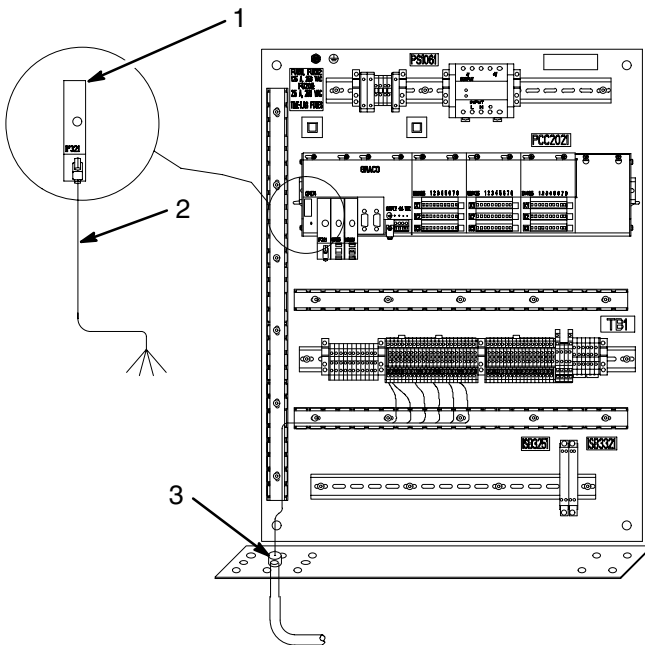

### Part No. 241378 Local Printer Accessory Kit

Ref. No.	Part No.	Description	Qty.
1*	114780	MODULE, interface, RS232	1
2	193738	WIRE HARNESS, local printer	1

\* Keep these spare parts on hand to reduce down time.

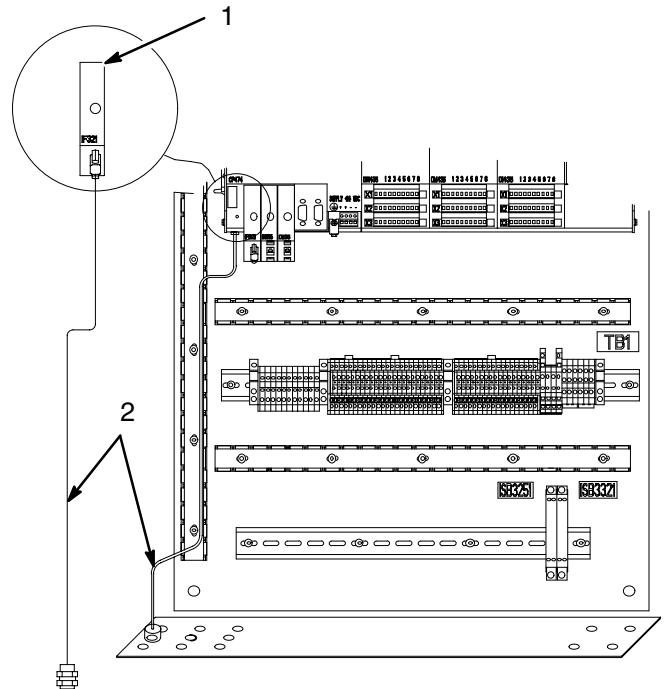

8992A

## Software Utilities Kit

### Part No. 241841 Utilities Installation Kit

Ref. No.	Part No.	Description	Qty.
1	115422	SOFTWARE, CD ROM	1
2	115420	CABLE, communication	1
3	115421	CABLE, null modem	1

# Parts

## Stand Mount

### Part No. 241501 PrecisionMix II Floor Stand Kit

Using the hardware supplied in Mounting Kit 241501, mount the PrecisionMix II controller to the left side of the mounting stand. Mount the color change panel to the upper right of the stand and the fluid panel module to the lower right.

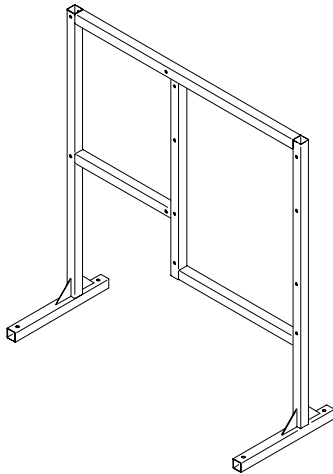

## Audio/Visual Alarm Indicator

### Part No. 241380 Audio/Visual Alarm Kit

Ref. No.	Part No.	Description	Qty.
1	115014	ALARM	1

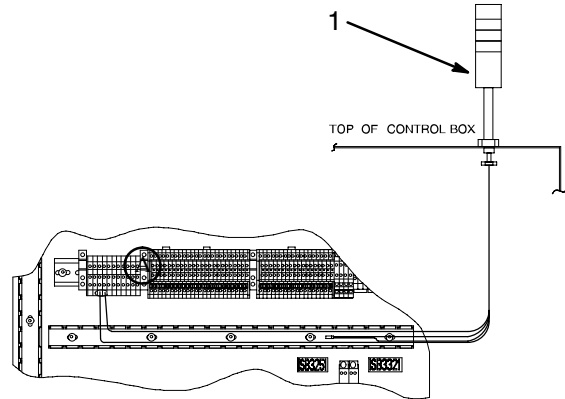

9002A

### Alarm Wiring Schematic

Wire Color	Function
Sky blue	Alarm input
Gray	Light input
Red	Jumper for flashing light
Brown	Jumper for flashing light
Yellow	Common

# Accessories

## Part No. 241647 Catalyst Change Kit

Ref. No.	Part No.	Description	Qty.
1	194905	BRACKET, color change, low pressure	4
2	205324	HOSE, fluid, 1/4", 12" long, PTFE	1
3	948944	VALVE, dump, low pressure	1
4	115263	SCREW, socket head cap, M4 x 12	4
5	111637	WASHER, lock, M4	4
6	115267	WASHER, flat, M4	4
7	115266	SCREW, socket head cap, M5 x 10	4
8	115269	WASHER, lock, M5	4
9	115270	WASHER, flat, M5	4
10	598095	TUBING, air, 5/32" OD	*

\* Order 25 ft. (7.6 m) minimum.

## Part No. 195048 Paint Shield for Operator Station

Package of 10 shields to protect Operator Station from getting overspray or other contaminants on the keypad and display area.

## Part No. 195049 Paint Shield for User Interface

Package of 10 shields to protect User Interface from getting overspray or other contaminants on the keypad and display area.

## Meter Kits

Kits include meter, pickup, and 3 ft. (0.9 m) cable.

### Part No. 241820 Clean Flush Meter

### Part No. 241822 Low Viscosity and Solvent, High Accuracy Meter

### Part No. 244039 Coriolis Meter Kit

## Intrinsically Safe Meter Kits

Kits include IS meter, IS pickup, and IS cable.

### Part No. 241824 PPM3050 IS Meter

## Part No. 241263 Printer Kit

Includes Part No. 113774 Thermal Printer (40 column) and Part No. 114990 Cable. Also includes customer's choice of Power Supply. See the Printer Power Supply table below. Order printer paper separately. See below.

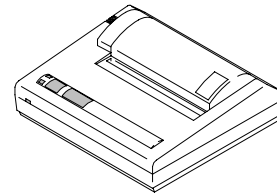

## Printer Power Supply

Part No.	Description
114442	120 VAC United States
114443	230 VAC Europe
114444	100 VAC Japan

## Part No. 514037 Printer Paper

Printer Replacement Paper, 1 roll

# Accessories

## Manual Dump Valve Kits

Kits include dump valve, pneumatic pushbutton box, and pressure switch.

**Part No. 949749 Low Pressure**

**Part No. 949750 High Pressure**

## 2K Fluid Outlet Valves (manually operated)

**Part No. 948025 Two Gun Valve, carbon steel**

**Part No. 570026 Four Gun Valve, stainless steel**

## Part No. 513052 Air Flow Switch

High flow air switch, 5 cfm.

## Part No. 241962 Hydro-Softfeel Material Application Kit

Specialized kit for applying and flushing Hydro-Softfeel materials. Includes manifold valves, connectors, integrator, and tubing.

## Cable Network P.C. AMR

115769 500 feet

115770 1000 feet

## Catalyst Supply Modules

949391 15 gallon portable

949578 15 gallon stationary

949438 80 gallon stationary



# 13

## Utilities Software



# Utilities Software

## Utilities Overview

The following information is a summary of when the PrecisionMix II Utilities are used. Further information on which steps to perform when upgrading software will be sent with future software upgrades.

### Update the Operating System, page 13–9.

The Operating System may need to be updated if there is a major software upgrade.

### Update the PrecisionMix II Program, page 13–11.

Updating the PrecisionMix II Program should only be necessary if the software is being upgraded.

### Restore the PrecisionMix II System (configuration and recipes), page 13–7.

The PrecisionMix II System needs to be restored if the controller loses its memory, which will cause a “Memory Failure” alarm. A memory loss can occur if the controller battery fails or if the memory is cleared from a configuration screen.

### Update the User Interface, page 13–13.

The User Interface needs to be updated if the software is being upgraded or the User Interface loses its memory. The most likely cause for a memory loss is the failure of the User Interface battery.



- Before using the Utility, make sure the computer screen saver is turned off.
- During uploads or downloads, do not use any other software on your computer as it may interfere with the process.
- If an Operating System Update or Controller Program Update is done, all the totalizers will be reset.

## Connection Error

When an upload or download button is pressed on one of the Utility Instruction windows, the Utilities software tries to connect (communicate) with the PrecisionMix II controller. If the controller does not respond, the process will terminate with an error message:

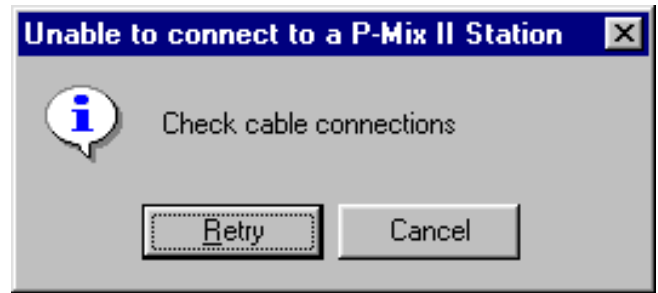

### If an error occurs:

- Check the cable connection (step 5, page 13–5).
- Turn the PrecisionMix II power off and back on again.
- Check the Communication Parameters Setup (step 6, page 13–5).

## Mode Switch (See Fig. 13.1)

The possible mode switch settings are as follows:

Switch Position	Used For
A	Controller download
B	Disable printer/network
f	Diagnostics ( <i>do not use in normal operation</i> )
1	Default setting for normal operation, backup and restore

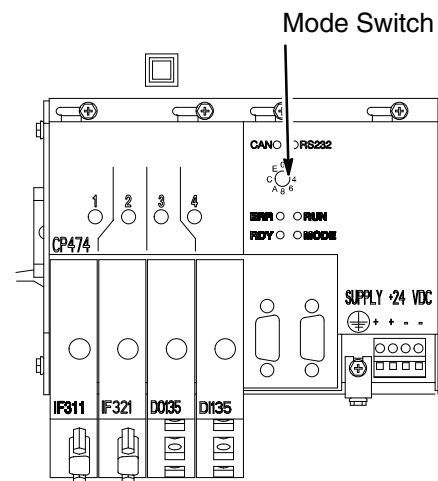

Fig. 13.1

# Utilities Software

## Backup PrecisionMix II

The Backup Utility allows you to backup the configuration that is stored in the PrecisionMix II controller. The configuration information consists of the parameters entered during system configuration and recipe setup, plus the totalizer information.

☞ The backup utility will backup the number of recipes that are set for use during configuration (refer to page 8–6). For faster backups and restores, set the number of recipes as low as possible.

### ⚠ CAUTION

If the controller battery fails or is not installed correctly, the controller memory could be lost. Backup the PrecisionMix II configuration periodically and before changing the controller battery.

1. Select File ► Backup PrecisionMix II (Fig. 13.2) from the toolbar or press the Backup button (Fig. 13.3) in the main window.

### File ► Backup PrecisionMix II



Fig. 13.2

## Backup Button



Fig. 13.3

2. An Instructions window to Backup PrecisionMix II will appear. See Fig. 13.4.

If you are familiar with the backup process, you can follow the steps in the window. The following instructions provide more detailed information.

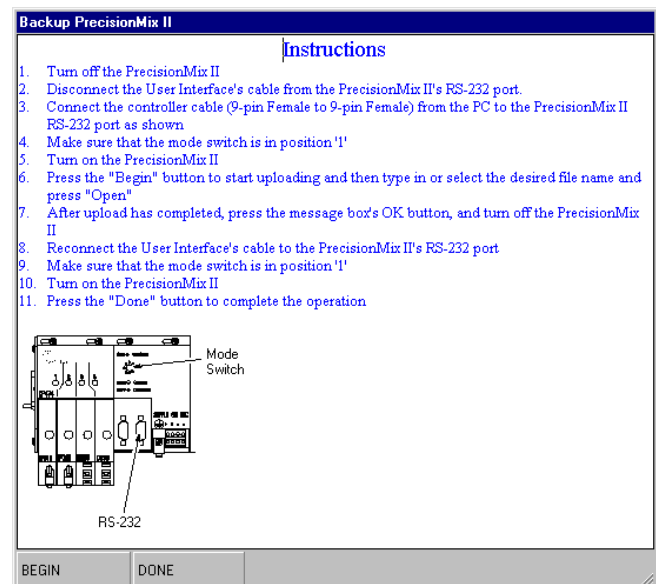
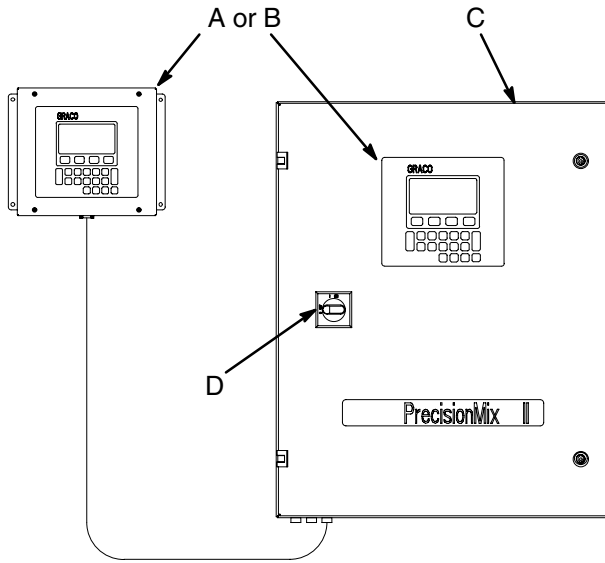

Fig. 13.4

# Utilities Software

## Backup PrecisionMix II – continued

3. Turn the PrecisionMix II power switch (D) to off. See Fig. 13.5.
4. Disconnect the User Interface (A or B) cable from the PrecisionMix II controller (C).



8992A

Fig. 13.5

6. The default setting for computer communications port is 1. If your computer has 2 serial ports and you use the second port, you need to change the Communication Parameters setting the first time you use the software.
  - a. Select Options ► Communication Parameters. See Fig. 13.7.



Fig. 13.7

5. Connect the communication cable between the computer serial port and the controller RS232 connector. See Fig. 13.6.

**⚠ CAUTION**

Do not connect the cable to the CAN connector, next to the RS232 connector, or the utilities software will not operate correctly.

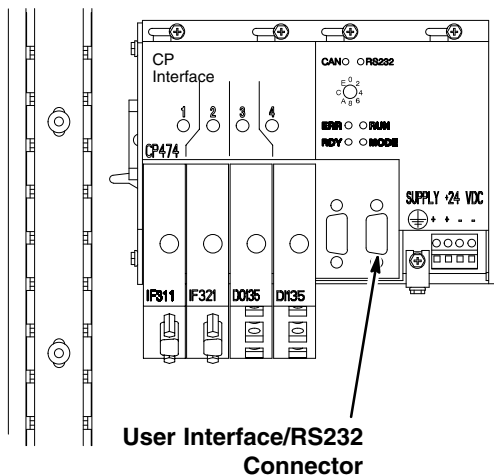

Fig. 13.6

- b. Select 2 for the Comm Port and press the OK button in the Communication Parameters dialog box. See Fig. 13.8.

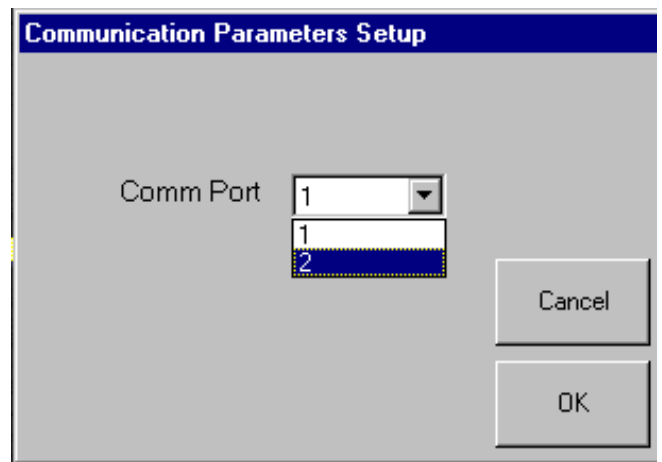

Fig. 13.8

7. Turn the PrecisionMix II power back on.

# Utilities Software

## Backup PrecisionMix II – continued

8. Press the BEGIN button on the Instructions window to begin the backup. See Fig. 13.9.

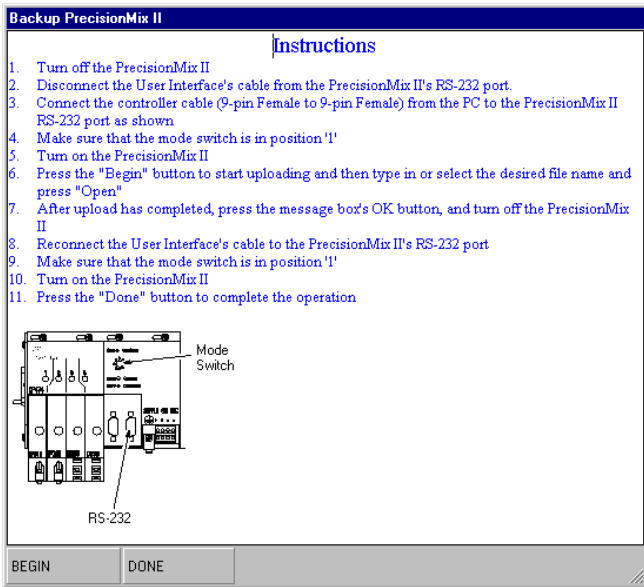



Fig. 13.9

-  If a connection error occurs, see page 13–3, for instructions.

9. After the upload button is pressed, the Save Backup dialog box appears. See Fig. 13.10. Type in a file name for the backup, such as the date, and press the Open button.

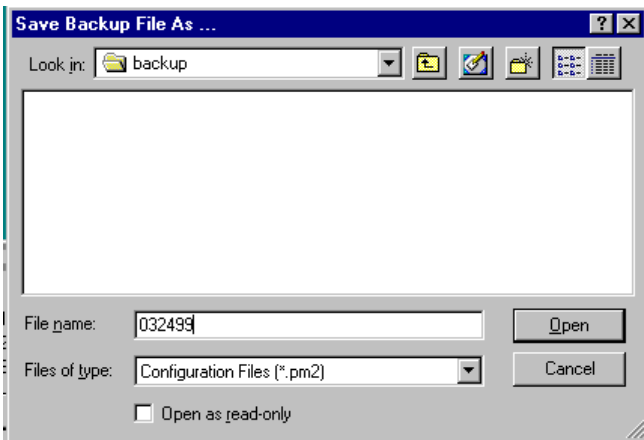

Fig. 13.10

10. A Progress meter appears and continues to display until the backup is complete. See Fig. 13.11.

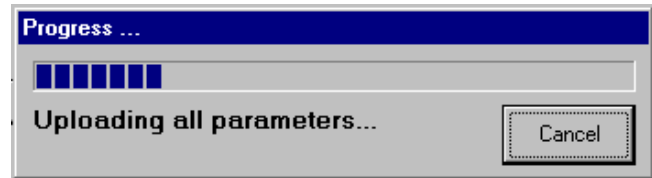

Fig. 13.11

 **If an error occurs during the backup:**

The backup is terminated and “Disconnected...” will display at the bottom of the Utilities main window. Check the cable connection, then restart the backup by pressing the upload button again.

**NOTE:** The backup can be terminated by pressing Cancel on the Progress meter (Fig. 13.11).

11. After the upload is complete, turn off the PrecisionMix II power.
12. Disconnect the communication cable and reconnect the User Interface cable to the PrecisionMix II controller. See Fig. 13.6.
13. Turn the PrecisionMix II controller power on.
14. Press the DONE button to close the Instructions window. See Fig. 13.9.

# Utilities Software

## Restore PrecisionMix II

The Restore Utility allows you to restore a configuration previously backed up for the PrecisionMix II controller. Refer to the Backup information, page 13–4.

1. Select File ► Restore PrecisionMix II (Fig. 13.12) from the toolbar or press the restore button (Fig. 13.13) on the main window.

### File ► Restore PrecisionMix II



Fig. 13.12

### Restore Button

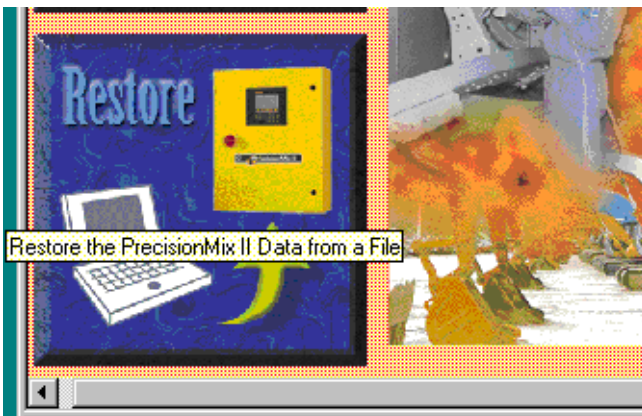

Fig. 13.13

2. An Instructions window to Restore PrecisionMix II will appear. See Fig. 13.14.

If you are familiar with the restore process, you can follow the steps in the window. The following instructions provide more detailed information.

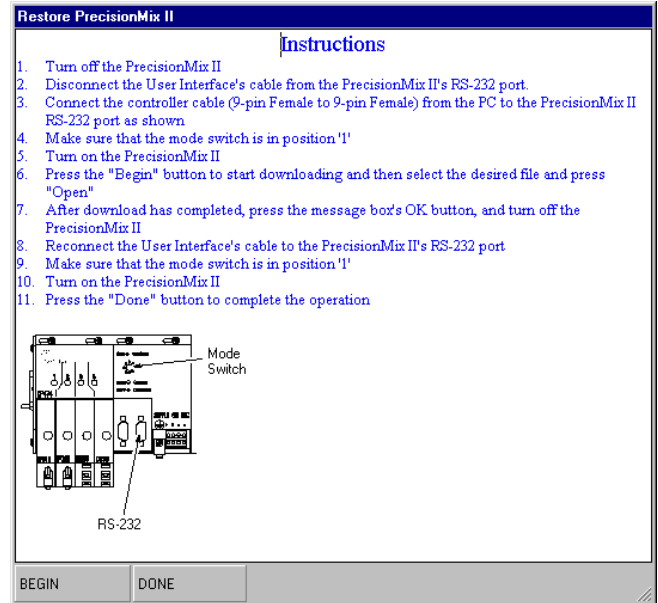

Fig. 13.14

3. Follow steps 3 to 7 on page 13–5.
4. Press the BEGIN button on the Instructions window to begin the restore. See Fig. 13.14.

☞ If a connection error occurs, see page 13–3, for instructions.

5. After the upload button is pressed, the Choose Backup File dialog box appears. See Fig. 13.15. Double-click on or select and press the Open button for the backup file you want to restore.

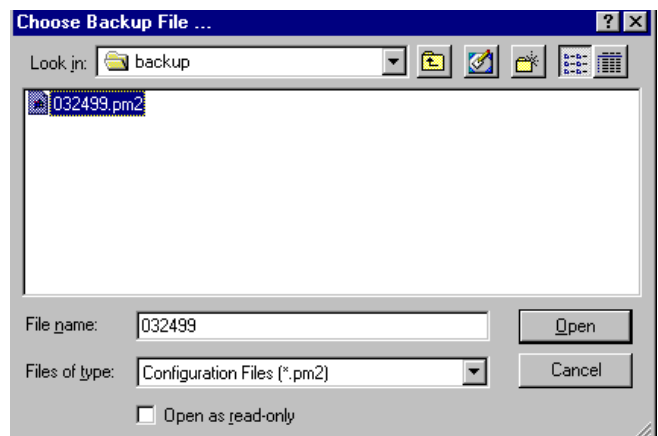

Fig. 13.15

# Utilities Software

## Restore PrecisionMix II – continued

6. A Progress meter appears and continues to display until the configuration parameters have finished downloading. See Fig. 13.16.

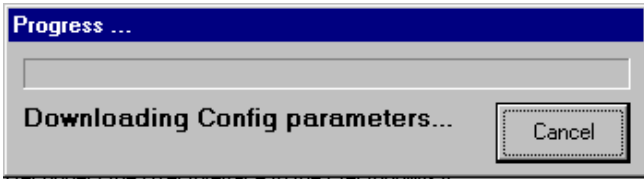

Fig. 13.16

After the configuration parameters finish downloading, a Progress meter for the recipe download appears and continues to display until all the recipes have finished downloading. See Fig. 13.17.

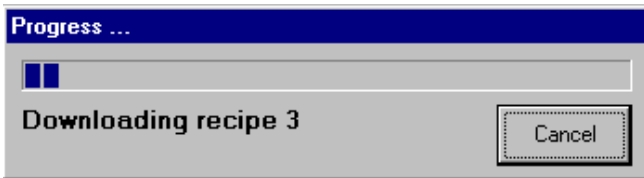

Fig. 13.17

### If an error occurs during the restore:

The configuration restore is terminated and "Disconnected..." will display at the bottom of the Utilities main window. Check the cable connection, then restart the backup by pressing the upload button again.

**NOTE:** The restore can be terminated by pressing Cancel on the Progress meter.

7. After the download is complete, turn off the PrecisionMix II power.
8. Disconnect the communication cable and reconnect the User Interface cable to the PrecisionMix II controller. See Fig. 13.6.
9. Turn the PrecisionMix II controller power on.
10. Press the DONE button to close the Instructions window. See Fig. 13.18.

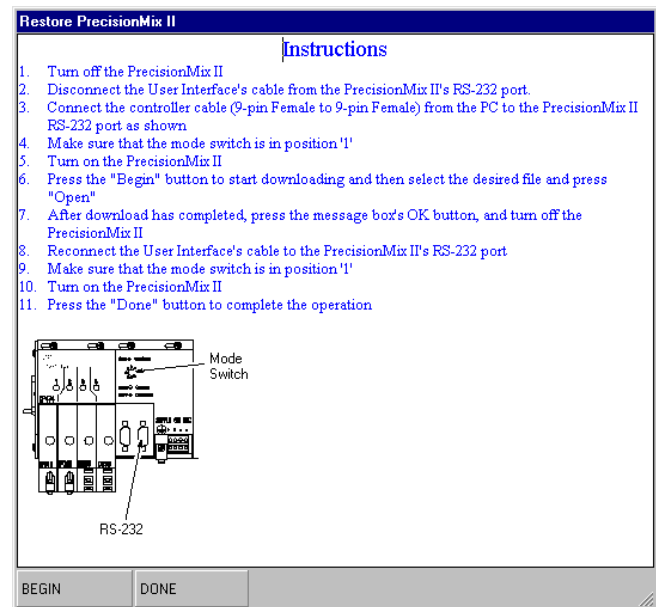



Fig. 13.18



# Utilities Software

## Update the Operating System

The Utility for Updating the Operating System is generally used when the software is upgraded.

 Updating the Operating System will reset the totalizers.

1. Select File ► Update ► Operating System. See Fig. 13.19.

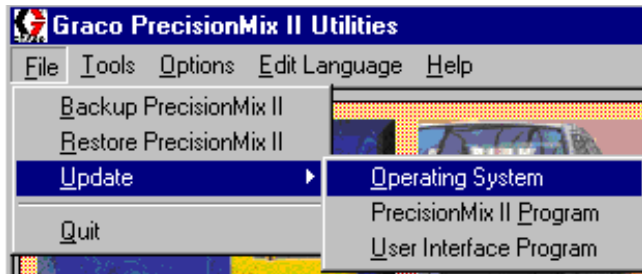

Fig. 13.19

2. An Instructions window to Update PrecisionMix II Operating System will appear. See Fig. 13.20.

If you are familiar with the update process, you can follow the steps in the window. The following instructions provide more detailed information.

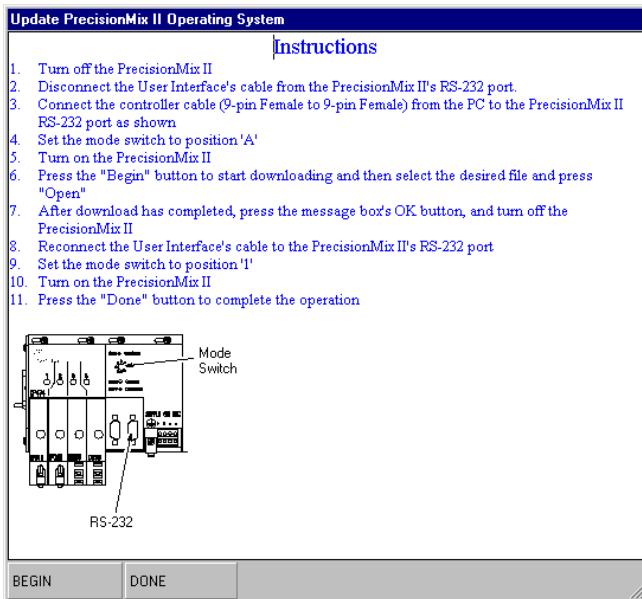

Fig. 13.20

3. Follow steps 3 to 6 on page 13–5.
4. Set the mode switch on the controller to A. See Fig. 13.21.

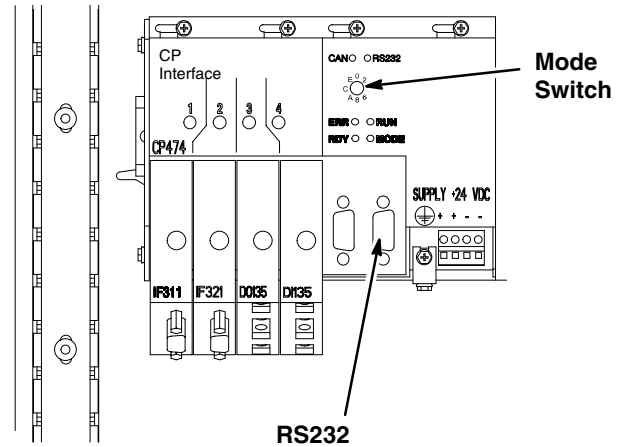



Fig. 13.21

5. Turn the PrecisionMix II power back on.
6. Press the BEGIN button on the Instructions window to begin the update. See Fig. 13.20.

 If a connection error occurs, see page 13–3, for instructions.

# Utilities Software

- After the BEGIN button is pressed a progress bar appears while Utilities try to connect with the controller.

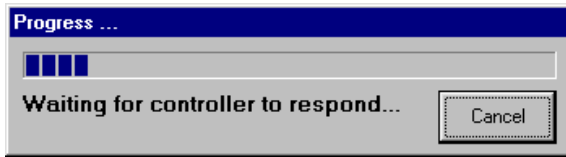

Fig. 13.22

- If the controller doesn't respond within a preset amount of time the following message box appears.



Fig. 13.23

In this case, check to make sure the cable is connected, power to the system is turned on, the mode switch on the controller is in the correct position, the correct COM port on the PC is selected, etc.

- After the controller responds, a series of operations occur to reset and clear the current memory contents of the controller. The following progress bar indicates this progress.

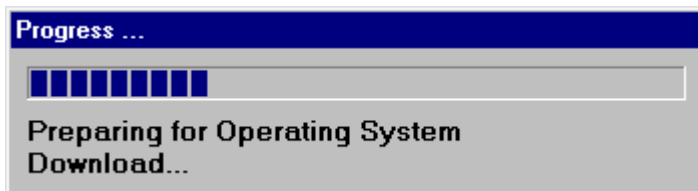

Fig. 13.24

- After the memory has been cleared, the operating system is downloaded while progress is monitored with the following progress bar.

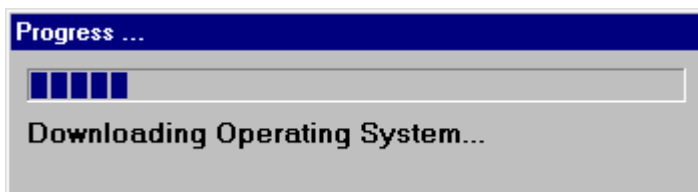

Fig. 13.25

- If an error occurs during download, a series of message boxes may appear indicating the errors. The download may be restarted after acknowledging the message boxes and correcting the cause of the error by returning to step 2.
- When the operating system download has completed the following message box will appear waiting for the user to acknowledge by pressing the button.



Fig. 13.26

- After the download is complete, turn off the PrecisionMix II power.
- Disconnect the communication cable and reconnect the User Interface cable to the PrecisionMix II controller.
- Set the mode switch to 1.
- Turn the PrecisionMix II controller power on.
- Press the DONE button to close the Instructions window. See Fig. 13.27.
- The system is now ready to update the PrecisionMix II Program.

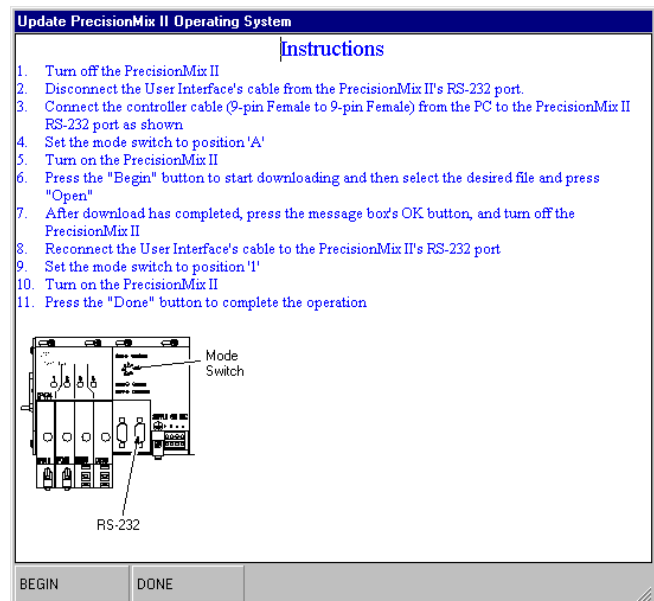



Fig. 13.27

# Utilities Software

## Update PrecisionMix II Program

This Utility allows the user to update the program for the PrecisionMix II controller. The program update usually does not require updating the operating system. If the operating system needs to be updated first, it will be noted in the information included with the program update files.

 Updating the PrecisionMix II Program will reset the totalizers.

1. Select File ► Update ► PrecisionMix II Program (Fig. 13.28) or press the Update PrecisionMix II Program button (Fig. 13.29).

### File ► Update ► PrecisionMix II Program

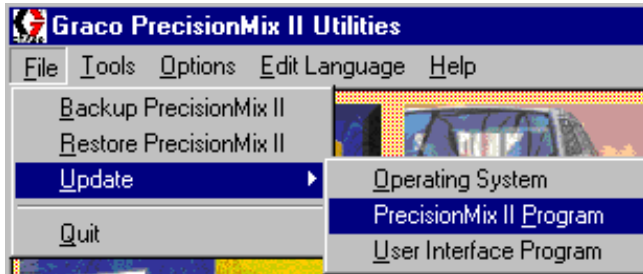

Fig. 13.28

### Update PrecisionMix II Program Button

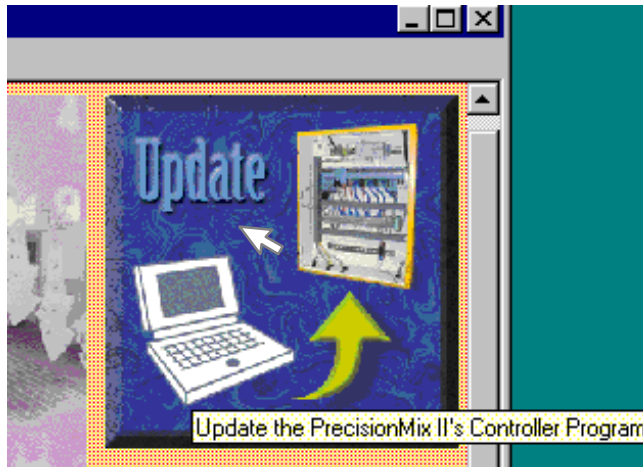

Fig. 13.29

2. An Instructions window to Update PrecisionMix II Program will appear. See Fig. 13.30.

If you are familiar with the update process, you can follow the steps in the window. The following instructions provide more detailed information.

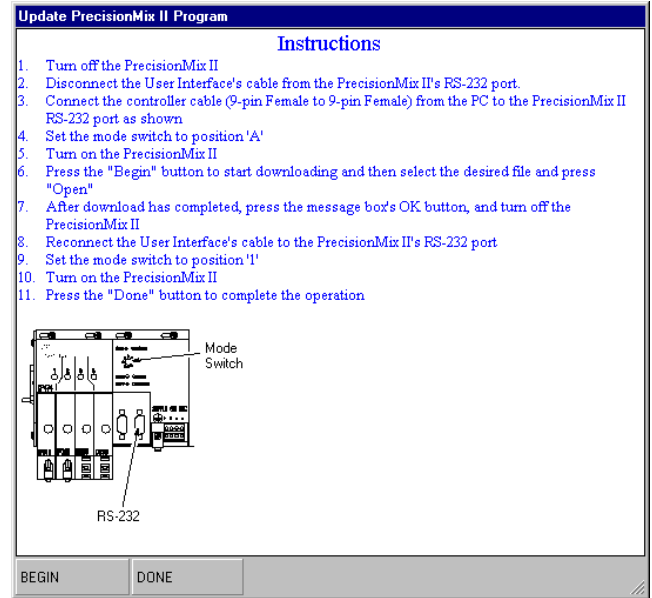

Fig. 13.30

3. Follow steps 3 to 6 on page 13–5.
4. Set the mode switch on the controller to A. See Fig. 13.31.

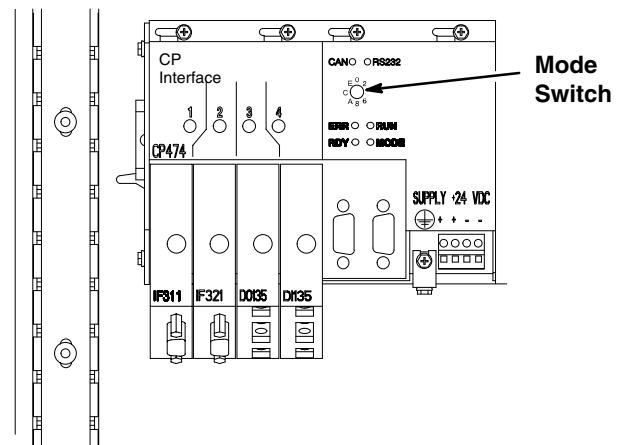



Fig. 13.31

5. Turn the PrecisionMix II power back on.

# Utilities Software

## Update PrecisionMix II Program – continued

6. Press the BEGIN button in the Instructions window to begin the update. See Fig. 13.30.

 If a connection error occurs, see page 13–3, for instructions.

## Connecting Utilities

1. After the download button is pressed a progress bar appears while Utilities tries to connect with the controller.

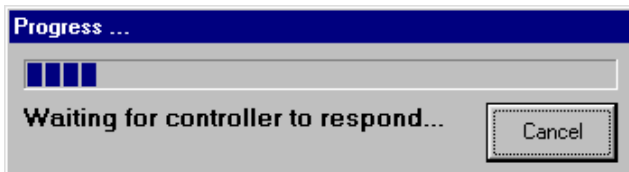

Fig. 13.32

2. If the controller doesn't respond within a preset amount of time the following message box appears.



Fig. 13.33

In this case, check to make sure the cable is connected, power to the system is turned on, the mode switch on the controller is in the correct position, the correct COM port on the PC is selected, etc.

3. After the controller responds, the Locate Program File List dialog box appears, displaying the default directory. Locate the Program File List in this directory or the location/disk where the file is stored. Double-click on the file or select it and press the Open button to start the download.

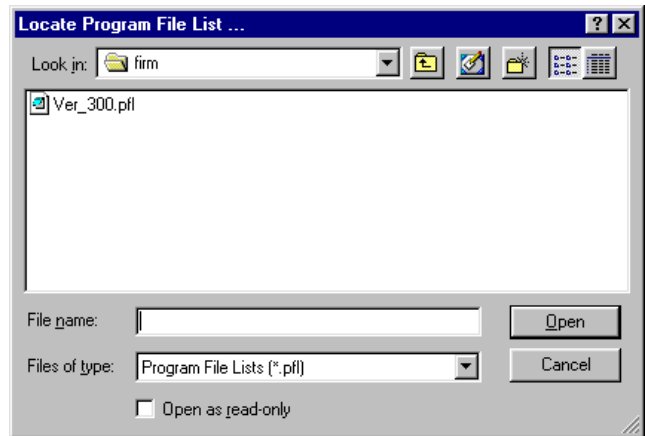

4. After the Program File List is selected, a series of operations occur to reset the controller. The following progress bar indicates this progress.



5. After the controller has been reset, the program is downloaded while progress is monitored with the following progress bar.

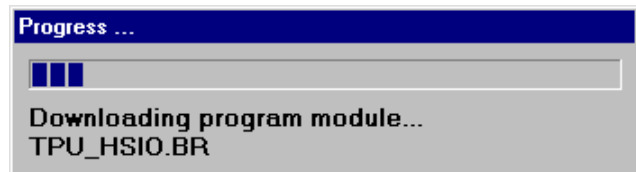

6. When the program download has completed the following message box will appear waiting for the user to acknowledge by pressing the button.

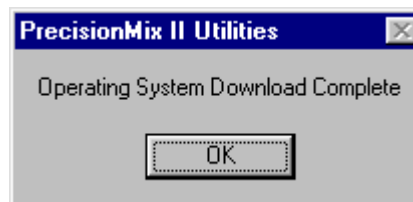

Fig. 13.34

7. After the download is complete, turn off the PrecisionMix II power.
8. Disconnect the communication cable and reconnect the User Interface cable to the PrecisionMix II controller. See Fig. 13.6.

# Utilities Software

## Connecting Utilities – continued

9. Set the mode switch to 1.
10. Turn the PrecisionMix II controller power on.
11. Press the DONE button to close the Instructions window. See Fig. 13.35.

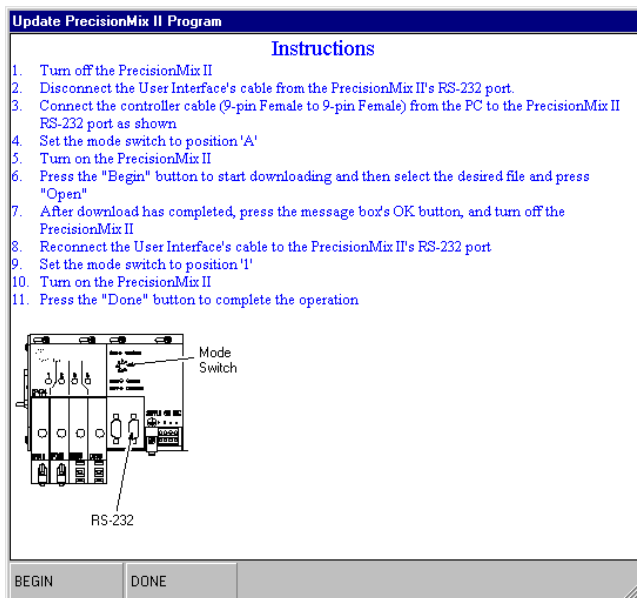

Fig. 13.35

## Update User Interface Program

If the battery fails or is not installed correctly, the User Interface setup memory could be lost. A copy of this setup is on the PrecisionMix II Maintenance Utilities software.

This utility allows the user to reload or update the program for the User Interface. Special instructions will be included with program update files about updating the User Interface.

1. Select File ► Update ► User Interface Program (Fig. 13.36) or press the Update User Interface Program button (Fig. 13.37).

## File ► Update ► User Interface Program

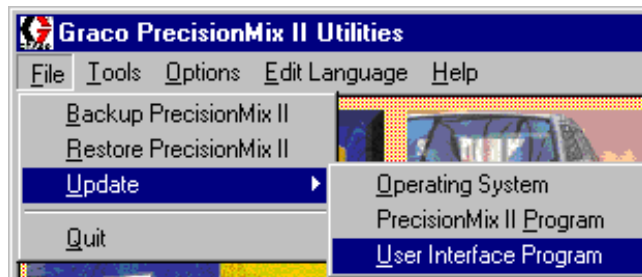

Fig. 13.36

## Update User Interface Program Button



Fig. 13.37

# Utilities Software

## Update User Interface Program – continued

2. An Instructions window to Update User Interface Program will appear. See Fig. 13.38.

If you are familiar with the update process, you can follow the steps in the window. The following instructions provide more detailed information.

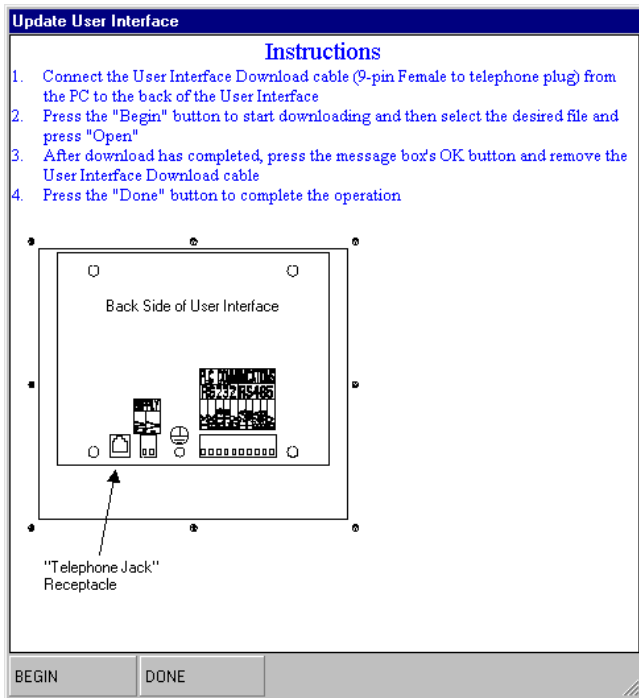

Fig. 13.38

Updating the User Interface does not require turning the PrecisionMix II power off and back on or changing the mode.

3. Connect the computer cable end (9 pin) to the computer serial port. Connect the other end of the cable (which looks like a telephone jack) to the User Interface. See Fig. 13.39.

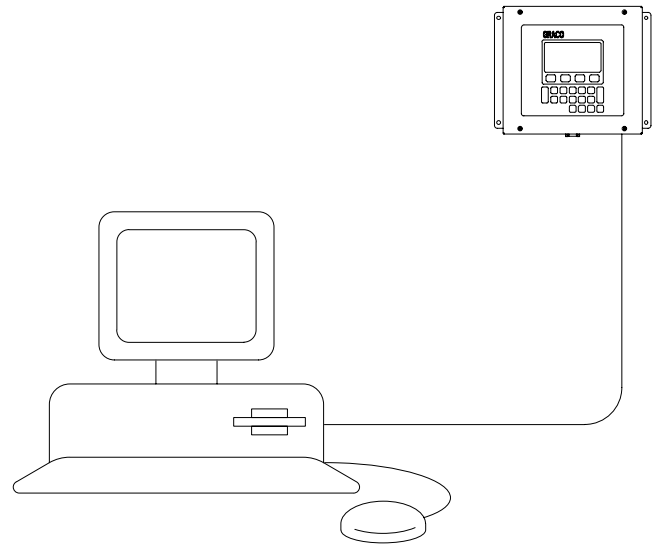

Fig. 13.39

4. Press the BEGIN button in the Instructions window to begin the update. See Fig. 13.38.

If a connection error occurs, see page 13–3, for instructions.

5. After the download button is pressed, the Locate Program Files dialog box appears, displaying the default directory. See Fig. 13.40. Locate the Program file in this directory or the location/disk where the file is stored. Double-click on the file or select it and press the Open button to start the download.

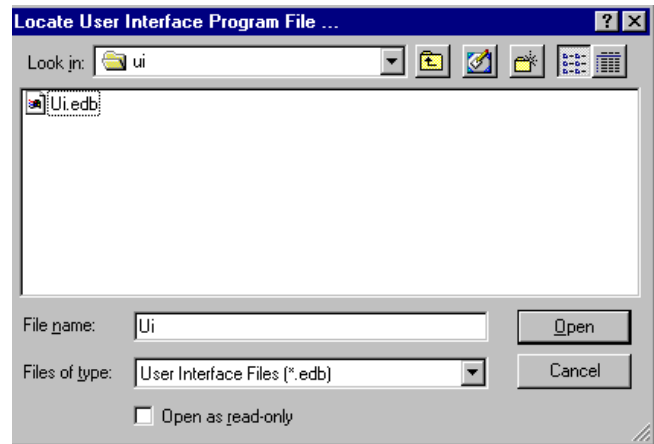

Fig. 13.40

# Utilities Software

## Update User Interface Program – continued

6. A Progress meter appears and continues to display until the update is complete. See Fig. 13.41.

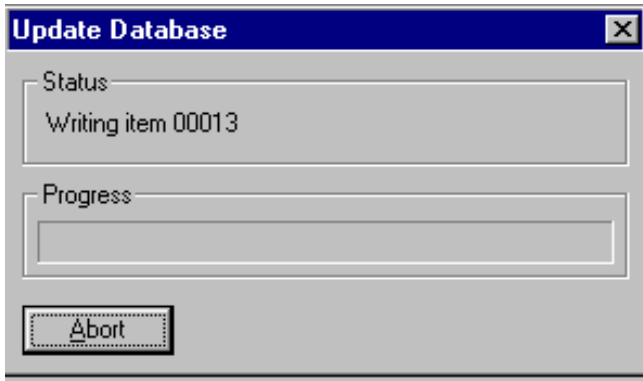

Fig. 13.41

### If an error occurs during the update:

The Update User Interface is terminated and “Disconnected...” will display at the bottom of the Utilities main window. Check the cable connection, then restart the update by pressing the download button again.

**NOTE:** The update can be terminated by pressing Abort on the Progress meter (Fig. 13.41).

7. After the download is complete, disconnect the cable from the computer and User Interface.

## Reset PrecisionMix II Password

This utility allows the user to reset the password of the PrecisionMix II controller to 0 (zero). The 0 setting disables the password requirement from the User Interface to enter system configuration or recipe setup menus.

1. Follow steps 3 to 6 on page 13–5.
2. Turn the PrecisionMix II power back on.
3. Select Tools ► Reset PrecisionMix II Password. See Fig. 13.42.

308916



Fig. 13.42

-  If a connection error occurs, see page 13–3, for instructions.

4. If the password reset is not successful, the system will display the warning dialog box shown in Fig. 13.43. Correct the problem and retry the password change or cancel it.

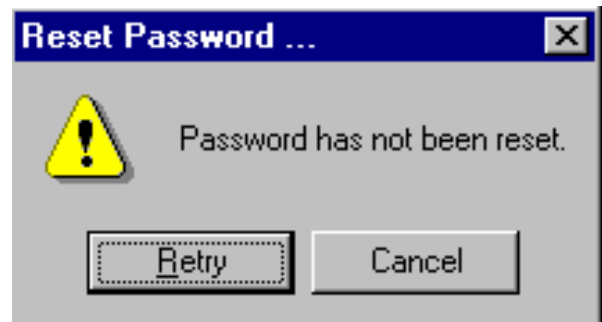

Fig. 13.43

5. If the password reset is successful, the system will confirm the reset with the dialog box shown in Fig. 13.44. Press the OK button to close the dialog box.



Fig. 13.44

6. Turn off the PrecisionMix II power.
7. Disconnect the communication cable and reconnect the User Interface cable to the PrecisionMix II controller. See Fig. 13.6.
8. Turn the PrecisionMix II controller power on.

# Utilities Software

## Set PrecisionMix II Date and Time

This utility allows the user to match the date and time of the PrecisionMix II to the date and time of the computer that is running the utility software.

1. Follow steps 3 to 6 on page 13–5.
2. Turn the PrecisionMix II power back on.
3. Select Tools ► Set PrecisionMix II Date and Time. See Fig. 13.45.



Fig. 13.45

☞ If a connection error occurs, see page 13–3, for instructions.

4. If setting the date and time is not successful, the system will display the warning dialog box shown in Fig. 13.46. Correct the problem and retry setting the date and time or cancel the setting.



Fig. 13.46

5. If setting the date and time is successful, the system will confirm the reset with the dialog box shown in Fig. 13.47. Press the OK button to close the dialog box.



Fig. 13.47

6. Turn off the PrecisionMix II power.
7. Disconnect the communication cable and reconnect the User Interface cable to the PrecisionMix II controller. See Fig. 13.6.
8. Turn the PrecisionMix II controller power on.



# Utilities Software

## Open Graco Web Site

If internet access is available, select Tools ► Open Graco Web Site to start the computer's default browser and connect to the Graco web site. See Fig. 13.48.



Fig. 13.48

## Edit Language

This utility allows the user to edit the “Other” language text stored in the PrecisionMix II controller or the User Interface. “Other” must be selected during system configuration, language selection. Refer to section 8, page 8–5.

## Edit User Interface Language

1. Select Edit Language ► User Interface. See Fig. 13.49.



Fig. 13.49

2. The Locate User Interface Program File dialog box appears, displaying the default directory. See Fig. 13.50. Locate the Program file in this directory or the location/disk where the file is stored. Double-click on the file or select it and press the Open button.

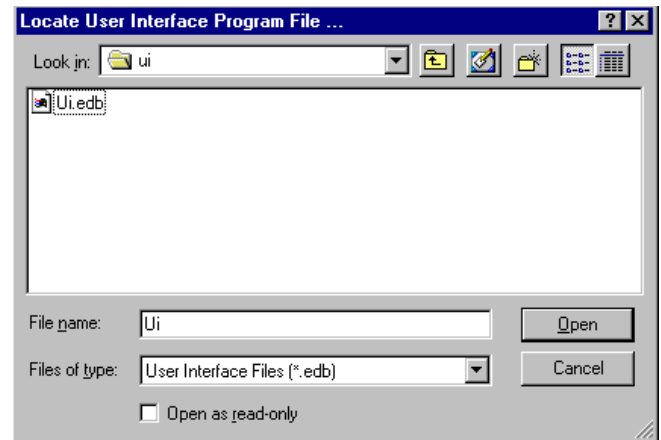

Fig. 13.50

3. A dialog box informs you that you can only edit string translations. Press the OK button.

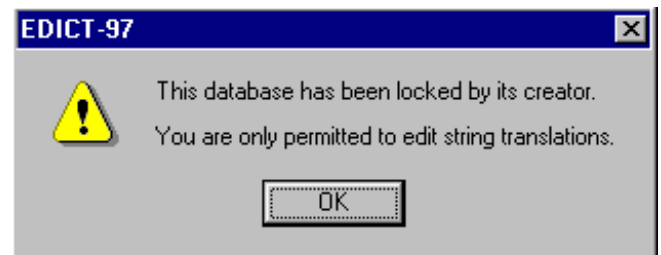



Fig. 13.51

# Utilities Software

## Edit Language

### Edit User Interface Language – continued

4. A Language Editor screen for Translating Database Strings appears. See Fig. 13.52.
5. Scroll down the screen until you reach the text you want to translate.
6. “U.S. English” is in the middle column, followed by the “Custom Translation” column. The translation can be entered directly into this screen or it can be entered into a text file and then imported into the database.

 You must press the “Enter” key on the computer keyboard after each entry or press the OK button on the screen to save changes to the database before updating the User Interface.

## Screen Entry

Type in the appropriate translation in the Custom Translation column.

Press the OK button to update the user interface file with your changes and close the screen.

Press the Cancel button to close the dialog box without making changes.



Fig. 13.52

# Utilities Software

## Edit Language

### Edit User Interface Language – continued

#### Exporting and Importing Text Files

- a. Press the Export button in the Language Editor screen to save data to a text file. This can be a convenient method of sending a file to a translator or to store more than one translation as separate files to import as needed.
- b. Name the file and press the OK button to create the text file. See Fig. 13.53.

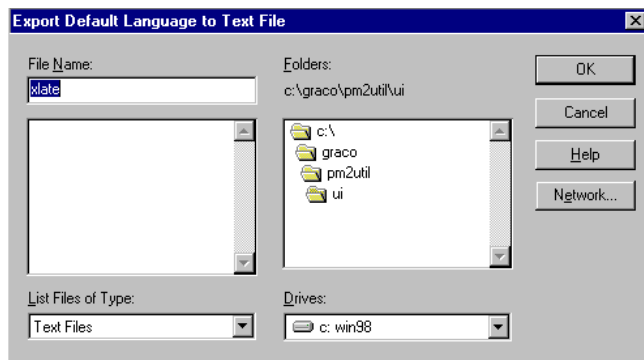

Fig. 13.53

- c. Open the text file and replace the English text with the desired translation. See Fig. 13.54.

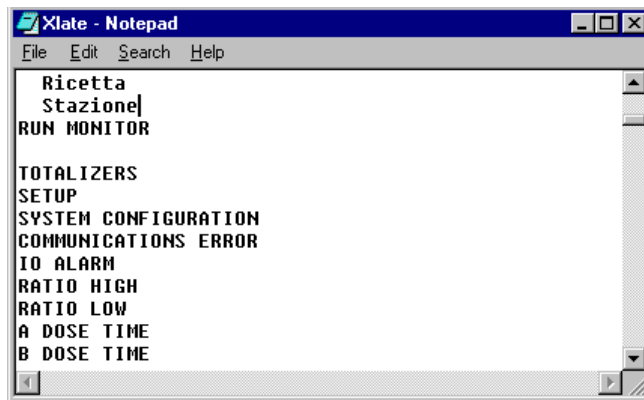



Fig. 13.54

- d. Press the Import button in the Language Editor screen to load the text file. A dialog box will warn you that importing a file will overwrite an existing translation. See Fig. 13.55. Press the Yes button to proceed.

 In order for the text file to import successfully:

- Each line of the text file must be in the same order as it was exported.
- There must not be any additional information at the end of the text file.

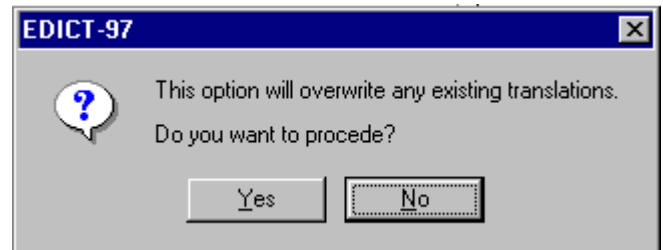

Fig. 13.55

- e. Select the desired text file, and press the OK button in the dialog box to update the database with your changes. Press the Cancel button to close the dialog box without making changes. See Fig. 13.56.

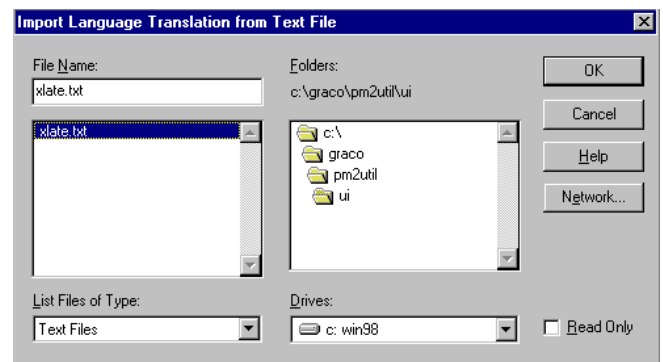

Fig. 13.56

# Utilities Software

## Edit Language

### Edit User Interface Language – continued

☞ Updating the User Interface does not require turning the PrecisionMix II power off and back on.

7. To update the User Interface with the translation, connect the computer cable end (9 pin) to the computer serial port. Connect the jack end of the cable to the User Interface. See Fig. 13.57.

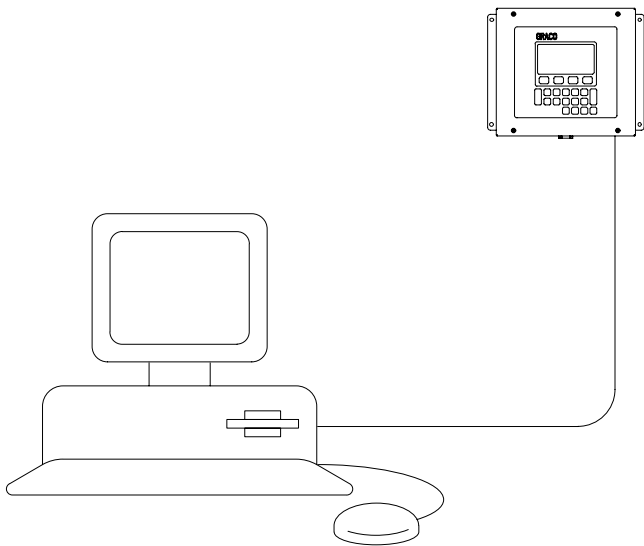

Fig. 13.57

8. Press the Update button (Fig. 13.58) on the Translate Database Strings screen.

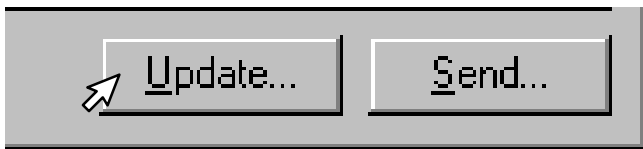

Fig. 13.58

☞ If a connection error occurs (Fig. 13.59), see page 13–3, for instructions.

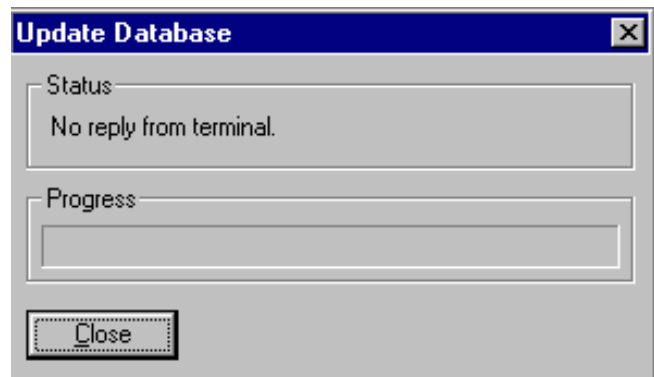

Fig. 13.59

9. The update will send the information to the User Interface. This may take some time to complete. A Progress meter will display the status of the update.

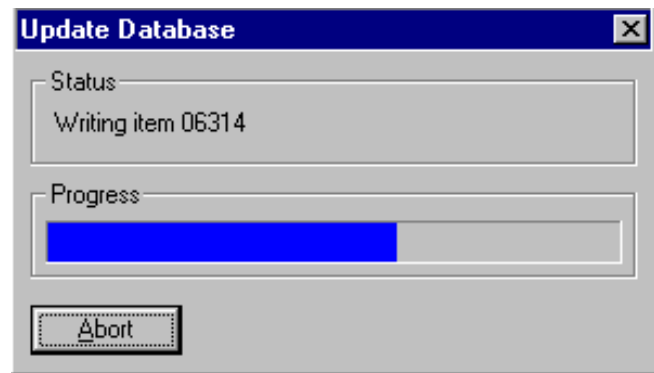

Fig. 13.60

10. When the Progress window closes, the update is complete. Wait for the User Interface to *need information*. Press the Home button and toggle through a number of the screens to verify the update was successful.

# Utilities Software

## Edit Language

### Edit Run Screen Monitor, Alarms, and Printer Reports Language

The procedure for editing the language for the Run Screen Monitor, the Alarm display and the Printer Reports is the same. The contents of the Language Editor screens and dialog boxes will vary. The following procedure shows the dialog boxes and screens that will appear when editing the Run Screen Monitor.

1. Select Edit Language ► Run Screen Monitor or Alarms or Printer Reports ►, choosing what you want to edit. See Fig. 13.61.



Fig. 13.61

2. A Language Editor screen appears. See Fig. 13.62. There is a column for the “English” (A), which cannot be edited, and column for the “Other Language” (B).
3. In the Other Language column, select the text you want to change (C). The selected text will appear in the text bar (D).



Fig. 13.62

# Utilities Software

## Edit Language

### Edit Run Screen Monitor Language – continued

4. Type the translation over the text in the text bar. Press ENTER to enter the text into the Other Language column (E) and go to the next line of text (F). See Fig. 13.63.
5. Continue typing and entering text until all the lines have been completed.

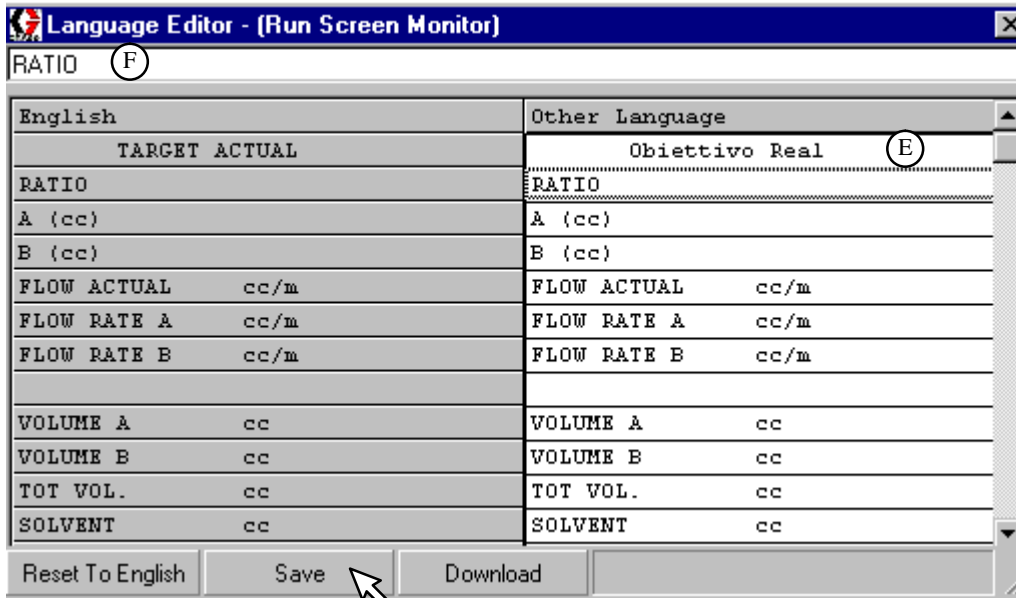

Fig. 13.63

6. Press the Save button to save the changes.
7. If the save is successful, "File saved" will display in the bottom right corner of the screen. See Fig. 13.64.

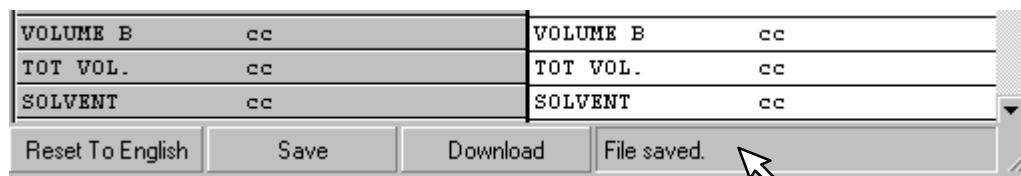

Fig. 13.64

# Utilities Software

## Edit Language

### Edit Run Screen Monitor Language – continued

- Download the language file for the Run Screen Monitor by pressing the Download button. See Fig. 13.65.

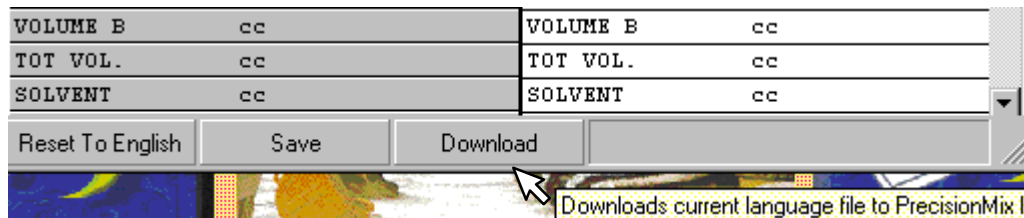

Fig. 13.65

- An Instructions window to Download Language File Program will appear. See Fig. 13.66. If you are familiar with the update process, you can follow the steps in the window. The following instructions provide more detailed information.

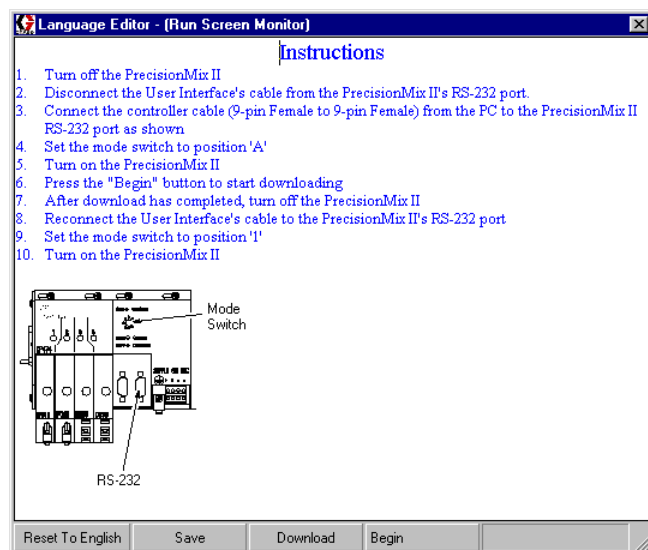

Fig. 13.66

- Follow steps 3 to 6 on page 13–5.
- Set the mode switch on the controller to A. See Fig. 13.67.

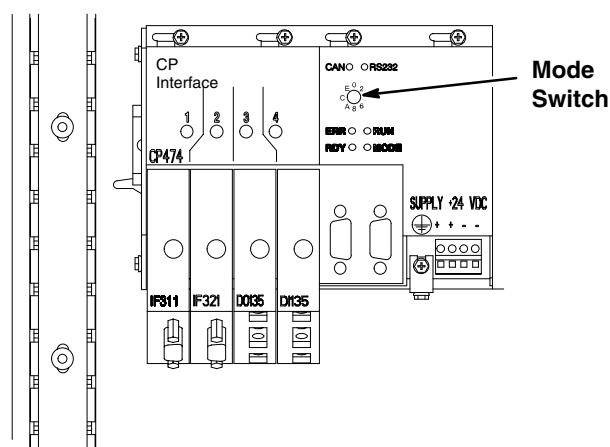
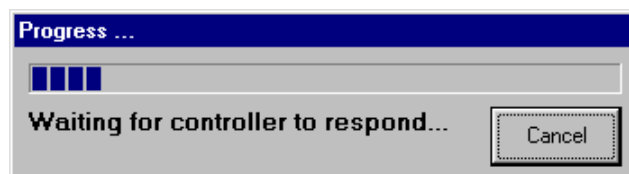

Fig. 13.67

- Turn the PrecisionMix II power back on.
- Press the BEGIN button in the Instruction screen to begin downloading the language file to the Run Screen Monitor. See Fig. 13.66.

- After the BEGIN button is pressed a progress bar appears while Utilities tries to connect with the controller.



# Utilities Software

## Edit Language

### Edit Run Screen Monitor Language – continued

11. If the controller doesn't respond within a preset amount of time the following message box appears. In this case, check to make sure the cable is connected, power to the system is turned on, the mode switch on the controller is in the correct position, the correct COM port on the PC is selected, etc.

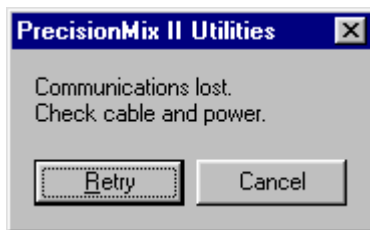

12. After the controller responds, the following progress bar indicates the progress of downloading the language file.

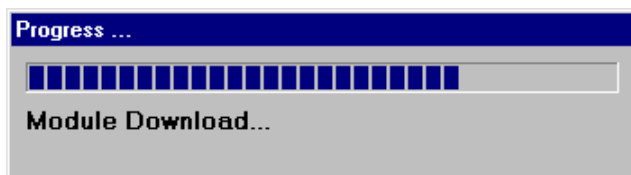

13. A "Save File" dialog box will display (Fig. 13.68), asking for confirmation to save the Other Language file with the Program files so future Program Updates will include this file. Answering "Yes" is recommended.

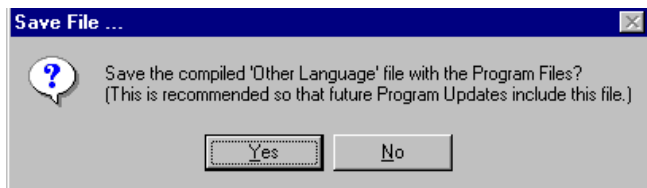

Fig. 13.68

14. The Locate Program Files Directory dialog box appears, displaying the default directory. See Fig. 13.69. Double-click on the file or select it and press the Open button.

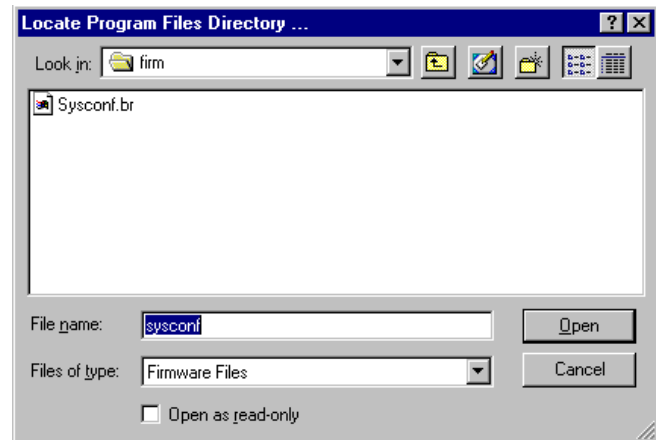

Fig. 13.69



# Utilities Software

## Edit Language

### Edit Run Screen Monitor Language – continued

15. Turn off the PrecisionMix II power.
16. Disconnect the communication cable and reconnect the User Interface cable to the PrecisionMix II controller.
17. Set the mode switch to 1.
18. Turn the PrecisionMix II controller power on.
19. Press the X button to close the Language Editor.

 If desired, the Other Language column can be reset to English by pressing the Reset to English button. See Fig. 13.70.

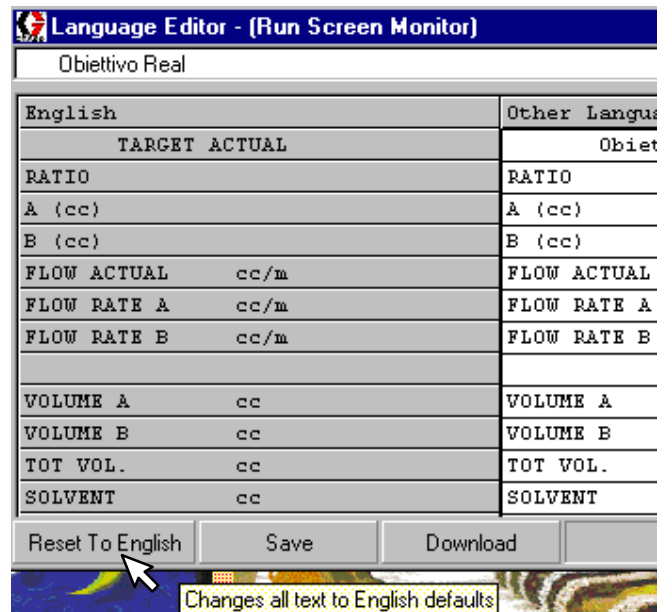

Fig. 13.70



**14**

# **Technical Data**



# Technical Data

Mix Ratio Range	0.6 to 30:1*
Mix Ratio Tolerance Range	1% minimum (user selectable)
Minimum Flow Rate	50 cc/minute with G3000 meter. Using appropriate accessory meters can enable system for flow rates as low as 10 cc/minute.
Maximum Flow Rate	2000 cc/minute with G3000 meter To 4000 cc/minute with lessor resolution meter options.
<i>With Flow Control:</i>	100 to 2000 cc/minute*
Maximum Fluid Working Pressure	
Basic Fluid Panel	3000 psi (21 MPa, 210 bar)
With High Pressure Color Change	3000 psi (21 MPa, 210 bar)
With Low Pressure Color Change	300 psi (2.1 MPa, 21 bar)
With Robo-Mix Fluid Panel	190 psi (1.3 MPa, 13 bar)
With Flow Control	250 psi (1.7 MPa, 17 bar)
Air Supply Pressure Range	80–125 psi (550–900 kPa, 5.5–9 bar) Filtration required for atomizing air quality desired.
Fluid Filtration Required	100 mesh (149 micron) minimum
Viscosity Range of Fluids	20 to 3000 cps with G3000 meters Heavier viscosities can be proportioned with use of optional meters and hardware.
Wetted Parts	
Meters and Fluid Panels	303, 304, 17–4 stainless steel; tungsten carbide (with nickel binder), Chemrez, PTFE, CV75
Maximum Power Requirement	125 watts
Power Supply Voltage Range	
120 Vac nominal	85–164 VAC, 50–60 Hz., single phase
220 Vac nominal	165–265 VAC, 50–60 Hz., single phase
Operating Temperature Range	
Controller	40°–122° F (4°–50° C)
Fluid Panel	40°–180° F (4°–82° C)
Communications	
Printer	RS–232
Network/PC	RS–485
Communication Protocol	Modbus

\* See your Graco Authorized distributor for other capabilities

Chemraz® is a registered trademark of the Green, Tweed, & Company.

# Technical Data

## Cable Lengths

Controller to Fluid Panel	
Standard .....	50 ft. (15.2 m)
Maximum .....	150 ft. (45.75 m)
Controller to Booth Control	
Standard .....	100 ft. (30.5 m)
Maximum .....	150 ft. (45.75 m)
Controller to Gun Flush Box	
Standard .....	100 ft. (30.5 m)
Maximum .....	150 ft. (45.75 m)
Controller to Flow Control I/P and Meters	
Standard .....	100 ft. (30.5 m)
Maximum .....	150 ft. (45.75 m)
Controller to Remote Operator Interface	
Standard .....	50 ft. (15.2 m)
Maximum .....	50 ft. (15.2 m)
Run Screen Monitor	
Standard .....	100 ft. (30.5 m)
Maximum .....	150 ft. (45.75 m)
Printer Cable	
Standard .....	10 ft. (3.05 m)
Maximum .....	50 ft. (15.2 m)
Network Cable	
Minimum .....	none
Total cable maximum length .....	4000 ft. (1220 m)
Maximum Number of Meter Inputs .....	4
Maximum Number of Colors .....	12
Maximum Number of Catalysts .....	3
Maximum Number of Recipes .....	63
Maximum Number of Systems/Network .....	32
Flow Control	
Operating Flow Rate Range .....	100–2000 cc/minute*
Maximum Turndown .....	8 times
Example:	100 cc to 800 cc/minute 200 cc to 1600 cc/minute
Analog Input Signal .....	0–20 mA
Current Output Signal .....	0–20 mA
Maximize I/P Override .....	24 VDC discrete
Maximum Fluid Output Pressure .....	100 psi (0.7 MPa, 7 bar)
Minimum Fluid Back Pressure .....	7 psi (48 kPa, 0.5 bar)

\* See your Graco Authorized distributor for other capabilities



# Graco Standard Warranty

Graco warrants all equipment manufactured by Graco and bearing its name to be free from defects in material and workmanship on the date of sale to the original purchaser for use. With the exception of any special, extended, or limited warranty published by Graco, Graco will, for a period of twelve months from the date of sale, repair or replace any part of the equipment determined by Graco to be defective. This warranty applies only when the equipment is installed, operated and maintained in accordance with Graco's written recommendations.

This warranty does not cover, and Graco shall not be liable for general wear and tear, or any malfunction, damage or wear caused by faulty installation, misapplication, abrasion, corrosion, inadequate or improper maintenance, negligence, accident, tampering, or substitution of non-Graco component parts. Nor shall Graco be liable for malfunction, damage or wear caused by the incompatibility of Graco equipment with structures, accessories, equipment or materials not supplied by Graco, or the improper design, manufacture, installation, operation or maintenance of structures, accessories, equipment or materials not supplied by Graco.

This warranty is conditioned upon the prepaid return of the equipment claimed to be defective to an authorized Graco distributor for verification of the claimed defect. If the claimed defect is verified, Graco will repair or replace free of charge any defective parts. The equipment will be returned to the original purchaser transportation prepaid. If inspection of the equipment does not disclose any defect in material or workmanship, repairs will be made at a reasonable charge, which charges may include the costs of parts, labor, and transportation.

**THIS WARRANTY IS EXCLUSIVE, AND IS IN LIEU OF ANY OTHER WARRANTIES, EXPRESS OR IMPLIED, INCLUDING BUT NOT LIMITED TO WARRANTY OF MERCHANTABILITY OR WARRANTY OF FITNESS FOR A PARTICULAR PURPOSE.**

Graco's sole obligation and buyer's sole remedy for any breach of warranty shall be as set forth above. The buyer agrees that no other remedy (including, but not limited to, incidental or consequential damages for lost profits, lost sales, injury to person or property, or any other incidental or consequential loss) shall be available. Any action for breach of warranty must be brought within two (2) years of the date of sale.

Graco makes no warranty, and disclaims all implied warranties of merchantability and fitness for a particular purpose in connection with accessories, equipment, materials or components sold but not manufactured by Graco. These items sold, but not manufactured by Graco (such as electric motors, switches, hose, etc.), are subject to the warranty, if any, of their manufacturer. Graco will provide purchaser with reasonable assistance in making any claim for breach of these warranties.

In no event will Graco be liable for indirect, incidental, special or consequential damages resulting from Graco supplying equipment hereunder, or the furnishing, performance, or use of any products or other goods sold hereto, whether due to a breach of contract, breach of warranty, the negligence of Graco, or otherwise.

## **FOR GRACO CANADA CUSTOMERS**

The parties acknowledge that they have required that the present document, as well as all documents, notices and legal proceedings entered into, given or instituted pursuant hereto or relating directly or indirectly hereto, be drawn up in English. Les parties reconnaissent avoir convenu que la rédaction du présente document sera en Anglais, ainsi que tous documents, avis et procédures judiciaires exécutés, donnés ou intentés à la suite de ou en rapport, directement ou indirectement, avec les procédures concernées.

## Graco Information

For the latest information about Graco products, visit [www.graco.com](http://www.graco.com).

**TO PLACE AN ORDER**, contact your Graco distributor or call to identify the distributor closest to you:

**Phone:** 612-623-6921 or **Toll Free:** 1-800-328-0211 **Fax:** 612-378-3505

*All written and visual data contained in this document reflects the latest product information available at the time of publication. Graco reserves the right to make changes at any time without notice.*

Original Instructions. This manual contains English. MM 308076

**Graco Headquarters:** Minneapolis  
**International Offices:** Belgium, China, Japan, Korea

**GRACO INC. P.O. BOX 1441 MINNEAPOLIS, MN 55440-1441**

**Copyright 1990, Graco Inc. is registered to ISO 9001**

**[www.graco.com](http://www.graco.com)**

Revised 03/2011