

INTERIOR MOULDING & TRIM



METRIE.

THE ART OF FORM





METRIE.

THE ART OF FORM

WHO WE ARE

Since our beginnings as a small family-owned business in 1926, our dedication to creating high-quality, finely crafted architectural elements has helped us grow to become the largest supplier and manufacturer of solid wood and composite moulding in North America.

METRIE.COM

DESIGN – PARTNERSHIP – CRAFTSMANSHIP



Our success is driven by a commitment to deliver excellence rooted in design, partnership and craftsmanship.

We believe beauty is in the details, and know that even the smallest of details adds up to create big differences.

Design is in our DNA, and permeates many aspects of our business. Our teams work on everything from trend forecasting to creating new profiles that meet the needs of our customers and homeowners.

We design and craft relationships you can count on – partnerships you can rely on. We collaborate with our partners while listening and talking to designers, architects, builders and contractors – adding value throughout the supply chain.



Our attention
to the details
helps people
create beautiful
interior spaces.
Spaces to live,
work and to truly
call home.



FIND US, FOLLOW US, LIKE US & WATCH US!



MANUFACTURING EXCELLENCE

Metrie operates five domestic manufacturing facilities between the U.S. and Canada. Our solid and finger-jointed wood mills are located close to their respective fiber sources to minimize the costs and environmental impacts of transportation while ensuring that all raw materials are responsibly sourced. Our state-of-the-art MDF mills are technologically advanced and designed for efficient operations, reflecting our customer commitment to delivering finely crafted, high quality products.



UNMATCHED QUALITY

Our mills allow us the flexibility to provide the right solutions to the markets we serve, understanding regional differences and adhering to strict specification standards. In addition, we have the ability to design, test and produce exclusive profiles to satisfy a custom order or to stay on top of the latest home trends. We have full in-house CAD capabilities and use computer-generated templates to manufacture profiles to extremely tight tolerances. Metrie has built a reputation for setting some of the highest industry standards.



RESPONSIBLE ACTIONS

With fine craftsmanship comes responsibility, and we are committed to being responsible stewards of forest resources. We strive to maximize the yield from every board using variable width and multiple rip-saws. Our resaws use ultra-thin blades to minimize saw kerf and any products that do not meet our length criteria are manufactured into finger-joint blocks to eventually become finger-jointed mouldings.



TheFinishedSpace.com



Facebook.com/OfficialMetrie



Twitter.com/OfficialMetrie



Instagram.com/OfficialMetrie



LinkedIn.com/Company/Metrie



Pinterest.com/OfficialMetrie



YouTube.com/OfficialMetrie



Houzz.com/pro/Metrie

TABLE of Contents

- 6 Architraves
- 9 Astragals
- 11 Back Bands
- 12 Baseboards
- 25 Baseboard Caps
- 26 Brick Moulds
- 27 Casings
- 42 Chair Rails
- 43 Corner Guards
- 44 Coves
- 45 Crowns
- 56 Door Stops
- 58 Flat Stock
- 61 Glass & Sash Beads
- 62 Hand Rails
- 63 Jambs
- 65 Lintels
- 66 Panel & Picture Moulds
- 67 Shiplaps
- 68 Squares
- 69 Tongue & Groove Paneling
- 70 Wainscot Caps
- 71 Miscellaneous
- 74 Notes
- 75 Index



Storage, Handling and Preparation of all Mouldings and S4S Boards

Prior to installation, it is important to acclimate your moulding and trim products by storing them in the installation space for at least 3 days. Wood and wood based products can expand and contract depending on internal and external environmental moisture levels. For best results, be sure to store products in a dry location and transport only if fully protected from water. Keep products clean from dirt and debris and finish according to paint and stain manufacturers' recommendations.



- 1 **ARCHITRAVES:** In classical architecture, it described the main beam resting on the tops of the columns. Today it is often used as a decorative moulding for ornamentation or finishing at the top of windows and doors.
- 2 **BASEBOARDS:** Baseboards are placed along the wall at the floor. They should be chosen to work in harmony with your casings to finish and tie the room together. Baseboards are usually thinner than the casing.
- 3 **BUILD-UPS:** Combining two or more moulding profiles to create a new or custom look. Also called stacking, build-ups make it easy to create the look of custom made trimwork without the high cost.
- 4 **CASINGS:** Casings define the overall character of a room and are often the most visible part of the trim. They are used primarily to cover the gap between drywall and the door or window frame. Casings are generally thicker than the base mouldings.
- 5 **CROWNS:** Crowns are placed along the wall at the ceiling. They come in a wide range of patterns and sizes. Crowns soften the transition from wall to ceiling while adding a distinctive look and charm to your room.
- 6 **FINISH BOARDS:** Finish Boards come in either S4S (Surfaced 4 Sides) or S3S (Surfaced 3 Sides) and are used for a multitude of purposes including shelving, window liner, bases, casing, etc.
- 7 **PANEL MOULDS:** Panel Moulds are used to frame wall paneling and add an accent to your walls. Often used in furniture construction.
- 8 **RAKE MOULD:** Rakes are often used as crowns. In fact, they are sometimes called "solid crowns".
- 9 **WAINSCOT:** Trimwork installed in the area below a chair rail. Numerous options are available including raised panel, shadow box and beaded. Combined with a chair rail and baseboard, Wainscoting creates a dramatic look to any room.
- 10 **WINDOW STOOL:** Also called window sill, a Window Stool is the surface installed below the sash of a window. Trim installed under window stool creates a distinctive look and adds a decorative touch.

ARCHITRAVES

ARCHITRAVES

High above windows and doors, architraves work to add grandeur to any space – reducing miter lines and elevating your look. A great architrave is, above all else, the dressing that's built to impress.



Stock Code **MTEK5000**
(1556499) Dimensions **1³/₁₆" x 3³/₄" x 16'**

COM

MH5000 1³/₁₆" x 3³/₄" x RL
(1556159)

H

MFP5000 1³/₁₆" x 3³/₄" x 16'
(1341811)

MDF/UL



Stock Code **MAKRB6**
(1009179) Dimensions **1¹/₄" x 4³/₁₆" x RL**

ALD

ARCHITRAVES

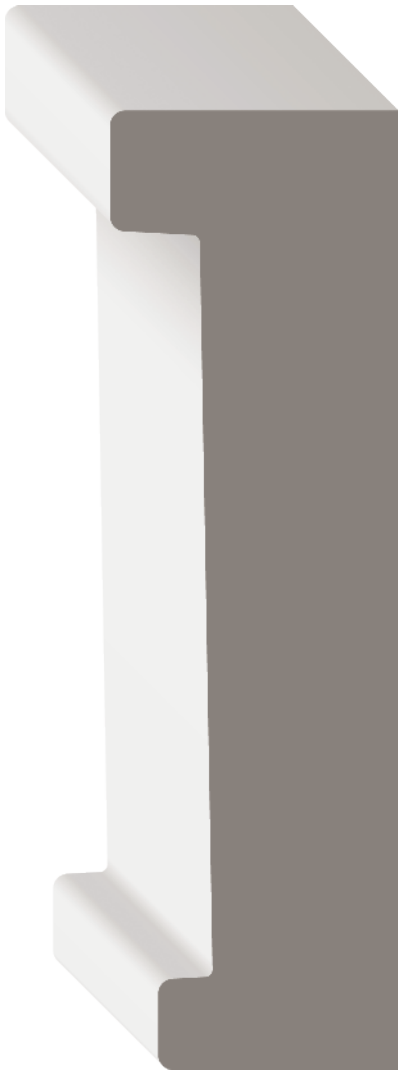

Stock Code
1322025

Dimensions
1½" x 5" x 12'
MDF/UL

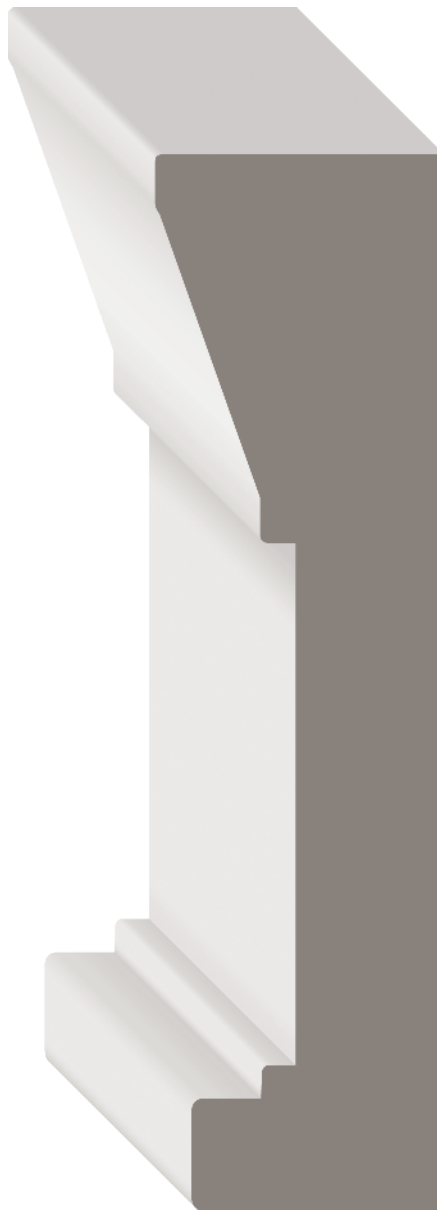

Stock Code
1328514
1677969

Dimensions
1½" x 5½" x 12'
1½" x 5½" x 16'
MDF/UL

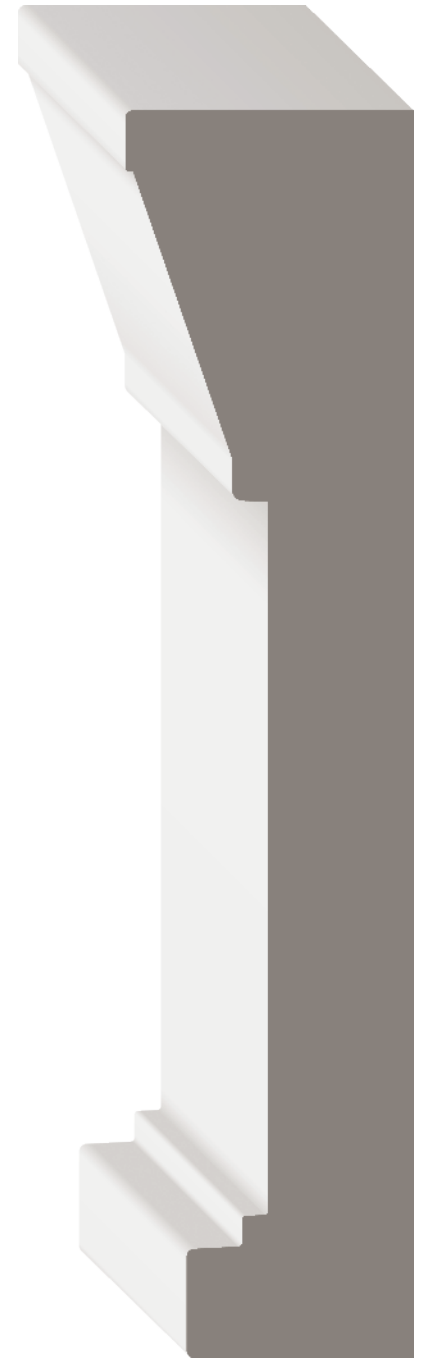

Stock Code
1324430

Dimensions
1½" x 6½" x 12'
MDF/UL

ARCHITRAVES



Stock Code
MFP5010
(1626186)

Dimensions
1 3/16" x 4 1/4" x 16'

MDF/UL



Stock Code
MTEK5020
(1611393)

Dimensions
1 3/16" x 5 1/4" x 16'

COM

MH5020 1 3/16" x 5 1/4" x RL
(1556160)

H

MFP5020 1 3/16" x 5 1/4" x RL
(1610429)

MDF/UL



Stock Code
MFP5030
(1328518)

Dimensions
1 3/16" x 6 1/4" x 16'

MDF/UL

ASTRAGALS

An astragal is commonly used to seal between a pair of doors. The astragal closes the clearance gap. The vertical moulding attaches to a stile on one of a pair of doors against which the other door strikes or closes.

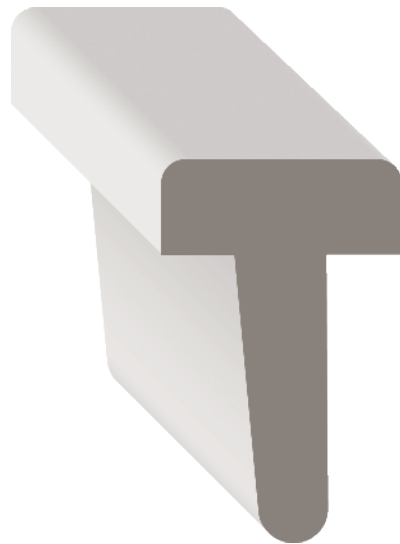

Stock Code
MHAST1315
(1002891)

Dimensions
1¼" x 2" x 7'

H

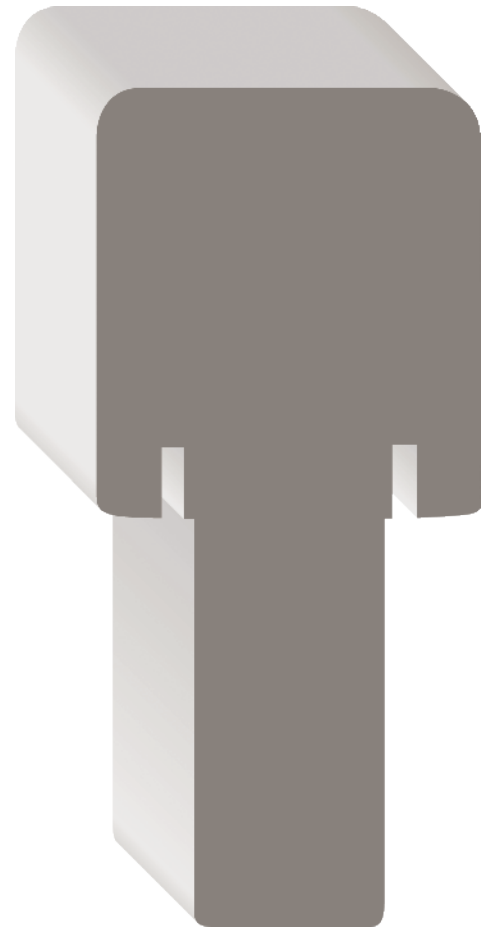

Stock Code
MHMP1321
(1008570)

Dimensions
2" x 4¾" x 99"

H

ASTRAGALS

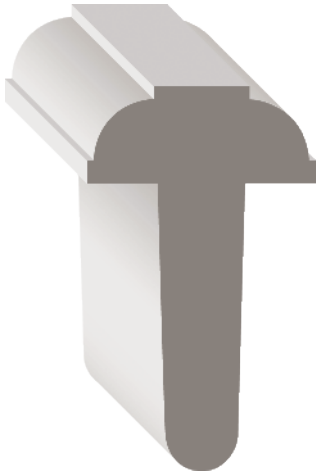

Stock Code
MHA18
(1003139)

Dimensions
1 3/16" x 2" x 8'

H



Stock Code
MPAST130508
(1567129)

Dimensions
1 1/4" x 2" x 8'

PFJ



Stock Code
MHA38
(1008937)

Dimensions
1 3/8" x 3" x 8'

MHA47
(1002639)

Dimensions
1 1/16" x 3" x 7'

MHA48
(1004654)

H

BACK BANDS

Back Bands are used in conjunction with casing or baseboard to create a wide variety of trim options for windows and doors.

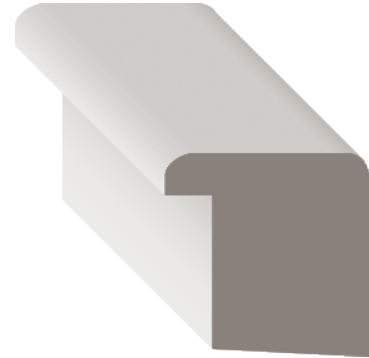

Stock Code
MP1021
(1588589)

Dimensions
1 1/8" x 1 1/8" x 16'

PFJ



Stock Code
1544824

Dimensions
1 5/32" x 1 1/2" x 16'
POP

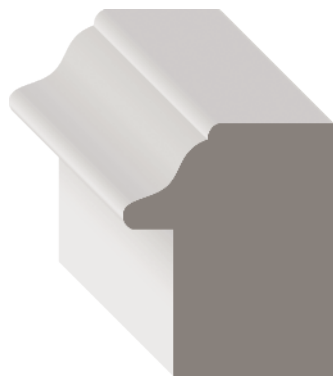

Stock Code
MH00408
(1555985)

Dimensions
1 1/8" x 1 5/16" x 8'

H

MP1022
(1611064)

1 1/8" x 1 5/16" x 16'

PFJ



Stock Code
MP1029
(1611065)

Dimensions
1 1/8" x 1 7/8" x 16'

PFJ

BASEBOARDS

BASEBOARDS

Your look starts here – at the foundation of a room.

A great baseboard complements a casing and creates a smooth transition from the wall to the floor, guiding you seamlessly from room to room.



Stock Code
MP211
(1611107)

Dimensions
 $\frac{7}{16}'' \times 4\frac{3}{16}'' \times 16'$

PFJ



Stock Code
MH04108
(1556001)

Dimensions
 $\frac{7}{16}'' \times 2\frac{1}{4}'' \times 8'$

MH04110
(1556002)
MH04112
(1556003)

$\frac{7}{16}'' \times 2\frac{1}{4}'' \times 10'$

$\frac{7}{16}'' \times 2\frac{1}{4}'' \times 12'$

H



Stock Code
MH3102
(1556073)

Dimensions
 $1\frac{3}{32}'' \times 3\frac{1}{4}'' \times \text{RL}$

MH310208
(1556074)
MH310210
(1556075)
MH310212
(1556076)

$1\frac{3}{32}'' \times 3\frac{1}{4}'' \times 8'$

$1\frac{3}{32}'' \times 3\frac{1}{4}'' \times 10'$

$1\frac{3}{32}'' \times 3\frac{1}{4}'' \times 12'$

H



Stock Code
MP290
(1611113)

Dimensions
 $\frac{1}{2}'' \times 3\frac{3}{16}'' \times 16'$

PFJ

BASEBOARDS



Stock Code
MP444
(1556318)

Dimensions
 $\frac{7}{16}'' \times 3\frac{3}{16}'' \times 15'$

PFJ



Stock Code
MFP444U
(1555905)

Dimensions
 $\frac{9}{16}'' \times 3\frac{1}{8}'' \times 16'$

MDF/UL



Stock Code
MFP3140
(1328267)

Dimensions
 $\frac{3}{8}'' \times 3\frac{1}{4}'' \times 14'$

MDF/UL



Stock Code
MFP8312
(1555941)

Dimensions
 $\frac{1}{2}'' \times 4\frac{1}{4}'' \times 16'$

MDF/UL

BASEBOARDS



Stock Code
MTEK625
(1556503)

Dimensions
1/2" x 2 1/4" x 16'

COM

- MH625 (1556173) 7/16" x 2 1/4" x RL
- MH62508 (1556174) 7/16" x 2 1/4" x 8'
- MH62510 (1556175) 7/16" x 2 1/4" x 10'
- MH62512 (1556176) 7/16" x 2 1/4" x 12'

H

MFP625 (1555931) 1/2" x 2 1/4" x 16'

MDF/UL

MP625 (1328825) 3/8" x 2 1/4" x 16'

PFJ



Stock Code
MECH624
(1610139)

Dimensions
5/16" x 2 3/4" x 14'

PEH



Stock Code
MH621
(1009329)

Dimensions
1/2" x 4 1/4" x RL

H



Stock Code
MAK623
(1006737)

Dimensions
9/16" x 3 1/4" x RL

ALD

- MTEK623 (1011022) 1/2" x 3 1/4" x 16'
- MTEK62307 (1006843) 1/2" x 3 1/4" x 7'

COM

MFVG623 (1555968) 1 3/32" x 3 1/4" x RL

FIR

MH623 (1626374) 7/16" x 3 1/4" x RL

MH62308 (1556170) 7/16" x 3 1/4" x 8'

MH62310 (1556171) 7/16" x 3 1/4" x 10'

MH62312 (1556172) 7/16" x 3 1/4" x 12'

H

MFP623 (1566985) 1/2" x 3 1/4" x 16'

MFP62312 (1555930) 1/2" x 3 1/4" x 12'

MDF/UL

MR0623 (1556440) 3/8" x 3 1/4" x RL

O

MP623 (1328824) 3/8" x 3 1/4" x 16'

MP280 (1611112) 1/2" x 3 1/4" x 16'

PFJ

BASEBOARDS



Stock Code
MAK618
(1008069)

Dimensions
1/2" x 5 1/4" x RL

ALD

MTEK618
(1556501)

1/2" x 5 1/4" x 16'

COM

MH618
(1556168)

1/2" x 5 1/4" x RL

H

MFP618
(1328523)

1/2" x 5 1/4" x 16'

MDF/UL

MP618
(1556324)

3/16" x 5 3/16" x 16'

PFJ



Stock Code
MFP624
(1610440)

Dimensions
1/2" x 4 1/4" - 16'

MDF/UL



Stock Code
MFP635
(1555933)

Dimensions
3/16" x 5 5/8" x 16'

MDF/UL



Stock Code
MFP414U
(1566948)

Dimensions
3/16" x 5 1/4" x 16'

MDF/UL

BASEBOARDS

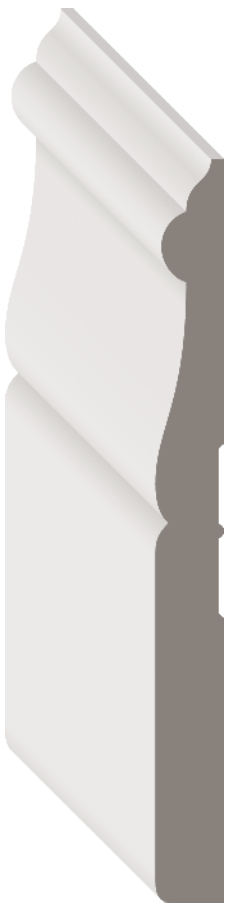

Stock Code
MFP8910
(1341835)

Dimensions
 $\frac{3}{8}$ " x $3\frac{3}{8}$ " x 16'

MDF/UL



Stock Code
MFP094
(1555833)

Dimensions
 $\frac{7}{16}$ " x 4" x 16'

MDF/UL



Stock Code
MFP310
(1555882)

Dimensions
 $\frac{1}{2}$ " x $4\frac{1}{8}$ " x 16'

MDF/UL



Stock Code
MH412U
(1556144)

Dimensions
 $\frac{7}{16}$ " x $4\frac{1}{4}$ " x RL

H

MFP412U
(1328503)

$\frac{7}{16}$ " x $4\frac{1}{4}$ " x 16'

MDF/UL

BASEBOARDS



Stock Code
MP653
(1328826)

Dimensions
 $\frac{3}{8}$ " x $3\frac{1}{4}$ " x 16'

PFJ



Stock Code
MP663
(1328829)

Dimensions
 $\frac{1}{2}$ " x $4\frac{3}{16}$ " x 16'

PFJ



Stock Code
MFP095
(1064044)

Dimensions
 $\frac{9}{16}$ " x 5" x 16'

MDF/UL



Stock Code
MFP206
(1509989)

Dimensions
 $\frac{9}{16}$ " x $5\frac{1}{4}$ " x 16'

MDF/UL

BASEBOARDS



Stock Code
MFP8243
(1555939)

Dimensions
1/2" x 4 1/4" x 16'

MDF/UL



Stock Code
MFP8234
(1555938)

Dimensions
3/16" x 5 1/2" x 16'

MDF/UL



Stock Code
MFP161
(1555868)

Dimensions
3/16" x 5 1/4" x 16'

MDF/UL



Stock Code
MFP163
(1555869)

Dimensions
3/16" x 7 1/4" x 16'

MDF/UL

BASEBOARDS



Stock Code
MFP207
(1002010)

Dimensions
 $\frac{1}{16}'' \times 7\frac{1}{4}'' \times 16'$

MDF/UL



Stock Code
1566981

Dimensions
 $\frac{1}{16}'' \times 5\frac{3}{4}'' \times 16'$

MDF/UL



Stock Code
MP673
(1328830)

Dimensions
 $\frac{1}{16}'' \times 5\frac{1}{8}'' \times 16'$

PFJ



Stock Code
MH545
(1556166)

Dimensions
 $\frac{1}{16}'' \times 5'' \times \text{RL}$

H

1328399
MFP545
(1341818)

$\frac{5}{8}'' \times 5'' \times 14'$
 $\frac{1}{16}'' \times 5'' \times 16'$

MDF/UL

BASEBOARDS

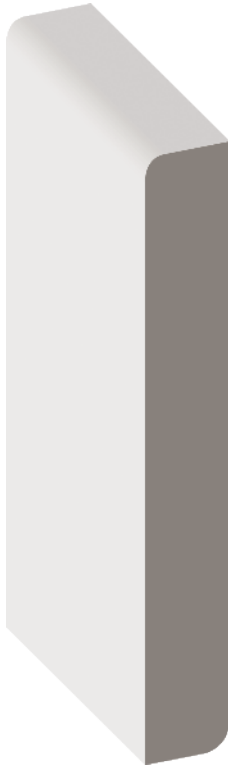

Stock Code Dimensions
MAK3111 1/2" x 3 1/4" x RL
 (1010058)
MAK3112 1/2" x 3 1/2" x RL
 (1555678)

ALD

MFVG3112 1/2" x 3 1/4" x RL
 (1002782)

FIR

MH3112 3/8" x 3 1/4" x RL
 (1556077)

H

MFP3112 1/2" x 3 1/4" x 16'
 (1009326)

MDF/UL

MP3112 3/8" x 3 3/16" x 16'
 (1556300)

PFJ



Stock Code Dimensions
MAUF573 1 1/32" x 3 1/4" x RL
 (1610088)

MAF

MACH573 3/8" x 3 1/4" x 14'
 (1609941)

MPH

MASC573 3/8" x 3 1/4" x 14'
 (1610046)

PCH



Stock Code Dimensions
MH469 1/2" x 3 1/2" x RL
 (1006585)

H

BASEBOARDS



Stock Code

MAK585B0
(1050670)

MAK585B010
(1681611)

Dimensions

$\frac{5}{8}$ " x 5" x RL

$\frac{5}{8}$ " x 5" x 10'

ALD



Stock Code

MFSP514
(1380952)

Dimensions

$\frac{1}{2}$ " x $5\frac{1}{4}$ " x 16'

MDF/UL



Stock Code

MAK603
(1009884)

Dimensions

$\frac{5}{8}$ " x $5\frac{1}{4}$ " x RL

ALD



Stock Code

MH569
(1008980)

MH669
(1009273)

Dimensions

$\frac{1}{2}$ " x $4\frac{1}{2}$ " x RL

$\frac{7}{16}$ " x $5\frac{1}{2}$ " x RL

H

BASEBOARDS



Stock Code
1324433

Dimensions
3/4" x 5 1/2" x 16'
MDF/UL



Stock Code
1324436

Dimensions
3/4" x 7 1/4" x 16'
MDF/UL



Stock Code
1318199

Dimensions
3/4" x 5 1/2" x 16'
MDF/UL



Stock Code
1318202

Dimensions
3/4" x 7 1/4" x 16'
MDF/UL

BASEBOARDS



Stock Code
MH751
(1003931)

Dimensions
5/8" x 7 1/4" x RL

H



Stock Code
1318184

Dimensions
5/8" x 5 1/2" x 16'
MDF/UL



Stock Code
MH750
(1004178)

Dimensions
5/8" x 5 1/4" x RL

H



Stock Code
MFP029
(1555822)

Dimensions
9/16" x 5 1/4" x 16'

MDF/UL

BASEBOARDS



Stock Code
1677449

Dimensions
1/2" x 5" x 16'
MDF/UL



Stock Code
1328537
1626223

Dimensions
1/2" x 6" x 14'
1/2" x 6" x 16'
MDF/UL

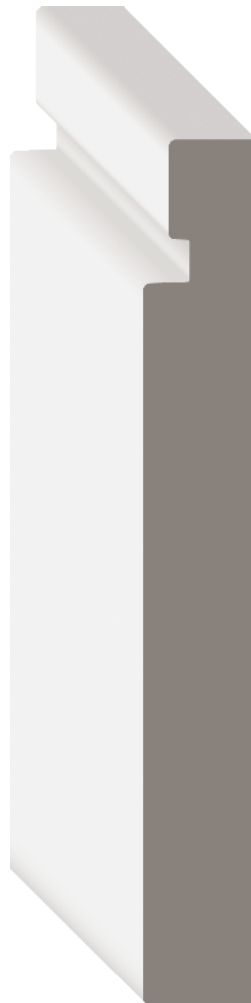

Stock Code
1323953

Dimensions
3/16" x 4 1/2" x 16'
MDF/UL



Stock Code
1323956

Dimensions
3/16" x 5 1/2" x 16'
MDF/UL

BASEBOARD CAPS

Baseboard caps are added to the top of regular baseboard moulding and flush to the wall to create a finished and more complex architectural moulding.



Stock Code
MP275
(1611111)

Dimensions
 $\frac{5}{8}$ " x $1\frac{1}{16}$ " x 16'

PFJ

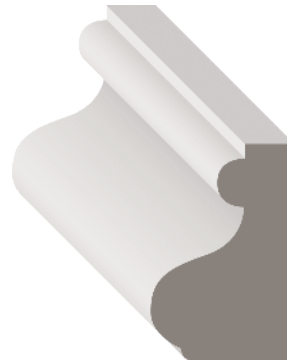

Stock Code
MH165
(1556023)

Dimensions
 $\frac{3}{4}$ " x $1\frac{1}{8}$ " x RL

H

MP165
(1611093)

$\frac{3}{4}$ " x $1\frac{1}{8}$ " x RL

PFJ

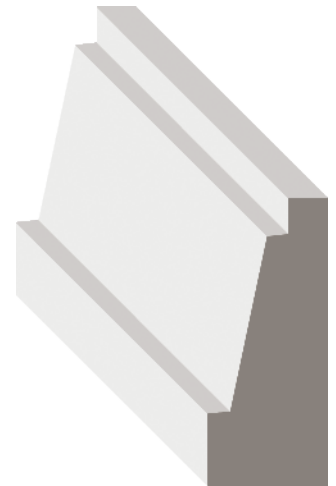

Stock Code
MP502
(1611148)

Dimensions
 $\frac{5}{8}$ " x $1\frac{1}{2}$ " x 16'

PFJ

BRICK MOULDS

BRICK MOULDS

A brick mould is mainly used as exterior casing around doors. The most common size is 2"; however, 1 1/2" and 1 1/4" sizes are available. Brick moulds can also be used in place of a crown and as a transition under window sills.



Stock Code	Dimensions
MH50708 (1610792)	1 3/16" x 1 1/2" x 8'
MH50712 (1556163)	1 3/16" x 1 1/2" x 12'

H



Stock Code	Dimensions
MP6921 (1611166)	1 1/4" x 2 1/4" x 18'

PFJ

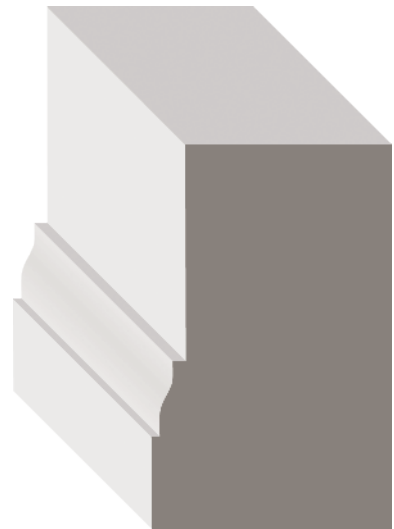

Stock Code	Dimensions
MFVG180 (1626279)	1 3/16" x 1 5/16" x RL

FIR

MH180 (1556025)	1 3/16" x 1 5/16" x RL
MH18007 (1556026)	1 3/16" x 1 5/16" x 7'

H

MP180 (1556281)	1 3/16" x 1 5/16" x 14'
MP18007 (1556282)	1 3/16" x 1 5/16" x 7'
MP18018 (1328752)	1 3/16" x 1 5/16" x 18'
MP180MIT8215 (1556285)	1 3/16" x 1 5/16" x 82 1/4"

PFJ

CASINGS

Casings bring a room together – left to right, top to bottom. And like any framing element, the options are endless, from build-ups of multiple pieces to full wraps. With casings, there's no wrong way, only your way.



Stock Code
MH301408
(1556070)

Dimensions
 $\frac{7}{16}$ " x $2\frac{3}{16}$ " x 8'

H



Stock Code
MP327
(1567148)

Dimensions
 $1\frac{1}{16}$ " x $2\frac{1}{4}$ " x 14'

PFJ



Stock Code
MH300007
(1328591)

Dimensions
 $\frac{1}{2}$ " x $1\frac{1}{2}$ " x 7'

MH300008
(1556057)

$\frac{1}{2}$ " x $1\frac{1}{2}$ " x 8'

MH300010
(1556058)

$\frac{1}{2}$ " x $1\frac{1}{2}$ " x 10'

MH300012
(1556059)

$\frac{1}{2}$ " x $1\frac{1}{2}$ " x 12'

H

MFP300007
(1555878)

$\frac{1}{2}$ " x $1\frac{5}{8}$ " x 7'

MFP3000
(1555877)

$\frac{1}{2}$ " x $1\frac{5}{8}$ " x 16'

MDF/UL

MEAON3000
(1555721)

$\frac{7}{16}$ " x $1\frac{1}{16}$ " x 14'

PAO

MEGON3000
(1555741)

$\frac{7}{16}$ " x $1\frac{1}{16}$ " x 14'

P60



Stock Code
MH3002
(1556060)

Dimensions
 $\frac{1}{2}$ " x $2\frac{3}{16}$ " X RL

MH300207
(1610661)

$\frac{1}{2}$ " x $2\frac{3}{16}$ " x 7'

MH300208
(1556062)

$\frac{1}{2}$ " x $2\frac{3}{16}$ " x 8'

MH300210
(1610663)

$\frac{1}{2}$ " x $2\frac{3}{16}$ " x 10'

MH300212
(1556064)

$\frac{1}{2}$ " x $2\frac{3}{16}$ " x 12'

H

MFP3002
(1050329)

$\frac{9}{16}$ " x $2\frac{1}{4}$ " x 16'

MFP300207
(1555880)

$\frac{9}{16}$ " x $2\frac{1}{4}$ " x 7'

MDF/UL

MRO3002
(1328875)

$\frac{7}{16}$ " x $2\frac{1}{4}$ " X RL

O

MEAON3002
(1006192)

$\frac{7}{16}$ " x $2\frac{1}{4}$ " x 14'

PAO

MEGON3002
(1002393)

$\frac{7}{16}$ " x $2\frac{1}{4}$ " x 14'

P60

CASINGS



Stock Code
MP256
(1556297)

Dimensions
5/8" x 1 5/8" x 14'

PFJ



Stock Code
MH258
(1556036)

Dimensions
1 1/16" x 2 3/16" x RL

MH25807
(1556037)

1 1/16" x 2 3/16" x 7'

H



Stock Code
MH005
(1610561)

Dimensions
3/4" x 3 7/16" x RL

MH00508
(1555986)

3/4" x 3 7/16" x 8'

H



Stock Code
MFP3122
(1555886)

Dimensions
1" x 3 1/2" x 16'

MDF/UL



Stock Code Dimensions
MH300507 $\frac{1}{2}$ " x $1\frac{1}{2}$ " x 7'
 (1556065)
MH300510 $\frac{1}{2}$ " x $1\frac{1}{2}$ " x 10'
 (1556067)

H

MP3005 $\frac{1}{2}$ " x $1\frac{1}{2}$ " x 14'
 (1328764)

PFJ



Stock Code Dimensions
MTEK356 $\frac{3}{16}$ " x $2\frac{1}{4}$ " x 16'
 (1556496)
MTEK35607 $\frac{3}{16}$ " x $2\frac{1}{4}$ " x 7'
 (1556497)
1681178 $\frac{3}{16}$ " x $2\frac{1}{4}$ " x $81\frac{1}{4}$ "
COM

MFP356 $\frac{3}{16}$ " x $2\frac{1}{4}$ " x 16'
 (1555892)
MFP35610 $\frac{3}{16}$ " x $2\frac{1}{4}$ " x 10'
 (1555893)
MFP35617 $\frac{3}{16}$ " x $2\frac{1}{4}$ " x 17'
 (1555894)
MFP35685 $\frac{3}{16}$ " x $2\frac{1}{4}$ " x 85"
 (1555895)
1681176 $\frac{3}{16}$ " x $2\frac{1}{4}$ " x $81\frac{1}{4}$ "
MDF/UL



Stock Code Dimensions
MH125 $\frac{3}{16}$ " x $2\frac{1}{16}$ " x RL
 (1556021)
MH12507 $\frac{3}{16}$ " x $2\frac{1}{16}$ " x 7'
 (1556022)

H



Stock Code Dimensions
MAK356WM $\frac{3}{4}$ " x $2\frac{1}{4}$ " x RL
 (1050667)

ALD

MFVG356WM07 $\frac{5}{8}$ " x $2\frac{1}{4}$ " x 7'
 (1555962)

FIR

MH356 $\frac{5}{8}$ " x $2\frac{1}{4}$ " x RL
 (1556134)

MH35607 $\frac{5}{8}$ " x $2\frac{1}{4}$ " x 7'
 (1556135)

MH35608 $\frac{5}{8}$ " x $2\frac{1}{4}$ " x 8'
 (1556136)

MH35610 $\frac{5}{8}$ " x $2\frac{1}{4}$ " x 10'
 (1556137)

MH35612 $\frac{5}{8}$ " x $2\frac{1}{4}$ " x 12'
 (1556138)

H

MEUF356 $\frac{7}{16}$ " x $2\frac{7}{32}$ " x 14'
 (1610265)

MUF

MRO356 $\frac{7}{16}$ " x $2\frac{1}{16}$ " x RL
 (1006931)

O

Stock Code Dimensions
MEAN356 $\frac{7}{16}$ " x $2\frac{7}{32}$ " x 14'
 (1555723)

PAO

MESC356 $\frac{7}{16}$ " x $2\frac{7}{32}$ " x 14'
 (1555777)

PCH

MED0356 $\frac{7}{16}$ " x $2\frac{7}{32}$ " x 14'
 (1555733)

PDO

MECH356 $\frac{7}{16}$ " x $2\frac{7}{32}$ " x 14'
 (1610135)

PEH

MESAN356 $\frac{7}{16}$ " x $2\frac{7}{32}$ " x 14'
 (1610198)

PEA

MESM356 $\frac{7}{16}$ " x $2\frac{7}{32}$ " x 14'
 (1007805)

PEM

MP356WM $\frac{5}{8}$ " x $2\frac{1}{4}$ " x 14'
 (1394452)

MP356WM07 $\frac{5}{8}$ " x $2\frac{1}{4}$ " x 7'
 (1382747)

PFJ

MEGON356 $\frac{7}{16}$ " x $2\frac{7}{32}$ " x 14'
 (1008298)

PGO

CASINGS



Stock Code
MH410U
 (1556140)
MH410U07
 (1556141)

Dimensions
1¹/₁₆" x 2¹/₄" x RL
1¹/₁₆" x 2¹/₄" x 7'

H

MFP410U
 (1566938)
MDF/UL



Stock Code
MH1208
 (1328587)
MH120807
 (1556017)

Dimensions
1¹/₁₆" x 2¹/₂" x RL
1¹/₁₆" x 2¹/₂" x 7'

H

MP1208
 (1328748)
PFJ



Stock Code
MH3211
 (1002120)

Dimensions
5⁵/₈" x 2¹/₄" x RL

H

MP190
 (1611102)
PFJ



Stock Code
MFP092
 (1555830)
MFP09207
 (1555831)

Dimensions
5⁵/₈" x 2¹/₂" x 16'
5⁵/₈" x 2¹/₂" x 7'

MDF/UL



Stock Code
MFP350
(1555891)

Dimensions
 $\frac{1}{16}'' \times 2\frac{1}{4}'' \times 16'$

MDF/UL



Stock Code
MH156
(1011098)

Dimensions
 $\frac{1}{16}'' \times 2\frac{1}{4}'' \times RL$

MH15607DS
(1005414)

$\frac{1}{16}'' \times 2\frac{1}{4}'' \times 7'$

H



Stock Code
MH4443D
(1556147)

Dimensions
 $\frac{1}{16}'' \times 3\frac{1}{8}'' \times RL$

MH4443D08
(1556148)

$\frac{1}{16}'' \times 3\frac{1}{8}'' \times 8'$

MH4443D12
(1556150)

$\frac{1}{16}'' \times 3\frac{1}{8}'' \times 12'$

H



Stock Code
MP113
(1611087)

Dimensions
 $\frac{5}{8}'' \times 3\frac{1}{4}'' \times 16'$

PFJ

CASINGS



Stock Code
MFP346
(1566915)

Dimensions
 $\frac{3}{16}$ " x 2 $\frac{1}{4}$ " x 17'

MDF/UL



Stock Code
MH411U
(1626369)

Dimensions
 $1\frac{1}{16}$ " x 3" x RL

MH411U08
(1009060)

$1\frac{1}{16}$ " x 3" x 8'

H

MFP411U
(1626154)

$1\frac{1}{16}$ " x 3" x 15'

MDF/UL



Stock Code
MFP093
(1555832)

Dimensions
 $\frac{5}{8}$ " x 3 $\frac{1}{4}$ " x 16'

MDF/UL



Stock Code
MFP8063
(1448090)

Dimensions
 $1\frac{1}{16}$ " x 3 $\frac{1}{4}$ " x 16'

MDF/UL



Stock Code
MH033
(1555997)

Dimensions
 $\frac{5}{8}'' \times 2\frac{3}{16}'' \times \text{RL}$

H



Stock Code
MH019
(1555991)

Dimensions
 $\frac{9}{16}'' \times 2\frac{1}{4}'' \times \text{RL}$

MH01907 (1555992) $\frac{9}{16}'' \times 2\frac{1}{4}'' \times 7'$
MH01910 (1555994) $\frac{9}{16}'' \times 2\frac{1}{4}'' \times 10'$

H

MFP019 (1555820) $\frac{9}{16}'' \times 2\frac{1}{4}'' \times 16'$
MFP01907 (1555821) $\frac{9}{16}'' \times 2\frac{1}{4}'' \times 7'$

MDF/UL



Stock Code
MP140
(1611091)

Dimensions
 $1\frac{9}{32}'' \times 2\frac{15}{32}'' \times 14'$

PFJ



Stock Code
MFP8233
(1046142)

Dimensions
 $\frac{9}{16}'' \times 3\frac{3}{4}'' \times 16'$

MDF/UL

CASINGS



Stock Code **MTEK003**
(1556485)

Dimensions
1¹/₁₆" x 3³/₄" x 16'

COM

MH003
(1626324)

Dimensions
5⁵/₈" x 3³/₄" x RL

MH00308
(1555984)

Dimensions
5⁵/₈" x 3³/₄" x 8'

H

MFP003
(1555819)

Dimensions
1¹/₁₆" x 3³/₄" x 16'

MDF/UL



Stock Code **MP150**
(1611092)

Dimensions
5⁵/₈" x 3³/₄" x 16'

PFJ



Stock Code **MH535**
(1556164)

Dimensions
1¹/₁₆" x 3¹/₂" x RL

MH53508
(1556165)

Dimensions
1¹/₁₆" x 3¹/₂" x 8'

H

MFP535
(1610431)

Dimensions
1¹/₁₆" x 3¹/₂" x 16'

MDF/UL



Stock Code **MH215**
(1556031)

Dimensions
5⁵/₈" x 3³/₁₆" x RL

H



Stock Code
1675150

Dimensions
1" x 3½" x 16'
MDF/UL

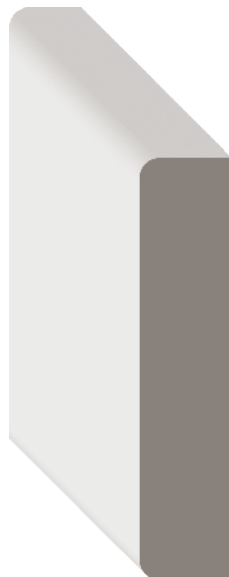

Stock Code
MH001
(1555978)

Dimensions
7/16" x 2¾" x RL

Stock Code
MH00107
(1555979)

Dimensions
7/16" x 2¾" x 7'

Stock Code
MH00108
(1328584)

Dimensions
7/16" x 2¾" x 8'

Stock Code
MH00110
(1555981)

Dimensions
7/16" x 2¾" x 10'

H



Stock Code
MH493
(1007076)

Dimensions
½" x 2¼" x RL

Stock Code
MH49307
(1008483)

Dimensions
½" x 2¼" x 7'

H



Stock Code
MFIG472
(1010019)

Dimensions
5/8" x 2½" x RL

Stock Code
MFIG47207
(1555964)

Dimensions
5/8" x 2½" x 7'

FIR

Stock Code
MH472
(1556152)

Dimensions
5/8" x 2½" x RL

Stock Code
MH47207
(1610775)

Dimensions
5/8" x 2½" x 7'

Stock Code
MH47207-VEN
(1610776)

Dimensions
11/16" x 2½" x 7'

H

Stock Code
MFP472
(1328373)

Dimensions
9/16" x 2½" x 14'

Stock Code
MFP492
(1555909)

Dimensions
½" x 2½" x 14'

Stock Code
MFP494
(1555910)

Dimensions
½" x 3¼" x 16'

Stock Code
MFP49408
(1566956)

Dimensions
½" x 3¼" x 8'

Stock Code
MFSP472
(1328569)

Dimensions
9/16" x 2½" x 16'

Stock Code
MFSP492
(1050402)

Dimensions
½" x 2½" x 16'

Stock Code
MFSP494
(1050405)

Dimensions
½" x 3¼" x 16'

MDF/UL

CASINGS



Stock Code	Dimensions
MH01007 (1555987)	7/16" x 1 1/2" x 7'
MH01008 (1328586)	7/16" x 1 1/2" x 8'
MH01010 (1555989)	7/16" x 1 1/2" x 10'
MH01012 (1555990)	7/16" x 1 1/2" x 12'

H



Stock Code	Dimensions
MTEK473 (1588769)	9/16" x 2 1/4" x 16'

COM

MFVG473 (1555965)	5/8" x 2 3/32" x RL
-----------------------------	---------------------

FIR

MFP473 (1555907)	9/16" x 2 1/4" x 16'
----------------------------	----------------------

MFP47307 (1555908)	9/16" x 2 1/4" x 7'
------------------------------	---------------------

MDF/UL

MACH473 (1609939)	1/2" x 2 1/4" x 14'
-----------------------------	---------------------

MPH

MAUF473 (1610086)	1/2" x 2 1/4" x 14'
-----------------------------	---------------------

MUF

MASC473 (1011389)	1/2" x 2 1/4" x 14'
-----------------------------	---------------------

PCH



Stock Code	Dimensions
MAK103B0 (1555675)	3/4" x 2 1/2" x RL

MAK103B008 (1668157)	3/4" x 2 1/2" x 8'
--------------------------------	--------------------

ALD

MFP10385B0 (1610320)	1 1/16" x 2 1/2" x 85"
--------------------------------	------------------------

MDF/UL

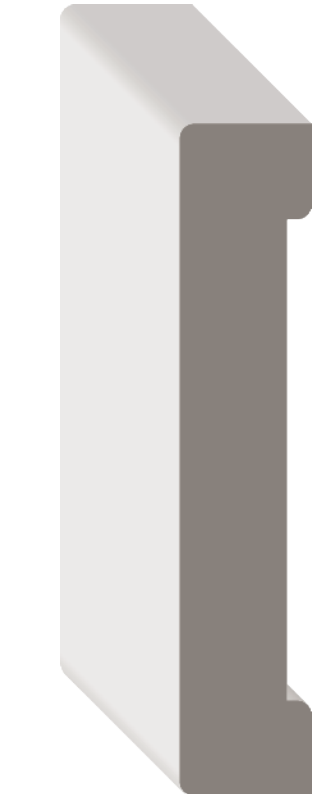

Stock Code	Dimensions
1670311	1 1/16" x 3 1/2" x 16'

PFJ



Stock Code	Dimensions
MFVG338 (1555958)	$\frac{3}{4}$ " x $3\frac{1}{2}$ " x RL
MFVG33807 (1555959)	$\frac{3}{4}$ " x $3\frac{1}{2}$ " x 7'
MFVG33808 (1555960)	$\frac{3}{4}$ " x $3\frac{1}{2}$ " x 8'

FIR



Stock Code	Dimensions
MAK104BO (1555676)	$\frac{3}{4}$ " x $3\frac{1}{2}$ " x RL
MAK104B008 (1050664)	$\frac{3}{4}$ " x $3\frac{1}{2}$ " x 8'

ALD

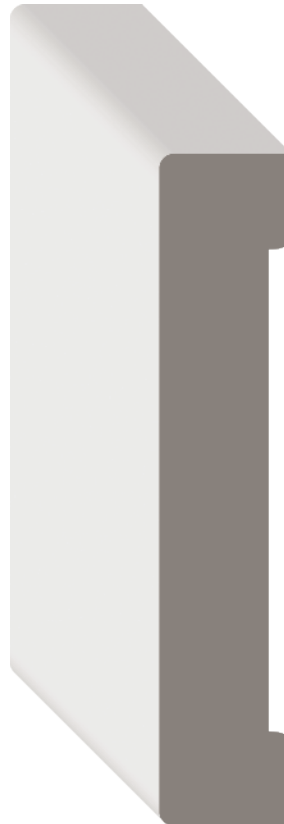

Stock Code	Dimensions
MTEK495 (1556498)	$\frac{1}{16}$ " x $3\frac{1}{2}$ " x 16'

COM

MH495 (1556156)	$\frac{5}{8}$ " x $3\frac{1}{2}$ " x RL
MH49507 (1556157)	$\frac{5}{8}$ " x $3\frac{1}{2}$ " x 7'
MH49508 (1556158)	$\frac{5}{8}$ " x $3\frac{1}{2}$ " x 8'
MH49507-VEN (1005003)	$\frac{1}{16}$ " x $3\frac{1}{2}$ " x 7'
MH49508-VEN (1610785)	$\frac{1}{16}$ " x $3\frac{1}{2}$ " x 8'

H

MFP495 (1555911)	$\frac{1}{16}$ " x $3\frac{1}{2}$ " x 16'
MFP49507 (1545341)	$\frac{1}{16}$ " x $3\frac{1}{2}$ " x 7'

MDF/UL



Stock Code	Dimensions
MAK413 (1007674)	$\frac{3}{4}$ " x $3\frac{1}{4}$ " x RL
MAK41308 (1009582)	$\frac{3}{4}$ " x $3\frac{1}{4}$ " x 8'

ALD

CASINGS



Stock Code

1675700
1675702

Dimensions

1" x 3½" x 16'
1" x 4¼" x 16'
MDF/UL



Stock Code

1391329

Dimensions

1" x 4½" x 16'
MDF/UL



Stock Code

1675698

Dimensions

¾" x 2¾" x 16'
MDF/UL



Stock Code

1390847

Dimensions

¾" x 3½" x 16'
MDF/UL



Stock Code
MP522
(1567173)

Dimensions
1¹/₁₆" x 4¹/₄" x 16'

PFJ



Stock Code
1675149

Dimensions
3³/₄" x 3¹/₂" x 16'

MDF/UL



Stock Code
1566900

Dimensions
1¹/₁₆" x 3¹/₄" x 17'

MDF/UL



Stock Code
MP111
(1611084)

Dimensions
1³/₁₆" x 3¹/₄" x 16'

PFJ

CASINGS



Stock Code
1677196

Dimensions
 $\frac{5}{8}$ " x $2\frac{3}{4}$ " x 16'
MDF/UL



Stock Code
1328425
1626213

Dimensions
 $\frac{5}{8}$ " x $3\frac{1}{4}$ " x 14'
 $\frac{5}{8}$ " x $3\frac{1}{4}$ " x 16'
MDF/UL

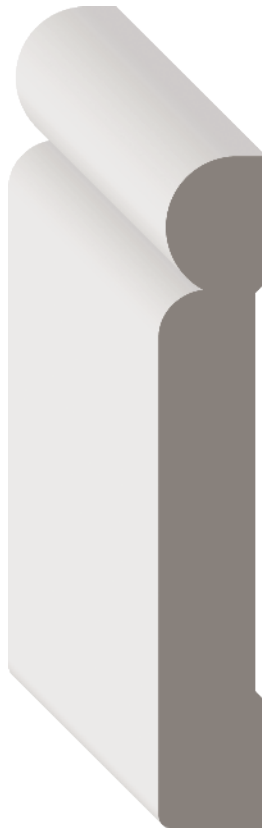

Stock Code
MH754H
(1011154)

Dimensions
 $1\frac{1}{16}$ " x $3\frac{1}{4}$ " x RL
H

MFP754H
(1567003)

$1\frac{1}{16}$ " x $3\frac{1}{4}$ " x 16'
MDF/UL



Stock Code
MFP750H
(1555935)

Dimensions
 $\frac{5}{8}$ " x $5\frac{1}{4}$ " x 16'
MDF/UL

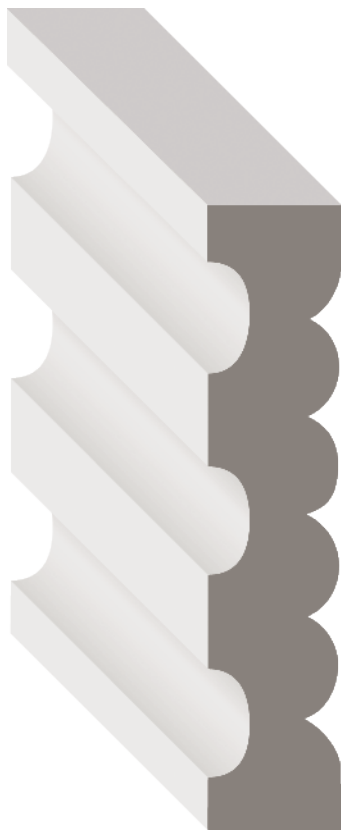

Stock Code
MH100108
(1556014)

Dimensions
 $\frac{5}{8}$ " x $3\frac{1}{4}$ " x 8'

H

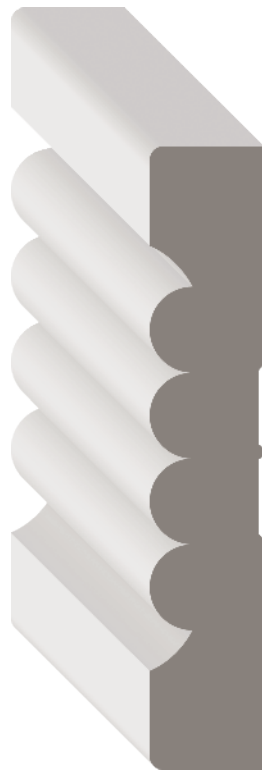

Stock Code
MFP908
(1555945)

Dimensions
 $\frac{9}{16}$ " x $3\frac{1}{4}$ " x 14'

MDF/UL

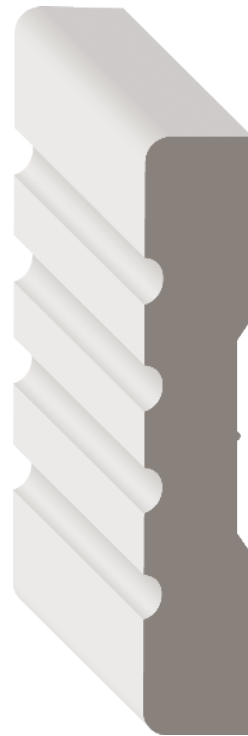

Stock Code
MFP340
(1555890)

Dimensions
 $\frac{9}{16}$ " x $3\frac{1}{8}$ " x 14'

MDF/UL

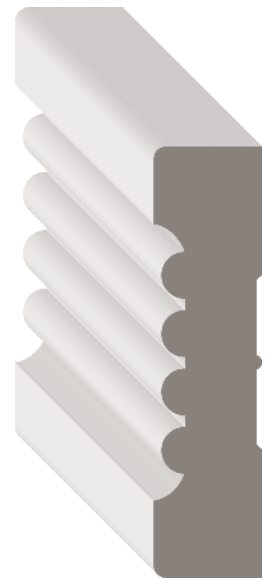

Stock Code
MFP907
(1328547)

Dimensions
 $\frac{9}{16}$ " x $2\frac{1}{4}$ " x 14'

MDF/UL

CHAIR RAILS

CHAIR RAILS

The chair rail runs along the wall, parallel with the baseboard. Adding a refined decor to any space, it's the subtle choice that makes a big impact. The chair rail perfectly complements a wainscot design.



Stock Code
1008285

Dimensions
9/16" x 1 3/4" x 8'
MDF/UL



Stock Code
MH18412
(1556027)

Dimensions
5/8" x 2 7/16" x 12'
H

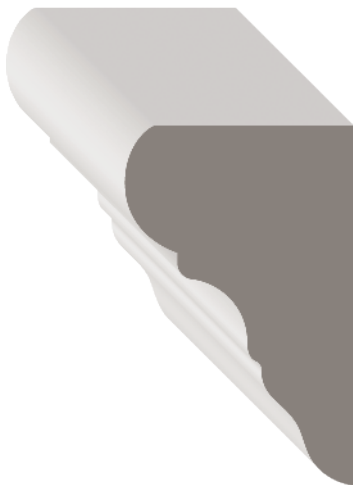

Stock Code
MFP409
(1626151)

Dimensions
1 1/16" x 1 7/8" x 14'
MDF/UL



Stock Code
1509921

Dimensions
5/8" x 2 1/2" x 12'
MDF/UL



Stock Code
MP1000
(1382796)

Dimensions
1 1/16" x 2 5/8" x 16'
PFJ



Stock Code
MH297
(1556053)

Dimensions
5/8" x 3" x RL
H

MFP297
(1555876)

1 1/16" x 3" x 16'
MDF/UL

CORNER GUARDS

Corner guards are used to protect the outside edges of the wall from damage and abrasion. Corner guards come in a wide variety of sizes and detailing.



Stock Code
MH328208
(1328620)
MH328210
(1556112)

Dimensions
1 1/16" x 1 1/16" x 8'
1 1/16" x 1 1/16" x 10'

Stock Code
MP328008
(1556312)

Dimensions
1 1/8" x 1 1/8" x 8'

PFJ

MH328008
(13286190)

1 1/16" x 1 1/16" x 8'

MH328010
(1556110)

1 1/16" x 1 1/16" x 10'

MH20408
(1556029)

1 1/4" x 1 1/4" x 8'

MH20410
(1556030)

1 1/4" x 1 1/4" x 10'

H

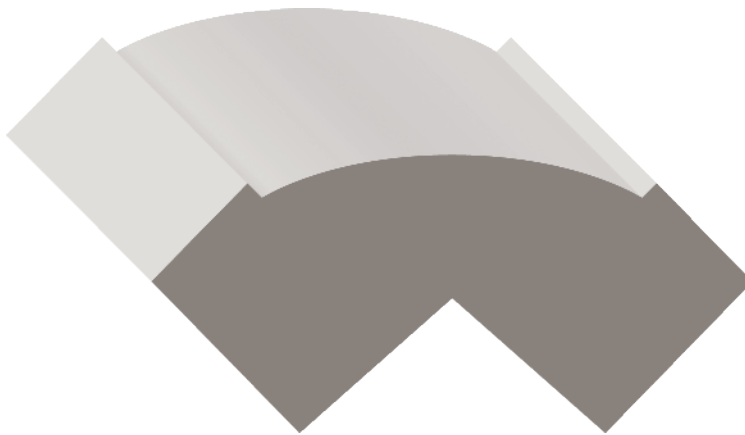

Stock Code
MPHOL90
(1556334)

Dimensions
2 3/16" x 2 3/16" x 18'

PFJ

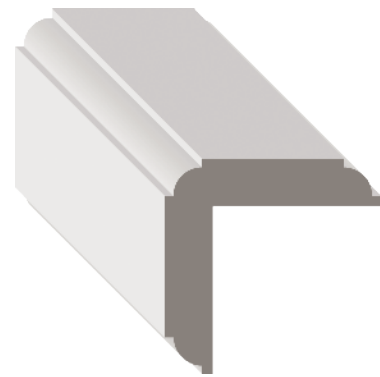

Stock Code
MP20208
(1328754)

Dimensions
1 1/8" x 1 1/8" x 8'

PFJ

COVES

COVES

Coves are commonly used to soften the transition on inside corners but may be used for a wide range of applications.



Stock Code
MP306
(1611117)

Dimensions
1 1/16" x 3 5/8" x 16'

PFJ



Stock Code
MH326008
(1556101)

Dimensions
1/2" x 1/2" x 8'

H

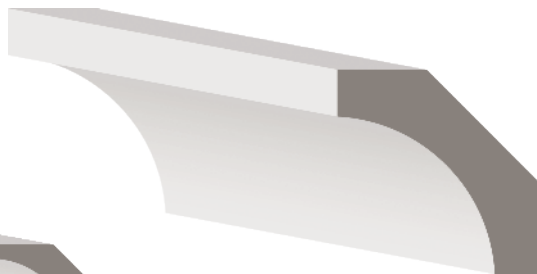

Stock Code
MH33408
(1556117)

Dimensions
1 1/16" x 1 1/16" x 8'

MH33410
(1556118)

1 1/16" x 1 1/16" x 10'

MH33412
(1556119)

1 1/16" x 1 1/16" x 12'

H



Stock Code
MH326408
(1556103)

Dimensions
1 1/16" x 1 1/16" x 8'

MH326410
(1556104)

1 1/16" x 1 1/16" x 10'

MH326412
(1610715)

1 1/16" x 1 1/16" x 12'

H

MP3264
(1328781)

1 1/16" x 1 1/16" x 14'

MP326408
(1556308)

1 1/16" x 1 1/16" x 8'

PFJ

CROWNS

Cap off your look with the perfect crown.
A great crown is the royal wrap-up
of all your moulding decisions.

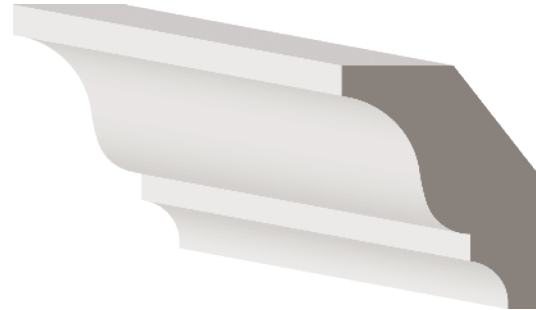

Stock Code
MH06812
(1009801)

Dimensions
1/2" x 1 5/8" x 12'

H

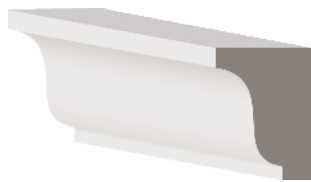

Stock Code
MH324208
(1556096)

Dimensions
1/2" x 1 1/16" x 8'

MH324210
(1556097)

1/2" x 1 1/16" x 10'

H

MP3242
(1328776)

1/2" x 1 1/16" x 14'

PFJ

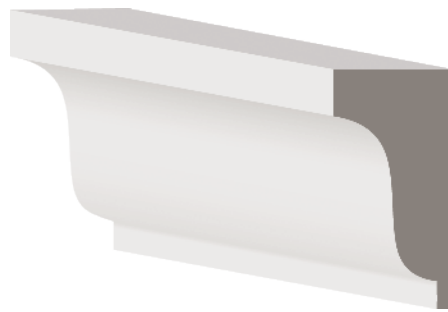

Stock Code
MH324408
(1610704)

Dimensions
3/16" x 1 1/4" x 8'

MH324410
(1556098)

3/16" x 1 1/4" x 10'

MH324412
(1556099)

3/16" x 1 1/4" x 12'

H

MP3244
(1556305)

5/8" x 1 3/16" x 14'

PFJ



Stock Code
MH324812
(1556100)

Dimensions
1 3/16" x 2 1/4" x 12'

H

MP3248
(1556306)

1 3/16" x 2 3/16" x 16'

PFJ

CROWNS

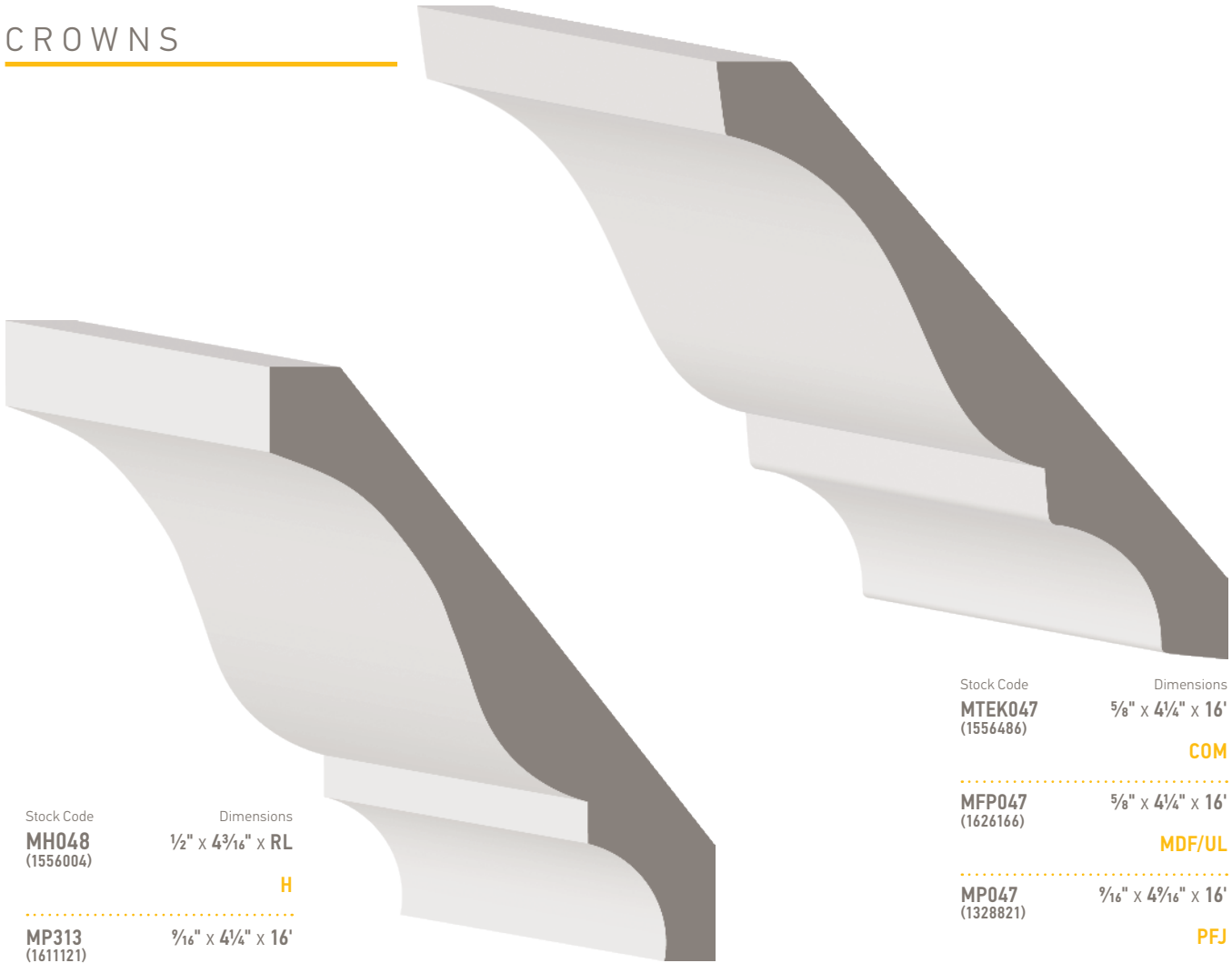

Stock Code
MH048
(1556004)

Dimensions
 $\frac{1}{2}'' \times 4\frac{3}{16}'' \times \text{RL}$

H

MP313
(1611121)

$\frac{9}{16}'' \times 4\frac{1}{4}'' \times 16'$

PFJ

Stock Code
MTEK047
(1556486)

Dimensions
 $\frac{5}{8}'' \times 4\frac{1}{4}'' \times 16'$

COM

MFP047
(1626166)

$\frac{5}{8}'' \times 4\frac{1}{4}'' \times 16'$

MDF/UL

MP047
(1328821)

$\frac{5}{16}'' \times 4\frac{9}{16}'' \times 16'$

PFJ

Stock Code
MH05408
(1556010)

Dimensions
 $\frac{7}{16}'' \times 2\frac{1}{4}'' \times 8'$

H

MH05412
(1556011)

$\frac{7}{16}'' \times 2\frac{1}{4}'' \times 12'$

MFP054
(1555829)

$\frac{7}{16}'' \times 2\frac{1}{4}'' \times 16'$

MDF/UL

MP054
(1328823)

$\frac{1}{2}'' \times 2\frac{1}{4}'' \times 16'$

PFJ

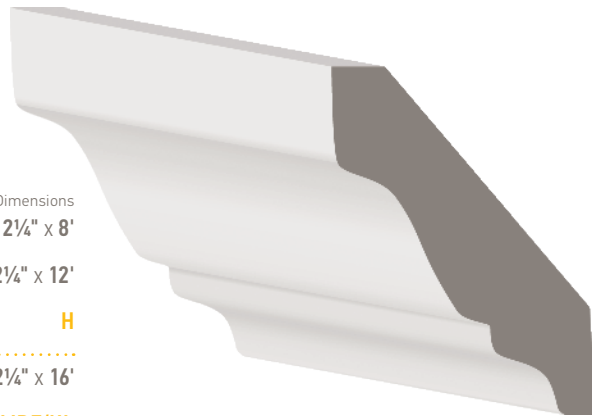

CROWNS

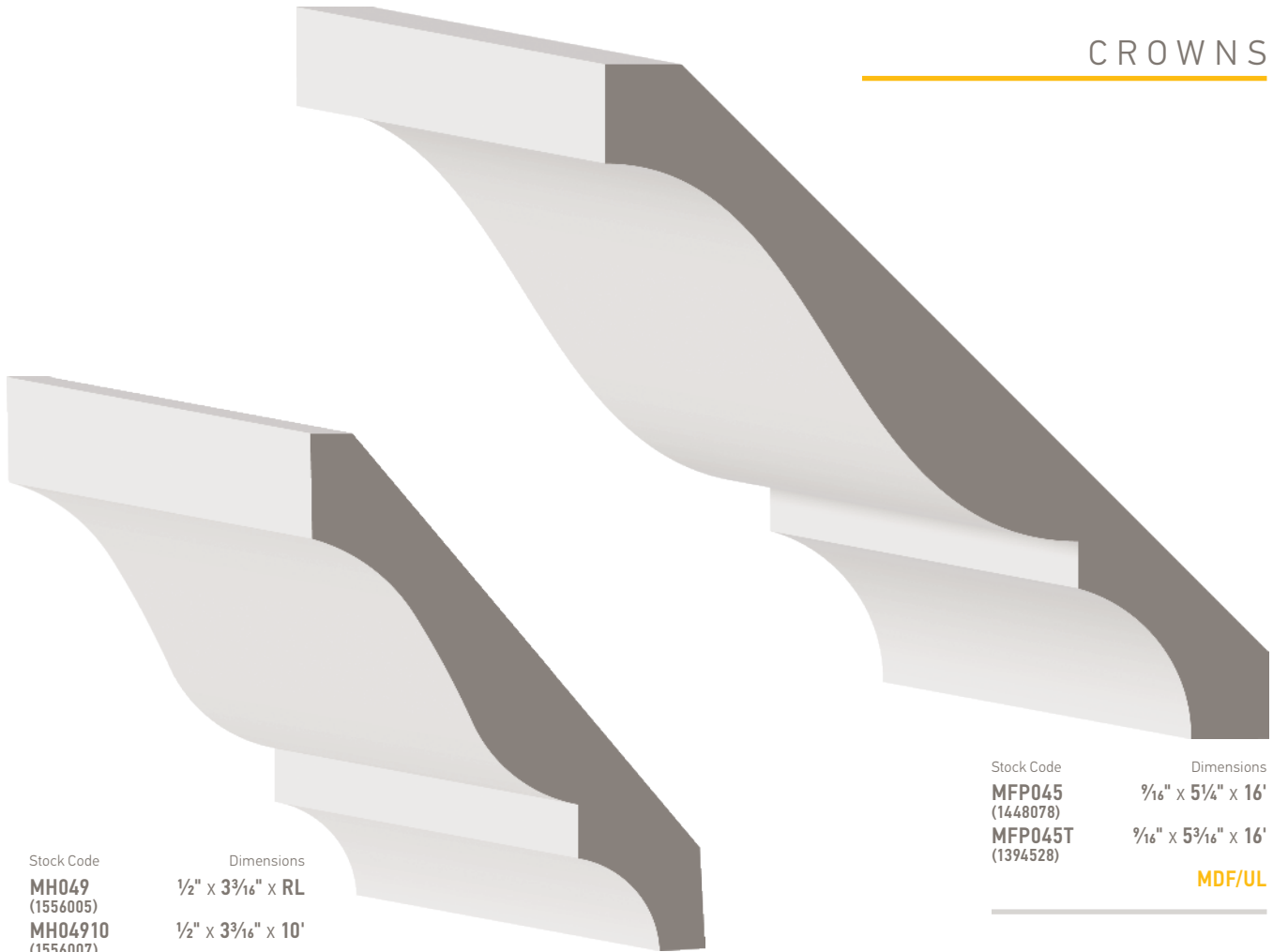

Stock Code
MH049
 (1556005)
MH04910
 (1556007)
MH04912
 (1556008)

Dimensions
 $\frac{1}{2}'' \times 3\frac{3}{16}'' \times \text{RL}$
 $\frac{1}{2}'' \times 3\frac{3}{16}'' \times 10'$
 $\frac{1}{2}'' \times 3\frac{3}{16}'' \times 12'$

H

MP049
 (1567113)

$\frac{1}{2}'' \times 3\frac{5}{8}'' \times 16'$

PFJ

Stock Code
MFP045
 (1448078)
MFP045T
 (1394528)

Dimensions
 $\frac{9}{16}'' \times 5\frac{1}{4}'' \times 16'$
 $\frac{9}{16}'' \times 5\frac{3}{16}'' \times 16'$

MDF/UL

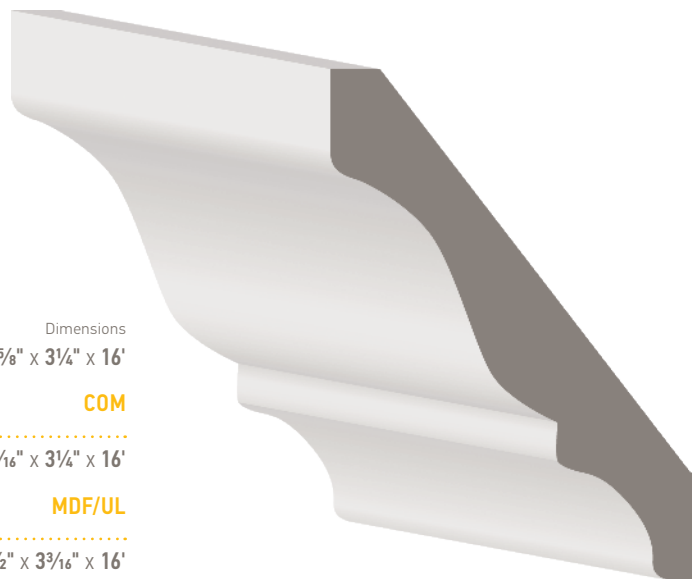

Stock Code
MTEK051
 (1556487)

Dimensions
 $\frac{5}{8}'' \times 3\frac{1}{4}'' \times 16'$

COM

MFP051
 (1555828)

$\frac{9}{16}'' \times 3\frac{1}{4}'' \times 16'$

MDF/UL

MP051
 (1328822)

$\frac{1}{2}'' \times 3\frac{3}{16}'' \times 16'$

PFJ

CROWNS

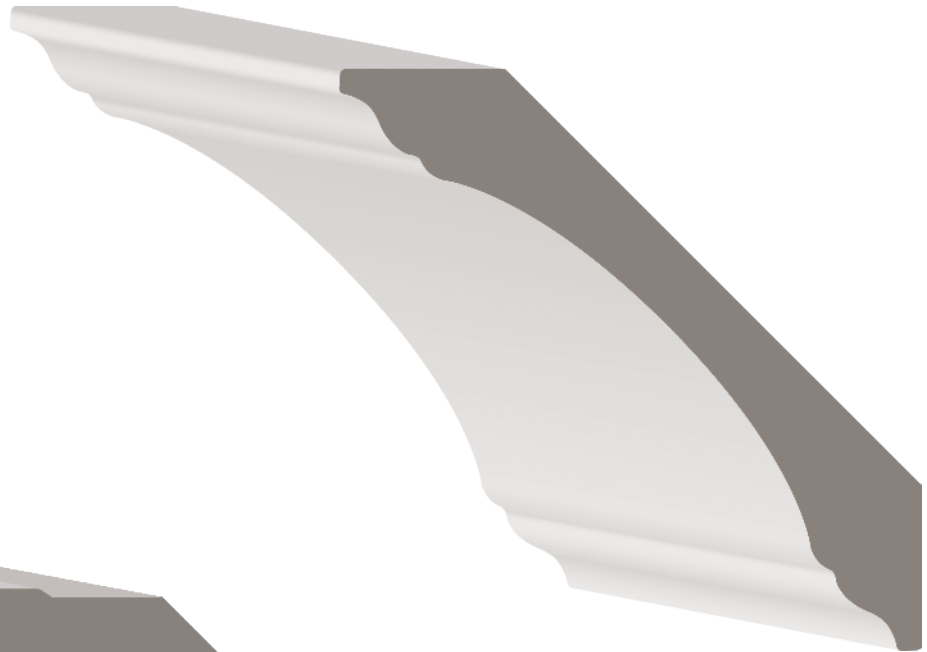

Stock Code
MH040
(1555999)

Dimensions
1 1/16" x 4 1/4" x RL

H

MFP040
(1328500)

1 1/16" x 4 1/4" x 16'

MDF/UL

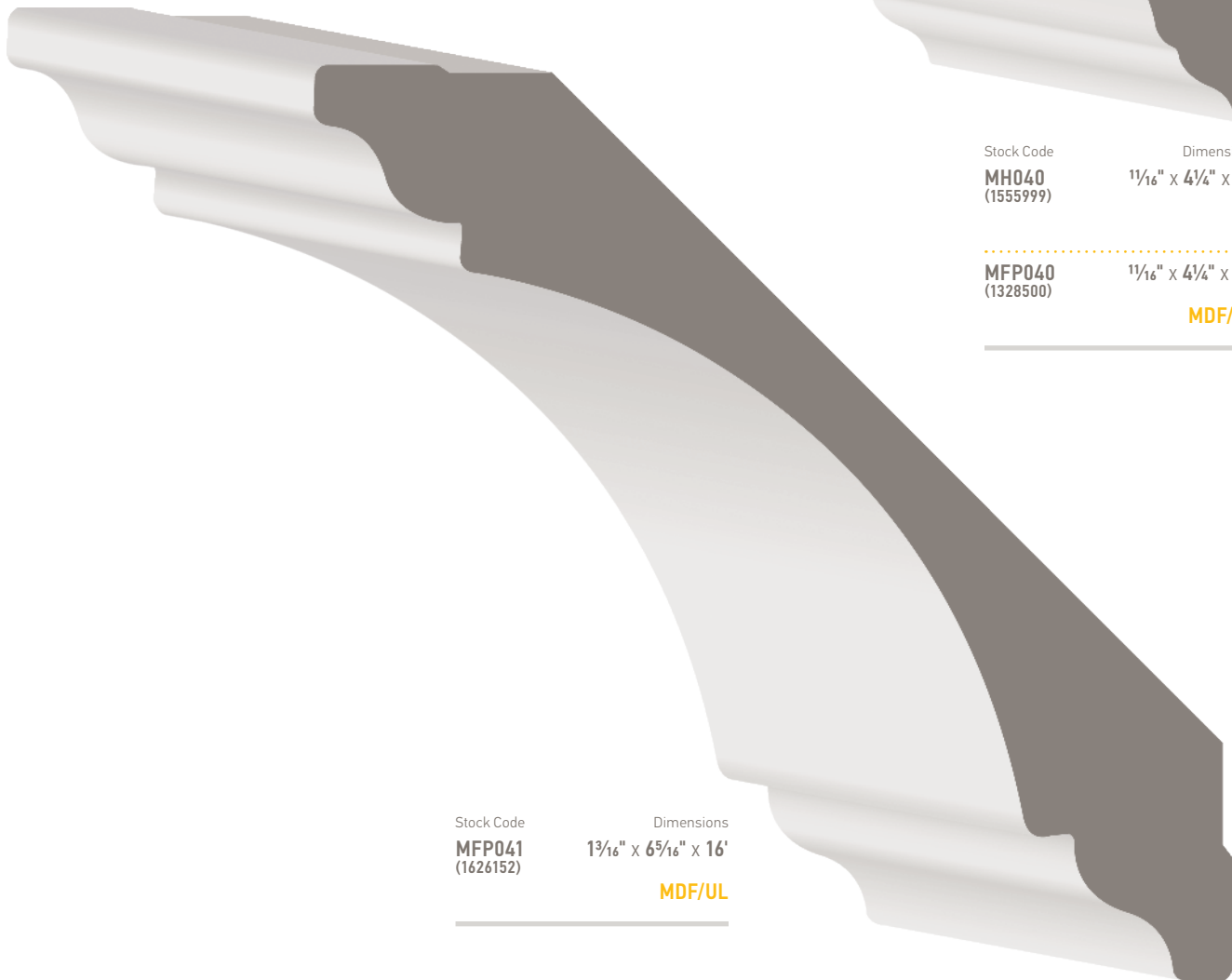

Stock Code
MFP041
(1626152)

Dimensions
1 3/16" x 6 5/16" x 16'

MDF/UL

CROWNS

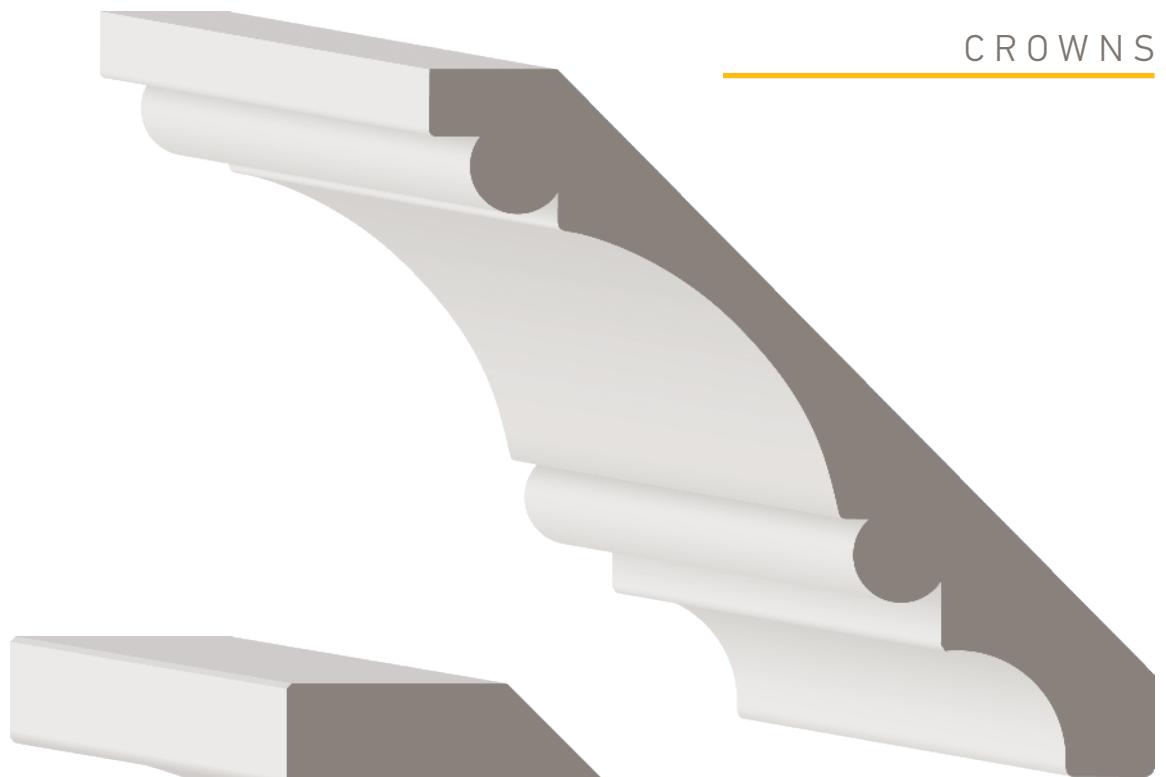

Stock Code
MH168
(1004558)

Dimensions
1¹/₁₆" x 5¹/₄" x RL

H

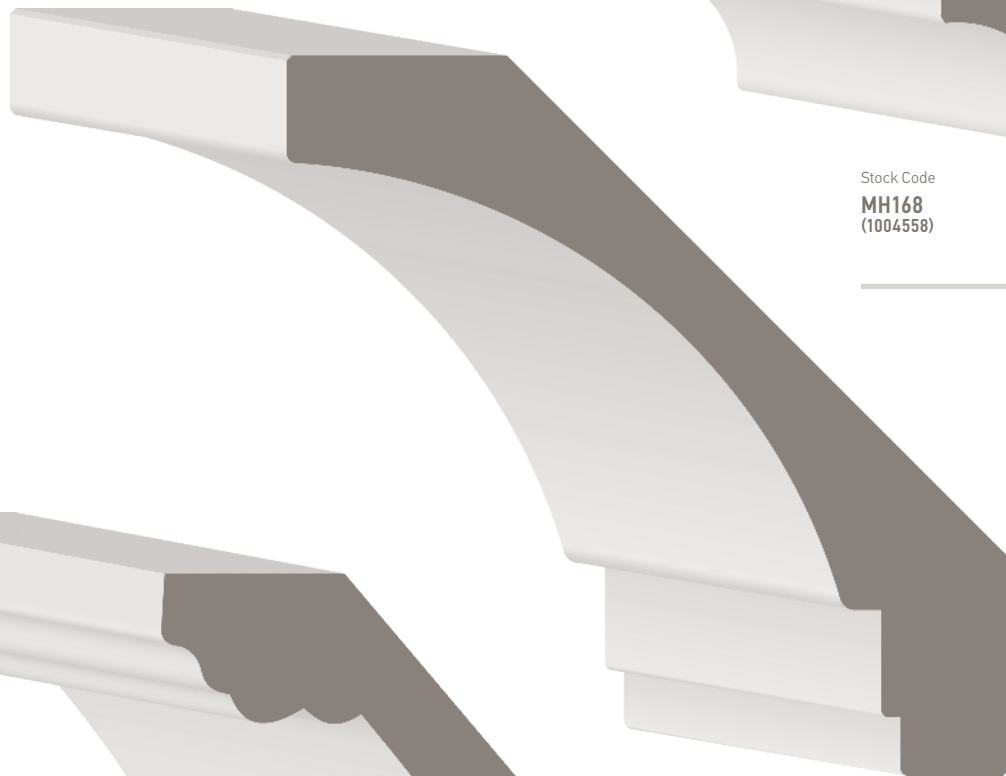

Stock Code
1328541

Dimensions
1³/₁₆" x 5¹/₄" x 16'
MDF/UL

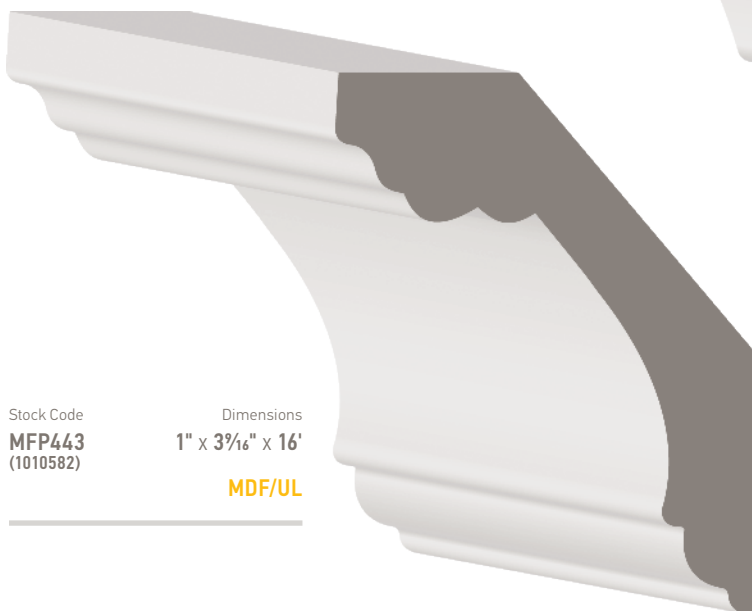

Stock Code
MFP443
(1010582)

Dimensions
1" x 3³/₁₆" x 16'
MDF/UL

CROWNS

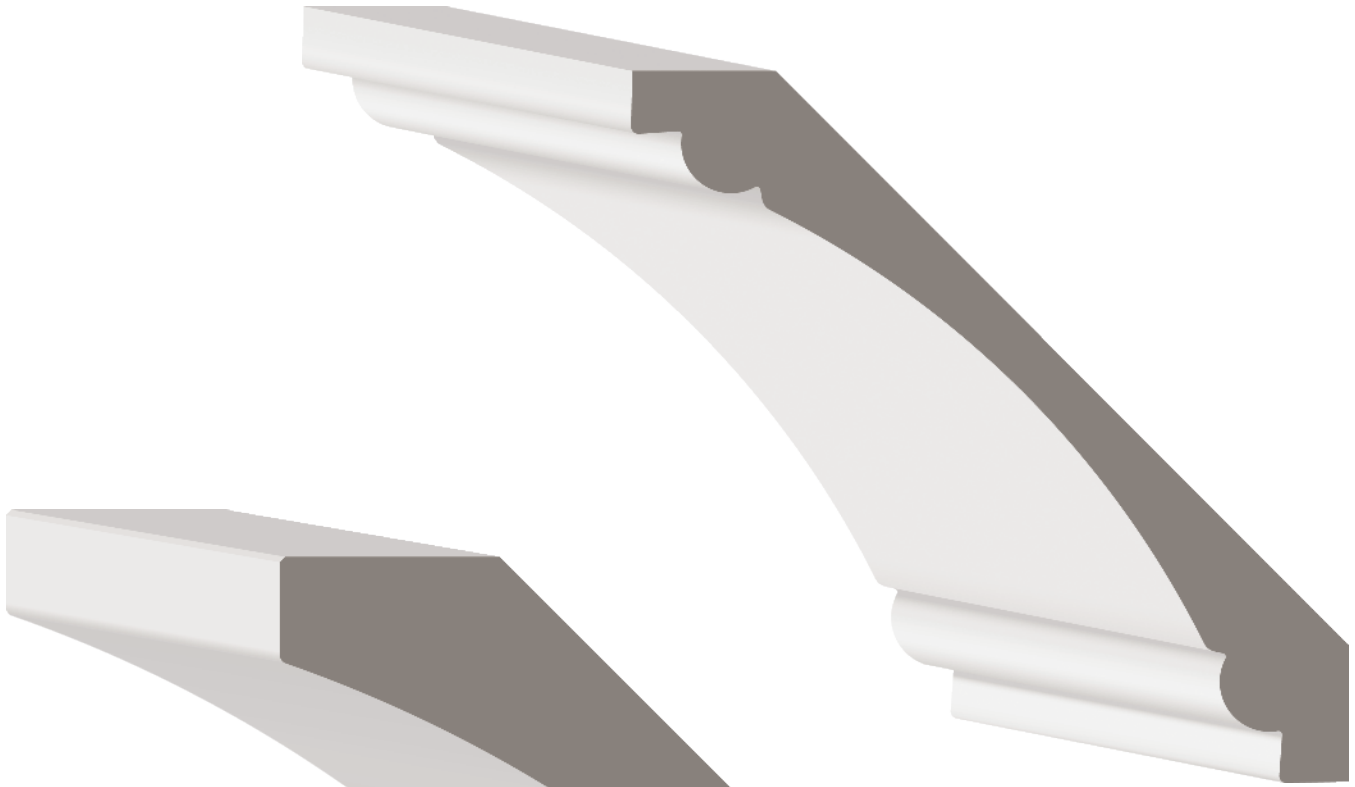

Stock Code
1318194

Dimensions
3/4" x 5 1/4" x 16'
MDF/UL

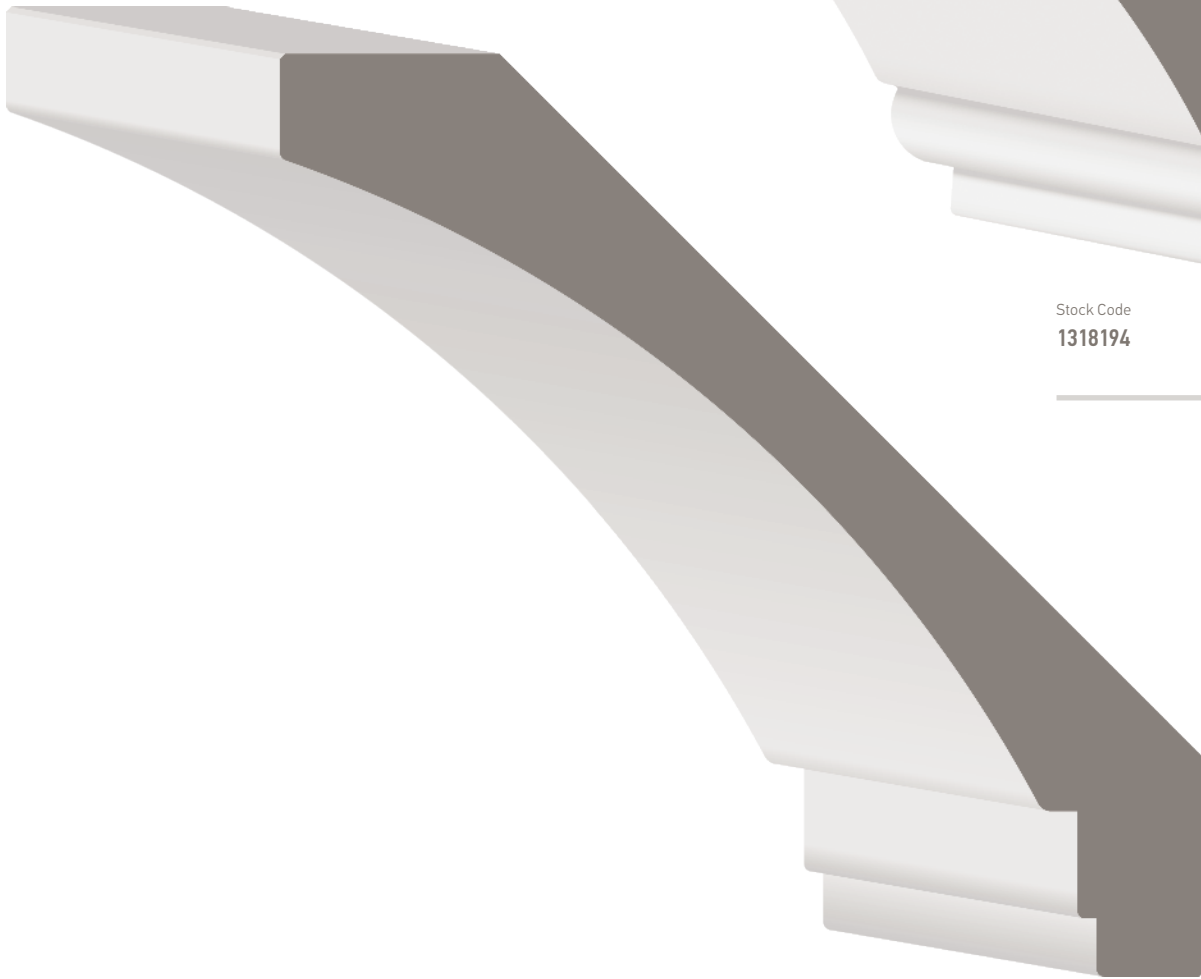

Stock Code
MFPU901
(1328544)

Dimensions
1 3/16" x 6 3/4" x 16'
MDF/UL

CROWNS



Stock Code
1326328

Dimensions
1" x 6¼" x 16'
MDF/UL

Stock Code
MP650
(1611161)

Dimensions
1½" x 5½" x 16'

PFJ

CROWNS

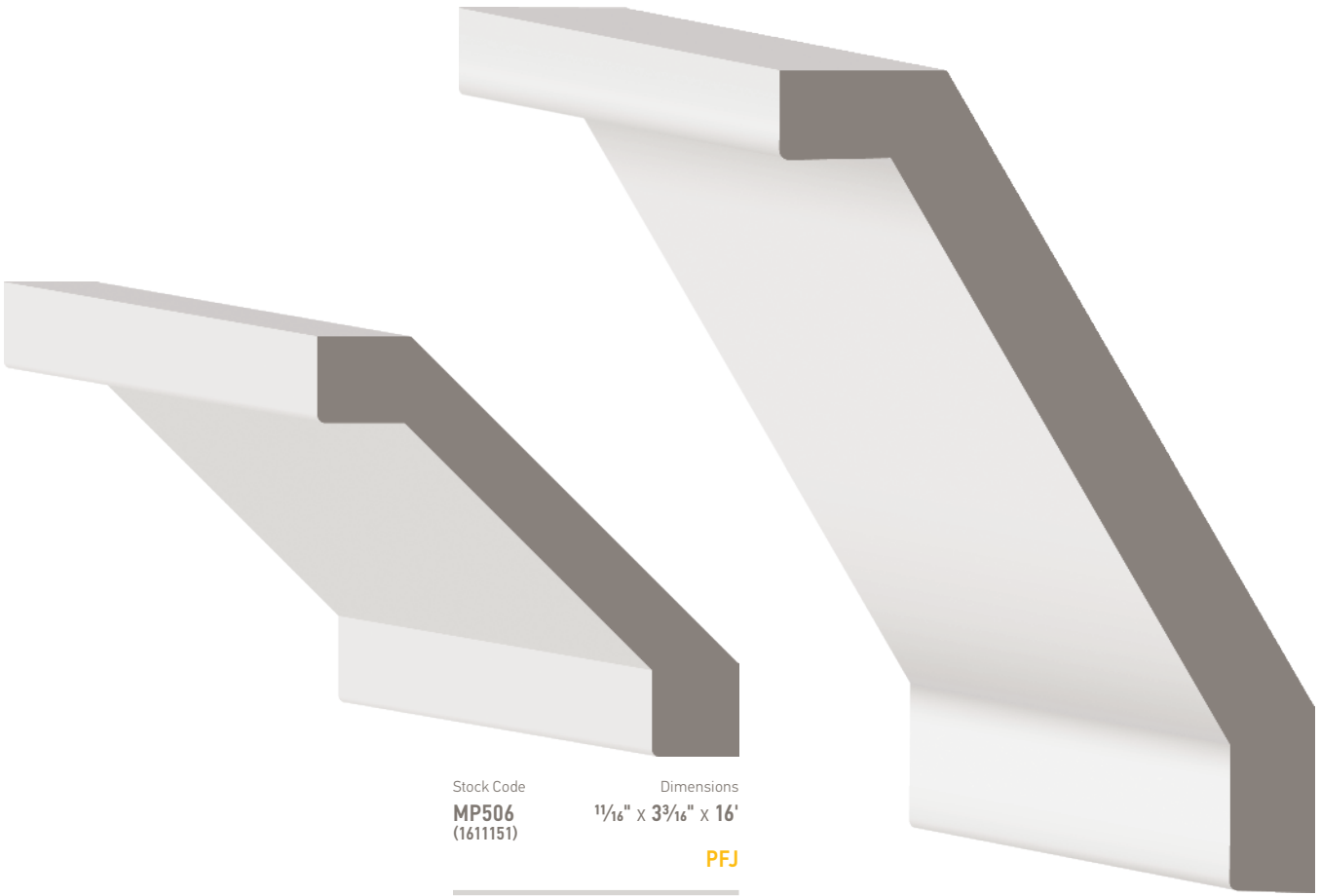

Stock Code
MP506
(1611151)

Dimensions
1¹/₁₆" x 3³/₁₆" x 16'

PFJ

Stock Code
1675701

Dimensions
1" x 5¹/₄" x 16'

MDF/UL

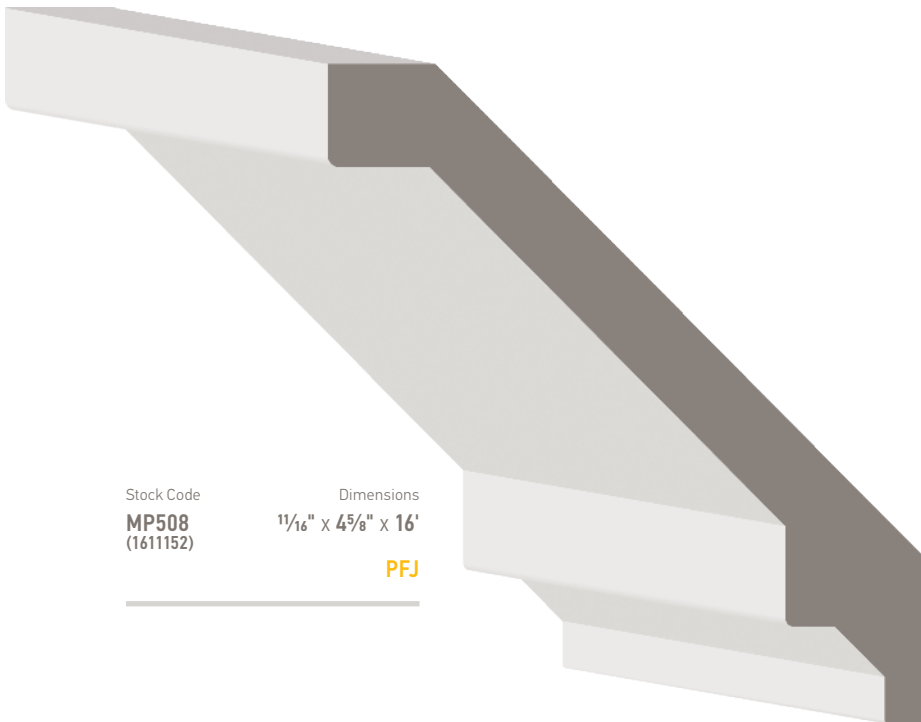

Stock Code
MP508
(1611152)

Dimensions
1¹/₁₆" x 4⁵/₈" x 16'

PFJ

CROWNS

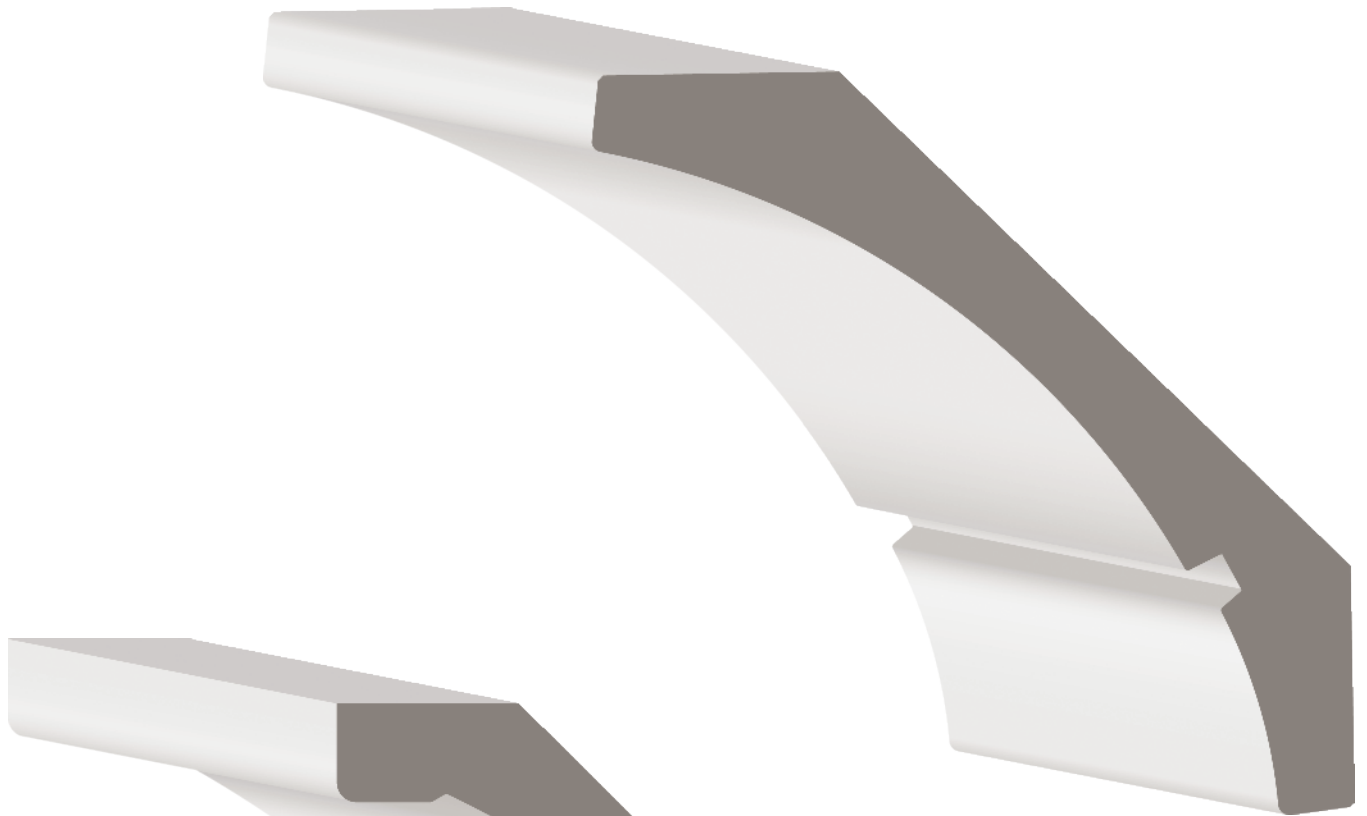

Stock Code
1324425

Dimensions
1 $\frac{3}{16}$ " x 5 $\frac{7}{16}$ " x 16'
MDF/UL

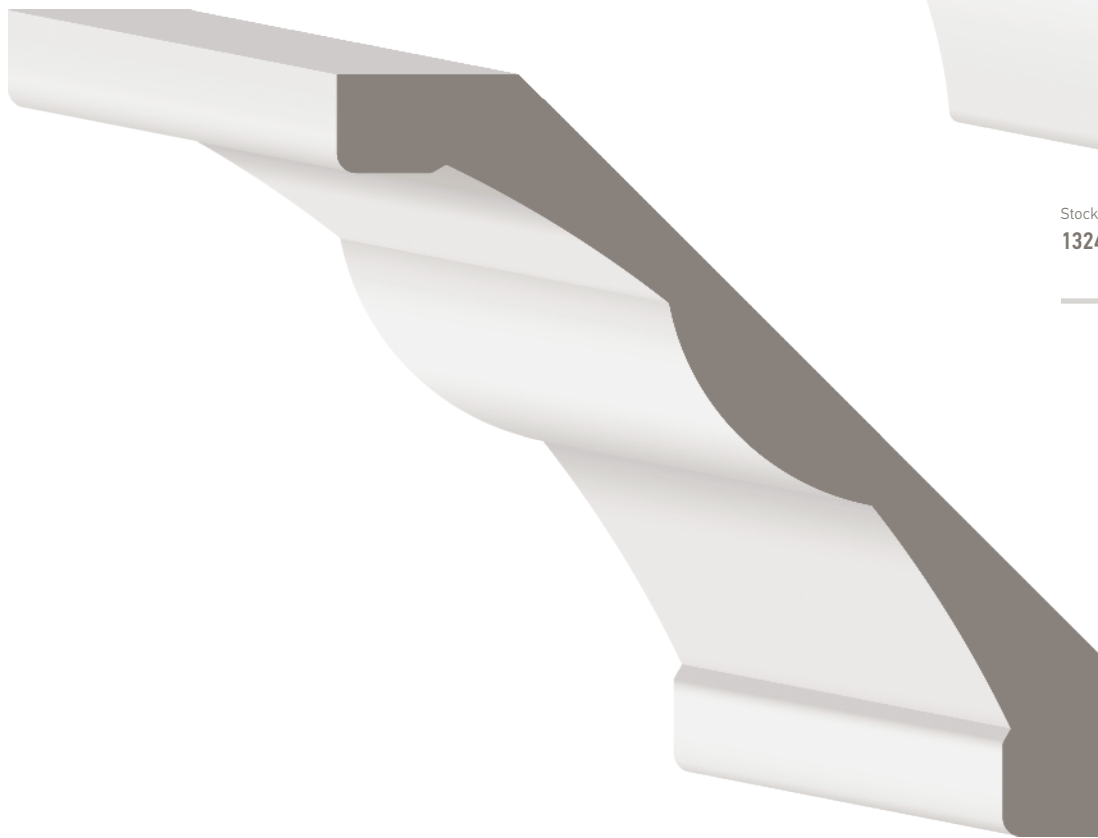

Stock Code
1320094

Dimensions
1" x 5 $\frac{11}{16}$ " x 16'
MDF/UL

CROWNS



Stock Code
MFP043
(1555825)

Dimensions
1" x 6⁵/₁₆" x 16'

MDF/UL

Stock Code
MP550
(1556322)

Dimensions
1¹/₈" x 5⁷/₁₆" x 16'

PFJ

CROWNS

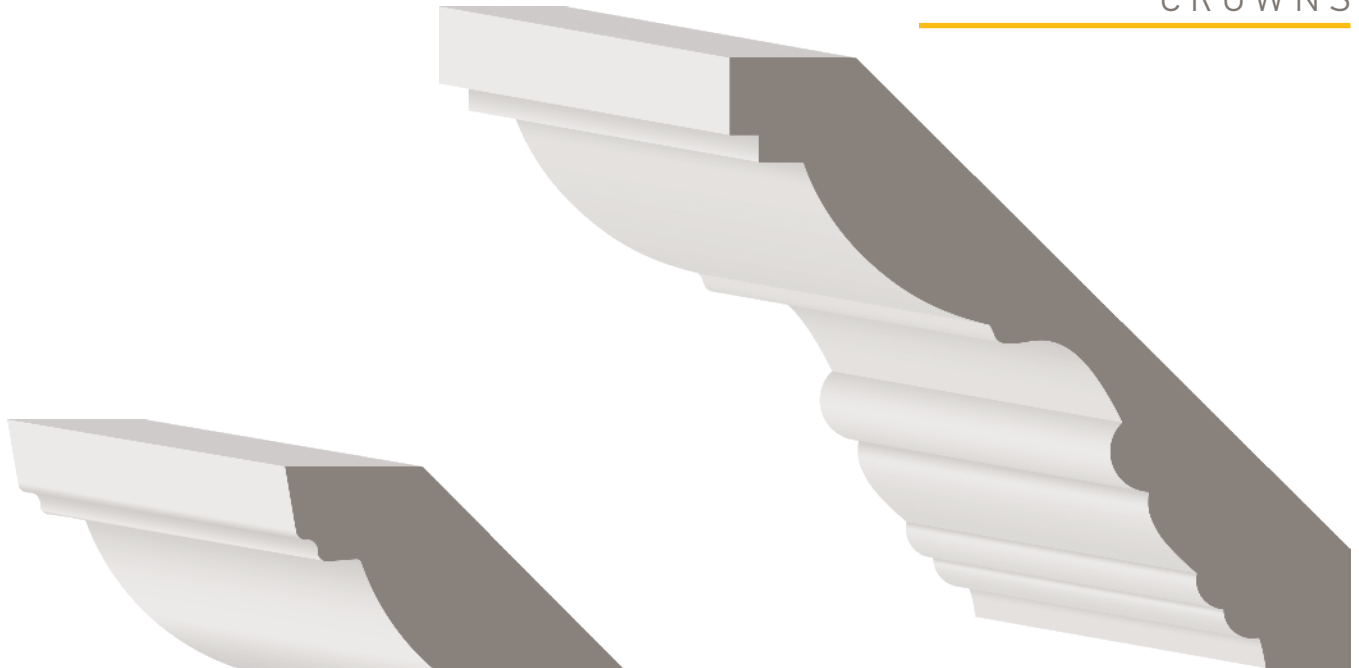

Stock Code
MFP712
(1555934)

Dimensions
1 1/16" x 4 1/2" x 16'

MDF/UL

Stock Code
1328411

Dimensions
1 1/16" x 4 1/2" x 14'
MDF/UL

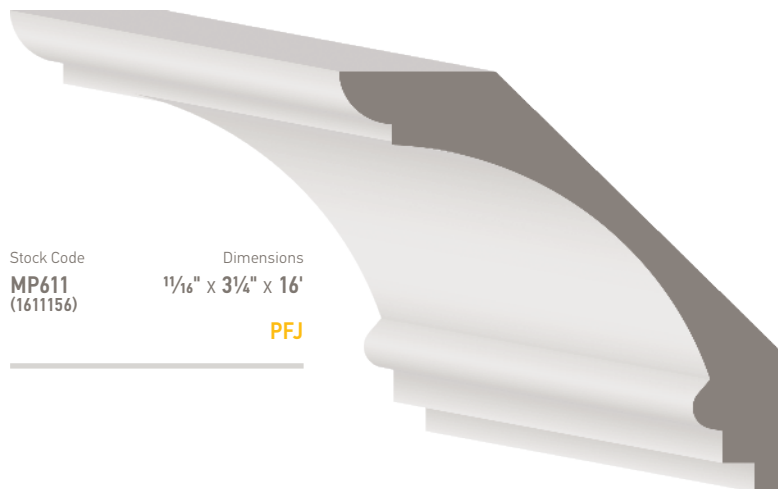

Stock Code
MP611
(1611156)

Dimensions
1 1/16" x 3 1/4" x 16'

PFJ

DOOR STOPS

DOOR STOPS

The door stop mouldings are attached to the door jamb on both sides and at the top. It is where the door comes to a rest when it is closed, stopping the door from moving any further, and covering the gap that would otherwise appear between the door and the jambs.

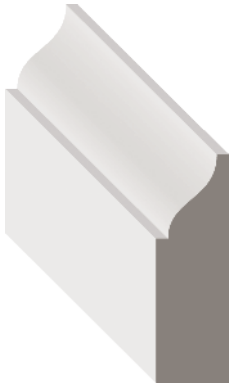

Stock Code
MH936
(1006795)

Dimensions
 $\frac{3}{8}$ " x $1\frac{3}{8}$ " x RL

H

MP936
(1556330)

$\frac{3}{8}$ " x $1\frac{3}{16}$ " x 14'

PFJ



Stock Code
MAK867CDAF07
(1609985)

Dimensions
 $\frac{1}{2}$ " x $1\frac{1}{4}$ " x 7'

MAK87608
(1004214)

$\frac{1}{2}$ " x $1\frac{1}{2}$ " x 8'

ALD

MH86607
(1556190)

$\frac{7}{16}$ " x $1\frac{5}{16}$ " x 7'

MH86608
(1556191)

$\frac{7}{16}$ " x $1\frac{5}{16}$ " x 8'

MH86610
(1556192)

$\frac{7}{16}$ " x $1\frac{5}{16}$ " x 10'

MH86612
(1610835)

$\frac{7}{16}$ " x $1\frac{5}{16}$ " x 12'

H



Stock Code
MH86508
(1588566)

Dimensions
 $\frac{7}{16}$ " x $1\frac{1}{2}$ " x 8'

MH86510
(1556189)

$\frac{7}{16}$ " x $1\frac{1}{2}$ " x 10'

MH86908
(1610836)

$\frac{7}{16}$ " x $1\frac{1}{16}$ " x 8'

MH86910
(1610837)

$\frac{7}{16}$ " x $1\frac{1}{16}$ " x 10'

H

MP865
(1611168)

$\frac{3}{8}$ " x $1\frac{5}{8}$ " x 12'

PFJ



Stock Code
MAK342208
(1004943)

Dimensions
 $\frac{3}{8}$ " x $1\frac{3}{16}$ " x 8'

ALD

MH342207
(1610731)

$\frac{3}{8}$ " x $1\frac{3}{16}$ " x 7'

H

MP342207
(1328803)

$\frac{3}{8}$ " x $1\frac{1}{4}$ " x 7'

PFJ

MEGON342207
(1610161)

$\frac{5}{16}$ " x $1\frac{1}{4}$ " x 7'

PGO

DOOR STOPS



Stock Code
MFPJLSTOP
(1050363)

Dimensions
 $\frac{1}{2}'' \times 1\frac{1}{16}'' \times 7'$

MDF/UL



Stock Code
1510155

Dimensions
 $\frac{7}{16}'' \times 1\frac{3}{16}'' \times 7'$
PFJ



Stock Code
MH59307
(1556167)

Dimensions
 $\frac{1}{2}'' \times 1\frac{1}{16}'' \times 80''$

H



Stock Code
MTEKOGCHAIR
(1611427)

Dimensions
 $\frac{7}{16}'' \times 3\frac{1}{4}'' \times 16'$

COM

MACH593
(1609942)

$\frac{7}{16}'' \times 1\frac{1}{16}'' \times 14'$

1675492

$\frac{7}{16}'' \times 1\frac{1}{16}'' \times 14'$

1675509

$\frac{7}{16}'' \times 1\frac{1}{16}'' \times 14'$

MPH

FLAT STOCK

FLAT STOCK

Finished boards come in either S4S (Surfaced 4 Sides) or S3S (Surfaced 3 Sides) and are used for a multitude of purposes, including shelving, window ledges, base, casing, etc.

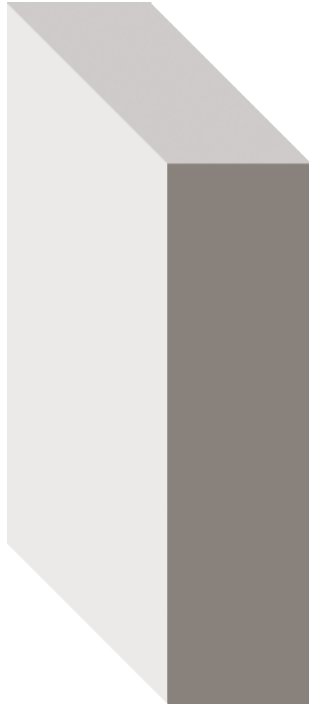

Stock Code	Thickness	Height	Length	Species
LAK102 (1609733)	3/4"	1-1/2"	RL	ALD
LAK103 (1555518)	3/4"	2-1/2"	RL	ALD
LAK104 (1555519)	3/4"	3-1/2"	RL	ALD
LAK10408 (1555520)	3/4"	3-1/2"	8'	ALD
LAK105 (1555521)	3/4"	4-9/16"	RL	ALD
LAK106 (1555522)	3/4"	5-1/2"	RL	ALD
LAK108 (1555523)	3/4"	7-1/4"	RL	ALD
LAK110 (1555524)	3/4"	9-1/4"	RL	ALD
LAK112 (1555525)	3/4"	11-1/4"	RL	ALD
LAK544 (1062743)	1"	3-1/2"	RL	ALD
LAK546 (1555526)	1"	5-1/2"	RL	ALD
LAK548 (1609747)	1"	7-1/4"	RL	ALD
LFVG1/02 (1609753)	1/2"	1-1/2"	RL	FIR
LFVG1/03 (1555536)	1/2"	2-1/2"	RL	FIR
LFVG1/04 (1555537)	1/2"	3-1/2"	RL	FIR
LFVG1/05 (1003639)	1/2"	4-1/2"	RL	FIR
LFVG1/06 (1555539)	1/2"	5-1/2"	RL	FIR
1670369	3/4"	1-1/2"	RL	FIR
LFVG102 (1006897)	11/16"	1-1/2"	RL	FIR
LFVG103 (1555544)	11/16"	2-1/2"	RL	FIR
LFVG10308 (1009554)	11/16"	2-1/2"	8'	FIR
LFVG104 (1555548)	11/16"	3-1/2"	RL	FIR
LFVG10408 (1555550)	11/16"	3-1/2"	8'	FIR
LFVG105 (1555553)	11/16"	4-9/16"	RL	FIR
LFVG106 (1609773)	11/16"	5-1/2"	RL	FIR
LFVG10608 (1555555)	11/16"	5-1/2"	8'	FIR
LFVG107 (1004673)	11/16"	6-9/16"	RL	FIR
LFVG108 (1609777)	11/16"	7-1/4"	RL	FIR
LFVG110 (1555561)	11/16"	9-1/4"	RL	FIR
LFVG112 (1555562)	11/16"	11-1/4"	RL	FIR
LFVG202 (1555564)	1-1/2"	1-1/2"	RL	FIR
LFVG203 (1555566)	1-1/2"	2-1/2"	RL	FIR
LFVG204 (1555567)	1-1/2"	3-1/2"	RL	FIR
LFVG206 (1555569)	1-1/2"	5-1/2"	RL	FIR
LFVG208 (1555572)	1-1/2"	7-1/4"	RL	FIR
LFVG210 (1555573)	1-1/2"	9-1/4"	RL	FIR
LFVG212 (1555574)	1-1/2"	11-1/4"	RL	FIR
LFVG404 (1555575)	3-1/2"	3-1/2"	RL	FIR
LFVG5412 (1006006)	1"	11-1/4"	RL	FIR
LFVG544 (1555577)	1"	3-1/2"	RL	FIR
LFVG545 (1007073)	1"	4-1/2"	RL	FIR
LFVG546 (1555579)	1"	5-1/2"	RL	FIR
LFVG548 (1555580)	1"	7-1/4"	RL	FIR
LHVG1/03 (1009553)	1/2"	2-1/2"	RL	H
LHVG1/04 (1006971)	1/2"	3-1/2"	RL	H
LHVG1/05 (1008226)	1/2"	4-1/2"	RL	H
LHVG1/06 (1011412)	1/2"	5-1/2"	RL	H
LHVG102 (1625886)	11/16"	1-1/2"	RL	H

Stock Code	Thickness	Height	Length	Species
LHVG10207 (1545317)	11/16"	1-1/2"	7"	H
LHVG10208 (1545318)	11/16"	1-1/2"	8"	H
LHVG10210 (1545319)	11/16"	1-1/2"	10"	H
LHVG10212 (1545320)	11/16"	1-1/2"	12"	H
LHVG103 (1555594)	11/16"	2-1/2"	RL	H
LHVG103S (1010931)	11/16"	2-1/2"	RL	H
LHVG10307 (1555596)	11/16"	2-1/2"	7"	H
LHVG10308 (1555597)	11/16"	2-1/2"	8"	H
LHVG10310 (1555598)	11/16"	2-1/2"	10"	H
LHVG10312 (1555599)	11/16"	2-1/2"	12"	H
LHVG104 (1625888)	11/16"	3-1/2"	RL	H
LHVG10407 (1555602)	11/16"	3-1/2"	7"	H
LHVG10408 (1555603)	11/16"	3-1/2"	8"	H
LHVG10410 (1609840)	11/16"	3-1/2"	10"	H
LHVG10412 (1555605)	11/16"	3-1/2"	12"	H
LHVG104S (1005116)	11/16"	3-1/2"	RL	H
LHVG105 (1328038)	11/16"	4-9/16"	RL	H
LHVG10508 (1555607)	11/16"	4-9/16"	8"	H
LHVG10510 (1609847)	11/16"	4-9/16"	10"	H
LHVG10512 (1609848)	11/16"	4-9/16"	12"	H
LHVG105S (1004878)	11/16"	4-9/16"	RL	H
LHVG106 (1555608)	11/16"	5-1/2"	RL	H
LHVG10608 (1609856)	11/16"	5-1/2"	8"	H
LHVG10610 (1007148)	11/16"	5-1/2"	10"	H
LHVG10612 (1010796)	11/16"	5-1/2"	12"	H
LHVG106S (1009433)	11/16"	5-1/2"	RL	H
LHVG107 (1555613)	11/16"	6-9/16"	RL	H
LHVG10708 (1609864)	11/16"	6-9/16"	8"	H
LHVG10710 (1609865)	11/16"	6-9/16"	10"	H
LHVG10712 (1609866)	11/16"	6-9/16"	12"	H
LHVG107S (1011152)	11/16"	6-9/16"	RL	H
LHVG108 (1625891)	11/16"	7-1/4"	RL	H
LHVG10808 (1007732)	11/16"	7-1/4"	8"	H
LHVG10810 (1004526)	11/16"	7-1/4"	10"	H
LHVG10812 (1555618)	11/16"	7-1/4"	12"	H
LHVG108S (1011007)	11/16"	7-1/4"	RL	H
LHVG110 (1555619)	11/16"	9-1/4"	RL	H
LHVG112 (1555620)	11/16"	11-1/4"	RL	H
LHVG202 (1555621)	1-1/2"	1-1/2"	RL	H
LHVG204 (1010062)	1-1/2"	3-1/2"	RL	H
LHVG206 (1011095)	1-1/2"	5-1/2"	RL	H
LHVG208 (1005716)	1-1/2"	7-1/4"	RL	H
LHVG544 (1008290)	1"	3-1/2"	RL	H
LHVG545 (1007968)	1"	4-1/2"	RL	H
LHVG546 (1002280)	1"	5-1/2"	RL	H
LHVG548 (1006688)	1"	7-1/4"	RL	H
LMP102 (1328077)	3/4"	1-1/2"	RL	MAP
LMP104 (1328085)	3/4"	3-1/2"	RL	MAP

Stock Code	Thickness	Height	Length	Species
LMP106 (1328090)	3/4"	5-1/2"	RL	MAP
LPOP1/04 (1609894)	1/2"	3-1/2"	RL	POP
LPOP1/06 (1609895)	1/2"	5-1/2"	RL	POP
LPOP102 (1625928)	3/4"	1-1/2"	RL	POP
LPOP10210 (1002101)	3/4"	1-1/2"	10"	POP
LPOP103 (1625929)	23/32"	2-1/2"	RL	POP
LPOP104 (1625930)	3/4"	3-1/2"	RL	POP
LPOP105 (1625931)	11/16"	4-9/16"	RL	POP
LPOP106 (1625932)	23/32"	5-1/2"	RL	POP
LPOP108 (1625933)	23/32"	7-1/4"	RL	POP
LPOP110 (1484185)	3/4"	9-1/4"	RL	POP
LPOP112 (1484231)	3/4"	11-1/4"	RL	POP
LPOP546 (1609908)	1-1/16"	5-1/2"	RL	POP
LPOP548 (1609909)	1-1/16"	7-1/4"	RL	POP
LRO102 (1328165)	3/4"	1-1/2"	RL	O
LRO103 (1328170)	3/4"	2-1/2"	RL	O
LRO104 (1328175)	3/4"	3-1/2"	RL	O
LRO105 (1328180)	3/4"	4-1/2"	RL	O
LRO106 (1328185)	3/4"	5-1/2"	RL	O
LRO108 (1625967)	3/4"	7-1/4"	RL	O
MACH102 (1609928)	11/16"	1-1/2"	14'	MPH
MACH104 (1609931)	11/16"	3-1/2"	14'	MPH
MACH105 (1609932)	11/16"	4-9/16"	14'	MPH
MACH106 (1609933)	11/16"	5-1/2"	14'	MPH
MACH107 (1609934)	11/16"	6-9/16"	14'	MPH
MACH108 (1609935)	11/16"	7-1/4"	14'	MPH
MACH110 (1609936)	11/16"	9-1/4"	14'	MPH
MASC102 (1610038)	21/32"	1-3/8"	14'	PCH
MASC104 (1610039)	21/32"	3-1/2"	14'	PCH
MASC105 (1555695)	5/8"	4-9/16"	14'	PCH
MASC106 (1007311)	5/8"	5-1/2"	14'	PCH
MASC107 (1009165)	21/32"	6-9/16"	14'	PCH
MASC108 (1610043)	21/32"	7-1/4"	14'	PCH
MASC110 (1610044)	11/16"	9-1/4"	14'	PCH
MAUF102 (1610078)	11/16"	1-1/2"	14'	MUF
MAUF104 (1610079)	11/16"	3-1/2"	14'	MUF
MAUF105 (1610080)	11/16"	4-9/16"	14'	MUF
MAUF106 (1610081)	11/16"	5-1/2"	14'	MUF
MAUF107 (1610082)	11/16"	6-9/16"	14'	MUF
MAUF108 (1610083)	11/16"	7-1/4"	14'	MUF
MAUF110 (1039384)	11/16"	9-1/4"	14'	MUF
MEAON102 (1555714)	21/32"	1-3/8"	14'	PAO
MEAON104 (1006601)	21/32"	3-1/2"	14'	PAO
MEAON105 (1010978)	21/32"	4-9/16"	14'	PAO
MEAON106 (1006811)	21/32"	5-1/2"	14'	PAO
MEAON107 (1009185)	21/32"	6-9/16"	14'	PAO
MEAON108 (1005712)	21/32"	7-1/4"	14'	PAO
MEAON110 (1006997)	21/32"	9-1/4"	14'	PAO

FLAT STOCK

Stock Code	Thickness	Height	Length	Species
MEGON102 (1003290)	21/32"	1-3/8"	14'	PGO
MEGON104 (1004315)	21/32"	3-1/2"	14'	PGO
MEGON105 (1009965)	5/8"	4-9/16"	14'	PGO
MEGON106 (1009010)	21/32"	5-1/2"	14'	PGO
MEGON107 (1007575)	21/32"	6-9/16"	14'	PGO
MEGON108 (1006844)	21/32"	7-1/4"	14'	PGO
MEGON110 (1010519)	21/32"	9-1/4"	14'	PGO
MESM102 (1006392)	21/32"	1-3/8"	14'	PEM
MESM104 (1010863)	21/32"	3-1/2"	14'	PEM
MESM105 (1002287)	21/32"	4-9/16"	14'	PEM
MESM106 (1007756)	21/32"	5-1/2"	14'	PEM
MESM107 (1003679)	21/32"	6-9/16"	14'	PEM
MESM108 (1006749)	21/32"	7-1/4"	14'	PEM
MESM110 (1002728)	21/32"	9-1/4"	14'	PEM
MFP1/04 (1555835)	1/2"	3-1/2"	16'	MDF/UL
MFP1/05 (1555836)	1/2"	4-1/2"	16'	MDF/UL
MFP1/06 (1555837)	1/2"	5-1/2"	16'	MDF/UL
MFP1/08 (1555838)	1/2"	7-1/4"	16'	MDF/UL
MFP102 (1626102)	11/16"	1-1/2"	16'	MDF/UL
MFP10208 (1328228)	11/16"	1-1/2"	8'	MDF/UL
MFP10210 (1555841)	11/16"	1-1/2"	10'	MDF/UL
MFP10212 (1626016)	11/16"	1-1/2"	12'	MDF/UL
MFP103 (1566872)	11/16"	2-1/2"	16'	MDF/UL
MFP10308 (1328231)	11/16"	2-1/2"	8'	MDF/UL
MFP10310 (1555845)	11/16"	2-1/2"	10'	MDF/UL
MFP10312 (1328232)	11/16"	2-1/2"	12'	MDF/UL
MFP104 (1555846)	11/16"	3-1/2"	16'	MDF/UL
MFP10408 (1328234)	11/16"	3-1/2"	8'	MDF/UL
MFP10410 (1367570)	11/16"	3-1/2"	10'	MDF/UL
MFP10412 (1328236)	11/16"	3-1/2"	12'	MDF/UL
MFP105 (1555850)	11/16"	4-9/16"	16'	MDF/UL
MFP10508 (1328239)	11/16"	4-9/16"	8'	MDF/UL
MFP10510 (1610328)	11/16"	4-9/16"	10'	MDF/UL
MFP10512 (1328241)	11/16"	4-9/16"	12'	MDF/UL
MFP106 (1555852)	11/16"	5-1/2"	16'	MDF/UL
MFP10608 (1328245)	11/16"	5-1/2"	8'	MDF/UL
MFP10610 (1555854)	11/16"	5-1/2"	10'	MDF/UL
MFP10612 (1428878)	11/16"	5-1/2"	12'	MDF/UL
MFP107 (1555856)	11/16"	6-9/16"	16'	MDF/UL
MFP108 (1555857)	11/16"	7-1/4"	16'	MDF/UL
MFP10808 (1555858)	11/16"	7-1/4"	8'	MDF/UL
MFP10810 (1006533)	11/16"	7-1/4"	10'	MDF/UL
MFP10812 (1328251)	11/16"	7-1/4"	12'	MDF/UL
MFP110 (1555861)	11/16"	9-1/4"	16'	MDF/UL
MFP11008 (1555862)	11/16"	9-1/4"	8'	MDF/UL
MFP11010 (1555863)	11/16"	9-1/4"	10'	MDF/UL
MFP112 (1555864)	11/16"	11-1/4"	16'	MDF/UL

Stock Code	Thickness	Height	Length	Species
MFP11208 (1328252)	3/4"	11-1/4"	8'	MDF/UL
MFP11210 (1555866)	11/16"	11-1/4"	10'	MDF/UL
MFP11212 (1555867)	11/16"	11-1/4"	12'	MDF/UL
MFP413 (1003499)	11/16"	4-13/16"	16'	MDF/UL
MFP5/44 (1555913)	1"	3-1/2"	16'	MDF/UL
MFP5/45 (1555914)	1"	4-9/16"	16'	MDF/UL
MFP5/46 (1545343)	1"	5-1/2"	16'	MDF/UL
MFP5/48 (1555916)	1"	7-1/4"	16'	MDF/UL
MFSP102 (1050386)	11/16"	1-1/2"	16'	MDF/UL
MFSP103 (1610482)	11/16"	2-1/2"	14'	MDF/UL
MFSP104 (1555951)	11/16"	3-1/2"	14'	MDF/UL
MFSP105 (1050388)	11/16"	4-9/16"	16'	MDF/UL
MFSP106 (1050389)	11/16"	5-1/2"	16'	MDF/UL
MFSP107 (1555952)	11/16"	6-9/16"	16'	MDF/UL
MFSP108 (1610494)	11/16"	7-1/4"	16'	MDF/UL
MFSP112 (1610496)	11/16"	11-1/4"	16'	MDF/UL
MP1/04 (1556261)	1/2"	3-1/2"	16'	PFJ
MP1/06 (1626420)	1/2"	5-1/2"	16'	PFJ
MP102 (1677047)	21/32"	1-1/2"	16'	PFJ
MP103 (1328734)	21/32"	2-1/2"	16'	PFJ
MP104 (1328737)	21/32"	3-1/2"	16'	PFJ
MP105 (1328739)	21/32"	4-9/16"	16'	PFJ
MP106 (1328741)	21/32"	5-1/2"	16'	PFJ
MP107 (1328743)	21/32"	6-9/16"	16'	PFJ
MP108 (1328744)	21/32"	7-1/4"	16'	PFJ
MP110 (1626438)	21/32"	9-1/4"	16'	PFJ
MP112 (1626439)	21/32"	11-1/4"	16'	PFJ
MP5/44 (1556319)	1"	3-1/2"	16'	PFJ
MP5/46 (1556320)	1"	5-1/2"	16'	PFJ
MP5/48 (1556321)	1"	7-1/4"	RL	PFJ
MTEK1/04 (1611361)	1/2"	3-1/2"	16'	COM
MTEK1/06 (1588767)	1/2"	5-1/2"	16'	COM
MTEK102 (1556488)	23/32"	1-1/2"	16'	COM
MTEK103 (1556489)	11/16"	2-1/2"	16'	COM
MTEK104 (1329017)	11/16"	3-1/2"	16'	COM
MTEK105 (1556491)	11/16"	4-9/16"	16'	COM
MTEK106 (1556492)	11/16"	5-1/2"	16'	COM
MTEK107 (1556493)	11/16"	6-9/16"	16'	COM
MTEK108 (1556494)	11/16"	7-1/4"	16'	COM
MTEK110 (1556495)	11/16"	9-1/4"	16'	COM
MTEK544 (1007214)	1"	3-1/2"	16'	COM
MTEK546 (1588772)	1"	5-1/2"	16'	COM

GLASS & SASH BEADS

Narrow wood strips or moulding used for edging against a door or window sash, or to secure glass panels to doors and windows.



Stock Code
MH704
(1008058)

Dimensions
5/8" x 5/8" x RL

H

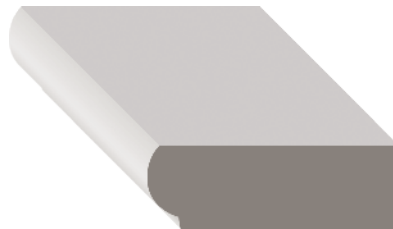

Stock Code
MH9531
(1002762)

Dimensions
7/16" x 1 1/4" x 16'

H

MFP953112 7/16" x 1 5/16" x 12'
(1050366)

MDF/UL

MP9531 3/8" x 1 5/16" x RL
(1611172)

PFJ



Stock Code
MAK9532
(1008384)

Dimensions
1/2" x 1 1/4" x RL

ALD

MTEK9532
(1556504)

7/16" x 1 1/4" x 12'

COM

MFVG9532
(1555969)

7/16" x 1 1/4" x RL

FIR

MH9532
(1008270)

7/16" x 1 1/4" x RL

H

MFP953212
(1555947)

7/16" x 1 1/4" x 12'

MDF/UL

HAND RAILS

HAND RAILS

Hand rails provide safety and support.

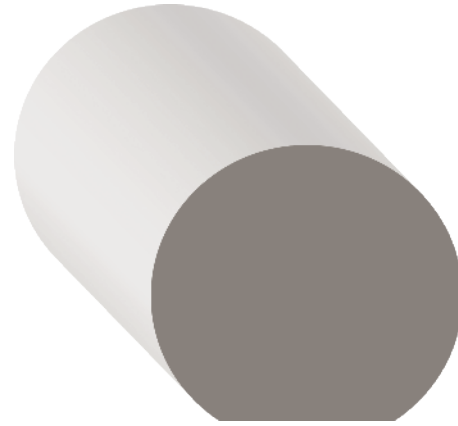

Stock Code	Dimensions
MH231 (1556034)	1 ¹ / ₁₆ " x 1 ⁵ / ₈ " x RL
MH23108 (1588539)	1 ⁷ / ₁₆ " x 1 ⁵ / ₈ " x 8'
MH23112 (1588540)	1 ⁷ / ₁₆ " x 1 ⁵ / ₈ " x 12'

H

MP231 (1556296)	1 ⁷ / ₁₆ " x 1 ⁵ / ₈ " x 18'
---------------------------	--

PFJ

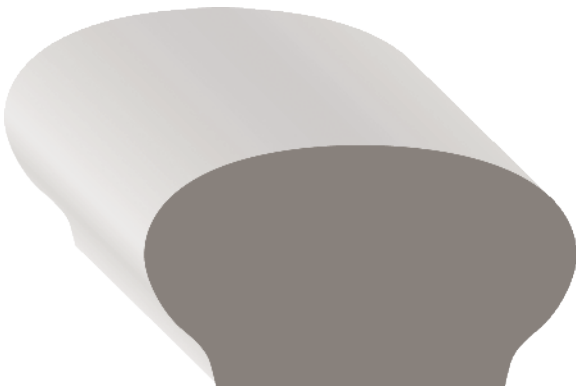

Stock Code	Dimensions
MH3507 (1341911)	1 ¹ / ₄ " x 2 ¹ / ₄ " x 8'
MH350708 (1556128)	1 ¹ / ₄ " x 2 ¹ / ₄ " x 12'
MH350712 (1556129)	1 ¹ / ₄ " x 2 ¹ / ₄ " x 12'
MH3507DS (1008100)	1 ¹ / ₄ " x 2 ¹ / ₄ " x RL

H

MP3507 (1611136)	1 ¹ / ₄ " x 2 ¹ / ₄ " x 18'
----------------------------	---

PFJ

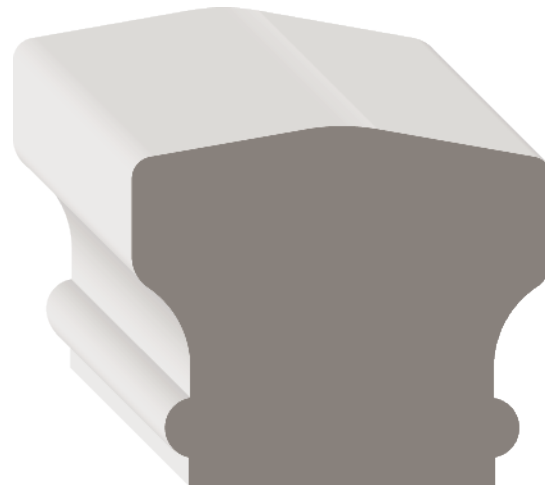

Stock Code	Dimensions
1681432	1 ⁷ / ₈ " x 2 ¹ / ₄ " x 16'
1681433	1 ⁷ / ₈ " x 2 ¹ / ₄ " x 18'

H

JAMBS

The top and two sides of a door or window frame that contact the door or sash: top jamb and side jambs. The most common size for interior use is 1 1/16" thick by 4-9/16" wide.



Stock Code	Thickness	Width	Length	Species
MAKJ458C99 (1065207)	1-7/32"	4-5/8"	98"	ALD
MAKJ458F9712 (1009803)	3/4"	4-5/8"	100"	ALD
MAKJ478F86 (1609996)	3/4"	4-7/8"	86"	ALD
MAKJ49F (1555689)	3/4"	4-9/16"	82-1/4"	ALD
MAKJ658F-S09 (1555691)	3/4"	6-5/8"	81-11/16"	ALD
MAKJ658F9712 (1566843)	3/4"	6-5/8"	98-3/16"	ALD
MAKJ69FX (1009977)	3/4"	6-9/16"	84"	ALD
MEAJ413FSA (1003615)	1-1/8"	4-13/16"	7'	PAO
MEAJ49FSA (1009332)	1-1/16"	4-9/16"	7'	PAO
MECHJ413FSA (1039441)	1-1/8"	4-13/16"	81-5/8"	PEH
MECHJ49FSA (1039934)	1-1/8"	4-9/16"	81-5/8"	PEH
MECHJ613KS (1039446)	1-3/16"	6-13/16"	7'	PEH
MEGONJ413FSA (1005648)	1-1/8"	4-13/16"	7'	PGO
MEGONJ49F (1009251)	11/16"	4-9/16"	7'	PGO
MEGONJ49FSA (1008361)	1-1/16"	4-9/16"	7'	PGO
MEGONJ613KS (1555750)	1-3/16"	6-13/16"	7'	PGO
MESANJ49FSA (1555774)	1-1/16"	4-9/16"	7'	PEA
MESCJ413FSA (1555782)	1-1/8"	4-13/16"	7'	CHR
MESCJ49FSA (1555785)	1-1/16"	4-9/16"	7'	PCH
MESCJ613KS (1555787)	1-3/16"	6-13/16"	7'	PCH
MESMJ413FSA (1002812)	1-1/8"	4-13/16"	7'	PEM
MESMJ49FSA (1007683)	1-1/16"	4-9/16"	7'	PEM
MESMJ613KS (1007638)	1-3/16"	6-13/16"	83-1/2"	PEM
MEUFJ413FSA (1039940)	1-1/8"	4-13/16"	81-5/8"	MUF
MEUFJ49FSA (1039935)	1-1/8"	4-9/16"	81-5/8"	MUF
MEUFJ613KS (1610273)	1-3/16"	6-13/16"	7'	MUF
MFPJ413C (1555949)	1-1/16"	4-13/16"	7'	MDF/UL
MFPJ49D (1555950)	1-1/16"	4-9/16"	7'	MDF/UL
MFSPJ413C (1610514)	1-1/16"	4-13/16"	81-5/8"	MDF/UL
MFVGJ49C (1555970)	1-3/16"	4-9/16"	81-5/8"	FIR
MFVGJ49C80 (1555971)	1-3/16"	4-9/16"	98-1/16"	FIR
MFVGJ69C (1610542)	1-3/16"	6-9/16"	81-5/8"	FIR
MFVGJ69C80 (1610543)	1-3/16"	6-9/16"	97-5/8"	FIR
MFVGJ69KL (1555974)	1-3/16"	6-9/16"	83-1/2"	FIR
MFVGJ71KL80 (1555976)	1-3/16"	7-1/4"	99-3/4"	FIR
MHJ413 (1610858)	11/16"	4-13/16"	81-5/8"	H
MHJ413C (1009731)	1-3/16"	4-13/16"	97-5/8"	H
MHJ413C80 (1002202)	1-3/16"	4-13/16"	97-5/8"	H
MHJ413FSA (1556205)	1-3/16"	4-13/16"	81-5/8"	H
MHJ415C70 (1006697)	1-3/16"	4-15/16"	85-5/8"	H
MHJ49 (1556208)	11/16"	4-9/16"	81-5/8"	H*
MHJ49C80 (1005860)	1-3/16"	4-9/16"	97-5/8"	H
MHJ49D3 (1008920)	1-3/16"	4-9/16"	81-5/8"	H
MHJ49F (1556215)	11/16"	4-9/16"	82-1/4"	H
MHJ49F-S09 (1610887)	11/16"	4-9/16"	81-11/16"	H
MHJ49FSA (1052660)	1-3/16"	4-9/16"	81-5/8"	H
MHJ49FX (1328645)	11/16"	4-9/16"	83-1/2"	H
MHJ49K (1677202)	1-3/16"	4-9/16"	83-1/2"	H

*Veneer

JAMBS

Stock Code	Thickness	Width	Length	Species
MHJ49KL-S01 (1677153)	1-3/16"	4-9/16"	82"	H
MHJ51K (1005130)	1-3/16"	5-1/4"	83-1/2"	H
MHJ613C (1668205)	1-3/16"	6-13/16"	81-5/8"	H
MHJ613K (1002897)	1-3/16"	6-13/16"	83-1/2"	H
MHJ69F-S09 (1610919)	11/16"	6-9/16"	81-11/16"	H
MHJ69K (1676282)	1-3/16"	6-9/16"	83-1/2"	H
MHJ69KL-S01 (1006358)	1-3/16"	6-9/16"	82"	H
MHJ69K-S17 (1010953)	1-3/16"	6-9/16"	81-3/4"	H
MHJ71K70 (1003092)	1-3/16"	7-1/4"	87-1/2"	H
MPJ411C (1611180)	1-7/32"	4-11/16"	81-5/8"	PFJ
MPJ413C (1556336)	1-7/32"	4-13/16"	81-5/8"	PFJ
MPJ413C80 (1556338)	1-7/32"	4-13/16"	96"	PFJ
MPJ413C-CC (1556339)	1-3/16"	4-13/16"	81-5/8"	PFJ
MPJ413F (1556341)	11/16"	4-13/16"	82-1/4"	PFJ
MPJ413F-S09 (1556342)	11/16"	4-13/16"	81-11/16"	PFJ
MPJ413K (1556345)	1-7/32"	4-13/16"	83-1/2"	PFJ
MPJ413KS70 (1556347)	1-7/32"	4-13/16"	86"	PFJ
MPJ415C70 (1611195)	1-3/16"	4-15/16"	85-5/8"	PFJ
MPJ49C (1314628)	1-7/32"	4-9/16"	81-5/8"	PFJ
MPJ49D (1556351)	1-7/32"	4-9/16"	81-5/8"	PFJ
MPJ49C80 (1052756)	1-7/32"	4-9/16"	97-5/8"	PFJ
MPJ49D80 (1328841)	1-3/16"	4-9/16"	97-5/8"	PFJ
MPJ49DCC80 (1678943)	1-3/16"	4-9/16"	97-5/8"	PFJ
MPJ49DCC (1328842)	1-3/16"	4-9/16"	81-5/8"	PFJ
MPJ49F (1556358)	11/16"	4-9/16"	82-1/4"	PFJ
MPJ49F-S09 (1556360)	11/16"	4-9/16"	81-11/16"	PFJ
MPJ49FX (1556361)	11/16"	4-9/16"	83-1/2"	PFJ
MPJ49K (1556362)	1-7/32"	4-9/16"	83-1/2"	PFJ
MPJ49K-S01 (1556364)	1-7/32"	4-9/16"	82"	PFJ
MPJ49K-S17 (1556366)	1-7/32"	4-9/16"	81-3/4"	PFJ
MPJ51C (1556368)	1-7/32"	5-1/4"	81-5/8"	PFJ
MPJ51K (1611232)	1-7/32"	5-1/4"	83-1/2"	PFJ
MPJ613C (1556370)	1-7/32"	6-13/16"	81-5/8"	PFJ
MPJ613K-S01 (1678901)	1-7/32"	6-13/16"	82"	PFJ
MPJ613K (1556371)	1-7/32"	6-13/16"	83-1/2"	PFJ
MPJ613KS70 (1556372)	1-7/32"	6-13/16"	86-3/4"	PFJ
MPJ69C (1314632)	1-7/32"	6-9/16"	81-5/8"	PFJ
MPJ69C80 (1472593)	1-7/32"	6-9/16"	97-5/8"	PFJ
MPJ69F (1556377)	11/16"	6-9/16"	82-1/4"	PFJ
MPJ69F-S09 (1556379)	11/16"	6-9/16"	81-11/16"	PFJ
MPJ69FX (1008055)	11/16"	6-9/16"	83-1/2"	PFJ
MPJ69K (1611249)	1-7/32"	6-9/16"	83-1/2"	PFJ
MPJ69K80 (1556383)	1-7/32"	6-9/16"	100"	PFJ
MPJ69K-S01 (1556390)	1-7/32"	6-9/16"	82"	PFJ
MPJ69K-S14 (1556391)	1-7/32"	6-9/16"	81-7/8"	PFJ
MPJ69K-S17 (1556392)	1-7/32"	6-9/16"	81-3/4"	PFJ
MPJ71C (1556394)	1-7/32"	7-1/4"	81-5/8"	PFJ

Stock Code	Thickness	Width	Length	Species
MPJ71C70 (1556395)	1-7/32"	7-1/4"	85-5/8"	PFJ
MPJ71C80 (1611266)	1-7/32"	7-1/4"	97-5/8"	PFJ
MPJ71K (1556397)	1-7/32"	7-1/4"	83-1/2"	PFJ
MPJ71K80 (1556398)	1-7/32"	7-1/4"	100"	PFJ
MPJ71K-S01 (1556400)	1-7/32"	7-1/4"	82"	PFJ
MPJ71K-S17 (1556401)	1-7/32"	7-1/4"	81-3/4"	PFJ
MPJ71KS70 (1611275)	11/16"	7-1/4"	86-3/4"	PFJ
MPJ878K80 (1556403)	1-7/32"	8-7/8"	8'	PFJ
MPJ878KS70 (1611278)	1-7/32"	8-7/8"	86-3/4"	PFJ
MTEKJ413C (1009762)	1-7/32"	4-13/16"	81-5/8"	COM
MTEKJ49D (1556509)	1-7/32"	4-9/16"	81-5/8"	COM
MTEKJ613K (1011084)	1-7/32"	6-13/16"	83-1/2"	COM
MTEKJ71K (1556513)	1-7/32"	7-1/4"	83-1/2"	COM

LINTELS

Lintels are used as an added accent to be used above doors and windows. Add this to S4S for a distinctive look.



Stock Code
MP504
(1611150)

Dimensions
1 7/16" x 2 3/8" x 16'

PFJ



Stock Code
MP912
(1611170)

Dimensions
1 7/16" x 2 7/16" x 16'

PFJ



Stock Code
MP911
(1611169)

Dimensions
1 1/4" x 2 1/4" x 16'

PFJ

PANEL & PICTURE MOULDS

The use of panel or picture moulding can be an effective and inexpensive way to frame wall paneling, paper or fabric, and add interest to walls.

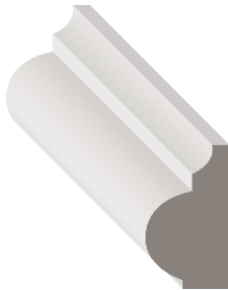

Stock Code
MH703
(1002359)

Dimensions
 $\frac{1}{2}'' \times \frac{3}{4}'' \times \text{RL}$

H

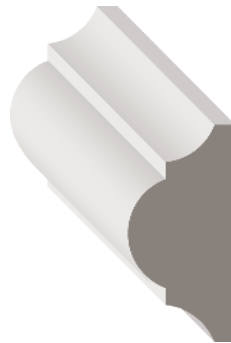

Stock Code
1567137

Dimensions
 $\frac{3}{16}'' \times 1\frac{1}{8}'' \times 16'$
PFJ



Stock Code
MP327808
(1556311)

Dimensions
 $\frac{3}{8}'' \times 1\frac{1}{8}'' \times 8'$

PFJ



Stock Code
MP503
(1611149)

Dimensions
 $\frac{1}{2}'' \times 1\frac{1}{8}'' \times \text{RL}$

PFJ

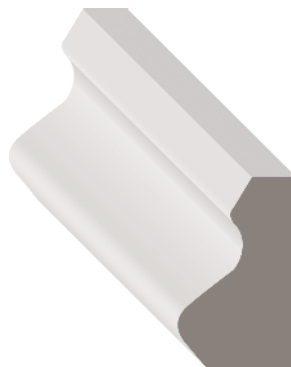

Stock Code
MH022
(1555996)

Dimensions
 $\frac{1}{2}'' \times 1'' \times \text{RL}$

H

MP022
(1556257)

$\frac{1}{2}'' \times 1'' \times 16'$

PFJ

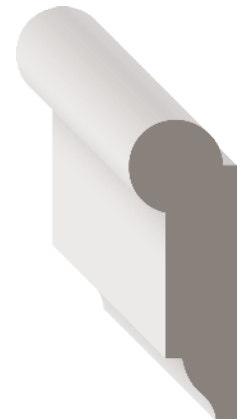

Stock Code
MH270
(1556047)

Dimensions
 $\frac{5}{8}'' \times 1\frac{1}{16}'' \times \text{RL}$

H

MP270
(1611110)

$1\frac{1}{16}'' \times 2\frac{1}{2}'' \times \text{RL}$

MP1010
(1611061)

$2\frac{1}{32}'' \times 1\frac{5}{8}'' \times \text{RL}$

PFJ

SHIPLAPS

A wall paneling treatment made from wide wooden boards installed horizontally to create a rustic, cottage or coastal look.

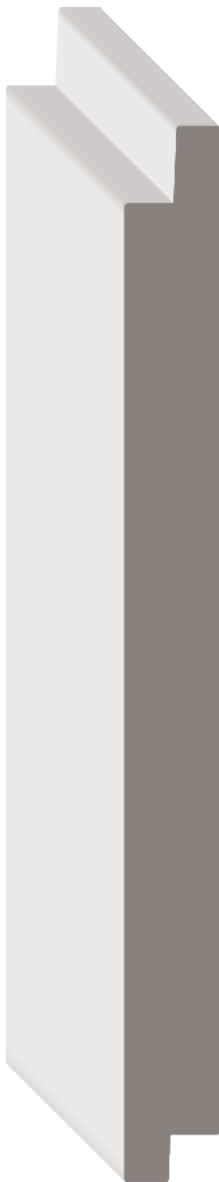

Stock Code
1676391

Dimensions
1 1/2" x 5 1/2" x 12"
COM

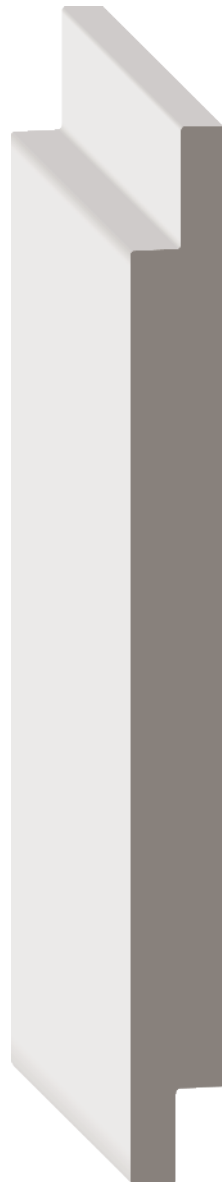

Stock Code
1678870

Dimensions
1 1/2" x 5 1/2" x 16"
MDF/UL

1678753 **1 1/2" x 5 1/2" x 16"**
PFJ



Stock Code
1678737

Dimensions
1 1/2" x 7 1/4" x 16"
MDF/UL

1678742 **1 1/2" x 7 1/4" x 16"**
PFJ

SQUARES

SQUARES

Squares are used in the framing of shelves and cabinets, or are used to build up other profiles. Its uses are mostly utilitarian.



Stock Code **MH351708**
(1556133) Dimensions **1 1/16" x 1 1/16" x 8'**

H



Stock Code **MH3520**
(1610751) Dimensions **1 1/16" x 1 1/16" x RL**
MH352007
(1610752) **1 1/16" x 1 1/16" x 7'**

H



Stock Code **MH3428**
(1626361) Dimensions **1/2" x 3/4" x RL**
MH342808
(1556122) **1/2" x 3/4" x 8'**
MH342810
(1556123) **1/2" x 3/4" x 10'**

H

MP342808
(1448253) **1/2" x 3/4" x 8'**

PFJ



Stock Code **MH351608**
(1556131) Dimensions **3/4" x 3/4" x 8'**
MH351610
(1556132) **3/4" x 3/4" x 10'**

H

MP3516
(1328808) **1 1/16" x 1 1/16" x 16'**
MP351608
(1556315) **1 1/16" x 1 1/16" x 8'**

PFJ

TONGUE & GROOVE PANELING

Panels used to decorate or cover a wall, fitted together edge to edge using a slot and ridge on the opposite edge.

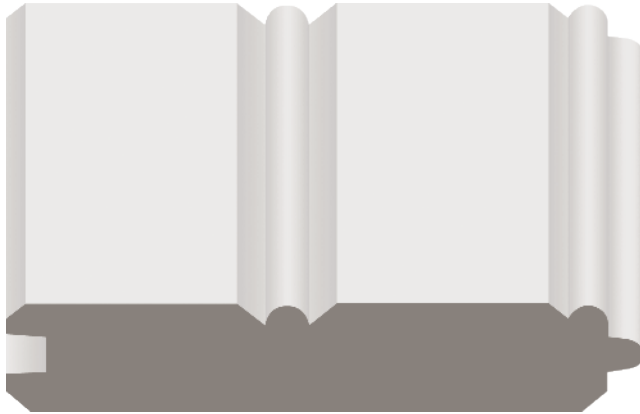

Stock Code	Dimensions
MXFMG104TG (1611449)	$\frac{1}{16}'' \times 3\frac{5}{16}'' \times \text{RL}$
MXFVG104TG (1626775)	$\frac{1}{16}'' \times 3\frac{5}{16}'' \times \text{RL}$
	FIR
MXHVG104TG (1011474)	$\frac{1}{16}'' \times 3\frac{5}{16}'' \times \text{RL}$
	H
MXPEX104TG (1556526)	$\frac{1}{16}'' \times 3\frac{5}{16}'' \times \text{RL}$
	PFJ



Stock Code	Dimensions
MXFMG106TG (1611450)	$\frac{1}{16}'' \times 5\frac{3}{8}'' \times \text{RL}$
MXFVG106TG (1556523)	$\frac{1}{16}'' \times 5\frac{3}{8}'' \times \text{RL}$
	FIR
MXHVG106TG (1009976)	$\frac{1}{16}'' \times 5\frac{3}{8}'' \times \text{RL}$
	H
MXPEX106TG (1556527)	$\frac{1}{16}'' \times 5\frac{3}{8}'' \times \text{RL}$
	PFJ



Stock Code	Dimensions
MXFMG104FLOOR (1003124)	$\frac{3}{4}'' \times 3\frac{3}{8}'' \times \text{RL}$
	FIR

WAINSCOT CAPS

WAINSCOT CAPS

A wainscot cap is used to finish the top edge of a wainscot wall treatment. It may also be used as one component of a larger chair rail profile.

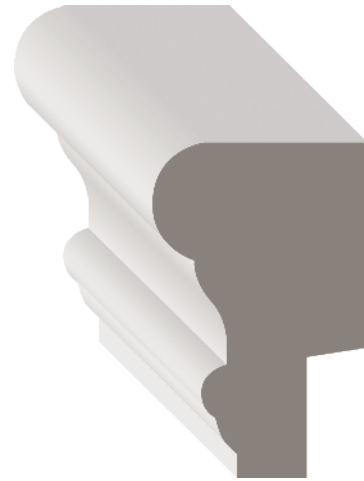

Stock Code
MFP850
(1626091)

Dimensions
1 1/16" x 1 3/4" x 8'

MDF/UL

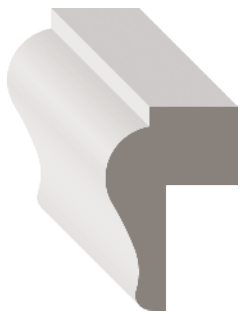

Stock Code
MP780
(1611167)

Dimensions
1" x 1 5/8" x 16'

PFJ



Stock Code
MH29208
(1556050)

Dimensions
3/16" x 1 1/8" x 8'

MH29210
(1556051)

3/16" x 1 1/8" x 10'

H



Stock Code
MH702
(1556181)

Dimensions
5/8" x 1 3/8" x RL

H



Stock Code
MH706
(1556184)

Dimensions
3/4" x 2" x RL

H

BED MOULDS

Similar to crown moulding, used to cover the joint between the ceiling and wall. Can be either sprung or plain, or flush to the wall as an extension of a cornice mould.

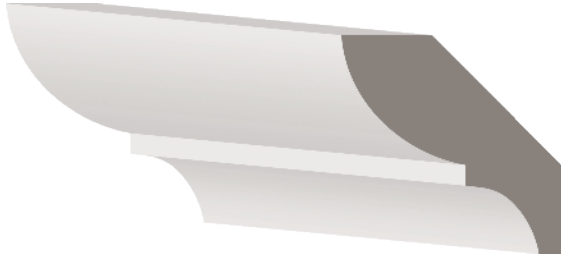

Stock Code
MH07512
(1556013)

Dimensions
1/2" x 1 5/8" x 12'

H

HALF ROUNDS

A cross section of a half round looks like a half circle and is used primarily as decorative trim. It works well as a trim piece for wallpaper or to add a decorative pattern to flat panels. This profile can also be used to put a rounded edge on various shelving.

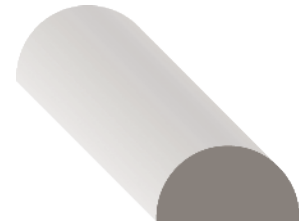

Stock Code
MH321208
(1556086)

Dimensions
3/8" x 3/4" x 8'

H

CHAMFER STRIPS

Utilized where kitchen cabinet tops meet the walls or as a linoleum cove. Sometimes used for window applications.



Stock Code
MH995
(1556198)

Dimensions
3/4" x 3/4" x RL

H

FULL ROUNDS

Full rounds are used for numerous purposes and projects. Some of the more common uses are closet poles, curtain rods and towel rods.

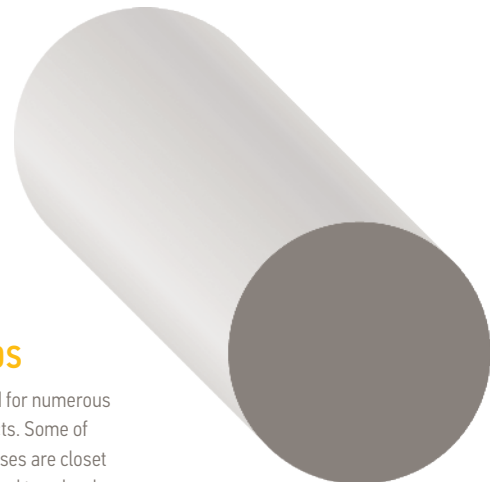

Stock Code	Dimensions
MH3226 (1328607)	1 5/16" x 1 5/16" x RL
MH322608 (1556091)	1 5/16" x 1 5/16" x 8'
MH322610 (1556092)	1 5/16" x 1 5/16" x 10'
MH322612 (1556093)	1 5/16" x 1 5/16" x 12'
MH3226DS (1005892)	1 5/16" x 1 5/16" x RL
MH3228 (1328609)	1 1/2" x 1 1/2" x RL
MH322808 (1610700)	1 1/2" x 1 1/2" x 8'

H

MISCELLANEOUS

SCREEN MOULDS

A very versatile profile; screen mould fits a wide variety of needs and uses. Traditionally used to hold mesh screening into wood screens, it also works well as edge trim on various shelving or wood trim for wallpaper.



Stock Code	Dimensions
MH327408 (1556107)	$\frac{1}{4}$ " x $\frac{3}{4}$ " x 8'
MH327410 (1556108)	$\frac{1}{4}$ " x $\frac{3}{4}$ " x 10'

H

MP327408 (1556309)	$\frac{1}{4}$ " x $\frac{3}{4}$ " x 8'
------------------------------	--

PFJ

LATTICE

A thin strip of flat moulding commonly used to hide seams and edges.



Stock Code	Dimensions
MH26808 (1556045)	$\frac{1}{4}$ " x $1\frac{1}{8}$ " x 8'
MH26810 (1556046)	$\frac{1}{4}$ " x $1\frac{1}{8}$ " x 10'
MH26812 (1610644)	$\frac{1}{4}$ " x $1\frac{1}{8}$ " x 12'
MH26708 (1556042)	$\frac{1}{4}$ " x $1\frac{3}{8}$ " x 8'

H



Stock Code	Dimensions
MH26608 (1556039)	$\frac{1}{4}$ " x $1\frac{5}{8}$ " x 8'
MH26612 (1556041)	$\frac{1}{4}$ " x $1\frac{5}{8}$ " x 12'
MH26408 (1556038)	$\frac{1}{4}$ " x $2\frac{1}{4}$ " x 8'

H

BASE SHOES

Commonly used to trim flooring materials and in combination with a traditional baseboard to conceal variations between the flooring and the base. This versatile profile solves numerous trimming needs.



Stock Code	Dimensions
MFVG3288 (1555957)	$\frac{7}{16}$ " x $1\frac{1}{16}$ " x RL

FIR

MH3288 (1328622)	$\frac{7}{16}$ " x $1\frac{1}{16}$ " x RL
MH328808 (1556114)	$\frac{7}{16}$ " x $1\frac{1}{16}$ " x 8'
MH328810 (1556115)	$\frac{7}{16}$ " x $1\frac{1}{16}$ " x 10'
MH328812 (1556116)	$\frac{7}{16}$ " x $1\frac{1}{16}$ " x 12'

H

MP129 (1382479)	$\frac{7}{16}$ " x $1\frac{1}{16}$ " x 16'
---------------------------	--

PFJ

QUARTER ROUNDS

Quarter Rounds come in several sizes and serve a variety of functions. They are most often used with baseboards.



Stock Code	Dimensions
MH320008 (1626335)	$\frac{1}{4}$ " x $\frac{1}{4}$ " x 8'
MH320208 (1556079)	$\frac{1}{2}$ " x $\frac{1}{2}$ " x 8'
MH320210 (1556080)	$\frac{1}{2}$ " x $\frac{1}{2}$ " x 10'
MH320608 (1556081)	$1\frac{1}{16}$ " x $1\frac{1}{16}$ " x 8'
MH320610 (1556082)	$1\frac{1}{16}$ " x $1\frac{1}{16}$ " x 10'
MH320612 (1610687)	$1\frac{1}{16}$ " x $1\frac{1}{16}$ " x 12'

H

MR03206 (1626639)	$\frac{3}{4}$ " x $\frac{3}{4}$ " x RL
-----------------------------	--

O

MP3206 (1328773)	$1\frac{1}{16}$ " x $1\frac{1}{16}$ " x 14'
MP320608 (1556303)	$1\frac{1}{16}$ " x $1\frac{1}{16}$ " x 8'

PFJ

MISCELLANEOUS



WAINSCOT

Trimwork installed in the area below a chair rail. Numerous options are available including raised panel, shadow box and beaded. Combined with a chair rail and baseboard, wainscoting creates a dramatic look in any room.

Stock Code

MFP222
(1002119)

Dimensions

3/8" x 5 3/4" x 10'

MDF/UL

STAIR TREADS



Stock Code

MFTKTREAD06
(1610517)

Dimensions

1 1/16" x 11 1/2" x 6'

MFTKTREAD08
(1610518)

1 1/16" x 11 1/2" x 8'

MFVGTREAD
(1610549)

1" x 11 1/4" x RL

FIR

INDEX

Stock Code	Profile Type	Dimensions	Species	Page
1008285	Chair Rail	9/16" x 1-3/4" x 8'	MDF/UL	42
1318184	Baseboard	5/8" x 5-1/2" x 16'	MDF/UL	23
1318194	Crown	3/4" x 5-1/4" x 16'	MDF/UL	50
1318199	Baseboard	3/4" x 5-1/2" x 16'	MDF/UL	22
1318202	Baseboard	3/4" x 7-1/4" x 16'	MDF/UL	22
1320094	Crown	1" x 5-11/16" x 16'	MDF/UL	53
1322025	Architrave	1-1/2" x 5" x 12'	MDF/UL	7
1323953	Baseboard	9/16" x 4-1/2" x 16'	MDF/UL	24
1323956	Baseboard	9/16" x 5-1/2" x 16'	MDF/UL	24
1324425	Crown	1-3/16" x 5-7/16" x 16'	MDF/UL	53
1324430	Architrave	1-1/2" x 6-1/2" x 12'	MDF/UL	7
1324433	Baseboard	3/4" x 5-1/2" x 16'	MDF/UL	22
1324436	Baseboard	3/4" x 7-1/4" x 16'	MDF/UL	22
1326328	Crown	1-1/4" x 6-1/4" x 16'	MDF/UL	51
1328399	Baseboard	5/8" x 5" x 14'	MDF/UL	19
1328411	Crown	11/16" x 4-1/2" x 14'	MDF/UL	55
1328425	Casing	5/8" x 3-1/4" x 14'	MDF/UL	40
1328514	Architrave	1-1/2" x 5-1/2" x 12'	MDF/UL	7
1328537	Baseboard	1/2" x 6" x 14'	MDF/UL	24
1328541	Crown	1-3/16" x 5-1/4" x 16'	MDF/UL	49
1390847	Casing	3/4" x 3-1/2" x 16'	MDF/UL	38
1391329	Casing	1" x 4-1/2" x 16'	MDF/UL	38
1509921	Chair Rail	5/8" x 2-1/2" x 12'	MDF/UL	42
1510155	Door Stop	7/16" x 1-3/16" x 7'	PFJ	57
1544824	Back Band	5/32" x 1-1/2" x 16'	POP	11
1566900	Casing	11/16" x 3-1/4" x 17'	MDF/UL	39
1566981	Baseboard	9/16" x 5-3/4" x 16'	MDF/UL	19
1567137	Panel Mould	9/16" x 1-1/8" x 16'	PFJ	66
1626213	Casing	5/8" x 3-1/4" x 16'	MDF/UL	40
1626223	Baseboard	1/2" x 6" x 16'	MDF/UL	24
1670311	Casing	11/16" x 3-1/2" x 16'	PFJ	36
1670369	Flat Stock	3/4" x 1-1/2" x RL	FIR	58
1675149	Casing	3/4" x 3-1/2" x 16'	MDF/UL	39
1675150	Casing	1" x 3-1/2" x 16'	MDF/UL	35
1675492	Door Stop	7/16" x 1-11/16" x 14'	MPH	57
1675509	Door Stop	7/16" x 1-11/16" x 14'	MPH	57
1675698	Casing	3/4" x 2-3/4" x 16'	MDF/UL	38
1675700	Casing	1" x 3-1/2" x 16'	MDF/UL	38
1675701	Crown	1" x 5-1/4" x 16'	MDF/UL	52
1675702	Casing	1" x 4-1/4" x 16'	MDF/UL	38
1676391	Shiplap	1/2" x 5-1/2" x 12'	COM	67
1677196	Casing	5/8" x 2-3/4" x 16'	MDF/UL	40
1677449	Baseboard	1/2" x 5" x 16'	MDF/UL	24
1677969	Architrave	1-1/2" x 5-1/2" x 16'	MDF/UL	7
1678737	Shiplap	1/2" x 7-1/4" x 16'	MDF/UL	67
1678742	Shiplap	1/2" x 7-1/4" x 16'	PFJ	67
1678753	Shiplap	1/2" x 5-1/2" x 16'	PFJ	67
1678870	Shiplap	1/2" x 5-1/2" x 16'	MDF/UL	67
1681176	Casing	9/16" x 2-1/4" x 81-1/4"	MDF/UL	29
1681178	Casing	9/16" x 2-1/4" x 81-1/4"	COM	29
1681432	Hand Rail	1-7/8" x 2-1/4" x 16'	H	62
1681433	Hand Rail	1-7/8" x 2-1/4" x 18'	H	62
LAK102 (1609733)	Flat Stock	3/4" x 1-1/2" x RL	ALD	58
LAK103 (1555518)	Flat Stock	3/4" x 2-1/2" x RL	ALD	58

Stock Code	Profile Type	Dimensions	Species	Page
LAK104 (1555519)	Flat Stock	3/4" x 3-1/2" x RL	ALD	58
LAK10408 (1555520)	Flat Stock	3/4" x 3-1/2" x 8'	ALD	58
LAK105 (1555521)	Flat Stock	3/4" x 4-9/16" x RL	ALD	58
LAK106 (1555522)	Flat Stock	3/4" x 5-1/2" x RL	ALD	58
LAK108 (1555523)	Flat Stock	3/4" x 7-1/4" x RL	ALD	58
LAK110 (1555524)	Flat Stock	3/4" x 9-1/4" x RL	ALD	58
LAK112 (1555525)	Flat Stock	3/4" x 11-1/2" x RL	ALD	58
LAK544 (1062743)	Flat Stock	1" x 3-1/2" x RL	ALD	58
LAK546 (1555526)	Flat Stock	1" x 5-1/2" x RL	ALD	58
LAK548 (1609747)	Flat Stock	1" x 7-1/4" x RL	ALD	58
LFVG102 (1609753)	Flat Stock	1/2" x 1-1/2" x RL	FIR	58
LFVG103 (1555536)	Flat Stock	1/2" x 2-1/2" x RL	FIR	58
LFVG104 (1555537)	Flat Stock	1/2" x 3-1/2" x RL	FIR	58
LFVG105 (1003639)	Flat Stock	1/2" x 4-1/2" x RL	FIR	58
LFVG106 (1555539)	Flat Stock	1/2" x 5-1/2" x RL	FIR	58
LFVG102 (1006897)	Flat Stock	11/16" x 1-1/2" x RL	FIR	58
LFVG103 (1555544)	Flat Stock	11/16" x 2-1/2" x RL	FIR	58
LFVG10308 (1009554)	Flat Stock	11/16" x 2-1/2" x 8'	FIR	58
LFVG104 (1555548)	Flat Stock	11/16" x 3-1/2" x RL	FIR	58
LFVG10408 (1555550)	Flat Stock	11/16" x 3-1/2" x 8'	FIR	58
LFVG105 (1555553)	Flat Stock	11/16" x 4-9/16" x RL	FIR	58
LFVG106 (1609773)	Flat Stock	11/16" x 5-1/2" x RL	FIR	58
LFVG10608 (1555555)	Flat Stock	11/16" x 5-1/2" x 8'	FIR	58
LFVG107 (1004673)	Flat Stock	11/16" x 6-9/16" x RL	FIR	58
LFVG108 (1609777)	Flat Stock	11/16" x 7-1/4" x RL	FIR	58
LFVG110 (1555561)	Flat Stock	11/16" x 9-1/4" x RL	FIR	58
LFVG112 (1555562)	Flat Stock	11/16" x 11-1/4" x RL	FIR	58
LFVG202 (1555564)	Flat Stock	1-1/2" x 1-1/2" x RL	FIR	58
LFVG203 (1555566)	Flat Stock	1-1/2" x 2-1/2" x RL	FIR	58
LFVG204 (1555567)	Flat Stock	1-1/2" x 3-1/2" x RL	FIR	58
LFVG206 (1555569)	Flat Stock	1-1/2" x 5-1/2" x RL	FIR	58
LFVG208 (1555572)	Flat Stock	1-1/2" x 7-1/4" x RL	FIR	58
LFVG210 (1555573)	Flat Stock	1-1/2" x 9-1/4" x RL	FIR	58
LFVG212 (1555574)	Flat Stock	1-1/2" x 11-1/4" x RL	FIR	58
LFVG404 (1555575)	Flat Stock	3-1/2" x 3-1/2" x RL	FIR	58
LFVG5412 (1006006)	Flat Stock	1" x 11-1/4" x RL	FIR	58
LFVG544 (1555577)	Flat Stock	1" x 3-1/2" x RL	FIR	58
LFVG545 (1007073)	Flat Stock	1" x 4-1/2" x RL	FIR	58
LFVG546 (1555579)	Flat Stock	1" x 5-1/2" x RL	FIR	58
LFVG548 (1555580)	Flat Stock	1" x 7-1/4" x RL	FIR	58
LHVG103 (1009553)	Flat Stock	1/2" x 2-1/2" x RL	H	58
LHVG104 (1006971)	Flat Stock	1/2" x 3-1/2" x RL	H	58
LHVG105 (1008226)	Flat Stock	1/2" x 4-1/2" x RL	H	58
LHVG106 (1011412)	Flat Stock	1/2" x 5-1/2" x RL	H	58
LHVG102 (1625886)	Flat Stock	11/16" x 1-1/2" x RL	H	58
LHVG10207 (1545317)	Flat Stock	11/16" x 1-1/2" x 7'	H	59
LHVG10208 (1545318)	Flat Stock	11/16" x 1-1/2" x 8'	H	59
LHVG10210 (1545319)	Flat Stock	11/16" x 1-1/2" x 10'	H	59
LHVG10212 (1545320)	Flat Stock	11/16" x 1-1/2" x 12'	H	59
LHVG103 (1555594)	Flat Stock	11/16" x 2-1/2" x RL	H	59
LHVG10307 (1555596)	Flat Stock	11/16" x 2-1/2" x 7'	H	59
LHVG10308 (1555597)	Flat Stock	11/16" x 2-1/2" x 8'	H	59
LHVG10310 (1555598)	Flat Stock	11/16" x 2-1/2" x 10'	H	59
LHVG10312 (1555599)	Flat Stock	11/16" x 2-1/2" x 12'	H	59

INDEX

Stock Code	Profile Type	Dimensions	Species	Page
MPJ49D (1556351)	Jamb	1-7/32" x 4-9/16" x 81-5/8"	PFJ	64
MPJ49D80 (1328841)	Jamb	1-7/32" x 4-9/16" x 97-5/8"	PFJ	64
MPJ49DCC (1328842)	Jamb	1-3/16" x 4-9/16" x 81-5/8"	PFJ	64
MPJ49DCC80 (1678943)	Jamb	1-3/16" x 4-9/16" x 97-5/8"	PFJ	64
MPJ49F (1556358)	Jamb	11/16" x 4-9/16" x 82-1/4"	PFJ	64
MPJ49F-S09 (1556360)	Jamb	11/16" x 4-9/16" x 81-11/16"	PFJ	64
MPJ49FX (1556361)	Jamb	11/16" x 4-9/16" x 83-1/2"	PFJ	64
MPJ49K (1556362)	Jamb	1-7/32" x 4-9/16" x 83-1/2"	PFJ	64
MPJ49K-S01 (1556364)	Jamb	1-7/32" x 4-9/16" x 82"	PFJ	64
MPJ49K-S17 (1556366)	Jamb	1-7/32" x 4-9/16" x 81-3/4"	PFJ	64
MPJ51C (1556368)	Jamb	1-7/32" x 5-1/4" x 81-5/8"	PFJ	64
MPJ51K (1611232)	Jamb	1-7/32" x 5-1/4" x 83-1/2"	PFJ	64
MPJ613C (1556370)	Jamb	1-7/32" x 6-13/16" x 81-5/8"	PFJ	64
MPJ613K (1556371)	Jamb	1-7/32" x 6-13/16" x 83-1/2"	PFJ	64
MPJ613K-S01 (1678901)	Jamb	1-7/32" x 6-13/16" x 82"	PFJ	64
MPJ613KS70 (1556372)	Jamb	1-7/32" x 6-13/16" x 86-3/4"	PFJ	64
MPJ69C (1314632)	Jamb	1-7/32" x 6-9/16" x 81-5/8"	PFJ	64
MPJ69C80 (1472593)	Jamb	1-7/32" x 6-9/16" x 97-5/8"	PFJ	64
MPJ69F (1556377)	Jamb	11/16" x 6-9/16" x 82-1/4"	PFJ	64
MPJ69F-S09 (1556379)	Jamb	11/16" x 6-9/16" x 81-11/16"	PFJ	64
MPJ69FX (1008055)	Jamb	11/16" x 6-9/16" x 83-1/2"	PFJ	64
MPJ69K (1611249)	Jamb	1-7/32" x 6-9/16" x 83-1/2"	PFJ	64
MPJ69K-S01 (1556390)	Jamb	1-7/32" x 6-9/16" x 82"	PFJ	64
MPJ69K-S14 (1556391)	Jamb	1-7/32" x 6-9/16" x 81-7/8"	PFJ	64
MPJ69K-S17 (1556392)	Jamb	1-7/32" x 6-9/16" x 81-3/4"	PFJ	64
MPJ69K80 (1556383)	Jamb	1-7/32" x 6-9/16" x 100"	PFJ	64
MPJ71C (1556394)	Jamb	1-7/32" x 7-1/4" x 81-5/8"	PFJ	64
MPJ71C70 (1556395)	Jamb	1-7/32" x 7-1/4" x 85-5/8"	PFJ	64
MPJ71C80 (1611266)	Jamb	1-7/32" x 7-1/4" x 97-5/8"	PFJ	64
MPJ71K (1556397)	Jamb	1-7/32" x 7-1/4" x 83-1/2"	PFJ	64
MPJ71K-S01 (1556400)	Jamb	1-7/32" x 7-1/4" x 82"	PFJ	64
MPJ71K-S17 (1556401)	Jamb	1-7/32" x 7-1/4" x 81-3/4"	PFJ	64
MPJ71K80 (1556398)	Jamb	1-7/32" x 7-1/4" x 100"	PFJ	64
MPJ71KS70 (1611275)	Jamb	1-7/32" x 7-1/4" x 86-3/4"	PFJ	64
MPJ878K80 (1556403)	Jamb	1-7/32" x 8-7/8" x 8'	PFJ	64
MPJ878KS70 (1611278)	Jamb	1-7/32" x 8-7/8" x 86-3/4"	PFJ	64
MRO3002 (1328875)	Casing	7/16" x 2-1/4" x RL	O	27
MRO3206 (1626639)	Quarter Round	3/4" x 3/4" x RL	O	73
MRO356 (1006931)	Casing	7/16" x 2-1/16" x RL	O	29
MRO623 (1556440)	Baseboard	3/8" x 3-1/4" x RL	O	14
MTEK003 (1556485)	Casing	11/16" x 3-1/4" x 16'	COM	34
MTEK047 (1556486)	Crown	5/8" x 4-1/4" x 16'	COM	46
MTEK051 (1556487)	Crown	5/8" x 3-1/4" x 16'	COM	47
MTEK1/04 (1611361)	Flat Stock	1/2" x 3-1/2" x 16'	COM	60
MTEK1/06 (1588767)	Flat Stock	1/2" x 5-1/2" x 16'	COM	60
MTEK102 (1556488)	Flat Stock	23/32" x 1-1/2" x 16'	COM	60
MTEK103 (1556489)	Flat Stock	11/16" x 2-1/2" x 16'	COM	60
MTEK104 (1329017)	Flat Stock	11/16" x 3-1/2" x 16'	COM	60
MTEK105 (1556491)	Flat Stock	11/16" x 4-9/16" x 16'	COM	60
MTEK106 (1556492)	Flat Stock	11/16" x 5-1/2" x 16'	COM	60
MTEK107 (1556493)	Flat Stock	11/16" x 6-9/16" x 16'	COM	60
MTEK108 (1556494)	Flat Stock	11/16" x 7-1/4" x 16'	COM	60
MTEK110 (1556495)	Flat Stock	11/16" x 9-1/4" x 16'	COM	60
MTEK356 (1556496)	Casing	9/16" x 2-1/4" x 16'	COM	29

Stock Code	Profile Type	Dimensions	Species	Page
MTEK35607 (1556497)	Casing	9/16" x 2-1/4" x 7'	COM	29
MTEK473 (1588769)	Casing	9/16" x 2-1/4" x 16'	COM	36
MTEK495 (1556498)	Casing	11/16" x 3-1/2" x 16'	COM	37
MTEK5000 (1556499)	Architrave	1-3/16" x 3-3/4" x 16'	COM	6
MTEK5020 (1611393)	Architrave	1-3/16" x 5-1/4" x 16'	COM	8
MTEK544 (1007214)	Flat Stock	1" x 3-1/2" x 16'	COM	60
MTEK546 (1588772)	Flat Stock	1" x 5-1/2" x 16'	COM	60
MTEK618 (1556501)	Baseboard	1/2" x 5-1/4" x 16'	COM	15
MTEK623 (1011022)	Baseboard	1/2" x 3-1/4" x 16'	COM	14
MTEK62307 (1006843)	Baseboard	1/2" x 3-1/4" x 7'	COM	14
MTEK625 (1556503)	Baseboard	1/2" x 2-1/4" x 16'	COM	14
MTEK9532 (1556504)	Sash Bead	7/16" x 1-1/4" x 12'	COM	61
MTEKJ413C (1009762)	Jamb	1-7/32" x 4-13/16" x 81-5/8"	COM	64
MTEKJ49D (1556509)	Jamb	1-7/32" x 4-9/16" x 81-5/8"	COM	64
MTEKJ613K (1011084)	Jamb	1-7/32" x 6-13/16" x 83-1/2"	COM	64
MTEKJ71K (1556513)	Jamb	1-7/32" x 7-1/4" x 83-1/2"	COM	64
MTEKOGCHAIR (1611427)	Door Stop	7/16" x 3-1/4" x 16'	COM	57
MXFMG104FLOOR (1003124)	T & G Panel	3/4" x 3-3/8" x RL	FIR	69
MXFMG104TG (1611449)	T & G Panel	9/16" x 3-5/16" x RL	FIR	69
MXFMG106TG (1611450)	T & G Panel	9/16" x 5-3/8" x RL	FIR	69
MXFVG104TG (1626775)	T & G Panel	9/16" x 3-5/16" x RL	FIR	69
MXFVG106TG (1556523)	T & G Panel	9/16" x 5-3/8" x RL	FIR	69
MXHVG104TG (1011474)	T & G Panel	9/16" x 3-5/16" x RL	H	69
MXHVG106TG (1009976)	T & G Panel	9/16" x 5-3/8" x RL	H	69
MXPEX104TG (1556526)	T & G Panel	9/16" x 3-5/16" x RL	PFJ	69
MXPEX106TG (1556527)	T & G Panel	9/16" x 5-3/8" x RL	PFJ	69



EXPLORE OTHER PRODUCTS FROM METRIE®

In addition to our vast profile assortment, we offer unique product solutions that make it easy to select and install millwork.



Coordinated Collections of interior moulding that are professionally designed to ensure harmonious proportions, timeless beauty and perfect scale.



Curated moulding & interior door combinations that complement today's top décor trends.



Pre-painted & ready to install moulding solution that allows you to finish before you start.



METRIE IS NORTH AMERICA'S LEADING MANUFACTURER AND DISTRIBUTOR OF INTERIOR FINISHINGS.

Our industry position has allowed us the resources, strength and leadership to create solutions that make it easier for consumers and design professionals to select, purchase and design with interior mouldings.

Metrie products distributed by:



2200 - 140TH AVENUE E, SUITE 600
SUMNER, WA 98390
T: 253.470.5050 F: 253.470.5051

© 2018 Metrie® MET-480-SEA_0618 Printed in USA

METRIE.COM