

federal register

WEDNESDAY, APRIL 5, 1972

WASHINGTON, D.C.

Volume 37 ■ Number 66

Pages 6819-6915

PART I

(Part II begins on page 6911)



HIGHLIGHTS OF THIS ISSUE

This listing does not affect the legal status of any document published in this issue. Detailed table of contents appears inside.

CANCER CONTROL MONTH, 1972—Presidential proclamation	6825
EQUAL EMPLOYMENT FOR WOMEN—Fair hiring, promotion, and fringe benefits insured Equal Employment Opportunity Comm. revised guidelines; effective 4-5-72.....	6835
SECURITIES CLEARING SYSTEMS—SEC rule emphasizes a free and open market must be maintained by national securities associations.....	6850
ECONOMIC STABILIZATION— Cost of Living Council amendments concerning exemptions for tuition fees, and foreign subsidiaries and air fares; effective 3-31-72.....	6827
Price Comm. amends regulations for insurance rates established by States and by rating bureaus; effective 3-31-72.....	6827
FIREWORKS—FDA proposal to ban cherry bombs, M-80 salutes, and similar devices; comments within 45 days.....	6868
SOCIAL DEVELOPMENT AND THE FINANCIAL COMMUNITY—FDIC encourages State banks to invest in minority business enterprises, securities of developing nations, and community rehabilitation corporations; comments within 45 days	6884
RAILWAY CROSSING SAFETY—National Transportation Safety Board announces 4-11-72 investigation hearing in New City, New York concerning recent train/school bus collision near Congers, N.Y.....	6882
STUDENT LOANS—HEW sets first quarter 1972 interest rate on special allowances at three-quarter percent.....	6849

30-year Reference Volumes
Consolidated Indexes and Tables

Presidential Proclamations and Executive Orders

Consolidated subject indexes and tabular finding aids to Presidential proclamations, Executive orders, and certain other Presidential documents promulgated during a 30-year period (1936-1965) are now available in two separately bound volumes, published under Title 3 of the Code of Federal Regulations, priced as follows:

Title 3, 1936-1965 Consolidated Indexes.....	\$3. 50
Title 3, 1936-1965 Consolidated Tables.....	\$5. 25

Compiled by Office of the Federal Register, National Archives and Records Service, General Services Administration

Order from Superintendent of Documents, U.S. Government Printing Office
Washington, D.C. 20402



Area Code 202 Phone 962-8626
(49 Stat. 500, as amended; 44 U.S.C., Ch. 15), under regulations prescribed by the Administrative Committee of the Federal Register, approved by the President (1 CFR Ch. I). Distribution is made only by the Superintendent of Documents, U.S. Government Printing Office, Washington, D.C. 20402.

The FEDERAL REGISTER will be furnished by mail to subscribers, free of postage, for \$2.50 per month or \$25 per year, payable in advance. The charge for individual copies is 20 cents for each issue, or 20 cents for each group of pages as actually bound. Remit check or money order, made payable to the Superintendent of Documents, U.S. Government Printing Office, Washington, D.C. 20402.

The regulatory material appearing herein is keyed to the CODE OF FEDERAL REGULATIONS, which is published, under 50 titles, pursuant to section 11 of the Federal Register Act, as amended (44 U.S.C. 1510). The CODE OF FEDERAL REGULATIONS is sold by the Superintendent of Documents. Prices of new books are listed in the first FEDERAL REGISTER issue of each month.

There are no restrictions on the republication of material appearing in the FEDERAL REGISTER or the CODE OF FEDERAL REGULATIONS.

Contents

THE PRESIDENT

PROCLAMATION

Cancer Control Month, 1972----- 6825

EXECUTIVE AGENCIES

AGRICULTURAL MARKETING SERVICE

Proposed Rule Making

Perishable agricultural commodities; rules of practice----- 6854

AGRICULTURE DEPARTMENT

See also Agricultural Marketing Service; Commodity Credit Corporation; Consumer and Marketing Service; Forest Service; Rural Electrification Administration.

Notices

Meat import limitations; second quarterly estimates----- 6876

CIVIL AERONAUTICS BOARD

Notices

Hearings, etc.:

Caribbean Air Transport Corp., Inc.----- 6883

Northeast U.S.-Puerto Rico/Virgin Islands fare increases----- 6883

Venezolana Internacional de Aviacion, S.A.----- 6883

CIVIL SERVICE COMMISSION

Rules and Regulations

Excepted service:

Department of the Air Force--- 6852

Department of Labor----- 6851

Office of Economic Opportunity--- 6851

COAST GUARD

Rules and Regulations

Drawbridge operation:

North River, Mass----- 6846

Sinepuxent Bay, Md----- 6847

Proposed Rule Making

Defect notification----- 6869

COMMERCE DEPARTMENT

See Import Programs Office.

COMMODITY CREDIT CORPORATION

Rules and Regulations

Honey; 1972-crop loan and purchase program----- 6830

CONSUMER AND MARKETING SERVICE

Rules and Regulations

Green asparagus for processing; standards for grades----- 6828

Proposed Rule Making

Grapes, sawdust pack; termination of standards for grades--- 6854

Limes grown in Florida; decision and referendum order----- 6855

Tomatoes grown in Florida; recommended decision----- 6857

Notices

Grain standards; Cairo, Ill., inspection point----- 6876

COST OF LIVING COUNCIL

Rules and Regulations

Coverage, exemptions and classification of economic units; miscellaneous amendments----- 6827

Notices

Secretary of the Treasury; delegation of authority to deny requests for certain exemptions--- 6883

EDUCATION OFFICE

Rules and Regulations

Low-interest loans to students; special allowances----- 6849

ENVIRONMENTAL PROTECTION AGENCY

Rules and Regulations

Pesticide chemicals in or on raw agricultural commodities; tolerances and exemptions from tolerances (4 documents)----- 6847-6849

Proposed Rule Making

Thiabendazole; fungicide tolerance ----- 6872

Notices

O,O - Diethyl S - (2 - chloro - 1 - phthalimidoethyl) phosphorodithioate; extension and renewal of temporary tolerances----- 6884

Pesticide chemical petitions:

E. I. du Pont de Nemours & Co., Inc. (3 documents)----- 6883, 6884

Mobil Chemical Co----- 6884

EQUAL EMPLOYMENT OPPORTUNITY COMMISSION

Rules and Regulations

Guidelines on discrimination because of sex----- 6835

FEDERAL AVIATION ADMINISTRATION

Rules and Regulations

Airworthiness directives:

Boeing airplanes----- 6831

Hartzell propellers----- 6831

Piper aircraft----- 6832

Standard instrument approach procedures; miscellaneous amendments----- 6833

Temporary restricted areas; designation----- 6832

FEDERAL DEPOSIT INSURANCE CORPORATION

Notices

Insured State nonmember banks; statement of policy and guidelines for "leeway investments"--- 6884

FEDERAL MARITIME COMMISSION

Notices

Det Bergenske Dampskibsselskab; revocation of certificates of financial responsibility----- 6885

Fred F. Noonan Co., Inc., et al.; agreement filed----- 6885

FEDERAL POWER COMMISSION

Rules and Regulations

Rate schedules and tariffs; price stabilization criteria----- 6852

Proposed Rule Making

Comprehensive reporting of lease rental charges----- 6872

(Continued on next page)

Notices

Environmental statements; availability for inspection:	
Nantahala Power and Light Co.	6887
Northwest Paper Co.	6888
Southern California Edison Co.	6890
National Gas Survey Distribution-Technical Advisory Committee and Distribution-Technical Advisory Task Force-General; designation of member; correction.	6886
<i>Hearings, etc.:</i>	
Amerada Hess Corp. et al.	6886
Caprock Pipeline Co.	6886
Cities Service Gas Co.	6890
Consumers Power Co.	6886
El Paso Natural Gas Co.	6887
Florida Gas Transmission Co.	6887
Lange, R. W.	6887
Mobil Oil Corp. et al.	6890
Natural Gas Pipeline Company of America	6888
Shell Oil Co.	6889
South Carolina Public Service Authority	6889
Tennessee Gas Pipeline Co.	6893
Washington Water Power Co.	6893
Western Oil & Minerals Corp.	6893

FEDERAL RESERVE SYSTEM**Rules and Regulations**

Credit by brokers and dealers; mutual fund shares.	6831
--	------

Notices

Twin Gates Corp.; acquisition of bank	6894
---------------------------------------	------

FEDERAL TRADE COMMISSION**Rules and Regulations**

Care labeling of textile wearing apparel; delegation of authority to act upon requests for exemptions	6835
Prohibited trade practices: Canaver International Corp. et al.	6833
O & P Motors, Inc., and Patricia V. Olsen	6834

FOOD AND DRUG ADMINISTRATION**Proposed Rule Making**

Fireworks devices; classification as banned hazardous substance.	6868
--	------

FOREST SERVICE**Notices**

Mt. Ashland Chairlift Number Two; availability of draft environmental statement.	6876
--	------

GENERAL SERVICES ADMINISTRATION**Notices**

Secretary of Defense; delegation of authority.	6894
--	------

HAZARDOUS MATERIALS REGULATIONS BOARD**Proposed Rule Making**

Transportation of hazardous materials; ethylene oxide; opening in tank car heads.	6871
---	------

HEALTH, EDUCATION, AND WELFARE DEPARTMENT

See also Education Office; Food and Drug Administration.

Notices

Office of Education; statement of organization, functions, and delegations of authority.	6881
--	------

IMPORT PROGRAMS OFFICE**Notices**

Duty-free entry of scientific articles; applications and decisions:	
Iowa State University et al.	6876
New York University et al.; correction	6878
Temple University Medical School	6879
University of Cincinnati	6879
University of Maryland	6880
University of Miami	6881

INDIAN AFFAIRS BUREAU**Rules and Regulations**

Wind River Indian Irrigation Project, Wyo.; operation and maintenance charges.	6835
--	------

INTERIOR DEPARTMENT

See also Indian Affairs Bureau; Land Management Bureau; National Park Service.

Notices

Environmental statements; availability:	
Bonneville Power Administration; final	6875
Cibola Project, Tex.; draft.	6875

INTERSTATE COMMERCE COMMISSION**Notices**

Assignment of hearings.	6900
Fourth section application for relief	6900
Motor carriers:	
Alternate route deviation notices	6900
Applications and certain other proceedings	6901
Intrastate applications	6905
Transfer proceedings	6907
Penn Central Transportation Co.; rerouting or diversion of traffic	6908
Poole Truck Line, Inc.; petition for declaratory order.	6908

LABOR DEPARTMENT

See Occupational Safety and Health Administration.

LAND MANAGEMENT BUREAU**Notices**

California; filing of State protraction diagrams (5 documents)	6874, 6875
Idaho; proposed withdrawal and reservation of lands.	6875

MONETARY OFFICES**Rules and Regulations**

Financial recordkeeping and reporting of currency and foreign transactions	6912
--	------

NATIONAL CREDIT UNION ADMINISTRATION**Proposed Rule Making**

Insurance; certified statements and premiums.	6873
---	------

NATIONAL PARK SERVICE**Notices**

Superintendents et al., Midwest Region; delegation of authority; correction	6875
---	------

NATIONAL TRANSPORTATION SAFETY BOARD**Notices**

Highway-grade crossing accident near Congers, N.Y.; investigation hearing.	6882
--	------

OCCUPATIONAL SAFETY AND HEALTH ADMINISTRATION**Rules and Regulations**

Safety and health regulations for construction; rollover protective structures and overhead protection; access roadways and grades	6837
--	------

PRICE COMMISSION**Rules and Regulations**

Price stabilization; insurance rates established by States and by rating bureaus.	6827
---	------

RURAL ELECTRIFICATION ADMINISTRATION**Proposed Rule Making**

Electric borrowers; manual for preservation of records.	6867
Telephone borrowers; policies and requirements for headquarters facilities	6868

SECURITIES AND EXCHANGE COMMISSION**Rules and Regulations**

Securities Exchange Act of 1934; operation of clearing and settling system for securities by national securities association.	6850
Standing audit committees composed of outside directors; interpretative release.	6850

Notices

Hearings, etc.:

American General Bond Fund, Inc	6895
E. F. Hutton Tax-Exempt Fund ..	6894
General Public Utilities Corp....	6985
Manufacturers Variable Account I and Manufacturers Life Insurance Co.....	6896
Penn Mutual Equity Fund, Inc.....	6898
Penn Mutual Life Insurance Co. and Penn Mutual Variable Annuity Account II.....	6897

SMALL BUSINESS ADMINISTRATION

Notices

First American Capital Corp.; surrender of license to operate as small business investment company	6899
Puerto Rican Forum Capital Corp.; issuance of license to operate as minority enterprise small business investment company	6899

TARIFF COMMISSION

Notices

Panty hose; findings and recommendation regarding importation and sale.....	6899
---	------

TRANSPORTATION DEPARTMENT

See Coast Guard; Federal Aviation Administration; Hazardous Materials Regulations Board; National Transportation Safety Board.

TREASURY DEPARTMENT

See Monetary Offices.

VETERANS ADMINISTRATION

Rules and Regulations

Medical; class II dental treatment	6847
--	------

List of CFR Parts Affected

The following numerical guide is a list of the parts of each title of the Code of Federal Regulations affected by documents published in today's issue. A cumulative list of parts affected, covering the current month to date, appears following the Notices section of each issue beginning with the second issue of the month.

A cumulative guide is published separately at the end of each month. The guide lists the parts and sections affected by documents published since January 1, 1972, and specifies how they are affected.

3 CFR

PROCLAMATION:	
4120.....	6825

5 CFR

213 (3 documents).....	6851, 6852
------------------------	------------

6 CFR

101.....	6827
300.....	6827

7 CFR

51.....	6828
1434.....	6830

PROPOSED RULES:

47.....	6854
51.....	6854
911.....	6855
966.....	6857
1701 (2 documents).....	6867, 6868

12 CFR

220.....	6831
----------	------

PROPOSED RULES:

741.....	6873
----------	------

14 CFR

39 (3 documents).....	6831, 6832
73.....	6832
97.....	6833

16 CFR

13 (2 documents).....	6833, 6834
423.....	6835

17 CFR

211.....	6850
231.....	6850
240.....	6850
241.....	6850
251.....	6850
271.....	6850

18 CFR

35.....	6852
154.....	6852

PROPOSED RULES:

141.....	6872
260.....	6872

21 CFR

PROPOSED RULES:

191.....	6868
----------	------

25 CFR

221.....	6835
----------	------

29 CFR

1604.....	6835
1926.....	6837

31 CFR

102.....	6912
103.....	6912

33 CFR

117 (2 documents).....	6846, 6847
------------------------	------------

PROPOSED RULES:

171.....	6869
----------	------

38 CFR

17.....	6847
---------	------

40 CFR

180 (4 documents).....	6847-6849
------------------------	-----------

PROPOSED RULES:

180.....	6872
----------	------

45 CFR

177.....	6849
----------	------

49 CFR

PROPOSED RULES:

173.....	6871
179.....	6871

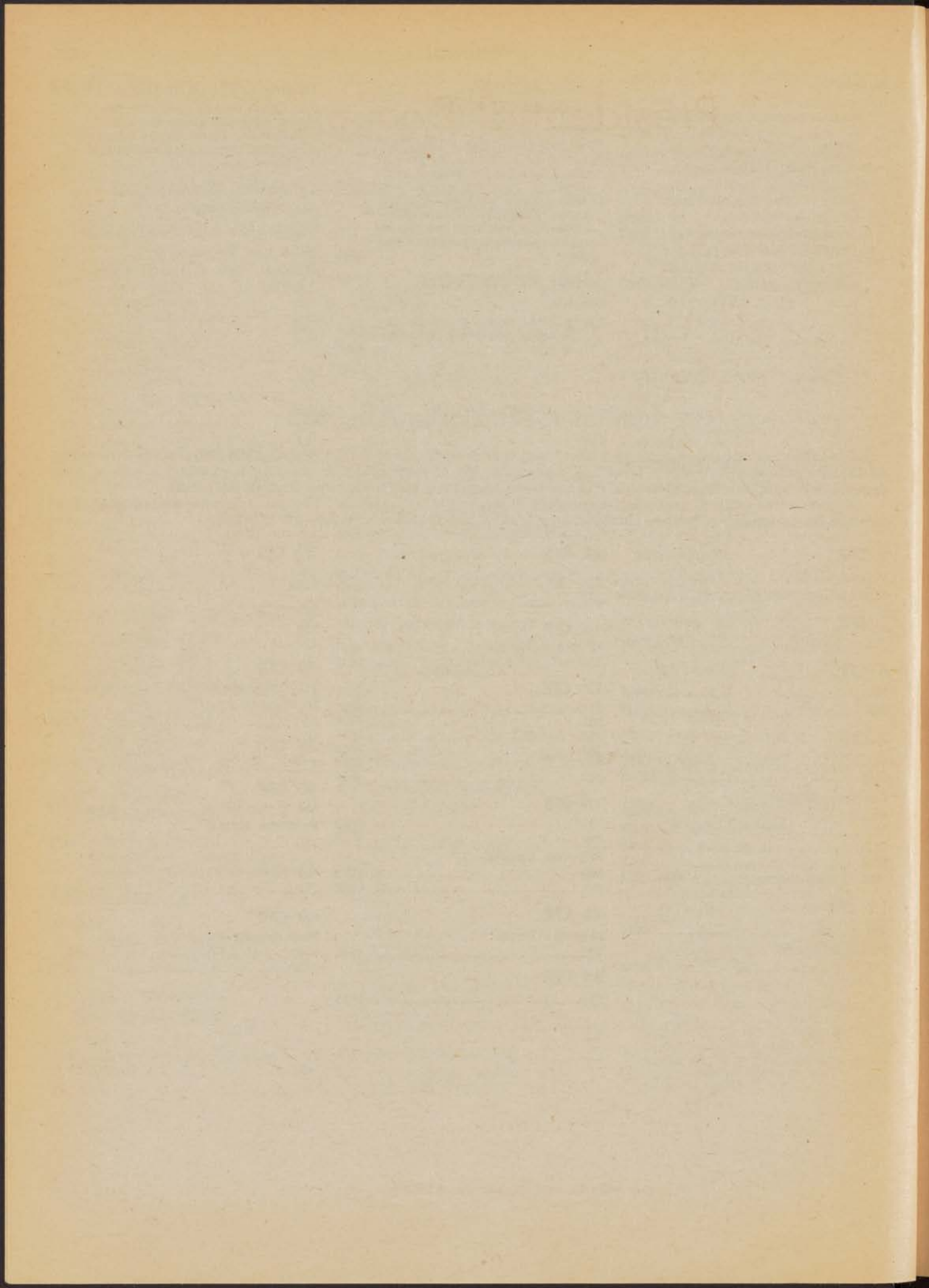

Presidential Documents

Title 3—The President

PROCLAMATION 4120

Cancer Control Month, 1972

By the President of the United States of America

A Proclamation

America is now committed to an all-out attempt to find a means of controlling cancer.

Last December I signed the National Cancer Act of 1971, a landmark piece of legislation authorizing new Federal support for cancer research over the next three years. This will be a massive effort, perhaps the largest attack against a single disease in the history of man.

Medical breakthroughs cannot be bought or forced. But the two out of every three American families who are touched by cancer now have the assurance that everything that *can* be done by Government *will* be done to control this brutal killer.

As a means of giving continued emphasis to the cancer problem, the Congress, by a joint resolution of March 28, 1938 (52 Stat. 148), requested the President to issue annually a proclamation setting aside the month of April as Cancer Control Month.

NOW, THEREFORE, I, RICHARD NIXON, President of the United States of America, do hereby proclaim the month of April 1972 as Cancer Control Month, and I invite the Governors of the States and the Commonwealth of Puerto Rico, and the appropriate officials of all other areas under the United States flag to issue similar proclamations.

To give new emphasis to this serious problem, and to encourage the determination of the American people to meet it, I also ask the medical and allied health professions, the communications industries, and all other interested persons and groups to unite during this appointed time in public reaffirmation of our Nation's strong commitment to control cancer.

IN WITNESS WHEREOF, I have hereunto set my hand this fourth day of April, in the year of our Lord nineteen hundred seventy-two, and of the Independence of the United States of America the one hundred ninety-sixth.

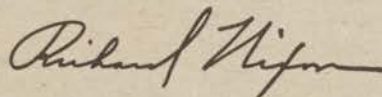

[FR Doc.72-5344 Filed 4-4-72; 12:33 pm]

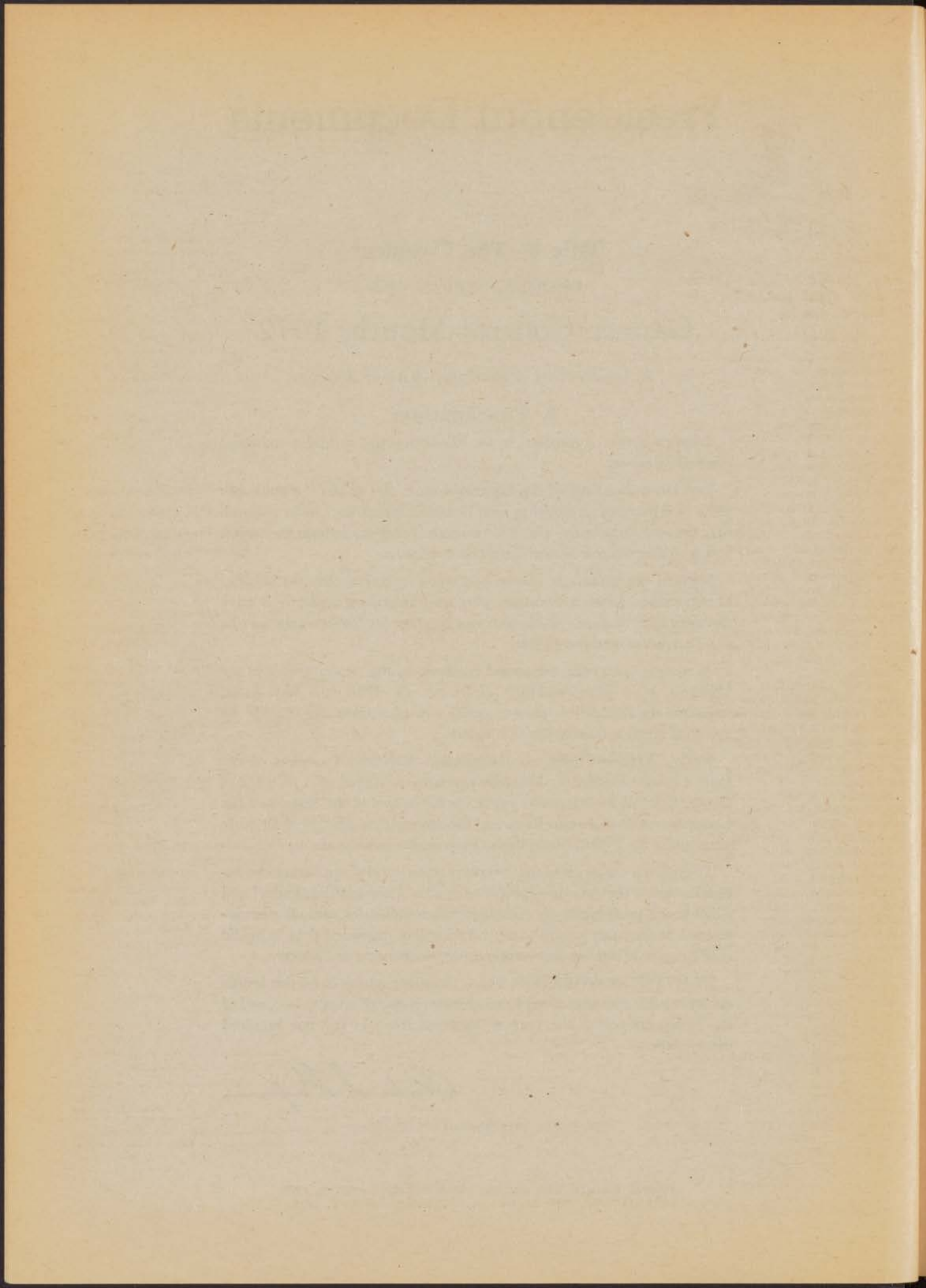

Rules and Regulations

Title 6—ECONOMIC STABILIZATION

Chapter I—Cost of Living Council

PART 101—COVERAGE, EXEMPTIONS AND CLASSIFICATION OF ECO- NOMIC UNITS

Miscellaneous Amendments

Part 101—Coverage, Exemptions and Classification of Economic Units was added to a new title 6 and a new chapter I of the Code of Federal Regulations on November 13, 1971 (36 F.R. 21788). Part 101 was amended and republished on January 27, 1972 (37 F.R. 1237), and further amended on February 4, 1972 (37 F.R. 3913), March 9, 1972 (37 F.R. 5043), and March 18, 1972 (37 F.R. 5700).

Subpart A is amended in § 101.2 to reflect a Council decision that, in determining the classification of price category firms under Subpart B of this part, the definition of "annual sales or revenues" does not include the gross receipts of wholly owned foreign subsidiaries, if those gross receipts are generated primarily from foreign sources. The Council's decision was based on the fact that such revenues are related to the economies of other countries and do not have a direct impact on the U.S. domestic economy.

Section 101.34(b), Subpart D is amended to make clear that the previous exemption of tuition fees for private nonprofit, educational organizations does not generally include fees and charges for medical services or price adjustments for unrelated business activities.

Subpart D is also amended in § 101.34 (d) to reflect the Council's decision to exempt rates and other charges in foreign air transportation. The Council recognized that most international air rates are set by international agreement which reflect considerations beyond those related exclusively to the domestic U.S. economy; and that except for a few minor instances, international air rates are reviewed and subject to some control by the Civil Aeronautics Board.

Subpart D is also amended to add a paragraph (k) to § 101.34 to reflect a Council decision to exempt fees and charges imposed by Indian Tribal Councils. The Council's decision was based on the fact that the functions of Indian Tribal Councils which include the power to tax, license and operate schools, are similar to the functions of State and local governments whose fees and charges are in a large part exempt. The Council also considered that the economic activities of certain Indian Tribal Councils are subject to budgetary controls by the Federal Government.

Because the purpose of these regulations is to amend and modify Part 101 to provide immediate guidance and information as to Cost of Living Council decisions, the Council finds that publication in accordance with usual rule making procedures is impracticable and that good cause exists for making this regulation effective in less than 30 days. Interested persons may submit written comments regarding the above amendments. Communications should be addressed to the Office of General Counsel, Cost of Living Council, New Executive Office Building, Washington, D.C. 20507.

These amendments shall become effective when filed with the Office of the Federal Register.

JAMES W. McLANE,
Deputy Director,
Cost of Living Council.

Part 101 Chapter I of Title 6 of the Code of Federal Regulations is amended as follows:

1. Subpart A is revised and amended in § 101.2 to read as follows:

§ 101.2 Definitions.

"Annual sales or revenues" means the total gross receipts of a firm during its most recent fiscal year from whatever source derived, except that it does not include the gross receipts of wholly owned foreign subsidiaries which derive their revenue primarily from transactions with foreign firms.

2. Subpart D is revised and amended in § 101.34 (b) and (d), and § 101.34(k) is added to read as follows:

§ 101.34 Certain price adjustments.

(b) *Tuition fees of private nonprofit educational organizations.* Tuition fees and other charges by private schools, colleges, and universities not operated for profit; except that: (1) Fees and charges resulting in income which is subject to tax under Part III of Subchapter F of the Internal Revenue Code of 1954, as amended, as unrelated business taxable income and (2) medical fees and charges, other than a health service fee levied on all students as a condition of enrollment, are not exempt under the provisions of this section.

(d) *Exports, imports, ocean shipping rates, and foreign air transportation.* * * *

(4) All rates, fares, and charges for foreign air transportation (as defined by the Federal Aviation Act, 49 U.S.C. 1301 (21)) which are set forth in tariffs filed with the Civil Aeronautics Board or

which are established or approved by the Civil Aeronautics Board.

(k) *Fees and charges imposed by Indian Tribal Councils.* Price adjustments, including rent adjustments, for any work, service, publication, report, document, benefit, privilege, authority, use, franchise, license, permit, certificate, registration, commodity, or similar thing of value or utility, performed, furnished, sold, leased, provided, granted, prepared, issued, or transferred by any Indian Tribal Council which is formally recognized by a State or the Federal Government are exempt whether or not all or part of a particular transaction takes place on or off Indian Tribal lands.

[FR Doc. 72-5256 Filed 3-31-72; 5:27 pm]

Chapter III—Price Commission

PART 300—PRICE STABILIZATION

Insurance Rates Established by States and by Rating Bureaus

The purpose of this amendment to § 300.20 *Insurers* of Part 300 of the regulations of the Price Commission is to provide a procedure for the elimination of duplicate prenotifications and quarterly reports data filed under that section.

Under the amendment rating bureaus would, when delegated that authority by insurers, be allowed to prenotify on behalf of their member and subscriber firms. Firms covered by such a prenotification procedure will need only to submit a copy of the delegation to the Commission.

In addition, States which set rates that may be charged for a particular line of insurance could themselves submit a certificate of compliance with § 300.20. Individual prenotifiers would then submit a letter stating that they intend to use the State set rates.

Insurers required to report quarterly will list those rate increases which have been prenotified by either themselves or another person. Complete data submission will still be required for rate increases not previously approved.

Because the purpose of this amendment is to provide immediate guidance and information as to the price stabilization rules in effect for insurers, and because it is procedural in nature, it is hereby found that notice and public procedure thereon is impracticable and that good cause exists for making it effective less than 30 days after publication.

(Economic Stabilization Act of 1970, as amended, Public Law 91-379, 84 Stat. 799; Public Law 91-558, 84 Stat. 1468; Public Law 92-8, 85 Stat. 13; Public Law 92-15, 85 Stat. 38; Economic Stabilization Act Amendments of 1971, Public Law 92-210; Executive Order No. 11640, 37 F.R. 1213, Jan. 27, 1972; Cost

of Living Council Order No. 4, 36 F.R. 20202, Oct. 16, 1971)

In consideration of the foregoing, § 300.20 of Title 6 of the Code of Federal Regulations is amended as set forth below, effective March 31, 1972.

Issued in Washington, D.C., on March 31, 1972.

C. JACKSON GRAYSON, Jr.,
Chairman, Price Commission.

Section 300.20 of Part 300 of Title 6 CFR is amended as follows:

1. Paragraph (a) is amended by inserting the following new definition after the definition of the word "Rate":

"Rating bureau" means a person who makes, files, or submits insurance rates applicable to or on behalf of or advisory for more than one insurer.

2. Paragraphs (d), (f), (g), and (h) are revised to read as follows:

§ 300.20 Insurers.

(d) Prenotification:

(1) Each prenotifier, or rating bureau acting for a prenotifier, shall file a written notice with the Price Commission and the appropriate State regulatory agency of each State to which the rate increase is applicable (or the State of domicile or delivery of the master policy for experience rated or group contracts applicable to a multi-State risk) of each proposed rate increase which affects, on a prenotifier by prenotifier basis, \$1 million or more in aggregate annualized premiums under the existing rate. Each person submitting a notice under this section shall certify to the Price Commission and the State regulatory authority that the proposed increase conforms to paragraphs (b) and (c) of this section. The certification must be signed by the chief executive officer of the prenotifier or by an individual to whom he has delegated that authority. A copy of the delegation must be filed with the Price Commission.

(2) In any State in which rates are established by a State regulatory agency, that agency may submit the data required by paragraph (j) of this section and certify to the Price Commission that the rate increases are in compliance with paragraphs (b) and (c) of this section. An insurer using those State rates needs only to prenotify and report quarterly to the Price Commission that it is using those rates, without submitting the data required by paragraph (j) of this section.

(f) Self-certification: Whenever a prenotifier, or a rating bureau acting for a prenotifier, cannot obtain a certification of a rate increase from a State regulatory agency in accordance with paragraph (e) of this section because—

(1) The State concerned has not agreed to furnish certifications under that paragraph; or

(2) The State regulatory agency did not act upon the filing within the period required under that paragraph;

The prenotifier or rating bureau shall immediately notify the Price Commission that it cannot obtain the certification and may request the Commission to act upon the certification filed with it under paragraph (d) of this section.

(g) Price Commission actions: With respect to any rate increase certified by a State regulatory agency under paragraphs (d) (2) or (e) of this section, or self-certified by a prenotifier or a rating bureau acting for a prenotifier under paragraph (f) of this section, the Price Commission may take any of the following actions during the period after receiving the certification or self-certification and before the end of the thirtieth day after the date the prenotifier or rating bureau filed under paragraph (d) of this section:

(1) Require the insurer to furnish additional information regarding the increase;

(2) Delay the effective date of the increase pending further Commission action;

(3) Suspend all or part of the effect of the increase, pending further action by the Price Commission or by the regulatory agency; or

(4) Limit, refuse, rescind, reduce, or modify the increase.

If the Price Commission does not act upon a request under this paragraph before the end of the period prescribed for its review in this paragraph, the increase may go into effect without Commission action. However, in any case in which that period would otherwise end on a Saturday, Sunday, or Federal holiday, it will end at the close of the next succeeding workday.

(h) Reporting: Each insurer that had annual revenues of \$50 million or more during the calendar year preceding any rate increase proposed by it shall file a quarterly report with the Price Commission, at the time it normally releases its quarterly reports but in any event not more than 45 days after the end of the quarter, of each rate increase by it during that quarter that affects \$250,000 or more in aggregate annualized premiums under the existing rate. However, with respect to a rate increase that has been prenotified by a prenotifier, or by a rating bureau acting for insurers, the report need not include the date required by paragraph (j) of this section, but must list the rate increase, the name of the prenotifier or rating bureau, date of prenotification, line of insurance, State or States affected, and aggregate annualized premium affected. In addition, each insurer that had annual revenues of \$50 million or more during the calendar year 1971 shall, not more than 90 days after the end of its last fiscal quarter ending before January 1, 1972, file a report with the Price Commission of each rate increase made by it during that quarter that affects \$250,000 or more in aggregate annualized premiums under the existing rate. Each report under this section shall be made on a form prescribed

by the Commission and shall contain the information required by that form.

[FR Doc.72-5217 Filed 4-4-72;8:54 am]

Title 7—AGRICULTURE

Chapter I—Consumer and Marketing Service (Standards, Inspections, Marketing Practices), Department of Agriculture

PART 51—FRESH FRUITS, VEGETABLES AND OTHER PRODUCTS (INSPECTION, CERTIFICATION AND STANDARDS)

Subpart—United States Standards for Grades of Green Asparagus for Processing¹

On page 3642 of the FEDERAL REGISTER of February 18, 1972, there was published a notice of proposed rule making to revise these grade standards by providing tolerances for defects and off-size; a requirement providing a minimum amount of green color, unless otherwise specified, in the U.S. No. 2 grade; and, definitions of serious damage by certain defects. The title of the standard was changed to bring it in line with the current format for titles and the format of the standards was changed in the interest of clarity and readability.

These grade standards are issued under authority of the Agricultural Marketing Act of 1946 (60 Stat. 1087, as amended; 7 U.S.C. 1621-1627), which provides for the issuance of official U.S. grades to designate different levels of quality for the voluntary use of producers, buyers and consumers. Official grading services are also provided under this act upon request of any financially interested party and upon payment of a fee to cover the cost of such services.

Statement of considerations leading to the revision of the grade standards. The U.S. Standards for Grades of Green Asparagus for Canning or Freezing have been in effect since December 22, 1937. They were published in the FEDERAL REGISTER in June 1967 for the purpose of codification.

The absence of tolerances made it impractical to apply the standards to a lot required to meet the requirements of one grade. For this reason, in August 1971, USDA's Consumer and Marketing Service prepared and submitted to the asparagus industry a draft for study to consider revision of the standards outlining proposed changes. Following this, the proposed revision was published in the FEDERAL REGISTER under notice of proposed rule making. Interested persons were given until March 15, 1972, to submit written data, views, or arguments

¹ Packing of the product in conformity with the requirements of these standards shall not excuse failure to comply with the provisions of the Federal Food, Drug, and Cosmetic Act or with applicable State laws and regulations.

regarding the proposal. Several comments were received dealing with changes not proposed by this revision. However, no objections were made to the changes proposed.

The addition of tolerances will allow for certification of lots of asparagus which must meet the requirements of one specified grade. Without tolerances, a shipment would have to be 100 percent free from scorable defects to meet the requirements. Also included in the revision are the following: The format of the standards is changed and other changes in arrangement and wording are made in the interest of clarity and readability; A requirement is added to the U.S. No. 2 grade providing that unless otherwise specified each spear shall have green color extending at least 3 inches below the tip; definitions for serious damage by broken tips, spreading tips and beetle eggs are added; and, the title is changed from U.S. Standards for Grades of Green Asparagus for Canning or Freezing to U.S. Standards for Grades of Green Asparagus for Processing, which is in line with the current format for titles.

The proposed revised standards are hereby adopted without change and are set forth below.

It is hereby found that good cause exists for not postponing the effective date of this revision beyond the date of publication hereof in the FEDERAL REGISTER, in that: (1) The 1972 packing season for Asparagus for Processing is well underway and it is in the interest of the public and the industry that this revision be placed in effect at the earliest possible date; and (2) no special preparation is required for compliance with this revision on the part of members of the Asparagus industry or of others.

Accordingly this revision shall become effective upon publication in the FEDERAL REGISTER (4-5-72), and will thereupon supersede the U.S. Standards for Grades of Green Asparagus for Canning or Freezing which have been in effect since December 22, 1937. (7 CFR 51.4075-51.4085)

Dated: March 28, 1972.

G. R. GRANGE,
Acting Administrator.

Sec.		
51.4075	U.S. No. 1.	
51.4076	U.S. No. 2.	
		GRADES
51.4077	Culls.	
51.4078	Butt.	
		APPLICATION OF STANDARDS
51.4079	Application of standards.	
		DIAMETER CLASSIFICATION
51.4080	Diameter classification.	
		DEFINITIONS
51.4081	Fresh.	
51.4082	Fairly well formed.	
51.4083	Damage.	
51.4084	Green color.	
51.4085	Serious damage.	

METRIC CONVERSION TABLE

Sec. 51.4086 Metric Conversion Table.

AUTHORITY: The provisions of this subpart issued under the Agricultural Marketing Act of 1946 (60 Stat. 1087, as amended; 7 U.S.C. 1621-1627).

GRADES

§ 51.4075 U.S. No. 1.

"U.S. No. 1" consists of spears of asparagus which meet the following requirements:

- (a) Basic requirements:
 - (1) Fresh; and,
 - (2) Fairly well formed.
- (b) Free from:
 - (1) Decay; and,
 - (2) Broken tips.
- (c) Free from damage caused by:
 - (1) Doubles;
 - (2) Spreading tips;
 - (3) Knife cuts;
 - (4) Broken butts;
 - (5) Hail;
 - (6) Freezing;
 - (7) Dirt;
 - (8) Disease;
 - (9) Beetles or other insects; or,
 - (10) Mechanical, or other means.
- (d) Size: Unless otherwise specified, each spear shall meet the following requirements:
 - (1) For diameter. Not less than one-fourth inch.
 - (2) For length. Not more than 7½ inches.

(e) Color: Unless otherwise specified, the spear shall have green color extending at least 4½ inches below the tip. There shall be no restrictions regarding the amount of white color permitted on a spear unless agreed upon by the processor and grower. (See § 51.4078.)

(f) For tolerances see "Application of Standards" § 51.4079.

§ 51.4076 U.S. No. 2.

"U.S. No. 2" consists of spears of asparagus which meet the following requirements:

- (a) Basic requirements:
 - (1) Fresh.
 - (b) Free from:
 - (1) Decay.
 - (c) Free from damage caused by:
 - (1) Dirt.
 - (d) Free from serious damage caused

by:

- (1) Disease;
- (2) Beetles or other insects; or,
- (3) Mechanical, or other means.

(e) Size. Unless otherwise specified, each spear shall be not more than 7½ inches in length.

(f) Color. Unless otherwise specified, the spear shall have green color extending at least 3 inches below the tip. There shall be no restrictions regarding the amount of white color permitted on a spear unless agreed upon by the processor and grower. (See § 51.4078.)

(g) For tolerances see "Application of Standards" § 51.4079.

CULLS

§ 51.4077 Culls.

"Culls" are spears of asparagus which do not meet the requirements of either of the foregoing grades. Length of spear

in excess of that specified in the lowest grade upon which a contract is based and any amount of white in excess of that which may be specified for that grade shall be considered as a "Butt".

BUTT

§ 51.4078 Butt.

That part of a spear that is in excess of the maximum length specified shall be classed as a butt; and if a contract between canner and grower restricts the amount of white on a spear, the white in excess of the amount specified shall also be classed as a butt; and in either case the remaining portion of the spear shall be considered as meeting the grade requirements in regard to these factors.

APPLICATION OF STANDARDS

§ 51.4079 Application of standards.

In the application of these standards to determine the percentage of U.S. No. 1 and U.S. No. 2 quality, culls, butts, and off-size in a lot, tolerances shall not apply.

(a) Tolerances. When lot of asparagus is required to meet a specified grade, the following tolerances, by weight, shall apply:

(1) For defects. 10 percent for spears in any lot which fail to meet the requirements of the grade other than for butts and off-size: Provided, That not more than one-tenth of this amount, or 1 percent, shall be allowed for spears affected by decay.

(2) For butts. 5 percent.

(3) For off-size. 10 percent, including not more than 5 percent for spears smaller than any specified minimum diameter.

DIAMETER CLASSIFICATION

§ 51.4080 Diameter classification.

(a) The following terms are provided for describing the diameter of the spears:

(1) Small. One-fourth inch to less than three-eighths inch in diameter.

(2) Medium. Three-eighths inch to less than five-eighths inch in diameter.

(3) Large. Five-eighths inch or larger in diameter.

(b) The diameter shall be the greatest thickness of the spear measured at a point 5 inches from the tip, except that spears which are less than 5 inches in length shall be measured at the base of the spear.

DEFINITIONS

§ 51.4081 Fresh.

"Fresh" means not wilted, limp or flabby.

§ 51.4082 Fairly well formed.

"Fairly well formed" means the spear is not badly flattened, crooked, or otherwise so badly deformed that its processing quality is materially affected.

§ 51.4083 Damage.

"Damage" means any defect which detracts from the processing quality of the portion of the spear that extends a distance of 4½ inches from the tip, or which materially detracts from the canning or freezing quality of the remaining portion of the spear exclusive of the

butt. Any one of the following defects, or any combination of defects the seriousness of which exceeds the maximum allowed for any one defect, shall be considered as damage:

(a) Doubles which detract from the appearance of that portion of the spear that extends a distance of $4\frac{1}{2}$ inches from the tip. Doubles which occur on the remaining portion of the spear shall not be regarded as damage.

(b) Spreading tips, when the tips are so spread or branched that the appearance is appreciably injured. Tips which have a "seedy" appearance shall be considered damaged.

(c) Dirt or sand which is so imbedded in the tip that it cannot be removed in the ordinary process of washing.

(d) Beetle eggs or holes which affect the portion of the spear that extends a distance of $4\frac{1}{2}$ inches from the tip, or which materially detract from the processing quality of the remaining portion of the spear exclusive of the butt.

§ 51.4084 Green color.

"Green color" means any shade or tinge of green color or purple color which will blanch green. The amount of green color shall be determined by measuring the distance from the extreme tip to the lowest point at which any shade of green color completely encircles the spear.

§ 51.4085 Serious damage.

"Serious damage" means any defect which seriously detracts from the processing quality of that part of the spear not classed as a butt. Any one of the following defects, or any combination of defects the seriousness of which exceeds the maximum allowed for any one defect, shall be considered as serious damage:

(a) Broken tips when three or more segments are missing from the tip or when the extreme tip is missing and the broken end is not at least fairly well concealed by lower scales.

(b) Spreading tips when the tip branches are more than three-quarter inch in length or when extending out from the spear.

(c) Beetle eggs when more than six eggs are present on the spear providing that not more than three eggs are present within a distance of $4\frac{1}{2}$ inches below the tip.

METRIC CONVERSION TABLE

§ 51.4086 Metric Conversion Table.

Inches:	Meters (mm.)
$\frac{1}{8}$ equals.....	3.2
$\frac{1}{4}$ equals.....	6.4
$\frac{3}{8}$ equals.....	9.5
$\frac{1}{2}$ equals.....	12.7
$\frac{5}{8}$ equals.....	15.9
$\frac{3}{4}$ equals.....	19.1
1 equals.....	25.4
2 equals.....	50.8
3 equals.....	76.2
4 equals.....	101.6
$4\frac{1}{2}$ equals.....	114.3
5 equals.....	127.0
$7\frac{1}{2}$ equals.....	190.5
10 equals.....	254.0

[FR Doc. 72-5218 Filed 4-4-72; 8:54 am]

Chapter XIV—Commodity Credit Corporation, Department of Agriculture

SUBCHAPTER B—LOANS, PURCHASES, AND OTHER OPERATIONS

PART 1434—HONEY

Subpart—1972-Crop Honey Loan and Purchase Program

On February 5, 1972, notice of proposed rule making regarding loan and purchase rates for 1972-crop honey, and detailed operating provisions to carry out the 1972 honey loan program were published in the FEDERAL REGISTER (37 F.R. 2775). Twenty-six responses were received from interested individual farmers, farm organizations and other interested parties. Most responses recommended an increase in loan and purchase rates. After considerations of all responses, it has been determined that the loan and purchase rates along with other operating procedures will remain the same as for the 1971 program. The Honey Price Support Regulations for 1970 and Subsequent Crops (35 F.R. 11773), as amended, which contain regulations of a general nature with respect to loan and purchase operations, are supplemented for the 1972 crop of honey as herein stated. The material previously appearing in this subpart in §§ 1434.40 through 1434.44 remains in full force and effect as to the crops to which it was applicable.

Subpart—1972-Crop Honey Loan and Purchase Program

Sec.	Purpose.
1434.40	Purpose.
1434.41	Availability.
1434.42	Maturity of loans.
1434.43	Loan and purchase rates.
1434.44	Discounts.

AUTHORITY: The provisions of this subpart issued under sec. 4, 62 Stat. 1070, as amended; 15 U.S.C. 714b. Interpret or apply sec. 5, 62 Stat. 1072, secs. 201, 401, 63 Stat. 1052, 1054; 15 U.S.C. 714c, U.S.C. 1446, 1421.

§ 1434.40 Purpose.

This subpart contains program provisions which, together with (a) the Honey Price Support Regulations for 1970 and Subsequent Crops, (b) the Cooperative Marketing Association-Eligibility Requirements for Price Support in Part 1425 of this chapter, and (c) any amendments to such regulations, set forth the requirements with respect to loans and purchases for 1972-crop honey.

§ 1434.41 Availability.

(a) **Loans.** Producers must request a loan on 1972-crop eligible honey on or before March 31, 1973.

(b) **Purchases.** Producers desiring to offer eligible honey not under loan for purchase must complete a Purchase Agreement at the county ASCS office on or before June 30, 1973.

§ 1434.42 Maturity of loans.

Unless demand is made earlier, loans on honey will mature on June 30, 1973.

§ 1434.43 Loan and purchase rates.

(a) **Table and nontable honey.** The rate for the quantity of 1972-crop honey placed under loan or acquired under loan

or purchase shall be the rate for the respective class and color set forth below:

Class and color: Table honey:	Cents per pound
1 White and lighter.....	14.8
2 Extra Light amber.....	13.8
3 Light amber.....	12.8
4 Other table honey.....	10.8
Nontable honey.....	10.8

(b) **Objectionable flavor, fermentation, or caramelization.** The settlement value for a lot of honey delivered under loan or for purchase which grades substandard on account of objectionable flavor, fermentation, or caramelization shall be the lower of its market value as determined by CCC or a value determined on the basis of the loan and purchase rate for nontable honey.

(c) **Grade not certified.** The settlement value for a lot of honey, delivered under loan or for purchase, on which the grade cannot be certified shall be the lower of its market value as determined by CCC or a value as determined on the basis of the loan and purchase rate for nontable honey.

(d) **Substandard.** The rate for a lot of honey delivered under a loan or for purchase which grades substandard on account of defects or moisture or a combination of defects and moisture shall be adjusted by the discounts in § 1434.44.

§ 1434.44 Discounts.

(a) **Defects.** The loan and purchase rate for a lot of honey delivered under a loan or for purchase which grades substandard on account of defects shall be adjusted by the following discount:

Substandard account of:	Discount (cents per pound)
Defects.....	2

(b) **Moisture.** The loan and purchase rate for a lot of honey delivered under a loan or for purchase which contains moisture in excess of 18.5 percent shall be adjusted by the following discounts which shall be in addition to the discount for defects:

Moisture (percent):	Discount (cents per pound)
18.5.....	0.0
19.0.....	0.5
19.5.....	1.0
20.0.....	1.5
20.5.....	2.0
21.0.....	2.5
21.5.....	3.0
22.0.....	3.5
22.5.....	4.0
23.0.....	4.5
23.5.....	5.0
24.0.....	5.5
24.5.....	6.0

(c) **Commingled storage.** The loan and purchase rate for a lot of honey tendered for loan or purchase by CCC while stored commingled in a warehouse, or delivered to a warehouse in bulk in satisfaction of a farm storage loan, shall be adjusted by the following discount:

Discount
(cents per
pound)

Bulk commingled..... 1.5

Effective date: Upon publication in the
FEDERAL REGISTER (4-5-72).

Signed at Washington, D.C., March 27,
1972.

KENNETH E. FRICK,
Executive Vice President,
Commodity Credit Corporation.

[FR Doc. 72-5200 Filed 4-4-72; 8:50 am]

Title 12—BANKS AND BANKING

Chapter II—Federal Reserve System

SUBCHAPTER A—BOARD OF GOVERNORS OF THE FEDERAL RESERVE SYSTEM

[Reg. T]

PART 220—CREDIT BY BROKERS AND DEALERS

Credit on Mutual Fund Shares

Section 220.125 is added to Part 220 as
follows:

§ 220.125 Extending, maintaining or ar-
ranging credit on mutual fund shares
having portfolio of exempted
securities.

(a) The Board of Governors has been
asked whether a broker or dealer may ex-
tend, maintain, or arrange for credit in a
special bond account subject to § 220.4
(i) on collateral consisting of shares of
registered open-end investment com-
panies whose portfolios are made up en-
tirely or in part of exempted securities.

(b) The term "exempted securities" is
defined in section 3(a) (12) of the Secu-
rities Exchange Act of 1934 (15 U.S.C.
sec. 78c(a) (12)) and generally includes
federal, state, and municipal securities.
Such securities are eligible as collateral
for extensions of credit in § 220.4(i) and
are entitled to good faith loan value in an
account carried pursuant to that section,
under § 220.8(b).

(c) This Part 220 (Regulation T)
provides that brokers and dealers may
not extend, maintain, or arrange for
credit to purchase any securities unless
the collateral for such credit consists of
exempted securities or securities that are
registered on a national securities ex-
change or appear on the Board's OTC
Margin List. Shares in registered open-
end investment companies are not "ex-
empted" securities, irrespective of the
composition of the portfolio of the com-
pany, nor are they registered on national
securities exchanges, or included on the
OTC Margin List. Accordingly, such
shares do not have loan value for pur-
poses of this Part 220, nor may brokers
or dealers extend credit against such
shares to purchase or carry any securi-
ties under § 220.4(i).

(d) The above-stated opinion is in
conformity with the Board's views ex-
pressed previously in its interpretations

announced in 1952 Bulletin 1105
(§ 220.109) and 1955 Bulletin 267
(§ 220.112) to the effect that brokers or
dealers are prohibited from arranging
credit to purchase unlisted shares issued
by open-end investment companies.

(Interprets and applies 15 U.S.C. 78g)

By order of the Board of Governors,
March 28, 1972.

[SEAL]

TYNAN SMITH,
Secretary of the Board.

[FR Doc. 72-5206 Filed 4-4-72; 8:50 am]

Title 14—AERONAUTICS AND SPACE

Chapter I—Federal Aviation Adminis- tration, Department of Transportation

[Airworthiness Docket No. 72-WE-5-AD;
Amdt. 39-1428]

PART 39—AIRWORTHINESS DIRECTIVES

Boeing Model 747 Airplanes

There have been reports of failures of
the landing gear alternate extension ac-
tuators on Boeing Model 747 airplanes
that could result in an inoperable land-
ing gear after an additional failure. Since
this condition is likely to exist or de-
velop in other airplanes of the same type
design, an airworthiness directive is be-
ing issued to require a functional check
inspection of the landing gear alternate
extension actuators in accordance with
Boeing Service Bulletin 747-32-2118 or
later FAA-approved revisions, or an
equivalent inspection approved by the
Chief, Aircraft Engineering Division,
FAA Western Region, until modified in
accordance with Boeing Service Bulletin
747-32-2118. The agency has determined
that inspection intervals must be estab-
lished by an AD rule to minimize possible
failures.

Since a situation exists that requires
immediate adoption of this regulation, it
is found that notice and public proce-
dure hereon are impracticable and good
cause exists for making this amendment
effective in less than 30 days.

In consideration of the foregoing, and
pursuant to the authority delegated to
me by the Administrator (31 F.R. 13697),
§ 39.13 of Part 39 of the Federal Aviation
Regulations is amended by adding the
following new airworthiness directive:

BOEING. Applies to Boeing Model 747 air-
planes, listed in Boeing Service Bulletin
747-32-2118, dated December 20, 1971,
or later FAA-approved revisions except
the Model 747-131.

Compliance required within the next 100
hours' time in service after the effective date
of this AD, unless already accomplished
within the last 400 hours' time in service,
and thereafter at intervals not to exceed 500
hours' time in service from the last inspec-
tion, until modified per Boeing Service Bul-
letin 747-32-2118, dated December 20, 1971,
or later FAA-approved revisions.

To detect failed landing gear alternate ex-
tension actuators, accomplish the following:

Inspect landing gear alternate extension
actuators in accordance with Boeing Service
Bulletin 747-32-2118, dated December 20,
1971, or later FAA-approved revisions, until
modified in accordance with Boeing Service
Bulletin 747-32-2118, dated December 20,
1971, or later FAA-approved revisions, or an
equivalent inspection approved by the Chief,
Aircraft Engineering Division, FAA Western
Region.

This amendment becomes effective
April 7, 1972.

(Secs. 313(a), 601, 603, Federal Aviation Act
of 1958, 49 U.S.C. 1354(a), 1421, and 1423;
sec. 6(c), Department of Transportation Act,
49 U.S.C. 1655(c))

Issued in Los Angeles, Calif., on
March 27, 1972.

ARVIN O. BASNIGHT,
Director, FAA Western Region.

[FR Doc. 72-5157 Filed 4-4-72; 8:46 am]

[Docket No. 72-EA-10; Amdt. 39-1427]

PART 39—AIRWORTHINESS DIRECTIVES

Hartzell Propellers

The Federal Aviation Administration
is amending § 39.13 of Part 39 of the
Federal Aviation Regulations so as to re-
voke AD 71-26-4 and issue a superseding
airworthiness directive applicable to cer-
tain Hartzell propellers.

Subsequent to the issuance of AD
71-26-4 there has been a report of an
additional cracked T10173 blade with
complete failure imminent. In view of the
foregoing AD 71-26-4 has been com-
pletely revised to include a change in
compliance time, a dye penetrant inspec-
tion and changes in serial numbers to
be affected. Thus a new airworthiness di-
rective is being issued so as to supersede
AD 71-26-4.

Since the foregoing deficiency can exist
in other blades of similar type design, ex-
pedient adoption of the amendment is
required. Therefore, notice and public
procedure hereon are impracticable and
good cause exists for making the amend-
ment effective in less than 30 days.

In consideration of the foregoing and
pursuant to the authority delegated to
me by the Administrator, 14 CFR 11.89
(31 F.R. 13697), § 39.13 of Part 39 of the
Federal Aviation Regulations is amended
so as to revoke AD 71-26-4 and issue a
new airworthiness directive as follows:

HARTZELL. Applies to all models of Hartzell
T10173 (—) and T10176 (—) type blades
including serial numbers listed below in-
stalled on Hartzell HC-B3TN-2, HC-
B3TN-3, HC-B3TN-5, HC-B3TF-7, and
HC-B4TN-3 series propellers used on
United Aircraft of Canada PT6A—,
AIRsearch TPE331— and Allison 250-B
type engines.

Blade Serial Numbers. All serial numbers
without prefix letters, all serial numbers pre-
fixed with letter "A" and all serial numbers

with prefix letter "B" up to serial No. B85887, except for the following serial numbers:

A97324	B63327	B80895	B82883
A97352	B63354	B80908	B82891
A98330	B63431	B80911	B82894
B38602	B63441	B80928	B82895
B39183	B69570	B82181	B82898
B39356	B71482	B82182	B82900
B40809	B71483	B82215	B82902
B40828	B75009	B82565	B82905
B41002	B75037	B82566	B82908
B41387	B75322	B82577	B84129
B41886	B76844	B82579	B84168
B41893	B76847	B82586	B84169
B44241	B76865	B82595	B84187
B44343	B78383	B82598	B84192
B49153	B78386	B82599	B84193
B53160	B78428	B82603	B84222
B53246	B79430	B82607	B84227
B53249	B79435	B82635	B84230
B53264	B79454	B82694	B84243
B63036	B80547	B82699	B84245
B63039	B80548	B82706	B84254
B63122	B80553	B82710	B84294
B63127	B80698	B82711	
B63131	B80715	B82876	
B63294	B80717	B82878	

Compliance required as indicated, unless already accomplished.

A. To prevent propeller blade failures, accomplish the following:

1. Propellers with a total of 1400 or more hours in service, inspect in accordance with paragraph (A) (5) within the next 100 hours in service after the effective date of this directive. If no cracks are found, shot peen propeller blade balance hole and service in accordance with Hartzell Bulletin No. 97, dated 1 December 1971, or equivalent procedure approved by the Chief, Engineering and Manufacturing Branch, Eastern Region.

2. Propellers with less than 1400 total hours in service, inspect in accordance with paragraph (A) (5) prior to the accumulation of 1500 total hours in service. If no cracks are found, shot peen propeller blade balance hole and service in accordance with Hartzell Bulletin No. 97, dated 1 December 1971, or equivalent procedure approved by the Chief, Engineering and Manufacturing Branch, Eastern Region.

3. Propellers whose total hours in service are unknown will be assumed to have a total of 1400 hours minimum and thus fall within the requirements for inspection and shot peening in accordance with paragraph (A) (1).

4. Propellers whose total time in service is unknown, inspect each blade for cracks by dye penetrant method or an equivalent method approved by the Chief, Engineering and Manufacturing Branch, Eastern Region, in the area of 2 to 6 inches outboard of the blade clamp (excluding the de-icers), within the next 15 hours' time in service after the effective date of this directive. Reinspect every 15 hours' time in service from last inspection until the inspection and shot peening requirements in accordance with paragraph (A) (1) are accomplished. If a cracked blade is found, remove and replace propeller before further flight with a propeller having blades to which this AD does not apply or have been inspected and altered in accordance with this directive.

5. Remove propeller from the aircraft and remove blades from hub. If lead wool is installed in balance hole, remove in accordance with Hartzell Bulletin No. 97 dated 1 December 1971, or equivalent procedure approved by the Chief, Engineering and Manufacturing Branch, Eastern Region. Inspect interior surfaces of balance hole for cracks in accordance with Hartzell Bulletin No. 97, Appendix "B", dated 1 December 1971, or equivalent procedure approved by the Chief, Engineer-

ing and Manufacturing Branch, Eastern Region. Replace any cracked blades before flight with blades to which this AD does not apply or which have been inspected and altered in accordance with this directive.

B. Propeller blade retirement for Beech 99 and A99 type aircraft. This applies only to blades affected by this directive.

1. Within 1500 hours' time in service after accomplishment of the inspection and shot peening requirements in accordance with paragraph (A) (1), remove the propeller(s) from the aircraft. Remove the blades from the hub, and replace with T10173—Category II type blades in accordance with instructions in Hartzell Overhaul Manual 118. Replaced blades must be retired from any further service in aircraft.

2. Propellers which have not been inspected and shot peened in accordance with paragraph (A) (2), as of the effective date of this directive may comply with the blade replacement requirements of paragraph (B) (1), in lieu of compliance with the requirements in paragraph (A) (2). (Hartzell Letter to Propeller Repair Stations dated 21 January 1972 pertains to this subject.)

This amendment is effective April 11, 1972.

(Secs. 313(a), 601, 603, Federal Aviation Act of 1958, 49 U.S.C. 1354(a), 1421, and 1423; sec. 6(c), Department of Transportation Act, 49 U.S.C. 1655(c))

Issued in Jamaica, N.Y., on March 28, 1972.

ROBERT H. STANTON,
Acting Director, Eastern Region.

[FR Doc. 72-5159 Filed 4-4-72; 8:46 am]

[Docket No. 72-EA-21; Amdt. 39-1426]

PART 39—AIRWORTHINESS DIRECTIVES

Piper Aircraft

The Federal Aviation Administration is amending § 39.13 of Part 39 of the Federal Aviation Regulations so as to amend AD 68-7-4.

Subsequent to the issuance of AD 68-7-4 the service history of the Piper PA 23-250 type aircraft to which the AD applies demonstrated that the inspection of the engine mount tubes aft of the firewall was difficult because the tubes were not readily accessible and further that no deficiencies were observed when inspected. Thus AD 68-7-4 will be relaxed to confine inspections to the tubes forward of the firewall.

Since the foregoing is relaxatory, notice and public procedure hereon are unnecessary and the amendment may be made effective in less than 30 days.

In consideration of the foregoing and pursuant to the authority delegated to me by the Administrator, 14 CFR 11.89 (31 F.R. 13697), § 39.13 of Part 39 of the Federal Aviation Regulations is amended so as to amend AD 68-7-4 as follows:

Delete in paragraph b. the phrase "the mount for cracks at all joints" and insert in lieu thereof "the engine mount tubes forward of the firewall for cracks."

This amendment is effective April 11, 1972.

(Secs. 313(a), 601, 603, Federal Aviation Act of 1958, 49 U.S.C. 1354(a), 1421 and 1423;

sec. 6(c), Department of Transportation Act, 49 U.S.C. 1655(c))

Issued in Jamaica, N.Y., on March 27, 1972.

ROBERT H. STANTON,
Acting Director, Eastern Region.

[FR Doc. 72-5160 Filed 4-4-72; 8:46 am]

[Airspace Docket No. 71-SO-186]

PART 73—SPECIAL USE AIRSPACE

Designation of Temporary Restricted Areas

On February 8, 1972, a notice of proposed rule making was published in the FEDERAL REGISTER (37 F.R. 2847) stating that the Federal Aviation Administration was considering amendments to Part 73 of the Federal Aviation Regulations that would designate temporary restricted areas in the Camp Lejeune/Crotan National Forest/Cherry Point area, and in the coastal region adjacent to Beaufort and Lake Waccamaw, N.C., to be utilized for a short period to accommodate a joint military training exercise.

Interested persons were afforded an opportunity to participate in the proposed rule making through the submission of comments. All comments received were favorable.

In consideration of the foregoing, Part 73 of the Federal Aviation Regulations is amended, effective 0901 G.m.t., April 27, 1972, as hereinafter set forth.

1. Section 73.53 (37 F.R. 2365) is amended by adding the following:

a. Name: R-5309A Exotic Dancer V—Joint Military Exercise.

Location: Camp Lejeune, N.C.

Boundaries: Beginning at a point on the northwest boundary of Restricted Area R-5306A at lat. 35°23'15" N., long. 76°34'40" W.; thence southwest along the boundary of R-5306A to lat. 35°02'00" N., long. 76°58'15" W.; thence clockwise along the boundary of the New Bern control zone to lat. 35°02'00" N., long. 77°09'00" W.; to lat. 35°15'00" N., long. 77°30'00" W.; to lat. 35°32'30" N., long. 77°09'30" W.; thence to point of beginning. Designated altitudes: 7,000 to 17,000 feet MSL.

Time of designation: Continuous, May 15, 1972, through May 25, 1972.

Controlling agency: Federal Aviation Administration, Washington ARTC Center.

Using agency: U.S. Atlantic Command, Norfolk, Va.

b. Name: R-5309B Exotic Dancer V—Joint Military Exercise.

Location: Camp Lejeune, N.C.

Boundaries: Beginning at a point on the northwest boundary of Restricted Area R-5306A at lat. 35°02'00" N., long. 76°58'15" W.; thence southwest and southeast along the boundary of R-5306A, R-5306B, and R-5306C to lat. 34°30'20" N., long. 77°15'50" W.; thence southwest along the boundary of Warning Area W-122 to lat. 34°17'45" N., long. 77°37'50" W.; to lat. 34°35'30" N., long. 77°42'30" W.; to lat. 34°37'30" N., long. 77°50'00" W.; to lat. 34°55'00" N., long. 77°49'30" W.; to lat. 35°15'00" N., long. 77°30'00" W.; to lat. 35°02'00" N., long. 77°09'00" W.; thence counterclockwise along the boundary of the New Bern control zone to point of beginning; excluding the airspace at and below 4,000 feet MSL within the Jacksonville, N.C., control zone and transition area

(8.5-statute-mile radius of New River MCAS, lat. 34°42'25" N., long. 77°26'35" W.; and 8.5-statute-mile radius and extensions of Albert Ellis, N.C., Airport, lat. 34°49'49" N., long. 77°36'42" W.); excluding that airspace from 1,000 to and including 4,000 feet MSL within 4 nautical miles either side of Fayetteville, N.C. VORTAC 102°M(98°T) radial, extending from the Jacksonville transition area westward to the restricted area boundary.

Designated altitudes: Surface to 17,000 feet MSL.

Time of designation: Continuous, May 15, 1972, through May 25, 1972.

Controlling agency: Federal Aviation Administration, Washington ARTCC Center.

Using agency: U.S. Atlantic Command, Norfolk, Va.

c. Name: R-5309C Exotic Dancer V—Joint Military Exercise.

Location: Camp Lejeune, N.C.

Boundaries: Beginning at a point on the southeast boundary of Restricted Area R-5306A at lat. 34°43'40" N., long. 76°46'30" W.; to lat. 34°37'45" N., long. 76°40'00" W., thence west along the boundary of Warning Area W-122 to lat. 34°37'30" N., long. 76°56'20" W.; to lat. 34°41'50" N., long. 76°56'20" W.; thence along the boundary of R-5306A to point of beginning.

Designated altitudes: Surface to FL 350.

Time of designation: Continuous, May 15, 1972, through May 25, 1972.

Controlling agency: Federal Aviation Administration, Washington, ARTC Center.

Using agency: U.S. Atlantic Command, Norfolk, Va.

(Sec. 307(a), Federal Aviation Act of 1958, 49 U.S.C. 1348(a); sec. 6(c), Department of Transportation Act, 49 U.S.C. 1655(c))

Issued in Washington, D.C., on March 30, 1972.

H. B. HELSTROM,
Chief, Airspace and Air
Traffic Rules Division.

[FR Doc.72-5158 Filed 4-4-72;8:46 am]

[Docket No. 11822; Amdt. 804]

PART 97—STANDARD INSTRUMENT APPROACH PROCEDURES

Miscellaneous Amendments

This amendment to Part 97 of the Federal Aviation Regulations incorporates by reference therein changes and additions to the Standard Instrument Approach Procedures (SIAP's) that were recently adopted by the Administrator to promote safety at the airports concerned.

The complete SIAP's for the changes and additions covered by this amendment are described in FAA Forms 3139, 8260-3, 8260-4, or 8260-5 and made a part of the public rule making dockets of the FAA in accordance with the procedures set forth in Amendment No. 97-696 (35 F.R. 5609).

SIAP's are available for examination at the Rules Docket and at the National Flight Data Center, Federal Aviation Administration, 800 Independence Avenue SW., Washington, DC 20591. Copies of SIAP's adopted in a particular region are also available for examination at the headquarters of that region. Individual copies of SIAP's may be purchased from the FAA Public Document Inspection Facility, HQ-405, 800 Independence Avenue SW., Washington, DC 20591, or from the applicable FAA regional office in ac-

cordance with the fee schedule prescribed in 49 CFR 7.85. This fee is payable in advance and may be paid by check, draft or postal money order payable to the Treasurer of the United States. A weekly transmittal of all SIAP changes and additions may be obtained by subscription at an annual rate of \$125 per annum from the Superintendent of Documents, U.S. Government Printing Office, Washington, D.C. 20402.

Since a situation exists that requires immediate adoption of this amendment, I find that further notice and public procedure hereon is impracticable and good cause exists for making it effective in less than 30 days.

In consideration of the foregoing, Part 97 of the Federal Aviation Regulations is amended as follows, effective on the dates specified:

1. Section 97.23 is amended by establishing, revising, or canceling the following VOR-VOR/DME SIAP's, effective May 4, 1972.

- Clarksburg, W. Va.—Benedum Airport; VOR Runway 3, Amdt. 7; Revised.
- Columbus, Ga.—Columbus Metropolitan Airport; VOR-A, Amdt. 14; Revised.
- Lima, Ohio—Allen County Airport; VOR Runway 27, Amdt. 8; Revised.
- Meridian, Miss.—Akin Airport; VOR Runway 4, Amdt. 1; Revised.
- Sheridan, Wyo.—Sheridan County Airport; VOR Runway 13, Amdt. 3; Revised.
- Columbia—Mount Pleasant, Tenn.—Maury County Airport; VOR/DME-A, Original; Established.
- Sheridan, Wyo.—Sheridan County Airport; VOR/DME Runway 31, Amdt. 2; Revised.
- Tangier, Va.—Tangier Island Airport; VOR/DME Runway 1, Amdt. 1; Revised.

2. Section 97.25 is amended by establishing, revising, or canceling the following SDF-LOC-LDA SIAP's effective May 4, 1972.

- Columbus, Ga.—Columbus Metropolitan Airport; LOC (BC) Runway 23, Amdt. 4; Revised.
- Huntington, W. Va.—Tri-State (Walker-Long Field); LOC (BC) Runway 30, Amdt. 6; Revised.

3. Section 97.27 is amended by establishing, revising or canceling the following NDB/ADF SIAP's, effective May 4, 1972.

- Clarksburg, W. Va.—Benedum Airport; NDB Runway 21, Original; Established.
- Columbus, Ga.—Columbus Metropolitan Airport; NDB Runway 5, Amdt. 20; Revised.
- Huntington, W. Va.—Tri-State (Walker-Long Field); NDB Runway 12, Amdt. 9; Revised.
- Lima, Ohio—Lima Airport; NDB Runway 9, Amdt. 2; Revised.
- Santa Barbara, Calif.—Santa Barbara Municipal Airport; NDB-A, Amdt. 1; Revised.

4. Section 97.29 is amended by establishing, revising, or canceling the following ILS SIAP's, effective, May 4, 1972.

- Clarksburg, W. Va.—Benedum Airport; ILS Runway 21, Original; Established.
- Columbus, Ga.—Columbus Metropolitan Airport; ILS Runway 5, Amdt. 15; Revised.
- Huntington, W. Va.—Tri-State (Walker-Long Field); ILS Runway 12, Amdt., 1; Revised.
- Santa Barbara, Calif.—Santa Barbara Municipal Airport; ILS Runway 7, Amdt. 16; Revised.

Santa Barbara, Calif.—Santa Barbara Municipal Airport; ILS/DMS Runway 7, Amdt. 1; Revised.

Washington, D.C.—Dulles International Airport; ILS Runway 1R, Amdt. 10; Revised.

5. Section 97.31 is amended by establishing, revising, or canceling the following Radar SIAP's, effective May 4, 1972.

Columbus, Ga.—Columbus Metropolitan Airport; Radar-1, Amdt. 1; Revised.

6. Section 97.33 is amended by establishing, revising, or canceling the following RNAV SIAP's, effective May 4, 1972.

Santa Barbara, Calif.—Santa Barbara Municipal Airport; RNAV-A, Amdt. 2; Revised.

(Secs. 307, 313, 601, 1110, Federal Aviation Act of 1958, 49 U.S.C. 1438, 1354, 1421, 1510; sec. 6(c) Department of Transportation Act, 49 U.S.C. 1655(c), 5 U.S.C. 552(a)(1))

Issued in Washington, D.C., on March 28, 1972.

WILLIAM G. SHREVE, Jr.,
Acting Director,
Flight Standards Service.

NOTE: Incorporation by reference provisions in §§ 97.10 and 97.20 (35 F.R. 5610) approved by the Director of the Federal Register on May 12, 1969.

[FR Doc.72-5051 Filed 4-4-72;8:45 am]

Title 16—COMMERCIAL PRACTICES

Chapter I—Federal Trade Commission

[Docket No. C-2163]

PART 13—PROHIBITED TRADE PRACTICES

Canaveral International Corp. et al.

Subpart—Advertising falsely or misleadingly: § 13.73 *Formal regulatory and statutory requirements*: 13.73-92 *Truth in Lending Act*; § 13.155 *Prices*: 13.155-95(a) *Truth in Lending Act*. Subpart—Misrepresenting oneself and goods—Goods: § 13.1623 *Formal regulatory and statutory requirements*: 13.1623-95 *Truth in Lending Act*; Misrepresenting oneself and goods—Prices: § 13.1823 *Terms and conditions*: 13.1823-20 *Truth in Lending Act*. Subpart—Neglecting, unfairly or deceptively, to make material disclosure: § 13.1852 *Formal regulatory and statutory requirements*: 13.1852-75 *Truth in Lending Act*; § 13.1905 *Terms and conditions*: 13.1905-60 *Truth in Lending Act*.

(Sec. 6, 38 Stat. 721; 15 U.S.C. 46. Interpret or apply sec. 5, 38 Stat. 719, as amended, 82 Stat. 146, 147; 15 U.S.C. 45, 1601-1605) [Cease and desist order, Canaveral International Corp. et al., Miami, Fla., Docket No. C-2163, March 2, 1972]

In the Matter of Canaveral International Corp., a Corporation, Baker Mobile Homes, Inc., a Corporation, Colonial Coach Estates, Inc., a Florida Corporation, and Colonial Coach Estates, Inc., a Georgia Corporation

Consent order requiring a Miami, Fla., seller and distributor of mobile homes

and other associated respondents to cease violating the Truth in Lending Act by failing to disclose to customers the annual finance charge, the total payments, the method of computing penalty charges, the cash price, the unpaid balance of cash price, the deferred payment price, the cash downpayment, and other disclosures required by Regulation Z of the said Act.

The order to cease and desist, including further order requiring report of compliance therewith, is as follows:

It is ordered. That respondents Canaveral International Corp., a corporation, Baker Mobile Homes, Inc., a corporation, Colonial Coach Estates, Inc., a Florida corporation, and Colonial Coach Estates, Inc., a Georgia corporation, their successors and assigns, and respondents' officers, agents, representatives and employees, directly or through any corporation, subsidiary, division or other device, in connection with any extension of consumer credit or any advertisement to aid, promote or assist directly or indirectly any extension of consumer credit, as "consumer credit" and "advertisement" are defined in Regulation Z (12 CFR Part 226) of the Truth in Lending Act (P.L. 90-321, 15 U.S.C. 1601 et seq.) do forthwith cease and desist from:

1. Failing to provide customers with the following consumer credit cost disclosures determined in accordance with §§ 226.4 and 226.5 of Regulation Z in the manner, form and amount required by §§ 226.6 and 226.8 of Regulation Z:

a. The finance charge expressed as an annual percentage rate.

b. The "total of payments."

c. The amount, or method of computing the amount, of any default, delinquency, or similar charges payable in the event of late payments.

d. A description of the penalty charge that may be imposed by respondents or their assignee for prepayment of the principal of the obligation with an explanation of the method of computation of such penalty and the conditions under which it may be imposed.

e. An identification of the method of computing any unearned portion of the finance charge in the event of prepayment of the obligation.

f. The "cash price."

g. The "unpaid balance of cash price."

h. All other charges which are included in the amount financed but which are not part of the finance charge.

i. The "unpaid balance" and "amount financed."

j. The "finance charge."

k. The "deferred payment price."

2. Failing to clearly and conspicuously disclose the type of security interest acquired in connection with their credit sales and the property to which the security interest relates as required by §§ 226.6(a) and 226.8(b)(5) of Regulation Z.

3. Failing to use the term "cash downpayment" to describe the downpayment in money made in connection with their credit sales, as required by § 226.8(c)(2) of Regulation Z.

4. Failing to use the term "trade-in" to describe the downpayment in property made in connection with their credit sales, as required by § 226.8(c)(2) of Regulation Z.

5. Failing to use the term "total downpayment" to describe the sum of the cash "downpayment" and "trade-in" as required by § 226.8(c)(2) of Regulation Z.

6. Failing, in any consumer credit transaction or advertisement, to make all disclosures, determined in accordance with §§ 226.4 and 226.5 of Regulation Z, in the manner, form and amount required by §§ 226.6, 226.8 and 226.10 of Regulation Z.

It is further ordered. That respondents deliver a copy of this order to cease and desist to all present and future personnel of respondents engaged in the consummation of any extension of consumer credit or in any aspect of preparation, creation, or placing of advertising, and that respondents secure a signed statement acknowledging receipt of said order from each such person.

It is further ordered. That respondents notify the Commission at least thirty (30) days prior to any proposed change in any of the respondents, such as dissolution, assignment, or sale resulting in the emergence of any successor corporations, the creation or dissolution of subsidiaries or any other change in the corporations which may affect compliance obligations arising out of the order.

It is further ordered. That the respondents herein shall, within sixty (60) days after service upon them of this order, file with the Commission a report in writing setting forth in detail the manner and form in which they have complied with this order.

Issued: March 2, 1972.

By the Commission.

[SEAL] CHARLES A. TOBIN,
Secretary.

[FR Doc.72-5152 Filed 4-4-72;8:46 am]

[Docket No. 2164]

PART 13—PROHIBITED TRADE PRACTICES

O & P Motors, Inc., and Patricia V. Olsen

Subpart—Advertising falsely or misleadingly: § 13.73 *Formal regulatory and statutory requirements*: 13.73-72 Truth in Lending Act; § 13.155 *Prices*: 13.155-95(a) Truth in Lending Act. Subpart—Misrepresenting oneself and goods—Goods: § 13.1623 *Formal regulatory and statutory requirements*: 13.1623-95 Truth in Lending Act; Misrepresenting oneself and goods—Prices: § 13.1823 *Terms and conditions*: 13.1823-20 Truth in Lending Act. Subpart—Neglecting, unfairly or deceptively, to make material disclosure: § 13.1852 *Formal regulatory and statutory requirements*: 13.1852-75 Truth in Lending Act; § 13.1905 *Terms and conditions*: 13.1905-60 Truth in Lending Act. Subpart—Securing signatures wrong-

fully: § 13.2175 *Securing signatures wrongfully*.

(Sec. 6, 38 Stat. 721; 15 U.S.C. 46. Interpret or apply sec. 5, 38 Stat. 719, as amended, 82 Stat. 146, 147; 15 U.S.C. 45, 1601-1605) [Cease and desist order, O & P Motors, Inc., et al., Jacksonville, Fla., Docket No. C-2164, March 2, 1972]

In the Matter of O & P Motors, Inc., a Corporation, and Patricia V. Olsen, Individually and as an Officer of said Corporation

Consent order requiring a Jacksonville, Fla., seller and distributor of used automobiles to cease violating the Truth in Lending Act in its consumer credit transactions by failing to disclose the cash price, cash downpayment, trade-in, total downpayment, unpaid balance of cash price, amount financed, annual percentage rate, and other terms required by Regulation Z of said Act.

The order to cease and desist, including further order requiring report of compliance therewith, is as follows:

It is ordered. That respondents O & P Motors, Inc., a corporation, its successors and assigns, and its officers, and Patricia V. Olsen, individually and as an officer of said corporation, and respondent's agents, representatives, and employees, directly or through any corporate or other device, in connection with any extension of consumer credit or advertisement to aid, promote or assist directly or indirectly any extension of consumer credit, as "consumer credit" and "advertisement" are defined in Regulation Z (12 CFR Part 226) of the Truth in Lending Act (Public Law 90-321, 15 U.S.C. 1601 et seq.), do forthwith cease and desist from:

1. Failing to use the term "cash price" to describe the price at which respondents offer in the regular course of business to sell for cash the automobiles which are the subject of the credit sale, as required by § 226.8(c)(1) of Regulation Z.

2. Failing to use the term "cash downpayment" to describe the downpayment in money made in connection with the credit sale, as required by § 226.8(c)(2) of Regulation Z.

3. Failing to use the term "trade-in" to describe the downpayment in property made in connection with the credit sale, as required by § 226.8(c)(2) of Regulation Z.

4. Failing to use the term "total downpayment" to describe the sum of the "cash downpayment" and "trade-in" as required by § 226.8(c)(2) of Regulation Z.

5. Failing to use the term "unpaid balance of cash price" to describe the difference between the cash price and the total downpayment as required by § 226.8(c)(3) of Regulation Z.

6. Failing to use the term "amount financed" to describe the amount of credit extended, as required by § 226.8(c)(7) of Regulation Z.

7. Failing to use the term "finance charge" to describe the sum of all charges required by § 226.4 of Regulation

Z to be included therein, as required by § 226.8(c) (8) (i) of Regulation Z.

8. Failing to disclose the sum of the cash price, all charges which are included in the amount financed but which are not part of the finance charge, and the finance charge, and to describe that sum as the "deferred payment price", as required by § 226.8(c) (8) (ii) of Regulation Z.

9. Failing to disclose the "annual percentage rate" determined in accordance with § 226.5 of Regulation Z, as required by § 226.8(b) (2) of Regulation Z.

10. Failing to disclose the number of payments scheduled to repay the indebtedness, as required by § 226.8(b) (3) of Regulation Z.

11. Failing to use the term "total of payments" to describe the sum of payments scheduled to repay the indebtedness as required by § 226.8(b) (3) of Regulation Z.

12. Failing to describe the type of security interest retained or acquired as required by § 226.8(b) (5) of Regulation Z.

13. Stating, in any advertisement, that no downpayment can be arranged when in truth and in fact respondents do require downpayments and do not customarily arrange for a credit sale with no downpayment, thereby violating § 226.10 (a) (1) of Regulation Z.

14. Stating, in any advertisement, the amount of the downpayment required and the amount of monthly installment payments which can be arranged in connection with a consumer credit transaction, without also stating all of the following items, in terminology prescribed under § 226.8 of Regulation Z, as required by § 226.10(d) (2) thereof:

- (i) The cash price;
- (ii) The amount of the downpayment required or that no downpayment is required, as applicable;
- (iii) The number, amount, and due dates or period of payments scheduled to repay the indebtedness if credit is extended;
- (iv) The amount of the finance charge expressed as an annual percentage rate; and
- (v) The deferred payment price.

15. Failing in any consumer credit transaction or advertising to make all disclosures, determined in accordance with §§ 226.4 and 226.5 of Regulation Z, at the time and in the manner, form and amount required by §§ 226.6, 226.8 and 226.10 of Regulation Z.

It is further ordered. That respondents deliver a copy of this order to cease and desist to all present and future personnel or respondents engaged in the consummation of any extension of consumer credit or in any aspect of preparation, creation, or placing of advertising, and that respondents secure a signed statement acknowledging receipt of said order from each such person.

It is further ordered. That respondents notify the Commission at least thirty (30) days prior to any proposed change in the corporate respondent, such as dis-

solution; assignment or sale, resulting in the emergence of a successor corporation; the creation or dissolution of subsidiaries; or any other change in the corporation which may affect compliance obligations arising out of the order.

It is further ordered. That the respondents shall, within sixty (60) days after service upon them of this order, file with the Commission a report in writing, setting forth in detail the manner and form in which they have complied with this order.

Issued: March 2, 1972.

By the Commission.

[SEAL] CHARLES A. TOBIN,
Secretary.

[FR Doc. 72-5153 Filed 4-4-72; 8:46 am]

PART 423—CARE LABELING OF TEXTILE WEARING APPAREL

Delegation of Authority To Act Upon Requests for Exemptions

§ 423.2 Exemptions.

(a) *Delegation of authority to grant or deny.* Pursuant to section 1 of Reorganization Plan No. 4 of 1961, authority to grant or deny requests for exemptions filed pursuant to § 423.1 is delegated, without power or redelegation, to the Director of the Bureau of Consumer Protection, subject to discretionary Commission review.

(b) *Procedure.* The Director of the Bureau of Consumer Protection will, by letter to the applicant, grant or deny each request for exemption, with a brief statement of the reason for any denial. The letter will be placed upon the public record. Within five (5) days after the letter is placed upon the record, computed in accordance with the Commission's rules, the Commission may place the matter upon its own docket for review, and may set aside the Director's decision and grant or deny the request for exemption. Also, within five (5) days following a decision by the Director on such a request, the applicant or any person who would be adversely affected may file with the Secretary a request for review and reversal thereof by the Commission. The Commission, in its discretion, may grant or deny the request, and will by letter notify the applicant and any such person of its decision, with a brief statement of the reason for any denial, and place the letter on the public record. If the Commission does not place the Director's decision upon its own docket for review, or if no timely request for review is filed, the Director's decision shall, upon the expiration of the 5-day period, become the action of the Commission.

By direction of the Commission dated March 14, 1972.

[SEAL] CHARLES A. TOBIN,
Secretary.

[FR Doc. 72-5190 Filed 4-4-72; 8:49 am]

Title 25—INDIANS

Chapter I—Bureau of Indian Affairs, Department of the Interior

SUBCHAPTER T—OPERATION AND MAINTENANCE

PART 221—OPERATION AND MAINTENANCE CHARGES

Wind River Indian Irrigation Project, Wyo.

On page 3060 of the FEDERAL REGISTER of February 11, 1972, there was published a notice of intention to amend § 221.95 Charges, of Title 25, Code of Federal Regulations, dealing with the irrigable lands of the Wind River Indian Irrigation Project, Wyo. The purpose of the amendment is to establish the assessment rate of 1972, and thereafter until further notice.

A 30-day period was prescribed for the public to have the opportunity to participate in the rule making process and submit written comments, suggestions or objections. On page 5625 of the FEDERAL REGISTER of March 17, 1972, there was published a notice of extension of 14 days correcting the 30-day period to 44 days. We have reviewed and considered all submitted protests and comments. Information does not indicate facts which would materially change the recommended charges.

The proposed amendment is hereby adopted without change as set forth below.

Section 221.95 is amended to read as follows:

§ 221.95 Charges.

In compliance with the provisions of the acts of August 1, 1914, and March 7, 1928 (38 Stat. 583, 25 U.S.C. 385; 45 Stat. 210, 25 U.S.C. 387), the operation and maintenance charges for the lands under the Wind River Irrigation Project, Wyo., for the calendar year 1972, and subsequent years until further notice, are hereby fixed at \$4.60 per acre for the assessable area under the constructed works on the diminished Wind River Project and at \$3.20 per acre on the Ceded Wind River Project; except in the case of all irrigable trust patent Indian land which lies within the Ceded Reservation and which is benefited by the Big Bend Drainage District where an additional assessment of \$0.45 (45 cents) per acre is hereby fixed.

CLYDE W. HOBBS,
Superintendent.

[FR Doc. 72-5184 Filed 4-4-72; 8:48 am]

Title 29—LABOR

Chapter XIV—Equal Employment Opportunity Commission

PART 1604—GUIDELINES ON DISCRIMINATION BECAUSE OF SEX

By virtue of the authority vested in it by section 713(b) of title VII of the

Civil Rights Act of 1964, 42 U.S.C., section 2000e-12, 78 Stat. 265, the Equal Employment Opportunity Commission hereby revises Title 29, Chapter XIV, Part 1604 of the Code of Federal Regulations.

These Guidelines on Discrimination Because of Sex supersede and enlarge upon the Guidelines on Discrimination Because of Sex, issued by the Equal Employment Opportunity Commission on December 2, 1965, and all amendments thereto. Because the material herein is interpretive in nature, the provisions of the Administrative Procedure Act (5 U.S.C. 553) requiring notice of proposed rule making, opportunity for public participation, and delay in effective date are inapplicable. The Guidelines shall be applicable to charges and cases presently pending or hereafter filed with the Commission.

Sec.	
1604.1	General principles.
1604.2	Sex as a bona fide occupational qualification.
1604.3	Separate lines of progression and seniority systems.
1604.4	Discrimination against married women.
1604.5	Job opportunities advertising.
1604.6	Employment agencies.
1604.7	Pre-employment inquiries as to sex.
1604.8	Relationship of Title VII to the Equal Pay Act.
1604.9	Fringe benefits.
1604.10	Employment policies relating to pregnancy and childbirth.

AUTHORITY: The provisions of this Part 1604 issued under sec. 713(b), 78 Stat. 265, 42 U.S.C. sec. 2000e-12.

§ 1604.1 General principles.

(a) References to "employer" or "employers" in this Part 1604 state principles that are applicable not only to employers but also to labor organizations and to employment agencies insofar as their action or inaction may adversely affect employment opportunities.

(b) To the extent that the views expressed in prior Commission pronouncements are inconsistent with the views expressed herein, such prior views are hereby overruled.

(c) The Commission will continue to consider particular problems relating to sex discrimination on a case-by-case basis.

§ 1604.2 Sex as a bona fide occupational qualification.

(a) The Commission believes that the bona fide occupational qualification exception as to sex should be interpreted narrowly. Labels—"Men's jobs" and "Women's jobs"—tend to deny employment opportunities unnecessarily to one sex or the other.

(1) The Commission will find that the following situations do not warrant the application of the bona fide occupational qualification exception:

(i) The refusal to hire a woman because of her sex based on assumptions of the comparative employment characteristics of women in general. For example, the assumption that the turnover rate among women is higher than among men.

(ii) The refusal to hire an individual based on stereotyped characterizations of the sexes. Such stereotypes include, for example, that men are less capable of assembling intricate equipment; that women are less capable of aggressive salesmanship. The principle of nondiscrimination requires that individuals be considered on the basis of individual capacities and not on the basis of any characteristics generally attributed to the group.

(iii) The refusal to hire an individual because of the preferences of coworkers, the employer, clients or customers except as covered specifically in subparagraph (2) of this paragraph.

(2) Where it is necessary for the purpose of authenticity or genuineness, the Commission will consider sex to be a bona fide occupational qualification, e.g., an actor or actress.

(b) Effect of sex-oriented State employment legislation.

(1) Many States have enacted laws or promulgated administrative regulations with respect to the employment of females. Among these laws are those which prohibit or limit the employment of females, e.g., the employment of females in certain occupations, in jobs requiring the lifting or carrying of weights exceeding certain prescribed limits, during certain hours of the night, for more than a specified number of hours per day or per week, and for certain periods of time before and after childbirth. The Commission has found that such laws and regulations do not take into account the capacities, preferences, and abilities of individual females and, therefore, discriminate on the basis of sex. The Commission has concluded that such laws and regulations conflict with and are superseded by title VII of the Civil Rights Act of 1964. Accordingly, such laws will not be considered a defense to an otherwise established unlawful employment practice or as a basis for the application of the bona fide occupational qualification exception.

(2) The Commission has concluded that State laws and regulations which discriminate on the basis of sex with regard to the employment of minors are in conflict with and are superseded by title VII to the extent that such laws are more restrictive for one sex. Accordingly, restrictions on the employment of minors of one sex over and above those imposed on minors of the other sex will not be considered a defense to an otherwise established unlawful employment practice or as a basis for the application of the bona fide occupational qualification exception.

(3) A number of States require that minimum wage and premium pay for overtime be provided for female employees. An employer will be deemed to have engaged in an unlawful employment practice if:

(i) It refuses to hire or otherwise adversely affects the employment opportunities of female applicants or employees in order to avoid the payment of minimum wages or overtime pay required by State law; or

(ii) It does not provide the same benefits for male employees.

(4) As to other kinds of sex-oriented State employment laws, such as those requiring special rest and meal periods or physical facilities for women, provision of these benefits to one sex only will be a violation of title VII. An employer will be deemed to have engaged in an unlawful employment practice if:

(i) It refuses to hire or otherwise adversely affects the employment opportunities of female applicants or employees in order to avoid the provision of such benefits; or

(ii) It does not provide the same benefits for male employees. If the employer can prove that business necessity precludes providing these benefits to both men and women, then the State law is in conflict with and superseded by title VII as to this employer. In this situation, the employer shall not provide such benefits to members of either sex.

(5) Some States require that separate restrooms be provided for employees of each sex. An employer will be deemed to have engaged in an unlawful employment practice if it refuses to hire or otherwise adversely affects the employment opportunities of applicants or employees in order to avoid the provision of such restrooms for persons of that sex.

§ 1604.3 Separate lines of progression and seniority systems.

(a) It is an unlawful employment practice to classify a job as "male" or "female" or to maintain separate lines of progression or separate seniority lists based on sex where this would adversely affect any employee unless sex is a bona fide occupational qualification for that job. Accordingly, employment practices are unlawful which arbitrarily classify jobs so that:

(1) A female is prohibited from applying for a job labeled "male," or for a job in a "male" line of progression; and vice versa.

(2) A male scheduled for layoff is prohibited from displacing a less senior female on a "female" seniority list; and vice versa.

(b) A Seniority system or line of progression which distinguishes between "light" and "heavy" jobs constitutes an unlawful employment practice if it operates as a disguised form of classification by sex, or creates unreasonable obstacles to the advancement by members of either sex into jobs which members of that sex would reasonably be expected to perform.

§ 1604.4 Discrimination against married women.

(a) The Commission has determined that an employer's rule which forbids or restricts the employment of married women and which is not applicable to married men is a discrimination based on sex prohibited by title VII of the Civil Rights Act. It does not seem to us relevant that the rule is not directed against all females, but only against married females, for so long as sex is a factor in the application of the rule, such

application involves a discrimination based on sex.

(b) It may be that under certain circumstances, such a rule could be justified within the meaning of section 703 (e) (1) of title VII. We express no opinion on this question at this time except to point out that sex as a bona fide occupational qualification must be justified in terms of the peculiar requirements of the particular job and not on the basis of a general principle such as the desirability of spreading work.

§ 1604.5 Job opportunities advertising.

It is a violation of title VII for a help-wanted advertisement to indicate a preference, limitation, specification, or discrimination based on sex unless sex is a bona fide occupational qualification for the particular job involved. The placement of an advertisement in columns classified by publishers on the basis of sex, such as columns headed "Male" or "Female," will be considered an expression of a preference, limitation, specification, or discrimination based on sex.

§ 1604.6 Employment agencies.

(a) Section 703(b) of the Civil Rights Act specifically states that it shall be unlawful for an employment agency to discriminate against any individual because of sex. The Commission has determined that private employment agencies which deal exclusively with one sex are engaged in an unlawful employment practice, except to the extent that such agencies limit their services to furnishing employees for particular jobs for which sex is a bona fide occupational qualification.

(b) An employment agency that receives a job order containing an unlawful sex specification will share responsibility with the employer placing the job order if the agency fills the order knowing that the sex specification is not based upon a bona fide occupational qualification. However, an employment agency will not be deemed to be in violation of the law, regardless of the determination as to the employer, if the agency does not have reason to believe that the employer's claim of bona fide occupational qualification is without substance and the agency makes and maintains a written record available to the Commission of each such job order. Such record shall include the name of the employer, the description of the job and the basis for the employer's claim of bona fide occupational qualification.

(c) It is the responsibility of employment agencies to keep informed of opinions and decisions of the Commission on sex discrimination.

§ 1604.7 Pre-employment inquiries as to sex.

A pre-employment inquiry may ask "Male _____, Female _____"; or "Mr. Mrs. Miss," provided that the inquiry is made in good faith for a nondiscriminatory purpose. Any pre-employment inquiry in connection with prospective employment which expresses directly or indirectly any limitation, specification, or discrimination as to sex

shall be unlawful unless based upon a bona fide occupational qualification.

§ 1604.8 Relationship of Title VII to the Equal Pay Act.

(a) The employee coverage of the prohibitions against discrimination based on sex contained in title VII is coextensive with that of the other prohibitions contained in title VII and is not limited by section 703(h) to those employees covered by the Fair Labor Standards Act.

(b) By virtue of section 703(h), a defense based on the Equal Pay Act may be raised in a proceeding under title VII.

(c) Where such a defense is raised the Commission will give appropriate consideration to the interpretations of the Administrator, Wage and Hour Division, Department of Labor, but will not be bound thereby.

§ 1604.9 Fringe benefits.

(a) "Fringe benefits," as used herein, includes medical, hospital, accident, life insurance and retirement benefits; profit-sharing and bonus plans; leave; and other terms, conditions, and privileges of employment.

(b) It shall be an unlawful employment practice for an employer to discriminate between men and women with regard to fringe benefits.

(c) Where an employer conditions benefits available to employees and their spouses and families on whether the employee is the "head of the household" or "principal wage earner" in the family unit, the benefits tend to be available only to male employees and their families. Due to the fact that such conditioning discriminatorily affects the rights of women employees, and that "head of household" or "principal wage earner" status bears no relationship to job performance, benefits which are so conditioned will be found a prima facie violation of the prohibitions against sex discrimination contained in the Act.

(d) It shall be an unlawful employment practice for an employer to make available benefits for the wives and families of male employees where the same benefits are not made available for the husbands and families of female employees; or to make available benefits for the wives of male employees which are not made available for female employees; or to make available benefits to the husbands of female employees which are not made available for male employees. An example of such an unlawful employment practice is a situation in which wives of male employees receive maternity benefits while female employees receive no such benefits.

(e) It shall not be a defense under title VIII to a charge of sex discrimination in benefits that the cost of such benefits is greater with respect to one sex than the other.

(f) It shall be an unlawful employment practice for an employer to have a pension or retirement plan which establishes different optional or compulsory retirement ages based on sex, or which differentiates in benefits on the basis of sex. A statement of the General

Counsel of September 13, 1968, providing for a phasing out of differentials with regard to optional retirement age for certain incumbent employees is hereby withdrawn.

§ 1604.10 Employment policies relating to pregnancy and childbirth.

(a) A written or unwritten employment policy or practice which excludes from employment applicants or employees because of pregnancy is in prima facie violation of title VII.

(b) Disabilities caused or contributed to by pregnancy, miscarriage, abortion, childbirth, and recovery therefrom are, for all job-related purposes, temporary disabilities and should be treated as such under any health or temporary disability insurance or sick leave plan available in connection with employment. Written and unwritten employment policies and practices involving matters such as the commencement and duration of leave, the availability of extensions, the accrual of seniority and other benefits and privileges, reinstatement, and payment under any health or temporary disability insurance or sick leave plan, formal or informal, shall be applied to disability due to pregnancy or childbirth on the same terms and conditions as they are applied to other temporary disabilities.

(c) Where the termination of an employee who is temporarily disabled is caused by an employment policy under which insufficient or no leave is available, such a termination violates the Act if it has a disparate impact on employees of one sex and is not justified by business necessity.

Effective date. This revision shall become effective on the date of its publication in the FEDERAL REGISTER (4-5-72).

Signed at Washington, D.C., this the 31st day of March 1972.

WILLIAM H. BROWN III,
Chairman.

[FR Doc.72-5213 Filed 3-31-72; 4:30 pm]

Chapter XVII—Occupational Safety and Health Administration, Department of Labor

PART 1926—SAFETY AND HEALTH REGULATIONS FOR CONSTRUCTION

Rollover Protective Structures and Overhead Protection; Access Roadways and Grades

Background. This proceeding was commenced by notice published in the FEDERAL REGISTER on October 29, 1971 (36 F.R. 20772). The notice invited interested persons to submit data, views, and arguments concerning: (1) Proposed standards for rollover protective structures and overhead protection on designated types of equipment used in construction work, and (2) a proposed amendment of § 1518.602(a)(3), relating to access roadways and grades. The proposal largely reflected the recommendations of the Advisory Committee on Construction Safety and Health.

The regulations to which the changes were proposed have application under the Construction Safety Act (40 U.S.C. 333) and the Williams-Steiger Occupational Safety and Health Act of 1970 (29 U.S.C. 651, et seq.).

The notice of proposed rule making invited interested persons to submit data, views, and arguments concerning the proposed changes, both orally and in writing. Written data, views, and arguments were received. Oral data, views, and arguments were received by Hearing Examiner Rhea M. Burrow during an informal hearing held on December 13 and 14, 1971. At the request of several participants, Hearing Examiner Burrow also received additional data, views, and arguments concerning the proposal after the hearing was adjourned on December 14.

The certified record of the proceeding, including the written comments received from interested persons, was submitted to the Advisory Committee on Construction Safety and Health for its review and advice pursuant to 29 CFR 1911.18. The Advisory Committee has considered the proposed revisions and has submitted its recommendations to the Assistant Secretary of Labor for Occupational Safety and Health for decision.

The major issues before me are:

1. When these rules for new equipment should become effective;
2. Whether the rules should apply to machines manufactured before July 1, 1969;
3. The type of rollover protective device appropriate for agricultural and industrial tractors used in construction;
4. The extent to which the rules would apply to agricultural and industrial tractors used in construction.

There are other issues in the proceeding, as to which I have accepted the expert reasoning of the Advisory Committee, the members of which were appointed upon the basis of their professional and technical experience in the construction safety and health field. (See section 107(e) of the Contract Work Hours and Safety Standards Act (40 U.S.C. 333) concerning the statutory qualifications of members of the Advisory Committee.)

Where substantive changes from the proposals have been made, they have been in response to comments which were regarded as persuasive. When substantive changes from the proposals have been requested but have not been made, the decision is based in large part on the contrary recommendations of the Advisory Committee and on the intrinsic appropriateness of the standards, as adopted, to assure safe and healthful places of employment.

The record shows that numerous operators of earthmoving equipment have been killed and injured because the machines which they were operating rolled over. Thus, there is a need for rollover protective structures (ROPS) which will protect the operators from this hazard.

The major issues are discussed below.

1. *Effective date for new equipment.*

would have required that machines manufactured on or after July 1, 1972, must be equipped with rollover protective structures. Comments indicated that a period of between 6 and 9 months was needed by manufacturers to adjust to the new standard. The adjustment time, it was stated, would have to run from the date of final promulgation of the rules. However, this matter has been under discussion since July 1971 and interested persons have, since that time, had adequate notice of the action proposed to be taken. In addition, the notice of proposed rulemaking, issued October 29, 1971, specifically mentioned the date of July 1, 1971. I find that a period in excess of 90 days is necessary to insure familiarization with the standard and adjustment to its terms. No shorter period is considered feasible. However, I further find that a period of less than 6 months is reasonable and appropriate for new equipment. Thus, the effective date for the new equipment standard is set at September 1, 1972.

2. *Machines manufactured before July 1, 1969.* Under the notice of proposed rulemaking, machines manufactured before July 1, 1969, would have to be fitted with rollover protective structures no later than July 1, 1975.

Numerous comments stated that the imposition of such a requirement was unreasonable because of: (a) Unavailability of the necessary devices and, (b) impracticability of the proposed rules with respect to existing machines.

A decision on this subject requires some analysis of the problems of bringing existing machines into compliance with the standards. This process, which is frequently referred to as "retrofit" or "retrofitting", has been significantly affected by the absence of comprehensive rules, national in scope, requiring ROPS on earthmoving equipment used in construction. Thus, firms which specialize in manufacturing and supplying ROPS to the industry probably have the capacity, in many instances, to expand their operations once these rules are promulgated. Too, other firms may well enter the field, thus increasing the availability of ROPS. On the other hand, there is substantial evidence in the record that the number of ROPS currently available is too small, compared to the projected demand, to be overcome even by a multi-fold increase in present capacity.

The question of the impracticability and unfeasibility of fitting older machines raises more serious questions. The assertion has been made that older machines, because of structural design, will be unable to withstand the stress factors which would be required. Moreover, it is contended that the fitting of such machines according to the specific requirements, as proposed, is difficult, if not impossible, because the strength of each individual machine frame cannot be measured with assurance or precision after sustained heavy use.

It is somewhat difficult to evaluate these contentions. Previous experience with fitting older machines cannot be fully relied on, because such experience

has been limited in scope. For example, when the U.S. Army Corps of Engineers required rollover protection in its construction contracts, contractors frequently made arrangements to borrow equipment which already met the corps' requirements, rather than making the necessary adjustments to their own machines. This type of borrowing of equipment is not a feasible alternative under the rules promulgated in this document, because all employers covered by the Williams-Steiger Act who are engaged in construction are affected by these rules. Thus, there is insufficient evidence of the capacity of various machines to sustain the stresses which would be required.

The suggested alternatives to setting a fixed minimum date by which all machines must come into compliance are: (a) To issue a rule exempting all machines manufactured before July 1, 1969; (b) to reserve this particular matter for further study to analyze the progress of employers, and of the construction industry as a whole, with fitting existing machines to meet the standards.

I find that the only reasonable alternative is to institute a more intensive review of the question of the practicality and feasibility of fitting machines manufactured before July 1, 1969. This review will include, and benefit from, an analysis of the progress which is made in the fitting of machines manufactured between July 1, 1969, and September 1, 1972. On the basis of the review, the reasonableness of a schedule for fitting older machines could then be satisfactorily determined. This review will commence immediately and will monitor the effectiveness with which the construction industry responds to the "retrofit" schedule promulgated today for existing machines manufactured since July 1, 1969. Depending on the results of this review, a new rule making proceeding would be initiated under section 6(b) of the Williams-Steiger Act. The rule making proceeding would consider the question of what specific minimum compliance dates should be set for machines manufactured before July 1, 1969.

Accordingly, § 1926.1000(c)(v) is revised to read as follows: "Machines manufactured before July 1, 1969: Reserved pending further study, development and review."

Where a standard has been reserved or where its effective date has been delayed, the working conditions involved would nonetheless be subject to the requirements of section 5(a)(1) of the Act. Thus, although an employer would not be required to meet the specific requirements of the standard, he would be subject to citation and proposed penalty if he failed to provide his employees with employment and a place of employment free from recognized hazards that are causing or likely to cause death or serious physical harm. It is not possible in the absence of specific facts to catalog the application of section 5(a)(1) in situations where the machines involved are operated without rollover protective structure. The particular facts may involve such things as the speed of the ma-

chine, the nature of the soil, the grade on which the machine is being used, the risk of falling objects, the training of the operator, etc. However, consistent with the policy of OSHA, no citation or proposed penalty will be issued under section 5(a)(1) except for serious violations. Moreover, in setting abatement requirements where citations are issued, OSHA would not necessarily require action by an employer to meet the specific requirements in the standards; the employer would be required only to make changes, such as modification in the method of operation of the machines, as are necessary to eliminate recognized hazards that are likely to cause death or serious physical harm to employees.

3. *ROPS for agricultural and industrial tractors used in construction.* Under the October 29 proposal, wheel-type agricultural and industrial tractors used in construction would have had to be equipped with ROPS consisting of "four or more uprights."

The purpose of requiring four uprights (as opposed to requiring one or more uprights) was to insure that adequate overhead protection would be provided on such machines, since the proposed overhead protection requirements could only be applied to machines with four or more uprights. However, the evidence at the hearing tended to show that ROPS of two-post design have proved satisfactory on agricultural and industrial tractors, and that the imposition of a requirement for a four-post ROPS would create unreasonable and inappropriate demands on users of such equipment.

The record demonstrates that overhead protection is needed in site-clearing operations. Section 1926.604 already requires this type of protection. Employees engaged in such operations will be protected from overhead hazards by the operation of § 1926.604.

Therefore, I find that the need for mandatory standards for rollover protection is more urgent than the need for mandatory standards for overhead protection in all construction activities on the machines in question. Accordingly, the proposed rules for overhead protection on agricultural and industrial tractors used in construction are made optional (except, of course, that § 1926.604 still applies with respect to site clearing). Rollover protective structures are required on such machines (see §§ 1926.1000 through 1926.1002).

4. *Coverage of agricultural and industrial tractors used in construction.* Under the October 29 proposal, all agricultural and industrial tractors used in construction would have been affected by the new subpart. Interested persons brought out that the Society of Automotive Engineers (SAE) standards, which are the source of the proposed rules, only apply to such vehicles of more than 20 engine horsepower. I have determined that the suggested change should be made because adequate ROPS standards do not exist for such machines of less than 20 engine horsepower and because the hazard of rollover is minimal on such machines

compared to the rollover hazard on machines of more than 20 engine horsepower. The change will also result in a desired consistency between the rules as promulgated and the SAE standards.

The rules as promulgated clarify the relationship to the rules of existing machines which meet the current ROPS requirements of the U.S. Army Corps of Engineers, the State of California, and the Bureau of Reclamation, U.S. Department of the Interior. The differences between such current governmental requirements and the rules promulgated in this document are minor, and the record shows that such other governmental rules have protected the safety and health of operators. Accordingly, existing machines which are in compliance with the current ROPS requirements (in effect as of the date of publication of this document in the FEDERAL REGISTER) of the U.S. Army Corps of Engineers, the State of California, and the Bureau of Reclamation, U.S. Department of the Interior, shall be deemed to meet the requirements of the rules published herein.

The Advisory Committee has recommended that I promulgate several newly issued standards of the Society of Automotive Engineers dealing with rollover protection. The standards in question are:

- SAE J320b Minimum performance criteria for rollover protective structures for prime movers;
- SAE J394a Rollover protective structures for wheeled front end loaders and wheeled dozers;
- SAE J395a Minimum performance criteria for rollover protective structures for track type tractors and track type front end loaders;
- SAE J396a Minimum performance criteria for rollover protective structures for motor graders;
- SAE J397a Critical zone for laboratory evaluation of rollover protective structures (ROPS) and falling object protective structures (FOPS) of construction and industrial vehicles.

These standards would, it is suggested, update the standards published today. In the near future, I intend to initiate action to implement the committee's recommendation.

In § 1926.602(a)(3), the word "designed" is deleted to avoid redundancy and to achieve greater precision.

In view of the foregoing, I hereby adopt the following changes in Part 1926 of Title 29, Code of Federal Regulations.

1. Part 1926 is amended by adding a new Subpart W, to read as set forth below:

Subpart W—Rollover Protective Structures; Overhead Protection

- Sec. -
- 1926.1000 Rollover protective structures (ROPS) for material handling equipment.
- 1926.1001 Minimum performance criteria for rollover protective structures for designated scrapers, loaders, dozers, graders, and crawler tractors.
- 1926.1002 Protective frame (ROPS) test procedures and performance requirements for wheel-type agricultural and industrial tractors used in construction.

Sec. 1926.1003 Overhead protection for operators of agricultural and industrial tractors.

AUTHORITY: The provisions of this Subpart W issued under sec. 1, 83 Stat. 96, 97, adding sec. 107 to Public Law 87-581, 76 Stat. 357; sec. 6(b), 84 Stat. 1593; 29 U.S.C. 655, 40 U.S.C. 333.

§ 1926.1000 Rollover protective structures (ROPS) for material handling equipment.

(a) *Coverage.* (1) This section applies to the following types of material handling equipment: To all rubber-tired, self-propelled scrapers, rubber-tired front-end loaders, rubber-tired dozers, wheel-type agricultural and industrial tractors, crawler tractors, crawler-type loaders, and motor graders, with or without attachments, that are used in construction work. This requirement does not apply to sideboom pipelaying tractors.

(2) The promulgation of specific standards for rollover protective structures for compactors and rubber-tired skid-steer equipment is reserved pending consideration of standards currently being developed.

(b) *Equipment manufactured on or after September 1, 1972.* Material handling machinery described in paragraph (a) of this section and manufactured on or after September 1, 1972, shall be equipped with rollover protective structures which meet the minimum performance standards prescribed in §§ 1926.1001 and 1926.1002, as applicable.

(c) *Equipment manufactured before September 1, 1972.* (1) All material handling equipment described in paragraph (a) of this section and manufactured or placed in service (owned or operated by the employer) prior to September 1, 1972, shall be fitted with rollover protective structures no later than the dates listed below:

(i) Machines manufactured on or after January 1, 1972, shall be fitted no later than April 1, 1973.

(ii) Machines manufactured between July 1, 1971, and December 31, 1971, shall be fitted no later than July 1, 1973.

(iii) Machines manufactured between July 1, 1970, and June 30, 1971, shall be fitted no later than January 1, 1974.

(iv) Machines manufactured between July 1, 1969, and June 30, 1970, shall be fitted no later than July 1, 1974.

(v) Machines manufactured before July 1, 1969: Reserved pending further study, development, and review.

(2) Rollover protective structures and supporting attachment shall meet the minimum performance criteria detailed in §§ 1926.1001 and 1926.1002, as applicable or shall be designed, fabricated, and installed in a manner which will support, based on the ultimate strength of the metal, at least two times the weight of the prime mover applied at the point of impact.

(i) The design objective shall be to minimize the likelihood of a complete overturn and thereby minimize the possibility of the operator being crushed as a result of a rollover or upset.

(ii) The design shall provide a vertical clearance of at least 52 inches from the work deck to the ROPS at the point of ingress or egress.

(d) *Remounting.* ROPS removed for any reason, shall be remounted with equal quality, or better, bolts or welding as required for the original mounting.

(e) *Labeling.* Each ROPS shall have the following information permanently affixed to the structure:

(1) Manufacturer or fabricator's name and address;

(2) ROPS model number, if any;

(3) Machine make, model, or series number that the structure is designed to fit.

(f) *Machines meeting certain existing governmental requirements.* Any machine in use, equipped with rollover protective structures, shall be deemed in compliance with this section if it meets the rollover protective structure requirements of the State of California, the U.S. Army Corps of Engineers, or the Bureau of Reclamation of the U.S. Department of the Interior in effect on April 5, 1972. The requirements in effect are:

(1) State of California: Construction Safety Orders, issued by the Department of Industrial Relations pursuant to Division 5, Labor Code, § 6312, State of California.

(2) U.S. Army Corps of Engineers: General Safety Requirements, EM-385-1-1 (March 1967).

(3) Bureau of Reclamation, U.S. Department of the Interior: Safety and Health Regulations for Construction, Part II (September 1971).

§ 1926.1001 Minimum performance criteria for rollover protective structures for designated scrapers, loaders, dozers, graders, and crawler tractors.

(a) *General.* This section prescribes minimum performance criteria for rollover protective structures (ROPS) for rubber-tired self-propelled scrapers; rubber-tired front-end loaders and rubber-tired dozers; crawler tractors, and crawler-type loaders, and motor graders. The vehicle and ROPS as a system shall have the structural characteristics prescribed in paragraph (f) of this section for each type of machine described in this paragraph.

(b) The static laboratory test prescribed herein will determine the adequacy of the structures used to protect the operator under the following conditions:

(1) For rubber-tired self-propelled scrapers, rubber-tired front-end loaders, and rubber-tired dozers: Operating between 0 and 10 miles per hour over hard clay where rollover would be limited to a maximum roll angle of 360° down a slope of 30° maximum.

(2) For motor graders: Operating between 0 and 10 miles per hour over hard clay where rollover would be limited to 360° down a slope of 30° maximum.

(3) For crawler tractors and crawler-

type loaders: Operating between 0 and 10 miles per hour over hard clay where rollover would be limited to a maximum roll angle of 360° down a slope of 45°.

(c) *Facilities and apparatus.* (1) The following material is necessary:

(i) Material, equipment, and tiedown means adequate to insure that the ROPS and its vehicle frame absorb the applied energy.

(ii) Equipment necessary to measure and apply loads to the ROPS. Adequate means to measure deflections and lengths should also be provided.

(iii) Recommended, but not mandatory, types of test setups are illustrated in Figure W-1 for all types of equipment to which this section applies; and in Figure W-2 for rubber-tired self-propelled scrapers; Figure W-3 for rubber-tired front-end loaders, rubber-tired dozers, and motor graders; and Figure W-4 for crawler tractors and crawler-type loaders.

(2) Table W-1 contains a listing of the required apparatus for all types of equipment described in paragraph (a) of this section.

TABLE W-1

Means to measure	Accuracy
Deflection of ROPS, inches.	±5% of deflection measured.
Vehicle weight, pounds.	±5% of the weight measured.
Force applied to frame, pounds.	±5% of force measured.
Dimensions of critical zone, inches.	±0.5 in.

(d) *Vehicle condition.* The ROPS to be tested must be attached to the vehicle structure in the same manner as it will be attached during vehicle use. A totally assembled vehicle is not required. However, the vehicle structure and frame which support the ROPS must represent the actual vehicle installation. All nor-

mally detachable windows, panels, or nonstructural fittings shall be removed so that they do not contribute to the strength of the ROPS.

(e) *Test procedure.* The test procedure shall include the following, in the sequence indicated:

(1) Energy absorbing capabilities of ROPS shall be verified when loaded laterally by incrementally applying a distributed load to the longitudinal outside top member of the ROPS, as shown in Figure W-1, W-2, or W-3, as applicable. The distributed load must be ap-

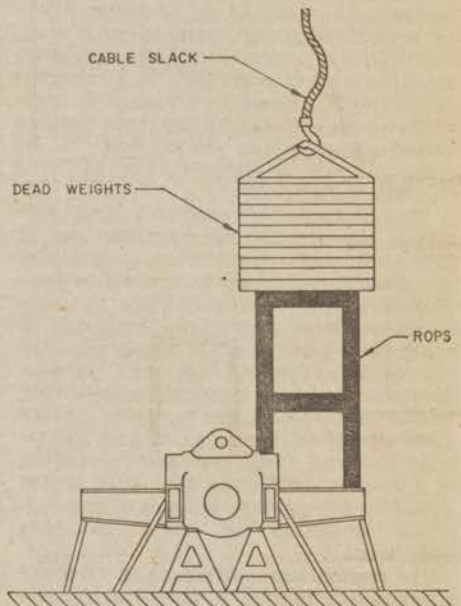

FIGURE W-1—Vertical loading setup for all types of equipment described in § 1926.1001(a).

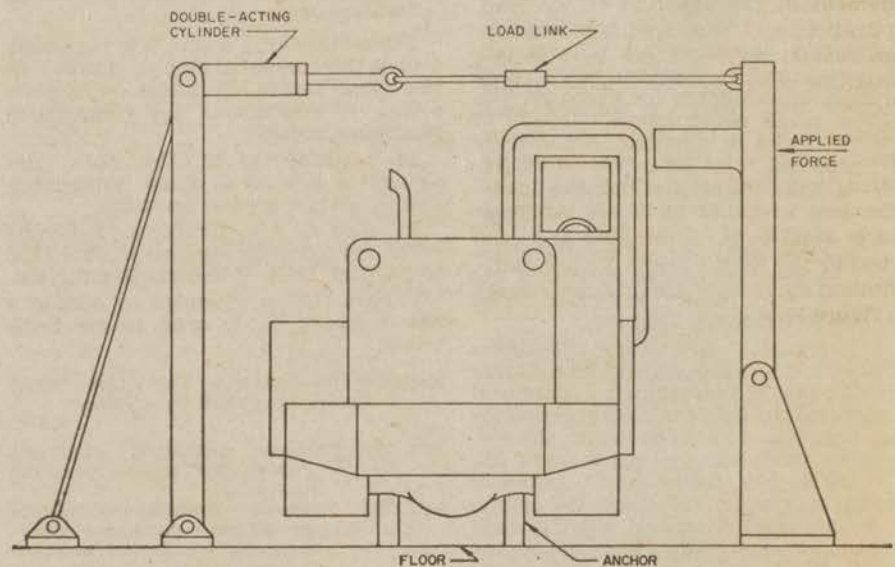

FIGURE W-2—Test setup for rubber-tired self-propelled scrapers.

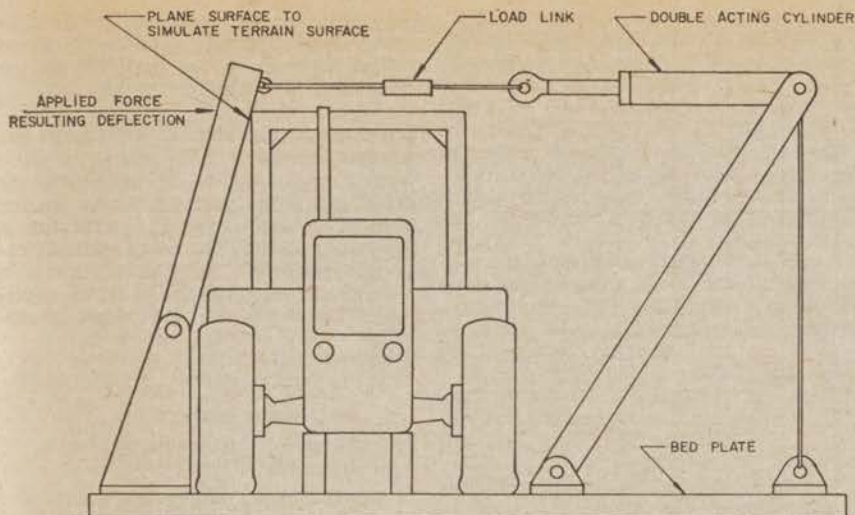

FIGURE W-3—Test setup for rubber-tired front-end loaders, rubber-tired dozers, and motor graders.

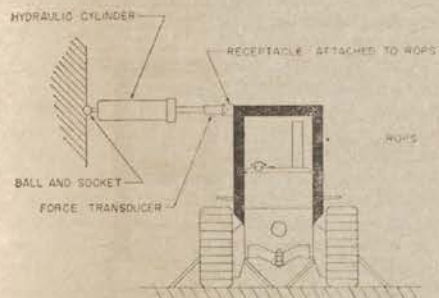
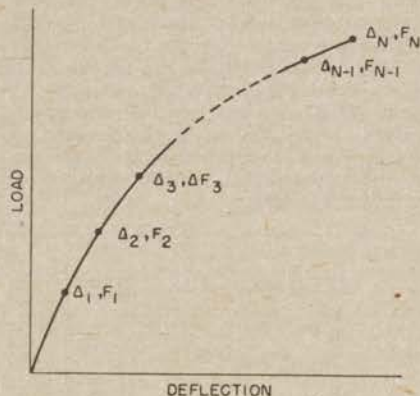

FIGURE W-4—Side-loading setup for crawler tractors and crawler loaders.

plied so as to result in approximately uniform deflection of the ROPS. The load increments should correspond with approximately 0.5 in. ROPS deflection increment in the direction of the load application, measured at the ROPS top edge. Should the operator's seat be off-center, the load shall be applied on the offcenter side. For each applied load increment, the total load (lb.) versus corresponding deflection (in.) shall be plotted, and the area under the load-deflection curve shall be calculated. This area is equal to the energy (in.-lb.) absorbed by the ROPS. For a typical load-deflection curve and calculation method, see Figure W-5.



Δ - TOTAL DEFLECTION
F - FORCE APPLIED

$$\text{AREA} = \frac{\Delta_1 F_1}{2} + (\Delta_2 - \Delta_1) \frac{F_1 + F_2}{2} + (\Delta_3 - \Delta_2) \frac{F_2 + F_3}{2} + \dots + (\Delta_N - \Delta_{N-1}) \frac{F_{N-1} + F_N}{2}$$

FIGURE W-5—Determination of energy area under force deflection curve for all types of ROPS equipment defined in § 1926.1001.

Incremental loading shall be continued until the ROPS has absorbed the amount of energy and the minimum applied load specified under paragraph (f) of this section has been reached or surpassed.

(2) To cover the possibility of the vehicle coming to rest on its top, the support capability shall be verified by applying a distributed vertical load to the top of the ROPS so as to result in approximately uniform deflection (see Figure W-1). The load magnitude is specified in paragraph (f) (2) (iii) of this section.

(3) The low temperature impact strength of the material used in the ROPS shall be verified by suitable material tests or material certification (see paragraph (f) (2) (iv) of this section).

(f) Performance requirements—(1) General performance requirements (i) No repairs or straightening of any member shall be carried out between each prescribed test.

(ii) During each test, no part of the ROPS shall enter the critical zone as detailed in SAE J397 (1969). Deformation of the ROPS shall not allow the plane of the ground to enter this zone.

(2) Specific performance requirements. (i) The energy requirement for purposes of meeting the requirements of paragraph (e) (1) of this section is to be determined by referring to the plot of the energy versus weight of vehicle (see Figure W-6 for rubber-tired self-propelled scrapers; Figure W-7 for rubber-tired front-end loaders and rubber-tired dozers; Figure W-8 for crawler tractors and crawler-type loaders; and Figure W-9 for motor graders. For purposes of this section, force and weight are measured as pounds (lb.); energy (U) is measured as inch-pounds.

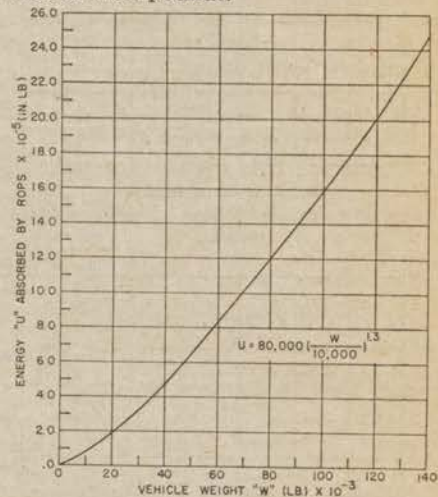

FIGURE W-6—Energy absorbed versus vehicle weight.

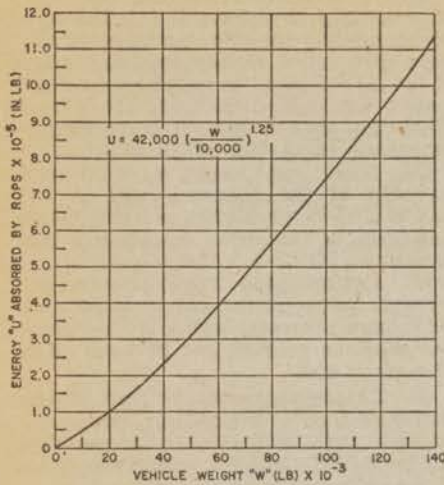

FIGURE W-7—Energy absorbed versus vehicle weight.

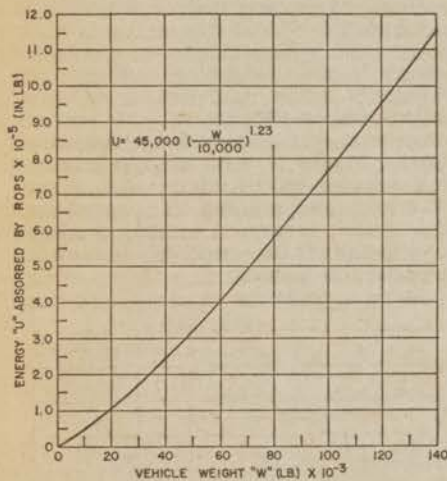

FIGURE W-8—Energy absorbed versus vehicle weight.

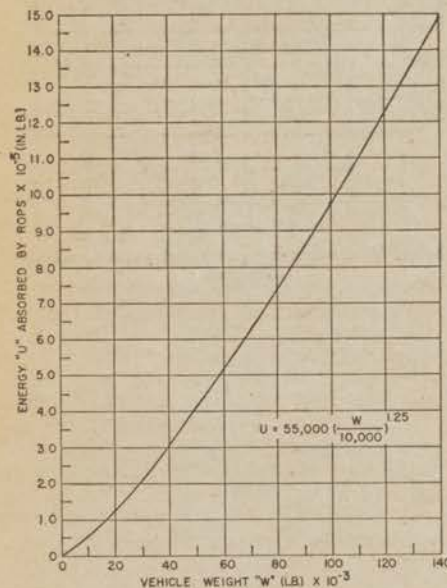

FIGURE W-9—Energy absorbed Versus Vehicle Weight.

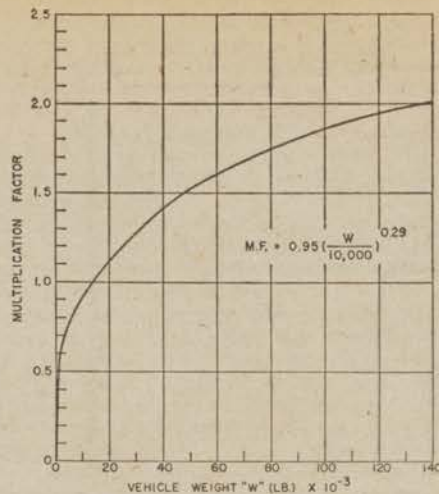

FIGURE W-10—Minimum horizontal load factor for self-propelled scrapers.

(ii) The applied load must attain at least a value which is determined by multiplying the vehicle weight by the corresponding factor shown in Figure W-10 for rubber-tired self-propelled scrapers; in Figure W-11 for rubber-tired front-end loaders and rubber-tired dozers; in Figure W-12 for crawler tractors and crawler-type loaders; and in Figure W-13 for motor graders.

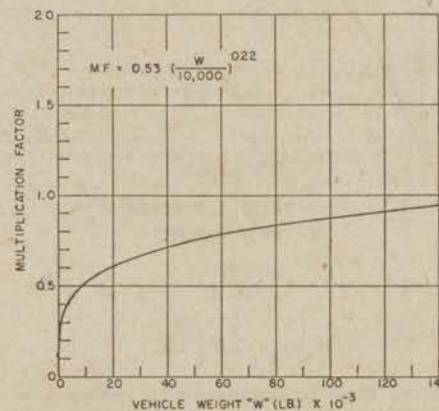

FIGURE W-11—Minimum horizontal load factor for rubber-tired loaders and dozers.

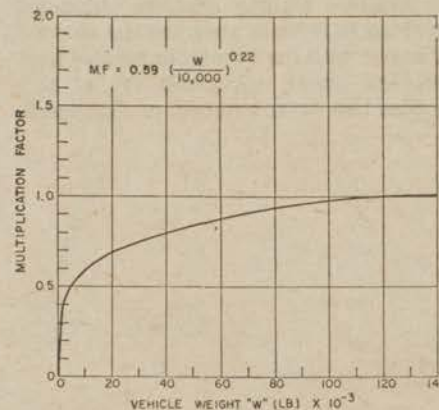

FIGURE W-12—Minimum horizontal load factor for crawler tractors and crawler-type loaders.

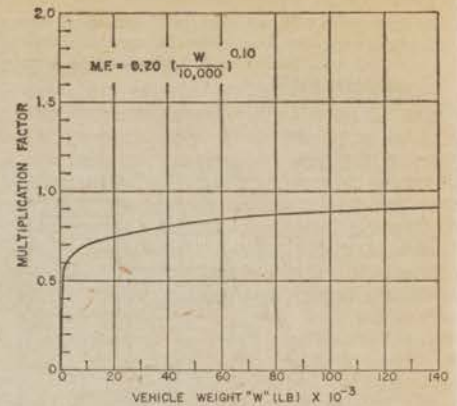

FIGURE W-13—Minimum horizontal load factor for motor graders.

(iii) The load magnitude for purposes of compliance with paragraph (e) (2) of this section is equal to the vehicle weight. The test of load magnitude shall only be made after the requirements of subparagraph (2) (i) of this paragraph are met.

(iv) Material used in the ROPS must have the capability of performing at zero degrees Fahrenheit, or exhibit Charpy V notch impact strength of 8 foot-pounds at minus 20° Fahrenheit. This is a standard Charpy specimen as described in American Society of Testing and Materials A 370, Methods and Definitions for Mechanical Testing of Steel Products (available at each Regional Office of the Occupational Safety and Health Administration). The purpose of this requirement is to reduce the tendency of brittle fracture associated with dynamic loading, low temperature operation, and stress raisers which cannot be entirely avoided on welded structures.

(g) *Definitions.* For purposes of this section, "vehicle weight" means the manufacturer's maximum weight of the prime mover for rubber-tired self-propelled scrapers. For other types of equipment to which this section applies, "vehicle weight" means the manufacturer's maximum recommended weight of the vehicle plus the heaviest attachment.

(h) *Source of standard.* This standard is derived from, and restates, the following Society of Automotive Engineers Recommended Practices: SAE J320a, Minimum Performance Criteria for Roll-Over Protective Structure for Rubber-Tired, Self-Propelled Scrapers; SAE J394, Minimum Performance Criteria for Roll-Over Protective Structure for Rubber-Tired Front End Loaders and Rubber-Tired Dozers; SAE J395, Minimum Performance Criteria for Roll-Over Protective Structure for Crawler Tractors and Crawler-Type Loaders; and SAE J396, Minimum Performance Criteria for Roll-Over Protective Structure for Motor Graders. These recommended practices shall be resorted to in the event that questions of interpretation arise. The recommended practices appear in the 1971 SAE Handbook, which may be examined in each of the Regional Offices of the Occupational Safety and Health Administration.

§ 1926.1002 Protective frame (ROPS) test procedures and performance requirements for wheel-type agricultural and industrial tractors used in construction.

(a) *General.* (1) The purpose of this section is to set forth requirements for frames for the protection of operators of wheel type agricultural and industrial tractors to minimize the possibility of operator injury resulting from accidental upsets during normal operation. With respect to agricultural and industrial tractors, the provisions of §§ 1026.1001 and 1926.1003 for rubber-tired dozers and rubber-tired loaders may be utilized in lieu of the requirements of this section.

(2) The protective frame which is the subject of this standard is a structure mounted to the tractor that extends above the operator's seat and conforms generally to Figure W-14.

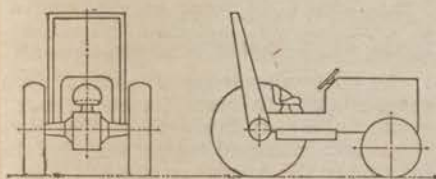

FIGURE W-14—Typical frame configuration.

(3) If an overhead weather shield is attached to the protective frame, it may be in place during tests: *Provided*, that it does not contribute to the strength of the protective frame. If such an overhead weather shield is attached, it must meet the requirements of paragraph (i) of this section.

(4) For overhead protection requirements, see § 1926.1003.

(5) If protective enclosures are used on wheel-type agricultural and industrial tractors, they shall meet the requirements of Society of Automotive Engineers Standard J168 (July 1970), Protective Enclosures, Test Procedures, and Performance Requirements. This standard appears in the 1971 SAE Handbook and may be examined in each Regional Office of the Occupational Safety and Health Administration.

(b) *Applicability.* The requirements of this section apply to wheel-type agricultural tractors used in construction work and to wheel-type industrial tractors used in construction work. See paragraph (j) of this section for definitions of agricultural tractors and industrial tractors.

(c) *Performance requirements.* (1) Either a laboratory test or a field test is required in order to determine the performance requirements set forth in subdivision (i) of this subparagraph.

(2) A laboratory test may be either static or dynamic. The laboratory test must be under conditions of repeatable and controlled loading in order to permit analysis of the protective frame.

(3) A field upset test, if used, shall be conducted under reasonably controlled conditions, both rearward and sideways, to verify the effectiveness of the protective frame under actual dynamic conditions.

(d) *Test procedures—general.* (1) The tractor used shall be the tractor with the greatest weight on which the protective frame is to be used.

(2) A new protective frame and mounting connections of the same design shall be used for each test procedure.

(3) Instantaneous and permanent frame deformation shall be measured and recorded for each segment of the test.

(4) Dimensions relative to the seat shall be determined with the seat unloaded and adjusted to its highest and most rearward latched position provided for a seated operator.

(5) If the seat is offset, the frame loading shall be on the side with the least space between the centerline of the seat and the upright.

(6) The low temperature impact strength of the material used in the protective structure shall be verified by suitable material tests or material certifications in accordance with § 1926.1001 (f) (2) (iv).

(e) *Test procedure for vehicle overturn—*(1) *Vehicle weight.* The weight of the tractor, for purposes of this section, includes the protective frame, all fuels, and other components required for normal use of the tractor. Ballast must be added if necessary to achieve a minimum total weight of 130 lb. (59 kg.) per maximum power takeoff horsepower at rated engine speed. The weight of the front end must be at least 33 lb. (15 kg.) per maximum power takeoff horsepower. In case power takeoff horsepower is unavailable, 95 percent of net engine flywheel horsepower shall be used.

(2) Agricultural tractors shall be tested at the weight set forth in subparagraph (1) of this paragraph.

(3) Industrial tractors shall be tested with items of integral or mounted equipment and ballast that are sold as standard equipment or approved by the vehicle manufacturer for use with the vehicle where the protective frame is expected to provide protection for the operator with such equipment installed. The total vehicle weight and front end weight as tested shall not be less than the weights established in subparagraph (1) of this paragraph.

(4) The test shall be conducted on a dry, firm soil bank as illustrated in Figure W-15. The soil in the impact area shall have an average cone index in the 0-6 in. (153 mm.) layer not less than 150 according to American Society of Agricultural Engineers Recommendation ASAE R313, Soil Cone Penetrometer (available in each Regional Office of the Occupational Safety and Health Administration). The path of travel of the vehicle shall be $12^\circ \pm 2^\circ$ to the top edge of the bank.

(5) The upper edge of the bank shall be equipped with an 18 in. (457 mm.) high ramp as described in Figure W-15 to assist in tipping the vehicle.

(6) The front and rear wheel tread settings, where adjustable, shall be at the position nearest to halfway between the minimum and maximum settings obtainable on the vehicle. Where only two settings are obtainable, the minimum setting shall be used.

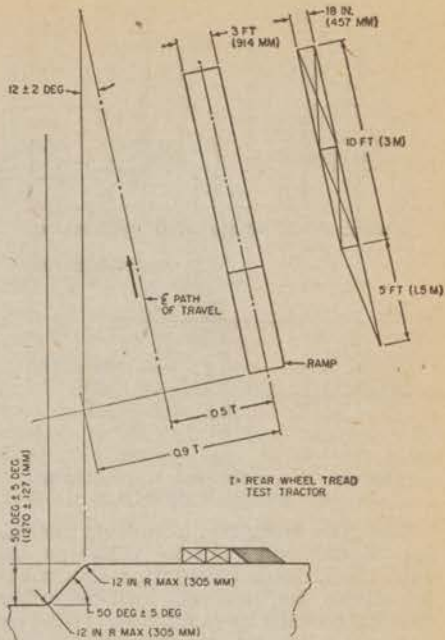

FIGURE W-15.

(7) *Vehicle Overturn Test—Sideways and Rearward.* (i) The tractor shall be driven under its own power along the specified path of travel at a minimum speed of 10 m.p.h. (16 km./hr.) or maximum vehicle speed if under 10 m.p.h. (16 km./hr.) up the ramp as described in subparagraph (5) of this paragraph to induce sideways overturn.

(ii) Rear upset shall be induced by engine power with the tractor operating in gear to obtain 3-5 m.p.h. (4.8-8 km./hr.) at maximum governed engine r.p.m. preferably by driving forward directly up a minimum slope of two vertical to one horizontal. The engine clutch may be used to aid in inducing the upset.

(f) *Other test procedures.* When the field upset test is not used to determine ROPS performance, either the static test or the dynamic test, contained in paragraph (g) or (h) of this section, shall be made.

(g) *Static test—*(1) *Test conditions.* (i) The laboratory mounting base shall include that part of the tractor chassis to which the protective frame is attached including the mounting parts.

(ii) The protective frame shall be instrumented with the necessary equipment to obtain the required load deflection data at the locations and directions specified in Figures W-16, W-17, and W-18.

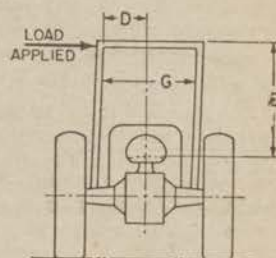

FIGURE W-16—Side load application.

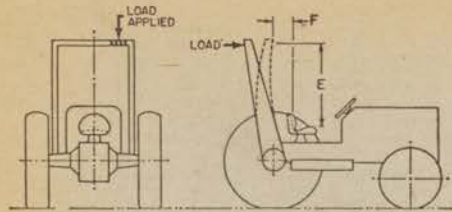

FIGURE W-17—Rear load application.

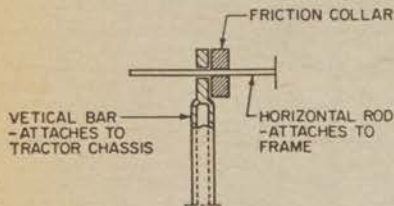

FIGURE W-18—Method of measuring instantaneous deflection.

(iii) The protective frame and mounting connections shall be instrumented with the necessary recording equipment to obtain the required load-deflection data to be used in calculating FSB (see paragraph (j) (3) of this section). The gauges shall be placed on mounting connections before the installation load is applied.

(2) *Test procedure.* (i) The side load application shall be at the upper extremity of the frame upright at a 90° angle to the centerline of the vehicle. The side load "L" shall be applied according to Figure W-16. "L" and "D" shall be recorded simultaneously. The test shall be stopped when:

(a) The strain energy absorbed by the frame is equal to the required input energy (E_{1r}) or

(b) Deflection of the frame exceeds the allowable deflection, or

(c) The frame load limit occurs before the allowable deflection is reached in the side load.

(ii) The L-D diagram, as shown by means of a typical example in Figure W-19, shall be constructed, using the data obtained in accordance with subdivision (i) of this subparagraph.

(iii) The modified L_m-D_m diagram shall be constructed according to subdivision (ii) of this subparagraph and according to Figure W-20. The strain energy absorbed by the frame (E_{1r}) shall then be determined.

(iv) E_{1r} , FER, and FSB shall be calculated.

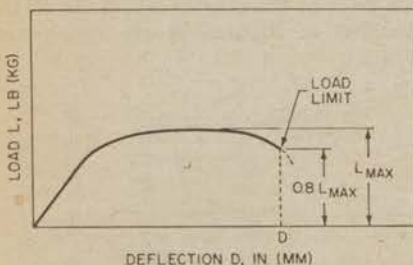

FIGURE W-19—Typical L-D diagram.

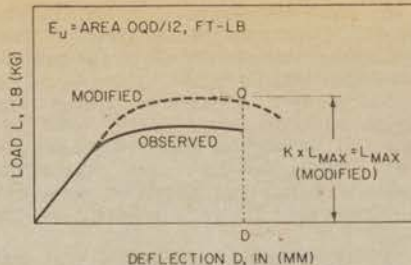

FIGURE W-20—Typical modified L_m-D_m diagram.

(v) The test procedure shall be repeated on the same frame utilizing L (rear input; see Figure W-18) and E_{1r} . Rear load application shall be uniformly distributed along a maximum projected dimension of 27 in. (686 mm.) and a maximum area of 160 sq. in. (1,032 sq. cm.) normal to the direction of load application. The load shall be applied to the upper extremity of the frame at the point which is midway between the centerline of the seat and the inside of the frame upright.

(h) *Dynamic test*—(1) *Test conditions.* (i) The protective frame and tractor shall meet the requirements of paragraphs (e) (2) or (3) of this section, as appropriate.

(ii) The dynamic loading shall be produced by use of a 4,410 lb. (2,000 kg.) weight acting as a pendulum. The impact face of the weight shall be 27 plus or minus 1 in. by 27 plus or minus 1 in. (686+ or -25 mm.) and shall be constructed so that its center of gravity is within 1 in. (25.4 mm.) of its geometric center. The weight shall be suspended from a pivot point 18-22 ft. (5.5-6.7 m.) above the point of impact on the frame and shall be conveniently and safely adjustable for height. (See Figure W-21.)

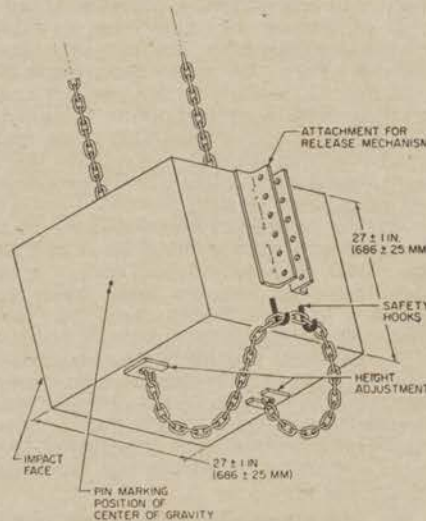

FIGURE W-21—Pendulum.

(iii) For each phase of testing, the tractor shall be restrained from moving when the dynamic load is applied. The restraining members shall be of 0.5-0.63 in. (12.5-16 mm.) steel cable and points

of attaching restraining members shall be located an appropriate distance behind the rear axle and in front of the front axle to provide a 15°-30° angle between a restraining cable and the horizontal. The restraining member shall either be in the plane in which the center gravity of the pendulum will swing or more than one restraining cable shall give a resultant force in this plane. (See Figure W-22.)

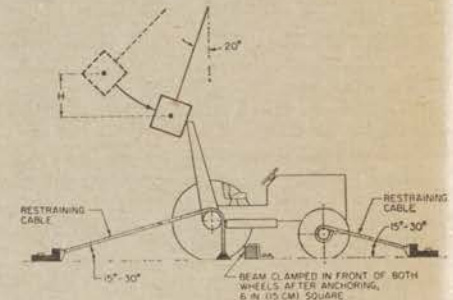

FIGURE W-22—Method of impact from rear.

(iv) The wheel tread setting shall comply with the requirements of paragraph (e) (6) of this section. The tires shall have no liquid ballast and shall be inflated to the maximum operating pressure recommended by the tire manufacturer. With specified tire inflation, the restraining cables shall be tightened to provide tire deflection of 6-8 percent of nominal tire section width. After the vehicle is properly restrained, a wooden beam 6 x 6 in. (15 x 15 cm.) shall be driven tightly against the appropriate wheels and clamped. For the test to the side, an additional wooden beam shall be placed as a prop against the wheel nearest the operator's station and shall be secured to the floor so that it is held tightly against the wheel rim during impact. The length of this beam shall be chosen so that when it is positioned against the wheel rim, it is at an angle of 25°-40° to the horizontal. It shall have a length 20-25 times its depth and a width two to three times its depth. (See Figures W-22 and W-23.)

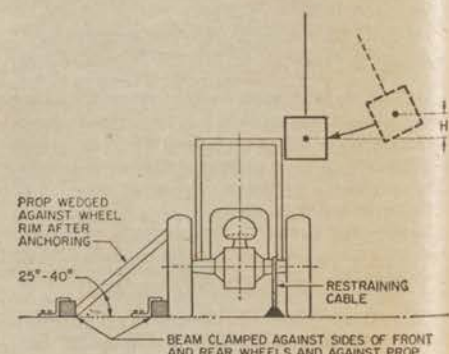

FIGURE W-23—Method of impact from side.

(v) Means shall be provided indicating the maximum instantaneous deflection along the line of impact. A simple friction device is illustrated in Figure W-23.

(vi) No repair or adjustments may be carried out during the test.

(vii) If any cables, props, or blocking shift or break during the test, the test shall be repeated.

(2) *Test procedure*—(i) *General*. The frame shall be evaluated by imposing dynamic loading to rear followed by a load to the side on the same frame. The pendulum dropped from the height (see definition "H" in paragraph (j) (3) of this section) imposes the dynamic load. The position of the pendulum shall be so selected that the initial point of impact on the frame shall be in line with the arc of travel of the center of gravity of the pendulum. A quick release mechanism should be used but, if used, shall not influence the attitude of the block.

(ii) *Impact at rear*. The tractor shall be properly restrained according to subparagraphs (1) (iii) and (iv) of this paragraph. The tractor shall be positioned with respect to the pivot point of the pendulum such that the pendulum is 20° from the vertical prior to impact, as shown in Figure W-22. The impact shall be applied to the upper extremity of the frame at the point which is midway between the centerline of the seat and the inside of the frame upright of a new frame.

(iii) *Impact at side*. The block and restraining shall conform to subparagraphs (1) (iii) and (iv) of this paragraph. The point of impact shall be that structural member of the protective frame likely to hit the ground first in a sideways accidental upset. The side impact shall be applied to the side opposite that used for rear impact.

(i) *Performance requirements*—(1) *General*. (i) The frame, overhead weather shield, fenders, or other parts in the operator area may be deformed but shall not shatter or leave sharp edges exposed to the operator, or violate dimensions as shown in Figures W-16 and W-17 as follows:

D=2 in. (51 mm.) inside of frame upright to vertical centerline of seat.

E=30 in. (762 mm.).

F=Not less than 0 in. and not more than 12 in. (305 mm.), measured at centerline front of seat backrest to crossbar along the line of load application as shown in Figure W-17.

G=24 in. (610 mm.).

(ii) The material and design combination used in the protective structure must be such that the structure can meet all prescribed performance tests at zero degrees Fahrenheit in accordance with § 1926.1001 (f) (2) (iv).

(2) *Vehicle overturn performance requirements*. The requirements of this paragraph (i) must be met in both side and rear overturns.

(3) *Static test performance requirements*. Design factors shall be incorporated in each design to withstand an overturn test as prescribed in this paragraph (i). The structural requirements will be generally met if FER is greater than 1 and FSB is greater than K-1 in both side and rear loadings.

(4) *Dynamic test performance requirements*. Design factors shall be incorporated in each design to withstand the overturn test prescribed in this paragraph (i). The structural requirements will be generally met if the dimensions in this paragraph (i) are adhered to in both side and rear loads.

(j) *Definitions applicable to this section*. (1) SAE J333a, Operator Protection for Wheel-Type Agricultural and Industrial Tractors (July 1970) defines "agricultural tractor" as a "wheel-type vehicle of more than 20 engine horsepower designed to furnish the power to pull, carry, propel, or drive implements that are designed for agricultural usage." Since this Part 1926 applies only to construction work, the following definition of "agricultural tractor" is adopted for purposes of this subpart: "Agricultural tractor" means a wheel-type vehicle of more than 20 engine horsepower, used in construction work, which is designed to furnish the power to pull, propel, or drive implements.

(2) "Industrial tractor" means that class of wheeled type tractor of more than 20 engine horsepower (other than rubber-tired loaders and dozers described in § 1926.1001), used in operations such as landscaping, construction services, loading, digging, grounds keeping, and highway maintenance.

(3) The following symbols, terms, and explanations apply to this section:

E_{1s} = Energy input to be absorbed during side loading. $E_{1s} = 723 + 0.4 W$ ft.-lb. ($E'_{1s} = 100 + 0.12 W'$, m.-kg.).

E_{1r} = Energy input to be absorbed during rear loading. $E_{1r} = 0.47 W$ ft.-lb. ($E'_{1r} = 0.14 W'$, m.-kg.).

W = Tractor weight as prescribed in § 1926.1002 (e) (1) and (e) (3), in lb. (W' , kg.).

L = Static load, lb. (kg.).

D = Deflection under L, in. (mm.).

L-D = Static load-deflection diagram.

L_m - D_m = Modified static load-deflection diagram (Figure W-20). To account for increase in strength due to increase in strain rate, raise L in plastic range to $L \times K$.

K = Increase in yield strength induced by higher rate of loading (1.3 for hot rolled low carbon steel 1010-1030). Low carbon is preferable; however, if higher carbon or other material is used, K must be determined in the laboratory. Refer to Charles H. Norris, et al., Structural Design for Dynamic Loads (1959), p. 3.

L_{max} = Maximum observed static load.

Load Limit = Point on L-D curve where observed static load is 0.8 L_{max} (refer to Figure W-19).

E_n = Strain energy absorbed by the frame, ft.-lb. (m.-kg.) area under L_m - D_m curve.

FER = Factor of energy ratio, $FER = E_n/E_{1s}$; also = E_n/E_{1r} .

P_b = Maximum observed force in mounting connection under static load, L, lb. (kg.).

FSB = Design margin for mounting connection $FSB = (P_b/P_b) - 1$.

H = Vertical height of lift of 4,410 lb. (2,000 kg.) weight, in. (H' , mm.). The weight shall be pulled back so that the height of its center of gravity above the point of impact is defined as follows: $H = 4.92 + 0.00190 W$ or ($H' = 125 + 0.107 W'$) (Figure W-24).

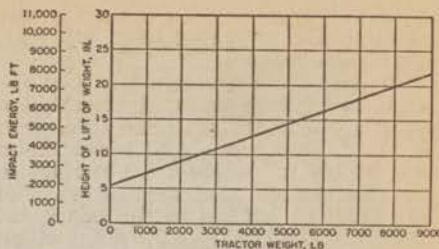

NOTATION OF FORMULAE
 $W = 4.52 + 0.00090 W$ OR ($H' = 125 + 0.107 W'$)
 W = TRACTOR WEIGHT AS DEFINED IN PARAGRAPH 3.3 IN POUNDS (W' IN KG.)

FIGURE W-24—Impact energy and corresponding lift height of 4,410 lb. (2,000 kg.) weight.

(k) *Source of standard*. The standard in this section is derived from, and restates, Society of Automotive Engineers Standard J334a (July 1970), Protective Frame Test Procedures and Performance Requirements. This standard shall be resorted to in the event that questions of interpretation arise. The standard appears in the 1971 SAE Handbook, which may be examined in each of the Regional Offices of the Occupational Safety and Health Administration.

§ 1926.1003 Overhead protection for operators of agricultural and industrial tractors.

(a) *General*—(1) *Purpose*. When overhead protection is provided on wheel-type agricultural and industrial tractors, the overhead protection shall be designed and installed according to the requirements contained in this section. The provisions of § 1926.1001 for rubber-tired dozers and rubber-tired loaders may be used in lieu of the standards contained in this section. The purpose of the standard is to minimize the possibility of operator injury resulting from overhead hazards such as flying and falling objects, and at the same time to minimize the possibility of operator injury from the cover itself in the event of accidental upset.

(2) *Applicability*. This standard applies to wheel-type agricultural tractors used in construction work and to wheel-type industrial tractors used in construction work. See § 1926.1002 (b) and (j). In the case of machines to which § 1926.604 (relating to site clearing) also applies, the overhead protection may be either the type of protection provided in § 1926.604 or the type of protection provided by this section.

(b) *Overhead protection*. When overhead protection is installed on wheel-type agricultural or industrial tractors used in construction work, it shall meet the requirements of this paragraph. The overhead protection may be constructed of a solid material. If grid or mesh is used, the largest permissible opening shall be such that the maximum circle which can be inscribed between the elements of the grid or mesh is 1.5 in. (38 mm.) in diameter. The overhead protection shall not be installed in such a way as to become a hazard in the case of upset.

(c) *Test procedures—general.* (1) The requirements of § 1926.1002 (d), (e), and (f) shall be met.

(2) Static and dynamic rear load application shall be uniformly distributed along a maximum projected dimension of 27 in. (686 mm.) and a maximum area of 160 in.² (1,032 cm.²) normal to the direction of load application. The load shall be applied to the upper extremity of the frame at the point which is midway between the centerline of the seat and the inside of the frame upright.

(3) The static and dynamic side load application shall be uniformly distributed along a maximum projected dimension of 27 in. (686 mm.) and a maximum area of 160 in.² (1,032 cm.²) normal to the direction of load application. The direction of load application is the same as in § 1926.1002 (g) and (h). To simulate the characteristics of the structure during an upset, the center of load application may be located from a point 24 in. (610 mm.) (K) forward to 12 in. (305 mm.) (K) forward to 12 in. (305 mm.) (L) rearward of the front of the seat backrest to best utilize the structural strength. See Figure W-25.

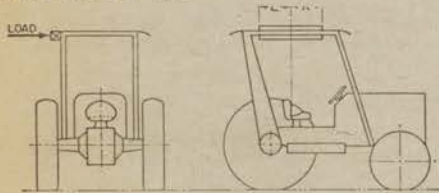

FIGURE W-25—Location for side load.

(d) *Drop test procedures.* (1) The same frame shall be subjected to the drop test following either the static or dynamic test.

(2) A solid steel sphere or material of equivalent spherical dimension weighing 100 lb. (45.4 kg.) shall be dropped once from a height 10 ft. (3,048 mm.) above the overhead cover.

(3) The point of impact shall be on the overhead cover at a point within the zone of protection as shown in Figure W-26, which is furthest removed from major structural members.

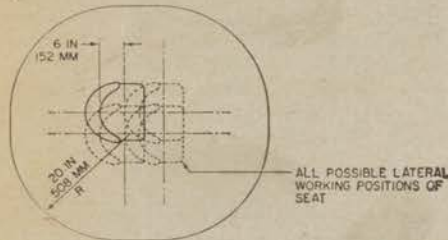

FIGURE W-26—Zone of protection for drop test.

(e) *Crush test procedure.* (1) The same frame shall be subjected to the crush test following the drop test and static or dynamic test.

(2) The test load shall be applied as shown in Figure W-27 with the seat positioned as specified in § 1926.1002(d) (4). Loading cylinders shall be pivotally mounted at both ends. Loads applied by each cylinder shall be equal within 2 percent, and the sum of the loads of the two

cylinders shall be two times the tractor weight as set forth in § 1926.1002(e) (1). The maximum width of the beam illustrated in Figure W-27 shall be 6 in. (152 mm.).

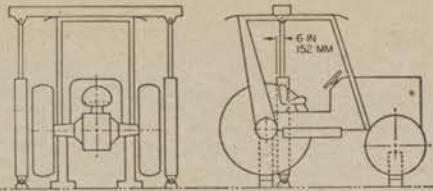

FIGURE W-27—Method of load application for crush test.

(f) *Performance requirements—(1) General.* The performance requirements set forth in § 1926.1002(i) (2), (3), and (4) shall be met.

(2) *Drop test performance requirements.* (i) Instantaneous deformation due to impact of the sphere shall not enter the protected zone as illustrated in Figures W-25, W-26, and W-28.

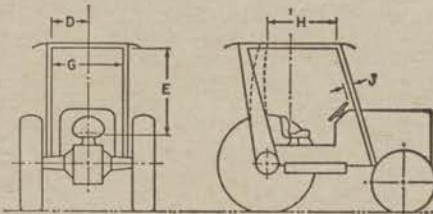

FIGURE W-28—Protected zone during crush and drop tests.

(ii) In addition to the dimensions set forth in § 1926.1002(i) (1) (i), the following dimensions apply to Figure W-28:

H = 17.5 in. (444 mm.)

J = 2 in. (50.8 mm.) measured from the outer periphery of the steering wheel.

(3) *Crush test performance requirements.* The protected zone as described in Figure W-28 must not be violated.

(g) *Source of standard.* This standard is derived from, and restates, the portions of Society of Automotive Engineers Standard J167 which pertain to overhead protection requirements. The full title of the SAE standard is: Protective Frame with Overhead Protection—Test Procedures and Performance Requirements. The SAE standard shall be resorted to in the event that questions of interpretation arise. The SAE standard appears in the 1971 SAE Handbook, which may be examined in each of the Regional Offices of the Occupational Safety and Health Administration.

2. Section 1926.602 is amended to read as follows:

§ 1926.602 **Material handling equipment.**

(a) * * *

(3) *Access roadways and grades.* (i) No employer shall move or cause to be moved construction equipment or vehicles upon any access roadway or grade unless the access roadway or grade is constructed and maintained to accommodate safely the movement of the equipment and vehicles involved.

(ii) Every emergency access ramp and berm used by an employer shall be

constructed to restrain and control runaway vehicles.

(6) *Rollover protective structures (ROPS).* See Subpart W of this part for requirements for rollover protective structures and overhead protection.

Effective dates. The amendments to § 1926.602 shall become effective 30 days from publication of this document in the FEDERAL REGISTER. Effective dates for Subpart W are specifically set forth therein.

(Sec. 1, 83 Stat. 96, 97, adding sec. 107 to Public Law 87-581, 76 Stat. 357; sec. 6(b), 84 Stat. 1593; 29 U.S.C. 655, 40 U.S.C. 333)

Signed at Washington, D.C. this 28th day of March 1972.

G. C. GUENTHER,
Assistant Secretary of Labor.

[FR Doc.72-4973 Filed 4-4-72;8:45 am]

Title 33—NAVIGATION AND NAVIGABLE WATERS

Chapter I—Coast Guard, Department of Transportation

[CGFR 71-47b]

PART 117—DRAWBRIDGE OPERATION REGULATIONS

North River, Mass.

This amendment adds regulations for the Union Street drawbridge and revises the regulations for the Route 3A drawbridge across the North River to require that the draws open on signal if at least 4 hours' notice has been given from May 1 through October 31 and at least 24 hours' notice has been given from November 1 through April 30. This amendment was circulated as a public notice dated October 6, 1971, by the Commander, First Coast Guard District and was published in the FEDERAL REGISTER as a notice of proposed rule making (CGFR 71-47a) on October 9, 1971 (36 F.R. 19703).

Thirty-seven letters and a petition with 225 signatures were received concerning this proposal. The petition and 20 letters supported this amendment on the grounds that the North River should be open along its entire length to large recreational craft.

Seventeen letters opposed these regulations on several grounds. Most writers opposed the regulations because opening the Union Street drawbridge would enable large recreational craft to use the waterway which they feel will pollute the river, cause the erosion of the river's banks by wake action and harm the marshes. Several writers felt that the North River should be preserved for small boats, canoes, and towboats. A few writers also objected to the regulations on the grounds that the North River is not suitable for navigation by large recreational craft above the Union Street bridge due to the existence of large rocks

in the waterway. In addition several writers objected to the expense of maintaining and operating the drawbridges. The Massachusetts Department of Natural Resources, Division of Conservation Services, however, has taken the position that these regulations would not have any deleterious long range effects on the North River and its wetlands.

The Coast Guard feels that there is significant public demand, as reflected in the petition and letters, to require these bridges to operate in accordance with regulations in this document. These regulations are intended to protect the public right to free and unobstructed navigation on the navigable waters of the United States. At a time when recreational boating is growing throughout the country, it is imperative that the Coast Guard assure that historical navigable waters, such as the North River, be available to all vessels capable of using them. These regulations make the North River available to the recreational boatman upon reasonable notice. In addition, it should make boating on the river safer, since vessels will be able to pass the bridges at high tide and avoid the strong currents that develop when the tide is ebbing.

Accordingly, Part 117 of Title 33 of the Code of Federal Regulations is amended by revising § 117.77 to read as follows:

§ 117.77 North River, Mass.; bridges at Route 3A and Union Street.

- (a) From May 1 through October 31 the draws shall open on signal if at least 4 hours' notice has been given.
- (b) From November 1 through April 30 the draws shall open on signal if at least 24 hours' notice has been given.
- (c) The owner of or agency controlling each bridge shall post a notice of the contents of this section in such a manner that it can be easily read from an approaching vessel on both the upstream and downstream sides of the bridges. This notice shall state how advance notice should be given.
- (d) The operating machinery of the draws shall be maintained in serviceable condition and the draws opened and closed at least every 3 months to make certain that the machinery will function properly for satisfactory operation.

(Sec. 5, 28 Stat. 362, as amended, sec. 6(g) (2), 80 Stat. 937; 33 U.S.C. 499, 49 U.S.C. 1655(g) (2); 49 CFR 1.46(c) (5), 33 CFR 1.05-1(c) (4) (36 F.R. 19160))

Effective date. This revision shall become effective on May 1, 1972.

W. M. BENKERT,
Rear Admiral, U.S. Coast Guard,
Chief, Office of Marine Environment and Systems.
[FR Doc.72-5210 Filed 4-4-72;8:50 am]

[CGFR 71-163a]

PART 117—DRAWBRIDGE OPERATION REGULATIONS

Sinepuxent Bay, Md.

This amendment changes the regulations for the U.S. 50 highway bridge

across Sinepuxent Bay, Ocean City, Md., to permit additional closed periods during the tourist season. This amendment was circulated as a public notice dated January 5, 1972, by the Commander, 5th Coast Guard District, and was published in the FEDERAL REGISTER as a notice of proposed rule making (CGFR 71-163) on December 29, 1971 (36 F.R. 25162). Two replies were received. One supported this change. The other had no objection.

Accordingly, Part 117 of Title 33, of the Code of Federal Regulations is amended by revising § 117.245(f) (16) to read as follows:

§ 117.245 Navigable waters discharging into the Atlantic Ocean south of and including Chesapeake Bay and into the Gulf of Mexico, except the Mississippi River and its tributaries and outlets; bridges where constant attendance of drawtenders is not required.

* * * * *

(f) Sinepuxent Bay, Ocean City, Md., U.S. Route 50 bridge. The draw shall open on signal, except that:

- (i) From October 1 through April 30 at least 3 hours' notice is required from 6 p.m. to 6 a.m. and
- (ii) From May through September 15, from 9 a.m. to 10 p.m. the draw shall open at 25 minutes after and 55 minutes after the hour for a maximum of 5 minutes to permit accumulated vessels to pass.

* * * * *
(Sec. 5, 28 Stat. 362, as amended, sec. 6(g) (2), 80 Stat. 937; 33 U.S.C. 499, 49 U.S.C. 1655(g) (2); 49 CFR 1.46(c) (5), 33 CFR 1.05-1(c) (4))

Effective date. This revision shall become effective on May 5, 1972.

Dated: March 30, 1972.
W. M. BENKERT,
Rear Admiral, U.S. Coast Guard,
Chief, Office of Marine Environment and Systems.
[FR Doc.72-5211 Filed 4-4-72;8:50 am]

Title 38—PENSIONS, BONUSES, AND VETERANS' RELIEF

Chapter I—Veterans Administration PART 17—MEDICAL

Class II Dental Treatment

Section 17.123a is revised to read as follows:

§ 17.123a Eligibility for class II dental treatment without rating action.

When an application has been made for class II dental treatment under § 17.123(b), the applicant may be deemed eligible and dental treatment authorized on a one-time completion basis without rating action if:

- (a) The examination to determine the need for dental care has been accom-

plished within 14 months after date of discharge or release unless delayed through no fault of the veteran, and sound dental judgment warrants a conclusion the condition originated in or was aggravated during service and the condition existed at the time of discharge or release from active service, and

(b) The treatment will not involve replacement of a missing tooth noted at the time of Veterans Administration examination except:

- (1) In conjunction with authorized extraction replacement, or
- (2) When a determination can be made on the basis of sound professional judgment that a tooth was extracted or lost on active duty.

(c) Individuals whose entire tour of duty consisted of active or inactive duty for training shall not be eligible for treatment under this section.

(72 Stat. 1114; 38 U.S.C. 210)

This VA Regulation is effective the date of approval.

Approved: March 29, 1972.
By direction of the Administrator.
[SEAL] FRED B. RHODES,
Deputy Administrator.
[FR Doc.72-5229 Filed 4-4-72;8:51 am]

Title 40—PROTECTION OF ENVIRONMENT

Chapter I—Environmental Protection Agency

SUBCHAPTER E—PESTICIDES PROGRAMS

PART 180—TOLERANCES AND EXEMPTIONS FROM TOLERANCES FOR PESTICIDE CHEMICALS IN OR ON RAW AGRICULTURAL COMMODITIES

2-Chloro-1-(2,4,5-Trichlorophenyl) Vinyl Dimethyl Phosphate

A petition (PP 1F1090) was filed by the Shell Chemical Co., Suite 1103, 1700 K Street NW., Washington, D.C. 20006, in accordance with provisions of the Federal Food, Drug, and Cosmetic Act (21 U.S.C. 346a), proposing establishment of a tolerance for negligible residues of the insecticide 2-chloro-1-(2,4,5 - trichlorophenyl) vinyl dimethyl phosphate in the raw agricultural commodity milk at 0.02 part per million resulting from direct application of the insecticide to cattle and to the ceilings and walls of dairy barns. Subsequently, the petitioner amended the petition by proposing a tolerance of 0.5 part per million for residues of this insecticide in milk fat reflecting negligible residues of 0.02 part per million in milk.

Part 120, chapter I, title 21, was redesignated Part 420 and transferred to Chapter III (36 F.R. 424). Subsequently, Part 420, chapter III, title 21 was redesignated Part 180 and transferred to sub-

chapter E, chapter I, title 40 (36 F.R. 22369).

Based on consideration given data submitted in the petition and other relevant material, it is concluded that:

1. The pesticide is useful for the purpose for which the tolerance is being established.

2. The tolerance on whole milk is not required as the residue is concentrated in the milk fat for which a tolerance of 0.5 part per million is being established.

3. Established tolerances for residues of this insecticide in the meat, fat, and meat byproducts of cattle will be adequate to cover residues resulting from the proposed uses on dairy cattle.

4. The tolerance established by this order will protect the public health.

Therefore, pursuant to provisions of the Federal Food, Drug, and Cosmetic Act (sec. 408(d)(2), 68 Stat. 512; 21 U.S.C. 346a(d)(2)), the authority transferred to the Administrator of the Environmental Protection Agency (35 F.R. 15623), and the authority delegated by the Administrator to the Deputy Assistant Administrator for Pesticides Programs (36 F.R. 9038), § 180.252 is amended by revising the paragraph "0.5 part per million * * *", as follows:

§ 180.252 2-Chloro-1-(2,4,5-trichlorophenyl)vinyl dimethyl phosphite; tolerances for residues.

0.5 part per million in milk fat (reflecting negligible residues in whole milk) and the meat and meat byproducts of cattle.

Any person who will be adversely affected by the foregoing order may at any time within 30 days after its date of publication in the FEDERAL REGISTER file with the Objections Clerk, Environmental Protection Agency, Room 3175, South Agriculture Building, 12th Street and Independence Avenue SW., Washington, D.C. 20460, written objections thereto in quintuplicate. Objections shall show wherein the person filing will be adversely affected by the order and specify with particularity the provisions of the order deemed objectionable and the grounds for the objections. If a hearing is requested, the objections must state the issues for the hearing. A hearing will be granted if the objections are supported by grounds legally sufficient to justify the relief sought. Objections may be accompanied by a memorandum or brief in support thereof.

Effective date. This order shall become effective on its date of publication in the FEDERAL REGISTER (4-5-72).

(Sec. 408(d)(2), 68 Stat. 512; 21 U.S.C. 346a(d)(2))

Dated: March 30, 1972.

WILLIAM M. UPHOLT,
Deputy Assistant Administrator
for Pesticides Programs.

[FR Doc.72-5143 Filed 4-4-72; 8:45 am]

PART 180—TOLERANCES AND EXEMPTIONS FROM TOLERANCES FOR PESTICIDE CHEMICALS IN OR ON RAW AGRICULTURAL COMMODITIES

m-(1-Methylbutyl)phenyl Methylcarbamate and *m*-(1-Ethylpropyl)phenyl Methylcarbamate

A petition (PP 2F1190) was filed by Chevron Chemical Co., 940 Hensley Street, Richmond, CA 94804, in accordance with provisions of the Federal Food, Drug, and Cosmetic Act (21 U.S.C. 346a), proposing establishment of a tolerance for negligible residues of an insecticide that is a mixture of 75 percent *m*-(1-methylbutyl)phenyl methylcarbamate and 25 percent *m*-(1-ethylpropyl)phenyl methylcarbamate in or on the raw agricultural commodities rice and rice straw at 0.05 part per million.

Part 120, chapter I, title 21 was redesignated Part 420 and transferred to chapter III (36 F.R. 424). Subsequently, Part 420, chapter III, title 21 was redesignated Part 180 and transferred to subchapter E, chapter I, title 40 (36 F.R. 22369).

Based on consideration given the data submitted in the petition and other relevant material, it is concluded that:

1. The insecticide is useful for the purpose for which the tolerance is being established.

2. The proposed usage is not reasonably expected to result in residues of the insecticide in eggs, meat, milk, and poultry. The usage is in the category specified in § 180.6(a)(3).

3. The tolerance established by this order will protect the public health.

Therefore, pursuant to provisions of the Federal Food, Drug, and Cosmetic Act (sec. 408(d)(2), 68 Stat. 512; 21 U.S.C. 346a(d)(2)), the authority transferred to the Administrator of the Environmental Protection Agency (35 F.R. 15623), and the authority delegated by the Administrator to the Deputy Assistant Administrator for Pesticides Programs (36 F.R. 9038), § 180.255 is revised in both the heading and text to read as follows:

§ 180.255 *m*-(1-Methylbutyl)phenyl methylcarbamate and *m*-(1-ethylpropyl)phenyl methylcarbamate; tolerances for residues.

Tolerances are established for negligible residues of an insecticide that is a mixture consisting of 75 percent *m*-(1-methylbutyl)phenyl methylcarbamate and 25 percent *m*-(1-ethylpropyl)phenyl methylcarbamate in or on the raw agricultural commodities corn grain, fresh corn including sweet corn (kernels plus cob with husk removed), corn fodder and forage, rice, and rice straw at 0.05 part per million (such tolerances to cover residues of both components).

Any person who will be adversely affected by the foregoing order may at any time within 30 days after its date of publication in the FEDERAL REGISTER file

with the Objections Clerk, Environmental Protection Agency, Room 3175, South Agriculture Building, 12th Street and Independence Avenue SW., Washington, DC, 20460, written objections thereto in quintuplicate. Objections shall show wherein the person filing will be adversely affected by the order and specify with particularity the provisions of the order deemed objectionable and the grounds for the objections. If a hearing is requested, the objections must state the issues for the hearing. A hearing will be granted if the objections are supported by grounds legally sufficient to justify the relief sought. Objections may be accompanied by a memorandum or brief in support thereof.

Effective date. This order shall become effective on its date of publication in the FEDERAL REGISTER (4-5-72).

(Sec. 408(d)(2), 68 Stat. 512; 21 U.S.C. 346a(d)(2))

Dated: March 30, 1972.

WILLIAM M. UPHOLT,
Deputy Assistant Administrator
for Pesticides Programs.

[FR Doc.72-5144 Filed 4-4-72; 8:45 am]

PART 180—TOLERANCES AND EXEMPTIONS FROM TOLERANCES FOR PESTICIDE CHEMICALS IN OR ON RAW AGRICULTURAL COMMODITIES

4-(2-Methyl-4-Chlorophenoxy) Butyric Acid

A petition (PP 1F1051) was filed by Rhodia Inc., Chipman Division, 120 Jersey Avenue, New Brunswick, NJ 08903, in accordance with provisions of the Federal Food, Drug, and Cosmetic Act (21 U.S.C. 346a), proposing establishment of a tolerance for negligible residues of the herbicide 4-(2-methyl-4-chlorophenoxy) butyric acid in or on the raw agricultural commodity peas with pods at 0.1 part per million.

Subsequently, the petitioner amended the petition by withdrawing the proposed tolerance on pea pods since it is understood that the term "peas" includes pods.

Part 120, chapter I, title 21 was redesignated Part 420 and transferred to chapter III (36 F.R. 424). Subsequently, Part 420, chapter III, title 21 was redesignated Part 180 and transferred to subchapter E, chapter I, title 40 (36 F.R. 22369).

Based on consideration given the data submitted in the petition and other relevant material, it is concluded that:

1. The herbicide is useful for the purpose for which the tolerance is being established.

2. The proposed use is not reasonably expected to result in residues of the herbicide in eggs, meat, milk, and poultry. The use is classified in the category specified in § 180.6(a)(3).

3. The tolerance established by this order will protect the public health.

Therefore, pursuant to provisions of the Federal Food, Drug, and Cosmetic Act (sec. 408(d)(2), 68 Stat. 512; 21 U.S.C. 346a(d)(2)), the authority transferred to the Administrator of the Environmental Protection Agency (35 F.R. 15623), and the authority delegated by the Administrator to the Deputy Assistant Administrator for Pesticides Programs (36 F.R. 9038), the following new section is added to Part 180, Subpart C, as follows:

§ 180.318 4-(2-Methyl-4-chlorophenoxy) butyric acid; tolerances for residues.

A tolerance of 0.1 part per million is established for negligible residues of the herbicide 4-(2-methyl-4-chlorophenoxy) butyric acid in or on the raw agricultural commodity peas.

Any person who will be adversely affected by the foregoing order may at any time within 30 days after its date of publication in the FEDERAL REGISTER file with the Objections Clerk, Environmental Protection Agency, Room 3175, South Agriculture Building, 12th Street and Independence Avenue SW., Washington, D.C. 20460, written objections thereto in quintuplicate. Objections shall show wherein the person filing will be adversely affected by the order and specify with particularity the provisions of the order deemed objectionable and the grounds for the objections. If a hearing is requested, the objections must state the issues for the hearing. A hearing will be granted if the objections are supported by grounds legally sufficient to justify the relief sought. Objections may be accompanied by a memorandum or brief in support thereof.

Effective date. This order shall become effective on its date of publication in the FEDERAL REGISTER (4-5-72).

(Sec. 408(d)(2), 68 Stat. 512; 21 U.S.C. 346a(d)(2))

Dated: March 29, 1972.

WILLIAM M. UPHOLT,
Deputy Assistant Administrator
for Pesticides Programs.

[FR Doc.72-5142 Filed 4-4-72;8:45 am]

PART 180—TOLERANCES AND EXEMPTION FROM TOLERANCES FOR PESTICIDE CHEMICALS IN OR ON RAW AGRICULTURAL COMMODITIES

Subpart D—Exemptions From Tolerances

α-(o,p-DINONYLPHENYL) - omega - HYDROXYPOLY (OXYETHYLENE) AND MIXTURES OF CORRESPONDING MONO- AND DIHYDROGEN PHOSPHATE ESTERS

A petition (PP 1F1128) was filed by GAF Corp., 140 West 51st Street, New York, NY 10020, in accordance with provisions of the Food, Drug, and Cosmetic Act (21 U.S.C. 346a), proposing establishment of an exemption from the requirement of a tolerance for residues of the following surfactants when used as

inert ingredients in pesticide formulations applied to growing crops or to raw agricultural commodities after harvest.

1. α-(o,p-Dinonylphenyl) - omega - hydroxypoly (oxyethylene) produced by the condensation of 1 mole of dinonylphenol (the nonyl group is a propylene trimer isomer) with an average of 4-14 moles of ethylene oxide.

2. Mixtures of corresponding mono- and dihydrogen phosphate esters.

Part 120, chapter I, title 21 was redesignated Part 420 and transferred to chapter III (36 F.R. 424). Subsequently, Part 420, chapter III, title 21 was redesignated Part 180 and transferred to subchapter E, chapter I, title 40 (36 F.R. 22369).

Based on consideration given data submitted in the petition and other relevant material, it is concluded that the compounds are useful for the purpose for which exemptions from tolerance are being established and that the exemptions established by this order will protect the public health.

Therefore, pursuant to provisions of the Federal Food, Drug, and Cosmetic Act (sec. 408(d)(2), 68 Stat. 512; U.S.C. 346a(d)(2)), the authority transferred to the Administrator of the Environmental Protection Agency (35 F.R. 15623), and the authority delegated by the Administrator to the Deputy Assistant Administrator for Pesticides Programs (36 F.R. 9038), § 180.1001 is amended by alphabetically inserting two new items in the table in paragraph (c), as follows:

§ 180.1001 Exemptions from the requirement of a tolerance.

(c) *	Inert ingredients	Limits	Uses
***	α-(o,p-Dinonylphenyl)-omega-hydroxypoly(oxyethylene) produced by the condensation of 1 mole of dinonylphenol (nonyl group is a propylene trimer isomer) with an average of 4-14 moles of ethylene oxide.	***	Surfactants, related adjuvants of surfactants.
***	α-(o,p-Dinonylphenyl)-omega-hydroxypoly(oxyethylene) mixture of dihydrogen phosphate and monohydrogen phosphate esters and the corresponding ammonium, calcium, magnesium, monoethanolamine, potassium, sodium, and zinc salts of the phosphate esters; the nonyl group is a propylene trimer isomer and the poly(oxyethylene) content averages 4-14 moles.	***	Do.

Any person who will be adversely affected by the foregoing order may at any time within 30 days after its date of publication in the FEDERAL REGISTER file with the Objections Clerk, Environmental Protection Agency, Room 3175, South Agriculture Building, 12th Street and Independence Avenue SW., Washington, D.C. 20460, written objections thereto in quintuplicate. Objections shall show wherein the person filing with be adversely affected by the order and specify

with particularity the provisions of the order deemed objectionable and the grounds for the objections. If a hearing is requested, the objections must state the issues for the hearing. A hearing will be granted if the objections are supported by grounds legally sufficient to justify the relief sought. Objections may be accompanied by a memorandum or brief in support thereof.

Effective date. This order shall become effective on its date of publication in the FEDERAL REGISTER (4-5-72).

(Sec. 408(d)(2), 68 Stat. 512; 21 U.S.C. 346a(d)(2))

Dated: March 30, 1972.

WILLIAM M. UPHOLT,
Deputy Assistant Administrator
for Pesticides Programs.

[FR Doc.72-5145 Filed 4-4-72;8:45 am]

Title 45—PUBLIC WELFARE

Chapter I—Office of Education, Department of Health, Education, and Welfare

PART 177—FEDERAL, STATE, AND PRIVATE PROGRAMS OF LOW-INTEREST LOANS TO VOCATIONAL STUDENTS AND STUDENTS IN INSTITUTIONS OF HIGHER EDUCATION

Special Allowances

Subparagraph (3) of § 177.4(c), Special allowances, which deals with the payment to lenders of the allowances authorized by section 2 of the "Emergency Insured Student Loan Act of 1969" (Public Law 91-95) is amended to provide for the payment of such an allowance for the period January 1, 1972, through March 31, 1972, inclusive.

As so amended § 177.4 reads as follows:

§ 177.4 Payment of interest benefits, administrative cost allowances and special allowance.

(c) Special allowances. ***
(3) Special allowances are authorized to be paid as follows:

(xi) For the period January 1, 1972, through March 31, 1972, inclusive, a special allowance is authorized to be paid in an amount equal to the rate of three fourths of 1 percent per annum of the average unpaid balance of disbursed principal of eligible loans.

(Sec. 2, 83 Stat. 141)

Dated: March 31, 1972.

PETER P. MUIRHEAD,
Acting Commissioner
of Education.

Approved: April 4, 1972.

ELLIOT L. RICHARDSON,
Secretary.

[FR Doc.72-5318 Filed 4-4-72;9:36 am]

Title 17—COMMODITY AND SECURITIES EXCHANGES

Chapter II—Securities and Exchange Commission

[Releases 33-5237, 34-9548, 35-17514, 40-7091, AS-123]

PART 211—INTERPRETATIVE RELEASES RELATING TO ACCOUNTING MATTERS (ACCOUNTING SERIES RELEASES)

PART 231—INTERPRETATIVE RELEASES RELATING TO THE SECURITIES ACT OF 1933 AND GENERAL RULES AND REGULATIONS THEREUNDER

PART 241—INTERPRETATIVE RELEASES RELATING TO THE SECURITIES EXCHANGE ACT OF 1934 AND GENERAL RULES AND REGULATIONS THEREUNDER

PART 251—INTERPRETATIVE RELEASES RELATING TO THE PUBLIC UTILITY HOLDING COMPANY ACT OF 1935 AND GENERAL RULES AND REGULATIONS THEREUNDER

PART 271—INTERPRETATIVE RELEASES RELATING TO THE INVESTMENT COMPANY ACT OF 1940 AND GENERAL RULES AND REGULATIONS THEREUNDER

Standing Audit Committees Composed of Outside Directors

As far back as 1917, it was urged that auditors in the United States should be appointed or selected by the stockholders in accordance with the practice in Great Britain and in Canada, and that State laws or company bylaws "should contain a provision for an independent report on the affairs of the company by an auditor appointed by the stockholders."¹

Following the McKesson-Robbins investigation, in 1940 the Commission advocated the adoption of a program for: (1) Current election of auditors at the annual meeting of stockholders; (2) nomination of auditors and arranging the details of the audit by a committee of nonofficer members of the board of directors; (3) addressing of the auditors' certificate, report or opinion to the stockholders; (4) mandatory attendance by auditors at the annual meetings of stockholders at which the audit report is presented; and (5) mandatory submission by auditors of a report on the amount of work done and of the reasons for noncompletion in situations where audit engagements are not completed. The stress of the program was on the responsibility of auditors to public investors.²

¹ John Thomas Madden, *Accounting Practice and Auditing: Modern Business Texts*, Vol. 21 (New York: Alexander Hamilton Institute, 1917, pp. 248-9).

² Accounting Series Release No. 19, December 5, 1940. (17 CFR Part 211; 11 F.R. 10918)

More recently others have supported these suggestions. In 1967, the executive committee of the American Institute of Certified Public Accountants recommended that standing audit committees of outside directors should nominate auditors for the annual audits of publicly owned companies and should discuss the audit work with the auditors appointed to perform the audit. The Institute considered that such standing audit committees " * * * can be a constructive force in the overall review of internal controls and financial structure, and give added assurance to stockholders as to the objectivity of corporate financial statements."³

A 1970 study has concluded that "[t]he potential for usefulness of corporate audit committees, * * * sufficiently exceeds the possibilities for disturbance that we strongly recommend that all companies with significant nonmanagement shareholder interests consider carefully the desirability of establishing an audit committee * * *"⁴

The Commission has a statutory duty to satisfy itself that the consolidated financial statements filed with it by publicly owned companies of increasingly sophisticated and interlocking affiliations satisfy the requirements of Rules 2-02 (b) and (c) of Regulation S-X (17 CFR 210.2-02 (b) and (c)) and/or Instruction 5 to Item 6 of Form S-1 (17 CFR 239.11), as appropriate. To this end, the Commission, in the light of the foregoing historical recital, endorses the establishment by all publicly held companies of audit committees composed of outside directors and urges the business and financial communities and all shareholders of such publicly held companies to lend their full and continuing support of the effective implementation of the above-cited recommendations in order to assist in affording the greatest possible protection to investors who rely upon such financial statements.

By the Commission,

[SEAL] RONALD F. HUNT,
Secretary.

MARCH 23, 1972.

[FR Doc.72-5209 Filed 4-4-72; 8:50 am]

[Release 34-9545]

PART 240—GENERAL RULES AND REGULATIONS, SECURITIES EXCHANGE ACT OF 1934

Operation of Clearing and Settling System for Securities by National Securities Association

On November 4, 1971, in Securities Exchange Act Release No. 9380 and the

³ "AICPA Executive Committee Statement on Audit Committees of Boards of Directors," *Journal of Accountancy*, Vol. 124 (Sept. 1967), p. 10.

⁴ R. K. Mautz and F. L. Neumann, *Corporate Audit Committees* (Urbana, Ill.: Bureau of Economic and Business Research, University of Illinois, 1970), p. 96.

FEDERAL REGISTER for November 10, 1971 at 36 F.R. 21525, the Securities and Exchange Commission published a proposal to adopt Rule 15Aj-3 (17 CFR 240.15Aj-3) under the Securities Exchange Act of 1934 (the Act). The Commission has received one comment letter. It has considered the comments and suggestions contained therein and has adopted the rule as stated below effective May 8, 1972.

The rule prescribes certain requirements applicable to a national association of securities dealers which establishes and operates facilities for clearing and settling securities transactions,¹ including the requirement that the applicable rules of the association incorporate as guides to interpretation and application certain public interest standards set forth in the Act and also that such rules of the association provide fair procedures for consideration of requests for or refusals of access to such system by customers, issuers, brokers and dealers. The rule also provides for the Commission review of adverse action by the association with respect to such requests for or refusals of access.²

Pursuant to section 15A(j) of the Act the NASD has submitted to the Commission amendments to its bylaws and a new schedule thereunder which, among other things, would provide complaint and hearing procedures for aggrieved persons who may be adversely affected by NCC action. The NASD has also submitted to the Commission pursuant to that section rules which, among other things, provide standards regarding who may obtain access to the system and the applicable rates to be charged those who clear through the system; standards for the inclusion or exclusion of securities from the system; standards for deleting securities (i.e., those securities qualified for clearance through the system), and for exclusion of those who clear through the system for failure to comply with applicable regulatory standards. In accordance with section 15A(j), the Commission has not disapproved these amendments and rules. The Commission also has determined that these provisions would be consistent with Rule 15Aj-3.

Rule 15Aj-3 and its statutory basis. The rule relates specifically to the Commission's function to make sure that rules of a national securities association, among other things, "are designed to * * * remove impediments to and perfect the mechanism of a free and open

¹ While the rule is applicable to action that may be taken by any securities association registered under section 15A of the Act, it has been adopted in light of the National Association of Securities Dealers, Inc.'s (NASD) establishment of the National Clearing Corp. (NCC) as a wholly owned subsidiary to provide a nationwide system to clear and settle over-the-counter transactions in securities and the NCC's and NASD's proposals to adopt rules governing the operation of and access to such a system.

² This rule of the Commission applies only to a system for clearance and or settlement of securities transactions set up directly or indirectly under rules of a national securities association.

market; and are not designed to permit unfair discrimination between customers or issuers, or brokers or dealers."

As stated in Release No. 9380, discharge of this function in the context of reviewing rules of an association (or its subsidiary) governing the operation of and access to a system of clearing and settling securities transactions is a novel problem in the administration of section 15A. The Commission, however, dealt with a similar problem when the Association proposed to establish the NASDAQ system, its system for providing automated quotations to members and the investing public. See Securities Exchange Act Release No. 8470 of December 16, 1968 and the FEDERAL REGISTER for December 24, 1968 at 33 F.R. 19167, announcing the adoption of Rule 15Aj-2 (17 CFR 240.15Aj-2). As the Commission indicated at that time, existing rules of the NASD (other than those of an organizational or procedural character) relate primarily to standards of business conduct or to conditions of membership. Apart from the possibility that the Commission may disapprove rules of this type which are on their face unlawful and/or in violation of the standards of the Act, the statute spells out a procedure whereby persons aggrieved as a result of the application of rules of conduct or rules limiting membership may have appropriate consideration of their grievance within the association and on review by the Commission. Rule 15Aj-3 provides a similar procedure where application of a rule of a national securities association or its subsidiary denies access to a facility for clearing and settling transactions which is maintained by the collective action of the association. The requirement of a fair and orderly procedure for consideration of specific access requests and grievance appears to the Commission essential to assure that such rules conform, in their actual operation, to the statutory requirements.

Commission action. The Securities and Exchange Commission, acting pursuant to the Securities Exchange Act of 1934, and more particularly sections 15A and 23(a) thereof, and deeming it in the public interest and for the protection of investors, hereby amends Part 240 of Chapter II of Title 17 of the Code of Federal Regulations by adopting § 240.15Aj-3 as set forth below, effective May 8, 1972.

§ 240.15Aj-3 Rules for a national securities association relating to a facility for clearing and/or settling securities transactions.

(a) Any national securities association which directly or indirectly adopts, or proposes to adopt, any rules providing for or regulating a system for the clearance and/or settlement of securities transactions shall incorporate in such rules a provision to the effect that insofar as such rules prescribe the conditions of access to such system, such rules shall be applied and interpreted in accordance with the standards of paragraph (b) (8) of section 15A of the Act, including the requirement that rules of such an association shall be designed to

promote just and equitable principles of trade, to remove impediments to and perfect the mechanism of a free and open market, and not to permit unfair discrimination between customers or issuers, or brokers or dealers; and to assure that any disciplinary action pursuant to such rules shall not be excessive or oppressive, having due regard to the public interest.

(b) Such rules shall also provide a fair and orderly procedure with respect to the determination of whether any customer or issuer or broker or dealer may be excluded or limited in respect of requested access to such system including provisions:

(1) For notice of an opportunity to be heard upon the specific grounds for exclusion or limitation which are under consideration;

(2) That a record shall be kept; and

(3) That the determination shall set forth the specific grounds upon which the exclusion or limitation is based.

(c) In the event of any such exclusion or limitation, such action shall be subject to review by the Commission, on its own motion, or upon application by any person aggrieved thereby filed within 30 days after such action has been taken or within such longer period as the Commission may determine. In any proceeding for such review, if the Commission, after appropriate notice and opportunity for hearing, and upon consideration of the record before the association and such other evidence as it may deem relevant, determines that the specific grounds on which such action is based exist in fact and are in accord with the applicable rules of the association (including the provisions thereof required to be included by paragraph (a) of this section), the Commission shall by order dismiss the proceeding. Otherwise, the Commission shall by order set aside the action of the association and require the association to accord the aggrieved person access to such system or to take such other action as may be appropriate, subject to such terms and conditions as the Commission determines to be in accordance with the public interest and consistent with the rules of such association.

(Sec. 15A(j), 52 Stat. 1070, 15 U.S.C. 78o-3 (j); sec. 23(a), 48 Stat. 901, as amended, 49 Stat. 1379, sec. 8, 15 U.S.C. 78w)

By the Commission.

[SEAL] RONALD F. HUNT,
Secretary.

MARCH 29, 1972.

[FR Doc.72-5228 Filed 4-4-72;8:54 am]

Title 5—ADMINISTRATIVE PERSONNEL

Chapter I—Civil Service Commission

PART 213—EXCEPTED SERVICE

Department of Labor

Section 213.3315 is amended to show that one additional position of Special

Assistant to the Assistant Secretary for Occupational Safety and Health is excepted under Schedule C. Effective on publication in the FEDERAL REGISTER (4-5-72), subparagraph (22) of paragraph (a) of § 213.3315 is amended as set out below.

§ 213.3315 Department of Labor.

(a) Office of the Secretary. * * *

(22) Two Special Assistants to the Assistant Secretary for Occupational Safety and Health.

(5 U.S.C. secs. 3301, 3302, E.O. 10577; 3 CFR 1954-58 Comp. p. 218)

UNITED STATES CIVIL SERVICE COMMISSION,
[SEAL] JAMES C. SPRY,
Executive Assistant to the Commissioners.

[FR Doc.72-5189 Filed 4-4-72;8:49 am]

PART 213—EXCEPTED SERVICE

Office of Economic Opportunity

Section 213.3373 of Schedule C is amended to reflect the consolidation of the Office of Special Programs, the Planning and Review Committee, and the Private Sector Division of the Office of Congressional and Public Affairs into the new Office of the Associate Director for Program Review. This section is also amended to show that the following positions are no longer excepted under Schedule C: Two Special Assistants and One Confidential Staff Assistant to the Chairman, Planning and Review Committee (interdepartmental activities).

Effective on publication in the FEDERAL REGISTER (4-5-72), § 213.3373 is amended by revoking subparagraphs (11), (20), (25), (26), and (28) of paragraph (a); amending the headnote and subparagraph (1) of paragraph (d); adding subparagraphs (7), (8), (9), and (10) to paragraph (d); and revoking subparagraph (9) of paragraph (e) as set out below.

§ 213.3373 Office of Economic Opportunity.

(a) Office of the Director. * * *

(11) [Revoked]

* * * * *

(20) [Revoked]

* * * * *

(25) [Revoked]

(26) [Revoked]

* * * * *

(28) [Revoked]

* * * * *

(d) Office of the Associate Director for Program Review. (1) One Confidential Assistant to the Associate Director.

* * * * *

(7) One Confidential Secretary to the Associate Director.

(8) Two Planning and Review Advisors to the Associate Director.

(9) Chief, Private Resources Division.

(10) Two Confidential Secretaries to the Associate Director (interdepartmental activities).

(e) Office of the Assistant Director for Congressional and Public Affairs. * * *
(9) [Revoked]

(5 U.S.C. secs. 3301, 3302, E.O. 10577; 3 CFR 1954-58 Comp., p. 218)

UNITED STATES CIVIL SERVICE COMMISSION,

[SEAL] JAMES C. SPRY,
Executive Assistant to
the Commissioners.

[FR Doc.72-5188 Filed 4-4-72; 8:49 am]

PART 213—EXCEPTED SERVICE

Department of the Air Force

Section 213.3309 is amended to show that one additional position of Private Secretary in the Office of the Military Assistant to the President is excepted under Schedule C.

Effective on publication in the FEDERAL REGISTER (4-5-72), subparagraph (8) of paragraph (a) of § 213.3309 is amended as set out below.

§ 213.3309 Department of the Air Force.

(a) Office of the Secretary. * * *

(8) Two Private Secretaries in the Office of the Military Assistant to the President.

(5 U.S.C. secs. 3301, 3302, E.O. 10577; 3 CFR 1954-58 Comp., p. 218)

UNITED STATES CIVIL SERVICE COMMISSION,

[SEAL] JAMES C. SPRY,
Executive Assistant to
the Commissioners.

[FR Doc.72-5319 Filed 4-4-72; 9:41 am]

Title 18—CONSERVATION OF POWER AND WATER RESOURCES

Chapter I—Federal Power Commission

[Docket No. R-440; Order 451]

PART 35—FILING OF RATE SCHEDULES

PART 154—RATE SCHEDULES AND TARIFFS

Price Stabilization Criteria

MARCH 29, 1972.

On August 18, 1971, this Commission issued its Order No. 437 (36 F.R. 16902) stating that it was the general policy of the Federal Power Commission to implement the Economic Stabilization Act of 1970 as amended and Executive Order No. 11615 insofar as those laws pertain to the Commission's regulatory jurisdiction under the Natural Gas Act (52 Stat. 821, et seq. as amended), the Federal Power Act (41 Stat. 1063 et seq. as amended), and all other statutes vesting legislative authority in the Commission,

including such regulatory definitions, orders, exceptions, and exemptions, as may be issued by the President or the Cost of Living Council.

On November 6, 1971, the Commission amended its original statement of policy in Order No. 437-A (36 F.R. 22367). The Commission reaffirmed its statement of policy promulgated in Order No. 437, took note of Executive Order No. 11627, and amendments to the regulations governing implementation of the Economic Stabilization Act of 1970, as amended. The Commission also noted that the objectives of the Economic Stabilization Act of 1970 are consistent with regulatory standards enunciated by Congress in the Federal Power Act and the Natural Gas Act. Specifically the objectives were stated to be consistent with the statutory standards which require the Commission among other things, to determine whether the rates established or proposed to be established by public utility and natural gas companies are just and reasonable. The Commission further stated that in discharging these statutory responsibilities through the regulatory process the Commission's regulatory purposes are consonant with objectives and purposes of the Economic Stabilization Act of 1970.

On March 17, 1972, the Price Commission amended Part 101—Coverage, Exemption and Classification of Economic Units, to Chapter I—Cost of Living Council, in Title 6—Economic Stabilization of the Code of Federal Regulations; Chapter II—Pay Board and Part 201—Stabilization of Wages and Salaries, to Title 6 of the Code of Federal Regulations; and Chapter III—Price Commission and Part 300—Price and Rent Stabilization to Title 6 of the Code of Federal Regulations, all set out in 37 F.R. 5701, March 18, 1972. Among other things these amendments add a new § 300.16a and call upon individual regulatory agencies to promulgate their own rules for implementing the Price Stabilization Act in accordance with the criteria set forth in that section.

The Commission will therefore amend its regulations under both the Federal Power Act and the Natural Gas Act to require that all applications for rate increases shall be accompanied by a special Price Stabilization Exhibit. This exhibit shall contain all of the necessary information by the applicant to demonstrate that the applicant's filing is in compliance with the intent and purposes of the Economic Stabilization Act of 1970, as amended, Executive Order Nos. 11615, 11627 and with the criteria also set out in the amendments to the Commission's regulations as hereinafter ordered. The exhibit and related testimony so filed, and any rebuttal thereto will be a part of the case and will be considered by the Commission in its overall determination as to whether the rate increase should or should not be granted.

The Commission finds:

(1) It is appropriate and in the public interest to establish criteria for the purpose of considering whether jurisdictional rate increases are consistent with

the Economic Stabilization Act of 1970, as amended, and Executive Orders 11615 and 11627.

(2) The requirements of 5 U.S.C. 553 (b) for notice and hearing do not apply to this order.

(3) In addition, the provisions of 5 U.S.C. 553 do not apply because notice and public procedure are impracticable and contrary to the public interest in light of the regulations promulgated by the Price Commission at 6 CFR Part 101 pursuant to the Economic Stabilization Act of 1970 as amended.

Pursuant to sections 202, 205, 206, 301, 304, 307, and 309 of the Federal Power Act (49 Stat. 848, 851, 852, 854, 855, 856, 858; 16 U.S.C. 824a, 824b, 824e, 825, 825c, 825f, 825h) and sections 4, 5, 7, 8, 10, 14, and 16 of the Natural Gas Act (76 Stat. 72; 52 Stat. 823, 824, 825, 826, 828, 830; 56 Stat. 83, 84; 61 Stat. 459; 15 U.S.C. 717c, 717d, 717f(d), 717f(e), 717f(f), 717f(h), 717g, 717i, 717m, 717o) the Commission orders:

(A) Section 154.63(f) Part 154 Subchapter E—Chapter I, Title 18 of the Code of Federal Regulations as amended by adding Statement Q as follows:

§ 154.63 Changes in a tariff, executed service agreement or part thereof.

(f) * * *

Statement Q—Price Stabilization Exhibit.

(a) All applications for rate increases shall be accompanied by a special Price Stabilization Exhibit. This exhibit shall contain all of the necessary information by the applicant to demonstrate that the applicant's filing is in compliance with the intent and purposes of the Economic Stabilization Act of 1970, as amended, Executive Order Nos. 11615, 11627 and with the criteria as hereinafter set out in (b) or with the special circumstances set forth in (c).

(b) These criteria are as follows:

(1) The increase is cost justified and does not reflect future inflationary expectations.

(2) The increase is the minimum required to assure continued, adequate, and safe service or to provide for necessary expansion to meet future requirements.

(3) The increase will achieve the minimum rate of return needed to attract capital at reasonable costs and will not impair the credit of the applicant.

(4) The increase does not reflect labor costs in excess of those allowed by Price Commission policies.

(5) The increase takes into account expected and obtainable productivity gains as determined under Price Commission policies.

(c) There are special circumstances which make the price increase in conformity with the Economic Stabilization Program although it does not meet any or all of the foregoing criteria. In making determinations under this subdivision, the Commission shall consider the following:

(1) The criteria set forth in (b) to the extent applicable.

(2) The past and current ratios of the utility's debt capital to the sum of its debt and equity capital and of the applicant's earnings to fixed charges available to pay those charges.

(3) Any financial data which relates to whether the applicant is entitled to a higher return on capital now than it was in the past.

(4) Direct and indirect labor costs, adjusted to reflect productivity gains, as determined by Commission policies; taxes; costs of

materials and supplies; discretionary costs; whether any costs incurred or expected to be incurred are in excess of those allowed by Commission policies; and a comparison of all these costs and cost-related items between the current period and recent periods in the past.

(5) Any other factors which are relevant to the goals of the Economic Stabilization Program.

(d) Justification for price increases in conformity with the above criteria shall not be required for price increases resulting from the pass-through of special allowable costs including taxes (except income tax), purchased gas costs, and fuel cost. However, the criteria shall apply to labor cost unless otherwise specified by this Commission.

(e) The requirements for this exhibit shall not apply to any applicant's price increase where the rate base-cost of service criteria are not the basis for assessing a price increase under the terms of the Natural Gas Act and the rules, regulations, and orders promulgated thereunder.

(f) Under existing Commission regulations and applicable law, rate increases for producers of natural gas are determined on an area basis utilizing, inter alia, composite cost data after investigation and study of the various gas producing areas. This practice was established by Area Rate Proceeding, Docket No. AR 61-1, et al. Opinion No. 468, 34 FPC 159 (1965), and affirmed by the Supreme Court in Permian Basin Area Rate Case, 309 U.S. 747 (1968). Small producers will not be required to file the exhibit since they are regulated under Order No. 428 (36 F.R. 5598, March 18, 1971) and its amendments and will be monitored for Price Stabilization purposes by using reports submitted pursuant to Order No. 428 as amended and § 154.104 of the Commission's regulations under the Natural Gas Act which requires filing of annual statements. Moreover, area maximum rates determined in conformity with the Natural Gas Act and intended to balance all interests are constitutionally permissible according to the U.S. Supreme Court. *Ibid.* Since the Commission will take into consideration the relationship between establishing an area ceiling and national economic stabilization goals in setting area rates, and because of the Price Commission Regulations, § 300.16a(d) (5), the requirements for filing the Price Stabilization Exhibit shall not apply to producers of natural gas. Staff shall develop Price Stabilization

data on a composite basis in all area rate cases commenced on or before June 1, 1972.

(B) Section 35.13(b) (4) (iv), Part 35—Filing of Rate Schedules, of Subchapter B—Regulations under the Federal Power Act, as amended, of Chapter I of Title 18 of the Code of Federal Regulations is amended by adding Statement P as follows:

§ 35.13 Filing of changes in rate schedules.

- (b) * * *
- (4) * * *
- (iv) * * *

Statement P—Price Stabilization Exhibit.

(a) All applications for rate increases shall be accompanied by a special Price Stabilization Exhibit. This exhibit shall contain all of the necessary information by the applicant to demonstrate that the applicant's filing is in compliance with the intent and purposes of the Economic Stabilization Act of 1970, as amended, Executive Order Nos. 11615, 11627 and with the criteria as hereinafter set out in (b) or with the special circumstances set forth in (c).

(b) These criteria are as follows:

(1) The increase is cost justified and does not reflect future inflationary expectations.

(2) The increase is the minimum required to assure continued, adequate, and safe service or to provide for necessary expansion to meet future requirements.

(3) The increase will achieve the minimum rate of return needed to attract capital at reasonable costs and will not impair the credit of the applicant.

(4) The increase does not reflect labor costs in excess of those allowed by Price Commission policies.

(5) The increase takes into account expected and obtainable productivity gains as determined under Price Commission policies.

(c) There are special circumstances which make the price increase in conformity with the Economic Stabilization Program although it does not meet any or all of the foregoing criteria. In making determinations under this subdivision, the Commission shall consider the following:

(1) The criteria set forth in (b) to the extent applicable.

(2) The past and current ratios of the utility's debt capital to the sum of its debt and equity capital and of the applicant's earnings to fixed charges available to pay those charges.

(3) Any financial data which relates to whether the applicant is entitled to a higher return on capital now than it was in the past.

(4) Direct and indirect labor costs, adjusted to reflect productivity gains, as determined by Commission policies; taxes; costs of materials and supplies; discretionary costs; whether any costs incurred or expected to be incurred are in excess of those allowed by Commission policies; and a comparison of all these costs and cost-related items between the current period and recent periods in the past.

(5) Any other factors which are relevant to the goals of the Economic Stabilization Program.

(d) Justification for price increases in conformity with the above criteria shall not be required for price increases resulting from the pass-through of special allowable costs including taxes (except income tax), purchased gas costs, and fuel cost. However, the criteria shall apply to labor cost unless otherwise specified by this Commission.

(e) The requirements for this exhibit shall not apply to any applicant's price increase where the rate base-cost of service criteria are not the basis for assessing a price increase under the terms of the Natural Gas Act and the rules, regulations, and orders promulgated thereunder.

(C) This order shall become effective 30 working days after issuance or upon the issuance of the Price Commission certificate of compliance, whichever first occurs, and shall terminate automatically when the price stabilization program is appropriately terminated by Executive order or Act of Congress.

By the Commission.¹

[SEAL] KENNETH F. PLUMB,
Secretary.

[FR Doc.72-5233 Filed 4-4-72;8:52 am]

¹ Commissioner Carver's concurring statement filed as part of the original document.

Proposed Rule Making

DEPARTMENT OF AGRICULTURE

Agricultural Marketing Service¹

[7 CFR Part 47]

PERISHABLE AGRICULTURAL COMMODITIES

Rules of Practice

Notice is hereby given that the U.S. Department of Agriculture is considering amending the rules of practice (7 CFR Part 47) issued pursuant to authority contained in the Perishable Agricultural Commodities Act, 1930 (46 Stat. 531 et seq., as amended; 7 U.S.C. 499a et seq.).

The Perishable Agricultural Commodities Act, 1930 (46 Stat. 531 et seq., as amended; 7 U.S.C. 499a et seq.), was amended by an act of Congress dated February 15, 1972 (Public Law 92-231), to provide that the Secretary shall order any commission merchant, dealer, or broker who is the losing party to pay the prevailing party, as reparation or additional reparation, reasonable fees and expenses incurred in connection with any oral reparation hearing. The purpose of the proposed amendment to the rules of practice is to provide procedures for the claiming of fees and expenses and adjudication of such claims.

All persons who desire to submit written data, views, or arguments for consideration in connection with the proposed amendment of the rules of practice should file the same, in duplicate, with the Hearing Clerk, U.S. Department of Agriculture, Room 112, Administration Building, Washington, D.C. 20250, not later than the 15th day after publication of this notice in the FEDERAL REGISTER. All written submissions made pursuant to this notice will be made available for public inspection at the office of the Hearing Clerk during regular business hours (7 CFR 1.27(b)).

The proposed amendments are as follows:

1. Amend 7 CFR 47.19 by changing the number of paragraph (d) to paragraph (e).

2. Amend 7 CFR 47.19 by adding the following new paragraph (d) and amending paragraph (e) to read as follows:

§ 47.19 Post-hearing procedure before the examiner.

(d) *Claim for award of fees and expenses*—(1) *Filing*. Prior to the close of the hearing, or within 20 days thereafter, each party may file with the examiner a claim for the award of the fees and ex-

penses which he incurred in connection with the oral hearing. No award of fees and expenses to the prevailing party and against the losing party shall be made unless a claim therefor has been filed, and failure to file a claim within the time allowed shall constitute a waiver thereof.

(2) *Fees and expenses which may be awarded to prevailing party*. Pursuant to section 7(a) of the act, the term "fees and expenses," as used herein is limited to: (i) Reasonable fees of an attorney or authorized representative for appearance at the hearing and for the taking of depositions necessary for introduction at the hearing; (ii) fees and mileage for necessary witnesses at the rates provided for witnesses in the courts of the United States; (iii) fees for the notarizing of a deposition and its reduction to writing; (iv) fees for serving subpoenas; and (v) other fees and expenses necessarily incurred in connection with the oral hearing. Fees and expenses which are not considered to be reasonable or necessarily incurred in connection with the oral hearing will not be awarded.

(3) *Form of claim*. A claim for fees and expenses shall be in the form of a written itemized statement of the fees and expenses claimed, which shall include an explanation of how each item was computed, to which there shall be attached an affidavit, made by the party or his authorized attorney or agent having knowledge of the facts, that each such item is correct and has been necessarily incurred in connection with the oral hearing in the proceeding and that the services for which fees are claimed were actually and necessarily performed.

(4) *Service of claim*. A copy of each such claim filed shall be served by the examiner on the other party or parties to the proceeding.

(5) *Objections to claim*. Within 10 days after being served with a copy of a claim for fees and expenses, the party so served may file with the examiner written objections to the allowance of any or all of the items claimed. If evidence is offered in support of an objection it must be in affidavit form. A copy of any such objections shall be served by the examiner on the other party or parties.

(6) *Reply to objections to claim*. A claimant who is served with a copy of objections to his claim may, within 10 days after such service, file with the examiner a reply to such objections. If evidence is offered in support of a reply it must be in affidavit form. A copy of any such reply shall be served by the examiner on the other party or parties.

(7) *Further inquiry by examiner*. Whenever it is deemed desirable or necessary for the proper disposition of a claim, the examiner may request statements as to specific matters from either or both parties. Any statements

so furnished shall be served by the examiner on the other party.

(8) *Number of copies*. All documents or papers authorized by this paragraph to be filed with the examiner shall be filed in triplicate: *Provided*, That, where there are more than two parties to the proceeding an additional copy shall be filed for each additional party.

(e) *The examiner's report*. The examiner, with the assistance and collaboration of such employees of the Department as may be assigned for the purpose, and within a reasonable time after the filing of the transcript with the hearing clerk, as provided in paragraph (a) of this section, or within a reasonable time after the termination of the period allowed for the filing of the submissions of the parties allowed by this section, shall prepare, upon the basis of the evidence received at the hearing and with due consideration of submissions of the parties filed pursuant to paragraph (d) of this section, his report. Such report shall be filed with the hearing clerk and shall be prepared in the form of a final order for the signature of the Secretary, but shall not be served upon the parties, unless and until it shall have been signed by the Secretary, as hereinafter provided.

(Sec. 15, 46 Stat. 537, as amended; 7 U.S.C. 499o)

Done at Washington, D.C., this 3d day of April 1972.

JOHN C. BLUM,
Deputy Administrator,
Regulatory Programs.

[FR Doc.72-5299 Filed 4-4-72;8:54 am]

Consumer and Marketing Service

[7 CFR Part 51]

SAWDUST PACK GRAPES

Proposed Termination of Standards for Grades¹

Notice is hereby given that the U.S. Department of Agriculture is considering the termination of U.S. Standards for Sawdust Pack Grapes (7 CFR 51.2150-51.2178). These grade standards are issued under authority of the Agricultural Marketing Act of 1946 (60 Stat. 1087, as amended; 7 U.S.C. 1621-1627), which provides for the issuance of official U.S. grades to designate different levels of quality for the voluntary use of producers, buyers and consumers. Official grading services are also provided under this act upon request of any financially

¹Packing of the product in conformity with the requirements of these standards shall not excuse failure to comply with the provisions of the Federal Food, Drug and Cosmetic Act or with applicable State laws and regulations.

¹ Formerly Consumer and Marketing Service. Name changed to Agricultural Marketing Service effective Apr. 2, 1972, 37 F.R. 6327.

interested party and upon payment of a fee to cover the cost of such services.

All persons who desire to submit written data, views or arguments for consideration in connection with the proposal should file the same, in duplicate, not later than April 15, 1972, with the Hearing Clerk, U.S. Department of Agriculture, Room 112, Administration Building, Washington, D.C. 20250, where they will be available for public review during official hours of business (7 CFR 1.27(b)).

Statement of considerations leading to the proposed termination of the grade standards. The U.S. Standards for Sawdust Pack Grapes were issued in August 1928. They were last revised in October 1953, and amended in October 1962. Sawdust pack grapes are a premium pack designed for long storage and overseas shipment. The standards supplemented the table grape standards. In May 1971, the table grape standards were revised and at that time provisions for certification of grapes for export were incorporated. It was the intention of the Department of Agriculture to terminate the sawdust pack standards at that time. However, several shippers stated that termination then would cause undue hardship and financial loss due to the fact that they had on hand a stock of containers marked "U.S. No. 1 Sawdust Pack". It was believed that one season would be sufficient to allow for disposal of the containers on hand. As there was no duplication of grade designations between the two standards, this request for additional time was considered reasonable.

The 1972 shipping season will begin in May and it is the Department's belief, concurred in by grape industry representatives recently consulted, that it is in the best interest of the industry to terminate the sawdust pack standards. This will eliminate any chance of error or confusion on the part of members of the industry.

Therefore, it is proposed that the U.S. Standards for Sawdust Pack Grapes (European or Vinifera type) (7 CFR 51.2150-51.2178) be terminated effective May 1, 1972.

Dated: March 31, 1972.

G. R. GRANGE,
Acting Administrator.

[FR Doc. 72-5246 Filed 4-4-72; 8:54 am]

[7 CFR Part 911]

[Docket No. AO-267-A6]

LIMES GROWN IN FLORIDA

Decision and Referendum Order With Respect to Proposed Further Amendment of Marketing Agreement and Order

Pursuant to the rules of practice and procedure governing proceedings to formulate marketing agreements and marketing orders (7 CFR Part 900), a public hearing was held at Homestead, Fla., on November 10, 11, and 12, 1971, after no-

tice thereof published in the FEDERAL REGISTER (36 F.R. 20610), on proposed further amendment of the marketing agreement, as amended, and Order No. 911, as amended (7 CFR Part 911; 36 F.R. 14125), regulating the handling of limes grown in Florida, to be made effective pursuant to the provisions of the Agricultural Marketing Agreement Act of 1937, as amended (7 U.S.C. 601-674).

On the basis of the evidence adduced at the hearing, and the record thereof, the recommended decision in this proceeding was filed on February 25, 1972, with the Hearing Clerk, U.S. Department of Agriculture. The notice of the filing of such recommended decisions, affording opportunity to file written exceptions thereto, was published in the FEDERAL REGISTER (F.R. Doc. 72-3153; 37 F.R. 4345), on March 2, 1972. No exception was filed.

The material issues, findings and conclusions, and the general findings of the recommended decision set forth in the FEDERAL REGISTER (F.R. Doc. 72-3153; 37 F.R. 4345), are hereby approved and adopted as the material issues, findings and conclusions, and the general findings of this decision as if set forth in full herein.

Further amendment of the marketing agreement and order. Annexed hereto and made a part hereof are documents entitled, respectively, "Marketing Agreement, as Amended, Regulating the Handling of Limes Grown in Florida," and "Order Amending the Order, as Amended, Regulating the Handling of Limes Grown in Florida" which have been decided upon as the appropriate and detailed means of effecting the foregoing conclusions. These documents shall not become effective unless and until the requirements of § 900.14 of the aforesaid rules of practice and procedure governing proceedings to formulate marketing agreements and marketing orders have been met.

Referendum order. Pursuant to the applicable provisions of the Agricultural Marketing Agreement Act of 1937, as amended (7 U.S.C. 601-674), it is hereby directed that a referendum be conducted among the producers who, during the period April 1, 1971, through March 31, 1972 (which period is hereby determined to be a representative period for the purpose of such referendum), were engaged, within the production area (as defined in 7 CFR Part 911), in the production of limes for market to ascertain whether such producers favor the issuance of the said annexed order amending the order, as amended, regulating the handling of such limes.

Minard F. Miller, Fruit and Vegetable Division, Consumer and Marketing Service, U.S. Department of Agriculture, P.O. Box 9, Lakeland, Fla. 33802, is hereby designated referendum agent of the Secretary of Agriculture to conduct said referendum.

The procedure applicable to such referendum shall be the "Procedure for the Conduct of Referenda in Connection with Marketing Orders for Fruits, Vegetables, and Nuts, Pursuant to the Agricultural

Marketing Agreement Act of 1937, as amended" (7 CFR 900.400 et seq.).

The ballots used in such referendum shall contain a summary describing the terms and conditions of the proposed amendatory order.

Copies of the aforesaid annexed order, of the aforesaid referendum procedure, and of this order may be examined in the office of the Hearing Clerk, U.S. Department of Agriculture, Room 112, Administration Building, Washington, D.C. 20250.

Ballots to be cast in each referendum, and other necessary forms and instructions, may be obtained from the referendum agent or any appointee.

It is hereby ordered, That all of this decision and referendum order, except the annexed marketing agreement, as amended, be published in the FEDERAL REGISTER. The regulatory provisions of the said marketing agreement are identical with those contained in the said order as further amended by the annexed order which will be published with this decision.

Dated: March 31, 1972.

RICHARD E. LYG,
Acting Secretary.

Order amending the order, as amended, regulating the handling of limes grown in Florida

§ 911.0 Findings and determinations.

The findings and determinations hereinafter set forth are supplementary and in addition to the findings and determinations made in connection with the issuance of the order and each of the previously issued amendments thereto; and all of said previous findings and determinations are hereby ratified and affirmed except insofar as such findings and determinations may be in conflict with the findings and determinations set forth herein.

(a) *Findings upon the basis of the hearing record.* Pursuant to the Agricultural Marketing Agreement Act of 1937, as amended (7 U.S.C. 601-674), and the applicable rules of practice and procedure effective thereunder (7 CFR Part 900), a public hearing was held at Homestead, Fla., on November 10, 11, and 12, 1971, upon proposed amendments to the amended marketing agreement and Order No. 911, as amended (7 CFR Part 911; 36 F.R. 14125), regulating the handling of limes grown in Florida. Upon the basis of the evidence introduced at such hearing and the record thereof, it is found that:

(1) The said order, as amended and as hereby further amended, and all the terms and conditions thereof, will tend to effectuate the declared policy of the act;

(2) The said order, as amended and as hereby further amended, regulates the handling of limes grown in the designated production area in the same

¹ This order shall not become effective unless and until the requirements of § 900.14 of the rules of practice and procedure governing proceedings to formulate marketing agreements to orders have been met.

manner as, and is applicable only to persons in the respective classes of industrial or commercial activity specified in the marketing agreement and order upon which hearings have been held;

(3) The said order, as amended and as hereby further amended, is limited in application to the smallest regional production area that is practicable, consistently with carrying out the declared policy of the act, and the issuance of several orders applicable to subdivisions of such production area would not effectively carry out the declared policy of the act;

(4) There are no differences in the production and marketing of limes grown in the production area covered by the said order, as amended and as hereby further amended, that makes necessary different terms and provisions applicable to different parts of such area; and

(5) All handling of limes grown in the production area is in the current of interstate or foreign commerce or directly burdens, obstructs, or affects such commerce.

It is, therefore, ordered, That, on and after the effective date hereof, all handling of limes grown in the production area shall be in conformity to, and in compliance with, the terms and conditions of the said order, as amended and as hereby further amended, as follows:

1. The title of § 911.10 *Handle* and that part of the first sentence of the section preceding (a) are amended to read, respectively, as follows:

§ 911.10 *Handle or ship.*

"Handle" is synonymous with "ship" and means to sell, consign, deliver, or transport limes within the production area or between the production area and any point outside thereof: *Provided*, That such term shall not include: * * *

2. Section 911.30 *Procedure* is amended by revising paragraph (a) and adding a new paragraph (c) to read, respectively, as follows:

§ 911.30 *Procedure.*

(a) Except as provided in paragraph (c) of this section, six members of the committee, including alternates acting for members, shall constitute a quorum and any decision, recommendation or other action of the committee shall require not less than five concurring votes including one by a handler member or an alternate acting as such.

(c) For any recommendation of the committee pursuant to § 911.53 as to the total quantity of limes deemed advisable to be handled during any week immediately following two or more continuous weeks of regulation pursuant to § 911.54 nine members of the committee, including alternates acting for members, shall constitute a quorum and nine concurring votes shall be required. The quorum and voting requirements specified in this paragraph shall not apply to recommendations pursuant to § 911.53 to increase the quantity that may be handled during the applicable week or pur-

suant to § 911.54 to terminate or suspend a regulation.

3. Sections 911.50 through 911.56 are redesignated and amended as indicated:

a. Section 911.50 *Marketing policy* is redesignated as § 911.46 and amended by revising the introductory sentence and paragraph (d) to read, respectively, as follows:

§ 911.46 *Marketing policy.*

Each fiscal year prior to making any recommendation pursuant to § 911.47 or § 911.53, the committee shall submit to the Secretary a report setting forth its marketing policy for such fiscal year.

(d) The expected shipments of limes produced in the production area and in other areas including foreign competing areas, together with a schedule of estimated weekly shipments of limes during such fiscal year;

b. Section 911.51 *Recommendations for regulation* is redesignated as § 911.47 and in paragraph (a) of such section "§ 911.52" is changed to "§ 911.48".

c. Section 911.52 *Issuance of regulations* is redesignated as § 911.48.

d. Section 911.53 *Modification, suspension, or termination of regulations* is redesignated as § 911.49 and in paragraph (a) of such section "§ 911.52" is changed to "§ 911.48".

e. Section 911.54 *Exemption certificate* is redesignated as § 911.50 and in the first sentence of such section "§ 911.52" is changed to "§ 911.48".

f. Section 911.55 *Inspection and certification* is redesignated as § 911.51 and in the first sentence of such section "§ 911.52" is changed to "§ 911.48".

g. Section 911.56 *Limes not subject to regulations* is redesignated as § 911.52 and is amended by revising the text therein preceding paragraph (b) to read as follows:

§ 911.52 *Limes not subject to regulations.*

Except as otherwise provided in this section, any person may, without regard to the provisions of §§ 911.41, 911.48, 911.51, and 911.54 through 911.58, and the regulation issued thereunder, handle limes (a) for consumption by charitable institutions; * * *

4. The following new sections are added immediately following § 911.52:

§ 911.53 *Recommendation for volume regulation.*

(a) The committee may, during any week, recommend to the Secretary the total quantity of limes which it deems advisable to be handled during the succeeding week: *Provided*, That such volume regulation shall not be recommended for any week except during the 18-week regulatory period beginning with the week preceding the first full week in May: *Provided, further*, That no such regulation shall be recommended after such regulations have been in ef-

fect for an aggregate of eight (8) weeks during the aforesaid period.

(b) In making its recommendations, the committee shall give due consideration to the following factors:

(1) Market prices for limes;

(2) Supply of limes en route to principal markets;

(3) Supply, maturity, and condition of limes in the production area;

(4) Market prices and supplies of fruits from competitive producing areas, including foreign competing areas, and supplies of other competitive fruits;

(5) Trend and level in consumer income; and

(6) Other relevant factors.

(c) At any time during a week for which the Secretary, pursuant to § 911.54, has fixed the quantity of limes which may be handled, the committee may recommend to the Secretary that such quantity be increased for such week. Each such recommendation, together with the committee's reason for such recommendation, shall be submitted promptly to the Secretary.

§ 911.54 *Issuance of volume regulations.*

Whenever the Secretary finds, from the recommendation and information submitted by the committee, or from other available information, that to limit the quantity of limes which may be handled during a specified week of a regulatory period will tend to effectuate the declared policy of the act, he shall fix such quantity: *Provided*, That such regulations during a regulatory period shall not in the aggregate limit the volume of lime shipments for more than eight (8) weeks. The quantity so fixed for any week, may be increased by the Secretary at any time during such week. Such regulations may, as authorized by the act, be made effective irrespective of whether the season average price of limes is in excess of the parity price. The Secretary may upon the recommendation of the committee, or upon other available information, terminate or suspend any regulation pursuant to this section at any time.

§ 911.55 *Prorate bases.*

(a) Each person who desires to handle limes shall submit to the committee, at such time and in such manner as may be designated by the committee, and upon forms made available by it, a written application for a prorated base and for allotments as provided in this section and § 911.56.

(b) Such application shall be substantiated in such manner and shall be supported by such information as the committee may require.

(c) The committee shall determine the accuracy of the information submitted pursuant to this section. Whenever the committee finds that there is an error, omission, or inaccuracy in any such information, it shall correct the same and shall give the person who submitted the information a reasonable opportunity to discuss with the committee the factors considered in making the correction.

(d) Each week during the regulatory period when volume regulation is likely to be recommended for the following week, the committee shall compute a prorated base for each handler who has made application in accordance with the provisions of this section. The prorated base for each such handler shall be computed by adding together the handler's shipments of limes in the current season and his shipments in the immediately preceding seasons, if any, within the representative period, in which he shipped limes and dividing such total by a divisor computed by adding together the number of weeks elapsed in the current season and 18 weeks for each of such immediately preceding seasons within the representative period in which the handler shipped limes. For purposes of this section "representative period" means the two preceding seasons together with the current season; the term "season" means the 18-week period beginning with the week preceding the first full week in May of any fiscal year; and the term "current season" means the period beginning with the week preceding the first full week in May of the current fiscal year through the fourth full week preceding the week of regulation: *Provided*, That when official shipping records are available to the committee he said "current season" shall extend through the third full week preceding the week of regulation.

§ 911.56 Allotments.

Whenever the Secretary has fixed the quantity of limes which may be handled during any week, the committee shall calculate the quantity of limes which may be handled during such week by each person who has applied for a prorated base and for whom such a base was computed by the committee. Such quantity shall be the allotment of such person and shall be that portion of the total quantity fixed by the Secretary which, expressed in terms of percent, is equal to the percentage that such applicant's prorated base is of the aggregate of the prorated bases of all such applicants. The committee shall give reasonable notice in writing to each person of the allotment computed for him pursuant to this section.

§ 911.57 Overshipments.

During any week for which the Secretary has fixed the total quantity of limes which may be handled, any person who has received an allotment including any handler who received zero allotment computed pursuant to §§ 911.55 and 911.56 may handle, in addition to the total allotment available to him, an amount of limes equivalent to 10 percent of such total allotment or 50 bushels, whichever is the greater.

§ 911.58 Undershipments.

If any person handles during any week a quantity of limes, covered by a regulation issued pursuant to § 911.54, in an amount less than the total allotment available to him for such week, he may handle, during the next week, only a quantity of limes, in addition to that per-

mitted by the allotment available to him for such week, equivalent to such undershipment or 50 percent of the allotment issued to him for the week during which the undershipment was made, whichever is the lesser: *Provided*, That the committee, with the approval of the Secretary, may increase or decrease such percentage.

§ 911.59 Allotment loans and transfers.

(a) A person to whom an allotment has been issued for a particular week may lend or transfer all or part of such allotment to other persons to whom allotments also have been issued.

(b) Loaned or transferred allotment may be used only during the particular week for which issued.

(c) Each party to any loan or transfer, shall, prior to the handling of any limes covered by a loan or transferred allotment, notify the committee of the loan or transfer including the applicable dates, if any, of repayment.

(d) If no volume regulation is in effect in the week when a loan repayment is due the repayment requirement shall be deemed canceled.

(e) Any handler to whom an allotment has been issued and who desires to be a party to any such loan or transfer arrangement, may communicate such information to the committee. As a service to handlers, the committee shall act as a clearinghouse of such information and make it available to all such handlers upon request. However, as required by paragraph (c) of this section each party to any such loan or transfer shall, prior to the handling of any limes covered by the loan or transferred allotment, notify the committee of the loan or transfer, including the applicable dates, if any, of repayment.

[FR Doc.72-5201 Filed 4-4-72;8:50 am]

[7 CFR Part 966]

TOMATOES GROWN IN FLORIDA

Notice of Recommended Decision and Opportunity To File Exceptions With Respect to Proposed Amendment of Marketing Agreement and Order

Pursuant to the rules of practice and procedure governing proceedings to formulate marketing agreements and marketing orders, as amended (7 CFR Part 900), notice is hereby given to the filing with the Hearing Clerk of this recommended decision with respect to the proposed amendment of Marketing Agreement No. 125 and Order No. 966, both as amended (7 CFR Part 966), hereinafter referred to collectively as the "order," regulating the handling of tomatoes grown in the Florida production area. This regulatory program is effective pursuant to the provisions of the Agricultural Marketing Agreement Act of 1937, as amended (7 U.S.C. 601-674), hereinafter referred to as the "act."

Interested persons may file written exceptions to this recommended decision in quadruplicate with the Hearing Clerk, U.S. Department of Agriculture, Room 112, Administration Building, Washing-

ton, D.C. 20250, not later than the close of business on the 15th day after its publication in the FEDERAL REGISTER. All such communications will be made available for public inspection at the office of the Hearing Clerk during regular business hours (7 CFR 1.27(b)).

Preliminary statement. A public hearing was held during the 5-week period October 4-November 4, 1971 in Orlando, Fla., pursuant to a notice thereof published in the FEDERAL REGISTER on April 28, 1971 (36 F.R. 7969) and as amended on August 25, 1971 (36 F.R. 16677).

The purpose of the hearing was to collect evidence with which to reevaluate the basis and method for regulating the handling of Florida tomatoes differently for different stages of maturity. Such authority, now provided in § 966.52, has been used on several occasions in past years to impose different minimum size limitations on shipments of Florida grown mature green tomatoes than those imposed on tomatoes of more advanced maturity. As required by § 608e-1 of the act, identical minimum size limitations were imposed on imported tomatoes.

The regulations imposed under the order have been recommended by the Florida Tomato Committee and supported by the Florida tomato industry. However, importers of Mexican tomatoes and others have opposed such regulations, both in views filed under rule making proceedings and in the courts. On March 19, 1971, the U.S. Court of Appeals for the District of Columbia recommended that a hearing should be provided for on "novel and crucial" issues.

This hearing was held in response to the Court's ruling. All interested parties were given an opportunity to present pertinent evidence on the material issues.

Sixteen witnesses appeared including representatives of the Florida tomato industry and the Florida Tomato Committee, an importer of Mexican tomatoes, a tomato repacker, and a retailer. Staff members of the University of Florida and private consulting firms, an expert witness from the U.S. Department of Agriculture, and two representatives of consumer organizations also testified.

The testimony amounted to 4,238 pages. In addition 116 exhibits were identified or received in evidence.

Material issues. The material issues on the record of the hearing are as follows:

(1) The basis for regulating tomato shipments differently by maturity. Involved in this issue are the following matters relating to tomato production, harvesting, and handling in Florida:

- (a) Season and scope of production;
- (b) Classes of producers;
- (c) Cultural practices;
- (d) Vine ripe production;
- (e) Mature green production;
- (f) Districts;
- (g) Packinghouse operations;
- (h) Controlled atmosphere ripening;
- (i) Machine harvesting;
- (j) Tomato growth and size characteristics;

(2) The effect of regulating tomato shipments differently by maturity on

Florida producers and others involved in the production and marketing of winter season tomatoes; and

(3) Whether § 966.51 *Recommendations for regulation*, should be amended to specify the factors to be considered in developing and recommending regulations.

Findings and conclusions. The following findings and conclusions on the material issues are based on evidence presented at the hearing and the record thereof:

(1) The basis for regulating tomato shipments differently by maturity.

(a) *Season and scope of production.* Planting of tomatoes in Florida usually begins in midsummer and is active through the fall and early winter. Most acreage is direct seeded, although in some parts of the State growers transplant seedlings. The latter practice is more prevalent in the more northerly areas of Florida where the production season is shorter due to a cooler climate.

Annual production varies considerably from year to year, reflecting the vagaries of weather. But the long-term trend has been downward. Shipments during the 1970-71 marketing season of 13.3 million 40-pound cartons were 27 percent above those in 1969-70, but 12 percent below the average of the three preceding seasons.

Harvest of Florida's fresh tomato crop typically gets underway in late October and continues well into the following June. During the five most recent seasons (1966-67 through 1970-71), an average of 22 percent of the total seasonal shipments occurred in October through December, 33 percent were made during the months January through March, and 45 percent from April to the end of the season.

Throughout each of the five aforementioned seasons, Florida shipped both "mature green" and "vine ripe" tomatoes. These terms refer to the stage of maturity of the tomatoes at the time of inspection. A "mature green" tomato is one that is mature as defined by U.S. Standards for Fresh Tomatoes and the skin of which is completely green in color. The U.S. Standards definition of mature is "that the contents of two or more seed cavities have developed a jelly-like consistency and the seeds are well-developed."

A "vine ripe" tomato is also mature but the skin color has reached at least the breaker stage. Breaker means that there is a definite change in color from green to a tannish yellow, pink, or red on not more than 10 percent of the surface. In appearance, such a tomato is green with just a touch of yellow or pink, usually at the blossom end of the tomato.

Under the marketing order, the maturity of Florida tomatoes, including color as an indication of the degree of maturity, is officially determined at the packinghouse where tomatoes are inspected by the Federal-State Inspection Service. Such inspection is compulsory when a marketing order regulation is in effect requiring all shipments meet a specified size or grade and to provide a basis for

collecting assessments needed to operate a marketing order program. Inspection is commonly used even when a market order program is not operating as a means of identifying the composition of particular lots being traded.

(b) *Classes of producers.* The terms vine ripe and mature green also are used to describe tomato growers in Florida in the sense that such terms indicate the particular maturity of tomatoes predominantly produced and harvested by such growers. Every grower when he plants an individual field has a basic intent to harvest tomatoes from that field as either mature green or vine ripe. His plans are influenced by many factors including type of soil, climate, the prospective supply of labor while the crop is growing and at harvest, and the packinghouse facilities that will be available to handle his harvested tomatoes.

The record shows that most growers specialize in harvesting just one maturity although a few persons have tomato operations so organized as to produce and harvest both vine ripe and mature green tomatoes. The record also shows that all fresh tomato growers, whether specialists or not, may at some time harvest both mature green and vine ripe tomatoes from their fields. As shown later herein, this results primarily from practical considerations in commercial harvesting practices.

(c) *Cultural practices.* The initial activities of preparing the soil and planting the tomato seed or seedlings are essentially the same for both maturities. But the vines usually are handled differently and harvesting practices for a vine ripe tomato operation vary greatly compared with one in which tomatoes are picked primarily mature green.

As the tomato vines grow they are either left on the ground or "staked". In staking tomatoes, the vines are tied to stakes or may be supported by a trellis-like system constructed of strings tied to stakes set at intervals in the row, and their growth is directed upward. The staked vines, unlike ground grown, are pruned and grow taller. They produce larger tomato fruit and a greater total quantity than ground grown vines and, because the tomatoes do not touch the ground, the incidence of disease is reduced.

Tomatoes, in both stake and ground culture, grow larger and mature earlier at the lower part of the vine. The quantity and size of the fruit progressively decreases toward the top of the vine.

(d) *Vine ripe production.* Tomatoes intended to be harvested as vine ripens are "staked". Such staking results in the tomato fruit being more accessible to the pickers and because, unlike ground grown, the vine does not have to be picked up and turned to expose the fruit, there is less damage to the vine than otherwise would result from the frequent harvesting required in a vine ripe operation. Vine ripe fields in Florida generally are picked every other day and all tomatoes showing "color" are picked. The frequent picking schedule is necessary in order to pick the vine ripens as close as

possible to the breaker stage, i.e., when the fruit is almost entirely or predominantly green. Tomatoes which are picked mature green or as breakers usually have a firm internal texture and a relatively tough surface. If left on the vine a "breaker" could turn red within a few days. As the fruit turns pink and then red, it becomes progressively softer and less able to withstand the frequent handling involved in a commercial tomato harvest, packing, and marketing operation without suffering bruising and other deterioration.

Harvesting of a vine ripe tomato field may continue for several months. However, as the vines get older and yields decline, the vine ripe grower may decide that continued harvest of the field would be uneconomical. Under such circumstances, he will pick both vine ripe and mature green tomatoes as he cleans out the field.

The record shows that the relative importance of "true" vine ripe tomato producers in Florida has been declining in terms of numbers of growers and the volume of their production. However, such producers harvest tomatoes during most of the season, and account for a significantly large portion of the tomato production in several districts of the production area in Florida.

(e) *Mature green production.* In a mature green tomato harvest operation, most fields are picked twice, but occasionally a third picking will be made if the condition of the remaining crop is suitable for such harvest and the market is relatively strong.

As the time for first picking of a mature green field nears, the grower must assess the progress of the tomato crop and decide whether enough fruit are sufficiently mature to warrant sending in a picking crew. The producer considers various external characteristics of his tomatoes which he can associate by experience with adequate maturity. He may squeeze the fruit to gauge its firmness. Some tomatoes may be cut—if the seeds give way before the edge of the knife and are not cut, the tomato is mature. Another common test is the amount of "colored" (vine ripe) tomatoes in the field. Usually a grower will pick only "vine ripe" tomatoes at first, and may do this several times until he decides that there are sufficient mature tomatoes in a field to warrant the initial full scale harvest. Then he has his crew pick every mature tomato. While most of the tomatoes will be mature green, some will have reached the breaker (vine ripe) stage.

The second and occasional third pickings occur at 7- to 10-day intervals. Within these intervals, tomatoes left on vines continue to grow in size and increase in maturity. Some vine ripe tomatoes are included in every subsequent mature green picking and constitute a significant economic commodity to the grower. The proportion of vine ripens included in each harvest of mature greens varies, primarily because of the effects of weather on the growth of the tomatoes. During unusually warm weather, the amount of vine ripens in a picking might

be above average if the harvest crews were unable to keep up with the crop; i.e. the tomatoes would grow unusually fast during the normal time interval between harvests. One witness testified that on occasion vine ripers account for up to 20 percent of the production from his basically mature green harvest operation. Conversely, when temperatures are low, the overall growth of tomatoes is slowed and the incidence of vine ripers in a second or third picking of mature greens may be relatively low.

Because of its more advanced stage of maturity, a vine ripe tomato is more tender than a mature green tomato and therefore usually requires special handling. When a mature green tomato grower makes the preliminary harvest of vine ripers, small containers may be used in the field to avoid pressure bruising. But when the full scale picking occurs, all tomatoes usually are placed in 60- to 90-pound field crates, and in some areas in pallet boxes which hold much larger amounts.

The largest portion of mature green tomatoes is produced on vines which lie on the ground. However, some tomatoes to be harvested mature green also may be staked. This practice is increasing in those areas of Florida where soil structure is suitable for the use of stakes. Staking of mature green fields is more expensive than allowing the vine to stay on the ground, but as with vine ripe culture, it results in less vine damage and better yields. In contrast to a staked vine ripe operation wherein tomatoes are picked at frequent intervals over several months, the staked mature green field is harvested only two or three times. Although the mature green harvest operation theoretically could be changed to a vine ripe operation, this would be impractical because a sharp increase in labor would be required, and as will be shown later, the harvest operation must be geared to the capacity of the packinghouse which will handle the tomatoes.

(f) *Districts.* The types of cultural systems used by Florida growers are related in part to soil and climatic factors, and vary by District within the State. District 1 is comprised of Dade County and is the southern-most tomato producing area in the State. Although a few people grow a small amount of vine ripe tomatoes on a trellis or hydroponically, all large tomato operations in the District are organized for mature green production. In this District, mature green tomatoes are harvested from vines on the ground, planted in soil composed of crushed coral rock. Stakes are not used since it is impracticable to drive them into the underlying coral. Harvest of the Dade County mature green crop usually begins in mid-November and continues into the following May. During the 1970-71 season, 164 million pounds of tomatoes were shipped from District 1, of which 93 percent were mature greens and 7 percent were vine ripe.

District 2 is in the Southeastern corner of the Florida peninsula and includes the Counties of Brevard, Broward, Glades, Indian River, Martin, Osceola, Okecho-

bee, Palm Beach, and St. Lucie. Tomato production is concentrated in sandy soils along the Atlantic Coast. Vine ripe culture is dominant in the more southern coastal area where the Gulf Stream moderates winter temperatures. Harvest begins in November and terminates during the following spring. The last shipments during the 1970-71 season from Pompano, the center of the area's vine ripe production and marketing, were reported on May 28, 1971. About 93 percent of the total seasonal shipments of 63 million pounds from the district's south coastal area were tomatoes of vine ripe maturity.

Mature green "ground" production is the prevalent practice in the more northerly Fort Pierce area of District 2; tomatoes there are grown for both fall and spring season harvest. For the entire 1970-71 marketing season, shipments reported from the Fort Pierce shipping point amounted to 96 million pounds, of which 96 percent were mature green.

District 3 is in the Southwestern corner of the peninsula, including the Counties of Charlotte, Collier, Hendry, Lee, and Monroe. Tomato growers in this District use all three basic types of culture—vine ripe and mature greens on stakes and mature greens on the ground. Vine ripe production is concentrated on lands close to the ocean, while green tomato operations are inland. Harvest is continuous from November into the following June, with seasonally heaviest shipments typically occurring in December and May. Shipments amounted to 115 million pounds in 1970-71; about 80 percent were mature green.

District 4 is on the west coast of Florida and includes the Counties of De Soto, Hardee, Highlands, Hillsborough, Manatee, Pinellas, Polk, and Sarasota. Tomato production is concentrated in the Manatee-Ruskin-Wauchula area, which is southeast of Tampa. Virtually all tomatoes are grown on stakes for harvest as mature greens. The 1970-71 tomato shipments from this area totaled 124 million pounds, 92 percent being mature green. Shipments begin in late October or early November and continue until frosts occur, usually during the first half of December. Spring crop harvest usually starts in April and runs into June.

Each of the Districts have unique characteristics with regard to tomato production and marketing. Nevertheless, producers in the various Districts are growing the same commodity in about the same manner as their neighbors, harvesting and handling their tomatoes in essentially the same way albeit at different stages of maturity, and selling them in the same market, often at the same time. The result is a continuous flow to market of both mature green and vine ripe tomatoes throughout Florida's November-June season. During the 1970-71 marketing season Florida's shipments totaled 562 million pounds, of which 81 percent were mature green and 19 percent were vine ripe.

(g) *Packinghouse operations.* Vine ripe and mature green tomatoes are not

only harvested differently, they also are handled differently.

Tomatoes harvested in a vine ripe operation are hauled from the field to a packinghouse where they are washed, waxed, mechanically segregated by size using sizing belts, and graded. They are then segregated by color so they can be placed in highly stratified packs such as 5 x 6 pinks, 5 x 6 light pinks, and 5 x 6 breakers. While many of the packinghouse operations have been mechanized, the color separation process depends upon the human eye and hand, resulting in relatively large labor requirements for a vine ripe packing operation. Most vine ripers are packed in 20-pound cartons, but special containers which provide additional protection for the product also are used. Some operators will individually wrap vine ripers to provide cushioning for the tomato during transportation and marketing.

Tomatoes picked during a mature green harvest go through essentially the same process. They are hauled in field boxes to the packinghouse where they are first sorted to remove those with "color." Tomatoes showing color move to a "pink" machine on which they are handled as indicated above for the tomatoes from a vine ripe operation.

The sorted out mature green tomatoes go to a "green" machine whereon they are segregated by size, graded, and jumble packed in cardboard containers. Since there is no need for a color separation, labor requirements are much less to operate a green than a pink machine. A 40-pound carton is the most common container for mature greens but smaller containers are becoming more popular.

Although essentially the same type of machinery is used to process vine ripe and mature green tomatoes, the organization and speed of operation is different. Since vine ripers are segregated by size and then color, they must be sorted an additional time than is the case for mature greens. Belts run slower for vine ripers than mature green in order to reduce bruising of the more tender vine ripers, and to facilitate visual color selection.

A typical tomato packinghouse is equipped to specialize in the handling of a particular maturity, but as noted some have secondary machinery so that both mature green and vine ripe tomatoes can be graded and packed. This specialization in packinghouse equipment is directly associated with the harvesting practices of the producers whose tomatoes are graded in such houses. Thus, in District 4 where virtually all tomatoes are produced to be harvested as mature greens, the bulk of the machinery in the packinghouse is designed to handle mature greens but each house will have a small "pink" machine for use in grading the vine ripe tomatoes that are picked incidental to mature green harvest. This specialization reduces the grower's flexibility in harvesting tomatoes with regard to the maturity at which such tomatoes may be picked. A basically mature green grower must time his harvests so that the incidence of vine ripers does not ex-

ceed the capacity of the vine ripe machine in the packinghouse handling his primarily mature green tomatoes. Otherwise his vine ripers will have to be left in the field or, if picked, dumped at the packinghouse.

Due to the additional handling required for vine ripe tomatoes—encompassing more labor, and different machinery and packages—the costs of such handling and preparation for market are substantially higher than those incurred for mature green tomatoes. Data in the record show that packing and selling costs run about 25 percent higher for vine ripers. When harvest charges are taken into account, the total cost of picking, packing, and selling tomatoes during the 1970-71 season averaged 4.6 cents per pound for mature greens as compared with 7.2 cents per pound for vine ripers.

The sized, graded, and packaged tomatoes usually are loaded directly on trucks or rail cars for transporting to market although when supplies are relatively large some may be held in the packinghouse for a day or more until sold. During periods of warm weather, refrigeration is commonly used both in the packinghouse and during transportation to maintain quality and retard ripening.

(h) *Controlled atmosphere ripening.* As a tomato ripens, it emits ethylene gas and the rate of emission increases as the fruit approaches a fully ripe condition. The introduction of additional ethylene into closed tomato ripening rooms under controlled conditions merely hastens the ripening process, with the further result of having the tomatoes all ripen at a uniform rate. The increasing use of smaller containers for mature green tomatoes is associated with the practice of gassing tomatoes. In this process, mature greens are placed in a room in which humidity and temperature are controlled. Ethylene gas is injected into the room and the tomatoes remain there for a day or two until the desired color appears. Since the tomatoes in the room tend to ripen uniformly, packinghouse operators can pack mature green tomatoes in 20- or 30-pound cartons, ripen them in a controlled atmosphere room and ship them direct to retail outlets, thus bypassing the repacking (ripening) operation in the terminal market.

Industry witnesses testified that the introduction of additional ethylene is not detrimental to a tomato. On the contrary, in their opinion the process hastens maturity and actually improves the quality of the product ultimately available to the consumer because there is less damage to tomatoes as compared with that which occurs during the repeated handling required for ordinary ripening. By the latter method, a lot of tomatoes often may be sorted several times over a period of days by the repacker as he attempts to obtain tomatoes of uniform color in the package he sends to the retail outlets.

(i) *Machine harvesting.* Because of rising wage rates and a decline in the supply and quality of field labor, efforts are being made to develop a method or

system by which fresh tomatoes can be effectively harvested by machines. The two major parts of such a system are a mechanical harvester that will operate efficiently under various soil conditions in Florida, and a tomato variety with sufficient strength to withstand the buffeting that occurs during harvest and which ripens with a high degree of uniformity. The latter characteristic is essential since each field will be machine picked only once; the plant will be severed from its roots, thus terminating further production.

The record shows that the machine harvesting system now in the testing stage is primarily a mature green operation. A witness testified to his belief that when the use of such a system becomes widespread and general, Florida growers will continue to harvest and market both mature green and vine ripe tomatoes. It is expected that they will continue to use the amount of "color" in the field as an indication of maturity, hand-picking the "color" one or more times until the field of tomatoes reaches the stage of maturity which justifies complete harvest by machine. Even then, it is anticipated that there will be vine ripe tomatoes among the machine harvested crop. And because of differences in production schedules of the various growers, at any given time throughout a season some growers probably will be hand picking only vine ripe tomatoes while others will be machine harvesting predominantly mature green tomatoes. Thus, both vine ripe and mature green tomatoes will be marketed simultaneously.

(j) *Tomato growth and size characteristics.* A tomato becomes "mature green" as many as 21 days before it reaches the so-called breaker stage, at which stage it is commonly considered to be "vine ripe". During that interval or maturation period of up to 21 days, the tomato continues to increase in size and weight according to the testimony of industry witnesses based upon their many years of experience in producing tomatoes. These witnesses differed however in their judgment as to the extent of such increases.

Research on the extent of growth during the maturation period is limited. The U.S. Department of Agriculture has published two documents, which were placed in evidence, containing material which relates to this matter. The more recent publication dealt with a study performed in Mississippi in the late 1930's. The author reported a substantial gain of 12 percent in tomato size took place during the last 4 days prior to breaking and becoming vine ripe. However, he did not discuss his method of analysis and it is impossible to determine whether the observed size increase related to diameter, volume or some other measure.

The other publication described a research project undertaken shortly after World War I. The research was performed in northern Virginia and southern Florida with a tomato variety which has not been used for many years. Average growth in Virginia during the usual period of maturation amounted to about a fifth of an inch, whereas the

experiment in Florida showed a gain of slightly over one-third of an inch. The tomatoes in Florida were grown under weather conditions of extreme stress which may have been responsible for the erratic growth pattern observed, comprised of an especially large increase during the 7-day period beginning 21 days before breaking and becoming vine ripe, and a small increase thereafter. Nevertheless, the growth pattern observed in this experiment suggests that there was a significant increase in size during the 21-day period of maturation.

The differences in tomato-growth rates during maturation, as measured in these USDA research projects and as testified to by various witnesses, are indicative of the variation in growth that may occur because of differences in such factors as cultural practices, varieties, type of soil, and season of production, and to the influence of short-run changes in weather.

The relative sizes of vine ripe and mature green tomatoes—of varieties now commonly used and as harvested over many weeks during a recent winter season—can be ascertained from shipment data compiled by the Florida Tomato Committee.

Each season since reactivation of the marketing order in 1968, the Florida Tomato Committee has reported, by grade and size, all shipments regulated under the marketing order. During the first two seasons these data gave some indication of the general size relationship among tomatoes of different maturities, but the data were not complete because only interstate shipments were regulated and therefore recorded. The quantity and size composition of Florida tomatoes that moved to market within the State were unknown.

In addition, the Florida shipment data for those seasons (1968-69 and 1969-70) provided no insight into the quantity of saleable tomatoes which were not marketed. When total supplies of tomatoes are larger than market demand, prices are depressed and some of the smaller and less valuable tomatoes are not shipped. During such periods of low prices, many small mature green tomatoes are abandoned in the fields or dumped at the packinghouse. Similarly, even though all vine ripe tomatoes are usually picked and moved from the fields because of cultural requirements, economic factors generally result in small vine ripers also not being shipped when the market is saturated with larger tomatoes. In addition, during significant portions of these two marketing seasons, regulations were in effect which restricted shipment of certain of the smaller sizes of tomatoes.

The deficiency in statistical data relating to tomato sizes was relieved in the 1970-71 marketing season. During that season, marketing order regulations limiting the sizes of tomatoes that could be shipped were imposed only briefly near the end of the season. But regulations requiring inspection of intrastate as well as interstate shipments were in effect all season. Therefore all shipments of Florida tomatoes, whether marketed within

or without the State, were inspected and recorded. Further, for an extended number of weeks during the main portion of the season, the market for tomatoes was unusually strong. During that period virtually every marketable tomato was picked, shipped, and recorded. The combination of (1) mandatory inspection of all shipments, (2) intensive harvest of all marketable tomatoes, and (3) only brief imposition of size requirements resulted in a detailed picture of the size and grade composition of the 1970-71 tomato crop in Florida.

The shipment data indicate that tomato sizes vary between districts in Florida, and that, overall, tomato sizes change during the season. While this variation may result from a number of factors, the primary causes are differences in cultural practices, changing weather conditions, and the general stage of harvest. Thus tomatoes produced using a ground cultural system may be smaller than those which are staked; extended periods of temperatures which are too low or too high will reduce size; and tomato sizes tend to decrease in the late stage of harvest, whether in a particular field or for a whole district.

Despite these variations in the general size of tomatoes, in every district and all through the season, vine ripe tomatoes averaged larger than mature green tomatoes. As indicated in the following table, a significantly larger portion of vine ripers shipped were 6 x 6 size or larger compared with mature greens. Conversely, the proportion of the vine ripers in the smaller sizes was much less than was the case for mature greens. These basic relationships prevailed in all Florida producing districts, regardless of whether the district harvested its tomatoes predominantly mature green or vine ripe.

PERCENTAGE DISTRIBUTION OF SHIPMENTS OF FLORIDA TOMATOES, BY SIZE AND DISTRICT, 1970/71 SEASON

District	6 x 6 and larger ¹		6 x 7 and smaller	
	Vine ripe	Mature green	Vine ripe	Mature green
		Percent		
1.....	56	38	44	62
2.....	83	53	17	47
3.....	80	55	20	45
4.....	75	60	25	40
State.....	79	50	21	50

¹ A 6 x 6 size tomato must be over 2¹/₃₂ inches and no more than 2³/₃₂ inches in diameter according to Florida tomato marketing order size classifications. A 6 x 7 size tomato must be over 2³/₃₂ inches and no more than 2¹/₃₂ inches in diameter.

Tomato size relationships between maturities during the months of strong markets and high prices in the 1970-71 season were particularly significant. Prices for tomatoes were especially high during much of the winter and early spring of 1971 because of tight supplies due to weather damage in both Florida and Mexico. Over the 15 consecutive week period—from mid-January through April, 1971—shipping point prices for 85 percent U.S. No. 1 6 x 6 size mature green tomatoes averaged 27 cents per

pound which was about 60 percent above the average price of a year earlier.

This sustained period of very high prices—the strongest market in many years—resulted in virtually every saleable tomato being picked and marketed. The proportions of the tomatoes shipped, by size categories, during this period were as shown in the following table. In every size category 6 x 6 and larger, the proportion of vine ripers substantially exceeded the proportion of mature greens.

FLORIDA TOMATOES, DISTRIBUTION OF SHIPMENTS BY SIZE CATEGORIES, MID-JANUARY THROUGH APRIL, 1971

Size	Vine ripe		Mature green	
	Percent	Percent	Percent	Percent
4 x 4.....	11.9	0	0	0
4 x 5.....	3.2	0	0	0
5 x 5.....	8.8	0	0	0
5 x 6.....	22.4	8.6	8.6	8.6
6 x 6.....	39.1	30.3	30.3	30.3
6 x 7.....	18.0	35.6	35.6	35.6
7 x 7.....	5.2	15.4	15.4	15.4
7 x 8.....	1.4	7.0	7.0	7.0

¹ Includes less than 0.1 percent of size 3 x 4 vine ripers.

Thus, not only did vine ripe tomatoes clearly average larger than mature green tomatoes, but a regulation providing for withholding mature greens 2¹/₃₂ inches and smaller in size (7 x 8) and vine ripers 2³/₃₂ inches and smaller (7 x 7 and 7 x 8) would have resulted in near equality of withholding between the two maturities during that time span. About 6.6 percent of the vine ripers would have been withheld compared with 7 percent of the mature greens.

Likewise a regulation providing for withholding mature greens 2³/₃₂ inches and smaller in size (7 x 7 and 7 x 8) and vine ripers 2¹/₃₂ inches and smaller (6 x 7, 7 x 7, and 7 x 8) would have provided proportionate withholding—24.6 percent vine ripers and 25.4 percent mature greens—of the two maturities in that period.

On the other hand, prices for 85 percent U.S. No. 1 6 x 6 size mature green tomatoes during November-December 1970, and May-June 1971, were about 17 cents per pound. Although vine ripe tomato sizes also averaged larger than mature green sizes during these periods, the quantities of each maturity in the smaller size classifications were relatively small, reflecting the impact of non-marketing. This was mostly due to the economic influence of low prices although regulations prohibited the shipment of the 7 x 7 size in both maturities in late May and June.

The size relationship among mature green and vine ripe tomatoes also is apparent from a comparison of average diameters of the two maturities. For each size category of Florida tomatoes, the average diameter was weighted by shipments of that size to compute a weighted average diameter for all tomatoes of each maturity. The average diameter for all vine ripe tomatoes during the mid-January through April period was 2.764 inches which is equivalent to about 2²/₃₂ inches. This was a little more than one size larger than the 2.488 or 2¹⁵/₃₂ inches

average diameter of all mature green tomatoes.

From these findings based on the record evidence, it is concluded that vine ripe tomatoes average larger than mature greens. This fact, together with the fact that all tomato growers, including mature green growers, harvest various portions of their crops at the vine ripe stage of maturity, is of substantial significance when considering the regulation of tomato shipments.

Because of the average size difference of the two maturities, a single minimum size requirement imposed on shipments of both vine ripe and mature green Florida tomatoes under normal conditions would require growers predominantly harvesting tomatoes at the mature green stage to withhold a disproportionately larger share of their crops from market as compared to those harvesting primarily at the vine ripe stage. Similarly as between growers who harvest both mature greens and vine ripers from their fields, the grower with the greater volume of vine ripers would be able to market a greater proportion of his crop. A regulation based on maturity, i.e., requiring larger minimum sizes for vine ripe tomatoes than mature green tomatoes, has the effect of achieving a proportionate sharing of withholding of both maturities.

(2) *The effect of regulating shipments differently by maturity on Florida producers and others involved in the production and marketing of winter season tomatoes:* Tomato growers space the planting of their crop so that there will be a steady flow of their commodity to market beginning several months later. But the vagaries of weather cause erratic growth which results in distorted harvest schedules. And growers sometimes misjudge market demand, and plant too many acres. The result, as the record shows, is an occasional oversupply of tomatoes available for market, which depresses prices to producers.

Numerous witnesses representing both the Florida and Mexican tomato industries agreed that some method was needed to cope with these periodic surplus supplies. Some thought promotional efforts would be most productive. One mentioned that the Mexican government has imposed minimum size and grade requirements on its shipments a number of times in recent seasons when prices on the U.S. market became depressed. A few had no specific suggestions. The Florida industry representatives testified to their belief that the approach used in past seasons was a proper way to balance tomato supplies with demand on the U.S. market. It is their position that requiring different minimum sizes for different maturities is an effective way to tailor the supply to demand and at the same time tend to equate the burden of withholding as between mature green and vine ripe tomatoes.

Shipments of Florida's tomatoes begin in November and continue into the following June. Distribution is nationwide and some are exported to Canada.

Throughout its marketing season and in each of the receiving markets, Florida tomatoes compete in varying degrees with tomatoes from other sources. Typically, they compete with small amounts of tomatoes from other States in early November and again very late in the spring, and hothouse tomatoes are available in light volume throughout Florida's marketing season. However, the greatest competition is with tomatoes from Mexico which have sharply increased in U.S. markets in recent years. Ten years ago, during the 1960-61 season, tomato imports from Mexico accounted for 20 percent of the U.S. winter market supply. During the November 1970-June 1971 marketing season, imported Mexican tomatoes accounted for about 45 percent of the total supply marketed in the United States.

When regulations have been considered, the U.S. market supply in nearly all instances has been comprised primarily of the crop in Florida about to be harvested and shipped, and the then current imports from Mexico. Various reports concerning acreage, growing conditions and current yields provided detailed information about the potential supply in Florida, and packout data showed the size and grade of Florida's tomatoes currently being marketed.

Current information regarding Mexican supplies is restricted to data compiled by the National Union of Horticultural Producers, a Mexican growers association, which shows by size and maturity the quantity of tomatoes crossing the border at Nogales, Ariz. These data account for about 90 percent of the total quantity of Mexican tomatoes crossing the U.S. border destined for markets in the United States and Canada.

With the potential supply identified in total and classified by size, that supply can then be related to estimated demand to determine the extent of withholding which may be necessary to maintain a reasonable level of returns to growers. Thus, if the potential supply exceeds demand by 10 percent and tomatoes of the smaller, less valuable sizes (those which return the least to the producer) account for a 10th of the supply, restrictions can be imposed which preclude such tomatoes from shipment.

This method of regulating shipments, which has been recommended by the Florida Tomato Committee, was subjected to intensive examination during the hearing. Special attention focused on the issue of whether regulations requiring larger minimum sizes for vine ripens than mature greens discriminated against tomatoes produced in other countries, particularly Mexico.

Mexico has been exporting tomatoes to the United States since the early part of this century, but the volume of such exports was relatively small until the early 1960's when a concerted effort was made to expand the export-oriented industry on the west coast. Vast irrigation systems were developed and there was an influx of capital and production skills. With an abundant supply of low cost labor also available, Mexican producers

reduced the scope of their mature green tomato operations and concentrated on developing a vine ripe tomato production system. Although most of their tomatoes are harvested at the vine ripe stage of maturity, mature green production is still common, and supplies of this maturity are exported throughout the season.

West Mexican tomato production and export sales have risen steadily and sharply. Exports to the United States during the November 1970-June 1971 marketing season, at 570 million pounds, were more than 300 percent of those a decade earlier. The increase in exports was particularly sharp during the late 1960's even though import regulations were imposed on several occasions following reactivation of the Florida Tomato Marketing Order for the 1968-69 marketing season. The 570 million pounds exported in the 1970-71 season were 63 percent above such exports during the 1967-68 season, just prior to the reactivation of marketing order regulations. One witness estimated that West Mexico's tomato crop now far exceeds output in Florida with production in the 1970-71 season of nearly a billion pounds being about 65 percent above that in Florida.

Published detailed information is not available as to the composition of the Mexican tomato crop by size and quality. Witnesses who surveyed the Mexican producing area at various times testified however that it is little different from that in Florida. Mexican tomato growers use the same varieties, produce and harvest at the same time of year, and use the same cultural methods used by growers in Florida. Grading, packing, and tomato transportation facilities in Mexico also match the most modern in the United States.

The main difference in production is that Florida harvests 80 percent of its tomatoes at the mature green stage of maturity whereas Mexico harvests most of its tomatoes as vine ripens. It has been contended that because of this difference, a regulation requiring larger minimum sizes for vine ripens than mature greens discriminated against Mexican tomatoes. However, inasmuch as vine ripe tomatoes average larger in size than mature greens, the burden of withholding under such regulations should fall evenly on the mature green and vine ripe tomatoes in both areas. On the other hand, a regulation making a single minimum size restriction applicable to both mature green and vine ripe tomatoes would result in a proportionately smaller withholding of vine ripens as compared to mature greens, regardless of the location of production.

When examining the impact of a regulation, it is appropriate to examine its effect on Florida growers and Mexican growers, and also on the importers of Mexican tomatoes.

At the producer level, the hearing evidence indicates that burden of withholding falls more heavily on Florida growers than on growers in Mexico. This is true because Florida tomatoes withheld under marketing order regulations

are nearly totally restricted from any fresh market outlet. In addition to the ban on sales in U.S. markets, exports of the restricted sizes to Canada are precluded because of reciprocal regulations imposed by that country. (Whenever shipments of U.S. fruits and vegetables are limited by a marketing order regulation, Canada prohibits the import from the United States of the restricted item. However, such items produced in other countries including Mexico still are permitted to enter Canada.) The only alternative outlets for affected Florida tomatoes are in Caribbean countries, which usually look to the United States as a market for their own tomatoes rather than as a source of supply.

Mexican tomatoes which cannot be shipped to the U.S. market because of marketing order regulations can be shipped to other countries such as Canada, or to consumers in Mexico. Although the Mexican domestic market is a secondary outlet for those tomatoes produced on the West Coast of Mexico, sales to this outlet are economically valuable. According to industry witnesses, average prices received for Mexican tomatoes shipped to Mexican markets have been as low as 8 pesos and as high as 60 pesos per 60 pounds, with the market considered good at a range of 20 to 25 pesos (\$1.60 to \$2). The record shows that average production and harvesting costs would be covered at 8 pesos, and a price of 20 pesos would exceed average production, harvesting and packing costs by approximately 50 percent.

The marketing of West Mexican tomatoes differs from practices in Florida in that the Mexican industry segregates its total marketable supply according to market outlets. The industry selectively grades its tomatoes with the result that annually only about 60 percent of their total production is exported to the United States, Canada, or elsewhere and the remainder is available to markets in Mexico. It is the West Mexican practice of selecting the tomatoes to be exported that may cause the proportion of their exports to the U.S. market affected by an import regulation to differ from the proportionate effect of a regulation on Florida or Mexican growers, i.e., an import regulation applies only to the segment of the Mexican crop selected for export whereas the regulation is applied to the total crop in Florida. This does not necessarily mean proportionately more Mexican tomatoes would be banned from the U.S. market as compared with Florida. As will be shown later herein, the proportionate effect upon imports might be smaller.

Most of the Mexican tomatoes imported into the United States are handled by importers located in Nogales, Ariz. The importers are middlemen in the marketing chain whose main function is to facilitate the entry of the tomatoes and arrange for the sale of such tomatoes to U.S. buyers. For these services, they receive a commission of 7.5 to 10 percent of gross sales, although on large sales a fixed fee may be charged. Some of the importers participate in

Mexican tomato production through various joint venture arrangements.

An import regulation imposed pursuant to a marketing order regulation would result in some reduction in volume from that which otherwise might be handled by importers. This would not necessarily result in reduced income to importers however.

The commission merchant, whether an importer at the border or a broker in the terminal market, who received a percentage of the sales dollars, might receive more than otherwise would prevail without a shipment regulation. Record evidence on recent research on tomato price and quantity relationships suggests that total revenue from sales of tomatoes can be increased substantially by the removal of smaller sizes from the market when total supplies are heavy. As stated in Exhibit 10 ("Supplying U.S. Markets with Fresh Winter Produce"), "—removal of 7 x 7 and 7 x 8 vine ripers from marketings would have increased the average price of the remainder of the supply (vine ripers and mature greens) by 12 percent, although only about a 2-percent increase in price would have offset the loss in revenue from not marketing these sizes."

The quantitative effect of minimum size requirements upon growers and importers can be determined using data available for the 1970-71 season. It has already been shown that a regulation providing for withholding mature green tomatoes $2\frac{1}{2}$ inches and smaller in size (7 x 7 and 7 x 8) and vine ripe tomatoes $2\frac{1}{2}$ inches and smaller (6 x 7, 7 x 7, and 7 x 8) during a representative period in the 1970-71 season would have resulted in near equality of withholding between the two maturities in Florida. Such a regulation would have precluded the shipment of 25.4 percent of Florida's mature greens and 24.6 percent of Florida's vine ripers.

During this period, Mexican authorities prohibited the export of 7 x 7 and smaller size tomatoes. However, 80.2 million pounds of 6 x 7 size vine ripe tomatoes and 6.5 million pounds of 6 x 7 size mature greens moved north across the Mexican-United States border. If an import regulation had been in effect (based upon the aforementioned 2-size requirement in Florida), the shipments of mature green tomatoes would have been unaffected. The 80.2 million pounds of vine ripers, which represented 24 percent of the total crossings of this maturity, would have been excluded. However, a portion of the 80.2 million pounds were destined for sale in Canada and therefore unaffected by the U.S. import requirements. Thus, the percentage of vine ripers ultimately excluded would have been something less than 24 percent.

In summary, imposition of the type of regulation advocated by the Florida Tomato Committee during the aforementioned period would have resulted in the dumping of about 25 percent of Florida's production, and the exclusion from the U.S. market of something less than 24 percent of the tomatoes from Mexico.

Any Mexican tomatoes so excluded would have been available for sale in Mexican markets, Canada, or elsewhere.

The fundamental reason for requiring different minimum sizes for different maturities is to equalize the proportionate burden of withholding among Florida producers. It was speculated that some growers in Florida might be able to minimize the impact of withholding on them by switching from harvesting their tomatoes vine ripe to harvesting them mature green. For example, this might have enabled them to pick and market 6 x 7 size tomatoes during portions of the 1968-69 and 1969-70 marketing seasons when regulations precluded shipments of 6 x 7 vine ripers but permitted shipment of mature green tomatoes of the same size.

It has been shown that when a Florida grower plants a field to tomatoes, he has a basic intent as to the maturity of the tomatoes he will harvest from that field. Further, differences in harvesting and packing methods restrict the freedom of such a grower to vary the maturity of tomatoes to be harvested from a field. To a limited degree, however, it is possible to switch from picking tomatoes vine ripe to picking them mature green. Whether this occurs depends upon the producer's evaluation of potential total economic returns.

When he changes from picking vine ripe to picking mature green, the producer sacrifices volume—size and weight—inasmuch as mature green tomatoes average smaller than vine ripers and weigh less. In some instances, such a sacrifice may be the best alternative. For example, if freezing weather is imminent, a vine ripe producer might harvest all the tomatoes possible (whether vine ripe or mature green) before everything is lost. Also, a prospective labor shortage which would preclude continuing harvest later in the season also might induce a vine ripe producer to finish off his field by picking it mature green.

Witnesses testified that a marketing order minimum size regulation would not in itself be an incentive to switch maturities because such a change would increase the likelihood of economic loss. For by switching from vine ripe to mature green, the producer would be reducing the volume that could be harvested from a field and concentrating his sales of that smaller volume of less valuable sizes of tomatoes on a depressed market (which would be the impetus for marketing order regulations in the first place). The alternative would be to continue to pick tomatoes vine ripe, harvest a larger total volume of the more valuable larger sizes, and hopefully benefit from higher prices as the market improves due to the effect of the marketing order regulations.

Another option reviewed would be to continue the vine ripe operation but also pick all 6 x 7 size tomatoes mature green. Representatives of both the Florida and Mexican industries agreed that this would be impractical. It would be necessary to pick the whole crop green or else employ more people to pick the 6 x 7 greens. And since the 6 x 7 mature greens

would be at various stages of maturity (i.e. from 1 to as many as 21 days away from changing color and becoming vine ripe), some would have grown much larger before turning color. Therefore, picking 6 x 7 tomatoes at the mature green stage would not be practicable to offset any loss occasioned by the prohibition of shipment of 6 x 7 vine ripe tomatoes because of the loss in potential size, weight and value of the tomatoes so harvested.

A third consideration relating to "switching" was whether, because of differences in the time and place of inspection, a Florida vine ripe grower who changed to picking his tomatoes mature green would have an advantage over his counterpart in Mexico who also changed to picking tomatoes mature green.

Florida tomatoes generally are inspected and certified as to grade, size, or maturity on the same day they are harvested although during the peak of the season some may not be so handled and inspected until the following day. Mexican tomatoes exported are inspected by U.S. inspectors at the United States-Mexican border, usually at the request of the importers who use the certification as to the composition of the shipment for trading purposes. When import regulations are in effect, the inspection is necessary to determine whether the shipment complies with such regulations and is therefore permitted to enter the United States.

It was contended that because it takes about 18 hours to transport Mexican tomatoes 600 miles from the main growing area to the U.S. border, it would be impractical to switch to picking tomatoes mature green since such tomatoes might advance to the vine ripe stage of maturity by the time they reached the border and were inspected. This contention suggests that under import regulations such as imposed in past years (permitting entry of 6 x 7 mature greens but precluding entry of 6 x 7 vine ripers) a 6 x 7-size Mexican tomato picked at the mature green stage could therefore not be marketed in the United States. The suggested advantage to Florida growers is that a 6 x 7-size Florida tomato picked mature green probably could be marketed when such regulations were in effect since inspection and certification would take place relatively soon after harvest and before the tomato reached the breaker stage.

Record evidence indicates that such an inequity would not occur. It is a common practice to cool Mexican tomatoes after harvest to remove field heat and retard ripening. Also, packinghouse and transportation facilities—which includes refrigeration equipment—are the same or better than such facilities in the United States. Thus, it is physically practicable to harvest and export Mexican tomatoes to the United States at the mature green stage of maturity. As has been shown, in recent years, Mexican mature green tomatoes regularly have moved north across the Mexican-United States border in substantial volume throughout each marketing season even

during periods of regulation. And for many years prior to the development of the vine ripe industry in the early 1960's, almost all Mexican tomatoes exported were mature green in maturity.

Even though some Mexican tomatoes are harvested and exported at the mature green stage of maturity, it is unlikely that there would be an incentive for producers generally to switch from picking their tomatoes as vine ripens to picking them mature green because of an import regulation imposed under 608e-1 of the Act. For in Mexico as in Florida, a producer making such a change would be sacrificing size and weight inasmuch as mature green tomatoes average smaller than vine ripens. It has been shown that picking 6 x 7 tomatoes at the mature green stage would not be practicable to offset any loss occasioned by the prohibition of export of 6 x 7 vine ripe tomatoes because of the loss in potential size, weight, and value of the tomatoes so harvested.

Evidence regarding the effect of shipment regulations such as advocated by the Florida tomato industry upon consumer interests is generally inconclusive. It was suggested that the overall nutritional value of tomatoes marketed would be reduced by imposing regulations such as those issued in past seasons because proportionately more vine ripe tomatoes than mature green tomatoes would be withheld from shipment. Further, it was assumed that vine ripe tomatoes are more nutritional than mature greens. As shown earlier herein, the type of regulation recommended by the Florida Tomato Committee does not result in disproportionate withholding between the two maturities. With regard to the relative nutritional values, there is no evidence of substantial differences between vine ripe and mature green tomatoes.

Several publications relating to various aspects of tomato quality were offered in evidence by counsel for Mexican tomato importers but not accepted by the Hearing Examiner on the grounds that they contained either outdated or immaterial evidence. These exhibits—Nos. 102, 103, 104, and 105—dealt with research performed generally in the 1920's or earlier on various nutritional characteristics of tomatoes of different maturities such as vitamins A and C values, starch content, acidity, and sugar/acid ratios. They showed for example that mature green tomatoes have a higher starch content and are more acid than those which are vine ripened. Further, some researchers said that acidity decreases as a tomato ripens while others found that the pattern is one of decreasing acidity through the pink stage and an increase thereafter. The ratio of sugar to acid is much lower in mature green tomatoes when fully ripened compared with those that fully ripen on the vine. Pink or fully ripe tomatoes scored much higher on Vitamin A values compared with mature green fruit. On the other hand, the difference between such pinks, ripens, and mature greens was relatively minor with regard

to vitamin C, which is the nutrient of greatest importance in tomatoes. Although these analyses concern quality attributes of tomatoes in general, their applicability to the present matter is dubious since the tomatoes were of a different variety than those presently used and the fully ripe tomatoes used in most of the research were much more advanced in maturity than the commercially grown "vine ripe" tomato presently marketed during the winter. As noted earlier herein, the winter "vine ripe" tomatoes are picked at a very early stage of maturity.

They are primarily green in color with a tinge of yellow, pink, or red color on 10 percent or less of the surface. Therefore, the Hearing Examiner's rulings relating to these submissions are upheld.

Some witnesses questioned the desirability of using ethylene gas in the handling of tomatoes. However, as has been shown, witnesses with many years of experience in marketing tomatoes believe that the use of additional ethylene, a gas emitted by the tomato itself, to hasten ripening results in a superior product in the retail store.

Consumers preferences for tomatoes have been examined on several occasions in the past by various researchers. Among the observations noted in the record were that consumers were aware of grade and size differences when they are making comparisons among large tomatoes such as 5 x 6's and 6 x 6's. Thus, a U.S. No. 1 5 x 6 size tomato is definitely superior to all other smaller and lower graded tomatoes. However, grade and size differences among smaller tomatoes such as 7 x 8, 7 x 7, and 6 x 7 are not significant to consumers.

Witnesses who produce or sell primarily vine ripe tomatoes said such tomatoes are the best, and that they probably could distinguish between vine ripe and mature green tomatoes placed before them even when both had been fully ripened. Florida producers and handlers testified that their largest chainstore buyers preferred mature greens. These witnesses also believed that it is virtually impossible for consumers to detect any material difference in appearance, texture, or taste between fully ripened mature green and vine ripe tomatoes.

The most recent survey of buyers' attitudes was that performed by the Department in its analysis of competitive aspects of fresh vegetable marketing, "Supplying U.S. Markets with Fresh Winter Produce," which is exhibit 10 in the record. It was found that wholesalers in both Chicago and New York City ranked tomatoes from Florida (mostly harvested mature green) in first place while those from Mexico (mostly harvested vine ripe) tied with California for second. Middlemen customers of wholesalers in Chicago ranked California ahead of Florida, Texas, and Mexico in that order, but Florida held first place among wholesalers' customers in New York City.

Restrictions on shipments of the smaller sizes of tomatoes also were believed by some to be responsible for high retail

prices for this commodity in recent seasons. However, the record shows that short supplies due to weather damage in both Florida and Mexico were largely responsible for high prices for tomatoes during much of the 1970-71 marketing season. Regulations affecting shipments were imposed only briefly during late May and the first half of June 1971. Supplies were similarly reduced by weather influences for many weeks during the 1969-70 marketing season, and the shipment of smaller sizes of tomatoes was precluded significantly by marketing order regulation only at the end of the season, beginning in late April 1970.

Although periods of high retail prices have occurred in recent years, prices received by Florida producers have not been unduly enhanced over those which prevailed during seasons prior to reactivation of the marketing order. Using parity relationships as a measure, such prices have in fact been somewhat less favorable to Florida producers than in earlier years. The average return to Florida producers for tomatoes was 99 percent of parity in 1968-69, 85 percent in 1969-70, and 87 percent in 1970-71. During the 5-year period 1963-64 through 1967-68, prices received by Florida producers averaged 91 percent of parity.

At the hearing a witness for the importers of Mexican tomatoes suggested that U.S. foreign policy and trade policy with regard to Mexico must be considered by the Secretary when promulgating and issuing regulations on tomatoes and, specifically, that the Secretary should avoid restrictions which might conflict with Article XI of the General Agreement on Tariffs and Trade (GATT) which provides with certain exceptions, for the general elimination of quantitative restrictions on imports.

GATT is a multilateral agreement of the United States and other countries relating to trade between the signatory countries and is concerned primarily with nondiscriminatory treatment, duties, and quantitative restrictions on commodities traded between such countries. GATT is not an enactment of Congress but rather an executive agreement entered into by the President under authority of section 350 of the Tariff Act of 1930, as amended (19 U.S.C. 1351). GATT is binding solely upon the countries that are signatories to the agreement. Mexico is not a signatory to GATT and, therefore the terms, conditions, prohibitions, and principles of GATT do not apply to that country.

It was, however, argued by a witness at the hearing that the provisions of Article XI of GATT have been made applicable to imports into the United States from Mexico by virtue of the Most-Favored-Nation Principle contained in section 251 of the Trade Expansion Act of 1962 (19 U.S.C. 1881). This section provides that "any duty or other import restriction or duty-free treatment" proclaimed in carrying out trade agreements under section 350 of the Tariff Act of 1930, as amended (19 U.S.C. 1351), or title II of the Trade Expansion Act of 1962 (19 U.S.C. 1821-1888) shall apply to products of all foreign countries, with

certain exceptions. The provisions of Article XI of GATT, stating the principles to be followed with respect to the elimination of quantitative restrictions on imports, are not "any duty or other import restriction or duty-free treatment" referred to in section 251. Furthermore, neither GATT nor the provisions of Article XI thereof have ever been proclaimed by the President of the United States in carrying out a trade agreement. Therefore, the provisions of Article XI have not been made applicable by virtue of the Most-Favored-Nation Principle to the importation of articles from Mexico into the United States.

Mexico, not being a signatory to GATT, would derive benefit therefrom under the Most-Favored-Nation Principle only to the extent that the tariff concessions granted by the United States under GATT are extended to the products of other countries. While duties on the importation of tomatoes have been proclaimed in carrying out trade agreements under the provisions of law referred to in the Most-Favored-Nation Principle, such duties are unrelated to the grade, size, quality, or maturity restrictions which are made applicable to imports of tomatoes by operation of section 608e-1. Further, the grade, size, quality, or maturity restrictions under section 608e-1 are not made operative by Presidential proclamation but rather are statutorily mandated by Congress by requiring the Secretary to issue the restrictions whenever such restrictions are applied to domestic shipments under a marketing order regulation.

Accordingly, Article XI of GATT is not applicable to the section 608e-1 import restrictions applicable to imports from Mexico. In any event, even if Article XI of GATT were applicable to imports of tomatoes from Mexico, the section 608e-1 restrictions would be authorized under the exceptions provided in paragraph 2 of Article XI.

It was contended during the hearing that tomato shipment regulations requiring larger minimum sizes for vine ripe tomatoes than mature green tomatoes were inappropriate and discriminatory, and therefore the authority to so regulate should be deleted from the Florida tomato marketing order and preference be given instead to regulating shipments by a combination of grade and a single minimum size or by grade alone. However, as the record evidence shows, the method used in recent years—i.e., to require different minimum sizes for different maturities—is appropriate and is nondiscriminatory to others involved in the marketing and consumption of tomatoes.

Since the marketing order presently contains authority to regulate by maturity, including different size limitations for mature green tomatoes than for those of a greater maturity, it is concluded that such authority should be retained in the Florida tomato marketing order and that no amendatory action is necessary.

(3) Whether § 969.51 *Recommendations for regulation* should be amended to specify the factors to be considered

in developing and recommending regulations:

The proposal in the notice of hearing to amend § 966.51 of the marketing order was as follows:

(a) The committee may recommend regulations to the Secretary pursuant to § 966.52 after consideration of the factors specified in paragraph (b) of this section.

(b) In making its recommendations the committee shall give due consideration to the following factors:

(1) Market prices for tomatoes by maturity, grades, and sizes for production area tomatoes and tomatoes from competing areas;

(2) Estimated supplies within the production area and from competing sources, by maturity, grades, and sizes;

(3) Estimated effect on shipments, assuming alternative maturity, grade, or size requirements, or combinations thereof; and

(4) Any other relevant factors which may influence tomato marketing or prices.

(c) Each recommendation for regulations as are provided for in § 966.52, together with the committee's reasons and supporting data or other material for such recommendation, shall be promptly submitted to the Secretary.

The record shows that the factors and considerations as proposed are virtually the same as those already being used by the Florida Tomato Committee. As has been discussed, a shipment regulation is intended to correct a depressed price situation or to prevent a depressed situation from occurring when it appears that the supply of tomatoes in relation to market demand will be excessive. There was general agreement among witnesses that, barring substantial crop changes because of weather, supply, and market conditions can be estimated accurately for approximately 2 weeks and reliable projections are possible for up to 4 weeks. Projections beyond 4 weeks tend to be less reliable. There also was general agreement that a shipment regulation should be issued promptly if it is to accomplish its intended purpose.

In developing a regulation for recommendation to the Secretary, the committee examines all the pertinent data and information relating to the current and prospective supply and price situation. Voluminous data and information concerning tomato production and marketing are published periodically by the Department and by the various State Departments of Agriculture in conjunction with the Department. Since these are official publications, this information is readily available to all interested persons. The typical information in these publications includes tomato prices on a daily basis; supply and market trends on a daily and weekly basis, and summaries of the supply and marketing conditions in past seasons. Detailed information on Florida's production indicates the acreage planted in tomatoes and the time at which such plantings were made; the acres already harvested, those still in production and the number of

times picked; and the effects of weather on quality and size of the tomatoes.

Additional data compiled weekly by the committee show shipments by district from Florida by grade, size, and maturity. Information regarding Mexican tomatoes is restricted to data on the size and maturity of tomato shipments crossing the border into the United States at Nogales. These represent about 90 percent of the border crossings and are furnished the committee by the Mexican National Union of Horticultural Producers. The Florida shipment and Mexican export data are regularly exchanged between the two producer groups.

Proposed regulations are developed during committee meetings open to all interested persons. The record shows that representatives of importers of Mexican tomatoes attended virtually all committee meetings in the last two marketing seasons and were accorded the opportunity to participate therein. A representative of the Secretary also attends. In addition to having the above mentioned material available at such meetings, the committee receives the observations of its fieldman and individual growers and handlers to further aid in evaluating the supply. To the extent possible the committee also obtains such observations from growers, importers, and handlers of Mexican tomatoes on the current and prospective status of the Mexican tomato crop.

Utilizing the above information, the committee then develops a proposed regulation designed to withhold a sufficient supply from market to correct the prospective supply-demand imbalance. This recommended regulation together with supporting information explaining the economic justification is then submitted to the Secretary for action thereon. The committee noted that the Secretary apparently considered this a practical method of operating, and did not object to the noticed proposal.

Several witnesses of the West Mexico Vegetable Distributors Association endorsed the concept in the proposal of factual analysis of current and prospective supply-price relationships for tomatoes and regulations needed to correct any imbalance. However, these witnesses in commenting on the proposal, emphasized considering the probable producer price resulting from the regulation and its relationship to parity and also the effect of such regulations on the various segments of the industry such as repackers, wholesalers, and retailers in the various areas of the country as well as its effect on importers of tomatoes and on consumers. Section 602 of the Act requires the Secretary to take into account the relationship of producer prices with parity. As to the other matters, they are inherent in the factors and considerations discussed elsewhere herein relating to developing, recommending, and issuing a regulation.

A witness for the importers contended that the Florida Tomato Committee had acted in the past to develop regulations which would discriminate against tomato imports from Mexico, and that

inadequate or erroneous information occasionally had been provided the Secretary in support of its recommendations. Therefore, it was proposed that an opportunity for a hearing be provided so they could confront and contest the data and views presented to the Secretary by the committee and others.

It was further proposed that there be provision for maintaining a public file with the Hearing Clerk in Washington, which would contain all the data and information submitted by the committee to the Secretary relating to the proposed regulation as well as submissions of any other interested persons. This material would also be subject to cross-examination during the proposed hearings.

The witness recommended that all segments of society throughout the country who were interested in or affected by the tomato regulation be afforded the opportunity to participate in such a hearing. Such segments of society were identified as tomato growers, packinghouse operators, repackers, brokers, importers, commission merchants, wholesalers, chain store operators, consumers and any others interested in the regulation. However, the witness recognized that such a hearing must be held and completed within a relatively short time in order for the proposed regulation to accomplish its intended purpose. In this regard, it was suggested that the Secretary omit publishing a notice of the hearing in the FEDERAL REGISTER but instead notify all such interested segments of society of the hearing by telephone or telegram.

He proposed that it was necessary or desirable for the Secretary to set the hearing within a matter of 3 or 4 days after the committee submitted its recommendation for regulation to the Secretary, and indicated that this would allow sufficient time for interested persons throughout the country to prepare for their presentation at the hearing and to travel from all parts of the country. The importer witness further recommended that the Secretary should arbitrarily restrict or cut short cross-examination of any witness in the event it appeared that the hearing would run more than 1 or 2 days. It was further recommended that if there was extreme urgency for the regulation, the hearing procedure could be omitted.

The importer witness then recommended that if a tomato shipment regulation is issued, the Secretary provide a fully detailed analysis of the basis for the regulation based upon all the data, views, and arguments submitted to him whether presented written or at the hearing. In his opinion, this analysis could be done in 1 or 2 days after the hearing.

The requirements of the Administrative Procedure Act encompass virtually all of the procedures recommended by the witness for the importers. After the committee's recommendation for regulation has been submitted to the Secretary, the procedure under which a regulation is issued is governed by section

553 of the Administrative Procedure Act (5 U.S.C. 553) which provides:

(b) General notice of proposed rule making shall be published in the FEDERAL REGISTER, unless persons subject thereto are named and either personally served or otherwise have actual notice thereof in accordance with law. The notice shall include:

- (1) a statement of the time, place, and nature of public rule making proceedings;
- (2) reference to the legal authority under which the rule is proposed; and
- (3) either the terms or substance of the proposed rule or a description of the subjects and issues involved.

Except when notice or hearing is required by statute, this subsection does not apply—

- (A) * * *
- (B) when the agency for good cause finds (and incorporates the finding and a brief statement of reasons therefore in the rules issued) that notice and public procedure thereon are impracticable, unnecessary, or contrary to the public interest.
- (c) After notice required by this section, the agency shall give interested persons an opportunity to participate in the rule making through submission of written data, views, or arguments with or without opportunity for oral presentation. After consideration of the relevant matter presented, the agency shall incorporate in the rules adopted a concise general statement of their basis and purpose.
 - (d) The required publication or service of a substantive rule shall be made not less than 30 days before its effective date, except:
 - (1) a substantive rule which grants or recognizes an exemption or relieves a restriction;
 - (2) interpretative rules and statements of policy; or
 - (3) as otherwise provided by the agency for good cause found and published with the rule.
 - (e) Each agency shall give an interested person the right to petition for the issuance, amendment, or repeal of a rule.

The Secretary in applying these procedures to marketing order regulations issues a notice of the proposed regulation and provides an opportunity for the public to submit written data, views, and arguments on the proposed regulation. As to those who would be directly regulated by the proposed regulation such as Florida growers, shippers and importers of Mexican tomatoes, such persons, as noted heretofore, have access to essentially the same information utilized by the Florida Tomato Committee in developing and recommending a regulation to the Secretary. Further, all persons who will be affected by the regulation are in a position to evaluate the effect of the proposed regulation on them by virtue of the terms of the regulation itself. Thus, all interested persons can furnish to the Secretary for his analysis any information or argument supporting their position as to the need for and type of regulation to be made effective. This of course is what is contemplated by the Administrative Procedure Act i.e., that the Secretary be provided and take into account the data, views, and arguments submitted by all interested persons in arriving at his determination.

In issuing a regulation the Secretary is required to provide a statement in support of the basis and purpose of the regulation. Here again, this comports

with the recommendation that the Secretary provide a detailed analysis of the data supporting the regulation.

The Administrative Procedure Act has taken into account the fact that there may be instances where it is "impracticable, unnecessary or contrary to the public interest" to go through the notice and public rule making procedure. Under conditions where the issuance or modification of a regulation required prompt and expedited action thereon, the Secretary has issued such regulations without the notice and rulemaking procedure.

The Administrative Procedure Act requires that the Secretary give any interested person the right to petition for the "issuance, amendment, or repeal" of the regulation. Thus, in the event an interested person disagrees with the regulation issued by the Secretary or the reasons supporting the regulation, whether issued after rule making or under the expedited procedure, he has the further opportunity to request that such regulations be reviewed by the Secretary.

Further, the Administrative Procedure Act provides all interested persons the opportunity to participate in rule making "through the submission of written data, views, or arguments with or without opportunity for oral presentation." Accordingly, in the event there are circumstances in which a hearing is appropriate, the Administrative Procedure Act provides that option to the Secretary. However, it should be noted that if novel or crucial issues again develop which would warrant a hearing they would be more appropriately handled through the hearing procedure provided by section 608c of the act for consideration of an amendment of the marketing order itself.

The record shows that the factors and considerations in the noticed proposal are virtually the same as those already being used by the committee in developing regulations. Further, such factors and considerations are essentially encompassed by §§ 966.50 and 966.51 relating to establishing a marketing policy and recommending regulations which provide as follows:

§ 966.50 *Marketing policy.* Prior to or at the same time as initial recommendations are made pursuant to § 966.51, the committee shall submit to the Secretary a report setting forth the marketing policy it deems desirable for the industry to follow in shipping tomatoes from the production area during the ensuing season. Additional reports shall be submitted from time to time if it is deemed advisable by the committee to adopt a new or modified marketing policy because of changes in the demand and supply situation with respect to tomatoes. The committee shall publicly announce the submission of each such marketing policy report and copies thereof shall be available at the committee's office for inspection by any producer or any handler. In determining each such marketing policy the committee shall give due consideration to the following:

- (a) Market prices of tomatoes, including prices by grades, sizes, and quality in different packs, and such prices by foreign competing areas;
- (b) Supply of tomatoes, by grade, size and quality in the production area, and in other production areas, including foreign competing production areas;

- (c) Trend and level of consumer income;
- (d) Marketing conditions affecting tomato prices; and
- (e) Other relevant factors.

§ 966.51 *Recommendations for regulations.* The committee, upon complying with the requirements of § 966.50, may recommend regulations to the Secretary whenever it finds that such regulations, as are provided for in this subpart, will tend to effectuate the declared policies of the act.

It is contemplated that the committee and the Secretary will continue to utilize such factors and considerations in developing, recommending, and issuing regulations. Accordingly, it is unnecessary to amend the marketing order as proposed in the notice of hearing.

Rulings on proposed findings and conclusions. The Hearing Examiner fixed December 23, 1971, as the time within which interested parties were to file briefs with respect to the matters involved in the hearing. Briefs were filed by the following: Counsel for the West Mexican Vegetable Distributors Association of Nogales, Ariz.; counsel for the Florida Tomato industry; and counsel on behalf of various consumer organizations.

In their brief, counsel for the West Mexican Distributors Association objected to the Hearing Examiner's ruling excluding from evidence certain testimony and exhibits offered by them at the hearing.

The direct testimony of Dr. Schnittker was offered in the form of a written statement and marked exhibit 101 for identification and offered in evidence. Portions of such testimony-exhibit were not received in evidence by the Examiner. A review of the record reveals that Dr. Schnittker was the last witness of the hearing and that one of the basic reasons for excluding such material was that the testimony-exhibit characterized, analyzed, and offered conclusions on the testimony and evidence which, in most part, made up the hearing record up to the time of his appearance as a witness and was in the form of a brief which appropriately should be filed after the close of the hearing. In addition to his general ruling that the testimony-exhibit was a brief rather than testimony, the Hearing Examiner further ruled on the excluded portions of the testimony-exhibit paragraph by paragraph and indicated additional bases for excluding specific portions of the material. Based on a review of the record and the bases of the rulings of the Hearing Examiner on the excluded portions of the testimony-exhibit, such rulings are sustained.

Certain affidavits submitted by the importer organization were not received by the Hearing Examiner. These were marked exhibits 111, 112, 113, 114, 115, and 116 for identification. These affidavits were excluded on the basis that there was no opportunity for cross-examination of the affiants on the matters contained therein.

Objection was made to the Hearing Examiner's ruling excluding affidavits marked for identification as exhibits 107, 108, 109, and 110 on the grounds that these affidavits had been submitted and

received in the *Holm v. Hardin* court proceeding and, therefore, should also be received in this proceeding. The Hearing Examiner ruled out these affidavits because there was no opportunity for cross-examination by interested persons in this proceeding. Further, with regard to the affidavit of Richard M. Fairbanks, exhibit 107, it did not contain facts of his independent knowledge but was merely his analysis of various documents, records and depositions involved in the court proceeding. As to his rulings on the affidavits, the Examiner also noted that the rules of practice had been amended specifically to eliminate the authority to receive affidavits in these proceedings. Objection was also made of the failure of the Hearing Examiner to receive in evidence documents marked for identification as exhibits 81 and 82. These were the depositions of Floyd F. Hedlund and Harold Willis, which were again part of the record of the *Holm v. Hardin* case. These depositions were also excluded on the ground that the deponents were not available for cross-examination by interested parties at this proceeding. Based on a review of the record and the rulings of the Hearing Examiner on each of the matters involved, such rulings are sustained.

Counsel for the West Mexican Vegetable Distributors Association made the further contention that the Hearing Examiner was predisposed in favor of the Florida growers. A review of the record however reveals that the Hearing Examiner conducted the hearing in a fair and impartial manner and that each of the persons appearing at the hearing had a full and complete opportunity to participate therein in accordance with the applicable rules of practice governing such proceedings.

Every point in the briefs was carefully considered along with record evidence in making the findings and reaching the conclusions herein set forth. To the extent that the findings and conclusions proposed in the briefs are inconsistent with findings and conclusions contained herein, requests to make such findings or to reach such conclusions are denied on the basis of facts found and stated in connection with this decision.

Summary findings and conclusions. Upon the basis of the evidence introduced at such hearing, the record thereof, and for the reasons stated, it is found and concluded that: The authority presently contained in section 966.52 of the Florida tomato marketing order which authorizes the regulation of shipments differently by maturities should be retained. Further, the procedures now provided for in the order as to Committee recommendations for regulations are proper and adequate; no significant purpose would be served by amending the order to further delineate these criteria. Accordingly, it is concluded that no amendatory action is necessary as a result of this proceeding, and this proceeding should be terminated.

Copies of this notice of recommended decision may be obtained from the Hearing Clerk, U.S. Department of Agriculture, Room 112, Administration Build-

ing, Washington, D.C. 20250, or may be there inspected.

Dated: March 31, 1972.

JOHN C. BLUM,
Deputy Administrator,
Regulatory Programs.

[FR Doc.72-5220 Filed 4-4-72;8:51 am]

Rural Electrification Administration

[7 CFR Part 1701]

ELECTRIC BORROWERS

Manual for Preservation of Records

Notice is hereby given that, pursuant to the Rural Electrification Act, as amended (7 U.S.C. 901 et seq.), REA proposes to issue revised REA Bulletin 180-2, Manual for Preservation of Borrowers' Records (Electric).

Persons interested in the provisions of revised REA Bulletin 180-2 may submit written data, views, or comments to the Director, Borrowers' Financial Management Division, Room 4307, South Building, Rural Electrification Administration, U.S. Department of Agriculture, Washington, D.C. 20250, not later than 30 days from the publication of this notice in the FEDERAL REGISTER. All written submissions made pursuant to this notice will be made available for public inspection at the Office of the Director, Borrowers' Financial Management Division, during regular business hours.

A copy of the proposed REA Bulletin 180-2 may be secured in person or by written request from the Director, Borrowers' Financial Management Division.

A summary of the changes in REA requirements included in the proposed bulletin is as follows:

REA BULLETIN 180-2

REA Bulletin 180-2, Manual for Preservation of Borrowers' Records (Electric) was issued in March 1957. Since that time, significant changes have been made by the electric utility industry in the length of accepted retention periods and in methods of keeping records for future use which need to be recognized.

The primary changes incorporated in the proposed revision of REA Bulletin 180-2 are as follows:

1. REA has adopted generally as its Manual for Preservation of Borrowers' Records (Electric) the Federal Power Commission's 1972 Regulations to Govern the Preservation of Records of Public Utilities and Licensees. That manual is supplemented by REA requirements for the retention of "Financial Requirement and Expenditure" reports as well as consumer accounts where patronage capital has not been allocated.

2. In accordance with the provisions of the new FPC Manual various media forms of the "originals" of records to be retained are made acceptable including paper and card stock, tape, microforms, microfilm and metallic recording data strips.

3. In accordance with the provisions of the new FPC Manual, retention periods for certain types of records are revised. Provision is also made for the retention of new types of records such as nuclear production records.

Dated: March 31, 1972.

JAMES N. MYERS,
Assistant Administrator-
Electric.

[FR Doc.72-5248 Filed 4-4-72;9:53 am]

[7 CFR Part 1701]

TELEPHONE BORROWERS

Policies and Requirements for
Headquarters Facilities

Notice is hereby given that, pursuant to the Rural Electrification Act, as amended (7 U.S.C. 901 et seq.), REA proposes to issue a revision of REA Bulletin 320-5, "Headquarters Facilities for Telephone Borrowers." On issuance of the revised REA Bulletin, Appendix A of Part 1701 will be amended accordingly.

Persons interested in this revision of the policies and requirements prescribed by REA for such headquarters facilities may submit written data, views, or comments to the Director, Telephone Operations and Standards Division, Room 1355, South Building, Rural Electrification Administration, U.S. Department of Agriculture, Washington, D.C. 20250, not later than 30 days from the publication of this notice in the FEDERAL REGISTER. All written submissions made pursuant to this notice will be made available for public inspection at the Office of the Director, Telephone Operations and Standards Division during regular office hours.

The text of the proposed revision of REA Bulletin 320-5 is as follows. A copy of proposed REA Bulletin 320-5 and Appendix A to the bulletin will be furnished on request to the Director, Telephone Operations and Standards Division.

REA BULLETIN 320-5

HEADQUARTERS FACILITIES FOR TELEPHONE
BORROWERS

I. Purpose. To set forth REA policy and procedure concerning loans for and construction of headquarters facilities for telephone borrowers, including the provisions of Public Laws 90-480 and 91-596 as they relate to buildings financed with Federal Funds.

II. General. A. The term "headquarters facilities," or a headquarters building project means a commercial office building, warehouse, garage, or a combination of these facilities which are required to make the project suitable for providing communication services to the public.

B. The borrower and its architect are responsible for determining the size and style of building, and for selecting the materials to be used in its construction consistent with the needs of the system and the environment of the community in which it is to be located.

C. The borrower is responsible for determining whether to purchase, remodel, or construct the facilities consistent with REA requirements and prudent management principles. REA assistance may be requested in these matters.

III. Policy. A. Generally, loans to finance headquarters facilities may be made on the same terms and conditions as loans for other telephone plant.

B. Headquarters facilities should be planned to meet economically the future requirements of the proposed system. The site should be large enough for possible future expansion. Discretion should be exercised to assure that unnecessary features and unduly high investment are avoided. Plans and specifications for the building should be

such that the facilities can be constructed within the amount provided in the loan budget. Borrowers may be required to provide any excess in construction costs from non-loan funds.

IV. Preloan requirements for headquarters buildings. The following supporting data shall be submitted as part of the area coverage design of the system or with the loan application which includes funds for headquarters facilities:

A. An estimate of the cost of the project, including equipment, other than switching equipment, all site development and other essential or desirable work on the property. If purchasing existing facilities, report the purchase price of the property showing the land value as a separate item, remodeling costs, and architectural services. Appendix B provides a suggested work sheet for estimating the cost of headquarters facilities.

B. Preliminary plans including a plot plan, locating building(s) thereon, and a floor plan. If remodeling is proposed, show existing and new floor plan, or a combined plan fully illustrating the work proposed.

C. A statement as follows: "The facilities described in this application will be designed and constructed to comply with the minimum standards contained in the American National Standards No. A117.1-1961, to insure that the facilities will be made accessible to and usable by the physically handicapped as required by Public Law 90-480. The following portions of the project need not be made accessible to, or usable by the public or the physically handicapped because of their intended use (insert 'none' or describe fully with the other supporting data)."

V. Borrowers' considerations. Before submission of the plans and specifications, the borrower should obtain necessary forms, bulletins, etc., from REA, and:

A. Obtain the services of a competent architect as set forth in REA Bulletin 342-1, "Architectural Services for Telephone Borrowers." Use REA Form 165, "Architectural Services Contract."

B. Refer to REA Bulletin 344-1, "Methods of Purchasing Materials and Equipment for use on Systems of Telephone Borrowers" for the applicable type of procedure.

C. Refer to REA Bulletin 387-1, "Preparation of Plans and Specifications for Construction of Telephone Borrowers' Buildings."

D. Use REA Form 257, "Contract to Construct Buildings."

VI. REA construction requirements and procedures. A. Following approval of the loan for headquarters facilities (or the determination of the availability of nonloan funds for such purpose), the borrower should inform the architect of the amount of funds available for construction of the facilities and any other information needed by the architect.

B. The design and construction of the headquarters facilities must comply with all applicable laws and regulations, including:

1. Public Law 90-480; an Act to insure that certain buildings financed with Federal funds are so designed and constructed as to be accessible to the physically handicapped. See Appendix "A", and paragraph V, "C" of this bulletin.

2. Public Law 91-596, the "Occupational Safety and Health Act of 1970." The Department of Labor has the responsibility for issuing rules and regulations pertaining to the Act, including occupational safety and health standards which are either national consensus standards or established Federal standards. These are published in the FEDERAL REGISTER, when issued, and codified in the Code of Federal Regulations under title 29.

C. Submit three copies of the final plans and specifications to REA for approval. A

cost estimate prepared by the architect should accompany the plans.

D. After approval of plans and specifications and bids, submit three copies of the construction contract to REA for approval.

E. The approval of title to real estate is a prerequisite to REA's advance of loan funds and approval of the construction contract. See REA Bulletin 380-1, "Right-of-Way and Title Procedures, Telephone."

F. Consult REA Bulletin 387-3, "Final Documents Required to Close Out Construction of Buildings."

Dated: March 30, 1972.

DAVID A. HAMIL,
Administrator.

[FR Doc.72-5247 Filed 4-4-72;8:53 am]

DEPARTMENT OF HEALTH,
EDUCATION, AND WELFARE

Food and Drug Administration

[21 CFR Part 191]

FIREWORKS DEVICES

Classification As Banned Hazardous
Substance

A. The National Society for the Prevention of Blindness, 79 Madison Avenue, New York, NY 10016, filed an objection and requested a hearing in response to the order published in the FEDERAL REGISTER of May 13, 1970 (35 F.R. 7415), that classified certain fireworks devices as "banned hazardous substances" (21 CFR 191.9(a)(3)) within the meaning of section 2(q)(1)(B) of the Federal Hazardous Substances Act. The objector was not opposed to the order as written, but rather requested that its scope be expanded.

On June 26, 1970, notice was published in the FEDERAL REGISTER (35 F.R. 10451) denying the objector's request for a hearing on the grounds that granting a hearing was not in the public interest because it would stay the effective date of the order, thus hindering the efficient enforcement of the act during the Fourth-of-July season. The notice stated that the objection would be treated as a petition to amend the regulations.

Therefore, pursuant to provisions of the Federal Hazardous Substances Act (sec. 2(q)(1)(B)), (2), 74 Stat. 374, as amended 80 Stat. 1304-05; 15 U.S.C. 1261) and the Federal Food, Drug, and Cosmetic Act (sec. 701(e), 52 Stat. 1055, as amended; 21 U.S.C. 371(e)), and under authority delegated to the Commissioner of Food and Drugs (21 CFR 2.120), notice is given that a petition has been filed by the National Society for the Prevention of Blindness proposing the amendment of 21 CFR 191.9(a)(3) to ban "all fireworks in keeping with the National Fire Protection Association model fireworks law" (except those intended for use solely for bona fide crop protection purposes as provided in 21 CFR 191.9(a)(3)(i) through (iv)) and, further, to expand the recordkeeping requirement of 21 CFR 191.9(a)(3)(iv) from 3 to 10 years.

Grounds given in support of the petition are:

1. The scope of 21 CFR 191.9(a) (3) "is not broad enough to protect public interest and children in particular";

2. The "labeling of cartons, shipping containers, wrappers and the items per se of all fireworks are inadequate to protect purchasers, users and innocent bystanders, all foreseeable victims";

3. The 3-year requirement "is an inadequate time for record preservation and a minimum of 10 years is necessary in that (1) eye injuries may not manifest themselves before that time (2) ingredients may need to be ascertained for treatment and diagnosis and a premature destruction of records may preclude this (3) identification for civil and criminal litigation will be made difficult if not impossible."

In support of these contentions, petitioner relies on statistical data contained in "Fireworks Incidents in the United States during 1969", published by the National Fire Protection Association, Boston, Mass., and the "1969 Annual Report National Society for the Prevention of Blindness, Inc."

B. The Commissioner has insufficient information to support the proposal of the National Society for the Prevention of Blindness. Publication of the proposal provides an opportunity for interested persons to submit appropriate data. In the interim, the Commissioner has obtained information from investigations and other sources which indicate that the exemption in 21 CFR 191.9(a) (3) permitting certain fireworks devices to be used for bona fide crop protection purposes is being grossly abused by some manufacturers and distributors to make fireworks available to the public for general use and that such fireworks have caused most of the firework deaths and serious injuries investigated by the Food and Drug Administration. Accordingly, the Commissioner finds that the degree or nature of the hazard involved in the presence or use of such devices in households is such that the objective of the protection of the public health and safety can be adequately served only by keeping them out of channels of interstate commerce.

Therefore, pursuant to the aforementioned statutory provisions and delegated authority, the Commissioner proposes that § 191.9(a) (3) be revised to read as follows:

§ 191.9 Banned hazardous substances.

(a) * * *

(3) Fireworks devices intended to produce audible effects (including but not limited to cherry bombs, M-80 salutes, silver salutes, and other large firecrackers, aerial bombs, and other fireworks designed to produce audible effects, and including kits and components intended to produce such fireworks) if the audible effect is produced by a charge of more than 2 grains of pyrotechnic composition.

Interested persons may, within 60 days after publication hereof in the FEDERAL REGISTER, file with the Hearing Clerk,

Department of Health, Education, and Welfare, Room 6-88, 5600 Fishers Lane, Rockville, Md. 20852, written comments (preferably in quintuplicate) regarding these proposals. Comments may be accompanied by a memorandum or brief in support thereof. Received comments may be seen in the above office during working hours, Monday through Friday.

Dated: March 24, 1972.

SAM D. FINE,
Associate Commissioner
for Compliance.

[FR Doc. 72-5272 Filed 4-4-72; 8:54 am]

DEPARTMENT OF
TRANSPORTATION

Coast Guard

[33 CFR Part 171]

[CGD 72-55 PH]

DEFECT NOTIFICATION

Notice of Proposed Rule Making

The Coast Guard is considering issuing new regulations which apply to the manufacturers of boats and associated equipment and supplement section 15 of the Federal Boat Safety Act of 1971 (85 Stat. 219), Notification of Defects; Repair or Replacement. Interested persons are invited to submit written statements regarding the proposal to the U.S. Coast Guard (CMC/82), 400 Seventh Street, SW., Washington, DC 20590. Statements should identify the public docket number, CGD 72-55 PH, and the name and address of the person. Where appropriate, comments should be directed to specific sections of the proposal. Statements should include data, views, or arguments supporting any recommended change or objection to the proposal.

The Coast Guard will hold an informal public hearing on May 3, 1972, at 9:30 a.m. in Conference Room 2230, Department of Transportation, Nassif Building, 400 Seventh Street, SW., Washington, DC 20590. Any person desiring to make an oral presentation at this hearing should notify the Executive Secretary, Marine Safety Council, Room 8234, U.S. Coast Guard (CMC), 400 Seventh Street, SW., Washington, DC 20590. (Phone—202-426-1477.)

The presiding officer at the hearing may apportion the time of persons making presentations in an equitable manner, question participants as to their statements and terminate or shorten the presentation of any party when, in the opinion of the presiding officer, such presentation is repetitive or is not relevant to the purpose of the hearing. Participants are encouraged to submit written statements.

All communications received on or before May 11, 1972, will be fully considered and evaluated before final action is taken on this proposal. Copies of written statements submitted by the public in response to this proposal and a tape

recording of the public hearing will be available for examination in Room 8234, Department of Transportation, Nassif Building, 400 Seventh Street, SW., Washington, DC. Copies of written statements will be furnished interested persons upon request to U.S. Coast Guard (CMC/82), Washington, D.C. 20590 in accordance with the payment provisions of 49 CFR 7.81.

This proposal may be changed in light of comments received.

Section 15 of the Act applies to manufacturers of boats and manufacturers of such associated equipment as is prescribed by regulation or order. Section 15(f) states that application of the section to items or classes of "associated equipment" must be made on determination that the application is reasonable, appropriate, and in furtherance of the purposes of the Act. The Coast Guard considers that the following items should be prescribed as "associated equipment."

- (a) Outboard engines.
- (b) Inboard engines.
- (c) Stern drive units.

Outboard engines are sold, for the most part, as distinct major units separately from any particular boat model or type. They are mechanically complex and provide the primary motive power and steering for a boat on which they are installed. Inboard engines are also produced, for the most part, independently from any particular boat model or type. While most inboard-powered boats are delivered with the engine installed, there are often several options and there are a significant number of engines marketed for replacement units. These engines provide the motive power of the boat.

Stern drive units are marketed much the same as inboard engines and provide power transmission and steering control. Each of these items is mechanically complex and a defect in design or manufacture can cause loss of power or control and endanger the occupants of the boat and others. Therefore, proposed § 171.03 (d) would define associated equipment as outboard engines, inboard engines, and stern drive units. Additional items of associated equipment will be the subject of future rule making.

Proposed §§ 171.05 and 171.11 prescribe time periods for meeting notification requirements of section 15 of the Act.

Proposed §§ 171.13 and 171.15 would require reports to the Commandant to assist the Coast Guard in evaluating (1) the severity of the defect, (2) the effectiveness of the manufacturer in notifying first purchasers, subsequent purchasers, dealers, and distributors to which the defective product may have been transferred or sold, and (3) the measures taken by the manufacturer to correct the defect. The initial report to the Coast Guard required by § 171.13 would be made at the same time the notification is given to first and subsequent purchasers, dealers, and distributors. Since some of this detailed information might not be available, paragraph (b) would allow the manufacturer to delay submission of the information required in the report if he

explains why it is not submitted and estimates when it will be available.

Notifications made according to section 15(c) must contain " * * * a clear description of such defect or failure to comply, an evaluation of the hazard related thereto, a statement of the measures to be taken to correct such defect or failure to comply, and an undertaking by the manufacturer to take such measures at his sole cost and expense." To assure that there is a "clear description" of the defect, proposed § 171.09 would require that the notification contain the make and model year (if appropriate), the inclusive dates of manufacture (month and year), and any other data necessary to describe the products that may be affected by the defect.

The Boating Safety Advisory Council, established pursuant to section 33 of the Act, was consulted regarding this major boating safety matter. The advice and comments of the Council have been considered in drafting these proposed regulations.

In consideration of the foregoing, it is proposed that a new Part 171 be added to Title 33 of the Code of Federal Regulations to read as follows:

PART 171—DEFECT NOTIFICATION

Sec.	
171.01	Purpose.
171.03	Definitions.
171.05	Manufacturer discovered defects.
171.07	Notice given by "more expeditious means."
171.09	Contents of notification.
171.11	Defects determined by the Commandant.
171.13	Initial report to the Commandant.
171.15	Followup report.
171.17	Penalties.
171.19	Address of Commandant.

AUTHORITY: The provisions of this Part 171 issued under sections 14 and 15 of the Federal Boat Safety Act of 1971 (Public Law 92-75, 85 Stat. 213, 218, 229 (Aug. 10, 1971)); 49 CFR 1.46(0) (1).

§ 171.01 Purpose.

This part prescribes rules to implement section 15 of the Federal Boat Safety Act of 1971 governing the notification of defects in boats and associated equipment.

§ 171.03 Definitions.

(a) "Act" means the Federal Boat Safety Act of 1971.

(b) "Manufacturer" means any person engaged in—

(1) The manufacture, construction, or assembly of boats or associated equipment; or

(2) The manufacture or construction of components for boats and associated equipment to be sold for subsequent assembly; or

(3) The importation into the United States for sale of boats, associated equipment, or components thereof.

(c) "Boat" means any vessel—

(1) Manufactured or used primarily for noncommercial use; or

(2) Leased, rented, or chartered to another for the latter's noncommercial use; or

(3) Engaged in the carrying of six or fewer passengers.

(d) "Associated equipment" means an—

- (1) Inboard engine,
- (2) Outboard engine, or
- (3) Stern drive unit

as shipped, transferred, or sold from the place of manufacture and includes all attached parts and accessories.

§ 171.05 Manufacturer discovered defects.

Each manufacturer who is required to furnish a notice of a defect or failure to comply with a standard prescribed pursuant to section 5 of the Act by section 15(a) of the Act shall furnish that notice within 30 days after he discovers or acquires information of the defect or failure to comply.

§ 171.07 Notice given by "more expeditious means."

Each manufacturer who gives the notice required by section 15 of the Act by more expeditious means than certified mail must give such notice in writing.

§ 171.09 Contents of notification.

Each notice required by section 15(a) of the Act must include the following additional information:

(a) The name and address of the manufacturer.

(b) Identifying classifications including the make, model year, if appropriate, the inclusive dates (month and year) of the manufacture, and any other data necessary to describe the boats or associated equipment that may be affected.

§ 171.11 Defects determined by the Commandant.

A manufacturer who is informed by the Commandant under section 15(e) of the Act that a boat or associated equipment contains a defect relating to safety or failure to comply with a standard prescribed pursuant to section 5 of the Act shall, within 30 days of receipt of the information—

(a) Furnish the notification described in section 15(c) of the Act to the persons designated in section 15(b) of the Act, or

(b) Present his views to the Commandant by certified mail to establish that there is no defect relating to safety or failure of compliance.

§ 171.13 Initial report to the Commandant.

(a) When a manufacturer gives a notification required by section 15 of the Act, he shall concurrently send to the Commandant by certified mail—

(1) A true or representative copy of each notice, bulletin, and other communication that he has given to the persons required to be notified under section 15(b) of the Act;

(2) The total number of boats or associated equipment potentially affected by the defect or failure to comply with a standard prescribed pursuant to section 5 of the Act; and

(3) If discovered or determined by the manufacturer, a chronology of all principal events upon which the determination is based.

(b) A manufacturer may submit an item required by paragraph (a) of this section that is not available at the time of submission to the Commandant when it becomes available if the manufacturer explains why it was not submitted within the time required and estimates when it will become available.

§ 171.15 Followup report.

(a) Each manufacturer who makes an initial report required by § 171.13 shall submit a followup report to the Commandant by certified mail within 60 days after the initial report. The followup report must contain at least the following information:

(1) A positive identification of the initial report;

(2) The number of units in which the defect was discovered as of the date of the followup report;

(3) The number of units in which corrective action has been completed as of the date of the followup report;

(4) The number of first purchasers not notified because of an out-of-date name or address, or both; and

(5) An updating of the information required by § 171.13.

(b) Each manufacturer shall submit any additional followup reports requested by the Commandant.

§ 171.17 Penalties.

(a) Each manufacturer who fails to furnish a notification as required by section 15(a) of the Act or fails to exercise reasonable diligence in fulfilling the undertaking given pursuant to section 15(c) of the Act is subject to the penalties prescribed by section 35(a) of the Act.

(b) Each manufacturer who fails to comply with any other provision of section 15 of the Act or the regulations in this part is subject to the penalties prescribed by section 35(b) of the Act.

§ 171.19 Address of Commandant.

Each report and communication sent to the Coast Guard required by this part must be submitted to:

U.S. Coast Guard (BBC/62), 400 Seventh Street SW., Washington, DC 20590.

This proposal is made under the authority of the Federal Boat Safety Act of 1971 (Public Law 92-75, 85 Stat. 213 (Aug. 10, 1971)); 49 CFR 1.46(0) (1) (36 F.R. 19593).

Dated: March 30, 1972.

A. C. WAGNER,
Rear Admiral, U.S. Coast Guard,
Chief, Office of Boating Safety.

[FR Doc.72-5103 Filed 4-4-72;8:45 am]

**Hazardous Materials Regulations
Board**

[49 CFR Parts 173, 179]

[Docket No. HM-100; Notice 72-4]

**TRANSPORTATION OF HAZARDOUS
MATERIALS**

**Ethylene Oxide; Opening in Tank Car
Heads**

The Hazardous Materials Regulations Board is considering amendment of §§ 173.124, 179.102, 179.201, and 179.202 of the Department's Hazardous Materials Regulations to authorize the shipment of ethylene oxide in insulated portable tanks and to upgrade the specifications of tank cars authorized for ethylene oxide. In addition, the Board proposes to remove authorization for the use of certain other tank cars in this service.

The Board has received petitions to make these changes to the regulations. Support for the petition to permit ethylene oxide to be transported in specially modified Specification 51 portable tanks is based on favorable experience data reported to the Board on shipments moving since 1964 under special permit.

The proposed changes for tank cars are based on recommendations by the Manufacturing Chemists Association, Inc. Its petition indicates that the present ethylene oxide tank car specifications warrant revisions for improved safety performance, that some currently authorized tanks cars for this service are obsolete, and that others are inadequate for safe rail transportation.

The Board believes that the adoption of this proposal would provide greater safety in the transportation of ethylene oxide. Also, the Board requests advice on the need for continuing the authorization for "Openings in tank heads to facilitate application of lining" which is found in § 173.124(a)(5) and numerous other sections such as §§ 173.119(a)(12), (e)(2), and (f)(3), 173.314(c) Note 16, 173.354(a)(4), 179.102-12, 179.102-17, 179.102-20, 179.102-6(a)(3), 179.202-1, and 179.202-18. The Board believes that this is an obsolete requirement and is no longer needed.

The Board is developing improved identification requirements for tank cars containing certain hazardous materials such as ethylene oxide. As part of this development, the Board will propose changes to the present marking requirements for tank cars in a separate notice. Any changes resulting from that notice of proposed rule making would be reflected in those sections dealing with marking of ethylene oxide tank cars.

In consideration of the foregoing, it is proposed to amend 49 CFR Parts 173 and 179 as follows:

PART 173—SHIPPERS

In § 173.124 paragraph (a), paragraph (a)(5) would be amended, Note 1 would be canceled, and paragraph (a)(6) would

be added; paragraph (b) would be canceled as follows:

§ 173.124 Ethylene oxide.

(a) * * *

(5) Specification 105A100W or 111A-100W4 (§§ 179.100, 179.200 of this chapter) tank car. Each 105A***W series tank car must be equipped with a 75 p.s.i.g. safety valve and must be stenciled 105A100W. Each tank car must be stenciled, in letters not less than 1½ inches high, "Ethylene Oxide Only" near the car specification number. Outage of each tank must be sufficient to prevent the tank from becoming entirely filled with liquid at 105° F. Each tank, loaded or empty, must be padded with dry nitrogen or other suitable dry inert gas charged to a pressure of 35 to 60 p.s.i.g. at 70° F. The gas must be free of impurities which may cause the ethylene oxide to rearrange chemically or polymerize violently. See §§ 179.102-12 and 179.202-18 of this chapter for special requirements for tank cars authorized for ethylene oxide.

NOTE 1 [Canceled]

(6) Specification 51 (§ 178.245 of this chapter) portable tank. Each tank, loaded or empty, must be padded with dry nitrogen or other suitable dry inert gas charged to a pressure of 35 to 60 p.s.i.g. at 70° F. The gas must be free of impurities which may cause the ethylene oxide to rearrange chemically or polymerize violently. Each tank must be constructed to be in compliance with the following requirements:

(i) The tank must be insulated with mineral wool or glass fiber of sufficient thickness so that the thermal conductance at 60° F. is not more than 0.075 B.t.u. per hour, per square foot, per degree Fahrenheit temperature differential.

(ii) The insulating material of the tank must be protected by a steel jacket having a minimum thickness of 14 gage. This jacket must be applied to prevent moisture from coming in contact with the insulation.

(iii) Each tank must be equipped with a safety relief valve or frangible disc, meeting the requirements of § 173.315 of this chapter, set to relieve at 75 p.s.i.g.

(iv) Filling must be such that the tank will not be liquid full below 185° F.

(v) Copper, silver, mercury, magnesium, or their alloys may not be used in any part of the tank or appurtenances if that part or appurtenance is normally in contact with ethylene oxide liquid or vapor.

(vi) Each tank must be equipped with a thermometer well.

(vii) Gaskets made of Teflon or interwoven stainless steel and Teflon are required.

(viii) The capacity of the tank may not exceed 300 gallons.

(b) [Canceled]

**PART 179—SPECIFICATIONS FOR
TANK CARS**

(A) Section 179.102-12 would be amended to read as follows:

§ 179.102 Special commodity requirements for pressure tank cars.

§ 179.102-12 Ethylene oxide.

(a) Each tank car used to transport ethylene oxide must be constructed to be in compliance with the following special requirements:

(1) The tank must be constructed in accordance with the DOT-105A * * * W Specification, and its jacket stenciled "DOT-105A100W" and "Ethylene Oxide Only." "Ethylene Oxide Only" must appear on both sides of the tank and in letters not less than 1½ inches high.

(2) Each safety relief valve must be in compliance with the requirements specified in the DOT-105A100W tank car specification. Each safety relief valve must have its discharge piped to the top of the manway bonnet assembly. Vapor exit from the assembly must be provided through a full opening weather cap located directly above the safety valve vent pipe. Compliance with this provision is required after (effective date of amendment) except that tank cars which are not in compliance and were built before (effective date of amendment) must be in compliance by (1 year following effective date).

(3) Copper, silver, mercury, magnesium, or their alloys may not be used in any part of the tank or appurtenances if that part or appurtenance is normally in contact with ethylene oxide liquid or vapor.

(4) Interior pipes of liquid discharge valves, vapor lines, gaging devices (when the device provides a means for passage of the lading from the interior to the exterior of the tank) and sampling lines must be equipped with excess flow valves of an approved design.

(5) Each tank must be equipped with a thermometer well.

(6) Each tank must be insulated with glass fiber except tank cars built before (effective date of amendment) are authorized in this service when insulated with cork.

(7) The manway protective housing and cover must be insulated with glass fiber or other material that will provide protection against heat deterioration of the valves and any resilient material contained within the housing. Compliance with this provision is required after (effective date of amendment) except that tank cars which are not in compliance and were built before (effective date of amendment) must be in compliance by (1 year following effective date).

(8) Gaskets made of Teflon or interwoven stainless steel and Teflon are required.

(B) In § 179.201-1 paragraph (a) table, footnote 2 would be added and reference thereto would replace § 173.314 (c) as the seventh entry in the column headed 111A100W4:

PROPOSED RULE MAKING

§ 179.201 Individual specification requirements applicable to nonpressure tank car tanks.

§ 179.201-1 Individual specification requirements.

(a) * * *

* See § 173.314(c) of this chapter for compressed gases and § 173.116 of this chapter for flammable liquids, unless otherwise specified in Part 173, Subpart C.

(C) Section 179.202-18 would be amended to read as follows:

§ 179.202 Special commodity requirements for nonpressure tank car tanks.

§ 179.202-18 Ethylene oxide.

(a) Each tank car used to transport ethylene oxide must be constructed to be in compliance with the following special requirements:

(1) The tank must be constructed in accordance with the DOT-111A100W4 specification and its jacket stenciled on both sides "ETHYLENE OXIDE ONLY" in letters not less than 1½ inches high.

(2) The safety relief valve, if not located on the manway nozzle, must be protected by an approved and insulated protective housing. Each safety relief valve must have its discharge piped to the top of the manway bonnet assembly or protective housing. Vapor exit from the manway bonnet assembly or protective housing must be provided through a full opening weather cap located directly above the safety valve vent pipe. Compliance with this provision is required after (effective date of amendment) except that tank cars which are not in compliance and were built before (effective date of amendment) must be in compliance by (1 year following effective date).

(3) Copper, silver, mercury, magnesium, or their alloys may not be used in any part of the tank or appurtenances if that part or appurtenance is normally in contact with ethylene oxide liquid or vapor.

(4) Interior pipes of liquid discharge valves, vapor lines, gaging devices (when the device provides a means for passage of the lading from the interior to the exterior of the tank) and sampling lines must be equipped with excess flow valves of an approved design.

(5) Each tank must be equipped with a thermometer well.

(6) Each tank must be insulated with glass fiber except tank cars built before (effective date of amendment) are authorized in this service when insulated with cork.

(7) Manway nozzle, cover plate, and protective housing must be in compliance with the requirements of section 179.100-12. The manway protective housing and cover must be insulated with glass fiber or other material that will provide protection against heat deterioration of the valves and any resilient material contained within the housing. Compliance with this provision is mandatory after (effective date of the amendment) except that tank cars which are not in compliance and were built before (effective date

of amendment) must be in compliance by (1 year following effective date).

(8) Gaskets made of Teflon or interwoven stainless steel and Teflon are required.

(9) Vacuum relief valves are prohibited.

Interested persons are invited to give their views on this proposal. Communications should identify the docket number and be submitted in duplicate to the Secretary, Hazardous Materials Regulations Board, Department of Transportation, 400 Sixth Street SW., Washington, D.C. 20590. Communications received on or before July 18, 1972, will be considered before final action is taken on the proposal. All comments received will be available for examination by interested persons at the Office of the Secretary, Hazardous Materials Regulations Board, both before and after the closing date for comments.

This proposal is made under the authority of sections 831-835 of title 18, United States Code, and section 9 of the Department of Transportation Act (49 U.S.C. 1657).

Issued in Washington, D.C., on March 31, 1972.

W. J. BURNS,
Chairman, Hazardous Materials
Regulations Board.

[FR Doc.72-5254 Filed 4-4-72; 8:54 am]

ENVIRONMENTAL PROTECTION AGENCY

[40 CFR Part 180]

THIABENDAZOLE

Proposed Fungicide Tolerance

Dr. C. C. Compton, Coordinator Inter-regional Research Project No. 4, State Agricultural Experiment Station, Rutgers University, New Brunswick, N.J. 08903, on behalf of the Agricultural Experiment Stations of Oregon and Washington submitted a petition (PP 1E1151), proposing establishment of a tolerance for residues of the fungicide thiabendazole ((2-(4-thiazolyl) benzimidazole)) in or on Hubbard squash at 1 part per million.

Based on consideration given the data submitted in the petition and other relevant material, it is concluded that:

1. The pesticide is useful for the purpose for which the tolerance is proposed.
2. The proposed usage is not reasonably expected to result in residues of the pesticide in eggs, meat, milk, and poultry. The usage is classified in the category specified in § 180.6(a)(3).
3. The proposed tolerance will protect the public health.

Therefore, pursuant to provisions of the Federal Food, Drug, and Cosmetic Act (sec. 408(e), 68 Stat. 514; 21 U.S.C. 346a(e)), the authority transferred to the Administrator of the Environmental Protection Agency (35 F.R. 15623), and the authority delegated by the Administrator to the Deputy Assistant Administrator for Pesticides Programs (36 F.R.

9038), it is proposed that § 180.242 be amended by inserting a new paragraph after the paragraph "2 parts per million * * *," as follows:

§ 180.242 Thiabendazole; tolerances for residues.

* * * * *
1 part per million in or on Hubbard squash.

* * * * *
Any person who has registered or submitted an application for the registration of an economic poison under the Federal Insecticide, Fungicide, and Rodenticide Act containing any of the ingredients listed herein may request, within 30 days after publication hereof in the FEDERAL REGISTER, that this proposal be referred to an advisory committee in accordance with section 408(e) of the act.

Interested persons may, within 30 days after publication hereof in the FEDERAL REGISTER, file with the Objections Clerk, Environmental Protection Agency, Room 3175, South Agriculture Building, 12th Street and Independence Avenue SW., Washington, DC 20460, written comments (preferably in quintuplicate) regarding this proposal. Comments may be accompanied by a memorandum or brief in support thereof.

Dated: March 30, 1972.

WILLIAM M. UPHOLT,
Deputy Assistant Administrator
for Pesticides Programs.

[FR Doc.72-5146 Filed 4-4-72; 8:45 am]

FEDERAL POWER COMMISSION

[18 CFR Parts 141, 260]

[Docket No. R-439]

COMPREHENSIVE REPORTING OF LEASE RENTAL CHARGES

Notice of Proposed Rule Making

MARCH 30, 1972.

Pursuant to 5 U.S.C. 553, sections 301, 304, and 309 of the Federal Power Act (49 Stat. 854, 855-856, 858-859; 16 U.S.C. 825, 825c, 825h) and sections 8, 10, and 16 of the Natural Gas Act (52 Stat. 825, 826, 830; 15 U.S.C. 717g, 717i, 717o), the Commission gives notice it proposes to revise for the reporting year 1972:

A. Schedule page 421 of FPC Form No. 1, annual report for electric utilities, licensees and others (Class A and Class B) prescribed by § 141.1.

B. Schedule page 533 of FPC Form No. 2, annual report for natural gas companies (Class A and Class B) prescribed by § 260.1.

The schedule page 421, entitled rents charged of FPC Form No. 1, and schedule page 533, entitled rents charged of FPC Form No. 2, are being proposed for revision to provide the Commission with more comprehensive information than is presently being reported in connection with leases.

The present schedules were designed at a time when leases were generally applicable only to contracts for the use of

vehicles, ADP equipment and segments of facilities leased from other utilities. Over the past few years the number and amounts of these lease agreements have increased considerably and have been broadened to cover the lease of gas turbines, nuclear fuel, pollution control structures and equipment, and other major items.

It is necessary and desirable that the Commission obtain reasonably comprehensive information on provisions of all lease agreements of \$25,000 or more.

The proposed revisions to FPC Form No. 1 would be issued under authority granted the Federal Power Commission by the Federal Power Act, particularly sections 301, 304, and 309 (49 Stat. 854, 855-856, 858-859; 16 U.S.C. 825, 825c, 825h).

The proposed revisions to FPC Form No. 2 would be issued under authority granted the Federal Power Commission under the Natural Gas Act, as amended, particularly sections 8, 10 and 16 (52 Stat. 825, 826, 830; 15 U.S.C. 717g, 717i, 717o).

Accordingly, effective for the reporting year 1972, it is proposed to revise:

(A) Schedule page 421, currently entitled rents charged, of FPC Form No. 1, annual report for electric utilities, licensees and others (Class A and Class B) prescribed by § 141.1, Chapter I, Title 18 of the Code of Federal Regulations, all as set out in Attachment A hereto.¹

(B) Schedule page 533, currently entitled rents charged, of FPC Form No. 2, annual report for natural gas companies (Class A and Class B) prescribed by § 260.1, Chapter I, Title 18 of the Code of Federal Regulations, all as set out in Attachment B hereto.¹

(C) Paragraph (d) of § 141.1 in Part 141, Subchapter D of Chapter I, Title 18 of the Code of Federal Regulations, as follows:

1. Delete schedule titled "Rents Charged" and substitute therefore schedule titled "Lease Rentals Charged" so that it will read:

§ 141.1 Form No. 1, Annual report for electric utilities, licensees and others (Class A and Class B).

(d) This annual report contains the following schedules:

Lease Rentals Charged.

(D) Paragraph (c) of § 260.1 in Part 260, Subchapter G of Chapter I, Title 18 of the Code of Federal Regulations, as follows:

1. Delete schedule titled "Rents Charged" and substitute therefore schedule titled "Lease Rentals Charged" so that it will read:

§ 260.1 Form No. 2, Annual report for natural gas companies (Class A and Class B).

(c) This annual report contains the following schedules:

Lease Rentals Charged.

¹ Attachments A and B, filed as part of the original document.

Any interested person may submit to the Federal Power Commission, Washington, D.C. 20426, not later than May 15, 1972, data, views, comments or suggestions in writing concerning the revisions to the annual report forms proposed herein. Written submittals will be placed in the Commission's public files and will be available for public inspection at the Commission's Office of Public Information, Washington, D.C. 20426, during regular business hours. The Commission will consider all such written submittals before acting on the matters herein proposed. An original and 14 conformed copies should be filed with the Secretary of the Commission. In addition, interested persons wishing to have their comments considered in the clearance of the proposed revisions in the report forms pursuant to 44 U.S.C. 3501-3511 may, at the same time, submit a conformed copy of their comments directly to the Clearance Officer, Statistical Policy Division, Office of Management and Budget, Washington, D.C. 20503. Submittals to the Commission should indicate the name, title, mailing address and telephone number of the person to whom should be addressed, and whether the person filing them requests a conference with the staff of the Federal Power Commission to discuss the proposed revisions. The Staff, in its discretion, may grant or deny requests for conference.

The Secretary shall cause prompt publication of this notice to be made in the FEDERAL REGISTER.

By direction of the Commission.

KENNETH F. PLUMB,
Secretary.

[FR Doc.72-5235 Filed 4-4-72; 8:52 am]

**NATIONAL CREDIT UNION
ADMINISTRATION**
[12 CFR Part 741]
INSURANCE

Certified Statements and Premiums

Notice is hereby given that the Administrator of the National Credit Union Administration, pursuant to the authority conferred by section 120, 73 Stat. 635, 12 U.S.C. 1766, proposes additions to Part 741 (12 CFR Part 741) by adding § 741.5 as set forth below.

Interested persons are invited to submit written comments, suggestions, or objections regarding the proposed additions to the Administrator, National Credit Union Administration, 1325 K Street NW., Washington, DC 20456, to be received not later than May 12, 1972.

HERMAN NICKERSON, Jr.,
Administrator.

MARCH 29, 1972.

§ 741.5 Insurance fee statements.

(a) On or before January 31 of each insurance (calendar) year, each federally

insured credit union which became insured prior to the beginning of that year shall file with the Administrator a certified statement showing the total amount of the member accounts in the credit union at the close of the preceding insurance (calendar) year and the amount of the premium charge for insurance due to the fund for that year, as computed under Title II, section 202(c) (1) of the Federal Credit Union Act. The certified statements required to be filed with the Administrator pursuant to this section shall be in such form and shall set forth such supporting information as the Administrator shall require. The Insurance Fee Statement, Form NCUA-1308, has been designated as the authorized statement required in this section. Copies of Form NCUA-1308 can be obtained from the National Credit Union Administration office in Washington, D.C., or any regional National Credit Union Administration office.

(b) Each credit union which was in existence prior to October 19, 1970, and which becomes federally insured after January 1 of any insurance (calendar) year shall file with the Administrator a certified statement to provide supporting information similar to that outlined in paragraph (a) of this section and the amount of the premium charge for insurance due to the fund for that year, as computed under Title II, section 202 (c) (2) of the Federal Credit Union Act, no later than 30 days after the date on which the credit union receives the Certificate of Insurance issued to it under section 201 of the Federal Credit Union Act. The Insurance Fee Statement, Form NCUA-1307, has been designated as the authorized statement required in this section. Copies of Form NCUA-1307 can be obtained from the National Credit Union Administration office in Washington, D.C., or any regional National Credit Union Administration office.

(c) Each credit union which is chartered after October 19, 1970, and which becomes federally insured in the insurance (calendar) year in which it is chartered shall file with the Administrator a certified statement to provide supporting information similar to that outlined in paragraph (a) of this section and the amount of the premium charge for insurance due to the fund for that year, as computed under Title II, section 202(c) (3) of the Federal Credit Union Act, no later than January 31 of the insurance (calendar) year following the year in which the credit union was chartered. The Insurance Fee Statement, Form NCUA-1309, has been designated as the authorized statement required in this section. Copies of Form NCUA-1309 can be obtained from the National Credit Union Administration office in Washington, D.C., or from any National Credit Union Administration regional office.

(d) Each such statement shall be certified by the president of the credit union, or by any officer of the credit union designated by its board of directors, that to the best of his knowledge and belief the statement is true, correct, and complete.

[FR Doc.72-5186 Filed 4-4-72; 8:49 am]

Notices

DEPARTMENT OF THE INTERIOR

Bureau of Land Management
CALIFORNIA

Notice of Filing of California State Protraction Diagram

MARCH 27, 1972.

Notice is hereby given that effective May 15, 1972, the following protraction diagram, approved December 20, 1971, is officially filed and of record in the Riverside District and Land Office. In accordance with title 43, Code of Federal Regulations, this protraction will become the basic record for describing the land for all authorized purposes at and after 10 a.m. on the above effective date. Until this date and time, the diagram has been placed in the open files and is available to the public for information only.

CALIFORNIA PROTRACTON DIAGRAM NO. 22
(REVISED)

- T. 13 S., R. 20 E.,
Secs. 1 to 15, inclusive;
Secs. 17 to 35, inclusive.
- T. 13 S., R. 21 E.,
Secs. 1 to 15, inclusive;
Secs. 17 to 35, inclusive.
- T. 14 S., R. 20 E.,
Secs. 1 to 35, inclusive.
- T. 14 S., R. 21 E.,
Sec. 26, NW $\frac{1}{4}$, S $\frac{1}{2}$;
Sec. 27, NE $\frac{1}{4}$, S $\frac{1}{2}$;
Sec. 28, S $\frac{1}{2}$;
Sec. 29, NW $\frac{1}{4}$, S $\frac{1}{2}$;
Sec. 30, NE $\frac{1}{4}$, S $\frac{1}{2}$;
Secs. 31 to 35, inclusive.
- T. 15 S., R. 21 E.,
Sec. 2, W $\frac{1}{2}$;
Secs. 3 to 10, inclusive;
Sec. 17, excluding mineral surveys;
Sec. 18;
Secs. 19 to 21, inclusive, excluding mineral surveys;
Sec. 22;
Sec. 23, W $\frac{1}{2}$;
Sec. 27;
Sec. 28, N $\frac{1}{2}$, SE $\frac{1}{4}$;
Sec. 29, W $\frac{1}{2}$;
Sec. 30;
Sec. 31, N $\frac{1}{2}$;
Sec. 32, NW $\frac{1}{4}$;
Sec. 33, NE $\frac{1}{4}$;
Sec. 34, N $\frac{1}{2}$;
Secs. 37, 38 and 39.

Copies of this diagram are for sale at two dollars (\$2.00) each by the Survey and Records Office, Bureau of Land Management, Federal Office Building, Room E-2841, Sacramento, Calif. 95825, and the District and Land Office, Bureau of Land Management, 1414 University Avenue, Post Office Box 723, Riverside, CA 92502.

DELMAR D. VAIL,
Manager.

[FR Doc.72-5176 Filed 4-4-72; 8:48 am]

CALIFORNIA

Notice of Filing of California State Protraction Diagram

MARCH 27, 1972.

Notice is hereby given that effective May 15, 1972, the following protraction diagram, approved December 20, 1971, is officially filed and of record in the Riverside District and Land Office. In accordance with title 43, Code of Federal Regulations, this protraction will become the basic record for describing the land for all authorized purposes at and after 10 a.m. on the above effective date. Until this date and time, the diagram has been placed in the open files and is available to the public for information only.

SAN BERNARDINO MERIDIAN, CALIFORNIA

CALIFORNIA PROTRACTON DIAGRAM NO. 103

San Miguel Island

- T. 1 S., R. 33 W.,
Secs. 19 and 20;
Secs. 29 to 34, inclusive.
- T. 1 S., R. 34 W.,
Sec. 11;
Secs. 25 to 28, inclusive;
Secs. 31 to 36, inclusive.
- T. 2 S., R. 33 W.,
Secs. 2 to 10, inclusive.
- T. 2 S., R. 34 W.,
Secs. 1 to 5, inclusive;
Sec. 12.

Prince Island

- T. 1 S., R. 33 W.,
Sec. 28.

Copies of this diagram are for sale at two dollars (\$2.00) each by the Survey and Records Office, Bureau of Land Management, Federal Office Building, Room E-2841, Sacramento, Calif. 95825, and the District and Land Office, Bureau of Land Management, 1414 University Avenue, Post Office Box 723, Riverside, CA 92502.

DELMAR D. VAIL,
Manager.

[FR Doc.72-5177 Filed 4-4-72; 8:48 am]

CALIFORNIA

Notice of Filing of California State Protraction Diagram

MARCH 27, 1972.

Notice is hereby given that effective May 15, 1972, the following protraction diagram, approved December 20, 1971, is officially filed and of record in the Riverside District and Land Office. In accordance with title 43, Code of Federal Regulations, this protraction will become the basic record for describing the land for all authorized purposes at and after 10 a.m. on the above effective date. Until this date and time, the diagram has been placed in the open files and is available to the public for information only.

SAN BERNARDINO MERIDIAN, CALIFORNIA

CALIFORNIA PROTRACTON DIAGRAM NO. 136

San Nicolas Island

- T. 10 S., R. 25 W.,
Secs. 30 to 34, inclusive.
- T. 10 S., R. 26 W.,
Secs. 23 to 28, inclusive;
Secs. 33 to 36, inclusive.
- T. 11 S., R. 25 W.,
Secs. 2 to 12, inclusive;
Secs. 14 to 18, inclusive.
- T. 11 S., R. 26 W.,
Secs. 1 to 4, inclusive;
Secs. 10 to 13, inclusive.

Copies of this diagram are for sale at two dollars (\$2.00) each by the Survey and Records Office, Bureau of Land Management, Federal Office Building, Room E-2841, Sacramento, Calif. 95825, and the District and Land Office, Bureau of Land Management, 1414 University Avenue, Post Office Box 723, Riverside, CA 92502.

DELMAR D. VAIL,
Manager.

[FR Doc.72-5178 Filed 4-4-72; 8:48 am]

CALIFORNIA

Notice of Filing of California State Protraction Diagram

MARCH 27, 1972.

Notice is hereby given that effective May 15, 1972, the following protraction diagram, approved December 20, 1971, is officially filed and of record in the Riverside District and Land Office. In accordance with Title 43, Code of Federal Regulations, this protraction will become the basic record for describing the land for all authorized purposes at and after 10 a.m. on the above effective date. Until this date and time, the diagram has been placed in the open files and is available to the public for information only.

SAN BERNARDINO MERIDIAN, CALIFORNIA

CALIFORNIA PROTRACTON DIAGRAM NO. 179

Anacapa Island

- T. 2 S., R. 24 W.,
Secs. 7 to 11, inclusive;
Secs. 16 to 18, inclusive.
- T. 2 S., R. 25 W.,
Sec. 12.

Santa Barbara Island

- T. 8 S., R. 21 W.,
Sec. 11;
Secs. 14 and 15;
Secs. 22 and 23.

Copies of this diagram are for sale at two dollars (\$2) each by the Survey and Records Office, Bureau of Land Management, Federal Office Building, Room E-2841, Sacramento, Calif. 95825, and the District and Land Office, Bureau of Land Management, 1414 University

Avenue, Post Office Box 723, Riverside, CA 92502.

DELMAR D. VAIL,
Manager.

[FR Doc.72-5179 Filed 4-4-72;8:48 am]

CALIFORNIA

Notice of Filing of California State Protraction Diagram

MARCH 27, 1972.

Notice is hereby given that effective May 15, 1972, the following protraction diagram, approved December 20, 1971, is officially filed and of record in the Riverside District and Land Office. In accordance with Title 43, Code of Federal Regulations, this protraction will become the basic record for describing the land for all authorized purposes at and after 10 a.m. on the above effective date. Until this date and time, the diagram has been placed in the open files and is available to the public for information only.

SAN BERNARDINO MERIDIAN, CALIFORNIA
CALIFORNIA PROTRACTION DIAGRAM NO. 180

T. 11 N., R. 1 W.,
Sec. 18, SW $\frac{1}{4}$;
Sec. 19, NW $\frac{1}{4}$.

Copies of this diagram are for sale at two dollars (\$2) each by the Survey and Records Office, Bureau of Land Management, Federal Office Building, Room E-2841, Sacramento, Calif. 95825, and the District and Land Office, Bureau of Land Management, 1414 University Avenue, Post Office Box 723, Riverside, CA 92502.

DELMAR D. VAIL,
Manager.

[FR Doc.72-5180 Filed 4-4-72;8:48 am]

CALIFORNIA

Notice of Filing of California State Protraction Diagram

MARCH 27, 1972.

Notice is hereby given that effective May 15, 1972, the following protraction diagram, approved December 20, 1971, is officially filed and of record in the Riverside District and Land Office. In accordance with Title 43, Code of Federal Regulations, this protraction will become the basic record for describing the land for all authorized purposes at and after 10 a.m. on the above effective date. Until this date and time, the diagram has been placed in the open files and is available to the public for information only.

SAN BERNARDINO MERIDIAN, CALIFORNIA
CALIFORNIA PROTRACTION DIAGRAM NO. 181

T. 13 S., R. 18 E.,
Secs. 1 to 15, inclusive;
Secs. 17 to 35, inclusive.
T. 13 S., R. 19 E.,
Secs. 1 to 15, inclusive;
Secs. 17 to 35, inclusive.
T. 14 S., R. 19 E.,
Secs. 1 to 15, inclusive;
Secs. 17 to 35, inclusive.

Copies of this diagram are for sale at two dollars (\$2) each by the Survey and Records Office, Bureau of Land Management, Federal Office Building, Room E-2841, Sacramento, Calif. 95825, and the District and Land Office, Bureau of Land Management, 1414 University Avenue, Post Office Box 723, Riverside, CA 92502.

DELMAR D. VAIL,
Manager.

[FR Doc.72-5181 Filed 4-4-72;8:48 am]

[Serial I-4874]

IDAHO

Notice of Proposed Withdrawal and Reservation of Lands

MARCH 28, 1972.

The Bureau of Sport Fisheries and Wildlife has filed an application, Serial No. I-4874 for the withdrawal of the lands described below, from all forms of appropriation under the public land laws, including the mining laws but not the mineral leasing laws, subject to valid existing rights.

The applicant desires the land for public purposes for management of migrating birds and other wildlife as a part of the Deer Flat National Wildlife Refuge.

For a period of 30 days from the date of publication of this notice, all persons who wish to submit comments, suggestions, or objections in connection with the proposed withdrawal may present their views in writing to the undersigned, officer of the Bureau of Land Management, Department of the Interior, Room 398, Federal Building 550 West Fort Street, Boise, Idaho 83702.

The authorized officer of the Bureau of Land Management will undertake such investigations as are necessary to determine the existing and potential demand for the lands and their resources. He will also undertake negotiations with the applicant agency with the view of adjusting the application to reduce the area to the minimum essential to meet the applicant's needs, to provide for the maximum concurrent utilization of the lands for purposes other than the applicant's, to eliminate lands needed for purposes more essential than the applicant's and to reach agreement on the concurrent management of the lands and their resources.

He will also prepare a report for consideration by the Secretary of the Interior who will determine whether or not the lands will be withdrawn as requested by the Bureau of Sport Fisheries and Wildlife.

The determination of the Secretary on the application will be published in the FEDERAL REGISTER. A separate notice will be sent to each interested party of record.

If circumstances warrant it, a public hearing will be held at a convenient time and place which will be announced.

The lands involved in the application are:

BOISE MERIDIAN, IDAHO

T. 11 N., R. 3E.,
Sec. 3, lot 7;
Sec. 10, unsurveyed island lying in
E $\frac{1}{2}$ SE $\frac{1}{4}$;

Sec. 15, unsurveyed island lying in SE $\frac{1}{4}$ SE $\frac{1}{4}$, unsurveyed island lying in sections 14 and 15, unsurveyed island lying in sections 15 and 22.

The areas described aggregate approximately 8.2 acres in Valley County.

RICHARD H. PETRIE,
Chief,

Division of Technical Services.

[FR Doc.72-5185 Filed 4-4-72;8:48 am]

National Park Service

[Order 5]

SUPERINTENDENTS ET AL., MIDWEST REGION

Delegation of Authority

Correction

In F.R. Doc. 72-4631 appearing at page 6324 in the issue for Tuesday, March 28, 1972, subparagraph (2) of paragraph (h) in section 1 should read as follows: "(2) Superintendents, Grade GS-13—in excess of \$50,000".

Office of the Secretary

[FES 72-7]

BONNEVILLE POWER ADMINISTRATION

Notice of Availability of Final Environmental Statement

Pursuant to section 102(2)(C) of the National Environmental Policy Act of 1969, the Bonneville Power Administration has prepared a final statement which discusses environmental considerations relating to BPA's projected program for fiscal year 1973.

Copies of the final environmental statement are available for review in the library of the headquarter's office of BPA, 1002 NE. Holladay Street, Portland, Ore. 97208; the Washington, D.C. Office in the Interior Building, Room 5600; or in the following Area and District Offices: Idaho Falls, Idaho; Portland, Ore.; Seattle, Wash.; Spokane, Wash.; Walla Walla, Wash.; Eugene, Ore.; Kalispell, Mont.; and Wenatchee, Wash.

Copies may be obtained by writing the National Technical Information Service, Department of Commerce, Springfield, Va. 22151, and enclosing \$3. Please refer to the statement number above.

W. W. LYONS,
Deputy Assistant
Secretary of the Interior.

MARCH 29, 1972.

[FR Doc.72-5182 Filed 4-4-72;8:48 am]

[INT DES 72-45]

CIBOLO PROJECT, TEX.

Notice of Availability of Draft Environmental Statement

Pursuant to section 102(2)(C) of the National Environmental Policy Act of 1969, the Department of the Interior has prepared a draft environmental state-

ment on a proposed water supply project designed to furnish a municipal and industrial water supply for the cities of Kenedy, Karnes City and San Antonio, Tex.

Copies are available for inspection at the following locations:

Office of Ecology, Room 7620, Bureau of Reclamation, Department of the Interior, Washington, D.C. 20240, Telephone (202) 343-4991.

Division of Engineering Support, Technical Services Branch, E&R Center, Denver Federal Center, Denver, Colo. 80225, Telephone (303) 234-3007.

Office of the Regional Director, Bureau of Reclamation, Herring Plaza, Box H-4377, Amarillo, TX 79101, Telephone (806) 376-2408.

Austin Development Office, Bureau of Reclamation, Post Office Box 1946, Federal Building, Austin, TX 78767, Telephone (512) 397-5641.

Single copies of the draft statement may be obtained on request to the Commissioner of Reclamation, Regional Director, or Austin Planning Officer. In addition, copies may be purchased from the National Technical Information Service, Department of Commerce, Springfield, Va. 22151. Please refer to the statement number above.

Dated: March 27, 1972.

W. W. LYONS,
Deputy Assistant
Secretary of the Interior.

[FR Doc.72-5183 Filed 4-4-72;8:48 am]

DEPARTMENT OF AGRICULTURE

Consumer and Marketing Service

GRAIN STANDARDS

Cairo, Ill., Grain Inspection Point

Statement of considerations. On February 3, 1972, there was published in the FEDERAL REGISTER (37 F.R. 2599) a notice announcing (1) a proposed transfer of the designation to operate the official grain inspection agency, as defined in section 3(m) of the U.S. Grain Standards Act (7 U.S.C. 75(m)), at Cairo, Ill., and (2) the application by J. R. Simpson, Cairo, Ill., for designation to operate the official grain inspection agency. Inspection agencies, members of the grain trade, and other interested parties were given until March 6, 1972, to submit written data, views, or arguments with respect to the proposed transfer and to make application for designation.

Comments were received from eight members of the grain trade recommending that J. R. Simpson be designated to operate the official grain inspection agency at Cairo. No applications for designation were received other than the application from J. R. Simpson, and no adverse comments were received.

After due consideration of all submissions made pursuant to the notice of February 3, 1972, and all other relevant matters, and pursuant to the authority contained in sections 3(m) and 7(f) of the U.S. Grain Standards Act (7 U.S.C.

75(m) and 79(f)), the designation as the official grain inspection agency at Cairo, Ill., is hereby transferred from the Woodson-Tenent Laboratories, Inc., to J. R. Simpson.

Effective date. This notice shall become effective 60 days after publication in the FEDERAL REGISTER.

Done in Washington, D.C., on March 30, 1972.

G. R. GRANGE,
Acting Administrator.

[FR Doc.72-5219 Filed 4-4-72;8:51 am]

Forest Service

MOUNT ASHLAND CHAIRLIFT NO. 2

Notice of Availability of Draft Environmental Statement

Pursuant to section 102(2)(C) of the National Environmental Policy Act of 1969, the Forest Service, Department of Agriculture, has prepared a draft environmental statement for Mount Ashland Chairlift No. 2 in Oregon, USDA-FS-DES(Adm) 72-27.

The environmental statement concerns a proposal to construct one additional chairlift at Mount Ashland to enlarge the existing winter sports facility.

This draft environmental statement was filed with CEQ on March 30, 1972.

Copies are available for inspection during regular working hours at the following locations:

USDA, Forest Service, South Agriculture Building, Room 3230, 12th Street and Independence Avenue SW., Washington, D.C. 20250.

USDA, Forest Service, Pacific Northwest Region, 319 Southwest Pine Street, Portland, OR 97208.

Rogue River National Forest, Supervisor's Office, Federal Building, Medford, Ore. 97501.

A limited number of single copies are available upon request to Rexford A. Resler, Regional Forester, Post Office Box 3623, Portland, Ore. 97208.

Copies are also available from the National Technical Information Service, U.S. Department of Commerce, Springfield, Va. 22151 for \$3 each. Please refer to the name and number of environmental statement above when ordering.

Copies of the environmental statement have been sent to various Federal, State, and local agencies as outlined in the Council on Environmental Quality Guidelines.

Comments are invited from the public and from State and local agencies which are authorized to develop and enforce environmental standards, and from Federal agencies having jurisdiction by law or special expertise with respect to any environmental impact for which comments have not been requested specifically.

Comments concerning the proposed action and requests for additional information should be addressed to Mr. Rexford A. Resler, U.S. Forest Service, Post Office Box 3623, Portland, OR 97208. Comments must be received within 50

days of the date of publication of this notice in order to be considered in the preparation of the final environmental statement.

LAWRENCE M. WHITFIELD,
Acting Deputy Chief,
Forest Service.

MARCH 30, 1972.

[FR Doc.72-5249 Filed 4-4-72;8:53 am]

Office of the Secretary

MEAT IMPORT LIMITATIONS

Second Quarterly Estimates

Public Law 88-482, approved August 22, 1964 (hereinafter referred to as the Act), provides for limiting the quantity of fresh, chilled, or frozen cattle meat (TSUS 106.10) and fresh, chilled, or frozen meat of goats and sheep except lamb (TSUS 106.20), which may be imported into the United States in any calendar year. Such limitations are to be imposed when it is estimated by the Secretary of Agriculture that imports of such articles, in the absence of limitations during such calendar year, would equal or exceed 110 percent of the estimated quantity of such articles, prescribed by section 2(a) of the Act.

In accordance with the requirements of the Act, the following second quarterly estimates are published:

1. The estimated aggregate quantity of such articles which would, in the absence of limitations under the Act, be imported during calendar year 1972 is 1,240.0 million pounds.

2. The estimated quantity of such articles prescribed by section 2(a) of the Act during the calendar year 1972, is 1,042.4 million pounds.

Since the estimated quantity of imports continues to exceed 110 percent of the estimated quantity prescribed by section 2(a) of the Act, under the Act limitations for the calendar year 1972 on the importation of fresh, chilled, or frozen cattle meat (TSUS 106.10) and fresh, chilled, or frozen meat of goats and sheep (TSUS 106.20), are required to be imposed but may be suspended. Such limitations were imposed by Proclamation 4114 of March 9, 1972, and were suspended during the balance of the calendar year 1972, unless because of changed circumstances further action under the Act becomes necessary.

Done at Washington, D.C., this 30th day of March 1972.

EARL L. BUTZ,
Secretary of Agriculture.

[FR Doc.72-5193 Filed 3-31-72;12:06 pm]

DEPARTMENT OF COMMERCE

Office of Import Programs

IOWA STATE UNIVERSITY ET AL.

Notice of Applications for Duty-Free Entry of Scientific Articles

The following are notices of the receipt of applications for duty-free entry of sci-

entific articles pursuant to section 6(c) of the Educational, Scientific, and Cultural Materials Importation Act of 1966 (Public Law 89-651; 80 Stat. 897). Interested persons may present their views with respect to the question of whether an instrument or apparatus of equivalent scientific value for the purposes for which the article is intended to be used is being manufactured in the United States. Such comments must be filed in triplicate with the Director, Special Import Programs Division, Office of Import Programs, Washington, D.C. 20230, within 20 calendar days after the date on which this notice of application is published in the FEDERAL REGISTER.

Amended regulations issued under cited Act, as published in the February 24, 1972, issue of the FEDERAL REGISTER, prescribe the requirements applicable to comments.

A copy of each application is on file, and may be examined during ordinary Commerce Department business hours at the Special Import Programs Division, Department of Commerce, Washington, D.C.

Docket No. 72-00345-90-46070. Applicant: Iowa State University, Ames Laboratory, Ames, Iowa 50010. Article: Scanning electron microscope, Model S-4. Manufacturer: Cambridge Scientific Instruments, Ltd., United Kingdom. Intended use of article: The article is intended to be used in conjunction with basic research studies on metal, ceramic, and semiconductor materials. Surface morphology of specimens will be examined using secondary electron, back scattering, and specimen current modes. The article will also be used to measure the crystallographic orientation of plates and needles having dimensions down to 0.5 micrometers in such materials as martensites, bainites, eutectoids, eutectics, dendrites and solid solution precipitates by means of selected area channeling patterns. Application received by Commissioner of Customs: January 27, 1972.

Docket No. 72-00344-33-46040. Applicant: National Institutes of Health, NAID/LVD, 9000 Rockville Pike, Bethesda, MD 20014. Article: Electron microscope, Model JEM 100B. Manufacturer: JEOL, Ltd., Japan. Intended use of article: The article is intended to be used for research aimed at a better understanding of multivirus (virus-helper virus)—host cell interaction of the adenovirus associated viruses, as well as other members of the parvovirus group. Further, studies of the nucleic acids by electron microscopy of these viruses as well as other viruses such as the adenovirus SV40 hybrids and members of the leucosis group, will also be conducted. Studies already in progress on the polypeptides of these viruses will be subjected to further study in the electron microscope from ultrastructural and immunological aspects. Application received by Commissioner of Customs: January 27, 1972.

Docket No. 72-00346-00-46040. Applicant: Cedars-Sinai Medical Center, 4833 Fountain Avenue, Los Angeles, CA 90029.

Article: High contrast, wide field observation attachment, JEM-ACW. Manufacturer: JEOL Ltd., Japan. Intended use of article: The article is intended to be used as an accessory to an existing electron microscope to provide high contrast, distortion free, superwide images in the following projects:

1. Reconstruction of heart muscle cells in dogs as well as the retina in fish.

2. Distortion free observation of glomeruli from renal biopsies under low magnification.

Application received by Commissioner of Customs: January 27, 1972.

Docket No. 72-00347-01-77040. Applicant: University of Utah, Purchasing Department, Building 40, Salt Lake City, Utah 84112. Article: Mass spectrometer, Model MS 30. Manufacturer: Associated Electrical Industries, Ltd., United Kingdom. Intended use of article: The article is intended to be used for the analysis and characterization of gaseous, liquid, and solid materials both alone and in connection with gas chromatographic and liquid chromatographic analysis of the compounds. The article will also be used for educational purposes to train personnel in analytical mass spectroscopy in the following areas:

1. Structural studies which include reaction products and intermediates, correlation studies, and natural products.

2. Analysis of drug metabolites, stable isotopic studies of biosynthesis, stable isotope studies of organic and inorganic reactions, membrane composition, complex lipids and complex mixtures.

Application received by Commissioner of Customs: January 27, 1972.

Docket No. 72-00348-33-46070. Applicant: Duke University, Erwin Road, Durham, N.C. 27706. Article: Scanning electron microscope, Model JSM-S1. Manufacturer: Japan Electron Optics Laboratory Co., Japan. Intended use of article: The article is intended to be used by undergraduates, graduates, postdoctoral fellows and faculty for instructional purpose in ecology-limnology, biosystematics and cell physiology as well as general biology and cytology. The article will also be used for research in paleoecology of African lake sediments, evolutionary diversification of plants and calcification mechanism in marine organisms. Application received by Commissioner of Customs: January 27, 1972.

Docket No. 72-00349-75-77000. Applicant: Department of Commerce—NOAA, Experimental Meteorology Laboratory, Post Office Box 8044, University of Miami Branch, Coral Gables, Fla. 33124. Article: Distrometer, Type RD-69. Manufacturer: Marc Wiebel, Switzerland. Intended use of article: The article will be used in cloud seeding (rain making) research to measure the distribution in time and space of raindrop sizes. This information in conjunction with known details of the seeding procedures, will tell the percentage of water droplets of different sizes, the time required for the growth of the water droplets, the density of the various sized droplets per unit

area and the duration of both the drop growth and the total rainfall. Finally, together with rainfall collecting instruments, it will give the total rainfall for the individual experiment periods. The article will also be used in the training of graduate students in Meteorology. Application received by Commissioner of Customs: January 28, 1972.

Docket No. 72-00350-33-09300. Applicant: University of Michigan, Medical Science Building II, Room 5614, Ann Arbor, Mich. 48104. Article: Vibrogen cell mill, M586621. Manufacturer: Max Planck Institute for Biochemistry, West Germany. Intended use of article: The article is intended to be used to prepare cell-free extracts of microorganisms for the specific purpose of isolating and studying intracellular enzymes. Application received by Commissioner of Customs: January 28, 1972.

Docket No. 72-00351-33-46500. Applicant: North Carolina Department of Mental Health, Research Division, Embryology Laboratory, Station B, Box 7532, Raleigh, N.C. 27611. Article: Ultramicrotome, Model OmU2. Manufacturer: C. Reichert Optische Werke AG, Austria. Intended use of article: The article is intended to be used to examine spinal cord and chicken embryonic tissues in developmental studies of the growing nervous system, specifically the formation of synapses. Application received by Commissioner of Customs: January 28, 1972.

Docket No. 72-00352-33-46500. Applicant: University of Pennsylvania, School of Medicine, Department of Anatomy, 36th Spruce Streets, Philadelphia, PA 19104. Article: Ultramicrotome, Model LKB 8800A. Manufacturer: LKB Produkter AB, Sweden. Intended use of article: The article will be used to prepare ultrathin serial sections of brain tissues in research investigations to discover the patterns of connection between neurons in the central nervous system. The article will also be used in training graduate students who are learning to conduct these types of research. Application received by Commissioner of Customs: January 28, 1972.

Docket No. 72-00353-33-46500. Applicant: Los Angeles County, University of Southern California Medical Center, Women's Hospital, Room 1L23, 1200 North State Street, Los Angeles, CA 90033. Article: Ultramicrotome, Model LKB 8800A. Manufacturer: LKB Produkter AB, Sweden. Intended use of article: The article is intended to be used to obtain ultrathin sections of male and female reproductive tissues, fertilized eggs and embryonic specimens for the purpose of obtaining ultrastructural information with the electron microscope. The objectives to be pursued in the investigations will include the ultrastructural description of reproductive tissues, the determination of ultrastructural effects from contraceptive methods, the study of fertilized eggs, the examination of sperm, and the study of early embryonic development. Application received by Commissioner of Customs: January 28, 1972.

Docket No. 72-00354-33-46595. Applicant: Mount Sinai Hospital, Madison Avenue and 100th Street, New York, N.Y. 10029. Article: Pyramitome. Manufacturer: LKB Produkter AB, Sweden. Intended use of article: The article is intended to be used in studying the morphology of the lens in the developing chick embryo. Of primary interest is the capsule, anterior, equatorial posterior and nucleous of the lens and their relationship to each other. The project will involve the measurement of lens capsule thickness as a function of time during development, with respect to location in the lens and also the relationship of various intracellular organelles in relation to their special location within the lens as a function of time. Application received by Commissioner of Customs: January 28, 1972.

Docket No. 72-00355-01-77030. Applicant: The University of Georgia, Department of Medicinal Chemistry, School of Pharmacy, Athens, Ga. 30601. Article: NMR Spectrometer, Model R-20A. Manufacturer: Hitachi Perkin-Elmer, Japan. Intended use of article: The article is intended to be used in research correlating biologic activity of organic compounds to physical-chemical properties. Specific acid and base catalyzed proton exchange kinetic constants and the energies of activation of N-H compounds are being studied. The effect on proton exchange kinetics due to complexation of carbamate esters and amides with nucleotides, and soluble proteins will be studied to make subtle and meaningful correlations between the delta G of binding and protolysis data. The article will also be used in a graduate course titled Advanced Pharmaceutical Analysis and in an undergraduate course in Pharmaceutical Drug Analysis. Application received by Commissioner of Customs: February 1, 1972.

Docket No. 72-00356-33-28500. Applicant: University of Texas Medical School at San Antonio, 7703 Floyd Curl Drive, San Antonio, TX 78229. Article: Cell electrophoresis apparatus, Model Mark II. Manufacturer: Ranks Brothers, United Kingdom. Intended use of article: The article is intended to be used to study the effects of a variety of chemicals which act on the surface of the Ehrlich ascites cancer cell. Its use will permit an assessment of the subtle alterations in electric charge density associated with the components forming the cell surface. These alterations will be reflected as changes in the rate of migration of the cancer cells when subjected to an electrical field. Application received by Commissioner of Customs: February 1, 1972.

Docket No. 72-00357-33-46040. Applicant: College of Medicine & Dentistry of New Jersey, New Jersey Medical School, Department of Anatomy, 100 Bergen Street, Newark, NJ 07103. Article: Electron microscope, Model EM 300. Manufacturer: Philips Electronic Instruments, NVD, The Netherlands. Intended use of article: The article will be used for the following research projects:

1. The effects of chronic administration of DDT in fish livers.

2. Ultrastructural aspects of development of the peripheral nervous system of telost fishes.

3. Investigations on growth and differentiation of tissues during amphibian development.

4. The synaptic organization of selected regions of the central nervous system of mammals.

The article will also be used in courses in electron microscopy, experimental electron microscopy, and microscopic anatomy of cells and tissues to train students in the techniques of electron microscopy. Application received by Commissioner of Customs: February 1, 1972.

Docket No. 72-00358-33-46040. Applicant: Brookhaven National Laboratory, Associated University, Inc., Upton, Long Island, N.Y. 11973. Article: Electron microscope, Model EM 300. Manufacturer: Philips Electronic Instruments, NVD, The Netherlands. Intended use of article: The article is intended to be used to obtain micrographs of the fine structure of cells, cell components, and macromolecules. Studies will be made from sections of plastic embedded biological material, isolated cell components, replicas of freeze-fractured cells, and isolated macromolecules in three-dimensional analysis of cellular structure, macromolecules and their aggregates. Application received by Commissioner of Customs: February 1, 1972.

Docket No. 72-00359-33-40600. Applicant: Florida State University, Department of Physics, Tallahassee, Fla. 32306. Article: Axial extraction penning source. Manufacturer: Amersfoort, The Netherlands. Intended use of article: The article is intended to be used for the efficient production of negative ions of a variety of elements. These negative ion beams will be injected into the Tandem Accelerator where they will be energized and focused into useful beams for heavy ion nuclear physics research. In addition the article will be used in the physics courses PSC 599 and PSC 699 for the training and qualification of students to work as physicists in basic research and technology. Application received by Commissioner of Customs: February 1, 1972.

Docket No. 72-00360-33-46040. Applicant: Harbor General Hospital, 1000 West Carson Street, Torrance, CA 90506. Article: Electron microscope, Model HU-11E. Manufacturer: Hitachi Ltd., Japan. Intended use of article: The article is intended to be used to study (a) isolated spermatozoa and ova and the fertilization process of humans and animals; (b) biopsies of kidneys, livers, brains, muscles, skin, and bone marrows of patients affected by a variety of diseases; and (c) developing organs of embryos from mouse, rabbit, and woman. The investigations are aimed at obtaining a better understanding of the various aspects of the fertilization process and of the lesions produced by diseases on a variety of organs. The article will also be used for educational purposes in the training of Pathology interns and residents and post-doctoral fellows in reproductive biology. Application received by Commissioner of Customs: February 1, 1972.

Docket No. 72-00361-33-46040. Applicant: University of Minnesota, Minneapolis, Minn. 55455. Article: Electron microscope, Model EM 300. Manufacturer: Philips Electronic Instruments, NVD, The Netherlands. Intended use of article: The article will be used in experiments designed to study the ultrastructure of the cell membrane before and after various enzyme and extraction procedures designed to remove specific proteins and nucleoproteins. Application received by Commissioner of Customs: February 3, 1972.

Docket No. 72-00362-33-68300. Applicant: State University of New York at Buffalo, The Research Foundation, 1807 Elmwood Avenue, Buffalo, NY 14207. Article: Microperfusion pump. Manufacturer: Wolfgang Hampel, West Germany. Intended use of article: The article will be used in a laboratory of kidney physiology to inject and perfuse individual kidney tubules in the rat with ultramicro volumes of fluid. The problems under investigation are designed to elucidate normal kidney function as well as changes seen with experimental kidney disease. Application received by Commissioner of Customs: February 3, 1972.

Docket No. 72-00363-33-46040. Applicant: University of Chicago, Department of Pathology, Division of Surgical Pathology, 950 East 59th Street, Chicago, IL 60637. Article: Electron microscope, Model EM-201. Manufacturer: Philips Electronic Instruments, NVD, The Netherlands. Intended use of article: The article is intended to be used for post doctoral training and research on ultrastructure of human cancer, particularly tumors of the hematopoietic tissues. Specifically, the instrument will be used for research on human tissue removed during surgery and for the study of experimental animal tissues. Ongoing projects include:

(a) A correlative light and electron microscopic study of human lymphomas and leukemias;

(b) A fine resolution study for localization of ferritin labelled antibodies, and for radioisotope labelled incorporation studies of mucopolysaccharide and protein synthesis; and

(c) A fine resolution study for the three dimensional reconstruction of consecutively serial sectioned cells of various, light microscopically not further identifiable human malignant tumors, and three dimensional study of subcellular components of muscle cells in human myopathies. Application received by Commissioner of Customs: February 3, 1972.

SETH M. BODNER,
Director,
Office of Import Programs.

[FR Doc.72-5194 Filed 4-4-72; 8:49 am]

NEW YORK UNIVERSITY ET AL.

Notice of Applications for Duty-Free Entry of Scientific Articles; Correction

The following notice of application as published in Volume 37, Number 47

(pages 5067-68) of the FEDERAL REGISTER, Thursday, March 9, 1972, pursuant to section 6(c) of the Educational, Scientific, and Cultural Materials Importation Act of 1966 (Public Law 89-651, 80 Stat. 897) is hereby amended to read: Article: Ultramicrotome, Model LKB 8800A instead of Article: Ultramicrotome, Model LKN 8800A.

Docket No. 72-00293-33-46500. Applicant: Veterans Administration Hospital, 800 Stadium Road, Columbia, MO 65201. Article: Ultramicrotome, Model LKB 8800A. Manufacturer: LKB Produkter AB, Sweden. Intended use of article: The article is intended to be used for three dimensional sectioning of human bone marrow and soft tissue tumors in connection with diagnosis and therapy of selected human neoplasms. The article will also be used in the training of physicians for specialties in laboratory medicine including interpretation and preparation of material for electron microscopy. Application received by Commissioner of Customs: December 23, 1971.

SETH M. BODNER,
Director,
Office of Import Programs.

[FR Doc.72-5199 Filed 4-4-72;8:49 am]

TEMPLE UNIVERSITY MEDICAL SCHOOL

Notice of Decision on Application for Duty-Free Entry of Scientific Article

The following is a decision on an application for duty-free entry of a scientific article pursuant to section 6(c) of the Educational, Scientific, and Cultural Materials Importation Act of 1966 (Public Law 89-651, 80 Stat. 897) and the regulations issued thereunder as amended (37 F.R. 3892 et seq.).

A copy of the record pertaining to this decision is available for public review during ordinary business hours of the Department of Commerce, at the Office of Import Programs, Department of Commerce, Washington, D.C.

Docket No.: 71-00439-33-46040. Applicant: Temple University Medical School, 3400 North Broad Street, Philadelphia, PA 19140. Article: Electron microscope, Model HU-12. Manufacturer: Hitachi, Ltd., Japan. Intended use of article: The article will be used for a study of the cross-linkages in the filaments of the pigment synthesizing organelle of the melanocyte; for a project involving the localization of isoproterenol to specific organelles in the cells of the salivary gland; and for an investigation to identify element copper in the enzyme tyrosinase.

Comments: Comments have been received from one domestic manufacturer, Forgflo Corporation (Forgflo), which alleges, inter alia, that its Model Paragon is "of equivalent scientific value to the instrument for which duty-free entry has been requested for the purposes stated in the application for which the instrument is intended to be used."

Decision: Application approved. No domestic manufacturer was both able and willing to produce an instrument or

apparatus within the United States of equivalent scientific value to the foreign article, for such purposes as the article is intended to be used, and have it available without unreasonable delay to the applicant at the time the application for the foreign article was received. (March 11, 1971.)

Reasons: The Department of Health, Education, and Welfare (HEW) advises in a memorandum dated July 9, 1971 that the study of cross-linkages in filaments of pigment synthesizing organelles of the melanocyte, in which there is evidence that failure of cross-linkage in these filaments is characteristic of malignant melanoma cells, will "require the optimum in resolution. * * *". Therefore the resolution limit, i.e., the resolving capability is a pertinent specification within the meaning of § 701.2(n) of the regulations.

Resolving capability bears an inverse relationship to its numerical rating in angstrom units, i.e., the lower the rating, the better the resolving capability. The foreign article has a specified resolving capability of three angstroms. Comparable electron microscopes are produced in the United States by one manufacturer, Forgflo. Forgflo has published specifications for two electron microscopes, i.e., the Model EMU-4C and the Paragon. The EMU-4C has a specified resolving capability of five angstroms, while the Paragon, according to its printed specifications, has a resolving capability of two angstroms. Accordingly, the EMU-4C is not of equivalent scientific value to the foreign article for the purposes that the foreign article is intended to be used.

The "Paragon" is an instrument that is customarily produced on order. Section 701.2(j) of the regulations defines produced on order as follows:

Produced on order means an instrument, apparatus, or accessory which a manufacturer lists in a current catalog and is able and willing to produce and have available without unreasonable delay to the applicant.

Section 701.11(b) of the regulations provides as to availability of such instruments:

An instrument, apparatus, or accessory shall be considered as being manufactured in the United States if it is customarily produced for stock, produced on order, or custom-made within the United States. In determining whether a U.S. manufacturer is able and willing to produce a produced on order, or custom-made instrument, apparatus or accessory and have it available without unreasonable delay to the applicant the Deputy Assistant Secretary shall take into account the normal commercial practices applicable to the production and delivery of instruments, apparatus, or accessories of the same general category * * *.

As to the Forgflo Model "Paragon", we note that: (1) The Department of Commerce knows of no instance wherein Forgflo demonstrated that it had produced an instrument conforming to the printed specifications of the Paragon. (2) Although the design of the Paragon apparently had been completed as of the date of the comments, the component parts were not. And further, the instru-

ment had not reached, in performance, its design specifications. (3) Forgflo's published material relating to the Paragon did not include information on delivery and Forgflo has never been able to provide the Department of Commerce with a firm delivery date. (4) Although Forgflo has accepted orders for the Paragon, delivery has been set back and Forgflo has not been able to deliver a single Paragon to this date.

Accordingly, we find that at the time the application for duty-free entry of the foreign article was received, no domestic manufacturer was both able and willing to make available to the applicant an instrument or apparatus of equivalent scientific value to the foreign article for such purposes as this article is intended to be used, within the meaning of § 701.11(b) of the regulations.

SETH M. BODNER,
Director,
Office of Import Programs.

[FR Doc.72-5198 Filed 4-4-72;8:49 am]

UNIVERSITY OF CINCINNATI

Notice of Decision on Application for Duty-Free Entry of Scientific Article

The following is a decision on an application for duty-free entry of a scientific article pursuant to section 6(c) of the Educational, Scientific, and Cultural Materials Importation Act of 1966 (Public Law 89-651, 80 Stat. 897) and the regulations issued thereunder as amended (37 F.R. 3892 et seq.).

A copy of the record pertaining to this decision is available for public review during ordinary business hours of the Department of Commerce, at the Office of Import Programs, Department of Commerce, Washington, D.C.

Docket No. 71-00461-33-46040. Applicant: University of Cincinnati, College of Medicine, Department of Surgery, Eden and Bethesda Avenues, Cincinnati, OH 45219. Article: Electron microscope, Model HU-12. Manufacturer: Hitachi, Ltd., Japan. Intended use of article: The article will be used in a research program concerned with the nature and causes of surgical infections complicating trauma, the factors related to bacterial infection which alter and impair the process of wound healing, and the diagnosis and control of cancer. The electron microscope will also be used in the research education of pre- and postdoctoral fellows, interns and residents in the Department of Surgery.

Comments: Comments have been received from one domestic manufacturer, Forgflo Corp. (Forgflo), which alleges, inter alia, that its Model EMU-4C and Paragon instruments are "of equivalent scientific value to the instrument for which duty-free entry has been requested for the purposes stated in the application for which the instrument is intended to be used."

Decision: Application approved. No domestic manufacturer was both able and willing to produce an instrument or apparatus within the United States of equivalent scientific value to the foreign

article, for such purposes as the article is intended to be used, and have it available without unreasonable delay to the applicant at the time the application for the foreign article was received. (March 25, 1971.)

Reasons: The Department of Health, Education, and Welfare (HEW) advises in a memorandum dated August 20, 1971 that, in the applicant's studies on control of infections following surgery, significant studies will involve examination of fine structural components of bacterial specimens at high resolution with negative staining for which "the best resolution available * * * will be needed." Therefore the resolution limit, i.e., the resolving capability is a pertinent specification within the meaning of section 701.2(n) of the regulations.

Resolving capability bears an inverse relationship to its numerical rating in angstrom units, i.e., the lower the rating, the better the resolving capability. The foreign article has a specified resolving capability of 3 angstroms. Comparable electron microscopes are produced in the United States by only one manufacturer, Forgflo. Forgflo has published specifications for two electron microscopes, i.e., the Model EMU-4C and the Paragon. The EMU-4C has a specified resolving capability of 5 angstroms, while the Paragon, according to its printed specifications, has a resolving capability of 2 angstroms. Accordingly, the EMU-4C is not of equivalent scientific value to the foreign article for the purposes that the foreign article is intended to be used.

The "Paragon" is an instrument that is customarily produced on order. Section 701.2(j) of the regulations defines produced on order as follows:

"Produced on order" means an instrument, apparatus, or accessory which a manufacturer lists in a current catalog and is able and willing to produce and have available without unreasonable delay to the applicant.

Section 701.11(b) of the regulations provides as to availability of such instruments:

An instrument, apparatus, or accessory shall be considered as being manufactured in the United States if it is customarily produced for stock, produced on order, or custom-made within the United States. In determining whether a U.S. manufacturer is able and willing to produce a produced on order, or custom-made instrument, apparatus or accessory and have it available without unreasonable delay to the applicant the Deputy Assistant Secretary shall take into account the normal commercial practices applicable to the production and delivery of instruments, apparatus, or accessories of the same general category * * *.

As to the Forgflo Model "Paragon", we note that: (1) The Department of Commerce knows of no instance wherein Forgflo demonstrated that it had produced an instrument conforming to the printed specifications of the Paragon. (2) Although the design of the Paragon apparently had been completed as of the date of the comments, the component parts were not. And further, the instrument had not reached, in performance, its design specifications. (3) Forgflo's published material relating to

the Paragon did not include information on delivery and Forgflo has never been able to provide the Department of Commerce with a firm delivery date. (4) Although Forgflo has accepted orders for the Paragon, delivery has been set back, and Forgflo has not been able to deliver a single Paragon to this date.

Accordingly, we find that at the time the application for duty-free entry of the foreign article was received, no domestic manufacturer was both able and willing to make available to the applicant an instrument or apparatus of equivalent scientific value to the foreign article for such purposes as this article is intended to be used, within the meaning of § 701.11(b) of the regulations.

SETH M. BODNER,
Director,
Office of Import Programs.

[FR Doc. 72-5195 Filed 4-4-72; 8:49 am]

UNIVERSITY OF MARYLAND

Notice of Decision on Application for Duty-Free Entry of Scientific Article

The following is a decision on an application for duty-free entry of a scientific article pursuant to section 6(c) of the Educational, Scientific, and Cultural Materials Importation Act of 1966 (Public Law 89-651, 80 Stat. 897), and the regulations issued thereunder as amended (37 F.R. 3892 et seq.).

A copy of the record pertaining to this decision is available for public review during ordinary business hours of the Department of Commerce, at the Office of Import Programs, Department of Commerce, Washington, D.C.

Docket No. 71-00414-33-46040. Applicant: University of Maryland, College Park, Md. 20740. Article: Electron Microscope, Model HU-12. Manufacturer: Hitachi, Ltd., Japan. Intended use of article: The article will be used for the study of the ultrastructure and assembly of myofibrils, myofilaments, and microtubules in dividing and differentiating chickembryo muscle cells grown in tissue culture; and to study isolated molecules of messenger RNA, DNA, and RNA-DNA hybrids from embryonic and adult muscle cells. Also electron microscopy will be taught in zoology courses.

Comments: Comments have been received from one domestic manufacturer, Forgflo Corporation (Forgflo), which alleges, inter alia, that its Model "Paragon" electron microscope is "superior to the instrument for which the applicant is applying for tariff relief, for the purposes stated in the application for which the instrument is intended to be used."

Decision: Application approved. No domestic manufacturer was both able and willing to produce an instrument or apparatus within the United States of equivalent scientific value to the foreign article, for such purposes as the article is intended to be used, and have it available without unreasonable delay to the applicant at the time the application for the foreign article was received. (February 23, 1971.)

Reasons: The Department of Health, Education, and Welfare (HEW) advises in a memorandum dated June 30, 1971, that the studies of the ultrastructure of muscle fibrils and microtubules and of isolated molecules of mRNA, DNA, and RNA-DNA hybrids will "require * * * the best resolution available." Therefore the resolution limit, i.e., the resolving capability is a pertinent specification within the meaning of § 701.2(n) of the regulations. Resolving capability bears an inverse relationship to its numerical rating in angstrom units, i.e., the lower the rating, the better the resolving capability. The foreign article has a specified resolving capability of 3 angstroms. Comparable electron microscopes are produced in the United States by only one manufacturer, Forgflo. Forgflo has published specifications for two electron microscopes, i.e., the Model EMU-4C and the Paragon. The EMU-4C has a specified resolving capability of 5 angstroms, while the Paragon, according to its printed specifications, has a resolving capability of 2 angstroms. Accordingly, the EMU-4C is not of equivalent scientific value to the foreign article for the purposes that the foreign article is intended to be used.

The "Paragon" is an instrument that is customarily produced on order. Section 701.2(j) of the regulations defines produced on order as follows:

Produced on order means an instrument, apparatus, or accessory which a manufacturer lists in a current catalog and is able and willing to produce and have available without unreasonable delay to the applicant.

Section 701.11(b) of the regulations provides as to availability of such instruments:

An instrument, apparatus, or accessory shall be considered as being manufactured in the United States if it is customarily produced for stock, produced on order, or custom-made within the United States. In determining whether a U.S. manufacturer is able and willing to produce a produced on order, or custom-made instrument, apparatus or accessory and have it available without reasonable delay to the applicant the Deputy Assistant Secretary shall take into account the normal commercial practices applicable to the production and delivery of instruments, apparatus, or accessories of the same general category * * *.

As to the Forgflo Model "Paragon", we note that: (1) The Department of Commerce knows of no instance wherein Forgflo demonstrated that it had produced an instrument conforming to the printed specifications of the Paragon. (2) Although the design of the Paragon apparently had been completed as of the date of the comments, the component parts were not. And further, the instrument had not reached, in performance, its design specifications. (3) Forgflo's published material relating to the Paragon did not include information on delivery and Forgflo has never been able to provide the Department of Commerce with a firm delivery date. (4) Although Forgflo has accepted orders for the Paragon, delivery has been set back and Forgflo has not been able to deliver a single Paragon to this date.

Accordingly, we find that at the time the application for duty-free entry of the foreign article was received, no domestic manufacturer was both able and willing to make available to the applicant an instrument or apparatus of equivalent scientific value to the foreign article for such purposes as this article is intended to be used, within the meaning of § 701.11(b) of the regulations.

SETH M. BODNER,
Director,

Office of Import Programs.

[FR Doc.72-5196 Filed 4-4-72;8:49 am]

UNIVERSITY OF MIAMI

Notice of Decision on Application for Duty-Free Entry of Scientific Article

The following is a decision on an application for duty-free entry of a scientific article pursuant to section 6(c) of the Educational, Scientific, and Cultural Materials Importation Act of 1966 (Public Law 89-651, 80 Stat. 897) and the regulations issued thereunder as amended (37 F.R. 3892 et seq.).

A copy of the record pertaining to this decision is available for public review during ordinary business hours of the Department of Commerce, at the Office of Import Programs, Department of Commerce, Washington, D.C.

Docket No. 71-00521-33-46040. Applicant: University of Miami, Post Office Box 8184, Coral Gables, FL 33124. Article: Electron microscope Model EM 300. Manufacturer: Philips Electronics NVD, the Netherlands. Intended use of article: The article will be used at the Department of Physiology and Biophysics of the Medical School for studies on cell junctions in normal and cancerous tissues. Research concerns the structural aspects of cellular communication in normal cells and the structural alterations in cancer cells.

Comments: No comments have been received with respect to this application.

Decision: Application approved. No instrument or apparatus of equivalent scientific value to the foreign article, for such purposes as this article is intended to be used, is being manufactured in the United States.

Reasons: The foreign article has a specified resolving capability of 3.5 angstroms. The most closely comparable domestic instrument is the Model EMU-4C electron microscope manufactured by the Forgio Corporation. The Model EMU-4C has a specified resolving capability of 5 angstroms. (The lower the numerical rating in terms of angstrom units, the better the resolving capability.) We are advised by the Department of Health, Education, and Welfare (HEW) in its memorandum dated September 3, 1971, that the additional resolving capability of the foreign article is pertinent to the purposes for which the foreign article is intended to be used. We, therefore, find that the Model EMU-4C is not of equivalent scientific value to the foreign article for such purposes as the article is intended to be used.

The Department of Commerce knows of no other instrument or apparatus of equivalent scientific value to the foreign article, for such purposes as this article is intended to be used, which is being manufactured in the United States.

SETH M. BODNER,
Director,

Office of Import Programs.

[FR Doc.72-5197 Filed 4-4-72;8:49 am]

DEPARTMENT OF HEALTH, EDUCATION, AND WELFARE

Office of the Secretary

OFFICE OF EDUCATION

Statement of Organization, Functions, and Delegations of Authority

The following statement supersedes all previous material issued in Part 6 (Office of Education) of the Statement of Organization, Functions and Delegations of Authority for the Department of Health, Education, and Welfare pertaining to Part 6-C, Delegations of Authority, Part 6-D, Reservation of Authority, and Part 6-E, Redelegation of Authority.

2-C *Delegations of authority.* Except as noted below and as provided in Part 1 (Office of the Secretary) and section 2-D of this Statement (Reservation of Authority), the Commissioner of Education shall exercise the functions vested in or delegated to the Secretary, the Department of Health, Education, and Welfare, the Commissioner, or the Office of Education by or under the following:

1. Establishment of Federal agency, Reorganization Plan No. 1, dated July 1, 1939, and Reorganization Plan No. 1, dated April 11, 1953; derived from the Acts of March 2, 1867, and July 20, 1868 (20 U.S.C. 1).

2. Establishment of and assistance to land-grant colleges and universities (Morrill Acts and special legislation in lieu thereof), except that authority to certify funds is reserved to the Secretary (Act of July 2, 1862; Act of August 30, 1890, as amended; and Act of June 29, 1935 (7 U.S.C. 301-329)).

3. Availability of library facilities (Joint Resolution No. 8, 52d Congress, approved April 12, 1892, as amended) (20 U.S.C. 91).

4. Inspection of Howard University (section 8 of Public Law 70-634, approved December 13, 1928, as amended) (20 U.S.C. 123).

5. Membership on District of Columbia Commission on Licensure (section 4 of Public Law 70-831, approved February 27, 1929, as amended) (2 District of Columbia Code 103).

6. Agreement with Housing and Home Finance Agency under title IV of the Housing Act of 1950 regarding college housing loans (Public Law 81-475, approved April 20, 1950, as amended) (12 U.S.C. 1749a(c)(2)).

7. Future Farmers of America (Public Law 81-740, approved August 30, 1950) (36 U.S.C. 271-291).

8. School construction in areas affected by Federal activities and in disaster relief areas (Public Law 81-815, approved Sept. 23, 1950, as amended) (20 U.S.C. 631-647).

9. Financial assistance for local educational agencies in areas affected by Federal activities and in disaster relief areas (Public Law 81-874, approved September 30, 1950, as amended) (20 U.S.C. 236-241-1, 242-244).

10. Immigration and Nationality Act—approval of schools for aliens under student visas (Public Law 82-414, approved June 27, 1952, as amended) (8 U.S.C. 1101(a)(15)(F)).

11. Veterans Readjustment Benefits Act of 1966—approval of accrediting agencies and membership on advisory committee (Public Law 89-358, approved March 3, 1966) (38 U.S.C. 1775, 1782-1783, 1786, 1788, 1790).

12. Consultation with National Science Foundation on study of effects on educational institutions of Federal contracts and grants for scientific research and development (Executive Order 10521 of March 17, 1954, as amended by Executive Order 10807 of March 3, 1959).

13. National Defense Education Act of 1958, including functions of the Secretary under section 1001(d) to study Federal programs in higher education, after initial contact has been made by the Secretary with the heads of departments and agencies concerned; and excepting the functions of the Secretary under sections 761(a) (Public Law 85-864, approved September 2, 1958, as amended) (20 U.S.C. 401-602).

14. Membership on Board of Trustees of the John F. Kennedy Center for the Performing Arts (Public Law 85-874, approved September 2, 1958, as amended).

15. Science Clubs (Public Law 85-875, approved September 2, 1958) (20 U.S.C. 2 note).

16. Education of the Handicapped Act except the functions of the Secretary under sections 604 and 653 (Public Law 91-230, title VI, approved April 13, 1970) (20 U.S.C. 1401-1461).

17. Preparation of national emergency plans and development of preparedness programs covering education functions and educational institutions (Executive Order 11490 of Oct. 28, 1969, Part II, section 1107, and those portions of Part 30, sections 3001, 3002, 3003, 3004, 3005, 3007, 3008, 3009, and 3010 which pertain to education).

18. Manpower Development and Training Act of 1962, except the responsibility for overall policy direction of the program, for coordination of program policies with those of related programs within the Department and with other departments and agencies, and the functions of the Secretary under sections 232 and 233 (Public Law 87-415, approved March 15, 1962, as amended) (42 U.S.C. 2571-2623).

19. Cooperative Research Act, except the functions of the Secretary under section 2(c) relating to the transfer of funds to other Federal agencies and section 2(e) (Public Law 83-531, approved July 26, 1954, as amended) (20 U.S.C. 331-332b).

20. Library Services and Construction Act, except the functions of the Secretary under section 502 (Public Law 84-597, approved June 19, 1956, as amended) (20 U.S.C. 351-358).

21. Grants for construction of educational broadcasting facilities under title III, part IV of the Communications Act of 1934, except the functions of the Secretary under sections 392-395 (Public Law 87-477, approved May 1, 1962, as amended) (47 U.S.C. 701-756).

22. Cuban refugee educational assistance programs, as assigned by the Commissioner of Welfare, under the Migration and Refugee Assistance Act of 1962 (Public Law 87-510, approved June 28, 1962, as amended) (22 U.S.C. 2601-2605).

23. Approval of recognized bodies for accrediting schools of medicine, dentistry, optometry, osteopathy, pharmacy, podiatry, nursing, and public health, membership on National Advisory Council on Education for Health Professions and the National Advisory Council on Nurse Training under the Public Health Service Act (Public Law 88-120, approved September 24, 1963, as amended, sections 721, 725, 841(a)(1), and 843(f)) (42 U.S.C. 293a(b)(1), et. seq.).

24. Higher Education Facilities Act of 1963, except the functions of the Secretary under section 306(b) to set limitations of general applicability respecting the amount of the annual interest grant or the amount on which such grant is based. (Public Law 88-204, approved December 16, 1963, as amended) (20 U.S.C. 701-757).

25. Vocational Education Act of 1963, except the functions of the Secretary under section 104(a)(2)(B) (Public Law 88-210, approved December 18, 1963, as amended) (20 U.S.C. 1241-1391).

26. Presidential Scholars (Executive Order 11155 of May 23, 1964).

27. Assistance in desegregation of public schools under title IV of the Civil Rights Act of 1964 (Public Law 88-352, approved July 2, 1964) (32 U.S.C. 2000 c-2000c-9).

28. Extension to the Trust Territory of the Pacific Islands of any program or of assistance under any program administered by the Commissioner of Education, except financial assistance under a grant-in-aid program (Public Law 88-487, approved August 22, 1964) (48 U.S.C. 1681).

29. Membership on and assistance to President's Commission on White House Fellowships (Executive Order 11183 of October 6, 1964).

30. Coordination of Federal education programs under Executive Order 11185 of October 16, 1964, as amended by Executive Order 11260 of December 15, 1965, and as amended by Executive Order 11410 of May 6, 1968, except the functions of the Secretary thereunder.

31. Financial assistance for follow through under the Economic Opportunity Act of 1964 (Public Law 88-452, approved August 30, 1964, as amended) (42 U.S.C. 2809(a)(2), 2971).

32. Vocational education facilities and supplements to certain grant-in-aid pro-

grams administered by the Commissioner of Education—Appalachian Regional Development Act of 1965 (Public Law 89-4, approved March 9, 1965, as amended) (40 U.S.C. App. 211, 214).

33. Elementary and Secondary Education Act of 1965, except the functions of the Secretary under sections 103(d), 309(b), and 708 (Public Law 89-10, approved April 11, 1965, as amended) (20 U.S.C. 241 a-m, 242-44, 821-887b).

34. Membership on the Federal Council on the Arts and Humanities and grants and loans for improving instructions in the humanities and arts under the National Foundation on the Arts and Humanities Act of 1965 (Public Law 89-209, approved September 29, 1965, as amended) (20 U.S.C. 958).

35. Higher Education Act of 1965, except the functions of the Secretary under section 205(a), section 303(a) and section 502 (Public Law 89-329, approved November 8, 1965, as amended) (20 U.S.C. 1001-1144; 42 U.S.C. 2751-2756).

36. Adult Education Act of 1966, except the functions of the Secretary under section 310 (Public Law 89-750, title III, approved November 3, 1966) (20 U.S.C. 1201-1211).

37. General Education Provisions Act, except the functions of the Secretary under sections 402(b), 404, and 424(b), and except for those evaluation funds which are received in any fiscal year for use at the initiative and direction of the Assistant Secretary for Planning and Evaluation; and except authority which is reserved to the Secretary to approve regulations, establish such advisory committees as he may deem appropriate, and appoint members thereof (Public Law 90-247, title IV, approved January 2, 1968, as amended) (20 U.S.C. 1221-1223g).

38. The agreements made with the Department of State in connection with educational aspects of international education exchange and international technical cooperation programs under:

a. Agricultural Trade Development and Assistance Act of 1954 (Public Law 83-480, approved July 10, 1954, as amended) (7 U.S.C. Ch. 41).

b. Foreign Assistance Act of 1961 (Public Law 87-195, approved September 4, 1961, as amended) (22 U.S.C. Ch. 32).

c. Mutual Educational and Cultural Exchange Act of 1961 (Public Law 87-256, approved September 21, 1961, as amended) (22 U.S.C. Ch. 33).

39. Mutual Educational and Cultural Exchange Act of 1961, section 102(b)(6), to the extent provided in section 4 of Executive Order 11034 of June 25, 1962 (Public Law 87-256, approved September 21, 1961, as amended) (22 U.S.C. 2451).

40. Emergency Insured Student Loan Act of 1969, except the functions of the Secretary under section 2 (Public Law 91-95, approved October 22, 1969) (20 U.S.C. 1078a).

41. Assistance to desegregating local educational agencies under the Emergency School Assistance Program, for which appropriations were made by Public Law 91-980, including that portion

of the program carried out under title II of the Economic Opportunity Act of 1964 (pursuant to authority delegated to the Secretary), except authority delegated to the Secretary under section 242 of that Act.

42. The Environmental Education Act, except the functions of the Secretary under section 3(c)(1) and section 4 thereof (Public Law 91-516, approved October 30, 1970) (20 U.S.C. 1531-1536).

43. Provision of administrative support under the National Commission on Libraries and Information Science Act, section 3(b). (Public Law 91-345, approved July 20, 1970) (20 U.S.C. 1502).

44. The Drug Abuse Education Act of 1970, except the functions of the Secretary under section 5 thereof (Public Law 91-527, approved December 3, 1970) (21 U.S.C. 1001-1007).

2-D *Reservation of authority.* No State grant-in-aid funds shall be withheld nor shall any State plan or amendment thereto submitted pursuant to any statute administered by the Office of Education be finally disapproved without the Commissioner's prior consultation and discussion with the Secretary. Regulations shall be approved by the Secretary in all instances in which authority for issuances has not been specifically delegated.

2-E *Redelegation of authority.* Authority contained in section 2-C except the making of regulations, may, to the extent permitted by law, be delegated or redelegated by the Commissioner of Education to such officials of the Office of Education as he may deem appropriate.

Dated: March 30, 1972.

RODNEY H. BRADY,
Assistant Secretary for
Administration and Management.

[FR Doc.72-5255 Filed 4-4-72; 8:54 am]

DEPARTMENT OF TRANSPORTATION

National Transportation Safety Board

[Docket No. SS-R/H-6]

HIGHWAY-GRADE CROSSING ACCIDENT NEAR CONGERS, N.Y.

Notice of Investigation Hearing

In the matter of the investigation of the highway-grade crossing accident involving a Penn Central freight train and a Rockland County schoolbus near Congers, N.Y., on March 24, 1972.

Notice is hereby given that a Highway/Grade Crossing Accident Investigation Hearing on the above matter will be held commencing at 9 a.m., e.s.t., on Tuesday, April 11, 1972, in the Ripples Banquet Hall, 60 Phillips Hill Road, New City, N.Y.

Dated this 3d day of April 1972.

LOUIS M. THAYER,
Chairman, Board of Inquiry.

[FR Doc.72-5320 Filed 4-4-72; 9:50 am]

CIVIL AERONAUTICS BOARD

[Docket No. 24091]

**CARIBBEAN AIR TRANSPORT CORP.,
INC.****Notice of Prehearing Conference and
Hearing Regarding Foreign Air
Carrier Permit**

Carabische Lucht Transport MIJ. N.V. (Caribbean Air Transport Comp. Inc.), Netherlands Antilles-New York, Houston, points in Florida and Puerto Rico, foreign air carrier permit, Docket 24091.

Notice is hereby given that a prehearing conference in the above-entitled matter is assigned to be held on May 3, 1972, at 10 a.m., local time, in room 503, Universal Building, 1825 Connecticut Avenue NW., Washington, DC, before Examiner Arthur S. Present.

Notice is also given that the hearing may be held immediately following conclusion of the prehearing conference unless a person objects or shows reason for postponement on or before April 21, 1972.

Dated at Washington, D.C., March 30, 1972.

[SEAL] RALPH L. WISER,
Chief Examiner.

[FR Doc.72-5251 Filed 4-4-72;8:53 am]

[Docket No. 24353]

**NORTHEAST U.S.—PUERTO RICO/
VIRGIN ISLANDS****Notice of Prehearing Conference
Regarding Fare Increases**

Notice is hereby given that a prehearing conference in the above-entitled matter is assigned to be held on April 25, 1972, at 10 a.m., local time, in room 726, Universal Building, 1825 Connecticut Avenue NW., Washington, DC, before Examiner Robert M. Johnson.

In order to facilitate the conduct of the conference parties are instructed to submit to the examiner and other parties (1) proposed statements of issues; (2) proposed stipulations; (3) requests for information; (4) statement of positions of parties; and (5) proposed procedural dates. The Bureau of Economics will circulate its material on or before April 12, 1972, and the other parties on or before April 19, 1972. The submissions of the other parties shall be limited to points on which they differ with the Bureau of Economics.

Dated at Washington, D.C., March 31, 1972.

[SEAL] RALPH L. WISER,
Chief Examiner.

[FR Doc.72-5252 Filed 4-4-72;8:53 am]

[Docket No. 24342]

**VENEZOLANA INTERNACIONAL DE
AVIACION, S.A. (VIASA)****Notice of Prehearing Conference and
Hearing Regarding Foreign Air
Carrier Permit**

Amendment of foreign air carrier permit; Venezuela-San Juan, New York, Miami, Houston, Washington, D.C., service, Docket 24342.

Notice is hereby given that a prehearing conference in the above-entitled matter is assigned to be held on April 21, 1972, at 10 a.m., local time, in room 805, Universal Building, 1825 Connecticut Avenue NW., Washington, DC, before Examiner E. Robert Seaver.

Notice is also given that the hearing may be held immediately following conclusion of the prehearing conference unless a person objects or shows reason for postponement on or before April 14, 1972.

Dated at Washington, D.C., March 30, 1972.

[SEAL] RALPH L. WISER,
Chief Examiner.

[FR Doc.72-5253 Filed 4-4-72;8:53 am]

COST OF LIVING COUNCIL

[Order No. 9]

SECRETARY OF THE TREASURY**Delegation of Authority To Deny
Certain Requests for Exemptions**

Pursuant to the Economic Stabilization Act of 1970, as amended (hereinafter referred to as the Act) and the authority delegated to the Cost of Living Council by Executive Order No. 11640, it is hereby ordered as follows:

1. There is hereby delegated to the Secretary of the Treasury (hereinafter referred to as the Secretary), subject to the general policy guidance of and coordination with the Cost of Living Council (hereinafter referred to as the Council) and in accordance with the general policy of the Act, authority to deny exemption requests that are the same as or substantially the same as exemptions considered and denied by the Council insofar as such requests are based upon the same or substantially the same reasons considered and rejected by the Council.

2. All executive departments and agencies shall furnish such necessary assistance to the Secretary as may be authorized by law.

3. The Secretary may redelegate to any agency, instrumentality, or official of the United States any authority under this order, and may, in carrying out the functions delegated by this order, utilize

the services of any other agencies, Federal or State, as may be available and appropriate.

By direction of the Council.

JAMES W. McLANE,
Deputy Director.

[FR Doc.72-5257 Filed 3-31-72;5:27 pm]

**ENVIRONMENTAL PROTECTION
AGENCY****E. I. DU PONT DE NEMOURS & CO.,
INC.****Notice of Filing of Petition Regarding
Pesticide Chemical**

Pursuant to provisions of the Federal Food, Drug, and Cosmetic Act (sec. 408(d)(1), 68 Stat. 512; 21 U.S.C. 346a(d)(1)), notice is given that a petition (PP 2F1245) has been filed by E. I. du Pont de Nemours & Co., Inc., Wilmington, Del. 19898, proposing establishment of tolerances (40 CFR Part 180) for negligible residues of the insecticide methomyl (S-methyl N-[(methylcarbamoyl)oxylthioacetimidate] in or on the raw agricultural commodities cucurbits at 0.2 part per million.

The analytical method proposed in the petition for determining residues of the insecticide is that of H. L. Pease and J. J. Kirkland, "Journal of Agricultural and Food Chemistry", vol. 16, pp. 554-557 (July-August, 1968).

Dated: March 30, 1972.

WILLIAM M. UPHOLT,
Deputy Assistant Administrator
for Pesticides Programs.

[FR Doc.72-5147 Filed 4-4-72;8:45 am]

**E. I. DU PONT DE NEMOURS & CO.,
INC.****Notice of Filing of Petition Regarding
Pesticide Chemical**

Pursuant to provisions of the Federal Food, Drug, and Cosmetic Act (sec. 408(d)(1), 68 Stat. 512; 21 U.S.C. 346a(d)(1)), notice is given that a petition (PP 2F1246) has been filed by E. I. du Pont de Nemours and Co., Inc., Wilmington, Del. 19898, proposing establishment of tolerances (40 CFR Part 180) for residues of the insecticide methomyl (S-methyl N-[(methylcarbamoyl)oxylthioacetimidate] in or on the raw agricultural commodities nectarines and peaches at 5 parts per million.

The analytical method proposed in the petition for determining residues of the insecticide is a modification of the method of H. L. Pease and J. J. Kirkland, "Journal of Agricultural and Food

Chemistry," vol. 16, pp. 554-7 (1968), using a flame photometric detector instead of a sulfur microcoulometric detector.

Dated: March 30, 1972.

WILLIAM M. UPHOLT,
Deputy Assistant Administrator
for Pesticides Programs.

[FR Doc.72-5148 Filed 4-4-72;8:45 am]

E. I. DU PONT DE NEMOURS & CO., INC.

Notice of Filing of Petition Regarding Pesticide Chemical

Pursuant to provisions of the Federal Food, Drug, and Cosmetic Act (sec. 408 (d) (1), 68 Stat. 512; 21 U.S.C. 346a(d) (1)), notice is given that a petition (PP 2F1247) has been filed by E. I. du Pont de Nemours & Co., Inc., Wilmington, Del. 19898, proposing establishment of tolerances (40 CFR Part 180) for residues of the insecticide methomyl (S-methyl N - [(methylcarbamoyl) oxy]thioacetimidate) in or on the raw agricultural commodities pea vines at 10 parts per million and peas at 5 parts per million.

The analytical method proposed in the petition for determining residues of the insecticide is that of H. L. Pease and J. J. Kirkland, "Journal of Agricultural and Food Chemistry," vol. 16, pp. 554-557 (July-August 1968).

Dated: March 30, 1972.

WILLIAM M. UPHOLT,
Deputy Assistant Administrator
for Pesticides Programs.

[FR Doc.72-5149 Filed 4-4-72;8:45 am]

MOBIL CHEMICAL CO.

Notice of Filing of Petition Regarding Pesticide Chemical

Pursuant to provisions of the Federal Food, Drug, and Cosmetic Act (sec. 408 (d) (1), 68 Stat. 512; 21 U.S.C. 346a(d) (1)), notice is given that a petition (PP 2F1250) has been filed by Mobile Chemical Co., Industrial Chemicals Division, Post Office Box 677, Richmond, VA 23208, proposing establishment of tolerances (40 CFR Part 180) for negligible residues of the insecticide *o*-ethyl S,S-dipropylphosphorodithioate in or on the raw agricultural commodities brussels sprouts and cabbage at 0.02 part per million.

The analytical method proposed in the petition for determining residues of the insecticide is a gas chromatographic procedure with microcoulometric detection.

Dated: March 30, 1972.

WILLIAM M. UPHOLT,
Deputy Assistant Administrator
for Pesticides Programs.

[FR Doc.72-5150 Filed 4-4-72;8:45 am]

0,0 - DIETHYL S - (2 - CHLORO - 1 - PHTHALIMIDOETHYL) PHOSPHOR- ODITHIOATE

Notice of Extension and Renewal of Temporary Tolerances

Hercules Inc., Wilmington, Del. 19899, was granted a temporary tolerance for residues of the insecticide 0,0-diethyl S-(2-chloro-1-phthalimidoethyl) phosphorodithioate and its oxygen analog 0,0-diethyl S-(2-chloro-1-phthalimidoethyl) phosphorothioate in or on citrus fruits at 1.5 parts per million on July 1, 1969 (notice was published in the FEDERAL REGISTER of July 9, 1969 (34 F.R. 11326)). The temporary tolerance was later extended to July 1, 1971 (notice was published in the FEDERAL REGISTER of September 30, 1970 (35 F.R. 15254)). The firm also was granted a temporary tolerance for residues of this insecticide and its oxygen analog in or on pecans at 0.01 part per million on March 15, 1971 (notice was published in the FEDERAL REGISTER of March 18, 1971 (36 F.R. 5254)).

The firm has requested a 1-year extension of the temporary tolerance on pecans at 0.01 part per million and a 1-year renewal of the temporary tolerance on citrus at a new level of 2.5 parts per million to obtain additional experimental data. It is concluded that such extension and renewal will protect the public health. The tolerance on pecans at the present level (0.01 part per million) is therefore extended, and the tolerance on citrus for the fresh fruit market only is renewed at the new level (2.5 parts per million). A condition under which the extension and renewal are granted is that the insecticide will be used in accordance with the temporary permits which are being issued concurrently by the Environmental Protection Agency and which provide for distribution under the Hercules Inc. name.

As extended, the temporary tolerance on pecans expires March 15, 1973. As renewed, the temporary tolerance on citrus expires March 15, 1973.

This action is taken pursuant to provisions of the Federal Food, Drug, and Cosmetic Act (sec. 408(j), 68 Stat. 516; 21 U.S.C. 346a(j)), the authority transferred to the Administrator of the Environmental Protection Agency (35 F.R. 15623), and the authority delegated by the Administrator to the Deputy Assistant Administrator for Pesticides Programs (36 F.R. 9038).

Dated: March 29, 1972.

WILLIAM M. UPHOLT,
Deputy Assistant Administrator
for Pesticides Programs.

[FR Doc.72-5151 Filed 4-4-72;8:46 am]

FEDERAL DEPOSIT INSURANCE CORPORATION

INSURED STATE NONMEMBER BANKS

Statement of Policy and Guidelines for "Leeway Investments"

The Federal Deposit Insurance Corporation feels that some of its examination policies may be inhibiting insured State banks not members of the Federal Reserve System from investing in the securities of corporations who are engaged in providing capital to minority business enterprises, securities of foreign governments, or the securities of corporations whose objectives and purposes are primarily of a civic or community nature or seem socially desirable to the bank's board of directors but whose risk as a bank investment may seem greater than normal. These policies include criticism by examiners of investments by banks in equity securities or other securities not of group I or "investment grade."

It has been suggested that these constraints have in some instances inhibited banks from participating effectively in the broad social movements that have taken place in the United States during the past decade. Indeed, Congress has enacted laws authorizing programs for community rehabilitation, low and moderate income housing, and many other social objectives, and the support and participation of the financial community has been solicited to achieve those goals. In this vein, the Urban Affairs Committee of the American Bankers Association has recently sponsored the formation of Minbanc Capital Corporation, a closed-end investment company whose primary objective is to make capital funds available to qualifying minority owned banks and whose capital stock has been offered exclusively to ABA member banks. Other similar corporations, such as "Mesbics," have also been recently suggested to facilitate the flow of capital to minority business enterprises.

By encouraging insured banks to restrict their investments to "investment" grade securities, the corporation has perhaps also inhibited some banks from acquiring debt securities of alleged merit, which technically fall short of "investment" grade quality by conventional standards of liquidity and other measurable qualitative factors. Such a situation might arise with respect to debt securities associated with community rehabilitation or development corporations which, while lacking the qualitative elements of "investment" grade securities, are regarded by knowledgeable bankers as "tolerable" risks to depository financial institutions on a restricted and controlled basis. Similar circumstances may prevail in the case of securities of a foreign government, particularly among the

new emerging nations, which not only suffer from liquidity imperfections arising from limitations on transfer and exchange rate fluctuations, but also qualitatively because of the absence of a reliable past record of debt performance and financial stability and an uncertain political climate.

The corporation does not wish to impede those banks that feel a strong sense of responsibility from providing limited financial assistance under the circumstances described. Accordingly, the board of directors is adjusting the corporation's examination policies to enable those insured State nonmember banks that so desire to invest in equity or capital debt securities falling within broad categories such as those discussed without fear of criticism by the corporation or its examiners, subject to the following conditions:

(1) That such investments are allowed for State nonmember banks by applicable State law;¹

(2) That they are not in conflict with the Voluntary Foreign Credit Restraint guidelines promulgated by the Board of Governors of the Federal Reserve System;

(3) That the aggregate total of all such investments not exceed the amount authorized by applicable State law or 10 percent of the bank's combined capital stock and surplus,² whichever is less;

(4) That all such investments have been approved by the bank's board of directors as "leeway investments" and are so identified on the bank's general or subsidiary ledger records.

Within the parameters outlined above, the acquisition of "leeway investments" will not be subject to criticism by corporation examiners, and in the absence of default or bankruptcy will be permitted to be carried on the bank's books at amortized acquisition cost.

Interested persons are given 45 days to submit written comments, suggestions or objections concerning this proposed policy statement. Address all such correspondence to:

Office of the Chairman, Federal Deposit Insurance Corporation, 550 17th Street NW, Washington, DC 20429.

By order of the Board of Directors, March 31, 1972.

FEDERAL DEPOSIT INSURANCE CORPORATION,

[SEAL] E. F. DOWNEY,
Secretary.

[FR Doc. 72-5250 Filed 4-4-72; 8:54 am]

FEDERAL MARITIME COMMISSION

DET BERGENSKE DAMPSKIBSELSKAB

Order of Revocation of Certificates of Financial Responsibility

Certificate of Financial Responsibility for Indemnification of Passengers for

¹The word "State" means any State of the United States, the District of Columbia, any territory of the United States, Puerto Rico, Guam, American Samoa, or the Virgin Islands.

²Surplus means that segment of the bank's capital structure duly established as "surplus" by action of the board of directors and so captioned on the bank's books.

Nonperformance of Transportation No. P-52 and Certificate of Financial Responsibility to Meet Liability Incurred for Death or Injury to Passengers or Other Persons on Voyages No. C-1,033.

Whereas, Det Bergenske Dampskibsselskab (Bergen Line), c/o Bergen Line, 505 Fifth Avenue, New York, NY 10017, has ceased to operate the passenger vessel "Meteor":

It is ordered, That Certificate (Performance) No. P-52 and Certificate (Casualty) No. C-1,033 covering the "Meteor" be and are hereby revoked effective March 28, 1972.

It is further ordered, That a copy of this order be published in the FEDERAL REGISTER and served on the certificant.

By the Commission.

FRANCIS C. HURNEY,
Secretary.

[FR Doc. 72-5205 Filed 4-4-72; 8:50 am]

FRED F. NOONAN CO., INC., ET AL.

Notice of Agreement Filed

Notice is hereby given that the following agreement has been filed with the Commission for approval pursuant to section 15 of the Shipping Act, 1916, as amended (39 Stat. 733, 75 Stat. 763, 46 U.S.C. 814).

Interested parties may inspect and obtain a copy of the agreement at the Washington office of the Federal Maritime Commission, 1405 I Street NW, Room 1015; or may inspect the agreement at the Field Offices located at New York, N.Y., New Orleans, La., and San Francisco, Calif. Comments on such agreements, including requests for hearing, may be submitted to the Secretary, Federal Maritime Commission, Washington, D.C. 20573, within 10 days after publication of this notice in the FEDERAL REGISTER. Any person desiring a hearing on the proposed agreement shall provide a clear and concise statement of the matters upon which they desire to adduce evidence. An allegation of discrimination or unfairness shall be accompanied by a statement describing the discrimination or unfairness with particularity. If a violation of the Act or detriment to the commerce of the United States is alleged, the statement shall set forth with particularity the acts and circumstances said to constitute such violation or detriment to commerce.

A copy of any such statement should also be forwarded to the party filing the agreement (as indicated hereinafter) and the statement should indicate that this has been done.

Notice of agreements filed by:

Paul A. Dezurick, Esq., Graham & James, 310 Sansome Street, San Francisco, CA 94104.

Agreement No. T-2610, between Fred F. Noonan Co., Inc. (Noonan), Pasha Truckaway Corp. (Pasha), and Canal Industrial Park, Inc. (CIP), sets forth

the basis for (1) the assignment to CIP by Noonan and Pasha of the "Southside Premises" located at Richmond, Calif.; (2) the lease to CIP by Noonan and Pasha of the existing improvements to the Southside Premises; and (3) the preferential assignment to Noonan by CIP of portions of the "Northside Premises" originally leased to Pasha by the Surplus Property Authority of the city of Richmond, but subsequently assigned to CIP by Pasha pursuant to the terms of FMC Agreement No. T-2427. It is the parties' intent that the combined effect of the implementation of the three basic provisions of Agreement No. T-2610 will be CIP's operation of the Southside Premises (formerly leased to Noonan and Pasha) in conjunction with its operations at the Northside Premises, with Noonan performing agency and clerking services for CIP's combined operation of both the Northside and Southside Premises.

Agreement No. T-2610-A implements the first basic provision of Agreement No. T-2610, the assignment to CIP of Noonan and Pasha's right, title, and interest in (1) the Southside Premises, consisting of 16.67 acres of land (exclusive of improvements); and (2) a contract with Parr-Richmond Terminal Co. (FMC Agreement No. T-2332, determined not to be subject to section 15) relating to the receipt and free-time storage of automobiles delivered at Parr-Richmond Terminal facilities. Canal Industrial Park, Inc. assumes all obligations of Noonan and Pasha under Agreement No. T-2332, and will be compensated directly by Parr-Richmond on the same basis as the assignors were compensated.

Agreement No. T-2610-B implements the second basic provision of Agreement No. T-2610, the lease to CIP by Noonan and Pasha of the existing improvements to the Southside Premises assigned to CIP by Noonan and Pasha under Agreement No. T-2610-A. The lease is for a term of 8 years and 4 months. As compensation, Noonan is to receive 50 percent of the net income received by CIP from its operation of the Southside Premises, to a maximum of \$35,000 during the terms of the lease of improvements, and Pasha is to receive \$1 annually.

Agreement No. T-2610-C implements the third basic provision of Agreement No. T-2610, the preferential assignment to Noonan by CIP of portions of the Northside and Southside Premises with CIP retaining secondary and temporary assignment rights. Agreement No. T-2610 provides that Noonan will have no right to collect wharfage and dockage fees on the Northside facilities.

Dated: March 31, 1972.

By order of the Federal Maritime Commission.

FRANCIS C. HURNEY,
Secretary.

[FR Doc. 72-5204 Filed 4-4-72; 8:50 am]

FEDERAL POWER COMMISSION
NATIONAL GAS SURVEY DISTRIBUTION-TECHNICAL ADVISORY COMMITTEE AND DISTRIBUTION-TECHNICAL ADVISORY TASK FORCE-GENERAL

**Order Designating Member;
 Correction**

MARCH 21, 1972.

In the order designating a member of the National Gas Survey Distribution-Technical Advisory Committee and Distribution-Technical Advisory Task Force-General, issued March 16, 1972, and published in the FEDERAL REGISTER, March 23, 1972 (37 F.R. 5974): Change paragraph "1. Membership," to read:

Mrs. Eunice P. Howe (Chairman, President's Consumer Advisory Council and former Assistant Attorney General, Commonwealth of Massachusetts).

KENNETH F. PLUMB,
Secretary.

[FR Doc.72-5168 Filed 4-4-72;8:47 am]

[Docket No. RI72-182, etc.]

AMERADA HESS CORP. ET AL.

Order Providing for Hearing on and Suspension of Proposed Changes in Rates, and Allowing Rate Changes To Become Effective Subject to Refund; Correction

MARCH 17, 1972.

In the order providing for hearing on and suspension of proposed changes in rates, and allowing rate changes to become effective subject to refund, issued February 23, 1972 and published in the FEDERAL REGISTER March 7, 1972 (37 F.R. 4932): Appendix "A", Docket No. RI72-183, Koch Industries, Inc., under column headed "Respondent" change "Koch Industries, Inc." to "Koch Development Company," opposite Rate Schedule No. 1.

KENNETH F. PLUMB,
Secretary.

[FR Doc.72-5169 Filed 4-4-72;8:47 am]

[Docket No. CP72-227]

CAPROCK PIPELINE CO.

Notice of Application

MARCH 28, 1972.

Take notice that on March 21, 1972, Caprock Pipeline Co. (applicant), Post Office Box 2542, Amarillo, Tex. 79105, filed in Docket No. CP72-227 an application pursuant to section 7(c) of the Natural Gas Act for a certificate of public convenience and necessity authorizing the acquisition from Pioneer Natural Gas Co. (Pioneer), and operation of certain gas gathering facilities, the construction and operation of minor interconnecting facilities with Northern Natural Gas Co. (Northern) and the operation of certain existing facilities for the transportation of natural gas for Pioneer

in Texas, all as more fully set forth in the application which is on file with the Commission and open to public inspection.

Applicant proposes to acquire Pioneer's field gathering system in the West Wellman Field, Terry County, Tex., at a net book cost of \$51,886; to gather Pioneer's gas for a gathering charge of 1 cent per Mcf at 14.65 p.s.i.a.; to deliver the gas at two points on the gathering system to Northern, which will redeliver it to applicant at a point of interconnection with applicant's existing Gaines County, Tex., facilities; and to transport the gas for Pioneer from the point of redelivery by Northern to El Paso Natural Gas Co.'s Plains Compressor Station in Yoakum County, Tex., at a charge of one-half cent per Mcf at 14.65 p.s.i.a. Applicant also proposes to construct certain minor interconnecting facilities at the point where it will receive the West Wellman Field gas from Northern in Gaines County, Tex.

Applicant states that the purpose of the proposed transportation service is to supply needed natural gas to Pioneer's West Texas distribution system, supplied by El Paso Natural Gas Company downstream of its Plains Compressor Station. Pioneer has advised applicant that its customers presently receiving gas from the West Wellman Field can be served from other sources of supply. Applicant estimates that the maximum volume of West Wellman Field gas to be transported will be 5,000 Mcf per day.

Applicant plans to finance the acquisition of the gathering facilities from the proceeds of a note in the amount of \$50,000 to Pioneer, with the balance from cash on hand. Applicant estimates the cost of the proposed new interconnection facilities at \$1,179, which it plans to finance from funds on hand.

Any person desiring to be heard or to make any protest with reference to said application should on or before April 18, 1972, file with the Federal Power Commission, Washington, D.C. 20426, a petition to intervene or a protest in accordance with the requirements of the Commission's rules of practice and procedure (18 CFR 1.8 or 1.10) and the regulations under the Natural Gas Act (18 CFR 157.10). All protests filed with the Commission will be considered by it in determining the appropriate action to be taken but will not serve to make the protestants parties to the proceeding. Any person wishing to become a party to a proceeding or to participate as a party in any hearing therein must file a petition to intervene in accordance with the Commission's rules.

Take further notice that, pursuant to the authority contained in and subject to the jurisdiction conferred upon the Federal Power Commission by sections 7 and 15 of the Natural Gas Act and the Commission's rules of practice and procedure, a hearing will be held without further notice before the Commission on this application if no petition to intervene is filed within the time required herein, if the Commission on its own review of the matter finds that a grant of

the certificate is required by the public convenience and necessity. If a petition for leave to intervene is timely filed, or if the Commission on its own motion believes that a formal hearing is required, further notice of such hearing will be duly given.

Under the procedure herein provided for, unless otherwise advised, it will be unnecessary for Applicant to appear or be represented at the hearing.

KENNETH F. PLUMB,
Secretary.

[FR Doc.72-5161 Filed 4-4-72;8:46 am]

[Project 785]

CONSUMERS POWER CO.

Notice of Application for Approval of Exhibit R (Recreational Use Plan) for Constructed Project

MARCH 27, 1972.

Public notice is hereby given that application for approval of an Exhibit R has been filed under the Federal Power Act (16 U.S.C. 791a-825r) by Consumers Power Co. (Correspondence to Mr. P. A. Perry, Secretary, Consumers Power Co., 212 West Michigan Avenue, Jackson, MI 49201) as part of the license for the Calkins Bridge Project No. 785, located on the Kalamazoo River, near the city of Allegan, in Allegan County, Mich.

The project reservoir is presently used primarily for sightseeing, boating, and canoeing, and limited fishing. Due to the abundance of other lakes and ponds near the project the poor water quality within the project reservoir, and the small amount of fee-owned lands within the project boundary, the recreational use of project lands and waters is limited.

Recreation facilities located outside the project boundary, but with access to the project reservoir, include two areas owned and maintained by the Michigan State Department of Natural Resources: One is the Lakeview Campground with ten tent or trailer campsites, a picnic area with tables and grills, sanitary facilities, and a boat launch area; the other is an improved boat launching site with two ramps, sanitary facilities, and parking facilities for 36 cars and boat trailers and for 73 cars. Access to the reservoir is also available at (1) a Highway turnout with a sheltered well and an unimproved boat launching site; (2) Echo Point Park, located in the Allegan State Game Area, which includes a picnic area with 10 tables, grills, and an improved boat ramp; and (3) Indian Shores Park, a private park for the use of Indian Shores Subdivision residents, which includes a well, picnic area with tables and grills, a playground area, and an improved boat ramp.

Licensee's development plans include constructing a boat launch ramp on fee-owned lands, improving access to the launch site and issuing recreational leases to the city of Allegan for development of a 12 acre recreational park and to the Boy Scout Area Council for use of an island in the project reservoir.

Any person desiring to be heard or to make any protest with reference to said application should on or before May 16, 1972, file with the Federal Power Commission, Washington, D.C. 20426, petitions to intervene or protests in accordance with the Commission's rules of practice and procedure (18 CFR 1.8 or 1.10). All protests filed with the Commission will be considered by it in determining the appropriate action to be taken but will not serve to make the protestants parties to the proceeding. Persons wishing to become parties to a proceeding or to participate as a party in any hearing therein must file petitions to intervene in accordance with the Commission's rules. The application is on file with the Commission and available for public inspection.

KENNETH F. PLUMB,
Secretary.

[FR Doc.72-5162 Filed 4-4-72;8:46 am]

[Docket No. RP71-13, etc.]

EL PASO NATURAL GAS CO.

Notice of Motion for Further Modification of Order Permitting Tracking Increases in Purchased Gas Costs

MARCH 27, 1972.

Take notice that El Paso Natural Gas Co. (El Paso), on March 13, 1972, filed in Docket No. RP71-13 a motion for further modification of the Commission's order, issued October 30, 1970, as amended by order issued July 30, 1971, insofar as it gives El Paso authority to file rate increases and decreases to reflect increases or decreases in the cost of purchased gas for its Southern Division System.

El Paso seeks further modification of the order issued October 30, 1970, as amended, so as to permit it to track the increase in cost of gas purchased on an intrastate basis and utilized as fuel in El Paso's plants and stations situated on its Southern Division System. El Paso states that in light of the fact that it is unable to acquire, on a jurisdictional basis, new supplies in the Permian Basin area in meaningful quantities and the increasingly effective competition in west Texas from intrastate pipeline purchasers, El Paso has undertaken an intrastate project, as more fully described in its motion, which it hopes will provide intrastate supplies and thereby preserve interstate supplies for the use and benefit of customers served by its interstate Southern Division System. El Paso says that in addition to the distribution, export and direct sale uses of the intrastate supplies in the city of El Paso, Tex., and surrounding area, it anticipates that these supplies will be utilized for fuel in plants and stations physically situated on El Paso's interstate system in Texas and that, in its motion, it seeks the only authority necessary to track the increased cost of the intrastate gas utilized as fuel at those locations.

Copies of the motion were served on all parties in Docket No. RP71-13 and RP71-14, all jurisdictional and nonjurisdictional customers of El Paso's Southern Division System and interested State regulatory commissions.

Answers or comments relating to the motion may be filed with the Federal Power Commission, Washington, D.C. 20426, on or before April 11, 1972.

KENNETH F. PLUMB,
Secretary.

[FR Doc.72-5163 Filed 4-4-72;8:46 am]

[Docket No. CP72-230]

FLORIDA GAS TRANSMISSION CO.

Notice of Application

MARCH 28, 1972.

Take notice that on March 22, 1972, Florida Gas Transmission Co. (applicant), Post Office Box 44, Winter Park, Fla. 32789, filed in Docket No. CP72-230 a budget-type application pursuant to section 7(c) of the Natural Gas Act, as implemented by § 157.7(b) of the regulations under said Act, for a certificate of public convenience and necessity authorizing the construction and installation, during the 12-month period commencing July 1, 1972, and operation of certain natural gas-purchase facilities, all as more fully set forth in the application which is on file with the Commission and open to public inspection.

Applicant states that the purpose of this budget-type application is to augment its ability to act with reasonable dispatch in contracting for and connecting to its pipeline system supplies of natural gas in producing areas generally co-extensive with its system and in maintaining its currently committed supplies of natural gas.

The total cost of the facilities proposed herein will not exceed \$7 million, with no single onshore project to exceed \$1 million and no single offshore project to exceed \$1,750,000. Applicant states that these costs will be financed from internally generated funds.

Any person desiring to be heard or to make any protest with reference to said application should on or before April 18, 1972, file with the Federal Power Commission, Washington, D.C. 20426, a petition to intervene or a protest in accordance with the requirements of the Commission's rules of practice and procedure (18 CFR 1.8 or 1.10) and the regulations under the Natural Gas Act (18 CFR 157.10). All protests filed with the Commission will be considered by it in determining the appropriate action to be taken but will not serve to make the protestants parties to the proceeding. Any person wishing to become a party to a proceeding or to participate as a party in any hearing therein must file a petition to intervene in accordance with the Commission's rules.

Take further notice that, pursuant to the authority contained in and subject to the jurisdiction conferred upon the Federal Power Commission by sections 7 and 15 of the Natural Gas Act and the Commission's rules of practice and procedure, a hearing will be held without further notice before the Commission on

this application if no petition to intervene is filed within the time required herein, if the Commission on its own review of the matter finds that a grant of the certificate is required by the public convenience and necessity. If a petition for leave to intervene is timely filed, or if the Commission on its own motion believes that a formal hearing is required, further notice of such hearing will be duly given.

Under the procedure herein provided for, unless otherwise advised, it will be unnecessary for applicant to appear or be represented at the hearing.

KENNETH F. PLUMB,
Secretary.

[FR Doc.72-5164 Filed 4-4-72;8:47 am]

[Docket No. CS71-232]

R. W. LANGE

Notice of Petition of Waiver of Regulations

MARCH 28, 1972.

Take notice that by letter filed March 21, 1972, R. W. Lange, Post Office Box 1034, Garden City, KS 67846, small producer certificate holder in Docket No. CS71-232, requests that the Commission waive in part paragraph (c) of § 157.40 of the regulations under the Natural Gas Act (18 CFR 157.40(c)) so as to permit the sale of natural gas under his small producer certificate from reserves acquired in place from Petroleum, Inc., a large producer.

Section 157.40(c) provides in part that sales may not be made pursuant to a small producer certificate from reserves acquired by a small producer by purchase of developed reserves in place from a large producer. Mr. Lange states that he has acquired the Hoskinson No. 1 well from Petroleum, Inc., that the well is marginal, and that Petroleum, Inc., proposed to plug and abandon the well.

Mr. Lang's letter is being construed as a petition for waiver of Commission regulations under paragraph (b) of § 1.7 of the Commission's rules of practice and procedure (18 CFR 1.7(b)). Any interested person may submit to the Federal Power Commission, Washington, D.C. 20426, not later than April 21, 1972, views and comments in writing concerning the petition for waiver. An original and 14 conformed copies should be filed with the Secretary of the Commission. The Commission will consider all such written submittals before acting on the petition.

KENNETH F. PLUMB,
Secretary.

[FR Doc.72-5166 Filed 4-4-72;8:47 am]

[Project 2692—North Carolina]

NANTAHALA POWER AND LIGHT CO.

Notice of Availability of Environmental Statement for Inspection

MARCH 28, 1972.

Notice is hereby given that on March 29, 1972, as required by § 2.81(b)

of Commission regulations under Order 415-B (36 F.R. 22738, November 30, 1971) a draft environmental statement containing information comparable to an agency draft statement pursuant to section 7 of the Guidelines of the Council on Environmental Quality (36 F.R. 7724, April 23, 1971) was placed in the public files of the Federal Power Commission. This statement deals with an application filed pursuant to the Federal Power Act by Nantahala Power and Light Co. for a major license for Nantahala Project No. 2692.

This statement is available for public inspection in the Commission's Office of Public Information, Room 2523, General Accounting Office, 441 G Street NW., Washington, D.C. Copies will be available from the National Technical Information Service, Department of Commerce, Springfield, Va. 22151.

The project consists of (1) a dam (1,042 feet long and 250 feet high), (2) a reservoir (surface area of 1,605 acres), (3) a 5.6 mile long pressure conduit, (4) two diversion dams (one 109 feet long and 16 feet high and the other 115 feet long and 16 feet high), (5) conduits (totaling approximately 3 miles) connecting to the main conduit, and (6) a powerhouse with installed capacity of 43,200 kw.

Any person desiring to present evidence regarding environmental matters in this proceeding must file with the Federal Power Commission a petition to intervene, and also file an explanation of their environmental position, specifying any difference with the environmental statement upon which the intervenor wishes to be heard, including therein a discussion of the factors enumerated in § 2.80 of Order 415-B. Written statement by persons not wishing to intervene may be filed for the Commission's consideration. The petitions to intervene or comments should be filed with the Commission on or before 60 days from March 29, 1972. The Commission will consider all response to the statement.

KENNETH F. PLUMB,
Secretary.

[FR Doc.72-5173 Filed 4-4-72; 8:47 am]

[Docket No. CP72-217]

NATURAL GAS PIPELINE CO. OF AMERICA

Notice of Application

MARCH 27, 1972.

Take notice that on March 6, 1972, Natural Gas Pipeline Co. of America (applicant), 122 South Michigan Avenue, Chicago, IL 60603, filed in Docket No. CP72-217 an application pursuant to section 7(c) of the Natural Gas Act for a certificate of public convenience and necessity authorizing the construction and operation of certain facilities required to operate its pipeline facilities at authorized levels of delivery capacity, all as more fully set forth in the application which is on file with the Commission and open to public inspection.

Applicant states that the winter season deliverability of its existing gas supply

is inadequate to support operation of its pipeline at authorized levels of capacity. To assure continued deliveries to existing customers, Applicant proposes to increase the peak day withdrawal capacity of its Sayre Storage Field in Beckham County, Okla., to 300,000 Mcf; to increase the capacity of its pipeline between its Sayre Storage Field and its Compressor Station No. 111 in Hutchinson County, Tex., in order to effectuate transportation of the increased daily withdrawal quantities from Sayre Storage; to increase the peak day and seasonal capacity of its storage fields in Iowa and Illinois by 75,000 Mcf and 7,500,000 Mcf, respectively; to increase the capacity of its main transmission system between its Iowa Storage Fields and Joliet, Ill., in order to effectuate transportation of the increased daily withdrawal quantities therefrom; and to utilize additional storage service in the amounts of 45,000 Mcf peak day and 4,500,000 Mcf seasonally which Applicant has contracted for with Michigan Wisconsin Pipe Line Co.

To effect the proposal herein, applicant proposes the construction and operation of:

(1) 13,000 additional compressor horsepower, approximately 0.4 mile of 10-inch gathering pipeline, five injection-withdrawal wells, purification and other miscellaneous facilities at its Sayre Storage Field in Beckham County, Okla.;

(2) 3,000 additional horsepower at Compressor Station No. 111, in Hutchinson County, Tex., 3,000 additional horsepower at Compressor Station No. 154, in Gray County, Tex., and approximately 15.78 miles of 26-inch pipeline partially looping its existing pipeline between its Sayre Storage Field and Compressor Station No. 111;

(3) Modification of one existing compressor unit, additional cushion gas and other miscellaneous facilities at Applicant's Cairo Mt. Simon Storage Field in Louisa County, Iowa;

(4) Nineteen injection-withdrawal wells, recompletion of an existing St. Peter reservoir well as a Mt. Simon well, approximately 0.5 mile of 8-inch gathering pipeline, additional cushion gas, and other miscellaneous facilities at Applicant's Columbus City Mt. Simon Storage Field in Louisa County, Iowa;

(5) Two injection-withdrawal wells, approximately 0.57 mile of 12-inch and 8-inch gathering pipelines, 2,000 additional horsepower at its Compressor Station No. 201, additional cushion gas, and other miscellaneous facilities at Applicant's Herscher Northwest Storage Field in Kankakee County, Ill.;

(6) 2,000 additional horsepower, approximately 0.89 mile of 8-inch and 6-inch gathering pipelines, additional cushion gas, and other miscellaneous facilities at Applicant's Loudon Storage Field in Fayette County, Ill.;

(7) Approximately 20.72 miles of 36-inch pipeline partially looping its existing pipeline between the Iowa storage fields and Joliet, Ill.

In addition to the preceding proposal, applicant requests that the inventory limitations on its storage fields imposed as conditions to certificate authorization

heretofore issued be increased to levels as follows:

	Mcf
Sayre Storage Field, Beckham County, Okla.	84,000,000
Cairo Mt. Simon Storage Field, Louisa County, Iowa	15,000,000
Herscher Northwest Storage Field, Kankakee County, Ill.	12,000,000
Loudon Storage Field, Fayette County, Ill.	47,000,000
Columbus City Mt. Simon Storage Field, Louisa County, Iowa	10,000,000

Applicant states that the cost of the facilities to be constructed, inclusive of additional cushion gas, is \$20,727,000. Applicant plans to finance said costs with funds to be obtained through interim and permanent financing.

Any person desiring to be heard or to make protest with reference to said application should on or before April 17, 1972, file with the Federal Power Commission, Washington, D.C. 20426, a petition to intervene or a protest in accordance with the requirements of the Commission's rules of practice and procedure (18 CFR 1.8 or 1.10) and the regulations under the Natural Gas Act (18 CFR 157.10). All protests filed with the Commission will be considered by it in determining the appropriate action to be taken but will not serve to make the protestants parties to the proceeding. Any person wishing to become a party to a proceeding or to participate as a party in any hearing therein must file a petition to intervene in accordance with the Commission's rules.

Take further notice that, pursuant to the authority contained in and subject to the jurisdiction conferred upon the Federal Power Commission by sections 7 and 15 of the Natural Gas Act and the Commission's rules of practice and procedure, a hearing will be held without further notice before the Commission on this application if no petition to intervene is filed within the time required herein, if the Commission on its own review of the matter finds that a grant of the certificate is required by the public convenience and necessity. If a petition for leave to intervene is timely filed, or if the Commission on its own motion believes that a formal hearing is required, further notice of such hearing will be duly given.

Under the procedure herein provided for, unless otherwise advised, it will be unnecessary for applicant to appear or be represented at the hearing.

KENNETH F. PLUMB,
Secretary.

[FR Doc.72-5165 Filed 4-4-72; 8:47 am]

[Project 2533-Minnesota]

NORTHWEST PAPER CO.

Notice of Availability of Environmental Statement for Inspection

MARCH 28, 1972.

Notice is hereby given that on March 31, 1972, as required by § 2.81(b) of Commission regulations under Order 415-B (36 F.R. 22738, November 30, 1971) a draft environmental statement containing information comparable to an

agency draft statement pursuant to section 7 of the Guidelines of the Council on Environmental Quality (36 F.R. 7724, April 23, 1971) was placed in the public files of the Federal Power Commission. This statement deals with an application for license filed by The Northwest Paper Co. for the Brainerd Project No. 2533—Minnesota.

This statement is available for public inspection in the Commission's Office of Public Information, Room 2523, General Accounting Office, 441 G Street NW., Washington, D.C. Copies will be available from the National Technical Information Service, Department of Commerce, Springfield, Va. 22151.

The existing project consists of: (1) A dam about 400 feet long and 30 feet high incorporating the powerhouse; (2) a spillway containing two 85-foot wide by 7-foot high Bascule gates and a 20-foot wide tainter gate; (3) a 14-mile long reservoir with an area of several thousand acres; (4) a powerhouse forming part of the dam and containing five generators with a total capacity of 3,342 kw; (5) a substation with three 2400/480 transformers; and (6) appurtenant facilities.

Any person desiring to present evidence regarding environmental matters in this proceeding must file with the Federal Power Commission a petition to intervene, and also file an explanation of their environmental position, specifying any difference with the environ-

mental statement upon which the intervenor wishes to be heard, including therein a discussion of the factors enumerated in § 2.80 of Order 415-B. Written statement by persons not wishing to intervene may be filed for the Commission's consideration. The petitions to intervene or comments should be filed with the Commission on or before 60 days from March 31, 1972. The Commission will consider all response to the statement.

KENNETH F. PLUMB,
Secretary.

[FR Doc.72-5174 Filed 4-4-72;8:47 am]

[Docket No. RI72-196]

SHELL OIL CO.

Order Providing for Hearing on and Suspension of Proposed Change in Rate, and Allowing Rate Change to Become Effective Subject to Refund

MARCH 28, 1972.

Respondent has filed a proposed change in rate and charge for the jurisdictional sale of natural gas, as set forth in Appendix A below.

The proposed changed rate and charge may be unjust, unreasonable, unduly discriminatory, or preferential, or otherwise unlawful.

The Commission finds: It is in the public interest and consistent with the Natural Gas Act that the Commission

enter upon a hearing regarding the lawfulness of the proposed change, and that the supplement herein be suspended and its use be deferred as ordered below.

The Commission orders:

(A) Under the Natural Gas Act, particularly sections 4 and 15, the regulations pertaining thereto (18 CFR Ch. I), and the Commission's rules of practice and procedure, a public hearing shall be held concerning the lawfulness of the proposed change.

(B) Pending hearing and decision thereon, the rate supplement herein is suspended and its use deferred until date shown in the "Date Suspended Until" column. This supplement shall become effective, subject to refund, as of the expiration of the suspension period without any further action by the Respondent or by the Commission. Respondent shall comply with the refunding procedure required by the Natural Gas Act and § 154.102 of the regulations thereunder.

(C) Unless otherwise ordered by the Commission, neither the suspended supplement, nor the rate schedule sought to be altered, shall be changed until disposition of this proceeding or expiration of the suspension period, whichever is earlier.

By the Commission.

[SEAL] KENNETH F. PLUMB,
Secretary.

APPENDIX A

Docket No.	Respondent	Rate scheduled No.	Supplement No.	Purchaser and producing area	Amount of annual increase	Date filing tendered	Effective date unless suspended	Date suspended until—	Cents per Mcf*		Rate in effect subject to refund in docket No.
									Rate in effect	Proposed increased rate	
RI72-196..	Shell Oil Co.....	2	10	Natural Gas Pipeline Co. of America (Clayton Field, Live Oak County, Tex., District No. 2).	\$62,389	3-1-72	4-2-72~	15.4536	24.0	

*The pressure base is 14.65 p.s.i.a.

The question presented here is whether the subject gas is entitled to an area rate of 19 cents, which is the rate established in Opinion No. 595 for gas sold under contracts dated prior to October 1, 1968, or an area rate of 24 cents which applies to contracts dated on or after October 1, 1968. As justification for the proposed 24 cents rate, Shell states that the gas to be delivered after April 1, 1972, was never covered by the July 15, 1950, contract and was in fact specifically declared to be surplus gas which Shell could have sold at any time. The proposed increase should be suspended for one day from the proposed effective date of April 1, 1972, pending determination as to whether the gas involved herein is entitled to the new or old gas price.

CERTIFICATE OF ABBREVIATED SUSPENSION

Pursuant to § 300.16(1)(3) of the Price Commission rules and regulations, 6 CFR Part 300 (1972), the Federal Power Commission certifies as to the abbreviated suspension period in this order as follows:

(1) This proceeding involves producer rates which are established on an area rather than company basis. This practice was established by "Area Rate Proceeding, Docket No. AR61-1, et al.," Opinion No. 468, 34 FPC 159 (1965), and affirmed by the Supreme Court

in "Permian Basin Area Rate Case," 390 U.S. 747 (1968). In such cases as this, producer rates are approved by this Commission if such rates are contractually authorized and are at or below the area ceiling.

(2) In the instant case, the requested increases do not exceed the ceiling rate for a 1 day suspension.

(3) By Order No. 423 (36 F.R. 3464) issued February 18, 1971, this Commission determined as a matter of general policy that it would suspend for only 1 day a change in rate filed by an independent producer under section 4(d) of the Natural Gas Act (15 U.S.C. 717c(d)) in a situation where the proposed rate exceeds the increased rate ceiling but does not exceed the ceiling for a 1 day suspension.

(4) In the discharge of our responsibilities under the Natural Gas Act, this Commission has been confronted with conclusive evidence demonstrating a natural gas shortage. (See Opinion Nos. 595, 598, and 607, and Order No. 435). In these circumstances and for the reasons set forth in Order No. 423 the Commission is of the opinion in this case that the abbreviated suspension authorized herein will be consistent with the letter and intent of the Economic Stabilization Act of 1970, as amended, as well as the rules and regulations of the Price Commission, 6 CFR

Part 300 (1972). Specifically, this Commission is of the opinion that the authorized suspension is required to assure continued, adequate and safe service and will assist in providing for necessary expansion to meet present and future requirements of natural gas.

[FR Doc.72-5170 Filed 4-4-72;8:47 am]

[Project 199]

SOUTH CAROLINA PUBLIC SERVICE AUTHORITY

Notice of Application for Change in Land Rights

MARCH 27, 1972.

Public notice is hereby given that application for approval of the conveyance of 409.7 acres of project land to Oakland Hunt Club to use for private hunting has been filed under the Federal Power Act (16 U.S.C. 791a-825r) by South Carolina Public Service Authority (Correspondence to Mr. J. B. Thomason, General Manager, South Carolina Public Service Authority, Santee-Cooper, Moncks Cor-

ner, S.C. 29461) in Project No. 199, located on the Santee and the Cooper Rivers, in Berkeley, Calhoun, Clarendon, Orangeburg, and Sumter Counties, S.C. The project lands to be conveyed are in Eutaw Parish and First St. Johns Parish, Berkeley County, S.C.

The application seeks Commission approval of a proposed conveyance of 409.7 acres of project land to Oakland Hunt Club to be used for private bird hunting, consisting of 203 acres known as Willow Grove Plantation located on the eastern side of the Cooper River in First St. Johns Parish, and 206.7 acres which are a portion of licensee's 1,163.7-acre Bluefield Plantation Tract in Eutaw Parish. In exchange for the receipt of the above tracts, Oakland Hunt Club would convey to licensee 409.7 acres of its own land for nonproject purposes.

The instrument of conveyance would retain licensee's right to use the land for project purposes and include the covenant pursuant to paragraph C of Order 313. No construction is planned on the lands; however, the land will be cleared in selected areas to allow the planting of cover crops.

Any person desiring to be heard or to make any protest with reference to said application should on or before May 5, 1972, file with the Commission, in accordance with the requirements of the Commission's rules of practice and procedure (18 CFR 1.8 or 1.10). All protests filed with the Commission will be considered by it in determining the appropriate action to be taken but will not serve to make the protestants parties to the proceeding. Persons wishing to become parties to a proceeding or to participate as a party in any hearing therein must file petitions to intervene in accordance with the Commission's rules. The application is on file with the Commission and available for public inspection.

KENNETH F. PLUMB,
Secretary.

[FR Doc.72-5167 Filed 4-4-72; 8:47 am]

[Project 120]

SOUTHERN CALIFORNIA EDISON CO. Notice of Availability of Environmental Statement for Inspection

MARCH 28, 1972.

Notice is hereby given that on August 21, 1970, as required by § 2.81(b) of Commission regulations under Order 415-B (36 F.R. 22738, November 30, 1971) a draft environmental statement containing information comparable to an agency draft statement pursuant to section 7 of the Guidelines of the Council on Environmental Quality (36 F.R. 7724, April 23, 1971) was placed in the public files of the Federal Power Commission. This statement deals with an application for a new major license filed pursuant to the Federal Power Act for constructed Big Creek No. 3 Project No. 120.

This statement is available for public inspection in the Commission's Office of Public Information, Room 2523, Gen-

eral Accounting Office, 441 G Street NW., Washington, D.C. Copies will be available from the National Technical Information Service, Department of Commerce, Springfield, Va. 22151.

This statement discusses the environmental impact of Big Creek No. 3 Project located in Fresno, Madera, Tulare, Kern, and Los Angeles Counties, Calif. The project consists of a dam with a concrete spillway; a reservoir; an unlined diversion tunnel; four penstocks; and a powerhouse containing a total installed capacity of 107,100 kw. The project has been in operation since 1923.

Any person desiring to present evidence regarding environmental matters in this proceeding must file with the Federal Power Commission a petition to intervene, and also file an explanation of their environmental position, specifying any difference with the environmental statement upon which the intervenor wishes to be heard, including therein a discussion of the factors enumerated in § 2.80 of Order 415-B. Written statement by persons not wishing to intervene may be filed for the Commission's consideration. The petitions to intervene or comments should be filed with the Commission on or before 60 days from March 27, 1972. The Commission will consider all response to the statement.

KENNETH F. PLUMB,
Secretary.

[FR Doc.72-5175 Filed 4-4-72; 8:48 am]

[Docket No. CP72-229]

CITIES SERVICE GAS CO.

Notice of Application

MARCH 30, 1972.

Take notice that on March 22, 1972, Cities Service Gas Co. (Applicant), Post Office Box 25128, Oklahoma City, Okla. 73125, filed in Docket No. CP72-229 an application pursuant to section 7(c) of the Natural Gas Act for a certificate of public convenience and necessity authorizing the installation and operation of certain natural gas compressor facilities in Newton County, Mo., all as more fully set forth in the application which is on file with the Commission and open to public inspection.

Applicant states that under the terms of Arkansas Louisiana Gas Co.'s (Arkla) proposed curtailment plan submitted in Docket No. RP71-122, Arkla proposes to reduce deliveries of natural gas to Applicant at a point near Jane, Mo., from a daily maximum volume of 133,000 Mcf to 55,020 Mcf, which, applicant says, is an insufficient volume of natural gas to enable it to serve the peak day firm requirements of its customers in the Springfield, Mo., area. On November 30, 1971, the Commission granted applicant interim relief by directing Arkla to deliver volumes of natural gas up to 75,000 Mcf per day whenever it was necessary to protect firm gas service to applicant's customers east of its Saginaw Compressor Station, with the condition that applicant take all necessary steps

to alleviate the capacity problem on its pipeline before the next heating season.

Applicant seeks authorization to install and operate an additional 2,000 horsepower compressor unit at its Saginaw Compressor Station near Joplin, Newton County, Mo., in order to enable it to compress sufficient supplemental volumes of natural gas from its Southern Trunk and Quapaw pipelines into its Springfield 16-inch pipeline to serve the peak day firm requirements of its customers east of the Saginaw Compressor Station during the 1972-73 heating season.

Applicant estimates the total cost of the proposed facilities at \$900,000, which it plans to finance from treasury cash.

Applicant states that the instant application is filed without modifying or prejudicing its position in the proceeding in Docket No. RP71-122.

Any person desiring to be heard or to make any protest with reference to said application should on or before April 24, 1972, file with the Federal Power Commission, Washington, D.C. 20426, a petition to intervene or a protest in accordance with the requirements of the Commission's rules of practice and procedure (18 CFR 1.8 or 1.10) and the regulations under the Natural Gas Act (18 CFR 157.10). All protests filed with the Commission will be considered by it in determining the appropriate action to be taken but will not serve to make the protestants parties to the proceeding. Any person wishing to become a party to a proceeding or to participate as a party in any hearing therein must file a petition to intervene in accordance with the Commission's rules.

Take further notice that, pursuant to the authority contained in and subject to the jurisdiction conferred upon the Federal Power Commission by sections 7 and 15 of the Natural Gas Act and the Commission's rules of practice and procedure, a hearing will be held without further notice before the Commission on this application if no petition to intervene is filed within the time required herein, if the Commission on its own review of the matter finds that a grant of the certificate is required by the public convenience and necessity. If a petition for leave to intervene is timely filed, or if the Commission on its own motion believes that a formal hearing is required, further notice of such hearing will be duly given.

Under the procedure herein provided for, unless otherwise advised, it will be unnecessary for Applicant to appear or be represented at the hearing.

KENNETH F. PLUMB,
Secretary.

[FR Doc.72-5230 Filed 4-4-72; 8:52 am]

[Docket No. R-338]

MOBIL OIL CORP. ET AL.

Order Denying Applications for Rehearing

MARCH 30, 1972.

Mobil Oil Corp. (Mobil) on February 29, 1972, and Amoco Production Co.

(Amoco) and the Public Service Commission for the State of New York (New York Commission) on March 1, 1972, filed timely applications for rehearing of the Commission's Order No. 449 issued January 31, 1972, in the above-entitled proceeding. Order No. 449 added a new § 2.71 to the Commission's General Policy and Interpretations under the Natural Gas Act providing that when pipeline companies transport liquids and liquefiable hydrocarbons from producing areas to processing plants for removal of such hydrocarbons, the contractual consideration to be received by the pipeline companies for such transportation will be the amount set forth in the parties' contracts unless the specified contractual consideration is less than 2 cents per hundred miles for liquefiable hydrocarbons and 20 cents per barrel for liquids, in which case the aforesaid minimum charges will apply.

Examination of the 15 specifications of alleged error in Mobil's application reveals that they are repetitive in nature and therefore can be summarized under seven primary contentions. Mobil first argues that the Commission erred in establishing the charges allocable to the transportation of liquids and liquefiable hydrocarbons in an "informal" rulemaking proceeding without requiring a trial-type hearing, including presentation of witnesses with right of cross-examination, issuance of an intermediate decision, and the filing of briefs. Mobil claims that the Commission's use of "informal" rulemaking has resulted (a) in denial to it of due process because of its inability to test the accuracy of the data relied upon by the Commission, (b) in consideration by the Commission of transportation costs apart from its section 7 certificate proceedings, and (c) in production of incomplete findings of facts which are not supported by substantial evidence.

Mobil cites a number of inapposite court decisions in support of its first contention, including *City of Chicago v. F.P.C.*, 500 F.2d 629 (D.C. Cir. No. 23,740 decided Dec. 2, 1971). The court's discussion of rulemaking proceedings in *City of Chicago* shows that the Commission correctly employed an informal rulemaking approach in this proceeding. The court there (slip op. p. 21) pointed out that section 16 of the Natural Gas Act gives the Commission broad power to prescribe such rules and regulations as it may find necessary or appropriate in carrying out the provisions of the Act. The court noted that when the Commission employs section 16, the Natural Gas Act does not specify the procedures to be used, but that the Administrative Procedure Act, particularly in section 4, sets forth the minimum requirements which the Commission must meet before exercising its power under section 16 of the Gas Act (slip op. p. 22). While the Commission may resort to full evidentiary hearings under section 4 of the Administrative Procedure Act, it may also find in its discretion that the minimum procedures of providing only for the " * * * submission of written data,

views or arguments with or without opportunity for oral presentation" are sufficient for the acquisition of the information which will enable the Commission to carry out effectively the provisions of the Gas Act. The court concluded that (slip op. p. 23):

" * * * The ability to choose with relative freedom the procedure it will use to acquire relevant information gives the Commission power to realistically tailor the proceedings to fit the issues before it, the information it needs to illuminate those issues and the manner of presentation which, in its judgment, will bring before it the relevant information in the most efficient manner.

The informal procedure utilized by the Commission in this proceeding permitted Mobil and all other interested parties to file comments and to participate in two conferences. The comments and facts thereby obtained constituted sufficient bases for the Commission's promulgation of § 2.71 by issuance of Order No. 449 and the procedures employed did not deny Mobil due process under the Natural Gas and Administrative Procedure Acts.

The cost of transporting the producers' liquids and liquefiables is an inappropriate matter for consideration in Mobil's section 7 proceedings. The issues in such cases are related to the usual considerations of demonstrating existence of markets, proving adequate gas reserves, and showing that the level of the proposed initial price is in the public interest. In initial certificate cases the producer is estimating the volumes of gas and liquids which will be produced and the pipeline purchaser is uncertain of the exact location of facilities and of their ultimate costs. Only after the pipeline company's facilities have been constructed and production has commenced does the pipeline company know for certain what its actual costs for moving liquids and liquefiables are. The variables which have to be considered in ascertaining the exact cost of transporting the producers' liquids and liquefiables were among the reasons for the Commission's conclusion that a general rule for application to all producers could properly be determined only in a rulemaking proceeding on the basis of generalized industry costs, rather than by means of the impractical and time-consuming trial-type hearings sought to be instituted by Mobil.¹

Mobil's second contention is that the pipeline cost data relied on by the Commission are inflated because they were taken from pipeline rate filings which have been subjected to contested proceedings resulting in disallowance of

¹ The court in *City of Chicago v. F.P.C.*, 385 F.2d 629 (D.C. Cir. 1967), pointed out the danger inherent in case-by-case adjudications when it stated at p. 644 " * * * The continued expressions of courts and commentators stressing the desirability of generalized approaches to generalized problems does not betoken a desire to meddle with administrative details and techniques, but rather an uneasiness lest an excessively individuated approach may be a seed bed that is too favorable to the rank weed of discrimination."

some of the costs originally claimed. In support of that argument Mobil refers to the fact that some of the data relied on by the Commission related to the costs claimed by four pipeline companies which subsequently agreed to make rate reductions accepting decreased rates of return and other cost reductions below those reflected in the data distributed at the conferences held in this proceeding. The short answer to that argument is that pipeline costs, exclusive of allowing increases in rates to track escalations in cost of purchased gas, have continued to rise above the level of the costs reflected in the data on which the Commission relied in determining charges in this proceeding.

There is no validity to Mobil's claims that the Commission relied on data reflecting inflated costs which have been reduced in contested rate proceedings because the cost of debt has continued to rise and pipeline companies have not encountered any decreases in operating and maintenance costs which would in any way support an argument that the cost data distributed in this proceeding are inflated above the actual costs being incurred by the pipeline companies. Not only have the costs risen considerably above those reflected in the studies distributed in this proceeding, but the scarcity of gas supplies has resulted in reduced sales volumes in some cases so that the unit cost of transporting gas would be slightly higher than the studies shown in this proceeding even if costs had not continued to rise.

Mobil's third contention is that the Commission violated § 1.18(e) of its rules of practice and procedure by relying on data which were offered by the pipeline companies as a settlement of the issues in the proceeding. Mobil points to paragraph one on page two of the minutes of the conference held on October 15, 1970, as support for the foregoing argument. That paragraph simply notes that the pipeline companies' position might be different from the one stated at the conference if their offer of settlement should be rejected. Mobil's third contention is untenable for at least five reasons. First, § 1.18(e) provides that offers of settlement are privileged and that such offers cannot be used in evidence against the person who made the offer. Since Mobil did not make the offer, it cannot complain because data submitted by the pipeline companies were used. Second, the pipeline companies only stated that their "position" might be different if their offer were rejected, not that they would argue that the data they had presented were incorrect. Third, the data submitted by the pipeline companies were taken from the Commission's public files and could be used in any event regardless of whether the pipeline companies' settlement offer was ever accepted. Fourth, the pipeline companies' settlement offer was accepted by the majority of the producers and other parties and approved by the Commission in Opinion No. 598 issued July 16, 1971, 46 FPC —, in *Area Rate Proceeding, et al. (Southern Louisiana Area)*, Docket Nos.

AR61-2, et al. Fifth, not one of the pipeline companies which offered the data relied on by the Commission has filed an application for rehearing of Order No. 449 or objected to the Commission's reliance on the data they distributed at the conference.

The fourth error alleged by Mobil is that the Natural Gas Act does not give the Commission authority to assert jurisdiction over the transportation of liquid hydrocarbons. The Supreme Court in *Permian Basin Area Rate Cases*, 390 U.S. 747 (1968), at p. 820, n. 111, affirmed the Commission's assertion of jurisdiction over the total raw stream of casinghead gas which includes entrained liquids. In *The Jupiter Corp. v. F. P. C.*, 424 F.2d 783, 792 (D.C. Cir. 1969), cert. denied, 397 U.S. 937 (1970), the court referred to a similar assertion of jurisdiction in *The Jupiter Corporation*, 39 FPC 954 (1968), but stated that it did not need to reach Jupiter's contentions to the effect that the Commission had taken a different position in the rulemaking notice issued in this proceeding in that the Commission was proposing to allocate out of the pipeline companies' cost of service the costs related to transporting liquid hydrocarbons. The court stated that it did not need to resolve those points in the Jupiter case because certain court proceedings related to Jupiter's contractual right to charge for liquid transportation had not yet been concluded.

Pipeline companies are providing a service in moving the producers' liquid hydrocarbons to processing plants. If the Commission does not fix minimum charges for such services, gas consumers will continue to pay costs related primarily to transporting the producers' liquid hydrocarbons. The Commission sees no essential difference between establishing a minimum rate to be charged for transporting actual liquids which are transported along with the raw gas stream and fixing a minimum charge for transporting liquefiable hydrocarbons which can be removed from the raw gas stream only by using sophisticated equipment. In reaching the foregoing conclusions the Commission is not implying that it has jurisdiction over the construction and operation of pipelines to transport hydrocarbons solely in liquid form. In Order No. 449 the Commission has asserted only such jurisdiction as is required to make certain that the producers pay their fair share of the cost of transporting their liquid hydrocarbons through interstate pipeline facilities subject to the Commission's jurisdiction.

Mobil's fifth alleged error is that the Commission improperly allowed the pipeline companies to increase their rates without requiring them to comply with section 4 of the Act. The import of Mobil's argument regarding section 4 is not clear. Pipeline companies are allowed to charge rates which recover a just and reasonable rate of return on their investments and reimburse them for the costs associated with operating and maintaining their facilities. The pipeline companies will not be able to increase their rates to their resale customers as

a result of the Commission's Order No. 449 since that order only requires the producers to pay a portion of the costs which the pipeline companies are presently recouping through rates being charged their customers. The revenues to be obtained from producers will therefore either forestall the filing of new rate increase proposals or serve as a basis for a reduction in rates below those presently being charged. On the other hand, if Mobil is only contending that the Commission cannot fix in a rulemaking proceeding charges applicable to transportation of liquid hydrocarbons, then its argument regarding section 4 merely merges with the first contention considered above, i.e., the question of whether the Commission can fix a charge in a rulemaking proceeding without first holding a trial-type hearing.

Mobil's sixth point is that the Commission did not consider critical differences in load factors, distances, cost incurred, etc., in fixing the charges specified in § 2.71 and thereby imposed discriminatory and unduly preferential high charges on short-haul transportation. Questions regarding load factors, distances, sizes of pipelines, etc., were discussed at length in Order No. 449, particularly at pages 6 to 10. Since the Order provides for the payment of a charge per mile of haul, the charge cannot possibly impose an excessively high charge on short-haul transportation of liquefiable hydrocarbons. While the charge for liquids is a flat minimum charge of 20 cents per barrel, that amount cannot be excessive for liquids because of the impediment to dry gas transportation caused by injection of actual liquids into a given dry-gas pipeline. Additionally, when it is considered that the producer does not have to invest in liquid storage facilities as is necessary with alternative hauling by barge or other mode of transportation, a charge of 20 cents per barrel is certainly not unreasonably high from the producer's viewpoint.

Mobil's seventh and final contention is that the Commission relied on data which was not distributed at the conference held on October 15, 1971. The only cost data employed other than those included in the pipeline companies' studies distributed at the conference were Transwestern Pipeline Co.'s transmission costs which were used only for the purpose of showing that its transportation costs were in line with costs of the other three major interstate pipeline purchasers in the Permian Basin area. Those costs were taken from Transwestern's rate filing in Docket No. RP70-19 which is available to the public for examination. As the court pointed out in the recent City of Chicago case supra. " * * * Frequently, statistics, scientific reports and studies will be amenable to various interpretations and effective regulation requires that the Commission bring to bear the full range of its knowledge, garnered from whatever source, in making the interpretation on which it bases important policy decisions" (slip op. pp. 29-30). The only other reference to matters outside the record in this

proceeding was to Commission decisions which indicated various ranges of charges for transportation services similar to those involved in this proceeding. Those citations were used only for comparison purposes and were not the factual data on which the Commission relied in fixing the minimum charges for transportation of liquid hydrocarbons. The Commission's reference to Red Snapper Pipe Line Company's charges for transporting natural gas and liquid hydrocarbons surely cannot be prejudicial to Mobil since it was one of Red Snapper's stockholders (38 FPC at 734, n. 47) and must know that Red Snapper's proposed charges were greater than those fixed by the Commission in Order No. 449.

Amoco's application first makes a legal argument to the effect that the Commission erred in fixing rates for transportation of liquid hydrocarbons without providing for a trial-type hearing. That argument has already been considered above and rejected in connection with Mobil's identical contentions. Amoco also asks the Commission to revoke Order No. 449 and then clarify in the order providing for a trial-type hearing whether § 2.71 should be interpreted to require Amoco to pay for the transportation of impurities, such as water and carbon dioxide, which are extracted from the raw gas stream in the producers' processing plants. There is nothing in any of the parties' comments or in the minutes of the conferences, or in the studies distributed by the pipeline companies indicating that producers are expected to pay for the transportation of impurities such as water and carbon dioxide. Section 2.71 clearly refers only to the transportation of liquids and liquefiable hydrocarbons and indicates that the transportation charges are applicable only to liquid hydrocarbons.

Amoco claims that § 2.71 could also be read as requiring producers to pay a charge for transporting liquid hydrocarbons in connection with gas being sold at contract prices which are below the area rates for such gas. Amoco is correct in assuming that § 2.71 should be so interpreted because the producers have had their liquid hydrocarbons transported at no cost to them up to the issuance of Order No. 449, except in a few instances where their sales contracts provided for such transportation reimbursement to the pipeline purchasers. It was the producers' failure to pay such costs which made it necessary to add the last sentence to § 2.71 indicating that the price producers are charging pipeline companies for natural gas will not be reduced if they pay at least the minimum transportation charges provided for in § 2.71.

Amoco further claims that it will be very difficult to compute the distance each well is from the processing plant and to determine the liquefiable hydrocarbon shrinkage volume for each well. After Order No. 449 has been revoked and a new hearing has been held to fix lawful rates, Amoco asks that a conference be held to determine an average charge to be applied to volumes transported from

all wells. Inasmuch as the Commission has not agreed to revoke Order No. 449, it appears premature for Amoco to request a conference on that basis at this time. In any event, Amoco has not shown any need to convene a conference because the producers and the pipeline companies already know the distance each well is from the processing plants as they had to ascertain those distances before they could purchase and install the necessary pipelines. The producers also have to determine the hydrocarbon content of the raw gas stream for their own accounting purposes. Consequently, applying the charges specified in § 2.71 should give rise to no administrative problems which cannot easily be solved by the producers and their pipeline purchasers in the course of their usual business procedures. Nonetheless, Amoco is free to renew its request for a conference if its request is not conditioned upon revocation of Order No. 449 and if it and its pipeline purchasers actually encounter problems when they begin to apply the charges specified in § 2.71.

The New York Commission's application makes only one contention and that is that the transportation rates fixed by Order No. 449 are too low. The New York Commission points to a transportation charge of 3.3 cents per Mcf made by Tidal Transmission Co., to the charge of 4 cents per Mcf made by Texas Eastern Transmission Corporation for transporting gas through its offshore facilities, and to a similar charge made by Michigan Wisconsin Pipe Line Co. for transporting gas for Texas Gas Transmission Corp. The New York Commission concludes from such rates that the charges provided for by Order No. 449 should be at least 4 cents per Mcf per hundred miles for liquefiable hydrocarbons and 40 cents per barrel for liquids, and asks that the Commission on rehearing increase the transportation rates accordingly.

The Commission explained at some length in Order No. 449 that the transportation rates to be established would have to be applicable for all situations and should not be excessive for the producers or require consumers to continue paying costs for transporting producers' liquefiable hydrocarbons and liquids. The Commission recognized that some services, particularly those rendered by using the newest high-cost facilities, might involve costs justifying rates in excess of those fixed in Order No. 449. The Commission also noted that services provided by a given pipeline company would have a lower unit cost when production was at its height in a particular producing area than at subsequent times when production had declined and load factors were reduced. The Commission also pointed out that the producers were providing a service to the pipeline companies in removing certain impurities from the raw gas stream. In light of all these considerations, the Commission found that charges of 2 cents per Mcf per hundred miles and 20 cents per barrel for liquefiable hydrocarbons and liquids, respectively, were in the public interest and fair to both the producers and consumers. The Commission is still of the opinion

that the charges set forth in § 2.71 are appropriate. Therefore, the New York Commission's request that the charges be increased must be denied.

The Commission finds. The assignments of error and grounds for rehearing set forth in the applications for rehearing of Mobil, Amoco, and the New York Commission present no new facts or principles of law which were not considered by the Commission when it issued its Order No. 449 or which, having now been considered, warrant any change or modification of said Order.

The Commission orders. The application for rehearing filed February 29, 1972, by Mobil Oil Corp., and the applications for rehearing filed March 1, 1972, by Amoco Production Co. and the Public Service Commission for the State of New York are denied.

By the Commission.

[SEAL] KENNETH F. PLUMB,
Secretary.

[FR Doc.72-5236 Filed 4-4-72;8:52 am]

[Dockets Nos. RP71-6, RP71-57, RP72-1]

TENNESSEE GAS PIPELINE CO.

Notice of Extension of Time and Postponement of Hearing

MARCH 29, 1972.

Notice is hereby given that the procedural dates prescribed by the order issued December 23, 1971, and modified by notices issued January 13, 1972, February 15, 1972, and March 8, 1972, are further modified, as follows:

1. The time within which parties shall serve their prepared direct testimony and exhibits is extended to and including April 28, 1972. The time within which any rebuttal evidence by Tennessee shall be served is extended to and including May 19, 1972.

2. Cross-examination of the evidence shall commence on May 30, 1972.

By direction of the Commission:

KENNETH F. PLUMB,
Secretary.

[FR Doc.72-5231 Filed 4-4-72;8:52 am]

[Project 2545]

WASHINGTON WATER POWER CO.

Notice of Amendment of Application for Major License

MARCH 29, 1972.

Public notice is hereby given that amendment of application for major license has been filed under the Federal Power Act (17 U.S.C. 791a-825r) by Washington Water Power Company (correspondence to R. D. Yoemans, Secretary, the Washington Water Power Company, Post Office Box 1445, Spokane, Wash. 99210), for its proposed Monroe Street plant of project No. 2545, located on the Spokane River, in Spokane, Stevens, and Lincoln Counties, Wash.,

¹Chairman Nassikas and Commissioner Moody dissenting.

near the cities of Spokane, Nine Mile Falls, and Reardan.

This amendment modifies applicant's application for major license (filed August 30, 1965) as it relates to the Monroe Street plant of project No. 2545.

The Monroe Street plant presently consists of: (1) An overflow rock-fill timber-crib dam with crest elevation 1,806 feet (m.s.l.); (2) a concrete and stone masonry headgate dam; (3) a 5-acre pond; (4) three 10-foot diameter steel penstocks; and (5) a powerhouse containing five generating units with a total installed capacity of 7,200 kw.

Applicant proposes to reconstruct the existing Monroe Street plant so that it would consist of: (1) A concrete gravity overflow dam about 240 feet long with a crest elevation 1,806 feet (m.s.l.); (2) a concrete intake structure at the left abutment of the dam; (3) a 5-acre pond; (4) one 14-foot diameter steel and reinforced concrete penstock about 420 feet long; (5) a remodeled powerhouse containing five generating units with an installed capacity of 7200 kw. (three turbines would be replaced); and (6) appurtenant facilities.

The reconstruction of the Monroe Street plant, which is estimated to cost \$1,565,000, is scheduled to be completed prior to spring 1974. Applicant states that the above changes are necessary because the present project works are not consistent with the city of Spokane's plan for development of the river in conjunction with the International Ecological Exposition planned for the summer of 1974 (EXPO 74), and because the present dam has been damaged by past floods and should be replaced before failure occurs.

Any person desiring to be heard or to make any protest with reference to said application should on or before May 8, 1972, file with the Federal Power Commission, in accordance with the requirements of the Commission's rules of practice and procedure (18 CFR 1.8 or 1.10). All protests filed with the Commission will be considered by it in determining the appropriate action to be taken but will not serve to make the protestant parties to the proceedings. Persons wishing to become parties to a proceeding must file petitions to intervene in accordance with the Commission's rules. The application is on file with the Commission and available for public inspection.

KENNETH F. PLUMB,
Secretary.

[FR Doc.72-5232 Filed 4-4-72;8:52 am]

[Docket No. RI72-168, etc.]

WESTERN OIL & MINERALS CORP.

Order Providing for Hearing and Suspension of Proposed Changes in Rates, and Allowing Rate Changes to Become Effective Subject to Refund; Correction

MARCH 23, 1972.

Western Oil & Minerals Corp., Docket No. RI72-168 et al., Amoco Production Co., Docket No. RI72-170.

In the order providing for hearing on and suspension of proposed changes in rates, and allowing rate changes to become effective subject to refund, issued January 28, 1972 and published in the FEDERAL REGISTER February 5, 1972 (37 F.R. 2815): Appendix "A" Docket No. RI72-170, Amoco Production Co., under column headed "Date Suspended Until" change "3-5-73" to "3-5-72", opposite Docket No. RI72-170, Rate Schedule No. 195, Amoco Production Co.

KENNETH F. PLUMB,
Secretary.

[FR Doc.72-5234 Filed 4-4-72; 8:52 am]

GENERAL SERVICES ADMINISTRATION

[Federal Property Management Regs.;
Temporary Reg. F-142]

SECRETARY OF DEFENSE

Delegation of Authority

1. *Purpose.* This regulation delegates authority to the Secretary of Defense to represent the consumer interests of the Department of Defense in a proceeding involving the establishment of policy for the creation of a domestic communications satellite system in the United States.

2. *Effective date.* This regulation is effective March 29, 1972.

3. *Delegation.* a. Pursuant to the authority vested in me by the Federal Property and Administrative Services Act of 1949, 63 Stat. 377, as amended, particularly sections 201(a) (4) and 205(d) (4) U.S.C. 481(a) (4) and 486(d)), authority is delegated to the Secretary of Defense to represent the consumer interests of the Department of Defense before the Federal Communications Commission in a proceeding (Docket No. 16495) involving the establishment of policy for the creation of a domestic communications satellite system in the United States.

b. The Secretary of Defense may redelegate this authority to any officer, official, or employee of the Department of Defense.

c. This authority shall be exercised in accordance with the policies, procedures, and controls prescribed by the General Services Administration, and, further, shall be exercised in cooperation with the responsible officers, officials, and employees thereof.

Dated: March 29, 1972.

ROD KREGER,
*Acting Administrator of
General Services.*

[FR Doc.72-5237 Filed 4-4-72; 8:52 am]

FEDERAL RESERVE SYSTEM

TWIN GATES CORP.

Acquisition of Bank

Twin Gates Corp., Wilmington, Del., a registered bank holding company, has

applied for the Board's approval under section 3(a) of the Bank Holding Company Act of 1956 (12 U.S.C. 1842(a)) to exchange 22.48 percent of the outstanding voting shares of City National Bank of Detroit, Detroit, Mich., for 22.48 percent of the outstanding shares of Northern States Financial Corp., Detroit, Mich., a proposed bank holding company.

On February 8, 1972, notice was published in the FEDERAL REGISTER (37 F.R. 2858) of the receipt of the application of Northern States Financial Corp. for Board approval to become a bank holding company through the acquisition of 80 percent or more of the voting shares of City National Bank of Detroit, and the acquisition of the indirect control of 13.2 percent of the voting shares of the National Bank of Rochester, Rochester, Mich. As an incident to Northern States Financial Corp.'s proposal, Twin Gates Corp. would exchange the shares that it now owns in City National Bank of Detroit for shares of Northern States Financial Corp.; the present application is for the Board's approval of the exchange of such shares. The factors that are considered in acting on the application are set forth in section 3(c) of the Act (12 U.S.C. 1842(c)).

The application may be inspected at the office of the Board of Governors or at the Federal Reserve Bank of Chicago. Any person wishing to comment on the application should submit his views in writing to the Secretary, Board of Governors of the Federal Reserve System, Washington, D.C. 20551, to be received not later than April 19, 1972.

Board of Governors of the Federal Reserve System, March 30, 1972.

[SEAL] TYNAN SMITH,
Secretary of the Board.

[FR Doc.72-5207 Filed 4-4-72; 8:50 am]

SECURITIES AND EXCHANGE COMMISSION

[812-3134]

E. F. HUTTON TAX-EXEMPT FUND

Notice of Filing of Application for Exemption

MARCH 30, 1972.

In the matter of E. F. Hutton Tax-Exempt Fund (National Series 1, 2, 3, and 4, California Series 1, 2, and 3, New York Series 1 and 2 and all subsequent national and State series similarly or otherwise titled), c/o E. F. Hutton & Co., Inc., One Battery Park Plaza, New York, N.Y. 10004, (812-3134).

Notice is hereby given that E. F. Hutton Tax-Exempt Fund (National Series 1, 2, 3, and 4, California Series 1, 2, and 3, New York Series 1 and 2 and all subsequent national and State series similarly or otherwise titled) (Applicant), registered under the Investment Company Act of 1940 (Act) as unit investment trusts (and including potential future such trusts), has filed an appli-

cation pursuant to section 6(c) of the Act for an order exempting the secondary market operations of Applicant's sponsor from the provisions of Rule 22c-1. The sponsor seeks to follow the practice of valuing Applicant's units, for repurchase and resale in the secondary market, once a week on the last business day of the week, as of 3:30 p.m., effective for all transactions made during the following week. All interested persons are referred to the application on file with the Commission for a statement of Applicant's representations contained therein which are summarized below.

Applicant is composed of various series, each of which is an unmanaged fund, with a portfolio consisting of tax-exempt municipal bonds. E. F. Hutton & Co., Inc., acts as sponsor for each series (Sponsor). No additions may be made to the portfolio of bonds of any series after the date of deposit of the bonds by the Sponsor and the number of units in a series may not be increased. The units are distributed by the Sponsor during the initial offering period at a 4 percent sales charge. The pricing procedures during such period comply with the requirements of Rule 22c-1.

The Sponsor also maintains a secondary market for the units by offering to repurchase them from holders at a price based on the aggregate "asked" side evaluation of the underlying bonds ("offering side of evaluation"). This value, according to the application, may be expected to exceed the redemption price (bid side evaluation) by at least \$10 per unit. In addition, the Sponsor resells such units with a 4 percent sales charge. The Sponsor seeks to have both the repurchase and resale price based on the unit evaluation of the preceding Friday made by an independent evaluator.

Rule 22c-1 provides, in part, that redeemable securities of registered investment companies may be sold, redeemed or repurchased at a price based on the current net asset value (computed on each day during which the New York Stock Exchange is open for trading not less frequently than once daily as of the time of the close of trading on such exchange) which is next computed after receipt of a tender of such security for redemption or of an order to purchase or sell such security.

Applicant asserts that the pricing by the Sponsor in the secondary market in no way affects the assets of the fund, and that the public unit holders benefit from such pricing procedure by receiving a normally higher repurchase price for their units without the cost burden of daily evaluations of the unit redemption value. In addition, the application states that the Sponsor has undertaken to adopt a procedure whereby the evaluator, without a formal evaluation, will provide estimated evaluations on trading days. In the case of a repurchase, if the evaluator cannot state that the current bid side evaluation is not equal to or not higher than the previous Friday's price, the Sponsor will order a full evaluation. In case of resale, if the evaluator cannot state that the previous Friday's price is no more than one-half point (\$5 on a

unit representing \$1,000 principal amount of underlying bonds) greater than the current offering price, a full evaluation will be ordered. Finally, the Sponsor has agreed to waive that portion of its annual \$0.275 per \$1,000 unit fee not required to pay for evaluations under a weekly pricing system.

Section 6(c) of the Act provides, in part, that the Commission may conditionally or unconditionally exempt any person, security, or transaction, or any class or classes of persons, securities, or transactions from any provisions of the Act or of any rule or regulation under the Act, if and to the extent such exemption is necessary or appropriate in the public interest and consistent with the protection of investors and the purposes fairly intended by the policy and provisions of the Act.

Notice is further given that any interested person may, not later than April 20, 1972, at 5:30 p.m., submit to the Commission in writing a request for hearing on the matter accompanied by a statement as to the nature of its interest, the reason for such request and the issues of fact or law proposed to be controverted, or he may request that he be notified if the Commission shall order a hearing thereon. Any such communication should be addressed: Secretary, Securities and Exchange Commission, Washington, D.C. 20549. A copy of such request shall be served personally or by mail (air mail if the person being served is located more than 500 miles from the point of mailing) upon Applicant at the address stated above. Proof of such service (by affidavit or in case of an attorney at law by certificate) shall be filed contemporaneously with the request. At any time after said date, as provided by Rule 0-5 of the rules and regulations promulgated under the Act, an order disposing of the application herein may be issued by the Commission upon the basis of the information stated in said application, unless an order for hearing upon said application shall be issued upon request or upon the Commission's own motion. Persons who request a hearing or advice as to whether a hearing is ordered, will receive notice of further developments in this matter, including the date of the hearing (if ordered) and any postponements thereof.

For the Commission, by the Division of Corporate Regulation, pursuant to delegated authority.

[SEAL] RONALD F. HUNT,
Secretary.

[FR Doc. 72-5208 Filed 4-4-72; 8:50 am]

[812-3150]

AMERICAN GENERAL BOND FUND, INC.

Notice of Filing of Application for Exemption

MARCH 30, 1972.

Notice is hereby given that American General Bond Fund, Inc., 280 Park Avenue, New York, NY 10017, (Applicant),

a closed-end, diversified, management company registered under the Investment Company Act of 1940 (Act) has filed an application for an order pursuant to section 6(c) of the Act declaring that Mr. Milford A. Viser shall not be deemed an interested person of Applicant as that term is defined under section 2(a) (19) of the Act solely by reason of his status as an honorary director of the Mutual Benefit Life Insurance Company (Mutual Benefit). All interested persons are referred to the application on file with the Commission for a statement of the representations made therein, which are summarized below.

Mr. Viser, a director of Applicant is a consultant as well as an honorary director of Mutual Benefit, a mutual life insurance company. Mutual Benefit has a wholly-owned subsidiary, Mutual Benefit Financial Service Company (FISCO), which is registered as a broker-dealer under the Securities Exchange Act of 1934.

Applicant states that FISCO sells only variable annuities, and does not deal in debt securities, to which, by its investment restrictions, Applicant's investments are limited. Applicant further states that FISCO does no business with American General Insurance Company (American) which is the parent company of Applicant's investment adviser, with Channing Company, Inc., which is Applicant's underwriter, or with any other subsidiary of American or with any of the Channing Funds, and no business is anticipated between these parties in the future.

Section 2(a) (19) of the Act, in pertinent part, defines an interested person of an investment company as any broker or dealer registered under the Securities Exchange Act of 1934 or any affiliated person of such broker or dealer. Section 2(a) (3) of the Act defines an affiliated person of another person to include any director or employee of such other person.

Section 6(c) of the Act provides that the Commission may conditionally or unconditionally exempt any person from any provision of the Act if and to the extent that such exemption is necessary or appropriate in the public interest and consistent with the protection of investors and the purposes fairly intended by the policy and provisions of the Act.

Applicant asserts that Mr. Viser should not be deemed an "interested person" of Applicant because his affiliation with Mutual Benefit does not and will not impair his independence in acting on behalf of Applicant and its stockholders, and the requested exemption is therefore consistent with the provisions of section 6(c).

Notice is further given that any interested person may, not later than April 20, 1972, at 5:30 p.m., submit to the Commission in writing a request for a hearing on the matter accompanied by a statement as to the nature of his interest, the reasons for such request and the issues of fact or law proposed to be controverted, or he may request that he be notified if the Commission shall order a hearing thereon. Any such communication should be addressed: Secretary,

Securities and Exchange Commission, Washington, D.C. 20549. A copy of such request shall be served personally or by mail (airmail if the person being served is located more than 500 miles from the point of mailing) upon Applicant at the address set forth above. Proof of such service (by affidavit or in case of an attorney at law by certificate) shall be filed contemporaneously with the request. At any time after said date, as provided by Rule 0-5 of the rules and regulations promulgated under the Act, an order disposing of the application herein may be issued by the Commission upon the basis of the information stated in said application shall be issued upon request or upon the Commission's own motion. Persons who request a hearing or advice as to whether a hearing is ordered will receive notice of further developments in this matter, including the date of the hearing (if ordered) and any postponements thereof.

For the Commission, by the Division of Corporate Regulation, pursuant to delegated authority.

[SEAL] RONALD F. HUNT,
Secretary.

[FR Doc. 72-5223 Filed 4-4-72; 8:51 am]

[70-5173]

GENERAL PUBLIC UTILITIES CORP.

Notice of Proposed Issue and Sale of Shares of Common Stock

MARCH 30, 1972.

Notice is hereby given that General Public Utilities Corporation, 80 Pine Street, New York, NY 10005 (GPU), a registered holding company, has filed a declaration and an amendment thereto with this Commission pursuant to the Public Utility Holding Company Act of 1935 (Act), designating sections 6(a), 7, and 12(c) of the Act and Rules 42 and 50 promulgated thereunder as applicable to the following proposed transaction. All interested persons are referred to the amended declaration, which is summarized below, for a complete statement of the proposed transaction.

GPU proposes to offer up to 3,440,000 authorized but unissued shares of its common stock (additional common stock) for subscription by the holders of its outstanding shares of common stock on the basis of one share of additional common stock for each ten (10) shares of common stock held on the record date of May 4, 1972, or such later date as GPU's registration statement under the Securities Act of 1933 may become effective. The subscription price, to be determined by GPU's board of directors on the record date, will be not more than the closing price of GPU common stock on the New York Stock Exchange on the day prior to the record date and not less than 85 percent thereof. The subscription period will expire May 26, 1972, unless the record date should be later than May 4, 1972, in which event the expiration date will be specified by amendment. The offering of the common stock will not be underwritten.

Rights to subscribe to the additional common stock will be evidenced by transferable subscription warrants which will be issued to all record holders of GPU common stock as promptly as practicable after the record date. No fractional shares will be issued; however, any holder with more than 10 shares, but not in exact multiples thereof, may purchase, at the subscription price, one extra share of additional common stock. A stockholder with less than 10 shares of common stock will be entitled to purchase, at the subscription price, one full share of additional common stock. In addition, each holder who exercises such warrant or warrants in full will be given the privilege of subscribing, subject to allotment, at the same subscription price, for shares of additional common stock not subscribed to pursuant to rights. GPU intends to take such action as is appropriate on its part to effect the admission of the warrants to dealing on the New York Stock Exchange. A commercial bank will be used as subscription agent in connection with the rights offering. GPU proposes to utilize the services of securities dealers in soliciting the exercise by the initial record holders of original issue warrants of the subscription privileges represented thereby and in disposing of the shares of additional common stock available to GPU for such disposition. GPU will pay compensation to the securities dealers, in an amount to be determined by the GPU board of directors at a later time and to be supplied by amendment, for the successful solicitation of the exercise of original issue warrants by the initial record holders thereof and in connection with the purchase of additional common stock by such dealers from GPU. The fee payable with respect to any single beneficial owner will not exceed \$250.

No warrants will be mailed to stockholders with registered addresses outside the United States, Bermuda, Canada, and Mexico. Such stockholders will be informed in advance by GPU of their rights. Any of such warrants as to which no instructions have been received before the close of business on the second business day preceding the expiration date of the warrants will be sold for cash, and the pro rata portions of such proceeds will be delivered to, or held for 2 years for the account of, such stockholders, after which such proceeds will become the property of GPU.

In connection with the rights offering, GPU may effect stabilization transactions in its common stock or warrants up to a maximum net long position equivalent to 300,000 shares.

During the 45 business days following the subscription period, GPU may make shares available for purchase by participating dealers. The price (before deduction of dealer fees) fixed by GPU shall be not less than the subscription price and shall in no event be below 90 percent of the last sale price on the New York Stock Exchange immediately preceding the time when such GPU sale price is fixed.

GPU will utilize the net proceeds realized from the sale of the common stock

for additional investments in its subsidiary companies or to pay a portion of its promissory notes then outstanding, the proceeds of which have been or will be used for such investments.

Fees and expenses to be incurred by GPU are estimated at \$650,000, including legal fees of \$39,000, accounting fees of \$21,000, and subscription agent charges of \$397,000. It is stated that no State commission and no Federal commission, other than this Commission, has jurisdiction over the proposed transaction.

Notice is further given that any interested person may, not later than April 21, 1972, request in writing that a hearing be held on such matter, stating the nature of his interest, the reasons for such request, and the issues of fact or law raised by said declaration which he desires to controvert; or he may request that he be notified if the Commission should order a hearing thereon. Any such request should be addressed: Secretary, Securities and Exchange Commission, Washington, D.C. 20549. A copy of such request should be served personally or by mail (airmail if the person being served is located more than 500 miles from the point of mailing) upon the declarant at the above-stated address, and proof of service (by affidavit or, in case of an attorney at law, by certificate) should be filed with the request. At any time after said date, the declaration, as amended or as it may be further amended, may be permitted to become effective as provided in Rule 23 of the general rules and regulations promulgated under the Act, or the Commission may grant exemption from such rules as provided in Rules 20(a) and 100 thereof or take such other action as it may deem appropriate. Persons who request a hearing or advice as to whether a hearing is ordered will receive notice of further developments in this matter, including the date of the hearing (if ordered) and any postponements thereof.

For the Commission, by the Division of Corporate Regulation, pursuant to delegated authority.

[SEAL] RONALD F. HUNT,
Secretary.

[FR Doc. 72-5224 Filed 4-4-72; 8:51 am]

[812-2844]

MANUFACTURERS VARIABLE ACCOUNT I AND MANUFACTURERS LIFE INSURANCE CO.

Notice of Filing of Application for Order Permitting Registration

MARCH 30, 1972.

Notice is hereby given that The Manufacturers Life Insurance Co. (Manufacturers), mutual life insurance company organized under the laws of Canada, and Manufacturers Variable Account I, 200 Bloom Street East, Toronto, Ontario, Canada (Account I), a separate account established by Manufacturers under the provisions of the Canadian and British Insurance Com-

panies Act, have filed an application for an order pursuant to section 7(d) of the Investment Company Act of 1940 (Act) permitting Manufacturers to register Account I as a unit investment trust under the Act and to make a public offering of its variable annuity contracts. All interested persons are referred to the application on file with the Commission for a statement of the representations made therein which are summarized below.

Manufacturers conducts the business of life, personal accident and business insurance in Canada, the District of Columbia, Puerto Rico, the Virgin Islands, all States of the United States except New York, and many other areas throughout the world. The application states that Manufacturers is the second largest life insurance company in Canada and among the twenty largest on the North American Continent when measured by assets. A substantial portion of Manufacturers' business arises from its operations in the United States. Manufacturers wishes to enter the variable annuity field in the United States. Account I is designed to serve as the facility for the issuance of tax qualified variable annuity contracts (contracts) to be sold by Manufacturers exclusively in the United States. An order of the Commission is necessary to permit the sale of such contracts in the United States because section 7(d) of the Act provides that no investment company, unless organized or otherwise created under the laws of the United States or of a State, and no depositor or trustee of or underwriter for such a company not so organized or created shall make use of the mails or any means or instrumentality of interstate commerce, directly or indirectly, to offer for sale, sell, or deliver after sale, in connection with a public offering, any security of which such company is the issuer. The Commission is authorized, however, upon application by an investment company organized or otherwise created under the laws of a foreign country, to issue a conditional or unconditional order permitting such company to register under the Act and to make a public offering of its securities by use of the mails and means or instrumentalities of interstate commerce if the Commission finds that, by reason of special circumstances or arrangements, it is both legally and practically feasible effectively to enforce the provisions of the Act against such company and that the issuance of such an order is consistent with the public interest and the protection of investors.

All assets of the Account will be invested in shares of an open-end management investment company (Fund) to be incorporated in Delaware and which along with its shares will be registered with the Commission. Investment advice will be furnished to the Fund by its adviser, ManEquity Management Co., a wholly owned subsidiary of Manufacturers incorporated in the State of Colorado, with its principal office in Denver, Colo. The adviser is registered as an investment adviser under the Investment Advisers Act of 1940. The Fund's Board of Directors will supervise investment de-

cisions for the Fund based on such investment advice, and must comply with the objections and policies of the Fund and with restrictions required under Canadian law for insurance company separate accounts. It is contemplated that the adviser will not use the personnel and services of Manufacturers in implementing its responsibilities under the investment advisory agreement. However, certain directors and non-operational officers of the adviser may be officers or employees of Manufacturers.

Sales of the contracts will be made only by associated persons of registered broker-dealers who are also members of the NASD. Such persons will also be insurance agents or brokers for Manufacturers who are qualified under applicable State law to sell variable annuities. The principal underwriter will be ManEquity, Inc., a wholly owned subsidiary of ManEquity Management Co. The underwriter, a Colorado corporation, has its principal office in Denver, Colo., and is a registered broker-dealer and a member of the NASD.

At the state level, Manufacturers will be subject to the same regulation with respect to its variable annuity operations as would a United States company engaged in such operations, with the one exception—that as an alien insurance company, it is required to maintain its Account I assets with a U.S. depository in order to conform to the deposit requirements of the Insurance Code of the State of Michigan which serves as Manufacturers "state of entry" required under insurance laws for doing business in the United States. To comply with Michigan deposit requirements, Manufacturers will establish, under a new trust agreement, a separate trust for the protection of owners and beneficiaries of contracts issued by Account I. This trust, which will be in the United States, will hold all of the assets of the Account I.

Manufacturers and Account I have requested an order from the Commission allowing Manufacturers to register Account I on certain terms and conditions. Among other things these terms and conditions require:

(1) That the assets of Account I be maintained in trust in the United States in a bank which (a) is trustee for such trust, (b) is a bank within the meaning of section 2(a)(5) of the Act, and (c) meets the qualifications set forth in section 26(a)(1) of the Act.

(2) That an agent in the United States be designated by Manufacturers, its directors and certain of its officers to accept service of process in connection with matters relating to Account I and that Manufacturers and certain of its officers and directors consent that any suit, action or proceeding concerning such matters before the Commission, or any appropriate court of the United States, may be commenced by the service of process upon such agent;

(3) That copies of books and records of Account I be furnished the Commission, at its request, in the United States, and that auditors or inspectors for the Commission be given free access to such

books and records at the principal office of Manufacturers in Toronto, Ontario, Canada; and

(4) That an accountant be appointed for Account I who is qualified to act as an independent public accountant under the Act and the rules thereunder, and who maintains a permanent office and place of business in the United States.

Manufacturers and Account I have also agreed that jurisdiction of the Commission is reserved to suspend or revoke the requested order in whole or in part if:

(a) Manufacturers or Account I, or Account I's custodian or underwriter, or the Fund of the Fund's investment, adviser shall have failed to comply with the Investment Company Act of 1940, the Investment Advisers Act of 1940, the Securities Act of 1933, the Securities Exchange Act of 1934, or any applicable Rules, Regulations or Orders of the Commission thereunder; or

(b) Any of the representations, undertakings, and agreements contained in or contemplated by the application shall not have been complied with; or

(c) Any change has occurred in the laws of the Dominion of Canada, or any subdivision thereof, creating an inconsistency with the protection of investors afforded by the representations, undertakings, and agreements contained in or contemplated by the application, and

(d) The Commission finds, after notice and opportunity for hearing, that suspension or revocation of the order requested herein is in the public interest and is necessary for the protection of investors.

Notice is further given that any interested person may, not later than April 19, 1972, at 5:30 p.m., submit to the Commission in writing a request for a hearing on the matter accompanied by a statement as to the nature of his interest, the reason for such request and the issues, if any, of fact or law proposed to be controverted, or he may request that he be notified if the Commission shall order a hearing thereon. Any such communication should be addressed: Secretary, Securities and Exchange Commission, Washington, D.C. 20549. A copy of such request shall be served personally or by mail (airmail if the person being served is located more than 500 miles from the point of mailing) upon Applicants at the address stated above. Proof of such service by affidavit (or in case of an attorney at law by certificate) shall be filed contemporaneously with the request. At any time after said date, as provided by Rule 0-5 of the rules and regulations promulgated under the Act, an order disposing of the application herein may be issued by the Commission upon the basis of the information stated in said application, unless an order for hearing upon said application shall be issued upon request or upon the Commission's own motion. Persons who request a hearing, or advice as to whether a hearing is ordered, will receive notice of further developments in the matter including the date of the hearing (if ordered) and any postponements thereof.

For the Commission, by the Division of Corporate Regulation, pursuant to delegated authority.

[SEAL]

RONALD F. HUNT,
Secretary.

[FR Doc.72-5227 Filed 4-4-72;8:51 am]

[812-3042]

**PENN MUTUAL LIFE INSURANCE CO.
AND PENN MUTUAL VARIABLE
ANNUITY ACCOUNT II**

Notice of Application for Exemption

MARCH 30, 1972.

Notice is hereby given that The Penn Mutual Life Insurance Co. (Penn Mutual), a mutual life insurance company organized under the laws of Pennsylvania, and Penn Mutual Variable Annuity Account II, 530 Walnut Street, Philadelphia, PA 19105 (Account II), a separate account of Penn Mutual registered as a unit investment trust under the Investment Company Act of 1940 (Act), (collectively called the "Applicants"), have filed an application pursuant to section 6(c) of the Act for an order exempting Applicants, to the extent noted below, from the provisions of sections 22(d), 26(a), and 27(c)(2) of the Act. All interested persons are referred to the application on file with the Commission for a statement of the representations contained therein, which are summarized below.

Account II was established by Penn Mutual in connection with the proposed sale of three types of individual variable annuity contracts (Contracts). The Contracts proposed to be issued by Penn Mutual are (1) periodic purchase payment deferred contracts; (2) single purchase payment deferred contracts; and (3) single purchase payment immediate contracts. Under the periodic purchase payment and single purchase payment deferred contracts, net purchase payments are allocated for accumulation on a fixed or variable basis to provide either fixed or variable annuities or a combination of both. Under single purchase payment immediate contracts, there is no accumulation period and only variable benefits are provided.

Net purchase payments that are to be accumulated on a variable basis, and funds allocated to provide variable benefits under the Contracts, are invested through Account II in shares of Penn Mutual Equity Fund, Inc. ("Fund"), a registered open-end management investment company incorporated in Delaware. The value of interests in Account II, before or after annuity benefits become payable, will vary to reflect investment performances of Fund shares.

Under Pennsylvania insurance law, the assets of Account II are owned by Penn Mutual and not held in trust by Penn Mutual. However, the income, gains, or losses, realized or unrealized, of Account II are credited to or charged against Account II in accordance with the Contracts, and without regard to other income, gains or losses of Penn Mutual. In addition, the assets held in Account II

may not be chargeable with liabilities arising out of any other business that might be conducted by Penn Mutual.

Applicants request exemption from the following provisions of the Act to the extent stated below:

Section 22(d) provides, in pertinent part, that no registered investment company or principal underwriter thereof shall sell any redeemable security to the public except at a public offering price described in the prospectus.

Applicants request exemption from the provisions of section 22(d) to permit dividends received under the Contracts during any accumulation period to be applied to the purchase of additional variable accumulation units in Account II without the imposition of charges for sales expenses. Any dividends on the Contracts resulting from divisible surplus will be declared on a uniform and nondiscriminatory basis according to each class of the Contracts.

Applicants also request an exemption from section 22(d) to permit the transfer to Account II of amounts accumulated on a fixed basis contract when: (1) All or part of a surrender or death benefit under a periodic purchase payment or a single purchase payment deferred contract is used to provide a variable annuity; (2) on the annuity date, all or part of the value of the fixed accumulation account under a periodic purchase payment or a single purchase payment deferred contract is used to provide a variable annuity; and (3) all or part of a surrender benefit, death benefit, or annuity benefit under a contract is used to provide a fixed settlement option without life contingencies, and thereafter all or part of the remaining value of the fixed settlement option is used by the payee thereof to provide a variable annuity. Applicants intend to allow the transfer of such amounts without the imposition of a sales charge since the payments giving rise to such amounts will have already been subject to sales charges equal to those which would have been imposed had such payments originally been paid into Account II.

An exemption from section 22(d) is also requested to permit amounts accumulated under other Penn Mutual life insurance, endowment, and fixed annuity contracts to be transferred to Account II for the purchase of any contract offered by Account II. From the amounts transferred, Penn Mutual proposes to deduct a charge of 1 1/4 percent for sales expenses and 3/4 percent for administrative expenses. Applicants represent that these reduced charges will not result in unfair discrimination among contract owners since they will only be applicable to amounts arising under other Penn Mutual contracts with respect to which sales and administrative expense charges have previously been levied.

With respect to periodic purchase payment contracts purchased with amounts transferred from at least 1 year old Penn Mutual life insurance, endowment, or fixed annuity contracts, applicants also request exemption from section

22(d) to permit charges for sales and administrative expenses on periodic purchase payments made subsequent to the initial purchase to be at the rate applicable to second or later year payments on the periodic payment contracts. The periodic purchase payment contracts provide for a sales and administrative expense deduction of 15 percent with respect to purchase payments made in the first contract year and 7 percent with respect to payments made thereafter. Applicants submit that the application of the second year charges in the circumstances described will not be unfairly discriminatory since persons who become contract owners upon transfer from other Penn Mutual life insurance, endowment, or fixed annuity contracts will already have paid a first year sales and administrative expense charge.

Applicants request exemption from the provisions of sections 26(a) and 27(c) (2) which, as here pertinent, provide that periodic payment plan certificates of a unit investment trust may not be sold unless the proceeds of all payments, other than sales loads, are deposited with a qualified bank as trustee or custodian, and are held under an agreement of custodianship. Such agreement must provide, in part, that: (i) The custodian bank shall have possession of all property of the unit investment trust and shall segregate and hold the same in trust; (ii) that the custodian bank shall not resign until either the unit investment trust has been liquidated or a successor custodian has been appointed; (iii) that the custodian may collect fees from the income and, if necessary, from the corpus of the unit investment trust for services performed and reimbursement of expenses incurred; and (iv) that no payment to the depositor or principal underwriter shall be allowed the custodian bank as an expense except a fee, not exceeding such reasonable amount as the Commission may prescribe, as compensation for performing bookkeeping and other administrative services normally performed by the custodian. Applicants state that a custodianship or trusteeship of the assets of Account II is unnecessary because the assets of the account will only consist of shares of the Fund which will be issued under an open account arrangement without the use of stock certificates. Applicants also state that Penn Mutual will operate as a regulated insurance company subject to the extensive supervision and control of the Pennsylvania Insurance Commission, and that such control and supervision will provide assurance against misfeasance and afford the essential protection of a trusteeship.

Applicants assert further that under Pennsylvania law neither Account II nor Penn Mutual may abrogate its obligation under the Contracts. Therefore, the dangers against which sections 26(a) and 27(c) (2) are directed are not present.

Penn Mutual and Account II have consented that any order granting the requested exemption from sections 26(a) and 27(c) (2) may be subject to the conditions that: (1) Any charges under the

Contracts for administrative services shall not exceed such reasonable amounts as the Commission shall prescribe, and the Commission shall reserve jurisdiction for such purpose; and (2) the payment of sums and charges out of the assets of Account II shall not be deemed to be exempted from regulation by the Commission by reason of the order.

Section 6(c) authorizes the Commission to exempt any person, security, or transaction, or any class or classes of persons, securities, or transactions, from the provisions of the Act and rules promulgated thereunder if and to the extent that such exemption is necessary or appropriate in the public interest and consistent with the protection of investors and the purposes fairly intended by the policy and provisions of the Act.

Notice is hereby given that any interested person may, not later than April 20, 1972 at 5:30 p.m., submit to the Commission in writing a request for a hearing on the matter accompanied by a statement as to the nature of his interest, the reason for such request, and the issues of fact or law proposed to be controverted; or he may request that he be notified if the Commission shall order a hearing thereon. Any such communication should be addressed: Secretary, Securities and Exchange Commission, Washington, D.C. 20549. A copy of such request shall be served personally or by mail (airmail if the person being served is located more than 500 miles from the point of mailing) upon Applicants at the address stated above. Proof of such service (by affidavit, or in the case of an attorney at law, by certificate) shall be filed contemporaneously with the request. At any time after said date, as provided by Rule 0-5 of the rules and regulations promulgated under the Act, an order disposing of the application herein may be issued by the Commission upon the basis of the information stated in said application, unless an order for hearing upon said application shall be issued upon request or upon the Commission's own motion. Persons who request a hearing or advice as to whether a hearing is ordered will receive notice of further developments in this matter, including the date of the hearing (if ordered), and any postponements thereof.

For the Commission, by the Division of Corporate Regulation, pursuant to Delegated Authority.

[SEAL] RONALD F. HUNT,
Secretary.

[FR Doc.72-5225 Filed 4-4-72; 8:51 am]

[812-3113]

PENN MUTUAL EQUITY FUND, INC. Notice of Application for Exemption

MARCH 30, 1972.

Notice is hereby given that Penn Mutual Equity Fund, Inc., 530 Walnut Street, Philadelphia, Pa. 19105 ("Applicant"), an open-end diversified management investment company registered under the Investment Company Act of 1940 ("Act"), has filed an application

pursuant to section 6(c) of the Act for an order of exemption from the provisions of section 15(b) of the Act to the extent necessary to permit Applicant's shares to be sold without an underwriting contract. All interested persons are referred to the application on file with the Commission for a statement of the representations contained therein which are summarized below.

Shares of the Applicant are offered only to the Penn Mutual Life Insurance Co. ("Penn Mutual"), and separate accounts of Penn Mutual, at a price equal to the net asset value per share. The Applicant is currently selling its shares only to Penn Mutual Variable Annuity Account I, a separate account of Penn Mutual that is registered under the Act as a unit investment trust. Applicant proposes to sell its shares to Penn Mutual Variable Annuity Account II ("Account II"), a separate account of Penn Mutual that is also registered under the Act as a unit investment trust. All net purchase payments under variable annuity contracts issued by Penn Mutual which are allocated to Account II will be invested in shares of the Applicant. Applicant has no present intention of offering its shares directly to the public.

Section 15(b) provides that no principal underwriter for a registered open-end investment company may offer for sale or sell any security of which such company is the issuer except pursuant to a written contract with such company.

Applicant contends that while Penn Mutual may be deemed an underwriter of the shares of the Applicant within the meaning of the Act, there is no function to be served by an underwriting contract.

Accordingly, Applicant requests an exemption from the provisions of section 15(b) to the extent necessary to permit sales of shares of the Applicant to Account II without a written underwriting contract complying with section 15(b) so long as the shares of Applicant are not offered directly to the public.

Section 6(c) authorizes the Commission to exempt any person, security, or transaction, or any class or classes of persons, securities, or transactions, from the provisions of the Act and Rules promulgated thereunder if and to the extent that such exemption is necessary or appropriate in the public interest and consistent with the protection of investors and the purposes fairly intended by the policy and provisions of the Act.

Notice is hereby given that any interested person may, not later than April 20, 1972, at 5:30 p.m., submit to the Commission in writing a request for a hearing on the matter accompanied by a statement as to the nature of his interest, the reason for such request, and the issues of fact or law proposed to be controverted; or he may request that he be notified if the Commission shall order a hearing thereon. Any such communication should be addressed: Secretary, Securities and Exchange Commission, Washington, D.C. 20549. A copy of such request shall be served personally or by mail (airmail if the person being served is located more than 500 miles from the

point of mailing) upon Applicant at the address stated above. Proof of such service (by affidavit, or in the case of an attorney at law, by certificate) shall be filed contemporaneously with the request. At any time after said date, as provided by Rule 0-5 of the rules and regulations promulgated under the Act, an order disposing of the application herein may be issued by the Commission upon the basis of the information stated in said application, unless an order for hearing upon said application shall be issued upon request or upon the Commission's own motion. Persons who request a hearing or advice as to whether a hearing is ordered will receive notice of further developments in this matter, including the date of the hearing (if ordered), and any postponements thereof.

For the Commission, by the Division of Corporate Regulation, pursuant to delegated authority.

[SEAL] RONALD F. HUNT,
Secretary.

[FR Doc.72-5226 Filed 4-4-72; 8:51 am]

SMALL BUSINESS ADMINISTRATION

[License No. 07/10-0040]

FIRST AMERICAN CAPITAL CORP.

Notice of Surrender of License to Operate as Small Business Investment Company

Notice is hereby given that First American Capital Corporation (First American), Suite 200, American Building, Cedar Rapids, Iowa 52401, has, pursuant to § 107.105 of the regulations governing small business investment companies (13 CFR 107.105 (1971)), surrendered its license to operate as a small business investment company (SBIC).

First American was incorporated on March 24, 1961, under the laws of the State of Oklahoma to operate solely as an SBIC under the Small Business Investment Act of 1958, as amended (15 U.S.C. 661 et seq.) (Act), and it was issued license number 10-0040 by the Small Business Administration (SBA) on June 19, 1961. With the approval of SBA, First American, on September 29, 1969, was acquired by Iowa Growth Investment Company (Iowa Growth), Suite 200, American Building, Cedar Rapids, Iowa 52401, an Oklahoma SBIC. First American has operated as a wholly owned subsidiary of Iowa Growth pending its dissolution which has now been completed.

Under the authority vested by the Act and the regulations promulgated thereunder, the voluntary surrender of the license of First American is hereby accepted and, accordingly, it is no longer licensed to operate as an SBIC.

Dated: March 28, 1972.

A. H. SINGER,
Associate Administrator
for Investment.

[FR Doc.72-5222 Filed 4-4-72; 8:51 am]

[License No. 02/02-5291]

PUERTO RICAN FORUM CAPITAL CORP.

Notice of Issuance of License To Operate as Minority Enterprise Small Business Investment Company

On November 18, 1971, a notice was published in the FEDERAL REGISTER (36 F.R. 22028), stating that the Puerto Rican Forum Capital Corp., 156 Fifth Avenue, New York, NY 10010, had filed an application with the Small Business Administration, pursuant to § 107.102 of the SBA rules and regulations governing small business investment companies (13 CFR 107.102 (1971)) for a license to operate as a minority enterprise small business investment company (MESBIC).

Interested parties were given to the close of business December 3, 1971, to submit their written comments to SBA.

Notice is hereby given that, having considered the application and all other pertinent information, SBA has issued License No. 02/02-5291 to the Puerto Rican Forum Capital Corp., pursuant to section 301(c) of the Small Business Investment Act of 1958, as amended.

Dated: March 29, 1972.

A. H. SINGER,
Associate Administrator
for Investment.

[FR Doc.72-5221 Filed 4-4-72; 8:51 am]

TARIFF COMMISSION

[337-25]

PANTY HOSE

Notice of Findings and Recommendation

Upon completion of its investigation (337-25) under section 337 of the Tariff Act of 1930, in response to a complaint of Tights, Inc., the Commission finds violation of section 337(a) of the Tariff Act of 1930 by unfair methods of competition and unfair acts in the importation and sale of panty hose manufactured in accordance with the claim of U.S. Patent No. Re. 25,360 owned by complainant, the effect or tendency of which is to destroy or substantially injure an industry, efficiently and economically operated, in the United States.

Accordingly, the Commission recommends that, in accordance with section 337(e) of the Tariff Act of 1930, the President direct the Secretary of the Treasury to instruct customs officers to exclude from entry into the United States panty hose manufactured in accordance with the claim of U.S. Patent No. Re. 25,360 until expiration of the patent, except where the importation is made under license of the registered owner of said patent.

Under the statute (19 U.S.C. 1377(c)) a rehearing before the Commission may be requested. In accordance with § 201.14 of the Commission's rules of practice and procedure (19 CFR 201.14) a motion for

a rehearing may be granted for good cause shown. Any such motion for a rehearing must be in writing and filed with the Secretary of the U.S. Tariff Commission, Washington, D.C. 20436, within twenty (20) days after publication of this notice. The motion must state clearly the grounds which are relied upon for the granting of a rehearing and must be accompanied by 19 true copies.

Issued: March 31, 1972.

[SEAL] KENNETH R. MASON,
Secretary.

[FR Doc. 72-5187 Filed 4-4-72; 8:49 am]

INTERSTATE COMMERCE COMMISSION

ASSIGNMENT OF HEARINGS

MARCH 31, 1972.

Cases assigned for hearing, postponement, cancellation or oral argument appear below and will be published only once. This list contains prospective assignments only and does not include cases previously assigned hearing dates. The hearings will be on the issues as presently reflected in the official docket of the Commission. An attempt will be made to publish notices of cancellation of hearings as promptly as possible, but interested parties should take appropriate steps to insure that they are notified of cancellation or postponements of hearings in which they are interested.

MC 106120 Sub 3, Badger Coaches, Inc., now being assigned hearing June 7, 1972, at Chicago, Ill., in a hearing room to be later designated.

MC-F-11200, MC 59583 Sub 131, Mason & Dixon Lines—Purchase—Econ Lines, now being assigned hearing June 12, 1972, at Chicago, Ill., in a hearing room to be designated later.

MC 11290, MC 98913 Sub 3, Gordons Transports—Control—J. B. Reed Motor Express, now being assigned hearing June 19, 1972, at Chicago, Ill.

MC 119657 Sub 9, George Transit Line, Inc., now being assigned hearing June 15, 1972, at Chicago, Ill., in a hearing room to be designated later.

No. 35407, Increased rates and charges by Matson Navigation, No. 35407, Sub 1; increased rates and charges, Seatrain Lines, Calif., No. 35407 Sub 2; increased rates and charges, Matson Navigation Co., No. 35407 Sub 3; increased rates and charges, Matson Navigation Co., No. 35407 Sub 4; increased rates and charges, Seatrain Lines, Calif., No. 35407 Sub 5; lumber and related commodities, West Coast to Hawaii, and No. 35407 Sub 6; various commodities, between California and Hawaii, now being assigned hearing July 10, 1972, at San Francisco, Calif., in a hearing room to be later designated.

MC-F-11043, Colonial Motor Freight Line, Inc.—Control—Griggs Trucking Co., now being assigned hearing May 24, 1972, at Columbia, S.C., in a hearing room to be later designated.

MC-C-7566, W. T. Mayfield Sons Trucking Co., Inc.—Investigation and revocation of certificates, now being assigned hearing May 16, 1972, at Atlanta, Ga., in a hearing room to be later designated.

MC-C-7715, Mangum Trucking Company, Inc.—Investigation and revocation of certificates, now being assigned hearing May 22, 1972, at Atlanta, Ga., in a hearing room to be later designated.

MC 106644 Sub 130, Superior Trucking Company, Inc., now being assigned hearing May 23, 1972, at Atlanta, Ga., in a hearing room to be later designated.

MC 135608, Inman Transport, Inc., now being assigned hearing May 15, 1972, at Atlanta, Ga., in a hearing room to be later designated.

MC 136136, Arnold J. Kellos, d.b.a. A. J. Kellos Construction Co., now being assigned hearing May 17, 1972, at Atlanta, Ga., in a hearing room to be later designated.

MC 65475 Sub 9, Jetco, Inc., now assigned May 22, 1972, at Washington, D.C., is canceled and application dismissed.

MC 120526 Sub 2, Griggs Trucking Co., now being assigned hearing May 24, 1972, at Columbia, S.C., in a hearing room to be later designated.

MC 103435 Sub 216, United-Buckingham Freight Lines, Inc., now being assigned hearing June 15, 1972, at Billings, Mont., in a hearing room to be later designated.

MC 109533 Sub 44, Overnite Transportation, now being assigned hearing July 11, 1972, in the Ramada Inn, Broadway and Route 4, Lexington, Ky.

MC-C-7405, William E. Hesselgrave, d.b.a. Pudget Sound Tours, and George V. Hesselgrave, d.b.a. Bellingham-Ferndale Stages, investigation of operations, now assigned April 25, 1972; MC 135987 Sub 1, Carbol Trailways, Ltd., now assigned April 24, 1972, and MC 136189, George V. Hesselgrave, d.b.a. Hesselgrave Charter Service, now assigned April 25, 1972, and No. 35474, Pacific Paper Products, Inc.—V-Garrett Freightlines, Inc., et al., now assigned April 26, 1972, at Seattle, Wash., will be held in Room 4054, Federal Office Bldg., 909 1st Ave., Seattle, Wash.

[SEAL] ROBERT L. OSWALD,
Secretary.

[FR Doc. 72-5243 Filed 4-4-72; 8:53 am]

FOURTH SECTION APPLICATION FOR RELIEF

MARCH 31, 1972.

Protests to the granting of an application must be prepared in accordance with Rule 1100.40 of the general rules of practice (49 CFR 1100.40) and filed within 15 days from the date of publication of this notice in the FEDERAL REGISTER.

LONG-AND-SHORT-HAUL

FSA No. 42393—*Paper and Paper Articles from Keltys, Tex.* Filed by Southwestern Freight Bureau, Agent (No. B-305), for interested rail carriers. Rates on paper and paper articles, in carloads, as described in the application, from Keltys, Tex., to points in southern and eastern territories; also returned shipments of newsprint paper winding cores in the reverse direction.

Grounds for relief—Market competition.

Tariffs—Supplements 61, 60, and 41 to Southwestern Freight Bureau, Agent, tariffs ICC 4781, 4657, and 4891, respectively.

Rates are published to become effective on May 7, 1972.

By the Commission.

[SEAL] ROBERT L. OSWALD,
Secretary.

[FR Doc. 72-5242 Filed 4-4-72; 8:53 am]

[Notice 11]

MOTOR CARRIER ALTERNATE ROUTE DEVIATION NOTICES

MARCH 31, 1972.

The following letter-notices of proposals to operate over deviation routes for operating convenience only have been filed with the Interstate Commerce Commission under the Commission's Revised Deviation Rules—Motor Carriers of Passengers, 1969 (49 CFR 1042.2(c)(9)) and notice thereof to all interested persons is hereby given as provided in such rules (49 CFR 1042.2(c)(9)).

Protests against the use of any proposed deviation route herein described may be filed with the Interstate Commerce Commission in the manner and form provided in such rules (49 CFR 1042.2(c)(9)) at any time, but will not operate to stay commencement of the proposed operations unless filed within 30 days from the date of publication.

Successively filed letter-notices of the same carrier under the Commission's Revised Deviation Rules—Motor carriers of Property, 1969, will be numbered consecutively for convenience in identification and protests, if any, should refer to such letter-notices by number.

MOTOR CARRIERS OF PASSENGERS

No. MC 29957 (Deviation No. 14), CONTINENTAL SOUTHERN LINES, INC., Post Office Box 8435, Jackson, MS 39204, filed March 21, 1972. Carrier proposes to operate as a common carrier, by motor vehicle, of passengers and their baggage, and express and newspapers in the same vehicle with passengers, over deviation routes as follows: (1) From Jackson, Miss., over Interstate Highway 55 to junction Interstate Highway 10, thence over Interstate Highway 10 to New Orleans, La., (2) from Jackson, Miss., over Interstate Highway 55 to junction U.S. Highway 51 (about 8 miles south of Pontchatoula, La.), thence over U.S. Highway 51 to junction Interstate Highway 10 (near LaPlace, La.), thence over Interstate Highway 10 to New Orleans, La., and (3) from junction Interstate Highway 55 and U.S. Highway 190, over U.S. Highway 190 to junction access roads on the north end of the Lake Pontchartrain Causeway, and return over the same routes, for operating convenience only. The notice indicates that the carrier is presently authorized to transport passengers and the same property, over pertinent service routes as follows: (1) From Mendenhall, Miss., over Mississippi Highway 13 to Columbia, Miss., thence over Mississippi Highway 24 to junction Mississippi Highway 35, thence over Mississippi Highway 35 via Jamestown and Sandy Hook, Miss., to the Mississippi-Louisiana State line,

thence over Louisiana 21 to Bush, La., thence over Louisiana Highway 484 to Talisheek, La., thence over Louisiana Highway 58 to Pearl River, La., thence over U.S. Highway 11 to junction U.S. Highway 90, thence over U.S. Highway 90 to New Orleans, La., (2) from Gulfport, Miss., over U.S. Highway 49 to Jackson, Miss., thence over U.S. Highway 51 via Grenada, Miss., to Memphis, Tenn., and (3) from New Orleans, La., over access roads to Lake Pontchartrain Causeway, thence over Lake Pontchartrain Causeway to access roads on the north end thereof, thence over access roads to junction U.S. Highway 190 near Mandeville, La., thence over U.S. Highway 190 to Covington, La., thence over Louisiana Highway 21 to a point about 2 miles from Bush, La., thence over unnumbered highway to Bush, La., and return over the same routes.

No. MC 29957 (Deviation No. 15), CONTINENTAL SOUTHERN LINES, INC., Post Office Box 8435, Jackson, Miss. 39204, filed March 21, 1972. Carrier proposes to operate as a common carrier, by motor vehicle, of passengers and their baggage, and express and newspapers in the same vehicle with passengers, over deviation routes as follows: (1) From Memphis, Tenn., over Interstate Highway 55 to St. Louis, Mo., with the following access routes: (a) From junction Interstate Highway 55 and Business Route U.S. Highway 61, about 5 miles south of Cape Girardeau, Mo., over Business Route U.S. Highway 61 to Cape Girardeau, Mo., (b) from junction Interstate Highway 55 and Business Route U.S. Highway 61, about 6 miles north of Cape Girardeau, Mo., over Business Route U.S. Highway 61 to Cape Girardeau, Mo., and (c) from junction Interstate Highways 55 and 57, near Sikeston, Mo., over Interstate Highway 57 to Cairo, Ill., and (2) from Memphis, Tenn., over Interstate Highway 55 to junction U.S. Highway 61 (near Holland, Mo.), thence over U.S. Highway 61 to junction Interstate Highway 55 (near Hayte, Mo.), thence over Interstate Highway 55 to junction U.S. Highway 61 (near Jackson, Mo.), thence over U.S. Highway 61 to junction Interstate Highway 55 (near Brewer, Mo.), thence over Interstate Highway 55 to St. Louis, Mo., with the following access routes:

(a) From junction Interstate Highway 55 and Business Route U.S. Highway 61, about 5 miles south of Cape Girardeau, Mo., over Business Route U.S. Highway 61 to Cape Girardeau, Mo., (b) from junction Interstate Highway 55 and Business Route U.S. Highway 61, about 6 miles north of Cape Girardeau, Mo., over Business Route U.S. Highway 61 to Cape Girardeau, Mo., and (c) from junction Interstate Highway 55 and Interstate Highway 57, over Interstate Highway 57 to junction U.S. Highway 60, thence over U.S. Highway 60 to Cairo, Ill., and return over the same routes, for operating convenience only. The notice indicates that the carrier is presently authorized to transport passengers and the same property, over pertinent service routes as follows: (1) From Memphis, Tenn., over

U.S. Highway 64 to junction Tennessee Highway 100, thence over Tennessee Highway 100 to junction Tennessee Highway 18, thence over Tennessee Highway 18 to junction U.S. Highway 45, thence over U.S. Highway 45 to Jackson, Tenn., thence over U.S. Highway 45 to junction U.S. Highway 45E, thence over U.S. Highway 45E to junction U.S. Highway 51, thence over U.S. Highway 51 to Cairo, Ill., thence over Illinois Highway 3 to East St. Louis, Ill., thence over Eads Bridge to St. Louis, Mo., (also from Cape Girardeau, Mo., over Missouri Highway 74 to and across the Mississippi River to Illinois Highway 146), thence over Illinois Highway 146 to junction Illinois Highway 3, and (2) from Red Bud, Ill., over Illinois Highway 159 to Belleville, Ill., thence over U.S. Highway 460 to East St. Louis, Ill., and return over the same routes.

By the Commission.

[SEAL] ROBERT L. OSWALD,
Secretary.

[FR Doc. 72-5239 Filed 4-4-72; 8:52 am]

[Notice 25]

MOTOR CARRIER APPLICATIONS AND CERTAIN OTHER PROCEEDINGS

MARCH 31, 1972.

The following publications are governed by the new Special Rule 1100.247 of the Commission's rules of practice, published in the FEDERAL REGISTER, issue of December 3, 1963, which became effective January 1, 1964.

The publications hereinafter set forth reflect the scope of the applications as filed by applicant, and may include descriptions, restrictions, or limitations which are not in a form acceptable to the Commission. Authority which ultimately may be granted as a result of the applications here noticed will not necessarily reflect the phraseology set forth in the application as filed, but also will eliminate any restrictions which are not acceptable to the Commission.

MOTOR CARRIERS OF PROPERTY

No. MC 47142 (Sub-No. 106) (Republication), filed March 12, 1970, published in the FEDERAL REGISTER issues of April 9, 1970, and December 15, 1971, and republished this issue. Applicant: C. I. WHITTEN TRANSFER CO., a corporation, 4417 Earl Court, Huntington, WV 25705. Applicant's representative: Joseph G. Dail, Jr., 1111 E Street NW., Washington, DC 20004. An order of the Commission, Division 1, acting as an Appellate Division, dated February 25, 1972, and served March 8, 1972, finds, that the present and future public convenience and necessity require operation by applicant, in interstate or foreign commerce, as a common carrier by motor vehicle, over irregular routes, of (1) commodities bearing a security classification by the U.S. Government, and (2) weapons, ammunition, and drugs which are designated sensitive by the U.S. Government between points in Connecticut, Delaware, Florida, Illinois, Indiana, Iowa,

Kentucky, Maine, Maryland, Massachusetts, Michigan, New Hampshire, New Jersey, New York, North Carolina, Ohio, Pennsylvania, Rhode Island, Tennessee, Vermont, Virginia, West Virginia, Wisconsin, and the District of Columbia, restricted against the transportation of shipments weighing in the aggregate more than 5,000 pounds from one consignor to one consignee on any one day. Restriction: The authority granted herein above shall be limited in point of time, to a period expiring 5 years from date of issue of the certificate herein. Because it is possible that other parties, who have relied upon the notice of the grants of authority as published, may have an interest in and would be prejudiced by the lack of proper notice of the authorities granted herein, a notice of the authorities granted herein will be published in the FEDERAL REGISTER and issuance of certificate in these proceedings will be withheld for a period of 30 days from the date of such publication, during which period any proper party in interest may file an appropriate petition for leave to intervene in these proceedings setting forth in detail the precise manner in which it has been so prejudiced.

No. MC 109397 (Sub-No. 177) (Republication), filed September 2, 1969, published in the FEDERAL REGISTER issue of October 2, 1969, and November 10, 1971, and republished this issue. Applicant: TRI-STATE TRANSIT CO., a Corporation, Post Office Box 113, Joplin, MO 64801. Applicant's representatives: Max G. Morgan, 600 Leininger Building, Oklahoma City, Okla. 73112, and Frank Hand, 740 15th Street NW., Washington, DC 20005. An order of the Commission, Division 1, acting as an Appellate Division, dated February 25, 1972, and served March 8, 1972, finds, that the present and future public convenience and necessity require operation by applicant, in interstate or foreign commerce, as a common carrier by motor vehicle, over irregular routes, of (1) commodities bearing a security classification by the U.S. Government, and (2) weapons, ammunition, and drugs which are designated sensitive by the U.S. Government, between points in the United States (except Alaska and Hawaii), restricted against the transportation of shipments weighing in the aggregate more than 5,000 pounds from one consignor to one consignee on any one day; that applicant is fit, willing and able properly to perform such service and to conform to the requirements of the Interstate Commerce Act and the Commission's rules and regulations thereunder. That the grant of authority herein, and applicant's existing authority that it duplicates shall be construed as conferring only a single operating right. The authority granted herein shall be limited in point of time, to a period expiring 5 years from the date of issuance of the certificate herein. Because it is possible that other parties, who have relied upon the notice of the application as published, may have an interest in and would be prejudiced by the lack of proper notice of

the authority described in the findings in this order, a notice of the authority actually granted will be published in the FEDERAL REGISTER and issuance of a certificate in this proceeding will be withheld for a period of 30 days from the date of such publication, during which period any proper party in interest may file and appropriate petition for leave to intervene in this proceeding setting forth in detail the precise manner in which it has been so prejudiced.

No. MC 124692 (Sub-No. 60) (Republication), filed March 20, 1969, published in the FEDERAL REGISTER issues of April 24, 1969, and June 19, 1969, and republished this issue. Applicant: SAMMONS TRUCKING, Post Office Box 933, Missoula, MT 59801. Applicant's representative: Gene P. Johnson, 502 First National Bank Bldg., Fargo, N. Dak. 58102. A report and order of the Commission, Division 1, acting as an Appellate Division, Decided March 2, 1972, and served March 14, 1972, finds, that the present and future public convenience and necessity require operation by applicant as a common carrier by motor vehicle, in interstate or foreign commerce, over irregular routes, of iron and steel articles, from the plantsite of CF&I Steel Corp., at Pueblo, Colo., to points in Idaho, Montana, Oregon, and Washington, restricted against the transportation of oilfield commodities as defined in Mercer Extension-Oil Field Commodities, 74 MCC 459 (1946); that applicant is fit, willing, and able properly to perform such service and to conform to the requirements of the Interstate Commerce Act and the Commission's rules and regulations thereunder; that a certificate authorizing such operation should be granted subject to the condition that said findings shall be subject to prior publication in the FEDERAL REGISTER of a notice of the authority actually granted, and conditioned upon the filing by applicant with this Commission, pursuant to section 217 of the Interstate Commerce Act, of appropriate new and revised tariffs in compliance with the requirements established in Restrictions on Service by Motor Common Carriers, 111 MCC 151 (1970), as described above: The report and order further finds that the certificate authorizing the above operations should be conditioned also upon applicant's acceptance of and compliance with the following conditions:

(1) That the authority granted herein shall be limited in point of time to a period expiring 3 years from the date of the certificate; that at the close of each full year for a period of 3 years after the date of the issuance of the certificate herein, applicant shall file with the Commission's Bureau of Economics a "Performance Report" shall, among other things, identify and describe with respect to origin, volume, and destination (a) the truckload, and (b) the less-than-truckload traffic transported by it under the authority granted herein. (2) That within 3 months prior to the expiration of the 3-year term, applicant, if it so desires, shall file with the Commission (with copies to be served upon the protestants in this proceeding), a

petition for permanent extension of the certificate issued herein, accompanied by a brief but detailed summary of the material contained in the two prior "Performance Reports" as well as other matter considered pertinent by applicant with respect to whether the authority granted should at that time be extended permanently. (3) That jurisdiction will be retained in order that the Commission may delete, modify, or impose such further terms, conditions, and limitations as the Commission in the future may find necessary to insure that applicant's operations comport with its obligation to serve the general public within the limits of its facilities, at its published rates, without discrimination. Because it is possible that other parties who have relied upon the notice in the FEDERAL REGISTER of the application as originally published may have an interest in and would be prejudiced by the lack of proper notice of the grant of authority in the findings herein, a notice of the authority actually granted will be published in the FEDERAL REGISTER and issuance of the certificate in the FEDERAL REGISTER and issuance of the certificate in this proceeding will be withheld for a period of 30 days from the date of such publication, during which period any proper party in interest in the proceeding setting forth in detail the precise manner in which it has been prejudiced.

No. MC 125403 (Sub-No. 6) (Republication), filed April 13, 1970, published in the FEDERAL REGISTER, issues of May 14, 1970, and May 28, 1970, and June 25, 1970, and republished this issue. Applicant: S. T. L. TRANSPORT, INC., 1000 Jefferson Road, Post Office Box 9796, Rochester, NY 14623. Applicant's representative: Raymond A. Richards, 23 West Main Street, Webster, NY 14580. A report and order of the Commission, Division 1, decided March 1, 1972, and served March 14, 1972, finds that the present and future public convenience and necessity require operation by applicant as a common carrier by motor vehicle, in interstate or foreign commerce, over irregular routes, of canned foodstuffs from Phelps, Shortsville, and Gorham, N.Y., and the plantsites and storage facilities of Comstock-Greenwood Foods, Inc., a division of Borden, Inc., at Rushville and Waterloo, N.Y., to points in Connecticut, Maine, Massachusetts, New Hampshire, Rhode Island, and Vermont; restricted to the transportation of traffic originating at the named origin points and destined to points in the named destination States; that applicant is fit, willing, and able properly to perform such service and to conform to the requirements of the Interstate Commerce Act and the Commission's rules and regulations thereunder; that a certificate authorizing such operation should be granted subject to the condition below, and subject to the further condition that the certificate shall be limited, in point of time, to a period expiring 3 years from its date of issue. Because it is possible that other persons, who have relied upon the notice of the application as published may

have an interest in and would be prejudiced by the lack of proper notice of the authority described in the findings of this report, a notice of the authority actually granted will be published in the FEDERAL REGISTER and issuance of a certificate in this proceeding will be withheld for a period of 30 days from the date of such publication, during which period any proper party in interest may file a petition to reopen or for other appropriate relief setting forth in detail the precise manner in which it has been so prejudiced.

NOTICE OF FILING OF PETITIONS

No. MC FF-52 (Notice of Filing of Petition for Modification of Permit), filed March 20, 1972. Petitioner: WESTRANSCO FREIGHT COMPANY, a corporation, 501 South Anderson Street, Los Angeles, CA 90033. Petitioner's representative: R. Y. Schureman, 1545 Wilshire Boulevard, Los Angeles, CA 90017. Petitioner holds authority in FF-52, the part here pertinent, to operate, in interstate commerce, as a freight forwarder of commodities generally, " * * * (2) from all points in the United States east of and including Minnesota, Iowa, Missouri, Arkansas, and Louisiana to points in all States west thereof, other than North Dakota and Texas, and to points in Louisiana and Florida, not including, however, any traffic destined to points in the Province of British Columbia and on Vancouver Island, Canada; * * * By the instant petition, petitioner requests the Commission to modify its Sixth Amended Permit and Order so as to delete from numbered (2) of the operating authority set forth therein the following restriction: " * * * (2) * * * not including, however, any traffic destined to points in the Province of British Columbia and on Vancouver Island, Canada; * * * Any interested person desiring to participate may file an original and six copies of his written representations, views or argument in support of or against the petition within 30 days from the date of publication in the FEDERAL REGISTER.

No. MC 4781 (Notice of Filing of Petition for Reopening for Further Hearing), filed February 14, 1972. Petitioner: DON PAFFILE, doing business as, PAFFILE TRUCK LINES, Lewiston, Idaho. Petitioner's representative: Donald P. Paffile, Lewiston, Idaho. Petitioner holds authority in certificate No. MC-117304 (Sub-No. 8) issued July 30, 1963, authorizing, as pertinent, the transportation (A) of machinery, mining equipment, mining supplies, mine ores except coal, and building materials, between points in Montana on and east of a line beginning at Monida Pass, Mont., and extending northerly to the boundary of the United States and Canada, near Babb, Mont., on the one hand, and, on the other, points in Montana, Idaho, Oregon, and Washington, restricted to the transportation of the above-specified commodities where either the origin or destination or both is a mine or mining camp; and (B) of heavy machinery, mining equipment, supplies and mine ores not including coal, between points in Idaho,

Washington, Oregon, and that part of Montana west of a line extending in a northerly direction from Monida Pass, Mont., to the boundary of the United States and Canada near Babb, Mont. Petitioner acquired this authority by purchase from Ernest George Smith in No. MC-FC-65489, by order entered April 30, 1963. The authority included in part (B) above was originally contained in certificate No. MC-4781, issued February 27, 1972, and the authority included in part (A) above was originally contained in certificate No. MC-4781 (Sub-No. 1), issued January 27, 1940. Both certificates were intended to reflect operations performed by the original owner prior to 1935.

Petitioner indicates that while the authority in part (A) is confined to mining supplies, part (B) is not so confined, and that the authority to transport "supplies" in part (B) authorizes the transportation of supplies of a general nature. Petitioner states that the original owner of the certificates indicated that he had been transporting groceries, hardware, and general supplies under part (B), and, upon purchasing such rights, petitioner continued this practice. Petitioner's operations were questioned by the Commission in No. MC-C-4706 and No. MC-C-4706 (Sub-No. 1), and by order served February 25, 1969, in No. MC-C-4706 (Sub-No. 1) Division 1 found that the term "supplies" as contained in part (B) above, is limited by the modifier "mining," and that accordingly petitioner could not transport under its authority anything other than supplies intended to be used in furtherance of a mining endeavor. By this petition, petitioner seeks to reopen the proceeding in No. MC-4781 for an interpretation as to actual meaning of the authority in part (B) above at the time such authority was originally issued. Petitioner contends that its authority should be amended to reflect such operations. Any interested person desiring to participate and to be heard in the matter may file an original and six copies of his written representations, views, or arguments in support of or against the petition, within 30 days of this publication in the FEDERAL REGISTER.

No. MC 30226 (Sub-No. 5 and Sub-No. 8) (Notice of Filing of Petition To Add a Shipper), filed March 23, 1972. Petitioner: HOWELL TRUCKING COMPANY, INC., Jersey City, N.J. Petitioner's representative: Martin Werner, 2 West 45th Street, New York, NY 10036. Petitioner holds Permit MC 30226 Sub 5, issued March 16, 1961, which authorizes the following transportation, over irregular routes: *Frozen foods and foods, other than frozen*, in vehicles equipped with mechanical refrigeration, from New York, N.Y., and Jersey City, N.J., to points in New Jersey, Fairfield County, Conn., and Dutchess, Nassau, Orange, Putnam, Rockland, Suffolk, Ulster, and Westchester Counties, N.Y., with no transportation for compensation on return except as otherwise authorized. Restriction: The service authorized herein is subject to the following conditions: The operations authorized herein are restricted against transporting the above-

specified commodities in bulk, in tank or hopper-type vehicles. The operations authorized herein are limited to a transportation service to be performed, under a continuing contract, or contracts, with the following shippers: The Great Atlantic and Pacific Tea Co., Inc., of New York, N.Y., Gristede Bros., Inc., of New York, N.Y. Petitioner also holds Permit No. MC 30226 (Sub-No. 8) dated June 24, 1966, which authorizes the following transportation, over irregular routes: *Returned shipments of foods*, in vehicles equipped with mechanical refrigeration (except commodities in bulk, in tank and hopper-type vehicles). From points in New Jersey, Fairfield County, Conn., and Dutchess, Nassau, Orange, Putnam, Rockland, Suffolk, Ulster, and Westchester Counties, N.Y., to New York, N.Y., and Jersey City, N.J., with no transportation for compensation on return except as otherwise authorized. Restriction: The operations authorized herein are limited to a transportation service to be performed, under a continuing contract, or contracts, with the following shippers: The Great Atlantic and Pacific Tea Co., Inc., of New York, N.Y., Gristede Bros., Inc., of New York, N.Y. Under said two (2) permits, petitioner is authorized to serve 2 named shippers: The Great Atlantic and Pacific Tea Co., Inc., and Gristede Bros., Inc. By this petition, petitioner seeks to add the name of Anderson Clayton & Co. of Dallas, Tex., as an additional contracting shipper for whom service may be performed under the above number permits. Any interested person desiring to participate may file an original and six copies of his written representations, views or argument in support of or against the petition within 30 days from the date of publication in the FEDERAL REGISTER.

No. MC 38478 (Notice of Filing of Petition To Correct and Clarify Certificate), filed March 6, 1972. Petitioner: FRANK RUMSEY AND BERNARD RUMSEY, a partnership, doing business as RUMSEY TRANSFER COMPANY, Wheatland, Wyo. Petitioner's representative: Robert S. Stauffer, 3539 Boston, Cheyenne, WY 82001. Petitioner holds a certificate in MC 38478 issued to them on May 22, 1961, pursuant to MC-FC 63402, authorizing the transportation of general commodities, with the usual exceptions, among other things, from Denver, Colo., to Chugwater, Wyo., over specified regular routes, serving specified intermediate and off-route points. Petition sets forth that the original certificate issued to their predecessor read: "Between Denver, Colo., and Chugwater, Wyo." By the instant petition, petitioners seek to correct and clarify said certificate. Any interested person desiring to participate may file an original and six copies of his written representations, views, or argument in support or against the petition within 30 days from the date of publication in the FEDERAL REGISTER.

No. MC 85255 (Sub-No. 31), Notice of Filing of Petition for Removal of Plant-site Restriction), filed March 9, 1972. Petitioner: PUGET SOUND TRUCK

INES, INC., Pier 62, Seattle, WA 98101. Petitioner's representative: Clyde H. MacIver (same address as above). Petitioner holds authority in No. MC 85255 (Sub-No. 31) as follows: Irregular routes: *Metal cans, combination metal and fiberboard cans, and can parts*, from the plantsites and storage facilities of the Continental Can Co., Inc., and the American Can Co. at Portland, Oreg., to points in that part of Washington in and west of Okanogan, Chelan, Kittitas, Yakima, and Klickitat Counties, with no transportation for compensation on return except as otherwise authorized. From the plantsites and storage facilities of the Continental Can Co., Inc., and the American Can Co. in that part of Washington in and west of Okanogan, Chelan, Kittitas, Yakima, and Klickitat Counties, to Portland, Oreg., with no transportation for compensation on return except as otherwise authorized. From the plantsites and storage facilities of the Continental Can Co. and the American Can Co. at Seattle, Wash., to Astoria, Oreg., with no transportation for compensation on return except as otherwise authorized. By the instant petition, petitioner requests that the Commission (1) determine that the plantsite restriction imposed is serving no useful purpose and (2) modify the territorial description therein to read as follows: "Between Portland, Oreg., and points in Washington in and west of Okanogan, Chelan, Kittitas, Yakima, and Klickitat Counties; and from Seattle, Wash., to Astoria, Oreg." Any interested person desiring to participate may file an original and six copies of his written representations, views, or argument in support of or against the petition within 30 days from the date of publication in the FEDERAL REGISTER.

No. MC 115846 (Sub-No. 2) (Notice of Filing of Petition To Amend Permit by Adding Two Points), filed February 28, 1972. Petitioner: CRIST TRUCKING, INC., 511 Union Avenue, Mt. Vernon, NY 12550. Petitioner's representatives: Martin Werner and Norman Weiss, 2 West 45th Street, New York, NY 10036. Petitioner holds a permit in No. MC 115846 (Sub-No. 2), authorizing it to perform the following transportation, under contract with Coca Cola Bottling Co., of New York, Inc., of New York, N.Y.: *Carbonated beverages*, in containers, and *empty containers, advertising material, supplies and equipment* used in the manufacture and distribution of carbonated beverages, between New York, Newburgh, Monticello, Poughkeepsie, Westhampton, Jericho, and Tuckahoe, N.Y., Bridgeport and Stamford, Conn., and Jersey City, Trenton, Paterson, Bridgewater Township (Somerset County), Asbury Park, and the sites of the plants of the Coca Cola Bottling Co., of New York, Inc., at Newark, N.J. By the instant petition, petitioner requests the Commission to amend its permit so as to add Elmsford, N.Y., and New Haven, Conn., to the list of points in New York, New Jersey, and Connecticut which petitioner may serve for its one customer. Any interested per-

son desiring to participate may file an original and six copies of his written representations, views, or argument in support of or against the petition within 30 days from the date of publication in the FEDERAL REGISTER.

No. MC 128320 and No. MC 128320 (Sub-No. 4), (Notice of Filing of Petition To Modify Permits by Adding a Contracting Shipper), filed March 13, 1972. Petitioner: ART QUIRING, Coin, Iowa. Petitioner's representative: Charles J. Kimball, 605 South 14th Street, Post Office Box 82028, Lincoln, NE 68501. Petitioner holds authority in MC 128320, to conduct operations as a motor contract carrier, over irregular routes, transporting: Foodstuffs, and exempt agricultural commodities, as defined in section 203(b) (6) of the Interstate Commerce Act, in mixed loads with foodstuffs, from points in Washington, Oregon, California, and Idaho, to points in Iowa, with no transportation for compensation on return except as otherwise authorized. Restriction: The operations authorized herein are limited to a transportation service to be performed, under a continuing contract, or contracts, with Hoxie Institutional Wholesale Co. of Des Moines, Iowa. In MC-129320 (Sub-No. 4), over irregular routes, transporting: Paper tissue, paper napkins, paper towels, wax paper, paper bags, and wrapping paper, from the storage facilities of Crown Zellerbach Paper Co., at or near Portland, Oreg., to points in Iowa, under a continuing contract, or contracts, with Hoxie Institutional Wholesale Co., of Waterloo, Iowa. By the instant petition, petitioner, seeks to add Hawkeye Wholesale Grocery Co., Inc., Iowa City, Iowa, as an additional contract shipper on the two specified permits. Any interested person desiring to participate may file an original and six copies of his written representations, views, or argument in support of or against the petition within 30 days from the date of publication in the FEDERAL REGISTER.

APPLICATIONS UNDER SECTIONS 5 AND 210a (b)

The following applications are governed by the Interstate Commerce Commission's special rules governing notice of filing of applications by motor carriers of property or passengers under sections 5(a) and 210a(b) of the Interstate Commerce Act and certain other proceedings with respect thereto (49 CFR 1.240).

MOTOR CARRIERS OF PROPERTY

No. MC-F-11252. (Correction of amendment) (IML FREIGHT, INC.—PURCHASE (PORTION)—MICHIGAN EXPRESS, INC.), published in the March 15, 1972, issue of the FEDERAL REGISTER on page 5419. By petition filed March 2, 1972, request is made for leave to amend prior application to include additional operating rights to be purchased, (1) between Detroit, and Mount Clemens, Mich., serving all intermediate points, and (2) between Benton Harbor and Detroit, Mich., over Interstate Highway 94 (formerly U.S. Highway 12) serving no intermediate points, serving off-

route points along U.S. Highway 31 from junction Interstate Highway 94 to Michigan Highway 89 over U.S. Highway 31, thence over Michigan Highway 89 to Fennville, Mich., thence in a southerly direction over county roads through Grand Junction, Bangor and Hartford, Mich., to junction Interstate 94; also serving Lansing, Mich., over U.S. Highway 127 from junction Interstate Highway 94; also serving Flint, Mich. over U.S. Highway 23 from junction Interstate Highway 94.

No. MC-F-11498. Authority sought for control and merger by COMMERCIAL CARRIERS, INC., 10701 Middlebelt Road, Romulus, MI 48174, of the operating rights and property of HUGHES TRUCK-A-WAY, INC., 1331 "B" Street, Hayward, CA 94543, and for acquisition by AMERICAN COMMERCIAL LINES, INC., 2919 Allen Parkway, Houston, TX 77019, and in turn by TEXAS GAS TRANSMISSION CORPORATION, 3800 Frederica Street, Owensboro, KY 42301, of control of such rights and property through the transaction. Applicants' attorneys and representatives: Bertram S. Silver, 140 Montgomery Street, San Francisco, CA 94104, Jack C. Goodman, 39 South La Salle Street, Chicago, IL 60603, Craig McAtee, 601 California Street, San Francisco, CA 94108, Charles R. Herrick, 10701 Middlebelt Road, Romulus, MI 48174, Richard C. Young, Post Office Box 1160, Owensboro, KY 42301, and Robert O. Koch, 3800 Frederica Street, Owensboro, KY 42301. Operating rights sought to be controlled and merged: Under a certificate of registration, in Docket No. MC-96780 Sub-1, covering the transportation of commodities, as a common carrier, in interstate commerce, within the State of California. COMMERCIAL CARRIERS, INC., is authorized to operate as a common carrier in all States in the United States (except Alaska and Hawaii). Application has been filed for temporary authority under section 210a(b). NOTE: No. MC-43038 Sub-450, is a matter directly related.

No. MC-F-11499. Authority sought for control and merger by YELLOW FREIGHT SYSTEM, INC., 92d Street, at State Line Road, Kansas City, Mo. 64114, of the operating rights and property of MIDSOUTH TRANSPORTS, INC., 1046 Arkansas, Memphis, TN 38102, and for acquisition by GEORGE E. POWELL, 801 W. 64th Terrace, Kansas City, MO 64113, and GEORGE E. POWELL, JR., 1040 West 57th Street, Kansas City, MO 64113, of control of such rights and property through the transaction. Applicants' attorneys: Carl L. Steiner, 39 South La Salle Street, Chicago, IL 60603, and A. O. Buck, 500 Court Square Building, Nashville, Tenn. 37201. Operating rights sought to be controlled and merged: Under certificates of registration in Dockets Nos. MC-99467 (Sub-No. 1) and MC-99467 (Sub-No. 4), covering the transportation of property and general commodities, as a common carrier, in interstate commerce, within the State of Tennessee. YELLOW FREIGHT SYS-

TEM, INC., is authorized to operate as a common carrier in Illinois, Kansas, Oklahoma, Missouri, Texas, Indiana, Kentucky, Michigan, Ohio, Minnesota, Iowa, Nebraska, Colorado, Tennessee, Georgia, Arizona, California, New Mexico, South Carolina, Wyoming, Utah, Wisconsin, Pennsylvania, Maryland, Virginia, Alabama, New Jersey, Nevada, Louisiana, Delaware, New York, Massachusetts, Connecticut, and the District of Columbia. Application has not been filed for temporary authority under section 210a(b). NOTE: MC-112713 (Sub-No. 141) is a matter directly related.

No. MC-F-11500. Authority sought for merger into NORMAN TRANSPORTATION LINES, INC., 6201 Lee Road, Maple Heights (Cleveland), OH 44137, of the operating rights and property of THE KEYSTONE TRANSPORTATION COMPANY, also of Maple Heights (Cleveland), Ohio 44137, and for acquisition by NORMAN JOSEPH, AMELIA M. MORAN, BEDIE N. JOSEPH, all of 435 Delaware Avenue, Buffalo, NY 14202, and MORTIMER A. SULLIVAN, 530 Walbridge Building, 43 Court Street, Buffalo, NY 14202, of control of such rights and property through the transaction. Applicants' representative: John H. Baker, 435 Delaware Avenue, Buffalo, NY 14202. Operating rights sought to be merged: Such merchandise as is dealt in by wholesale, retail, and chain grocery and food business houses, and, in connection therewith, equipment, materials, and supplies used in the conduct of such business, as a contract carrier over irregular routes, between points and places in a defined area in Pennsylvania and Ohio, between points and places in the above-specified territory, on the one hand, and, on the other, Akron and Cleveland, Ohio, and Pittsburgh, Pa. NORMAN TRANSPORTATION LINES, INC., is authorized to operate as a contract carrier in New York, Ohio, and Pennsylvania. Application has been filed for temporary authority under section 210a(b). NOTE: Pursuant to order dated November 23, 1945 in MC-F-2823 transferee acquired control of transferor.

No. MC-F-11501. Authority sought for purchase by AUBREY FREIGHT LINES, INC., 625 Grove Street, Elizabeth, NJ 07202, of the operating rights of WHITEHALL TRANSPORT, INC., 1200 Main Street, Post Office Box 387, Whitehall, WI 54773, and for acquisition by MURIEL D. MURRAY, 625 Grove Street, Elizabeth, NJ 07202, of control of such rights through the purchase. Applicants' attorney: George A. Olsen, 69 Tonnele Avenue, Jersey City, NJ 07306. Operating rights sought to be transferred: Meat, meat products, and meat byproducts, and etc., as a contract carrier, over irregular routes, from Whitehall and Eau Claire, Wis., and St. Paul and Minneapolis, Minn., to points in Kentucky, Pennsylvania, New York, New Jersey, Virginia, West Virginia, Maryland, Delaware, Connecticut, Rhode Island, Massachusetts, Vermont, New Hampshire, Maine, and the District of Columbia, from Whitehall and Eau Claire, Wis., to points

in Minnesota, with restrictions, from Whitehall and Eau Claire, Wis., to points in Illinois, Indiana, Iowa, Michigan, Nebraska, and Ohio, from Milwaukee, Wis., to points in Maryland, Michigan, New Jersey, Ohio, Pennsylvania, and the District of Columbia, with restriction; groceries and dairy products (except in bulk), from certain specified points in Wisconsin, to points in New York, Ohio, Pennsylvania, Maryland, Delaware, New Jersey, Connecticut, Massachusetts, Vermont, New Hampshire, Rhode Island, Maine, and the District of Columbia; animal feed, whey, and powdered milk and dried milk solids, from ports and storage facilities in New Jersey, New York, N.Y., and Charleston, S.C., to points in Minnesota and Wisconsin, with restrictions. Vendee is authorized to operate as a common carrier in Illinois, Pennsylvania, Maryland, New Jersey, New York, Massachusetts, Connecticut, and the District of Columbia, and as a contract carrier in New York, New Jersey, Connecticut, Pennsylvania, Ohio, Illinois, Michigan, Utah, Wisconsin, Maryland, and the District of Columbia. Application has not been filed for temporary authority under section 210a(b).

No. MC-F-11502. Authority sought for control by HOLMES FREIGHT LINES, INC., 7878 I Street, Omaha, NE 68127, of (1) BYERS TRANSPORTATION COMPANY, INC., and (2) COMMERCIAL FREIGHT LINES, INC., both of 4200 Gardner Avenue, Kansas City, MO 64120, and for acquisition by THOMAS FULKERSON, and K. SUSAN EDMUNDS, both of Omaha, Nebr. 68127, of control of BYERS TRANSPORTATION COMPANY, INC., and COMMERCIAL FREIGHT LINES, INC., through the acquisition by HOLMES FREIGHT LINES, INC. Applicants' attorneys: Donald L. Stern, 530 Univac Building, Omaha, NE 68108, and Richard K. Andrews, 1500 Commerce Bank Building, Kansas City, MO 64108. Operating rights sought to be controlled: (1) General commodities with usual exceptions, as a common carrier over regular routes, between Kansas City, Mo., and St. Joseph, Mo., serving the intermediate and off-route points of Lansing, Leavenworth, and Atchinson, Kans., and points in the Kansas City, Mo.-Kansas City, Kans., commercial zone, as defined by the Commission, between Kansas City, Kans., and East St. Louis, Ill., serving intermediate and off-route points in the St. Louis, Mo.-East St. Louis, Ill., commercial zone, as defined by the Commission, and points in the Kansas City, Mo.-Kansas City, Kans., commercial zone, as defined by the Commission, without restriction and the off-route points of Belleville and Alton, Ill., restricted to truckload lots only, between Kansas City, Mo., and Lake City, Mo., serving intermediate and off-route points within 2 miles of Lake City, between junction U.S. Highway 40 and Missouri Highway 7, and Lake City, Mo., serving intermediate and off-route points within 2 miles of Lake City, between Wentzville, and St. Louis, Mo., serving the intermediate and off-route points of Wendon Springs, Mo., and points within

2 miles of Weldon Springs, between East St. Louis, Ill., and St. Joseph, Mo., between Maryville, Mo., and Omaha, Nebr., serving no intermediate points, between Sheridan and St. Joseph, Mo., serving all intermediate points between Maryville and Sheridan, Mo., including Maryville and serving the off-route points of Conception Junction, Clyde, Conception, Rosendale, and Rea, Mo.;

Lubricating oils, greases, gasoline, naphtha, furniture polish, rubber tires, insecticide liquid, batteries, wax, candies, empty drums, tanks, barrels, and signs, between Quincy, Ill., and Browning, Mo.; used empty containers for fresh meat and packinghouse products, from Booneville, Mo., to Kansas City, Kans.; petroleum products, in containers, soap, cleaning compounds, fresh meat, and packinghouse products, in truckload lots, over irregular routes; from Kansas City, Kans., to points in Missouri; paint, varnish, and painters' supplies, in truckload lots, from Kansas City, Mo., to certain specified points in Kansas; paper and paper articles, in truckload lots, from St. Joseph, Mo., to certain specified points in Kansas; general commodities, with usual exceptions, between points in Clay, Jackson, and Platte Counties, Mo., and Douglas, Johnson, Leavenworth, and Wyandotte Counties, Kans.; between points in that part of Nodaway, Gentry, and Worth Counties, Mo., on and east of U.S. Highway 71 and on west of U.S. Highway 169, on the one hand, and, on the other, Omaha, Nebr., Council Bluffs and Des Moines, Iowa, Kansas City, Kans., Kansas City, Mo., and those points in that part of Iowa on and south of U.S. Highway 34 and on and west of U.S. Highway 169, with restriction;

Meats, meat products, and meat by-products and articles distributed by meat packinghouses, as described in sections A and C of appendix I to the report in Descriptions in Motor Carrier Certificates, 61 M.C.C. 209 and 766 (except hides and commodities, in bulk, in tank vehicles), from the plantsite and storage facilities of Missouri Beef Packers, Inc., at or near Phelps City, Mo., to points in Illinois, Iowa, Kansas, Missouri, and Nebraska, with restriction; and (2) general commodities, with certain specified exceptions, and numerous other specified commodities, as a common carrier, over regular and irregular routes, from, to, and between specified points in the States of Nebraska, Illinois, Missouri, Iowa, Kansas, Oklahoma, Indiana, Colorado, Wisconsin, Arkansas, and Minnesota, with certain restrictions, serving various intermediate and off-route points, as more specifically described in Docket No. MC-84511 and Sub-numbers thereunder. This notice does not purport to be a complete description of all of the operating rights of the carrier involved. The foregoing summary is believed to be sufficient for purposes of public notice regarding the nature and extent of this carrier's operating rights, without stating, in full, the entirety, thereof. HOLMES FREIGHT LINES, INC., is au-

thorized to operate as a common carrier in Iowa, Illinois, and Nebraska. Application has been filed for temporary authority under section 210a(b).

No. MC-F-11503. Authority sought for purchase by OLD COLONY TRANSPORTATION CO., INC., 676 Dartmouth Street, South Dartmouth, MA 02748, of the operating rights and property of CHAPIN MOTOR FREIGHT, INC., West Main Street Road, Malone, N.Y. 12953, and for acquisition by GEORGE VIGANT, also of South Dartmouth, Mass. 02748, of control of such rights and property through the purchase. Applicants' attorneys: Francis E. Barrett, Jr., 10 Industrial Park Road, Hingham, MA 02043, and Cornelius J. Carey, 19 West Main Street, Malone, NY 12953. Operating rights sought to be transferred: Under a certificate of registration, in Docket No. MC-98036 Sub 2, covering the transportation of general commodities, as a common carrier, in interstate commerce, within the State of New York. Vendee is authorized to operate as a common carrier in Massachusetts, Maine, New Hampshire, New York, New Jersey, Connecticut, Rhode Island, and Vermont. Application has been filed for temporary authority under section 210a(b). NOTE: MC-106051 Sub 46, is a matter directly related.

By the Commission.

[SEAL] ROBERT L. OSWALD,
Secretary.

[FR Doc.72-5240 Filed 4-4-72; 8:53 am]

NOTICE OF FILING OF MOTOR CARRIER INTRASTATE APPLICATIONS

MARCH 31, 1972.

The following applications for motor common carrier authority to operate in intrastate commerce seek concurrent motor carrier authorization in interstate or foreign commerce within the limits of the intrastate authority sought, pursuant to section 206(a)(6) of the Interstate Commerce Act, as amended October 15, 1962. These applications are governed by Special Rule 1.245 of the Commission's rules of practice, published in the FEDERAL REGISTER, issue of April 11, 1963, page 3533, which provides, among other things, that protests and requests for information concerning the time and place of State Commission hearings or other proceedings, any subsequent changes therein, any other related matters shall be directed to the State Commission with which the application is filed and shall not be addressed to or filed with the Interstate Commerce Commission.

Tennessee Docket No. MC 2668 (Sub-No. 5), filed March 8, 1972. Applicant: HOHENWALD TRUCK LINES, INC., Columbia Highway, Hohenwald, Tenn. Applicant's representative: A. O. Buck, 500 Court Square Building, Nashville, Tenn. 37201. Certificate of public convenience and necessity sought to operate a freight service as follows: Transportation of general commodities, except household goods, Classes A and B ex-

plosives, commodities in bulk, commodities requiring special equipment, and those injurious or contaminating to other lading. Route 1: Between Linden, Tenn., and Memphis, Tenn., serving no intermediate points: From Linden over Tennessee Highway 20 to its junction with Law Road; thence over Law Road to its junction with Interstate Highway 40; thence over Interstate Highway 40 to Memphis and return over the same route. Route 2: Between Buffalo, Tenn., and Memphis, Tenn., serving no intermediate points: From Buffalo over Interstate Highway 40 to Memphis, and return over the same route. Applicant proposes to utilize the above sought authority in conjunction with all of its present authority and seeks corresponding interstate authority. Restriction: Restricted against the handling of any traffic moving between any point in Davidson County, Tenn., and Memphis, Tenn. Both intrastate and interstate authority sought.

HEARING: April 20, 1972 at 9:30 a.m., at the Commission's Court Room, C-1-110 Cordell Hull Building, Nashville, Tenn. Requests for procedural information including the time for filing protests concerning this application should be addressed to the Tennessee Public Service Commission, Cordell Hull Building, Nashville, Tenn. 37219 and should not be directed to the Interstate Commerce Commission.

California Docket No. 53212, filed March 17, 1972. Applicant: ALCO TRANSPORTATION CO., 1603 Chapin Road, Montebello, CA 90640. Applicant's representative: Donald Murchison, 9454 Wilshire Boulevard, Suite 400, Beverly Hills, CA 90212. Certificate of public convenience and necessity sought to operate a freight service as follows: Transportation of (A) *general commodities*, except: (1) Used household goods and personal effects not packed in accordance with the crated property requirements set forth in paragraph (d) of Item No. 10-C of Minimum Rate Tariff No. 4-A. (2) Automobiles, trucks and buses, viz: new and used finished or unfinished passenger automobiles (including jeeps), ambulances, hearses, and taxis; freight automobiles, automobile chassis, trucks, truck chassis, truck trailers, trucks, and trailers combined, buses and bus chassis. (3) Livestock, viz: bucks, bulls, calves, cattle, cows, dairy cattle, ewes, goats, hogs, horses, kids, lambs, oxen, pigs, sheep, sheep camp outfits, sows, steers, stags, or swine. (4) Commodities requiring the use of special refrigeration or temperature control in specially designed and constructed refrigerated equipment. (5) Liquids, compressed gases, commodities in semi-plastic form and commodities in suspension in liquids in bulk, in tank trucks, tank trailers, tank semitrailers, or a combination of such highway vehicles. (6) Commodities when transported in bulk in dump trucks or in hopper-type trucks. (7) Commodities when transported in motor vehicles equipped for mechanical mixing in transit. (8) Logs.

(B) Between: (1) All points and places in the Los Angeles Basin territory as described in Exhibit "A" hereto attached. (2) All points and places in the Los Angeles Basin territory, on the one hand, and, on the other hand, San Diego territory, as described in Exhibit "A", via Interstate 5, with service to all intermediate points and all points on and within 10 miles laterally of said highways between the Los Angeles Basin territory and the San Diego territory, inclusive. (3) All points and places in the Los Angeles Basin territory, on the one hand, and, on the other hand, the San Diego Territory via Interstate 15, with service to all intermediate points and all points on and within 10 miles laterally of said highway between Los Angeles Basin territory and the San Diego territory, inclusive. (4) All points and places in San Diego territory. (5) All points and places as set forth in subparagraph 3 above, on the one hand, and, on the other hand, points and places in the San Francisco territory, as described in Exhibit "B" hereto attached, via U.S. Highways 101, Interstate 5, 15, and 580, U.S. Highway 50, State Highways 1, 99, 120, and 280, with service to all intermediate points south of San Luis Obispo and Bakersfield, inclusive, and all points on and within 10 miles laterally of said highways south of San Luis Obispo and Bakersfield, inclusive. (6) All points and places in the Los Angeles Basin territory, on the one hand, and, on the other hand, Mojave, via Interstate 5 and State Highway 14, serving all intermediate points on and within 10 miles laterally of said highways between Mojave and said Los Angeles Basin territory, inclusive, and (7) all points and places in the Los Angeles Basin territory on the one hand, and, on the other hand, Barstow, via Interstate 15, serving all intermediate points on and within 10 miles laterally of said highways between Barstow and said Los Angeles Basin territory, inclusive.

Applicant proposes to establish through routes and joint rates between any and all points described in subparagraphs 2, 3, 5, 6, and 7, inclusive and between any and all points presently authorized to be served. Exhibit "A" *Description—Los Angeles Basin territory.* Los Angeles Basin territory includes that area embraced by the following boundary: Beginning at the point the Ventura County-Los Angeles County boundary line intersects the Pacific Ocean; thence northeasterly along said county line to the point it intersects State Highway No. 118, approximately 2 miles west of Chatsworth; easterly along State Highway No. 118 to Sepulveda Boulevard; northerly along Sepulveda Boulevard to Chatsworth Drive to the corporate boundary of the city of San Fernando; westerly and northerly along said corporate boundary to McClay Avenue; northeasterly along McClay Avenue and its prolongation to the Angeles National Forest boundary; southeasterly and easterly along the Angeles National Forest and San Bernardino National Forest boundary to the county road known as Mill Creek Road;

westerly along Mill Creek Road to the county road 3.8 miles north of Yucaipa; southerly along said county road to and including the unincorporated community of Yucaipa; westerly along Redlands Boulevard to U.S. Highway No. 99; northwesterly along U.S. Highway No. 99 to the corporate boundary of the city of Redlands; westerly and northerly along said corporate boundary to Brookside Avenue; westerly along Brookside Avenue to Barton Avenue; westerly along Barton Avenue and its prolongation to Palm Avenue; westerly along Palm Avenue to La Cadena Drive; southwestly along La Cadena Drive to Iowa Avenue; southerly along Iowa Avenue to U.S. Highway No. 60;

Southwesterly along U.S. Highways Nos. 60 and 395 to the county road approximately 1 mile north of Perris; easterly along said county road via Nuevo and Lakeview to the corporate boundary of the city of San Jacinto; easterly, southerly and westerly along said corporate boundary to San Jacinto Avenue; southerly along San Jacinto Avenue to State Highway No. 74; westerly along State Highway No. 74 to the corporate boundary of the city of Hemet; southerly, westerly, and northerly along said corporate boundary to the right of way of The Atchison, Topeka & Santa Fe Railway Co.; southwestly along said right of way to Washington Avenue; southerly along Washington Avenue, through and including the unincorporated community of Winchester to Benton Road; westerly along Benton Road to the county road intersecting U.S. Highway No. 395, 2.1 miles north of the unincorporated community of Temecula; southerly along said county road to U.S. Highway No. 395; southeasterly along U.S. Highway No. 395 to the Riverside County-San Diego County boundary line; westerly along said boundary line to the Orange County-San Diego County boundary line; southerly along said boundary line to the Pacific Ocean; northwesterly along the shoreline of the Pacific Ocean to point of beginning. San Diego territory includes that area embraced by the following imaginary line starting at the northerly junction of U.S. Highways 101-E and 101-W (4 miles north of La Jolla); thence easterly to Miramar on State Highway No. 395; thence southeasterly to Lakeside on the El Cajon-Ramona Highway; thence southerly to Bostonia on U.S. Highway No. 80;

Thence southeasterly to Jamul on State Highway No. 94; thence due south to the international boundary line, west to the Pacific Ocean and north along the coast to point of beginning. Exhibit "B" San Francisco territory includes all the city of San Jose and that area embraced by the following boundary. Beginning at the point of San Francisco-San Mateo boundary line meets the Pacific Ocean; thence easterly along said boundary line to a point 1 mile west of U.S. Highway 101; southerly along an imaginary line 1 mile west of and paralleling U.S. Highway 101 to its intersection with Southern Pacific Co. right-of-way at Arastradero

Road; southeasterly along the Southern Pacific Co. right-of-way to Pollard Road, including industries served by the Southern Pacific Co. spur line extending approximately 2 miles southwest from Simla to Permanente; easterly along Pollard Road to West Parr Avenue; easterly along West Parr Avenue to Capri Drive; southerly along Capri Drive to East Parr Avenue; easterly along East Parr Avenue to the Southern Pacific Co. right-of-way; southerly along the Southern Pacific Co. right-of-way to the Campbell-Los Gatos city limits; easterly along said limits and the prolongation thereof to the San Jose-Los Gatos Road; northeasterly along San Jose-Los Gatos Road to Foxworthy Avenue; easterly along Foxworthy Avenue to Almaden Road; southerly along Almaden Road to Hillsdale Avenue; easterly along Hillsdale Avenue to U.S. Highway 101; northwesterly along U.S. Highway 101; to Tully Road; northeasterly along Tully Road to White Road; northwesterly along White Road to McKee Road; southwesterly along McKee Road to Capitol Avenue;

Northwesterly along Capitol Avenue to State Highway 17 (Oakland Road); northerly along State Highway 17 to Warm Springs; northerly along the unnumbered highway via Mission San Jose and Niles to Hayward; northerly along Foothill Boulevard to Seminary Avenue; easterly along Seminary Avenue to Mountain Boulevard; northerly along Mountain Boulevard and Moraga Avenue to Estates Drive; westerly along Estates Drive, Harbord Drive and Broadway Terrace to College Avenue; northerly along College Avenue to Dwight Way; easterly along Dwight Way to the Berkeley-Oakland boundary line; northerly along said boundary line to the campus boundary of the University of California; northerly and westerly along the campus boundary of the University of California to Euclid Avenue; northerly along Euclid Avenue to Marin Avenue; westerly along Marin Avenue to Arlington Avenue; northerly along Arlington Avenue to U.S. Highway 40 (San Pablo Avenue); northerly along U.S. Highway 40 to and including the city of Richmond; southwesterly along the highway extending from the city of Richmond to Point Richmond; southerly along an imaginary line from Point Richmond to the San Francisco waterfront at the foot of Market Street; westerly along said waterfront and shore line to the Pacific Ocean; southerly along the shoreline of the Pacific Ocean to point of beginning. Both intrastate and interstate authority sought.

HEARING: Date, time, and place not shown. Requests for procedural information including the time for filing protests concerning this application should be addressed to the Public Utilities Commission, State of California, State Building, Civic Center, 455 Golden Gate Avenue, San Francisco, CA 94102, and should not be directed to the Interstate Commerce Commission.

Tennessee Docket No. MC 5441 (Sub-No. 1) (Correction) filed February 22, 1972, published in the FEDERAL REGISTER issue of March 8, 1972, and republished

in part as corrected this issue. Applicant: NASHVILLE-CLARKSVILLE EXPRESS, INC., Post Office Box 986, Clarksville, Tenn. 37040. Applicant's representative: Clarence Evans, 18th Floor, Third National Bank Building, Nashville, TN 37219. Note: The sole purpose of this partial republication is to add "all of the foregoing routes to be tacked with applicant's existing authority," which was erroneously omitted in the previous publication. The rest of the application remains as previously published.

Florida Docket No. 72138-CCT filed March 16, 1972. Applicant: GATOR FREIGHTWAYS, INC., 2175 Commonwealth Avenue, Jacksonville, FL 32209. Applicant's representative: J. E. Allen, Post Office Box 1086, Jacksonville, FL 32201. Certificate of public convenience and necessity sought to operate a freight service as follows: Transportation of *general commodities*, between Jacksonville, Fla., over U.S. Highway 90 to Pensacola, serving as a motor common carrier the intermediate points of Madison and points within 10 miles thereof; Tallahassee and points within 25 miles thereof; Marianna and points within 10 miles thereof; and points within 25 miles of Pensacola. All points so described being limited to service wholly within the State of Florida. In addition to the authority above described, applicant seeks authority between Tallahassee and Pensacola, from Tallahassee over Florida State Highway 20 to the junction of Florida Highway 20 and U.S. Highway 231; thence over U.S. Highway 231 to Panama City; thence over U.S. Highway 98 to Pensacola, serving the intermediate points of Panama City and 25 miles thereof and Fort Walton Beach and 10 miles thereof. All points so designated being restricted to points within the State of Florida and authority is sought for the territory herein described for intrastate and interstate commerce.

HEARING: 9:30 a.m., Monday, May 1, 1972, at Florida Public Service Commission District Office, room 100, 2255 Phyllis Street, Jacksonville, FL. Requests for procedural information including the time for filing protests concerning this application should be addressed to the Florida Public Service Commission, 700 South Adams Street, Tallahassee, FL 32304 and should not be directed to the Interstate Commerce Commission.

By the Commission.

[SEAL] ROBERT L. OSWALD,
Secretary.

[FR Doc.72-5238 Filed 4-4-72; 8:52 am]

[Notice 39]

MOTOR CARRIER TRANSFER PROCEEDINGS

Synopses of orders entered pursuant to section 212(b) of the Interstate Commerce Act, and rules and regulations prescribed thereunder (49 CFR Part 1132), appear below:

As provided in the Commission's special rules of practice any interested person may file a petition seeking recon-

sideration of the following numbered proceedings within 20 days from the date of publication of this notice. Pursuant to section 17(8) of the Interstate Commerce Act, the filing of such a petition will postpone the effective date of the order in that proceeding pending its disposition. The matters relied upon by petitioners must be specified in their petitions with particularity.

No. MC-FC-73502. By order of March 24, 1972, the Motor Carrier Board approved the transfer to The Portsmouth Trucking Co., a corporation, Youngstown, Ohio 44501, of the operating rights in permit No. MC-124847, issued June 12, 1968, to William T. Kiser, Olive Hill, Ky. 41164, authorizing the transportation of limestone, from Olive Hill, and Carter City, Ky., and points within 10 miles of each, to points in specified counties in both Ohio and Kentucky; slag, from Ashland, Ky., to specified counties in Ohio and West Virginia; and sand and gravel, from Haverhill, Ohio, and points within 2 miles thereof, to points in Carter, Boyd, and Greenup Counties, Ky., Paul F. Beery and Boyd B. Ferris, 88 East Broad Street, Columbus, OH 43215, attorneys for applicants.

No. MC-FC-73538. By order of March 23, 1972, the Motor Carrier Board approved the transfer to Warren Transportation Co., a corporation, Hayward, Calif. 94543, of certificate of registration No. MC-121472 (Sub-No. 1) issued June 3, 1965, to E. Guy Warren, doing business as Warren Transportation Co., Hayward, Calif. 94543, evidencing a right to engage in the transportation in interstate commerce corresponding in scope to certificate of public convenience and necessity granted in Decisions Nos. 45417, 45792, 50499, 53170, and 57964, dated March 6, and June 5, 1971, August 31, 1954, May 28, 1956, and February 3, 1959, respectively, issued by the Public Utilities Commission of California. Marvin Handler, Handler, Baker & Greene, attorney for applicants, 405 Montgomery Street, San Francisco, CA 94104.

No. MC-FC-73552. By order of March 27, 1972, the Motor Carrier Board approved the transfer to Henry's Transportation, Inc., 30 Village Street, Millis, MA 02054 of Certificate of Registration No. MC-58428 (Sub-No. 1) issued October 30, 1963, to Henry J. Lewandowski, doing business as Henry's Transportation, Millis, Mass. 02054, evidencing a right to engage in transportation in intrastate commerce as described in State Certificate No. 6162 issued July 6, 1944, by the Public Utilities Commission of Massachusetts.

No. MC-FC-73575. By order of March 27, 1972, the Motor Carrier Board approved the transfer to Trans Eastern Vans, Inc., Brooklyn, N.Y., of the operating rights set forth in certificate No. MC-113021, issued November 25, 1960, to Nick's Moving & Storage Co., Inc., Brooklyn, N.Y., authorizing the transportation of: Household goods as defined by the Commission, between New York, N.Y., and points in Nassau and Suffolk

Counties, N.Y., on the one hand, and, on the other, points in New York, New Jersey, Pennsylvania, Connecticut, and Massachusetts. Morris Honig, 150 Broadway, New York, NY 10038, attorney for applicants.

[SEAL] ROBERT L. OSWALD,
Secretary.

[FR Doc.72-5241 Filed 4-4-72;8:53 am]

[Rev. S.O. 994; ICC Order 57, Amdt. 7]

**PENN CENTRAL TRANSPORTATION
CO.**

Rerouting or Diversion of Traffic

Upon further consideration of ICC Order No. 57 (Penn Central Transportation Co., George P. Baker, Richard C. Bond, Jervis Langdon, Jr., and Willard Wirtz, trustees), and good cause appearing therefor:

It is ordered, That:

ICC Order No. 57 be, and it is hereby, amended by substituting the following paragraph (g) for paragraph (g) thereof:

(g) *Expiration date.* This order shall expire at 11:59 p.m., June 30, 1972, unless otherwise modified, changed, or suspended.

It is further ordered, That this amend-

ment shall become effective at 11:59 p.m., March 31, 1972, and that this order shall be served upon the Association of American Railroads, Car Service Division, as agent of all railroads subscribing to the car service and car hire agreement under the terms of that agreement, and upon the American Short Line Railroad Association; and that it be filed with the Director, Office of the Federal Register.

Issued at Washington, D.C., March 29, 1972.

[SEAL] INTERSTATE COMMERCE
COMMISSION,
R. D. PFAHLER,
Agent.

[FR Doc.72-5245 Filed 4-4-72;8:53 am]

POOLE TRUCK LINE, INC.

**Notice of Petition for Declaratory
Order**

MARCH 31, 1972.

No. MC-C-7739 (Notice of Filing of Petition for Issuance of a Declaratory Order), filed March 13, 1972. Petitioner: POOLE TRUCK LINE, INC., Evergreen, Ala. Petitioner's representative: Robert E. Tate, Post Office Drawer 500, Evergreen, AL 36401. Petitioner requests issuance of a declaratory order as to

whether laminated wood flooring may be transported under certificates of public convenience and necessity authorizing the transportation of lumber. Petitioner submits that the question arises because of differences of opinion on the part of various motor carriers and certain personnel of the Interstate Commerce Commission concerning the scope of the commodity description "lumber." Petitioner has been transporting laminated flooring under its "lumber" authority from and to various points, and claims to have knowledge that its competitors have also been transporting laminated flooring under "lumber" authority either in competition with petitioner or from origins petitioner does not serve. Petitioner contends that laminated wood flooring, like plywood and residential flooring should be considered to be "lumber."

Any interested person desiring to participate and to be heard in this matter may file an original and six copies of his written representations, views, or arguments, in support of or against the petition, within 30 days of this publication in the FEDERAL REGISTER.

By the Commission.

[SEAL] ROBERT L. OSWALD,
Secretary.

[FR Doc.72-5244 Filed 4-4-72;8:53 am]

CUMULATIVE LIST OF PARTS AFFECTED—APRIL

The following numerical guide is a list of parts of each title of the Code of Federal Regulations affected by documents published to date during April.

1 CFR	Page	16 CFR	Page	33 CFR	Page
PROPOSED RULES:		13..... 6662-6664, 6731-6733, 6833,	6834	117.....	6846, 6847
Ch. I.....	6804	423.....	6835	PROPOSED RULES:	
Ch. II.....	6817	17 CFR		171.....	6869
3 CFR		211.....	6850	36 CFR	
PROCLAMATION:		231.....	6850	2.....	6735
4120.....	6825	240.....	6850	38 CFR	
EXECUTIVE ORDERS:		241.....	6850	3.....	6676
11663.....	6647	251.....	6850	17.....	6847
11664.....	6651	271.....	6850	21.....	6679
5 CFR		PROPOSED RULES:		40 CFR	
213.....	6851, 6852	270.....	6758	180.....	6847-6849
6 CFR		18 CFR		PROPOSED RULES:	
101.....	6827	35.....	6852	180.....	6872
300.....	6827	154.....	6852	41 CFR	
301.....	6653	PROPOSED RULES:		4-4.....	6735
401.....	6653	141.....	6872	4-12.....	6736
7 CFR		260.....	6872	4-16.....	6737
51.....	6828	19 CFR		9-7.....	6680
59.....	6656	153.....	6665	9-16.....	6680
905.....	6729	21 CFR		45 CFR	
908.....	6660	53.....	6733	177.....	6849
910.....	6660	121.....	6734	46 CFR	
914.....	6661	135c.....	6734	310.....	6661
987.....	6729	165.....	6734	PROPOSED RULES:	
1421.....	6730	PROPOSED RULES:		146.....	6694
1434.....	6830	191.....	6868	251.....	6759
PROPOSED RULES:		22 CFR		47 CFR	
47.....	6854	602.....	6665	0.....	6737
51.....	6854	603.....	6665	73.....	6738
911.....	6855	24 CFR		74.....	6738
966.....	6857	600.....	6667	79.....	6685
987.....	6693	1710.....	6674	89.....	6687
1046.....	6693	25 CFR		91.....	6687
1201.....	6745	221.....	6835	93.....	6687
1488.....	6745	PROPOSED RULES:		PROPOSED RULES:	
1701.....	6867, 6868	161.....	6692	1.....	6752
9 CFR		26 CFR		73.....	6753, 6754
PROPOSED RULES:		PROPOSED RULES:		81.....	6752
322.....	6694	1.....	6688	87.....	6752
12 CFR		301.....	6689	89.....	6752
220.....	6831	29 CFR		91.....	6752, 6757
PROPOSED RULES:		1604.....	6835	93.....	6752
204.....	6694	1926.....	6837	49 CFR	
210.....	6695	31 CFR		PROPOSED RULES:	
741.....	6873	102.....	6912	171.....	6747
14 CFR		103.....	6912	173.....	6747, 6871
39.....	6731, 6831, 6832	32 CFR		178.....	6747
71.....	6731	PROPOSED RULES:		179.....	6871
73.....	6832	1606.....	6696	50 CFR	
97.....	6833	1608.....	6696	33.....	6687
385.....	6661	1670.....	6696		
PROPOSED RULES:					
71.....	6746, 6747				

LIST OF FEDERAL REGISTER PAGES AND DATES—APRIL

Pages	Date
6641-6722.....	Apr. 1
6723-6818.....	4
6819-6915.....	5

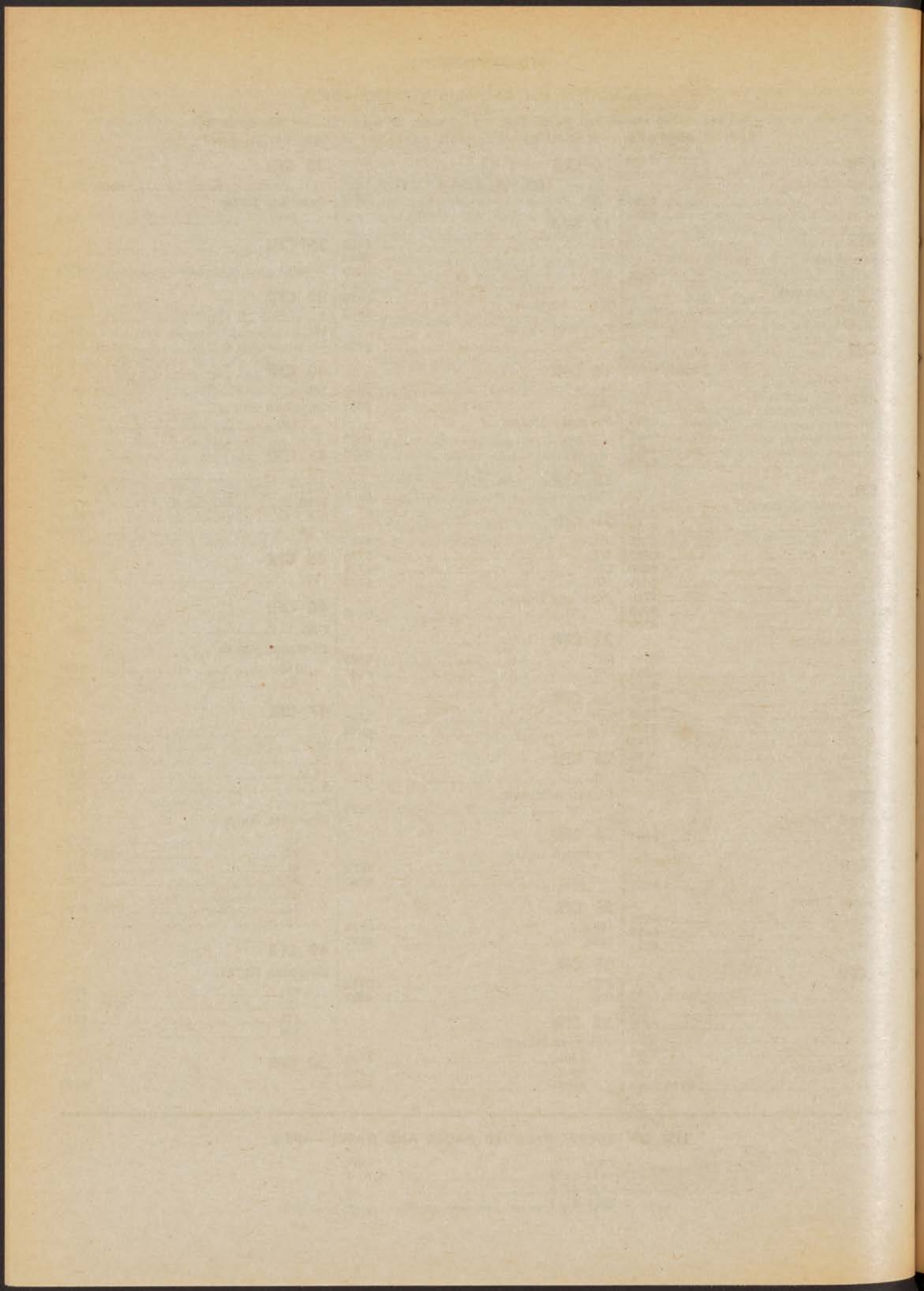

federal register

WEDNESDAY, APRIL 5, 1972

WASHINGTON, D.C.

Volume 37 ■ Number 66

PART II



DEPARTMENT OF THE TREASURY

Monetary Offices



Financial Recordkeeping and Reporting
of Currency and Foreign Transactions

Title 31—MONEY AND FINANCE: TREASURY

Chapter I—Monetary Offices, Department of the Treasury

PART 102—INSTRUCTIONS RELATING TO REPORTS OF CURRENCY TRANSACTIONS

PART 103—FINANCIAL RECORDKEEPING AND REPORTING OF CURRENCY AND FOREIGN TRANSACTIONS

On June 10, 1971, a notice of proposed rule making to implement the provisions of titles I and II of Public Law 91-508 (84 Stat. 1114 et seq.), was published in the FEDERAL REGISTER (36 F.R. 11208 (1971)). In accordance with the notice, interested parties were afforded an opportunity to submit written comments.

After consideration of all such relevant matters as were presented by interested parties regarding the rules proposed, the regulations set forth below have been adopted.

[SEAL] SAMUEL R. PIERCE, JR.,
General Counsel.
EUGENE T. ROSSIDES,
Assistant Secretary.

Part 102 is repealed effective July 1, 1972.

Part 103 is added to Title 31 CFR as follows:

- Sec. Subpart A—Definitions
- 103.11 Meaning of terms.
- Subpart B—Reports Required To Be Made
- 103.21 Determination by the Secretary.
- 103.22 Reports of currency transactions.
- 103.23 Reports of transportation of currency or monetary instruments.
- 103.24 Reports of foreign financial accounts.
- 103.25 Filing of reports.
- 103.26 Identification required.
- Subpart C—Records Required To Be Maintained
- 103.31 Determination by the Secretary.
- 103.32 Records to be made and retained by persons having financial interests in foreign financial accounts.
- 103.33 Records to be made and retained by financial institutions.
- 103.34 Additional records to be made and retained by banks.
- 103.35 Additional records to be made and retained by brokers and dealers in securities.
- 103.36 Nature of records and retention period.
- 103.37 Person outside the United States.
- Subpart D—General Provisions
- 103.41 Dollars as including foreign currency.
- 103.42 Photographic or other reproductions of Government obligations.
- 103.43 Availability of information.
- 103.44 Disclosure.
- 103.45 Exceptions, exemptions, modifications, and reports.
- 103.46 Enforcement.
- 103.47 Civil penalty.
- 103.48 Forfeiture of currency or monetary instruments.

- Sec. 103.49 Criminal penalty.
- 103.50 Enforcement authority with respect to transportation of currency or monetary instruments.

AUTHORITY: The provisions of this Part 103 issued under sec. 21 of the Federal Deposit Insurance Act, 84 Stat. 1114, 12 U.S.C. 1829b; 84 Stat. 1116, 12 U.S.C. 1951-1959; and the Currency and Foreign Transactions Reporting Act, 84 Stat. 1118, 31 U.S.C. 1051-1122.

Subpart A—Definitions

§ 103.11 Meaning of terms.

When used in this part and in forms prescribed under this part, where not otherwise distinctly expressed or manifestly incompatible with the intent thereof, terms shall have the meanings ascribed in this section.

Bank. (a) Each agency, branch or office within the United States of any person doing business in one or more of the capacities listed below:

- (1) A commercial bank or trust company organized under the laws of any State or of the United States;
- (2) A private bank;
- (3) A savings and loan association or a building and loan association organized under the laws of any State or of the United States;
- (4) An insured institution as defined in section 401 of the National Housing Act;
- (5) A savings bank, industrial bank or other thrift institution;
- (6) A credit union organized under the laws of any State or of the United States; and

(7) Any other organization chartered under the banking laws of any State and subject to the supervision of the bank supervisory authorities of a State.

(b) Each agent, agency, branch or office within the United States of a foreign bank.

Broker or dealer in securities. A broker or dealer in securities, registered or required to be registered with the Securities and Exchange Commission under the Securities Exchange Act of 1934.

Currency. The coin and currency of the United States or of any other country, which circulate in and are customarily used and accepted as money in the country in which issued. It includes U.S. silver certificates, U.S. notes and Federal Reserve notes, but does not include bank checks or other negotiable instruments not customarily accepted as money.

Domestic. When used herein, refers to the doing of business within the United States, and limits the applicability of the provision where it appears to the performance by such institutions or agencies of functions within the United States.

Financial institution. Each agency, branch or office within the United States of any person doing business in one or more of the capacities listed below:

- (1) A bank;
- (2) A broker or dealer in securities;
- (3) A person who engages as a business in dealing in or exchanging currency as, for example, a dealer in foreign ex-

change or a person engaged primarily in the cashing of checks;

(4) A person who engages as a business in the issuing, selling or redeeming of travelers' checks, money orders, or similar instruments, except one who does so as a selling agent exclusively or as an incidental part of another business;

(5) An operator of a credit card system which issues, or authorizes the issuance of, credit cards that may be used for the acquisition of monetary instruments, goods, or services outside the United States.

(6) A licensed transmitter of funds, or other person engaged in the business of transmitting funds abroad for others.

Foreign bank. A bank organized under foreign law, or an agency, branch or office located outside the United States of a bank. The term does not include an agent, agency, branch or office within the United States of a bank organized under foreign law.

Investment security. An instrument which:

- (1) Is issued in bearer or registered form;
- (2) Is of a type commonly dealt in upon securities exchanges or markets or commonly recognized in any area in which it is issued or dealt in as a medium for investment;
- (3) Is either one of a class or series or by its terms is divisible into a class or series of instruments; and
- (4) Evidences a share, participation or other interest in property or in an enterprise or evidences an obligation of the issuer.

Monetary instruments. Coin or currency of the United States or of any other country, travelers' checks, money orders, investment securities in bearer form or otherwise in such form that title thereto passes upon delivery, and negotiable instruments (except warehouse receipts or bills of lading) in bearer form or otherwise in such form that title thereto passes upon delivery. The term does not include bank checks made payable to the order of a named person which have not been endorsed or which bear restrictive endorsements.

Person. An individual, a corporation, a partnership, a trust or estate, a joint stock company, an association, a syndicate, joint venture, or other unincorporated organization or group, and all entities cognizable as legal personalities.

Secretary. The Secretary of the Treasury or any person duly authorized by the Secretary to perform the function mentioned.

Transaction in currency. A transaction involving the physical transfer of currency from one person to another. A transaction which is a transfer of funds by means of bank check, bank draft, wire transfer, or other written order, and which does not include the physical transfer of currency is not a transaction in currency within the meaning of this part.

United States. The various States, the District of Columbia, the Commonwealth

of Puerto Rico, and the territories and possessions of the United States.

Subpart B—Reports Required To Be Made

§ 103.21 Determination by the Secretary.

The Secretary hereby determines that the reports required by this subpart have a high degree of usefulness in criminal, tax, or regulatory investigations or proceedings.

§ 103.22 Reports of currency transactions.

(a) Each financial institution shall file a report of each deposit, withdrawal, exchange of currency or other payment or transfer, by, through, or to such financial institution, which involves a transaction in currency of more than \$10,000.¹

(b) Except as otherwise directed in writing by the Secretary, this section shall not (1) require reports of transactions with Federal Reserve Banks or Federal Home Loan Banks; (2) require reports of transactions solely with, or originated by, financial institutions or foreign banks; or (3) require a bank to report transactions with an established customer maintaining a deposit relationship with the bank, in amounts which the bank may reasonably conclude do not exceed amounts commensurate with the customary conduct of the business, industry or profession of the customer concerned. A report listing such customers who engage in transactions which are not reported because of the exemption contained in this paragraph shall be made to the Secretary upon demand therefor made by him.

§ 103.23 Reports of transportation of currency or monetary instruments.

(a) Each person who physically transports, mails, or ships, or causes to be physically transported, mailed or shipped, currency or other monetary instruments in an aggregate amount exceeding \$5,000 on any one occasion from the United States to any place outside the United States, or into the United States from any place outside the United States, shall make a report thereof.² A person is deemed to have caused such transportation, mailing or shipping when he aids, abets, counsels, commands, procures or requests it to be done by a financial institution or any other person. A transfer of funds through normal banking procedures which does not involve the physical transportation of currency or monetary instruments is not required to be reported by this section.

(b) Each person who receives in the United States currency or other monetary instruments in an aggregate amount exceeding \$5,000 on any one occasion which have been transported, mailed, or shipped to such person from any place outside the United States with respect to

which a report has not been filed under paragraph (a) of this section, whether or not required to be filed thereunder, shall make a report thereof, stating the amount, the date of receipt, the form of monetary instruments, and the person from whom received.

(c) This section shall not require reports by (1) a Federal Reserve bank, (2) a bank, a foreign bank, or a broker or dealer in securities, in respect to currency or other monetary instruments mailed or shipped through the postal service or by common carrier, (3) a person who is not a citizen or resident of the United States in respect to currency or other monetary instruments mailed or shipped from abroad to a bank or broker or dealer in securities through the postal service or by common carrier, (4) a common carrier of passengers in respect to currency or other monetary instruments in the possession of its passengers, (5) a common carrier of goods in respect to shipments of currency or monetary instruments not declared to be such by the shipper, (6) a travelers' check issuer or its agent in respect to the transportation of travelers' checks prior to their delivery to selling agents for eventual sale to the public, nor by (7) a person engaged as a business in the transportation of currency, monetary instruments and other commercial papers with respect to the transportation of currency or other monetary instruments overland between established offices of banks or brokers or dealers in securities and foreign banks.

(d) This section does not require that more than one report be filed covering a particular transportation, mailing or shipping of currency or other monetary instruments with respect to which a complete and truthful report has been filed by a person. However, no person required by paragraph (a) or (b) of this section to file a report shall be excused from liability for failure to do so if, in fact, a complete and truthful report has not been filed.

§ 103.24 Reports of foreign financial accounts.

Each person subject to the jurisdiction of the United States (except a foreign subsidiary of a U.S. person) having a financial interest in, or signature or other authority over, a bank, securities or other financial account in a foreign country shall report such relationship as required on his Federal income tax return for each year in which such relationship exists, and shall provide such information concerning each such account as shall be specified in a special tax form to be filed by such persons.

§ 103.25 Filing of reports.

(a) Reports required to be filed by the first paragraph of § 103.22 shall be filed on or before the 45th day following that on which the reported transactions occur. They shall be filed with the Commissioner of Internal Revenue on forms to be prescribed by him, with the approval of the Secretary. All information called for in such forms shall be furnished.

(b) Reports required to be filed by § 103.23(a) shall be filed at the time of entry into the United States or at the time of departure, mailing or shipping from the United States, unless otherwise directed or permitted by the Commissioner of Customs. They shall be filed with the Customs officer in charge at any Customs port of entry or departure, or as otherwise permitted or directed by the Commissioner of Customs. If the currency or other monetary instruments with respect to which a report is required do not accompany a person entering or departing from the United States, such reports may be filed by mail on or before the date of entry, departure, mailing or shipping, with the Commissioner of Customs, Attention: Currency Transportation Reports, Washington, D.C. 20226. They shall be on forms to be prescribed by the Secretary and all information called for in such forms shall be furnished.

(c) Reports required to be filed by § 103.23(b) shall be filed with the Commissioner of Customs within 30 days after receipt of the currency or other monetary instruments. They may be filed with the Customs officer in charge at any port of entry or departure, or by mail addressed to the Commissioner of Customs, Attention: Currency Transportation Reports, Washington, D.C. 20226. They shall be on forms to be prescribed by the Secretary and all information called for in such forms shall be furnished.

(d) Forms to be used in making the reports required by §§ 103.22 and 103.23 may be obtained from any Internal Revenue office; in addition, forms to be used in making the reports required by § 103.23 may be obtained from any office of the Bureau of Customs.

§ 103.26 Identification required.

Before effecting any transaction with respect to which a report is required under the first paragraph of § 103.22, a financial institution shall verify and record the identity, and record the account number on its books or the social security or taxpayer identification number, if any, of a person with whom or for whose account such transaction is to be effected. Verification of identity for a customer of the financial institution depositing or withdrawing funds may be by reference to his account or other number on the books of the institution. Verification of identity in any other case may be by examination, for example, of a driver's license, passport, alien identification card, or other appropriate document normally acceptable as a means of identification.

Subpart C—Records Required To Be Maintained

§ 103.31 Determination by the Secretary.

The Secretary hereby determines that the records required to be kept by this subpart have a high degree of usefulness in criminal, tax, or regulatory investigations or proceedings.

¹ Forms filed as part of the original document.

² Forms filed as part of the original document.

§ 103.32 Records to be made and retained by persons having financial interests in foreign financial accounts.

Records of accounts required by § 103.24 to be reported on a Federal income tax return shall be retained by each person having a financial interest in any such account. Such records shall contain the name in which each such account is maintained, the number or other designation of such account, the name and address of the foreign bank or other person with whom such account is maintained, the type of such account, and the maximum value of each such account during the reporting period. Such records shall be retained for a period of 5 years and shall be kept at all times available for inspection as authorized by law. In the computation of the period of 5 years, there shall be disregarded any period beginning with a date on which the taxpayer is indicted or information instituted on account of the filing of a false or fraudulent Federal income tax return or failing to file a Federal income tax return, and ending with the date on which final disposition is made of the criminal proceeding.

§ 103.33 Records to be made and retained by financial institutions.

Each financial institution shall retain either the original or a microfilm or other copy or reproduction of each of the following:

(a) A record of each extension of credit in an amount in excess of \$5,000, except an extension of credit secured by an interest in real property, which record shall contain the name and address of the person to whom the extension of credit is made, the amount thereof, the nature or purpose thereof, and the date thereof;

(b) A record of each advice, request, or instruction received regarding a transaction which results in the transfer of funds, or of currency, other monetary instruments, checks, investment securities, or credit, of more than \$10,000 to a person, account, or place outside the United States;

(c) A record of each advice, request, or instruction given to another financial institution or other person located within or without the United States, regarding a transaction intended to result in the transfer of funds, or of currency, other monetary instruments, checks, investment securities, or credit, of more than \$10,000 to a person, account or place outside the United States;

§ 103.34 Additional records to be made and retained by banks.

(a) With respect to each deposit or share account opened with a bank after June 30, 1972, by a person residing or doing business in the United States or a citizen of the United States, such bank shall secure and maintain a record of the taxpayer identification number of the person maintaining the account; or in the case of an account of one or more individuals, such bank shall secure and maintain a record of the social security

number of an individual having a financial interest in that account.

(b) Each bank shall, in addition, retain either the original or a microfilm or other copy or reproduction of each of the following:

(1) Each document granting signature authority over each deposit or share account;

(2) Each statement, ledger card or other record on each deposit or share account, showing each transaction in, or with respect to, that account;

(3) Each check, clean draft, or money order drawn on the bank or issued and payable by it, except those drawn on accounts which can be expected to have drawn on them an average of at least 100 checks per month over the calendar year or on each occasion on which such checks are issued, and which are (i) dividend checks, (ii) payroll checks, (iii) employee benefit checks, (iv) insurance claim checks, (v) medical benefit checks, (vi) checks drawn on governmental agency accounts, (vii) checks drawn by brokers or dealers in securities, (viii) checks drawn on fiduciary accounts, (ix) checks drawn on other financial institutions, or (x) pension or annuity checks;

(4) Each item other than bank charges or periodic charges made pursuant to agreement with the customer, comprising a debit to a customer's deposit or share account, not required to be kept, and not specifically exempted, under subparagraph (3) of this paragraph;

(5) Each item, including checks, drafts, or transfers of credit, of more than \$10,000 remitted or transferred to a person, account or place outside the United States;

(6) A record of each remittance or transfer of funds, or of currency, other monetary instruments, checks, investment securities, or credit, of more than \$10,000 to a person, account or place outside the United States;

(7) Each check or draft in an amount in excess of \$10,000 drawn on or issued by a foreign bank, purchased, received for credit or collection, or otherwise acquired by the bank;

(8) Each item, including checks, drafts or transfers of credit, of more than \$10,000 received directly and not through a domestic financial institution, by letter, cable or any other means, from a person, account or place outside the United States;

(9) A record of each receipt of currency, other monetary instruments, checks, or investment securities, and of each transfer of funds or credit, of more than \$10,000 received on any one occasion directly and not through a domestic financial institution, from a person, account or place outside the United States; and

(10) Records prepared or received by a bank in the ordinary course of business, which would be needed to reconstruct a demand deposit account and to trace a check deposited in such account through its domestic processing system

or to supply a description of a deposited check. This subparagraph shall be applicable only with respect to demand deposits.

§ 103.35 Additional records to be made and retained by brokers and dealers in securities.

(a) With respect to each brokerage account opened with a broker or dealer in securities after June 30, 1972, by a person residing or doing business in the United States or a citizen of the United States, such broker or dealer shall secure and maintain a record of the taxpayer identification number of the person maintaining the account; or in the case of an account of one or more individuals, such broker or dealer shall secure and maintain a record of the social security number of an individual having a financial interest in that account.

(b) Every broker or dealer in securities shall, in addition, retain either the original or a microfilm or other copy or reproduction of each of the following:

(1) Each document granting signature or trading authority over each customer's account;

(2) Each record described in § 240.17a-3(a) (1), (2), (3), (5), (6), (7), (8), and (9) of Title 17, Code of Federal Regulations;

(3) A record of each remittance or transfer of funds, or of currency, checks, other monetary instruments, investment securities, or credit, of more than \$10,000 to a person, account or place outside the United States;

(4) A record of each receipt of currency, other monetary instruments, checks, or investment securities and of each transfer of funds or credit, of more than \$10,000 received on any one occasion directly and not through a domestic financial institution, from any person, account or place outside the United States.

§ 103.36 Nature of records and retention period.

(a) Wherever it is required that there be retained either the original of a microfilm or other copy or reproduction of a check, draft, monetary instrument, investment security, or other similar instrument, there shall be retained a copy of both front and back of each such instrument or document, except that no copy need be retained of the back of any instrument or document which is entirely blank or which contains only standardized printed information, a copy of which is on file.

(b) Records required by this subpart to be retained by financial institutions may be those made in the ordinary course of business by a financial institution. If no record is made in the ordinary course of business of any transaction with respect to which records are required to be retained by this subpart, then such a record shall be prepared in writing by the financial institution.

(c) Records which are required by § 103.34(b) (10) to be retained by banks shall be retained for a period of 2 years. All other records which are required by

this subpart to be retained by financial institutions shall be retained for a period of 5 years. All such records shall be filed or stored in such a way as to be accessible within a reasonable period of time, taking into consideration the nature of the record, and the amount of time expired since the record was made.

§ 103.37 Person outside the United States.

For the purposes of this subpart, a remittance or transfer of funds, or of currency, other monetary instruments, checks, investment securities, or credit to the domestic account of a person whose address is known by the person making the remittance or transfer, to be outside the United States, shall be deemed to be a remittance or transfer to a person outside the United States, except that, unless otherwise directed by the Secretary, this section shall not apply to a transaction on the books of a domestic financial institution involving the account of a customer of such institution whose address is within approximately 50 miles of the location of the institution, or who is known to be temporarily outside the United States.

Subpart D—General Provisions

§ 103.41 Dollars as including foreign currency.

Wherever in this part an amount is stated in dollars, it shall be deemed to mean also the equivalent amount in any foreign currency.

§ 103.42 Photographic or other reproductions of Government obligations.

Nothing herein contained shall require or authorize the microfilming or other reproduction of

(a) Currency or other obligation or security of the United States as defined in 18 U.S.C. 8, or

(b) Any obligation or other security of any foreign government,

the reproduction of which is prohibited by law.

§ 103.43 Availability of information.

The Secretary may make any information set forth in any reports received pursuant to this part available to any other department or agency of the United States upon the request of the head of such department or agency, made in writing and stating the particular information desired, the criminal, tax, or regulatory investigation or proceeding in connection with which the information is sought, and the official need therefor.

§ 103.44 Disclosure.

All reports required under this part and all records of such reports are specifically exempted from disclosure under section 552 of title 5, United States Code.

§ 103.45 Exceptions, exemptions, modifications, and reports.

(a) The Secretary, in his sole discretion, may by written order or authorization make exceptions to, grant exemptions from, impose additional record-keeping or reporting requirements authorized by statute, or otherwise modify,

the requirements of this part. Such exceptions, exemptions, requirements or modifications may be conditional or unconditional, may apply to particular persons or to classes of persons, and may apply to particular transactions or classes of transactions. They shall, however, be applicable only as expressly stated in the order or authorization, and they shall be revocable in the sole discretion of the Secretary.

(b) The Secretary shall have authority to further define all terms used herein.

§ 103.46 Enforcement.

(a) Responsibility for assuring compliance with the requirements of this part is delegated as follows:

(1) To the Comptroller of the Currency, with respect to national banks and banks in the District of Columbia;

(2) To the Board of Governors of the Federal Reserve System, with respect to State bank members of the Federal Reserve System;

(3) To the Federal Home Loan Bank Board, with respect to insured building and loan associations, insured savings and loan associations, and insured institutions as defined in section 401 of the National Housing Act;

(4) To the Administrator of the National Credit Union Administration, with respect to Federal credit unions;

(5) To the Federal Deposit Insurance Corporation, with respect to all other banks except agents of foreign banks which agents are not supervised by State or Federal bank supervisory authorities;

(6) To the Securities and Exchange Commission, with respect to brokers and dealers in securities;

(7) To the Commissioner of Customs with respect to §§ 103.23 and 103.48;

(8) To the Commissioner of Internal Revenue except as otherwise specified in this section.

(b) Overall responsibility for coordinating the procedures and efforts of the agencies listed herein and assuring compliance with this part, is delegated to the Assistant Secretary (Enforcement, Tariff and Trade Affairs, and Operations). Periodic reports shall be made by each such agency to the Assistant Secretary, with copies to the General Counsel of the Treasury Department and to the Commissioner of Internal Revenue.

§ 103.47 Civil penalty.

(a) For any willful violation of any requirement of this part, the Secretary may assess upon any domestic financial institution, and upon any partner, director, officer or employee thereof who willfully participates in the violation, a civil penalty not exceeding \$1,000.

(b) For any failure to file a report required under § 103.23 or for filing such a report containing any material omission or misstatement, the Secretary may assess a civil penalty up to the amount of the currency or monetary instruments transported, mailed or shipped, less any amount forfeited under § 103.48.

§ 103.48 Forfeiture of currency or monetary instruments.

Any currency or other monetary instruments which are in the process of

any transportation with respect to which a report is required under § 103.23 are subject to seizure and forfeiture to the United States if such report has not been filed as required in § 103.25, or contains material omissions or misstatements. The Secretary may, in his sole discretion, remit or mitigate any such forfeiture in whole or in part upon such terms and conditions as he deems reasonable.

§ 103.49 Criminal penalty.

(a) Any person who willfully violates any provision of this part may, upon conviction thereof, be fined not more than \$1,000 or be imprisoned not more than 1 year, or both. Such person may in addition, if the violation is of any provision authorized by title I of Public Law 91-508 and if the violation is committed in furtherance of the commission of any violation of Federal law punishable by imprisonment for more than 1 year, be fined not more than \$10,000 or be imprisoned not more than 5 years, or both.

(b) Any person who willfully violates any provision of title II of Public Law 91-508, or of this part authorized thereby, where the violation is either

(1) Committed in furtherance of the commission of any other violation of Federal law, or

(2) Committed as part of a pattern of illegal activity involving transactions exceeding \$100,000 in any 12-month period, may, upon conviction thereof, be fined not more than \$500,000 or be imprisoned not more than 5 years, or both.

(c) Any person who knowingly makes any false, fictitious or fraudulent statement or representation in any report required by this part may, upon conviction thereof, be fined not more than \$10,000 or be imprisoned not more than 5 years, or both.

§ 103.50 Enforcement authority with respect to transportation of currency or monetary instruments.

(a) If the Secretary has reason to believe that currency or monetary instruments are in the process of transportation and with respect to which a report required under § 103.23 has not been filed or contains material omissions or misstatements, he may apply to any court of competent jurisdiction for a search warrant. Upon a showing of probable cause, the court may issue a warrant authorizing the search of any or all of the following:

(1) One or more designated persons.

(2) One or more designated or described places or premises.

(3) One or more designated or described letters, parcels, packages, or other physical objects.

(4) One or more designated or described vehicles. Any application for a search warrant pursuant to this section shall be accompanied by allegations of fact supporting the application.

(b) This section is not in derogation of the authority of the Secretary under any other law or regulation.

Effective date. This part shall become effective July 1, 1972.

[FR Doc.72-5171 Filed 4-4-72; 8:47 am]

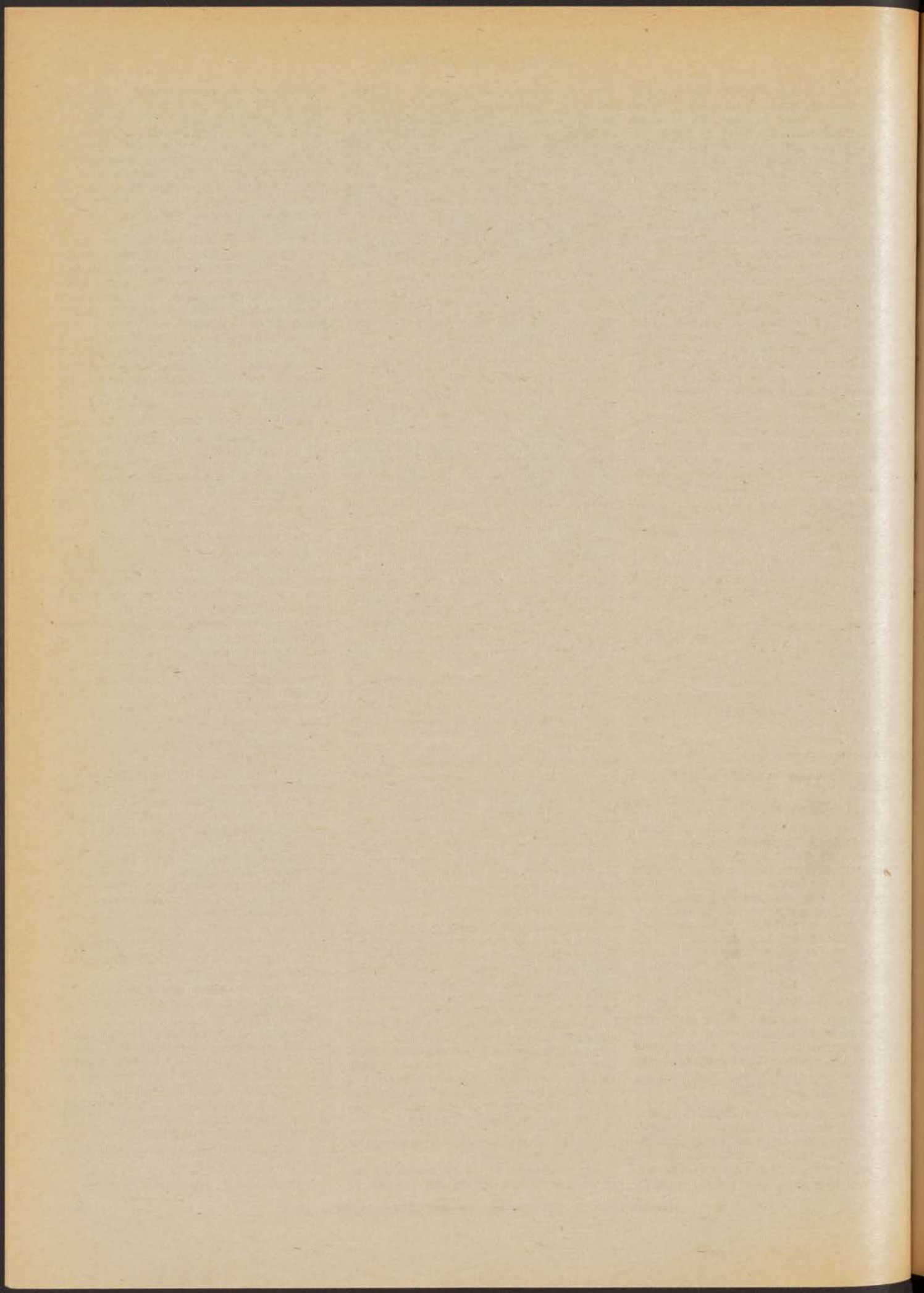

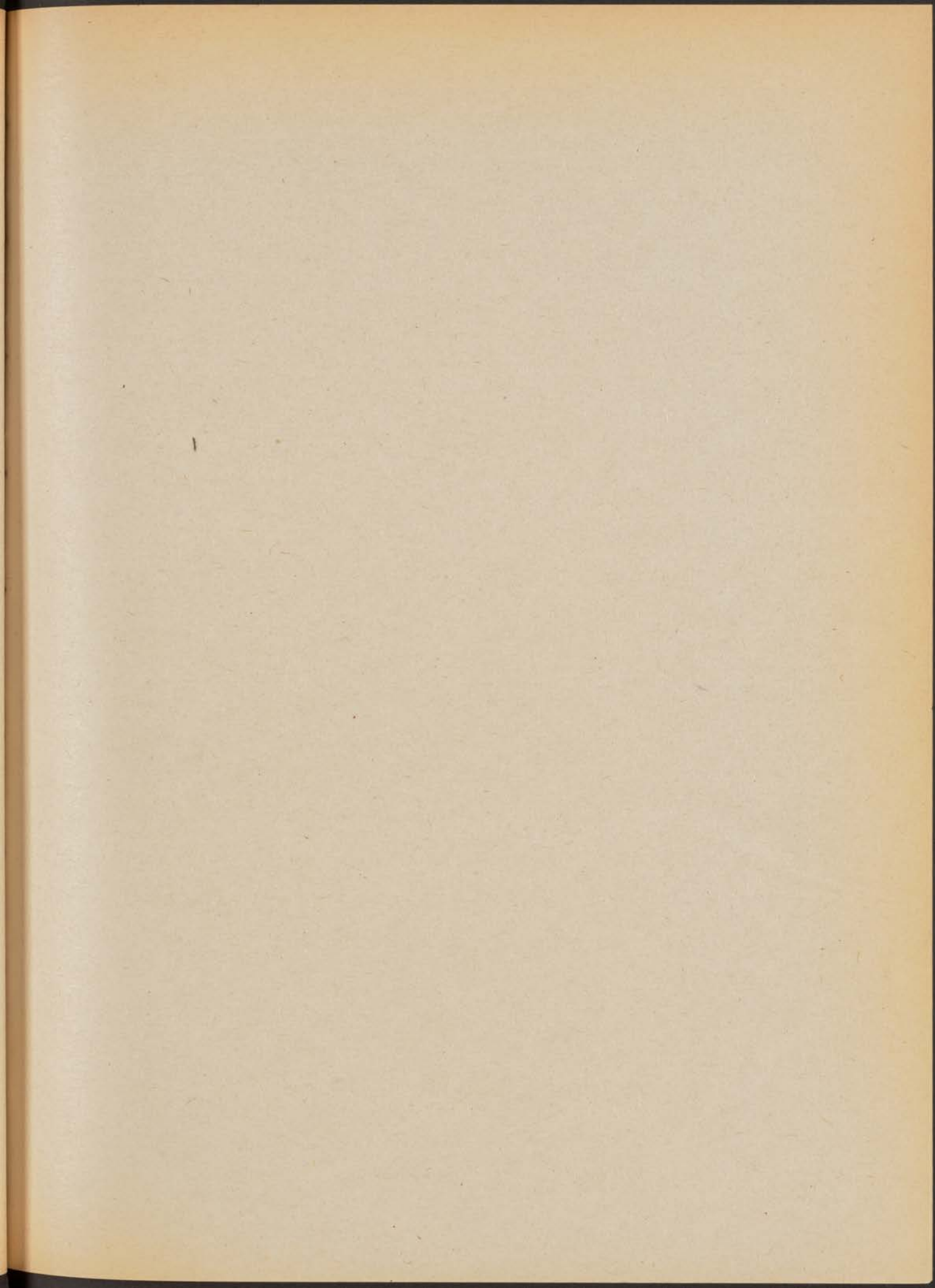

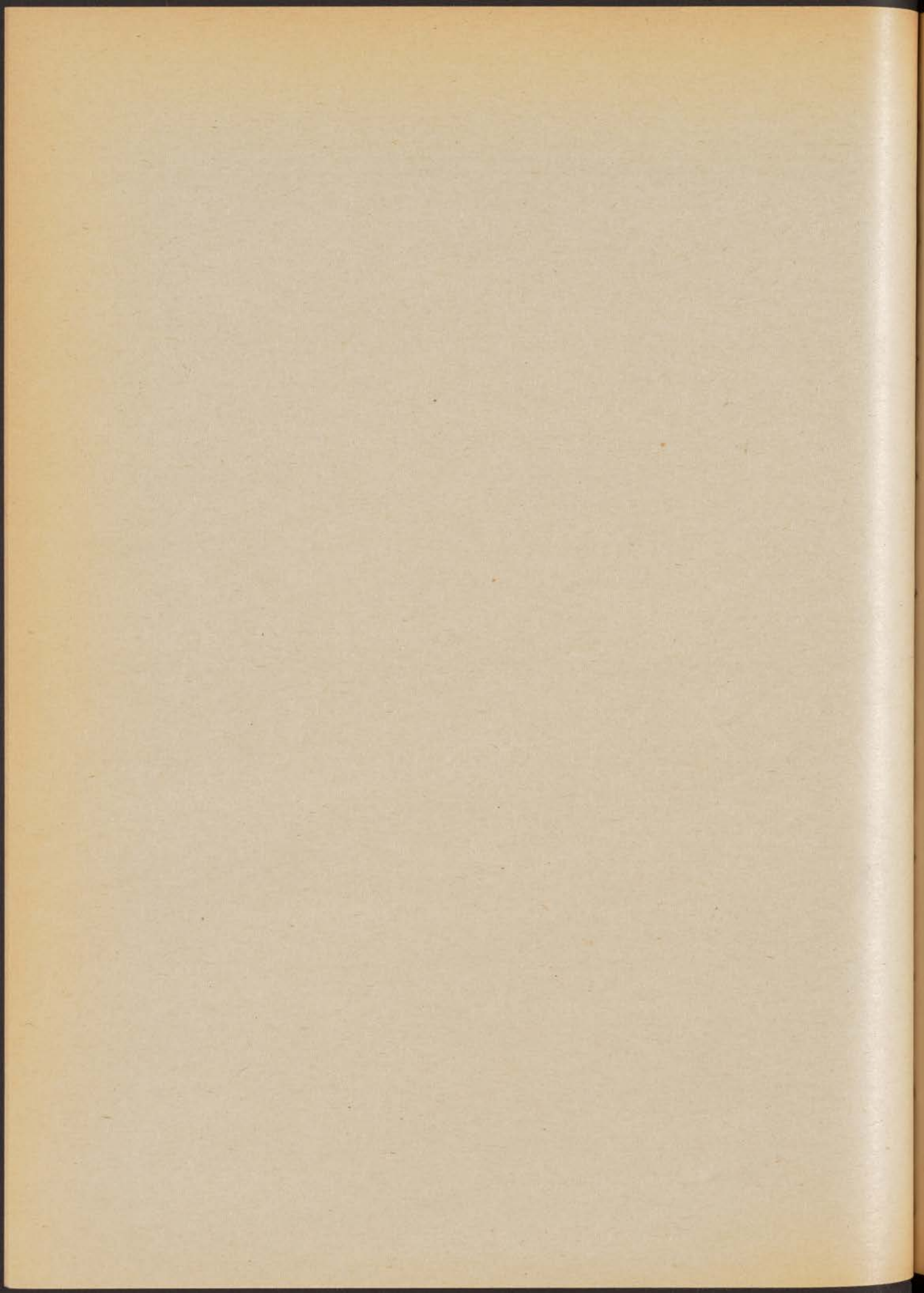

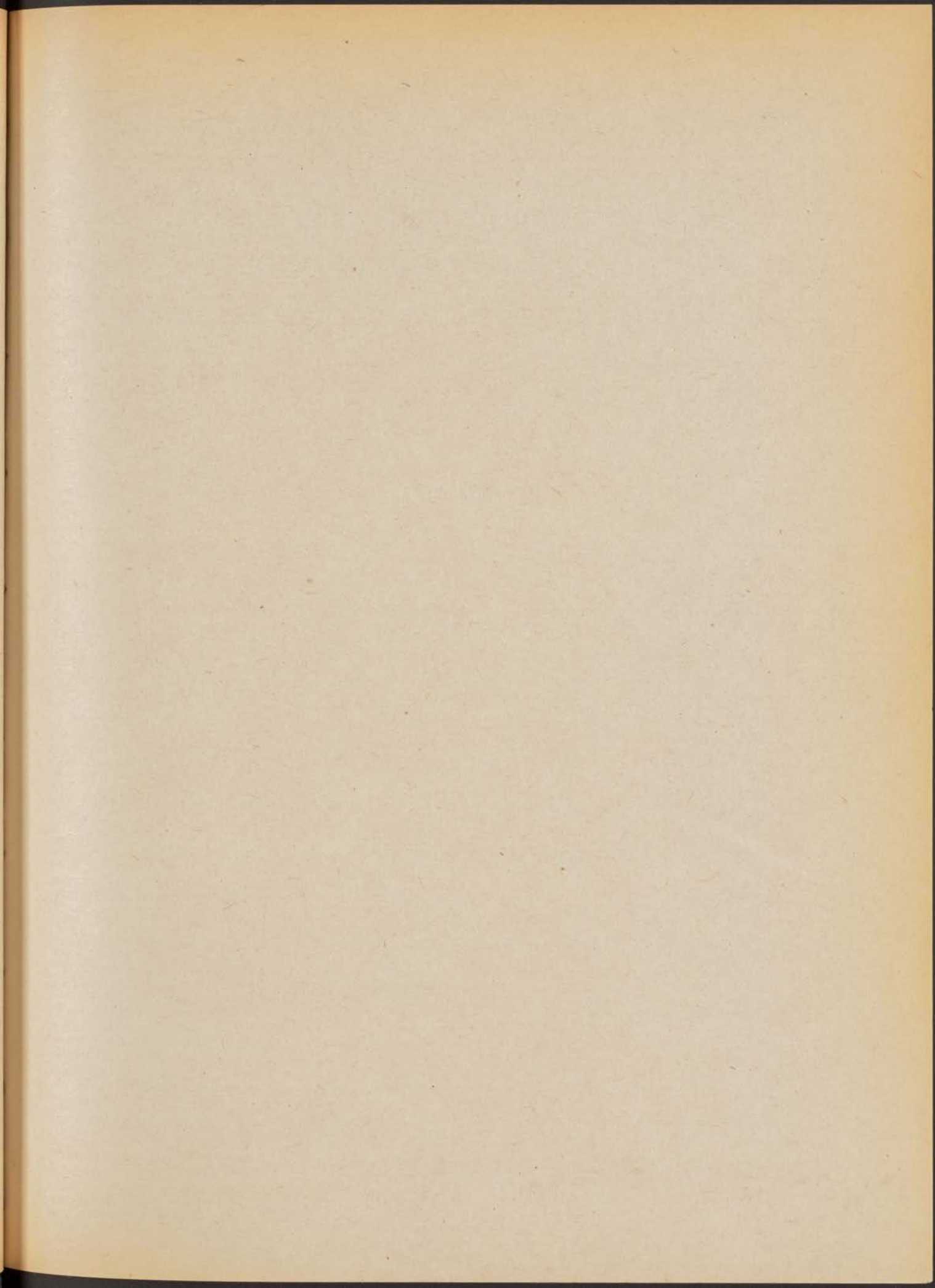

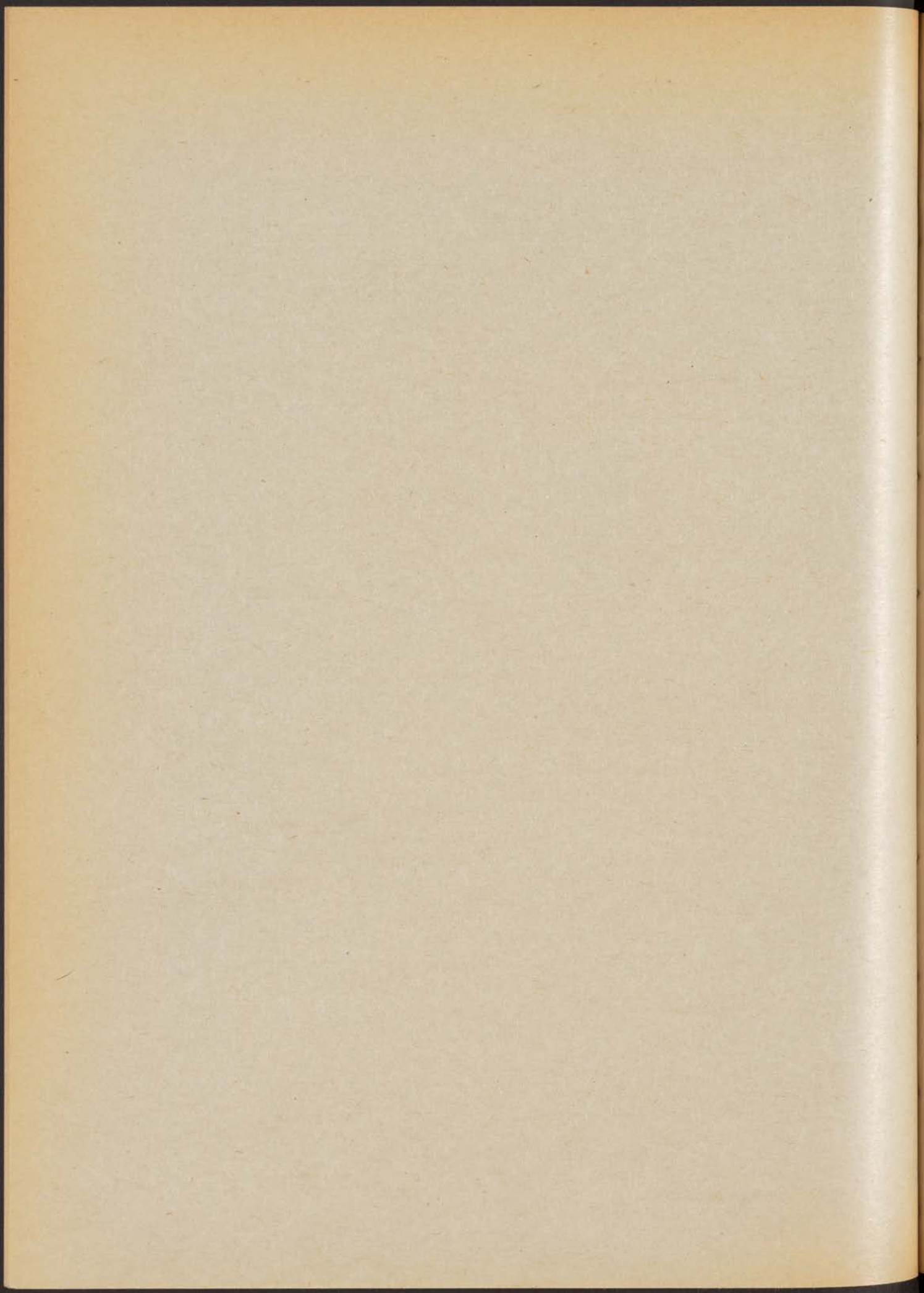

Richard Nixon 1970

of the President

Official Correspondence

Volume 1

1970

January - February

March - April

May - June

July - August

September - October

November - December

**Public Papers
of the Presidents
of the
United States**

Richard Nixon/1970

1305 Pages/Price: \$15.75

Contents

- Messages to the Congress
- Public speeches and letters
- The President's news conferences
- Radio and television reports to the American people
- Remarks to informal groups

Published by

Office of the Federal Register
National Archives and Records
Service
General Services Administration

Order from

Superintendent of Documents
U.S. Government Printing Office
Washington, D.C. 20402

Prior Volumes

Volumes covering the administrations of Presidents Truman, Eisenhower, Kennedy, Johnson, and the first year of President Nixon are available at varying prices from the Superintendent of Documents, U.S. Government Printing Office, Washington, D.C. 20402.

